

MO108 NEUTRON ACER TENDL-2023 LIBRARY; T=0.K

Principal cross sections

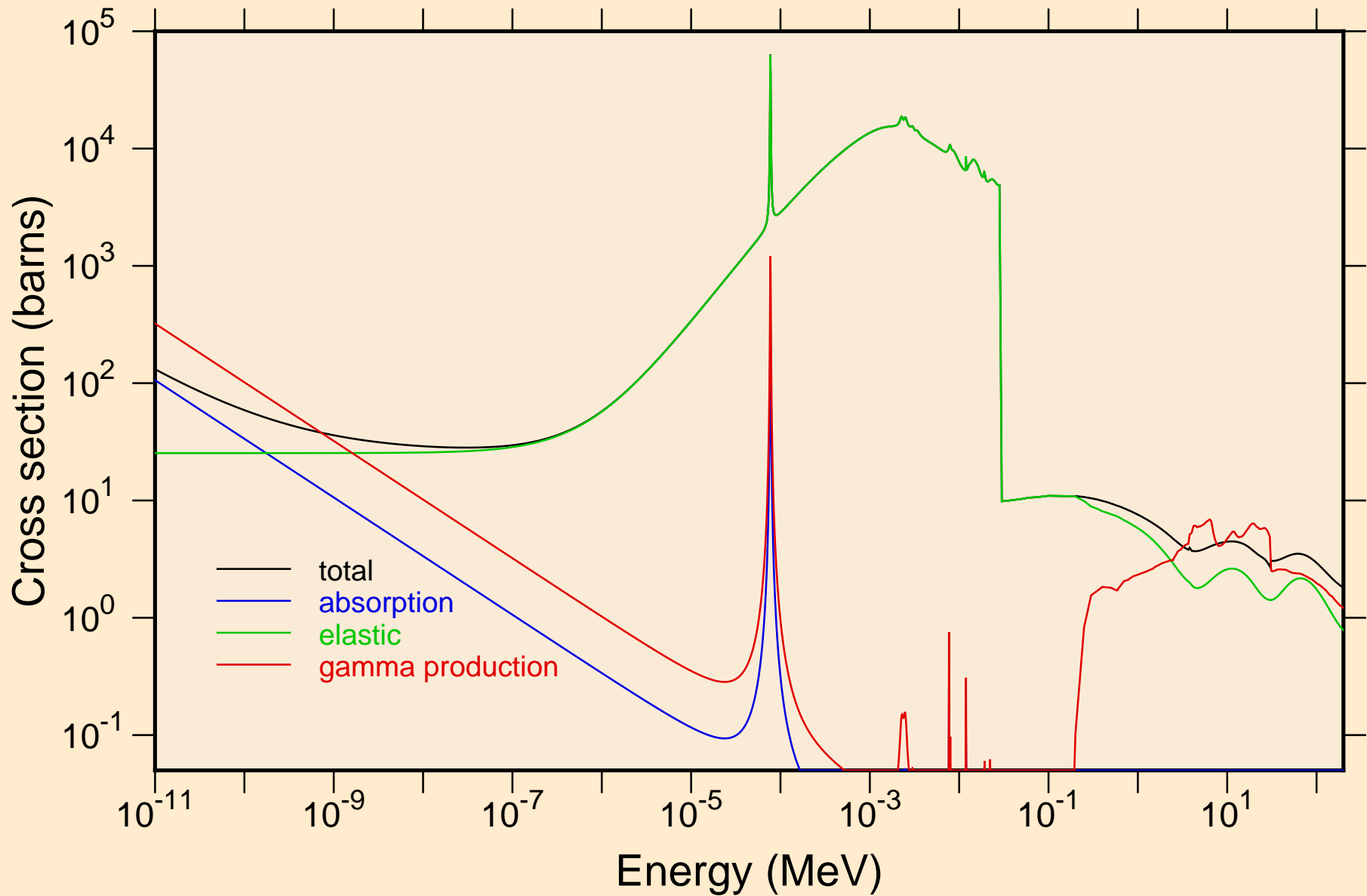

MO108 NEUTRON ACER TENDL-2023 LIBRARY; T=0.K
resonance total cross section

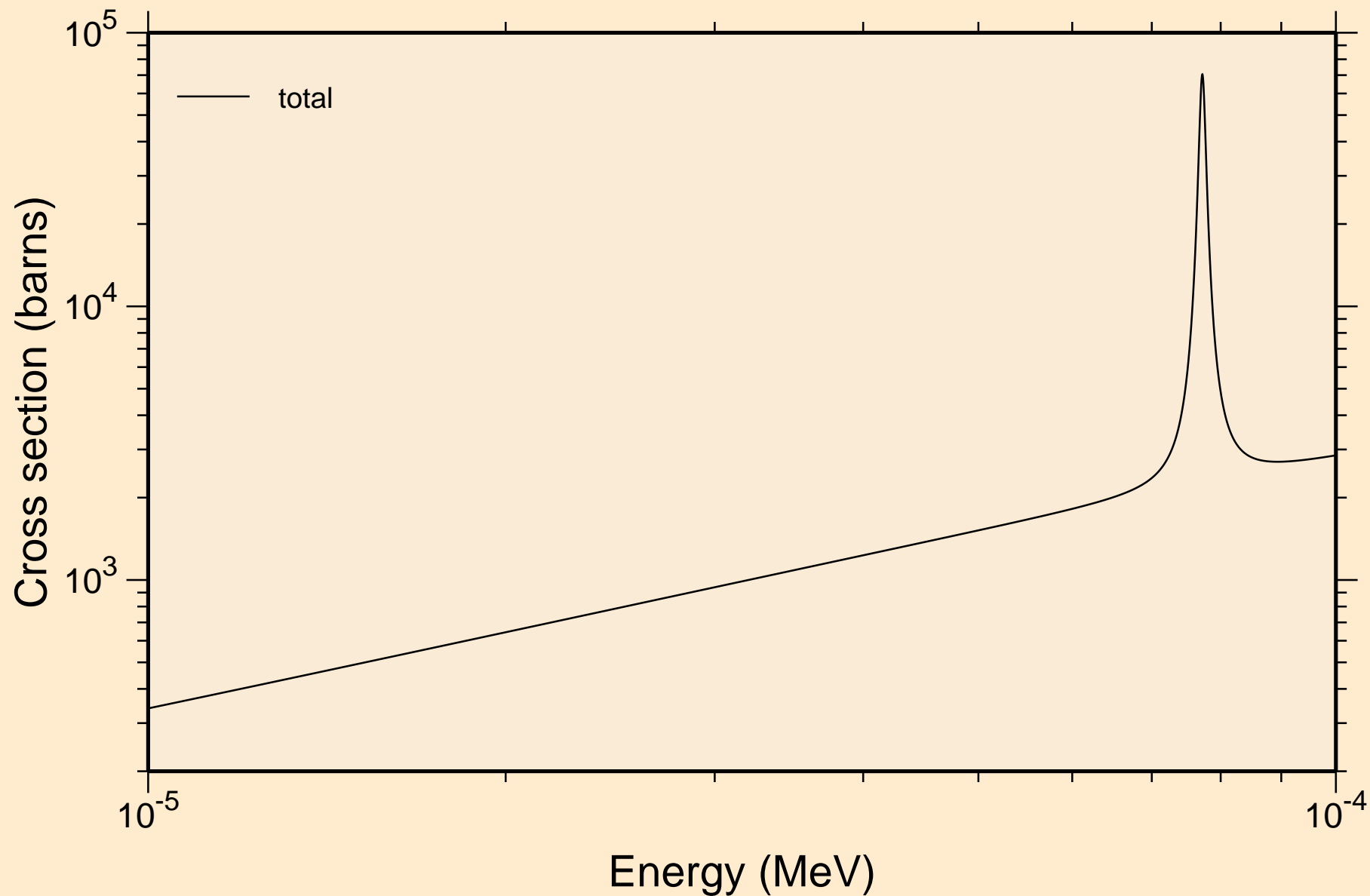

MO108 NEUTRON ACER TENDL-2023 LIBRARY; T=0.K
resonance total cross section

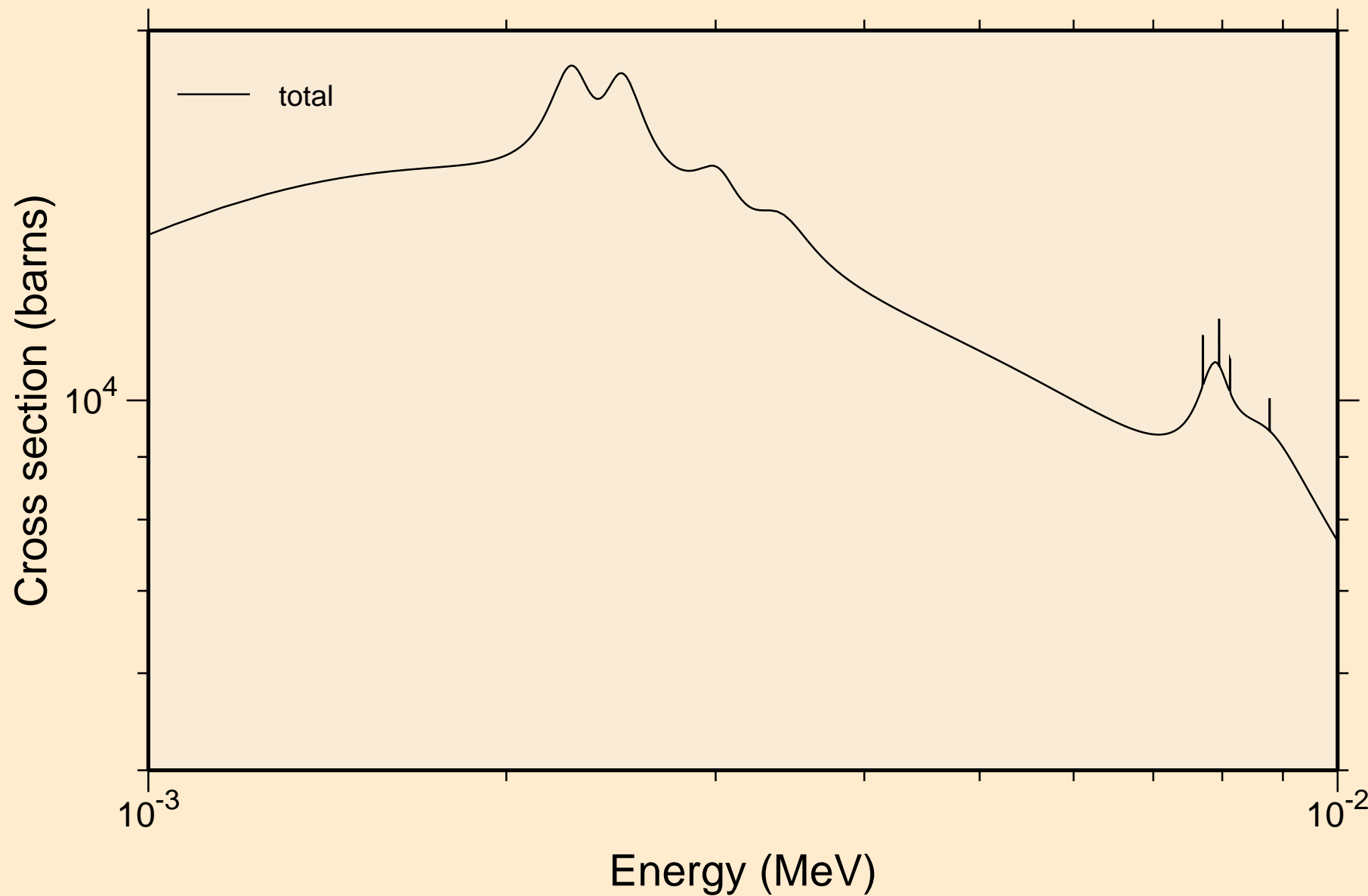

MO108 NEUTRON ACER TENDL-2023 LIBRARY; T=0.K
resonance total cross section

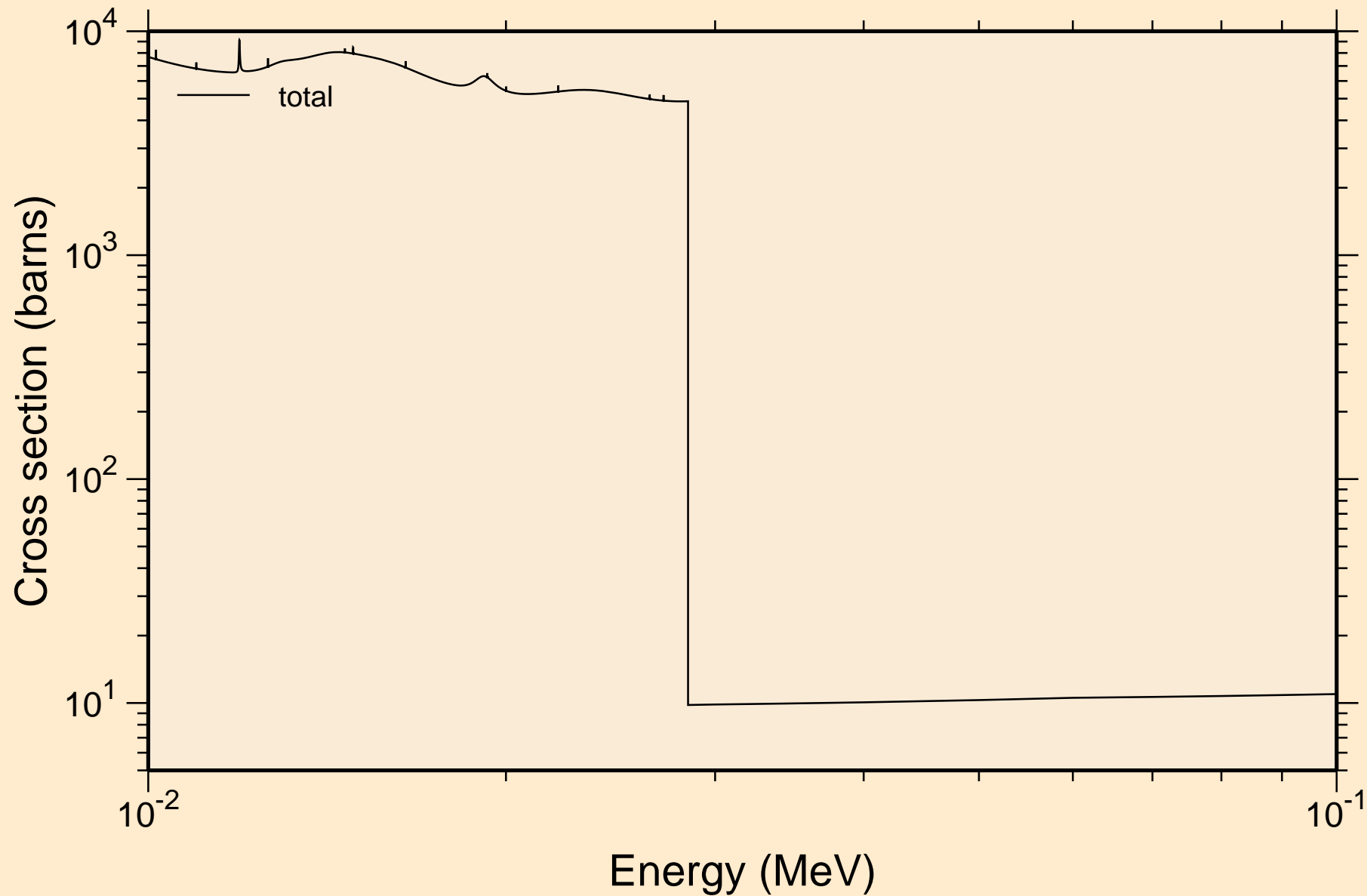

M0108 NEUTRON ACER TENDL-2023 LIBRARY; T=0.K
resonance total cross section

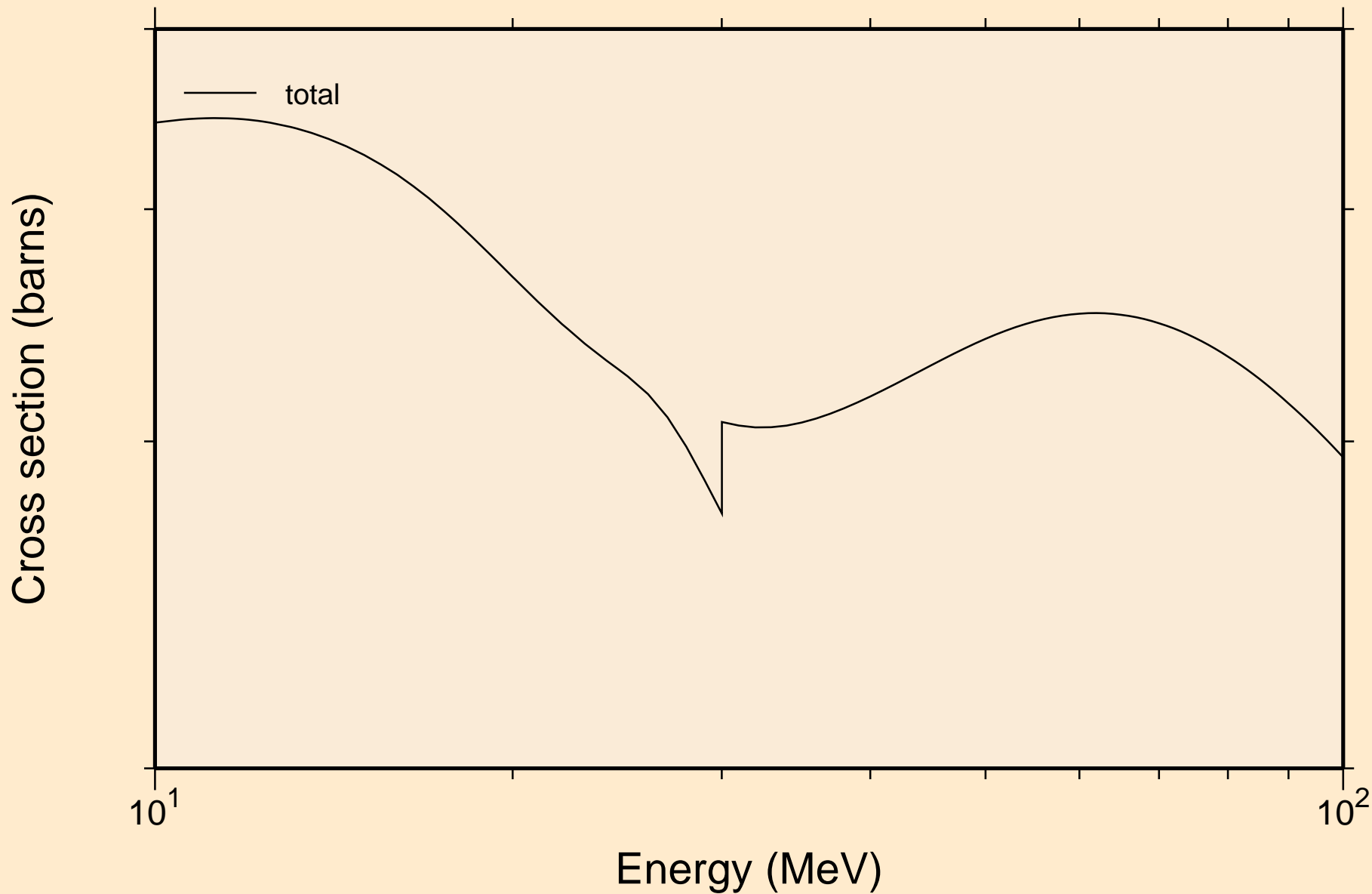

MO108 NEUTRON ACER TENDL-2023 LIBRARY; T=0.K
resonance absorption cross sections

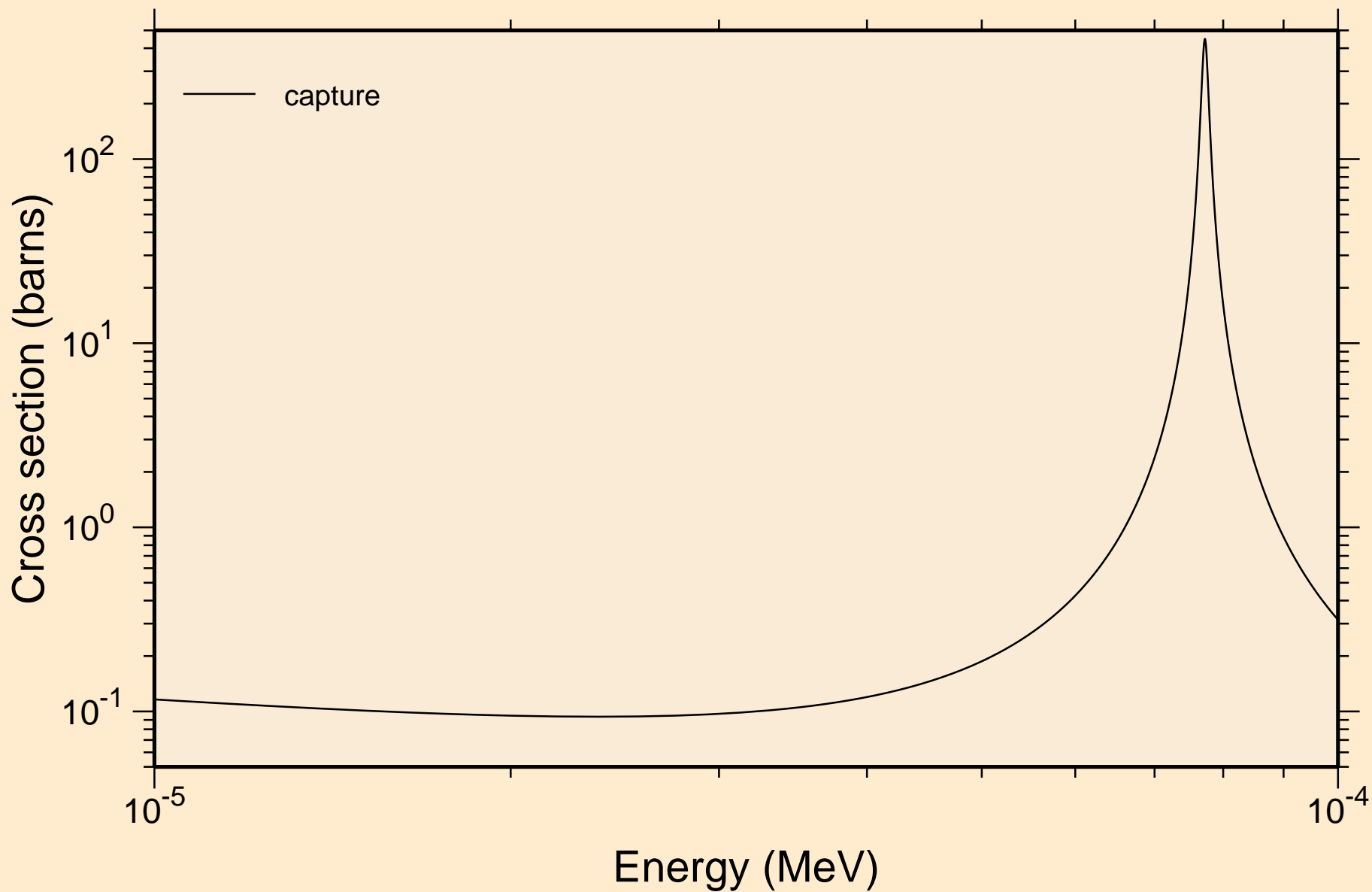

MO108 NEUTRON ACER TENDL-2023 LIBRARY; T=0.K
resonance absorption cross sections

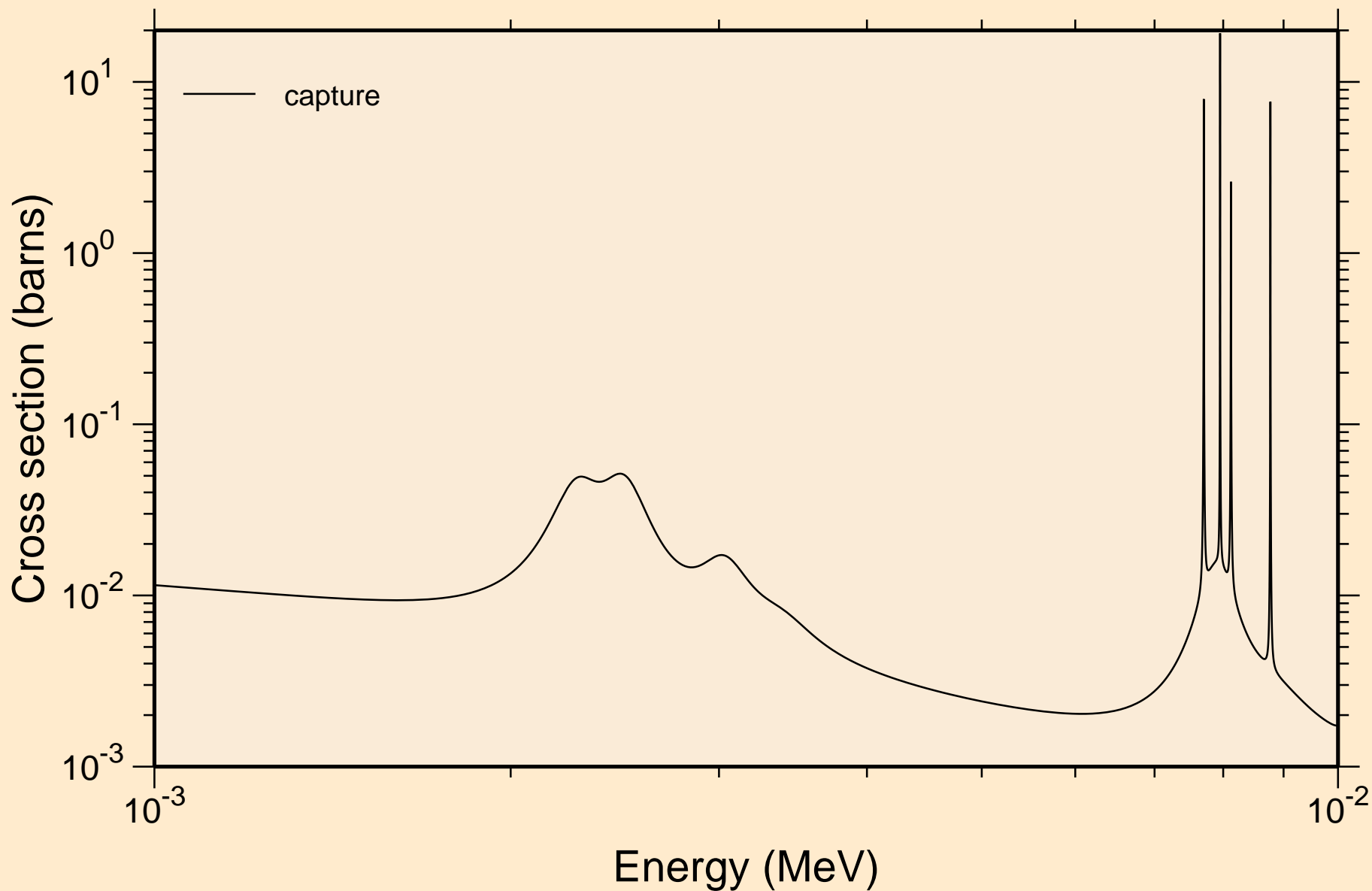

MO108 NEUTRON ACER TENDL-2023 LIBRARY; T=0.K
resonance absorption cross sections

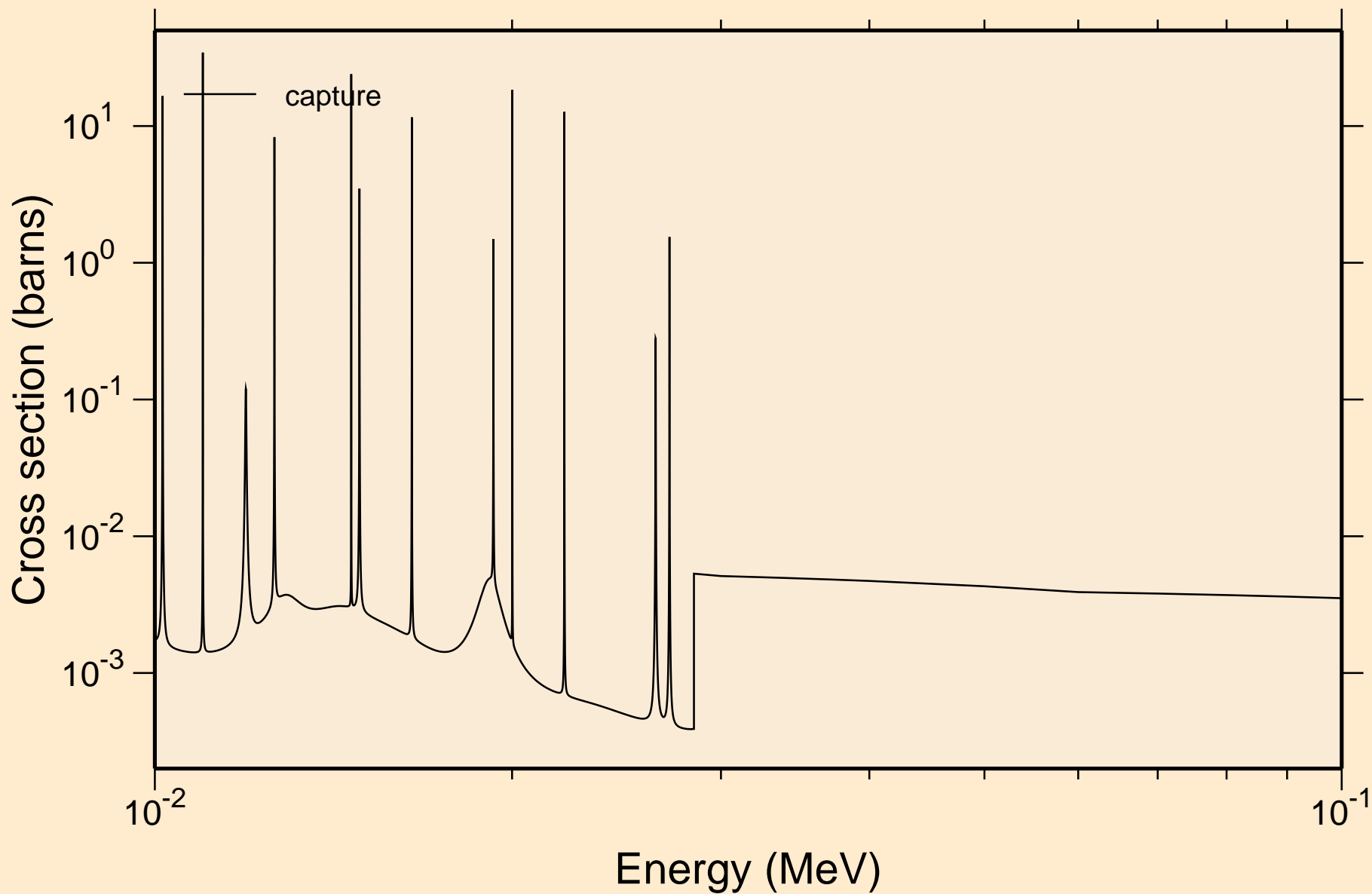

MO108 NEUTRON ACER TENDL-2023 LIBRARY; T=0.K
resonance absorption cross sections

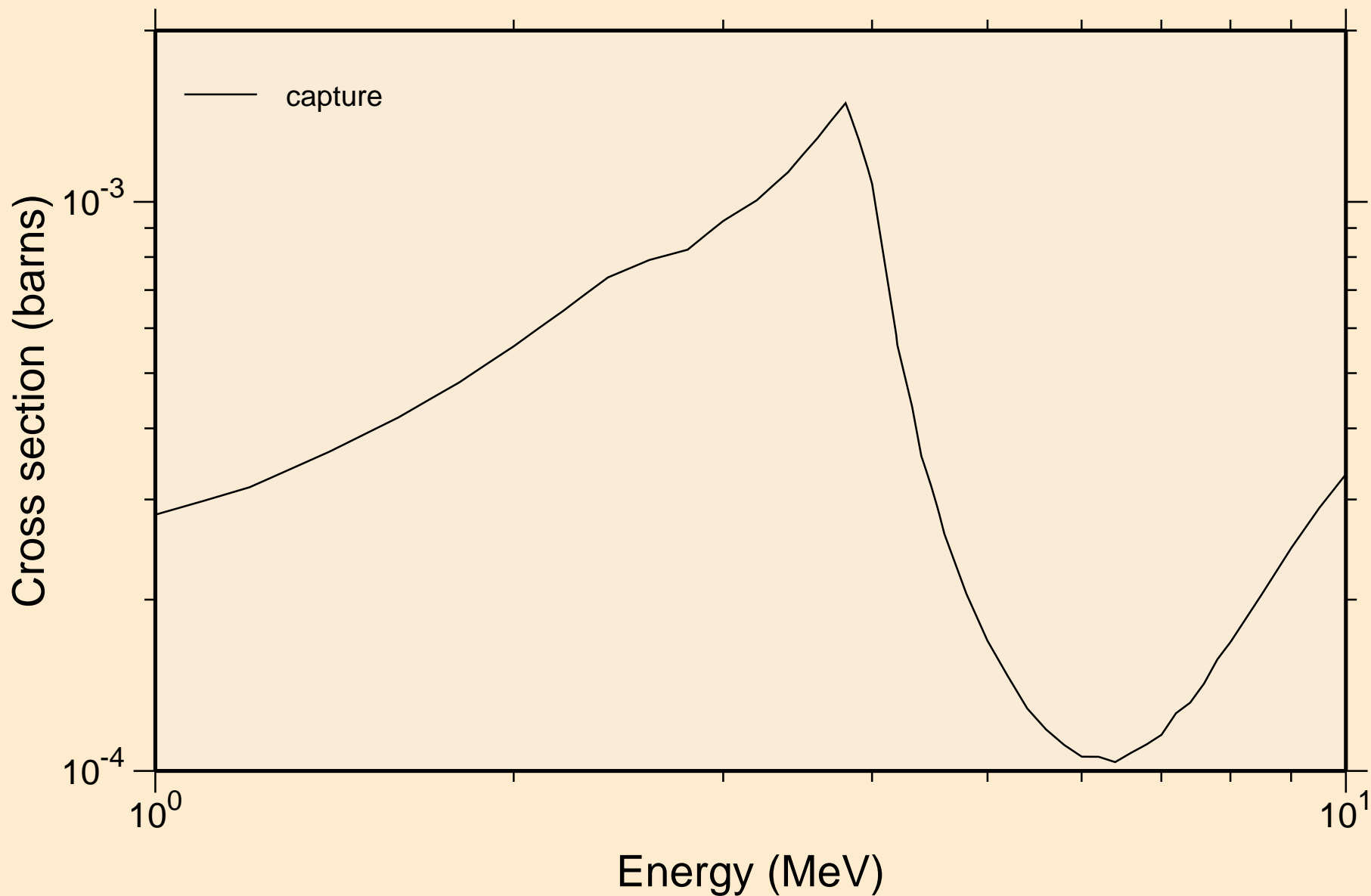

MO108 NEUTRON ACER TENDL-2023 LIBRARY; T=0.K

Heating

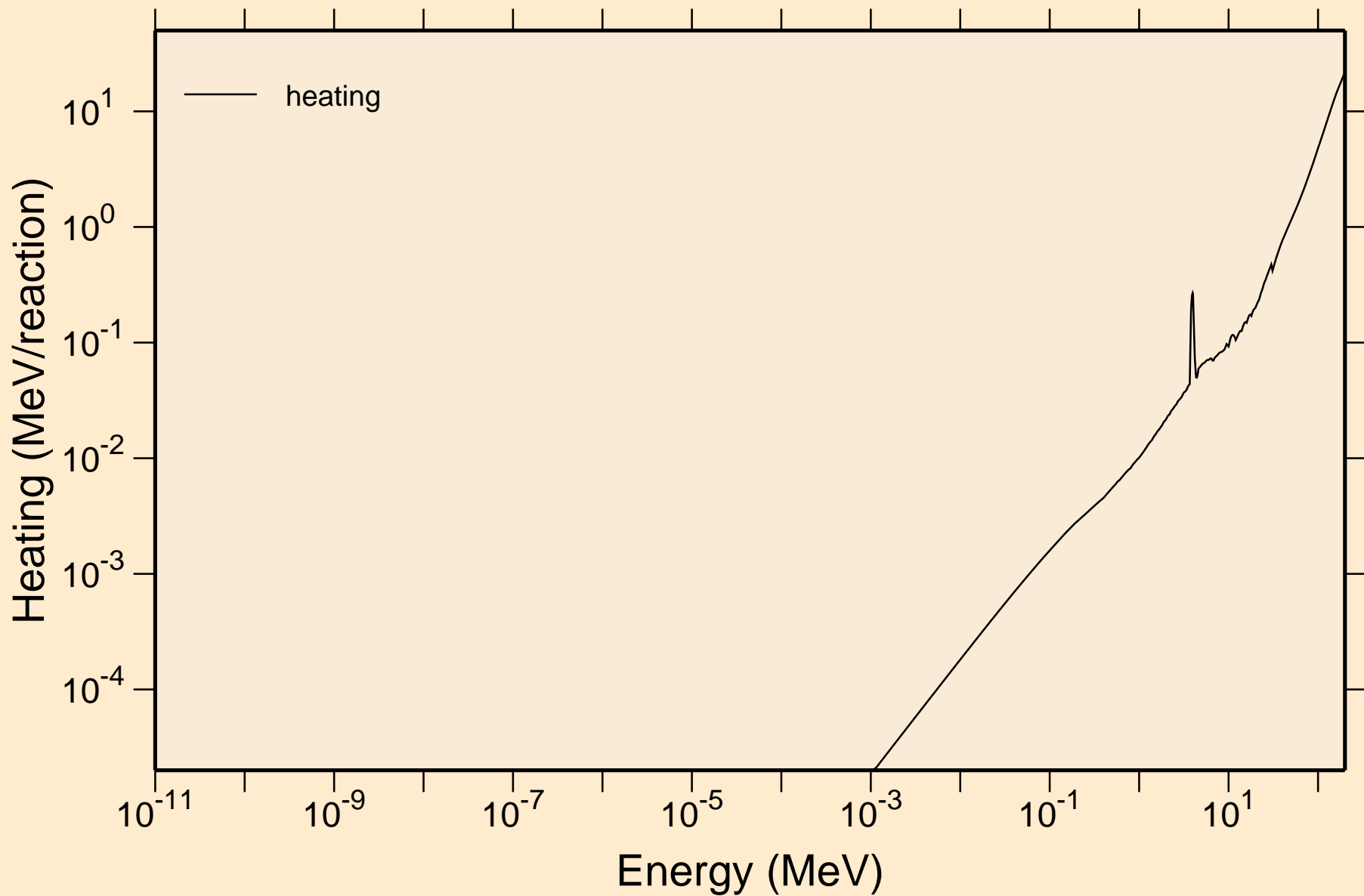

MO108 NEUTRON ACER TENDL-2023 LIBRARY; T=0.K
Damage

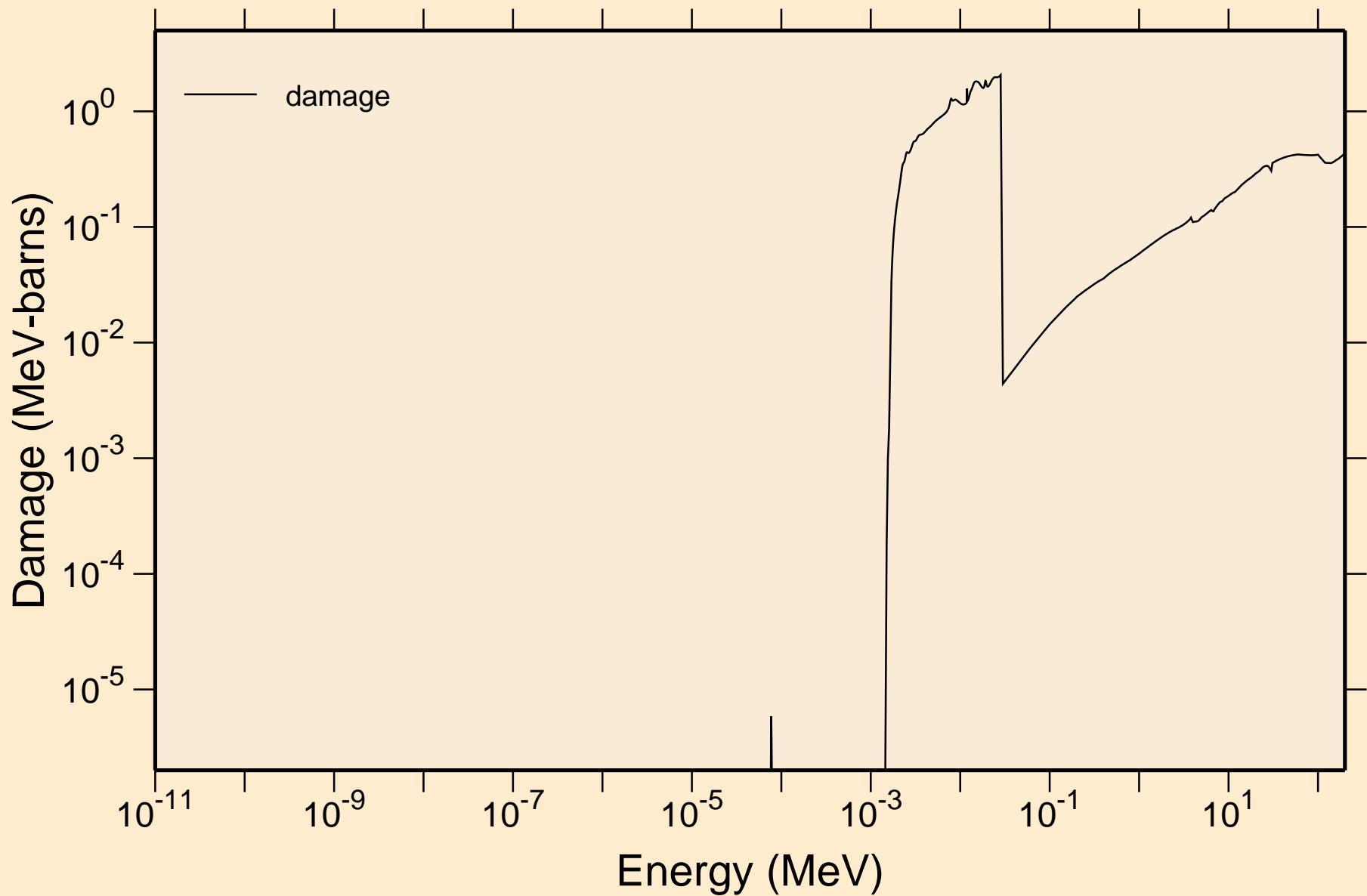

MO108 NEUTRON ACER TENDL-2023 LIBRARY; T=0.K
Non-threshold reactions

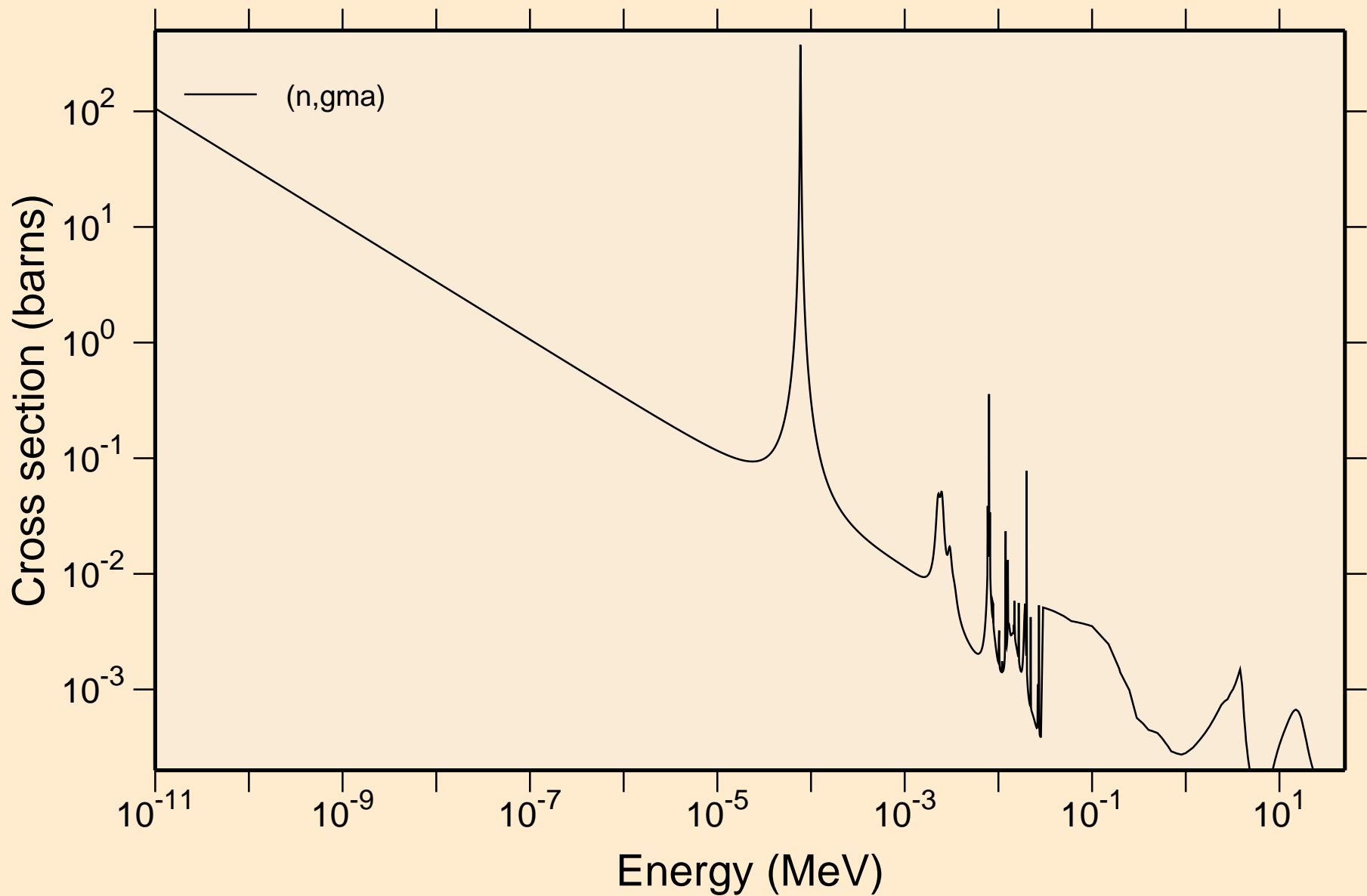

MO108 NEUTRON ACER TENDL-2023 LIBRARY; T=0.K

Principal cross sections

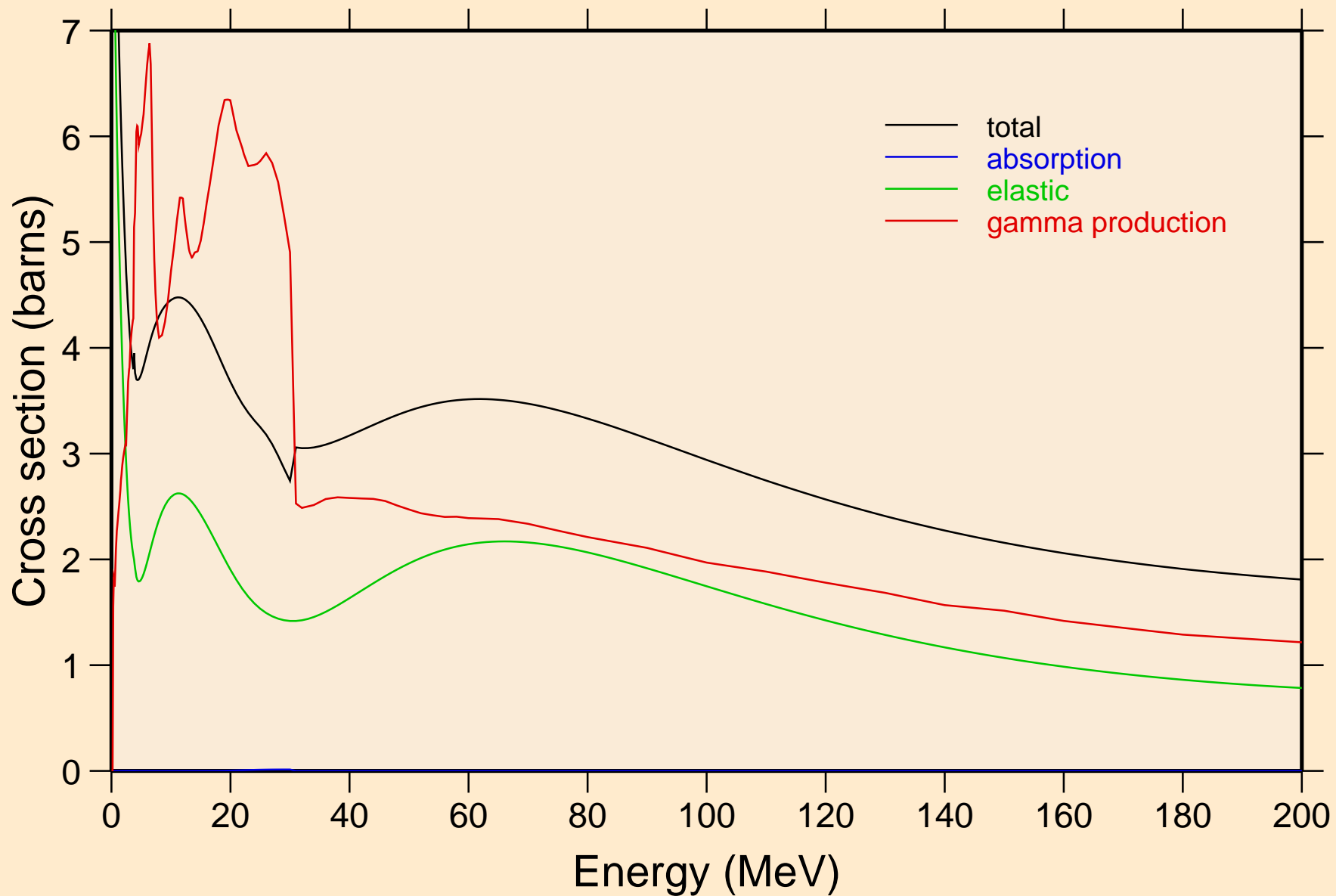

MO108 NEUTRON ACER TENDL-2023 LIBRARY; T=0.K

Heating

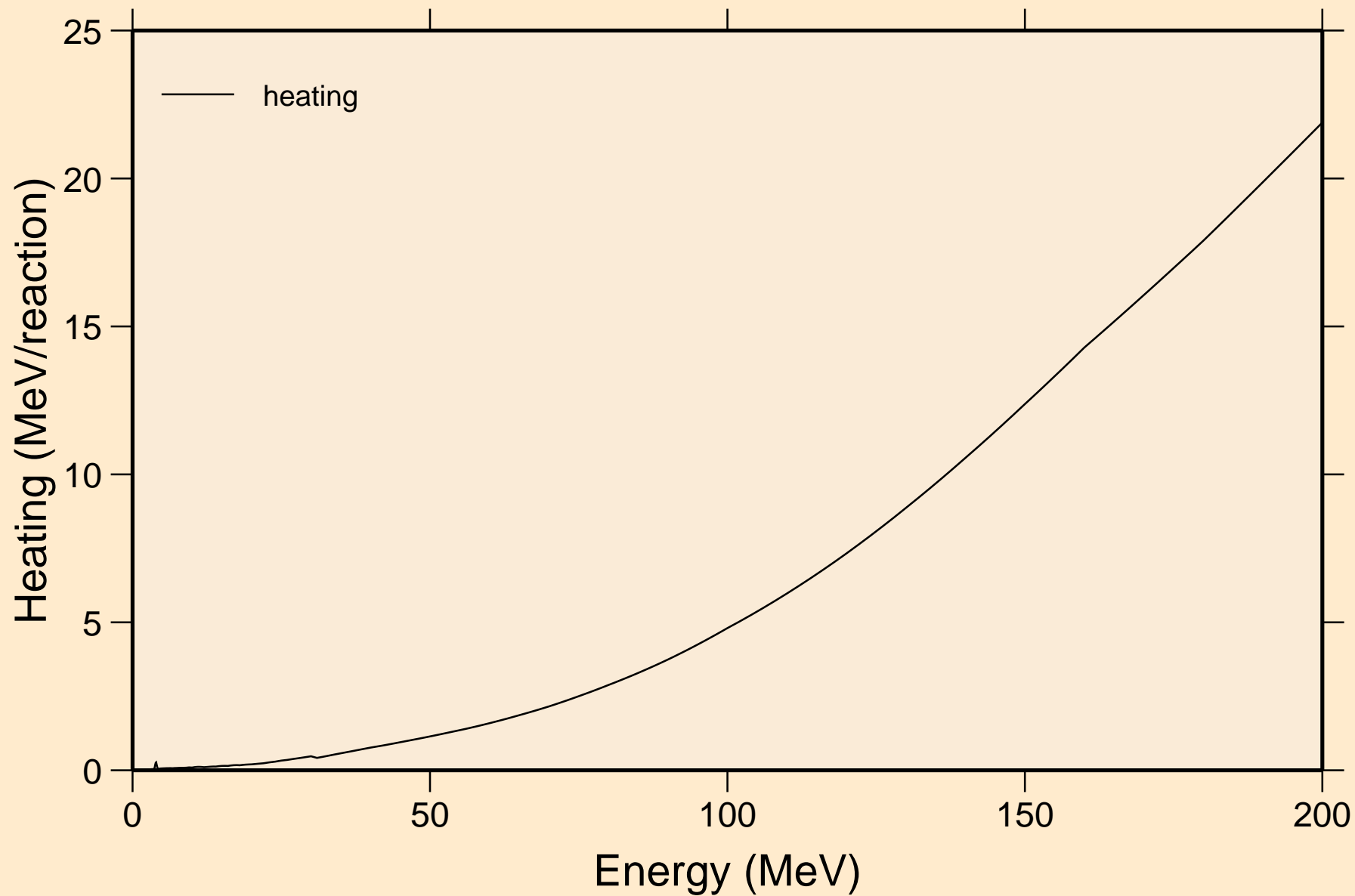

MO108 NEUTRON ACER TENDL-2023 LIBRARY; T=0.K
Damage

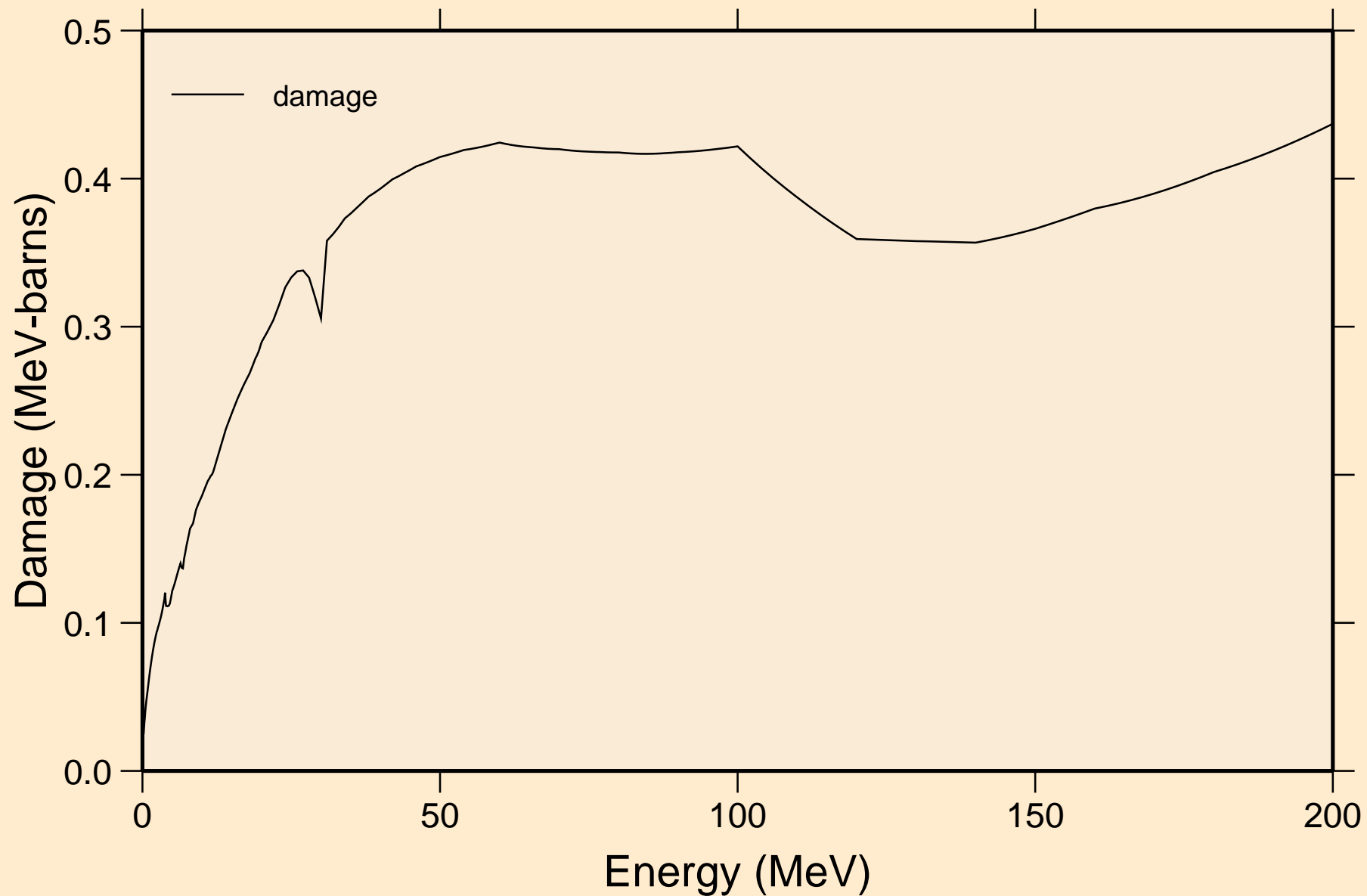

MO108 NEUTRON ACER TENDL-2023 LIBRARY; T=0.K
Non-threshold reactions

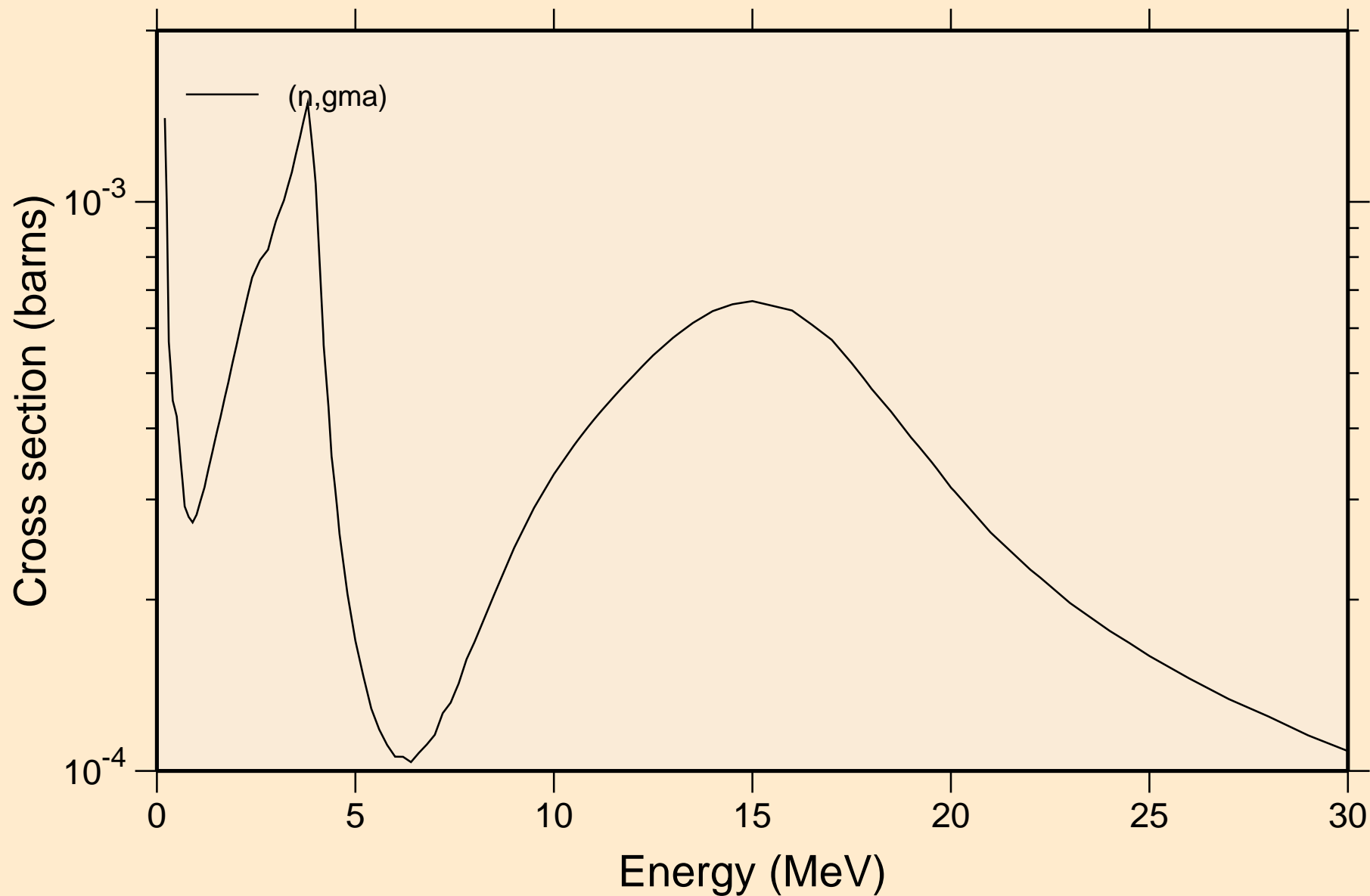

MO108 NEUTRON ACER TENDL-2023 LIBRARY; T=0.K
Inelastic levels

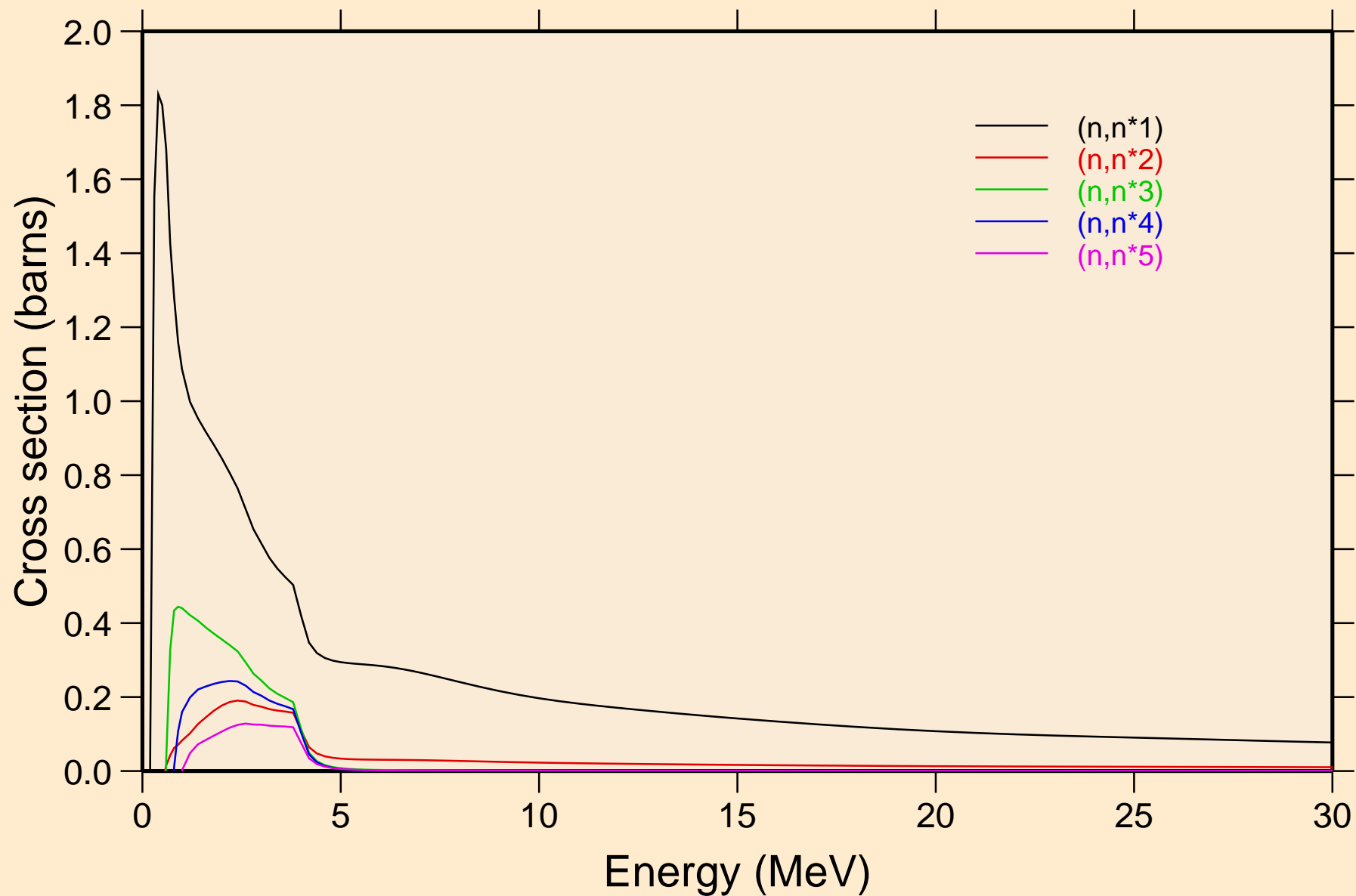

MO108 NEUTRON ACER TENDL-2023 LIBRARY; T=0.K
Inelastic levels

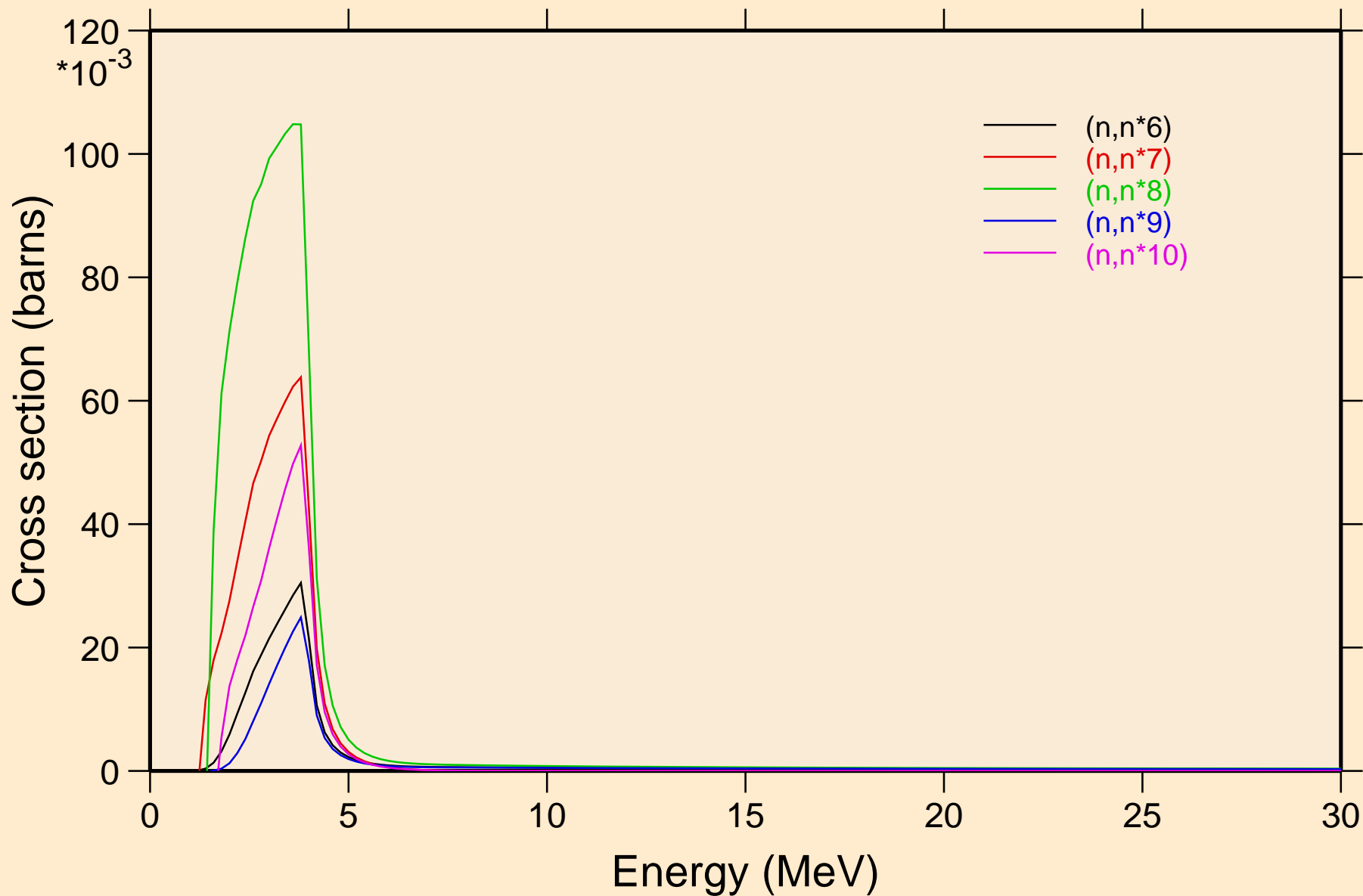

MO108 NEUTRON ACER TENDL-2023 LIBRARY; T=0.K
Inelastic levels

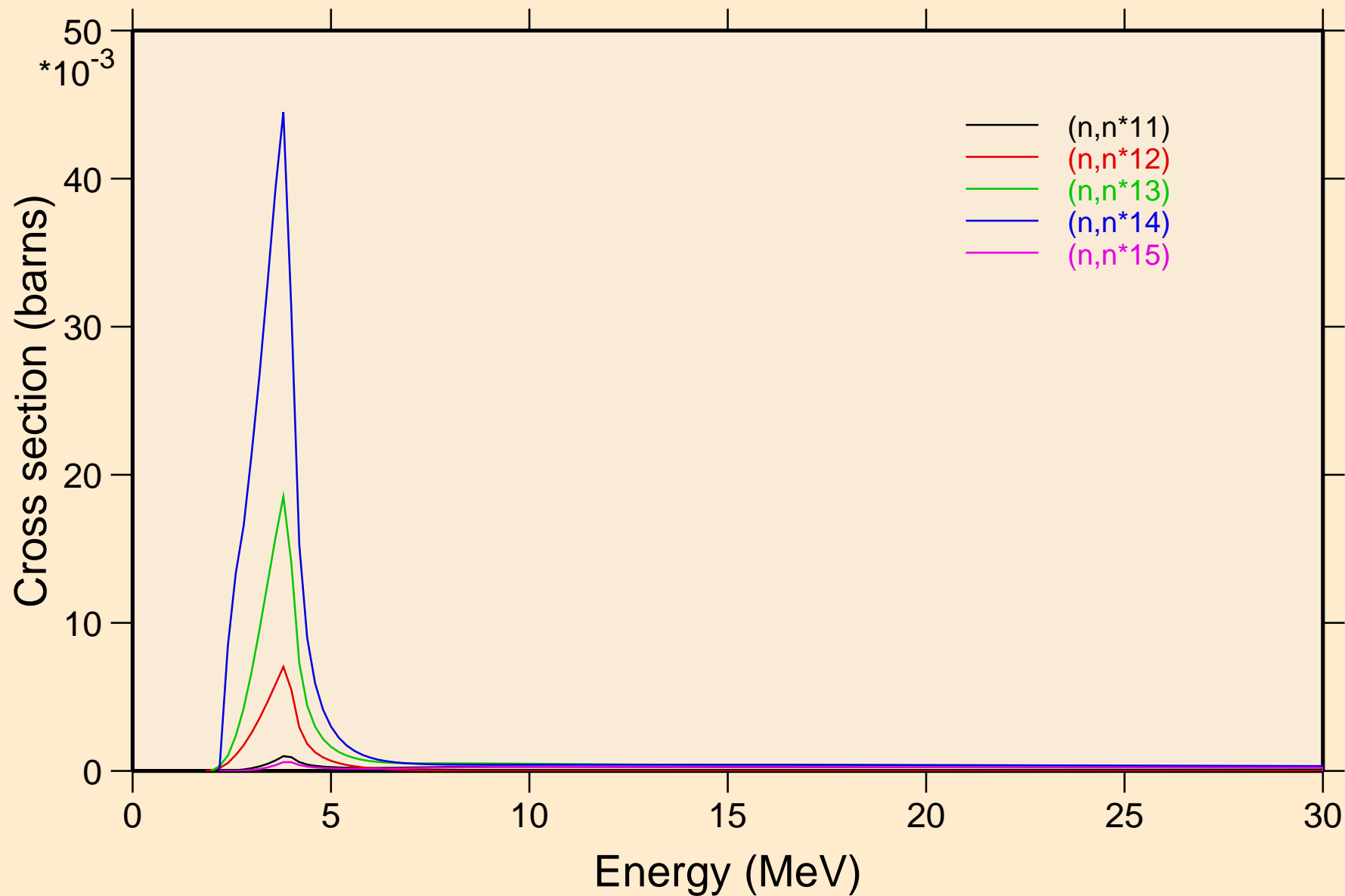

MO108 NEUTRON ACER TENDL-2023 LIBRARY; T=0.K
Inelastic levels

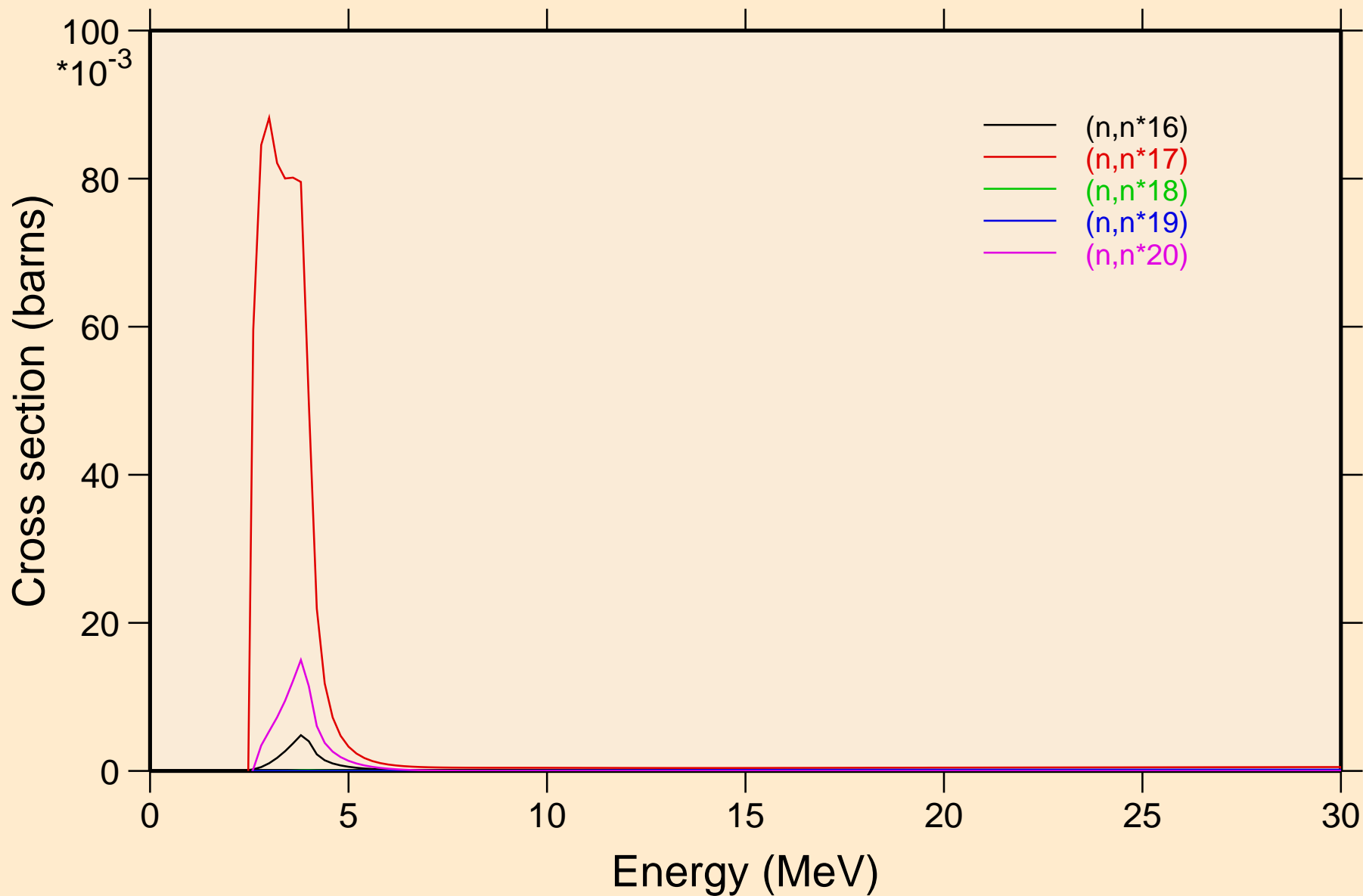

MO108 NEUTRON ACER TENDL-2023 LIBRARY; T=0.K
Inelastic levels

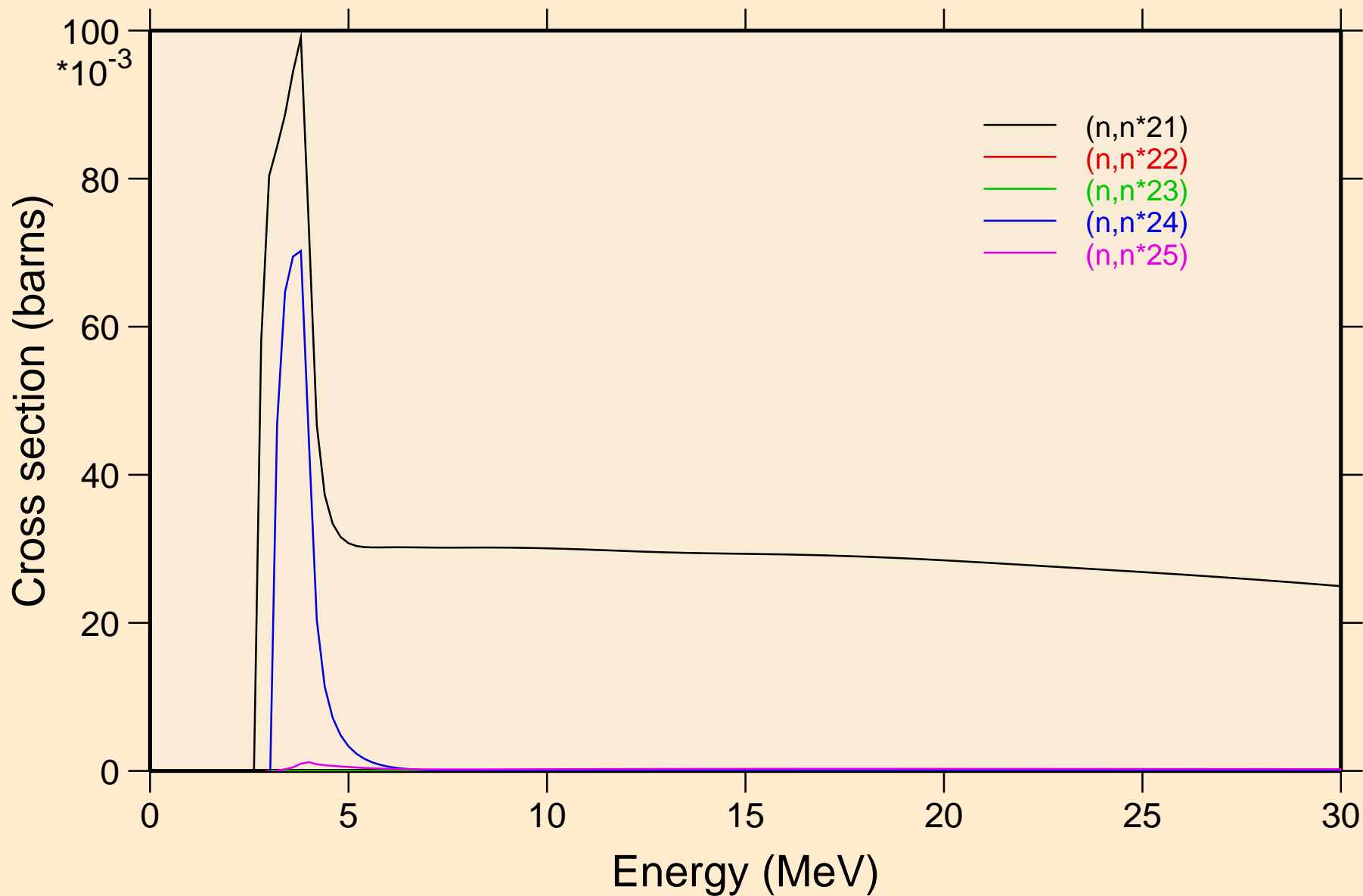

MO108 NEUTRON ACER TENDL-2023 LIBRARY; T=0.K
Inelastic levels

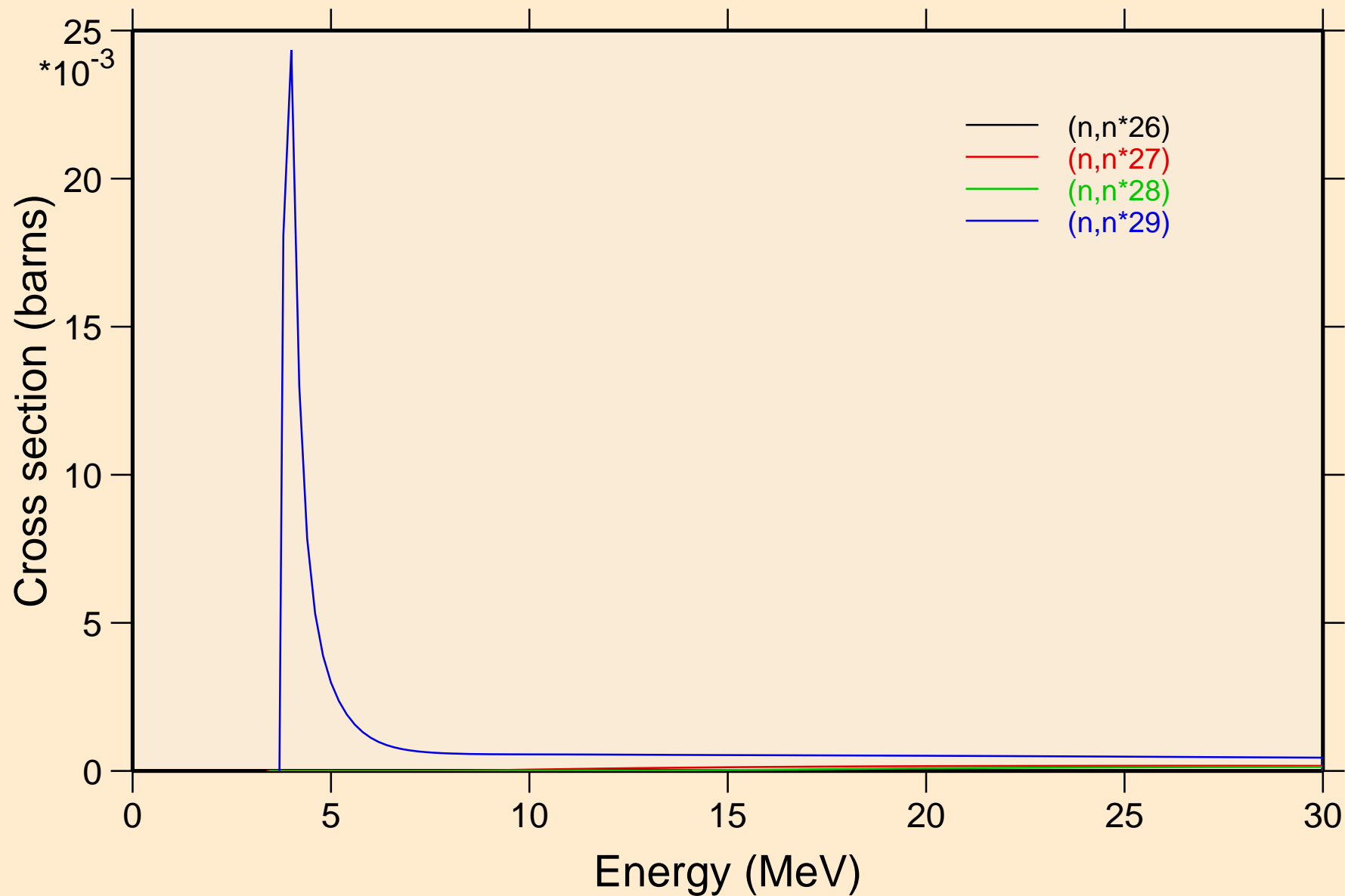

MO108 NEUTRON ACER TENDL-2023 LIBRARY; T=0.K
Threshold reactions

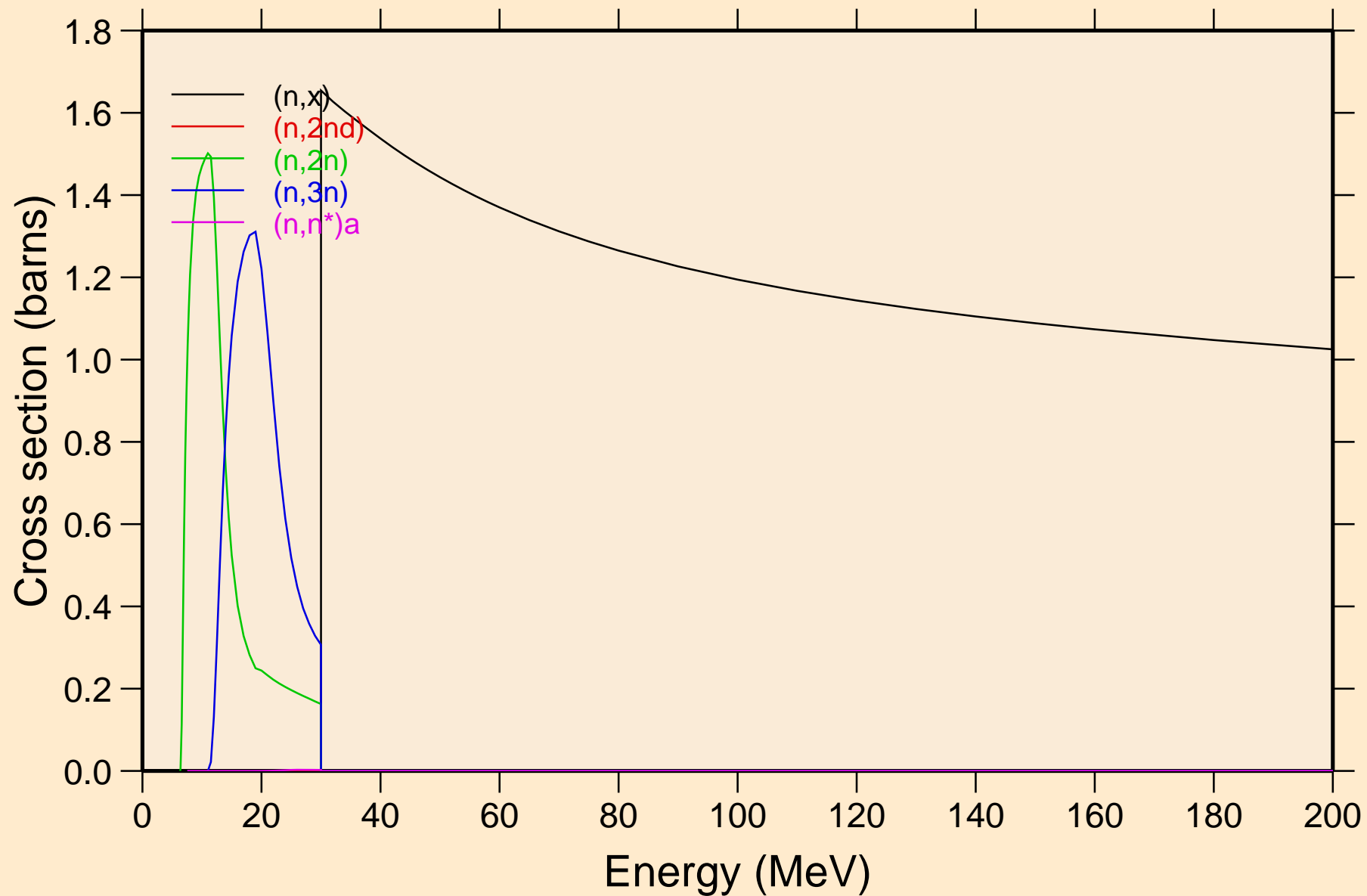

MO108 NEUTRON ACER TENDL-2023 LIBRARY; T=0.K

Threshold reactions

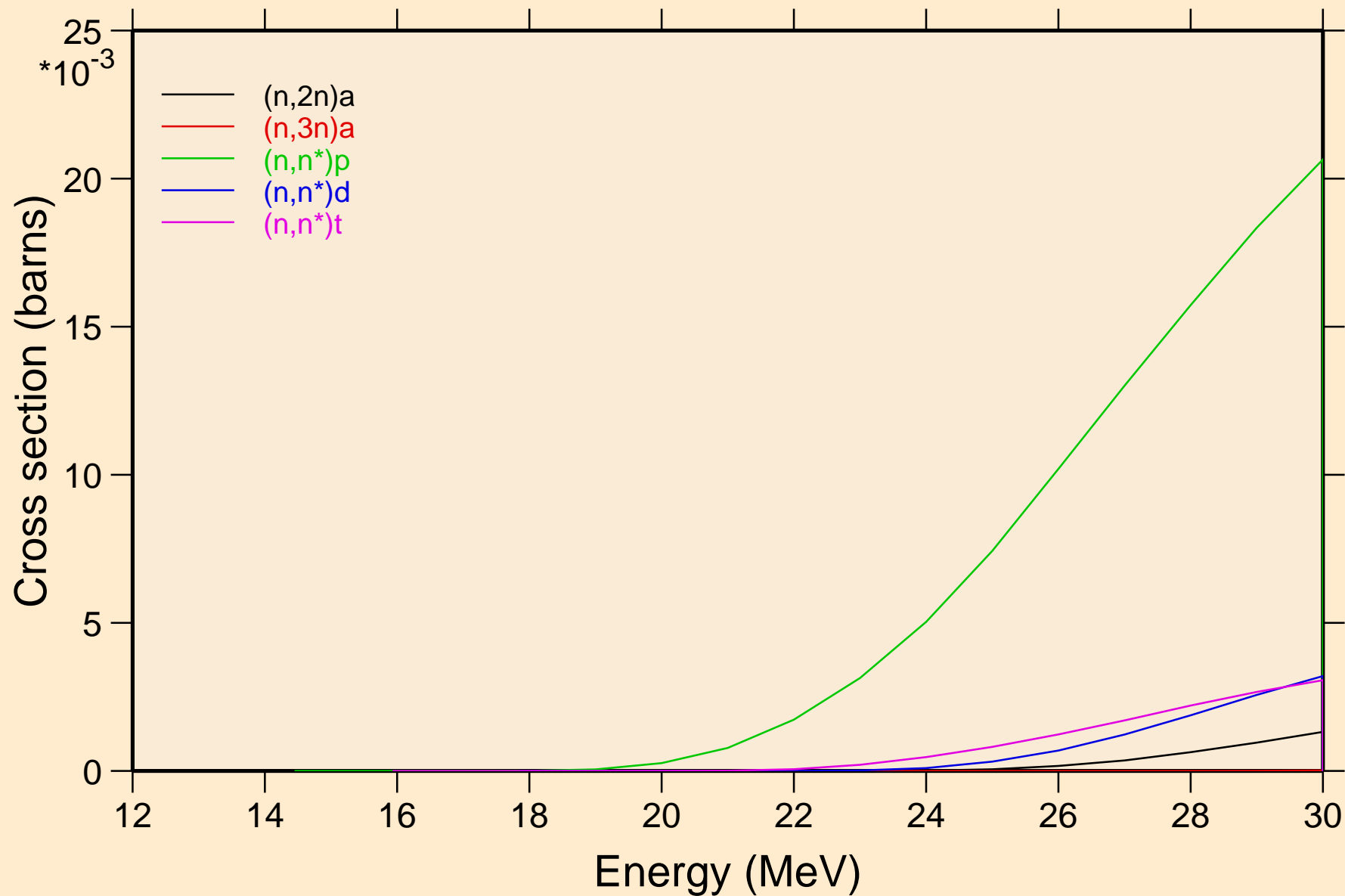

MO108 NEUTRON ACER TENDL-2023 LIBRARY; T=0.K
Threshold reactions

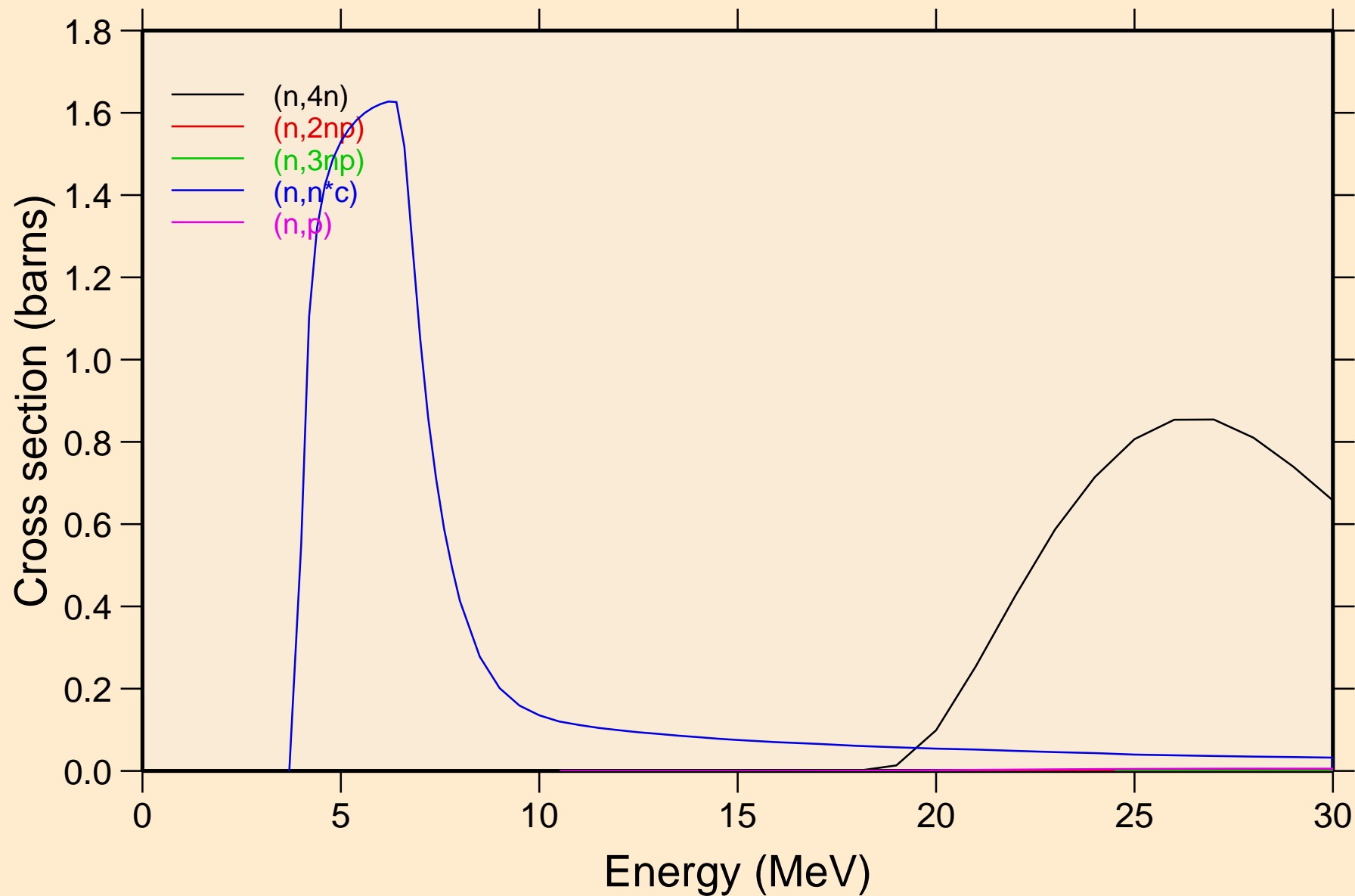

MO108 NEUTRON ACER TENDL-2023 LIBRARY; T=0.K
Threshold reactions

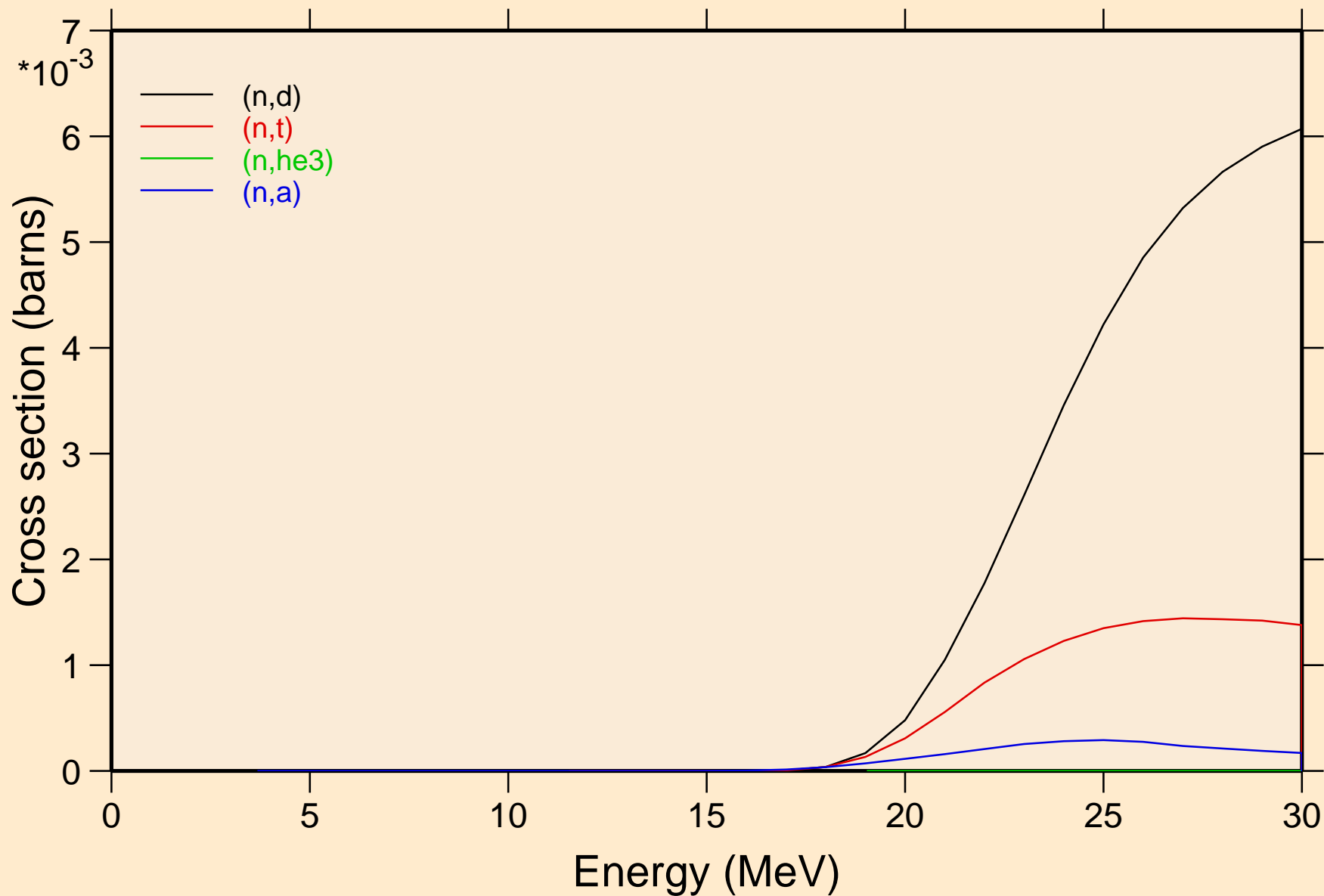

MO108 NEUTRON ACER TENDL-2023 LIBRARY; T=0.K
Threshold reactions

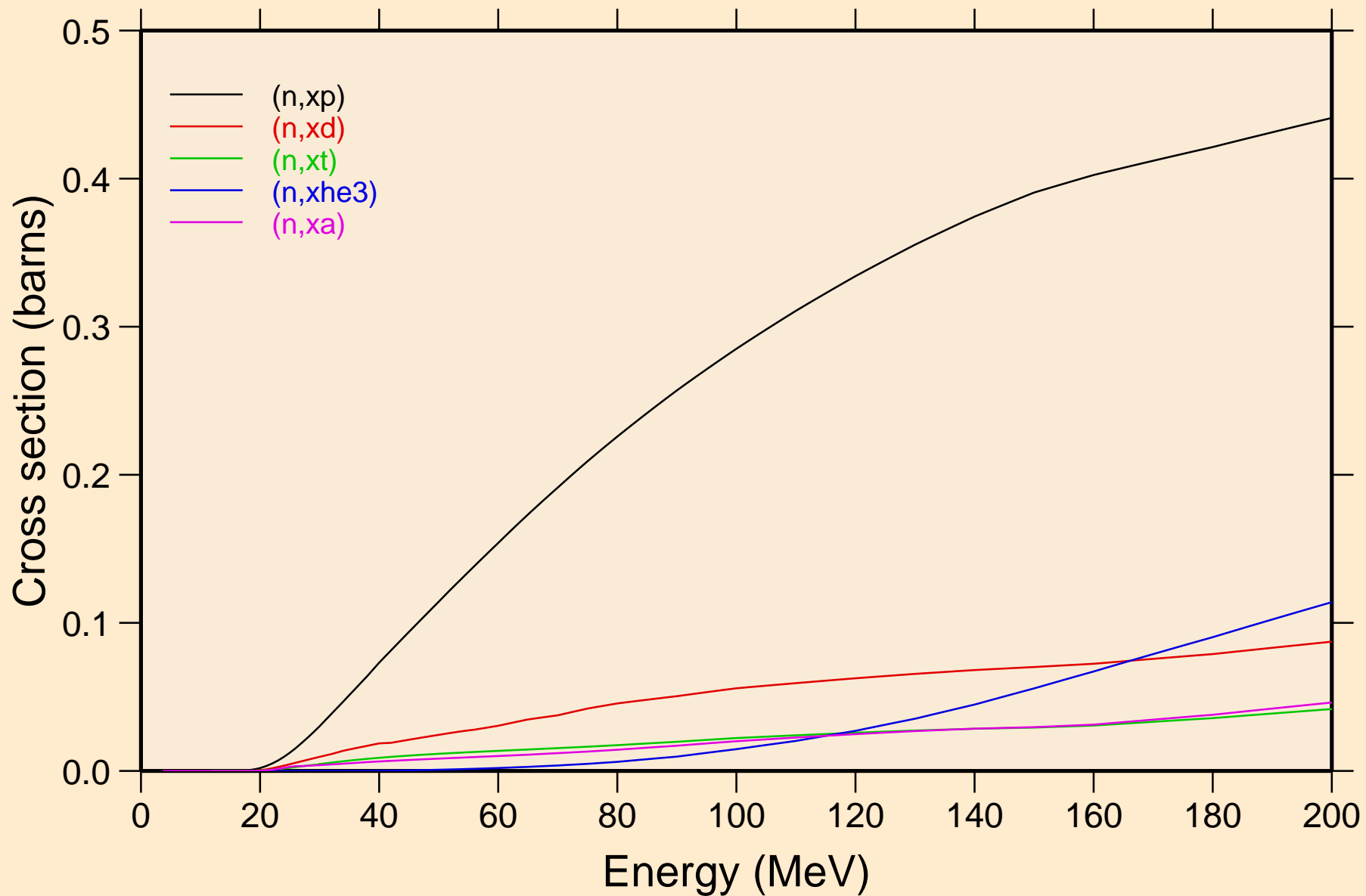

MO108 NEUTRON ACER TENDL-2023 LIBRARY; T=0.K
angular distribution for elastic

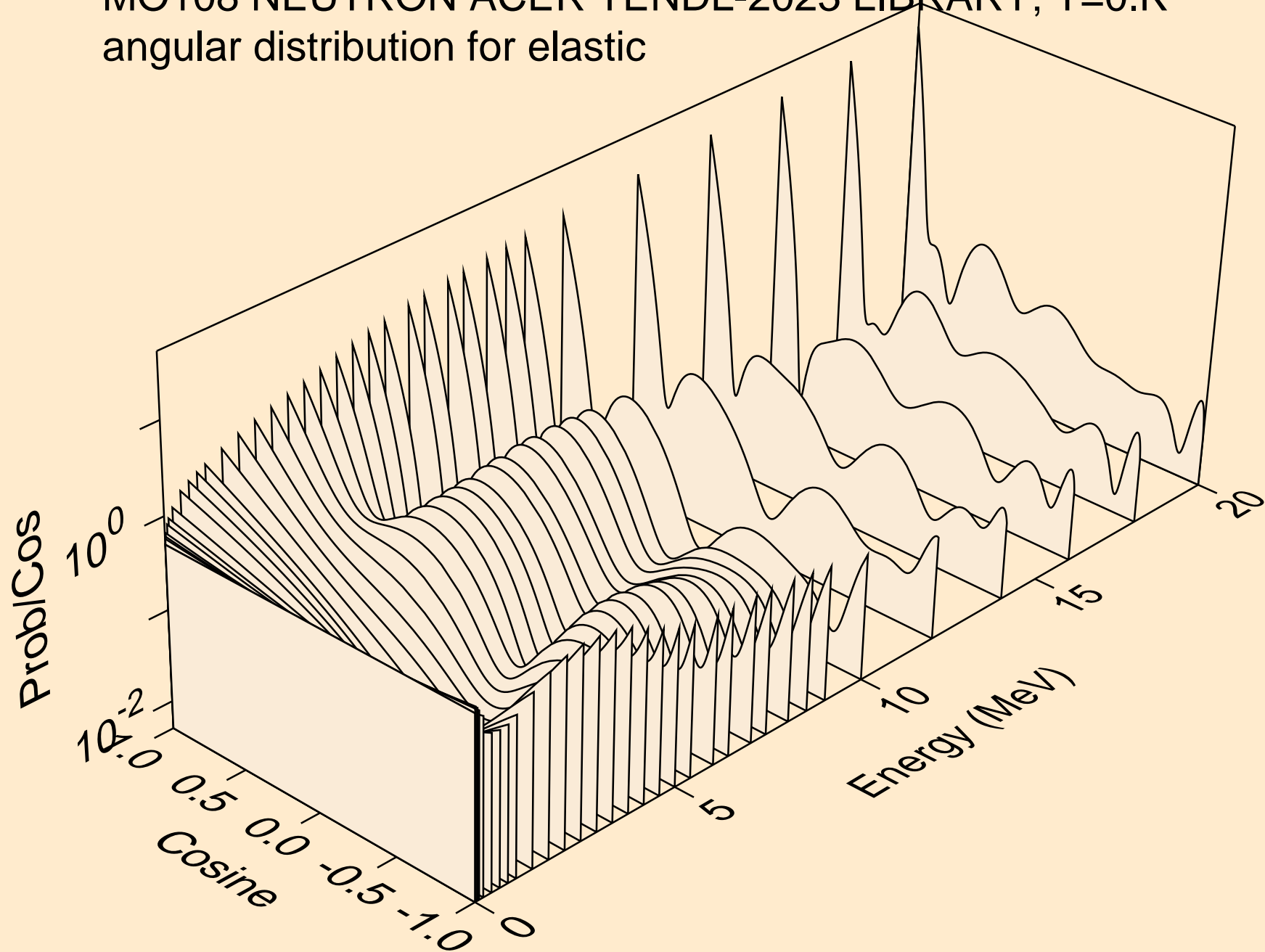

MO108 NEUTRON ACER TENDL-2023 LIBRARY; T=0.K
angular distribution for elastic

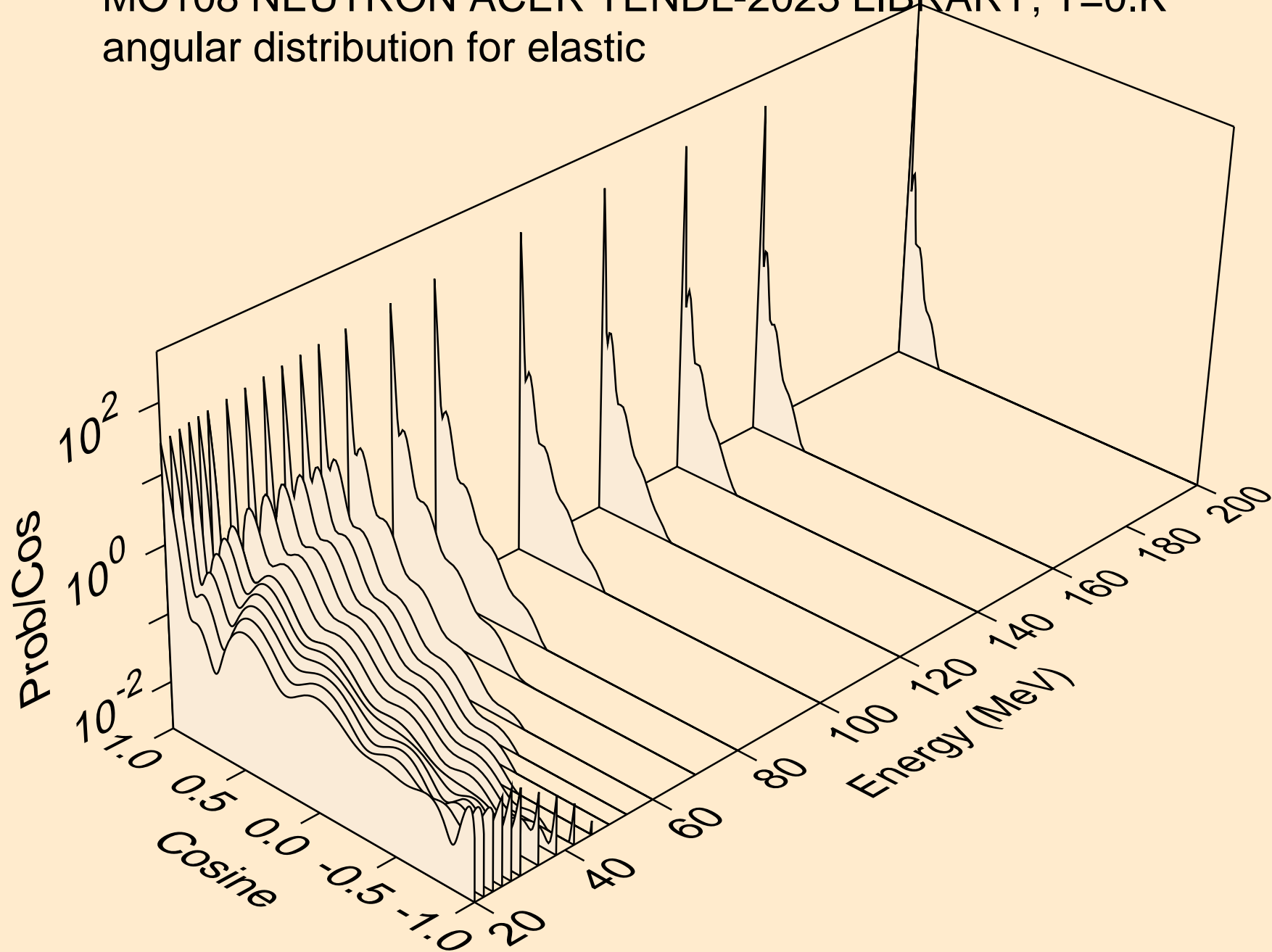

MO108 NEUTRON ACER TENDL-2023 LIBRARY; T=0.K
angular distribution for (n,n*1)

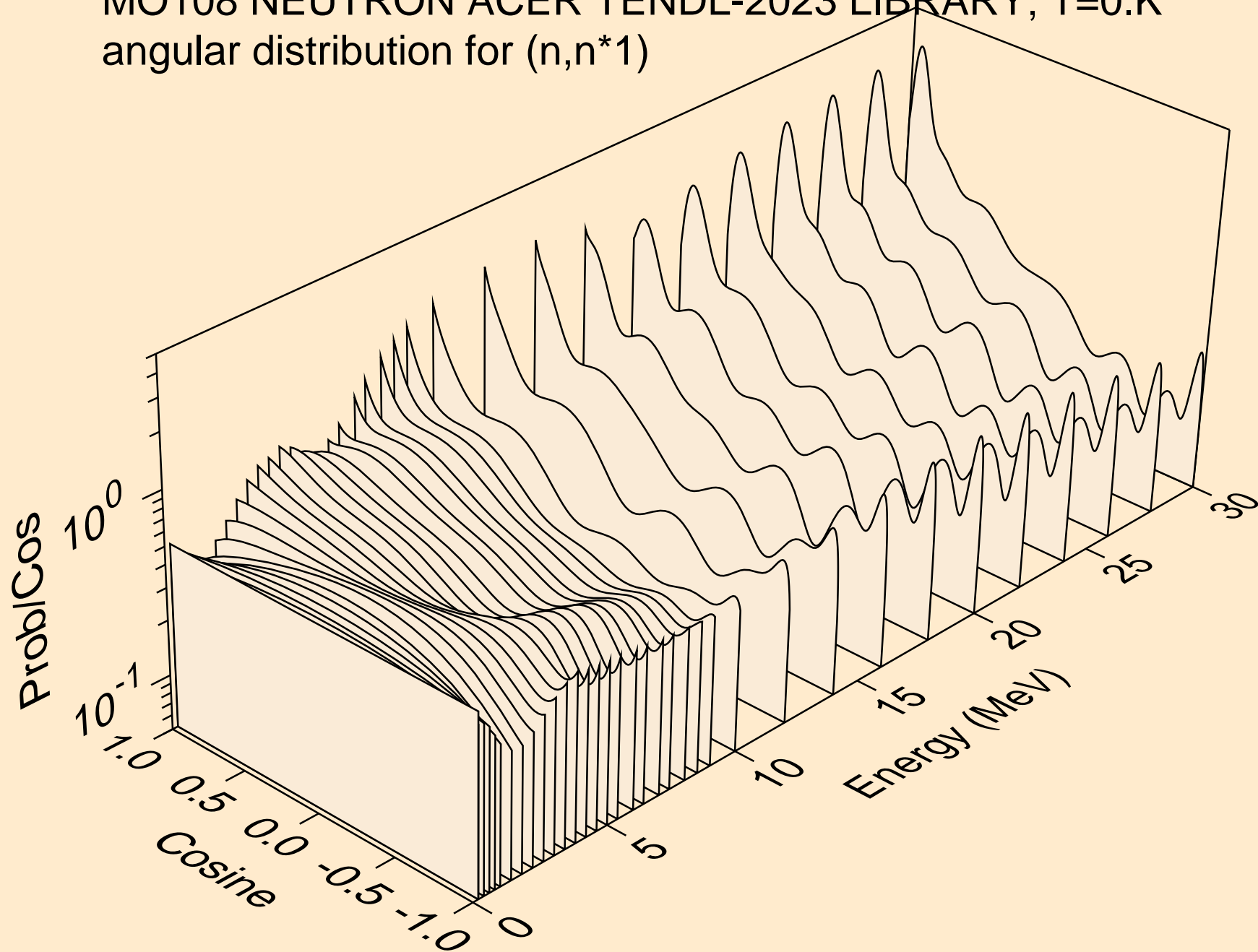

MO108 NEUTRON ACER TENDL-2023 LIBRARY; T=0.K
angular distribution for (n,n*2)

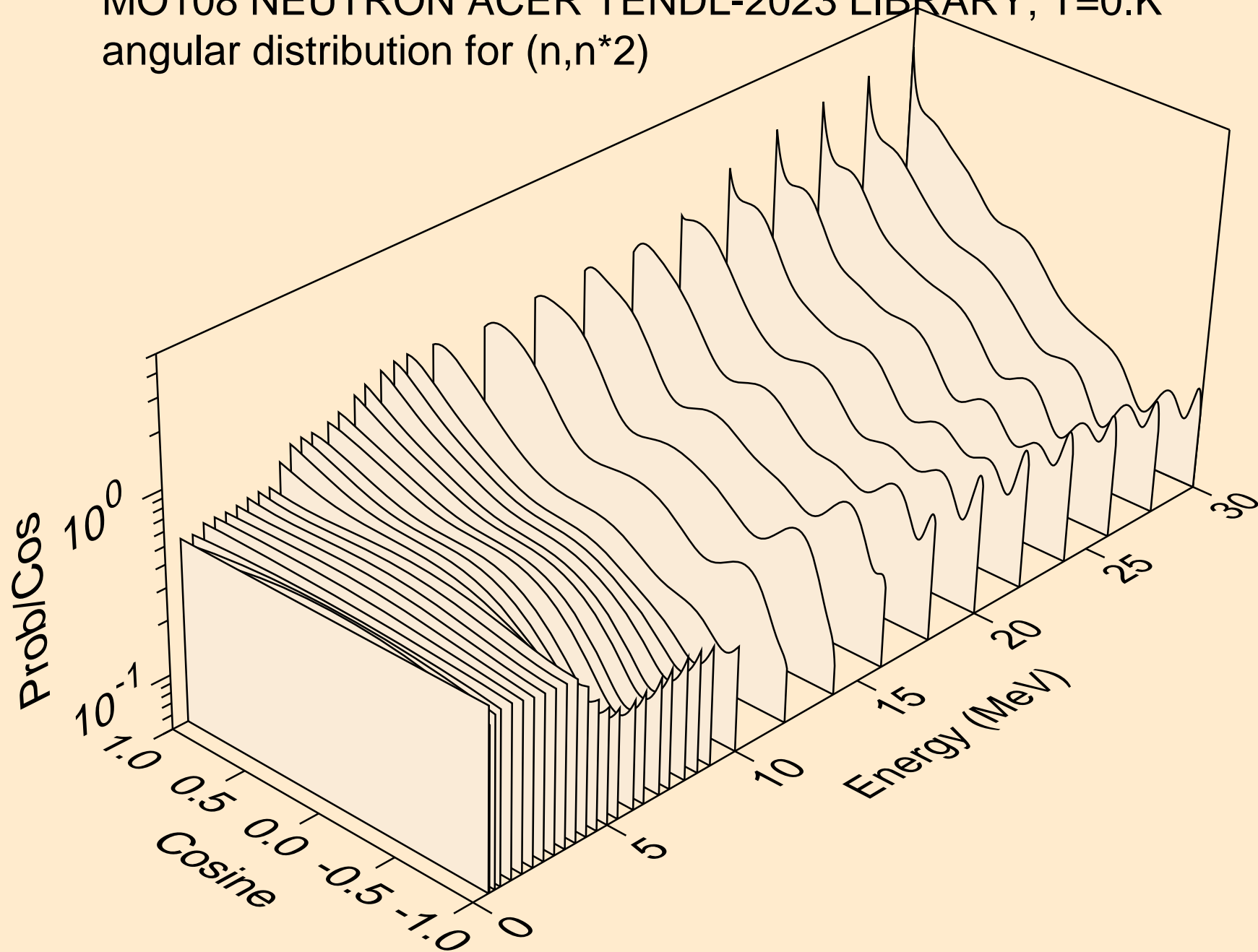

MO108 NEUTRON ACER TENDL-2023 LIBRARY; T=0.K
angular distribution for (n,n*3)

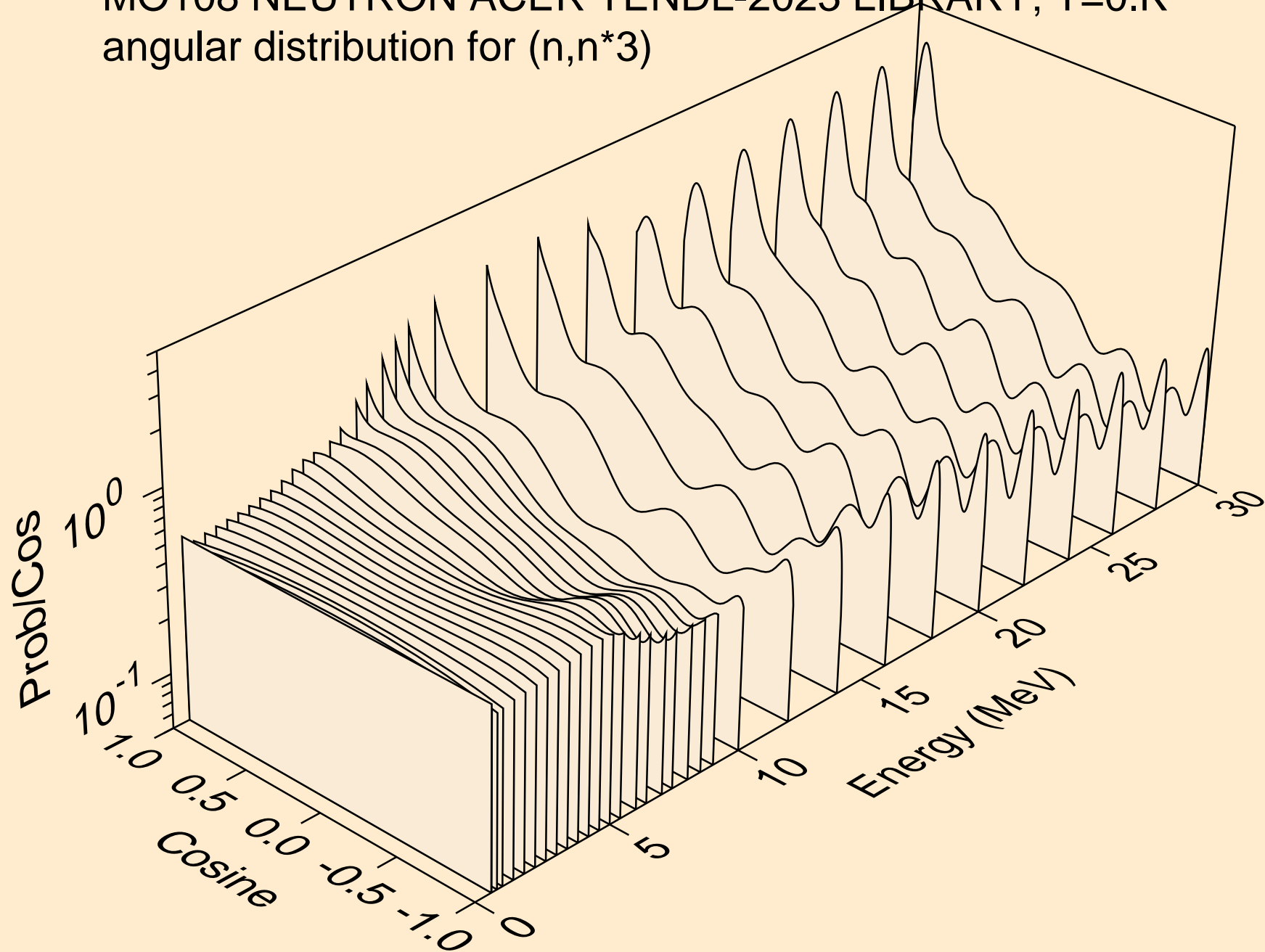

MO108 NEUTRON ACER TENDL-2023 LIBRARY; T=0.K
angular distribution for (n,n*4)

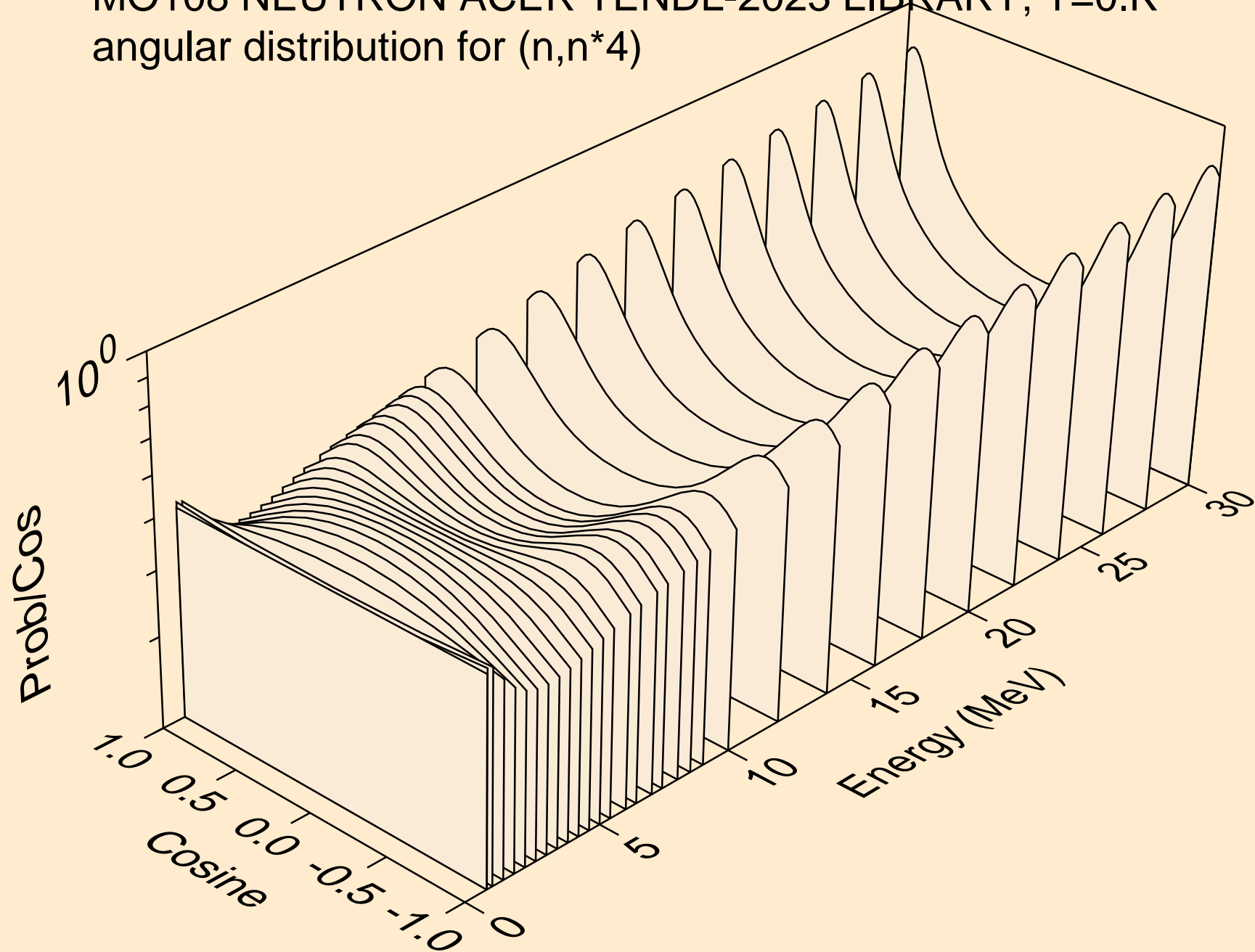

MO108 NEUTRON ACER TENDL-2023 LIBRARY; T=0.K
angular distribution for (n,n*5)

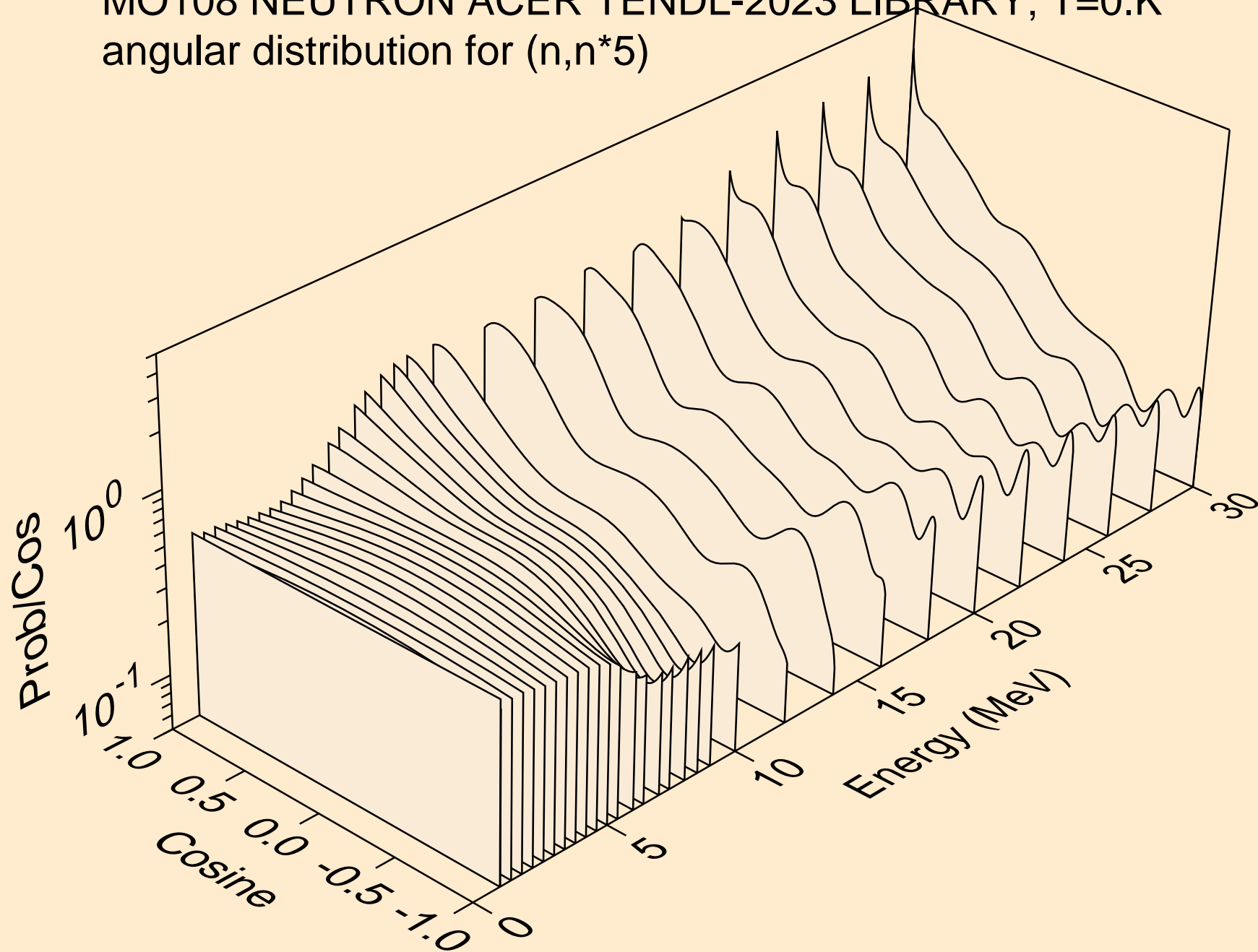

MO108 NEUTRON ACER TENDL-2023 LIBRARY; T=0.K
angular distribution for (n,n*6)

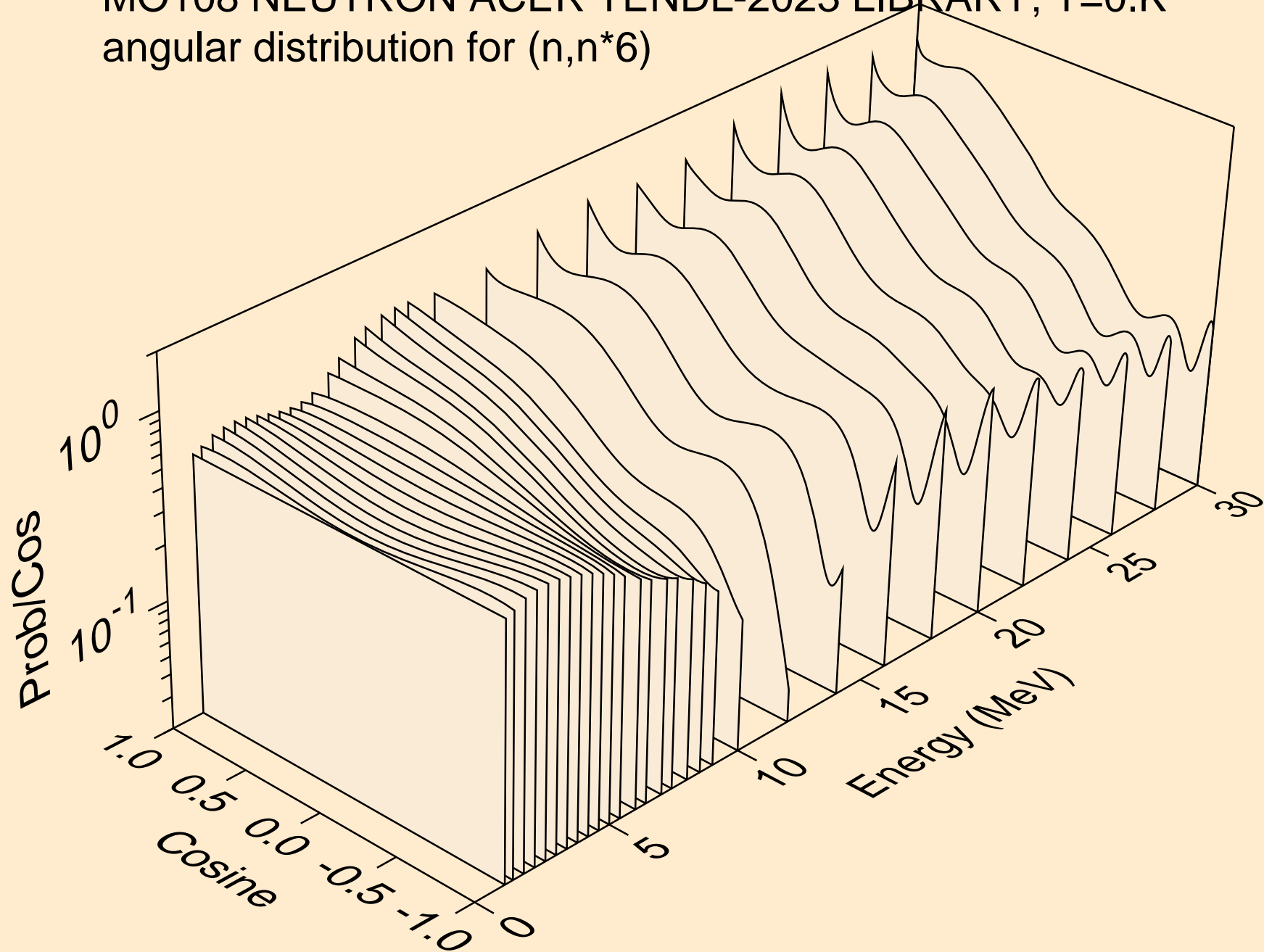

MO108 NEUTRON ACER TENDL-2023 LIBRARY; T=0.K
angular distribution for (n,n*7)

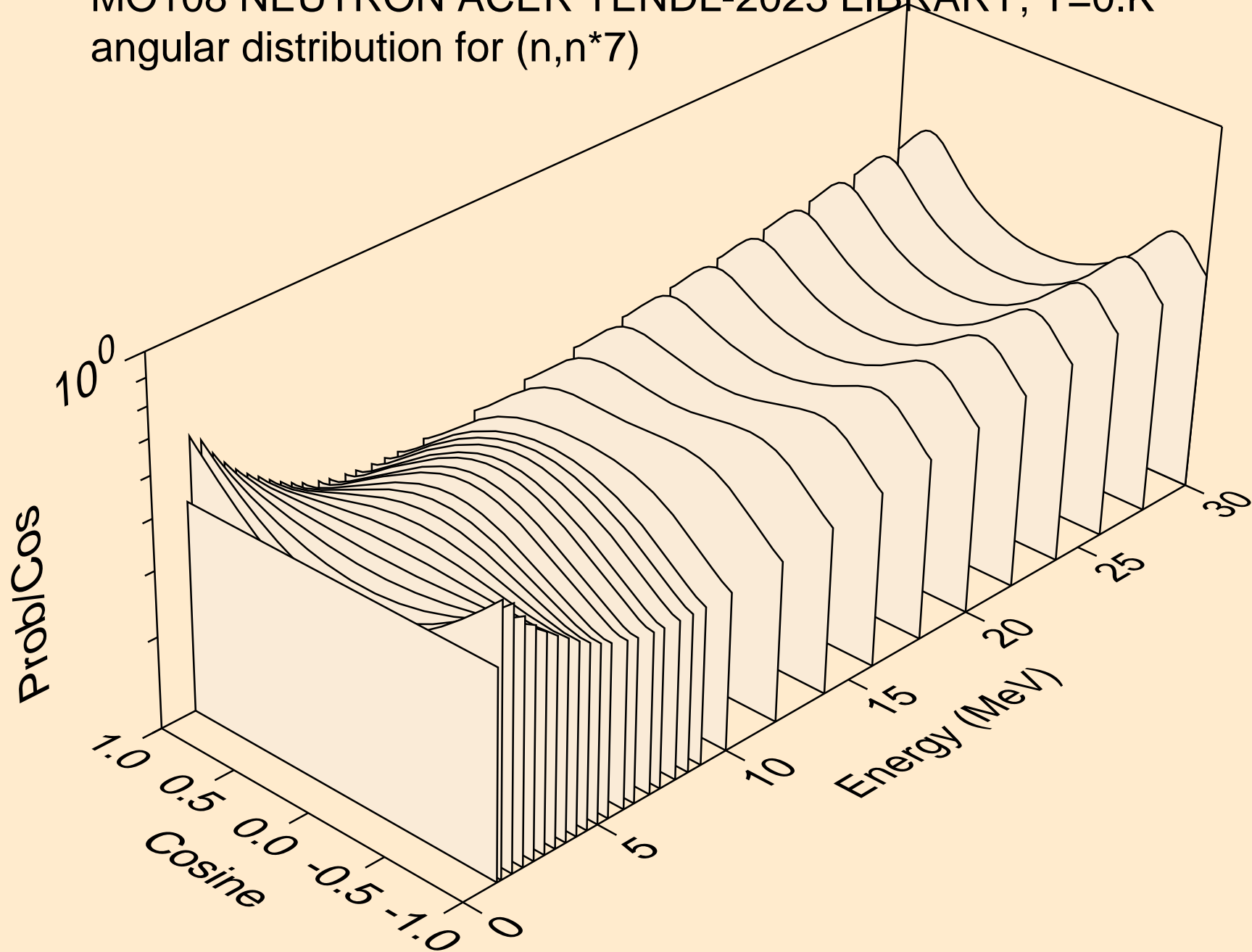

MO108 NEUTRON ACER TENDL-2023 LIBRARY; T=0.K
angular distribution for (n,n*8)

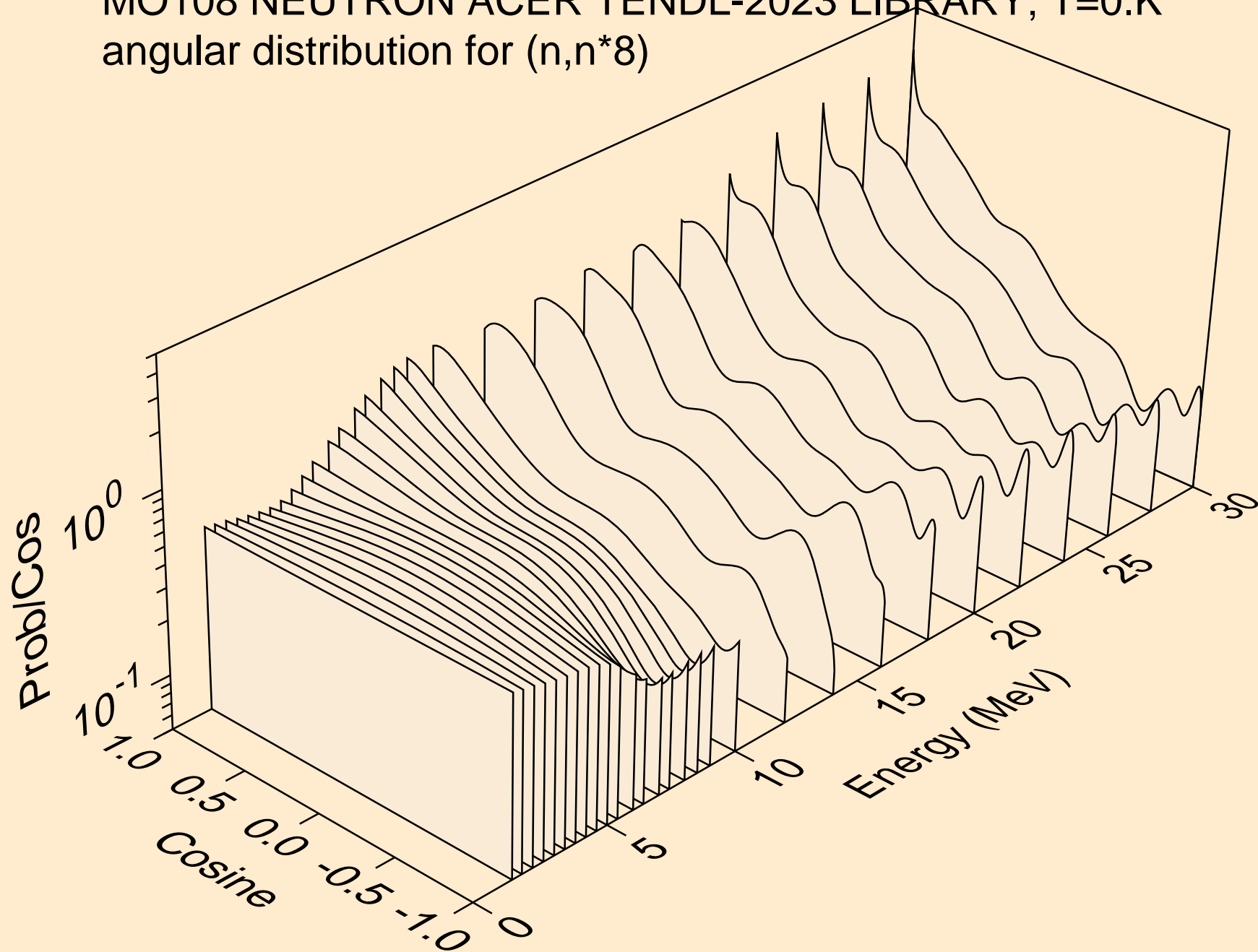

MO108 NEUTRON ACER TENDL-2023 LIBRARY; T=0.K
angular distribution for (n,n*9)

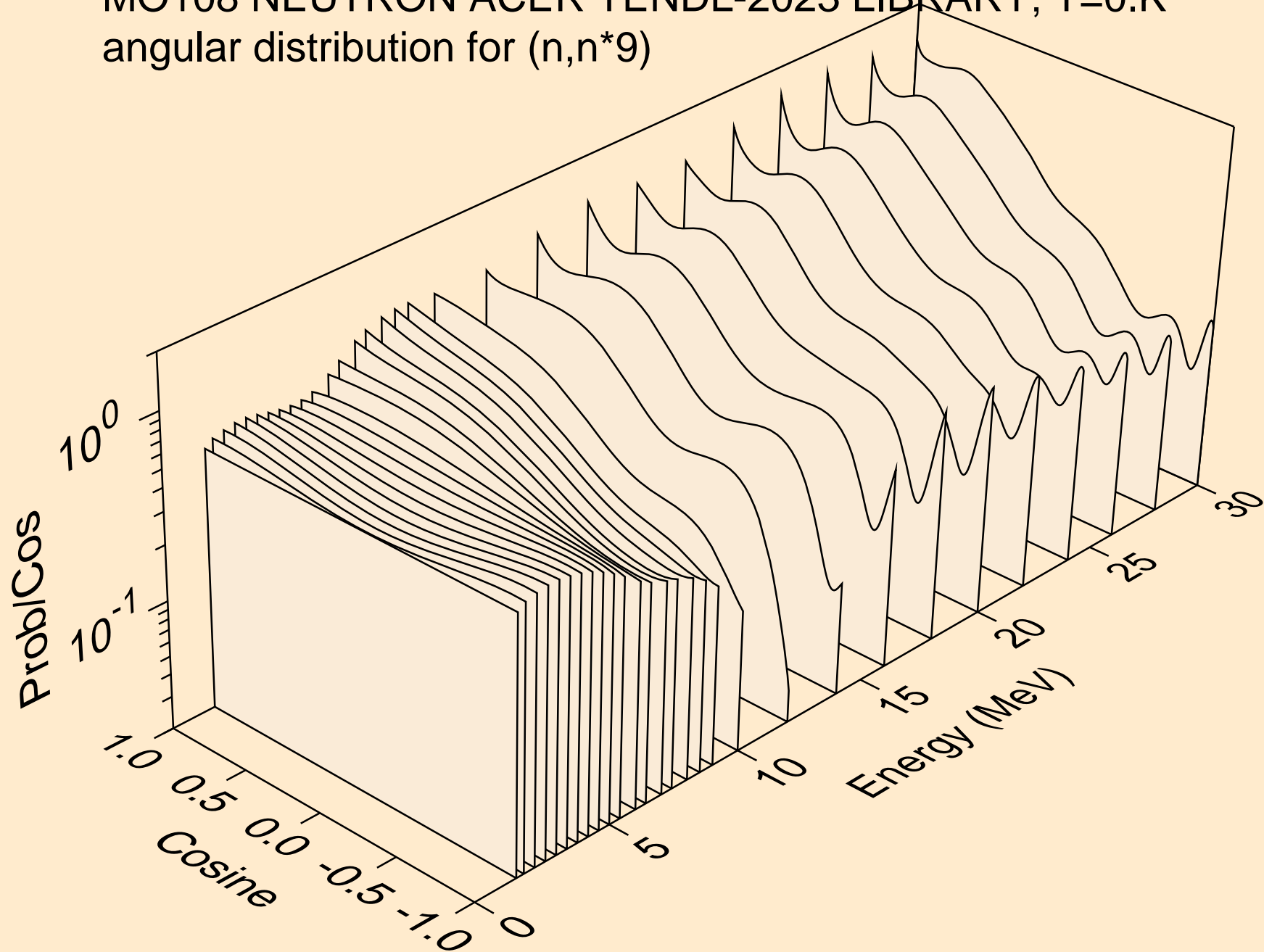

MO108 NEUTRON ACER TENDL-2023 LIBRARY; T=0.K
angular distribution for (n,n*10)

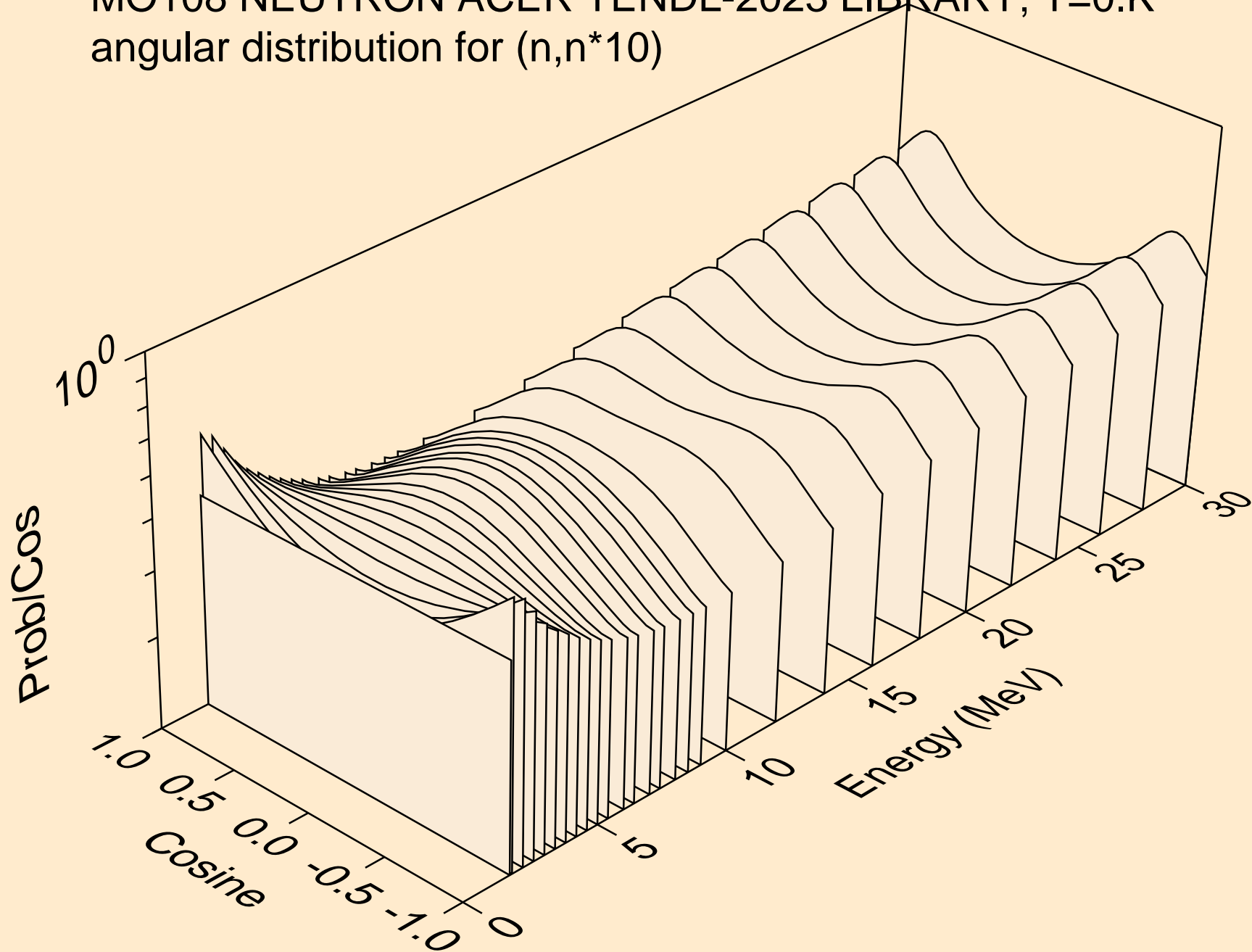

MO108 NEUTRON ACER TENDL-2023 LIBRARY; T=0.K
angular distribution for (n,n*11)

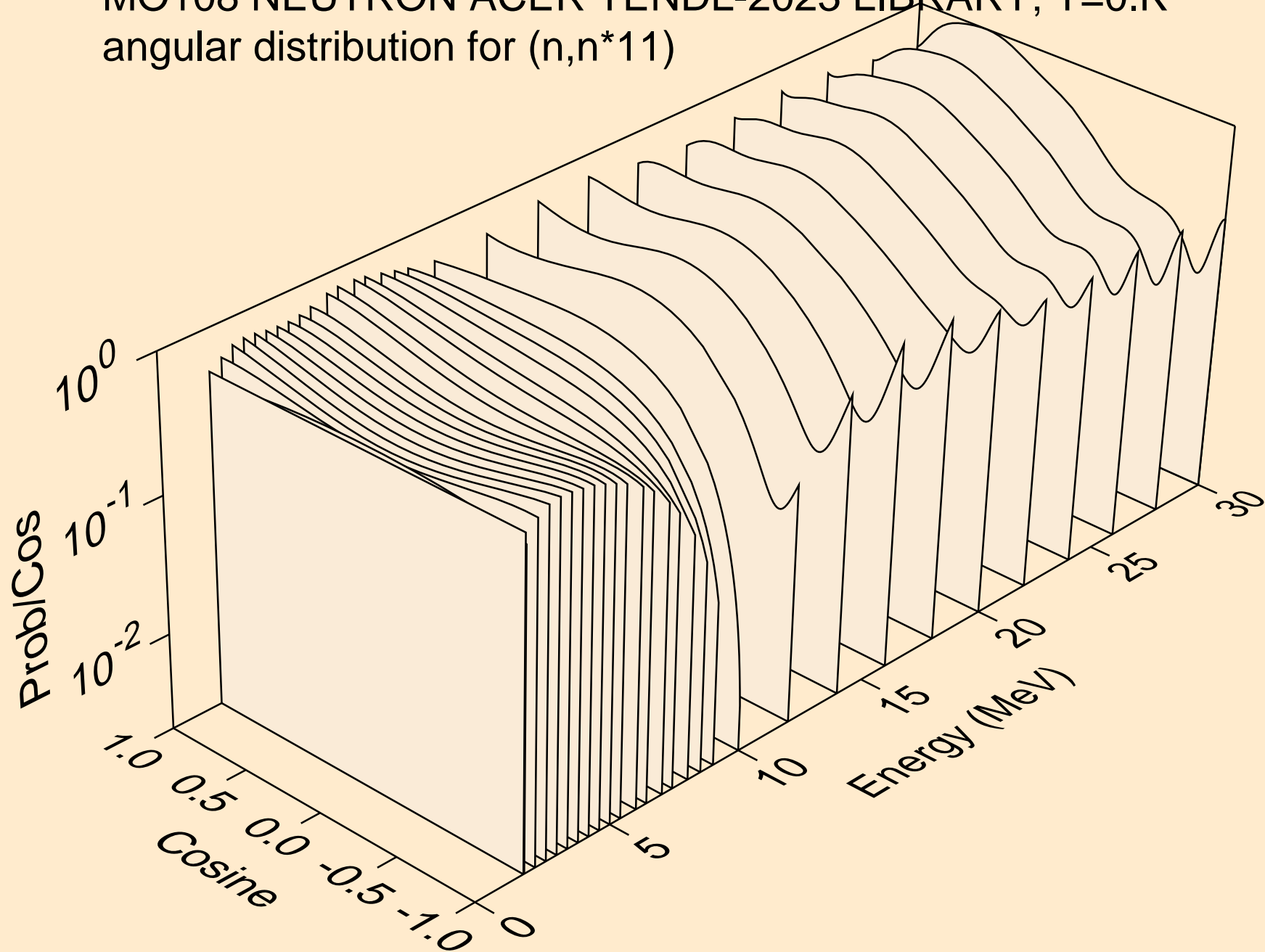

MO108 NEUTRON ACER TENDL-2023 LIBRARY; T=0.K
angular distribution for (n,n*12)

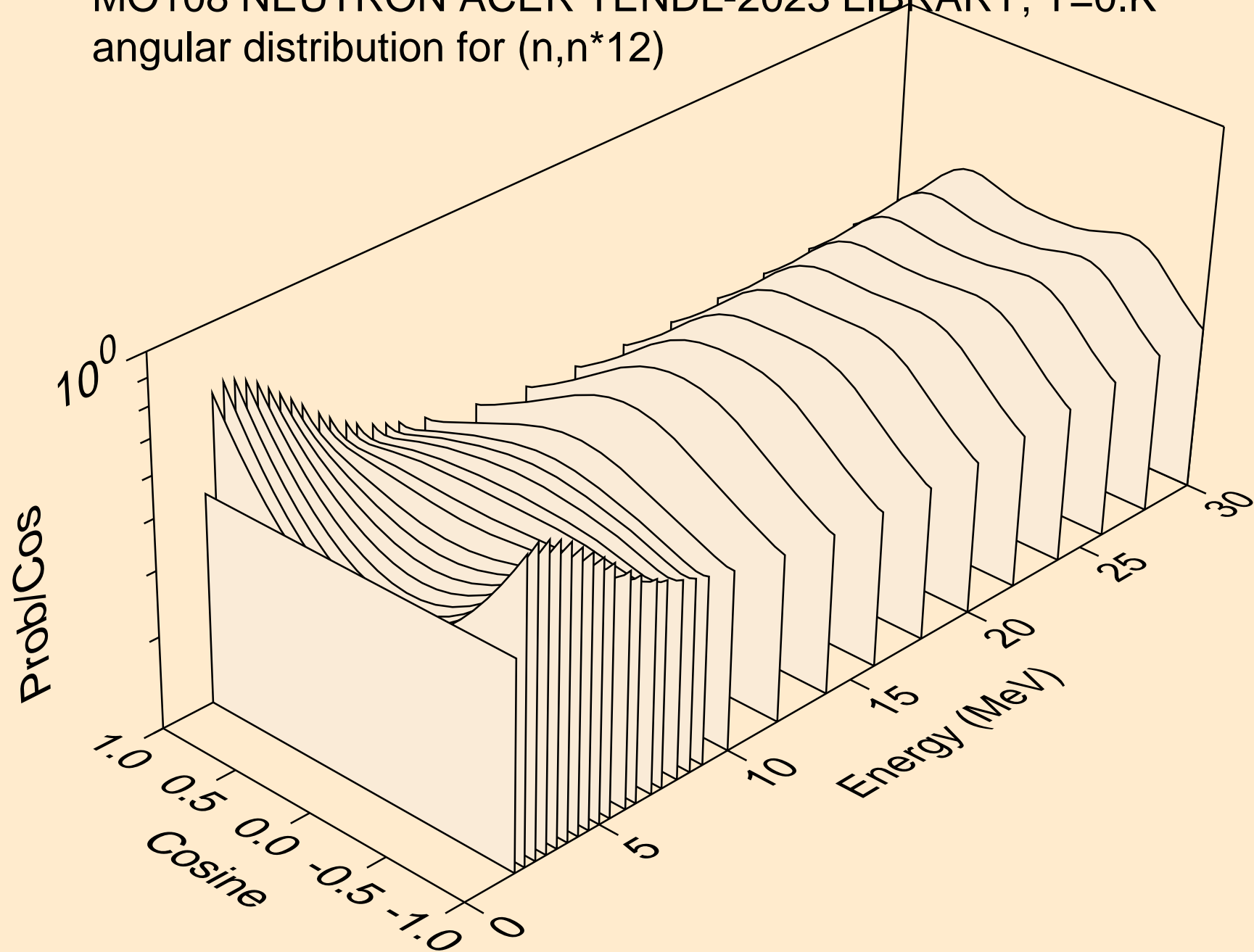

MO108 NEUTRON ACER TENDL-2023 LIBRARY; T=0.K
angular distribution for (n,n*13)

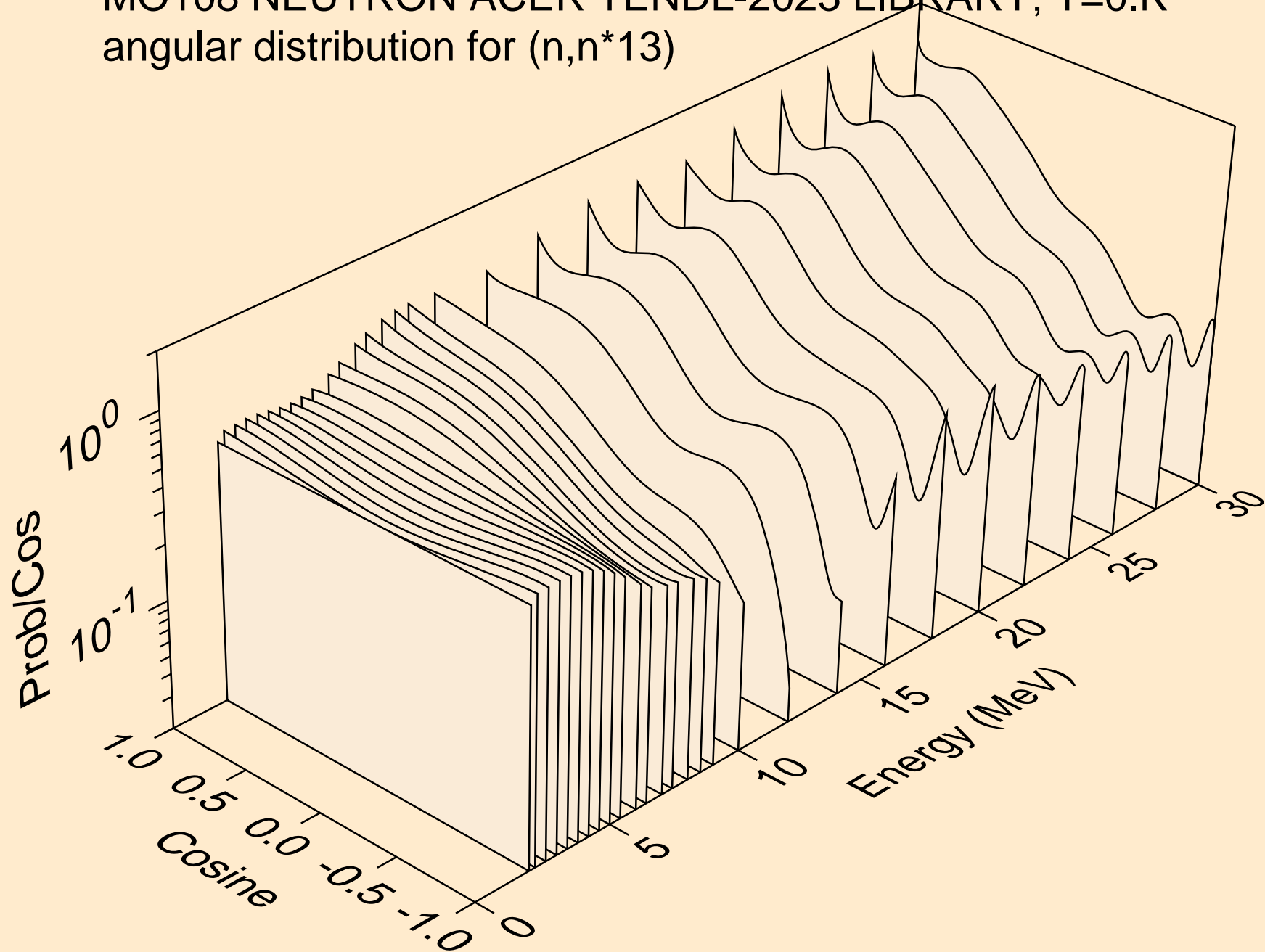

MO108 NEUTRON ACER TENDL-2023 LIBRARY; T=0.K
angular distribution for (n,n*14)

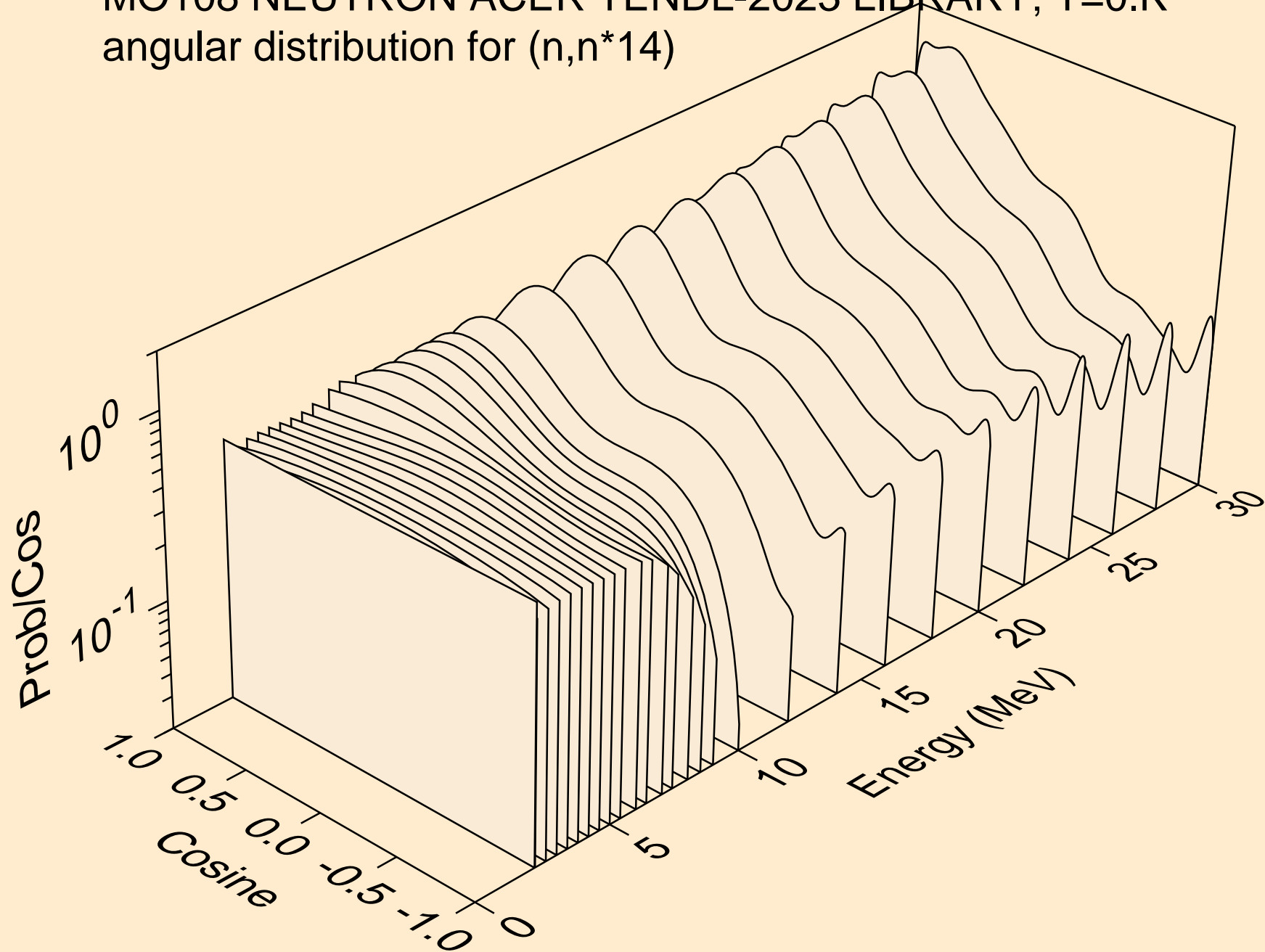

MO108 NEUTRON ACER TENDL-2023 LIBRARY; T=0.K
angular distribution for (n,n*15)

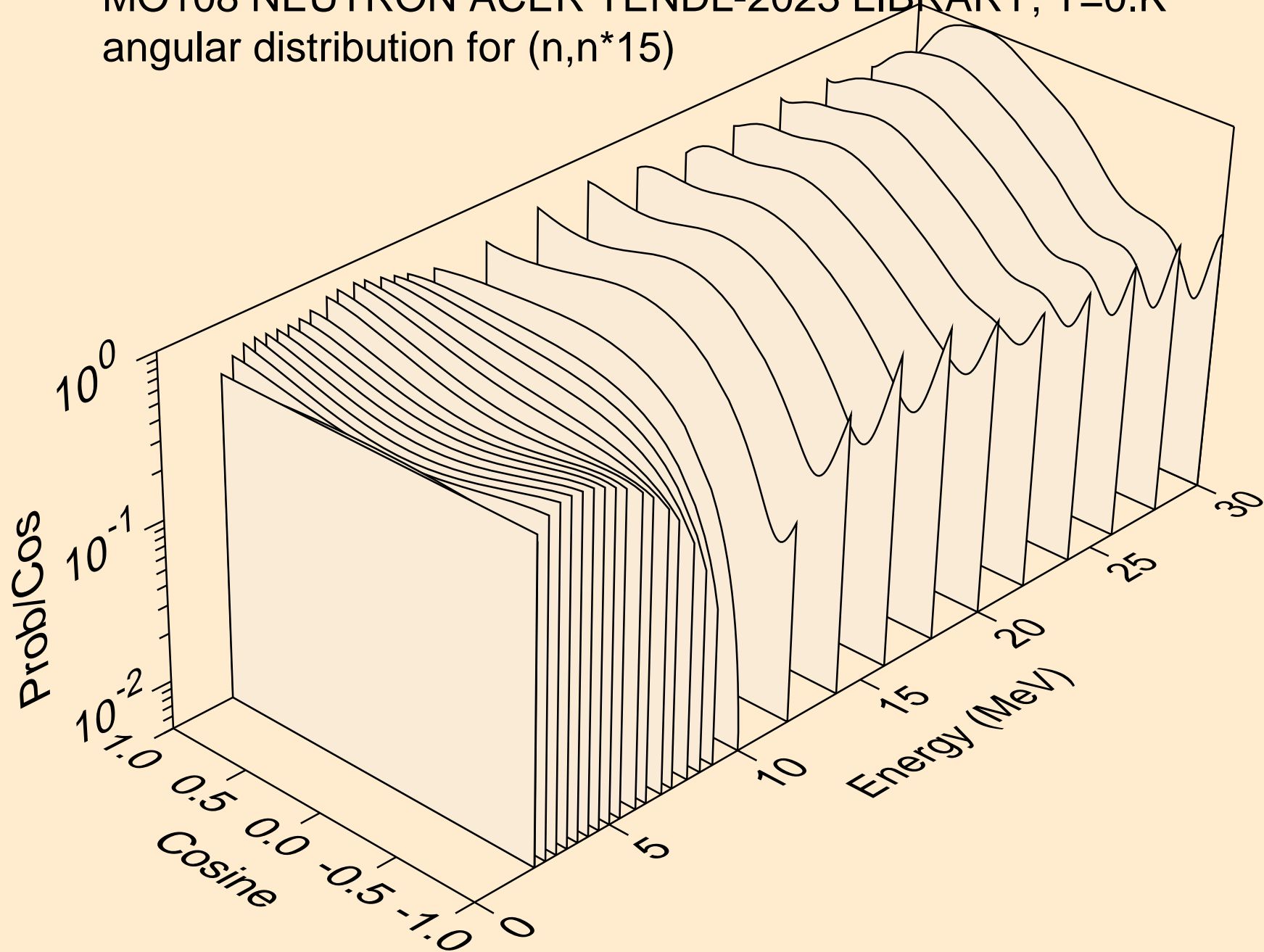

MO108 NEUTRON ACER TENDL-2023 LIBRARY; T=0.K
angular distribution for (n,n*16)

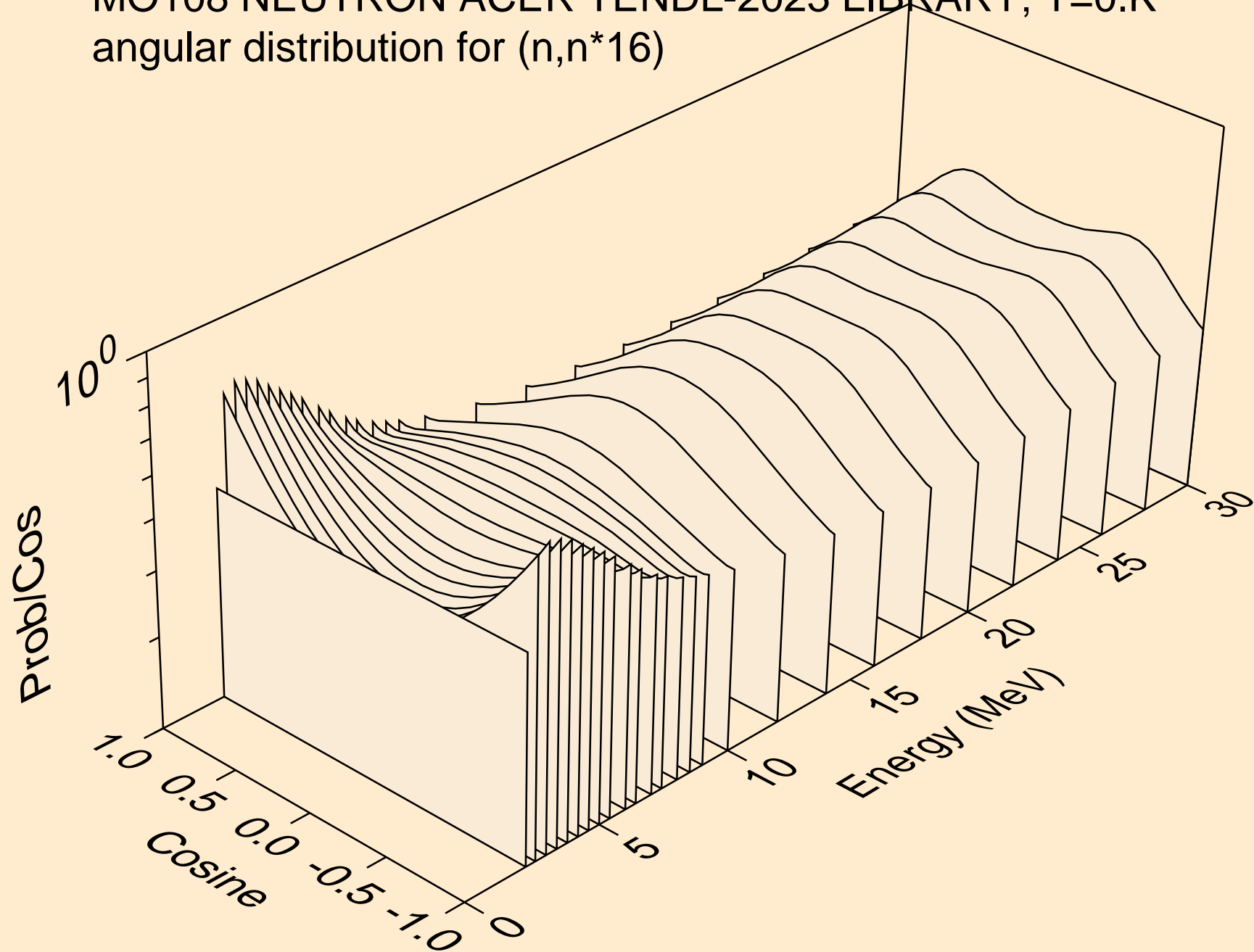

MO108 NEUTRON ACER TENDL-2023 LIBRARY; T=0.K
angular distribution for (n,n*17)

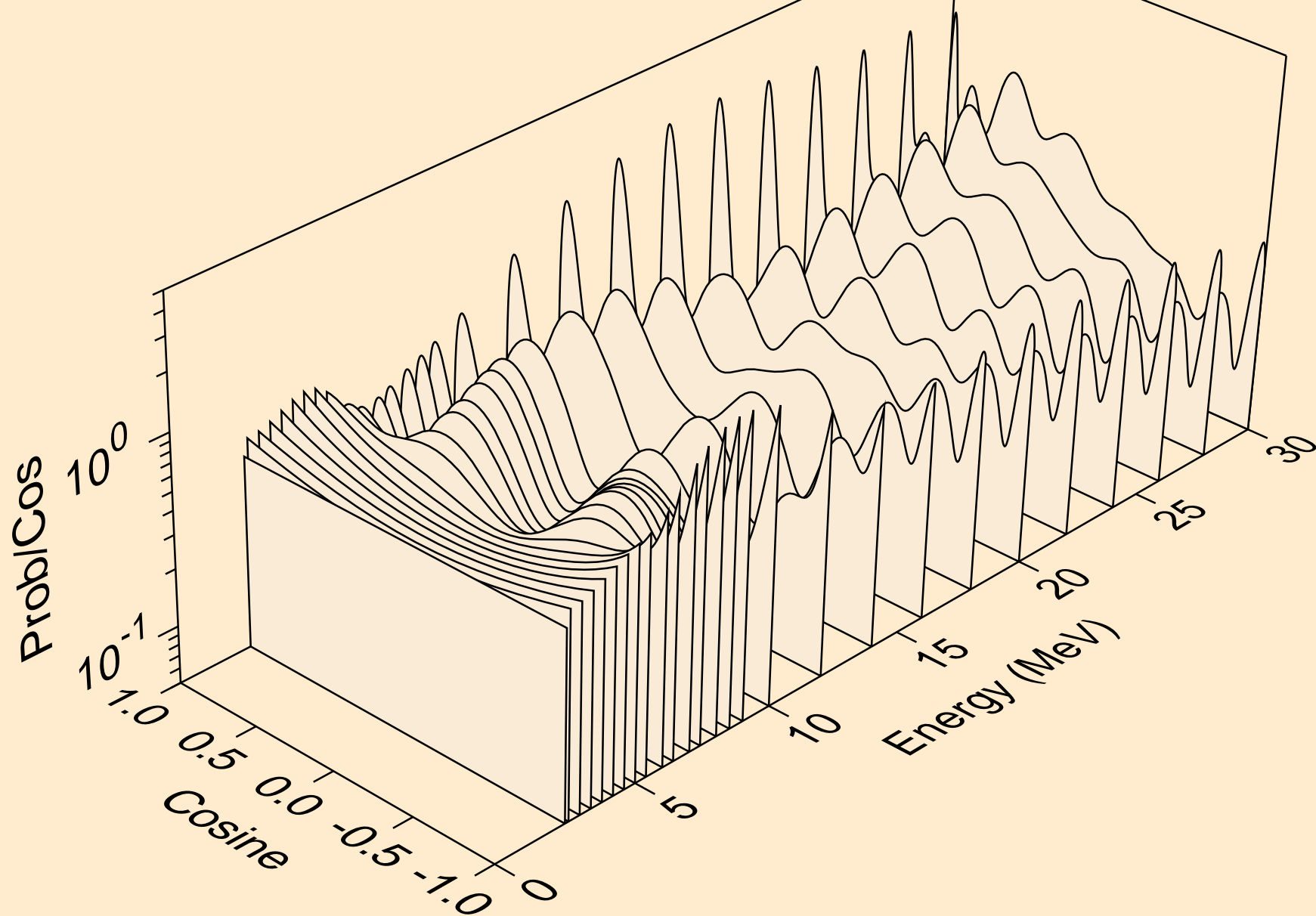

MO108 NEUTRON ACER TENDL-2023 LIBRARY; T=0.K
angular distribution for (n,n*18)

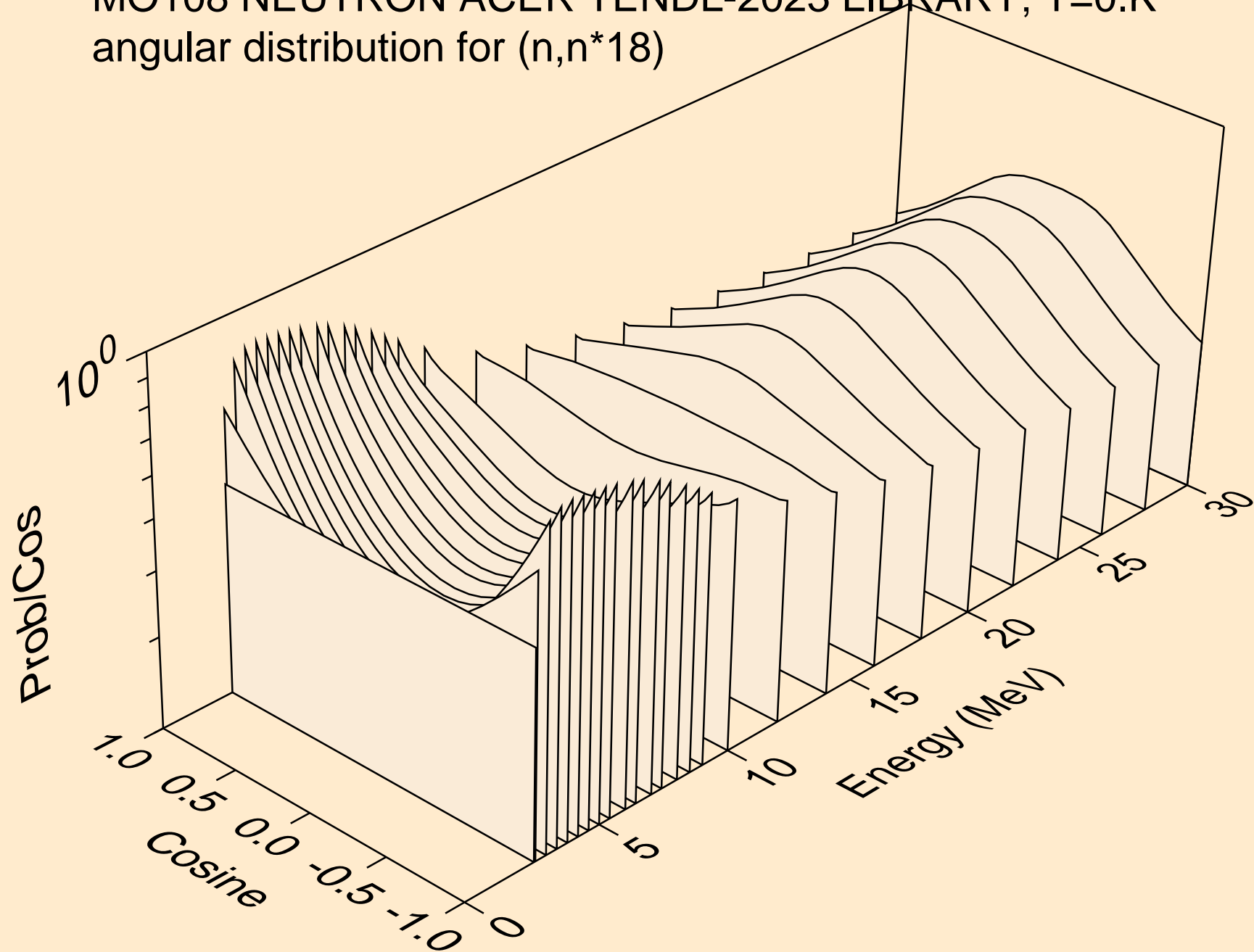

MO108 NEUTRON ACER TENDL-2023 LIBRARY; T=0.K
angular distribution for (n,n*19)

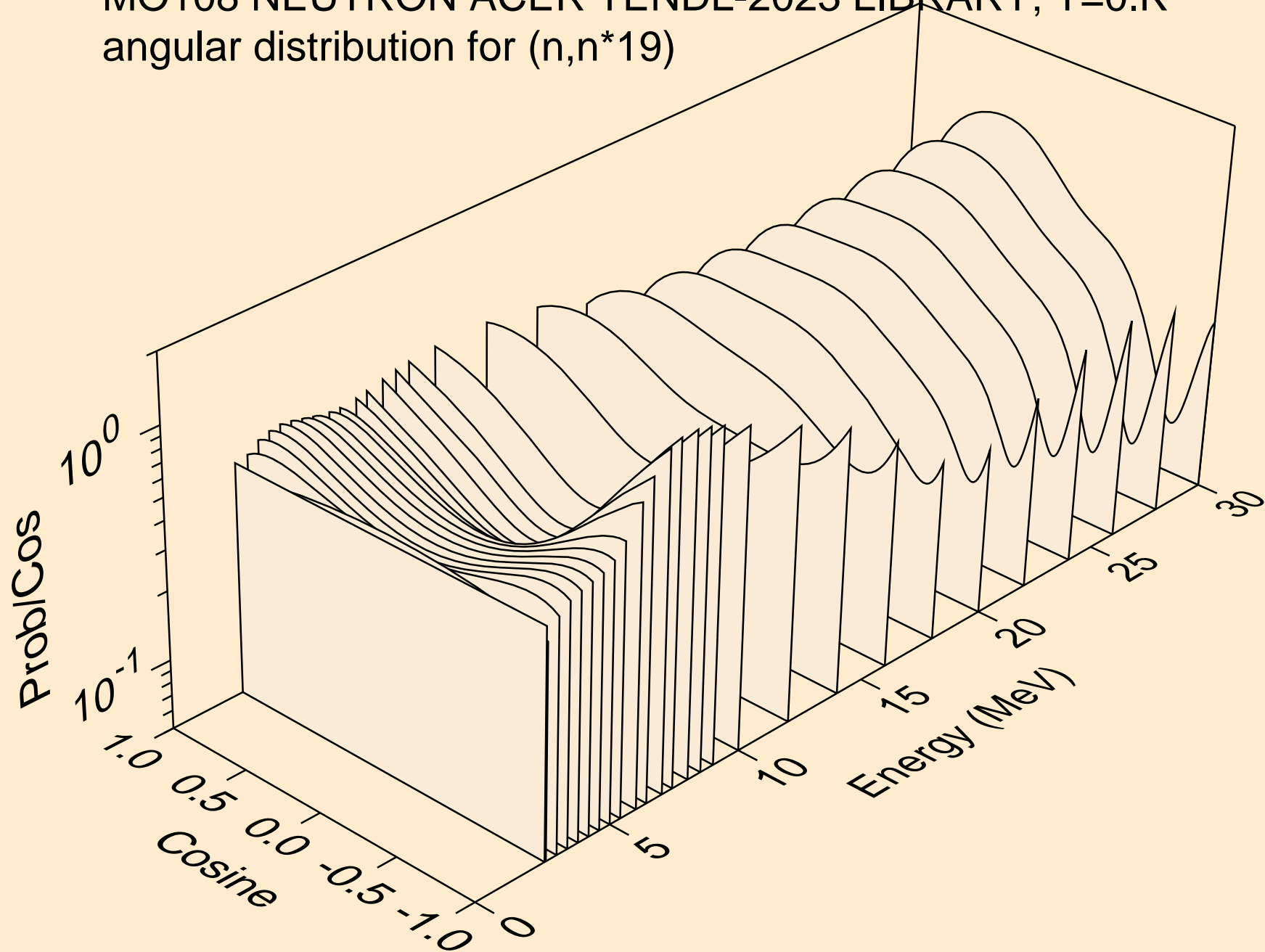

MO108 NEUTRON ACER TENDL-2023 LIBRARY; T=0.K
angular distribution for (n,n*20)

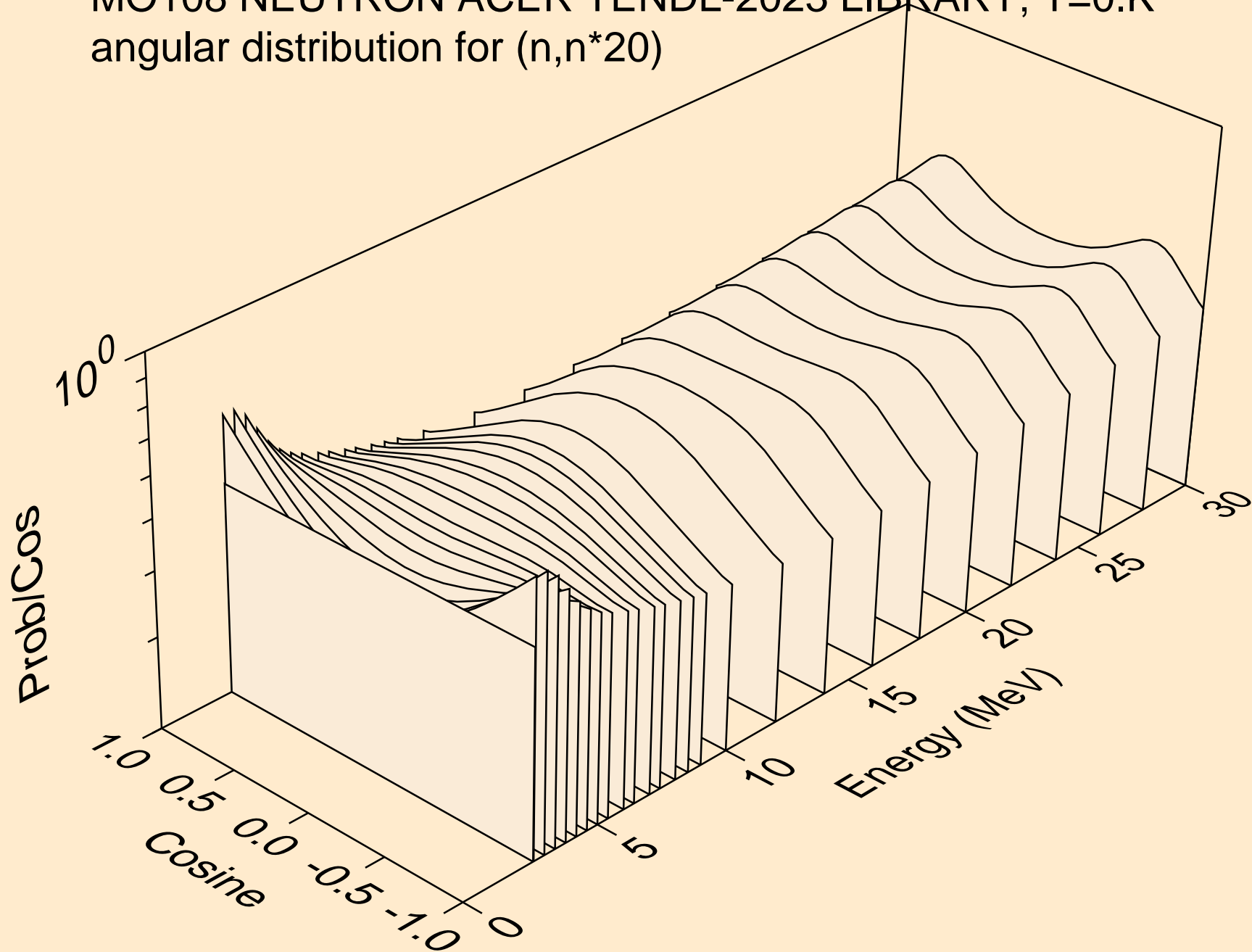

MO108 NEUTRON ACER TENDL-2023 LIBRARY; T=0.K
angular distribution for (n,n*21)

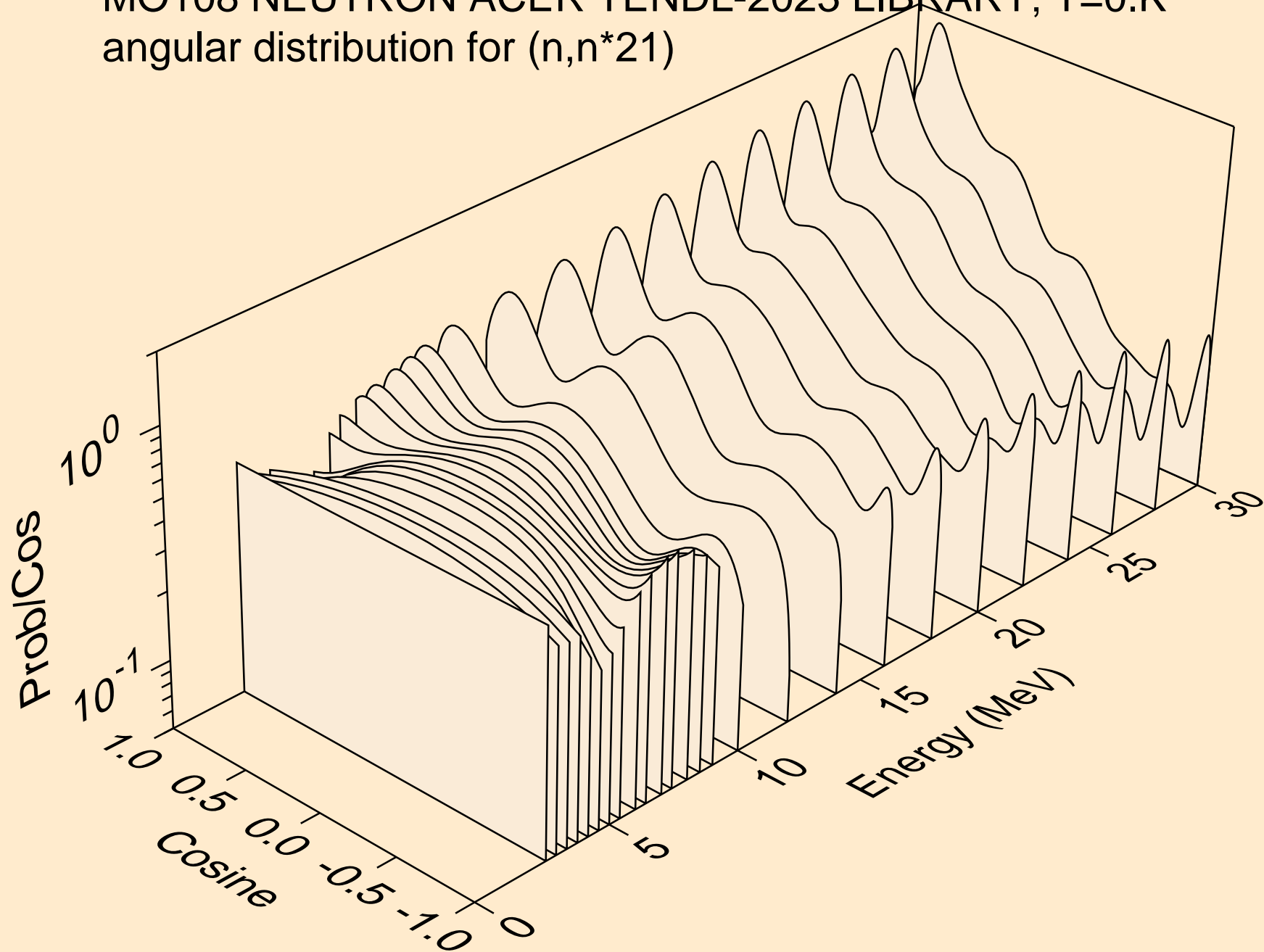

MO108 NEUTRON ACER TENDL-2023 LIBRARY; T=0.K
angular distribution for (n,n*22)

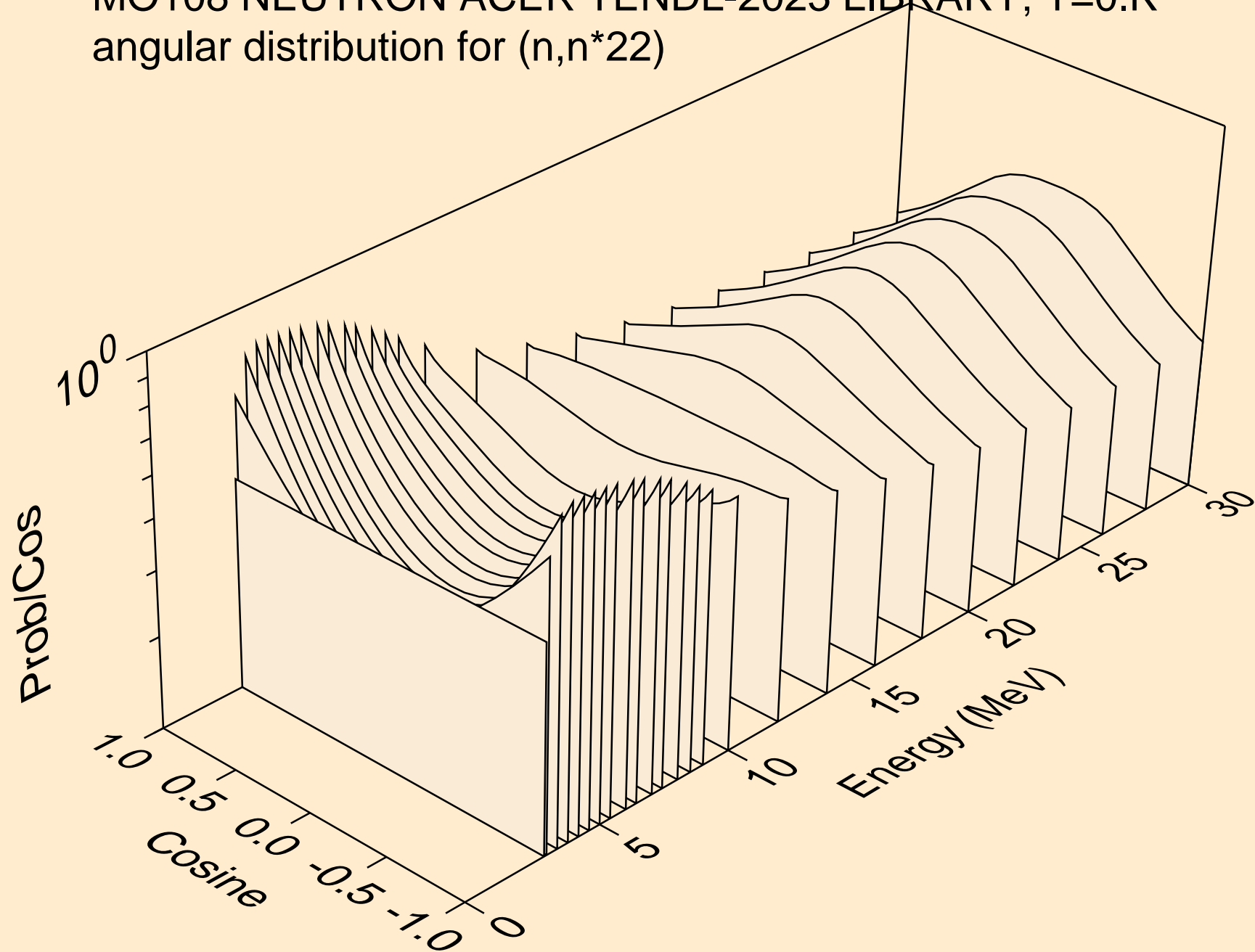

MO108 NEUTRON ACER TENDL-2023 LIBRARY; T=0.K
angular distribution for (n,n*23)

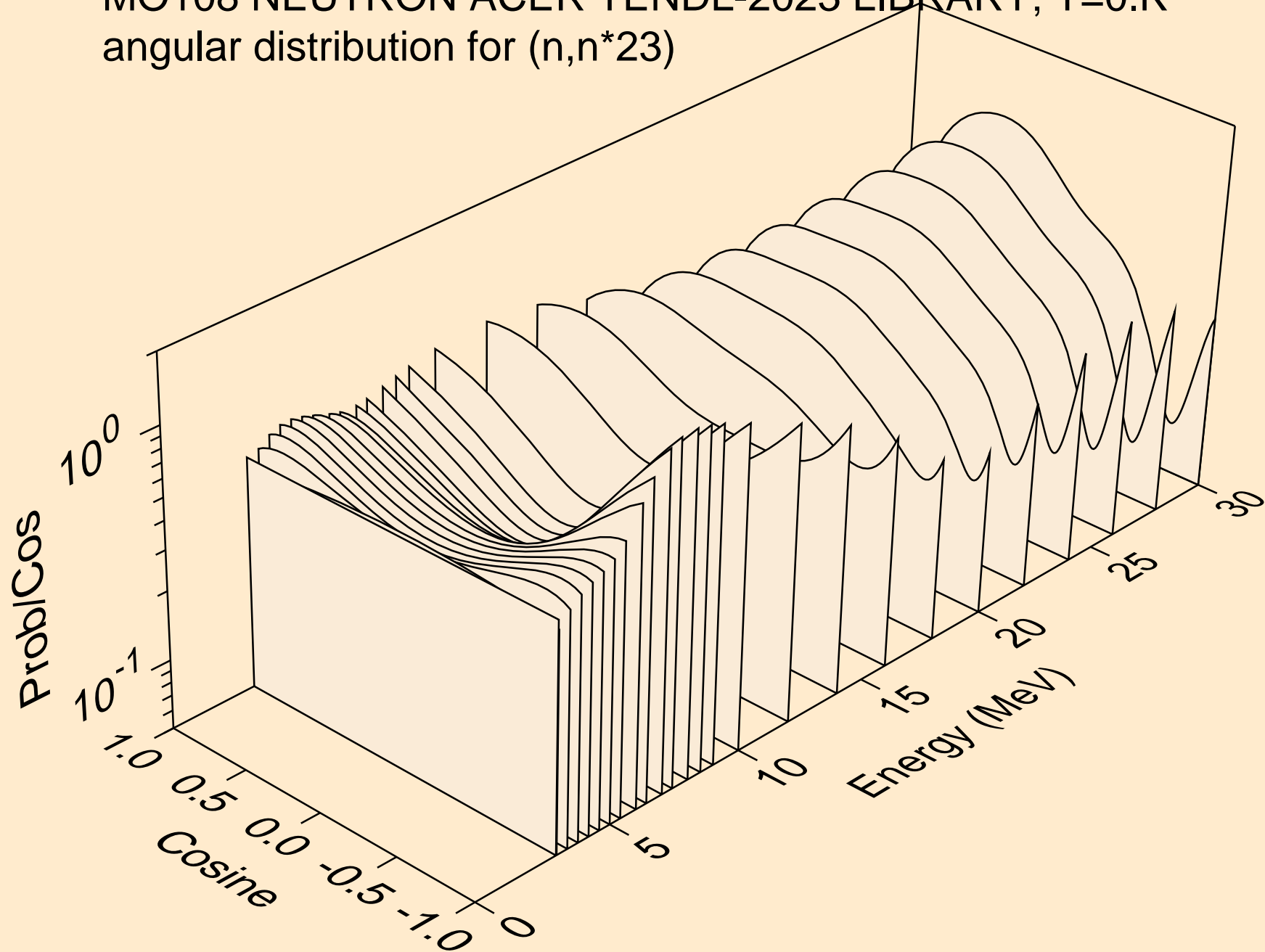

MO108 NEUTRON ACER TENDL-2023 LIBRARY; T=0.K
angular distribution for (n,n*24)

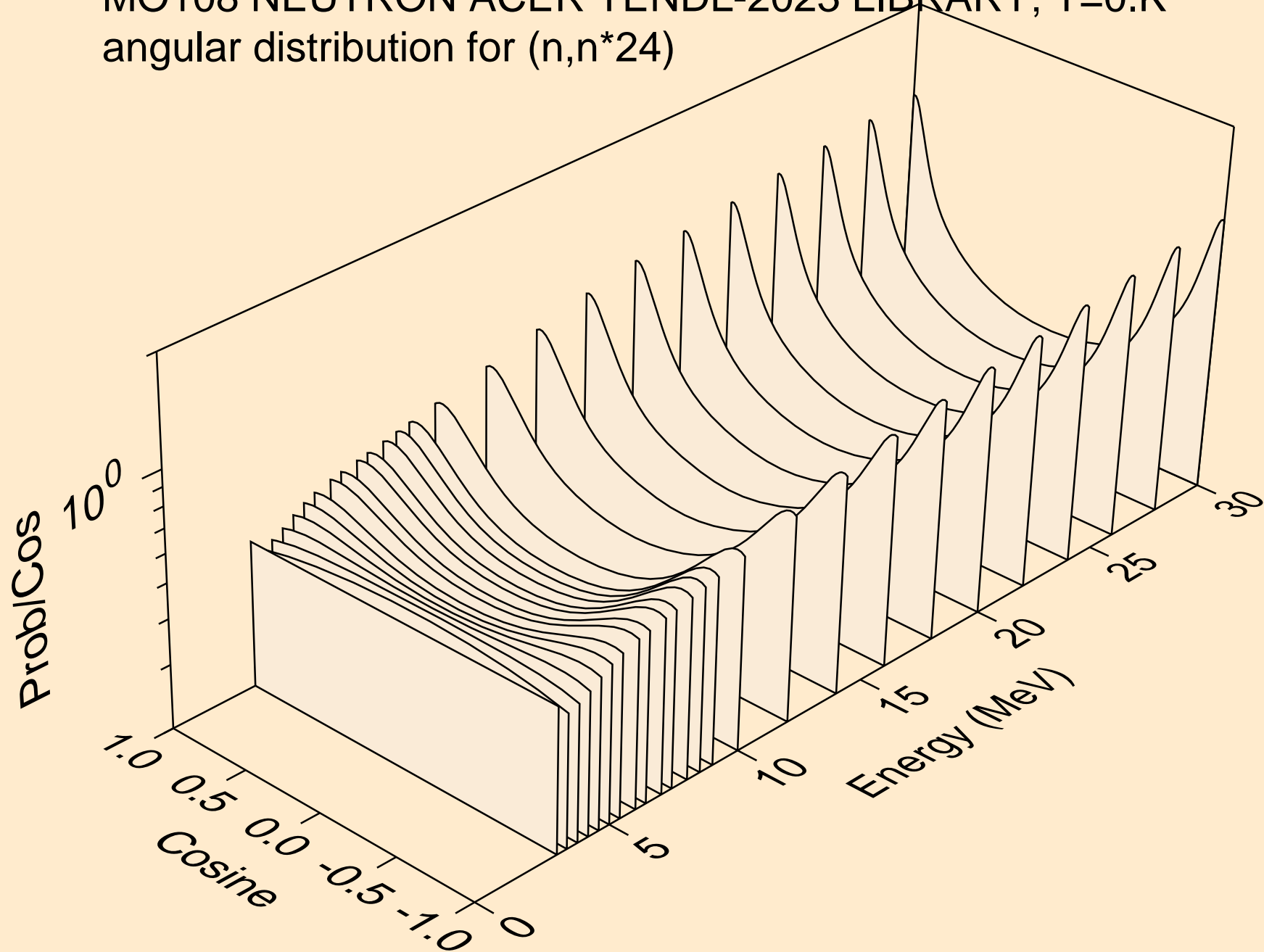

MO108 NEUTRON ACER TENDL-2023 LIBRARY; T=0.K
angular distribution for (n,n*25)

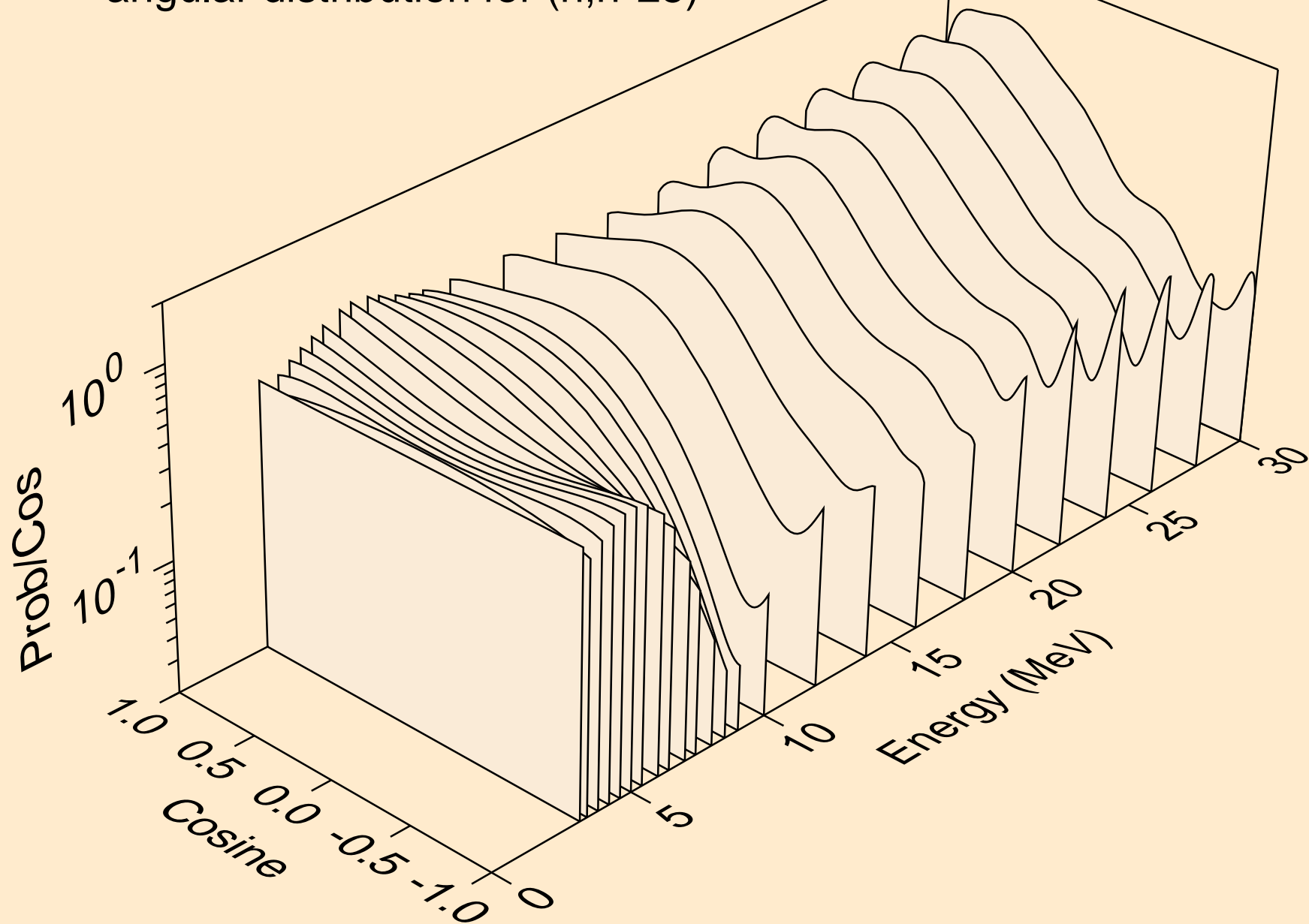

MO108 NEUTRON ACER TENDL-2023 LIBRARY; T=0.K
angular distribution for (n,n*26)

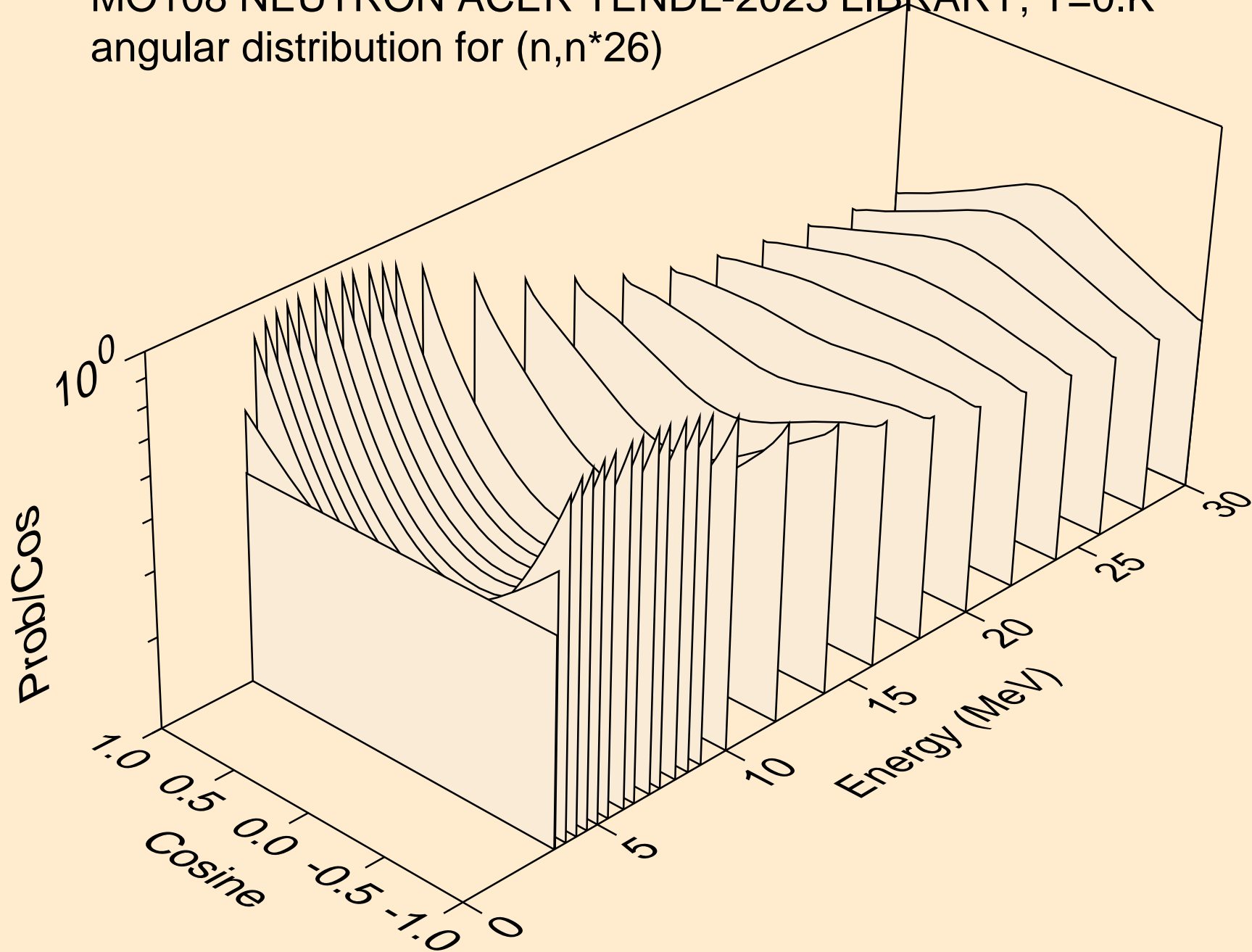

MO108 NEUTRON ACER TENDL-2023 LIBRARY; T=0.K
angular distribution for (n,n*27)

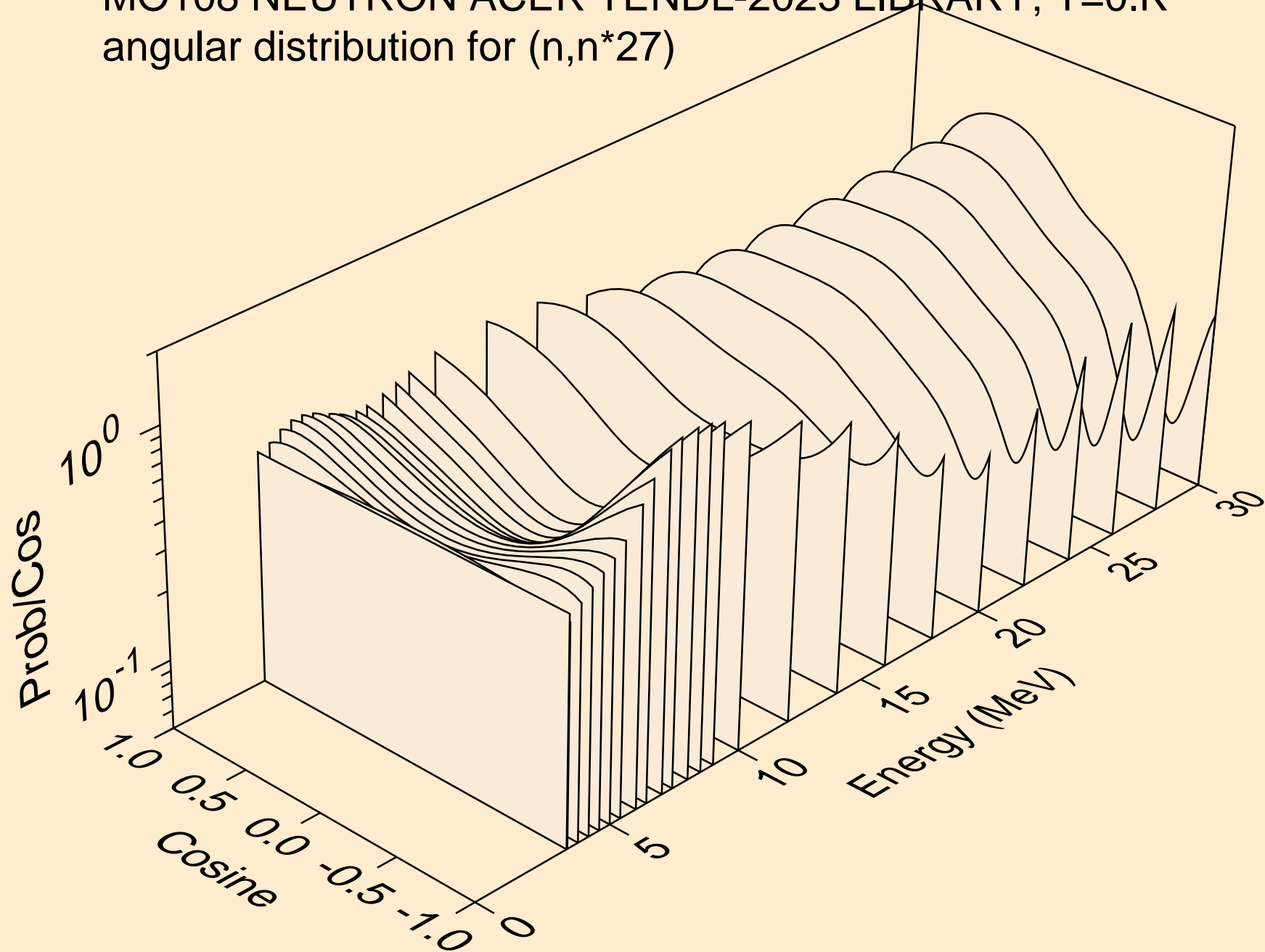

MO108 NEUTRON ACER TENDL-2023 LIBRARY; T=0.K
angular distribution for (n,n*28)

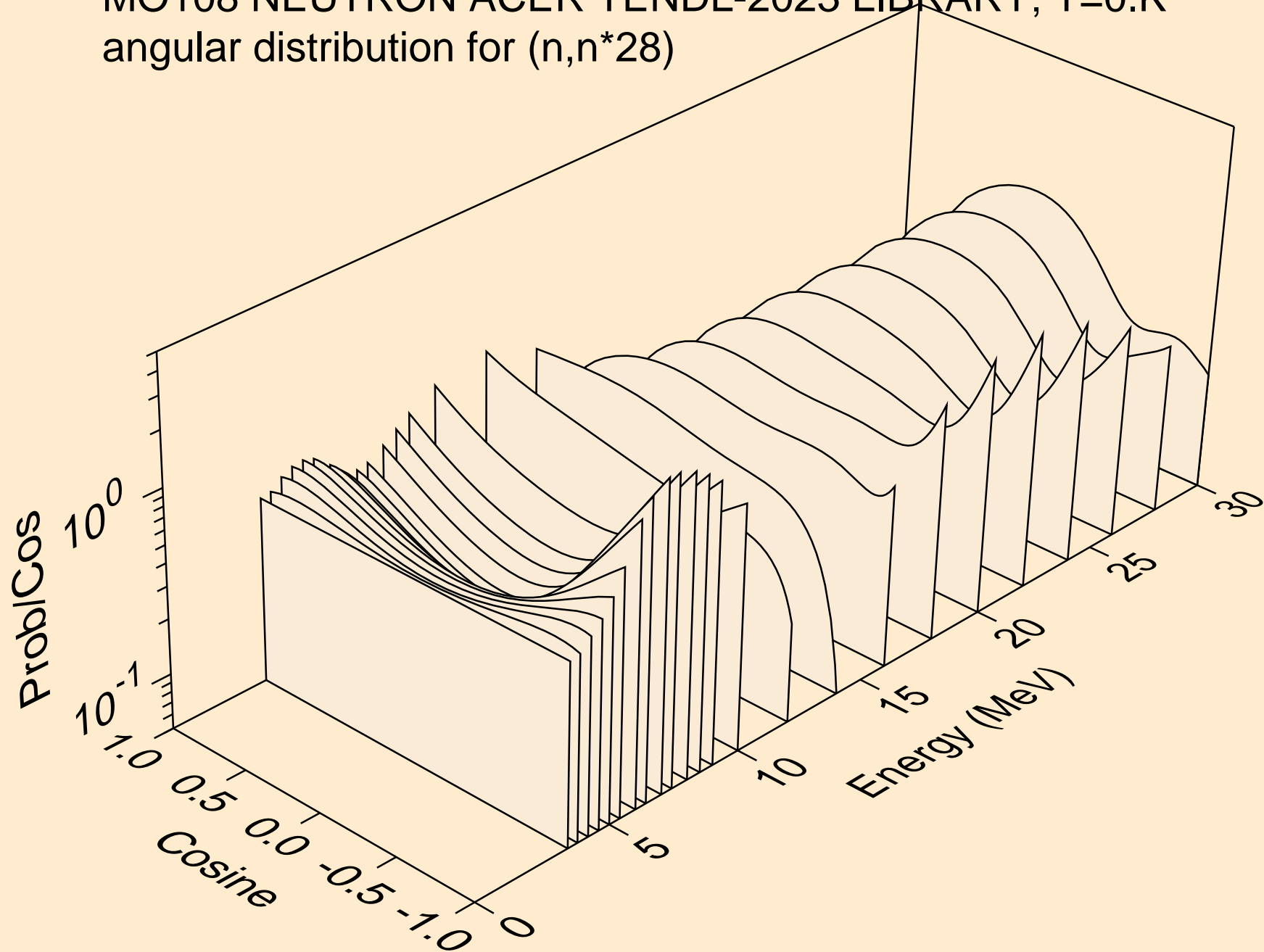

MO108 NEUTRON ACER TENDL-2023 LIBRARY; T=0.K
angular distribution for (n,n*29)

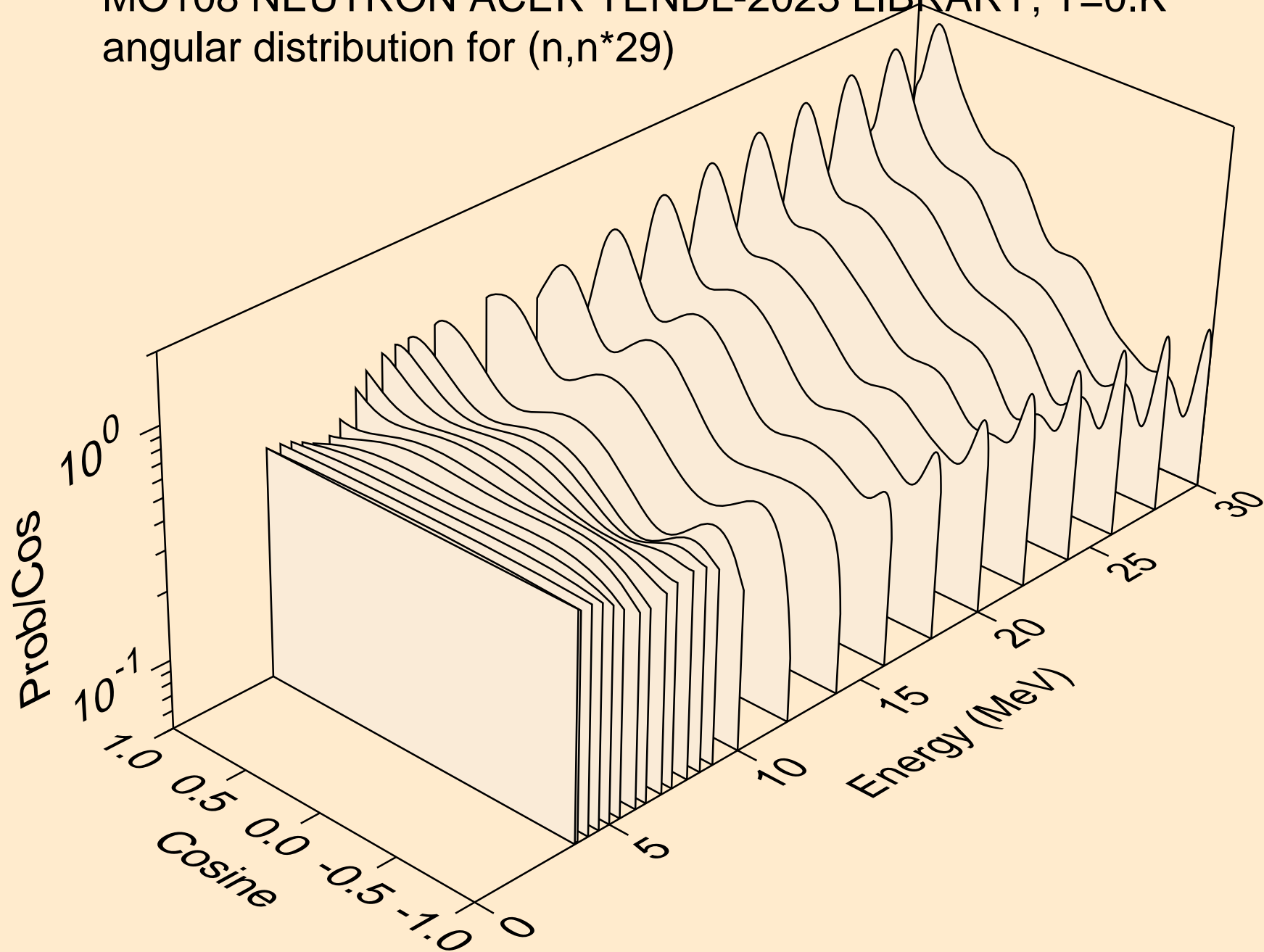

MO108 NEUTRON ACER TENDL-2023 LIBRARY; T=0.K
Neutron emission for (n,x)

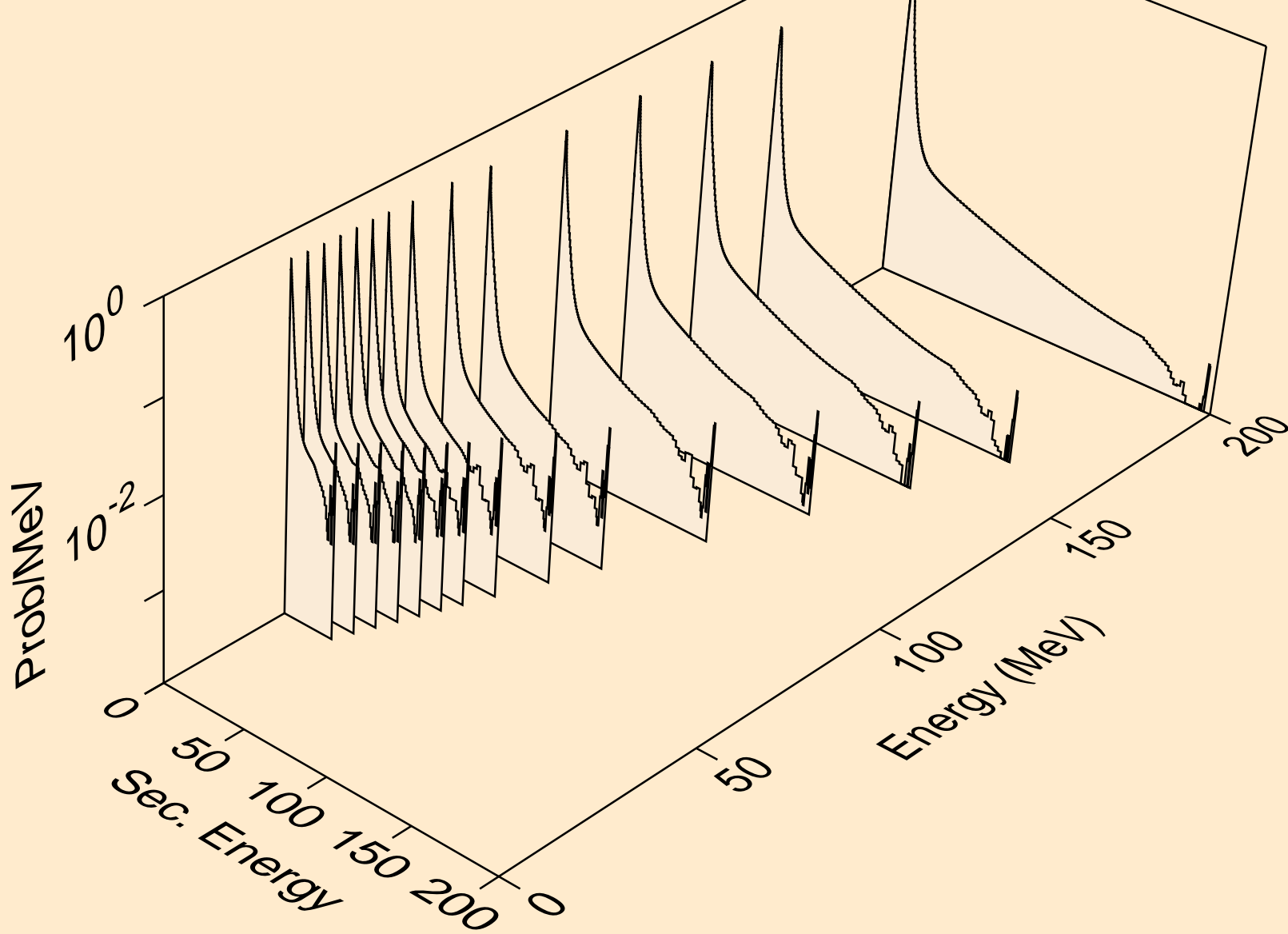

MO108 NEUTRON ACER TENDL-2023 LIBRARY; T=0.K
Neutron emission for (n,2nd)

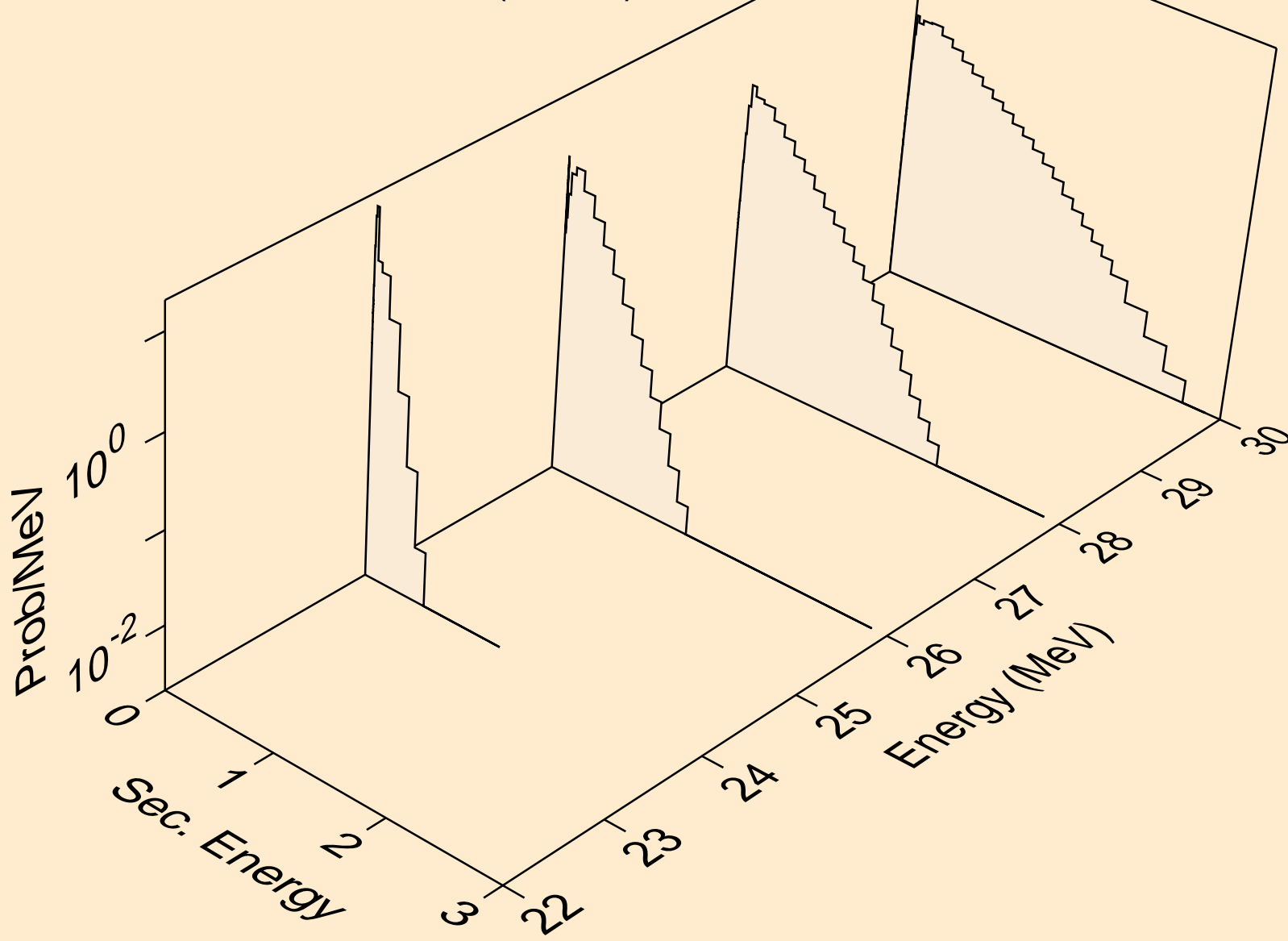

MO108 NEUTRON ACER TENDL-2023 LIBRARY; T=0.K
Neutron emission for (n,2n)

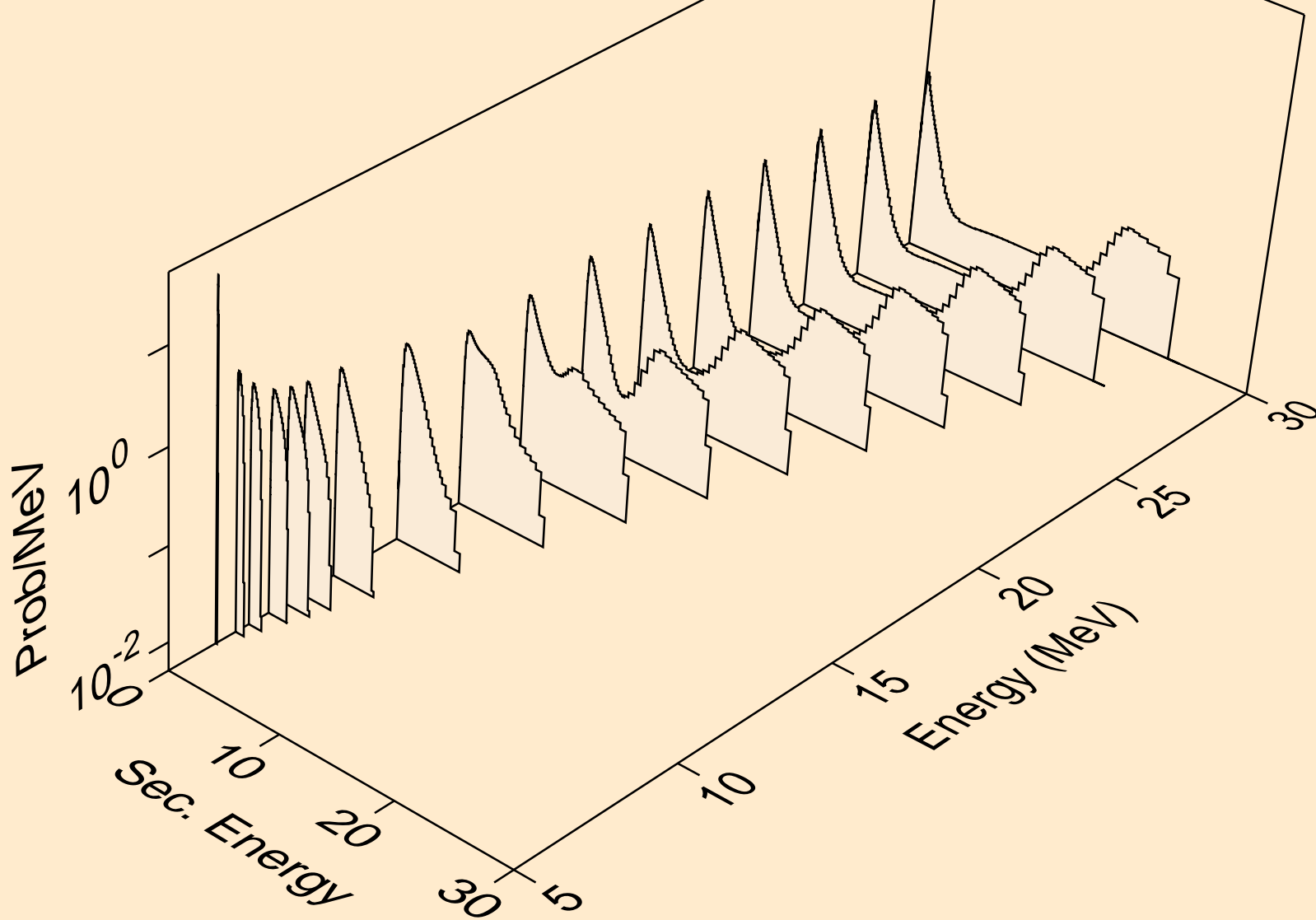

MO108 NEUTRON ACER TENDL-2023 LIBRARY; T=0.K
Neutron emission for (n,3n)

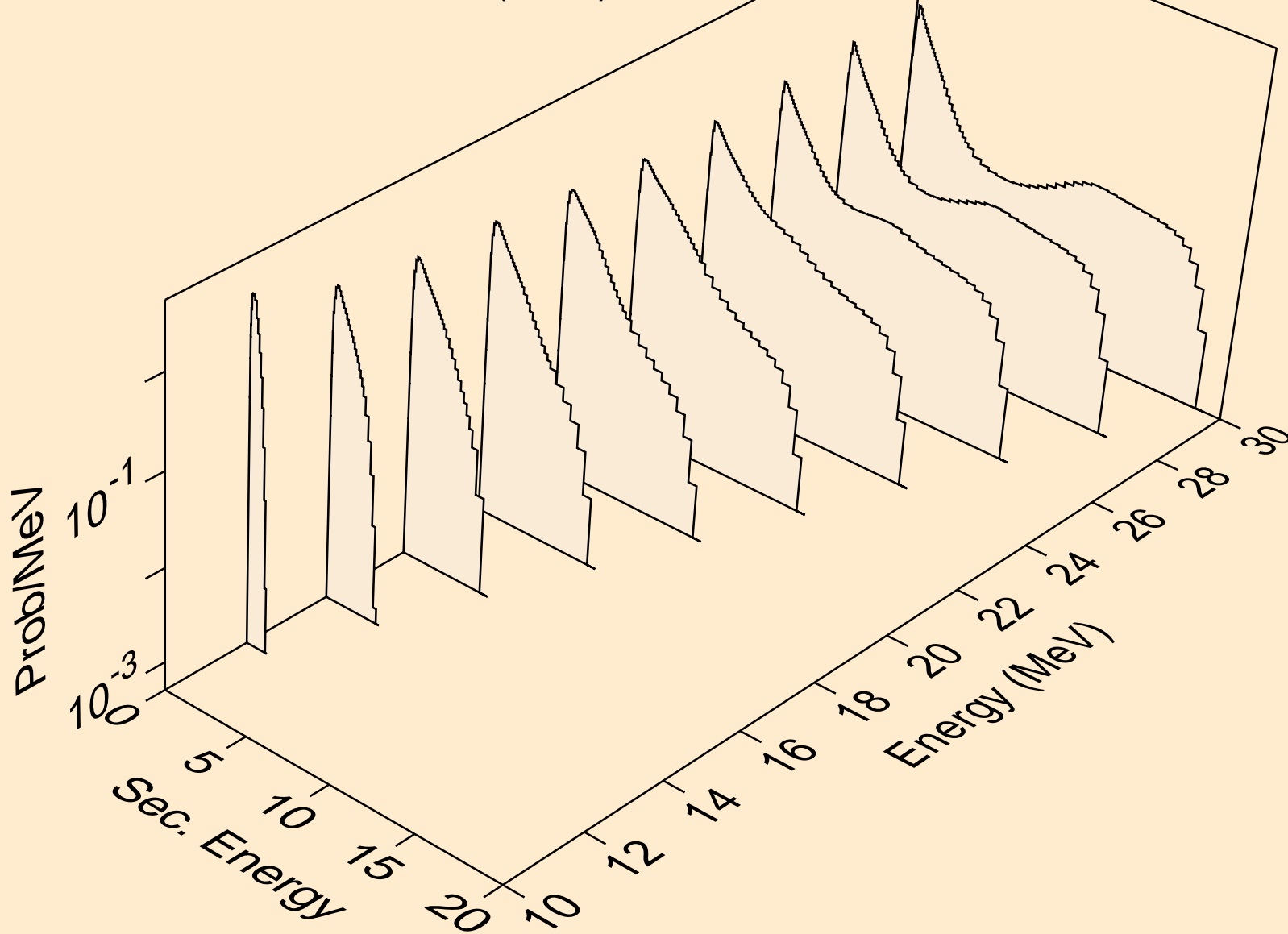

MO108 NEUTRON ACER TENDL-2023 LIBRARY; T=0.K
Neutron emission for (n,n*)a

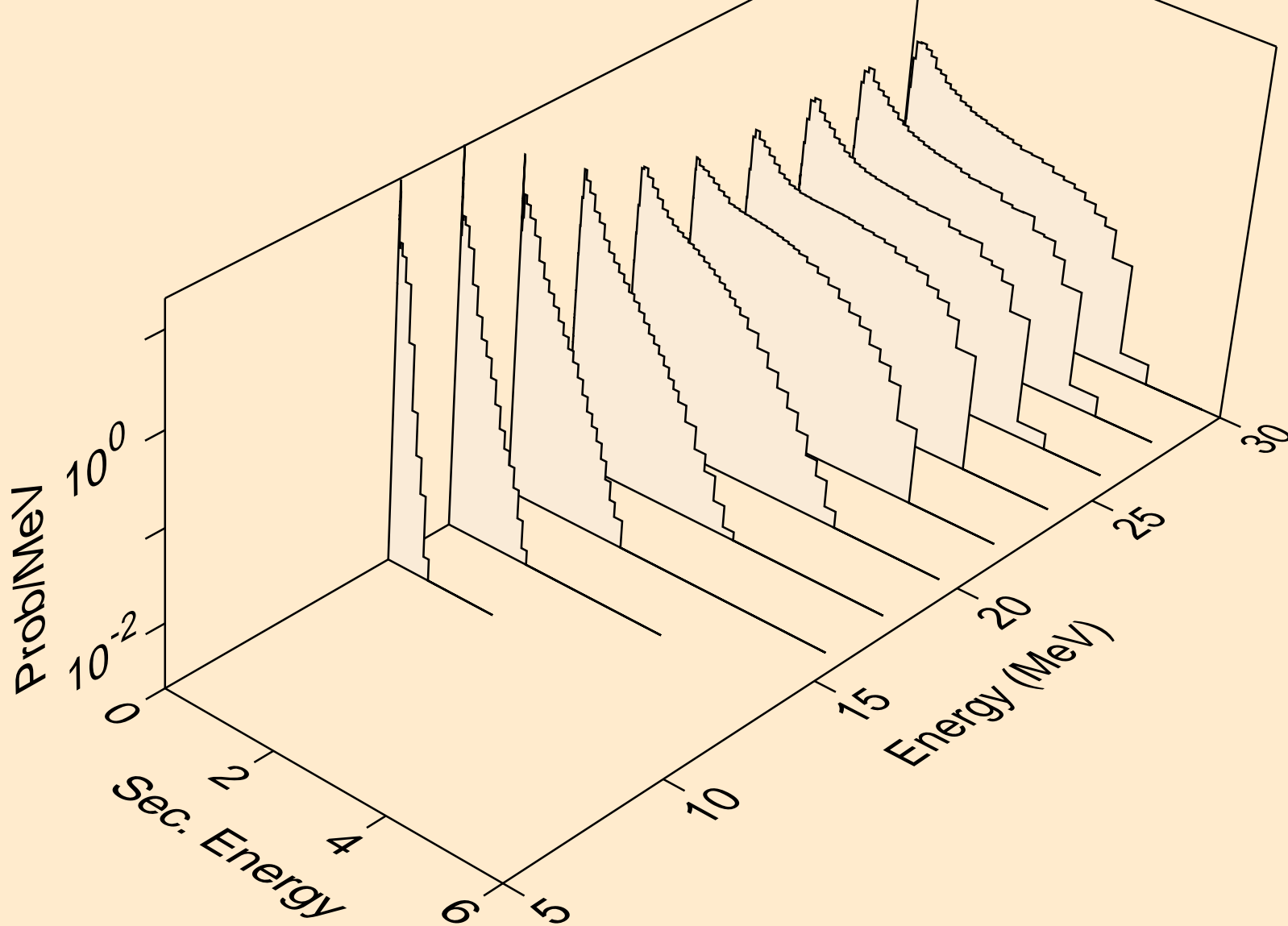

MO108 NEUTRON ACER TENDL-2023 LIBRARY; T=0.K
Neutron emission for (n,2n)a

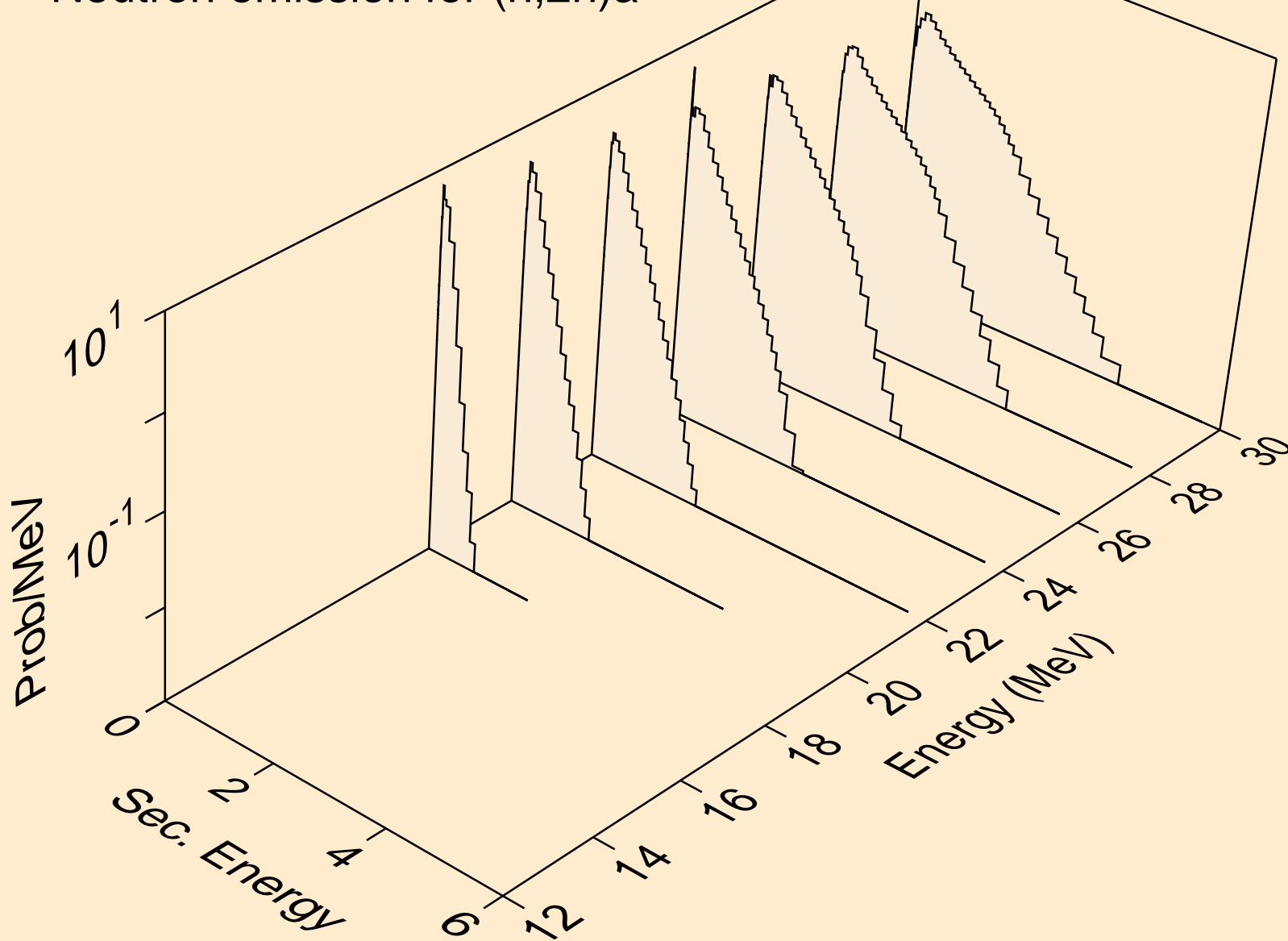

MO108 NEUTRON ACER TENDL-2023 LIBRARY; T=0.K
Neutron emission for (n,3n)a

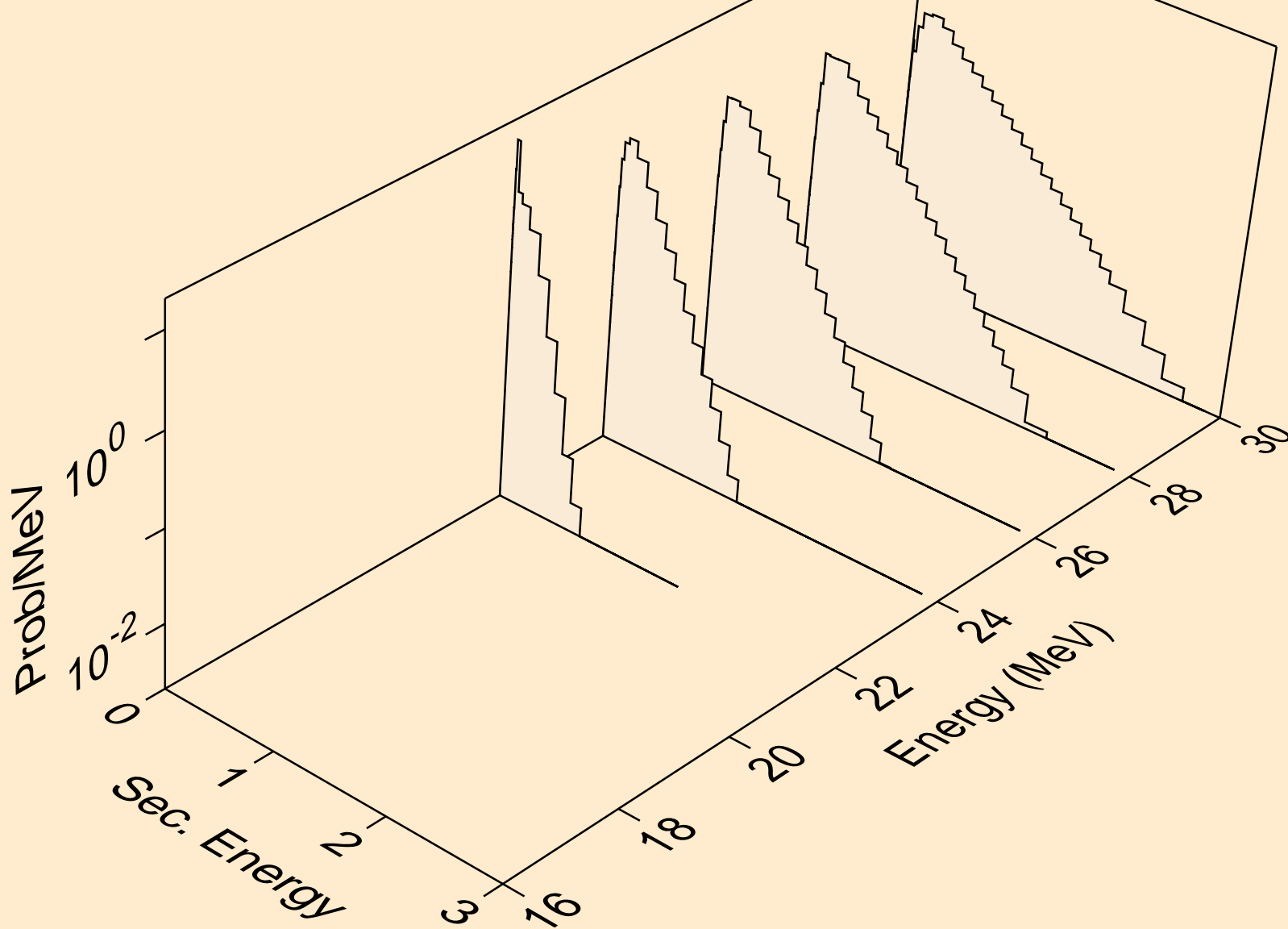

MO108 NEUTRON ACER TENDL-2023 LIBRARY; T=0.K
Neutron emission for (n,n*)p

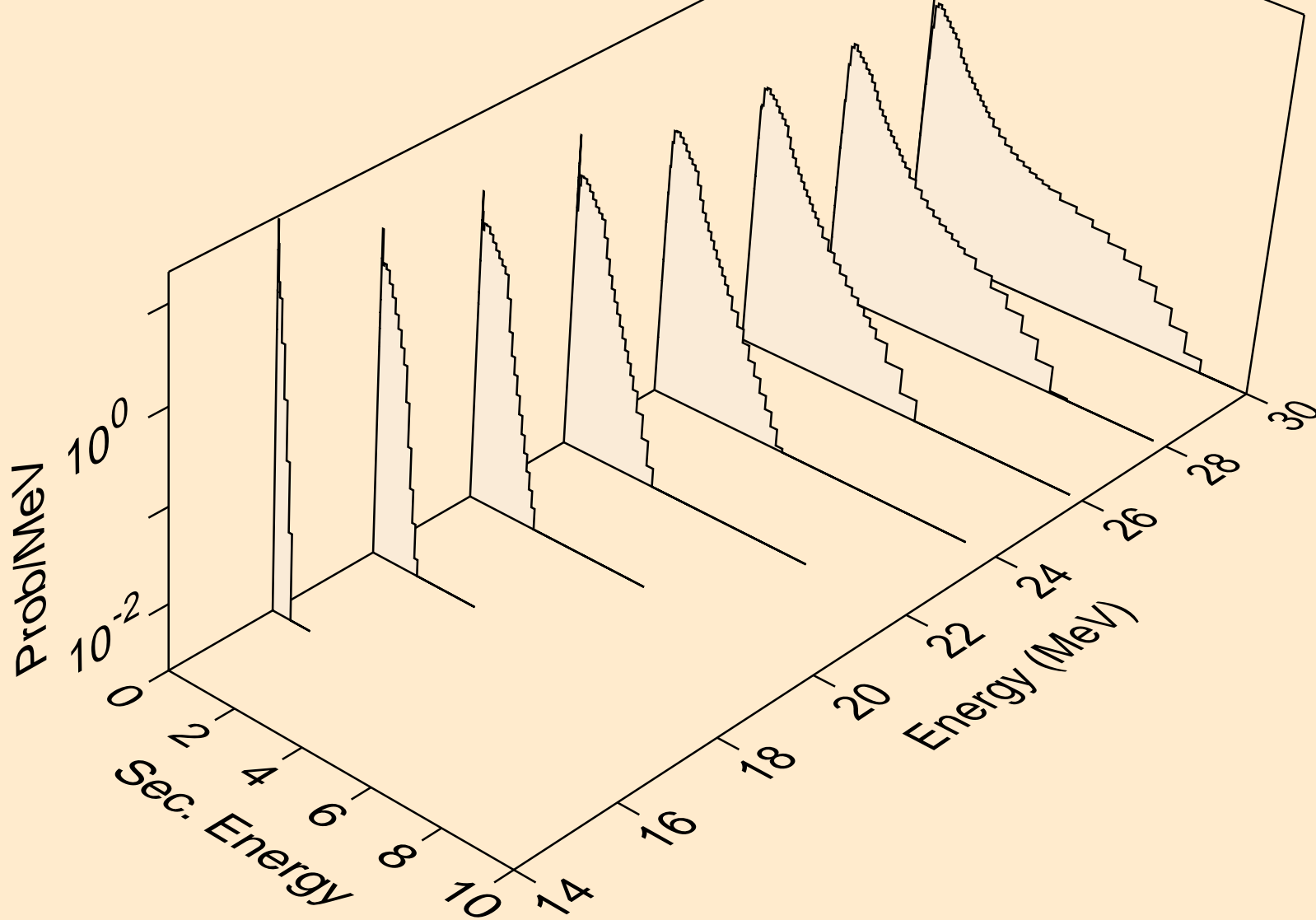

MO108 NEUTRON ACER TENDL-2023 LIBRARY; T=0.K
Neutron emission for (n,n*)d

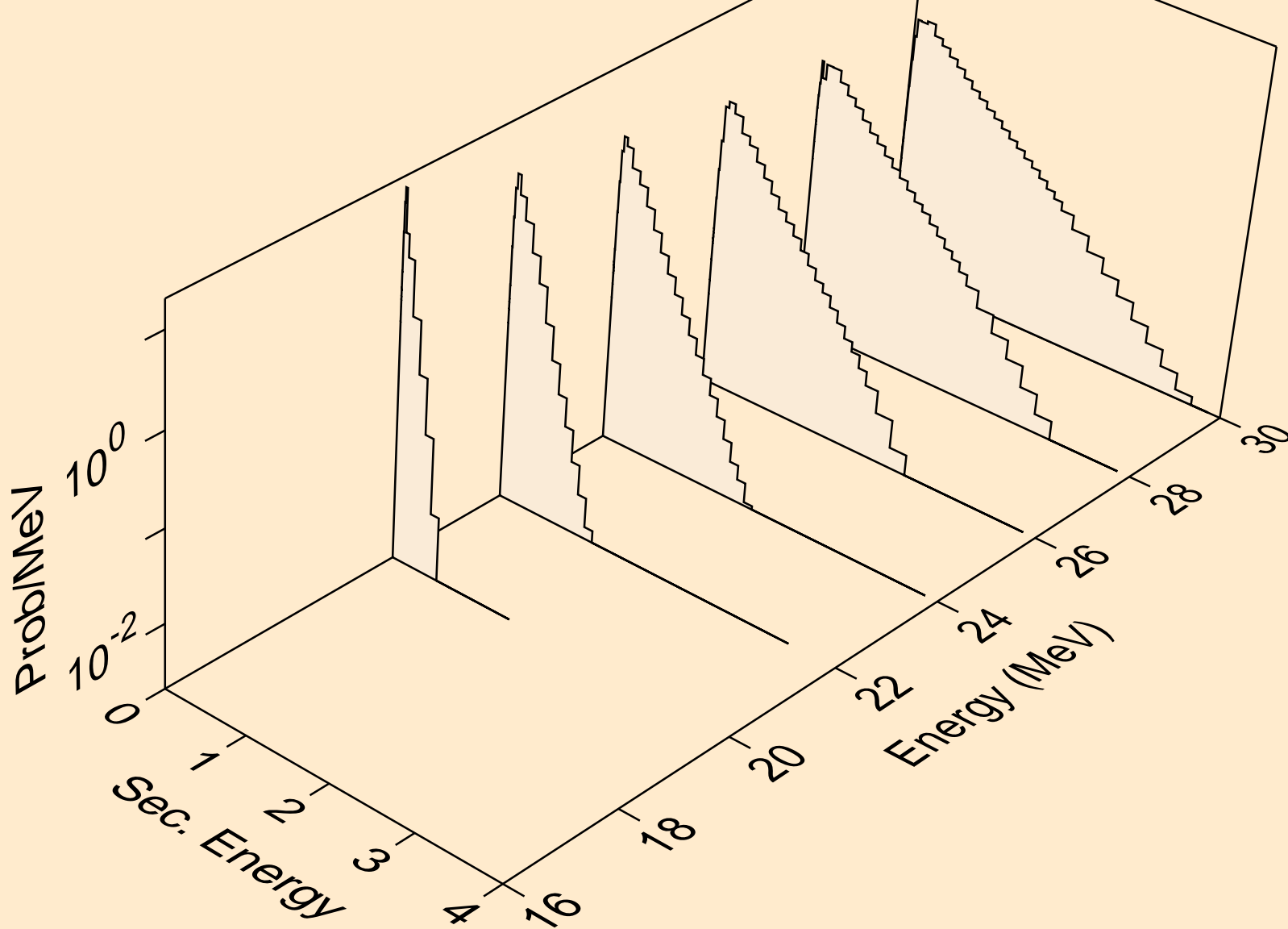

MO108 NEUTRON ACER TENDL-2023 LIBRARY; T=0.K
Neutron emission for (n,n*)t

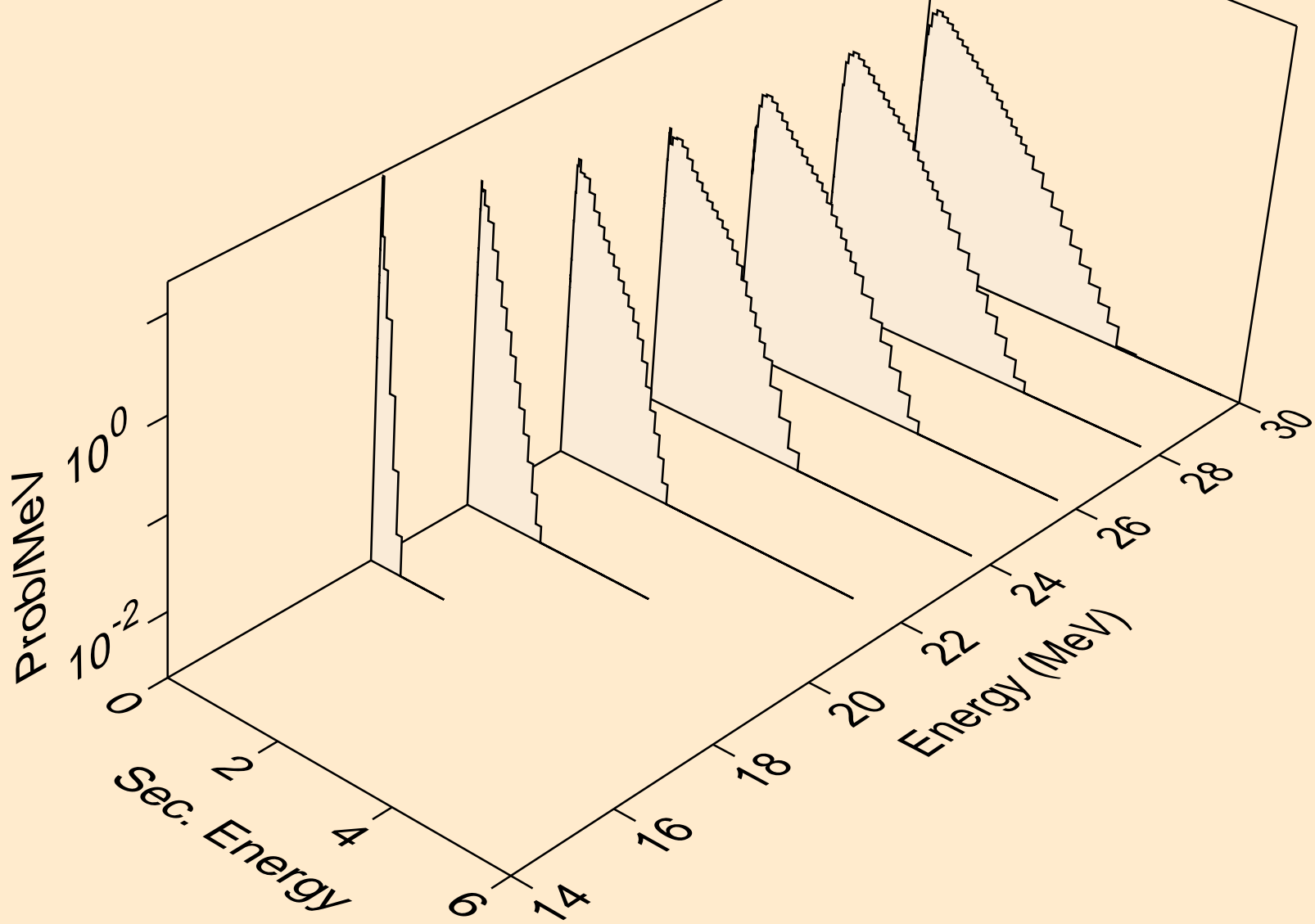

MO108 NEUTRON ACER TENDL-2023 LIBRARY; T=0.K
Neutron emission for (n,4n)

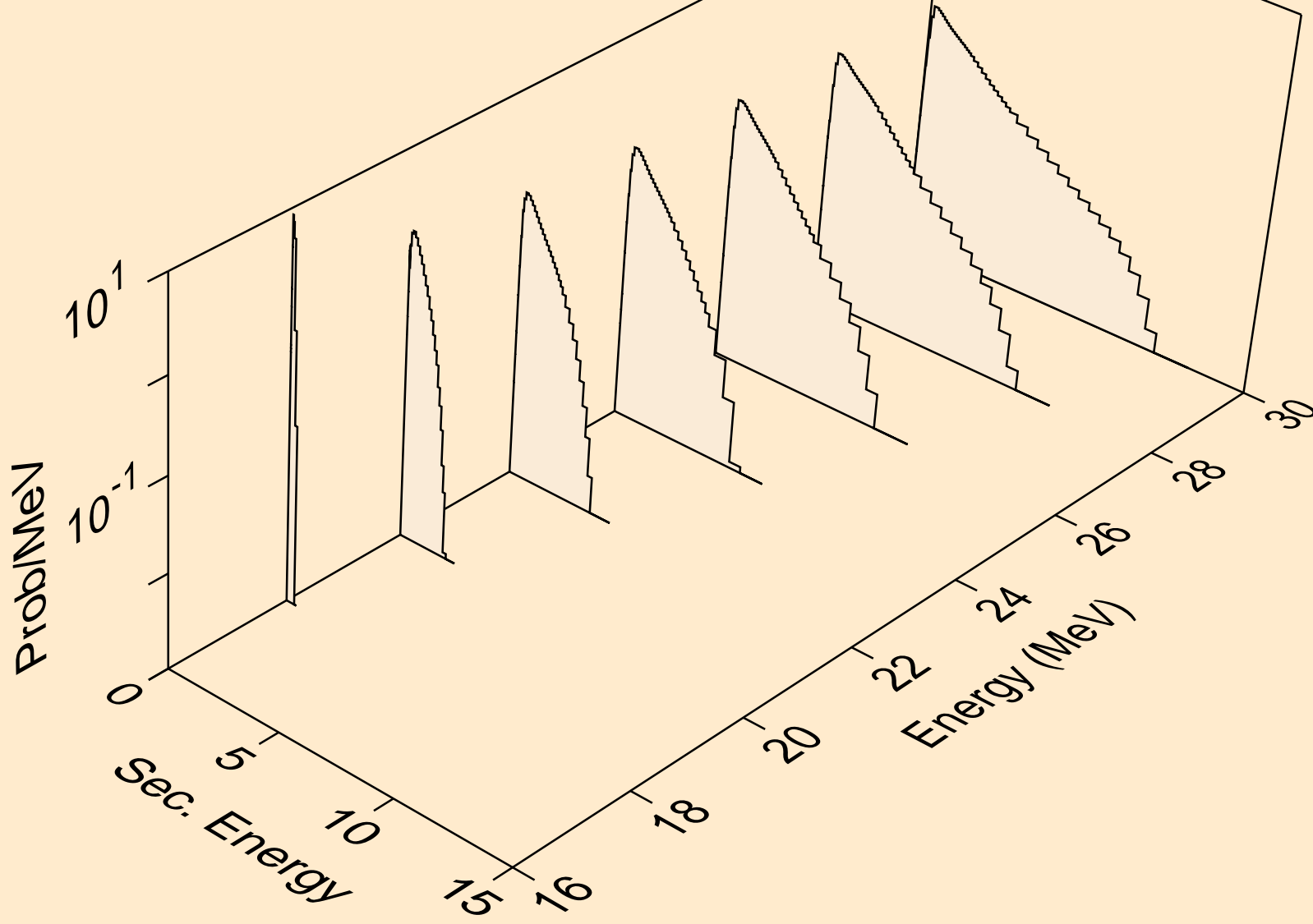

MO108 NEUTRON ACER TENDL-2023 LIBRARY; T=0.K
Neutron emission for (n,2np)

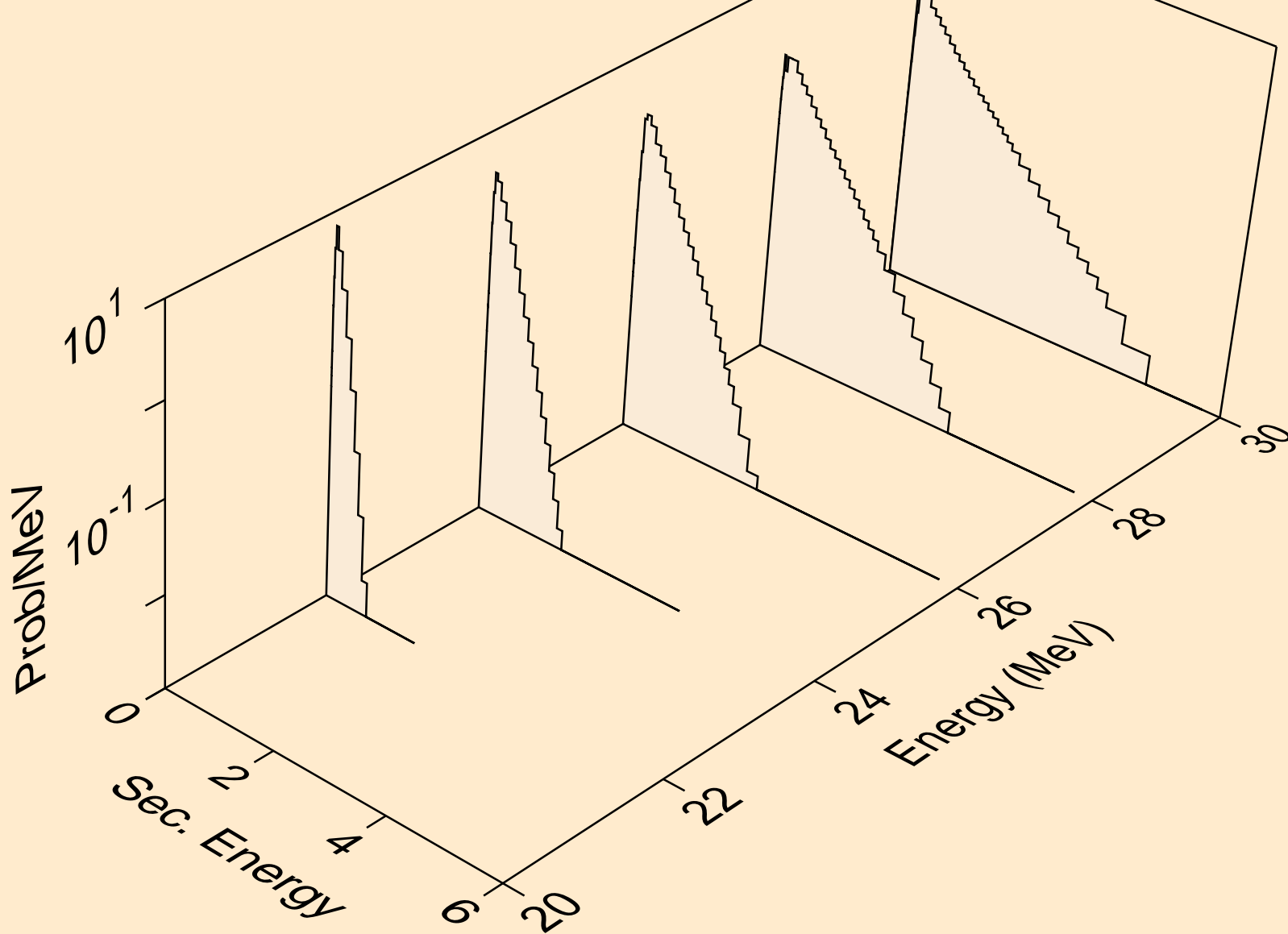

MO108 NEUTRON ACER TENDL-2023 LIBRARY; T=0.K
Neutron emission for (n,3np)

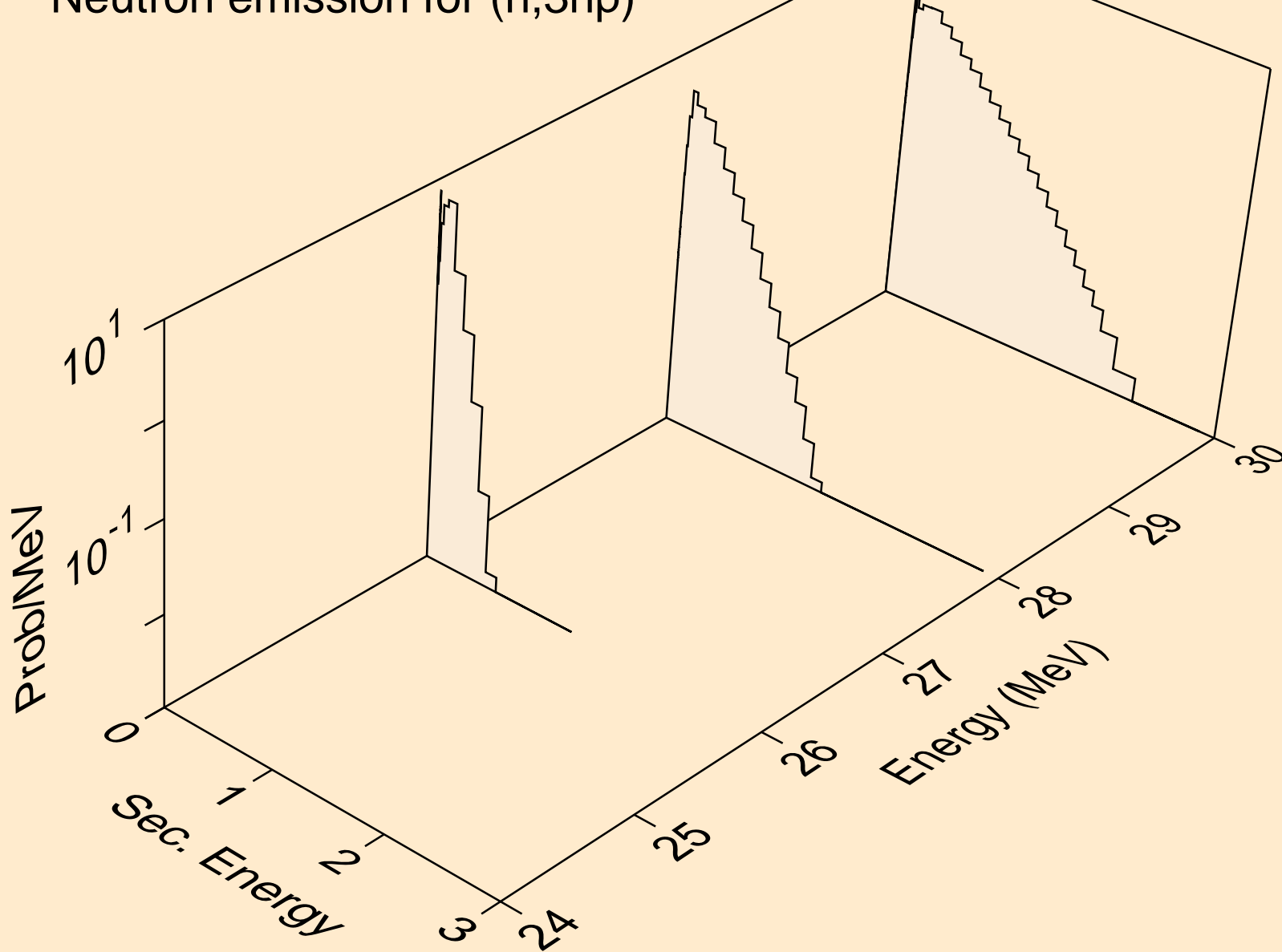

MO108 NEUTRON ACER TENDL-2023 LIBRARY; T=0.K
Neutron emission for (n,n*c)

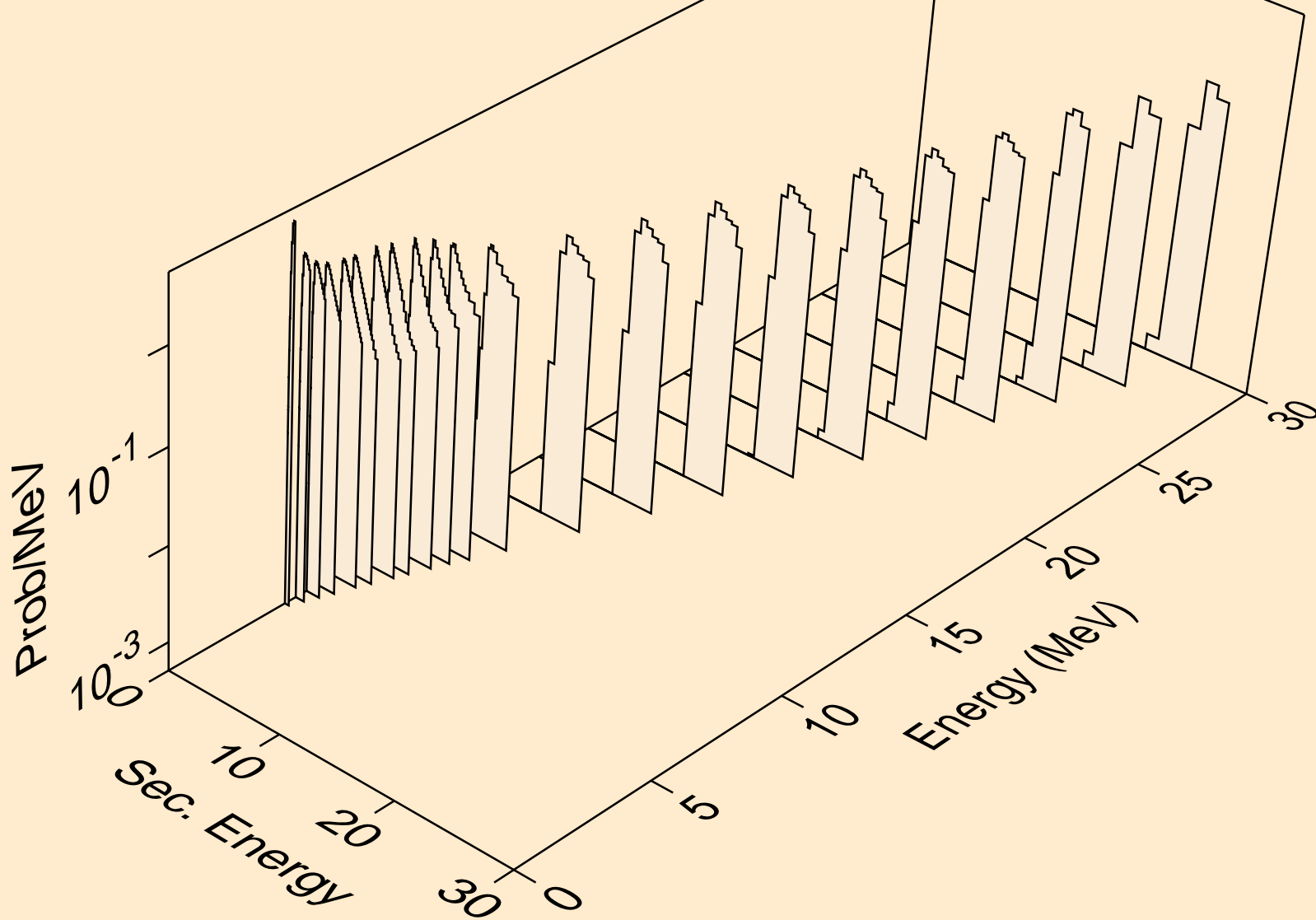

MO108 NEUTRON ACER TENDL-2023 LIBRARY; T=0.K
Photon emission for (n,x)

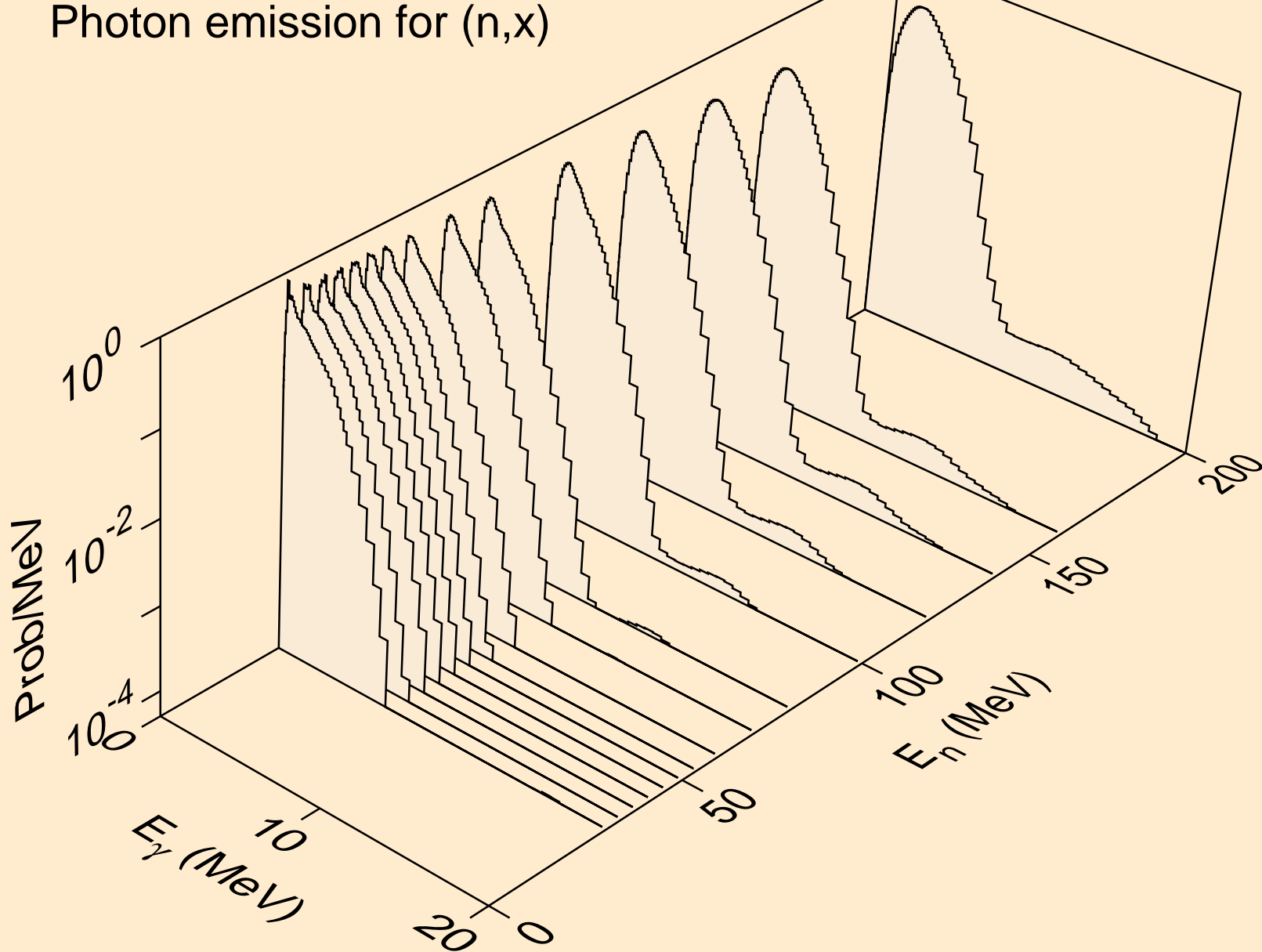

MO108 NEUTRON ACER TENDL-2023 LIBRARY; T=0.K
Photon emission for (n,2nd)

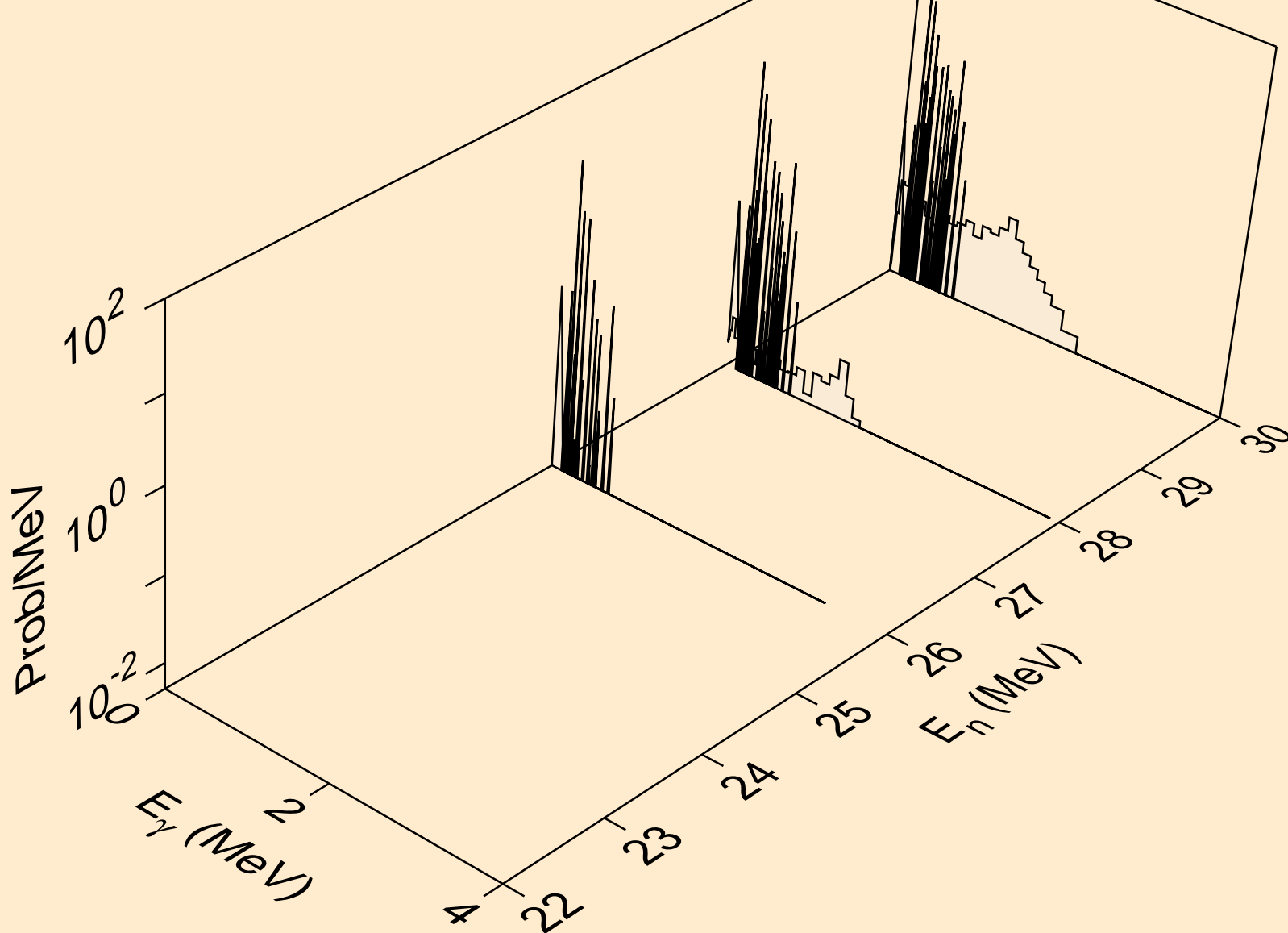

MO108 NEUTRON ACER TENDL-2023 LIBRARY; T=0.K
Photon emission for (n,2n)

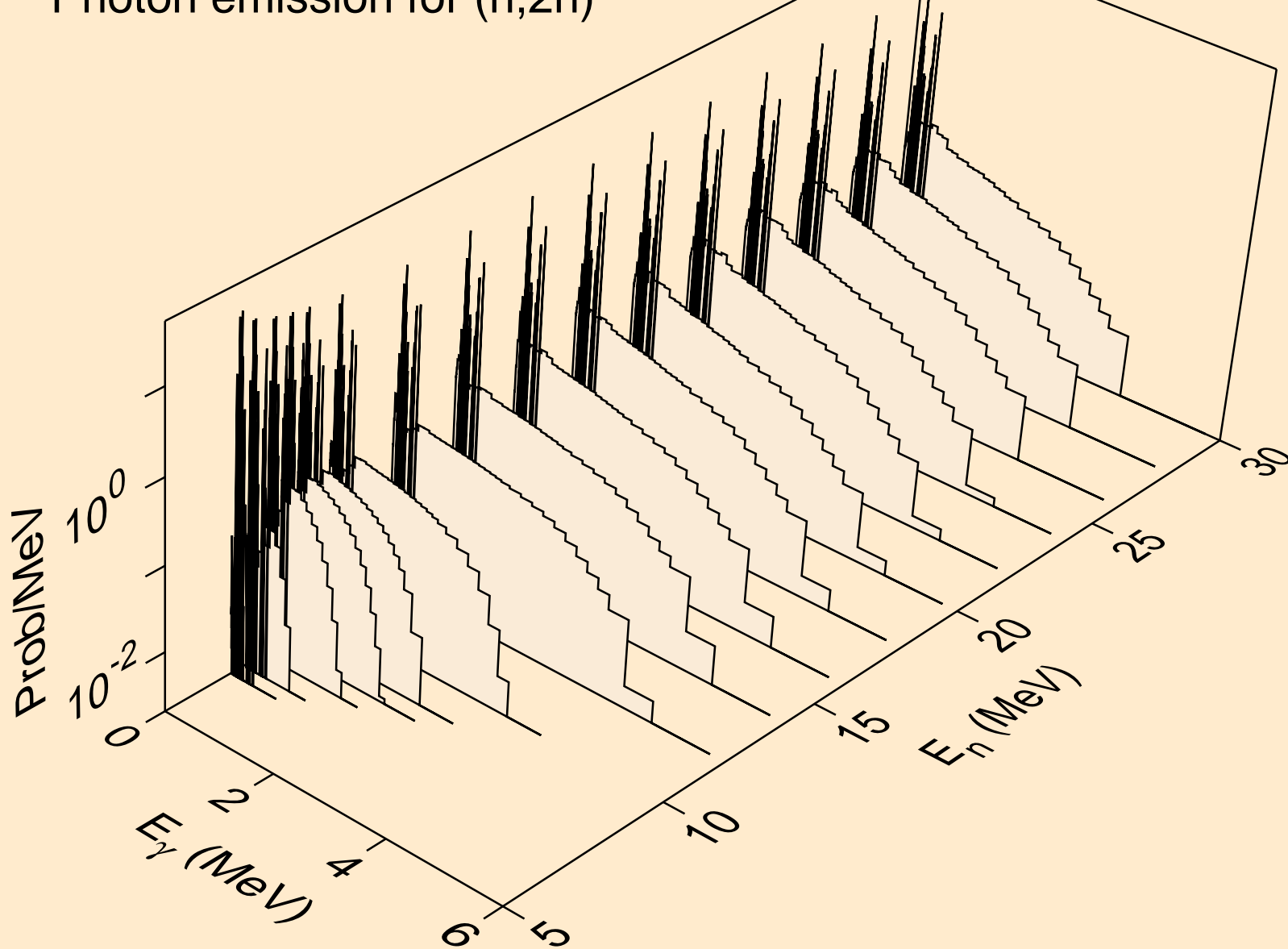

MO108 NEUTRON ACER TENDL-2023 LIBRARY; T=0.K
Photon emission for (n,3n)

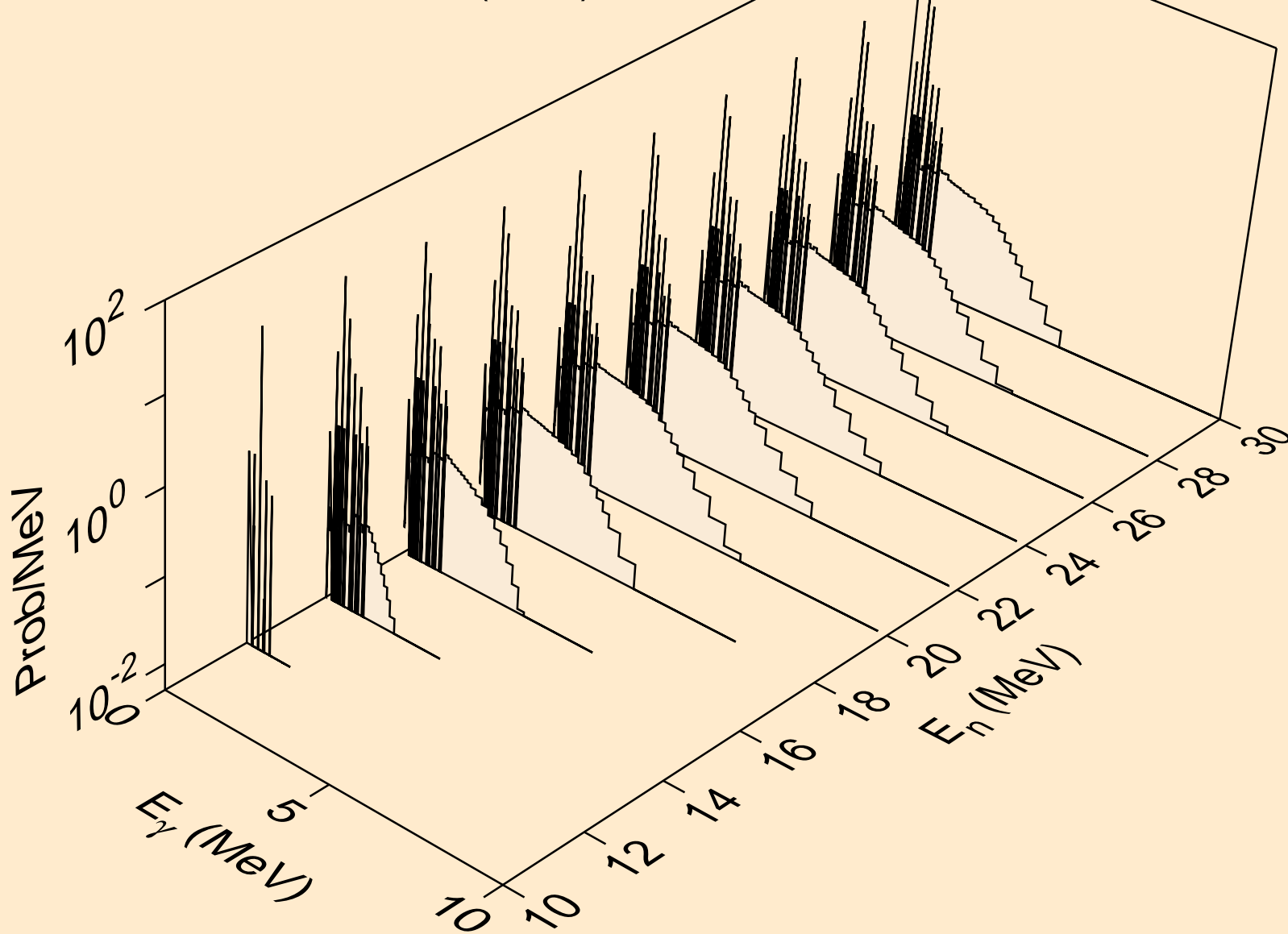

MO108 NEUTRON ACER TENDL-2023 LIBRARY; T=0.K
Photon emission for (n,n*)a

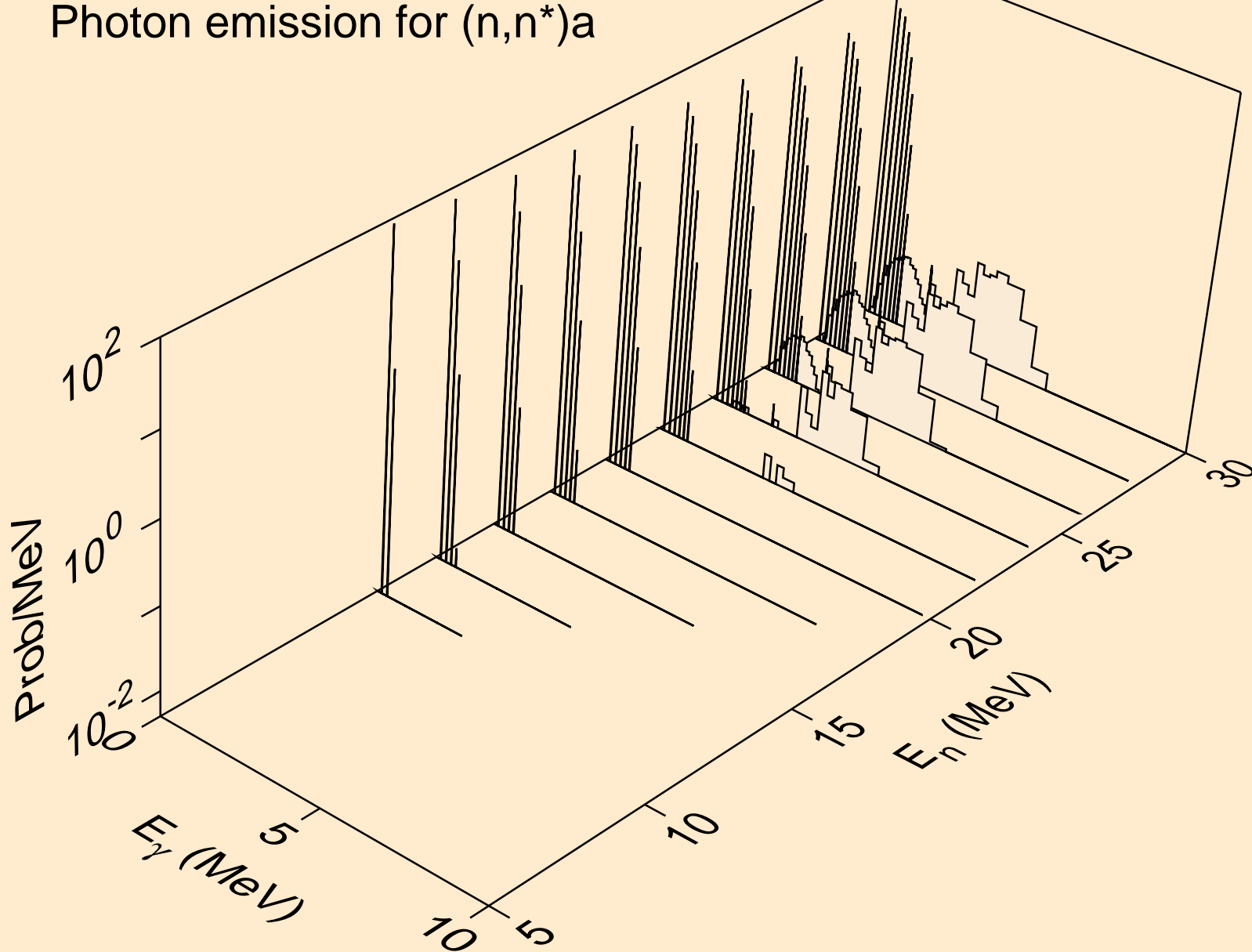

MO108 NEUTRON ACER TENDL-2023 LIBRARY; T=0.K
Photon emission for (n,2n)a

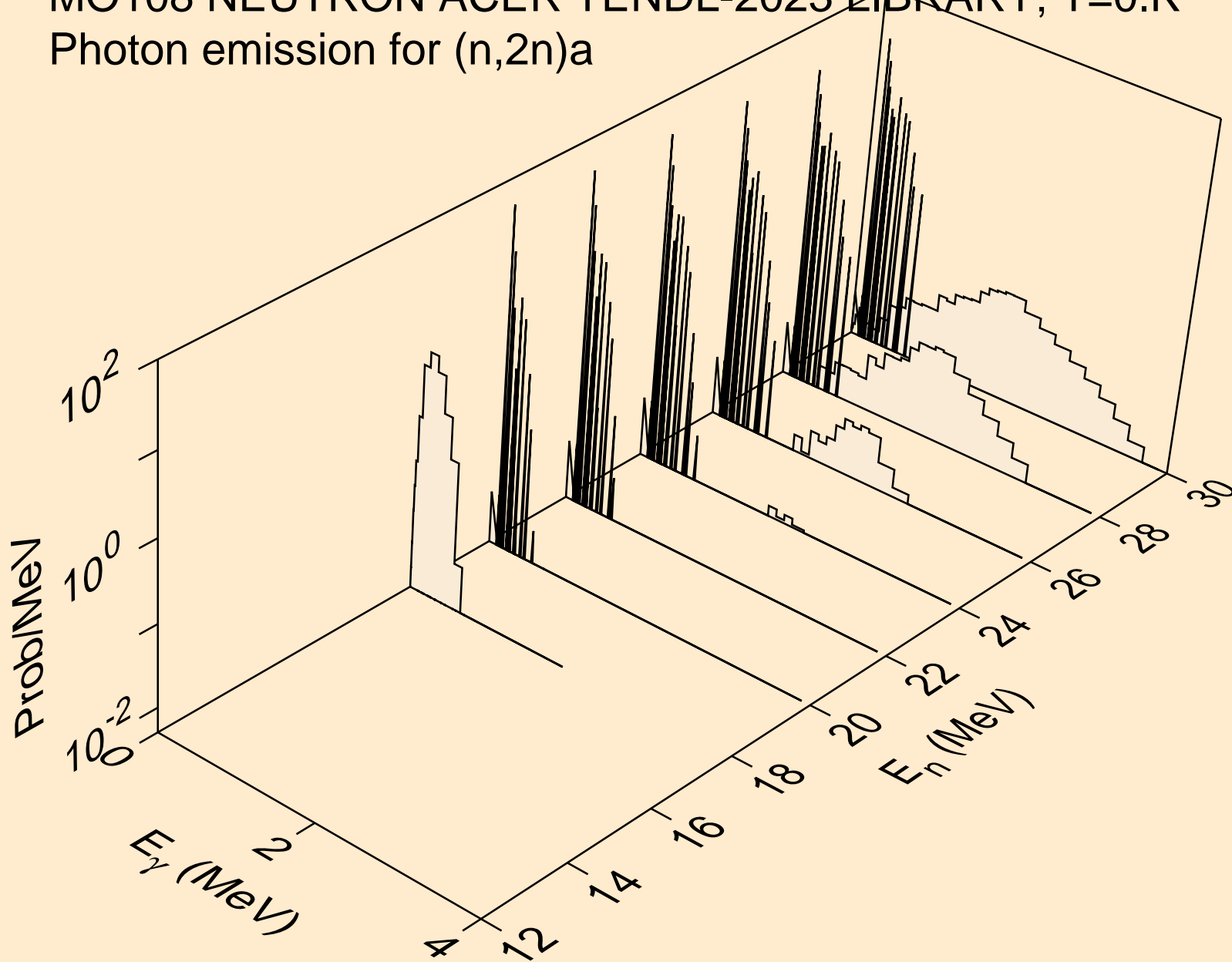

MO108 NEUTRON ACER TENDL-2023 LIBRARY; T=0.K
Photon emission for (n,3n)a

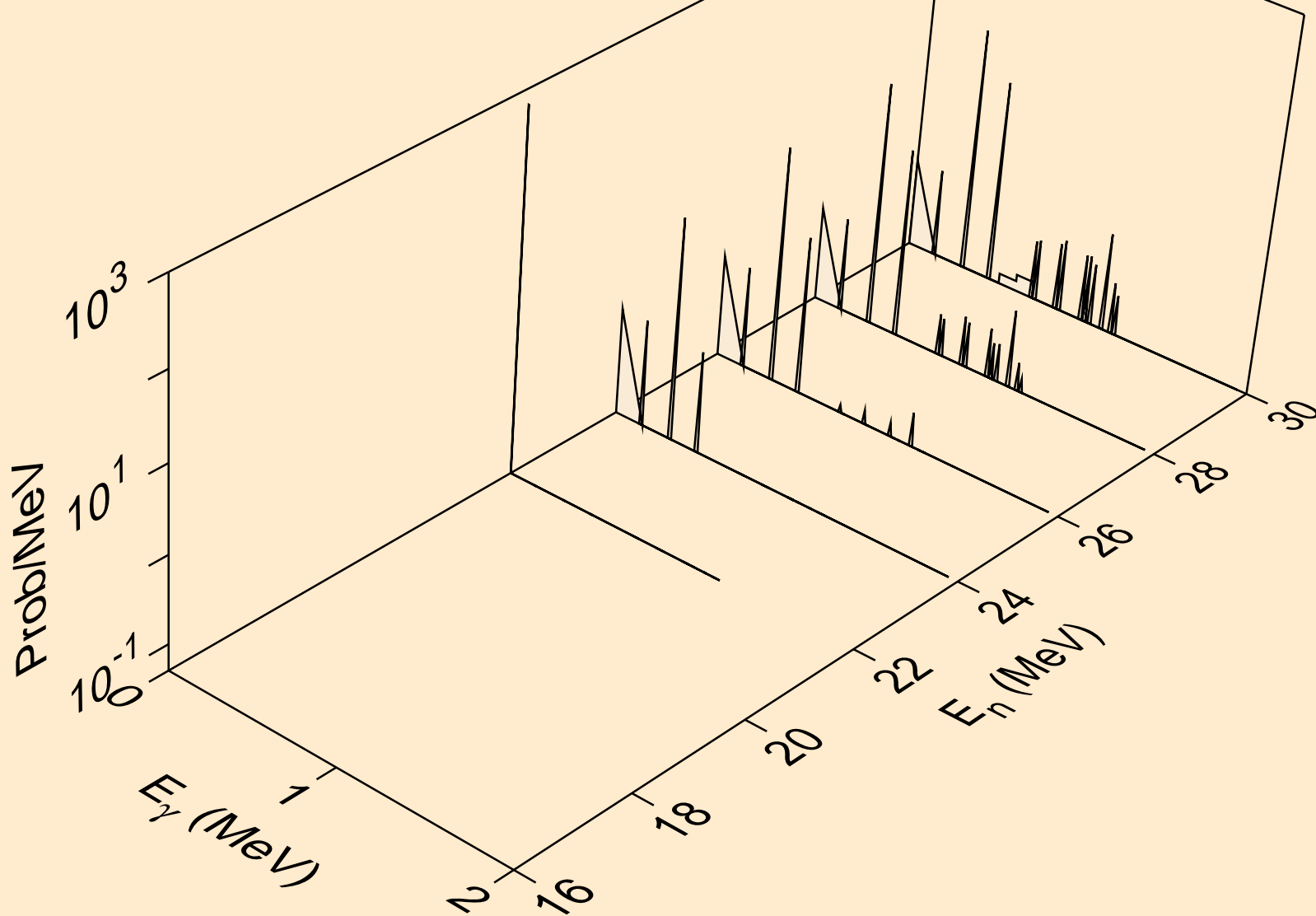

MO108 NEUTRON ACER TENDL-2023 LIBRARY; T=0.K
Photon emission for (n,n*)p

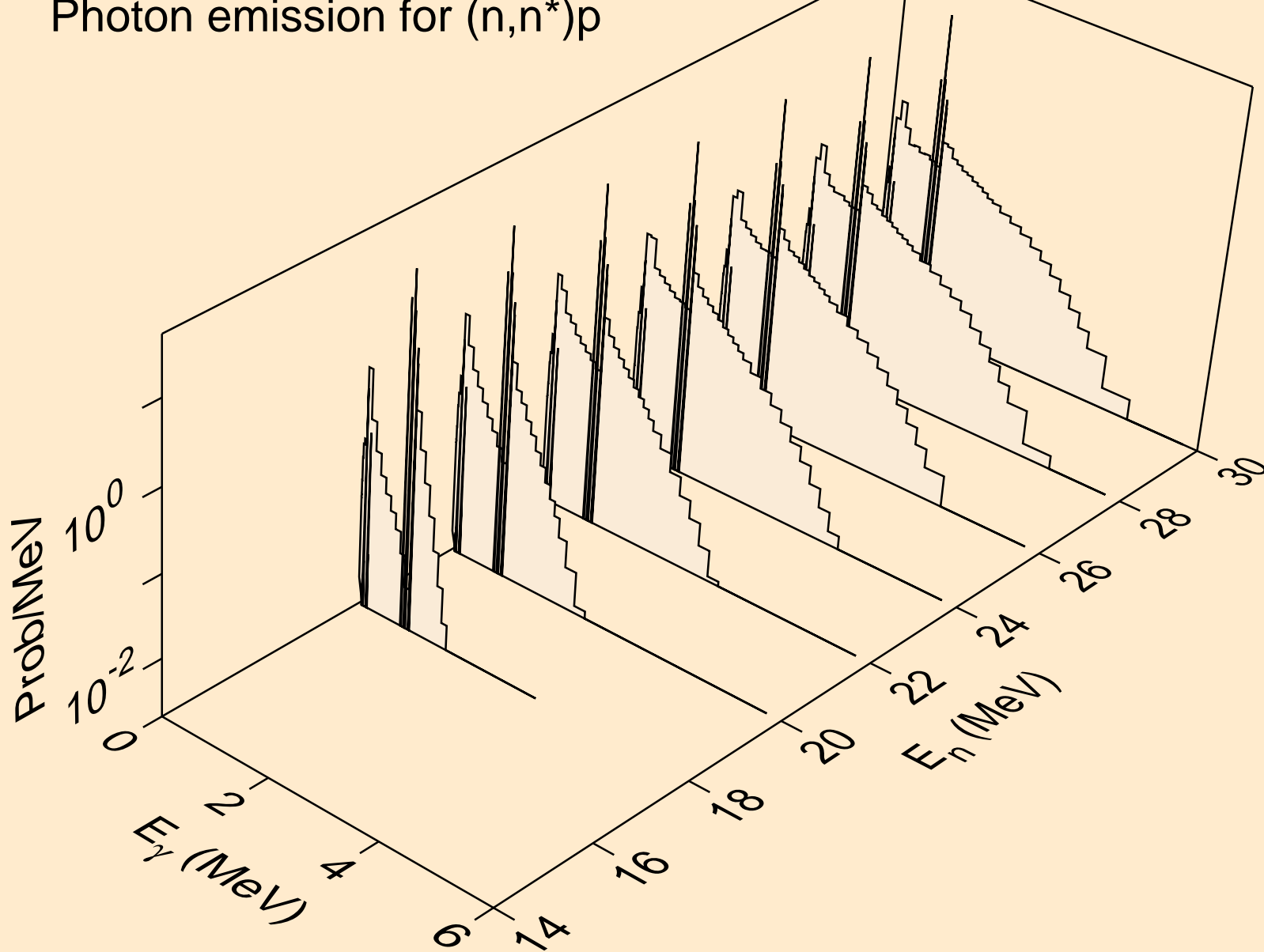

MO108 NEUTRON ACER TENDL-2023 LIBRARY; T=0.K
Photon emission for (n,n*)d

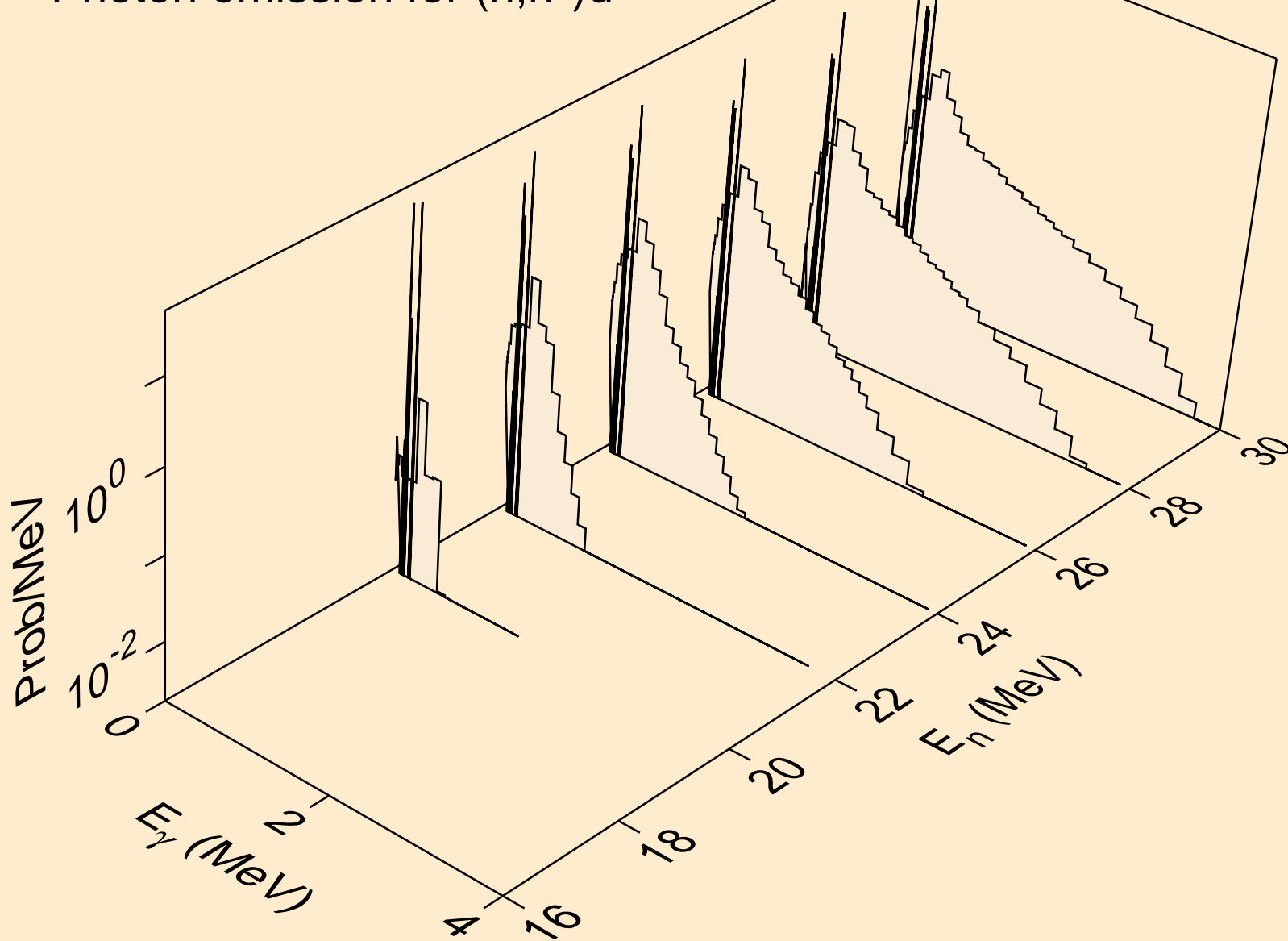

MO108 NEUTRON ACER TENDL-2023 LIBRARY; T=0.K
Photon emission for (n,n*)t

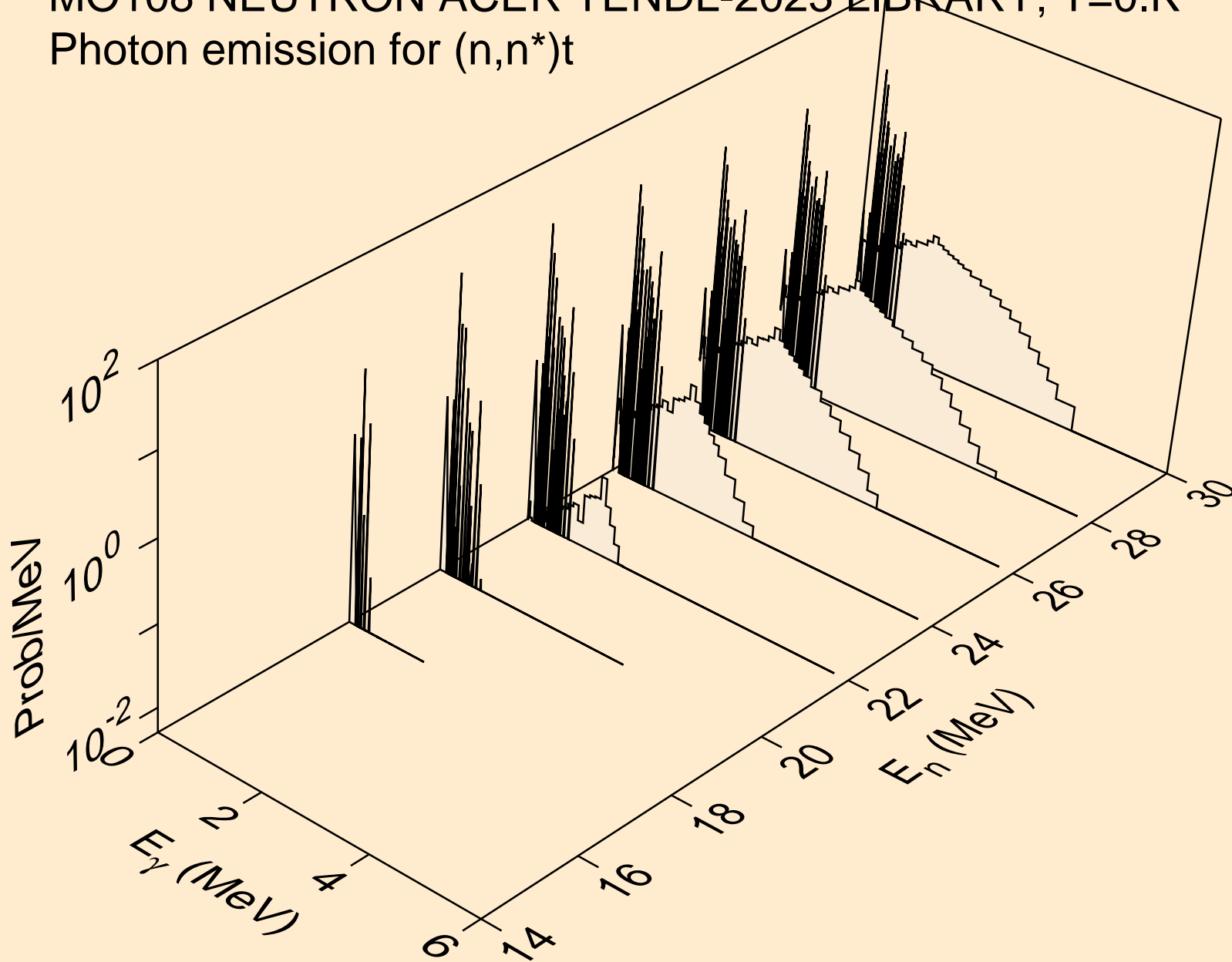

MO108 NEUTRON ACER TENDL-2023 LIBRARY; T=0.K
Photon emission for (n,4n)

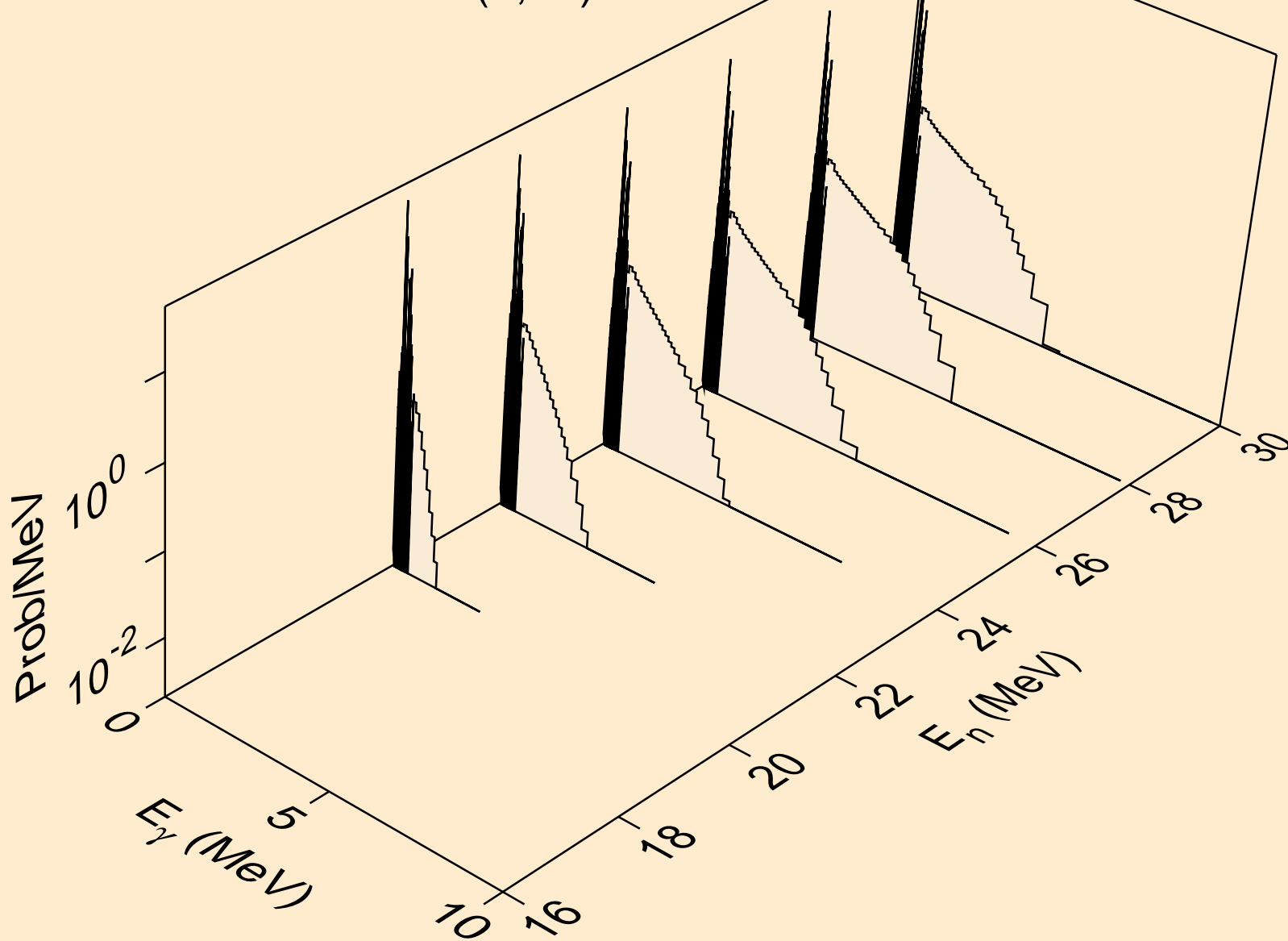

MO108 NEUTRON ACER TENDL-2023 LIBRARY; T=0.K
Photon emission for (n,2np)

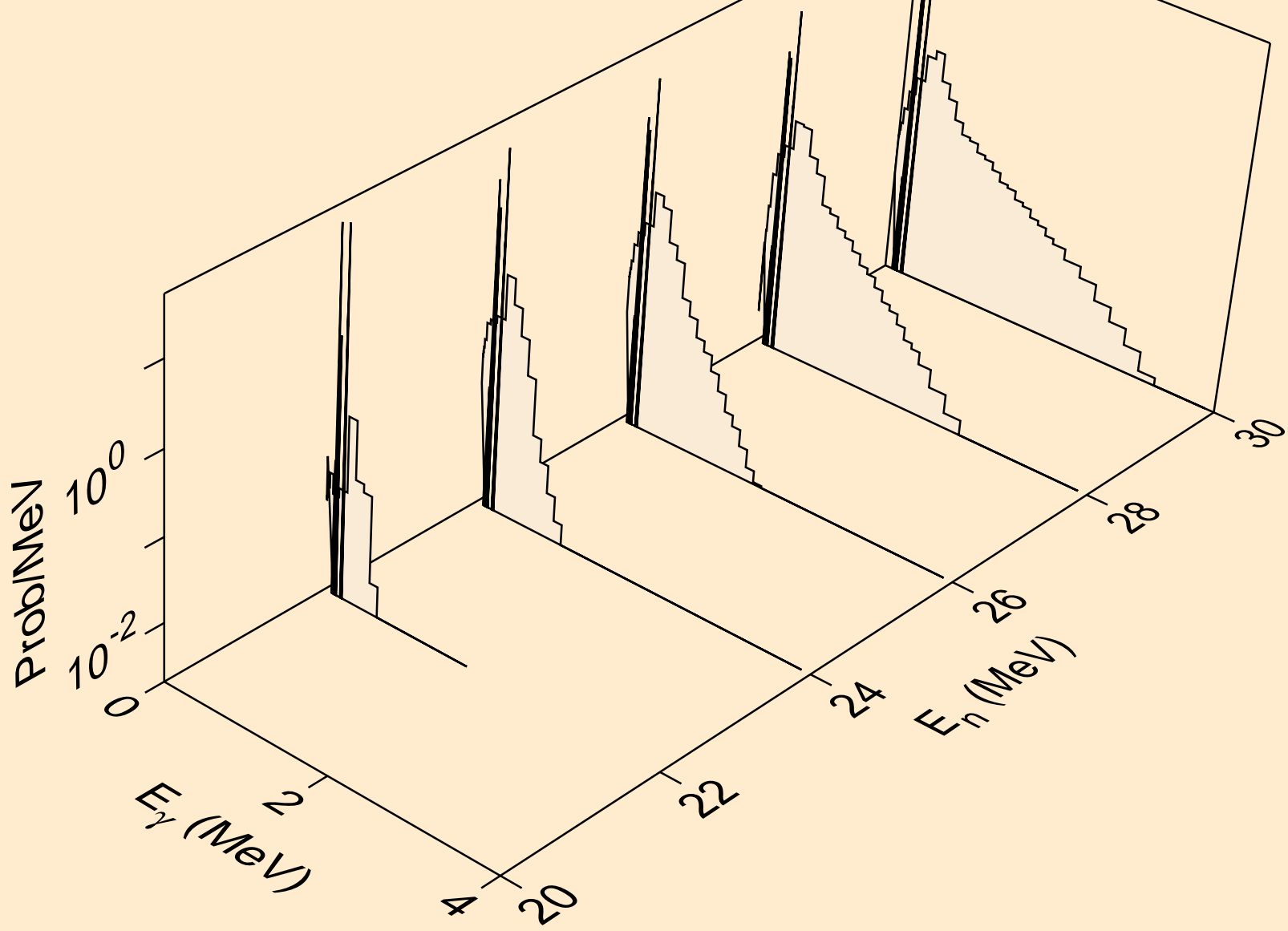

MO108 NEUTRON ACER TENDL-2023 LIBRARY; T=0.K
Photon emission for (n,3np)

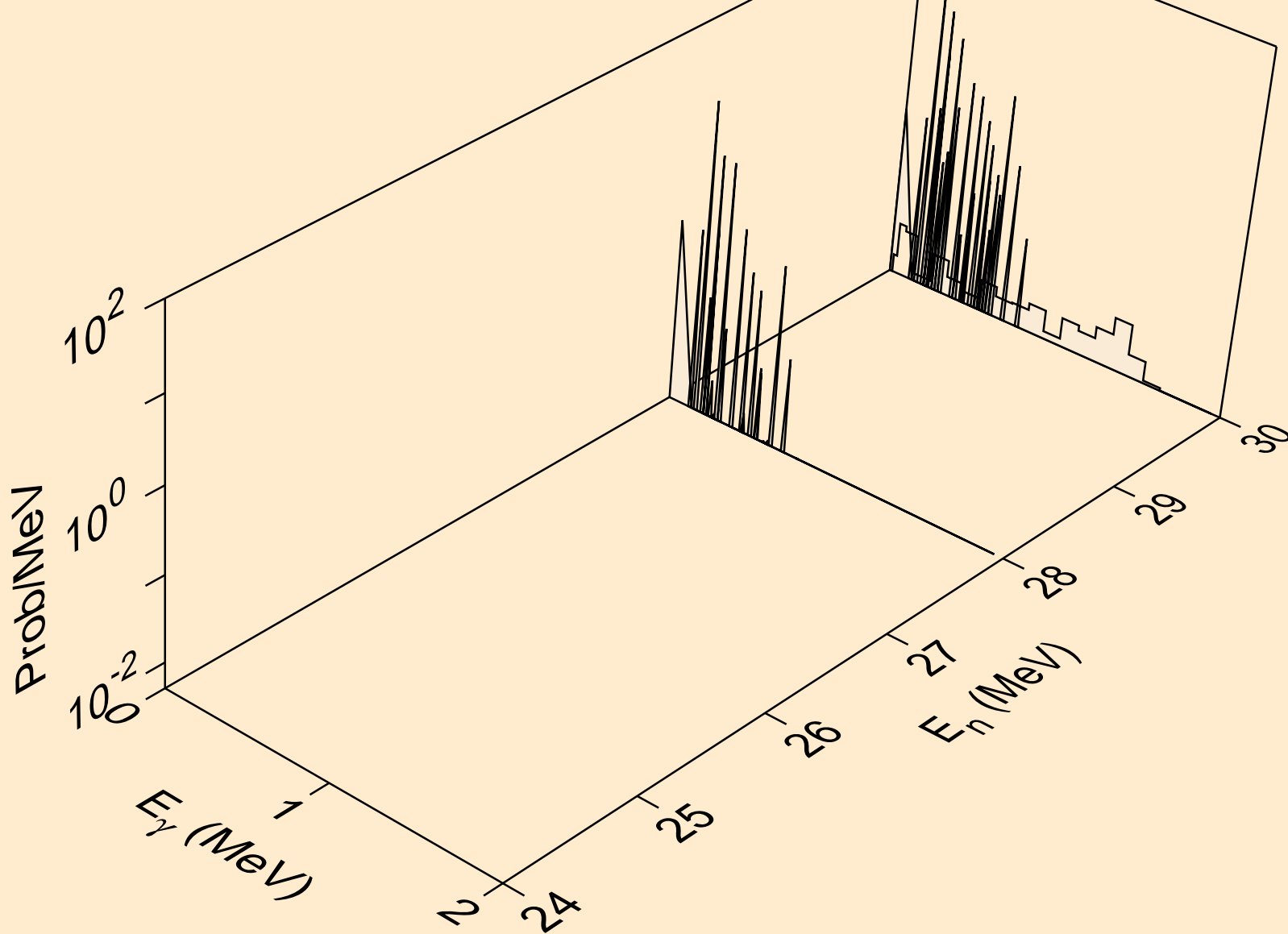

MO108 NEUTRON ACER TENDL-2023 LIBRARY; T=0.K
Photon emission for (n,n*c)

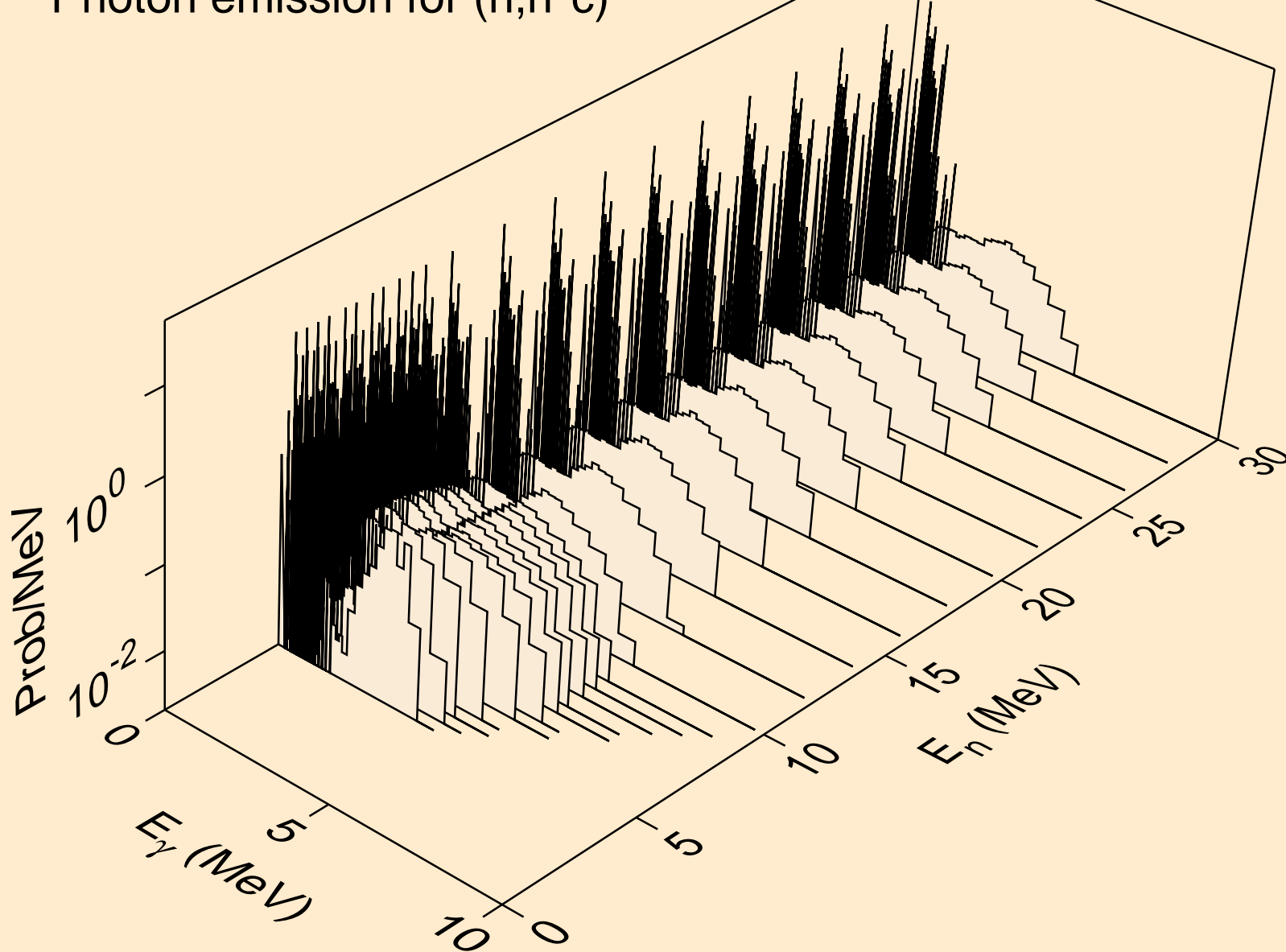

MO108 NEUTRON ACER TENDL-2023 LIBRARY; T=0.K
Photon emission for (n,gma)

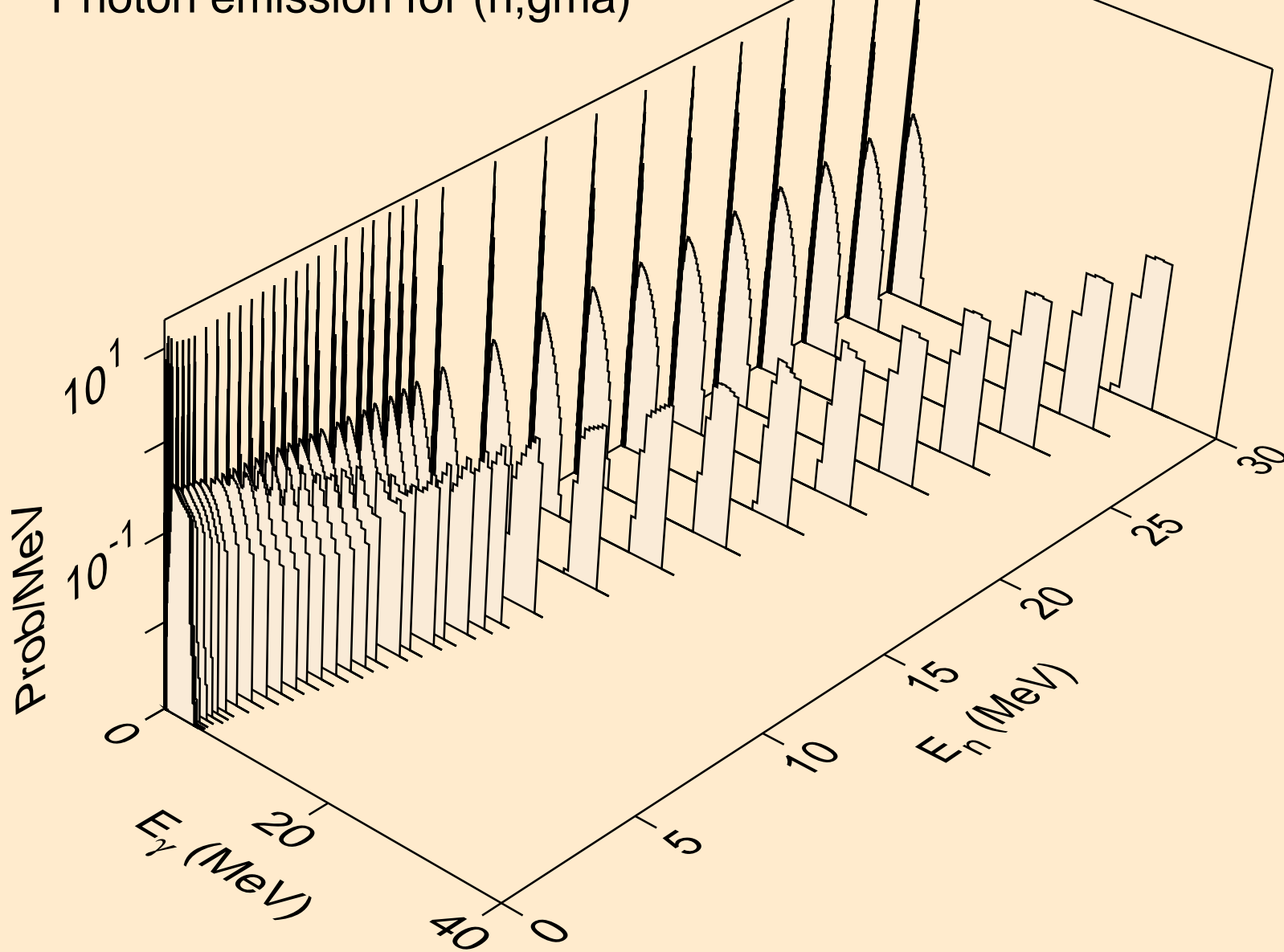

MO108 NEUTRON ACER TENDL-2023 LIBRARY; T=0.K
Photon emission for (n,p)

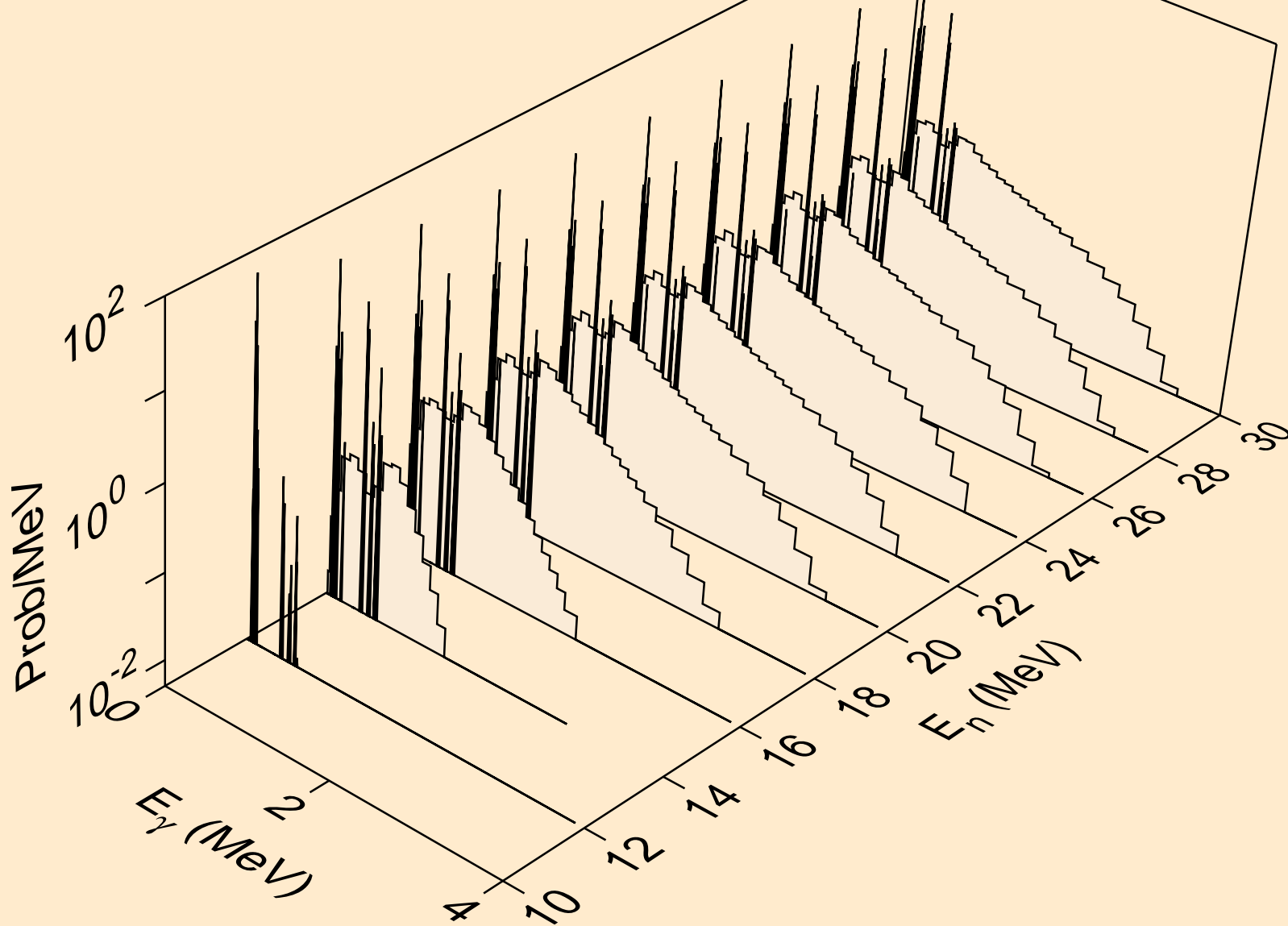

MO108 NEUTRON ACER TENDL-2023 LIBRARY; T=0.K
Photon emission for (n,d)

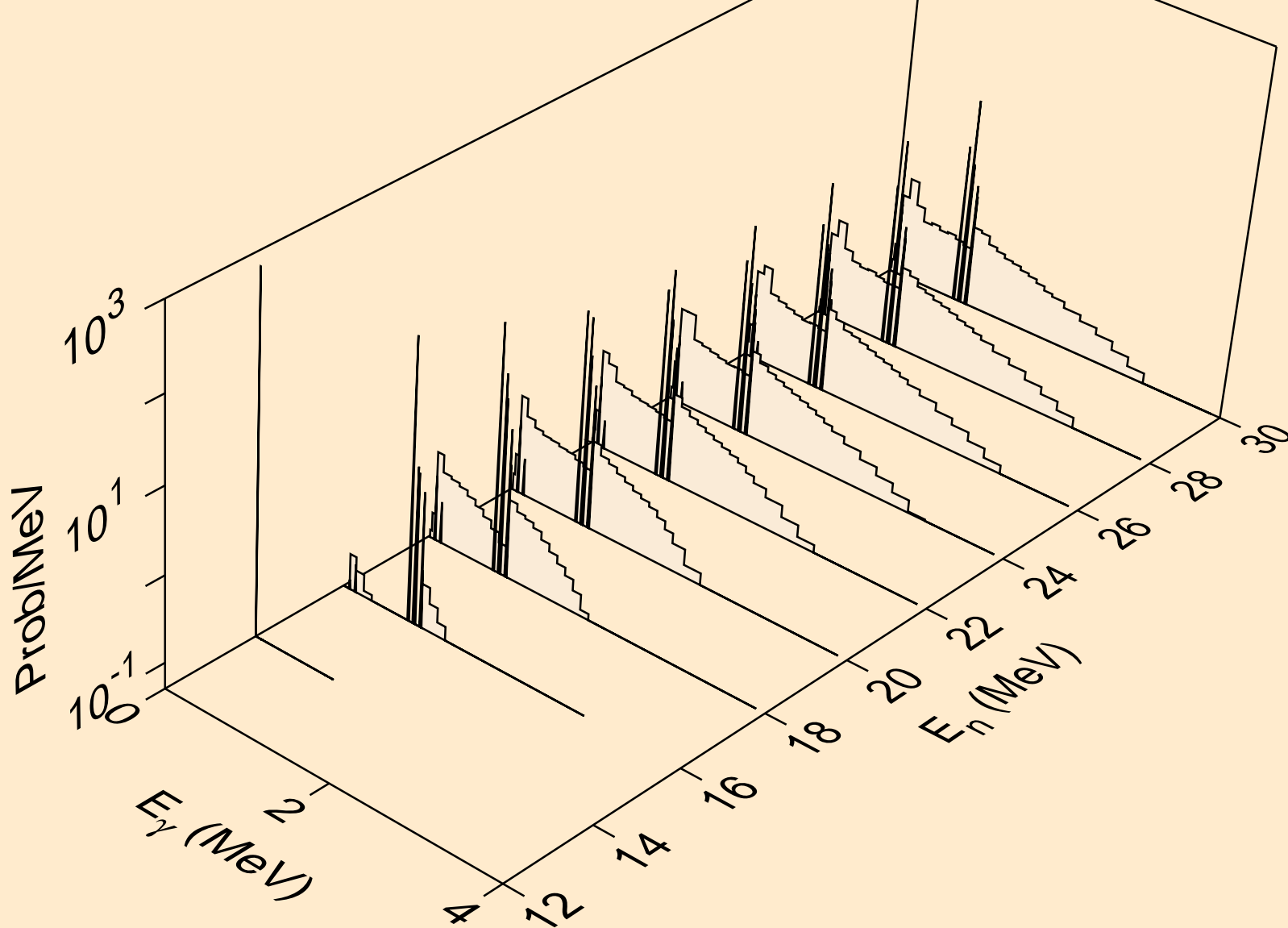

MO108 NEUTRON ACER TENDL-2023 LIBRARY; T=0.K
Photon emission for (n,t)

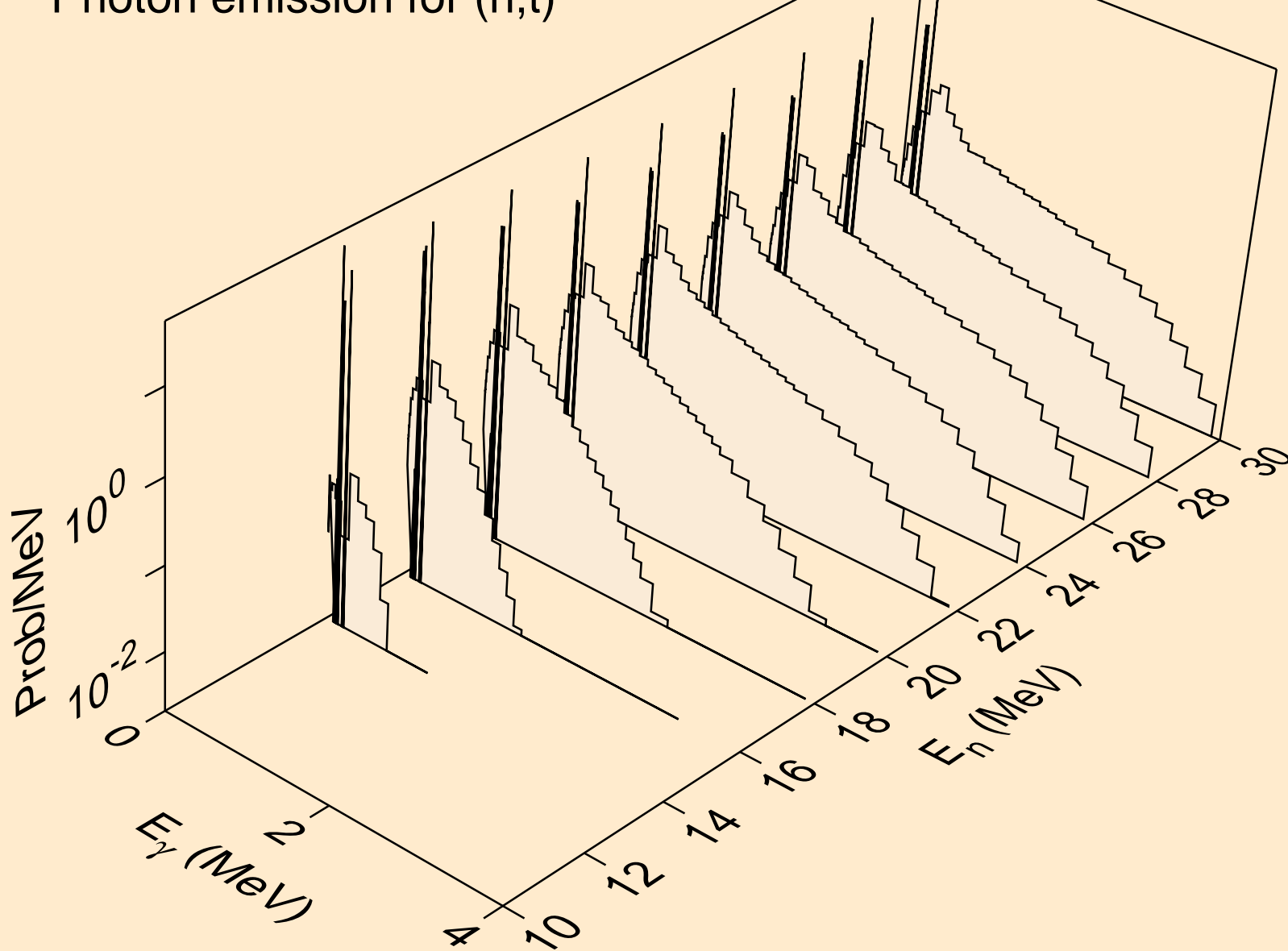

MO108 NEUTRON ACER TENDL-2023 LIBRARY; T=0.K
Photon emission for (n,he3)

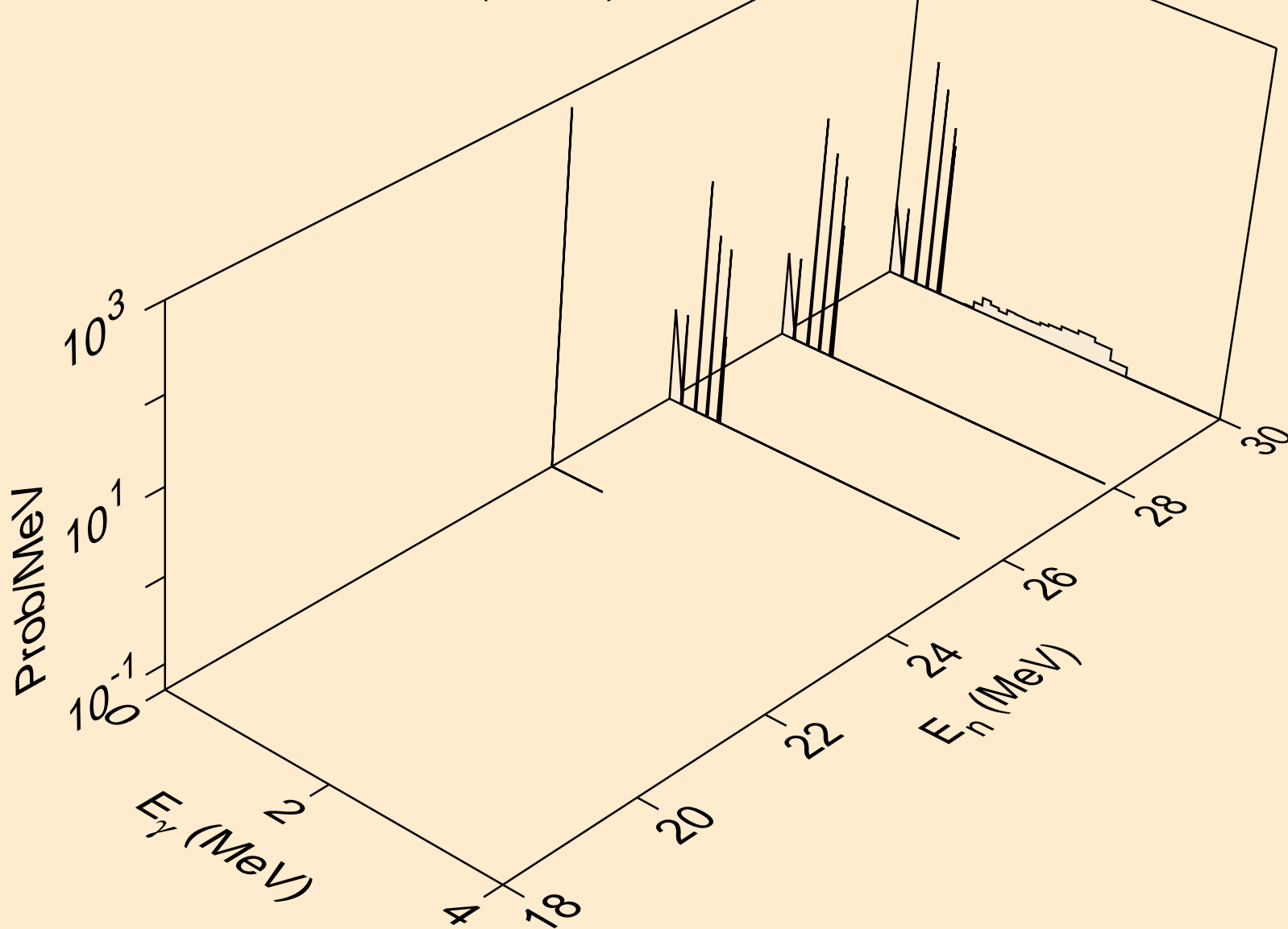

MO108 NEUTRON ACER TENDL-2023 LIBRARY; T=0.K
Photon emission for (n,a)

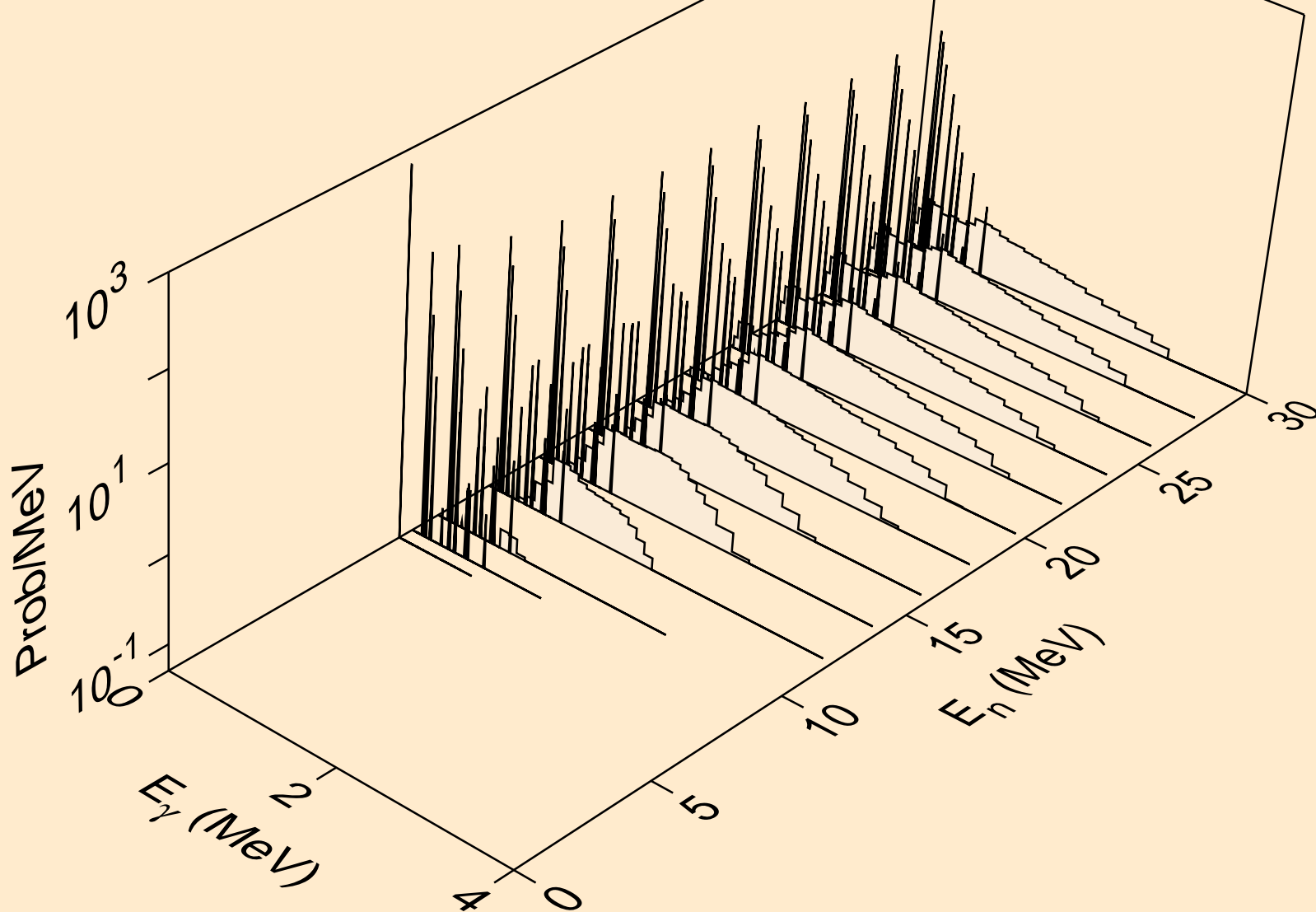

MO108 NEUTRON ACER TENDL-2023 LIBRARY; T=0.K
thermal capture photon spectrum

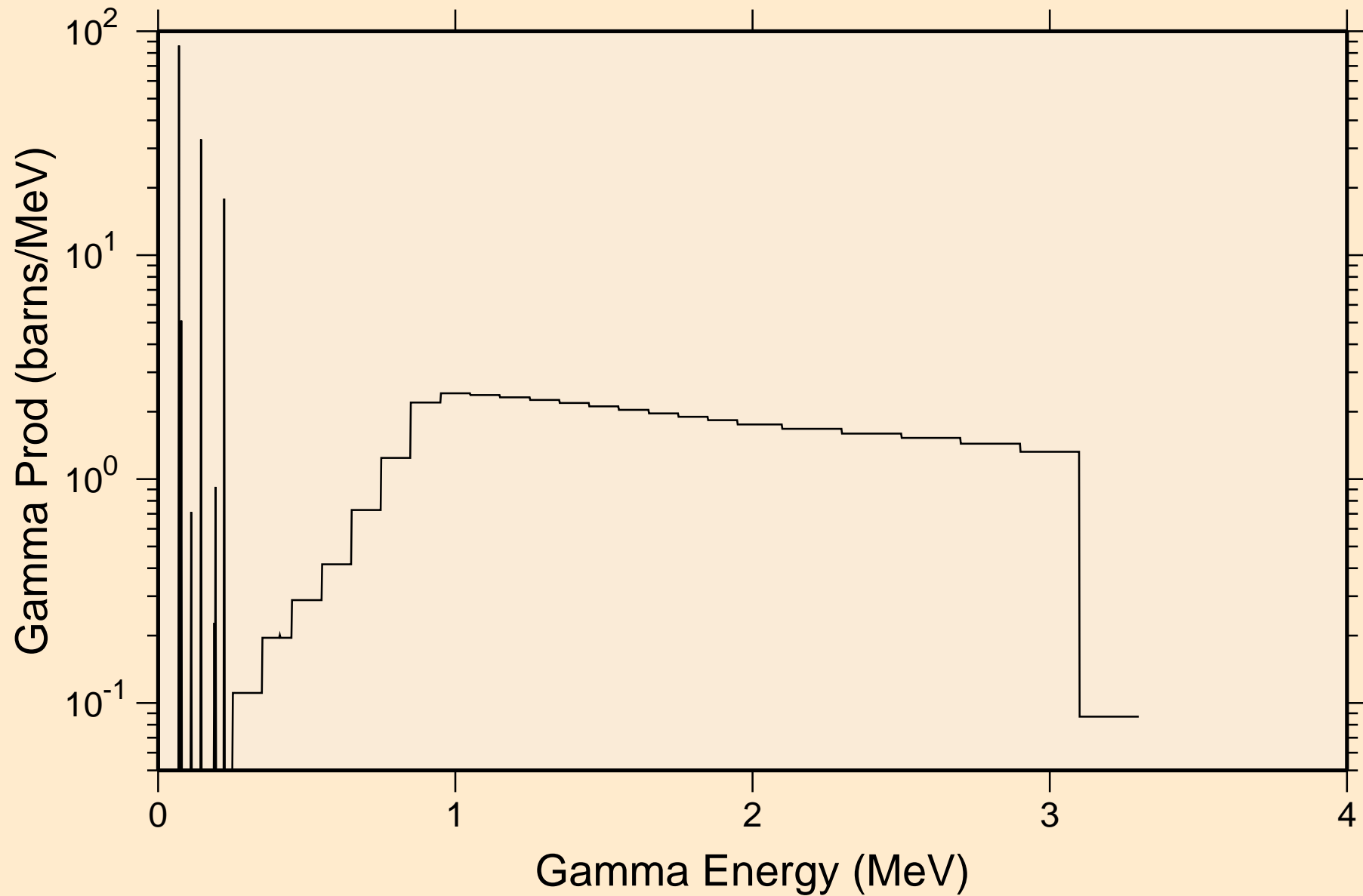

MO108 NEUTRON ACER TENDL-2023 LIBRARY; T=0.K
14 MeV photon spectrum

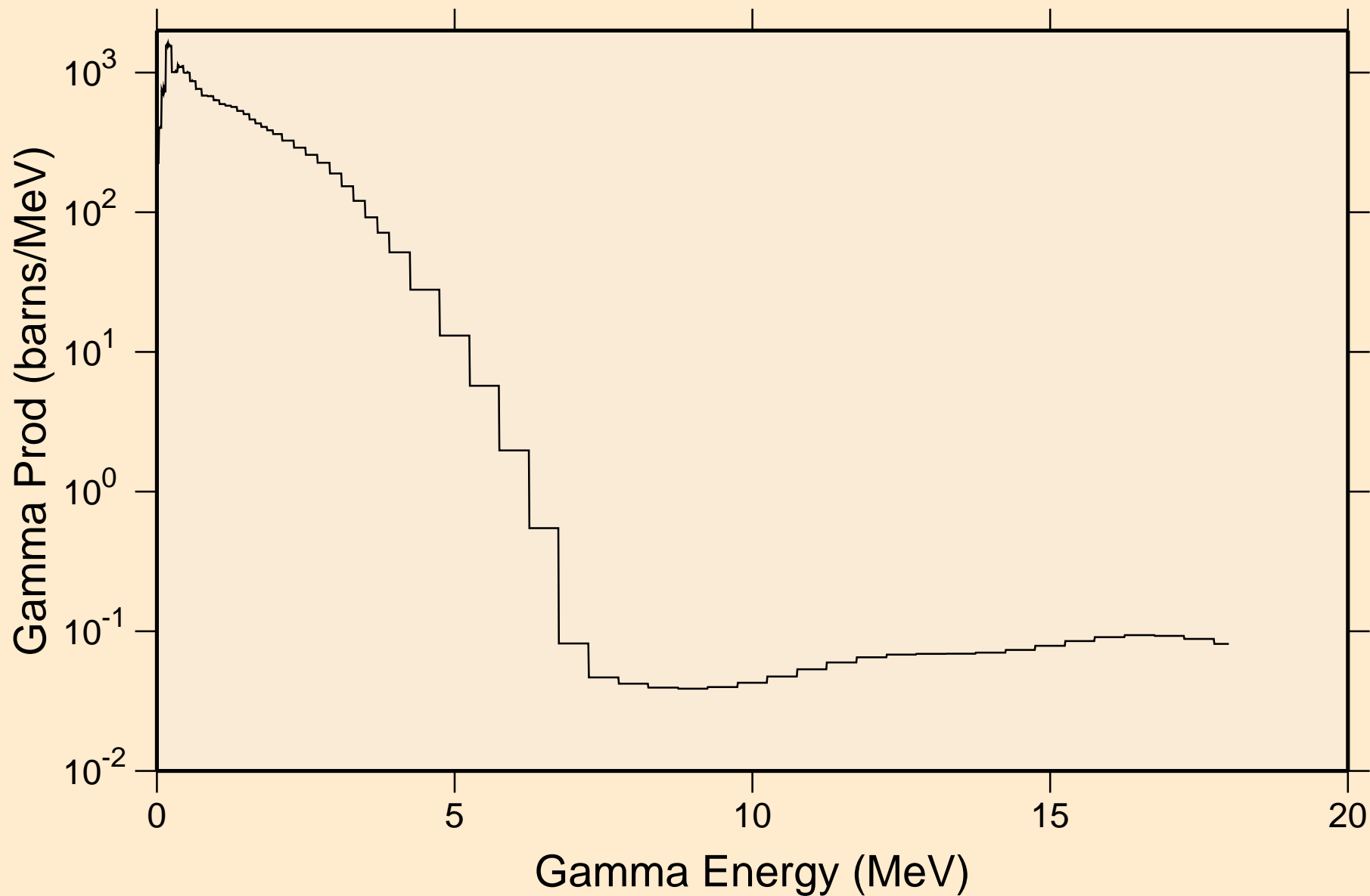

MO108 NEUTRON ACER TENDL-2023 LIBRARY; T=0.K
Particle heating contributions

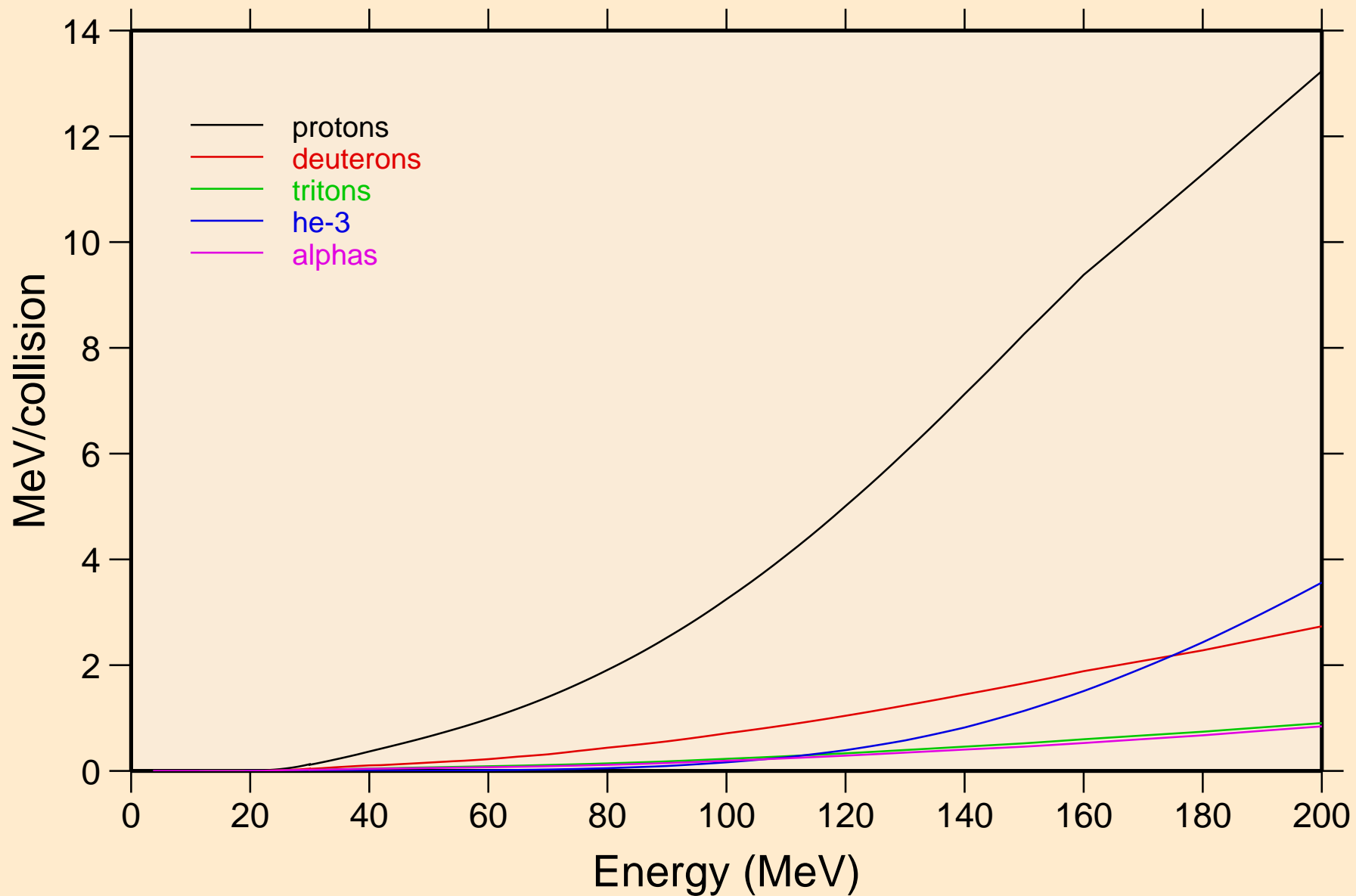

MO108 NEUTRON ACER TENDL-2023 LIBRARY; T=0.K
Recoil Heating

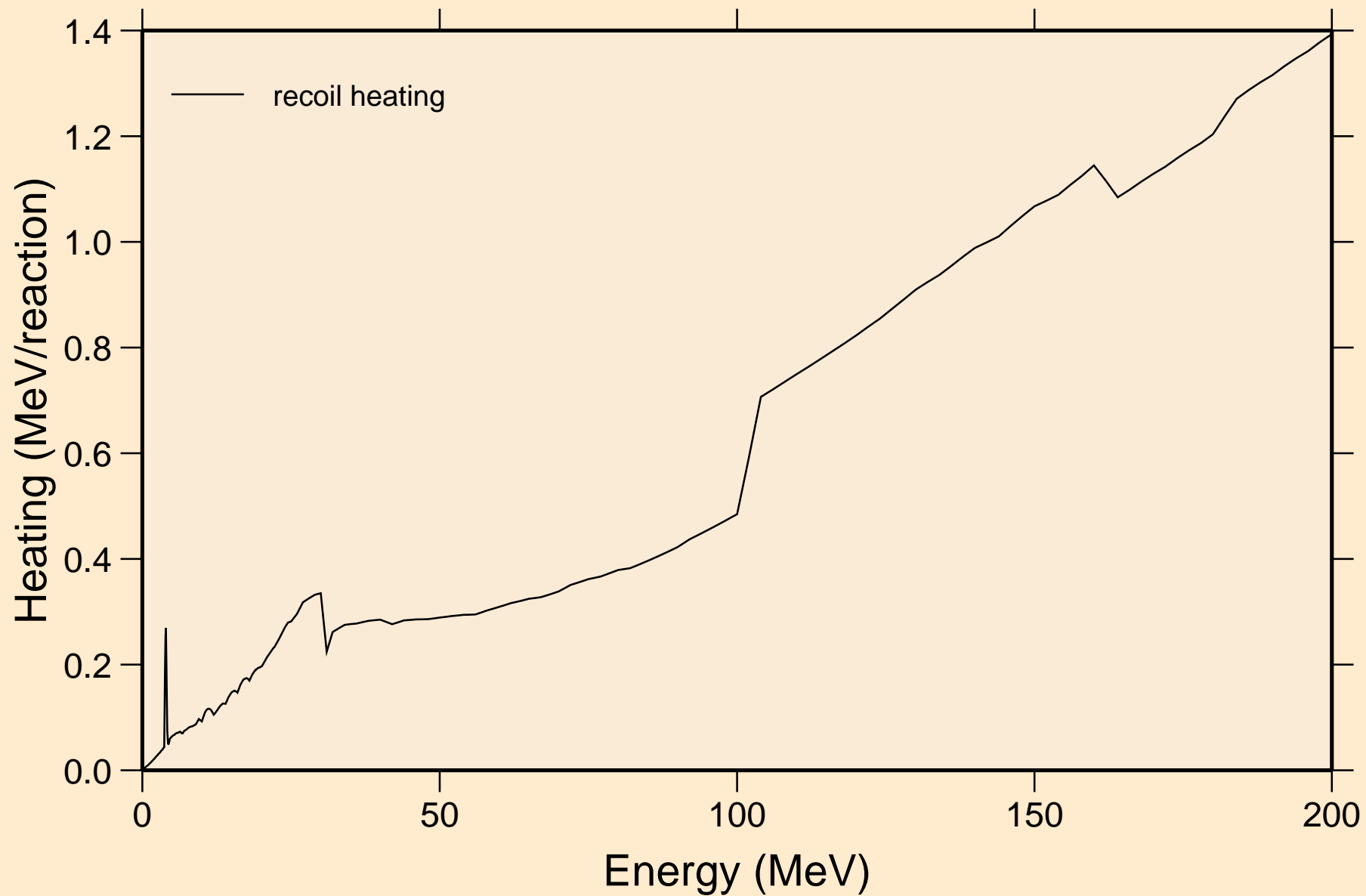

MO108 NEUTRON ACER TENDL-2023 LIBRARY; T=0.K

Particle production cross sections

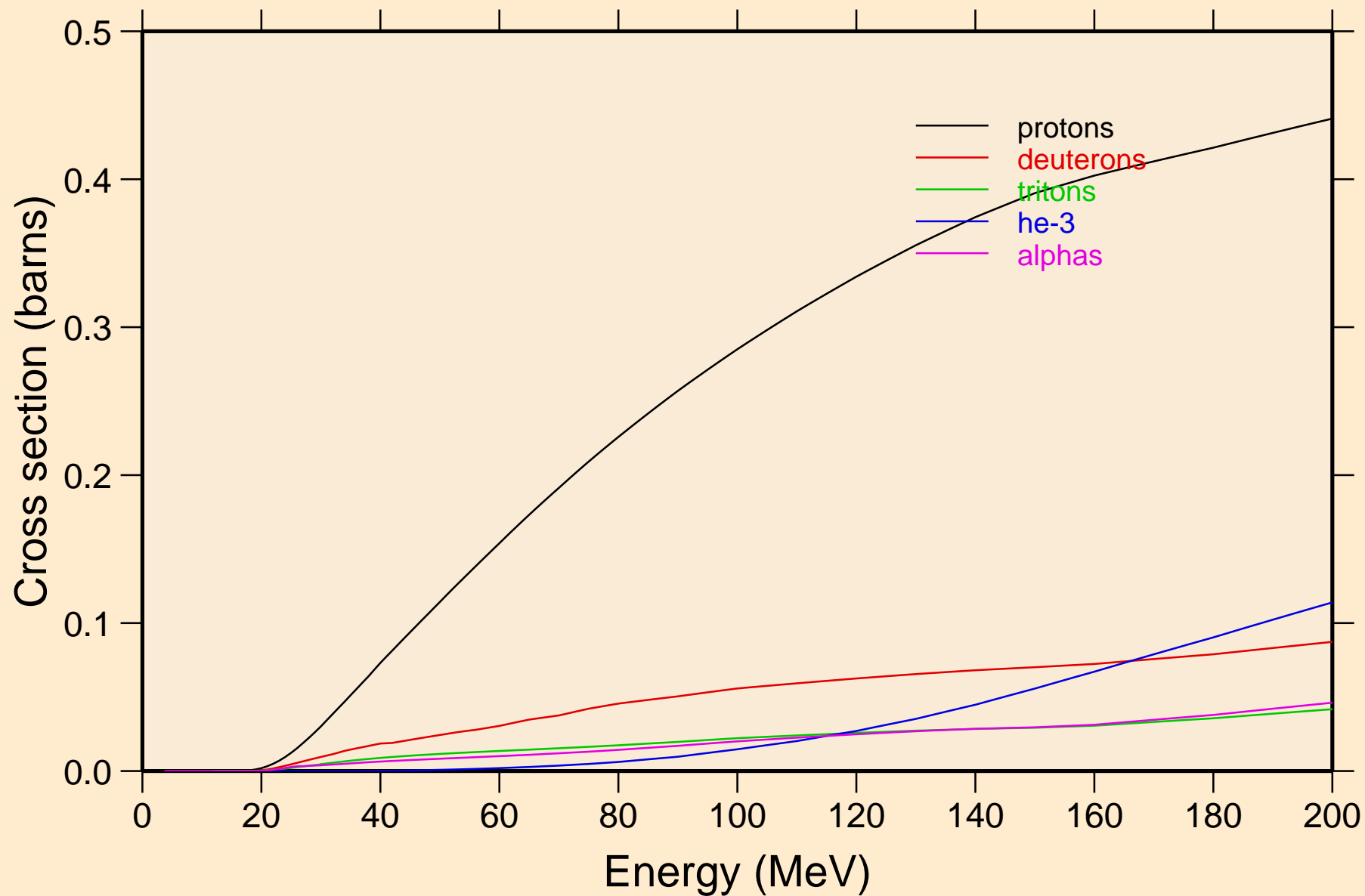

MO108 NEUTRON ACER TENDL-2023 LIBRARY; T=0.K
protons from (n,x)

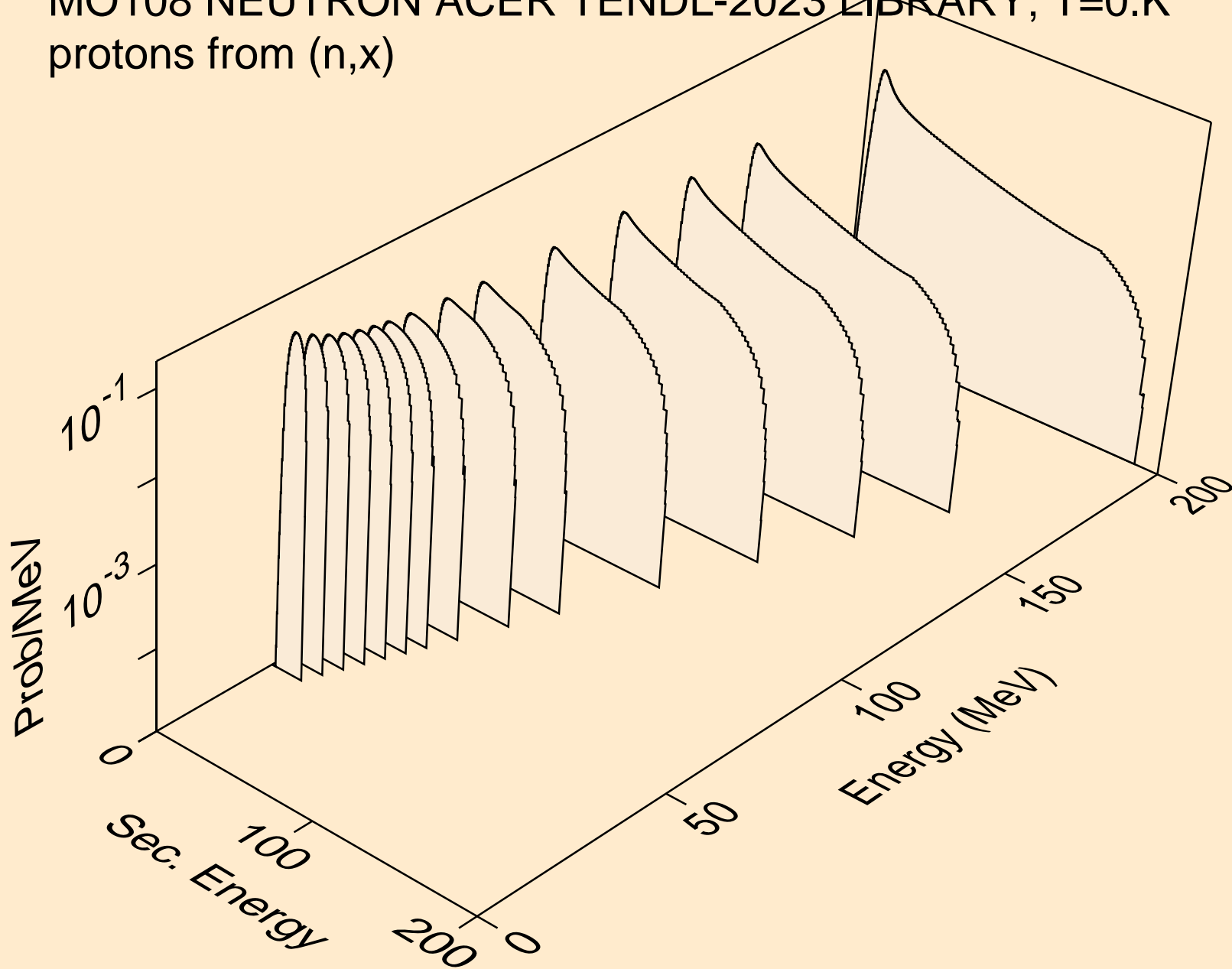

MO108 NEUTRON ACER TENDL-2023 LIBRARY; T=0.K
protons from (n,n*)p

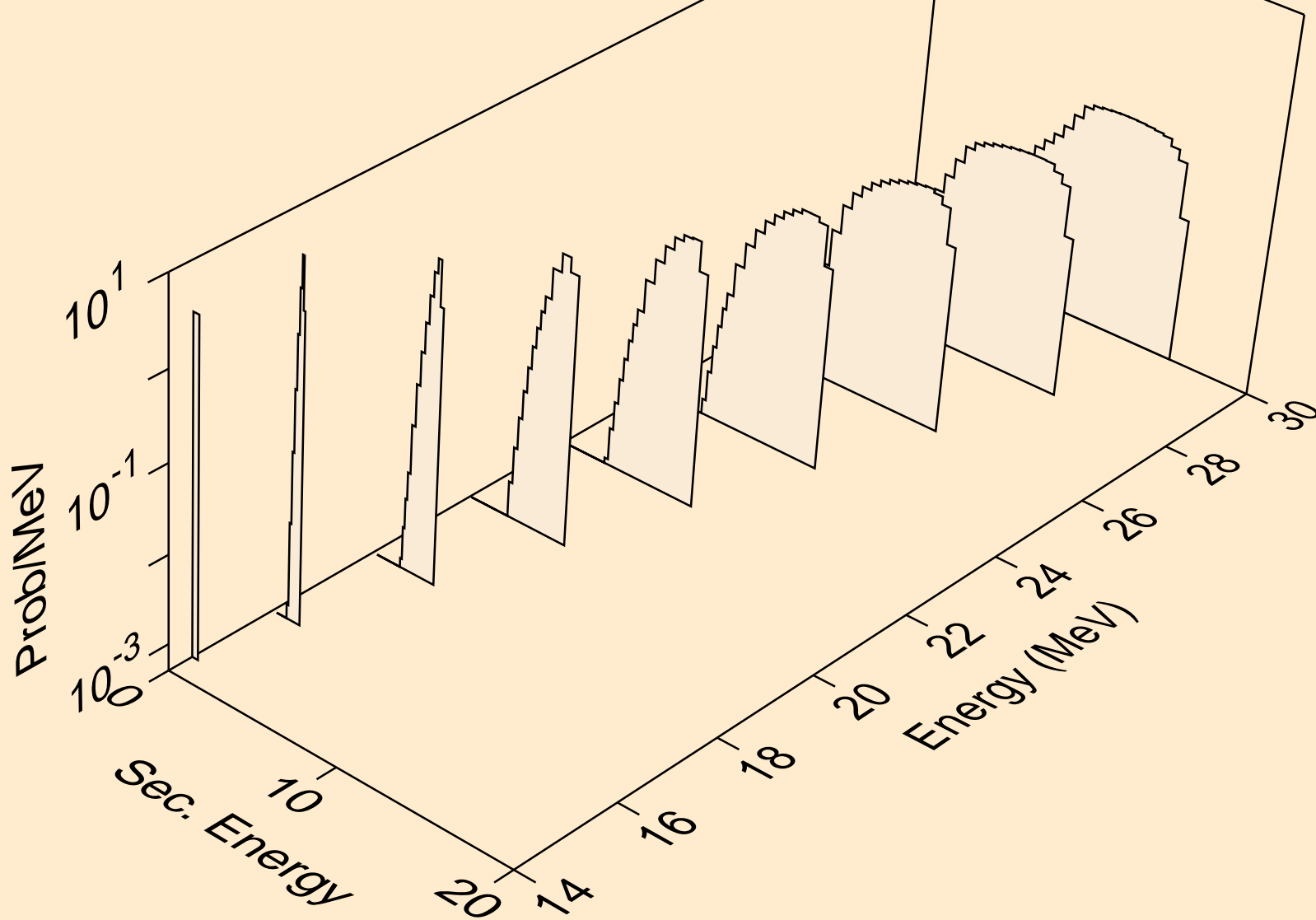

MO108 NEUTRON ACER TENDL-2023 LIBRARY; T=0.K
protons from (n,2np)

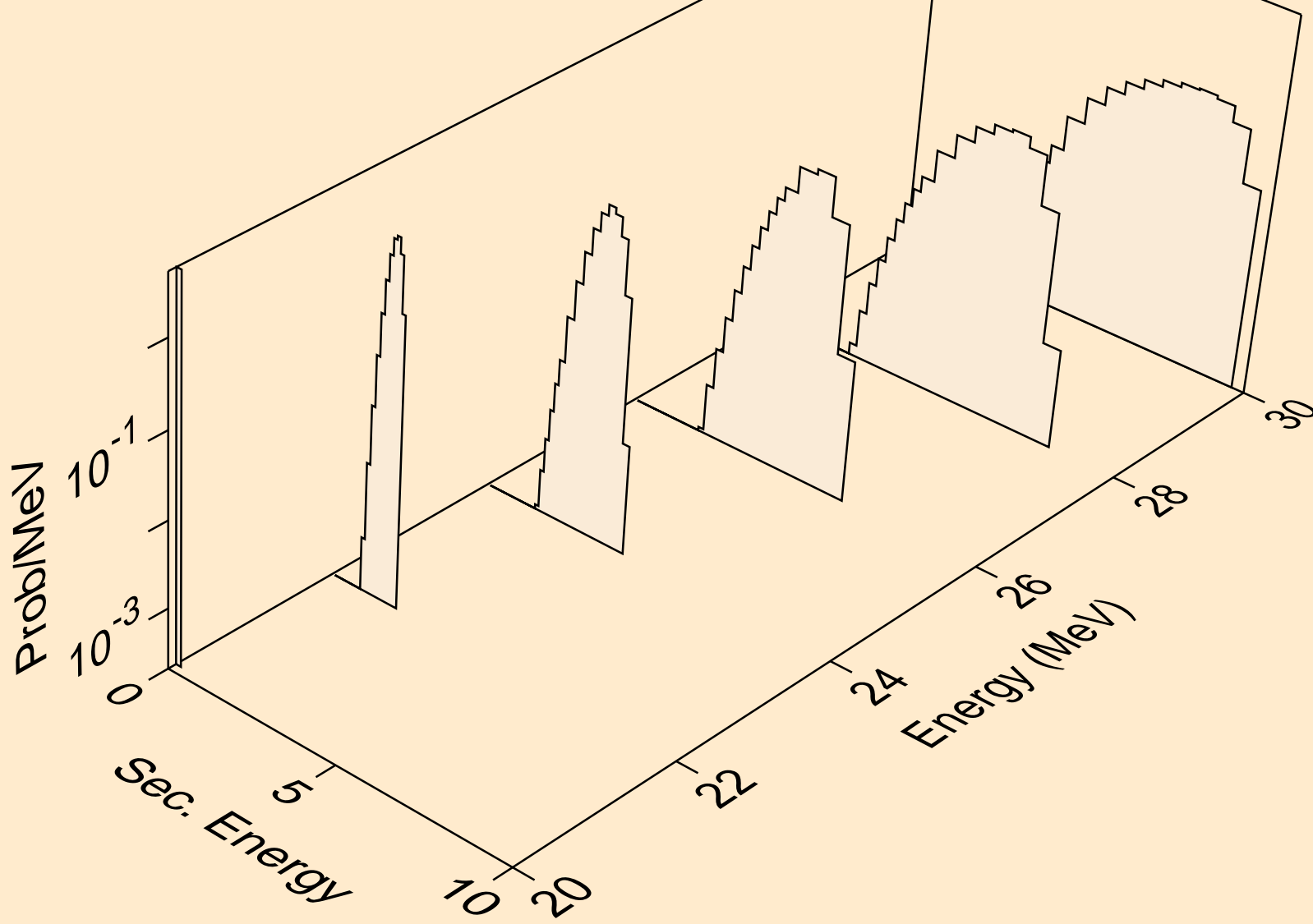

MO108 NEUTRON ACER TENDL-2023 LIBRARY; T=0.K
protons from (n,3np)

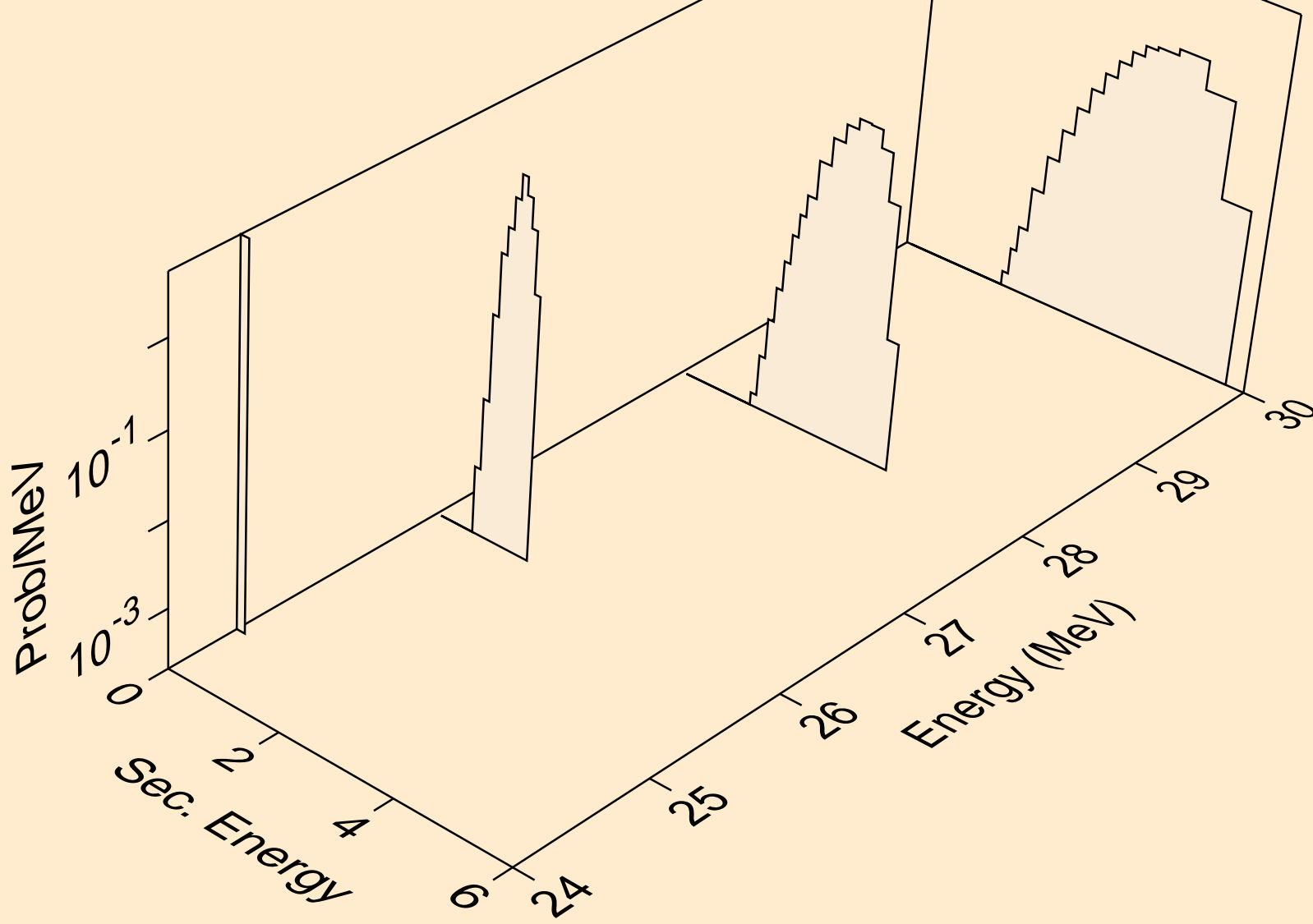

MO108 NEUTRON ACER TENDL-2023 LIBRARY; T=0.K
protons from (n,p)

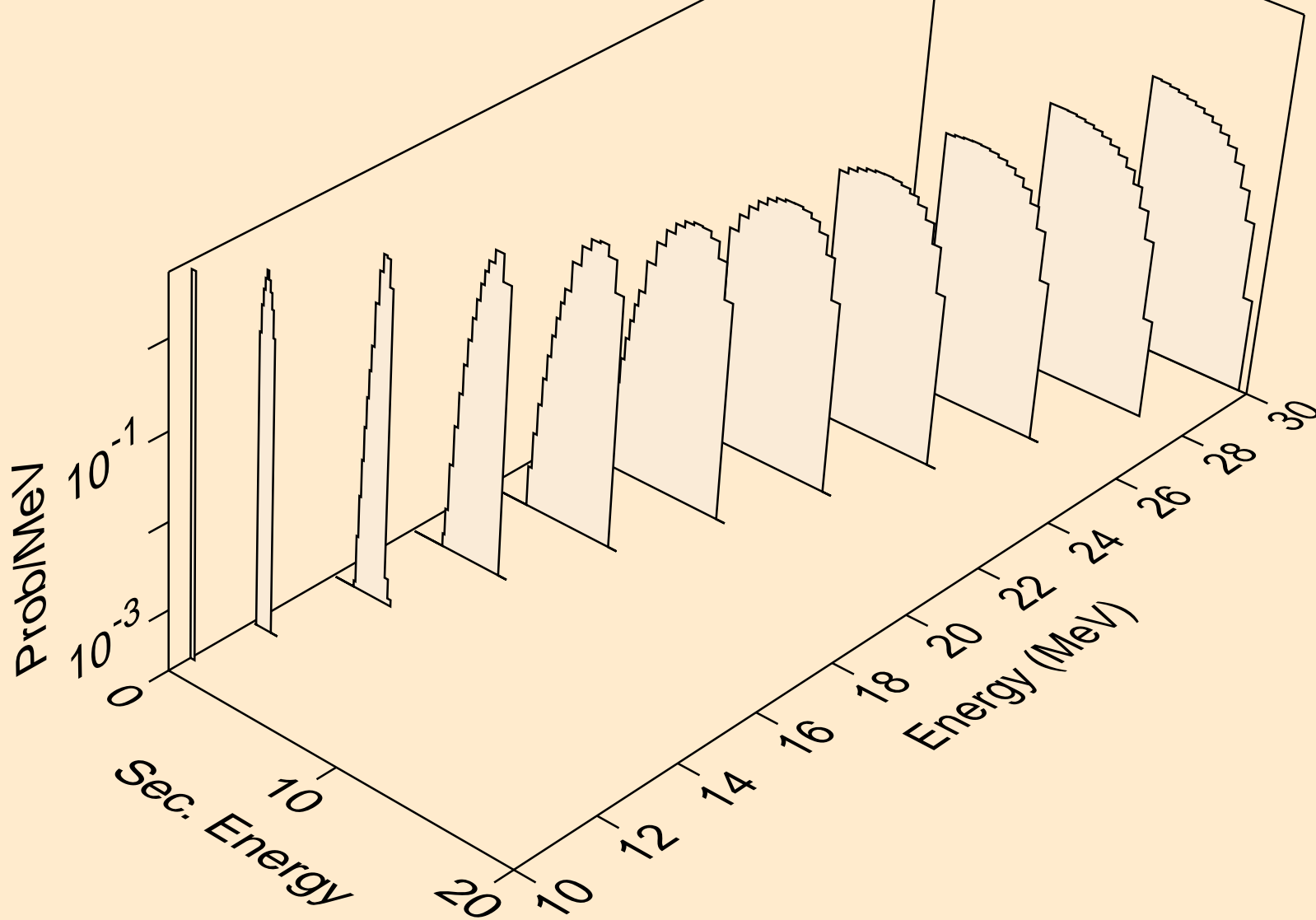

MO108 NEUTRON ACER TENDL-2023 LIBRARY; T=0.K
deuterons from (n,x)

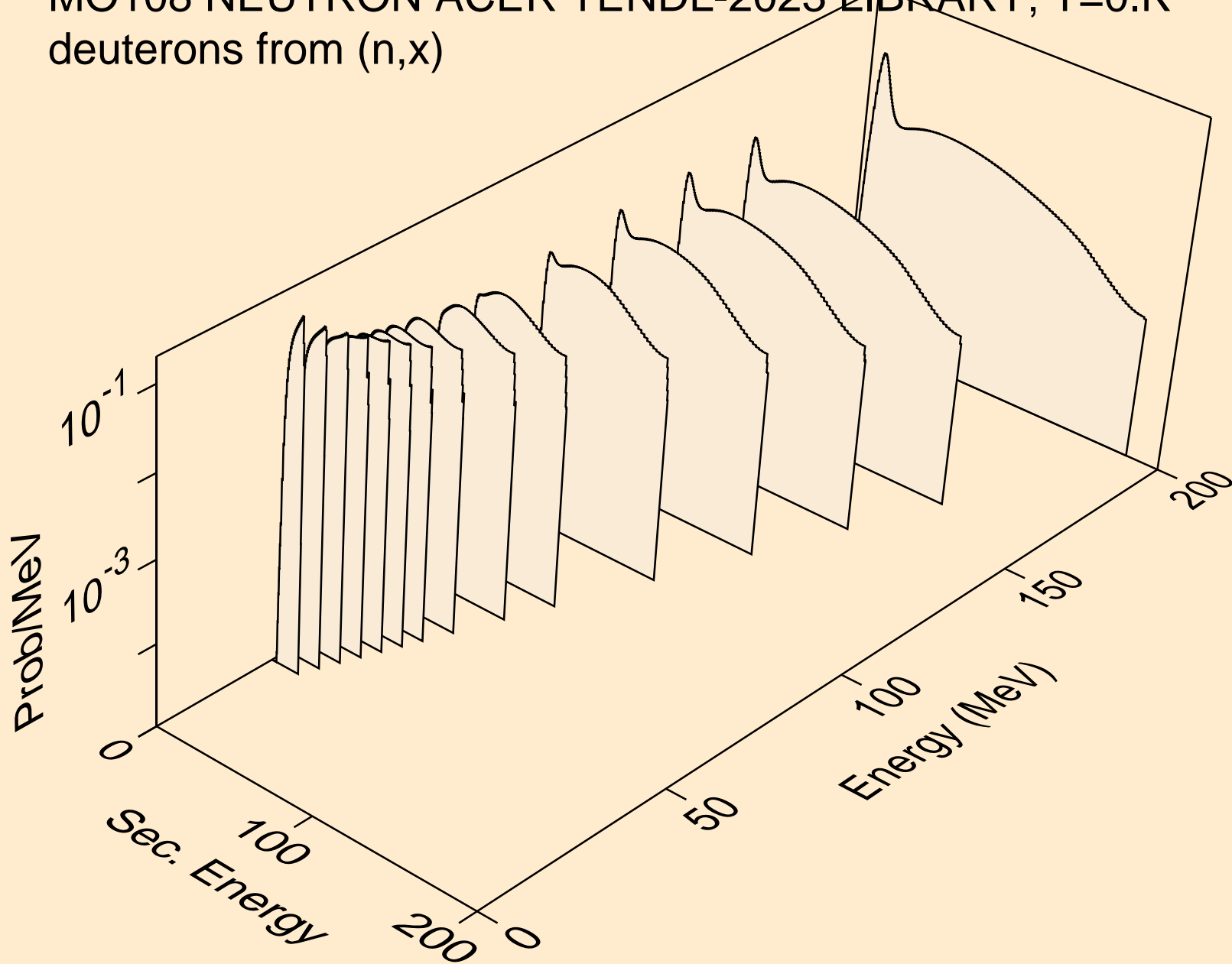

MO108 NEUTRON ACER TENDL-2023 LIBRARY; T=0.K
deuterons from (n,2nd)

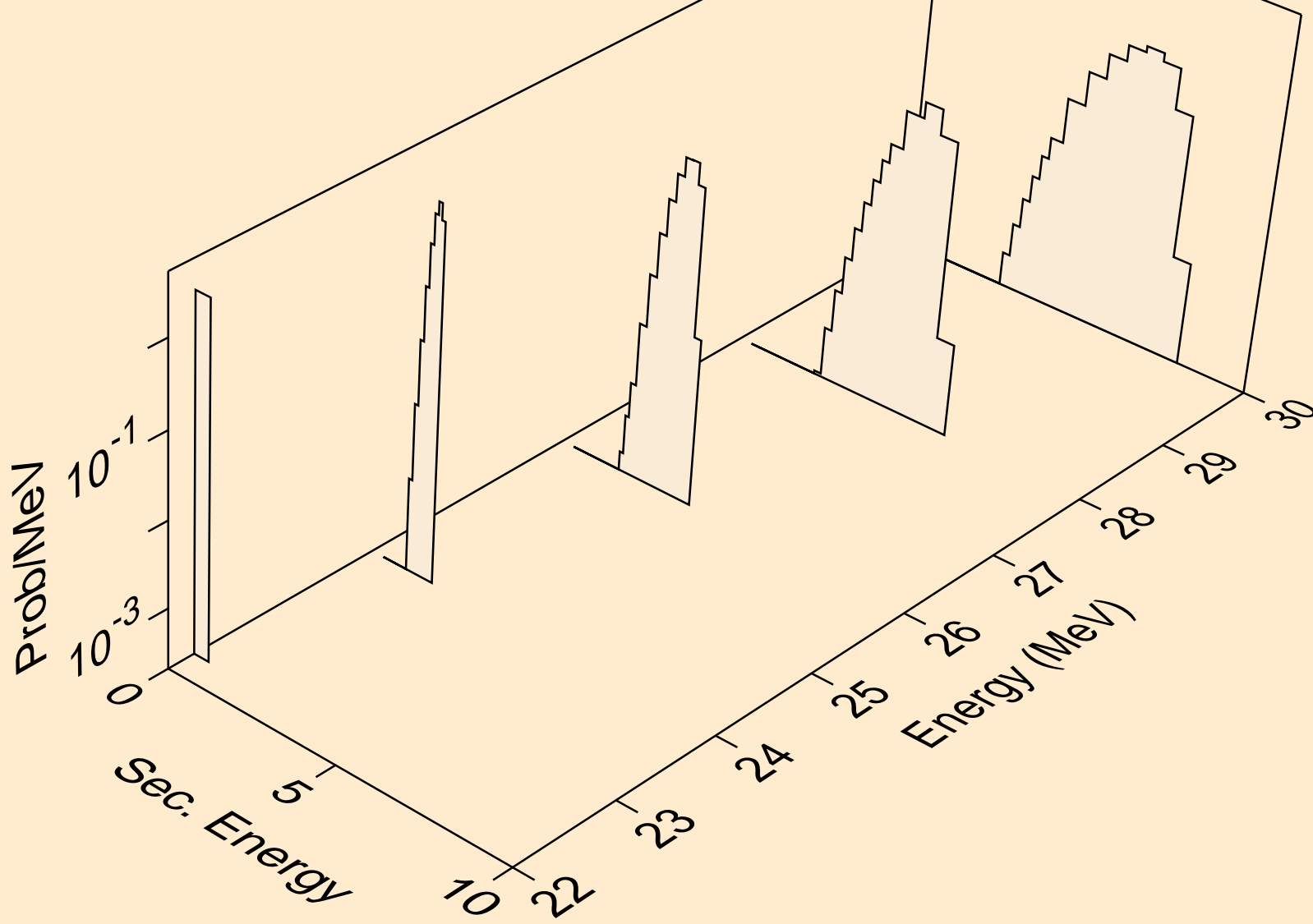

MO108 NEUTRON ACER TENDL-2023 LIBRARY; T=0.K
deuterons from (n,n*)d

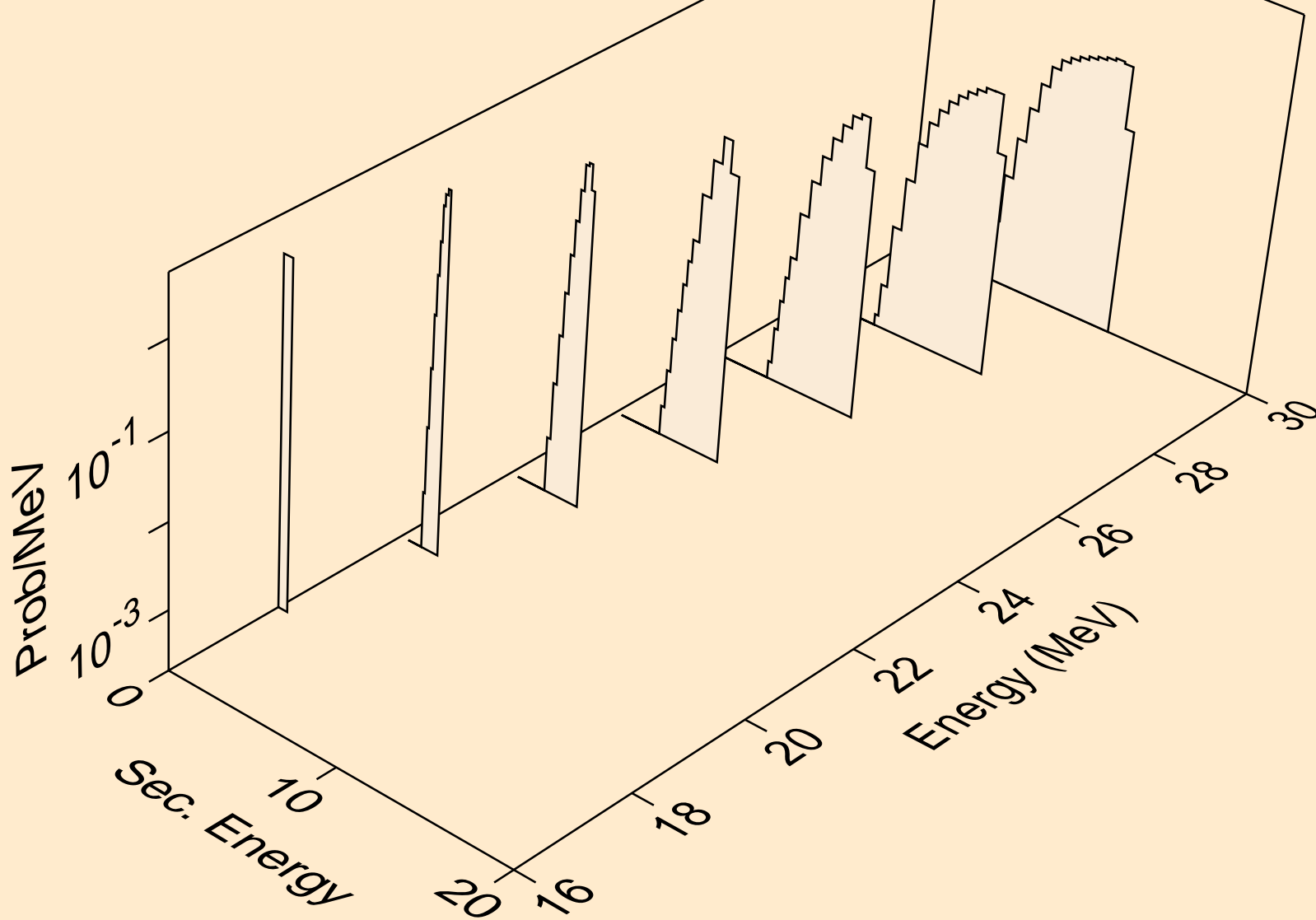

MO108 NEUTRON ACER TENDL-2023 LIBRARY; T=0.K
deuterons from (n,d)

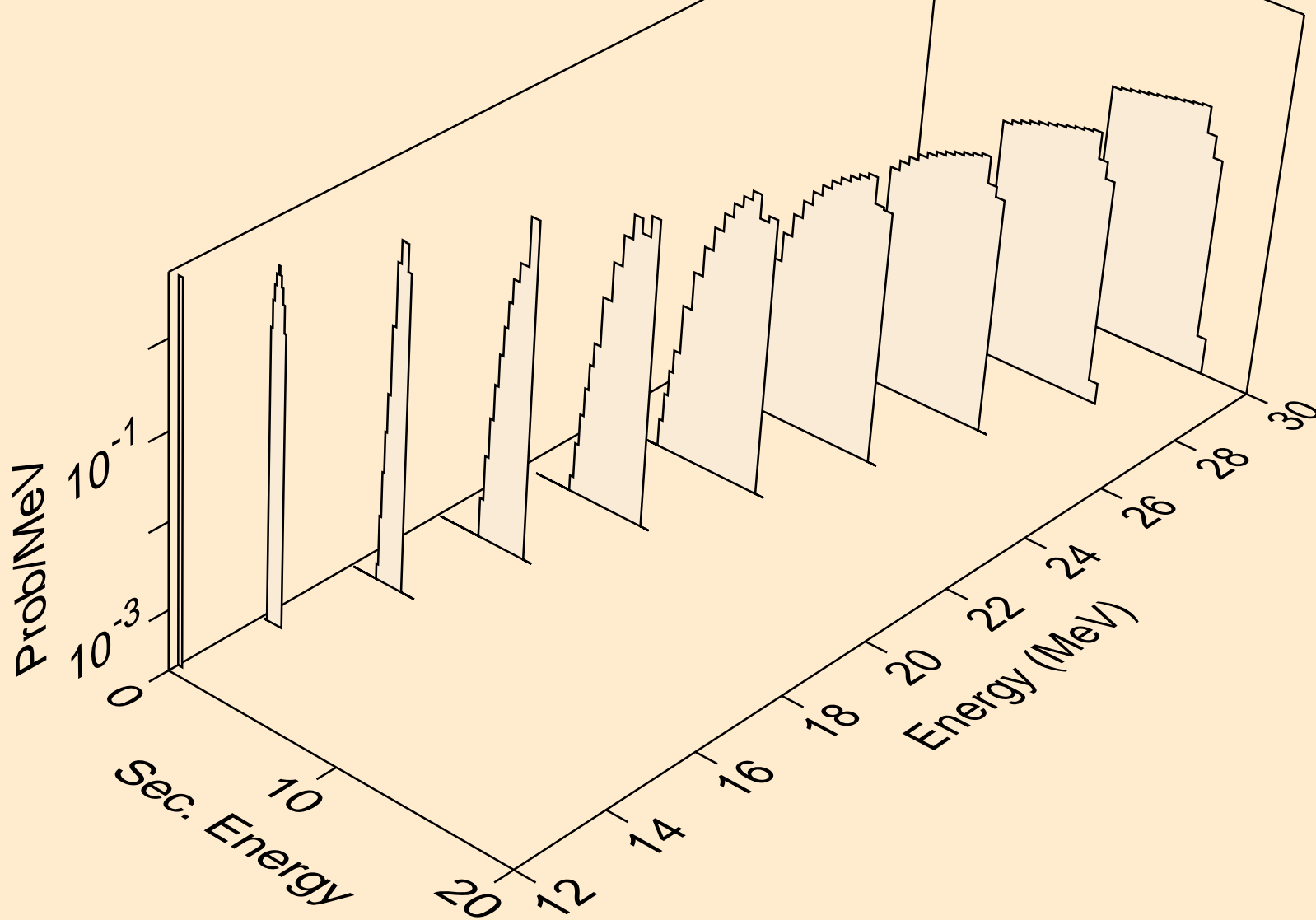

MO108 NEUTRON ACER TENDL-2023 LIBRARY; T=0.K
tritons from (n,x)

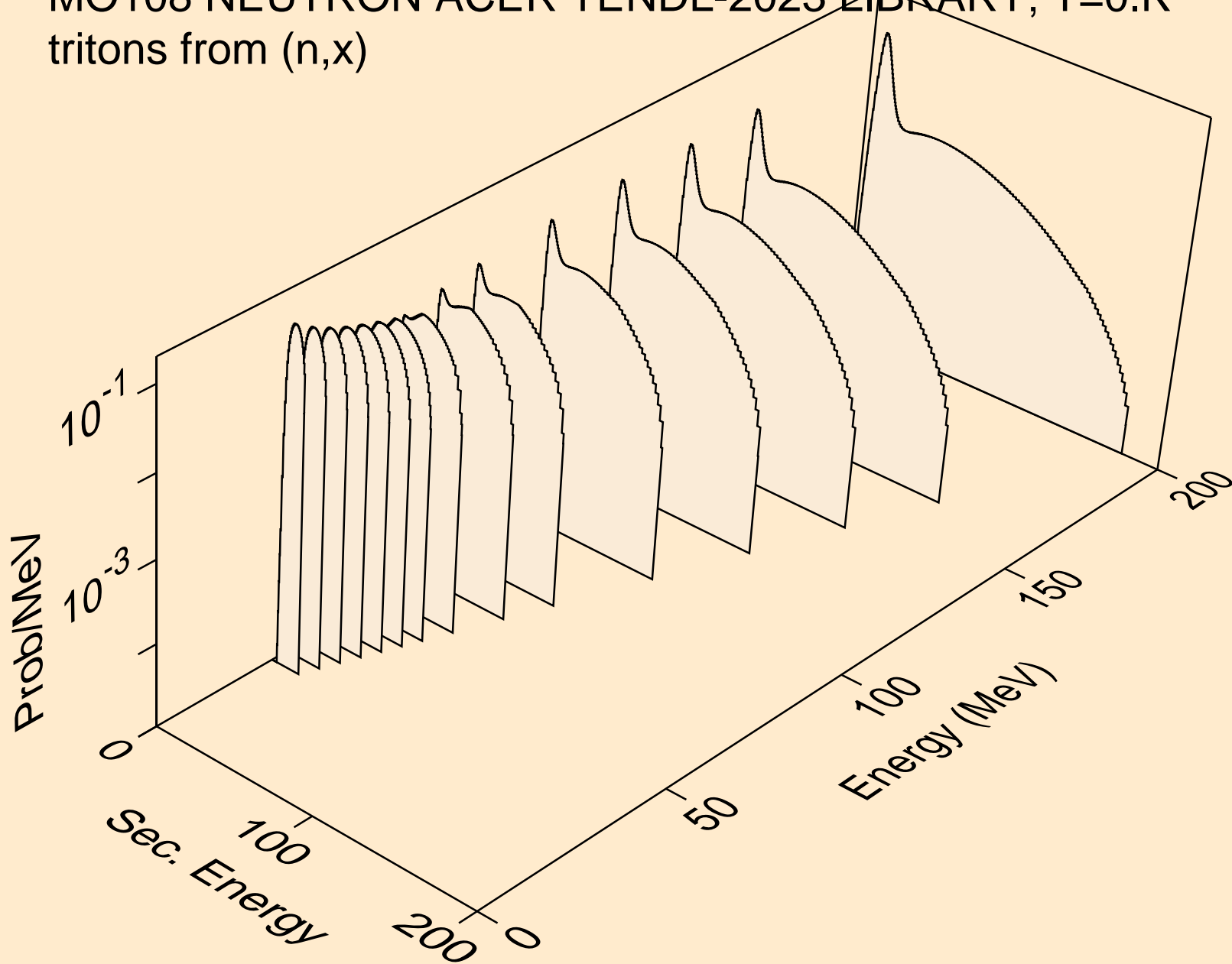

MO108 NEUTRON ACER TENDL-2023 LIBRARY; T=0.K
tritons from (n,n*)t

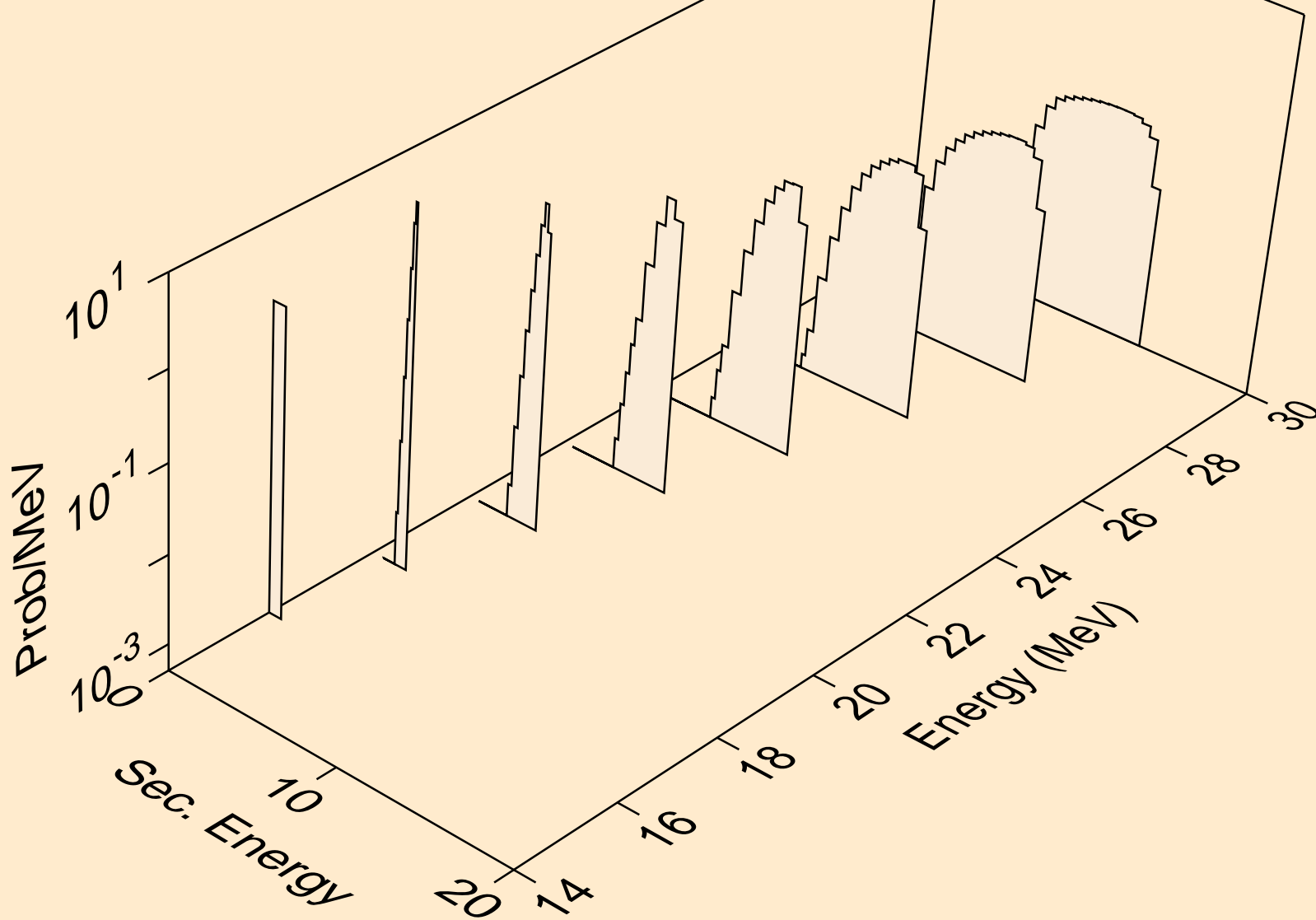

MO108 NEUTRON ACER TENDL-2023 LIBRARY; T=0.K
tritons from (n,t)

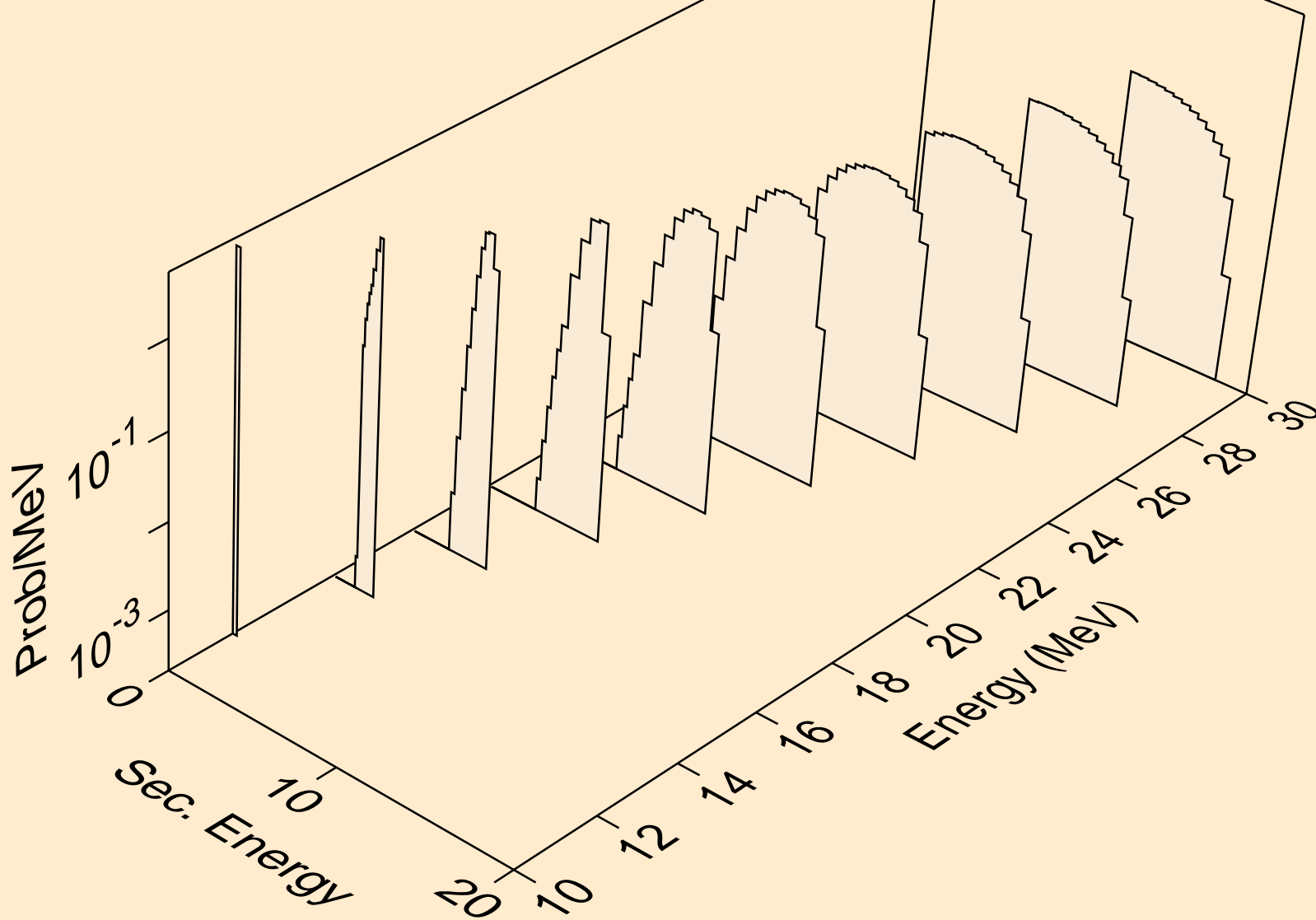

MO108 NEUTRON ACER TENDL-2023 LIBRARY; T=0.K
he3s from (n,x)

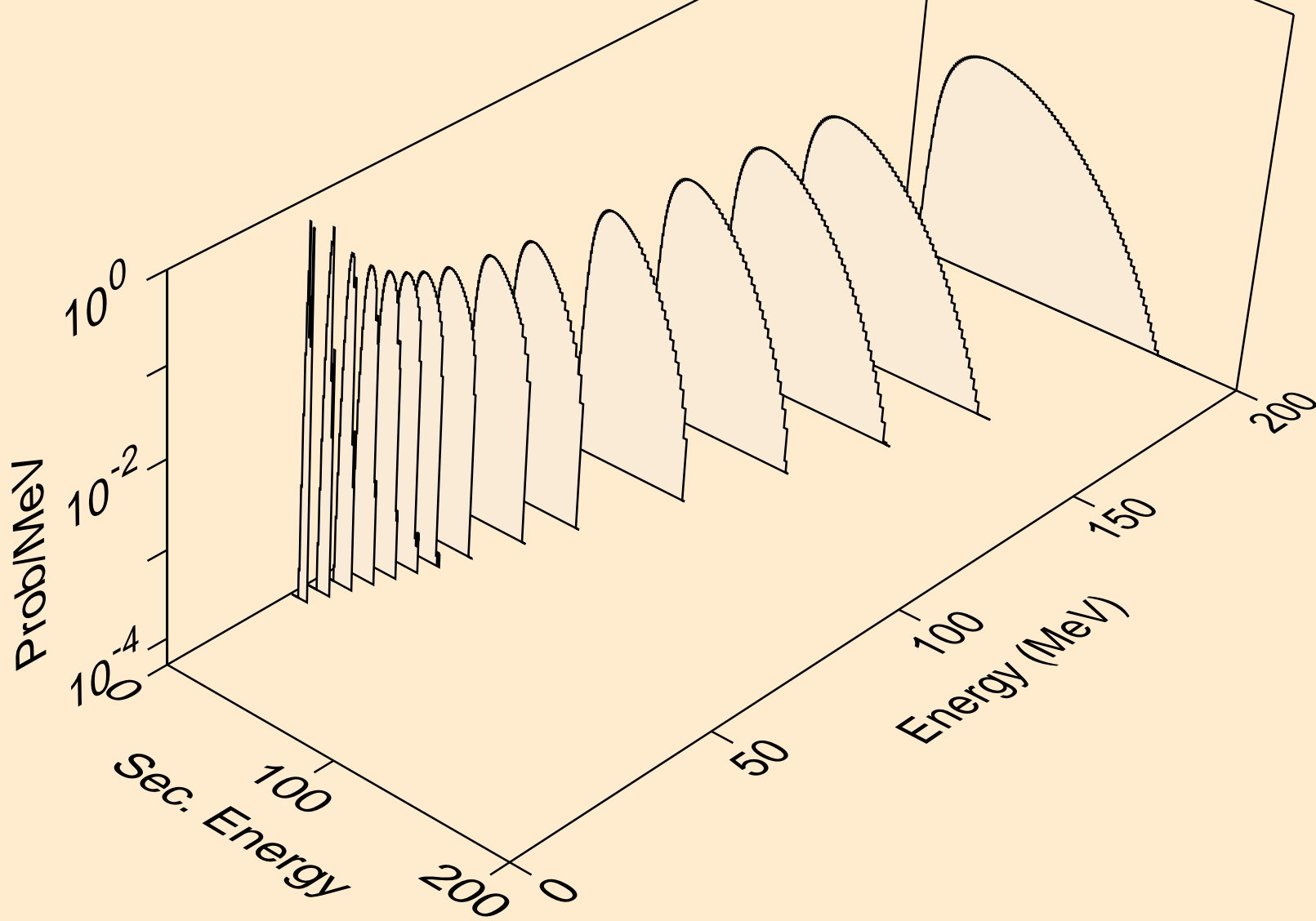

MO108 NEUTRON ACER TENDL-2023 LIBRARY; T=0.K
he3s from (n,he3)

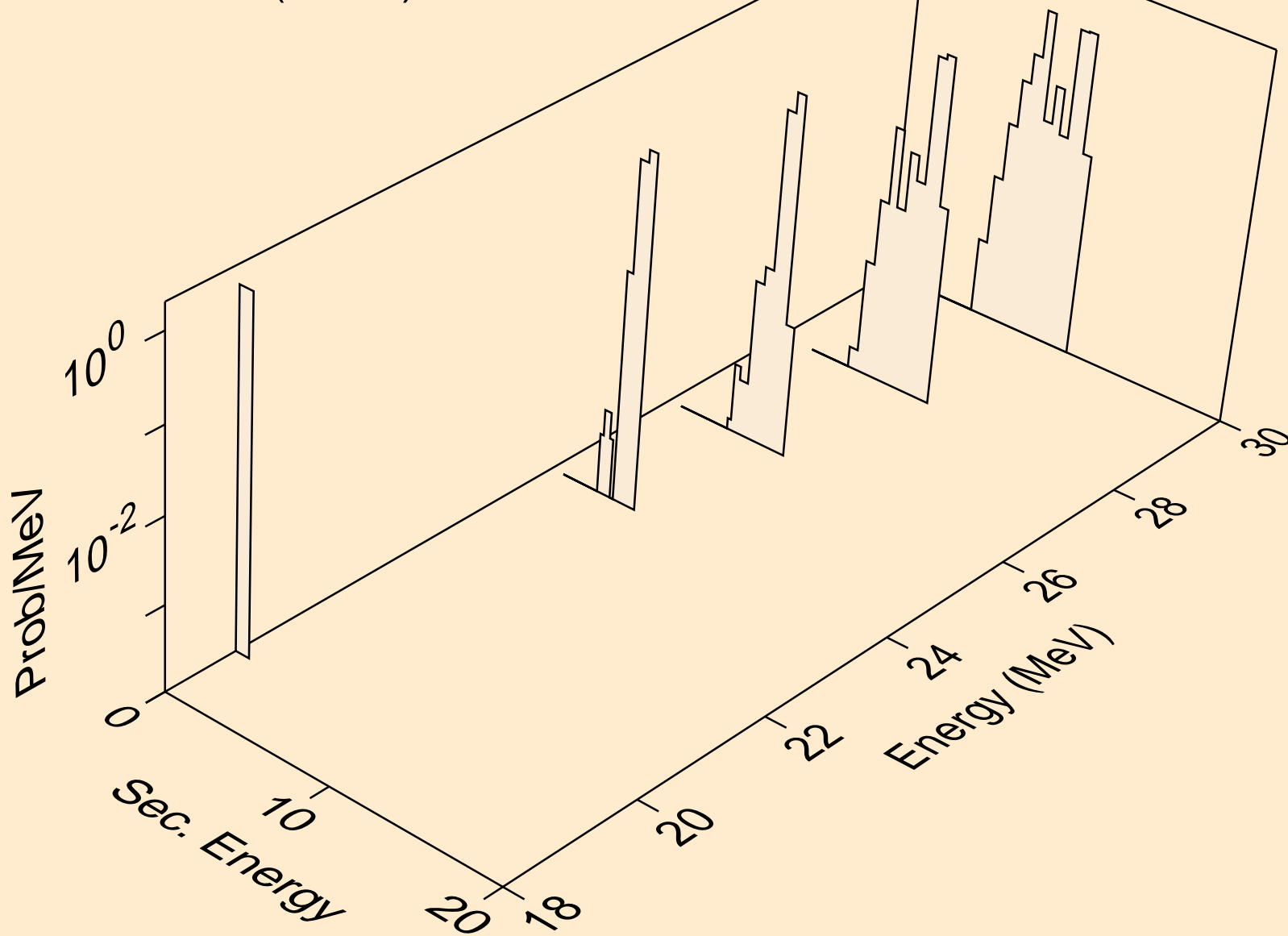

MO108 NEUTRON ACER TENDL-2023 LIBRARY; T=0.K
alphas from (n,x)

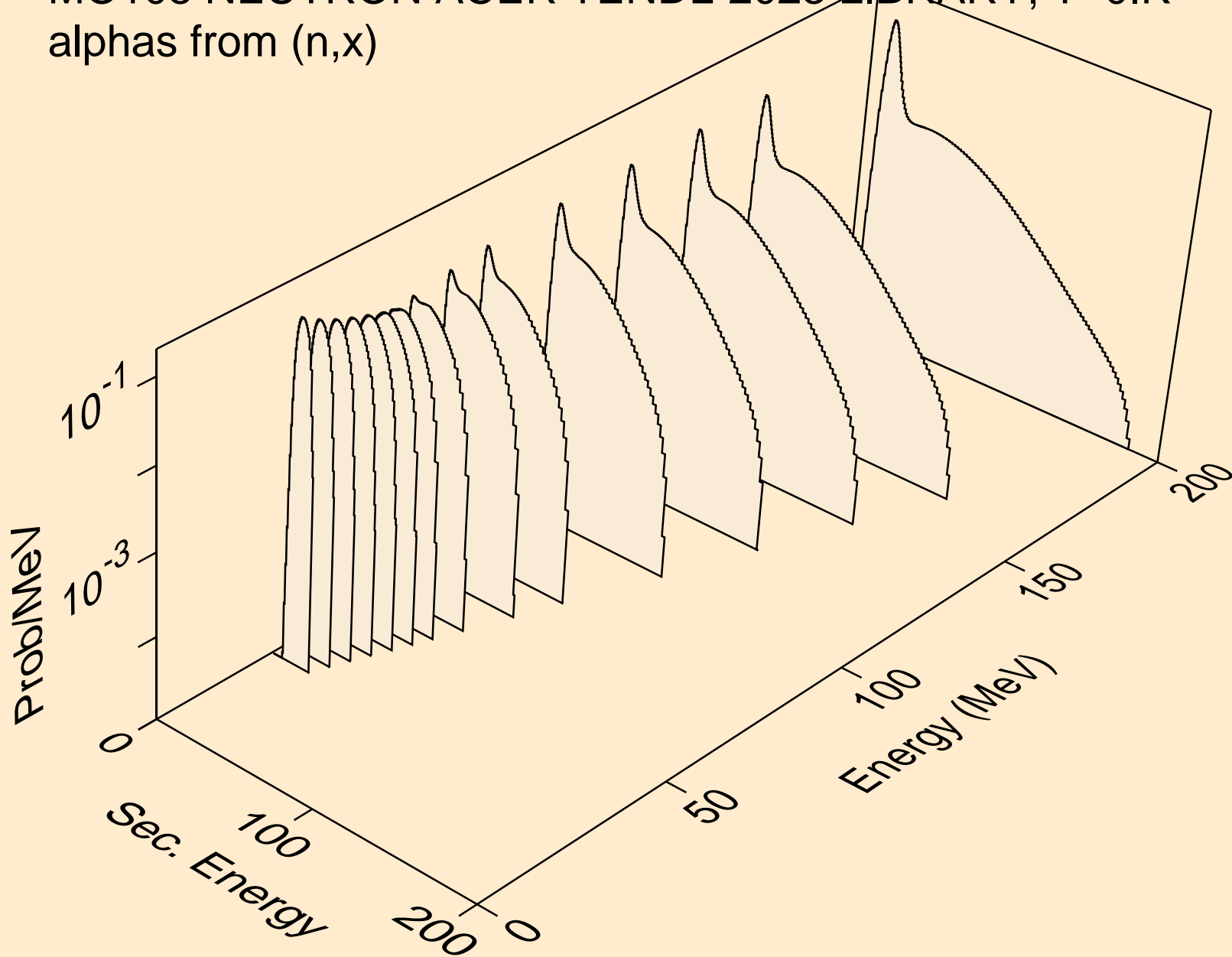

MO108 NEUTRON ACER TENDL-2023 LIBRARY; T=0.K
alphas from (n,n*)a

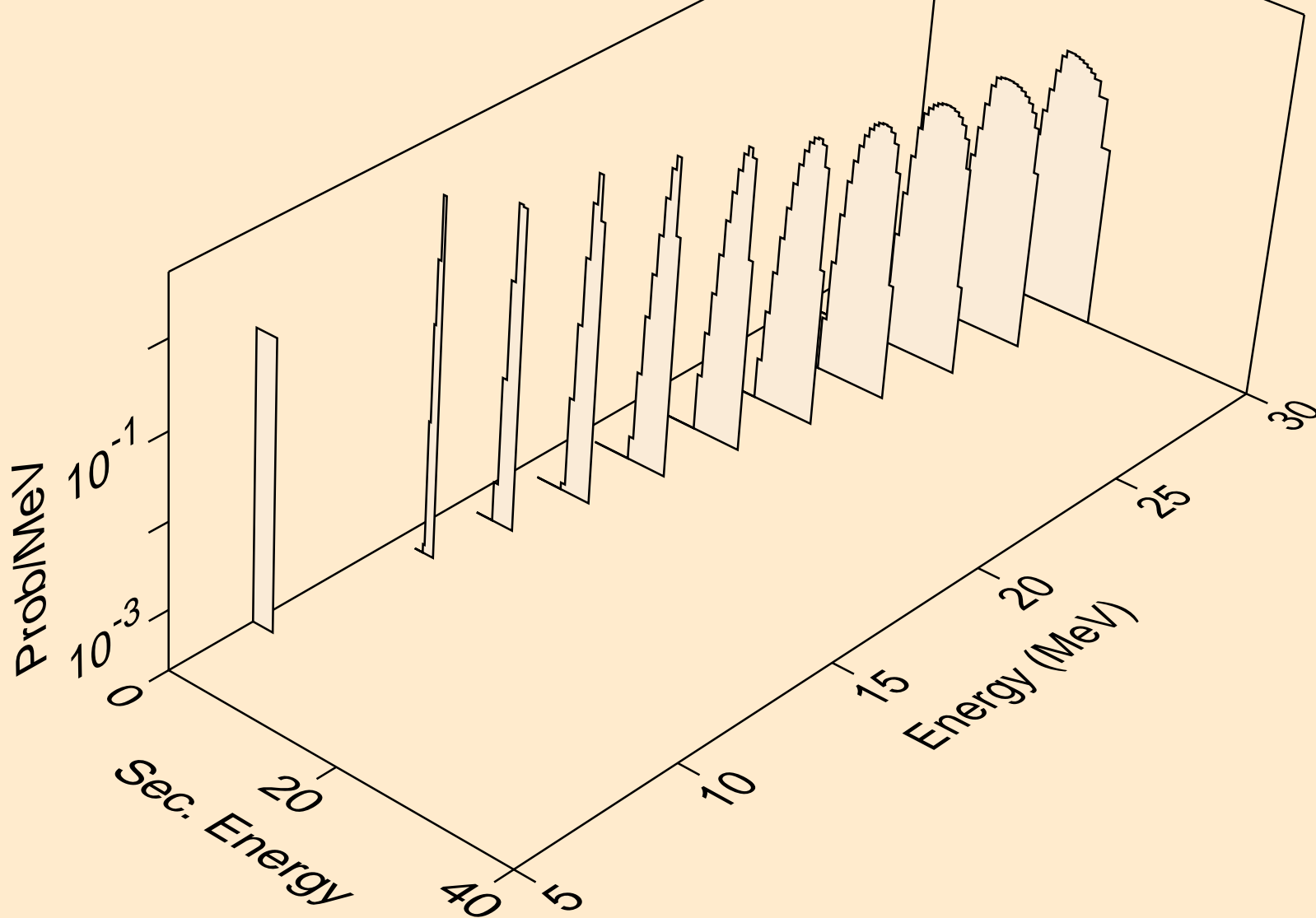

MO108 NEUTRON ACER TENDL-2023 LIBRARY; T=0.K
alphas from (n,2n)a

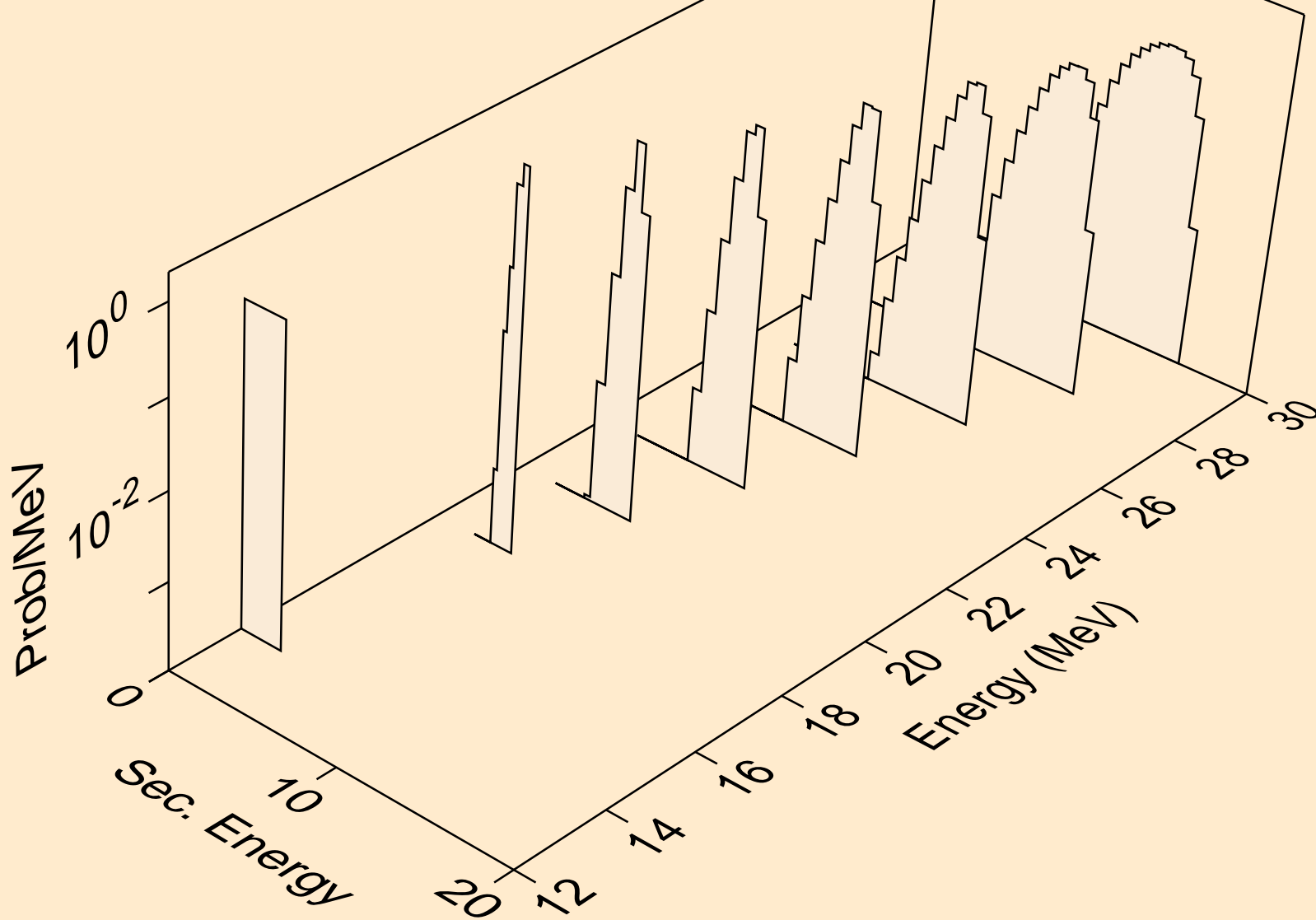

MO108 NEUTRON ACER TENDL-2023 LIBRARY; T=0.K
alphas from (n,3n)a

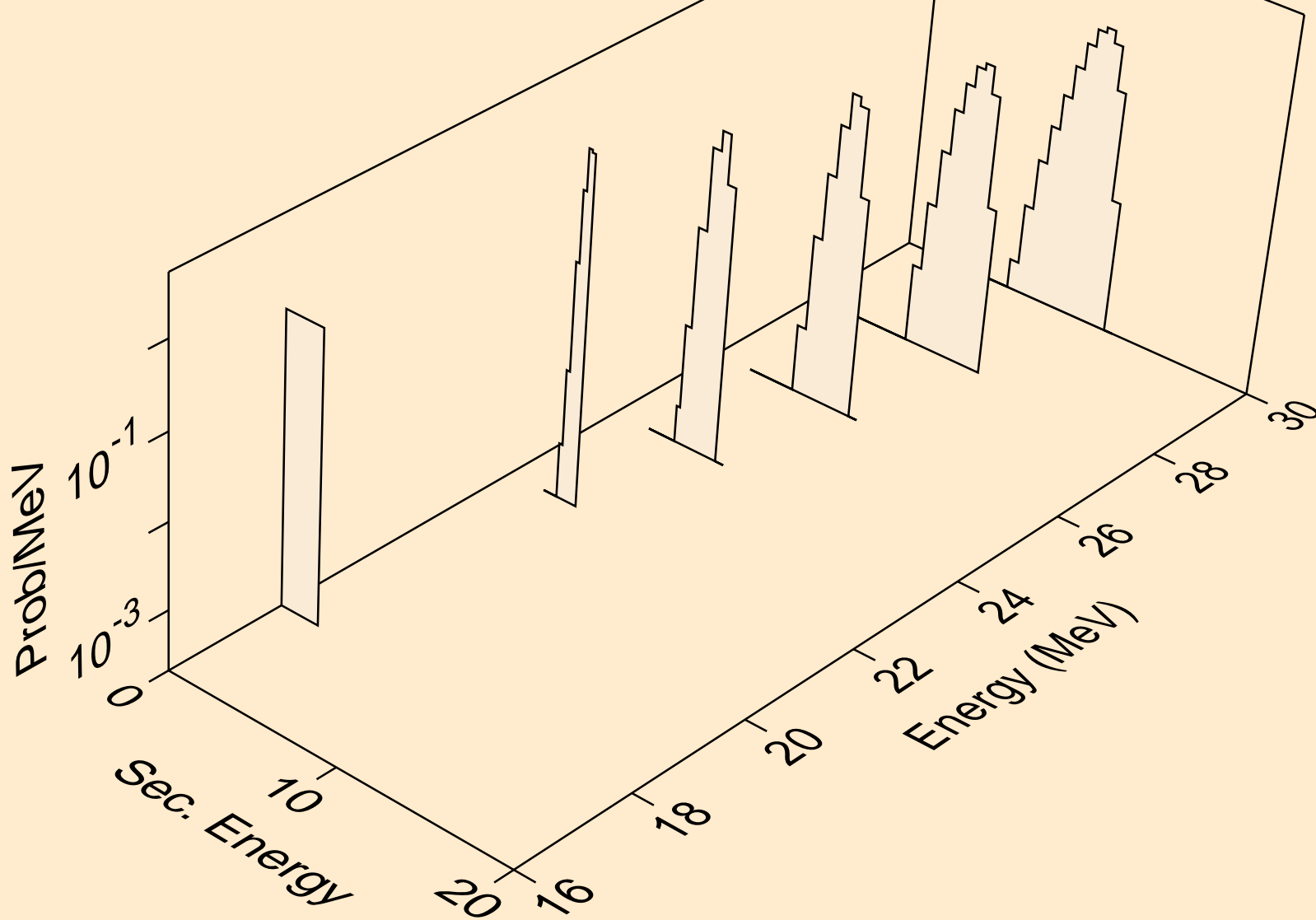

MO108 NEUTRON ACER TENDL-2023 LIBRARY; T=0.K
alphas from (n,a)

