

NB090 NEUTRON ACER TENDL-2023 LIBRARY; T=0.K

Principal cross sections

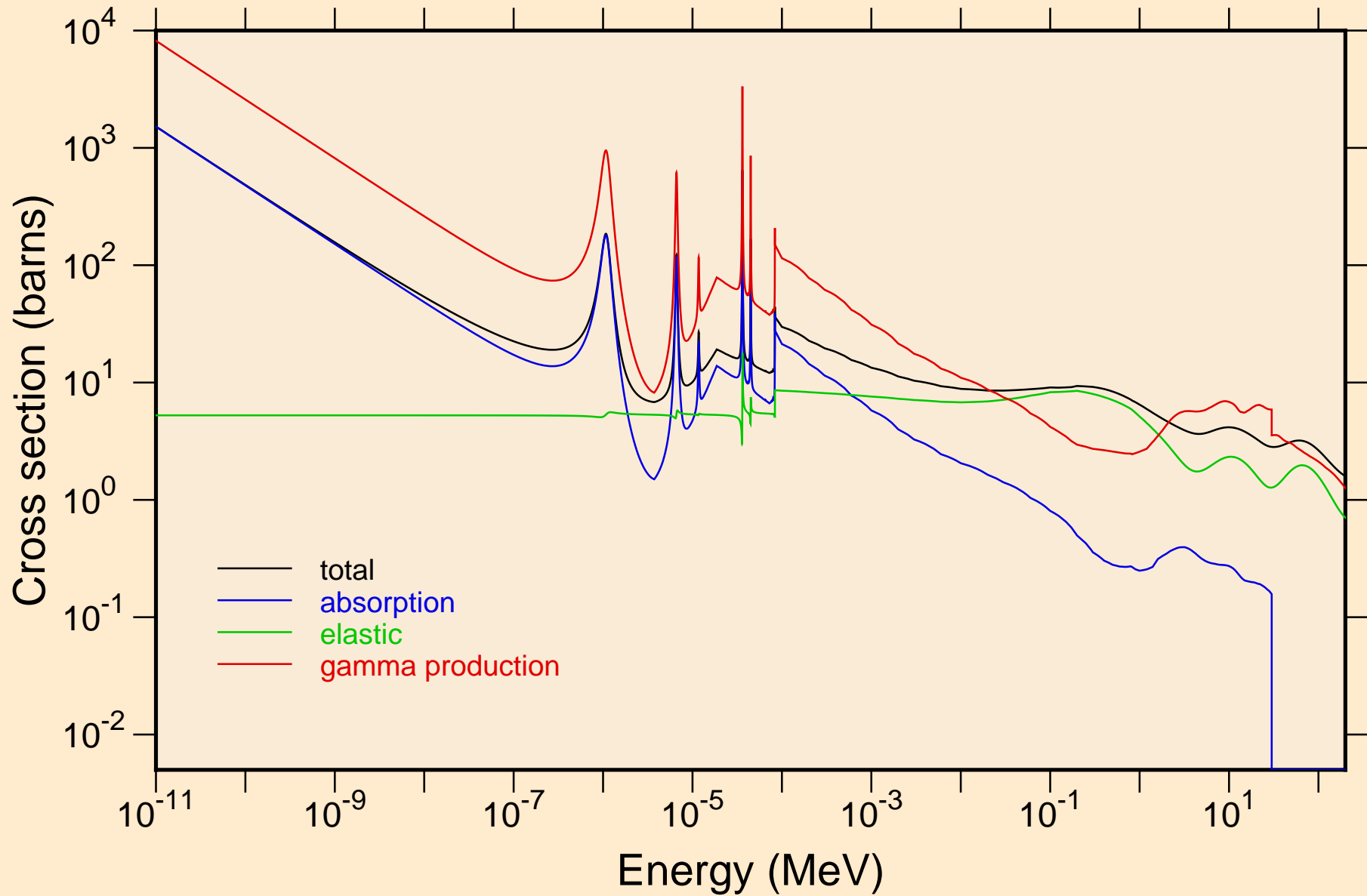

NB090 NEUTRON ACER TENDL-2023 LIBRARY; T=0.K
resonance total cross section

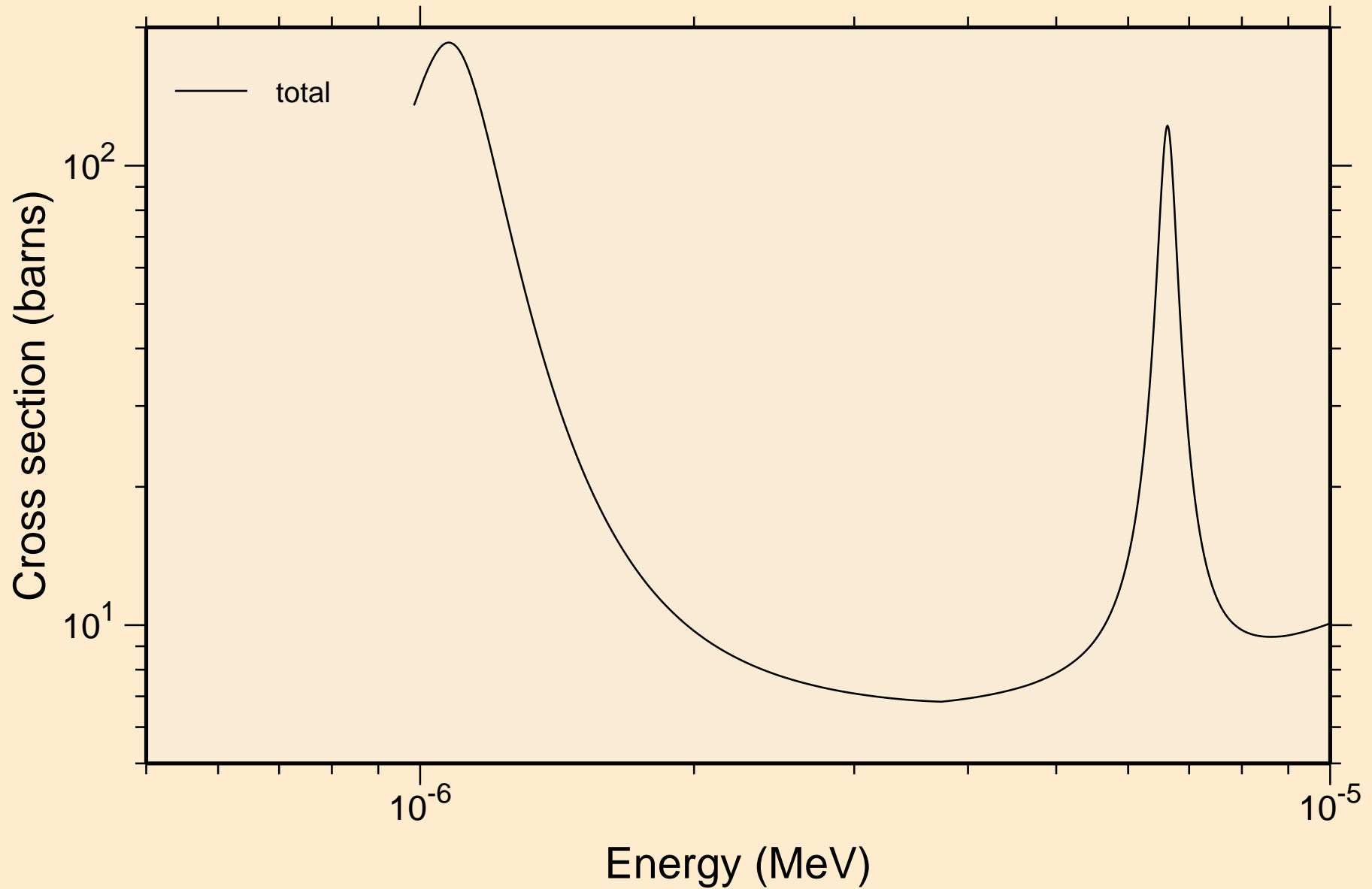

NB090 NEUTRON ACER TENDL-2023 LIBRARY; T=0.K
resonance total cross section

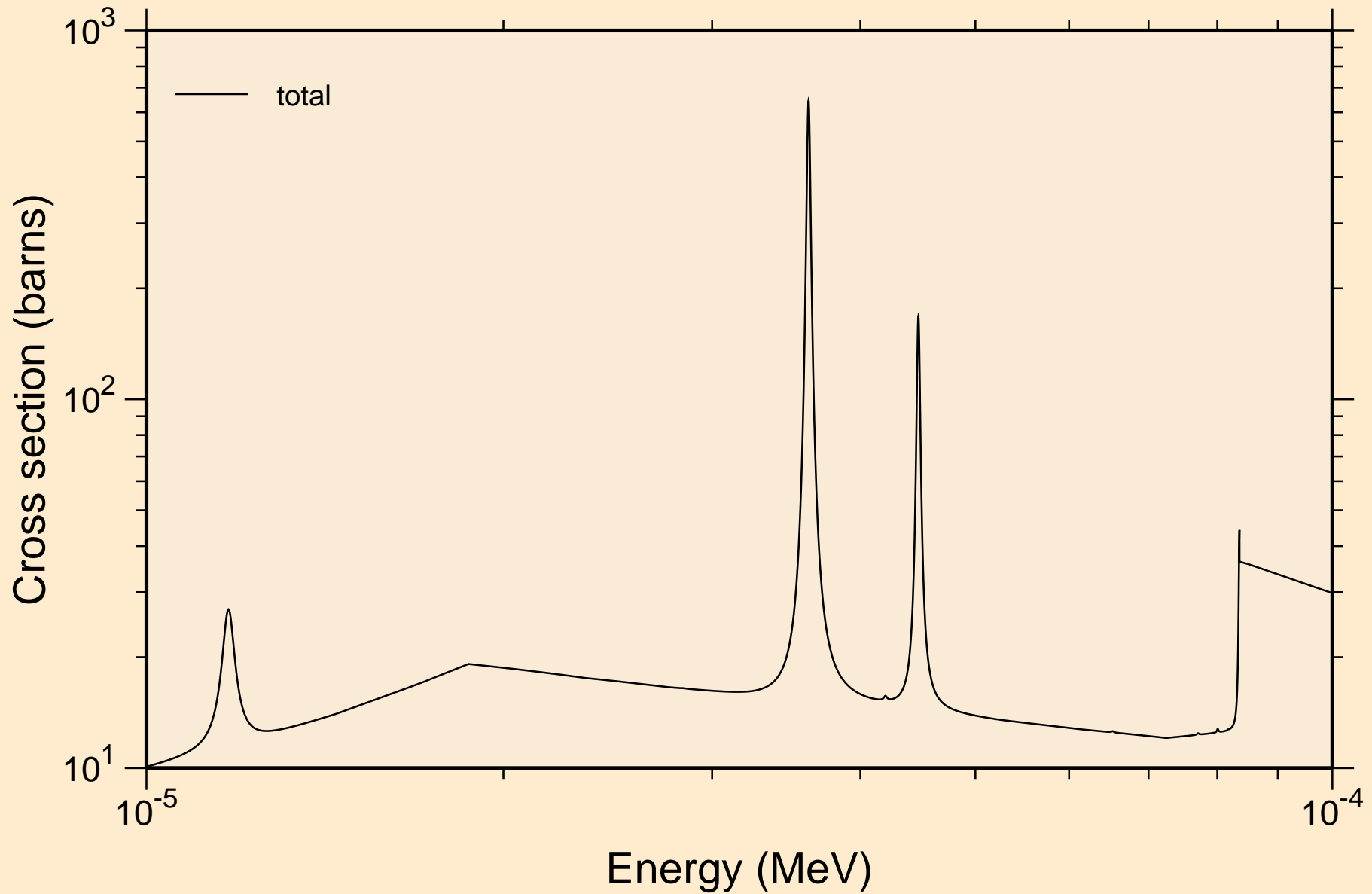

NB090 NEUTRON ACER TENDL-2023 LIBRARY; T=0.K
resonance total cross section

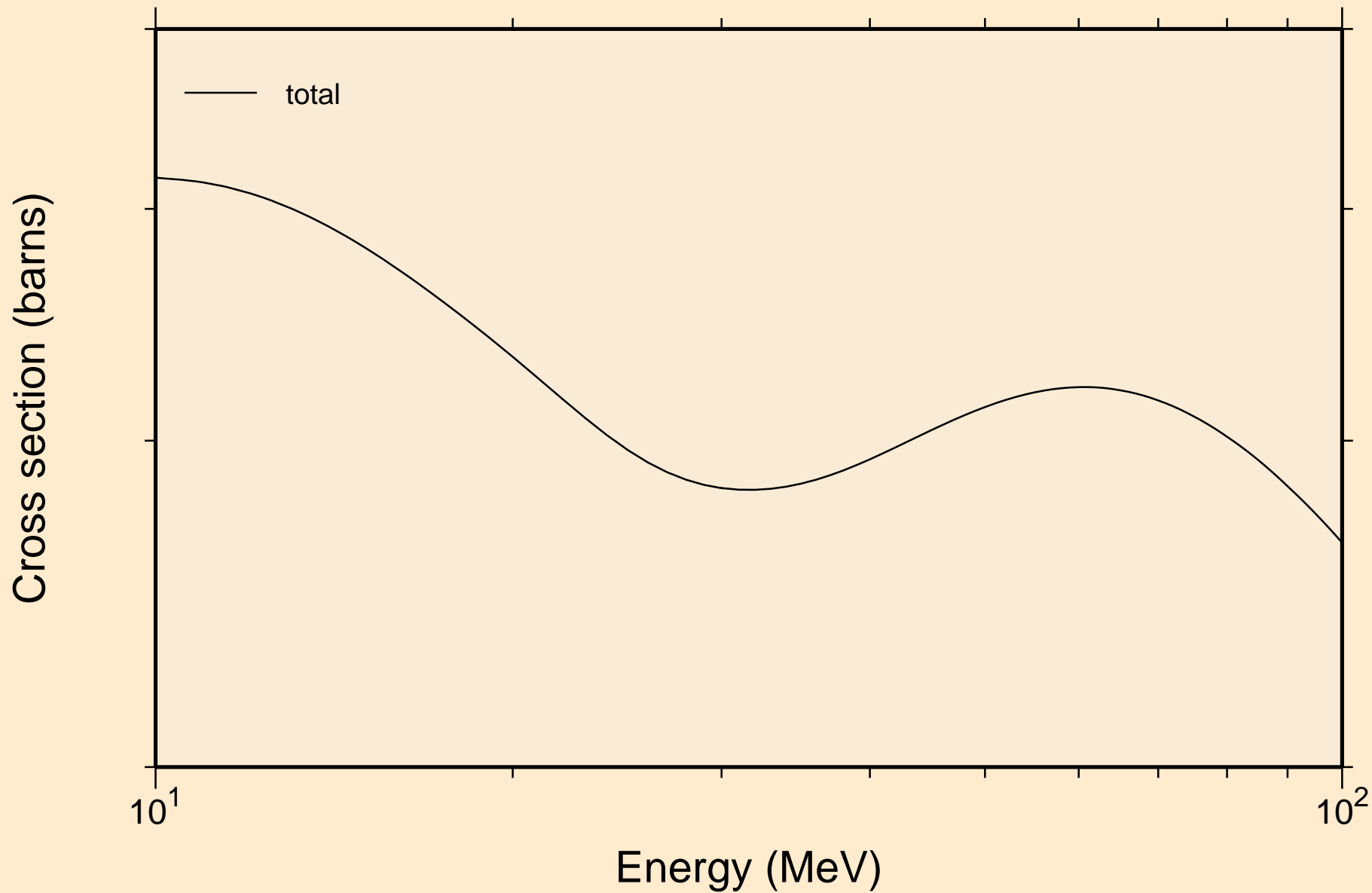

NB090 NEUTRON ACER TENDL-2023 LIBRARY; T=0.K
resonance absorption cross sections

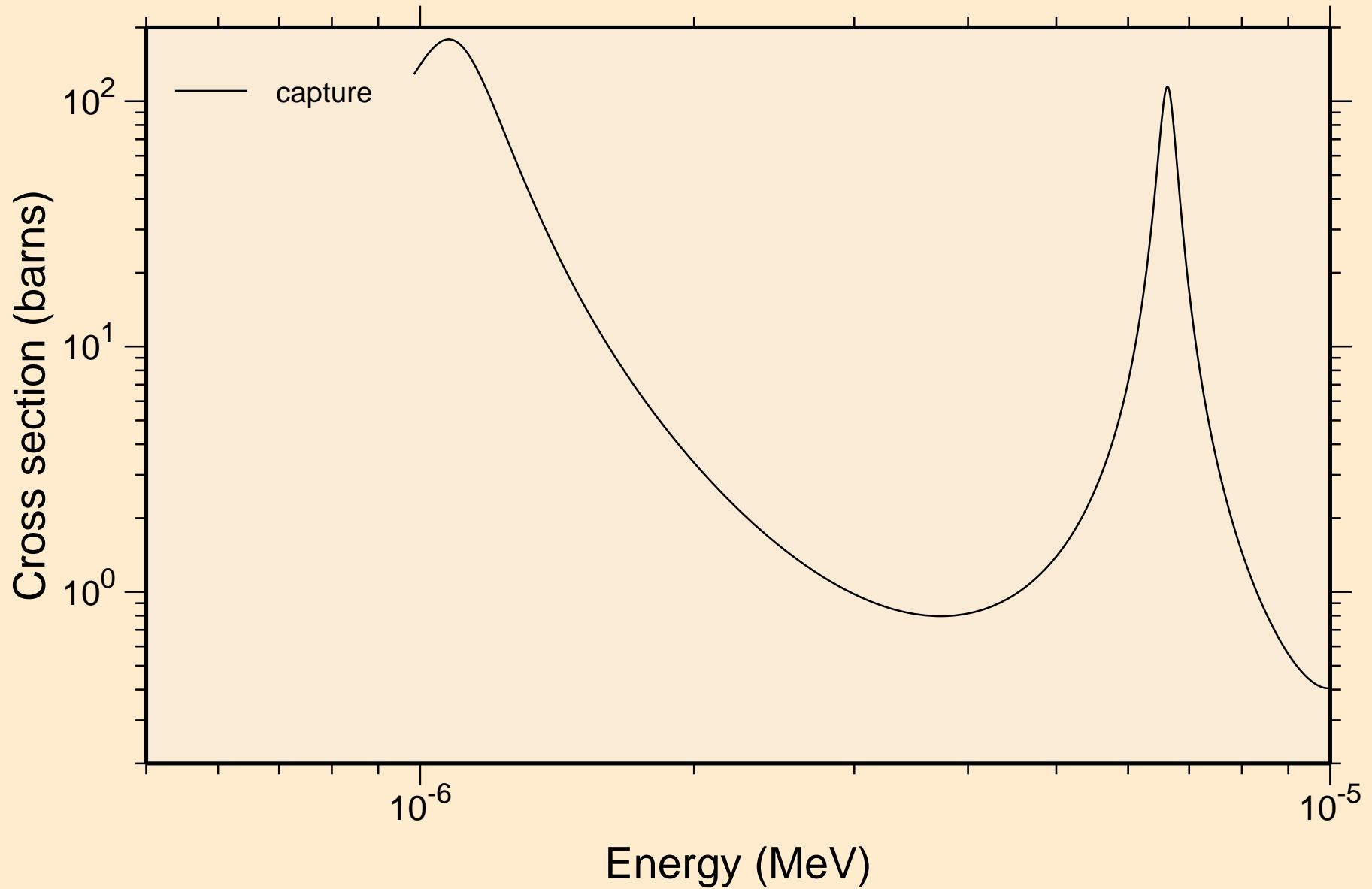

NB090 NEUTRON ACER TENDL-2023 LIBRARY; T=0.K
resonance absorption cross sections

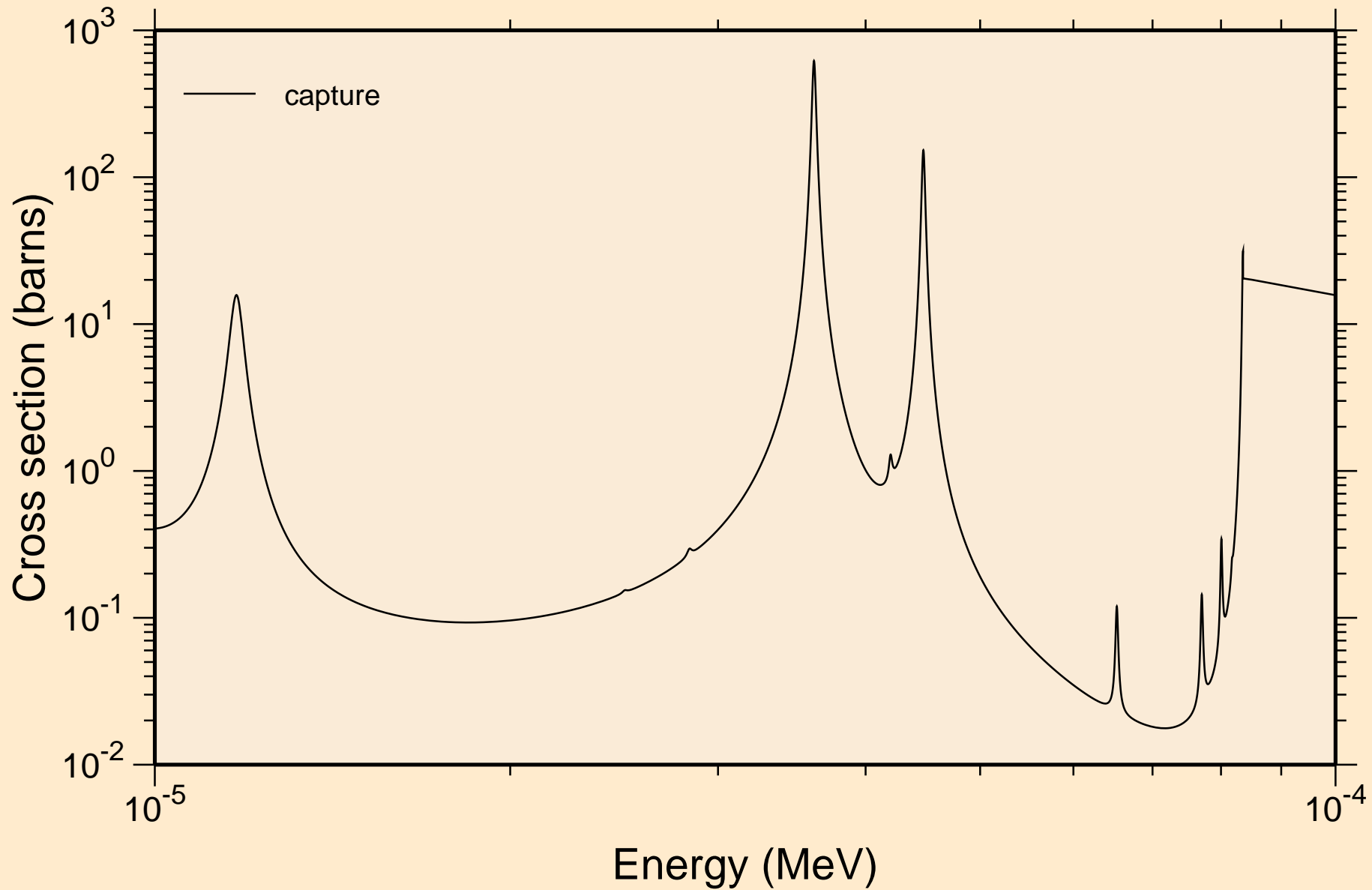

NB090 NEUTRON ACER TENDL-2023 LIBRARY; T=0.K
resonance absorption cross sections

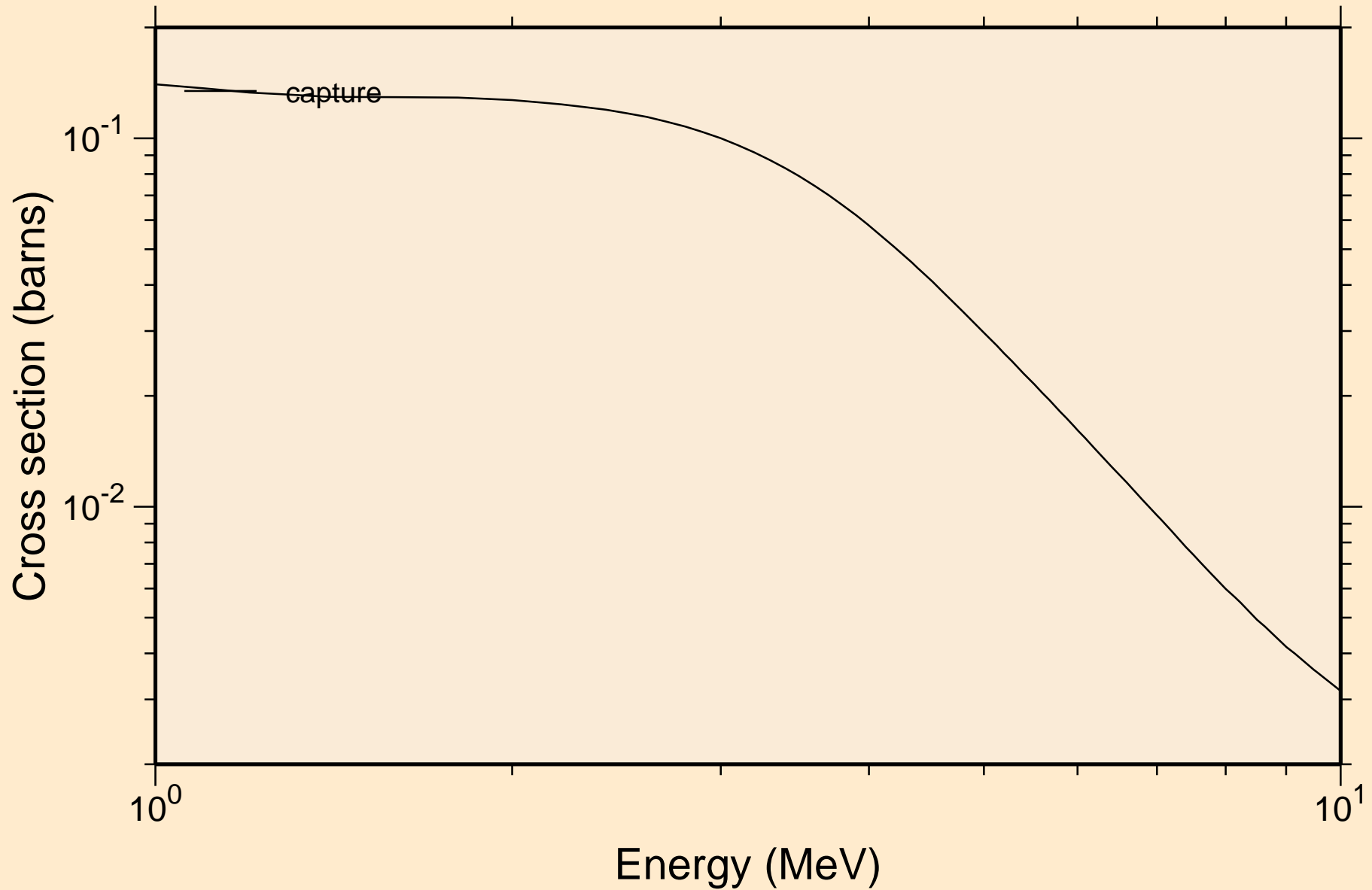

NB090 NEUTRON ACER TENDL-2023 LIBRARY; T=0.K
Heating

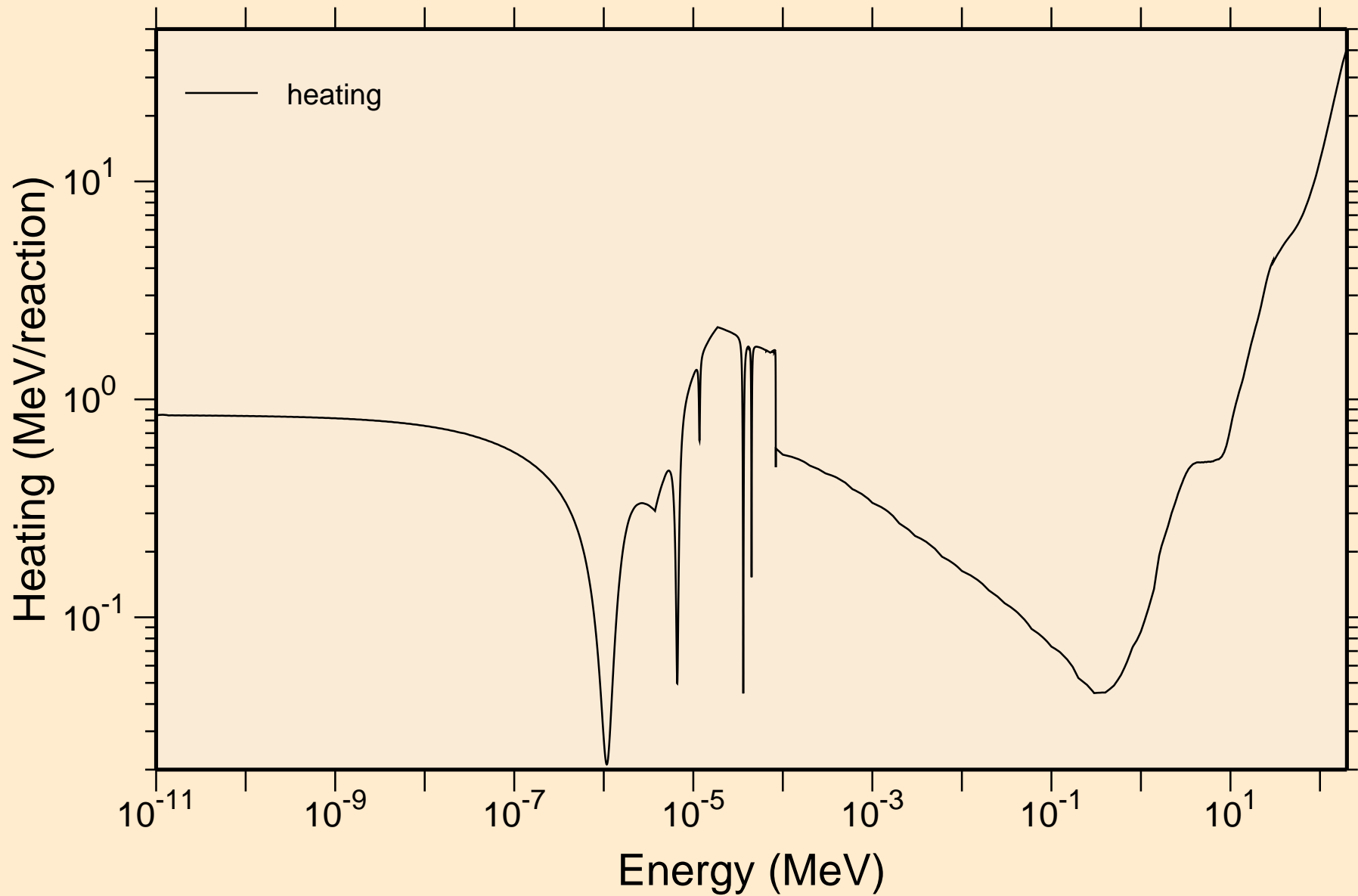

NB090 NEUTRON ACER TENDL-2023 LIBRARY; T=0.K
Damage

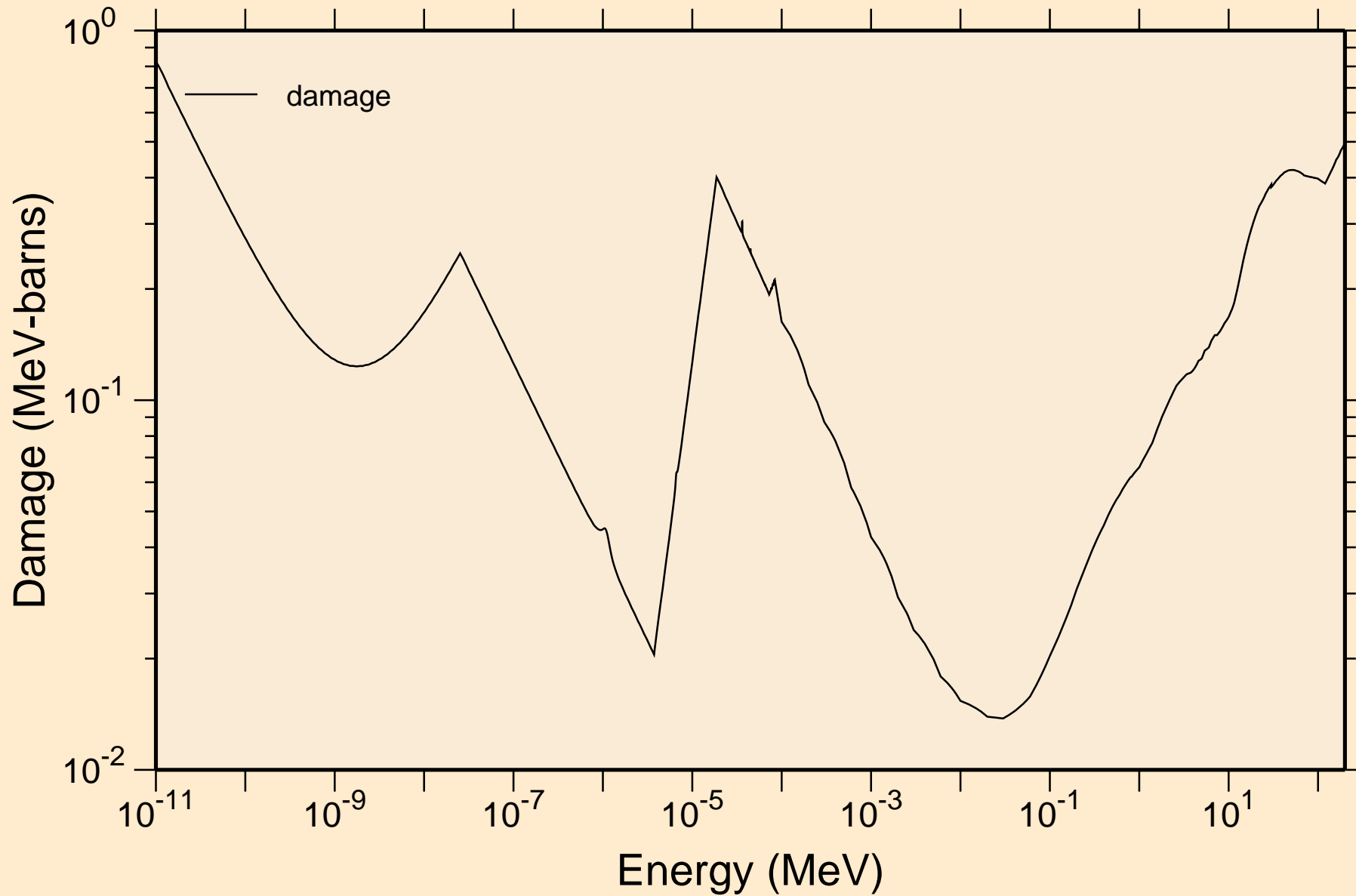

NB090 NEUTRON ACER TENDL-2023 LIBRARY; T=0.K

Non-threshold reactions

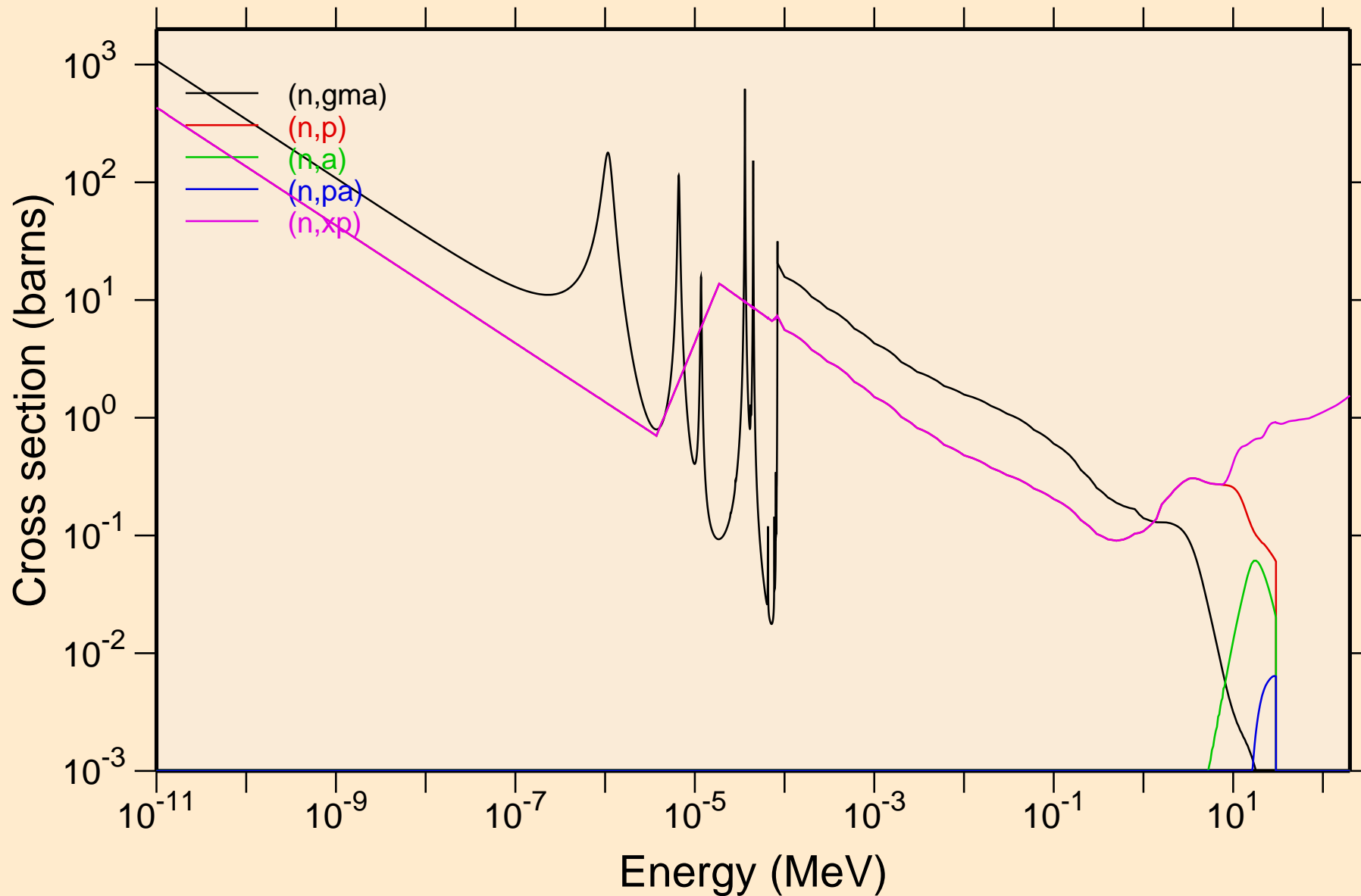

NB090 NEUTRON ACER TENDL-2023 LIBRARY; T=0.K
Non-threshold reactions

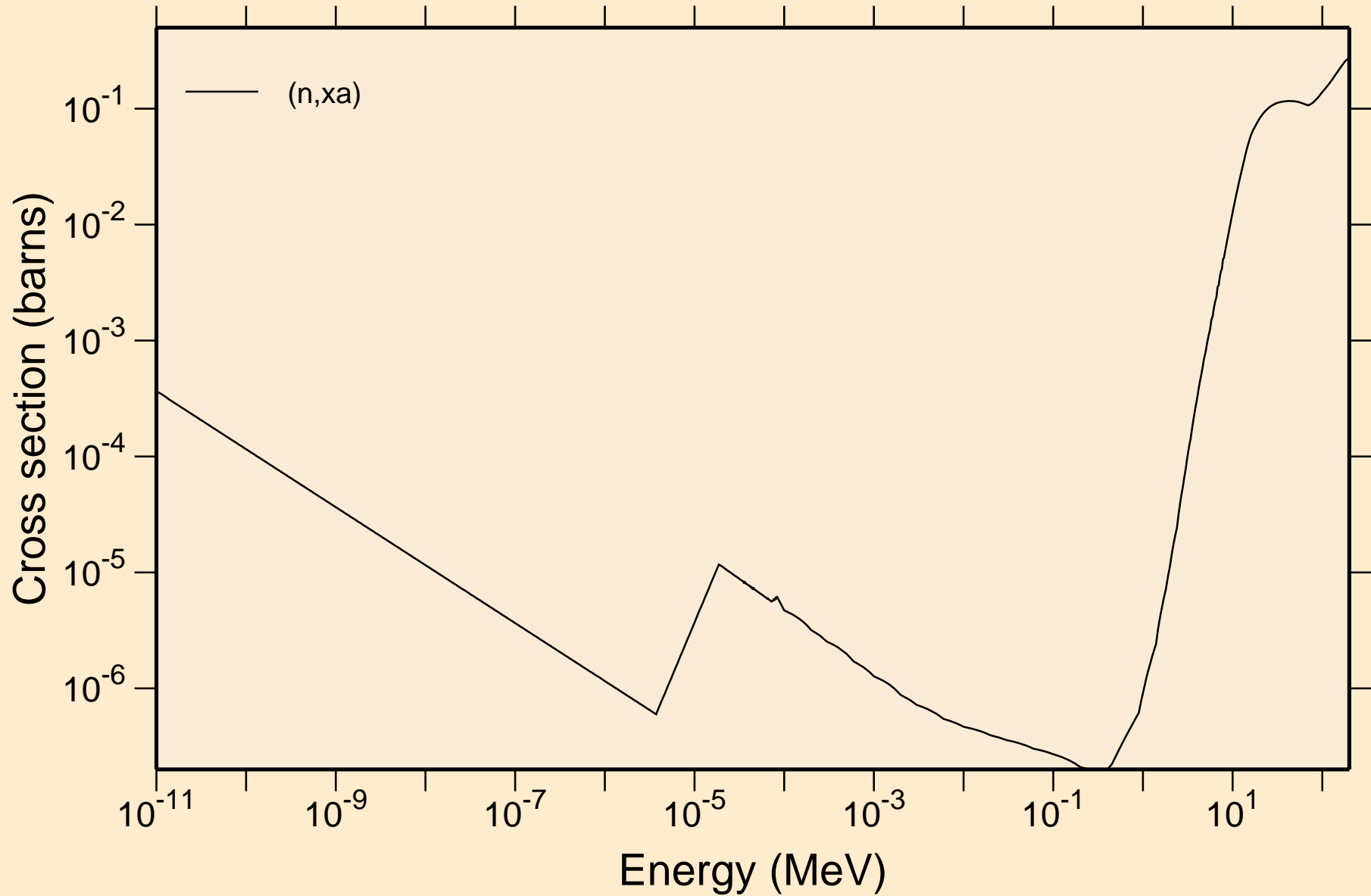

NB090 NEUTRON ACER TENDL-2023 LIBRARY; T=0.K

Principal cross sections

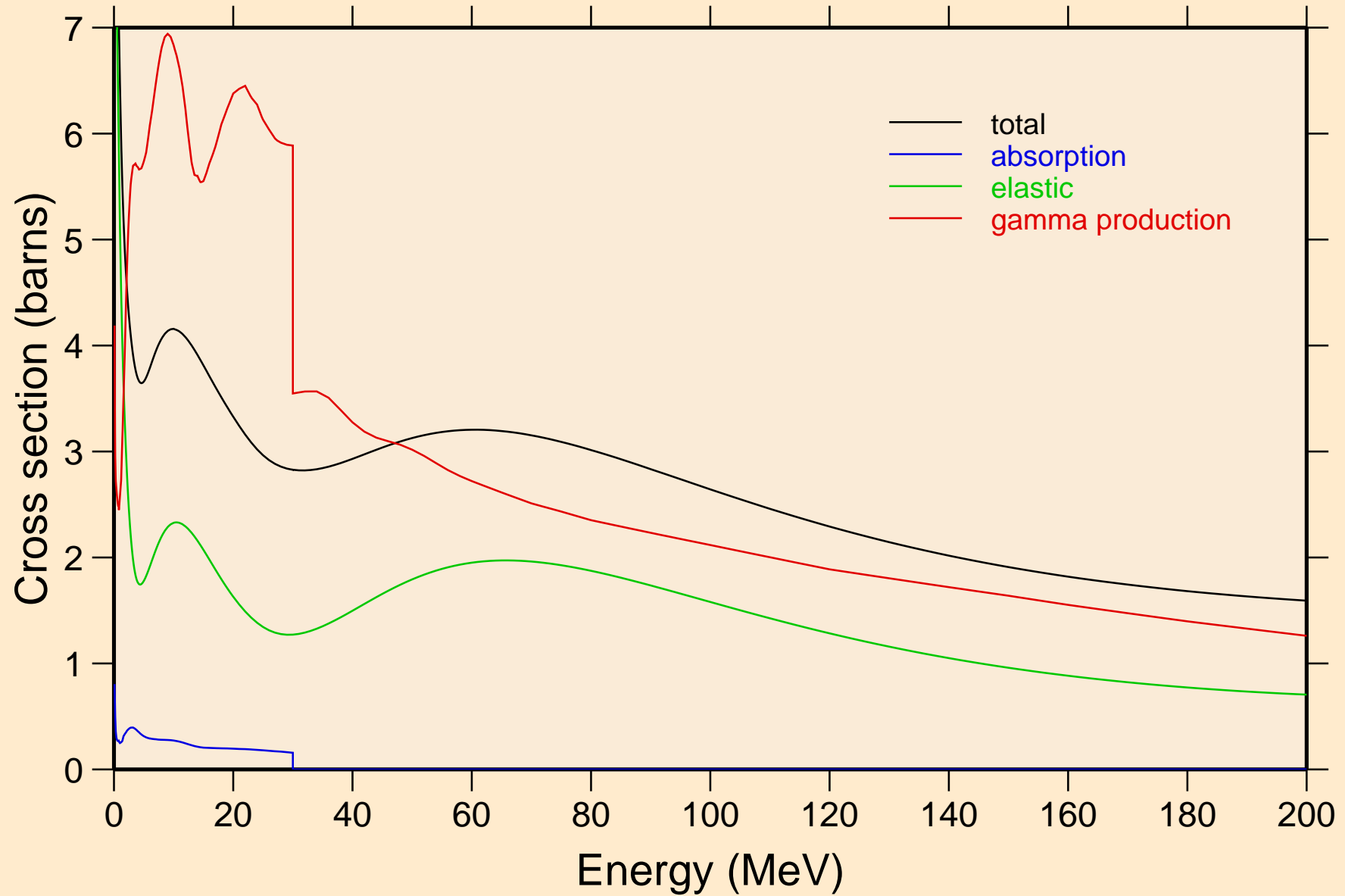

NB090 NEUTRON ACER TENDL-2023 LIBRARY; T=0.K

Heating

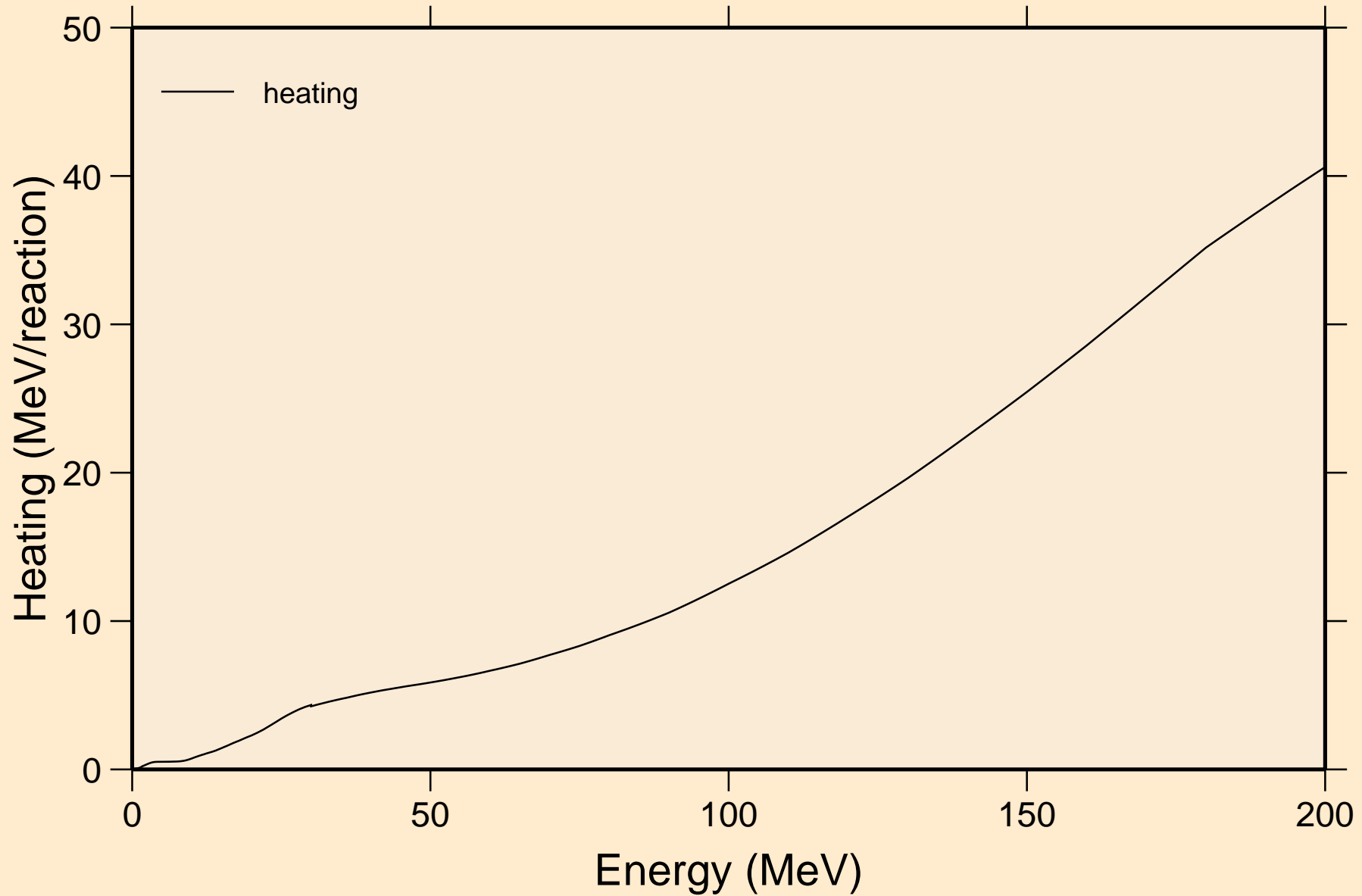

NB090 NEUTRON ACER TENDL-2023 LIBRARY; T=0.K
Damage

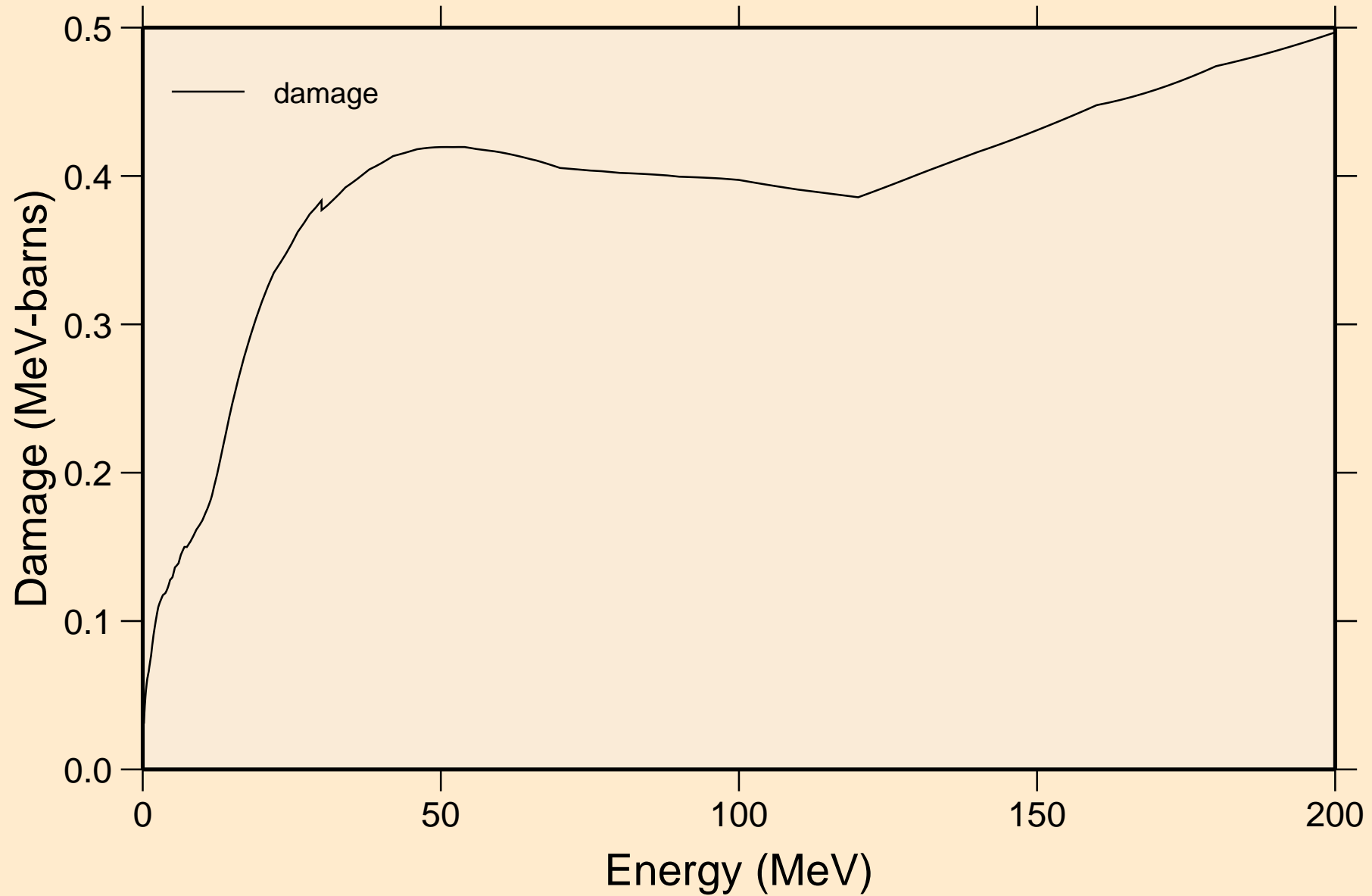

NB090 NEUTRON ACER TENDL-2023 LIBRARY; T=0.K

Non-threshold reactions

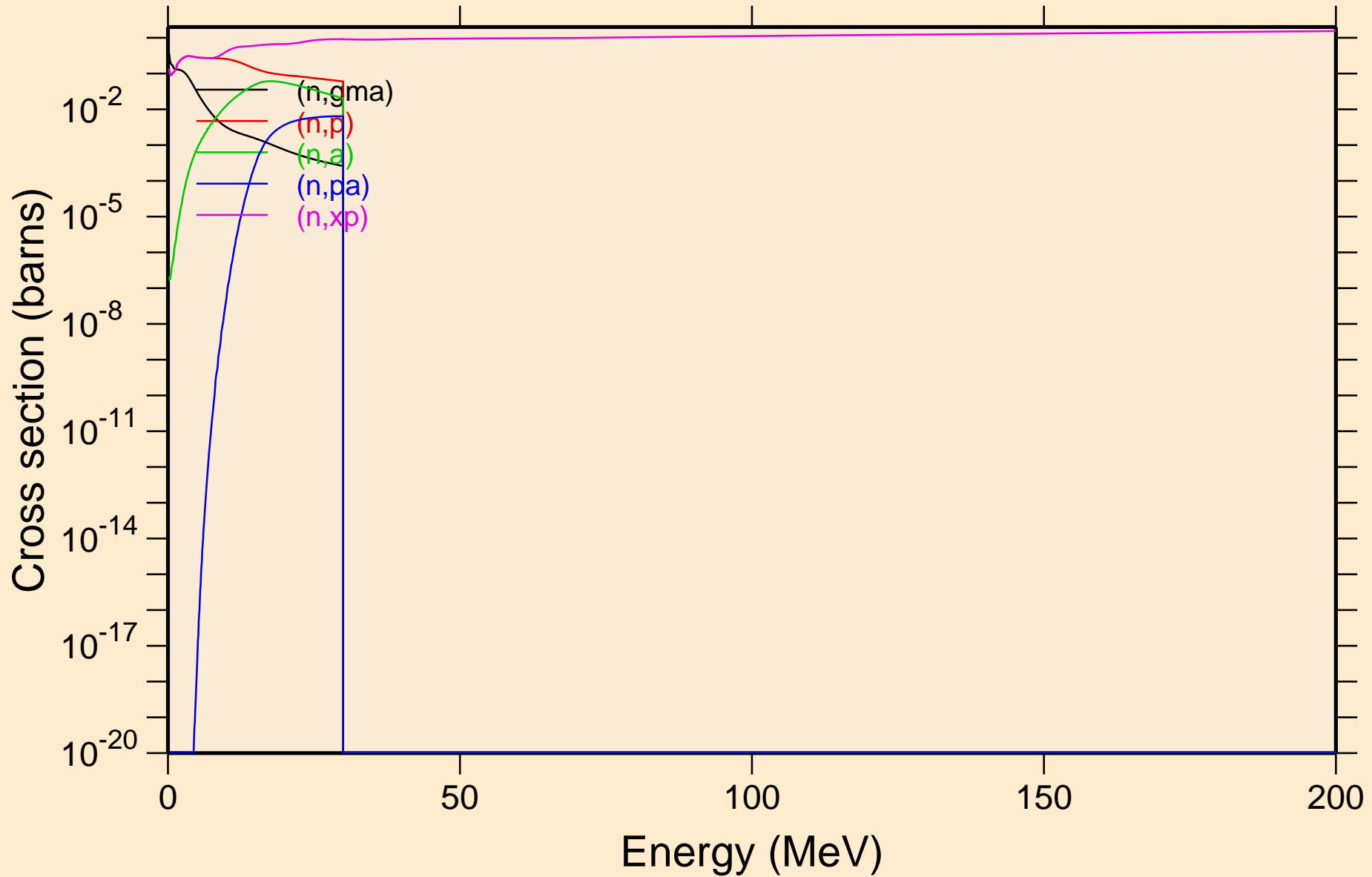

NB090 NEUTRON ACER TENDL-2023 LIBRARY; T=0.K
Non-threshold reactions

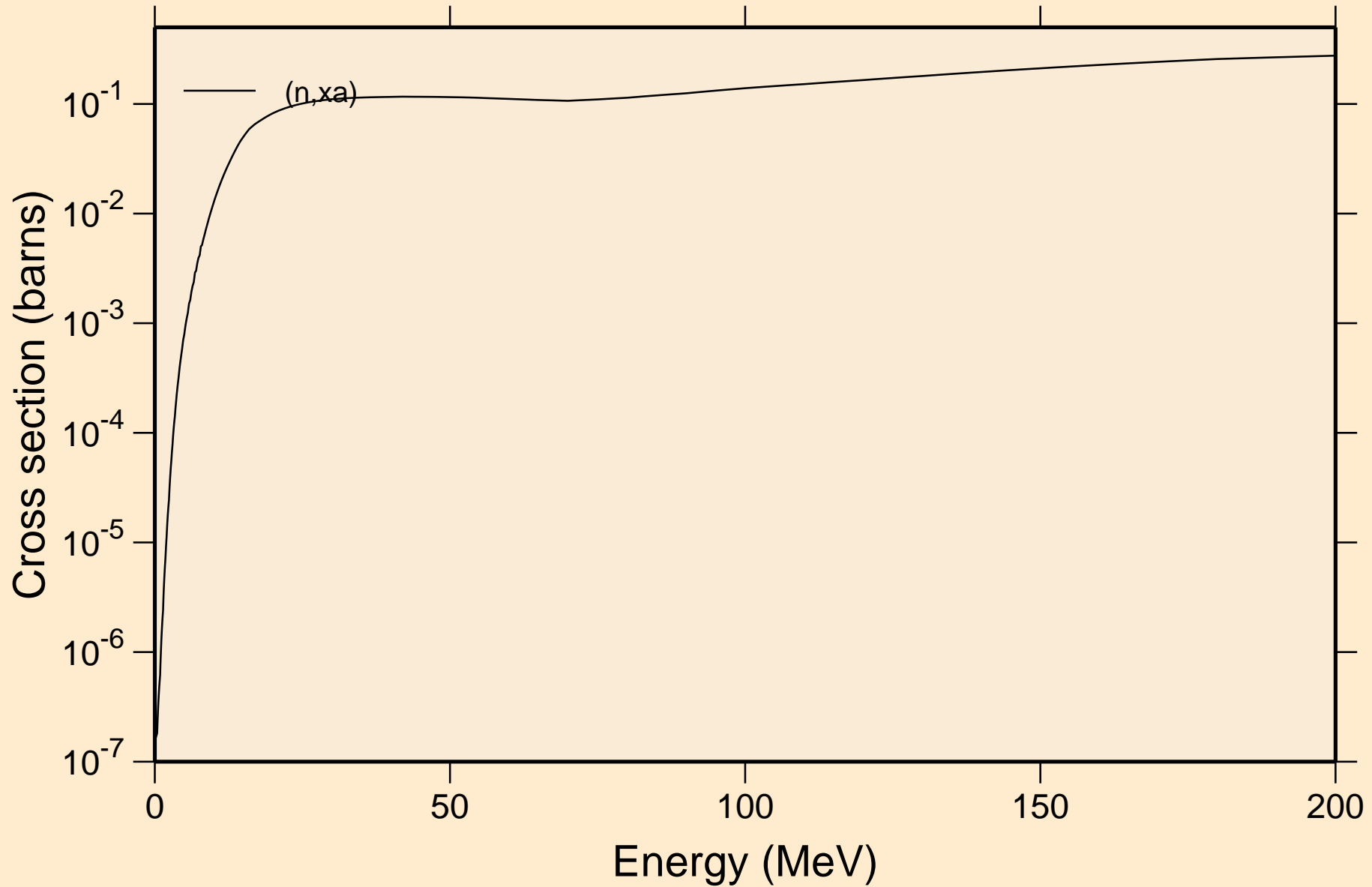

NB090 NEUTRON ACER TENDL-2023 LIBRARY; T=0.K
Inelastic levels

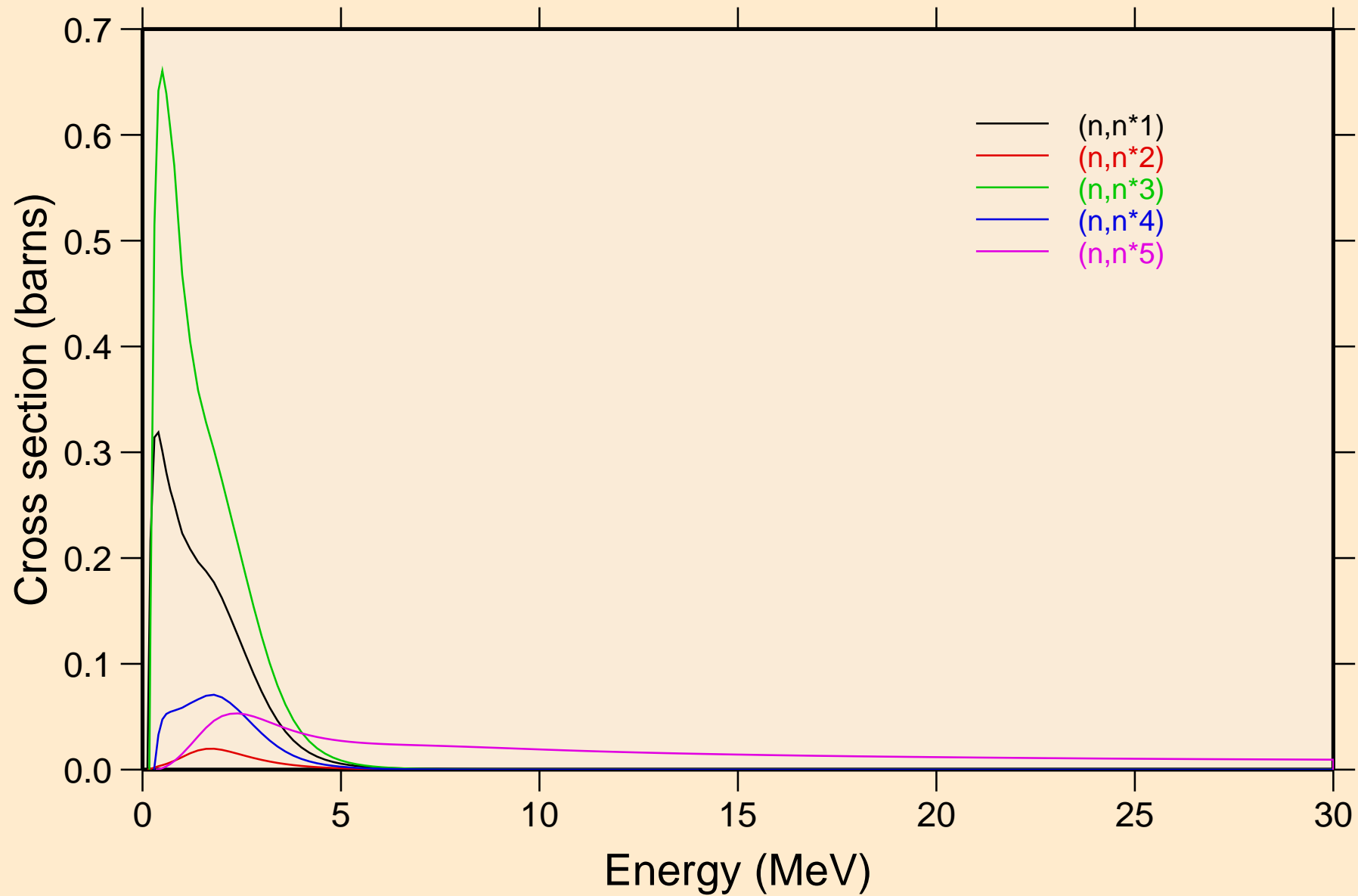

NB090 NEUTRON ACER TENDL-2023 LIBRARY; T=0.K
Inelastic levels

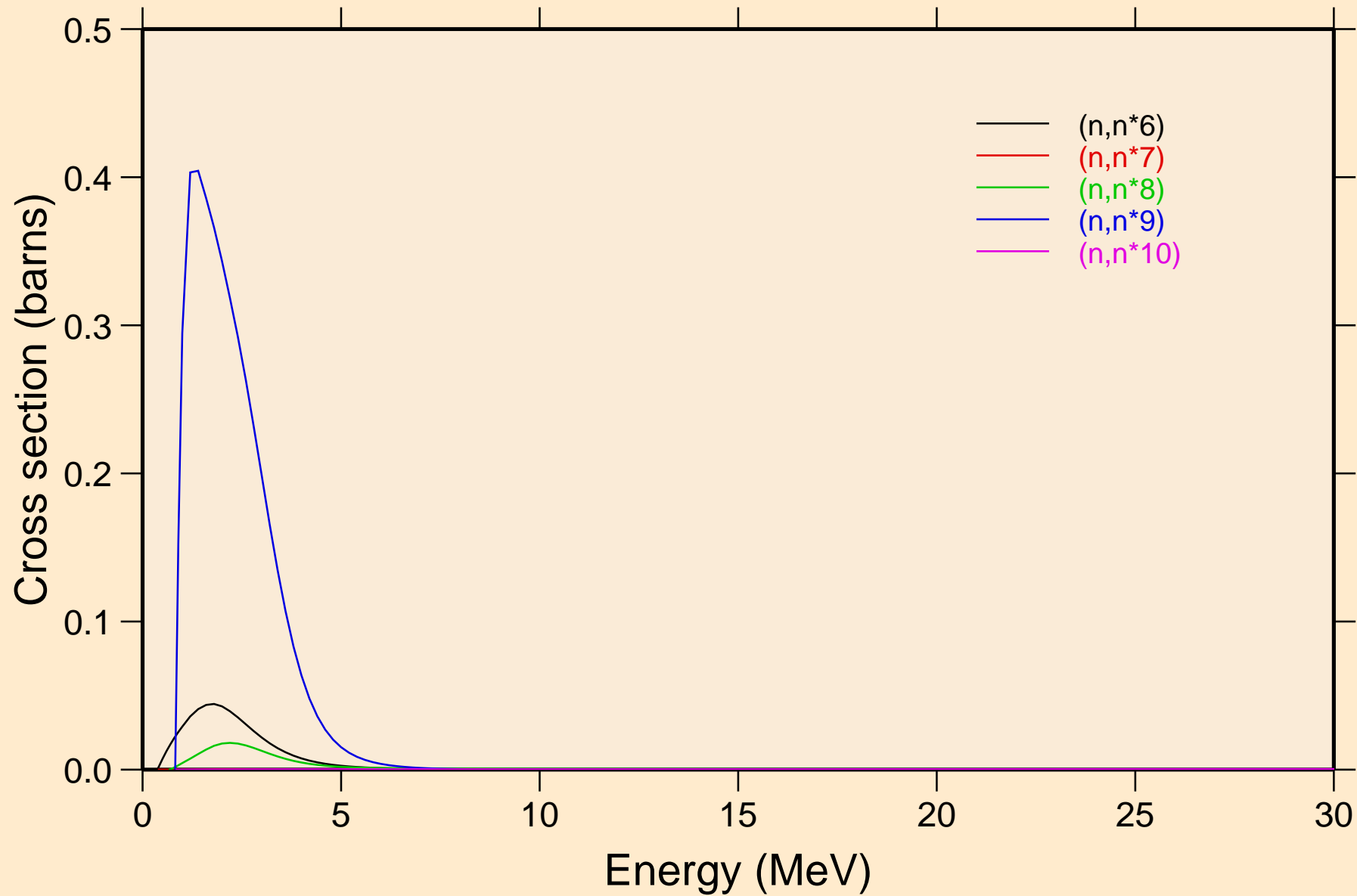

NB090 NEUTRON ACER TENDL-2023 LIBRARY; T=0.K
Inelastic levels

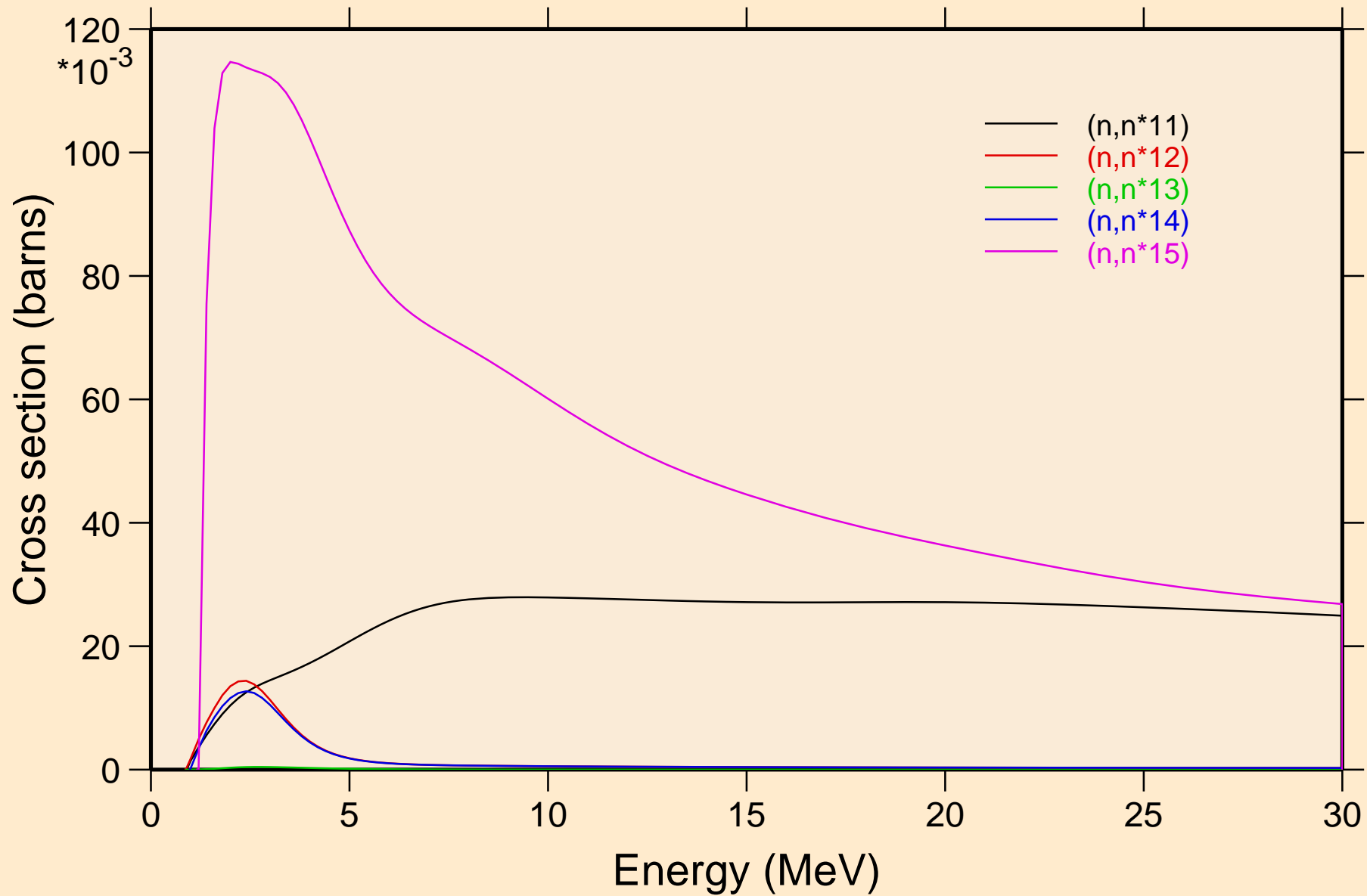

NB090 NEUTRON ACER TENDL-2023 LIBRARY; T=0.K
Inelastic levels

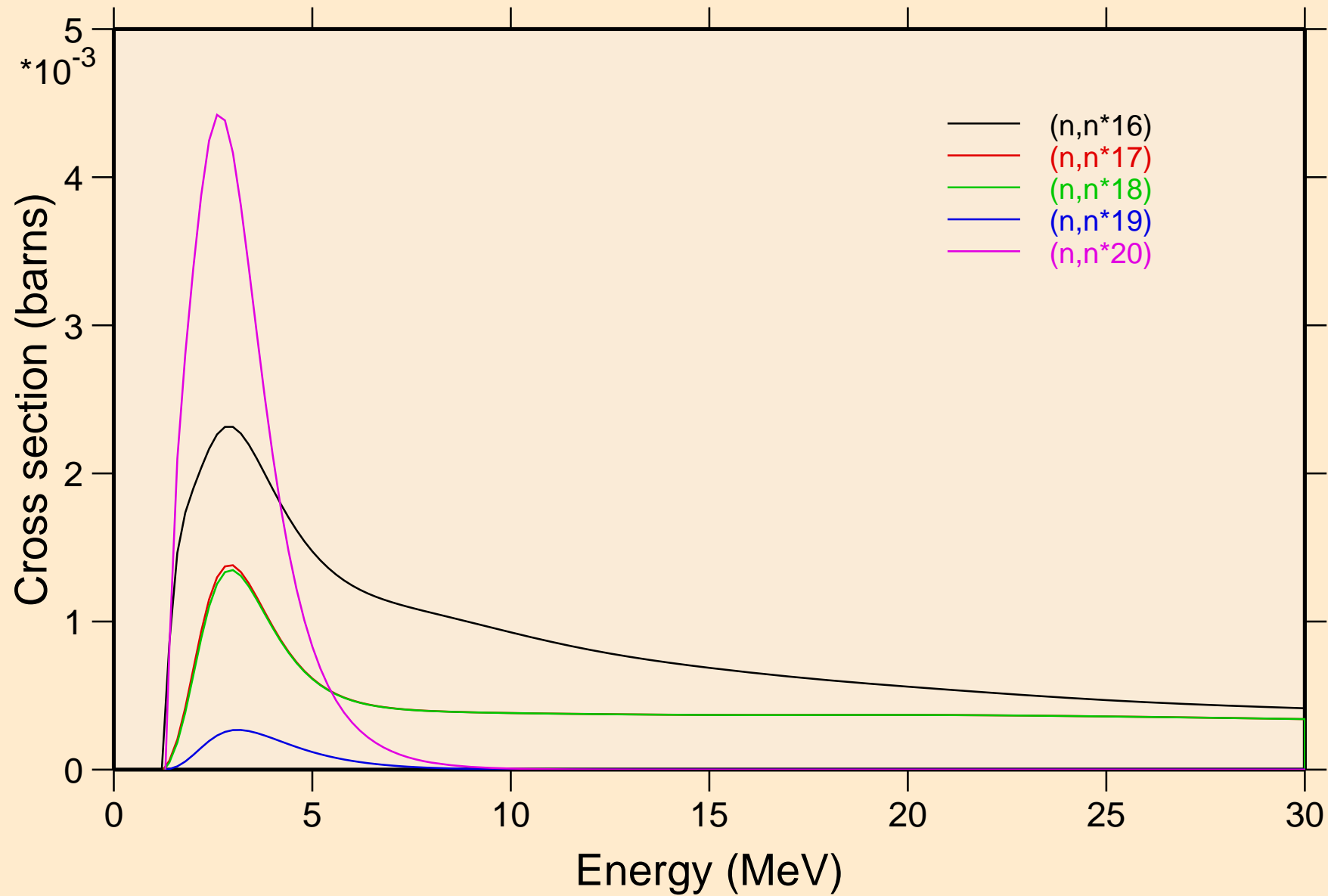

NB090 NEUTRON ACER TENDL-2023 LIBRARY; T=0.K
Inelastic levels

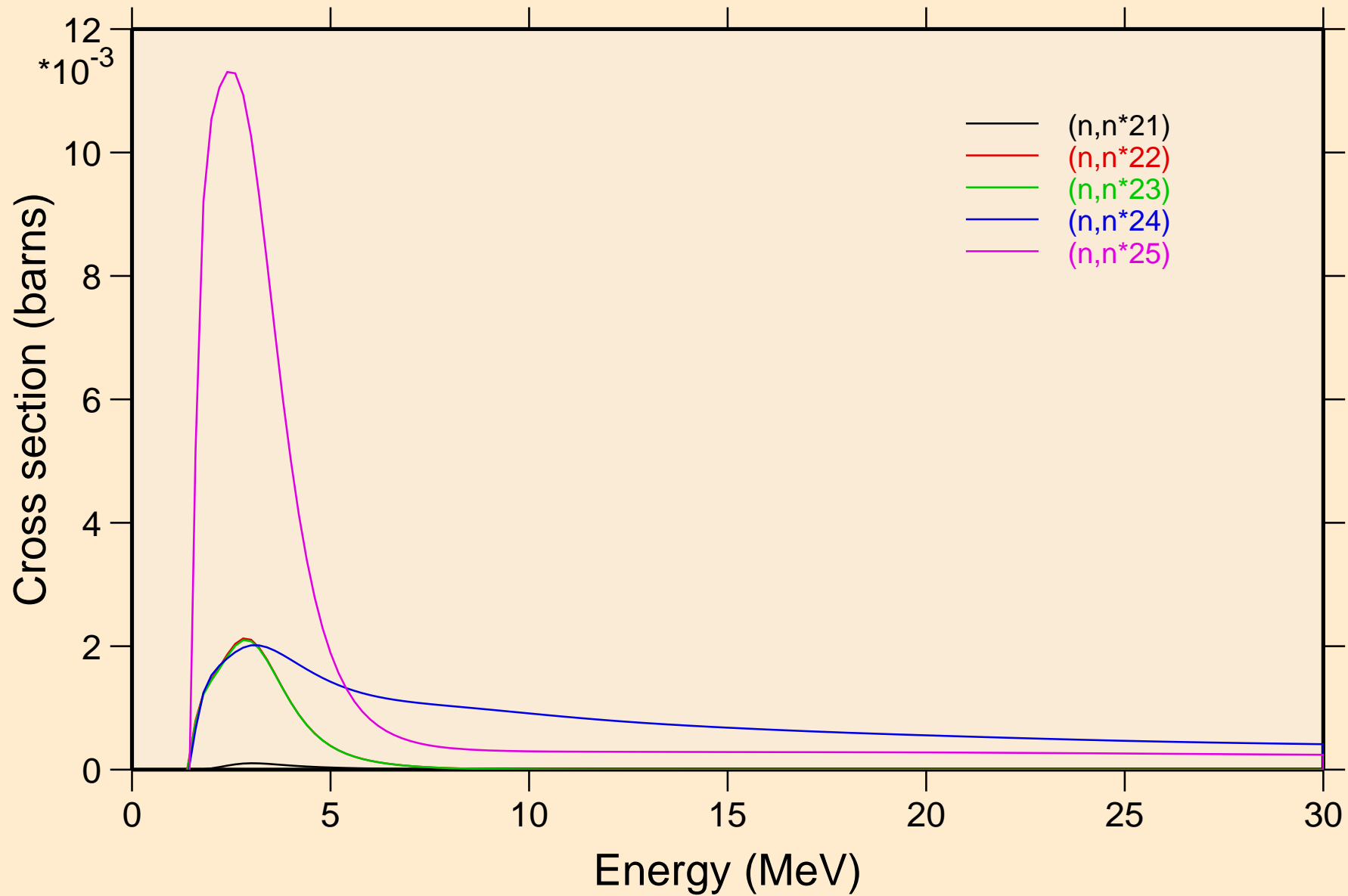

NB090 NEUTRON ACER TENDL-2023 LIBRARY; T=0.K
Threshold reactions

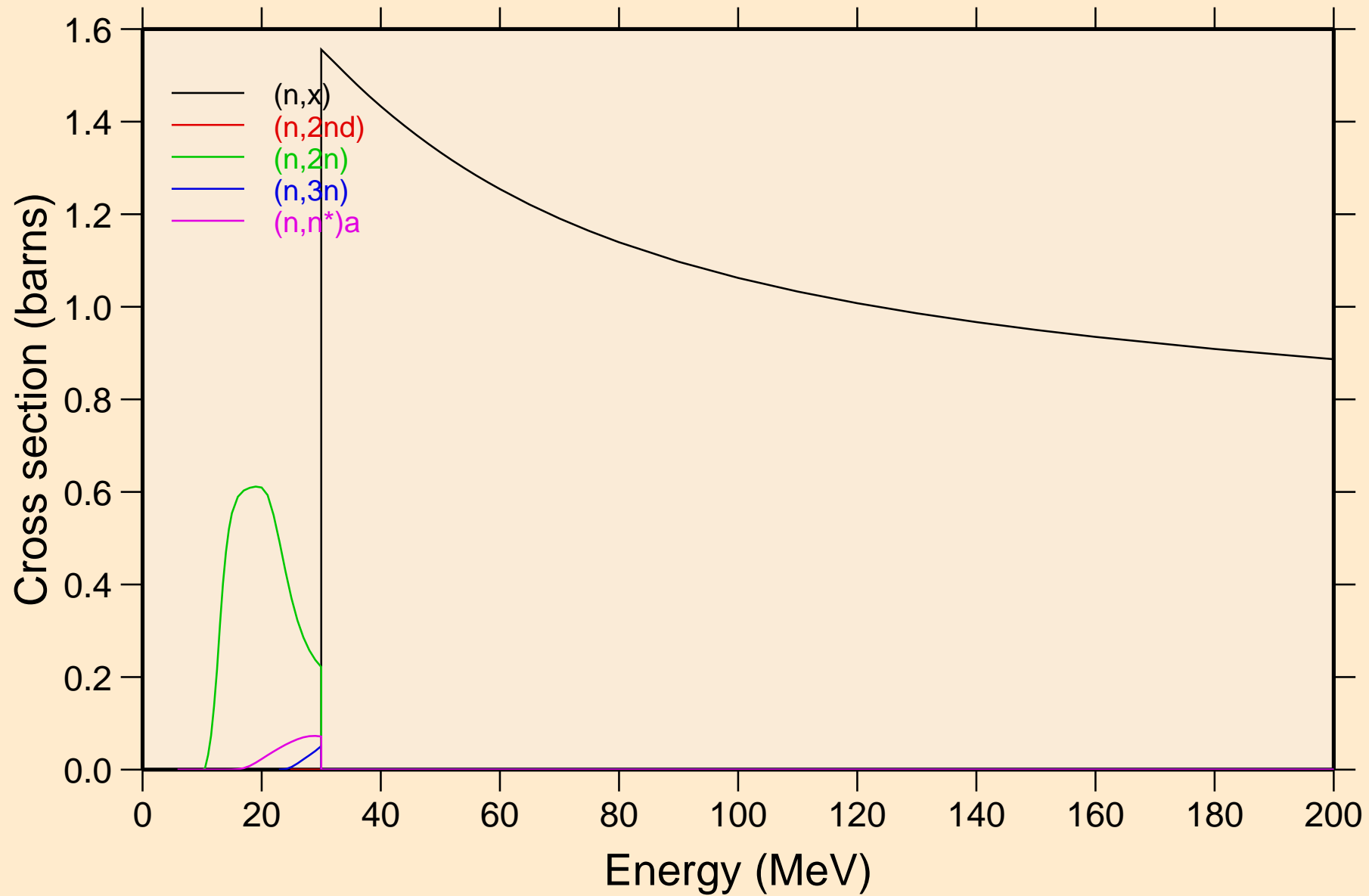

NB090 NEUTRON ACER TENDL-2023 LIBRARY; T=0.K
Threshold reactions

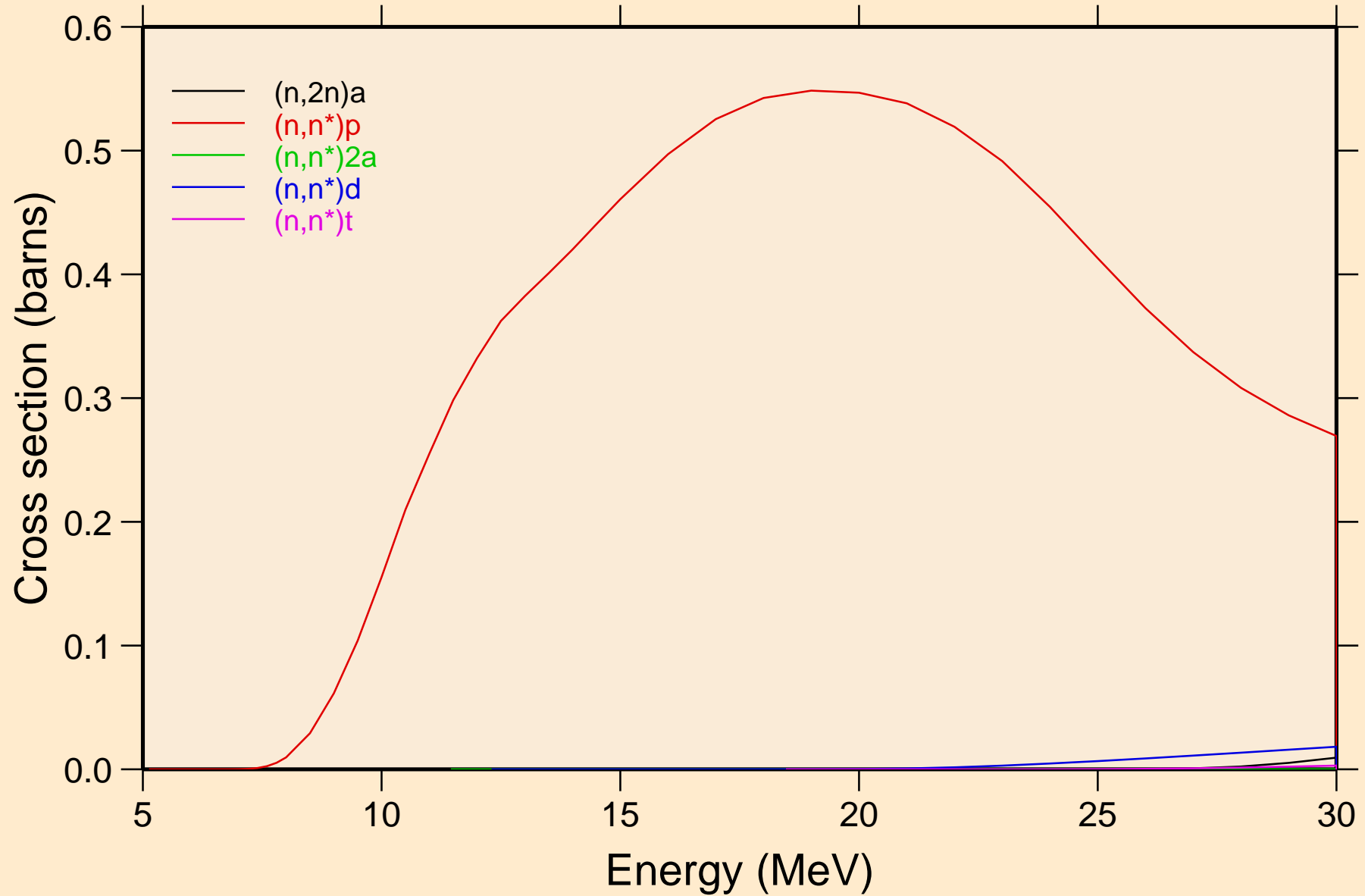

NB090 NEUTRON ACER TENDL-2023 LIBRARY; T=0.K
Threshold reactions

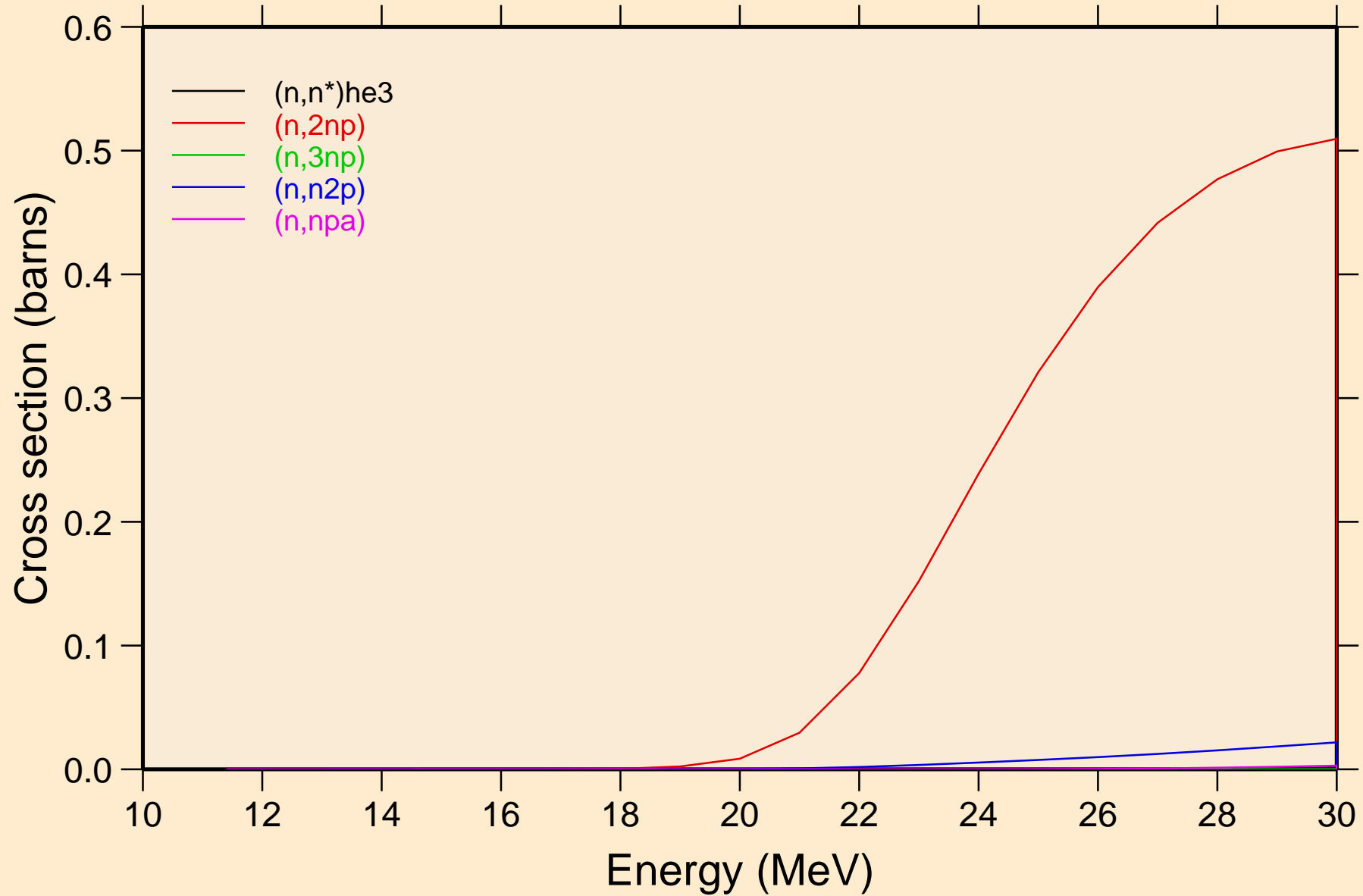

NB090 NEUTRON ACER TENDL-2023 LIBRARY; T=0.K
Threshold reactions

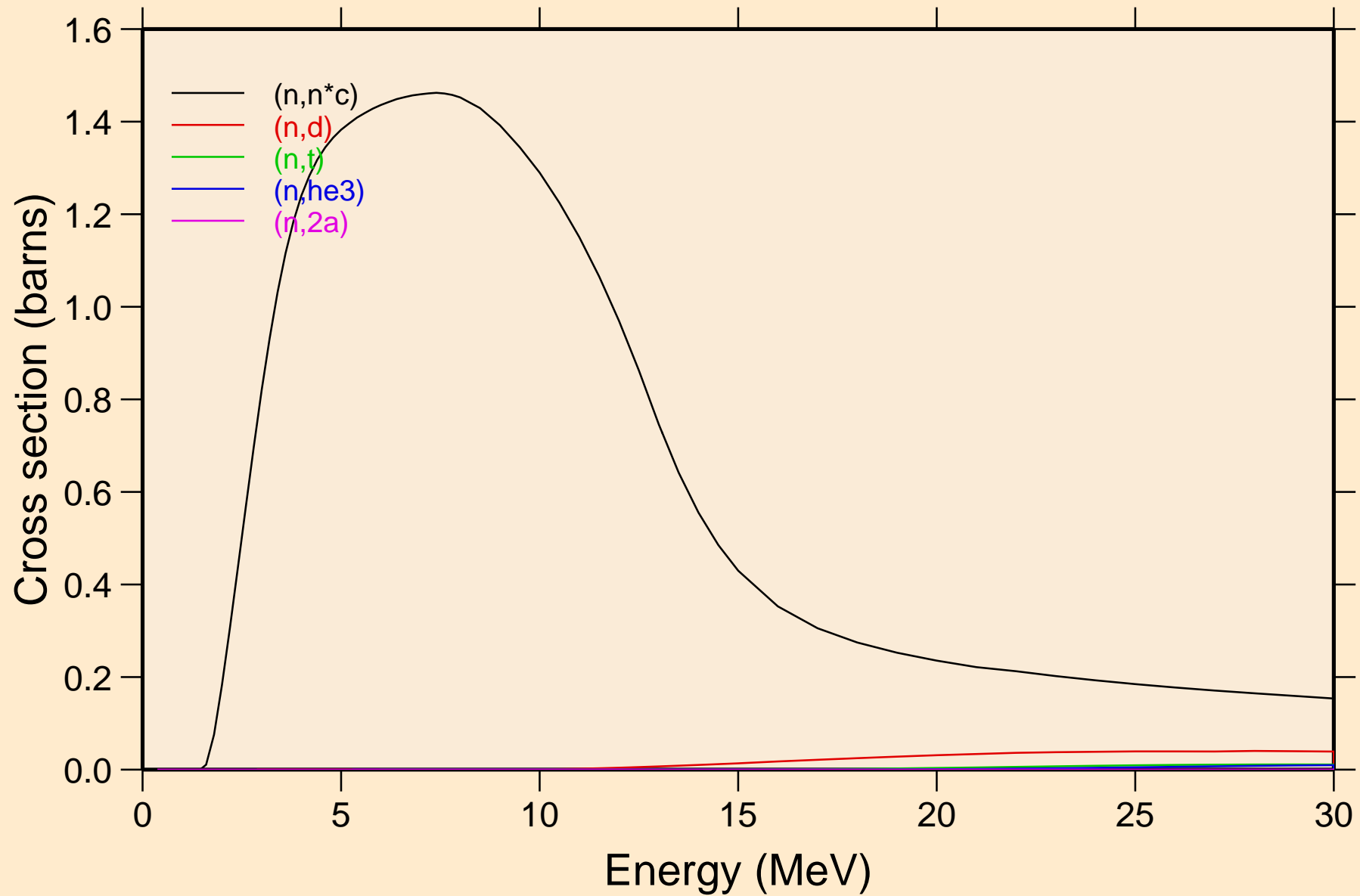

NB090 NEUTRON ACER TENDL-2023 LIBRARY; T=0.K
Threshold reactions

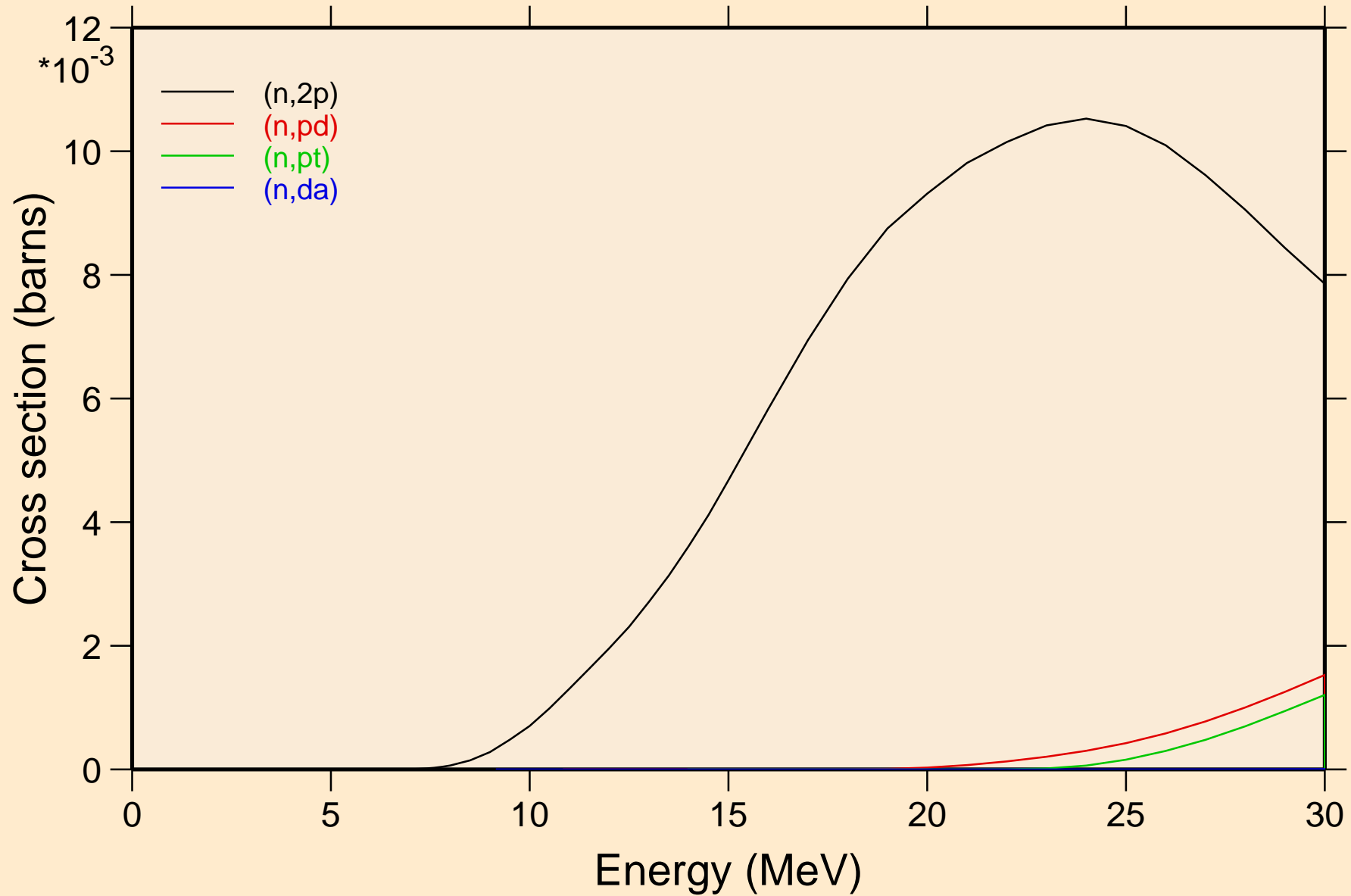

NB090 NEUTRON ACER TENDL-2023 LIBRARY; T=0.K
Threshold reactions

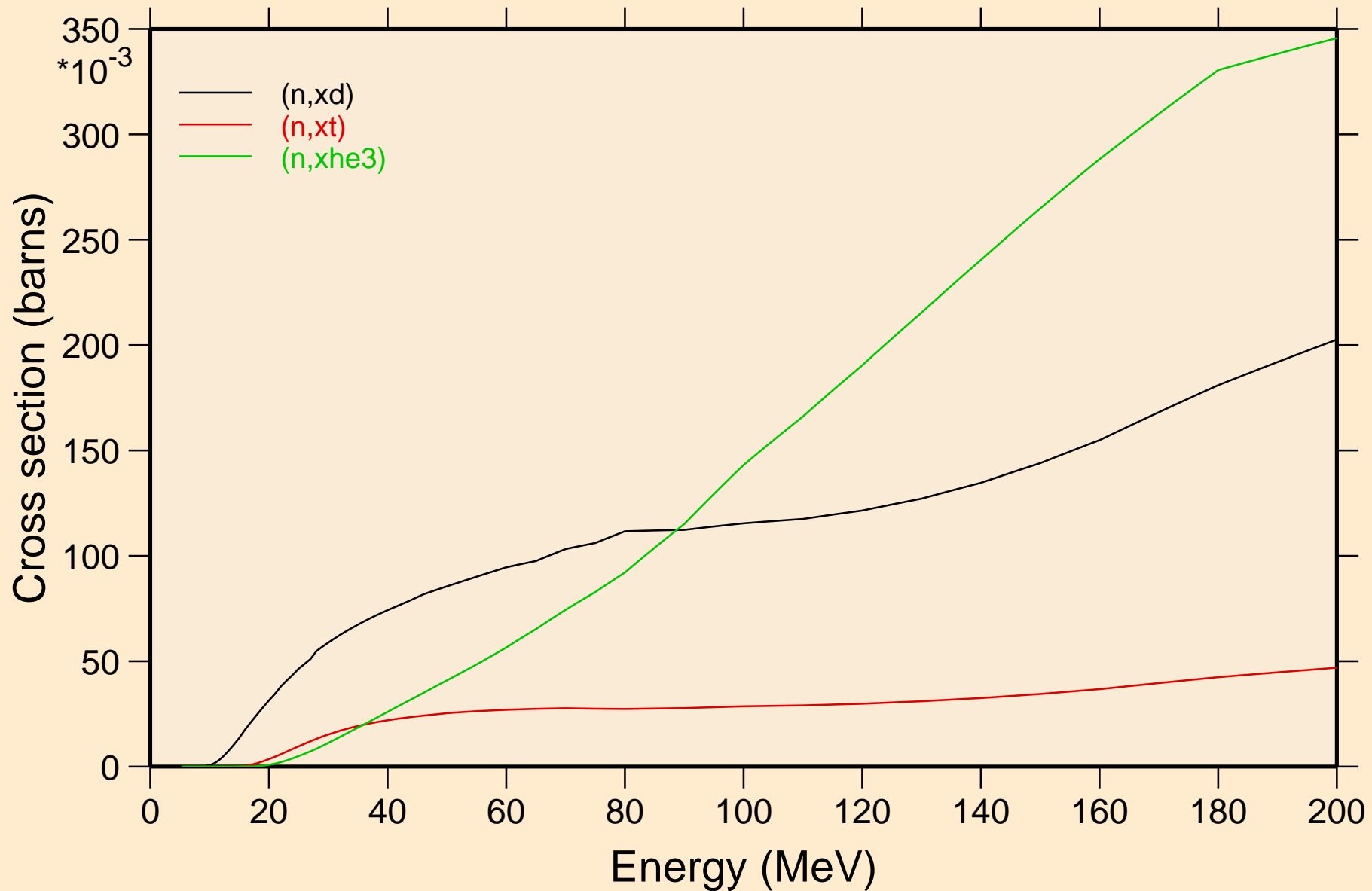

NB090 NEUTRON ACER TENDL-2023 LIBRARY; T=0.K
angular distribution for elastic

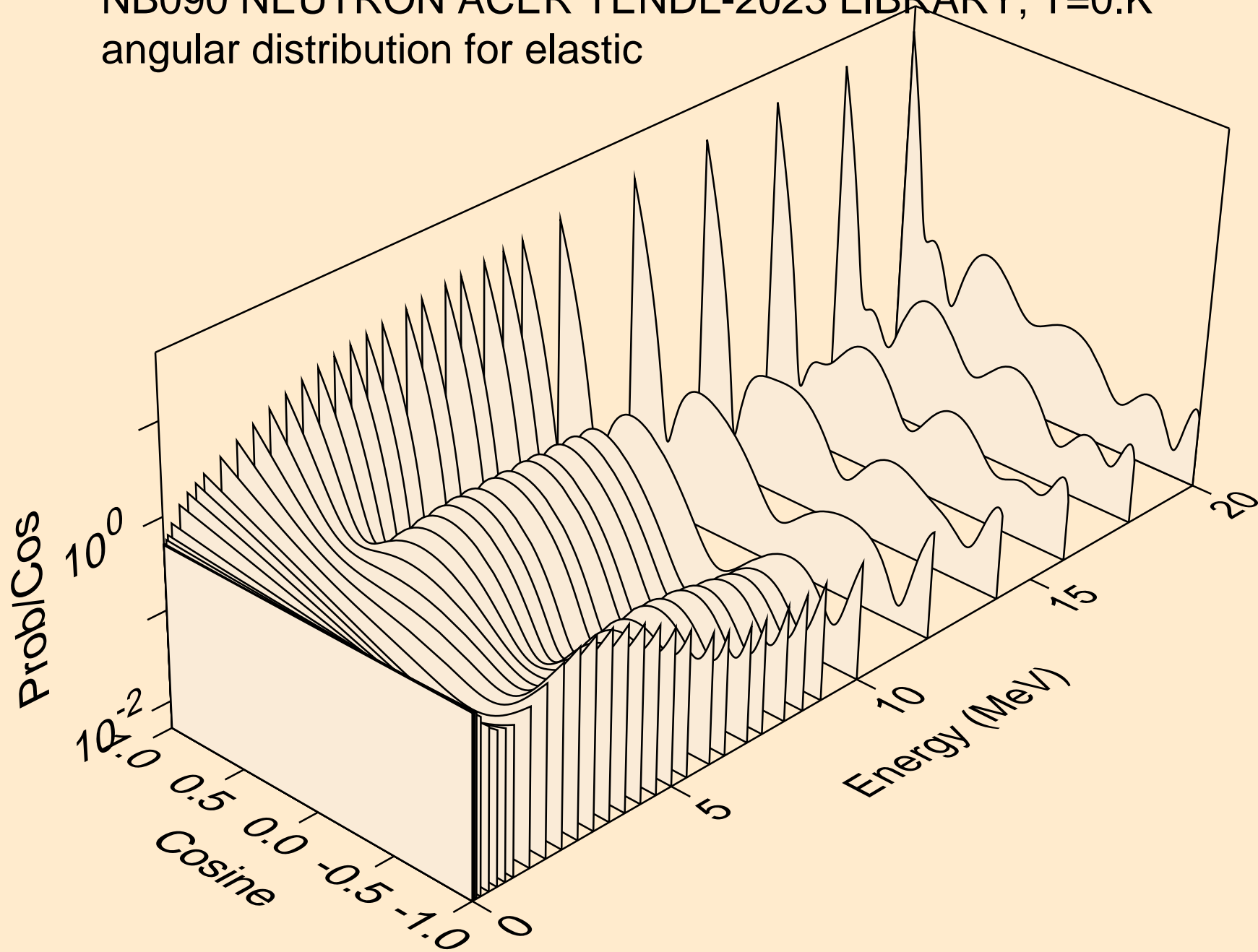

NB090 NEUTRON ACER TENDL-2023 LIBRARY; T=0.K
angular distribution for elastic

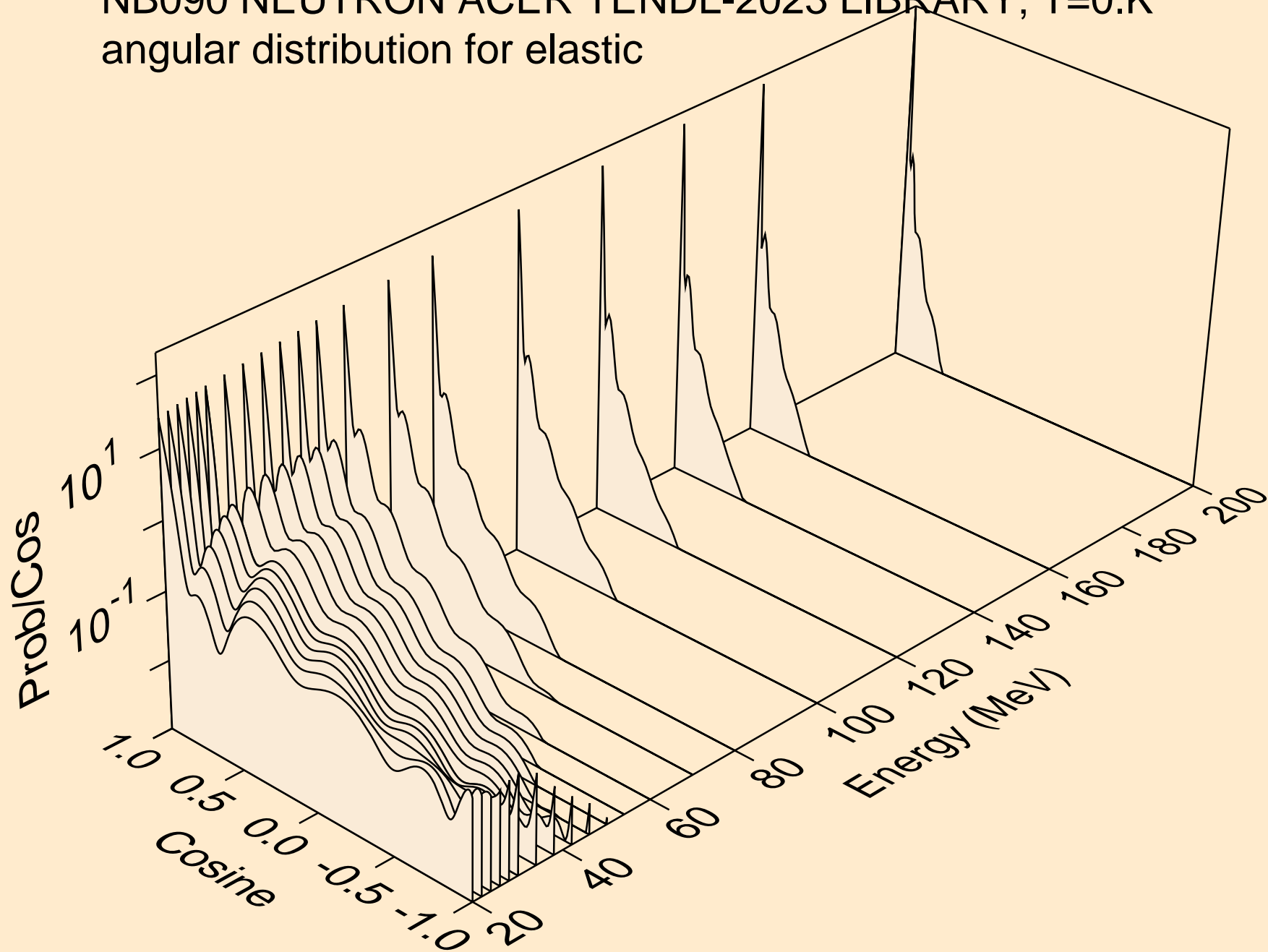

NB090 NEUTRON ACER TENDL-2023 LIBRARY; T=0.K
angular distribution for (n,n*1)

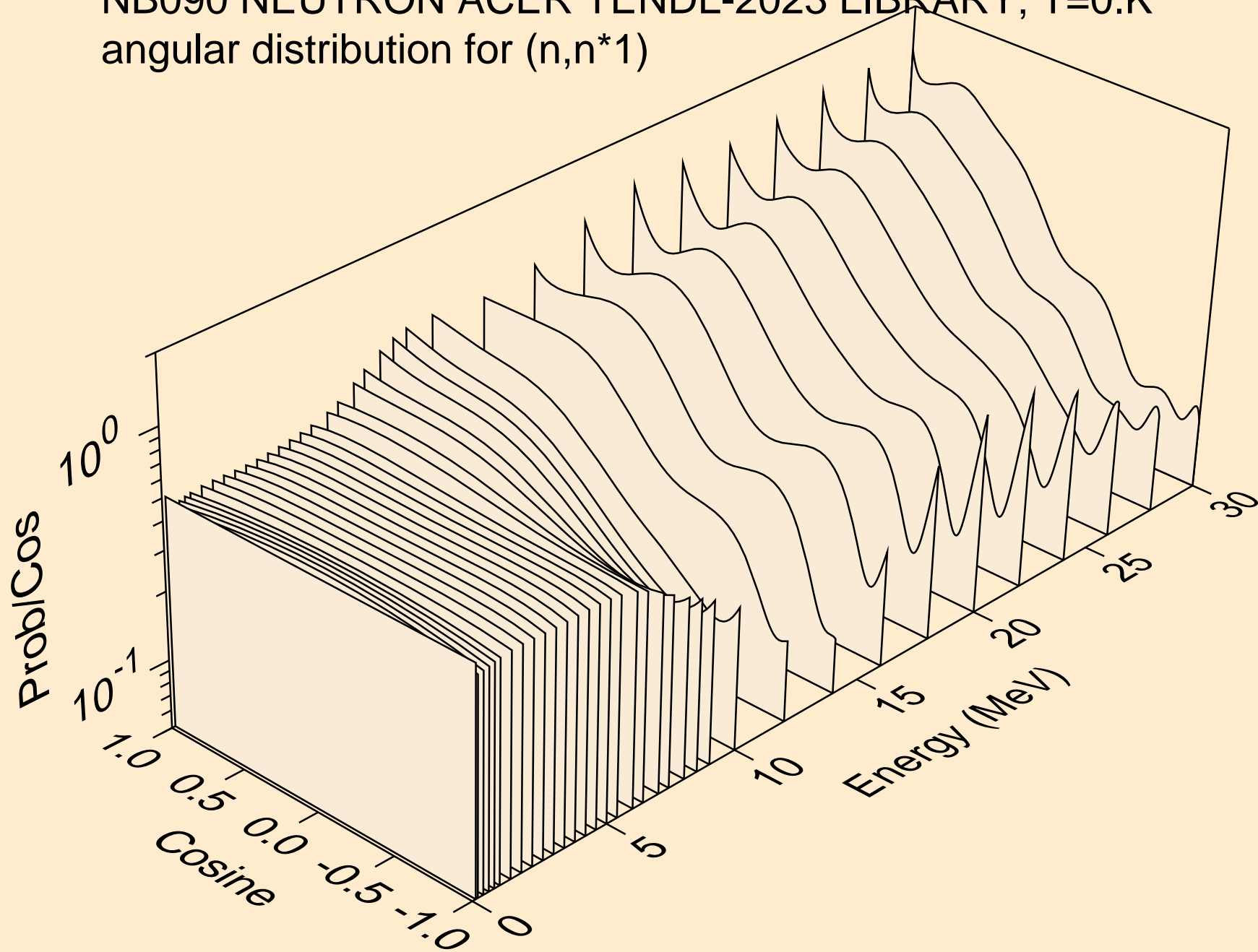

NB090 NEUTRON ACER TENDL-2023 LIBRARY; T=0.K
angular distribution for (n,n*2)

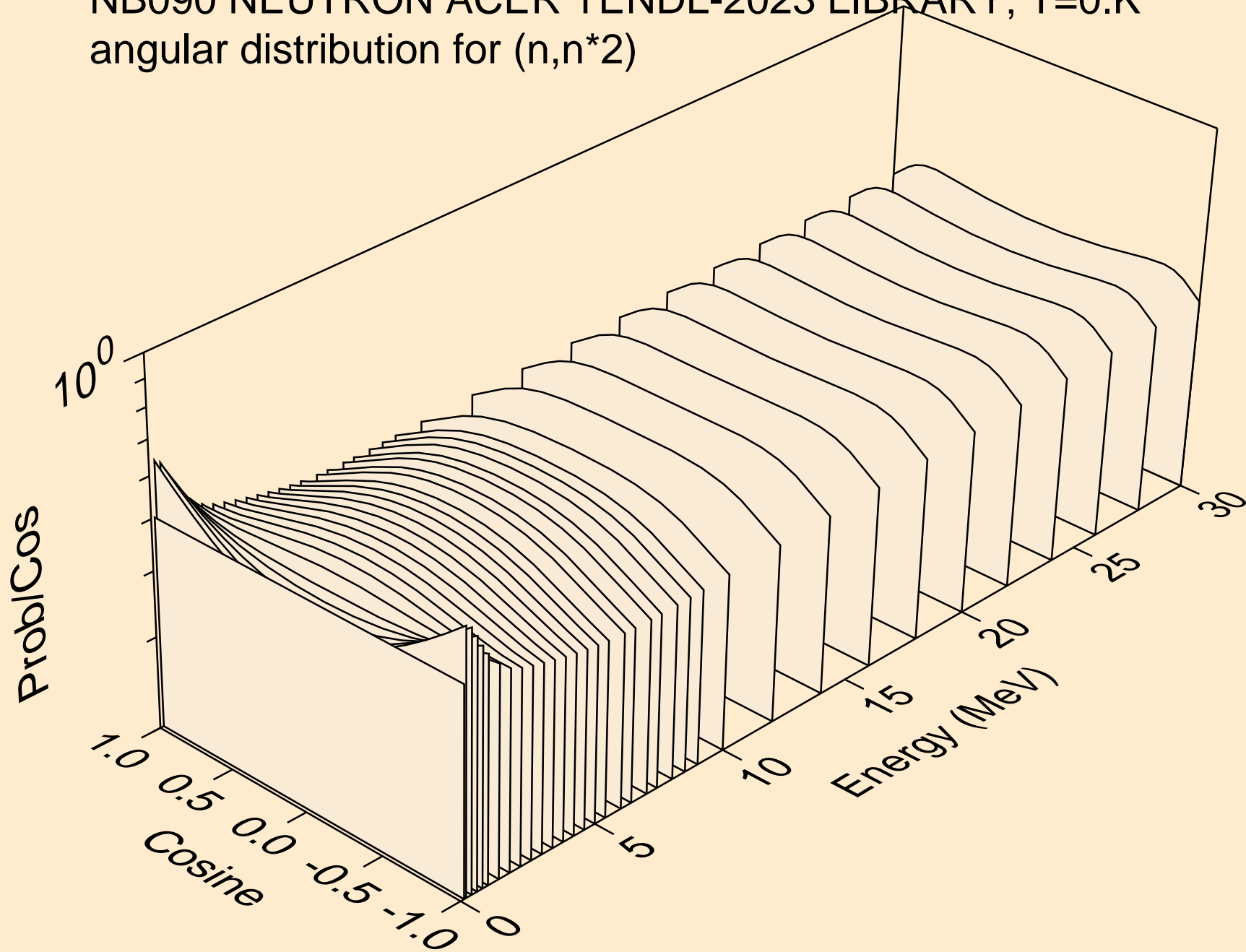

NB090 NEUTRON ACER TENDL-2023 LIBRARY; T=0.K
angular distribution for (n,n*3)

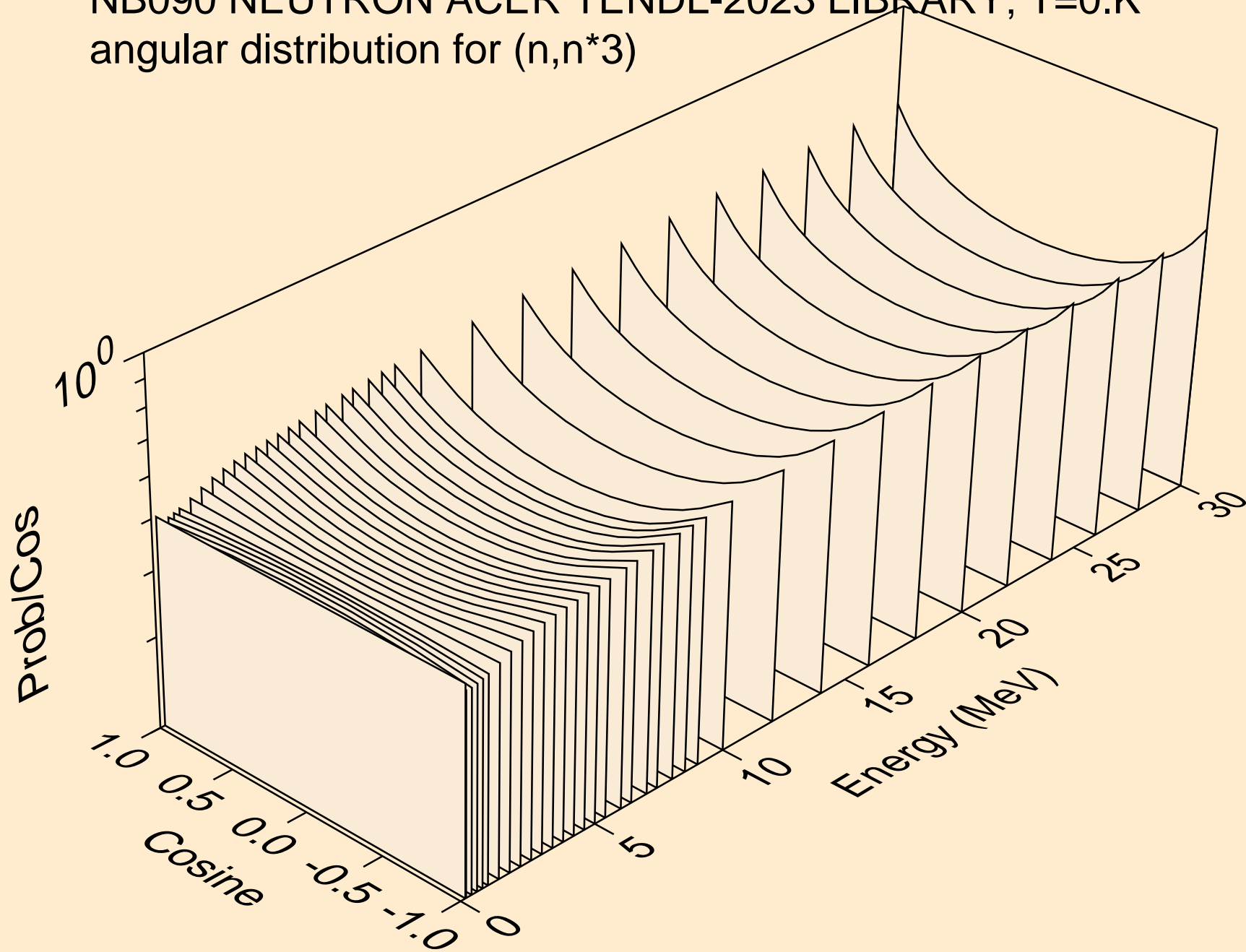

NB090 NEUTRON ACER TENDL-2023 LIBRARY; T=0.K
angular distribution for (n,n*4)

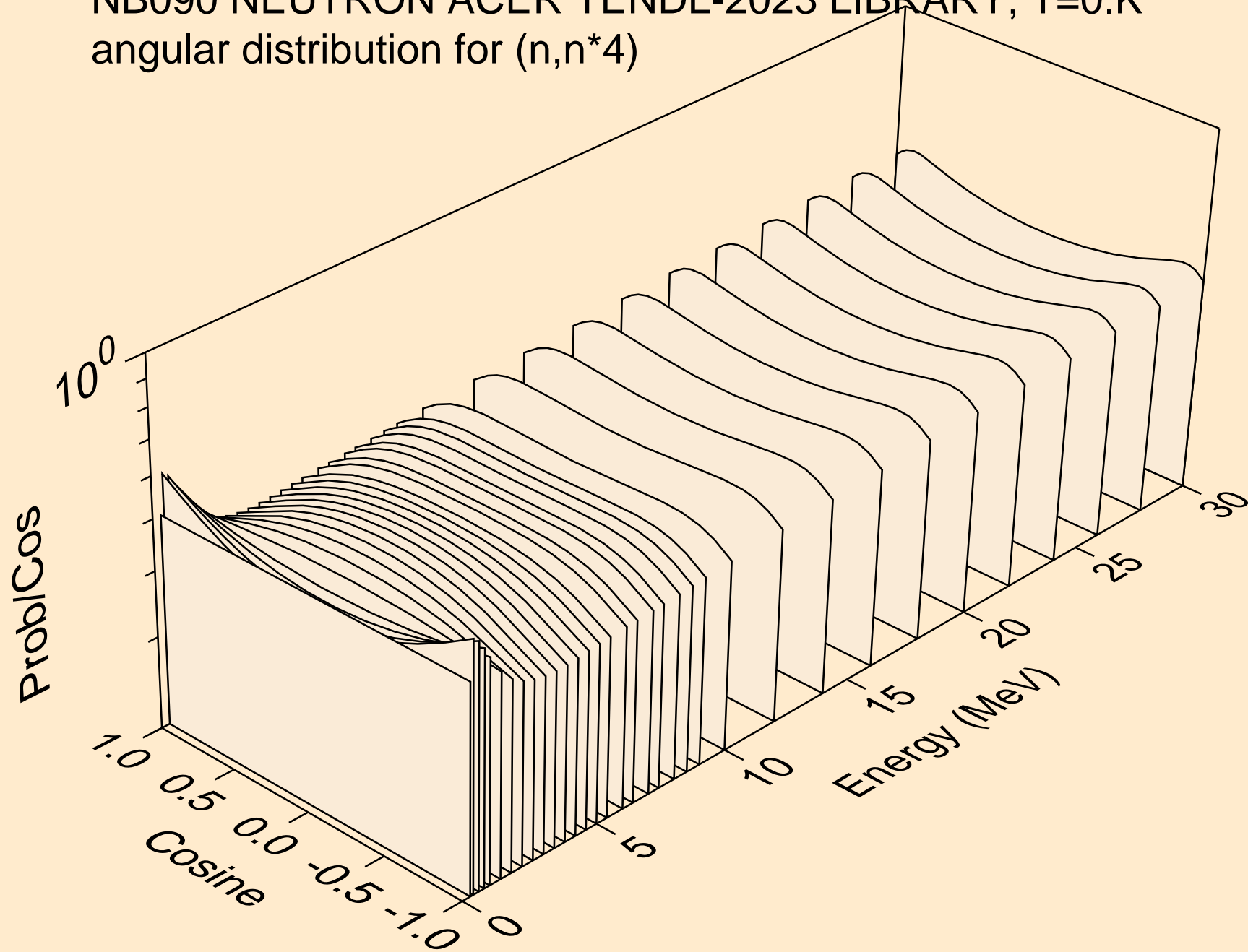

NB090 NEUTRON ACER TENDL-2023 LIBRARY; T=0.K
angular distribution for (n,n*5)

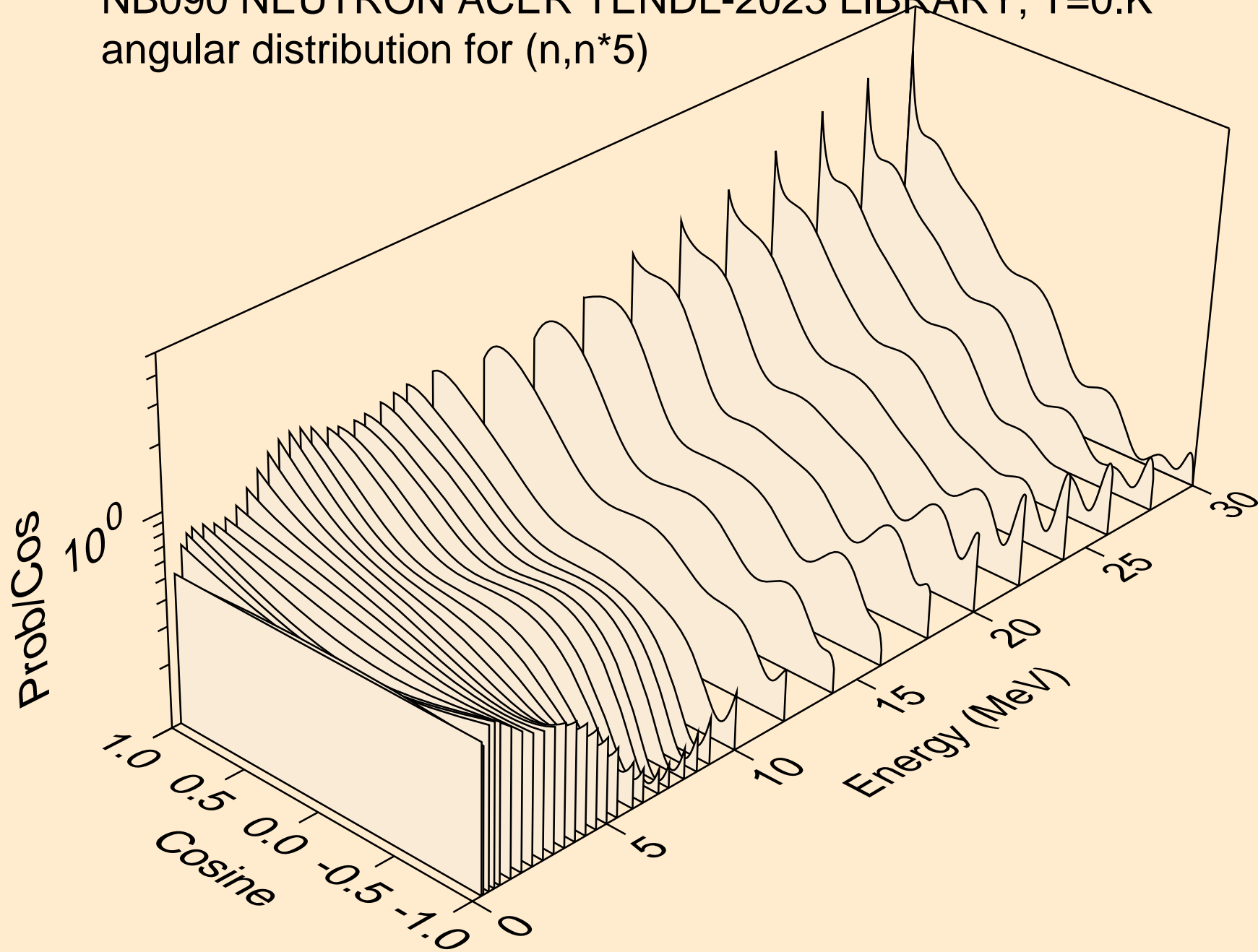

NB090 NEUTRON ACER TENDL-2023 LIBRARY; T=0.K
angular distribution for (n,n*6)

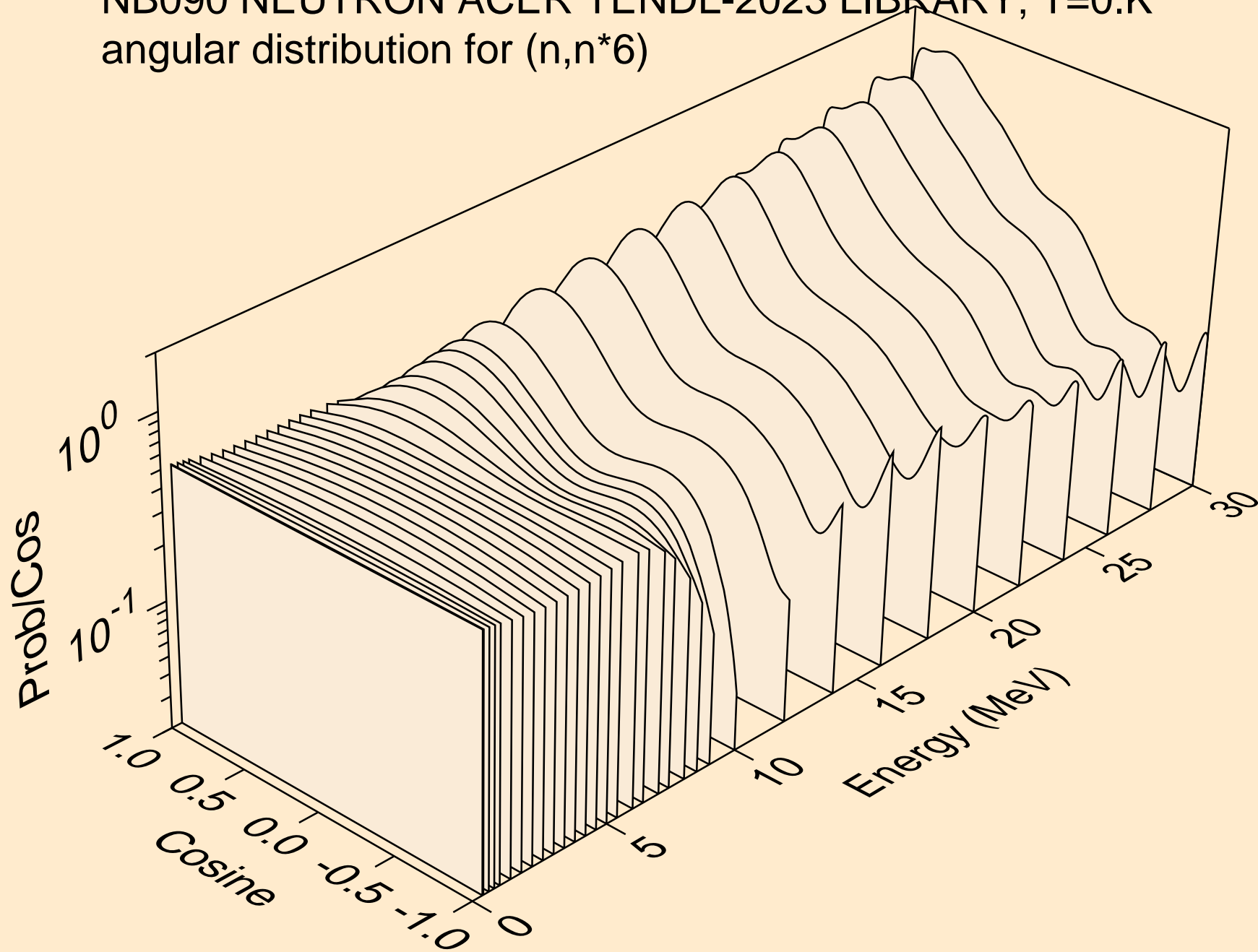

NB090 NEUTRON ACER TENDL-2023 LIBRARY; T=0.K
angular distribution for (n,n*7)

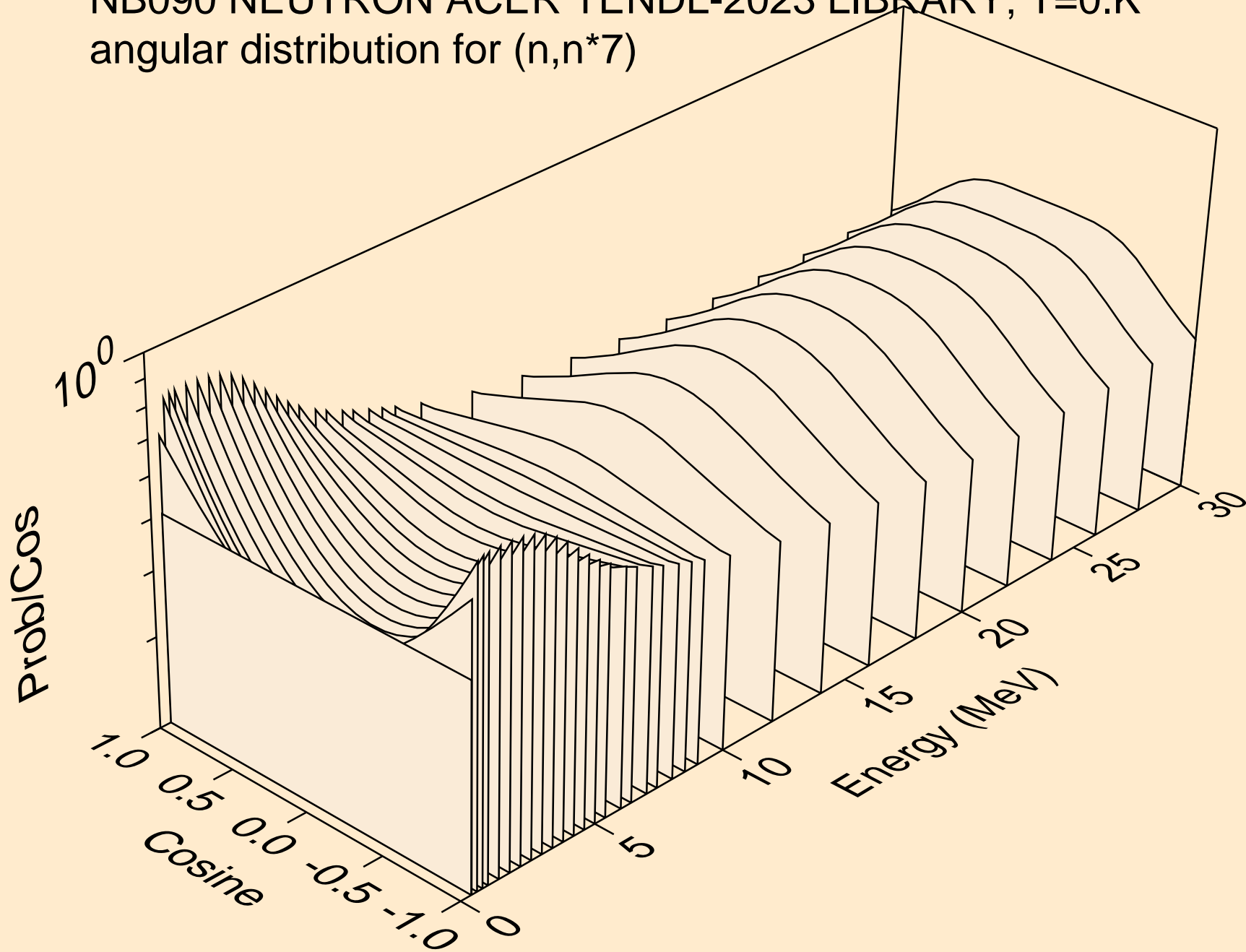

NB090 NEUTRON ACER TENDL-2023 LIBRARY; T=0.K
angular distribution for (n,n*8)

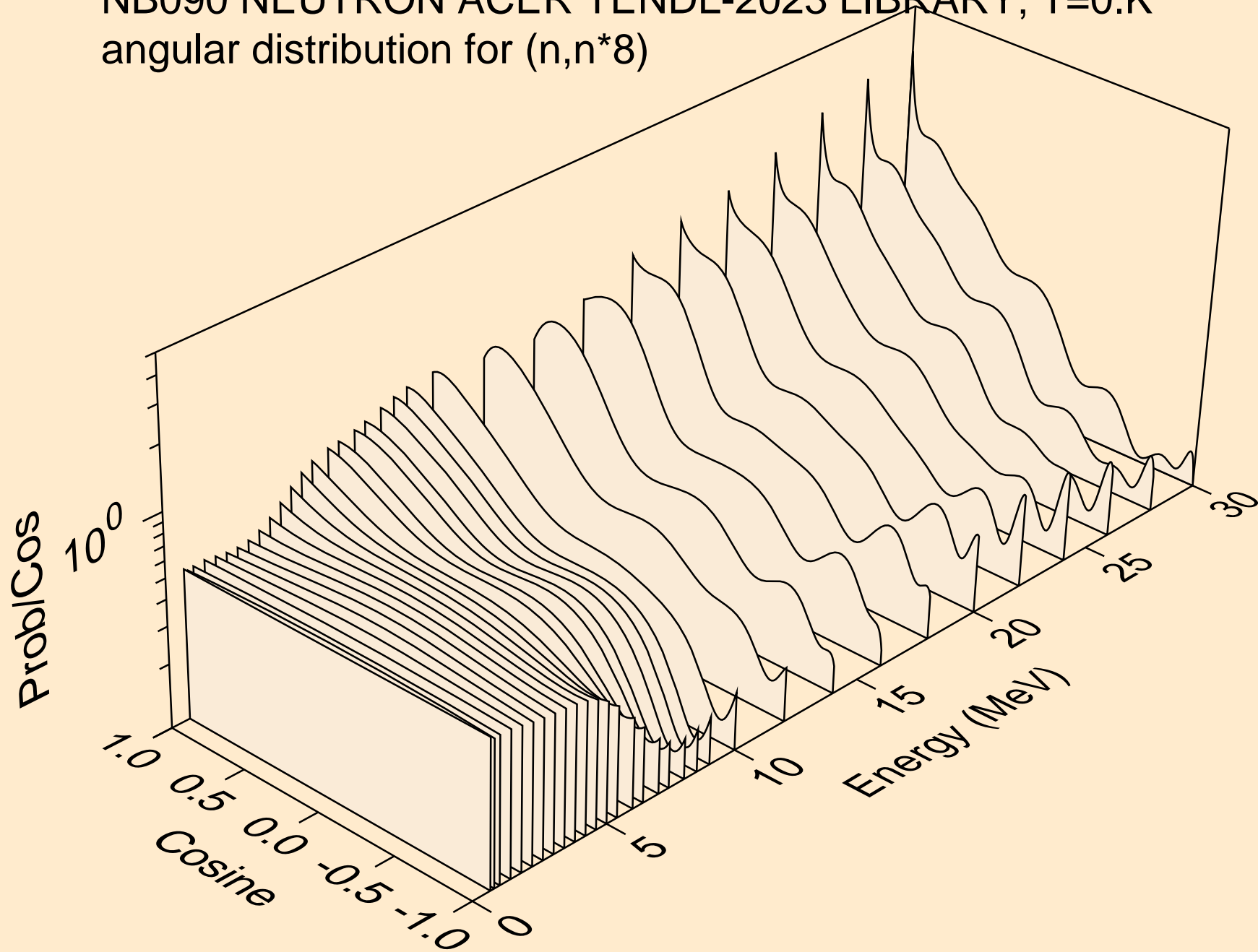

NB090 NEUTRON ACER TENDL-2023 LIBRARY; T=0.K
angular distribution for (n,n*9)

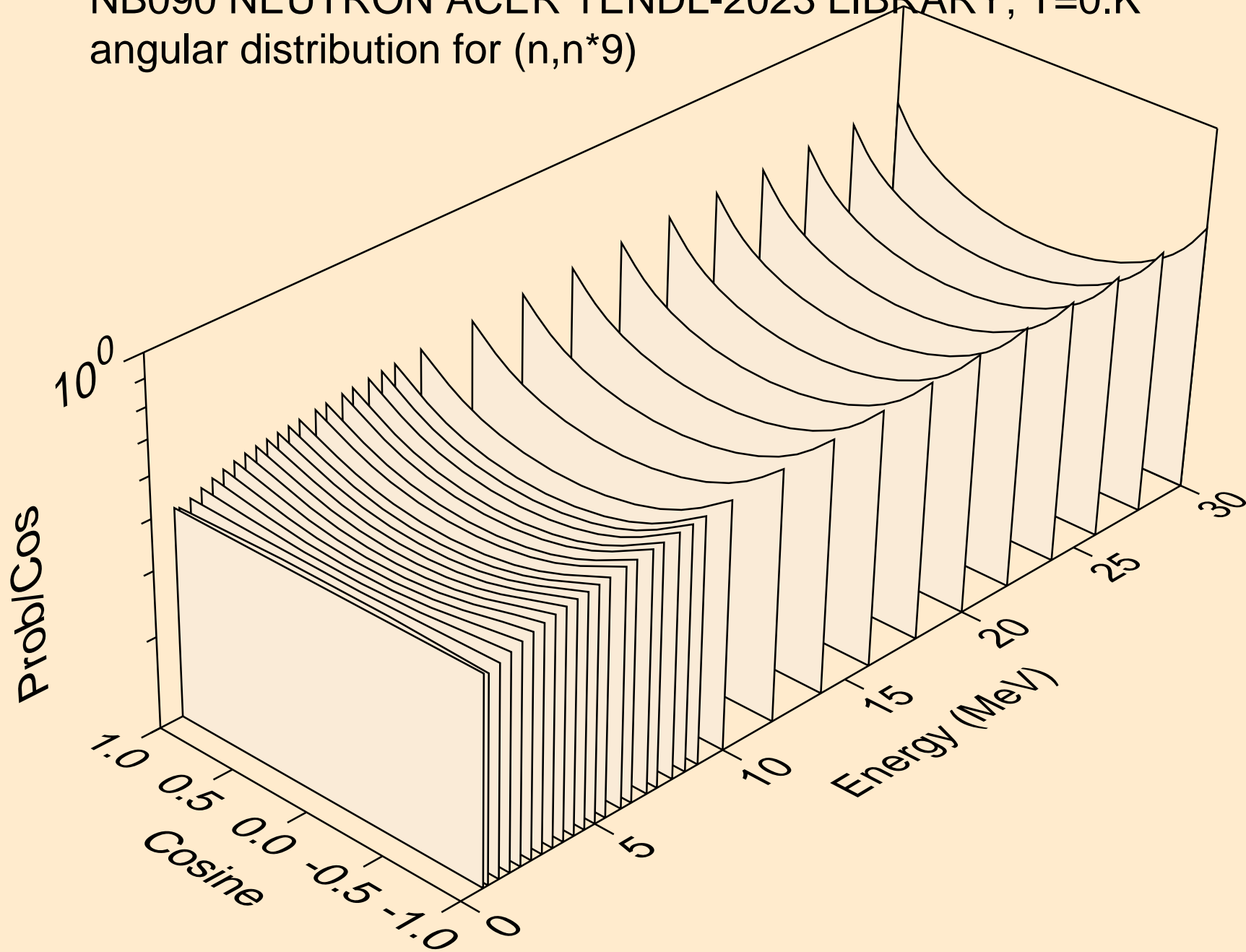

NB090 NEUTRON ACER TENDL-2023 LIBRARY; T=0.K
angular distribution for (n,n*10)

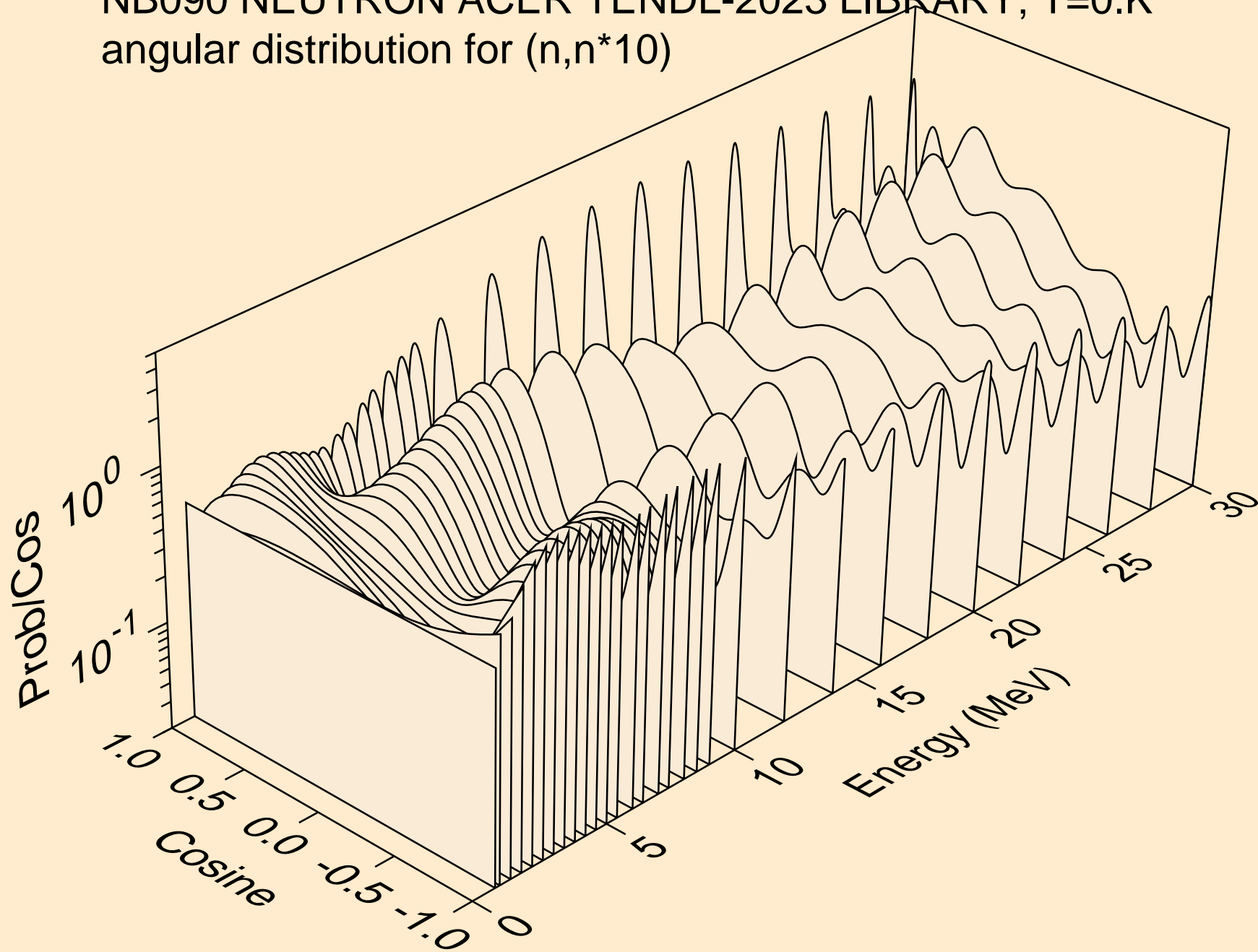

NB090 NEUTRON ACER TENDL-2023 LIBRARY; T=0.K
angular distribution for (n,n*11)

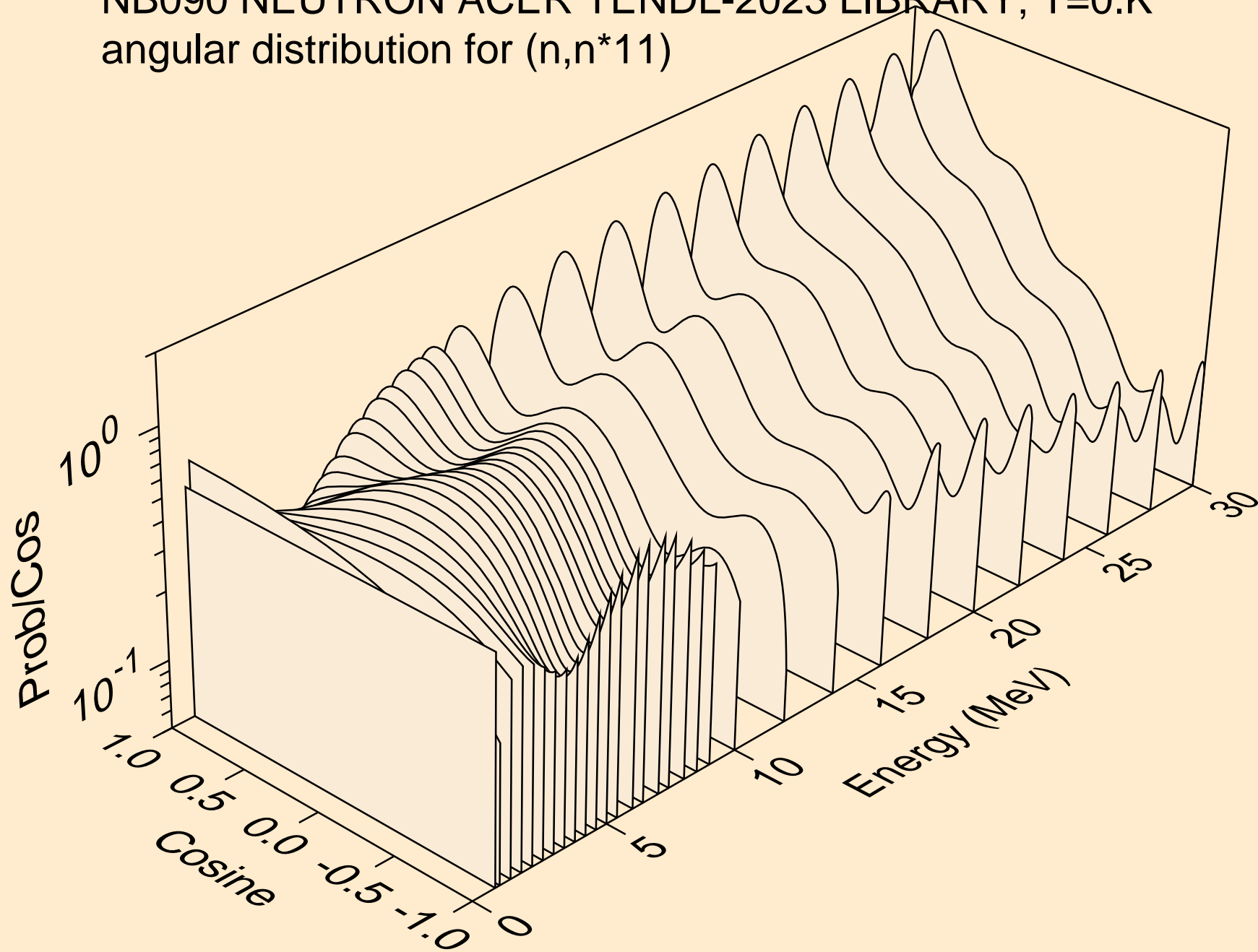

NB090 NEUTRON ACER TENDL-2023 LIBRARY; T=0.K
angular distribution for (n,n*12)

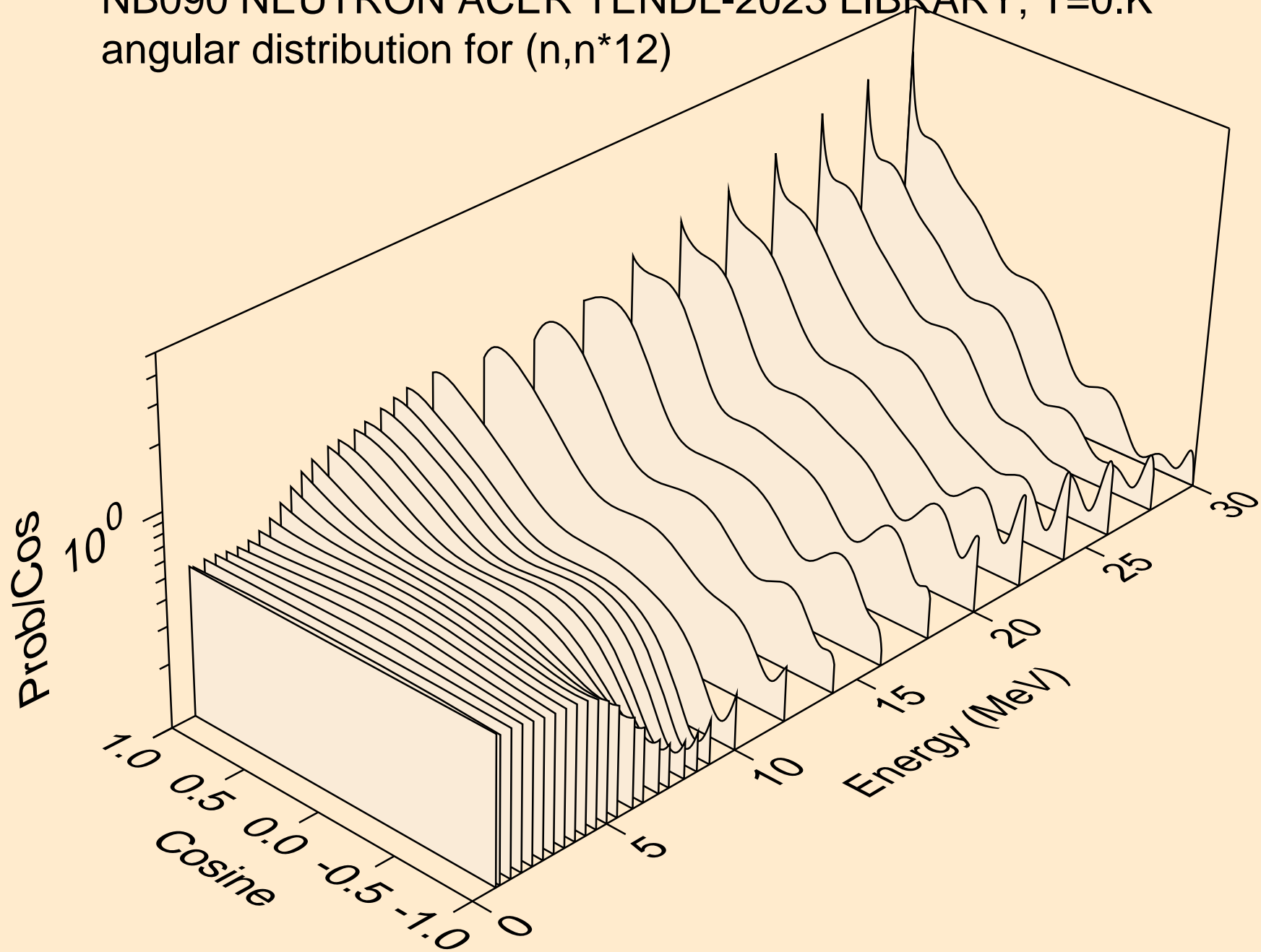

NB090 NEUTRON ACER TENDL-2023 LIBRARY; T=0.K
angular distribution for (n,n*13)

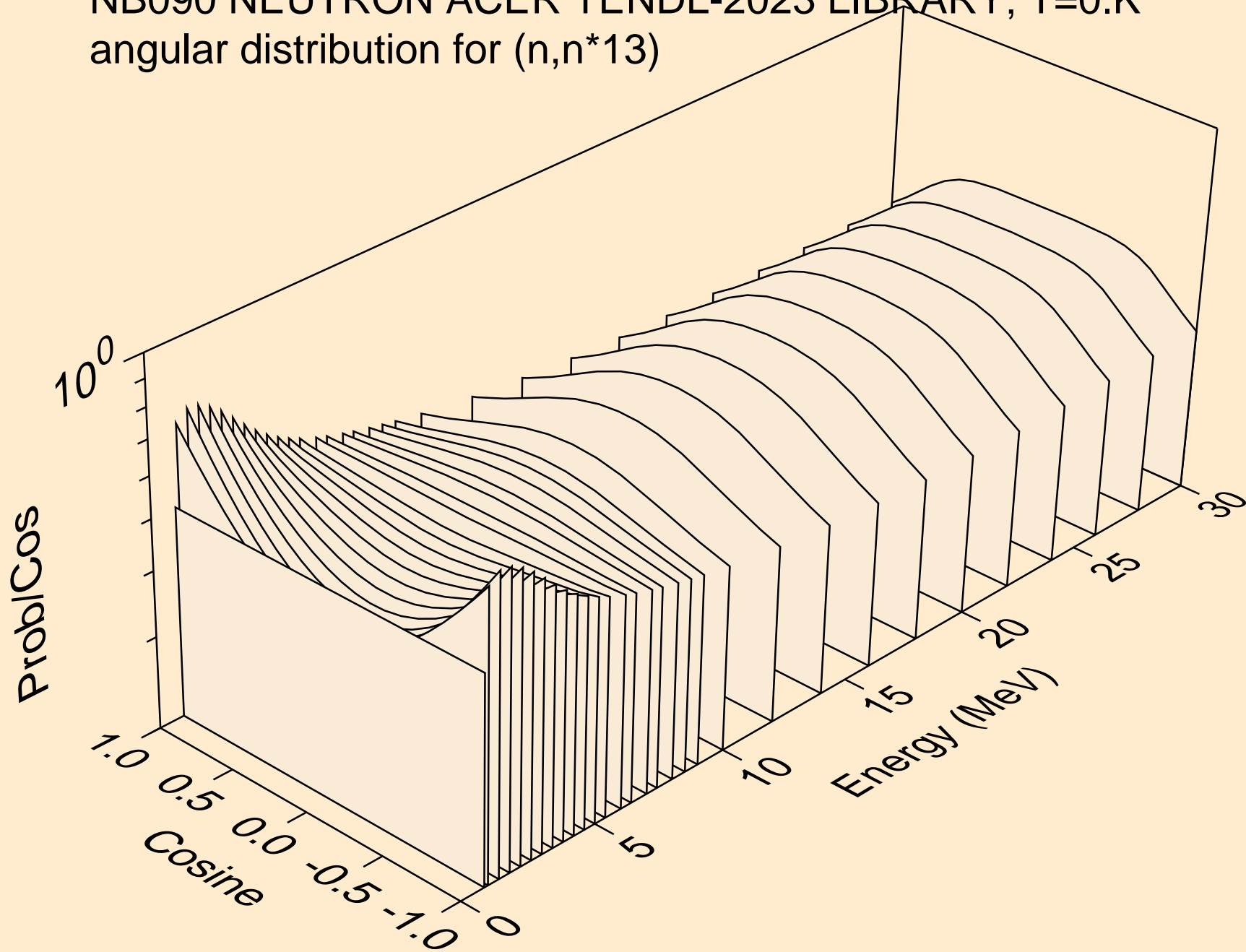

NB090 NEUTRON ACER TENDL-2023 LIBRARY; T=0.K
angular distribution for (n,n*14)

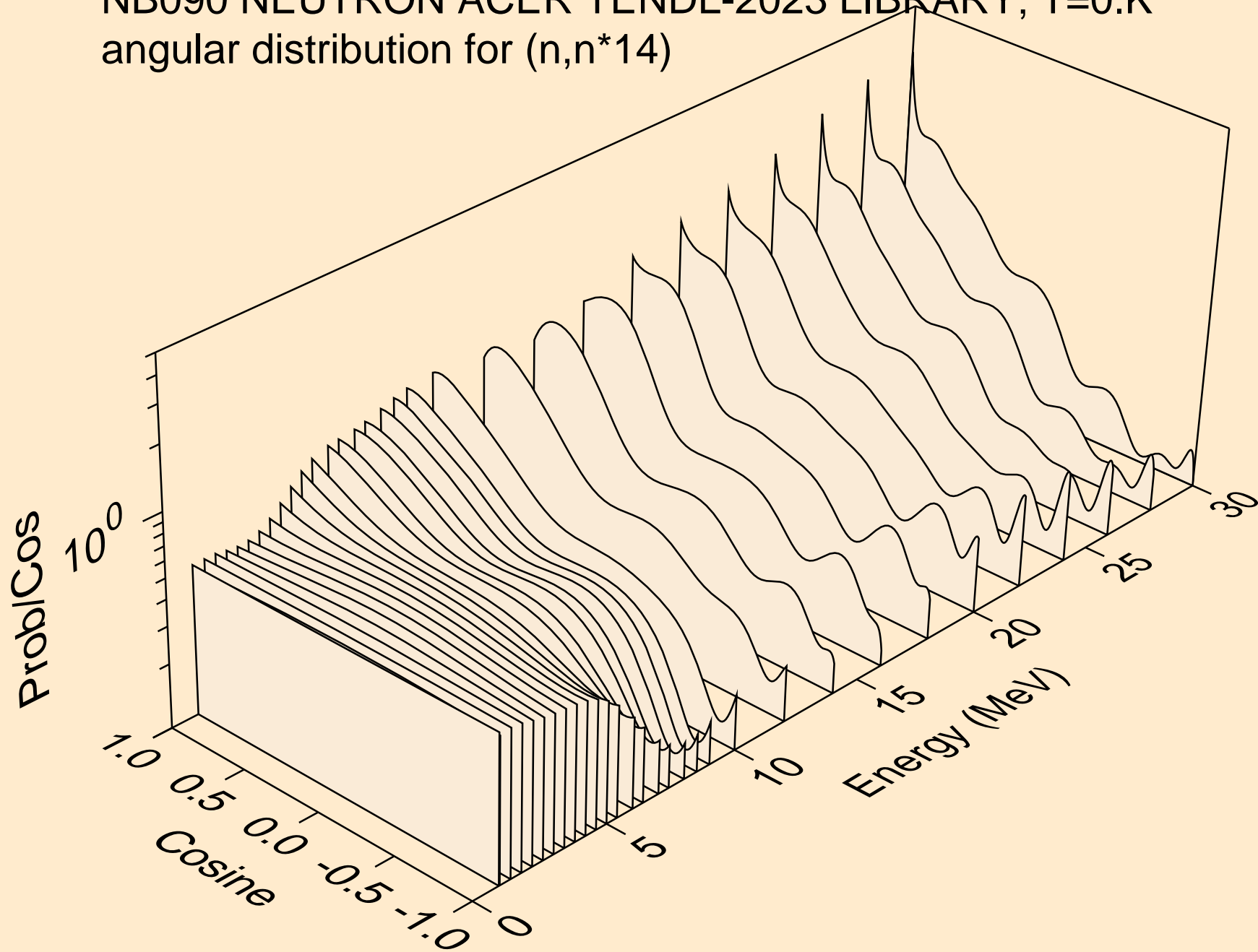

NB090 NEUTRON ACER TENDL-2023 LIBRARY; T=0.K
angular distribution for (n,n*15)

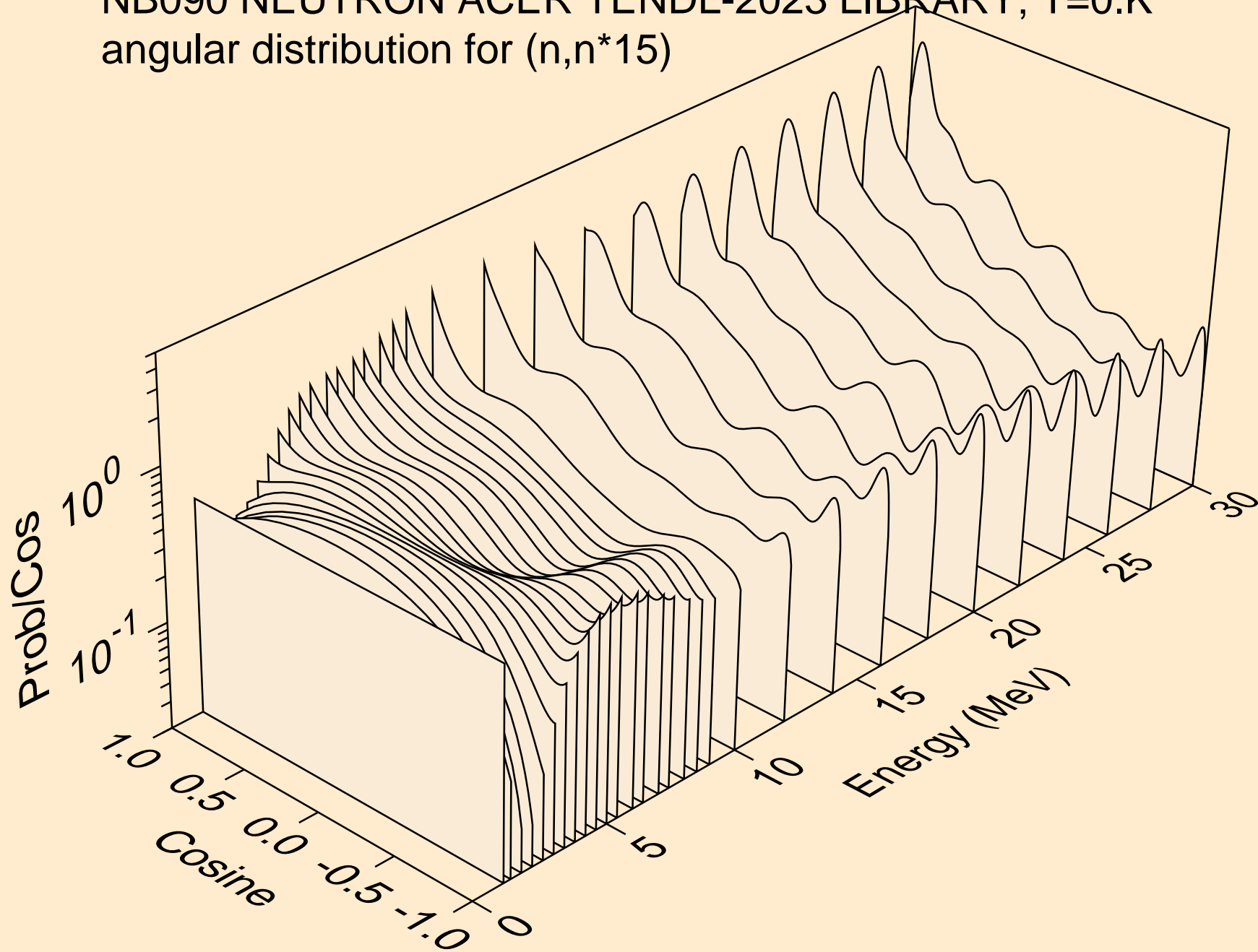

NB090 NEUTRON ACER TENDL-2023 LIBRARY; T=0.K
angular distribution for (n,n*16)

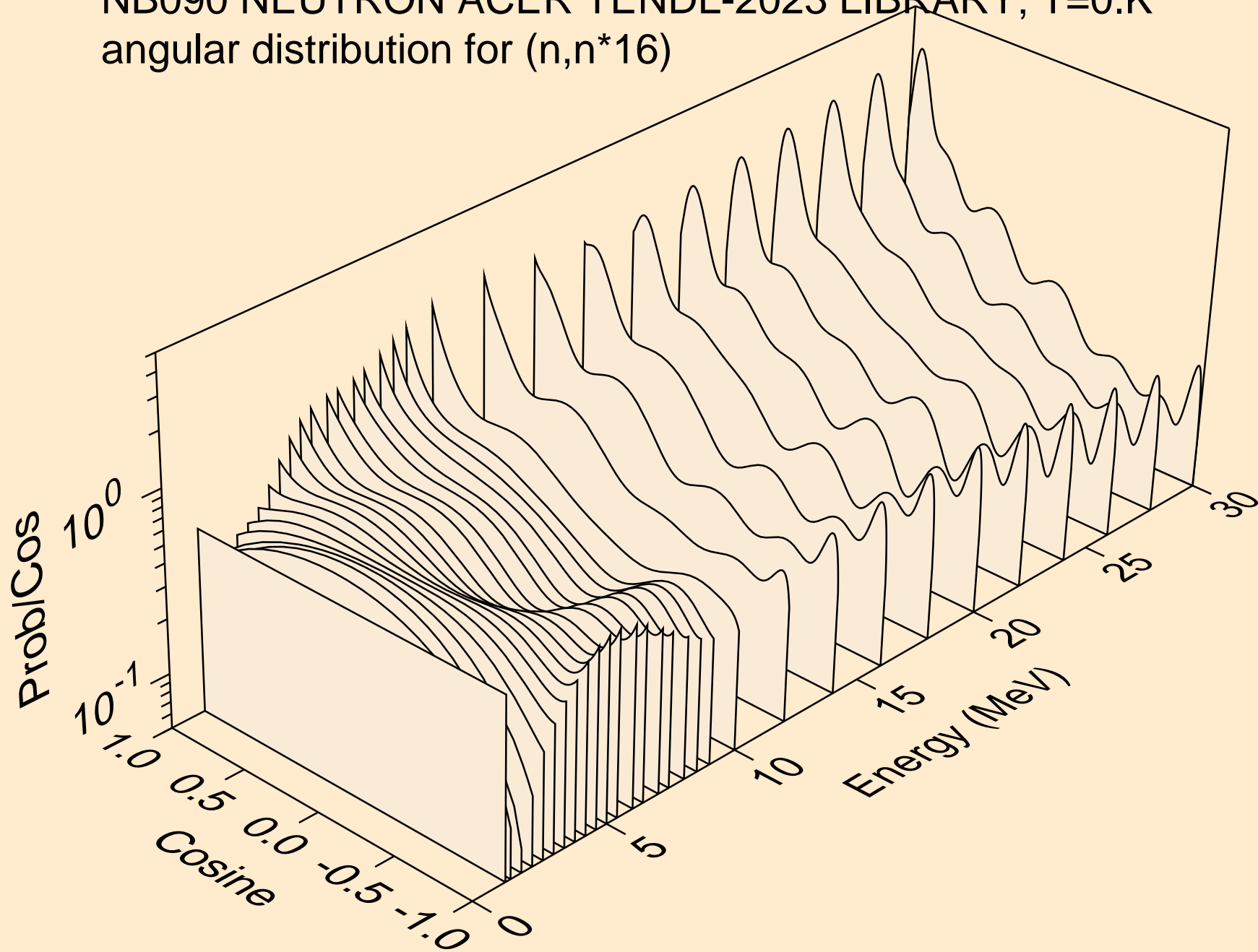

NB090 NEUTRON ACER TENDL-2023 LIBRARY; T=0.K
angular distribution for (n,n*17)

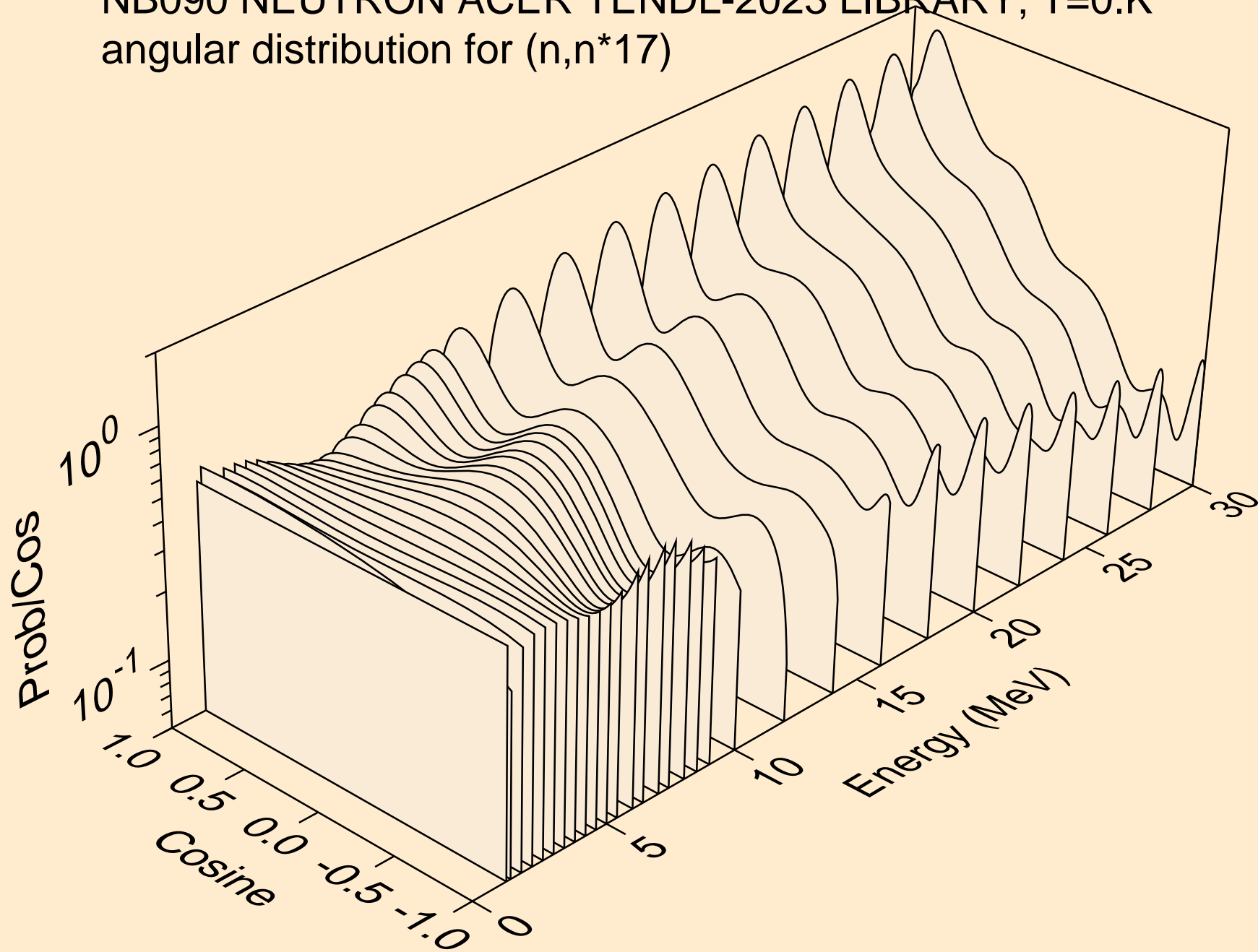

NB090 NEUTRON ACER TENDL-2023 LIBRARY; T=0.K
angular distribution for (n,n*18)

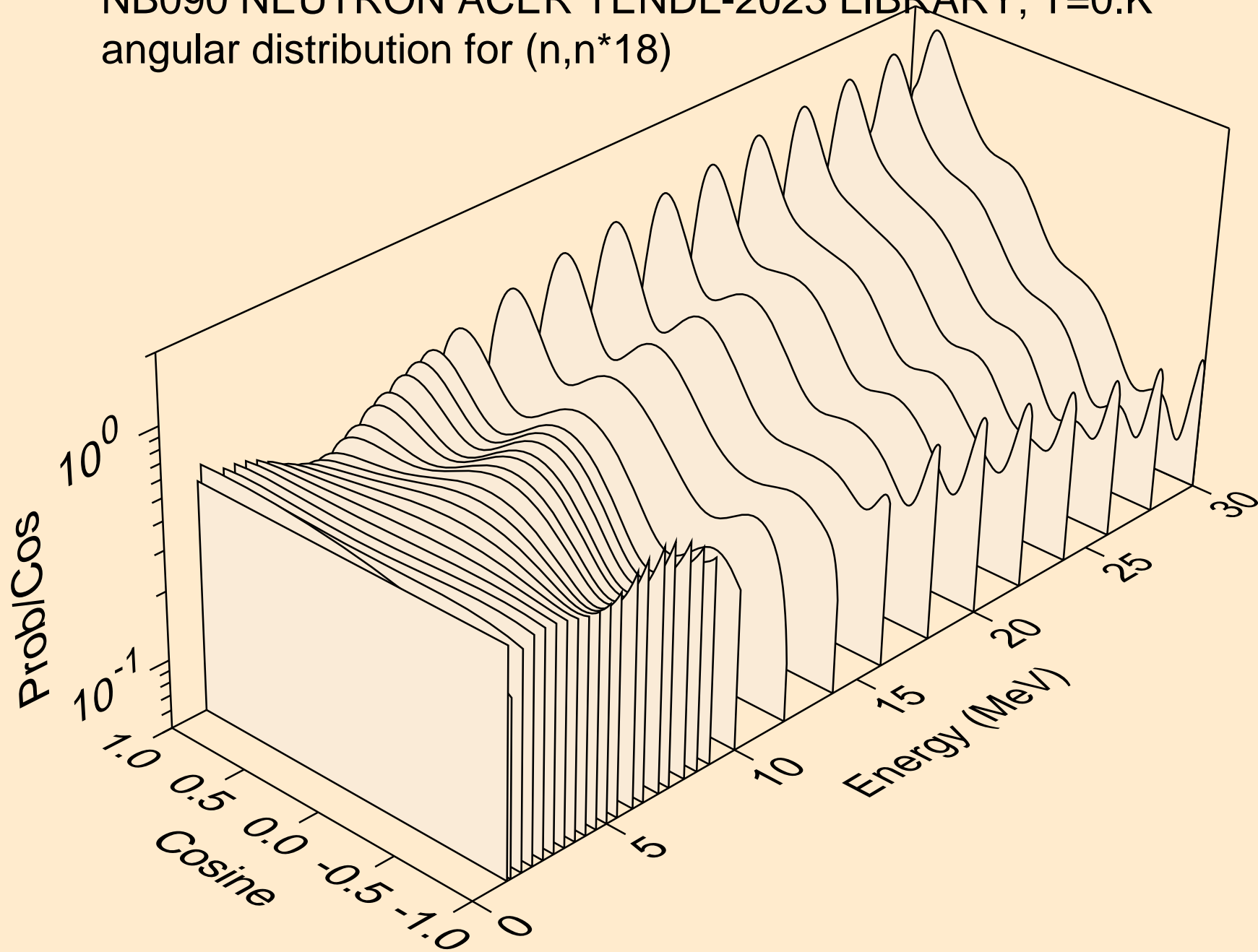

NB090 NEUTRON ACER TENDL-2023 LIBRARY; T=0.K
angular distribution for (n,n*19)

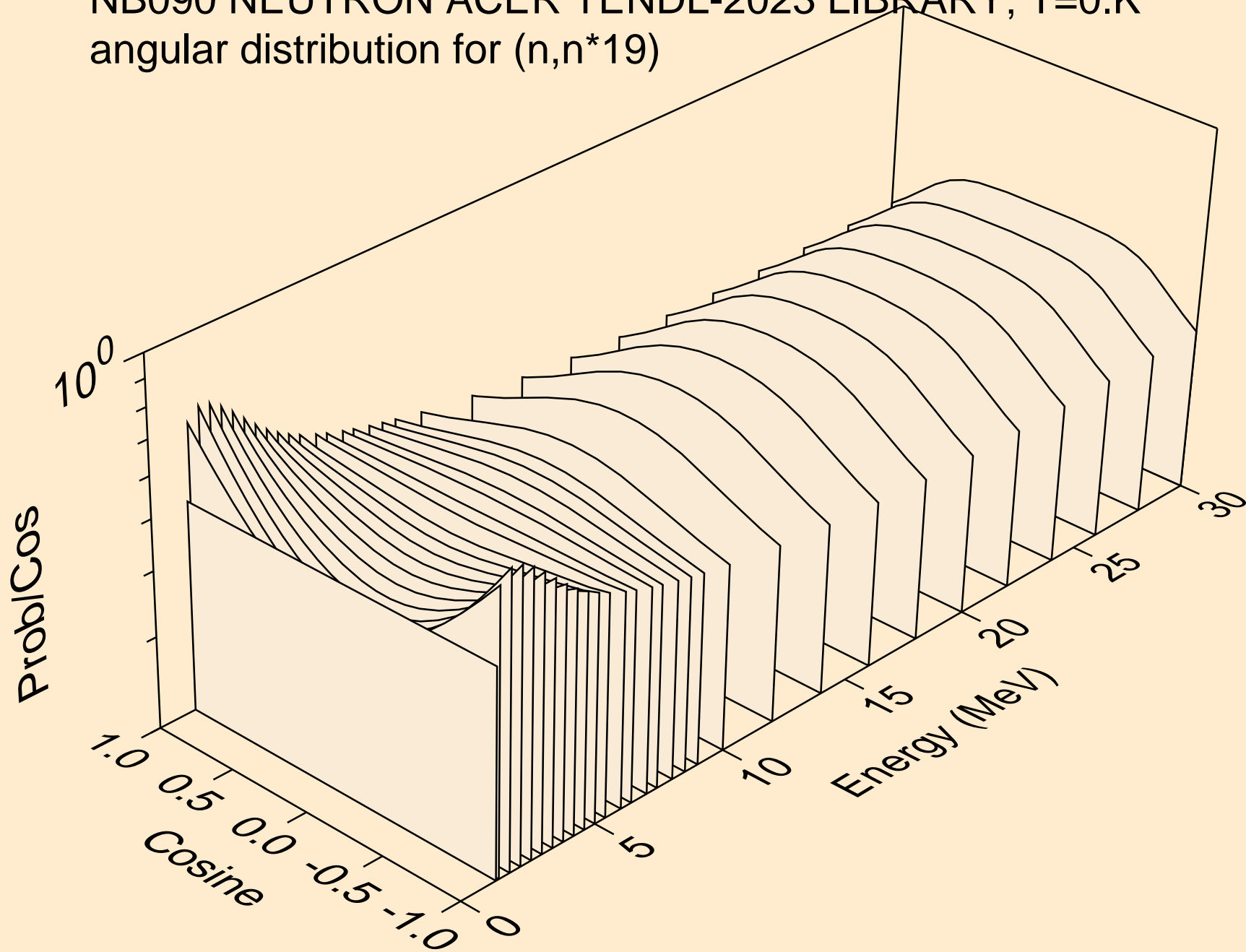

NB090 NEUTRON ACER TENDL-2023 LIBRARY; T=0.K
angular distribution for (n,n*20)

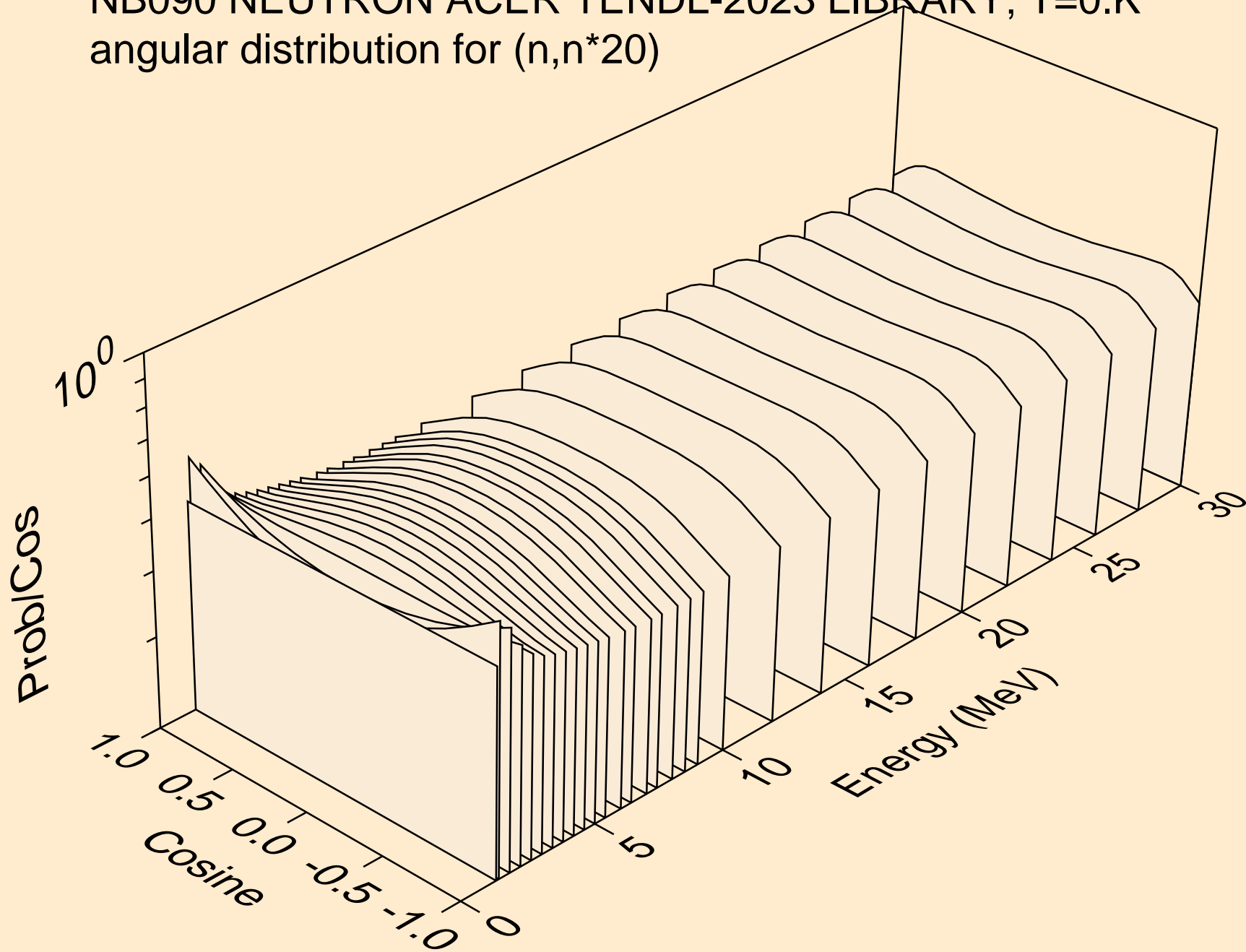

NB090 NEUTRON ACER TENDL-2023 LIBRARY; T=0.K
angular distribution for (n,n*21)

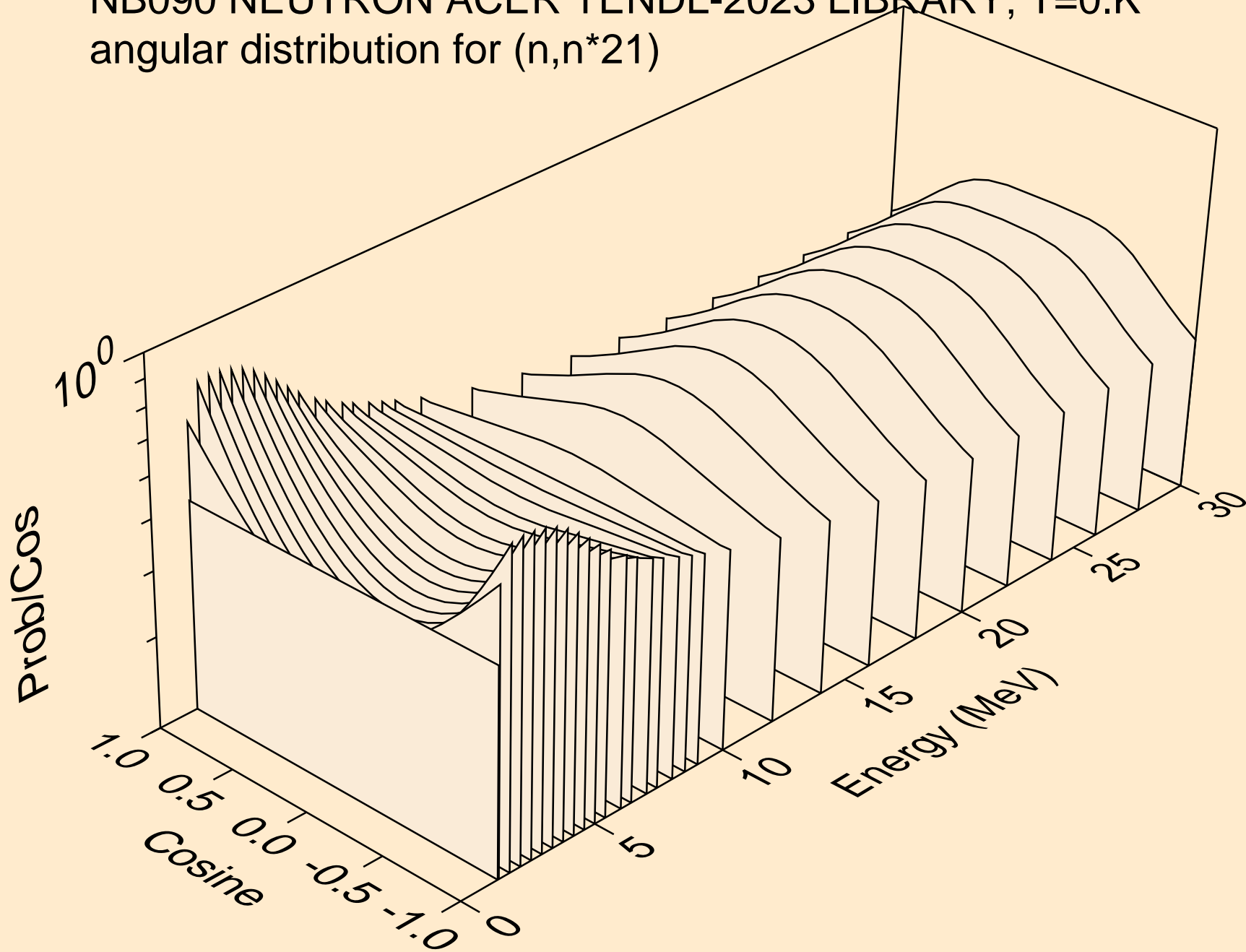

NB090 NEUTRON ACER TENDL-2023 LIBRARY; T=0.K
angular distribution for (n,n*22)

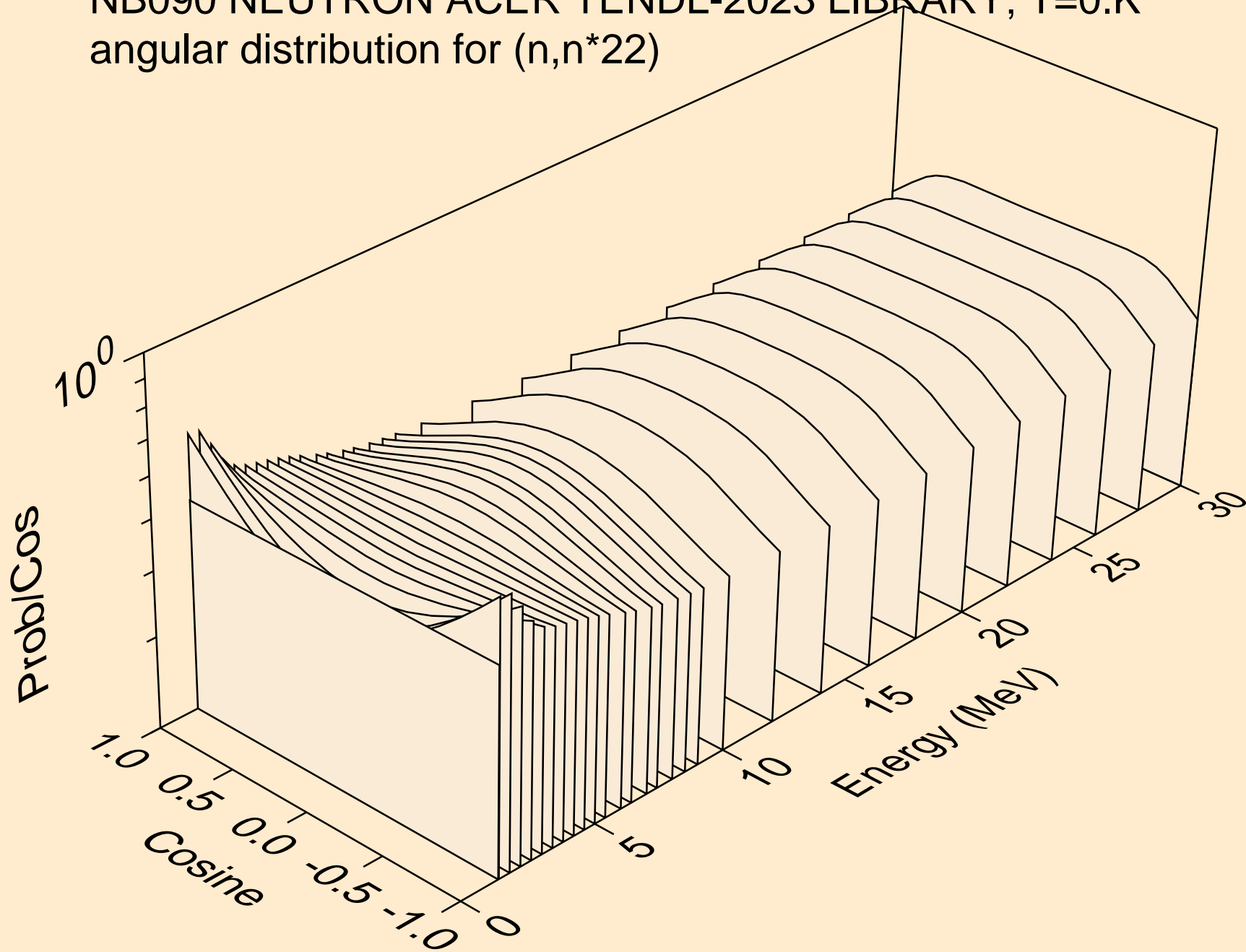

NB090 NEUTRON ACER TENDL-2023 LIBRARY; T=0.K
angular distribution for (n,n*23)

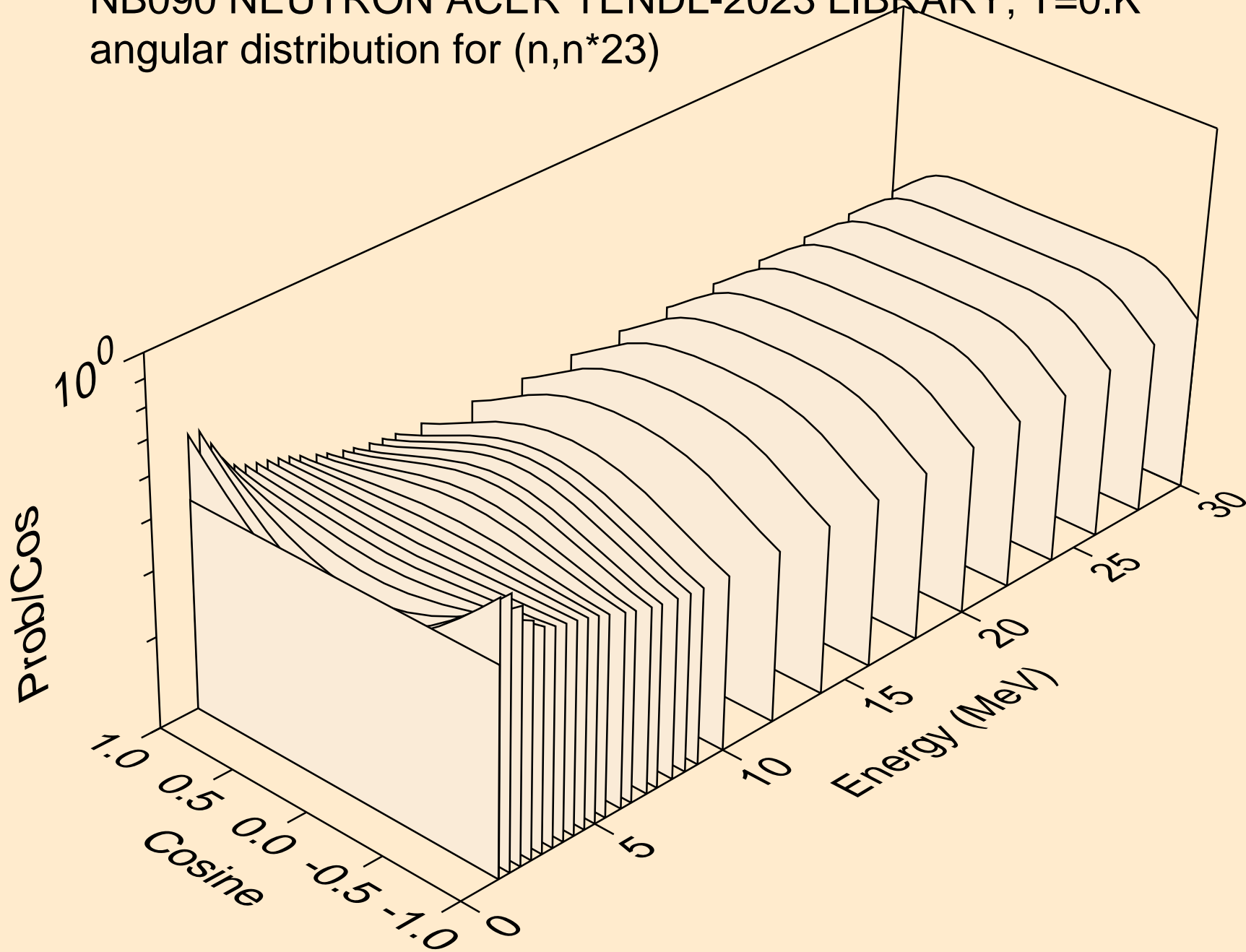

NB090 NEUTRON ACER TENDL-2023 LIBRARY; T=0.K
angular distribution for (n,n*24)

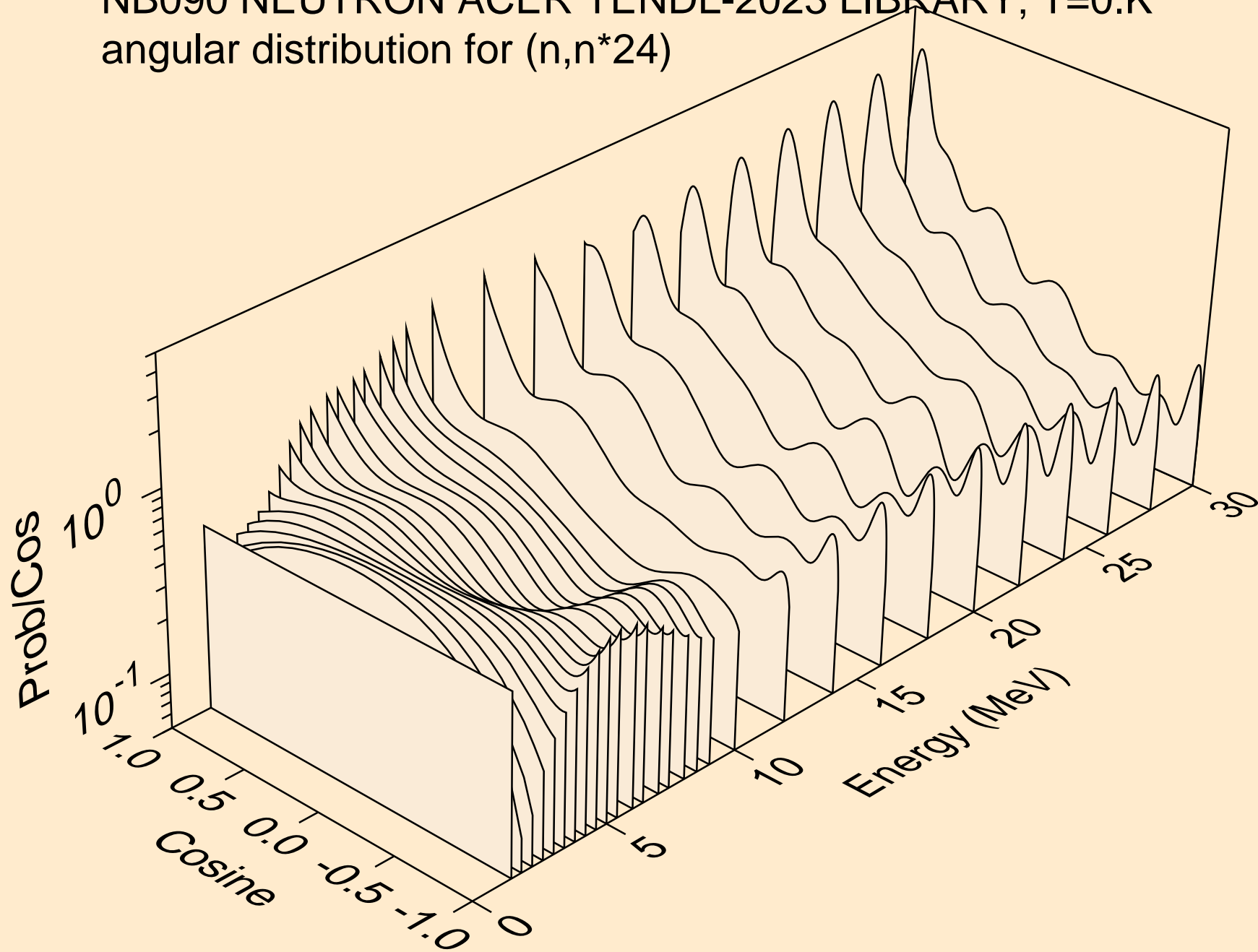

NB090 NEUTRON ACER TENDL-2023 LIBRARY; T=0.K
angular distribution for (n,n*25)

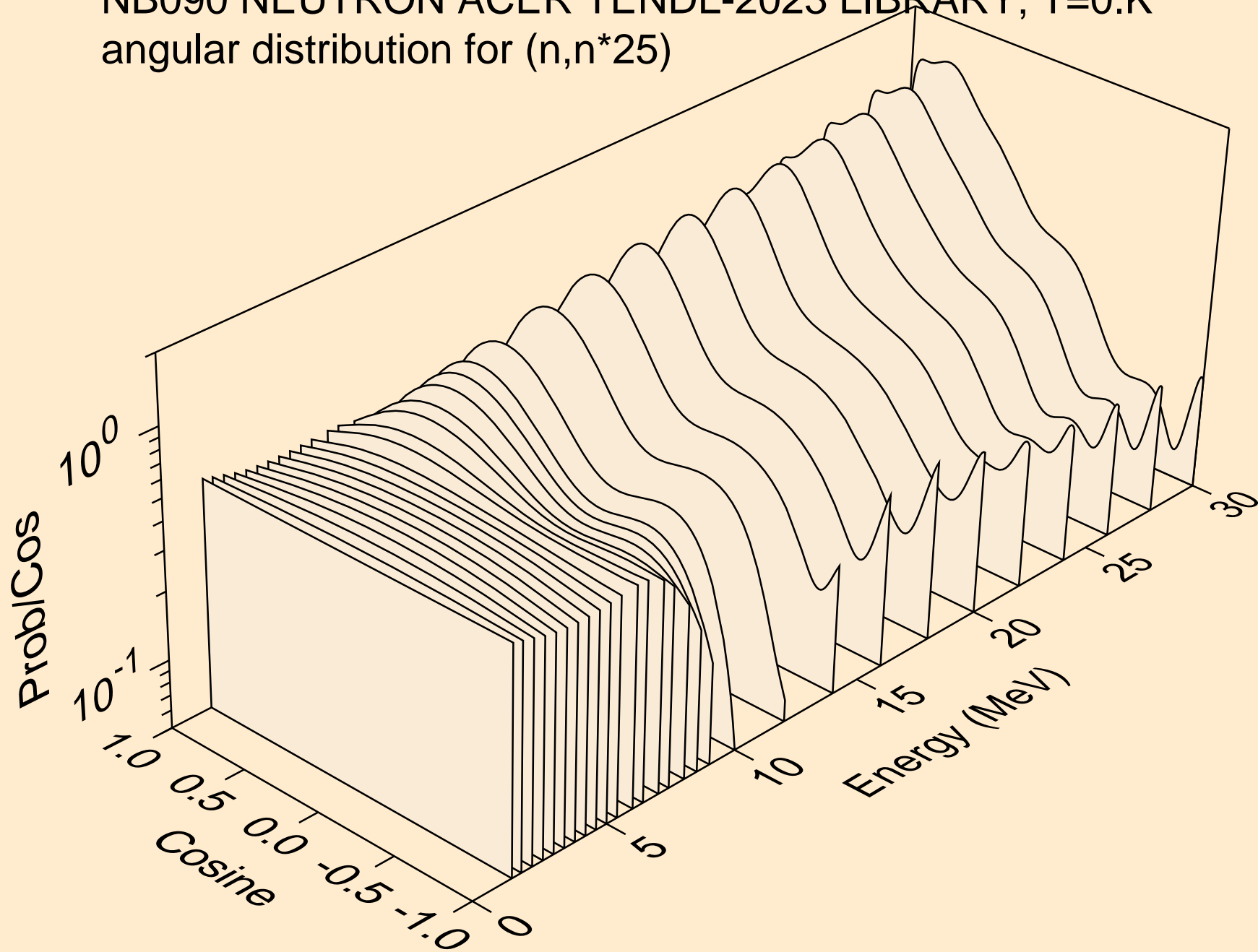

NB090 NEUTRON ACER TENDL-2023 LIBRARY; T=0.K
Neutron emission for (n,x)

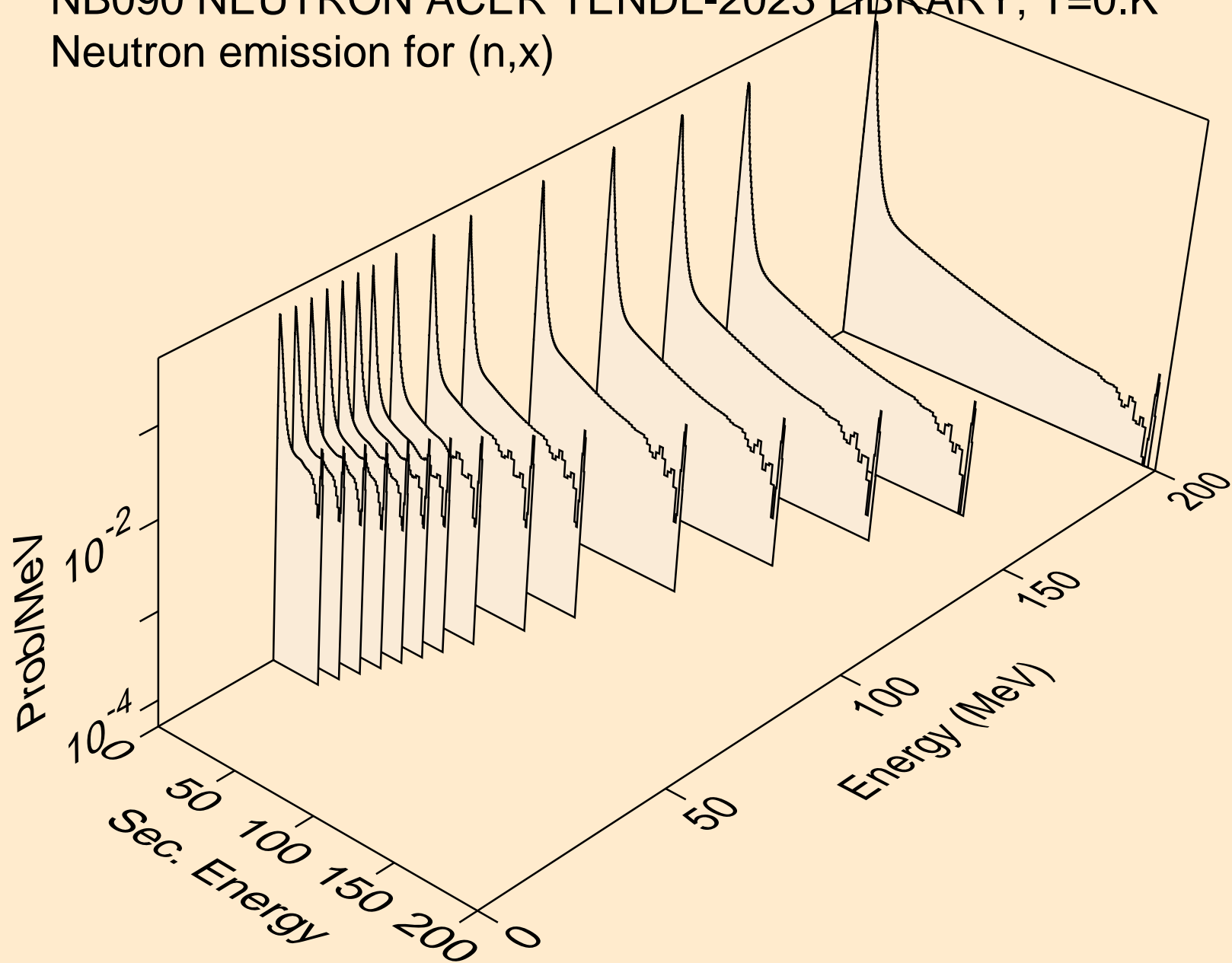

NB090 NEUTRON ACER TENDL-2023 LIBRARY; T=0.K
Neutron emission for (n,2nd)

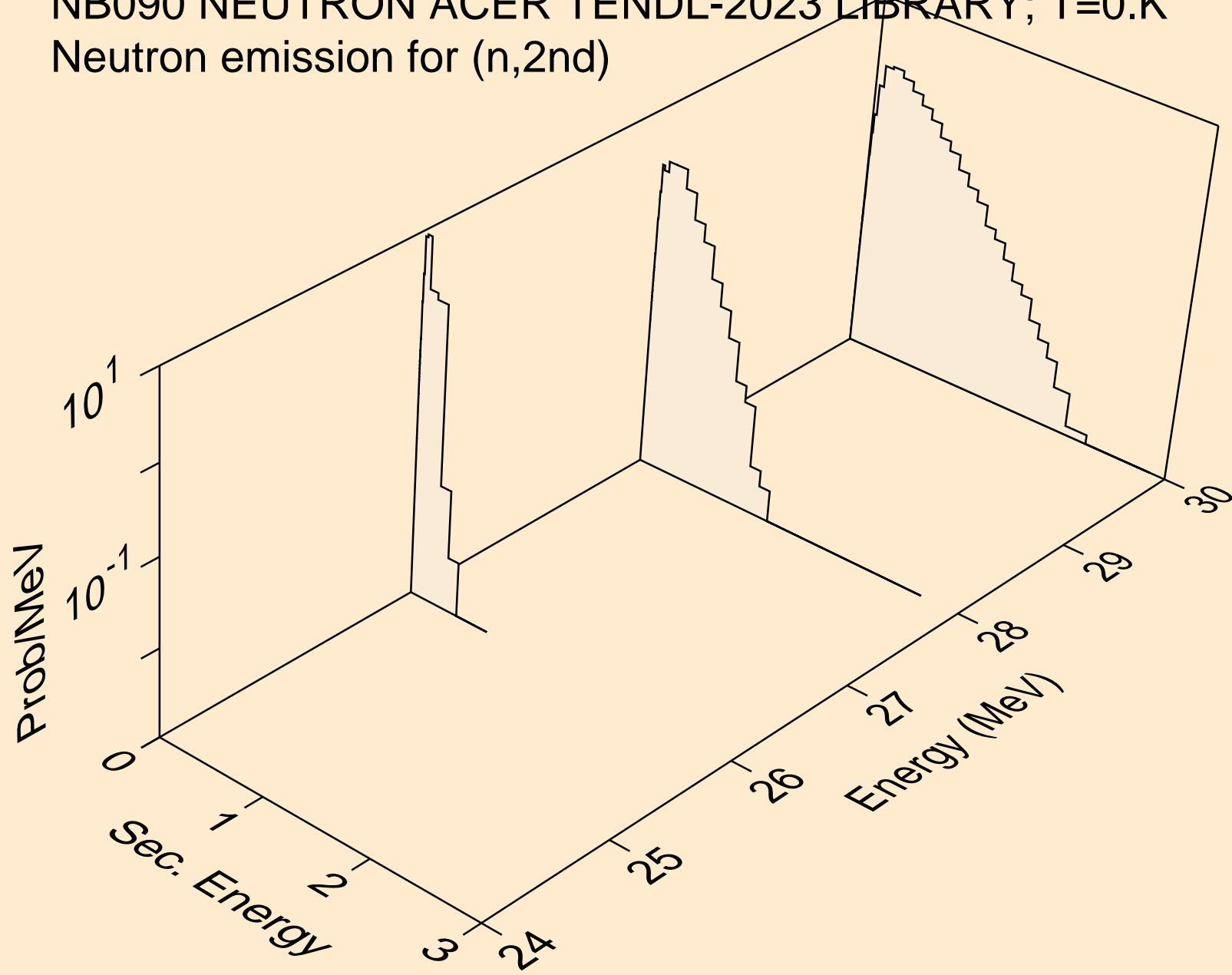

NB090 NEUTRON ACER TENDL-2023 LIBRARY; T=0.K
Neutron emission for (n,2n)

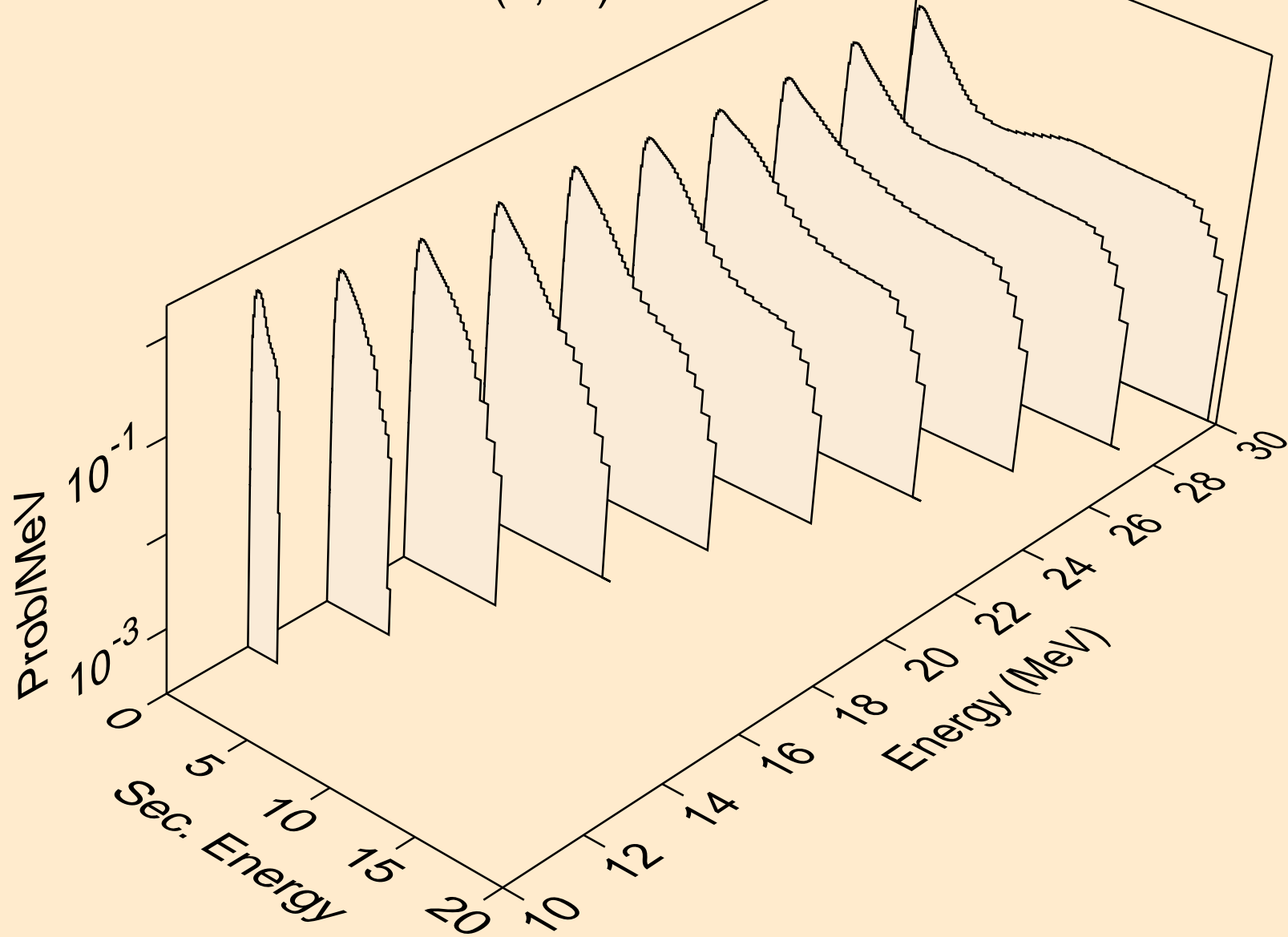

NB090 NEUTRON ACER TENDL-2023 LIBRARY; T=0.K
Neutron emission for (n,3n)

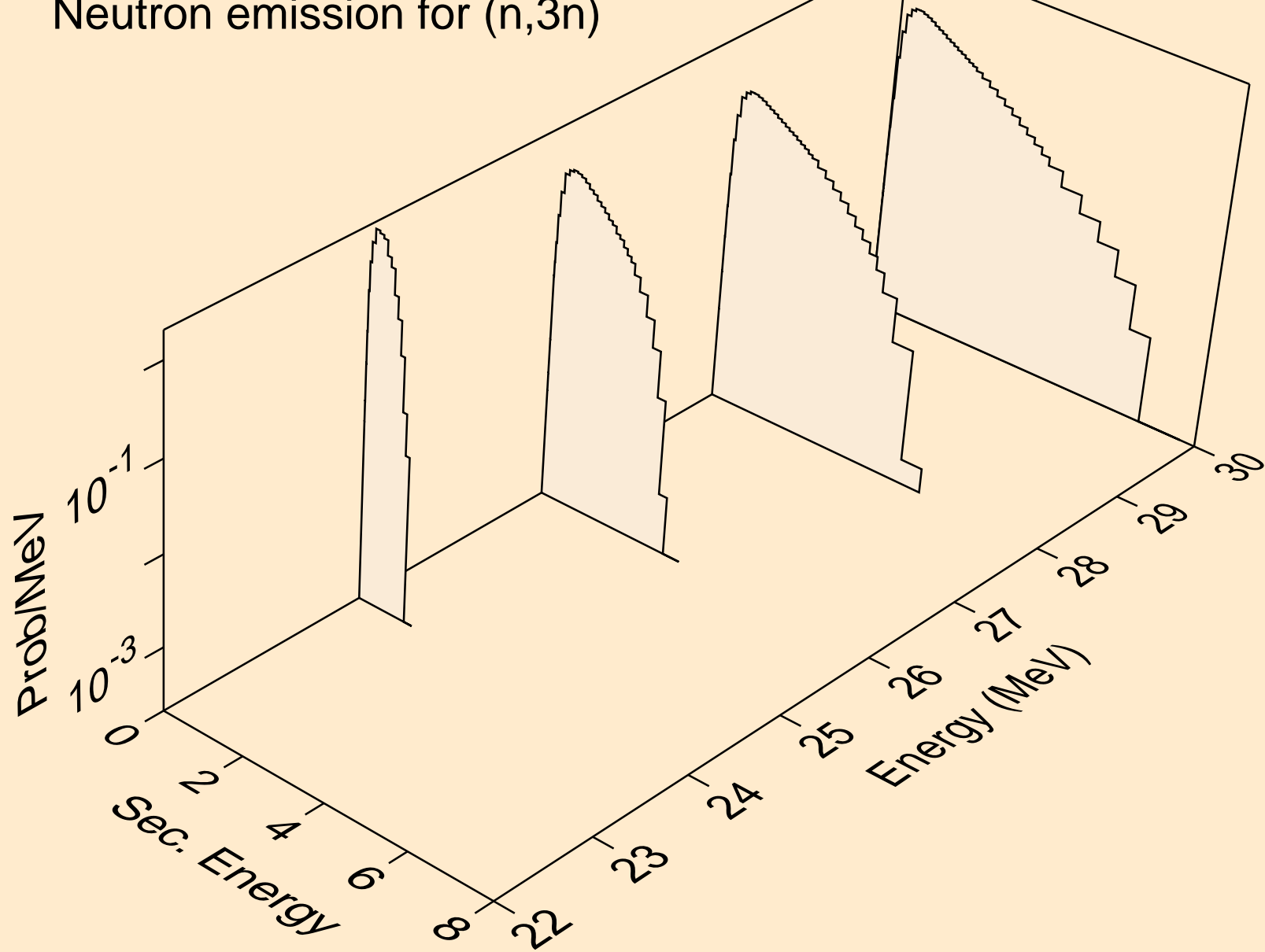

NB090 NEUTRON ACER TENDL-2023 LIBRARY; T=0.K
Neutron emission for (n,n*)a

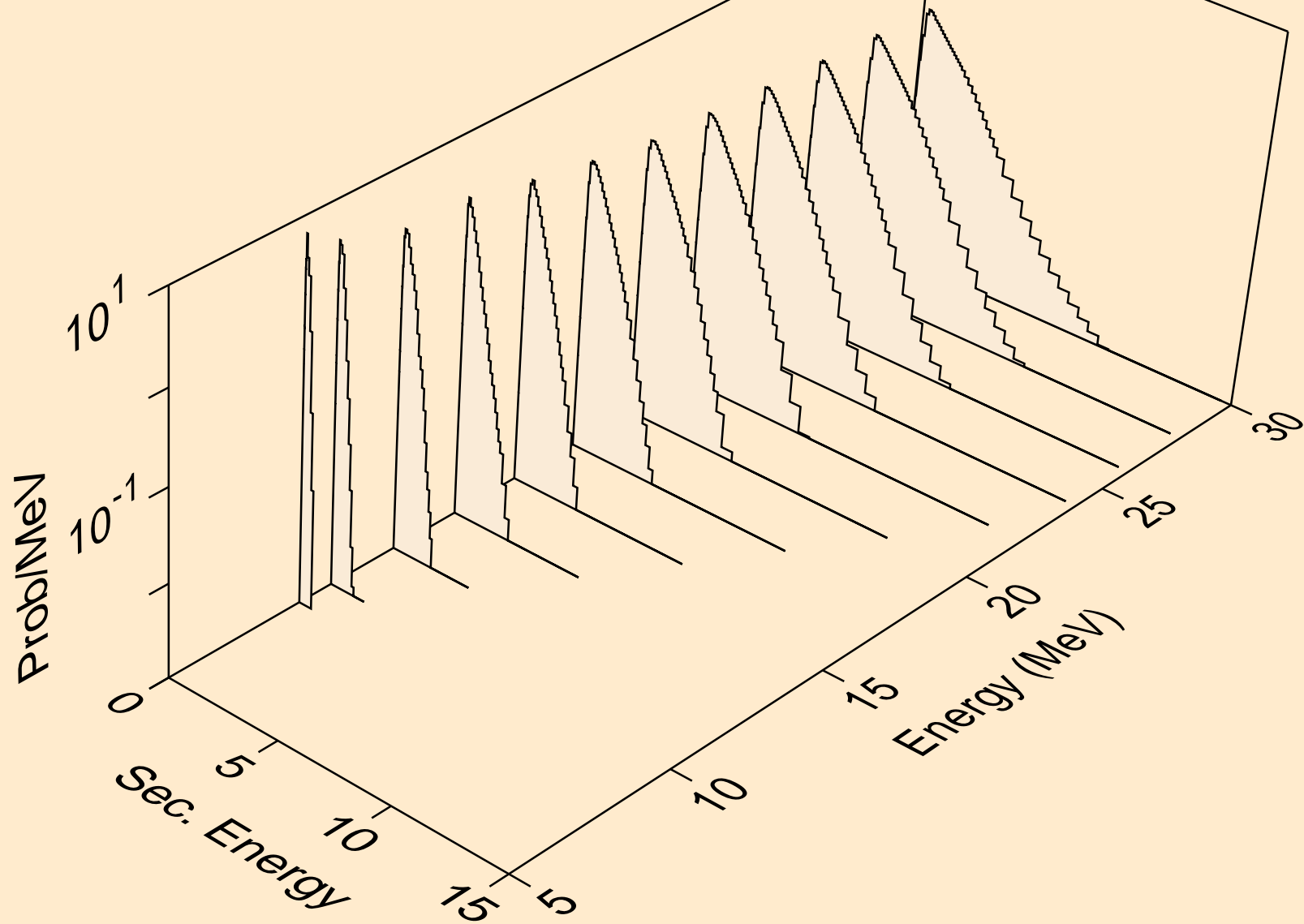

NB090 NEUTRON ACER TENDL-2023 LIBRARY; T=0.K
Neutron emission for (n,2n)a

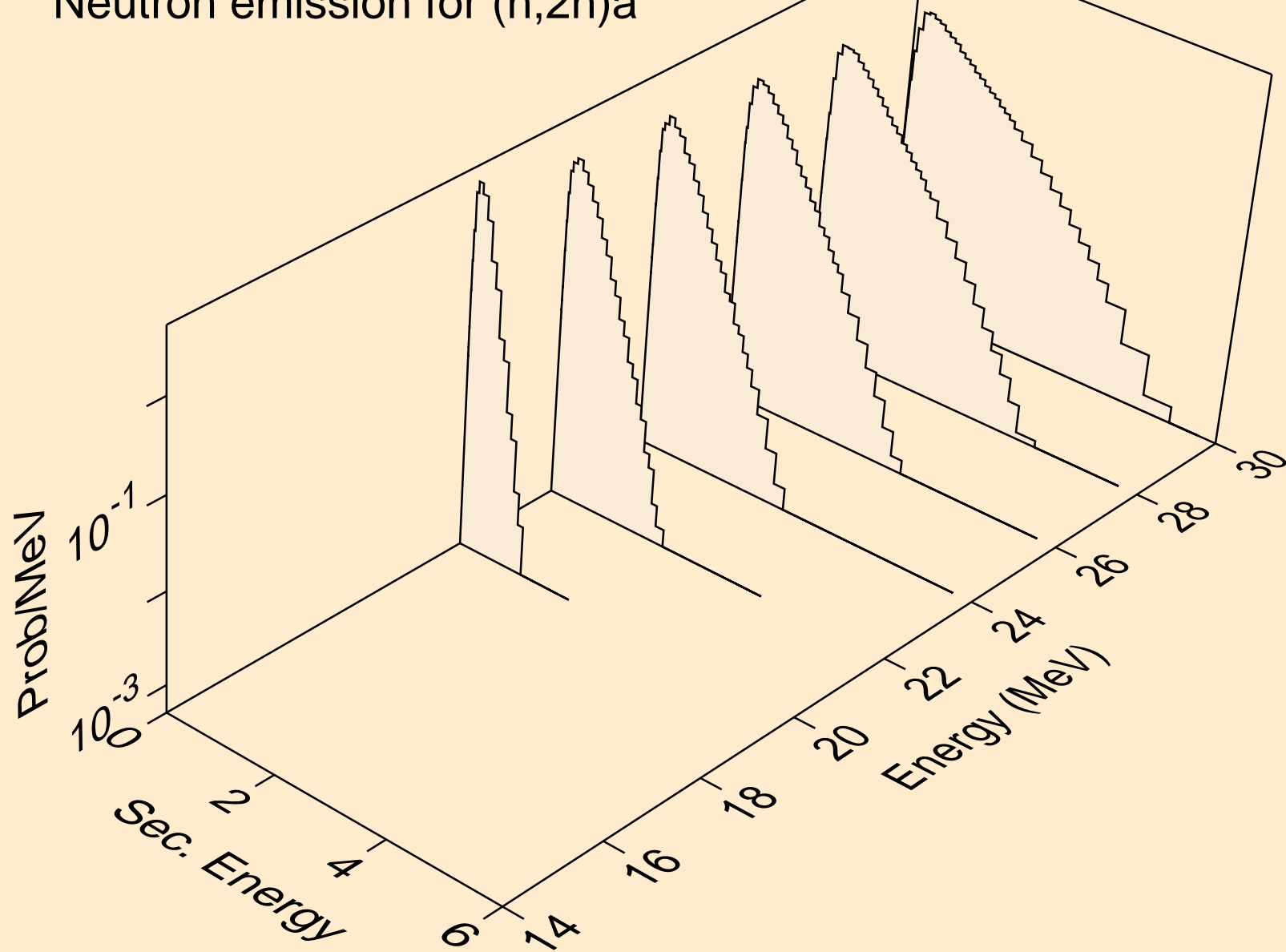

NB090 NEUTRON ACER TENDL-2023 LIBRARY; T=0.K
Neutron emission for (n,n*)p

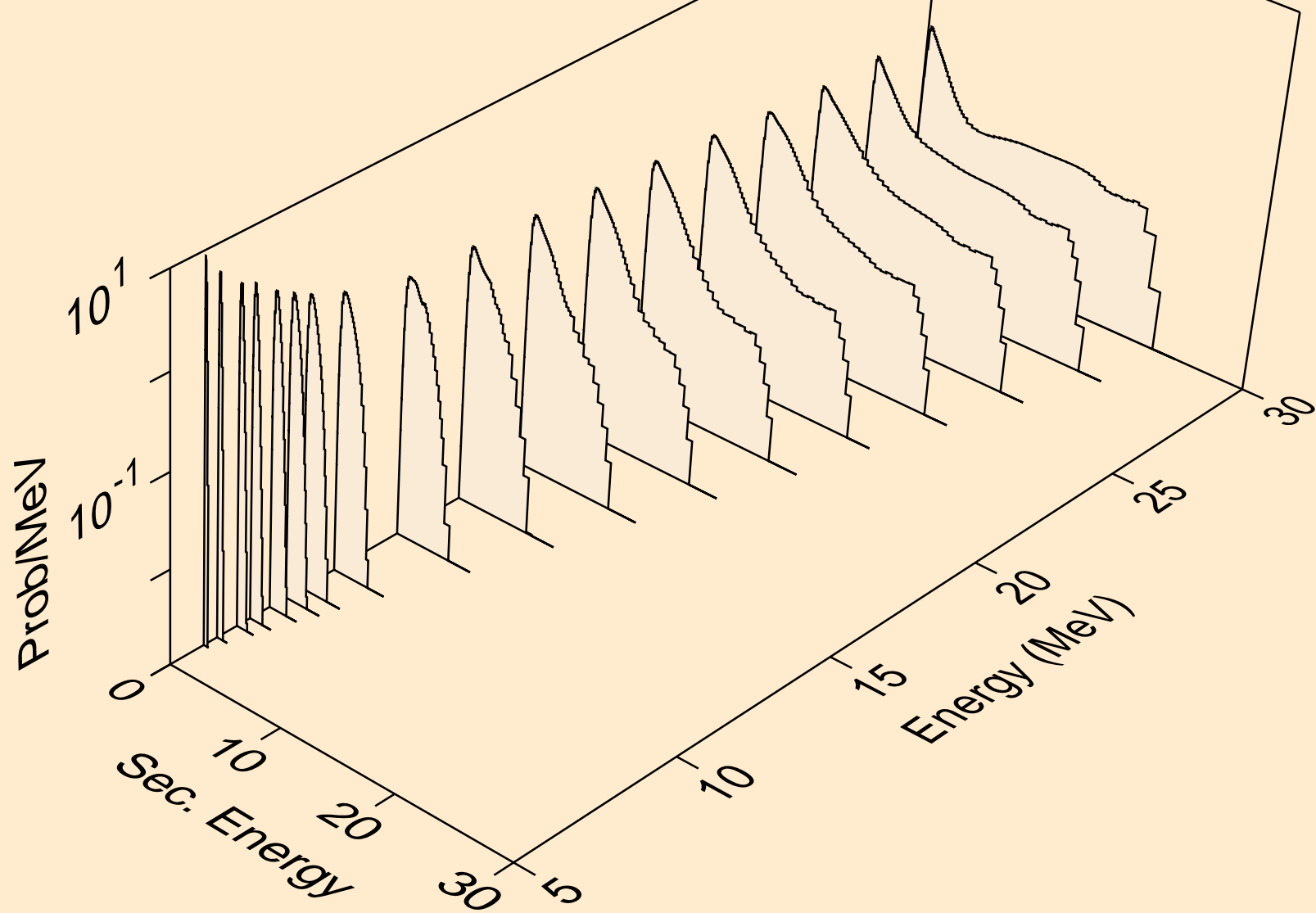

NB090 NEUTRON ACER TENDL-2023 LIBRARY; T=0.K
Neutron emission for (n,n*)2a

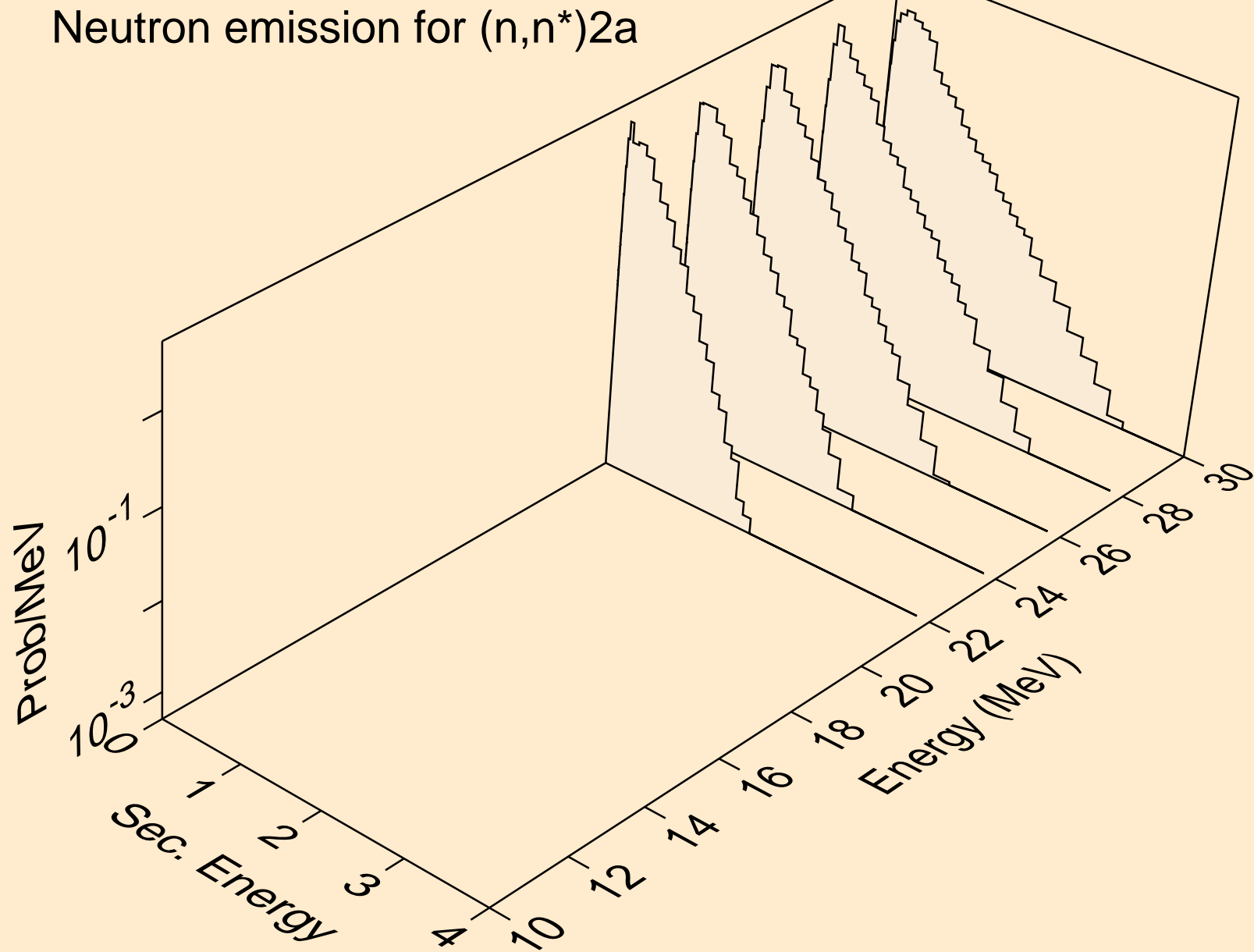

NB090 NEUTRON ACER TENDL-2023 LIBRARY; T=0.K
Neutron emission for (n,n*)d

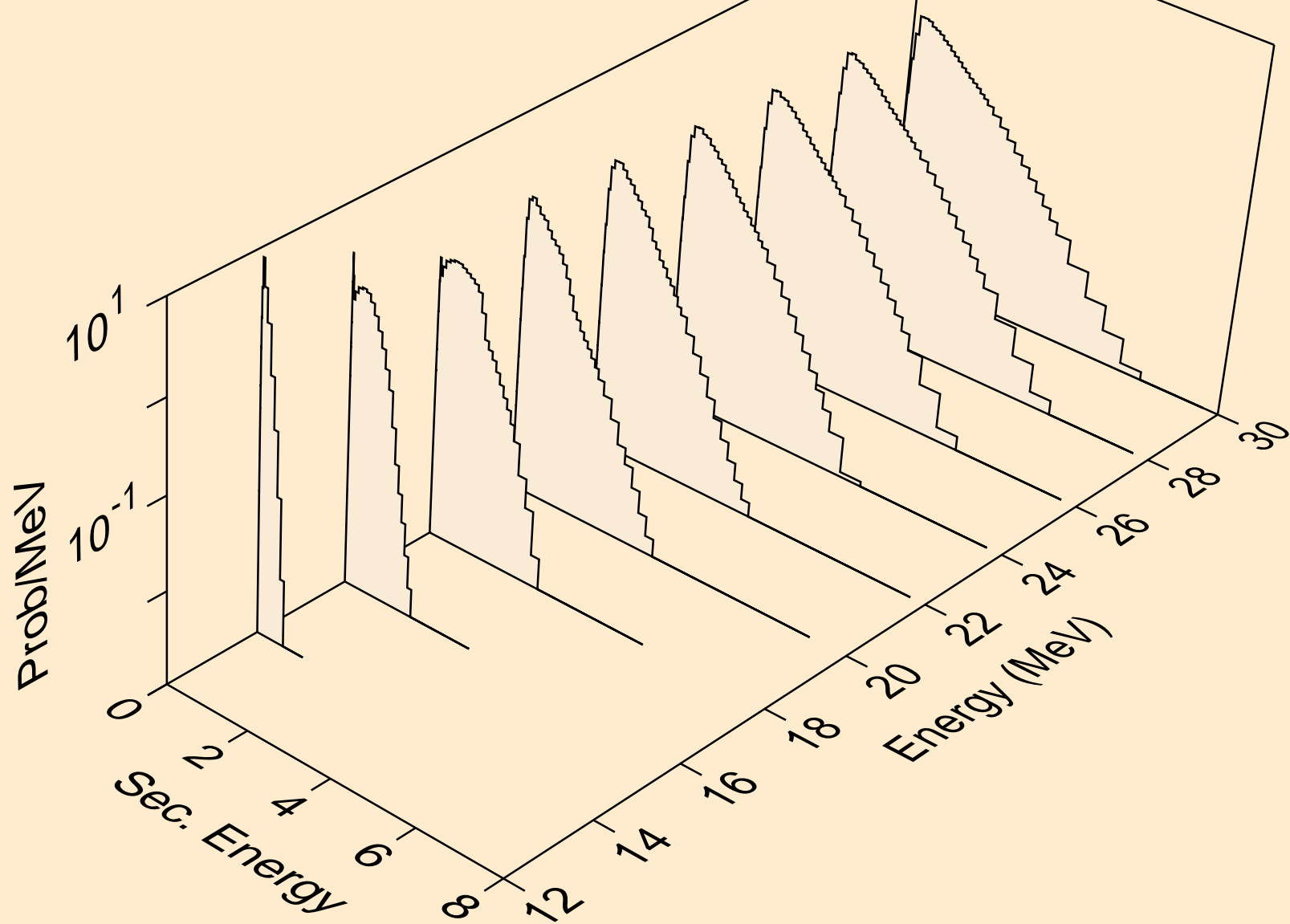

NB090 NEUTRON ACER TENDL-2023 LIBRARY; T=0.K
Neutron emission for (n,n*)t

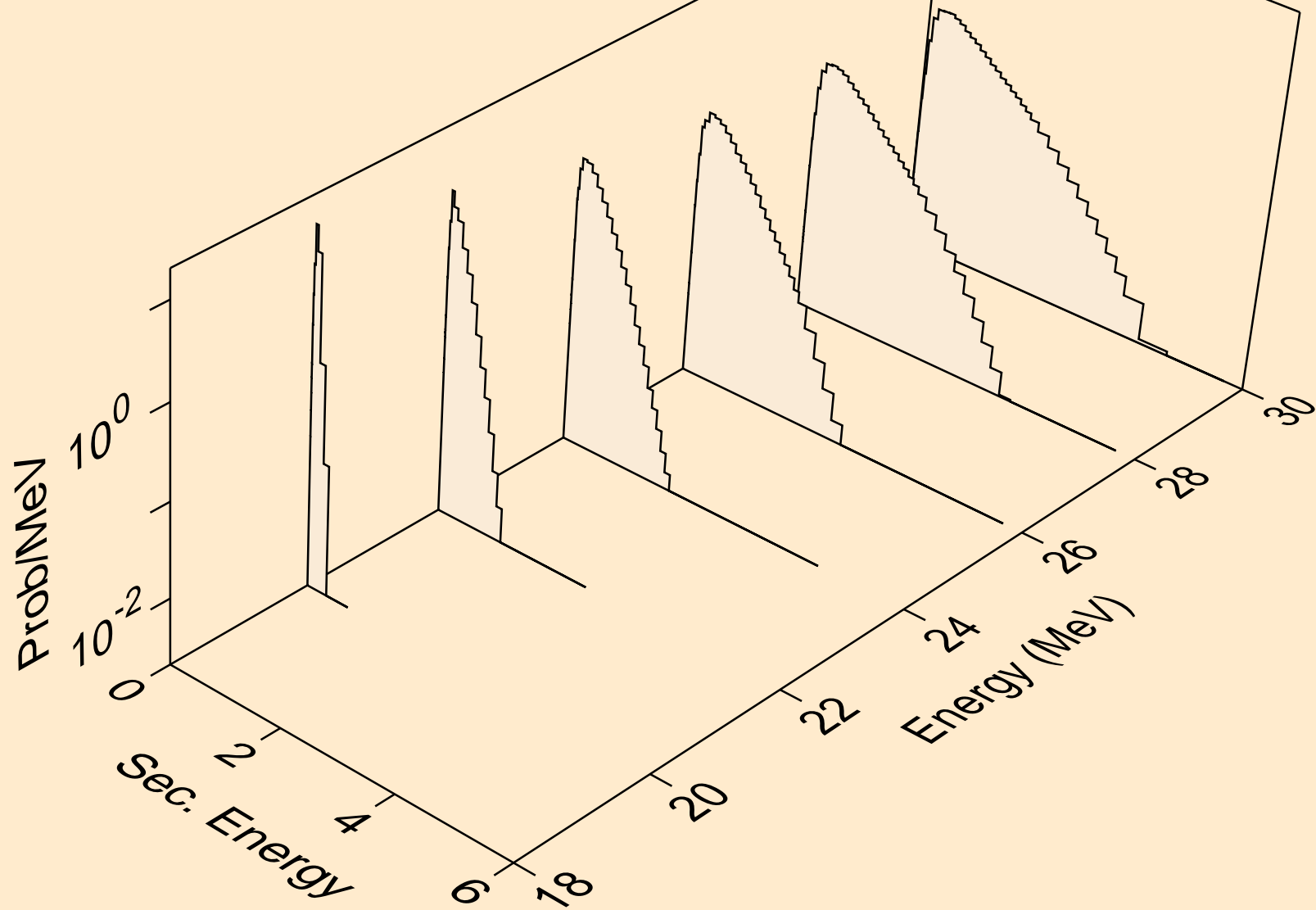

NB090 NEUTRON ACER TENDL-2023 LIBRARY; T=0.K
Neutron emission for (n,n*)he3

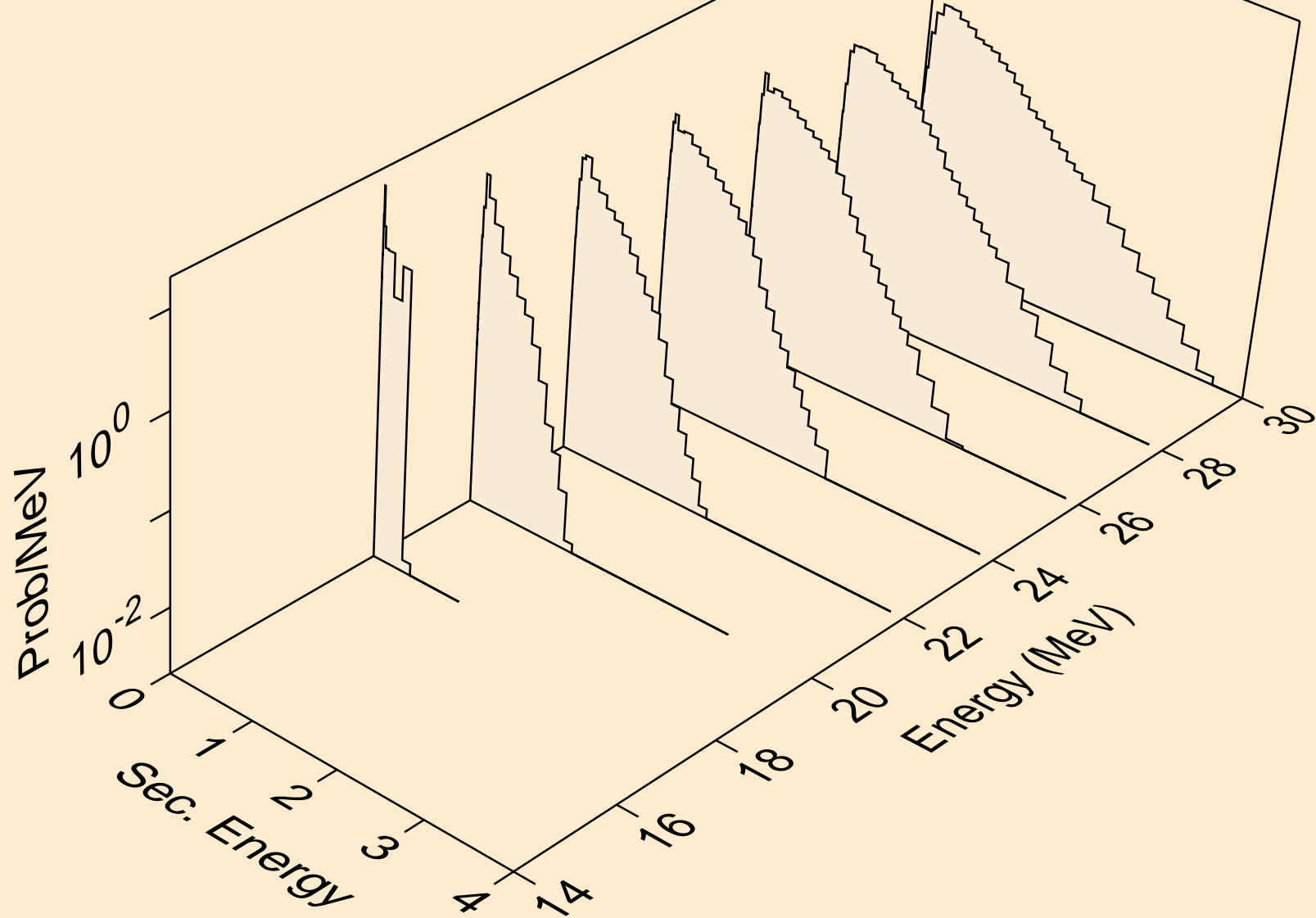

NB090 NEUTRON ACER TENDL-2023 LIBRARY; T=0.K
Neutron emission for (n,2np)

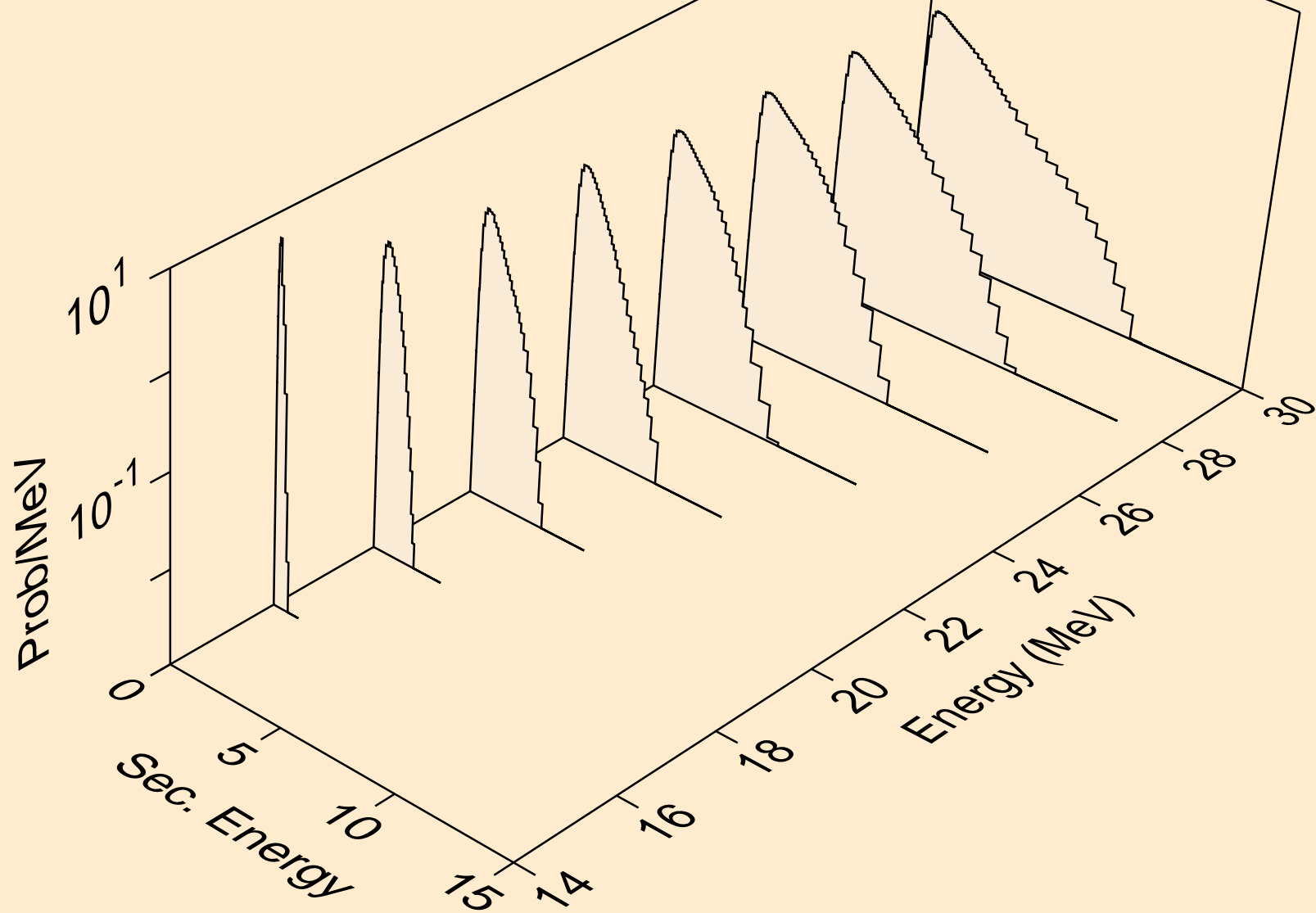

NB090 NEUTRON ACER TENDL-2023 LIBRARY; T=0.K
Neutron emission for (n,3np)

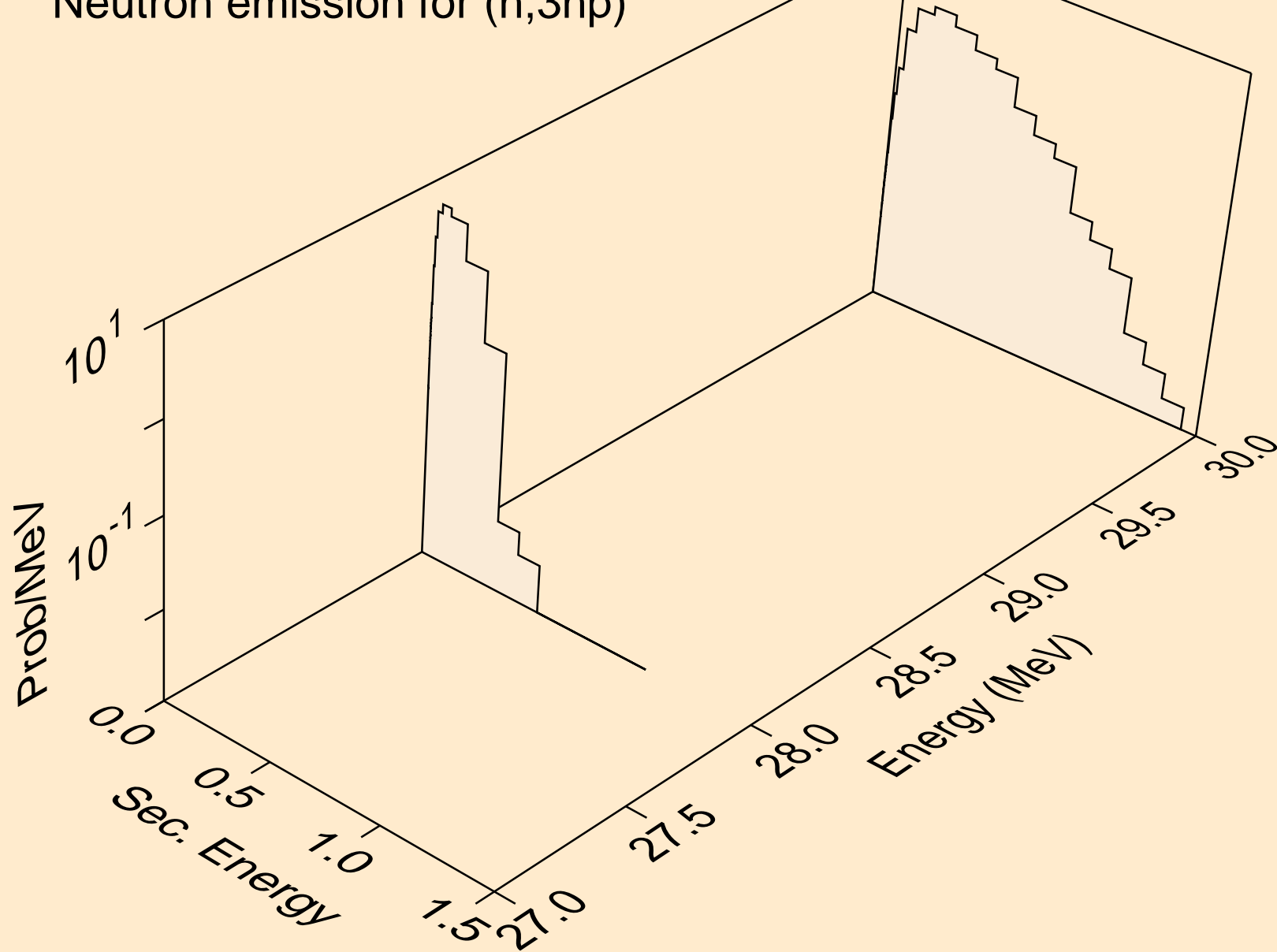

NB090 NEUTRON ACER TENDL-2023 LIBRARY; T=0.K
Neutron emission for (n,n2p)

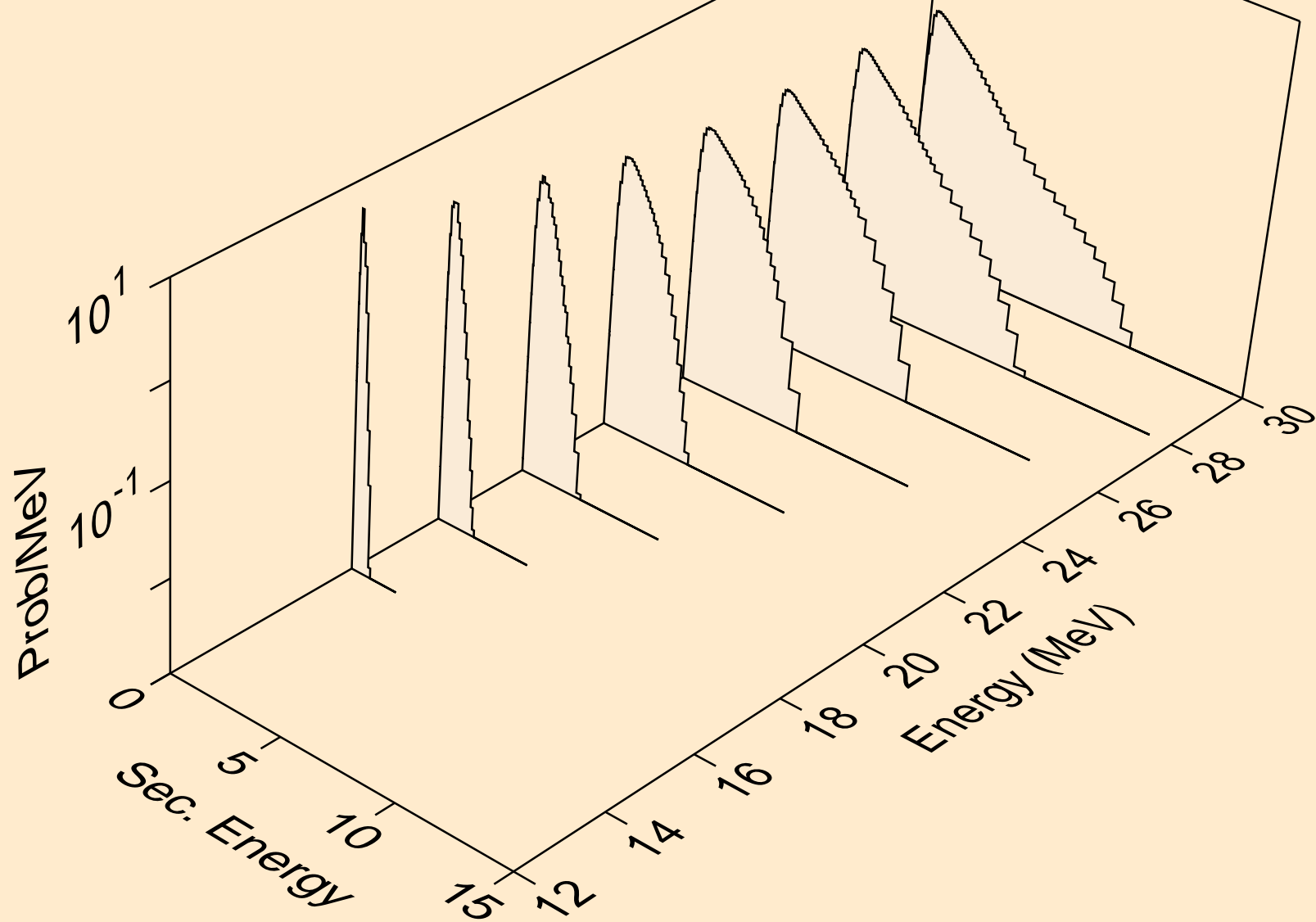

NB090 NEUTRON ACER TENDL-2023 LIBRARY; T=0.K
Neutron emission for (n,npa)

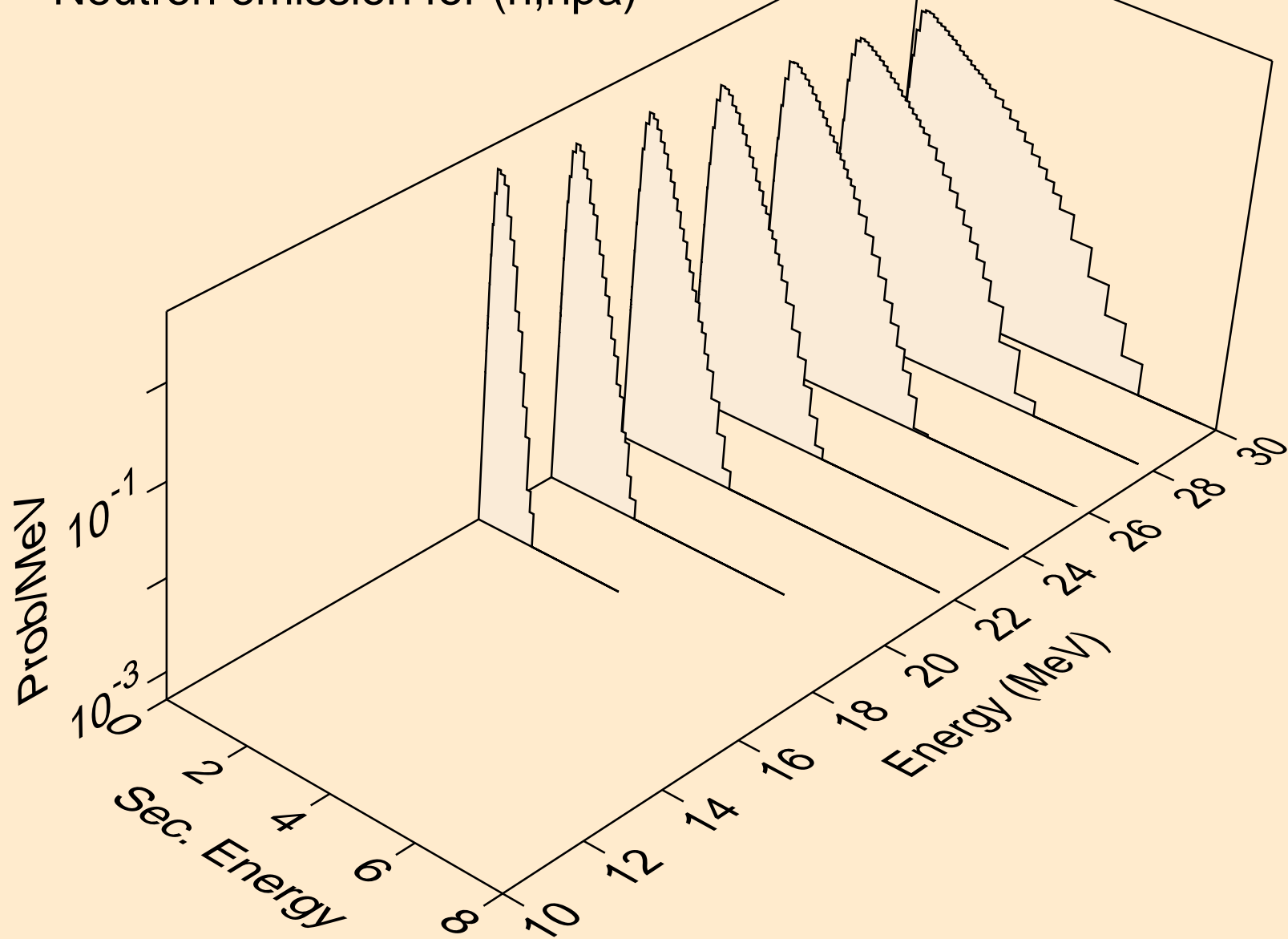

NB090 NEUTRON ACER TENDL-2023 LIBRARY; T=0.K
Neutron emission for (n,n*c)

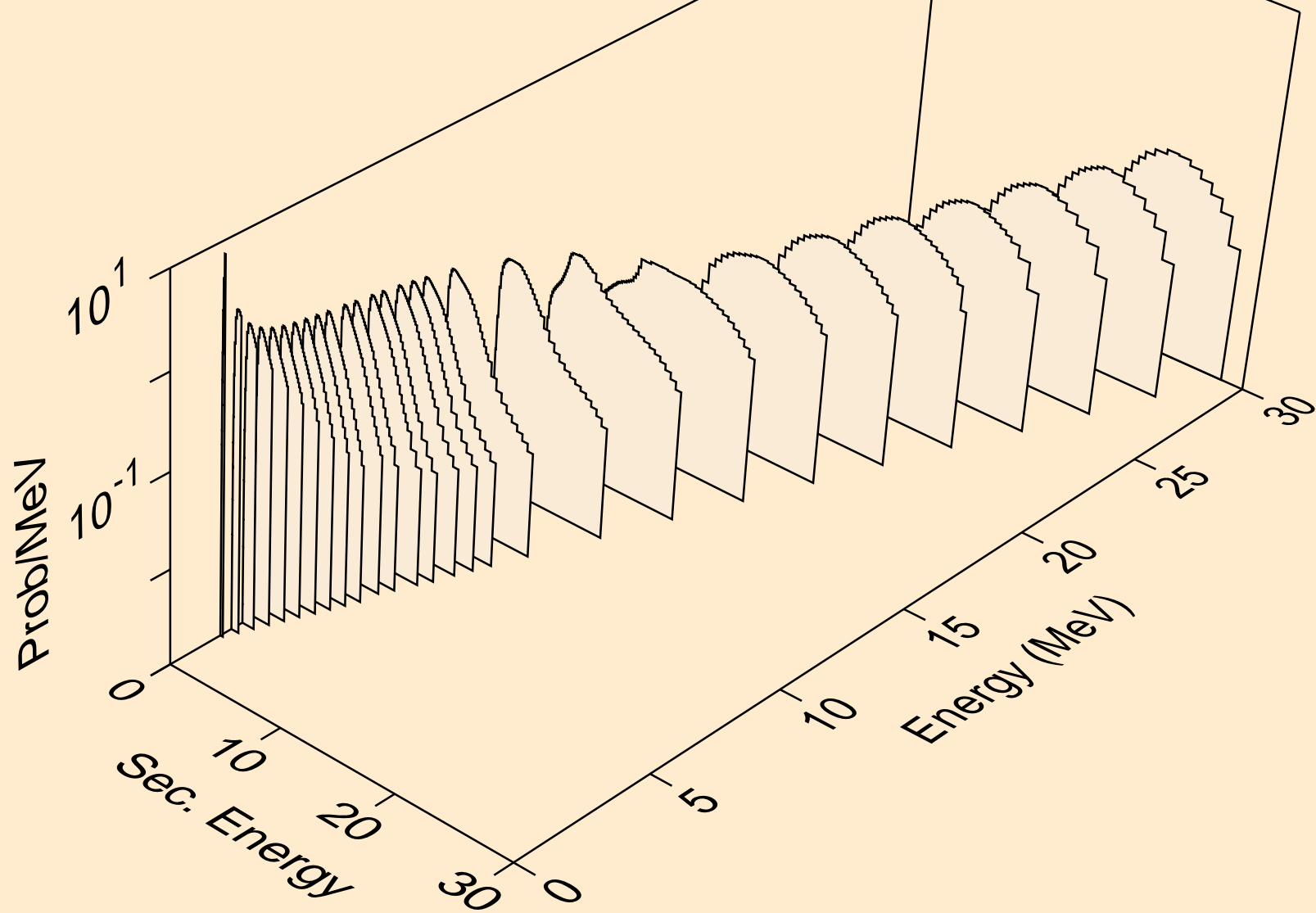

NB090 NEUTRON ACER TENDL-2023 LIBRARY; T=0.K
Photon emission for (n,x)

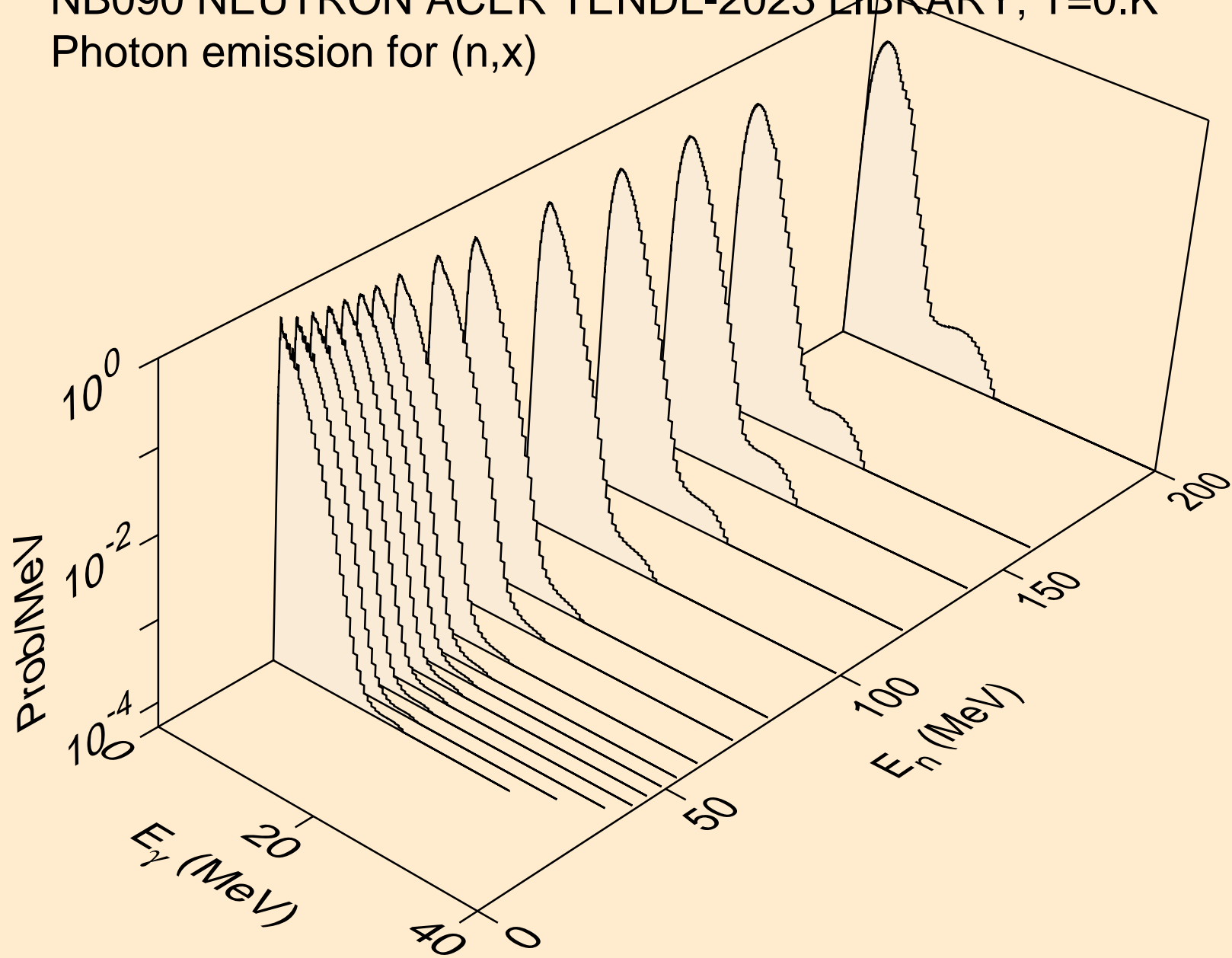

NB090 NEUTRON ACER TENDL-2023 LIBRARY; T=0.K
Photon emission for (n,2nd)

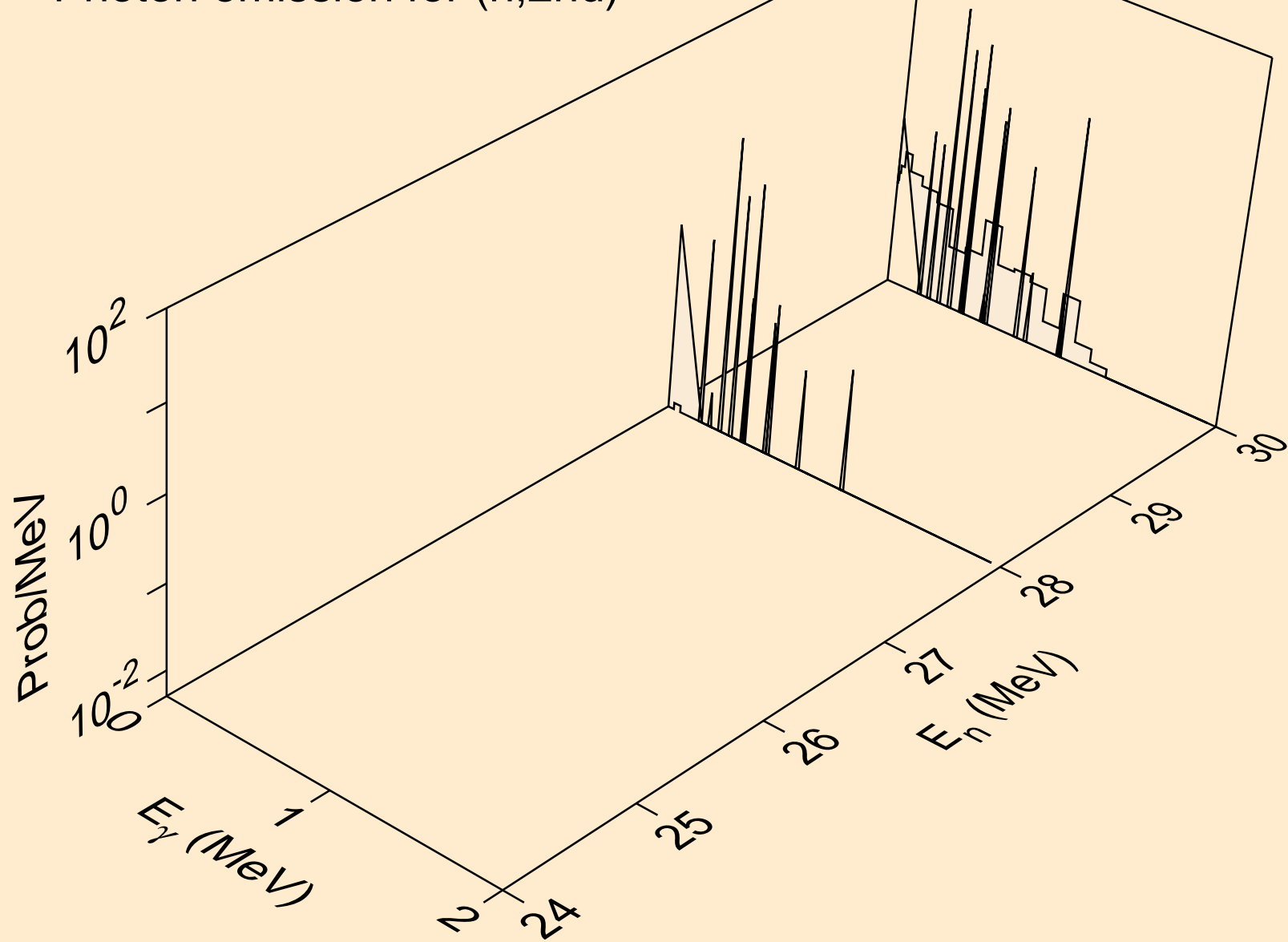

NB090 NEUTRON ACER TENDL-2023 LIBRARY; T=0.K
Photon emission for (n,2n)

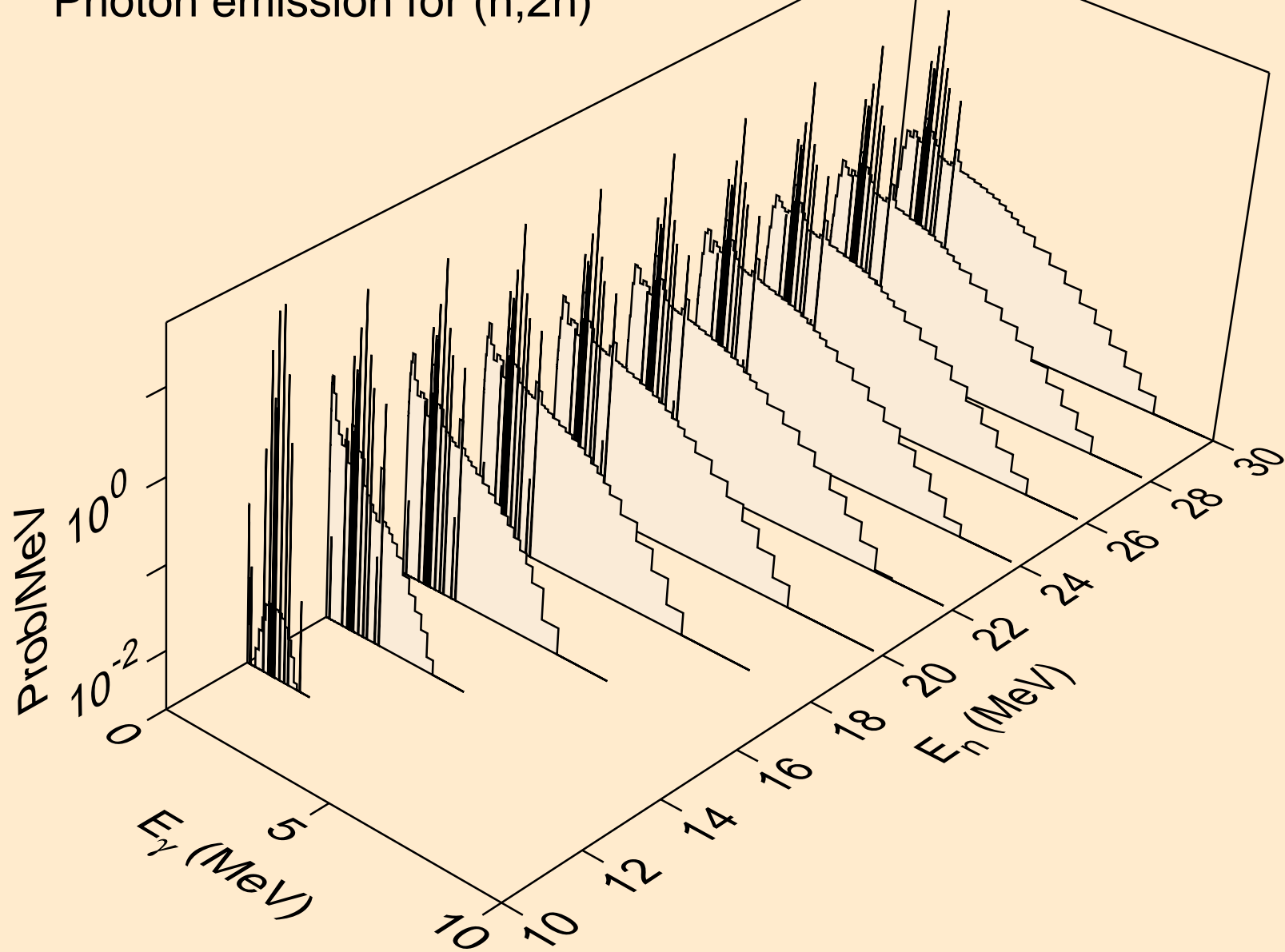

NB090 NEUTRON ACER TENDL-2023 LIBRARY; T=0.K
Photon emission for (n,3n)

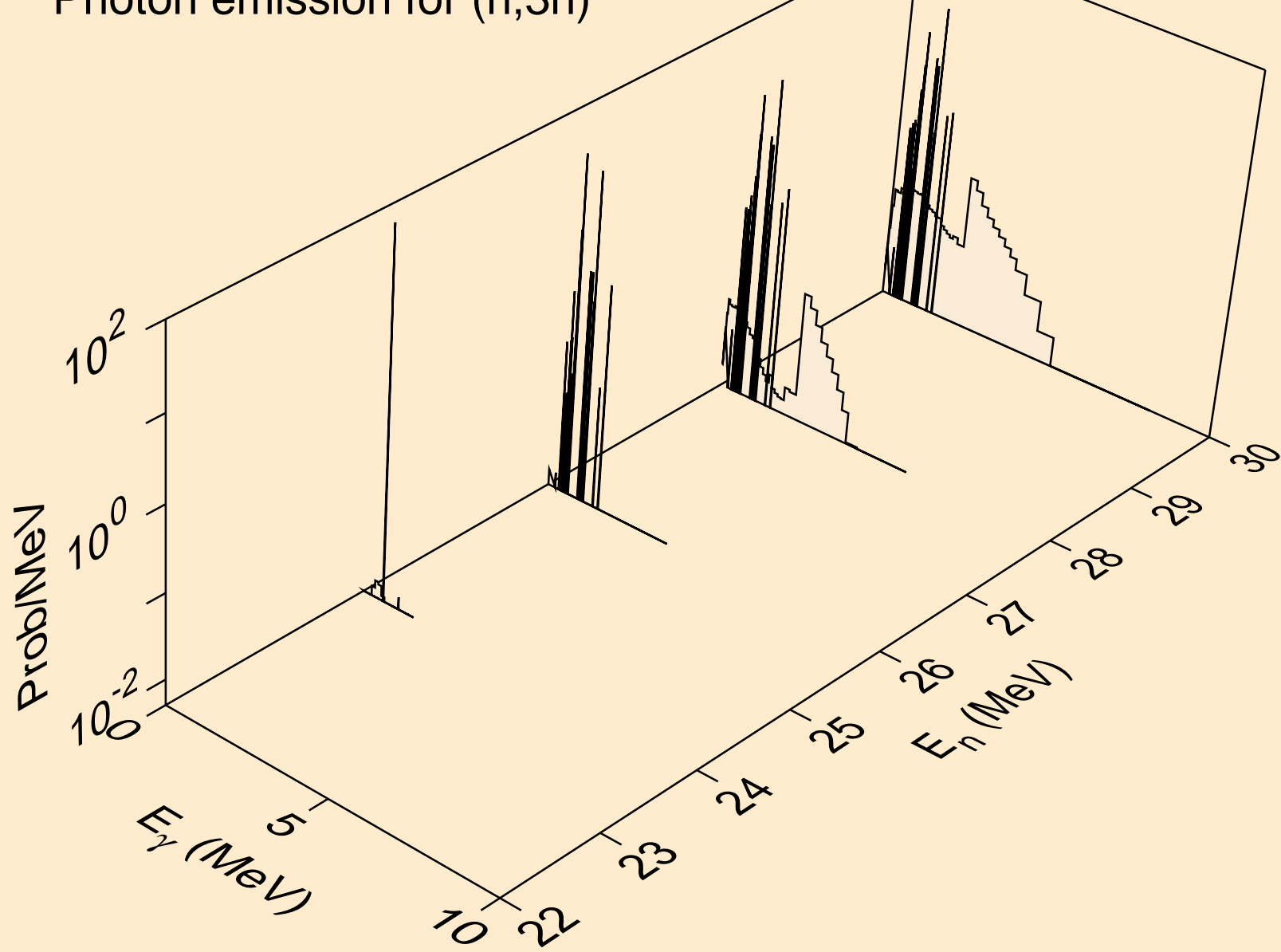

NB090 NEUTRON ACER TENDL-2023 LIBRARY; T=0.K
Photon emission for (n,n*)a

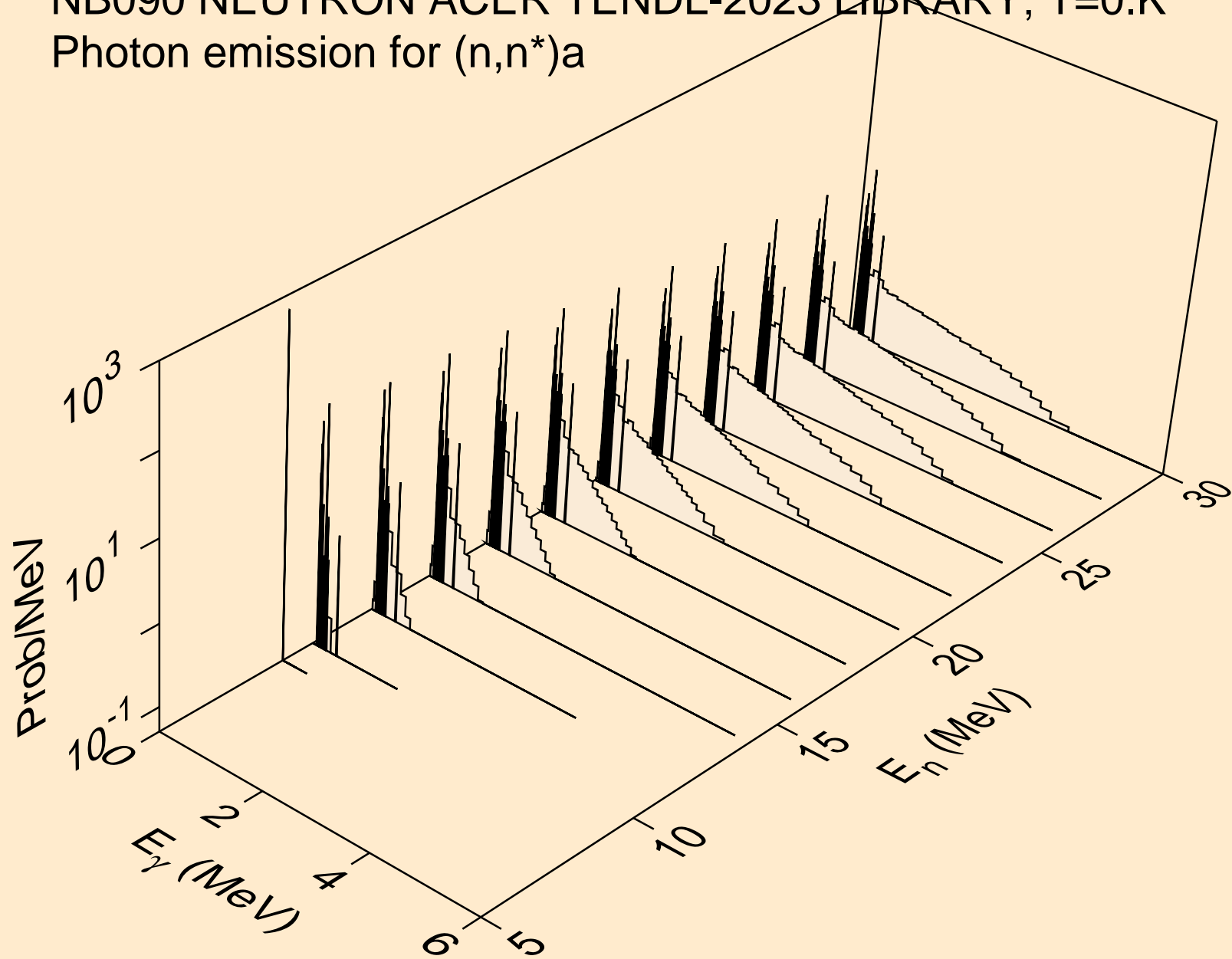

NB090 NEUTRON ACER TENDL-2023 LIBRARY; T=0.K
Photon emission for (n,2n)a

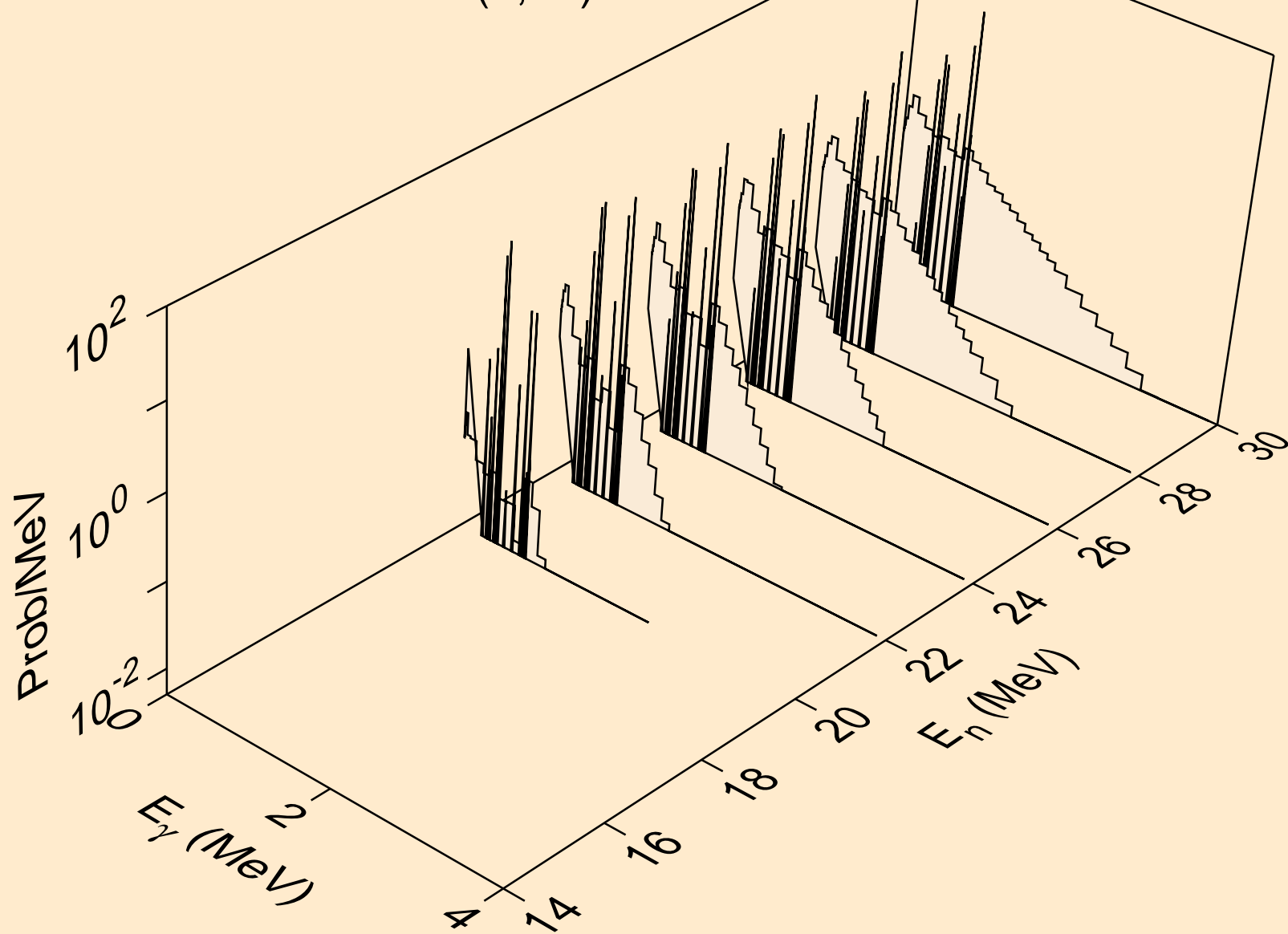

NB090 NEUTRON ACER TENDL-2023 LIBRARY; T=0.K
Photon emission for (n,n*)p

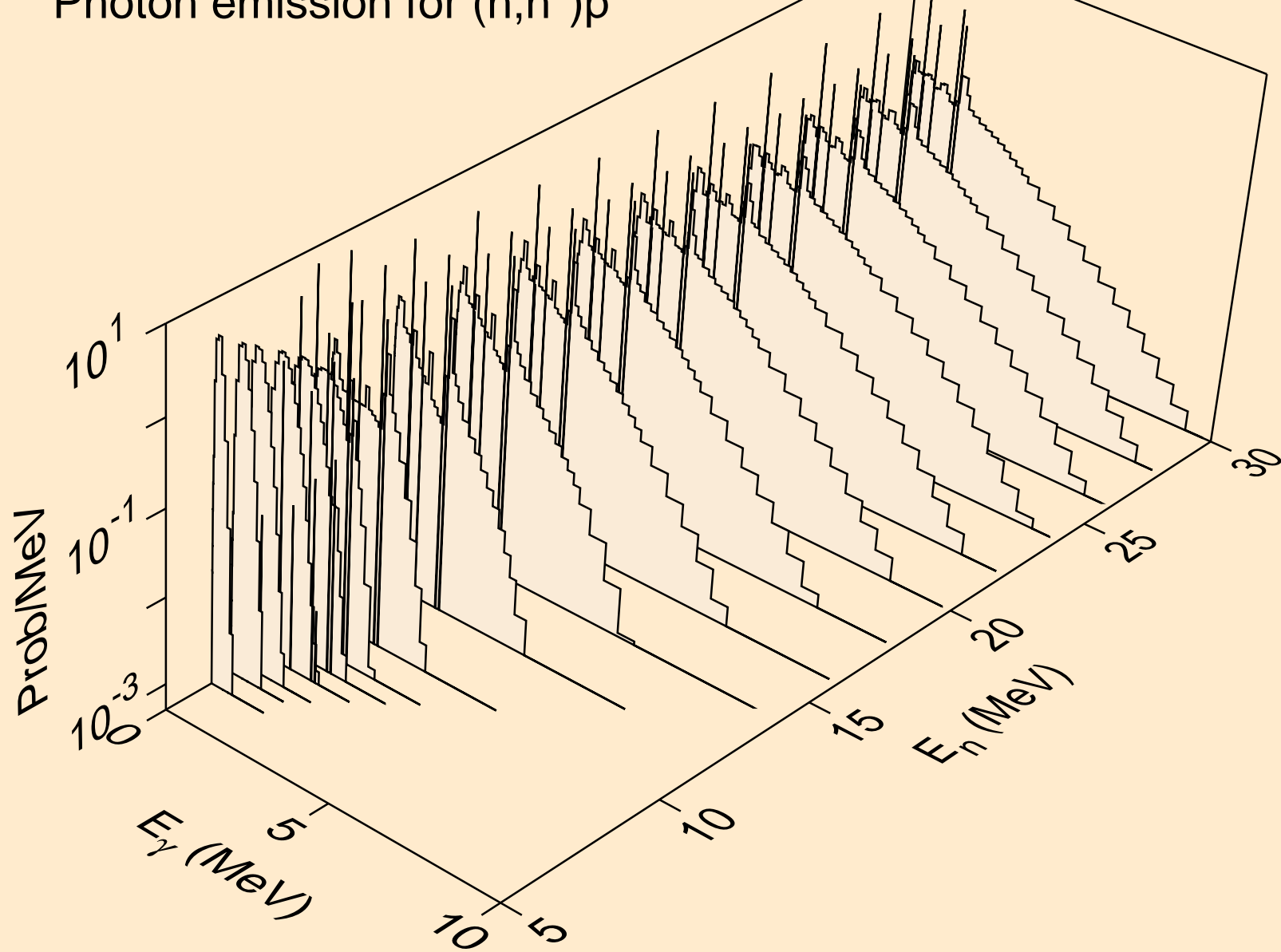

NB090 NEUTRON ACER TENDL-2023 LIBRARY; T=0.K
Photon emission for (n,n*)2a

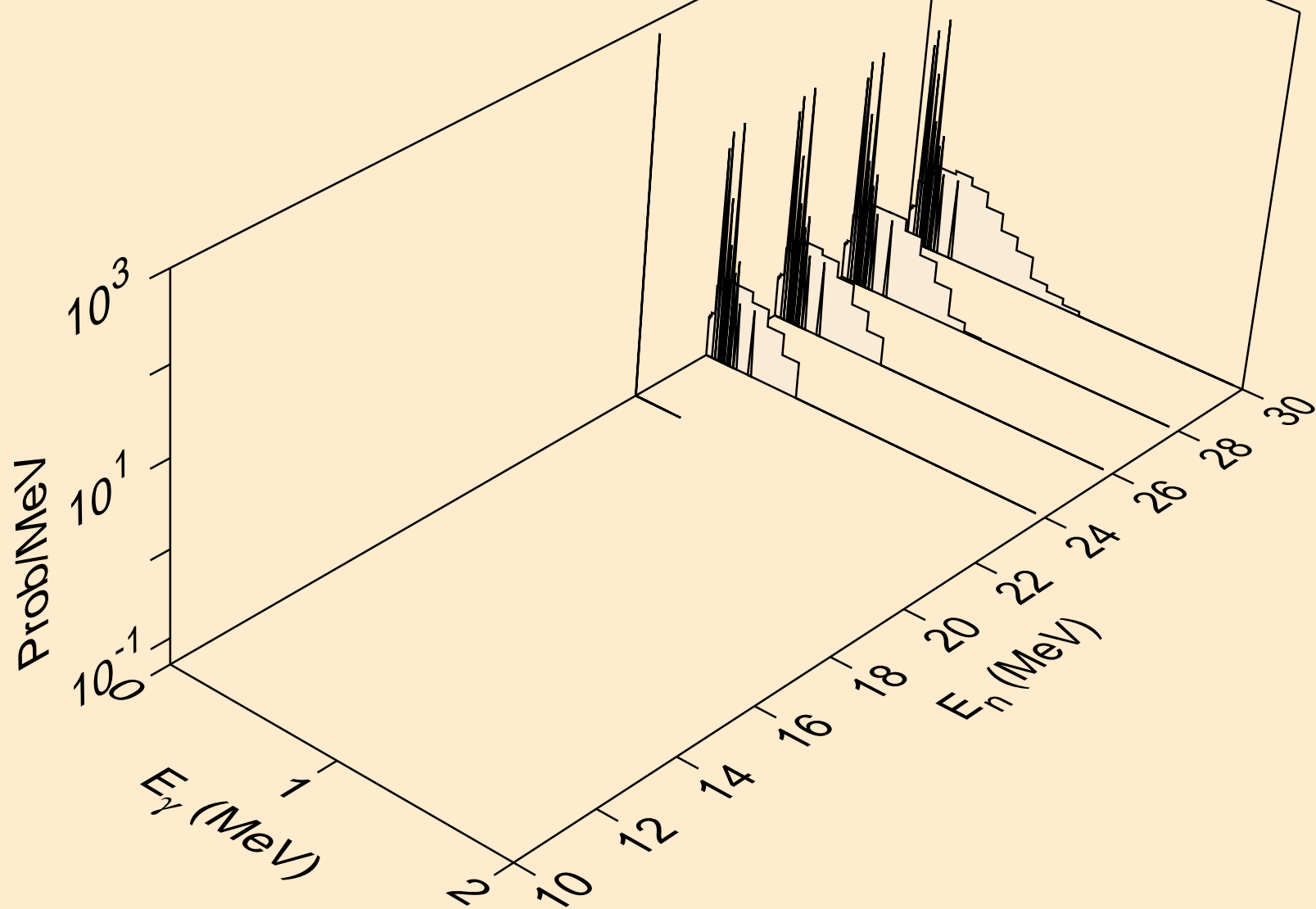

NB090 NEUTRON ACER TENDL-2023 LIBRARY; T=0.K
Photon emission for (n,n*)d

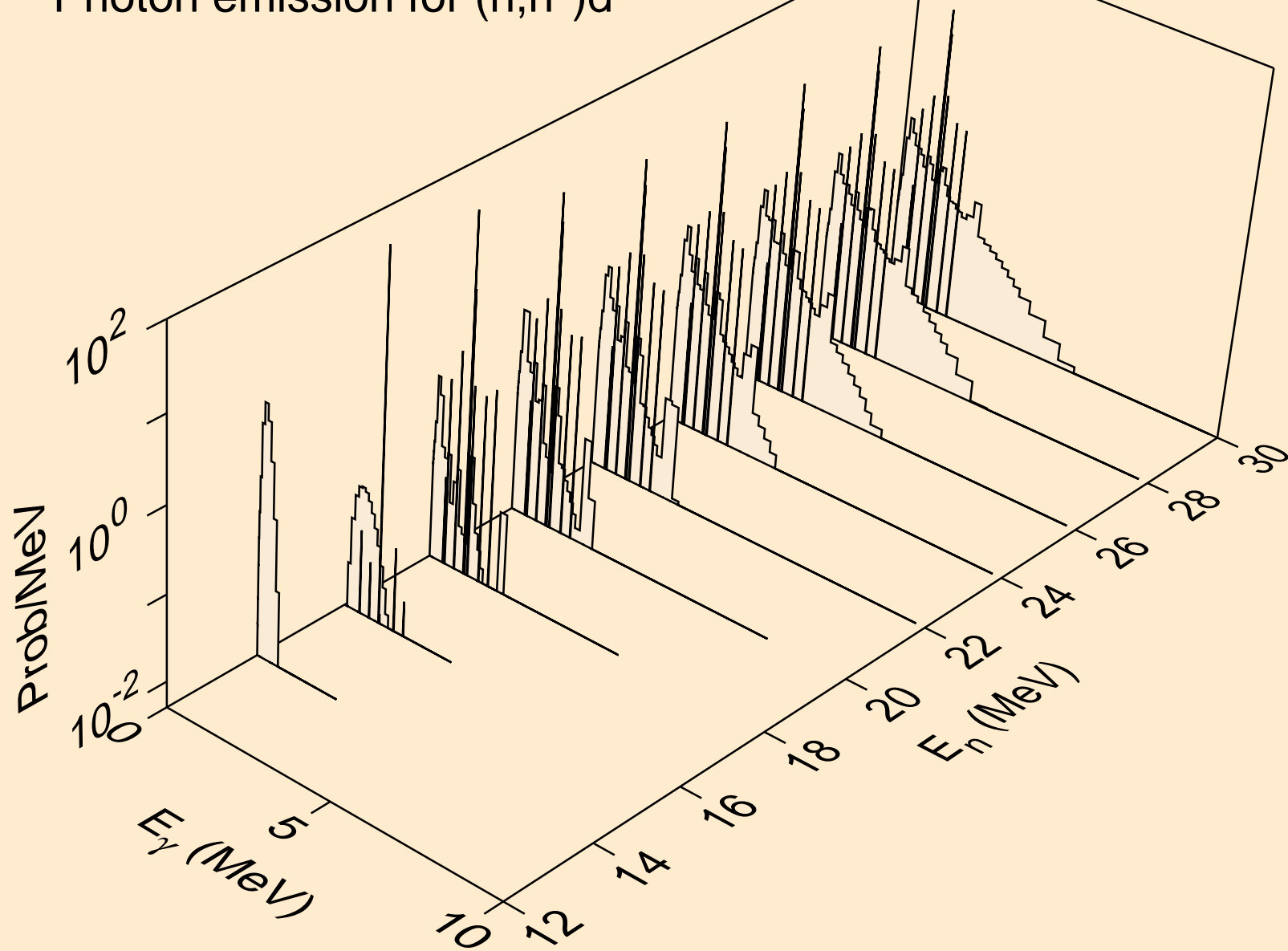

NB090 NEUTRON ACER TENDL-2023 LIBRARY; T=0.K
Photon emission for (n,n*)t

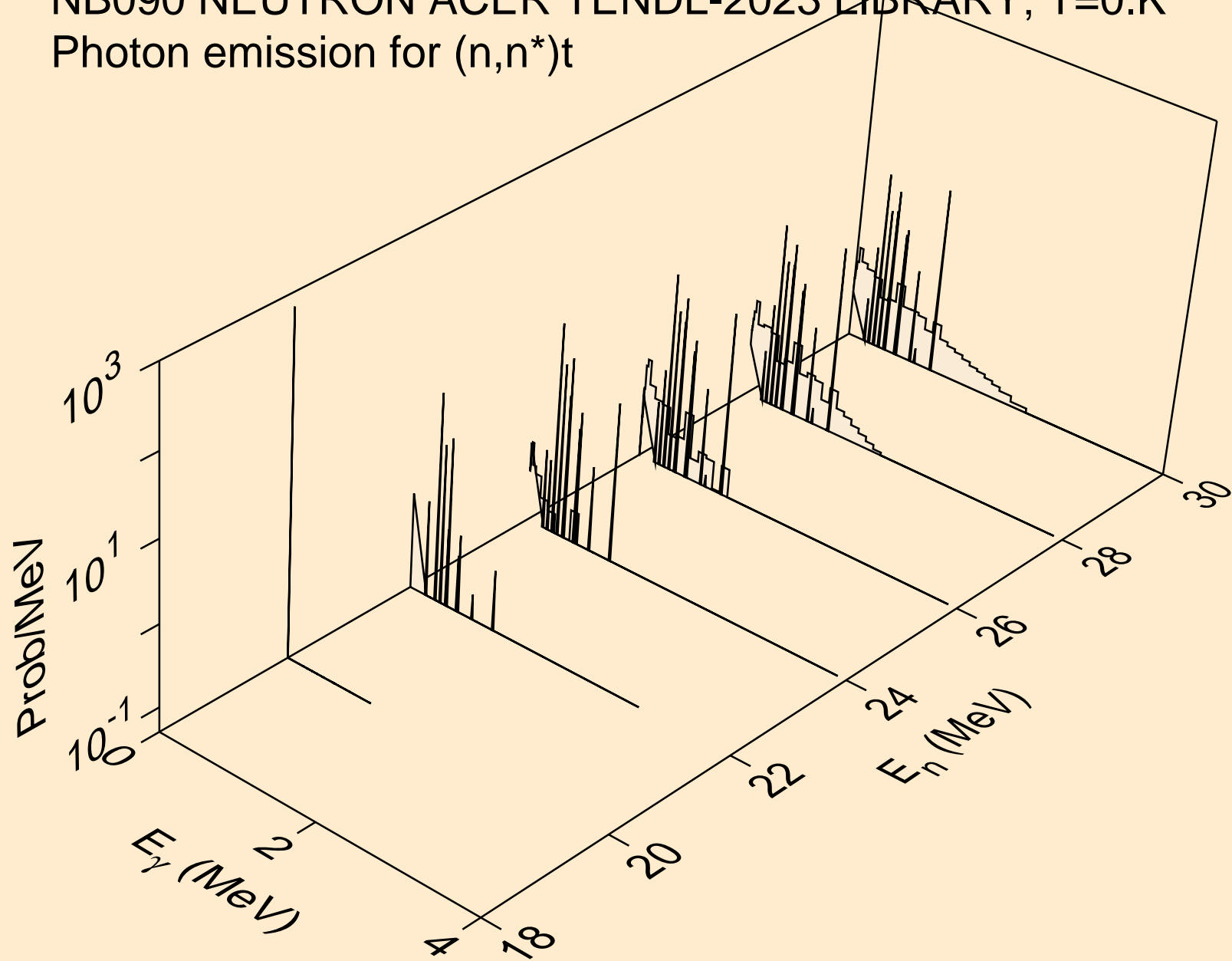

NB090 NEUTRON ACER TENDL-2023 LIBRARY; T=0.K
Photon emission for (n,n*)he3

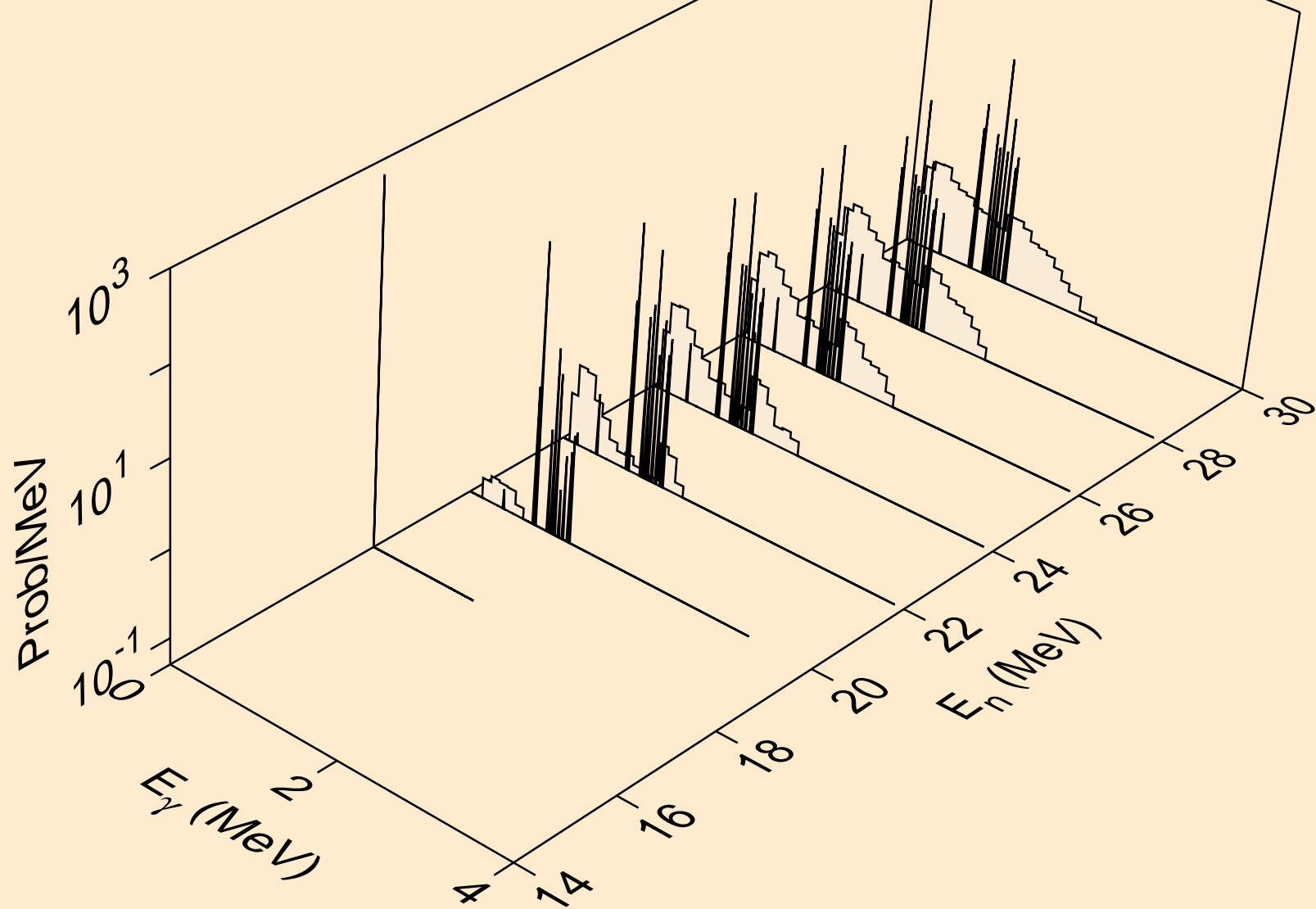

NB090 NEUTRON ACER TENDL-2023 LIBRARY; T=0.K
Photon emission for (n,2np)

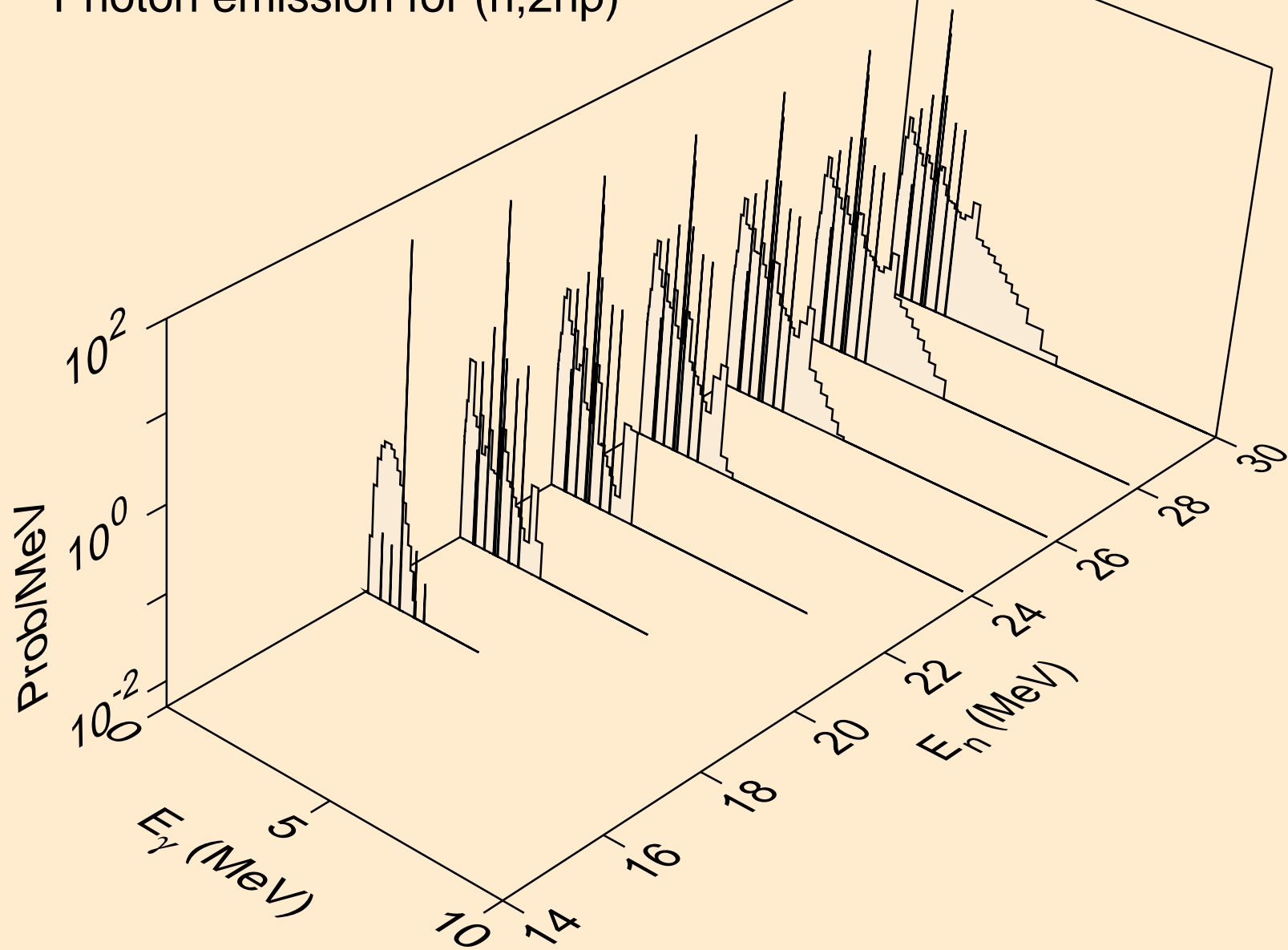

NB090 NEUTRON ACER TENDL-2023 LIBRARY; T=0.K
Photon emission for (n,3np)

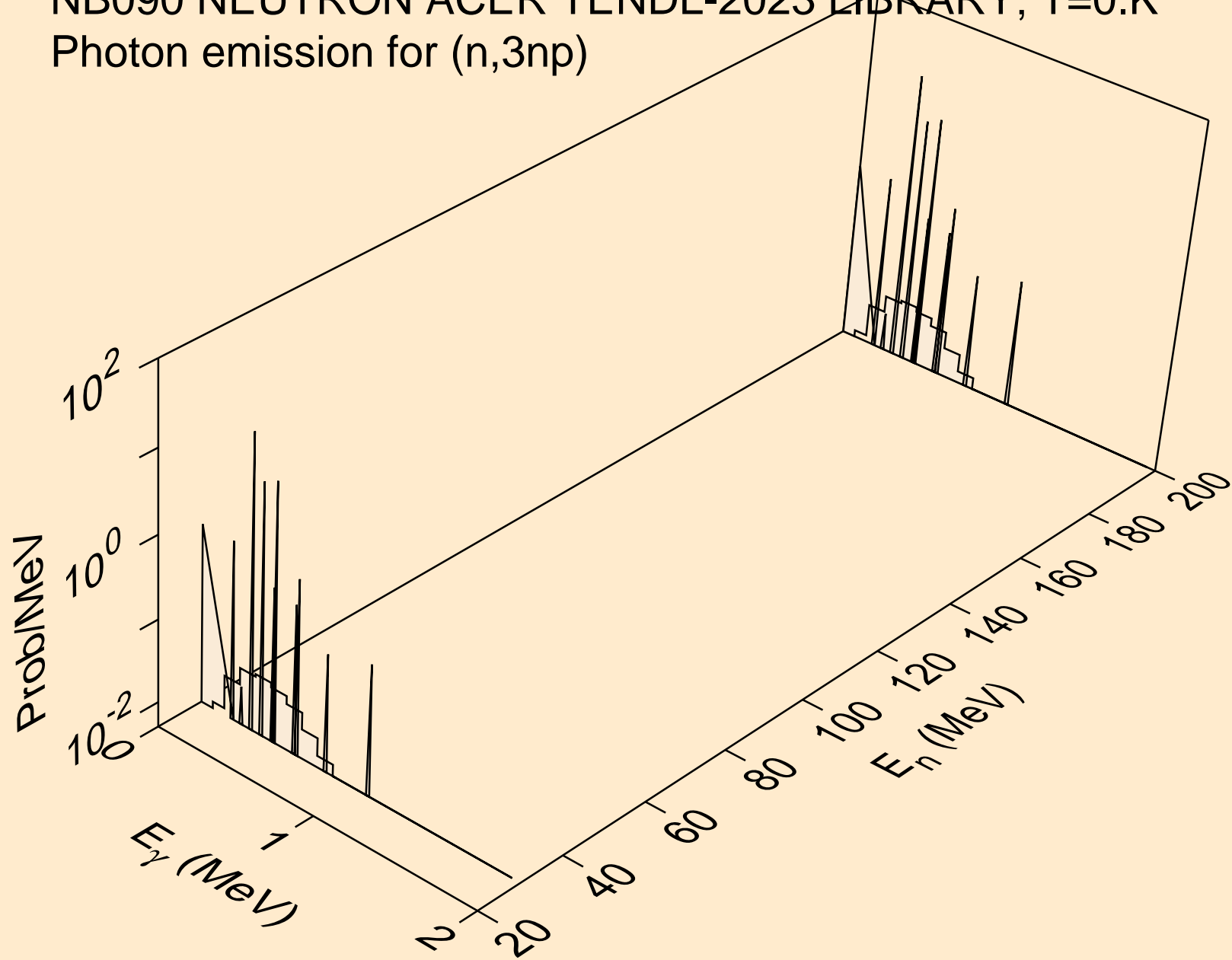

NB090 NEUTRON ACER TENDL-2023 LIBRARY; T=0.K
Photon emission for (n,n2p)

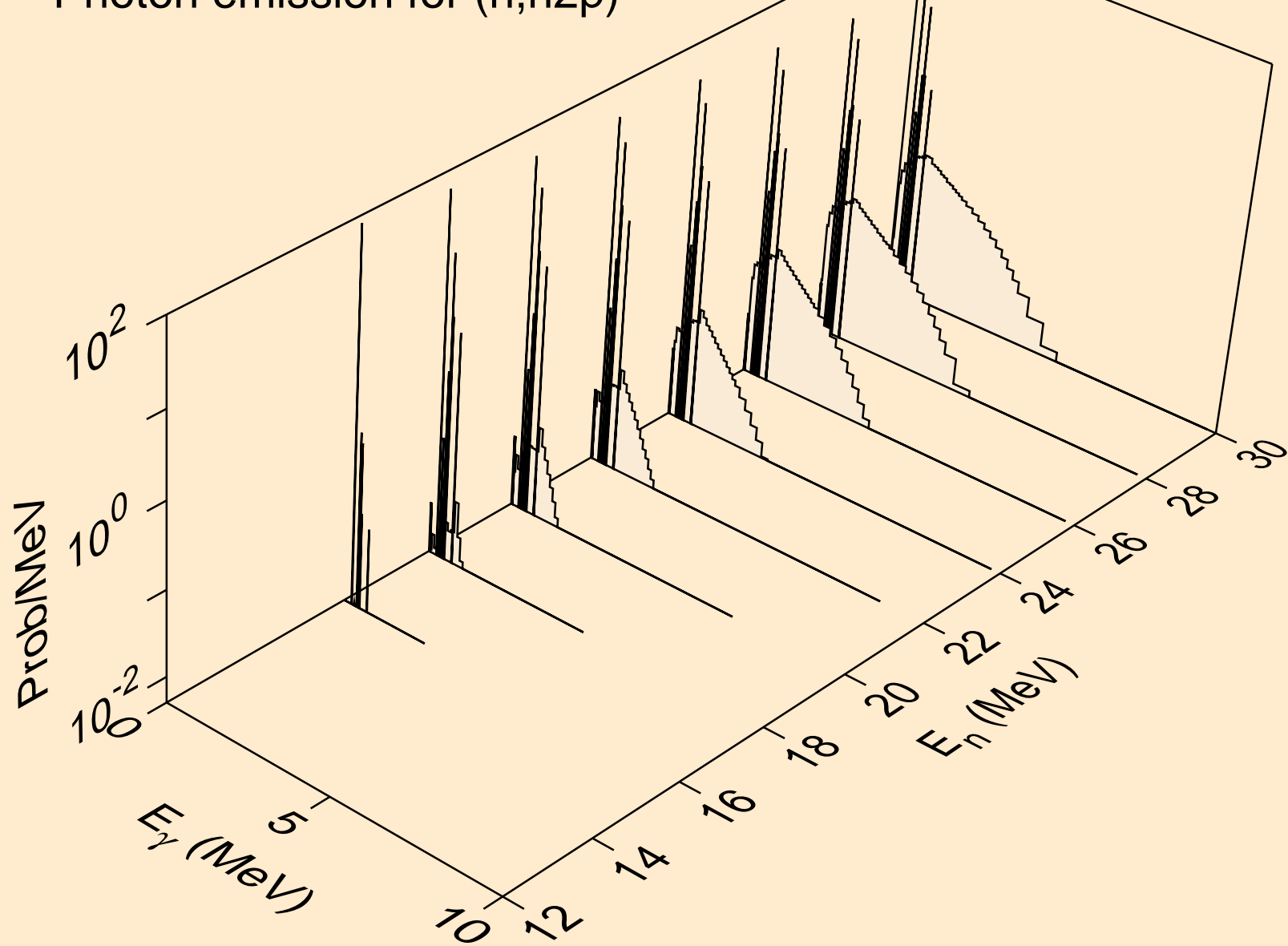

NB090 NEUTRON ACER TENDL-2023 LIBRARY; T=0.K
Photon emission for (n,npa)

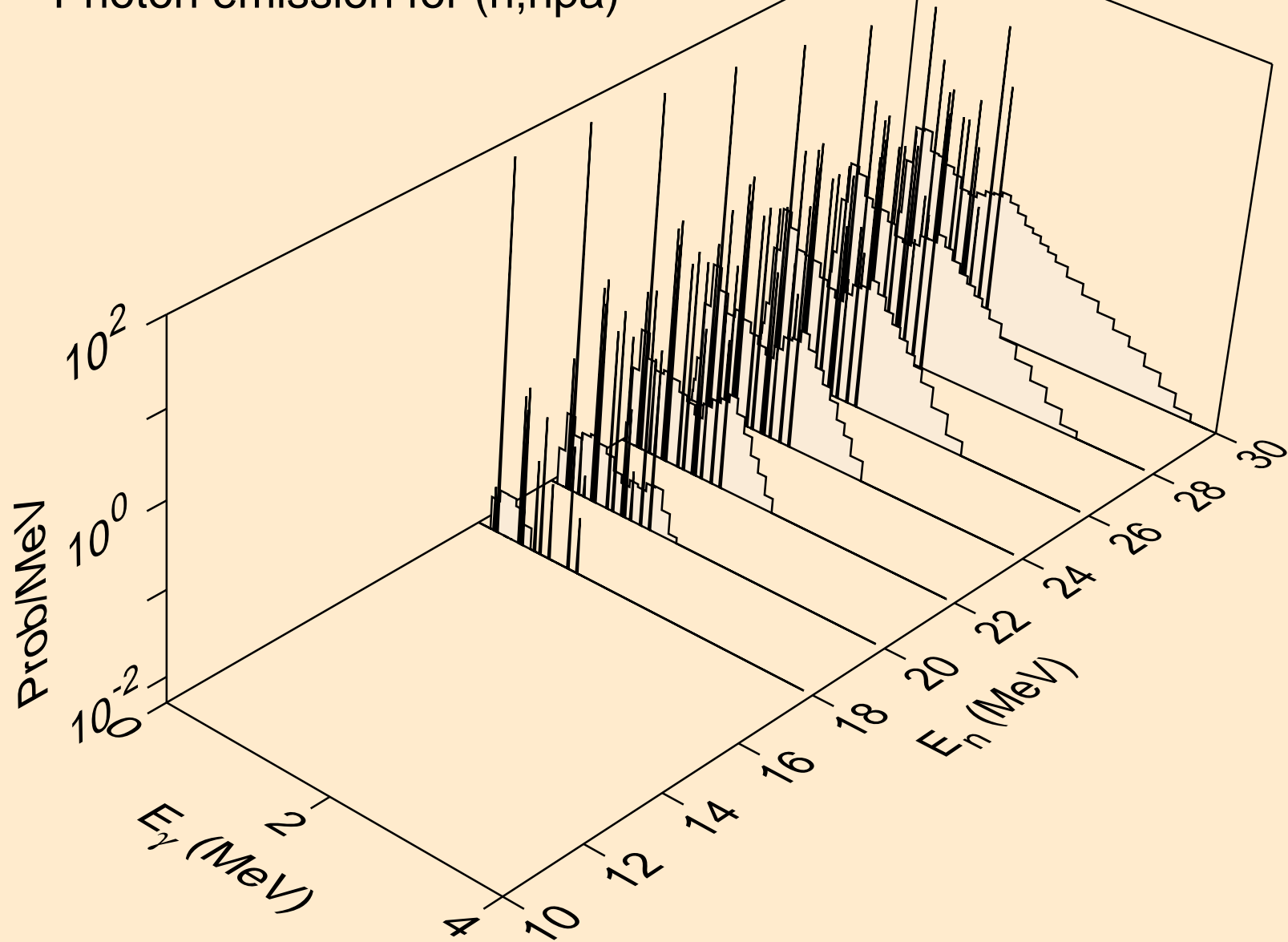

NB090 NEUTRON ACER TENDL-2023 LIBRARY; T=0.K
Photon emission for (n,n*c)

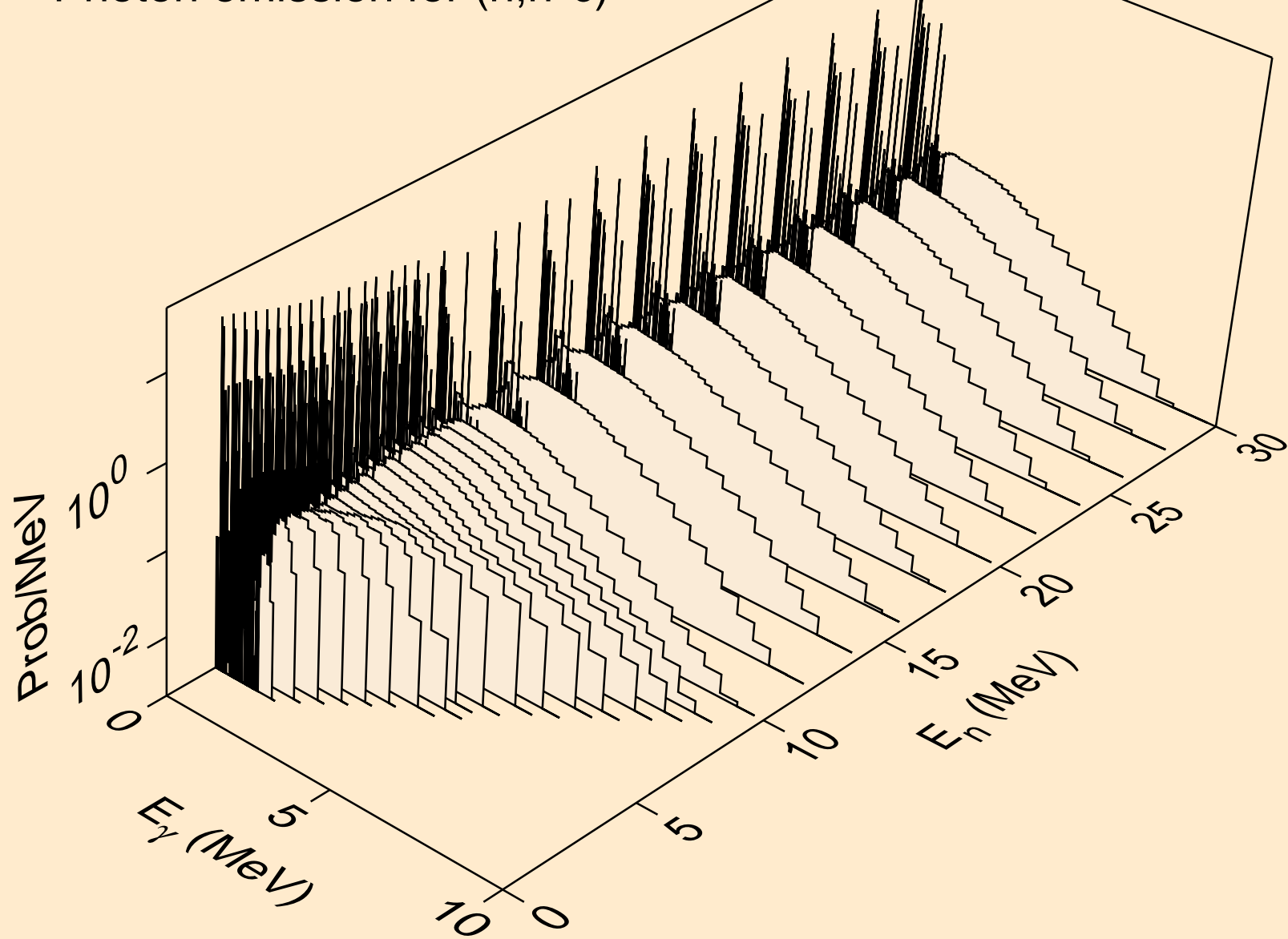

NB090 NEUTRON ACER TENDL-2023 LIBRARY; T=0.K
Photon emission for (n,gma)

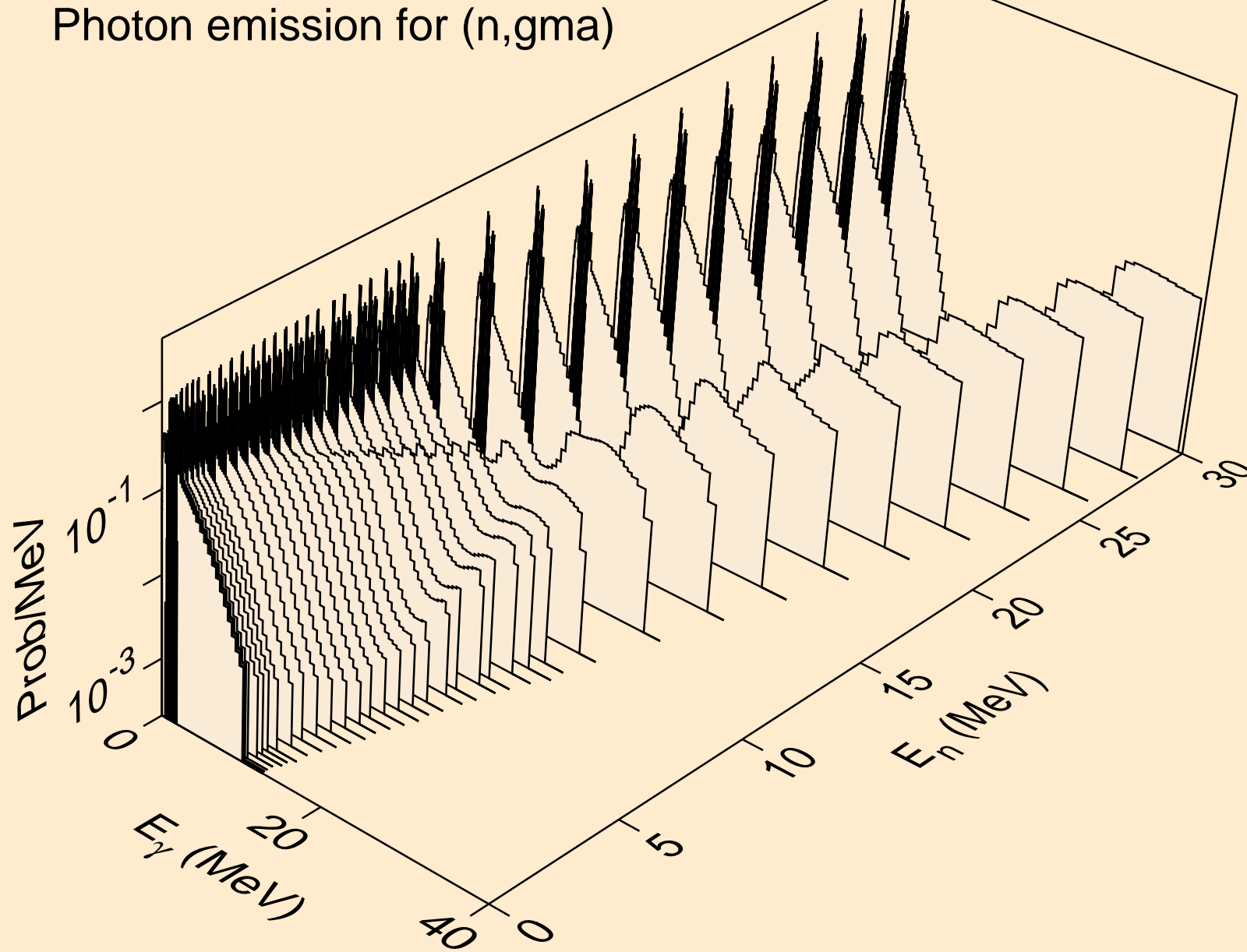

NB090 NEUTRON ACER TENDL-2023 LIBRARY; T=0.K
Photon emission for (n,p)

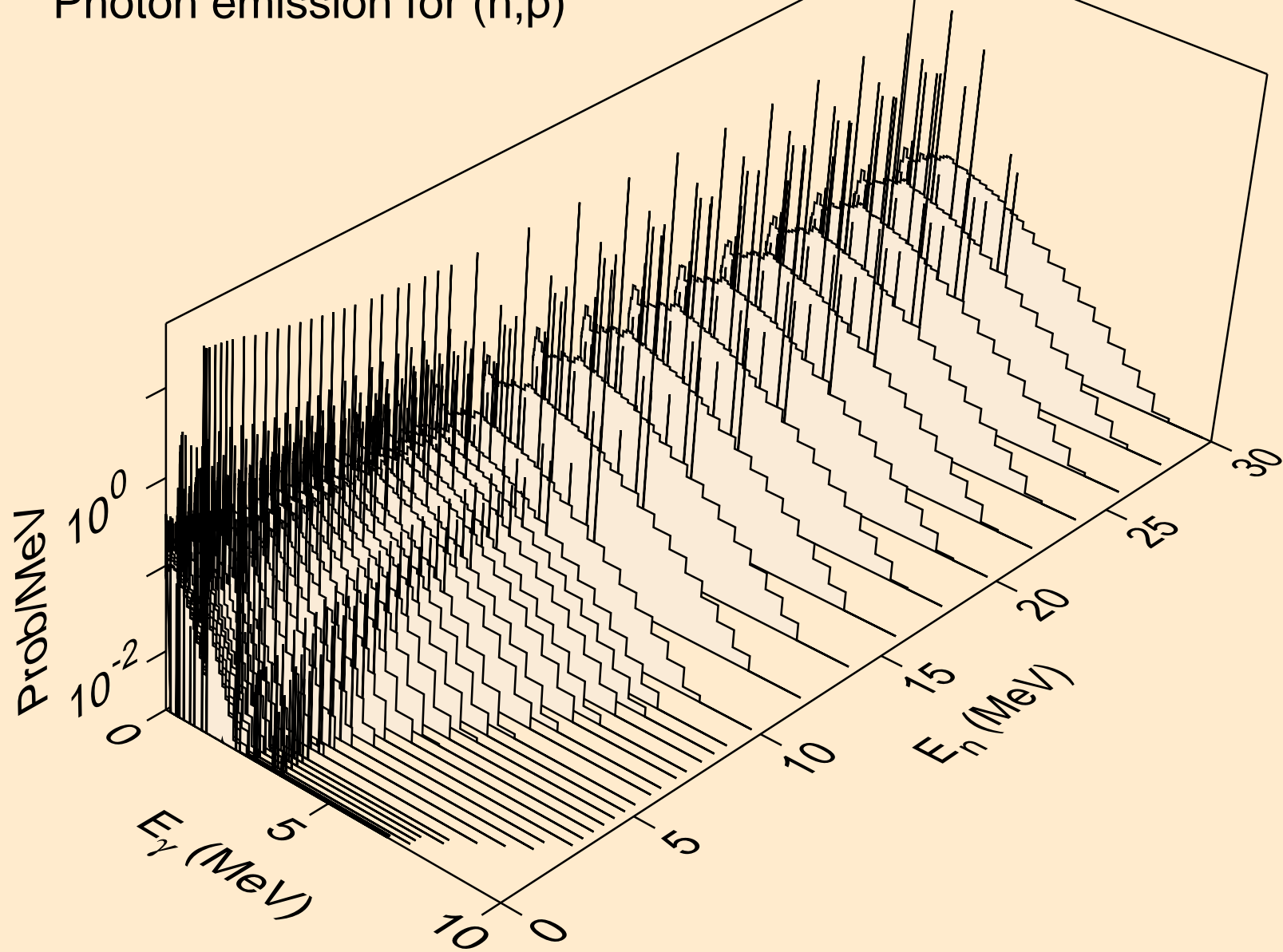

NB090 NEUTRON ACER TENDL-2023 LIBRARY; T=0.K
Photon emission for (n,d)

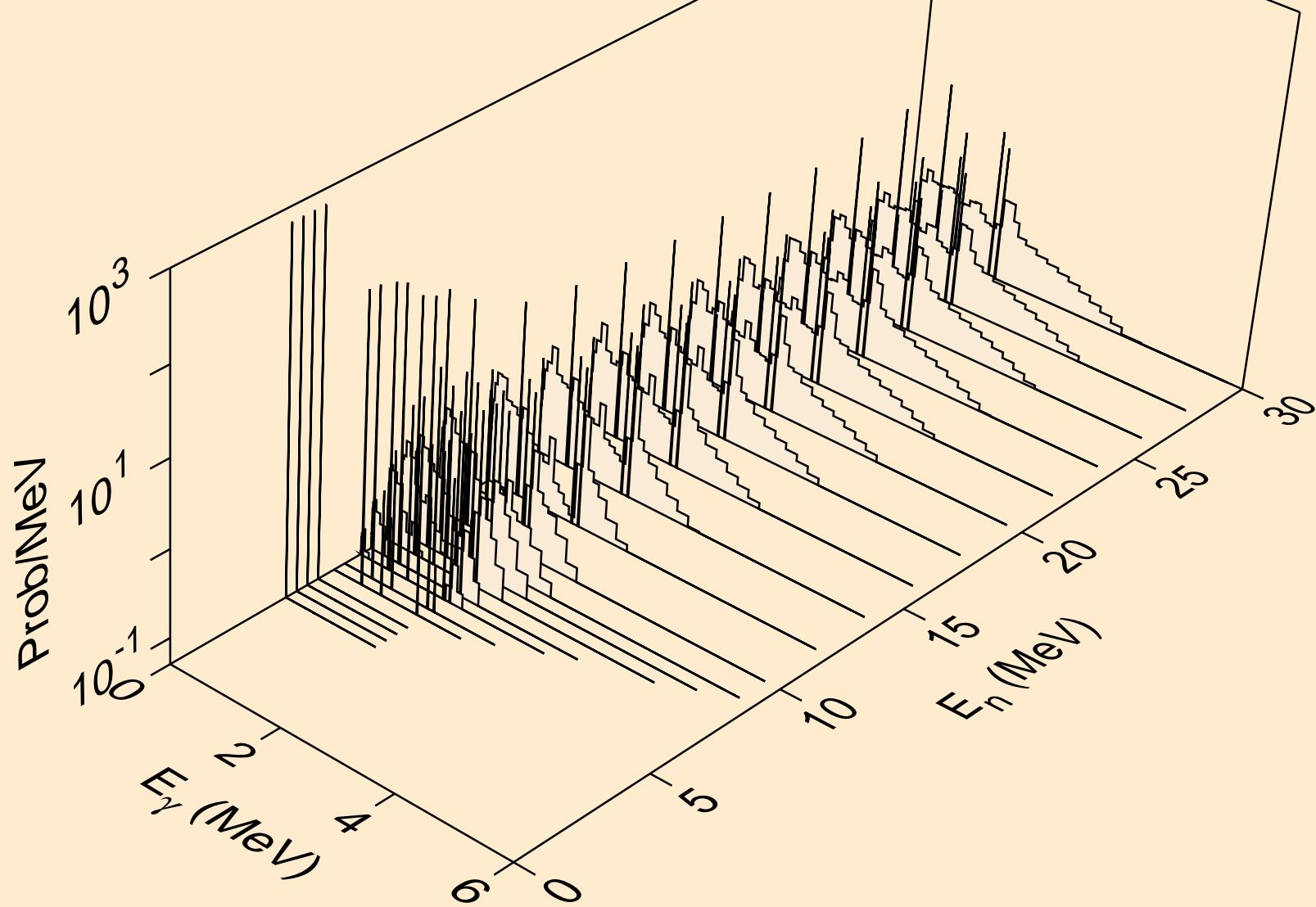

NB090 NEUTRON ACER TENDL-2023 LIBRARY; T=0.K
Photon emission for (n,t)

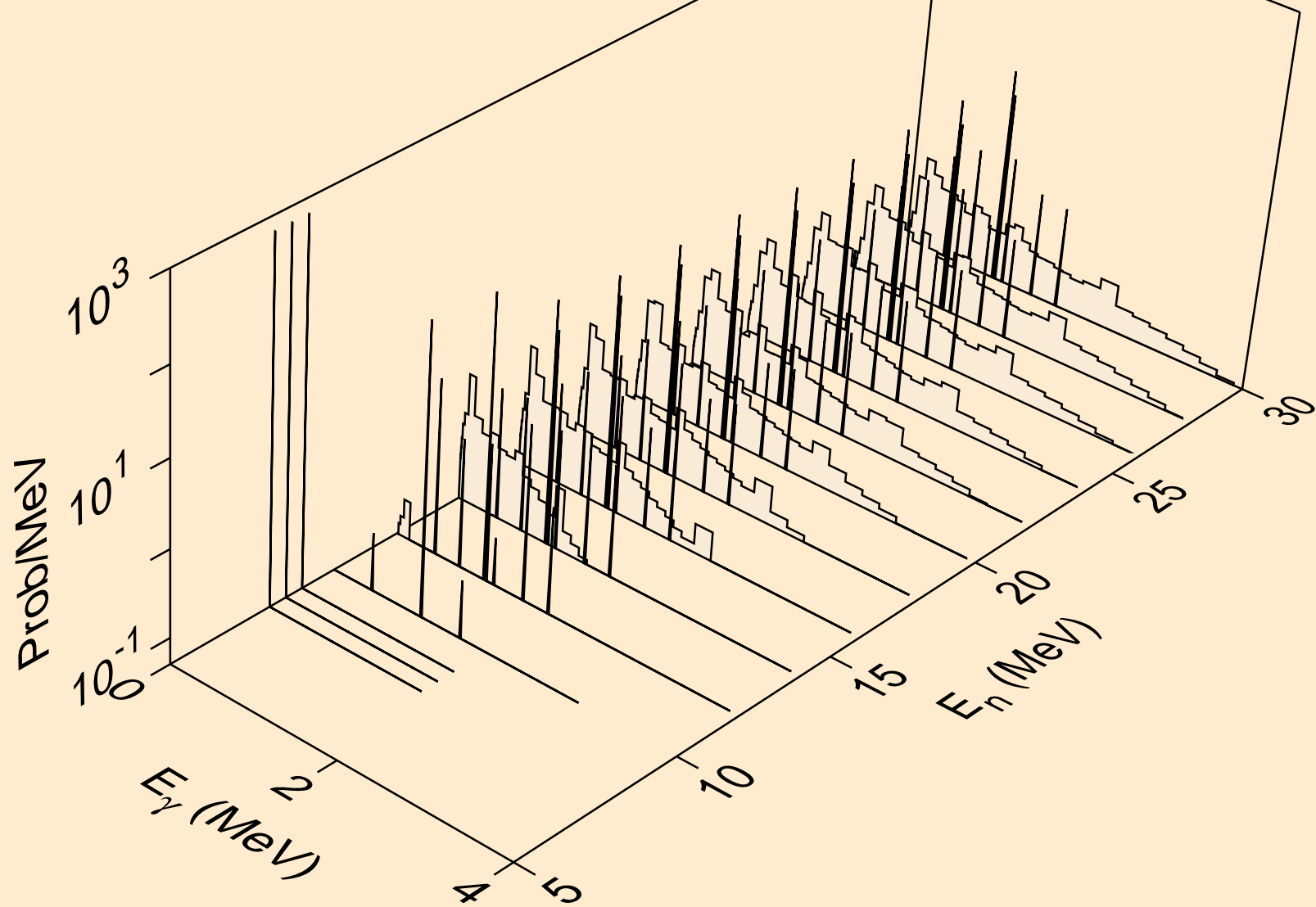

NB090 NEUTRON ACER TENDL-2023 LIBRARY; T=0.K
Photon emission for (n,he3)

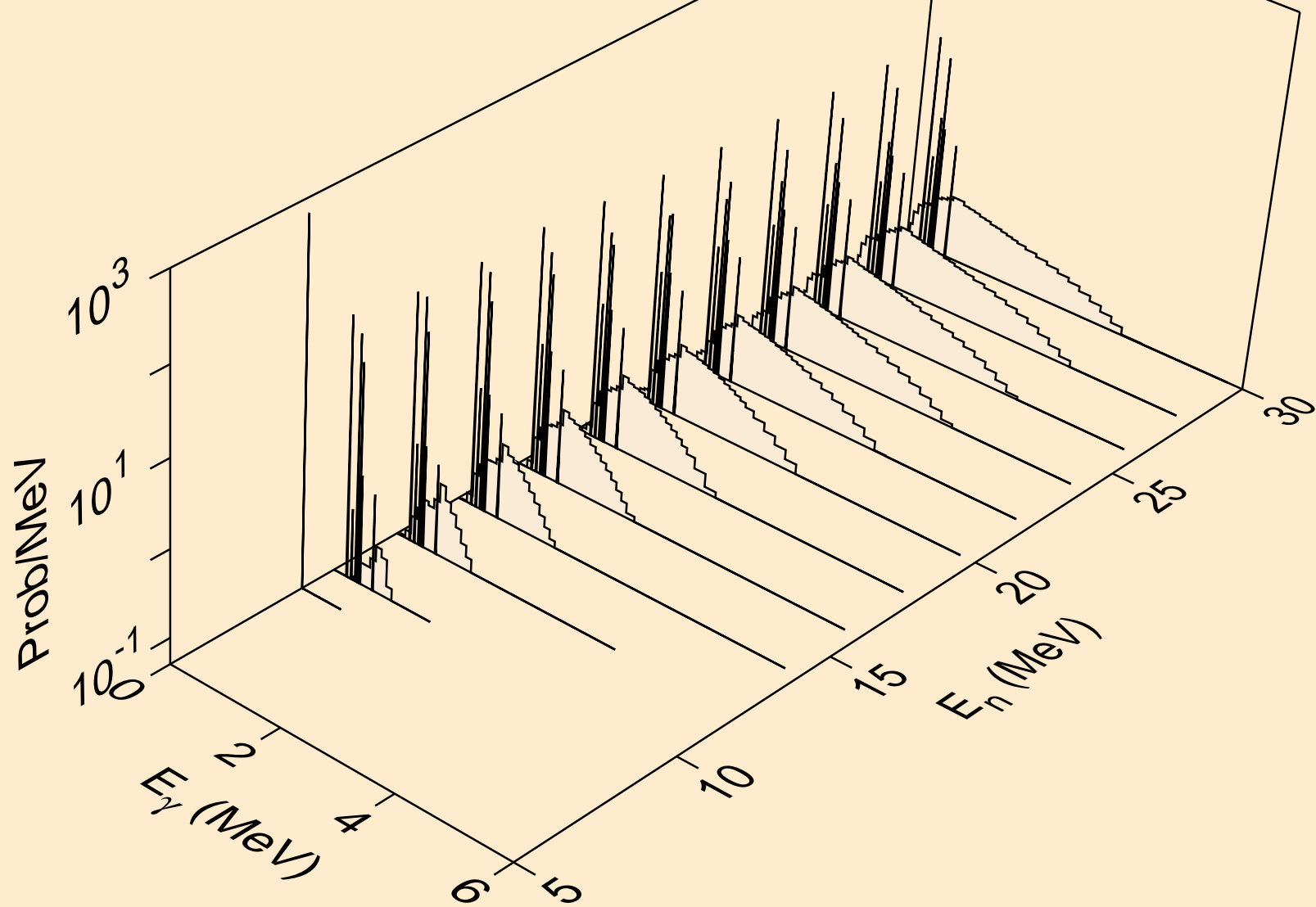

NB090 NEUTRON ACER TENDL-2023 LIBRARY; T=0.K
Photon emission for (n,a)

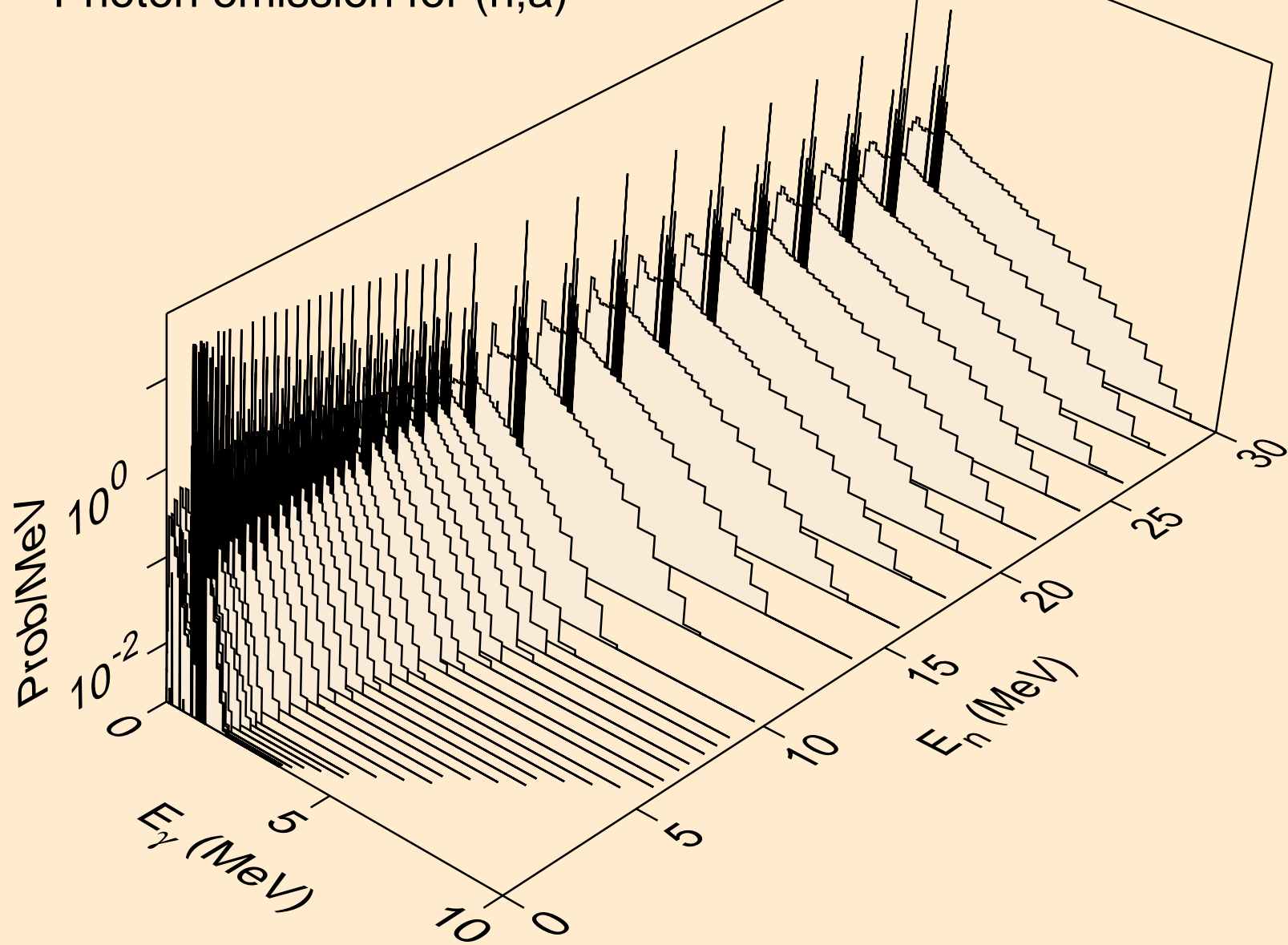

NB090 NEUTRON ACER TENDL-2023 LIBRARY; T=0.K
Photon emission for (n,2a)

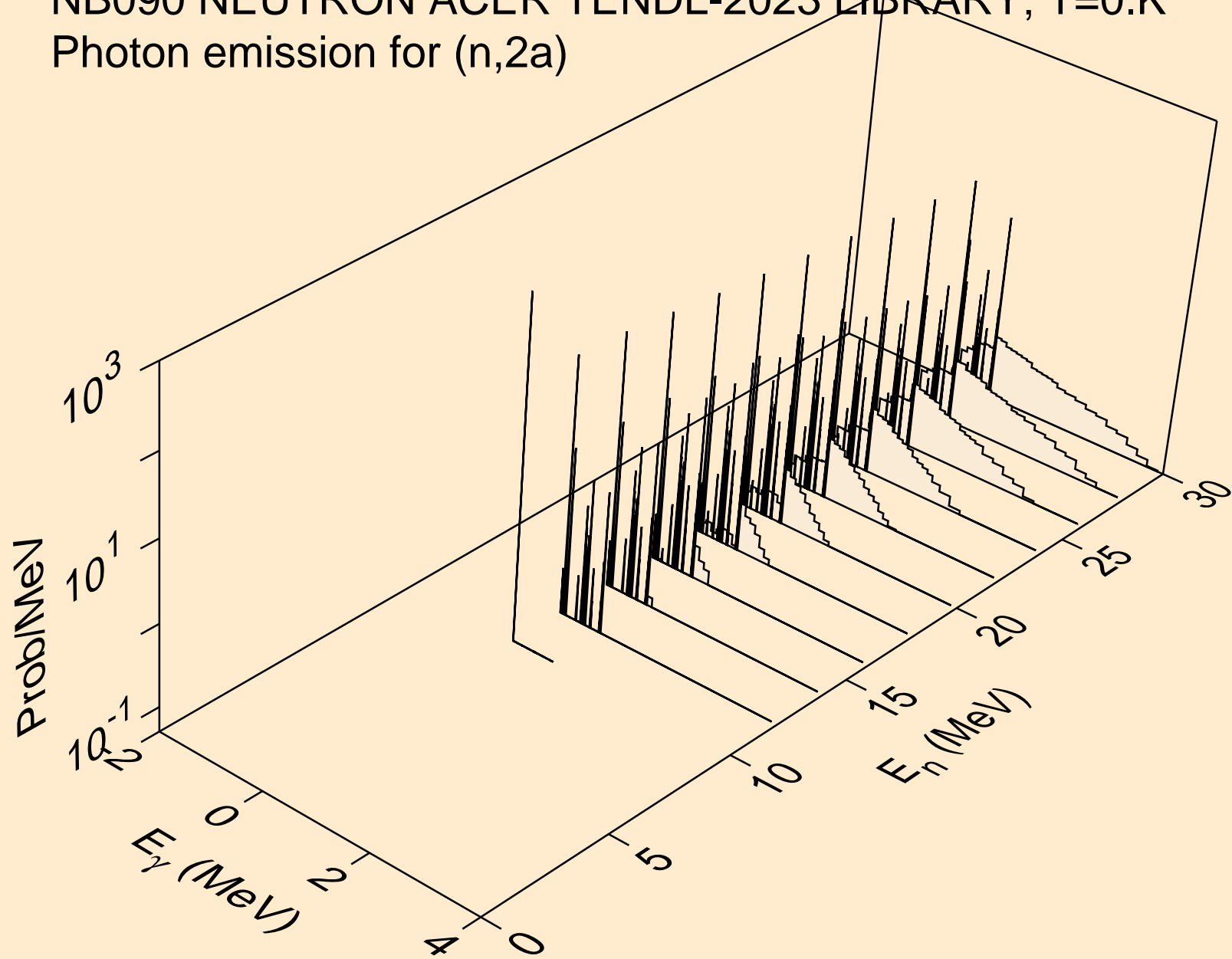

NB090 NEUTRON ACER TENDL-2023 LIBRARY; T=0.K
Photon emission for (n,2p)

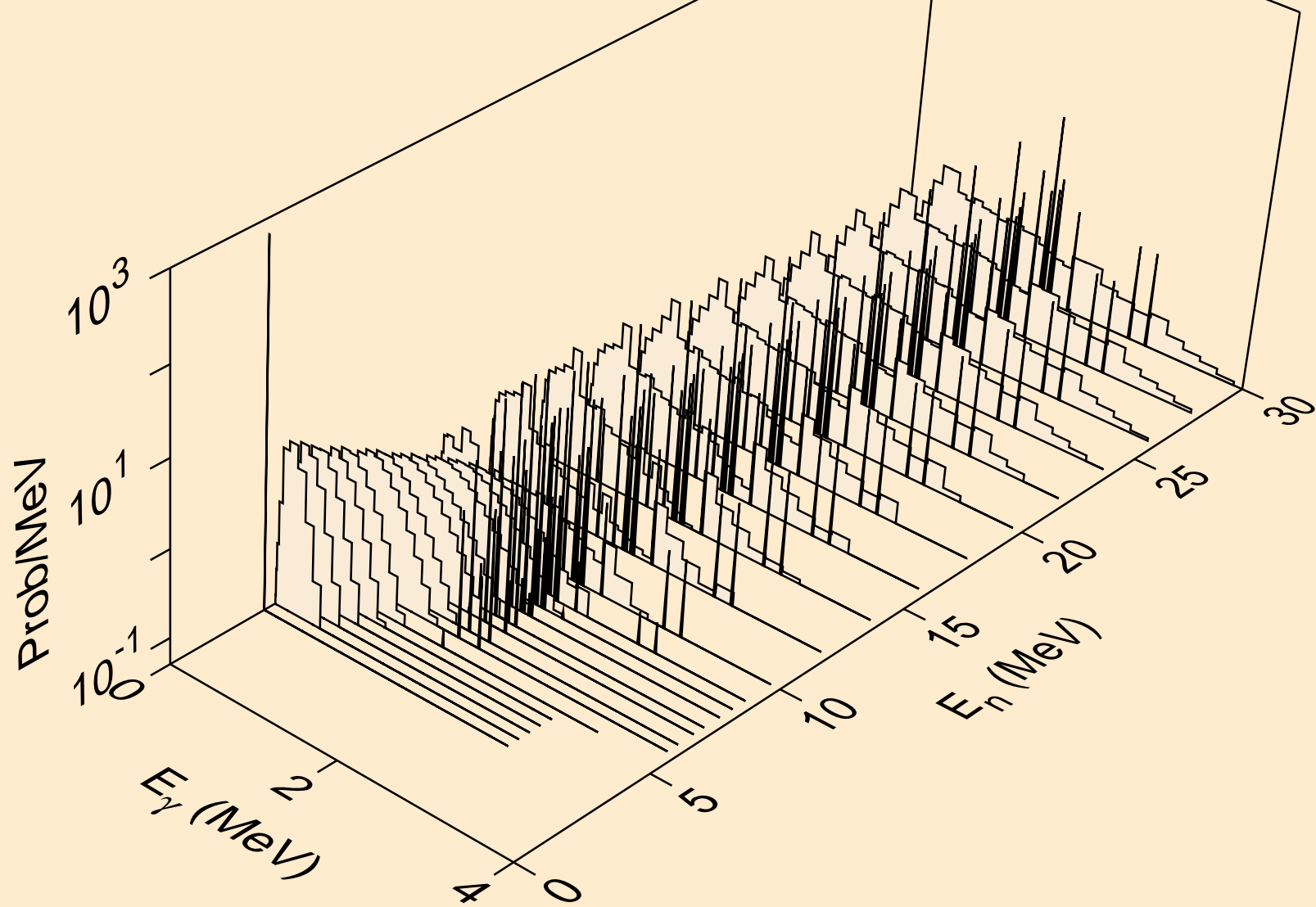

NB090 NEUTRON ACER TENDL-2023 LIBRARY; T=0.K
Photon emission for (n,p)

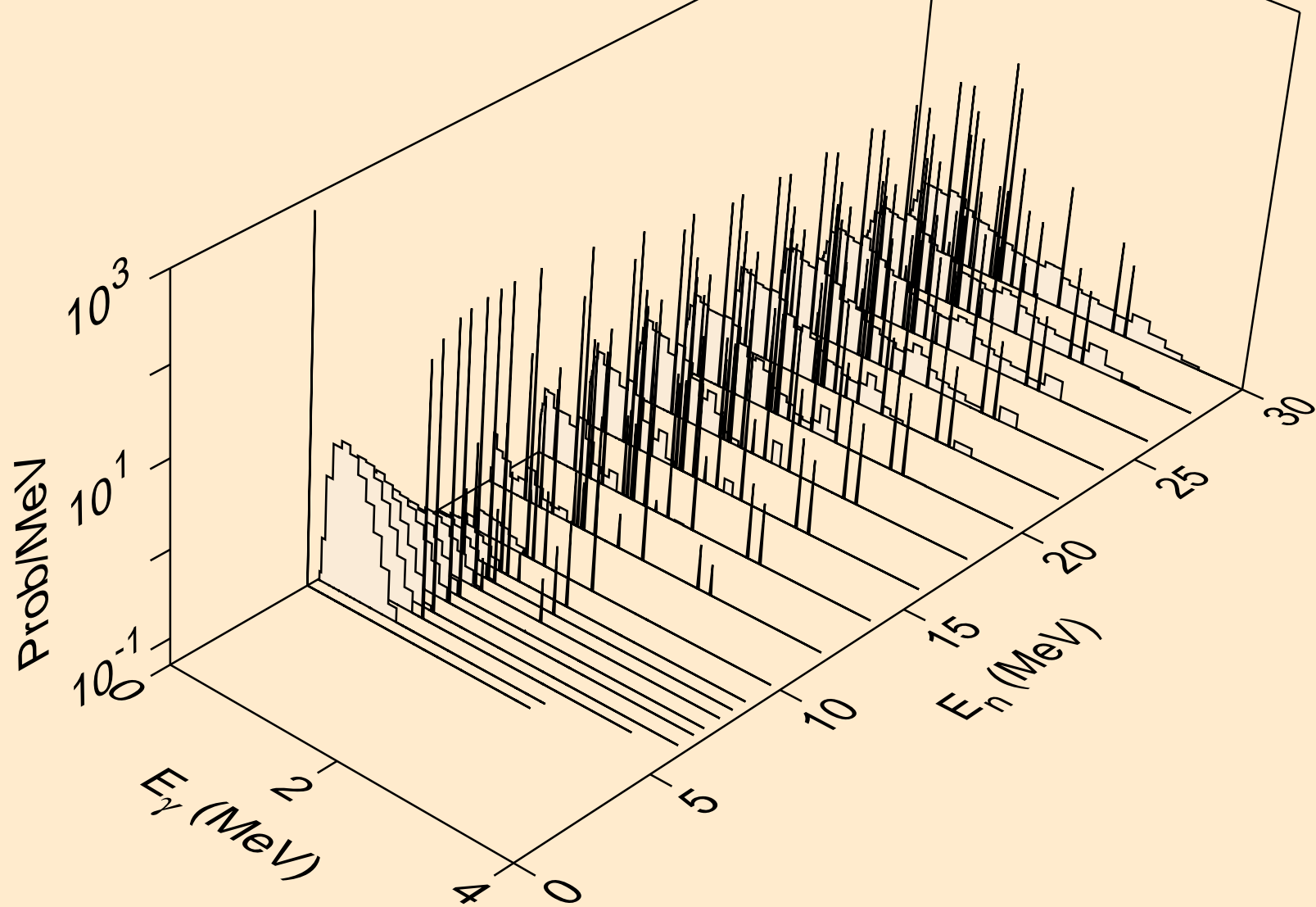

NB090 NEUTRON ACER TENDL-2023 LIBRARY; T=0.K
Photon emission for (n,pd)

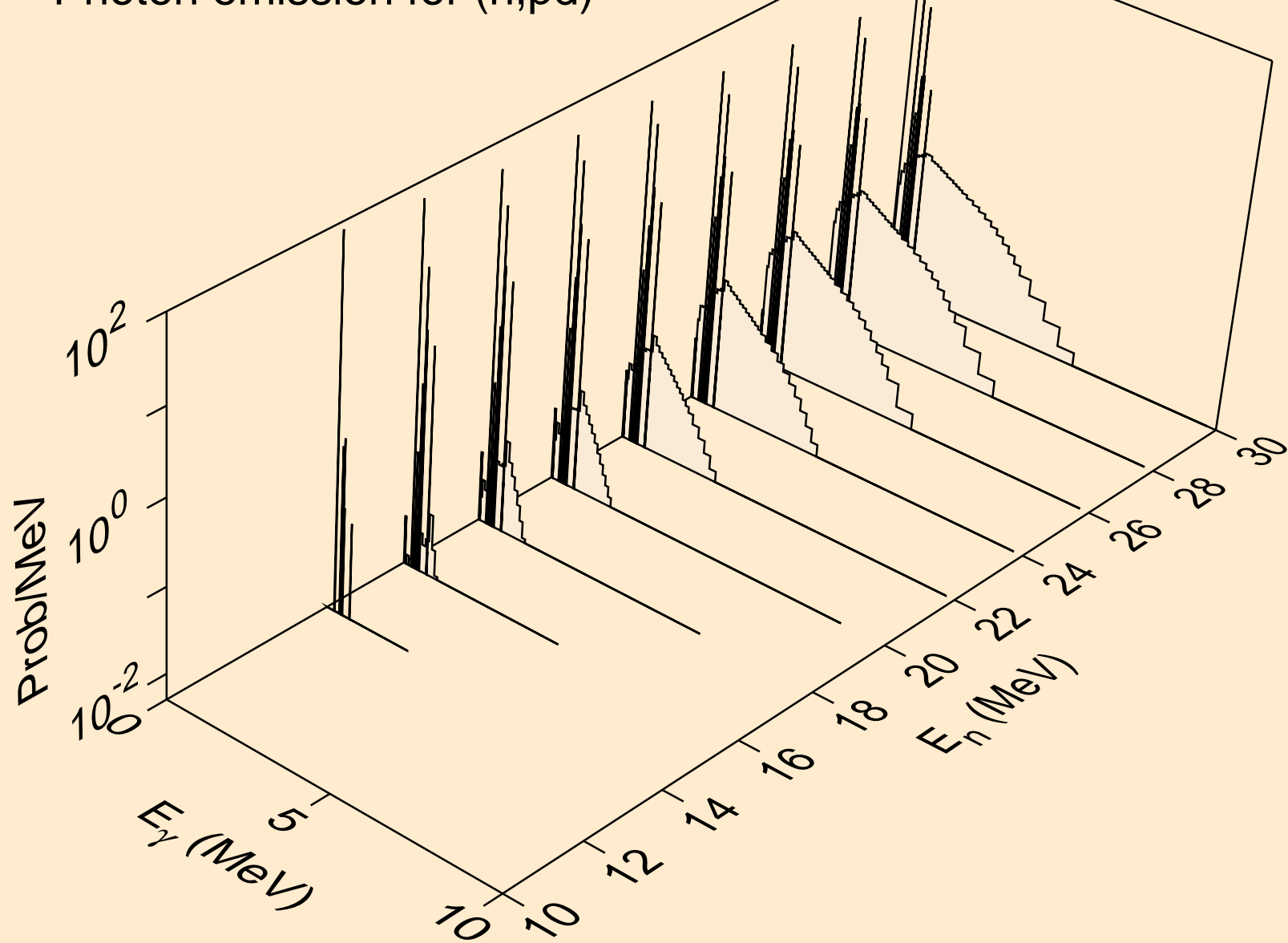

NB090 NEUTRON ACER TENDL-2023 LIBRARY; T=0.K
Photon emission for (n,pt)

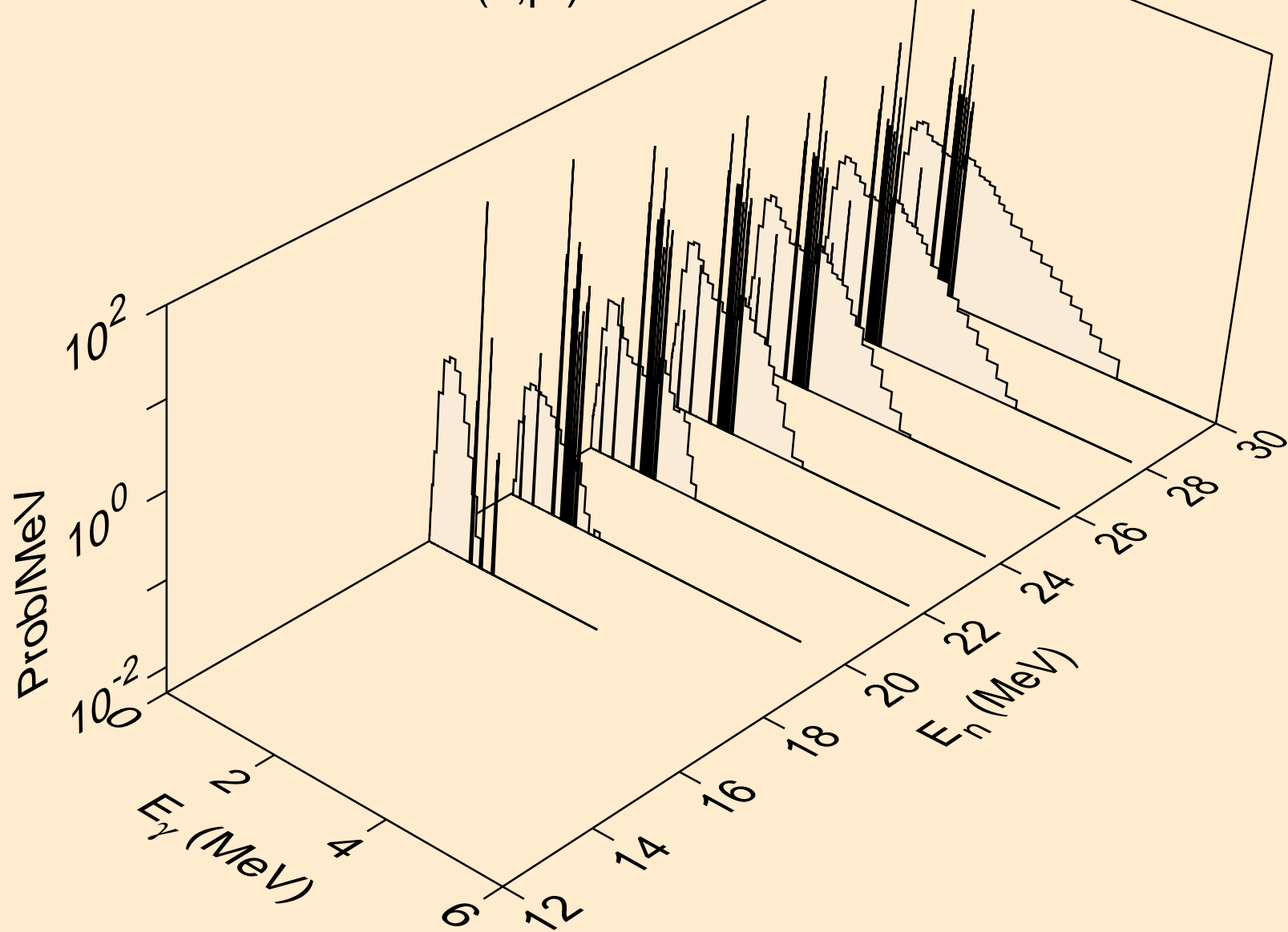

NB090 NEUTRON ACER TENDL-2023 LIBRARY; T=0.K
Photon emission for (n,da)

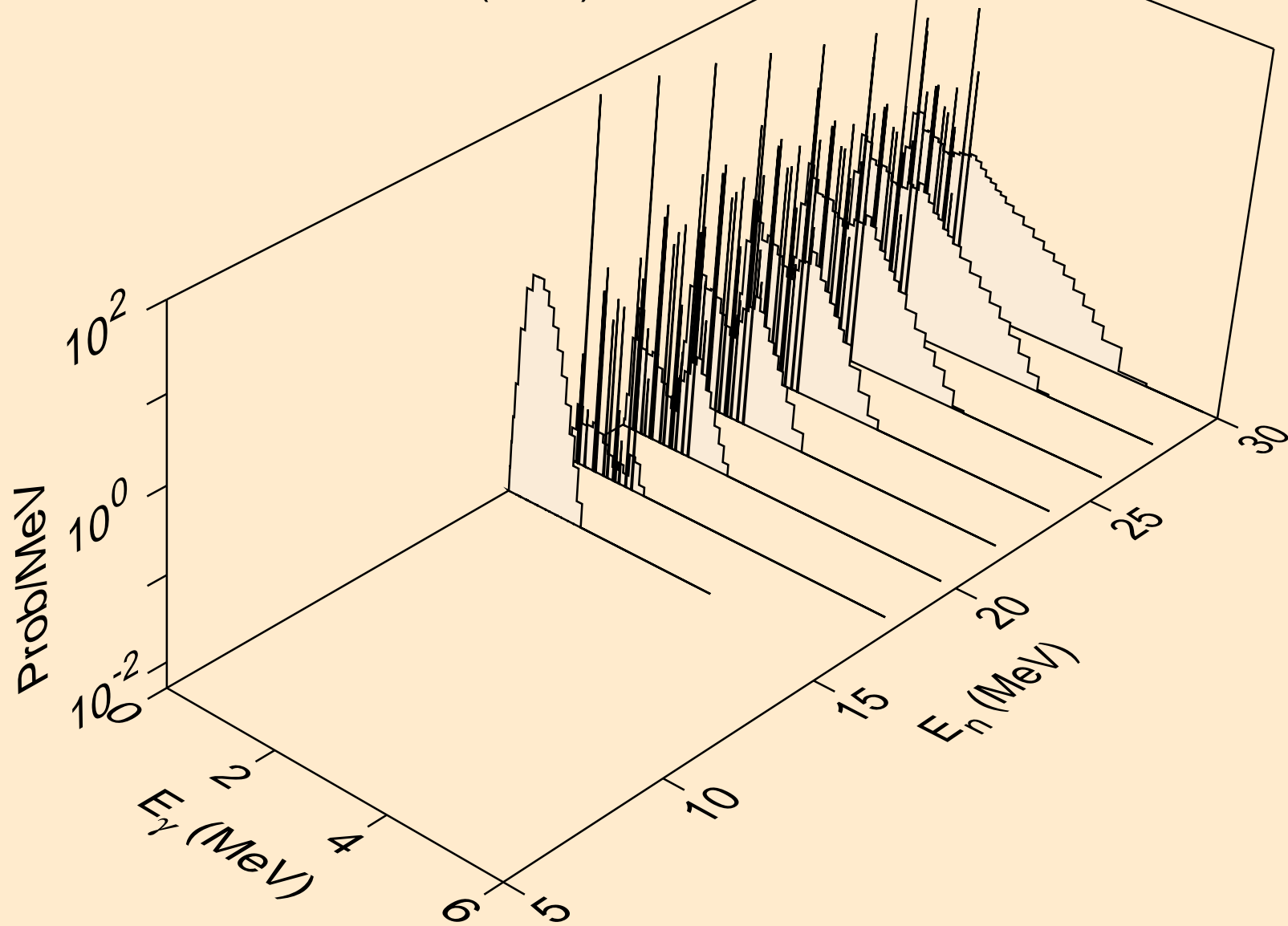

NB090 NEUTRON ACER TENDL-2023 LIBRARY; T=0.K
thermal capture photon spectrum

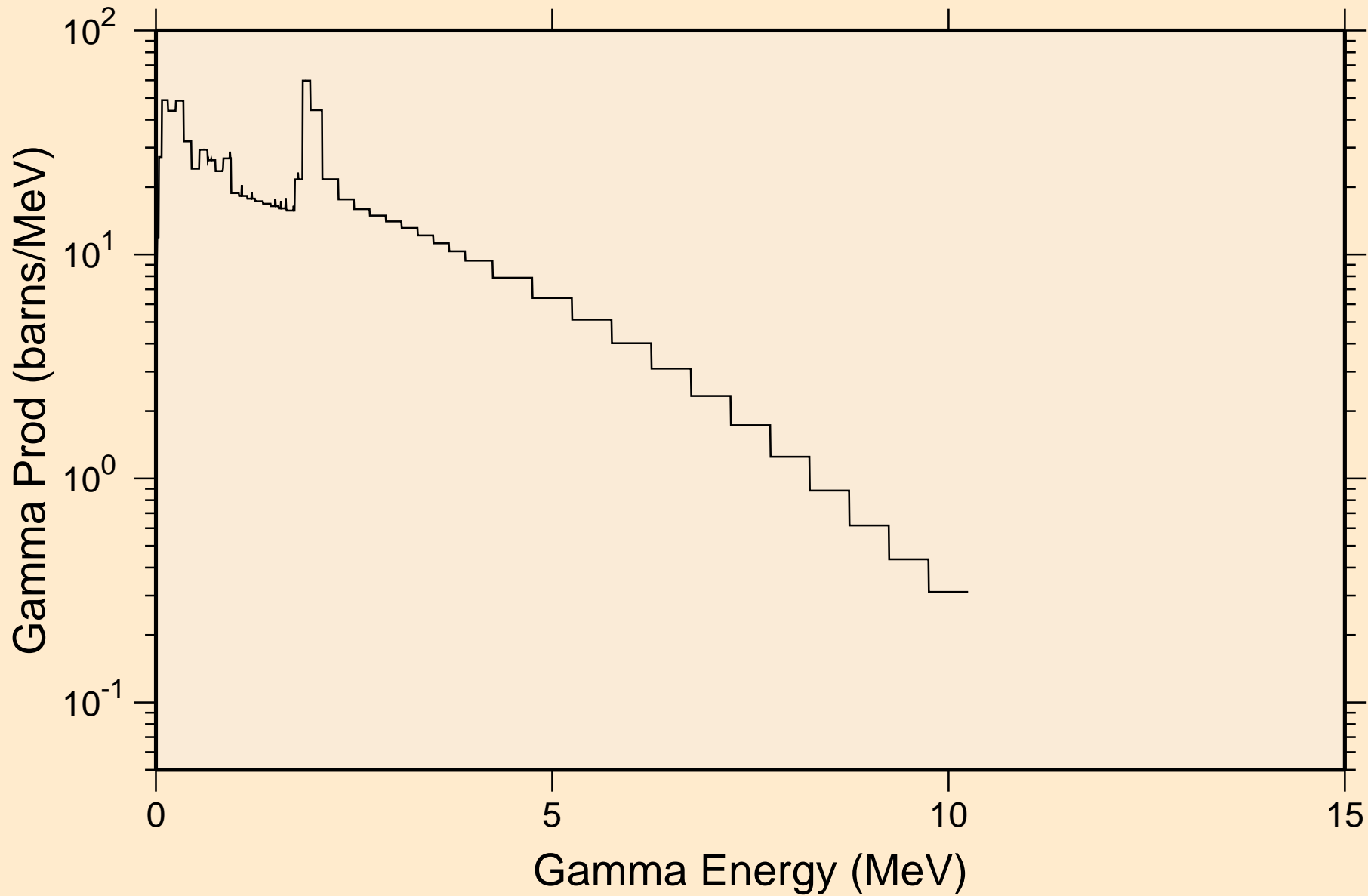

NB090 NEUTRON ACER TENDL-2023 LIBRARY; T=0.K
14 MeV photon spectrum

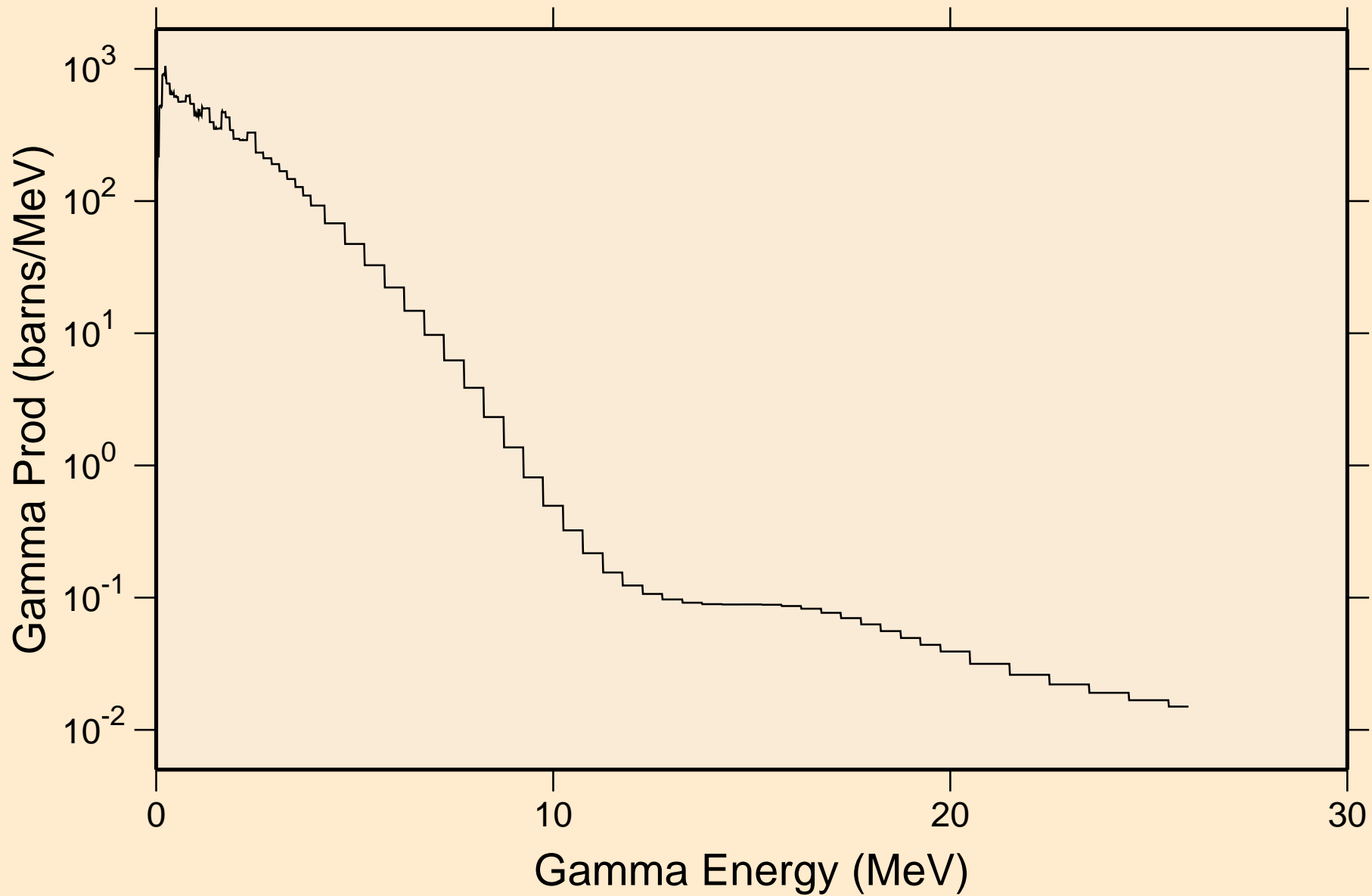

NB090 NEUTRON ACER TENDL-2023 LIBRARY; T=0.K

Particle heating contributions

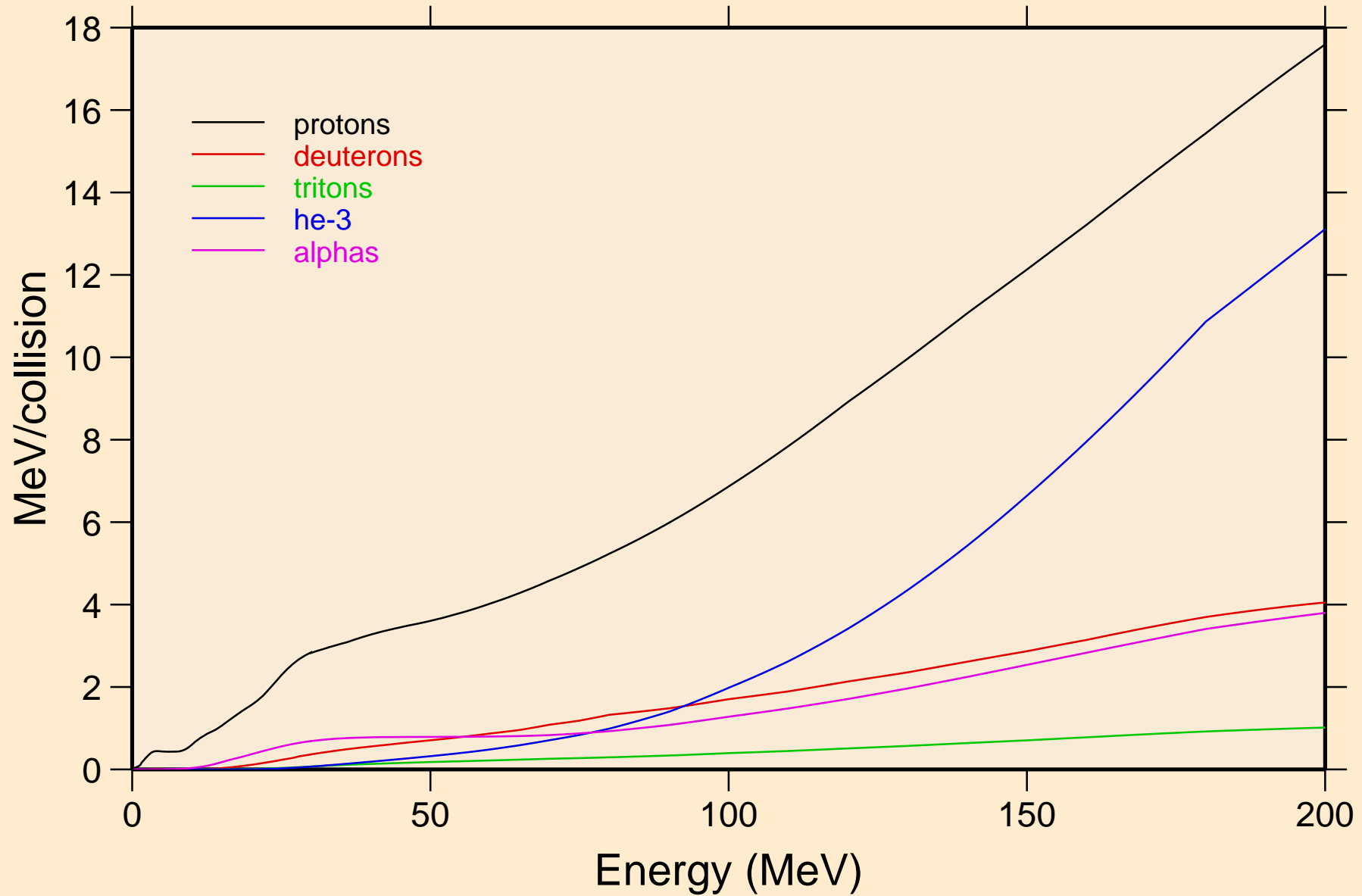

NB090 NEUTRON ACER TENDL-2023 LIBRARY; T=0.K

Recoil Heating

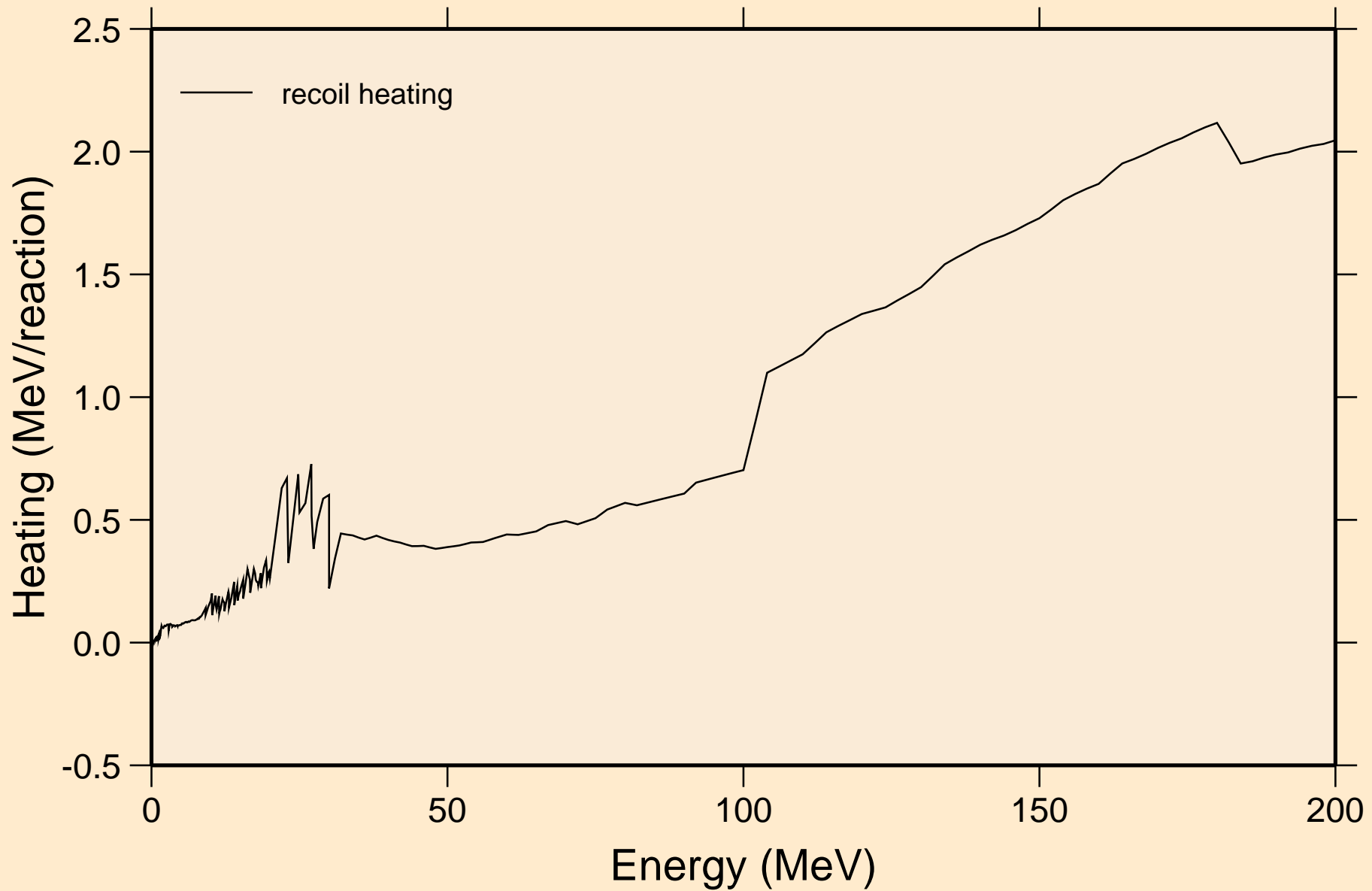

NB090 NEUTRON ACER TENDL-2023 LIBRARY; T=0.K

Particle production cross sections

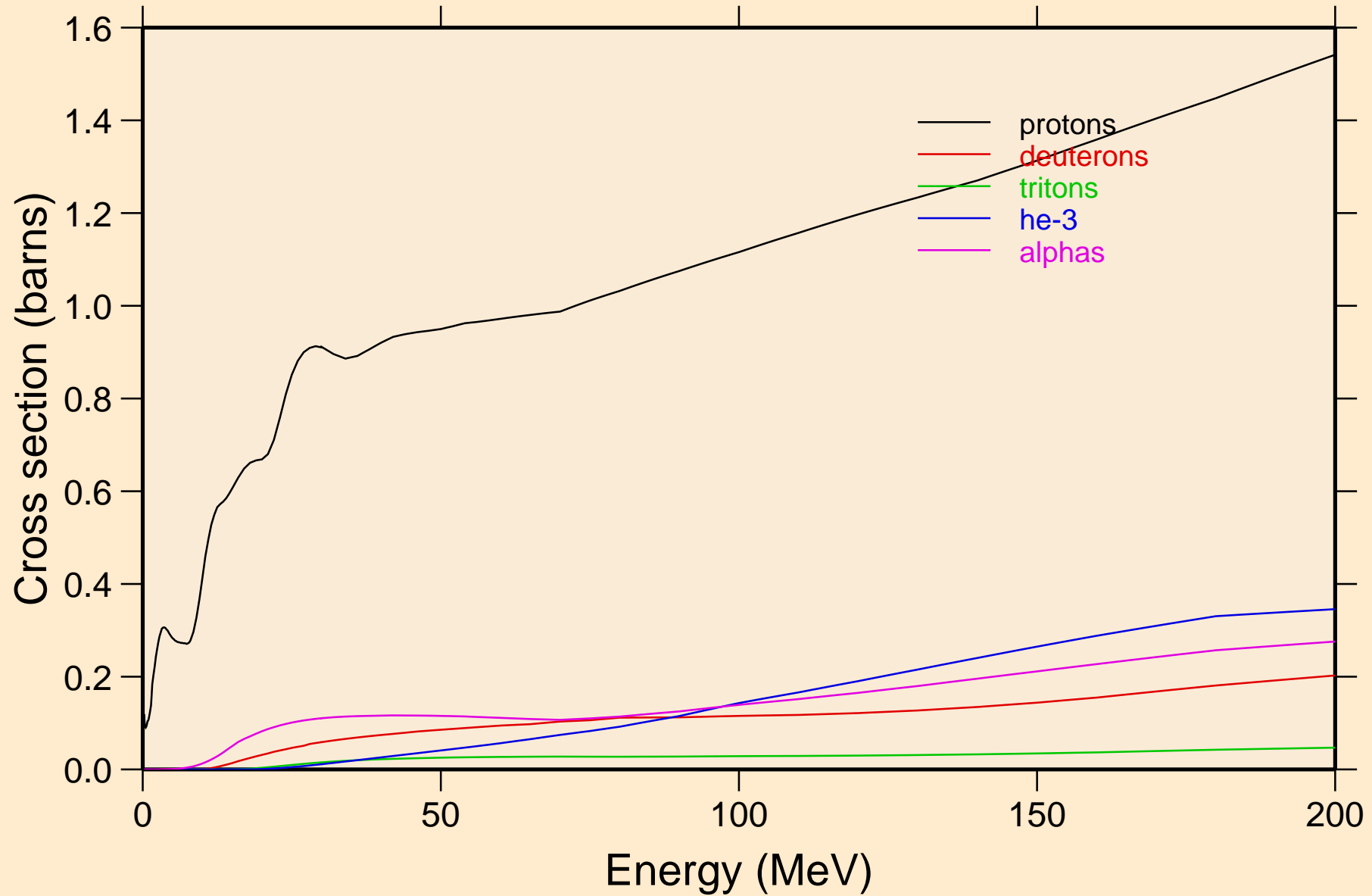

NB090 NEUTRON ACER TENDL-2023 LIBRARY; T=0.K
protons from (n,x)

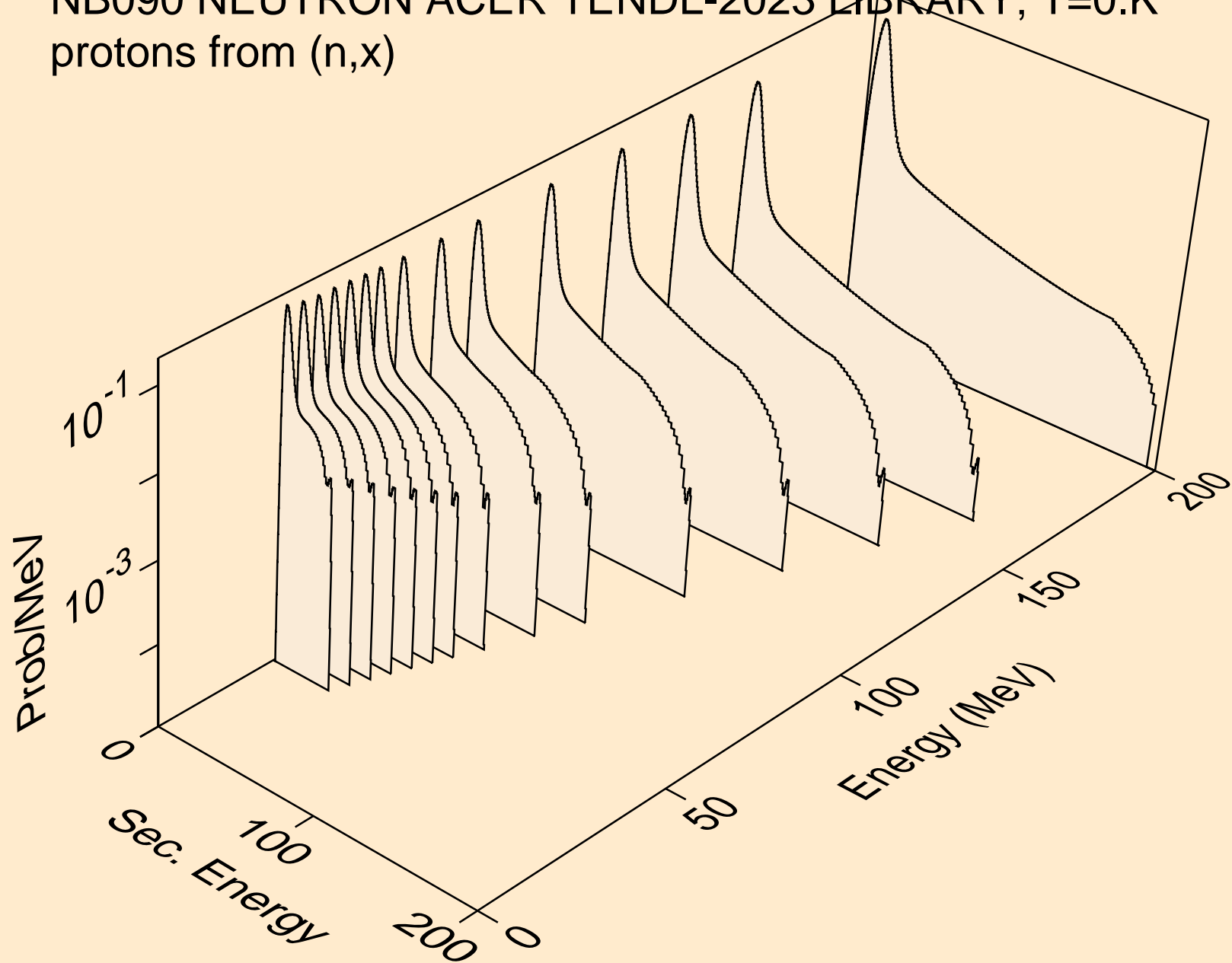

NB090 NEUTRON ACER TENDL-2023 LIBRARY; T=0.K
protons from (n,n*)p

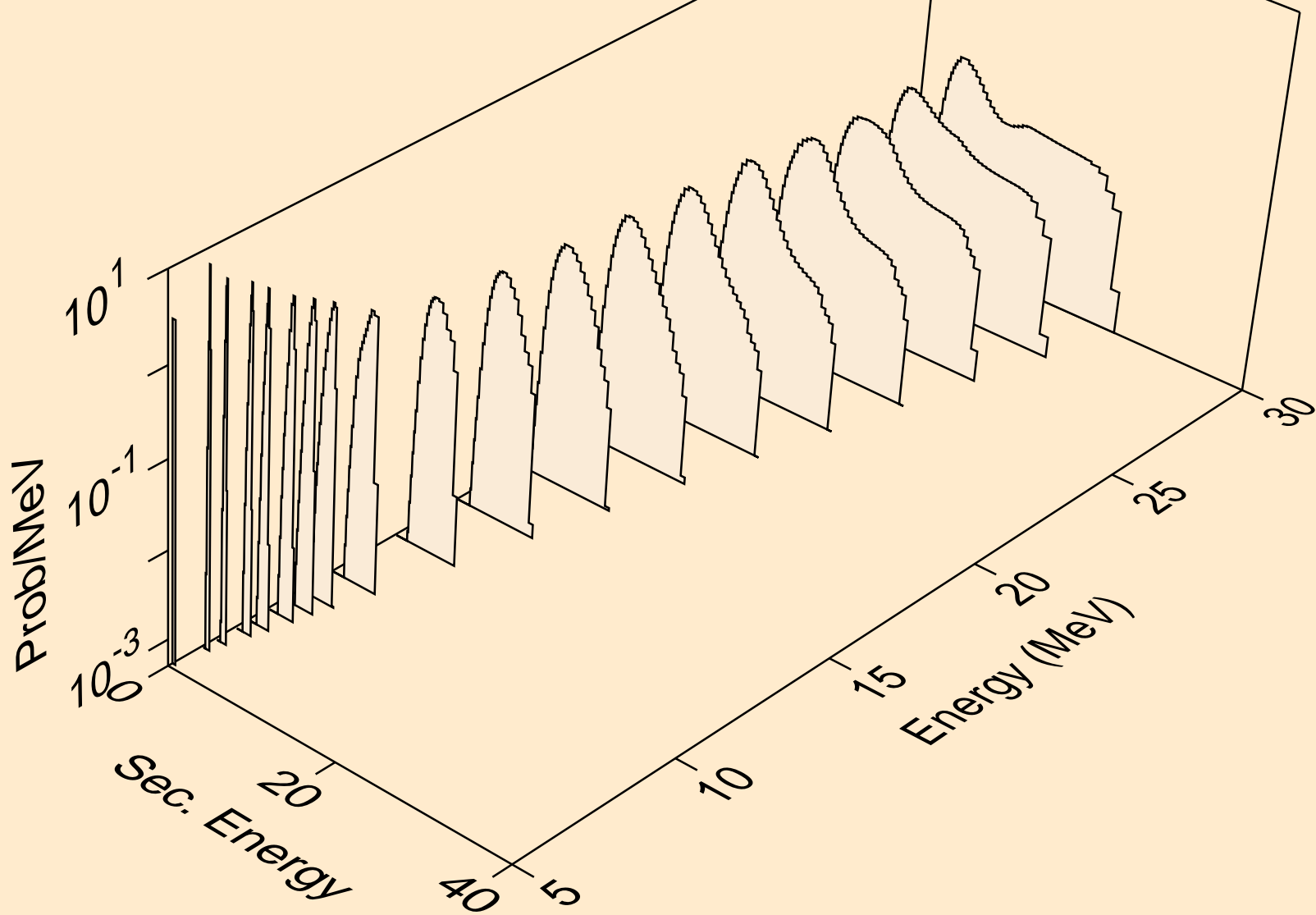

NB090 NEUTRON ACER TENDL-2023 LIBRARY; T=0.K
protons from (n,2np)

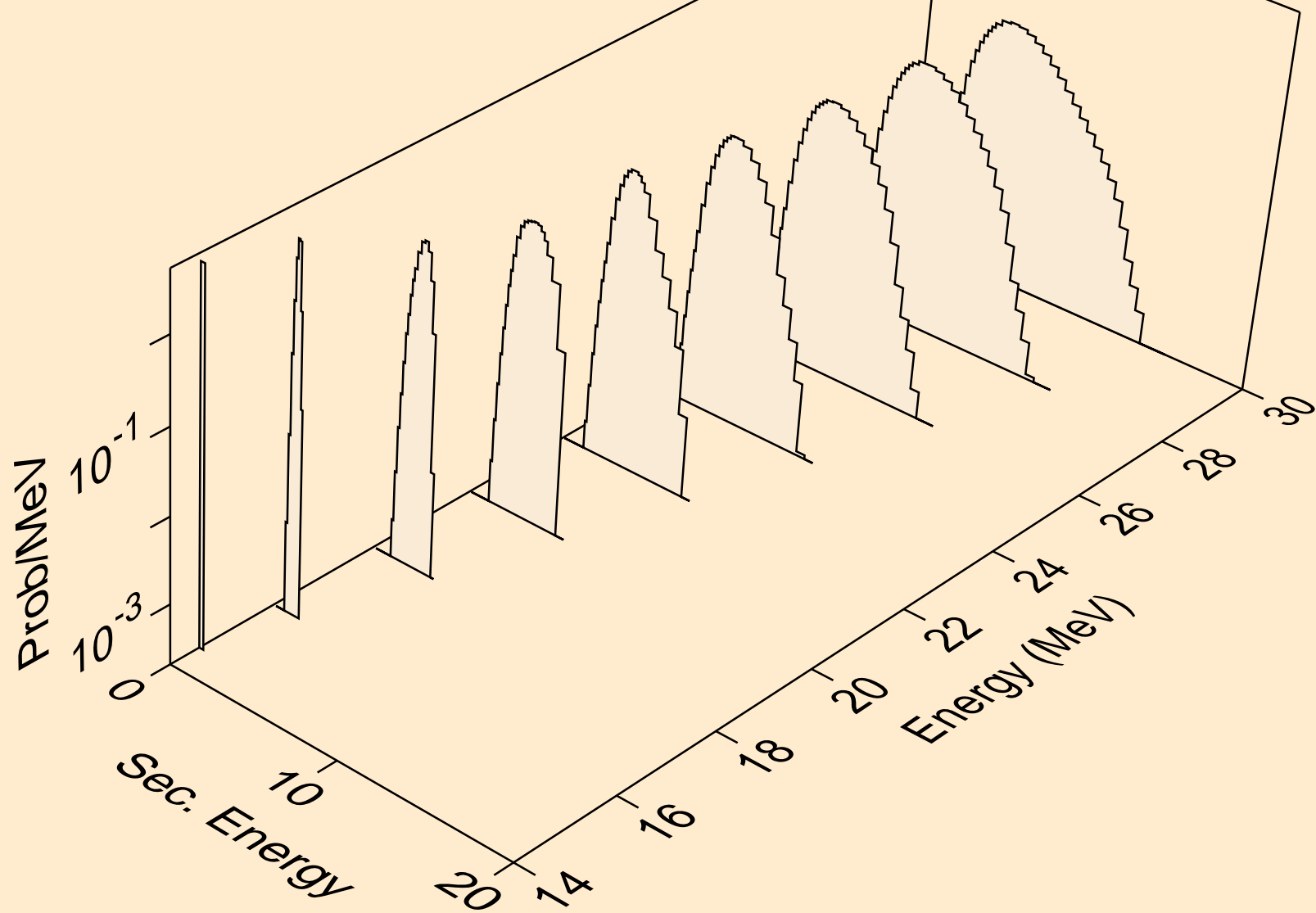

NB090 NEUTRON ACER TENDL-2023 LIBRARY; T=0.K
protons from (n,3np)

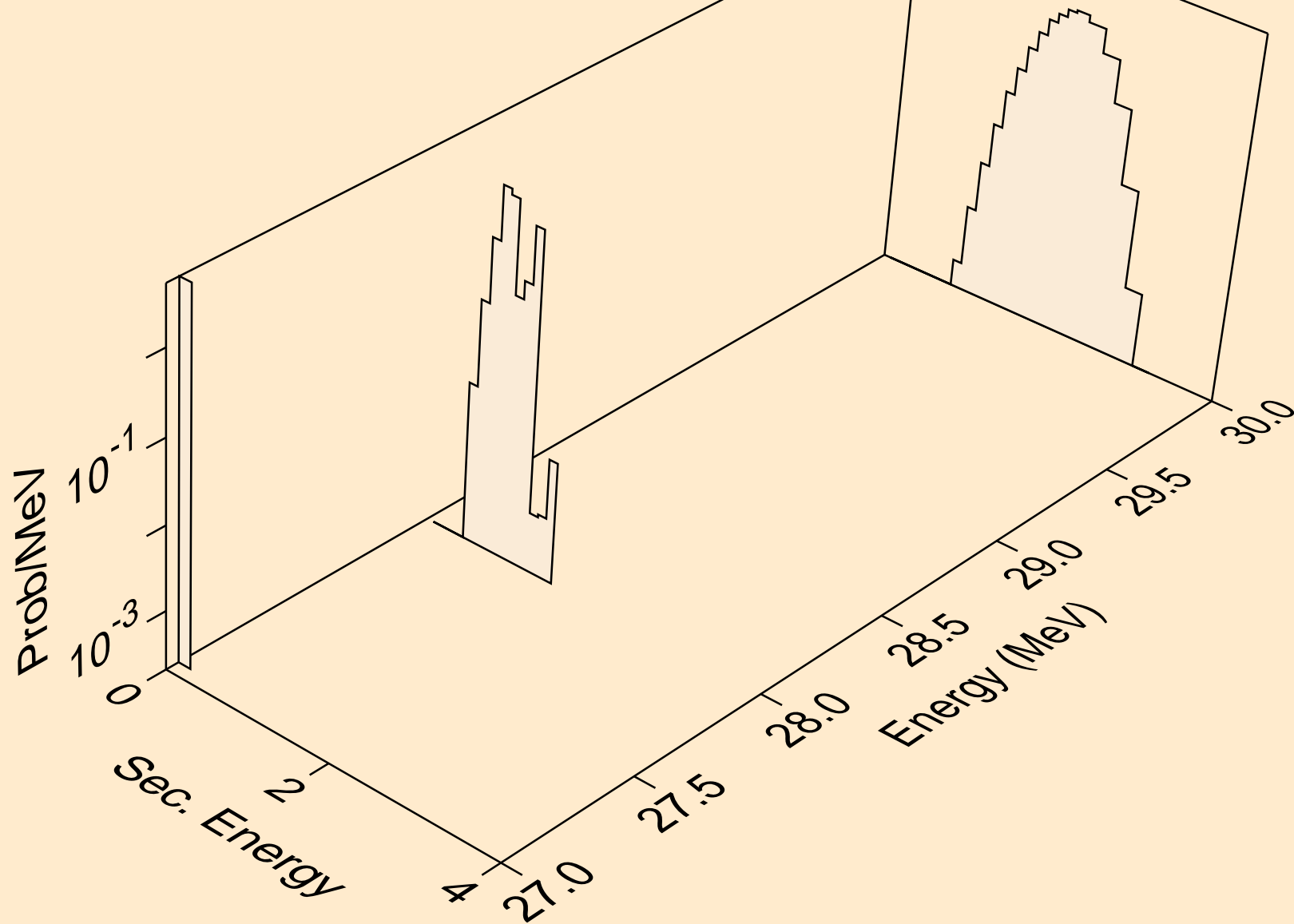

NB090 NEUTRON ACER TENDL-2023 LIBRARY; T=0.K
protons from (n,n2p)

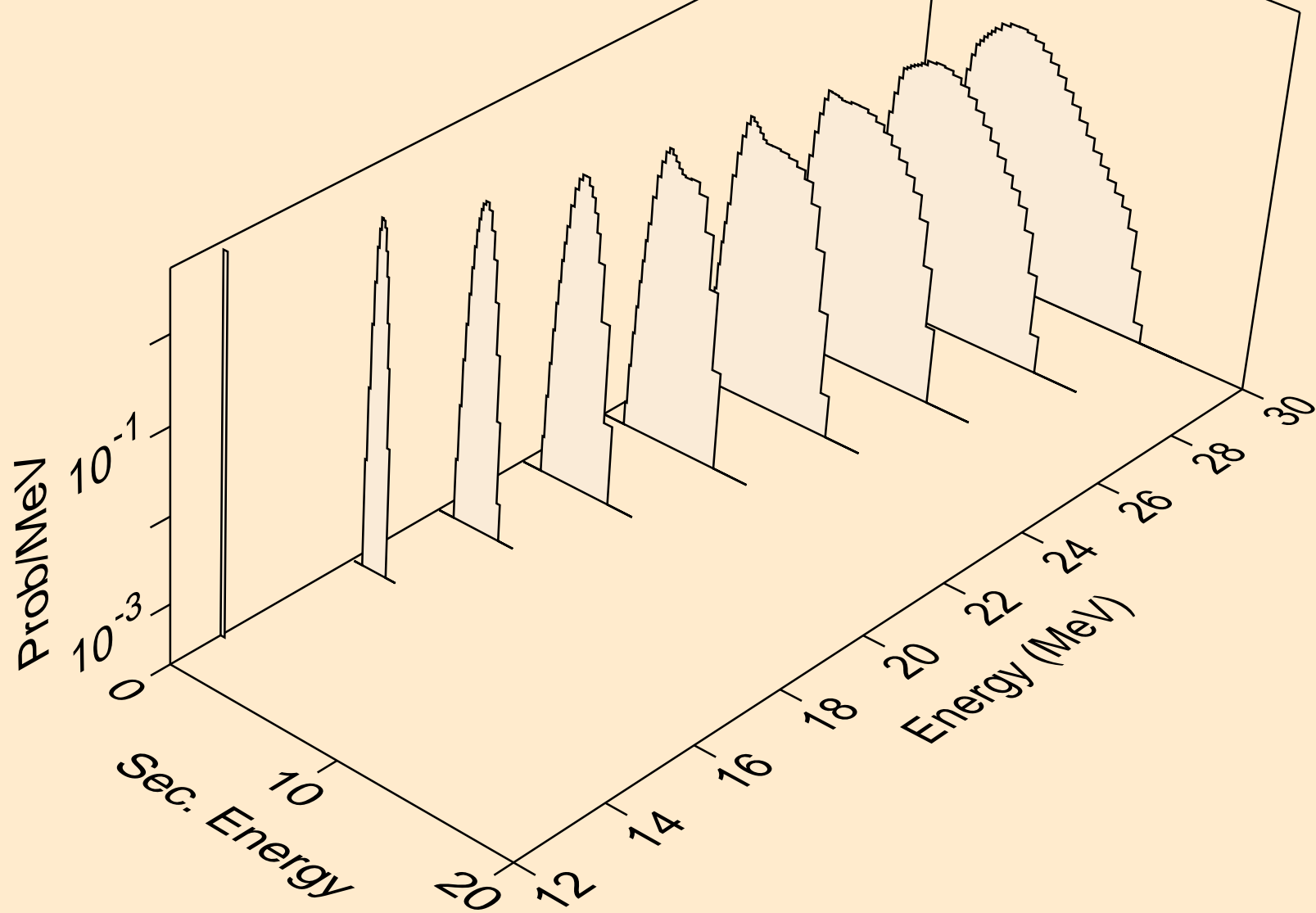

NB090 NEUTRON ACER TENDL-2023 LIBRARY; T=0.K
protons from (n,npa)

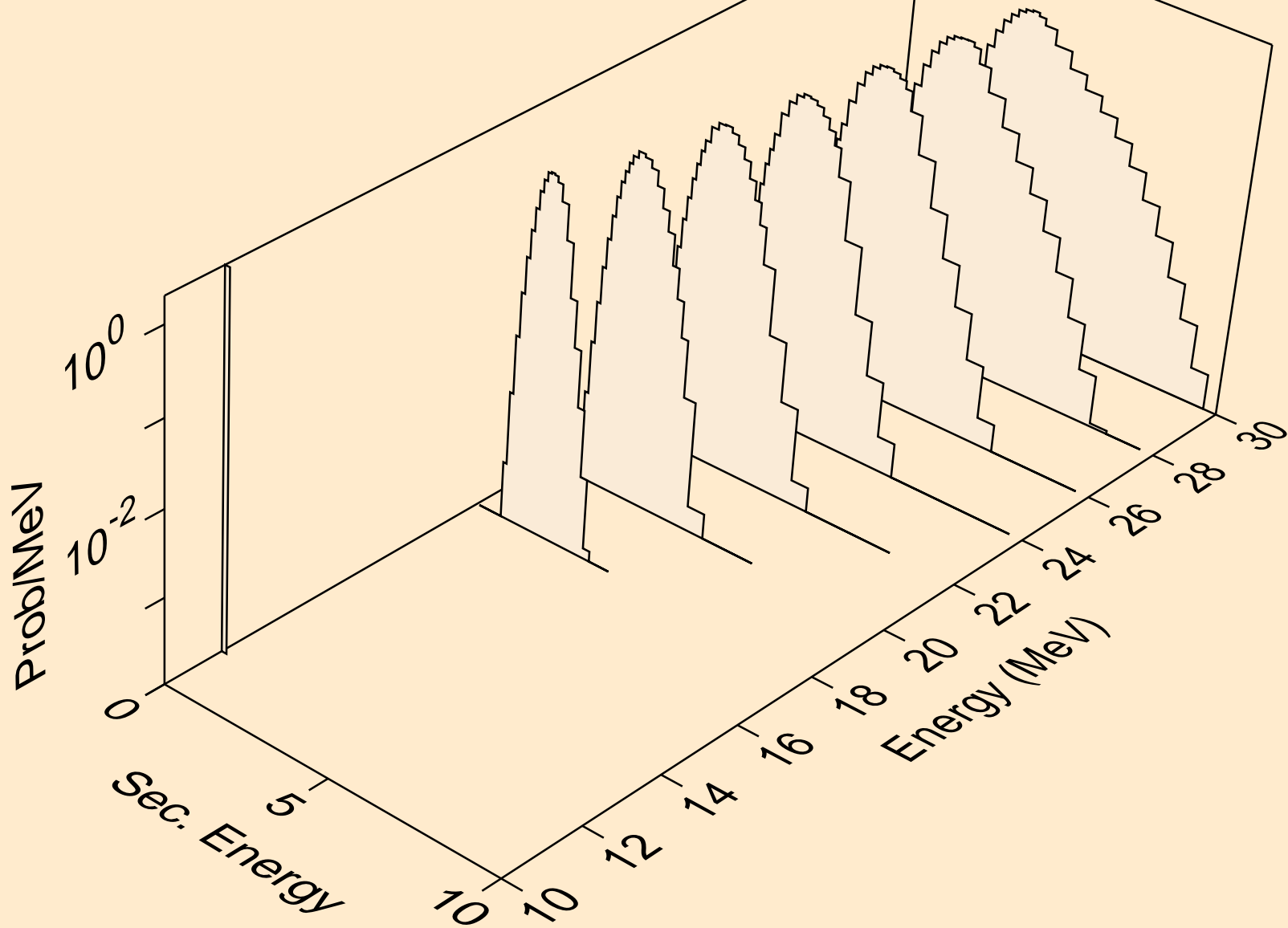

NB090 NEUTRON ACER TENDL-2023 LIBRARY; T=0.K
protons from (n,p)

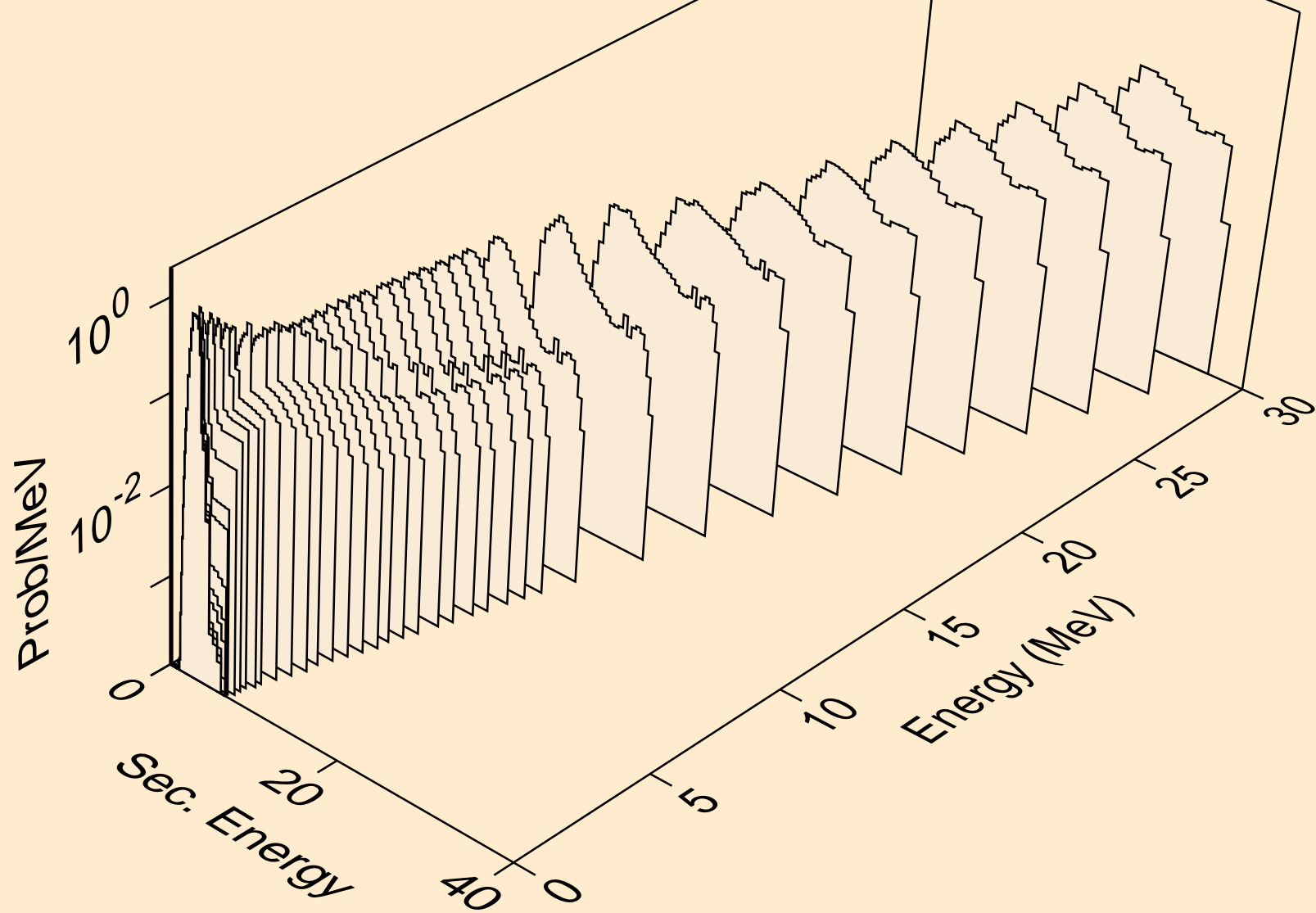

NB090 NEUTRON ACER TENDL-2023 LIBRARY; T=0.K
protons from (n,2p)

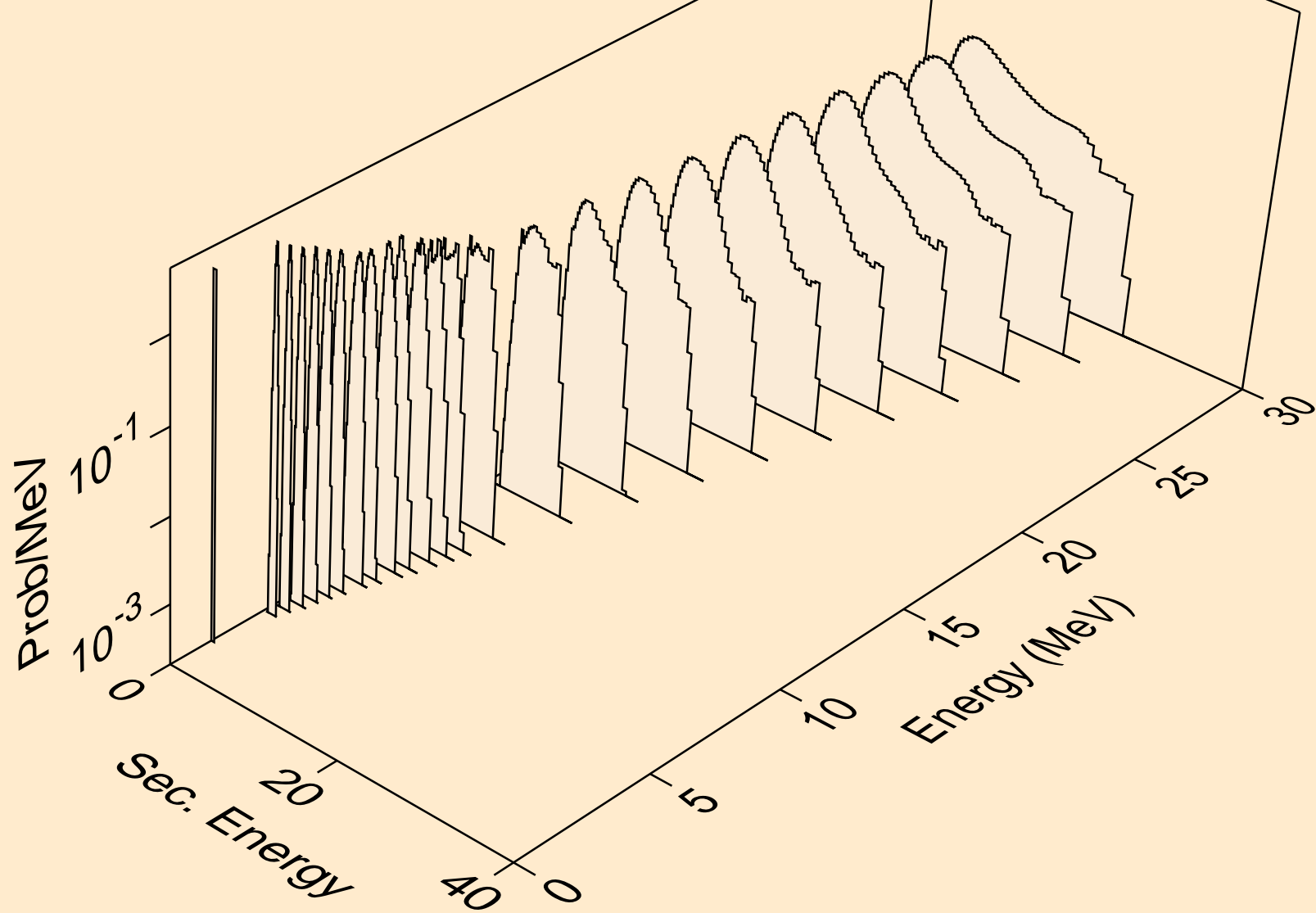

NB090 NEUTRON ACER TENDL-2023 LIBRARY; T=0.K
protons from (n,p)

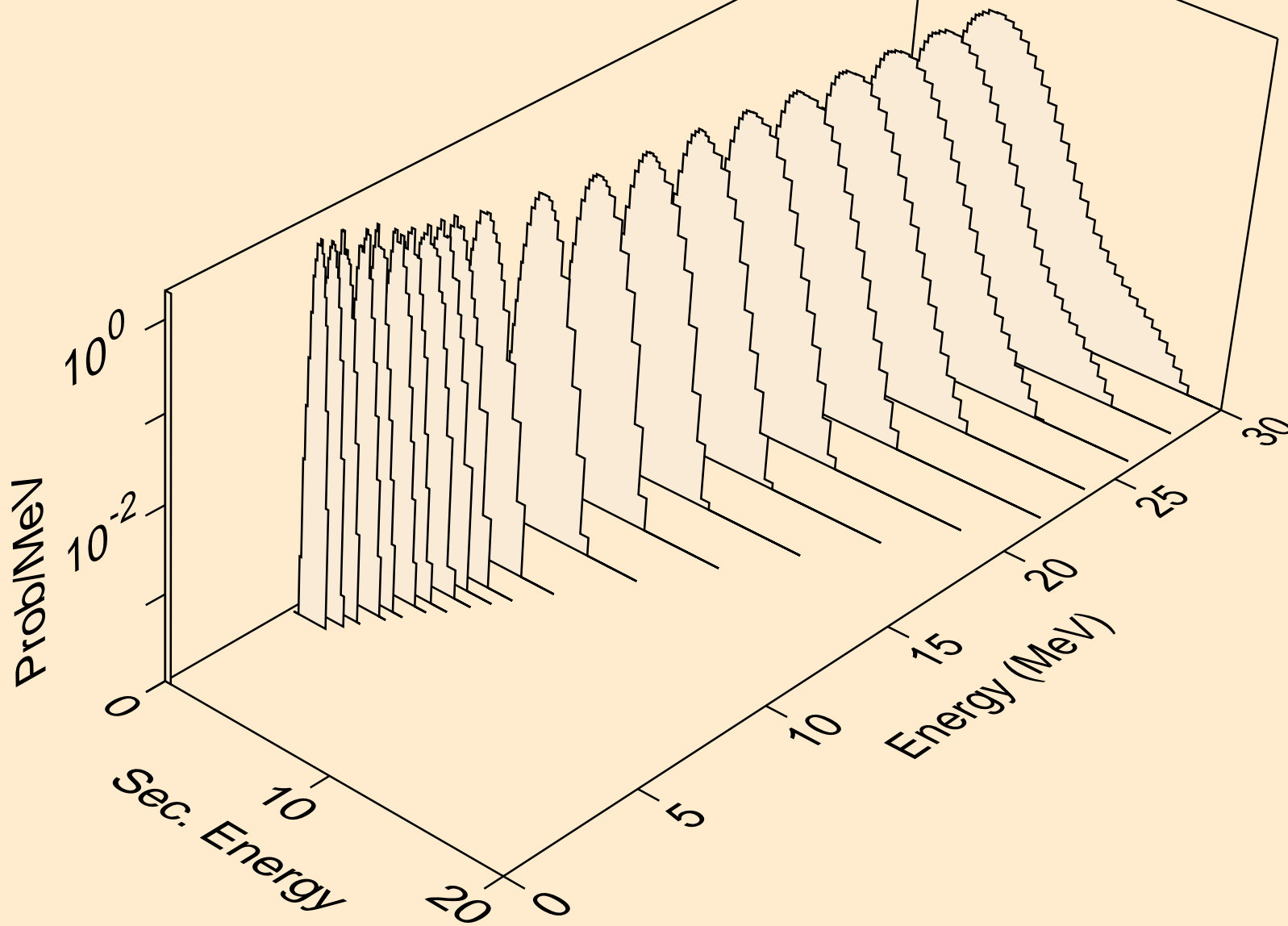

NB090 NEUTRON ACER TENDL-2023 LIBRARY; T=0.K
protons from (n,pd)

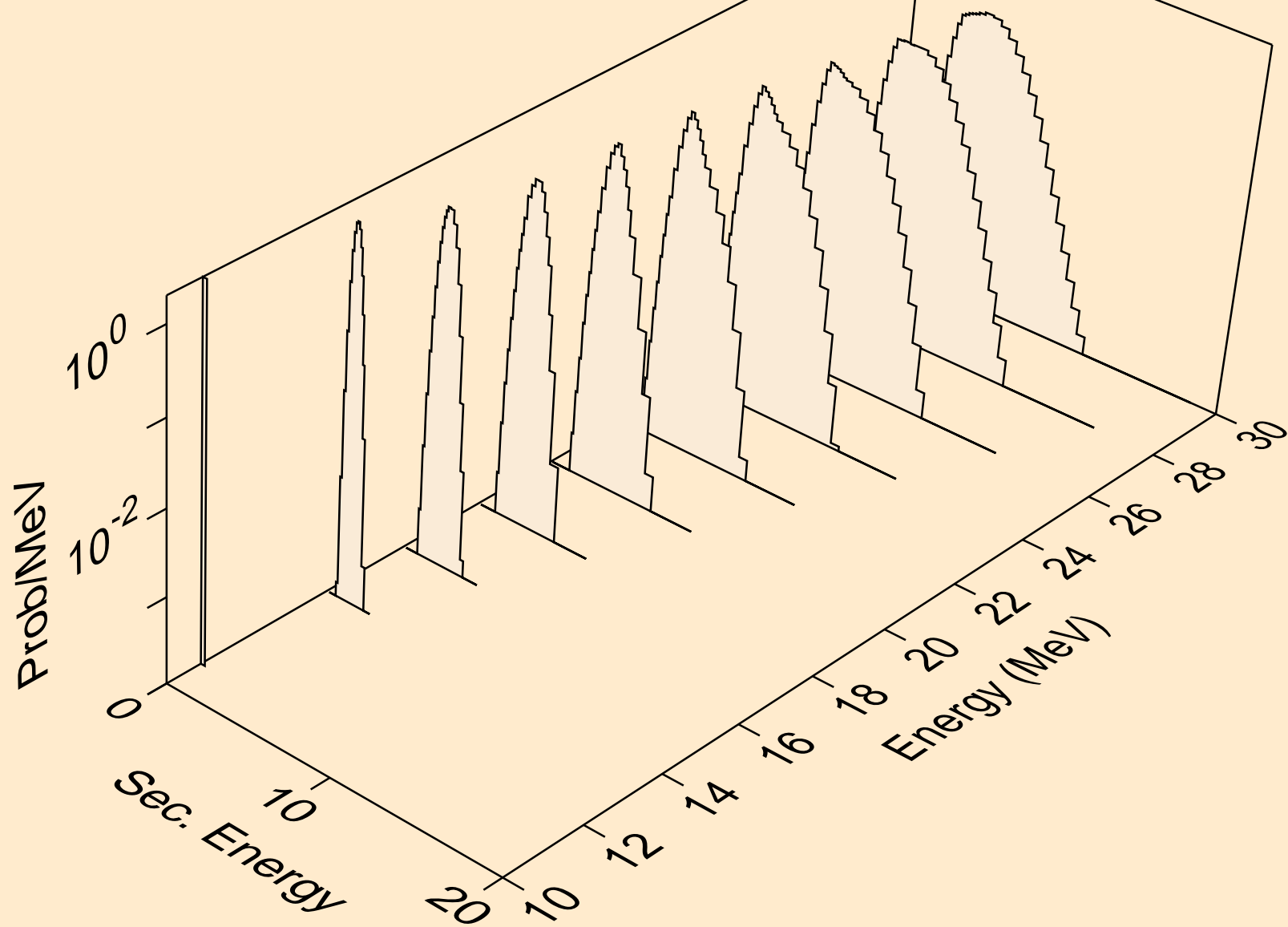

NB090 NEUTRON ACER TENDL-2023 LIBRARY; T=0.K
protons from (n,pt)

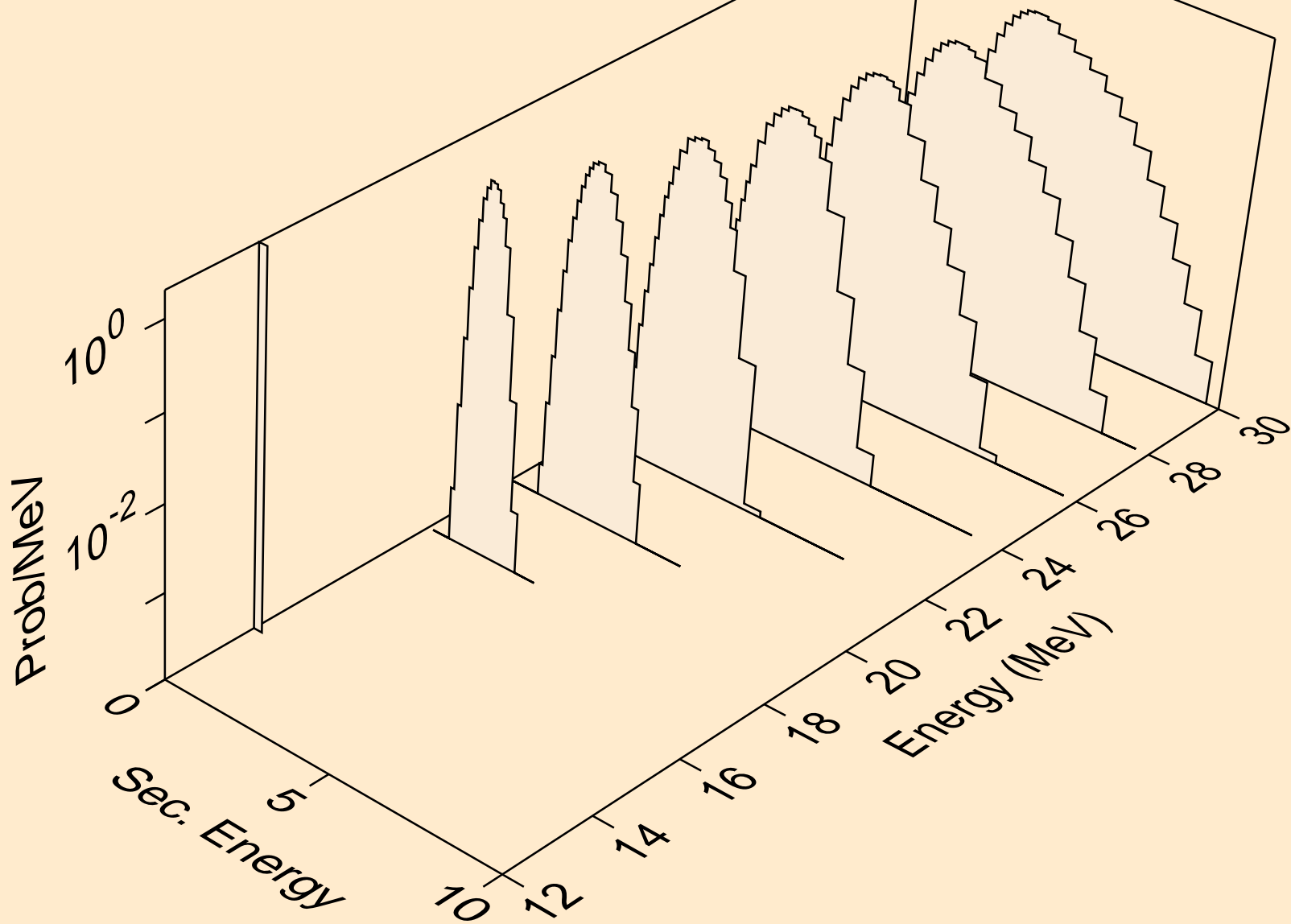

NB090 NEUTRON ACER TENDL-2023 LIBRARY; T=0.K
deuterons from (n,x)

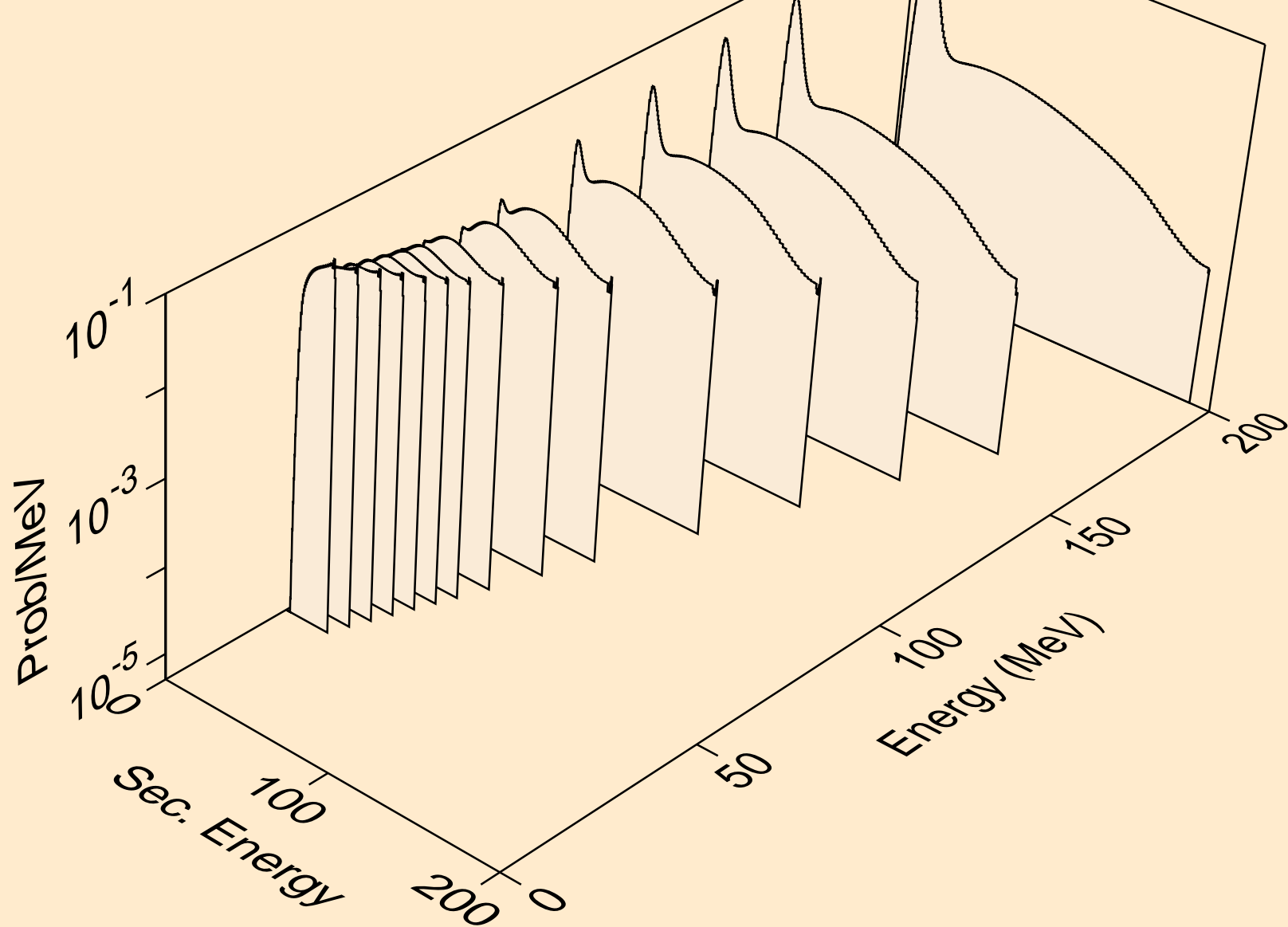

NB090 NEUTRON ACER TENDL-2023 LIBRARY; T=0.K
deuterons from (n,2nd)

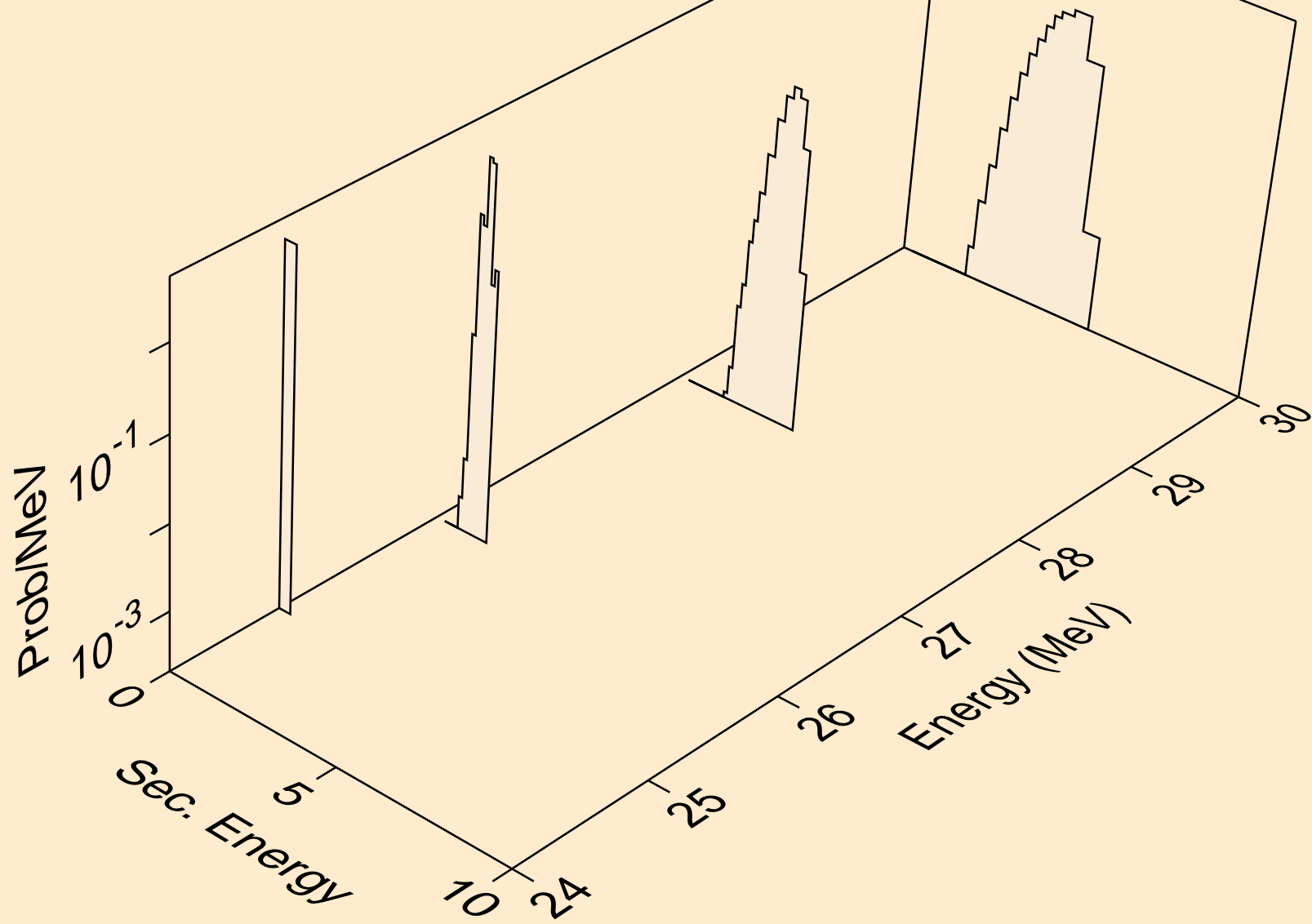

NB090 NEUTRON ACER TENDL-2023 LIBRARY; T=0.K
deuterons from (n,n*)d

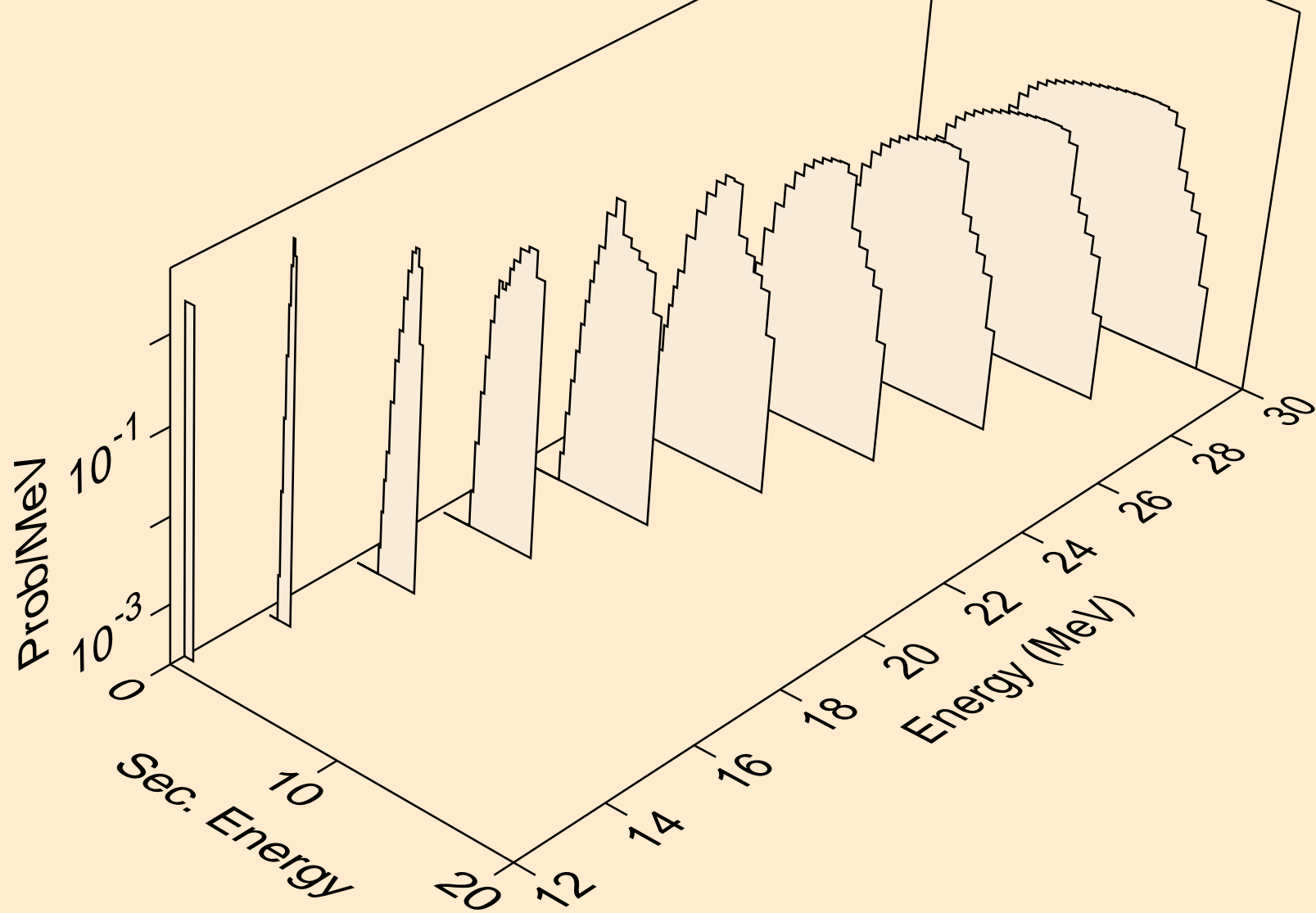

NB090 NEUTRON ACER TENDL-2023 LIBRARY; T=0.K
deuterons from (n,d)

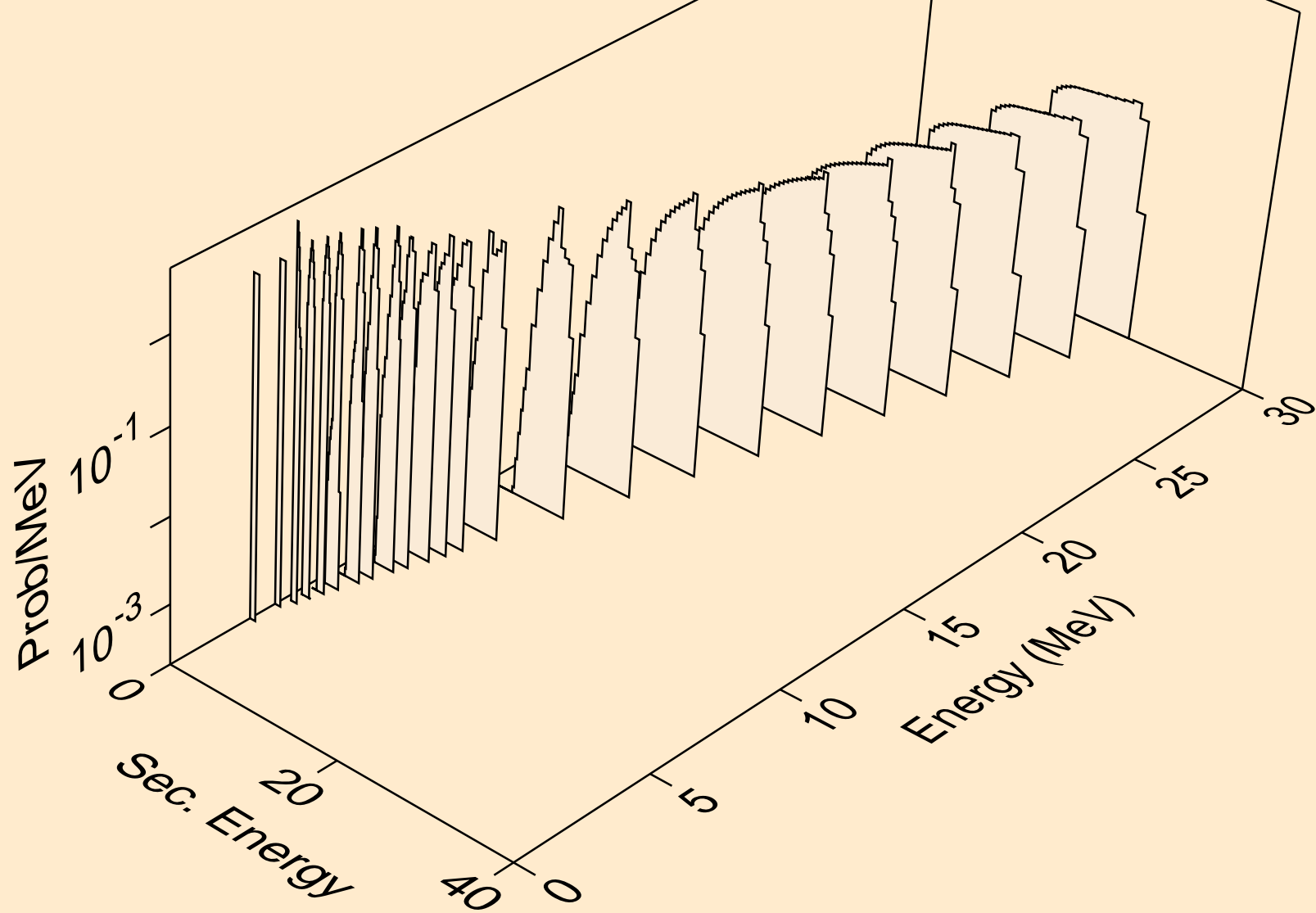

NB090 NEUTRON ACER TENDL-2023 LIBRARY; T=0.K
deuterons from (n,pd)

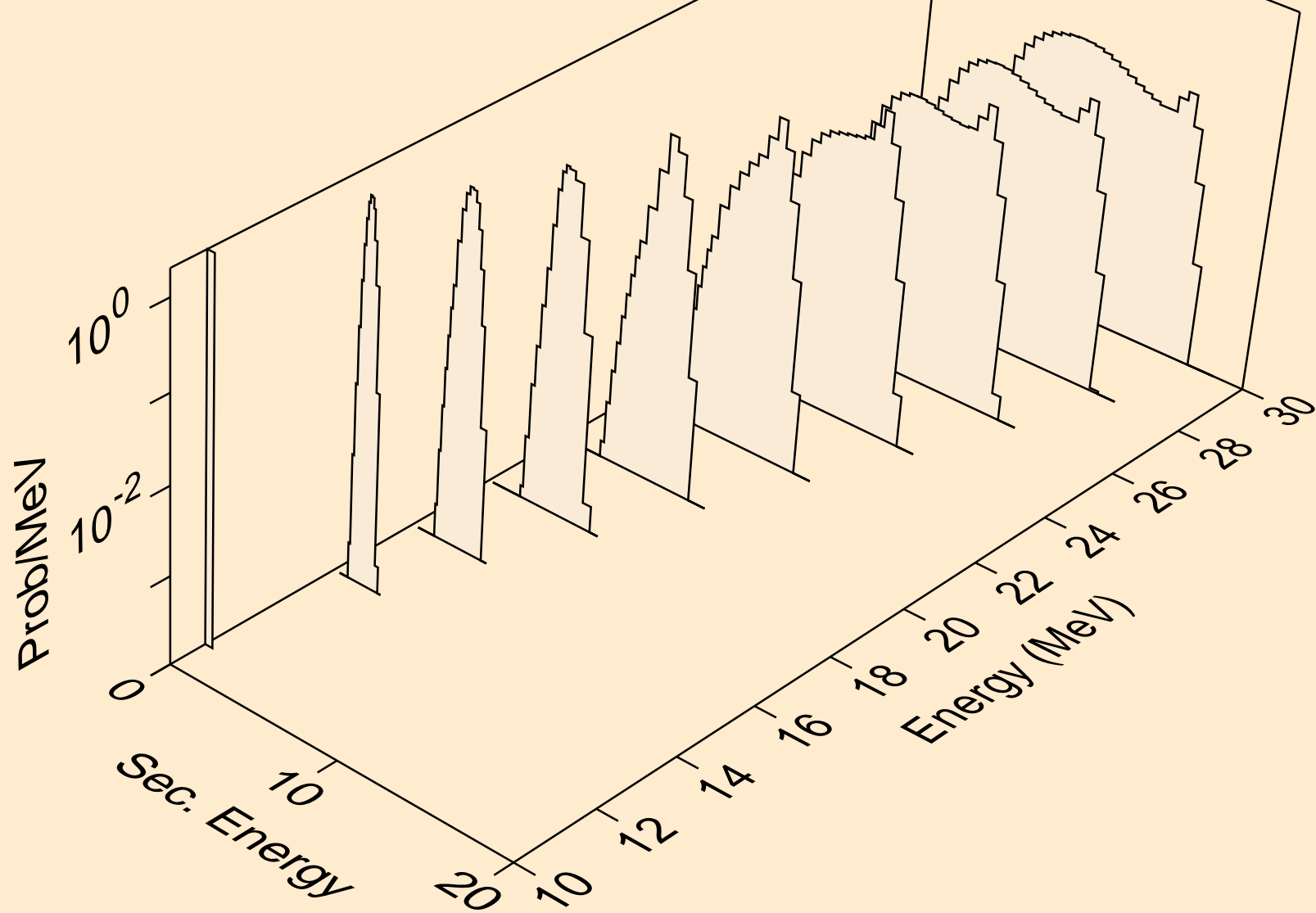

NB090 NEUTRON ACER TENDL-2023 LIBRARY; T=0.K
deuterons from (n,da)

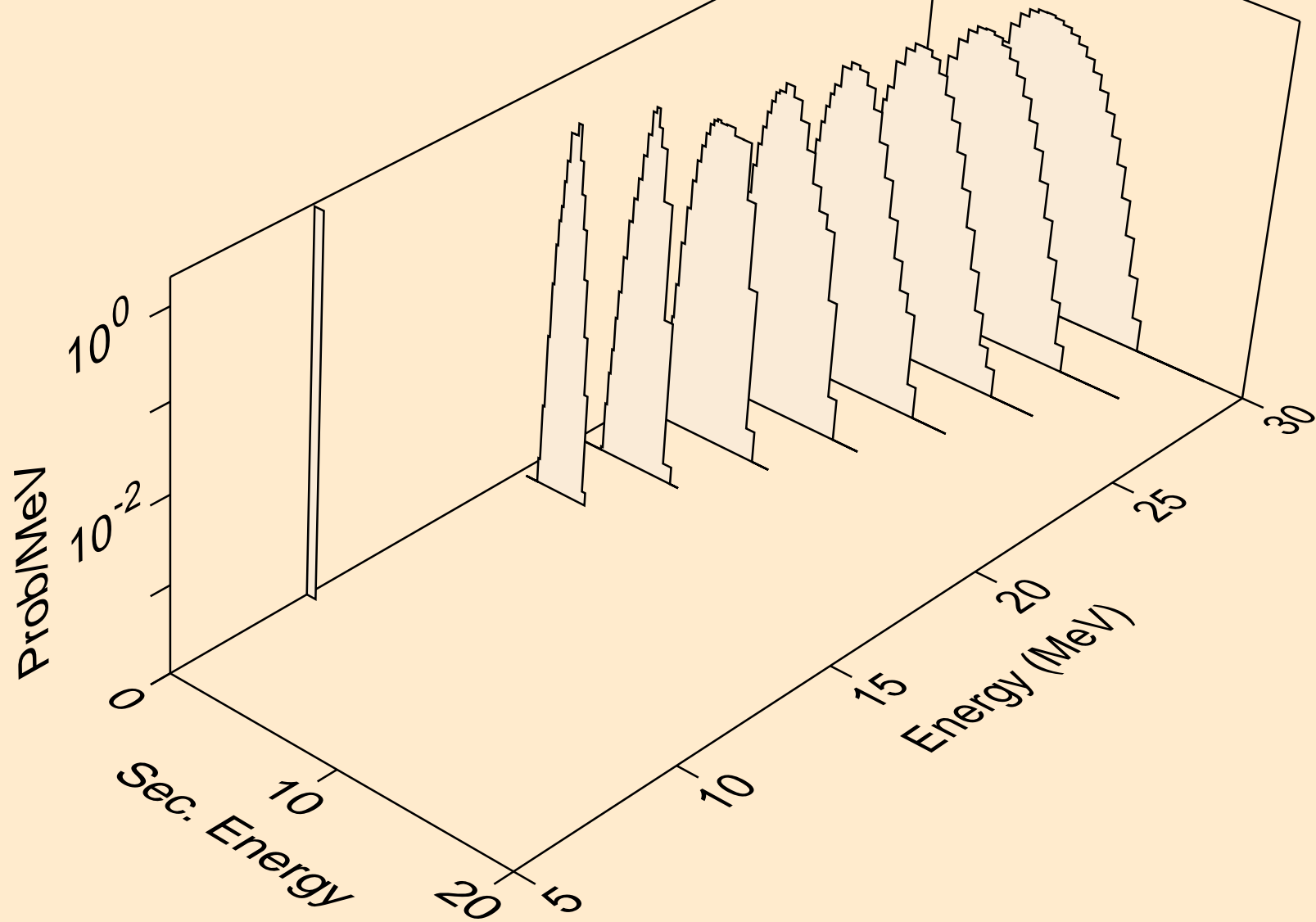

NB090 NEUTRON ACER TENDL-2023 LIBRARY; T=0.K
tritons from (n,x)

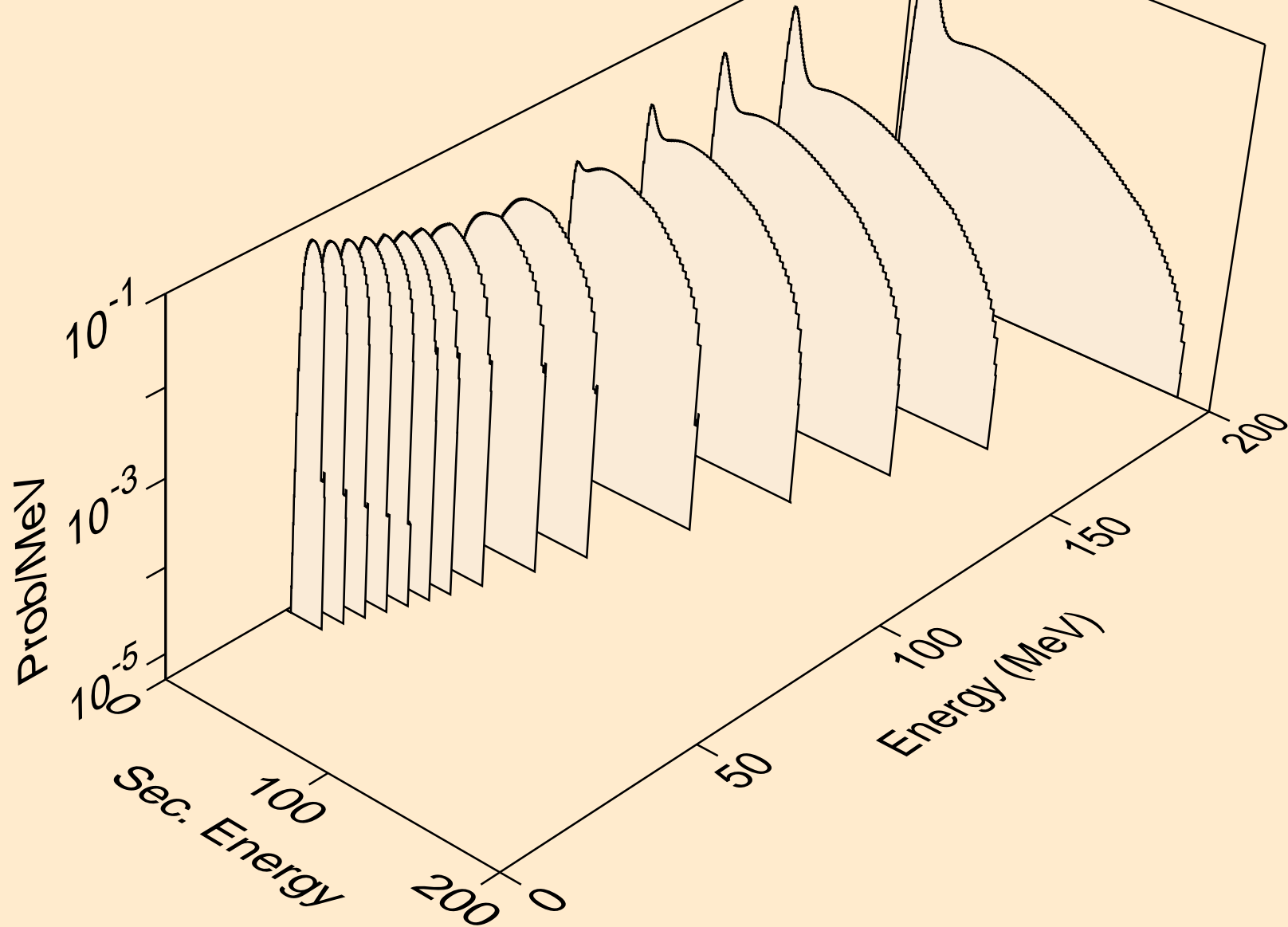

NB090 NEUTRON ACER TENDL-2023 LIBRARY; T=0.K
tritons from (n,n*)t

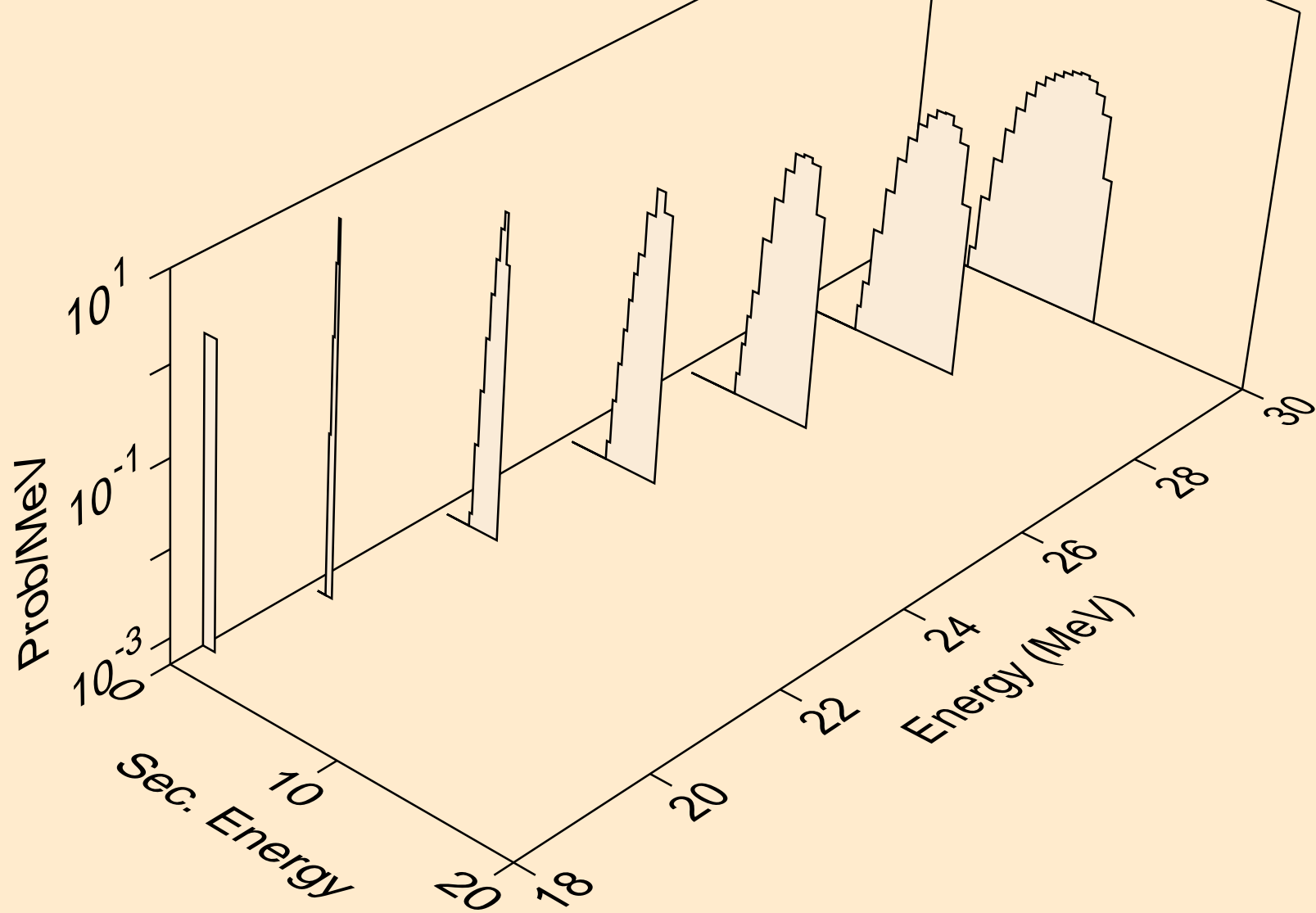

NB090 NEUTRON ACER TENDL-2023 LIBRARY; T=0.K
tritons from (n,t)

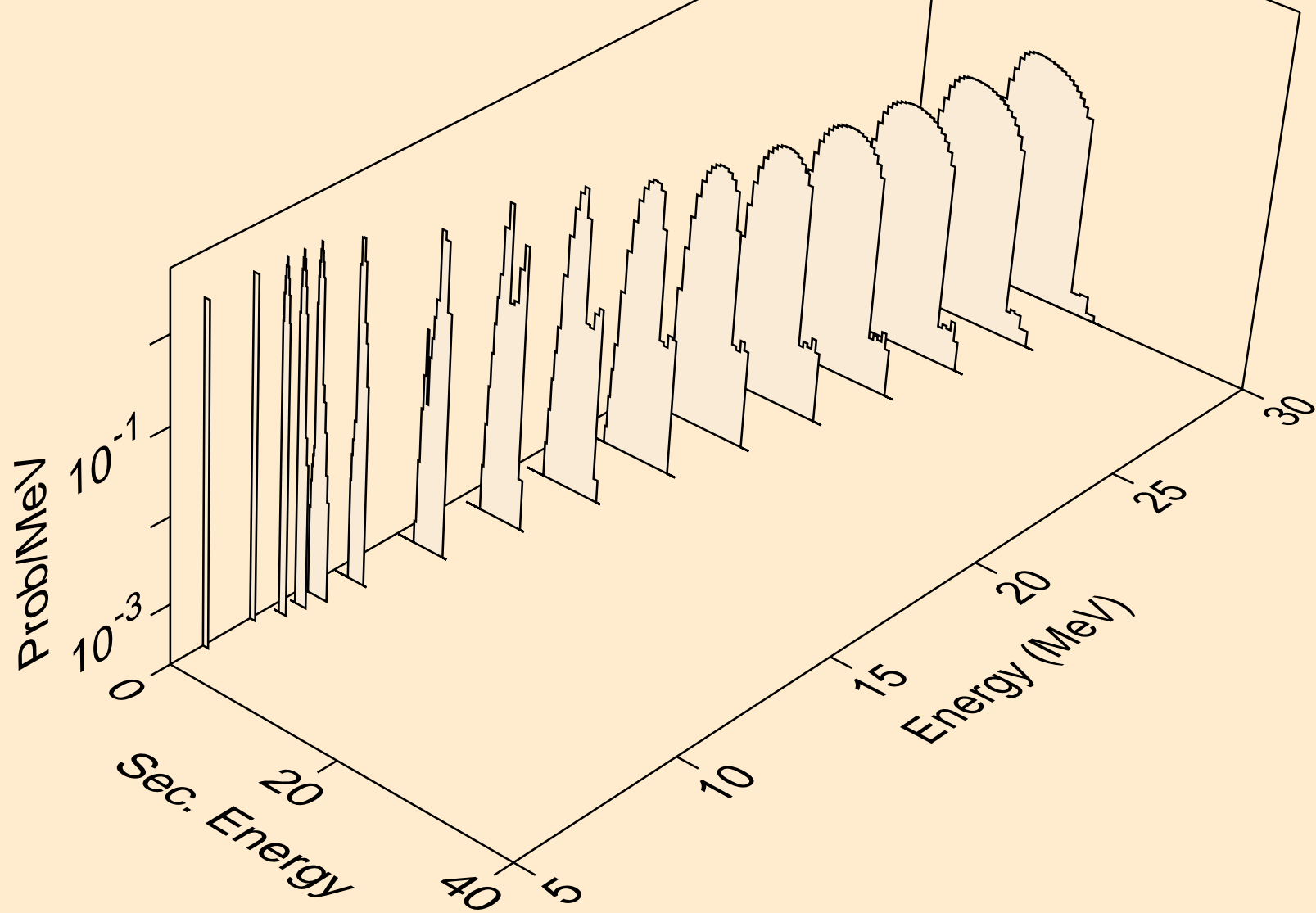

NB090 NEUTRON ACER TENDL-2023 LIBRARY; T=0.K
tritons from (n,pt)

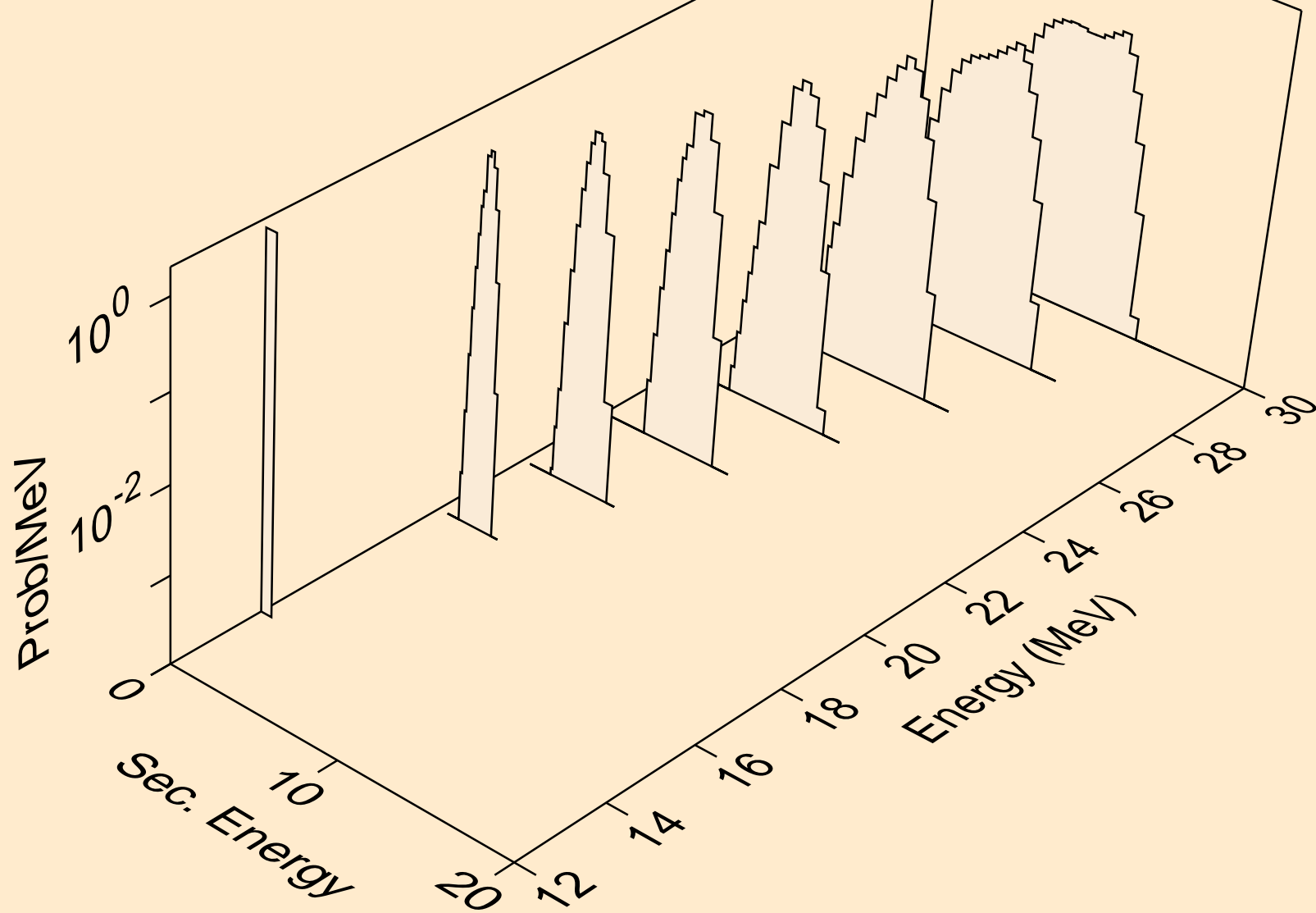

NB090 NEUTRON ACER TENDL-2023 LIBRARY; T=0.K
he3s from (n,x)

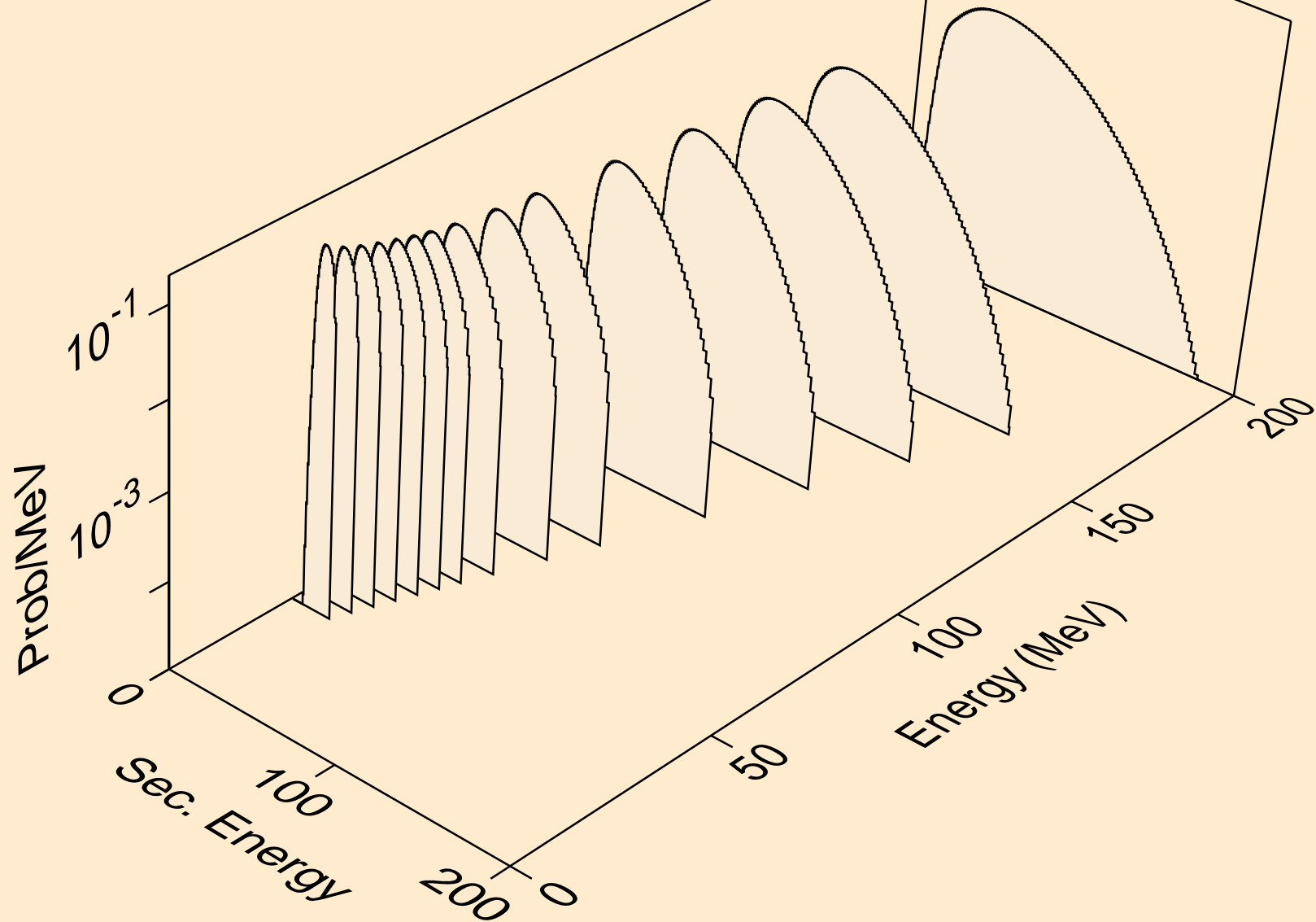

NB090 NEUTRON ACER TENDL-2023 LIBRARY; T=0.K
he3s from (n,n*)he3

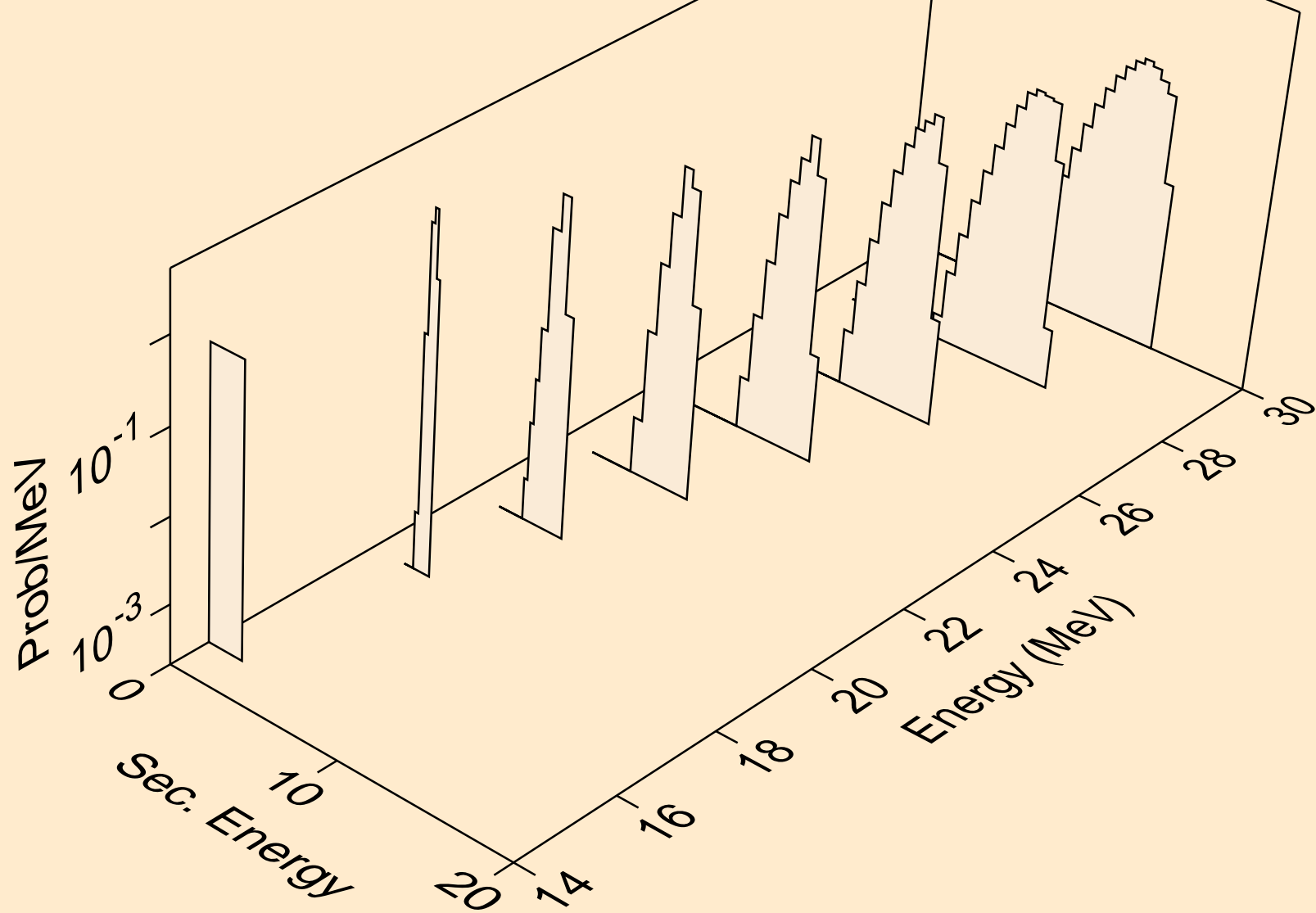

NB090 NEUTRON ACER TENDL-2023 LIBRARY; T=0.K
he3s from (n,he3)

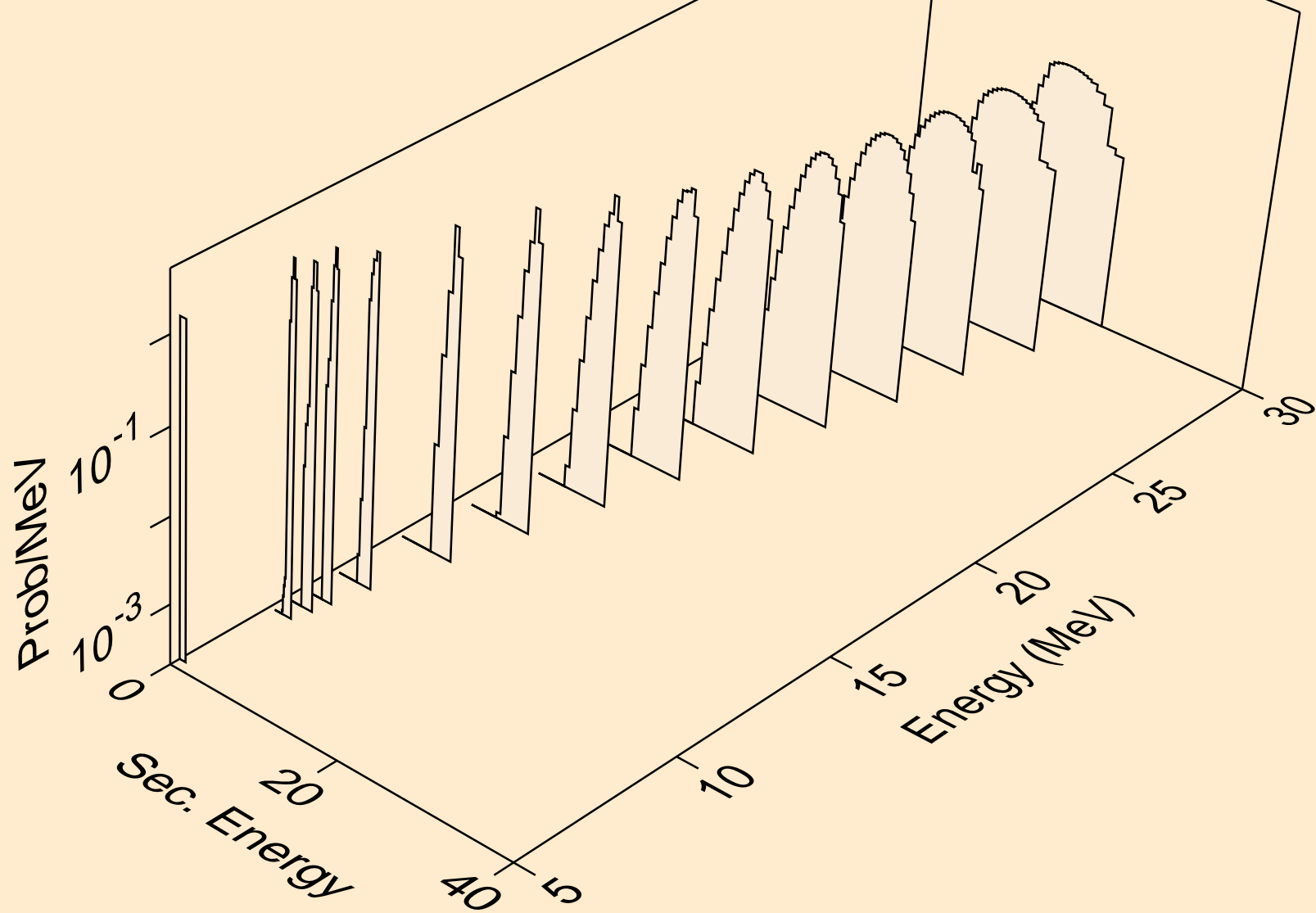

NB090 NEUTRON ACER TENDL-2023 LIBRARY; T=0.K
alphas from (n,x)

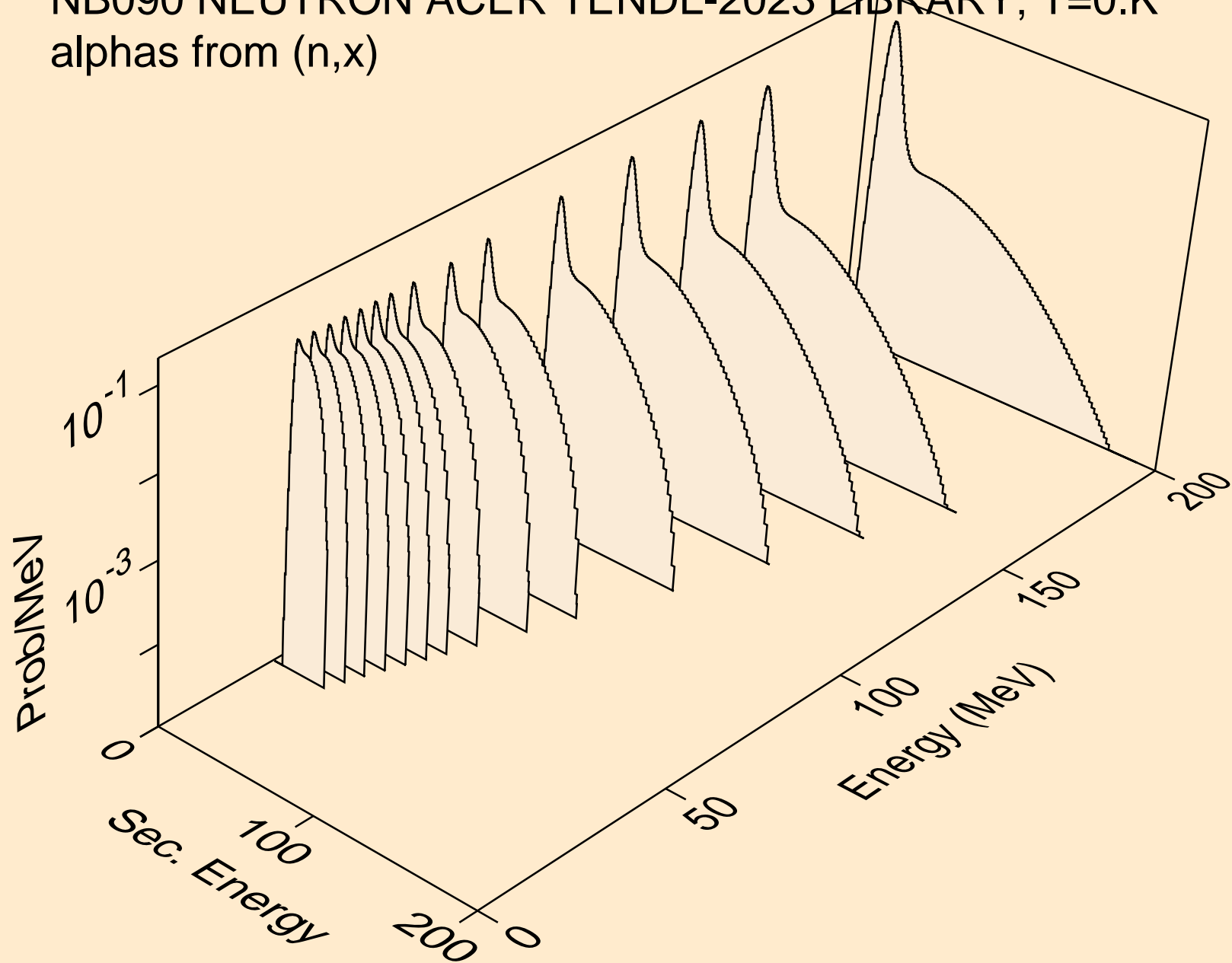

NB090 NEUTRON ACER TENDL-2023 LIBRARY; T=0.K
alphas from (n,n*)a

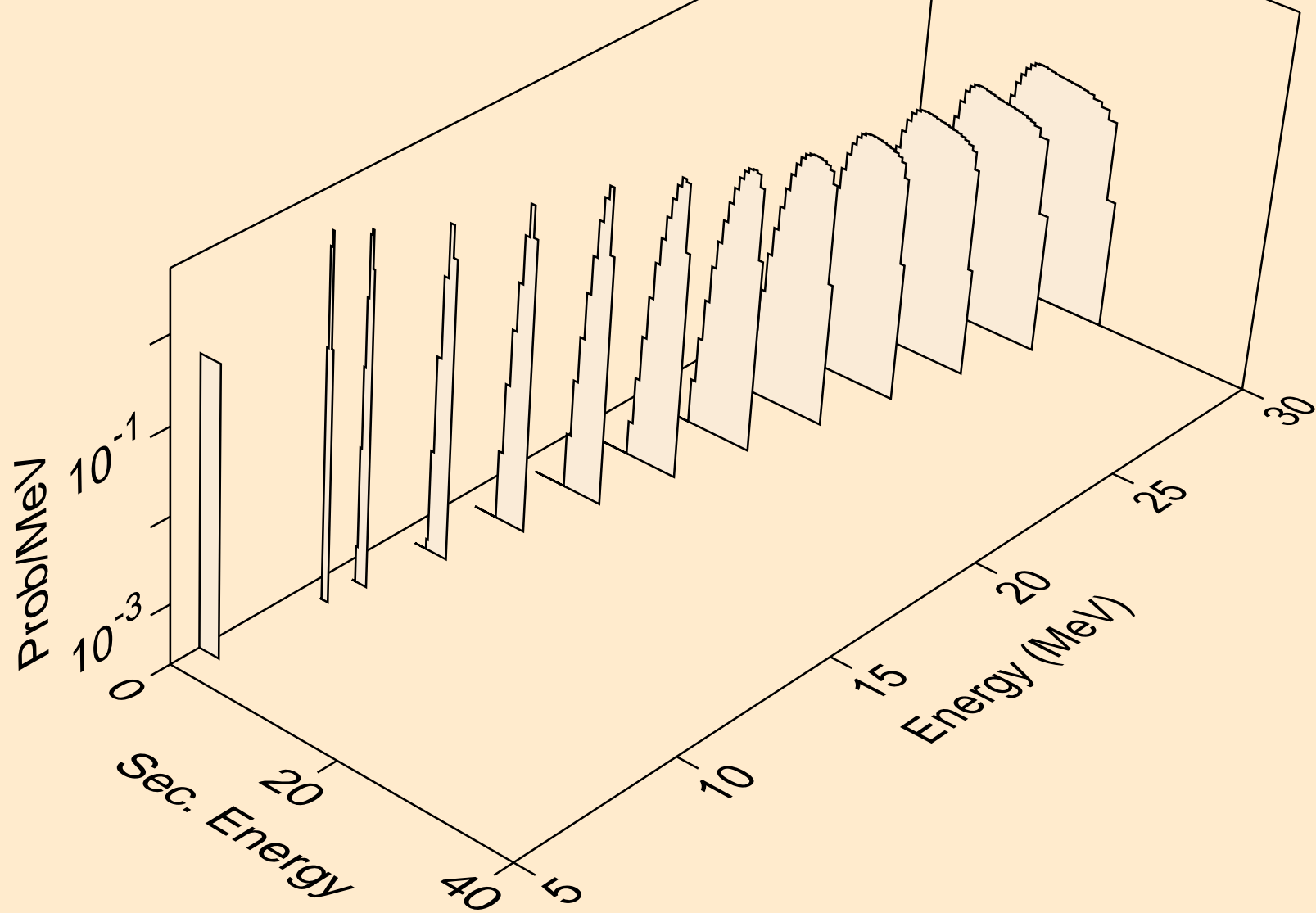

NB090 NEUTRON ACER TENDL-2023 LIBRARY; T=0.K
alphas from (n,2n)a

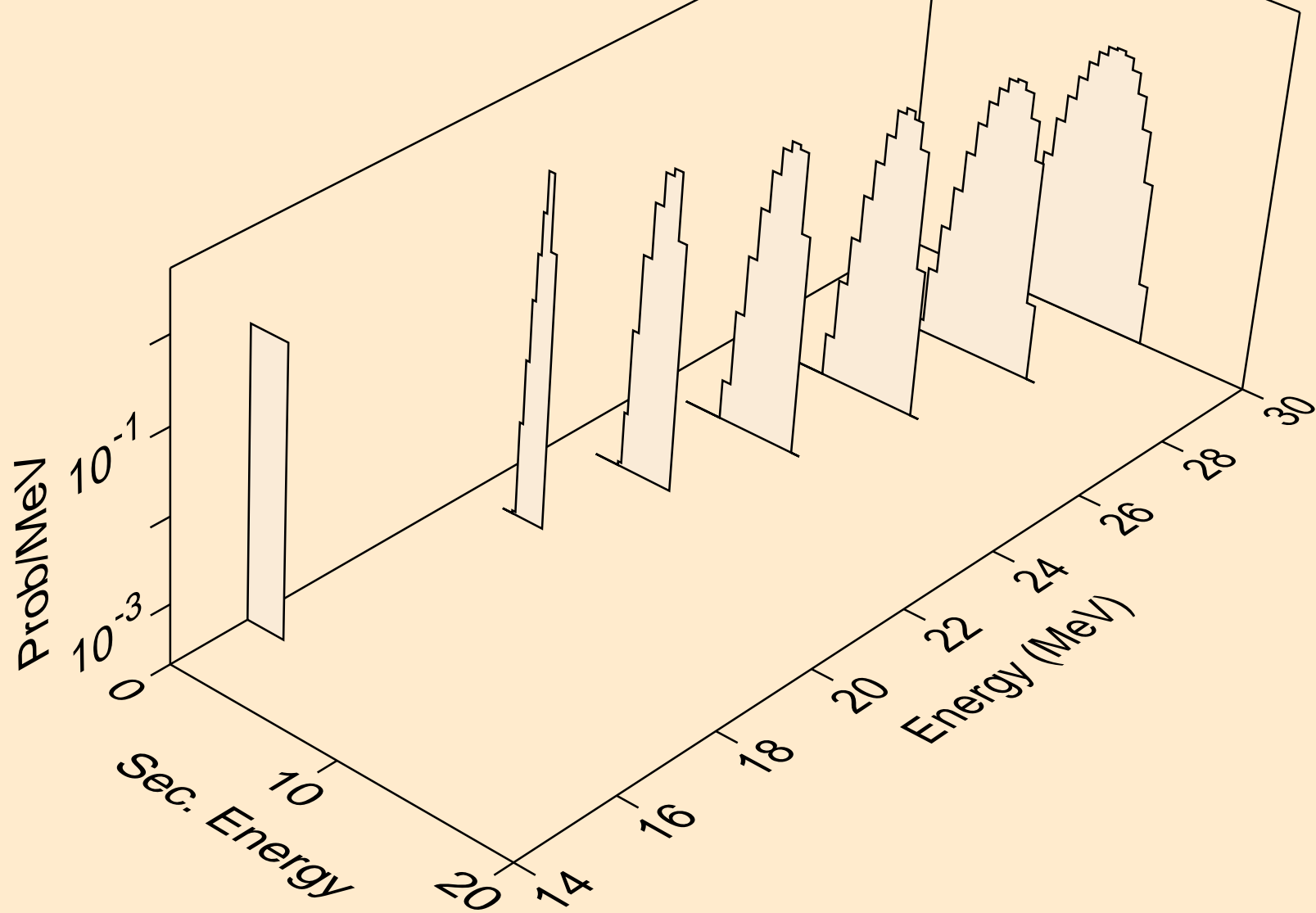

NB090 NEUTRON ACER TENDL-2023 LIBRARY; T=0.K
alphas from (n,n*)2a

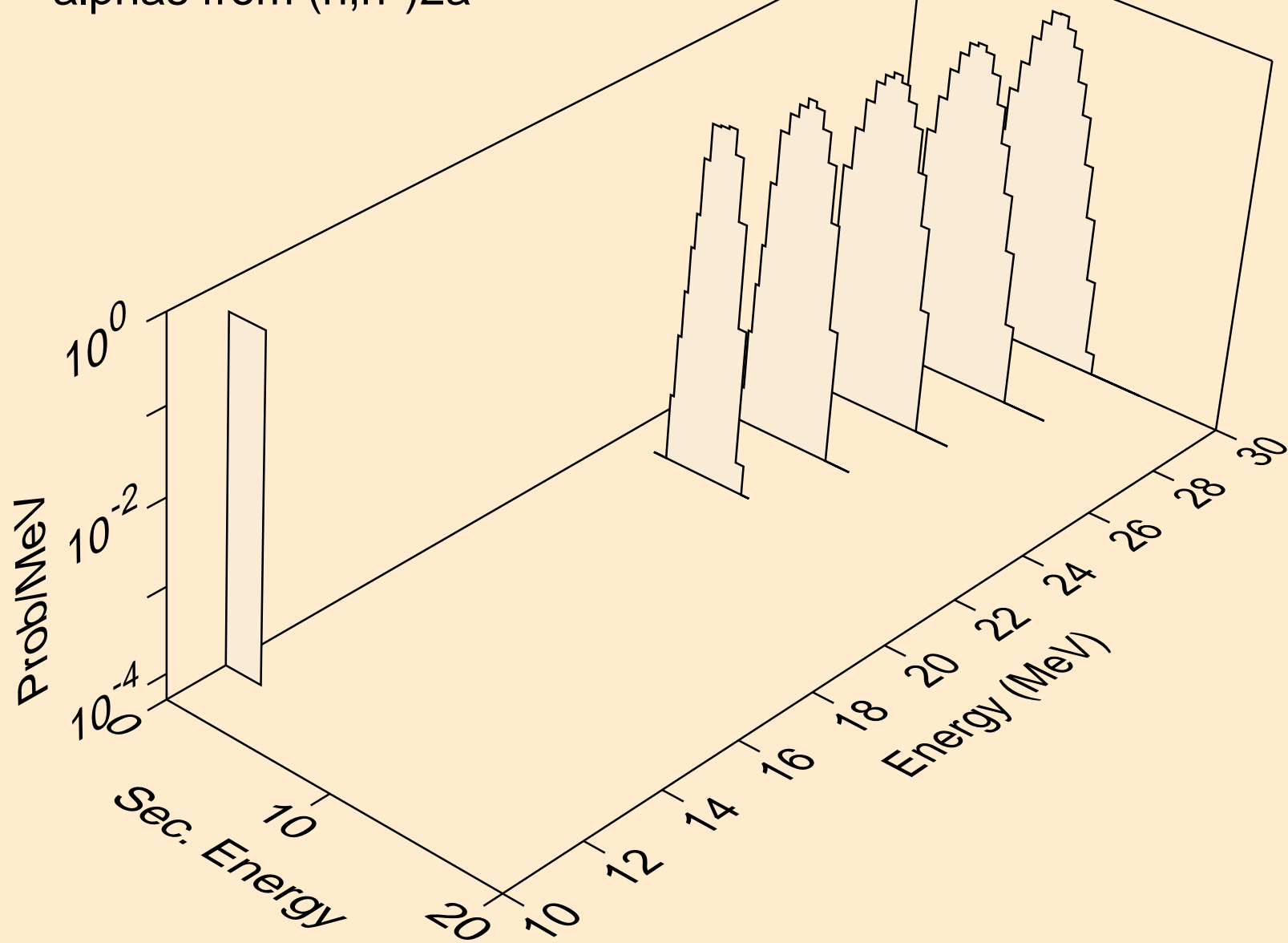

NB090 NEUTRON ACER TENDL-2023 LIBRARY; T=0.K
alphas from (n,npa)

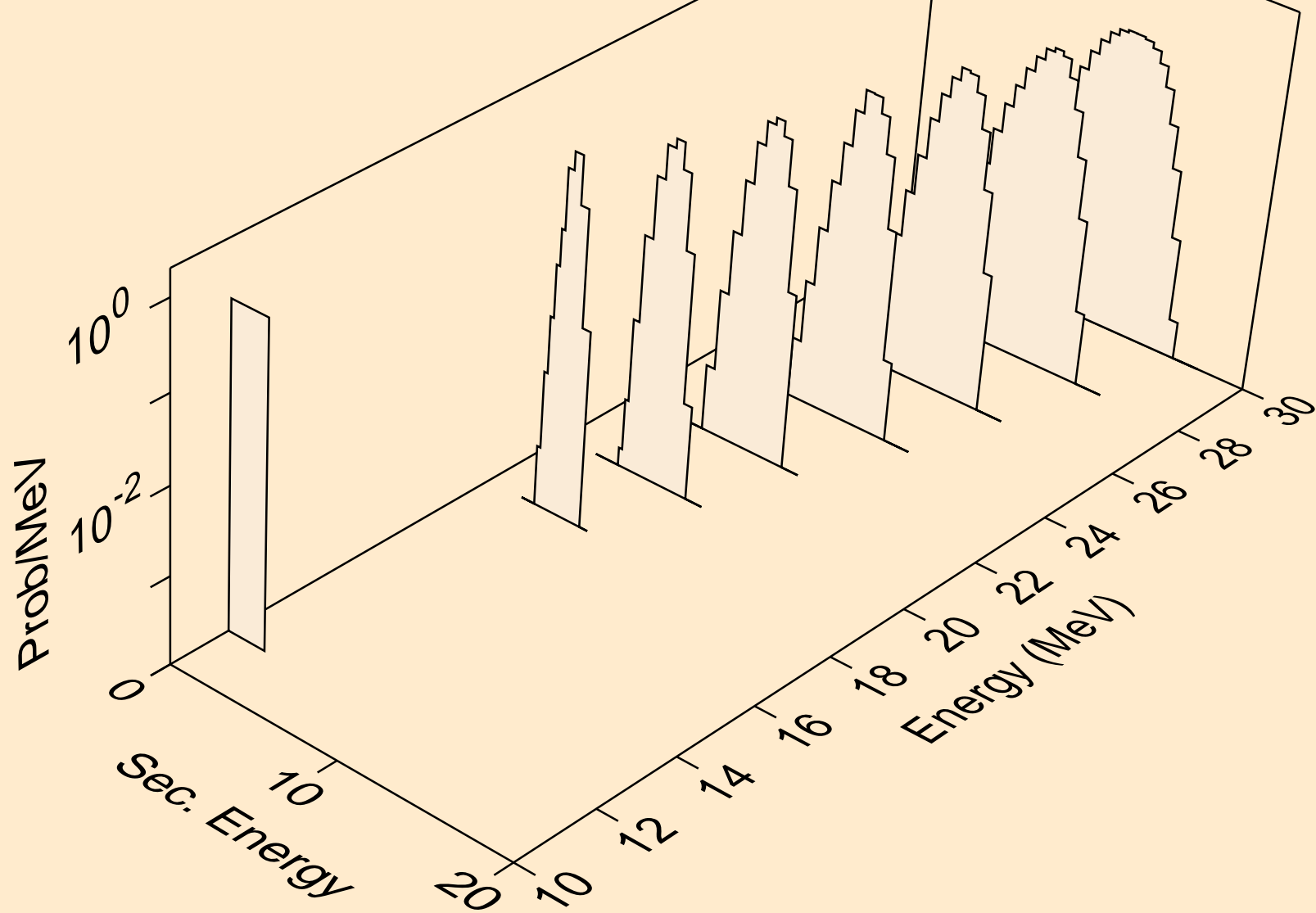

NB090 NEUTRON ACER TENDL-2023 LIBRARY; T=0.K
alphas from (n,a)

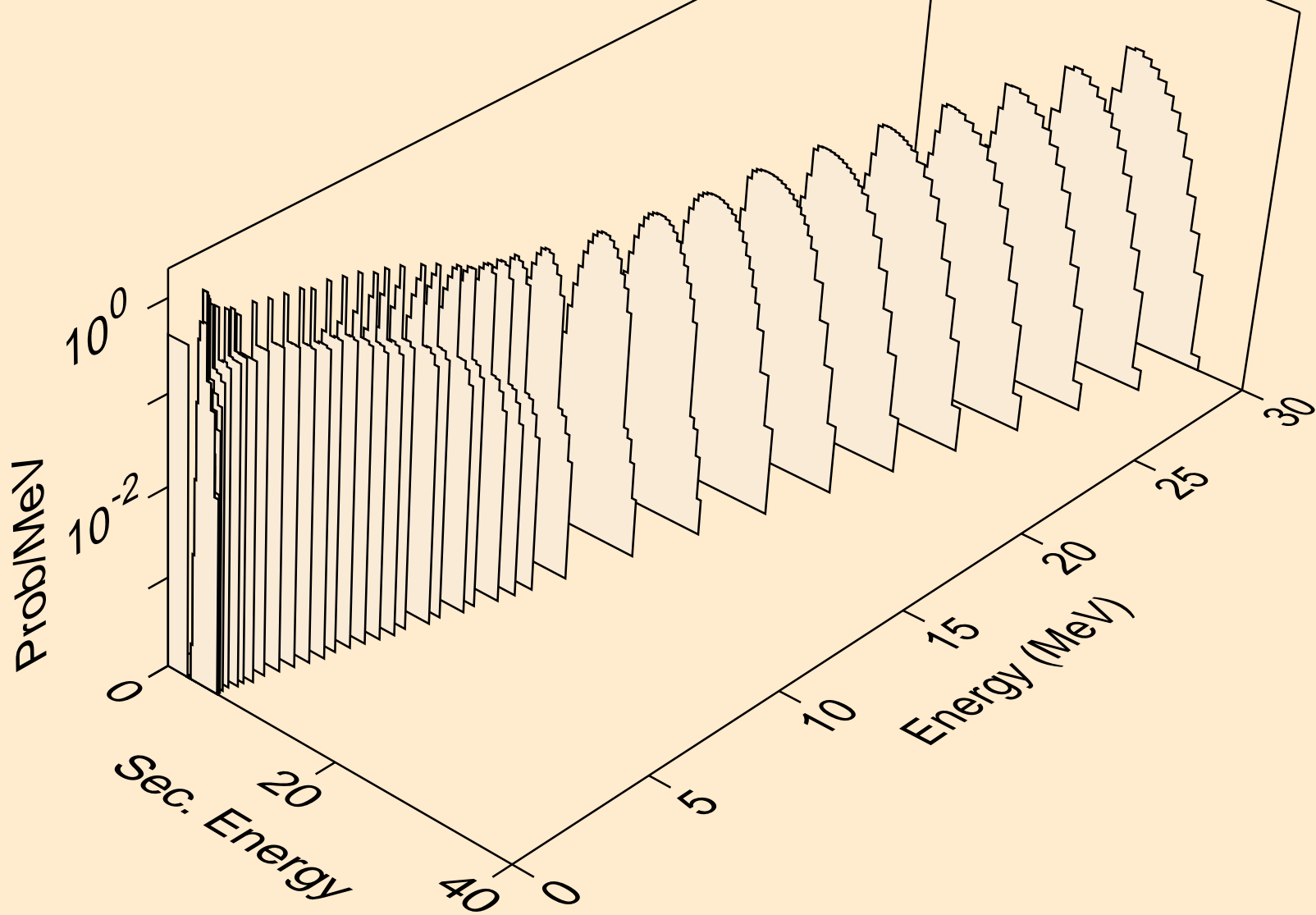

NB090 NEUTRON ACER TENDL-2023 LIBRARY; T=0.K
alphas from (n,2a)

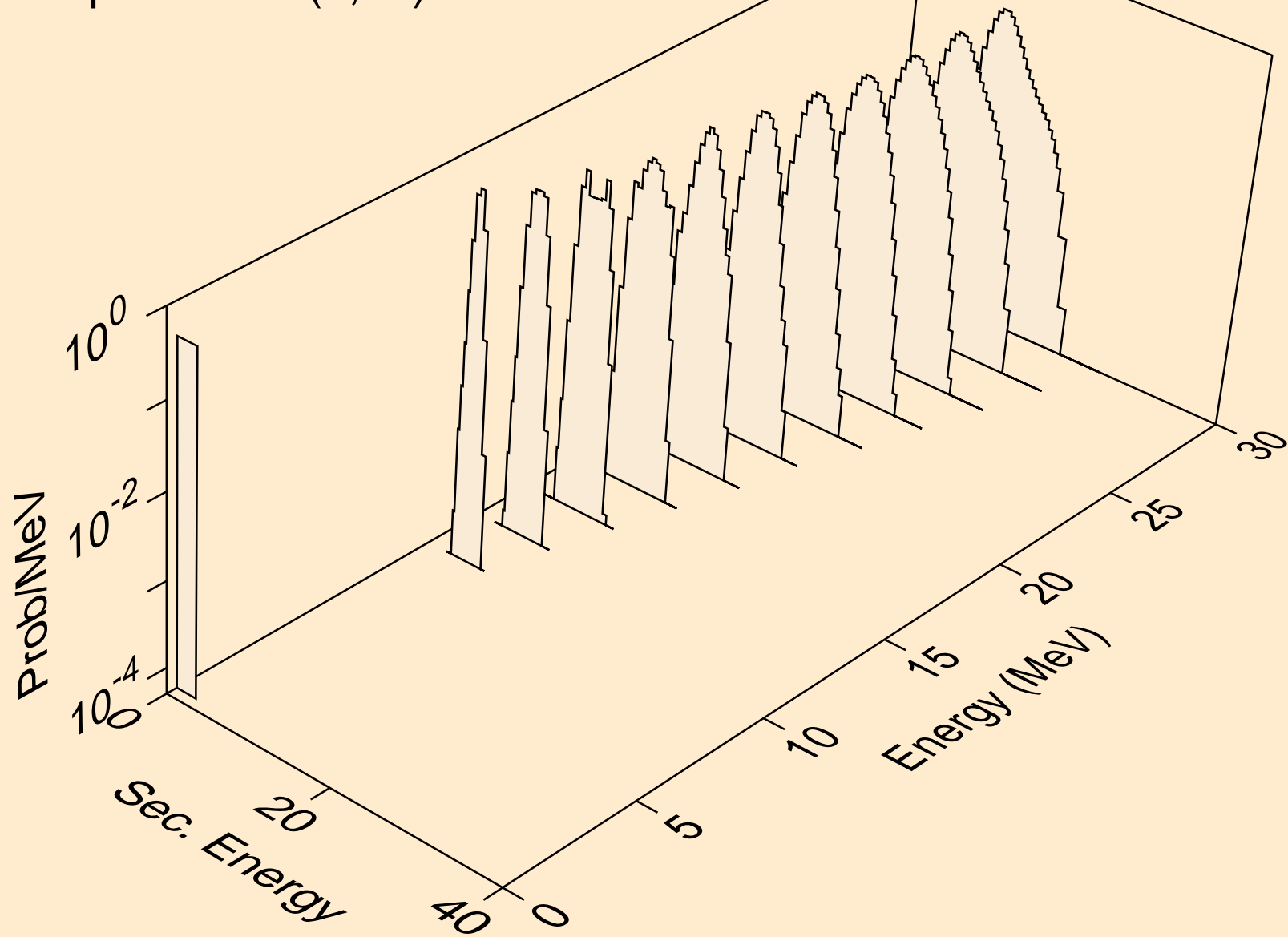

NB090 NEUTRON ACER TENDL-2023 LIBRARY; T=0.K
alphas from (n,pa)

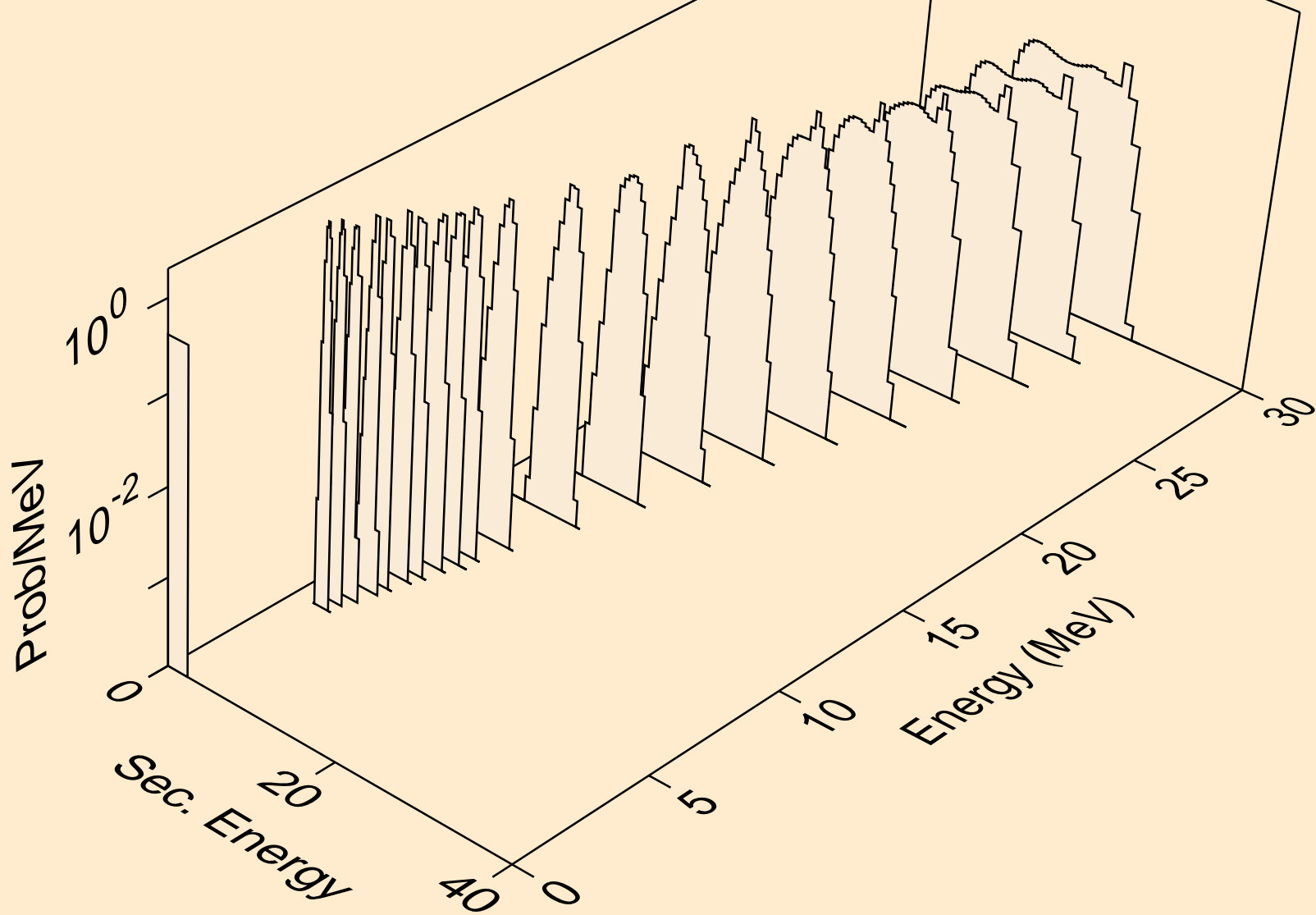

NB090 NEUTRON ACER TENDL-2023 LIBRARY; T=0.K
alphas from (n,da)

