

# NB095M NEUTRON ACER TENDL-2023 LIBRARY; T=0.K

## Principal cross sections

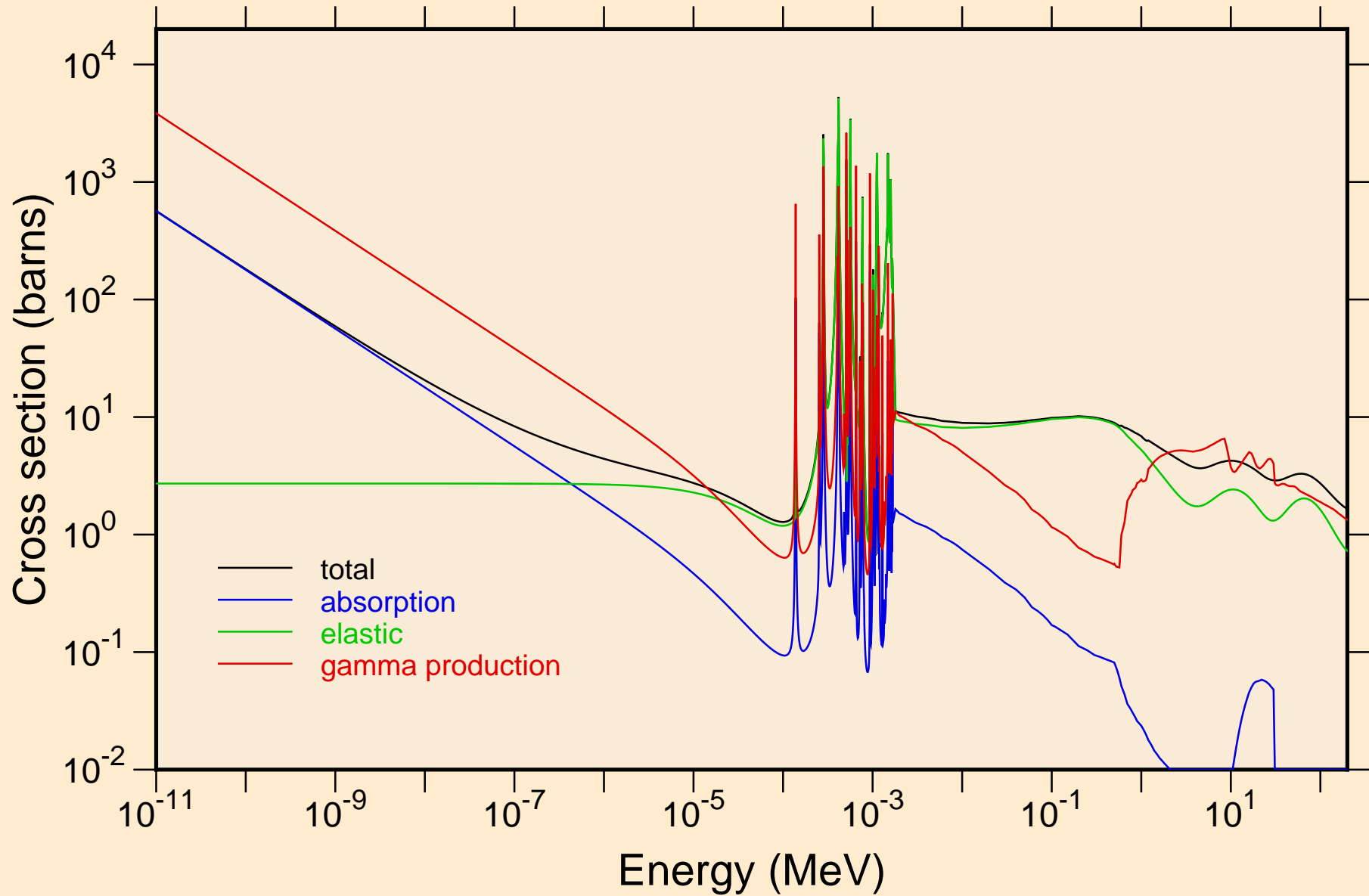

NB095M NEUTRON ACER TENDL-2023 LIBRARY; T=0.K  
resonance total cross section

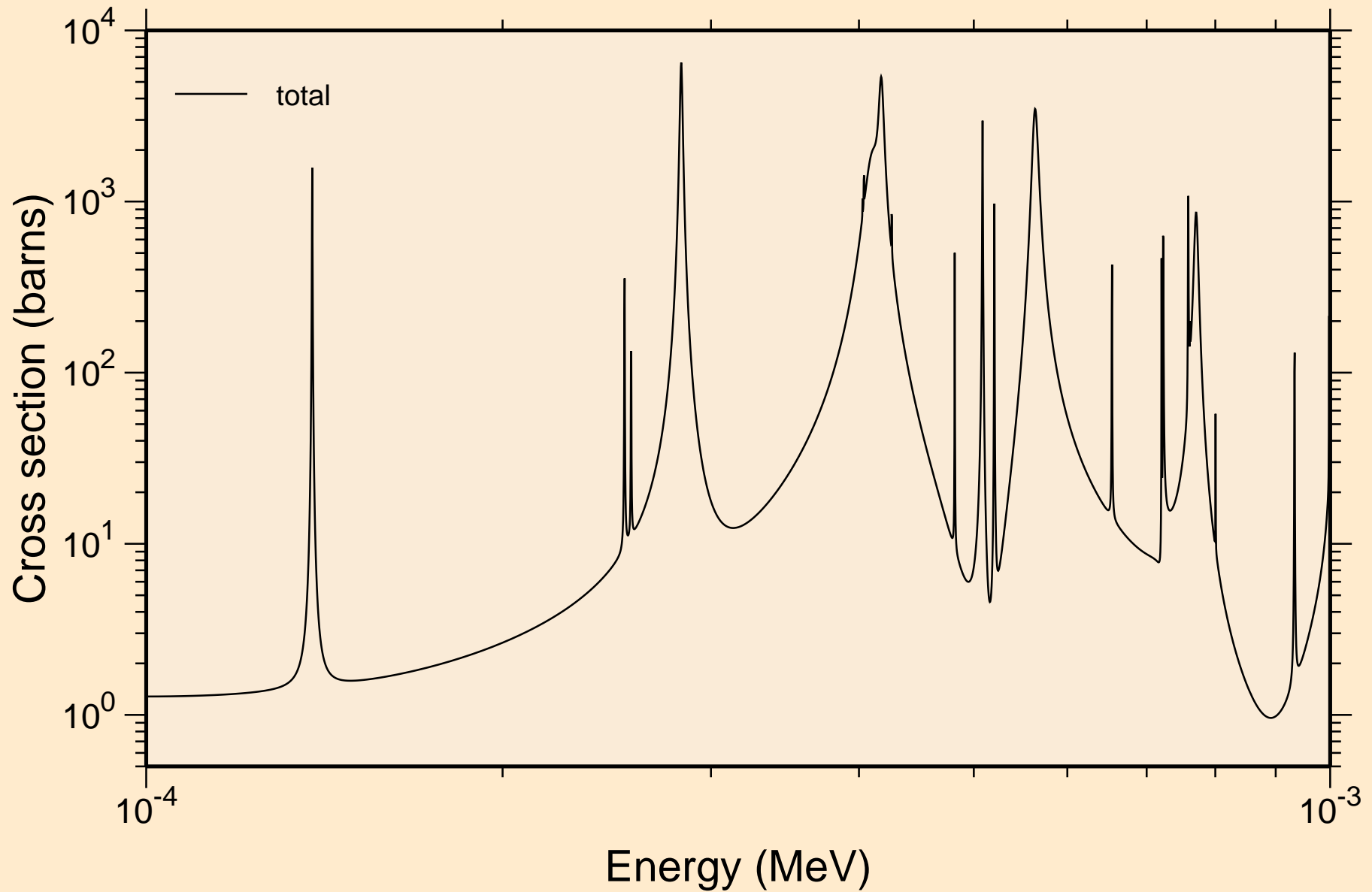

NB095M NEUTRON ACER TENDL-2023 LIBRARY; T=0.K  
resonance total cross section

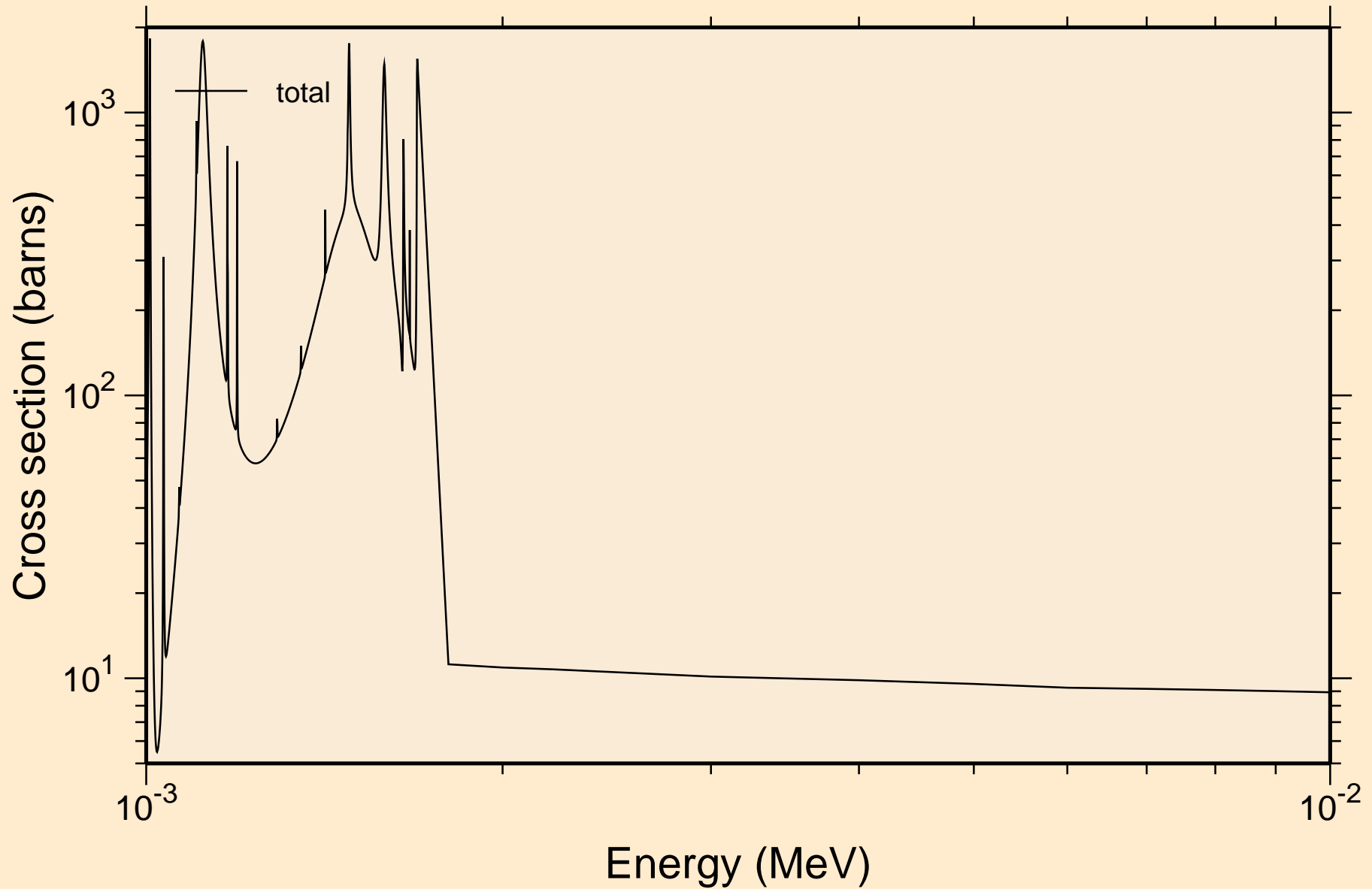

NB095M NEUTRON ACER TENDL-2023 LIBRARY; T=0.K  
resonance total cross section

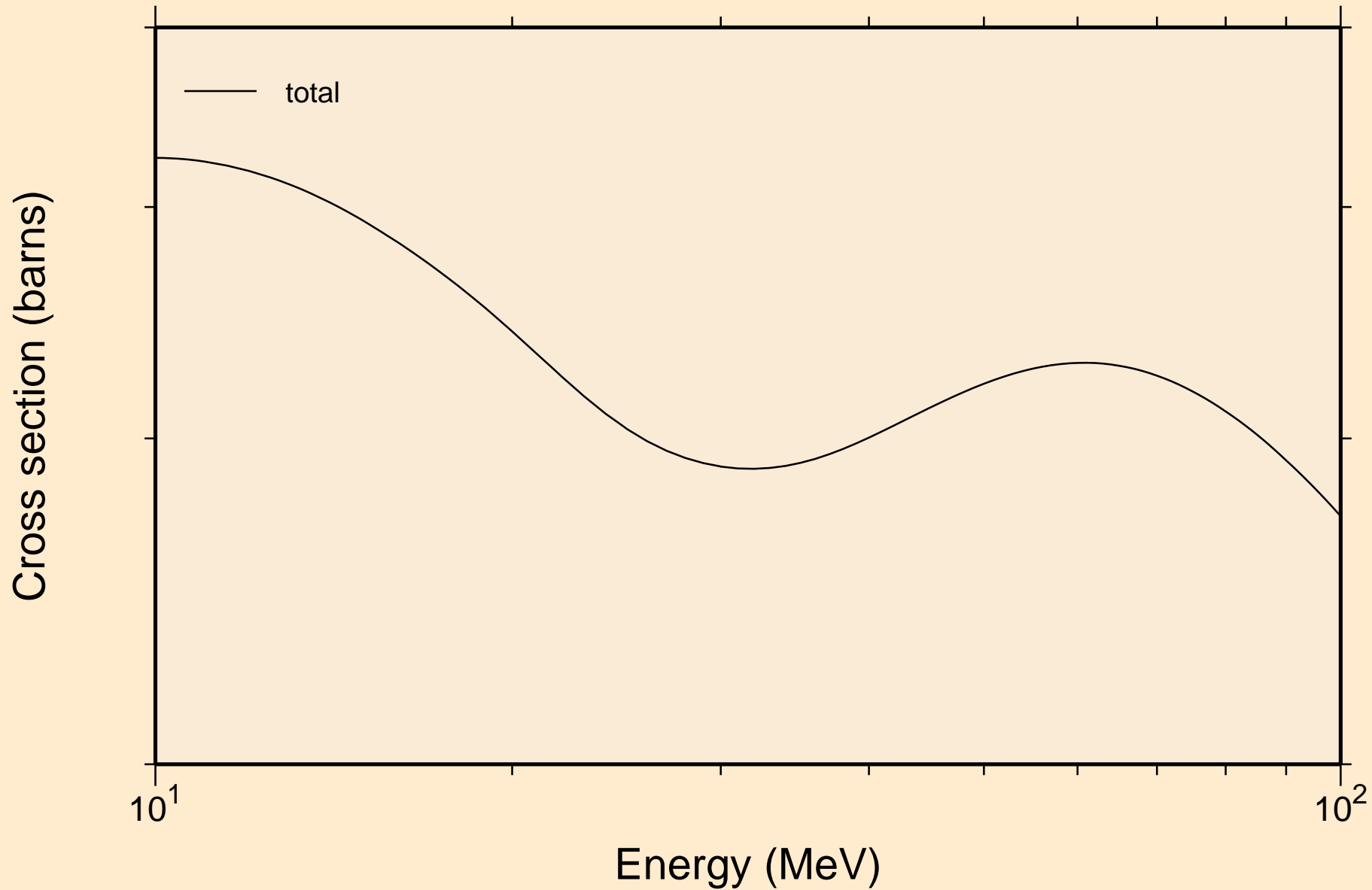

NB095M NEUTRON ACER TENDL-2023 LIBRARY; T=0.K  
resonance absorption cross sections

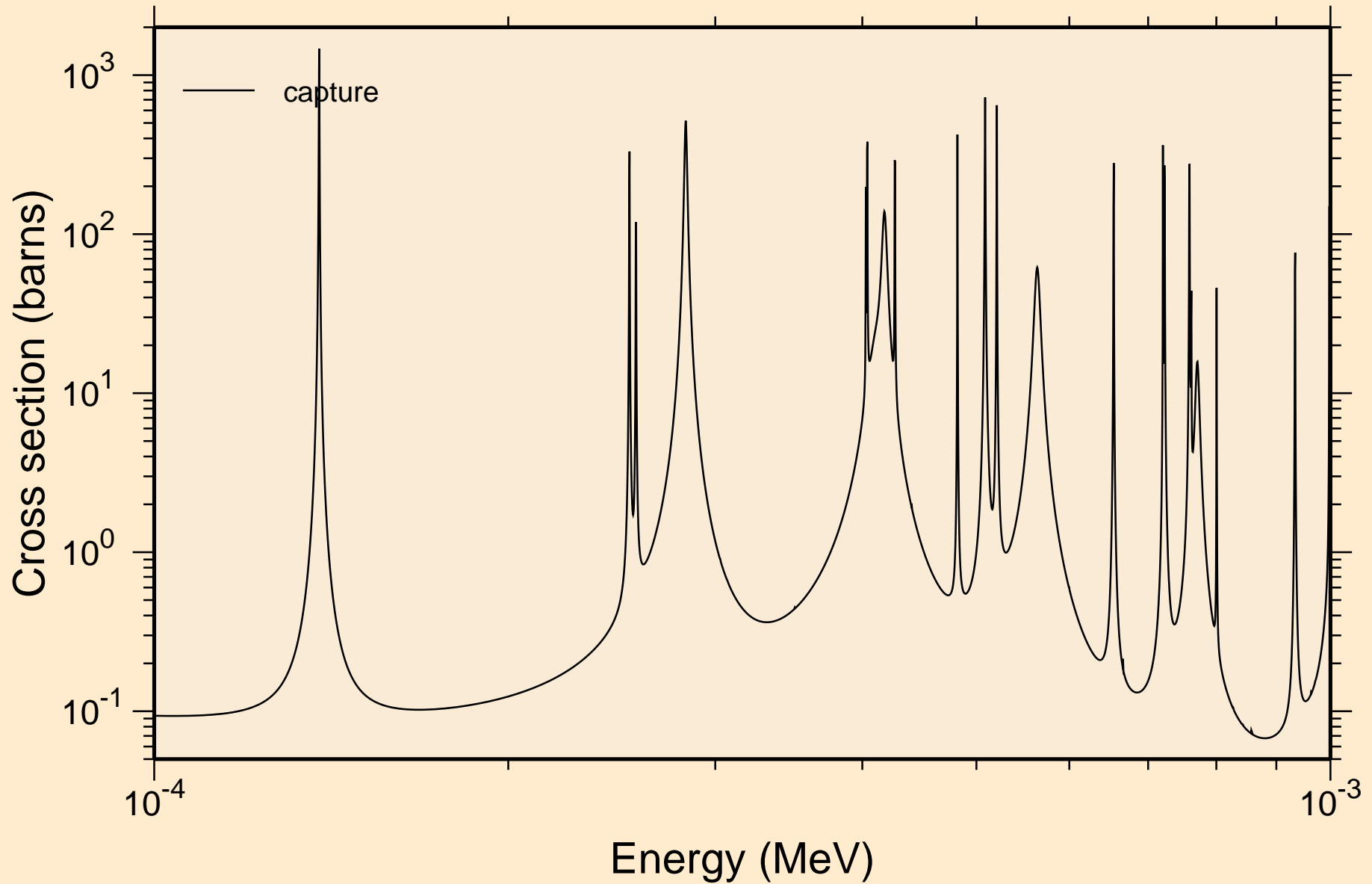

NB095M NEUTRON ACER TENDL-2023 LIBRARY; T=0.K  
resonance absorption cross sections

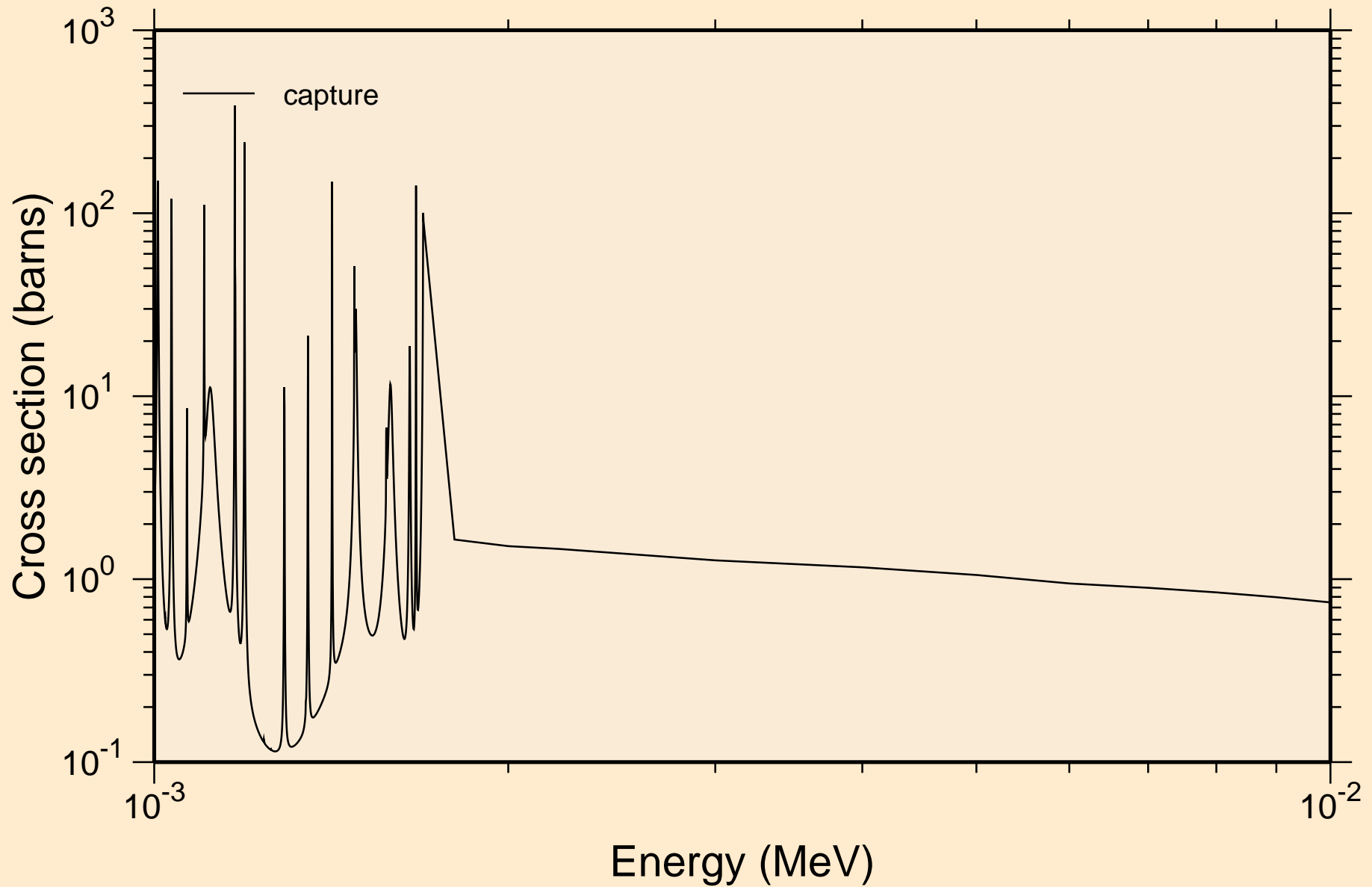

NB095M NEUTRON ACER TENDL-2023 LIBRARY; T=0.K  
resonance absorption cross sections

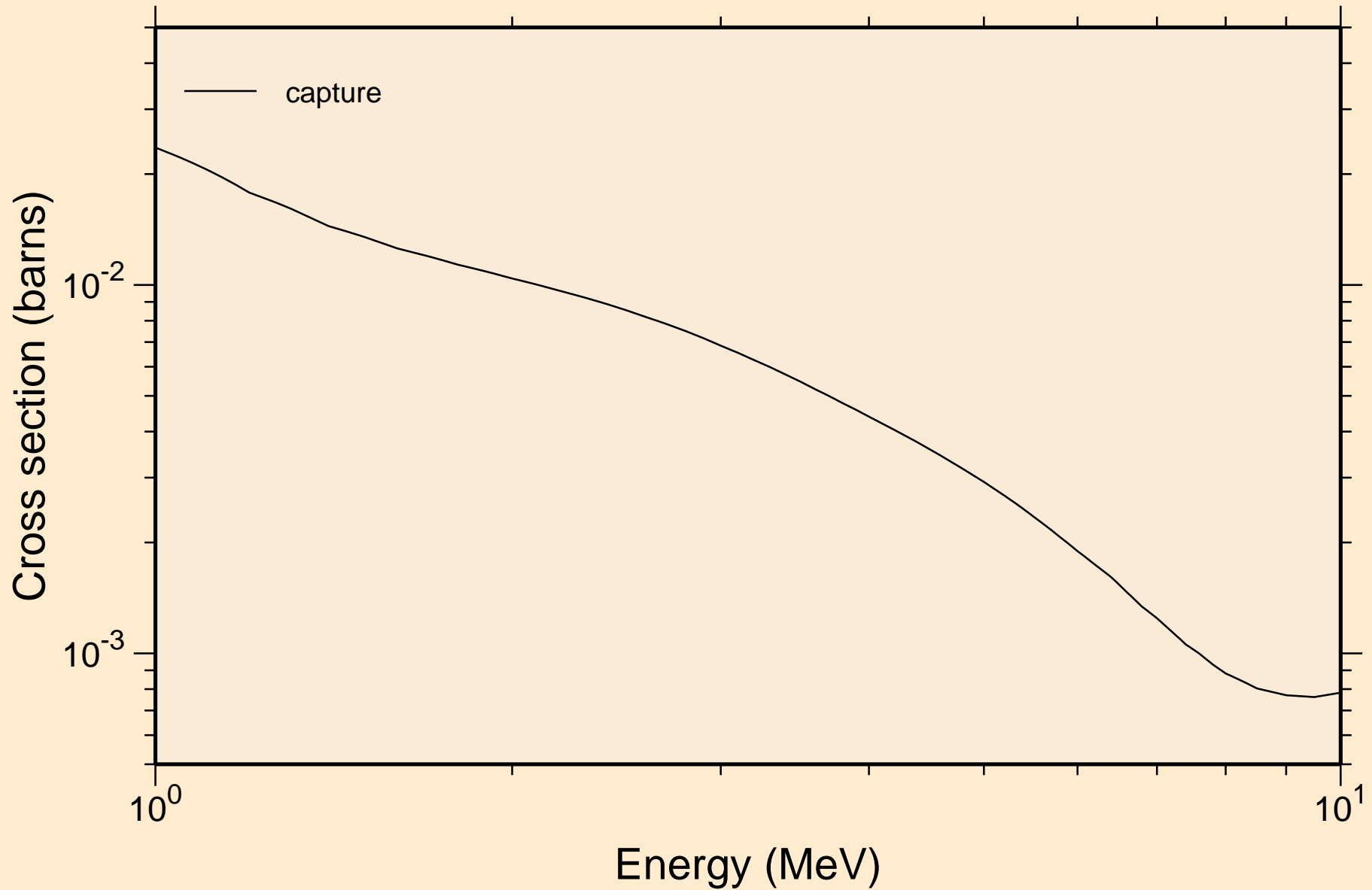

NB095M NEUTRON ACER TENDL-2023 LIBRARY; T=0.K  
Heating

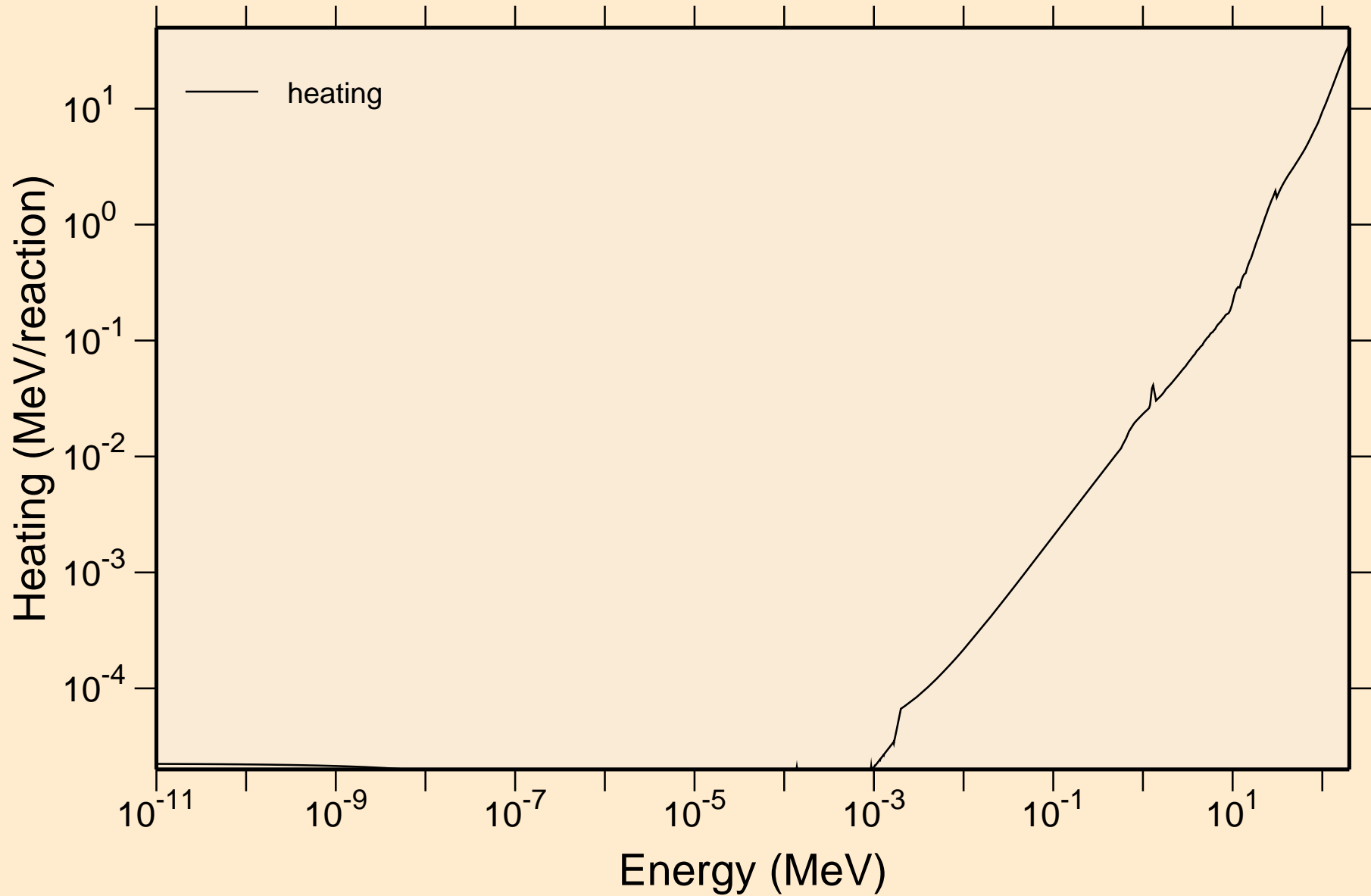

# NB095M NEUTRON ACER TENDL-2023 LIBRARY; T=0.K

## Damage

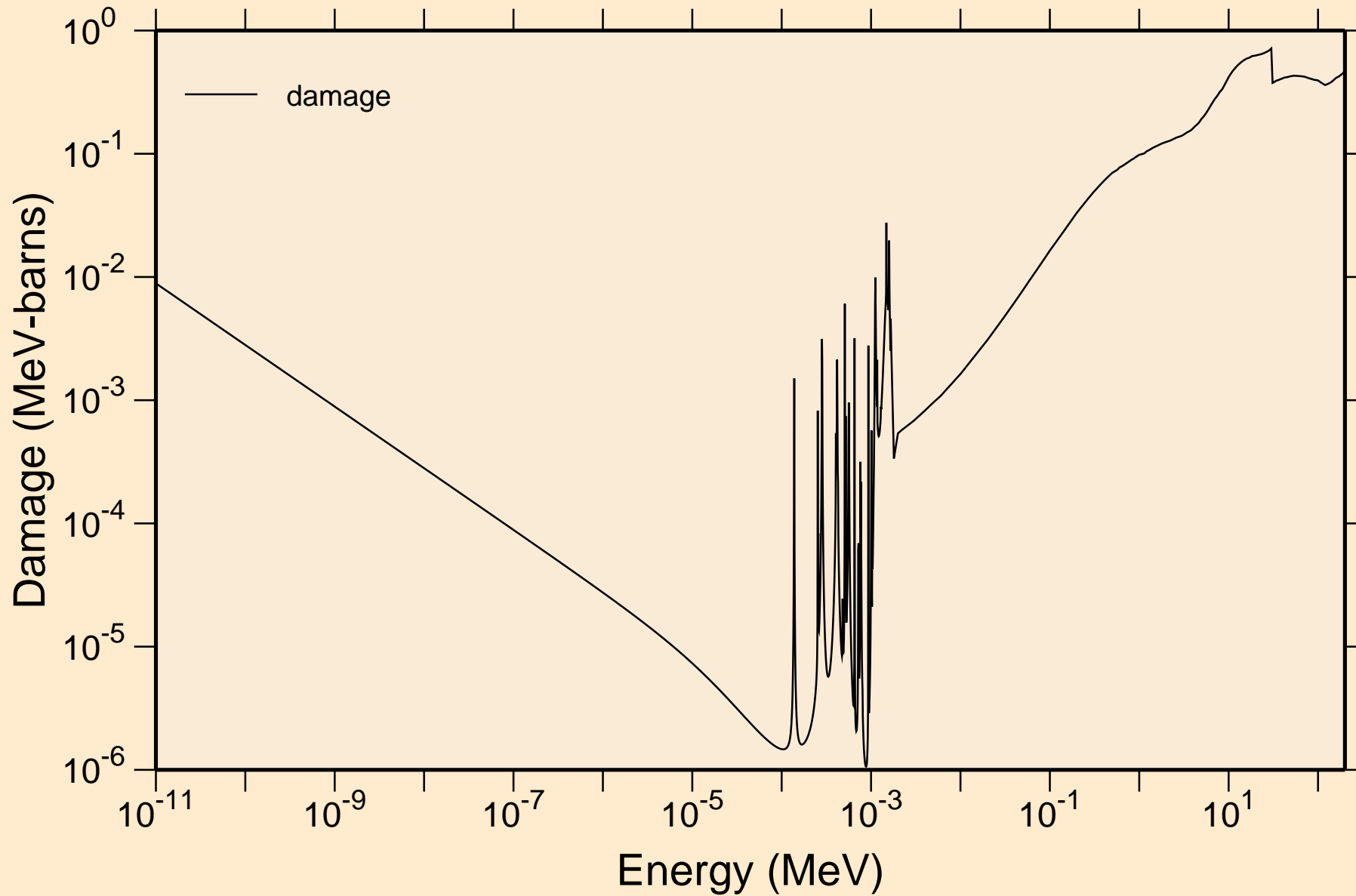

NB095M NEUTRON ACER TENDL-2023 LIBRARY; T=0.K  
Non-threshold reactions

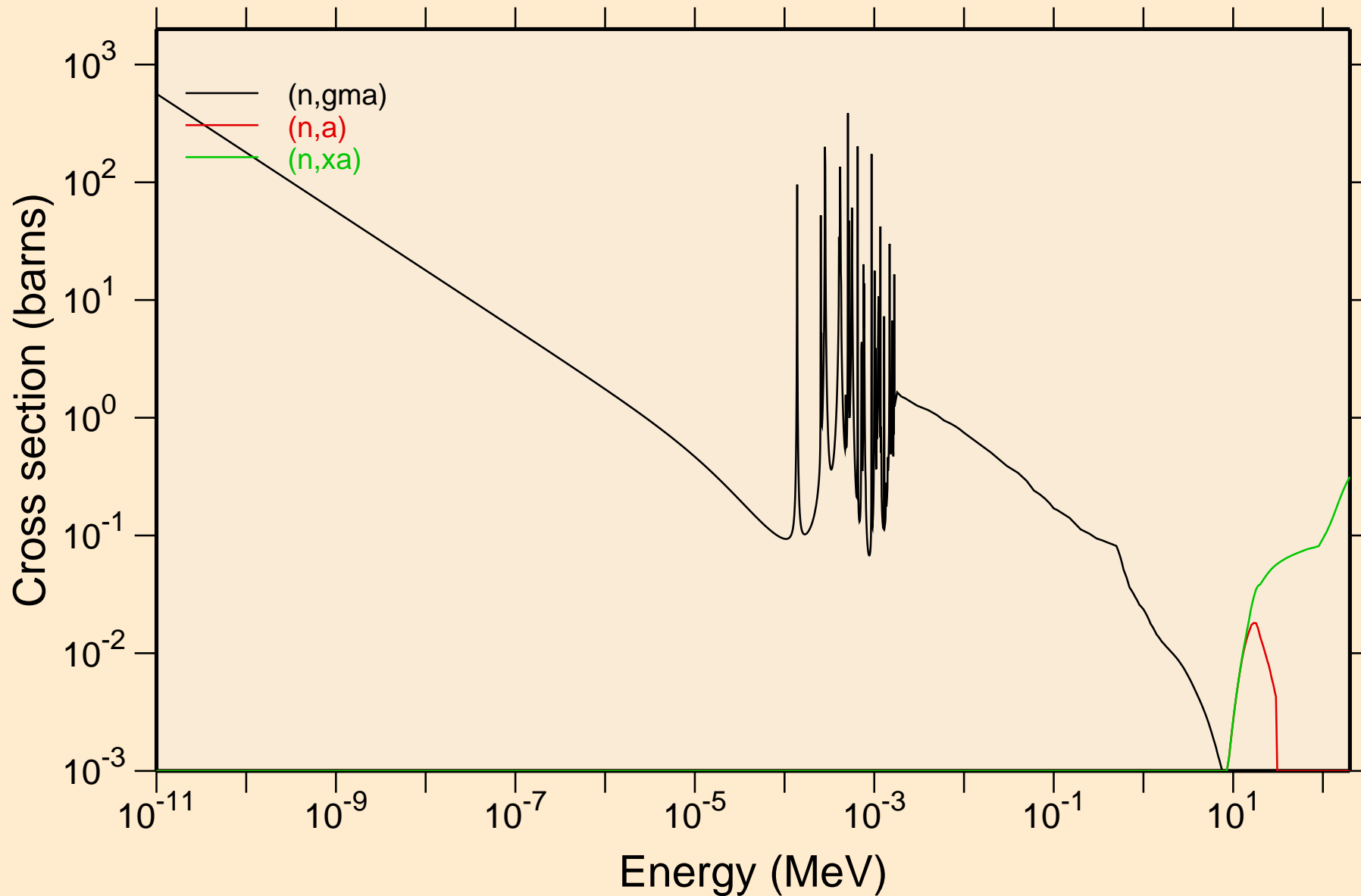

# NB095M NEUTRON ACER TENDL-2023 LIBRARY; T=0.K

## Principal cross sections

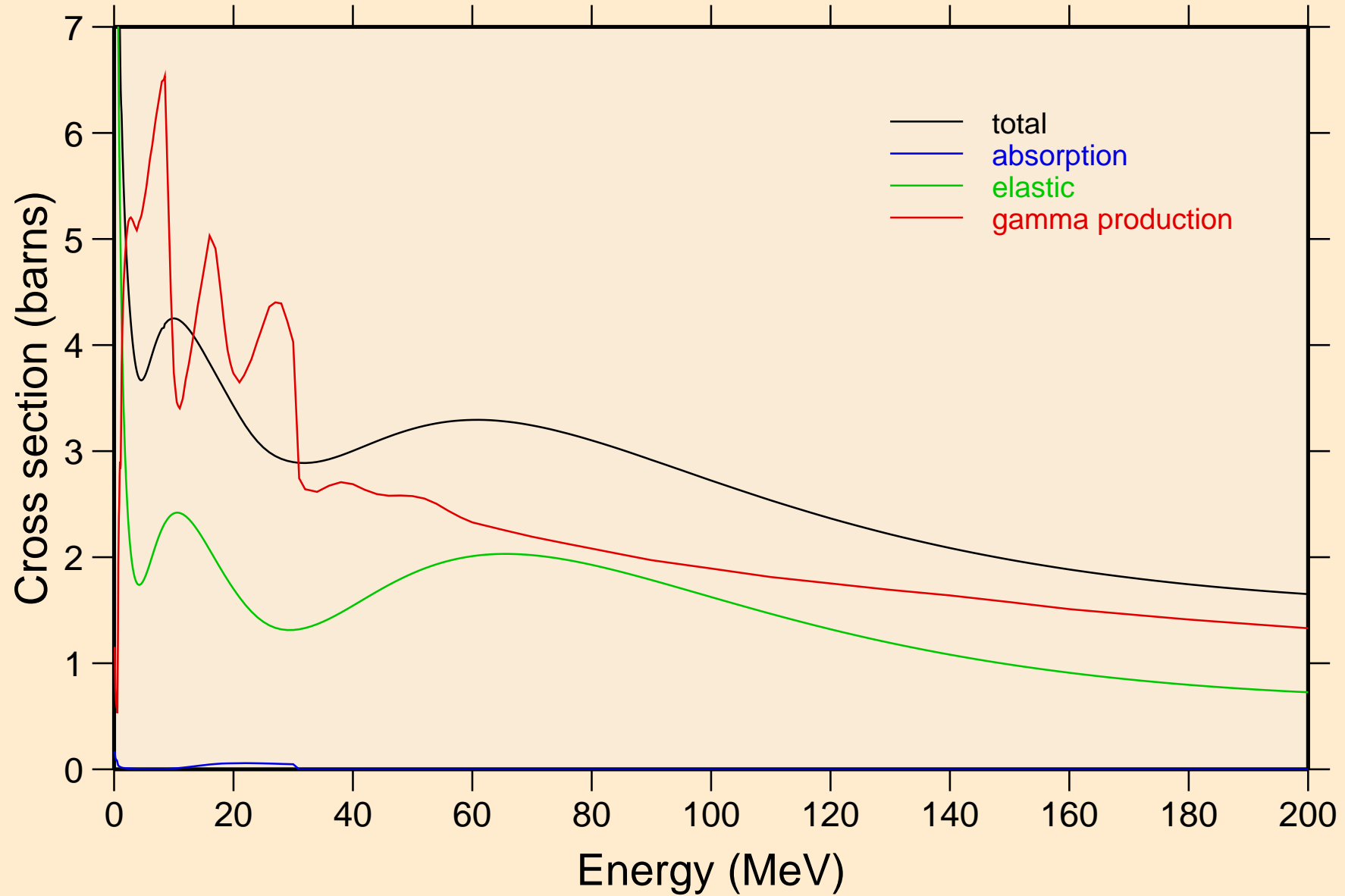

# NB095M NEUTRON ACER TENDL-2023 LIBRARY; T=0.K

## Heating

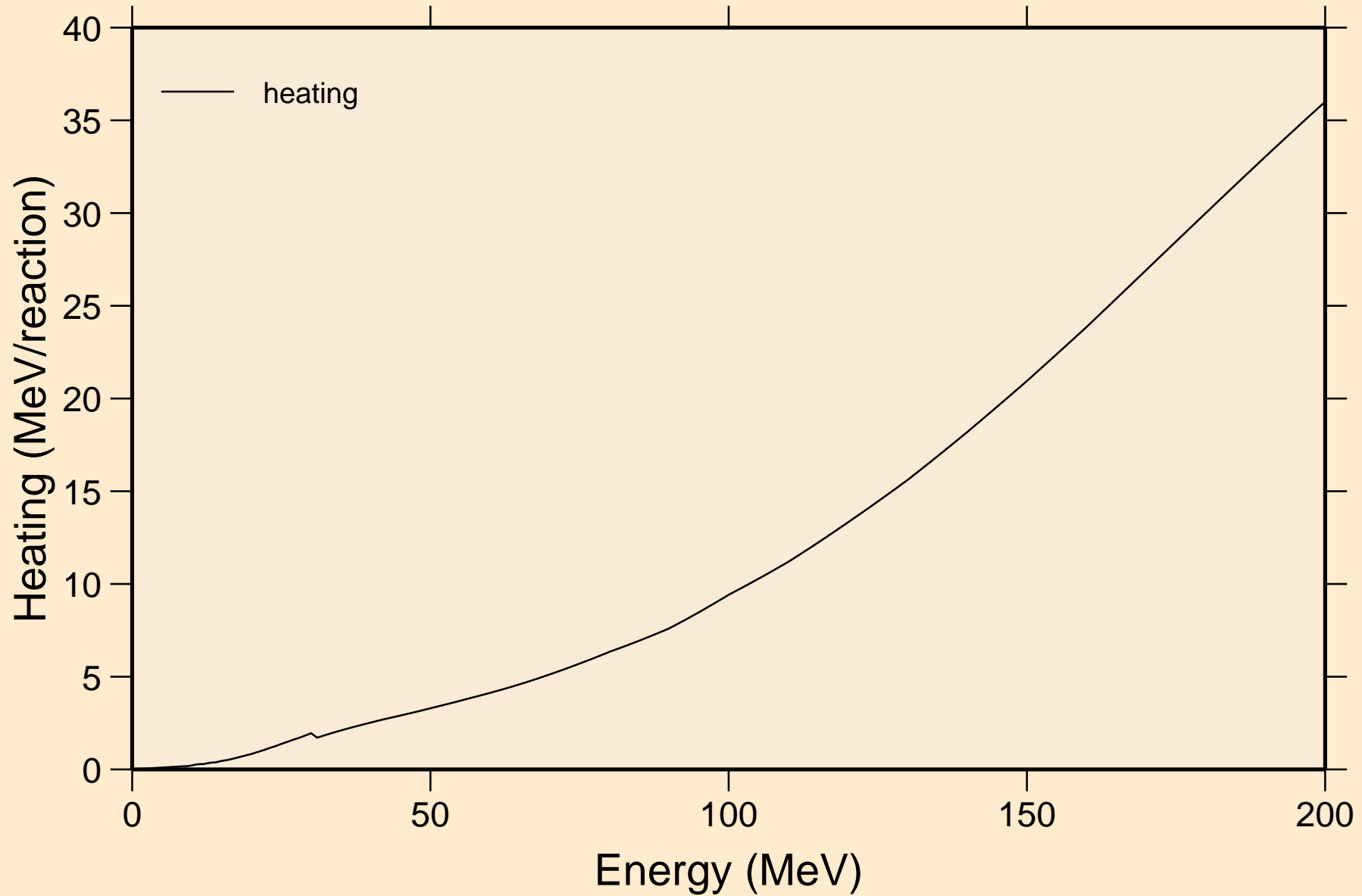

# NB095M NEUTRON ACER TENDL-2023 LIBRARY; T=0.K

## Damage

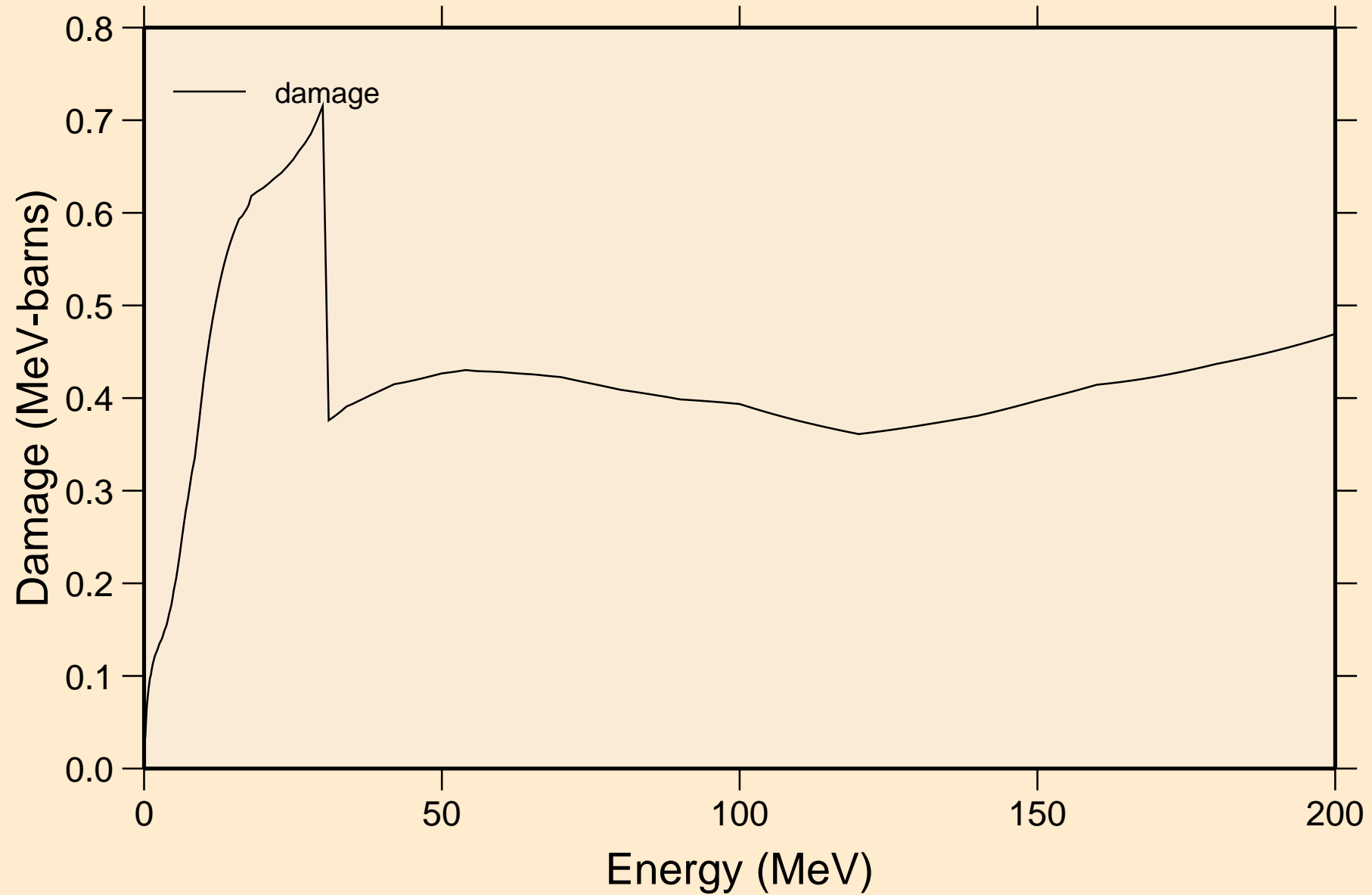

NB095M NEUTRON ACER TENDL-2023 LIBRARY; T=0.K  
Non-threshold reactions

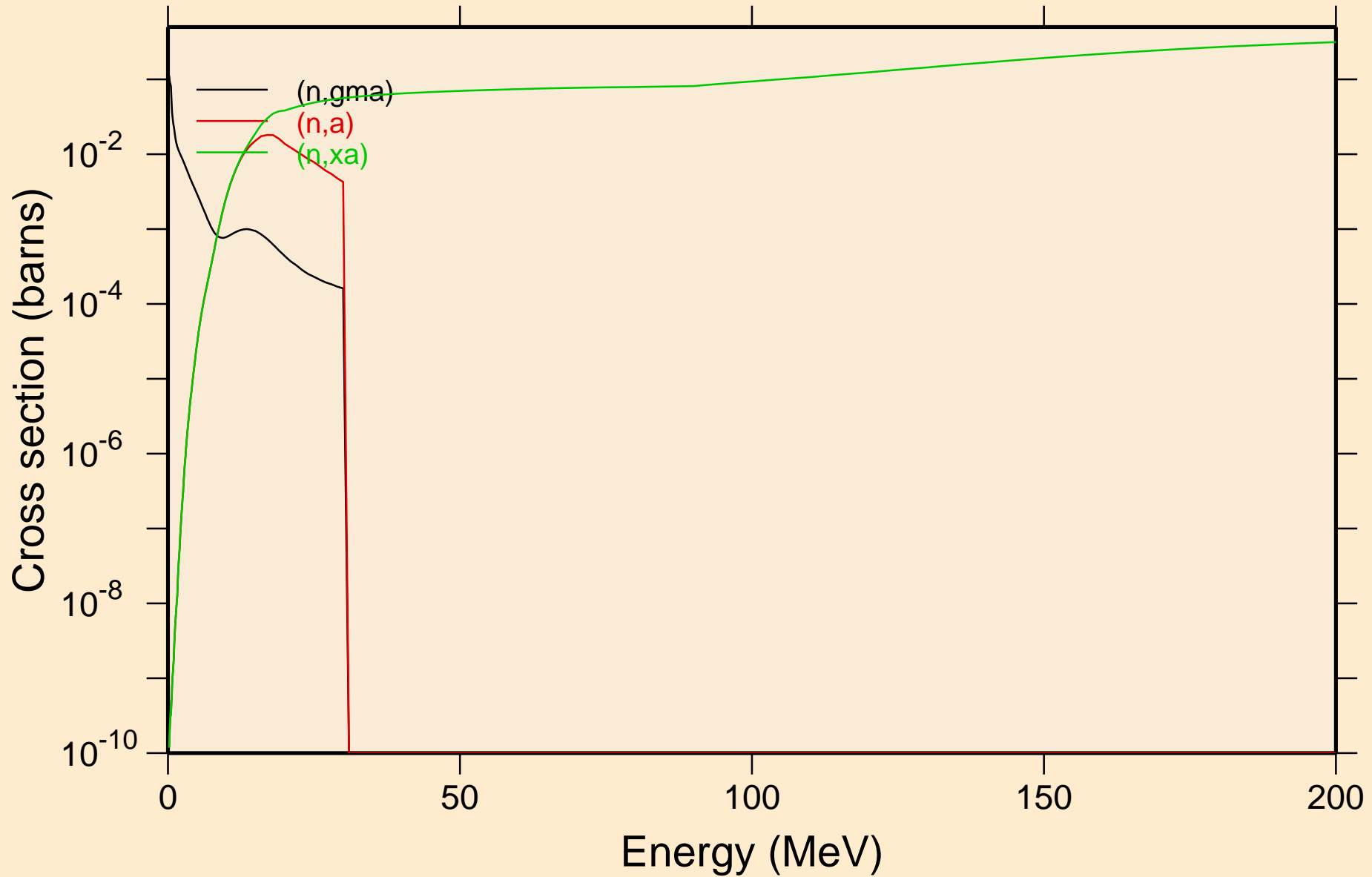

NB095M NEUTRON ACER TENDL-2023 LIBRARY; T=0.K  
Inelastic levels

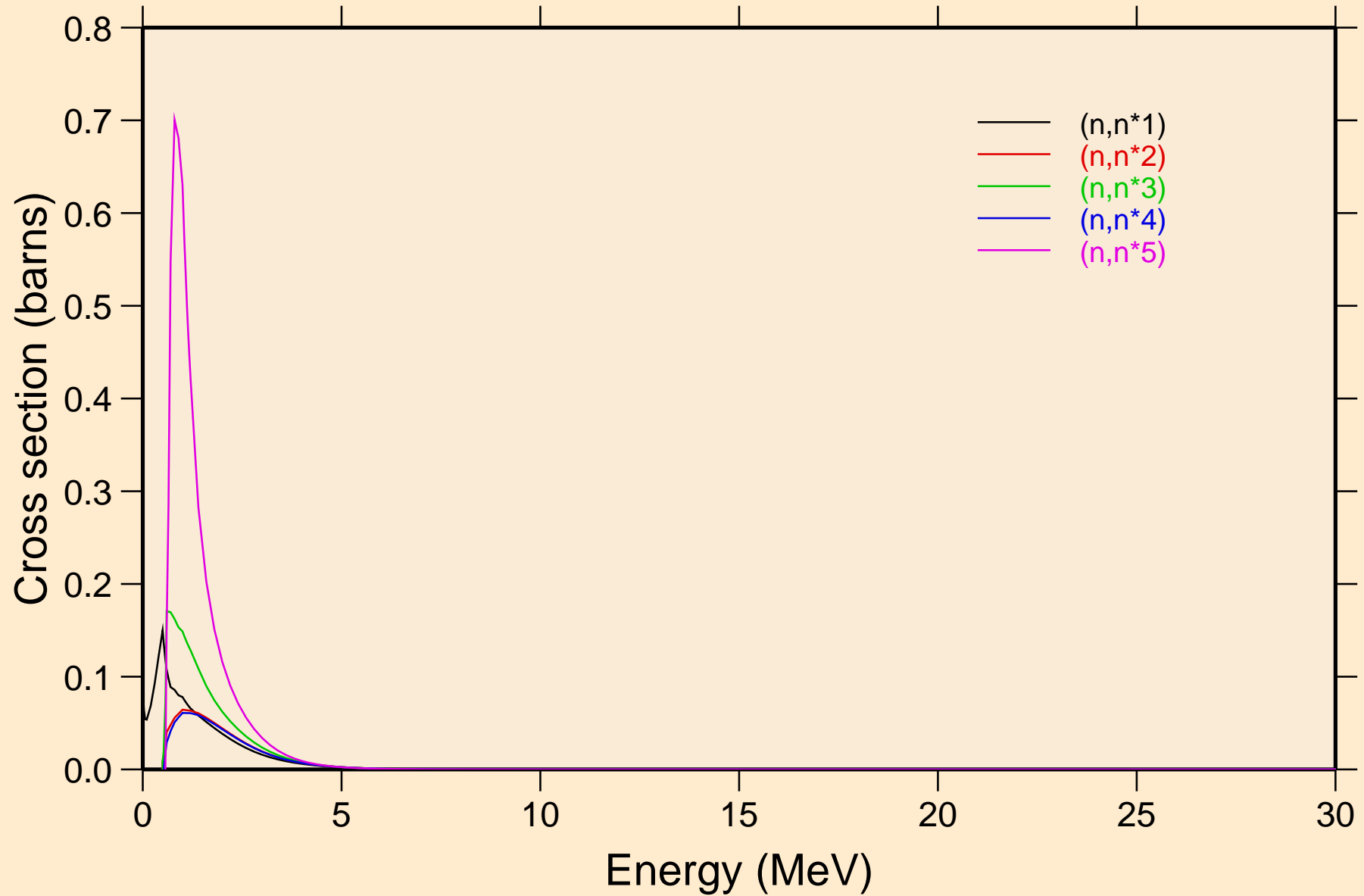

NB095M NEUTRON ACER TENDL-2023 LIBRARY; T=0.K  
Inelastic levels

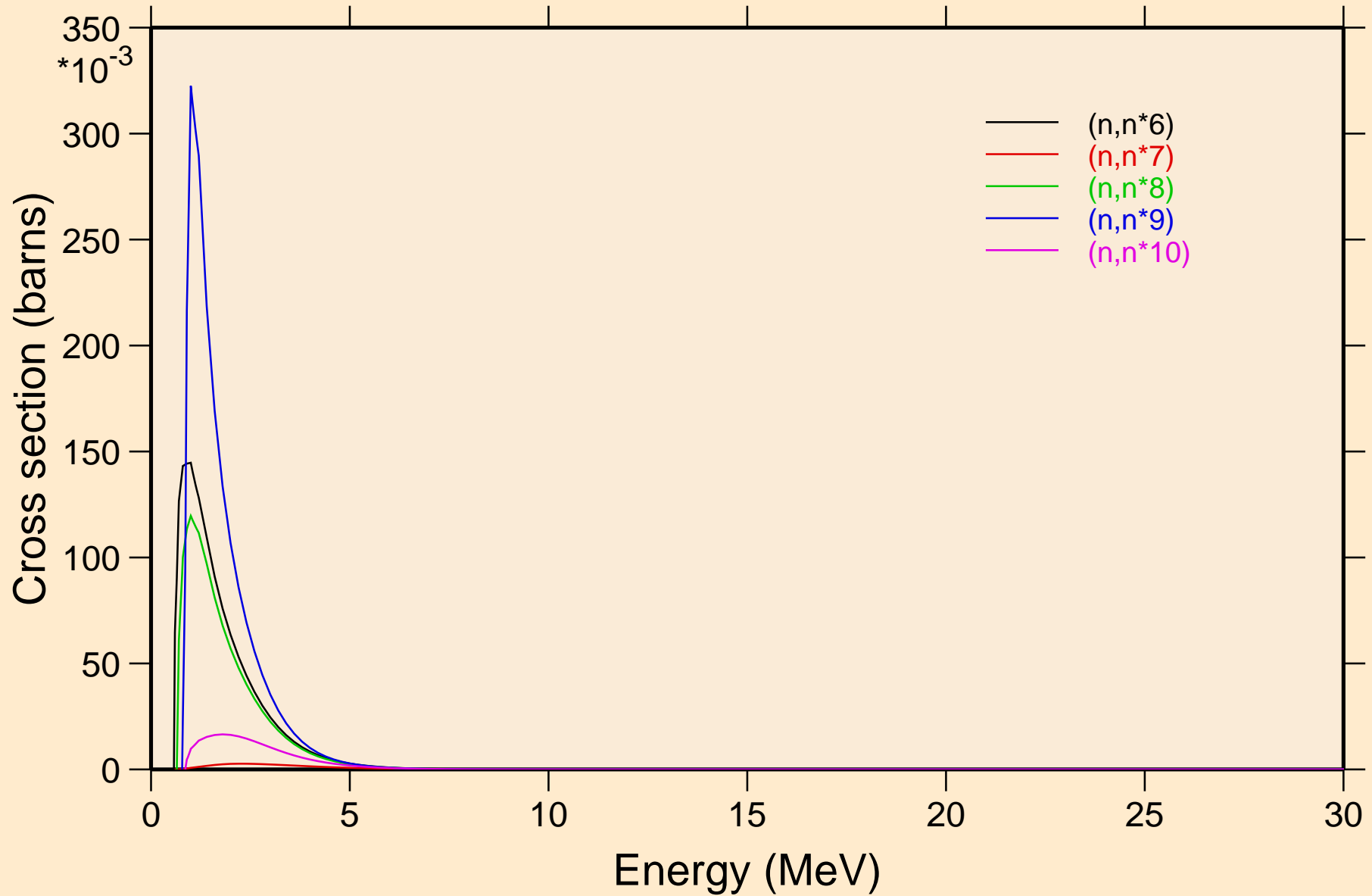

NB095M NEUTRON ACER TENDL-2023 LIBRARY; T=0.K  
Inelastic levels

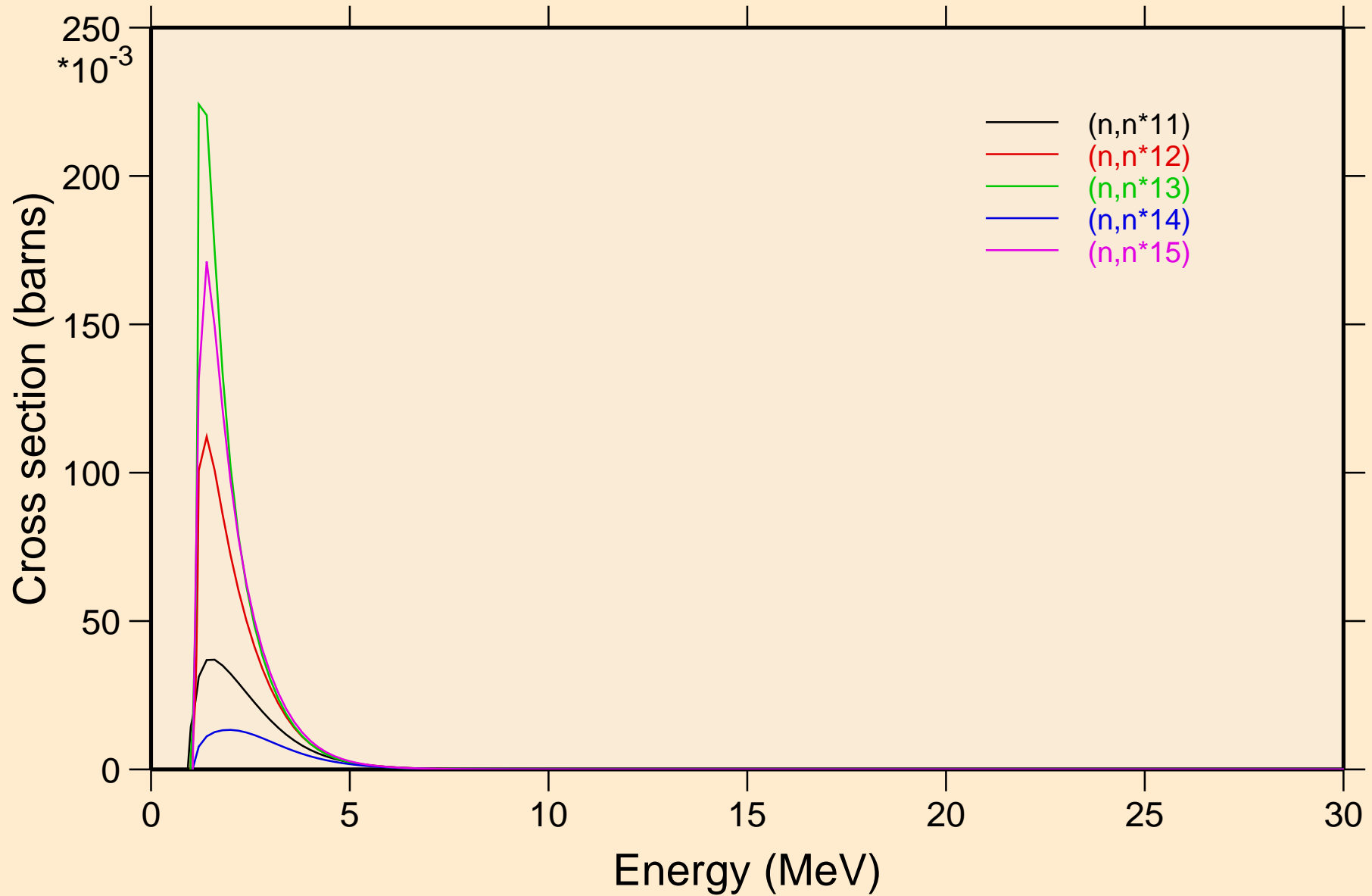

NB095M NEUTRON ACER TENDL-2023 LIBRARY; T=0.K  
Inelastic levels

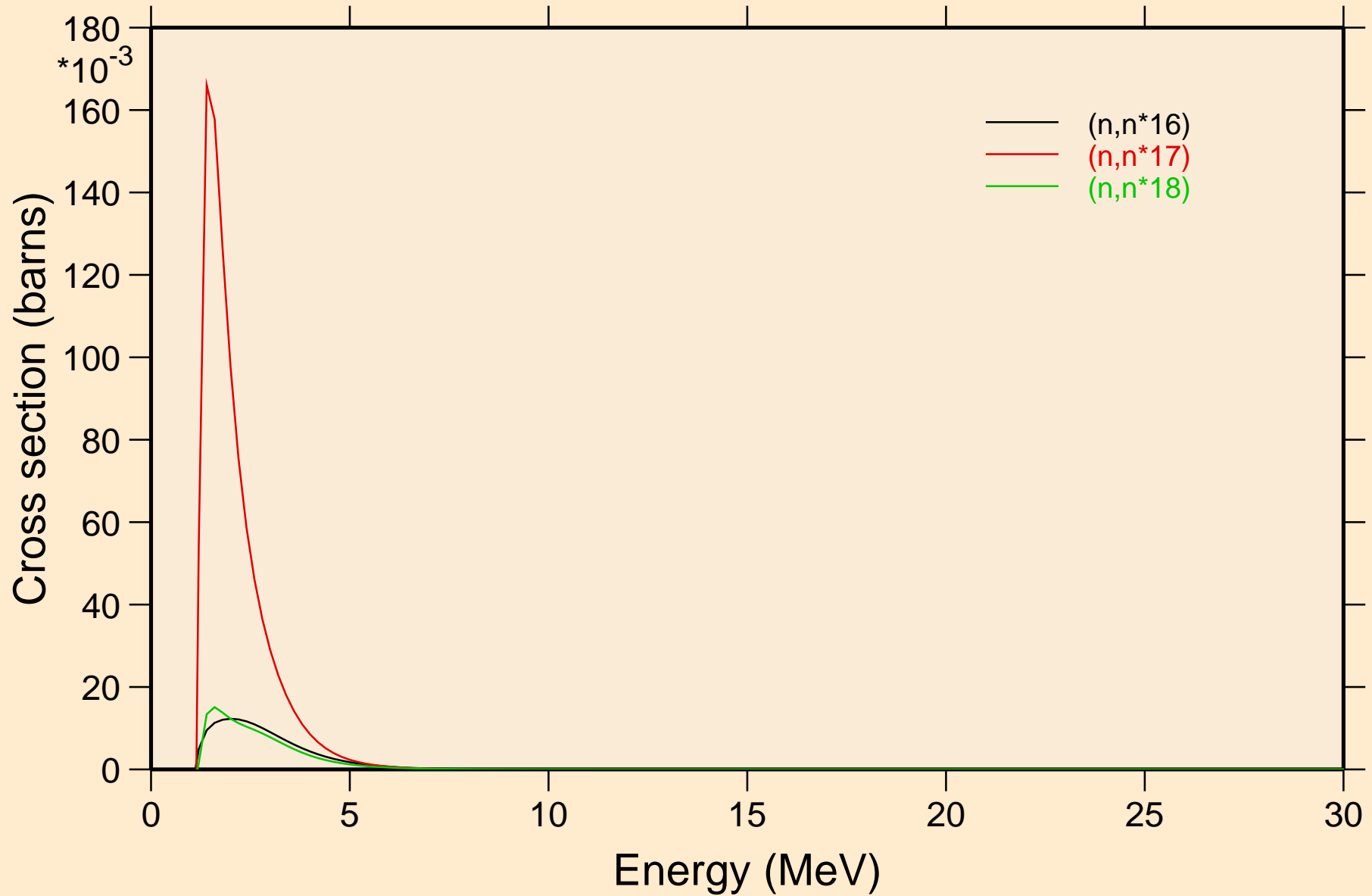

# NB095M NEUTRON ACER TENDL-2023 LIBRARY; T=0.K

## Threshold reactions

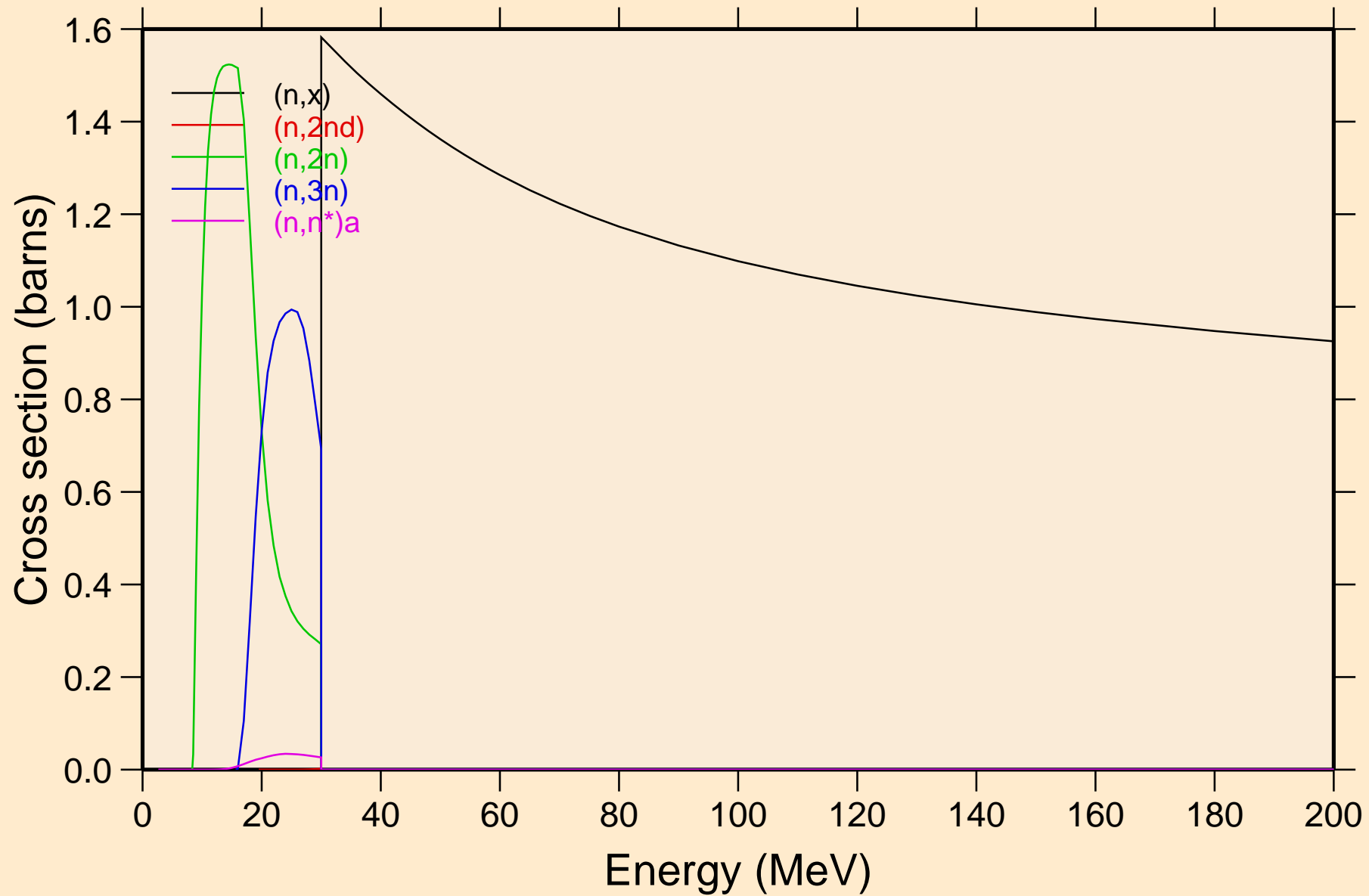

NB095M NEUTRON ACER TENDL-2023 LIBRARY; T=0.K  
Threshold reactions

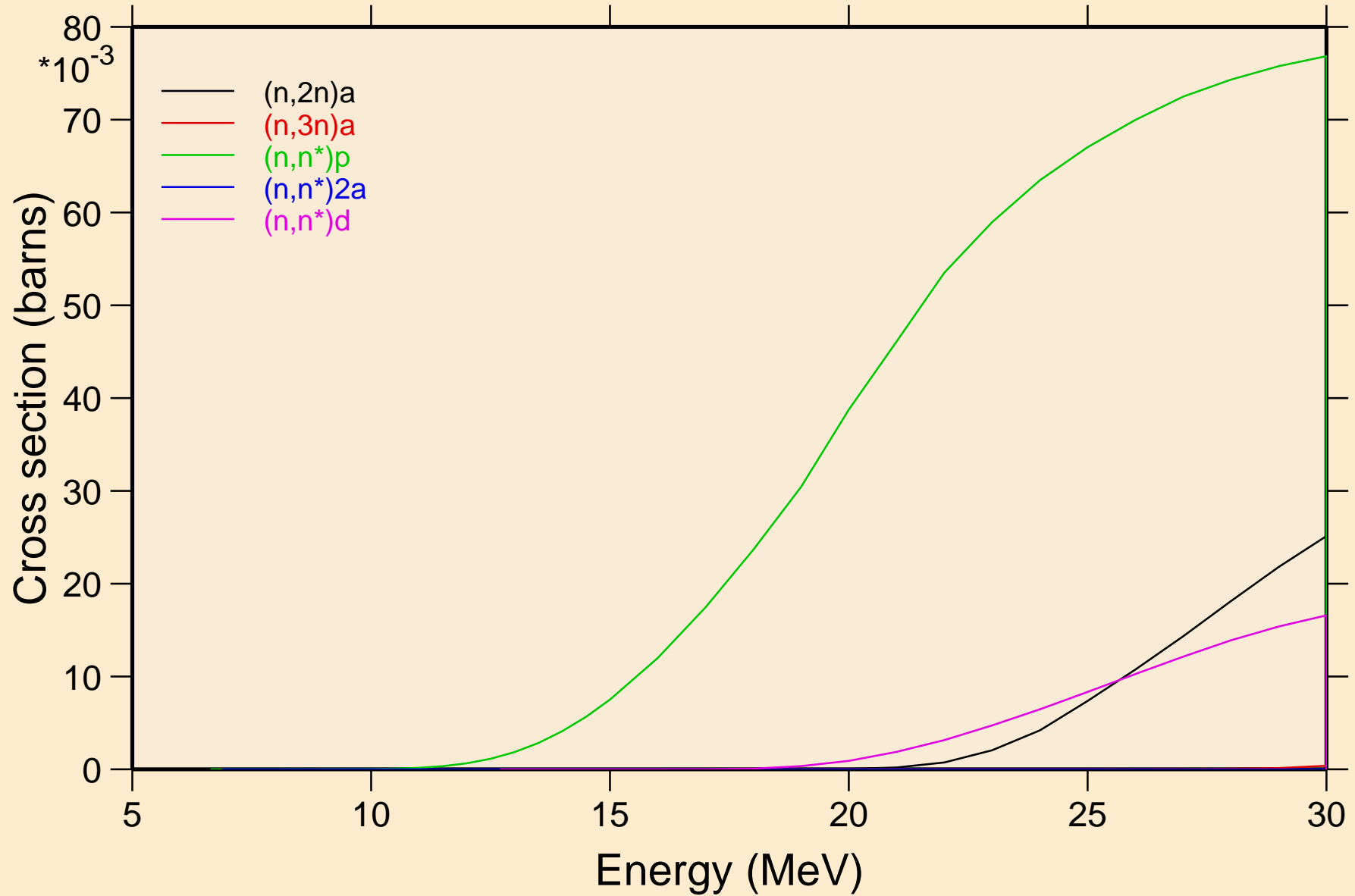

# NB095M NEUTRON ACER TENDL-2023 LIBRARY; T=0.K

## Threshold reactions

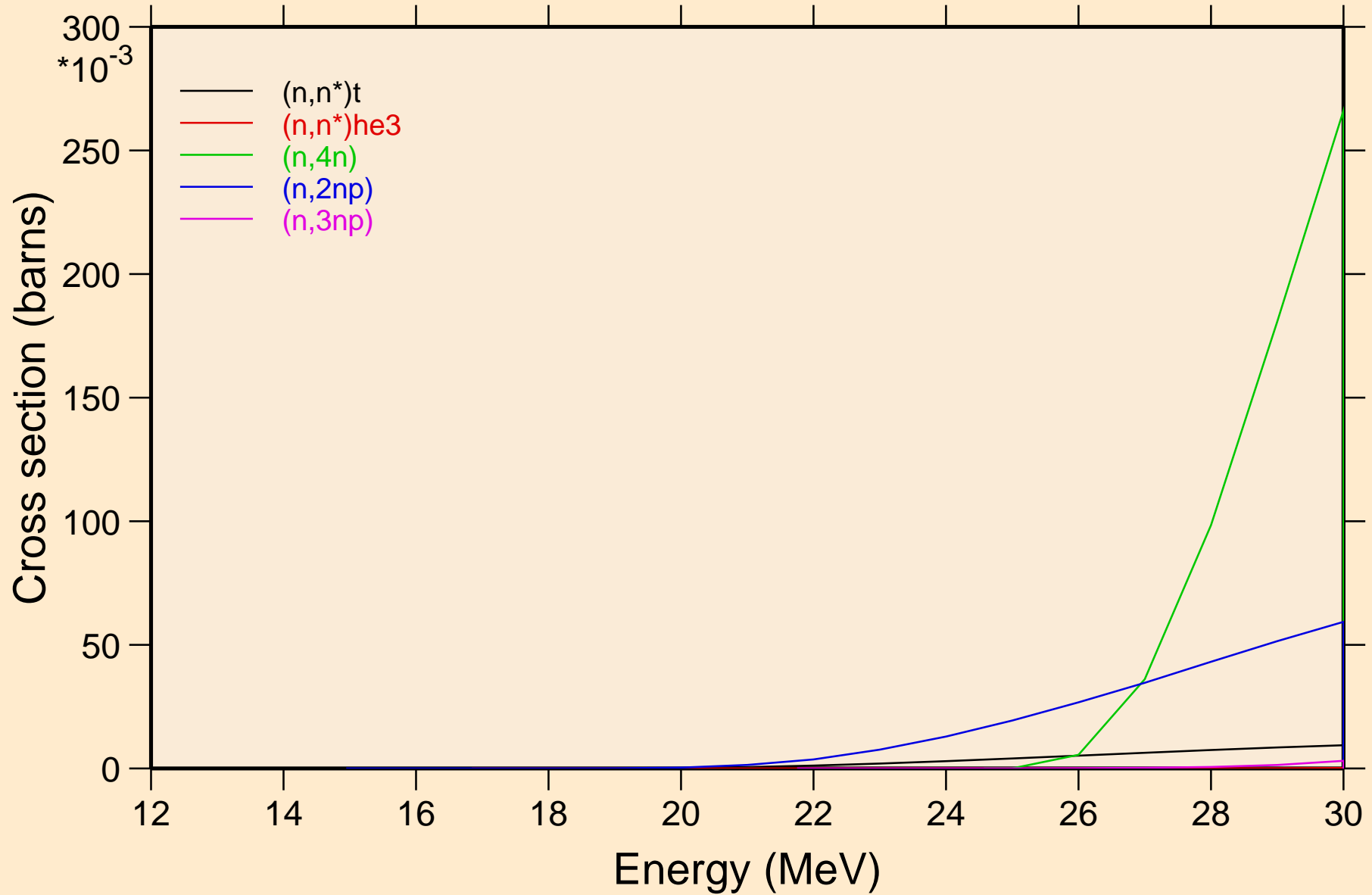

NB095M NEUTRON ACER TENDL-2023 LIBRARY; T=0.K  
Threshold reactions

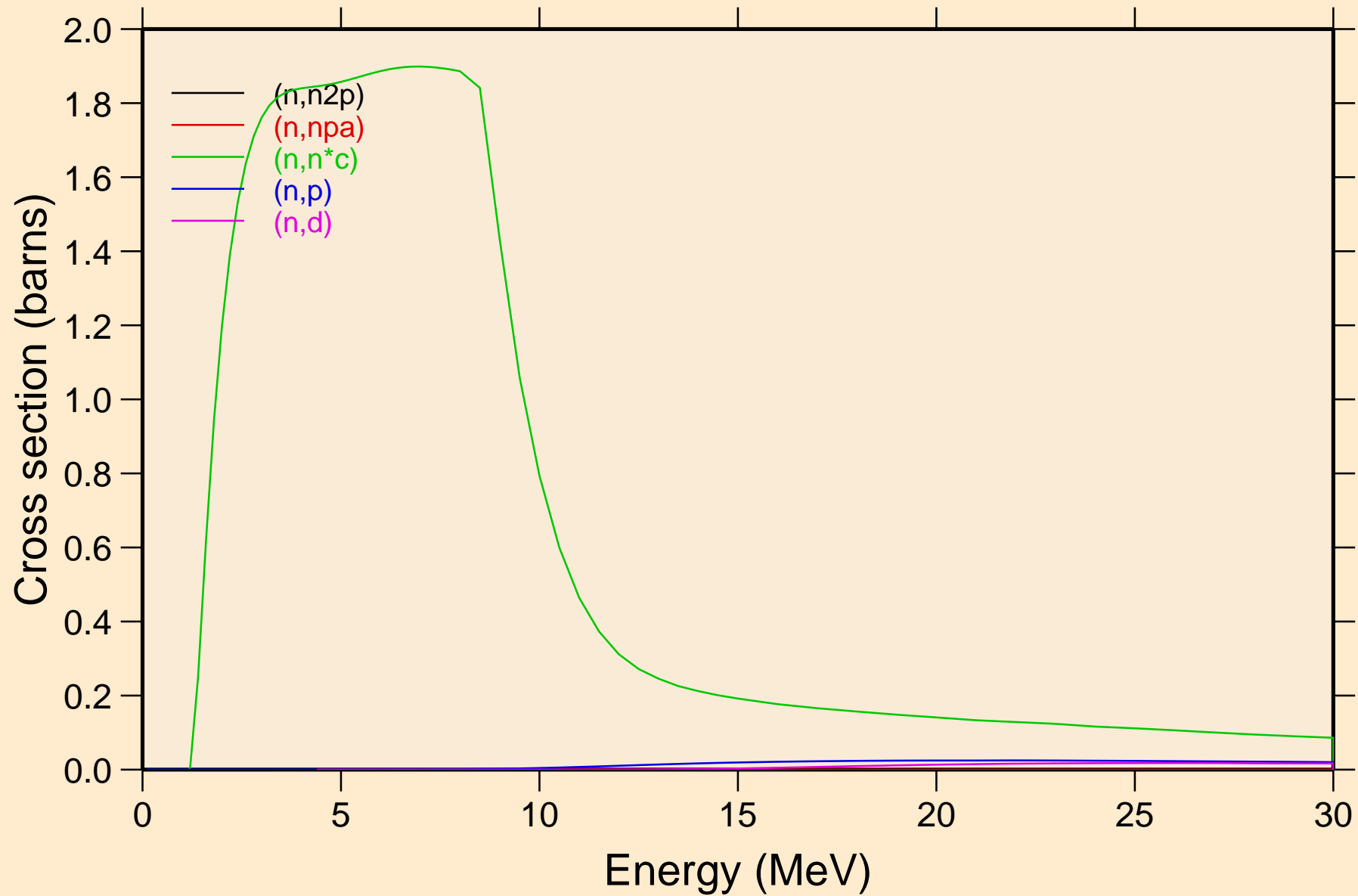

NB095M NEUTRON ACER TENDL-2023 LIBRARY; T=0.K  
Threshold reactions

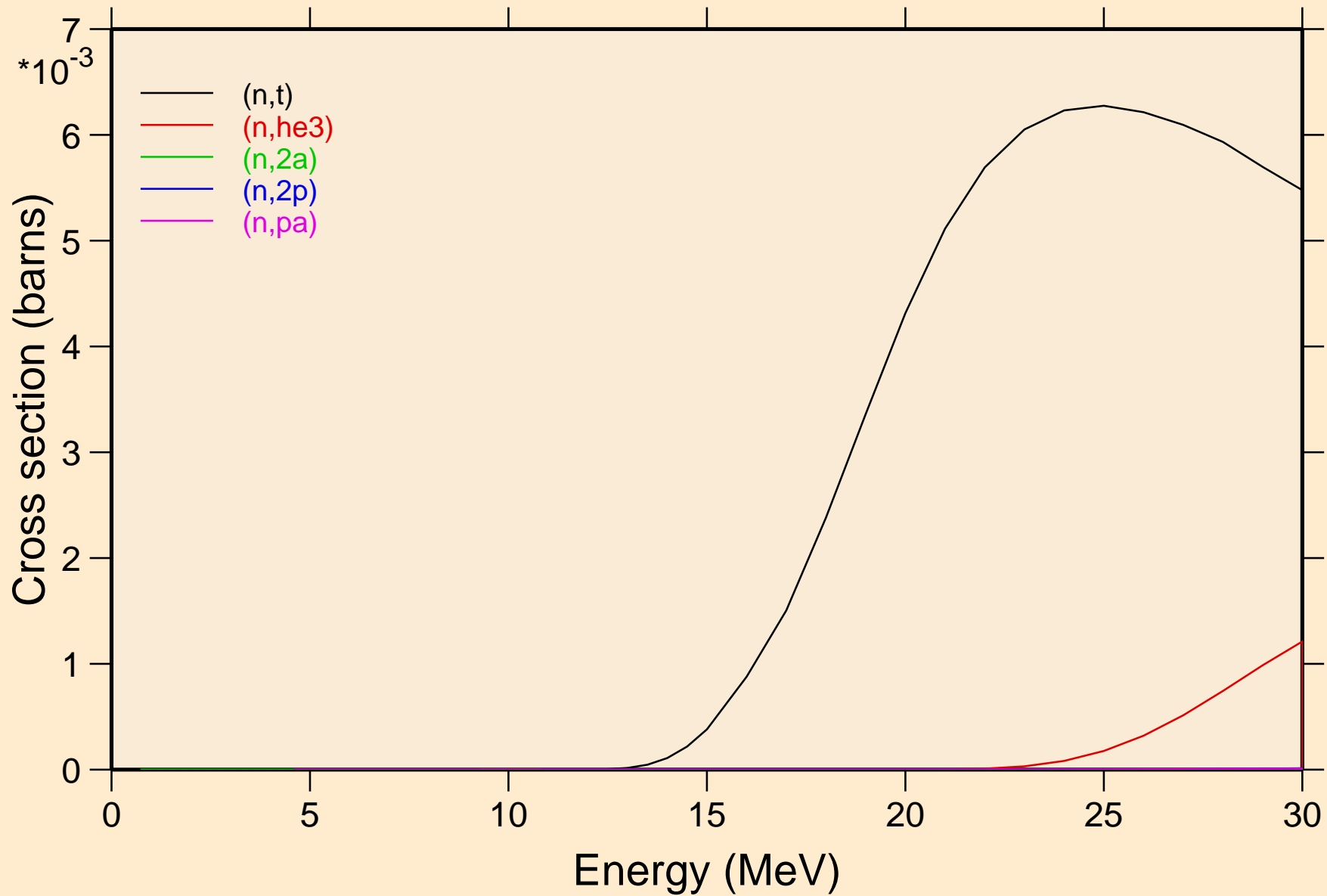

NB095M NEUTRON ACER TENDL-2023 LIBRARY; T=0.K  
Threshold reactions

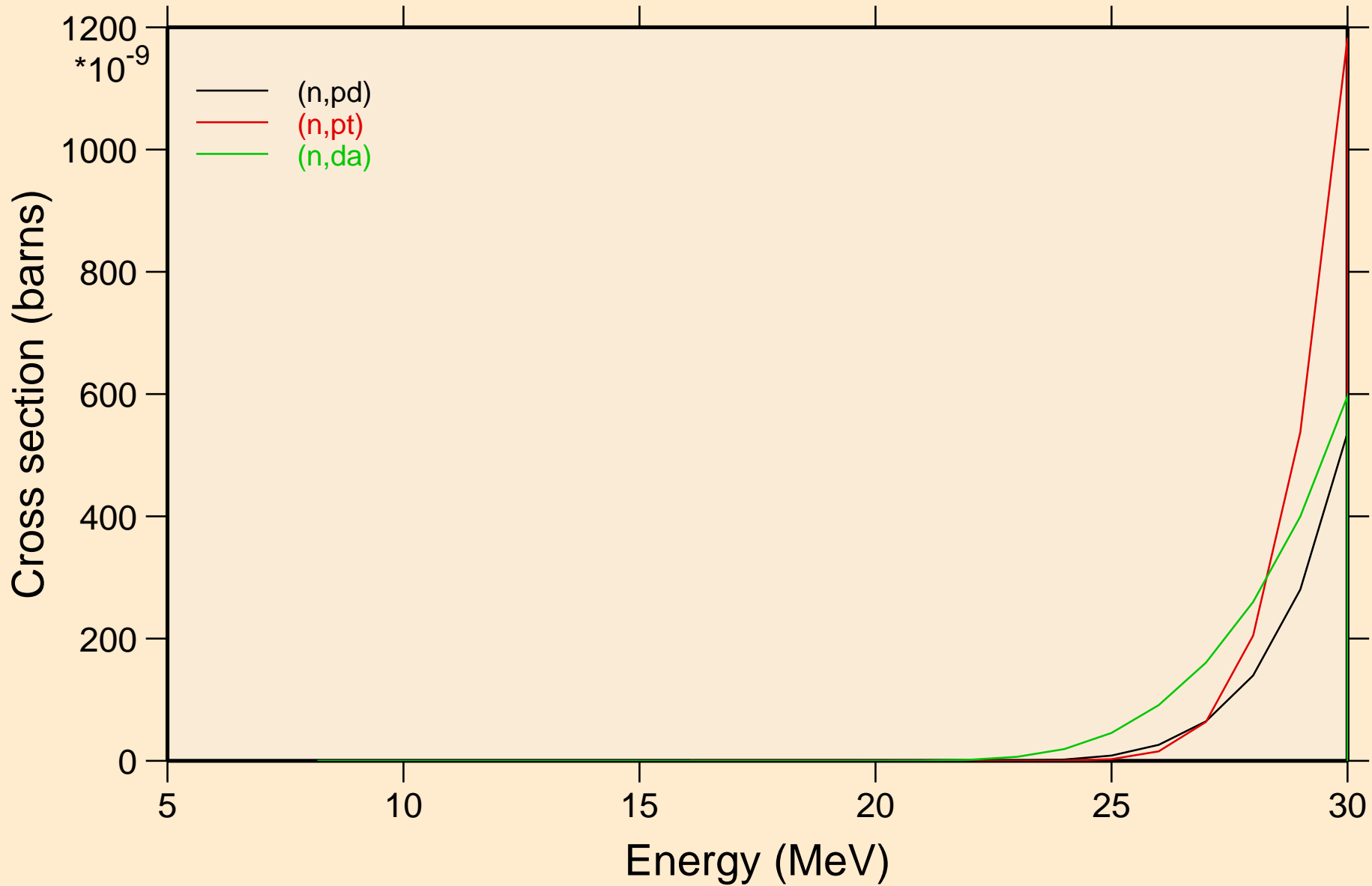

NB095M NEUTRON ACER TENDL-2023 LIBRARY; T=0.K  
Threshold reactions

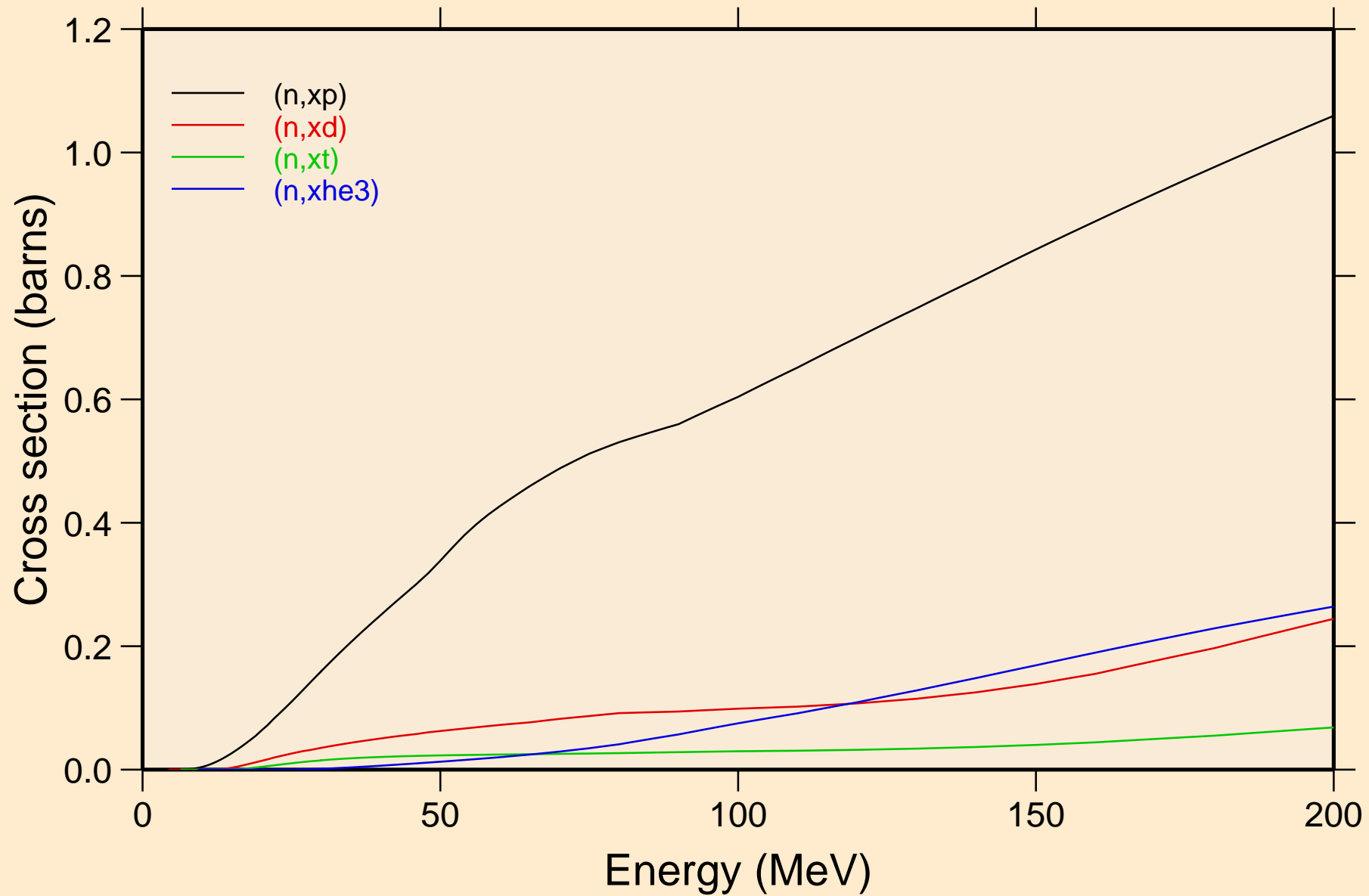

NB095M NEUTRON ACER TENDL-2023 LIBRARY; T=0.K  
angular distribution for elastic

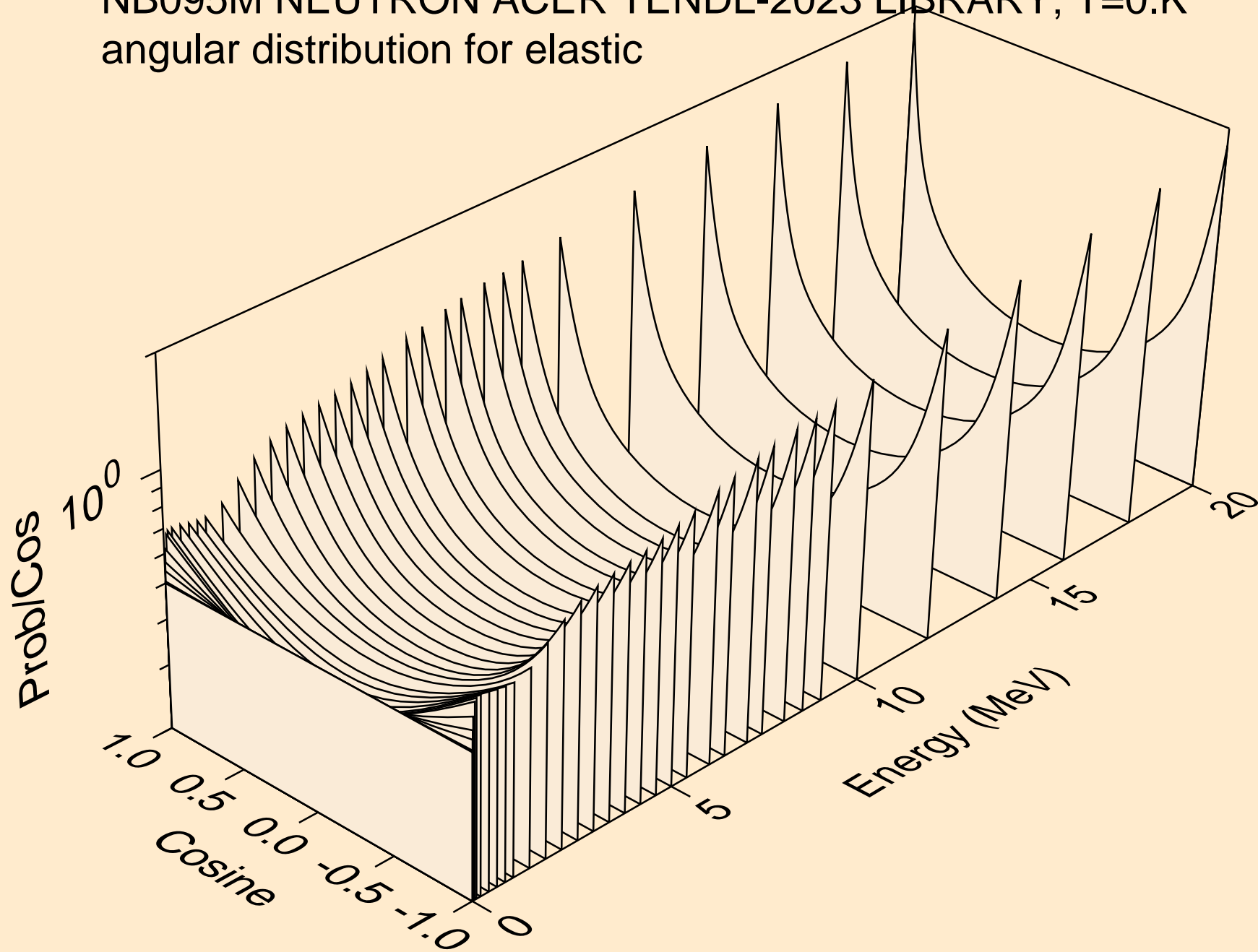

NB095M NEUTRON ACER TENDL-2023 LIBRARY; T=0.K  
angular distribution for elastic

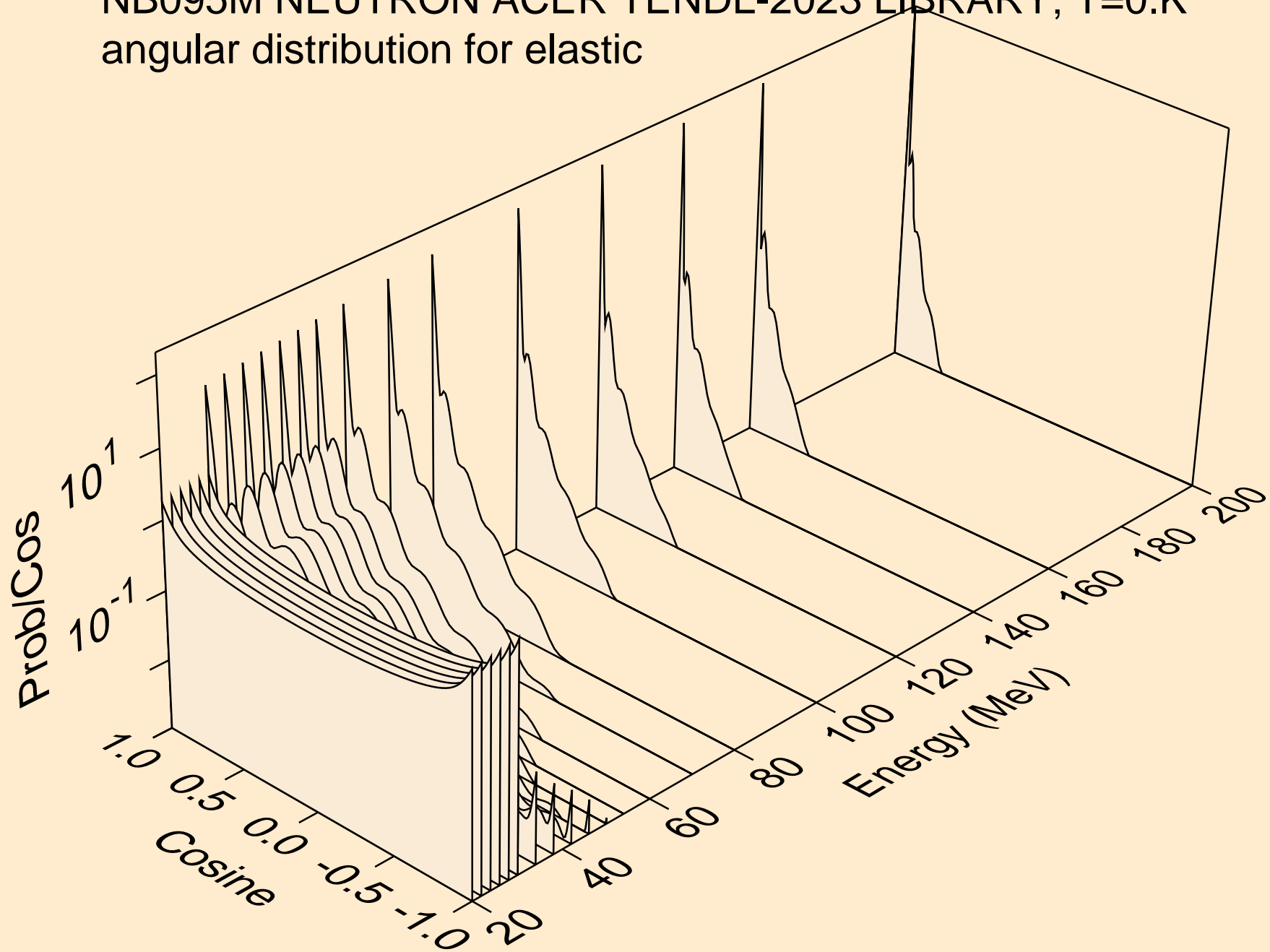

NB095M NEUTRON ACER TENDL-2023 LIBRARY; T=0.K  
angular distribution for (n,n\*1)

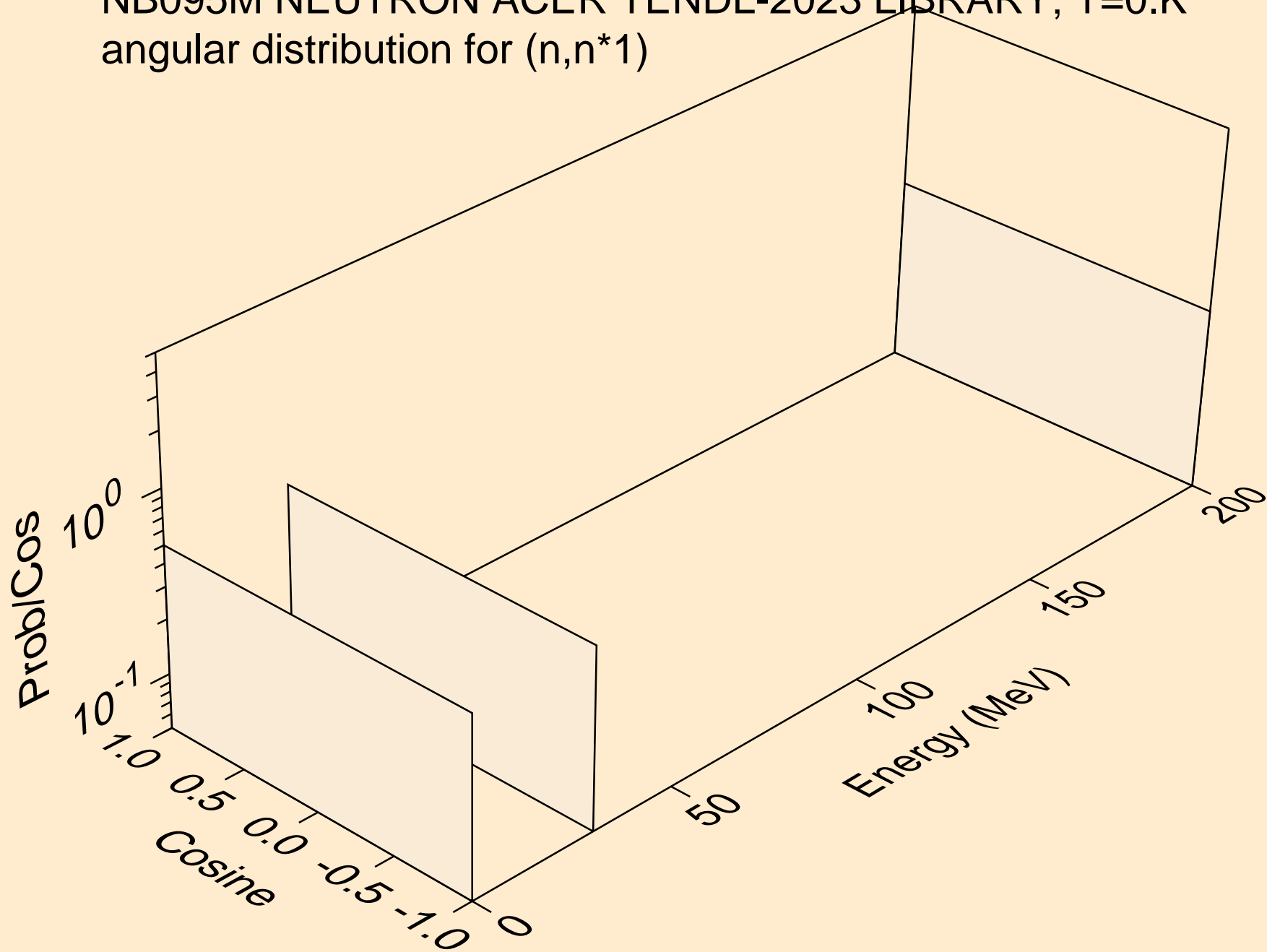

NB095M NEUTRON ACER TENDL-2023 LIBRARY; T=0.K  
angular distribution for (n,n\*2)

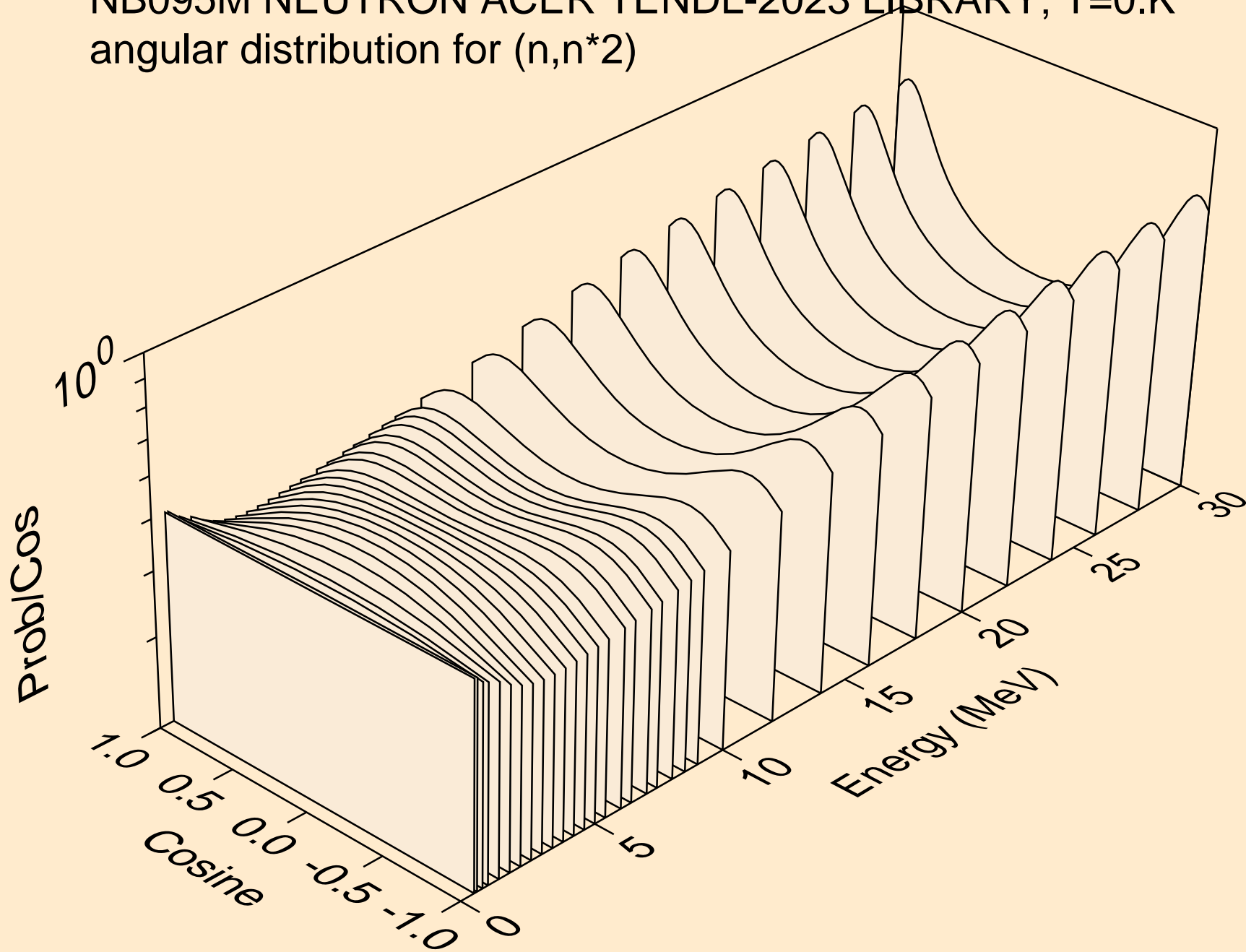

NB095M NEUTRON ACER TENDL-2023 LIBRARY; T=0.K  
angular distribution for (n,n\*3)

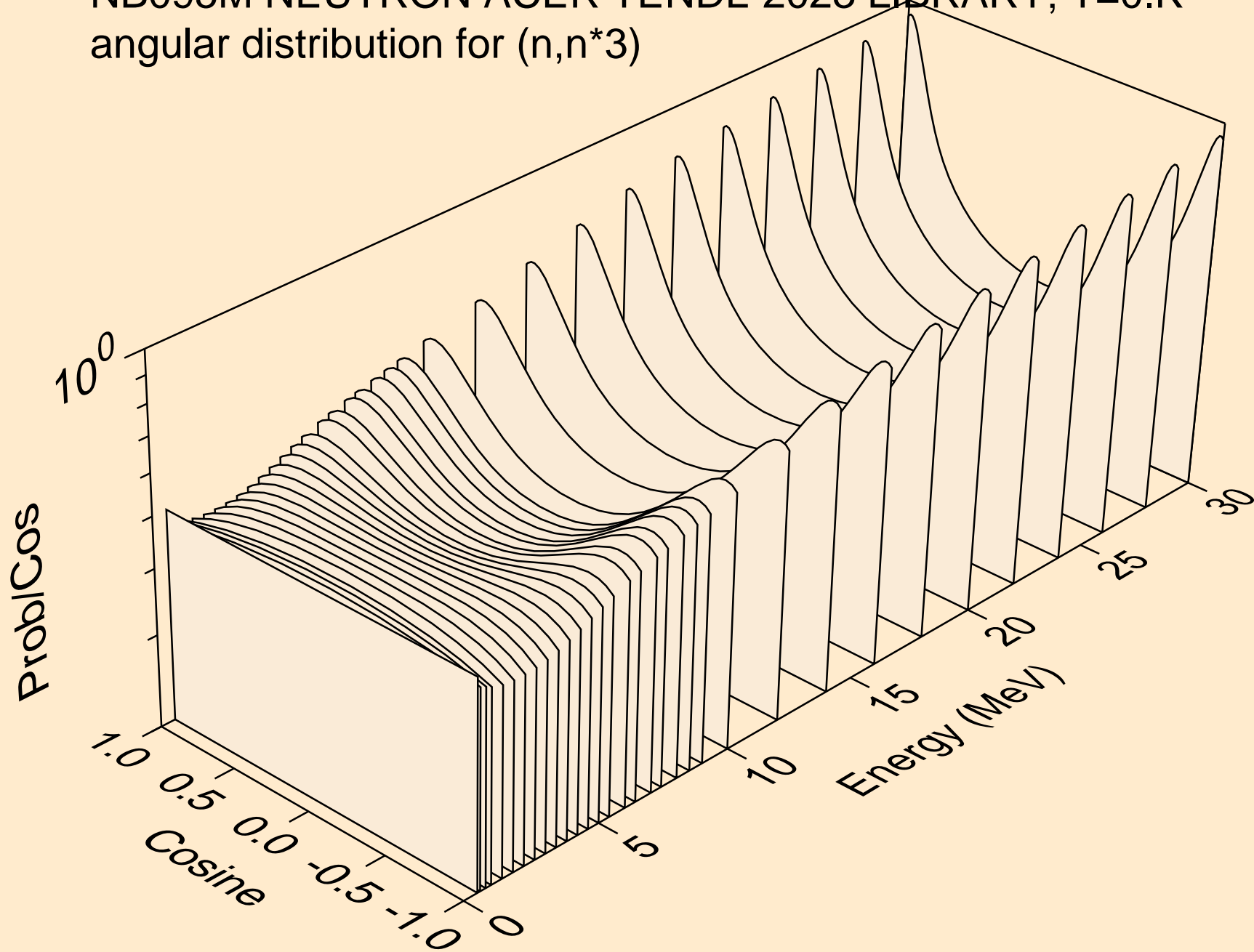

NB095M NEUTRON ACER TENDL-2023 LIBRARY; T=0.K  
angular distribution for (n,n\*4)

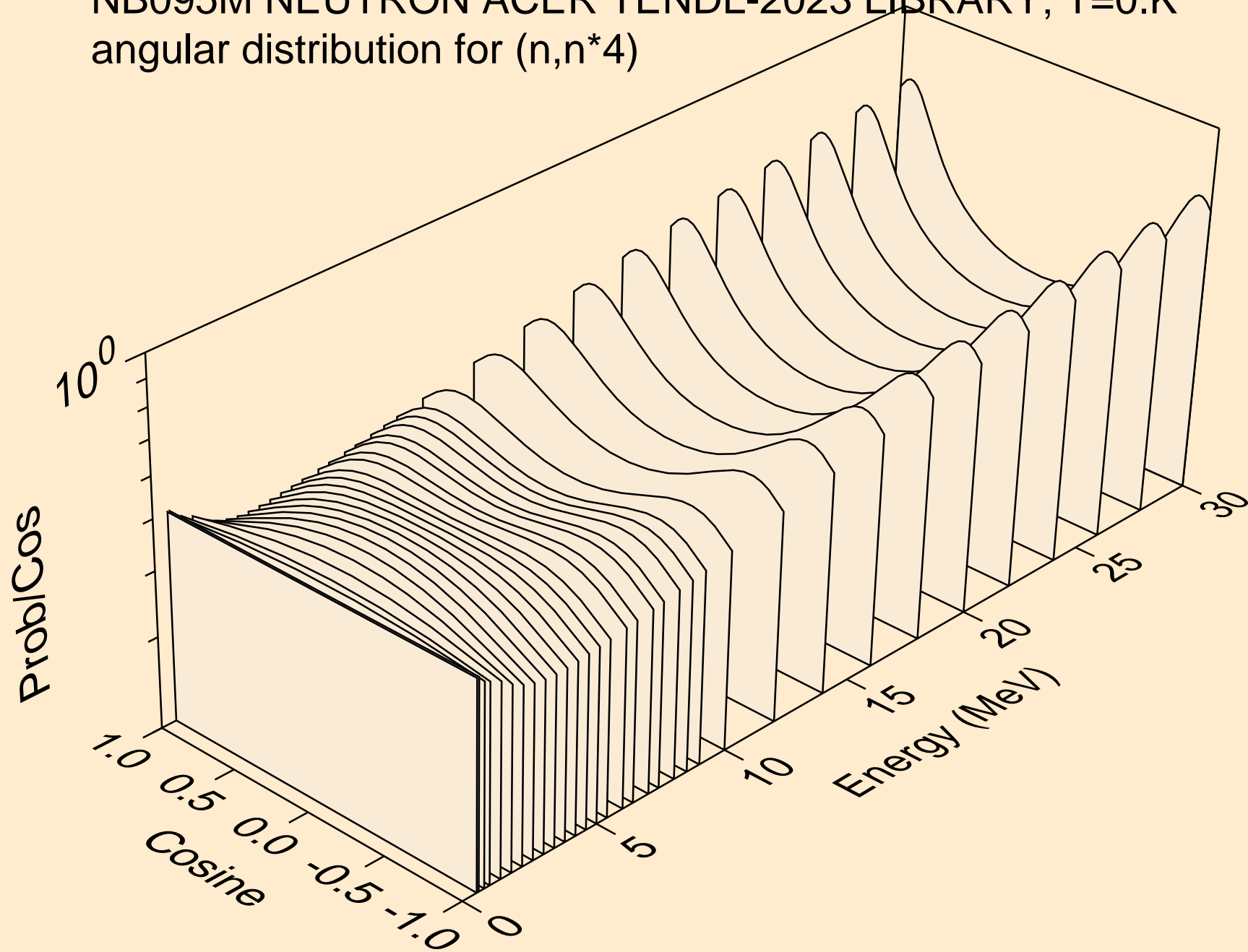

NB095M NEUTRON ACER TENDL-2023 LIBRARY; T=0.K  
angular distribution for (n,n\*5)

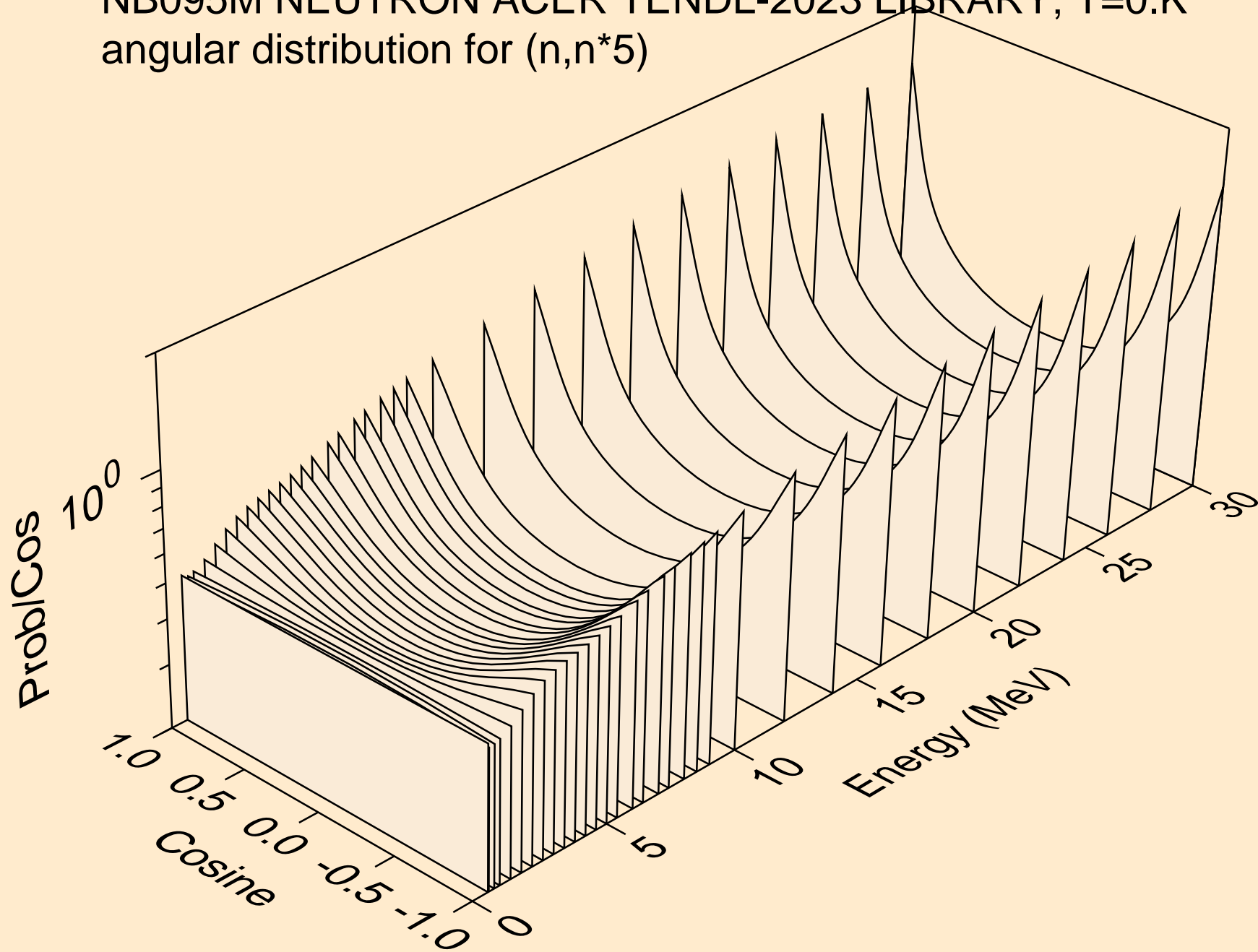

NB095M NEUTRON ACER TENDL-2023 LIBRARY; T=0.K  
angular distribution for (n,n\*6)

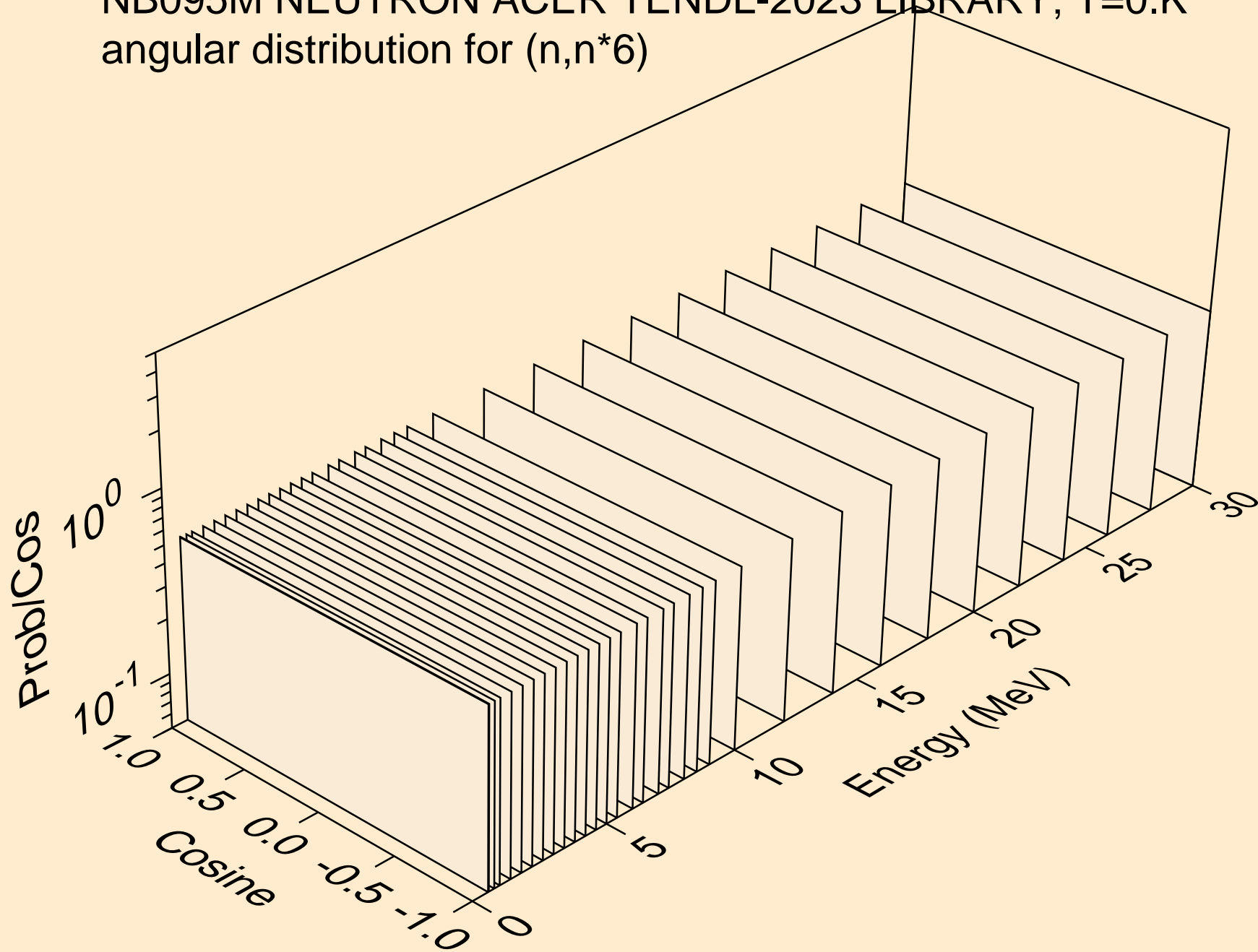

NB095M NEUTRON ACER TENDL-2023 LIBRARY; T=0.K  
angular distribution for (n,n\*7)

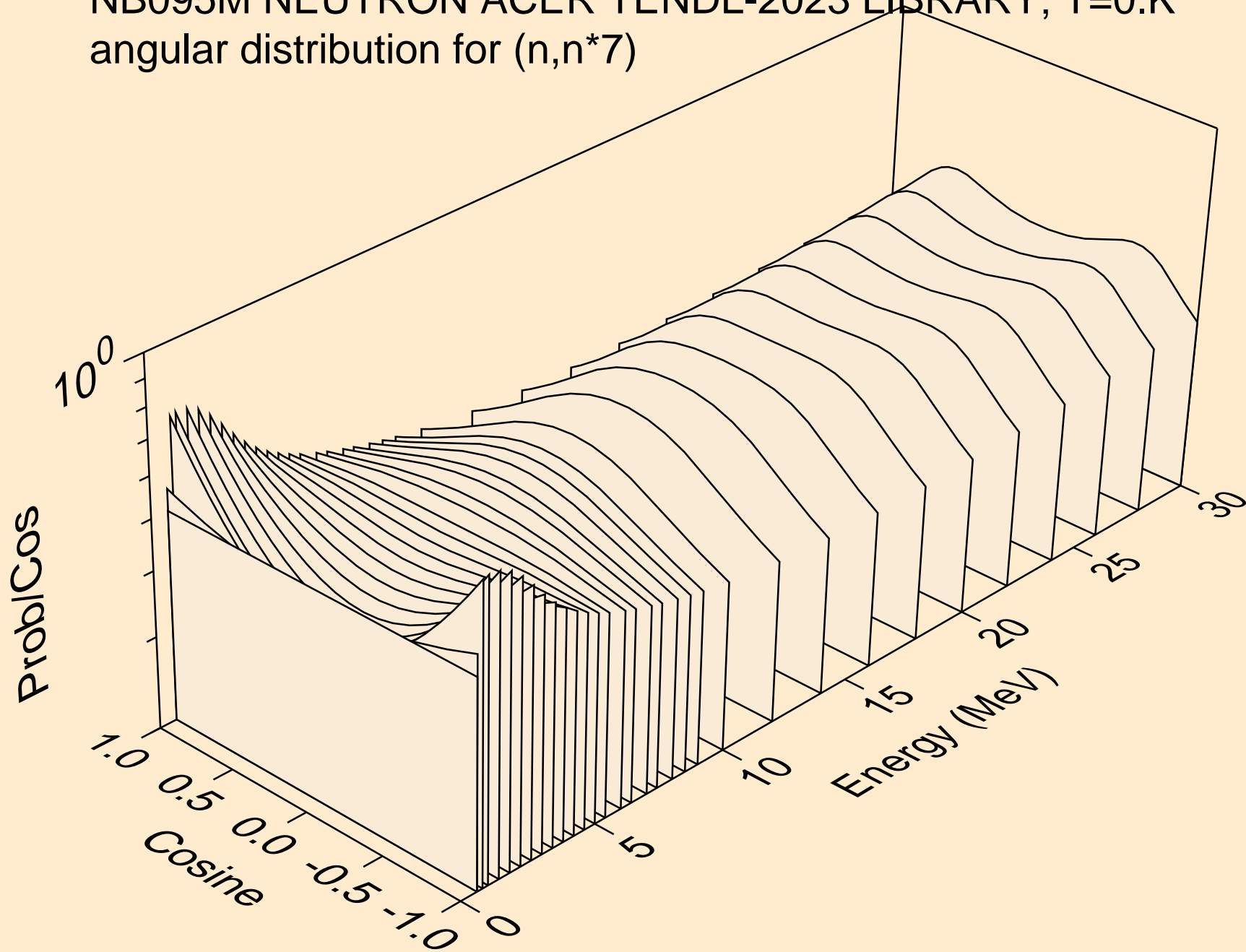

NB095M NEUTRON ACER TENDL-2023 LIBRARY; T=0.K  
angular distribution for (n,n\*8)

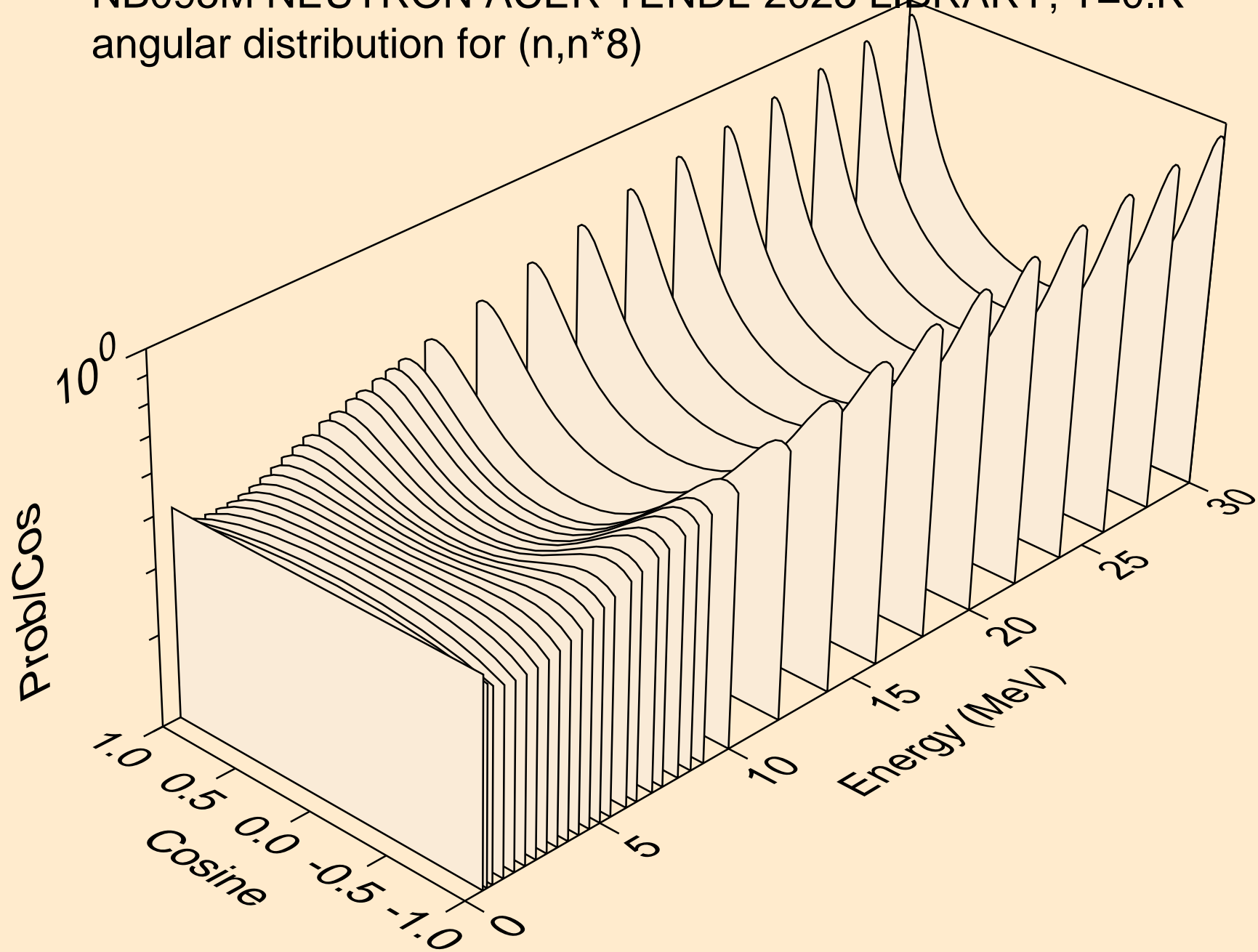

NB095M NEUTRON ACER TENDL-2023 LIBRARY; T=0.K  
angular distribution for (n,n\*9)

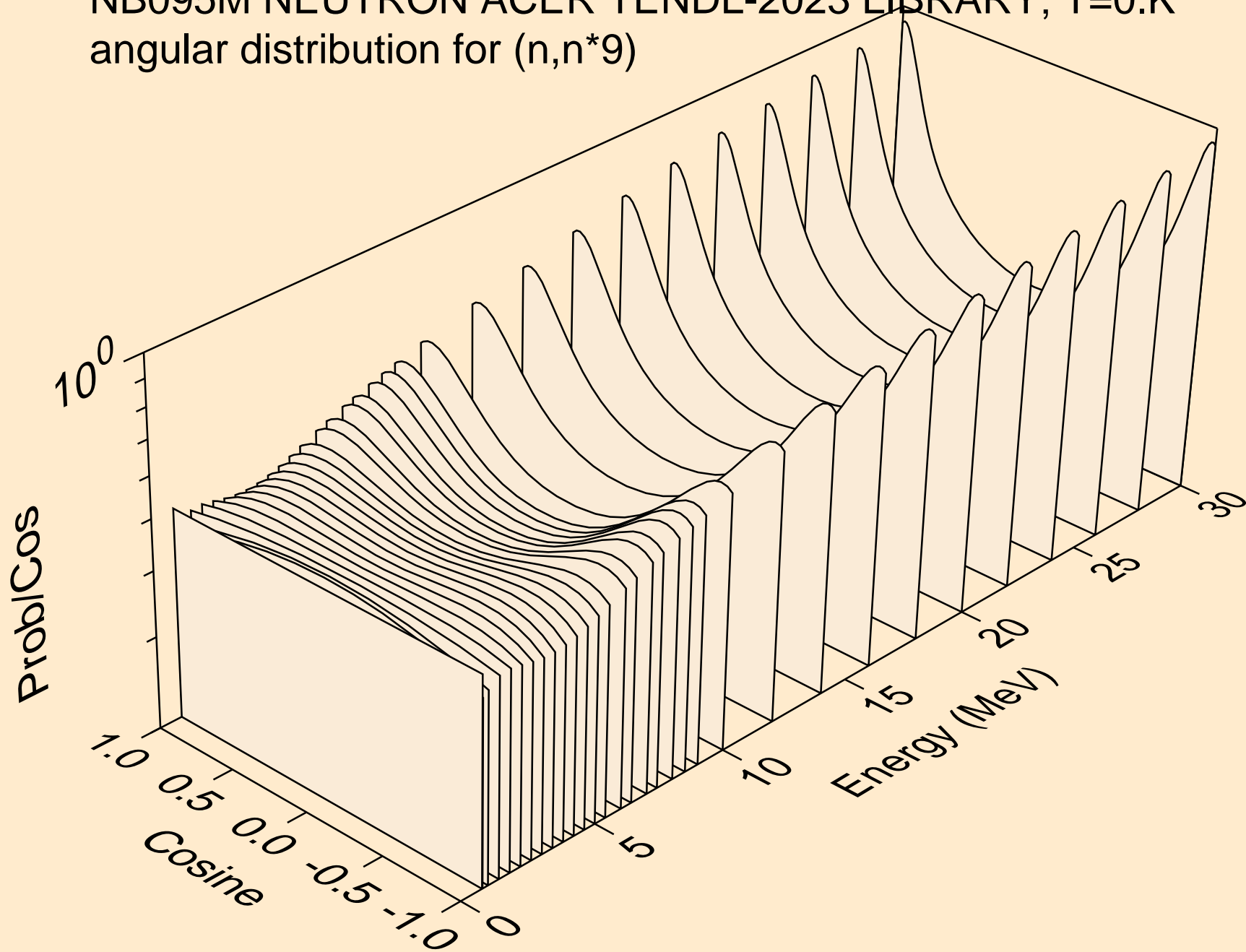

NB095M NEUTRON ACER TENDL-2023 LIBRARY; T=0.K  
angular distribution for (n,n\*10)

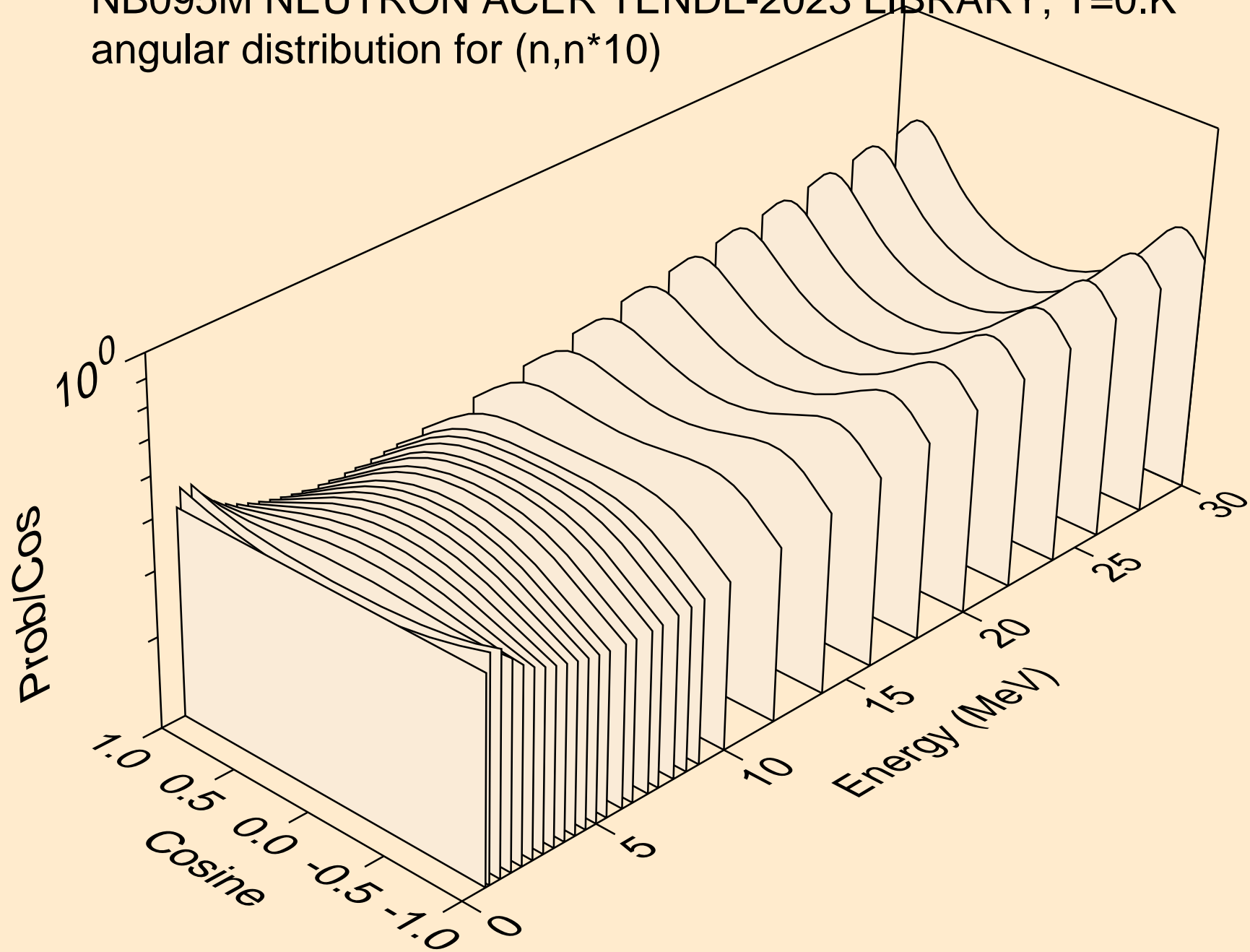

NB095M NEUTRON ACER TENDL-2023 LIBRARY; T=0.K  
angular distribution for (n,n\*11)

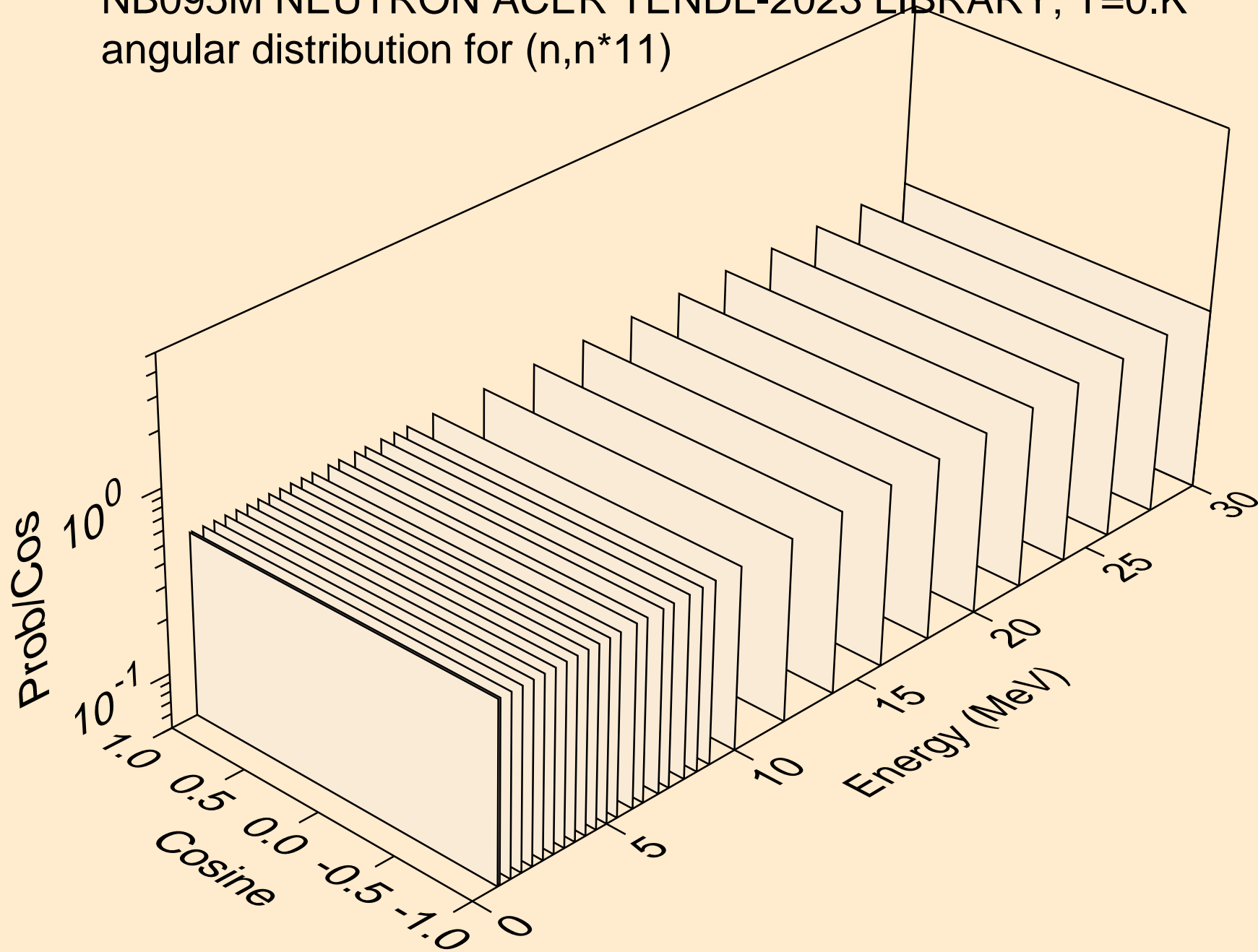

NB095M NEUTRON ACER TENDL-2023 LIBRARY; T=0.K  
angular distribution for (n,n\*12)

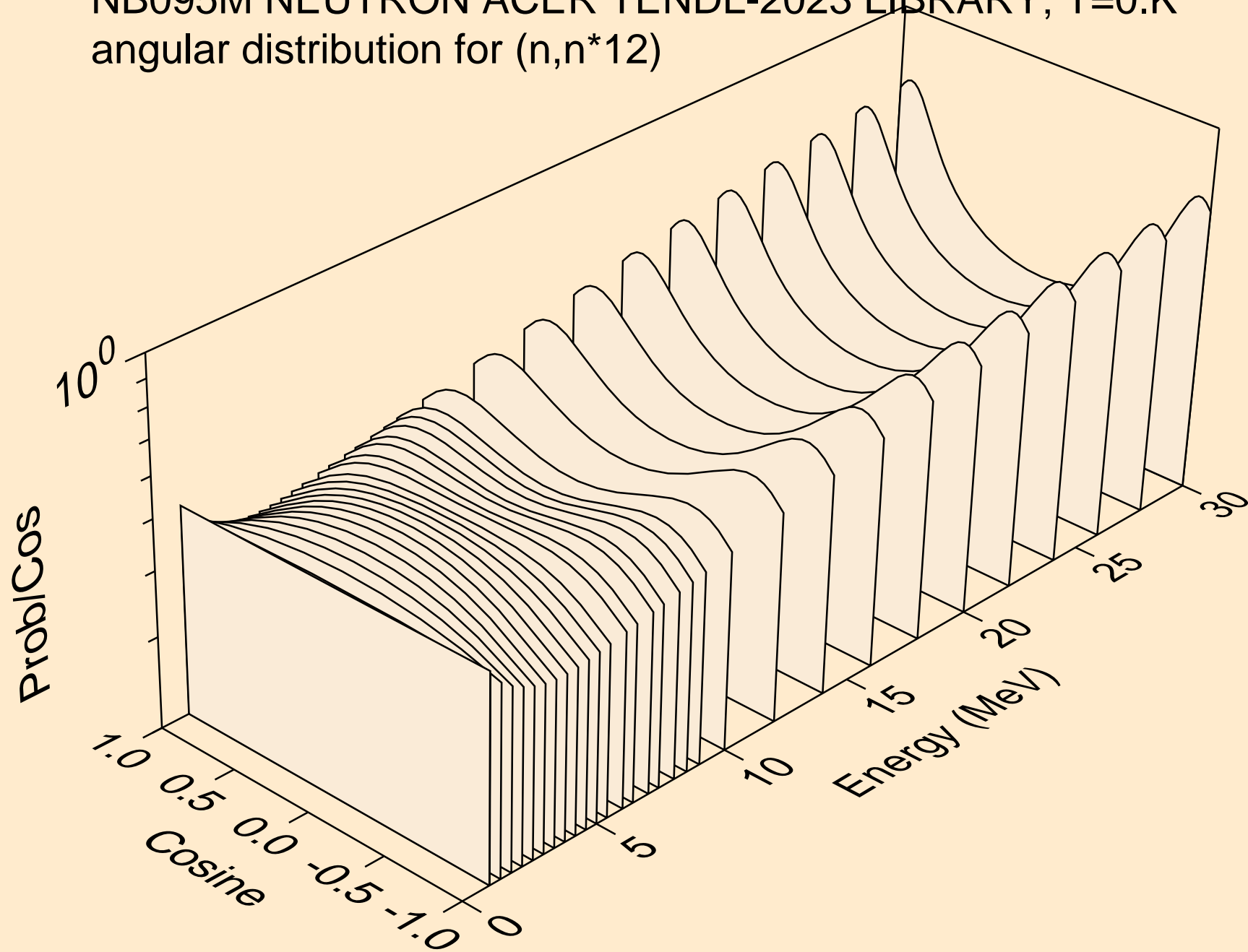

NB095M NEUTRON ACER TENDL-2023 LIBRARY; T=0.K  
angular distribution for (n,n\*13)

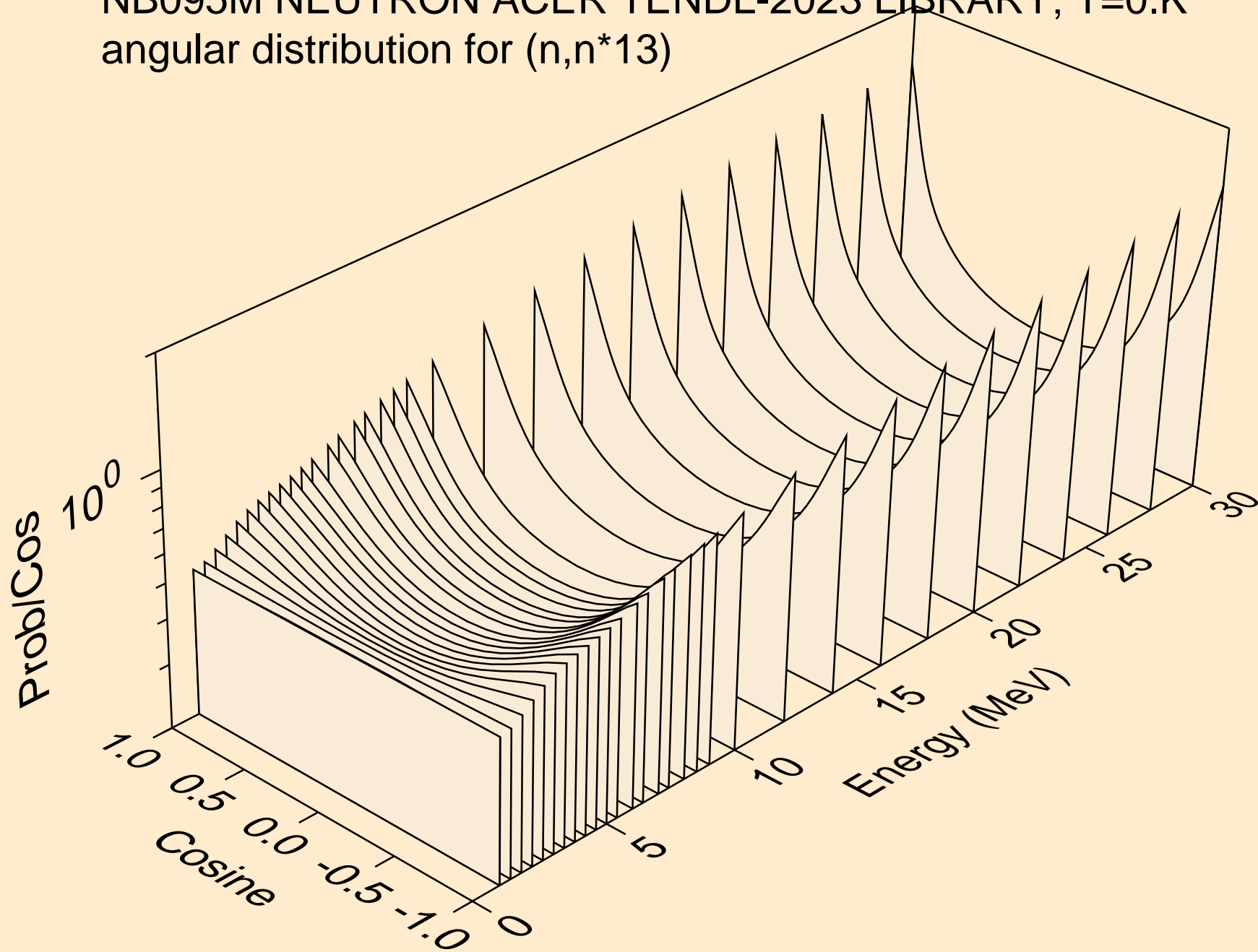

NB095M NEUTRON ACER TENDL-2023 LIBRARY; T=0.K  
angular distribution for (n,n\*14)

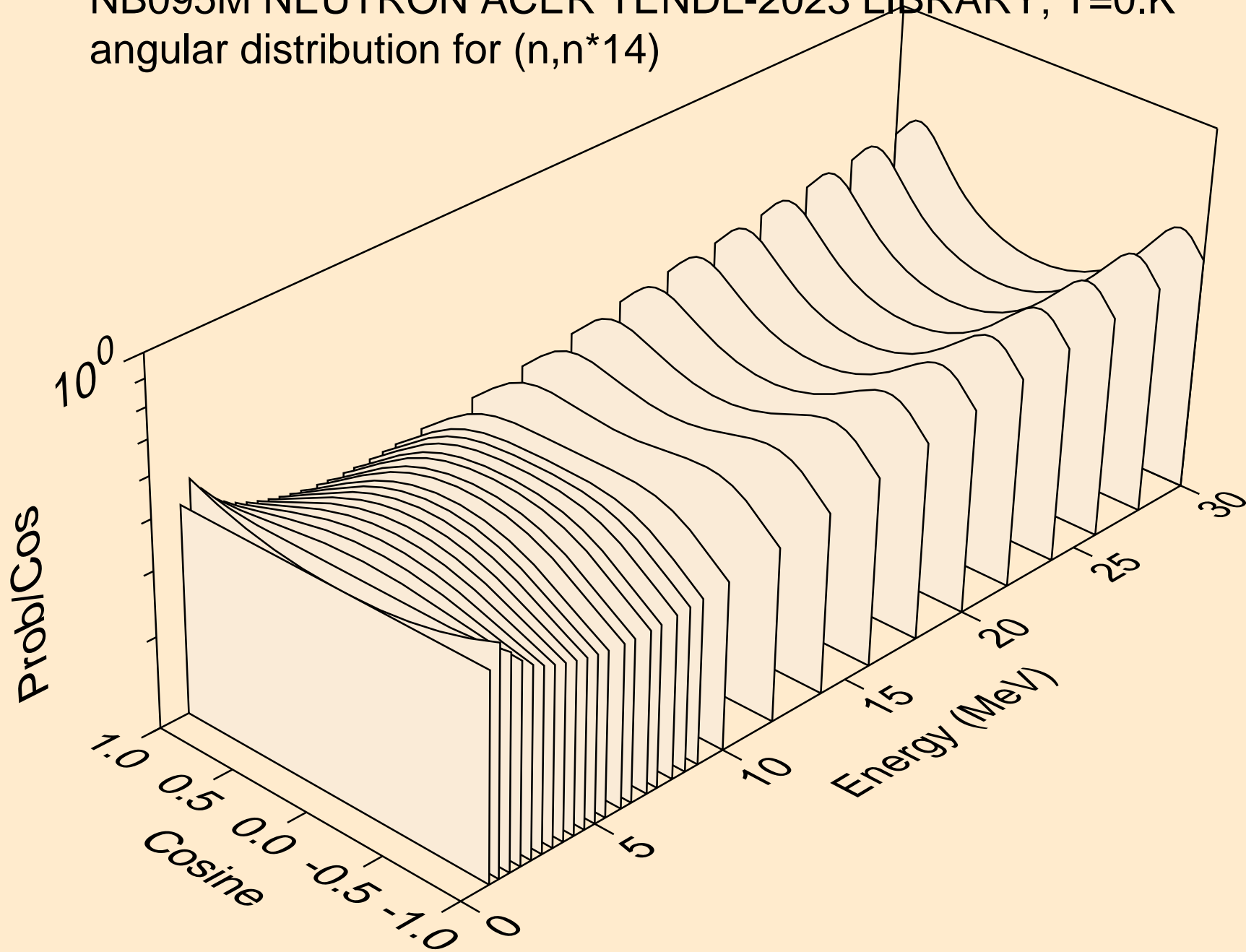

NB095M NEUTRON ACER TENDL-2023 LIBRARY; T=0.K  
angular distribution for (n,n\*15)

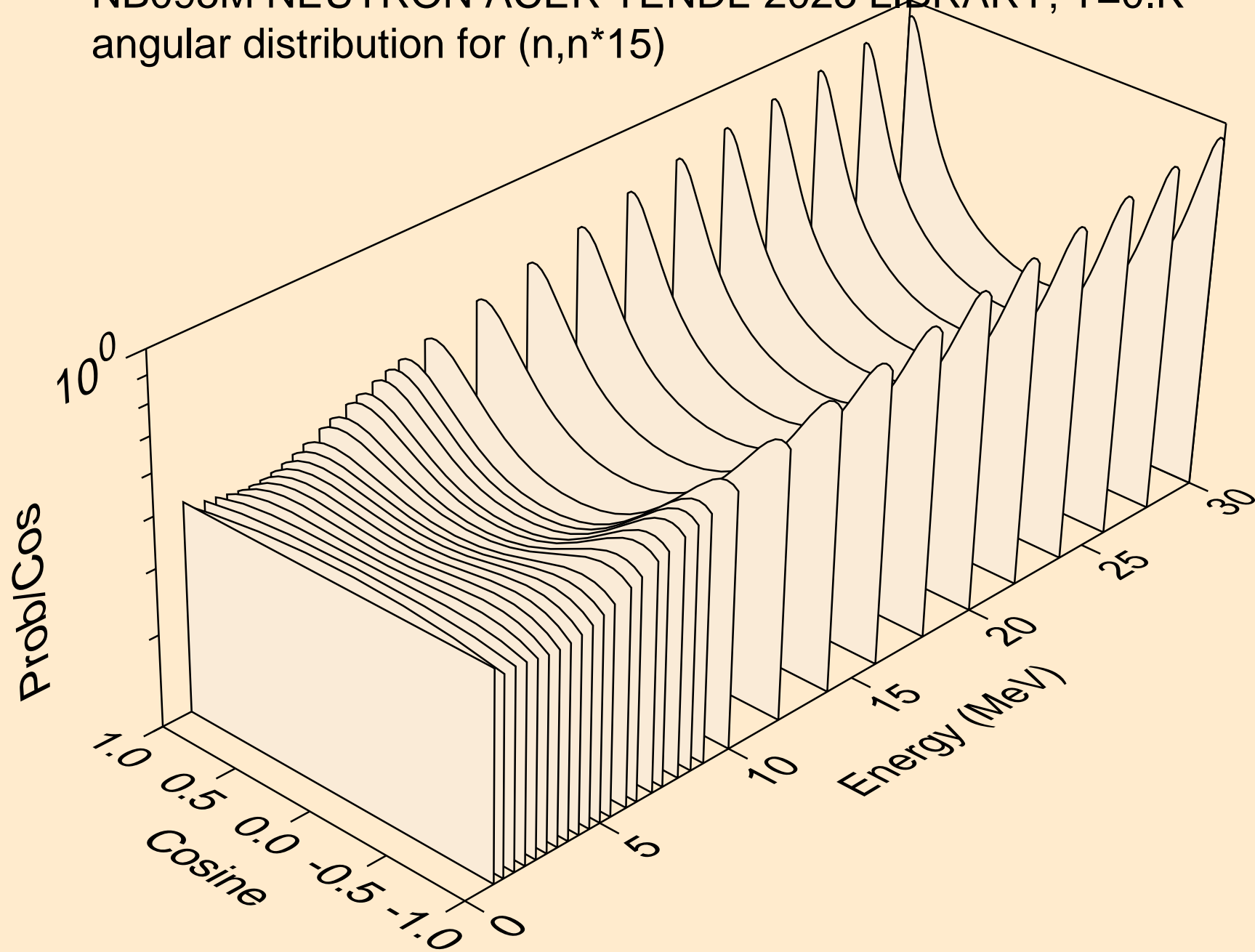

NB095M NEUTRON ACER TENDL-2023 LIBRARY; T=0.K  
angular distribution for (n,n\*16)

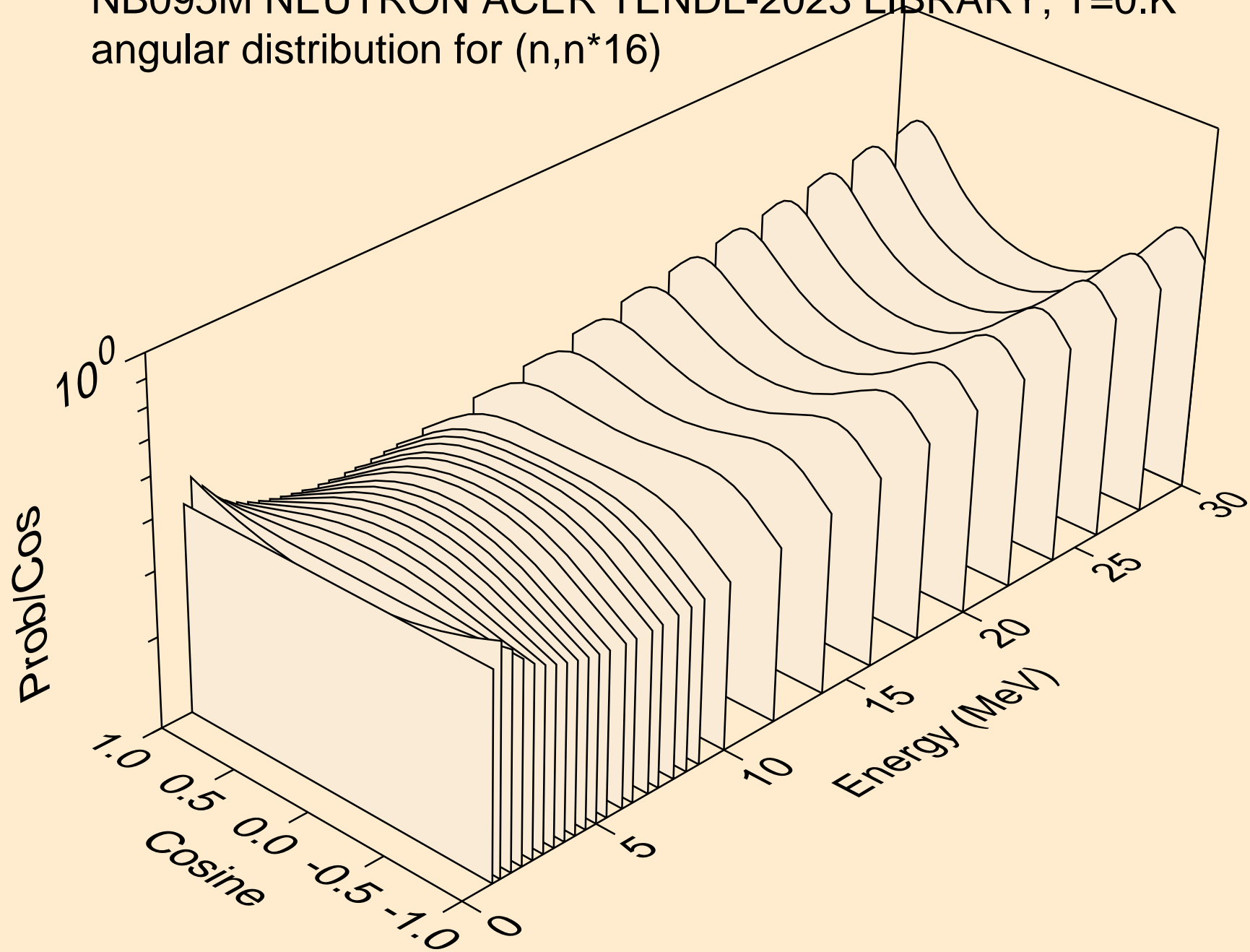

NB095M NEUTRON ACER TENDL-2023 LIBRARY; T=0.K  
angular distribution for (n,n\*17)

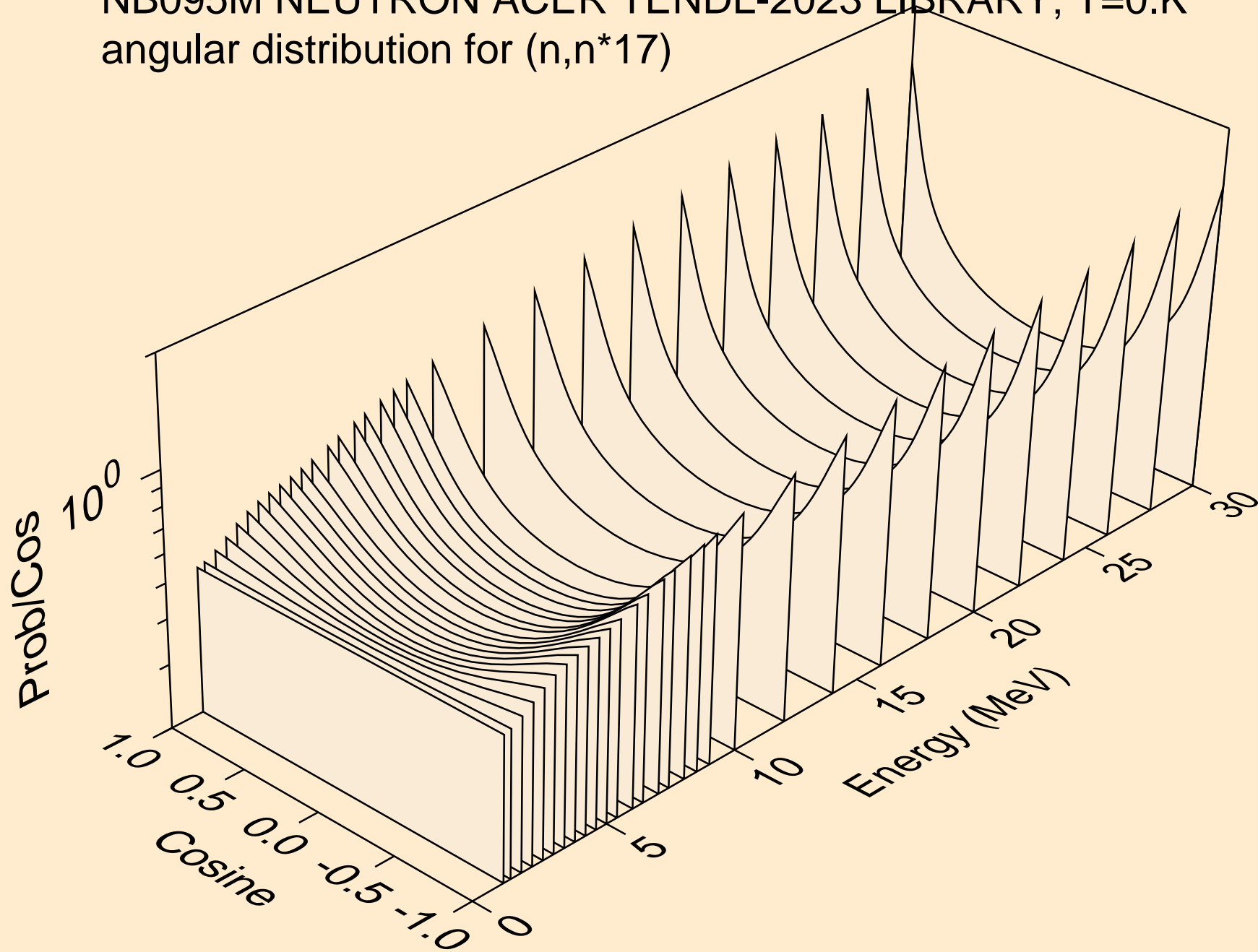

NB095M NEUTRON ACER TENDL-2023 LIBRARY; T=0.K  
angular distribution for (n,n\*18)

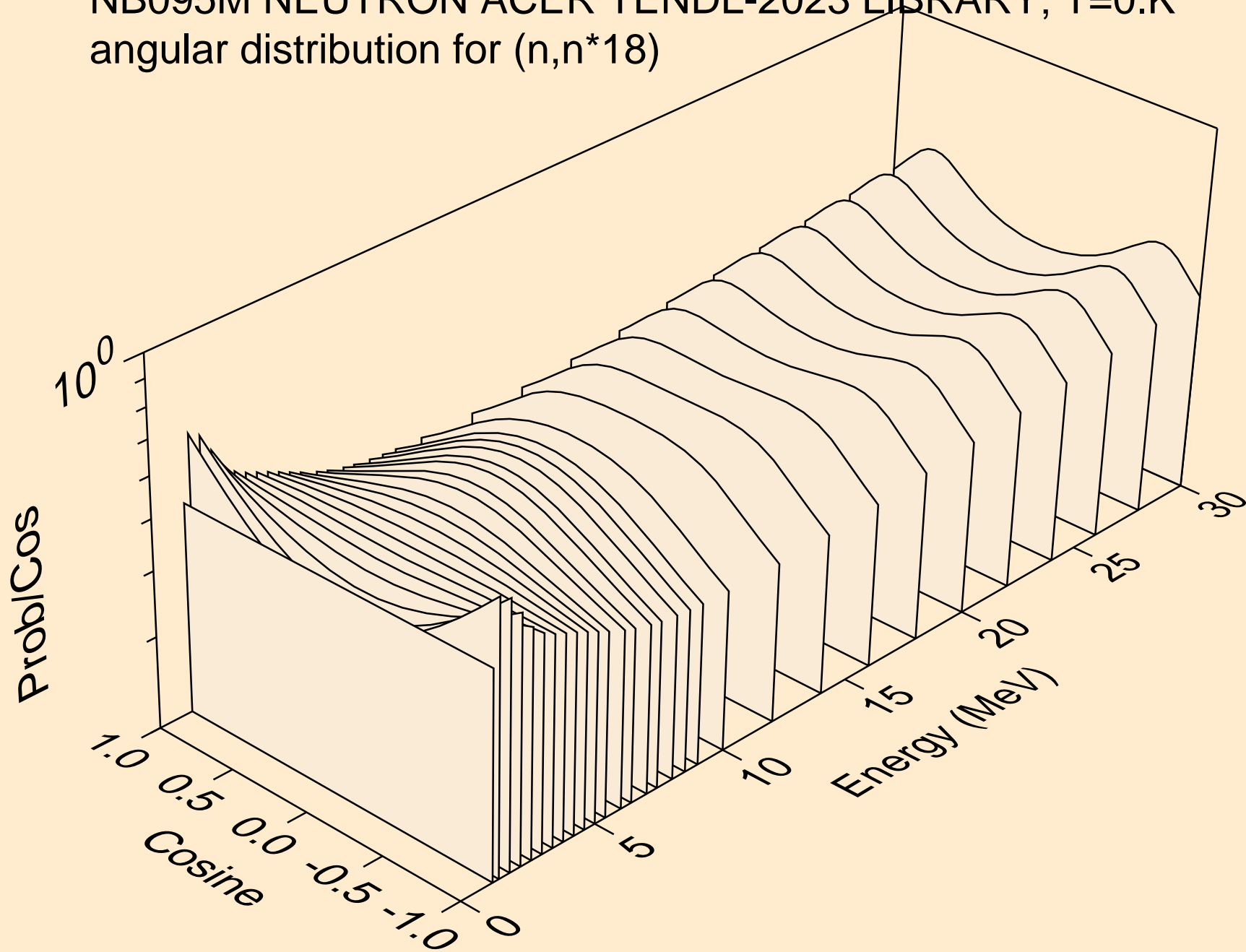

NB095M NEUTRON ACER TENDL-2023 LIBRARY; T=0.K  
Neutron emission for (n,x)

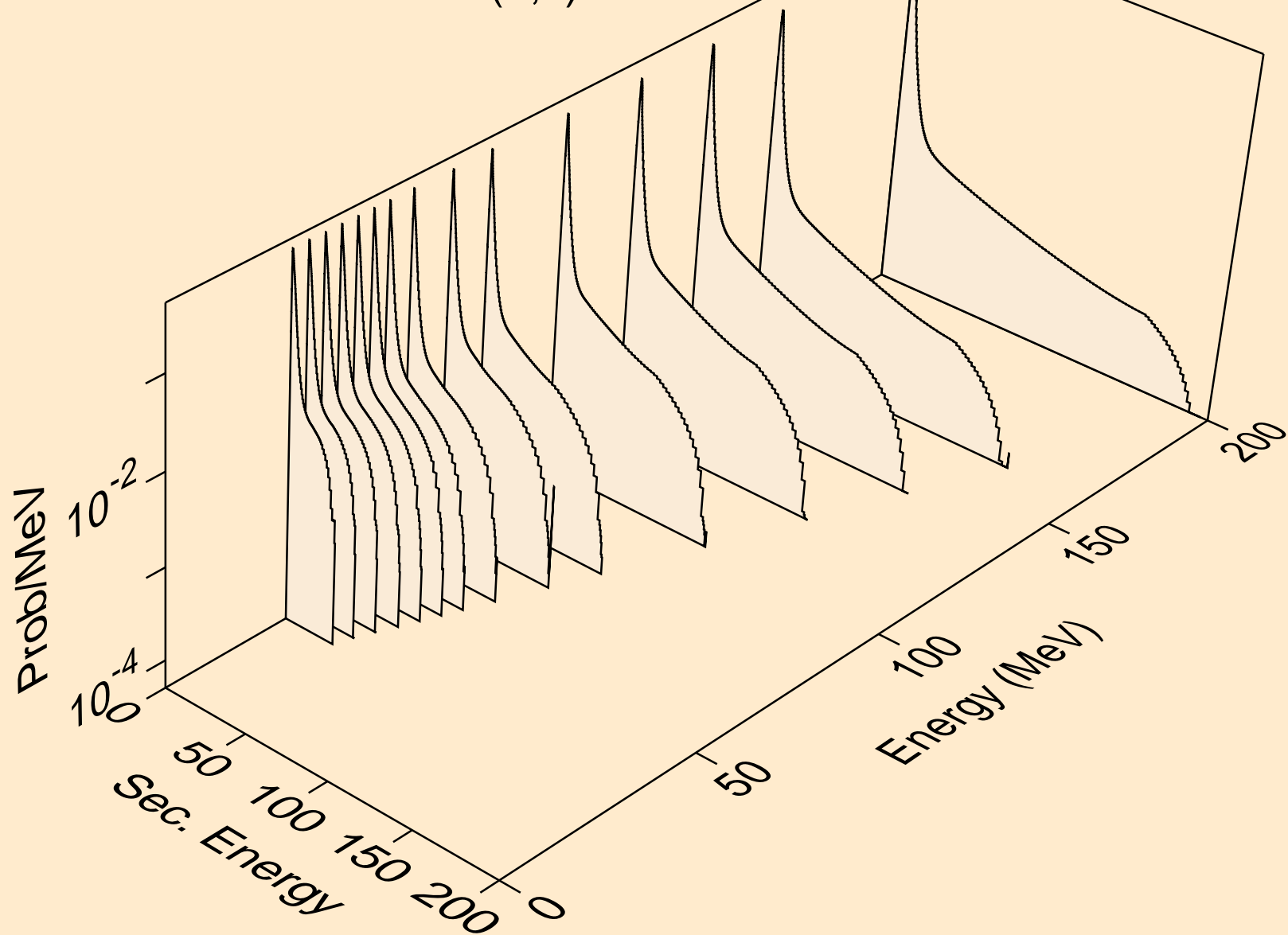

NB095M NEUTRON ACER TENDL-2023 LIBRARY; T=0.K  
Neutron emission for (n,2nd)

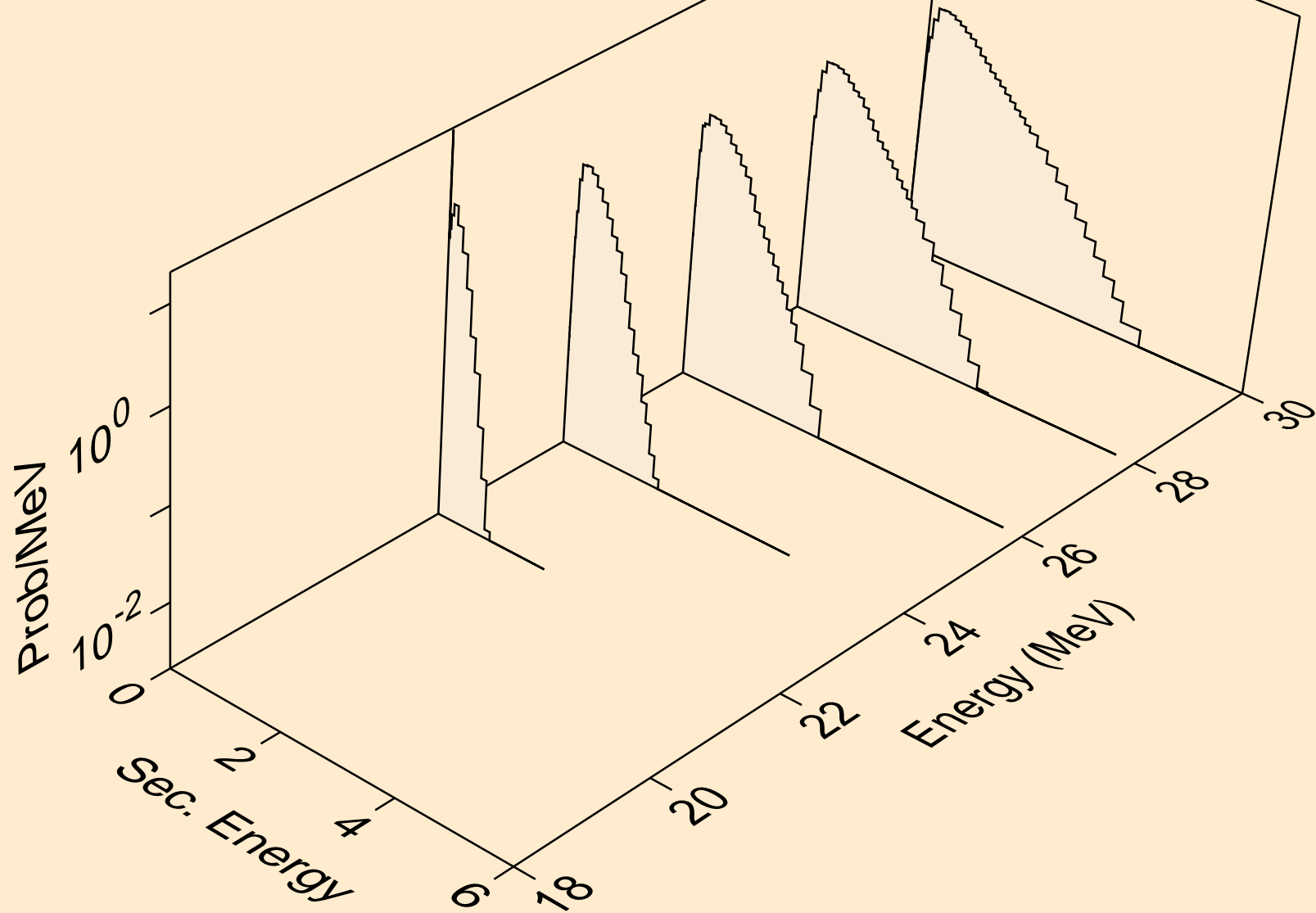

NB095M NEUTRON ACER TENDL-2023 LIBRARY; T=0.K  
Neutron emission for (n,2n)

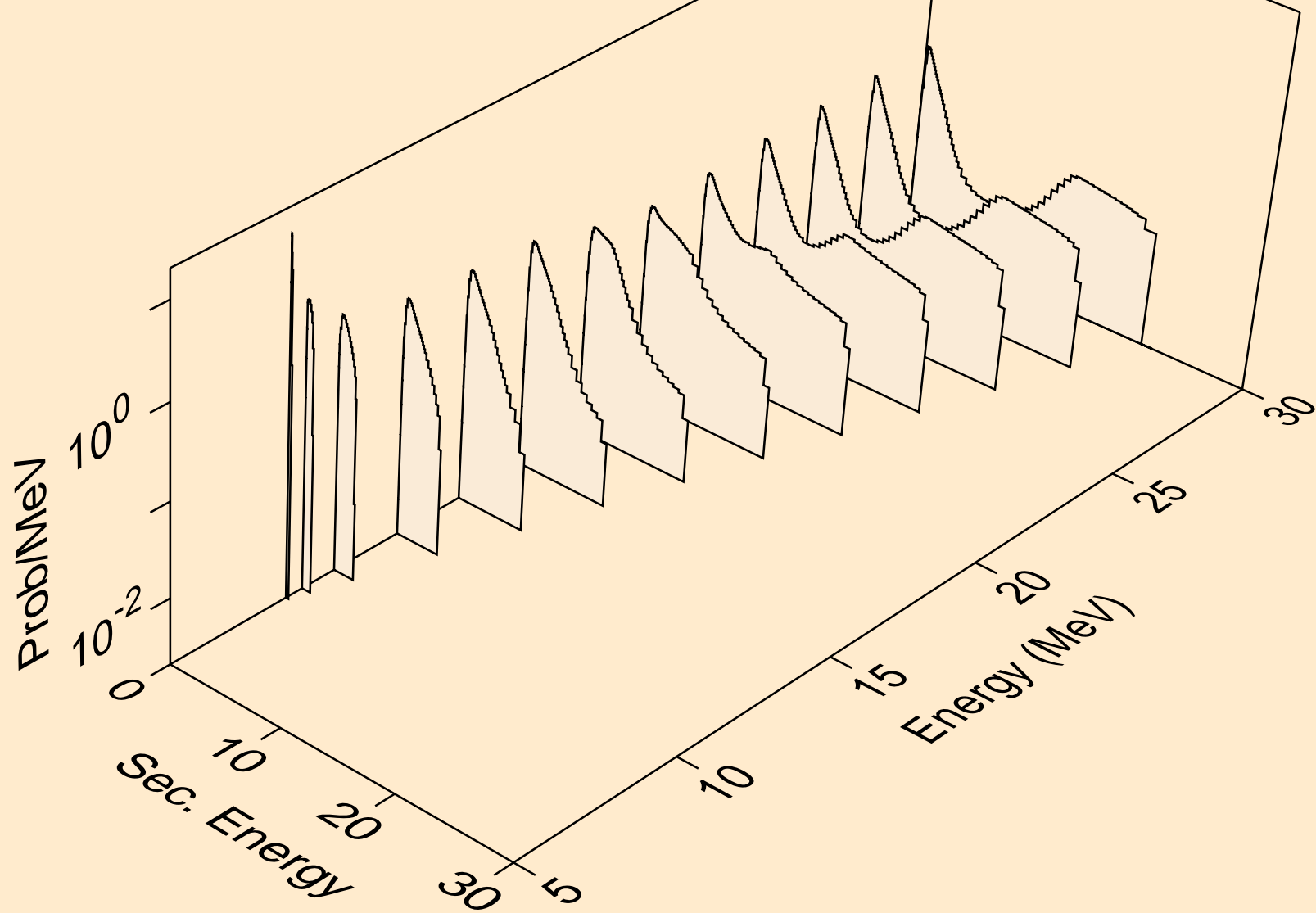

NB095M NEUTRON ACER TENDL-2023 LIBRARY; T=0.K  
Neutron emission for (n,3n)

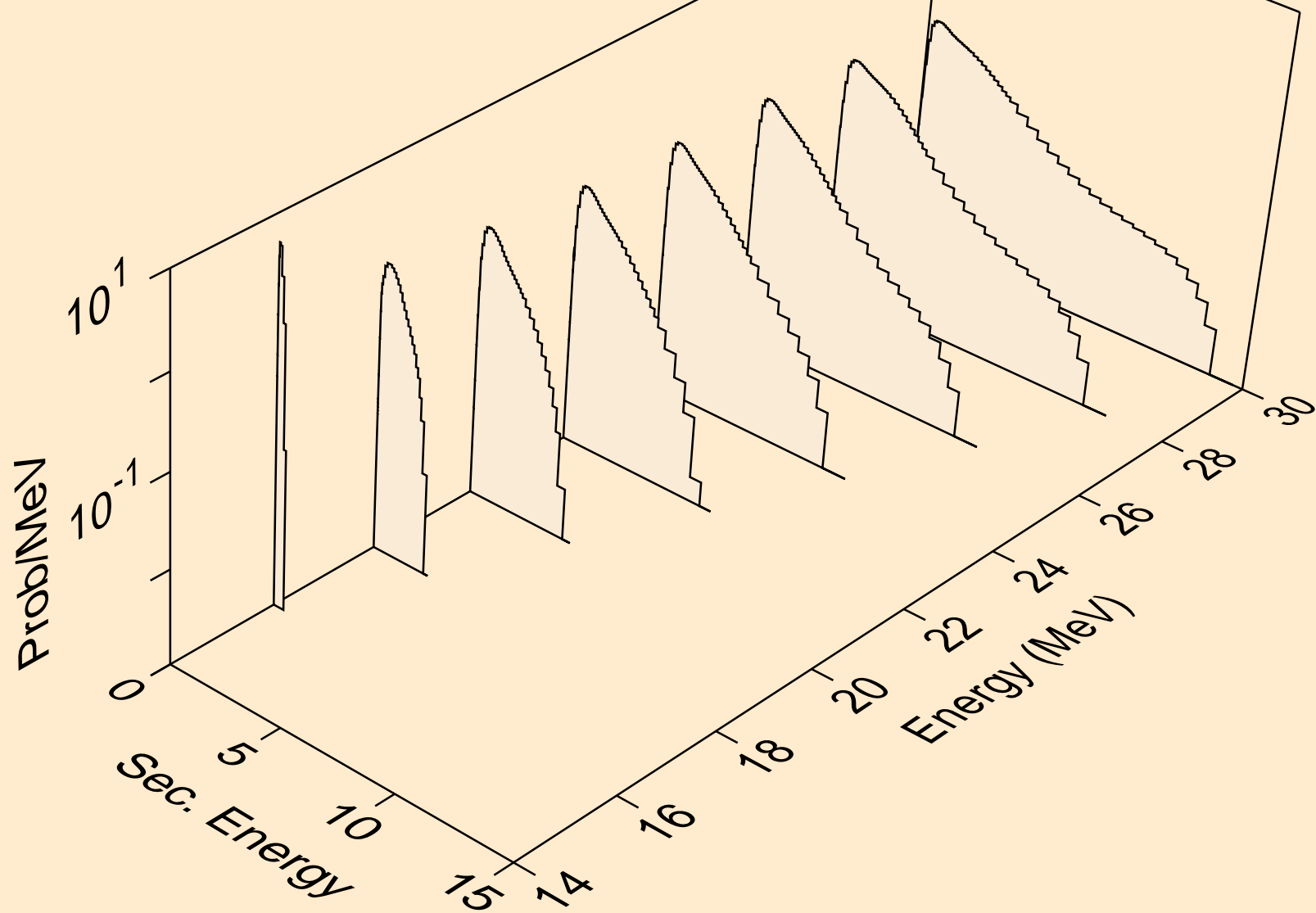

NB095M NEUTRON ACER TENDL-2023 LIBRARY; T=0.K  
Neutron emission for (n,n\*)a

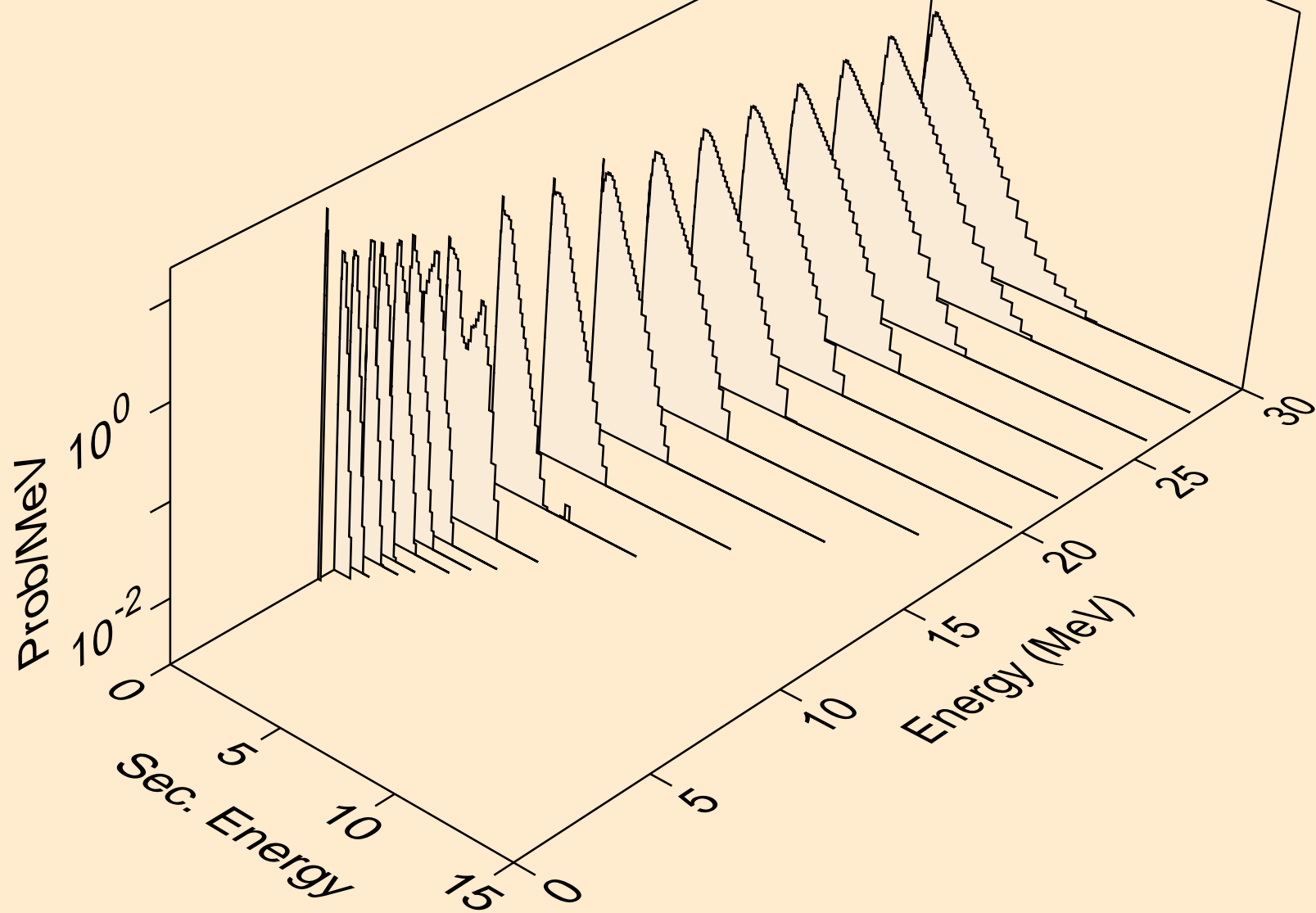

NB095M NEUTRON ACER TENDL-2023 LIBRARY; T=0.K  
Neutron emission for (n,2n)a

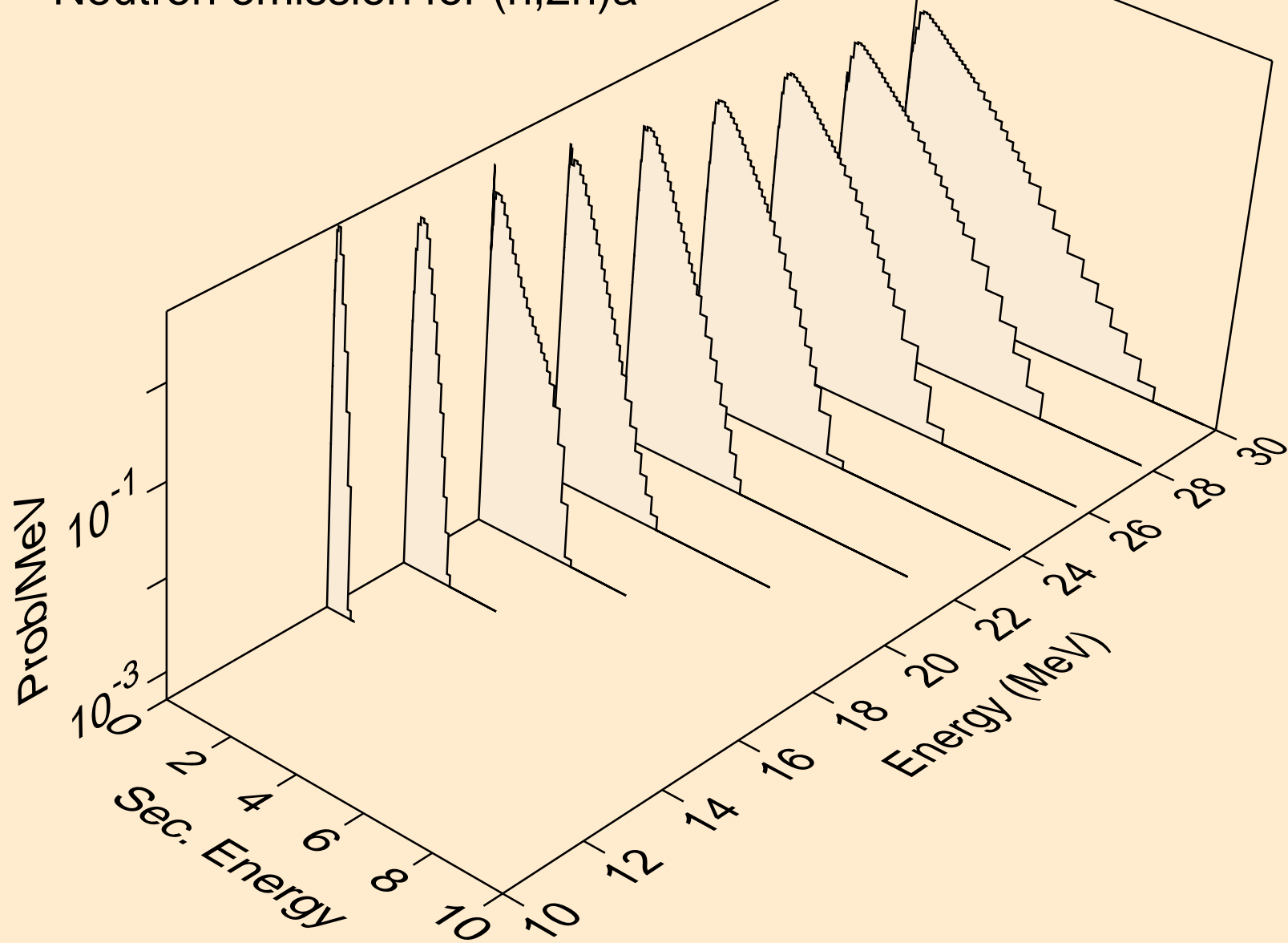

NB095M NEUTRON ACER TENDL-2023 LIBRARY; T=0.K  
Neutron emission for (n,3n)a

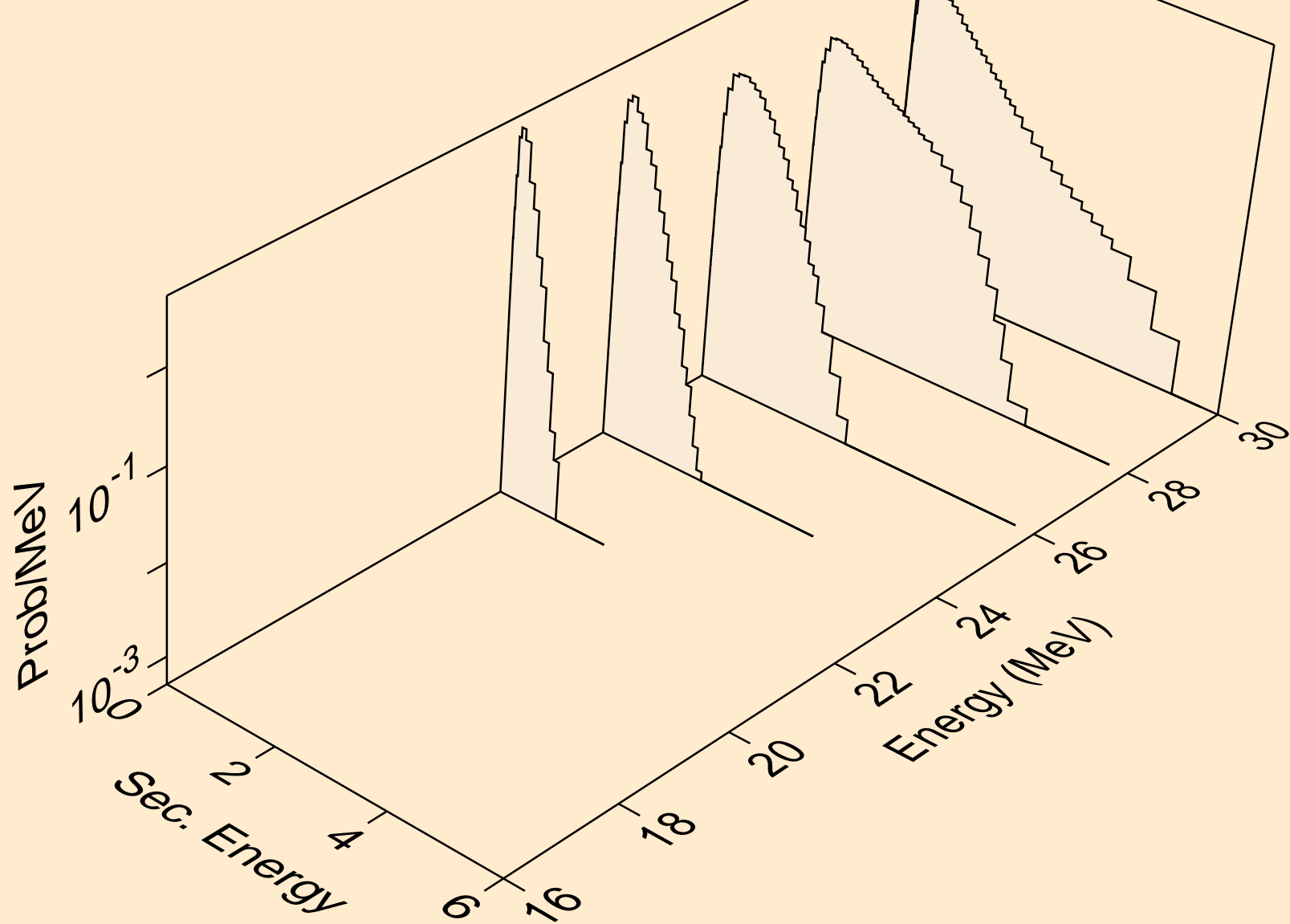

NB095M NEUTRON ACER TENDL-2023 LIBRARY; T=0.K  
Neutron emission for (n,n\*)p

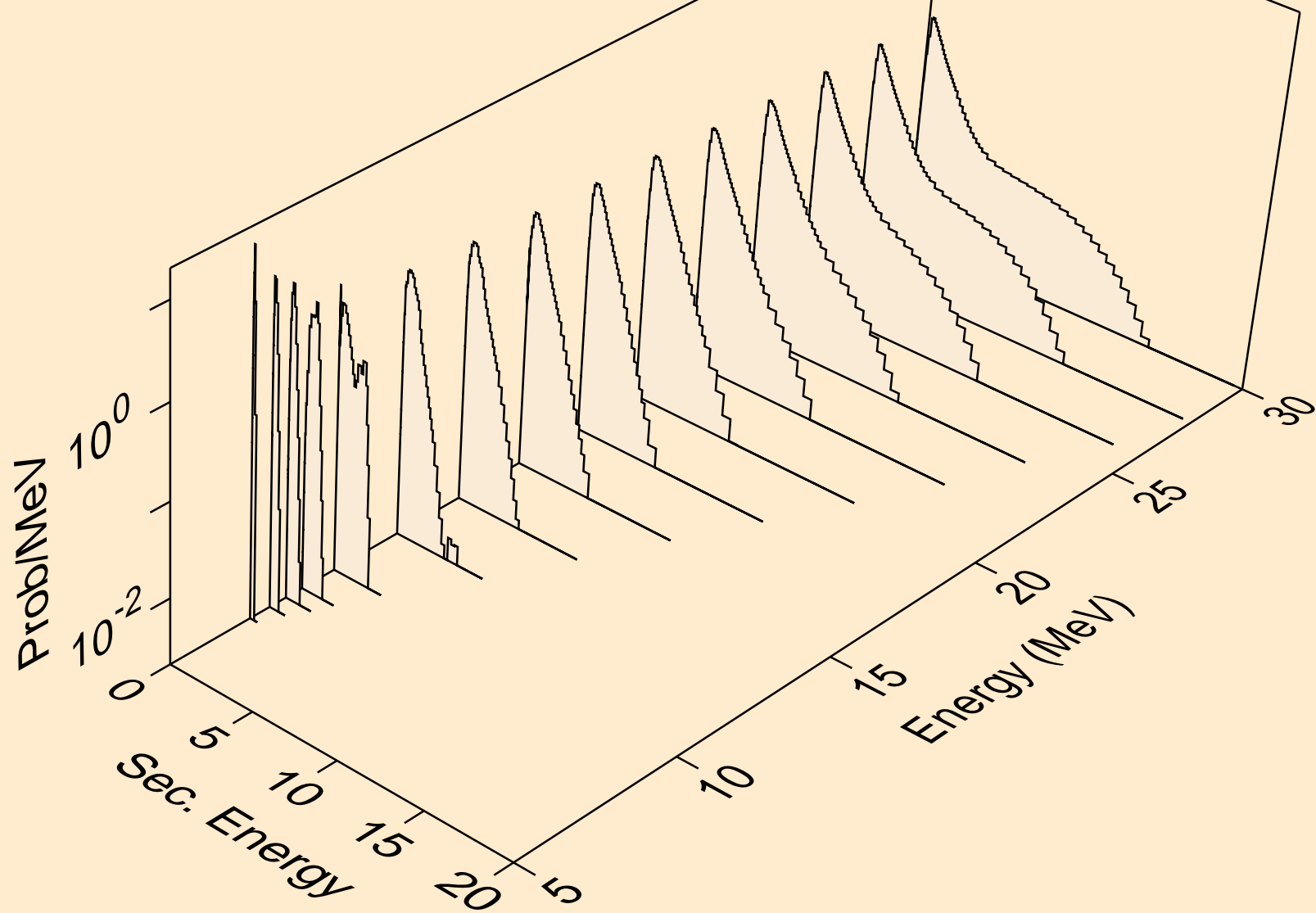

NB095M NEUTRON ACER TENDL-2023 LIBRARY; T=0.K  
Neutron emission for (n,n\*)2a

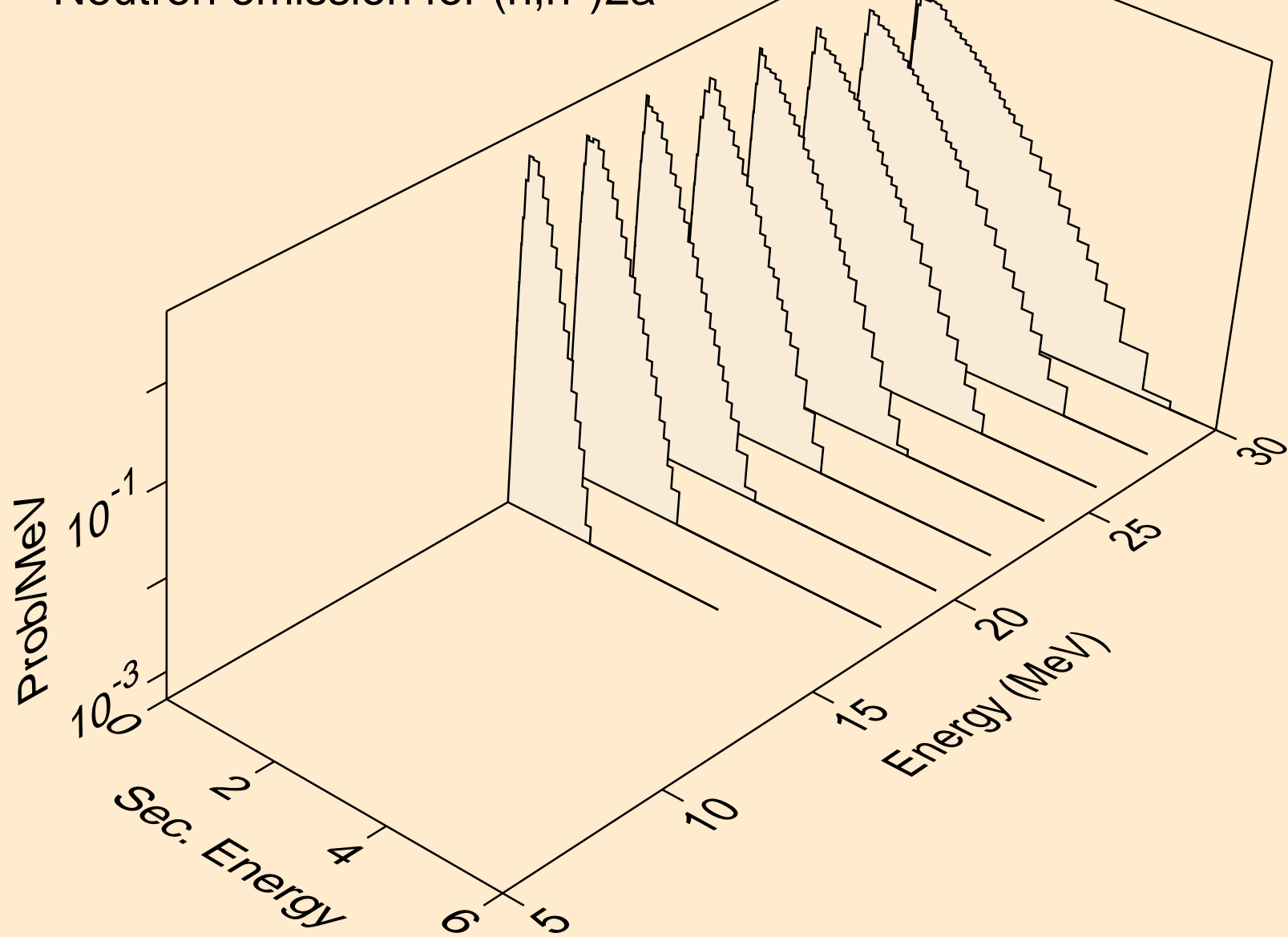

NB095M NEUTRON ACER TENDL-2023 LIBRARY; T=0.K  
Neutron emission for (n,n\*)d

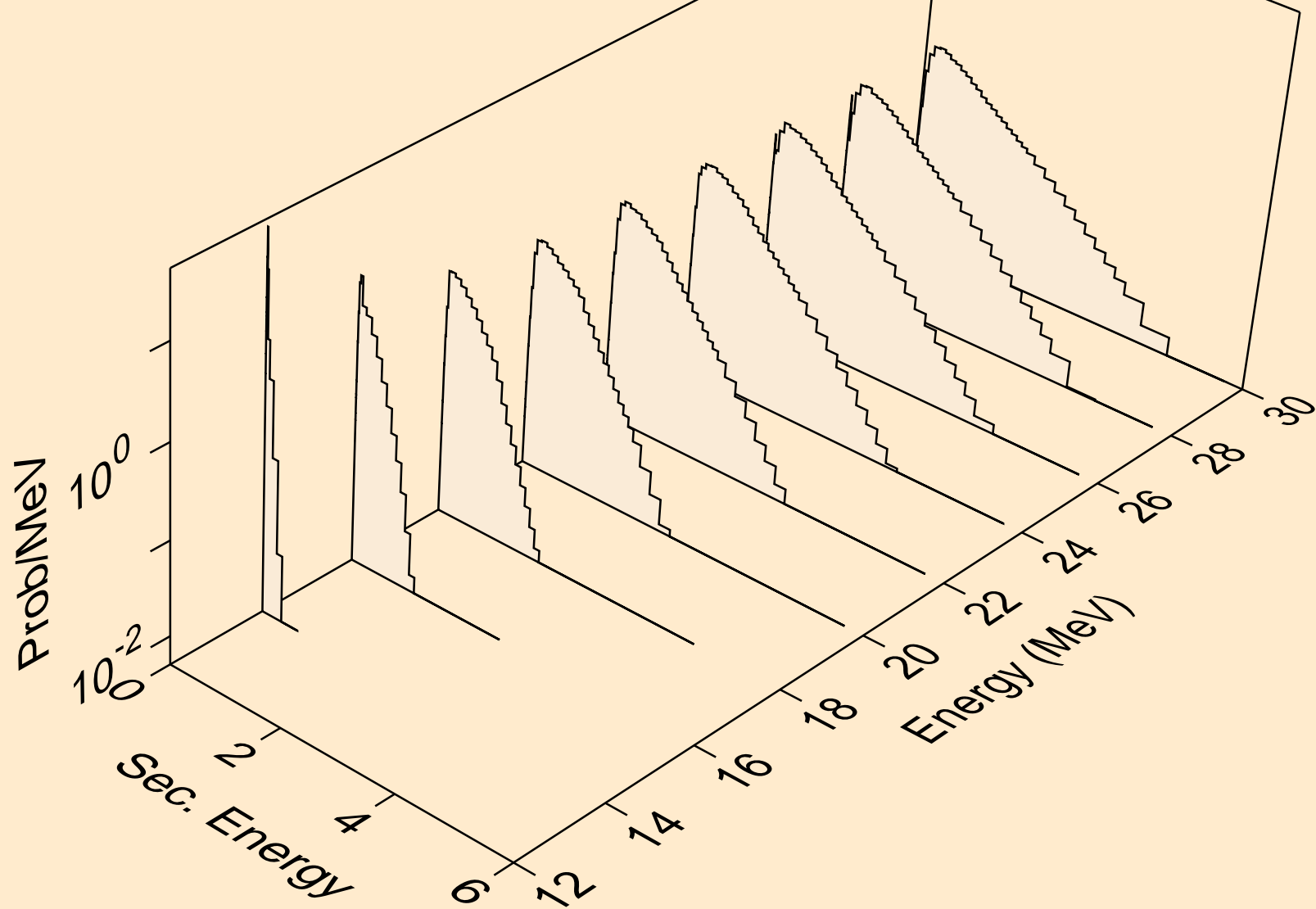

NB095M NEUTRON ACER TENDL-2023 LIBRARY; T=0.K  
Neutron emission for (n,n\*)t

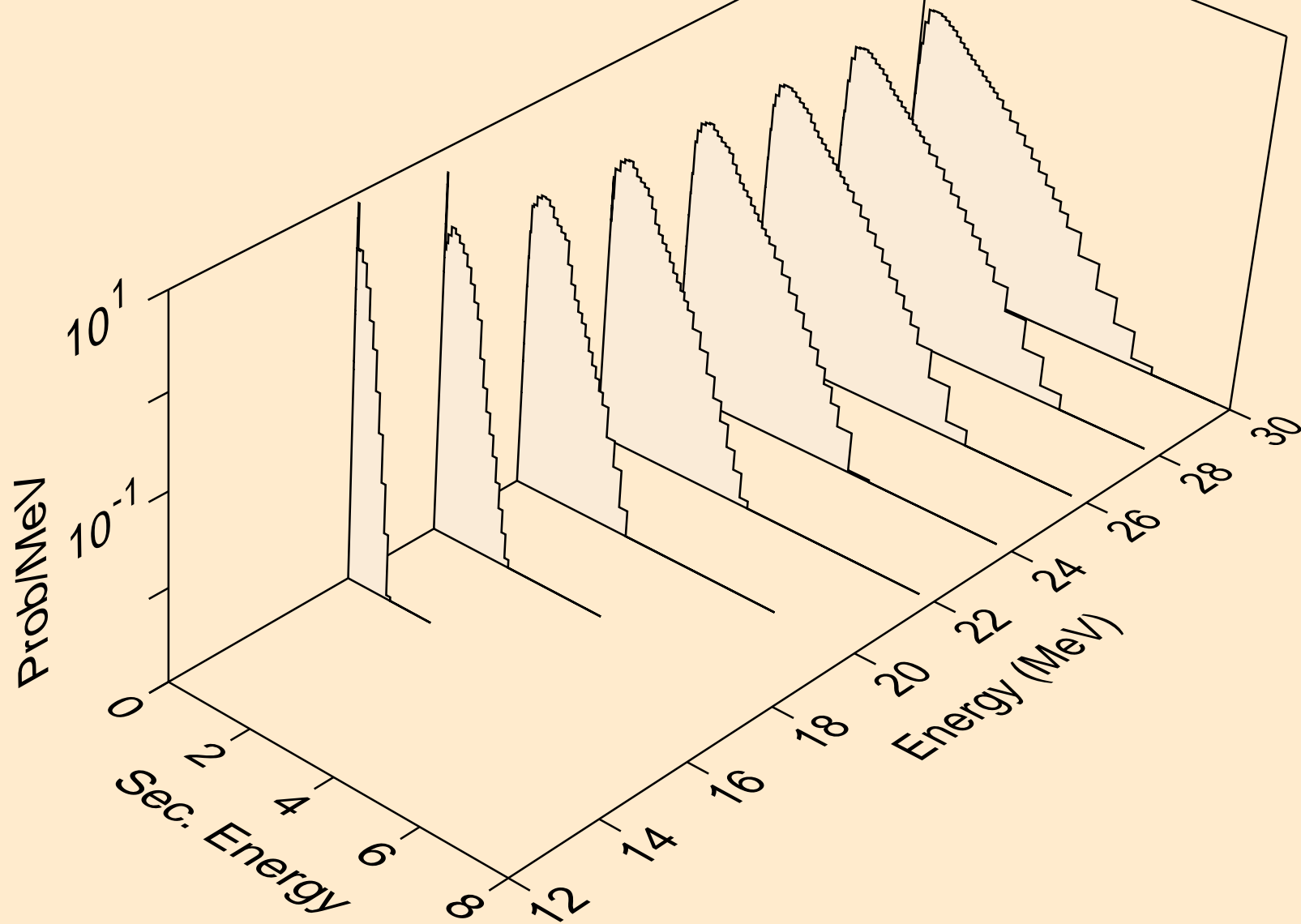

NB095M NEUTRON ACER TENDL-2023 LIBRARY; T=0.K  
Neutron emission for (n,n\*)he3

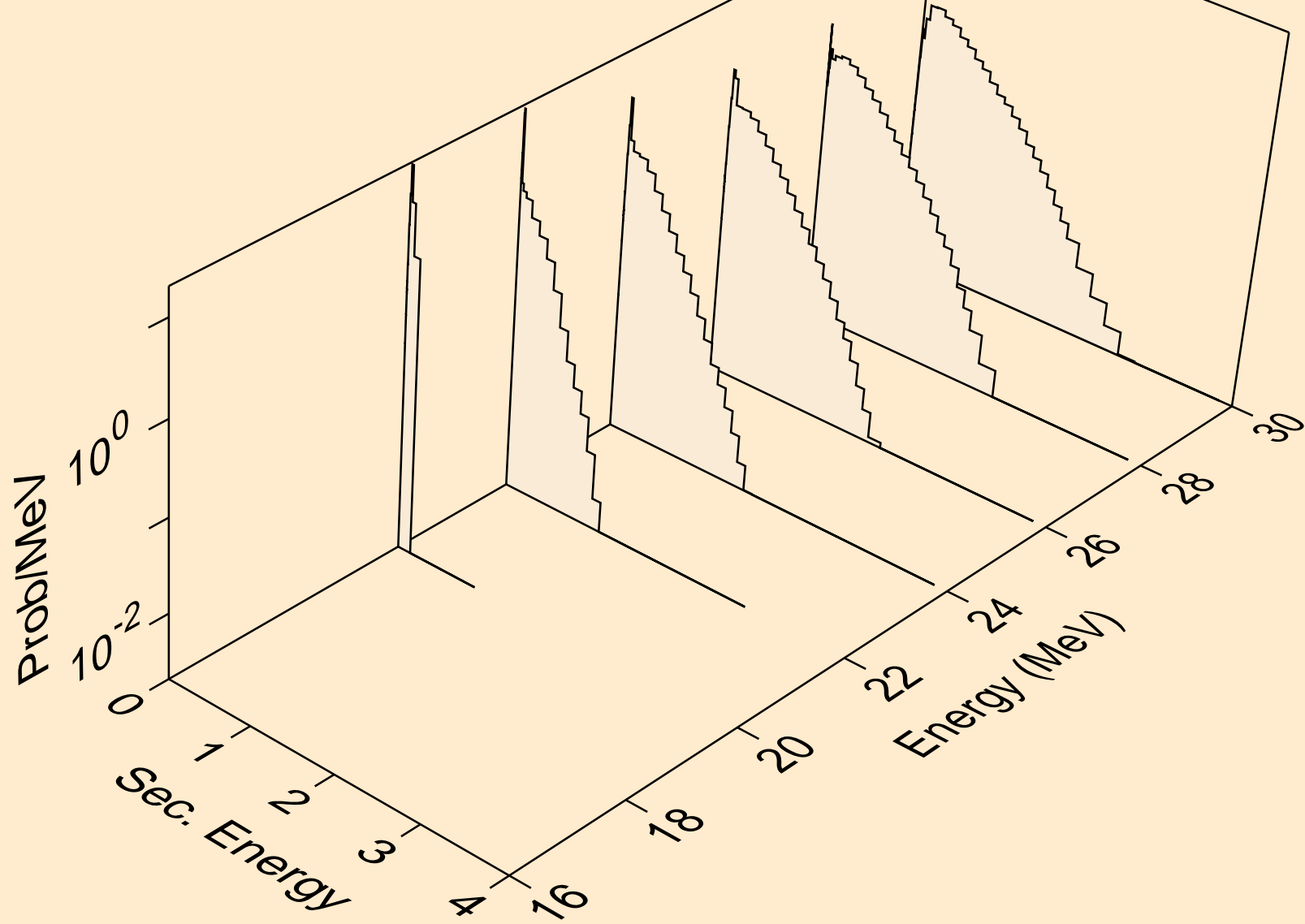

NB095M NEUTRON ACER TENDL-2023 LIBRARY; T=0.K  
Neutron emission for (n,4n)

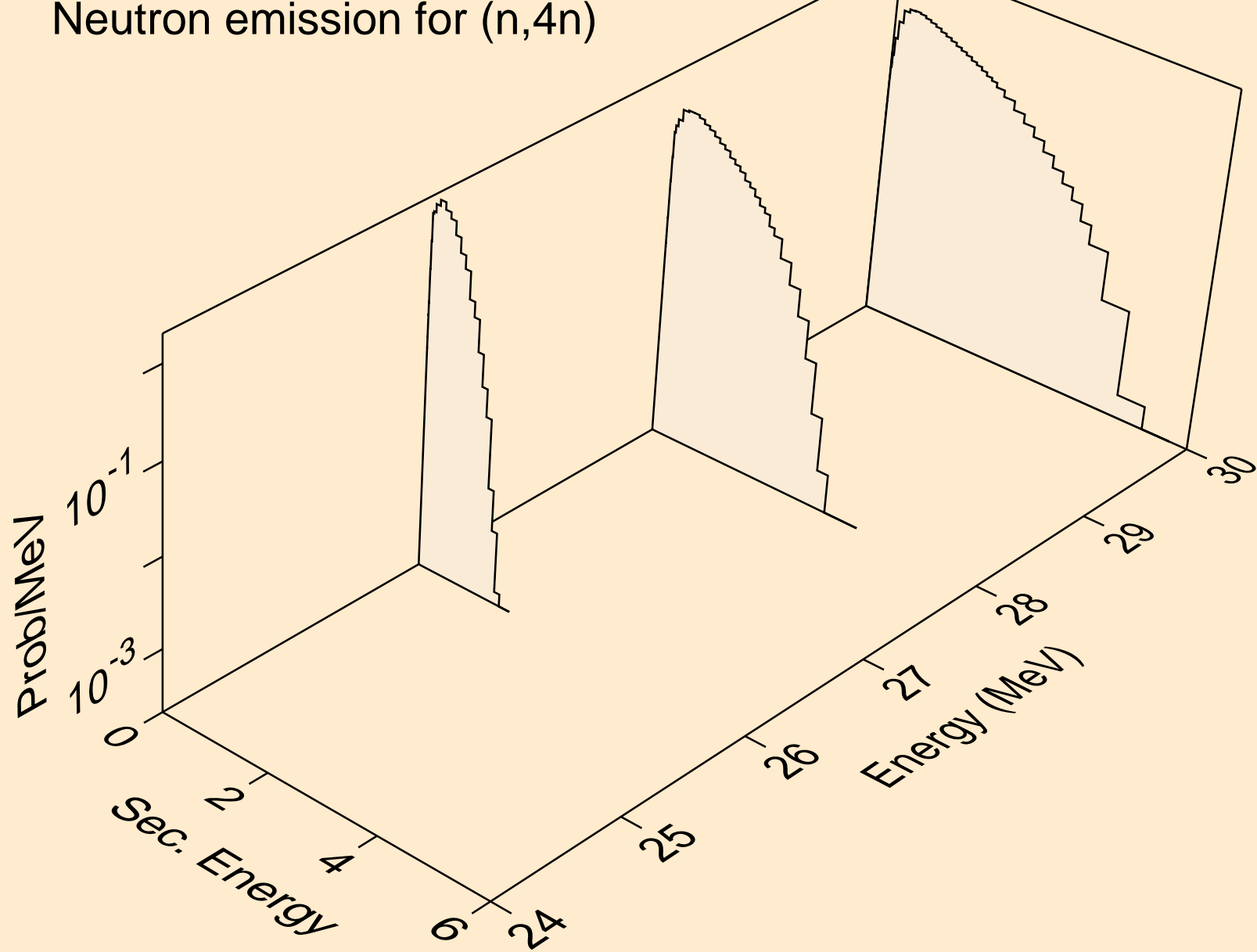

NB095M NEUTRON ACER TENDL-2023 LIBRARY; T=0.K  
Neutron emission for (n,2np)

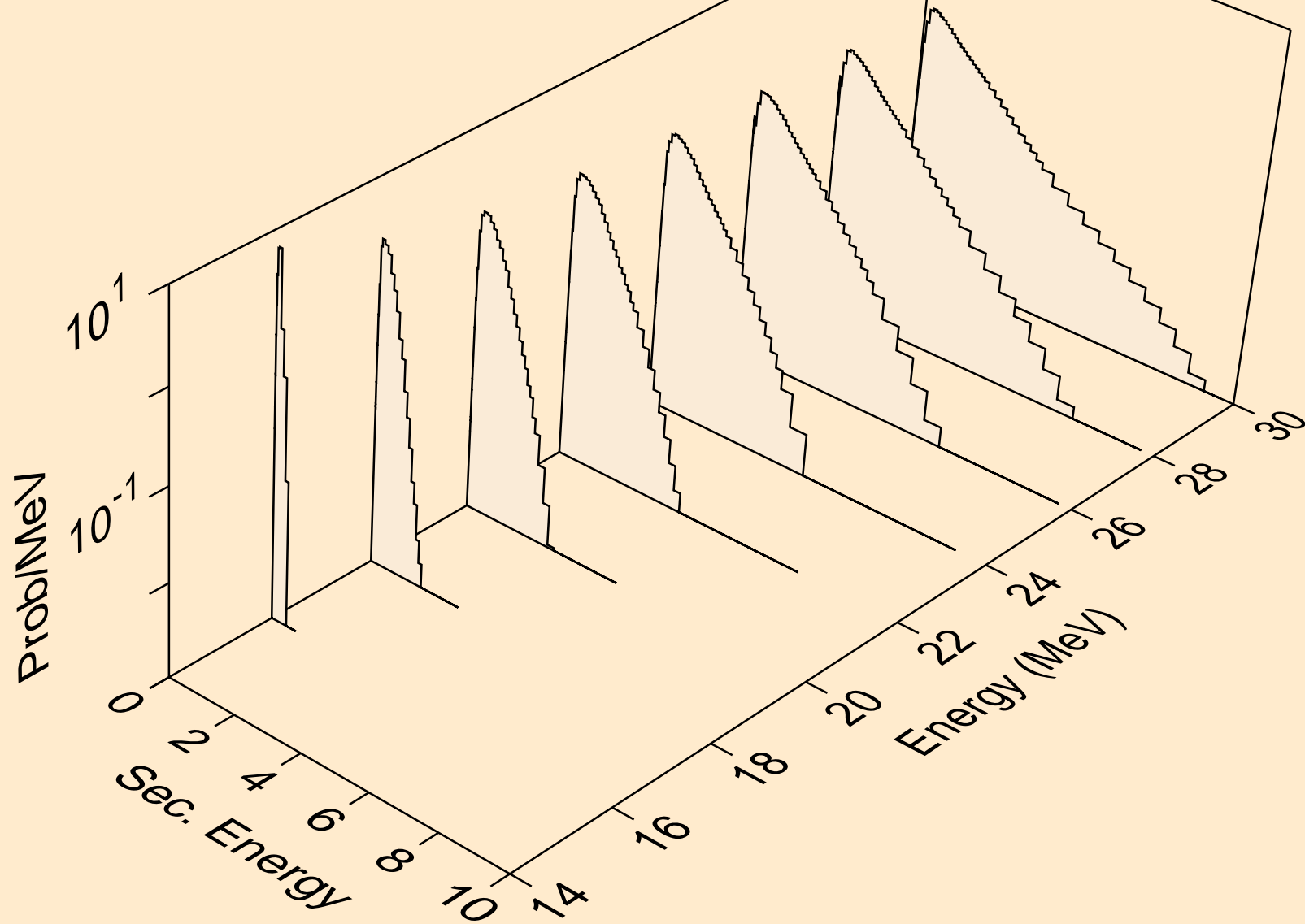

NB095M NEUTRON ACER TENDL-2023 LIBRARY; T=0.K  
Neutron emission for (n,3np)

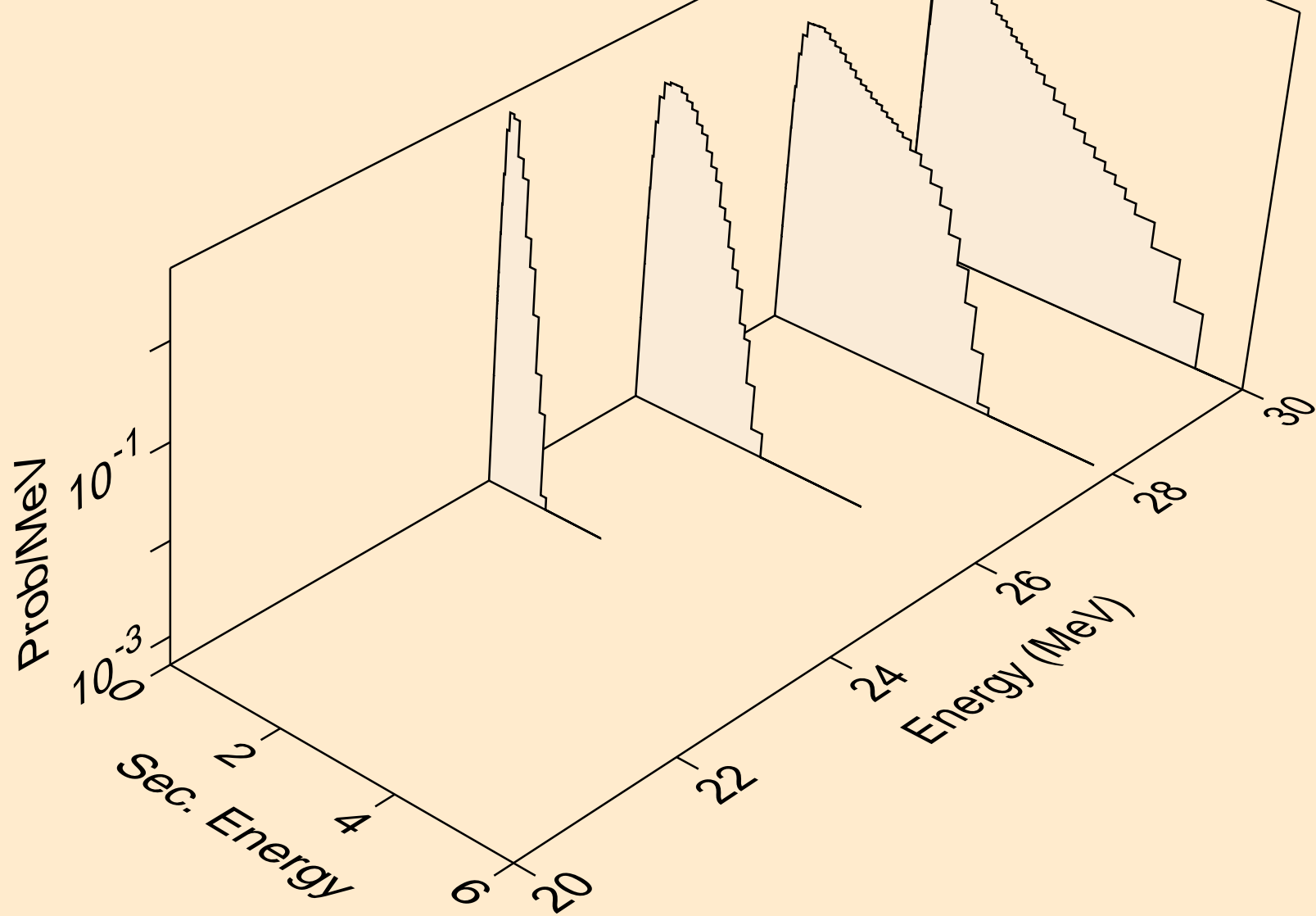

NB095M NEUTRON ACER TENDL-2023 LIBRARY; T=0.K  
Neutron emission for (n,n2p)

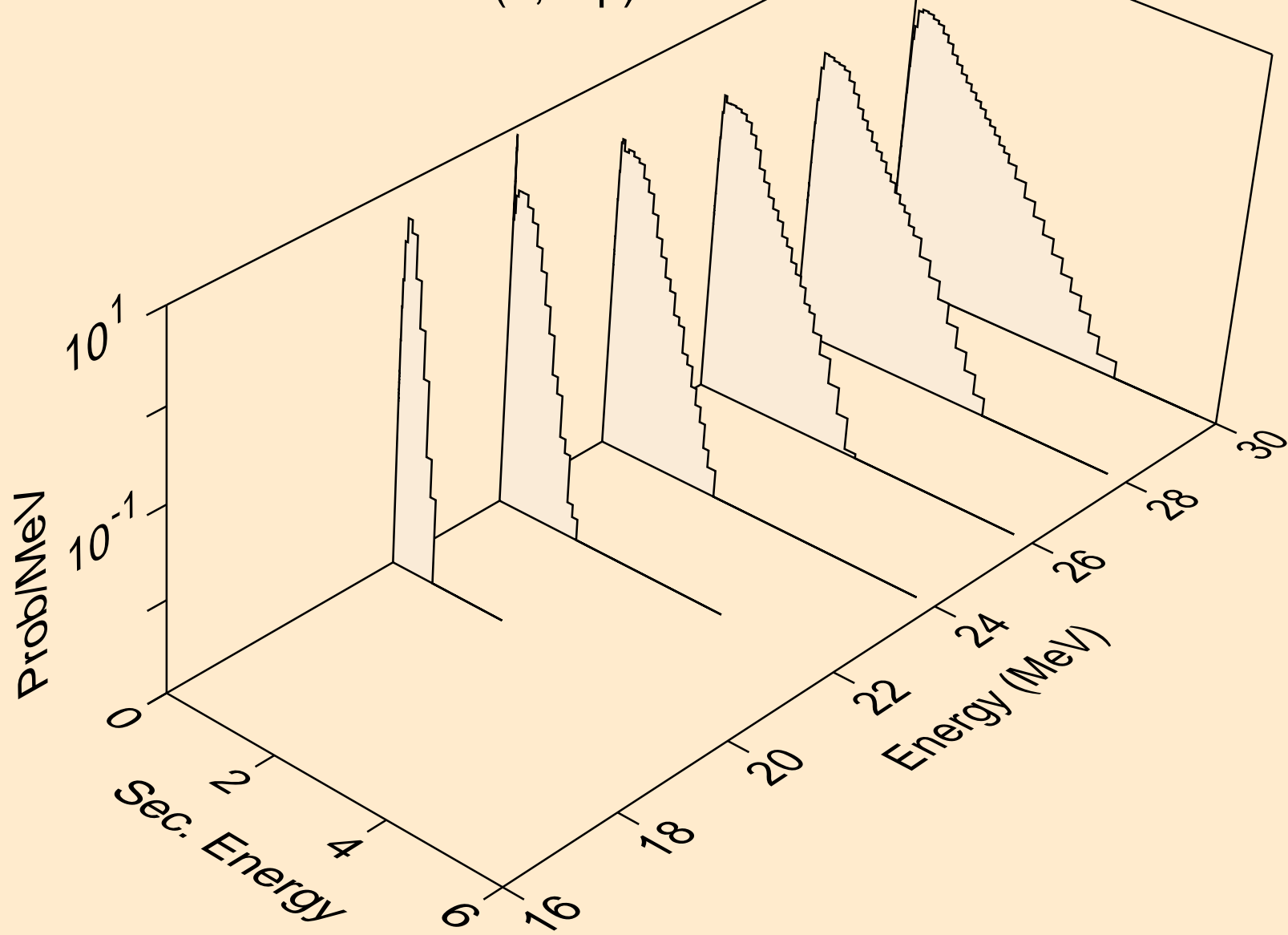

NB095M NEUTRON ACER TENDL-2023 LIBRARY; T=0.K  
Neutron emission for (n,npa)

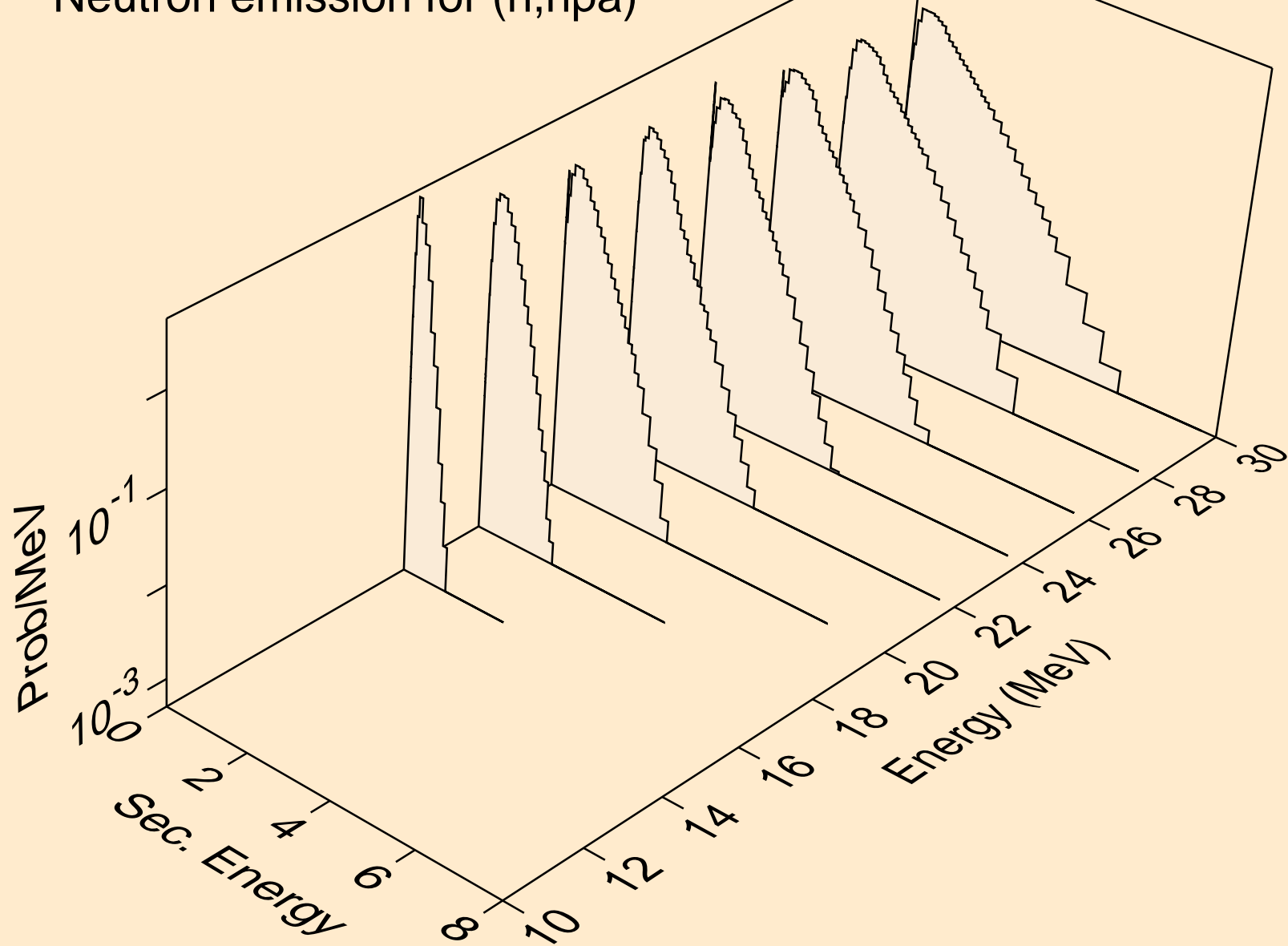

NB095M NEUTRON ACER TENDL-2023 LIBRARY; T=0.K  
Neutron emission for (n,n\*c)

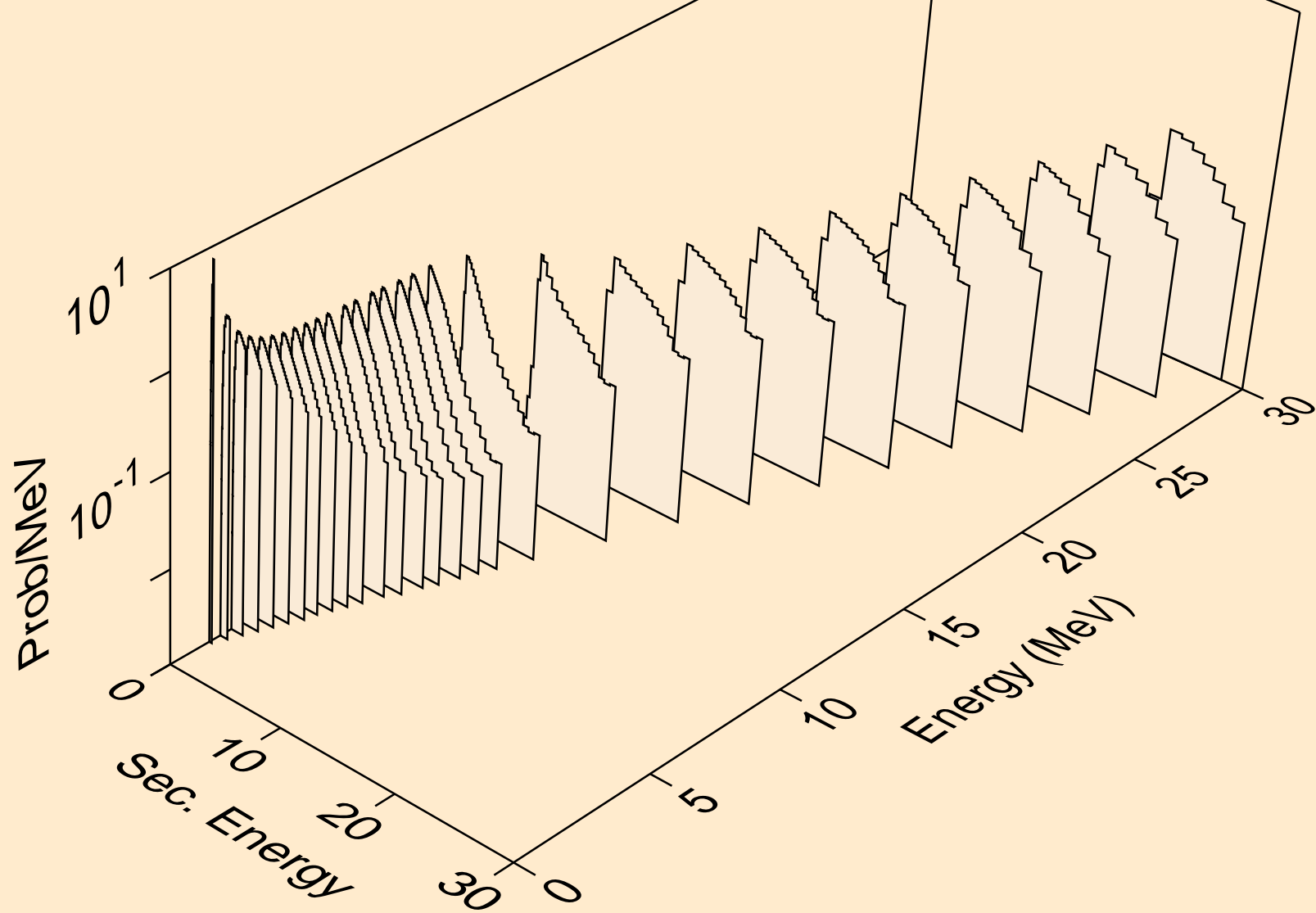

NB095M NEUTRON ACER TENDL-2023 LIBRARY; T=0.K  
Photon emission for (n,x)

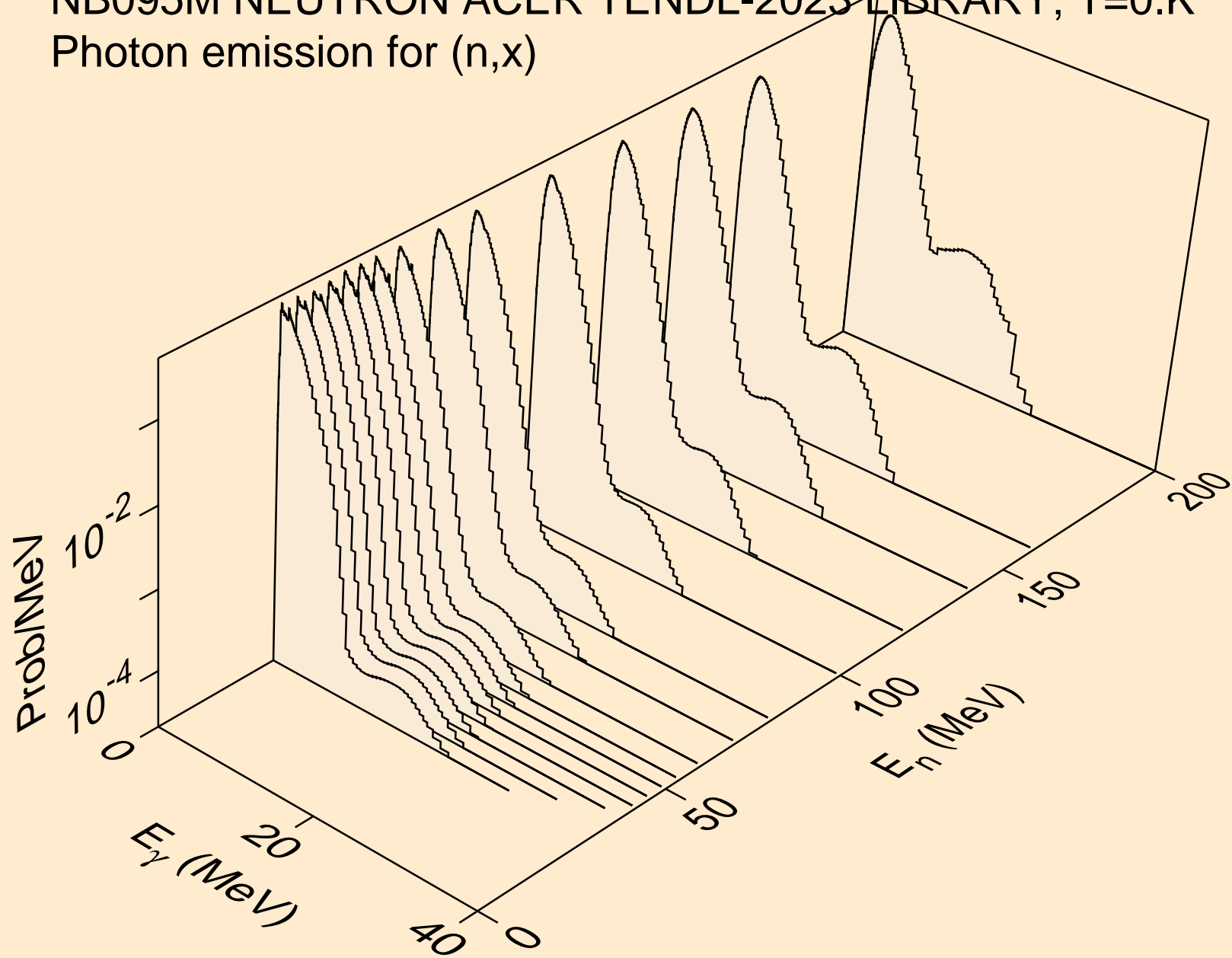

NB095M NEUTRON ACER TENDL-2023 LIBRARY; T=0.K  
Photon emission for (n,2nd)

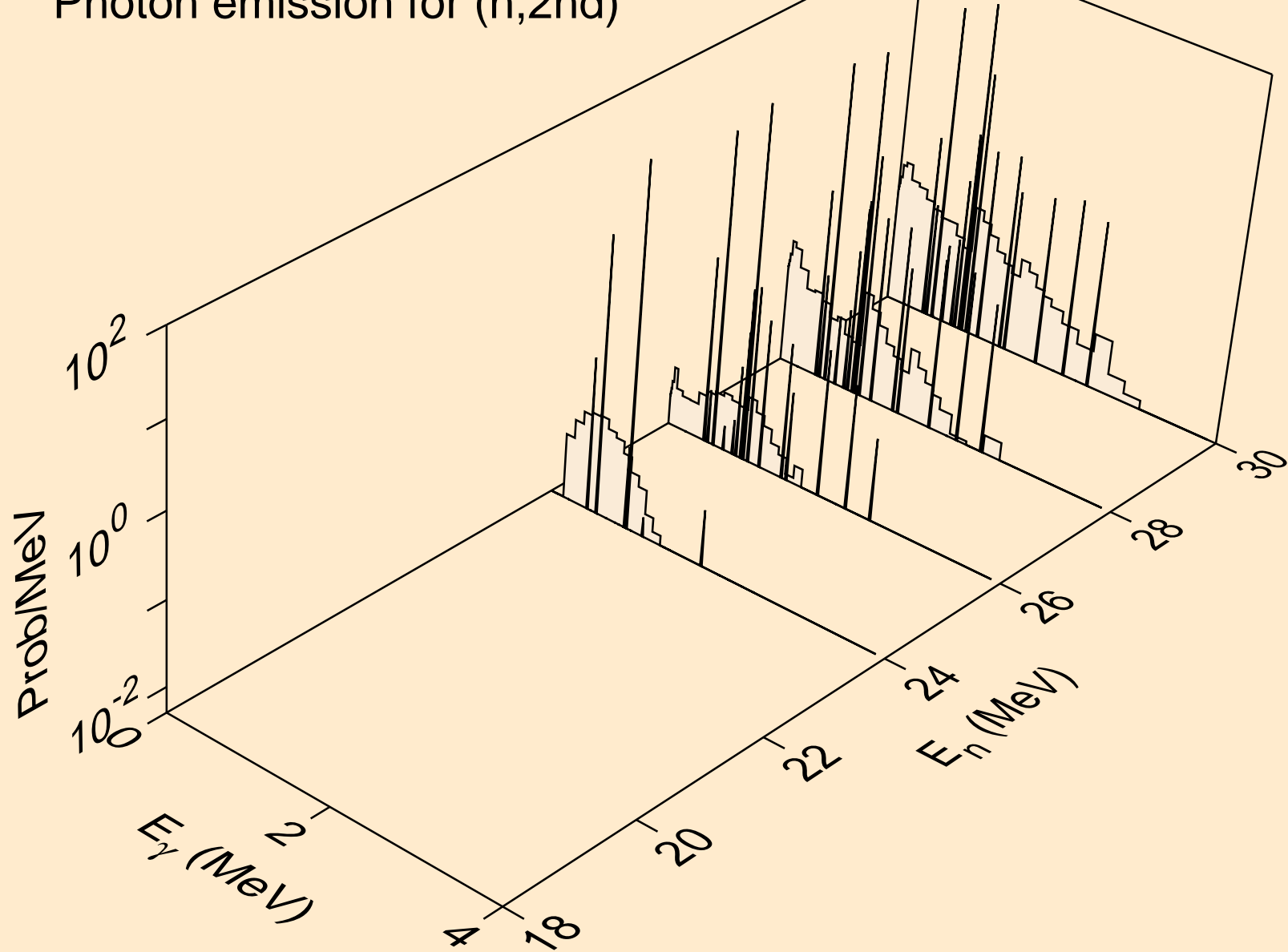

NB095M NEUTRON ACER TENDL-2023 LIBRARY; T=0.K  
Photon emission for (n,2n)

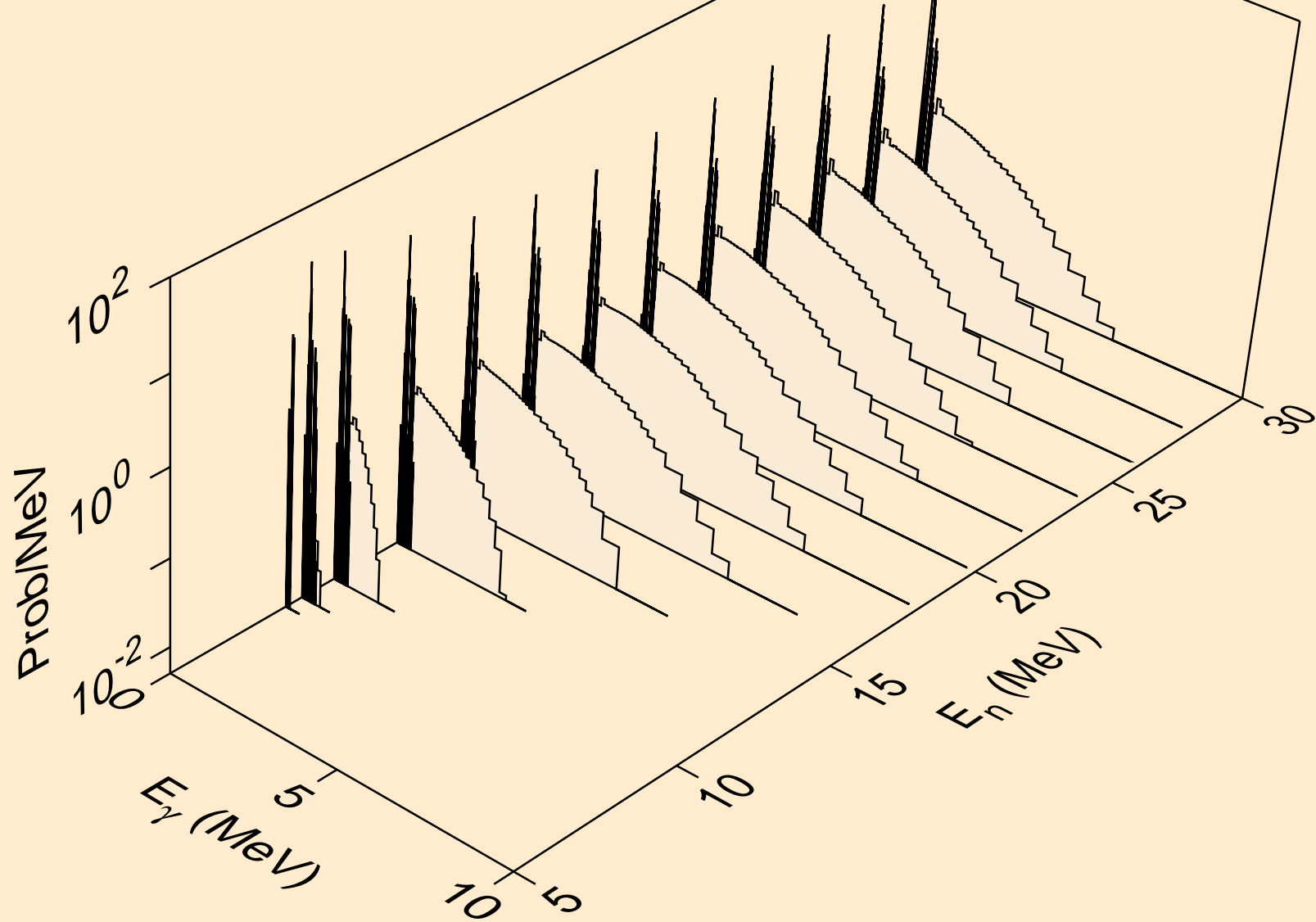

NB095M NEUTRON ACER TENDL-2023 LIBRARY; T=0.K  
Photon emission for (n,3n)

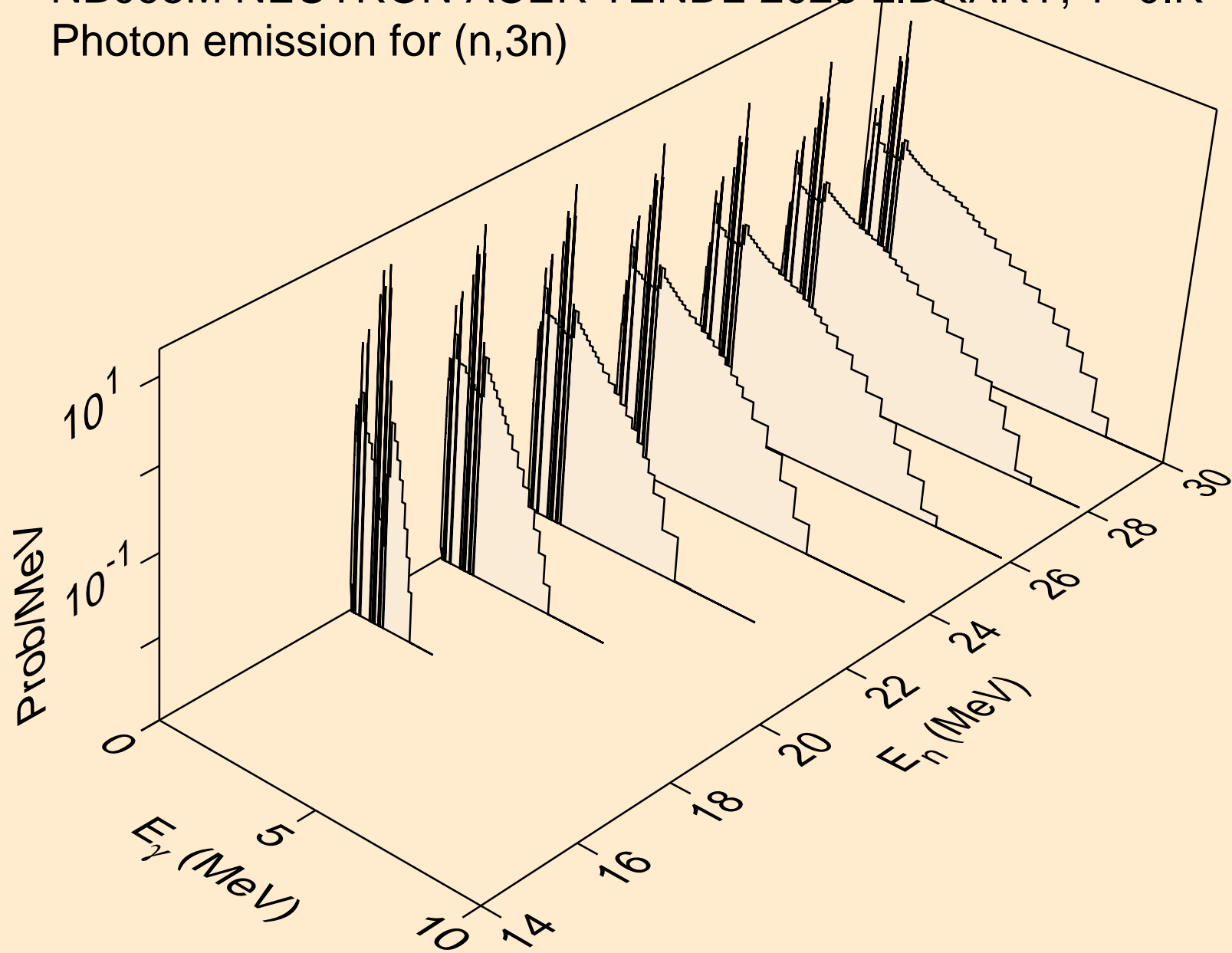

NB095M NEUTRON ACER TENDL-2023 LIBRARY; T=0.K  
Photon emission for (n,n\*)a

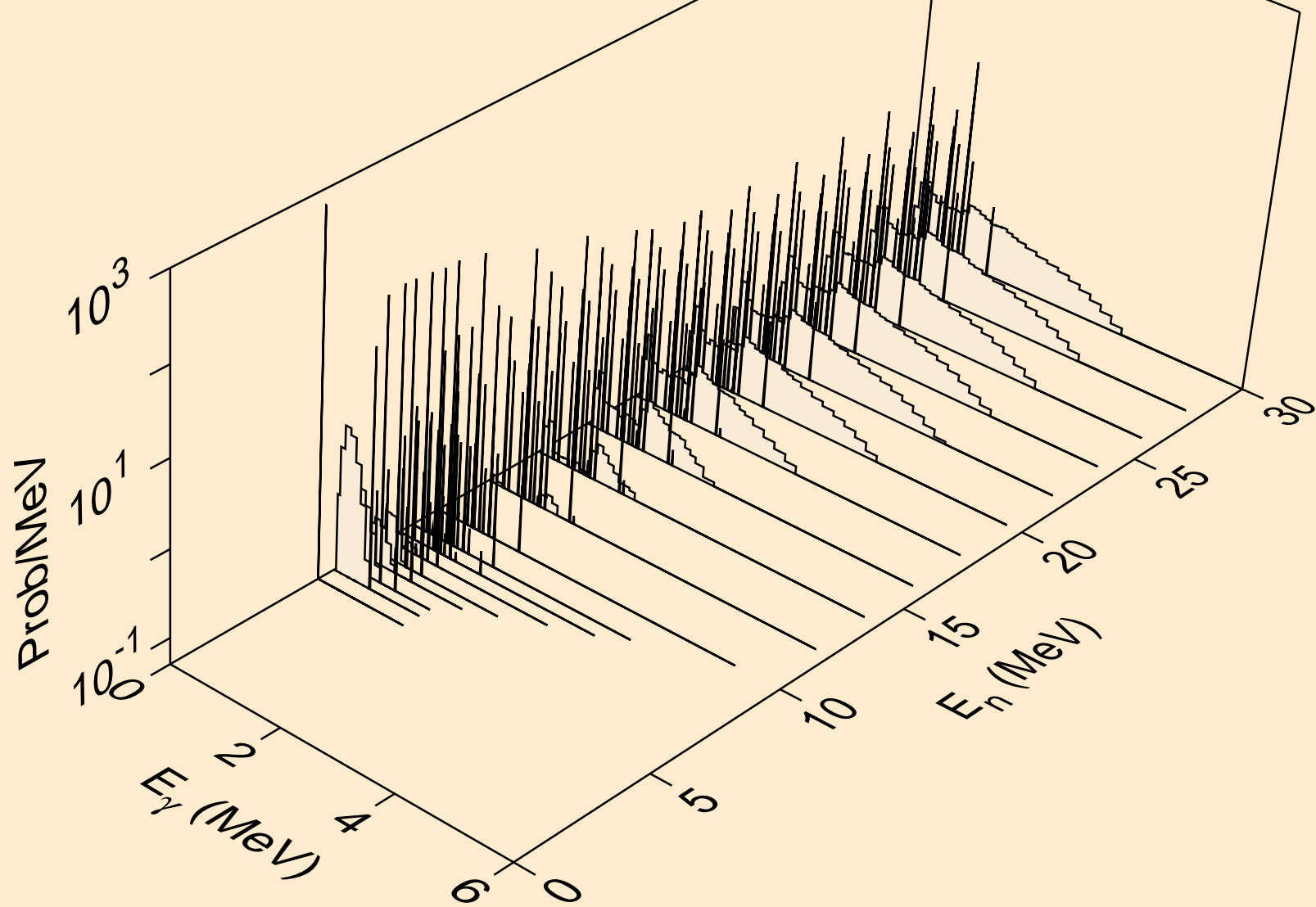

NB095M NEUTRON ACER TENDL-2023 LIBRARY; T=0.K  
Photon emission for (n,2n)a

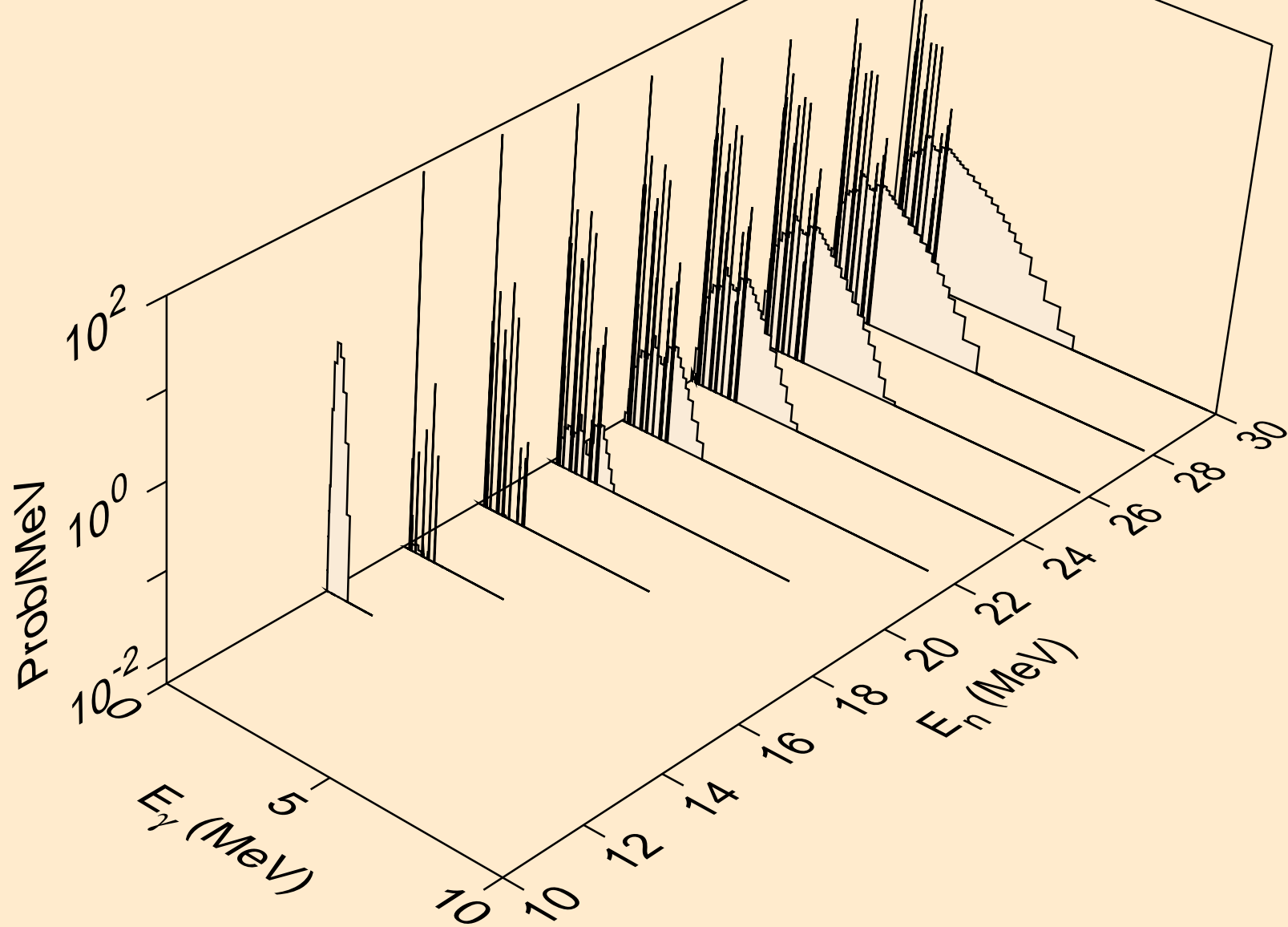

NB095M NEUTRON ACER TENDL-2023 LIBRARY; T=0.K  
Photon emission for (n,3n)a

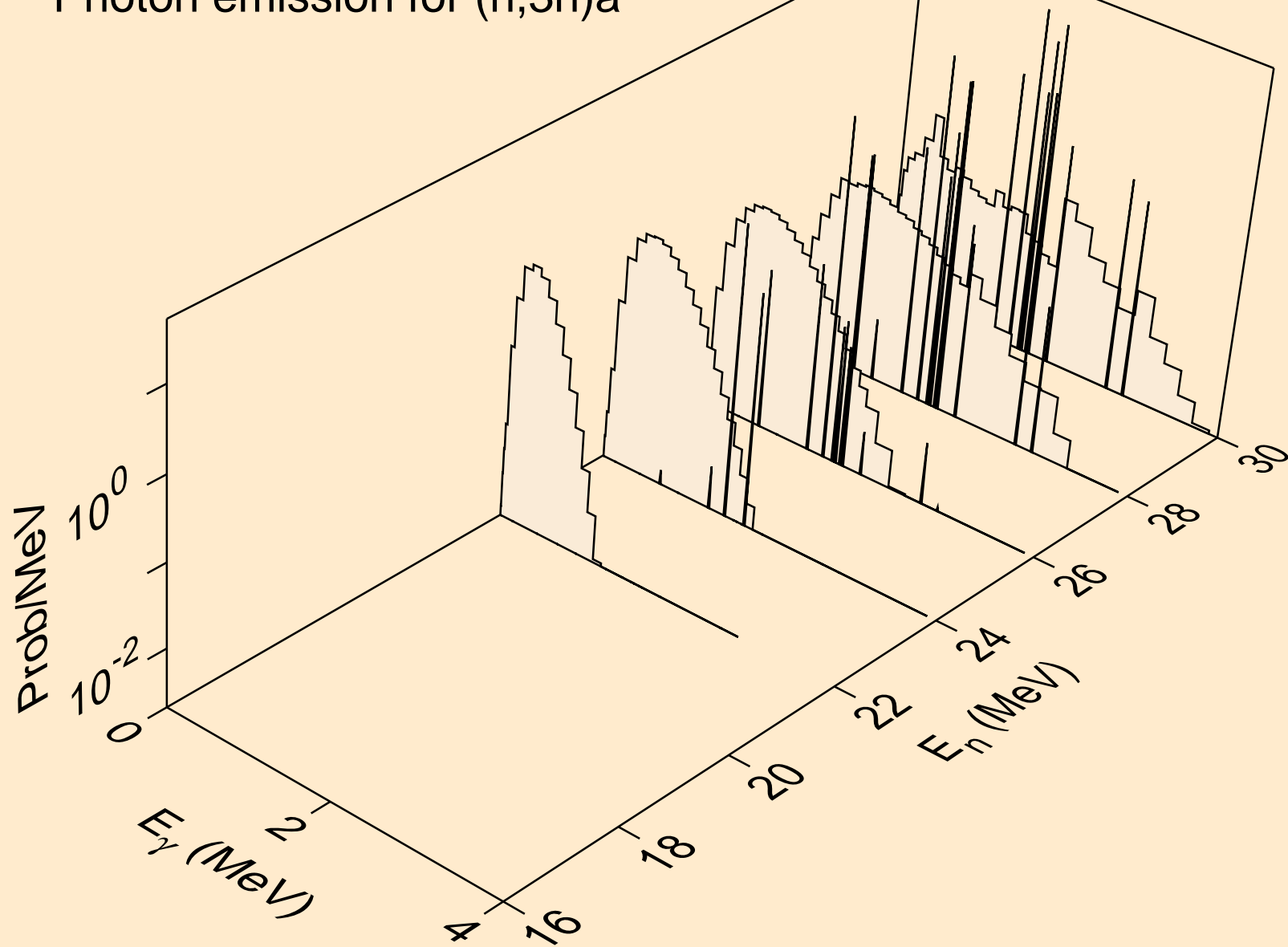

NB095M NEUTRON ACER TENDL-2023 LIBRARY; T=0.K  
Photon emission for (n,n\*)p

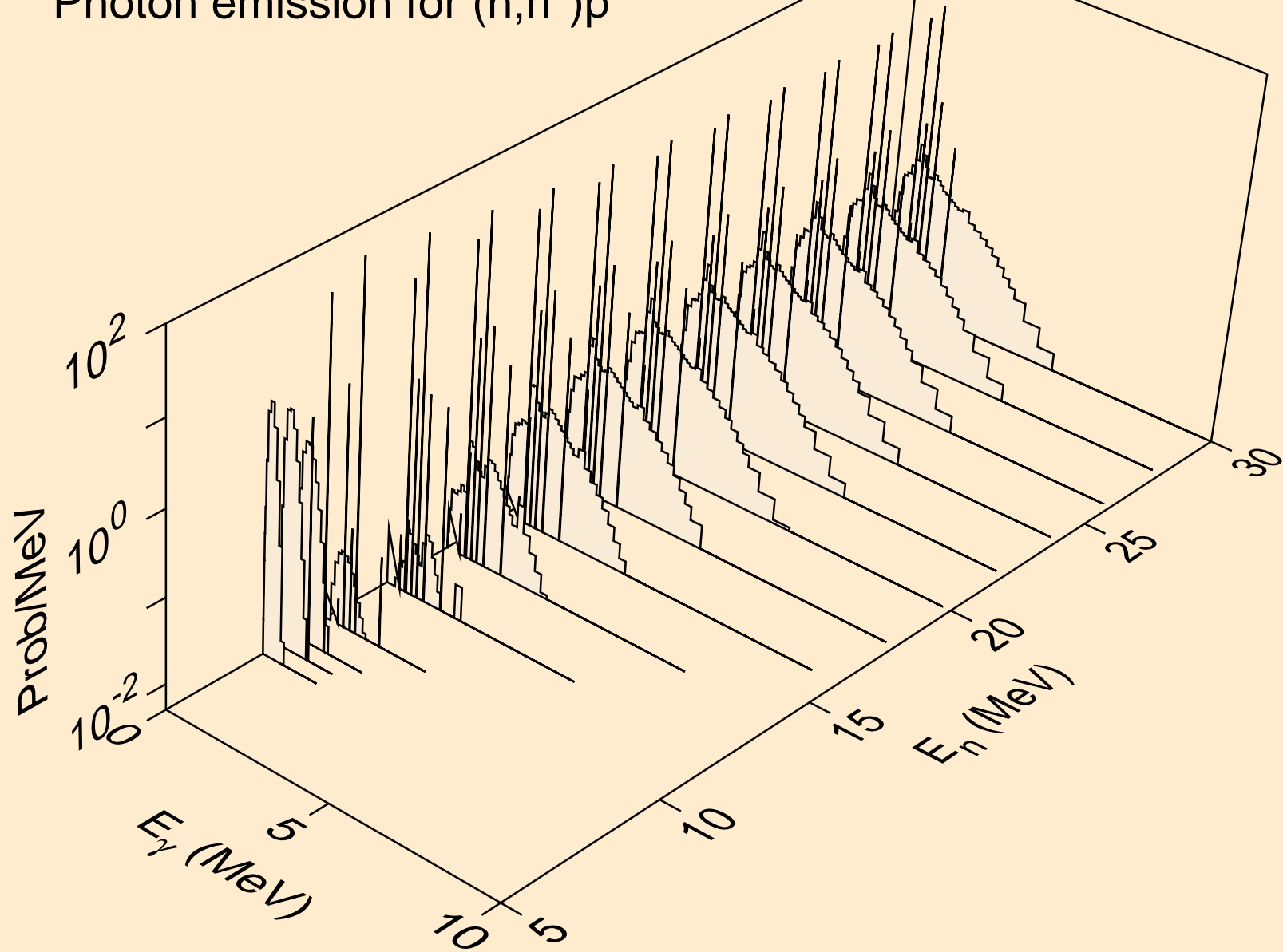

NB095M NEUTRON ACER TENDL-2023 LIBRARY; T=0.K  
Photon emission for (n,n\*)2a

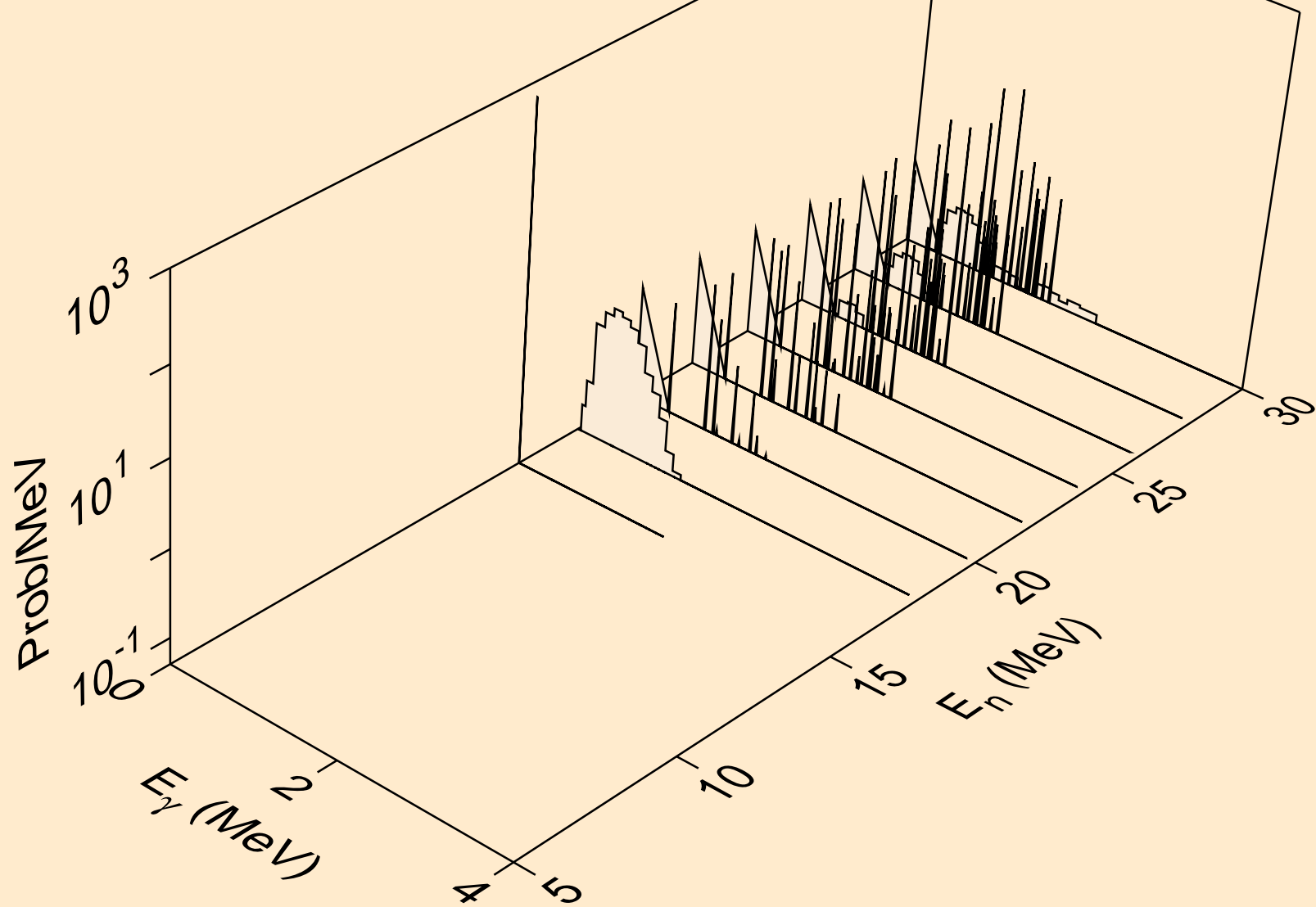

NB095M NEUTRON ACER TENDL-2023 LIBRARY; T=0.K  
Photon emission for (n,n\*)d

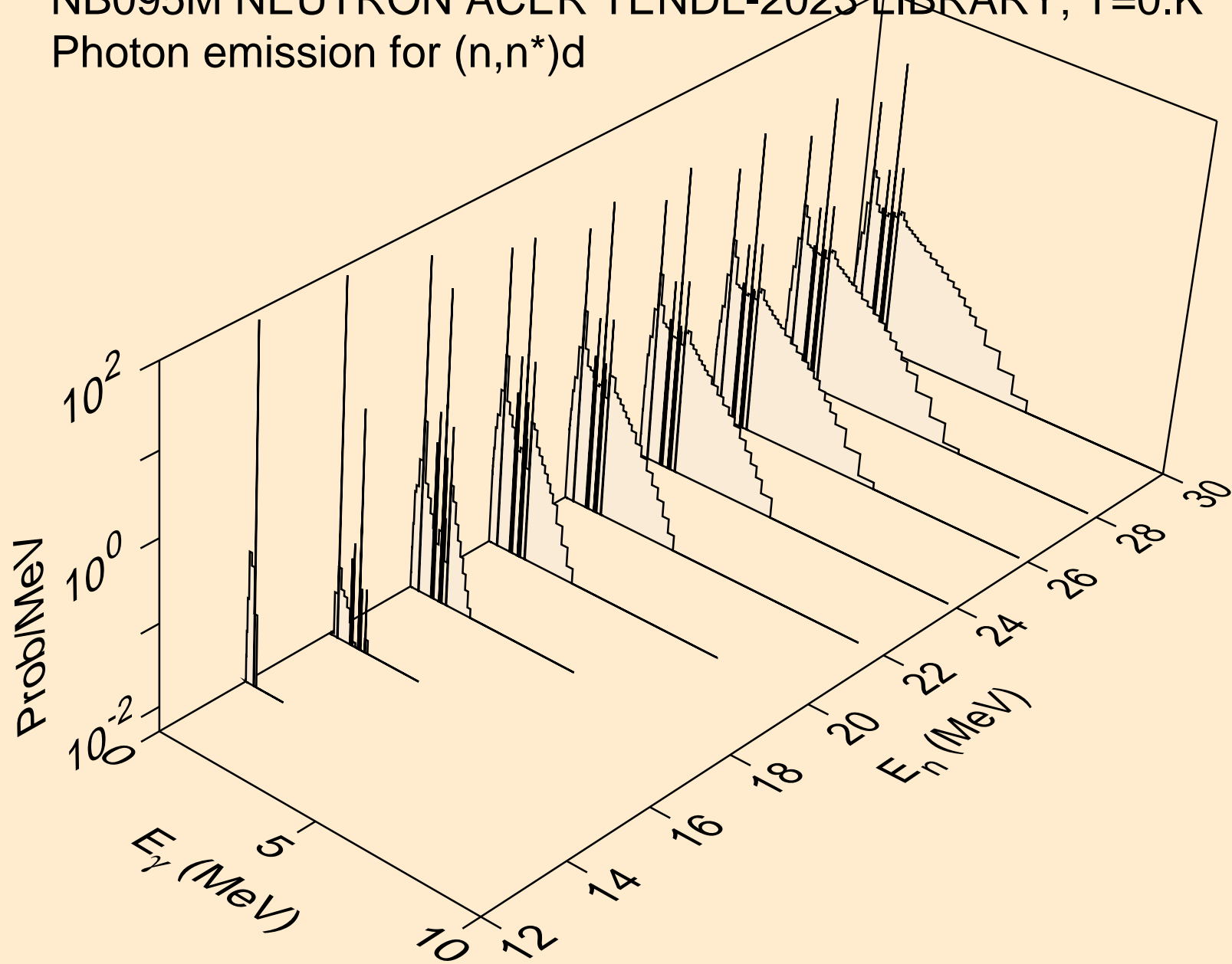

NB095M NEUTRON ACER TENDL-2023 LIBRARY; T=0.K  
Photon emission for (n,n\*)t

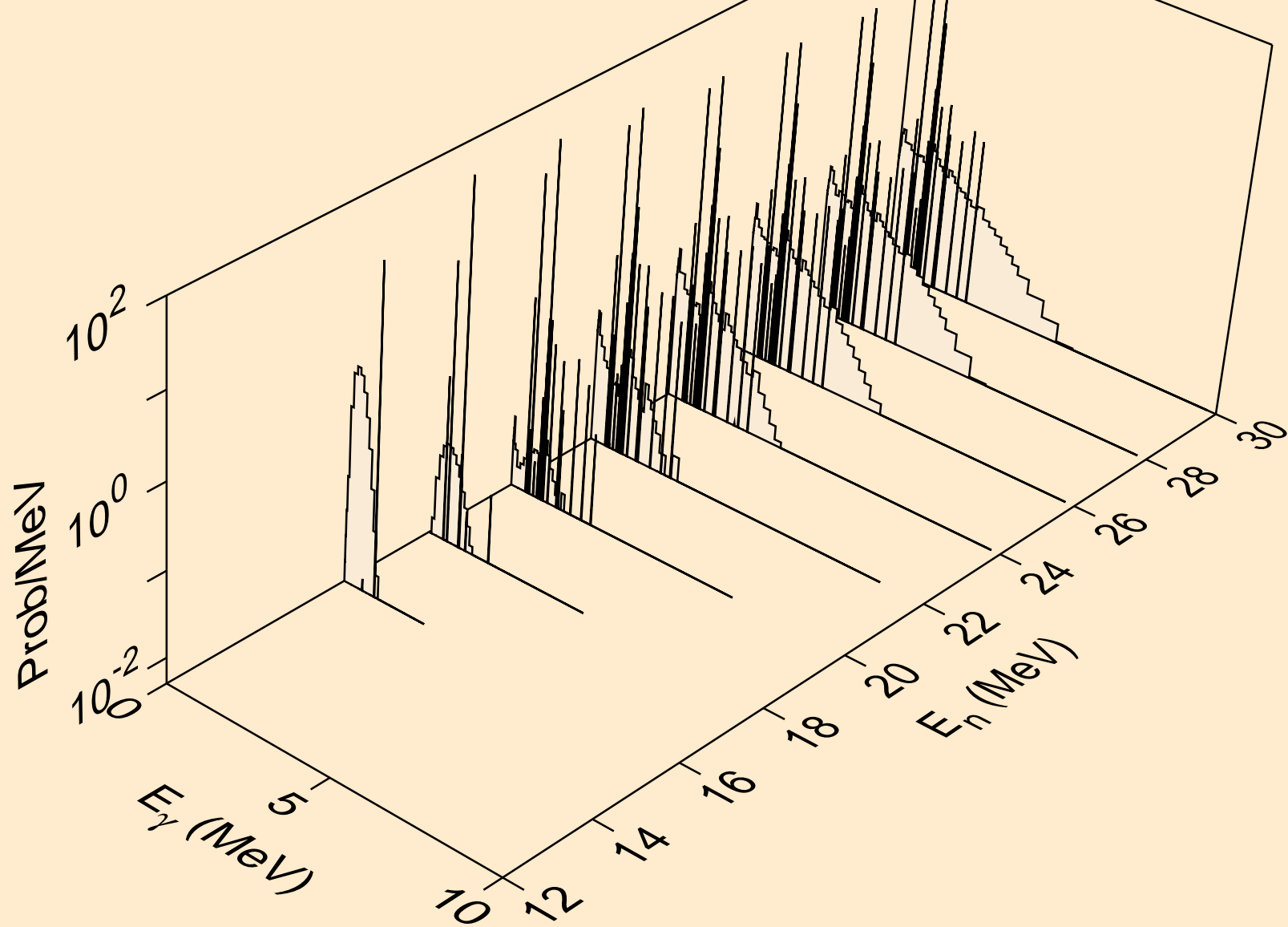

NB095M NEUTRON ACER TENDL-2023 LIBRARY; T=0.K  
Photon emission for (n,n\*)he3

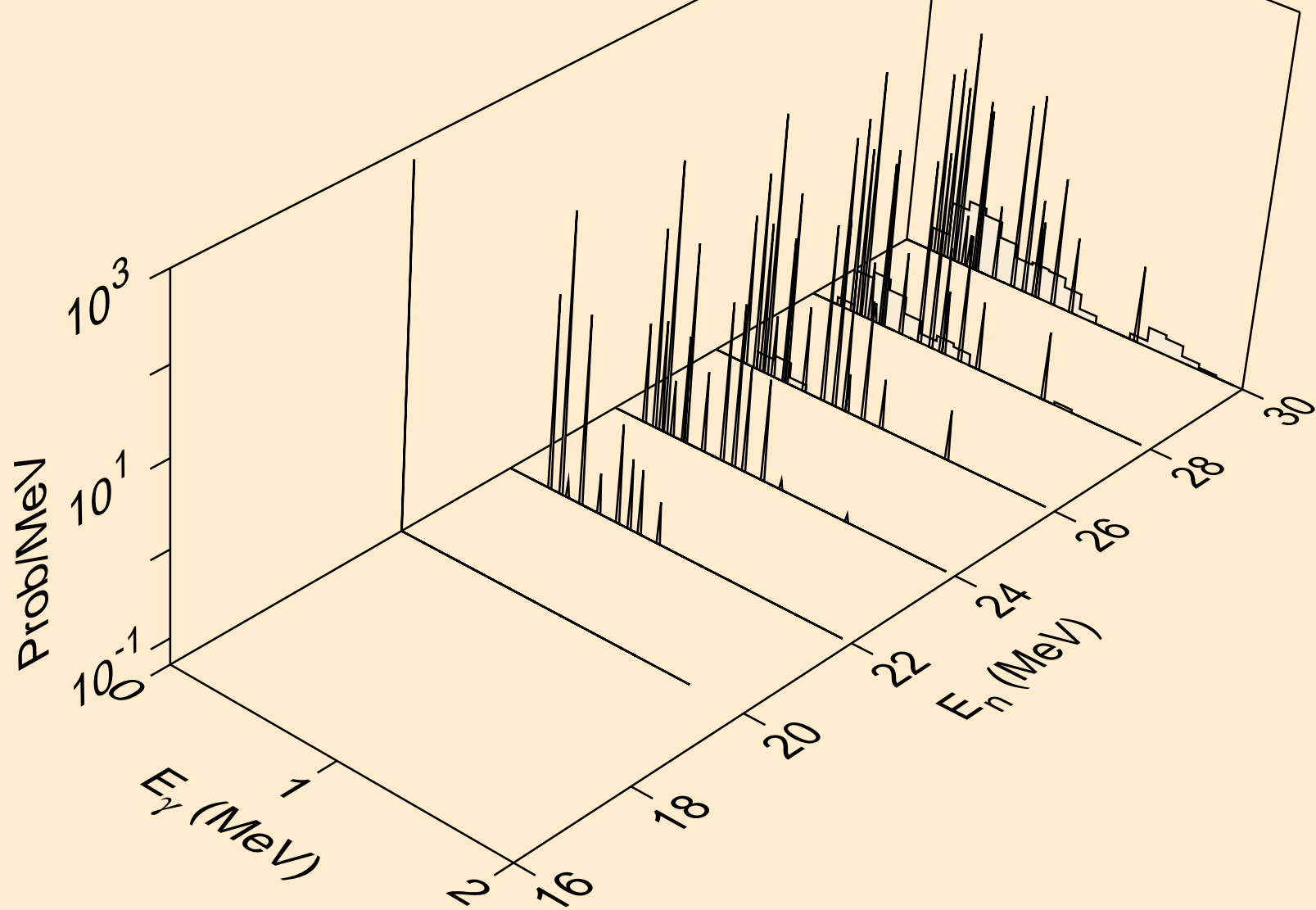

NB095M NEUTRON ACER TENDL-2023 LIBRARY; T=0.K  
Photon emission for (n,4n)

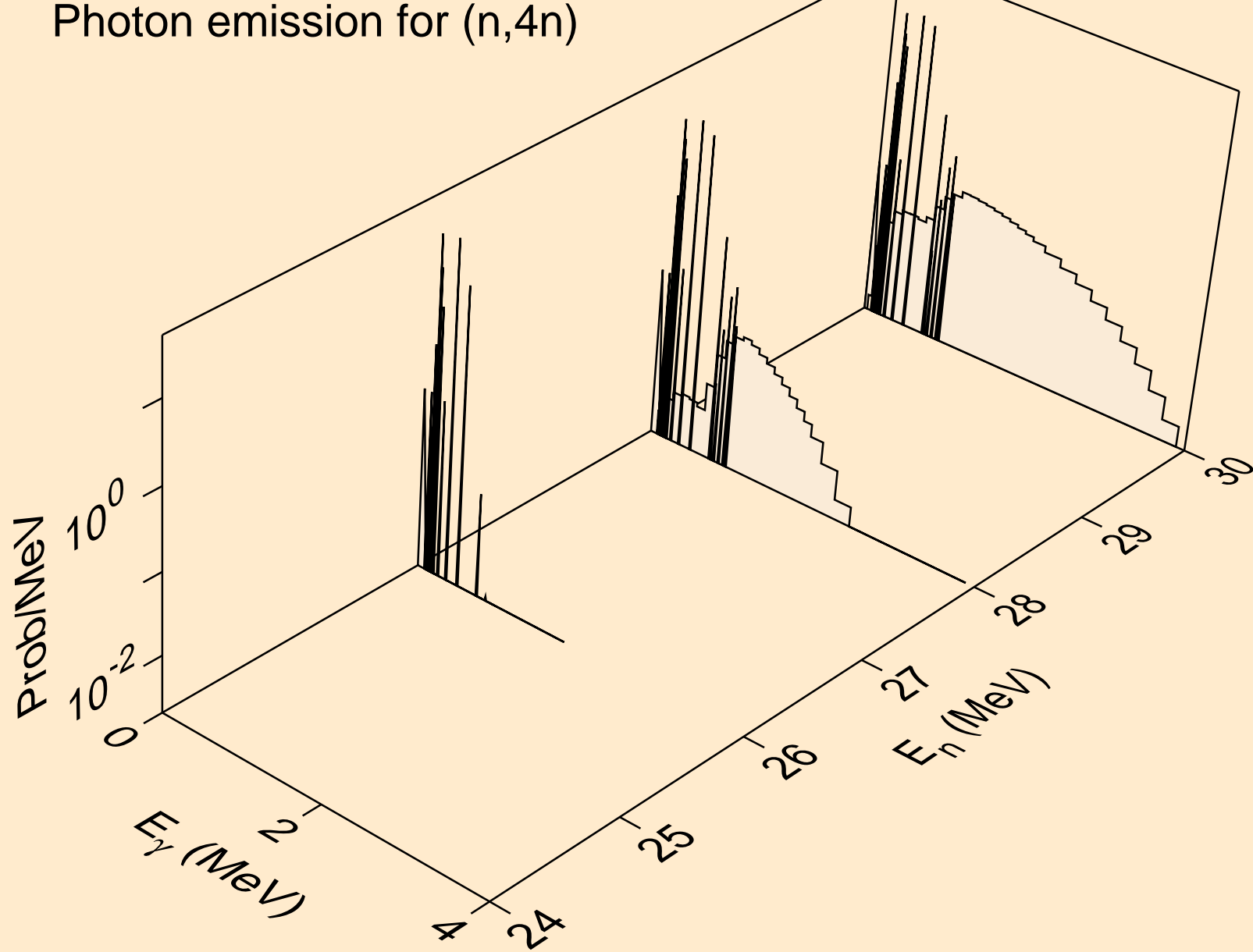

NB095M NEUTRON ACER TENDL-2023 LIBRARY; T=0.K  
Photon emission for (n,2np)

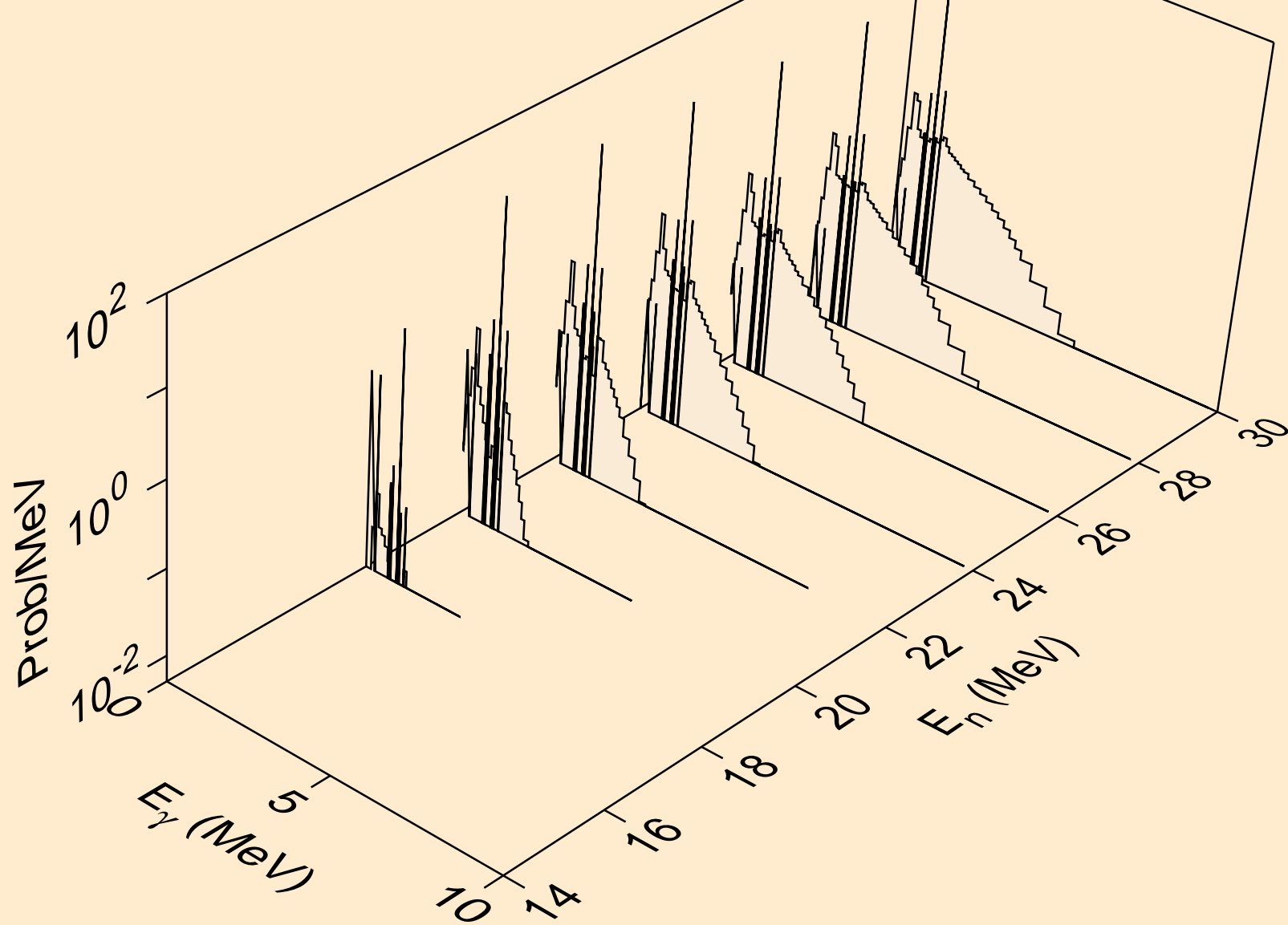

NB095M NEUTRON ACER TENDL-2023 LIBRARY; T=0.K  
Photon emission for (n,3np)

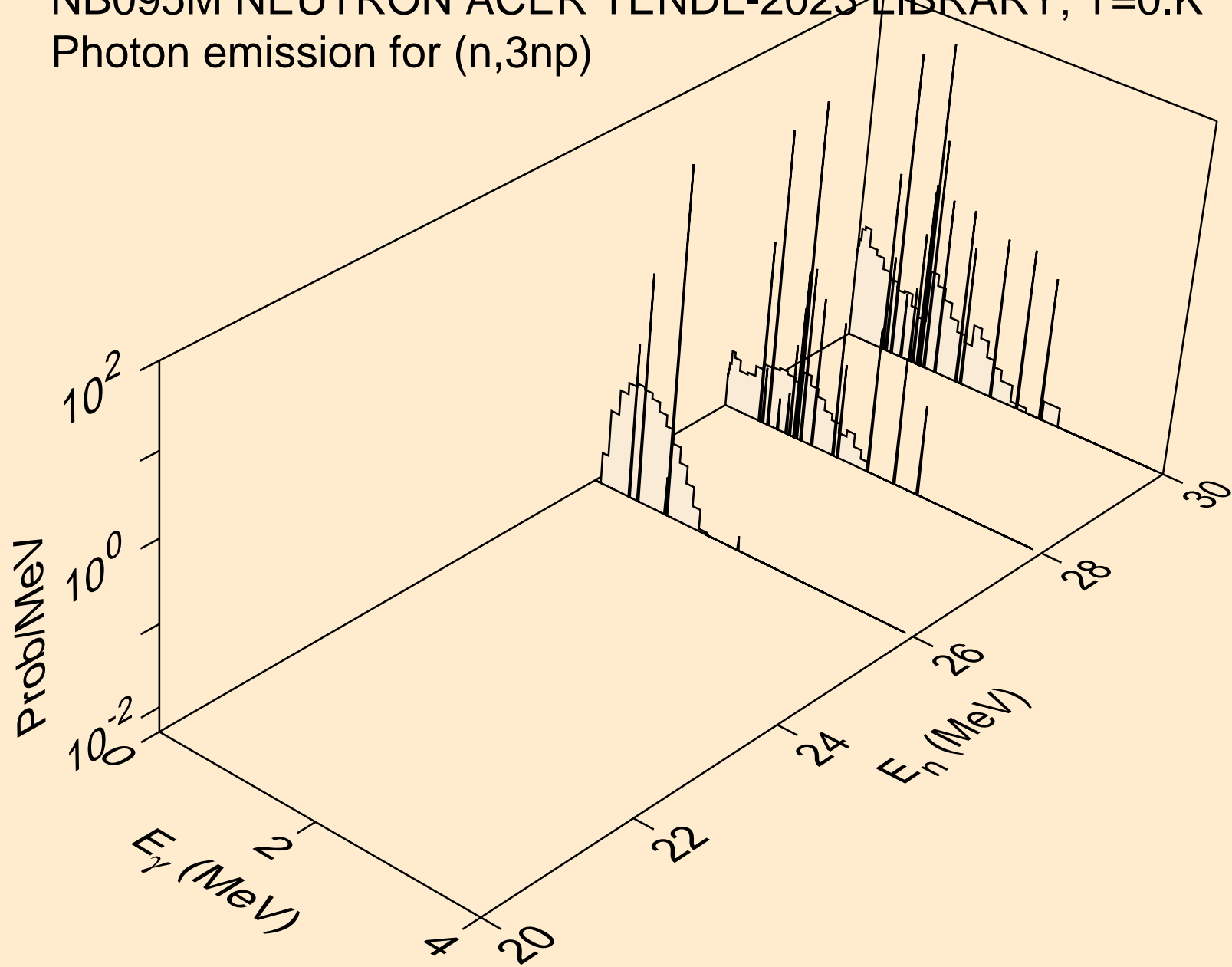

NB095M NEUTRON ACER TENDL-2023 LIBRARY; T=0.K  
Photon emission for (n,n2p)

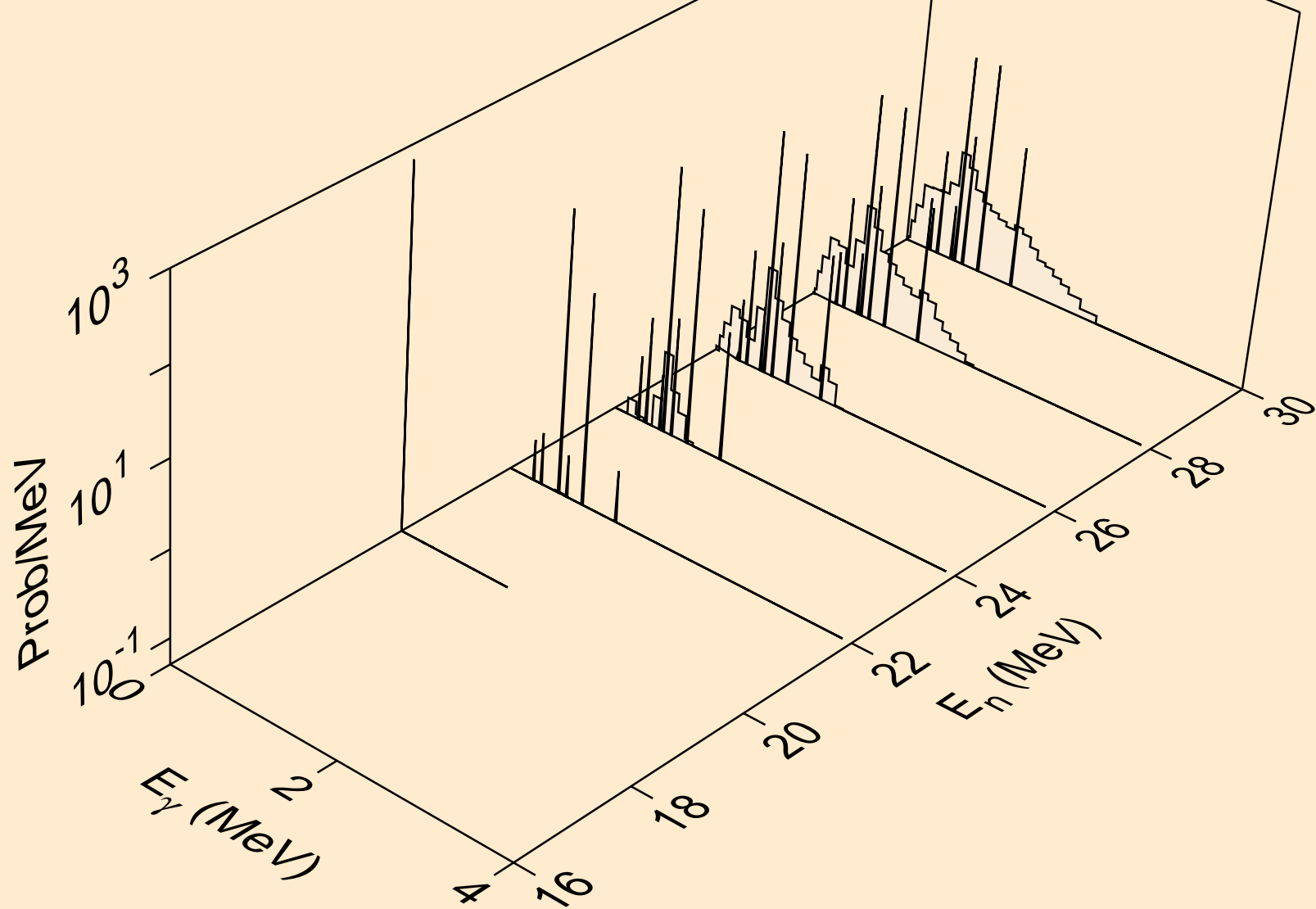

NB095M NEUTRON ACER TENDL-2023 LIBRARY; T=0.K  
Photon emission for (n,npa)

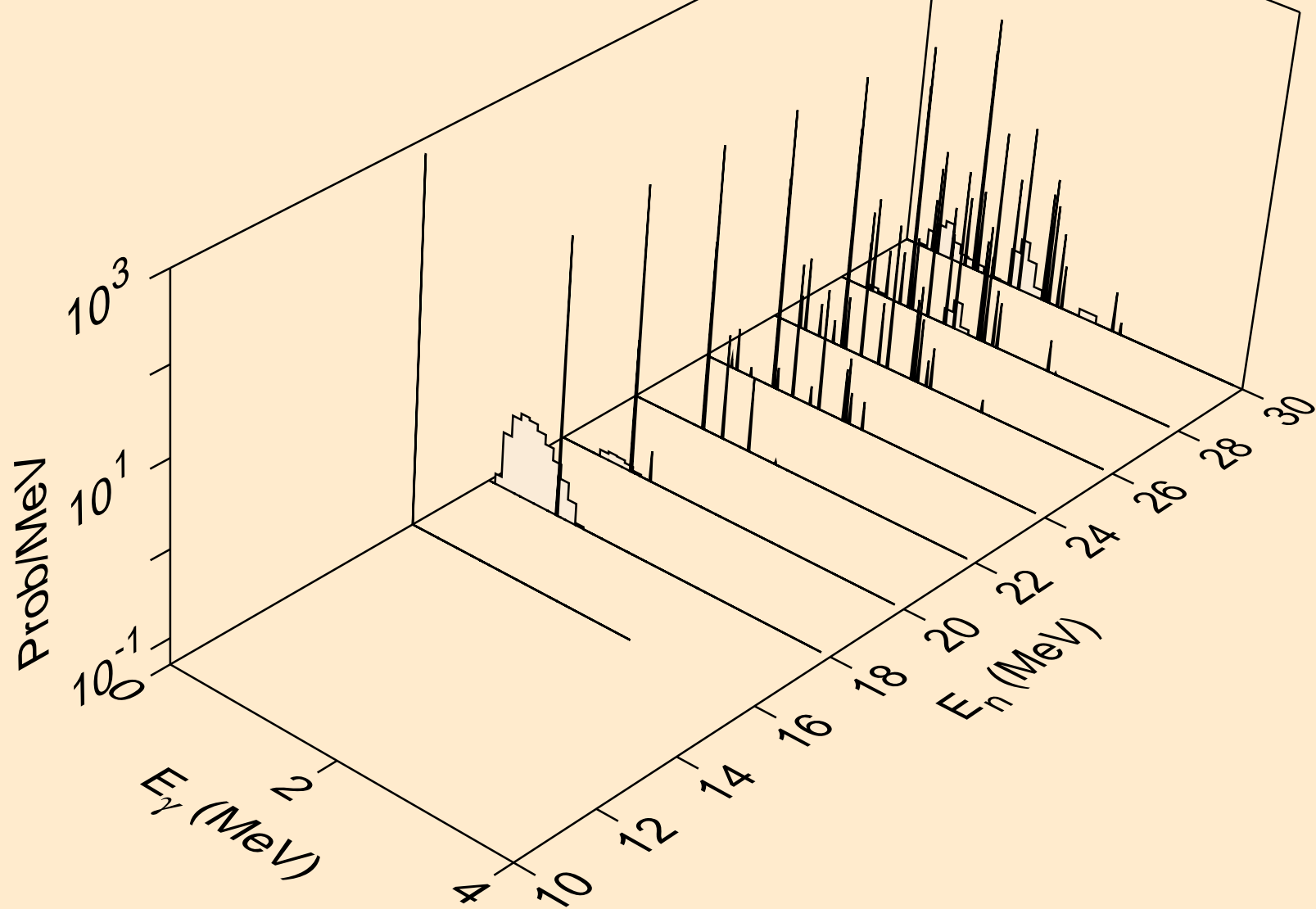

NB095M NEUTRON ACER TENDL-2023 LIBRARY; T=0.K  
Photon emission for (n,n\*2)

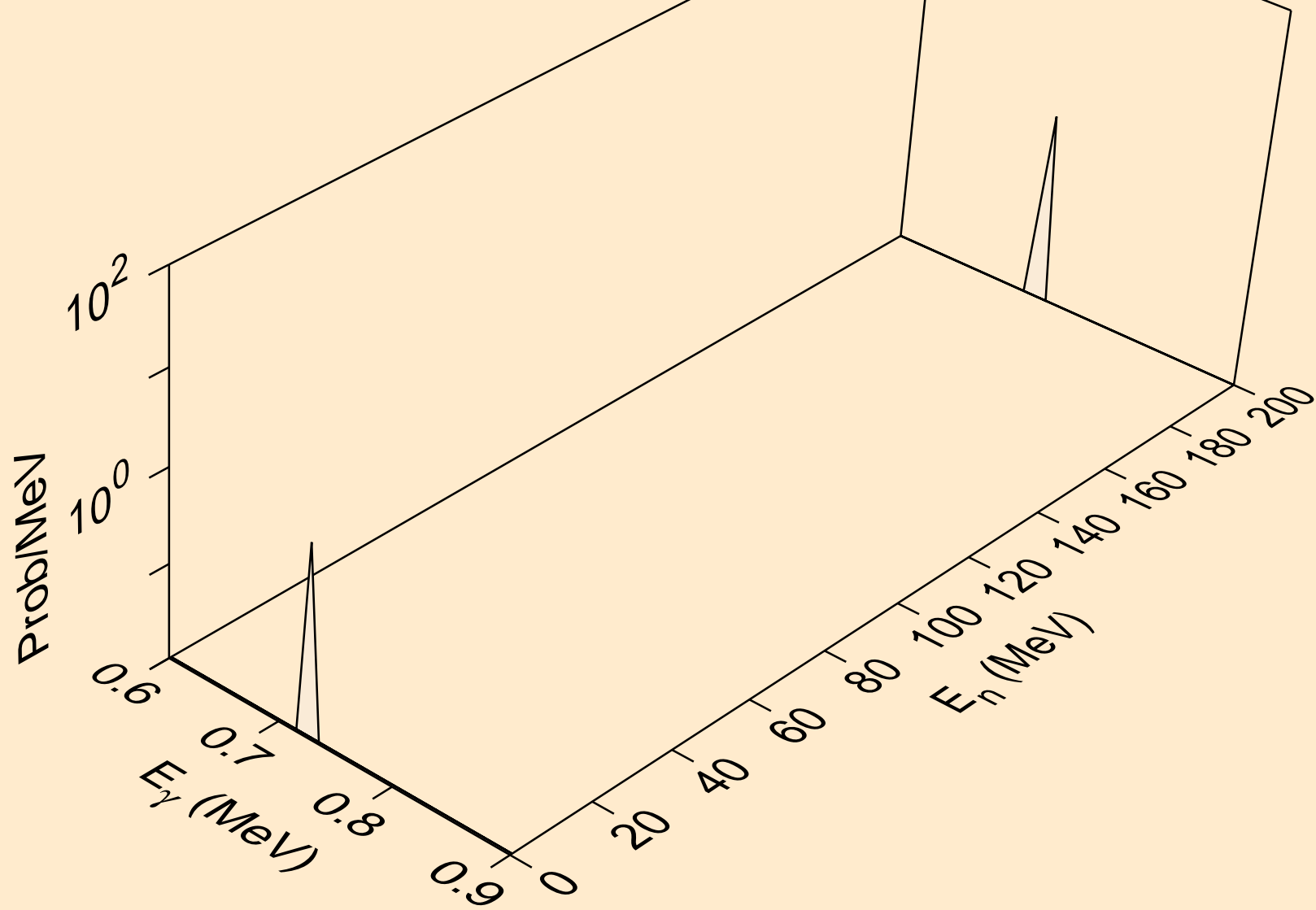

NB095M NEUTRON ACER TENDL-2023 LIBRARY; T=0.K  
Photon emission for (n,n\*3)

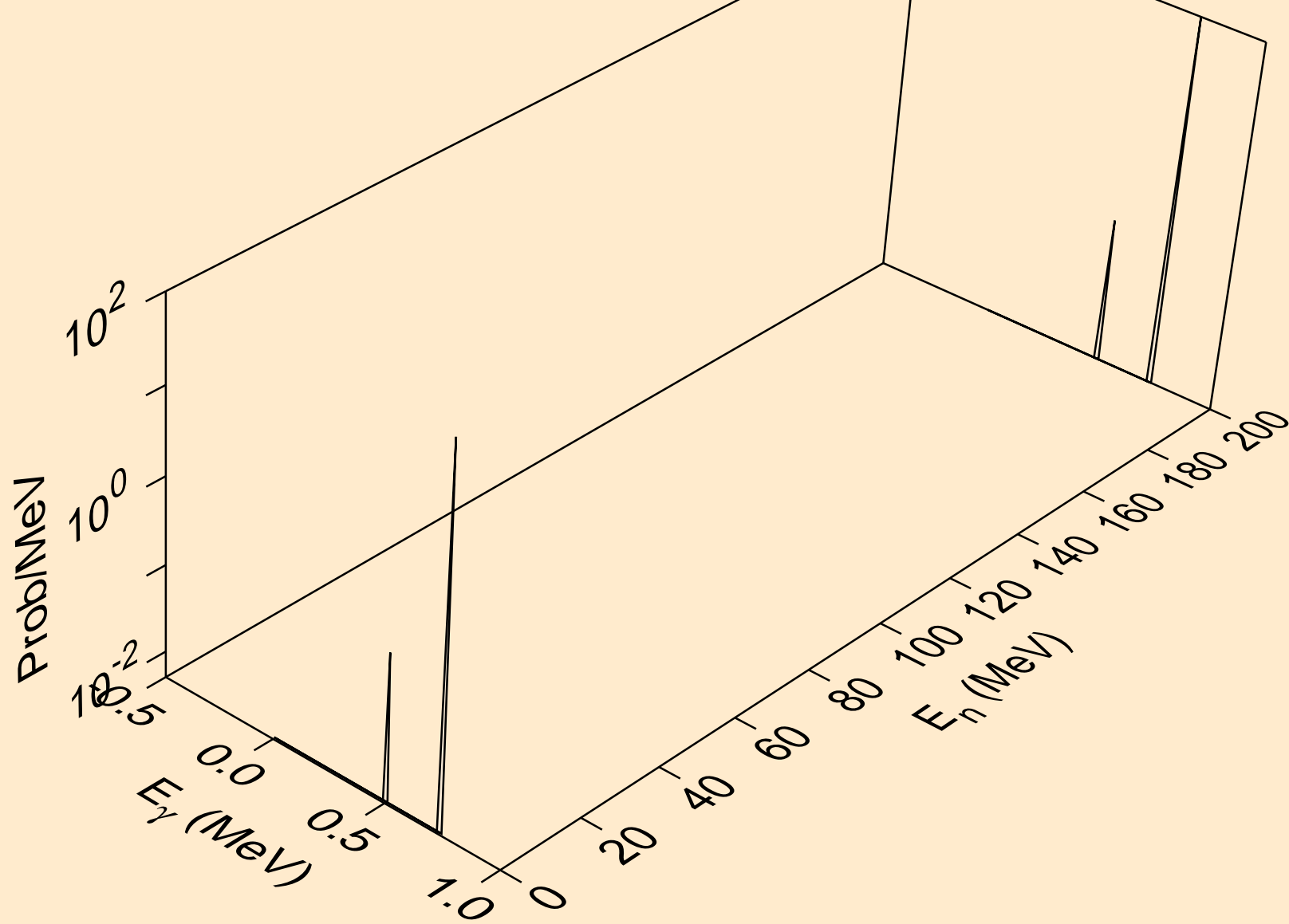

NB095M NEUTRON ACER TENDL-2023 LIBRARY; T=0.K  
Photon emission for (n,n\*4)

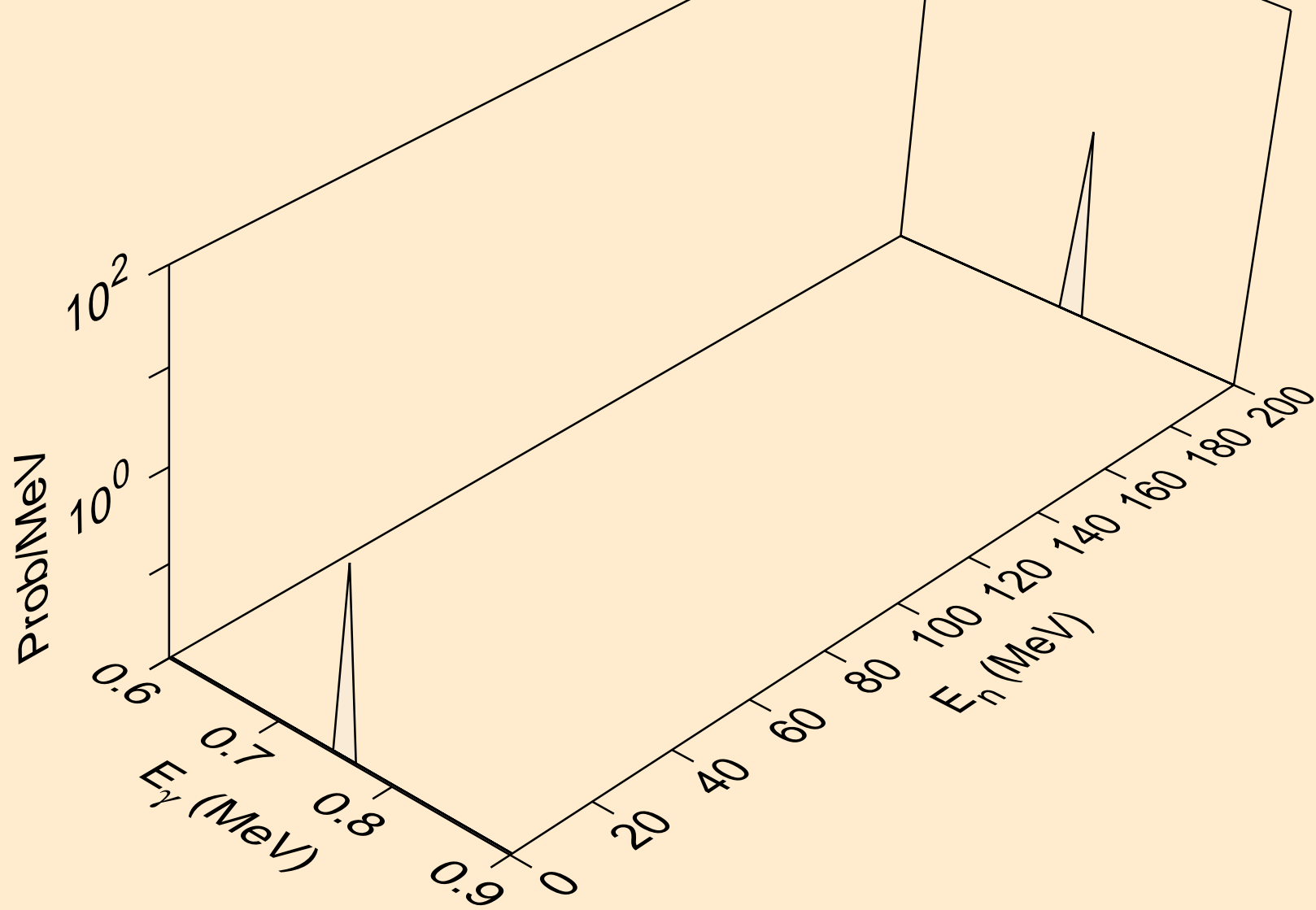

NB095M NEUTRON ACER TENDL-2023 LIBRARY; T=0.K  
Photon emission for (n,n\*5)

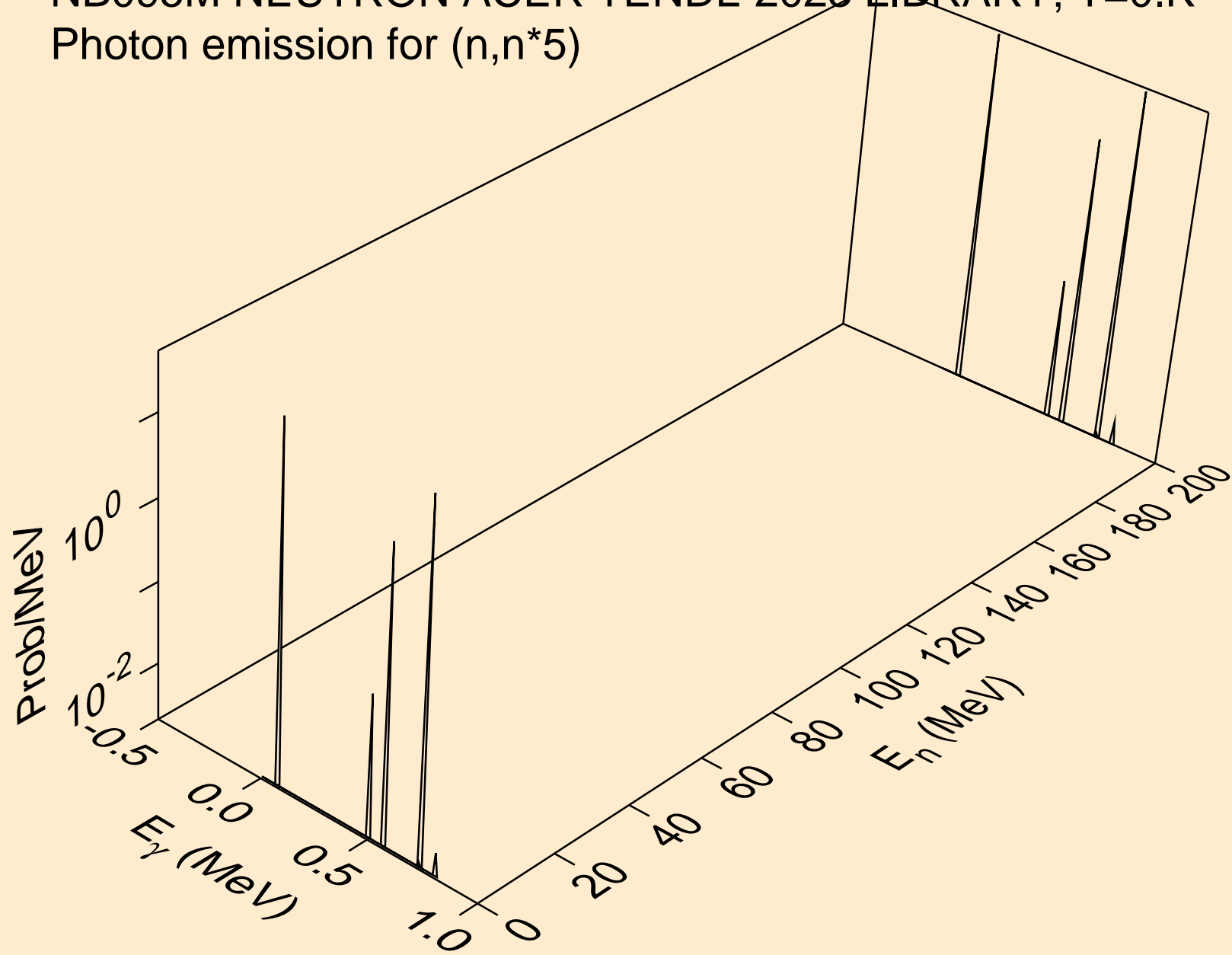

NB095M NEUTRON ACER TENDL-2023 LIBRARY; T=0.K  
Photon emission for (n,n\*6)

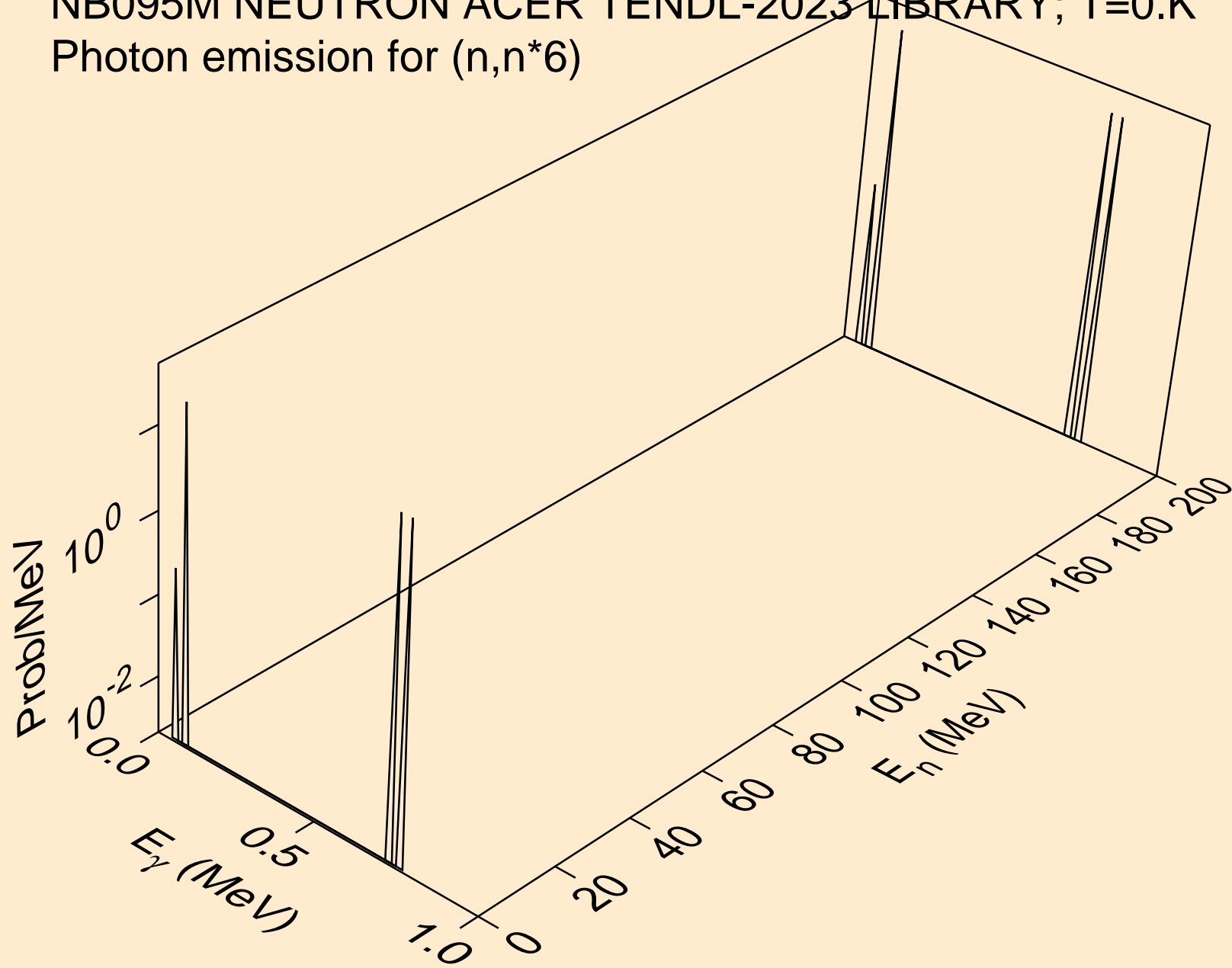

NB095M NEUTRON ACER TENDL-2023 LIBRARY; T=0.K  
Photon emission for (n,n\*7)

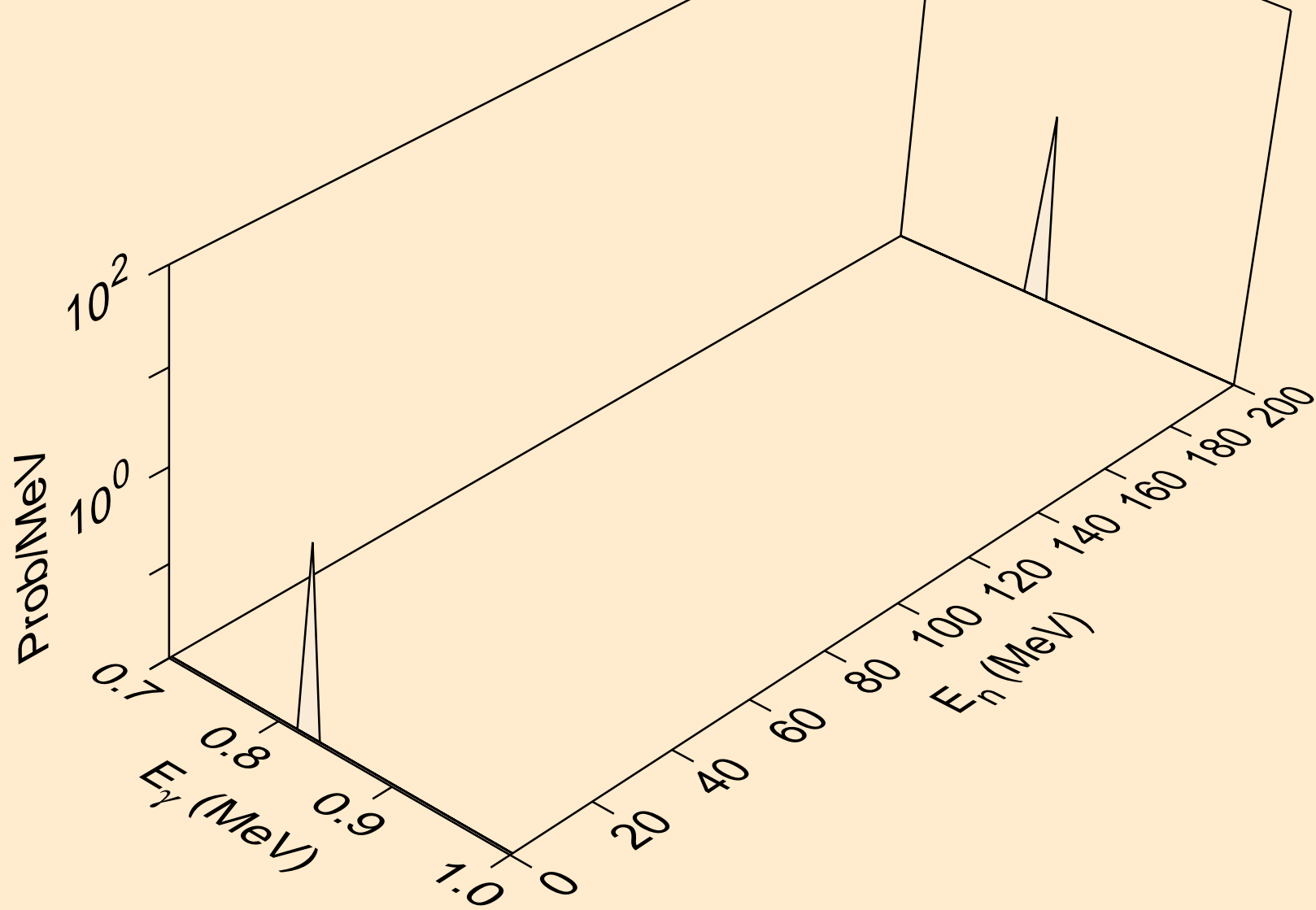

NB095M NEUTRON ACER TENDL-2023 LIBRARY; T=0.K  
Photon emission for (n,n\*8)

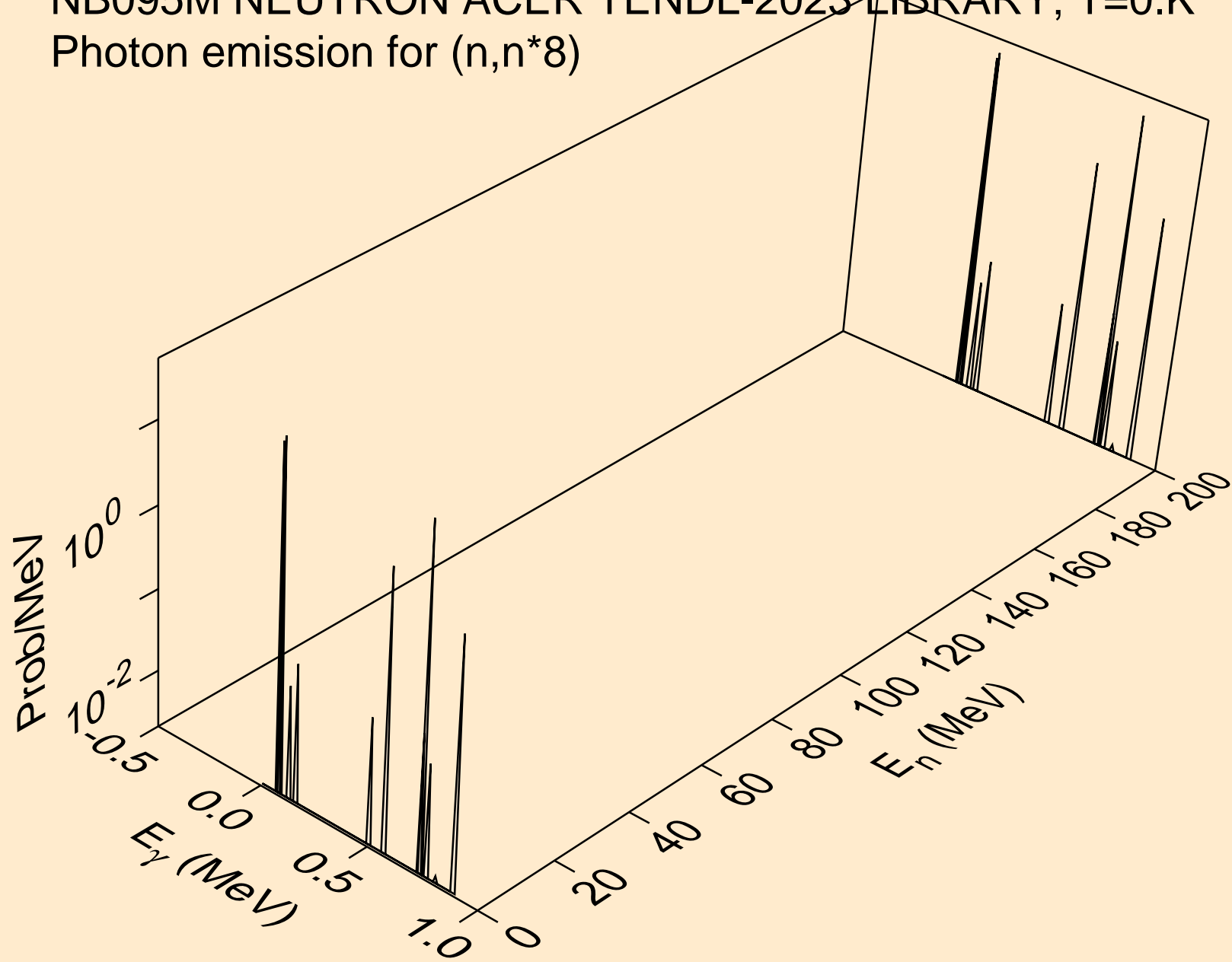

NB095M NEUTRON ACER TENDL-2023 LIBRARY; T=0.K  
Photon emission for (n,n\*9)

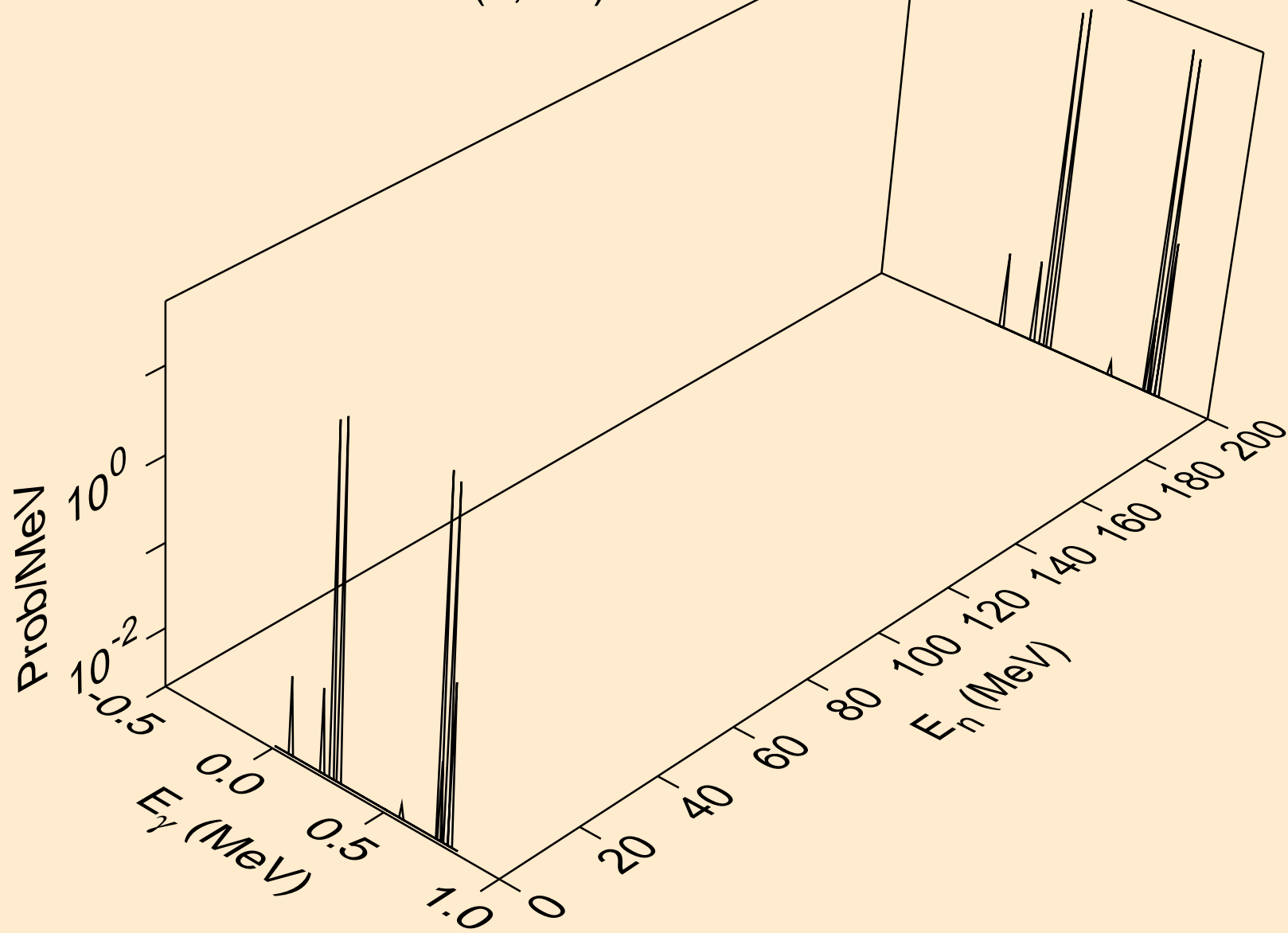

NB095M NEUTRON ACER TENDL-2023 LIBRARY; T=0.K  
Photon emission for (n,n\*10)

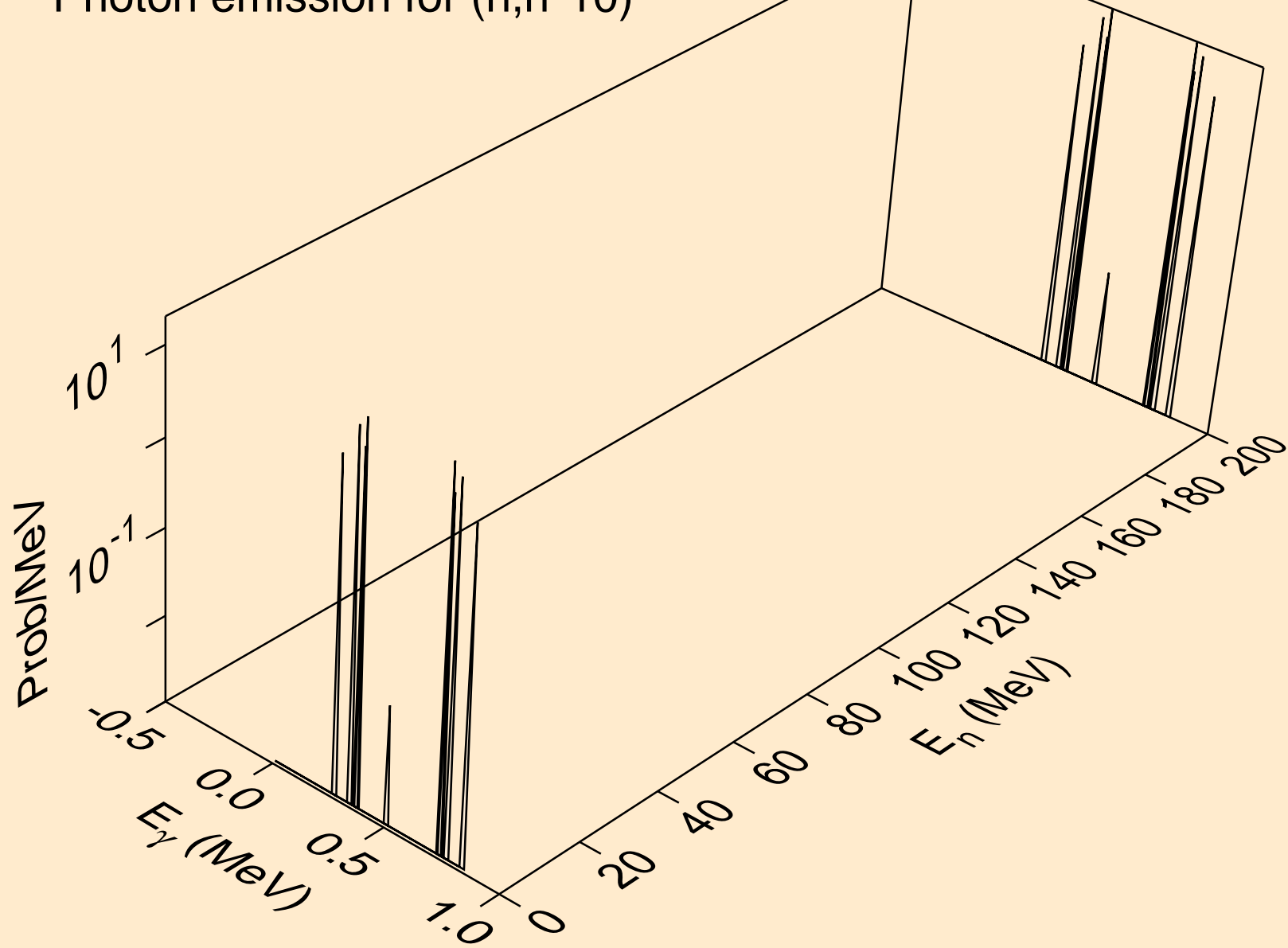

NB095M NEUTRON ACER TENDL-2023 LIBRARY; T=0.K  
Photon emission for (n,n\*11)

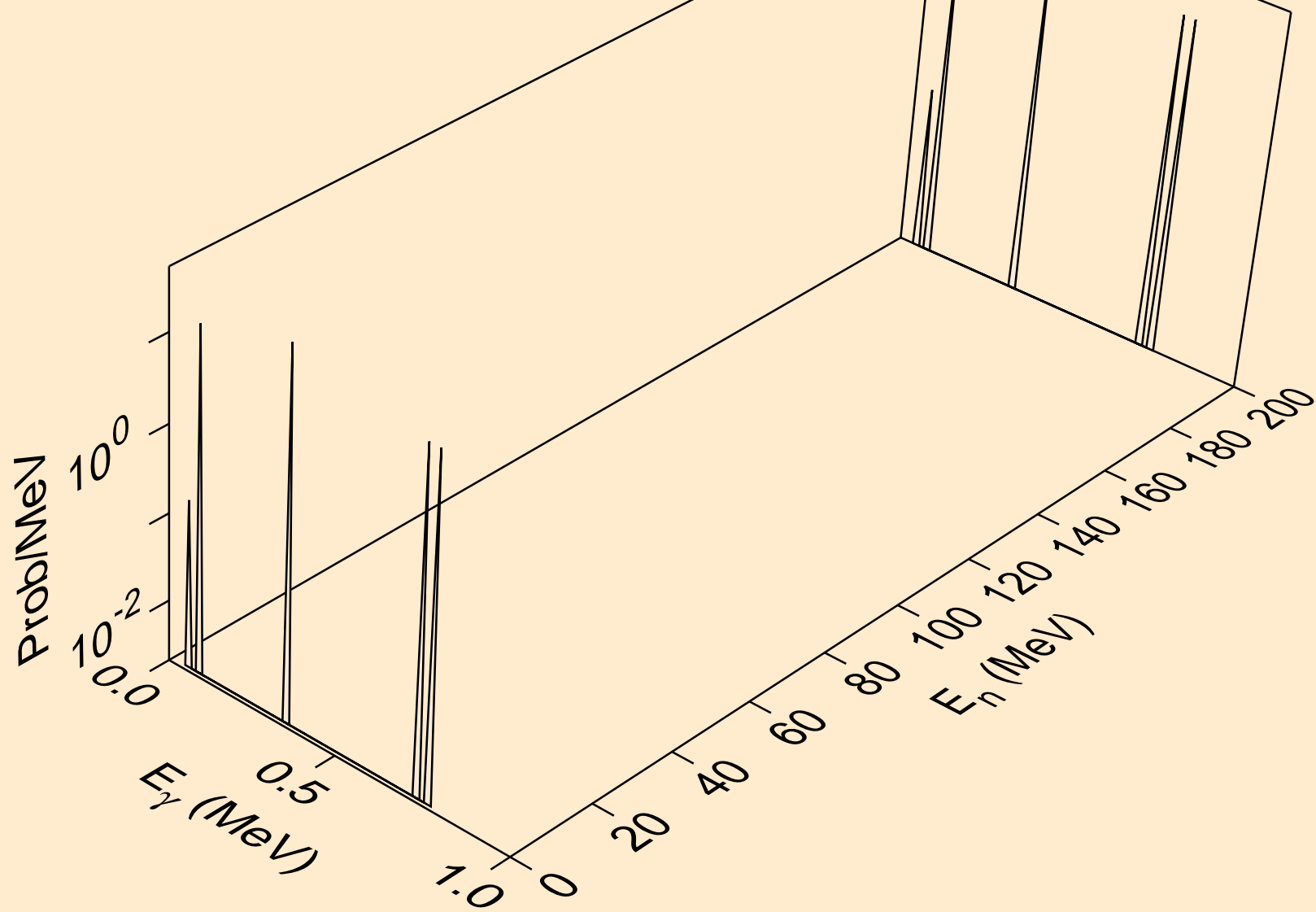

NB095M NEUTRON ACER TENDL-2023 LIBRARY; T=0.K  
Photon emission for (n,n\*12)

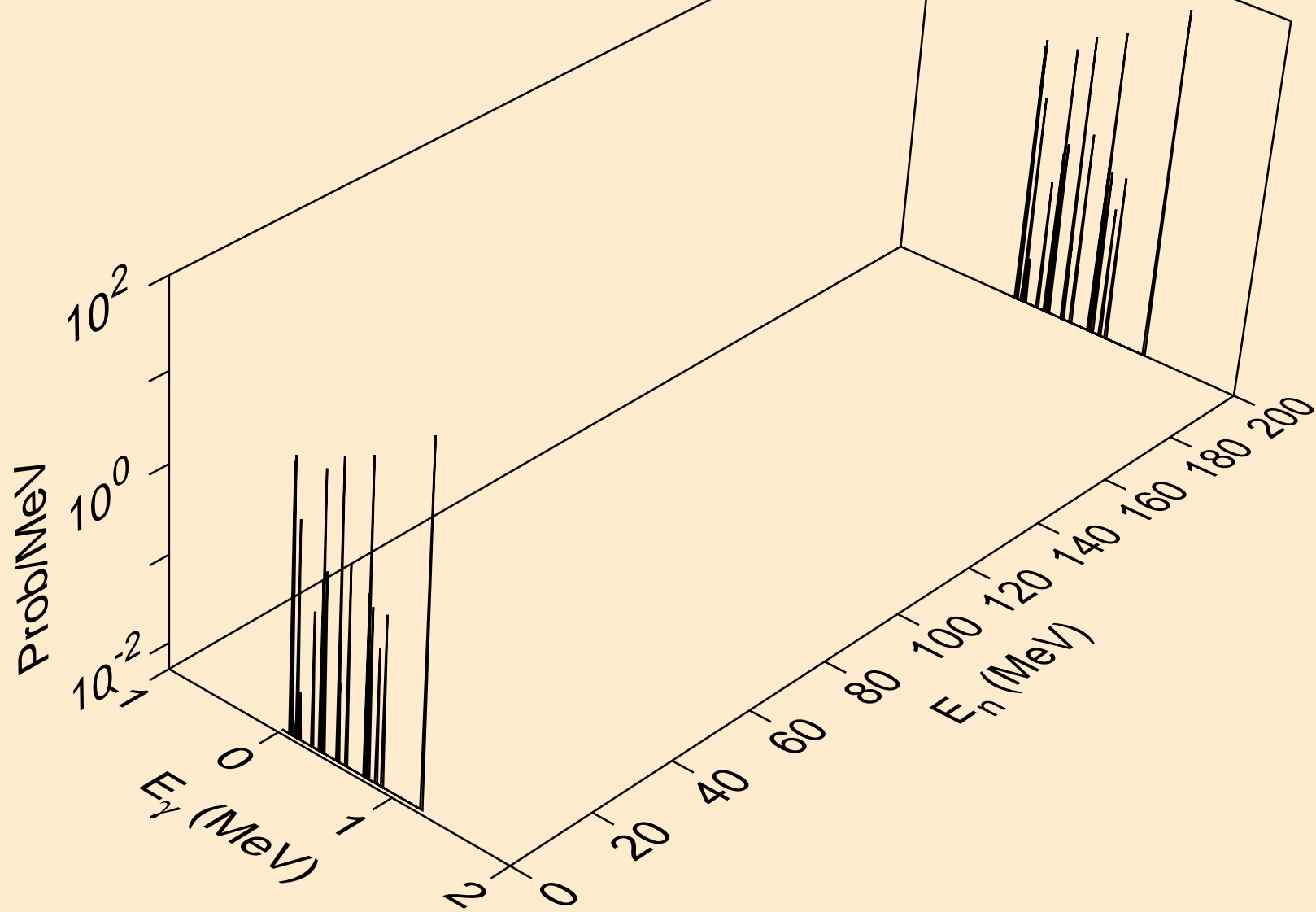

NB095M NEUTRON ACER TENDL-2023 LIBRARY; T=0.K  
Photon emission for (n,n\*13)

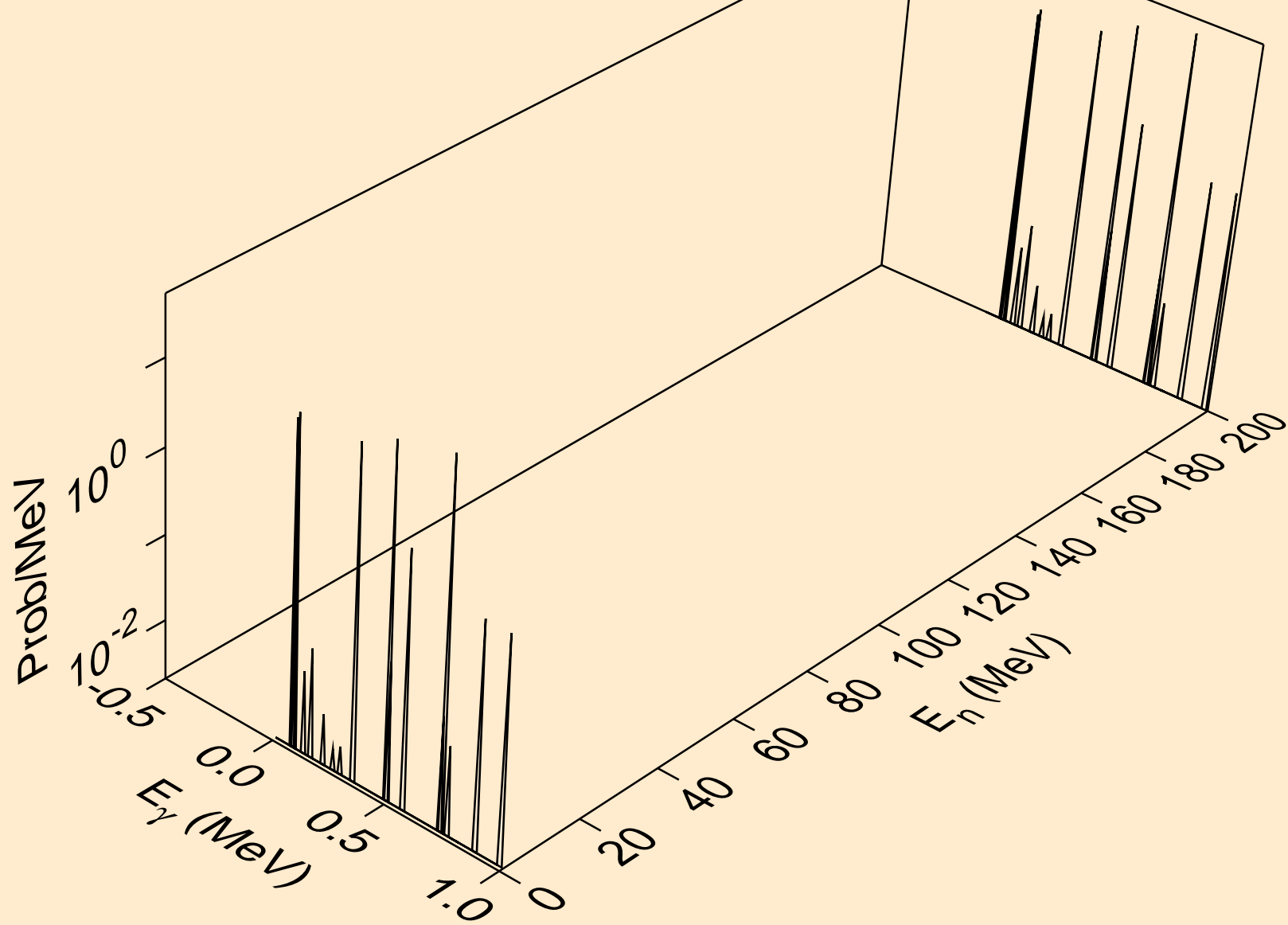

NB095M NEUTRON ACER TENDL-2023 LIBRARY; T=0.K  
Photon emission for (n,n\*14)

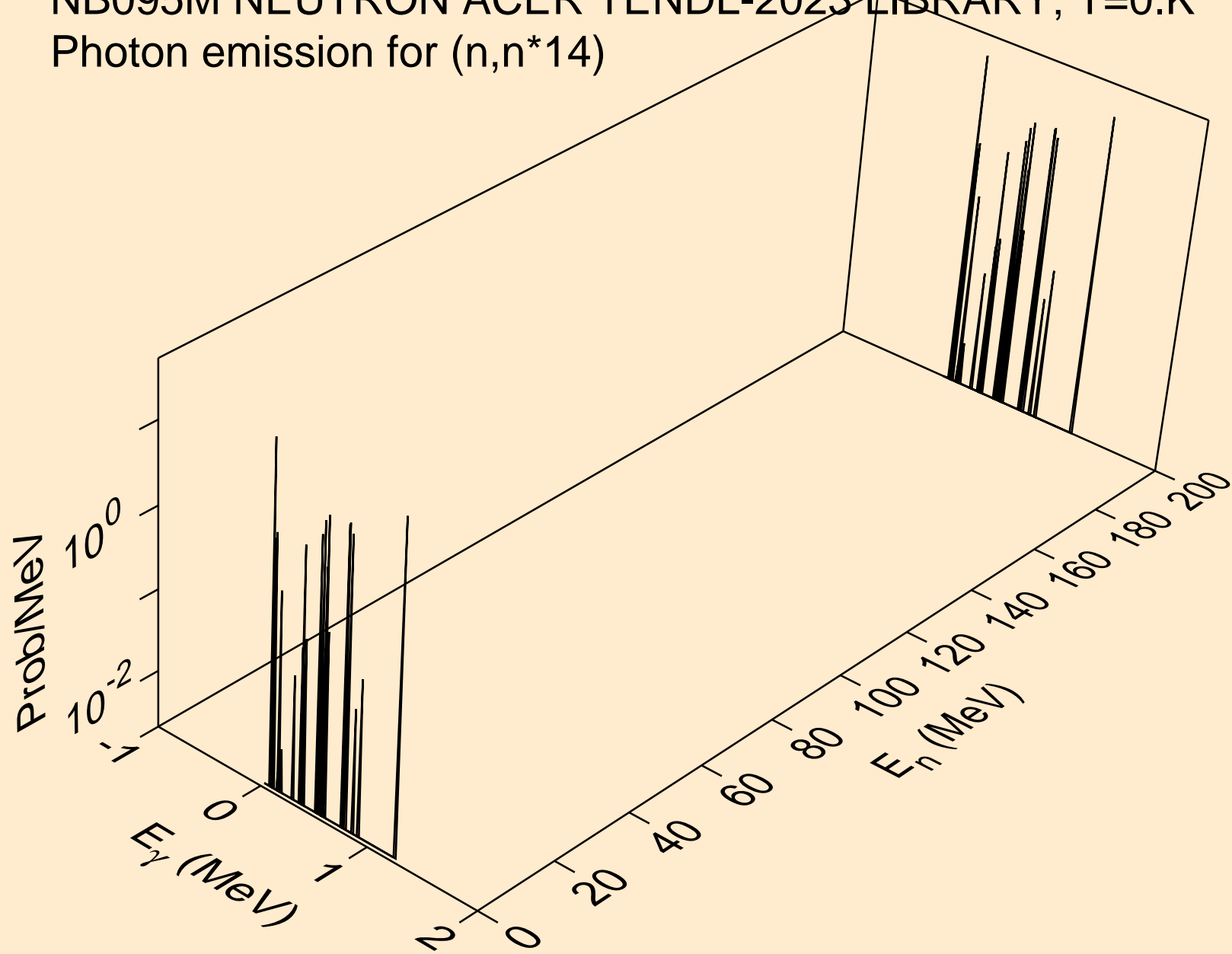

NB095M NEUTRON ACER TENDL-2023 LIBRARY; T=0.K  
Photon emission for (n,n\*15)

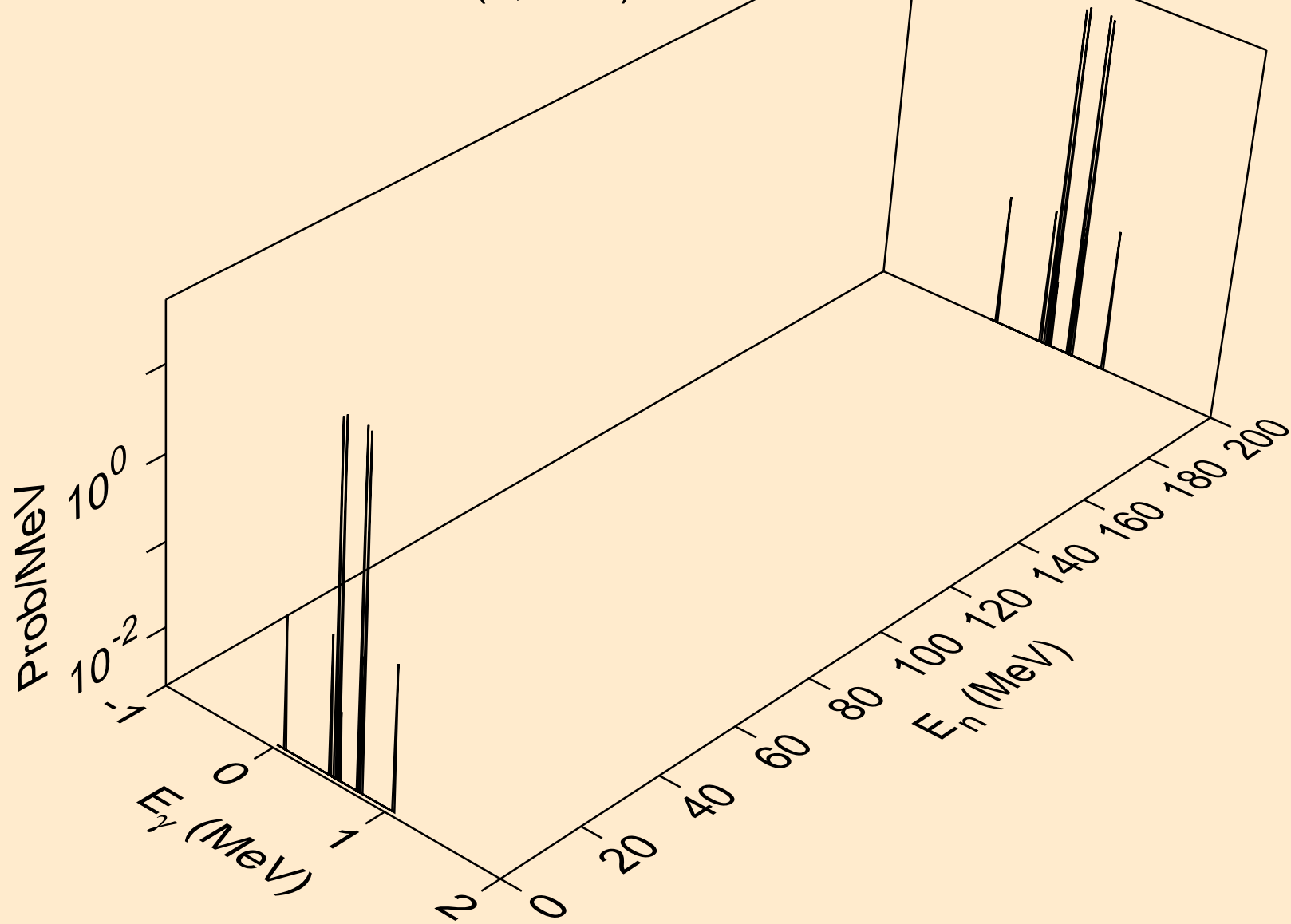

NB095M NEUTRON ACER TENDL-2023 LIBRARY; T=0.K  
Photon emission for (n,n\*16)

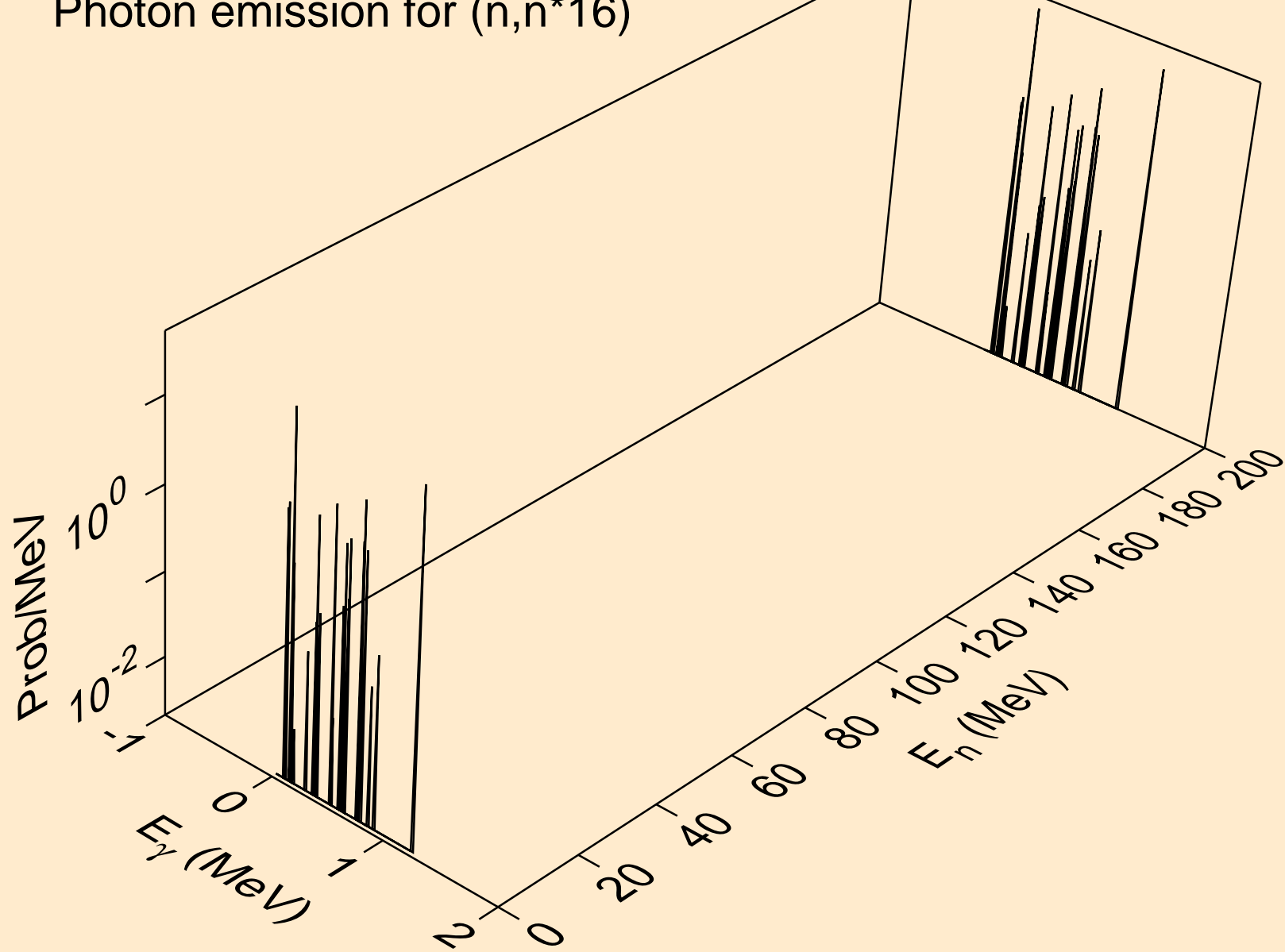

NB095M NEUTRON ACER TENDL-2023 LIBRARY; T=0.K  
Photon emission for (n,n\*17)

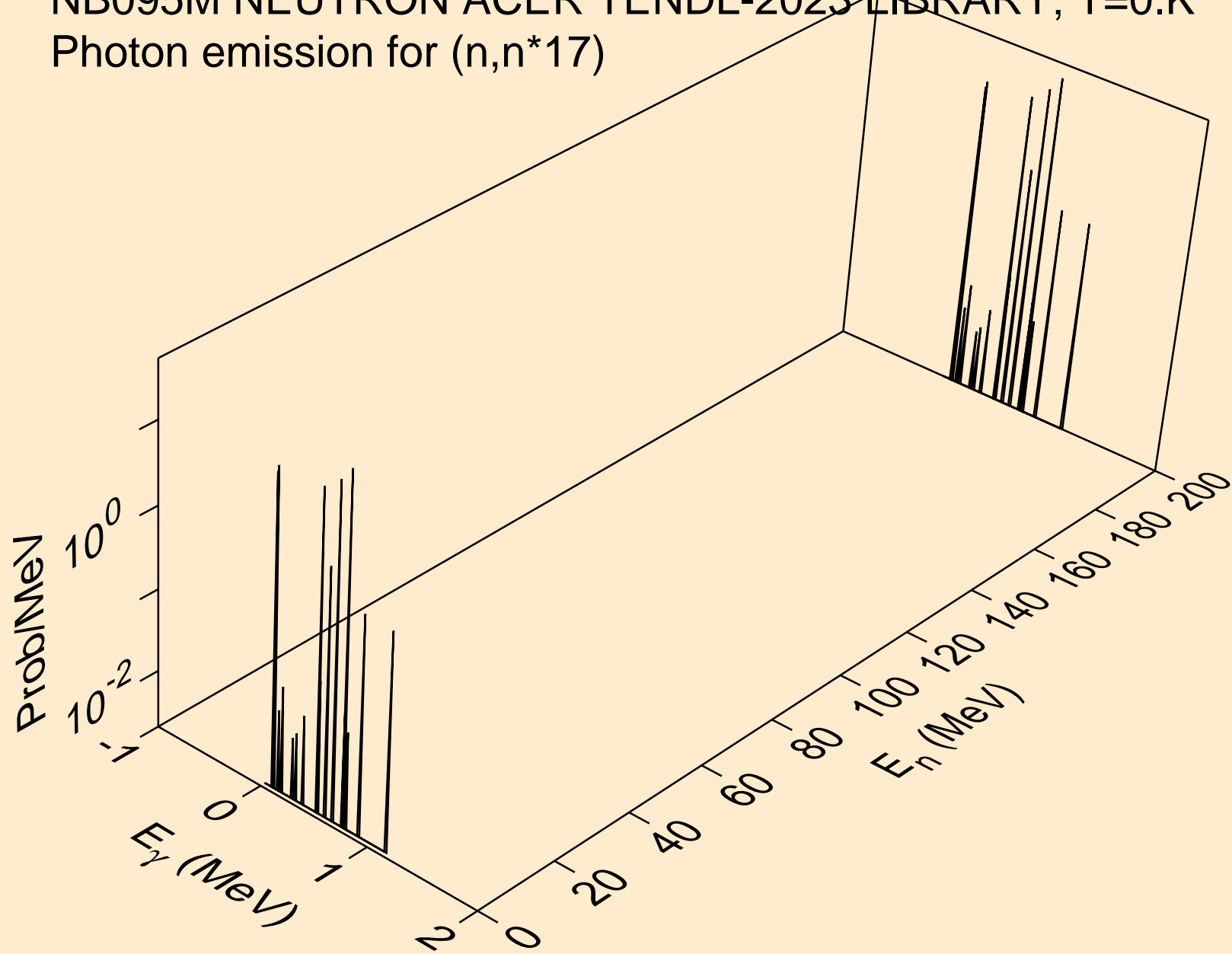

NB095M NEUTRON ACER TENDL-2023 LIBRARY; T=0.K  
Photon emission for (n,n\*18)

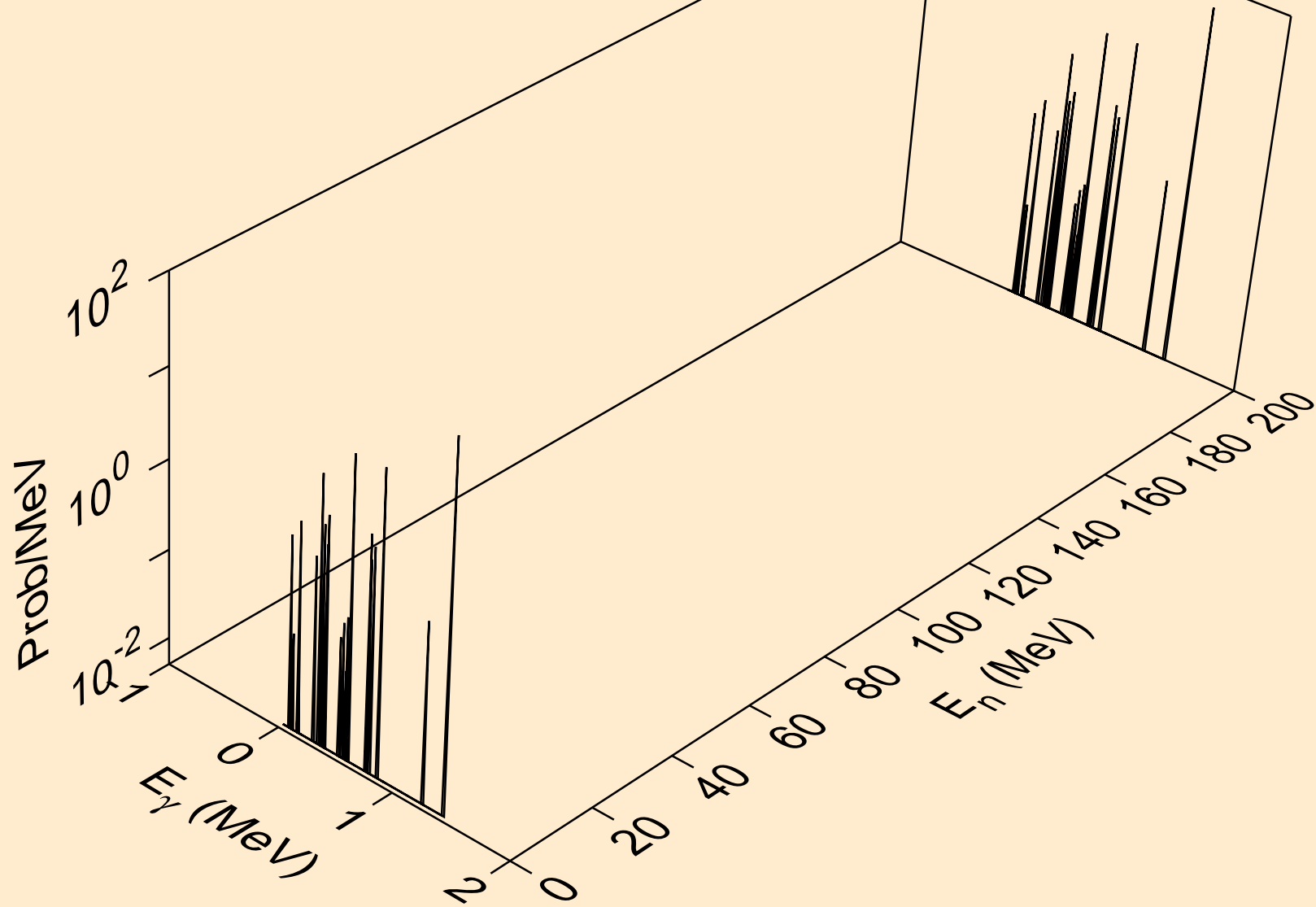

NB095M NEUTRON ACER TENDL-2023 LIBRARY; T=0.K  
Photon emission for (n,n\*c)

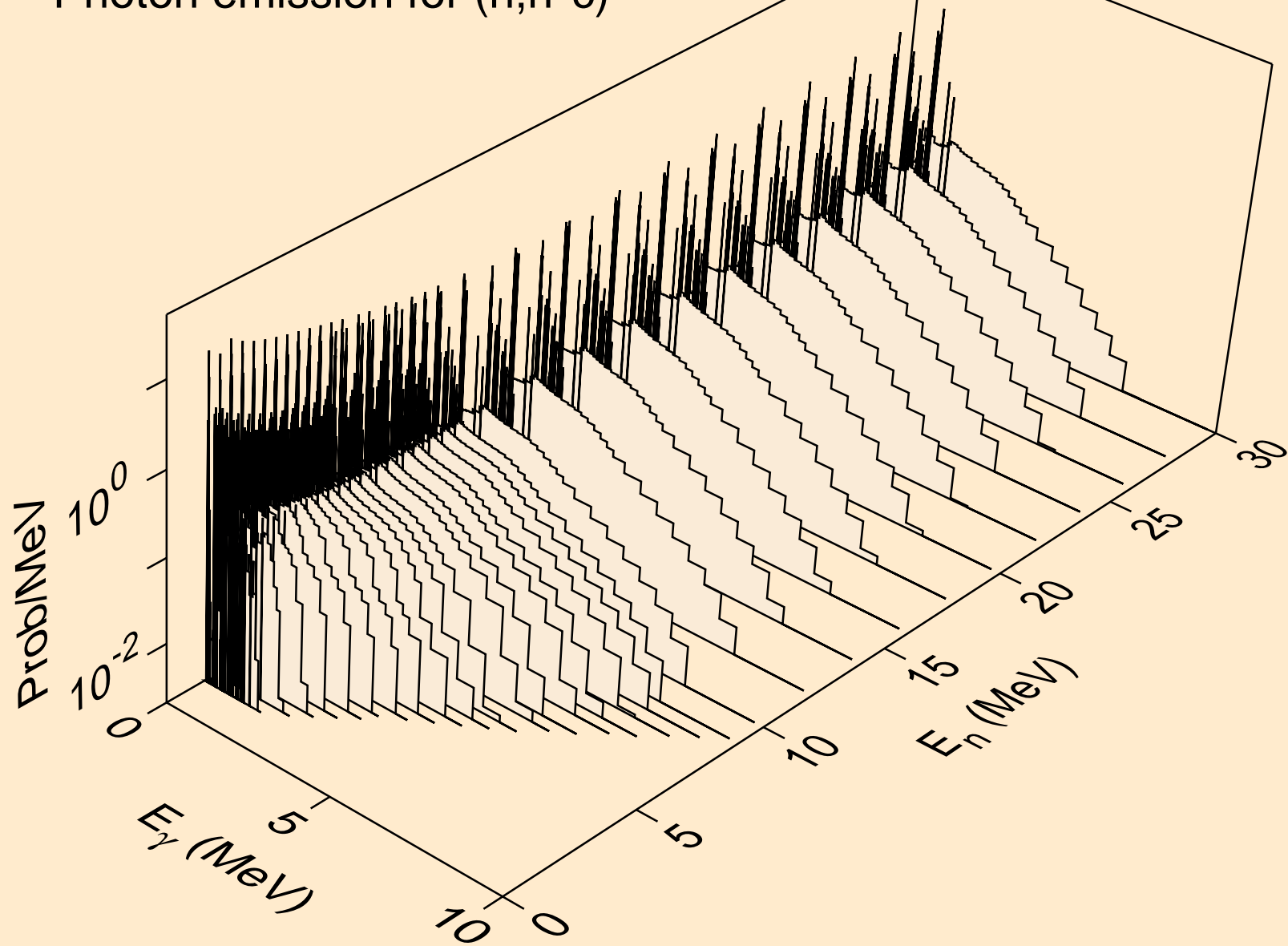

NB095M NEUTRON ACER TENDL-2023 LIBRARY; T=0.K  
Photon emission for (n,gma)

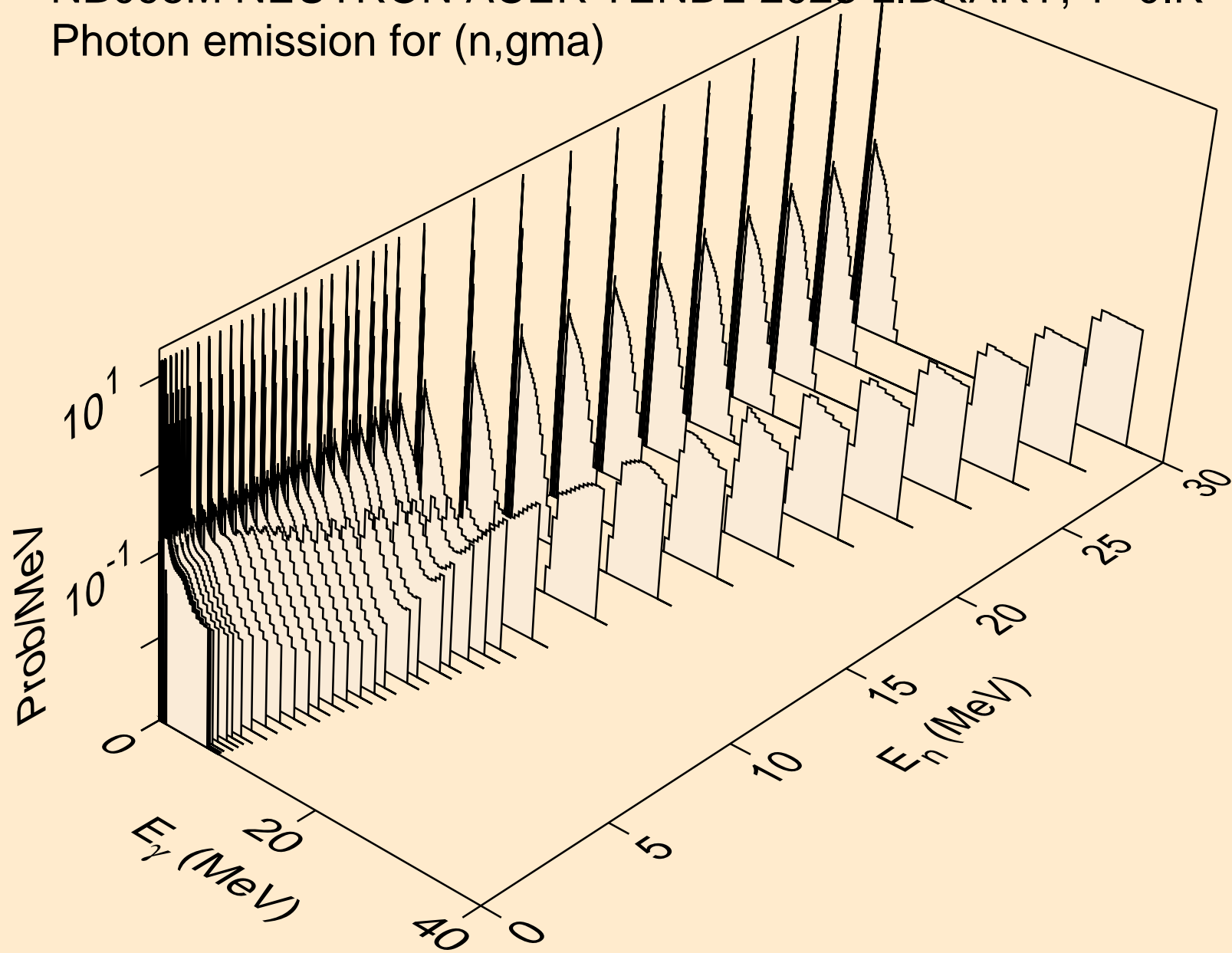

NB095M NEUTRON ACER TENDL-2023 LIBRARY; T=0.K  
Photon emission for (n,p)

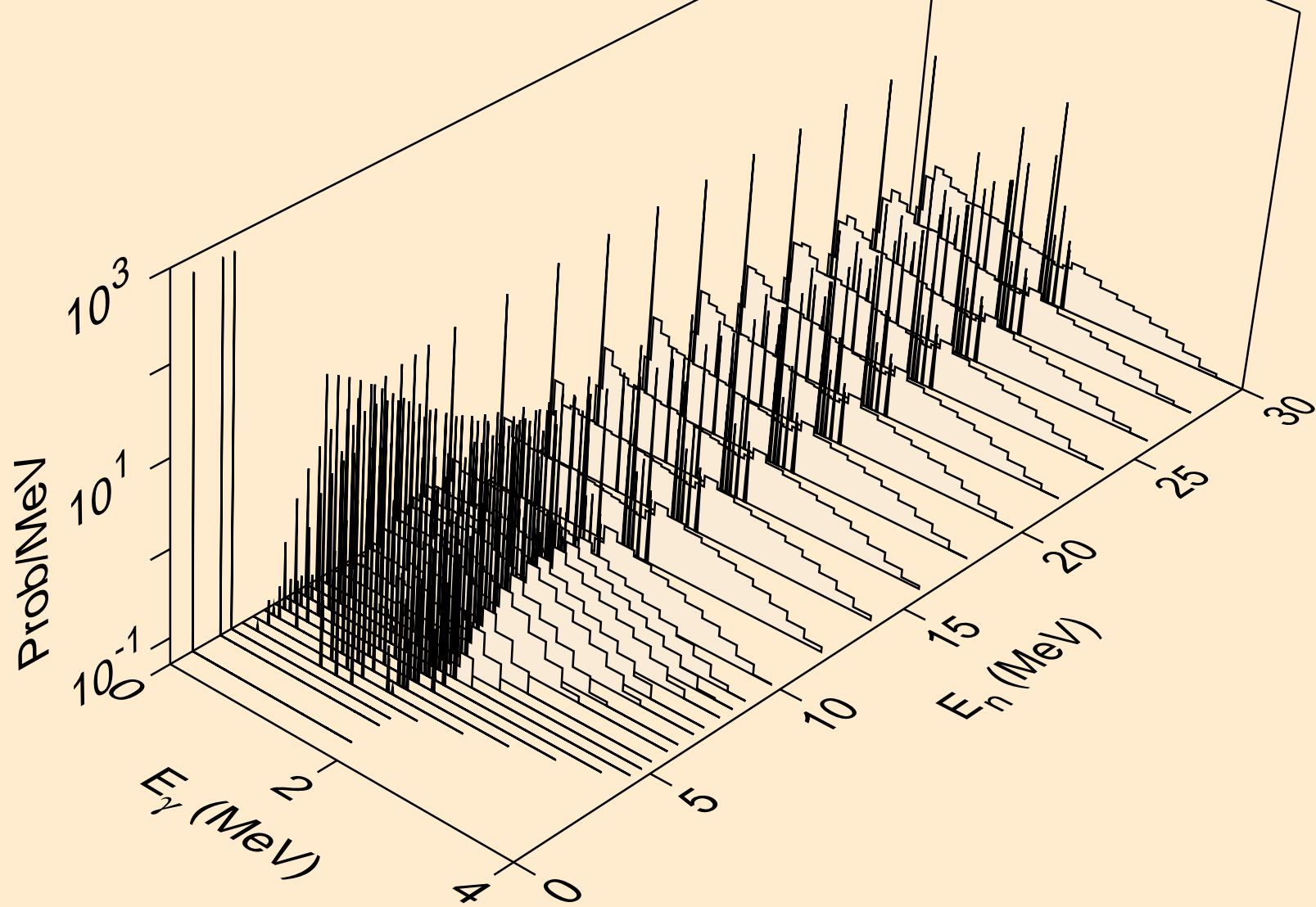

NB095M NEUTRON ACER TENDL-2023 LIBRARY; T=0.K  
Photon emission for (n,d)

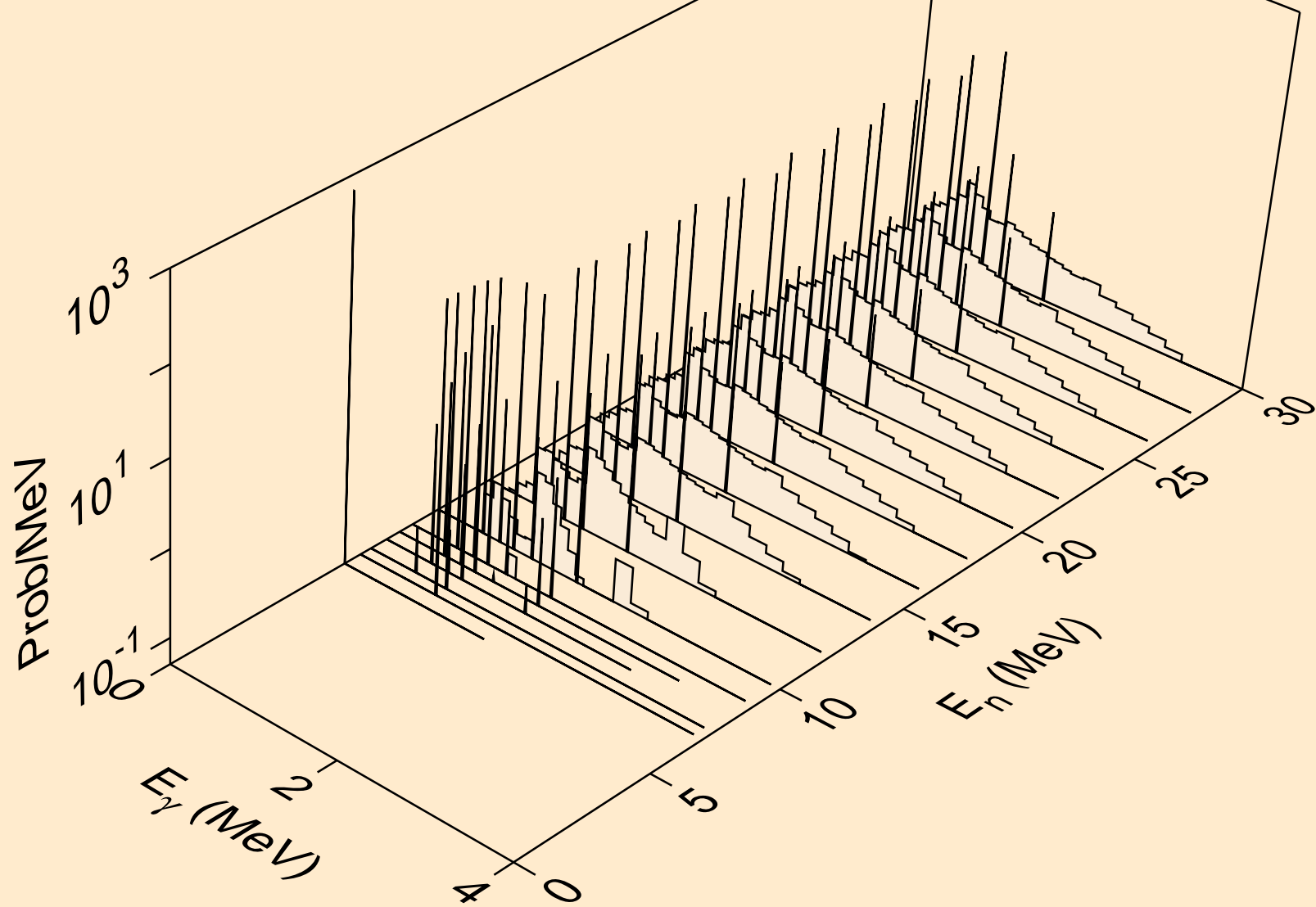

NB095M NEUTRON ACER TENDL-2023 LIBRARY; T=0.K  
Photon emission for (n,t)

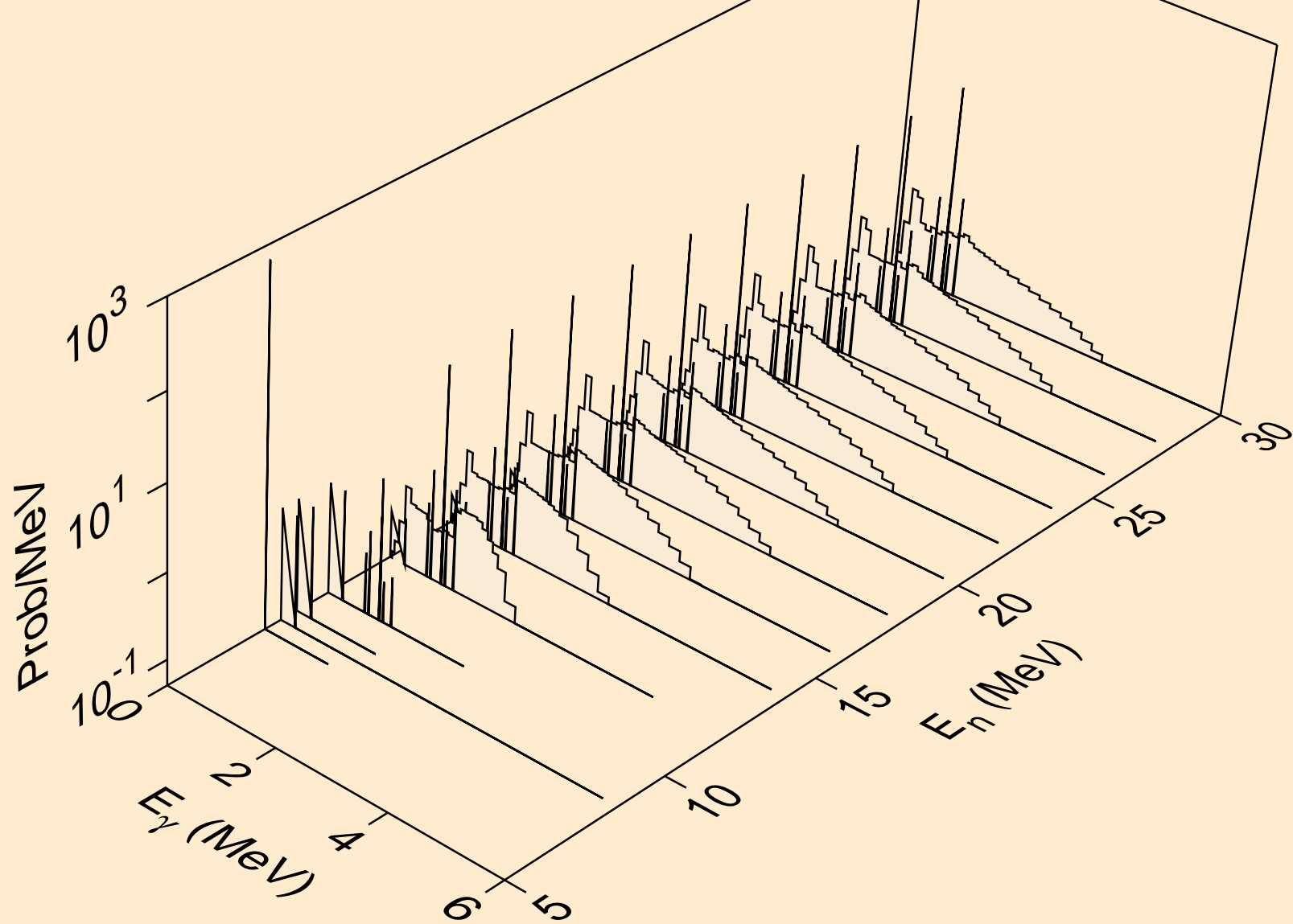

NB095M NEUTRON ACER TENDL-2023 LIBRARY; T=0.K  
Photon emission for (n,he3)

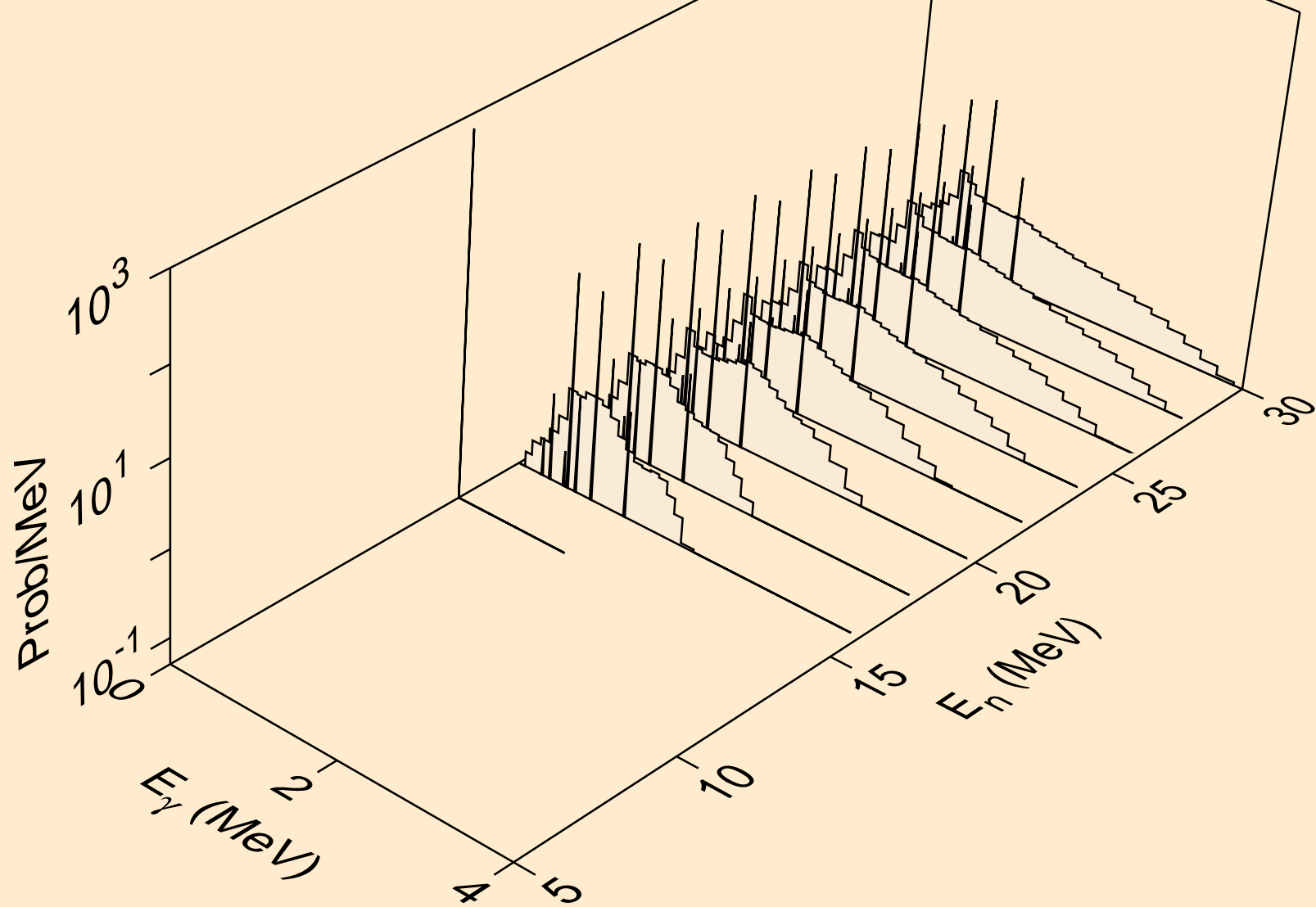

NB095M NEUTRON ACER TENDL-2023 LIBRARY; T=0.K  
Photon emission for (n,a)

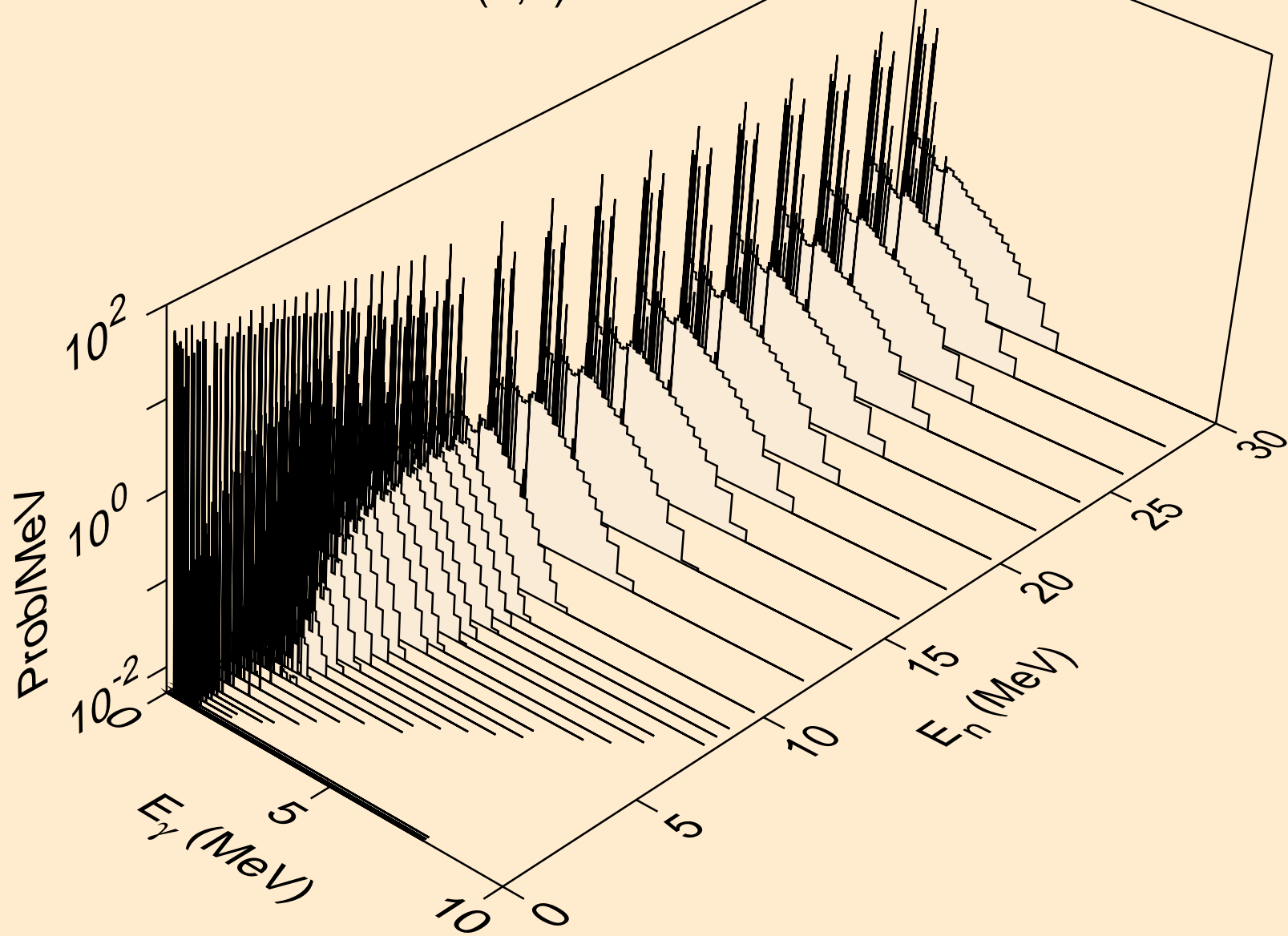

NB095M NEUTRON ACER TENDL-2023 LIBRARY; T=0.K  
Photon emission for (n,2a)

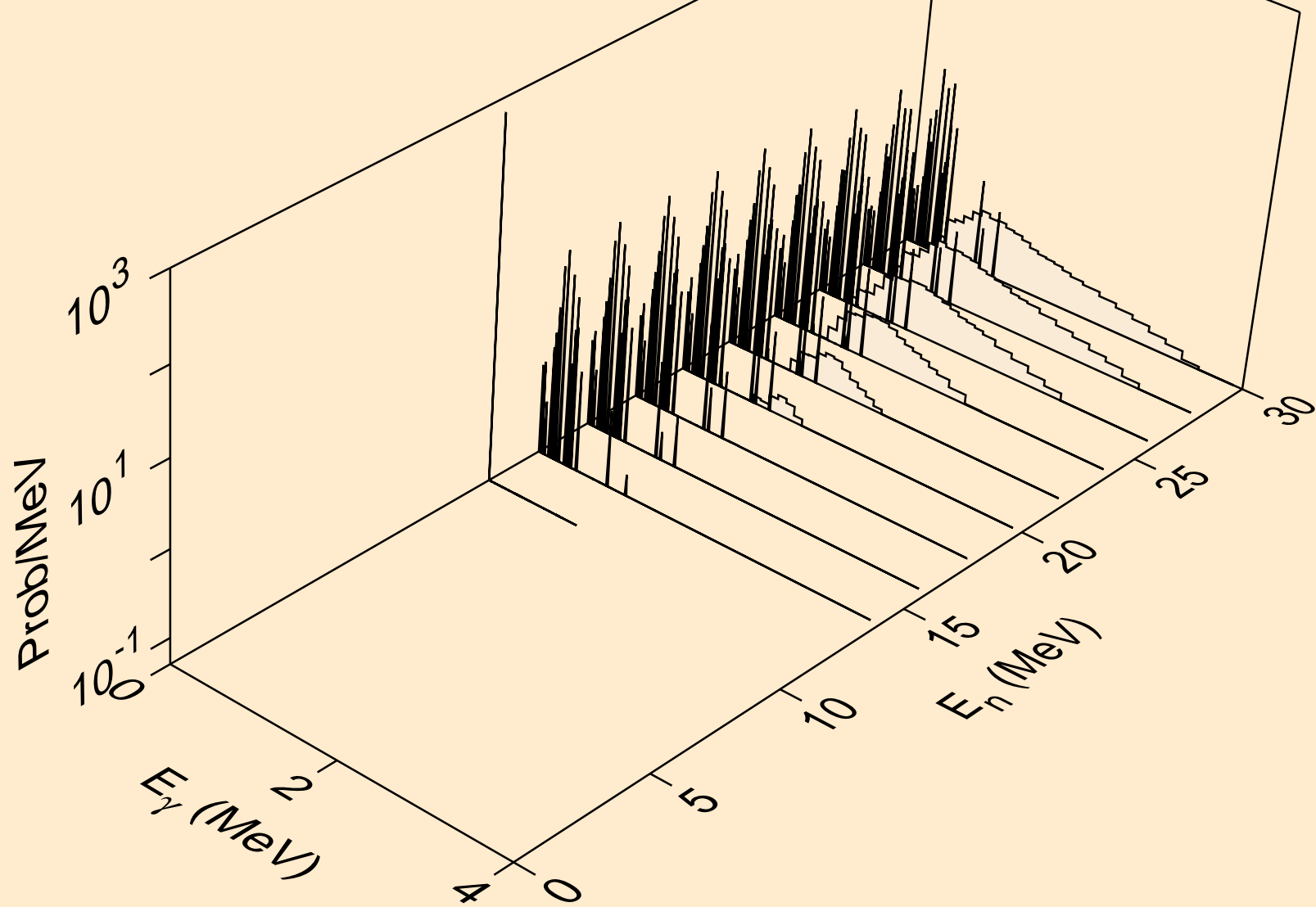

NB095M NEUTRON ACER TENDL-2023 LIBRARY; T=0.K  
Photon emission for (n,2p)

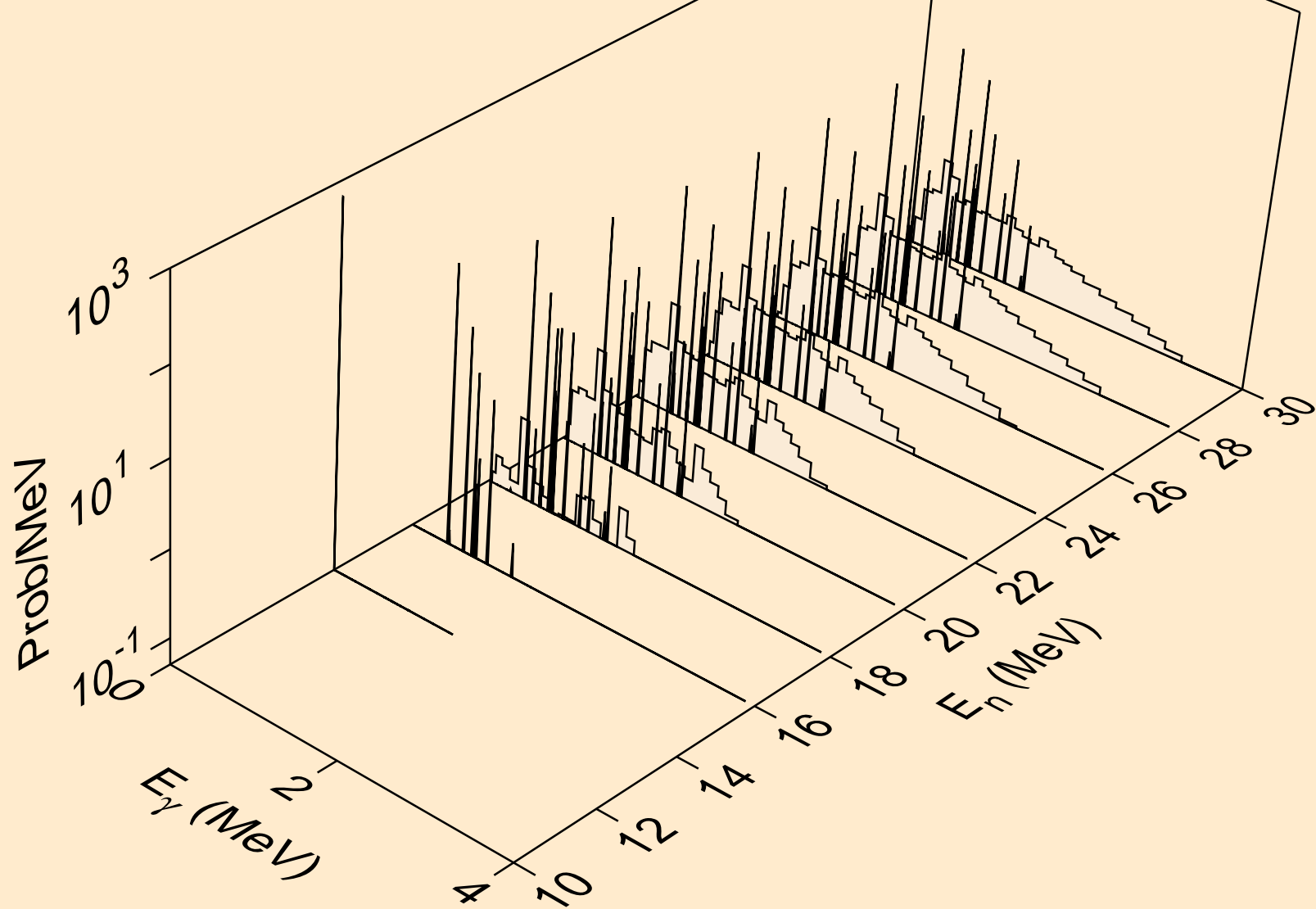

NB095M NEUTRON ACER TENDL-2023 LIBRARY; T=0.K  
Photon emission for (n,p $\alpha$ )

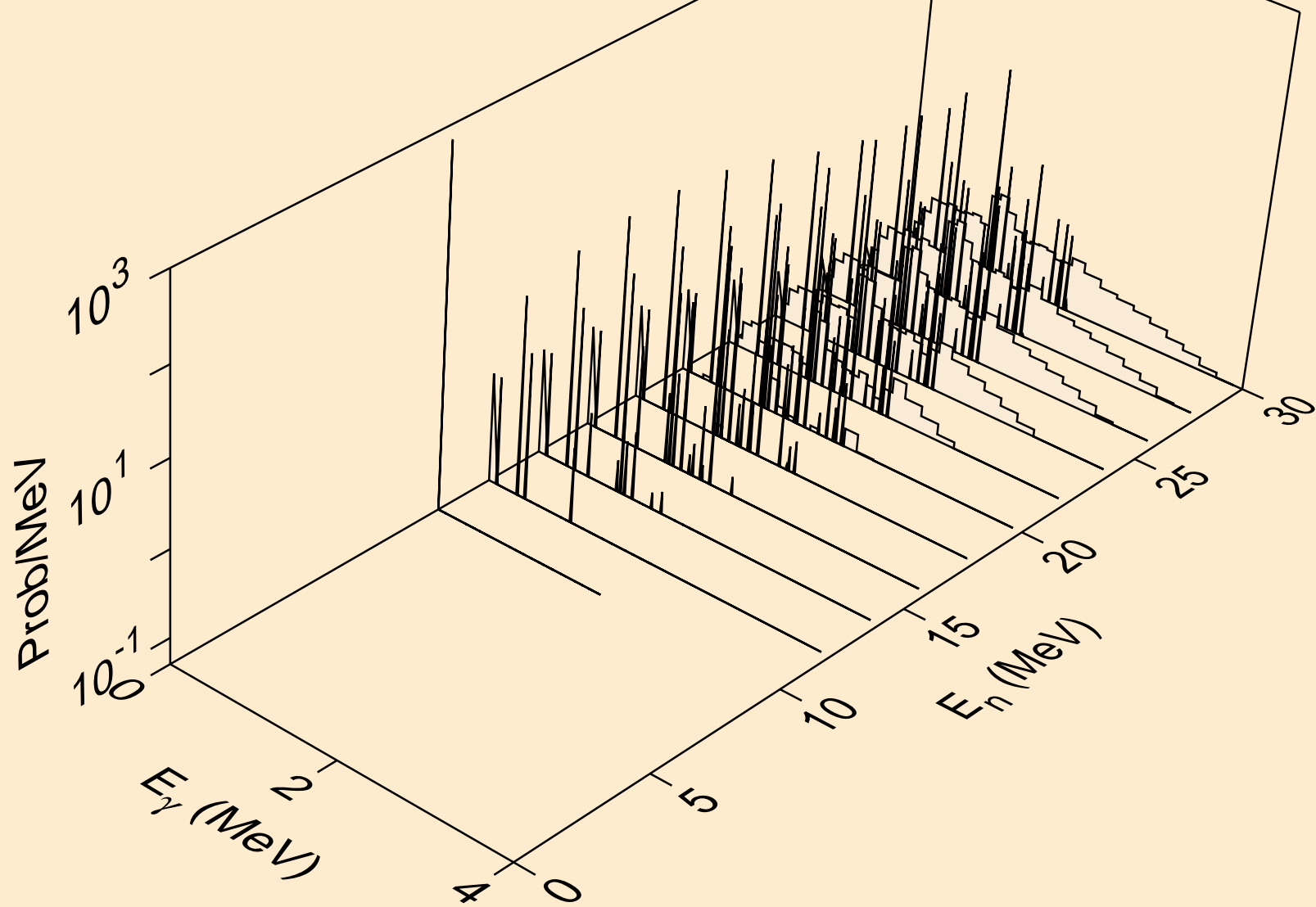

NB095M NEUTRON ACER TENDL-2023 LIBRARY; T=0.K  
Photon emission for (n,pd)

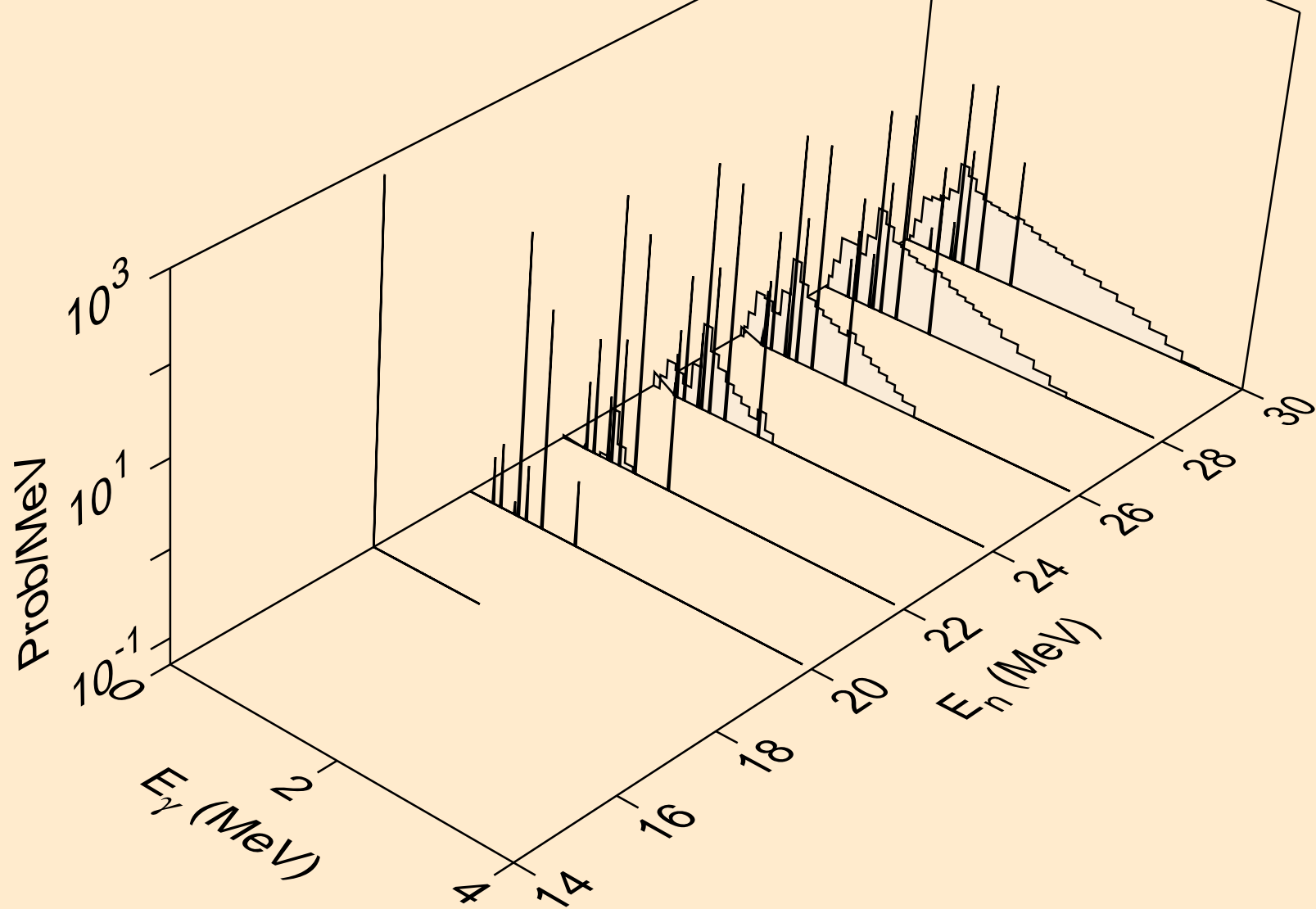

NB095M NEUTRON ACER TENDL-2023 LIBRARY; T=0.K  
Photon emission for (n,pt)

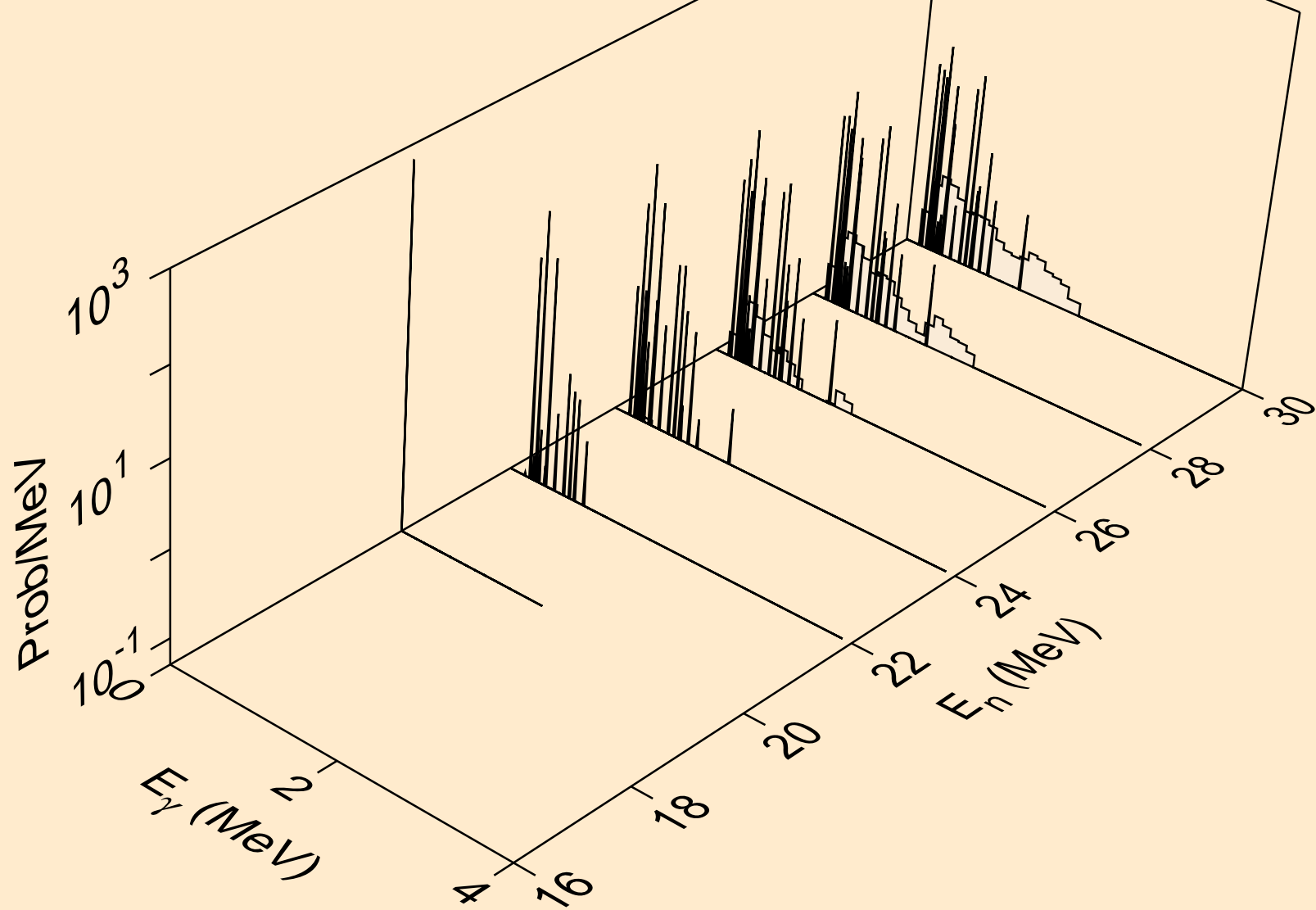

NB095M NEUTRON ACER TENDL-2023 LIBRARY; T=0.K  
Photon emission for (n,da)

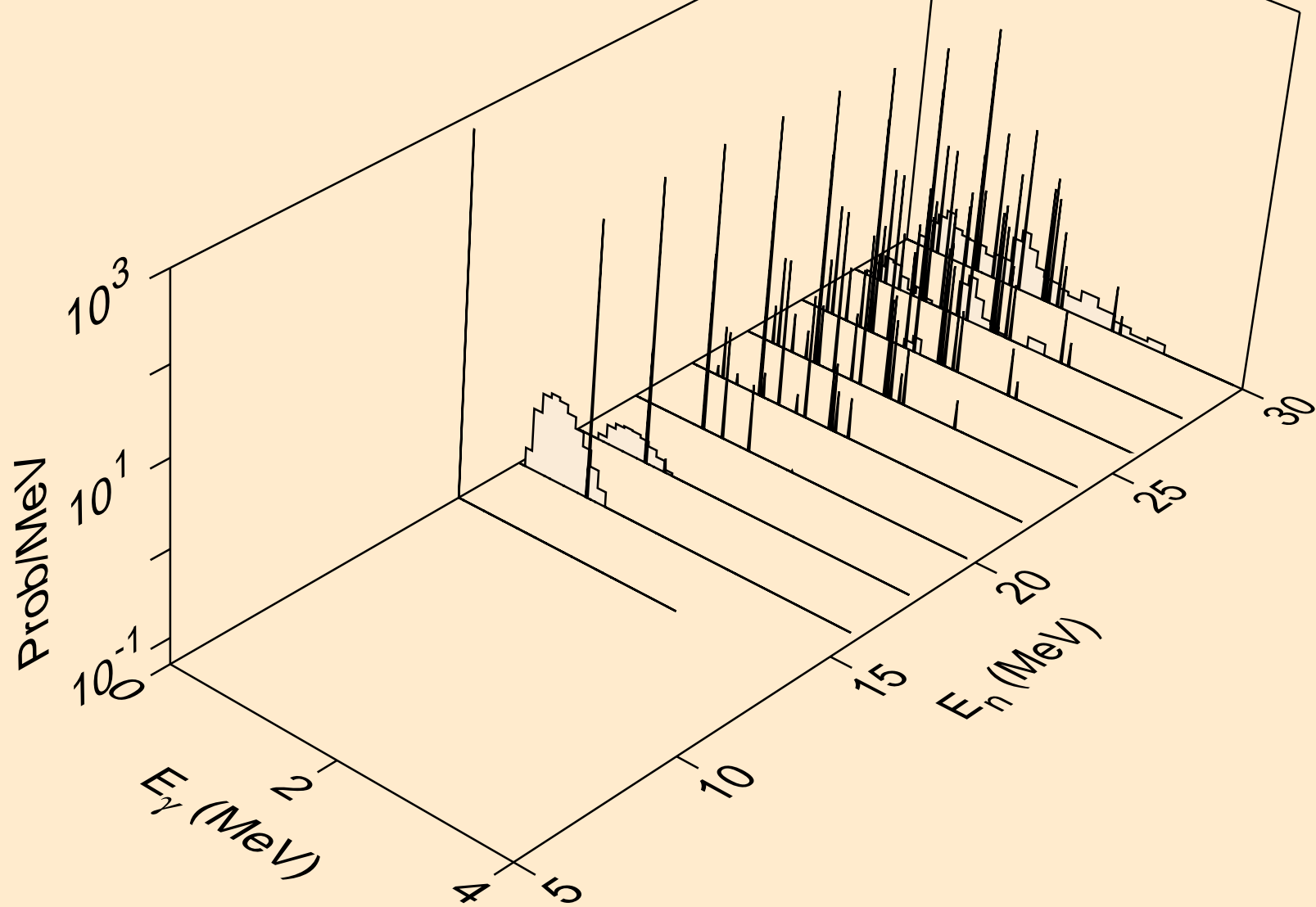

NB095M NEUTRON ACER TENDL-2023 LIBRARY; T=0.K  
thermal capture photon spectrum

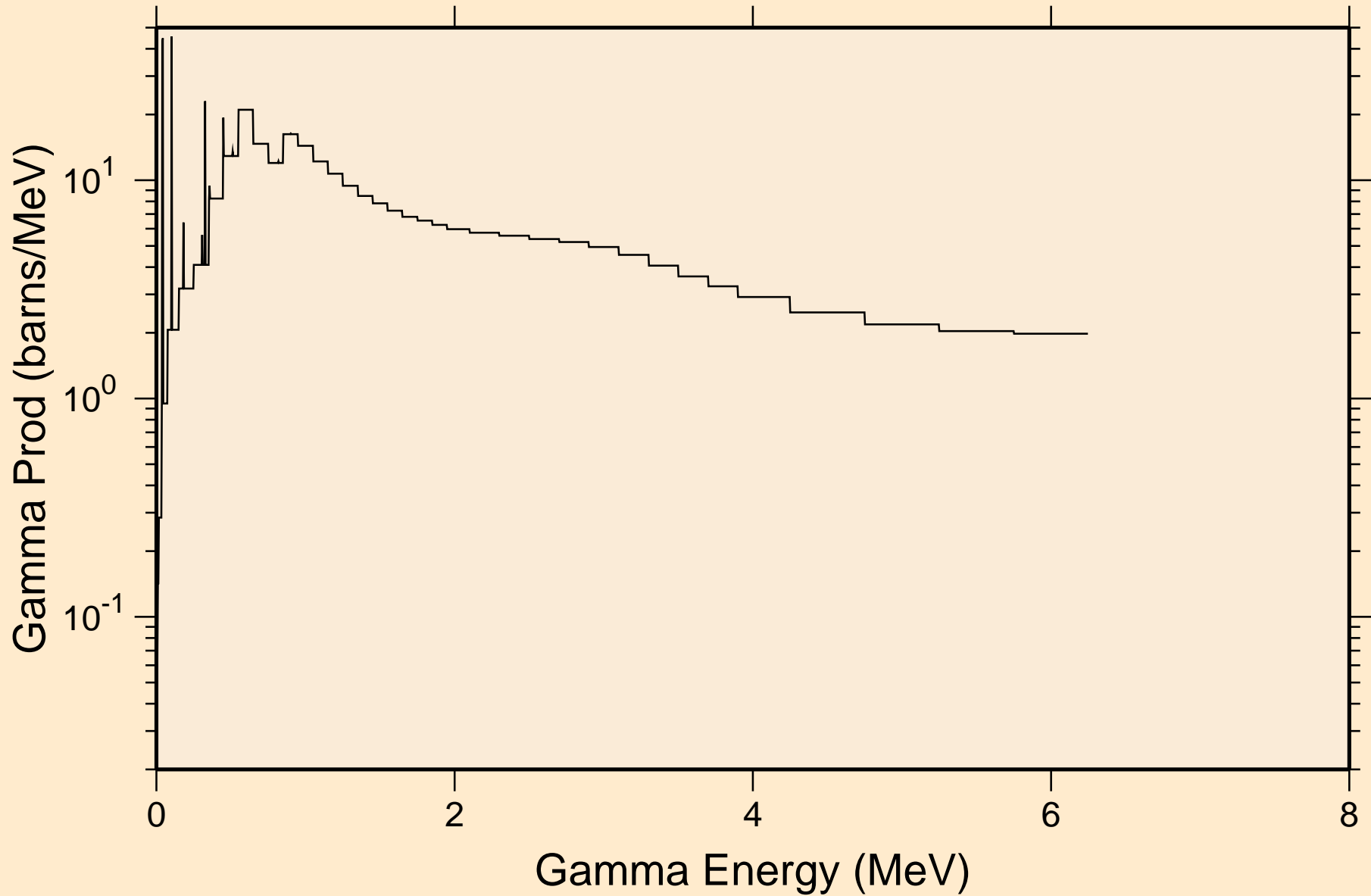

NB095M NEUTRON ACER TENDL-2023 LIBRARY; T=0.K  
14 MeV photon spectrum

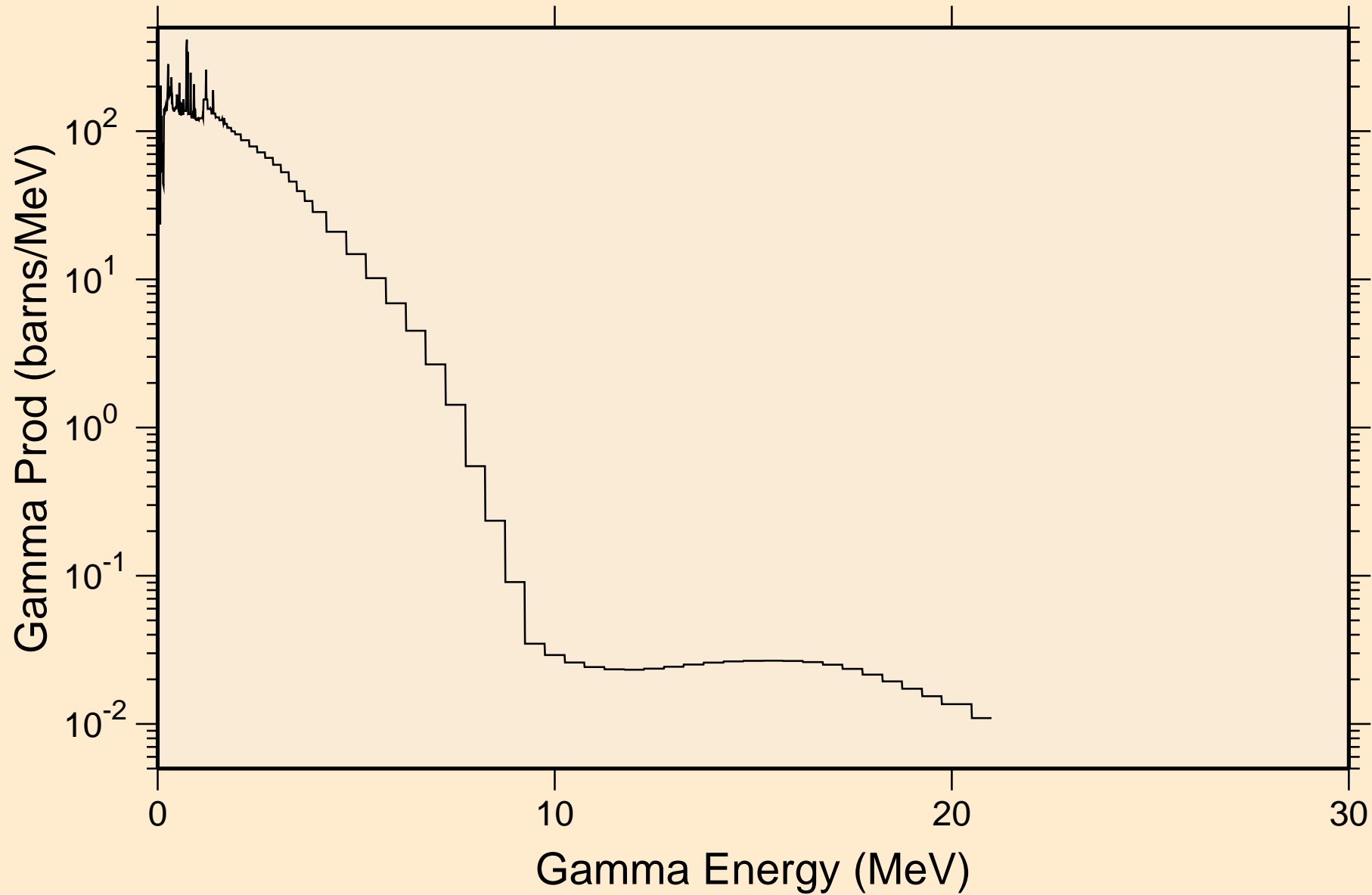

# NB095M NEUTRON ACER TENDL-2023 LIBRARY; T=0.K

## Particle heating contributions

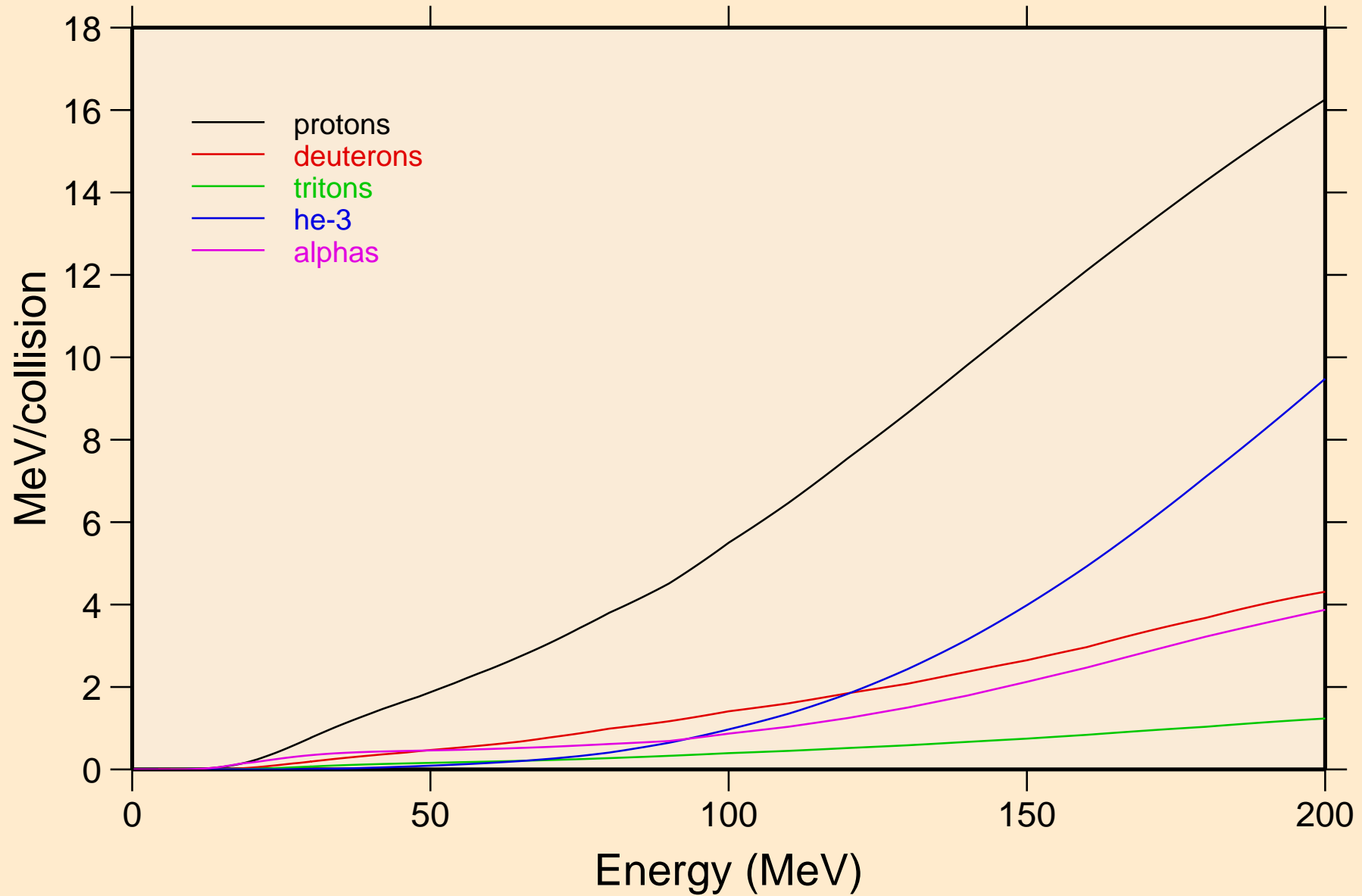

NB095M NEUTRON ACER TENDL-2023 LIBRARY; T=0.K  
Recoil Heating

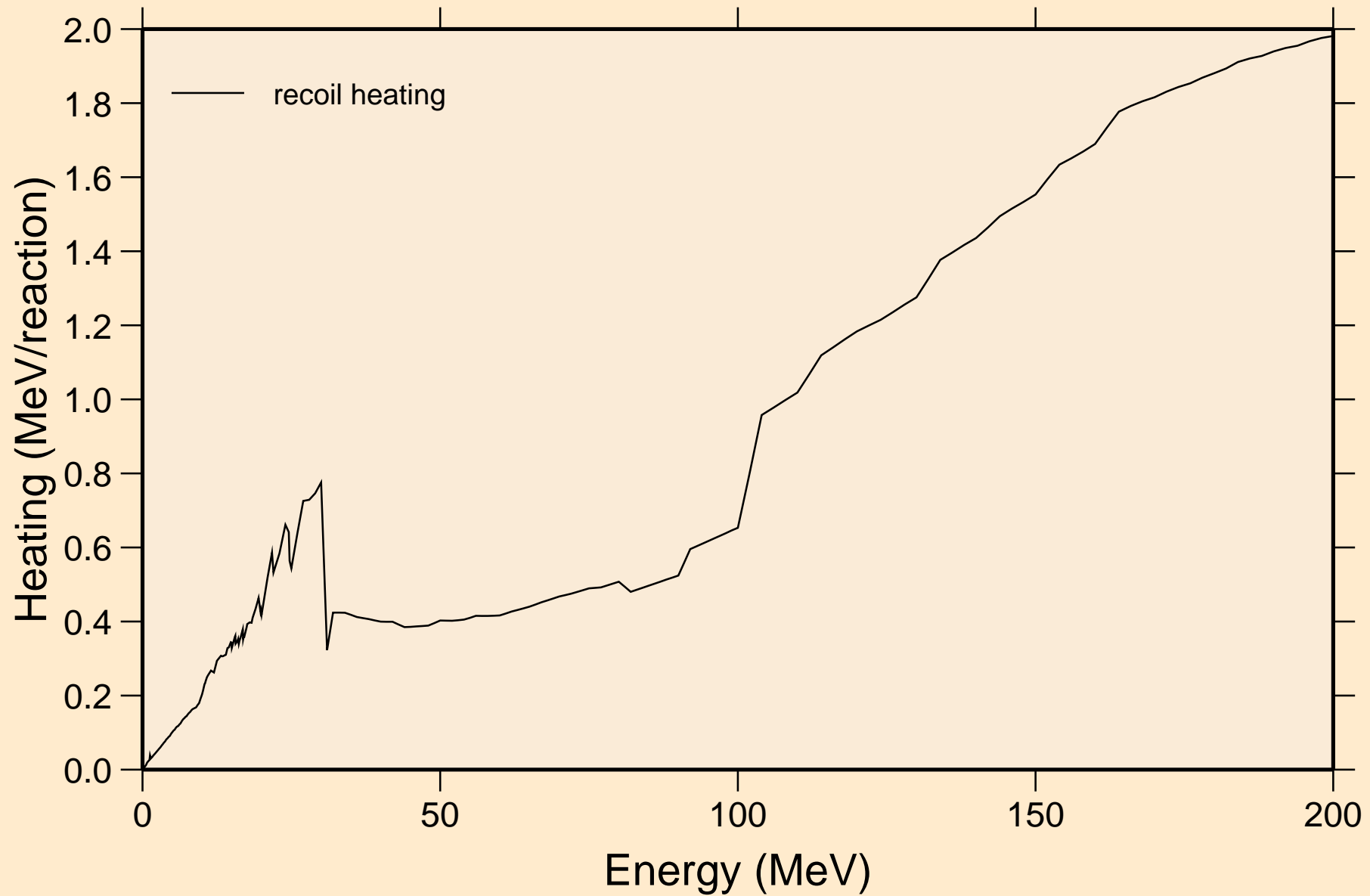

NB095M NEUTRON ACER TENDL-2023 LIBRARY; T=0.K  
Particle production cross sections

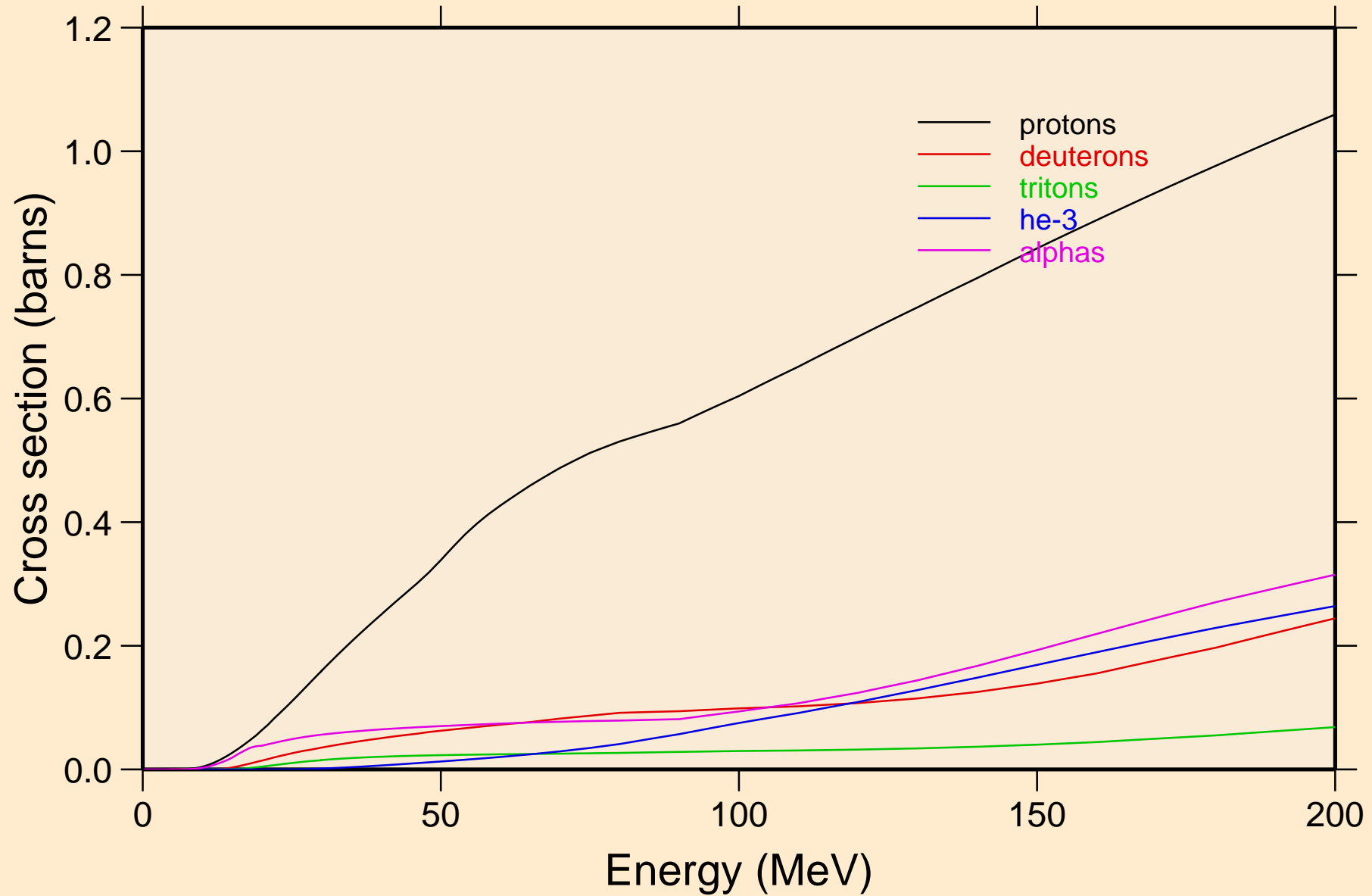

NB095M NEUTRON ACER TENDL-2023 LIBRARY; T=0.K  
protons from (n,x)

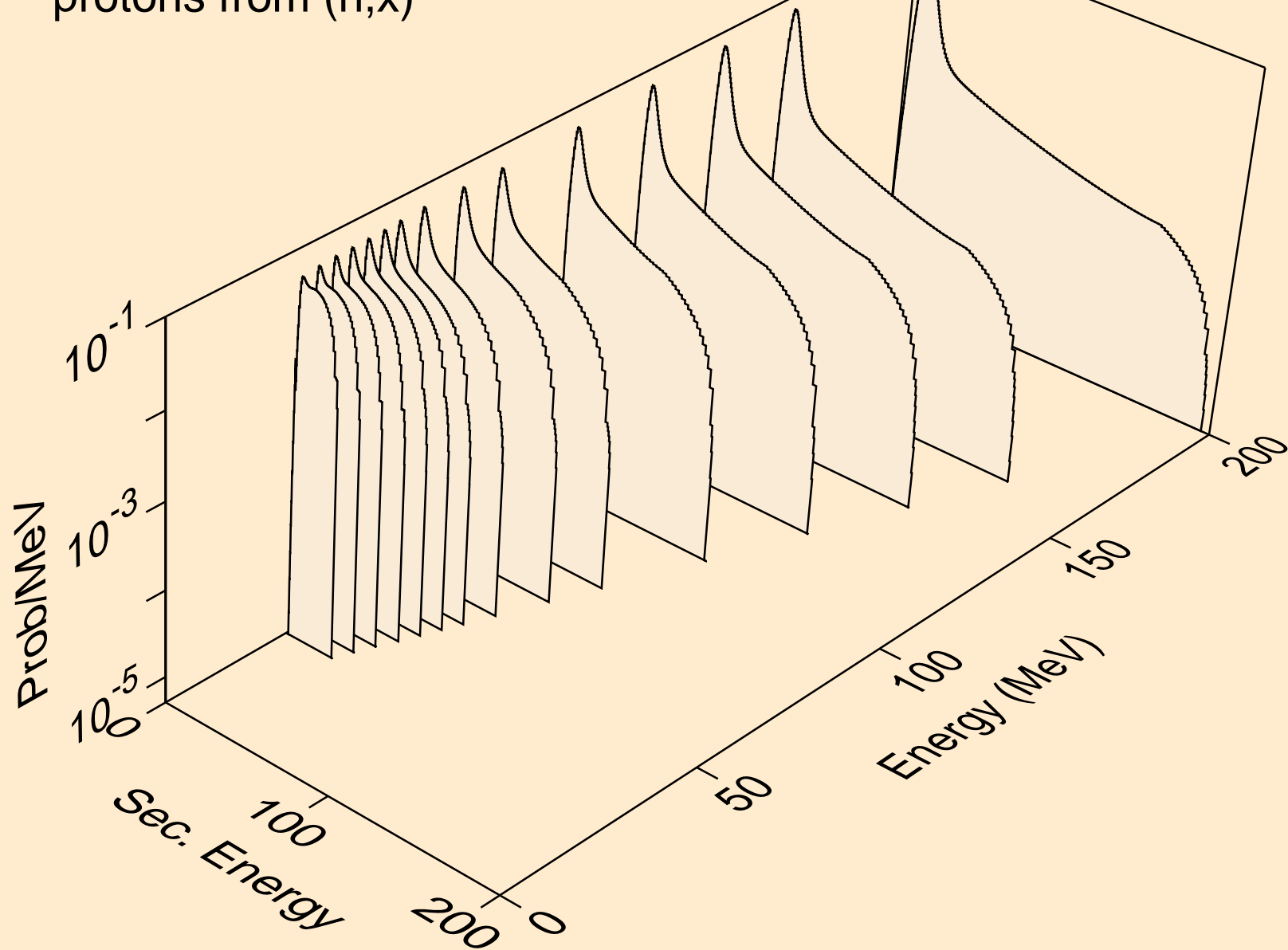

NB095M NEUTRON ACER TENDL-2023 LIBRARY; T=0.K  
protons from (n,n\*)p

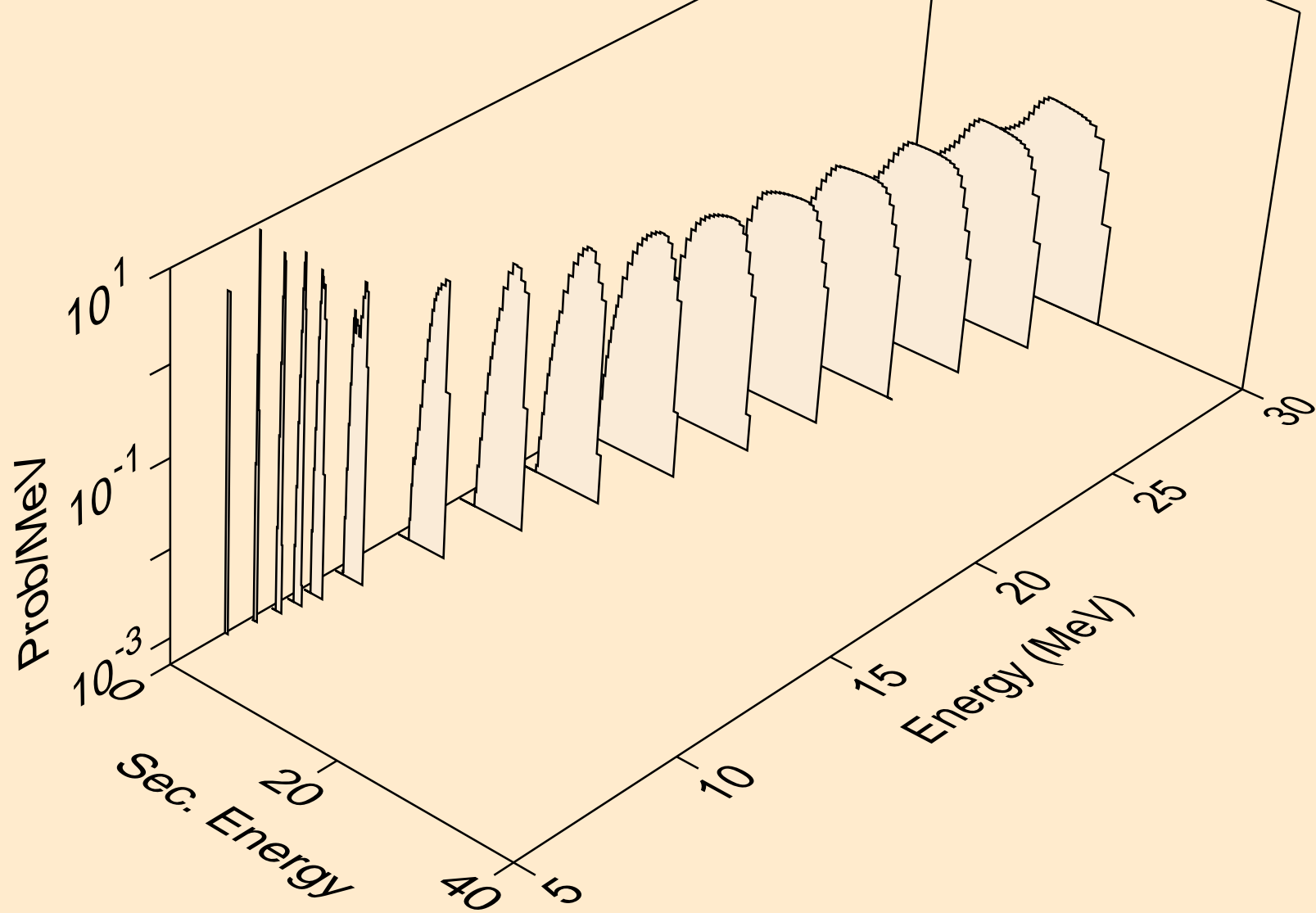

NB095M NEUTRON ACER TENDL-2023 LIBRARY; T=0.K  
protons from (n,2np)

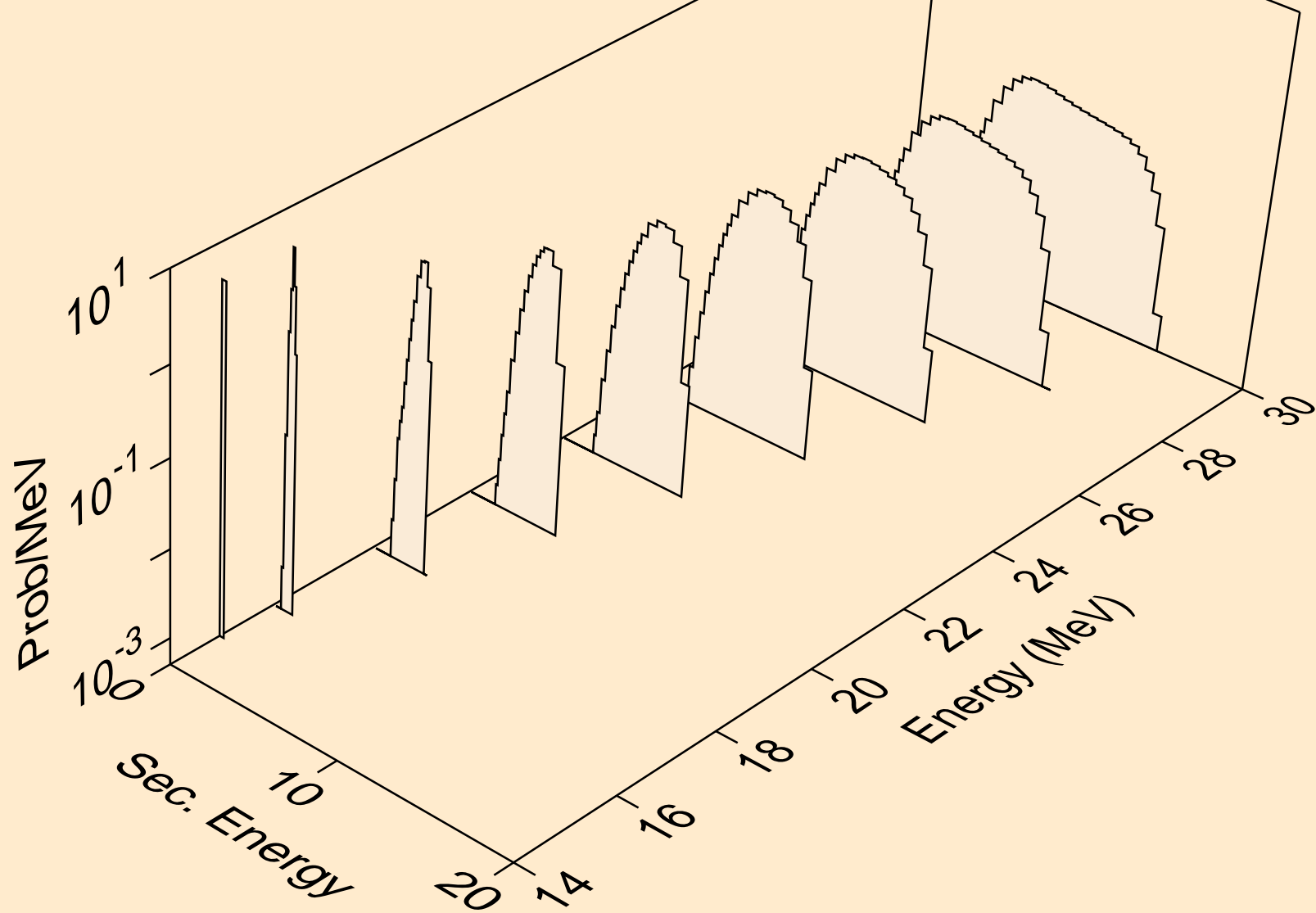

NB095M NEUTRON ACER TENDL-2023 LIBRARY; T=0.K  
protons from (n,3np)

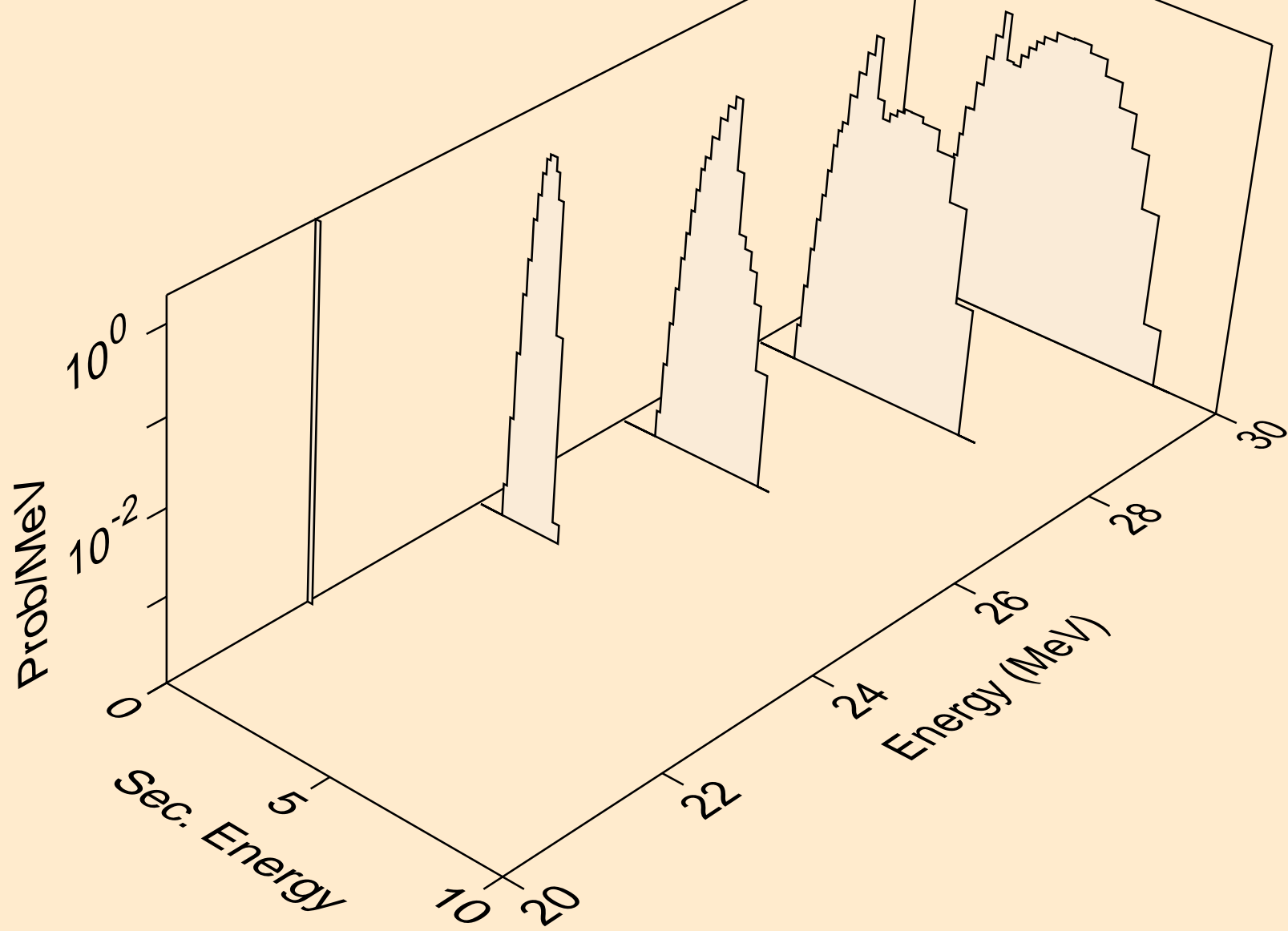

NB095M NEUTRON ACER TENDL-2023 LIBRARY; T=0.K  
protons from (n,n2p)

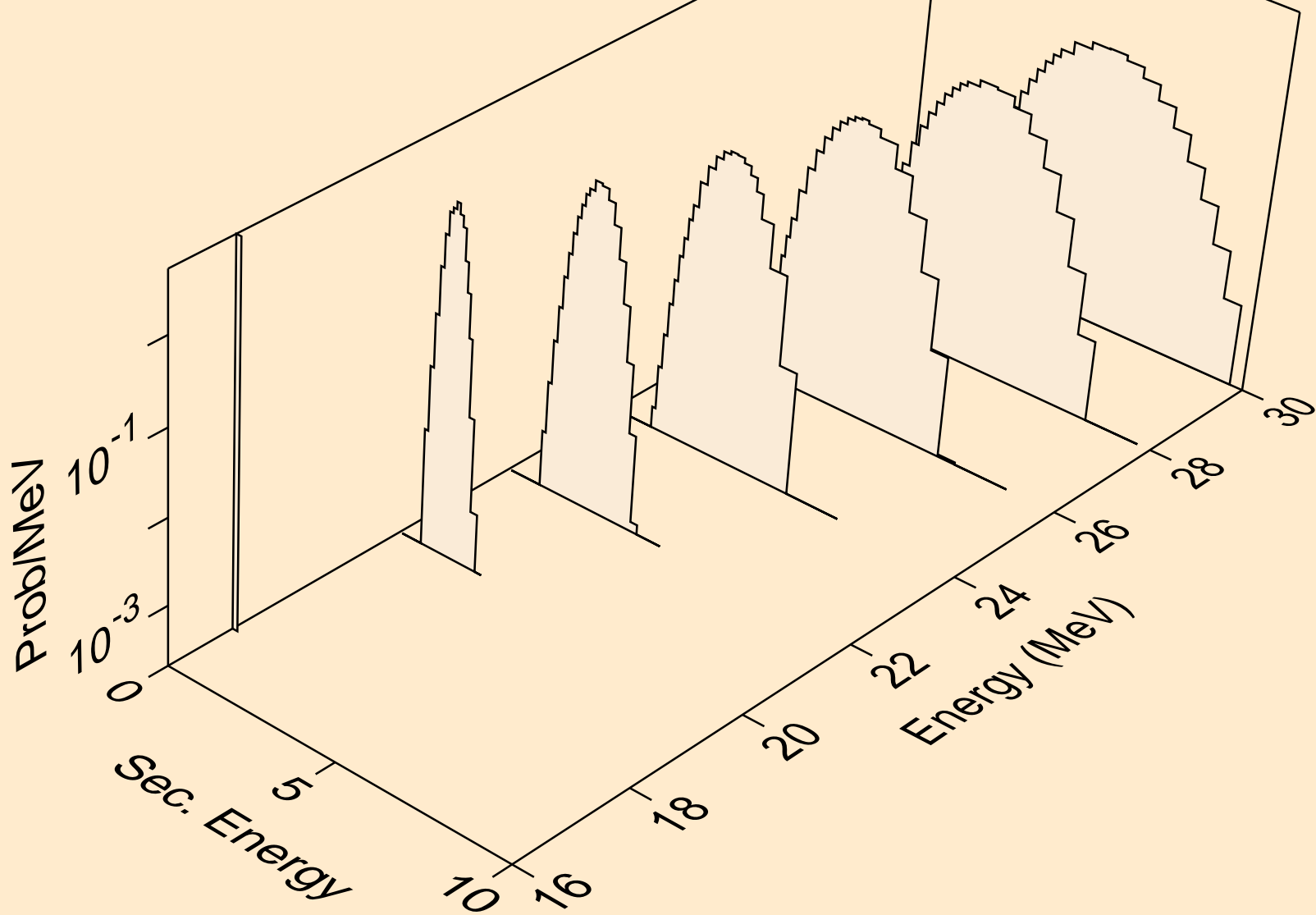

NB095M NEUTRON ACER TENDL-2023 LIBRARY; T=0.K  
protons from (n,npa)

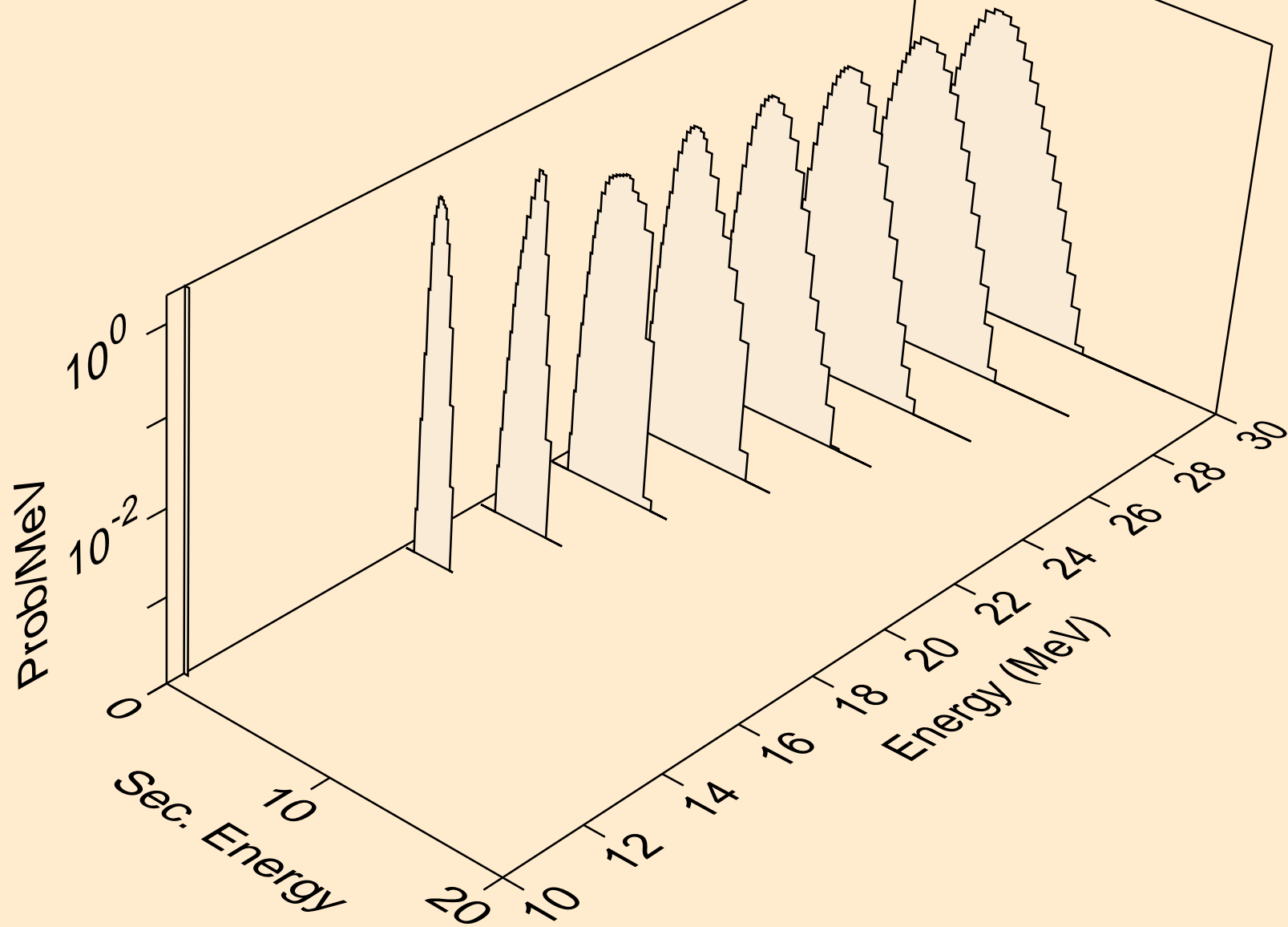

NB095M NEUTRON ACER TENDL-2023 LIBRARY; T=0.K  
protons from (n,p)

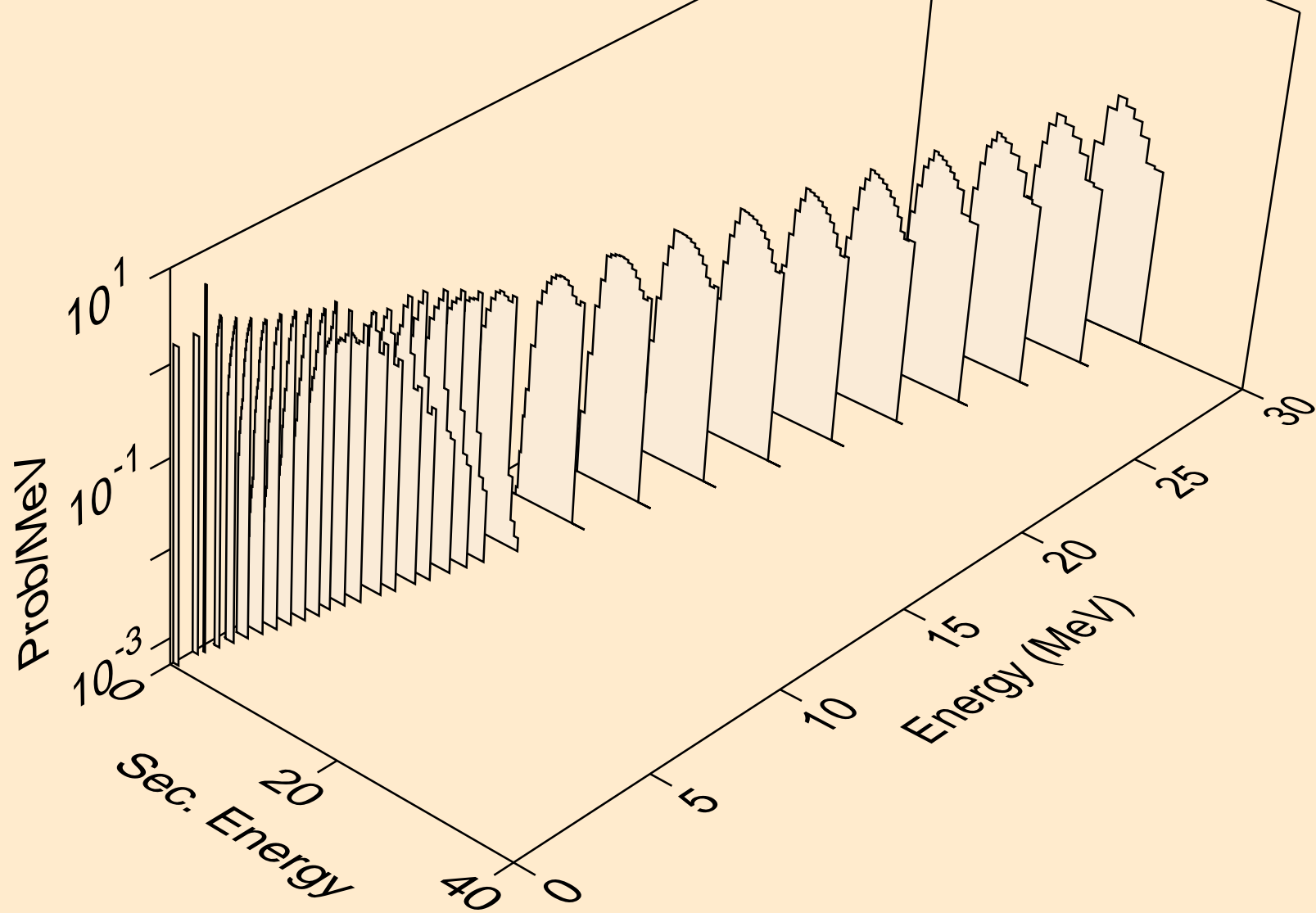

NB095M NEUTRON ACER TENDL-2023 LIBRARY; T=0.K  
protons from (n,2p)

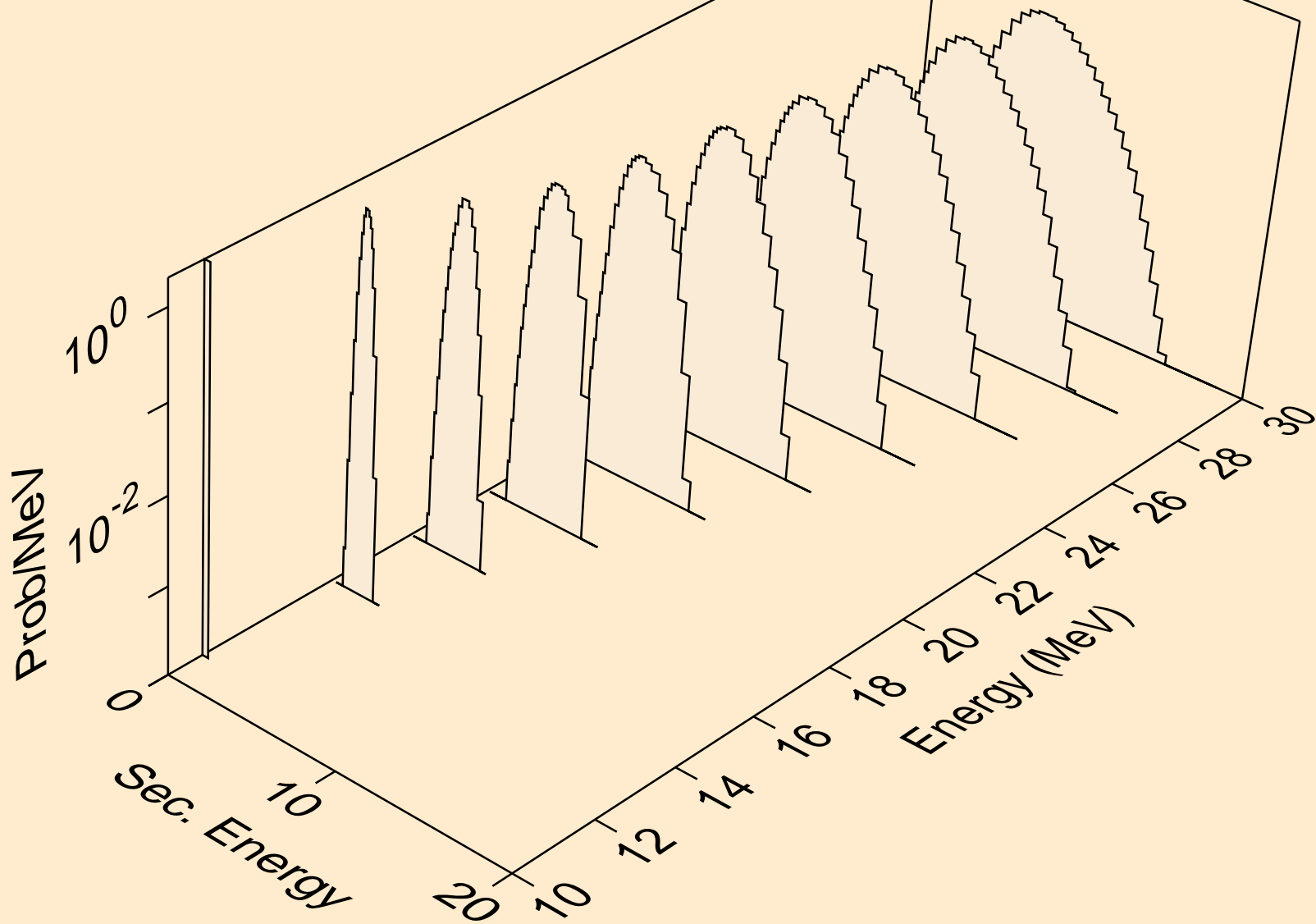

NB095M NEUTRON ACER TENDL-2023 LIBRARY; T=0.K  
protons from (n,p)

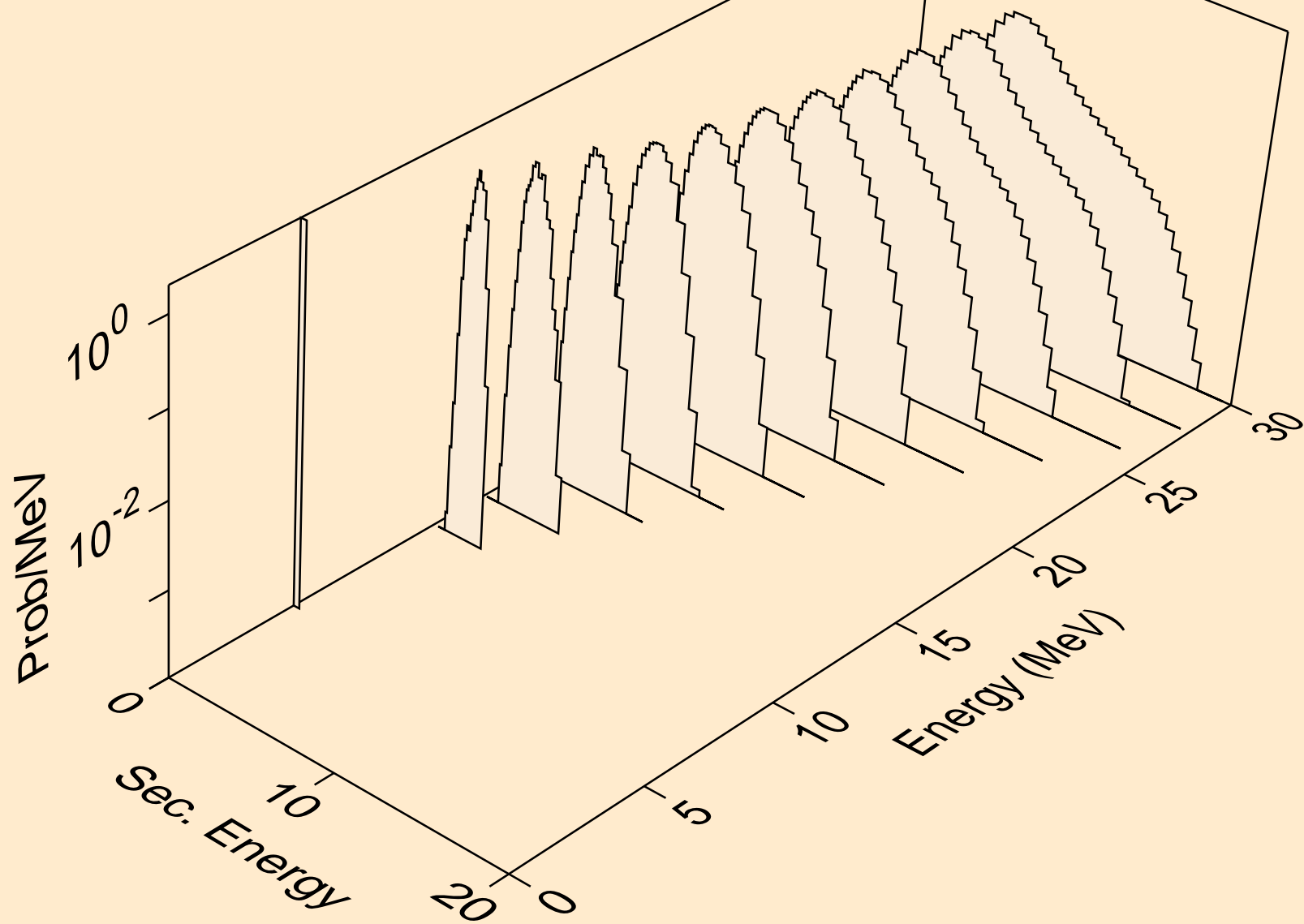

NB095M NEUTRON ACER TENDL-2023 LIBRARY; T=0.K  
protons from (n,pd)

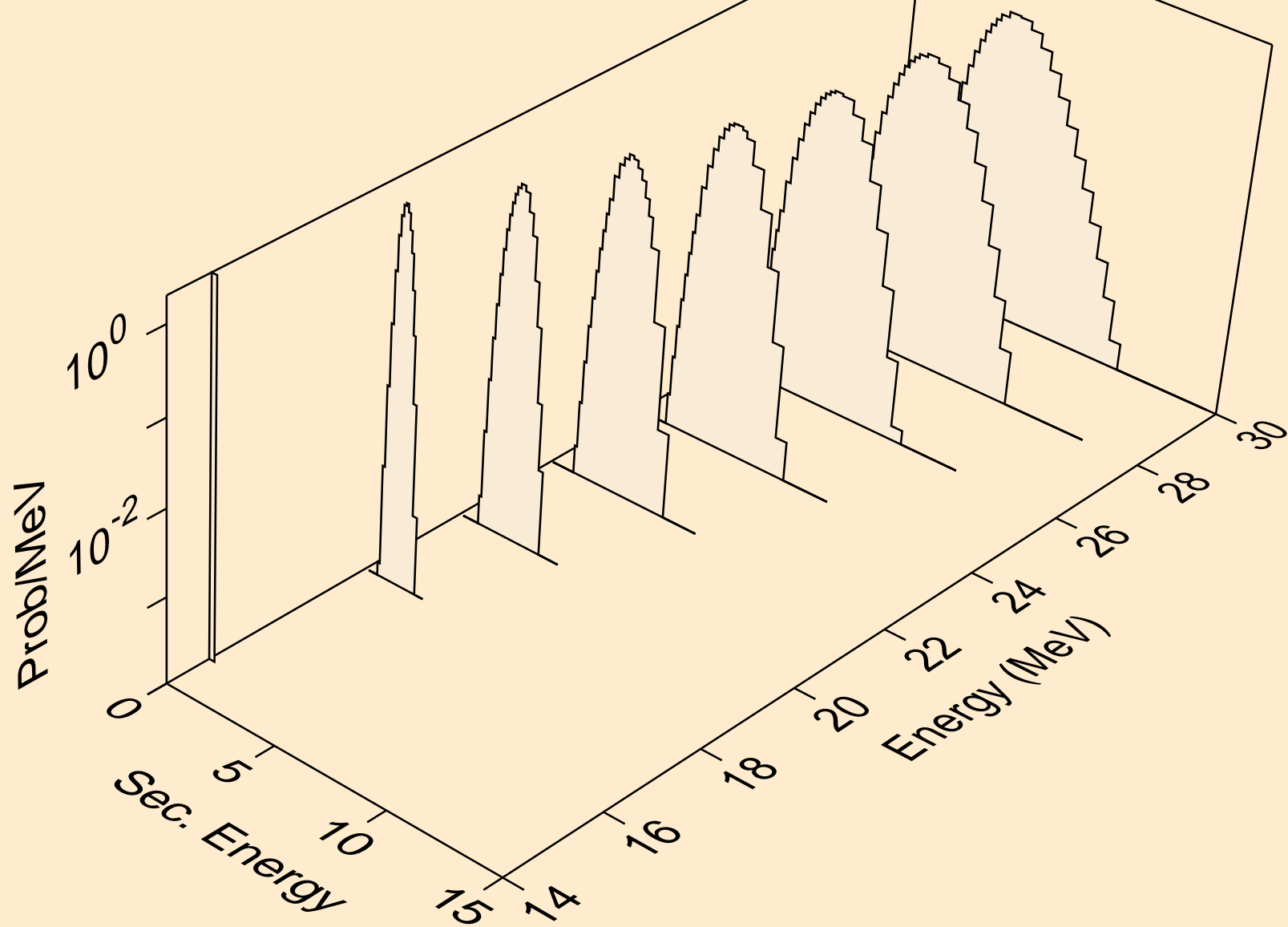

NB095M NEUTRON ACER TENDL-2023 LIBRARY; T=0.K  
protons from (n,pt)

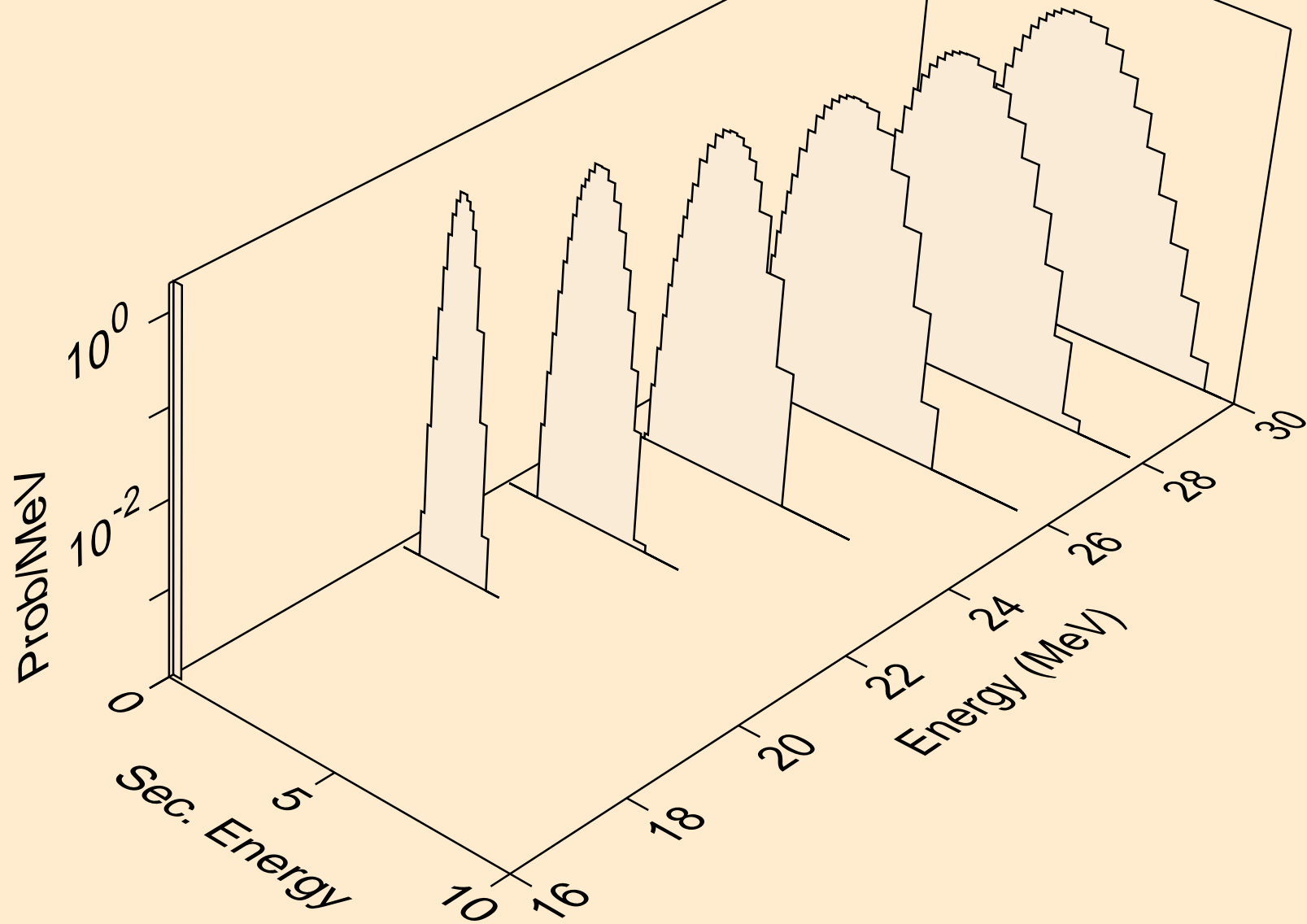

NB095M NEUTRON ACER TENDL-2023 LIBRARY; T=0.K  
deuterons from (n,x)

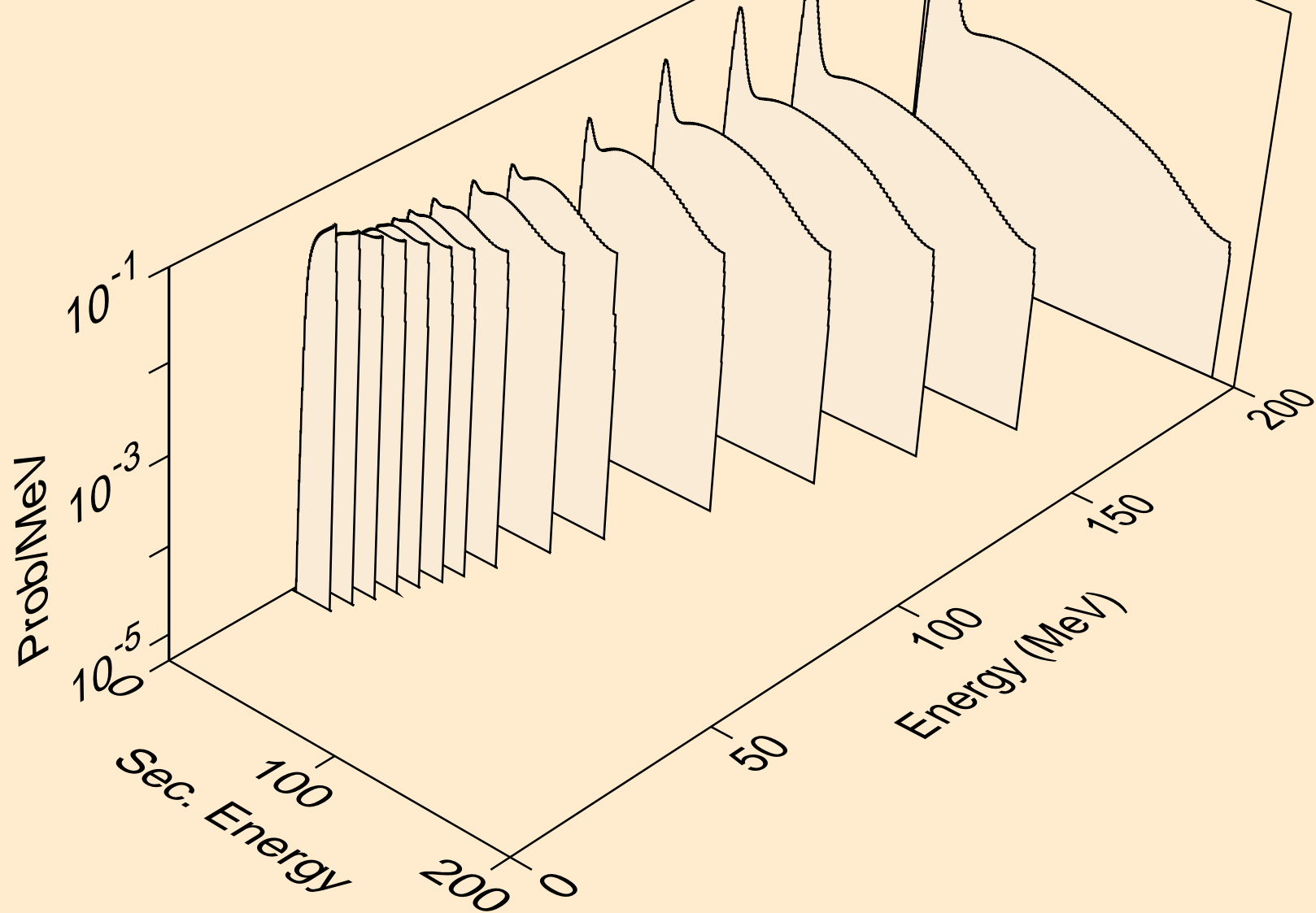

NB095M NEUTRON ACER TENDL-2023 LIBRARY; T=0.K  
deuterons from (n,2nd)

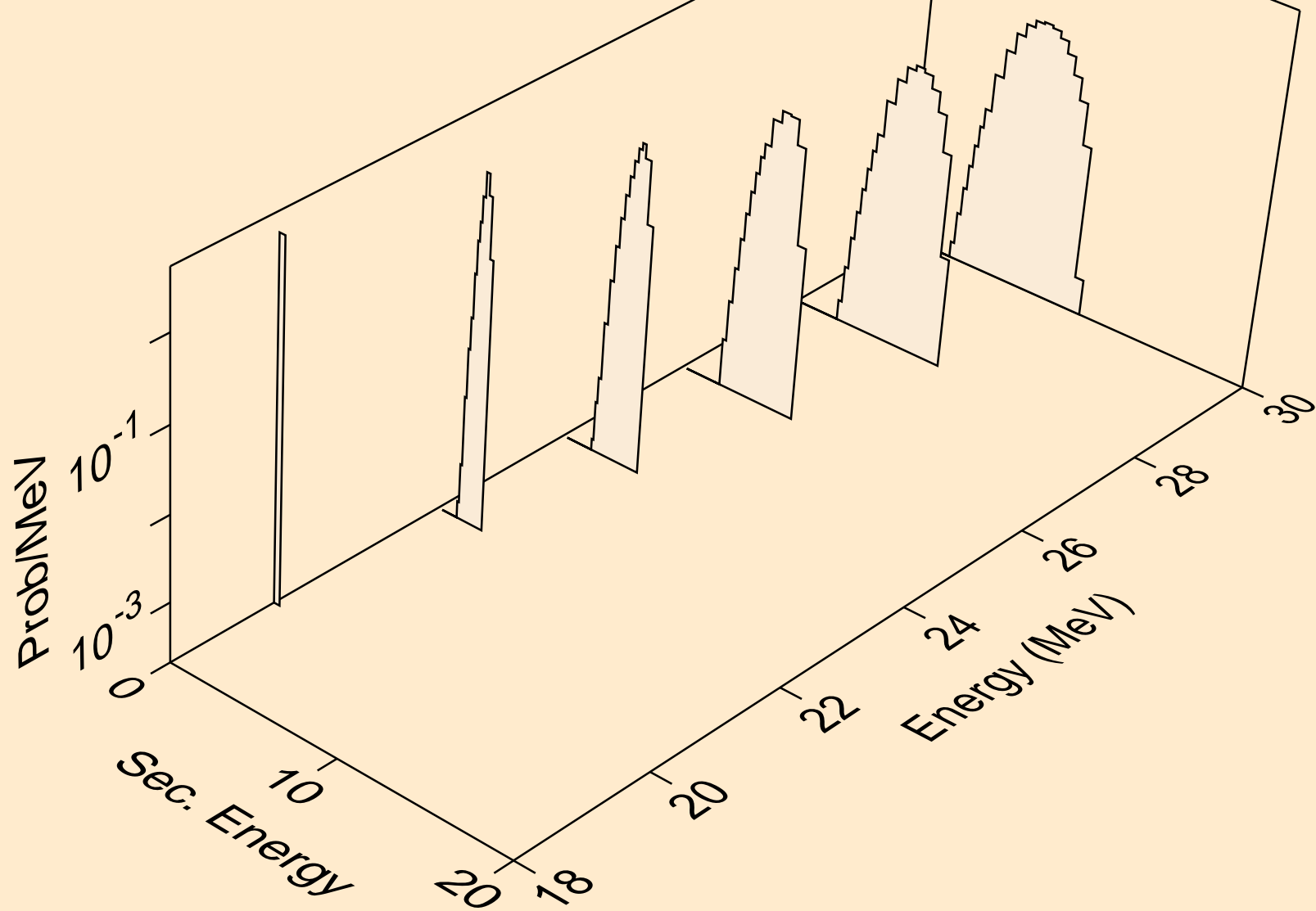

NB095M NEUTRON ACER TENDL-2023 LIBRARY; T=0.K  
deuterons from (n,n\*)d

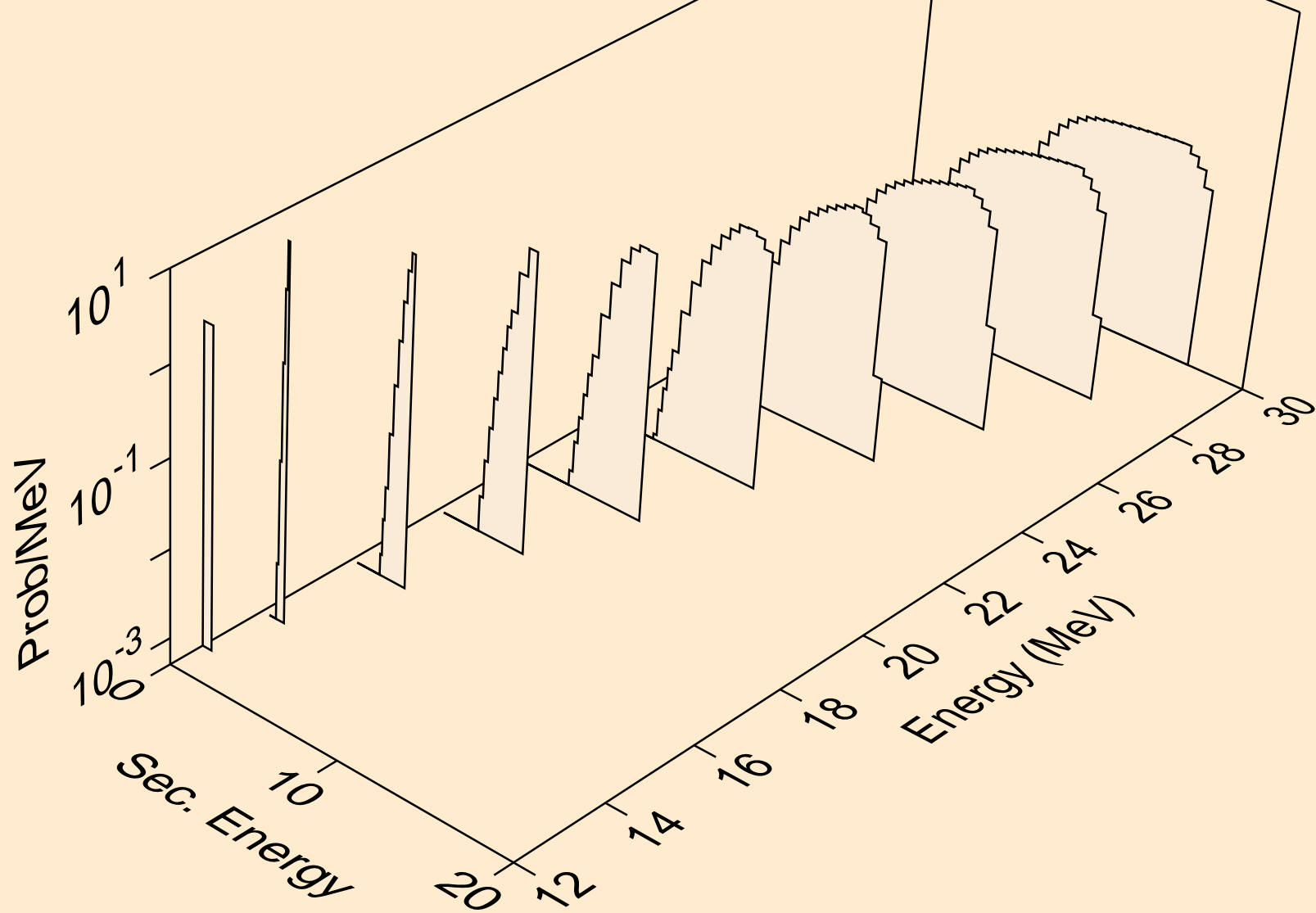

NB095M NEUTRON ACER TENDL-2023 LIBRARY; T=0.K  
deuterons from (n,d)

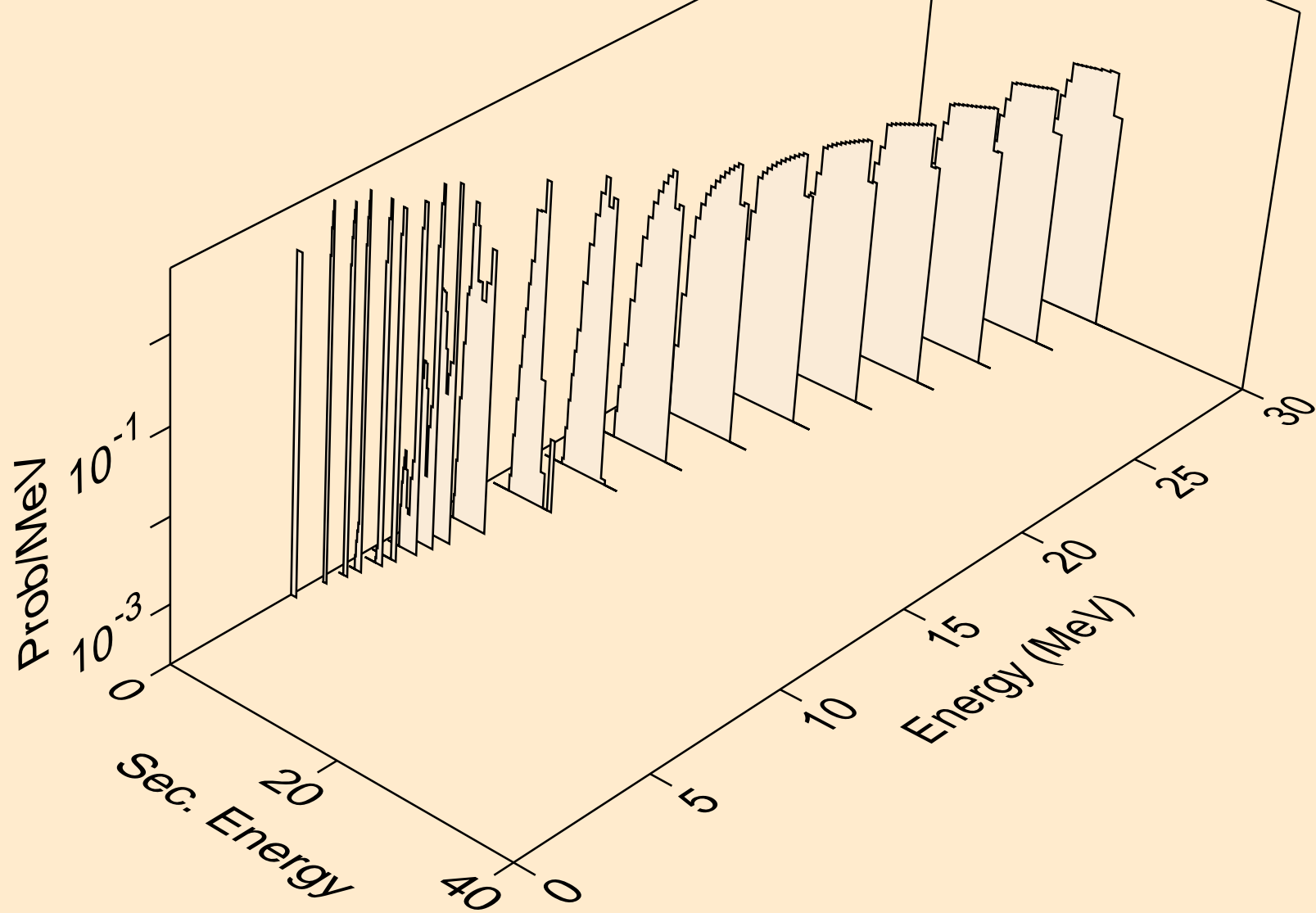

NB095M NEUTRON ACER TENDL-2023 LIBRARY; T=0.K  
deuterons from (n,pd)

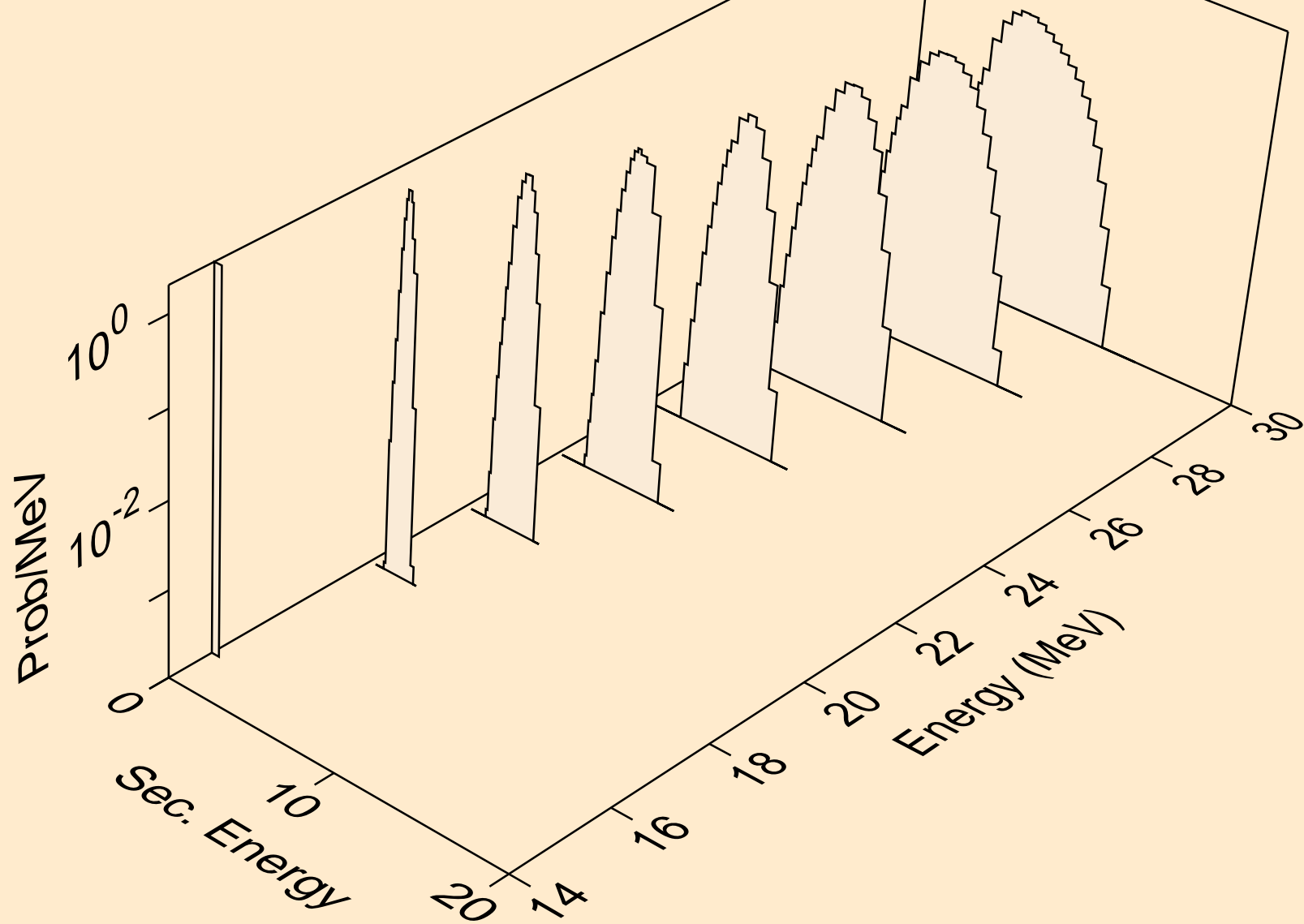

NB095M NEUTRON ACER TENDL-2023 LIBRARY; T=0.K  
deuterons from (n,da)

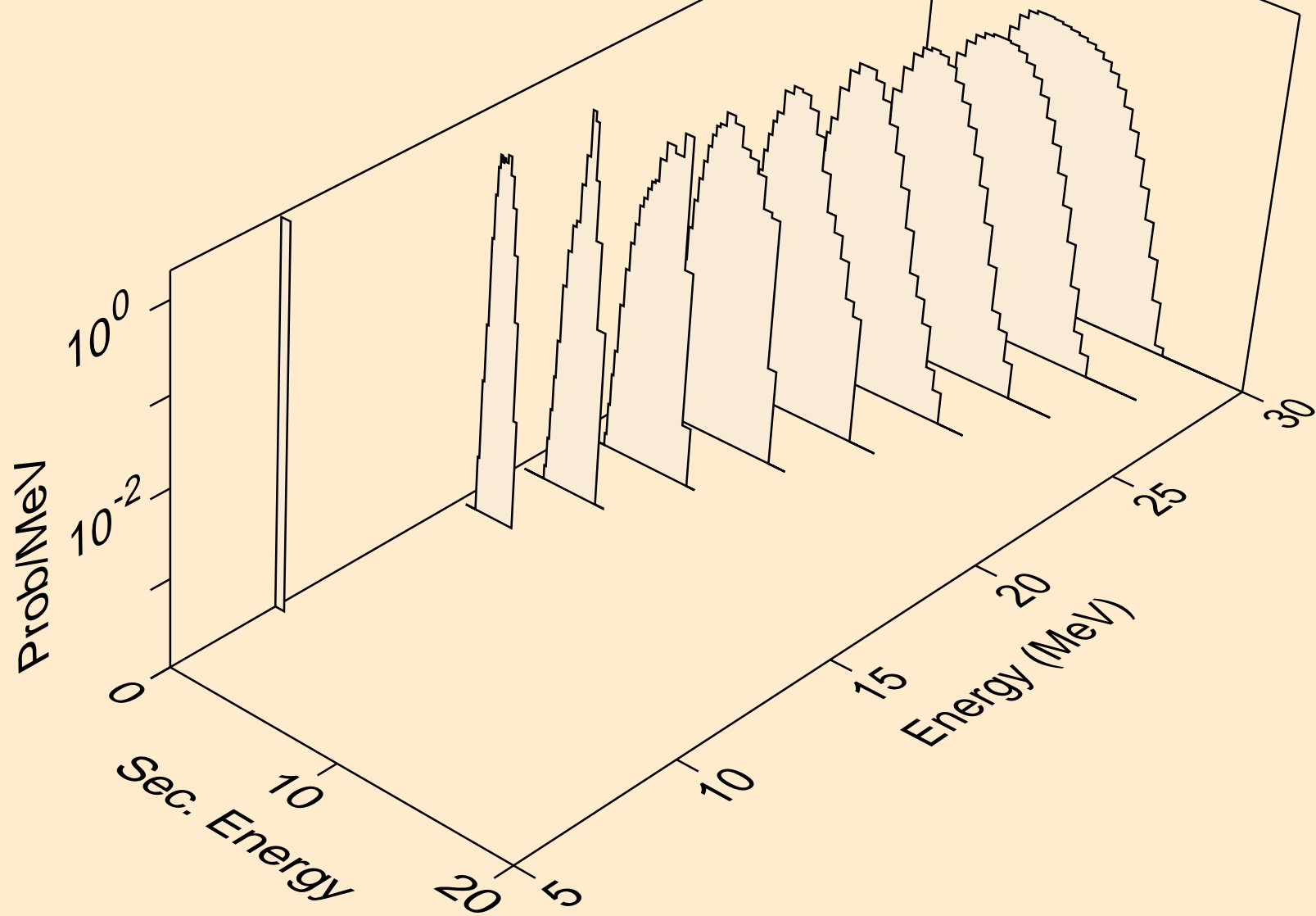

NB095M NEUTRON ACER TENDL-2023 LIBRARY; T=0.K  
tritons from (n,x)

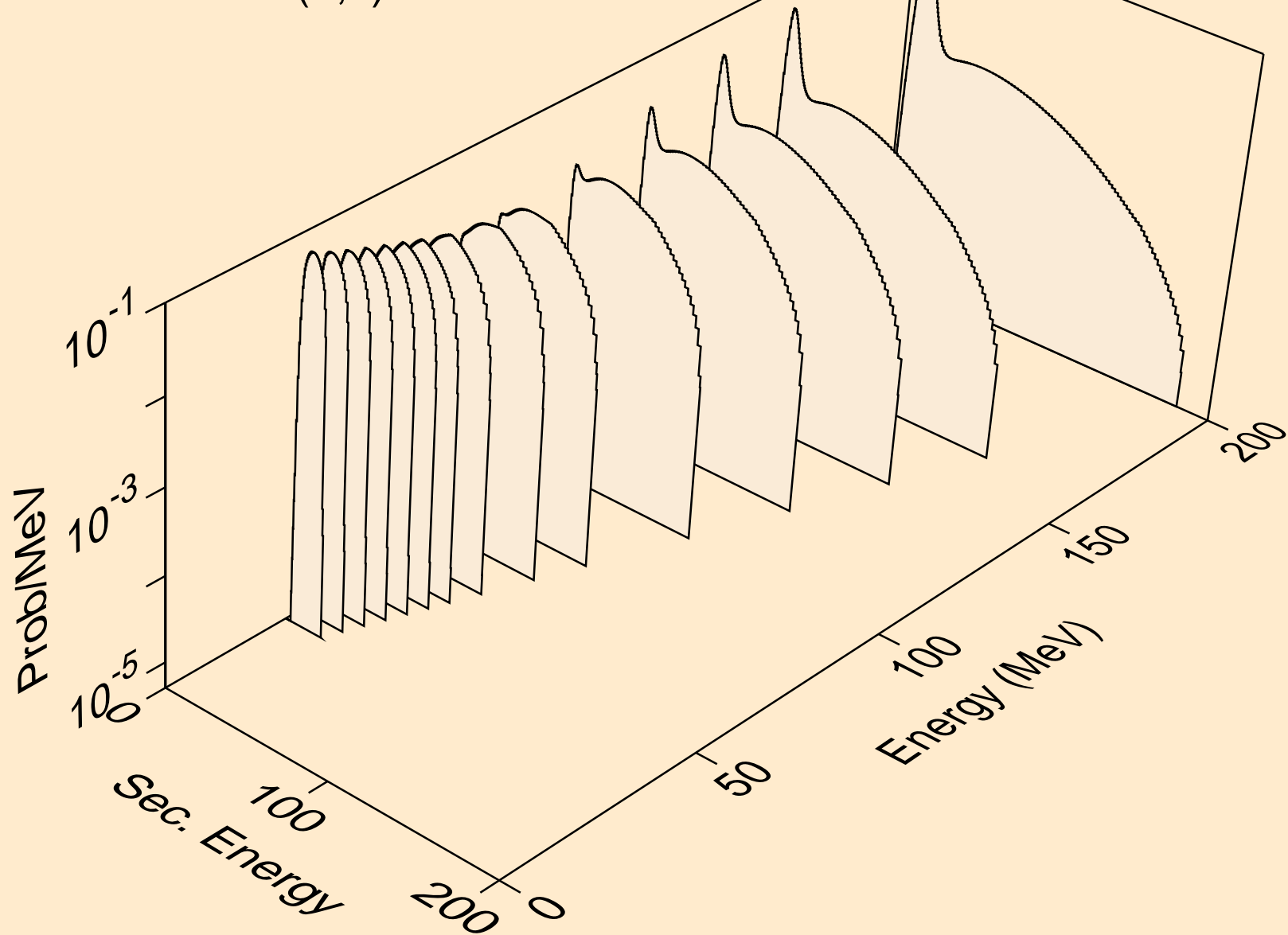

NB095M NEUTRON ACER TENDL-2023 LIBRARY; T=0.K  
tritons from (n,n\*)t

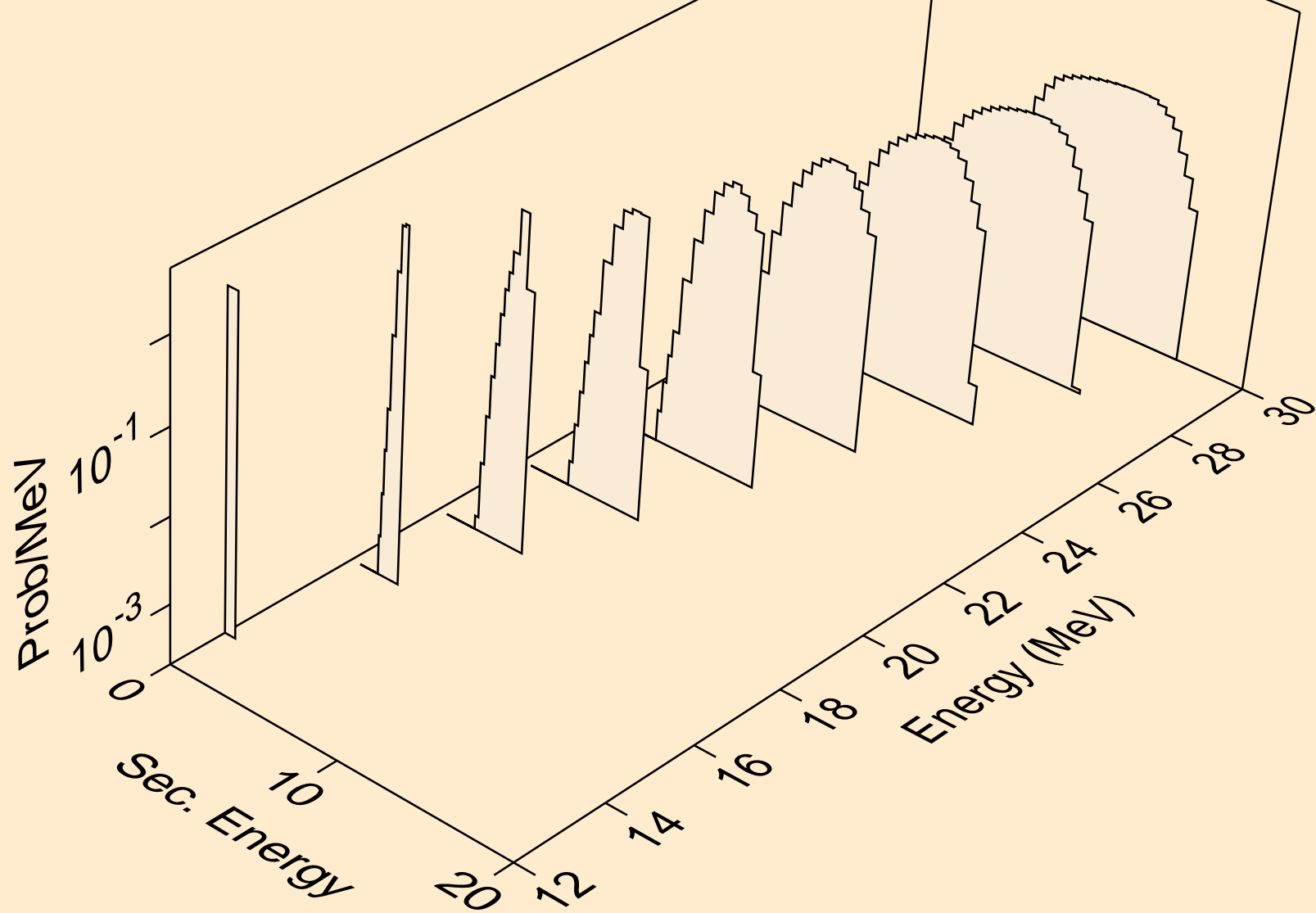

NB095M NEUTRON ACER TENDL-2023 LIBRARY; T=0.K  
tritons from (n,t)

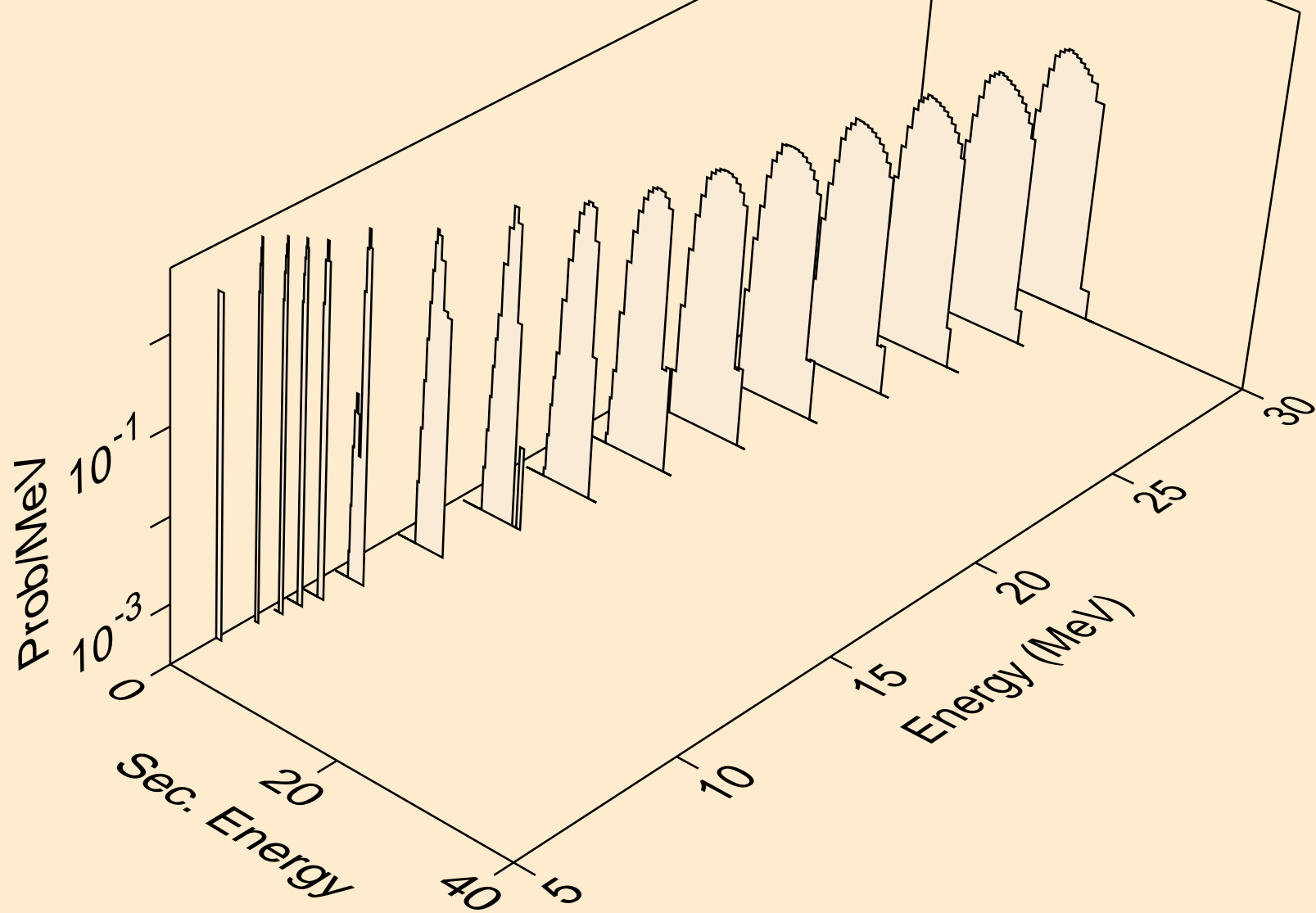

NB095M NEUTRON ACER TENDL-2023 LIBRARY; T=0.K  
tritons from (n,pt)

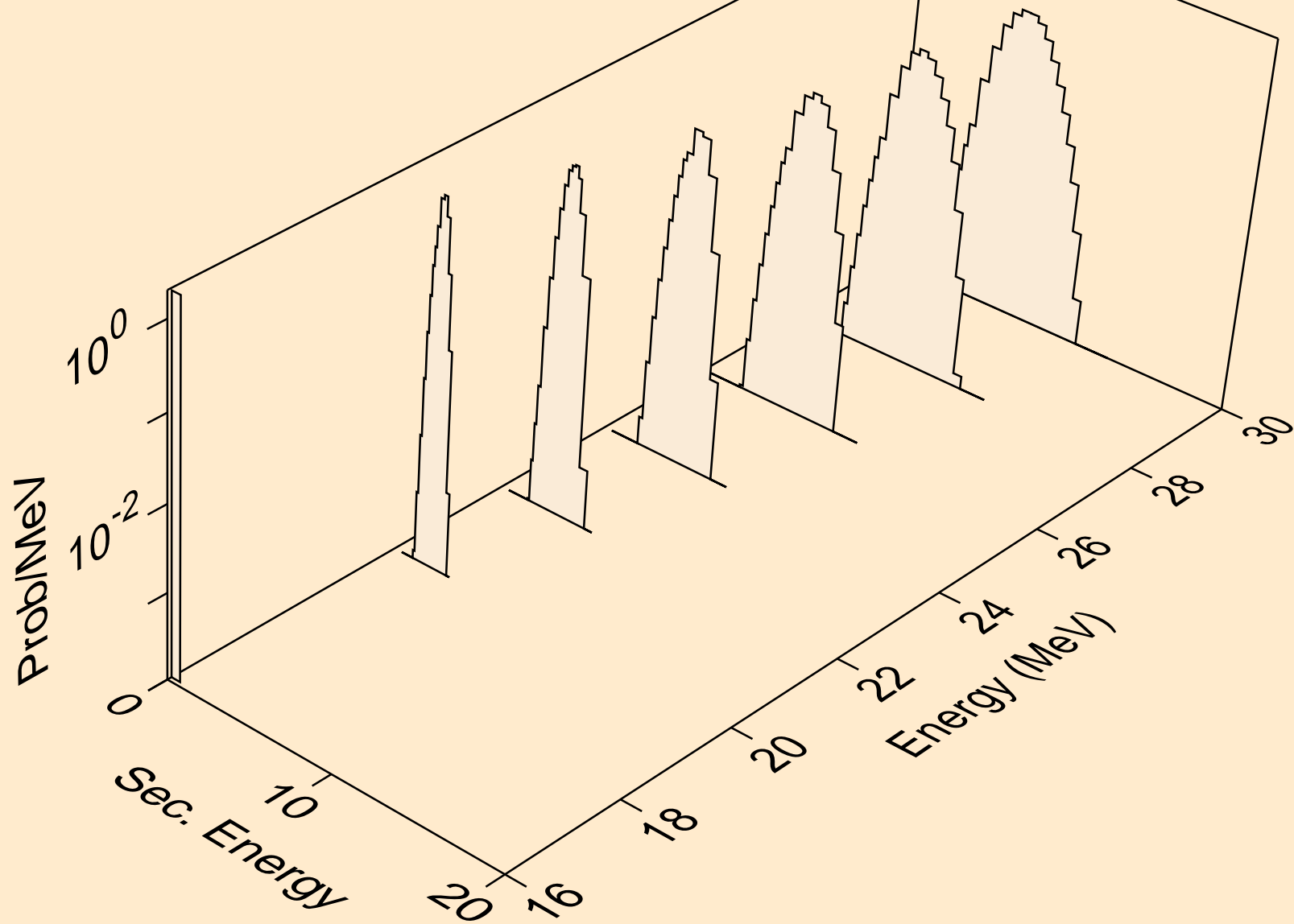

NB095M NEUTRON ACER TENDL-2023 LIBRARY; T=0.K  
he3s from (n,x)

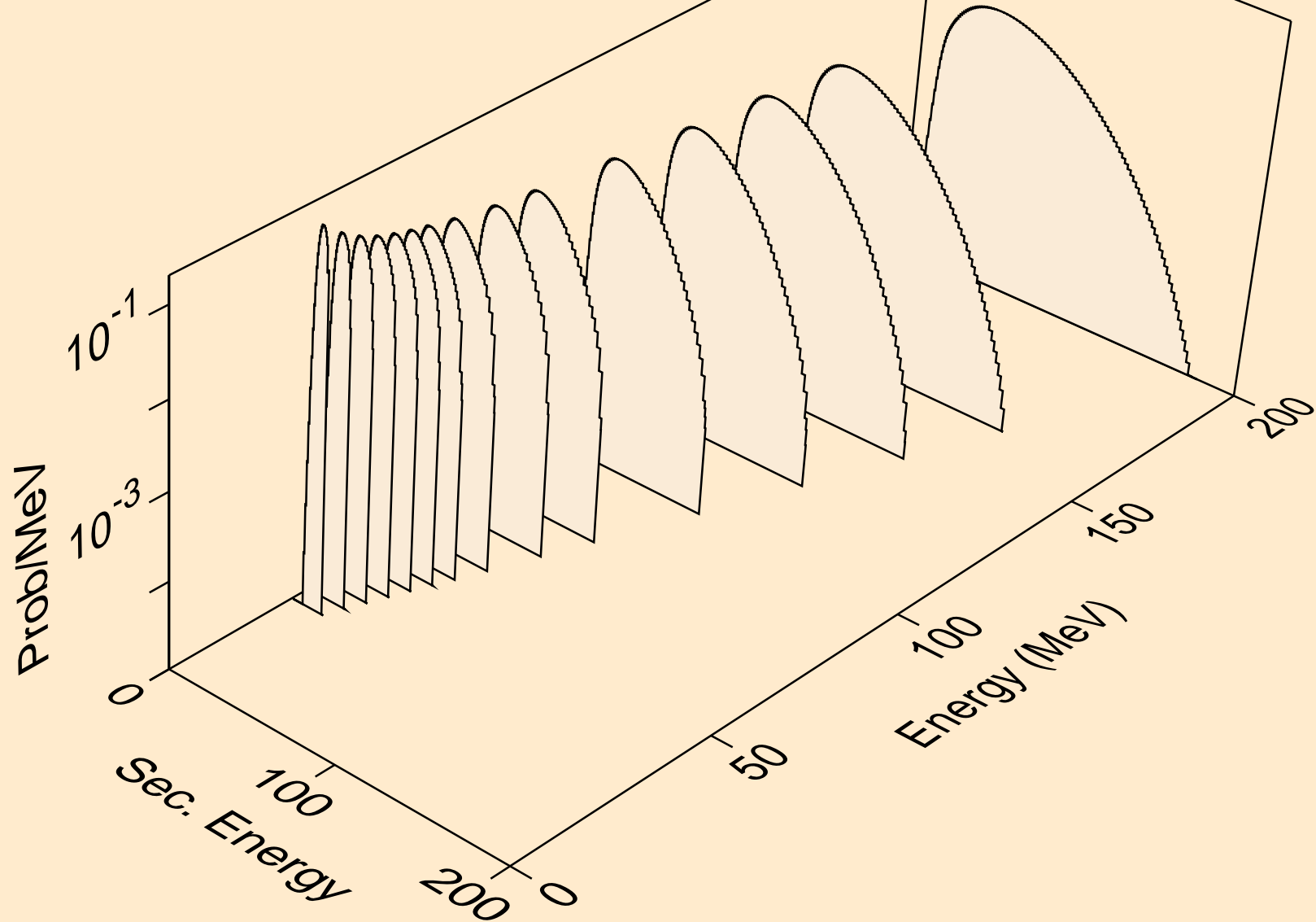

NB095M NEUTRON ACER TENDL-2023 LIBRARY; T=0.K  
he3s from (n,n\*)he3

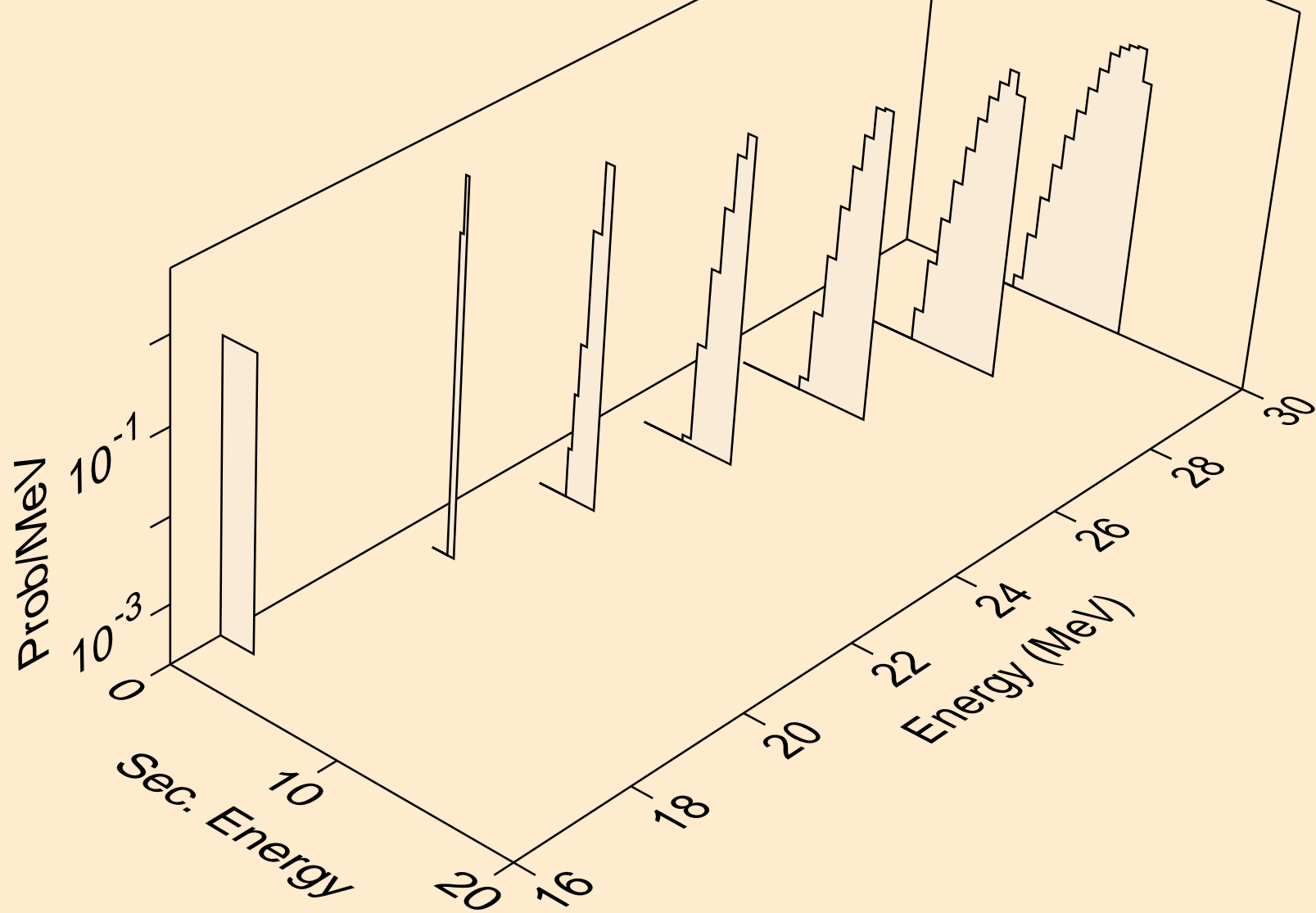

NB095M NEUTRON ACER TENDL-2023 LIBRARY; T=0.K  
he3s from (n,he3)

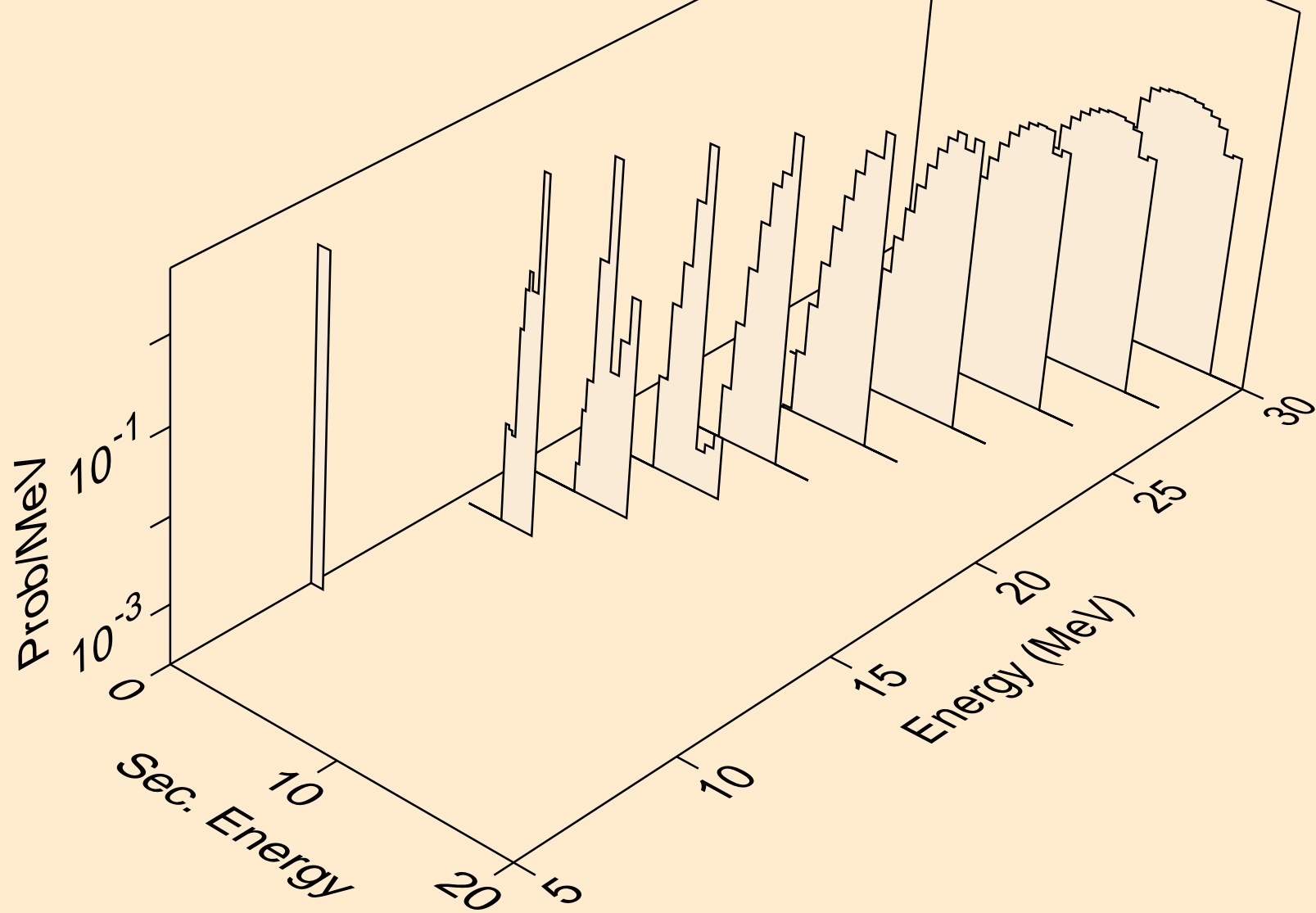

NB095M NEUTRON ACER TENDL-2023 LIBRARY; T=0.K  
alphas from (n,x)

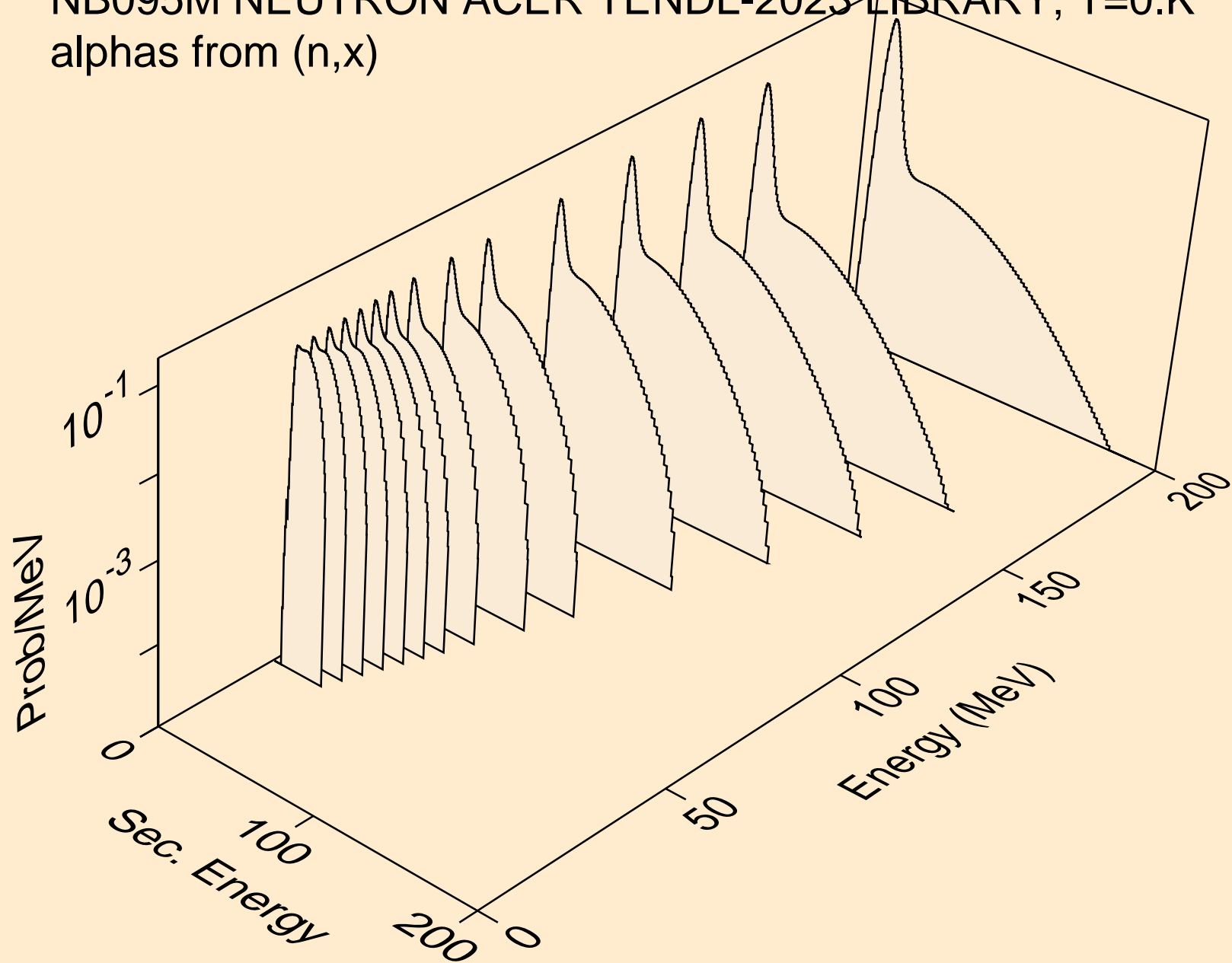

NB095M NEUTRON ACER TENDL-2023 LIBRARY; T=0.K  
alphas from (n,n\*)a

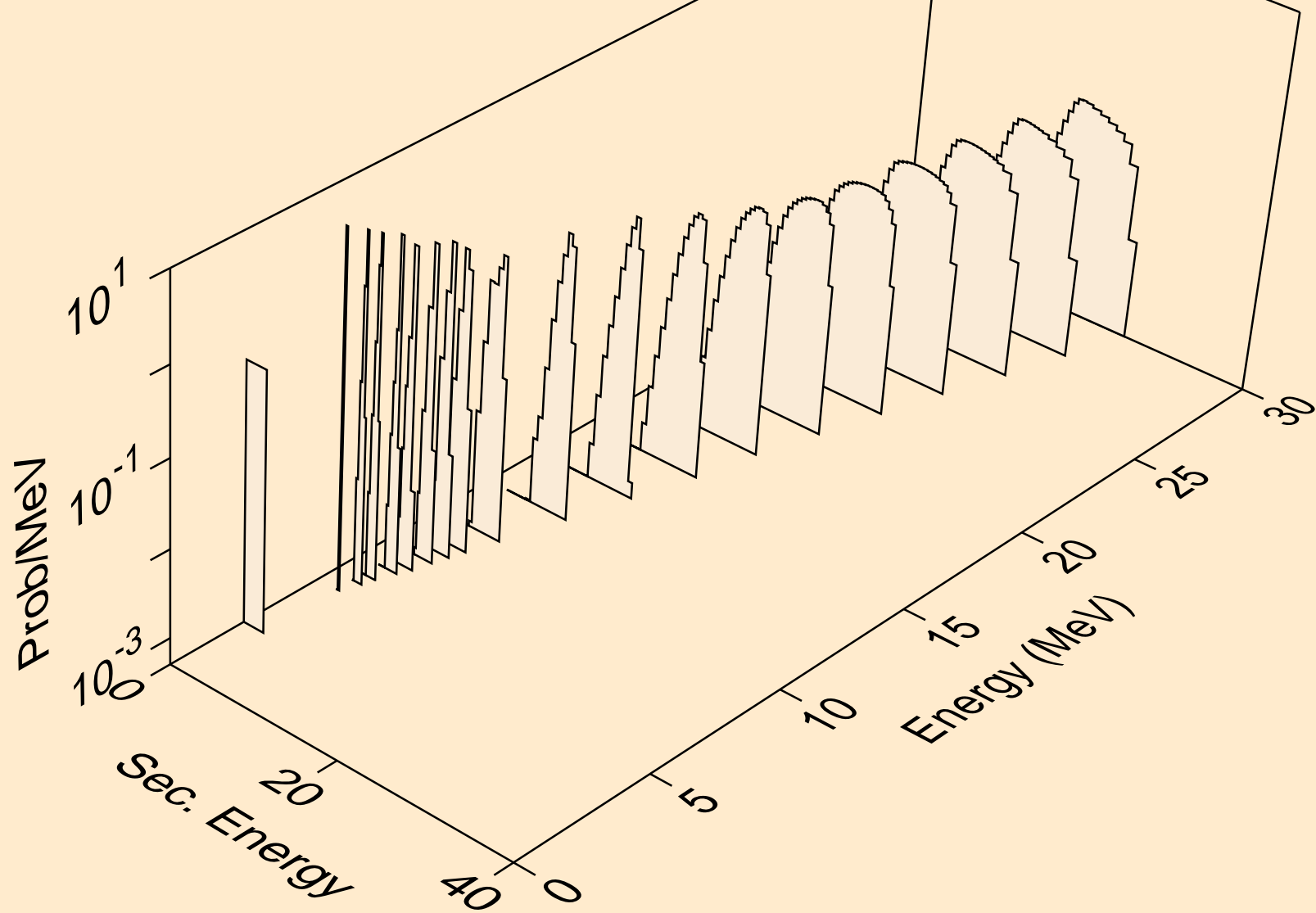

NB095M NEUTRON ACER TENDL-2023 LIBRARY; T=0.K  
alphas from (n,2n)a

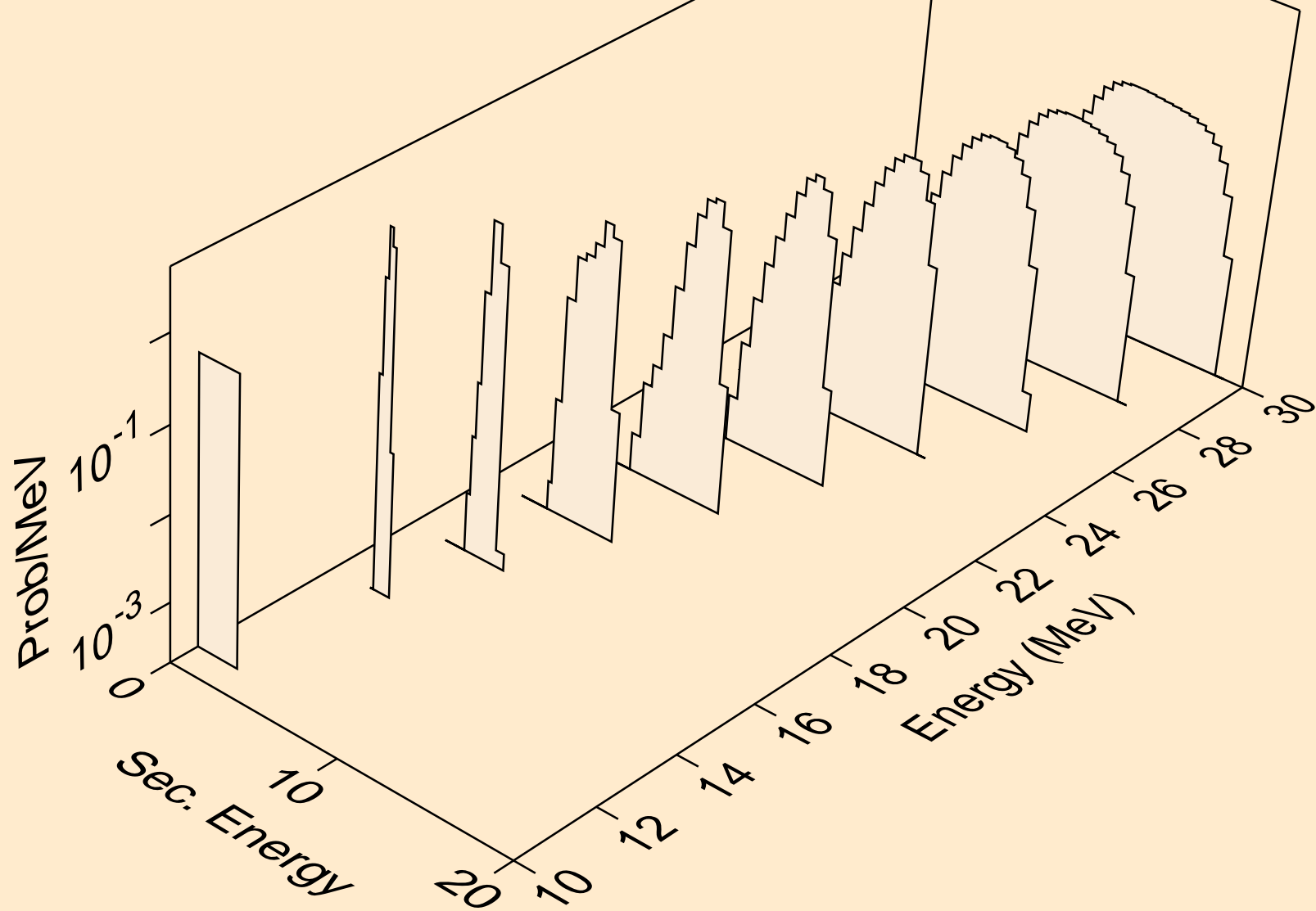

NB095M NEUTRON ACER TENDL-2023 LIBRARY; T=0.K  
alphas from (n,3n)a

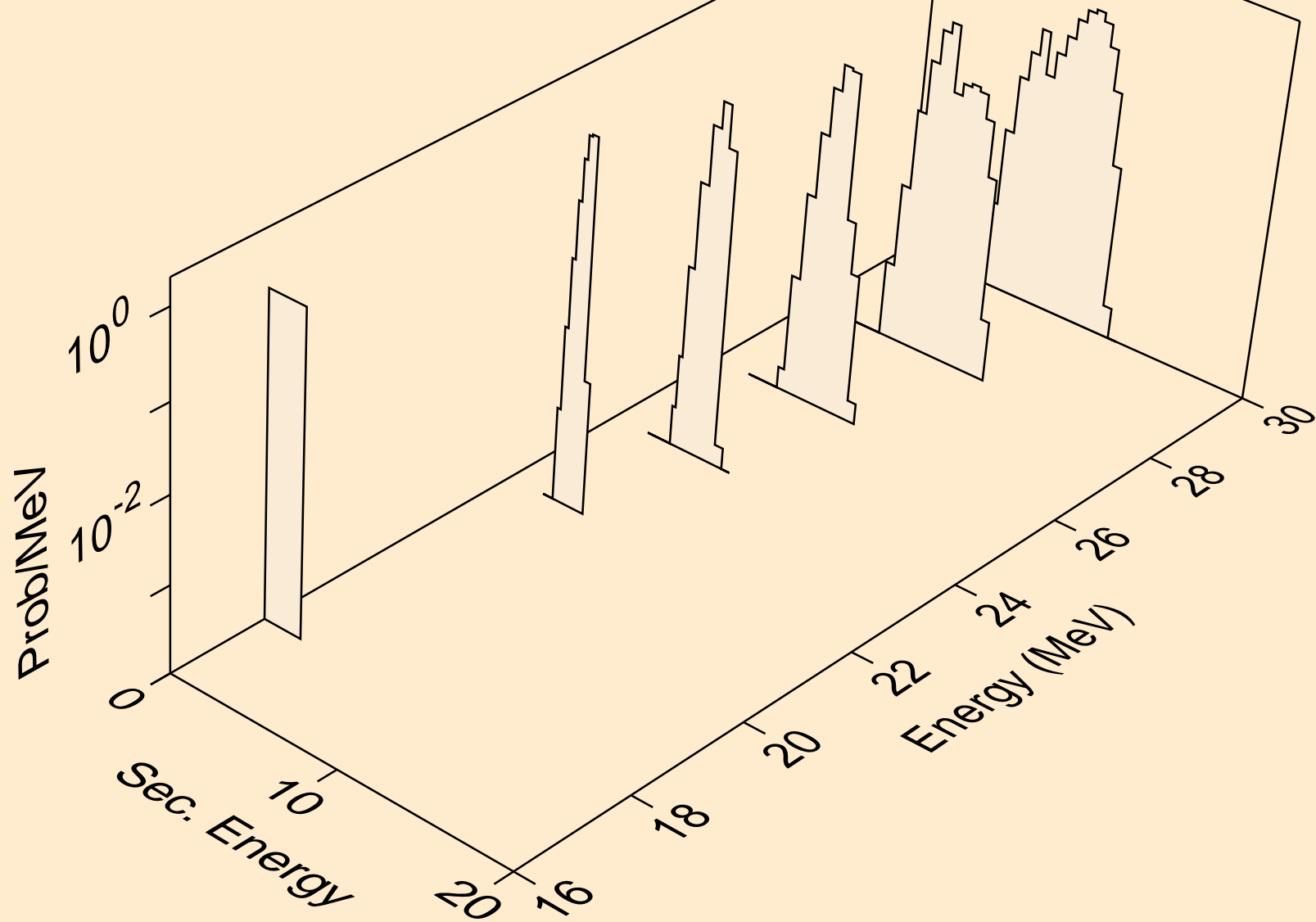

NB095M NEUTRON ACER TENDL-2023 LIBRARY; T=0.K  
alphas from (n,n\*)2a

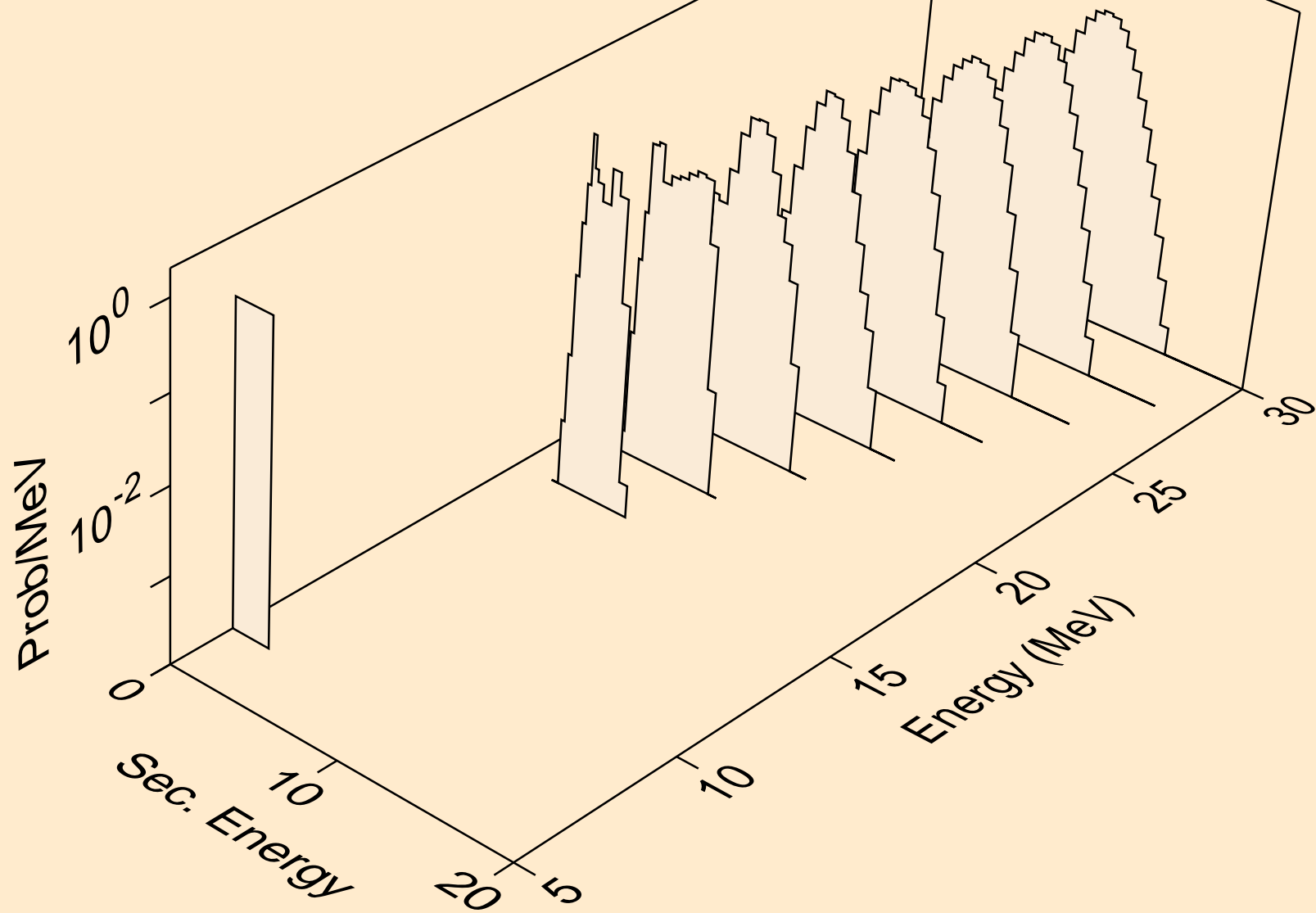

NB095M NEUTRON ACER TENDL-2023 LIBRARY; T=0.K  
alphas from (n,npa)

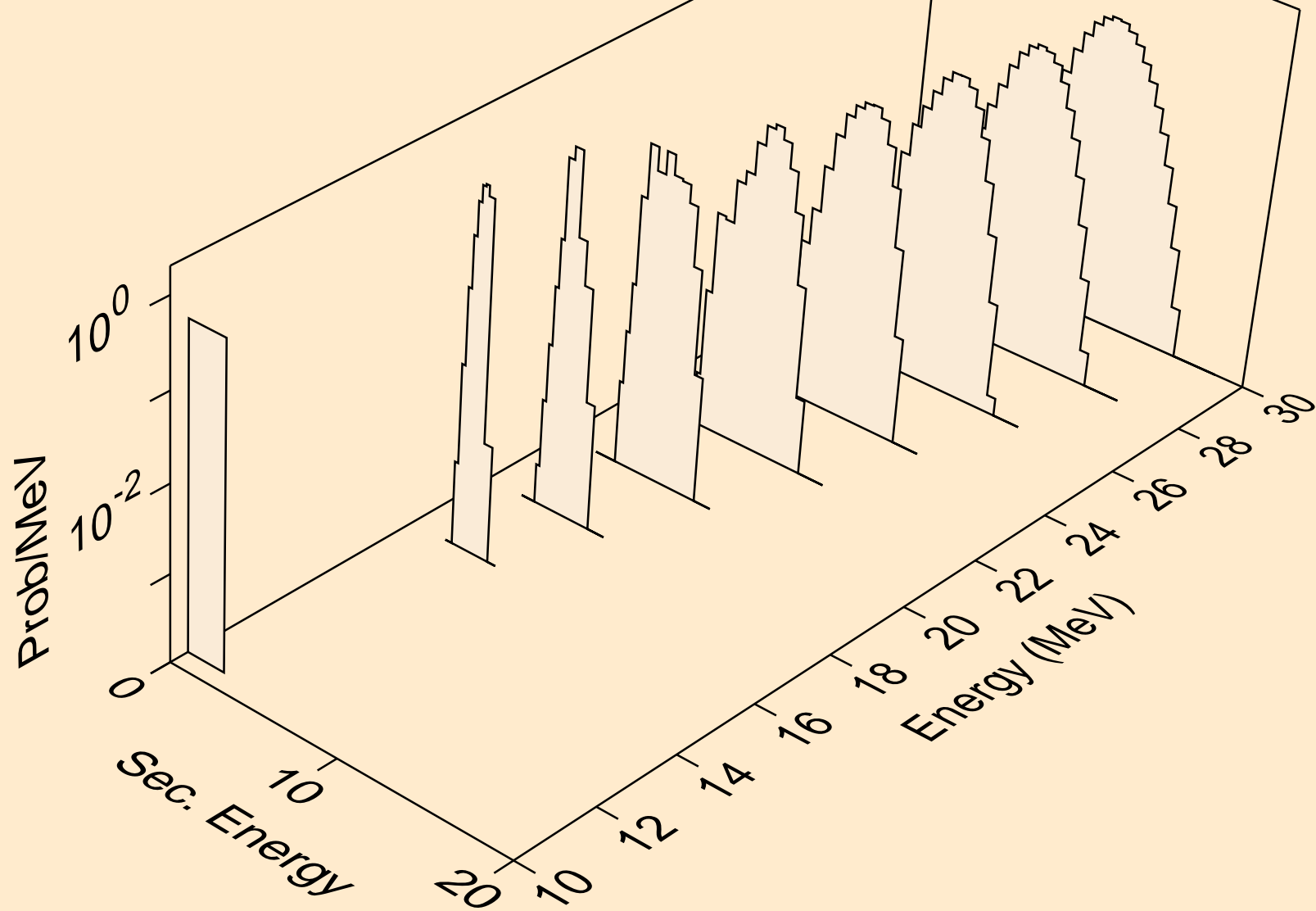

NB095M NEUTRON ACER TENDL-2023 LIBRARY; T=0.K  
alphas from (n,a)

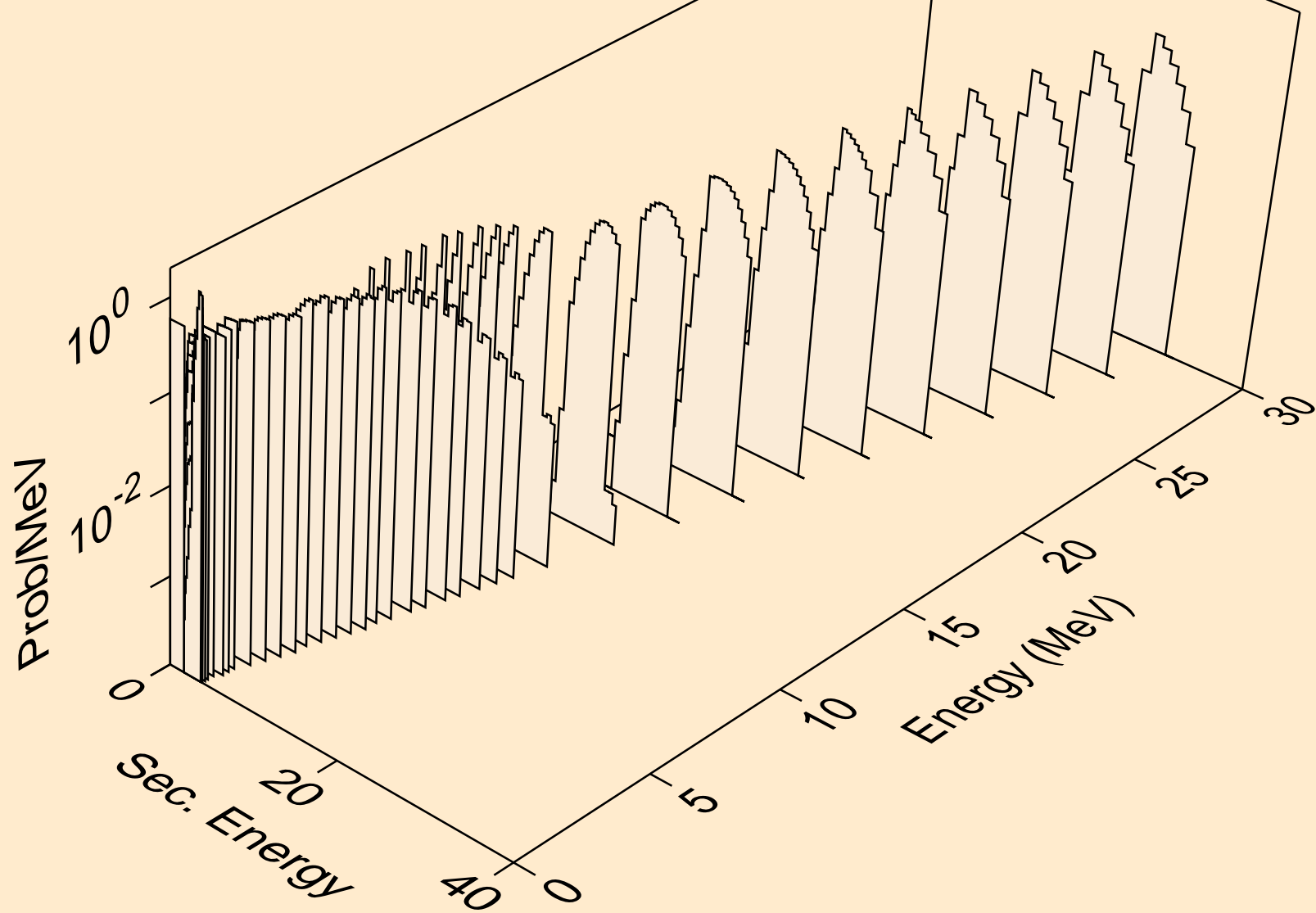

NB095M NEUTRON ACER TENDL-2023 LIBRARY; T=0.K  
alphas from (n,2a)

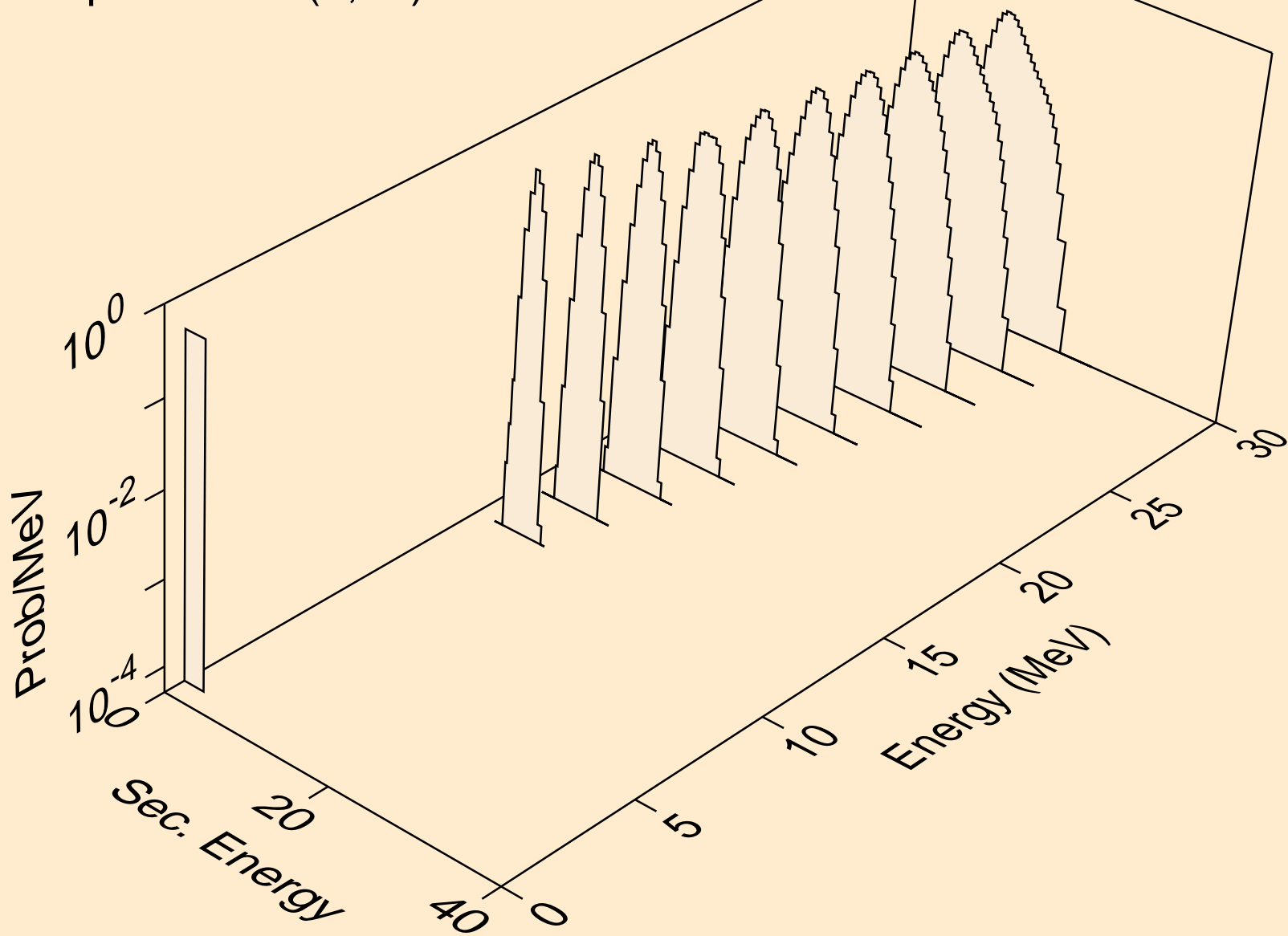

NB095M NEUTRON ACER TENDL-2023 LIBRARY; T=0.K  
alphas from (n,pa)

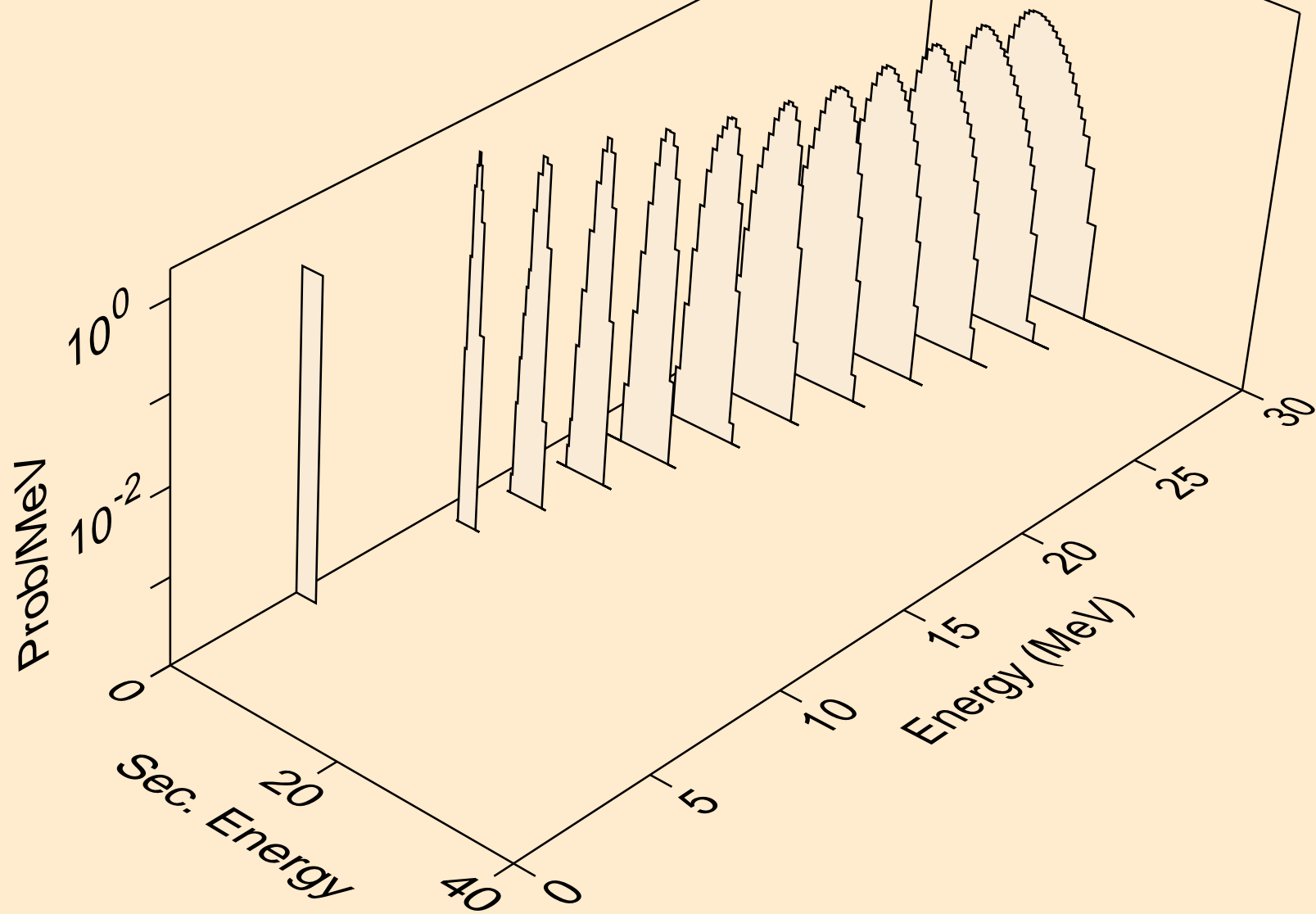

NB095M NEUTRON ACER TENDL-2023 LIBRARY; T=0.K  
alphas from (n,da)

