

OS199 NEUTRON ACER TENDL-2023 LIBRARY; T=0.K

Principal cross sections

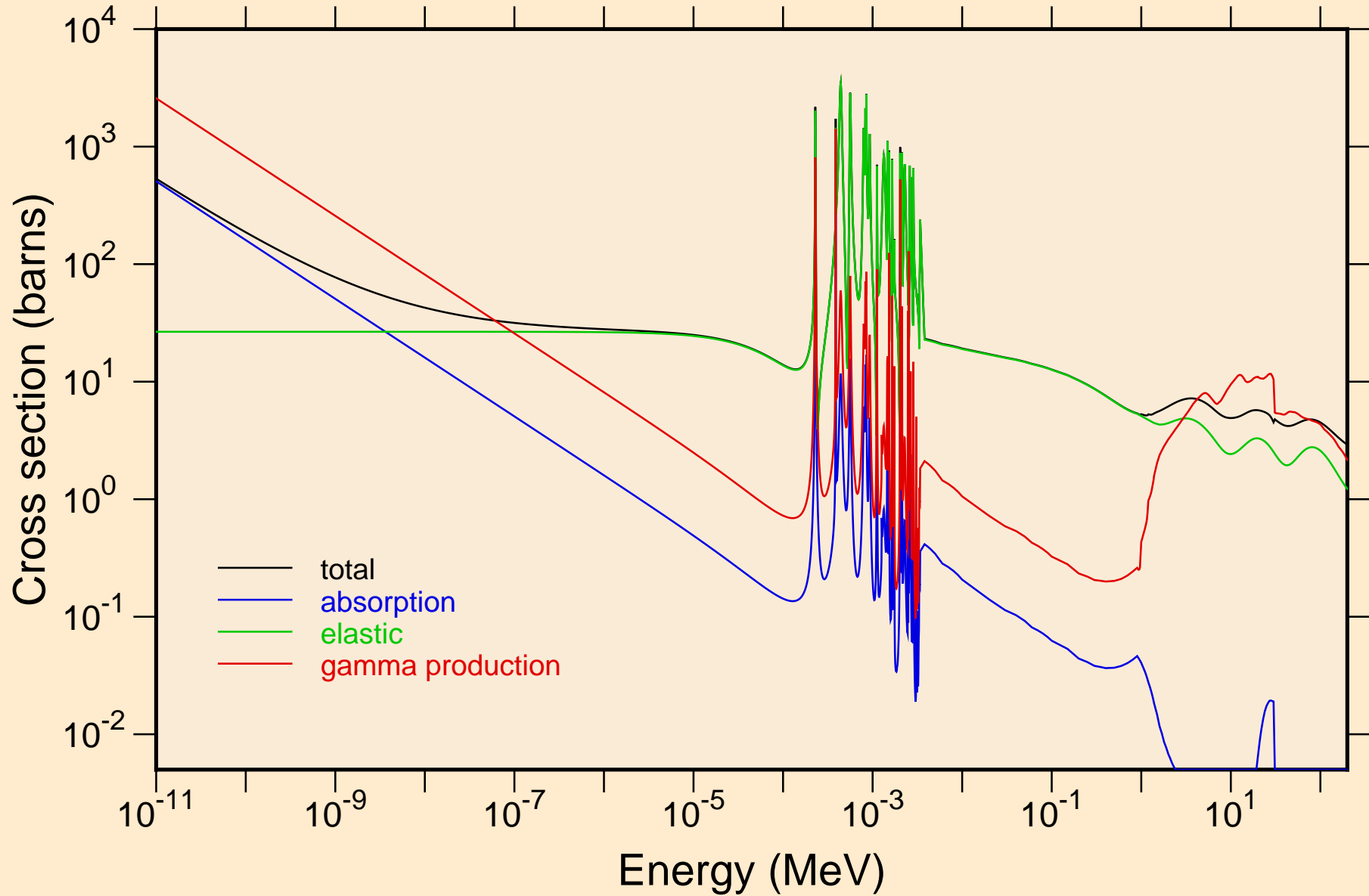

OS199 NEUTRON ACER TENDL-2023 LIBRARY; T=0.K
resonance total cross section

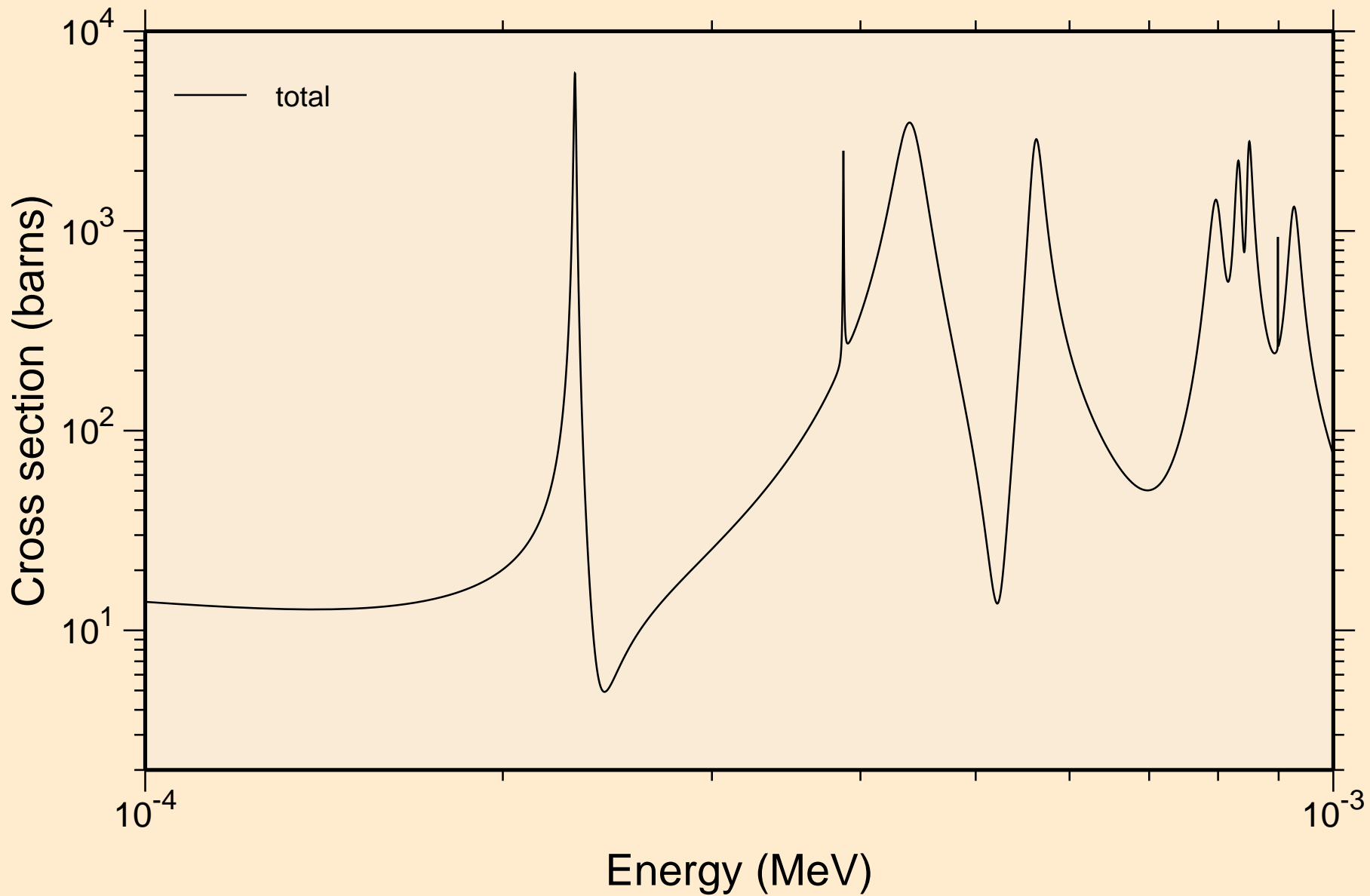

OS199 NEUTRON ACER TENDL-2023 LIBRARY; T=0.K
resonance total cross section

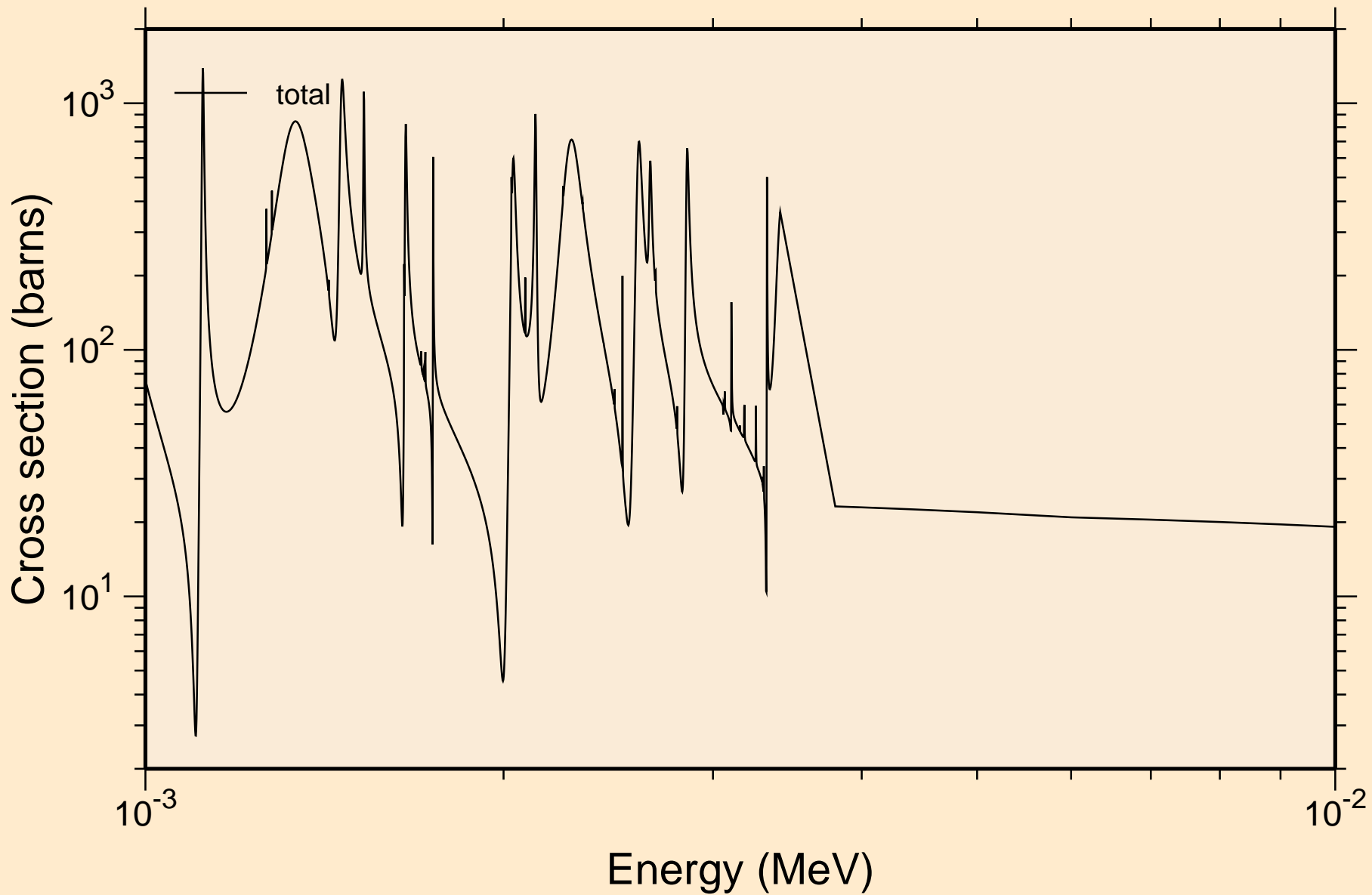

OS199 NEUTRON ACER TENDL-2023 LIBRARY; T=0.K
resonance total cross section

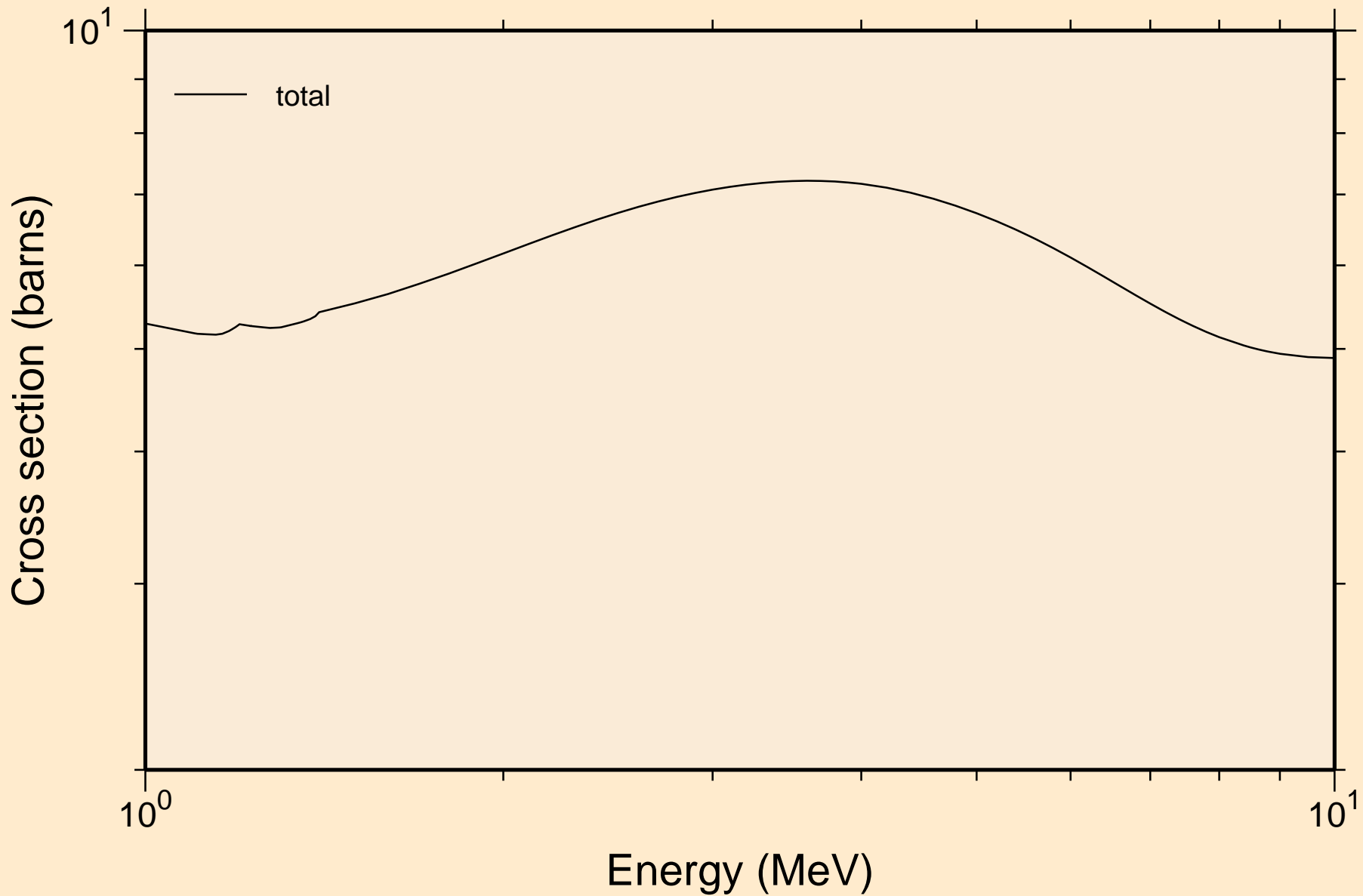

OS199 NEUTRON ACER TENDL-2023 LIBRARY; T=0.K
resonance absorption cross sections

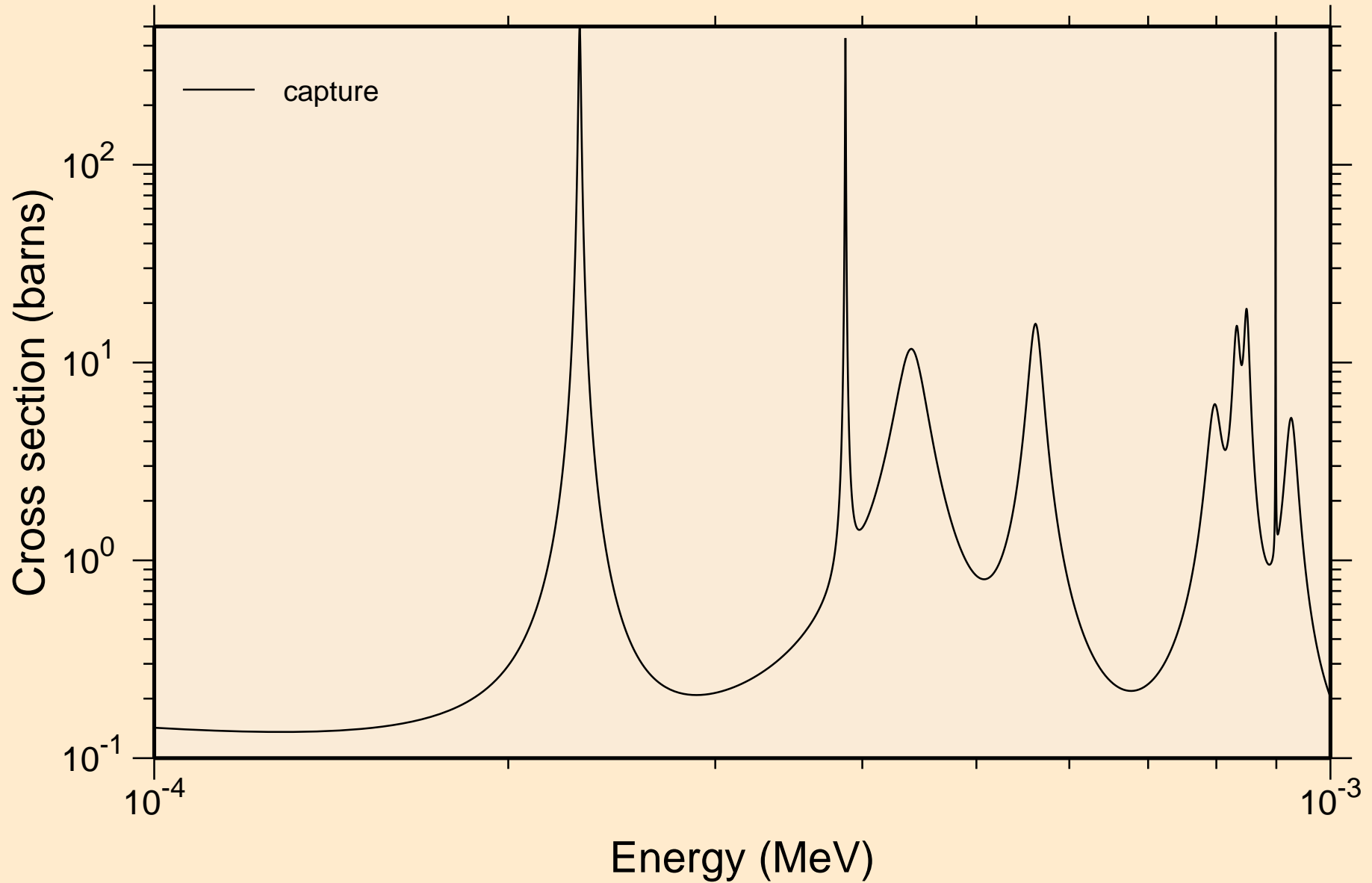

OS199 NEUTRON ACER TENDL-2023 LIBRARY; T=0.K
resonance absorption cross sections

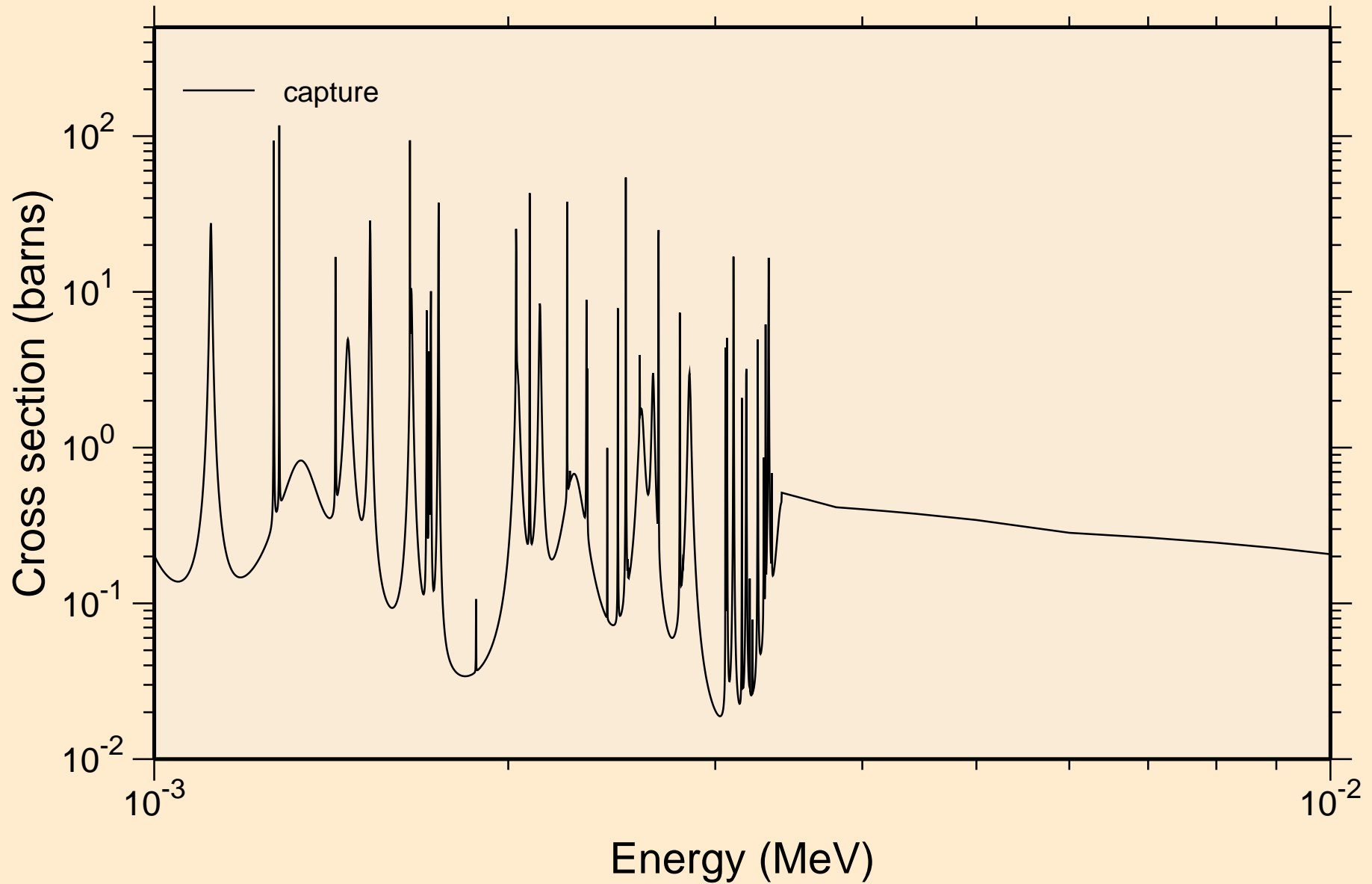

OS199 NEUTRON ACER TENDL-2023 LIBRARY; T=0.K
resonance absorption cross sections

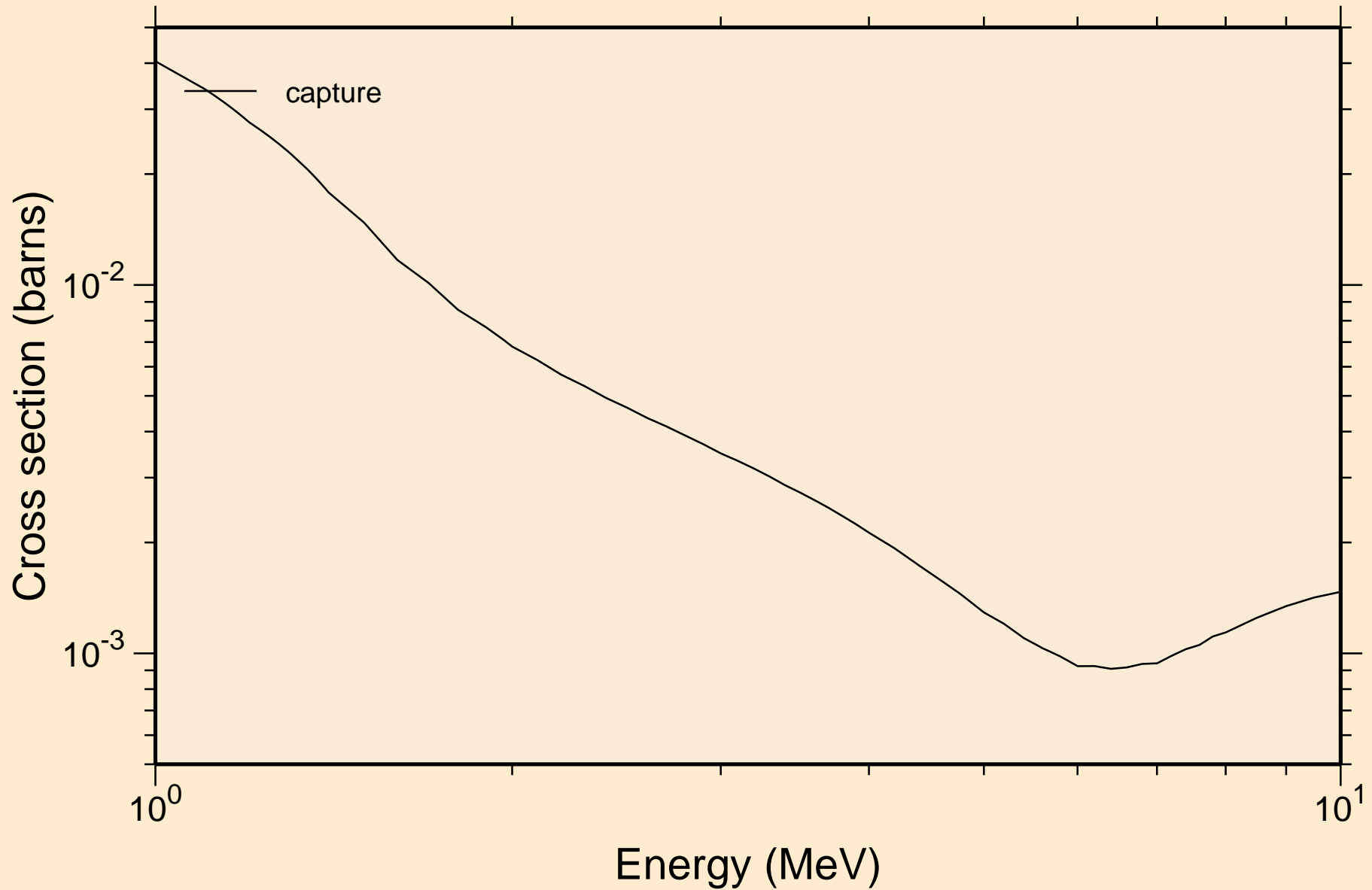

OS199 NEUTRON ACER TENDL-2023 LIBRARY; T=0.K

Heating

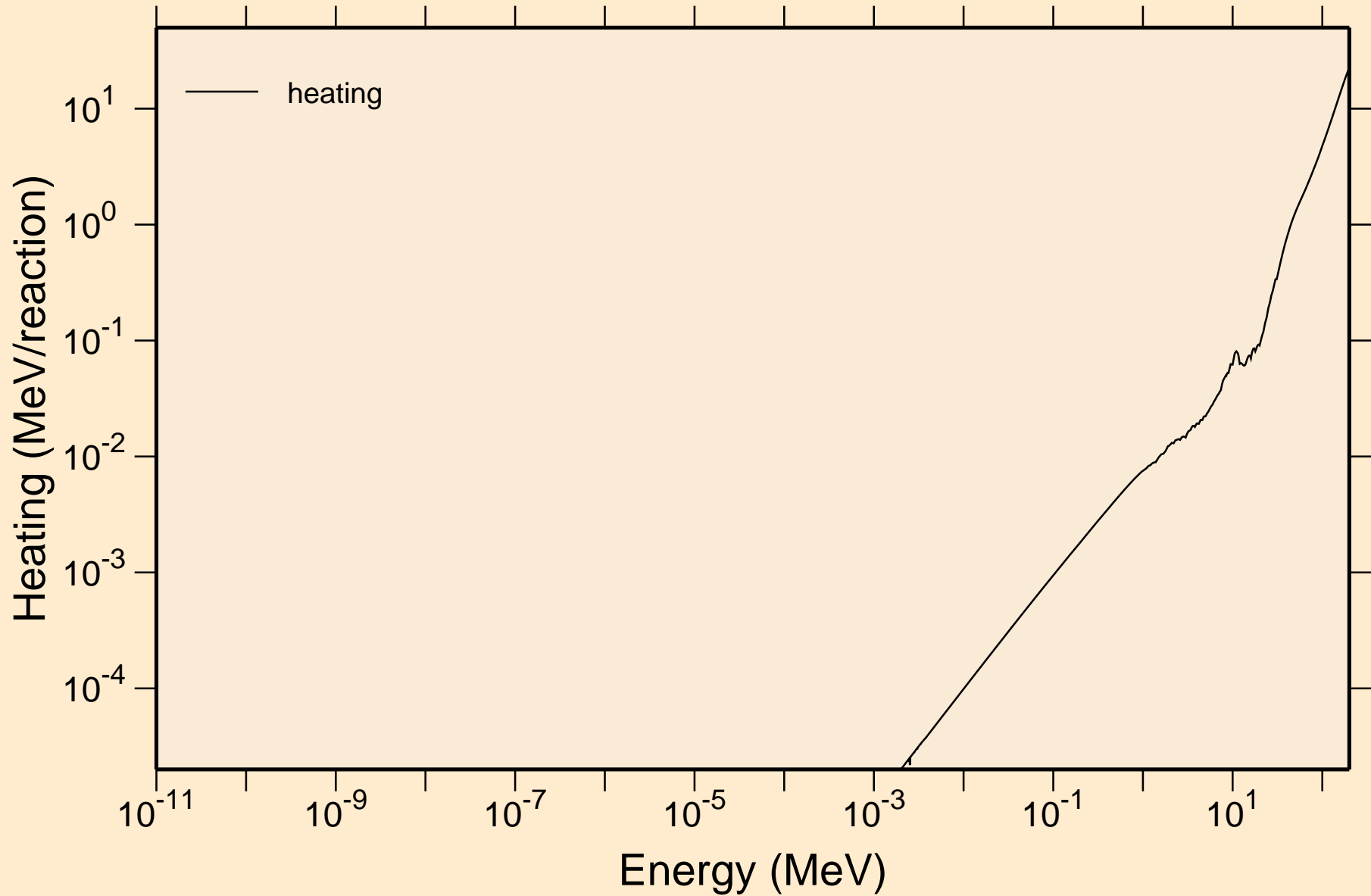

OS199 NEUTRON ACER TENDL-2023 LIBRARY; T=0.K

Damage

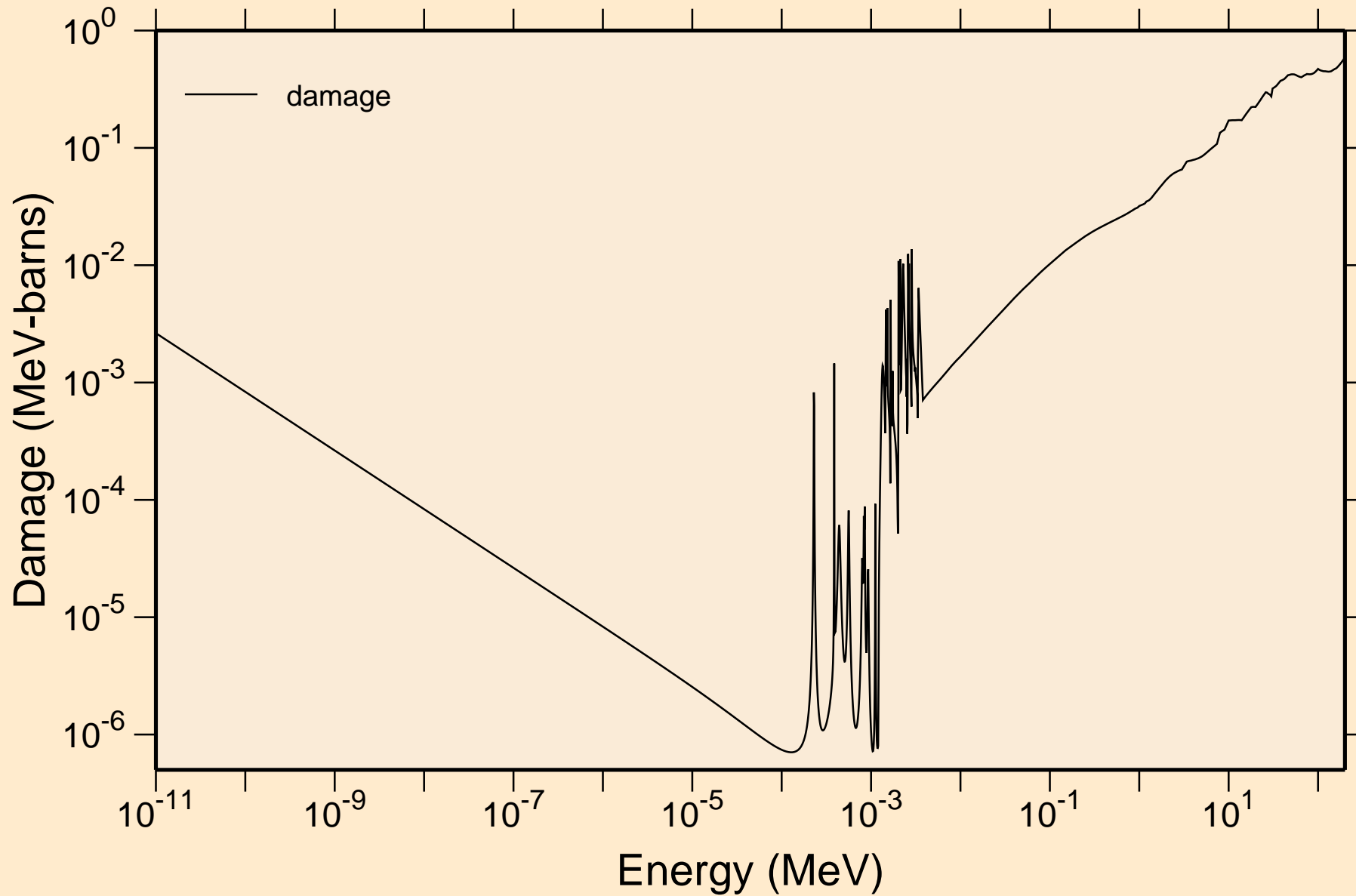

OS199 NEUTRON ACER TENDL-2023 LIBRARY; T=0.K
Non-threshold reactions

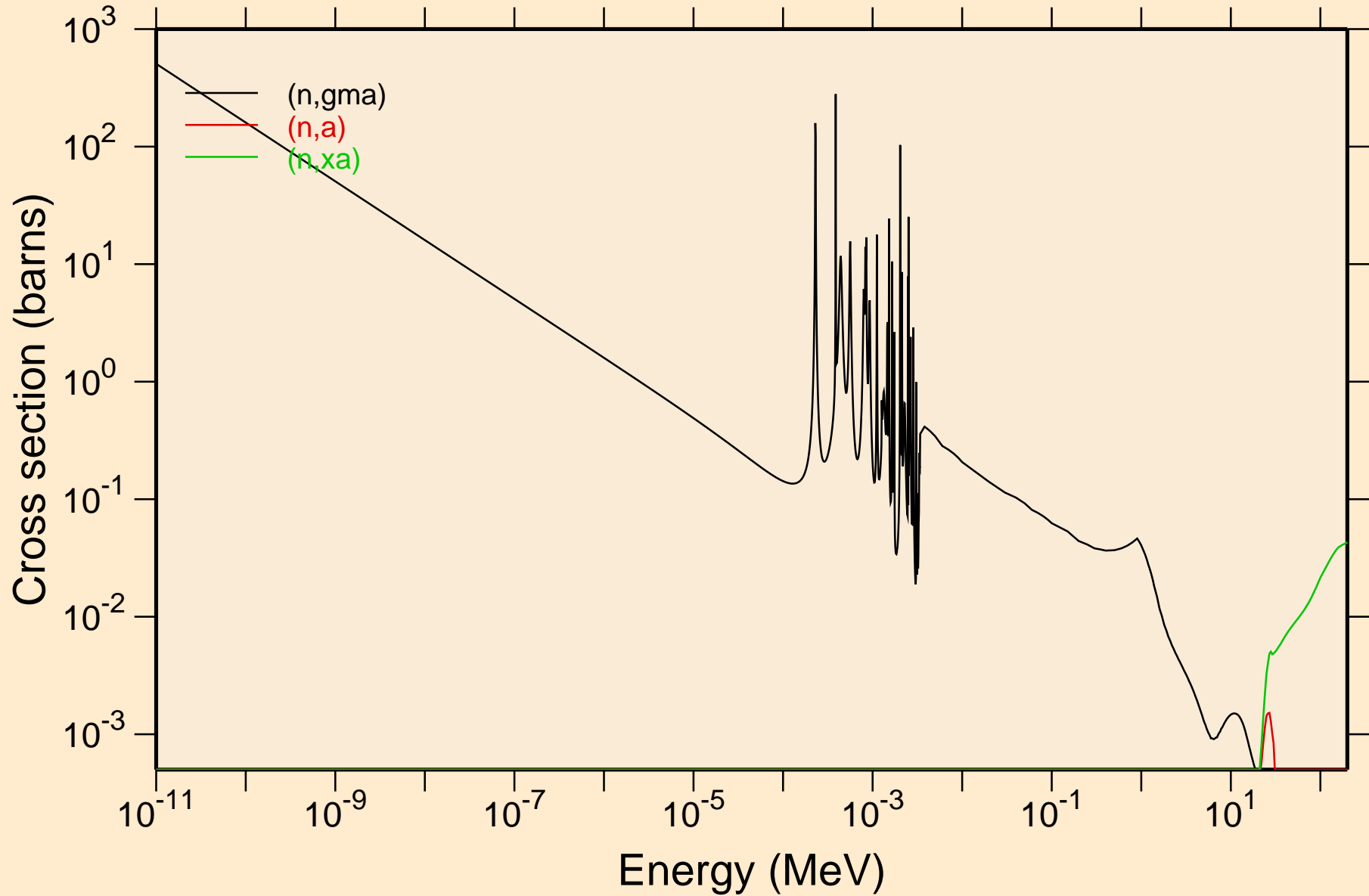

OS199 NEUTRON ACER TENDL-2023 LIBRARY; T=0.K
Principal cross sections

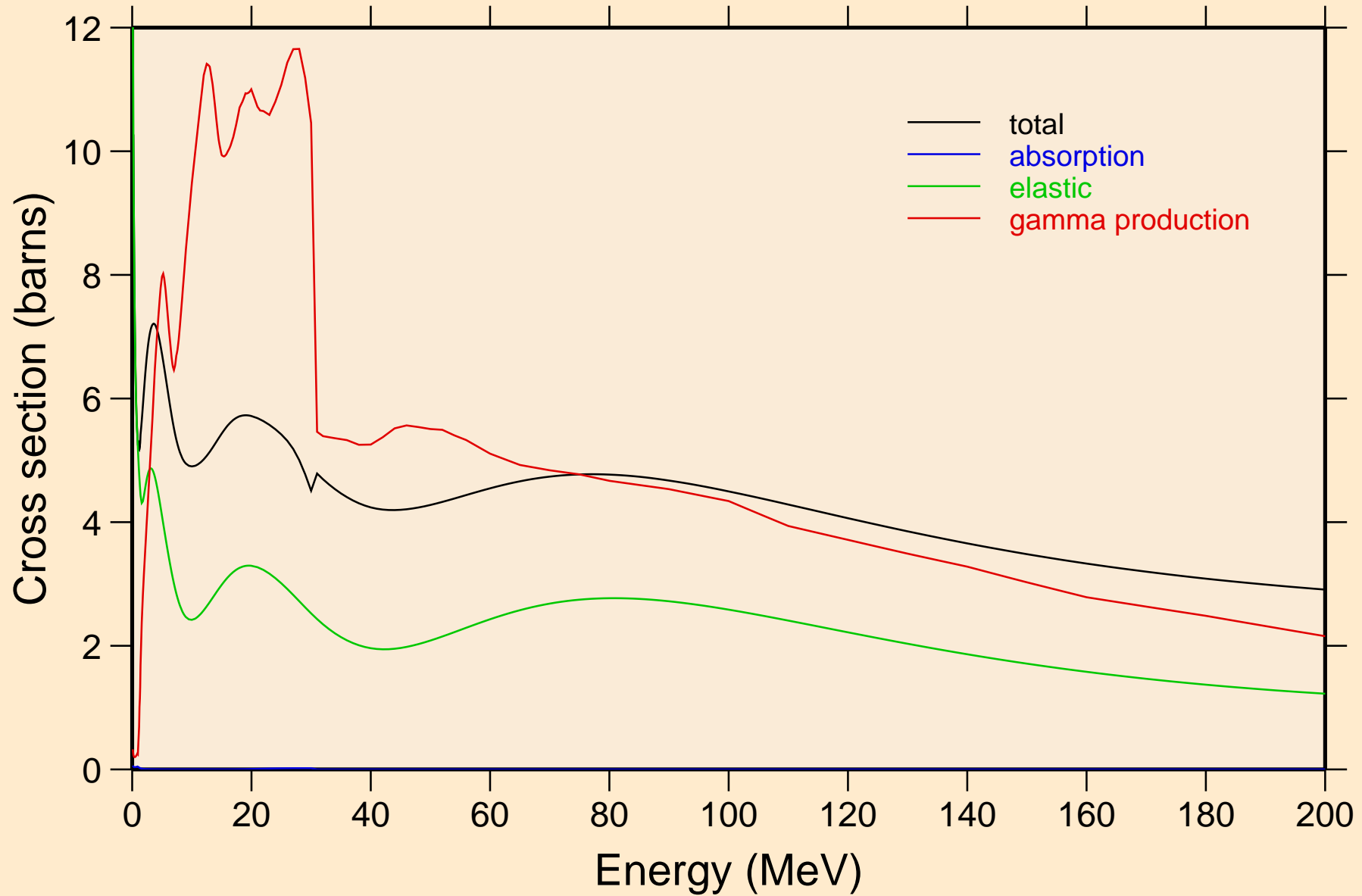

OS199 NEUTRON ACER TENDL-2023 LIBRARY; T=0.K

Heating

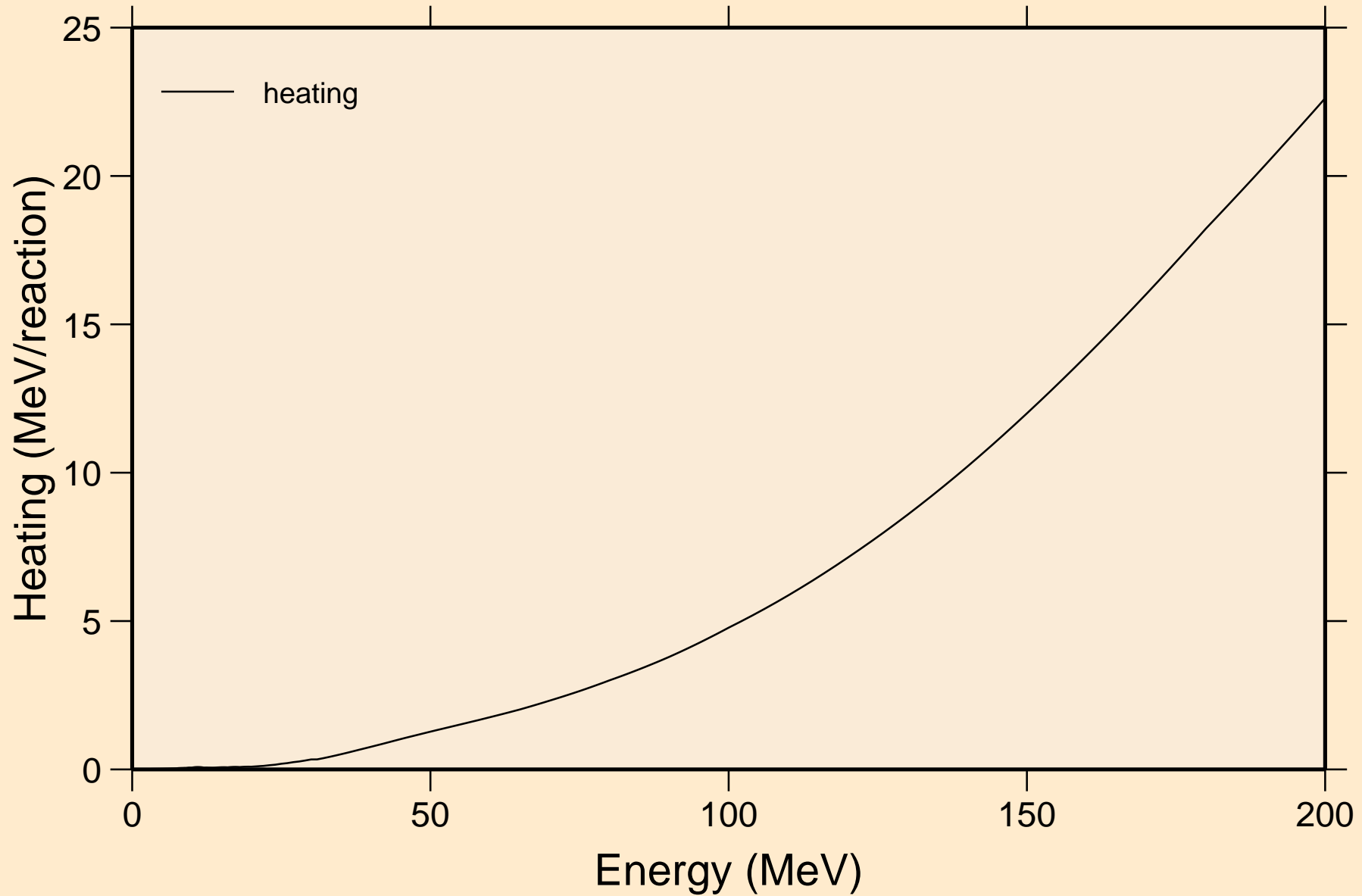

OS199 NEUTRON ACER TENDL-2023 LIBRARY; T=0.K

Damage

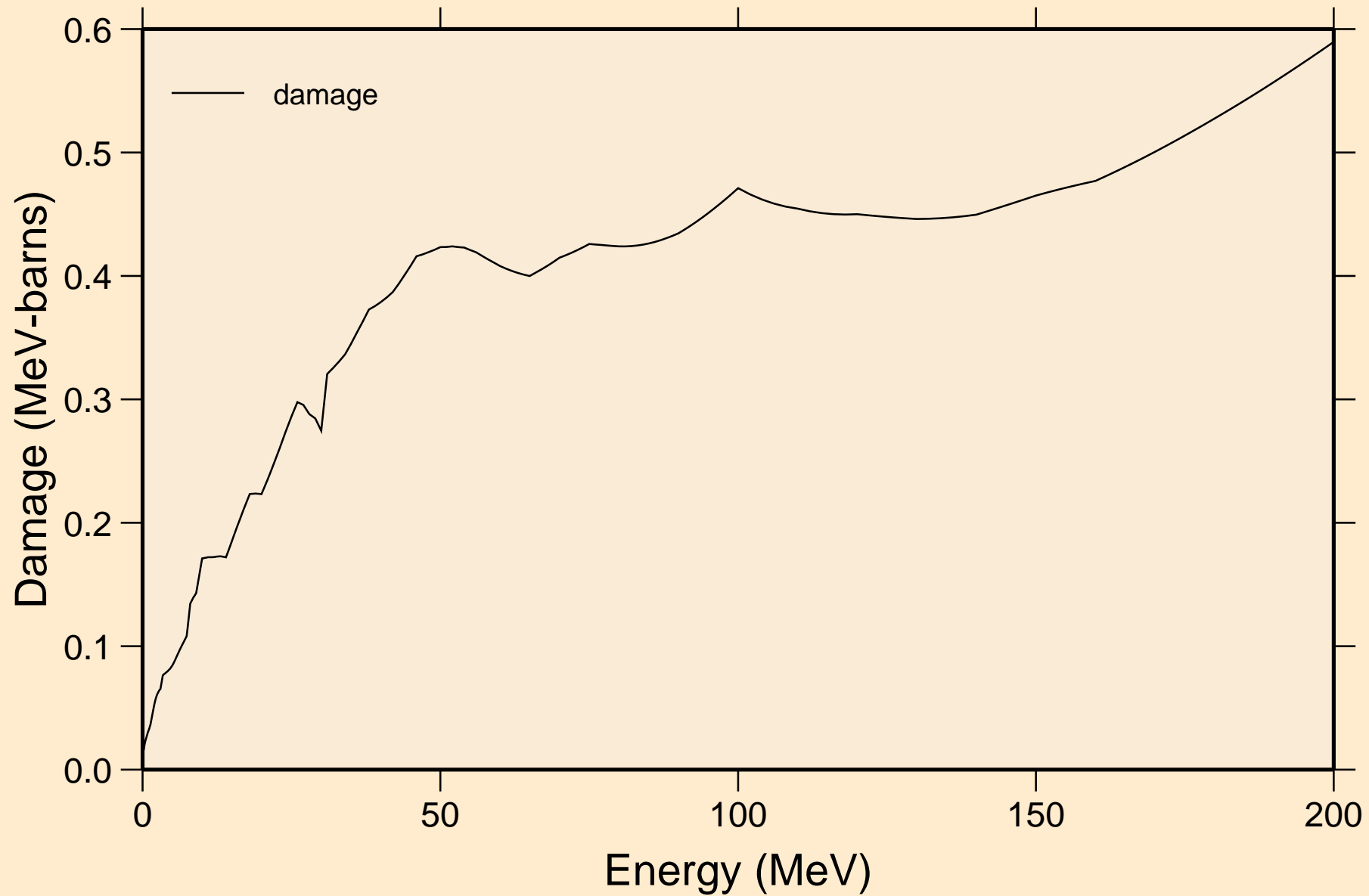

OS199 NEUTRON ACER TENDL-2023 LIBRARY; T=0.K

Non-threshold reactions

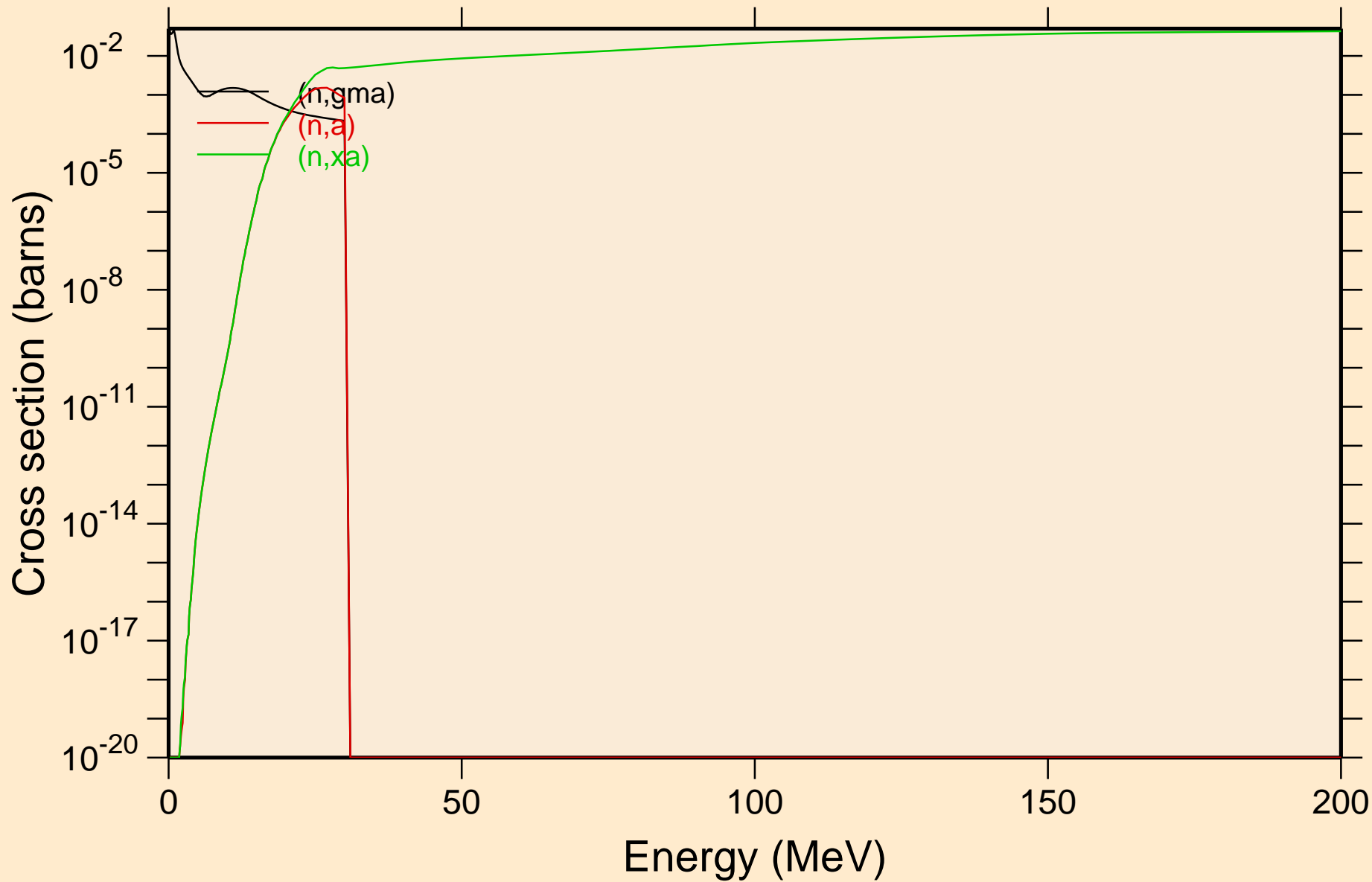

OS199 NEUTRON ACER TENDL-2023 LIBRARY; T=0.K

Inelastic levels

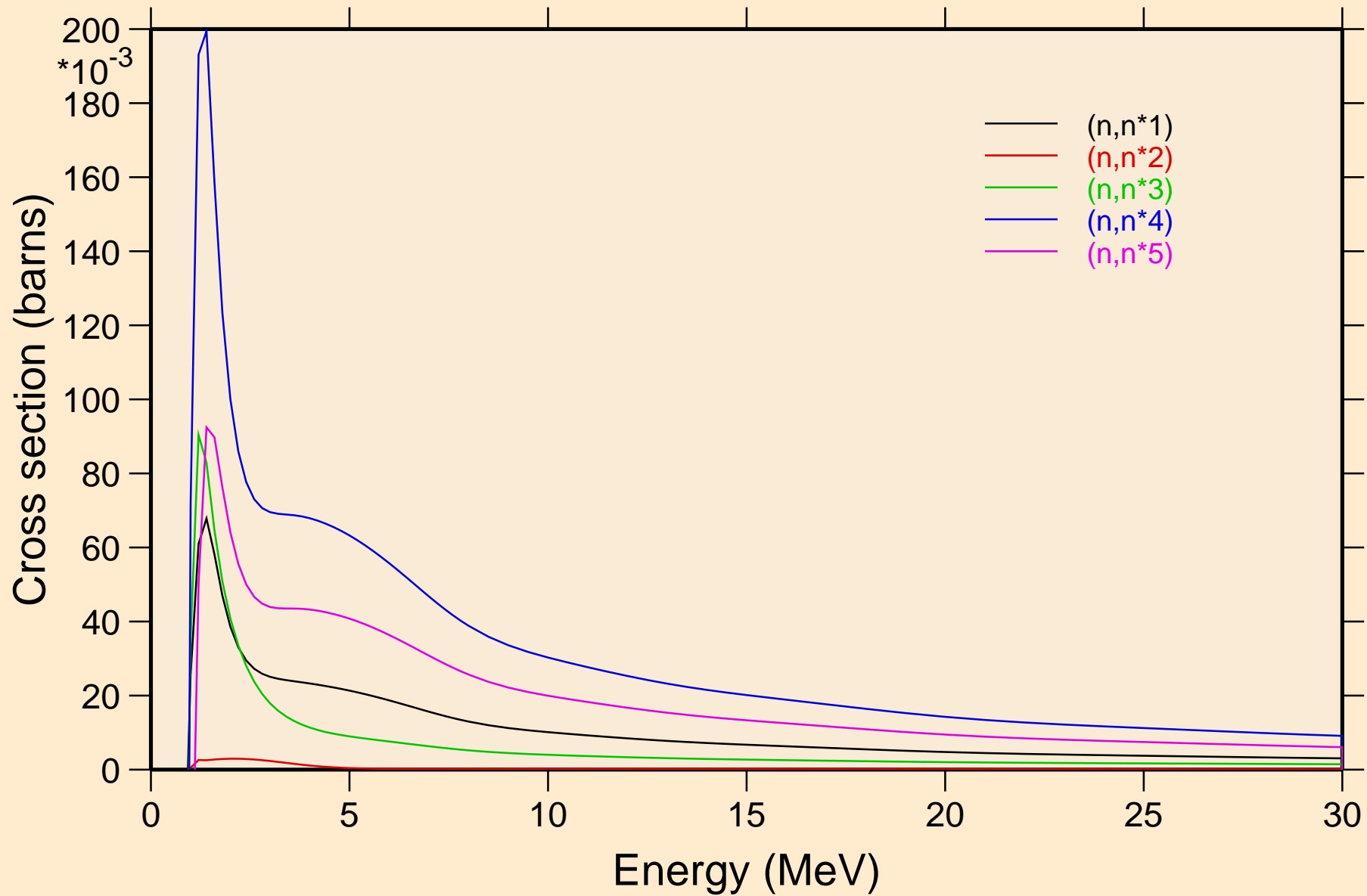

OS199 NEUTRON ACER TENDL-2023 LIBRARY; T=0.K

Inelastic levels

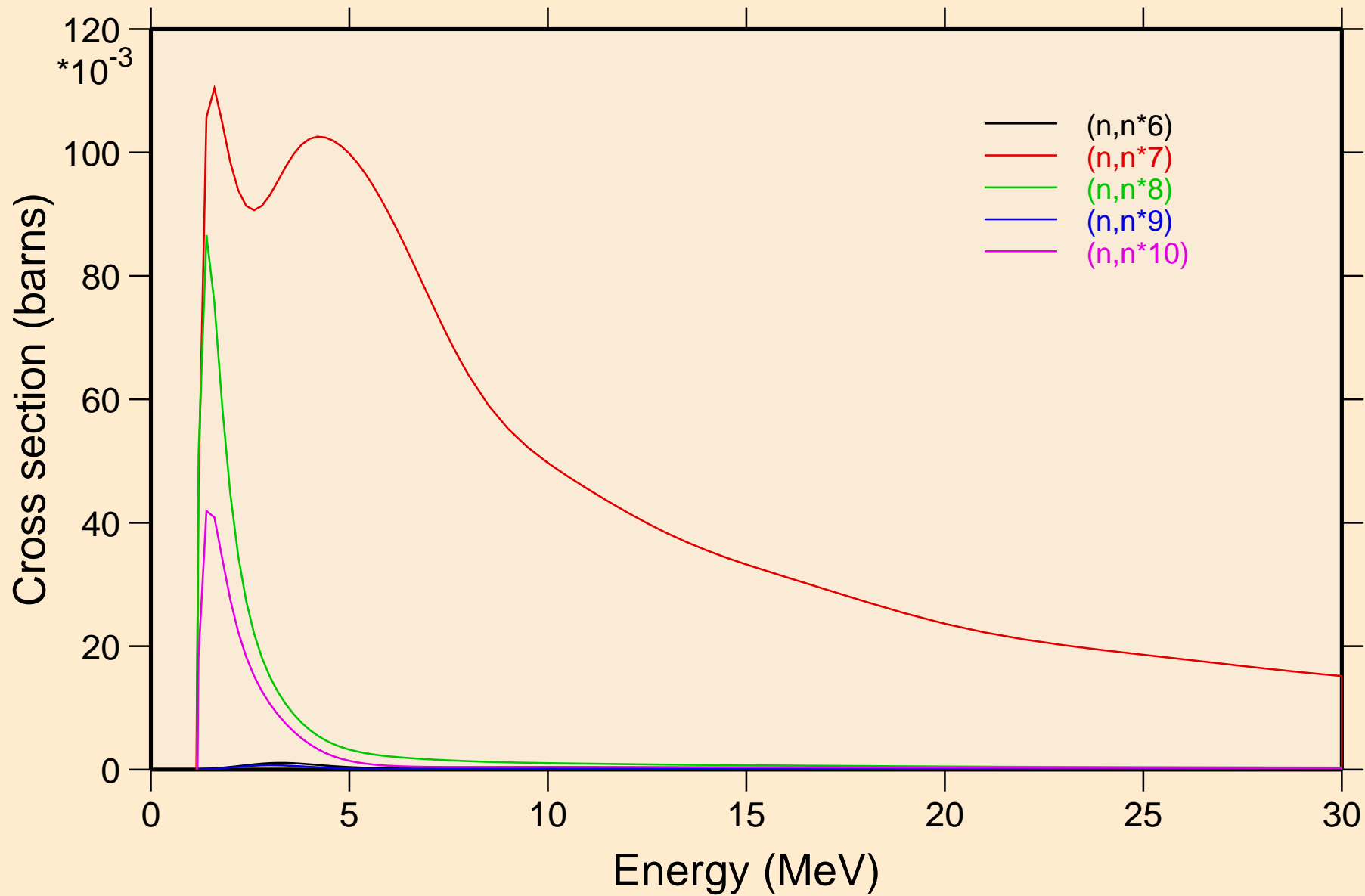

OS199 NEUTRON ACER TENDL-2023 LIBRARY; T=0.K
Inelastic levels

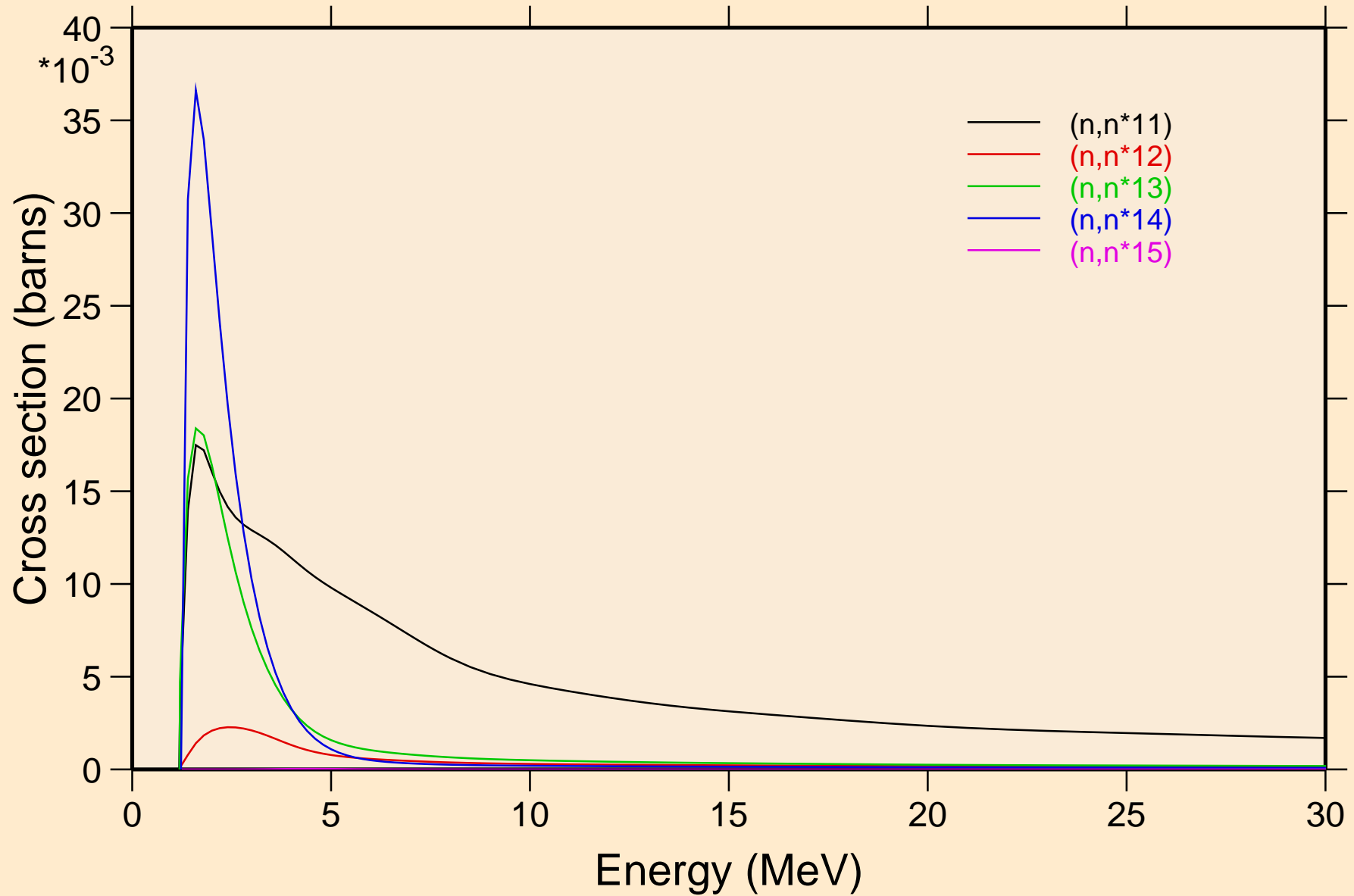

OS199 NEUTRON ACER TENDL-2023 LIBRARY; T=0.K
Inelastic levels

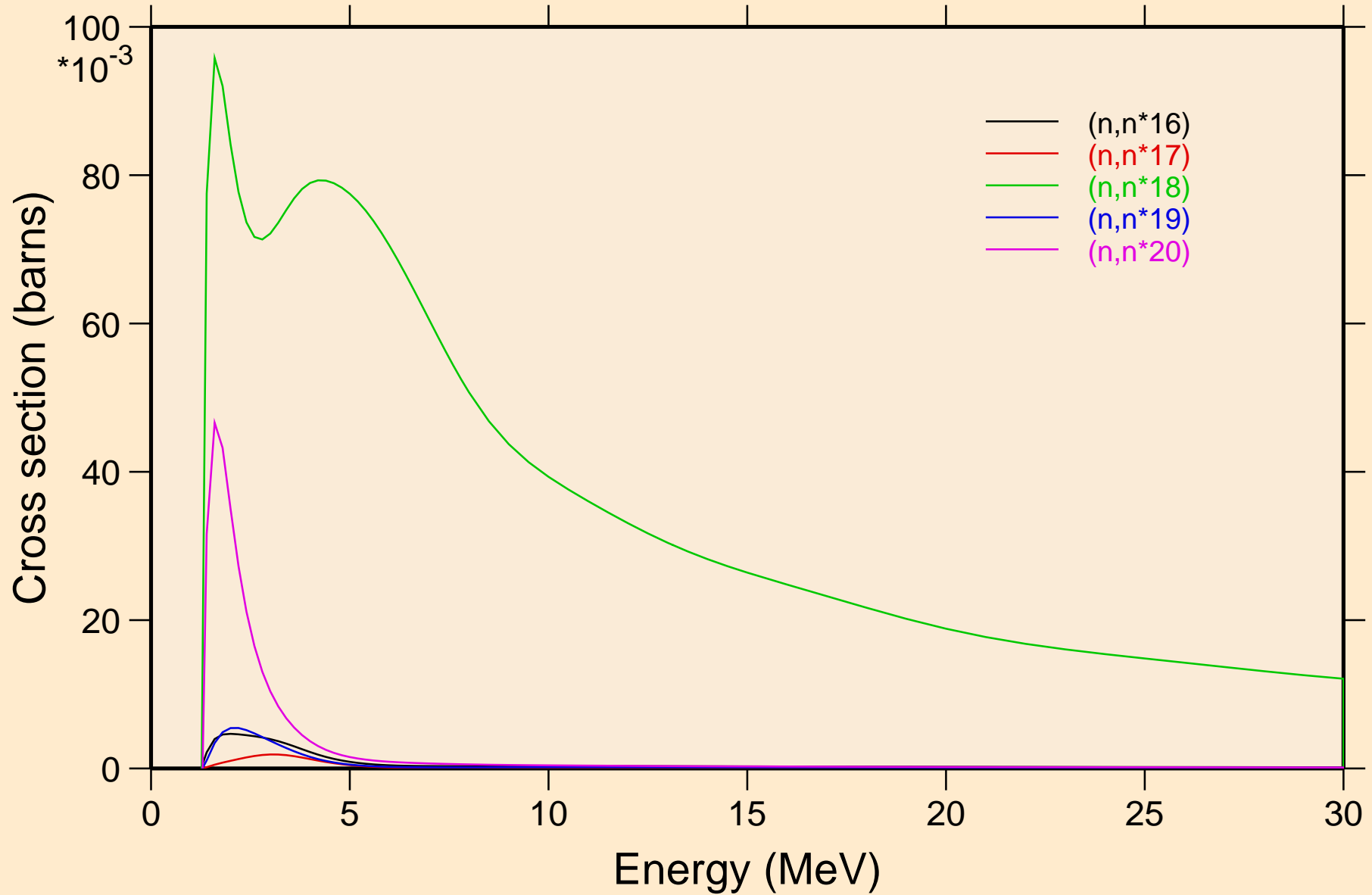

OS199 NEUTRON ACER TENDL-2023 LIBRARY; T=0.K
Inelastic levels

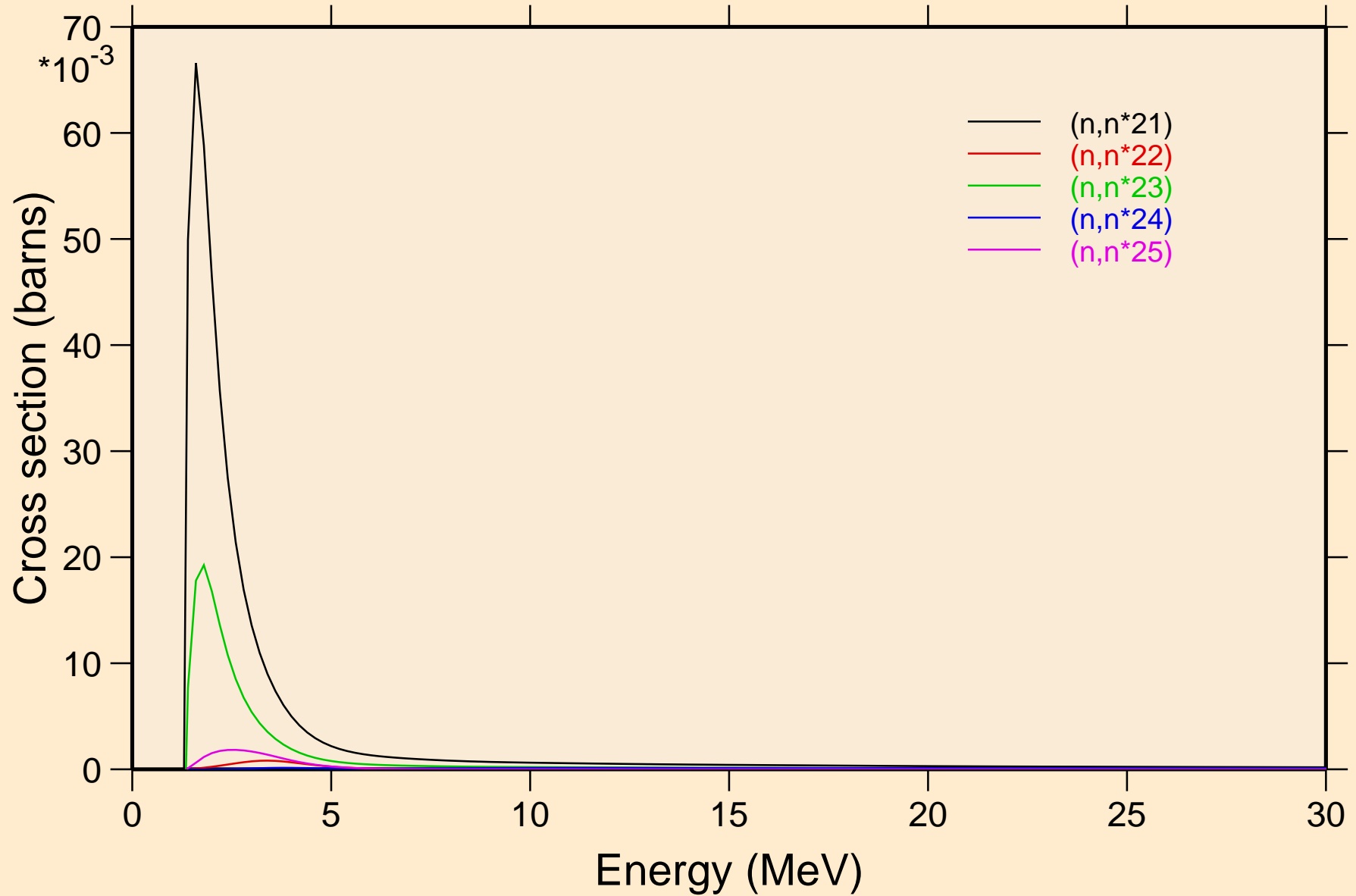

OS199 NEUTRON ACER TENDL-2023 LIBRARY; T=0.K

Inelastic levels

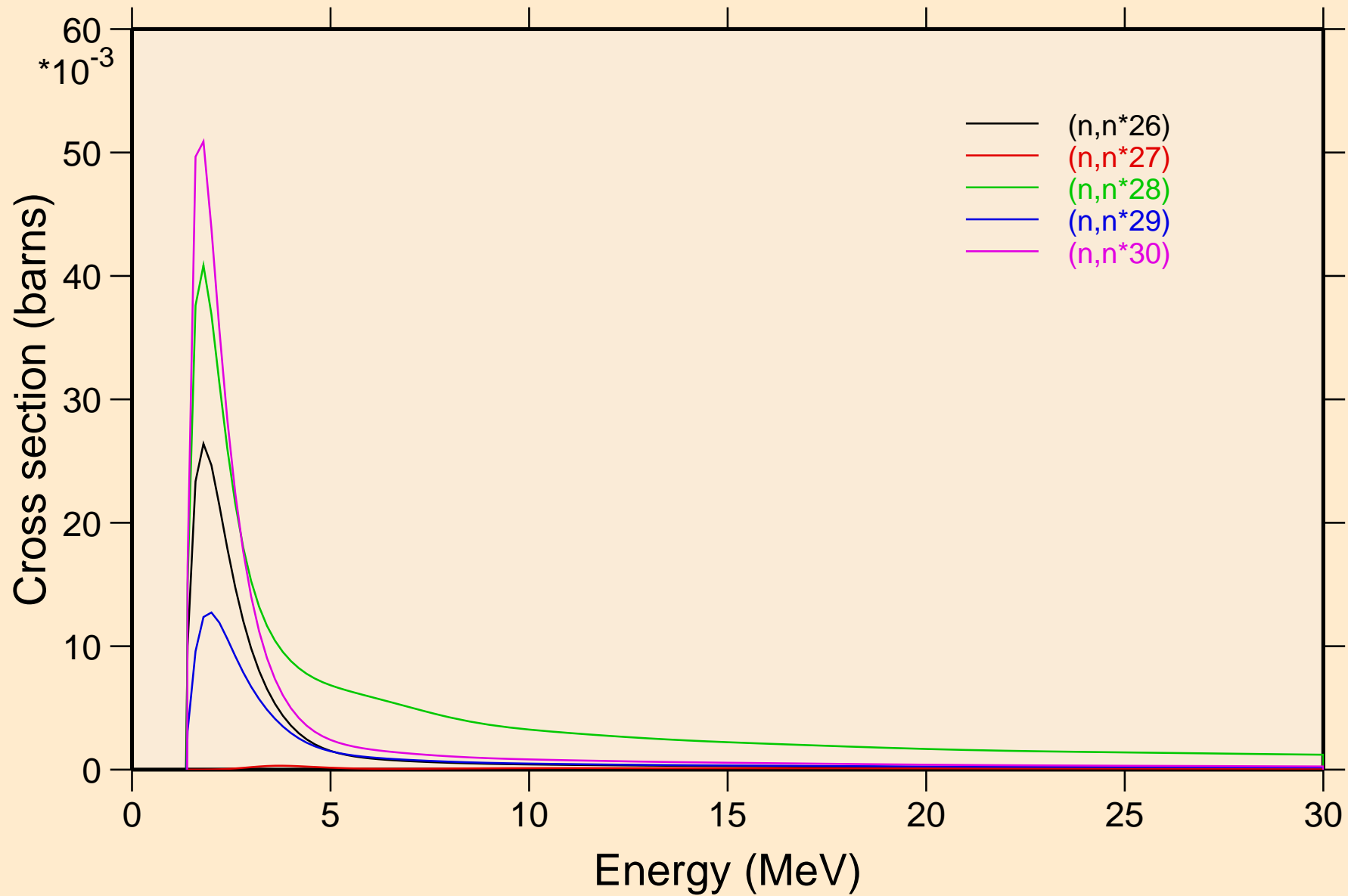

OS199 NEUTRON ACER TENDL-2023 LIBRARY; T=0.K
Threshold reactions

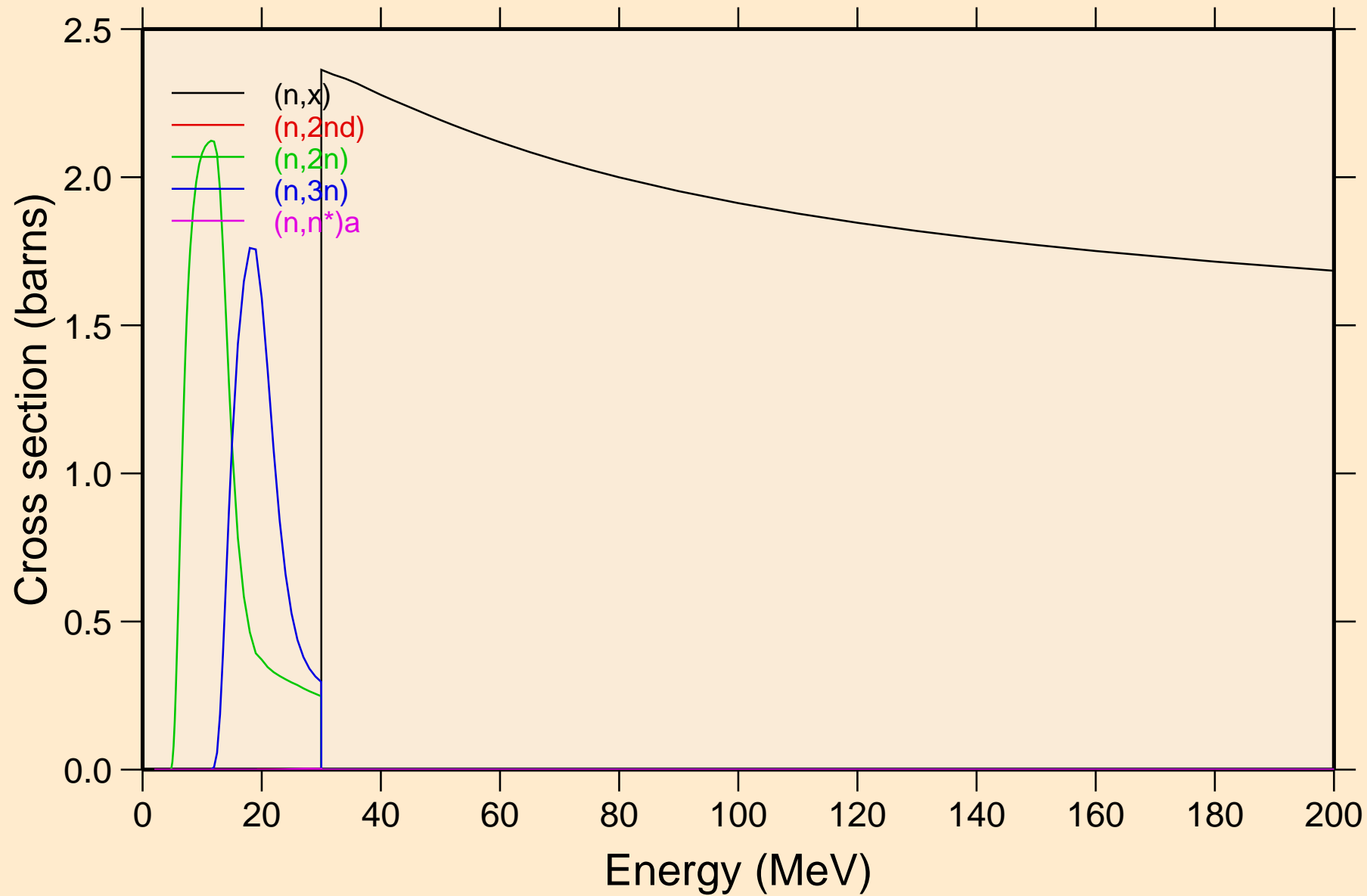

OS199 NEUTRON ACER TENDL-2023 LIBRARY; T=0.K
Threshold reactions

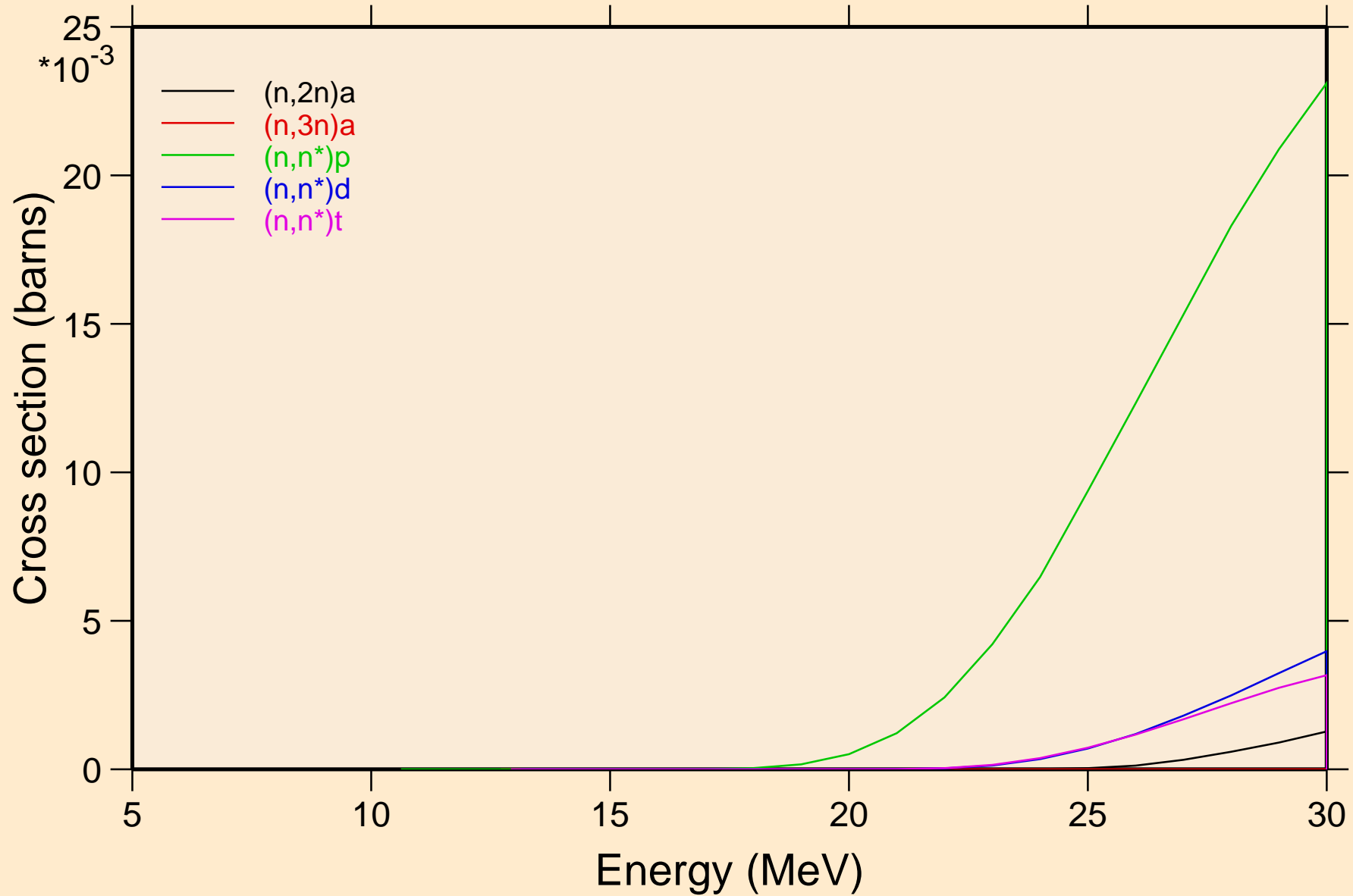

OS199 NEUTRON ACER TENDL-2023 LIBRARY; T=0.K
Threshold reactions

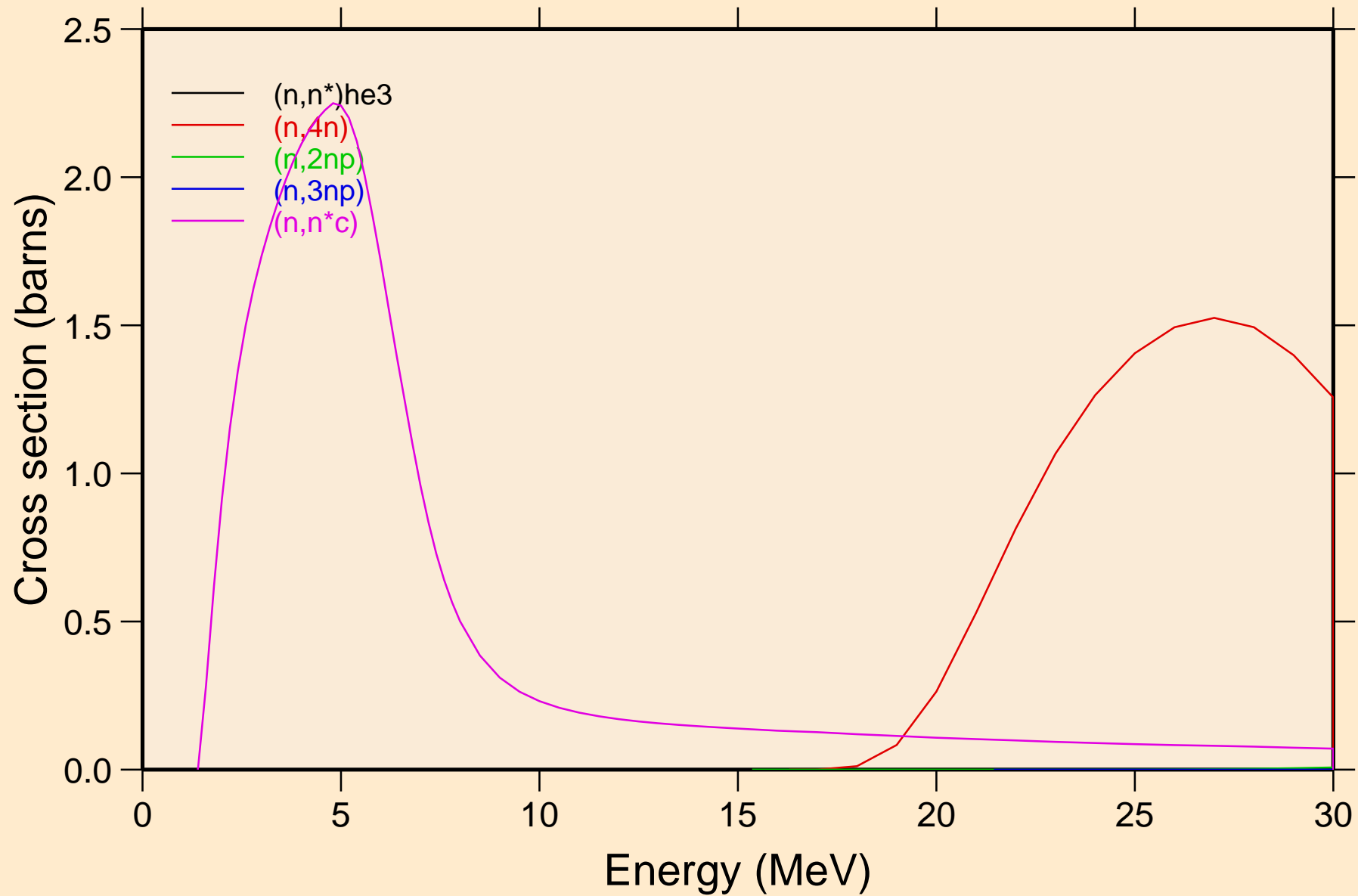

OS199 NEUTRON ACER TENDL-2023 LIBRARY; T=0.K
Threshold reactions

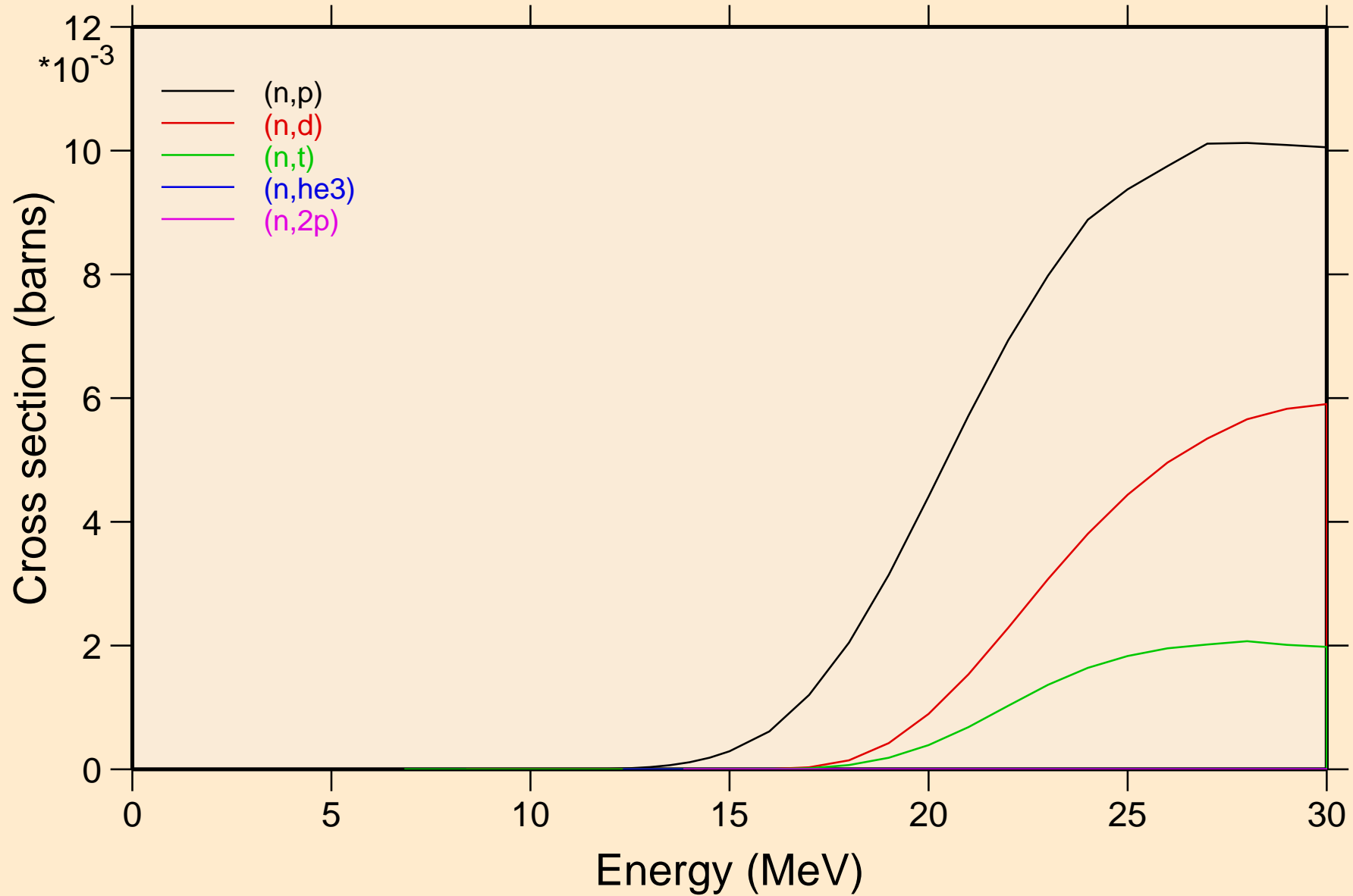

OS199 NEUTRON ACER TENDL-2023 LIBRARY; T=0.K
Threshold reactions

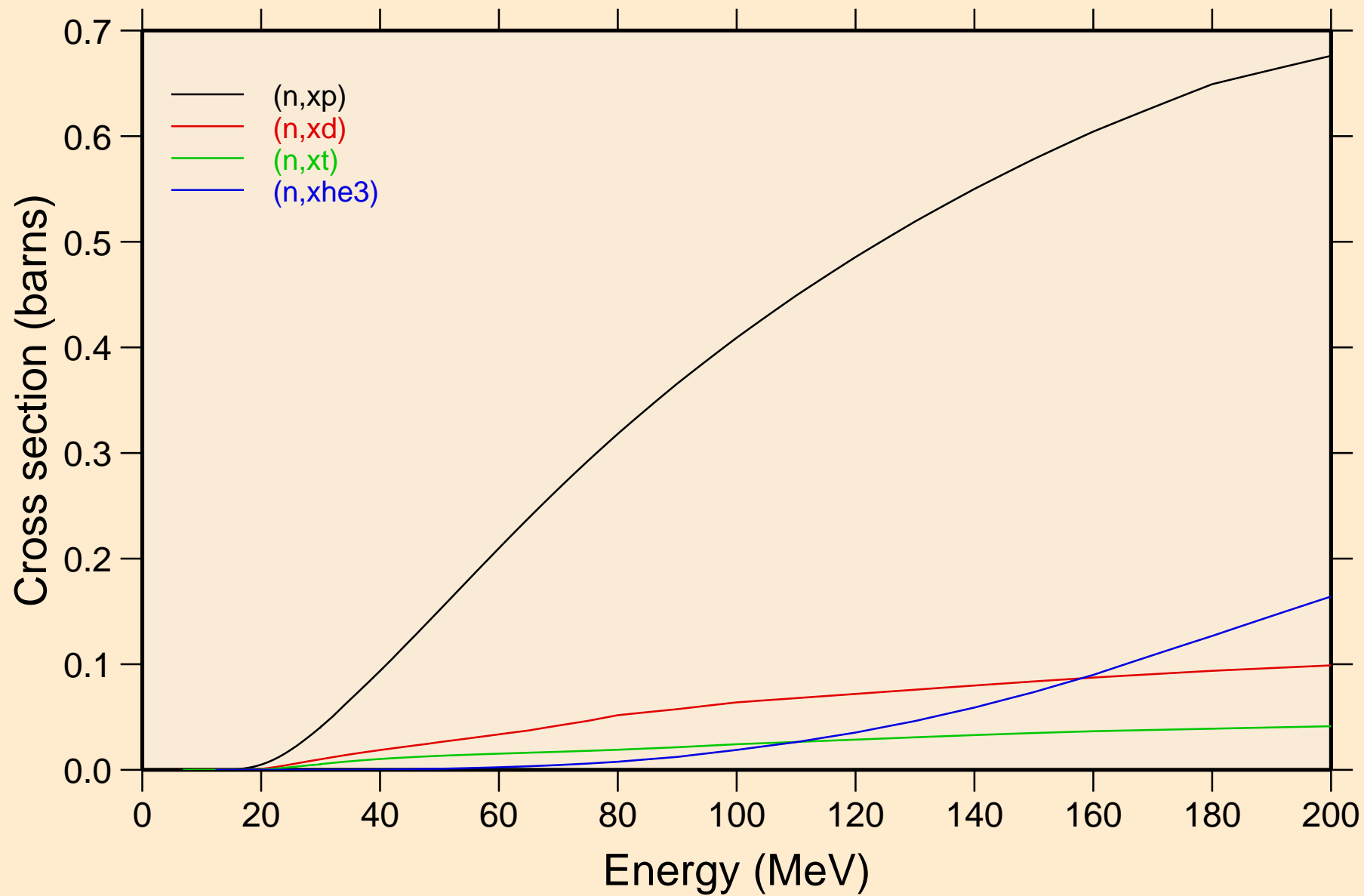

OS199 NEUTRON ACER TENDL-2023 LIBRARY; T=0.K
angular distribution for elastic

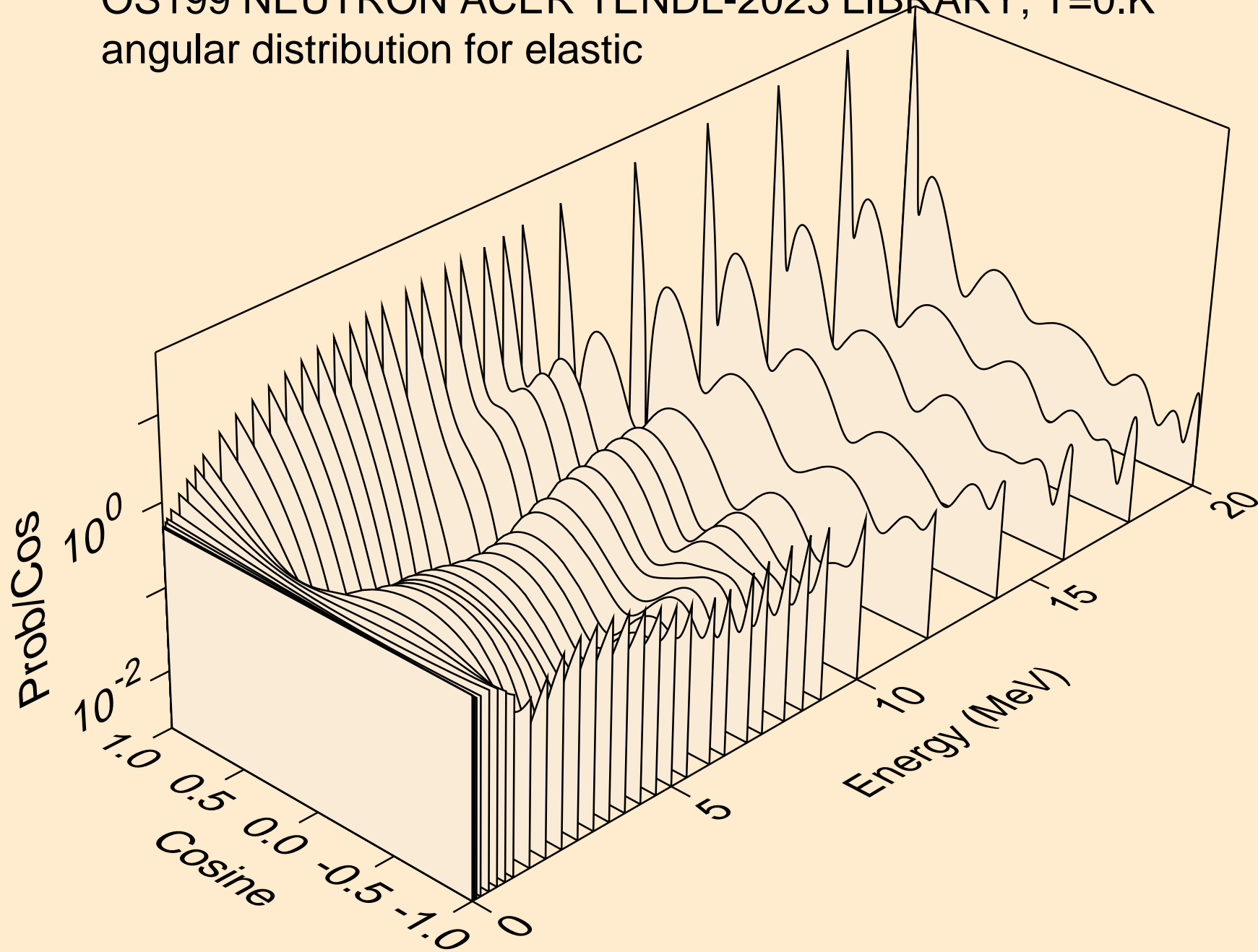

OS199 NEUTRON ACER TENDL-2023 LIBRARY; T=0.K
angular distribution for elastic

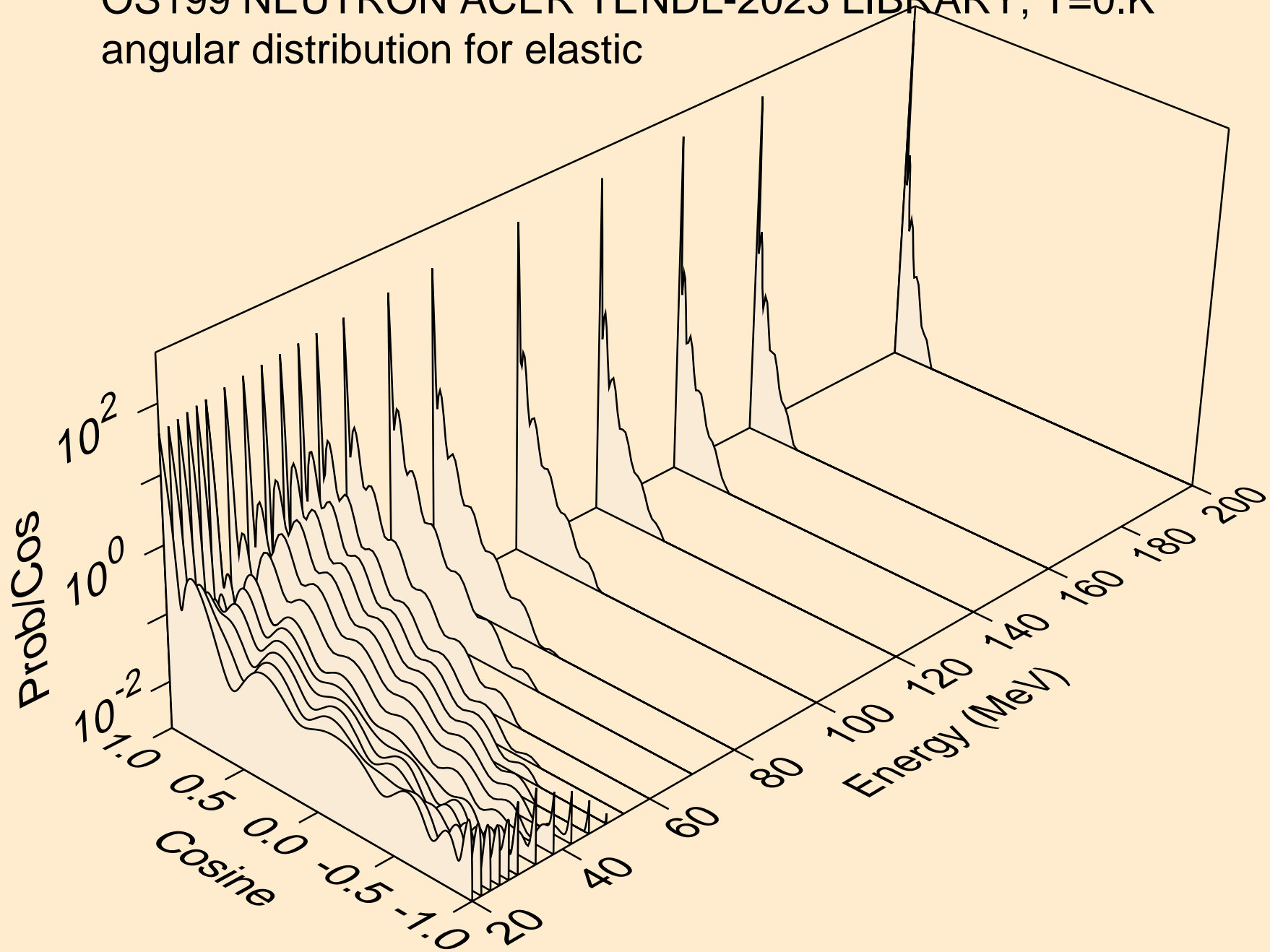

OS199 NEUTRON ACER TENDL-2023 LIBRARY; T=0.K
angular distribution for (n,n*1)

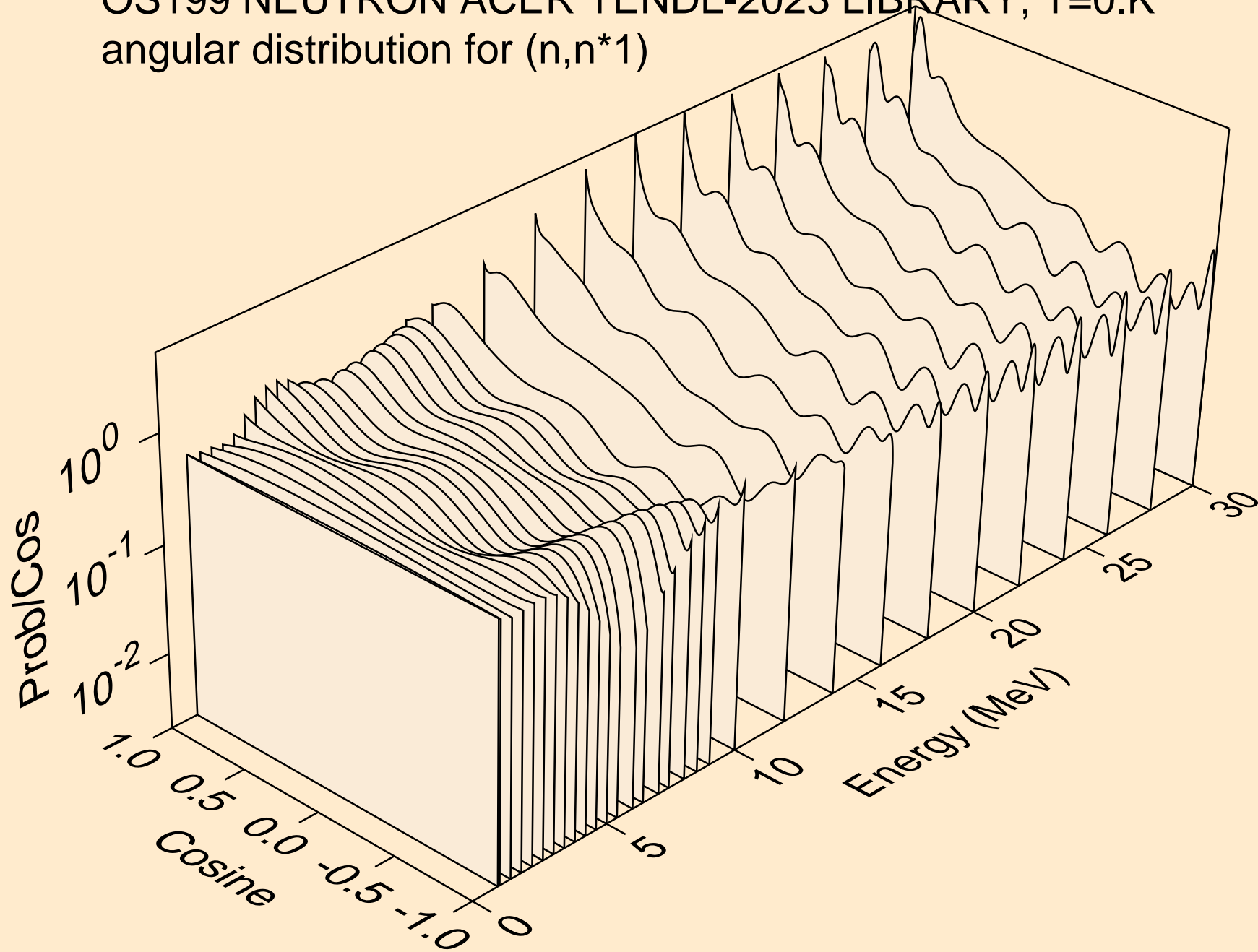

OS199 NEUTRON ACER TENDL-2023 LIBRARY; T=0.K
angular distribution for (n,n*2)

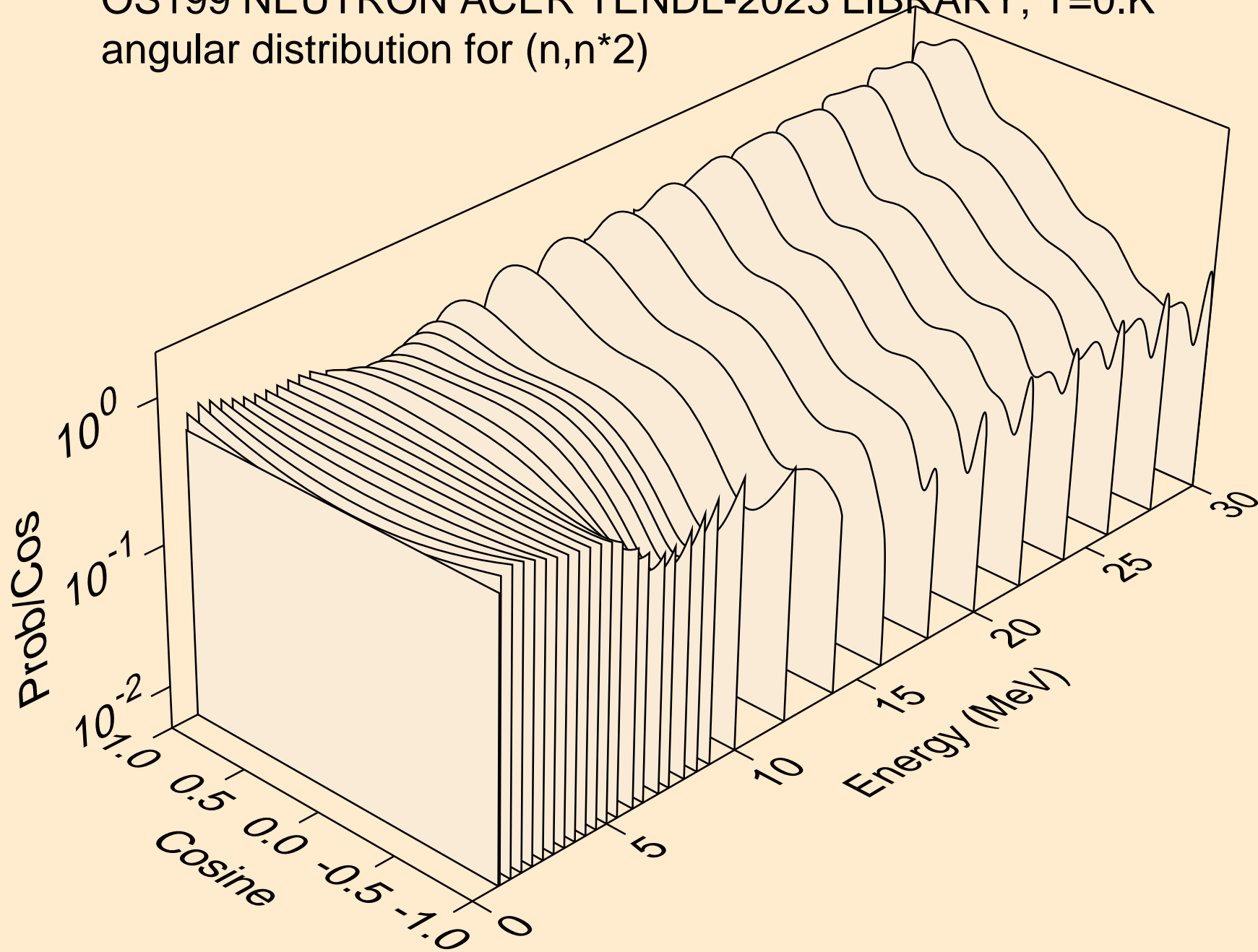

OS199 NEUTRON ACER TENDL-2023 LIBRARY; T=0.K
angular distribution for (n,n*3)

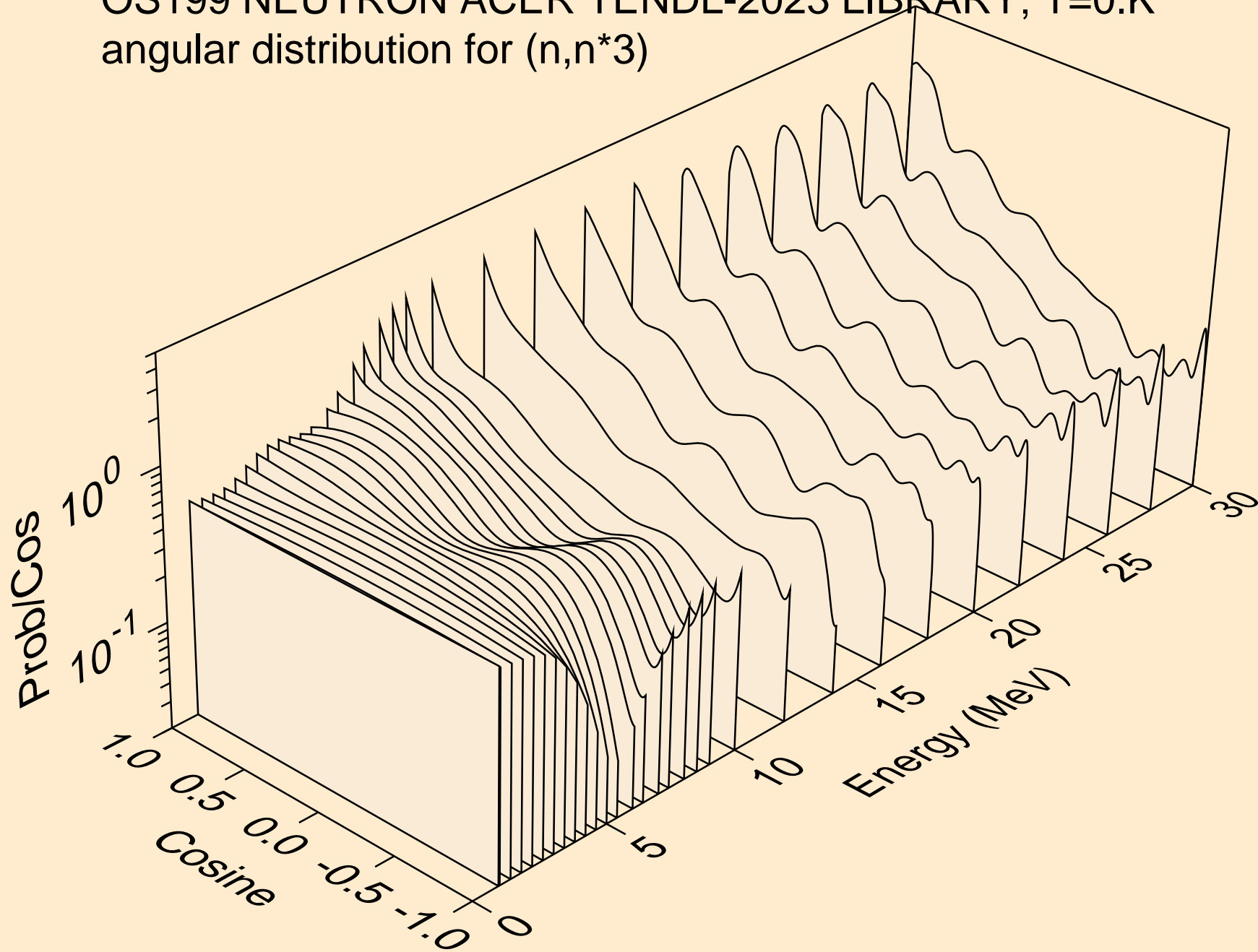

OS199 NEUTRON ACER TENDL-2023 LIBRARY; T=0.K
angular distribution for (n,n*4)

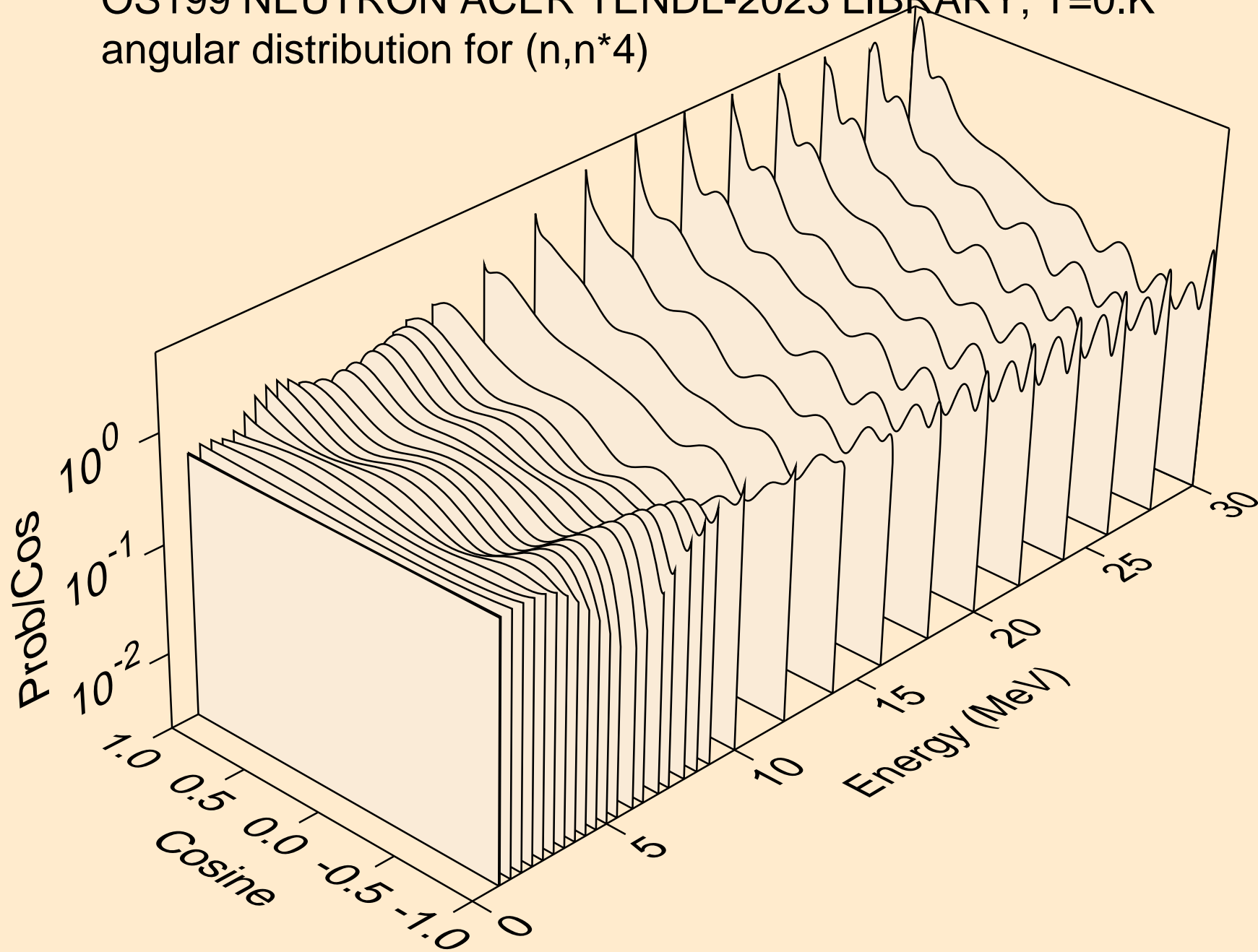

OS199 NEUTRON ACER TENDL-2023 LIBRARY; T=0.K
angular distribution for (n,n*5)

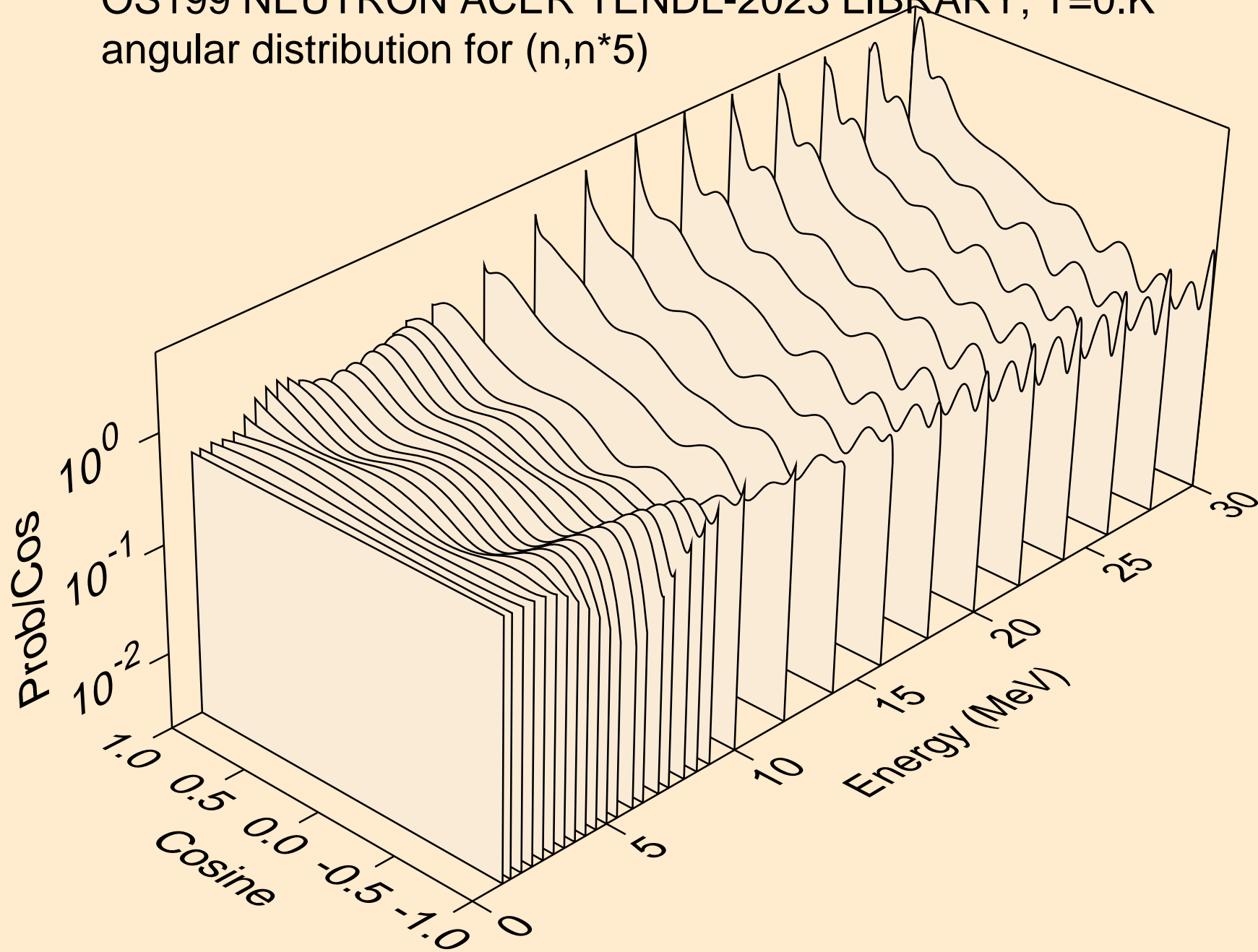

OS199 NEUTRON ACER TENDL-2023 LIBRARY; T=0.K
angular distribution for (n,n*6)

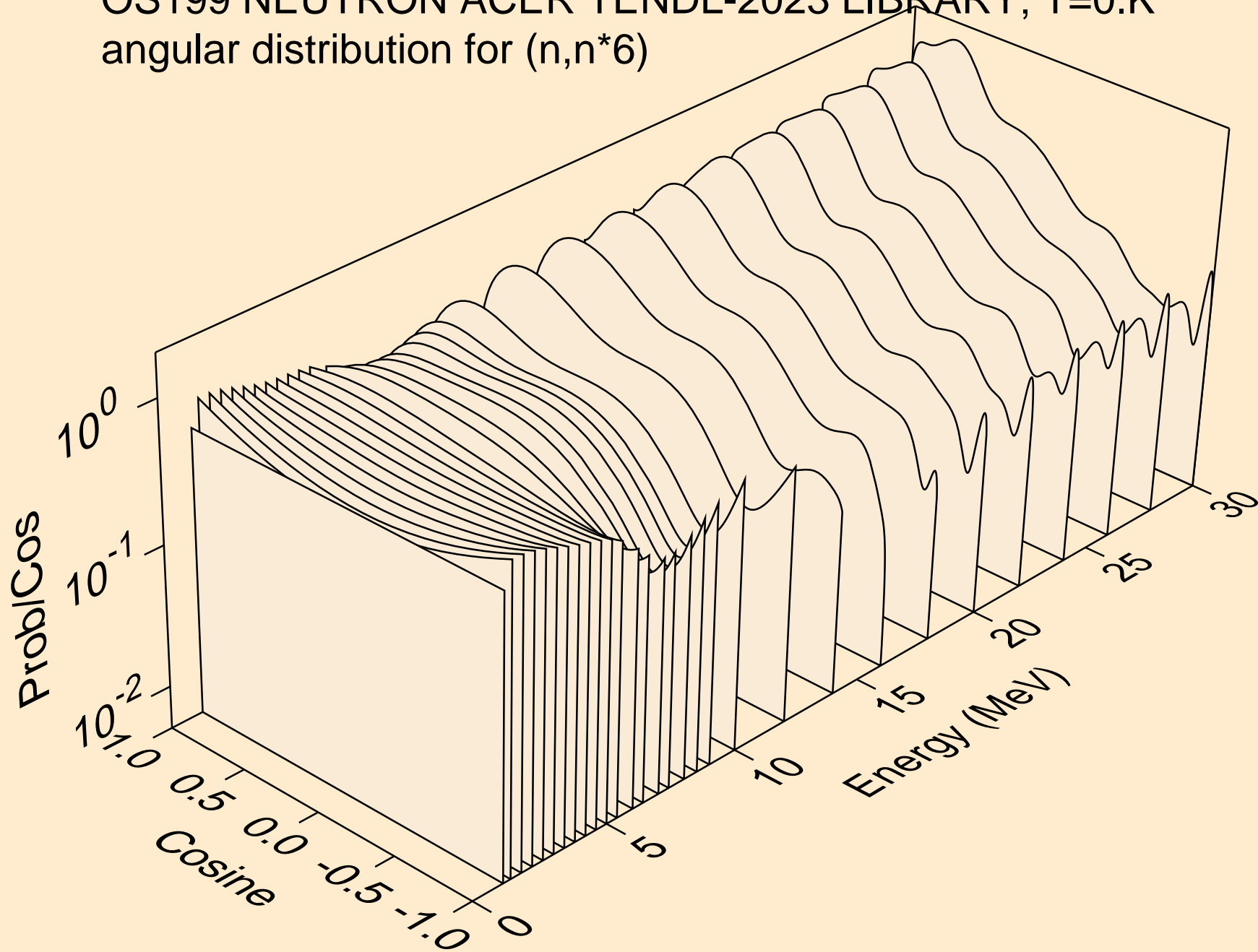

OS199 NEUTRON ACER TENDL-2023 LIBRARY; T=0.K
angular distribution for (n,n*7)

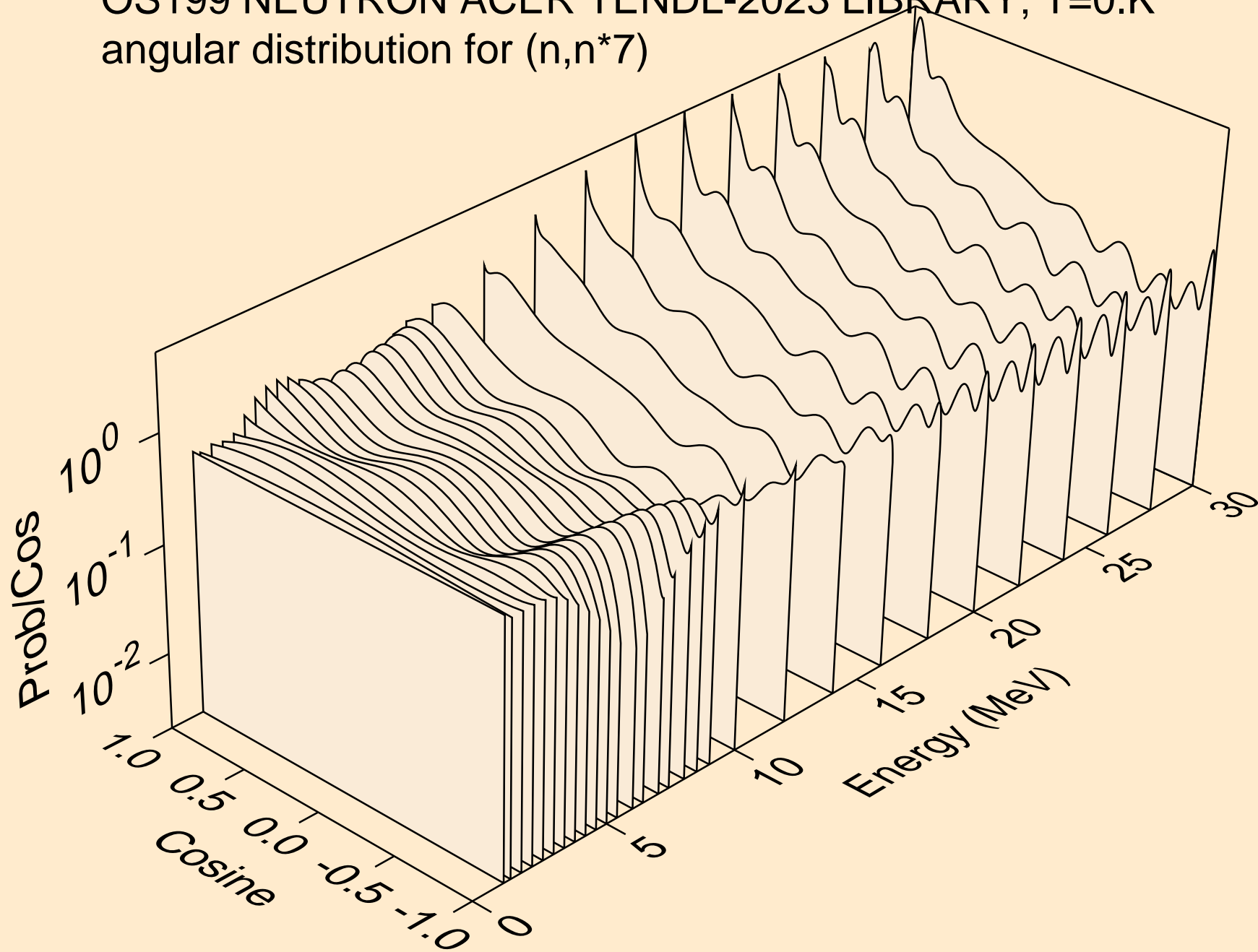

OS199 NEUTRON ACER TENDL-2023 LIBRARY; T=0.K
angular distribution for (n,n*8)

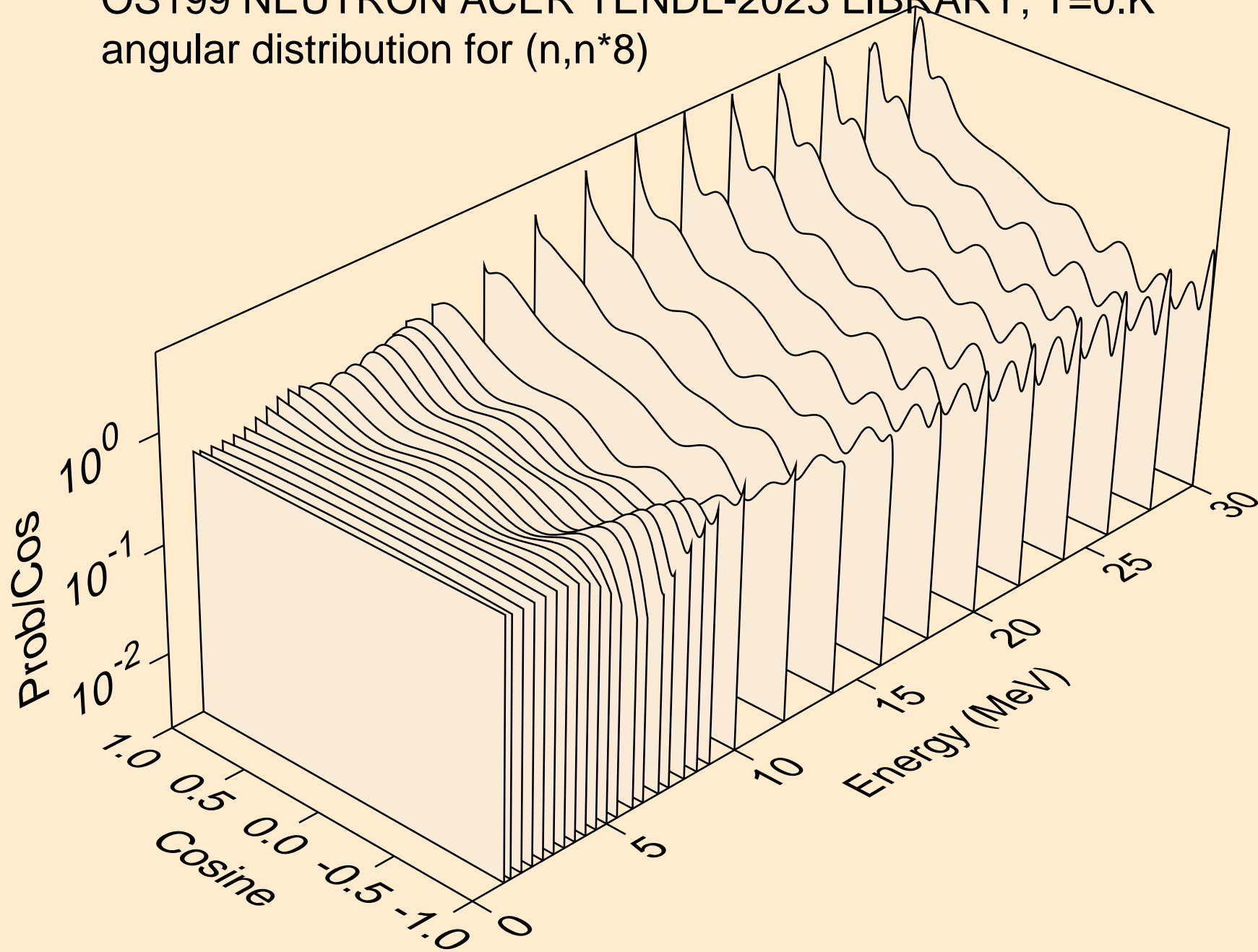

OS199 NEUTRON ACER TENDL-2023 LIBRARY; T=0.K
angular distribution for (n,n*9)

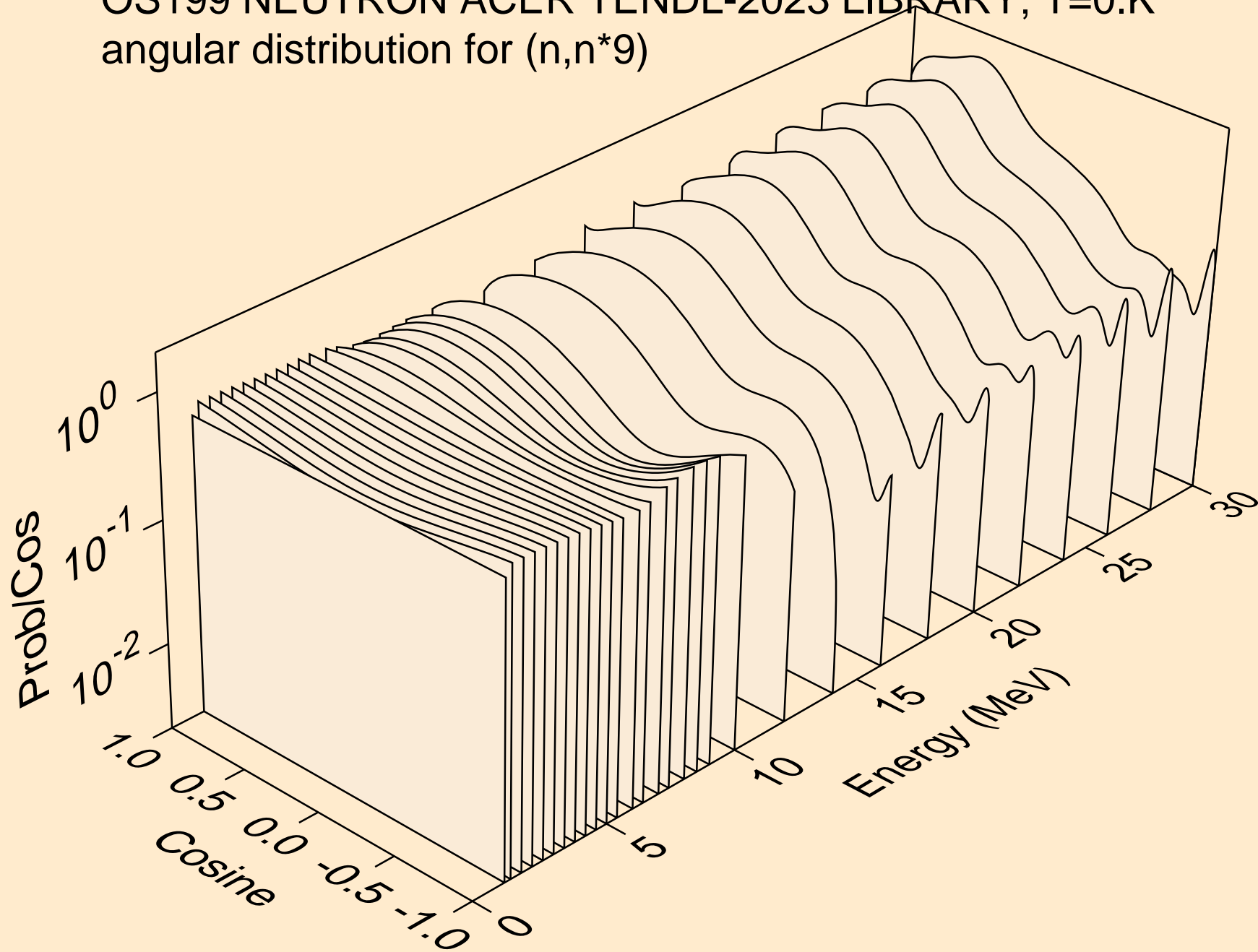

OS199 NEUTRON ACER TENDL-2023 LIBRARY; T=0.K
angular distribution for (n,n*10)

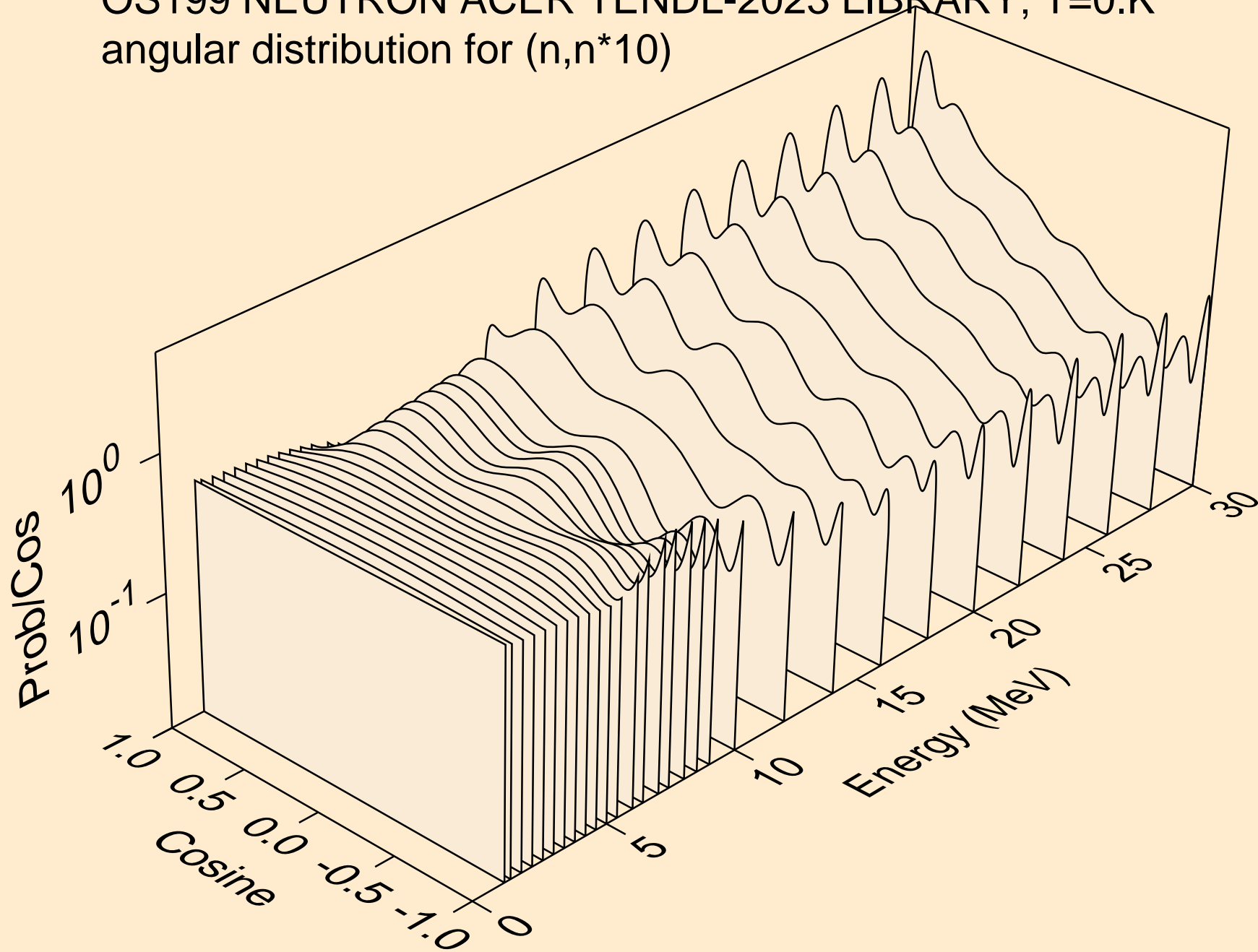

OS199 NEUTRON ACER TENDL-2023 LIBRARY; T=0.K
angular distribution for (n,n*11)

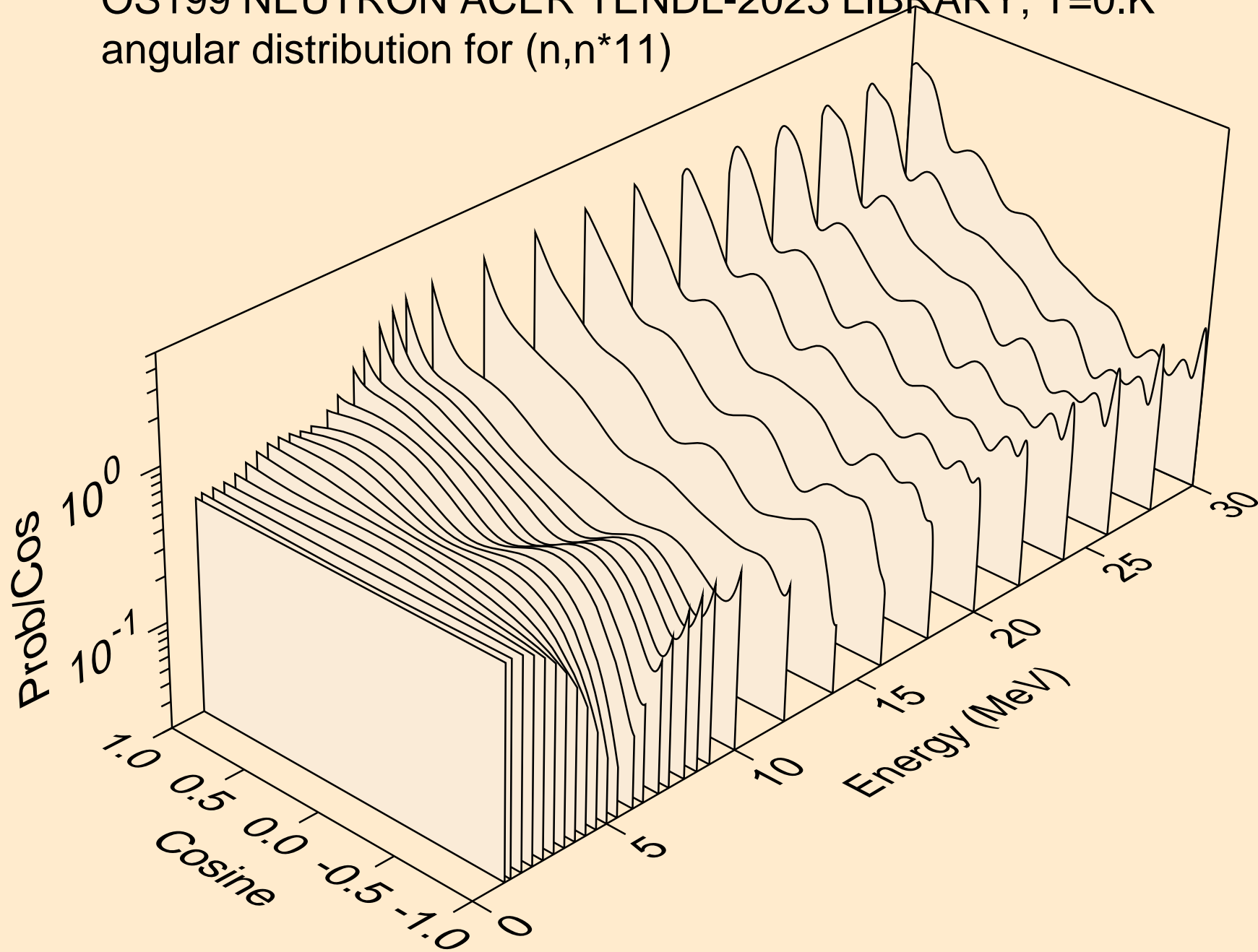

OS199 NEUTRON ACER TENDL-2023 LIBRARY; T=0.K
angular distribution for (n,n*12)

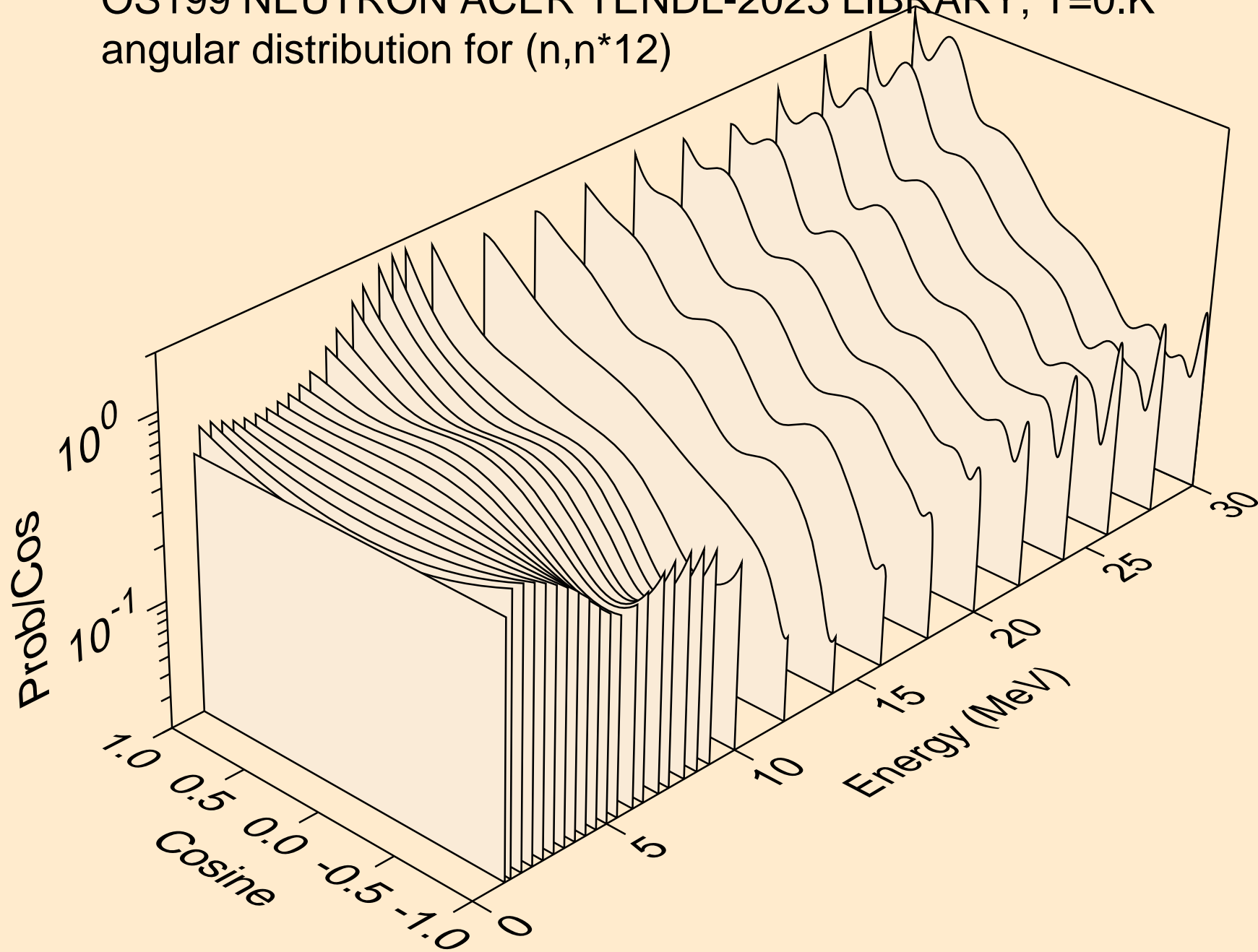

OS199 NEUTRON ACER TENDL-2023 LIBRARY; T=0.K
angular distribution for (n,n*13)

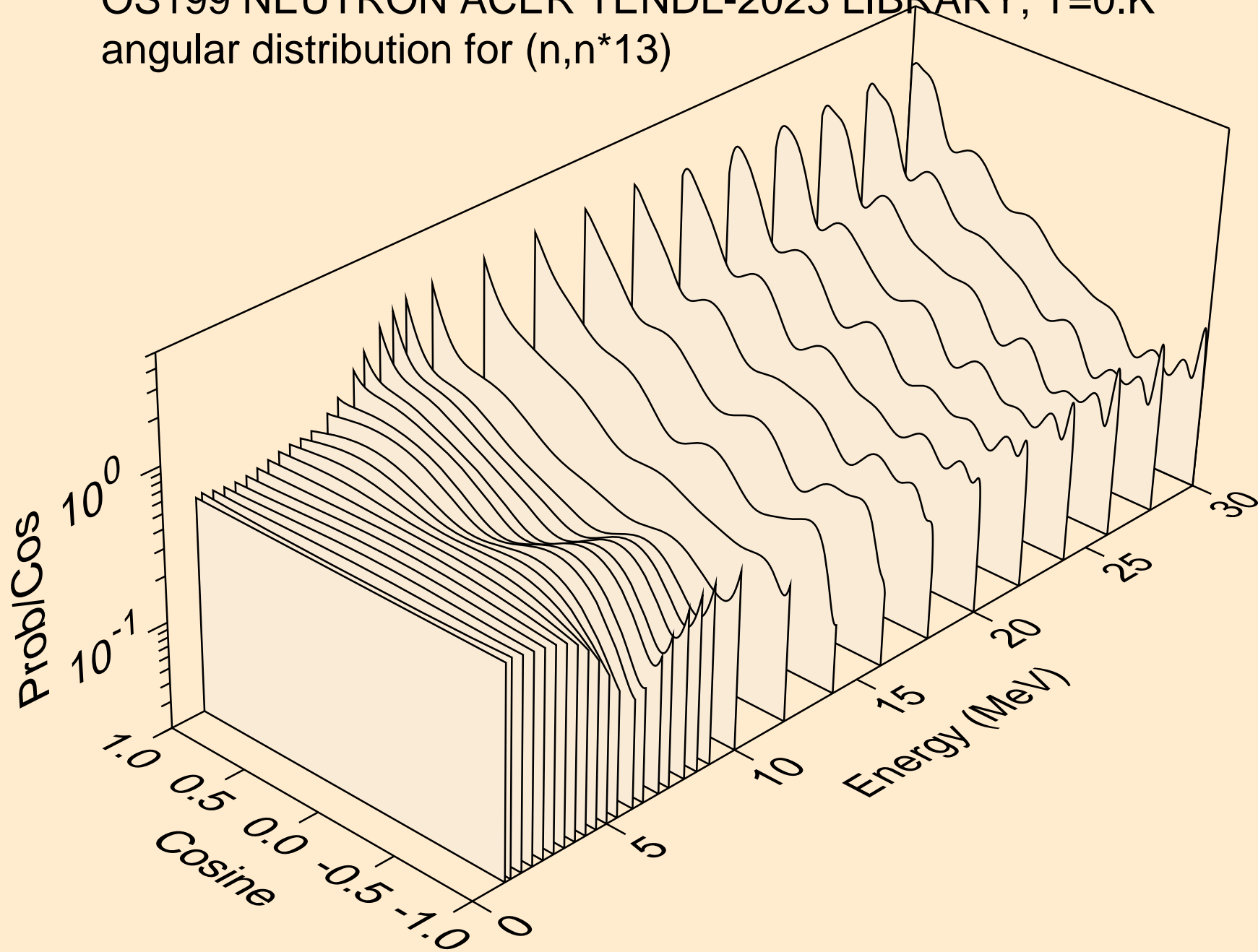

OS199 NEUTRON ACER TENDL-2023 LIBRARY; T=0.K
angular distribution for (n,n*14)

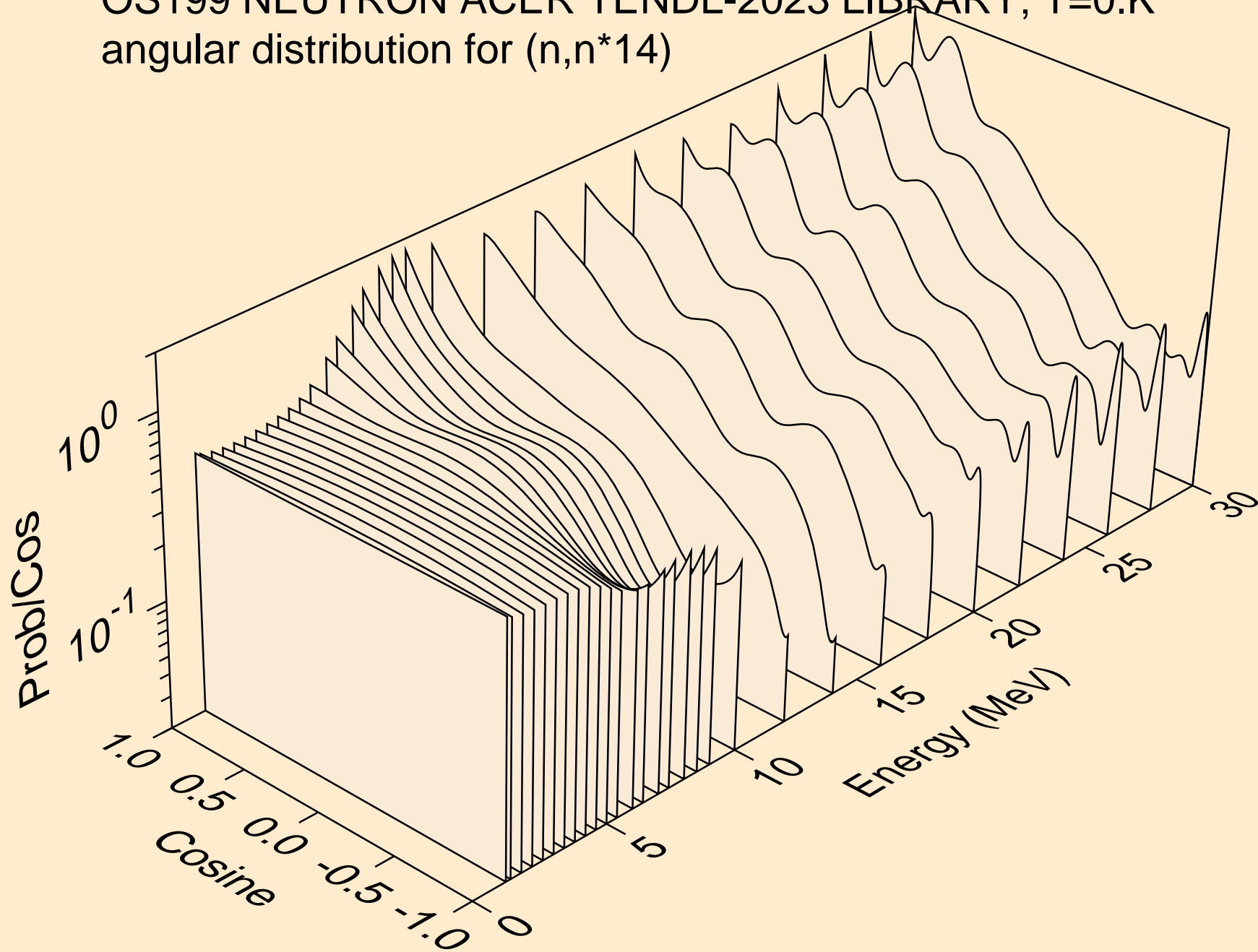

OS199 NEUTRON ACER TENDL-2023 LIBRARY; T=0.K
angular distribution for (n,n*15)

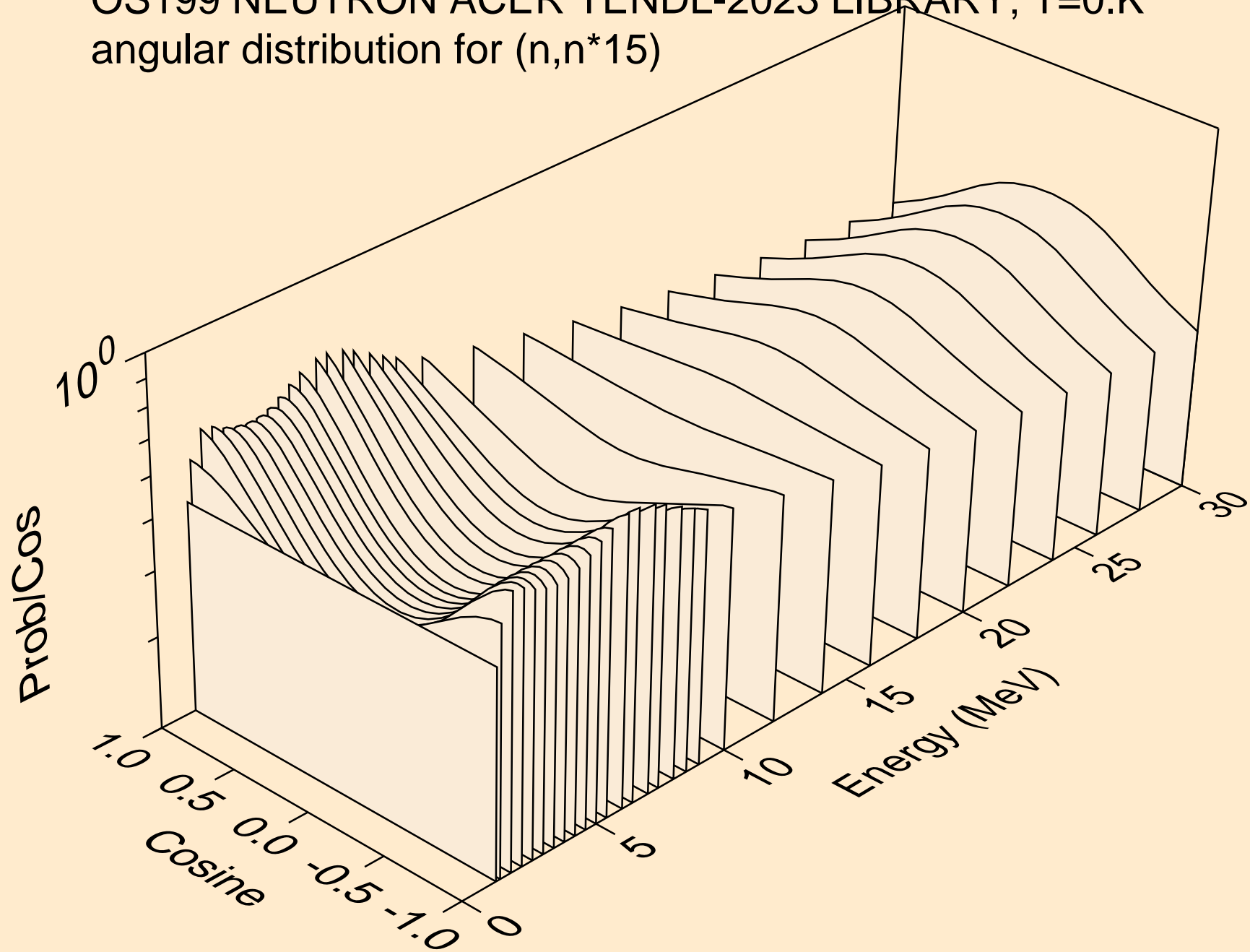

OS199 NEUTRON ACER TENDL-2023 LIBRARY; T=0.K
angular distribution for (n,n*16)

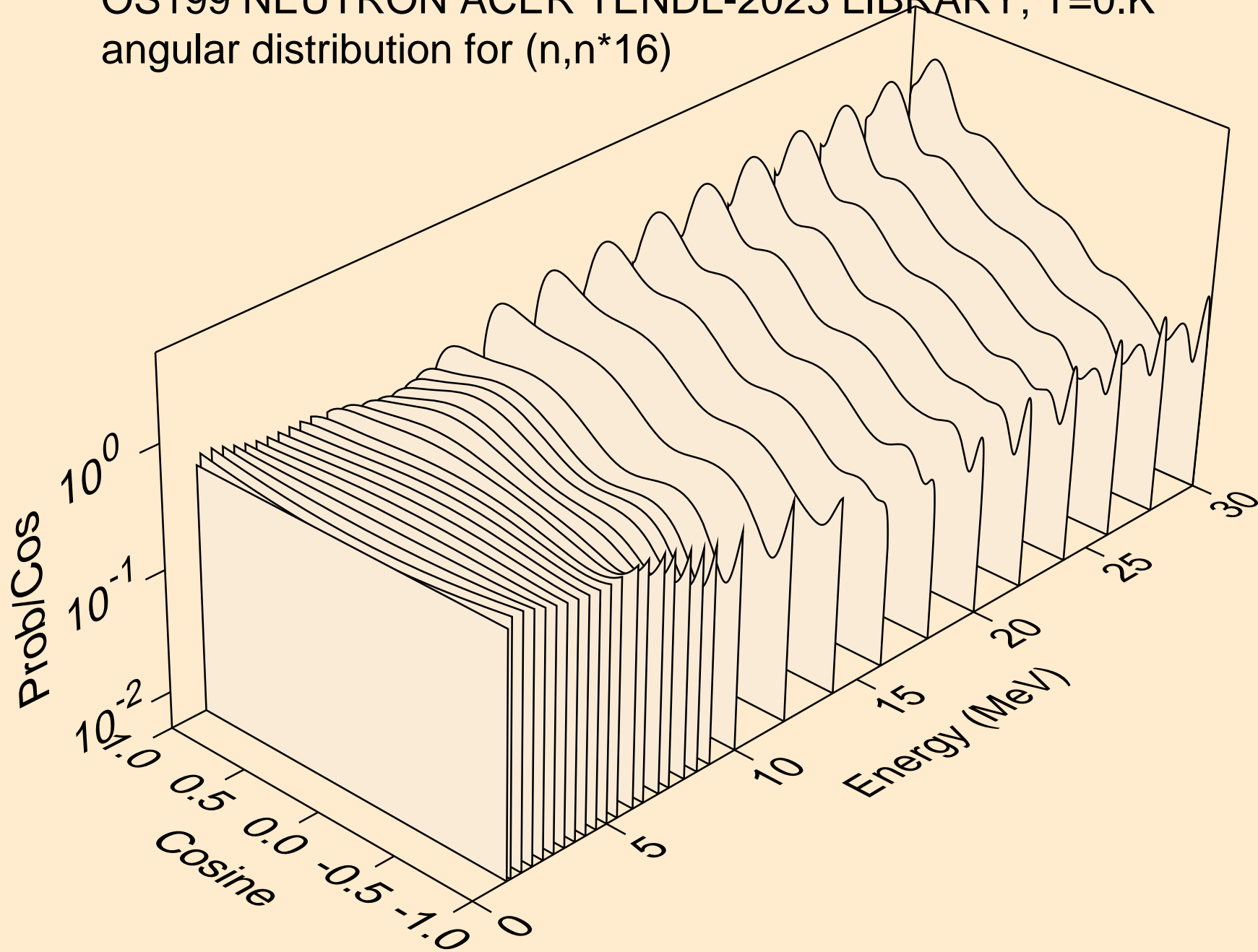

OS199 NEUTRON ACER TENDL-2023 LIBRARY; T=0.K
angular distribution for (n,n*17)

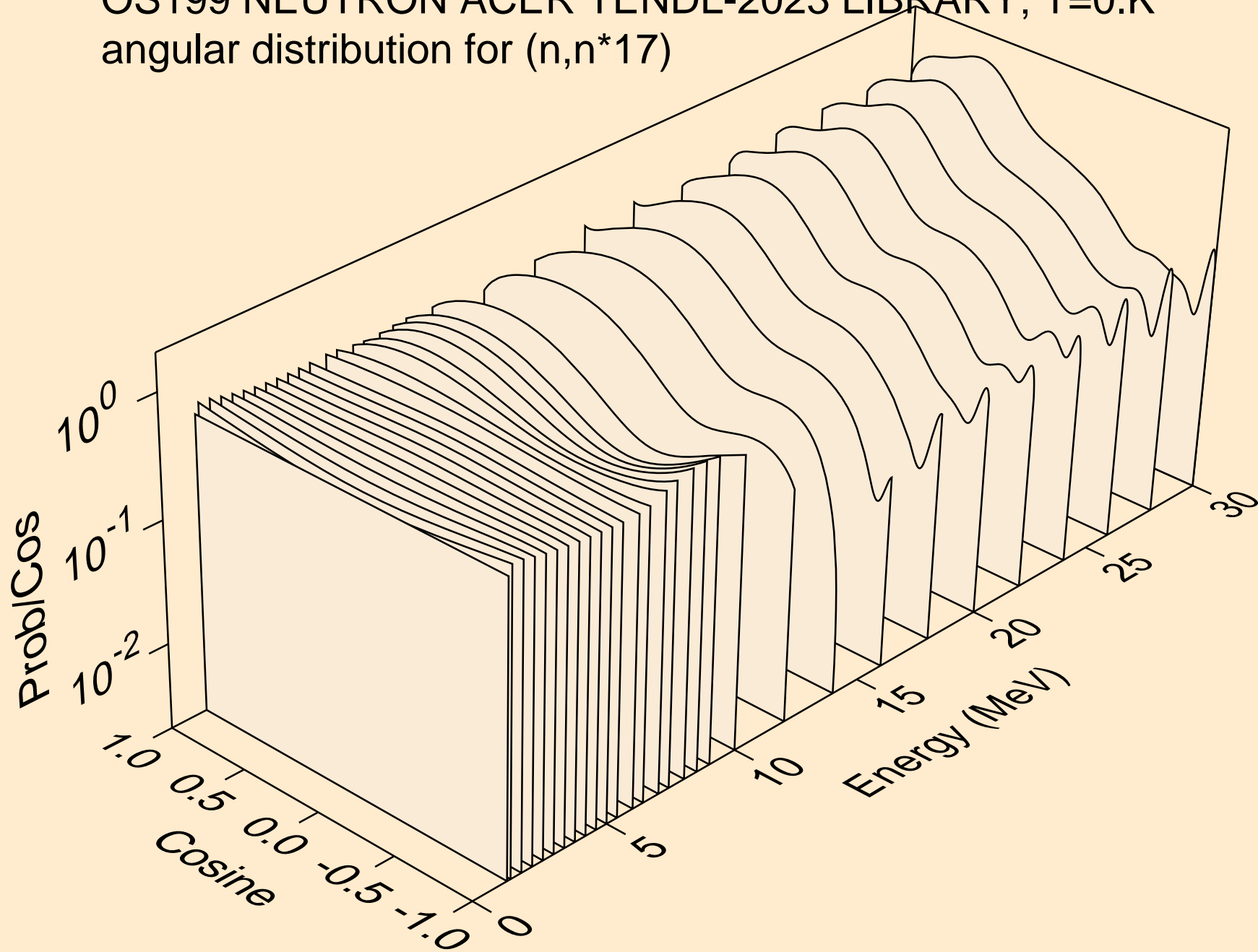

OS199 NEUTRON ACER TENDL-2023 LIBRARY; T=0.K
angular distribution for (n,n*18)

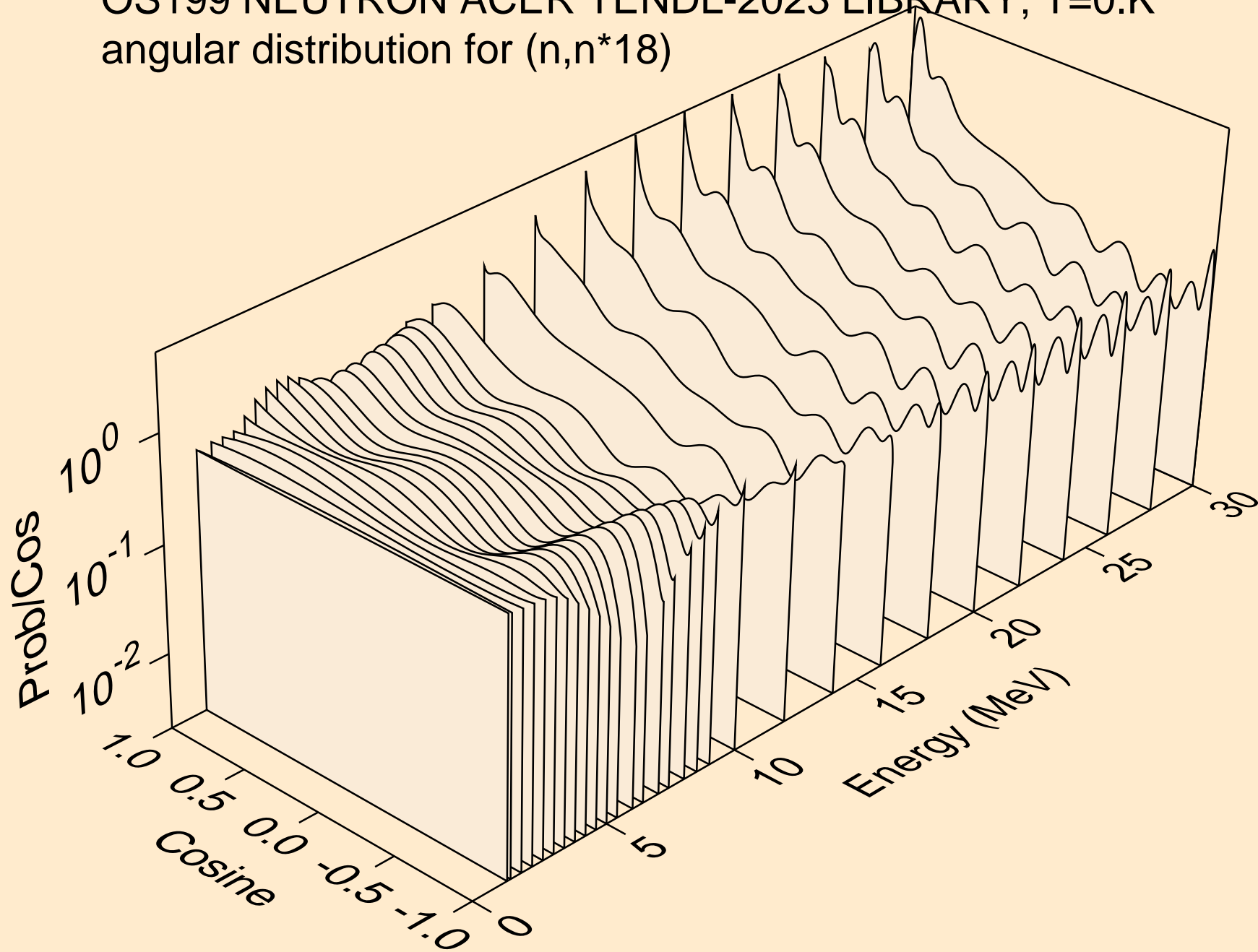

OS199 NEUTRON ACER TENDL-2023 LIBRARY; T=0.K
angular distribution for (n,n*19)

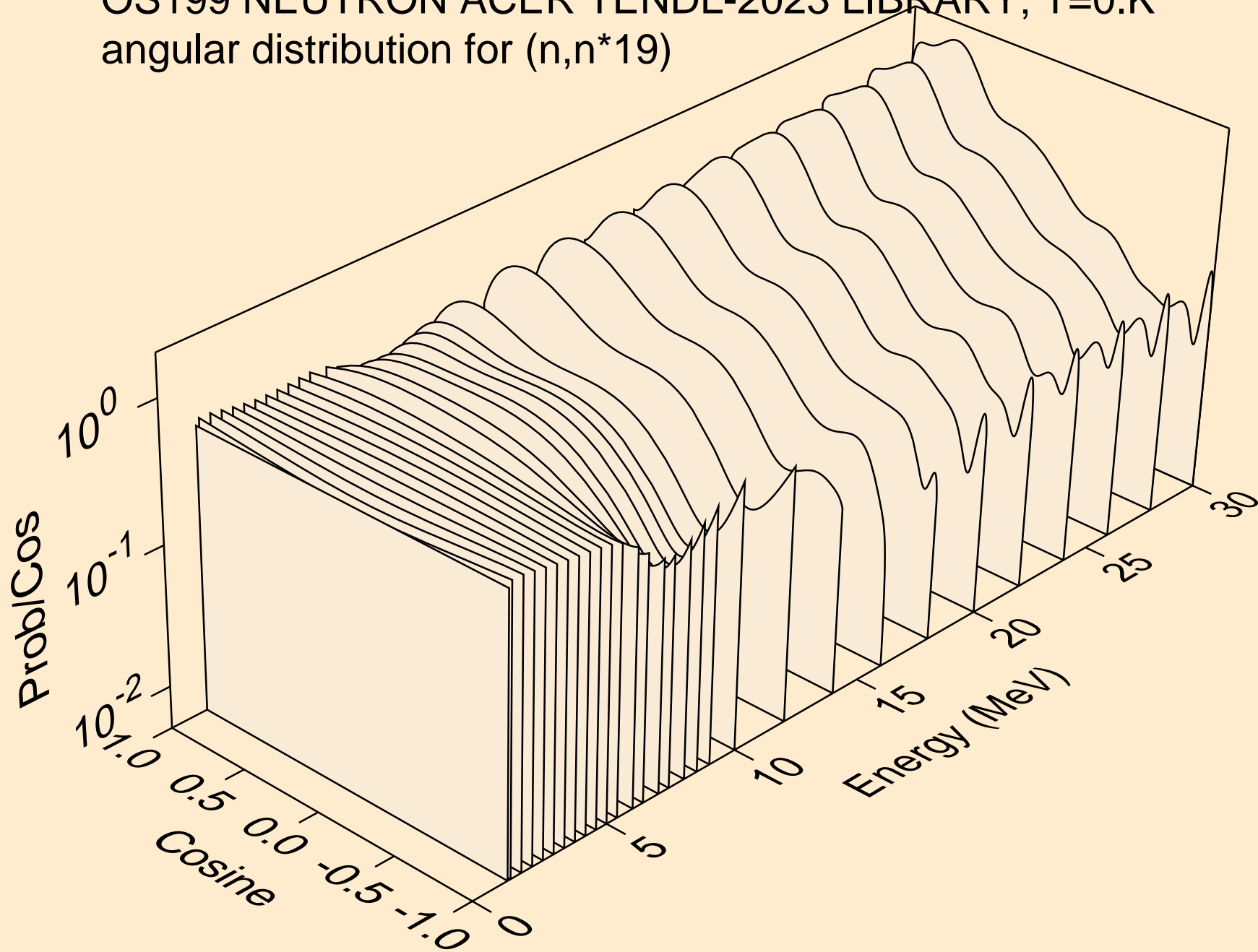

OS199 NEUTRON ACER TENDL-2023 LIBRARY; T=0.K
angular distribution for (n,n*20)

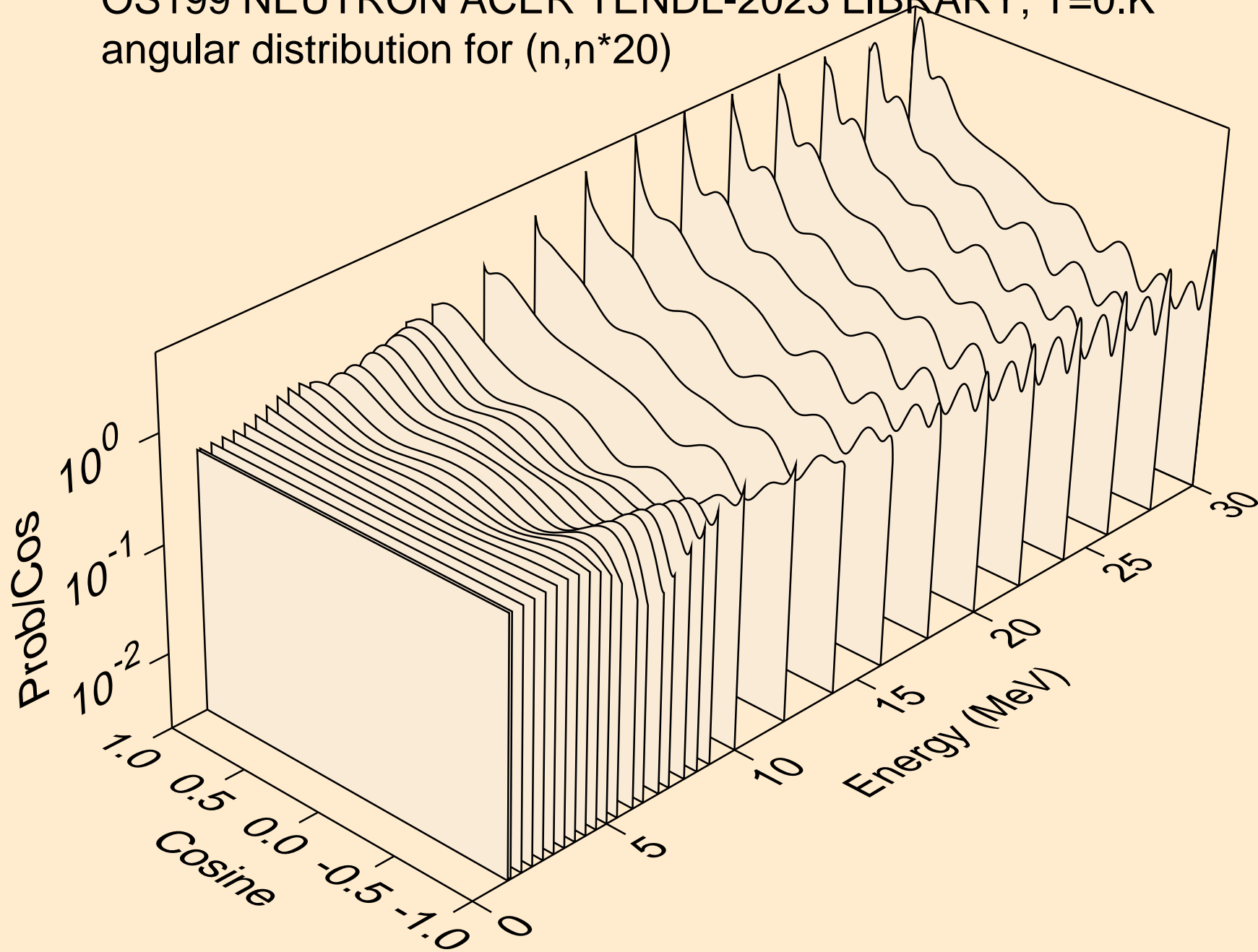

OS199 NEUTRON ACER TENDL-2023 LIBRARY; T=0.K
angular distribution for (n,n*21)

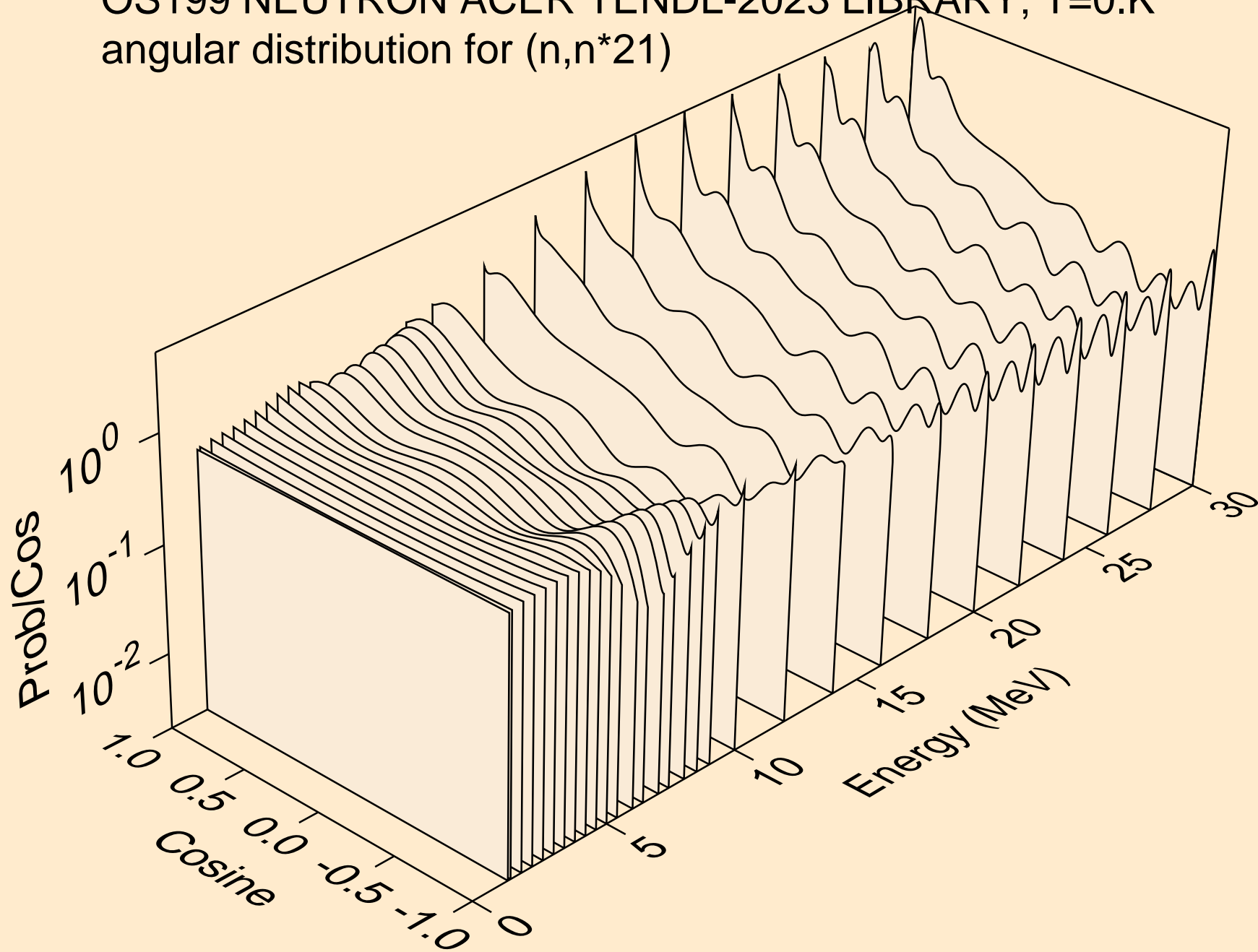

OS199 NEUTRON ACER TENDL-2023 LIBRARY; T=0.K
angular distribution for (n,n*22)

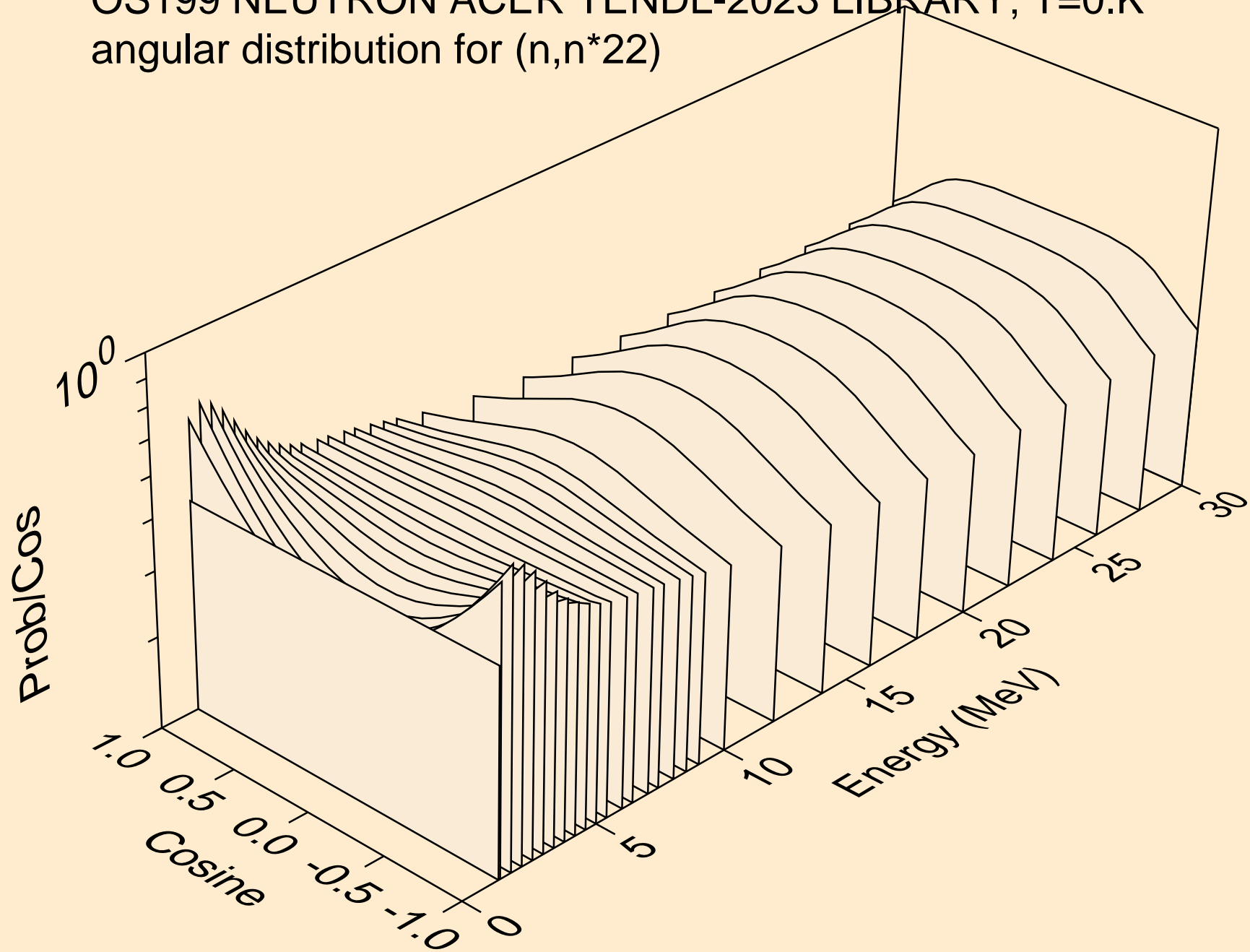

OS199 NEUTRON ACER TENDL-2023 LIBRARY; T=0.K
angular distribution for (n,n*23)

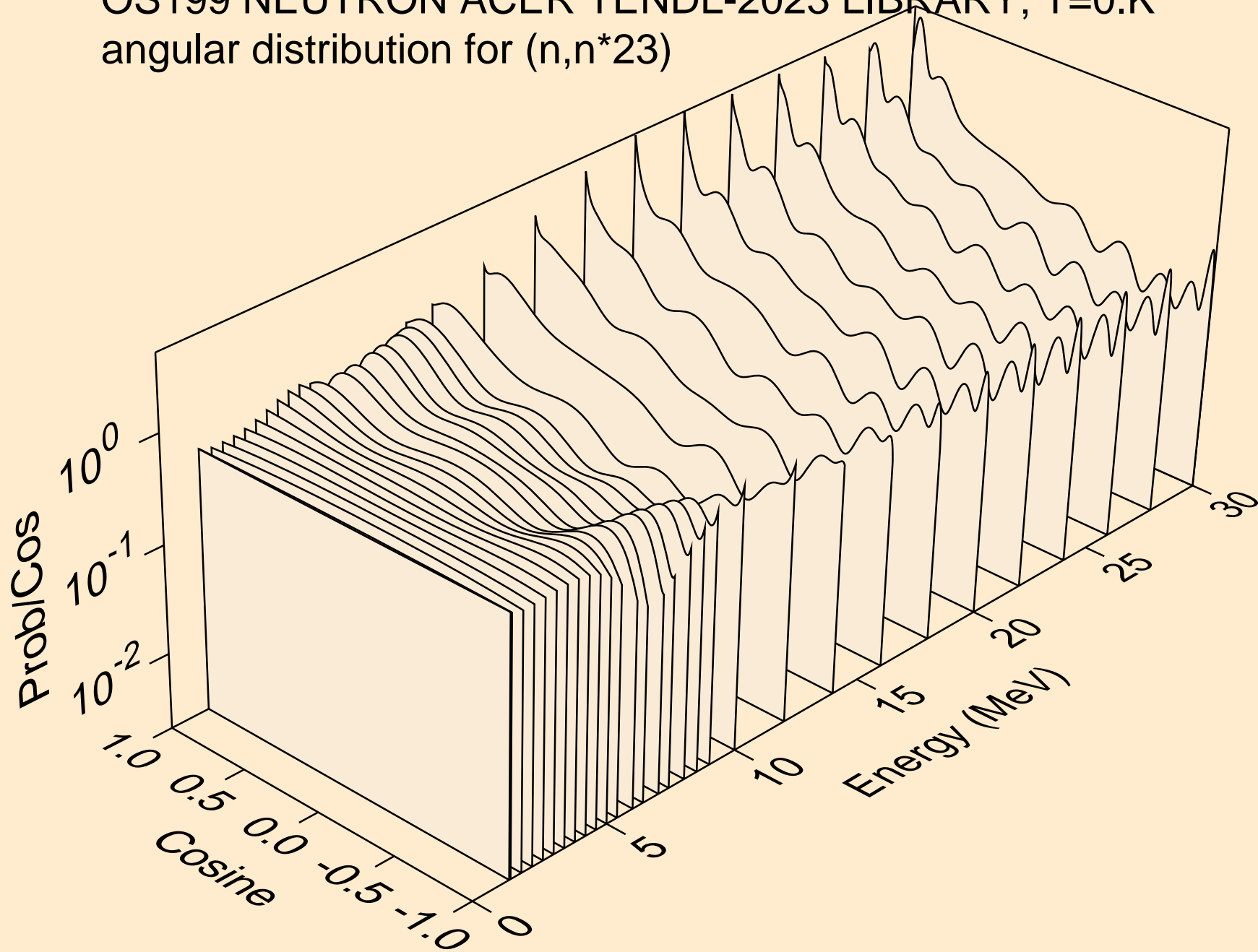

OS199 NEUTRON ACER TENDL-2023 LIBRARY; T=0.K
angular distribution for (n,n*24)

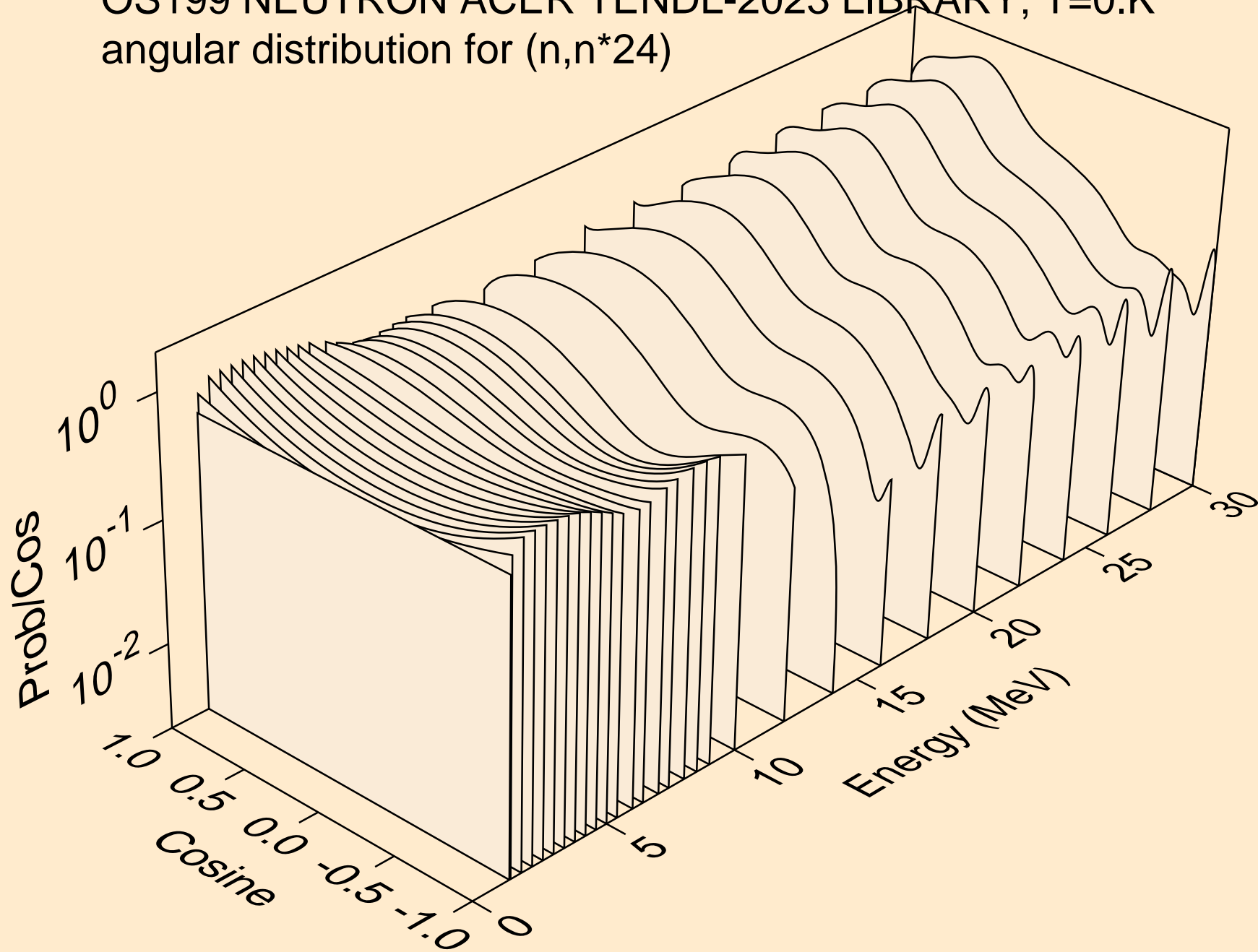

OS199 NEUTRON ACER TENDL-2023 LIBRARY; T=0.K
angular distribution for (n,n*25)

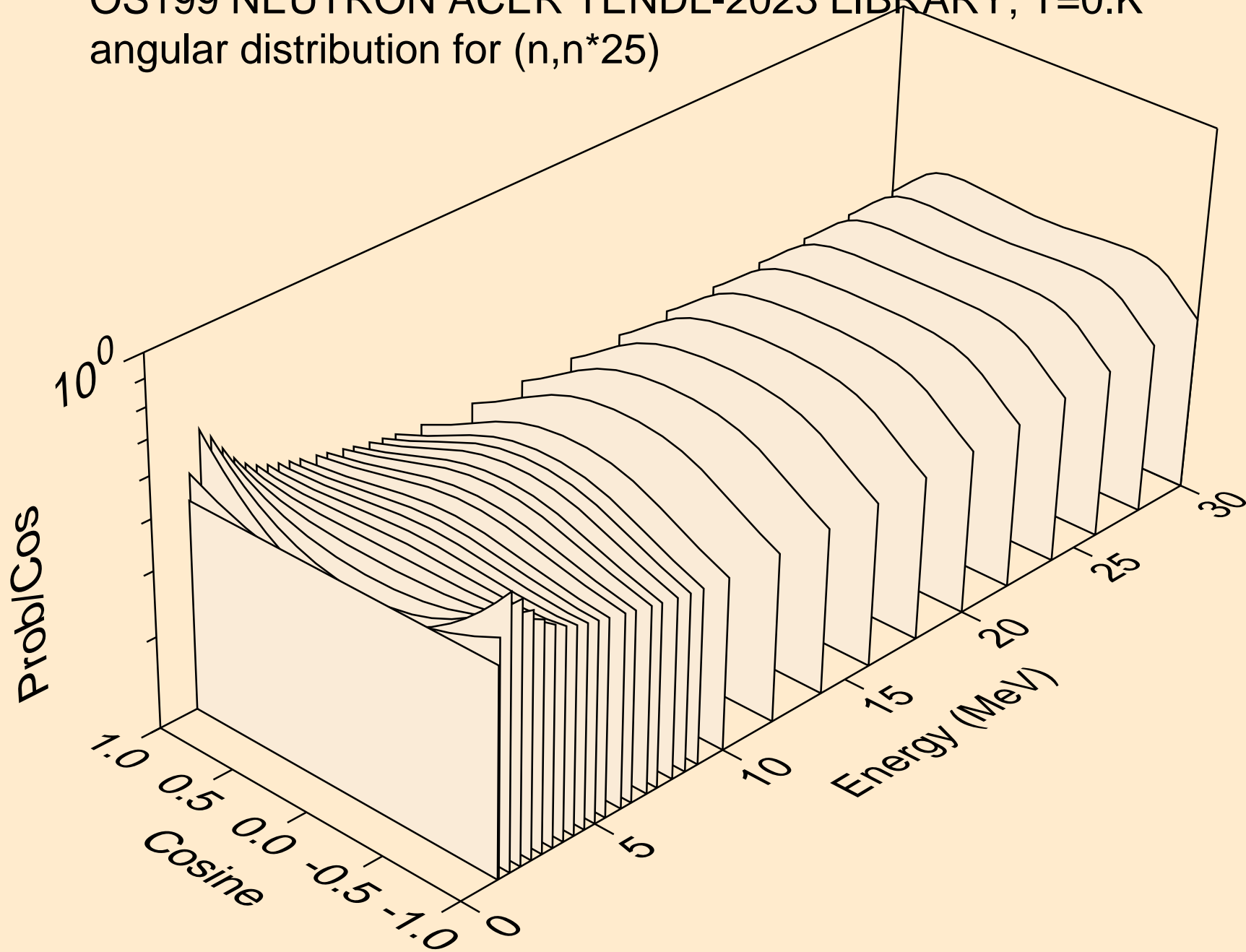

OS199 NEUTRON ACER TENDL-2023 LIBRARY; T=0.K
angular distribution for (n,n*26)

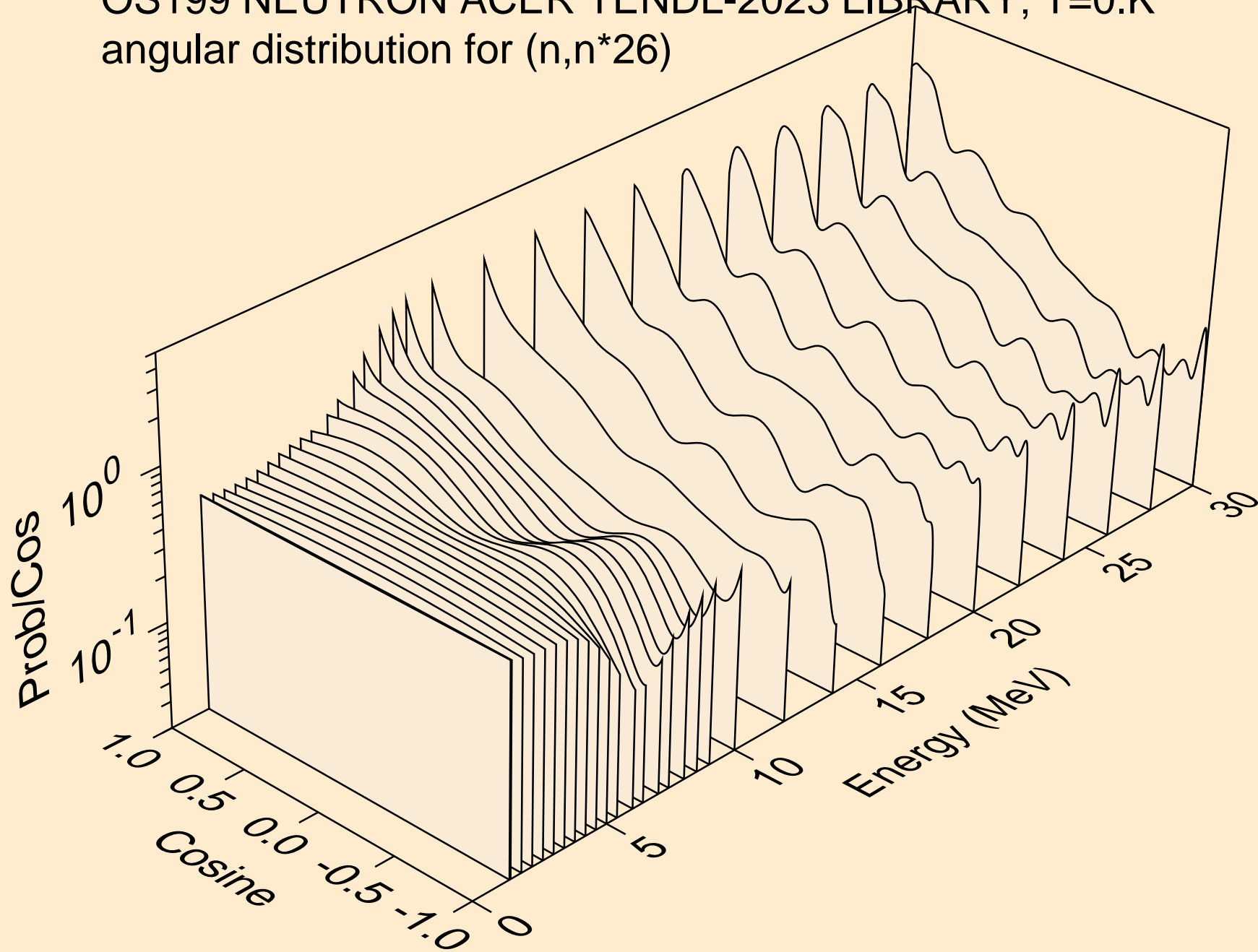

OS199 NEUTRON ACER TENDL-2023 LIBRARY; T=0.K
angular distribution for (n,n*27)

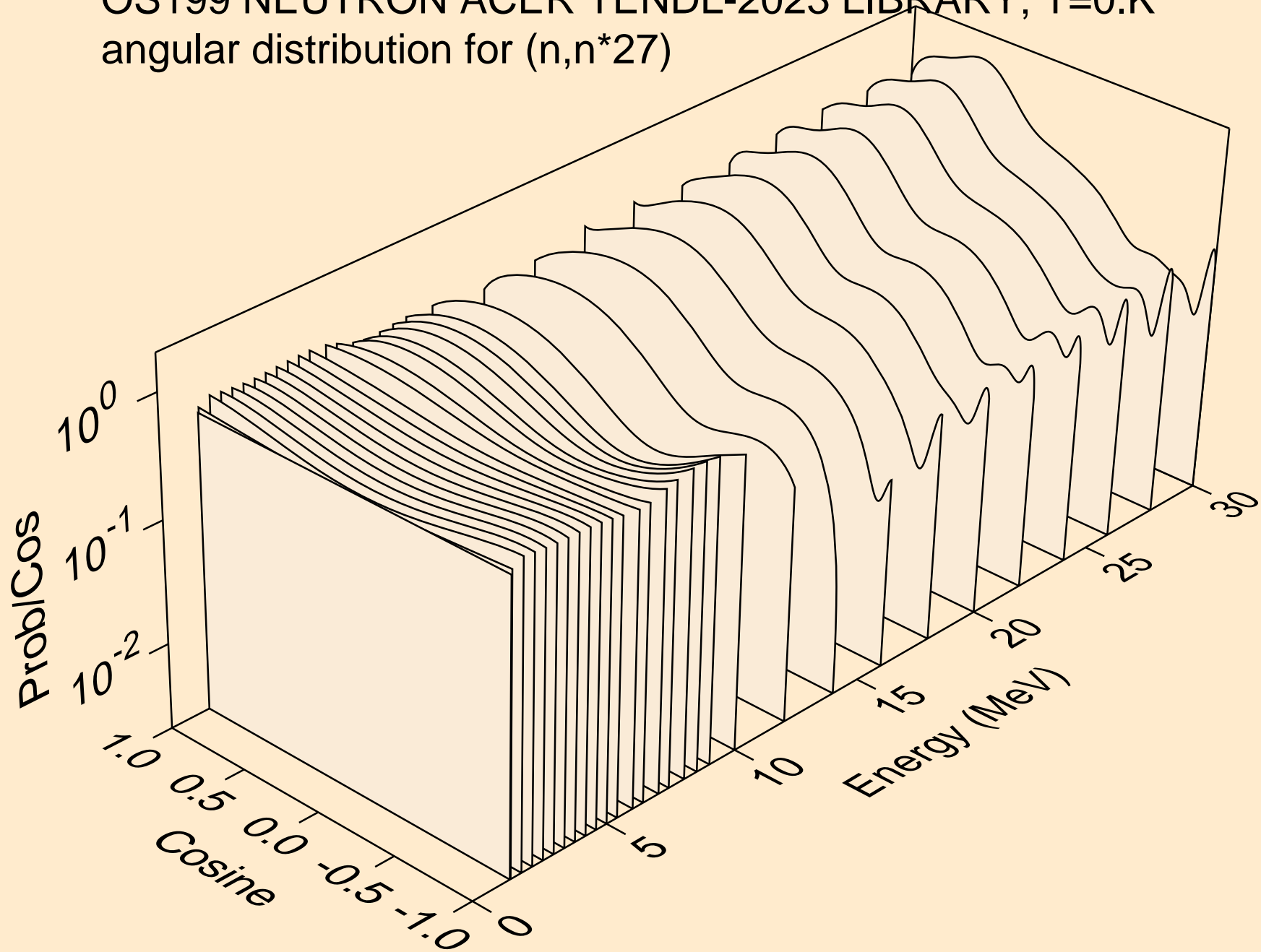

OS199 NEUTRON ACER TENDL-2023 LIBRARY; T=0.K
angular distribution for (n,n*28)

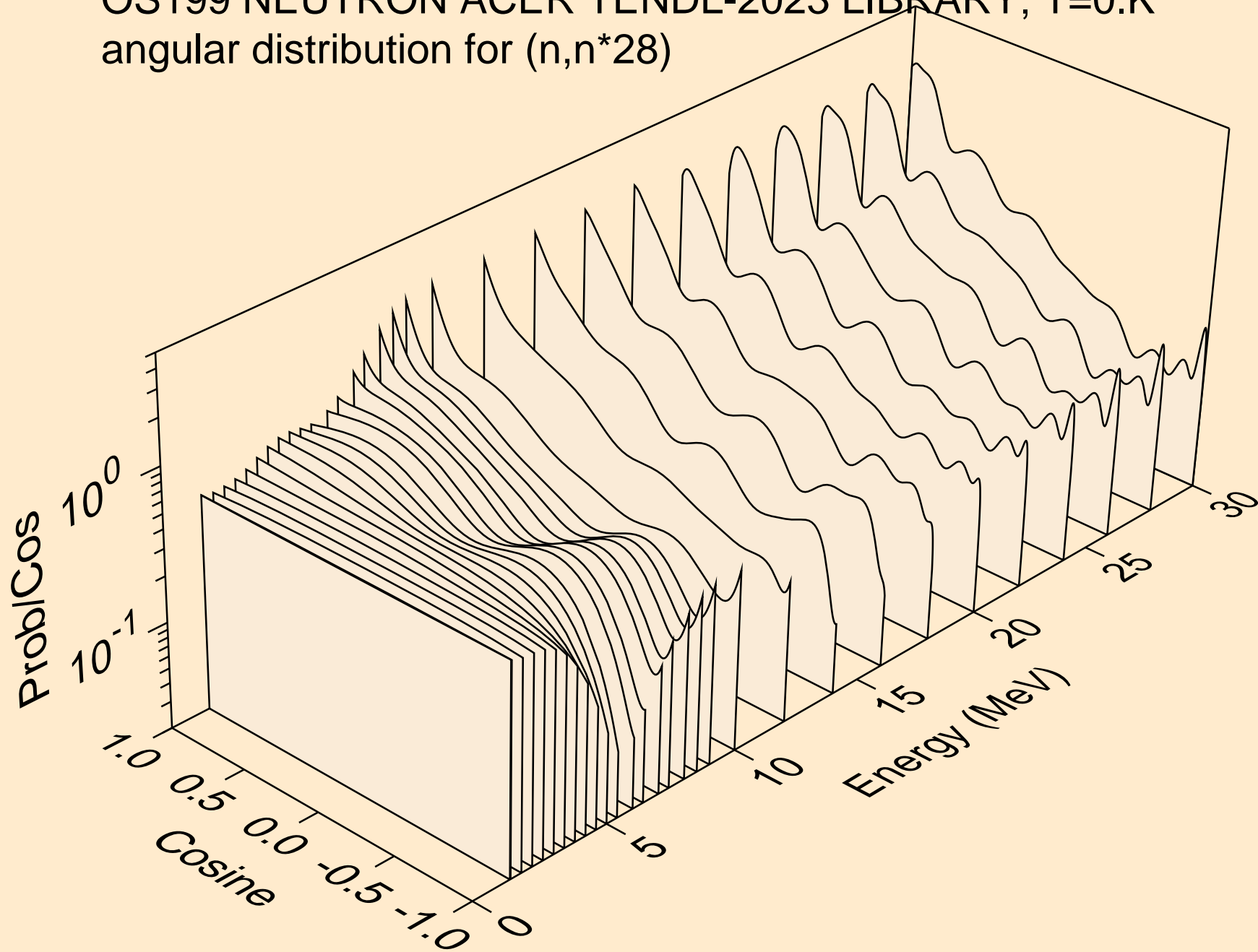

OS199 NEUTRON ACER TENDL-2023 LIBRARY; T=0.K
angular distribution for (n,n*29)

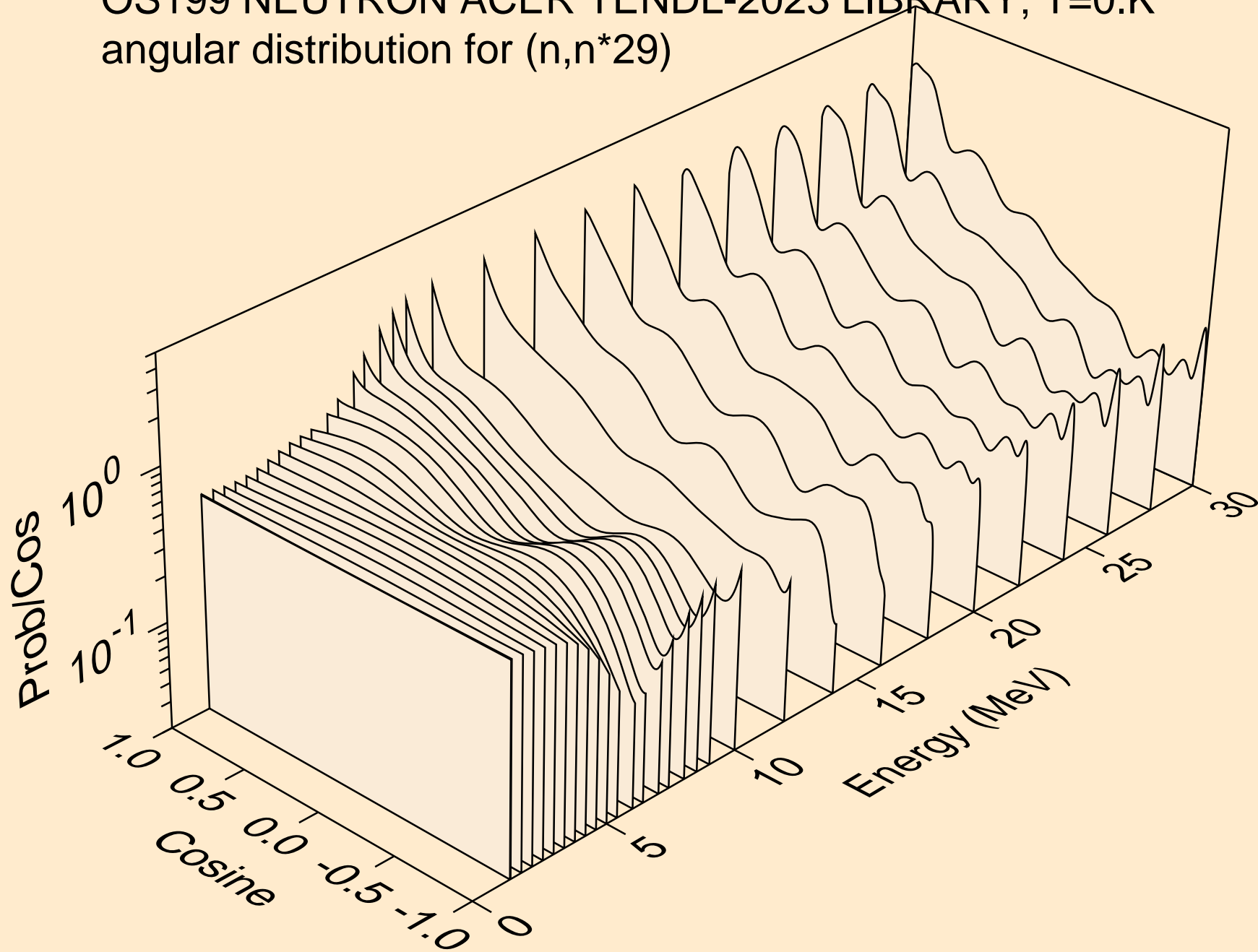

OS199 NEUTRON ACER TENDL-2023 LIBRARY; T=0.K
angular distribution for (n,n*30)

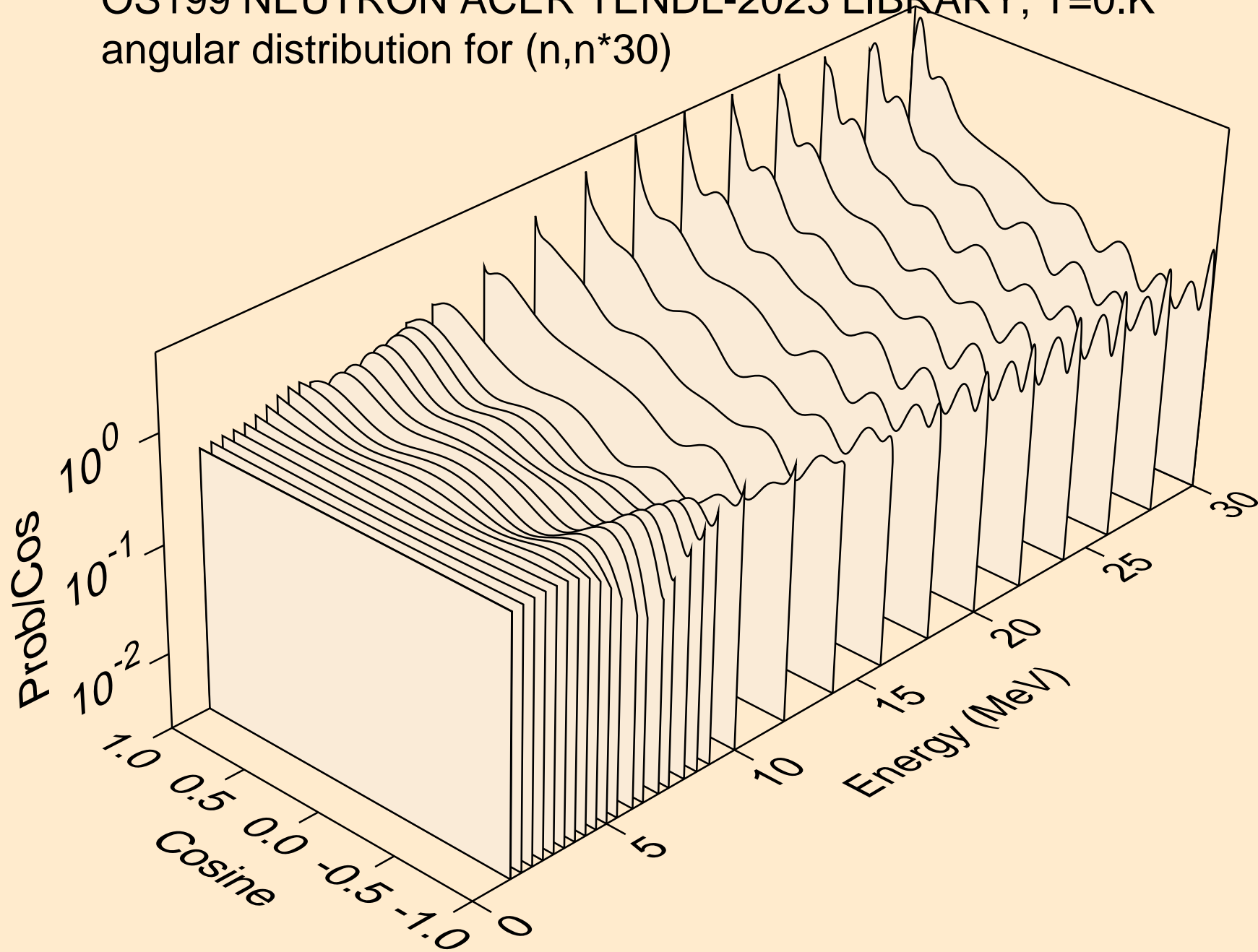

OS199 NEUTRON ACER TENDL-2023 LIBRARY; T=0.K
Neutron emission for (n,x)

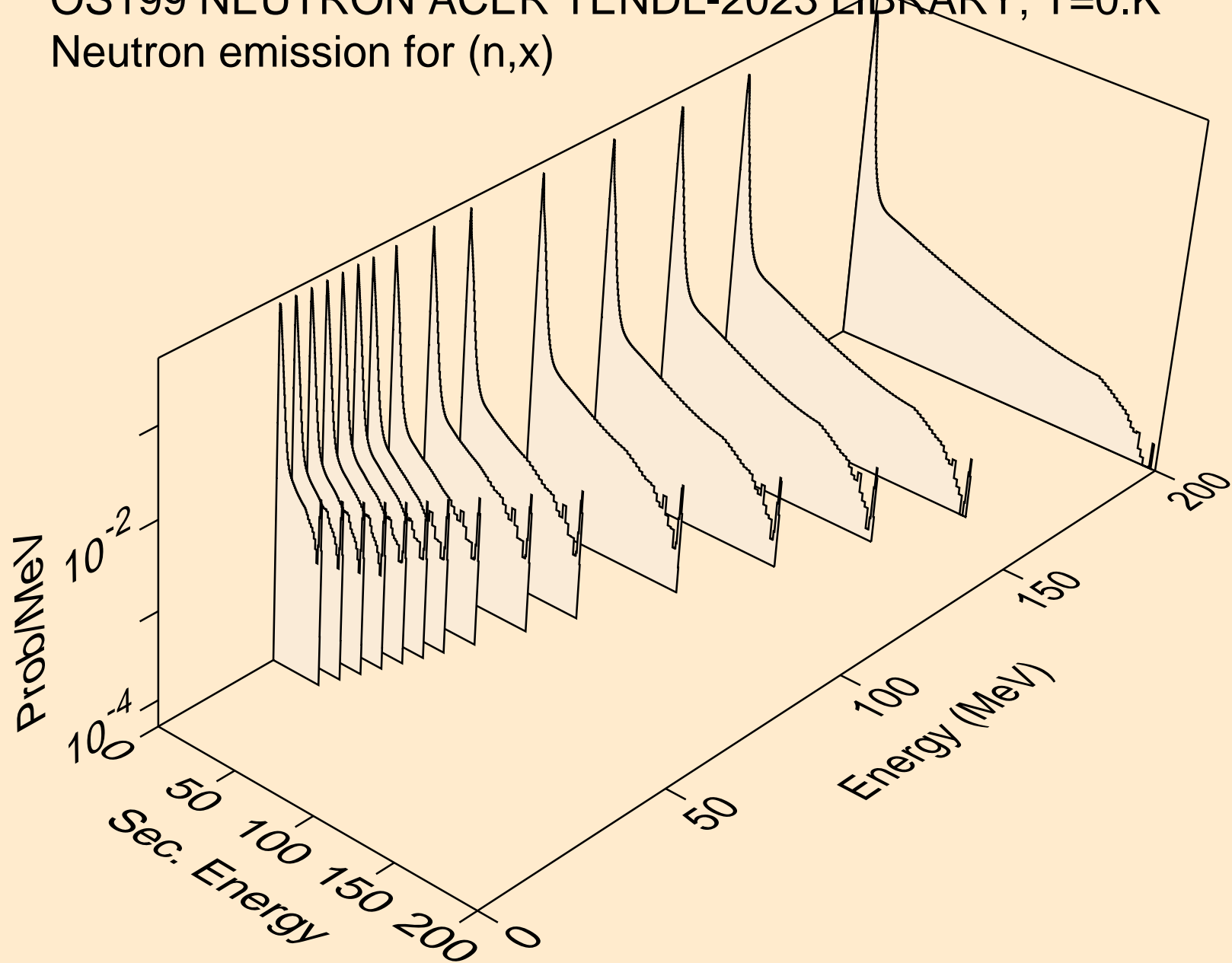

OS199 NEUTRON ACER TENDL-2023 LIBRARY; T=0.K
Neutron emission for (n,2nd)

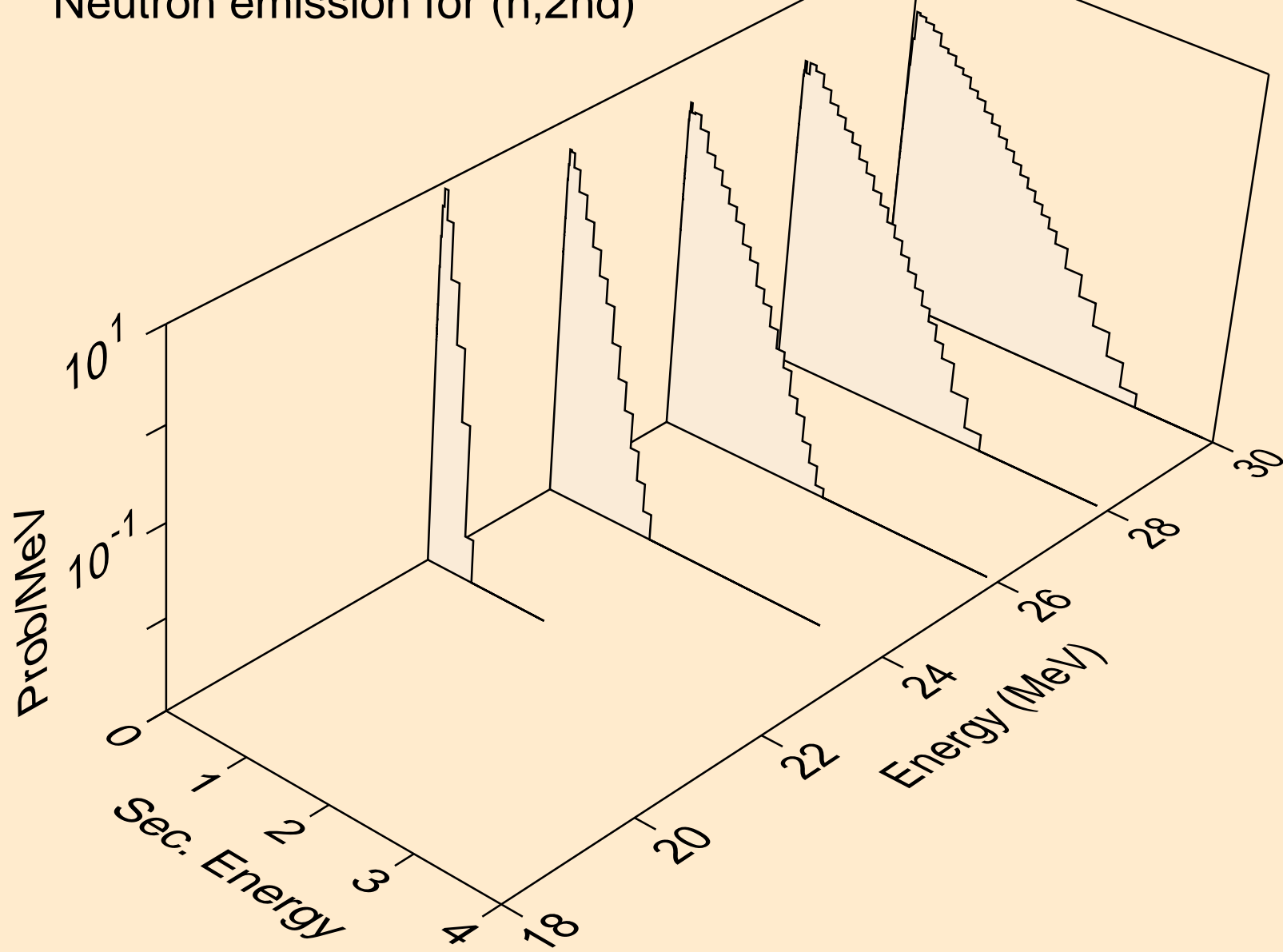

OS199 NEUTRON ACER TENDL-2023 LIBRARY; T=0.K
Neutron emission for (n,2n)

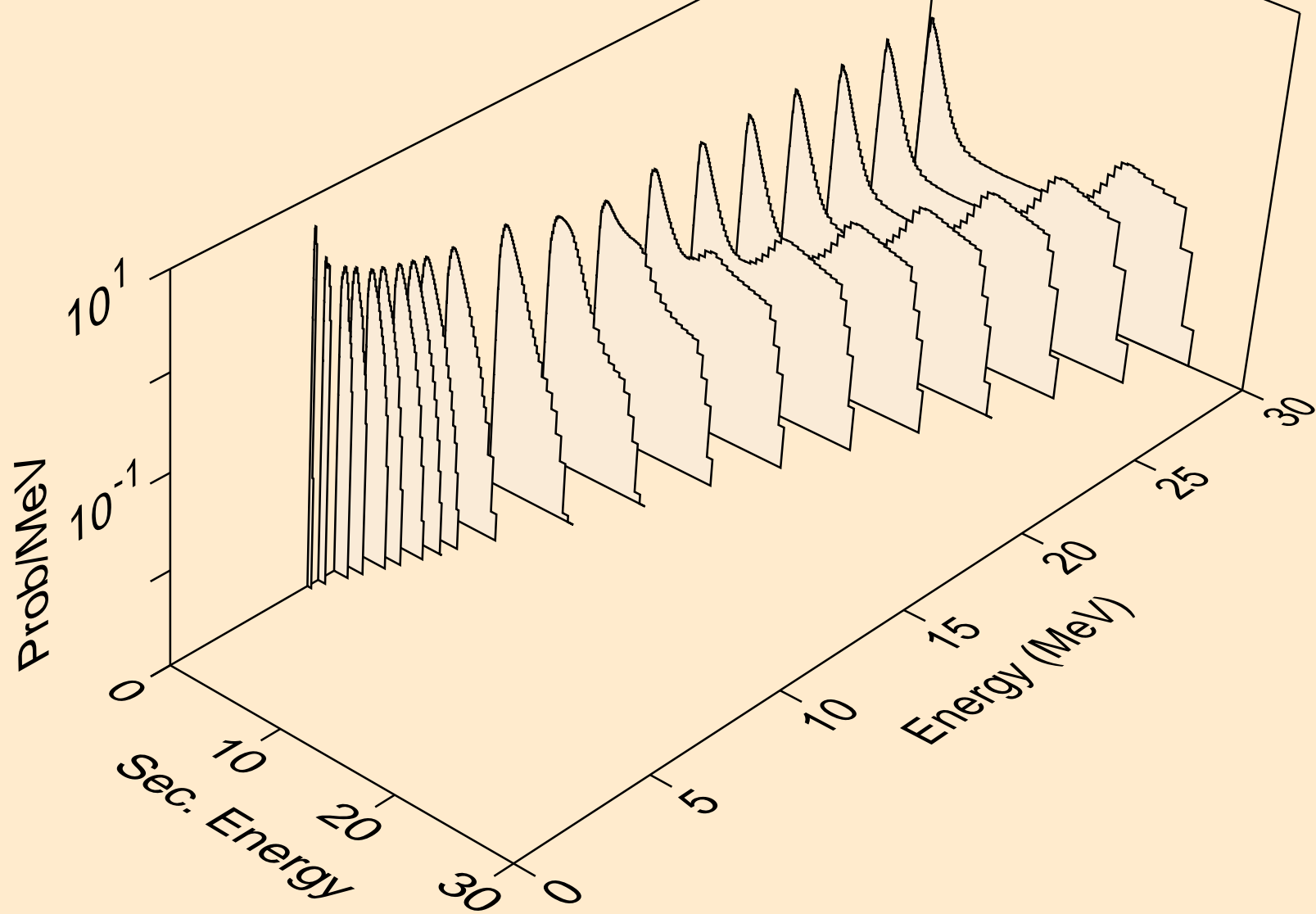

OS199 NEUTRON ACER TENDL-2023 LIBRARY; T=0.K
Neutron emission for (n,3n)

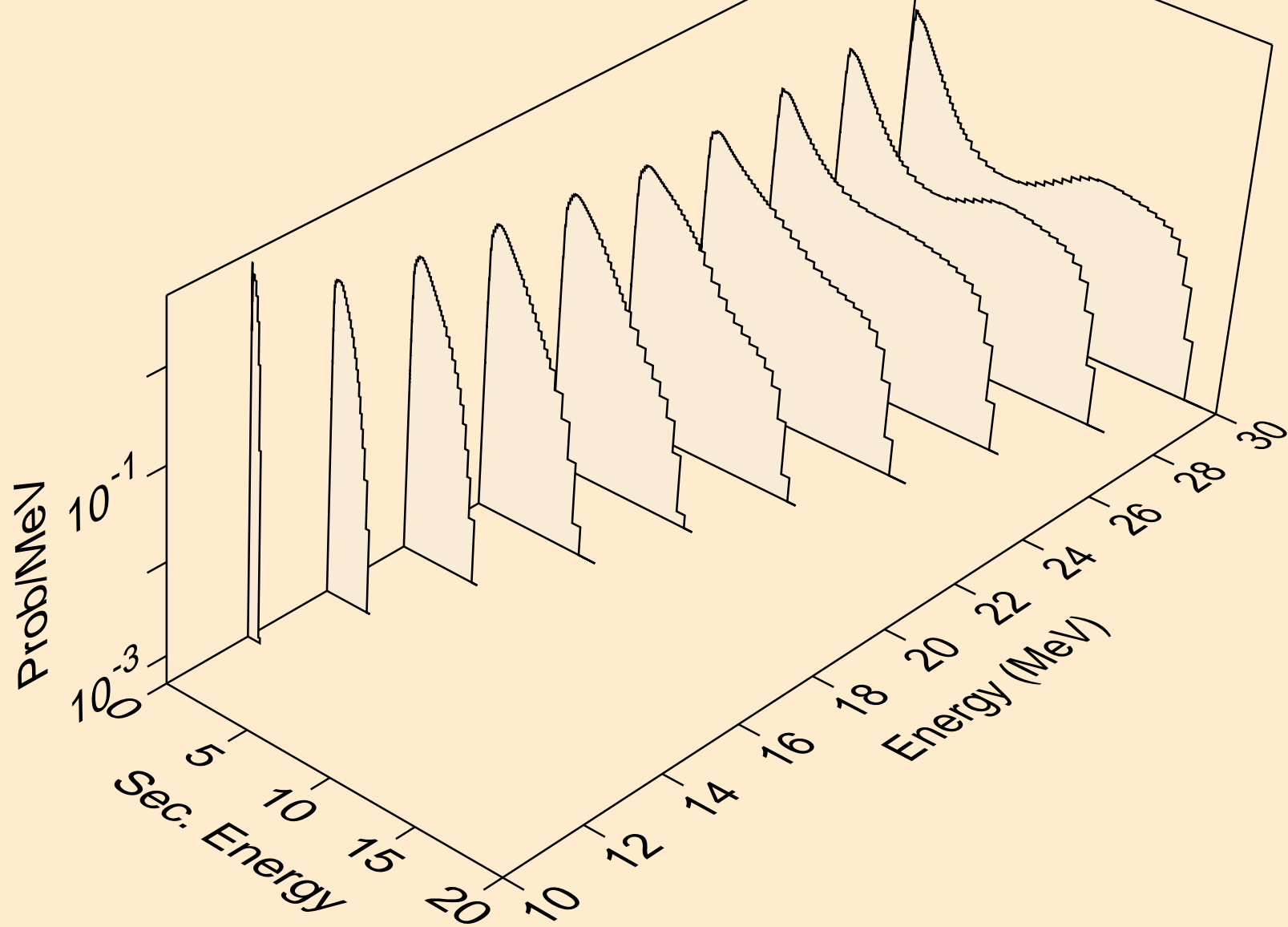

OS199 NEUTRON ACER TENDL-2023 LIBRARY; T=0.K
Neutron emission for (n,n*)a

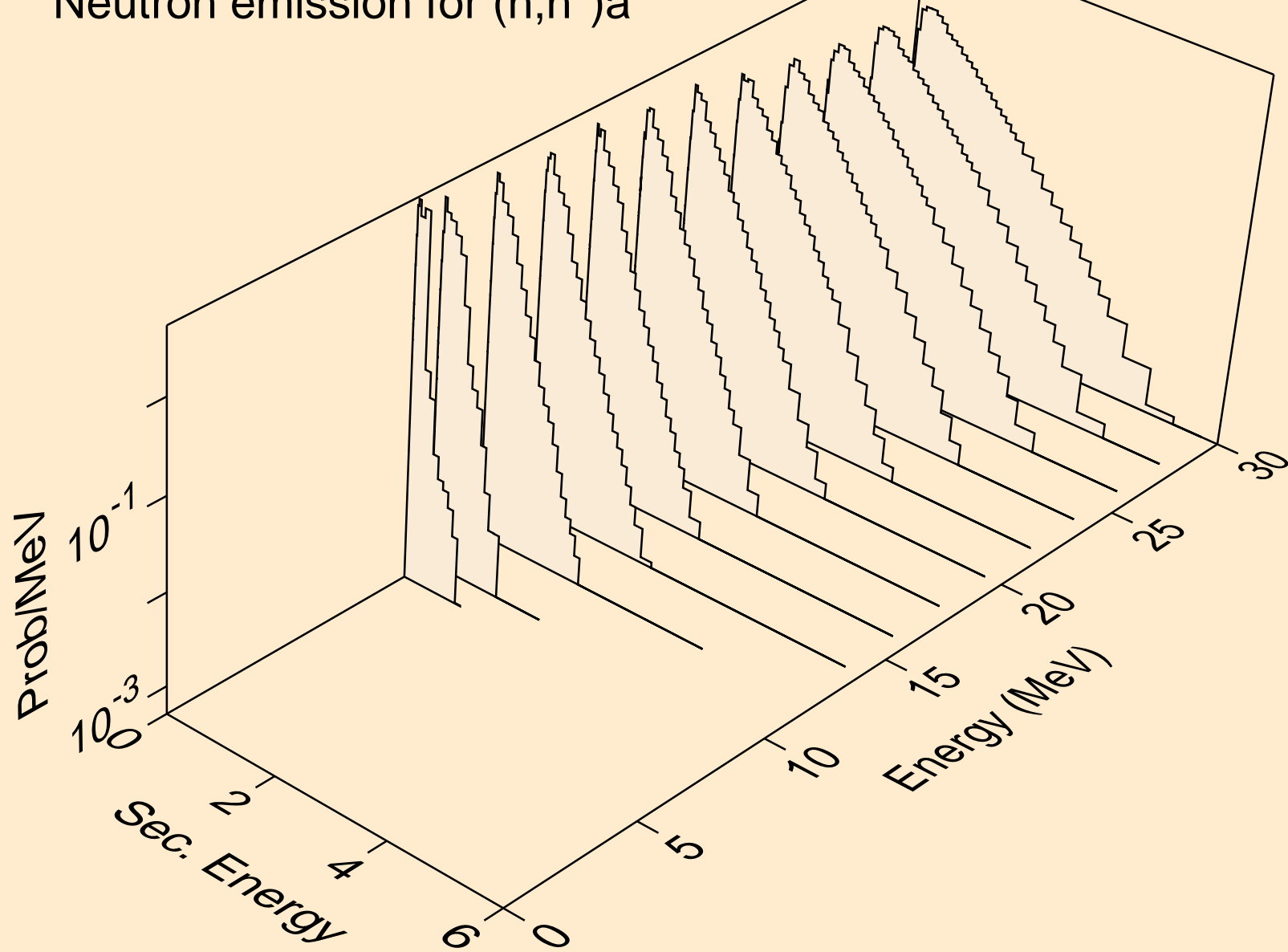

OS199 NEUTRON ACER TENDL-2023 LIBRARY; T=0.K
Neutron emission for (n,2n)a

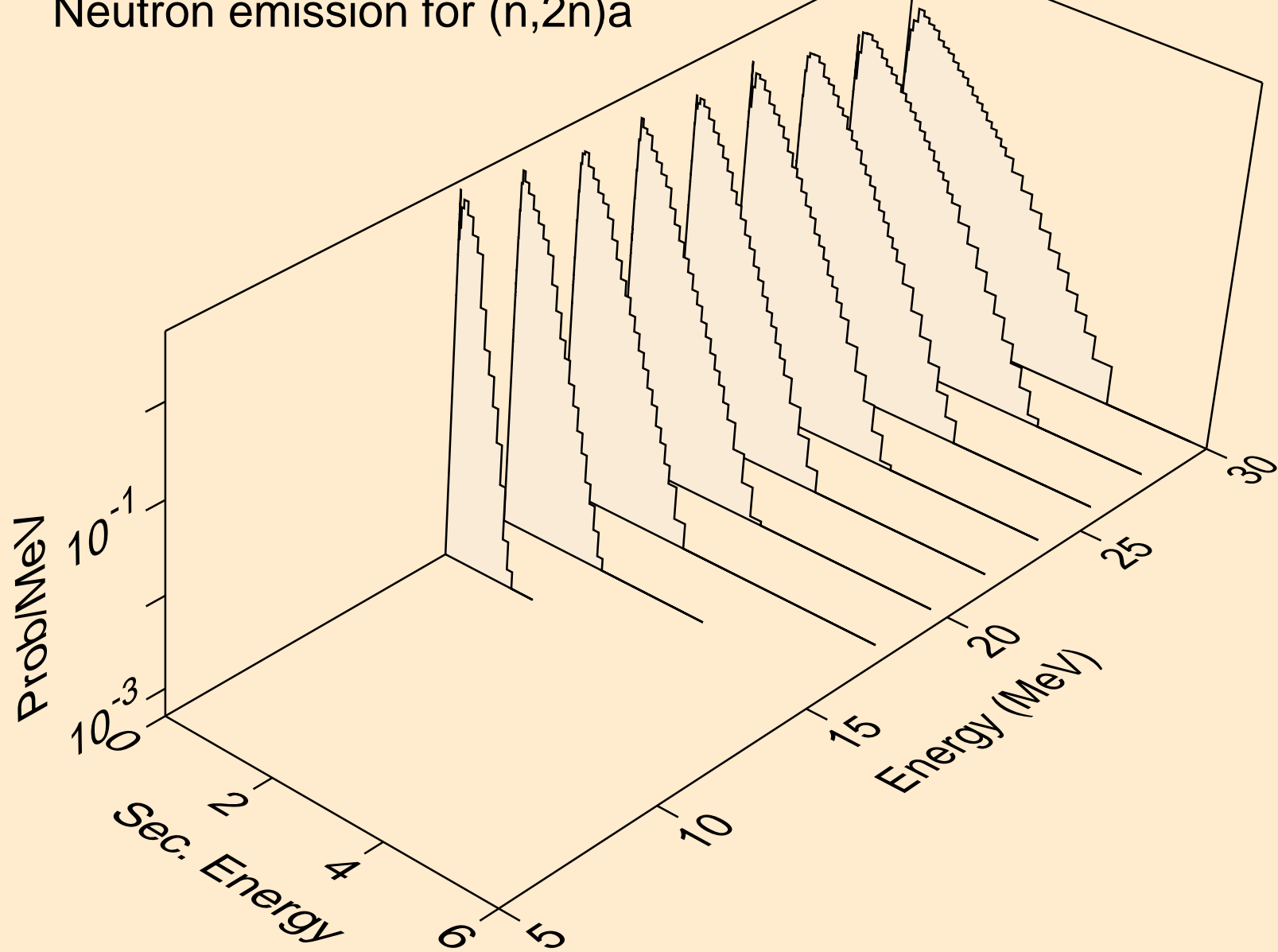

OS199 NEUTRON ACER TENDL-2023 LIBRARY; T=0.K
Neutron emission for (n,3n)a

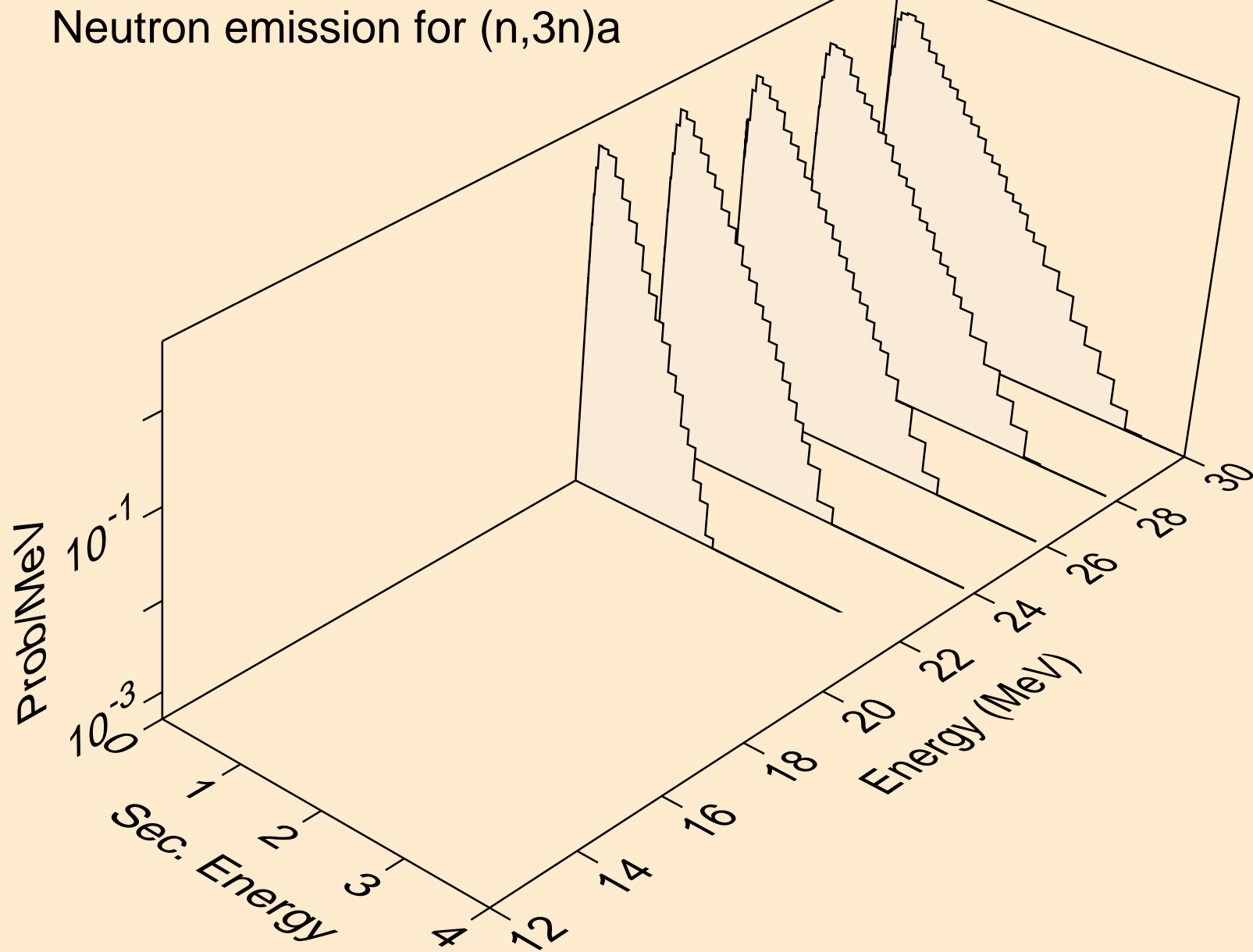

OS199 NEUTRON ACER TENDL-2023 LIBRARY; T=0.K
Neutron emission for (n,n*)p

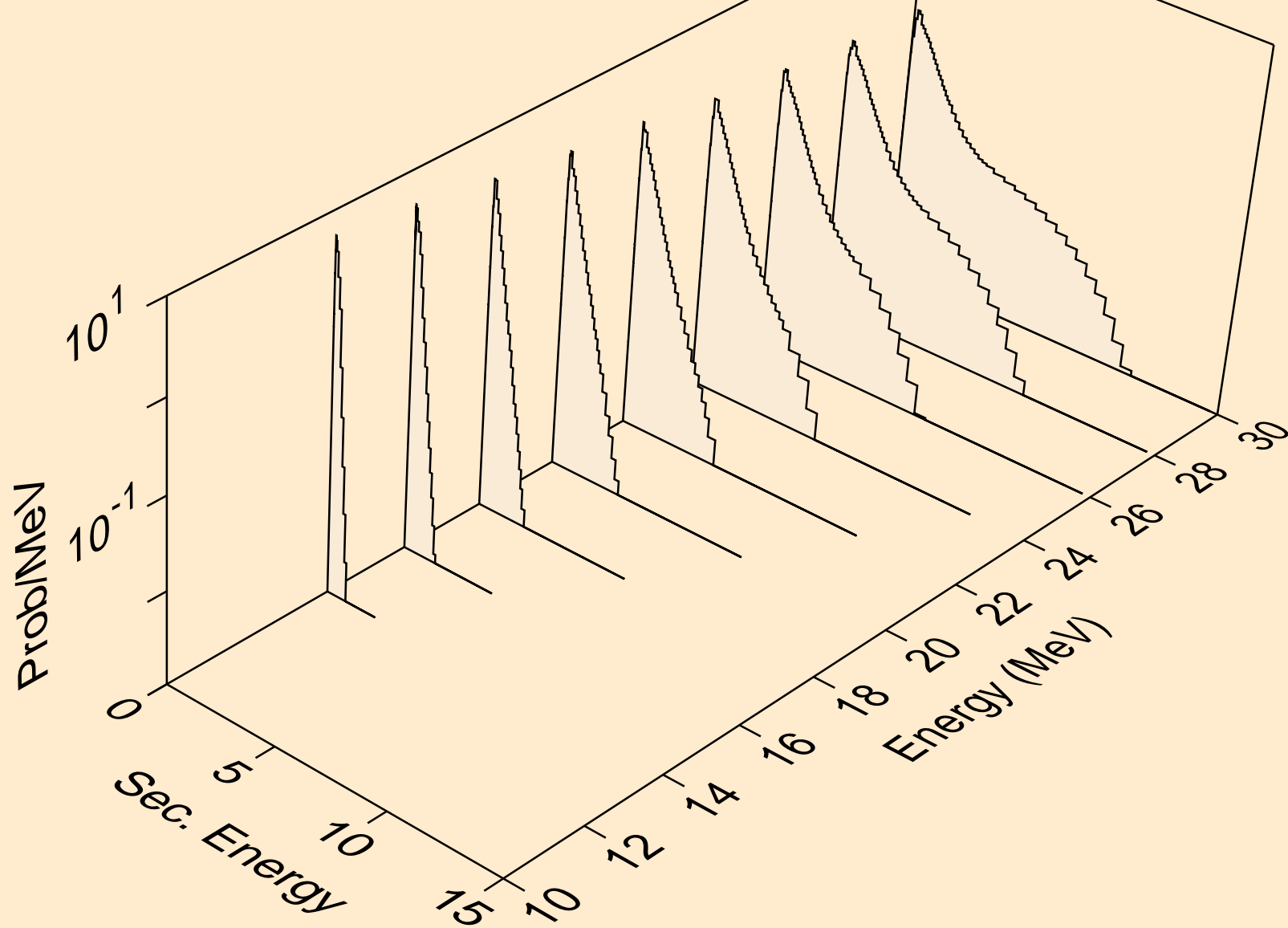

OS199 NEUTRON ACER TENDL-2023 LIBRARY; T=0.K
Neutron emission for (n,n*)d

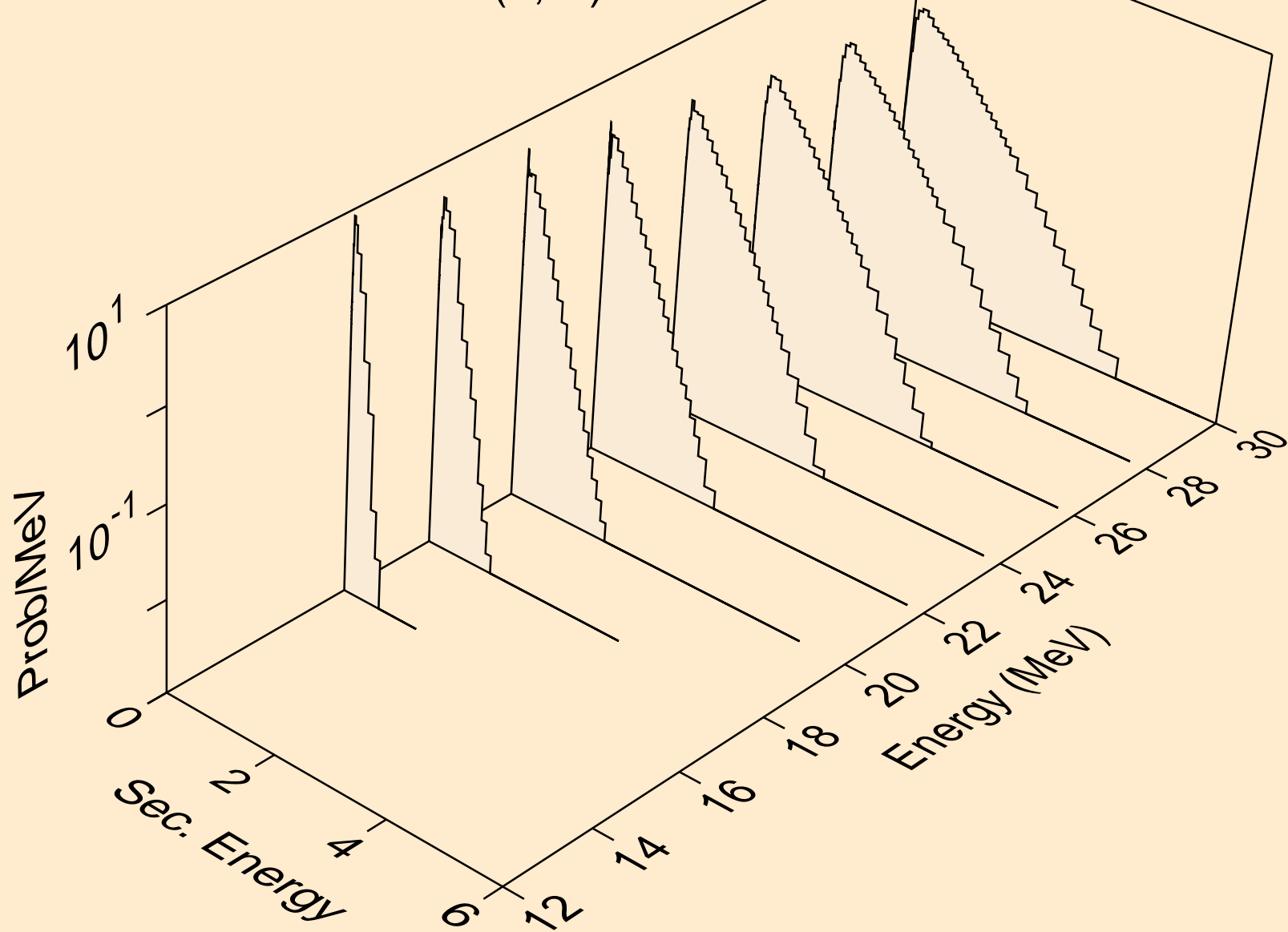

OS199 NEUTRON ACER TENDL-2023 LIBRARY; T=0.K
Neutron emission for (n,n*)t

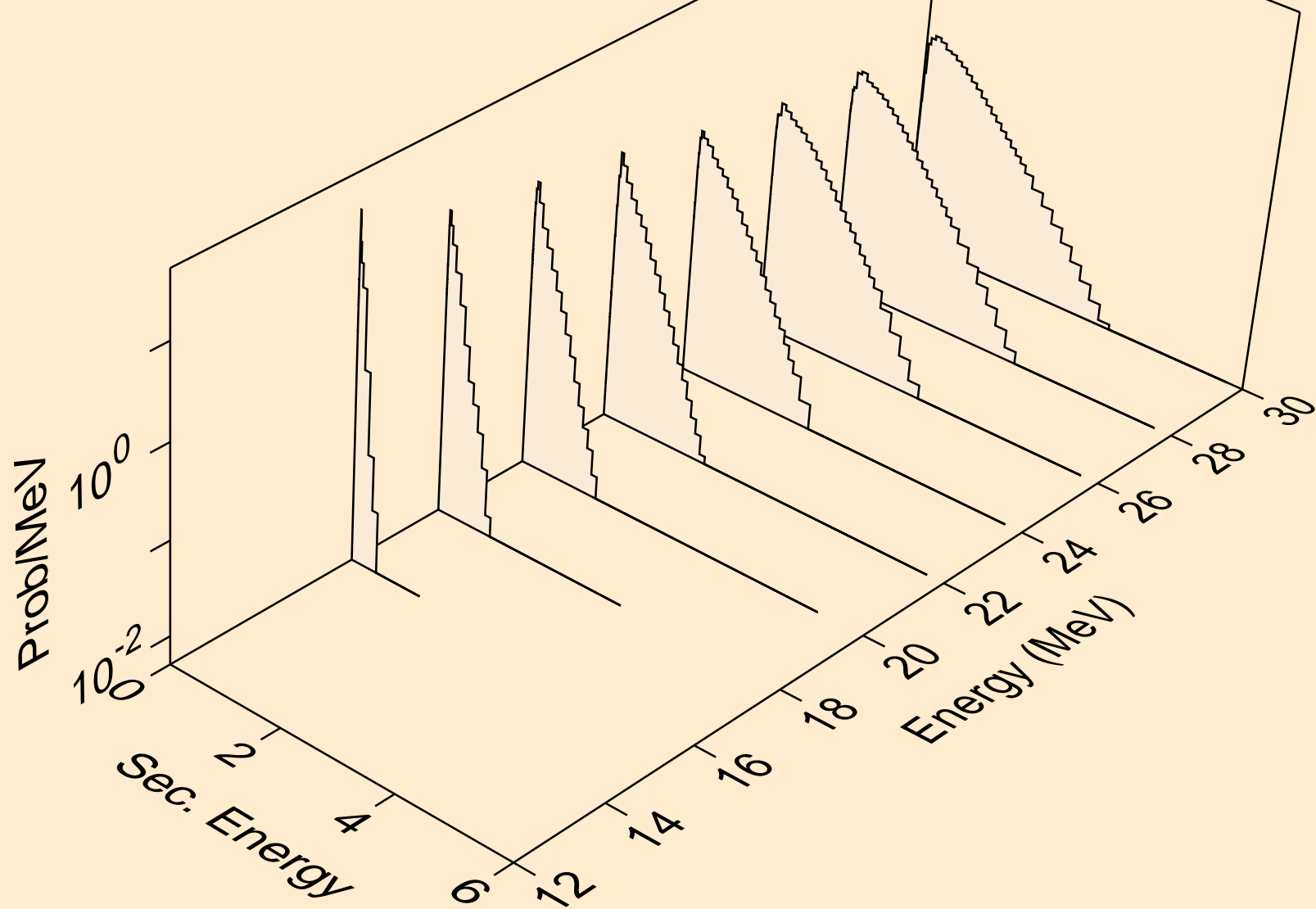

OS199 NEUTRON ACER TENDL-2023 LIBRARY; T=0.K
Neutron emission for (n,n*)he3

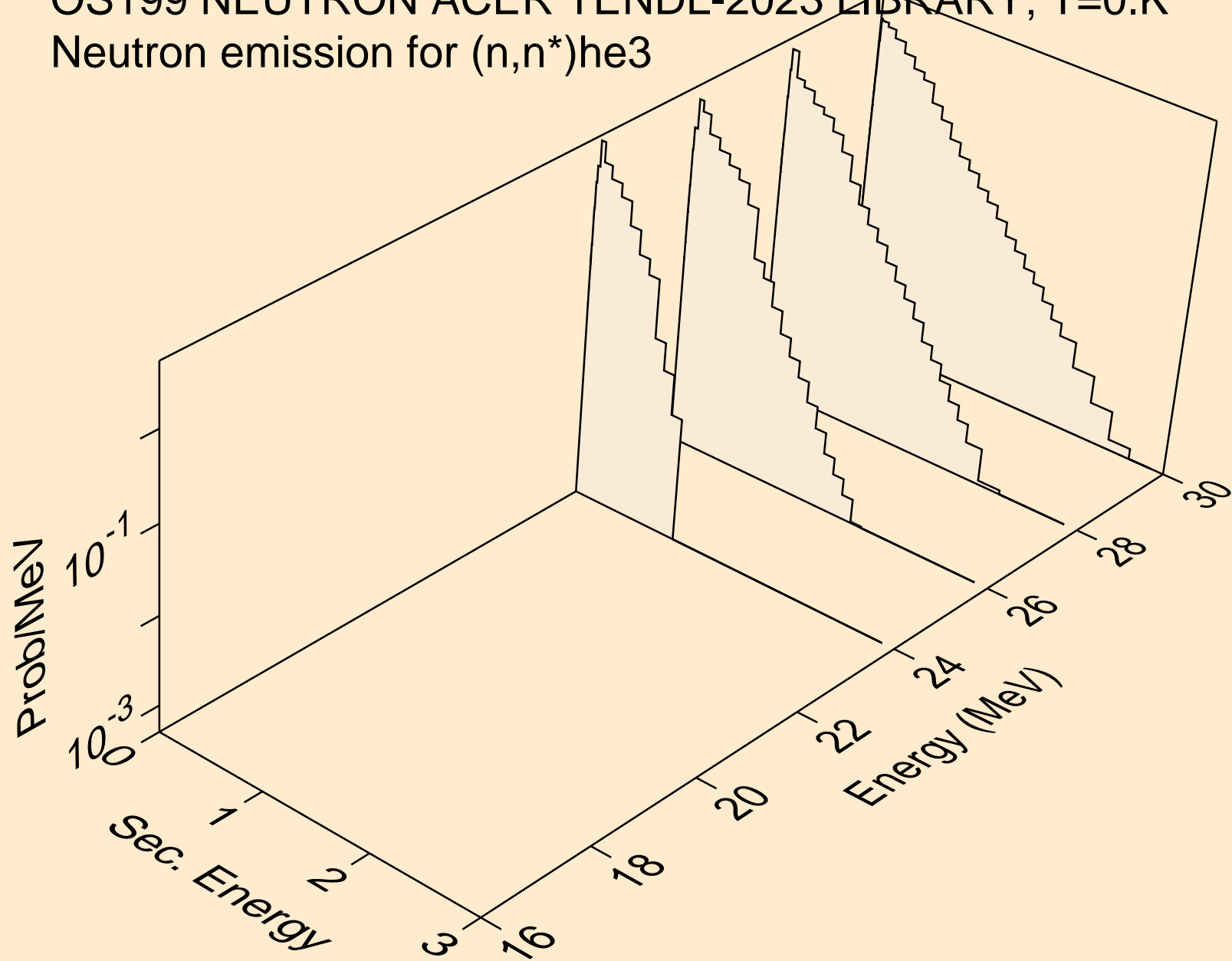

OS199 NEUTRON ACER TENDL-2023 LIBRARY; T=0.K
Neutron emission for (n,4n)

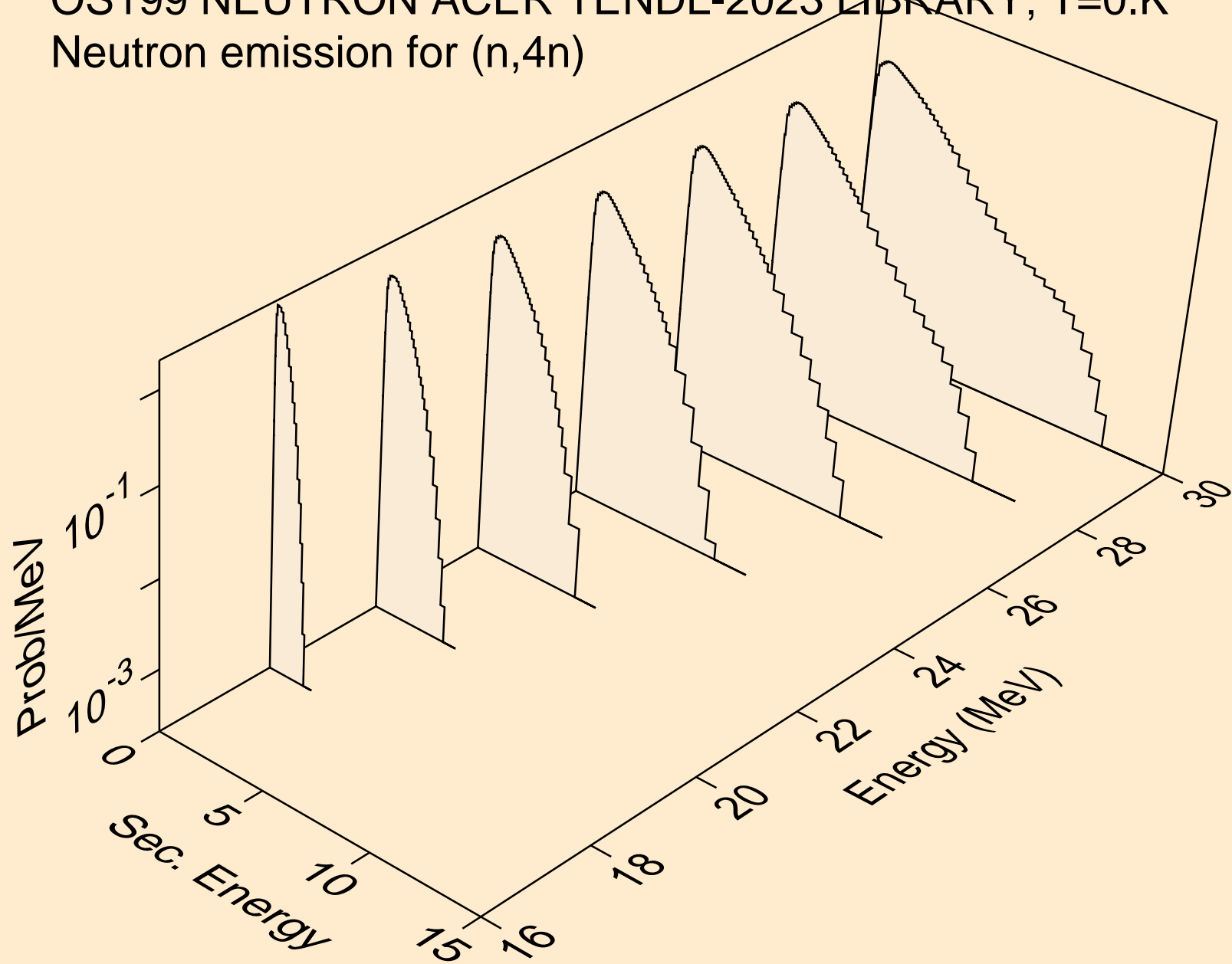

OS199 NEUTRON ACER TENDL-2023 LIBRARY; T=0.K
Neutron emission for (n,2np)

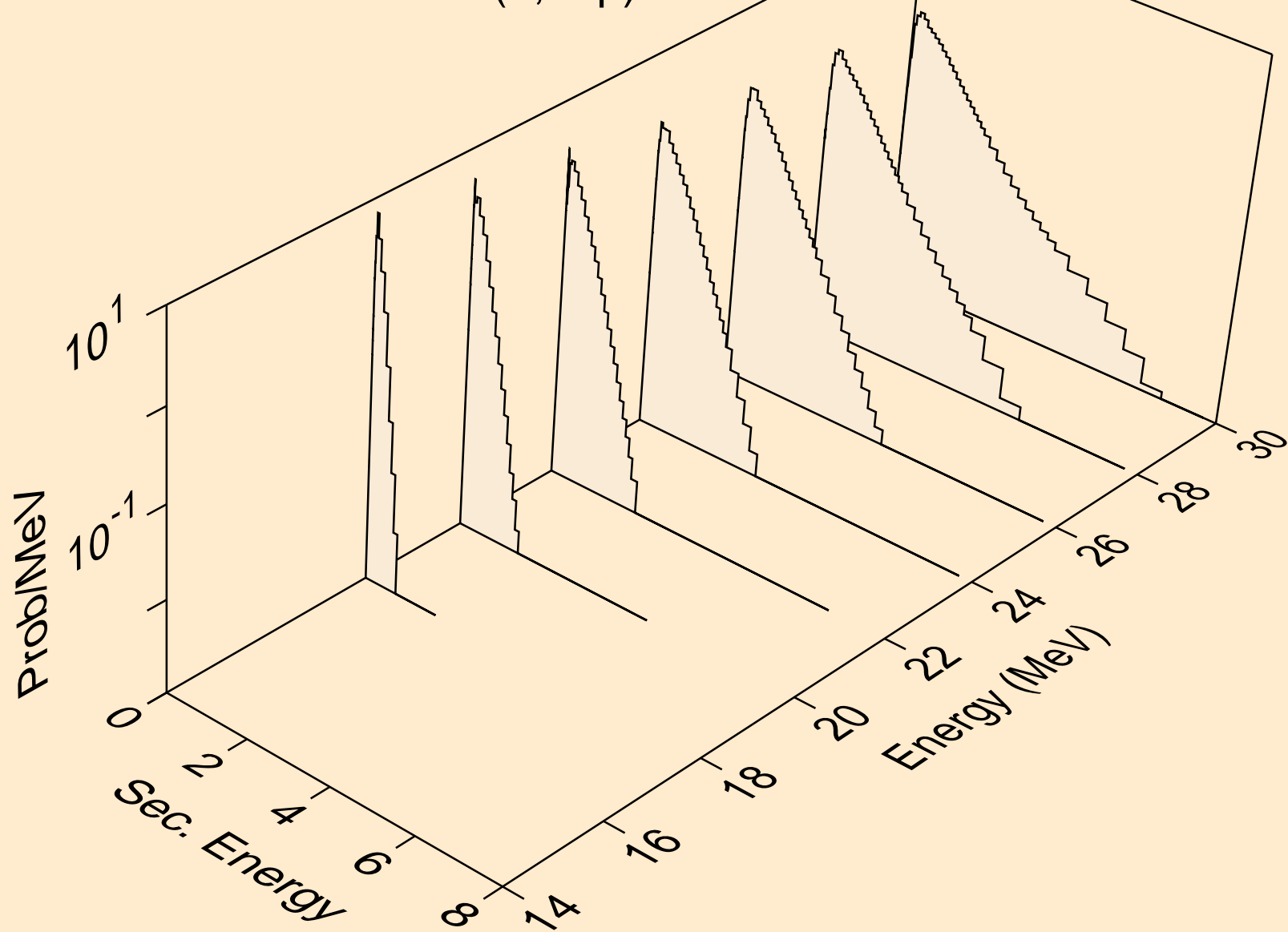

OS199 NEUTRON ACER TENDL-2023 LIBRARY; T=0.K
Neutron emission for (n,3np)

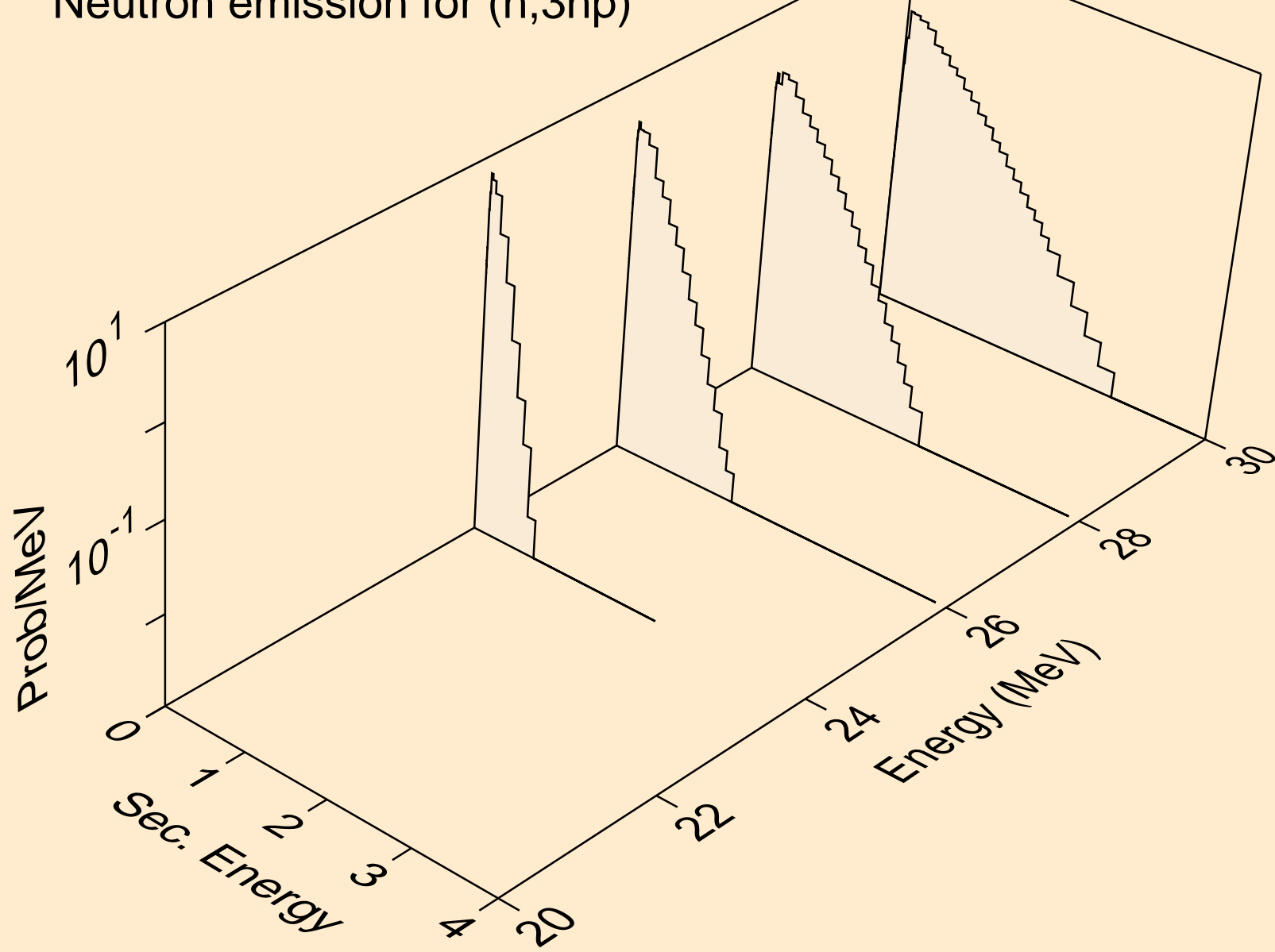

OS199 NEUTRON ACER TENDL-2023 LIBRARY; T=0.K
Neutron emission for (n,n*c)

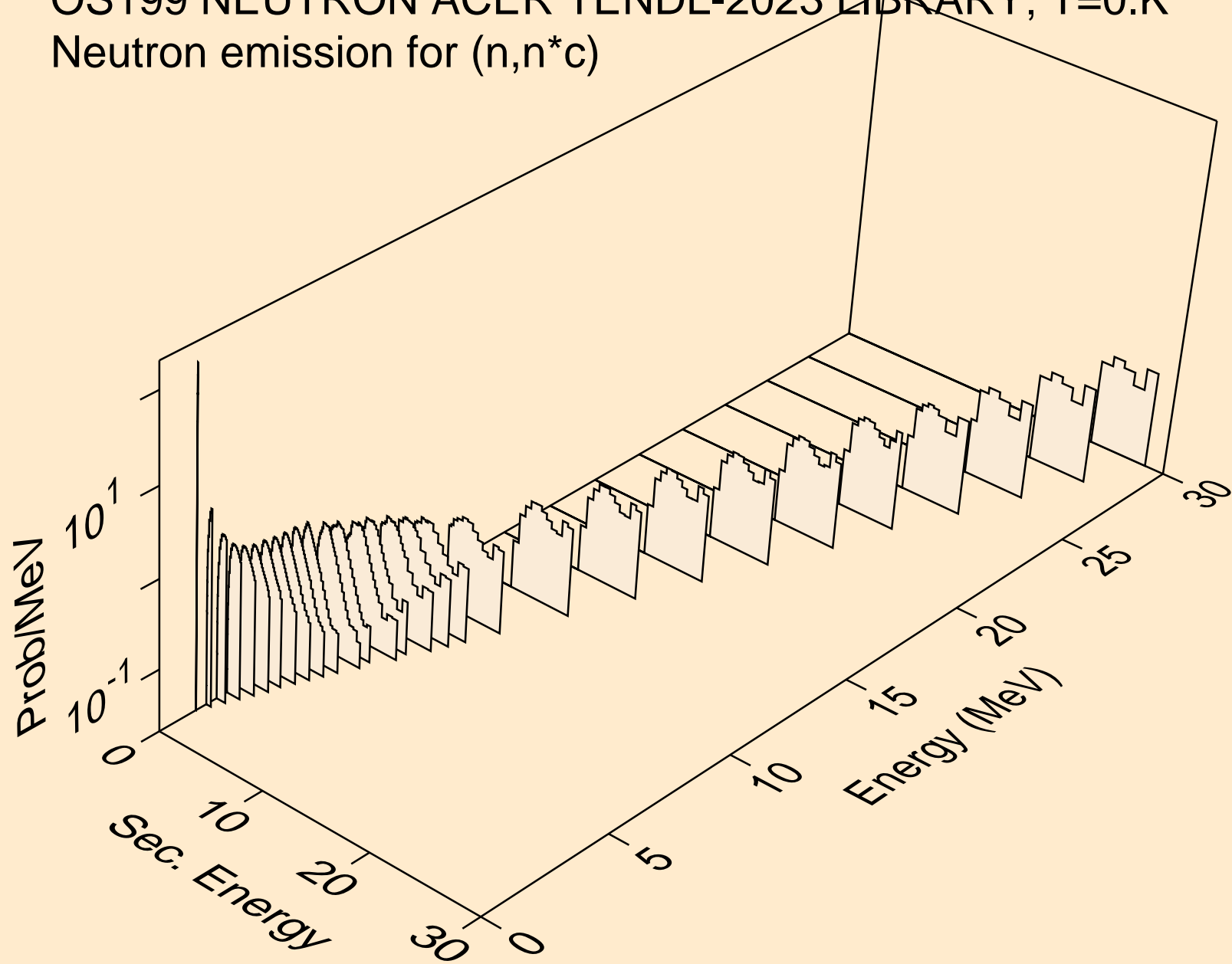

OS199 NEUTRON ACER TENDL-2023 LIBRARY; T=0.K
Photon emission for (n,x)

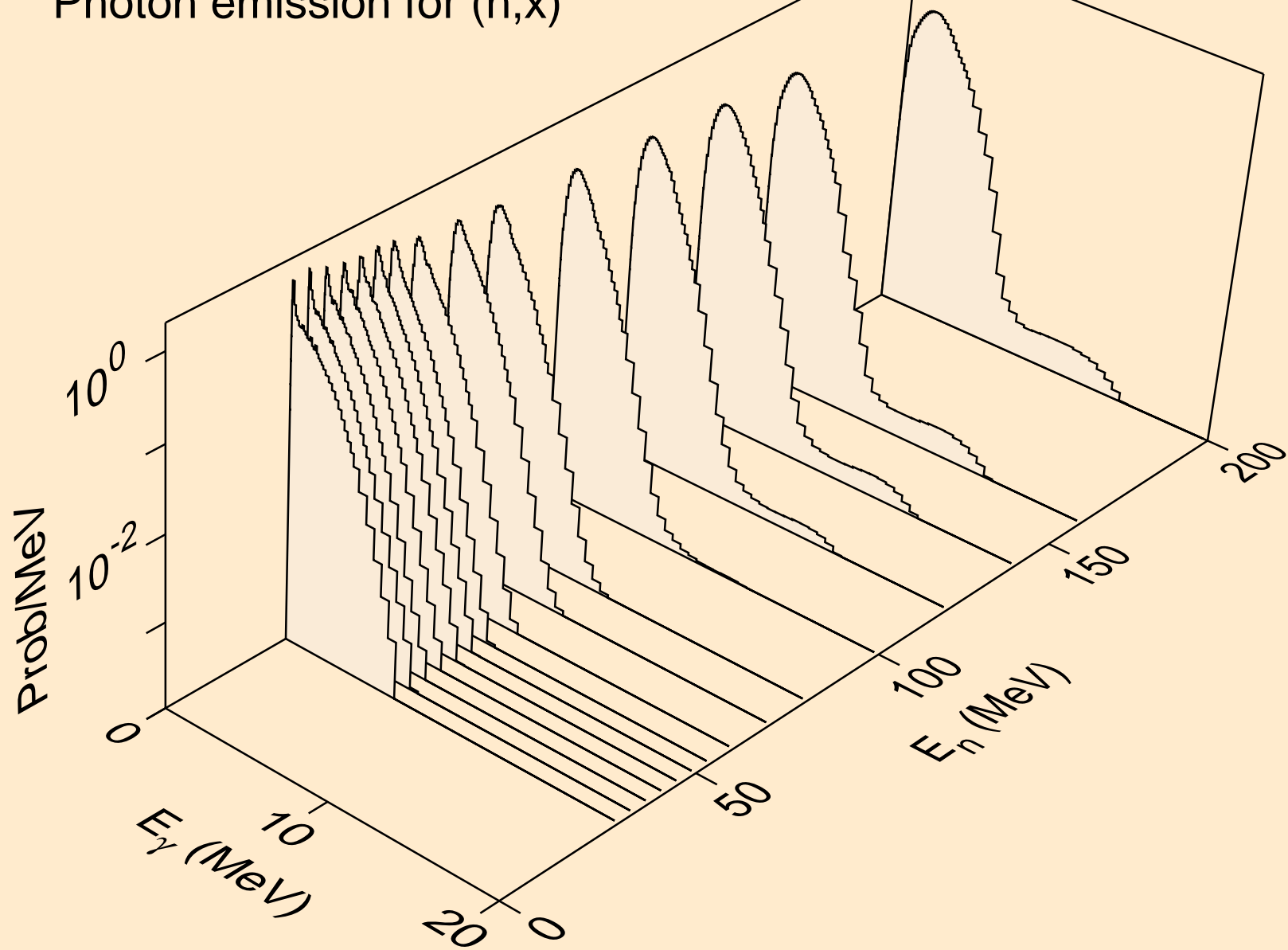

OS199 NEUTRON ACER TENDL-2023 LIBRARY; T=0.K
Photon emission for (n,2nd)

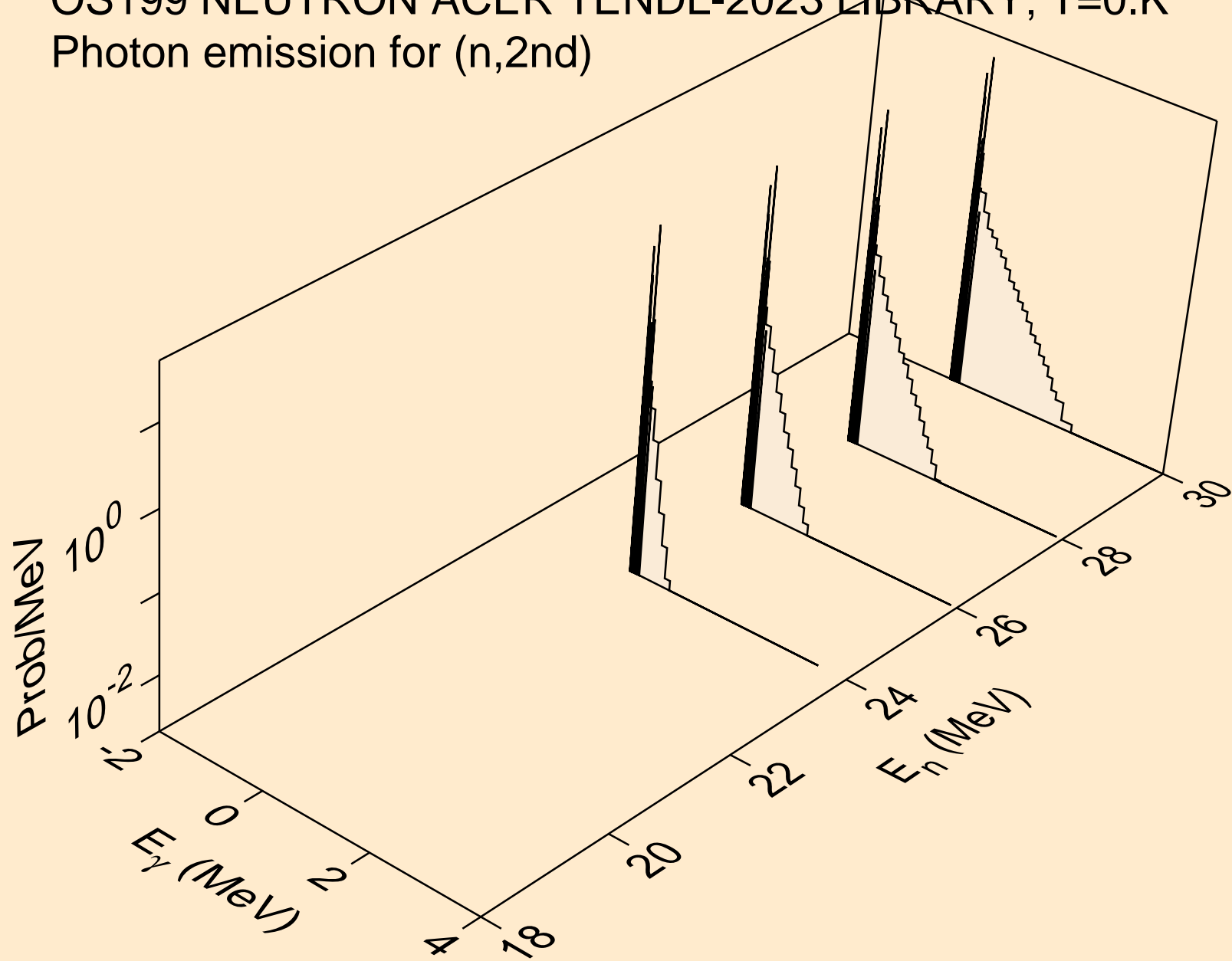

OS199 NEUTRON ACER TENDL-2023 LIBRARY; T=0.K
Photon emission for (n,2n)

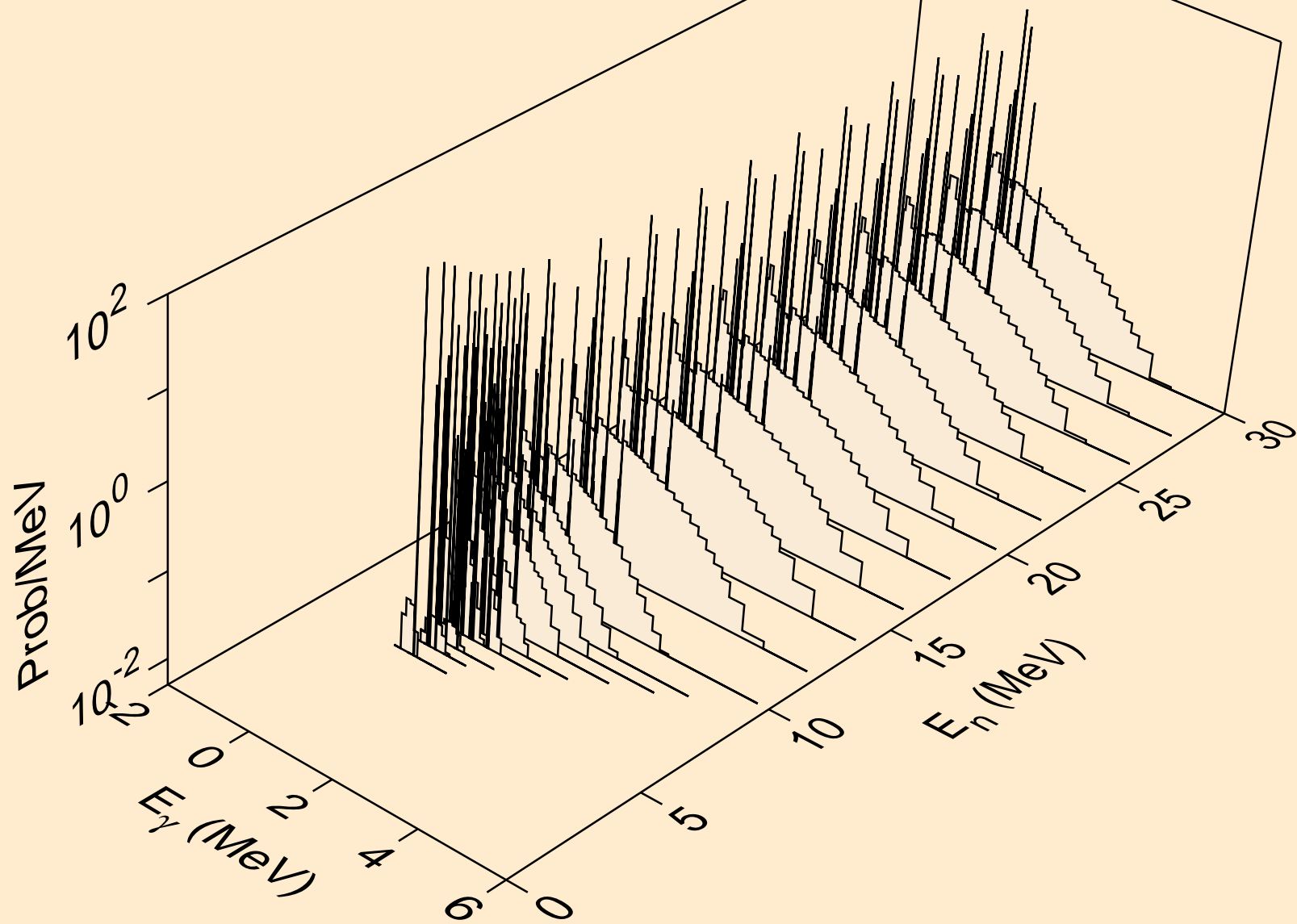

OS199 NEUTRON ACER TENDL-2023 LIBRARY; T=0.K
Photon emission for (n,3n)

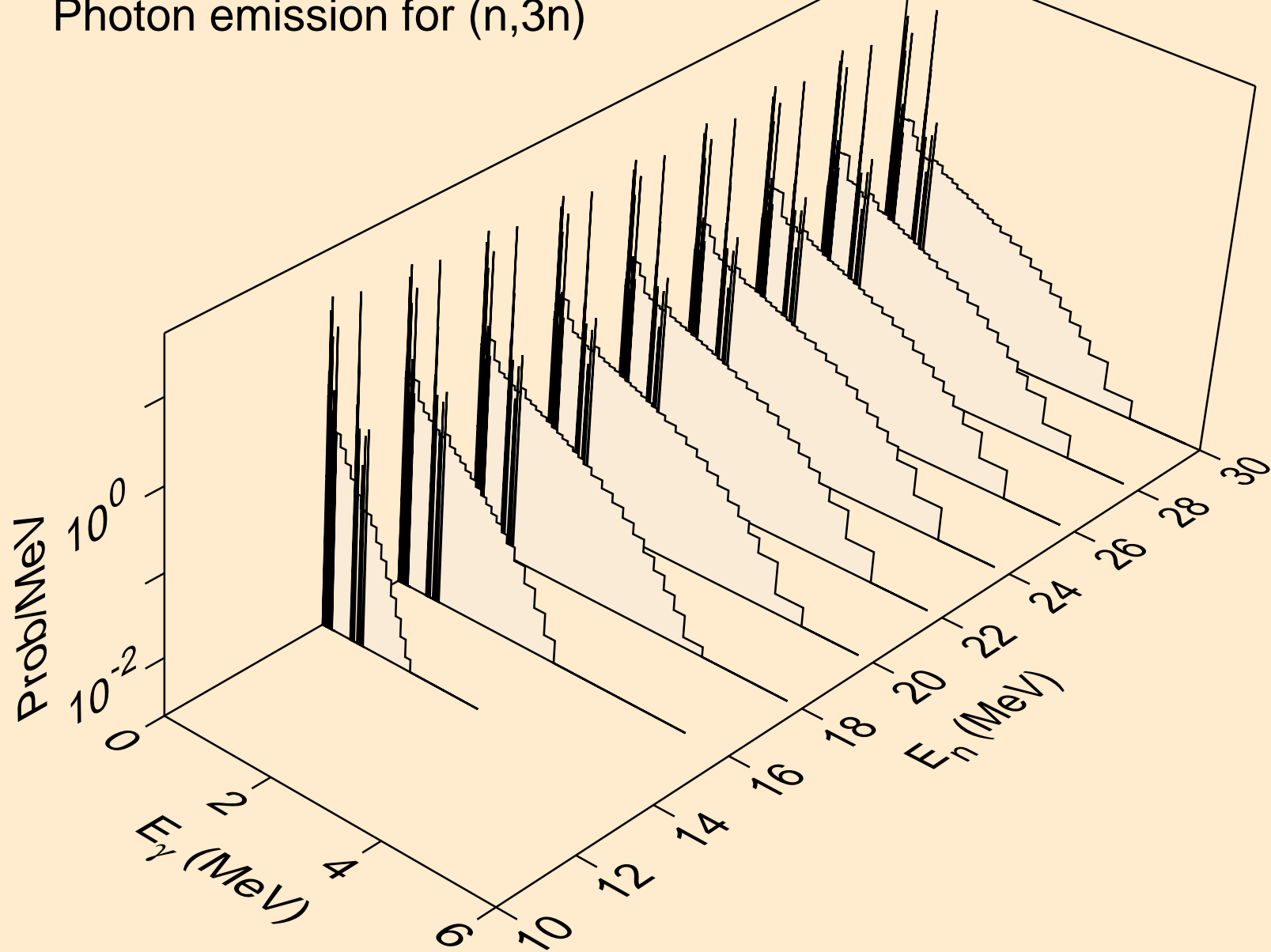

OS199 NEUTRON ACER TENDL-2023 LIBRARY; T=0.K
Photon emission for (n,n*)a

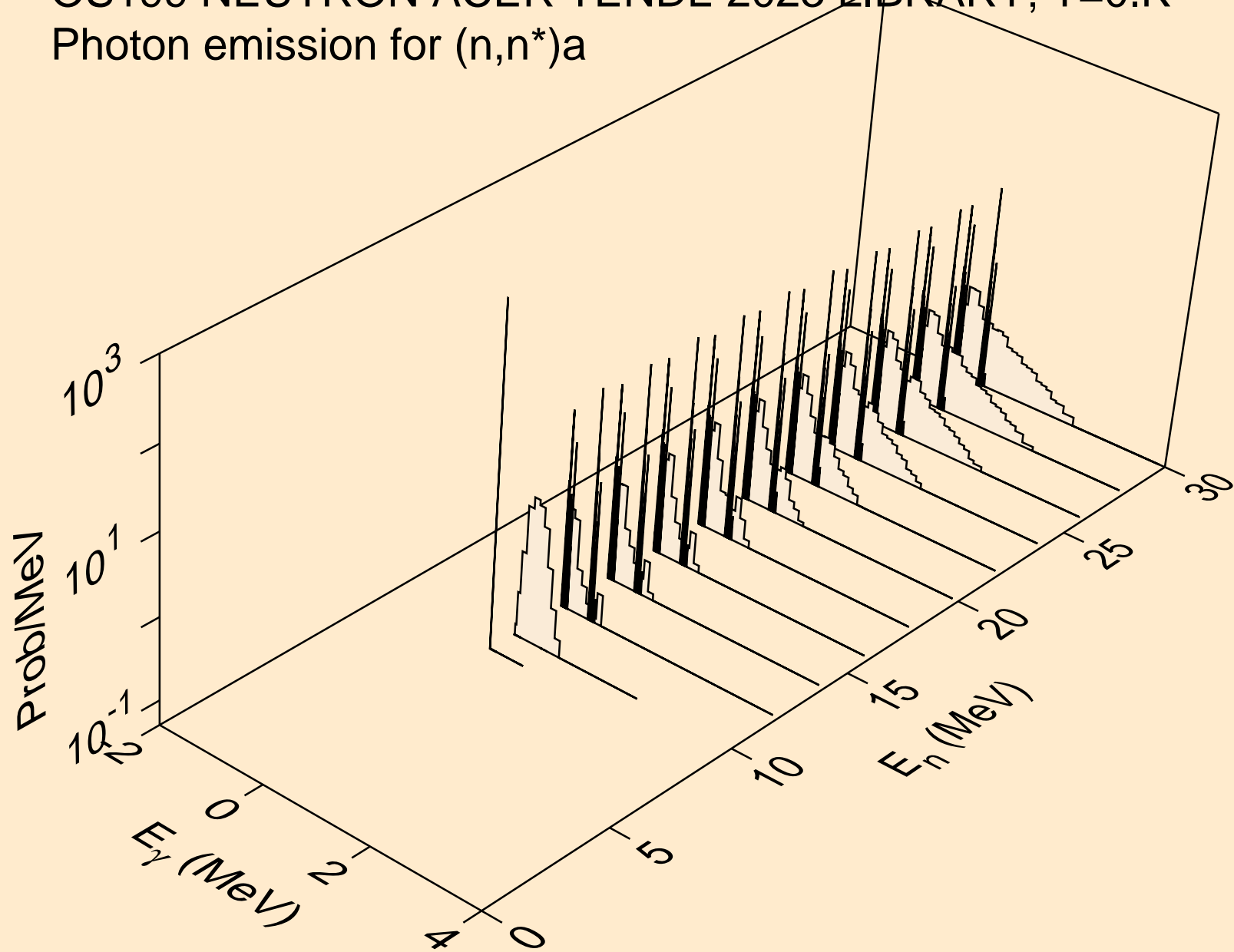

OS199 NEUTRON ACER TENDL-2023 LIBRARY; T=0.K
Photon emission for (n,2n)a

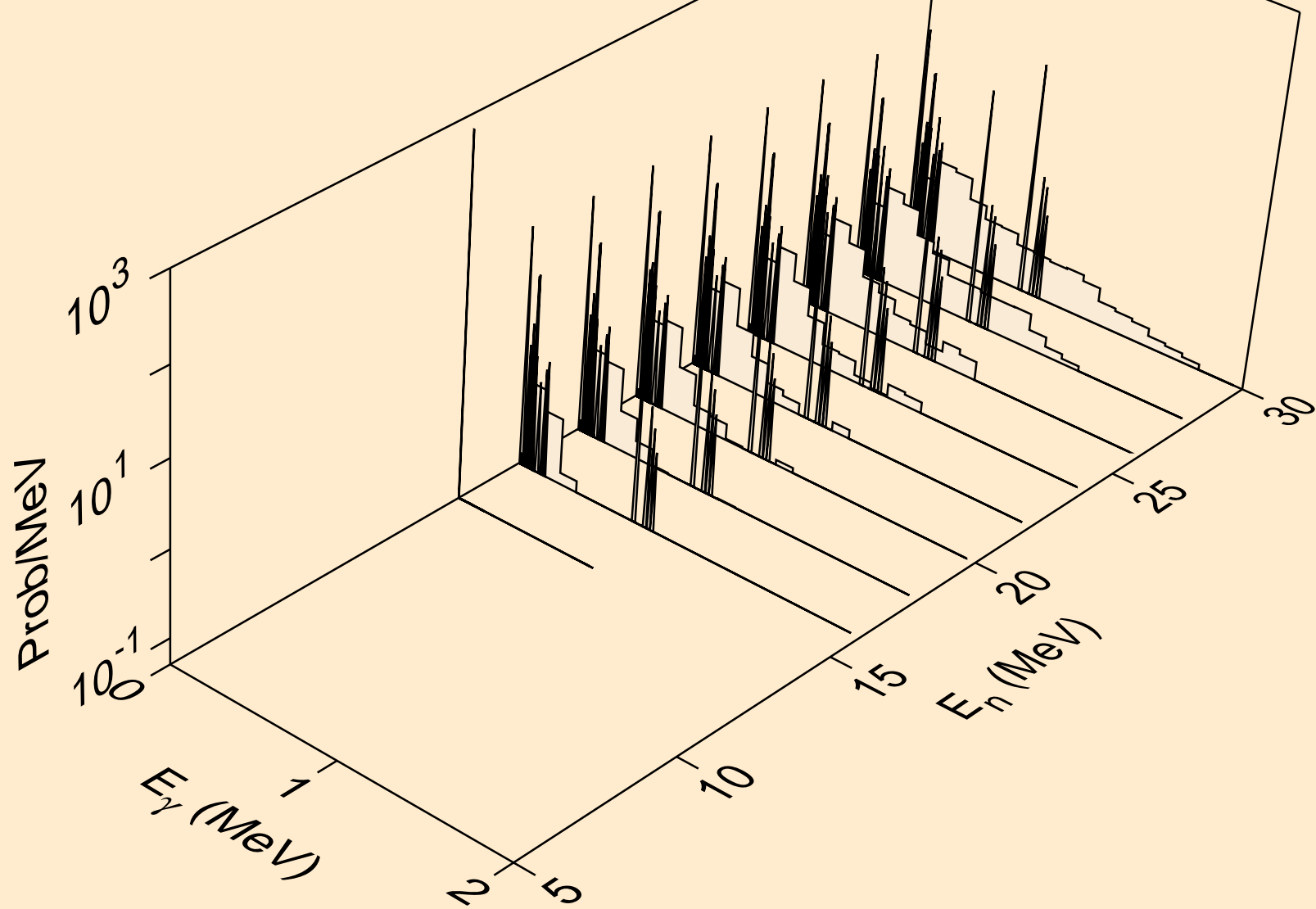

OS199 NEUTRON ACER TENDL-2023 LIBRARY; T=0.K
Photon emission for (n,3n)a

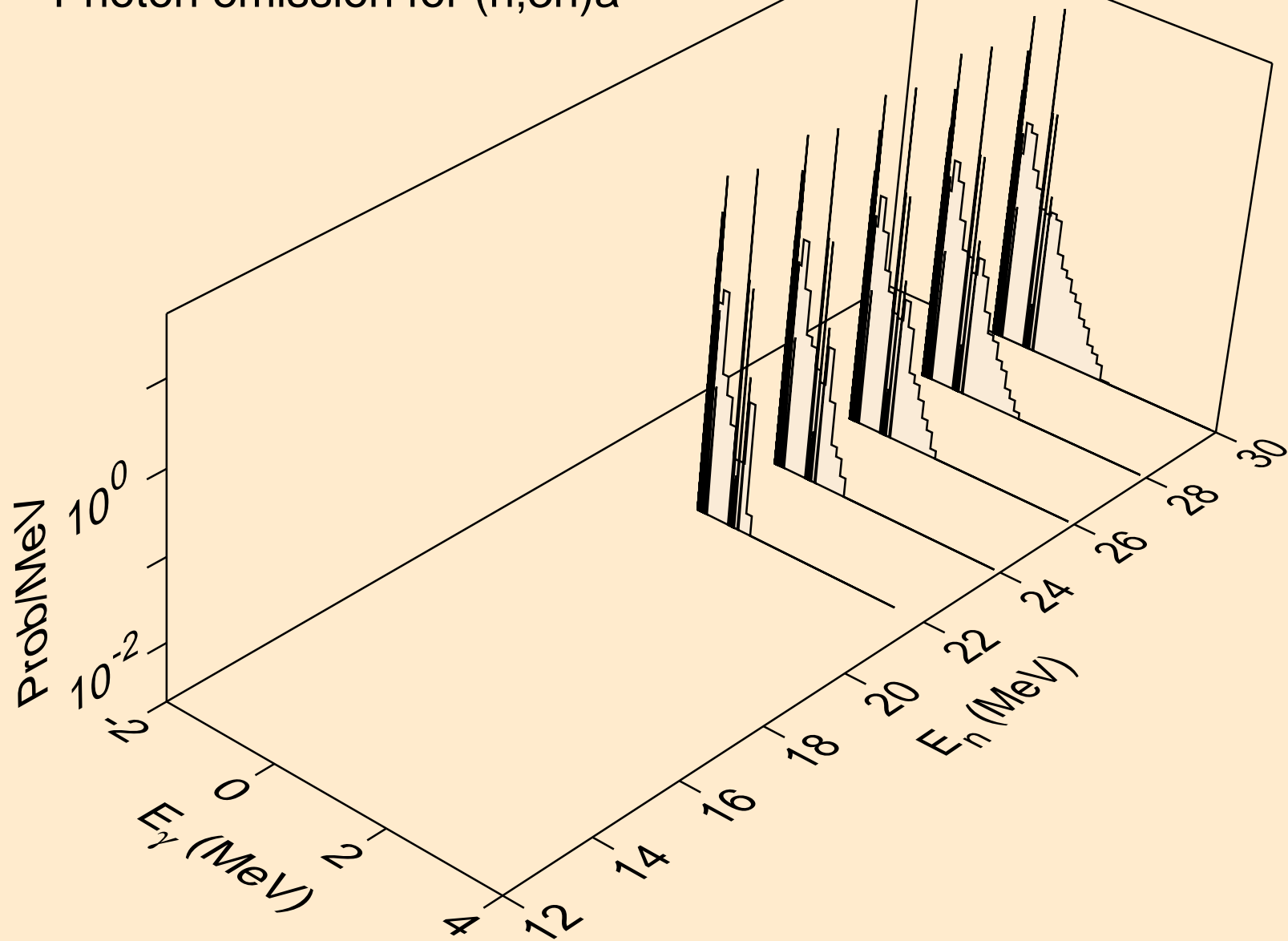

OS199 NEUTRON ACER TENDL-2023 LIBRARY; T=0.K
Photon emission for (n,n*)p

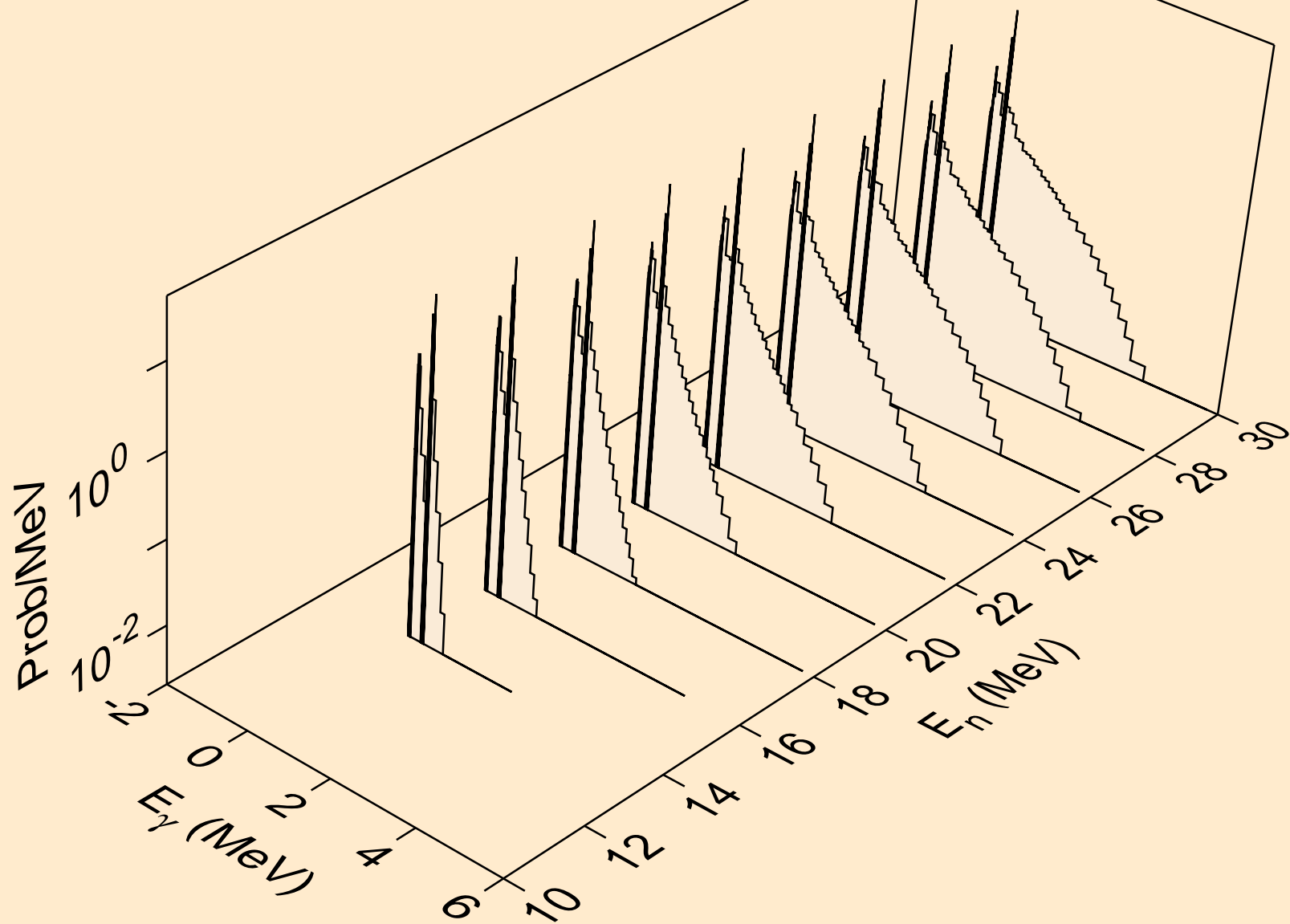

OS199 NEUTRON ACER TENDL-2023 LIBRARY; T=0.K
Photon emission for (n,n*)d

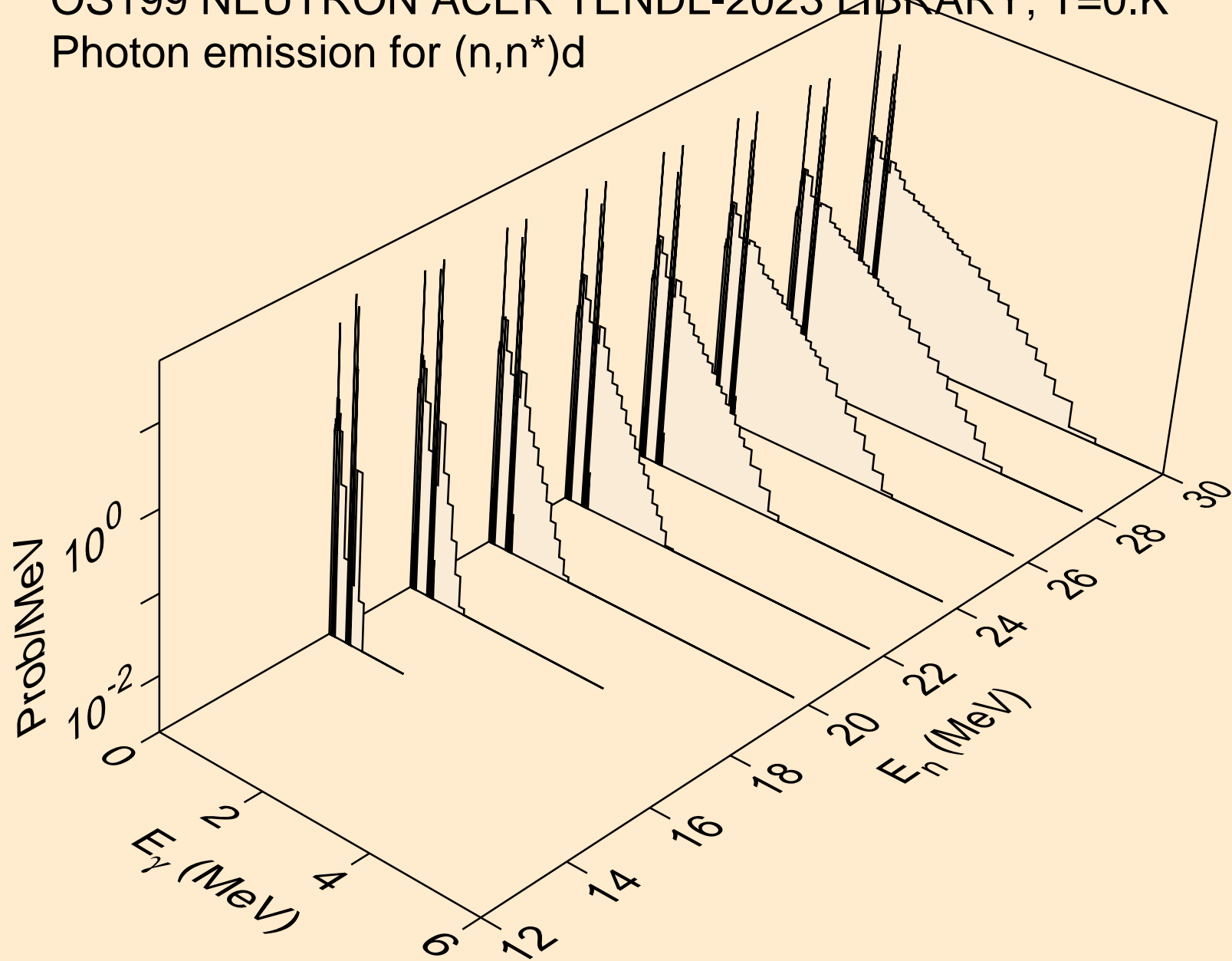

OS199 NEUTRON ACER TENDL-2023 LIBRARY; T=0.K
Photon emission for (n,n*)t

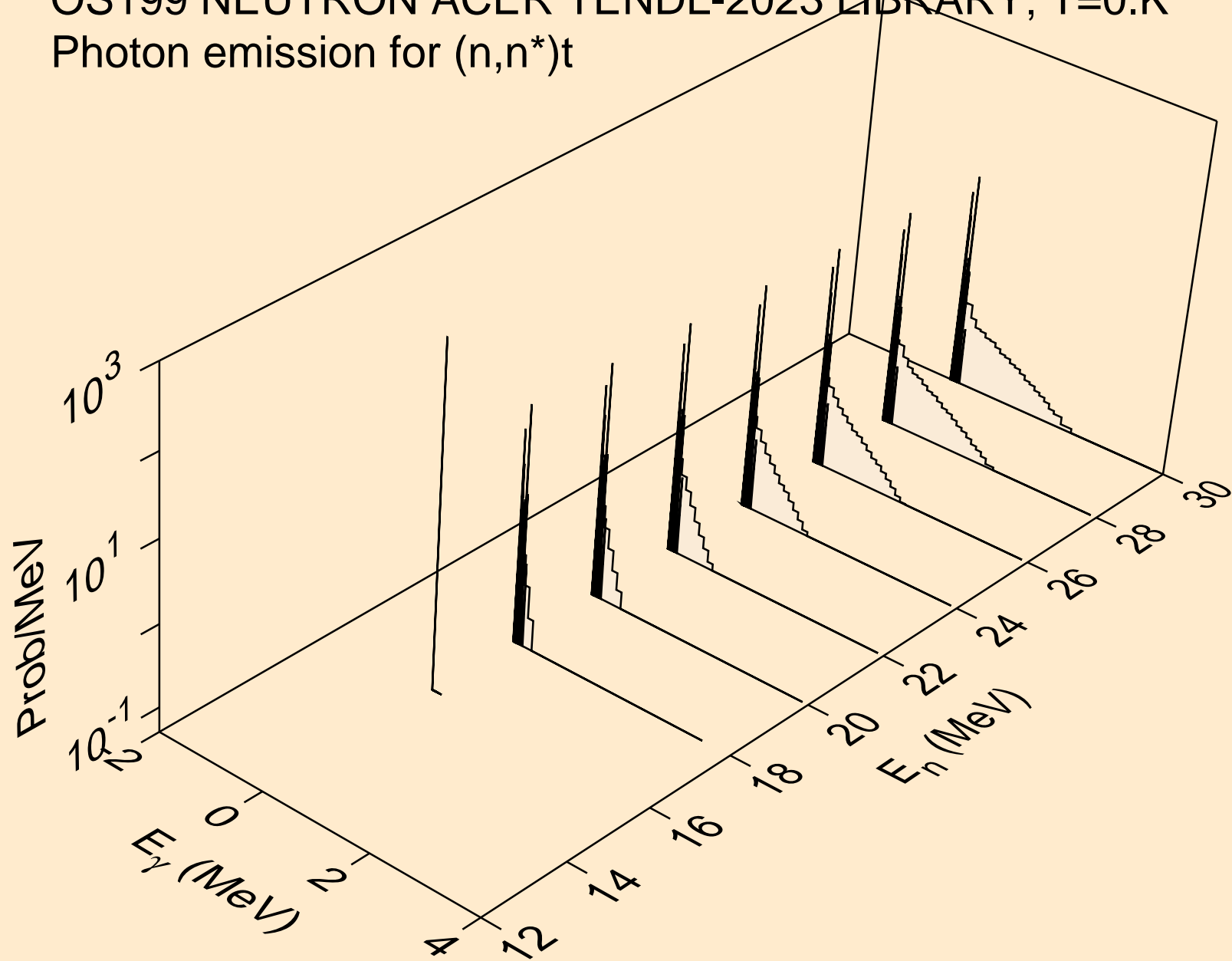

OS199 NEUTRON ACER TENDL-2023 LIBRARY; T=0.K
Photon emission for (n,n*)he3

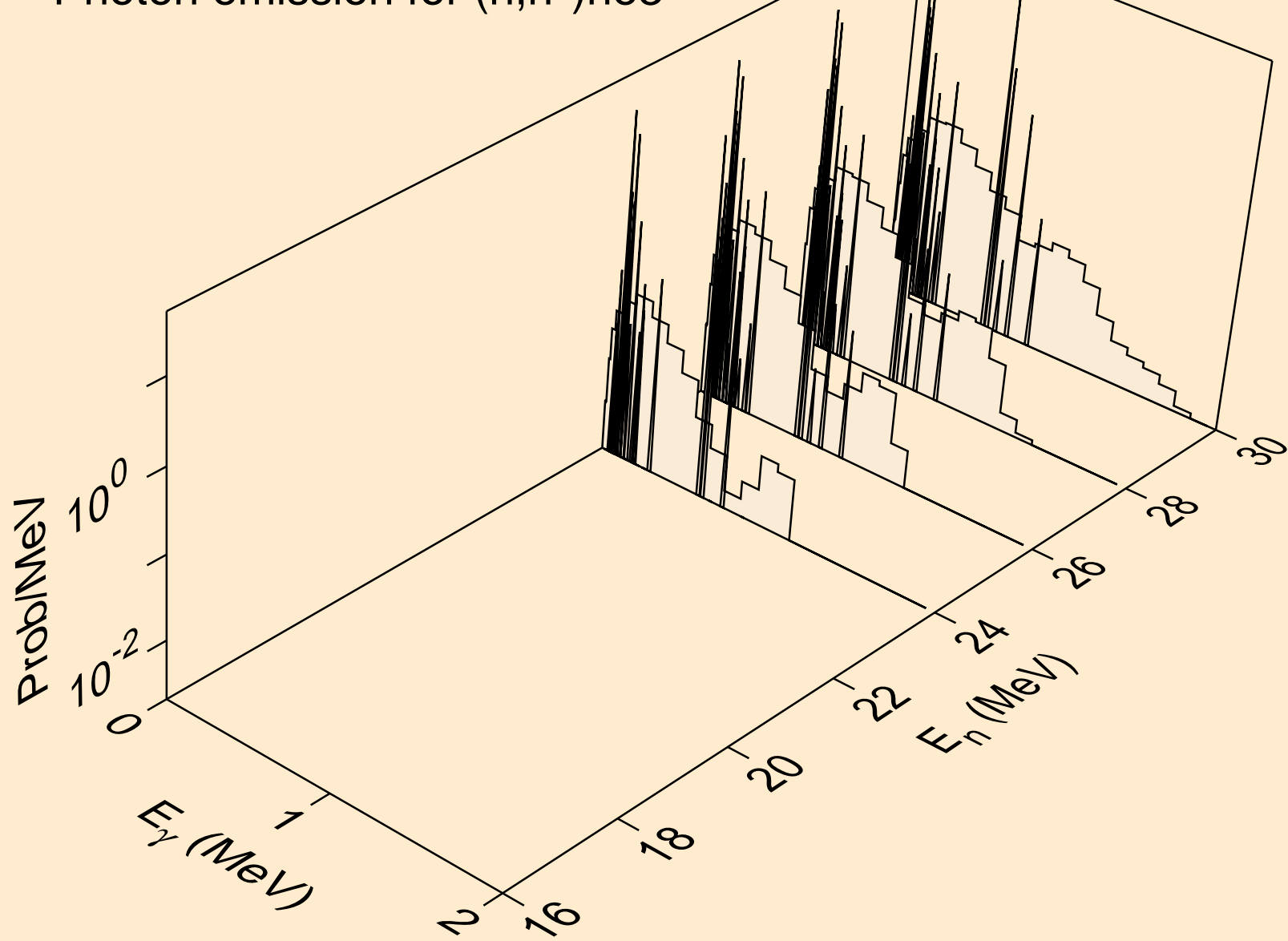

OS199 NEUTRON ACER TENDL-2023 LIBRARY; T=0.K
Photon emission for (n,4n)

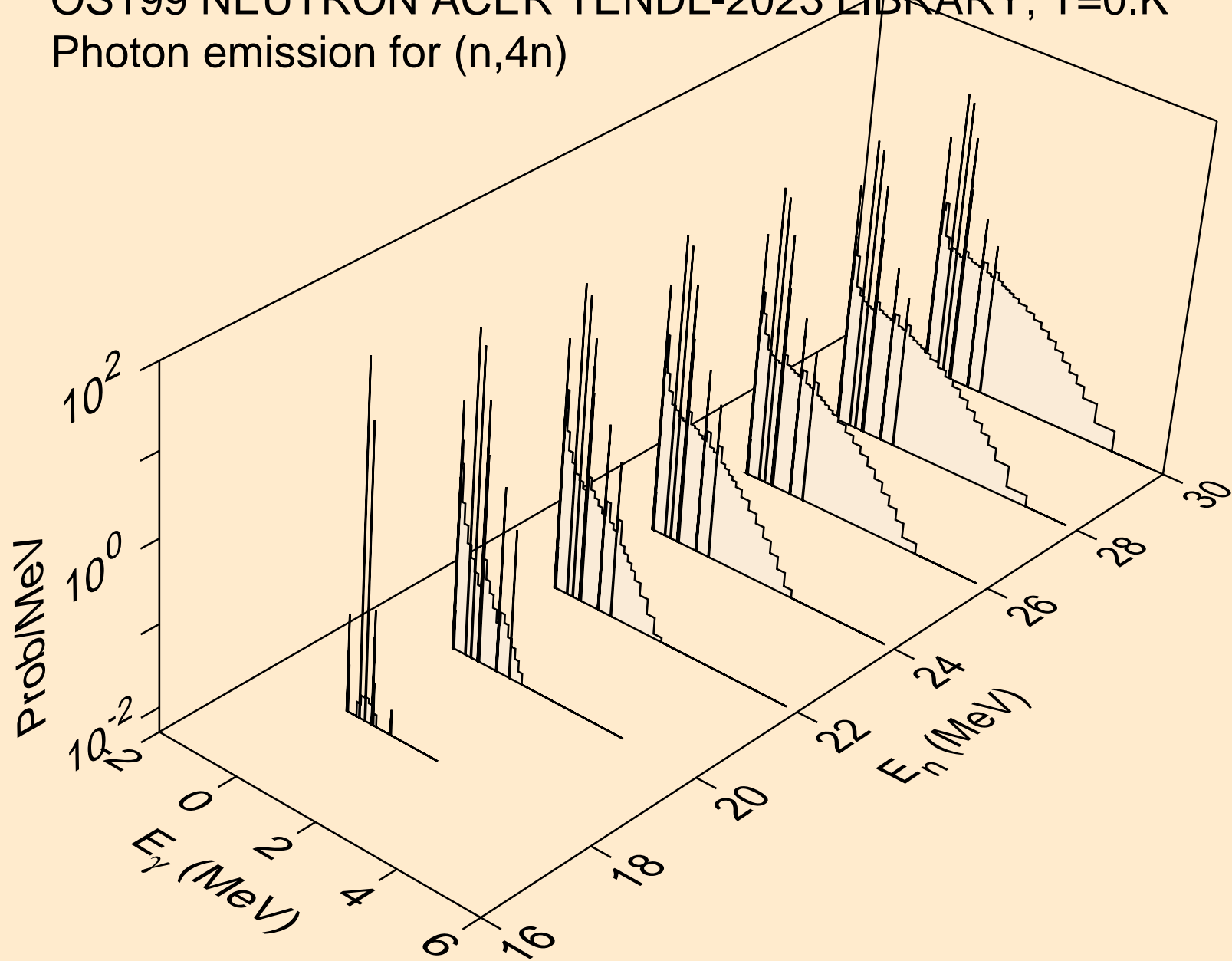

OS199 NEUTRON ACER TENDL-2023 LIBRARY; T=0.K
Photon emission for (n,2np)

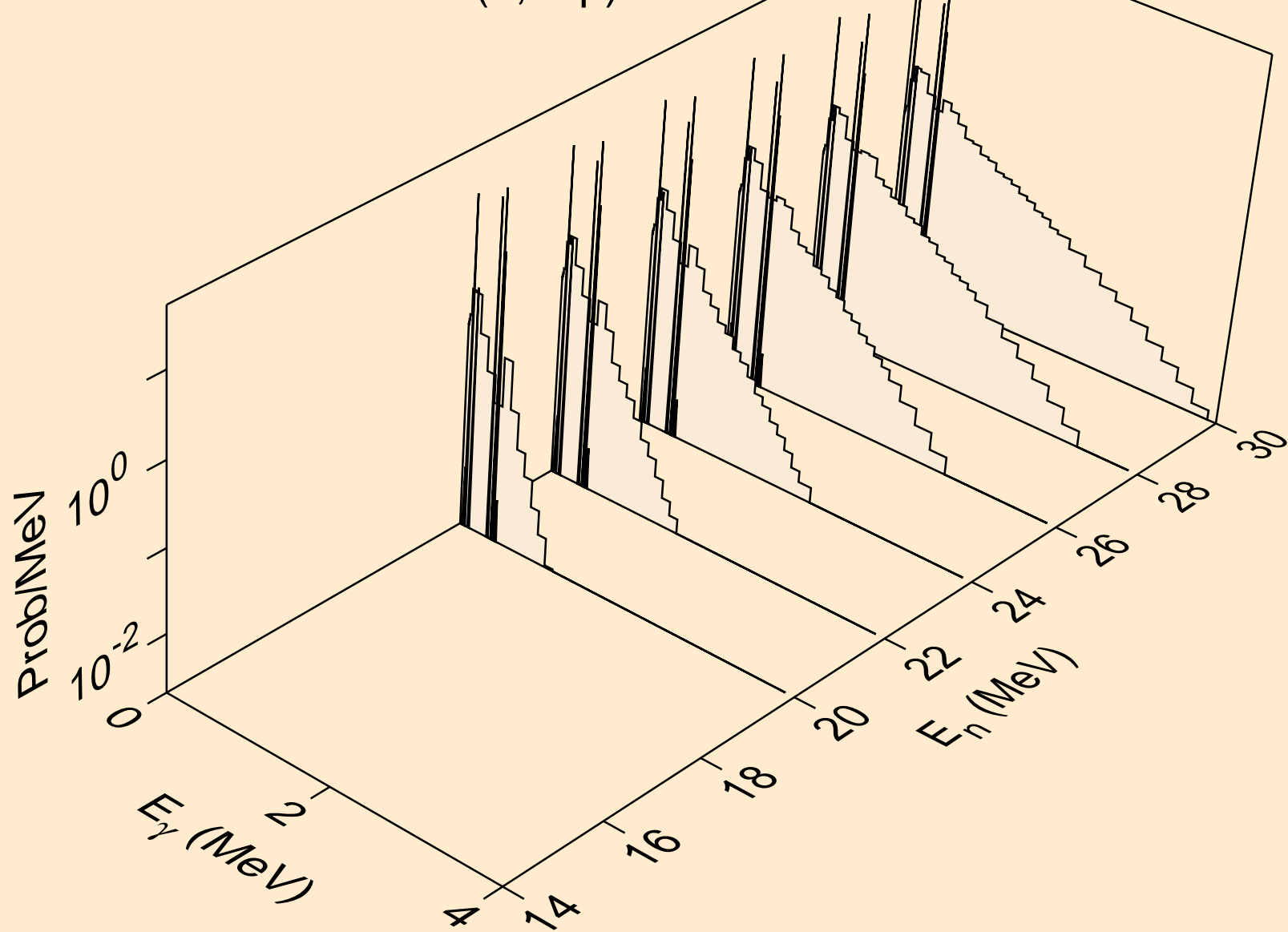

OS199 NEUTRON ACER TENDL-2023 LIBRARY; T=0.K
Photon emission for (n,3np)

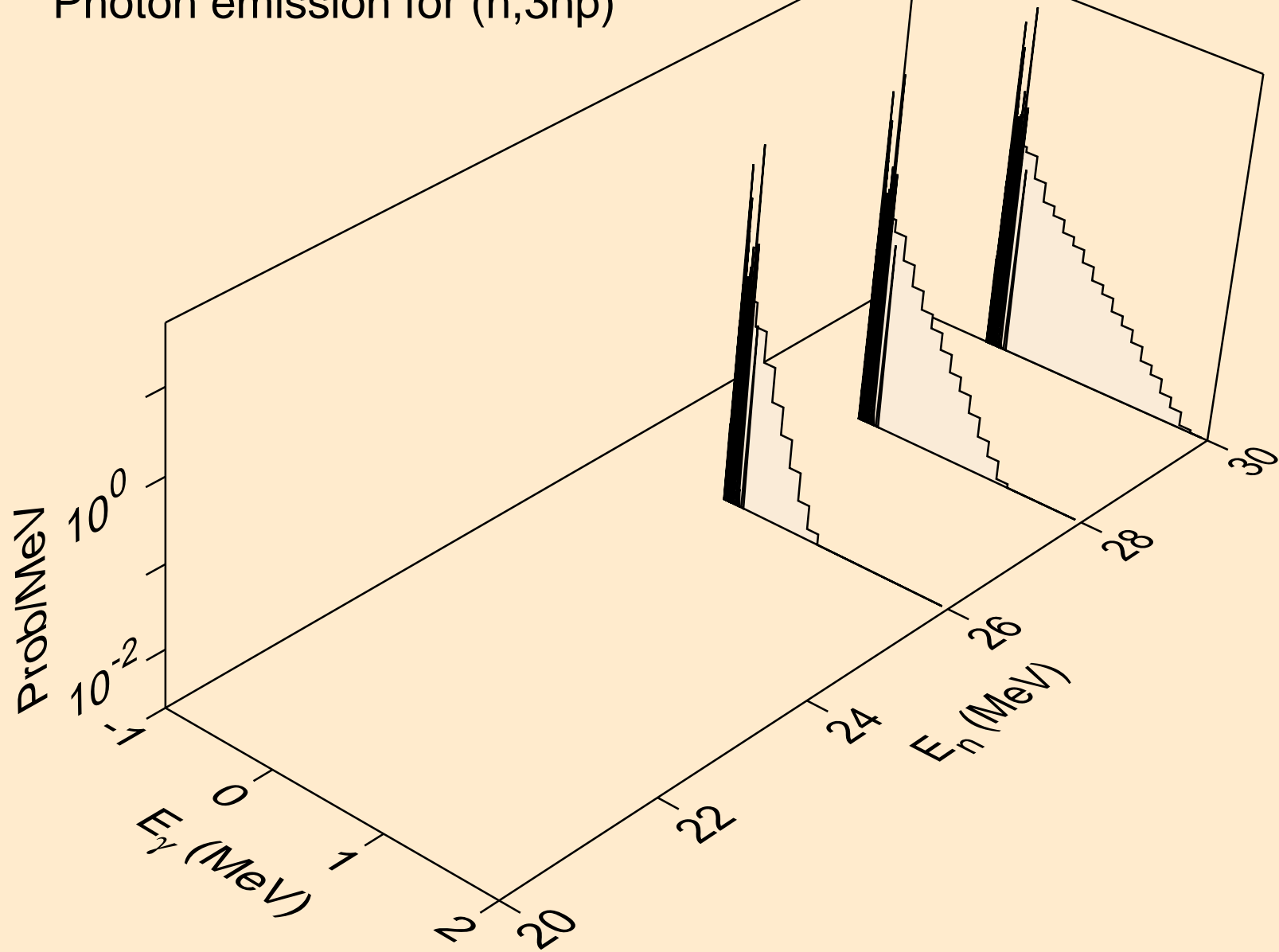

OS199 NEUTRON ACER TENDL-2023 LIBRARY; T=0.K
Photon emission for (n,n*c)

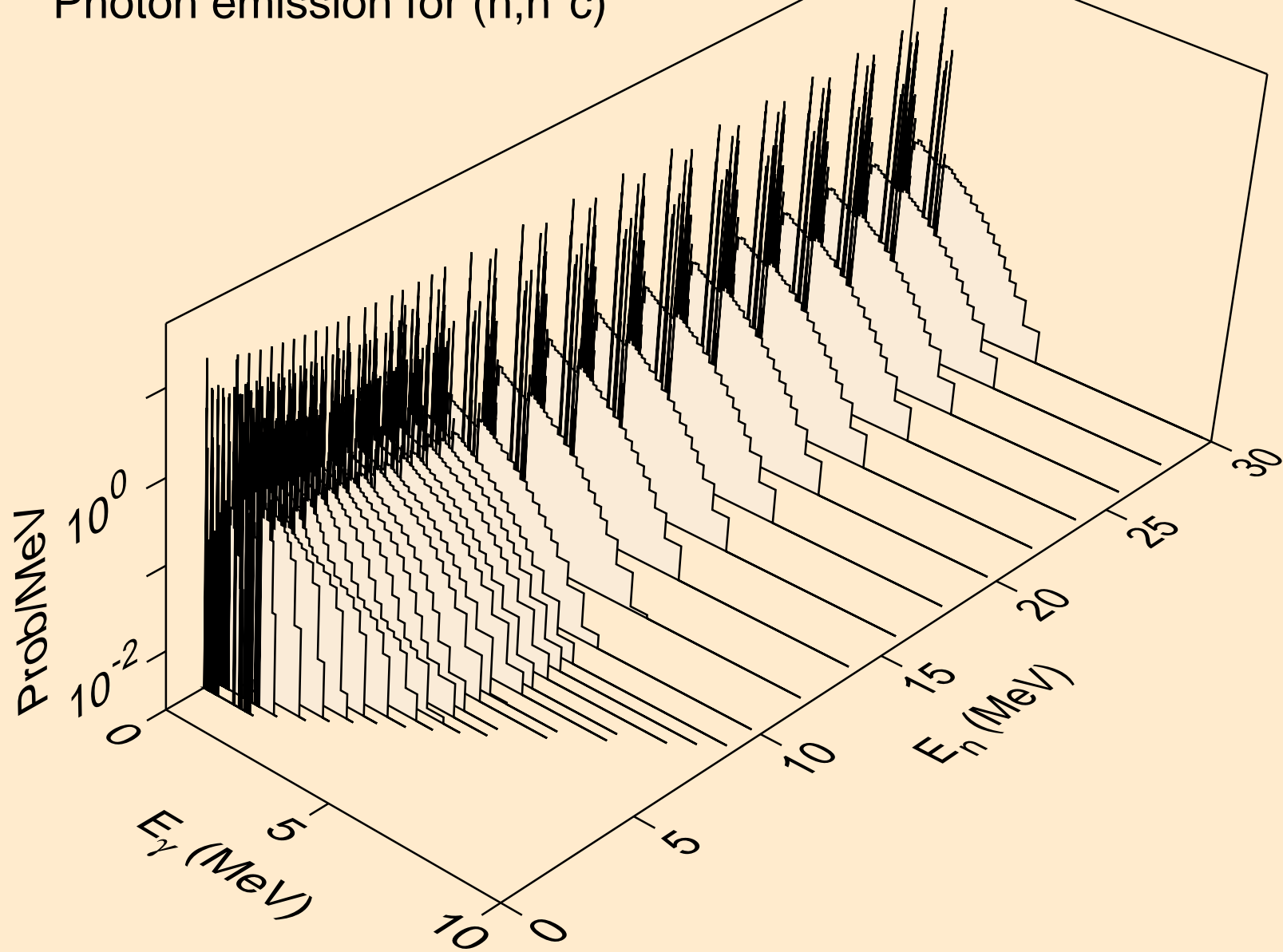

OS199 NEUTRON ACER TENDL-2023 LIBRARY; T=0.K
Photon emission for (n,gma)

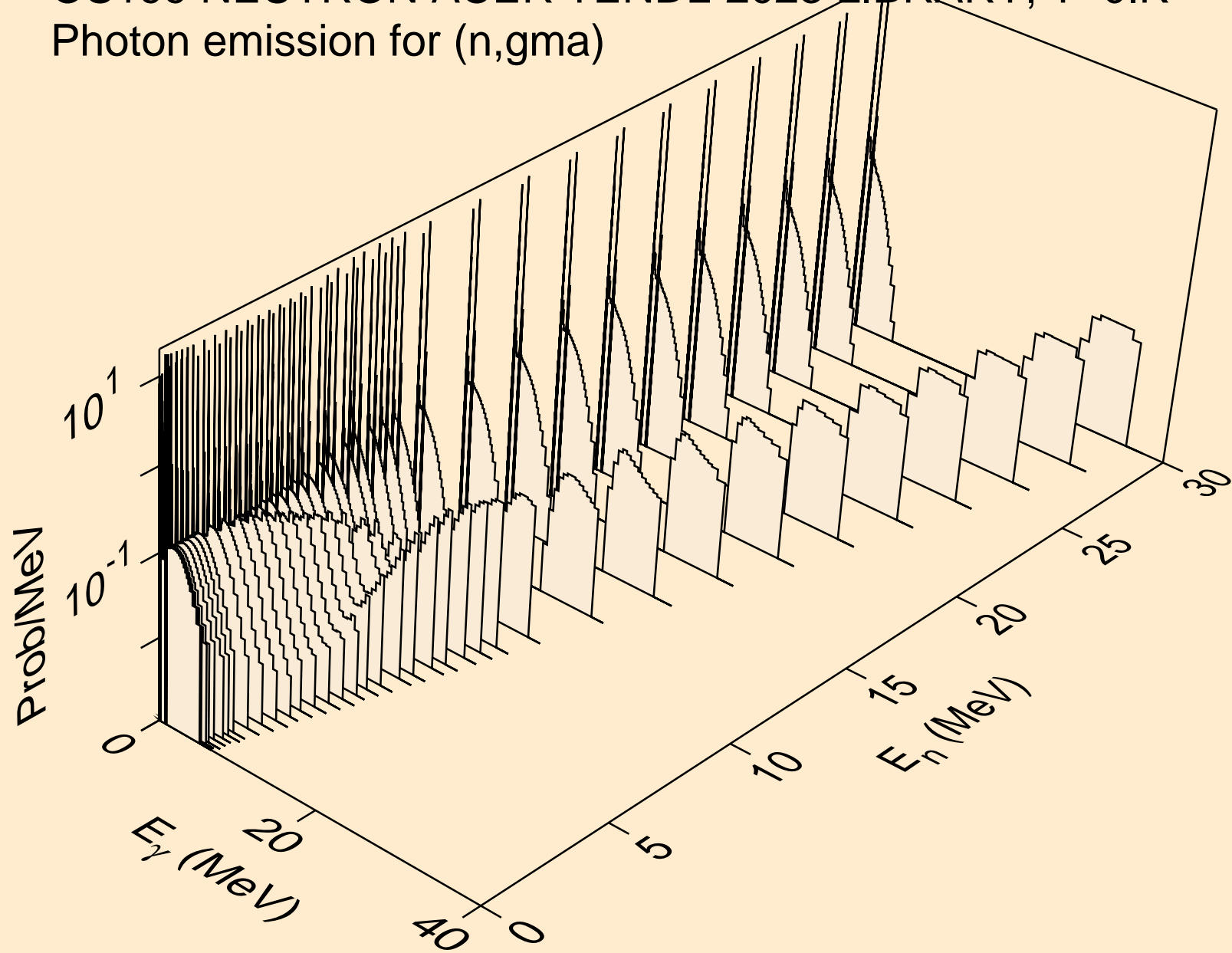

OS199 NEUTRON ACER TENDL-2023 LIBRARY; T=0.K
Photon emission for (n,p)

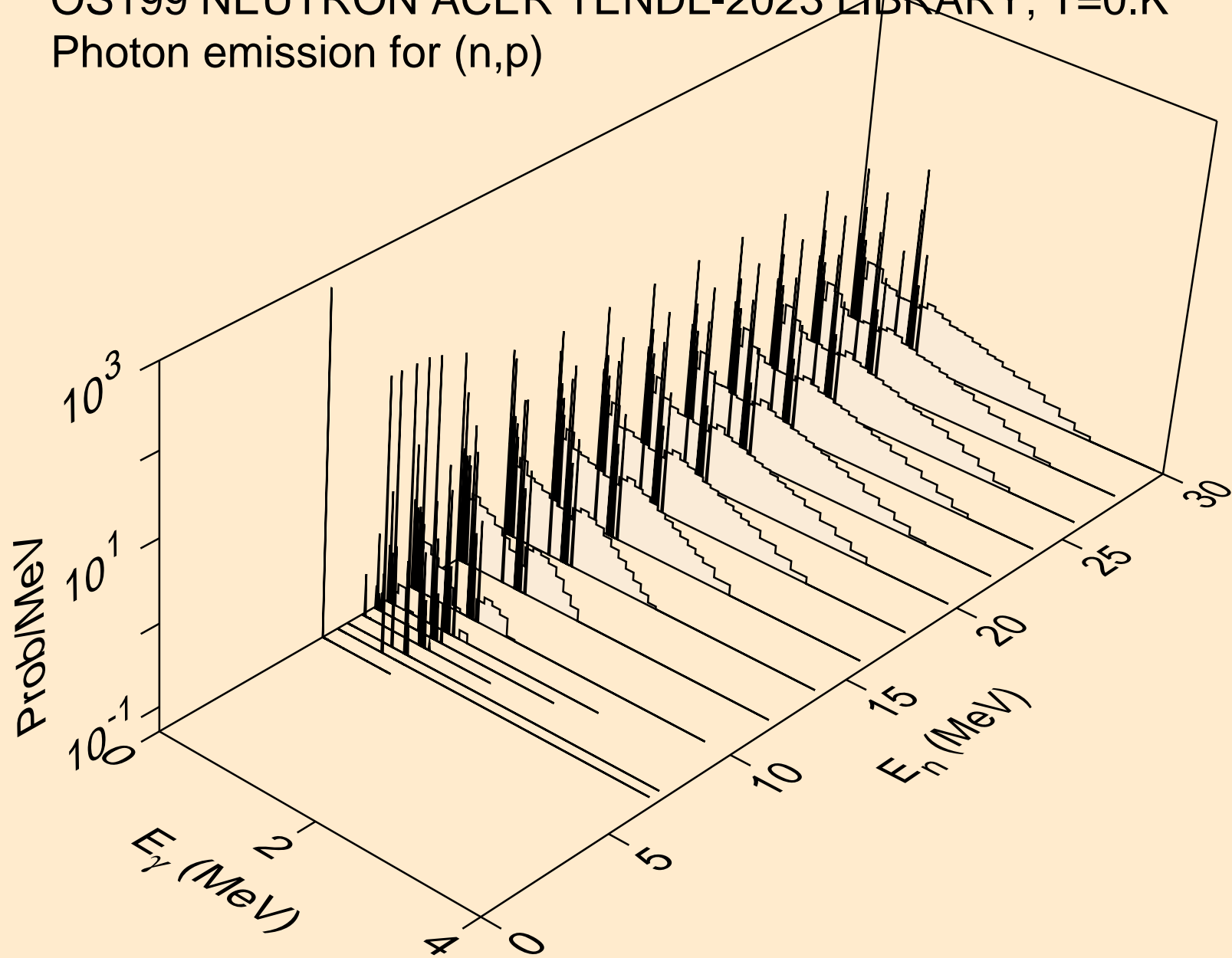

OS199 NEUTRON ACER TENDL-2023 LIBRARY; T=0.K
Photon emission for (n,d)

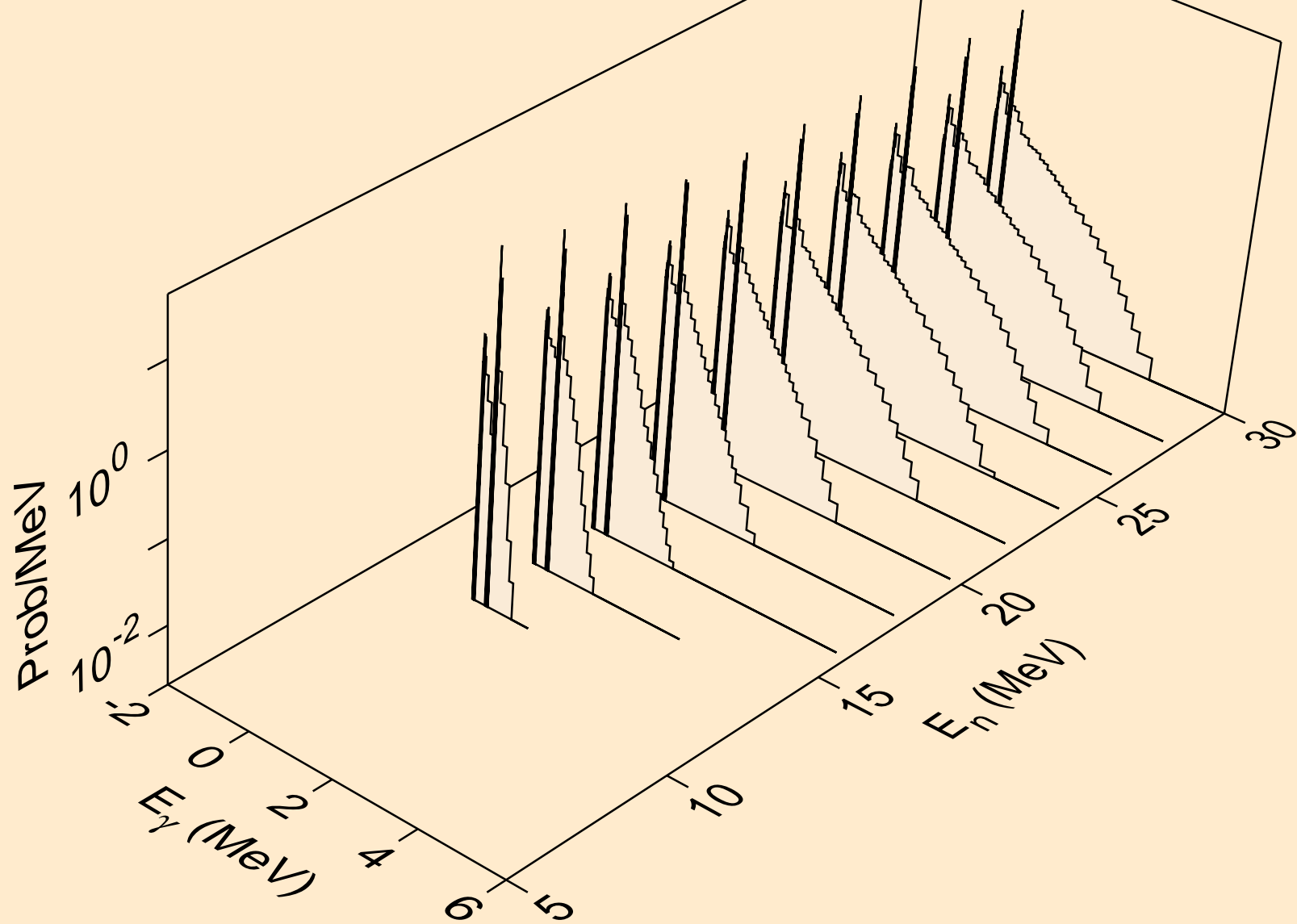

OS199 NEUTRON ACER TENDL-2023 LIBRARY; T=0.K
Photon emission for (n,t)

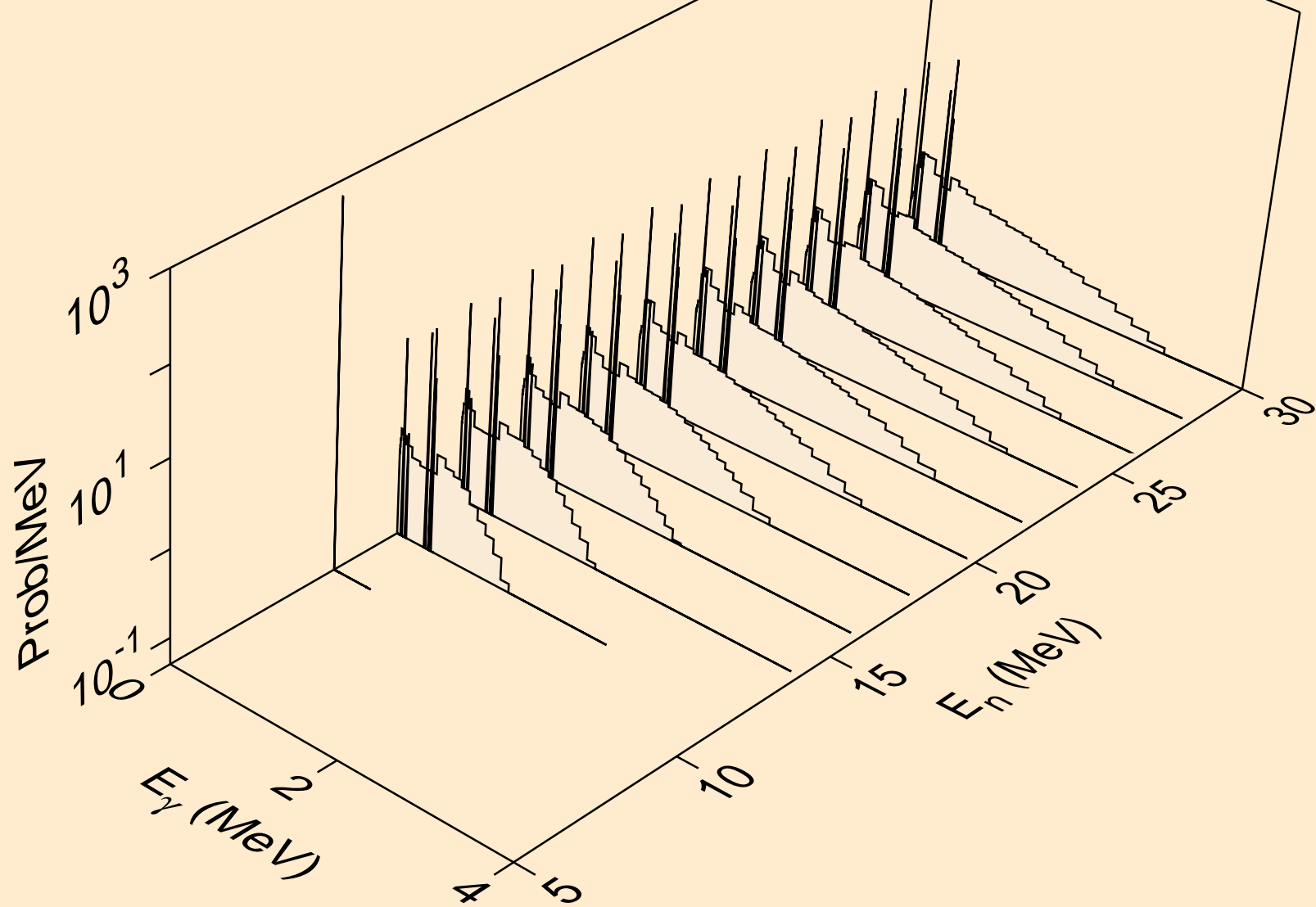

OS199 NEUTRON ACER TENDL-2023 LIBRARY; T=0.K
Photon emission for (n,he3)

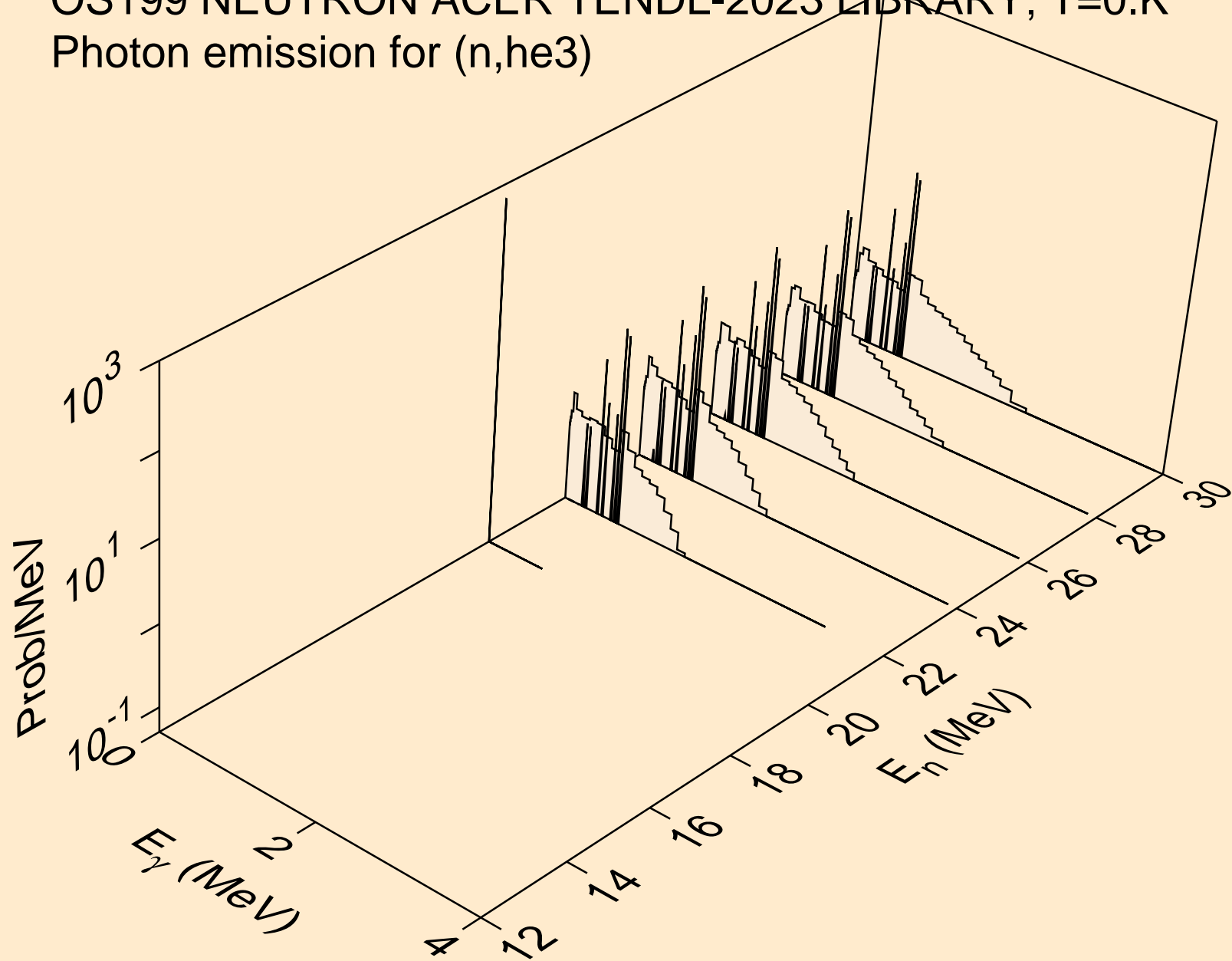

OS199 NEUTRON ACER TENDL-2023 LIBRARY; T=0.K
Photon emission for (n,a)

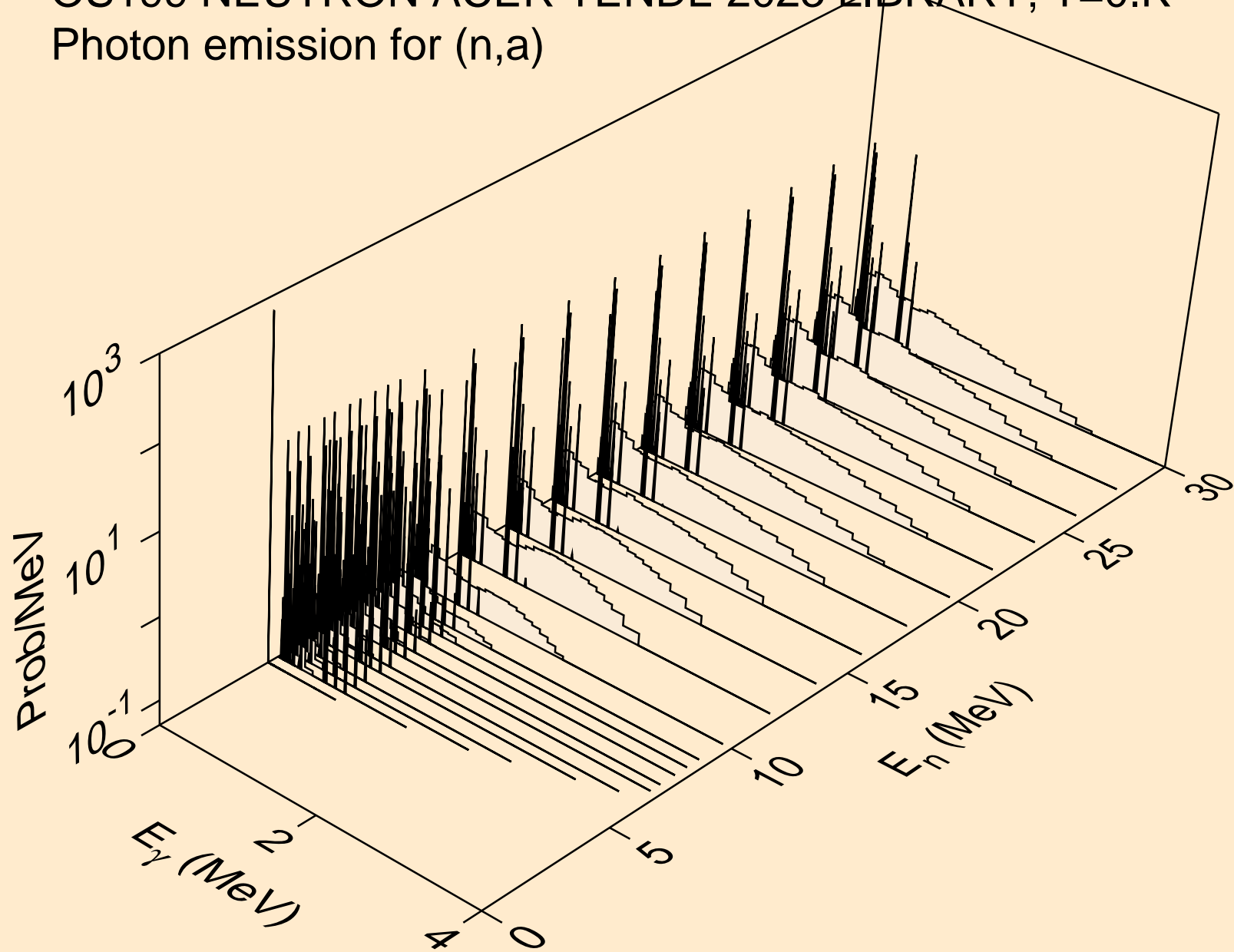

OS199 NEUTRON ACER TENDL-2023 LIBRARY; T=0.K
Photon emission for (n,2p)

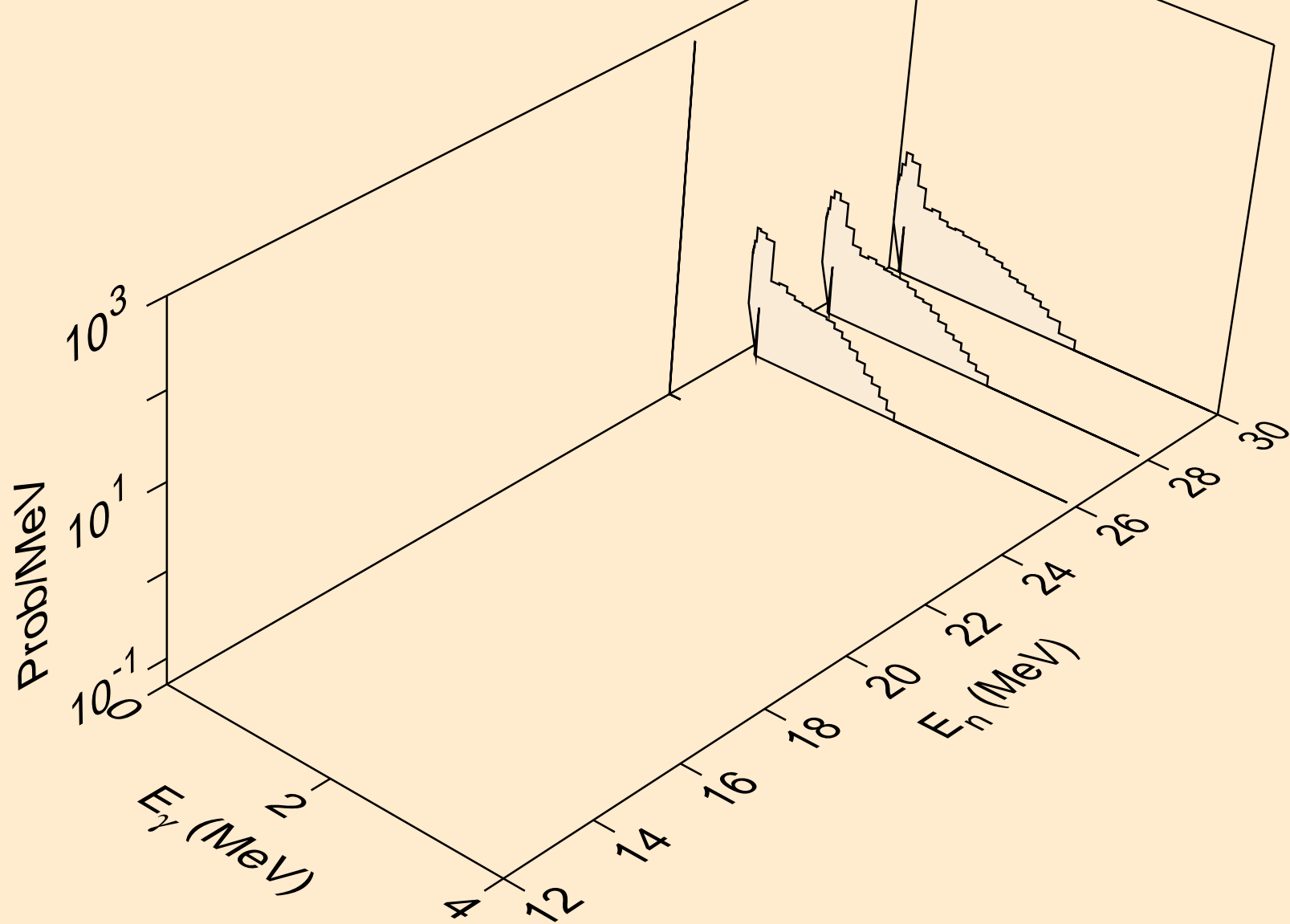

OS199 NEUTRON ACER TENDL-2023 LIBRARY; T=0.K
thermal capture photon spectrum

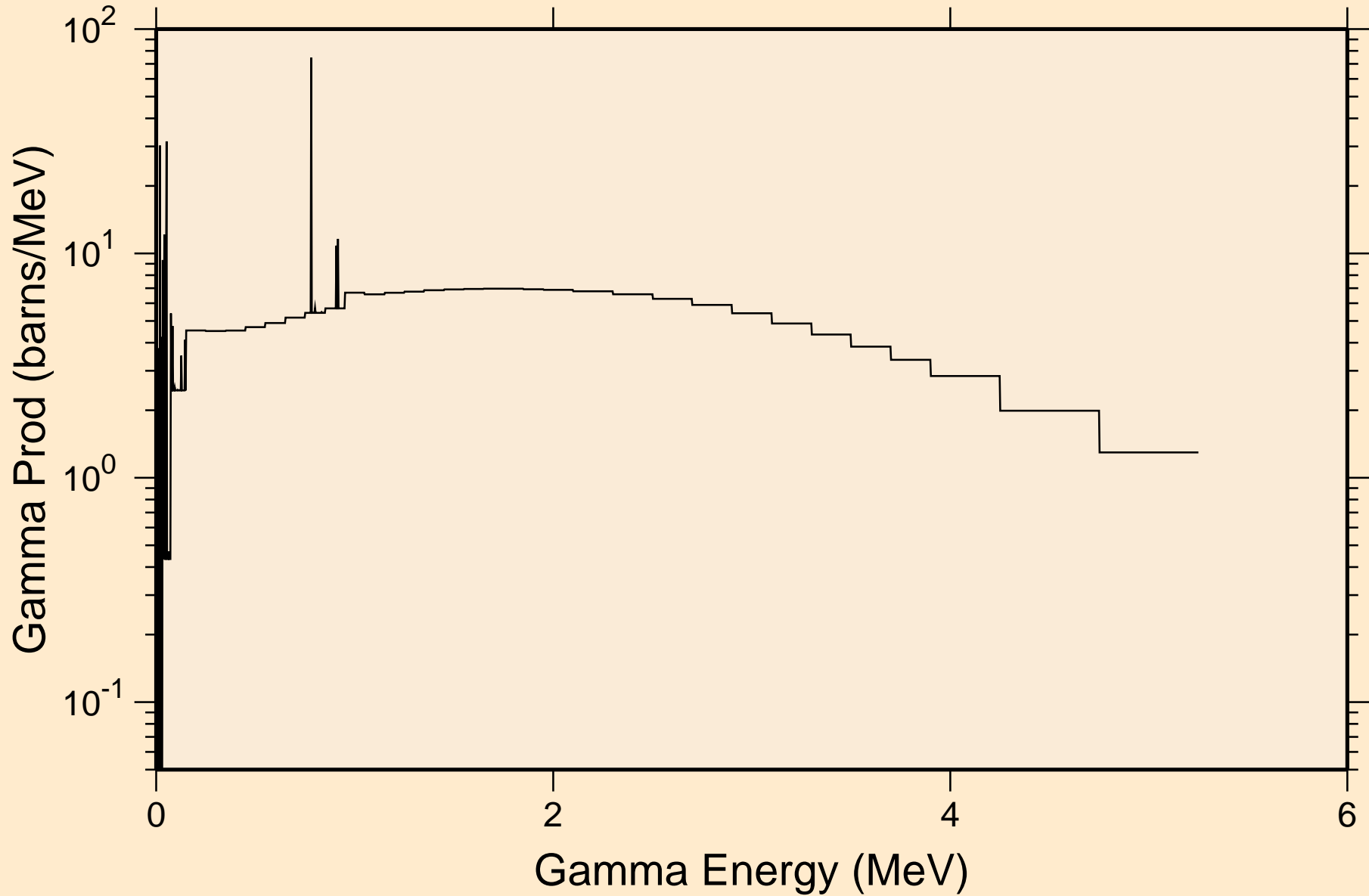

OS199 NEUTRON ACER TENDL-2023 LIBRARY; T=0.K
14 MeV photon spectrum

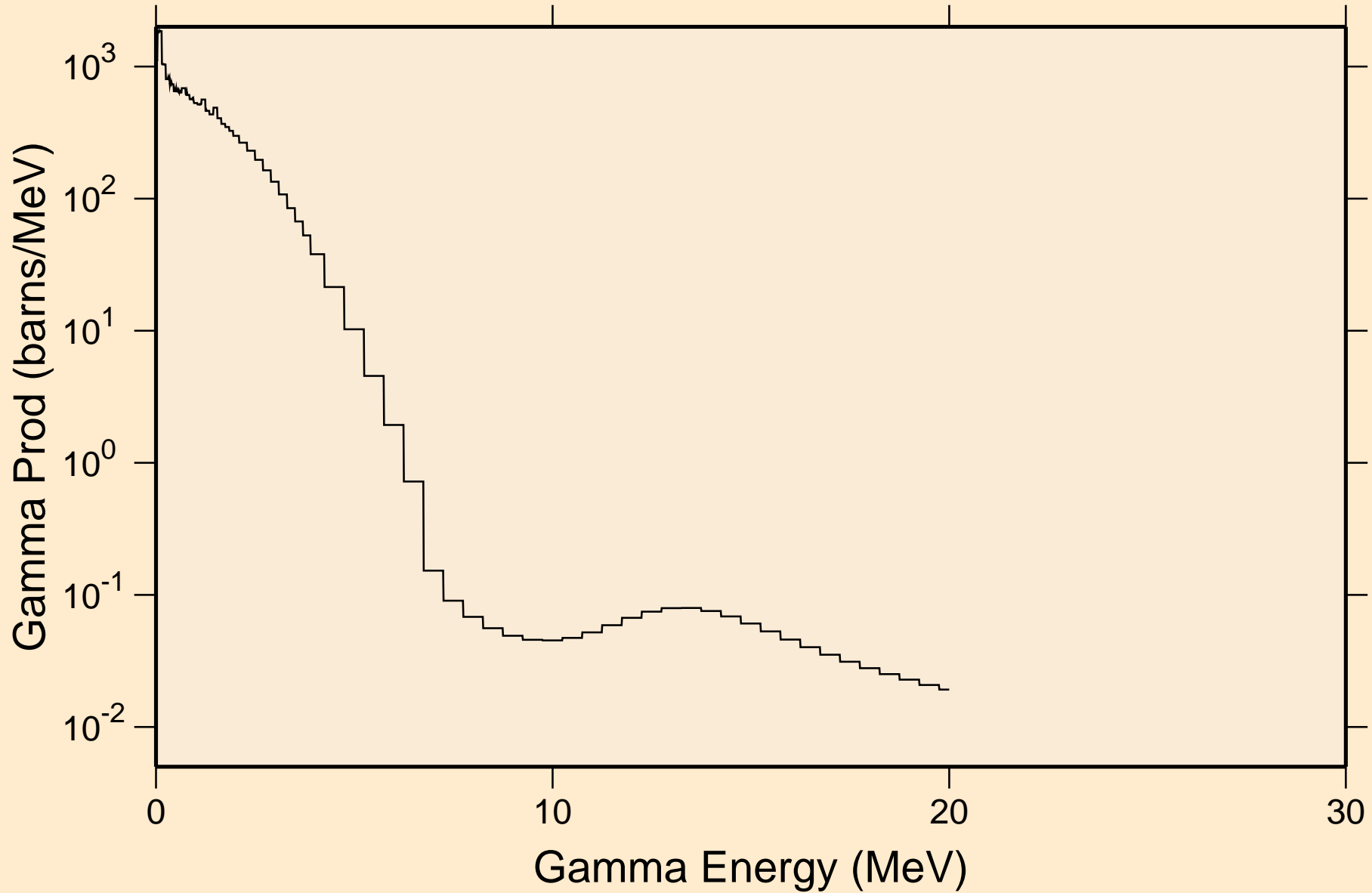

OS199 NEUTRON ACER TENDL-2023 LIBRARY; T=0.K

Particle heating contributions

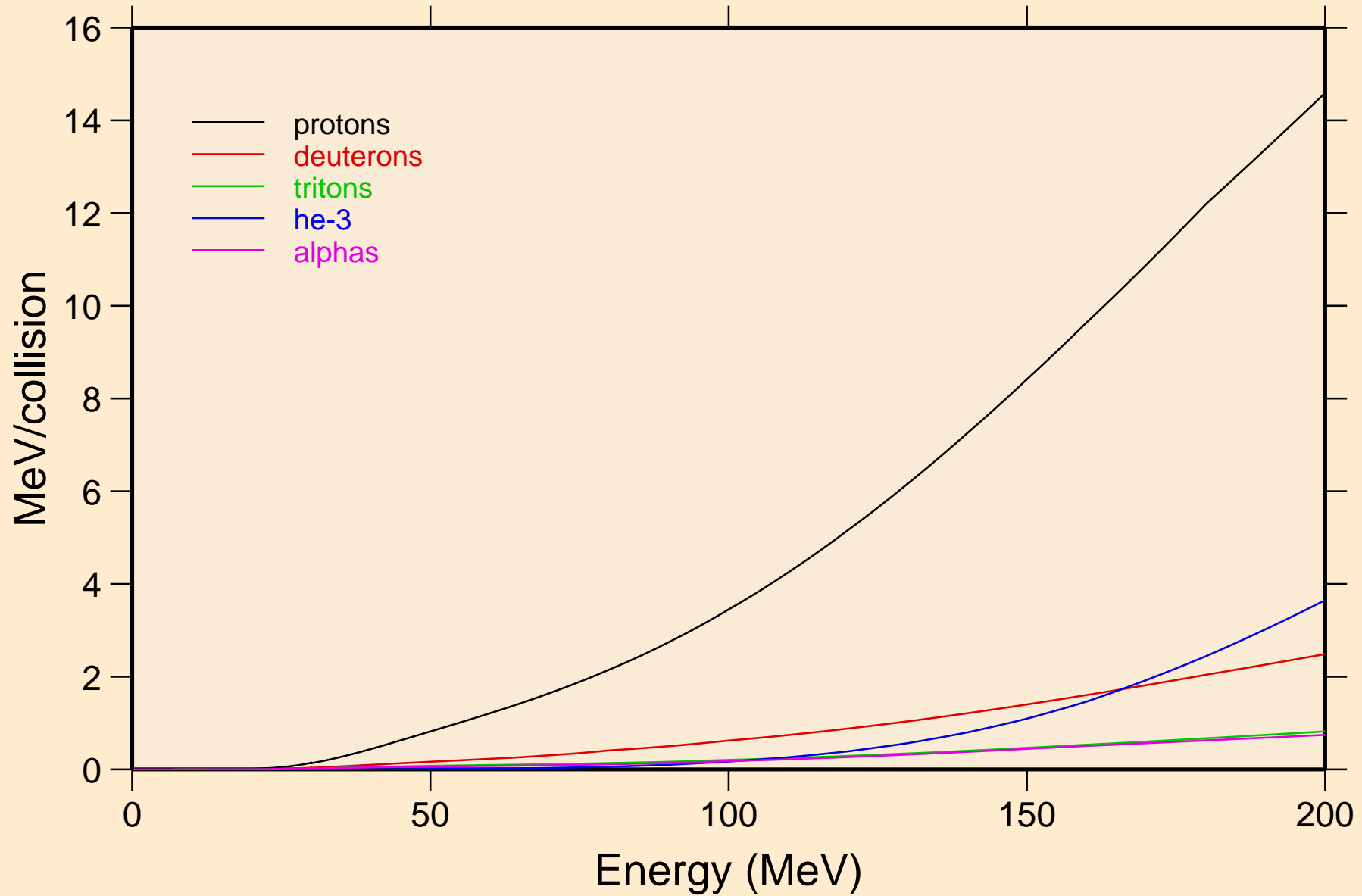

OS199 NEUTRON ACER TENDL-2023 LIBRARY; T=0.K
Recoil Heating

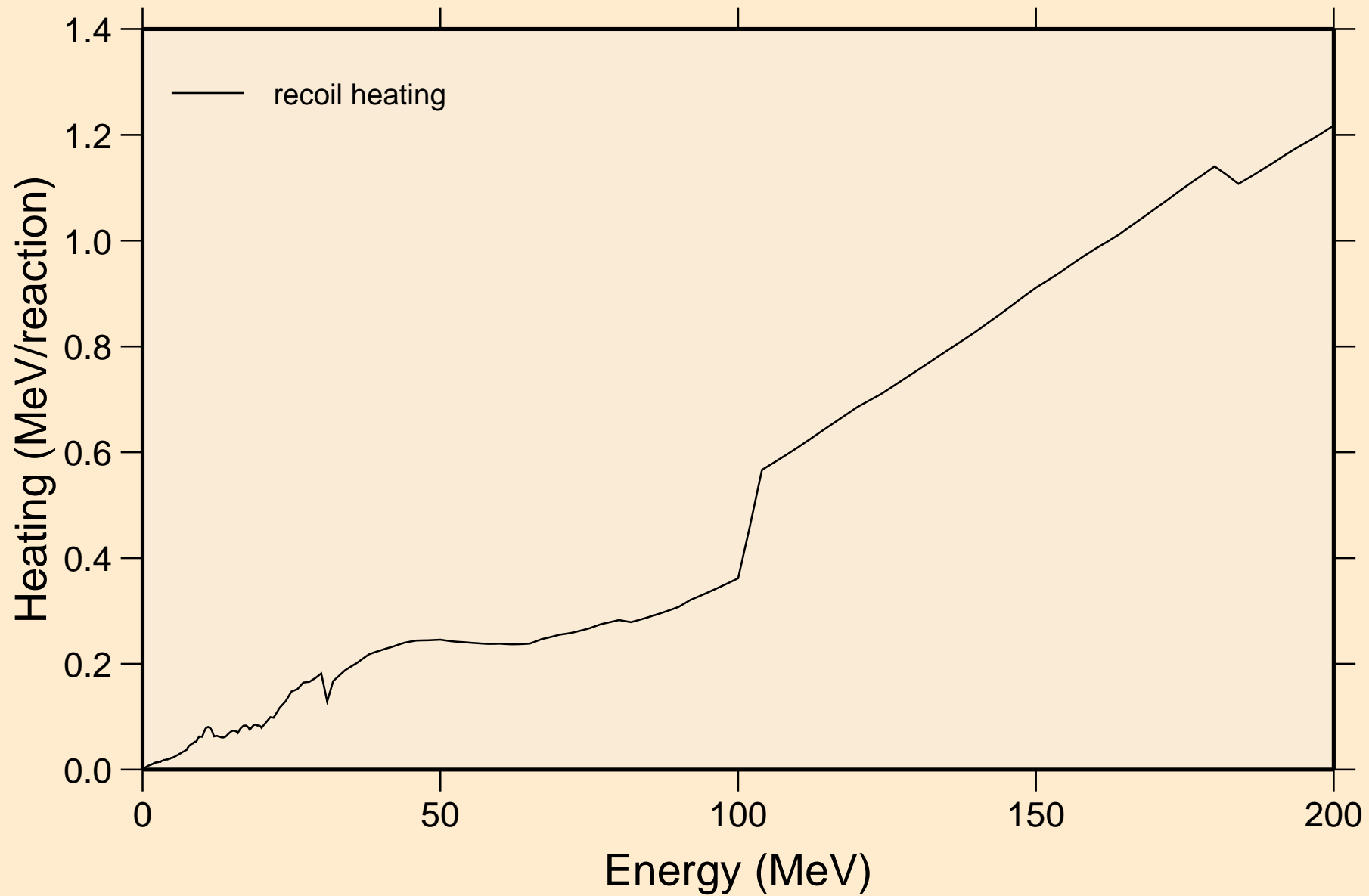

OS199 NEUTRON ACER TENDL-2023 LIBRARY; T=0.K
Particle production cross sections

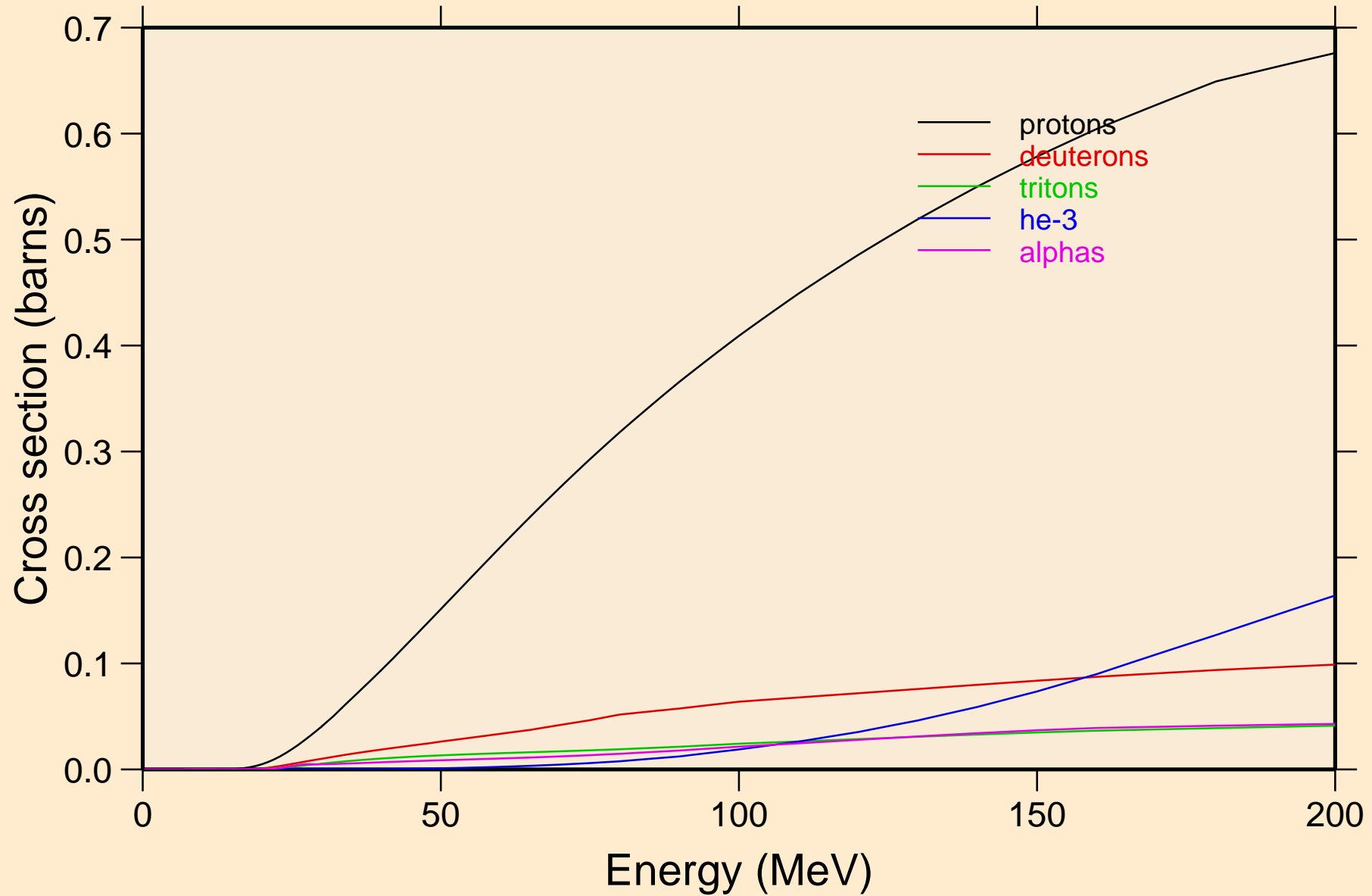

OS199 NEUTRON ACER TENDL-2023 LIBRARY; T=0.K
protons from (n,x)

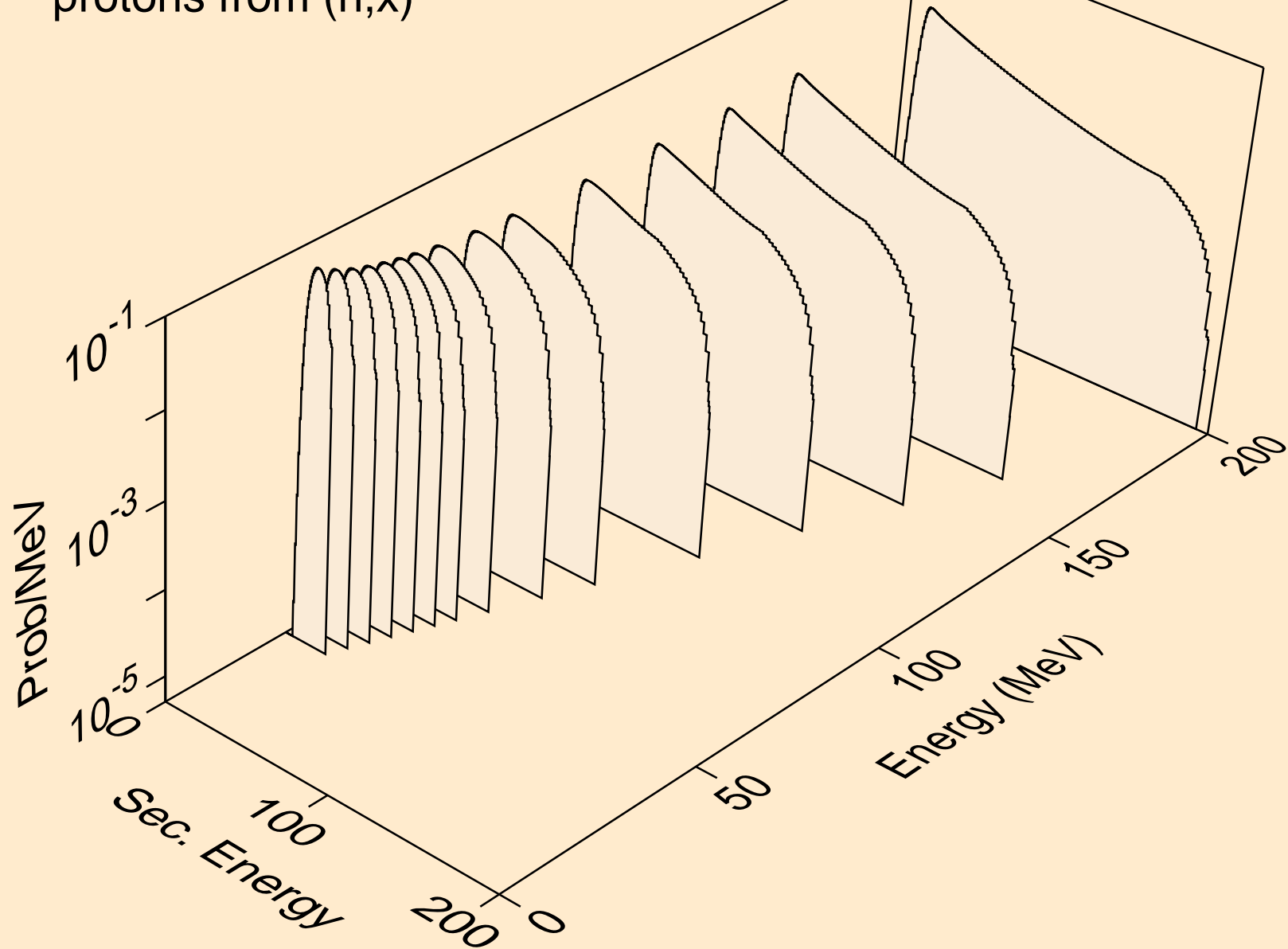

OS199 NEUTRON ACER TENDL-2023 LIBRARY; T=0.K
protons from (n,n*)p

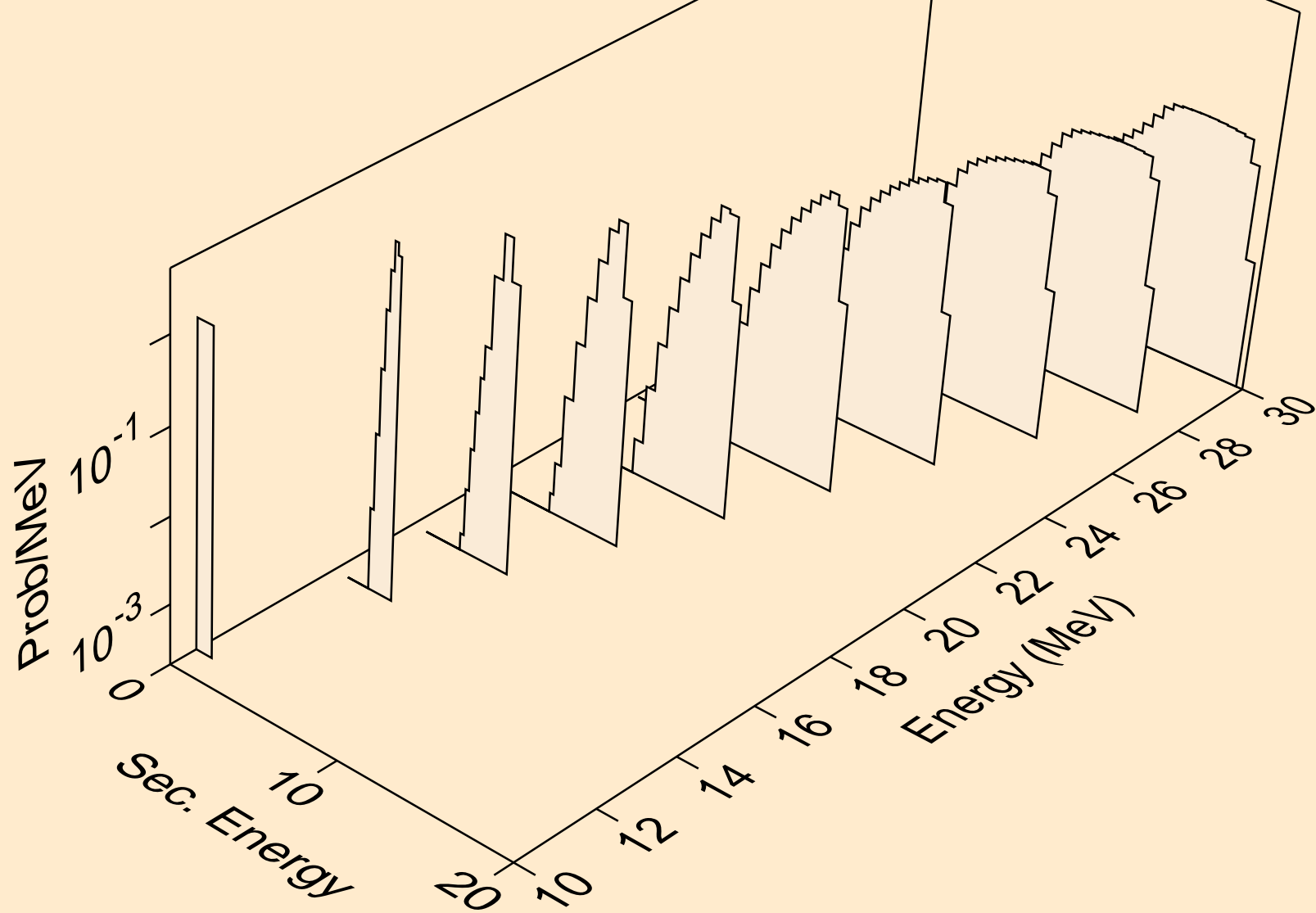

OS199 NEUTRON ACER TENDL-2023 LIBRARY; T=0.K
protons from (n,2np)

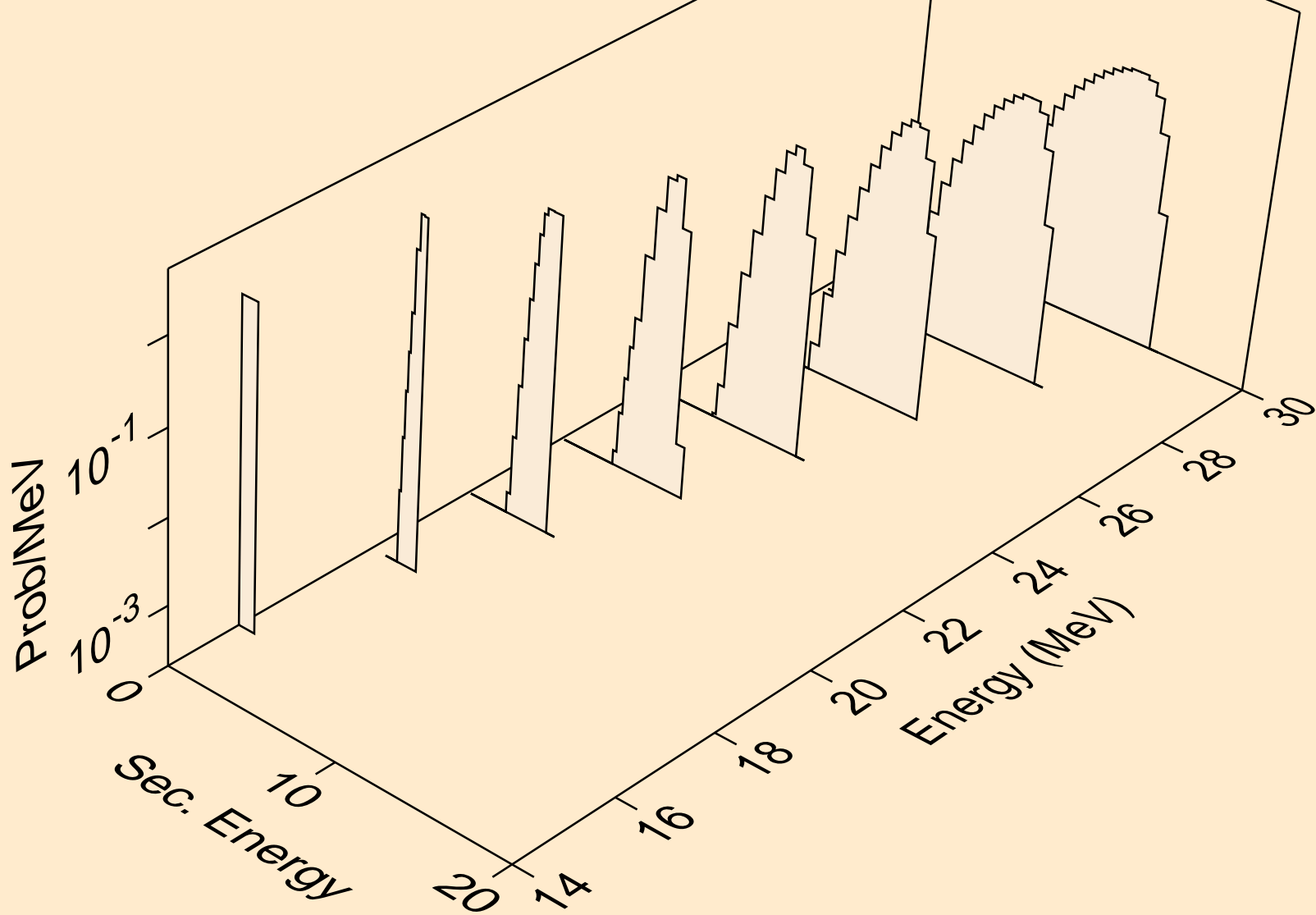

OS199 NEUTRON ACER TENDL-2023 LIBRARY; T=0.K
protons from (n,3np)

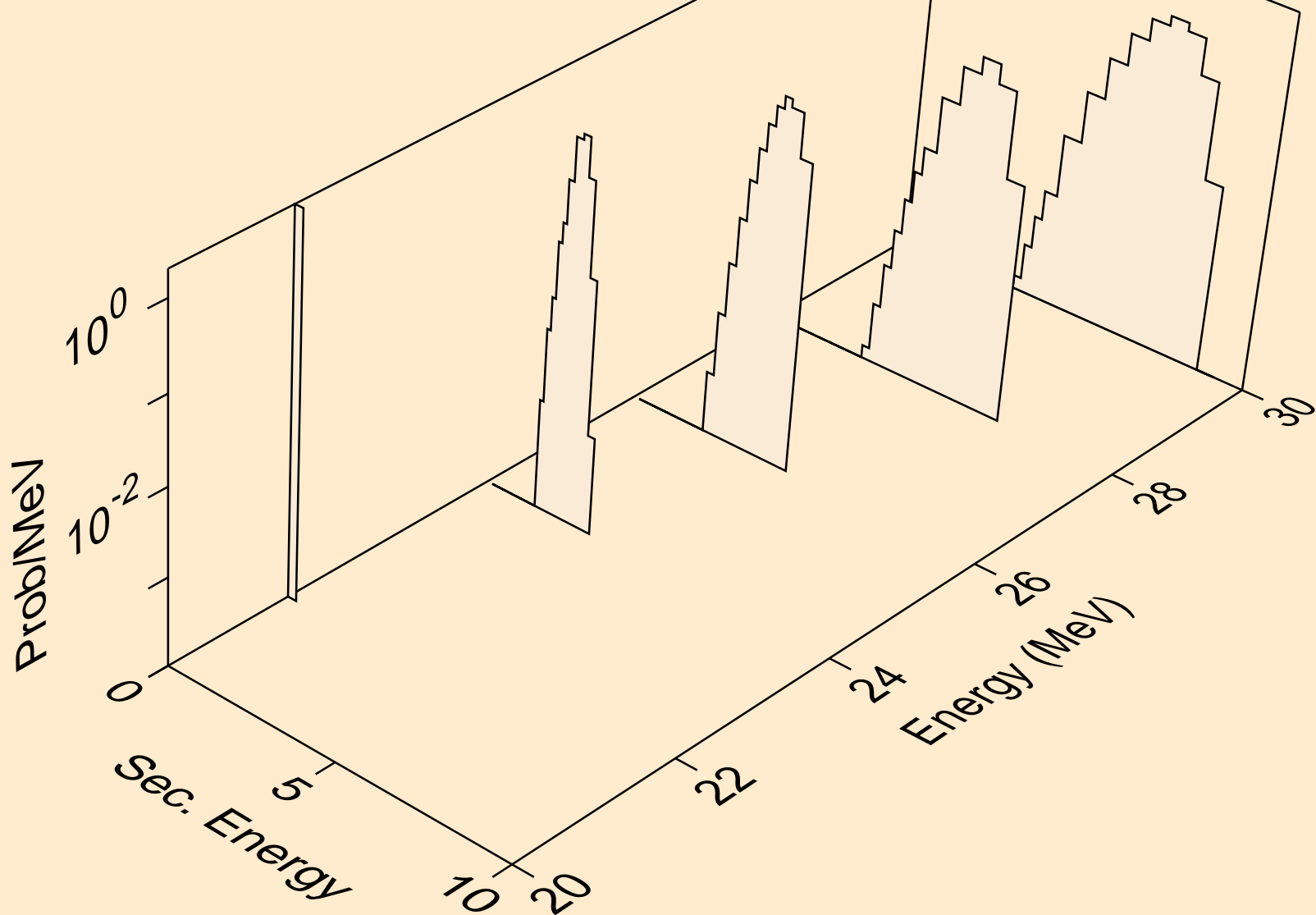

OS199 NEUTRON ACER TENDL-2023 LIBRARY; T=0.K
protons from (n,p)

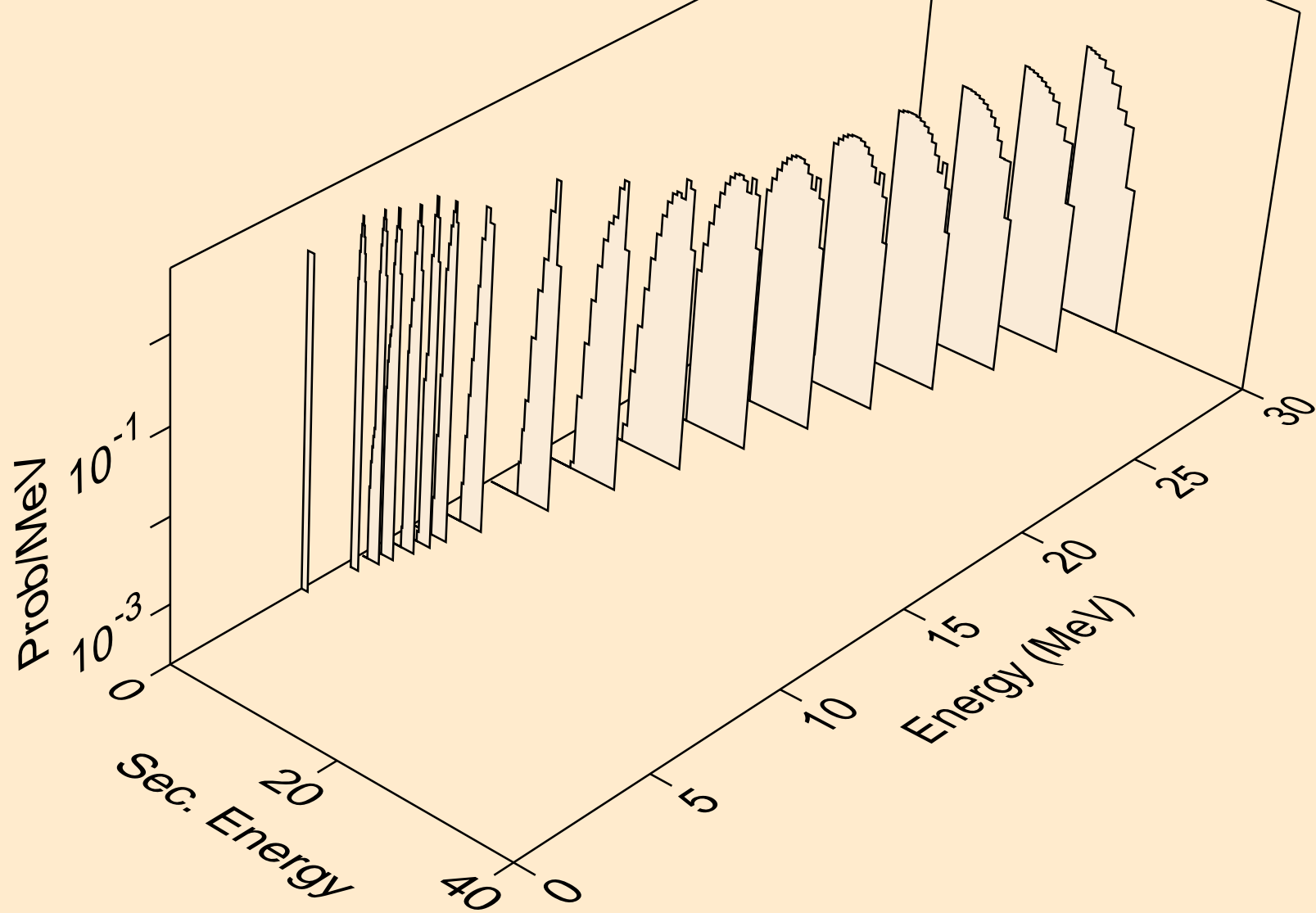

OS199 NEUTRON ACER TENDL-2023 LIBRARY; T=0.K
protons from (n,2p)

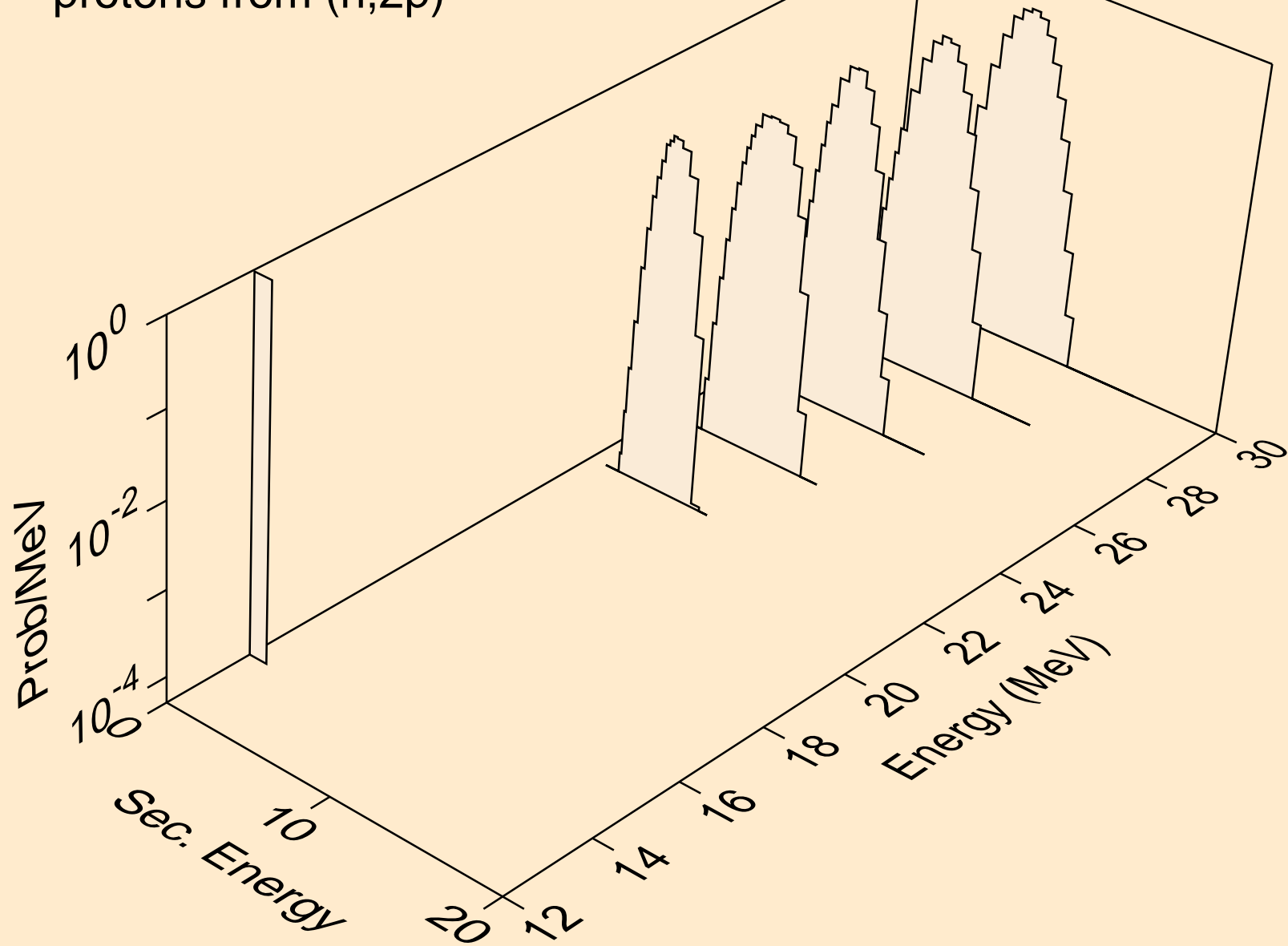

OS199 NEUTRON ACER TENDL-2023 LIBRARY; T=0.K
deuterons from (n,x)

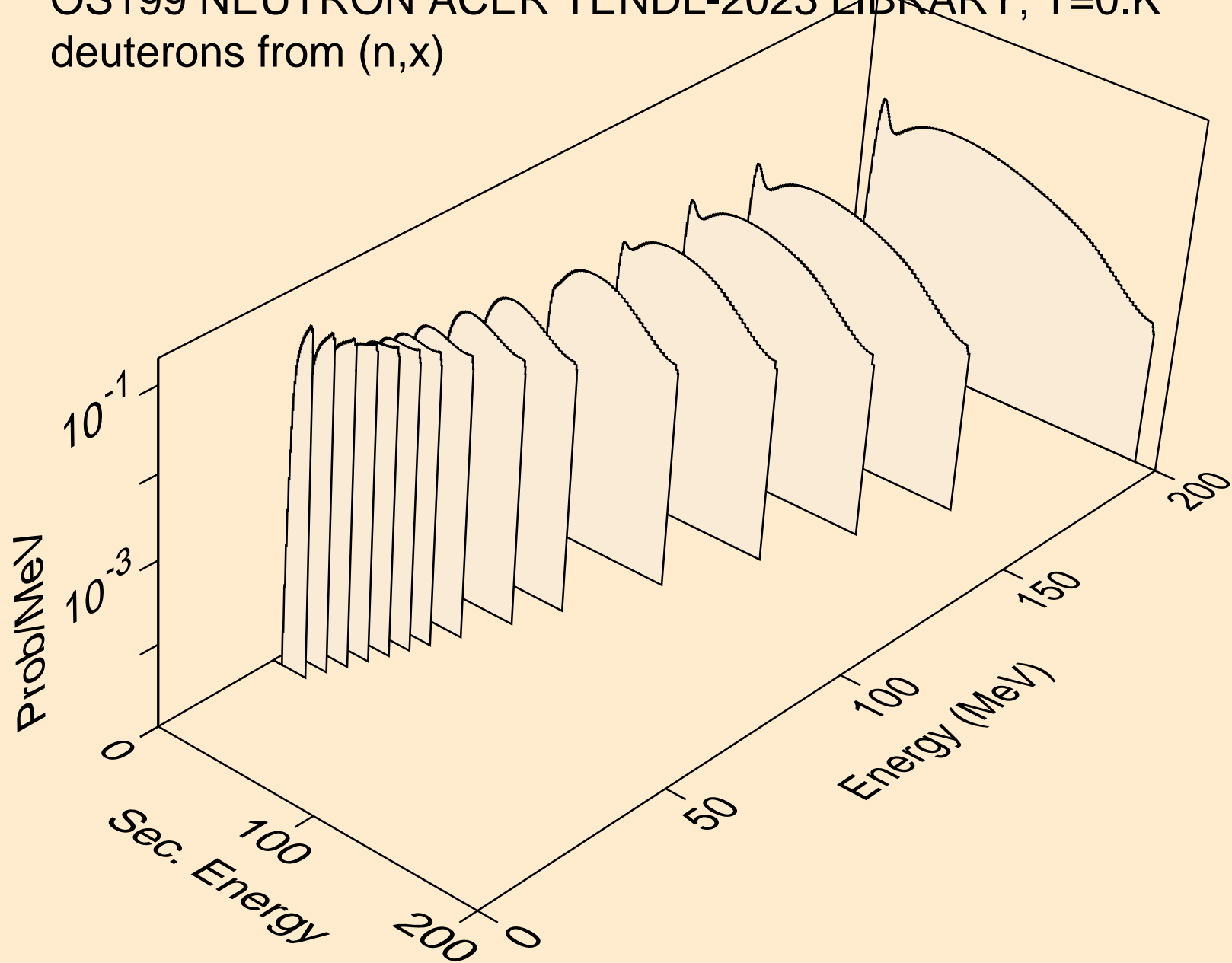

OS199 NEUTRON ACER TENDL-2023 LIBRARY; T=0.K
deuterons from (n,2nd)

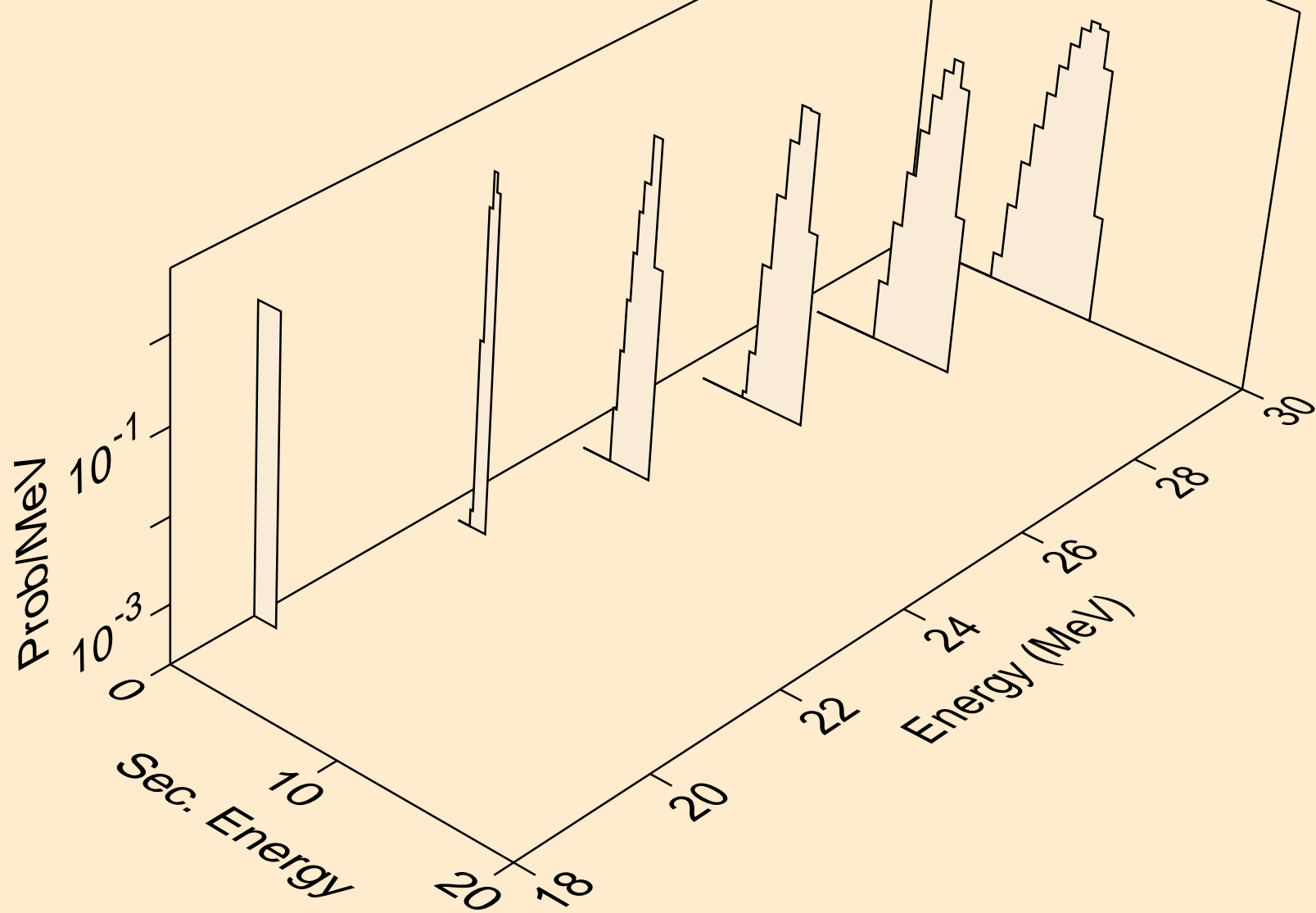

OS199 NEUTRON ACER TENDL-2023 LIBRARY; T=0.K
deuterons from (n,n*)d

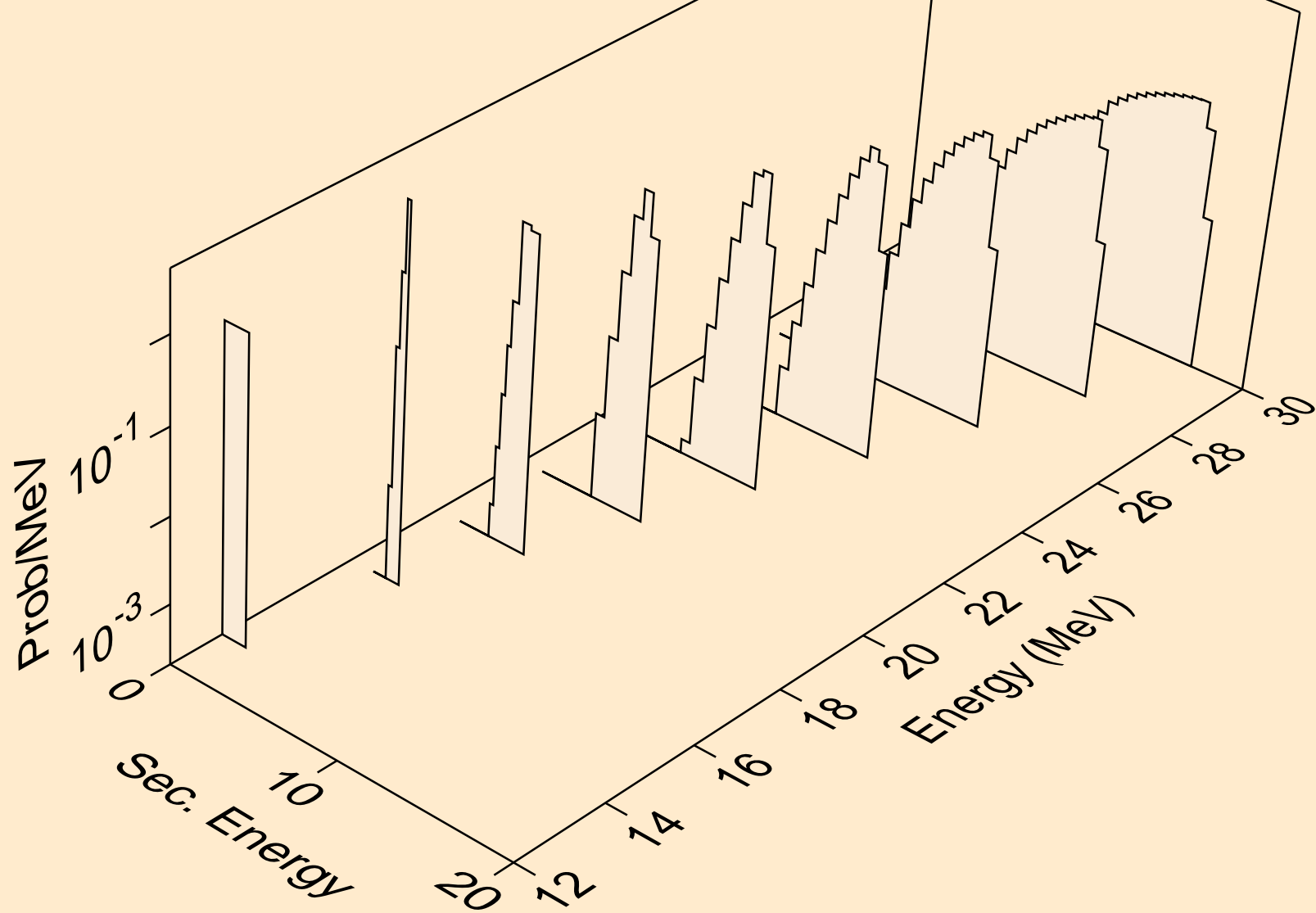

OS199 NEUTRON ACER TENDL-2023 LIBRARY; T=0.K
deuterons from (n,d)

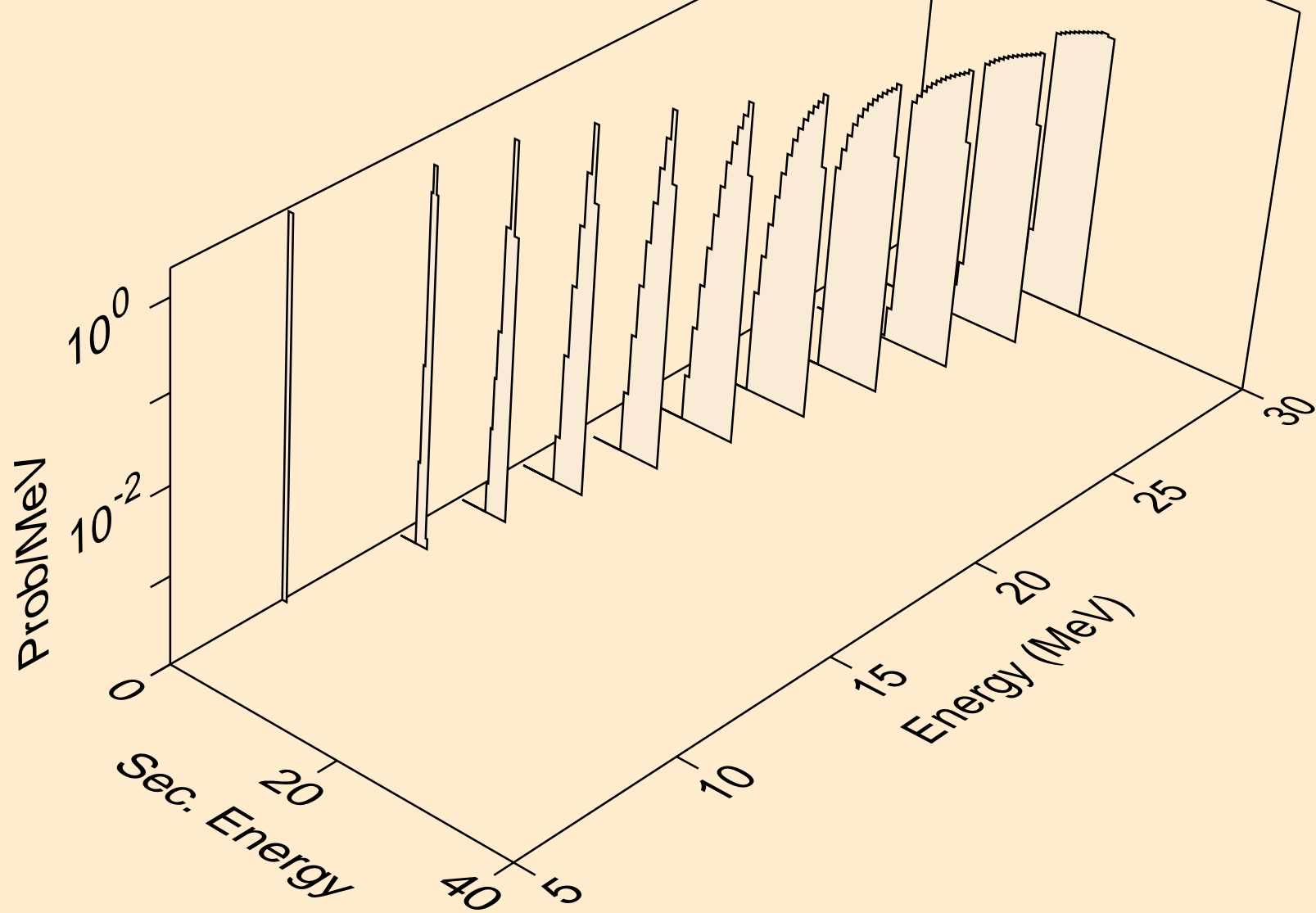

OS199 NEUTRON ACER TENDL-2023 LIBRARY; T=0.K
tritons from (n,x)

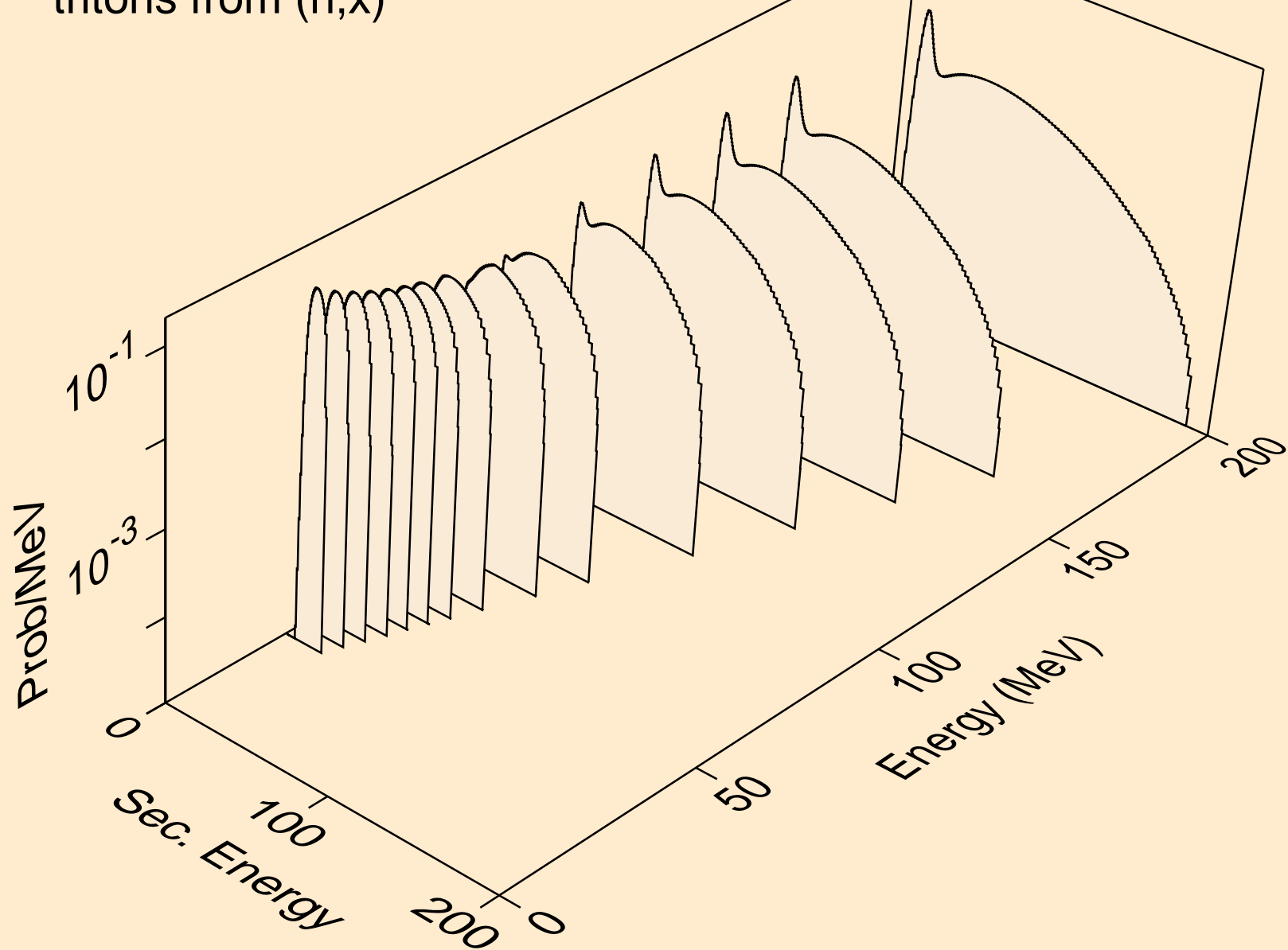

OS199 NEUTRON ACER TENDL-2023 LIBRARY; T=0.K
tritons from (n,n*)t

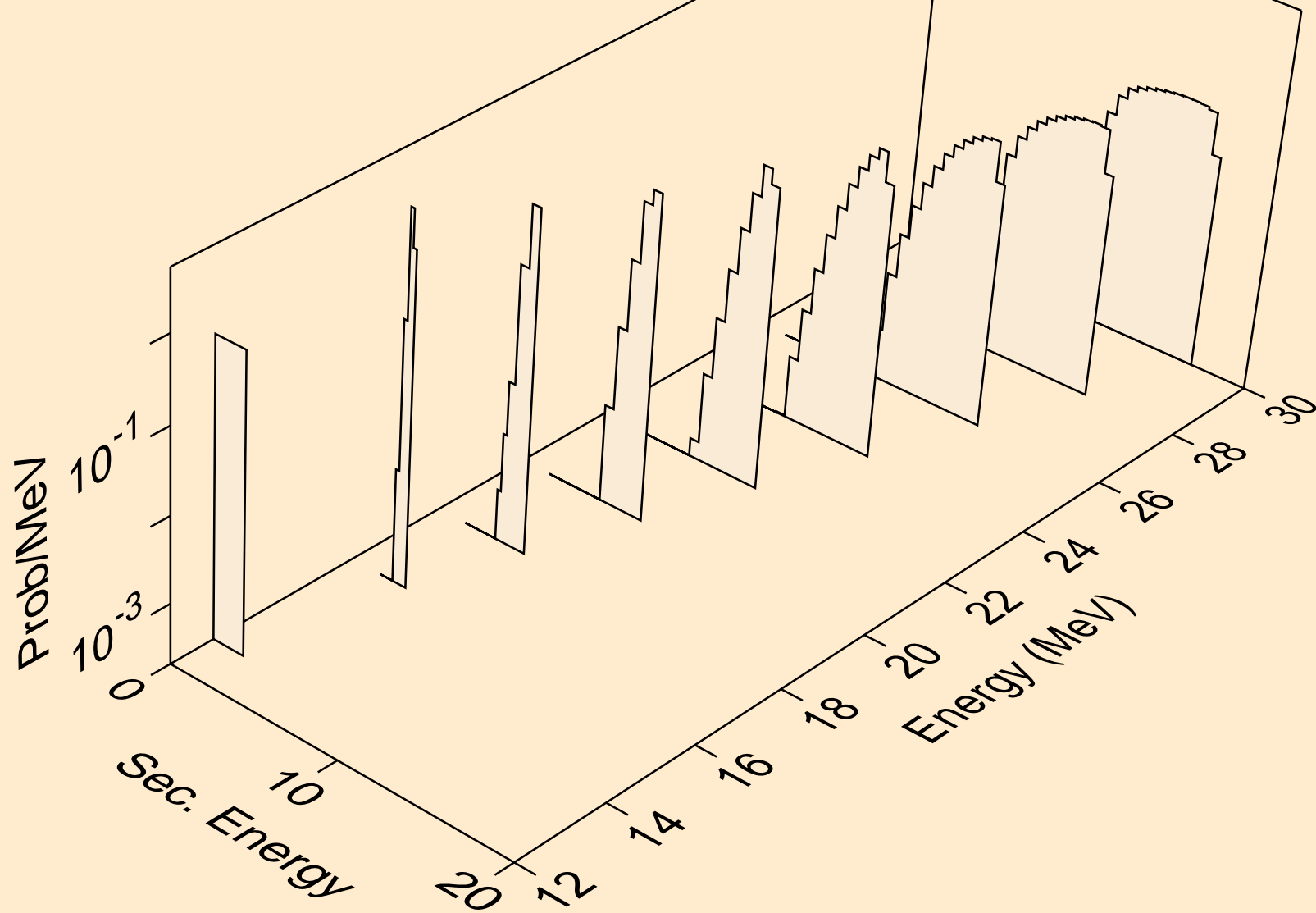

OS199 NEUTRON ACER TENDL-2023 LIBRARY; T=0.K
tritons from (n,t)

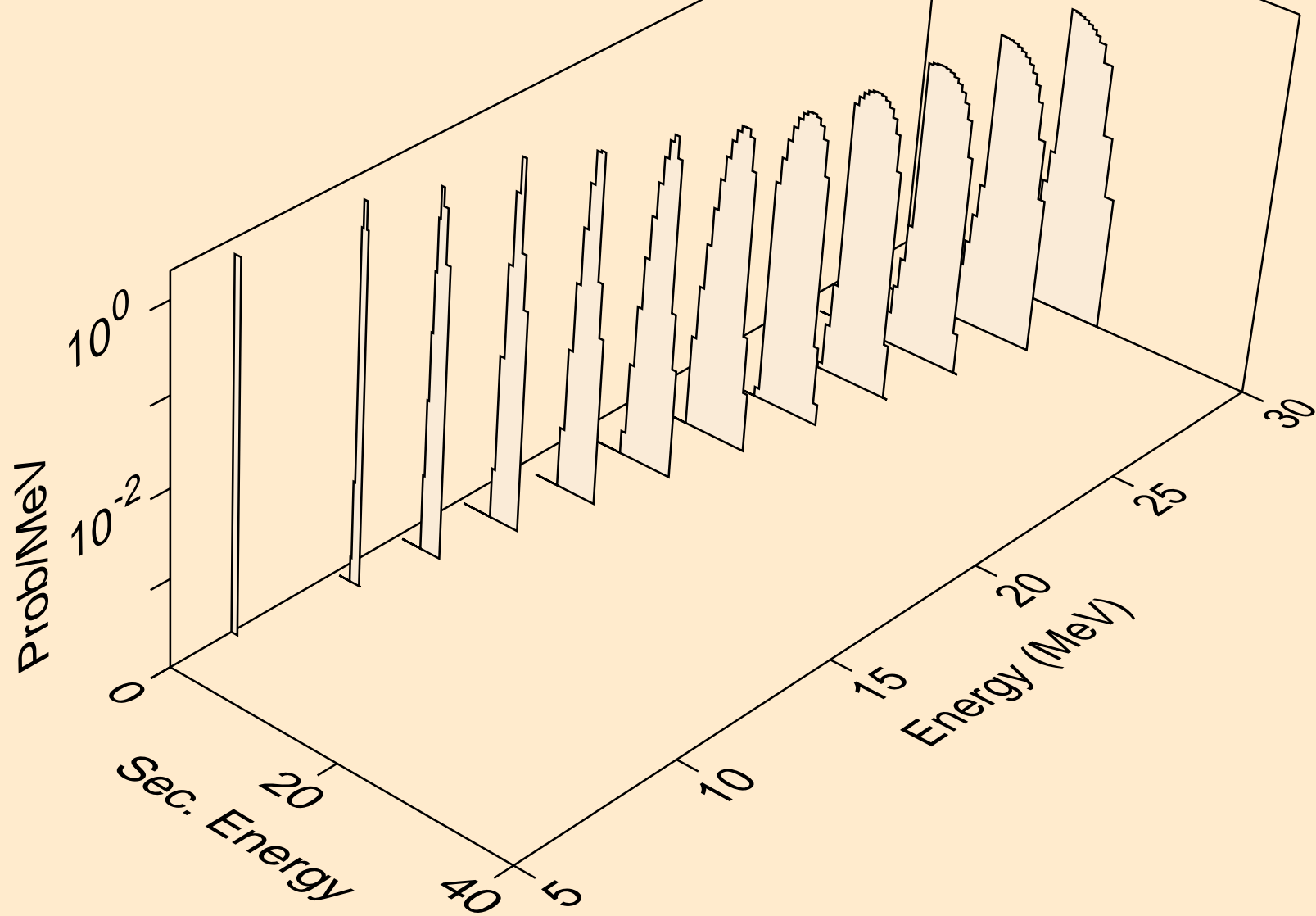

OS199 NEUTRON ACER TENDL-2023 LIBRARY; T=0.K
he3s from (n,x)

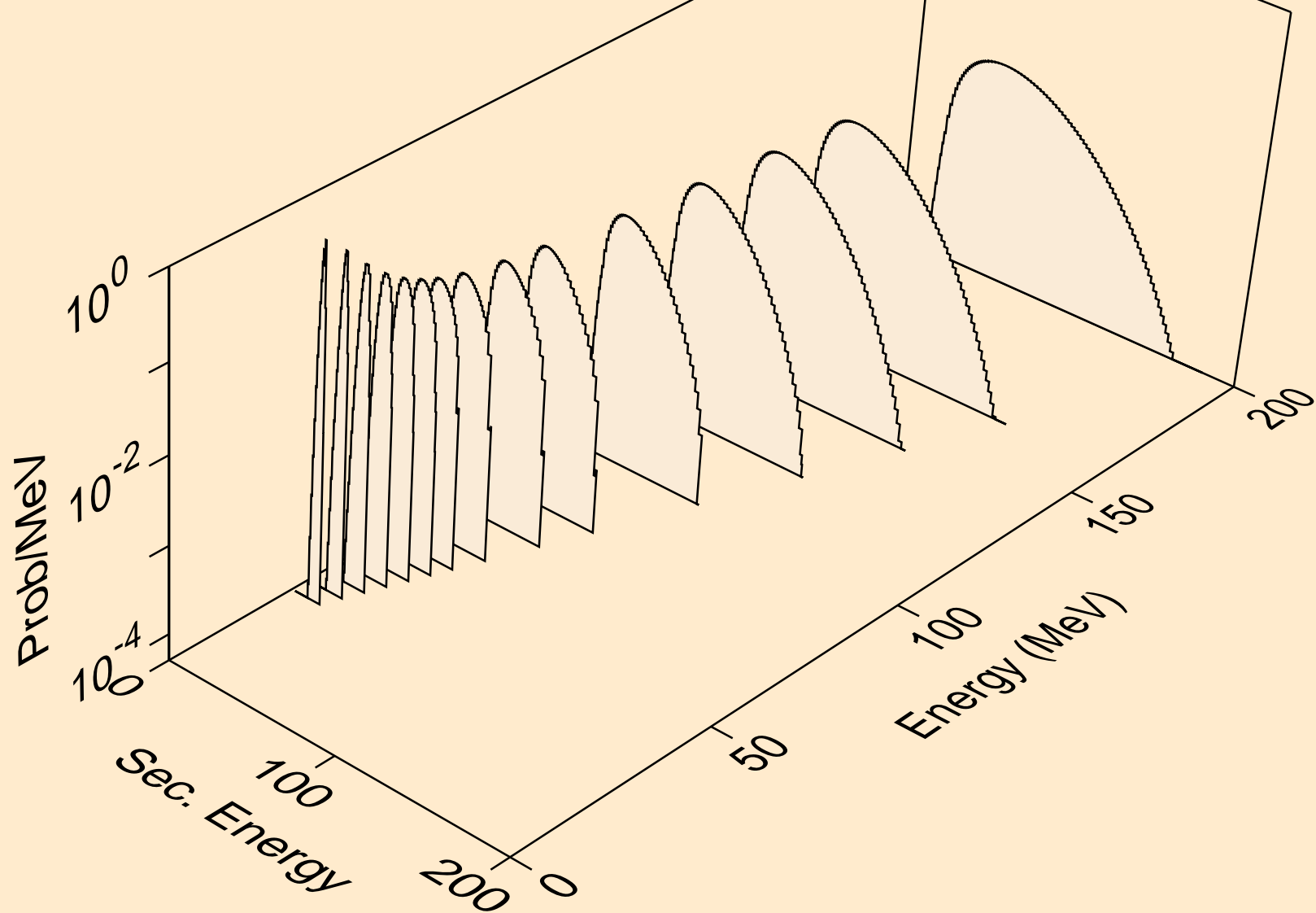

OS199 NEUTRON ACER TENDL-2023 LIBRARY; T=0.K
he3s from (n,n*)he3

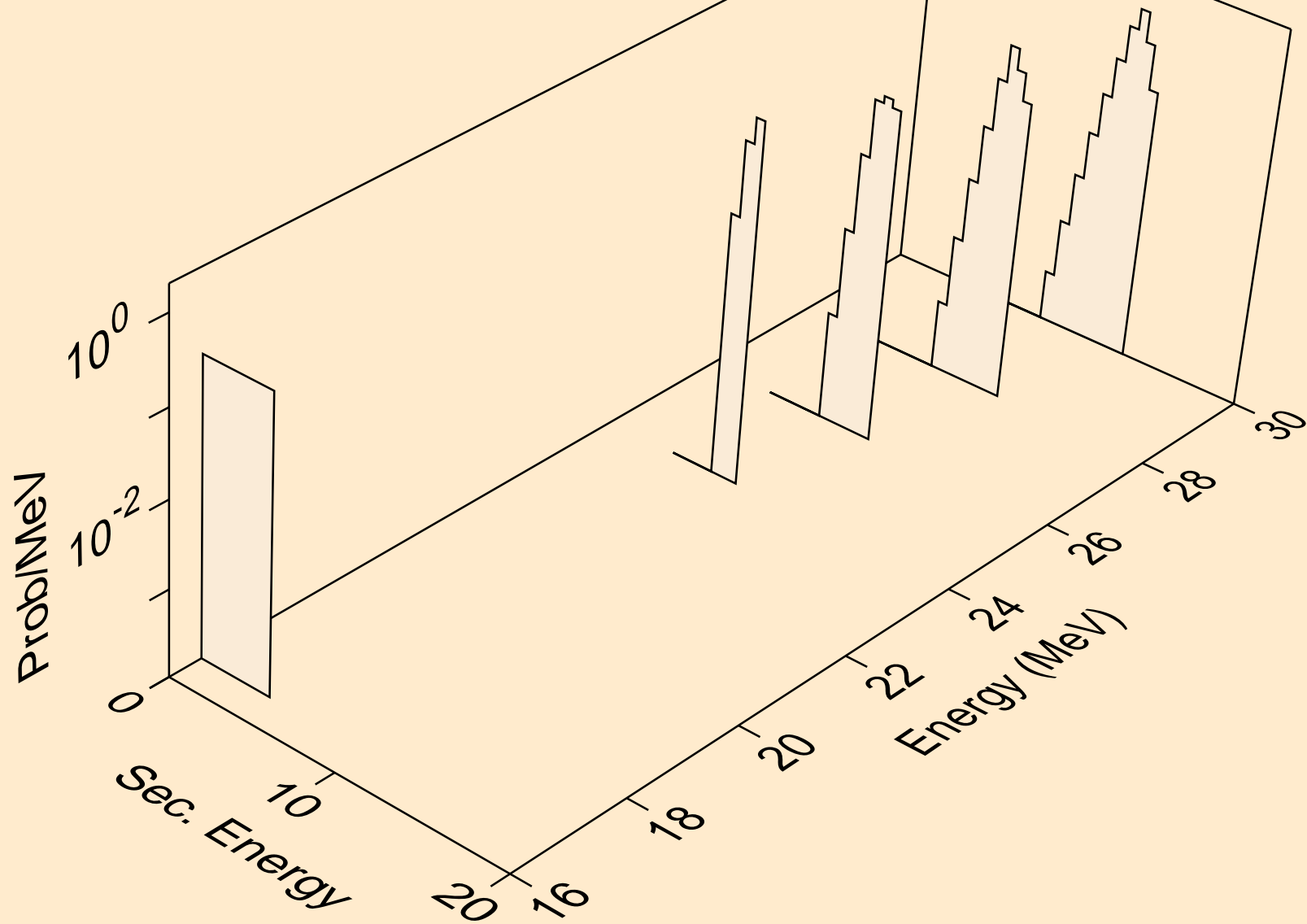

OS199 NEUTRON ACER TENDL-2023 LIBRARY; T=0.K
he3s from (n,he3)

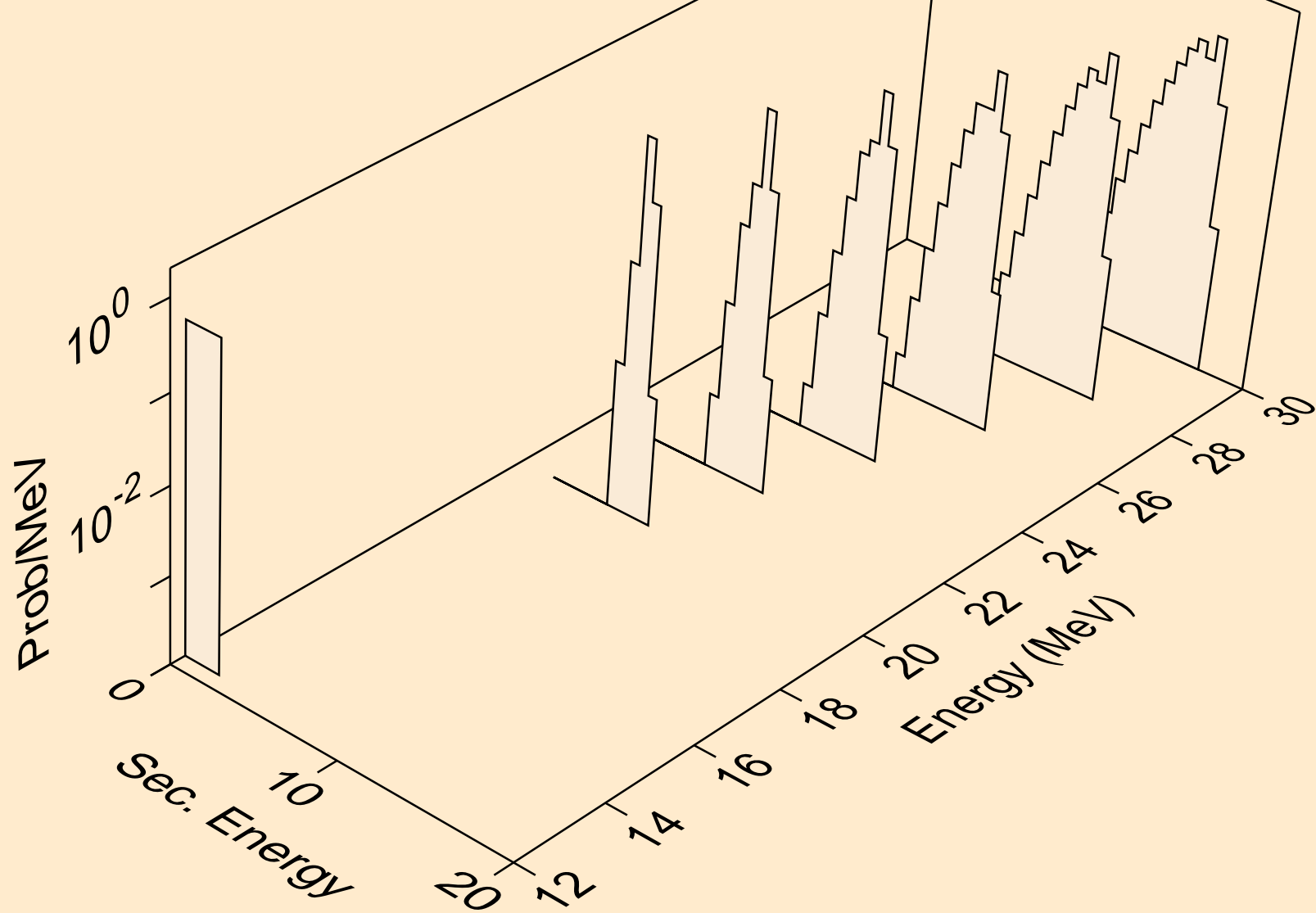

OS199 NEUTRON ACER TENDL-2023 LIBRARY; T=0.K
alphas from (n,x)

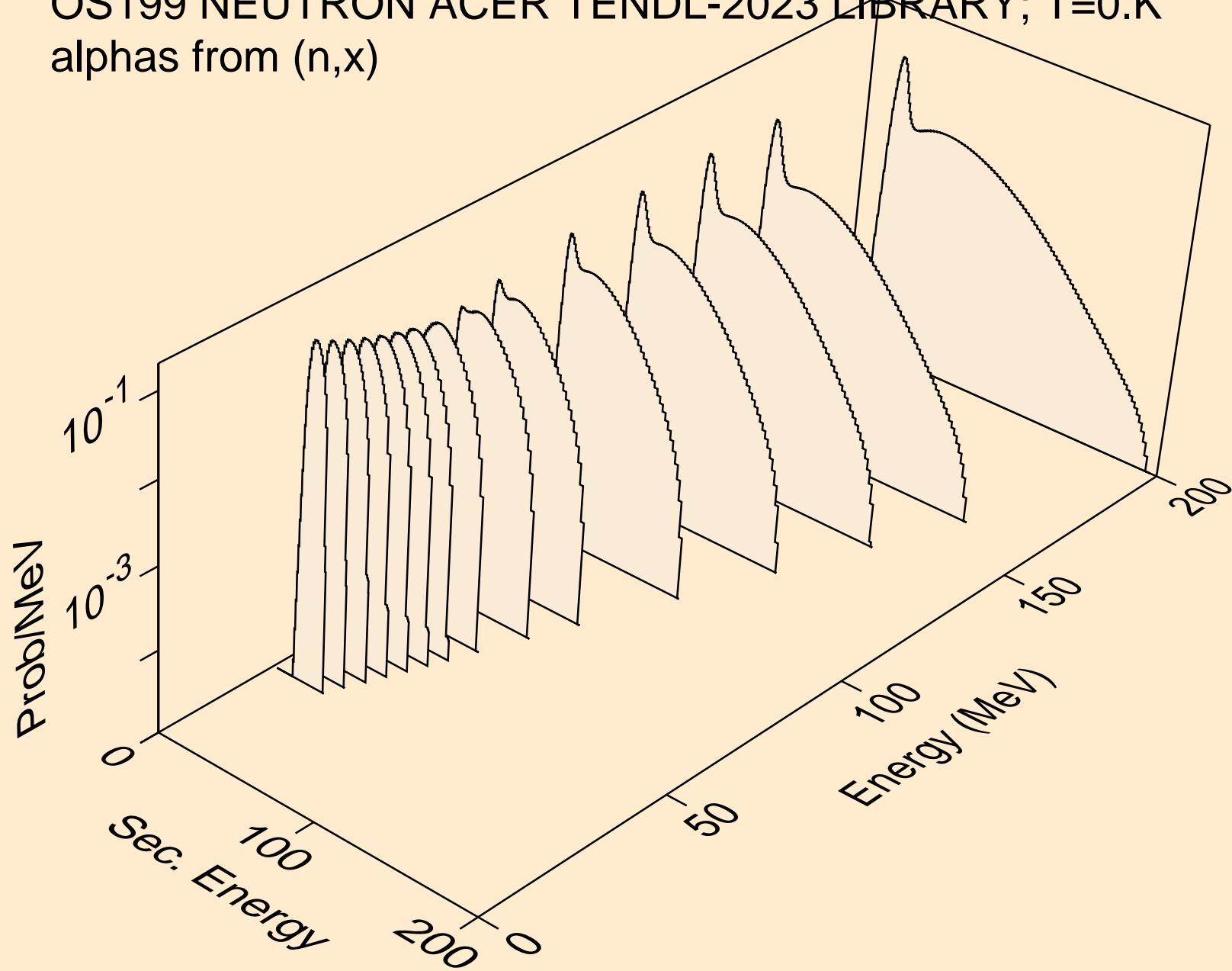

OS199 NEUTRON ACER TENDL-2023 LIBRARY; T=0.K
alphas from (n,n*)a

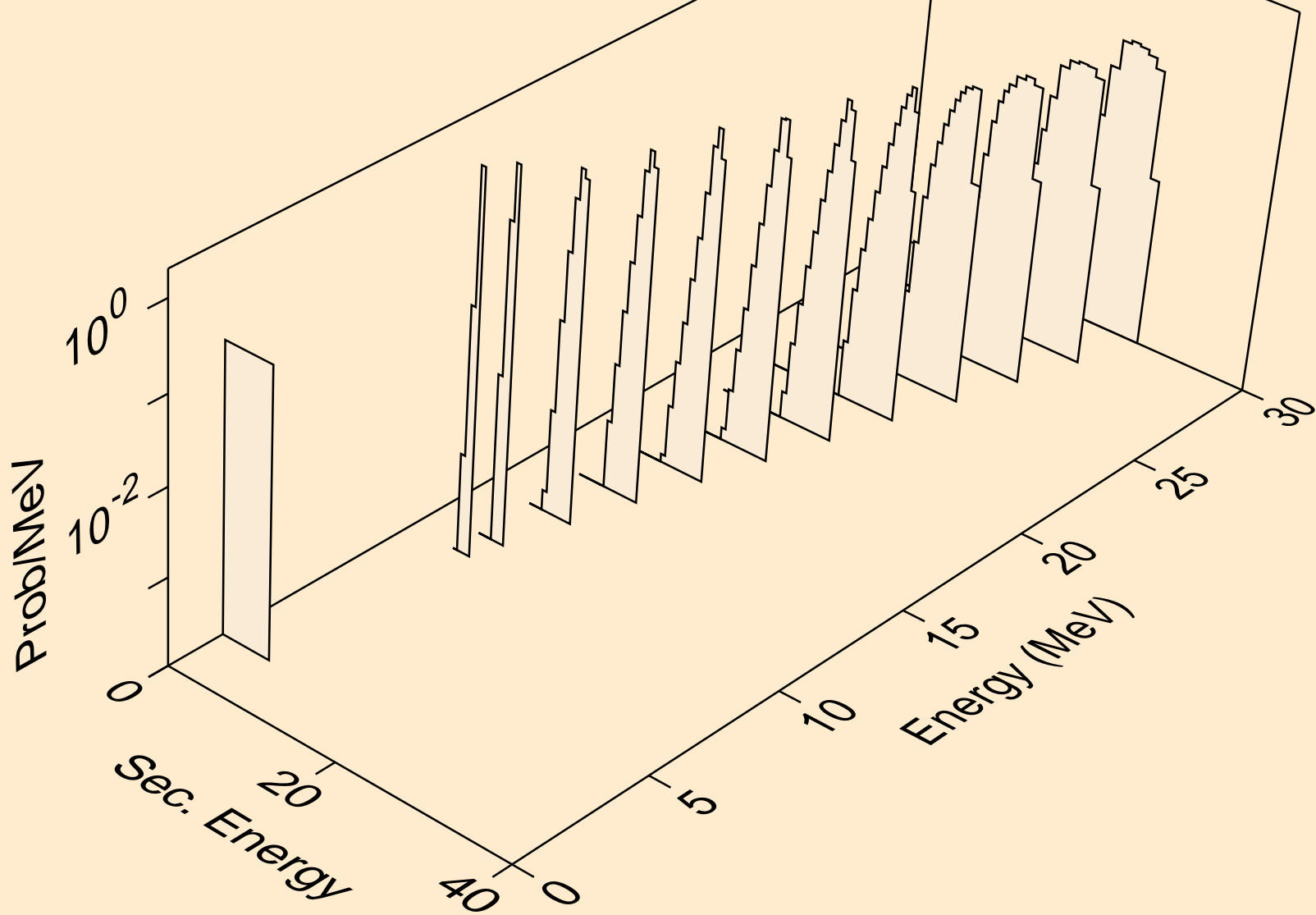

OS199 NEUTRON ACER TENDL-2023 LIBRARY; T=0.K
alphas from (n,2n)a

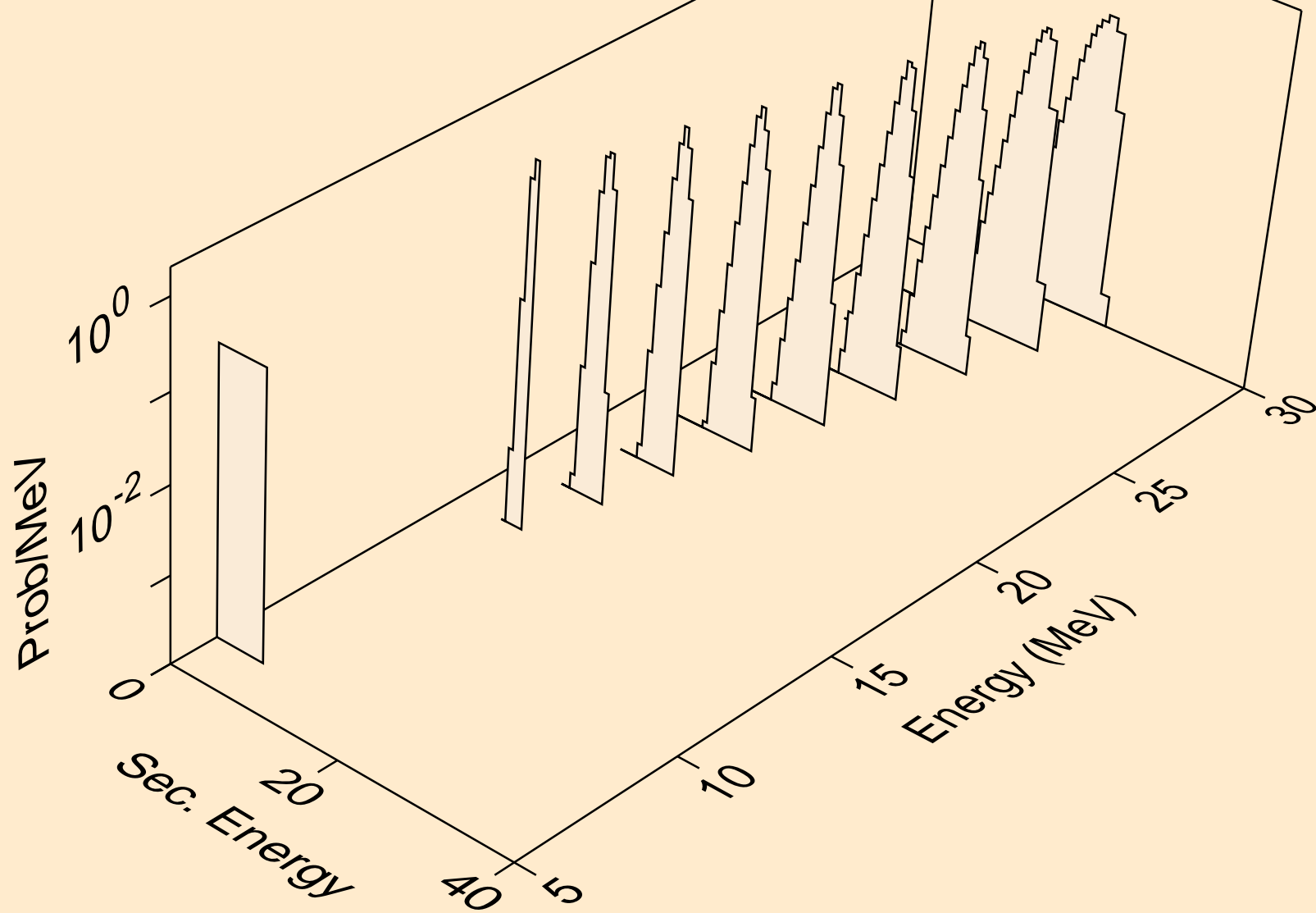

OS199 NEUTRON ACER TENDL-2023 LIBRARY; T=0.K
alphas from (n,3n)a

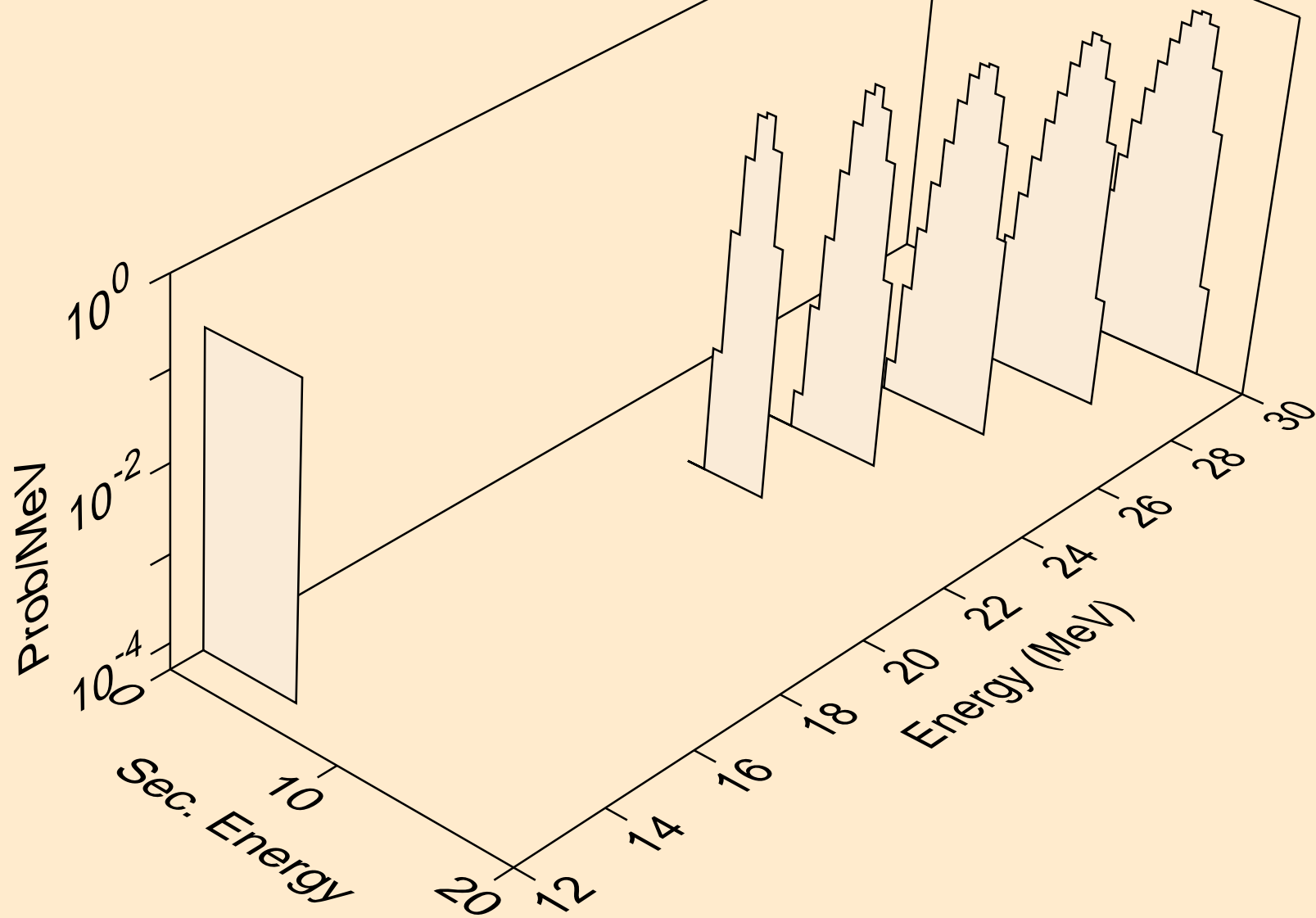

OS199 NEUTRON ACER TENDL-2023 LIBRARY; T=0.K
alphas from (n,a)

