

# PB185 NEUTRON ACER TENDL-2023 LIBRARY; T=0.K

## Principal cross sections

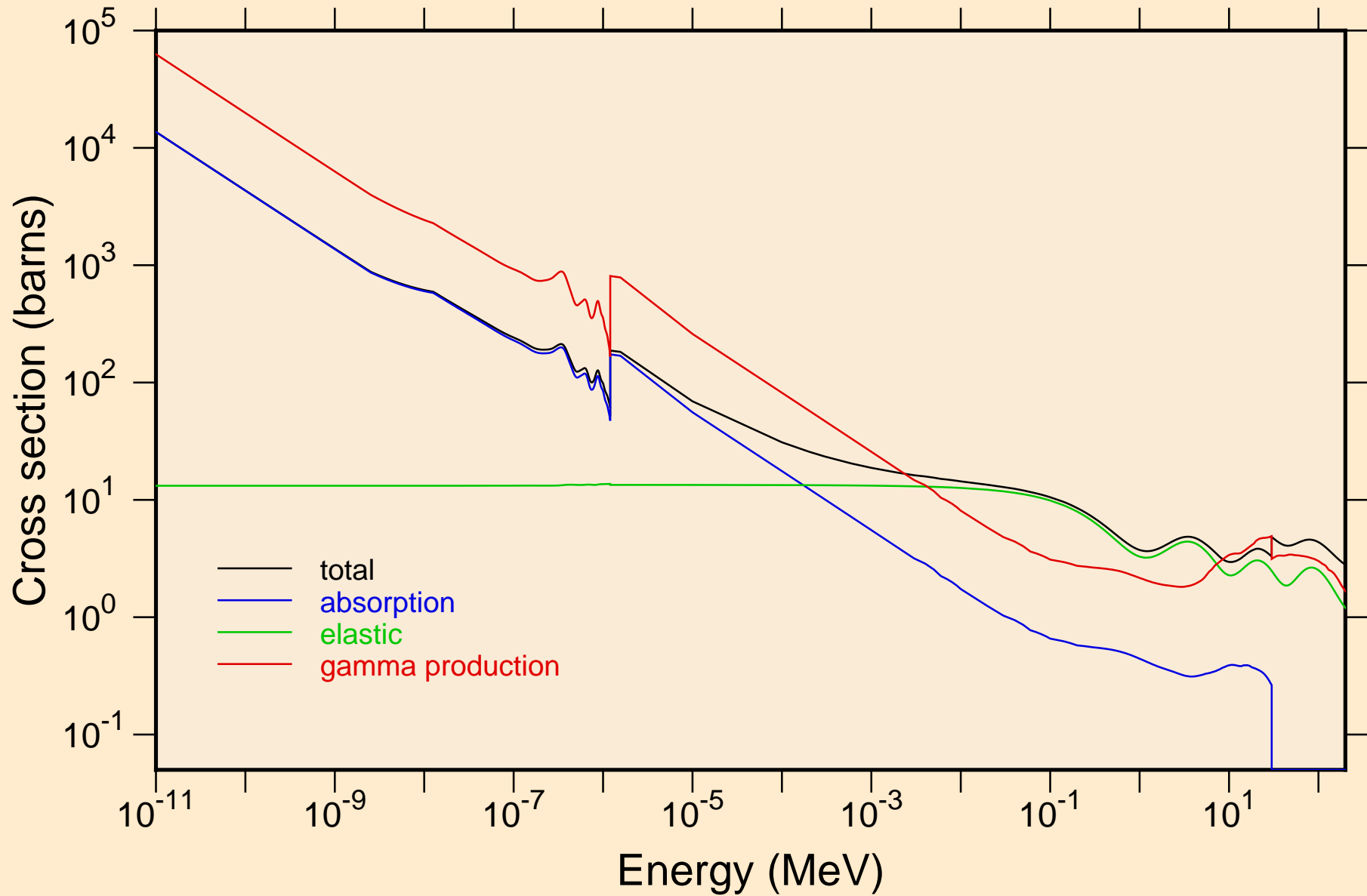

# PB185 NEUTRON ACER TENDL-2023 LIBRARY; T=0.K

## Heating

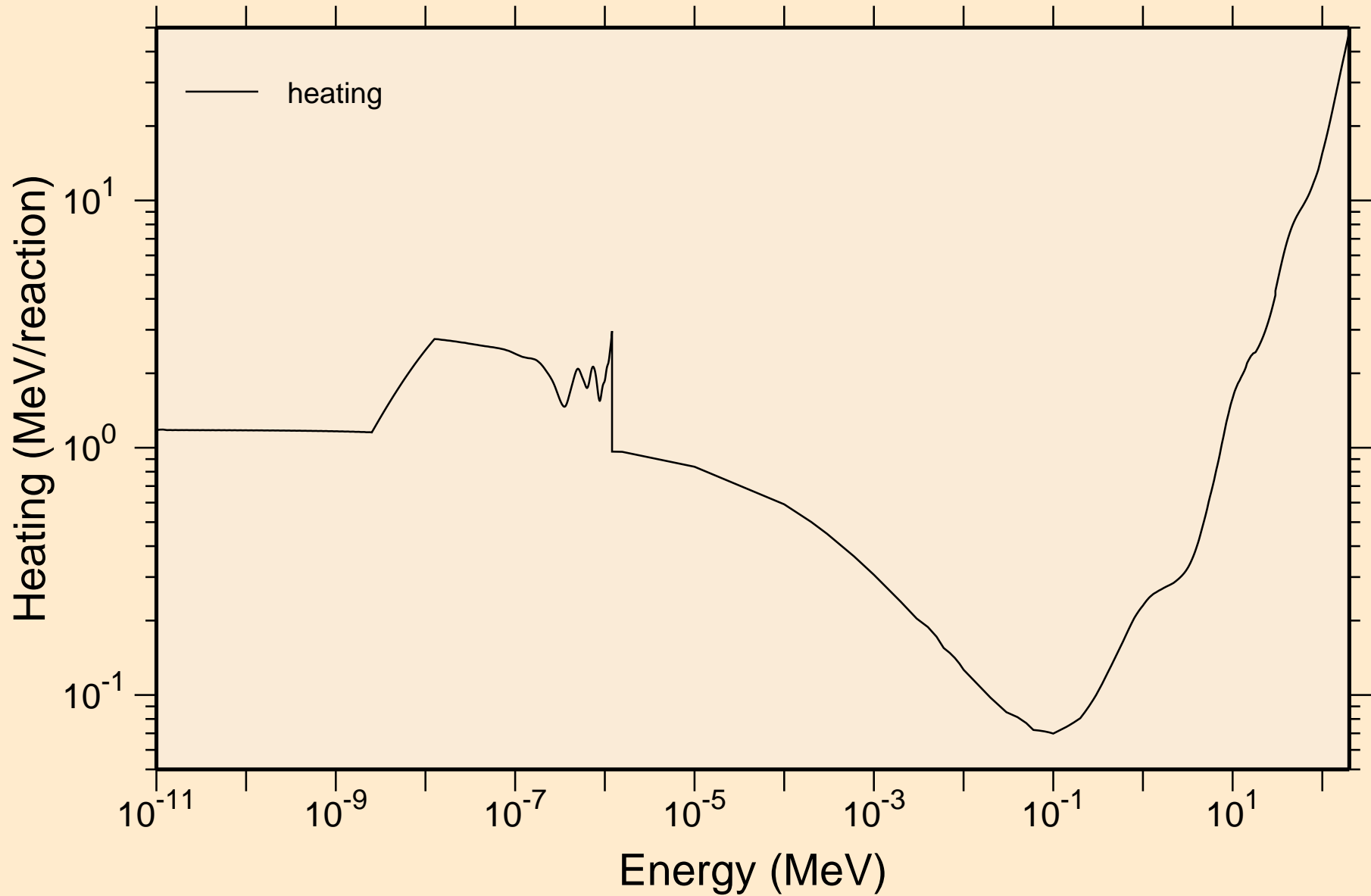

PB185 NEUTRON ACER TENDL-2023 LIBRARY; T=0.K  
Damage

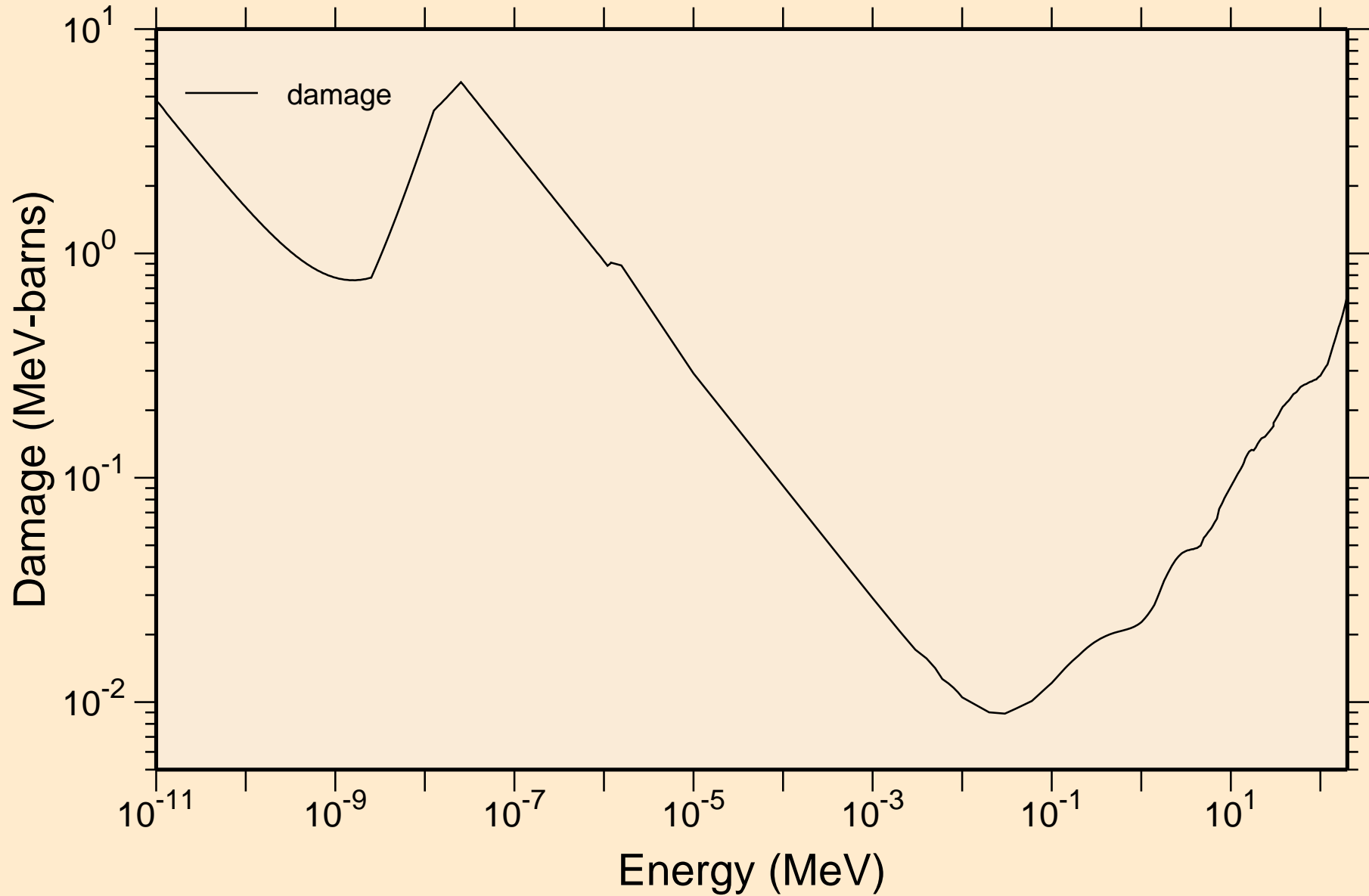

PB185 NEUTRON ACER TENDL-2023 LIBRARY; T=0.K  
Non-threshold reactions

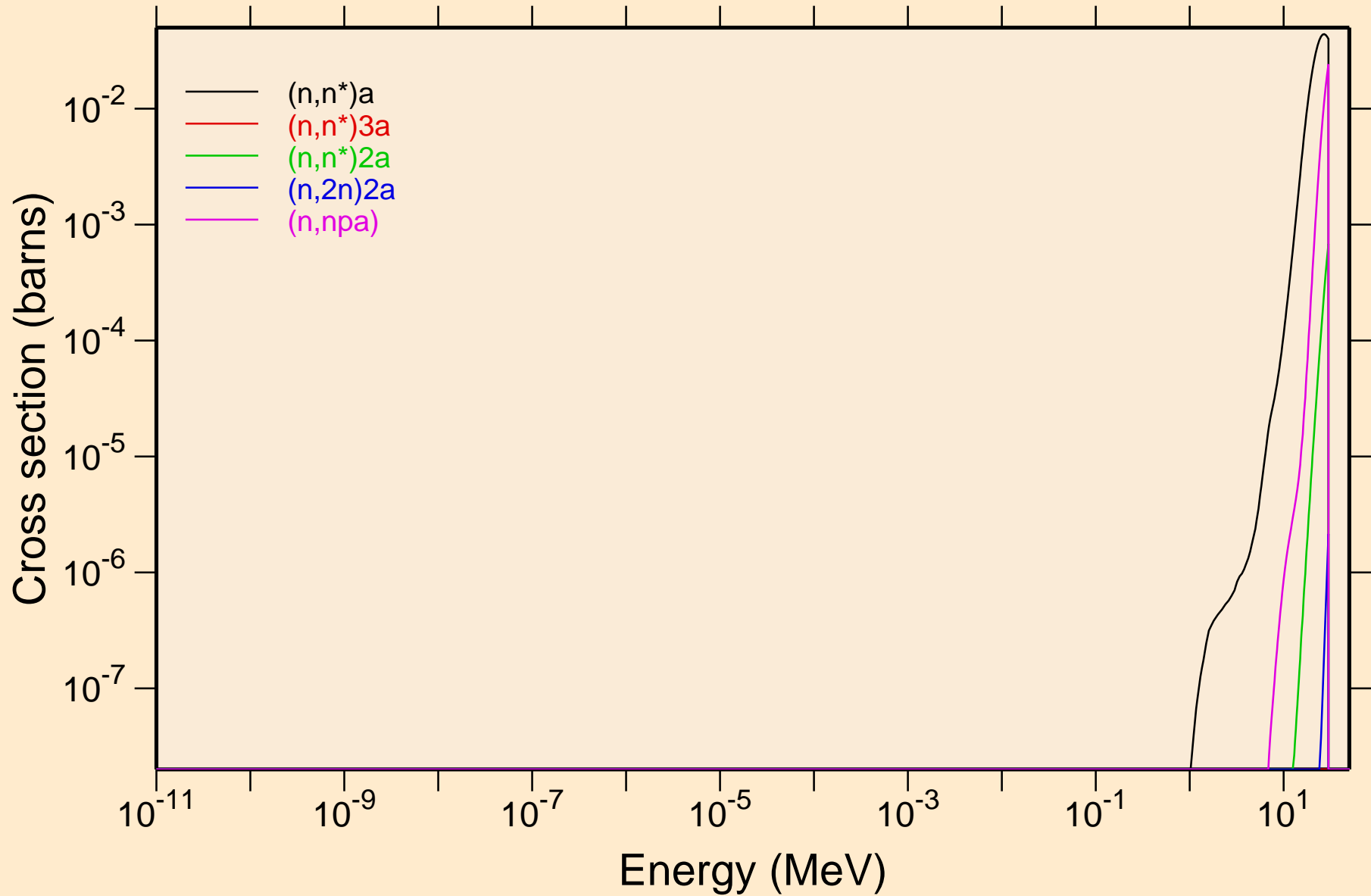

PB185 NEUTRON ACER TENDL-2023 LIBRARY; T=0.K  
Non-threshold reactions

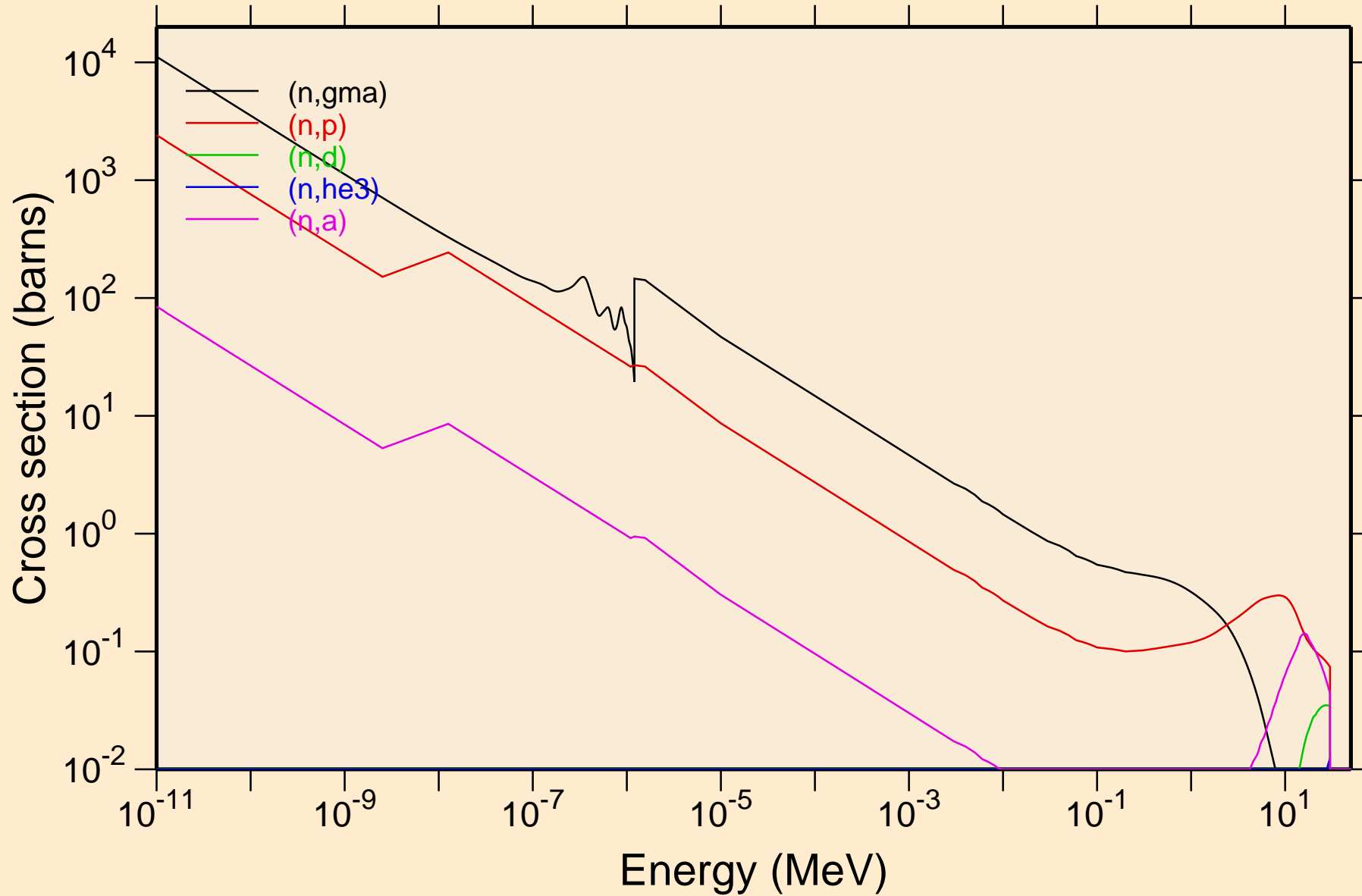

PB185 NEUTRON ACER TENDL-2023 LIBRARY; T=0.K  
Non-threshold reactions

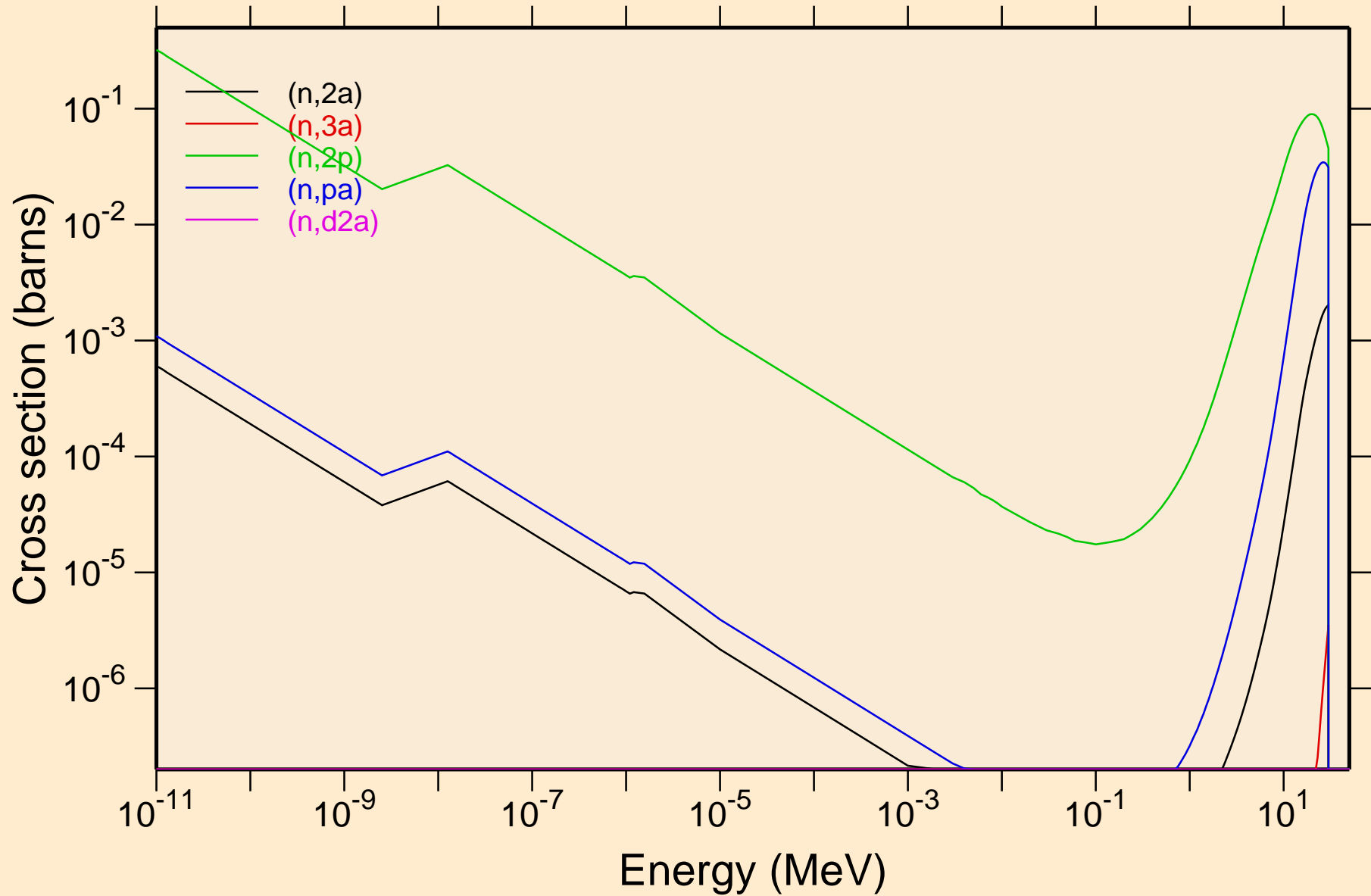

PB185 NEUTRON ACER TENDL-2023 LIBRARY; T=0.K  
Non-threshold reactions

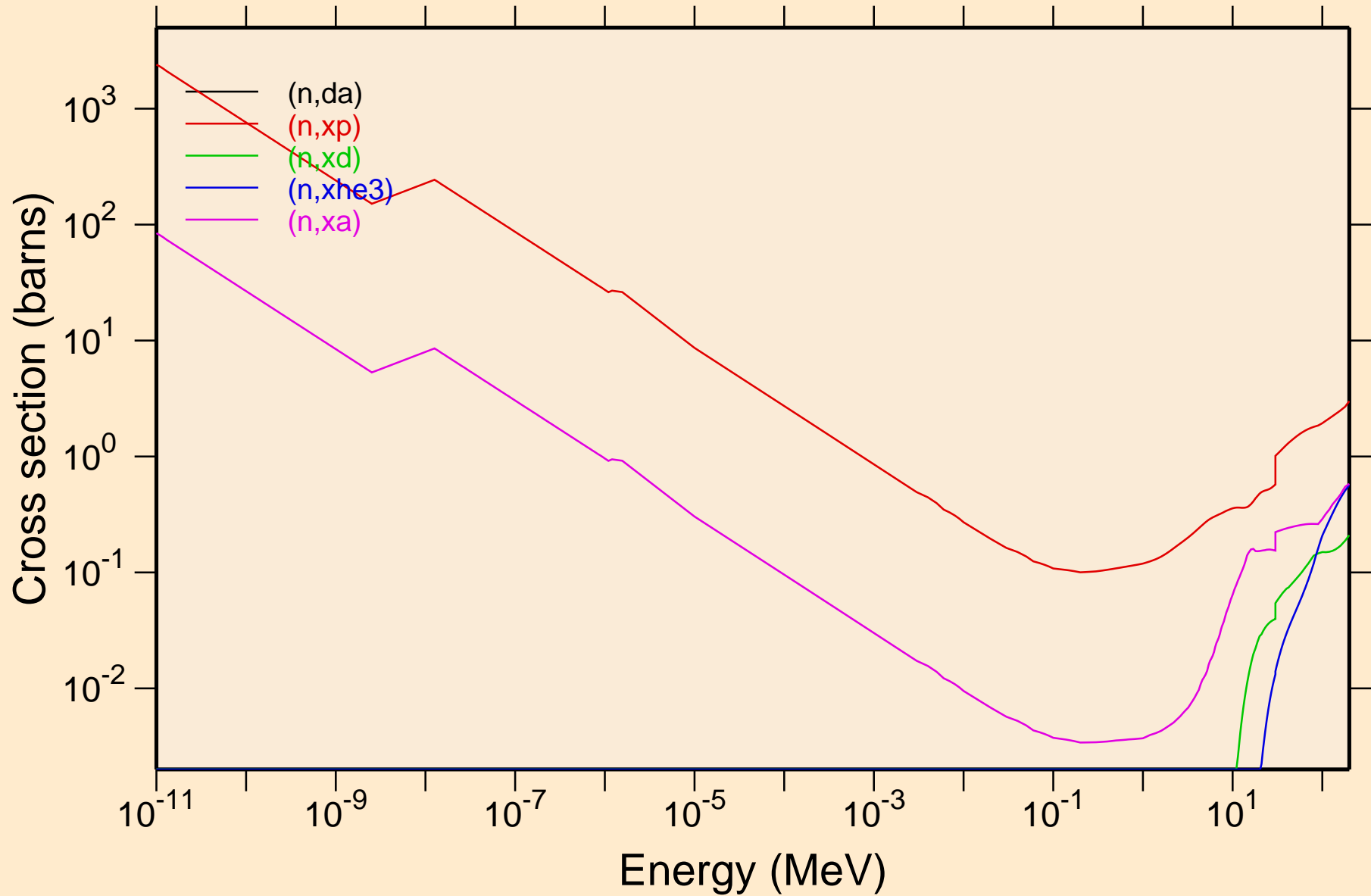

# PB185 NEUTRON ACER TENDL-2023 LIBRARY; T=0.K

## Principal cross sections

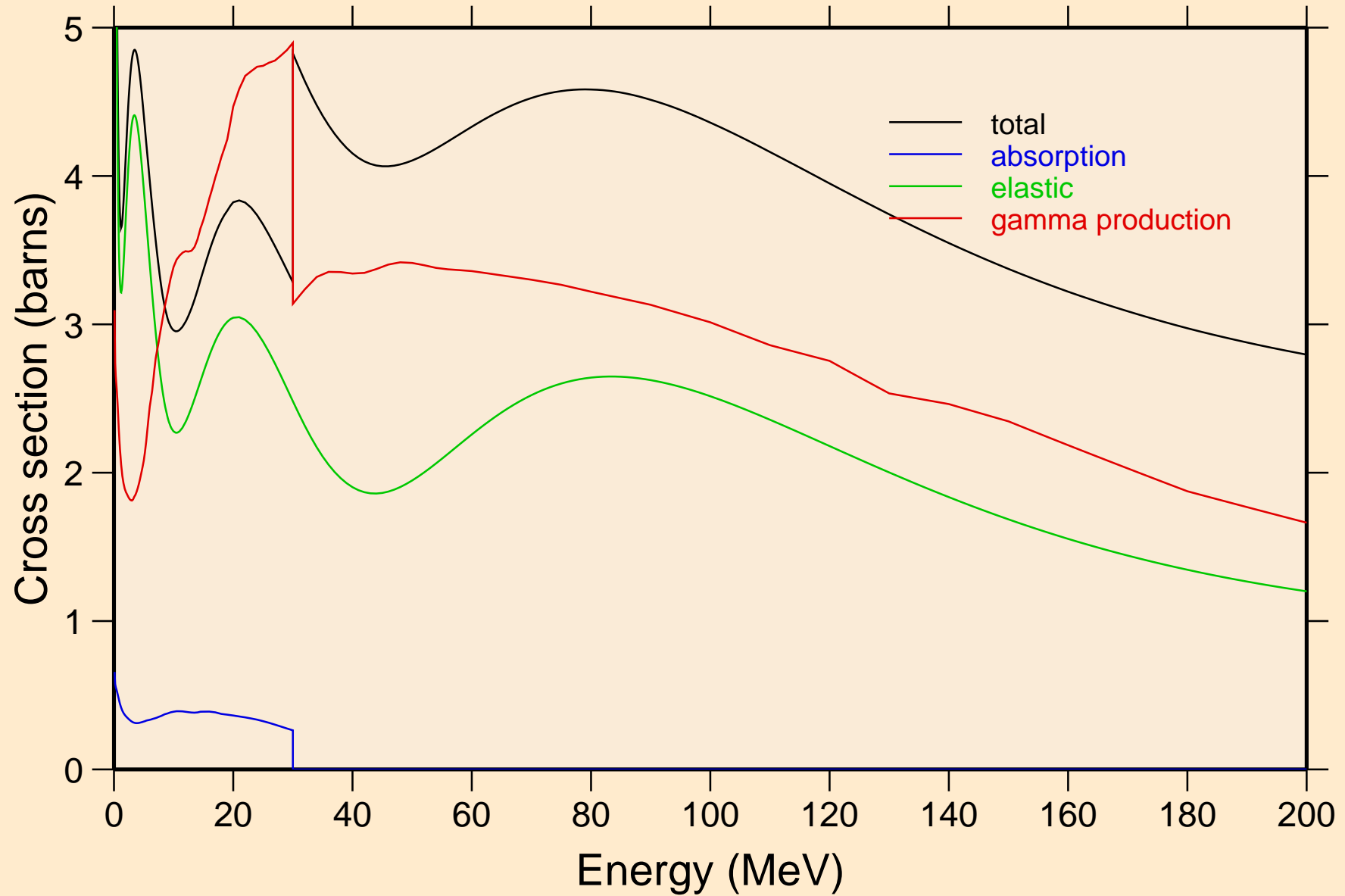

# PB185 NEUTRON ACER TENDL-2023 LIBRARY; T=0.K

## Heating

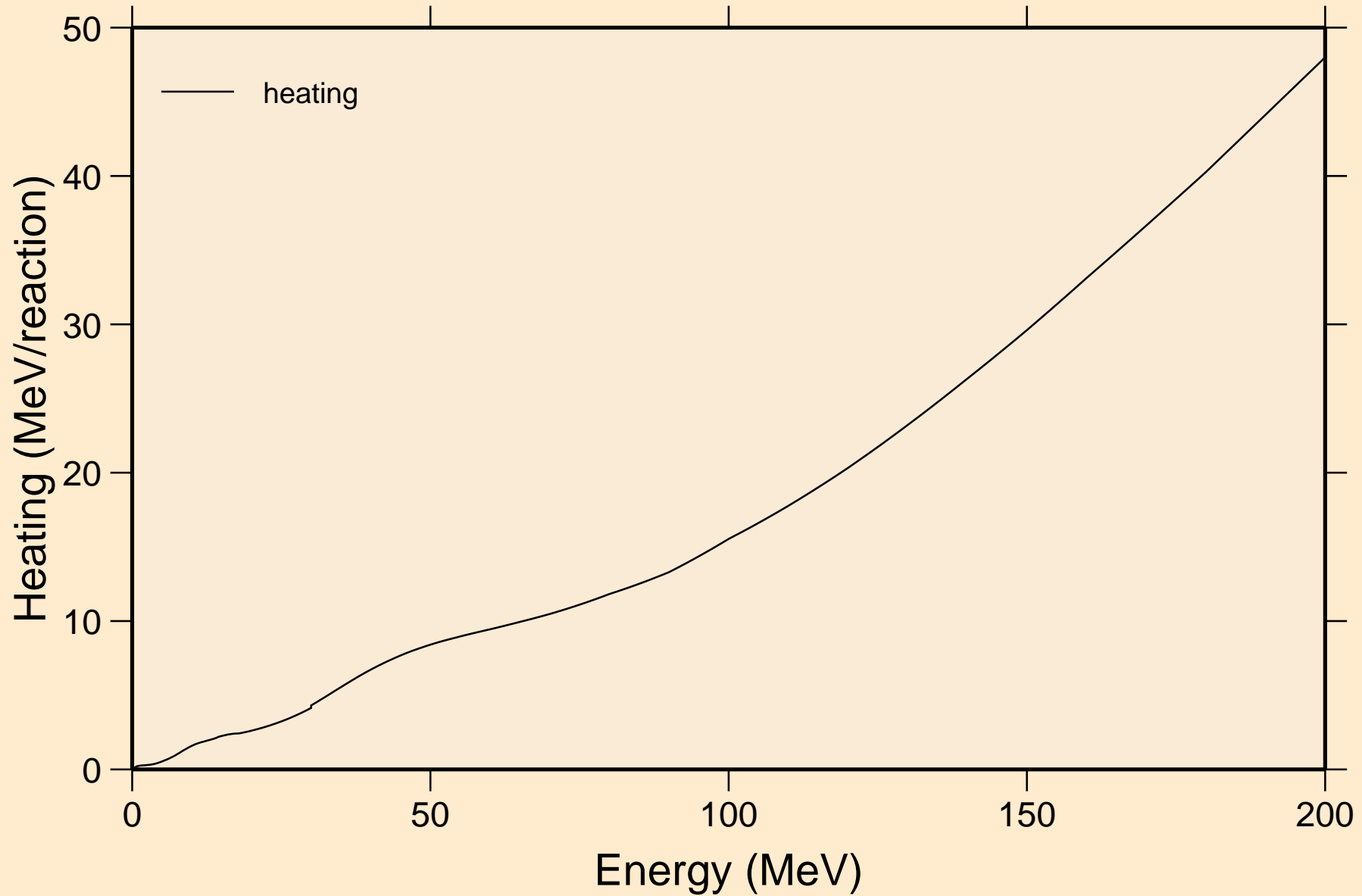

PB185 NEUTRON ACER TENDL-2023 LIBRARY; T=0.K  
Damage

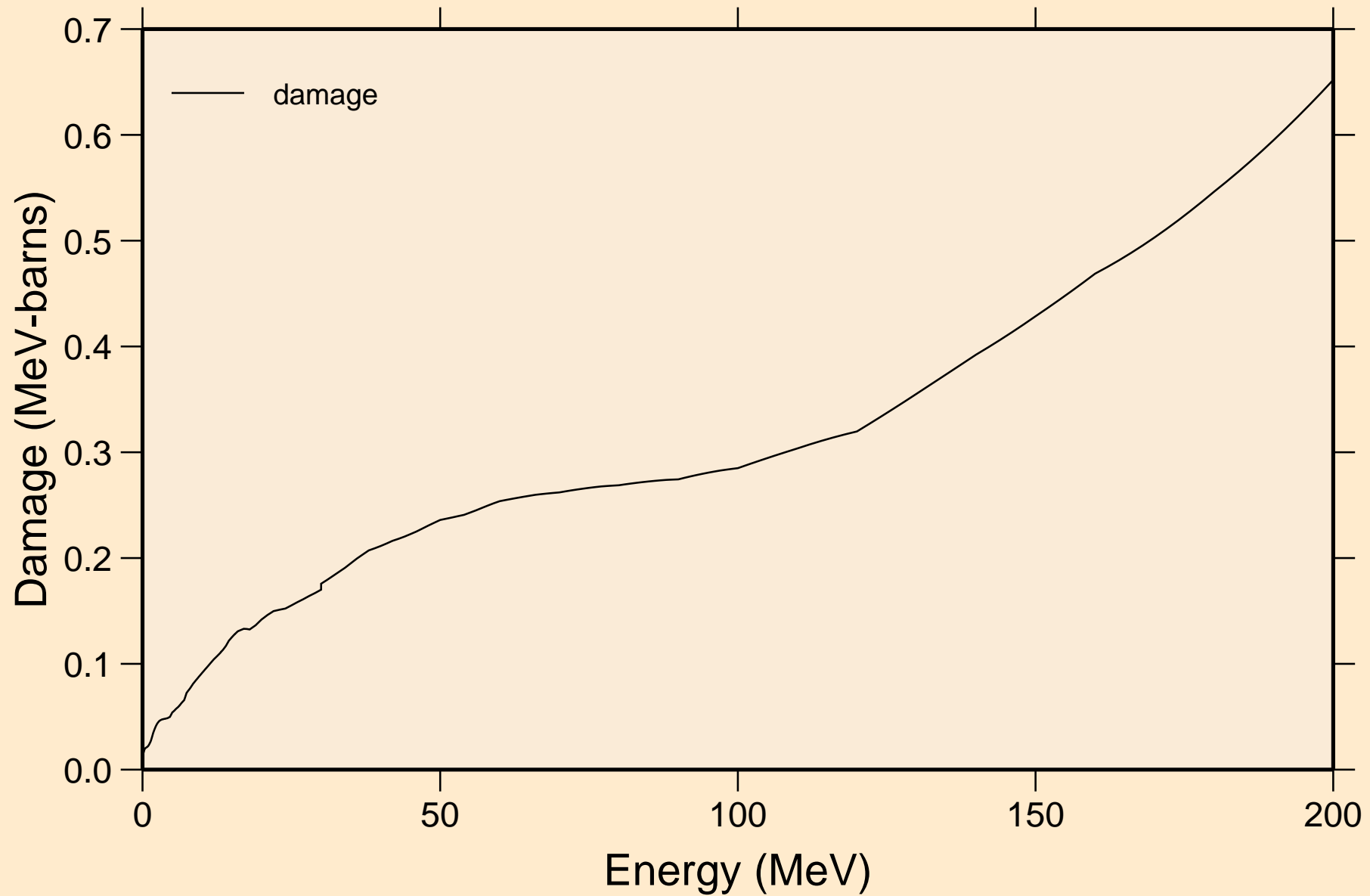

PB185 NEUTRON ACER TENDL-2023 LIBRARY; T=0.K  
Non-threshold reactions

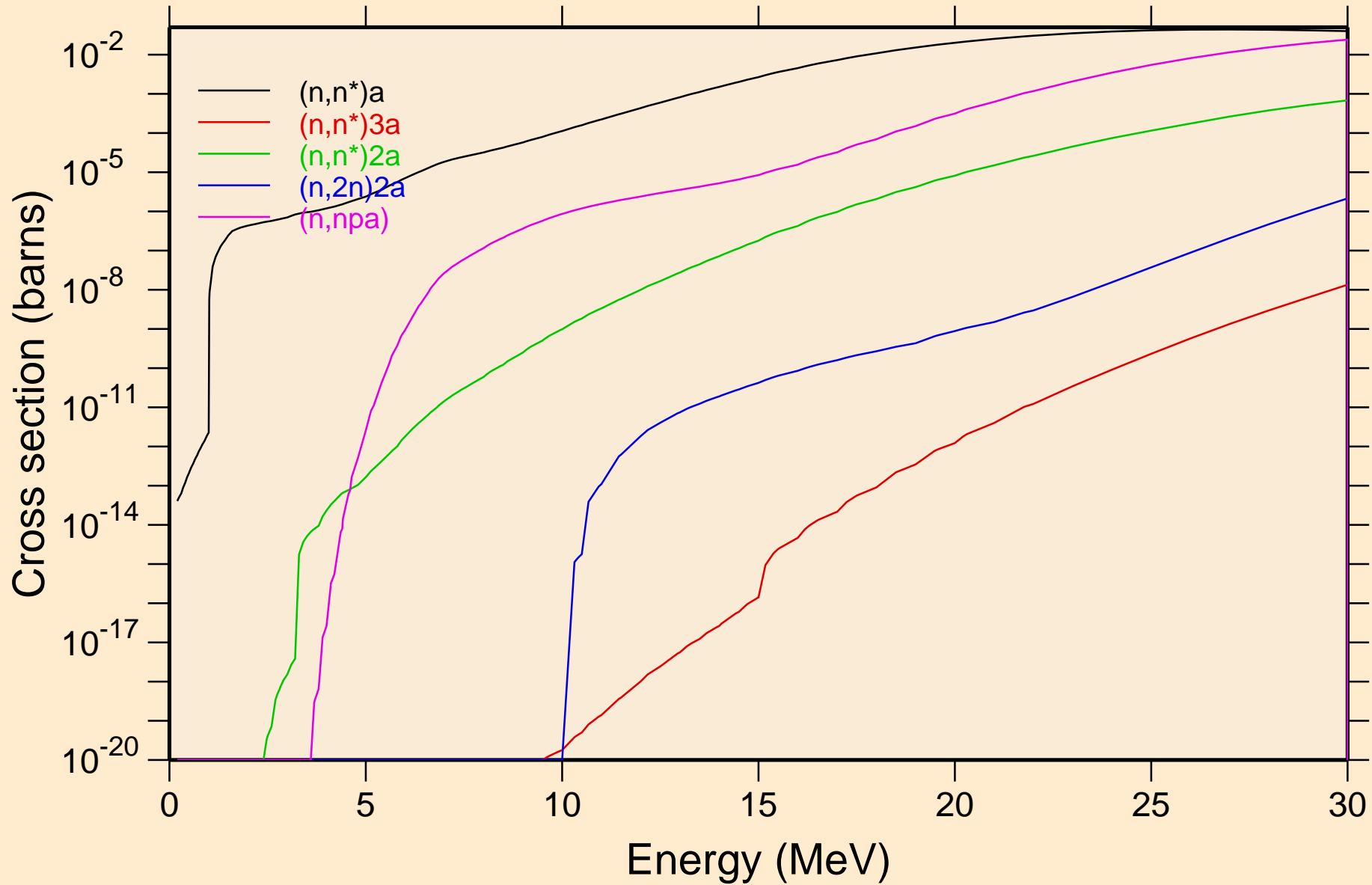

PB185 NEUTRON ACER TENDL-2023 LIBRARY; T=0.K  
Non-threshold reactions

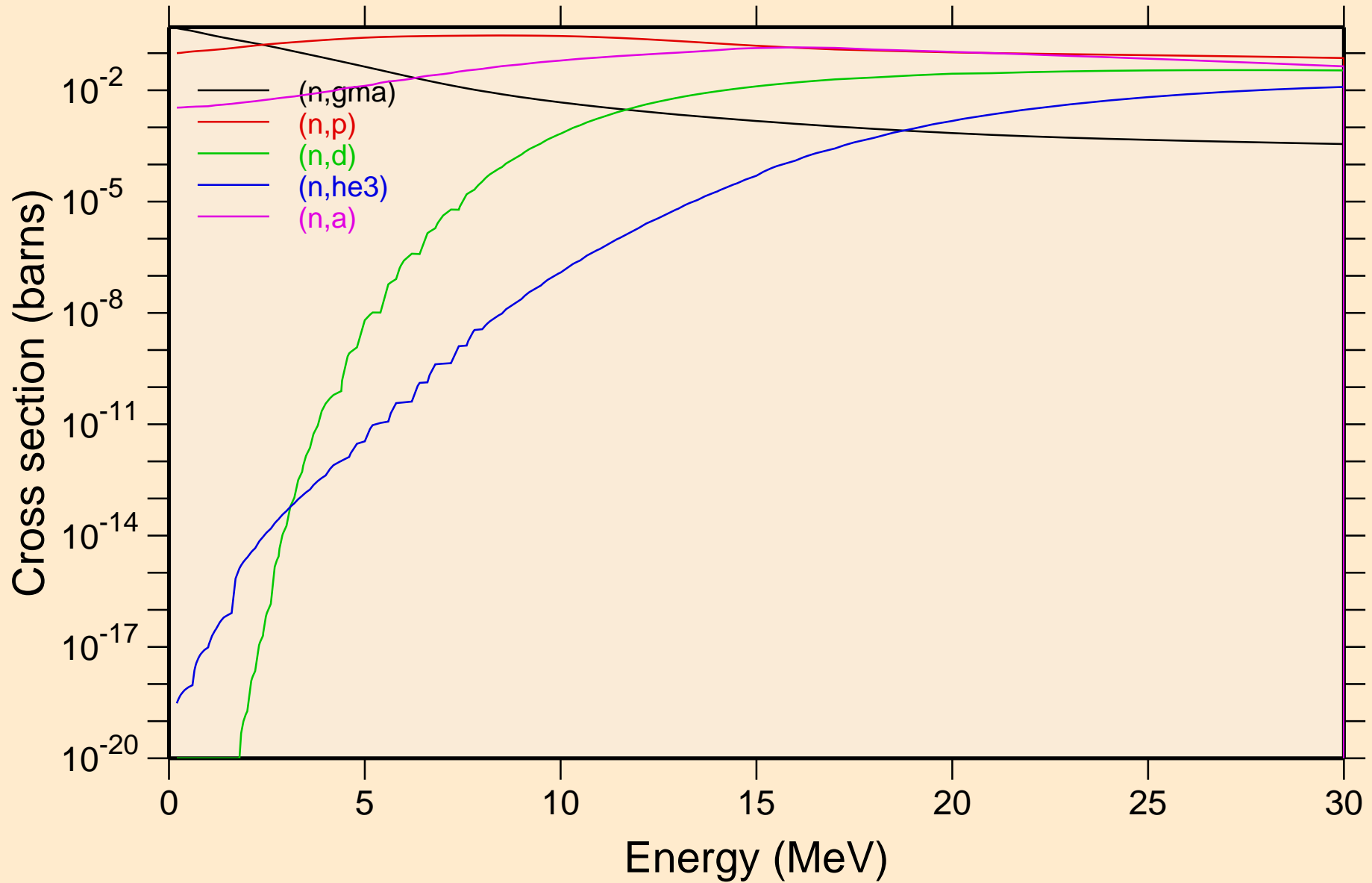

PB185 NEUTRON ACER TENDL-2023 LIBRARY; T=0.K  
Non-threshold reactions

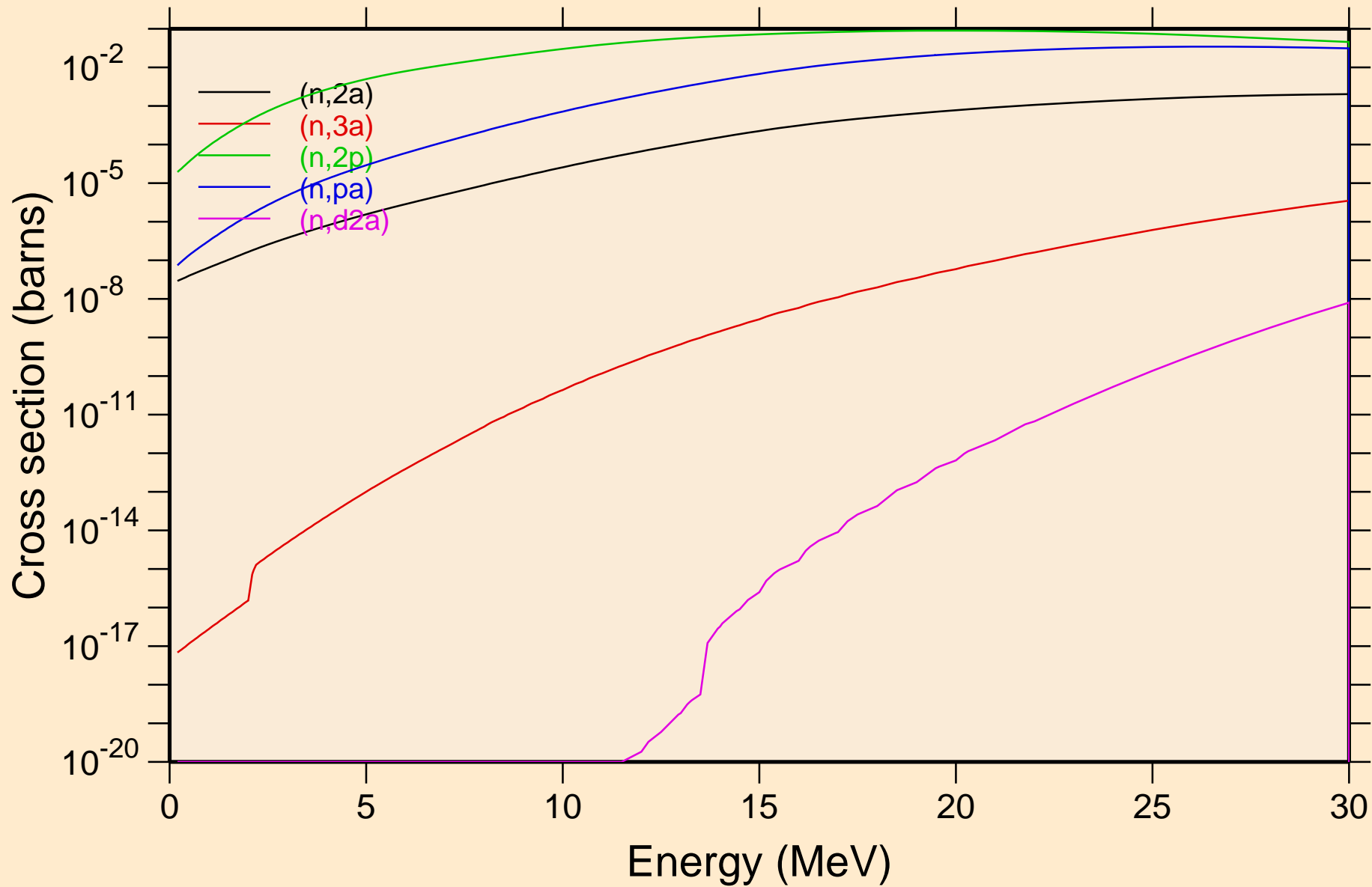

PB185 NEUTRON ACER TENDL-2023 LIBRARY; T=0.K  
Non-threshold reactions

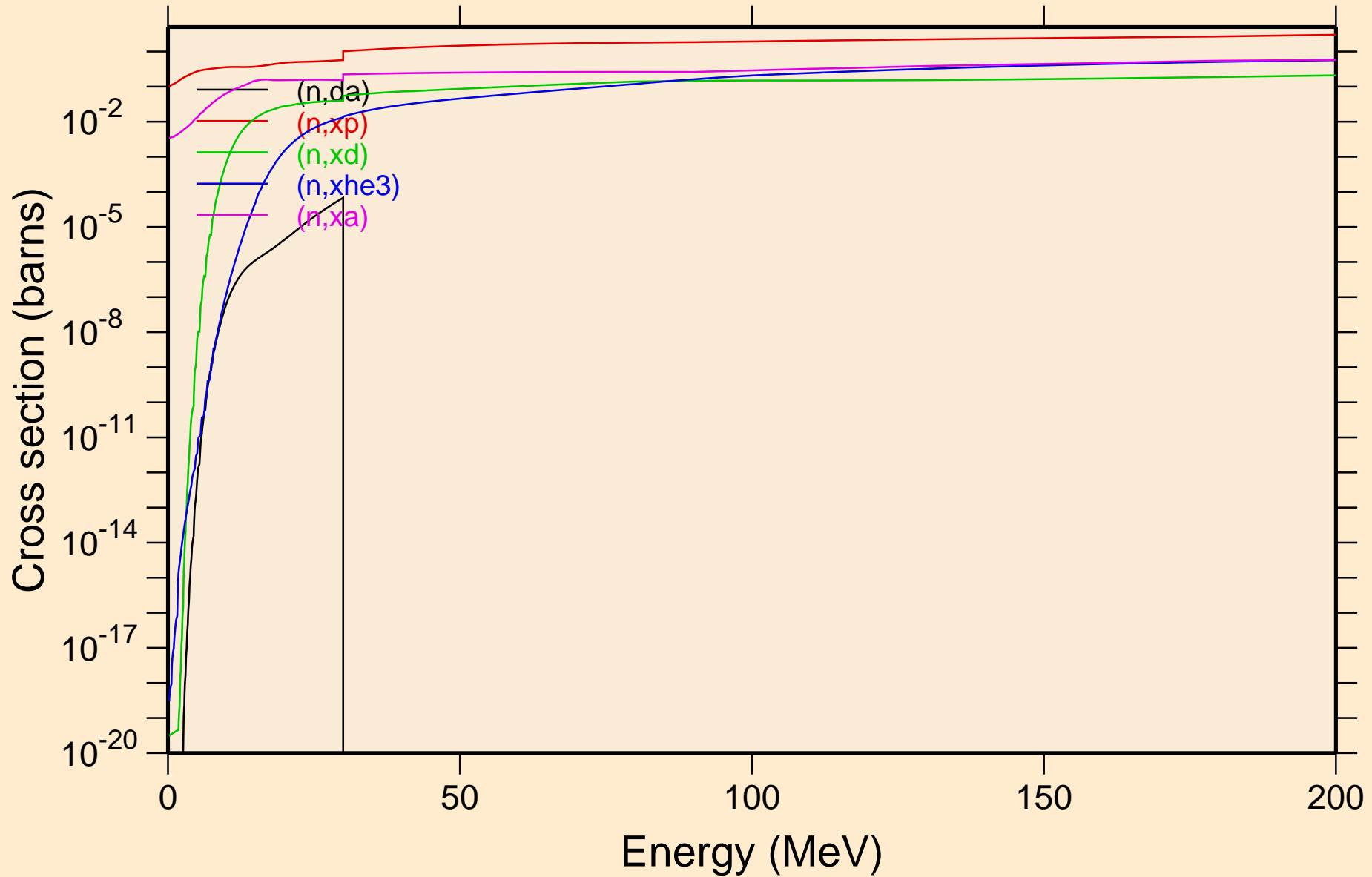

PB185 NEUTRON ACER TENDL-2023 LIBRARY; T=0.K  
Inelastic levels

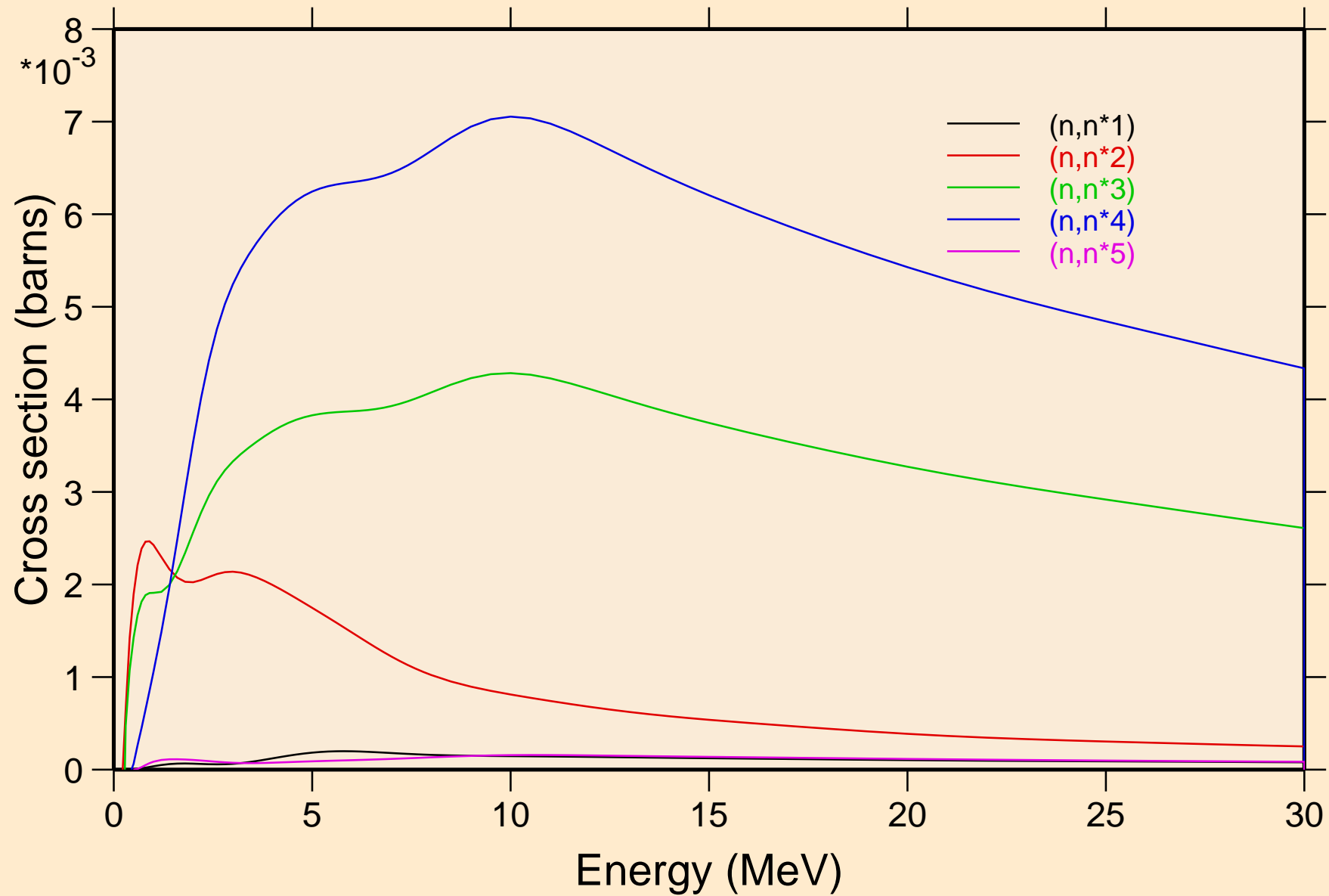

PB185 NEUTRON ACER TENDL-2023 LIBRARY; T=0.K  
Inelastic levels

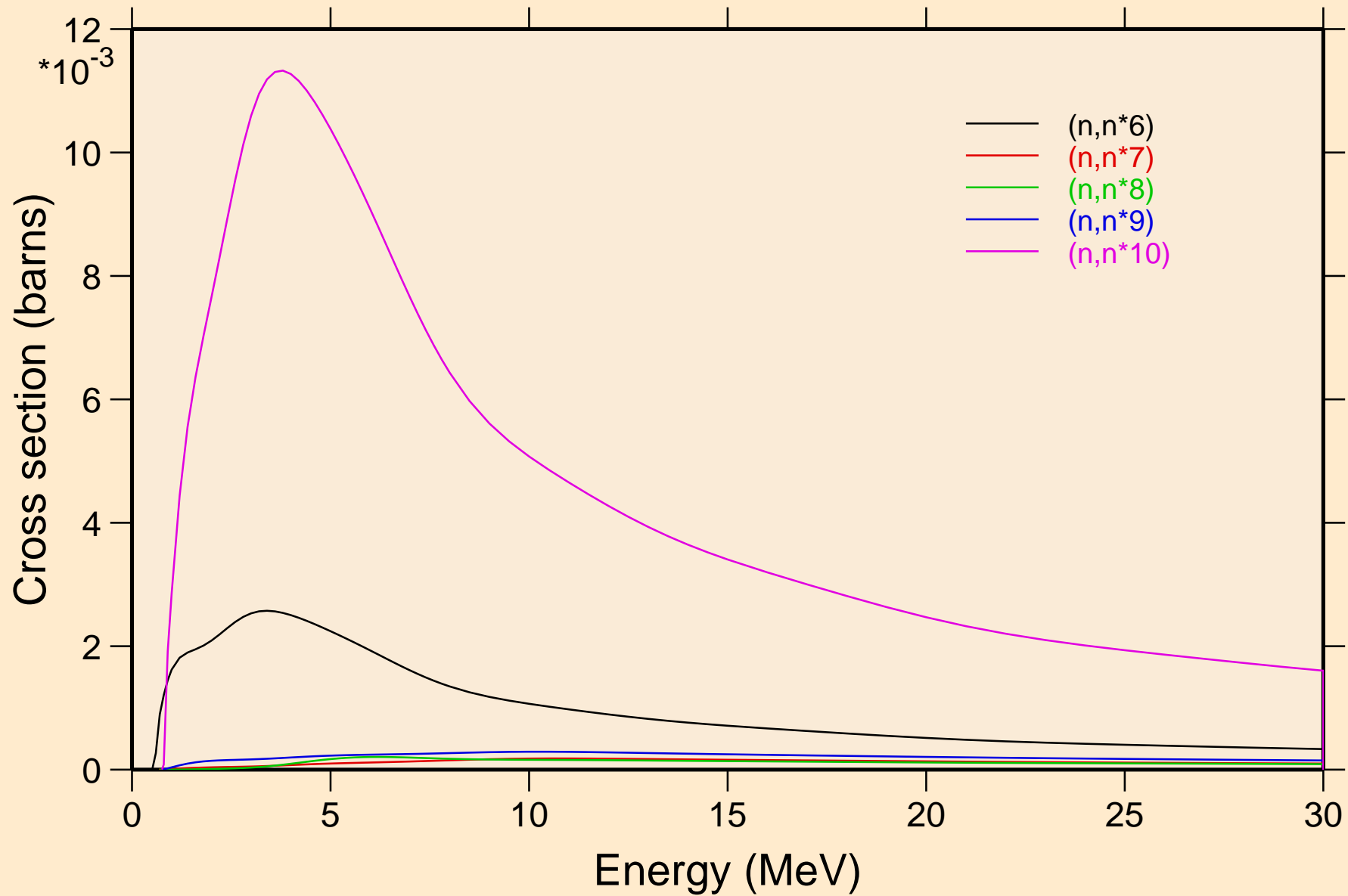

PB185 NEUTRON ACER TENDL-2023 LIBRARY; T=0.K  
Inelastic levels

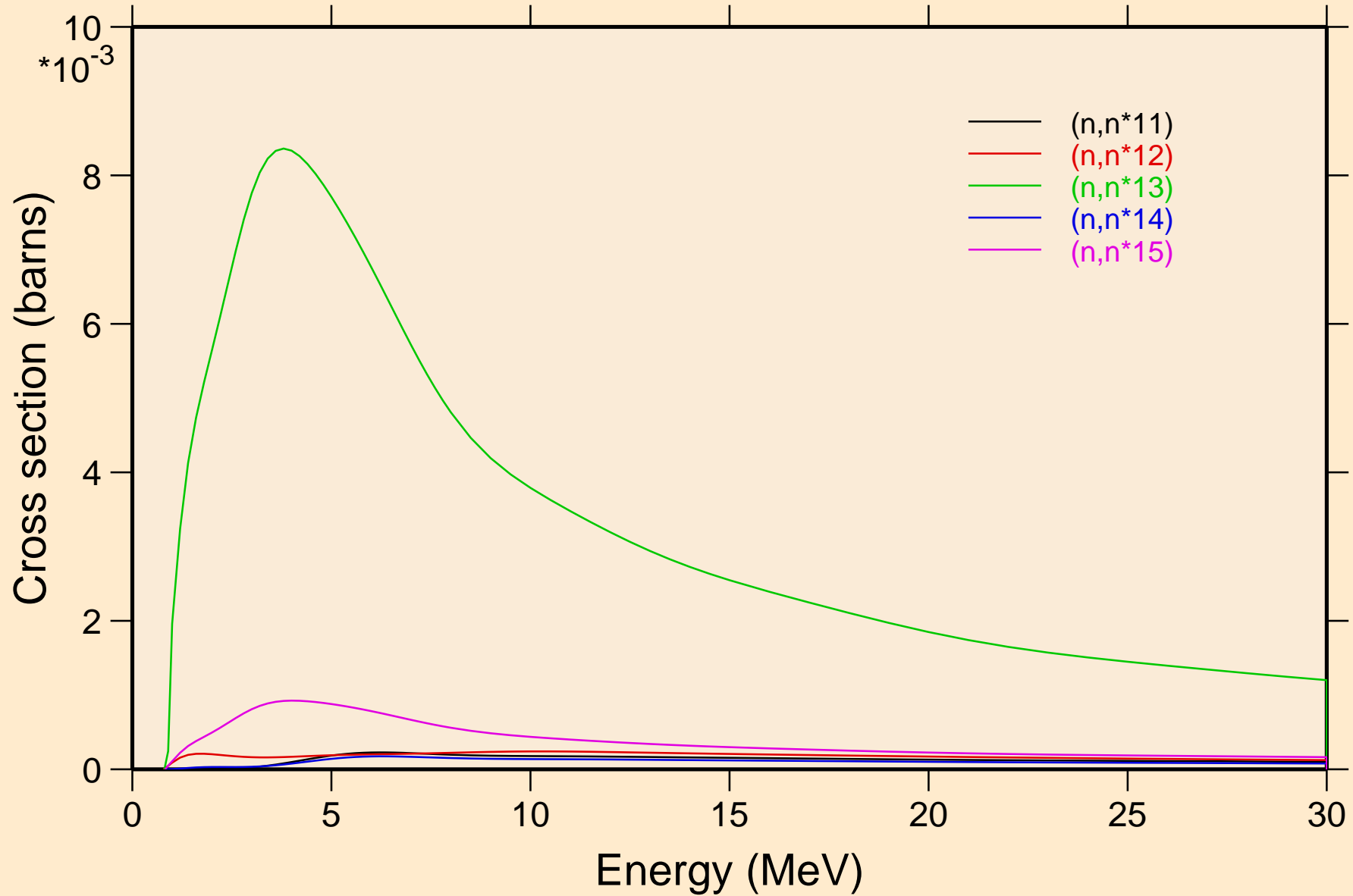

PB185 NEUTRON ACER TENDL-2023 LIBRARY; T=0.K  
Inelastic levels

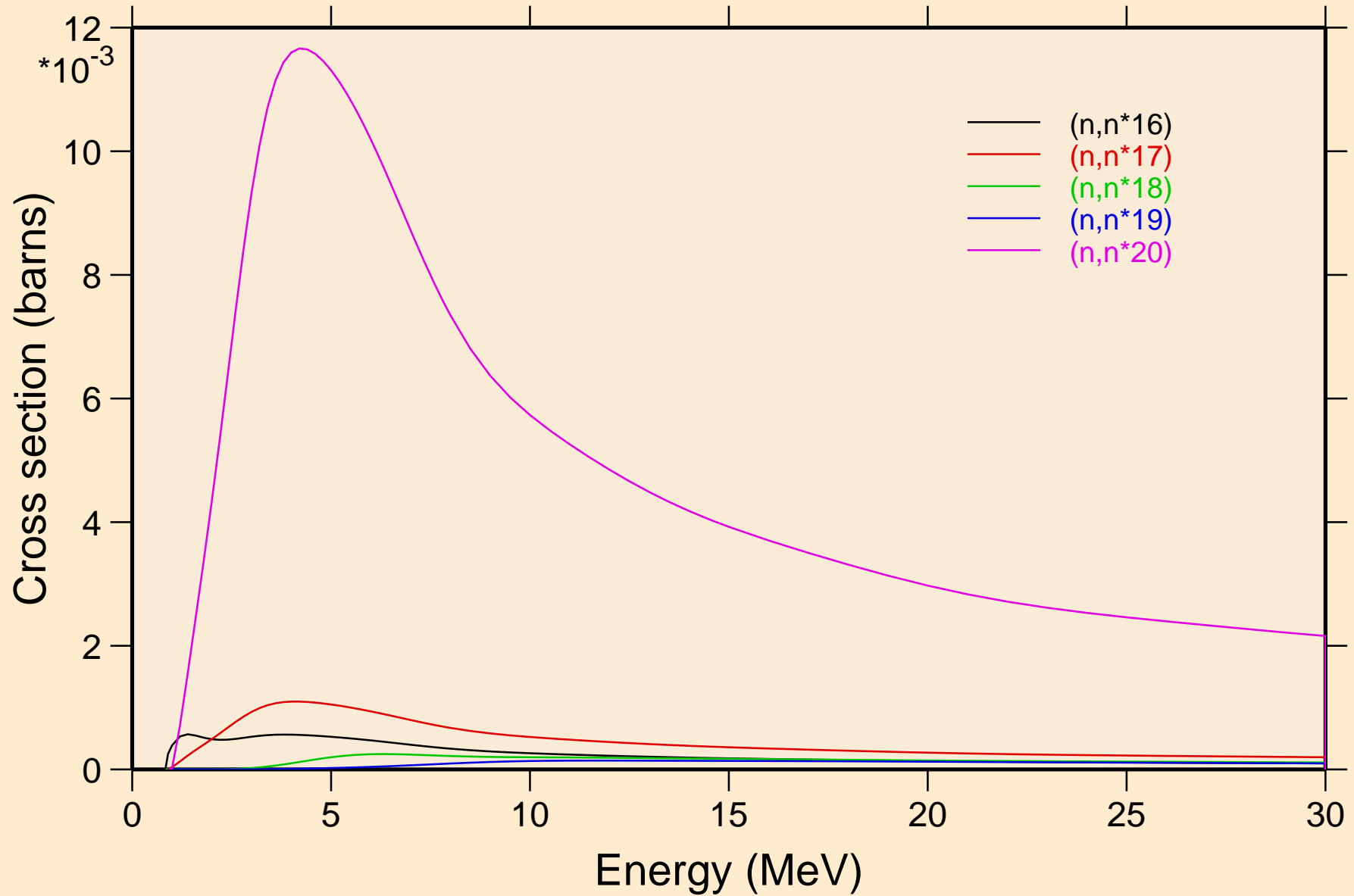

PB185 NEUTRON ACER TENDL-2023 LIBRARY; T=0.K  
Threshold reactions

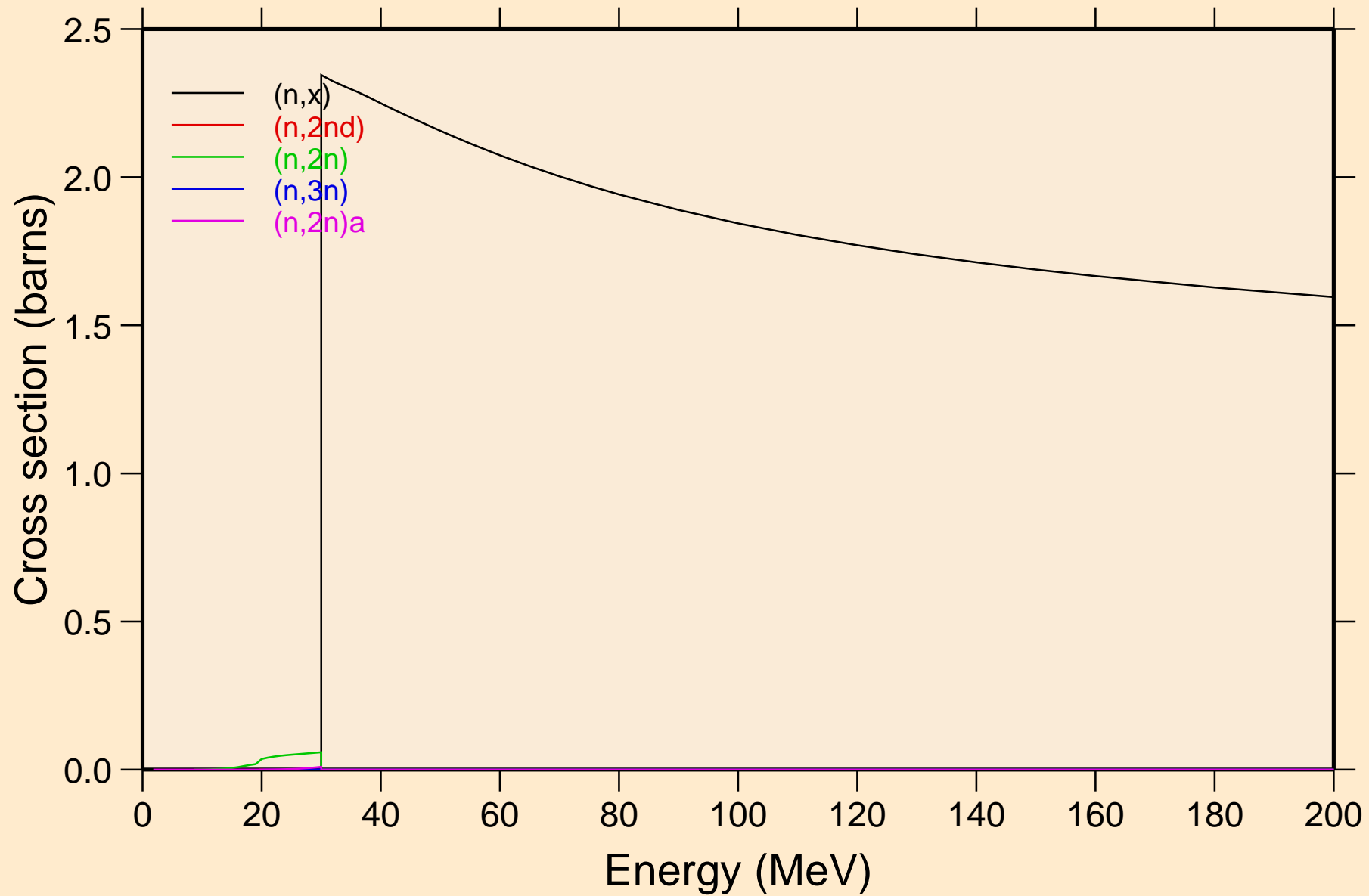

PB185 NEUTRON ACER TENDL-2023 LIBRARY; T=0.K  
Threshold reactions

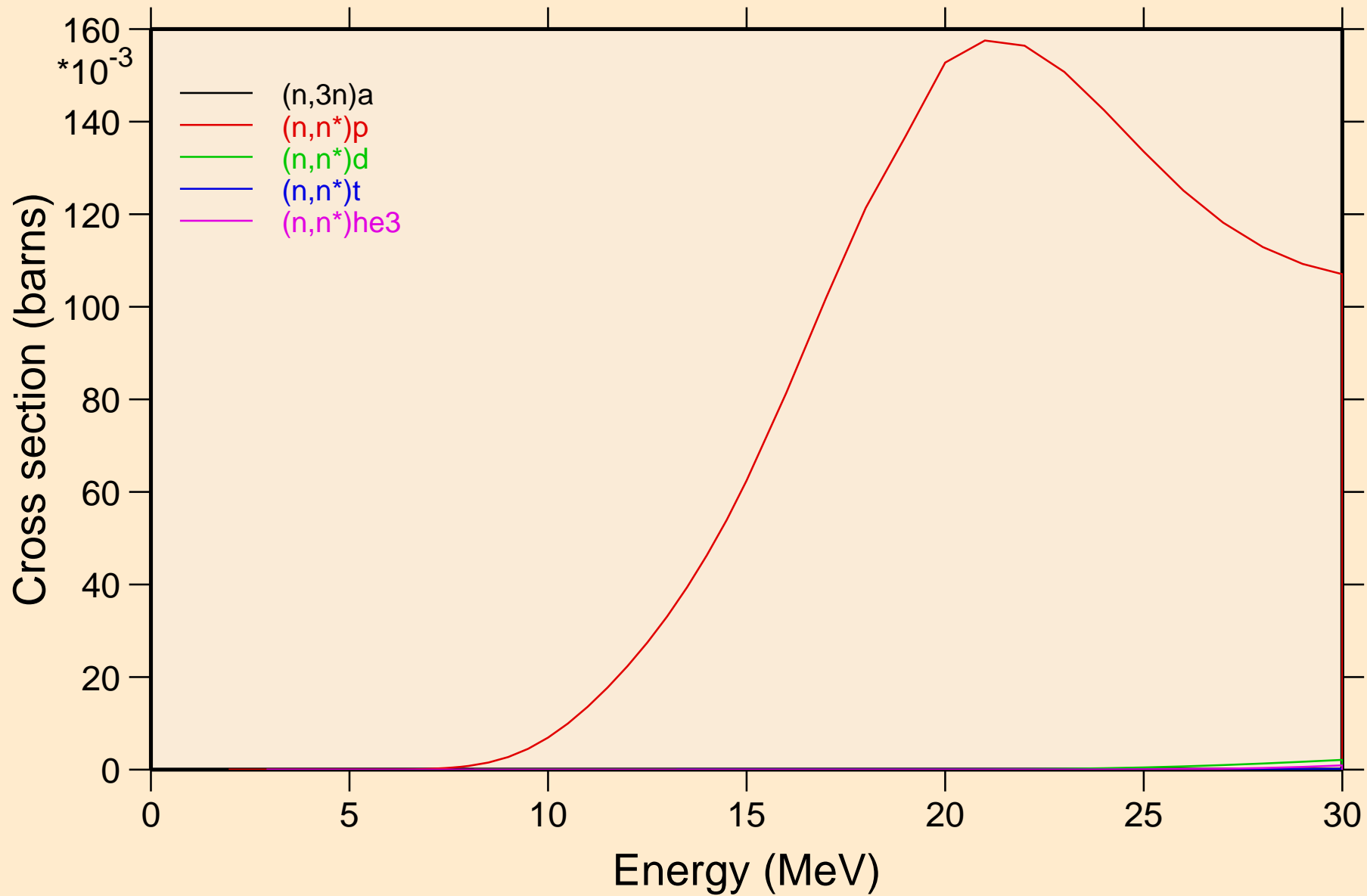

PB185 NEUTRON ACER TENDL-2023 LIBRARY; T=0.K  
Threshold reactions

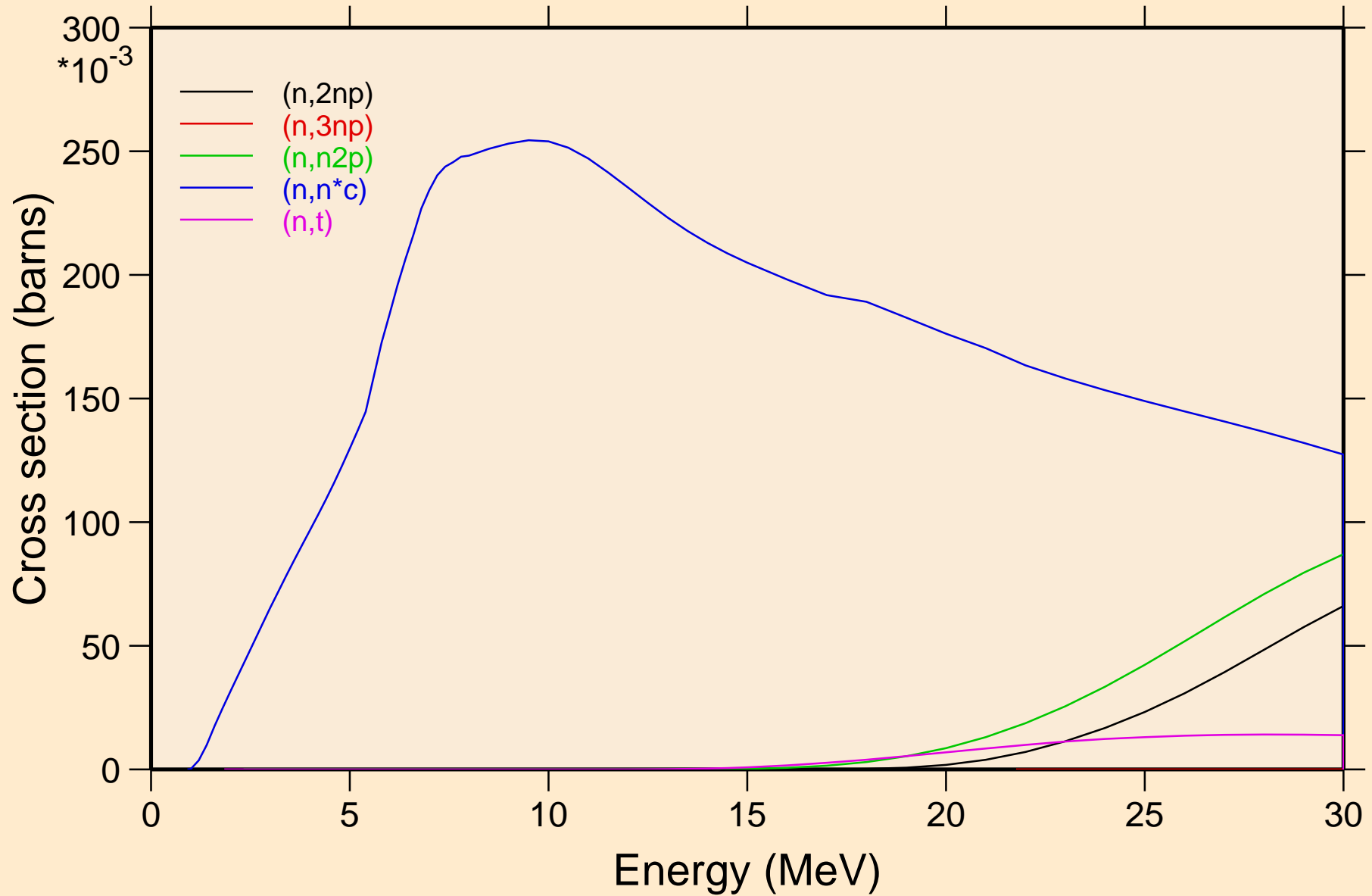

PB185 NEUTRON ACER TENDL-2023 LIBRARY; T=0.K  
Threshold reactions

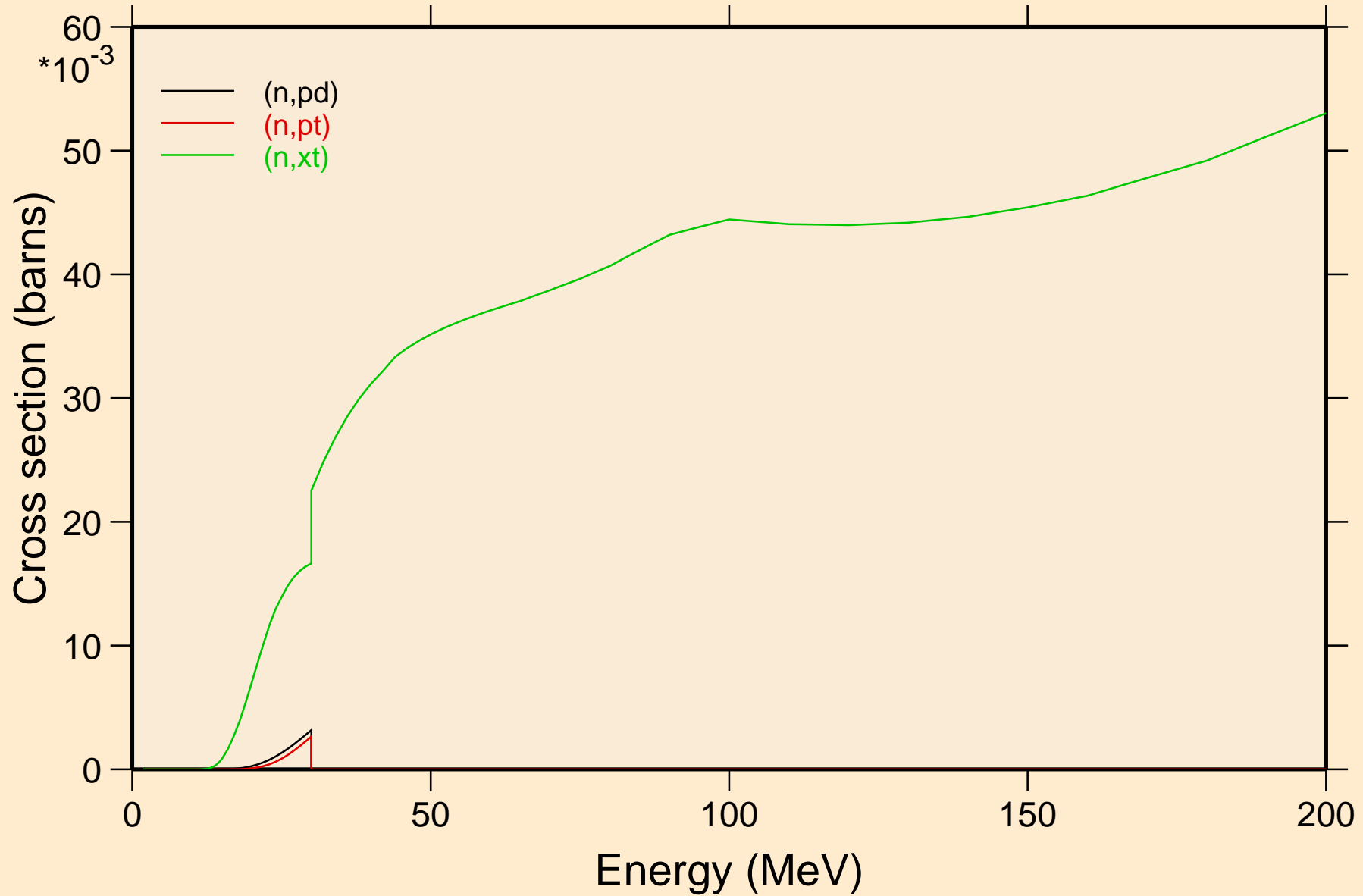

PB185 NEUTRON ACER TENDL-2023 LIBRARY; T=0.K  
angular distribution for elastic

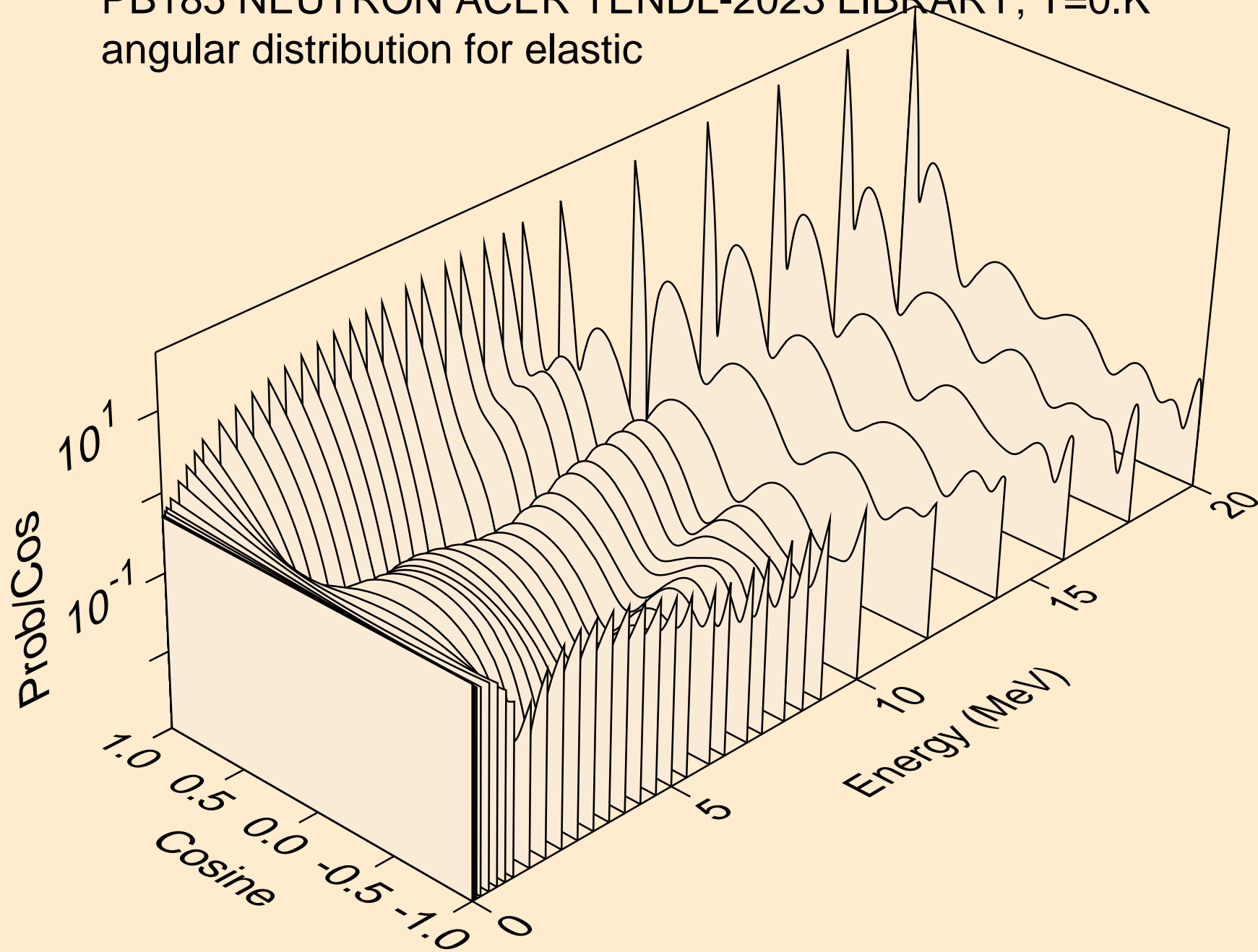

PB185 NEUTRON ACER TENDL-2023 LIBRARY; T=0.K  
angular distribution for elastic

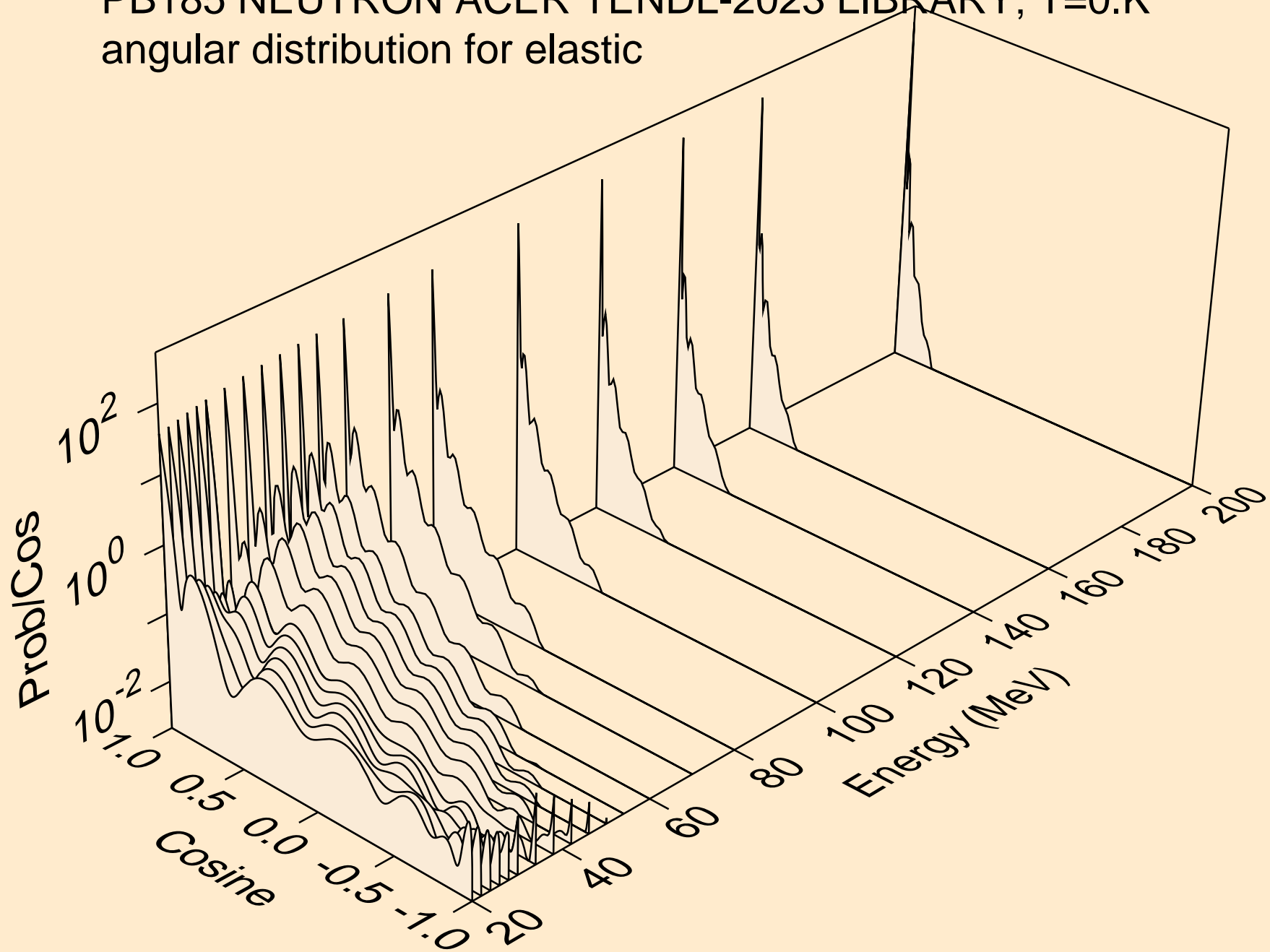

PB185 NEUTRON ACER TENDL-2023 LIBRARY; T=0.K  
angular distribution for (n,n\*1)

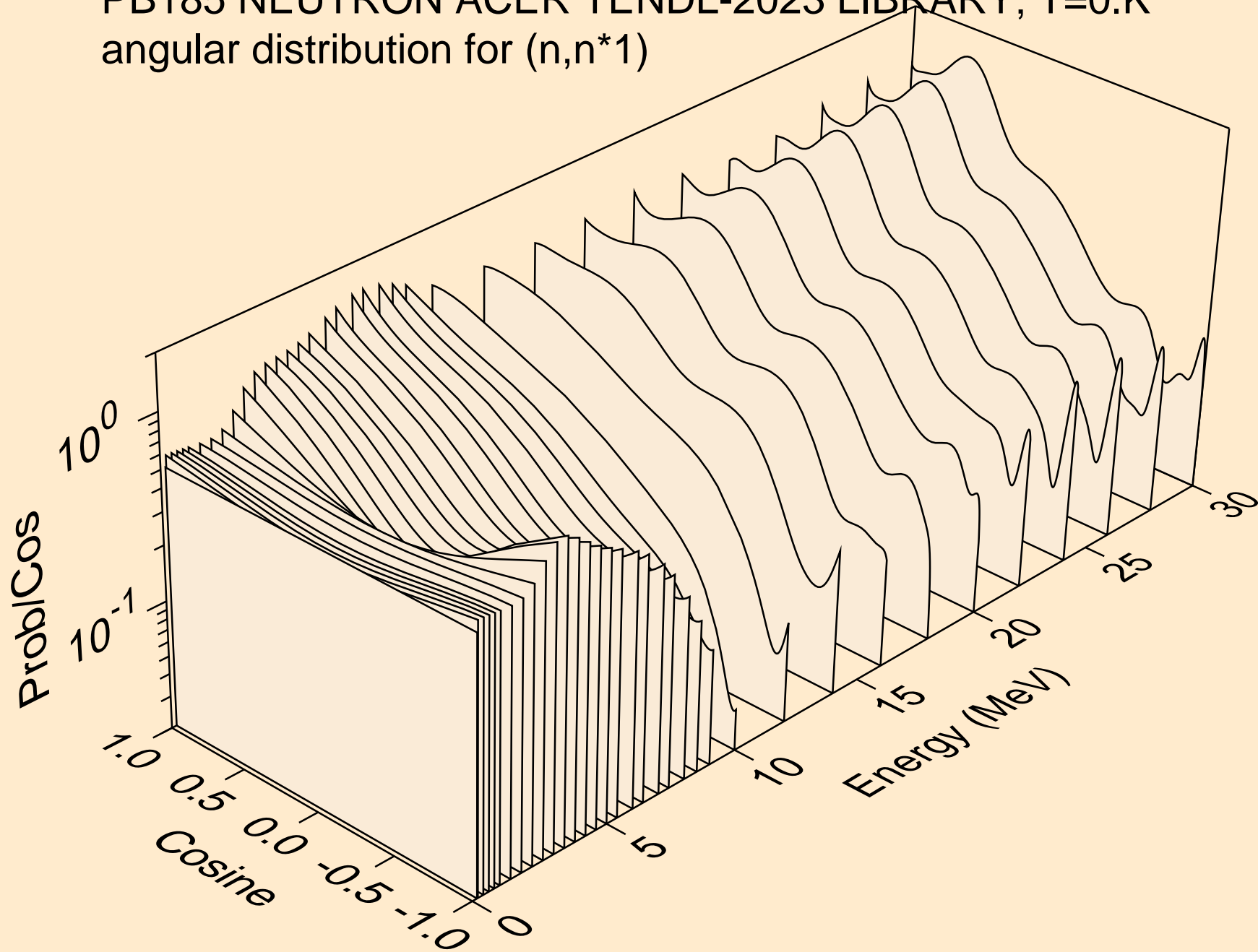

PB185 NEUTRON ACER TENDL-2023 LIBRARY; T=0.K  
angular distribution for (n,n\*2)

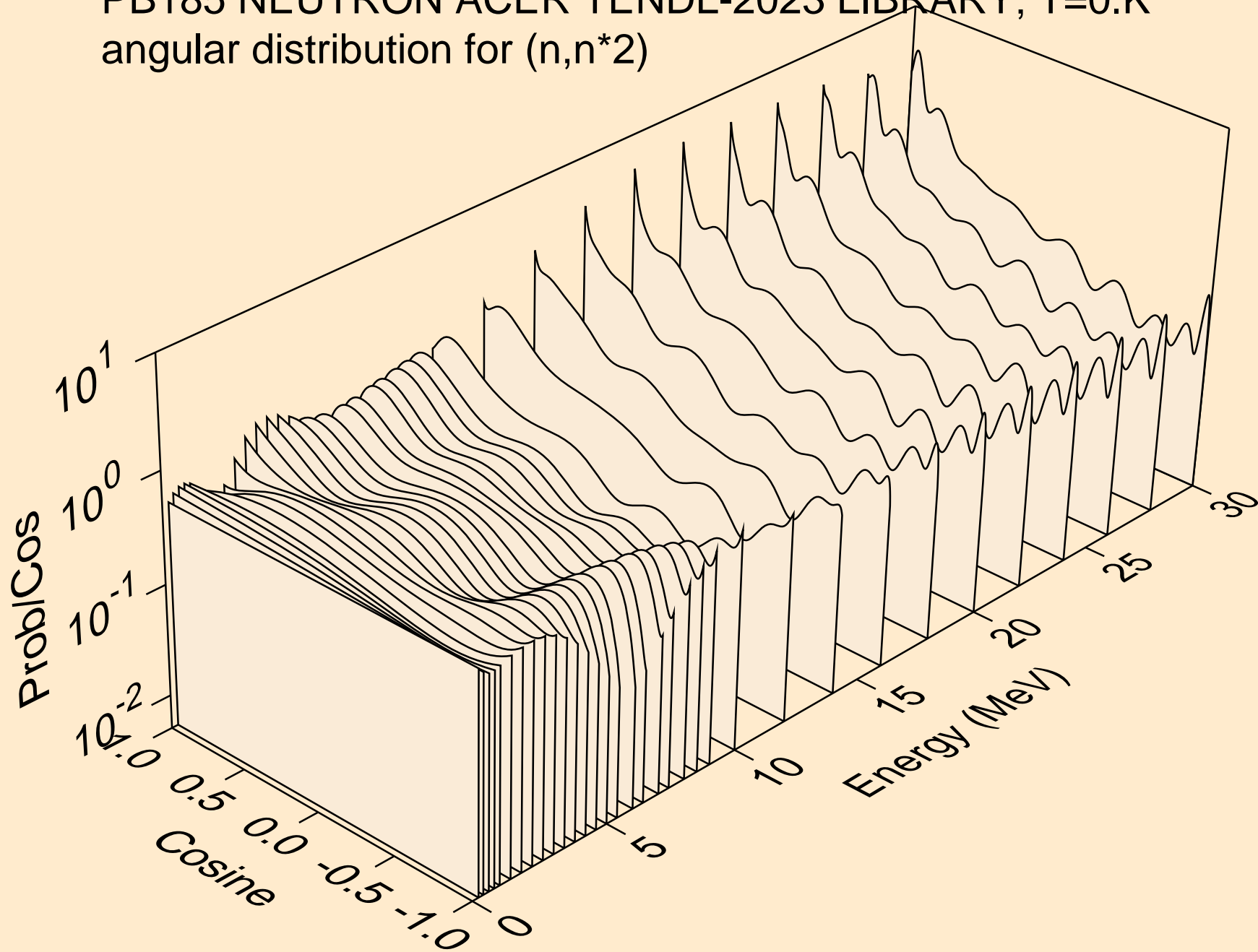

PB185 NEUTRON ACER TENDL-2023 LIBRARY; T=0.K  
angular distribution for (n,n\*3)

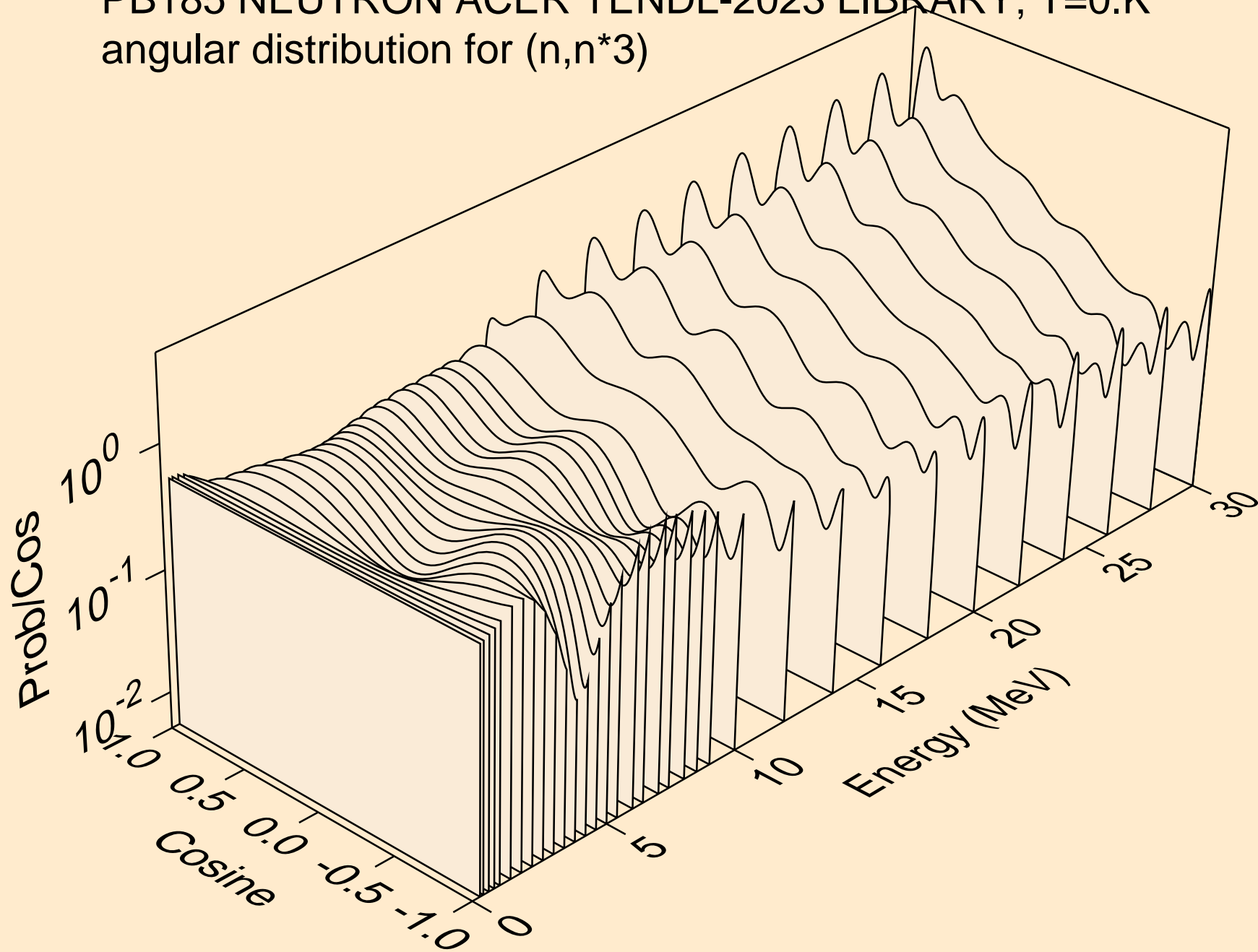

PB185 NEUTRON ACER TENDL-2023 LIBRARY; T=0.K  
angular distribution for (n,n\*4)

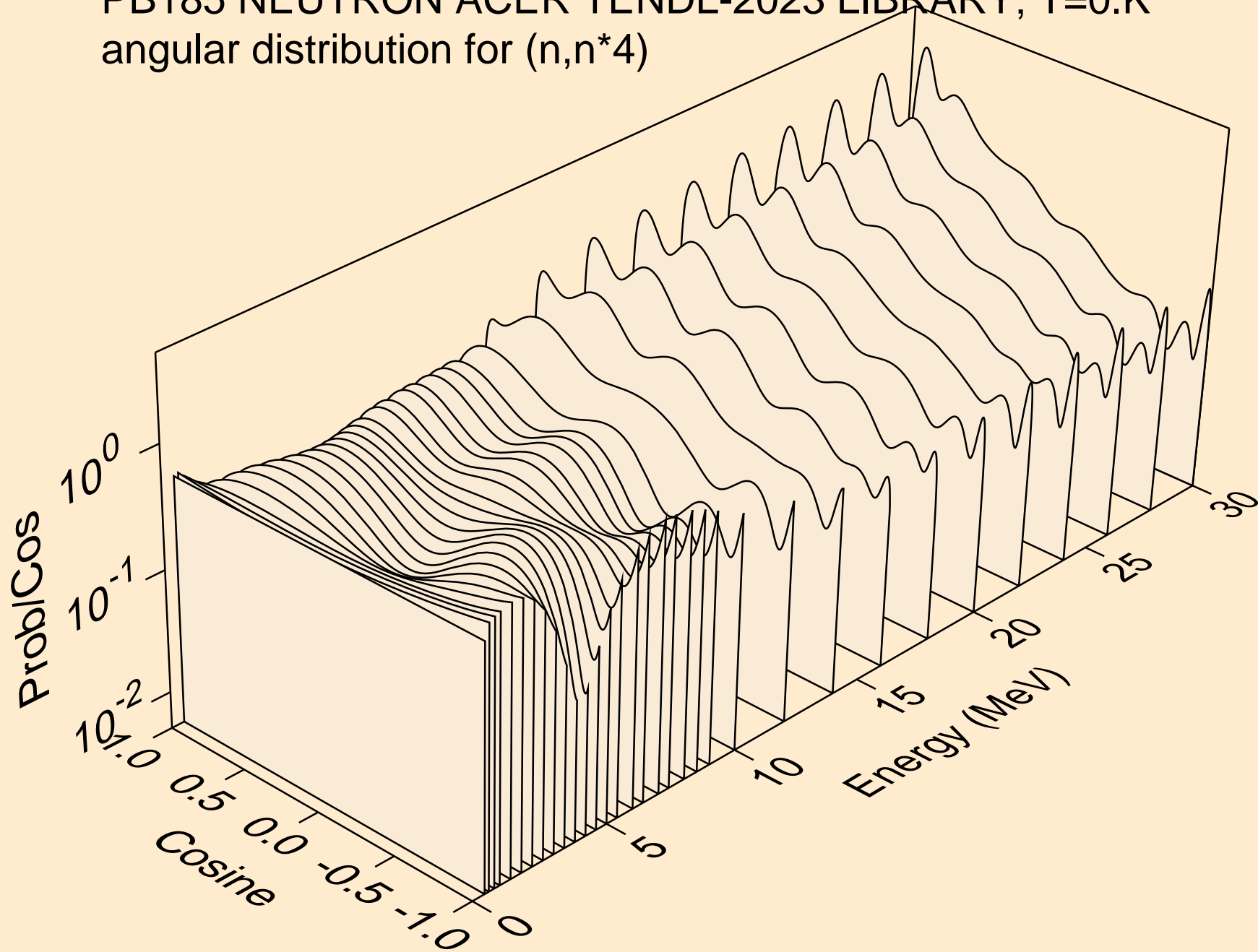

PB185 NEUTRON ACER TENDL-2023 LIBRARY; T=0.K  
angular distribution for (n,n\*5)

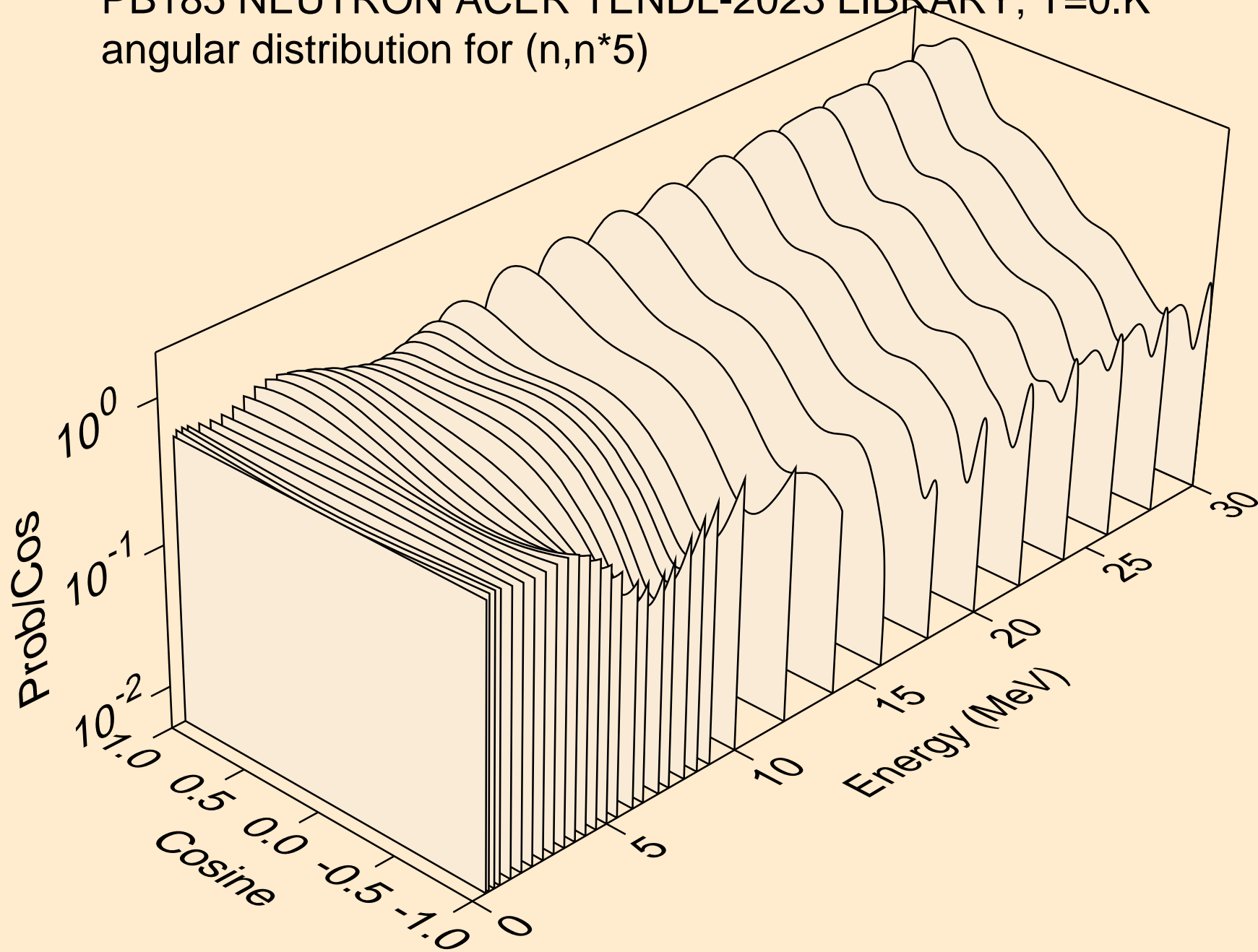

PB185 NEUTRON ACER TENDL-2023 LIBRARY; T=0.K  
angular distribution for (n,n\*6)

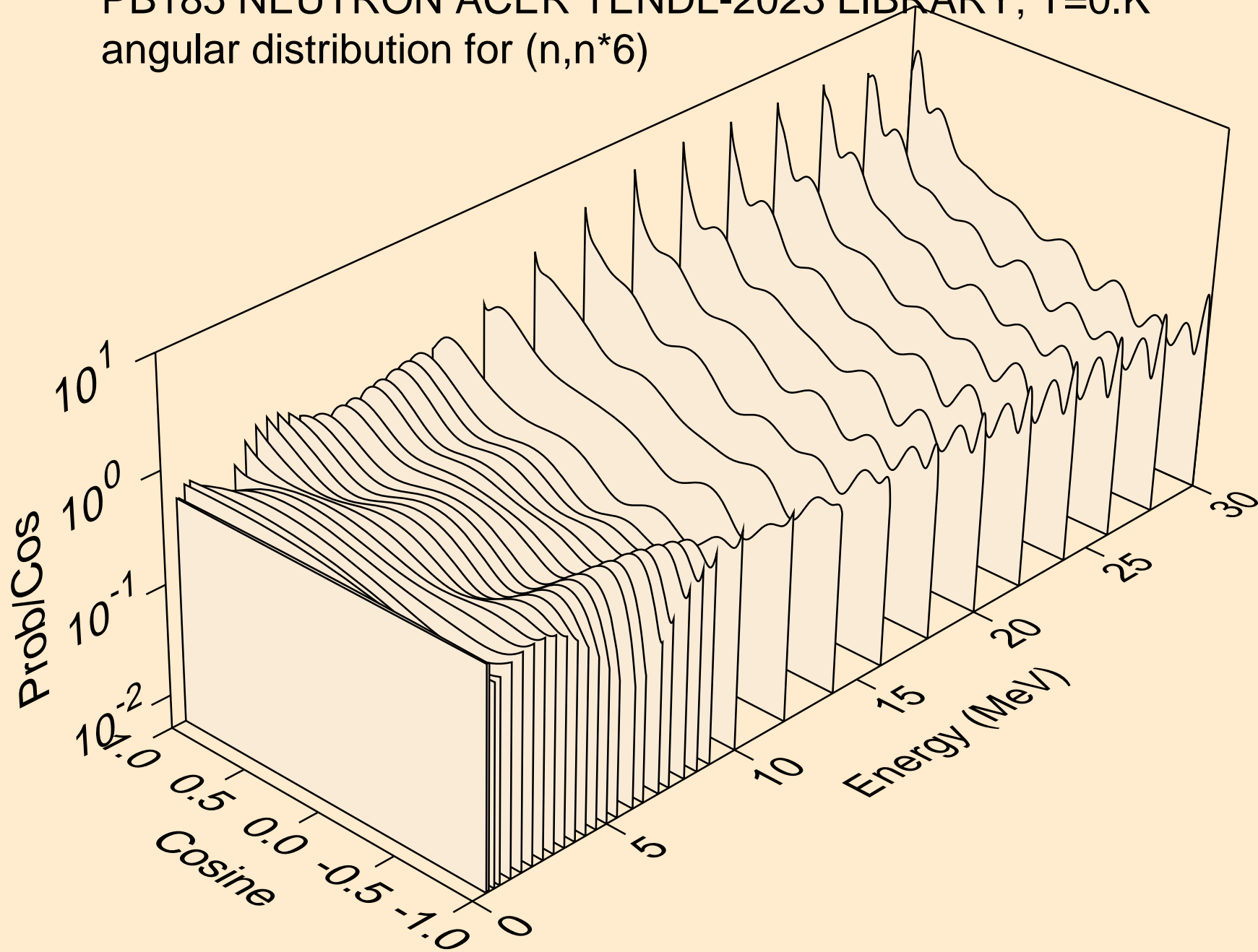

PB185 NEUTRON ACER TENDL-2023 LIBRARY; T=0.K  
angular distribution for (n,n\*7)

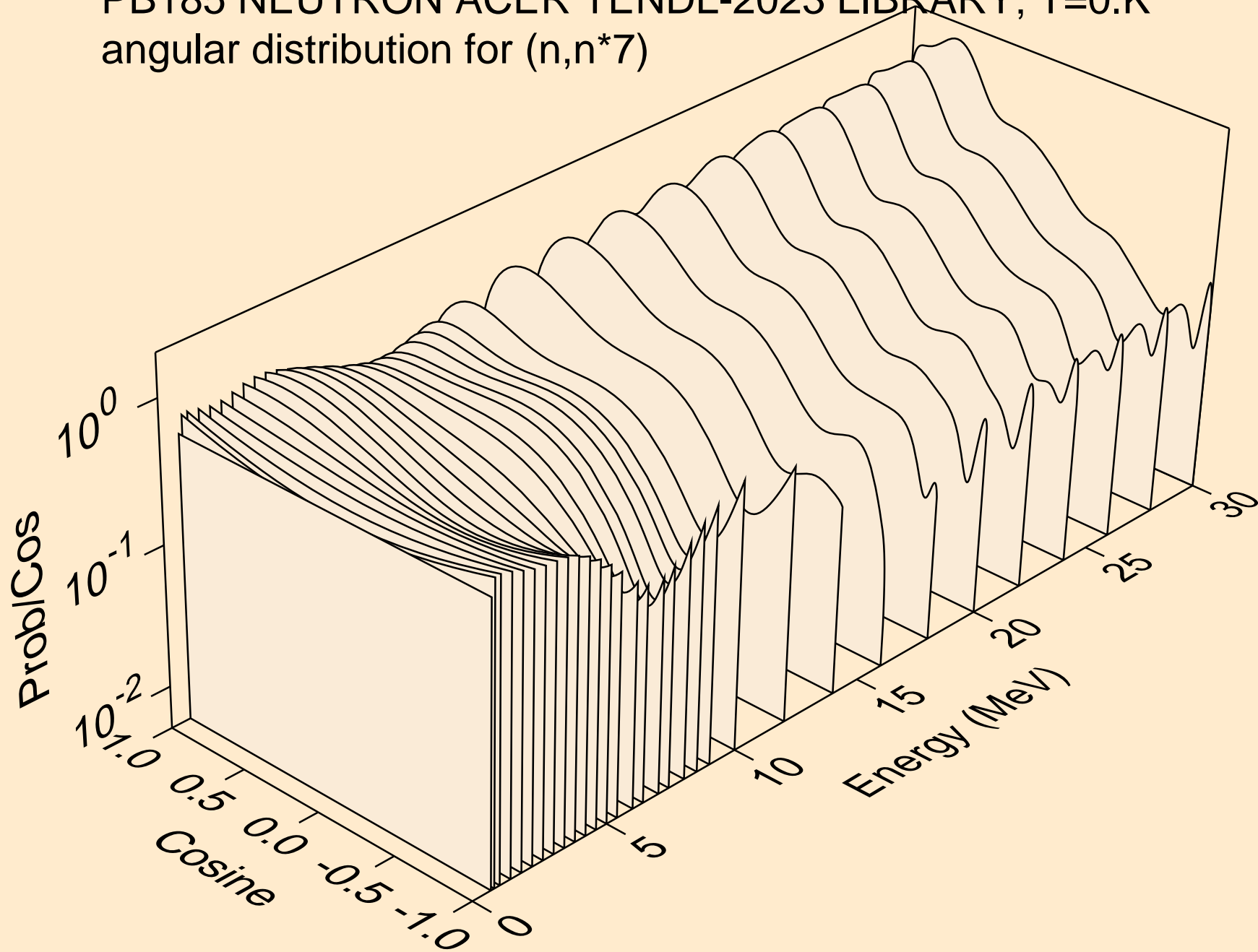

PB185 NEUTRON ACER TENDL-2023 LIBRARY; T=0.K  
angular distribution for (n,n\*8)

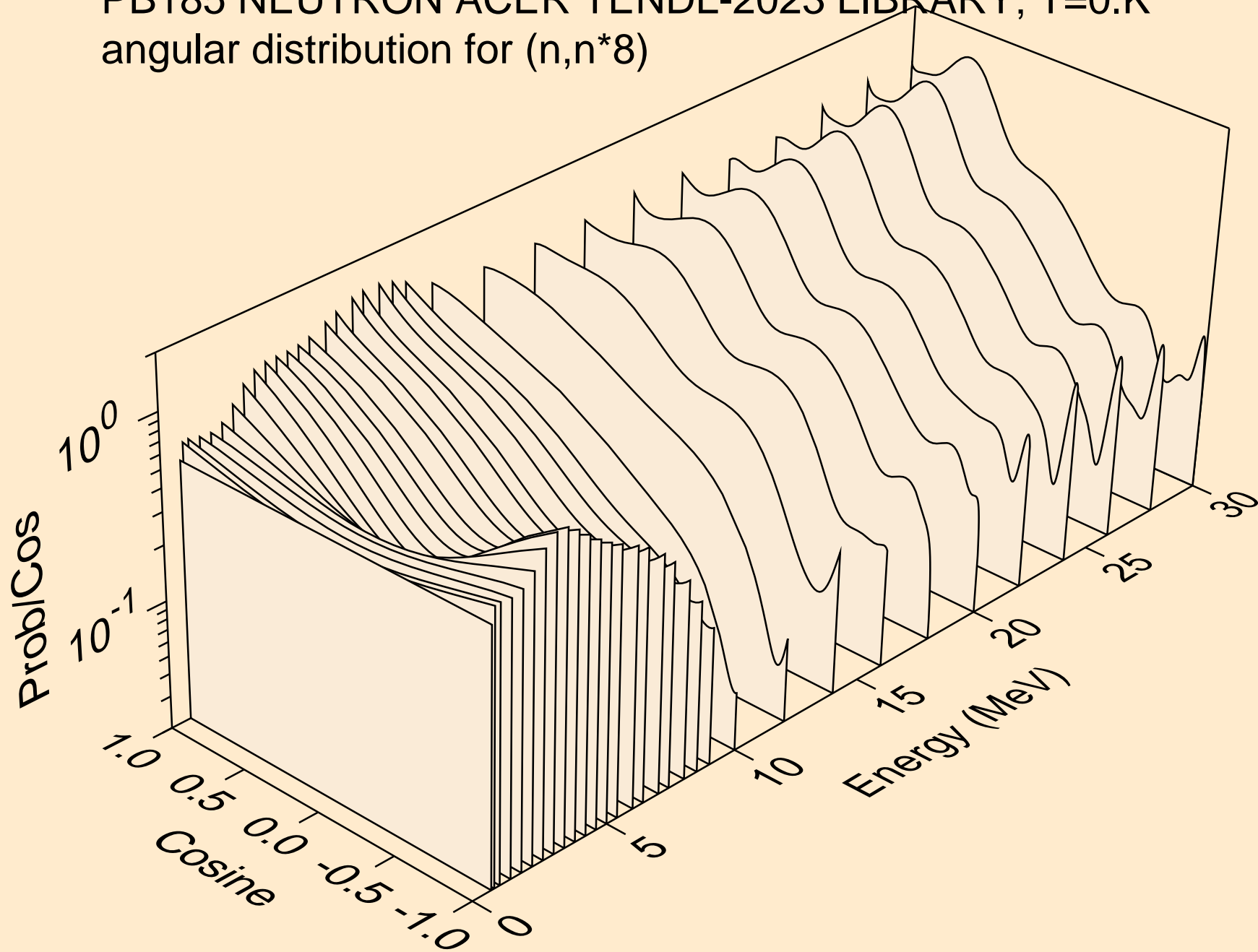

PB185 NEUTRON ACER TENDL-2023 LIBRARY; T=0.K  
angular distribution for (n,n\*9)

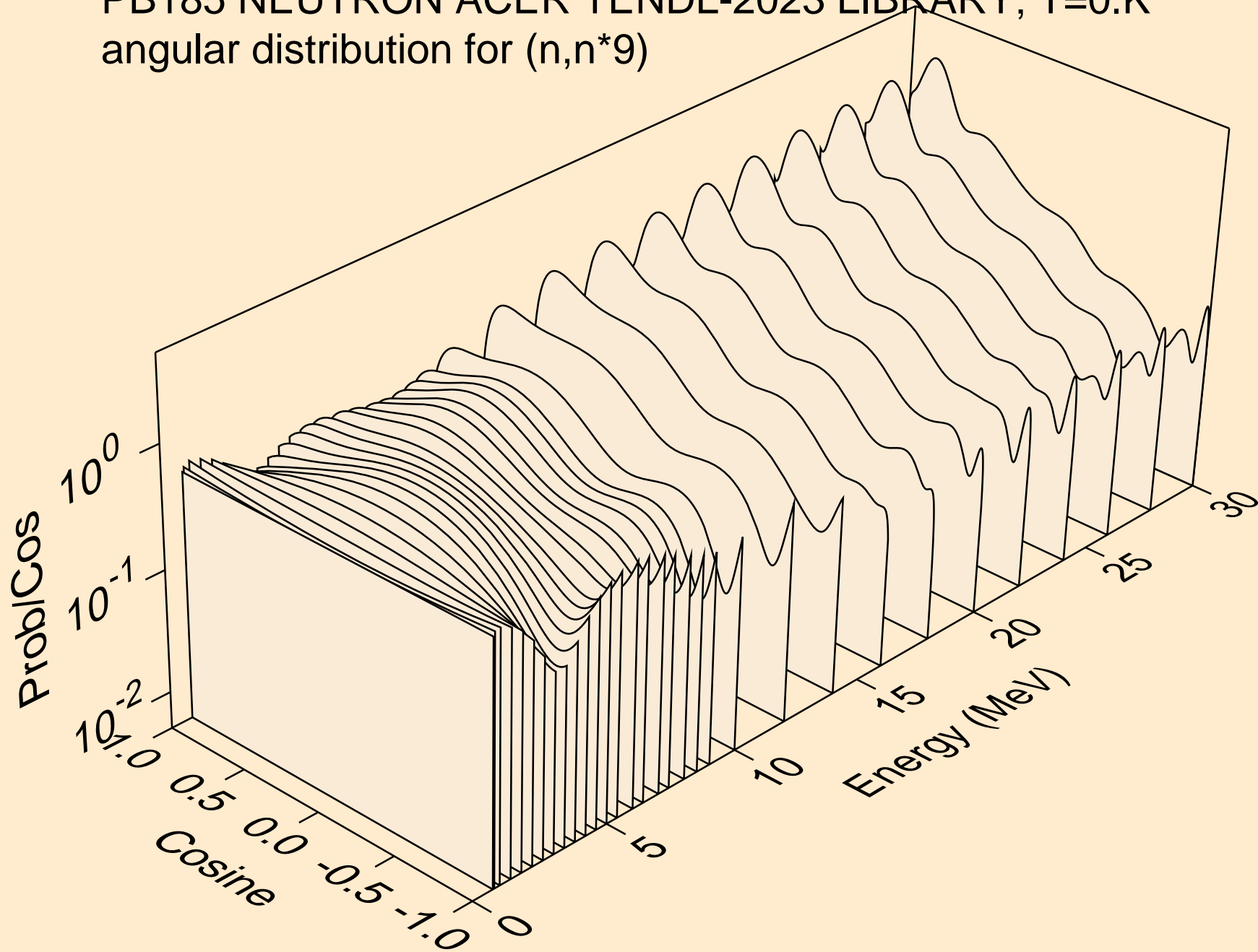

PB185 NEUTRON ACER TENDL-2023 LIBRARY; T=0.K  
angular distribution for (n,n\*10)

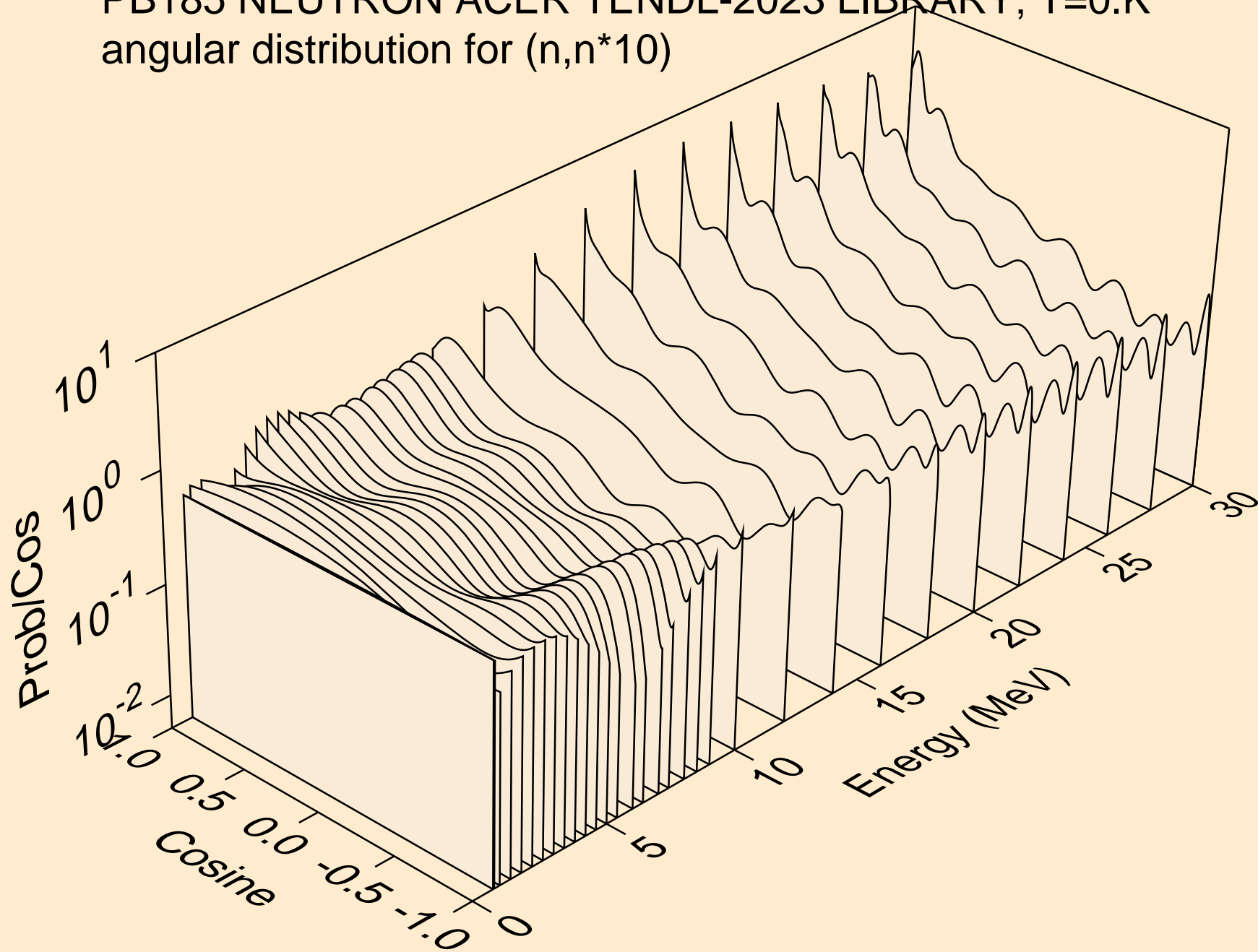

PB185 NEUTRON ACER TENDL-2023 LIBRARY; T=0.K  
angular distribution for (n,n\*11)

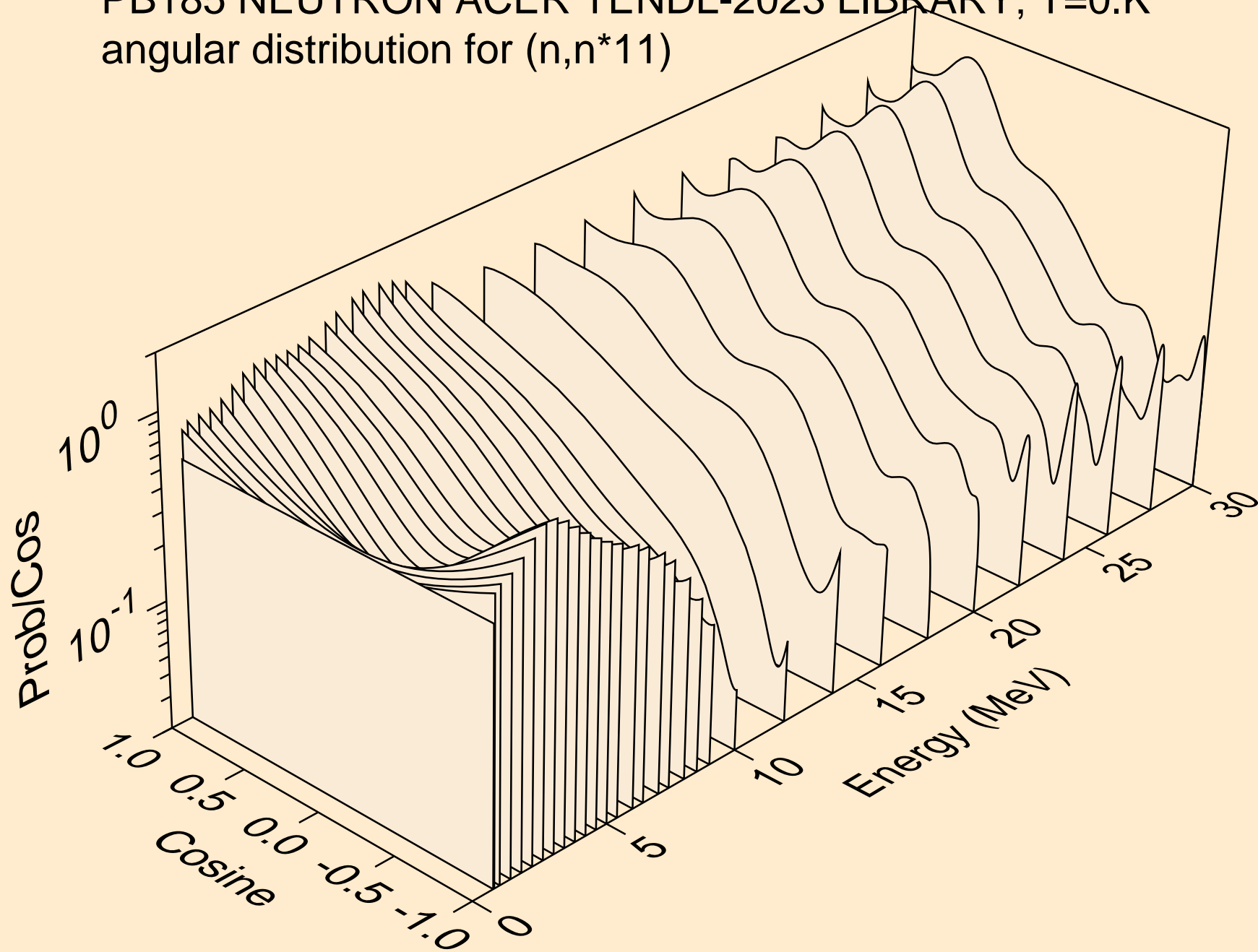

PB185 NEUTRON ACER TENDL-2023 LIBRARY; T=0.K  
angular distribution for (n,n\*12)

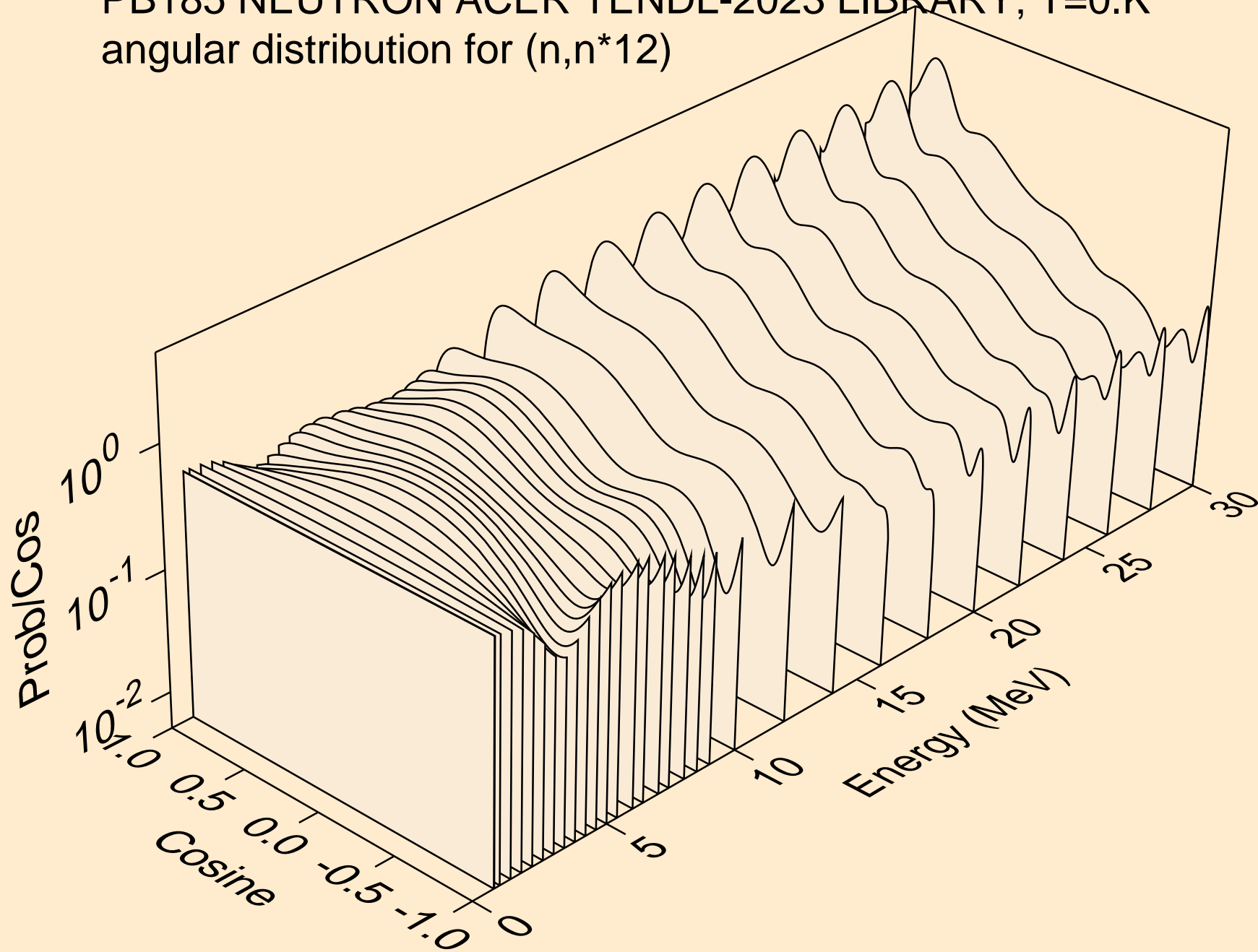

PB185 NEUTRON ACER TENDL-2023 LIBRARY; T=0.K  
angular distribution for (n,n\*13)

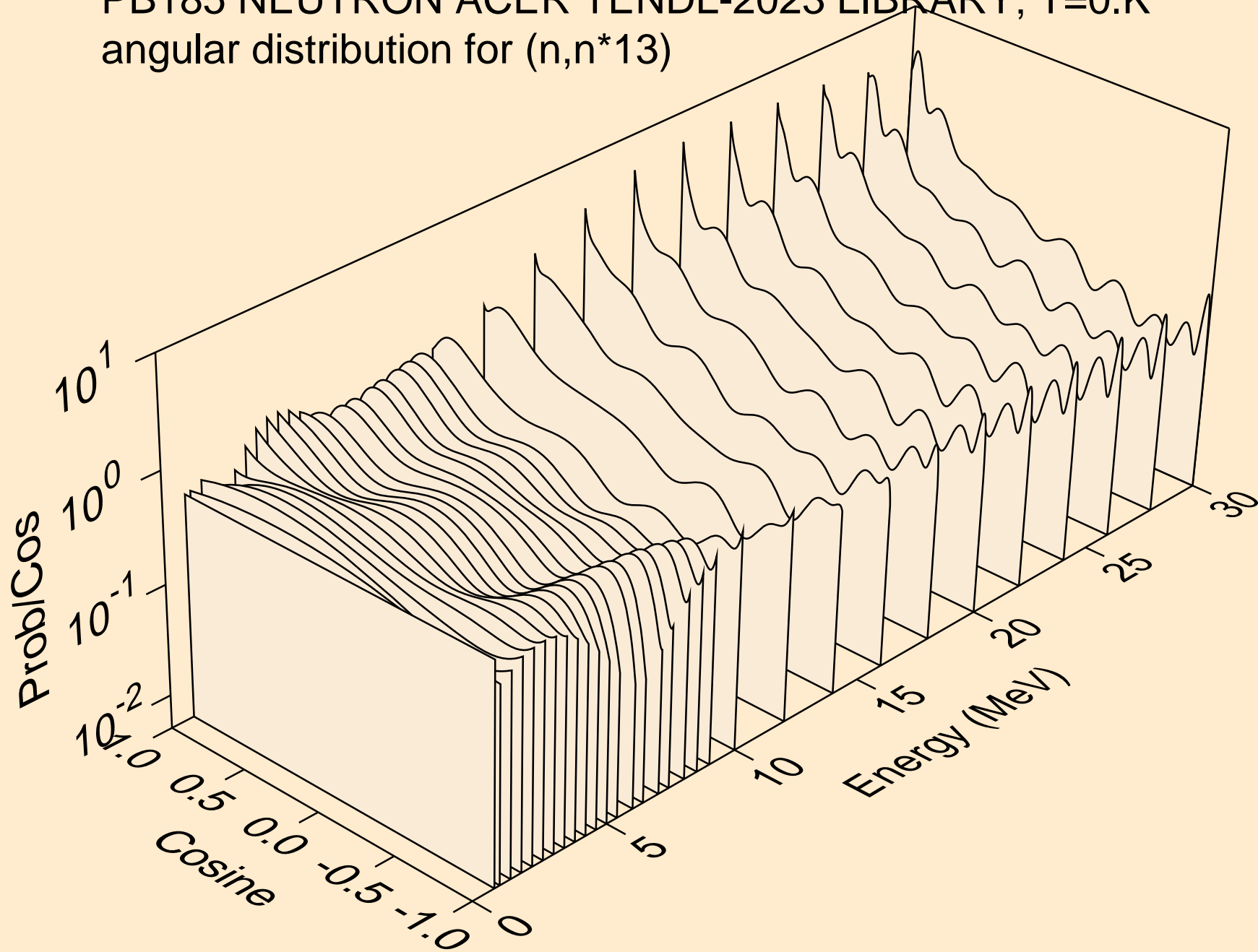

PB185 NEUTRON ACER TENDL-2023 LIBRARY; T=0.K  
angular distribution for (n,n\*14)

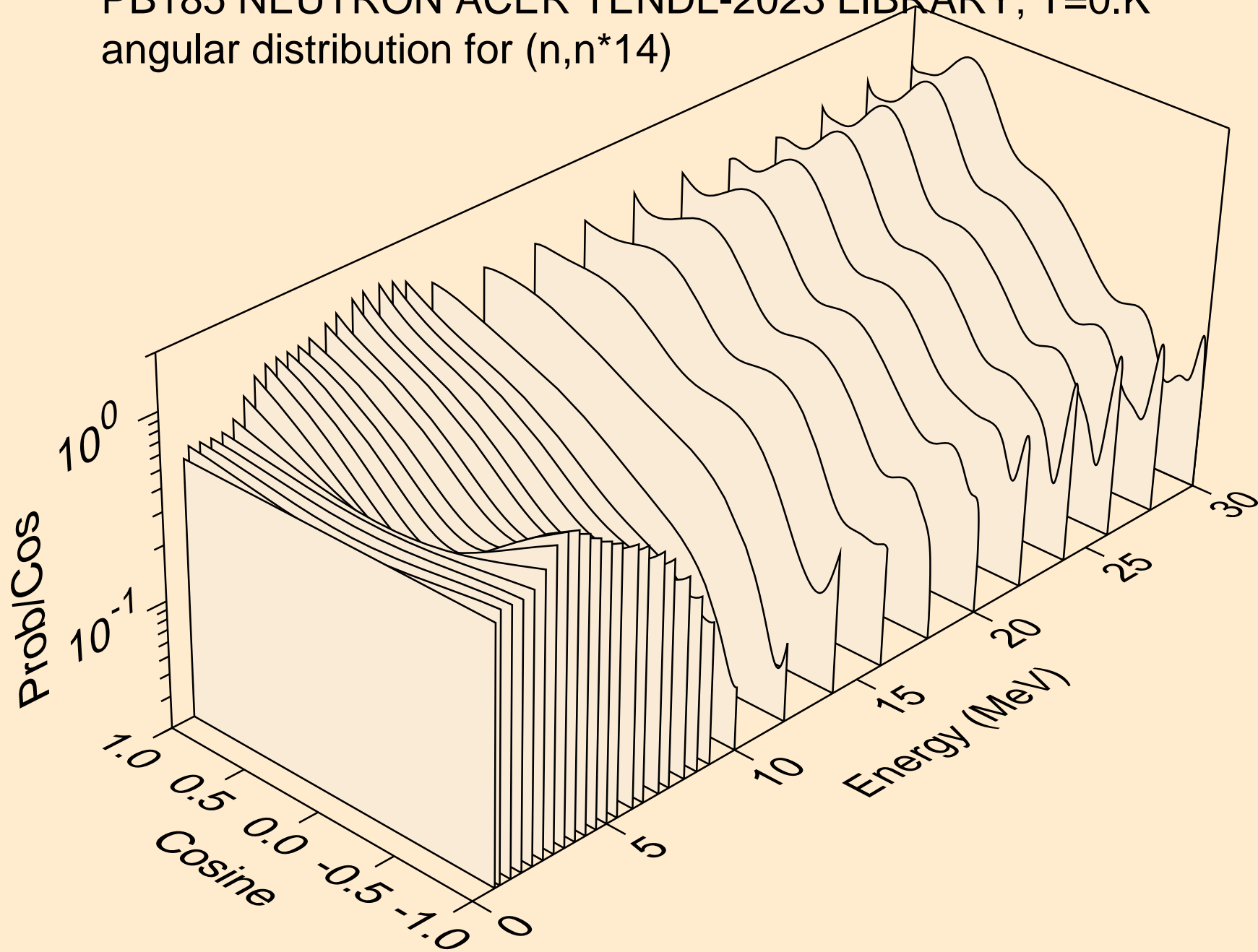

PB185 NEUTRON ACER TENDL-2023 LIBRARY; T=0.K  
angular distribution for (n,n\*15)

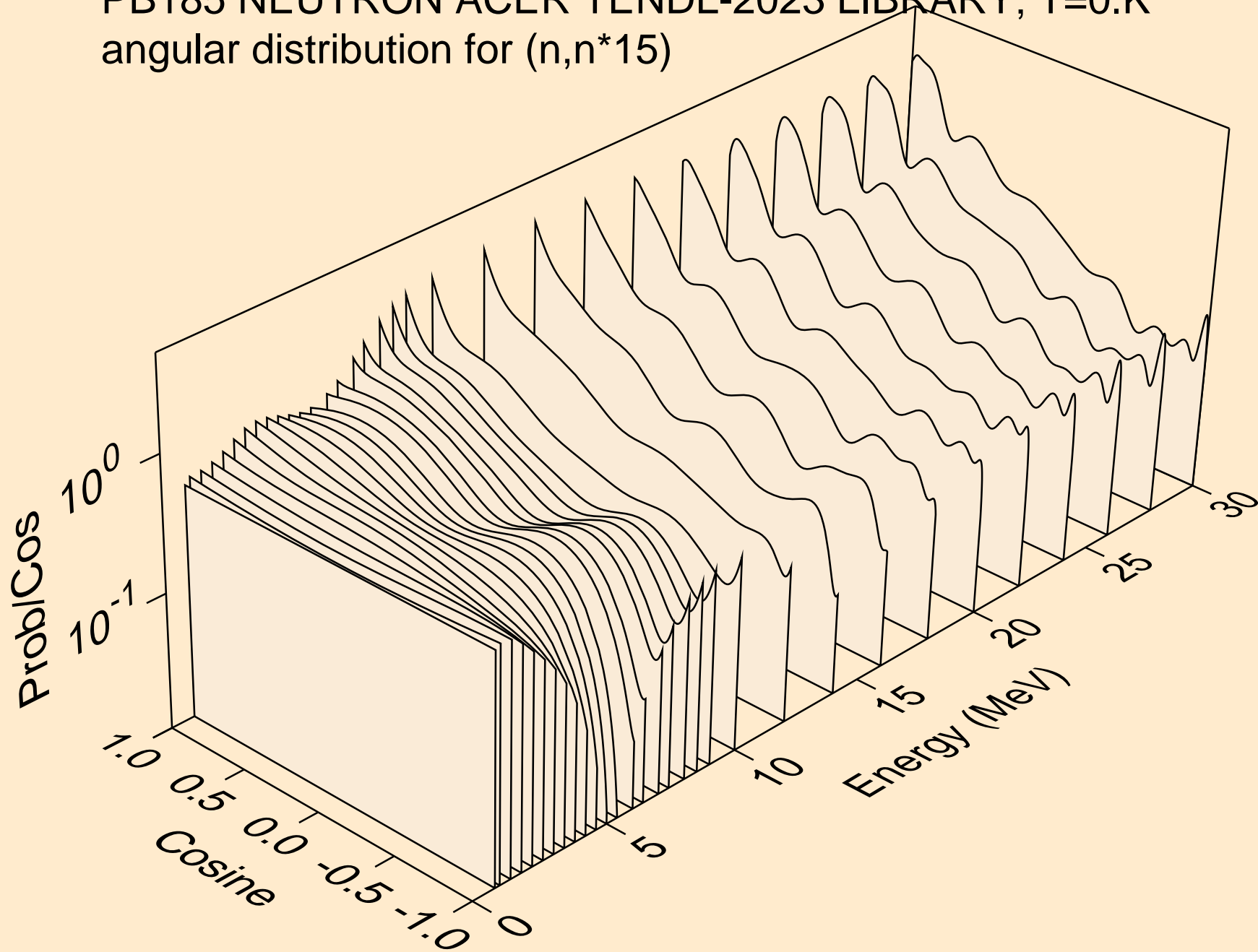

PB185 NEUTRON ACER TENDL-2023 LIBRARY; T=0.K  
angular distribution for (n,n\*16)

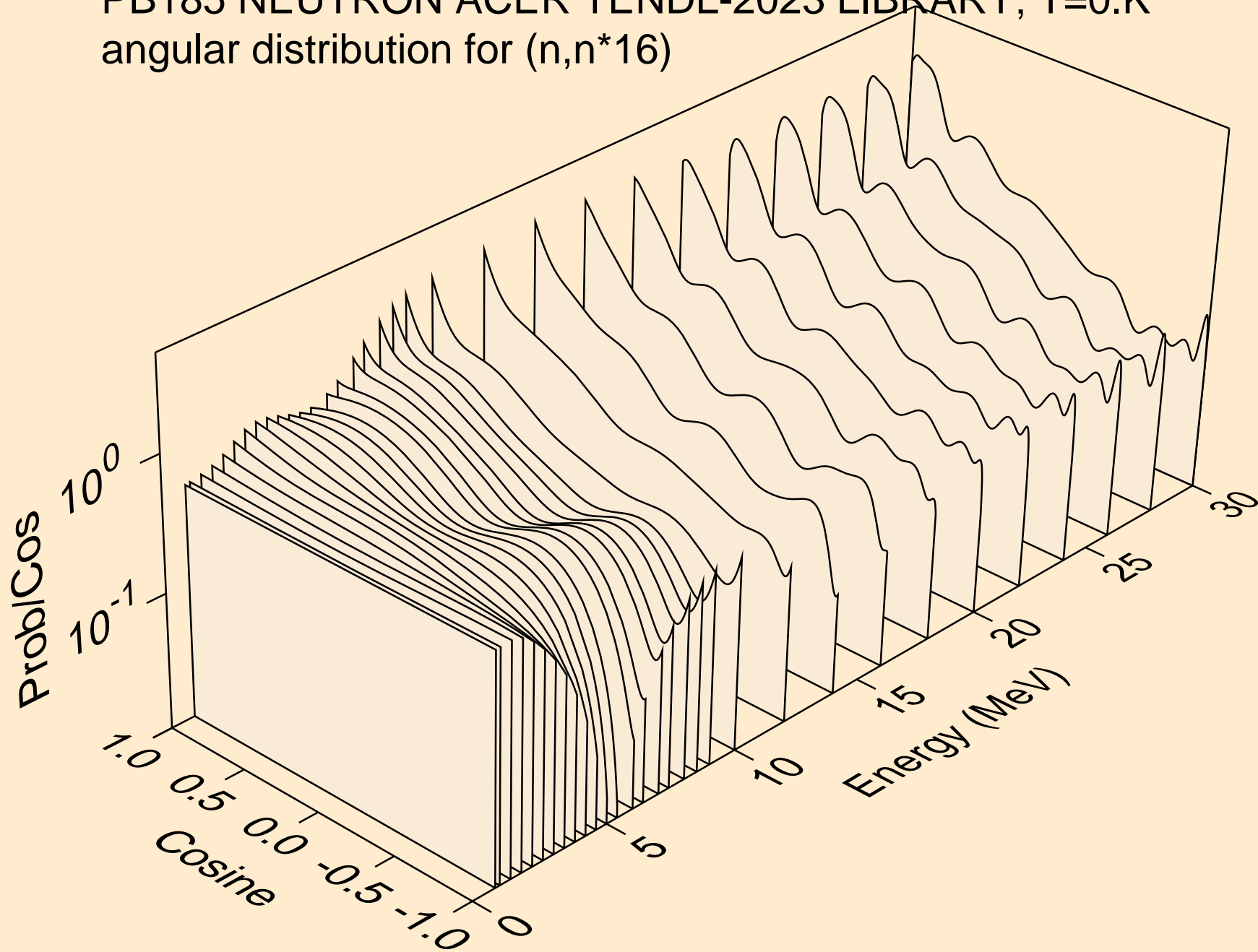

PB185 NEUTRON ACER TENDL-2023 LIBRARY; T=0.K  
angular distribution for (n,n\*17)

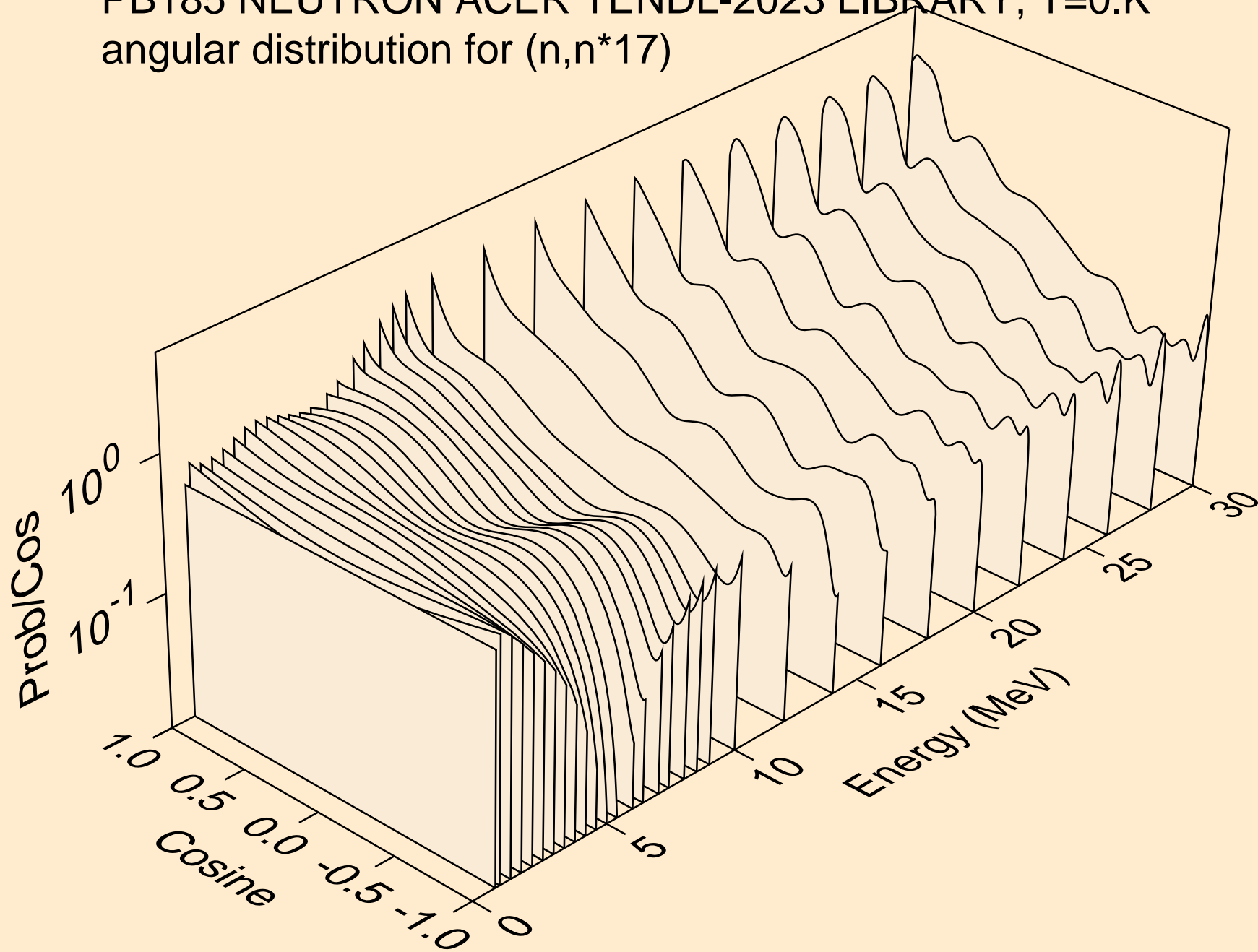

PB185 NEUTRON ACER TENDL-2023 LIBRARY; T=0.K  
angular distribution for (n,n\*18)

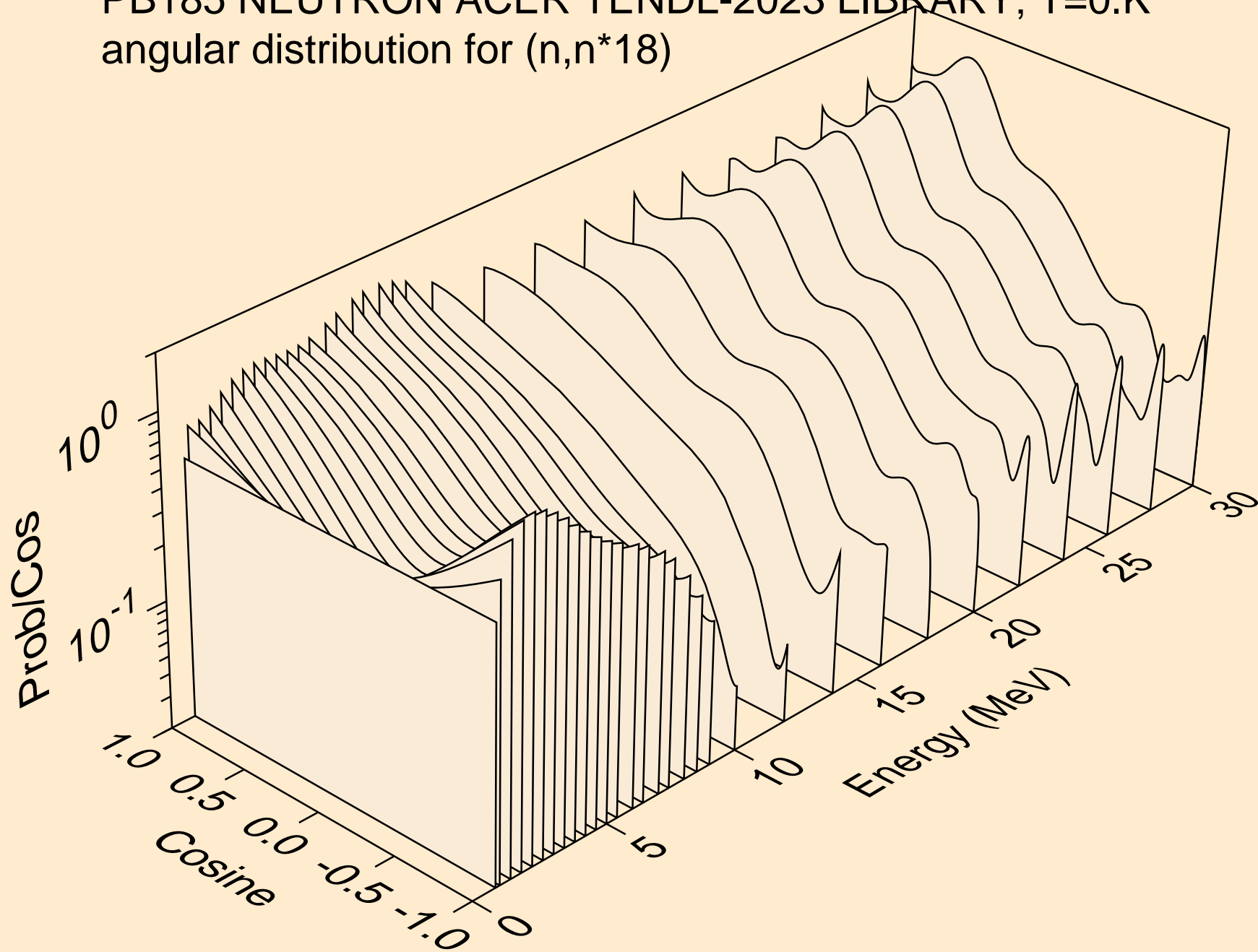

PB185 NEUTRON ACER TENDL-2023 LIBRARY; T=0.K  
angular distribution for (n,n\*19)

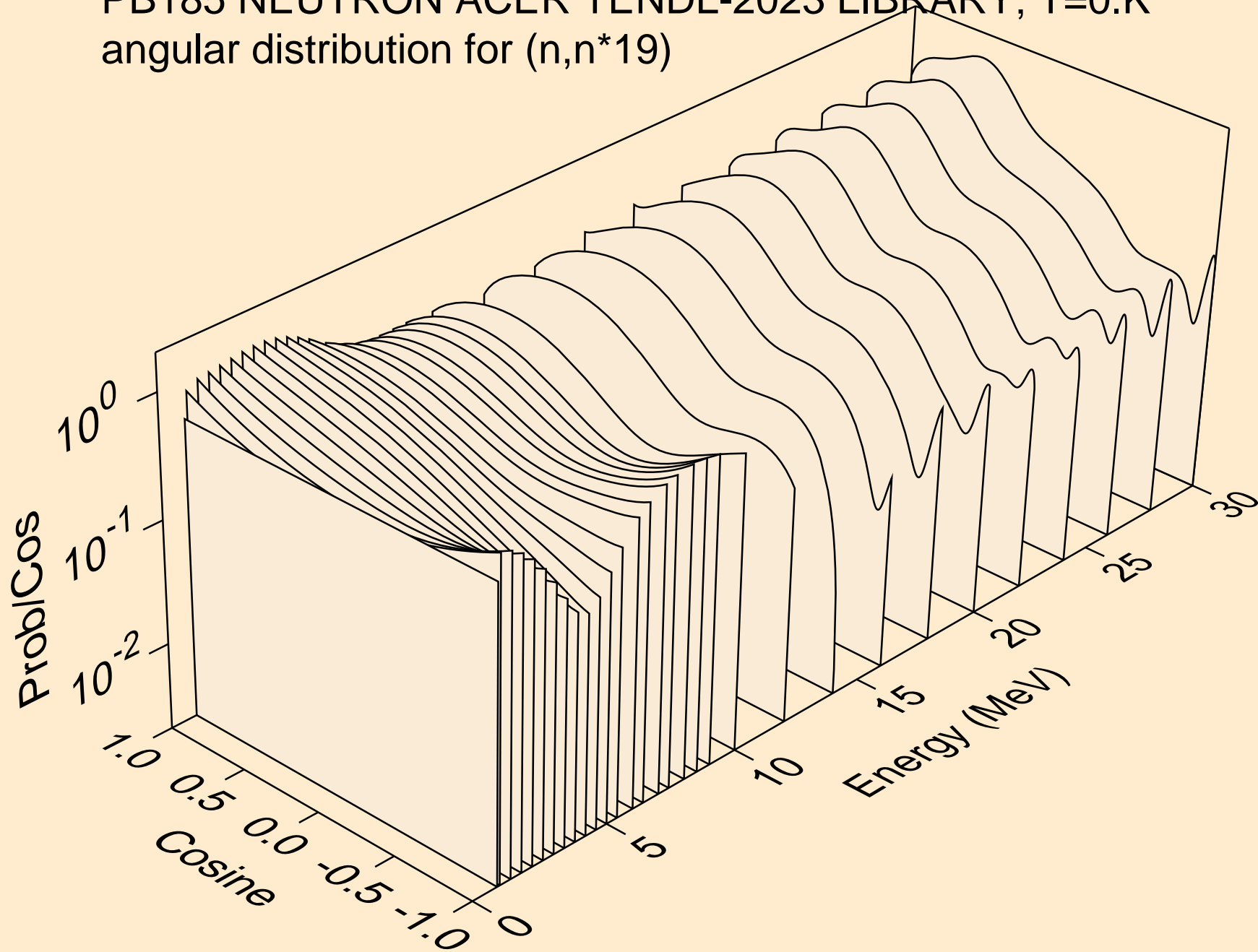

PB185 NEUTRON ACER TENDL-2023 LIBRARY; T=0.K  
angular distribution for (n,n\*20)

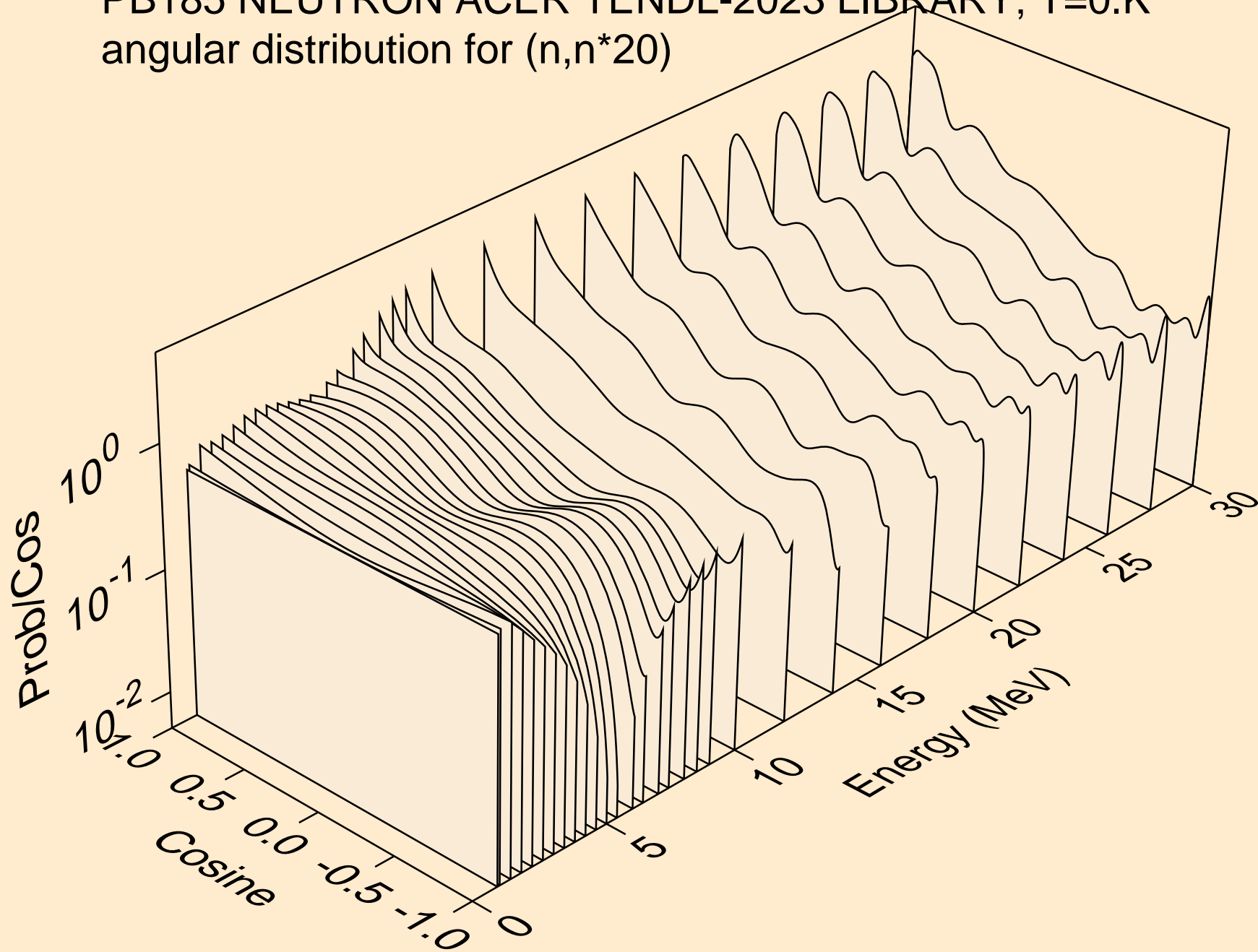

PB185 NEUTRON ACER TENDL-2023 LIBRARY; T=0.K  
Neutron emission for (n,x)

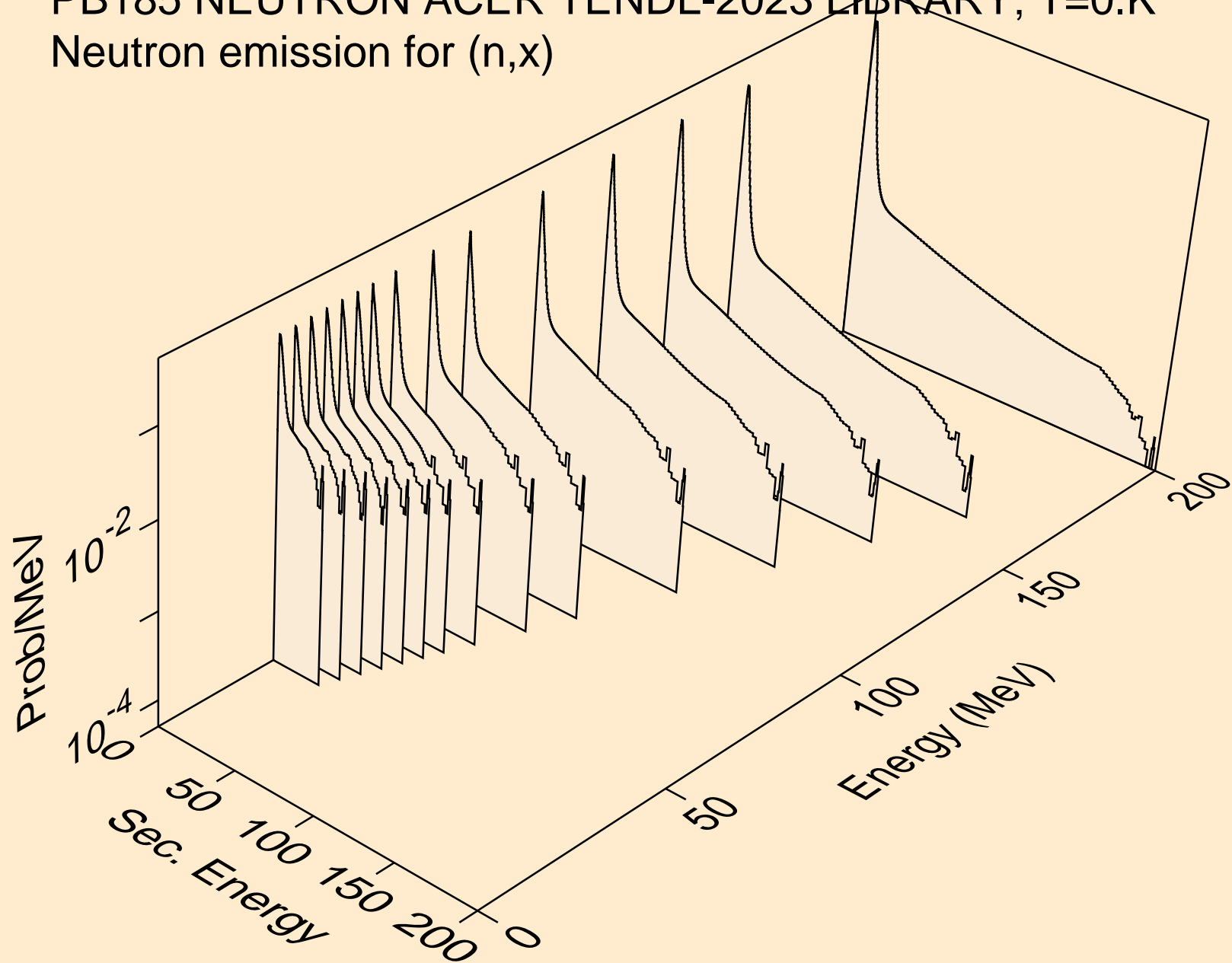

PB185 NEUTRON ACER TENDL-2023 LIBRARY; T=0.K  
Neutron emission for (n,2nd)

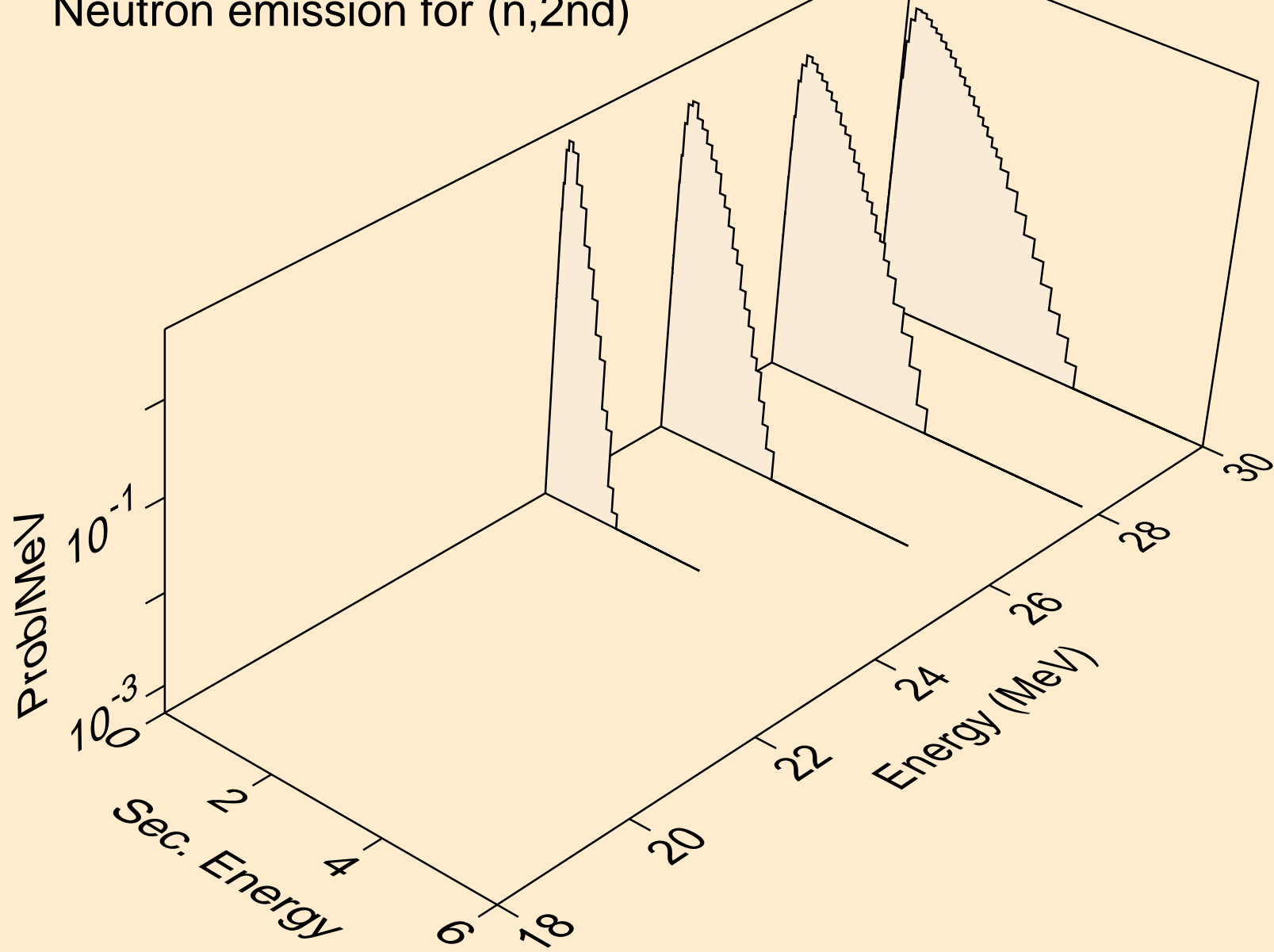

PB185 NEUTRON ACER TENDL-2023 LIBRARY; T=0.K  
Neutron emission for (n,2n)

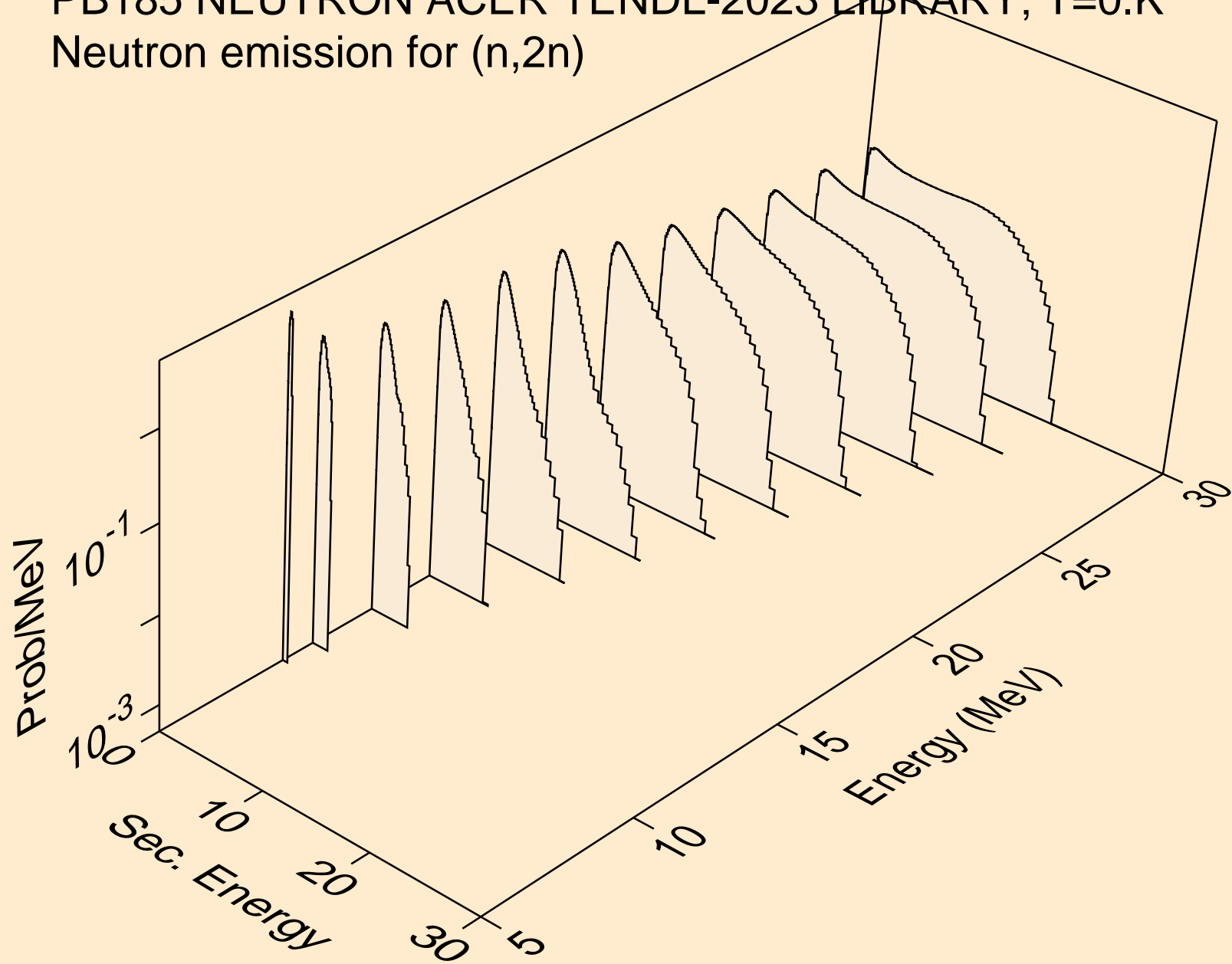

PB185 NEUTRON ACER TENDL-2023 LIBRARY; T=0.K  
Neutron emission for (n,3n)

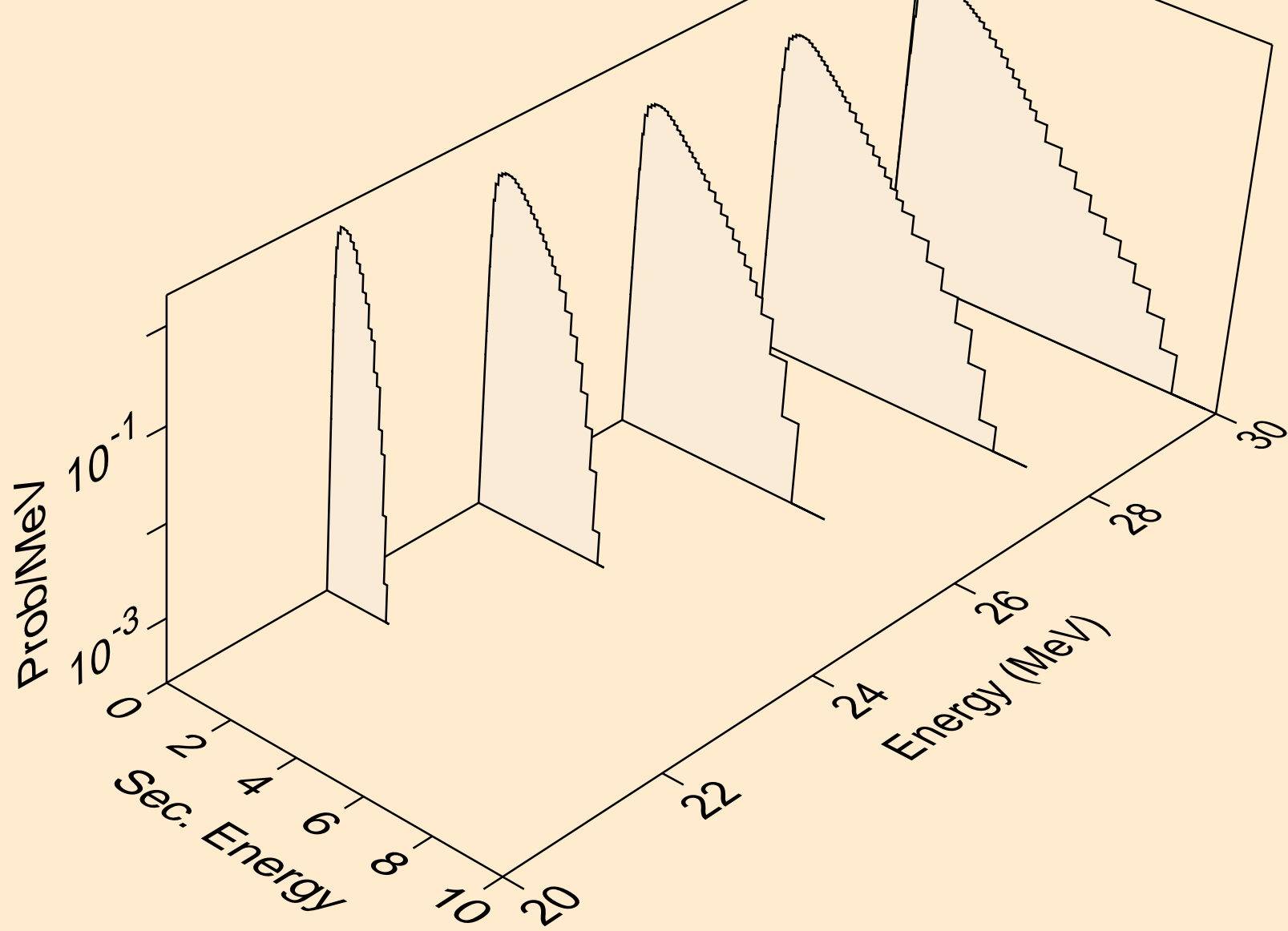

PB185 NEUTRON ACER TENDL-2023 LIBRARY; T=0.K  
Neutron emission for (n,n\*)a

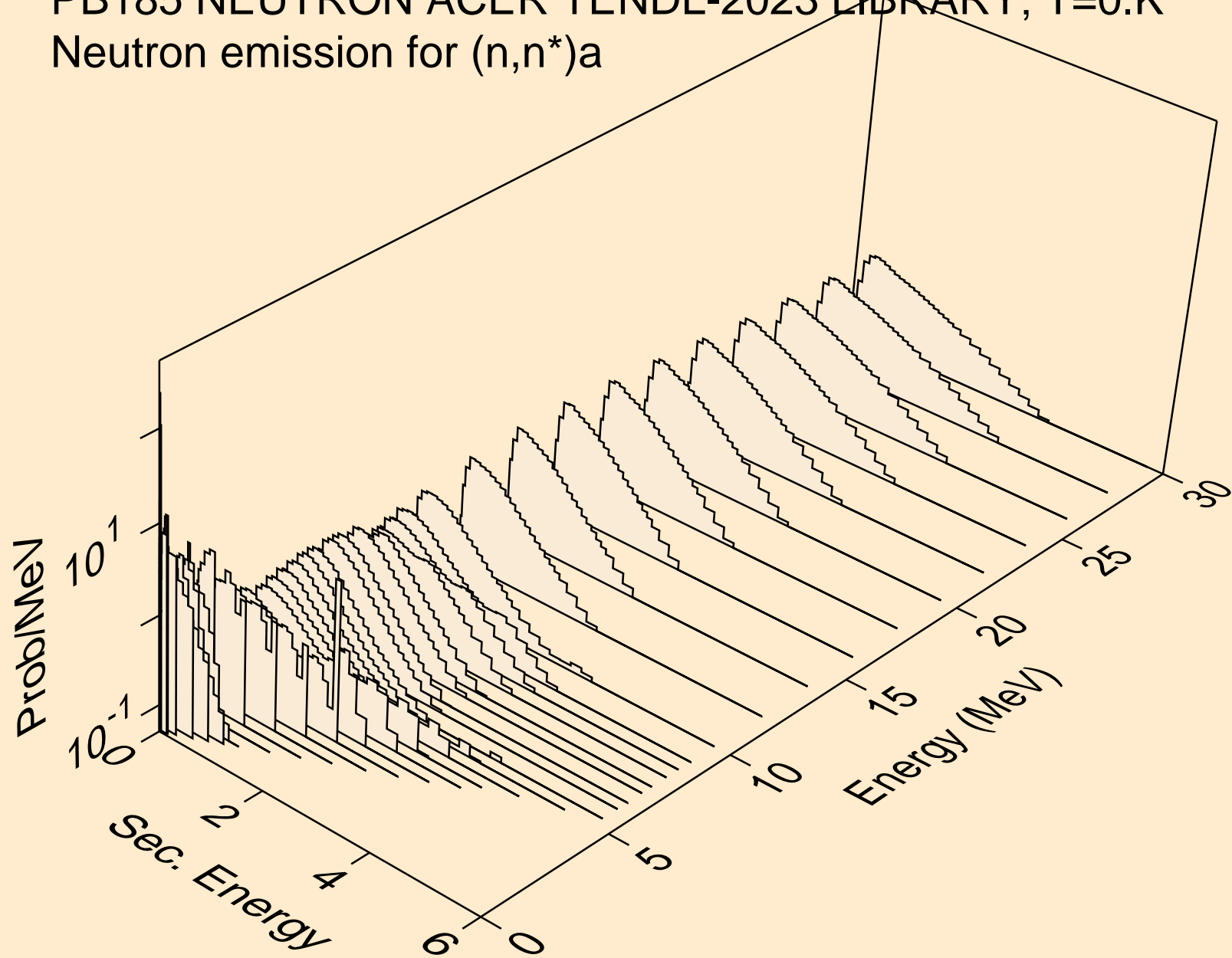

PB185 NEUTRON ACER TENDL-2023 LIBRARY; T=0.K  
Neutron emission for (n,n\*)3a

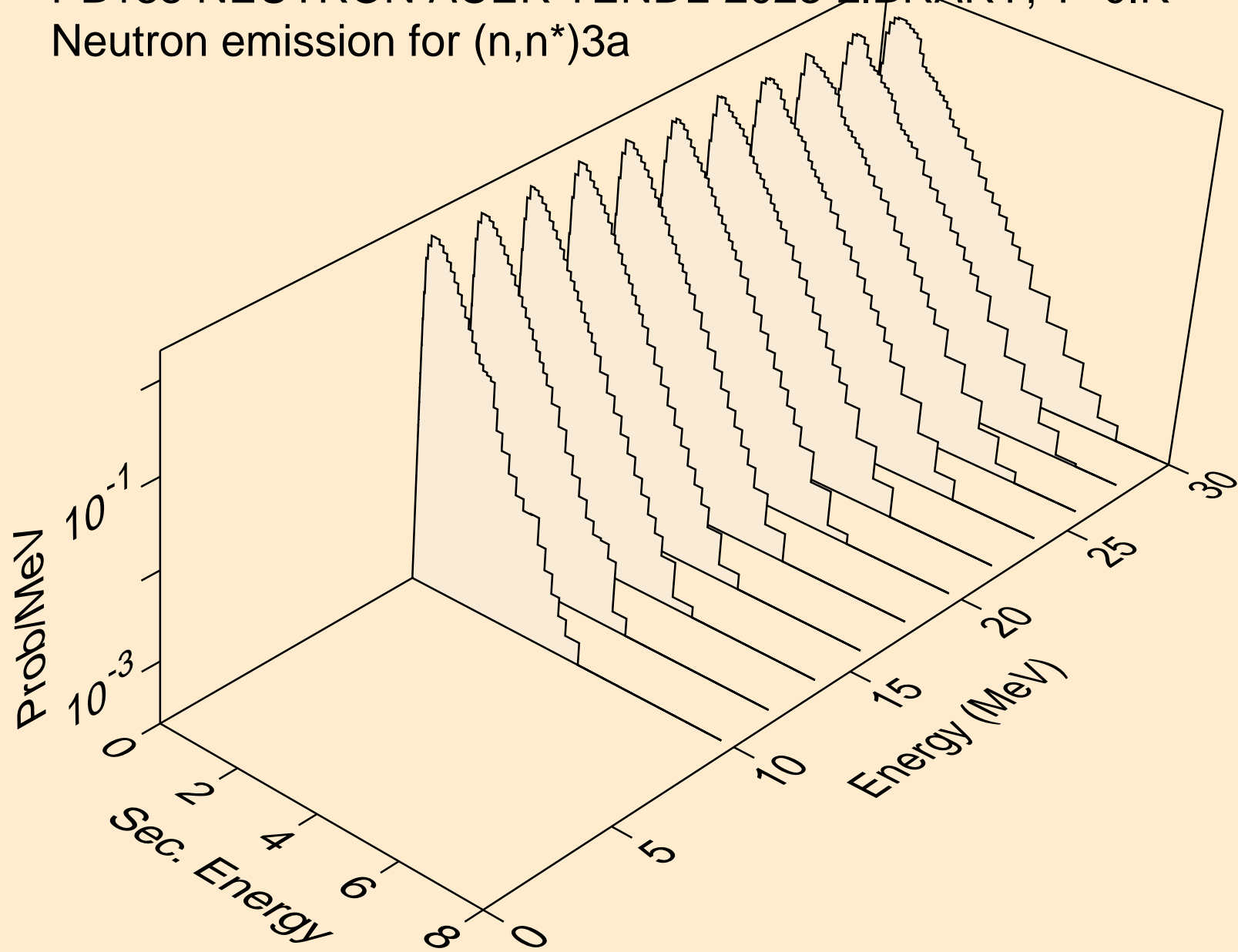

PB185 NEUTRON ACER TENDL-2023 LIBRARY; T=0.K  
Neutron emission for (n,2n)a

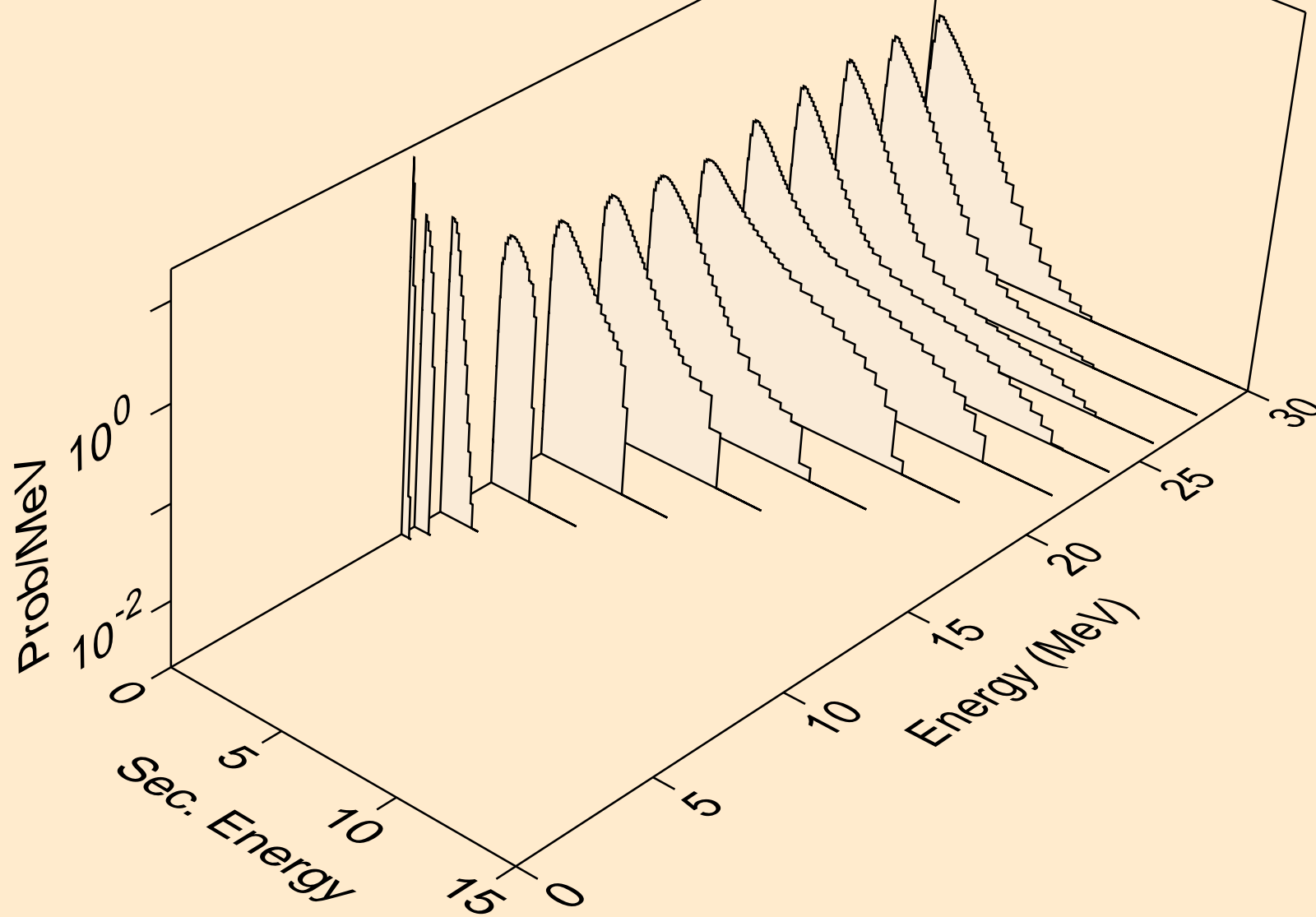

PB185 NEUTRON ACER TENDL-2023 LIBRARY; T=0.K  
Neutron emission for (n,3n)a

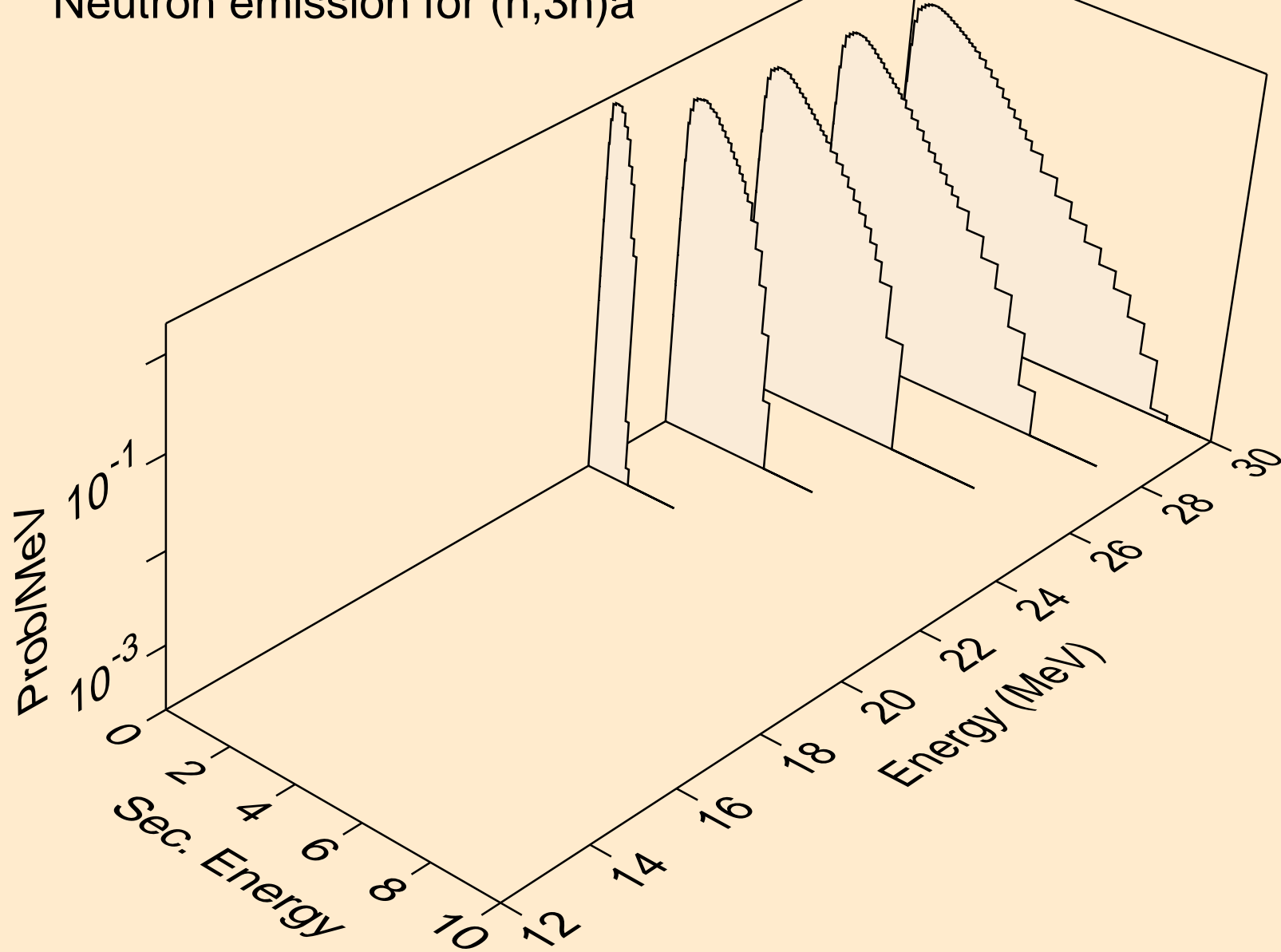

PB185 NEUTRON ACER TENDL-2023 LIBRARY; T=0.K  
Neutron emission for (n,n\*)p

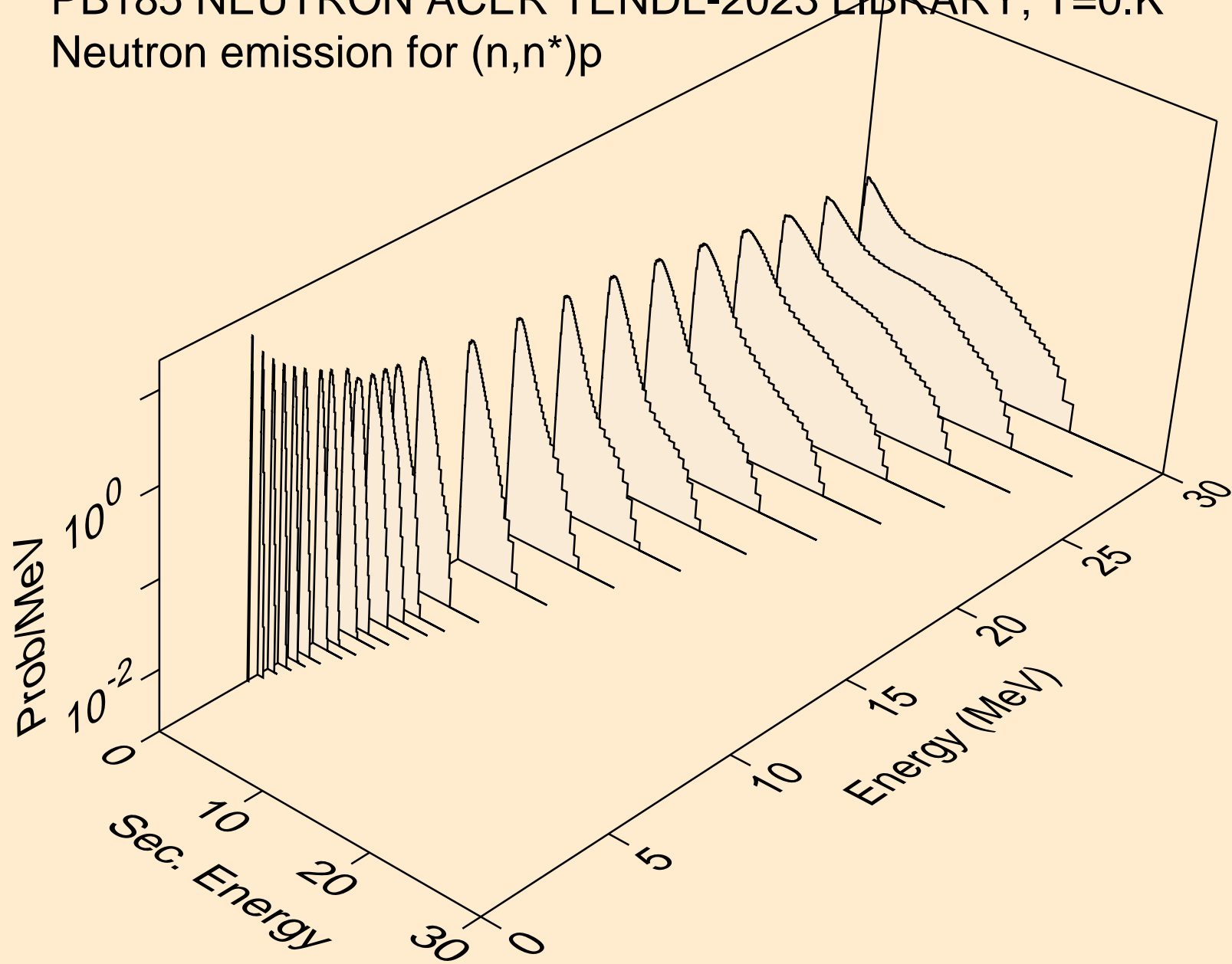

PB185 NEUTRON ACER TENDL-2023 LIBRARY; T=0.K  
Neutron emission for (n,n\*)2a

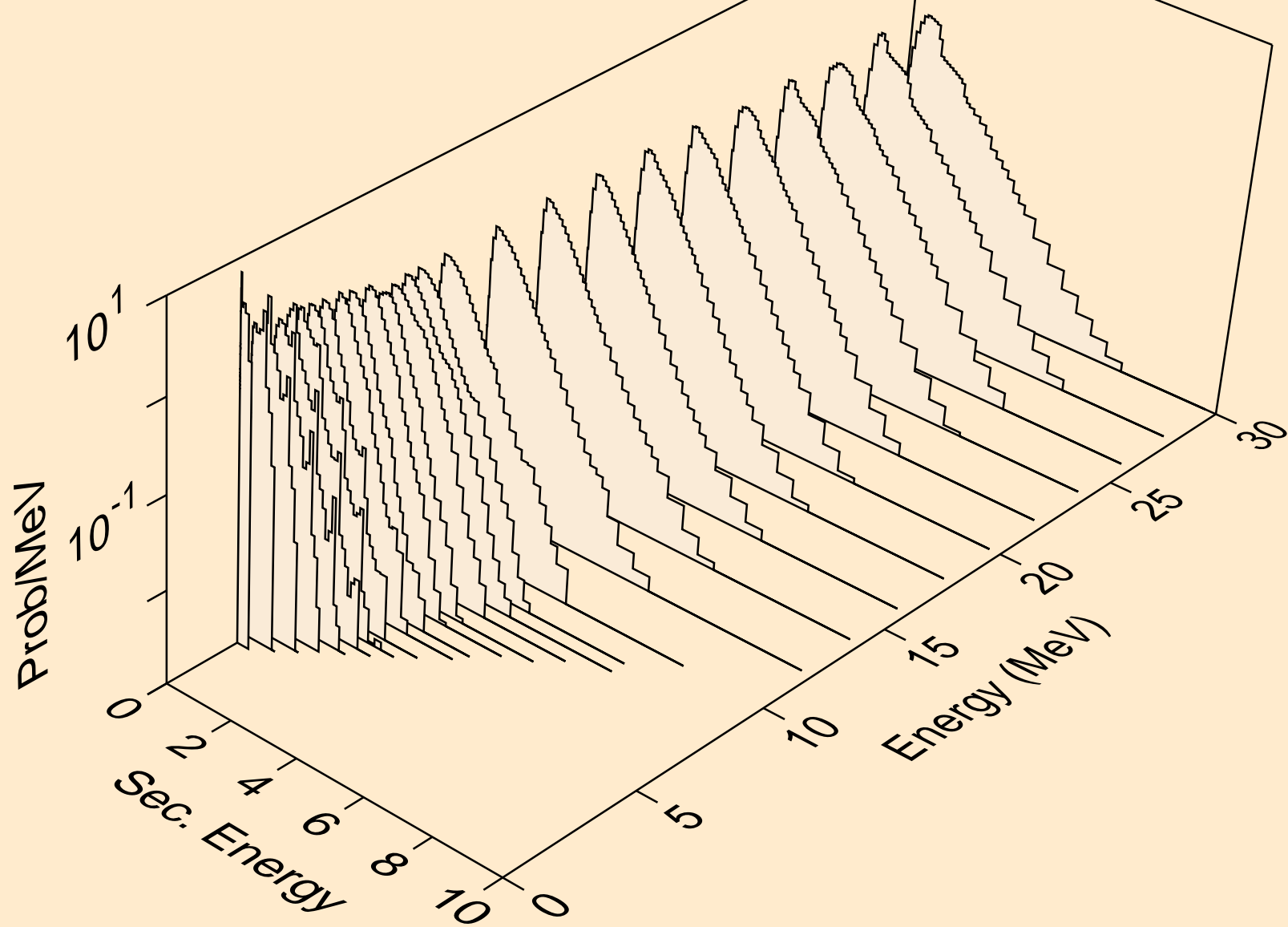

PB185 NEUTRON ACER TENDL-2023 LIBRARY; T=0.K  
Neutron emission for (n,2n)2a

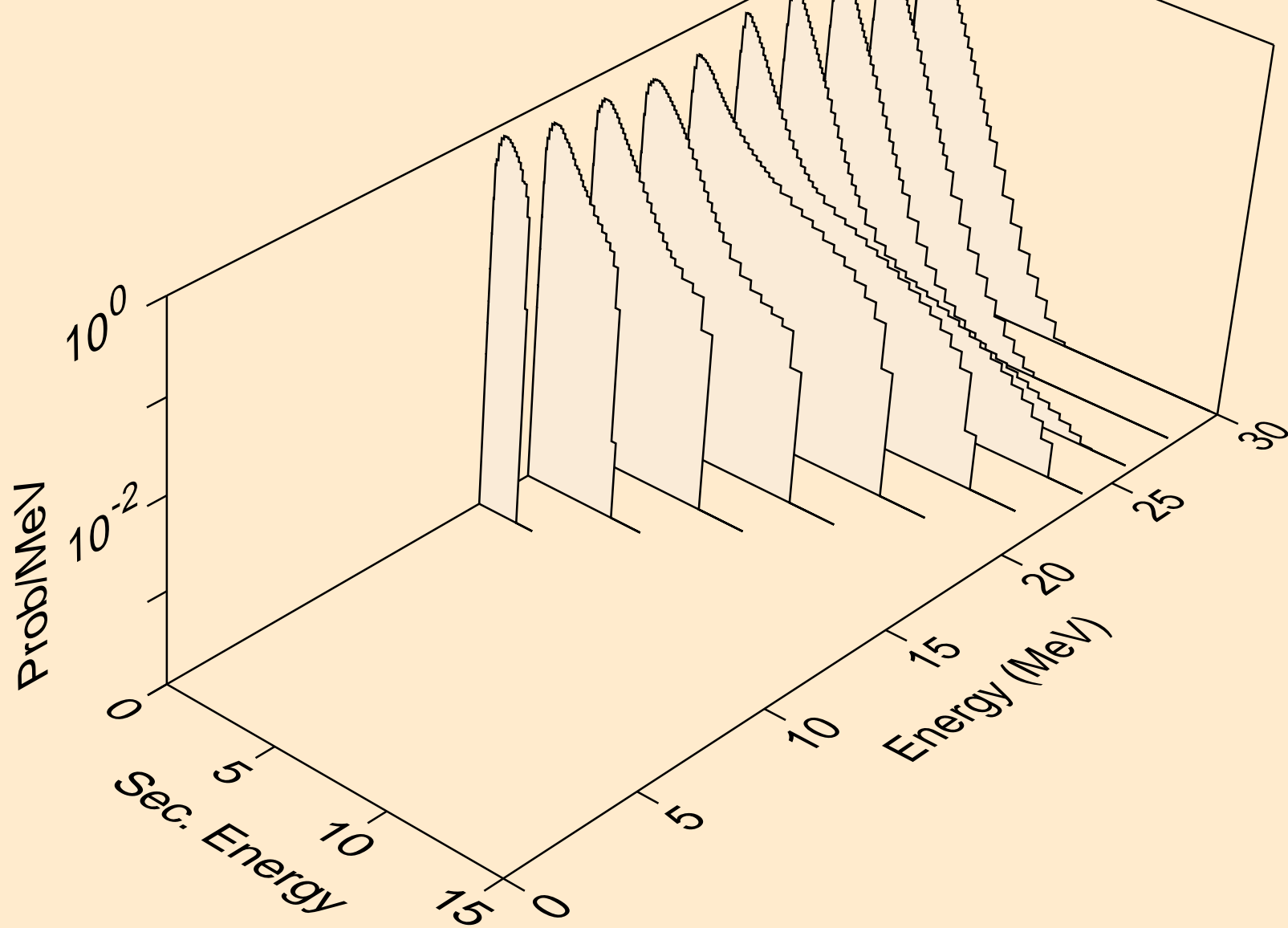

PB185 NEUTRON ACER TENDL-2023 LIBRARY; T=0.K  
Neutron emission for (n,n\*)d

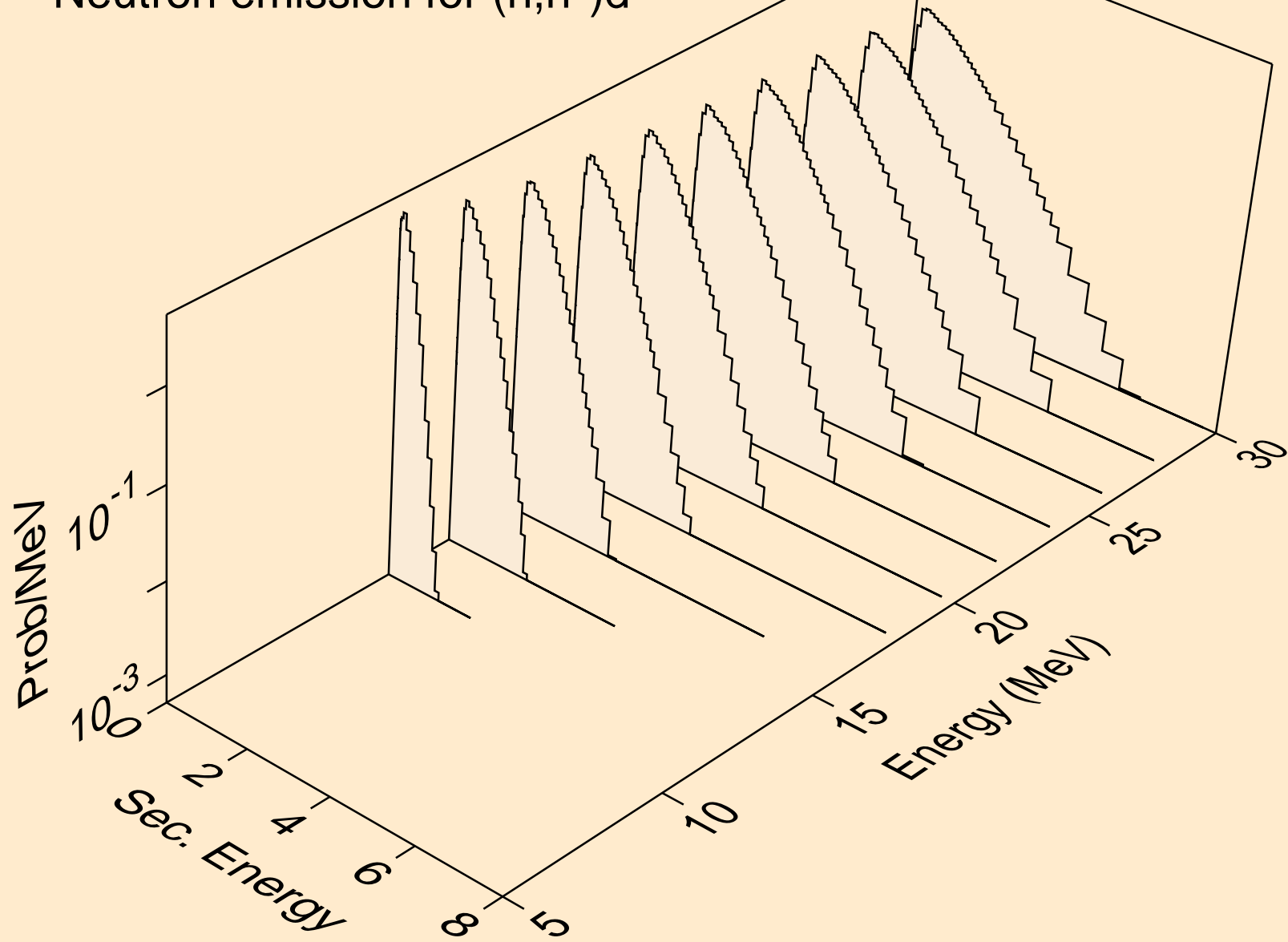

PB185 NEUTRON ACER TENDL-2023 LIBRARY; T=0.K  
Neutron emission for (n,n\*)t

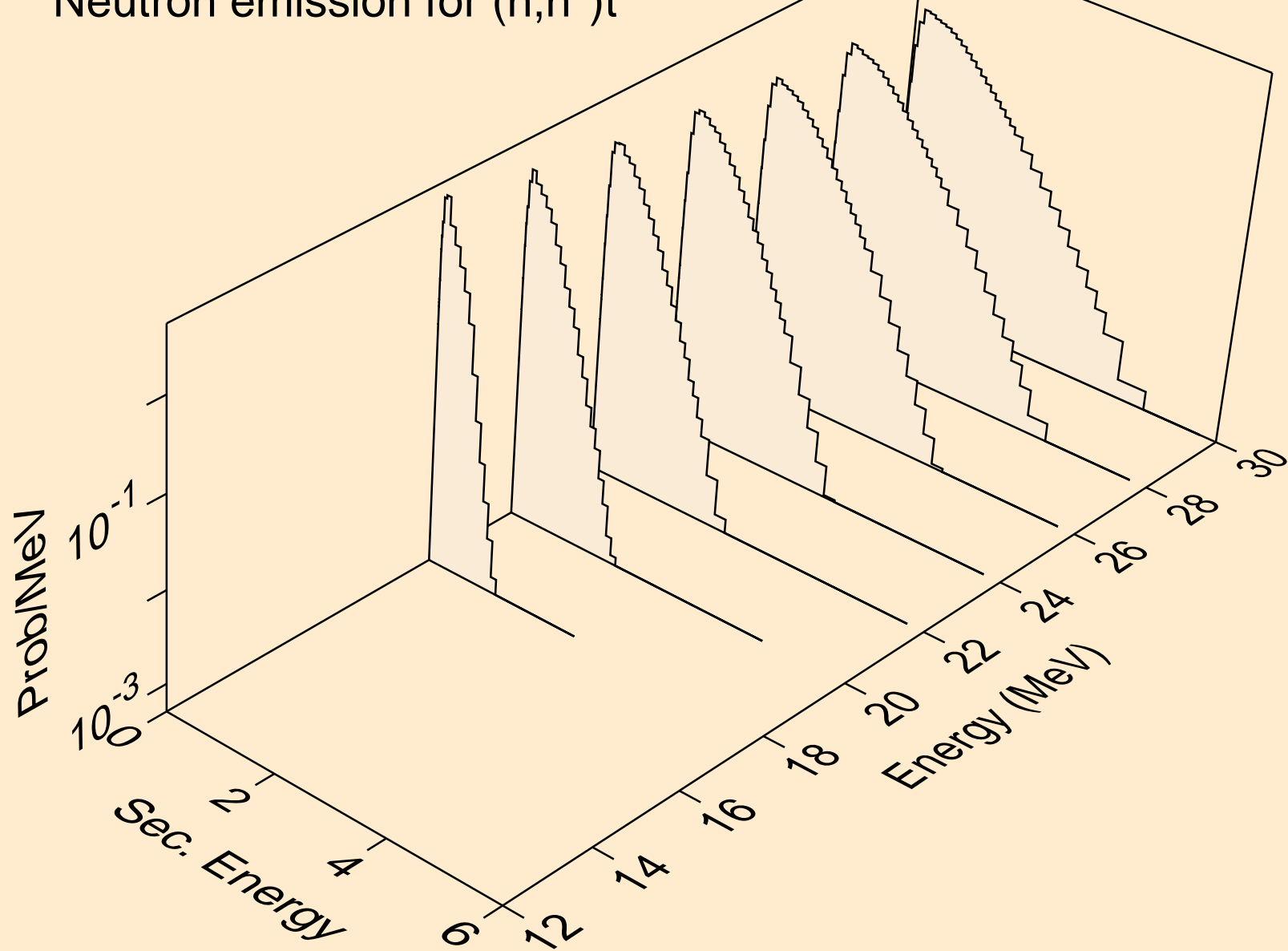

PB185 NEUTRON ACER TENDL-2023 LIBRARY; T=0.K  
Neutron emission for (n,n\*)he3

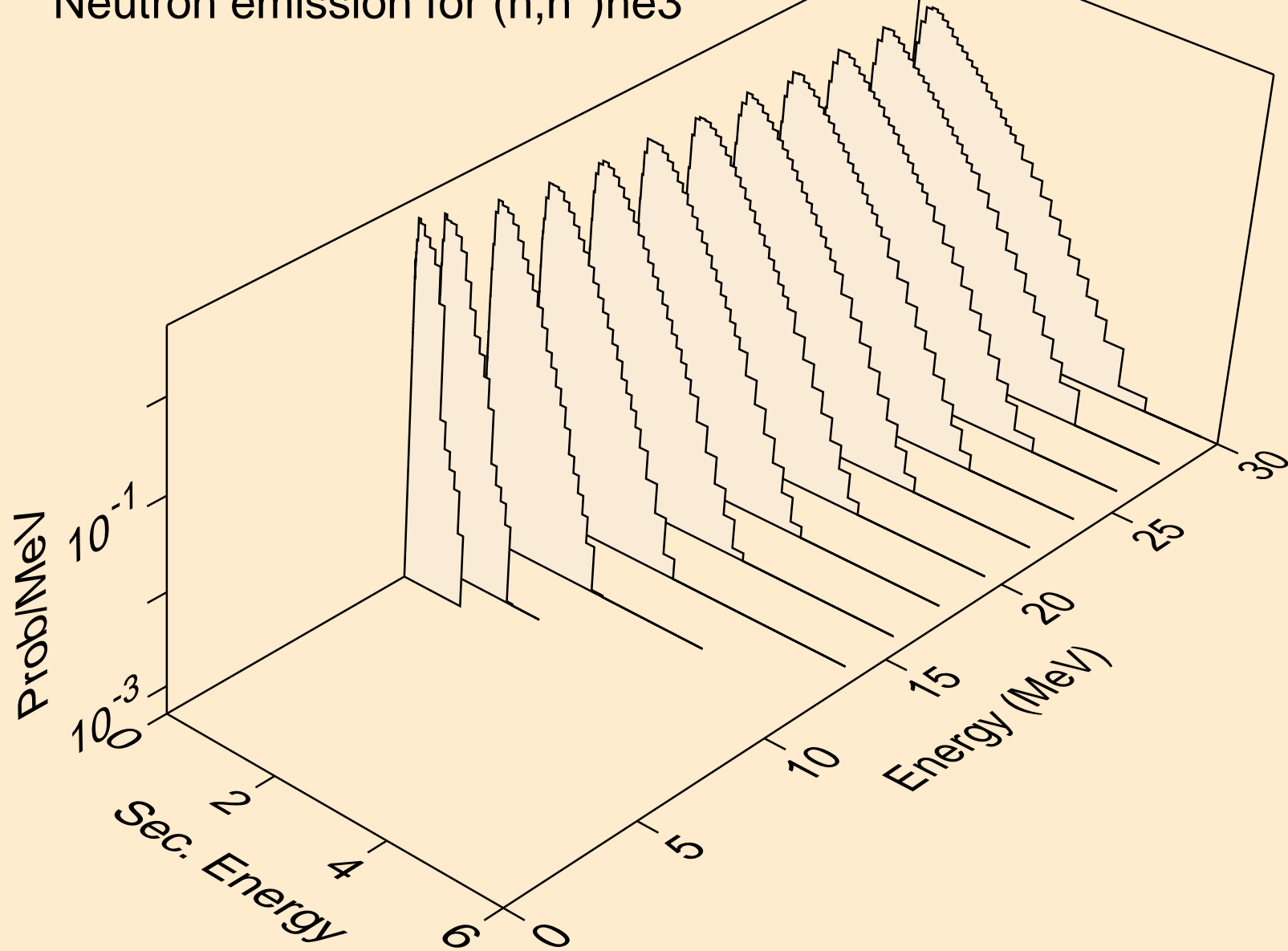

PB185 NEUTRON ACER TENDL-2023 LIBRARY; T=0.K  
Neutron emission for (n,2np)

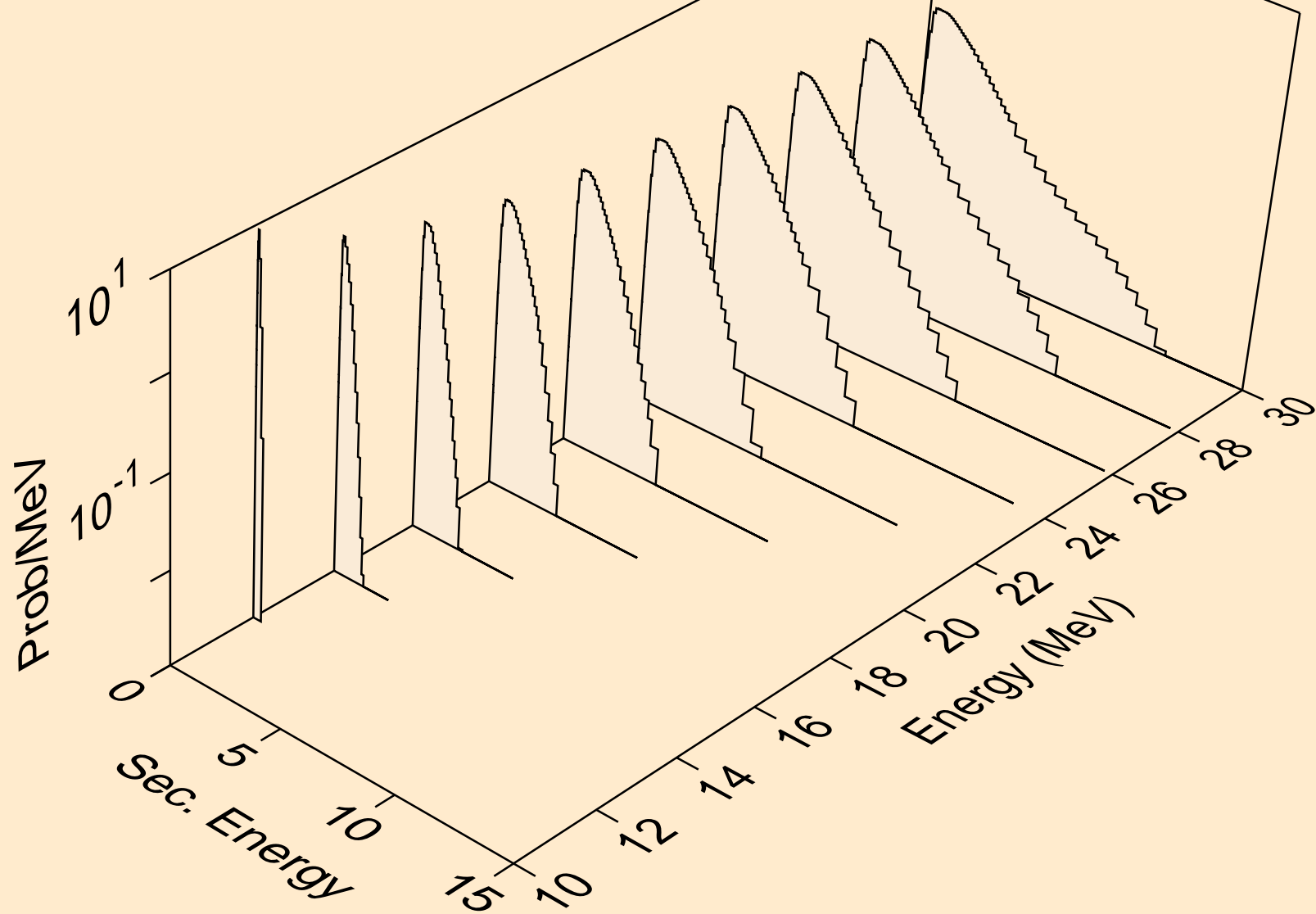

PB185 NEUTRON ACER TENDL-2023 LIBRARY; T=0.K  
Neutron emission for (n,3np)

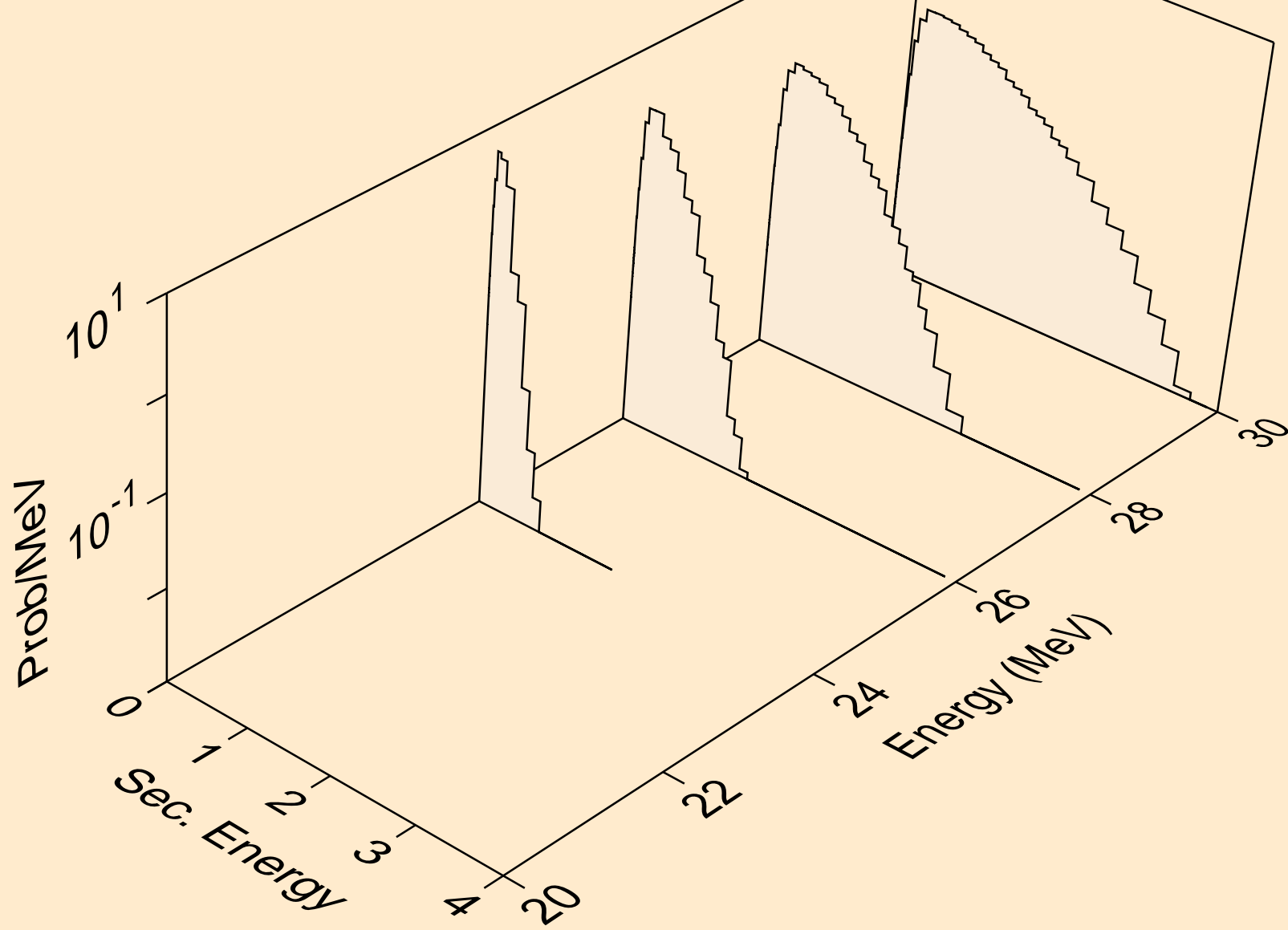

PB185 NEUTRON ACER TENDL-2023 LIBRARY; T=0.K  
Neutron emission for (n,n2p)

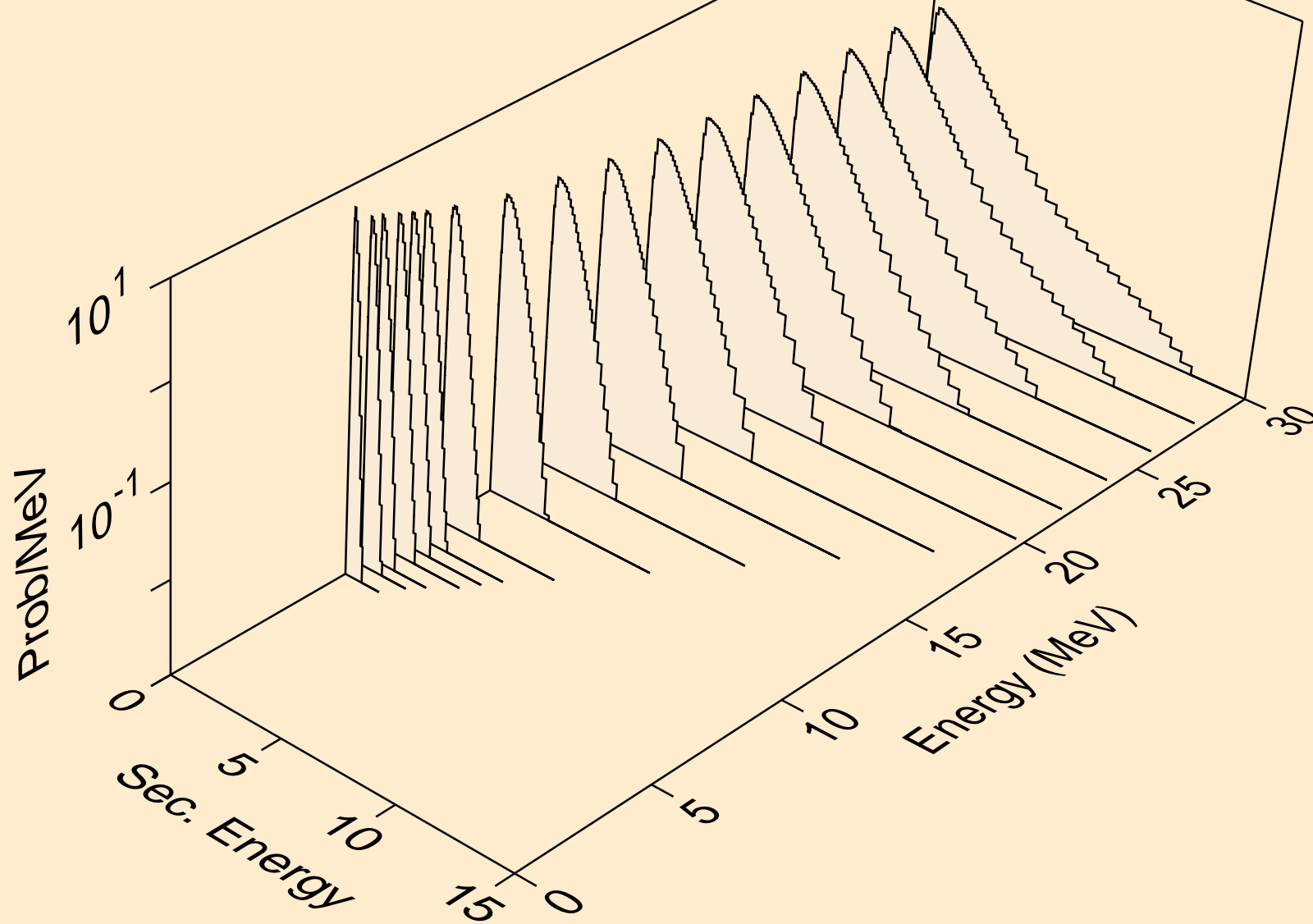

PB185 NEUTRON ACER TENDL-2023 LIBRARY; T=0.K  
Neutron emission for (n,npa)

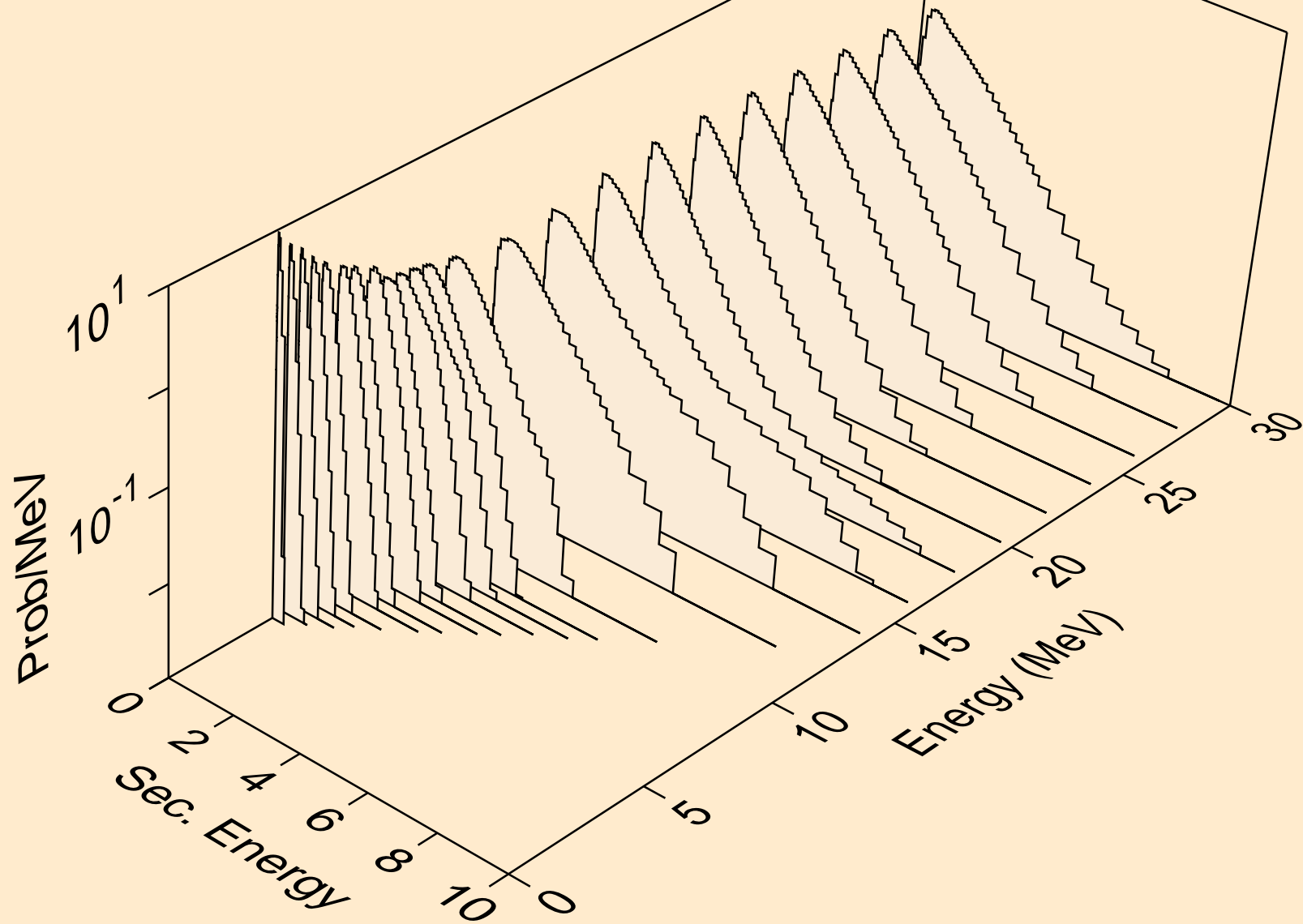

PB185 NEUTRON ACER TENDL-2023 LIBRARY; T=0.K  
Neutron emission for (n,n\*c)

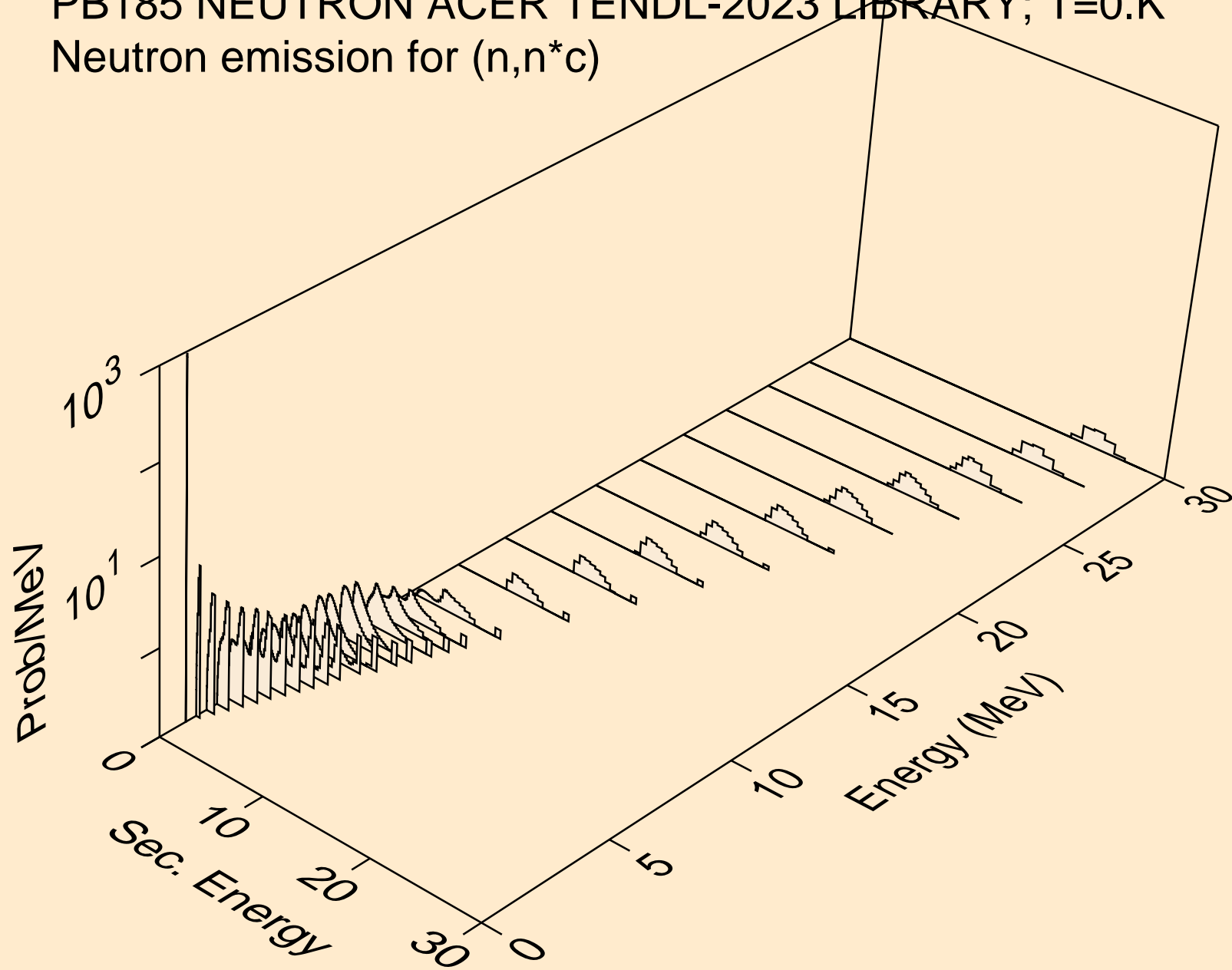

PB185 NEUTRON ACER TENDL-2023 LIBRARY; T=0.K  
Photon emission for (n,x)

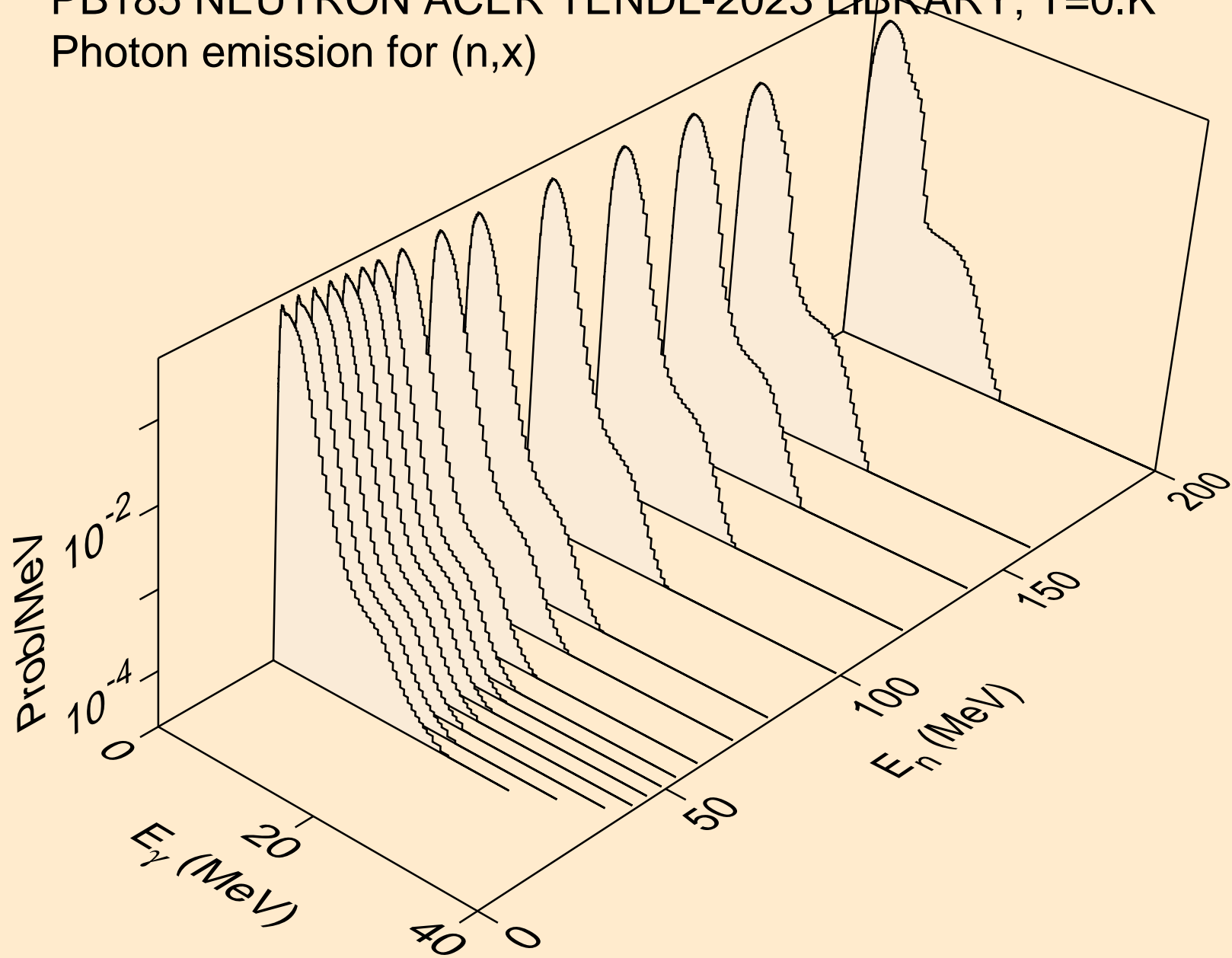

PB185 NEUTRON ACER TENDL-2023 LIBRARY; T=0.K  
Photon emission for (n,2nd)

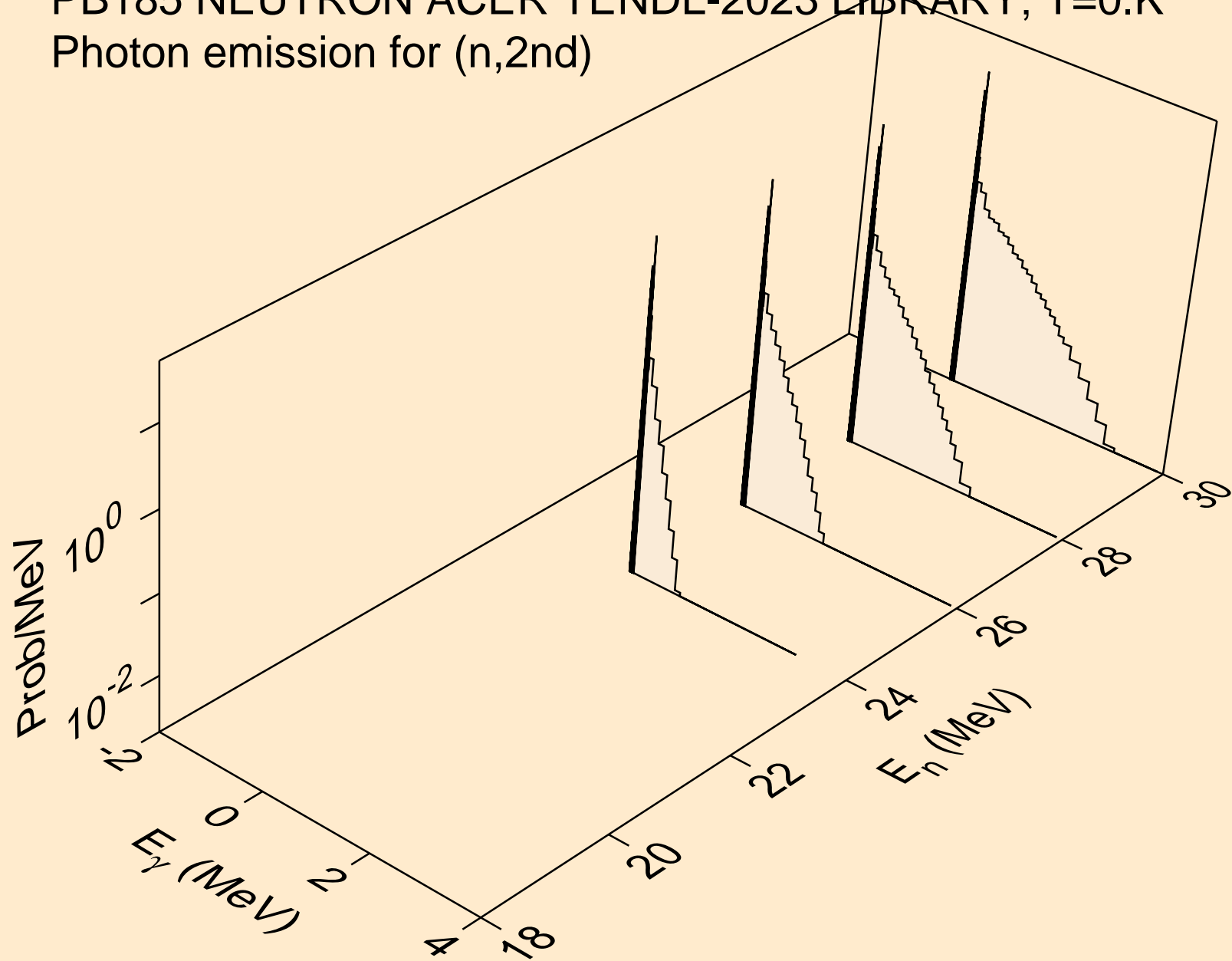

PB185 NEUTRON ACER TENDL-2023 LIBRARY; T=0.K  
Photon emission for (n,2n)

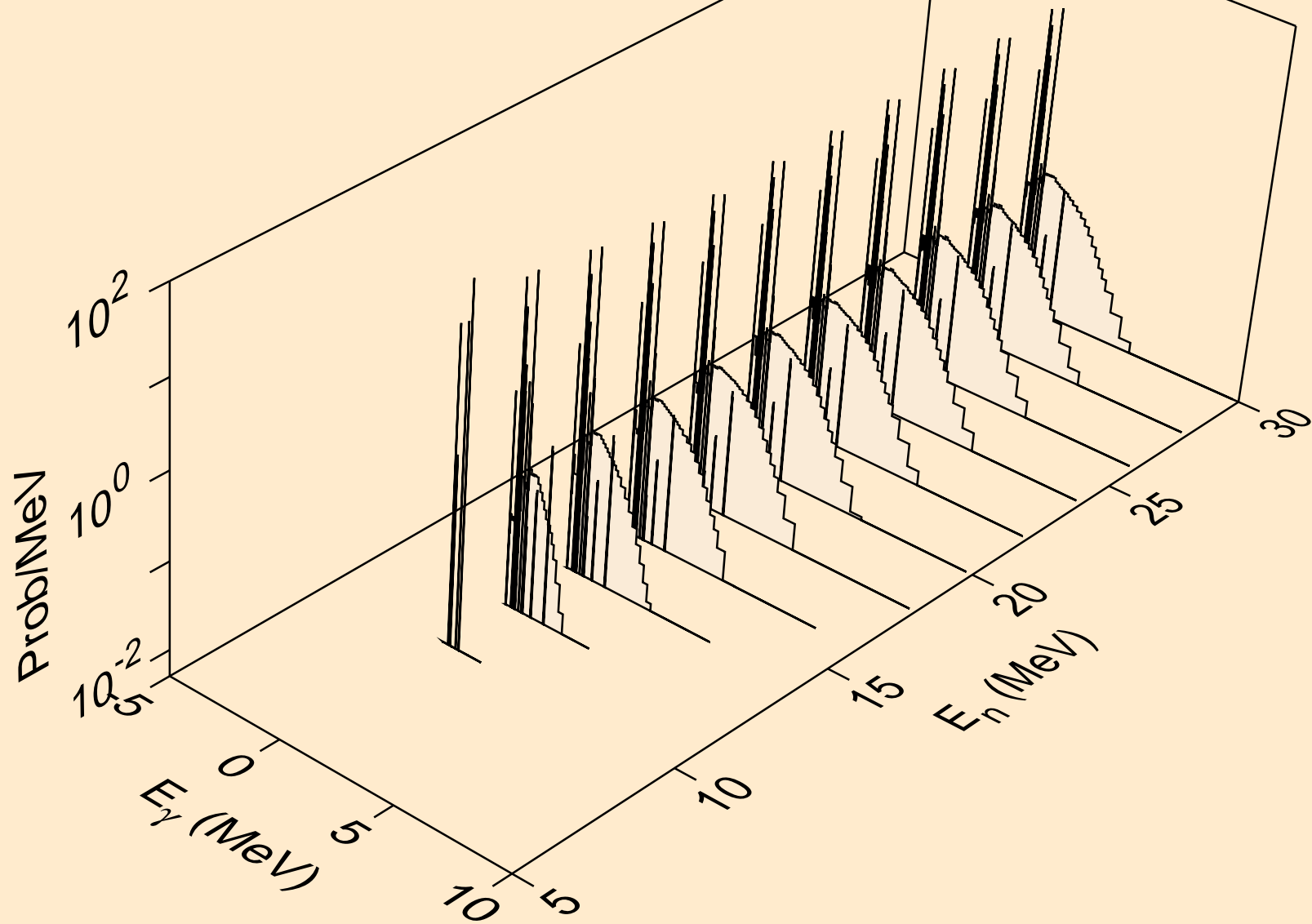

PB185 NEUTRON ACER TENDL-2023 LIBRARY; T=0.K  
Photon emission for (n,3n)

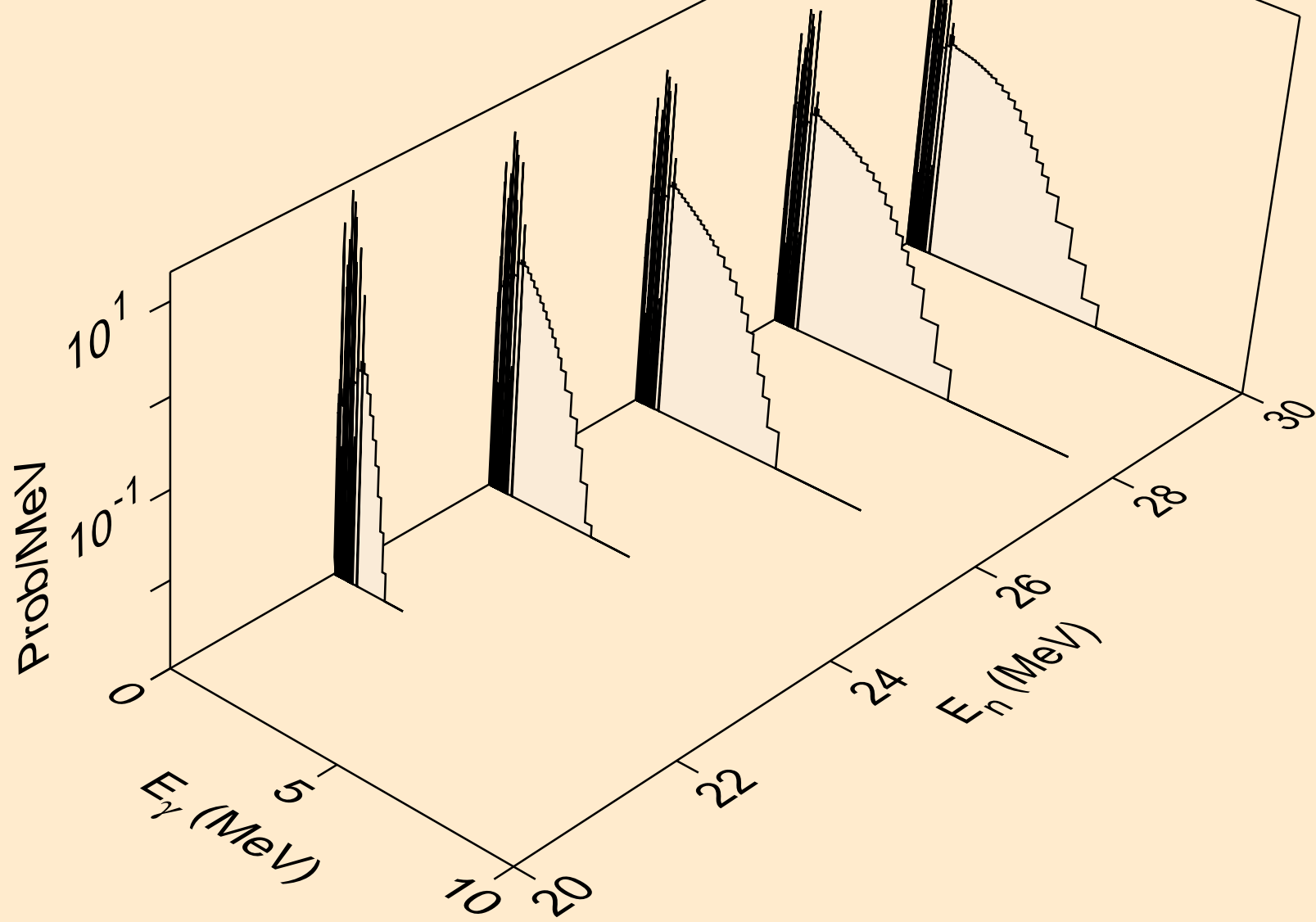

PB185 NEUTRON ACER TENDL-2023 LIBRARY; T=0.K  
Photon emission for (n,n\*)a

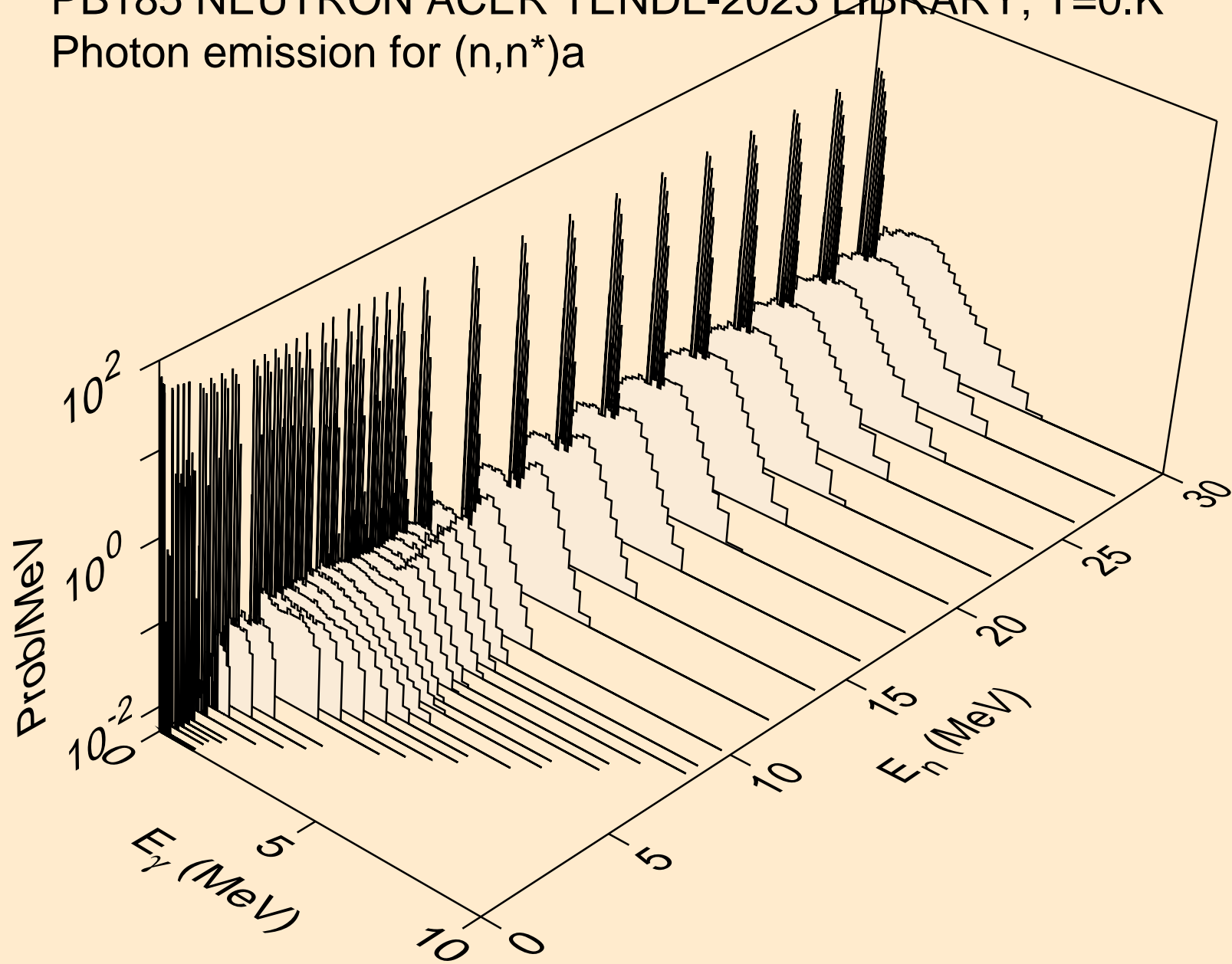

PB185 NEUTRON ACER TENDL-2023 LIBRARY; T=0.K  
Photon emission for (n,n\*)3a

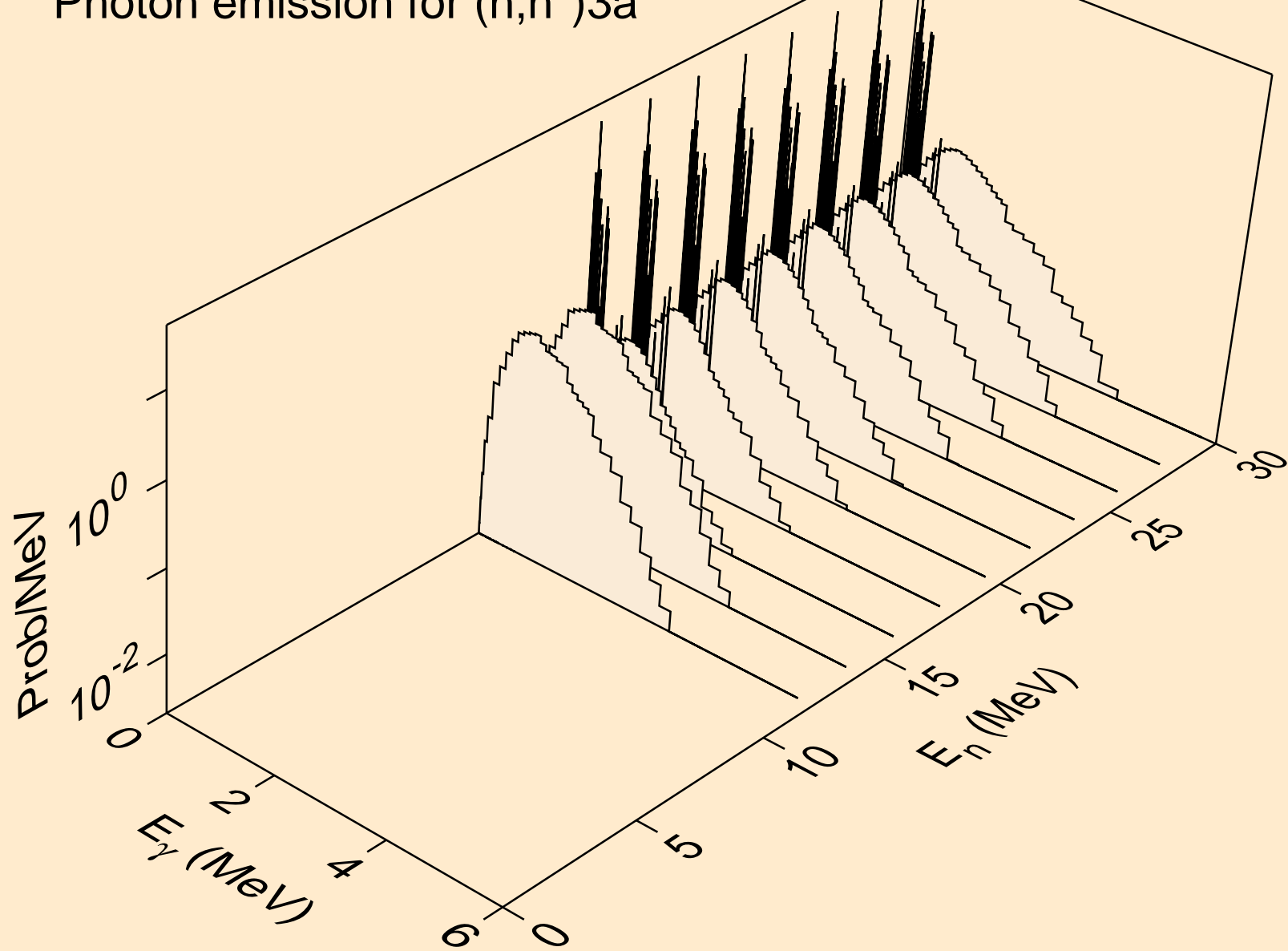

PB185 NEUTRON ACER TENDL-2023 LIBRARY; T=0.K  
Photon emission for (n,2n)a

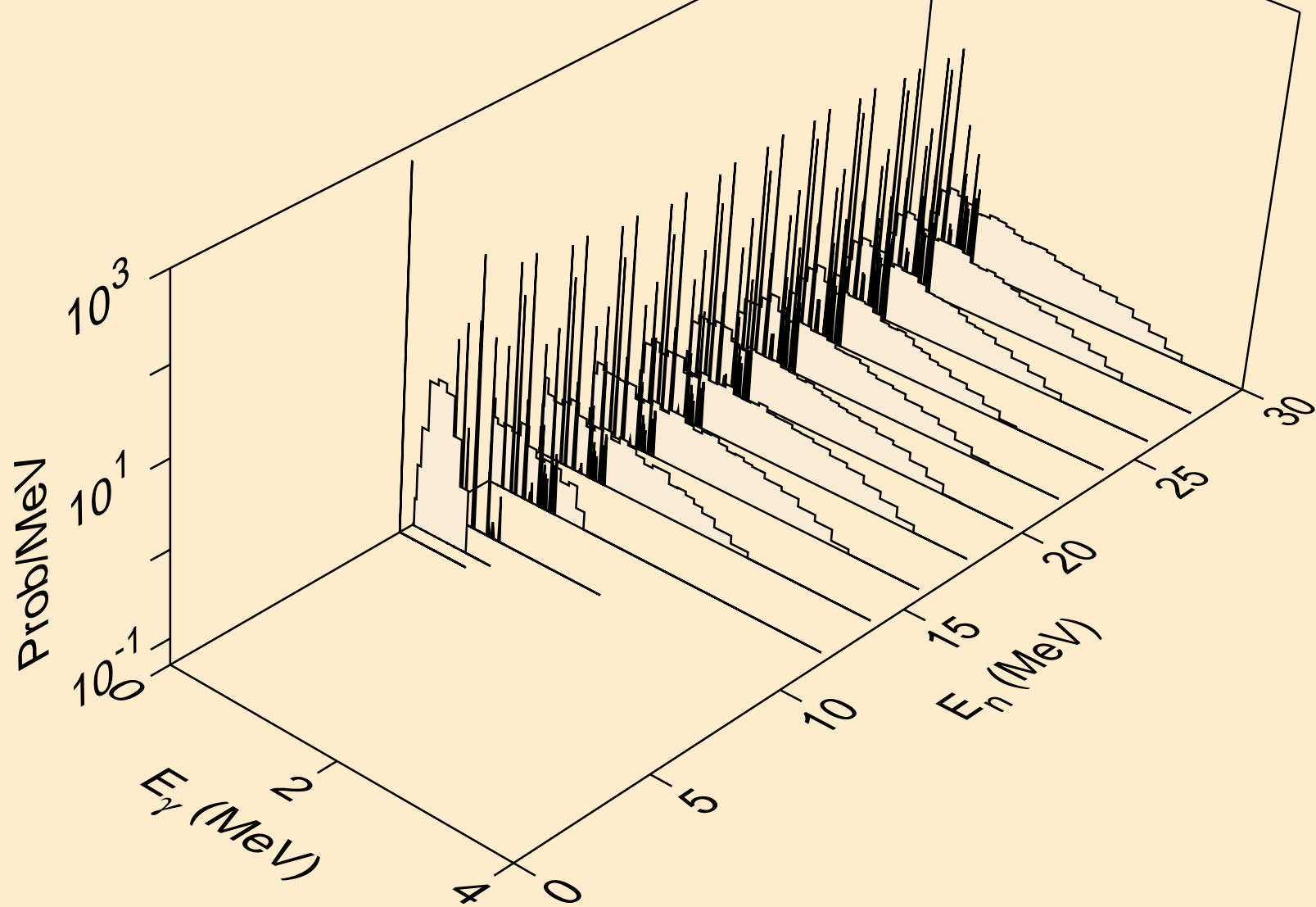

PB185 NEUTRON ACER TENDL-2023 LIBRARY; T=0.K  
Photon emission for (n,3n)a

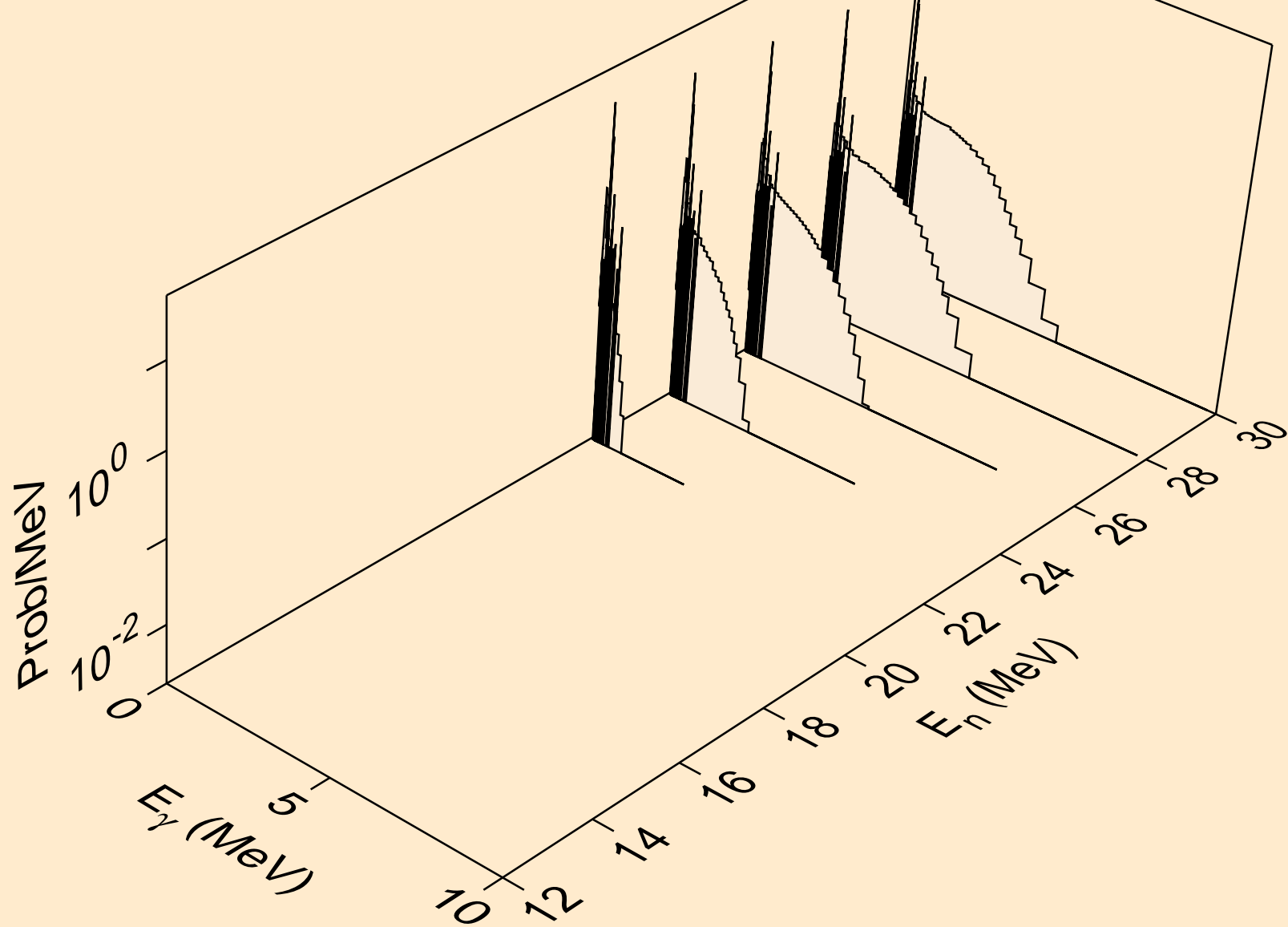

PB185 NEUTRON ACER TENDL-2023 LIBRARY; T=0.K  
Photon emission for (n,n\*)p

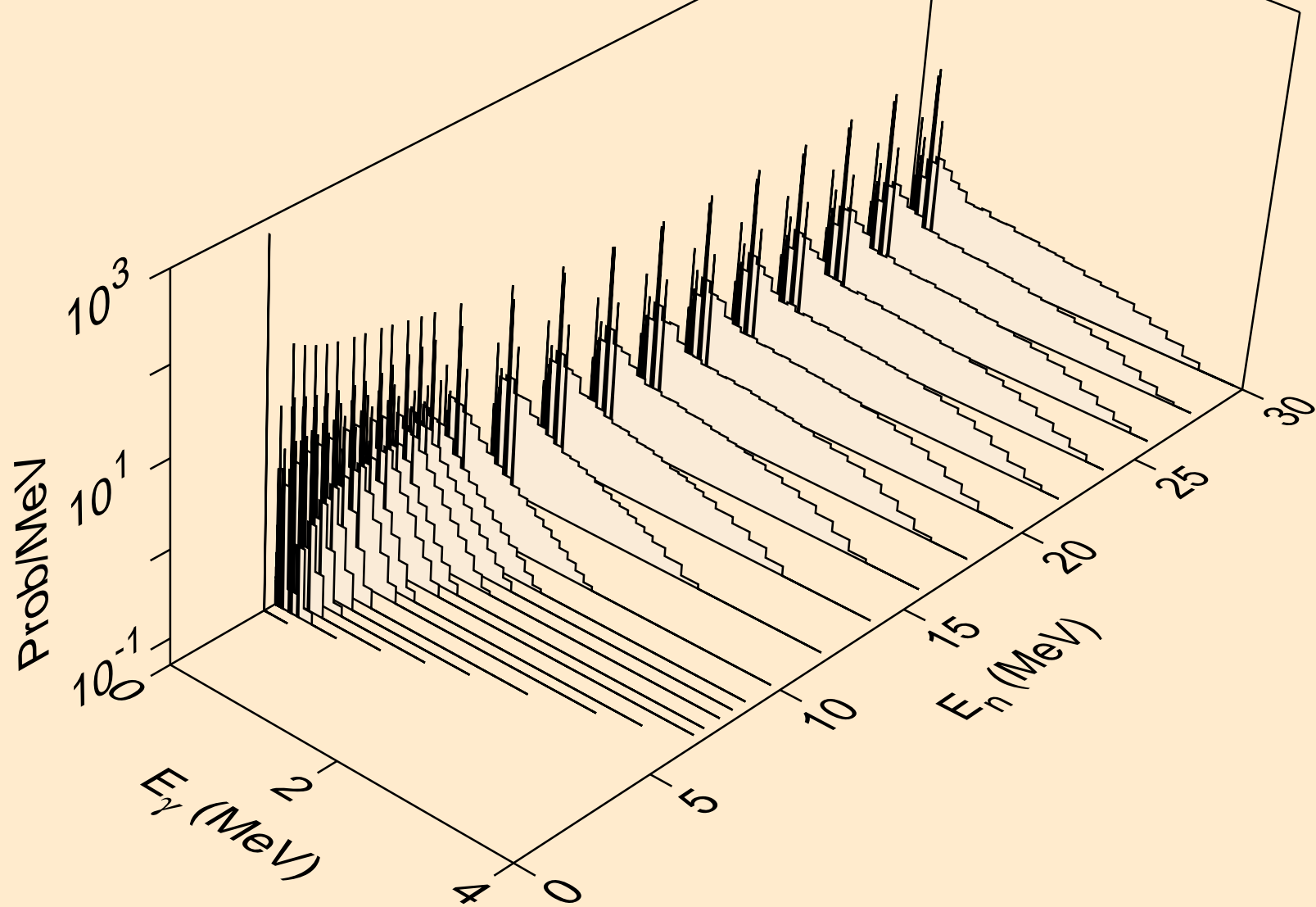

PB185 NEUTRON ACER TENDL-2023 LIBRARY; T=0.K  
Photon emission for (n,n\*)2a

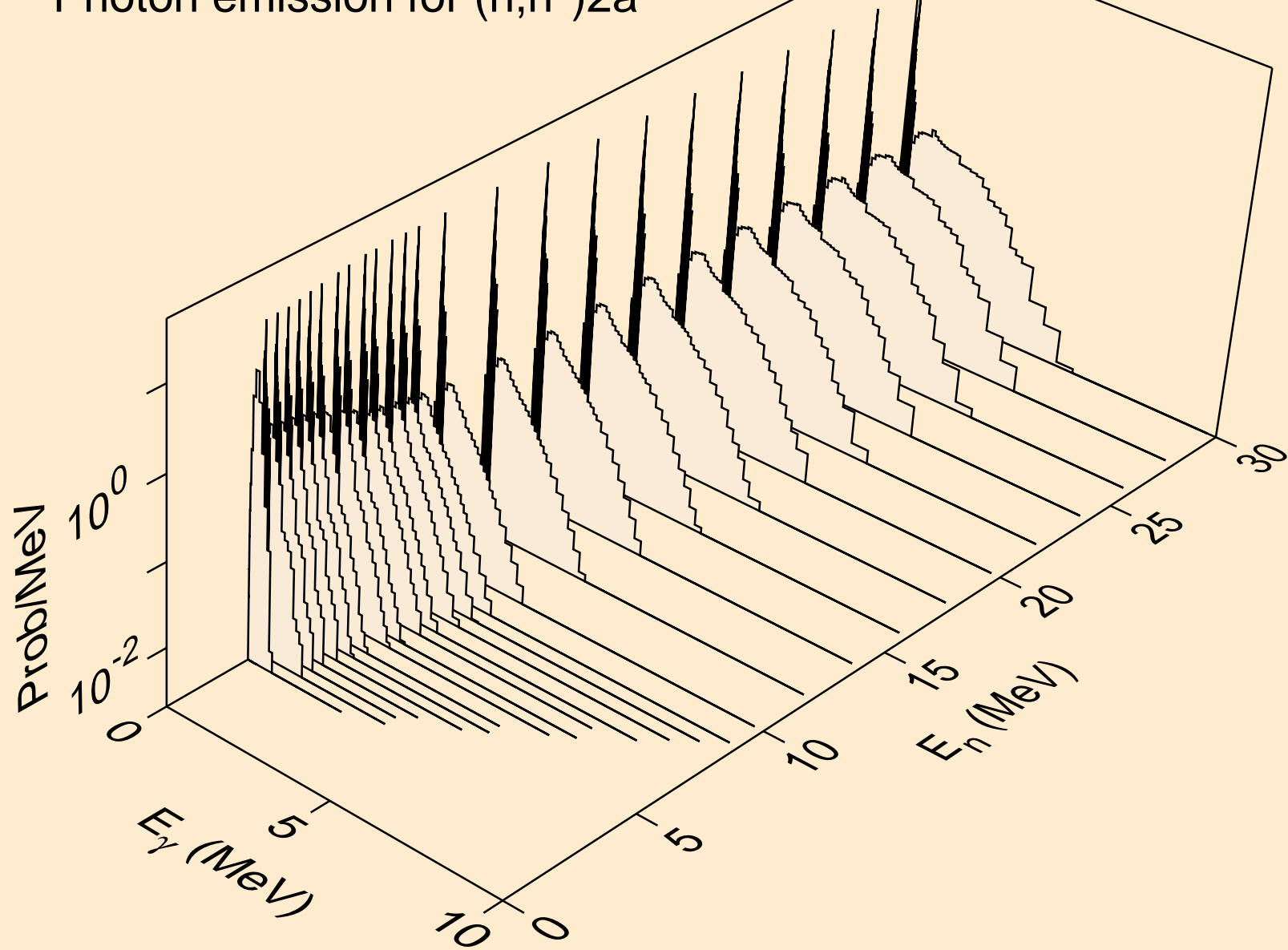

PB185 NEUTRON ACER TENDL-2023 LIBRARY; T=0.K  
Photon emission for (n,2n)2a

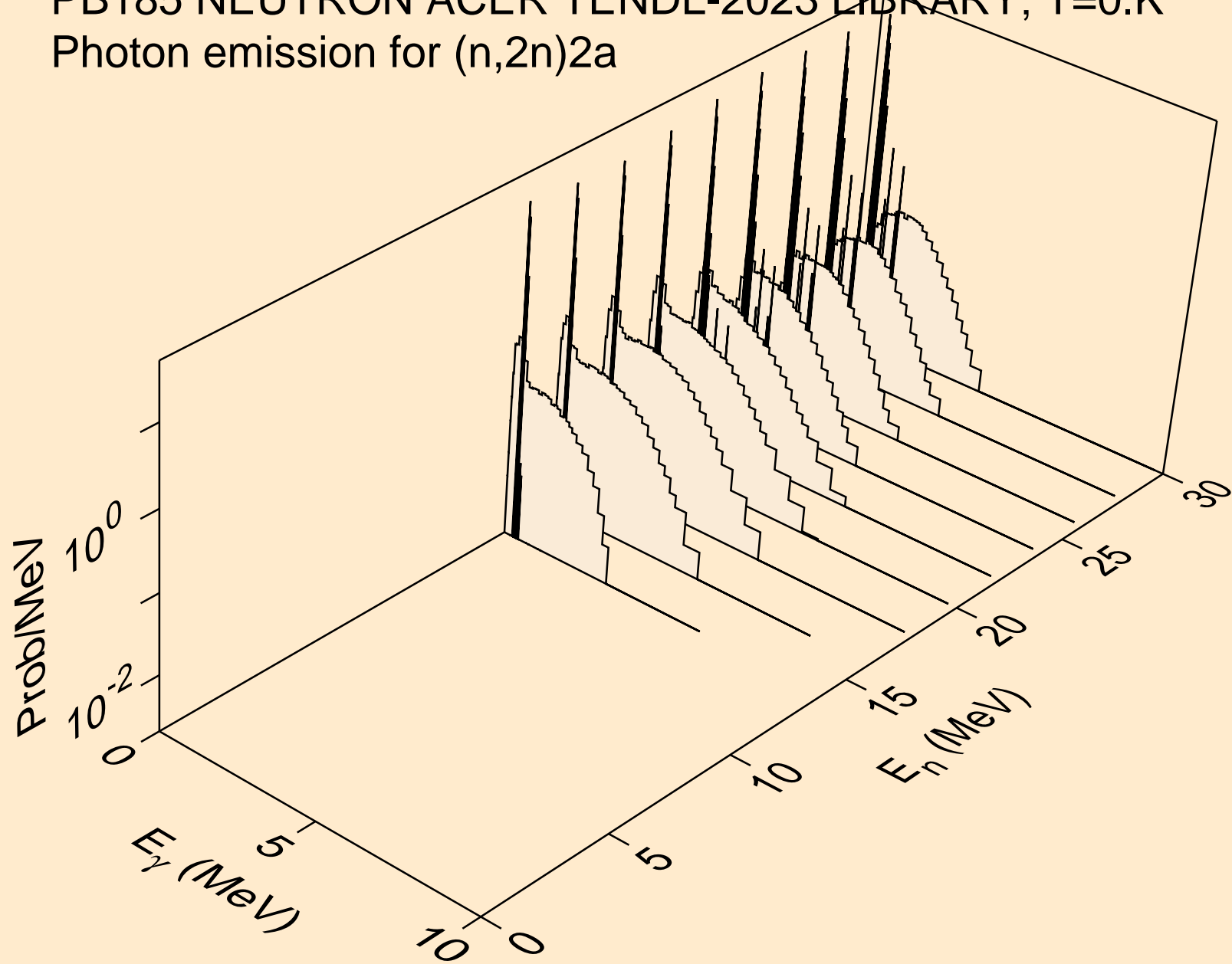

PB185 NEUTRON ACER TENDL-2023 LIBRARY; T=0.K  
Photon emission for (n,n\*)d

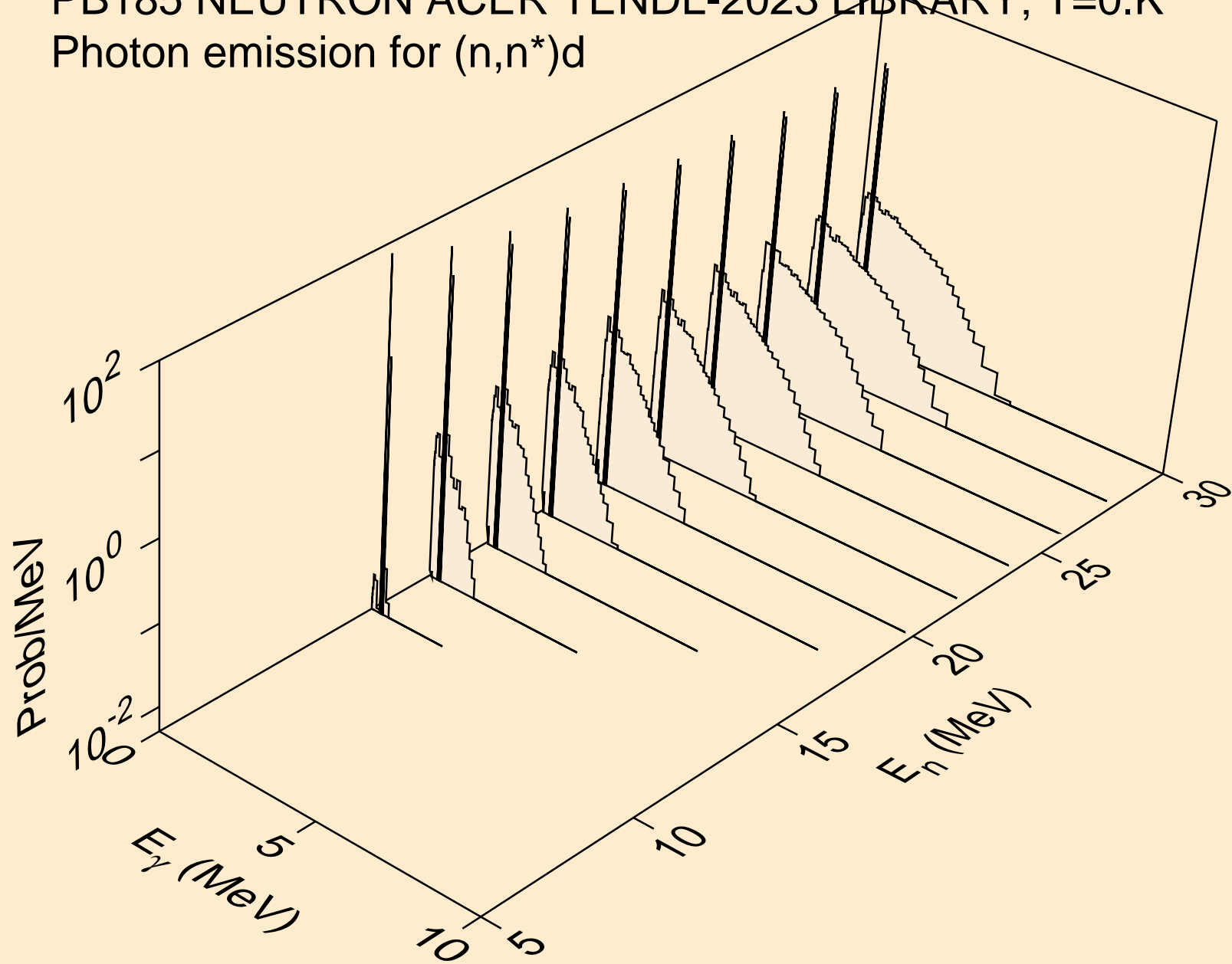

PB185 NEUTRON ACER TENDL-2023 LIBRARY; T=0.K  
Photon emission for (n,n\*)t

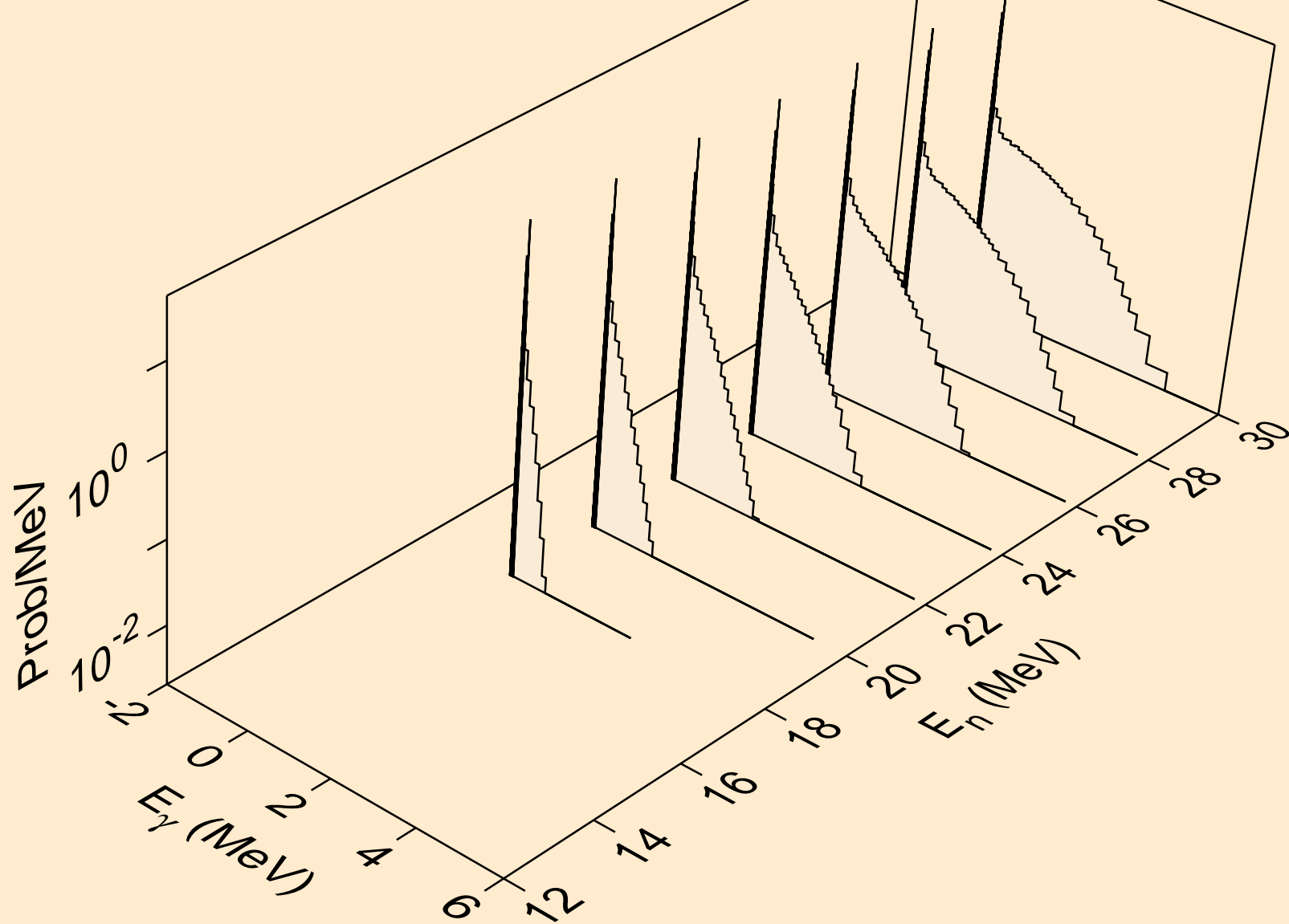

PB185 NEUTRON ACER TENDL-2023 LIBRARY; T=0.K  
Photon emission for (n,n\*)he3

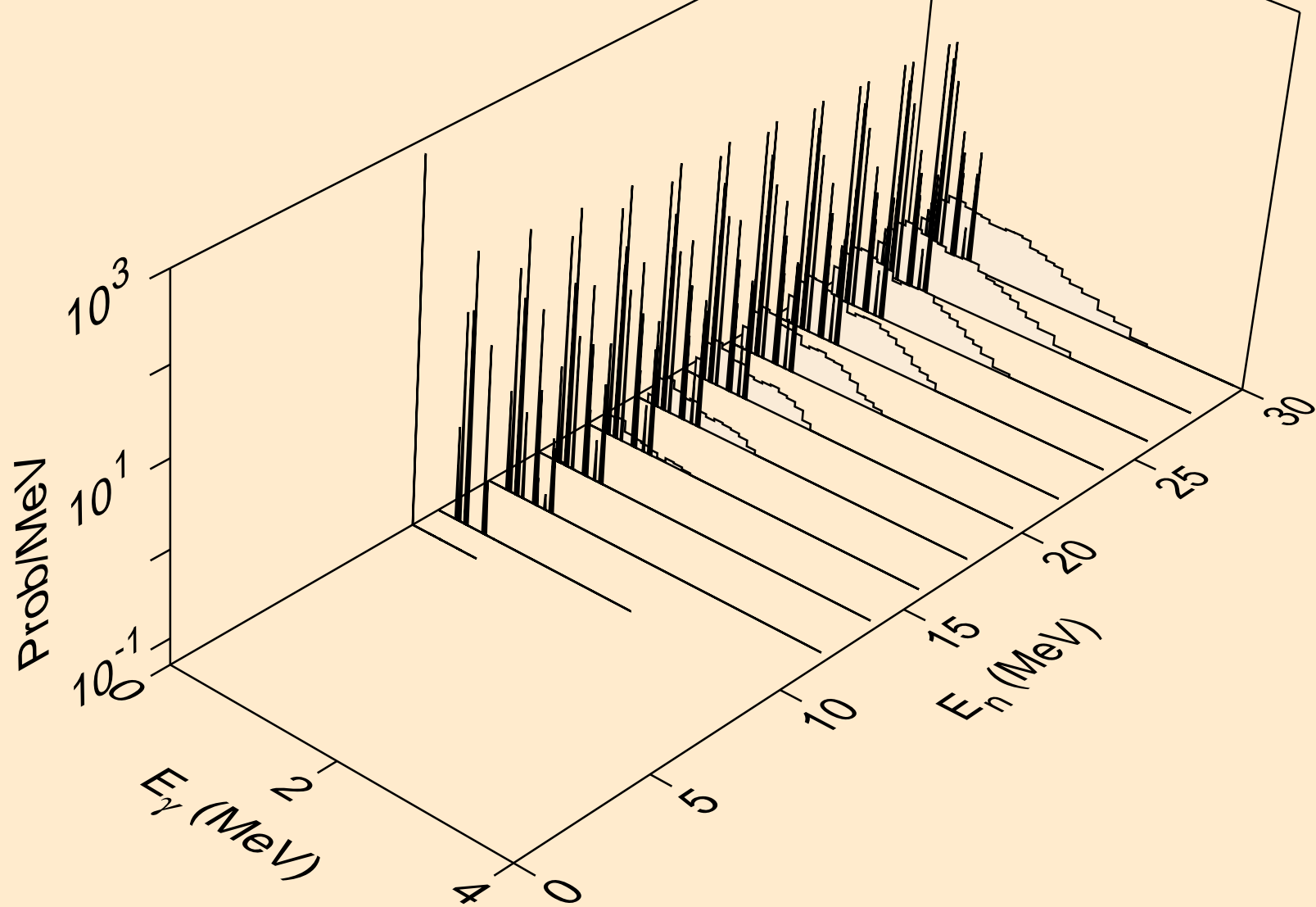

PB185 NEUTRON ACER TENDL-2023 LIBRARY; T=0.K  
Photon emission for (n,2np)

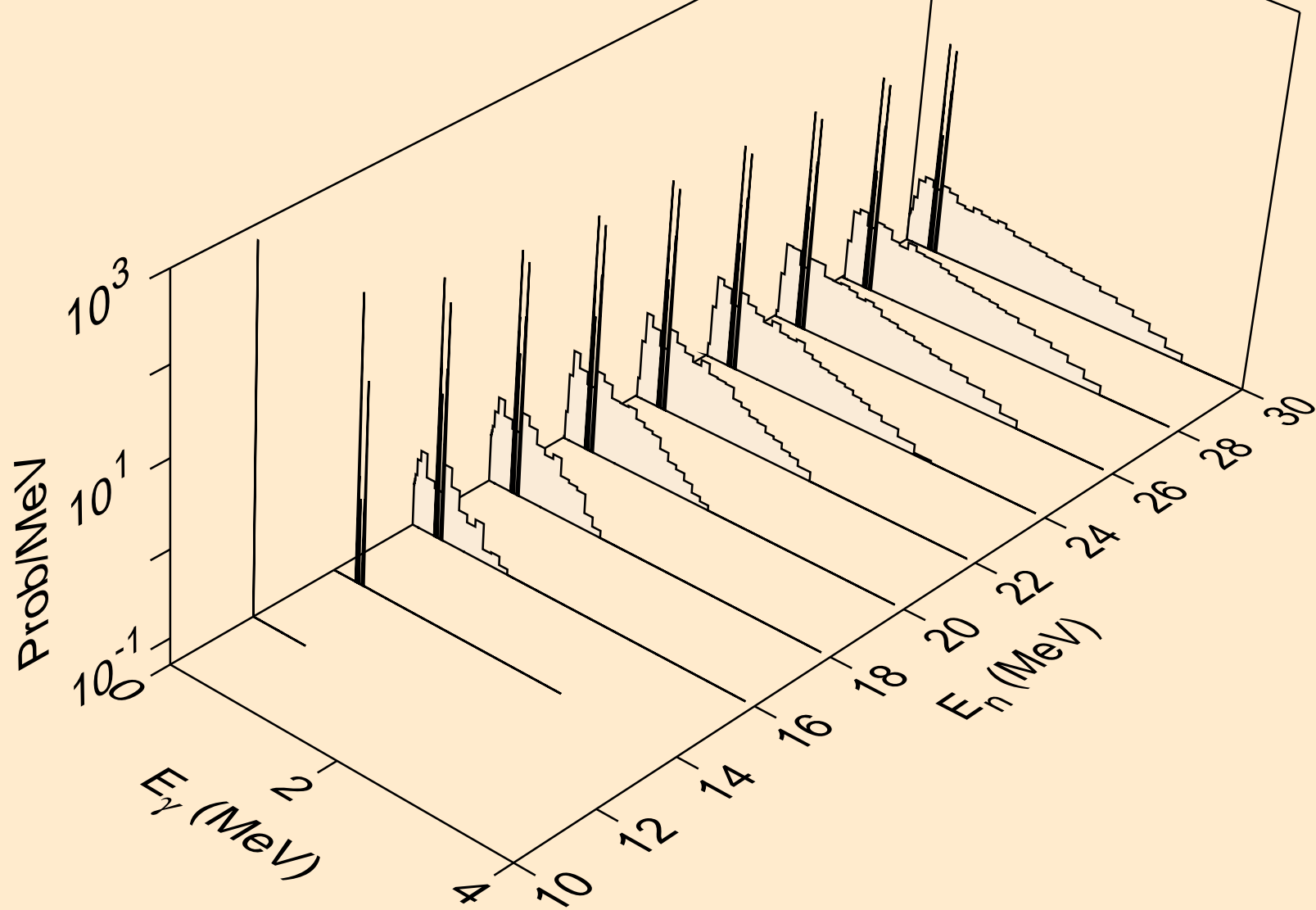

PB185 NEUTRON ACER TENDL-2023 LIBRARY; T=0.K  
Photon emission for (n,3np)

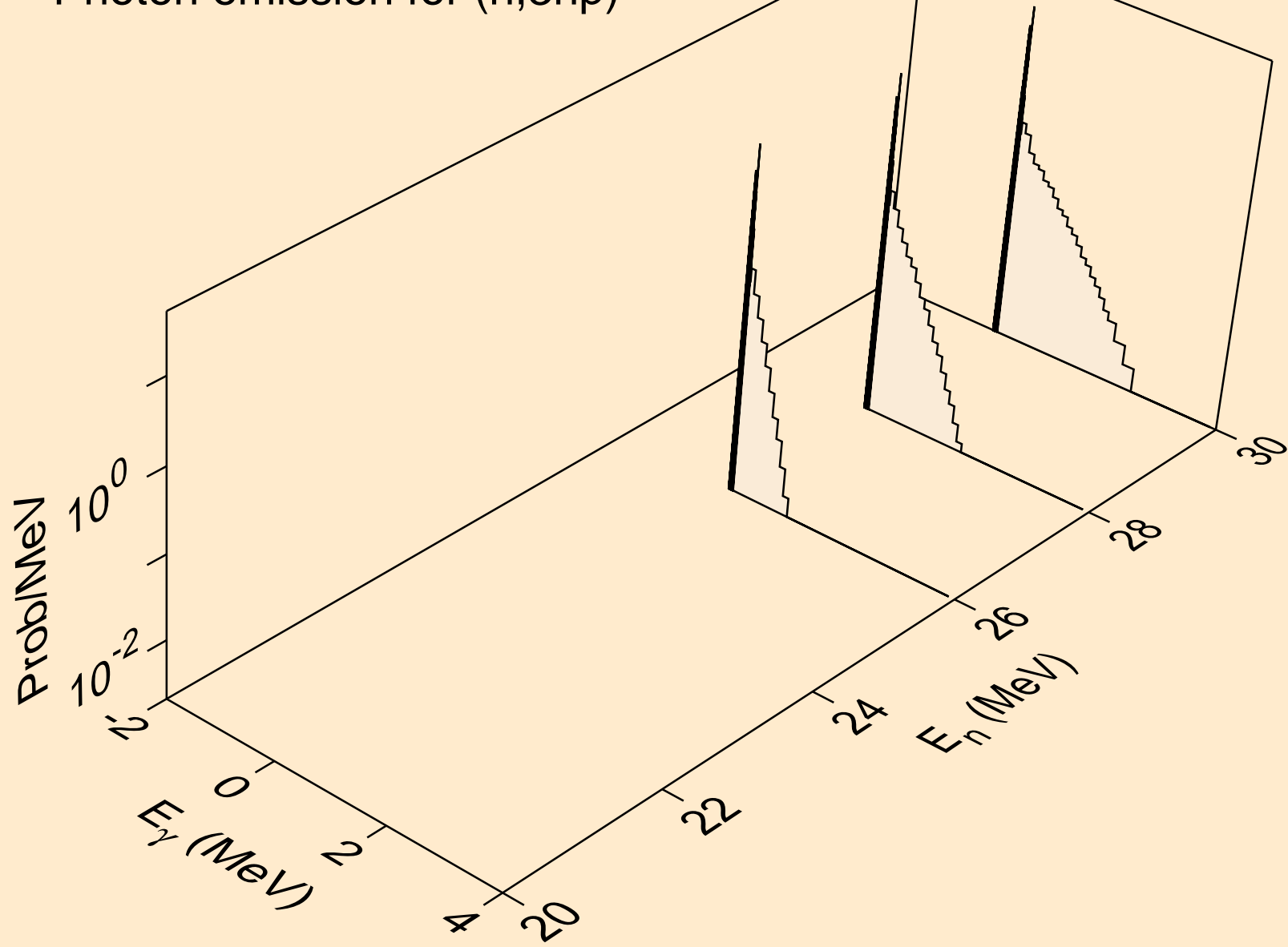

PB185 NEUTRON ACER TENDL-2023 LIBRARY; T=0.K  
Photon emission for (n,n2p)

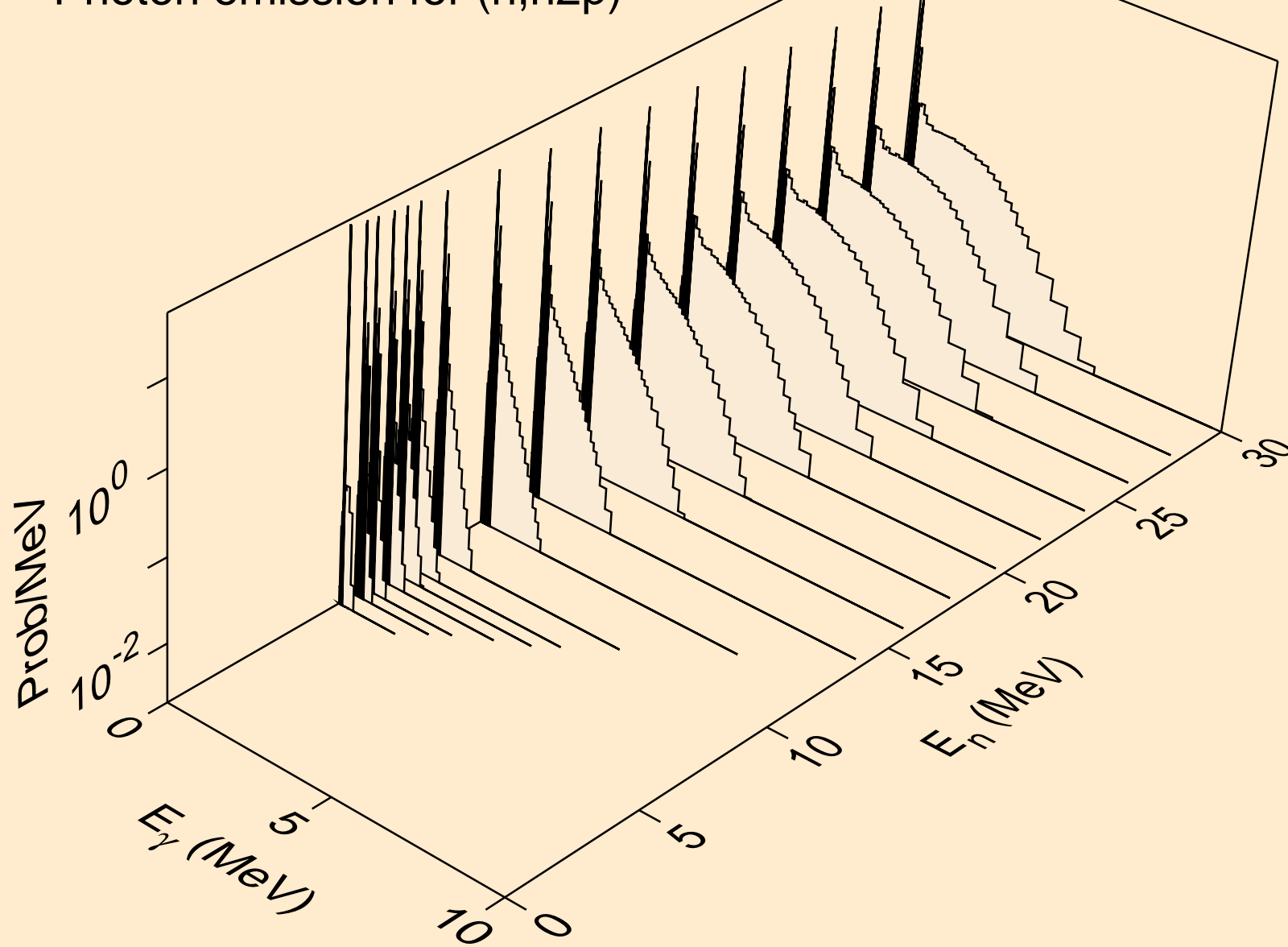

PB185 NEUTRON ACER TENDL-2023 LIBRARY; T=0.K  
Photon emission for (n,npa)

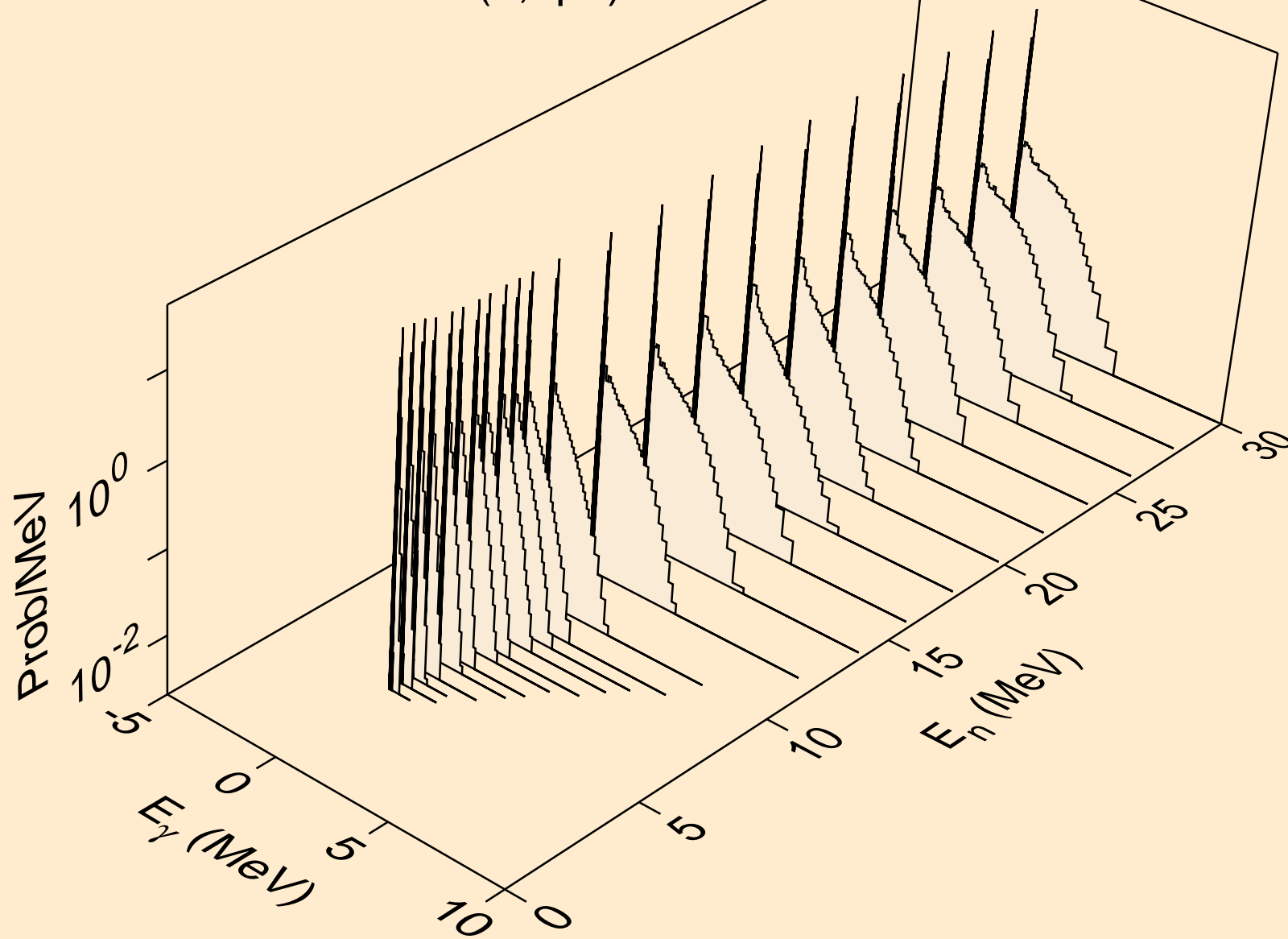

PB185 NEUTRON ACER TENDL-2023 LIBRARY; T=0.K  
Photon emission for (n,n\*c)

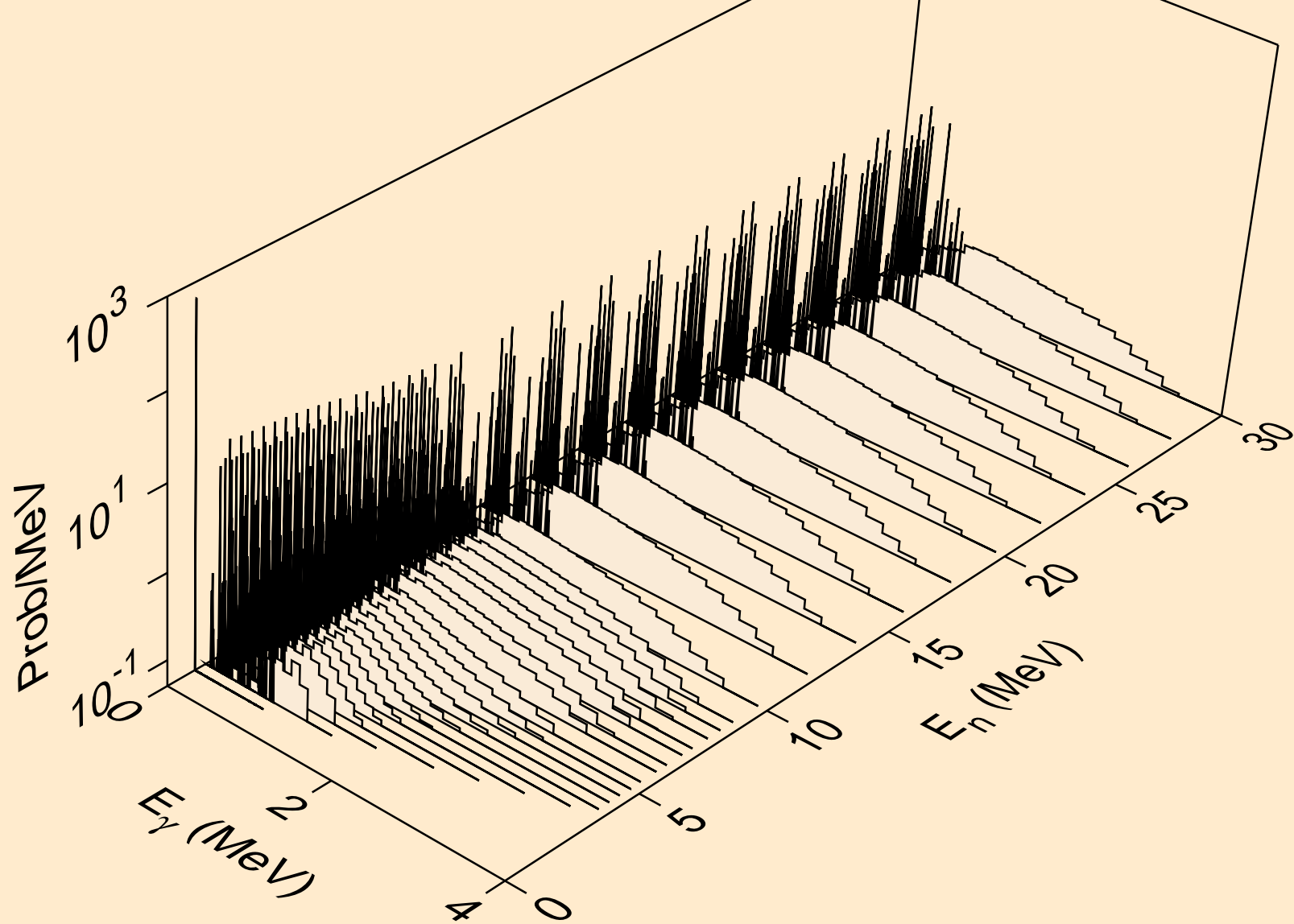

PB185 NEUTRON ACER TENDL-2023 LIBRARY; T=0.K  
Photon emission for (n,gma)

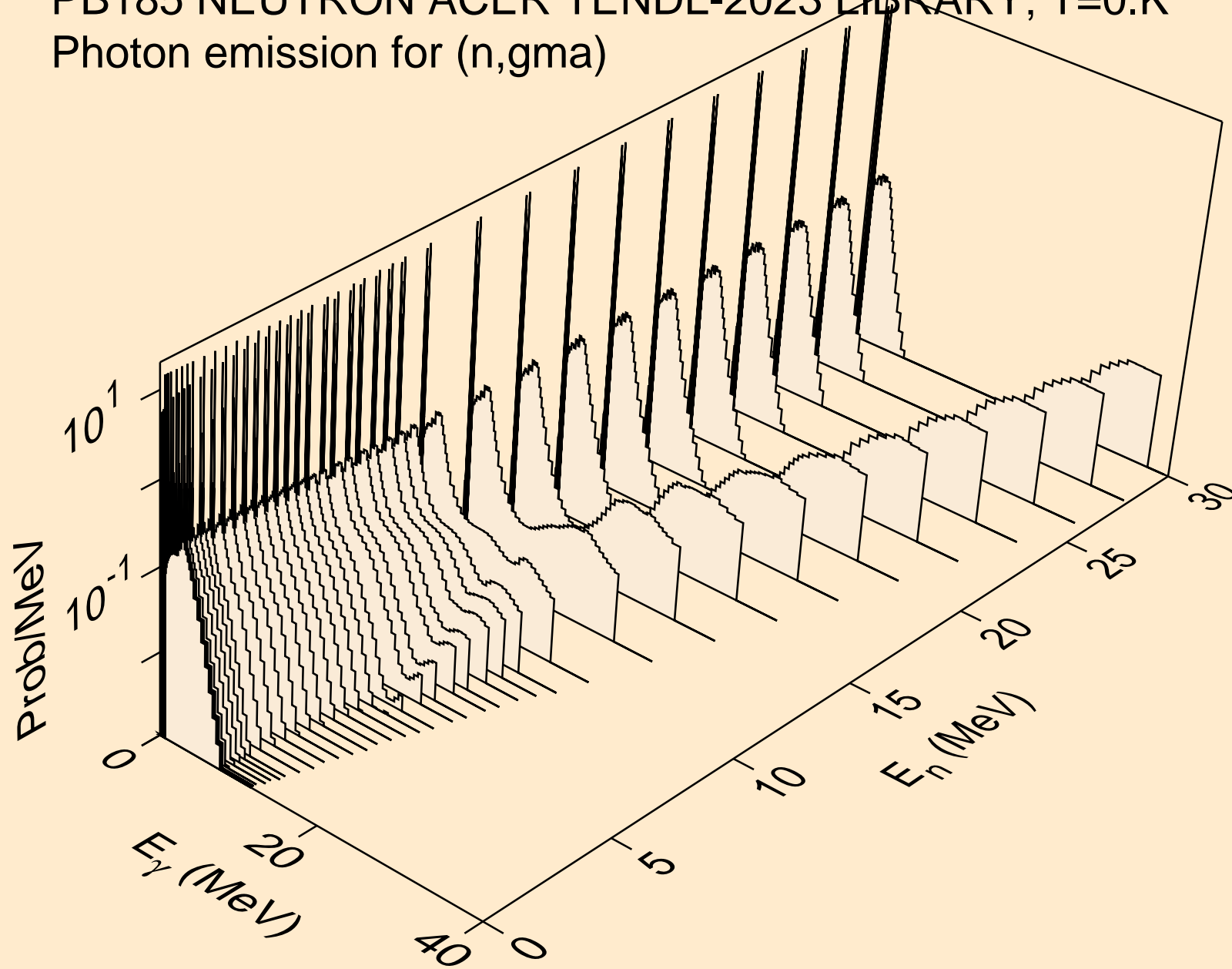

PB185 NEUTRON ACER TENDL-2023 LIBRARY; T=0.K  
Photon emission for (n,p)

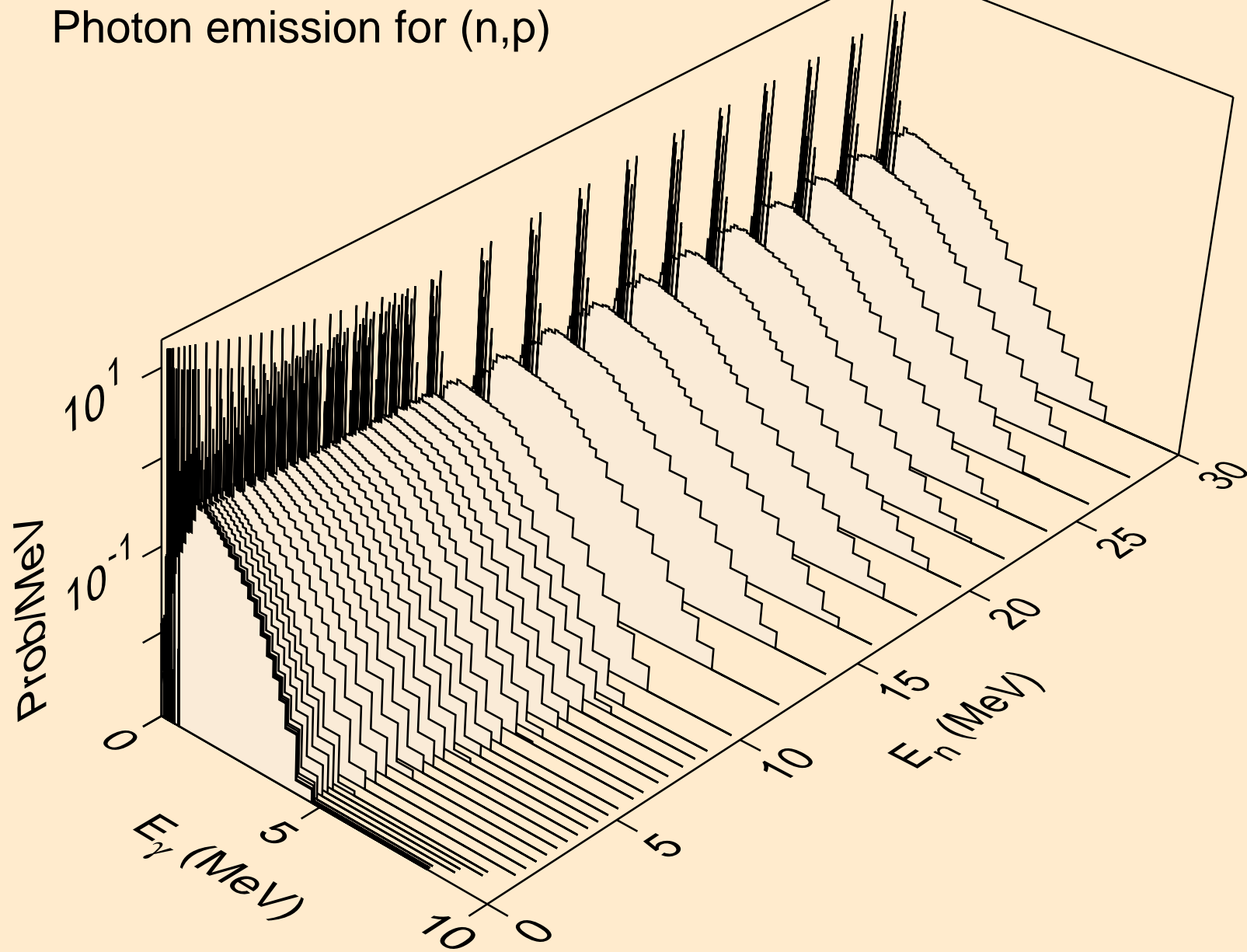

PB185 NEUTRON ACER TENDL-2023 LIBRARY; T=0.K  
Photon emission for (n,d)

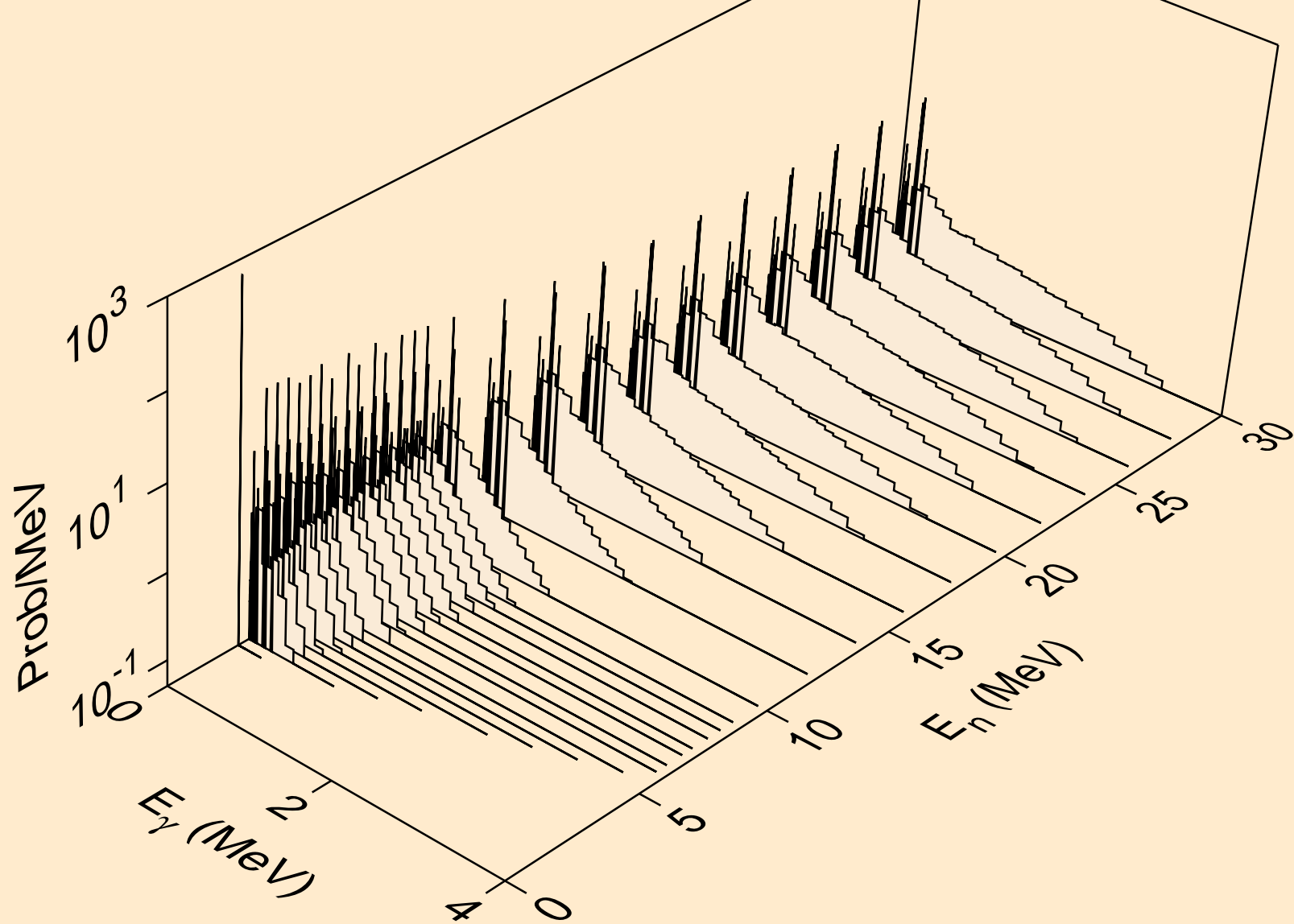

PB185 NEUTRON ACER TENDL-2023 LIBRARY; T=0.K  
Photon emission for (n,t)

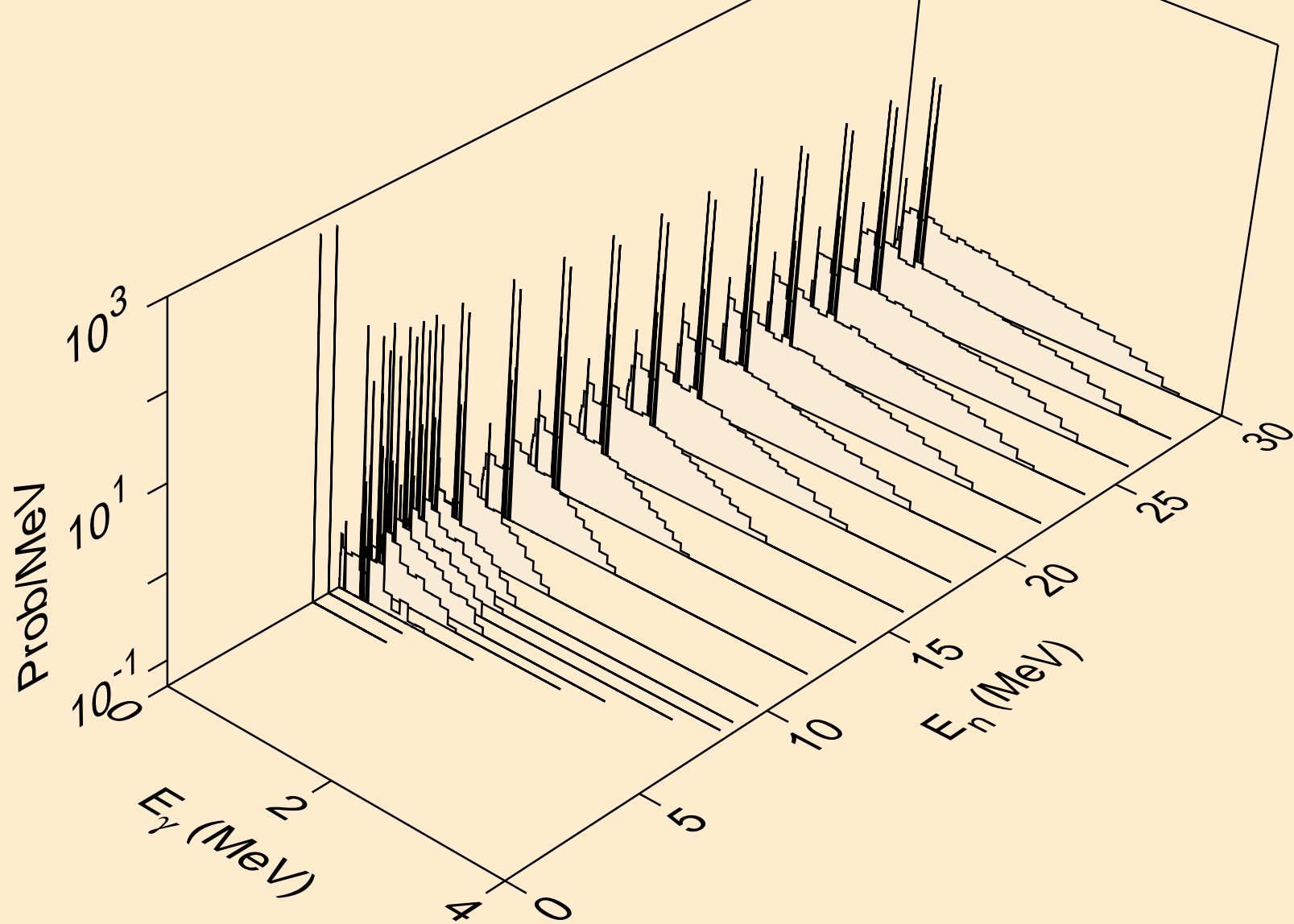

PB185 NEUTRON ACER TENDL-2023 LIBRARY; T=0.K  
Photon emission for (n,he3)

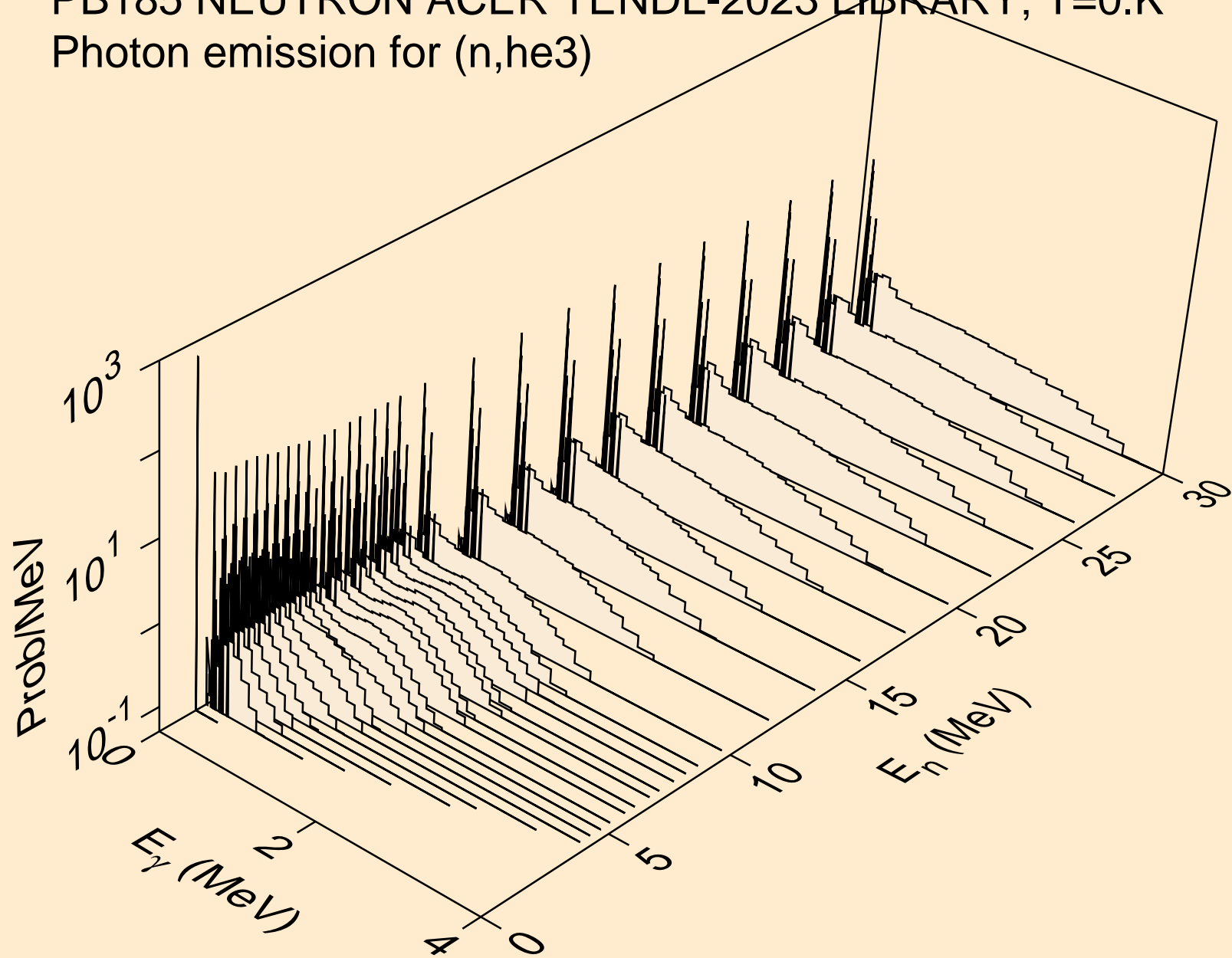

PB185 NEUTRON ACER TENDL-2023 LIBRARY; T=0.K  
Photon emission for (n,a)

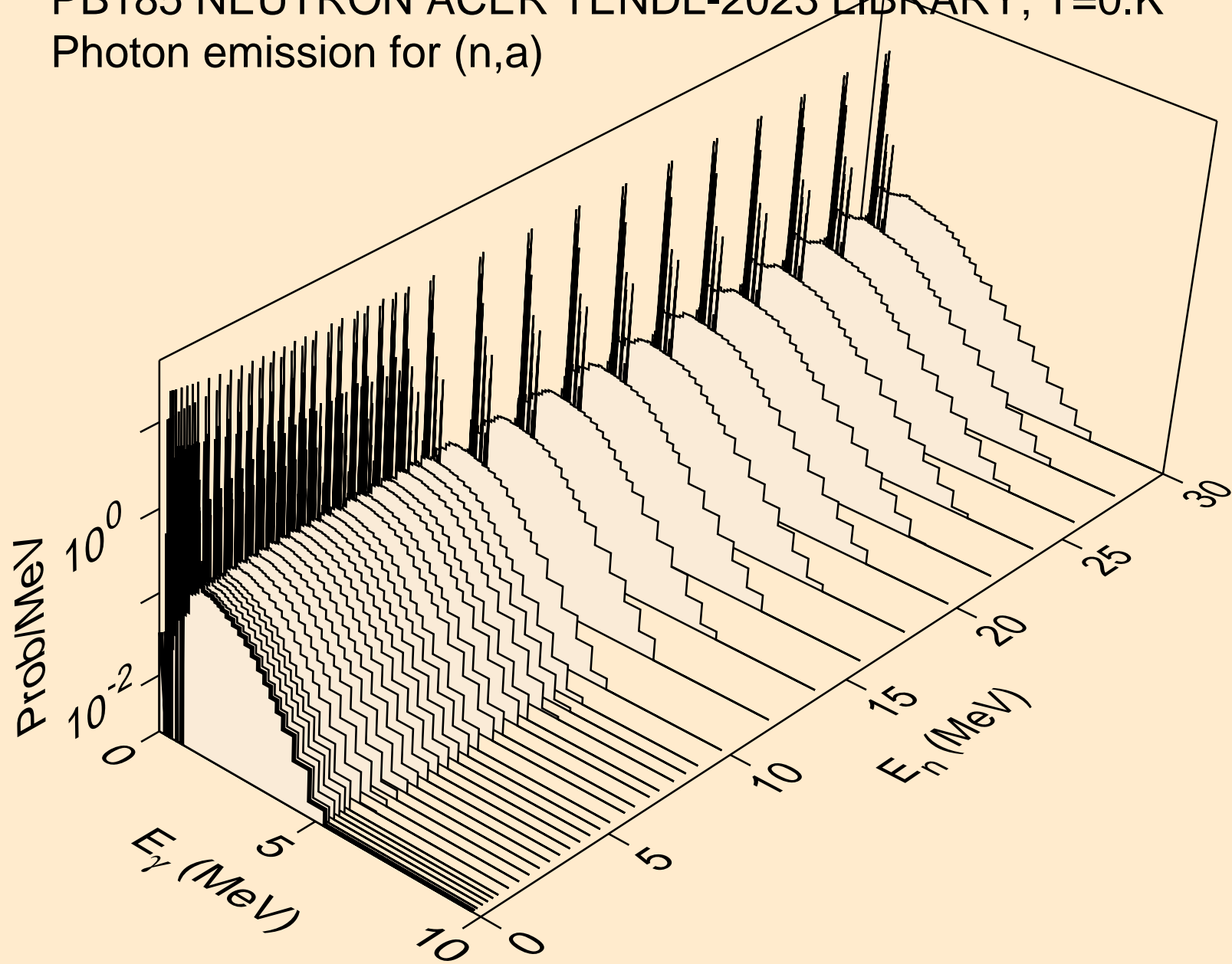

PB185 NEUTRON ACER TENDL-2023 LIBRARY; T=0.K  
Photon emission for (n,2a)

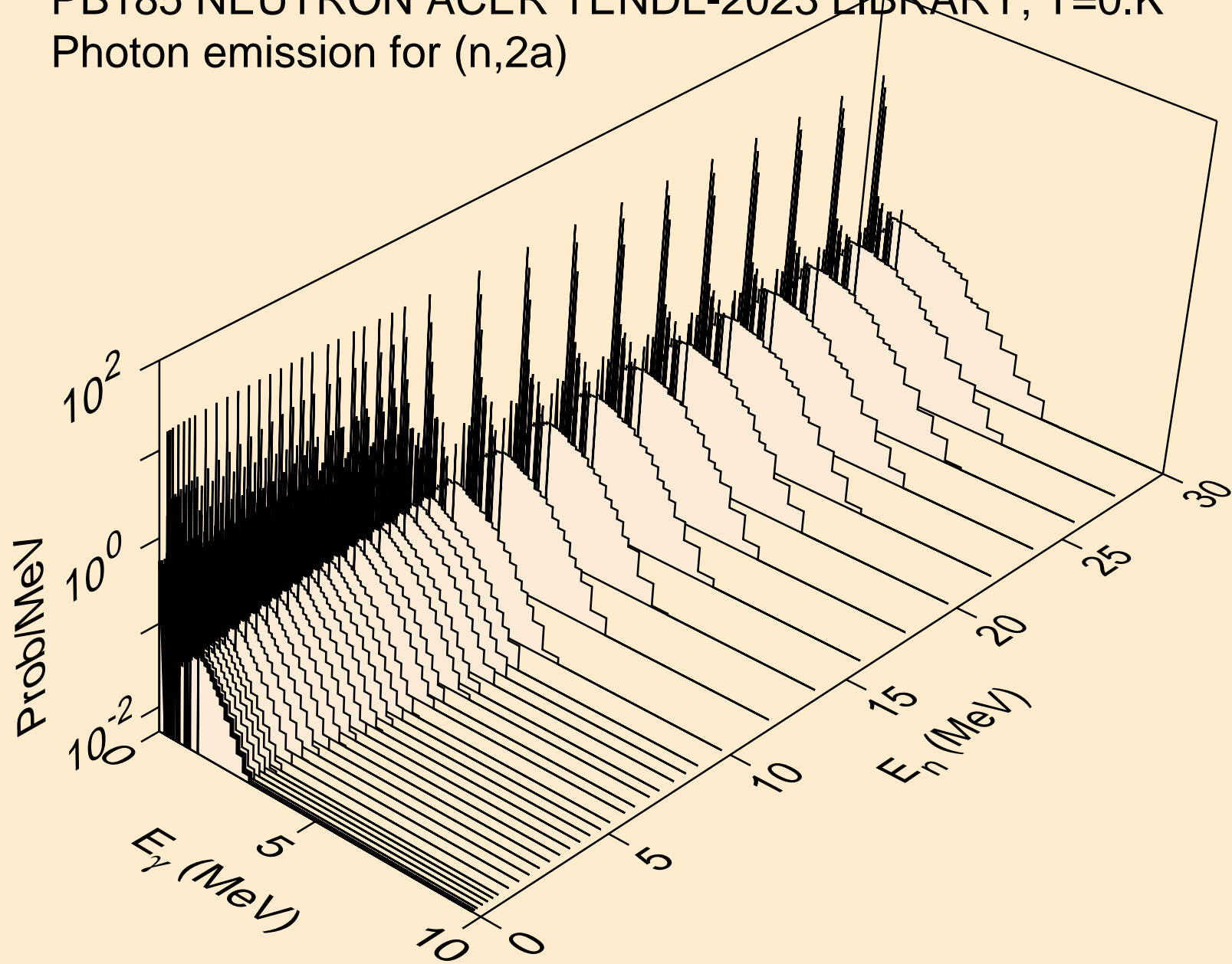

PB185 NEUTRON ACER TENDL-2023 LIBRARY; T=0.K  
Photon emission for (n,3a)

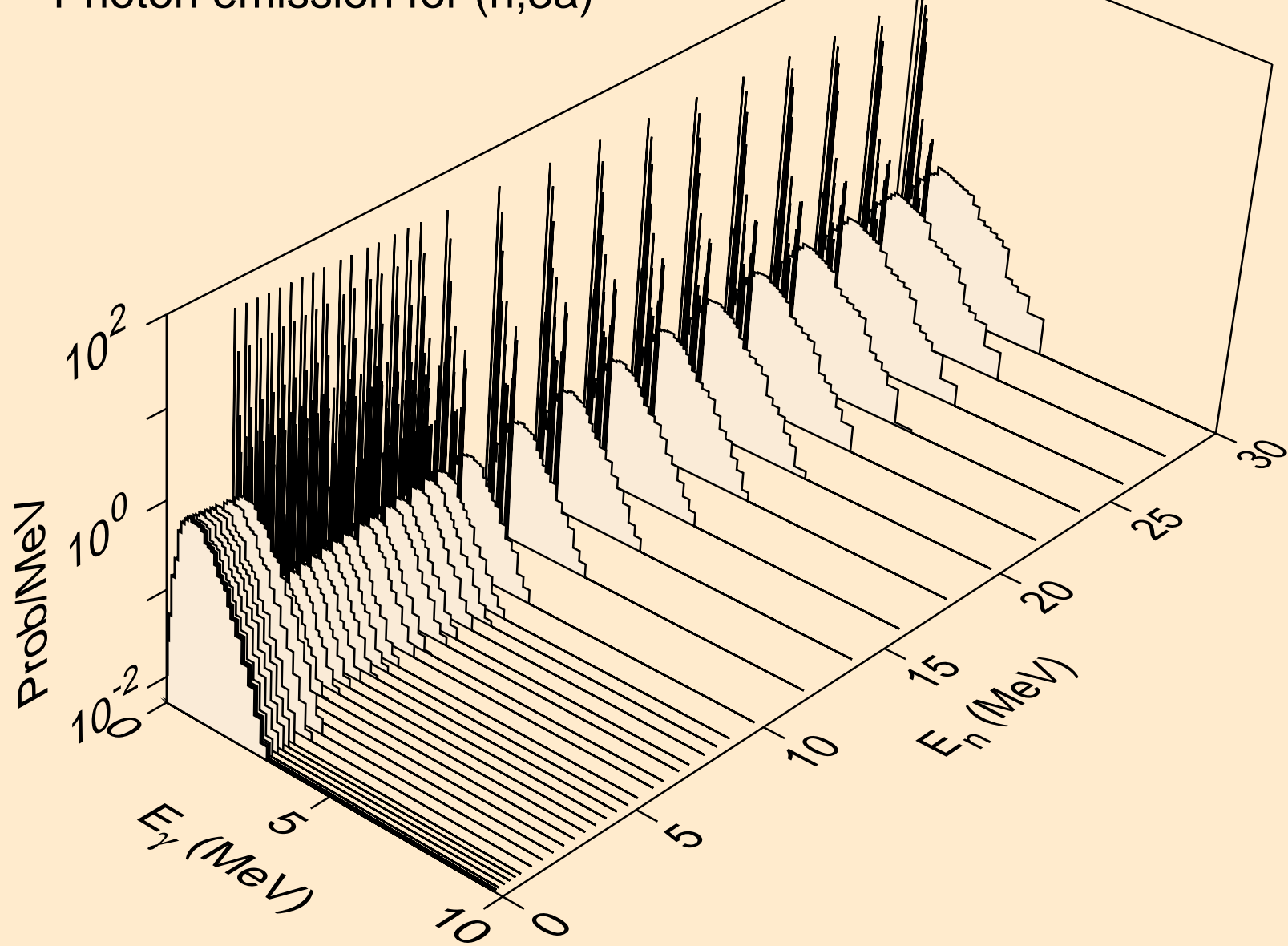

PB185 NEUTRON ACER TENDL-2023 LIBRARY; T=0.K  
Photon emission for (n,2p)

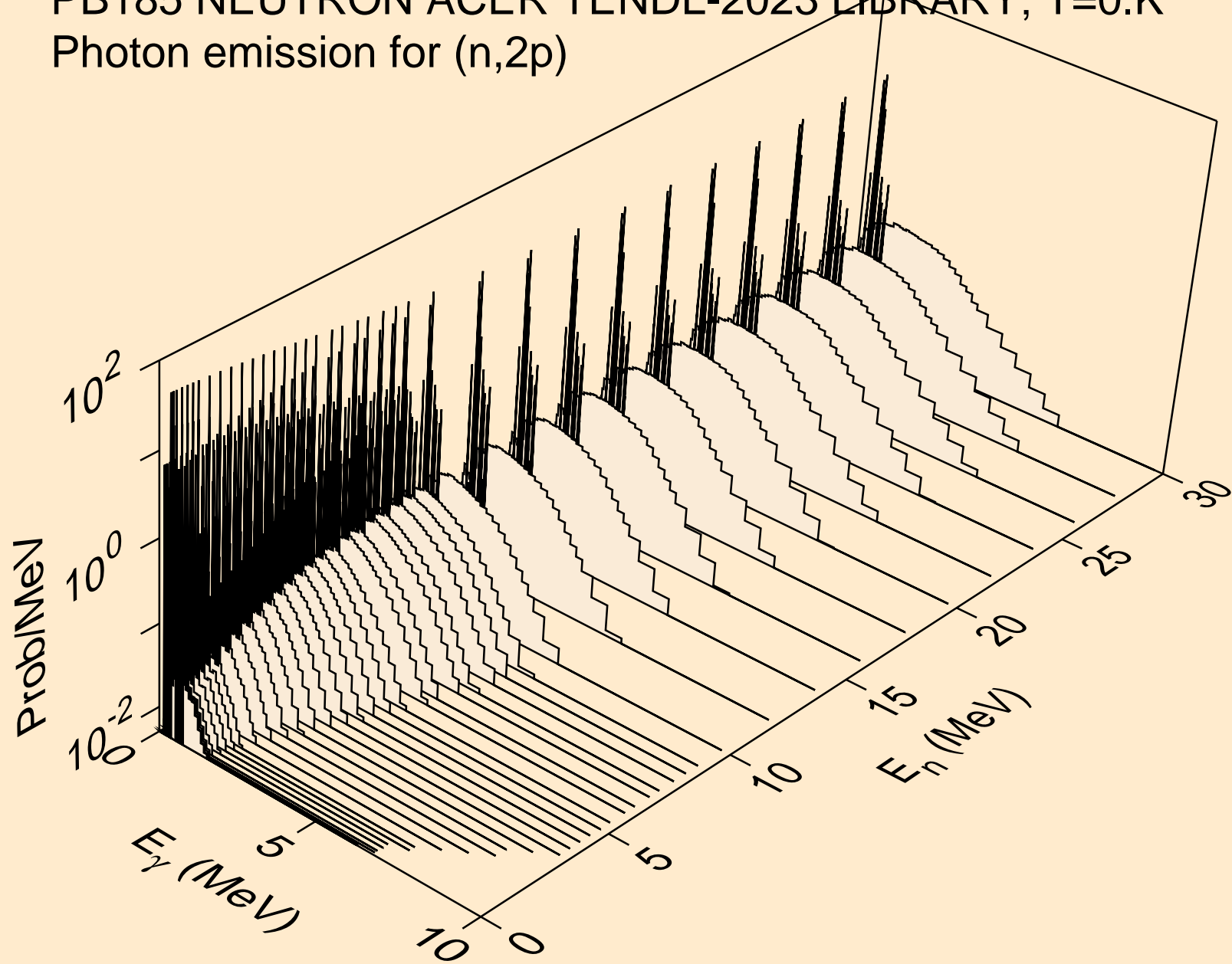

PB185 NEUTRON ACER TENDL-2023 LIBRARY; T=0.K  
Photon emission for (n,p $\alpha$ )

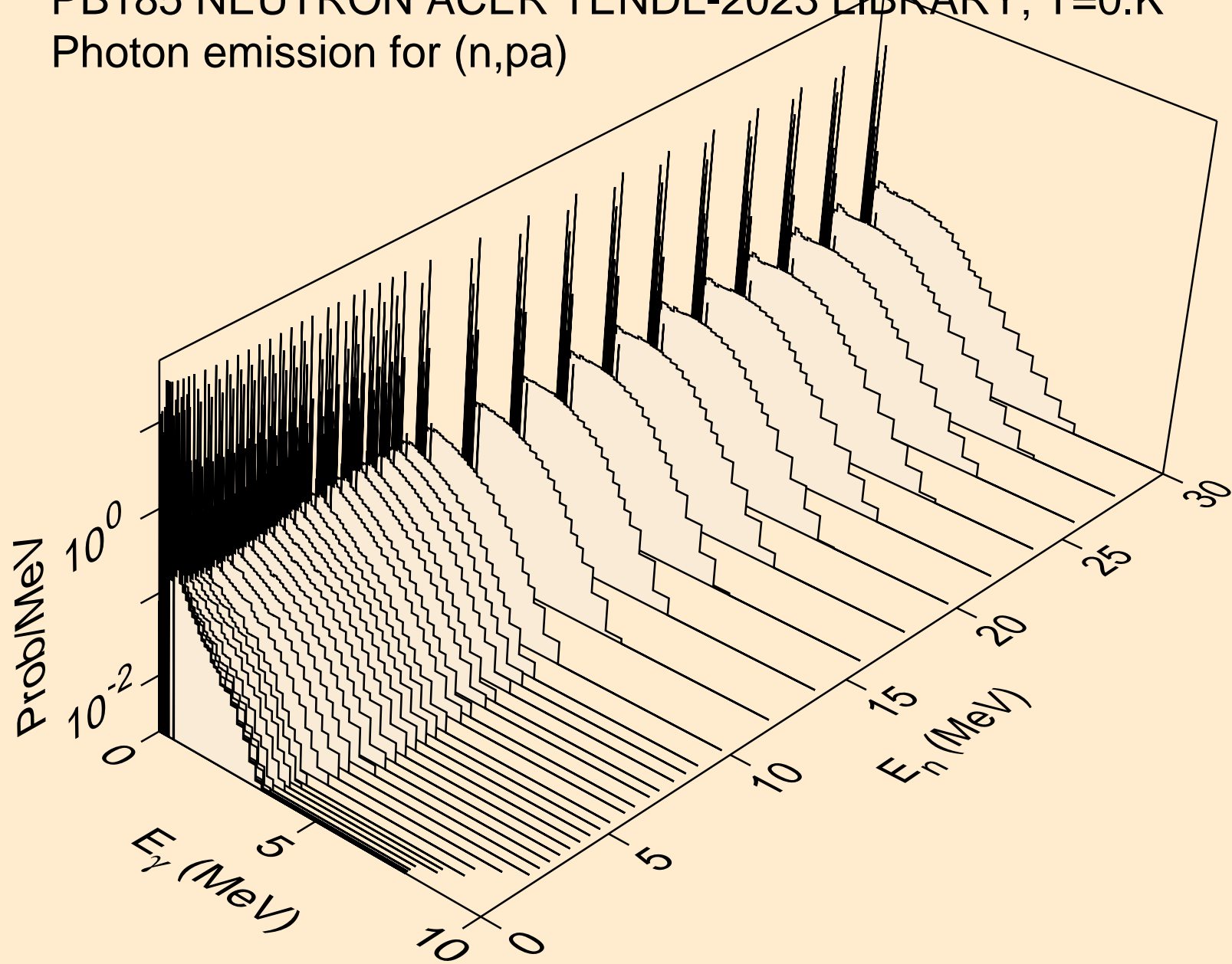

PB185 NEUTRON ACER TENDL-2023 LIBRARY; T=0.K  
Photon emission for (n,d2a)

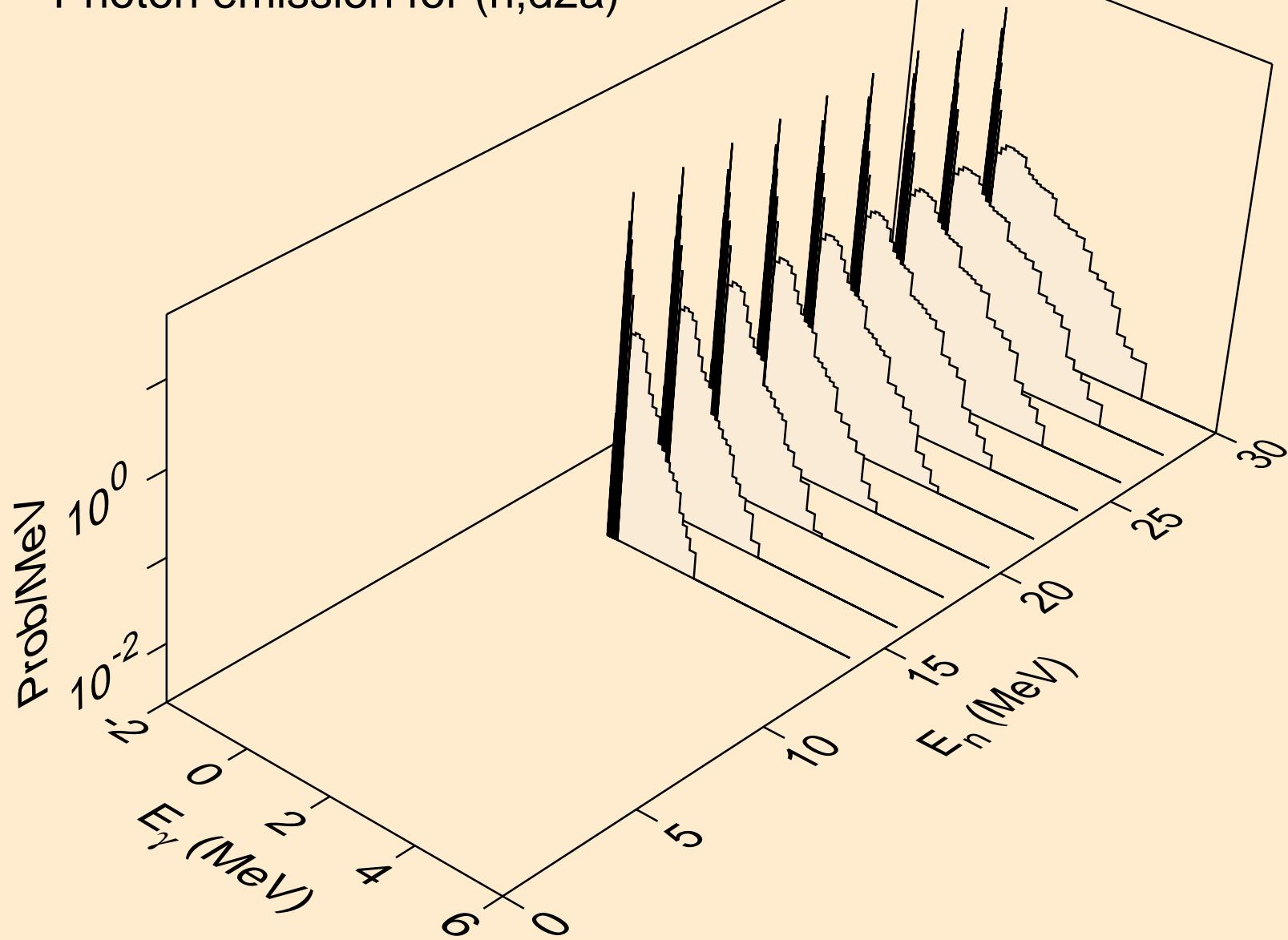

PB185 NEUTRON ACER TENDL-2023 LIBRARY; T=0.K  
Photon emission for (n,pd)

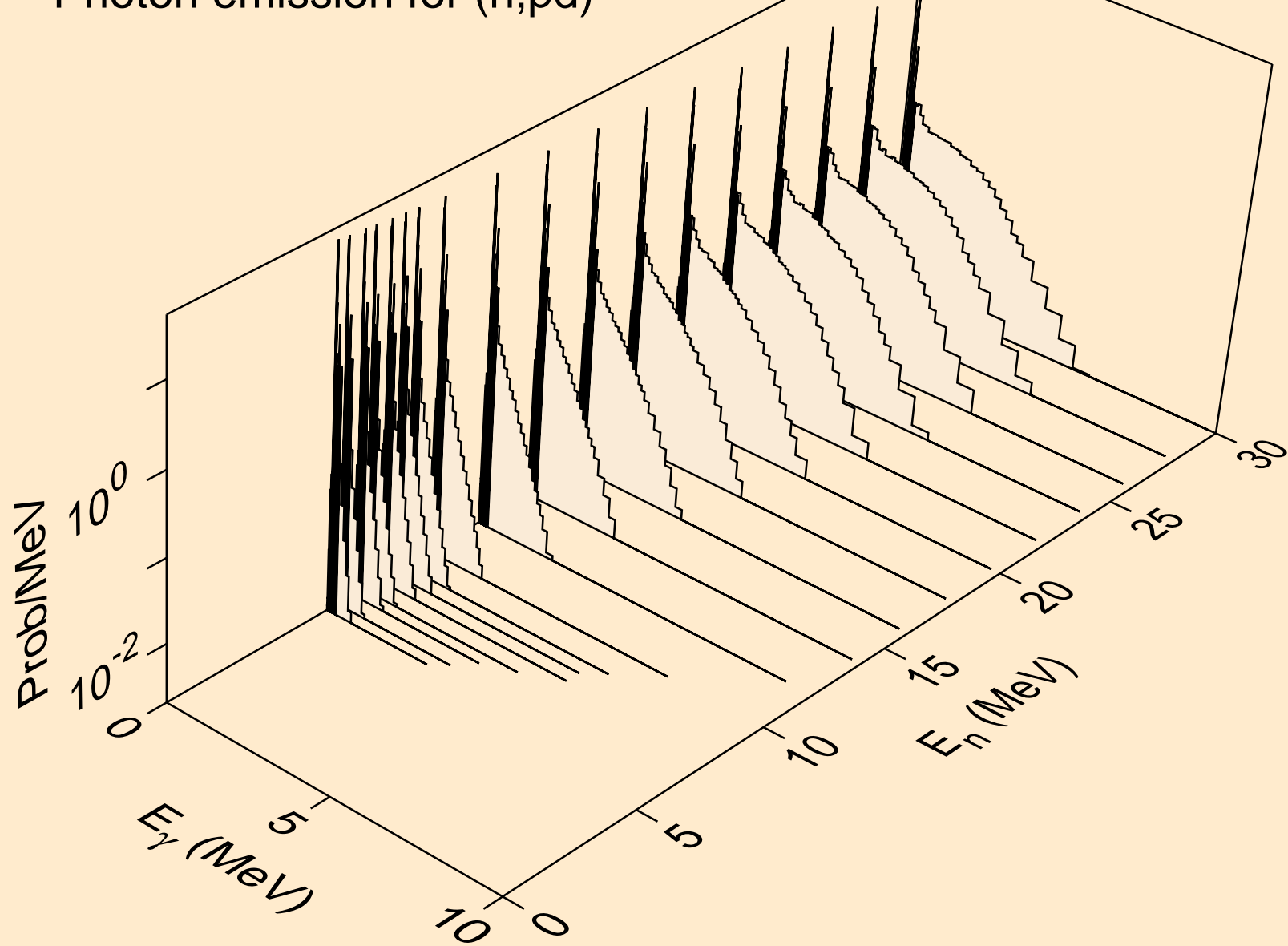

PB185 NEUTRON ACER TENDL-2023 LIBRARY; T=0.K  
Photon emission for (n,pt)

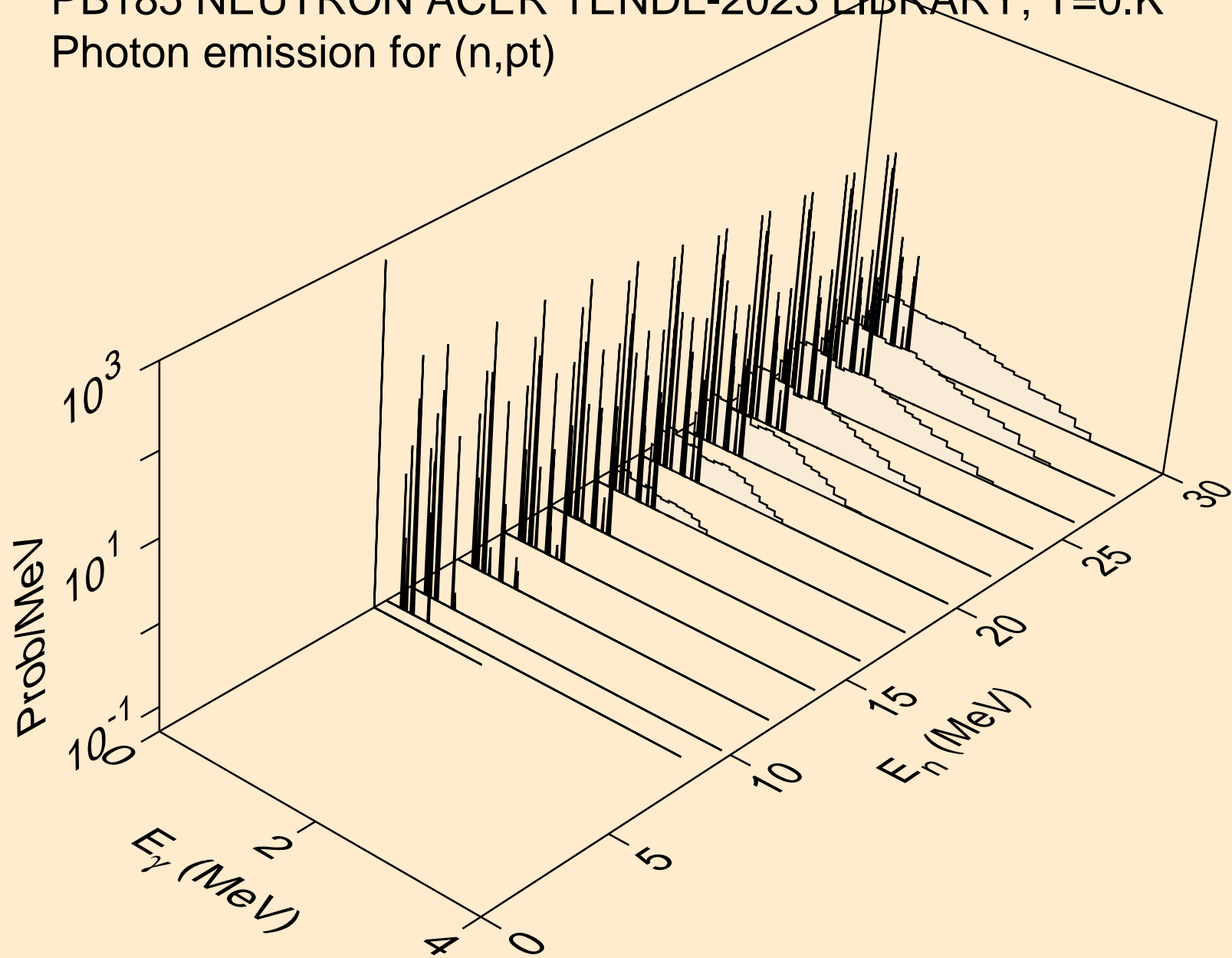

PB185 NEUTRON ACER TENDL-2023 LIBRARY; T=0.K  
Photon emission for (n,da)

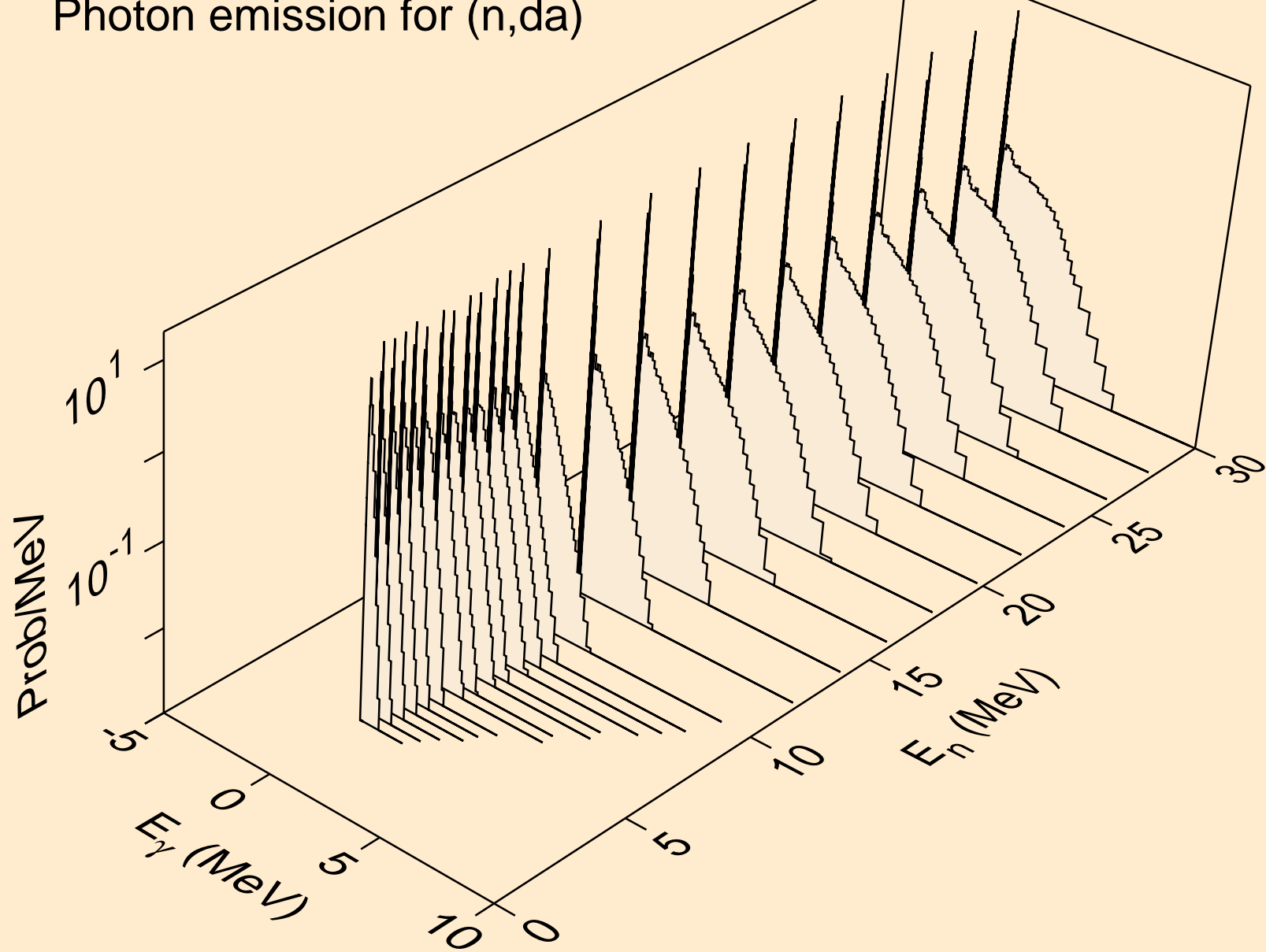

PB185 NEUTRON ACER TENDL-2023 LIBRARY; T=0.K  
thermal capture photon spectrum

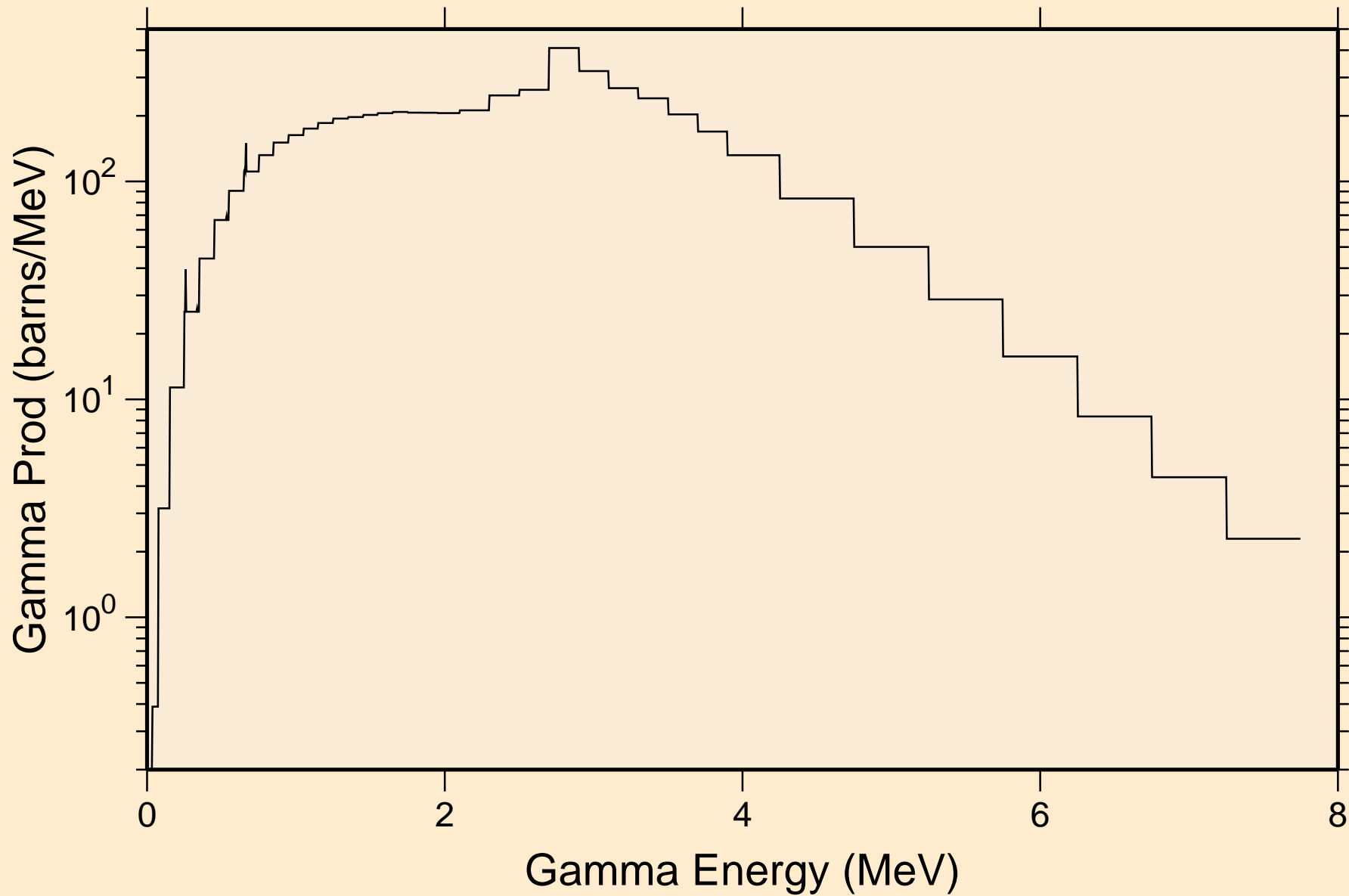

PB185 NEUTRON ACER TENDL-2023 LIBRARY; T=0.K  
14 MeV photon spectrum

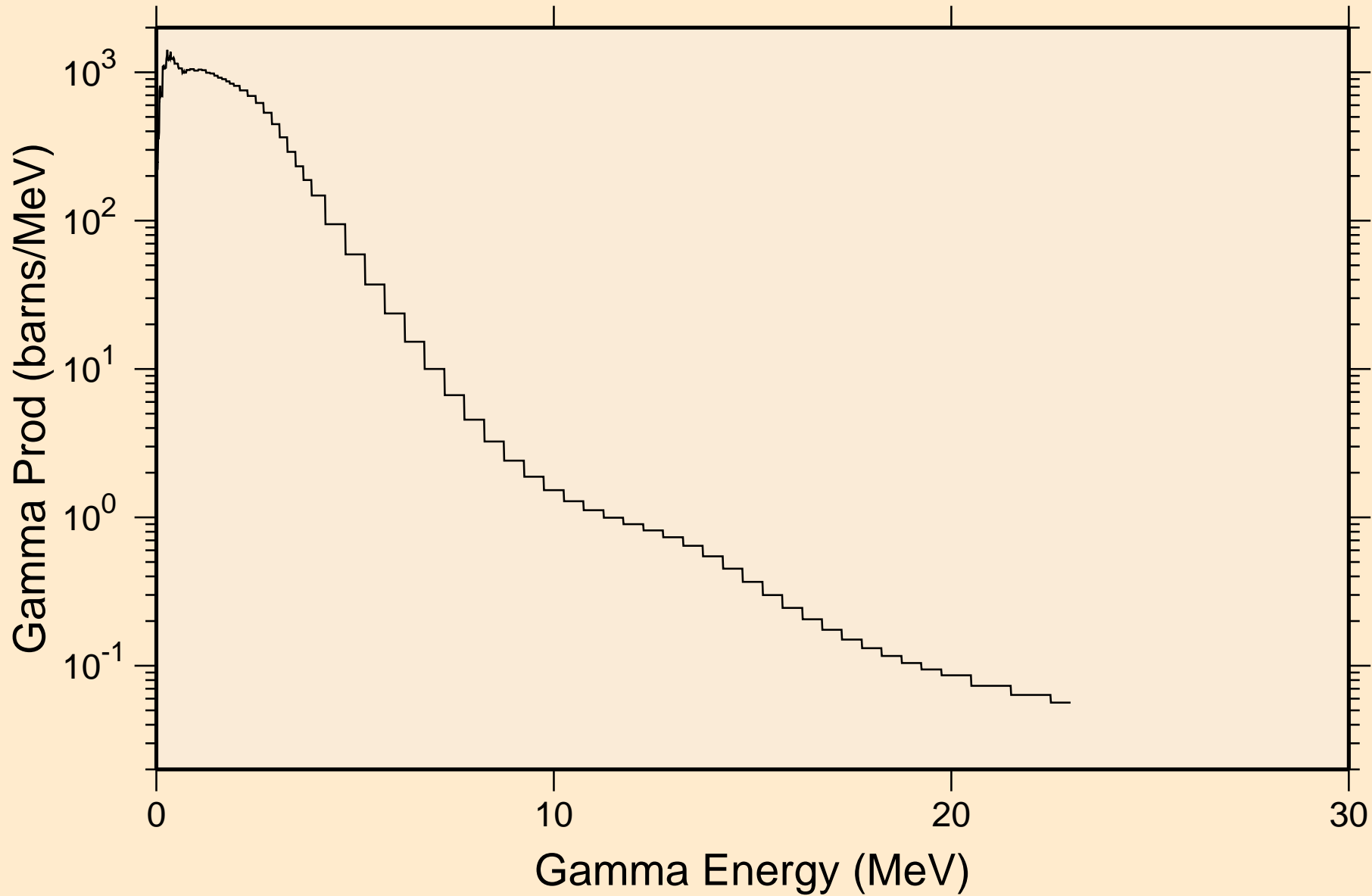

PB185 NEUTRON ACER TENDL-2023 LIBRARY; T=0.K  
Particle heating contributions

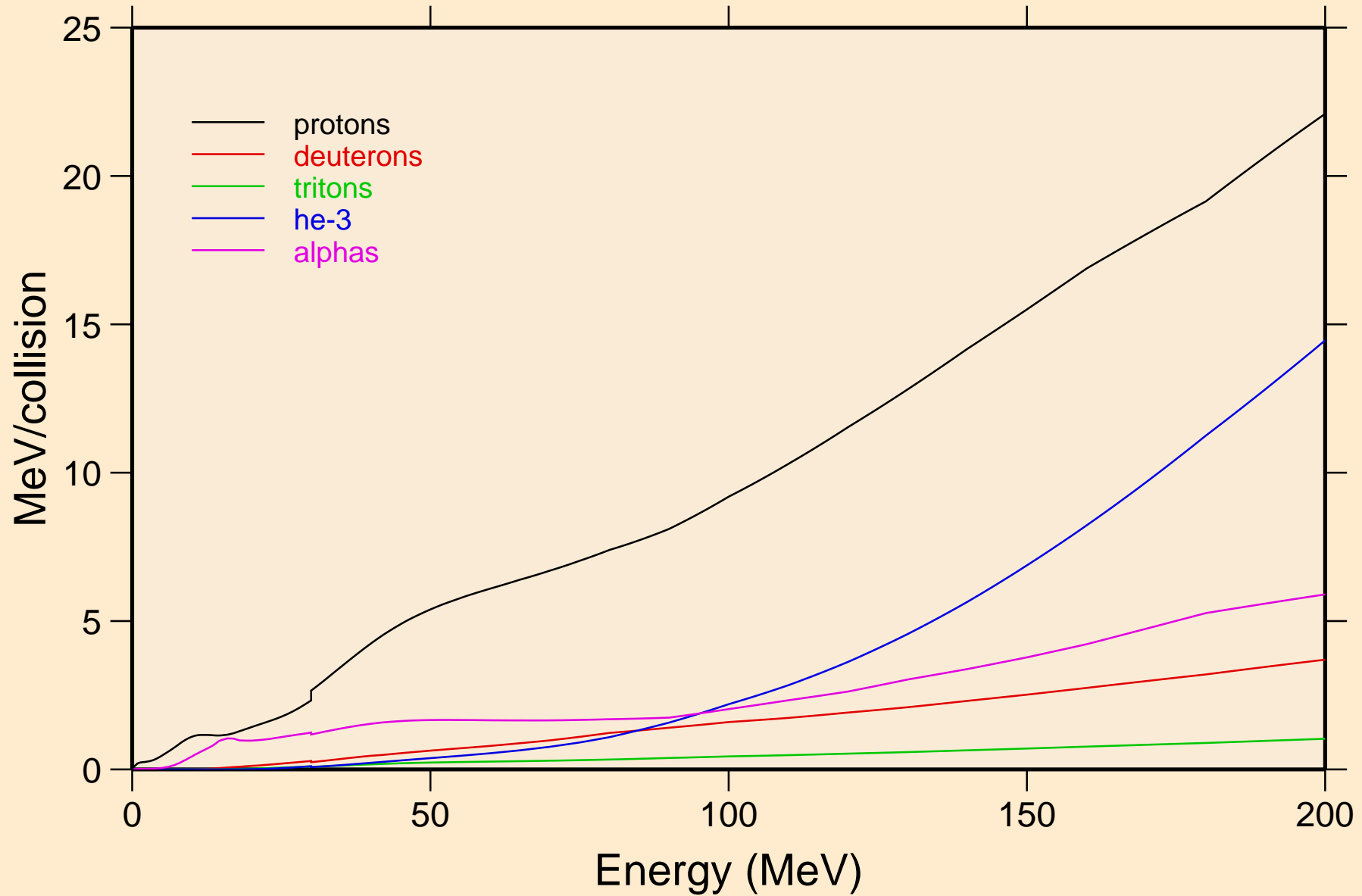

PB185 NEUTRON ACER TENDL-2023 LIBRARY; T=0.K  
Recoil Heating

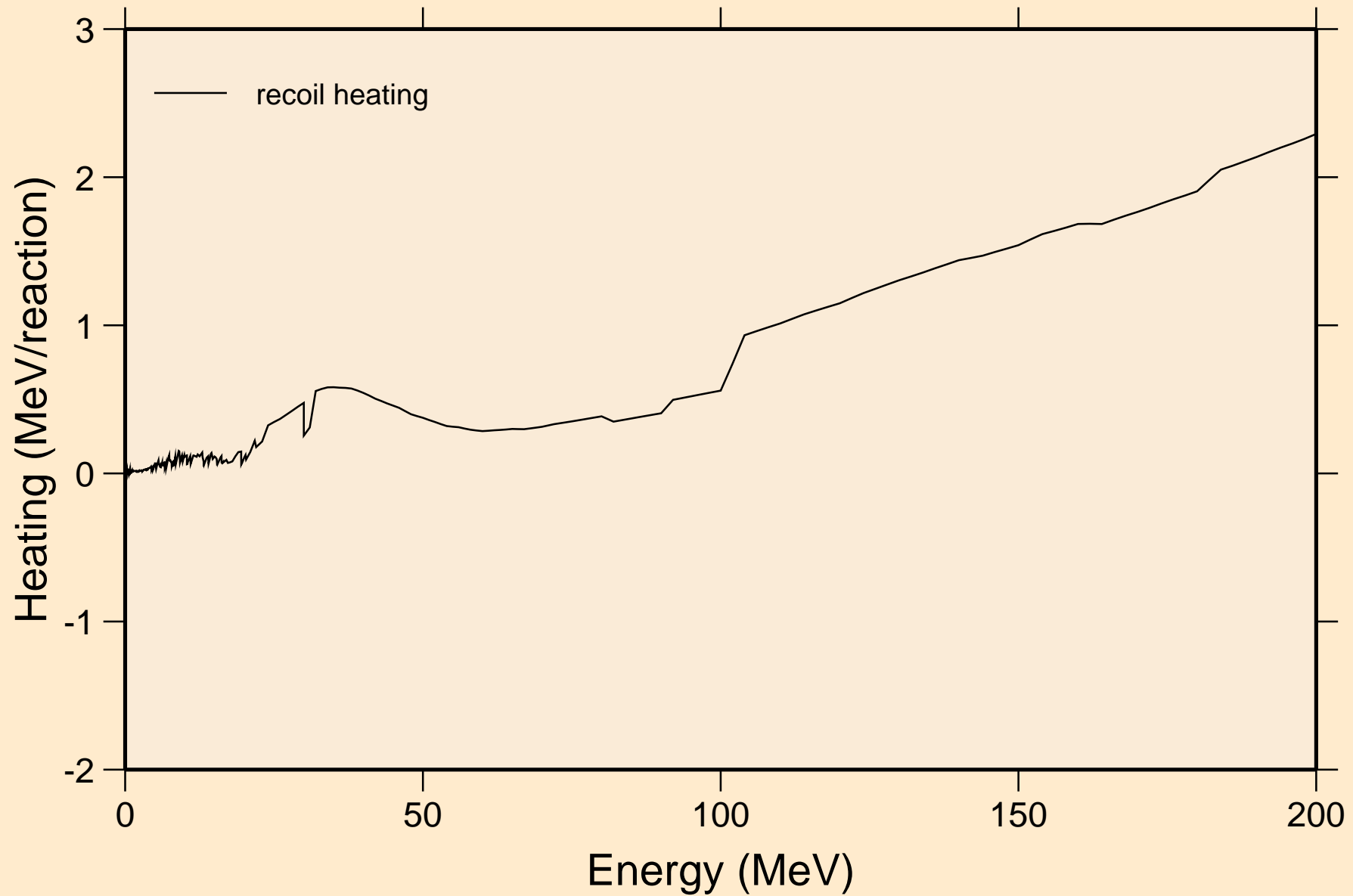

PB185 NEUTRON ACER TENDL-2023 LIBRARY; T=0.K  
Particle production cross sections

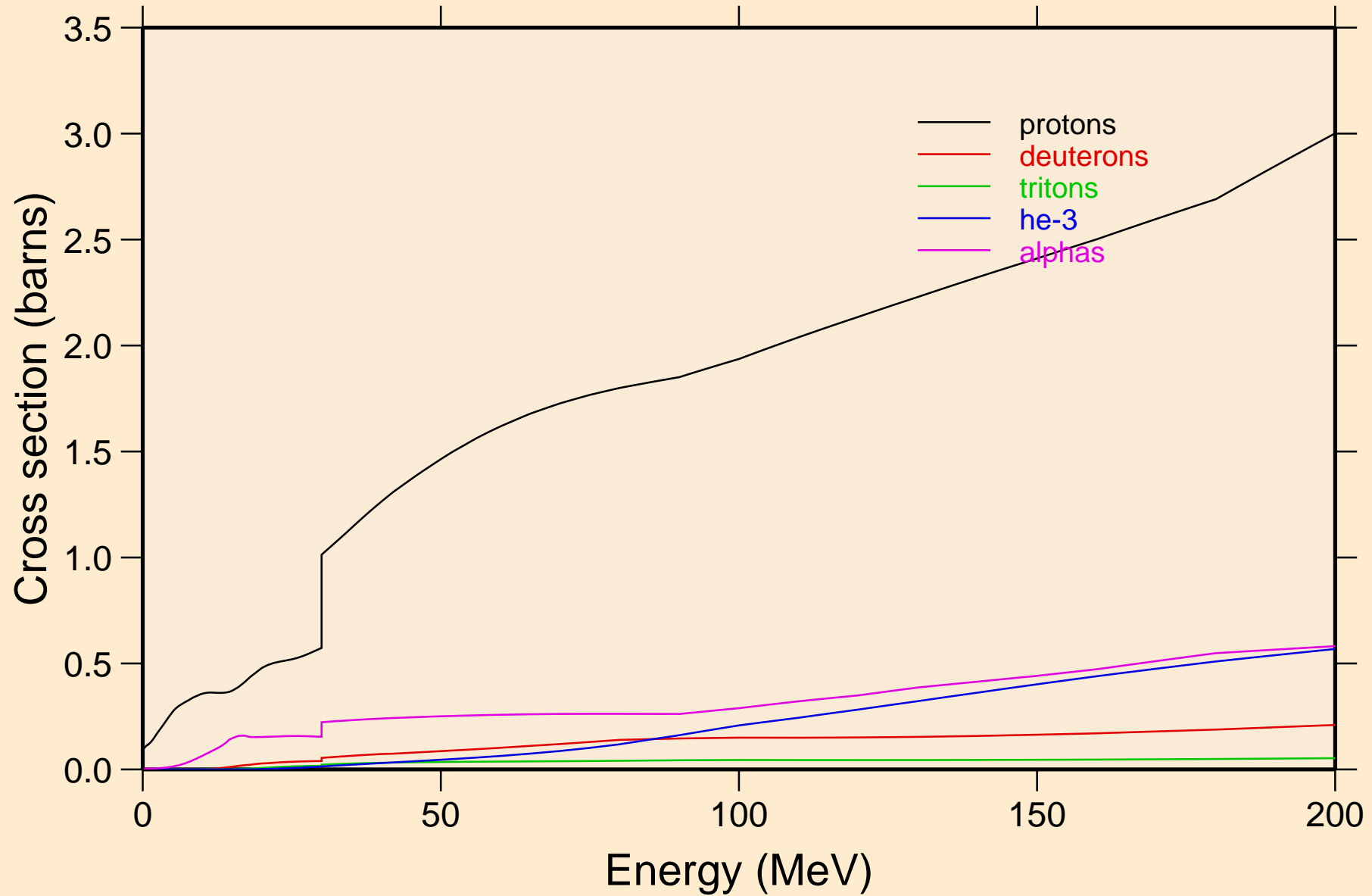

PB185 NEUTRON ACER TENDL-2023 LIBRARY; T=0.K  
protons from (n,x)

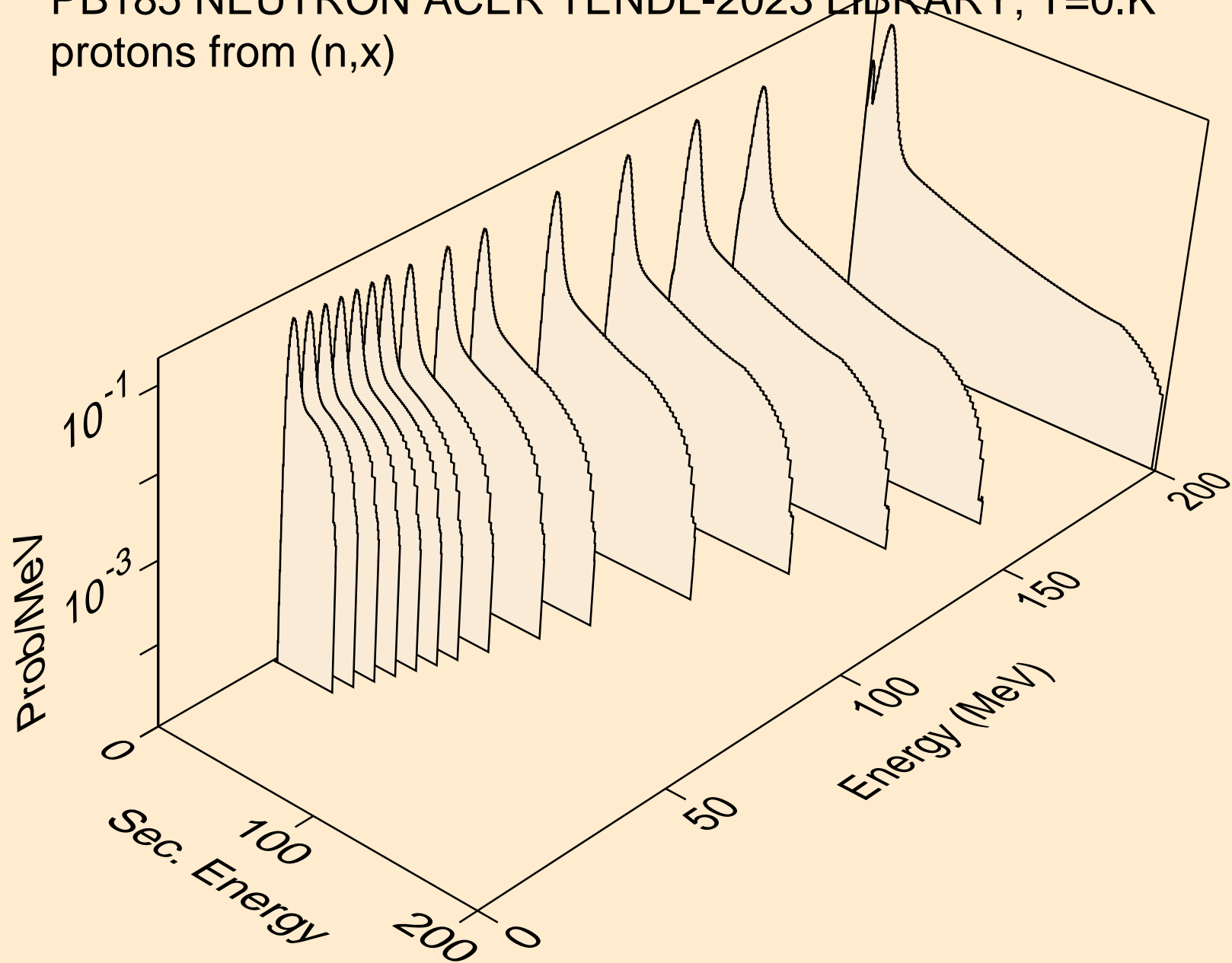

PB185 NEUTRON ACER TENDL-2023 LIBRARY; T=0.K  
protons from (n,n\*)p

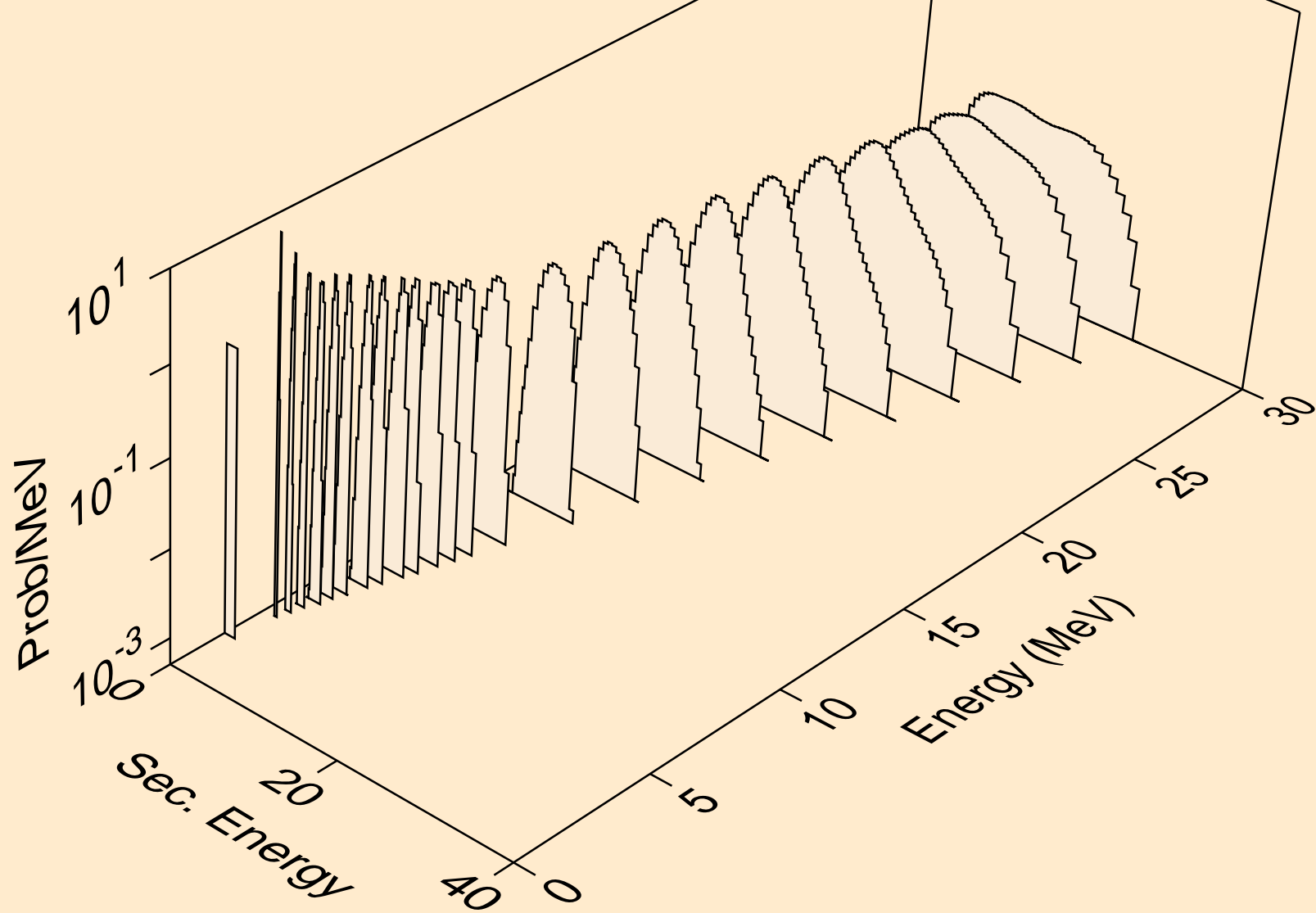

PB185 NEUTRON ACER TENDL-2023 LIBRARY; T=0.K  
protons from (n,2np)

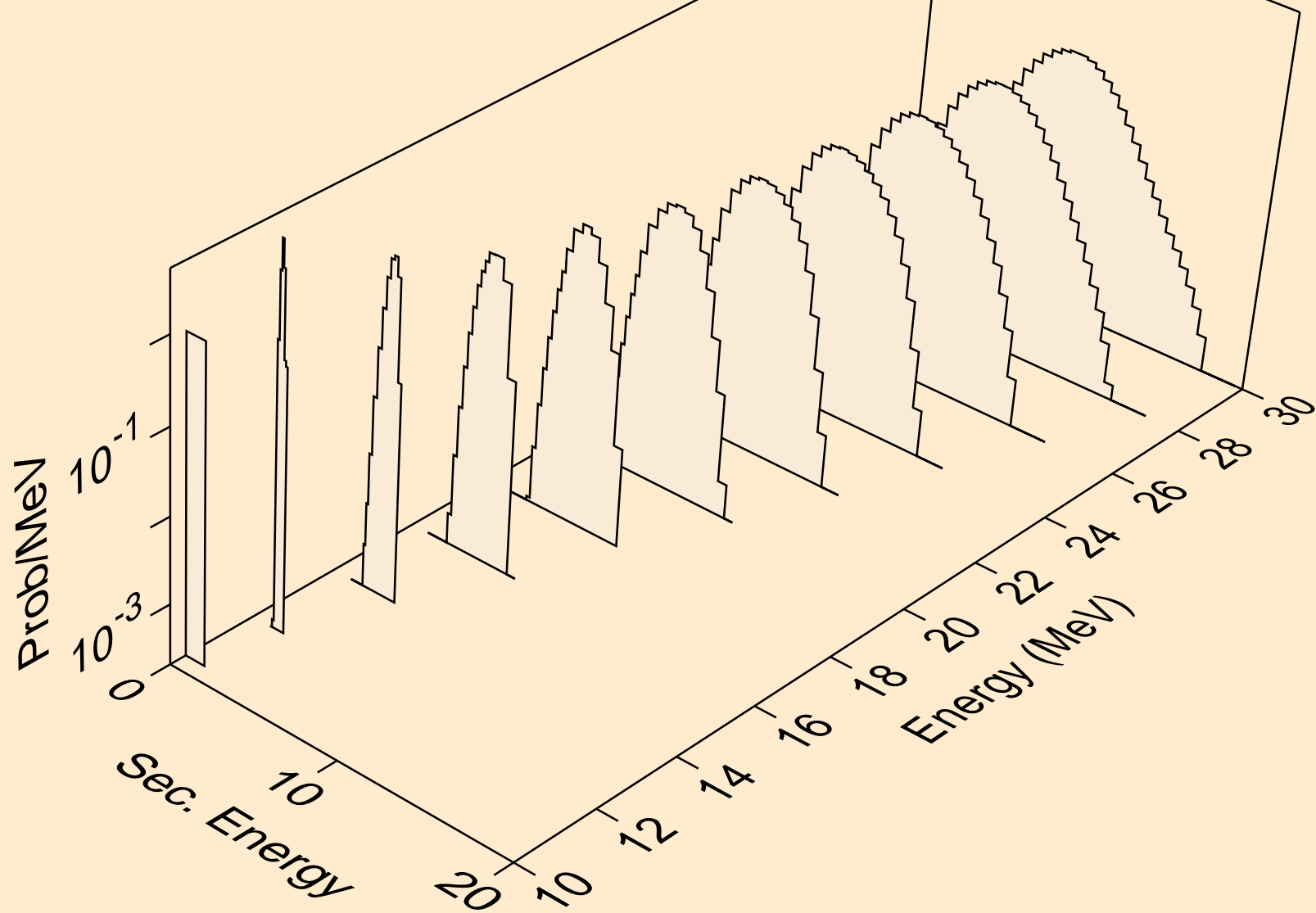

PB185 NEUTRON ACER TENDL-2023 LIBRARY; T=0.K  
protons from (n,3np)

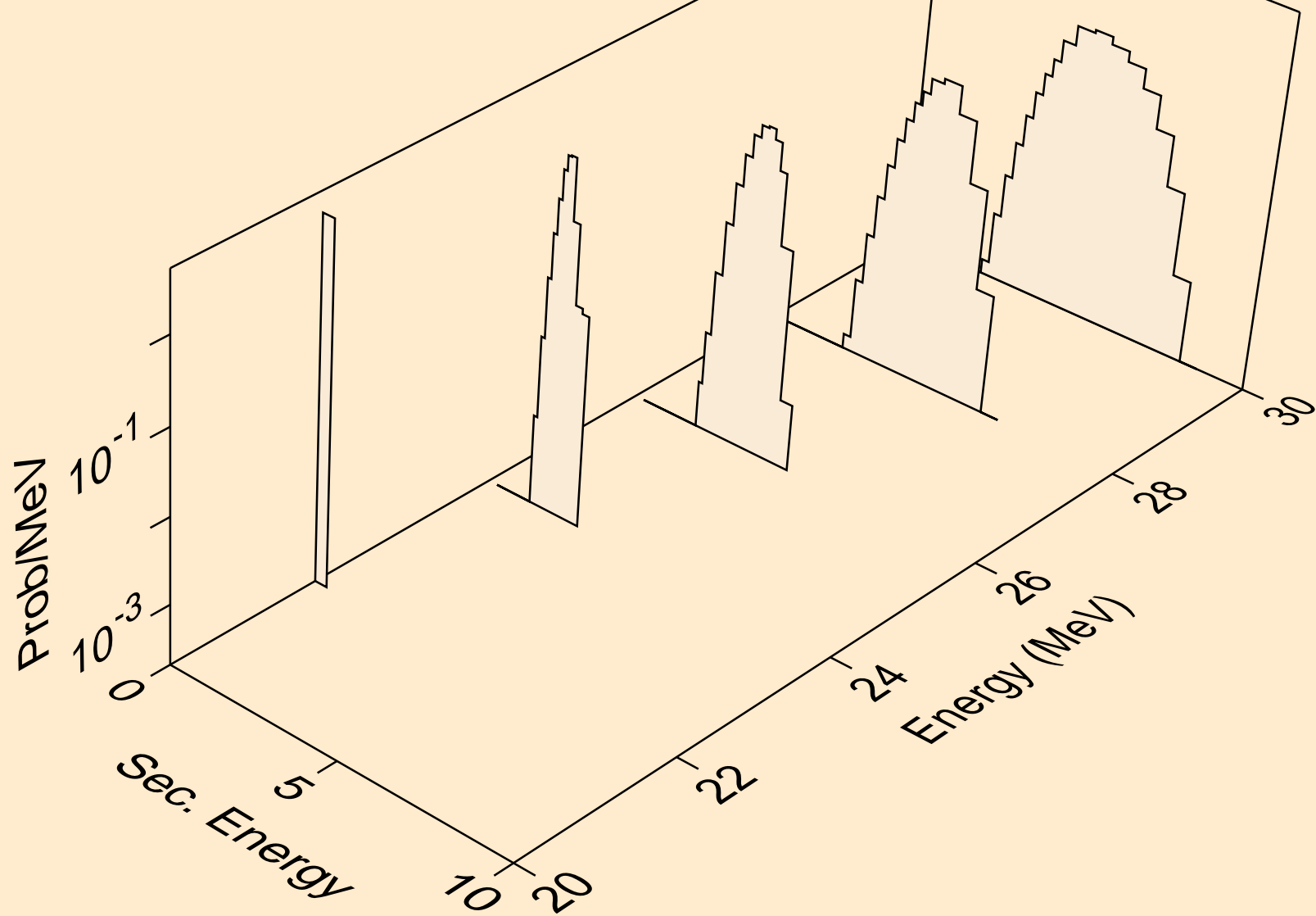

PB185 NEUTRON ACER TENDL-2023 LIBRARY; T=0.K  
protons from (n,n2p)

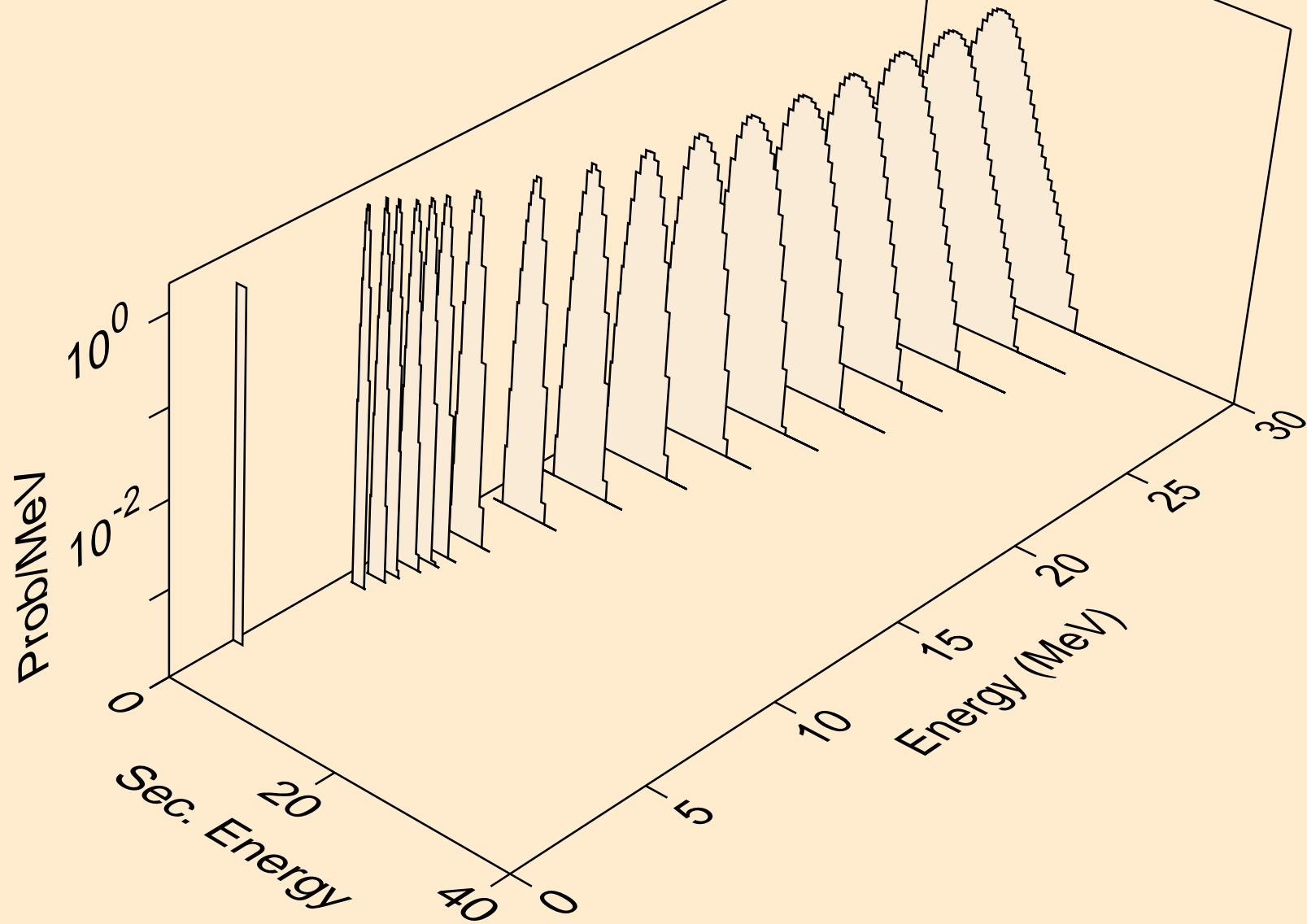

PB185 NEUTRON ACER TENDL-2023 LIBRARY; T=0.K  
protons from (n,npa)

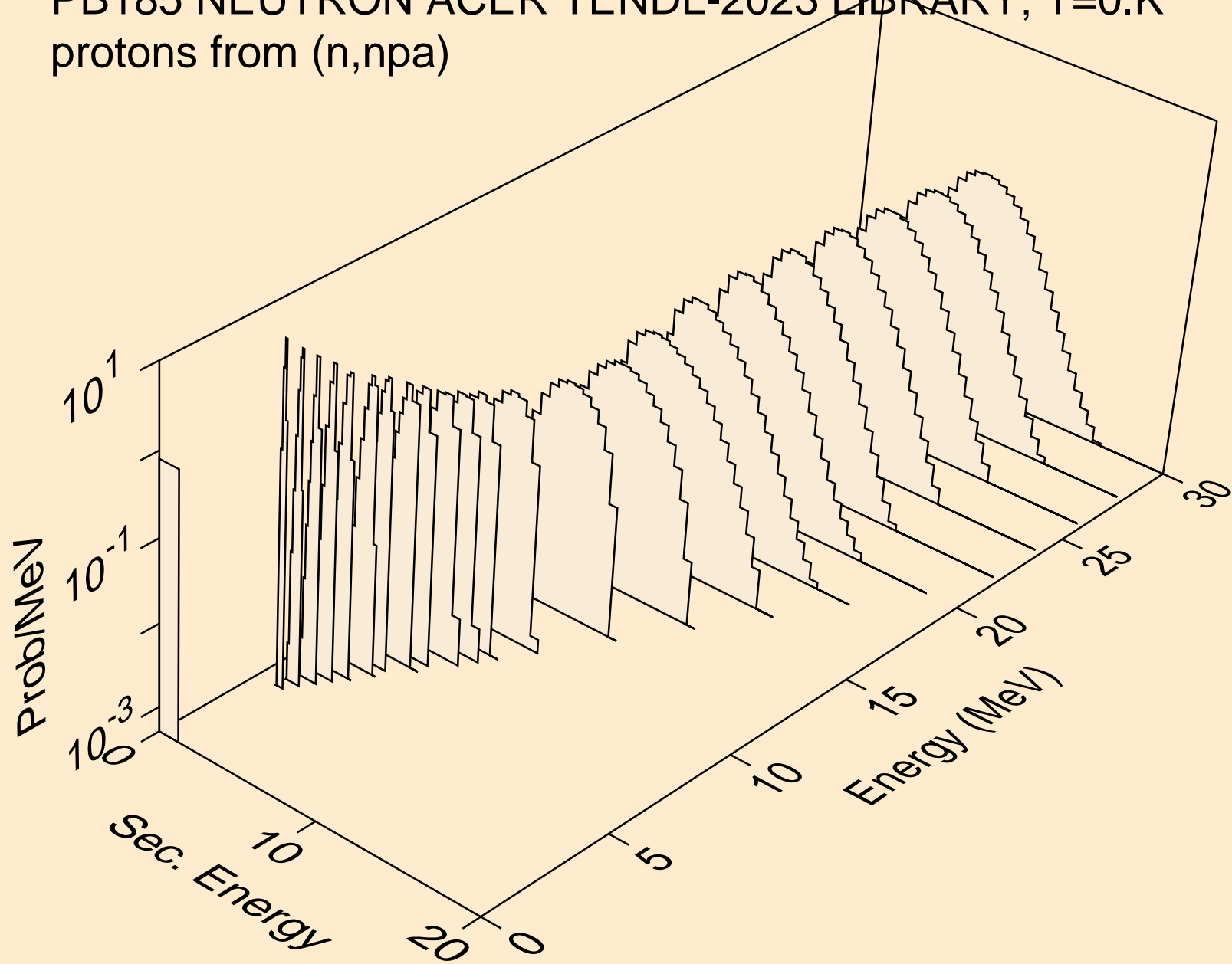

PB185 NEUTRON ACER TENDL-2023 LIBRARY; T=0.K  
protons from (n,p)

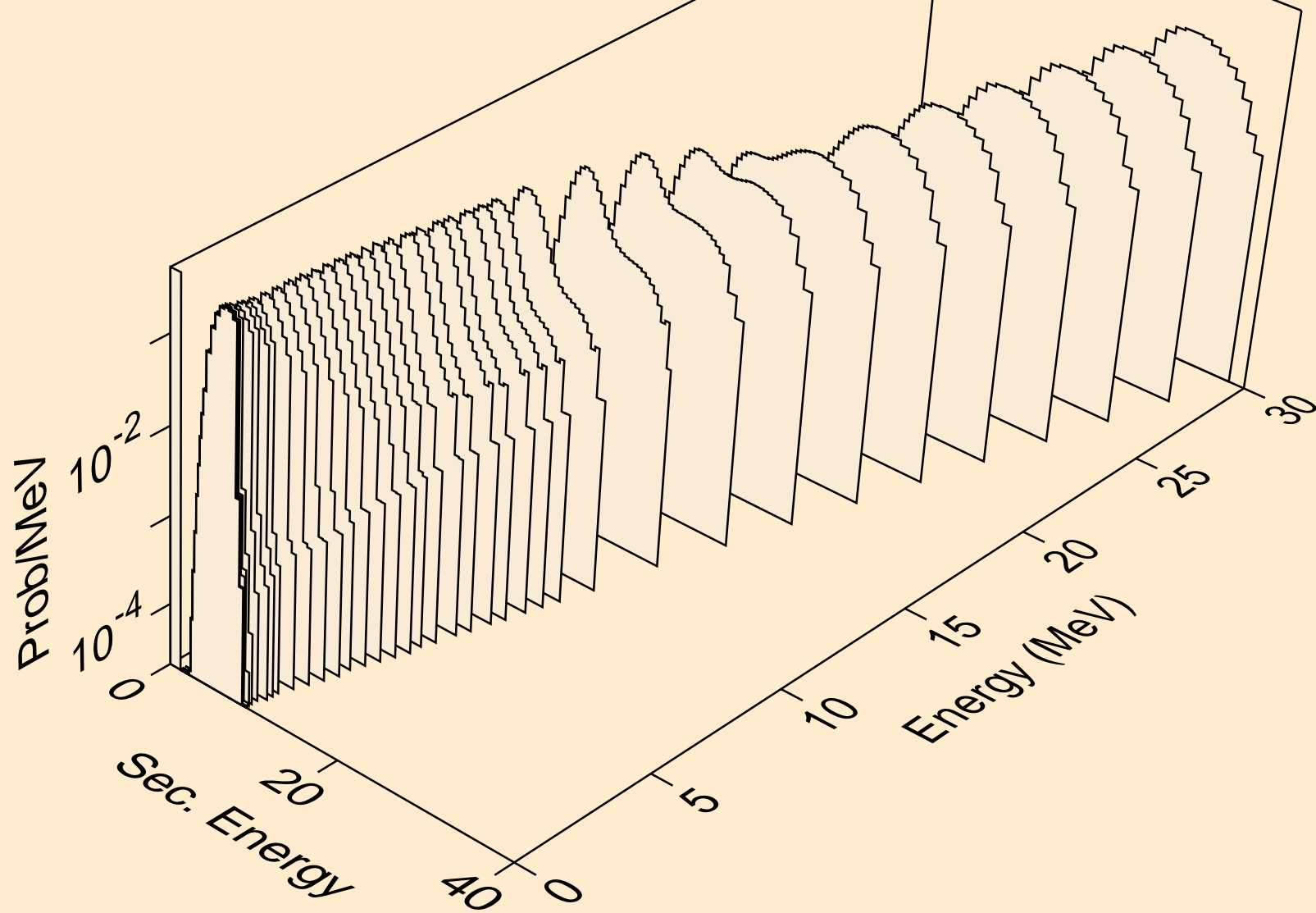

PB185 NEUTRON ACER TENDL-2023 LIBRARY; T=0.K  
protons from (n,2p)

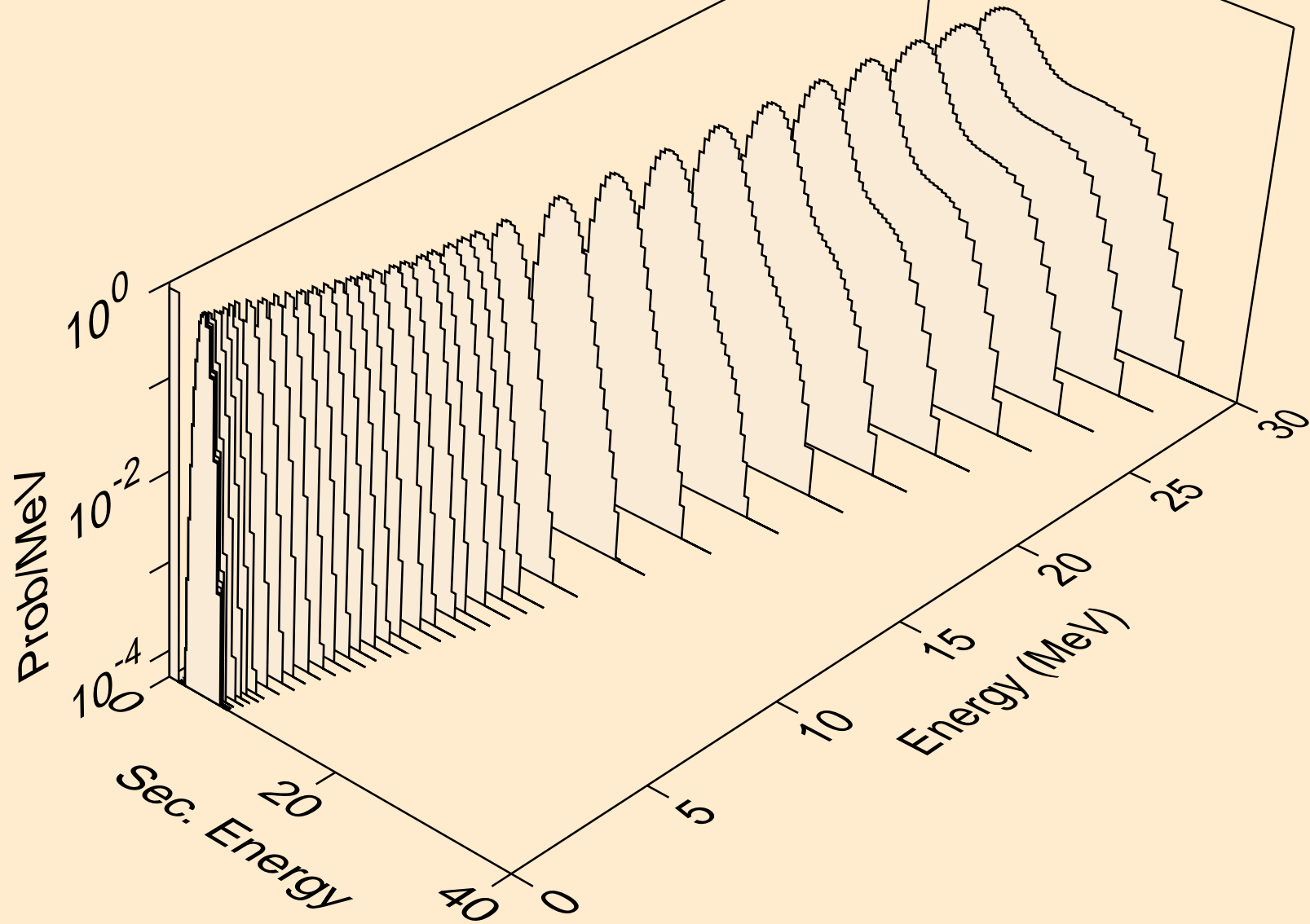

PB185 NEUTRON ACER TENDL-2023 LIBRARY; T=0.K  
protons from (n,p)

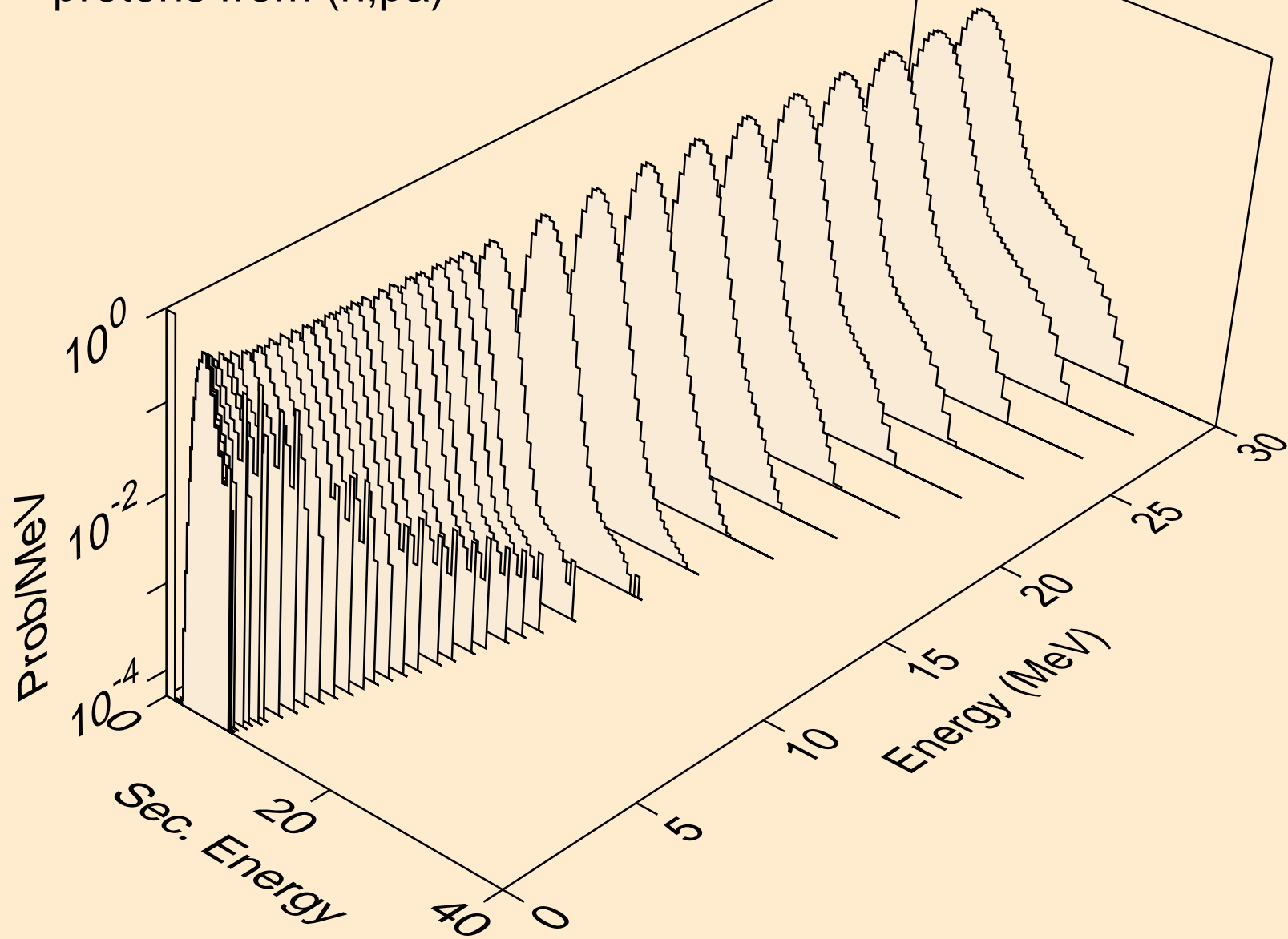

PB185 NEUTRON ACER TENDL-2023 LIBRARY; T=0.K  
protons from (n,pd)

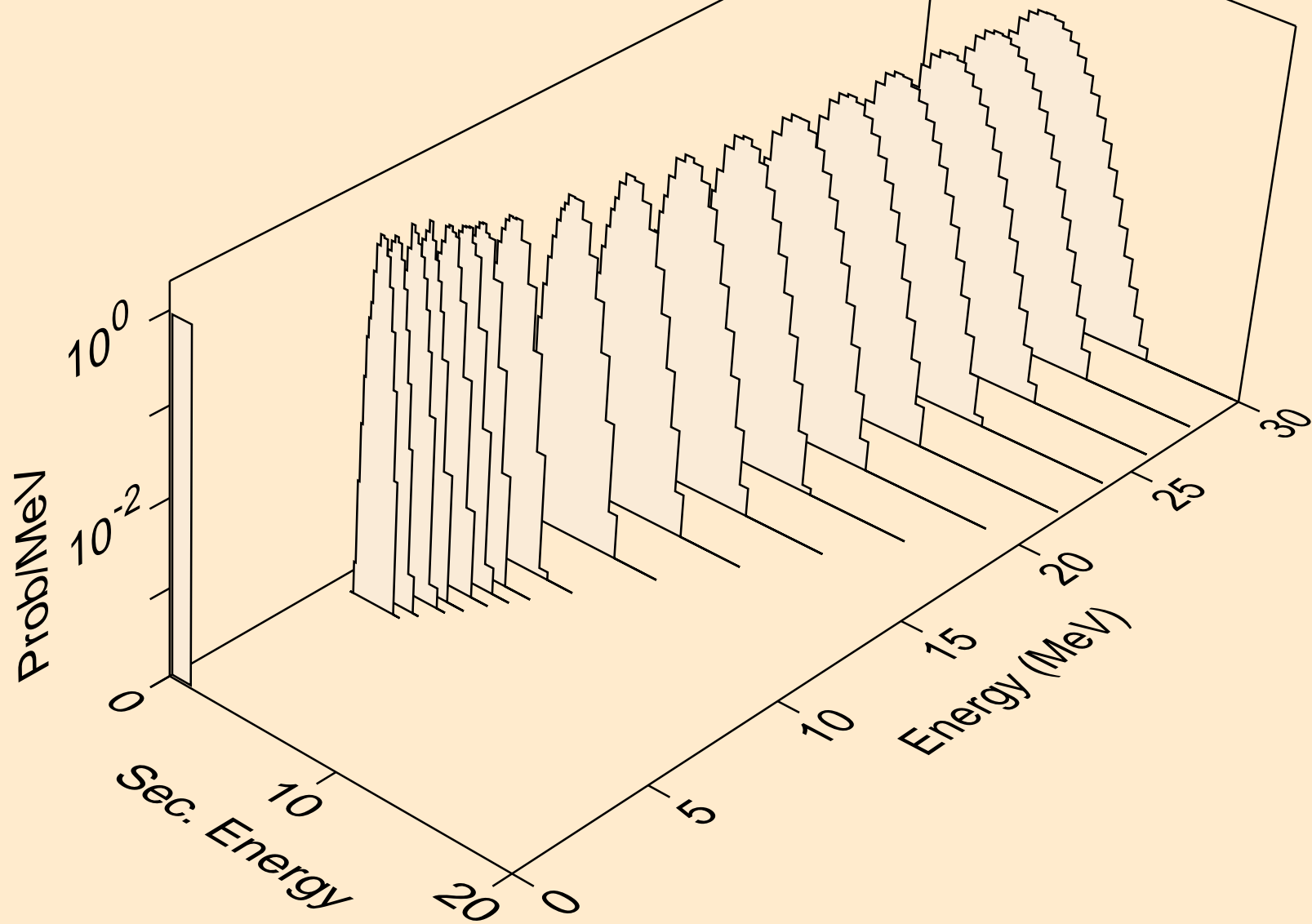

PB185 NEUTRON ACER TENDL-2023 LIBRARY; T=0.K  
protons from (n,pt)

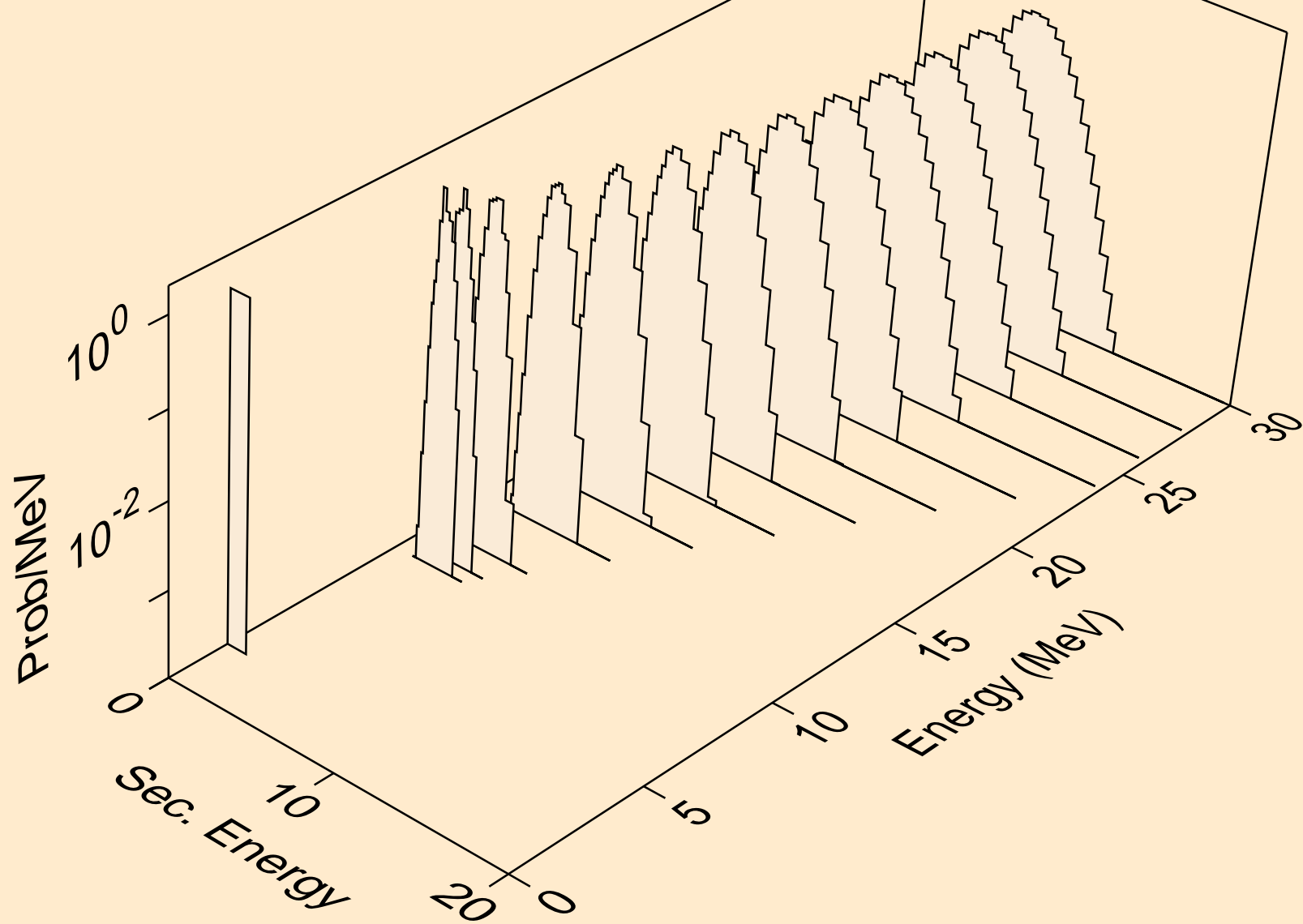

PB185 NEUTRON ACER TENDL-2023 LIBRARY; T=0.K  
deuterons from (n,x)

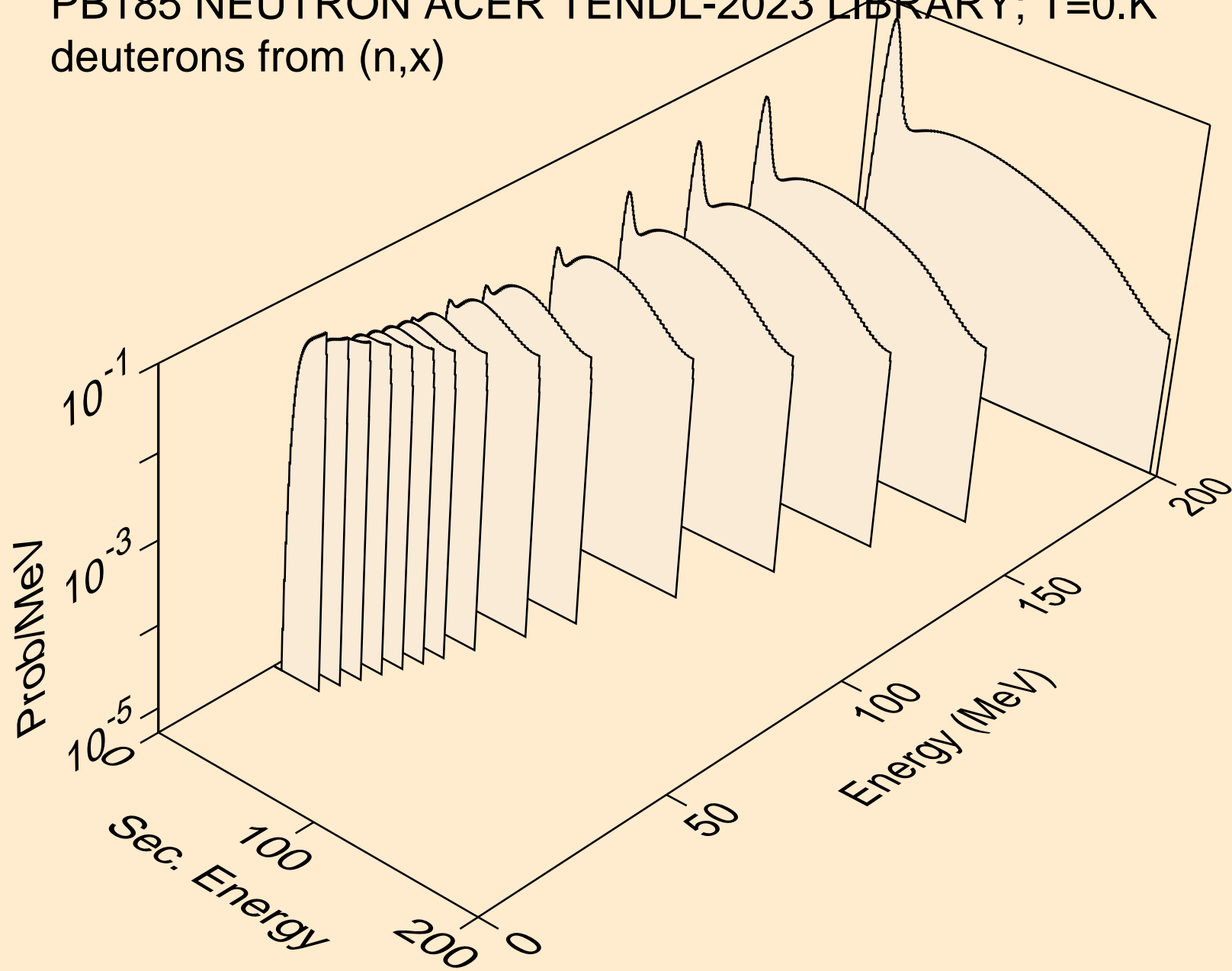

PB185 NEUTRON ACER TENDL-2023 LIBRARY; T=0.K  
deuterons from (n,2nd)



PB185 NEUTRON ACER TENDL-2023 LIBRARY; T=0.K  
deuterons from (n,n\*)d

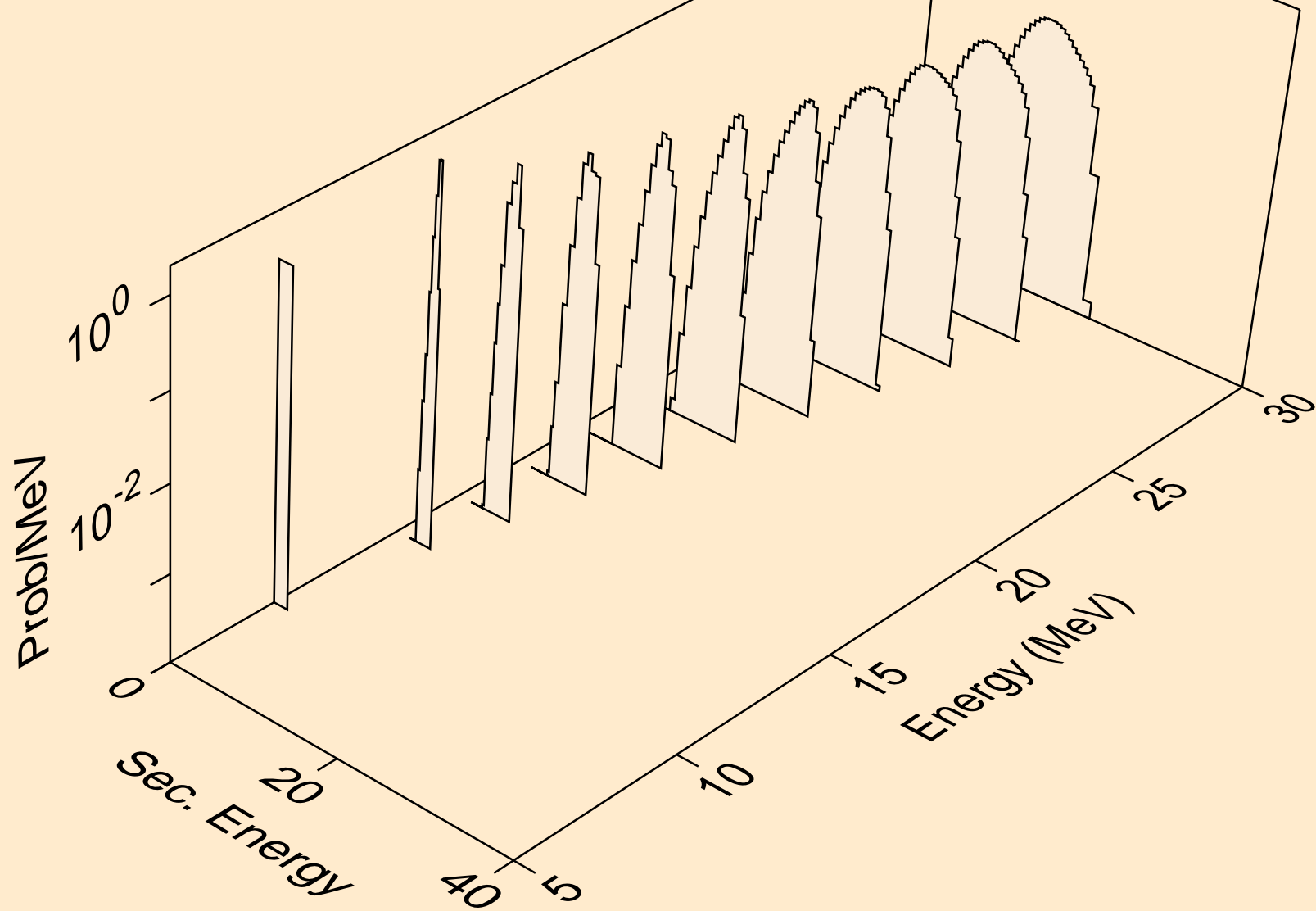

PB185 NEUTRON ACER TENDL-2023 LIBRARY; T=0.K  
deuterons from (n,d)

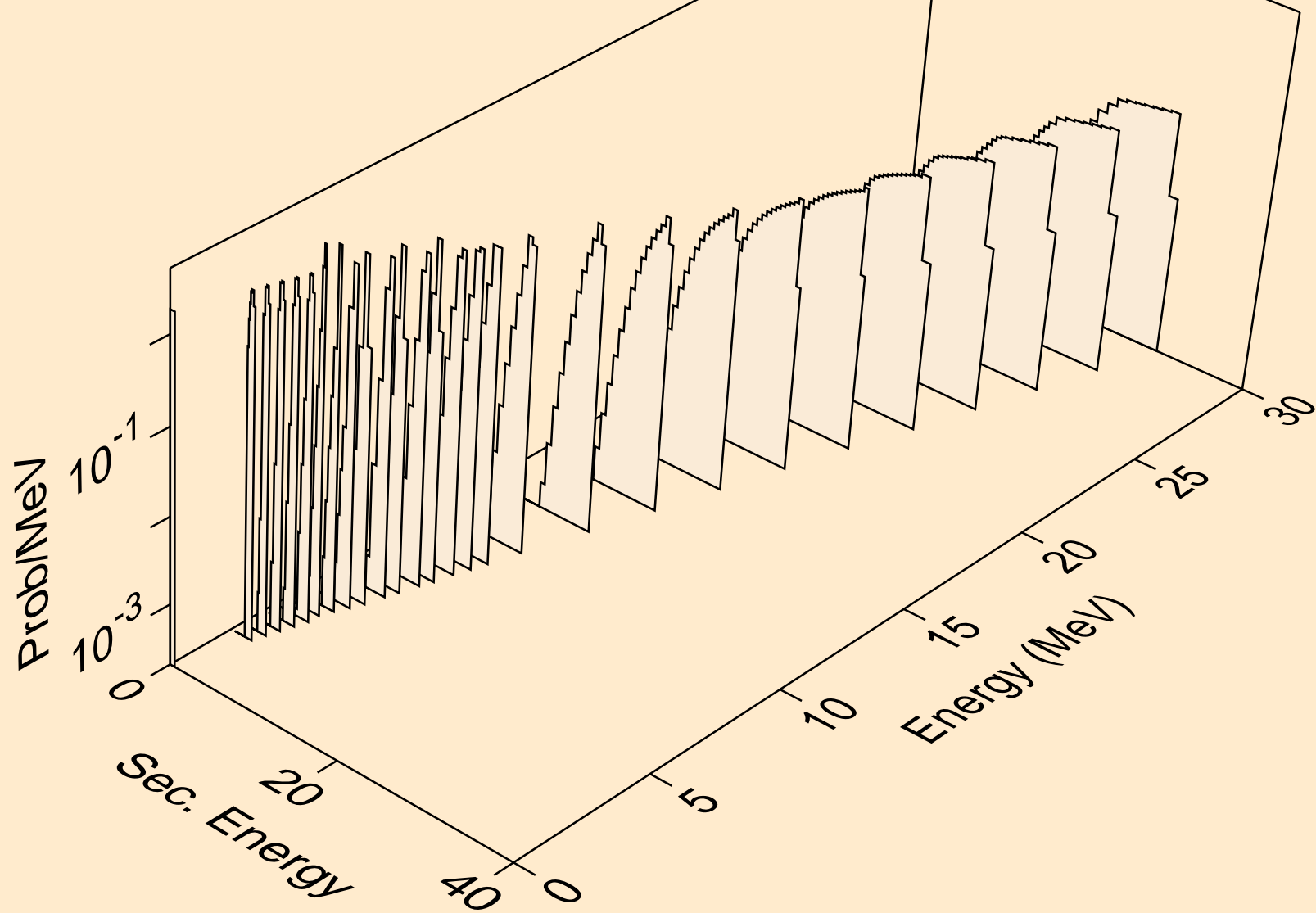

PB185 NEUTRON ACER TENDL-2023 LIBRARY; T=0.K  
deuterons from (n,d2a)

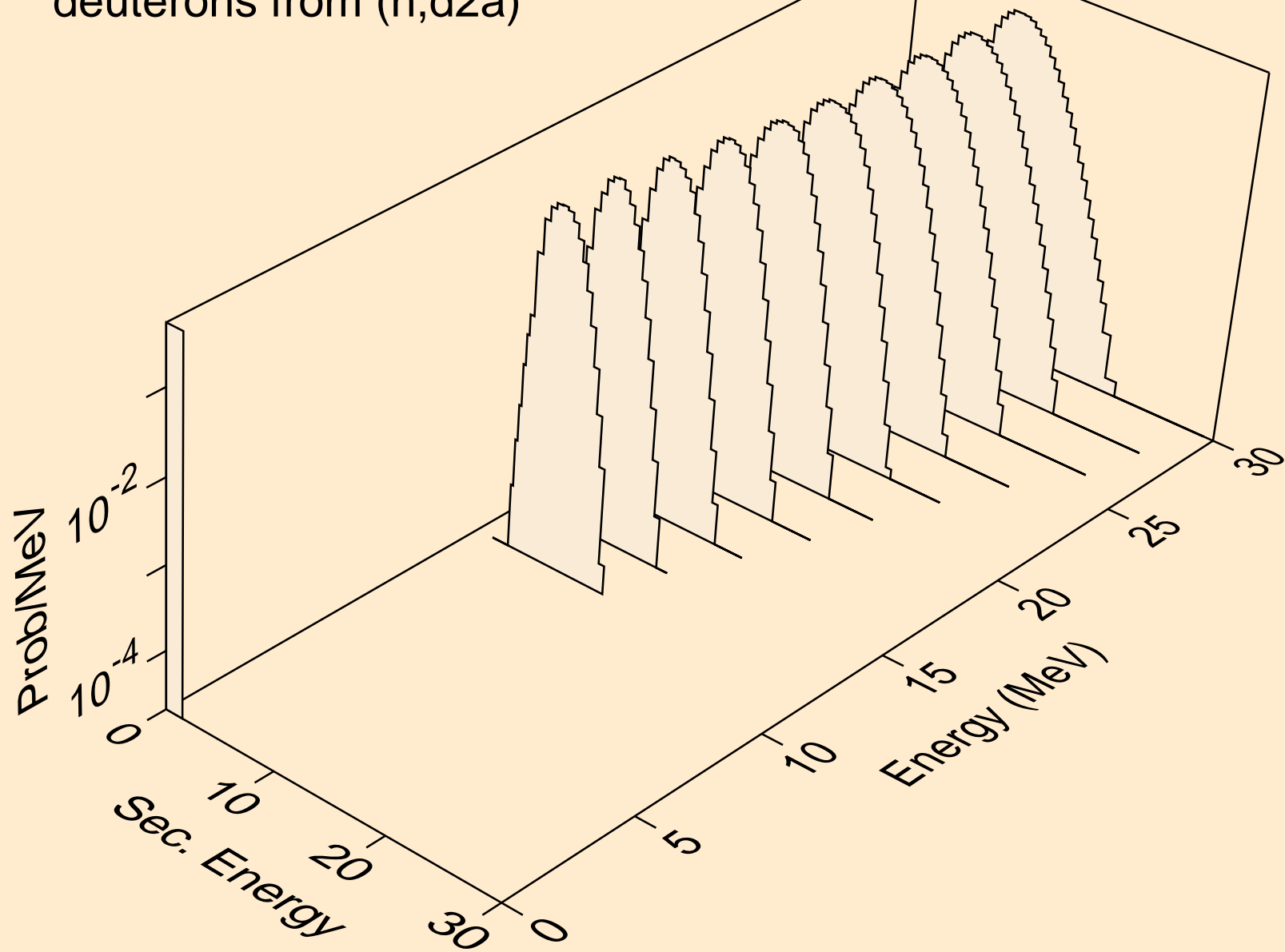

PB185 NEUTRON ACER TENDL-2023 LIBRARY; T=0.K  
deuterons from (n,pd)

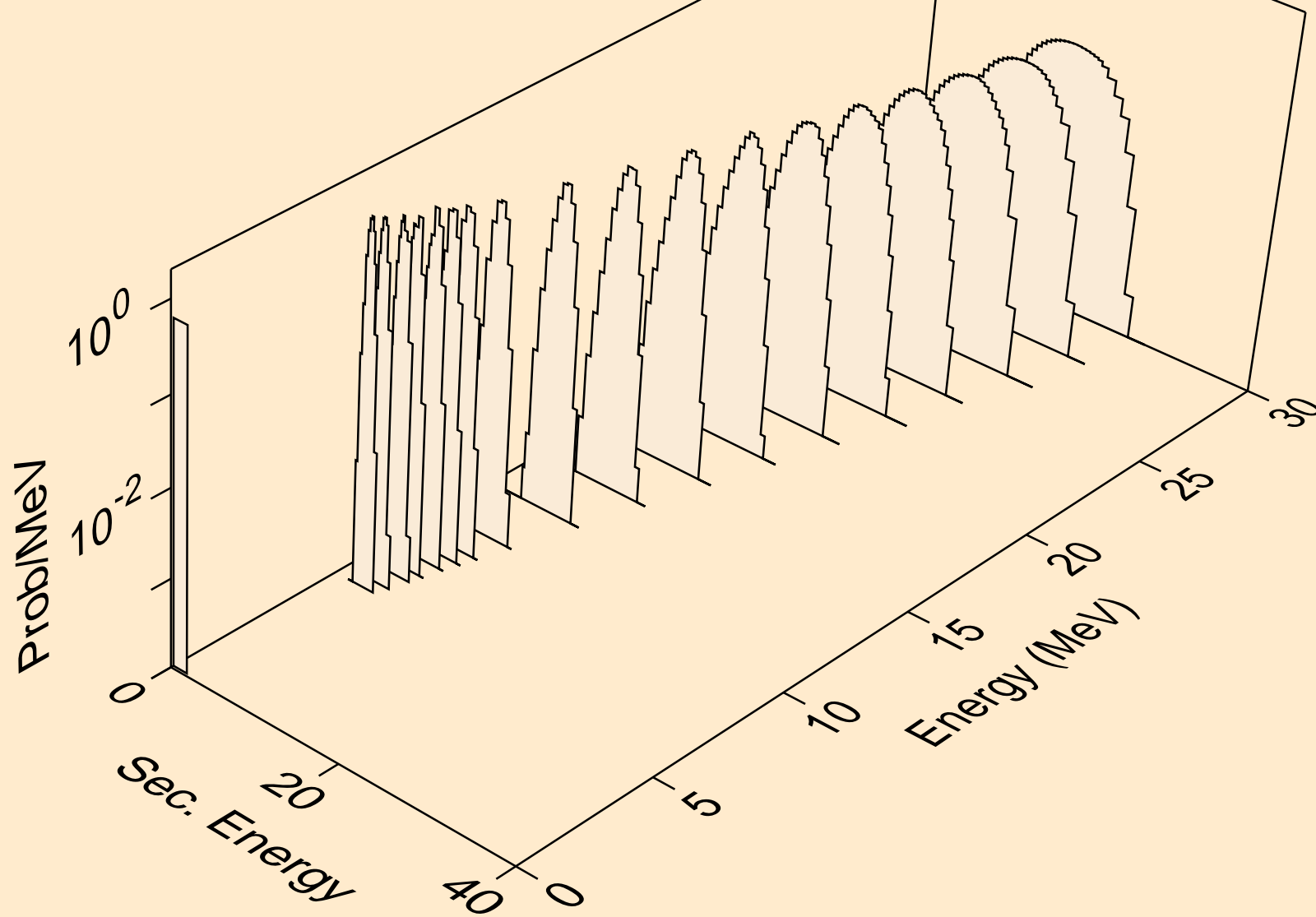

PB185 NEUTRON ACER TENDL-2023 LIBRARY; T=0.K  
deuterons from (n,da)

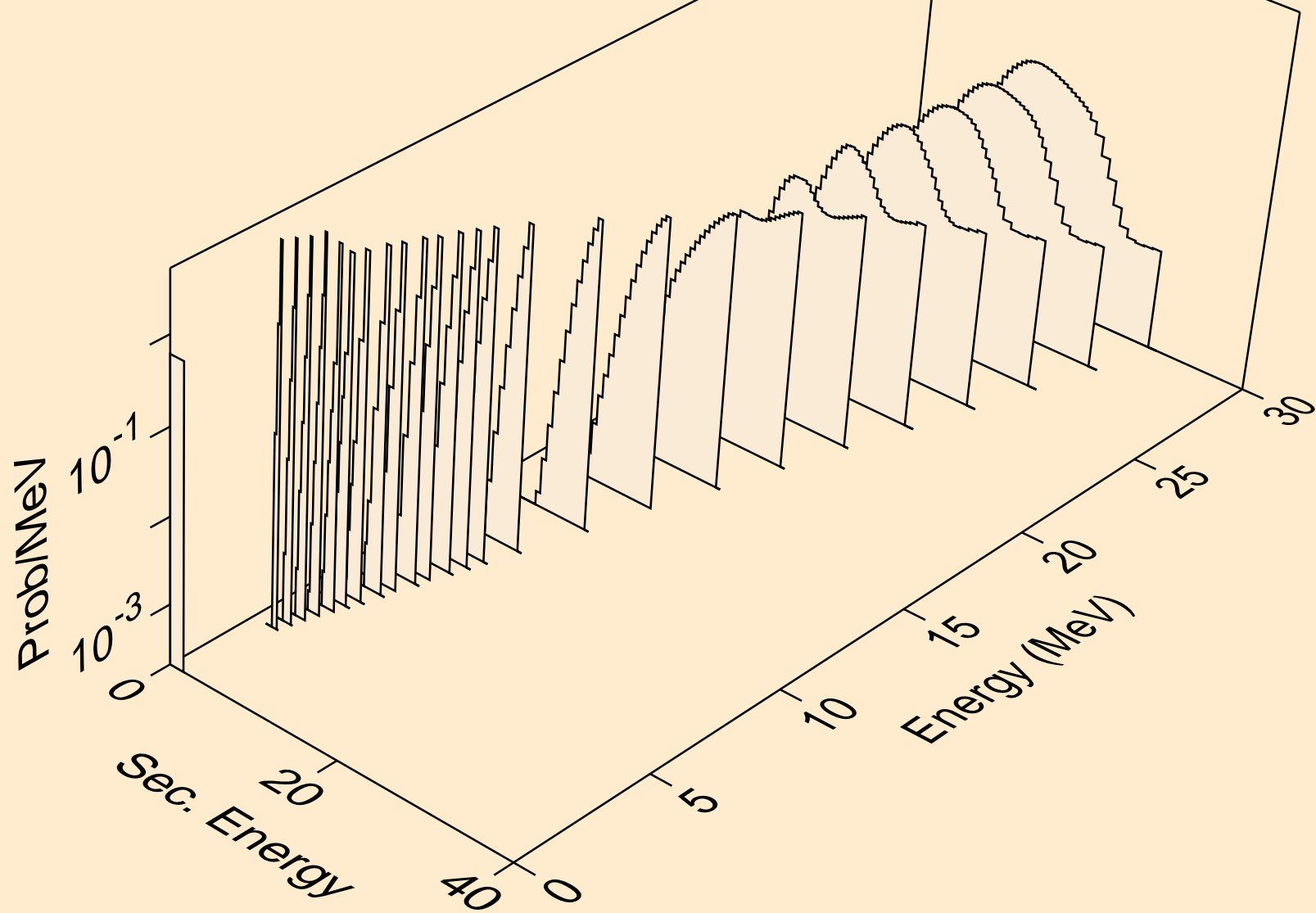

PB185 NEUTRON ACER TENDL-2023 LIBRARY; T=0.K  
tritons from (n,x)

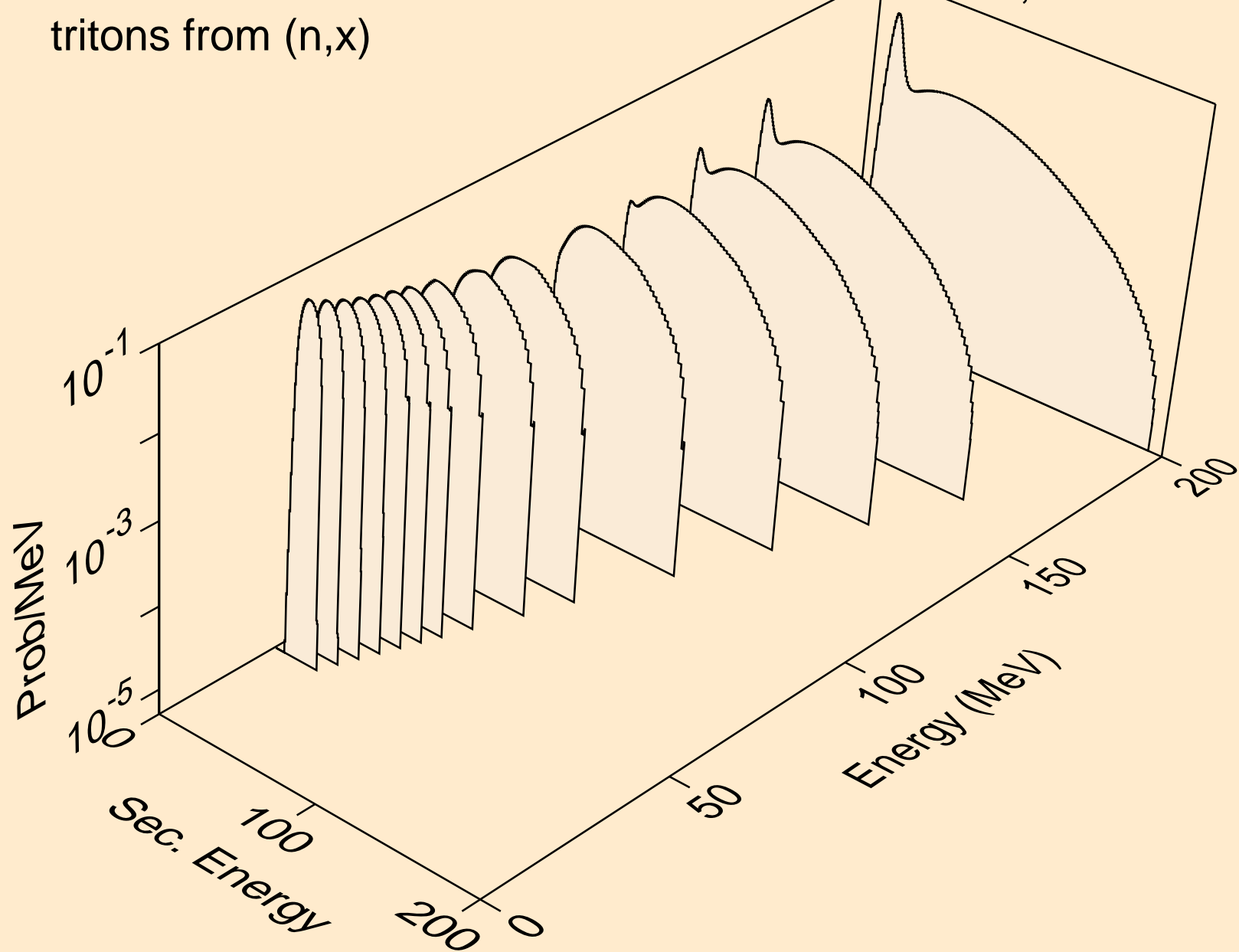

PB185 NEUTRON ACER TENDL-2023 LIBRARY; T=0.K  
tritons from (n,n\*)t

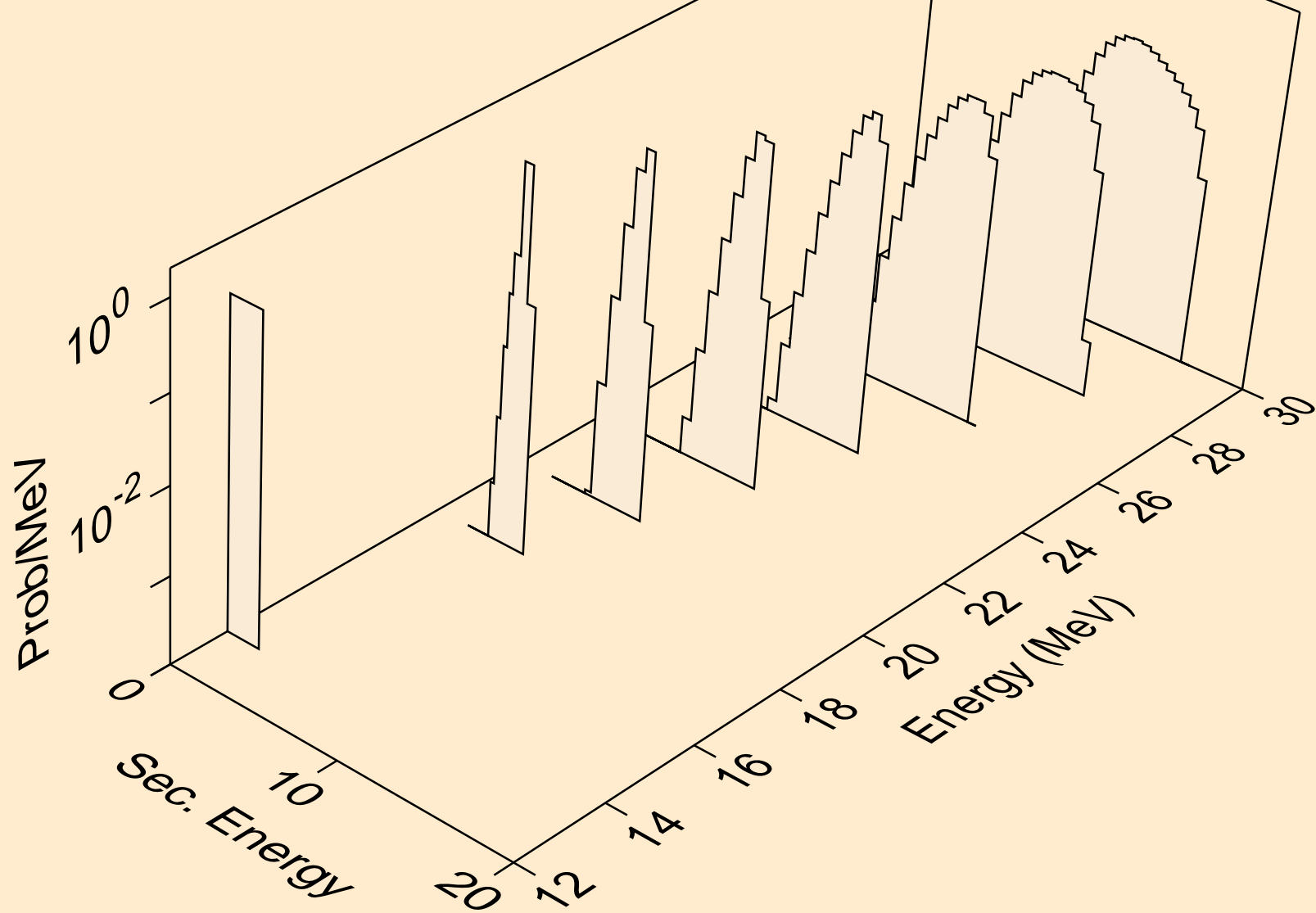

PB185 NEUTRON ACER TENDL-2023 LIBRARY; T=0.K  
tritons from (n,t)

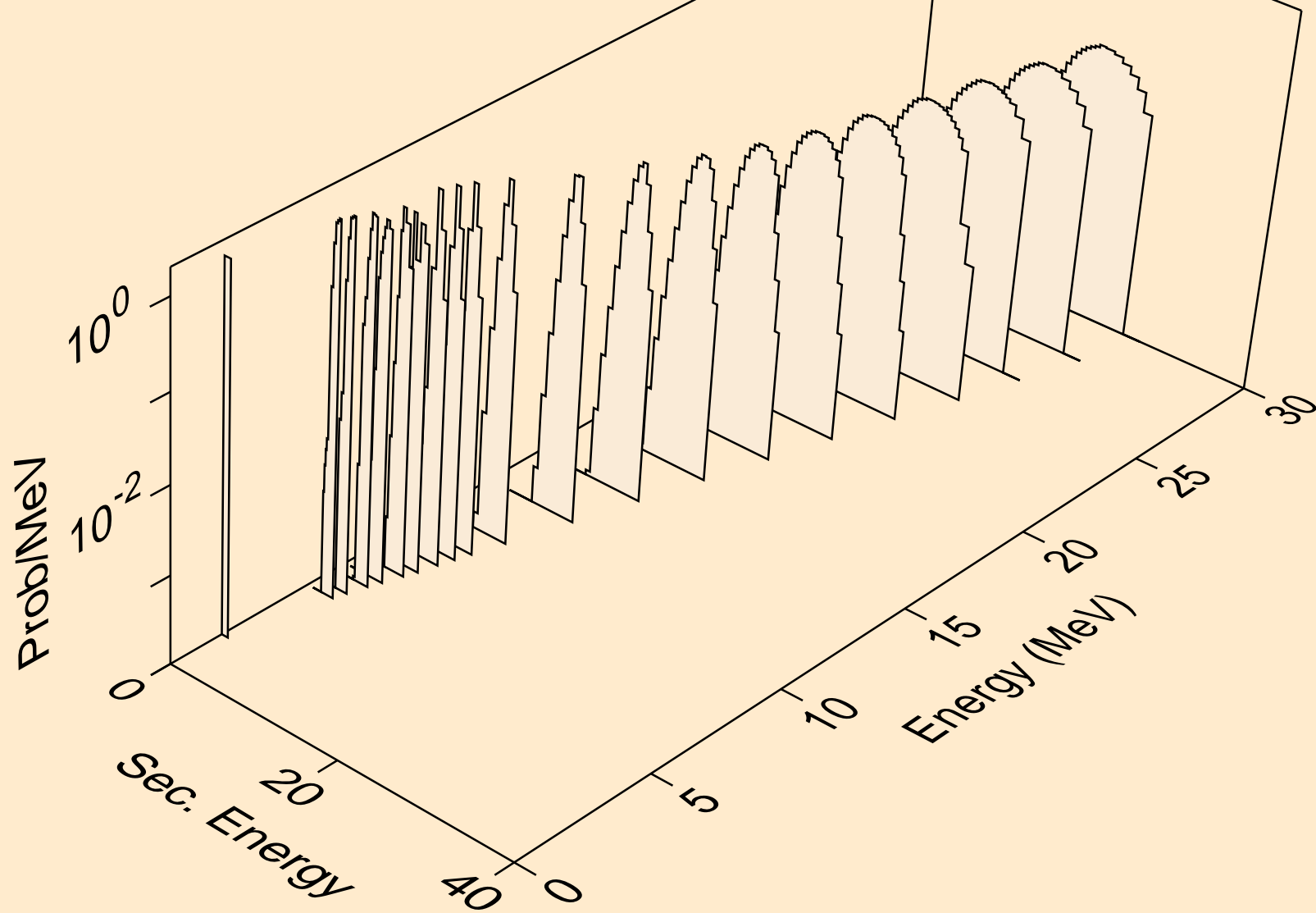

PB185 NEUTRON ACER TENDL-2023 LIBRARY; T=0.K  
tritons from (n,pt)

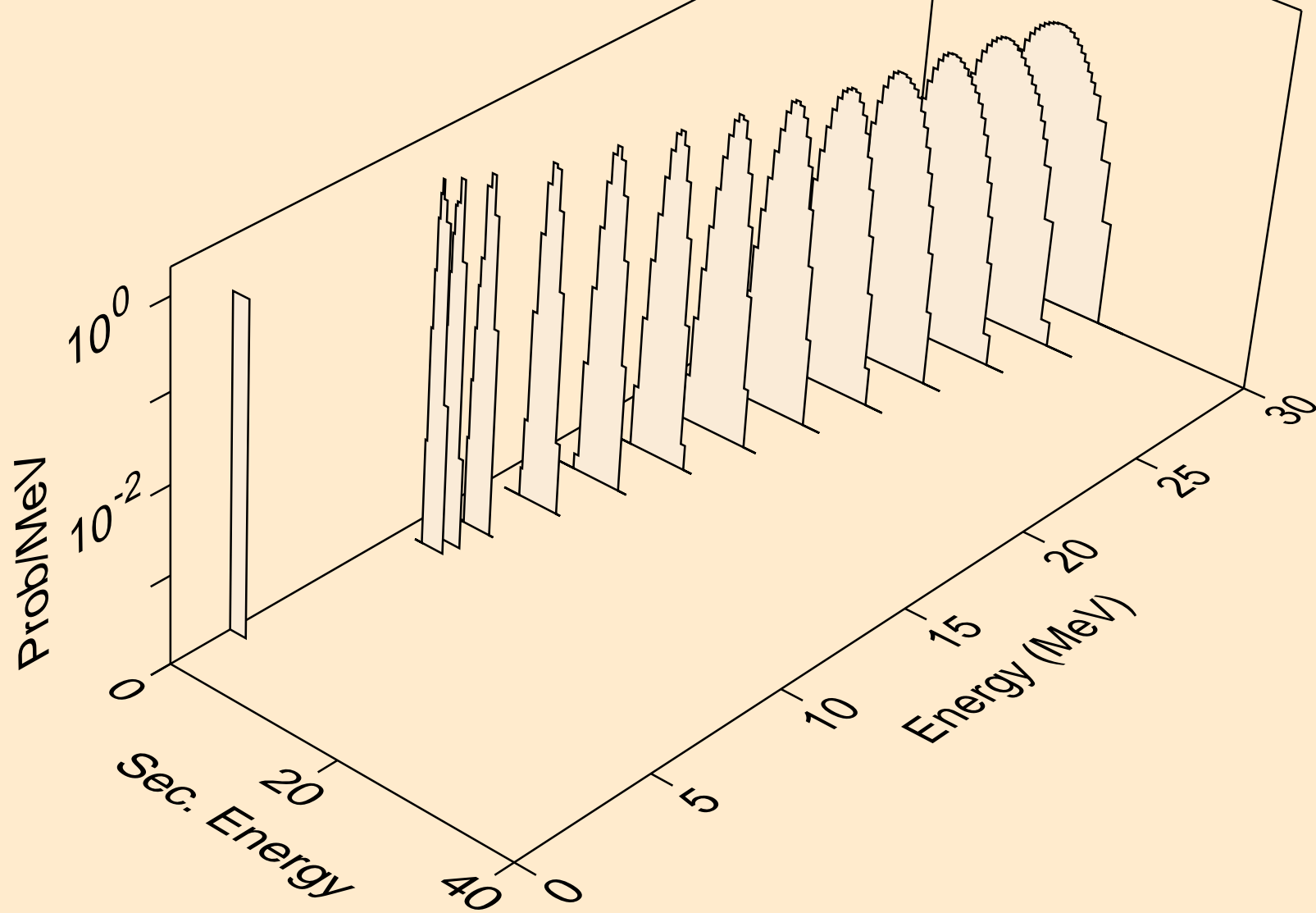

PB185 NEUTRON ACER TENDL-2023 LIBRARY; T=0.K  
he3s from (n,x)

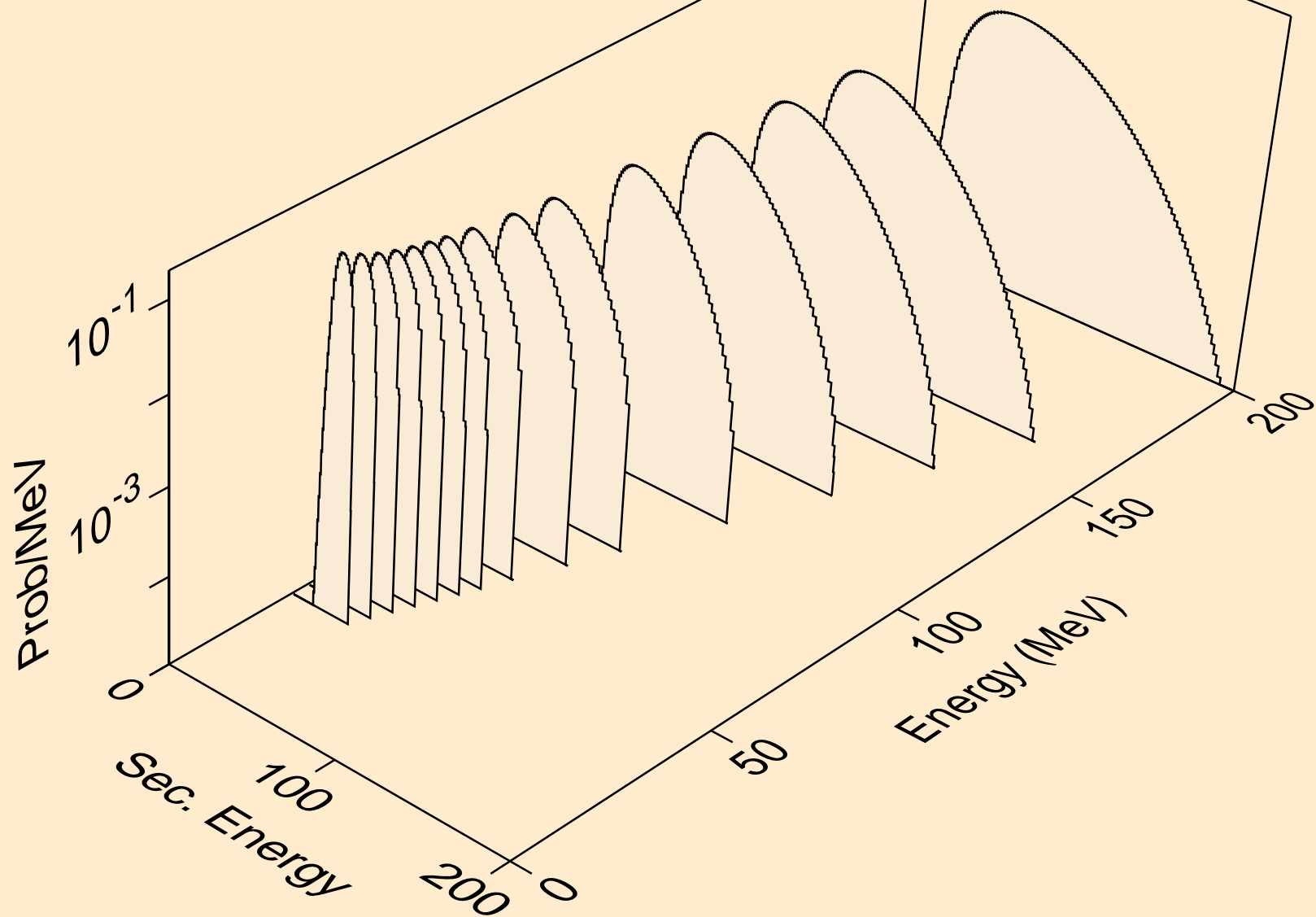

PB185 NEUTRON ACER TENDL-2023 LIBRARY; T=0.K  
he3s from (n,n\*)he3

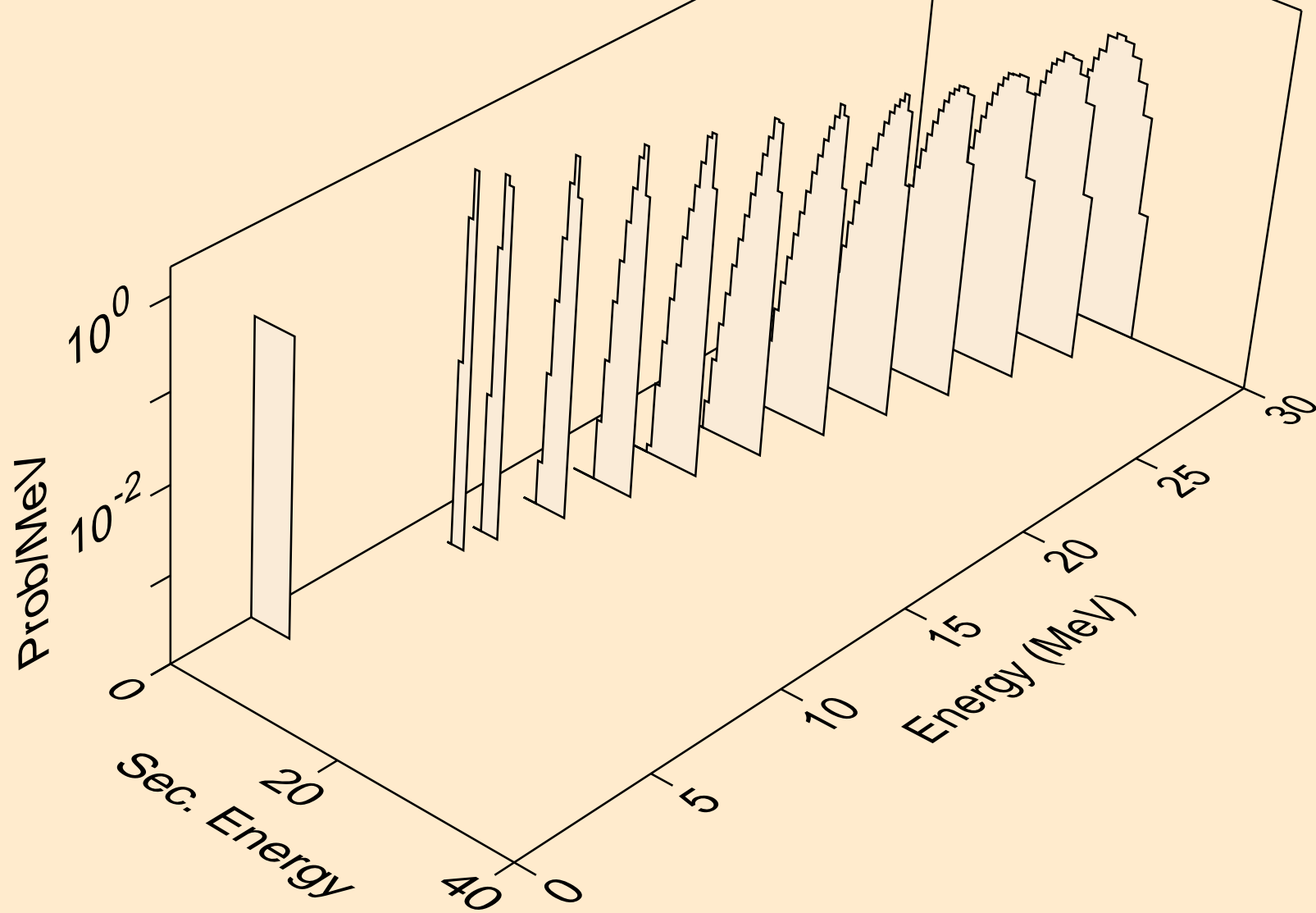

PB185 NEUTRON ACER TENDL-2023 LIBRARY; T=0.K  
he3s from (n,he3)

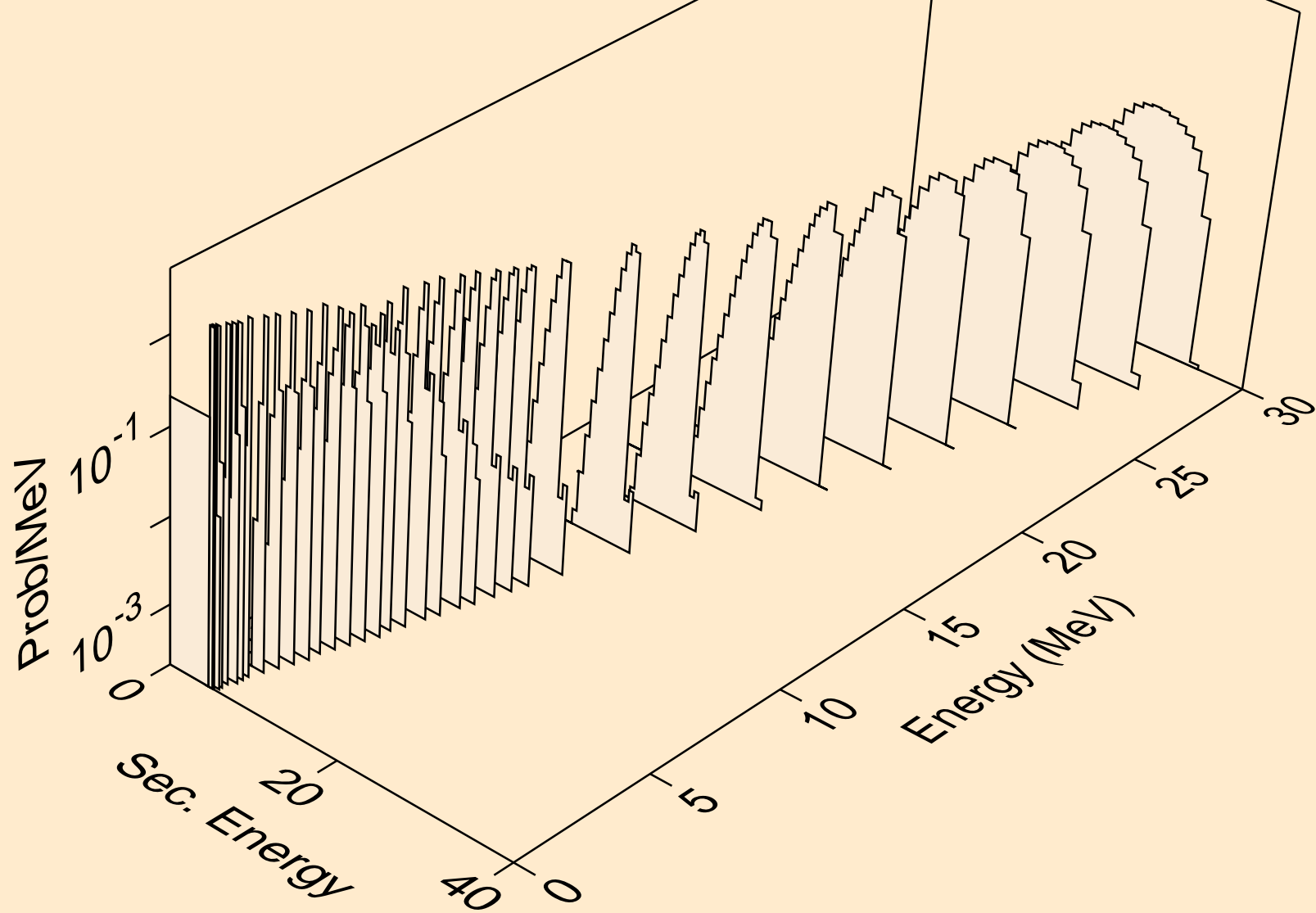

PB185 NEUTRON ACER TENDL-2023 LIBRARY; T=0.K  
alphas from (n,x)

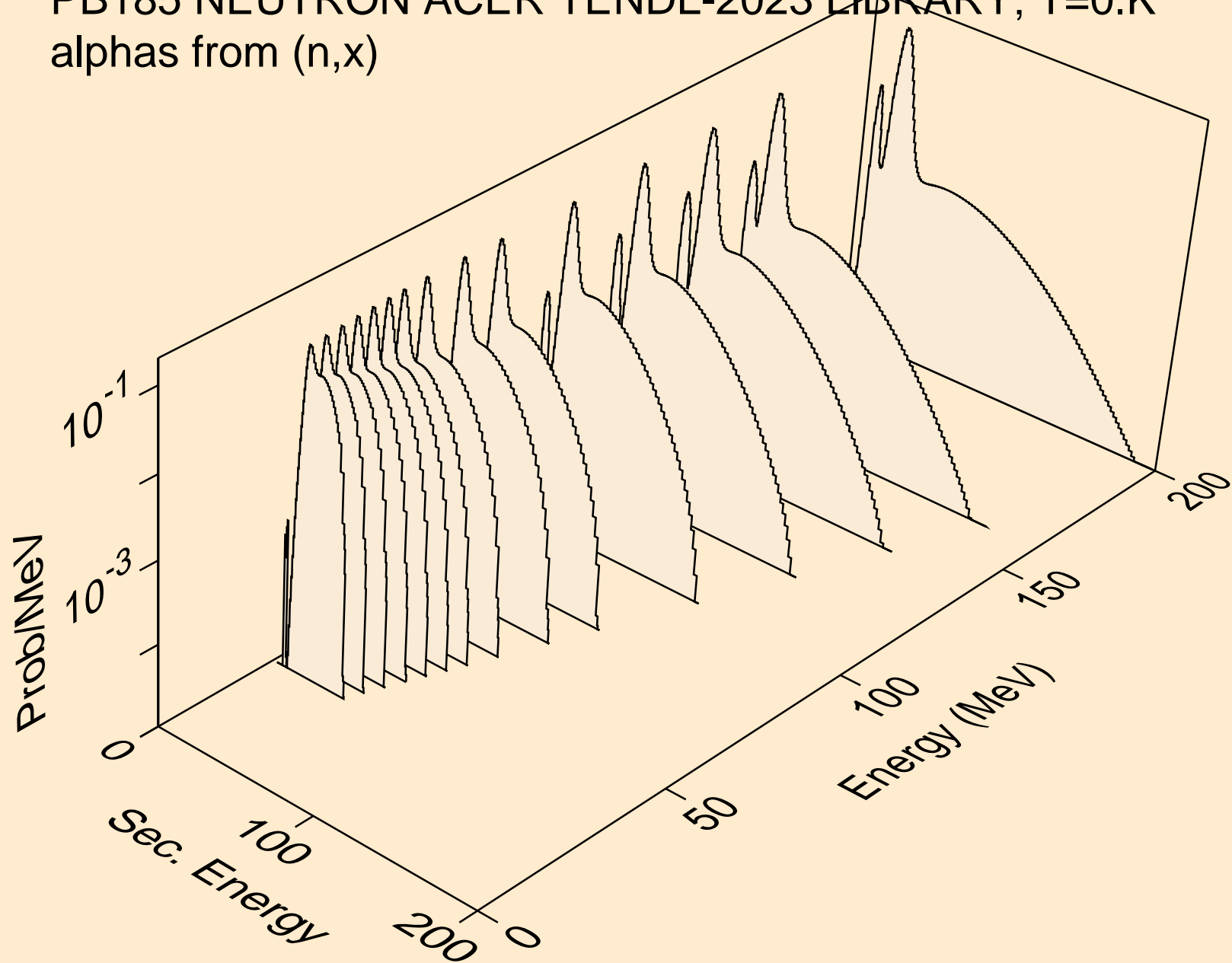

PB185 NEUTRON ACER TENDL-2023 LIBRARY; T=0.K  
alphas from (n,n\*)a

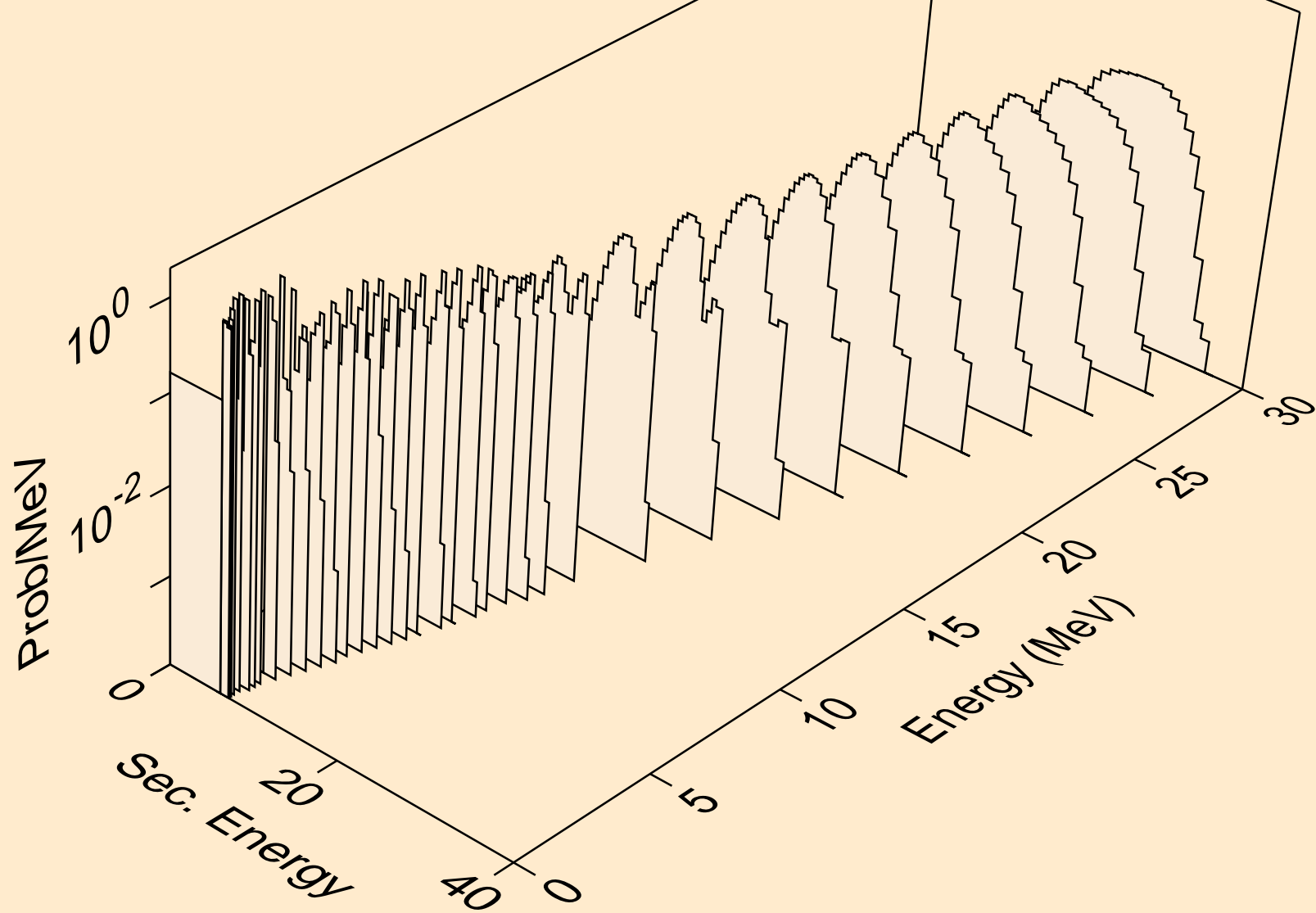

PB185 NEUTRON ACER TENDL-2023 LIBRARY; T=0.K  
alphas from (n,n\*)3a

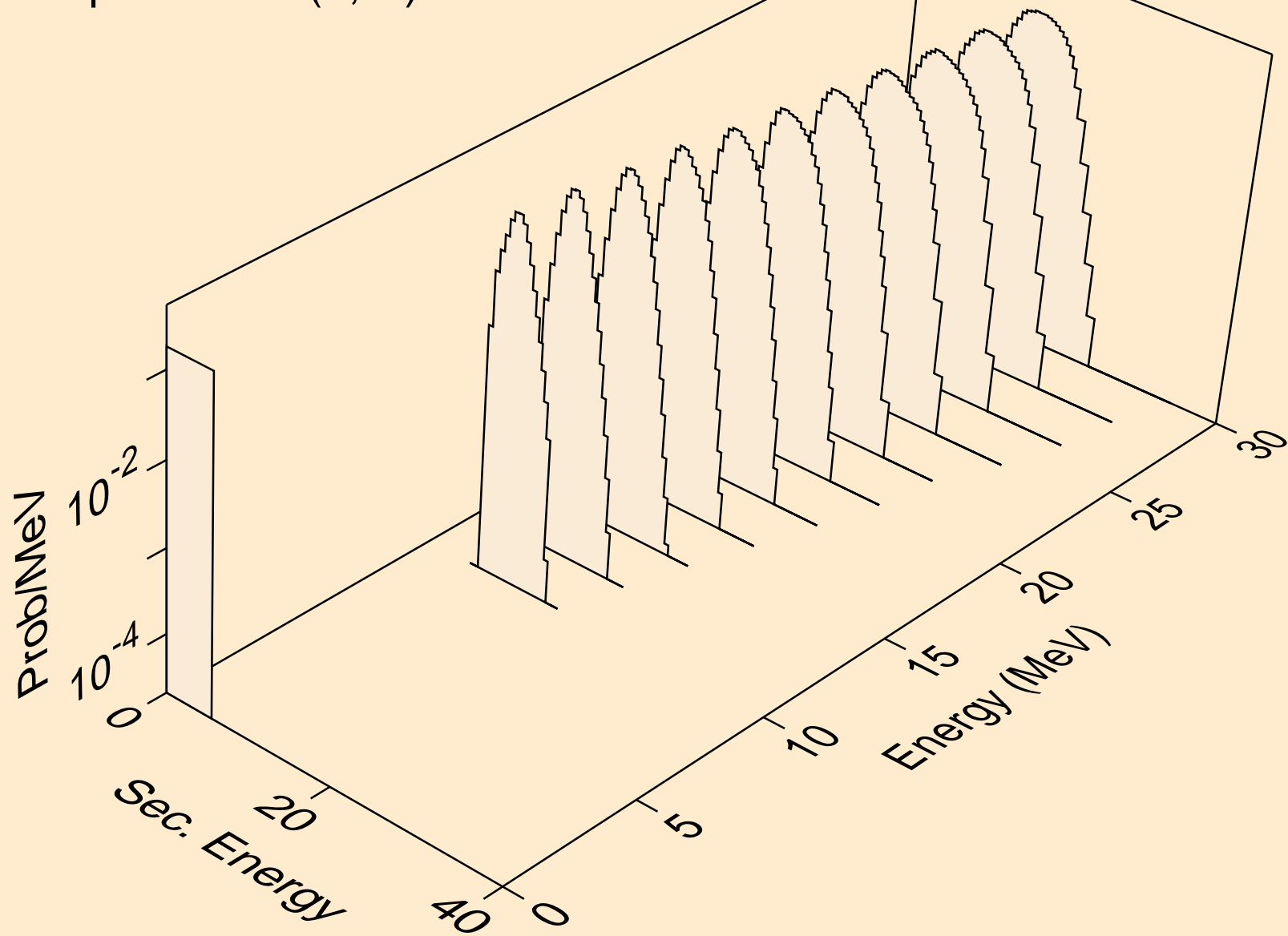

PB185 NEUTRON ACER TENDL-2023 LIBRARY; T=0.K  
alphas from (n,2n)a

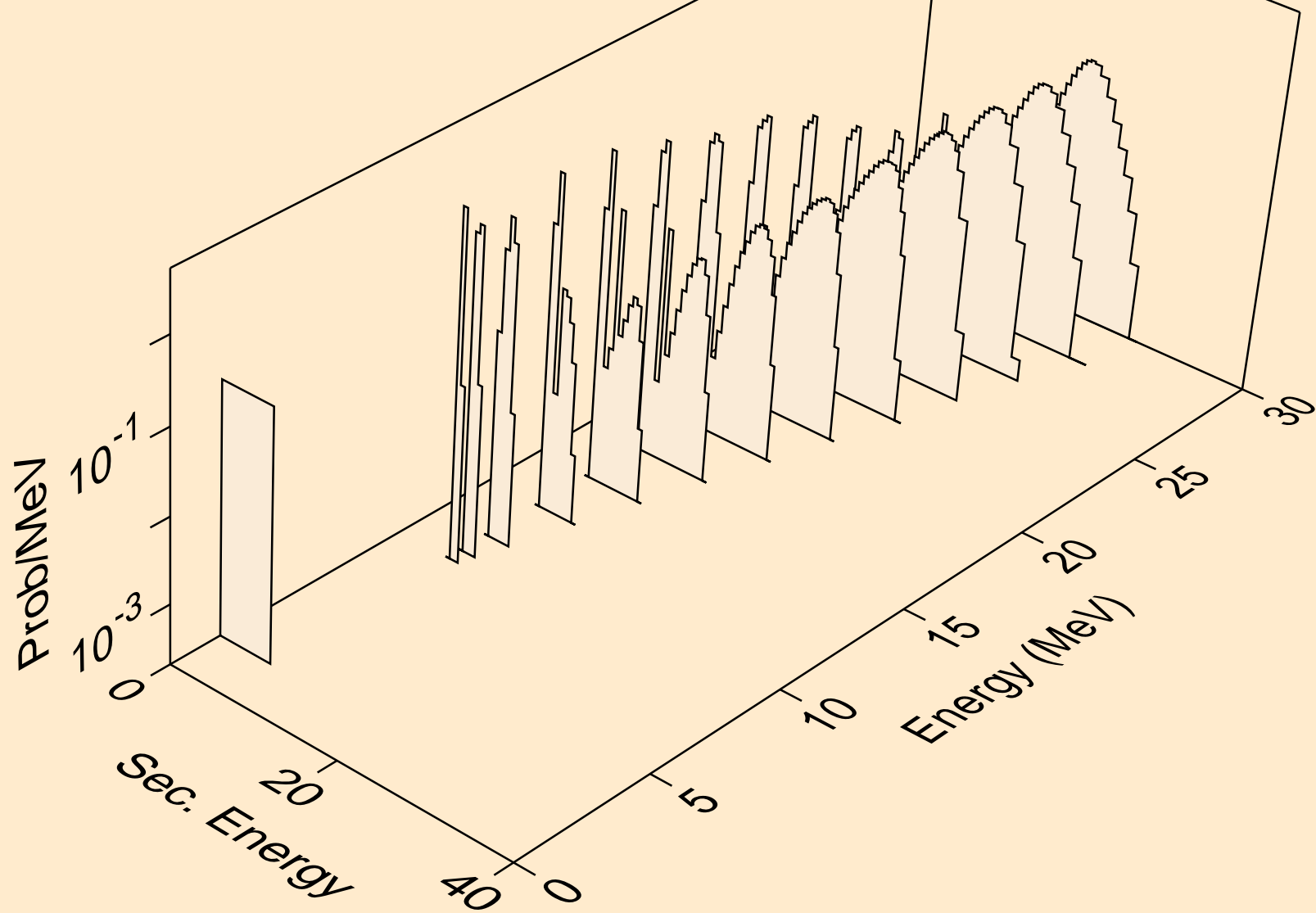

PB185 NEUTRON ACER TENDL-2023 LIBRARY; T=0.K  
alphas from (n,3n)a

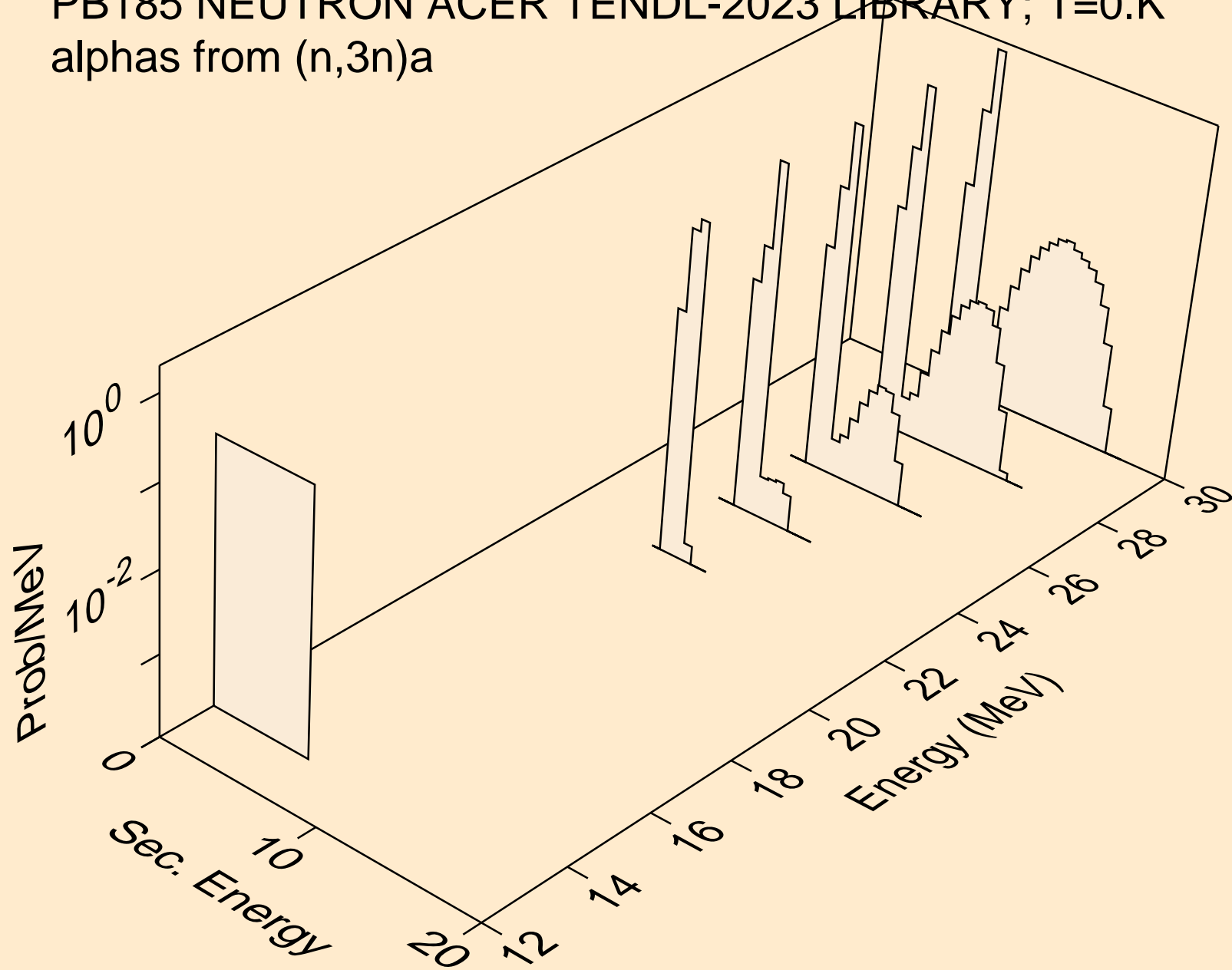

PB185 NEUTRON ACER TENDL-2023 LIBRARY; T=0.K  
alphas from (n,n\*)2a

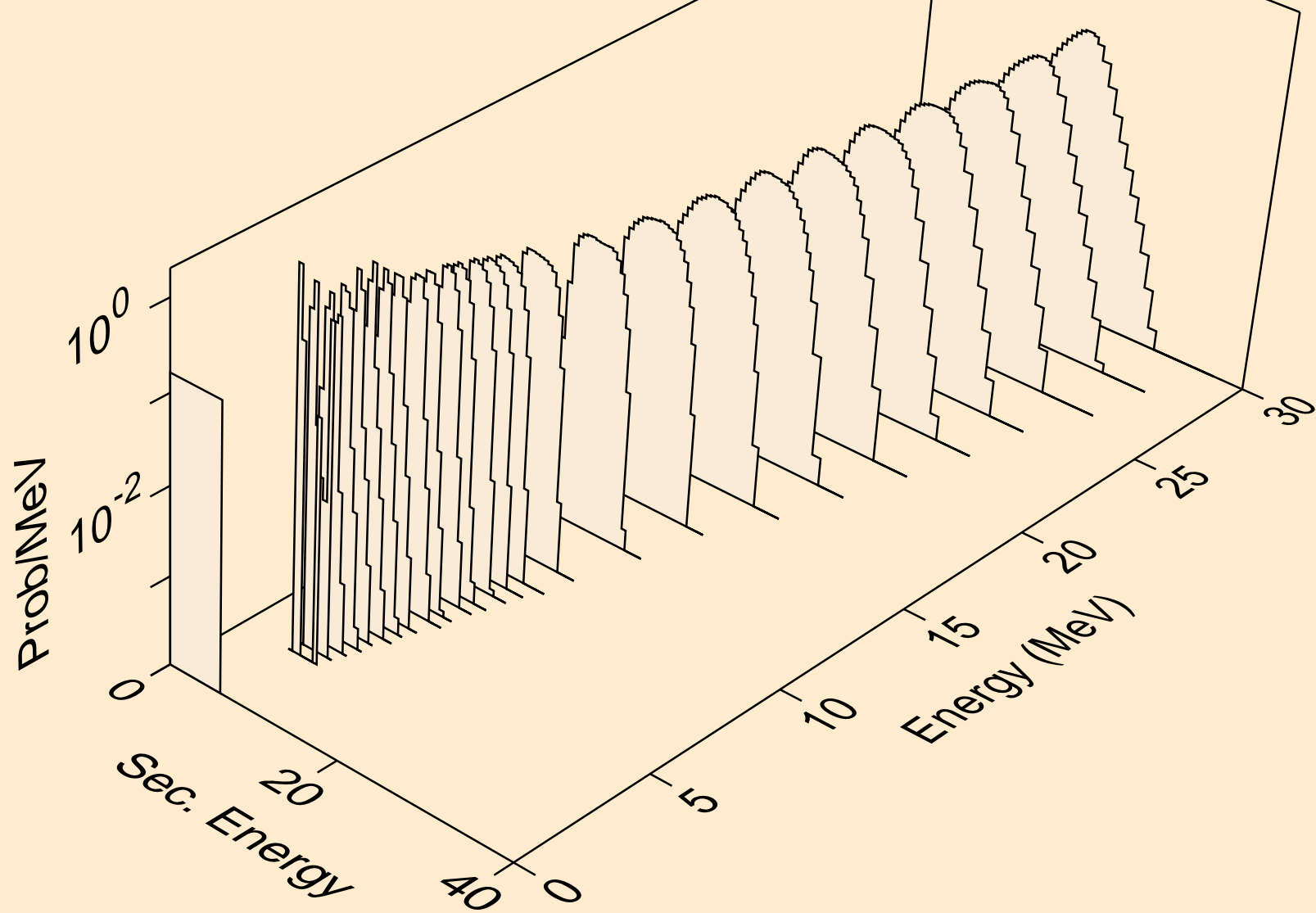

PB185 NEUTRON ACER TENDL-2023 LIBRARY; T=0.K  
alphas from (n,2n)2a

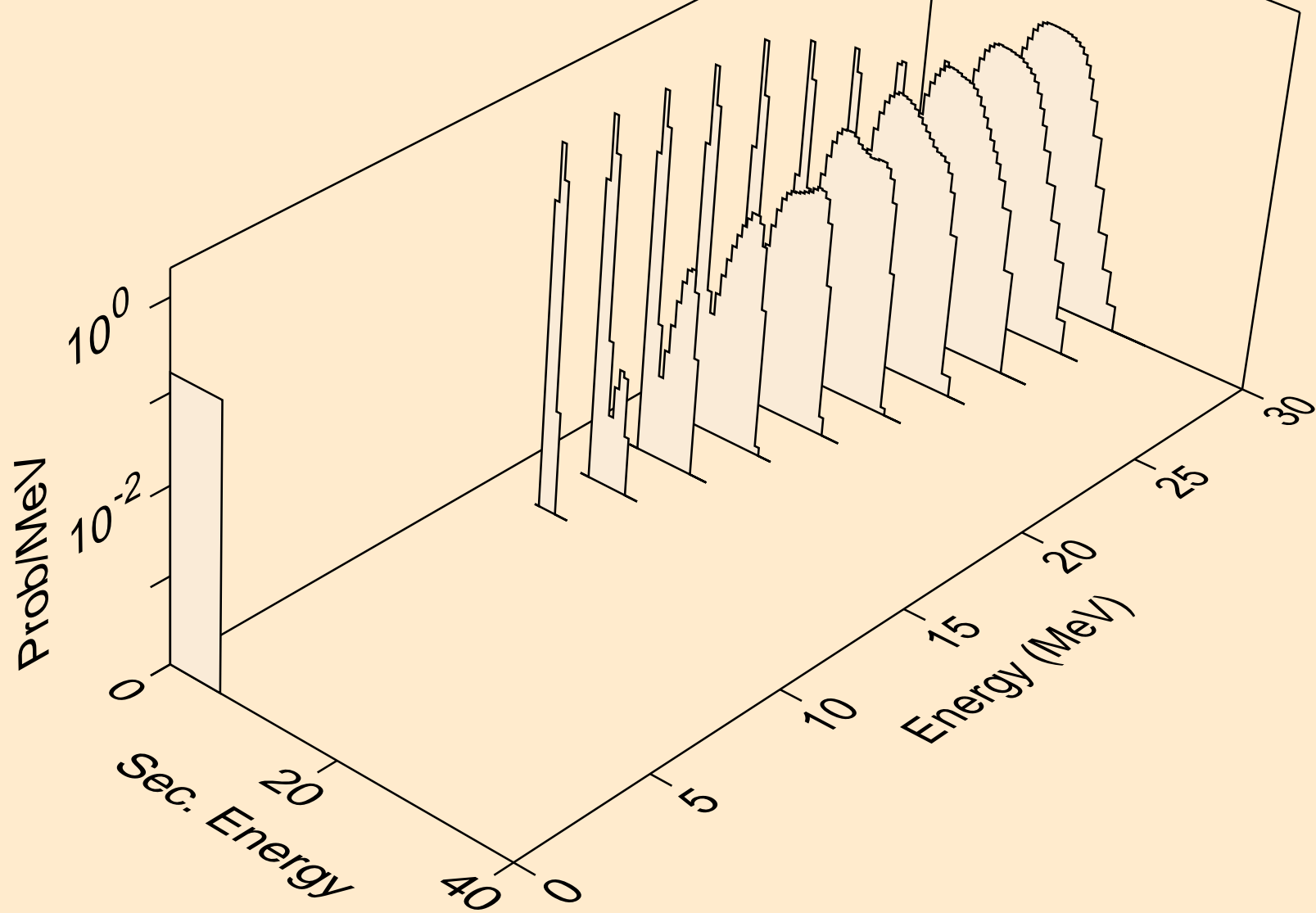

PB185 NEUTRON ACER TENDL-2023 LIBRARY; T=0.K  
alphas from (n,npa)

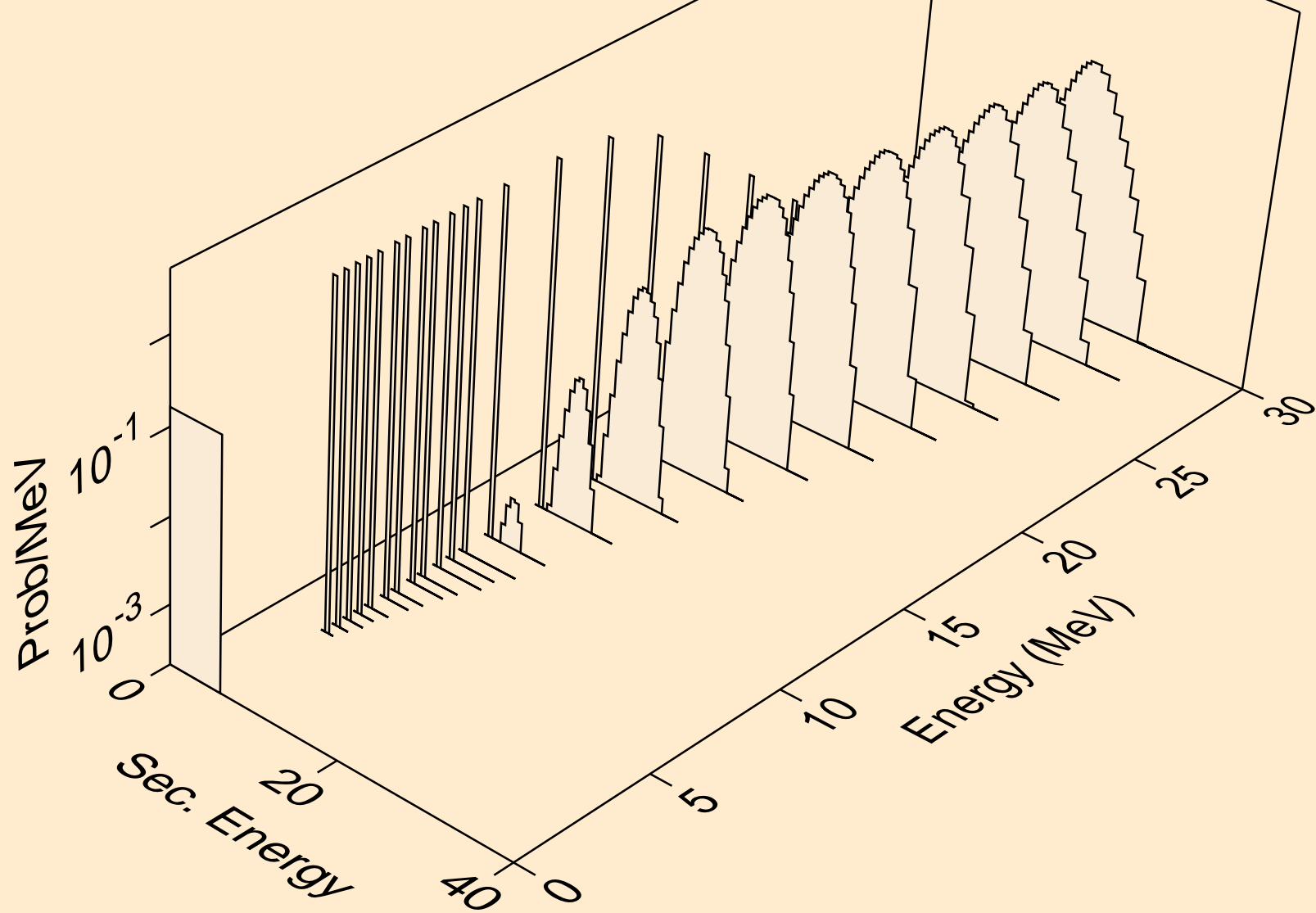

PB185 NEUTRON ACER TENDL-2023 LIBRARY; T=0.K  
alphas from (n,a)

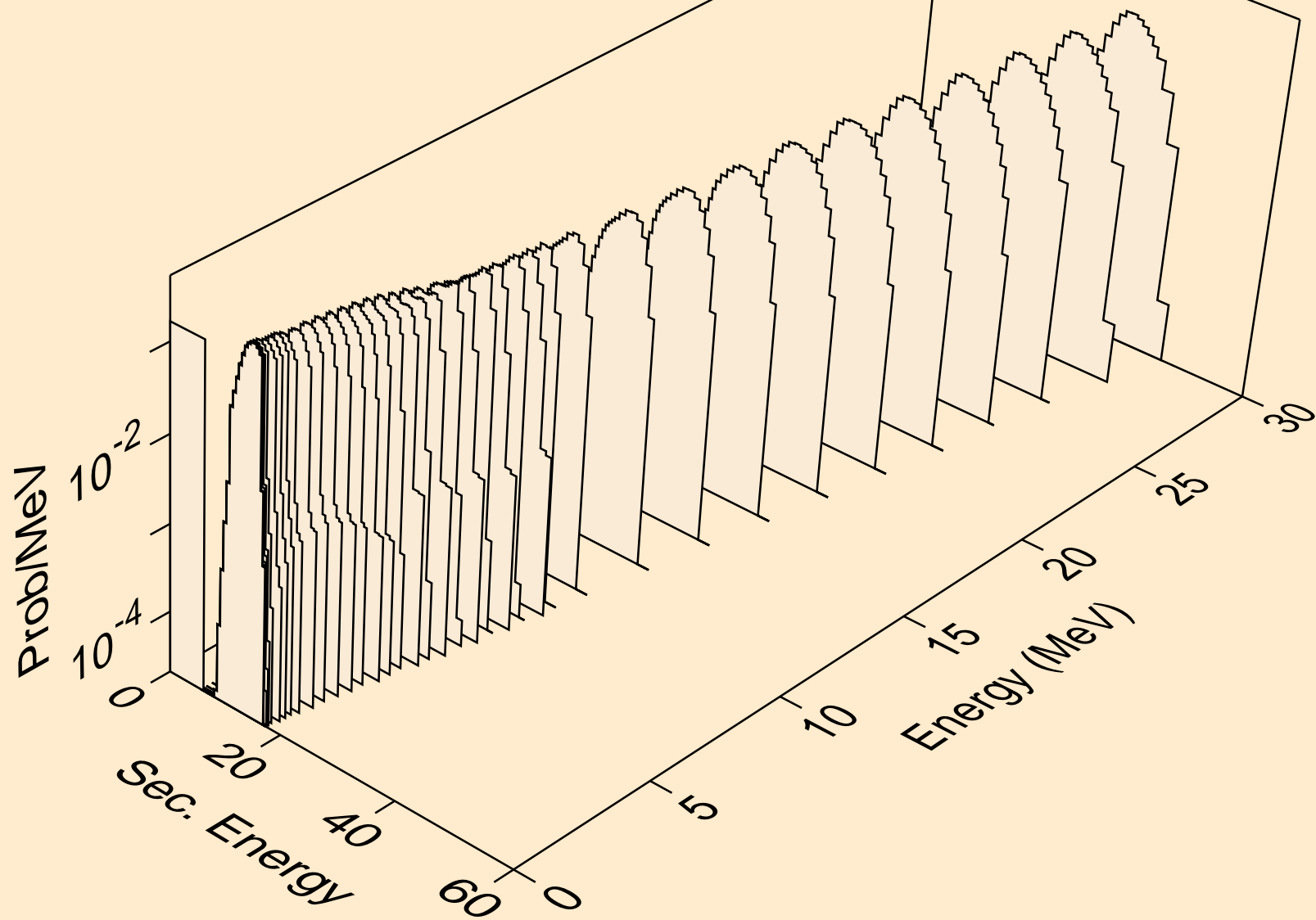

PB185 NEUTRON ACER TENDL-2023 LIBRARY; T=0.K  
alphas from (n,2a)

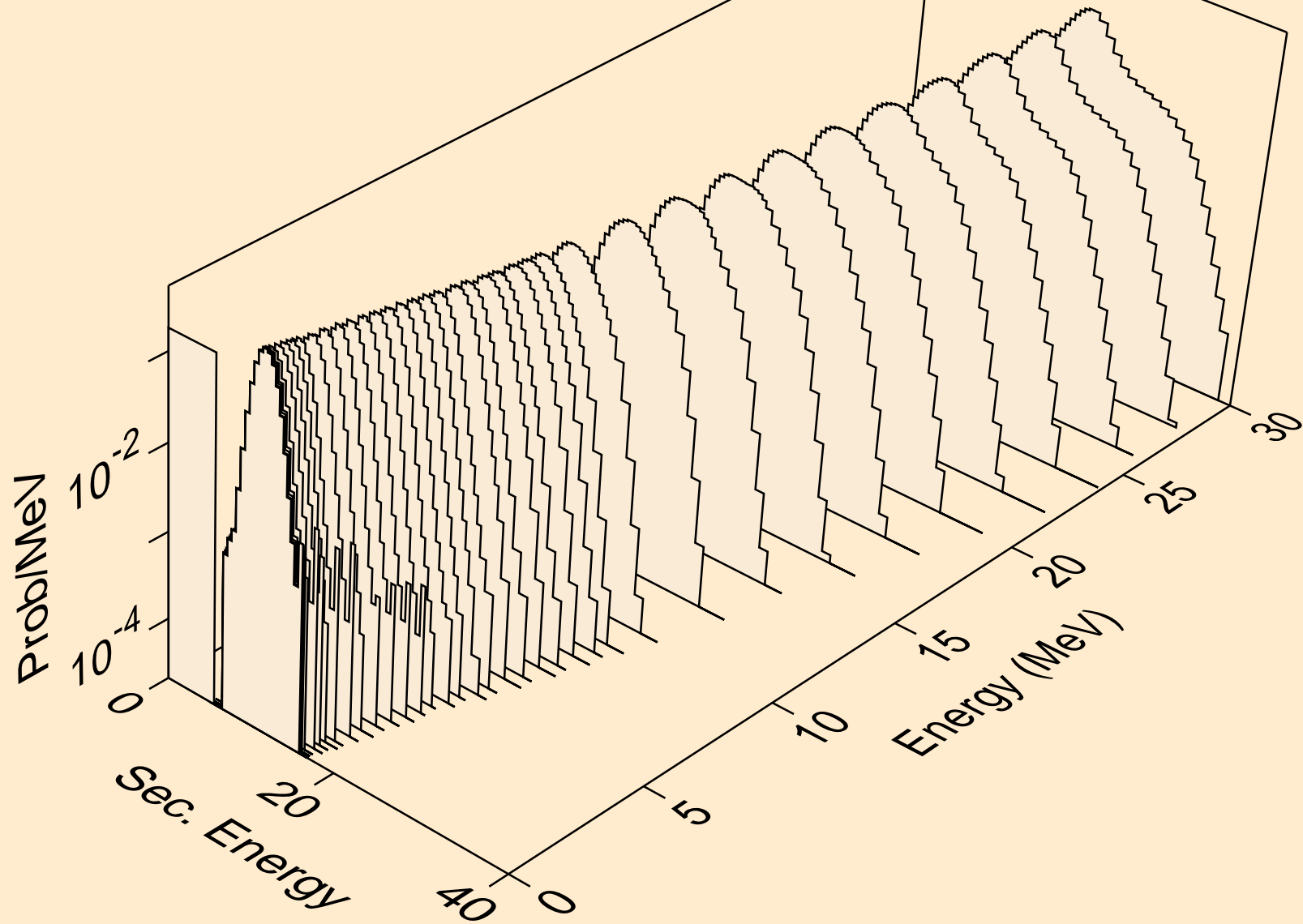

PB185 NEUTRON ACER TENDL-2023 LIBRARY; T=0.K  
alphas from (n,3a)

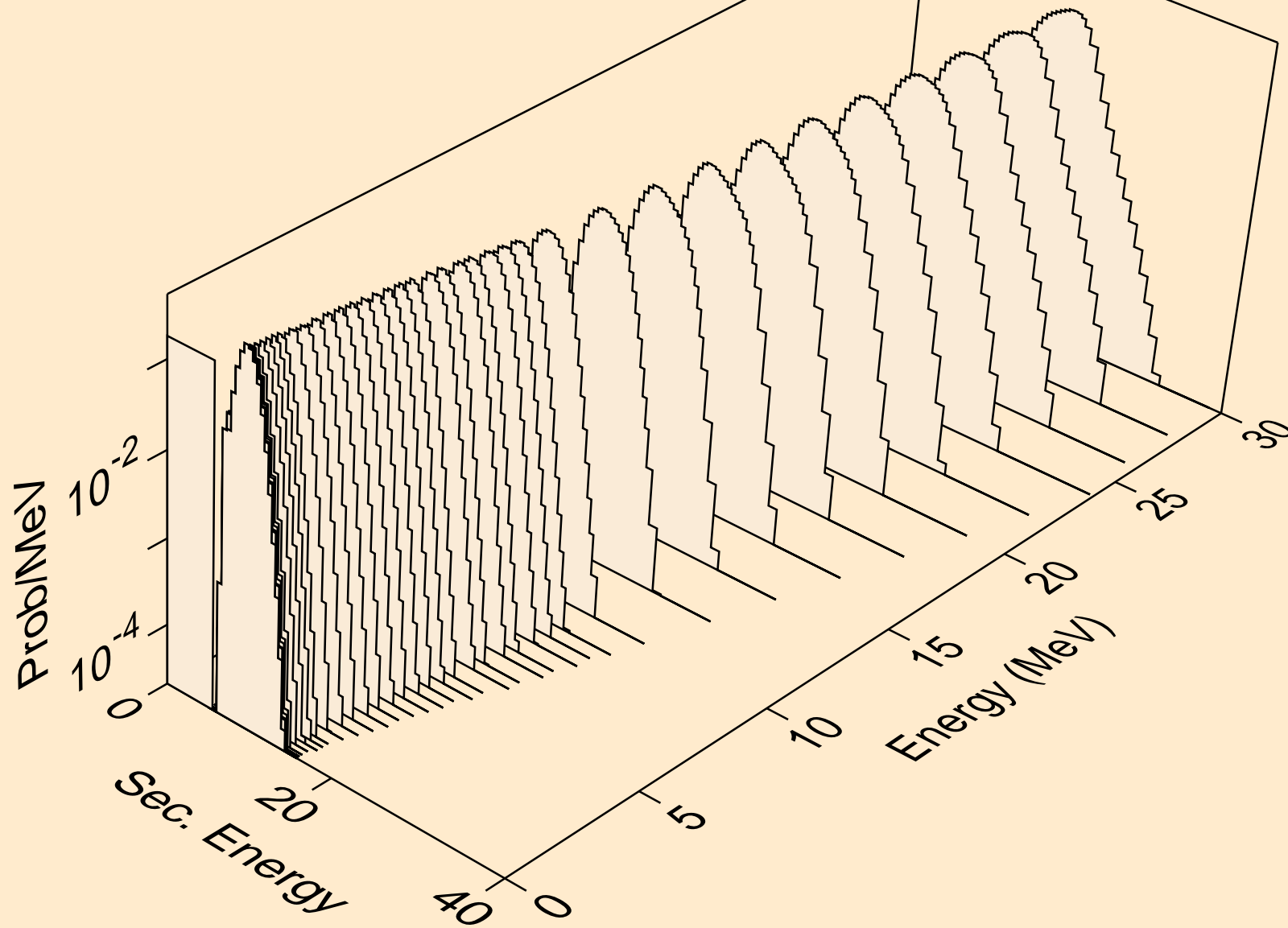

PB185 NEUTRON ACER TENDL-2023 LIBRARY; T=0.K  
alphas from (n,pa)

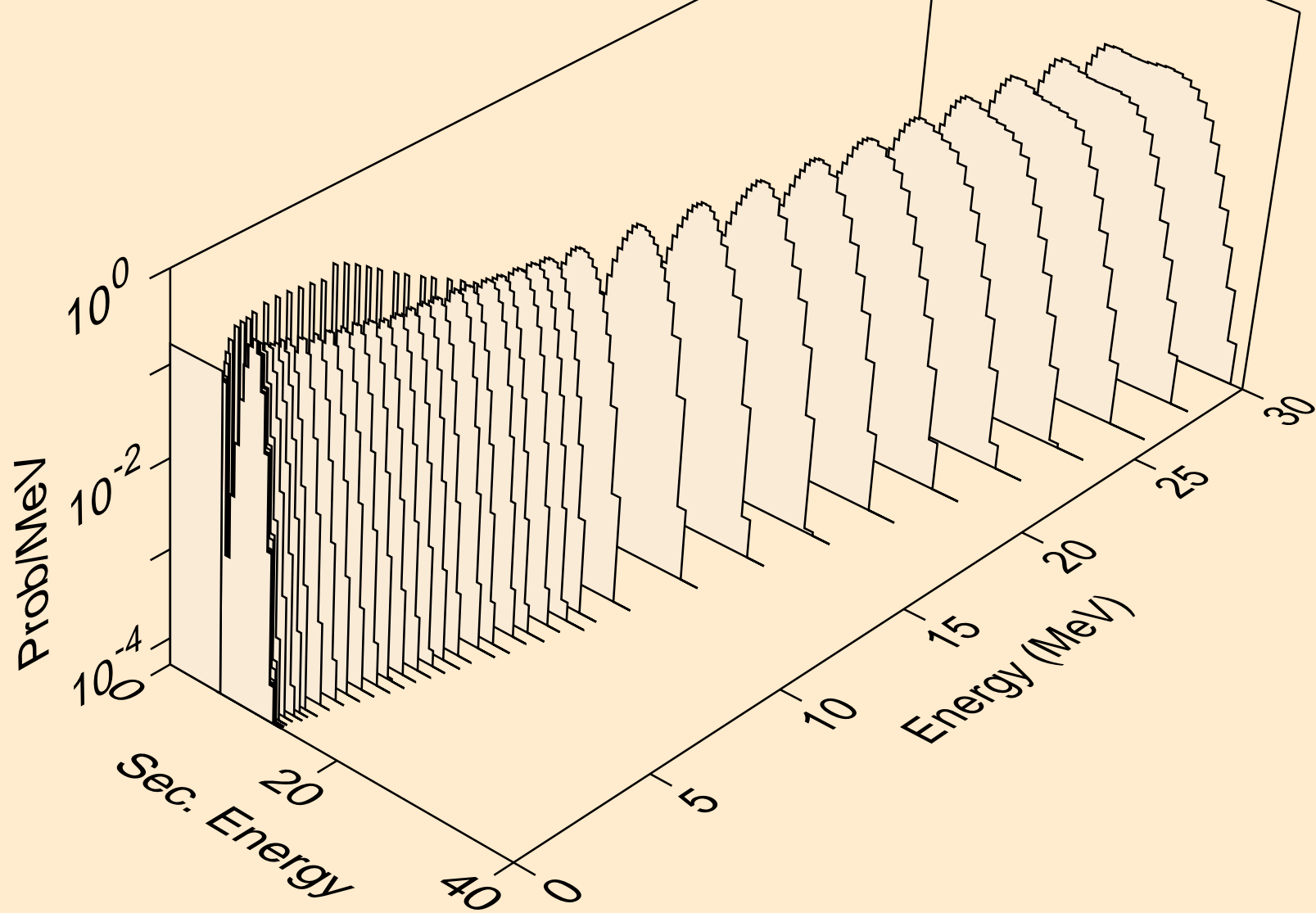

PB185 NEUTRON ACER TENDL-2023 LIBRARY; T=0.K  
alphas from (n,d2a)

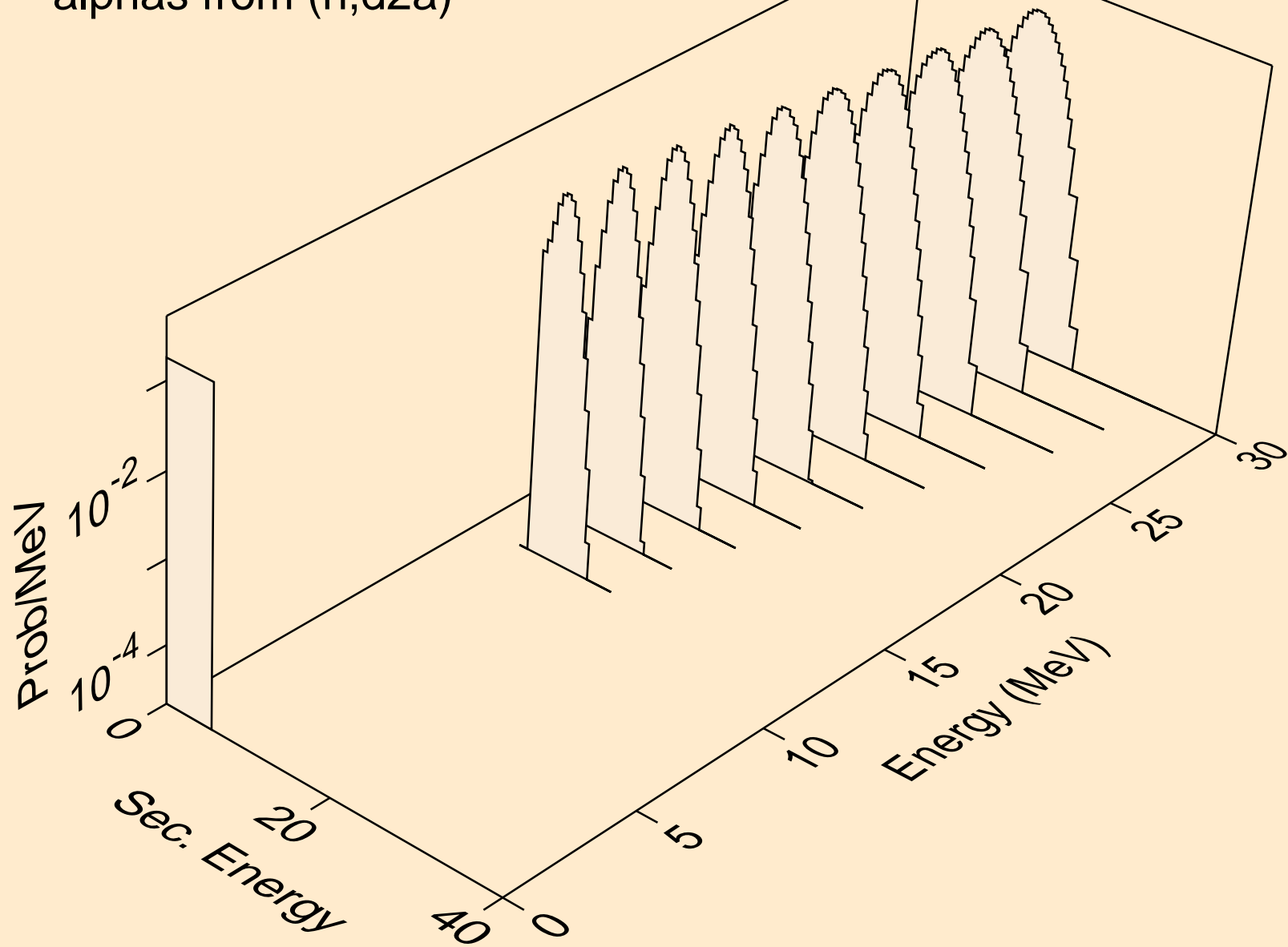

PB185 NEUTRON ACER TENDL-2023 LIBRARY; T=0.K  
alphas from (n,da)

