

PB191M NEUTRON ACER TENDL-2023 LIBRARY; T=0.K  
Principal cross sections

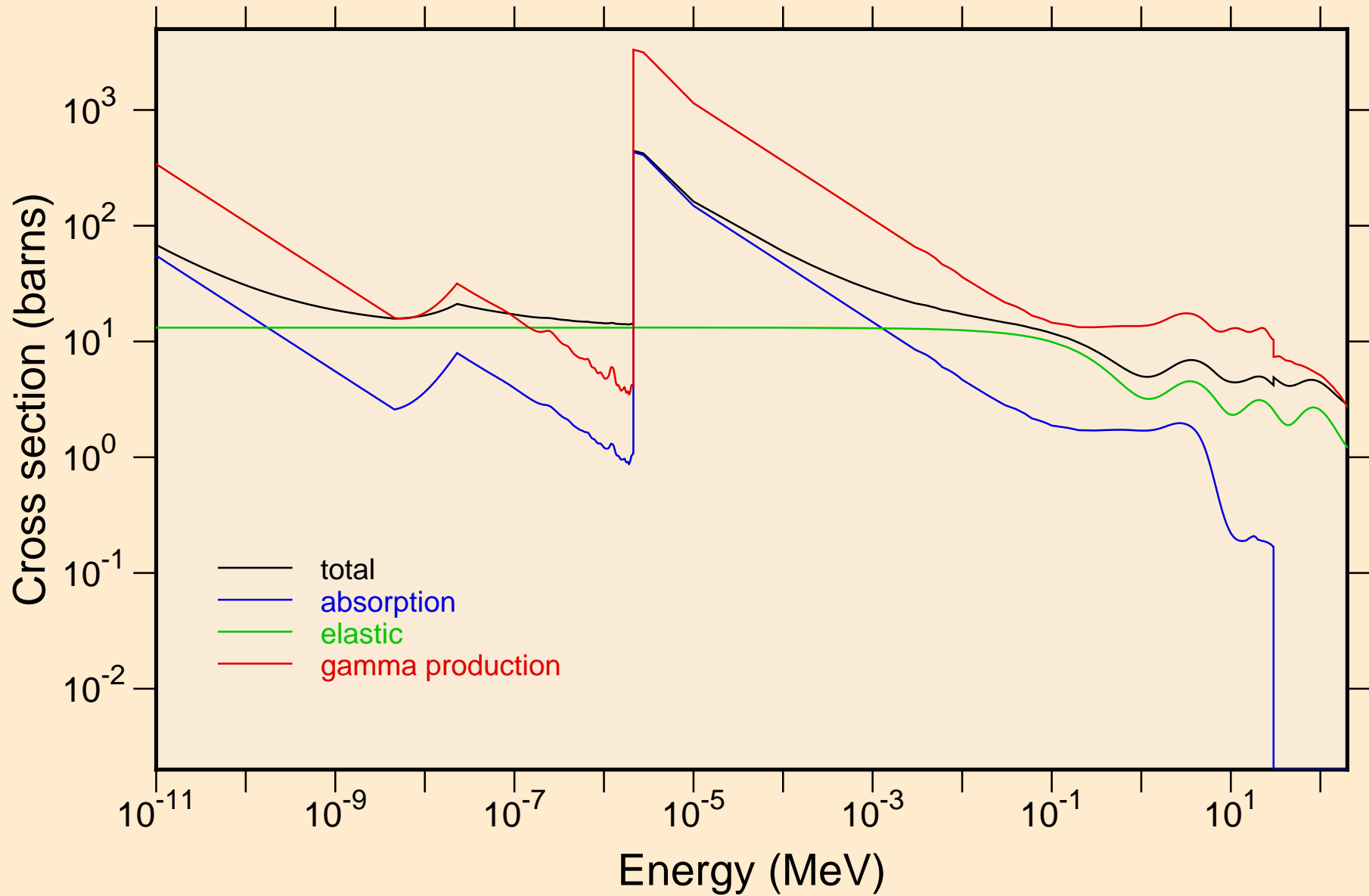

# PB191M NEUTRON ACER TENDL-2023 LIBRARY; T=0.K

## Heating

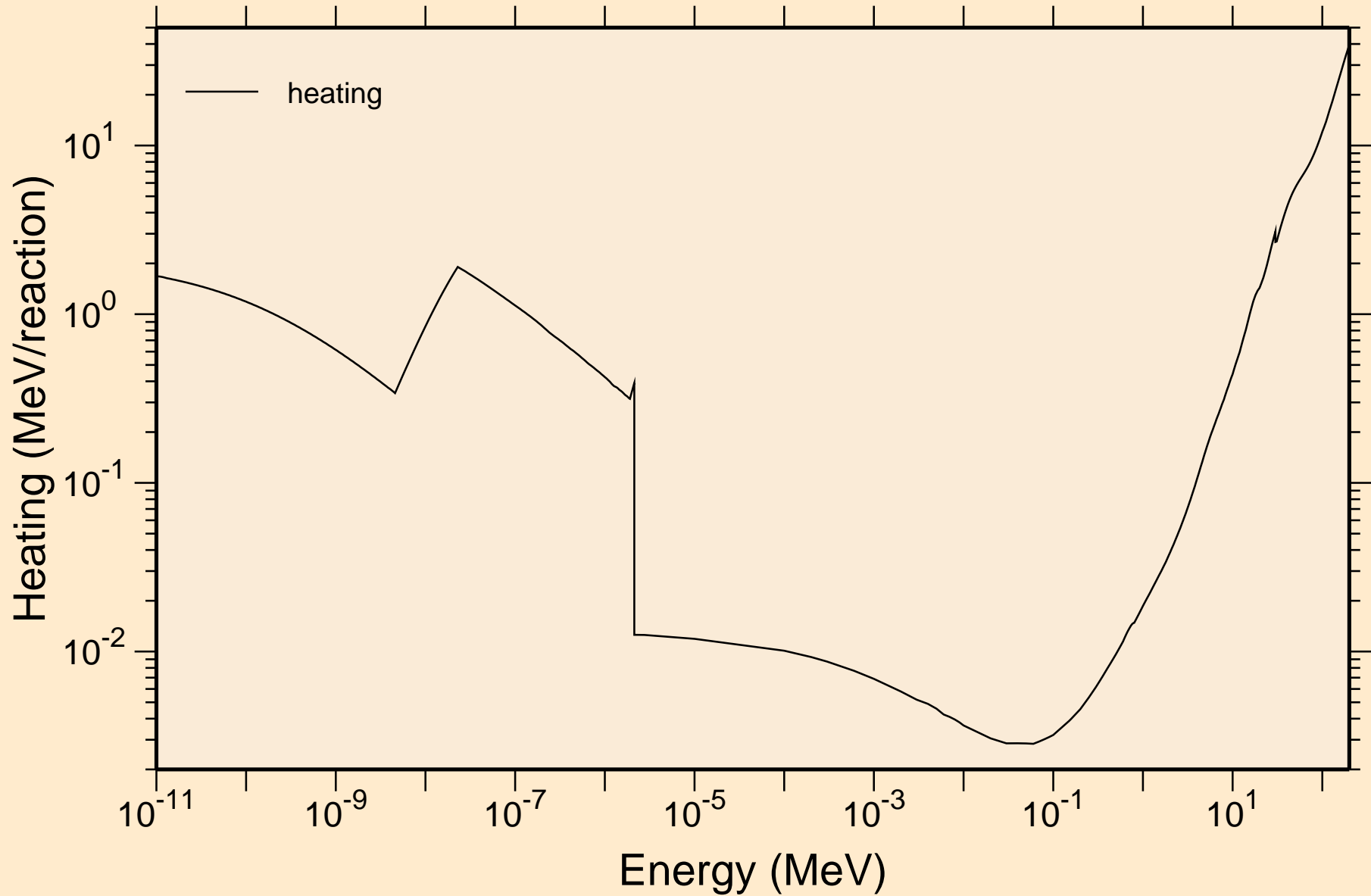

PB191M NEUTRON ACER TENDL-2023 LIBRARY; T=0.K  
Damage

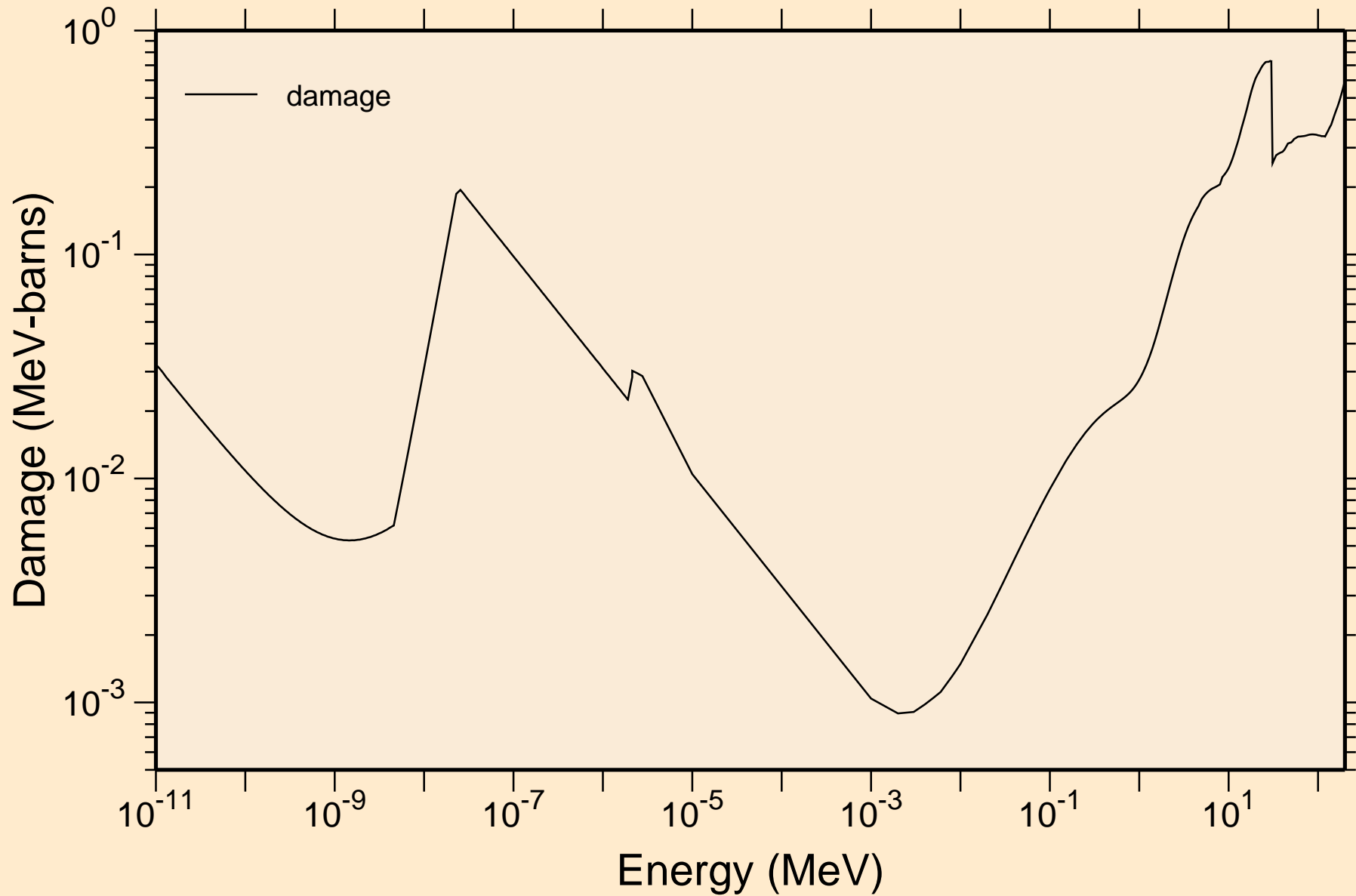

PB191M NEUTRON ACER TENDL-2023 LIBRARY; T=0.K  
Non-threshold reactions

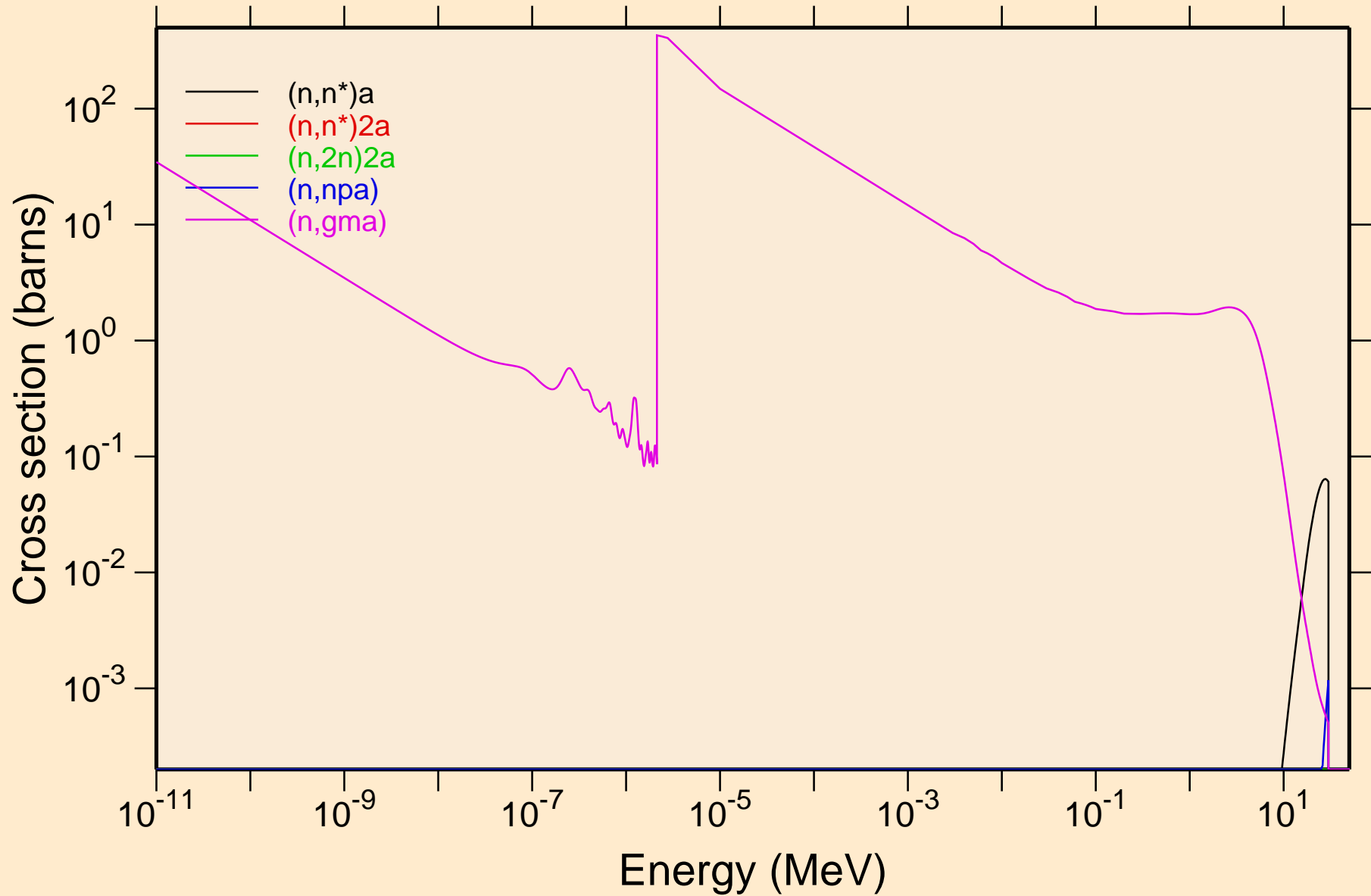

PB191M NEUTRON ACER TENDL-2023 LIBRARY; T=0.K  
Non-threshold reactions

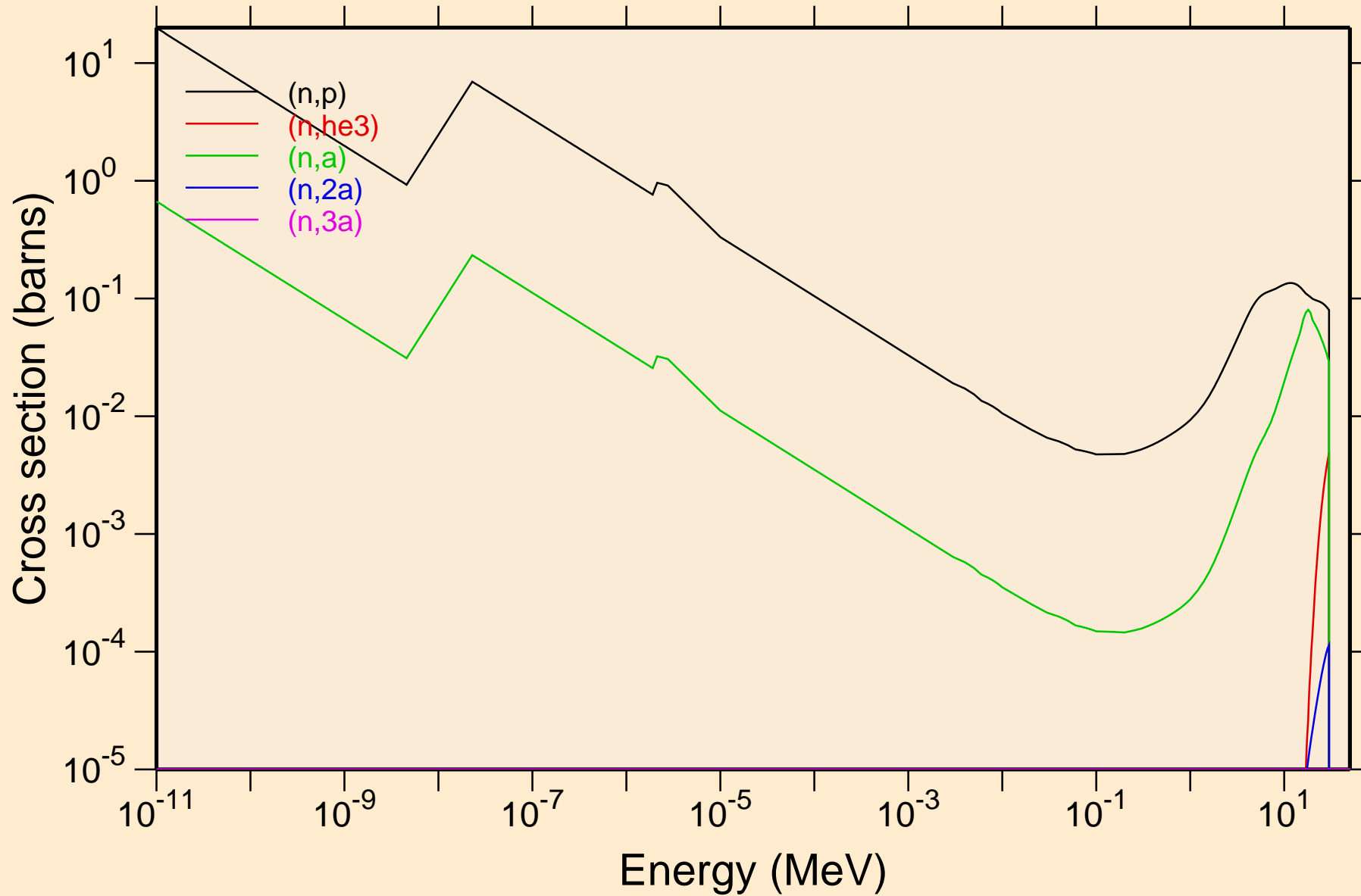

PB191M NEUTRON ACER TENDL-2023 LIBRARY; T=0.K  
Non-threshold reactions

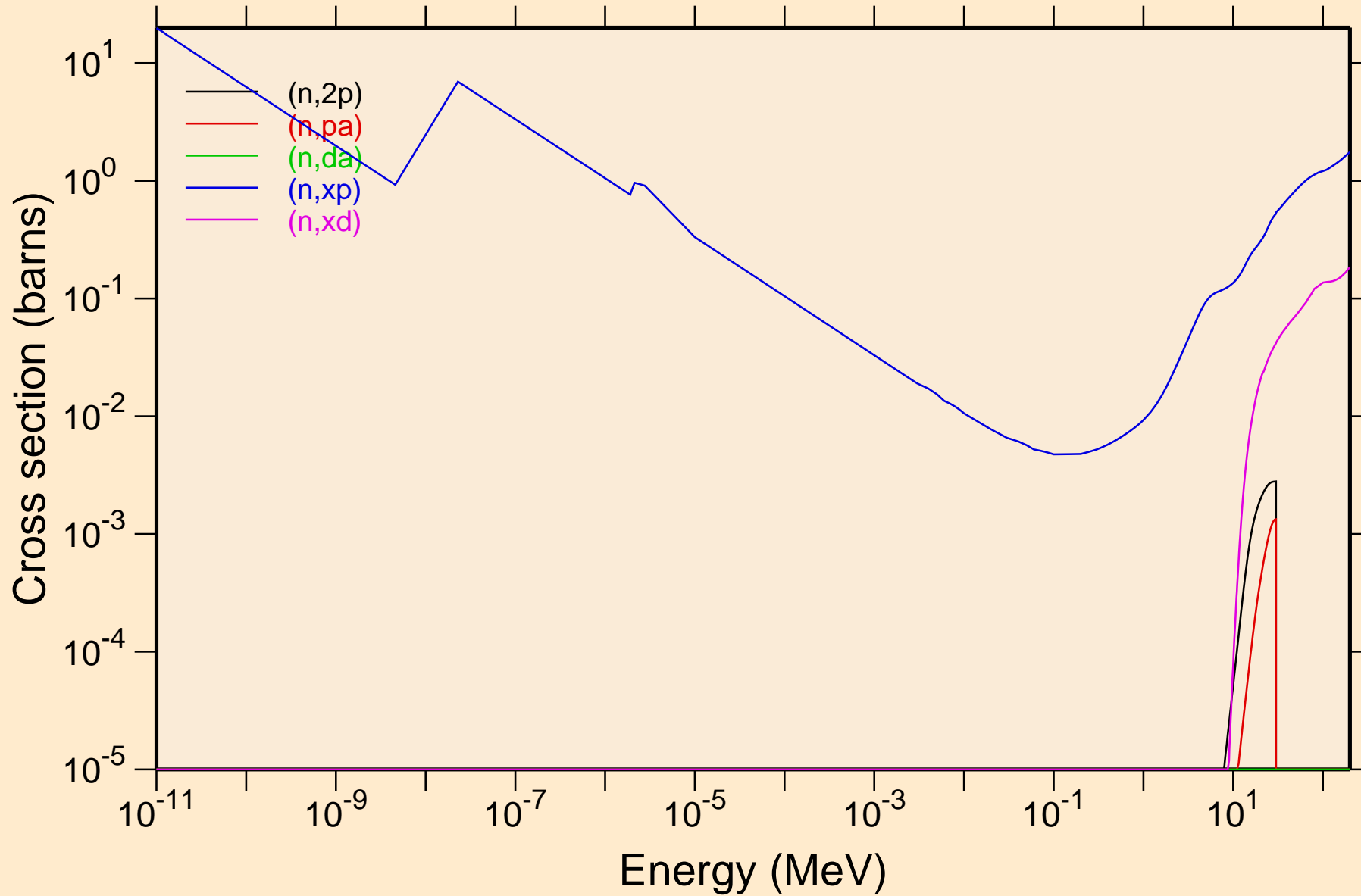

PB191M NEUTRON ACER TENDL-2023 LIBRARY; T=0.K  
Non-threshold reactions

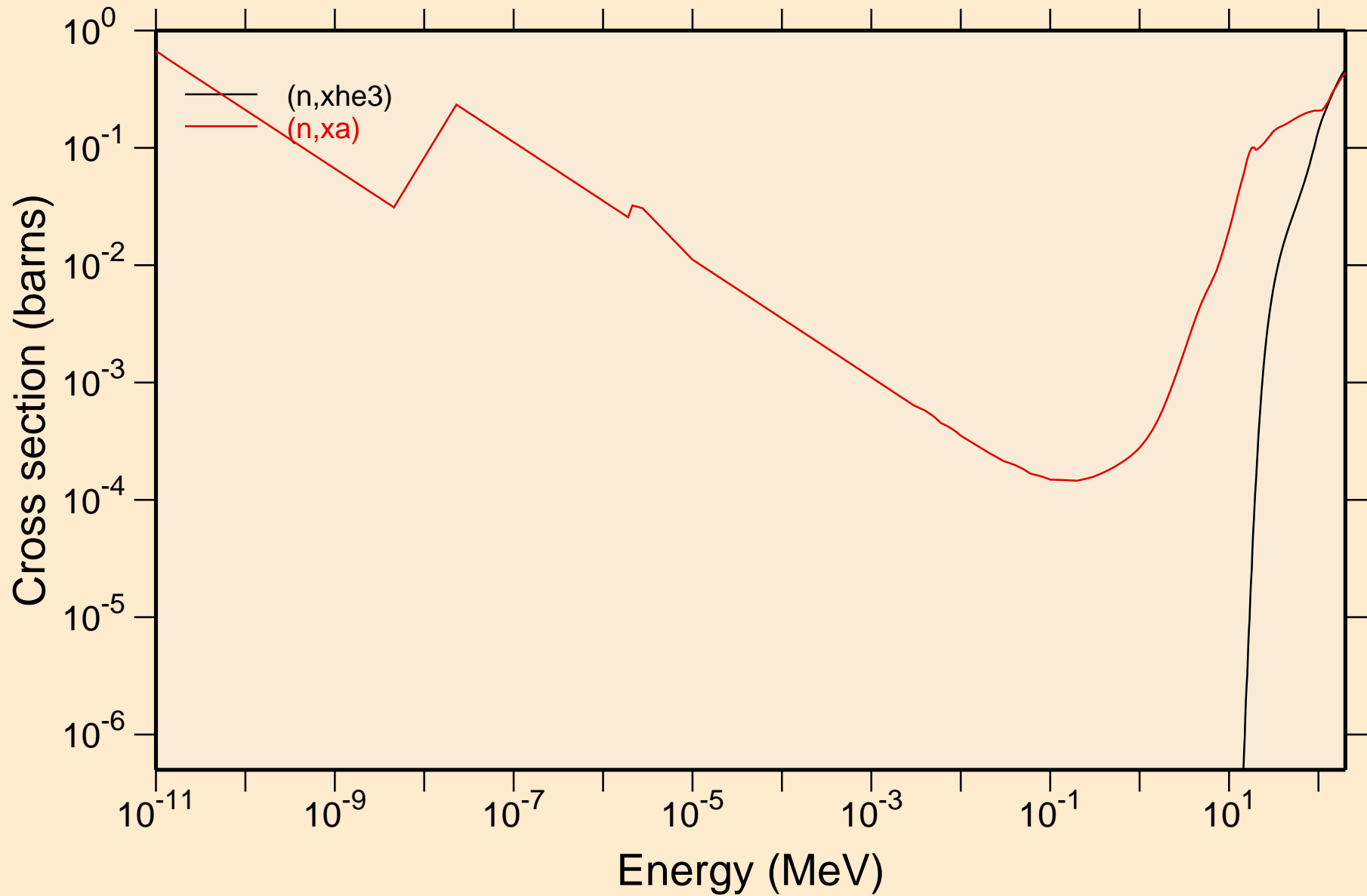

PB191M NEUTRON ACER TENDL-2023 LIBRARY; T=0.K  
Principal cross sections

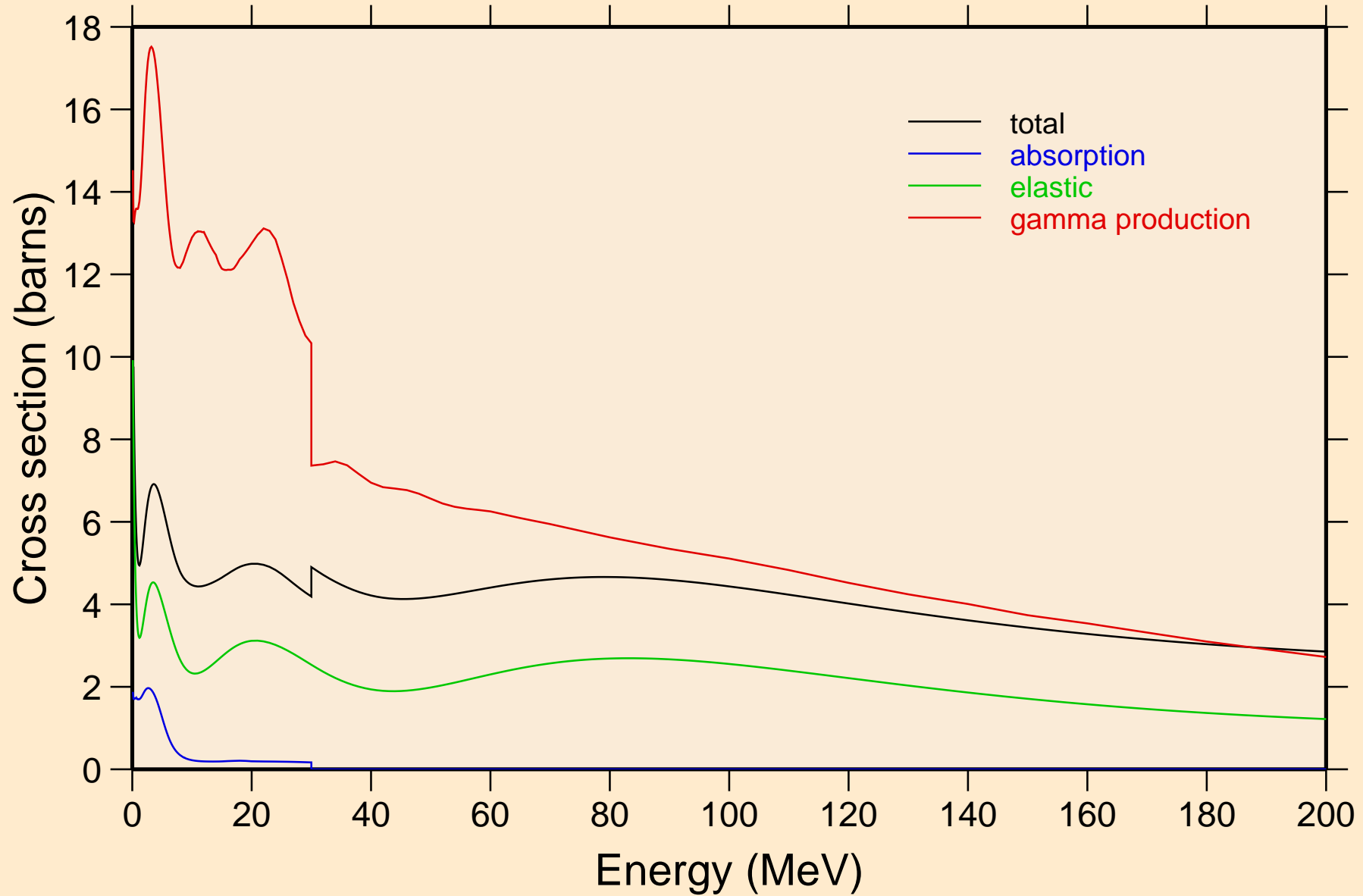

# PB191M NEUTRON ACER TENDL-2023 LIBRARY; T=0.K

## Heating

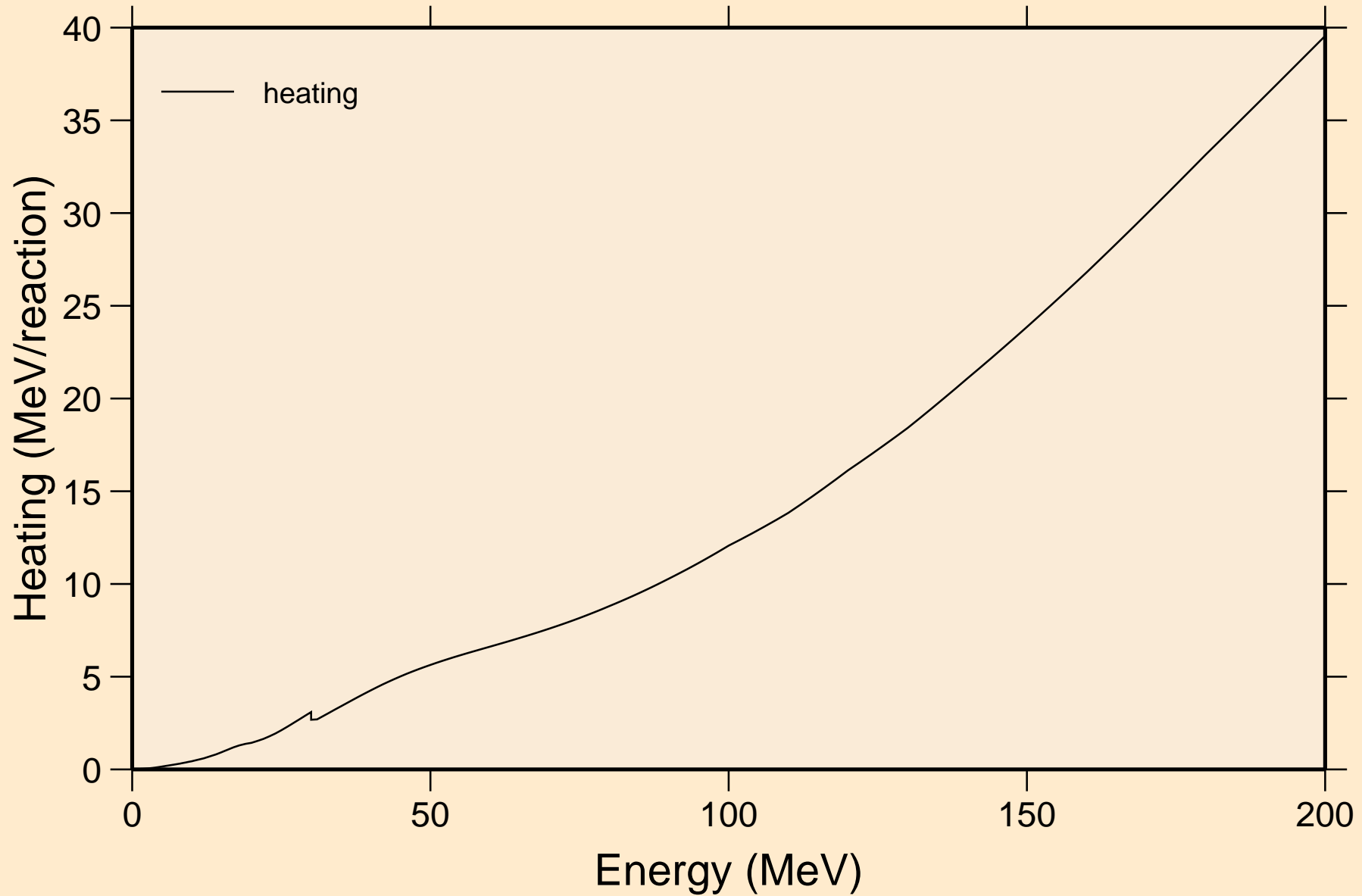

# PB191M NEUTRON ACER TENDL-2023 LIBRARY; T=0.K

## Damage

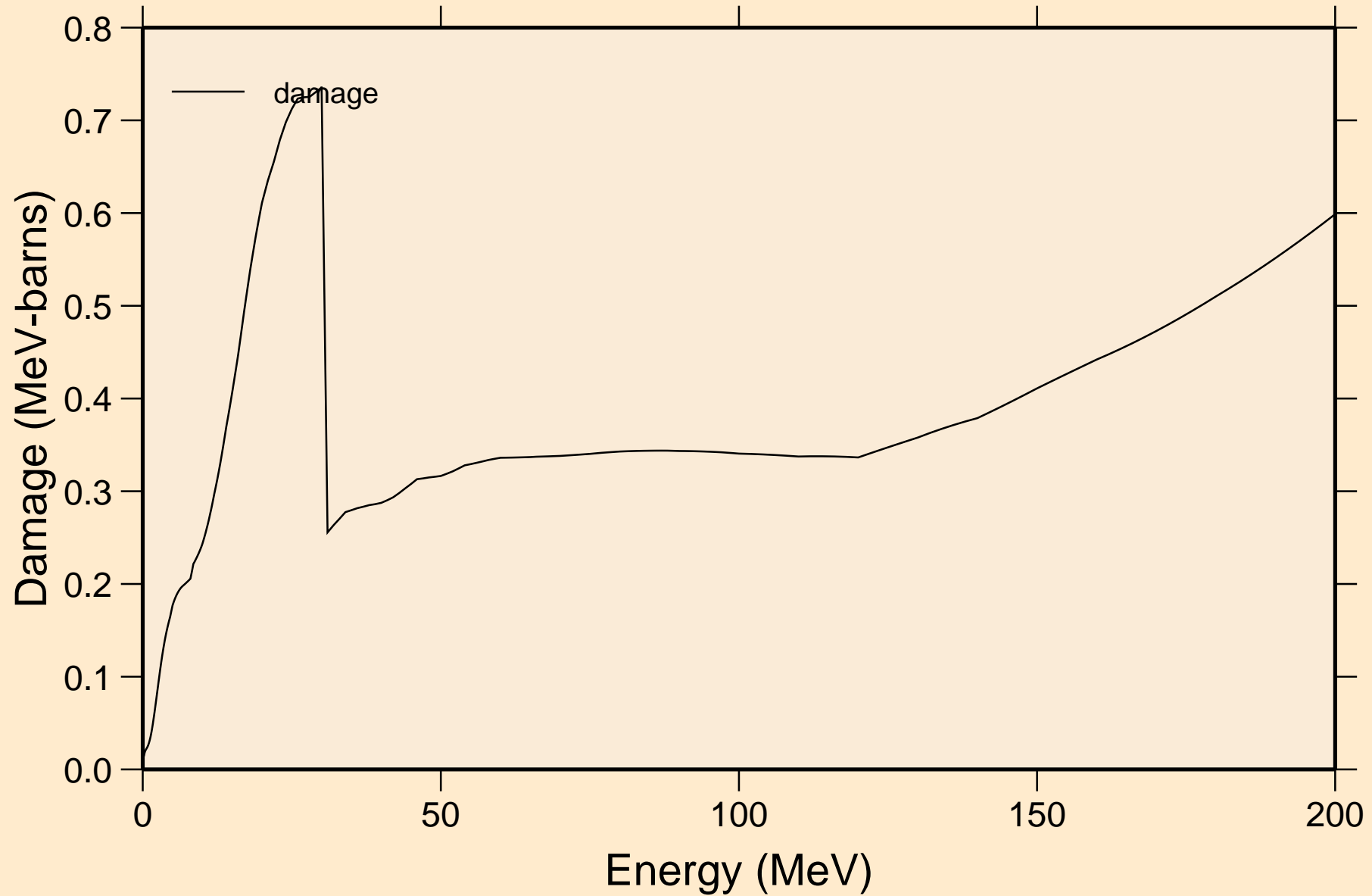

PB191M NEUTRON ACER TENDL-2023 LIBRARY; T=0.K  
Non-threshold reactions

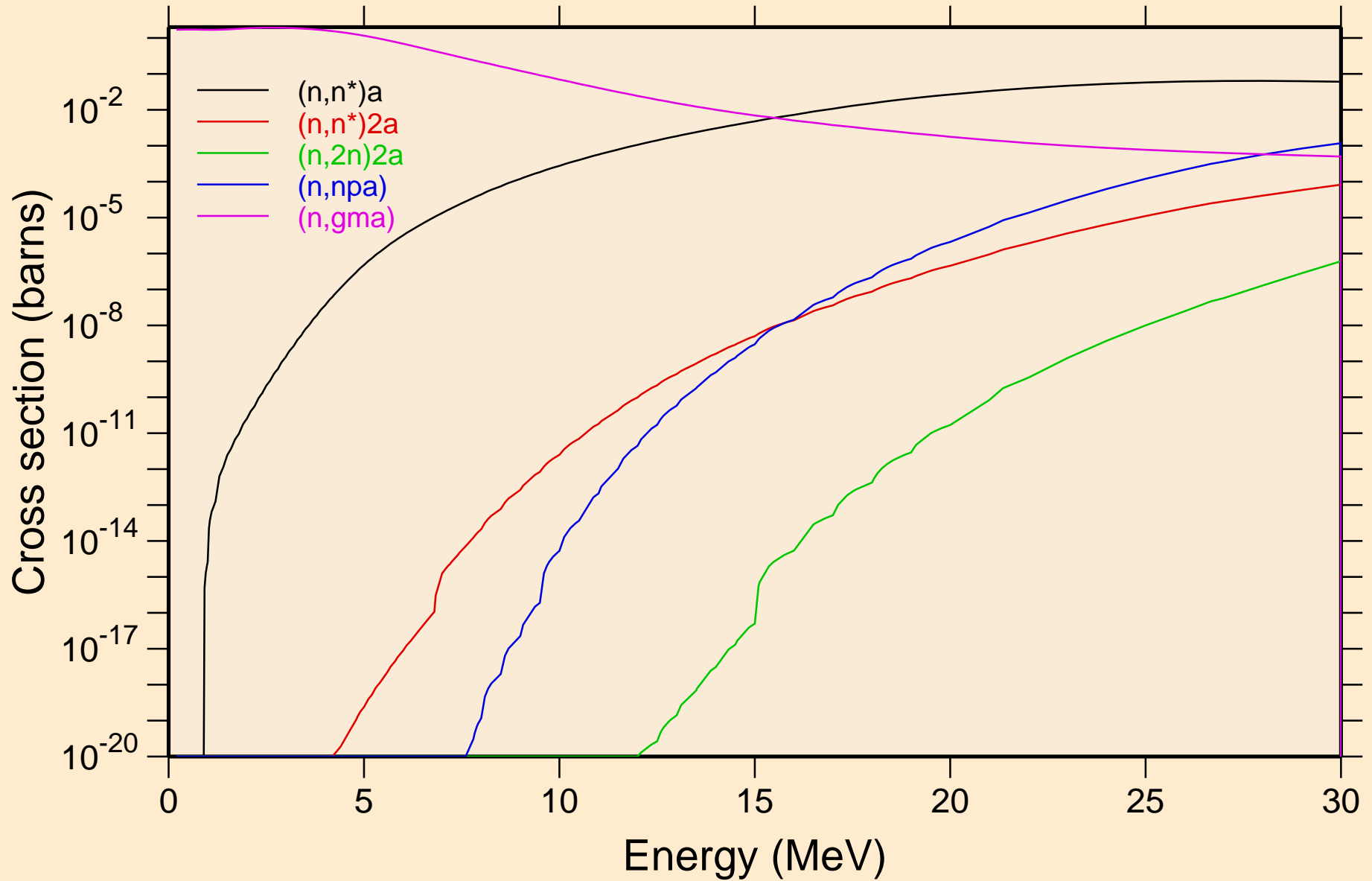

PB191M NEUTRON ACER TENDL-2023 LIBRARY; T=0.K  
Non-threshold reactions

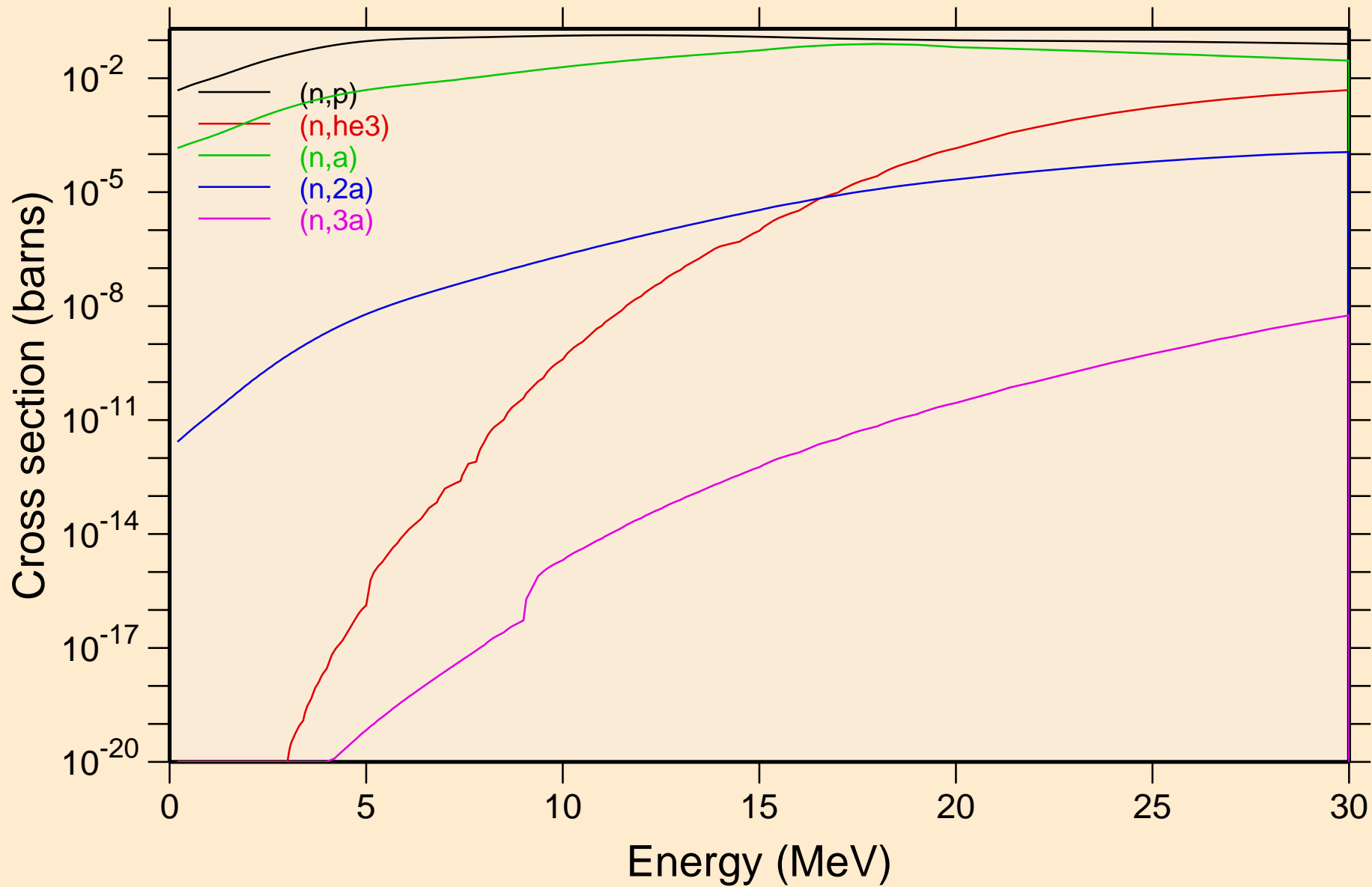

PB191M NEUTRON ACER TENDL-2023 LIBRARY; T=0.K  
Non-threshold reactions

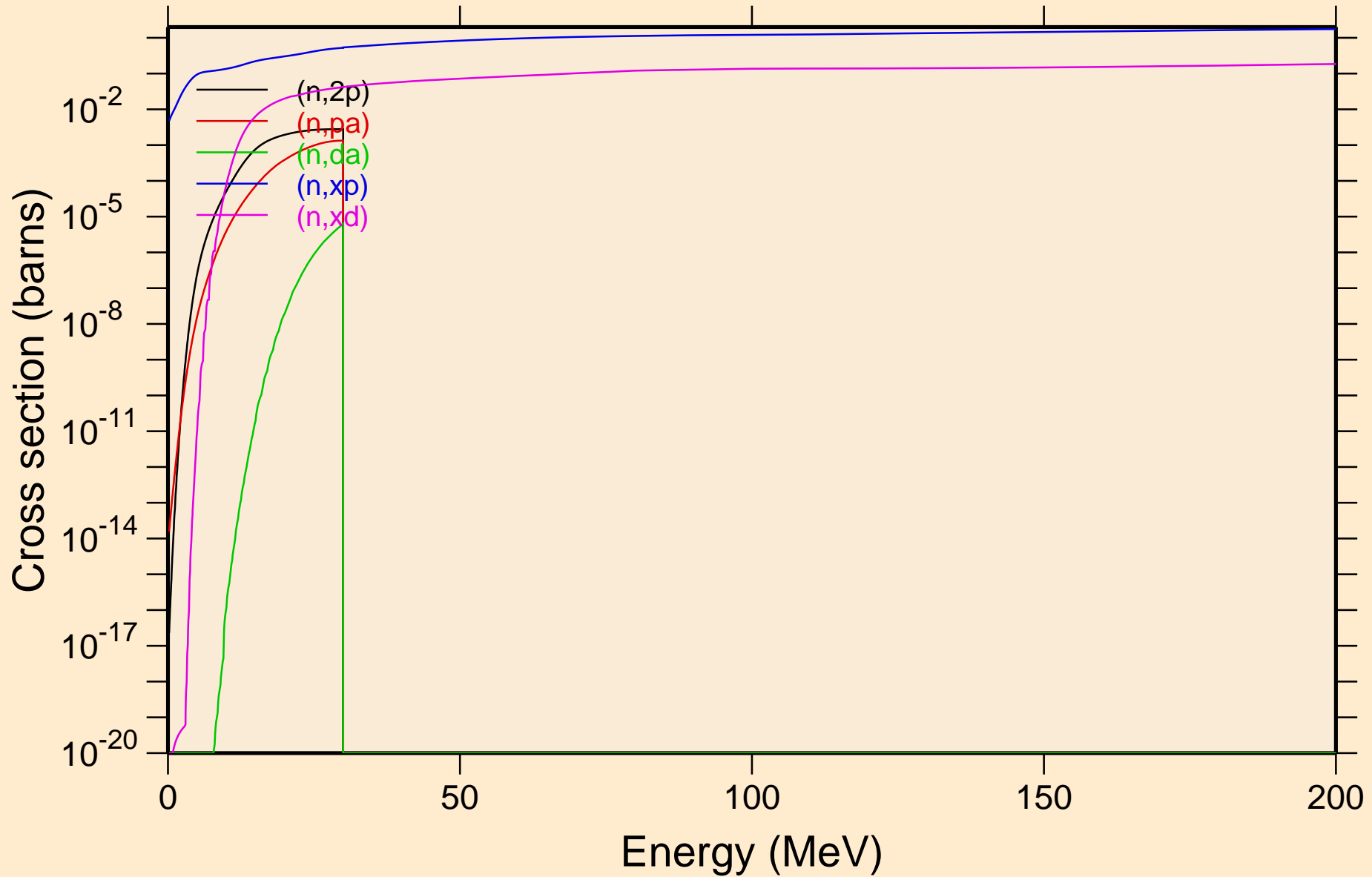

PB191M NEUTRON ACER TENDL-2023 LIBRARY; T=0.K  
Non-threshold reactions

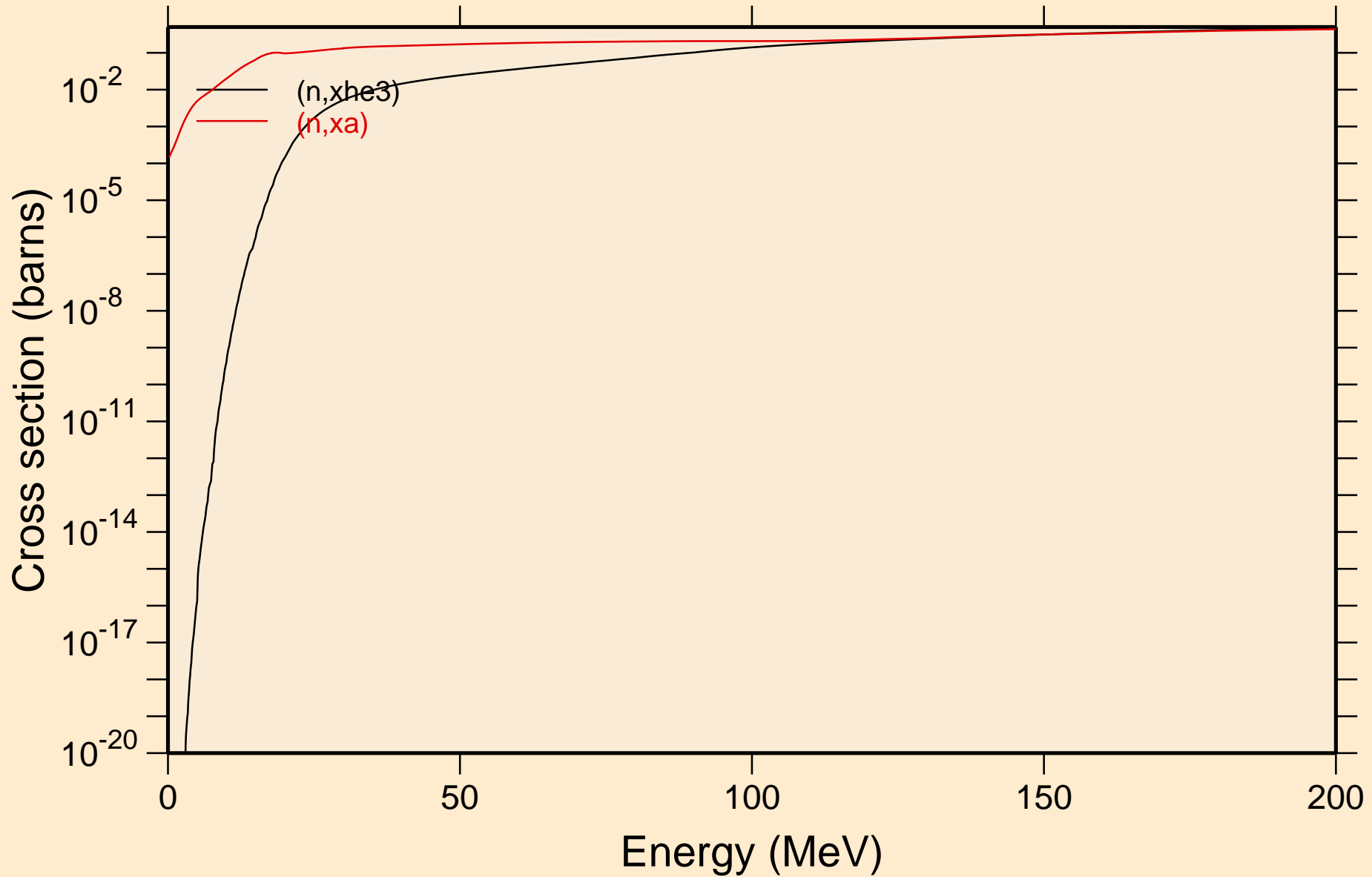

PB191M NEUTRON ACER TENDL-2023 LIBRARY; T=0.K  
Inelastic levels

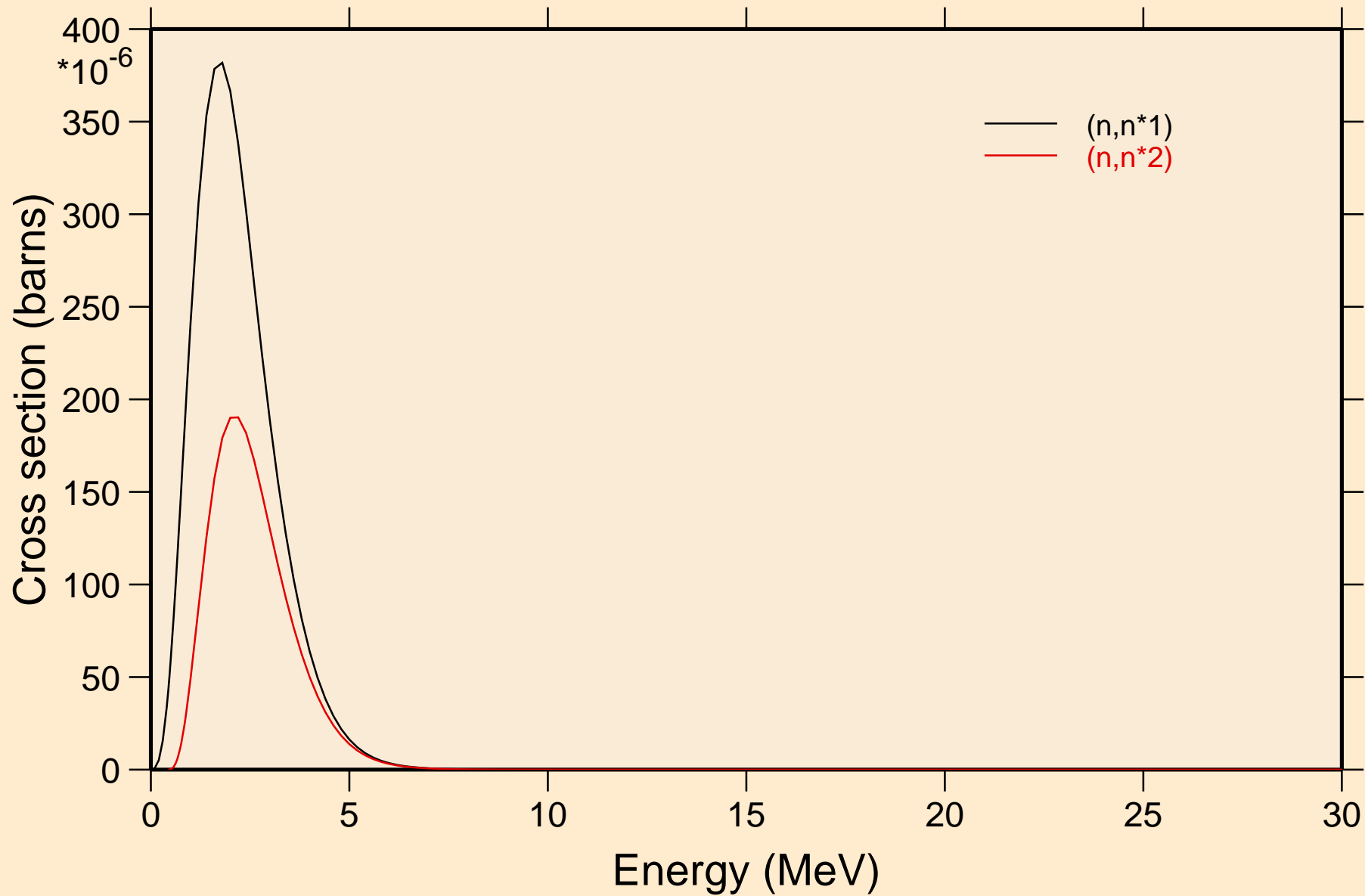

PB191M NEUTRON ACER TENDL-2023 LIBRARY; T=0.K  
Threshold reactions

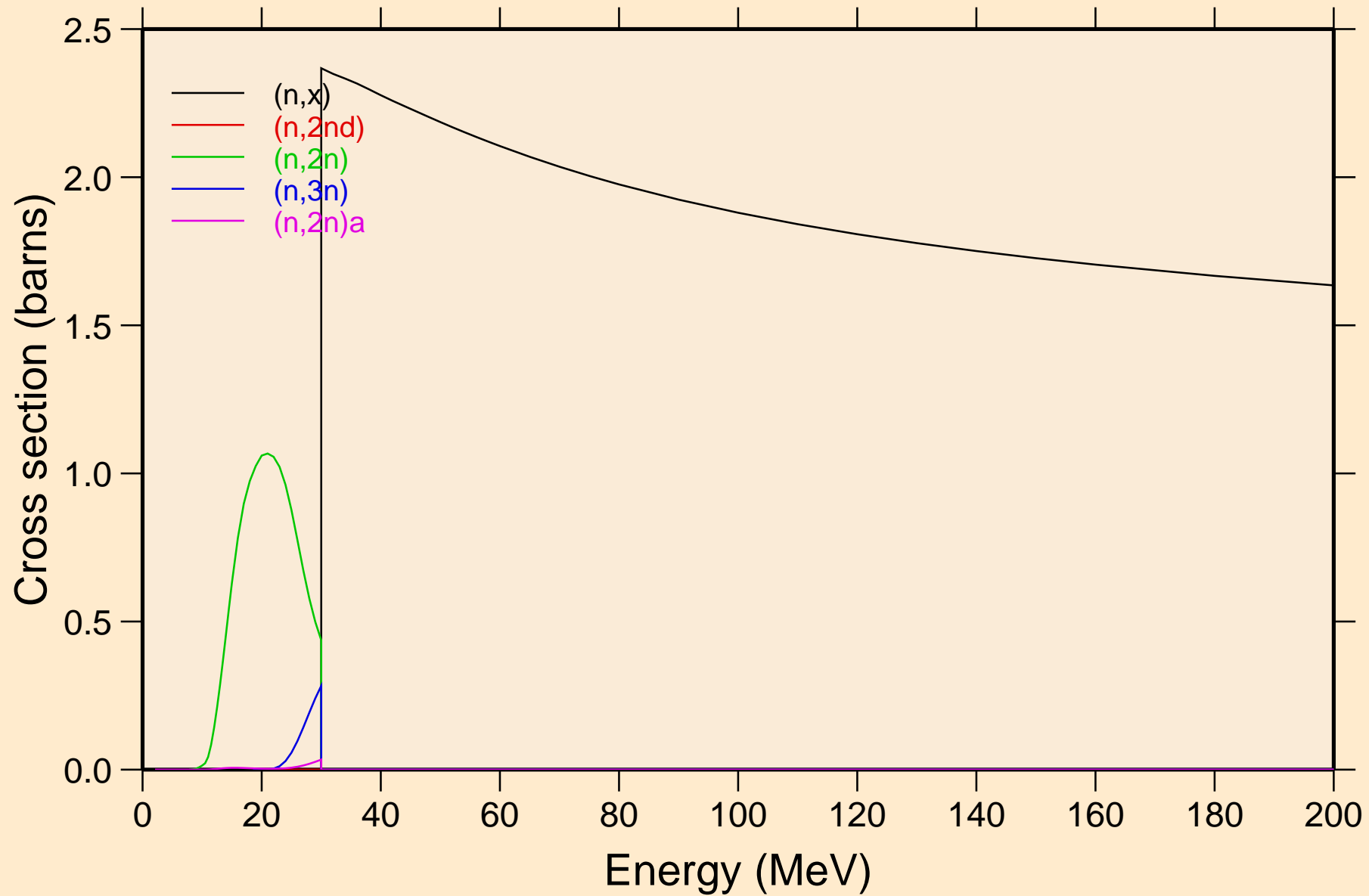

PB191M NEUTRON ACER TENDL-2023 LIBRARY; T=0.K  
Threshold reactions

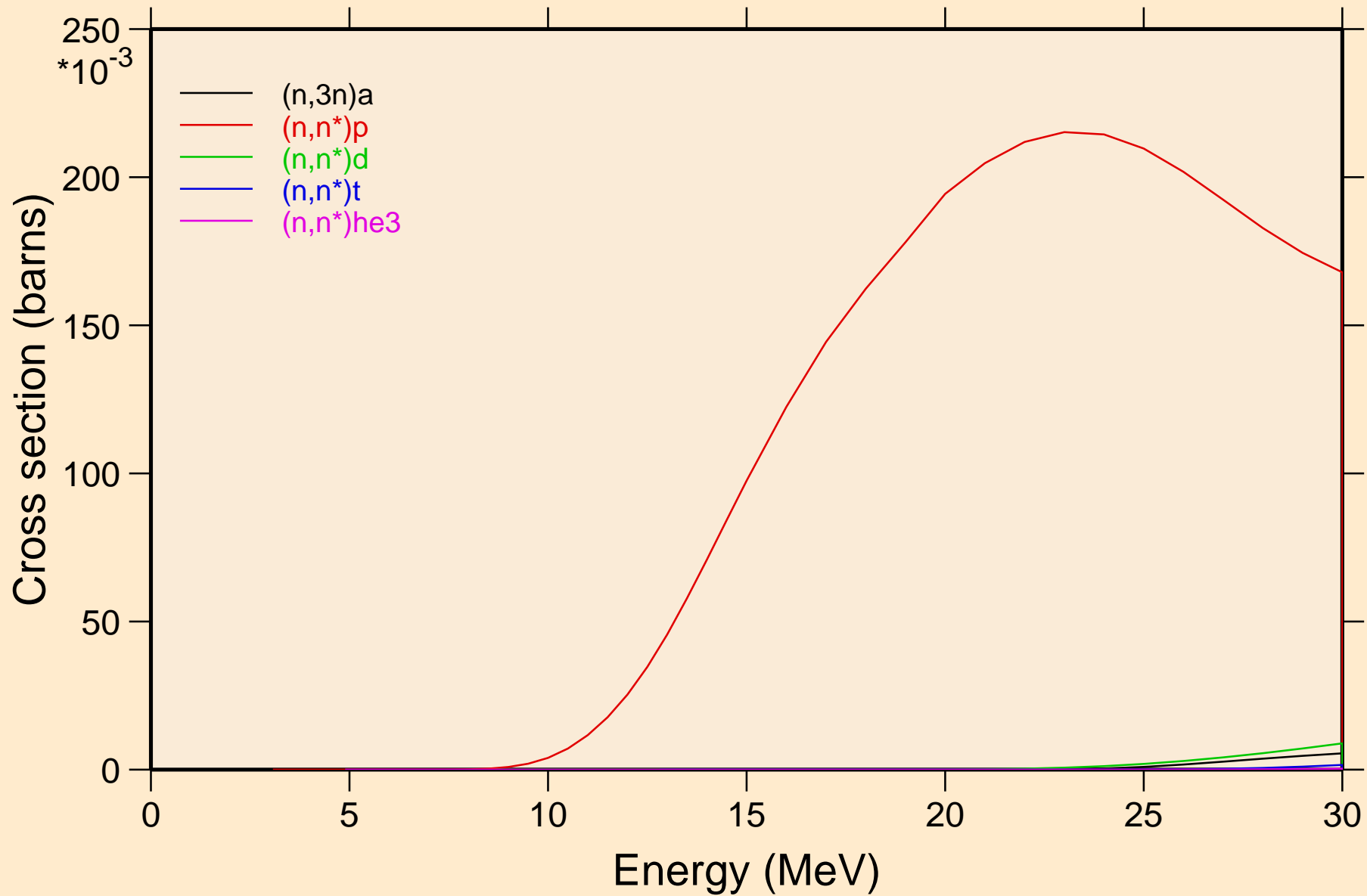

PB191M NEUTRON ACER TENDL-2023 LIBRARY; T=0.K  
Threshold reactions

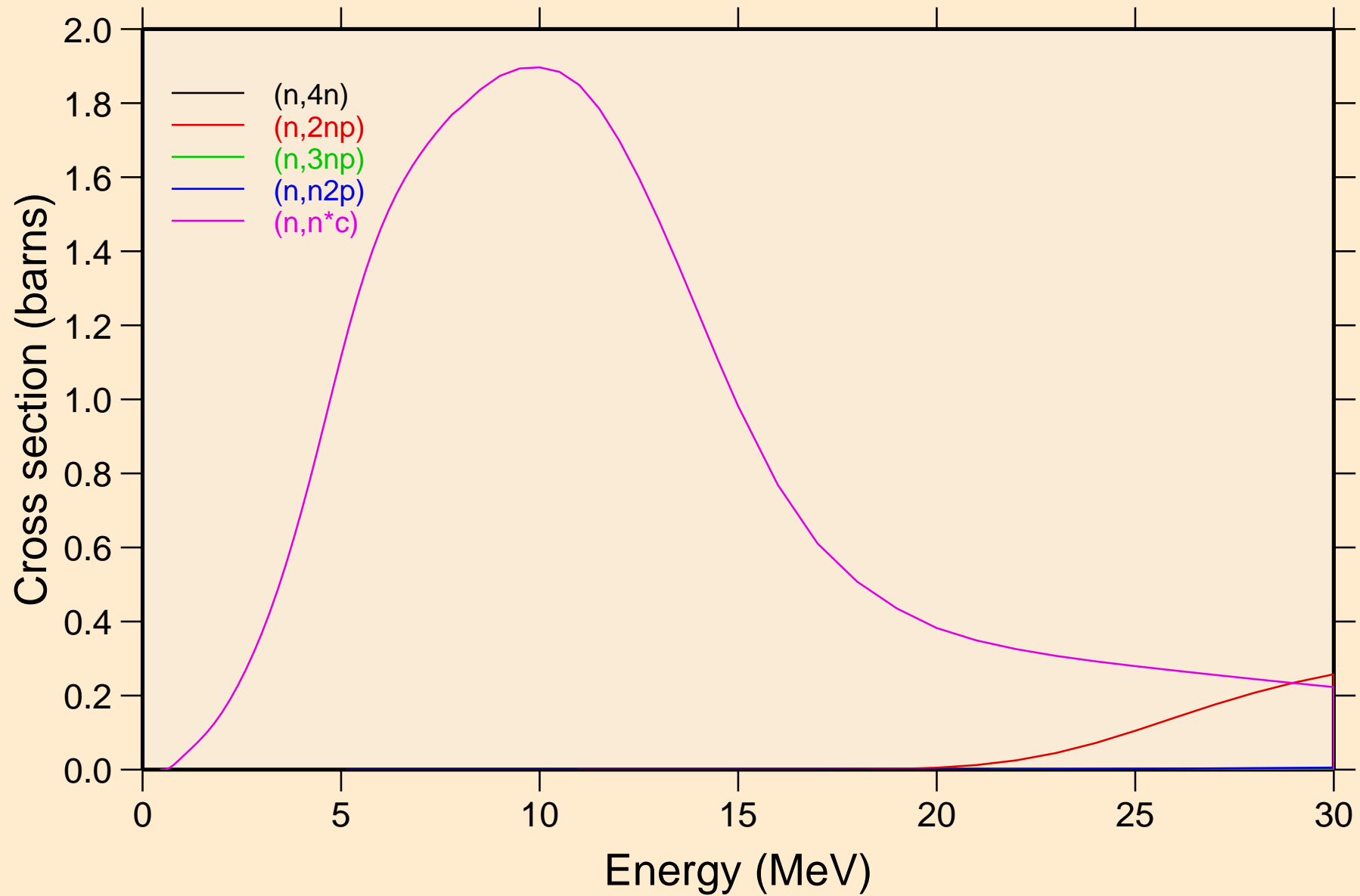

PB191M NEUTRON ACER TENDL-2023 LIBRARY; T=0.K  
Threshold reactions

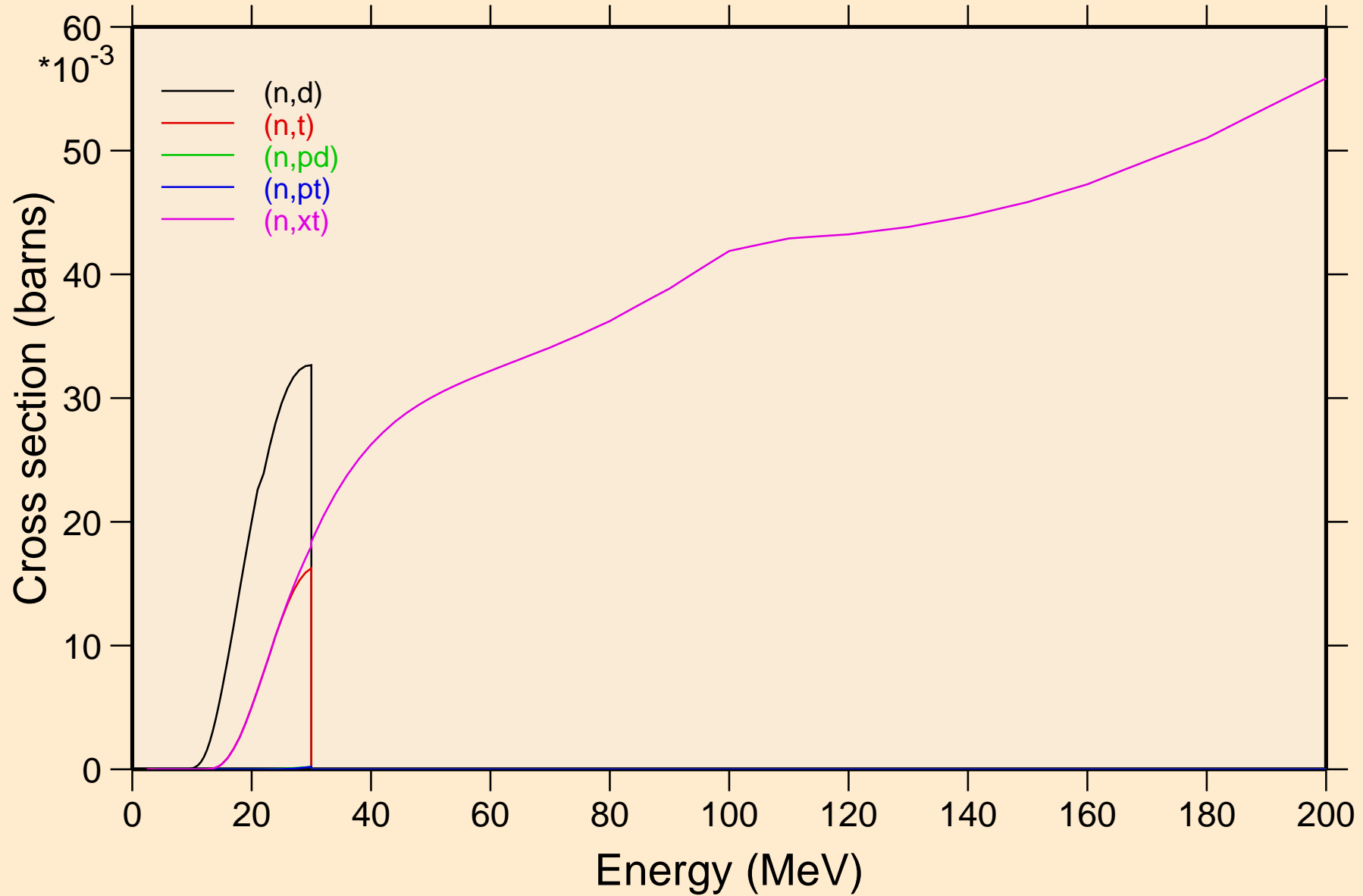

PB191M NEUTRON ACER TENDL-2023 LIBRARY; T=0.K  
angular distribution for elastic

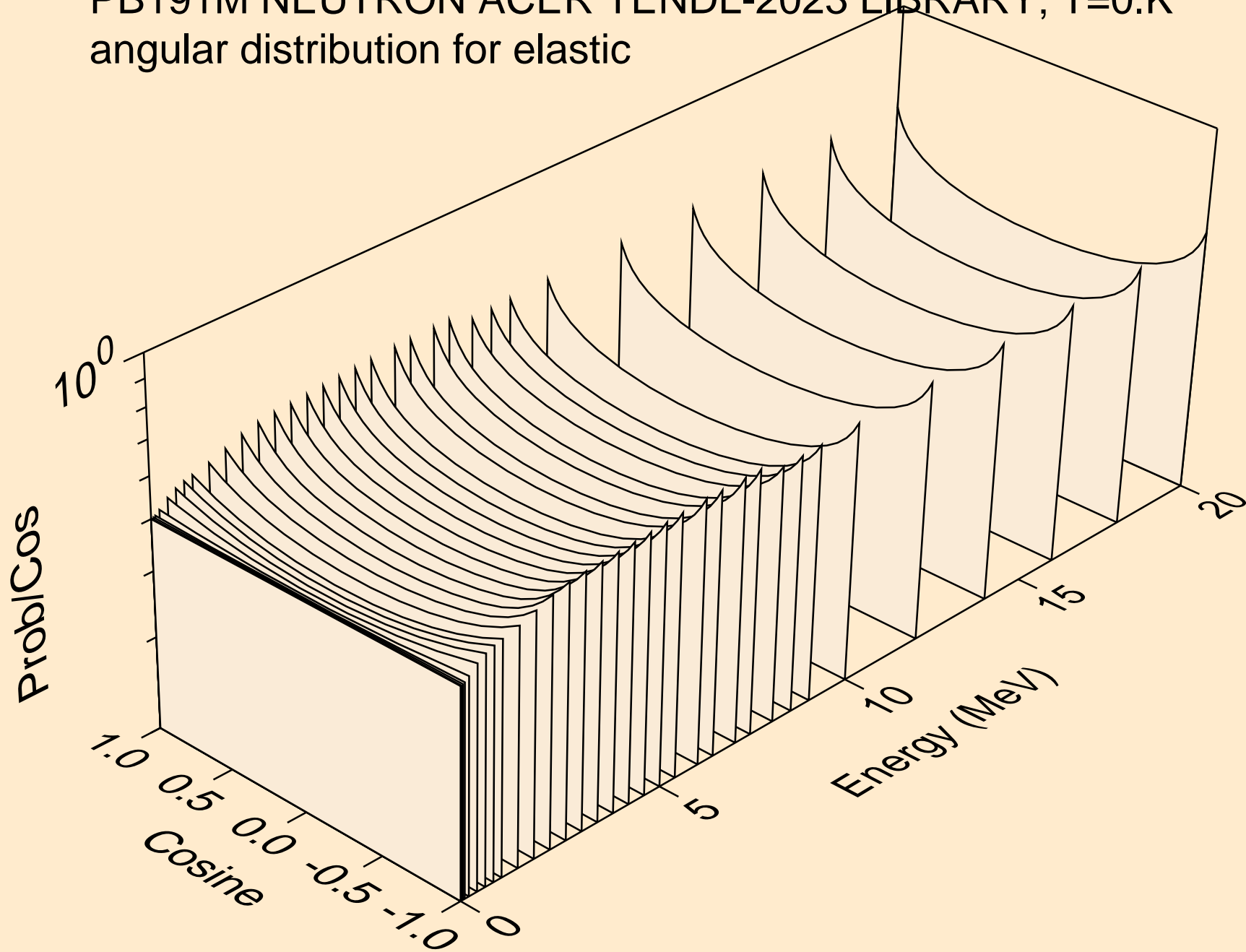

PB191M NEUTRON ACER TENDL-2023 LIBRARY; T=0.K  
angular distribution for elastic

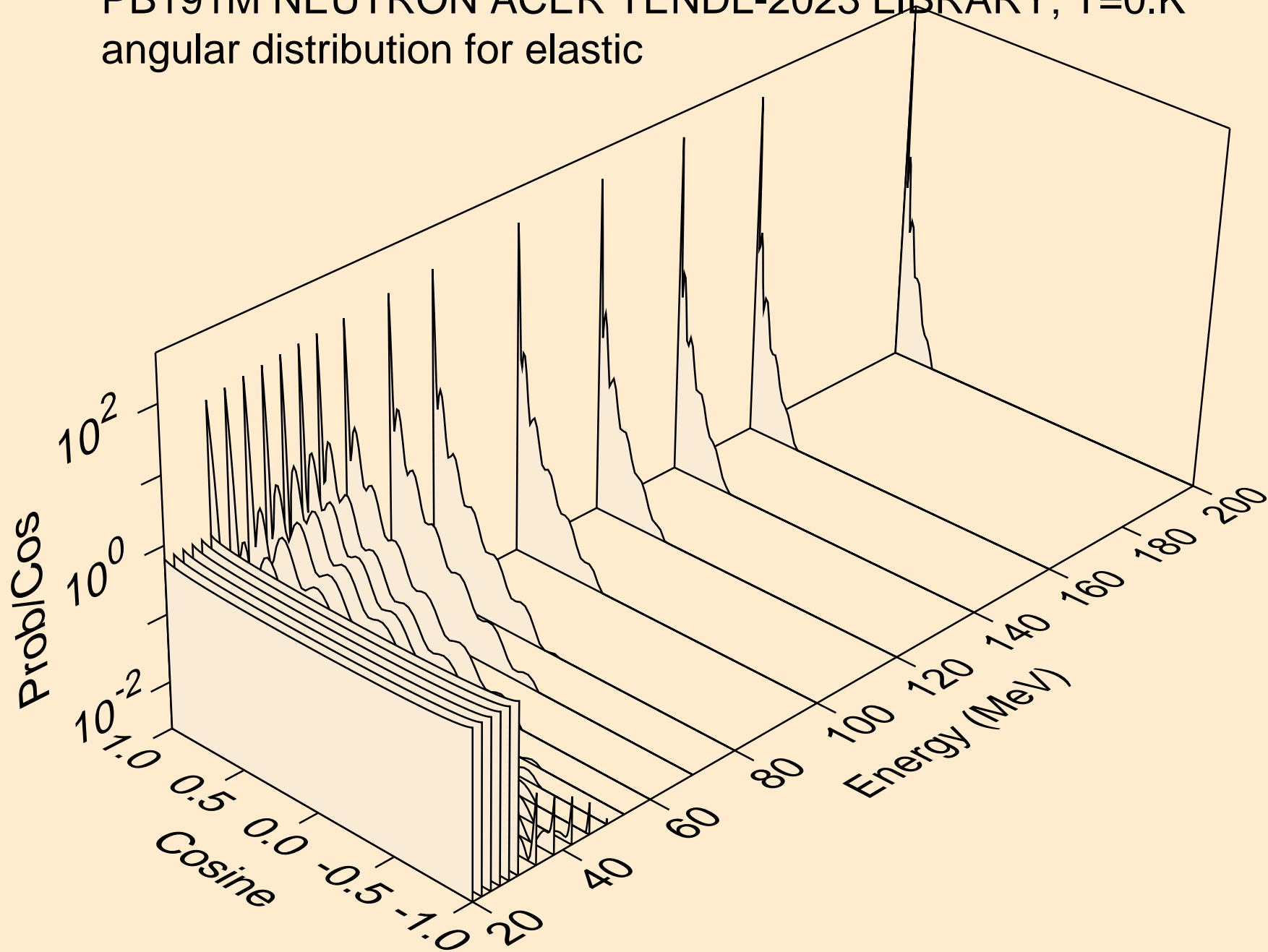

PB191M NEUTRON ACER TENDL-2023 LIBRARY; T=0.K  
angular distribution for (n,n\*1)

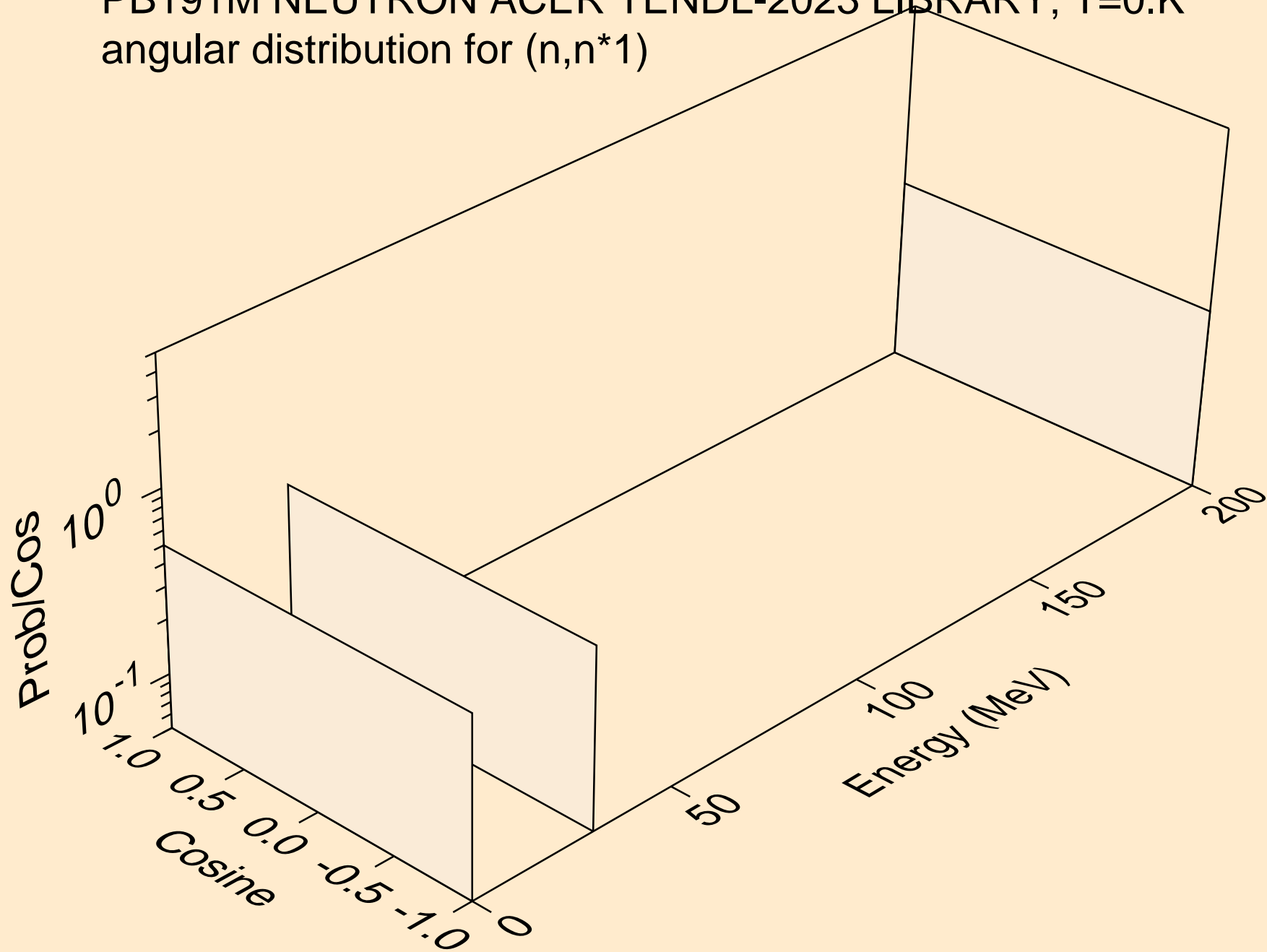

PB191M NEUTRON ACER TENDL-2023 LIBRARY; T=0.K  
angular distribution for (n,n\*2)

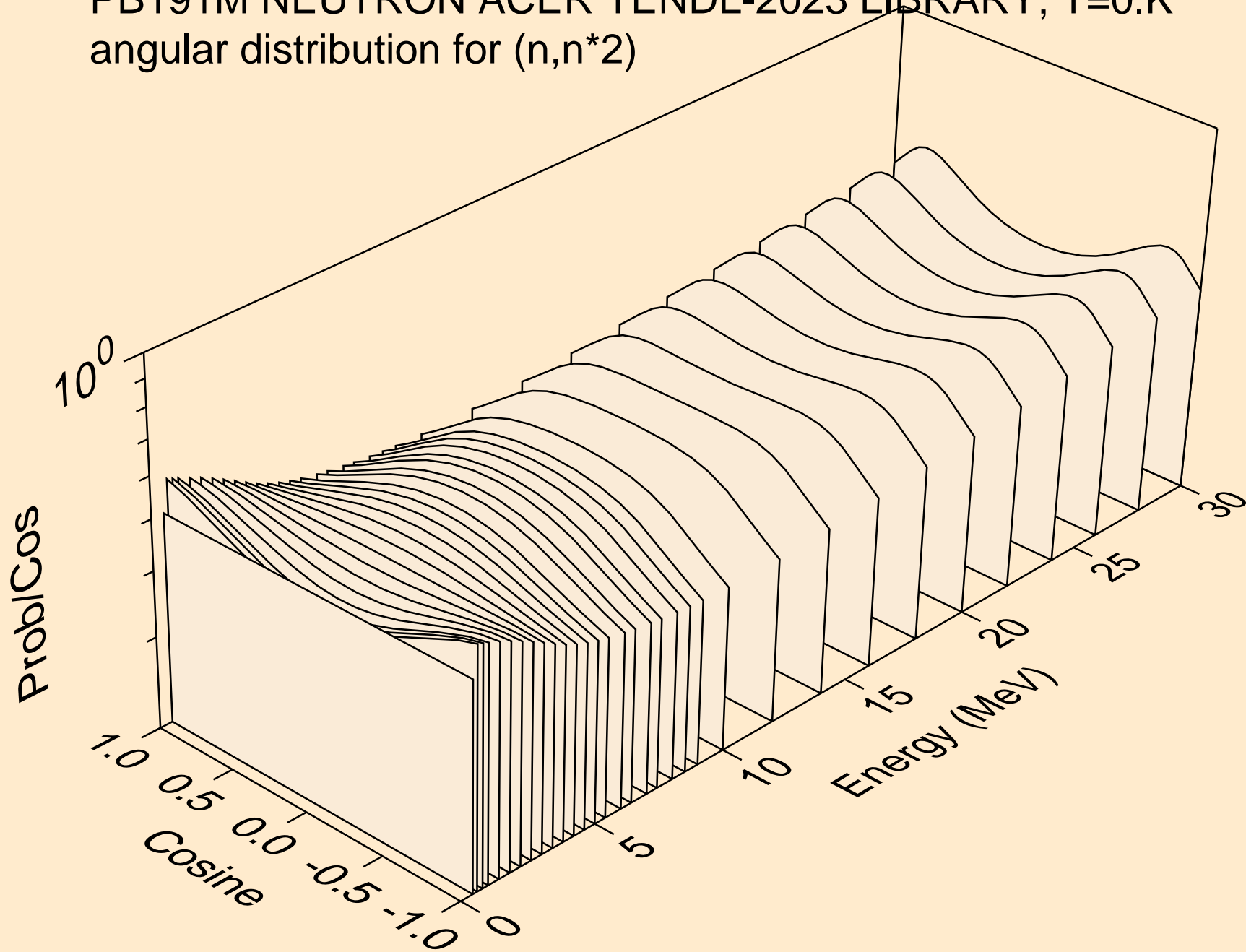

PB191M NEUTRON ACER TENDL-2023 LIBRARY; T=0.K  
Neutron emission for (n,x)

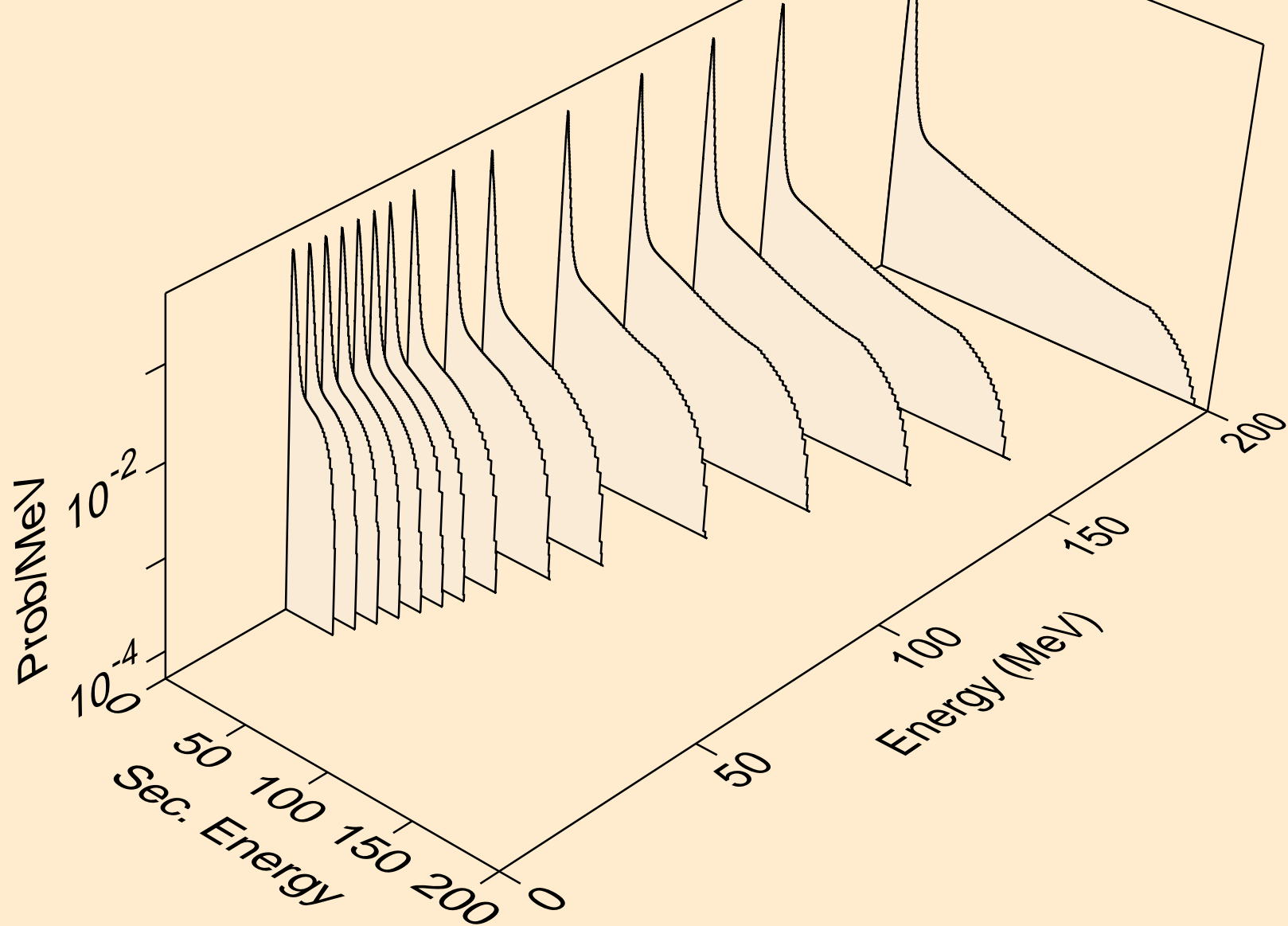

PB191M NEUTRON ACER TENDL-2023 LIBRARY; T=0.K  
Neutron emission for (n,2nd)

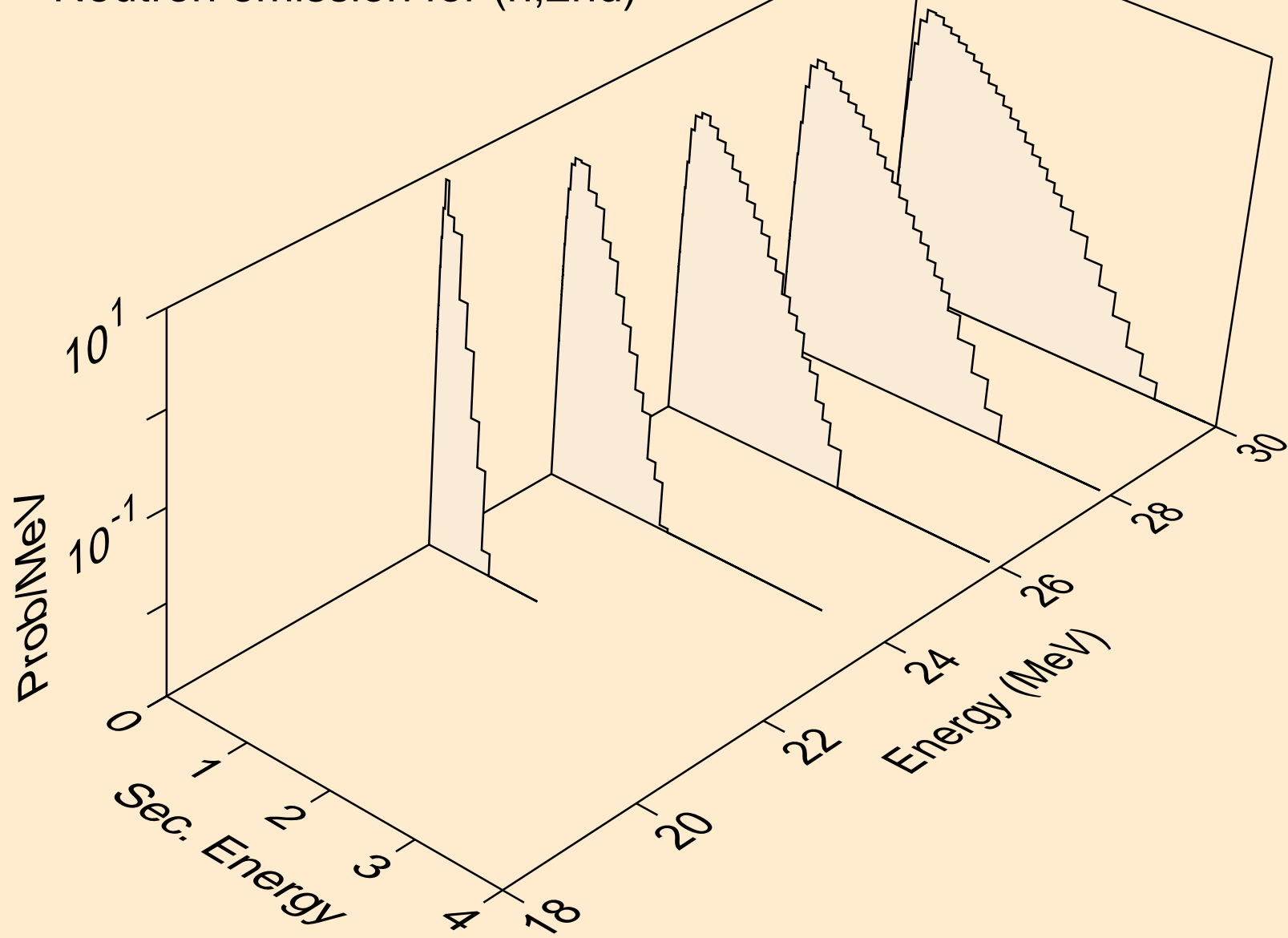

PB191M NEUTRON ACER TENDL-2023 LIBRARY; T=0.K  
Neutron emission for (n,2n)

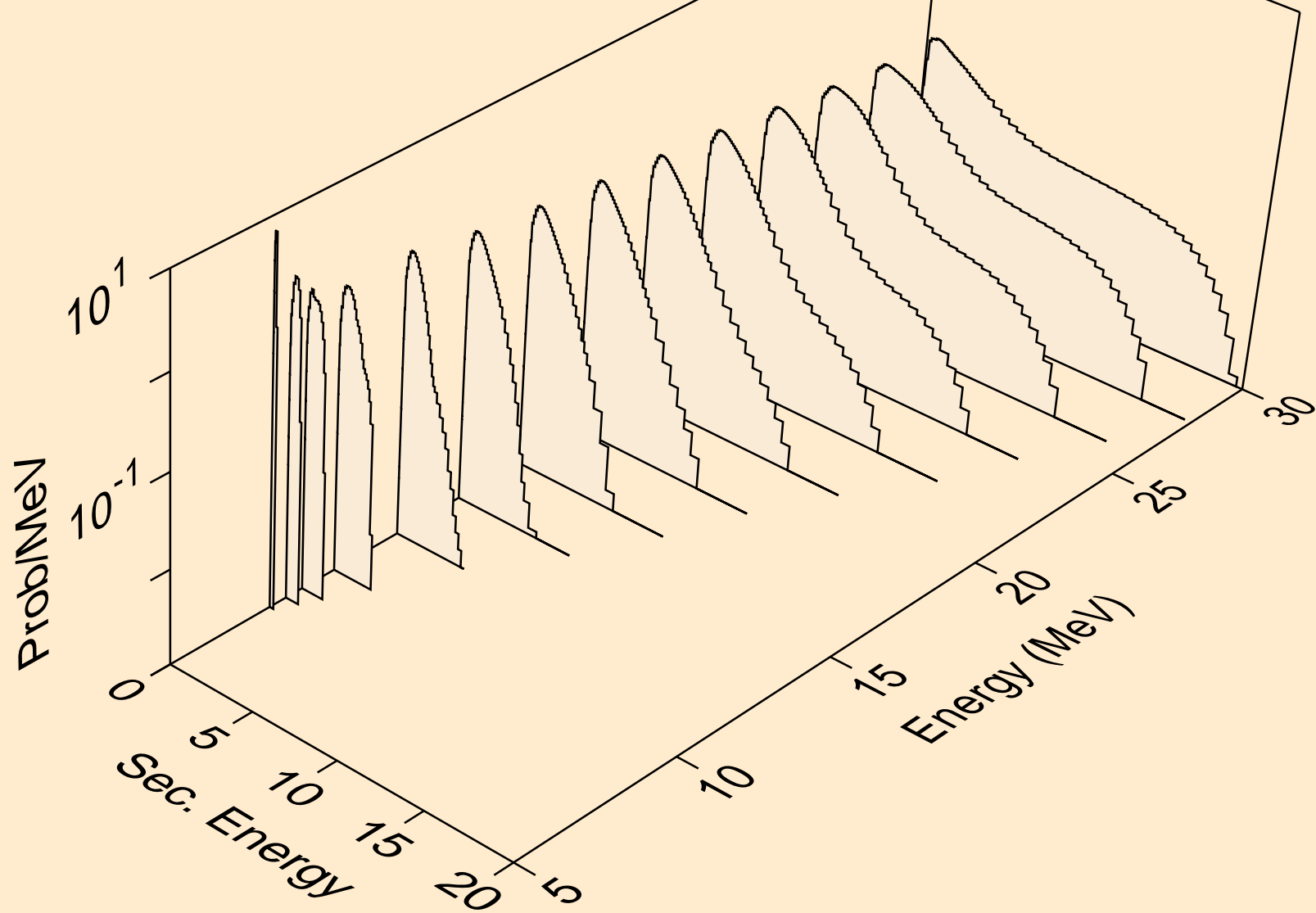

PB191M NEUTRON ACER TENDL-2023 LIBRARY; T=0.K  
Neutron emission for (n,3n)

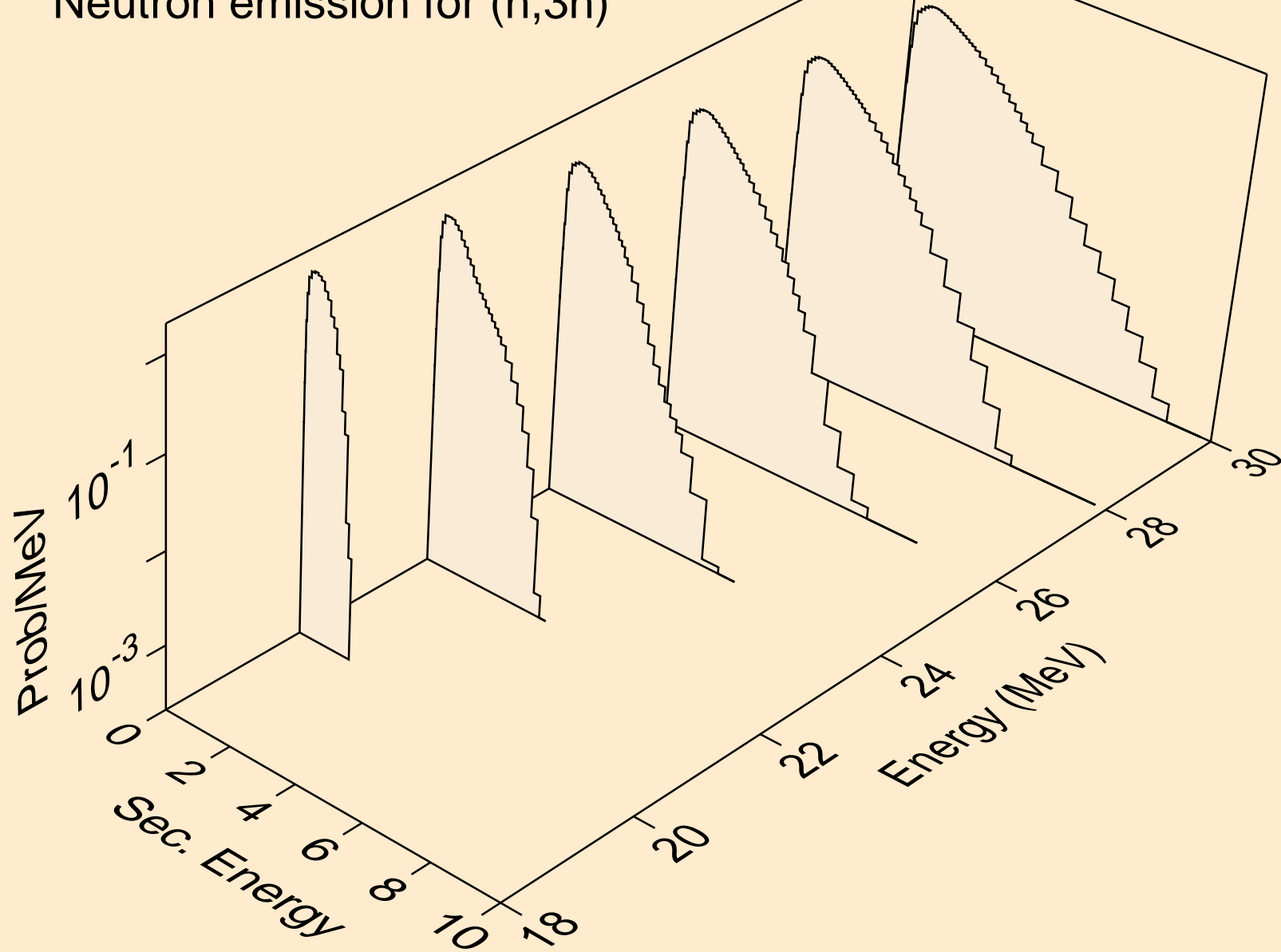

PB191M NEUTRON ACER TENDL-2023 LIBRARY; T=0.K  
Neutron emission for (n,n\*)a

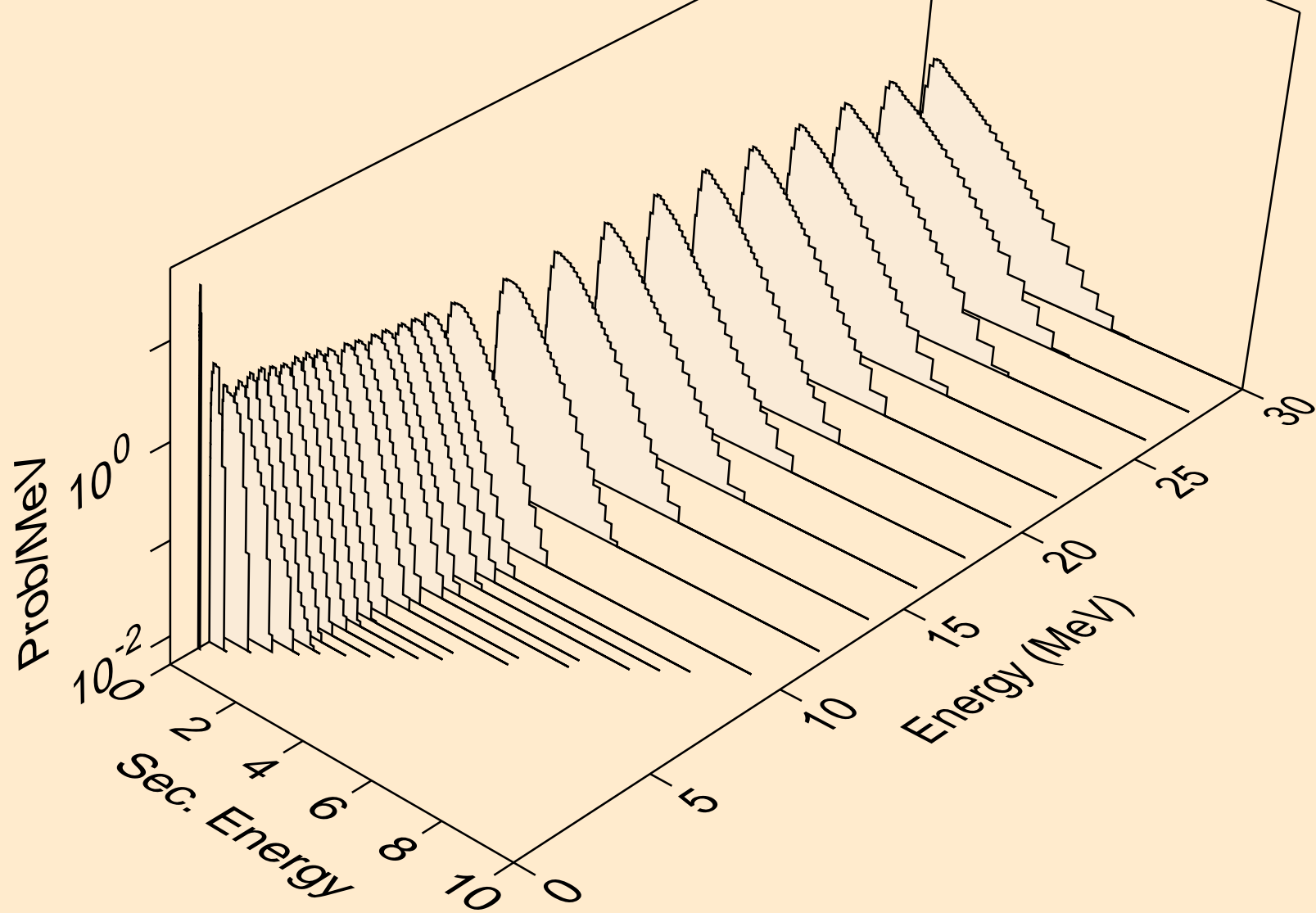

PB191M NEUTRON ACER TENDL-2023 LIBRARY; T=0.K  
Neutron emission for (n,2n)a

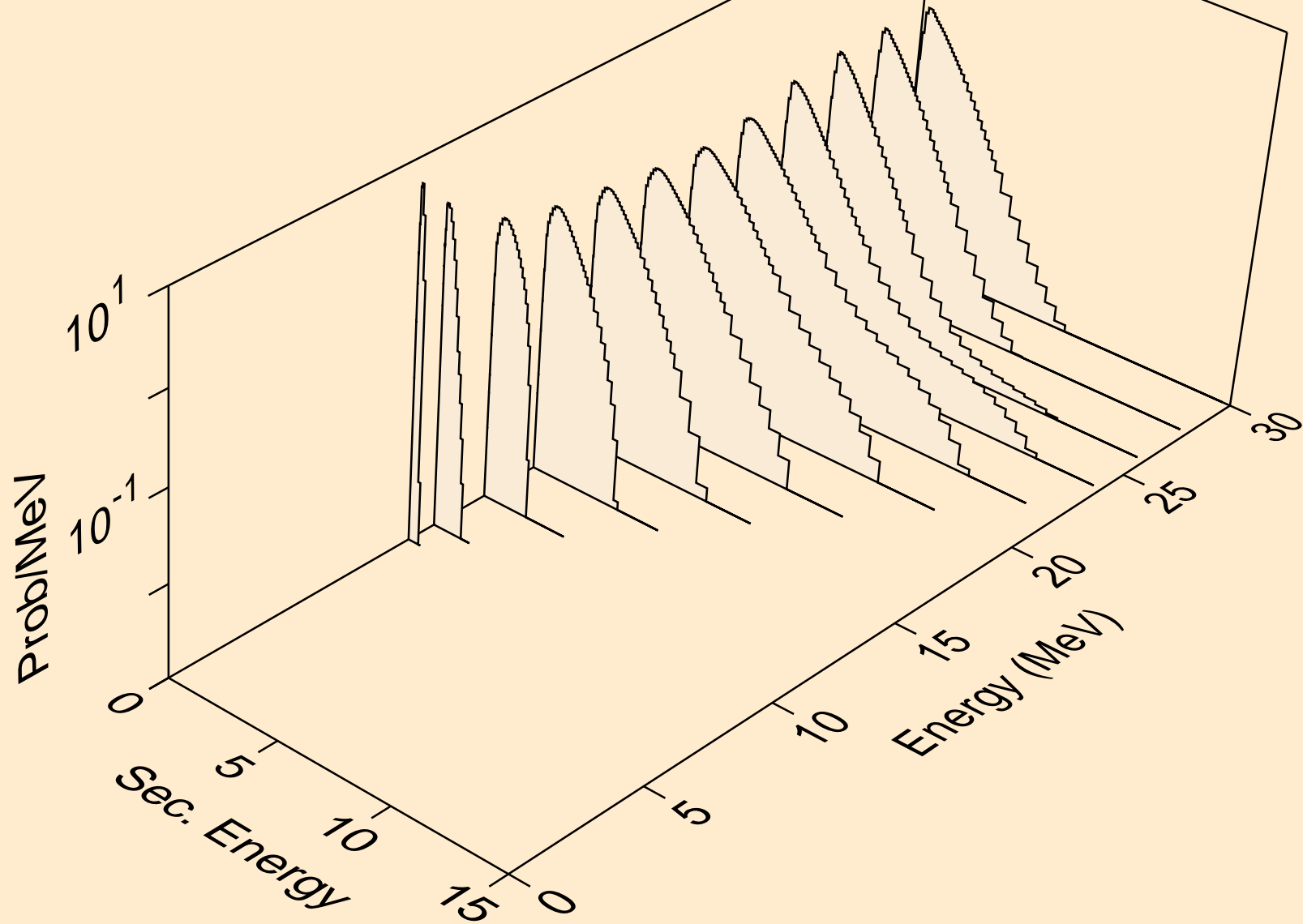

PB191M NEUTRON ACER TENDL-2023 LIBRARY; T=0.K  
Neutron emission for (n,3n)a

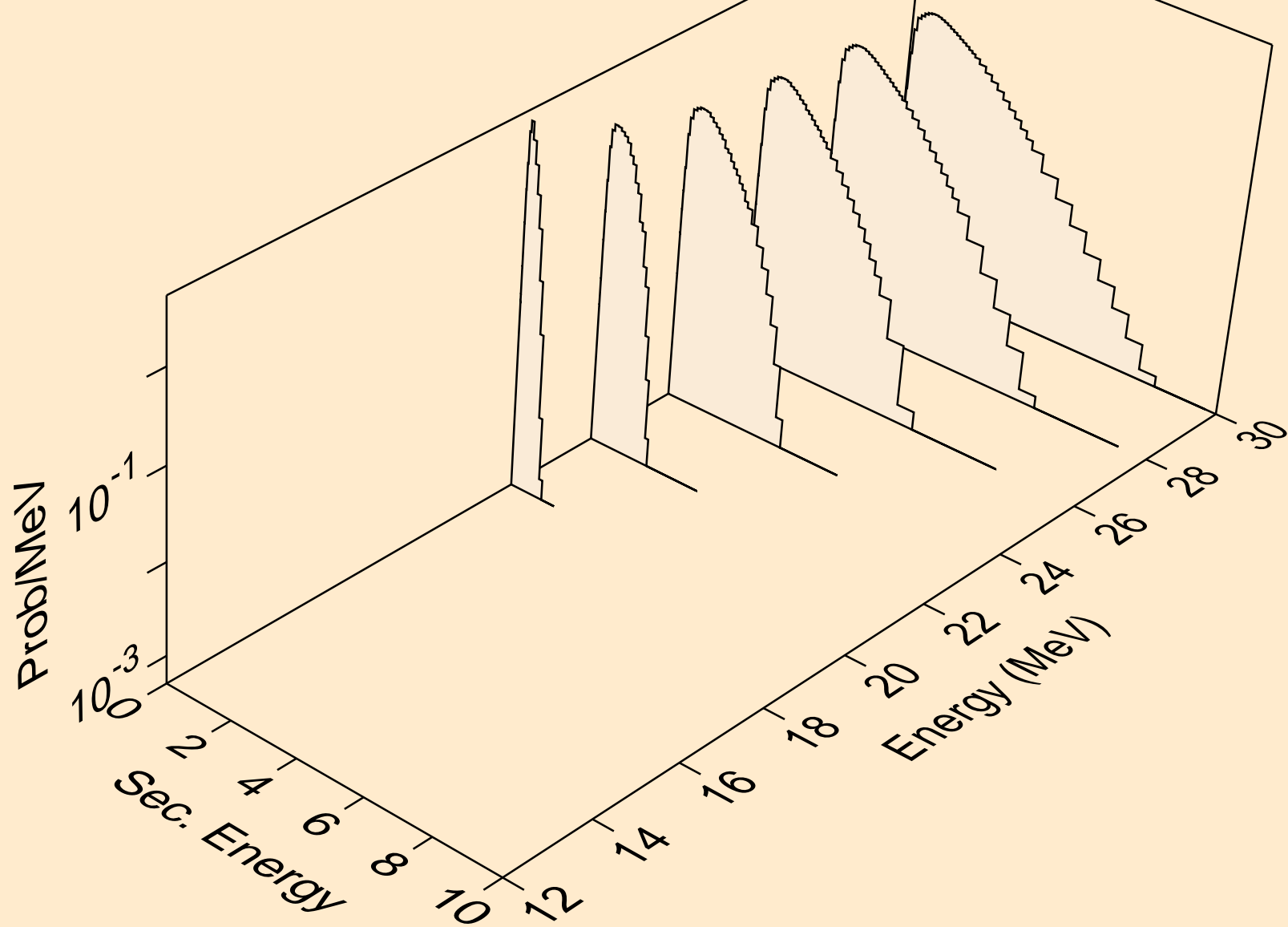

PB191M NEUTRON ACER TENDL-2023 LIBRARY; T=0.K  
Neutron emission for (n,n\*)p

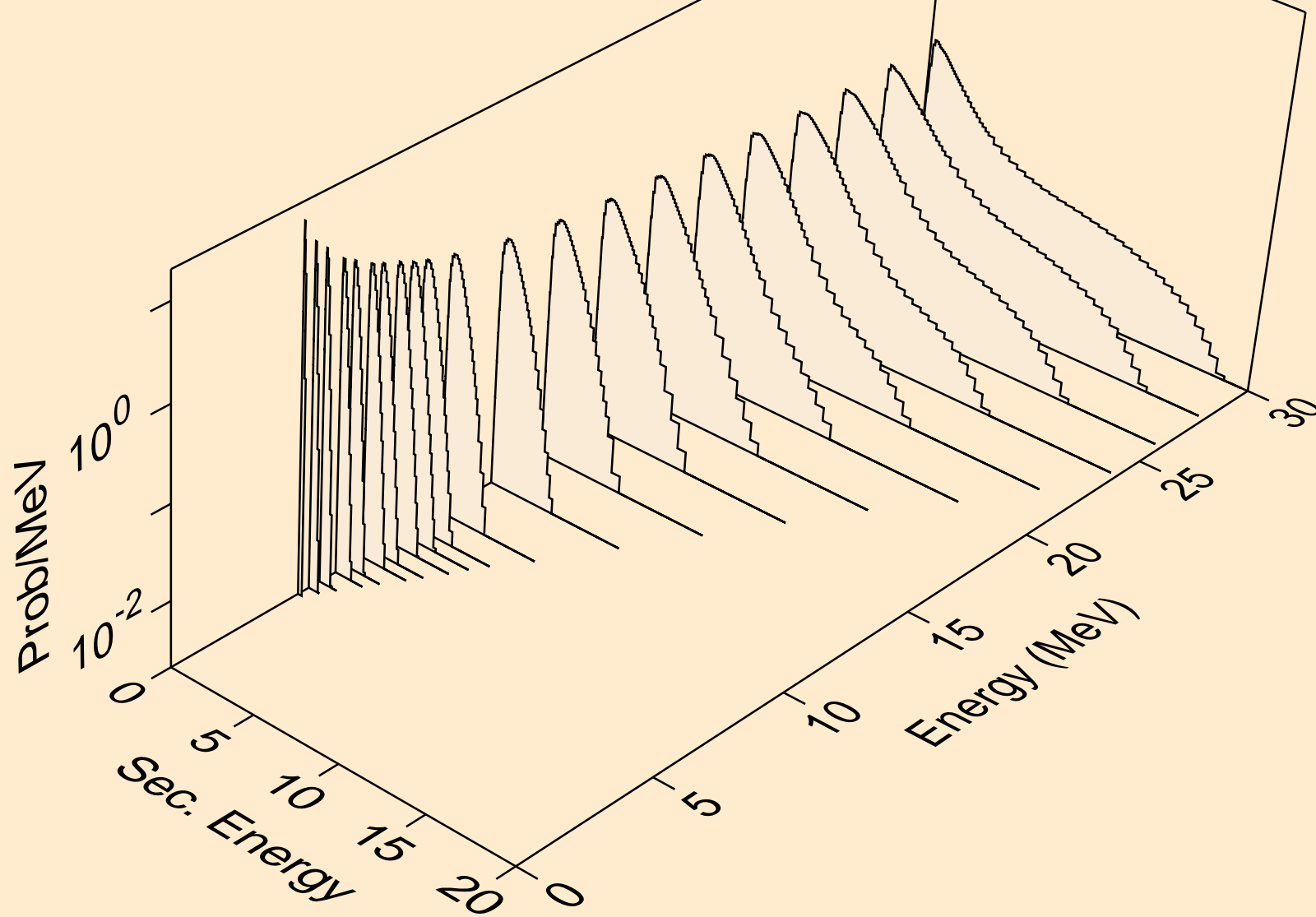

PB191M NEUTRON ACER TENDL-2023 LIBRARY; T=0.K  
Neutron emission for (n,n\*)2a

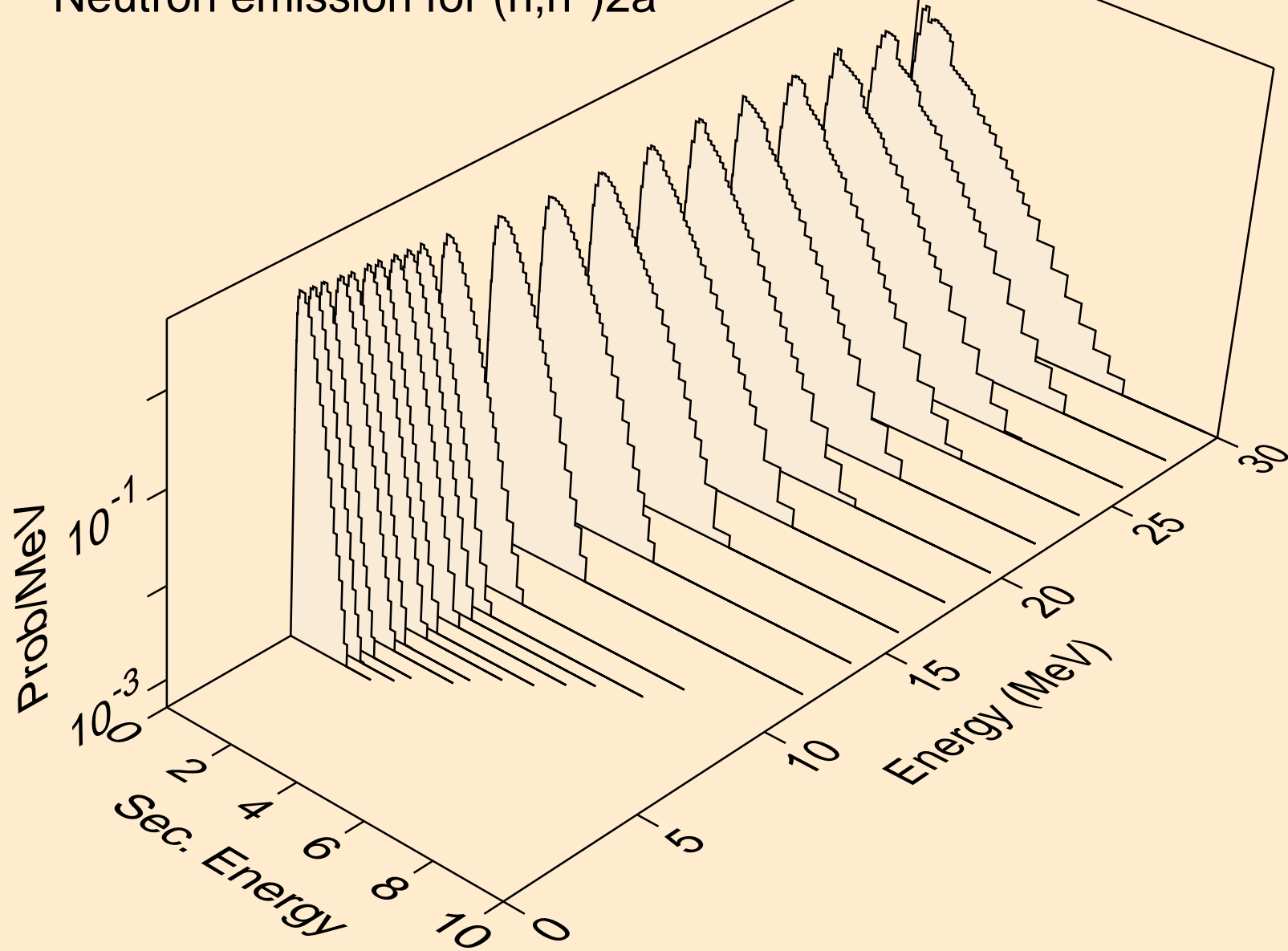

PB191M NEUTRON ACER TENDL-2023 LIBRARY; T=0.K  
Neutron emission for (n,2n)2a

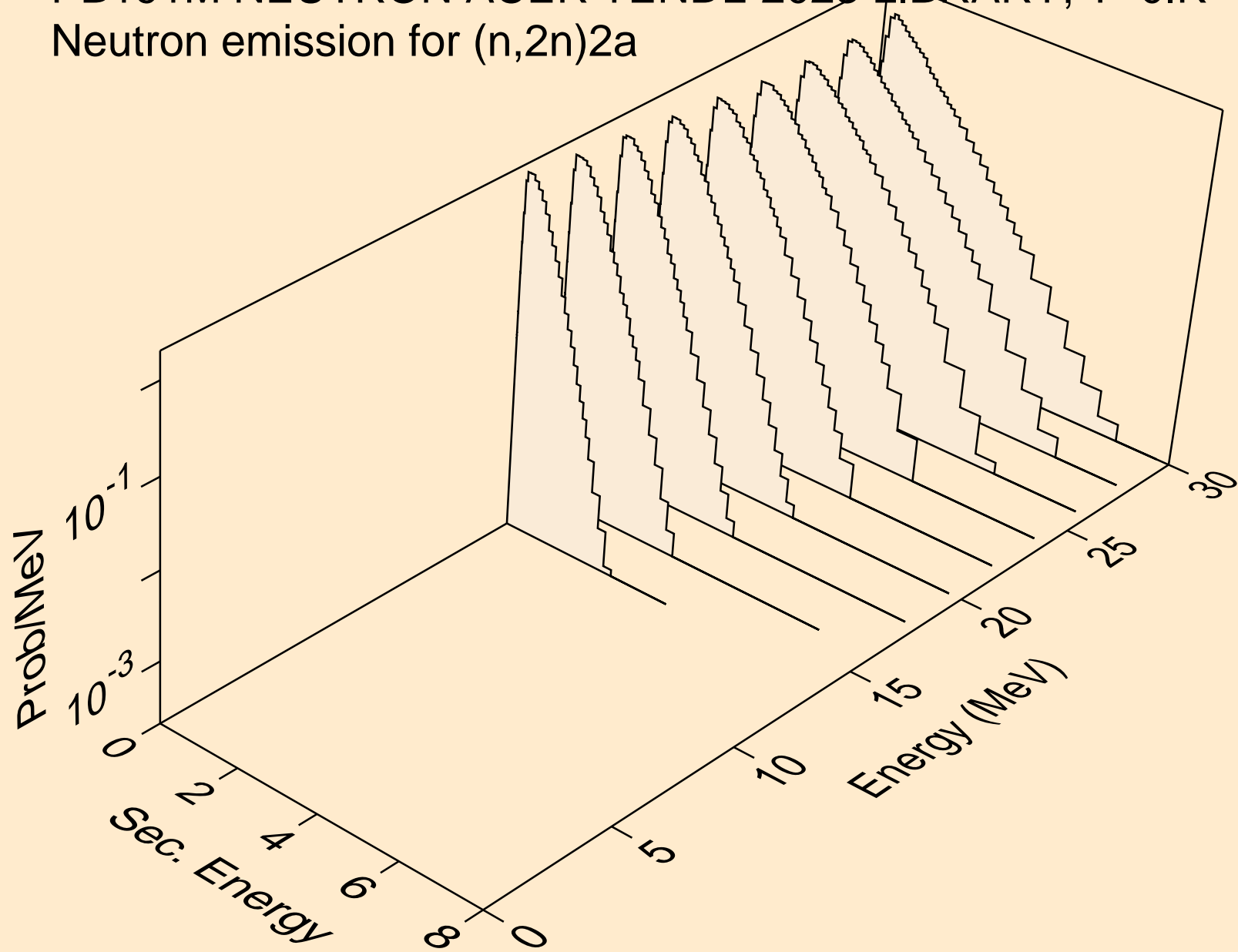

PB191M NEUTRON ACER TENDL-2023 LIBRARY; T=0.K  
Neutron emission for (n,n\*)d

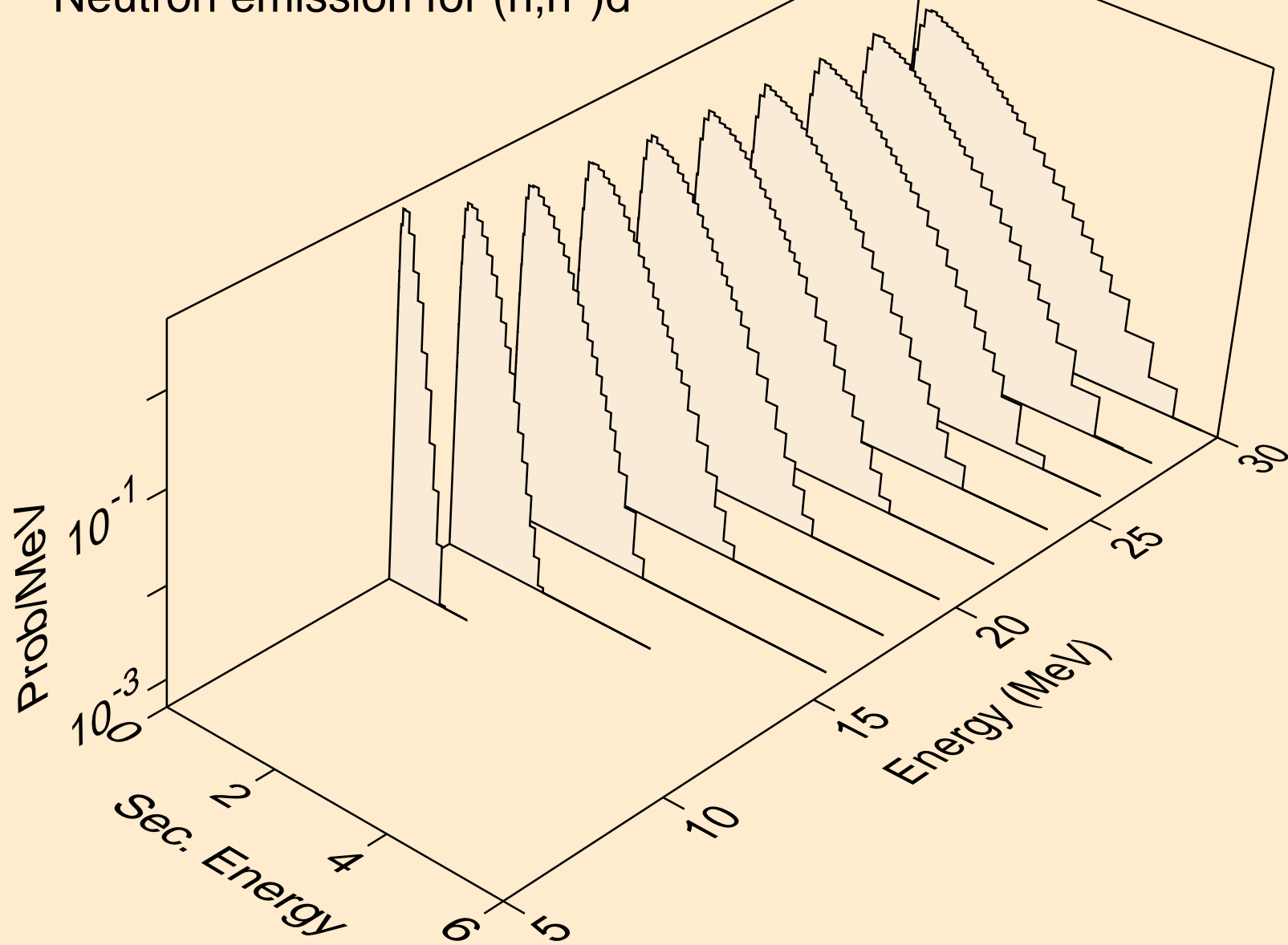

PB191M NEUTRON ACER TENDL-2023 LIBRARY; T=0.K  
Neutron emission for (n,n\*)t

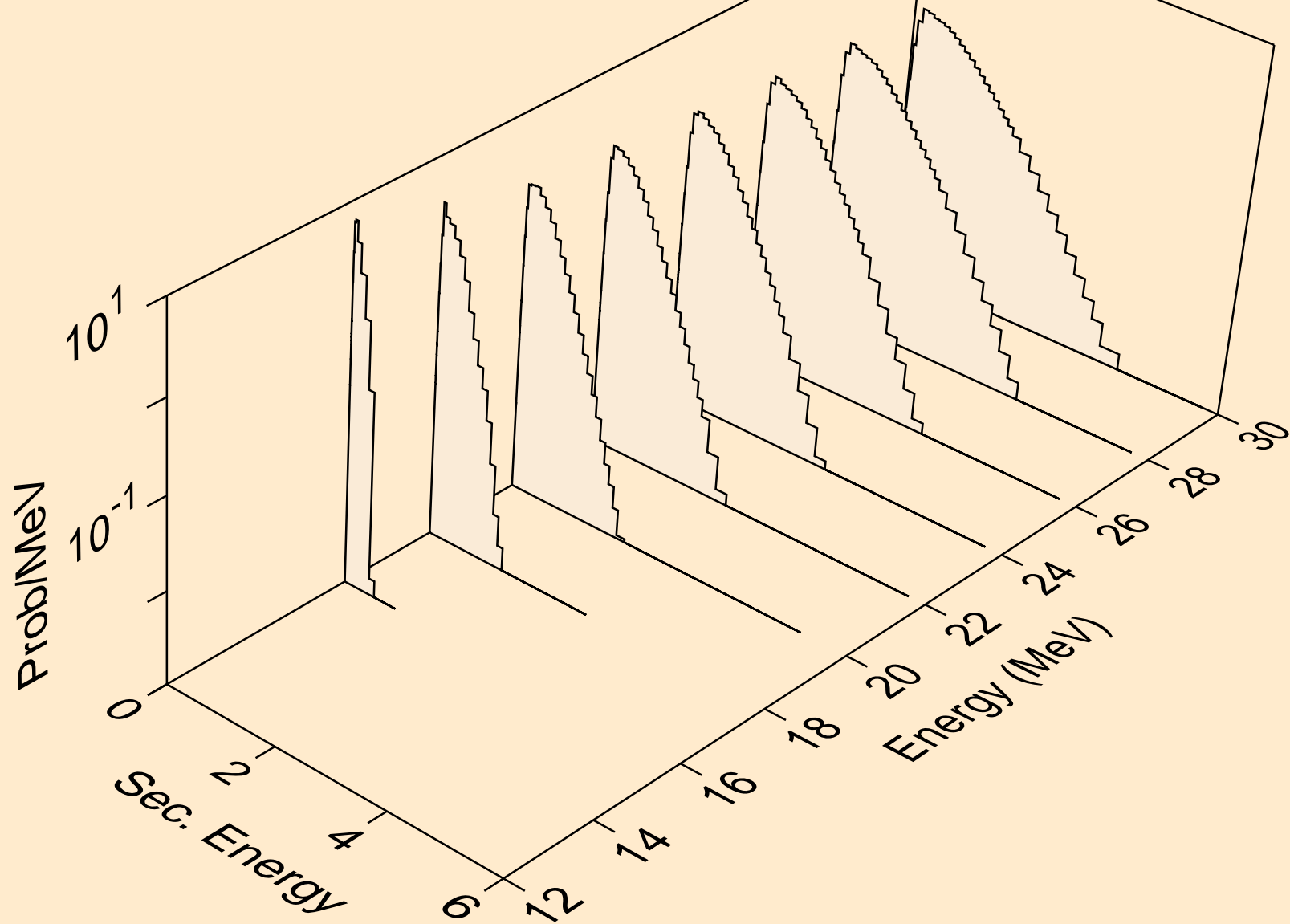

PB191M NEUTRON ACER TENDL-2023 LIBRARY; T=0.K  
Neutron emission for (n,n\*)he3

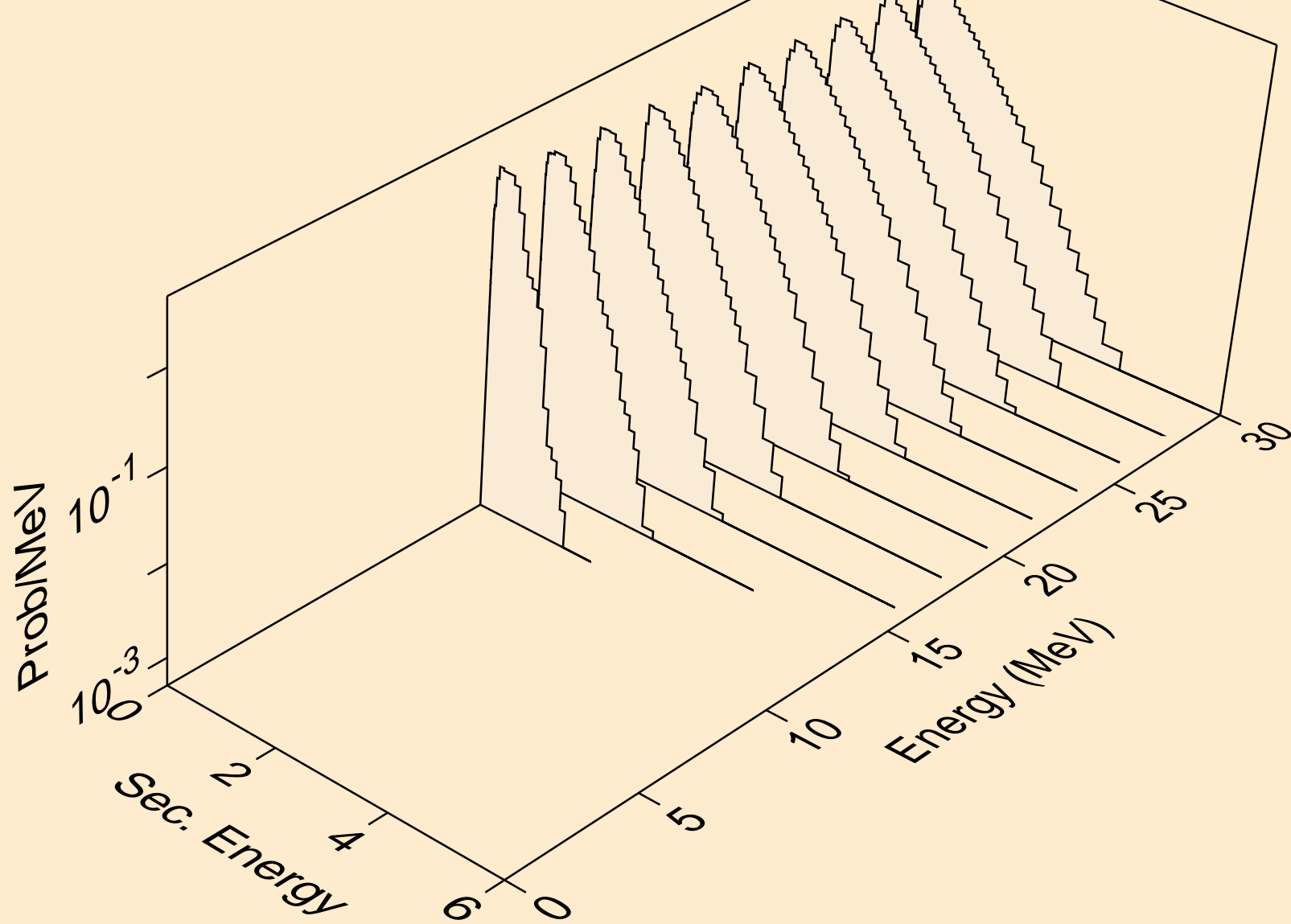

PB191M NEUTRON ACER TENDL-2023 LIBRARY; T=0.K  
Neutron emission for (n,4n)

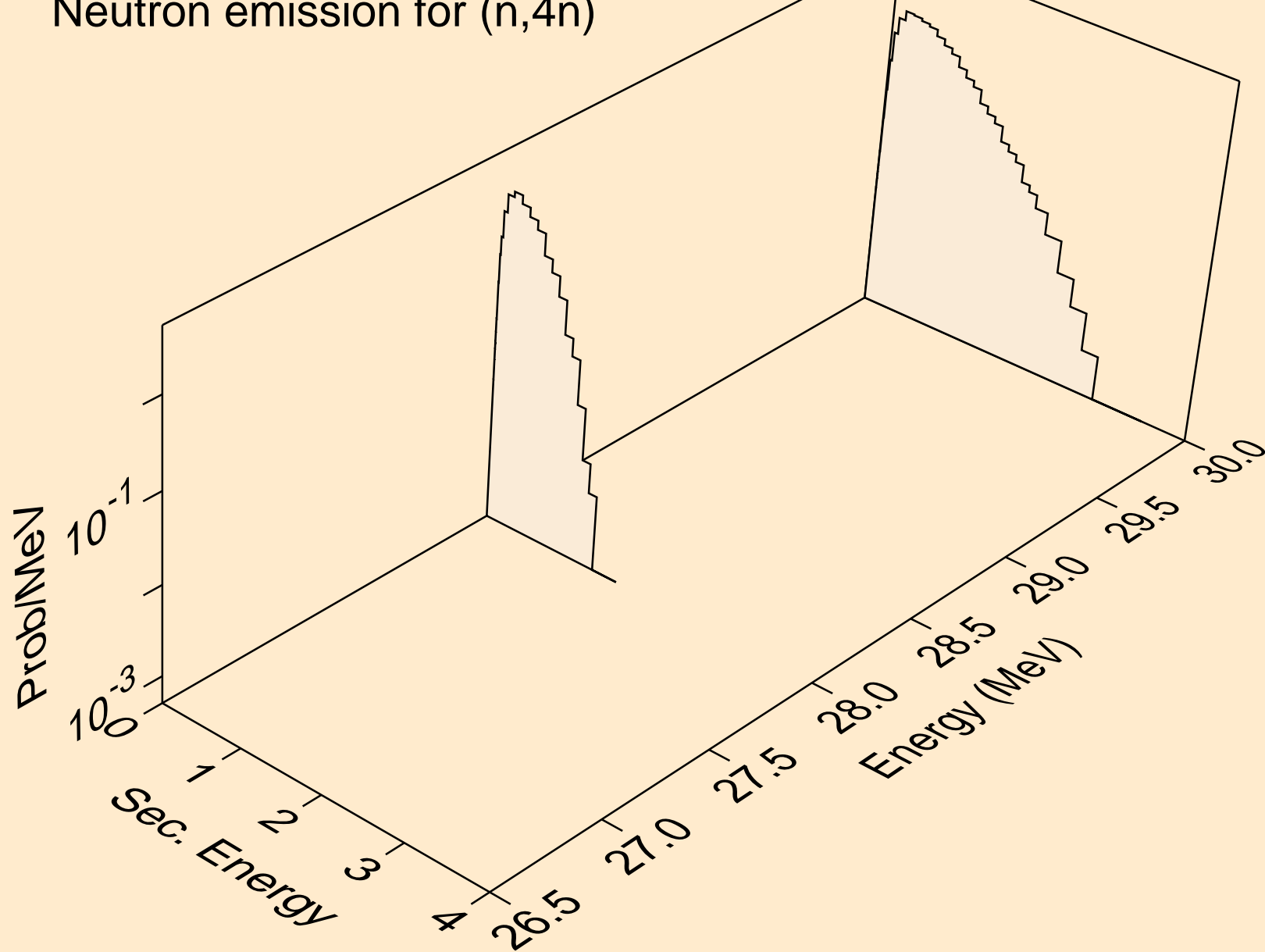

PB191M NEUTRON ACER TENDL-2023 LIBRARY; T=0.K  
Neutron emission for (n,2np)

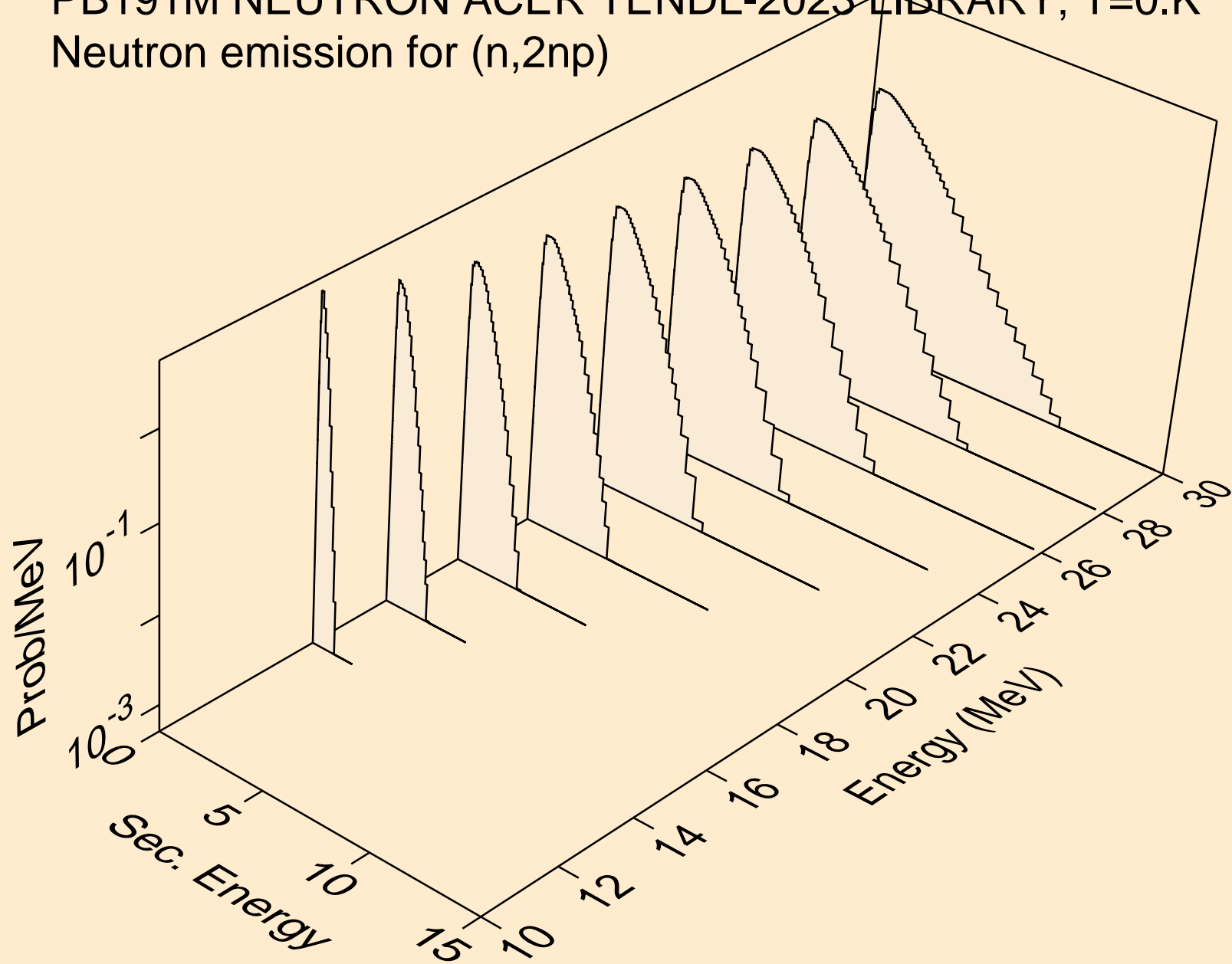

PB191M NEUTRON ACER TENDL-2023 LIBRARY; T=0.K  
Neutron emission for (n,3np)

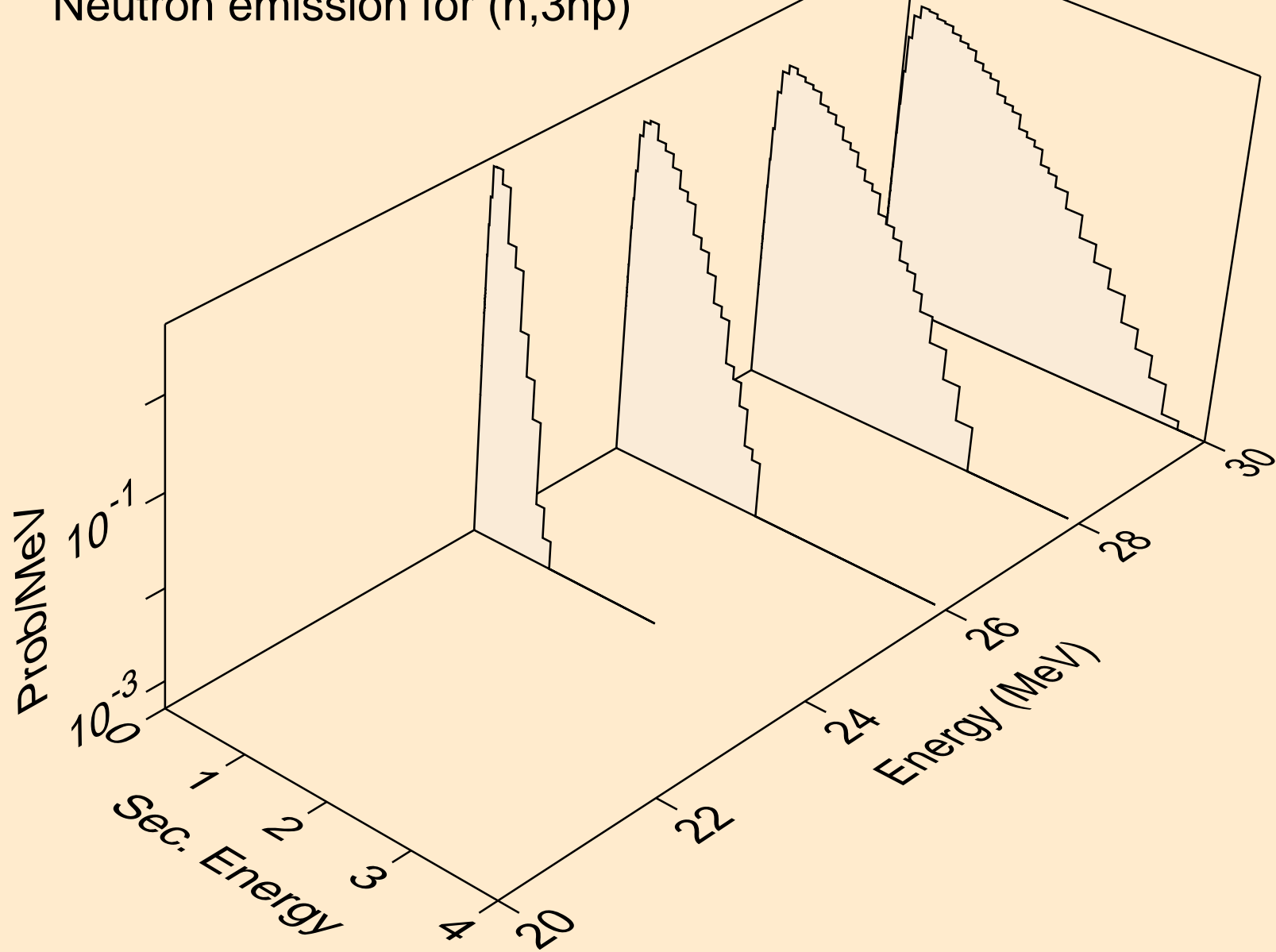

PB191M NEUTRON ACER TENDL-2023 LIBRARY; T=0.K  
Neutron emission for (n,n2p)

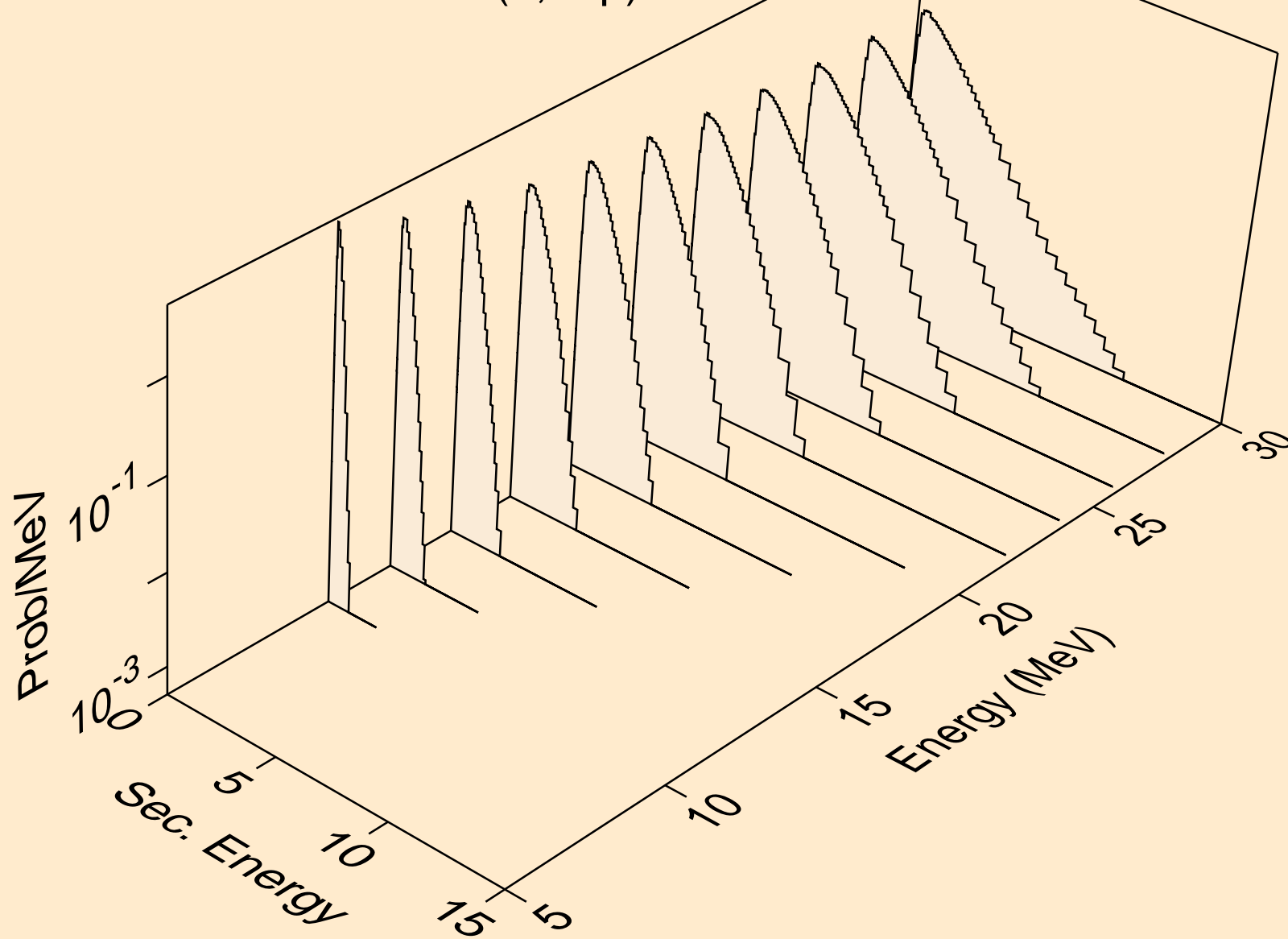

PB191M NEUTRON ACER TENDL-2023 LIBRARY; T=0.K  
Neutron emission for (n,npa)

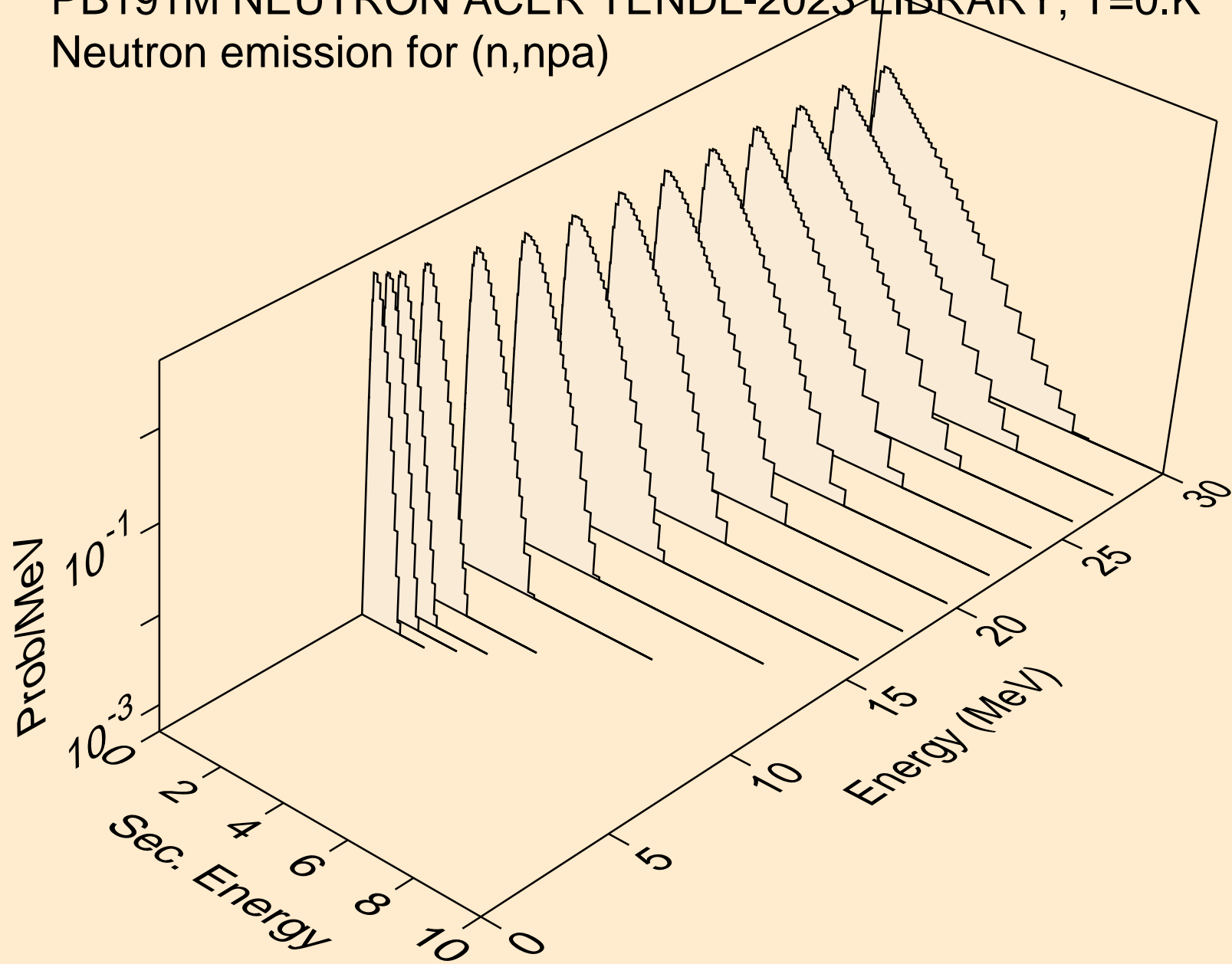

PB191M NEUTRON ACER TENDL-2023 LIBRARY; T=0.K  
Neutron emission for (n,n\*c)

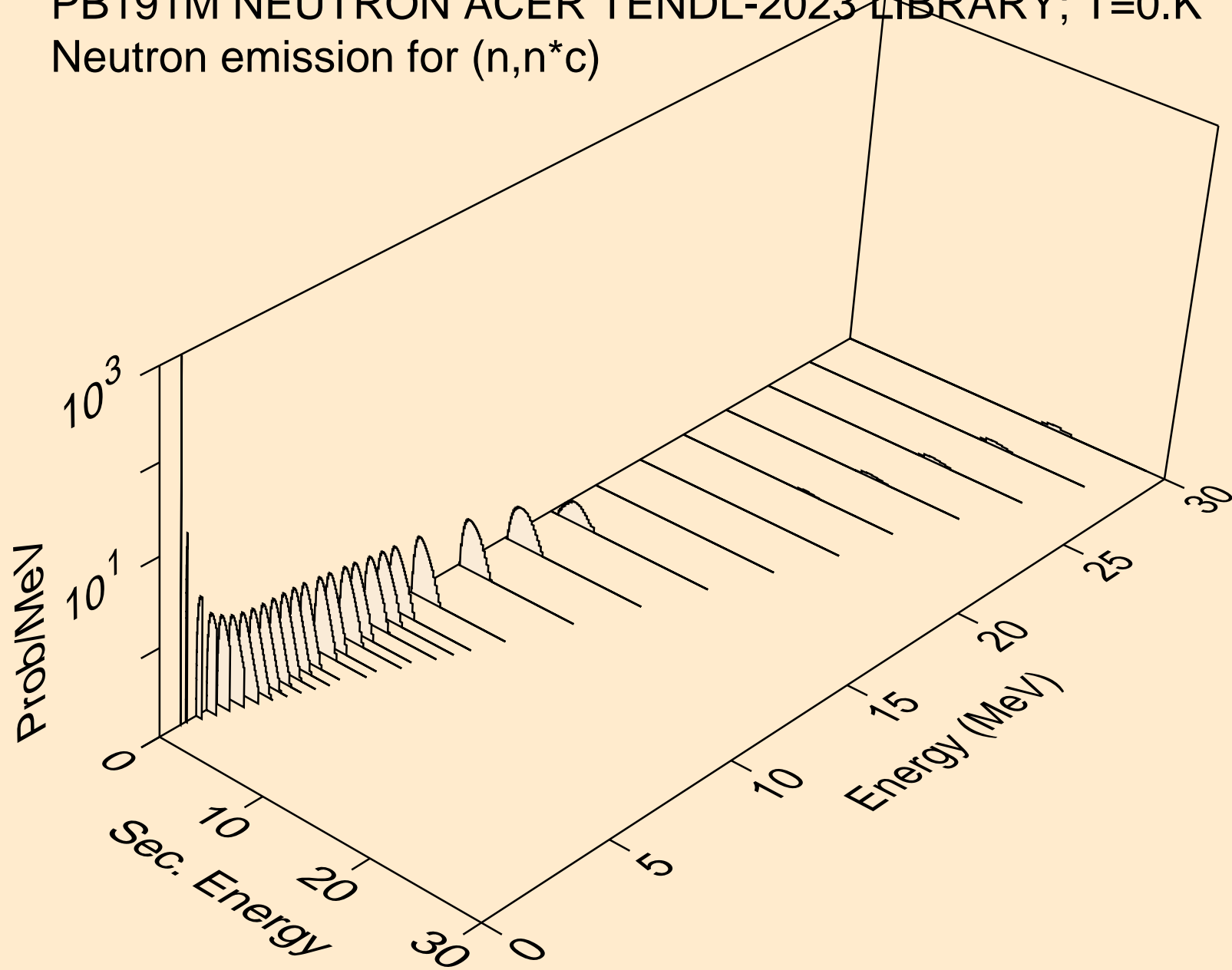

PB191M NEUTRON ACER TENDL-2023 LIBRARY; T=0.K  
Photon emission for (n,x)

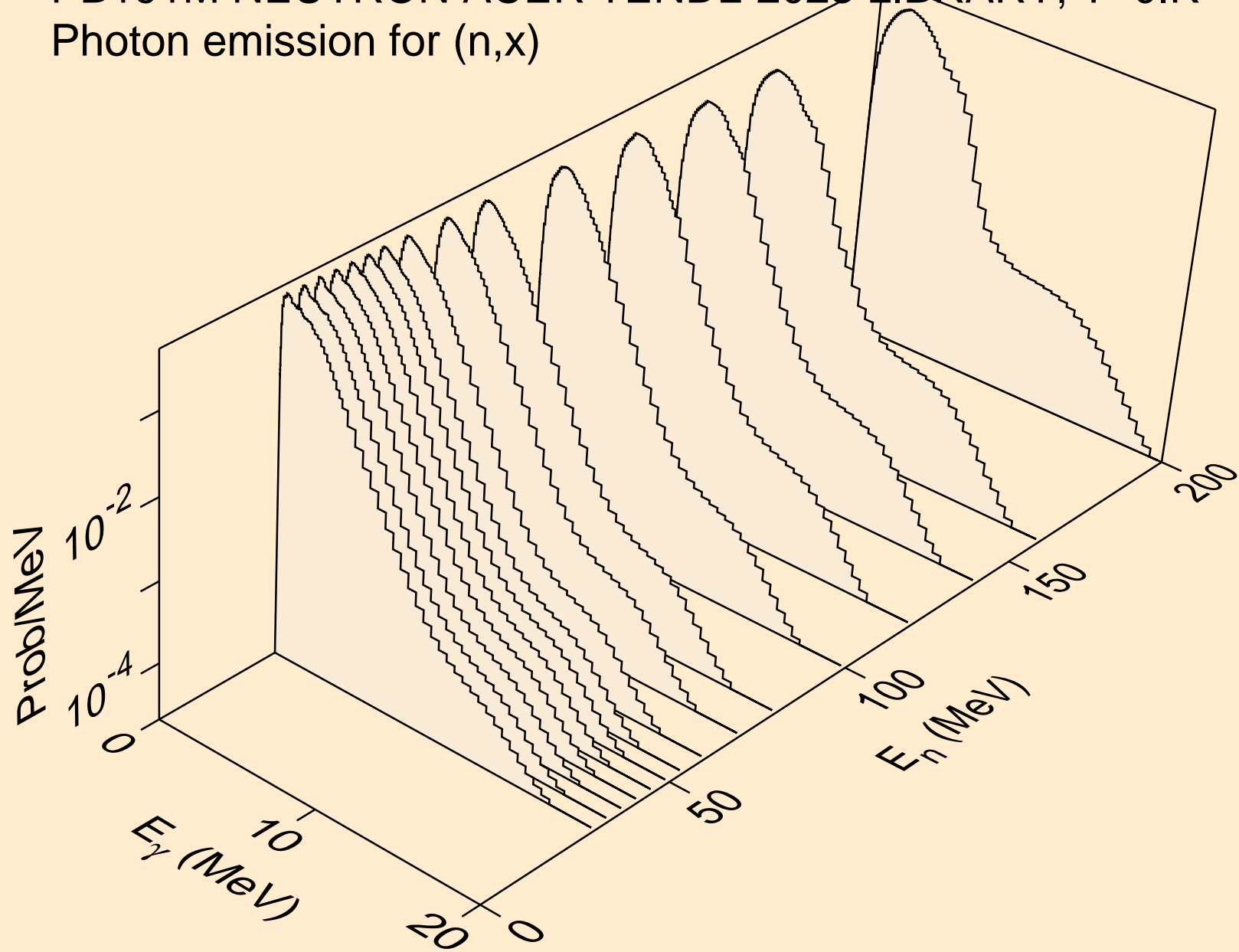

PB191M NEUTRON ACER TENDL-2023 LIBRARY; T=0.K  
Photon emission for (n,2nd)

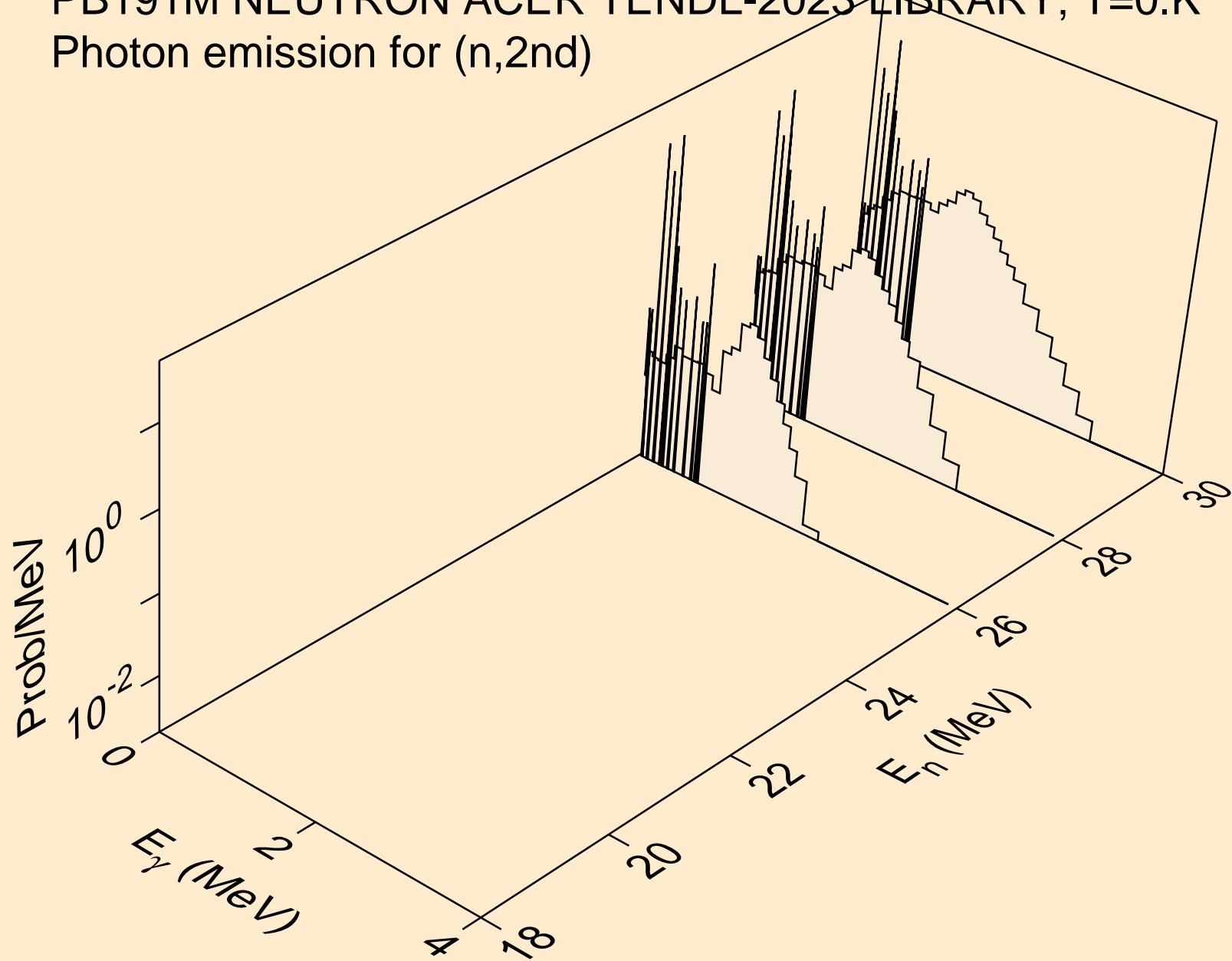

PB191M NEUTRON ACER TENDL-2023 LIBRARY; T=0.K  
Photon emission for (n,2n)

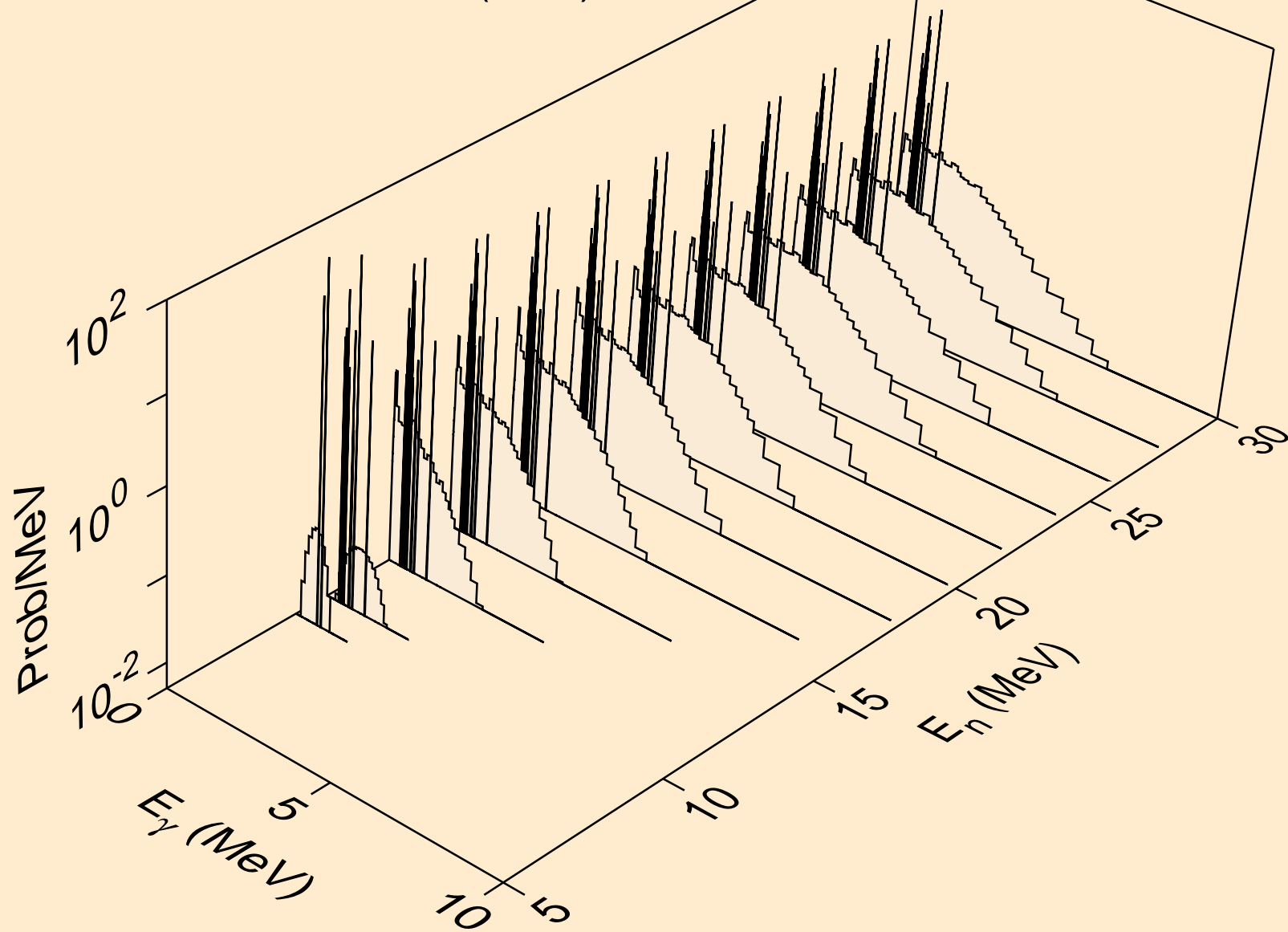

PB191M NEUTRON ACER TENDL-2023 LIBRARY; T=0.K  
Photon emission for (n,3n)

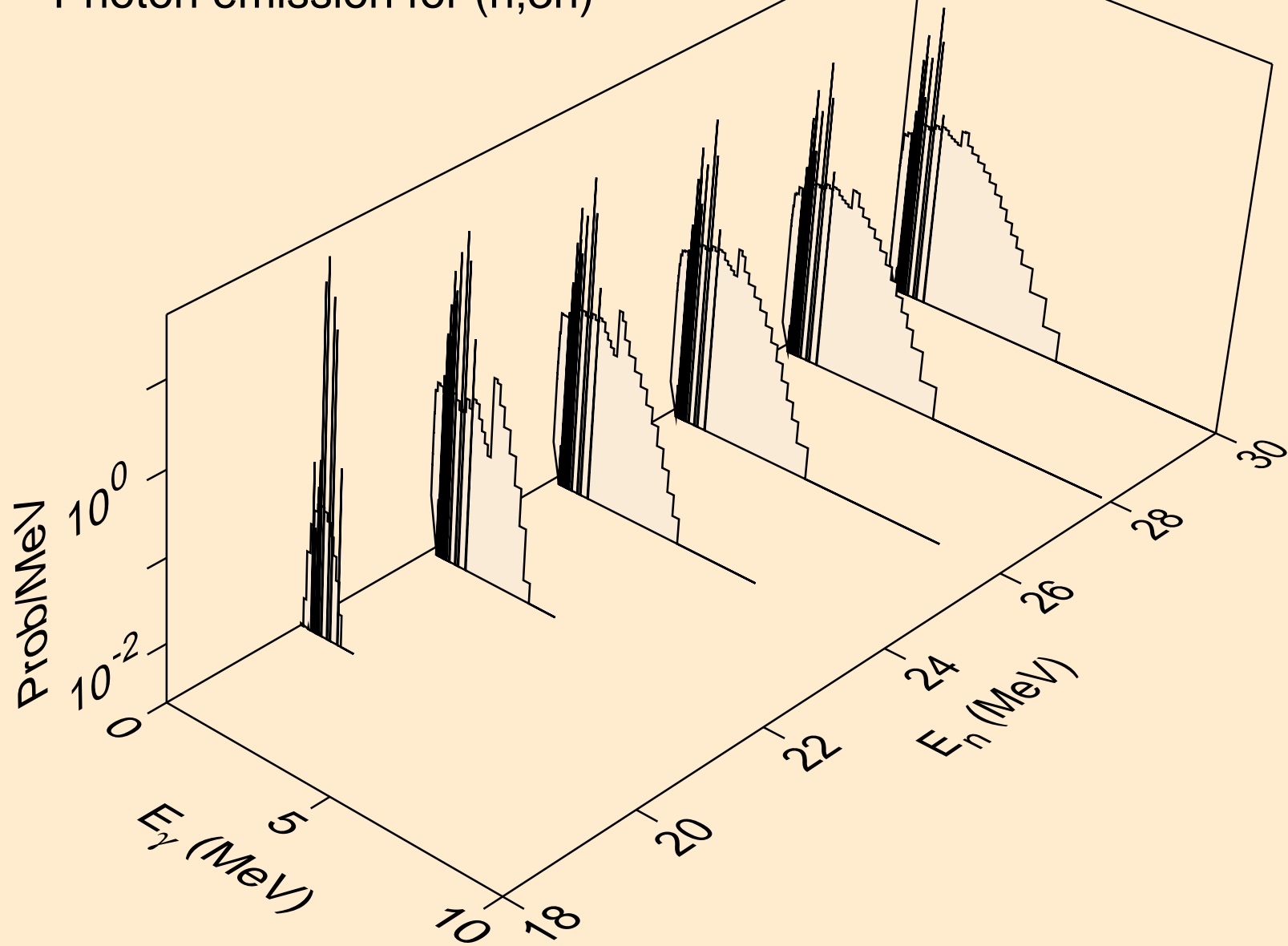

PB191M NEUTRON ACER TENDL-2023 LIBRARY; T=0.K  
Photon emission for (n,n\*)a

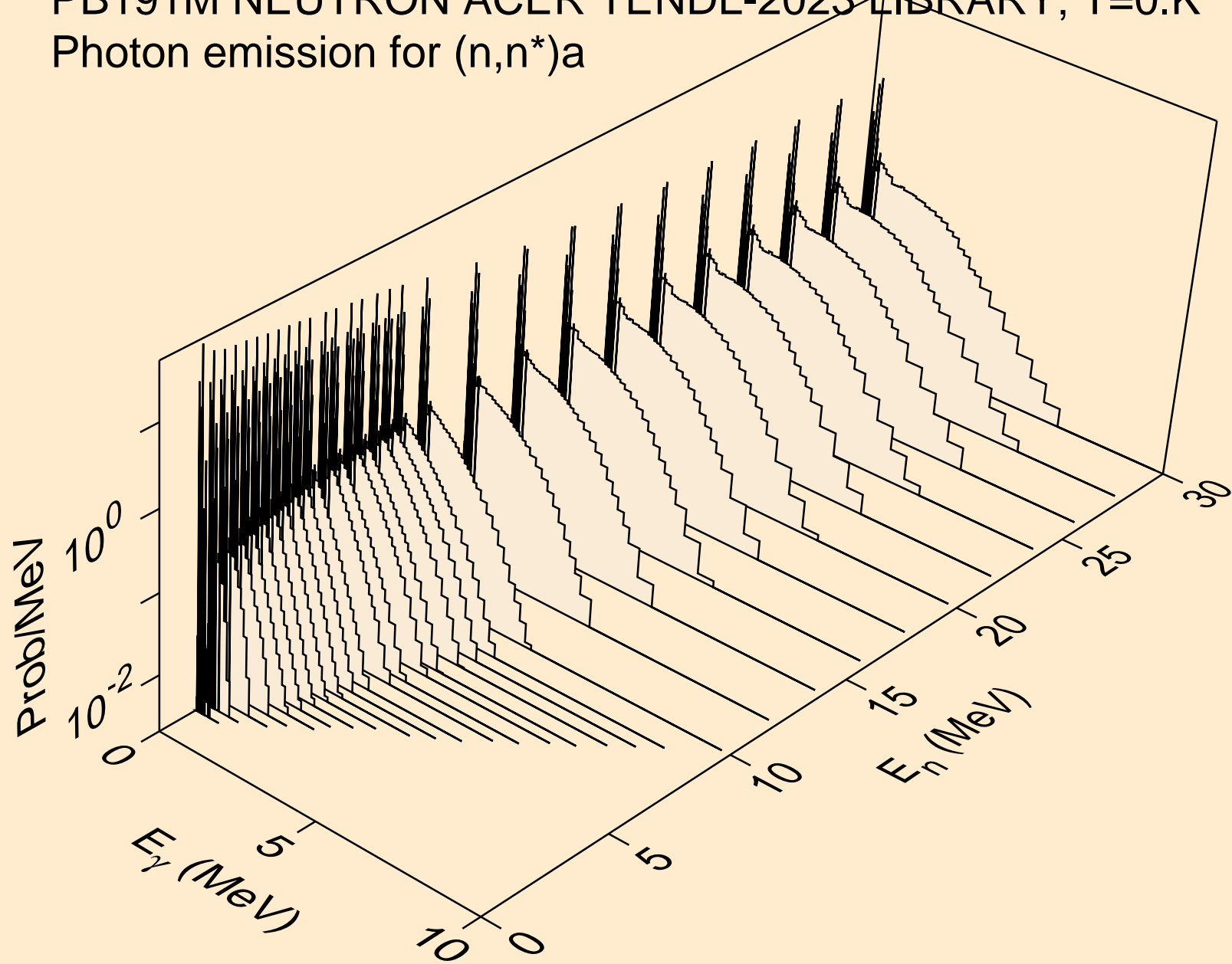

PB191M NEUTRON ACER TENDL-2023 LIBRARY; T=0.K  
Photon emission for (n,2n)a

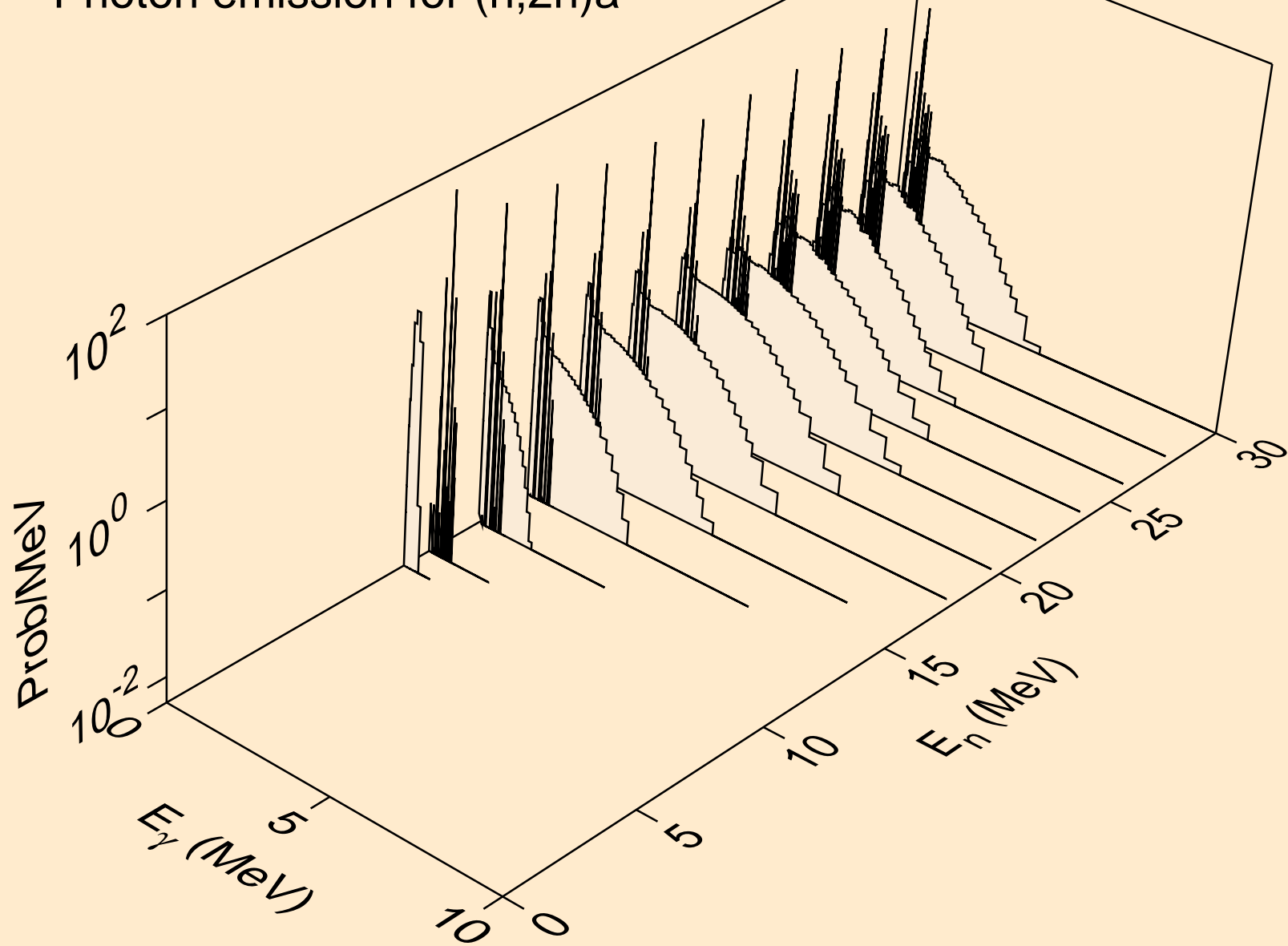

PB191M NEUTRON ACER TENDL-2023 LIBRARY; T=0.K  
Photon emission for (n,3n)a

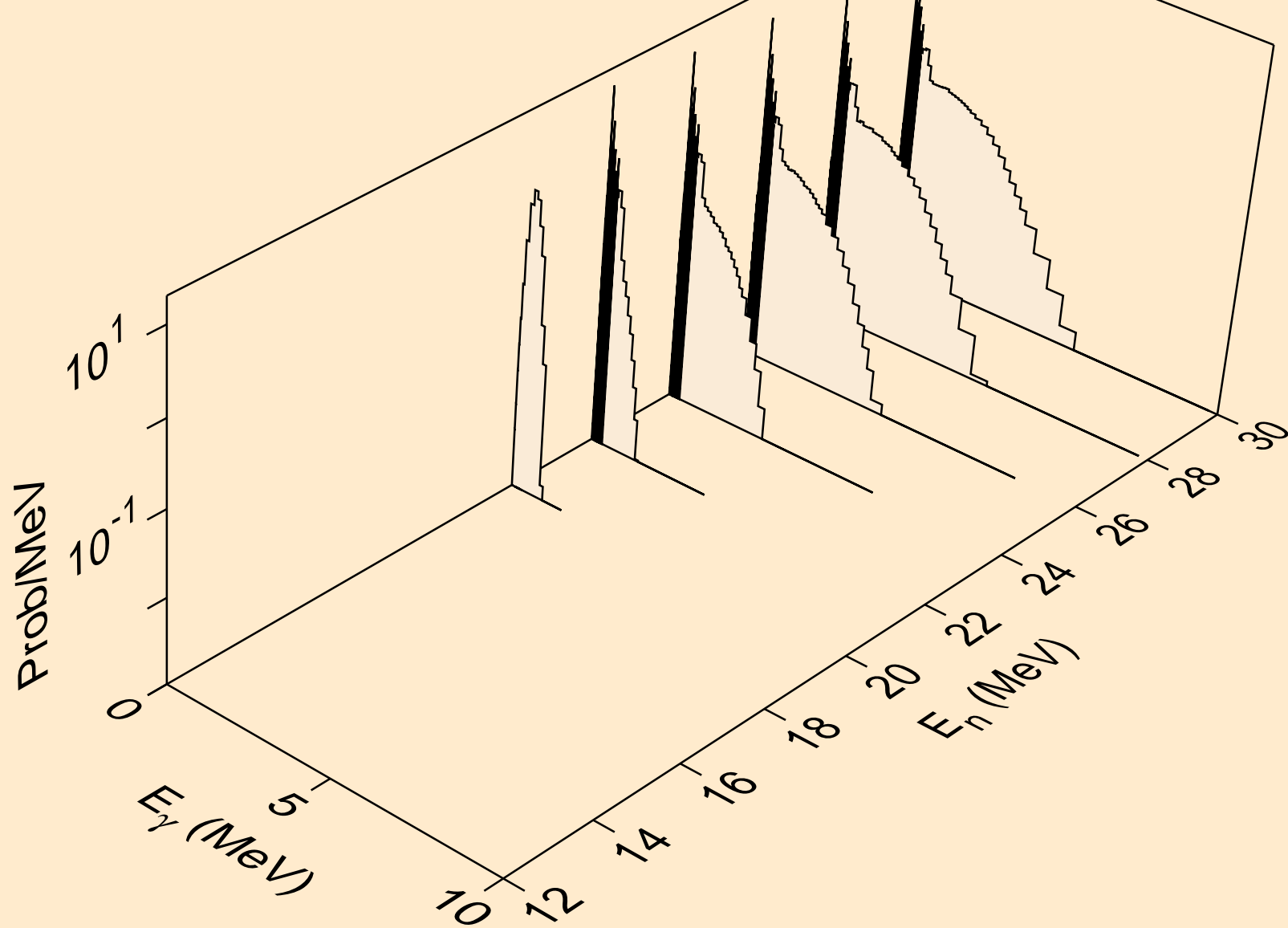

PB191M NEUTRON ACER TENDL-2023 LIBRARY; T=0.K  
Photon emission for (n,n\*)p

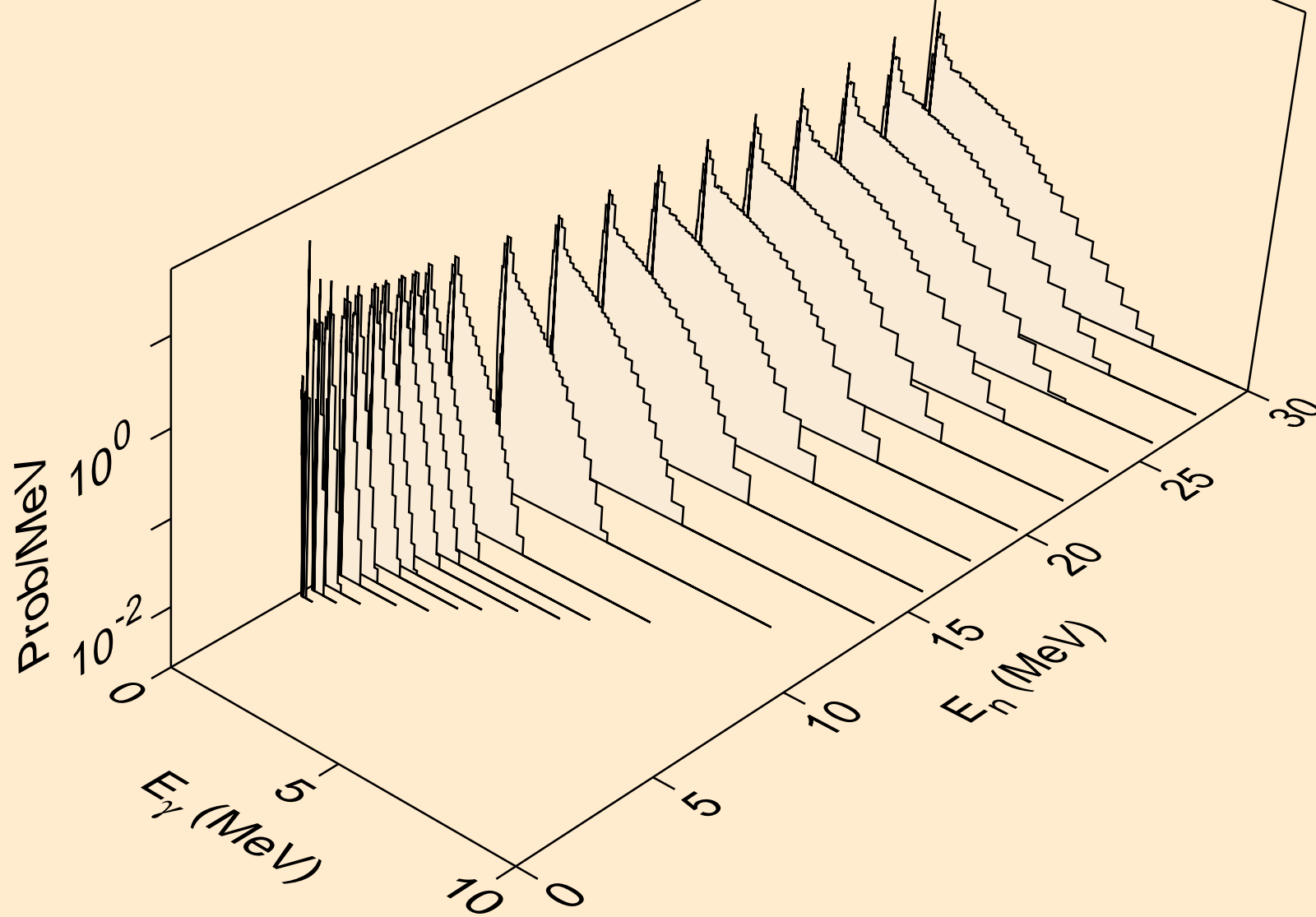

PB191M NEUTRON ACER TENDL-2023 LIBRARY; T=0.K  
Photon emission for (n,n\*)2a

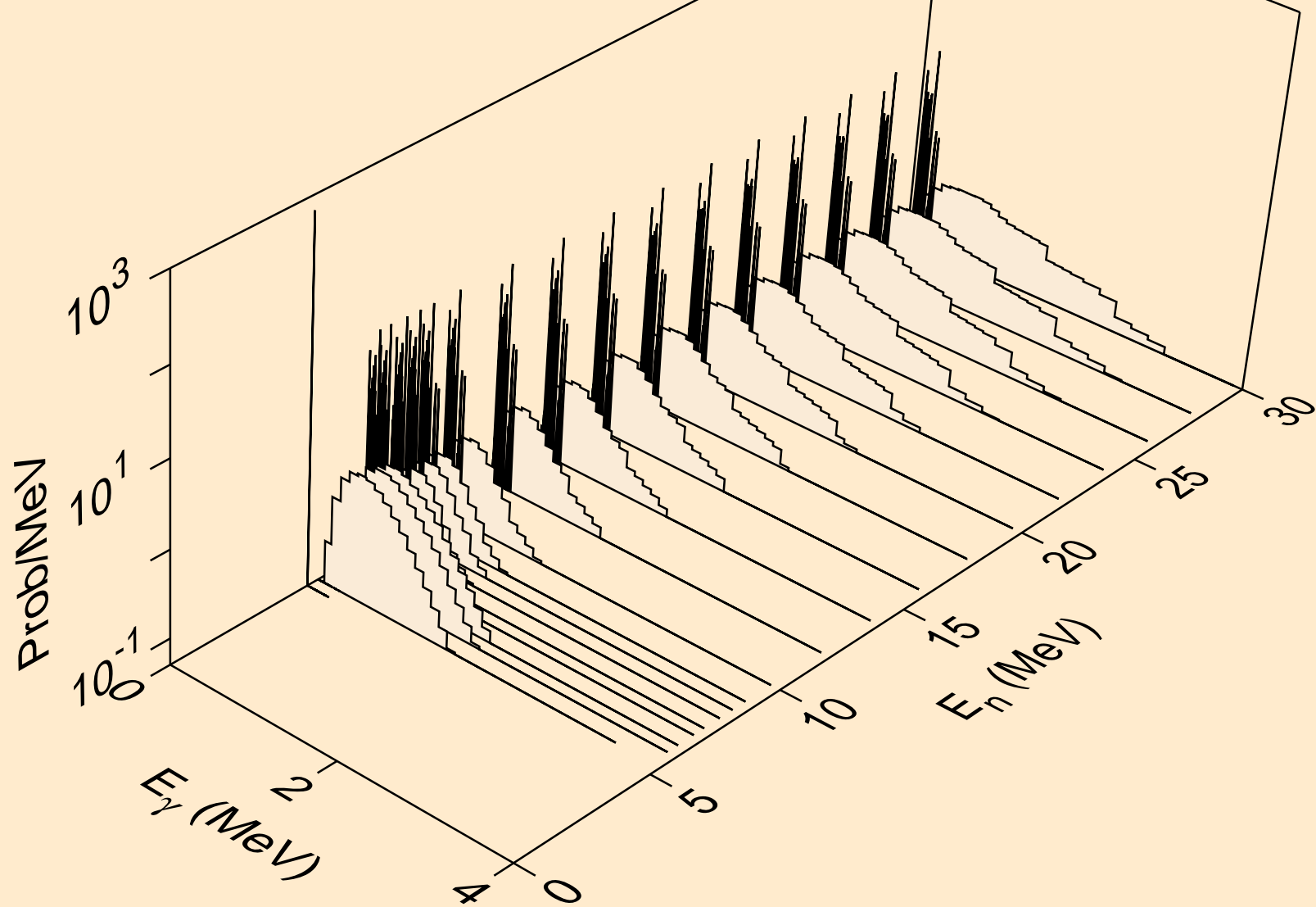

PB191M NEUTRON ACER TENDL-2023 LIBRARY; T=0.K  
Photon emission for (n,2n)2a

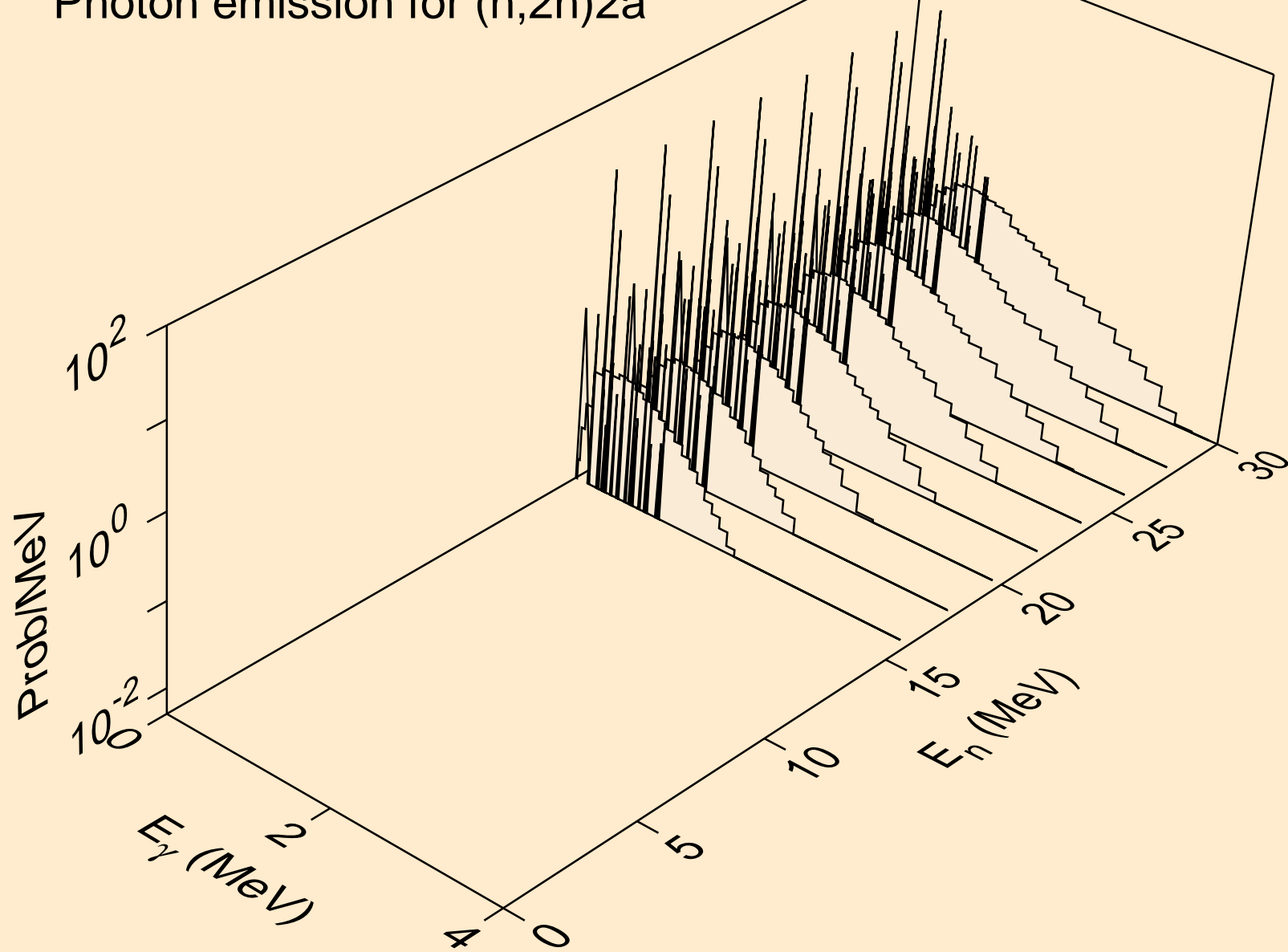

PB191M NEUTRON ACER TENDL-2023 LIBRARY; T=0.K  
Photon emission for (n,n\*)d

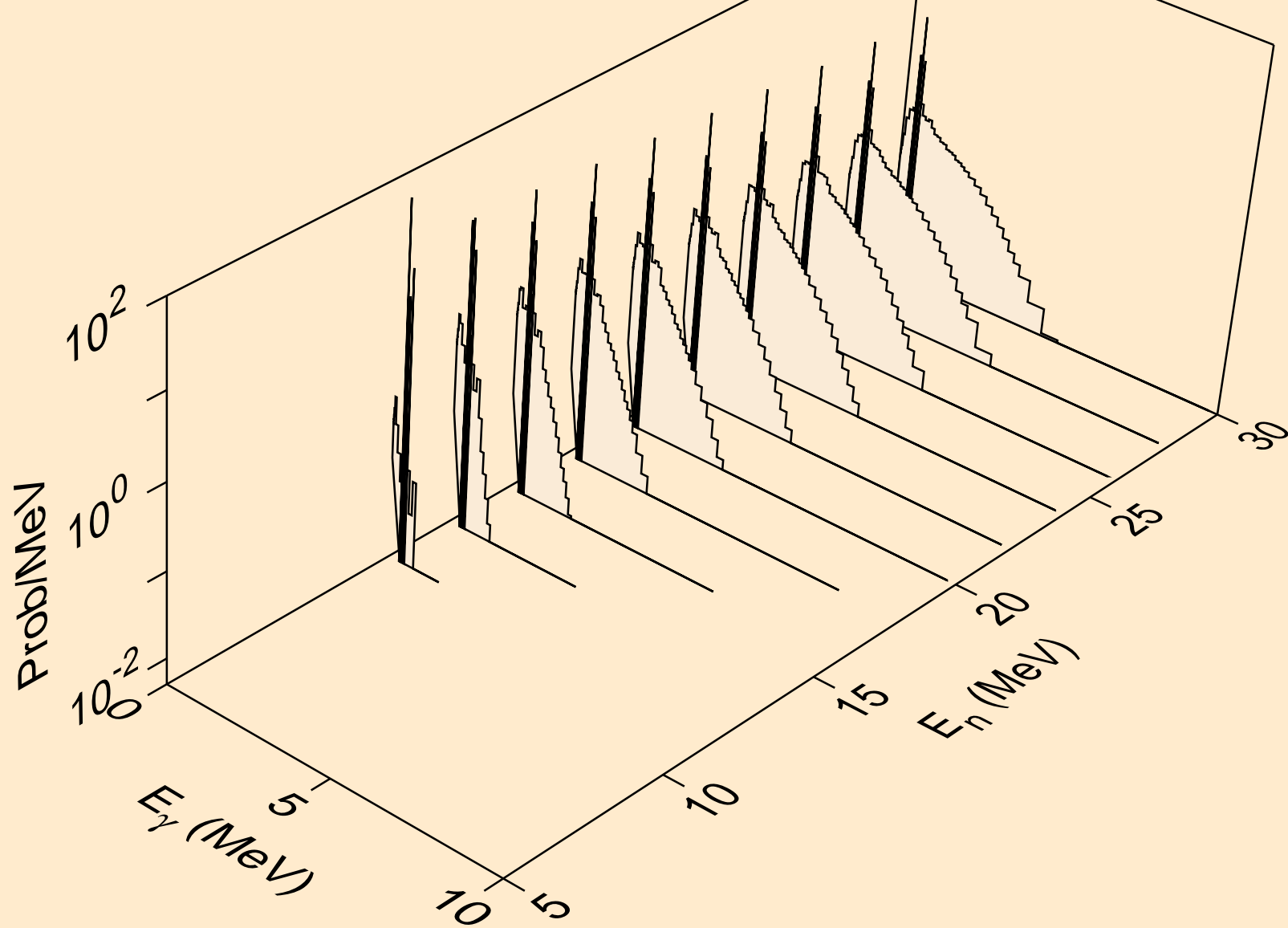

PB191M NEUTRON ACER TENDL-2023 LIBRARY; T=0.K  
Photon emission for (n,n\*)t

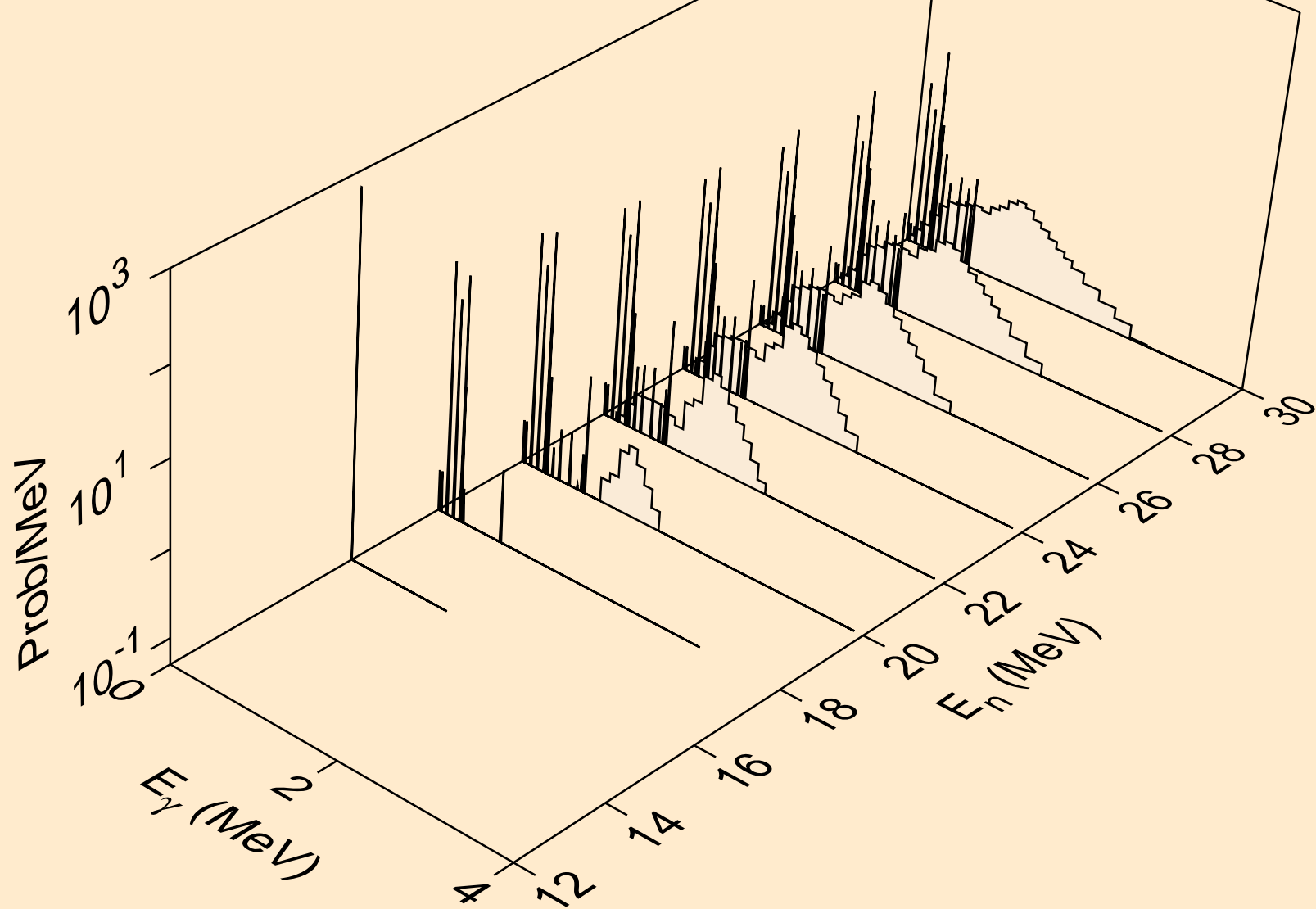

PB191M NEUTRON ACER TENDL-2023 LIBRARY; T=0.K  
Photon emission for (n,n\*)he3

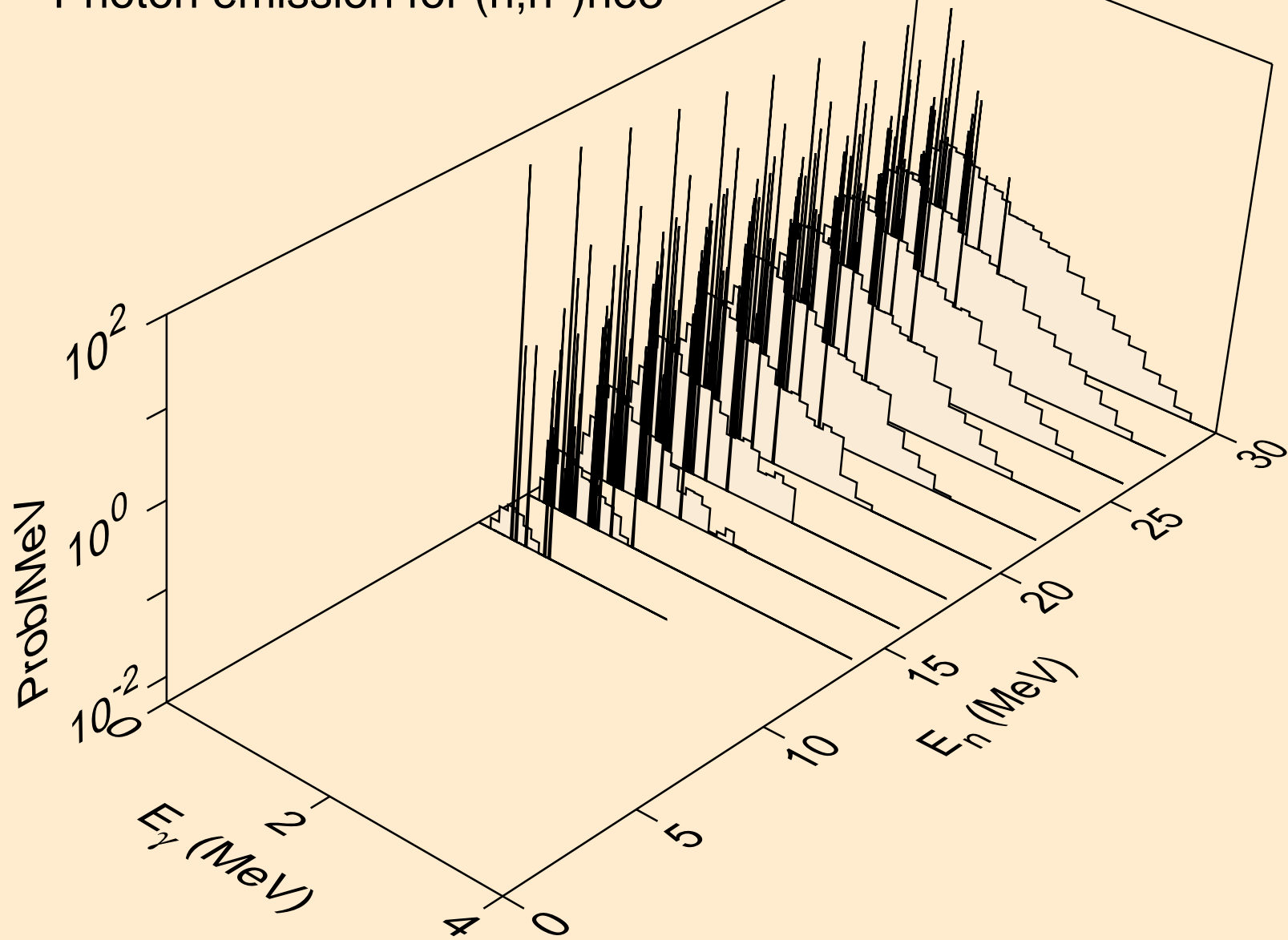

PB191M NEUTRON ACER TENDL-2023 LIBRARY; T=0.K  
Photon emission for (n,4n)

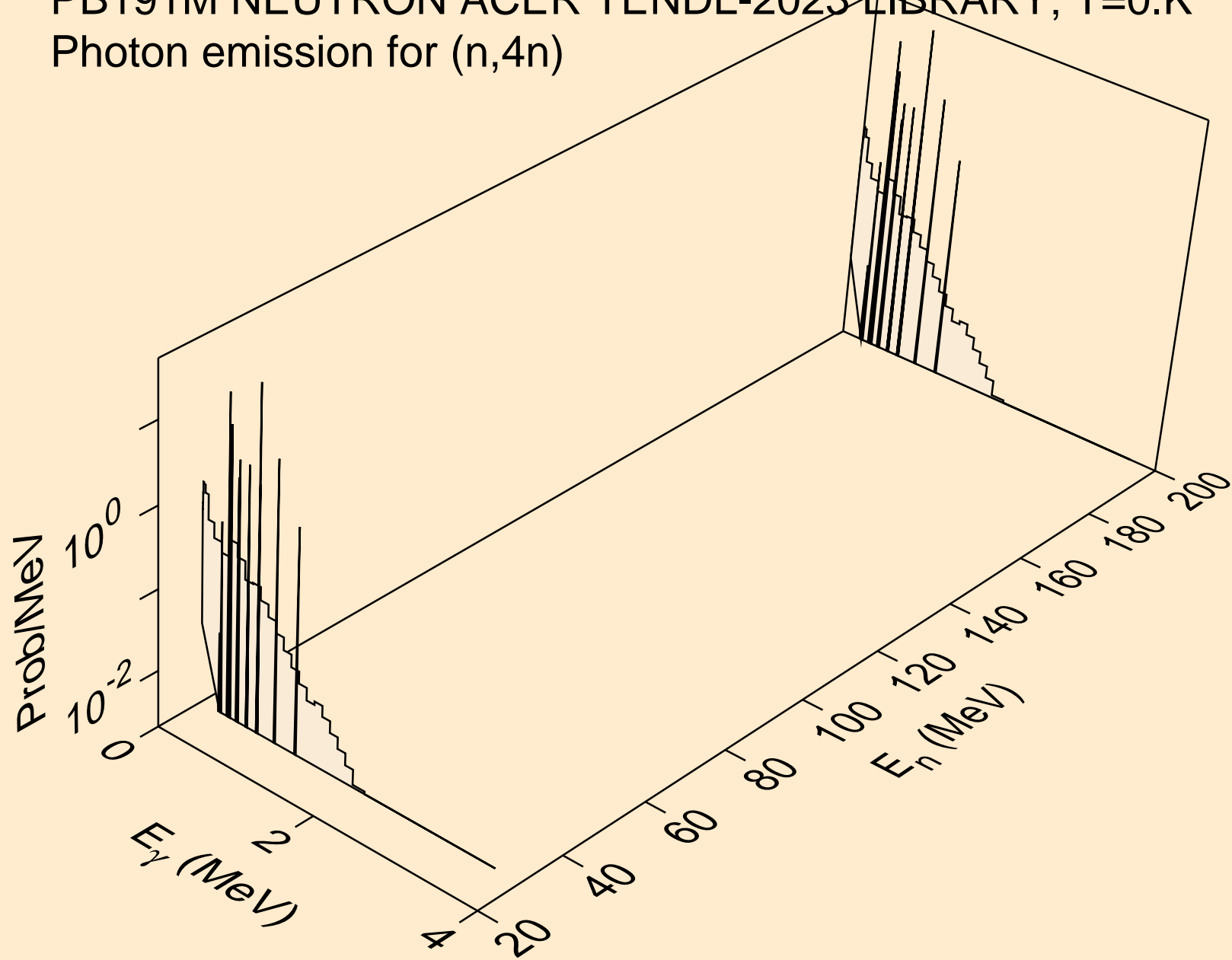

PB191M NEUTRON ACER TENDL-2023 LIBRARY; T=0.K  
Photon emission for (n,2np)

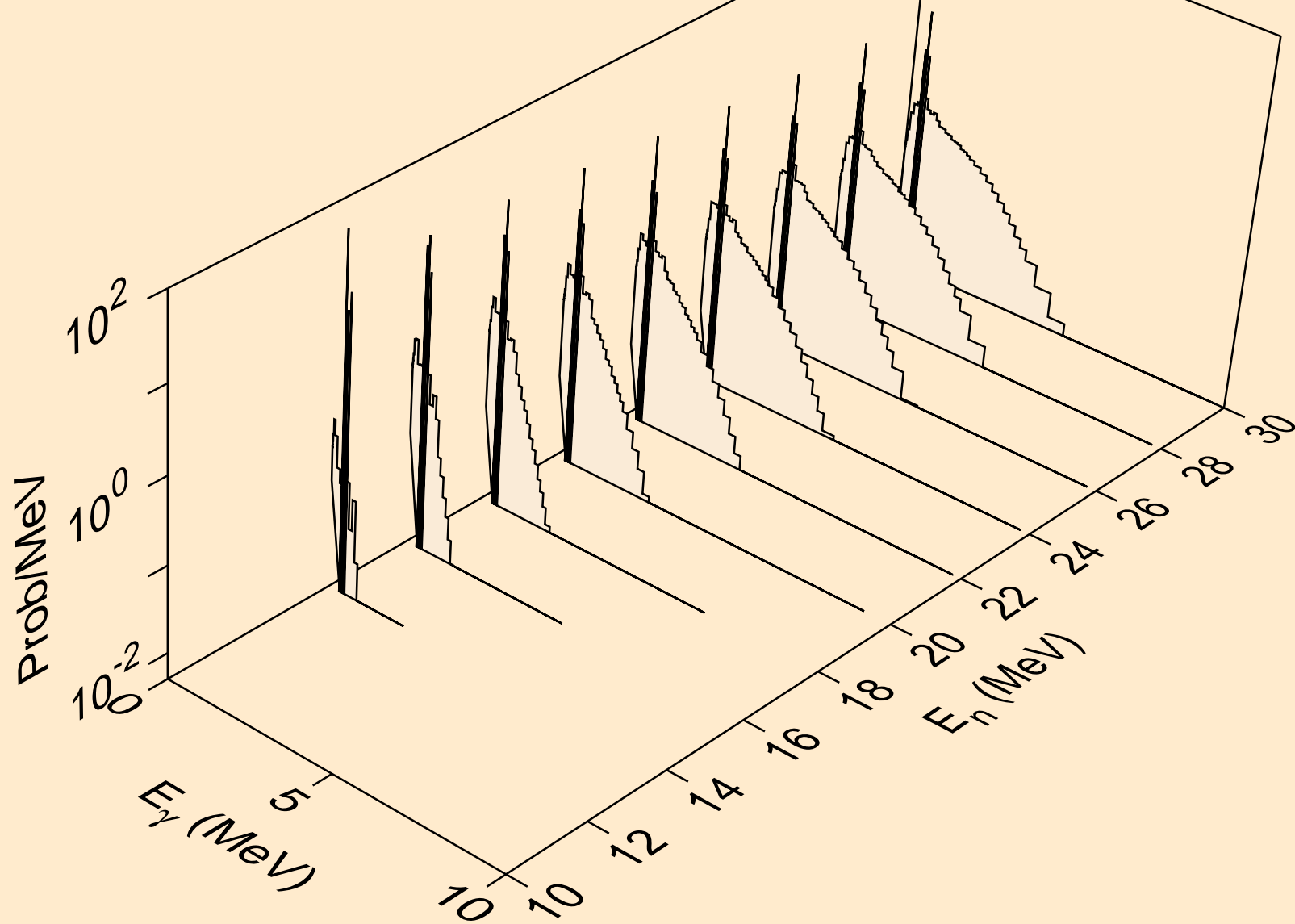

PB191M NEUTRON ACER TENDL-2023 LIBRARY; T=0.K  
Photon emission for (n,3np)

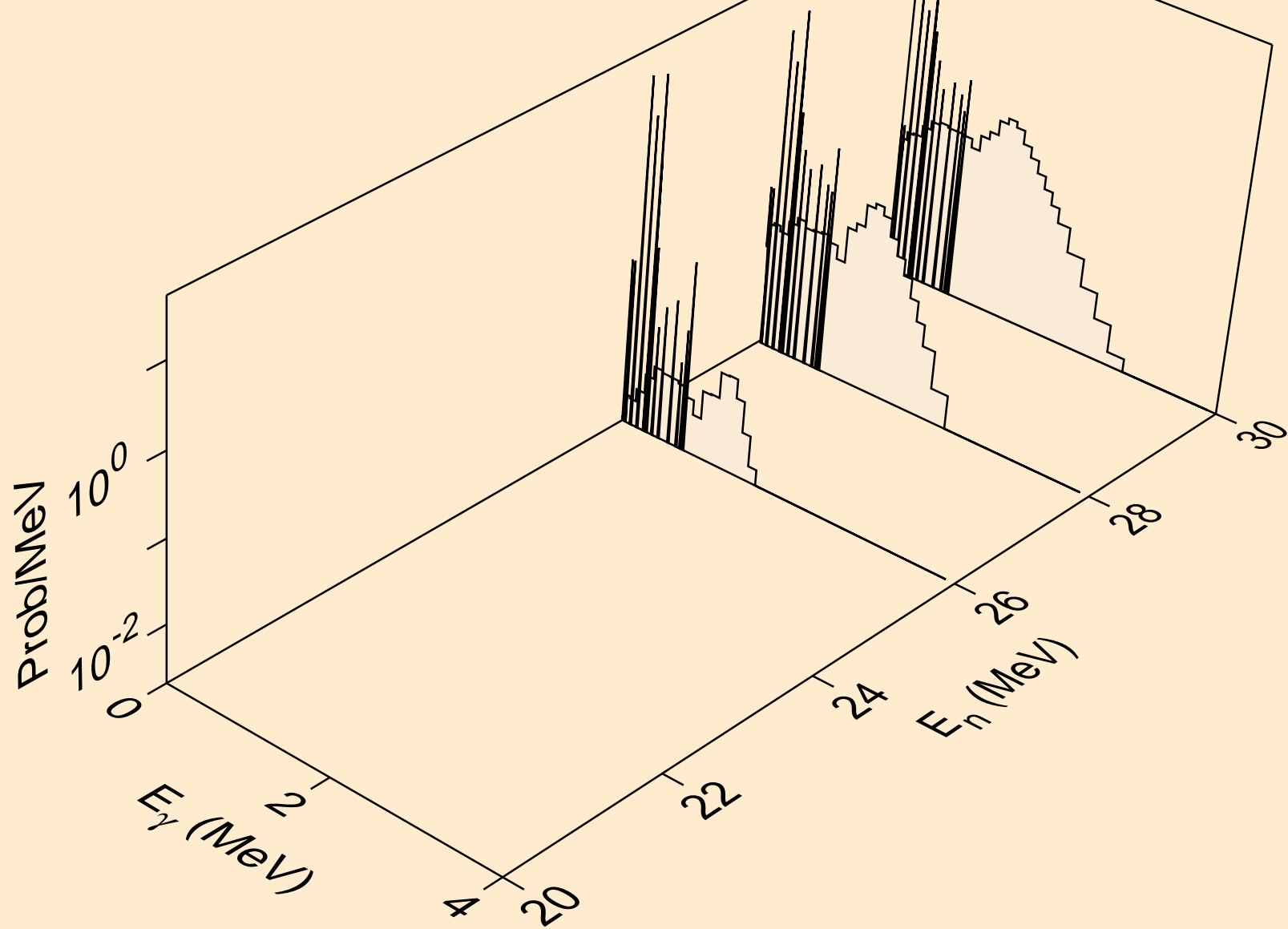

PB191M NEUTRON ACER TENDL-2023 LIBRARY; T=0.K  
Photon emission for (n,n2p)

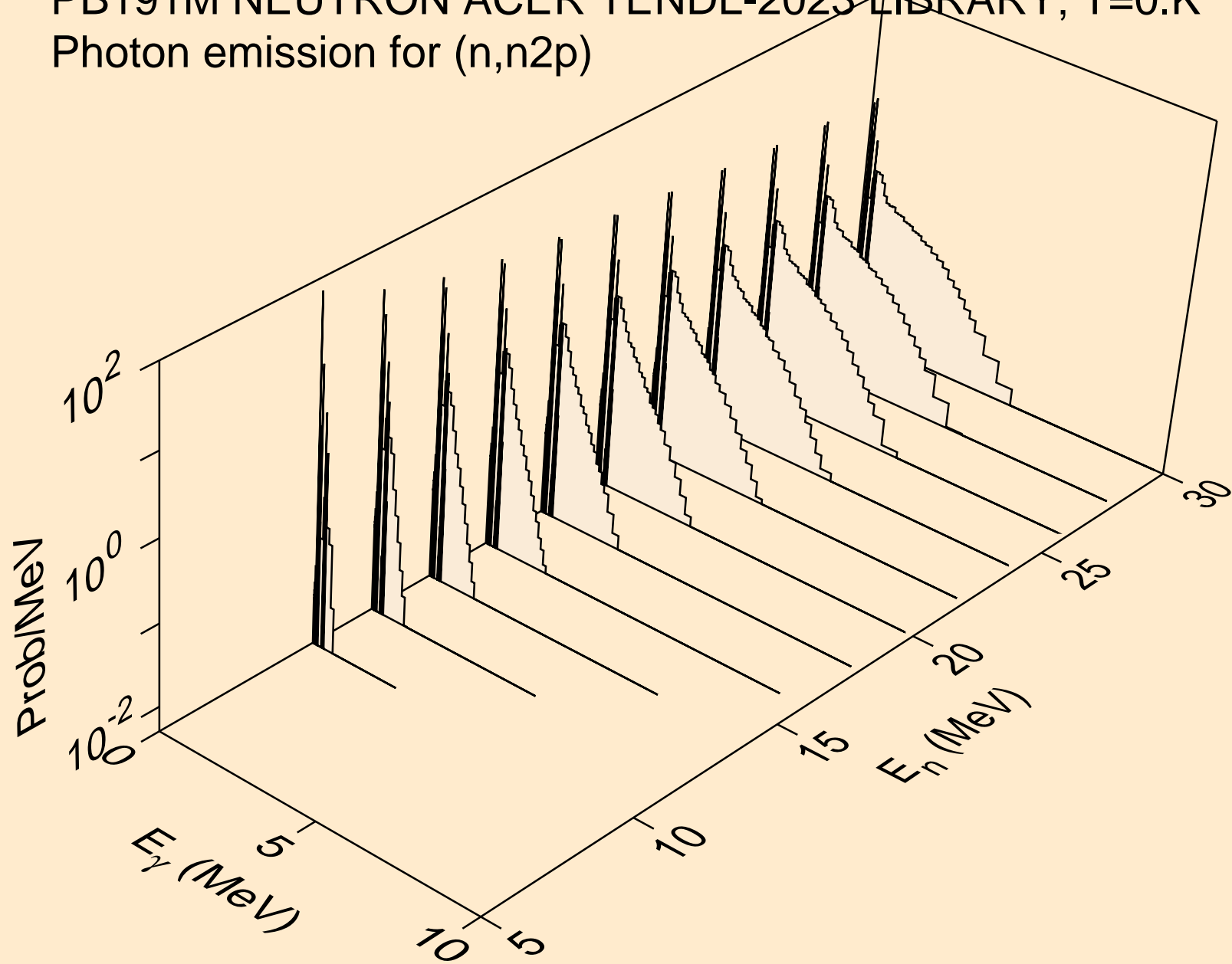

PB191M NEUTRON ACER TENDL-2023 LIBRARY; T=0.K  
Photon emission for (n,npa)

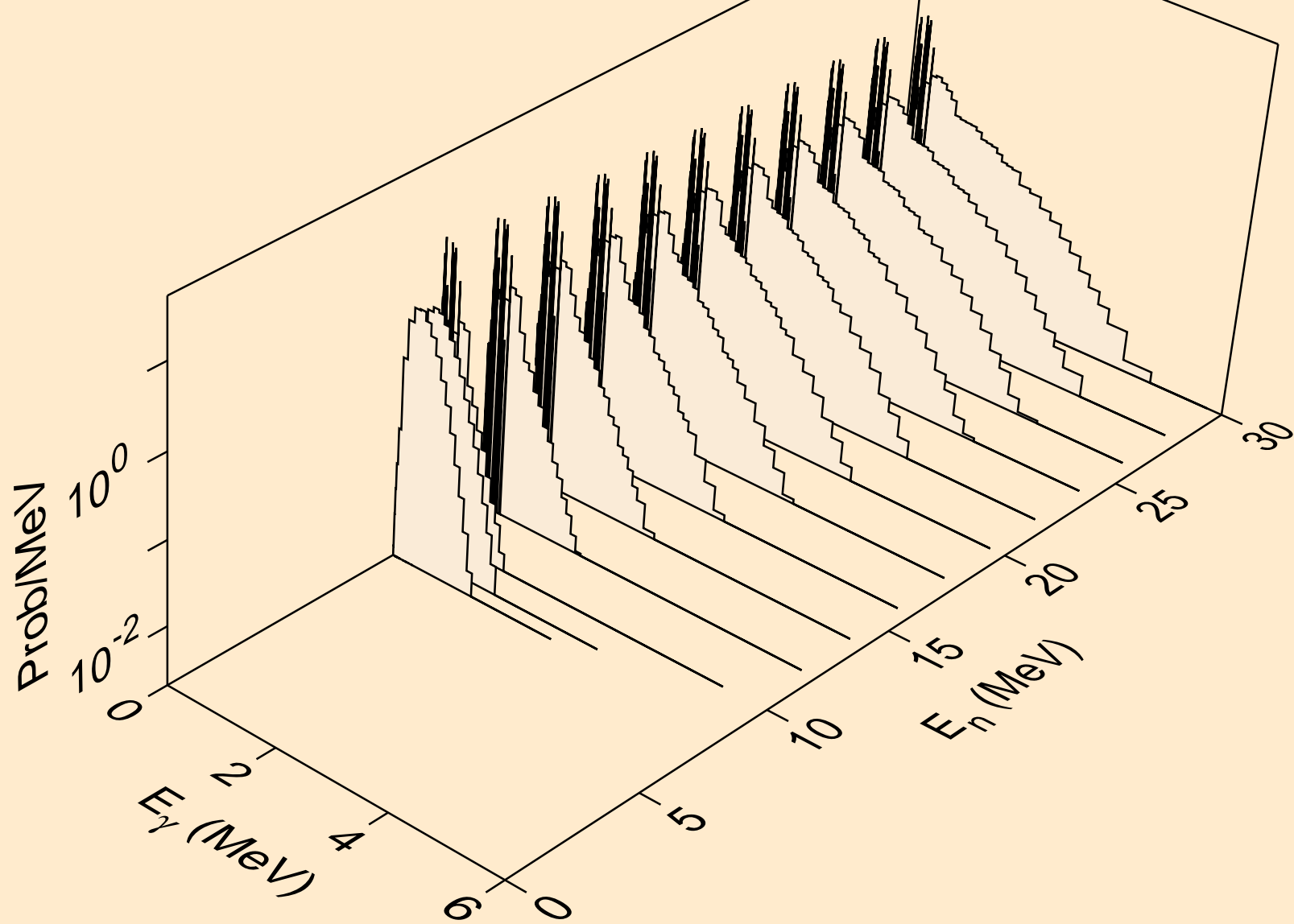

PB191M NEUTRON ACER TENDL-2023 LIBRARY; T=0.K  
Photon emission for (n,n\*2)

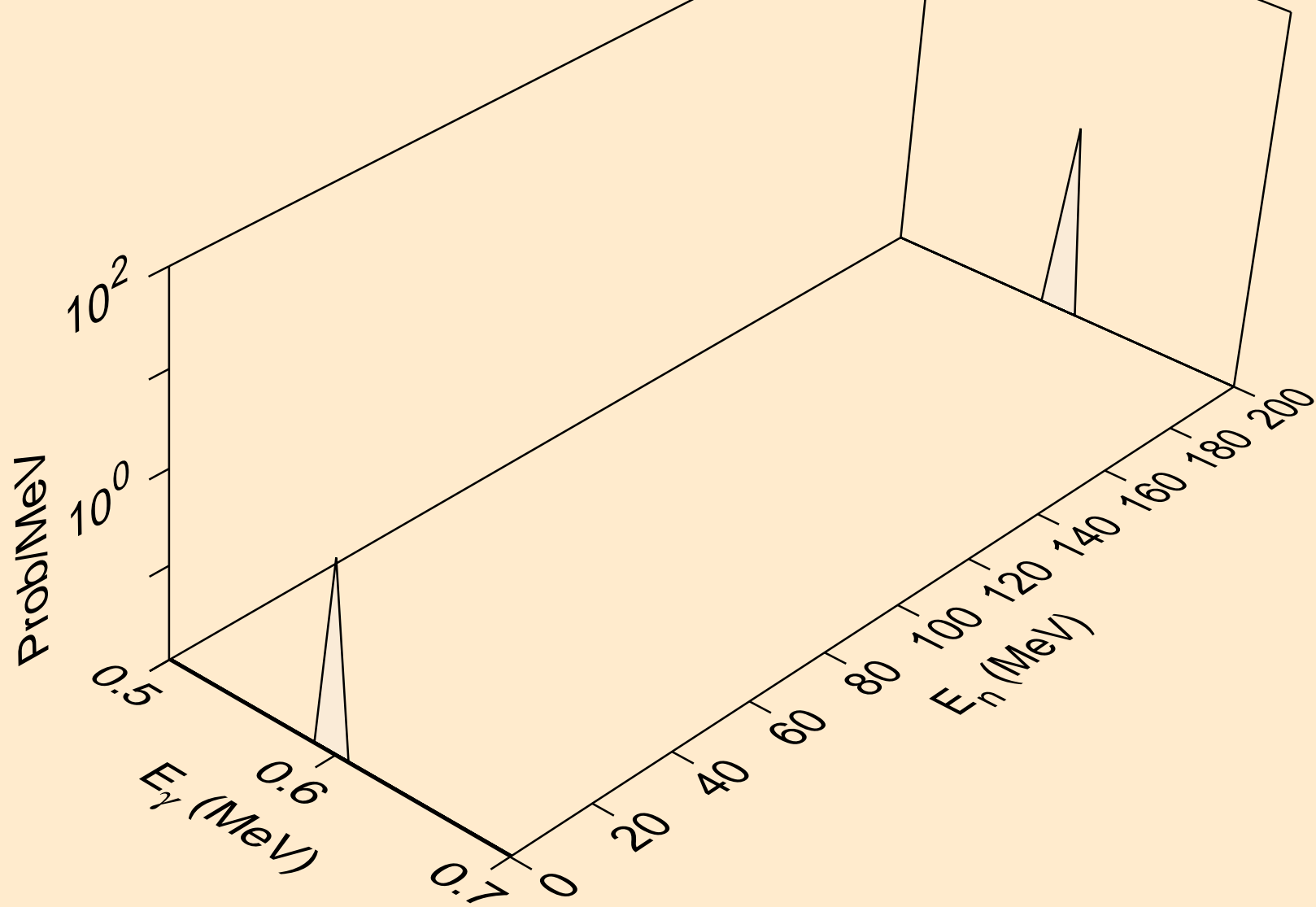

PB191M NEUTRON ACER TENDL-2023 LIBRARY; T=0.K  
Photon emission for (n,n\*c)

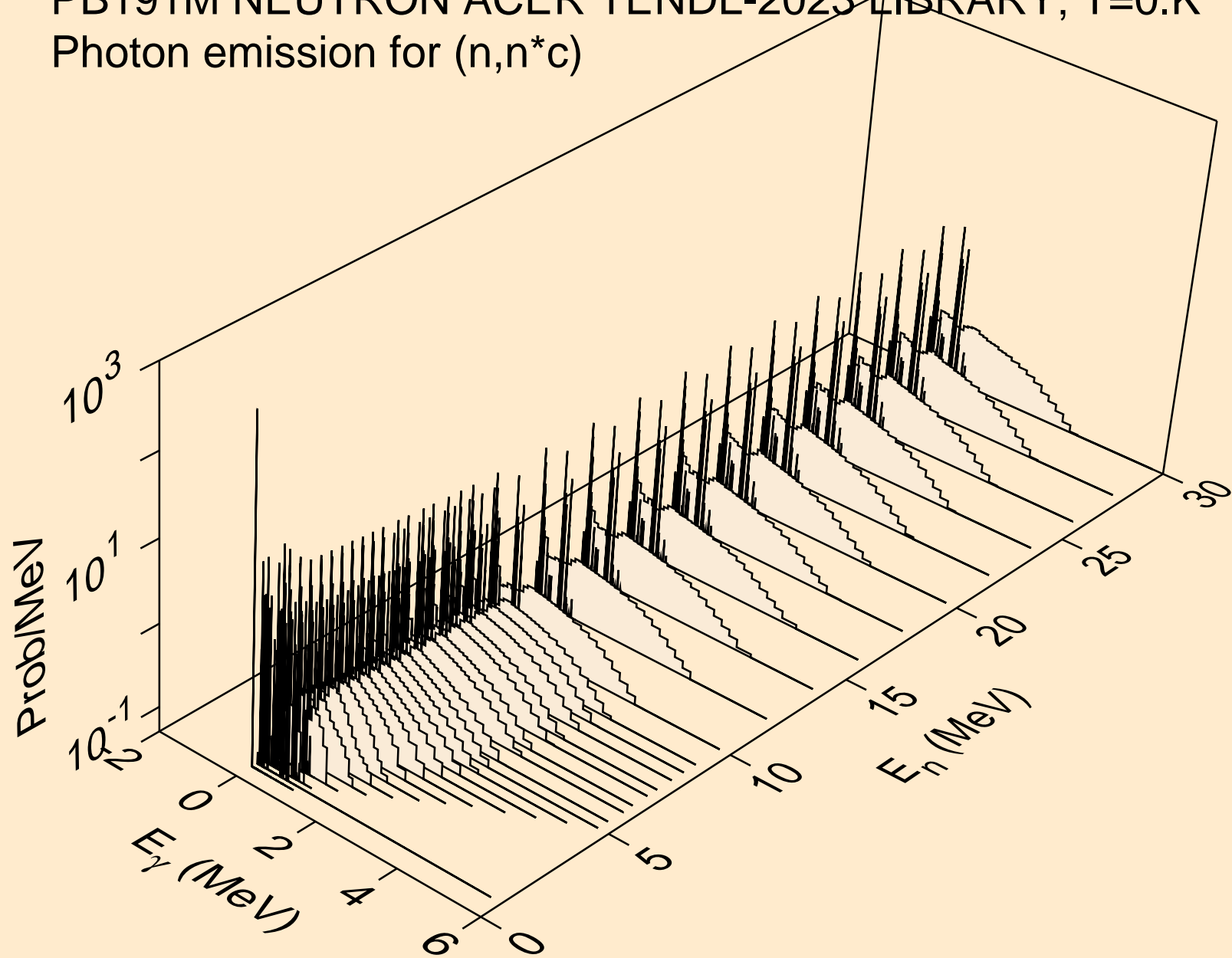

PB191M NEUTRON ACER TENDL-2023 LIBRARY; T=0.K  
Photon emission for (n,gma)

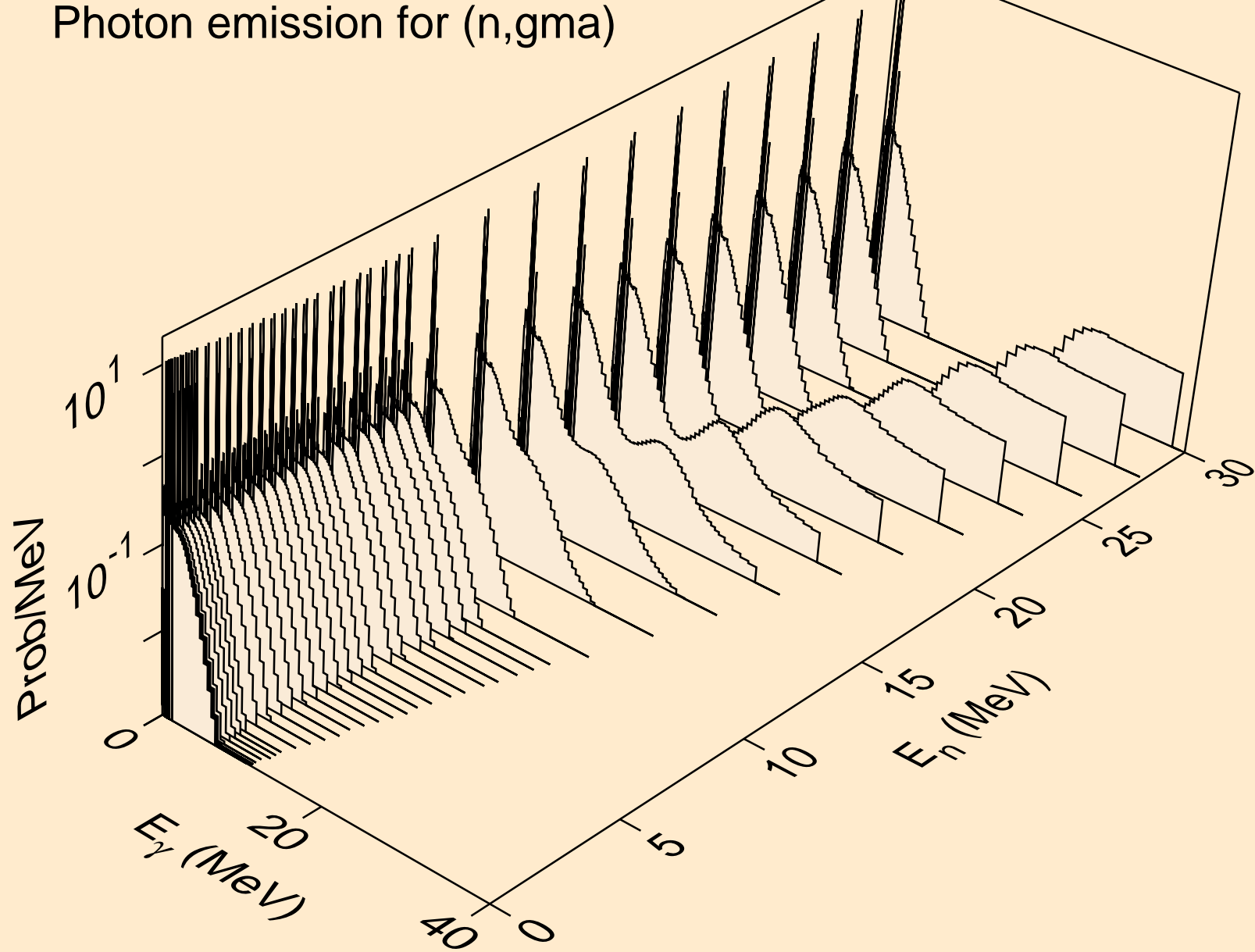

PB191M NEUTRON ACER TENDL-2023 LIBRARY; T=0.K  
Photon emission for (n,p)

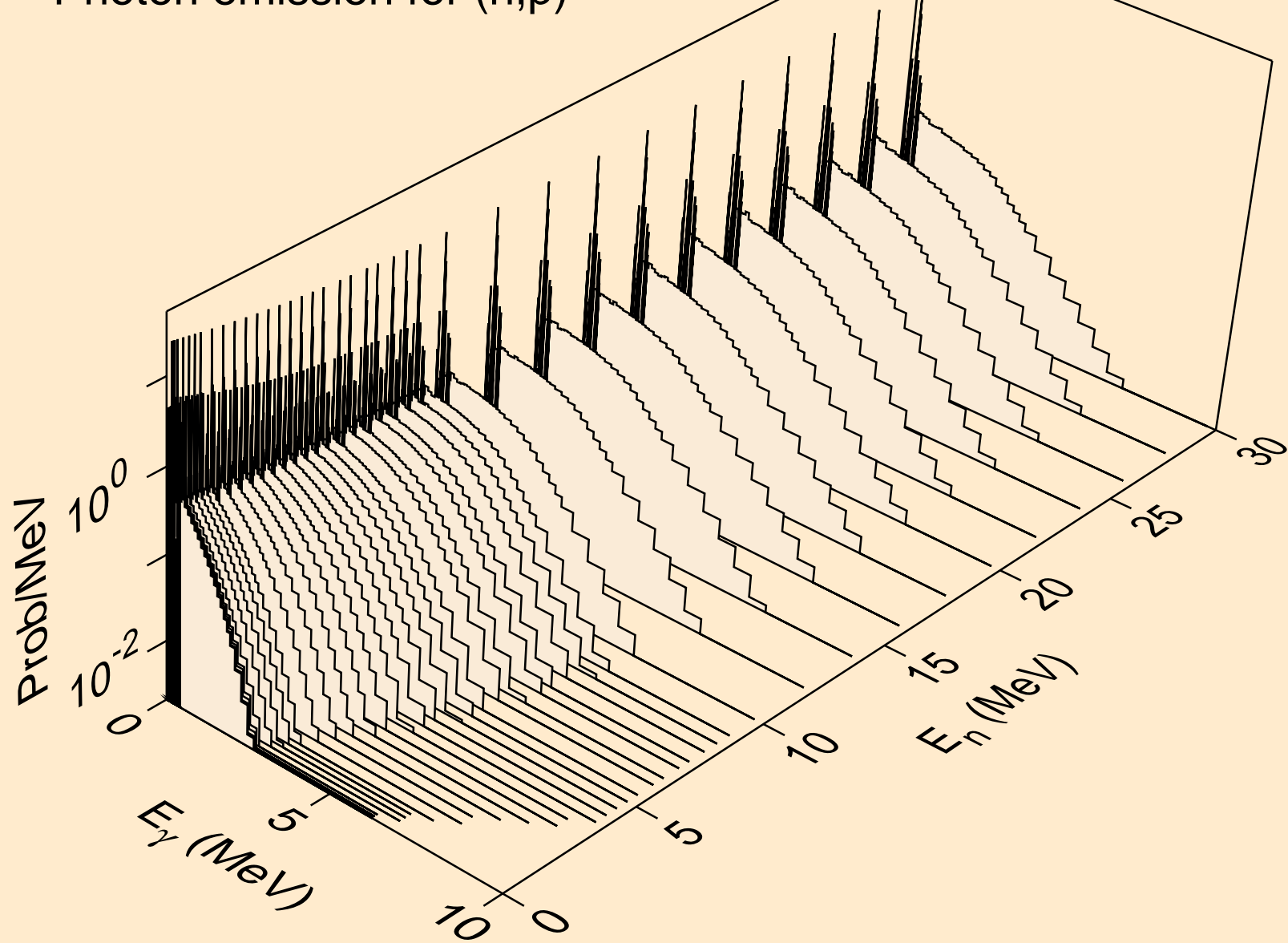

PB191M NEUTRON ACER TENDL-2023 LIBRARY; T=0.K  
Photon emission for (n,d)

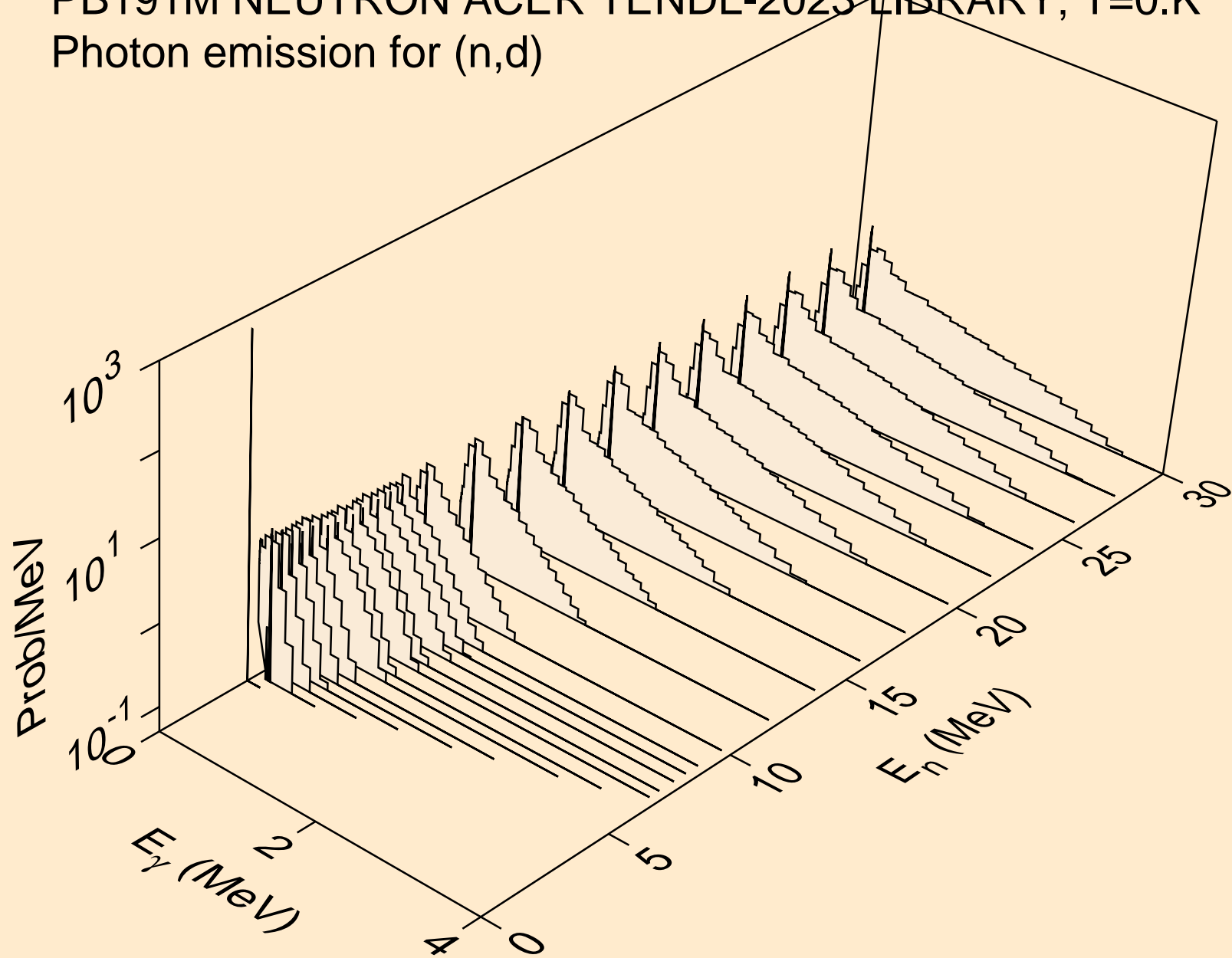

PB191M NEUTRON ACER TENDL-2023 LIBRARY; T=0.K  
Photon emission for (n,t)

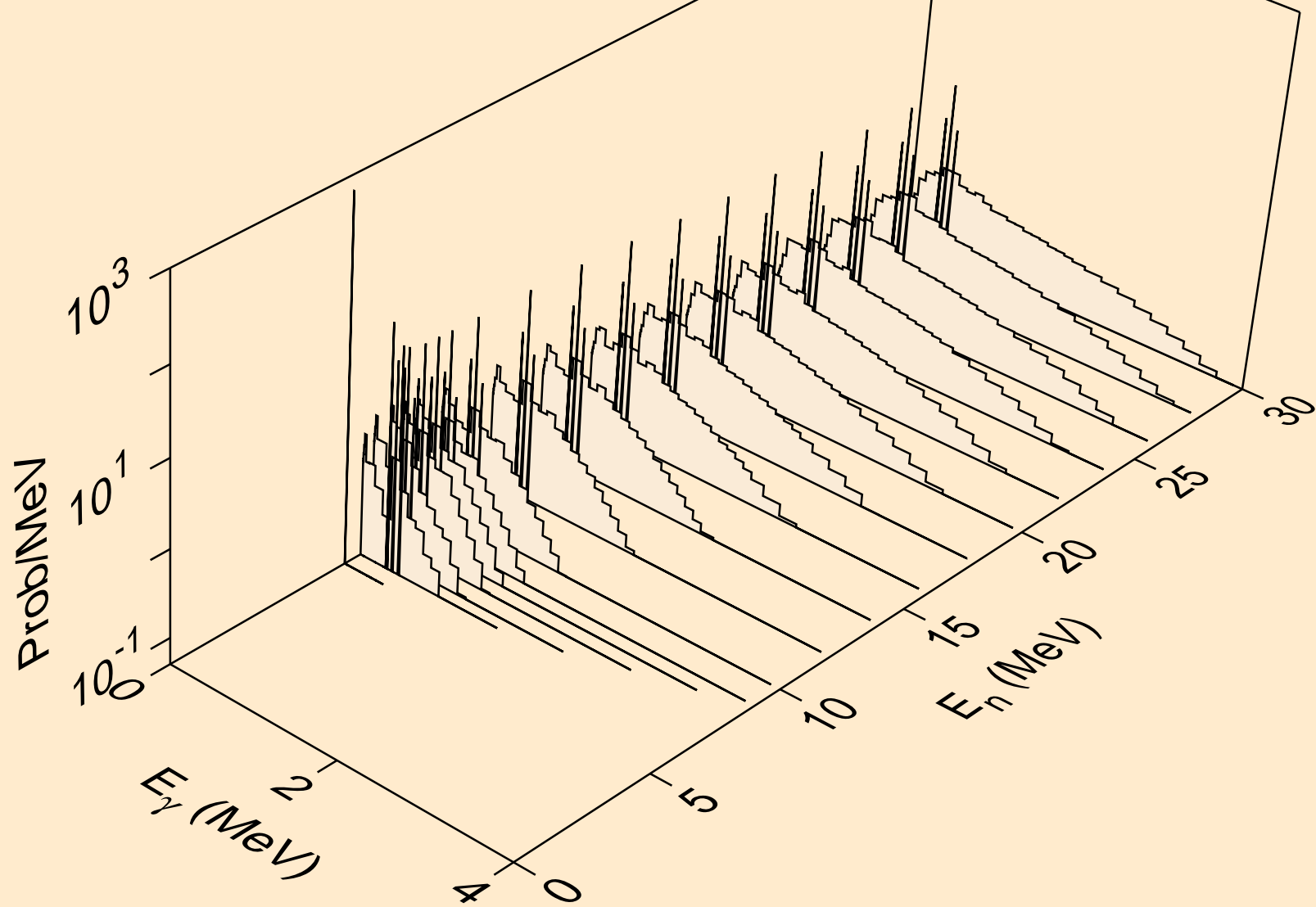

PB191M NEUTRON ACER TENDL-2023 LIBRARY; T=0.K  
Photon emission for (n,he3)

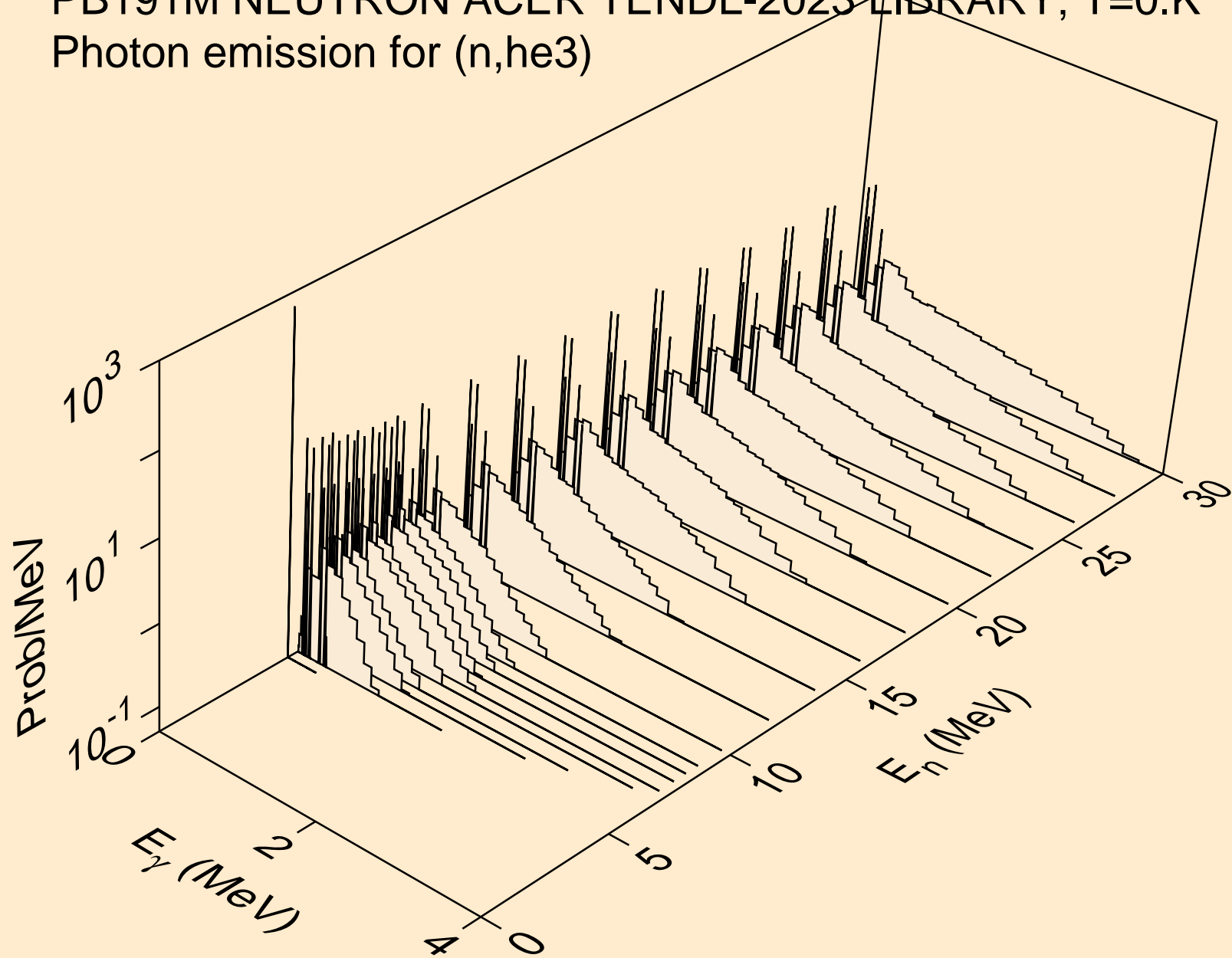

PB191M NEUTRON ACER TENDL-2023 LIBRARY; T=0.K  
Photon emission for (n,a)

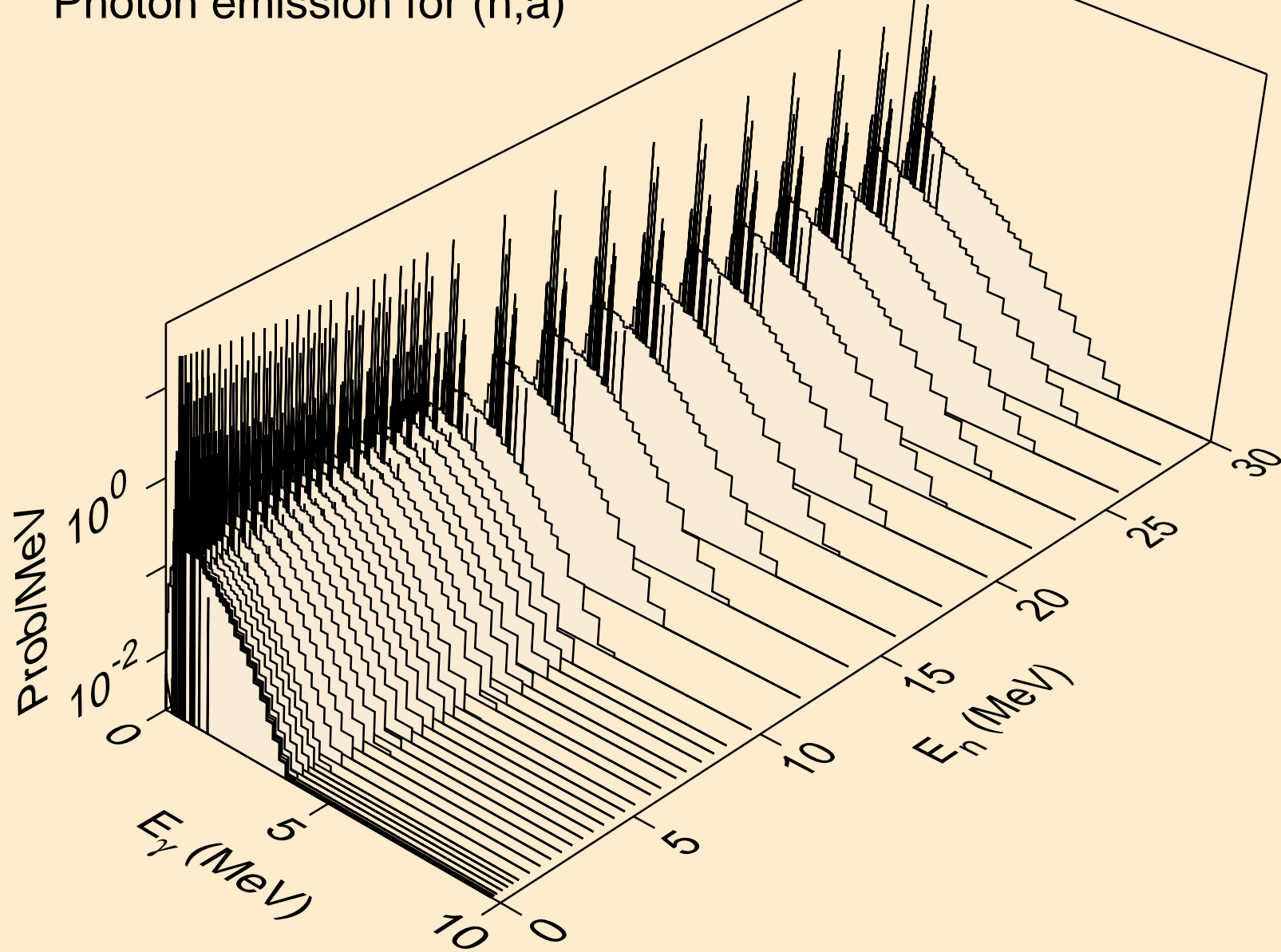

PB191M NEUTRON ACER TENDL-2023 LIBRARY; T=0.K  
Photon emission for (n,2a)

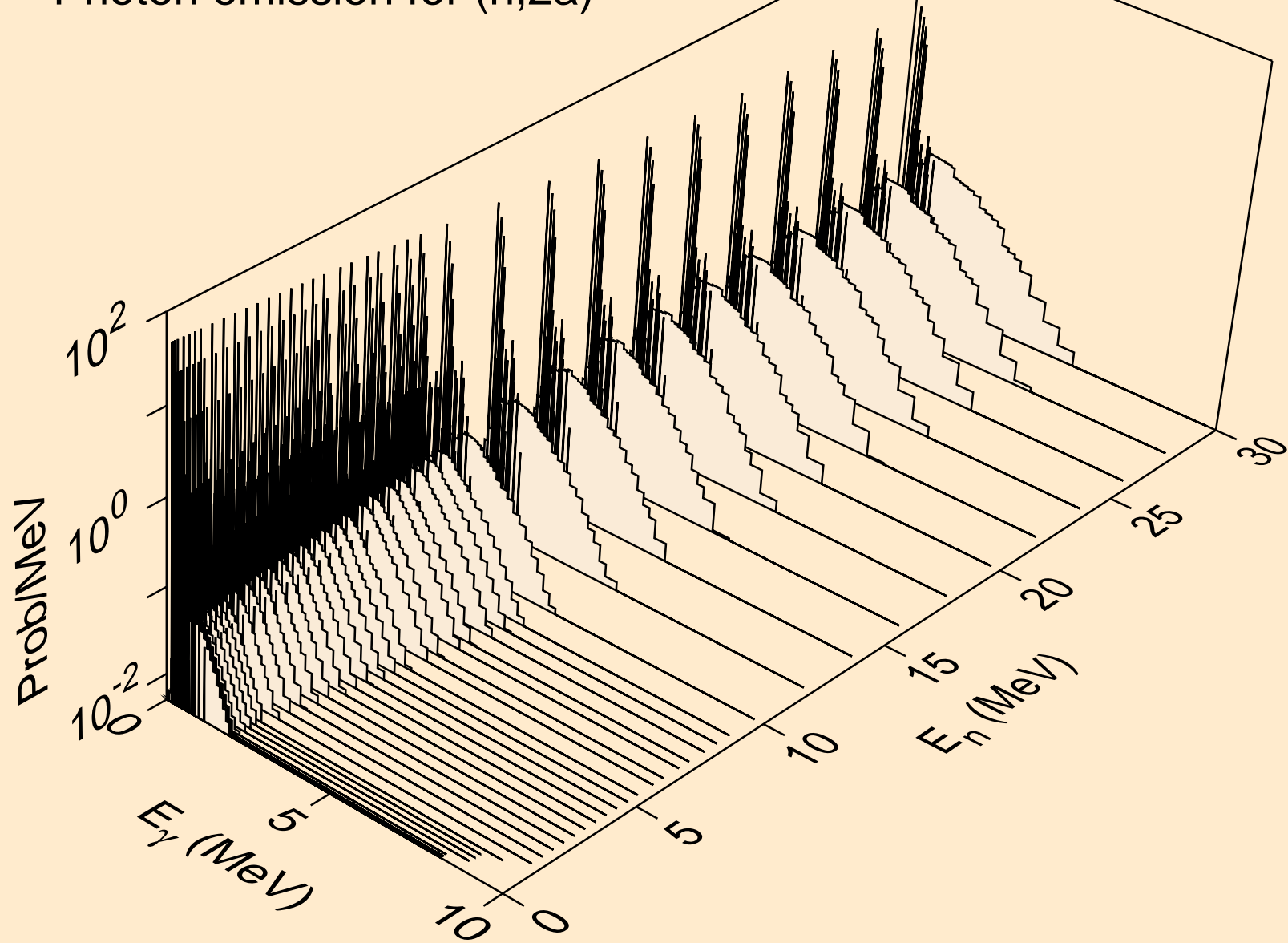

PB191M NEUTRON ACER TENDL-2023 LIBRARY; T=0.K  
Photon emission for (n,3a)

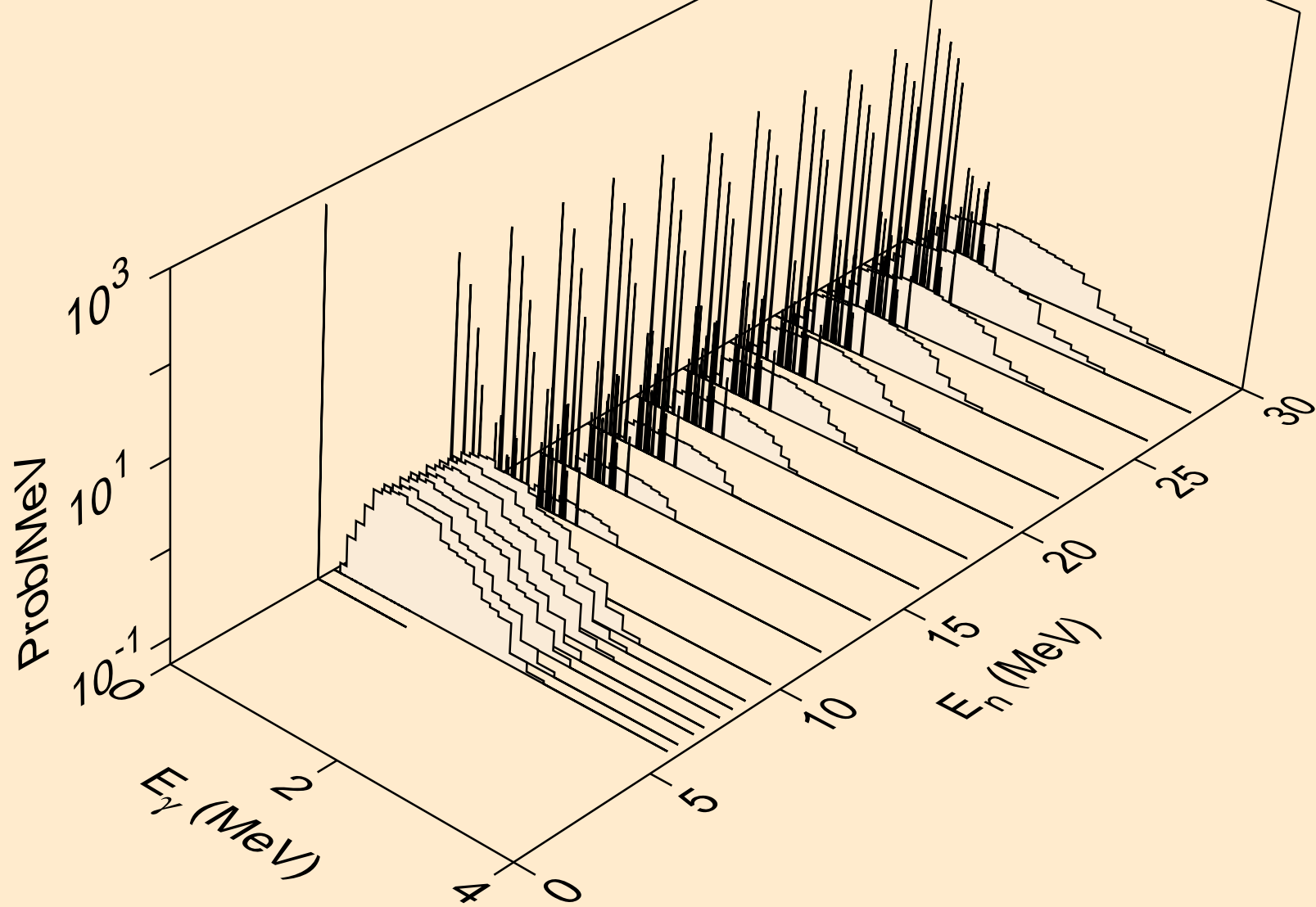

PB191M NEUTRON ACER TENDL-2023 LIBRARY; T=0.K  
Photon emission for (n,2p)

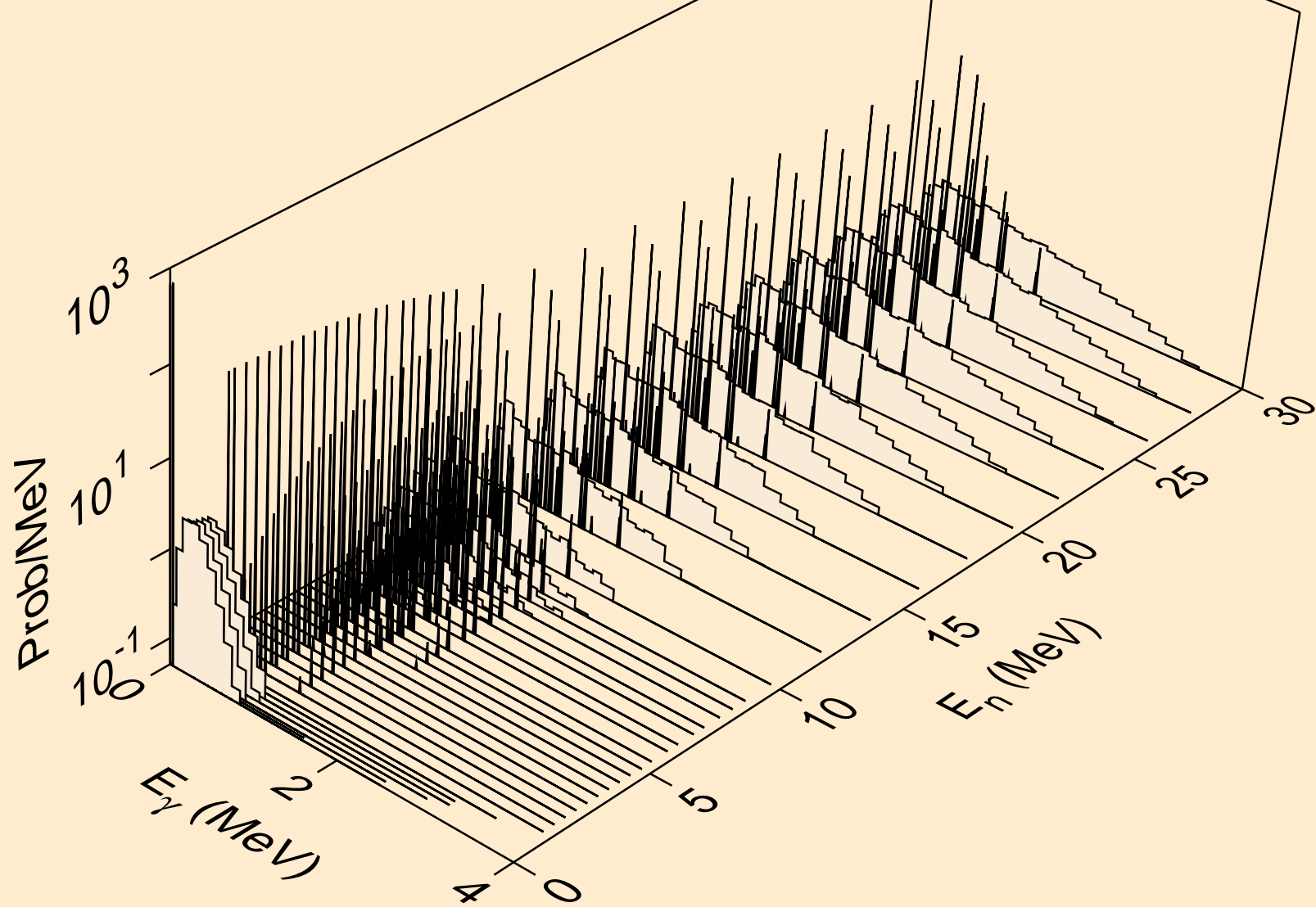

PB191M NEUTRON ACER TENDL-2023 LIBRARY; T=0.K  
Photon emission for (n,p $\alpha$ )

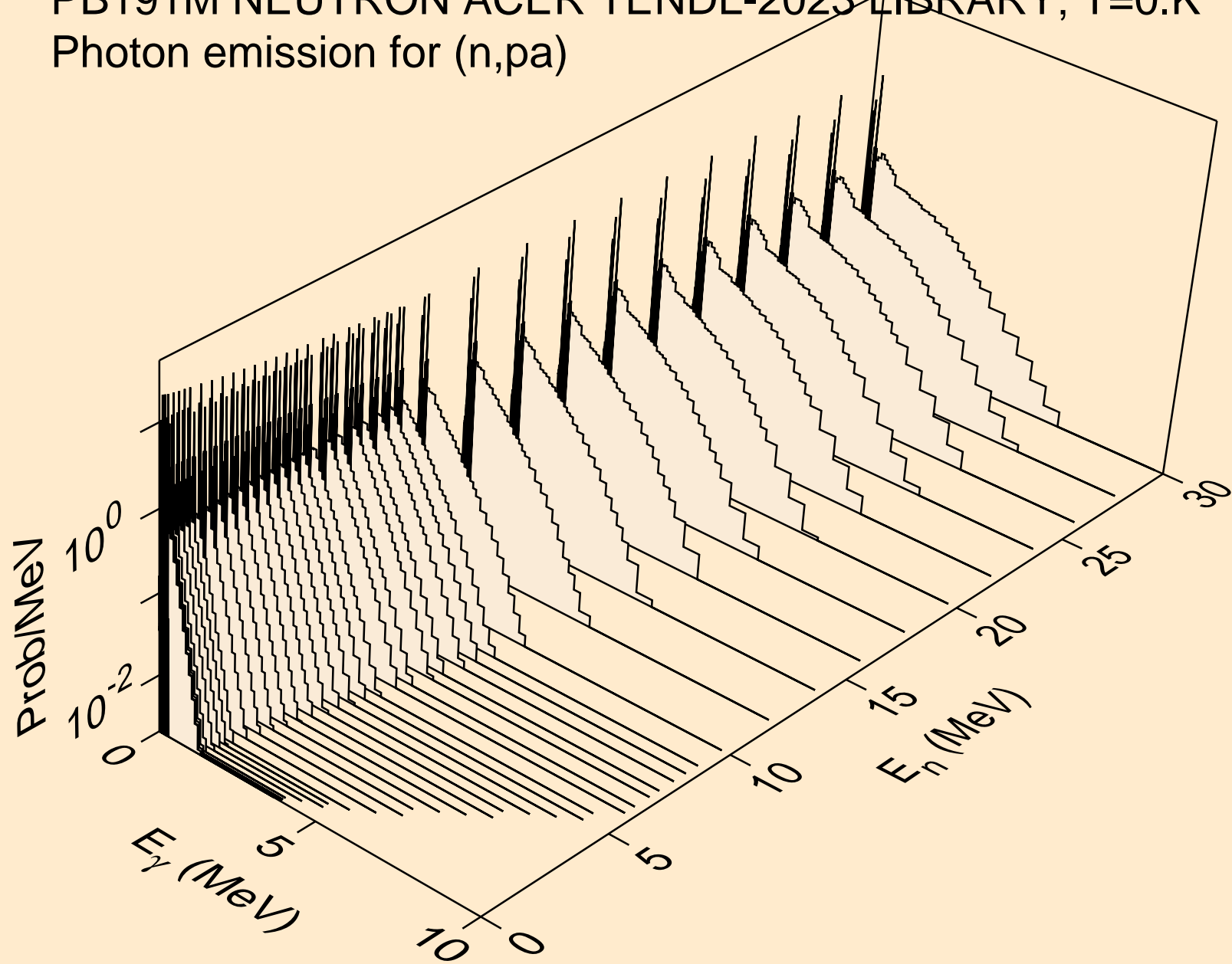

PB191M NEUTRON ACER TENDL-2023 LIBRARY; T=0.K  
Photon emission for (n,pd)

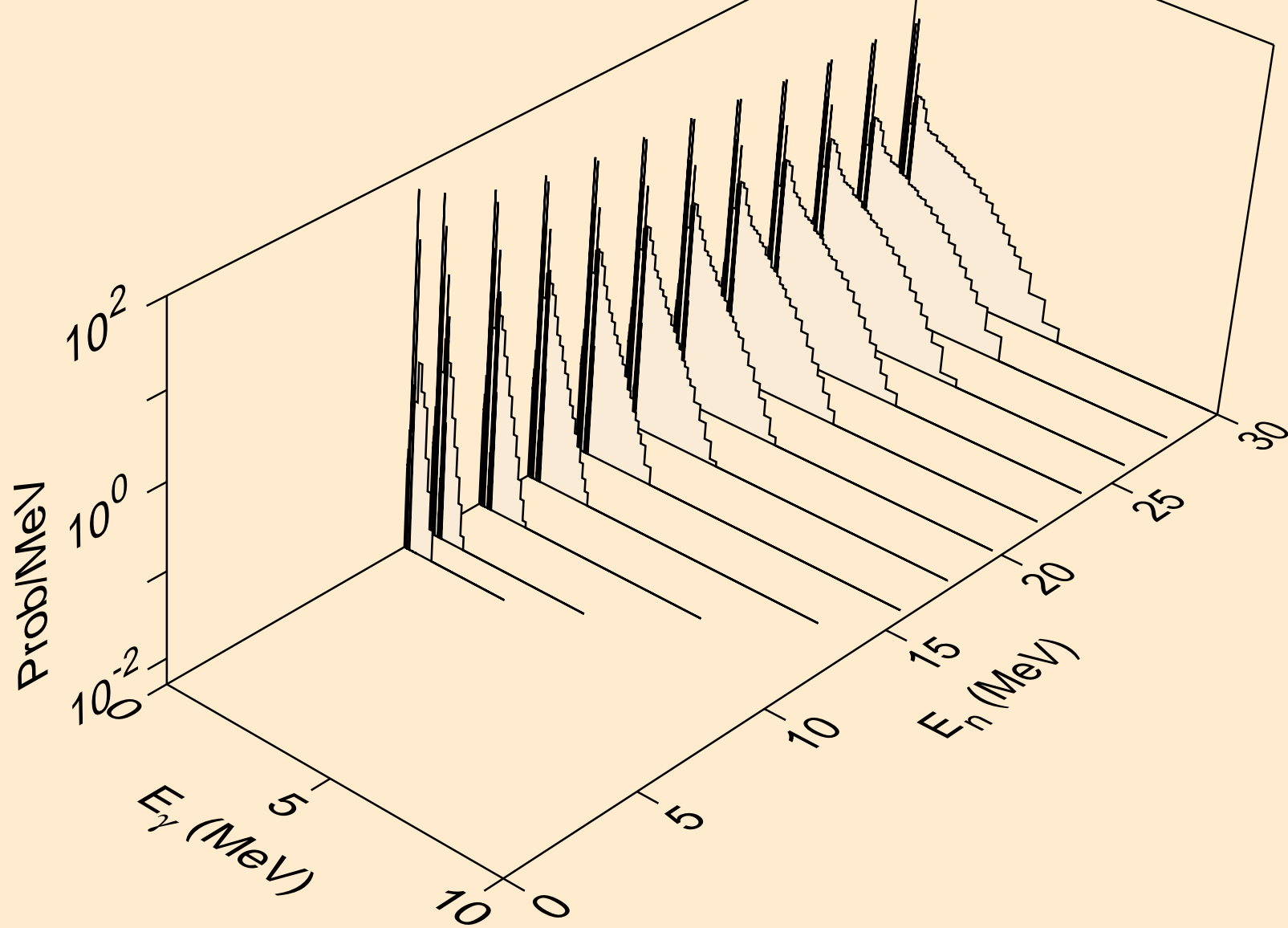

PB191M NEUTRON ACER TENDL-2023 LIBRARY; T=0.K  
Photon emission for (n,pt)

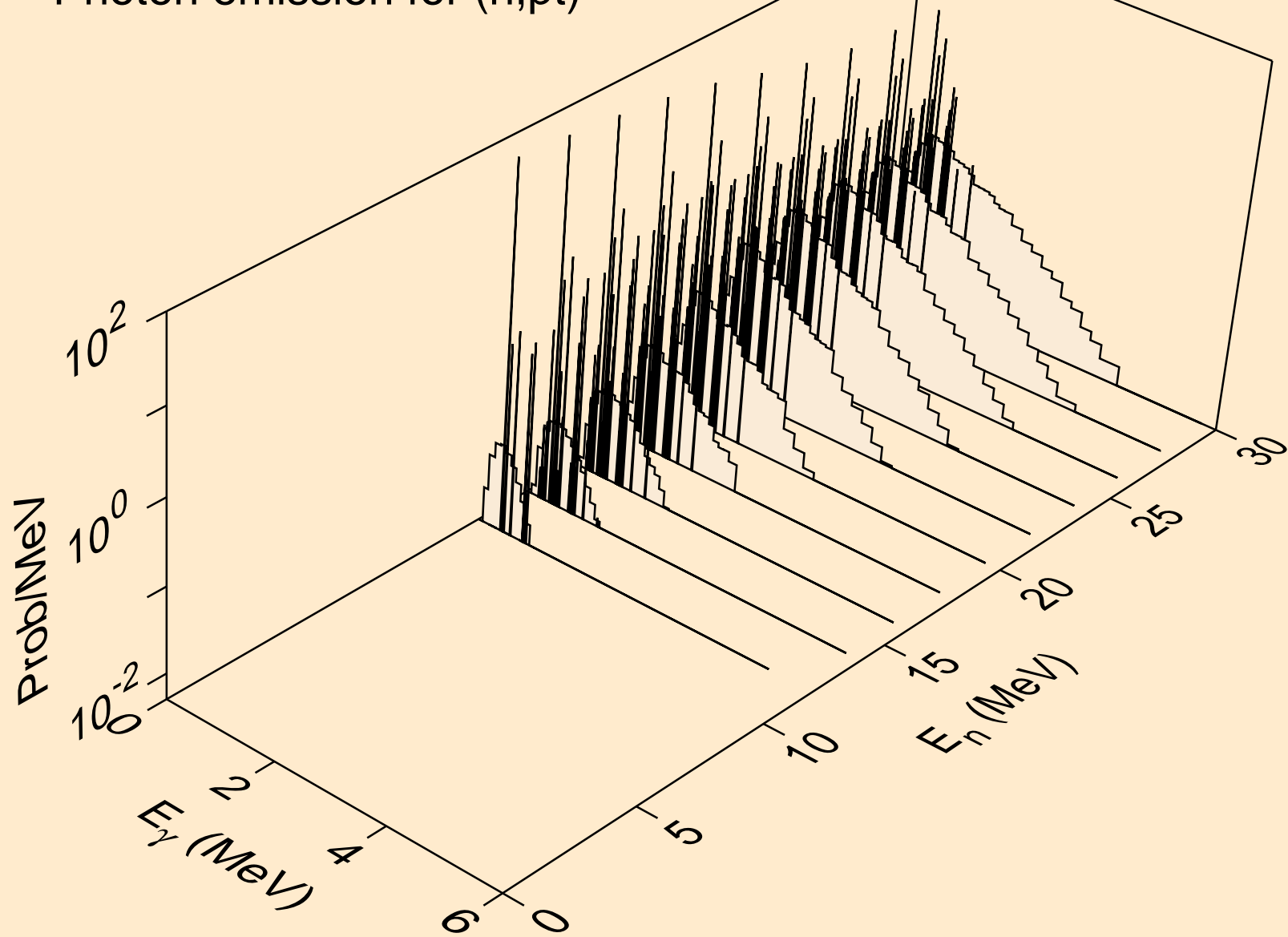

PB191M NEUTRON ACER TENDL-2023 LIBRARY; T=0.K  
Photon emission for (n,da)

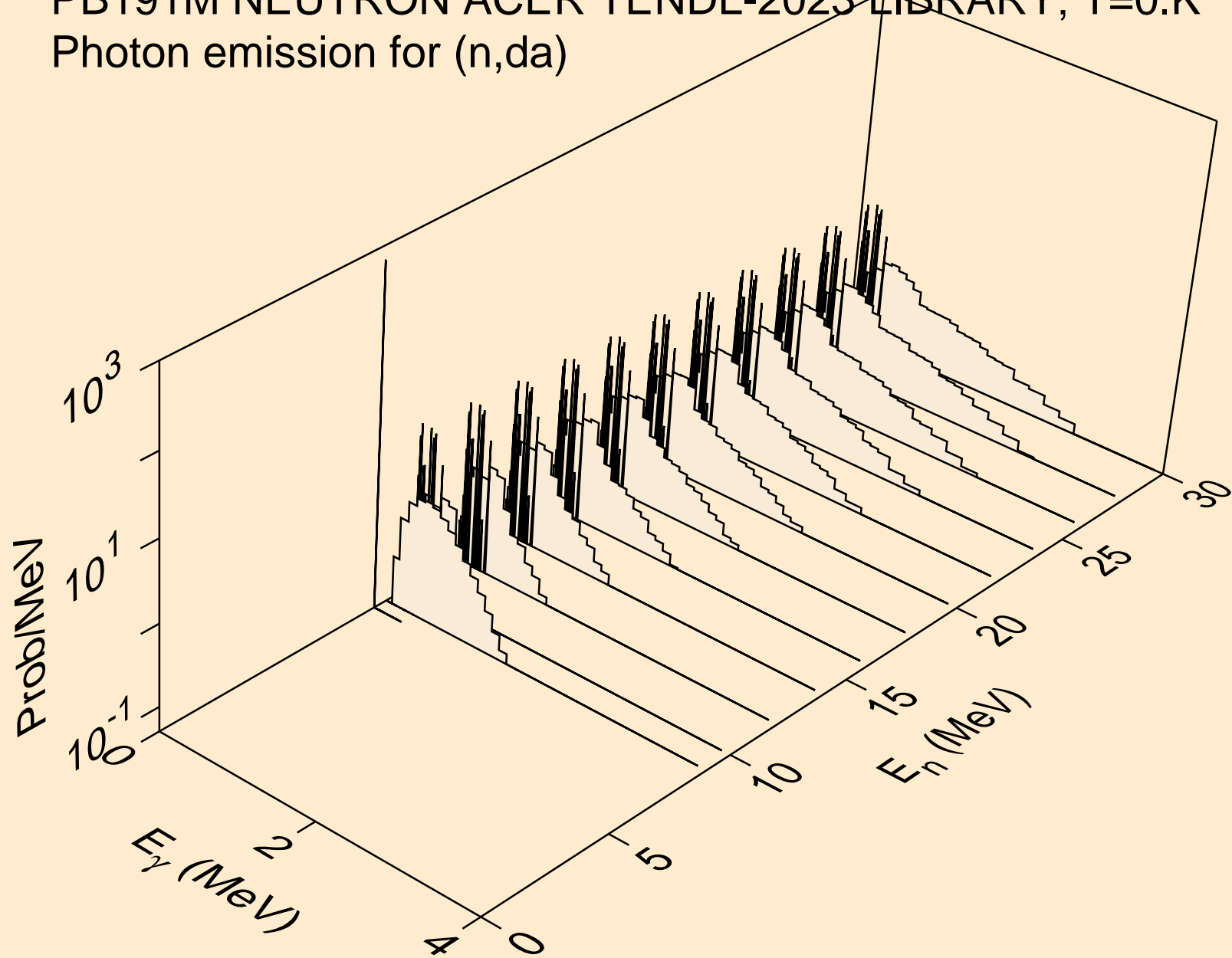

PB191M NEUTRON ACER TENDL-2023 LIBRARY; T=0.K  
thermal capture photon spectrum

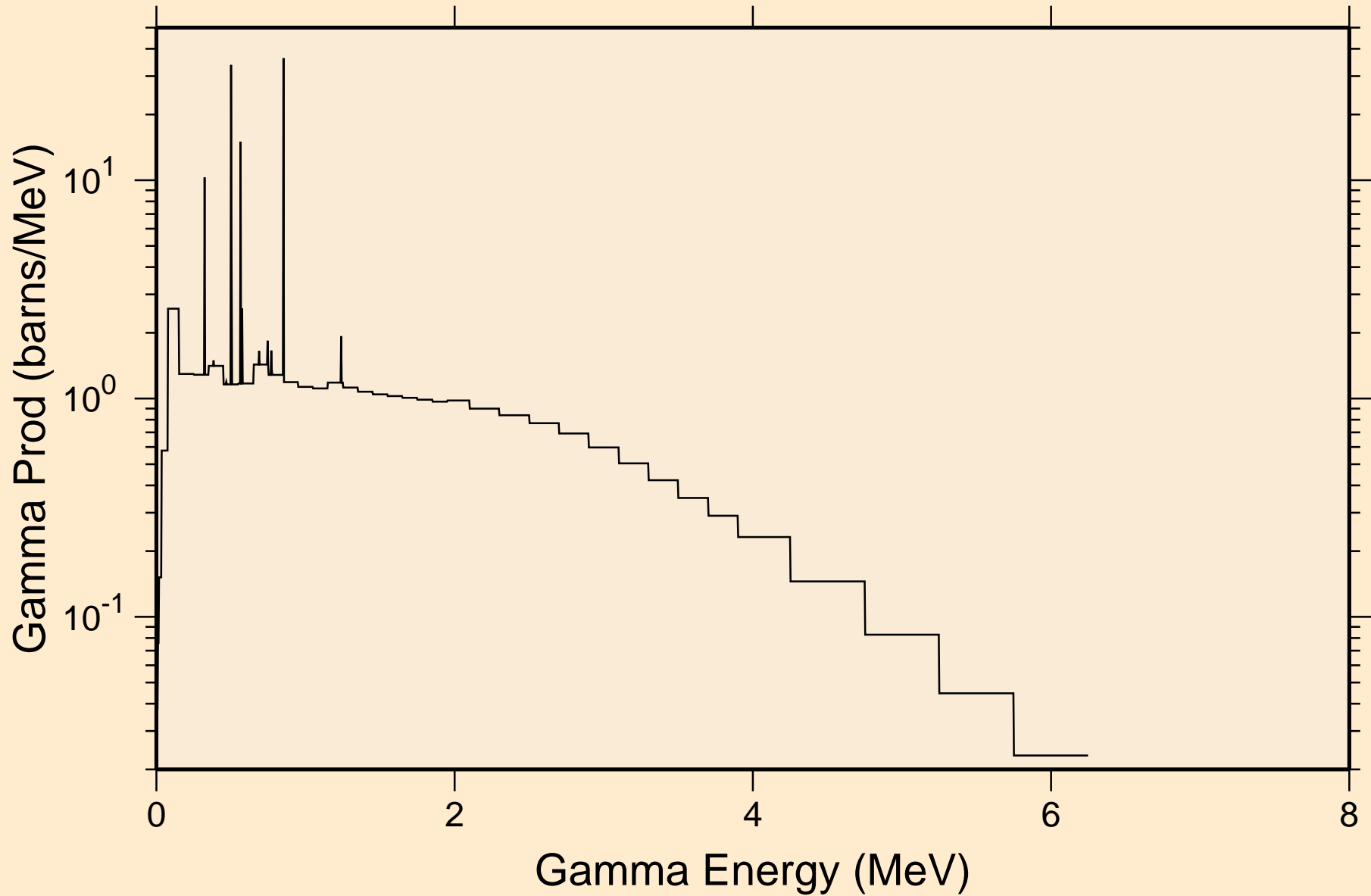

PB191M NEUTRON ACER TENDL-2023 LIBRARY; T=0.K  
14 MeV photon spectrum

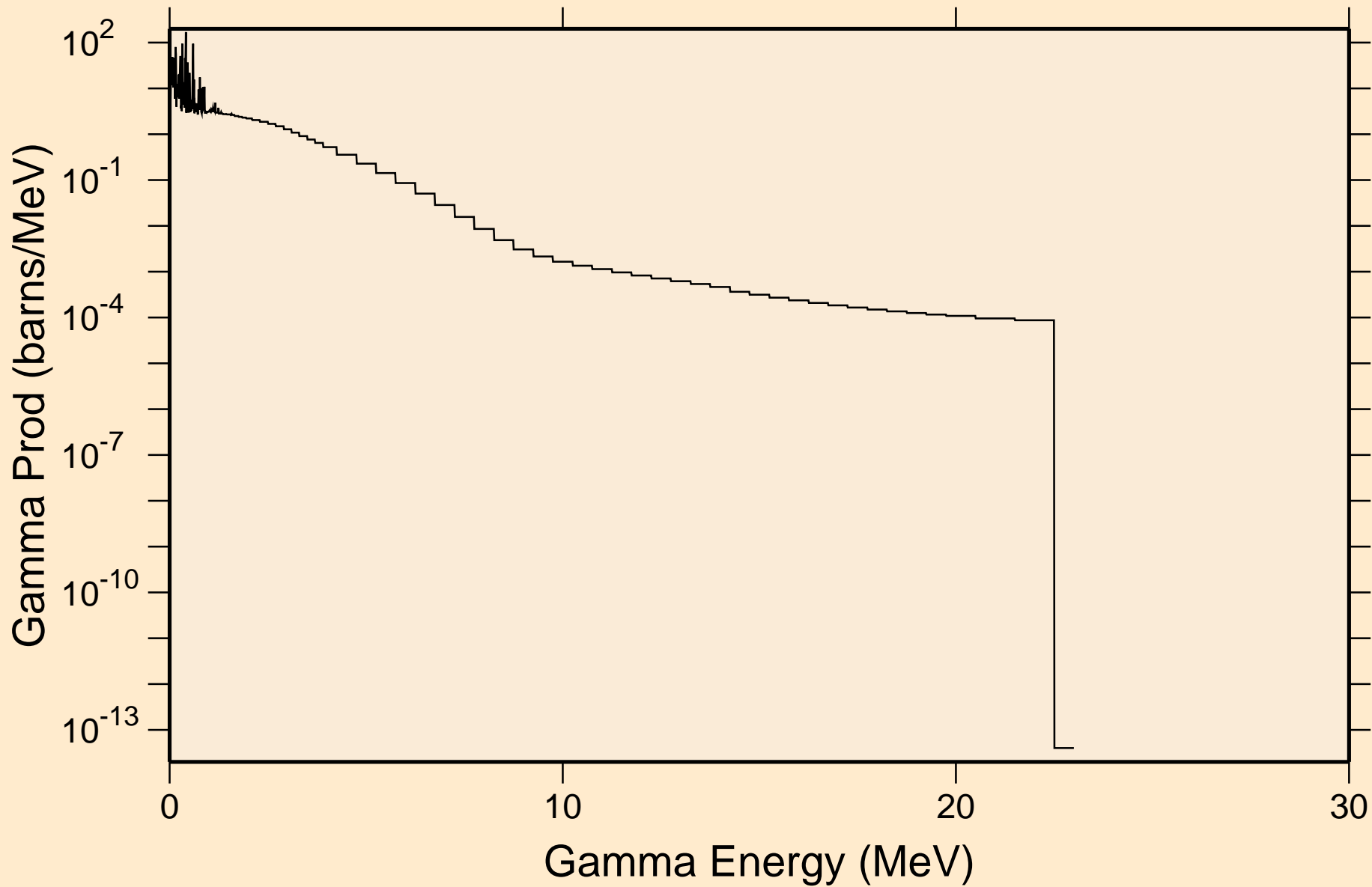

# PB191M NEUTRON ACER TENDL-2023 LIBRARY; T=0.K

## Particle heating contributions

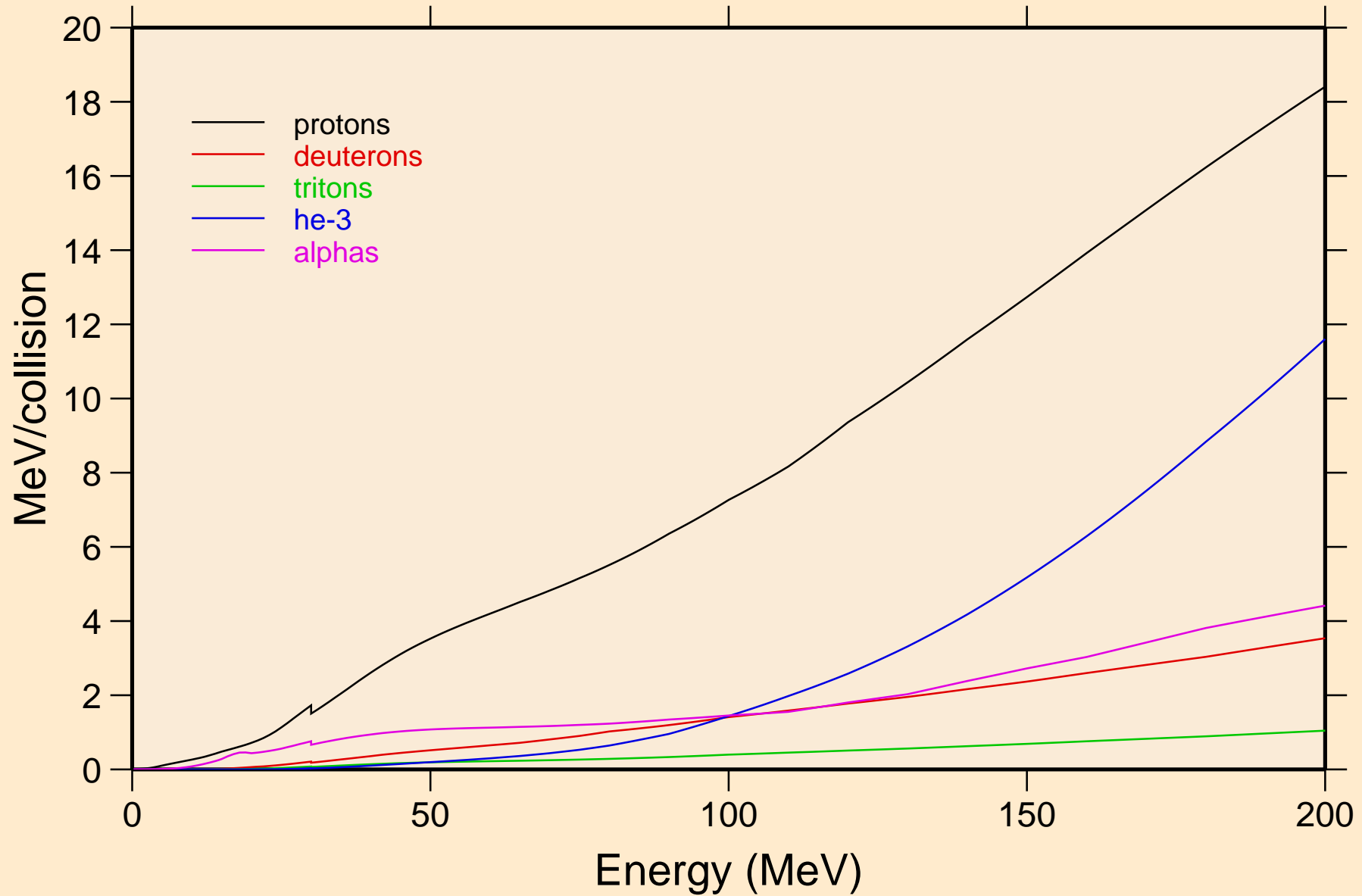

PB191M NEUTRON ACER TENDL-2023 LIBRARY; T=0.K  
Recoil Heating

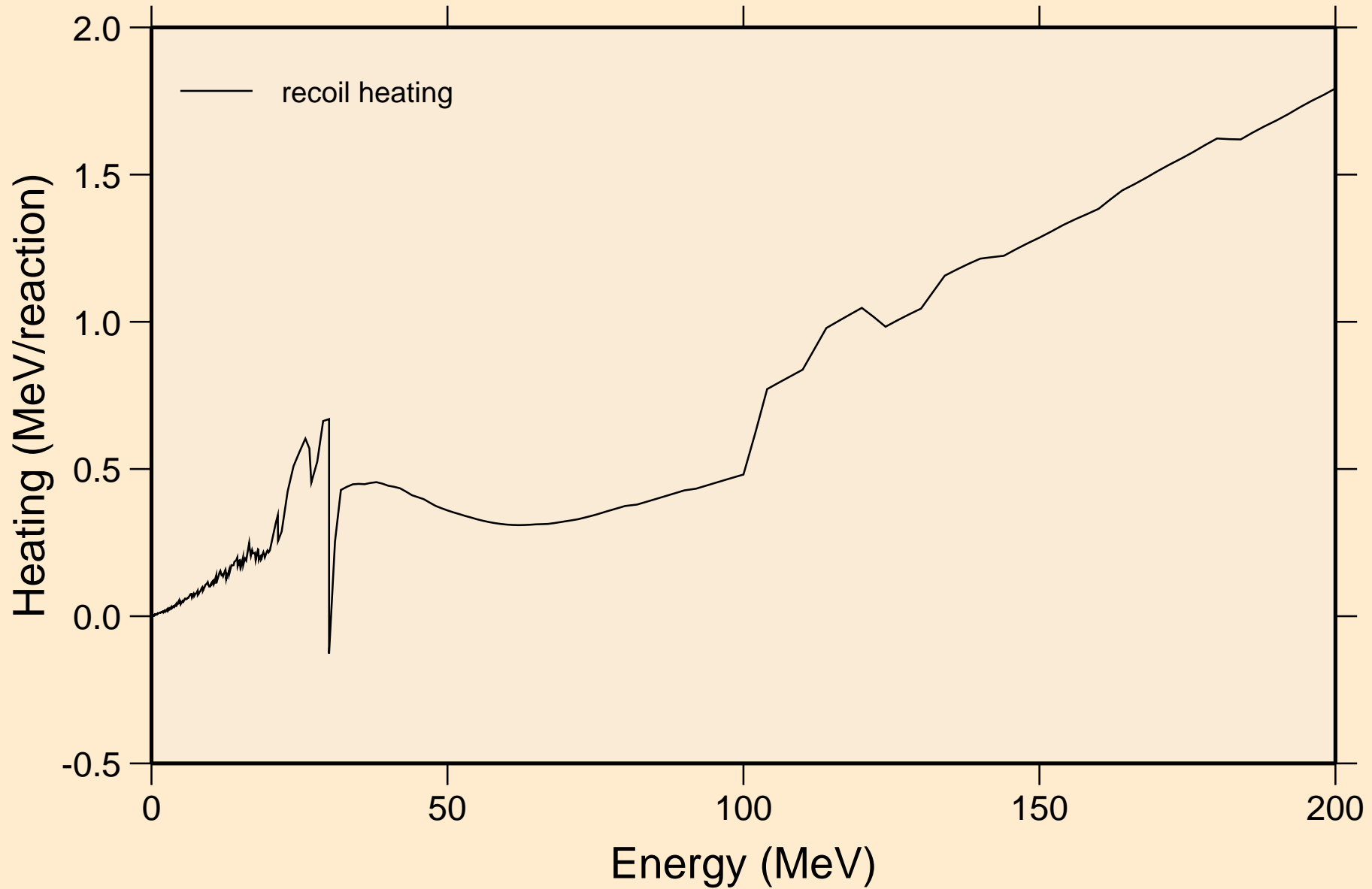

# PB191M NEUTRON ACER TENDL-2023 LIBRARY; T=0.K

## Particle production cross sections

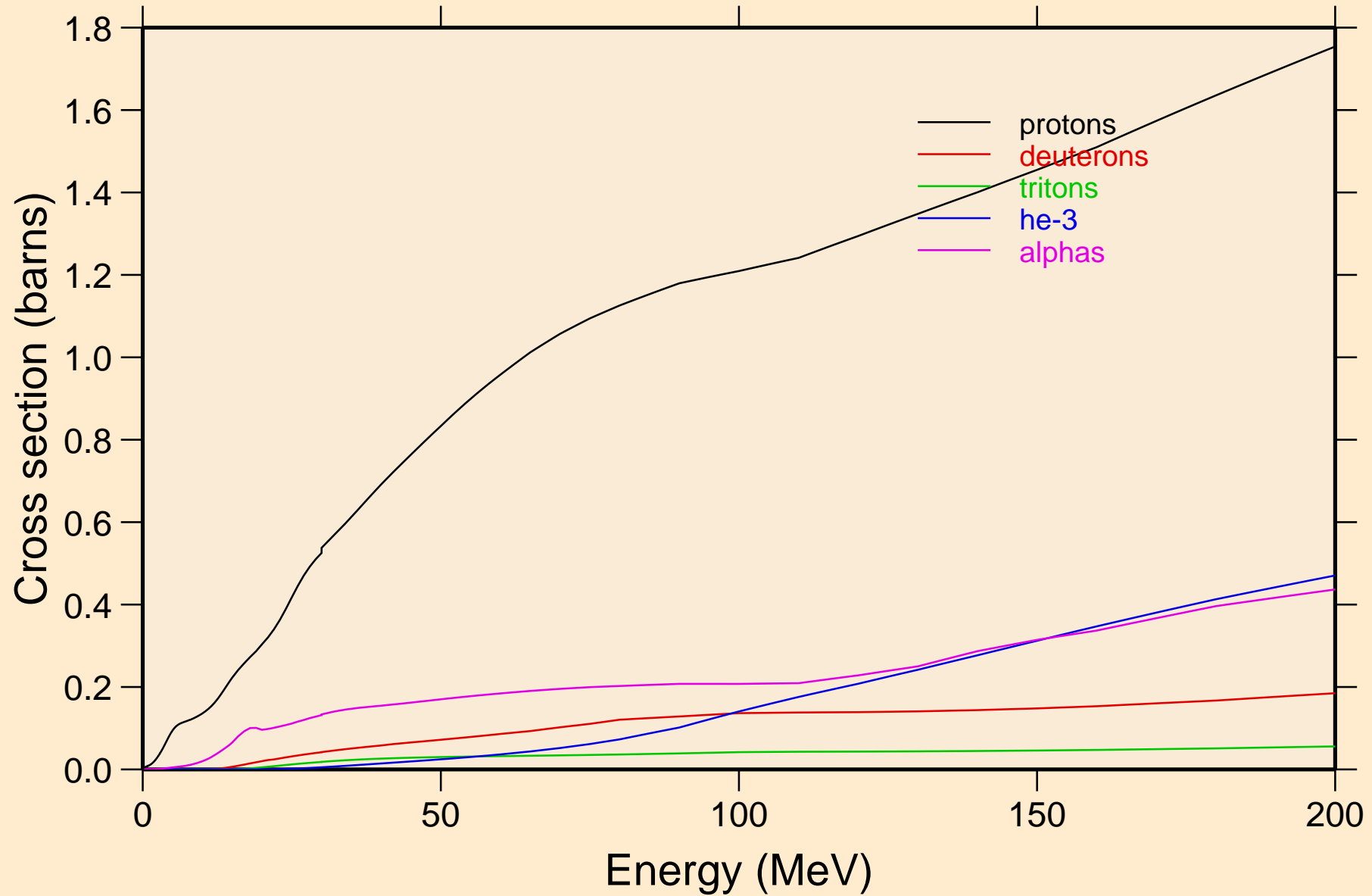

PB191M NEUTRON ACER TENDL-2023 LIBRARY; T=0.K  
protons from (n,x)

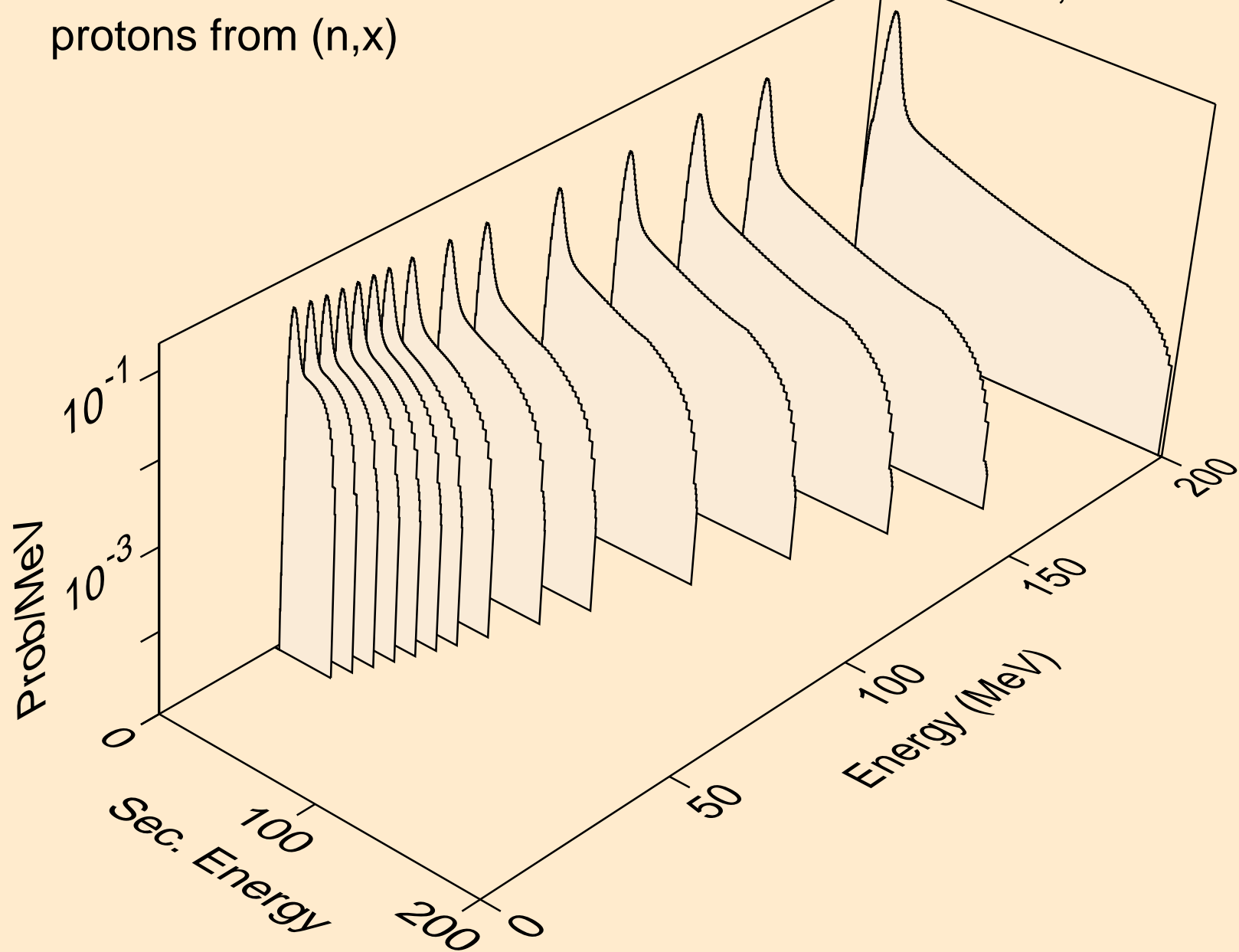

PB191M NEUTRON ACER TENDL-2023 LIBRARY; T=0.K  
protons from (n,n\*)p

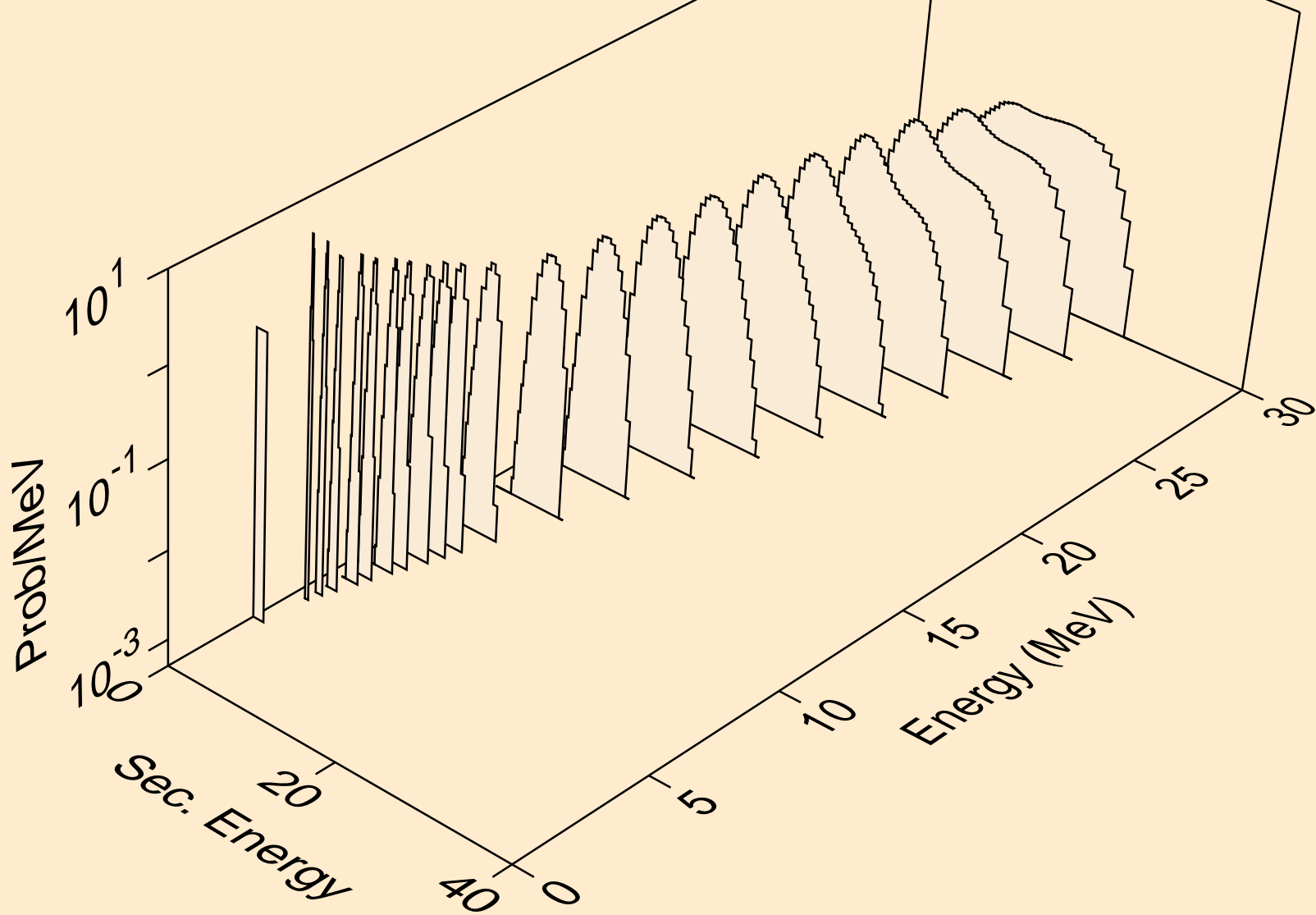

PB191M NEUTRON ACER TENDL-2023 LIBRARY; T=0.K  
protons from (n,2np)

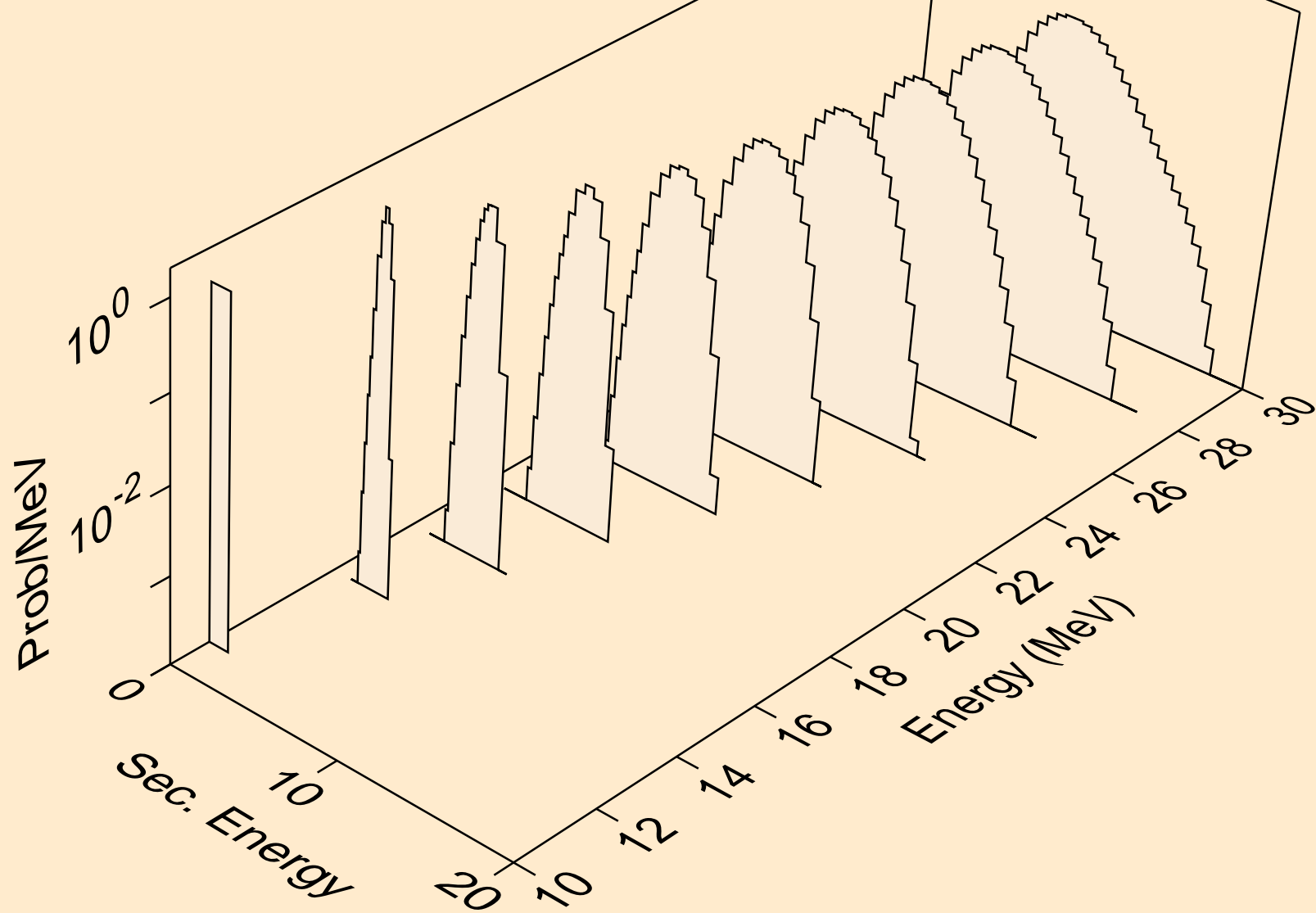

PB191M NEUTRON ACER TENDL-2023 LIBRARY; T=0.K  
protons from (n,3np)

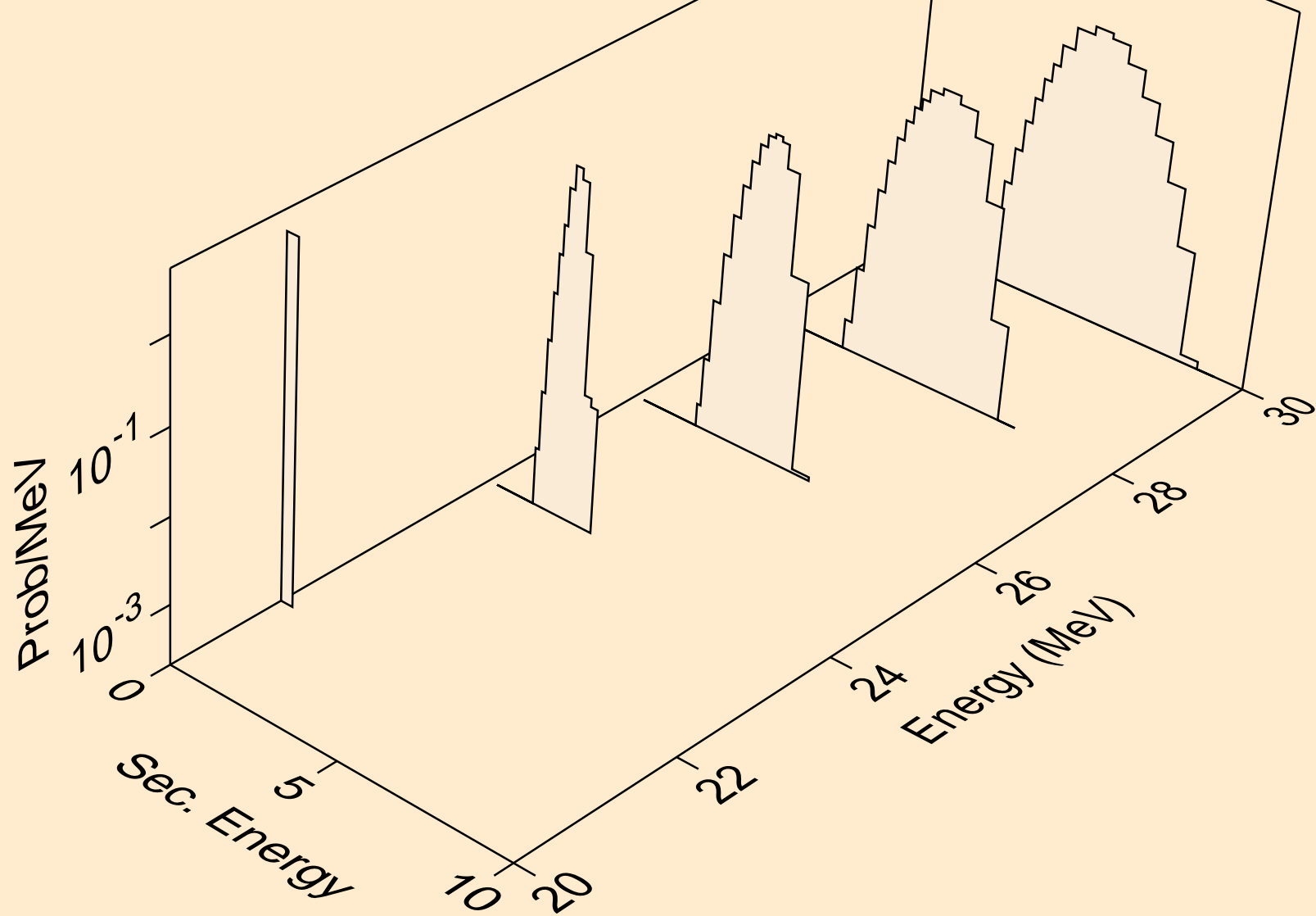

PB191M NEUTRON ACER TENDL-2023 LIBRARY; T=0.K  
protons from (n,n2p)

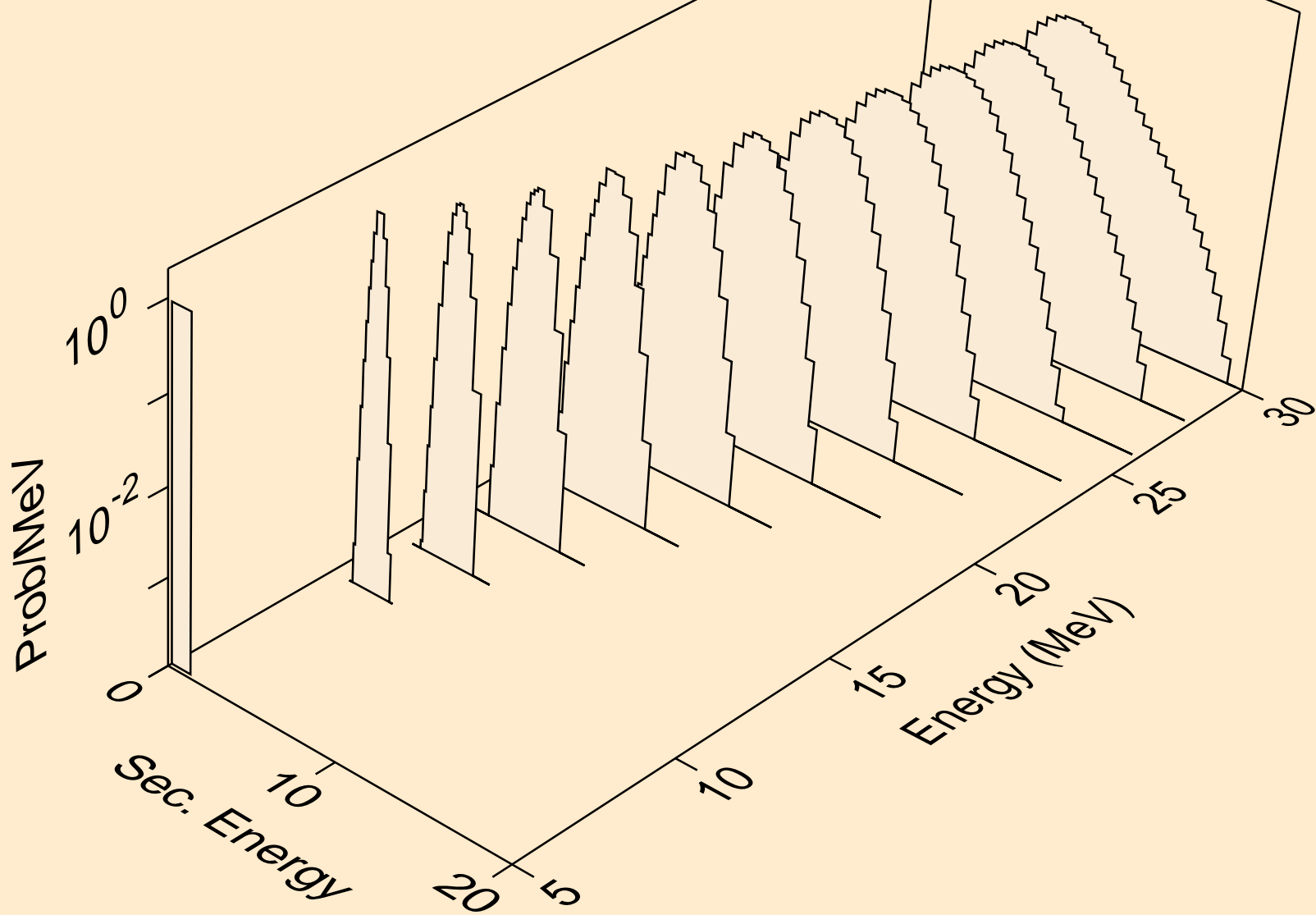

PB191M NEUTRON ACER TENDL-2023 LIBRARY; T=0.K  
protons from (n,npa)

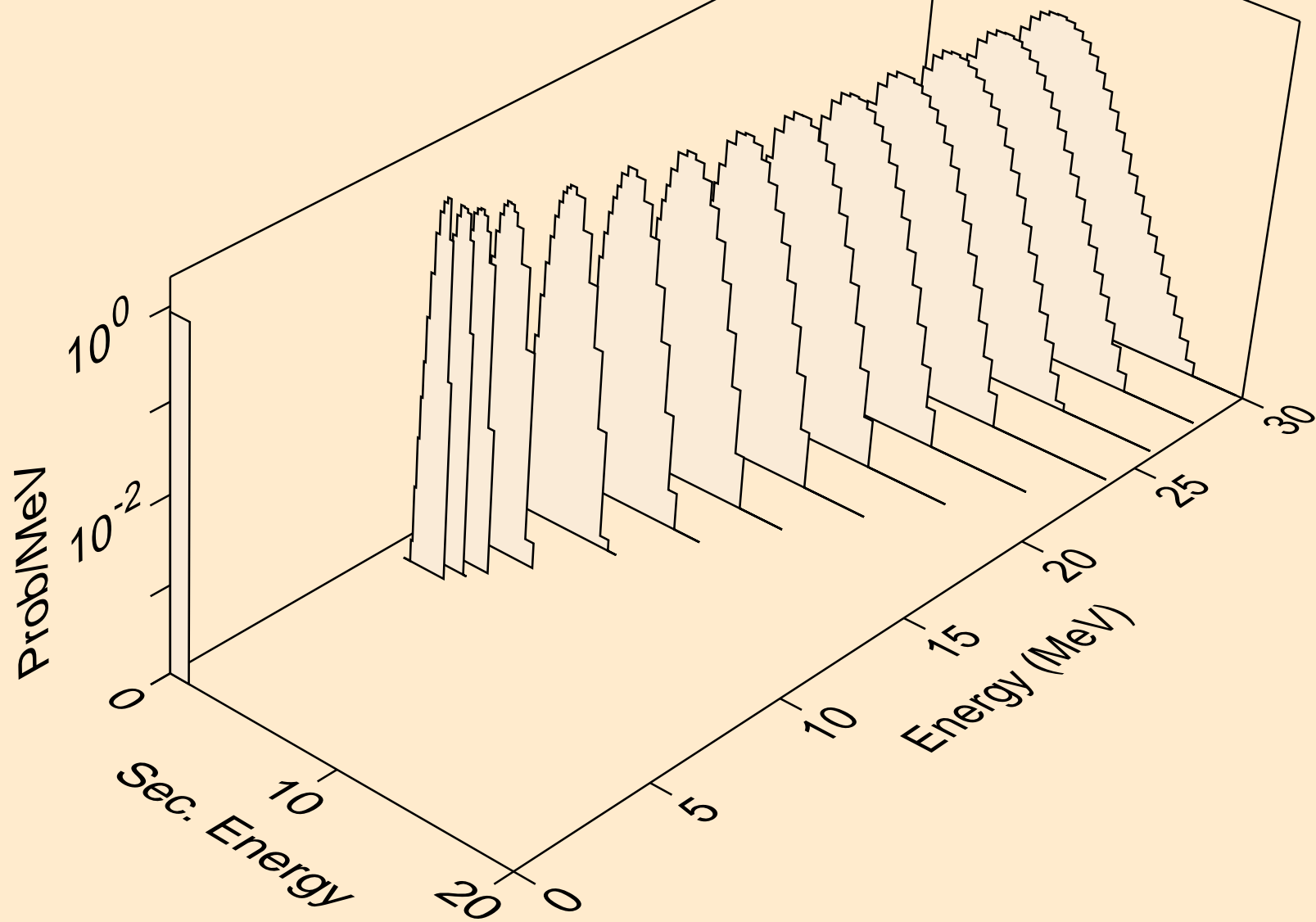

PB191M NEUTRON ACER TENDL-2023 LIBRARY; T=0.K  
protons from (n,p)

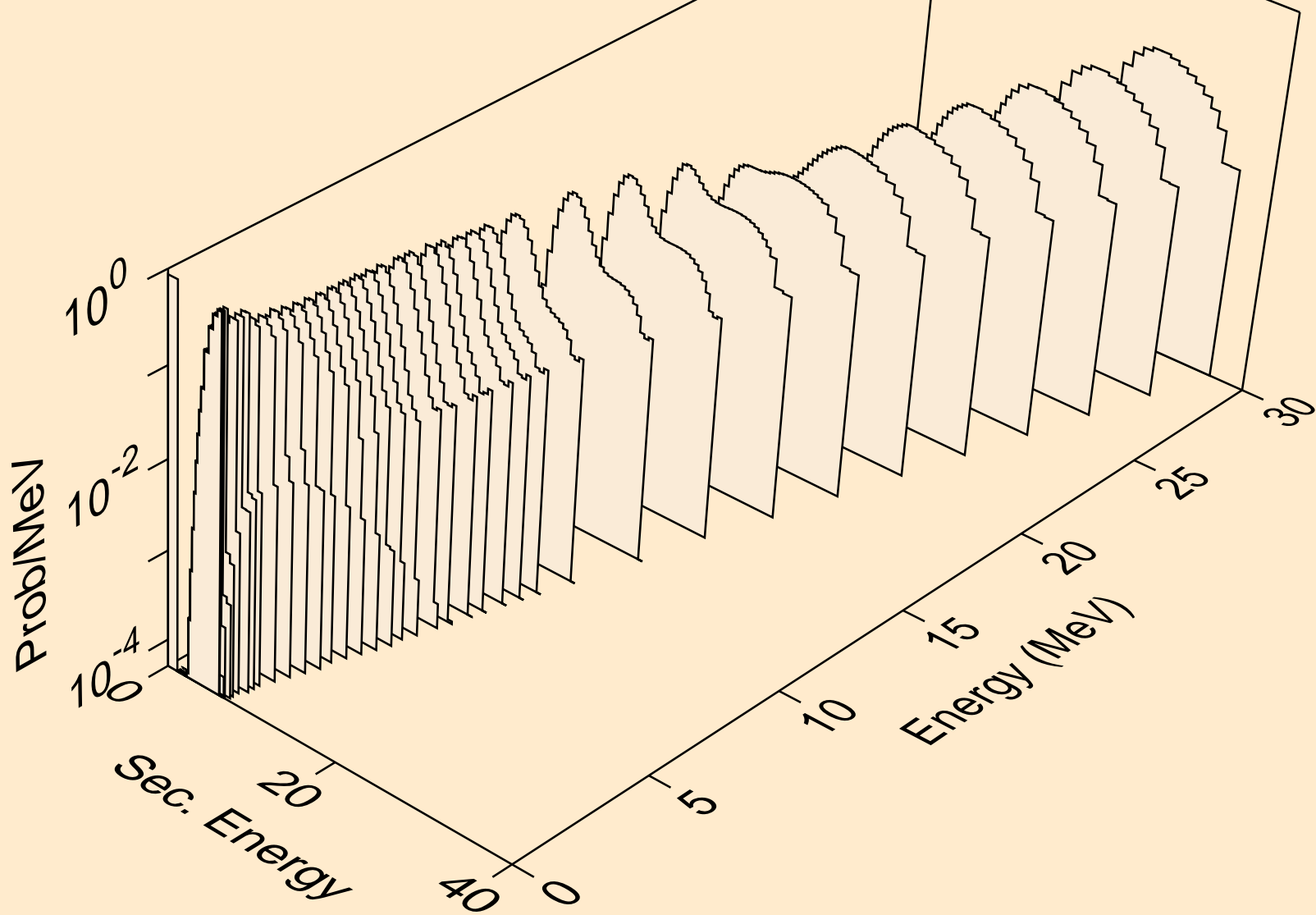

PB191M NEUTRON ACER TENDL-2023 LIBRARY; T=0.K  
protons from (n,2p)

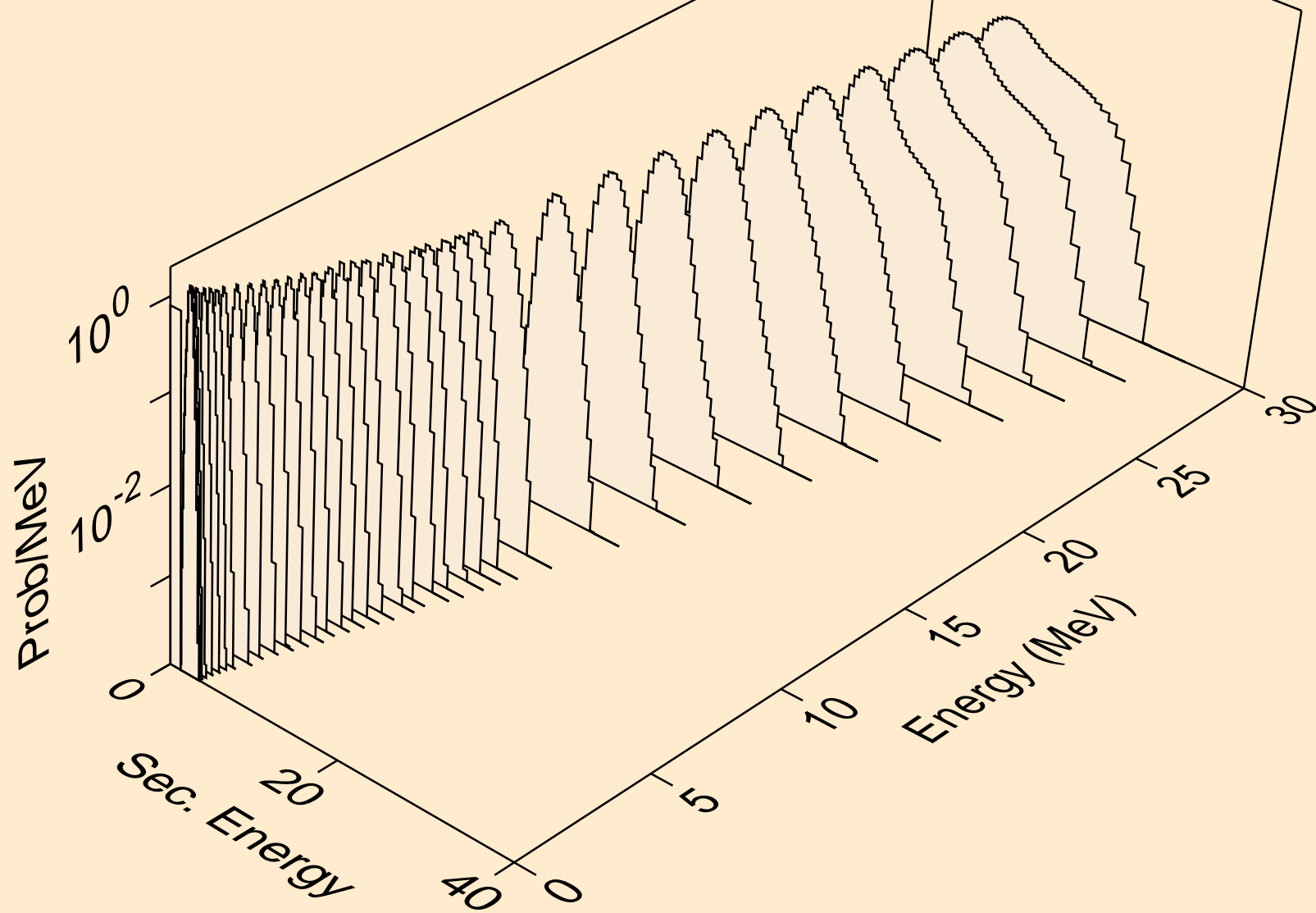

PB191M NEUTRON ACER TENDL-2023 LIBRARY; T=0.K  
protons from (n,p)

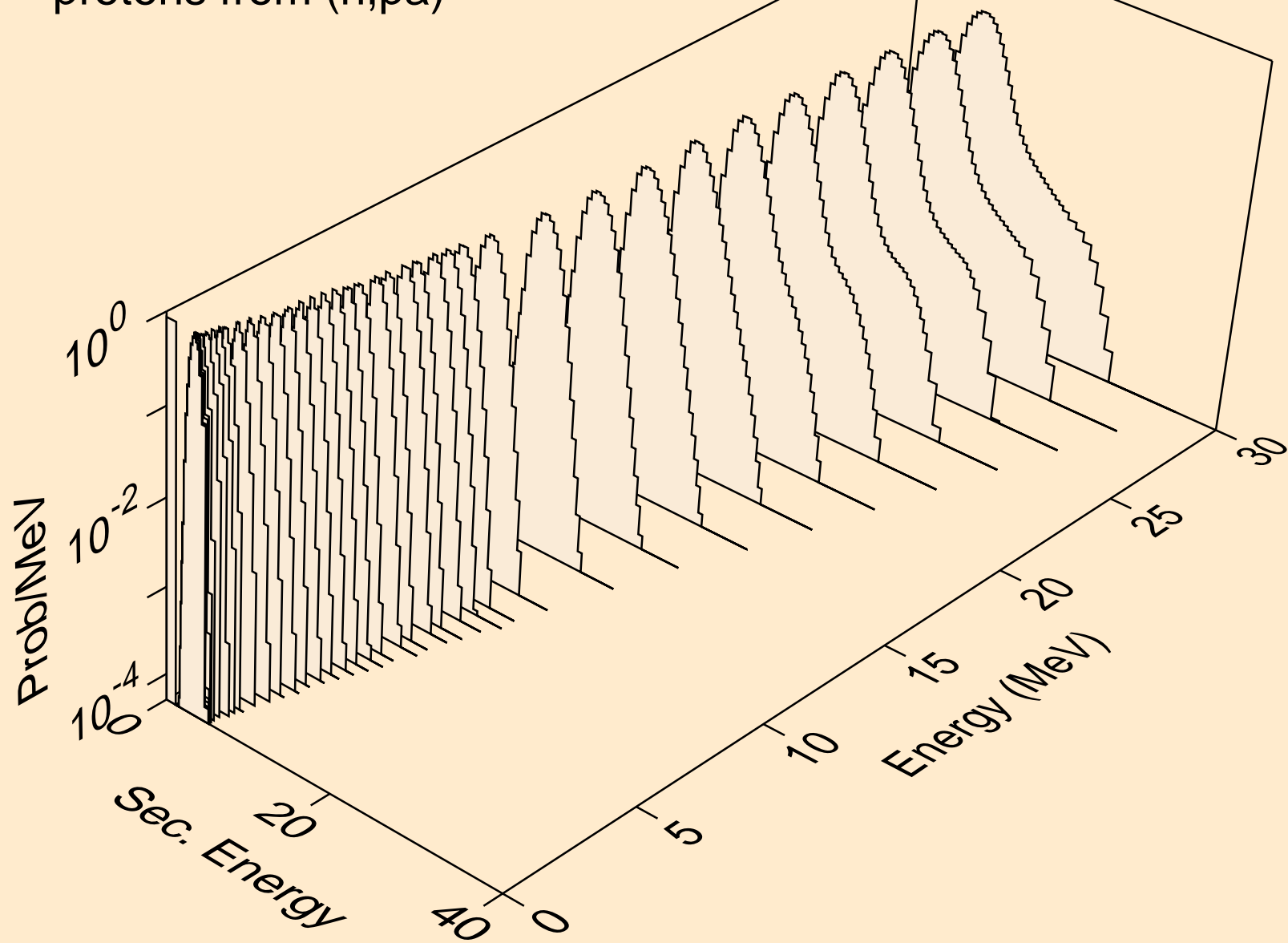

PB191M NEUTRON ACER TENDL-2023 LIBRARY; T=0.K  
protons from (n,pd)

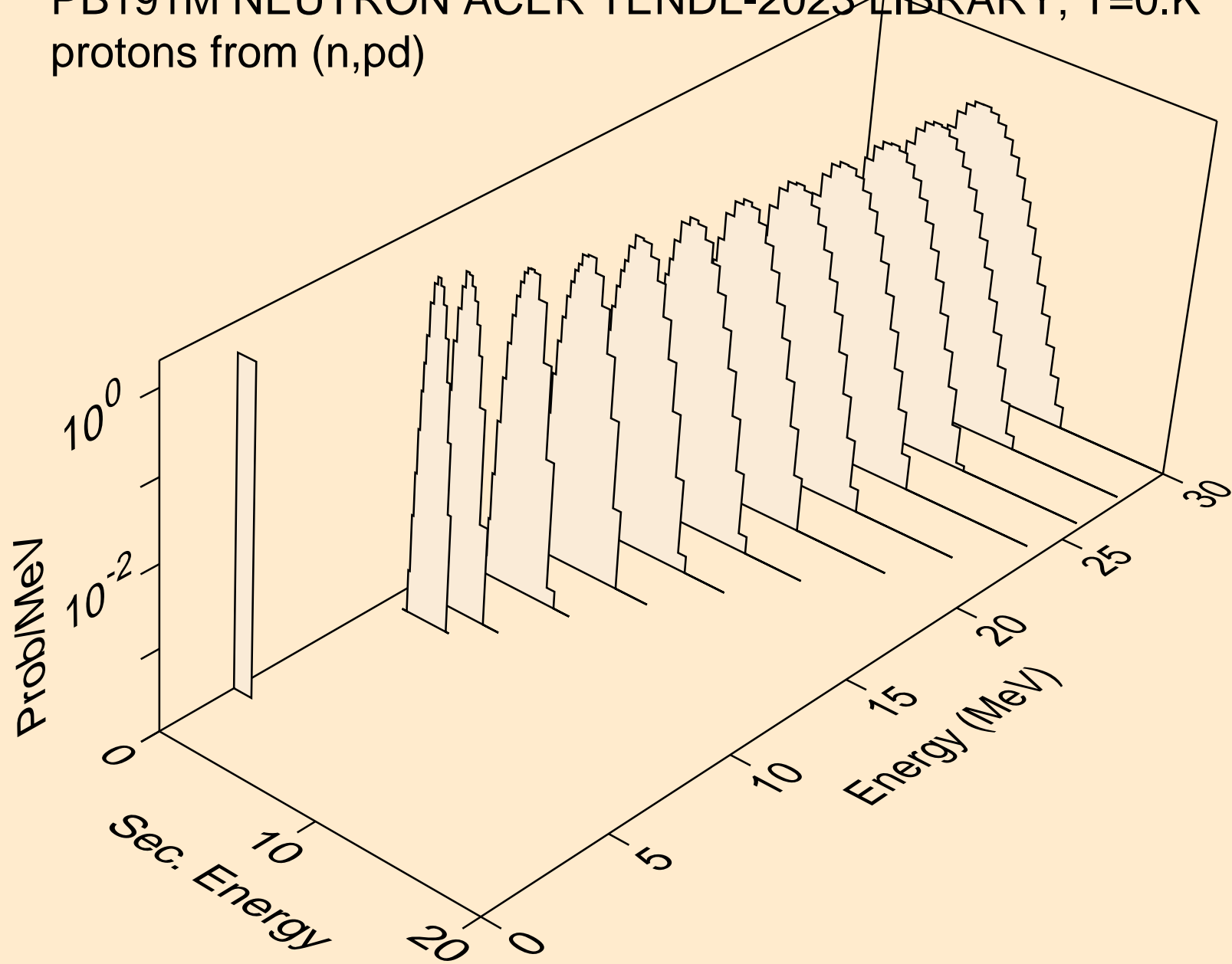

PB191M NEUTRON ACER TENDL-2023 LIBRARY; T=0.K  
protons from (n,pt)

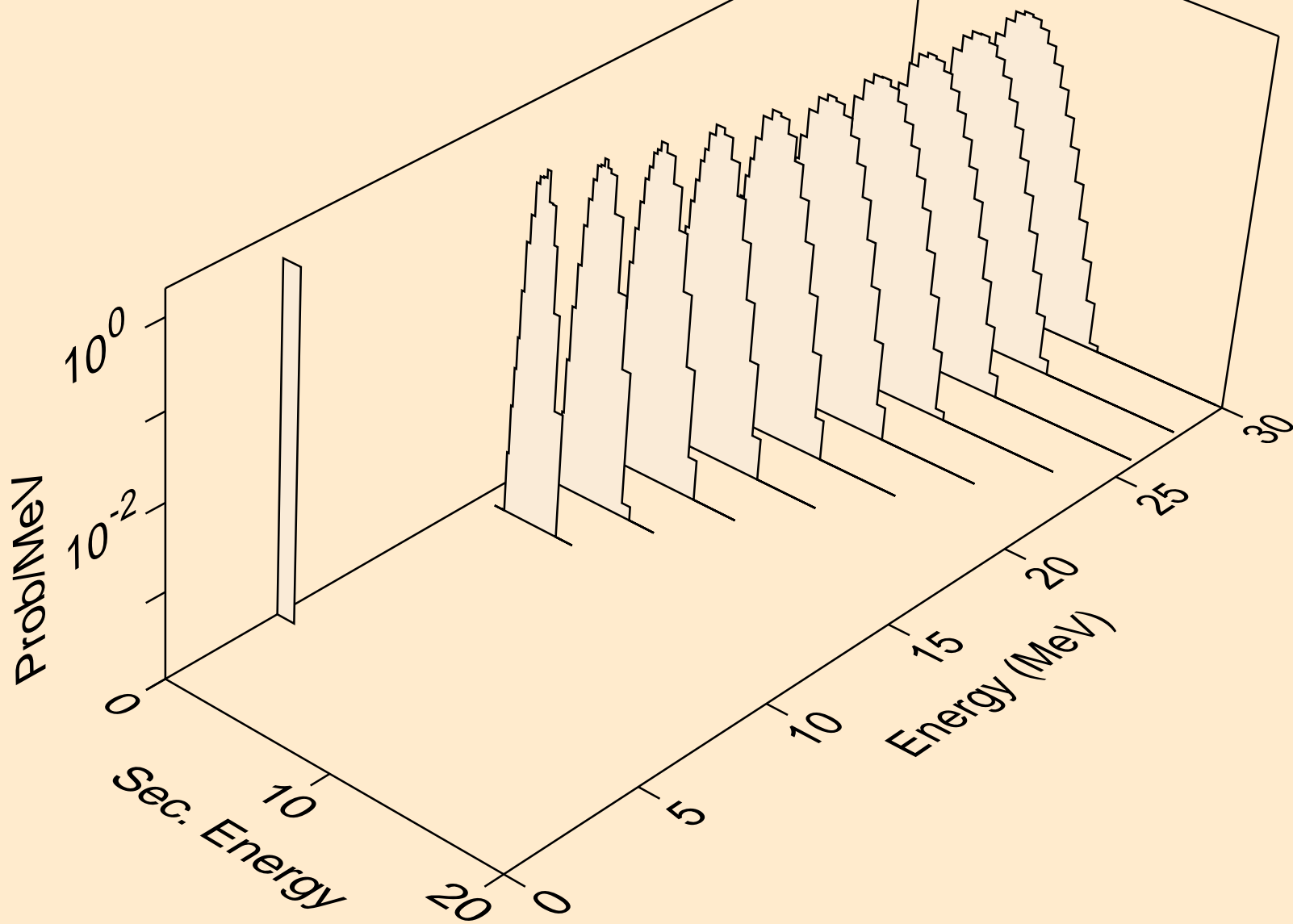

PB191M NEUTRON ACER TENDL-2023 LIBRARY; T=0.K  
deuterons from (n,x)

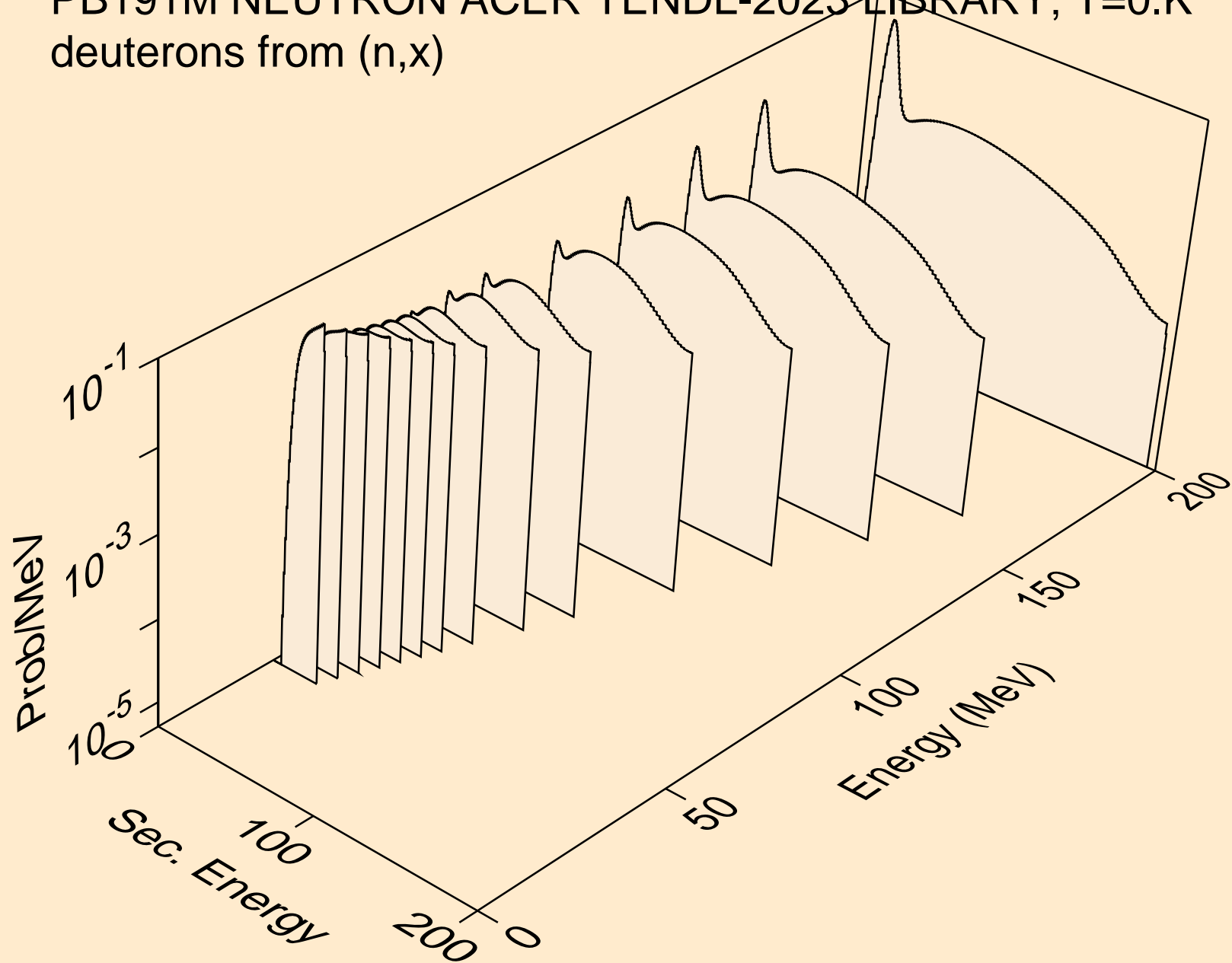

PB191M NEUTRON ACER TENDL-2023 LIBRARY; T=0.K  
deuterons from (n,2nd)

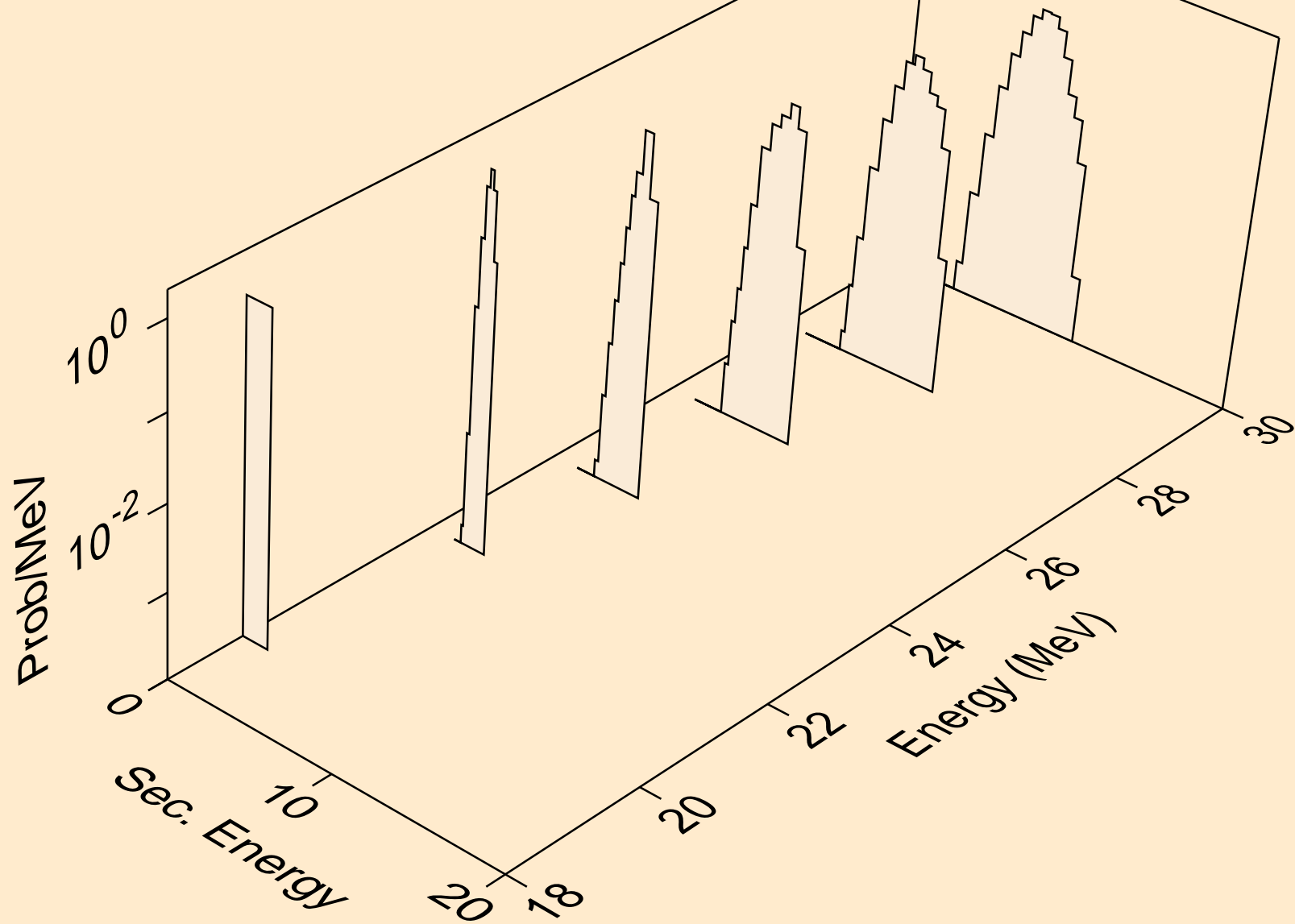

PB191M NEUTRON ACER TENDL-2023 LIBRARY; T=0.K  
deuterons from (n,n\*)d

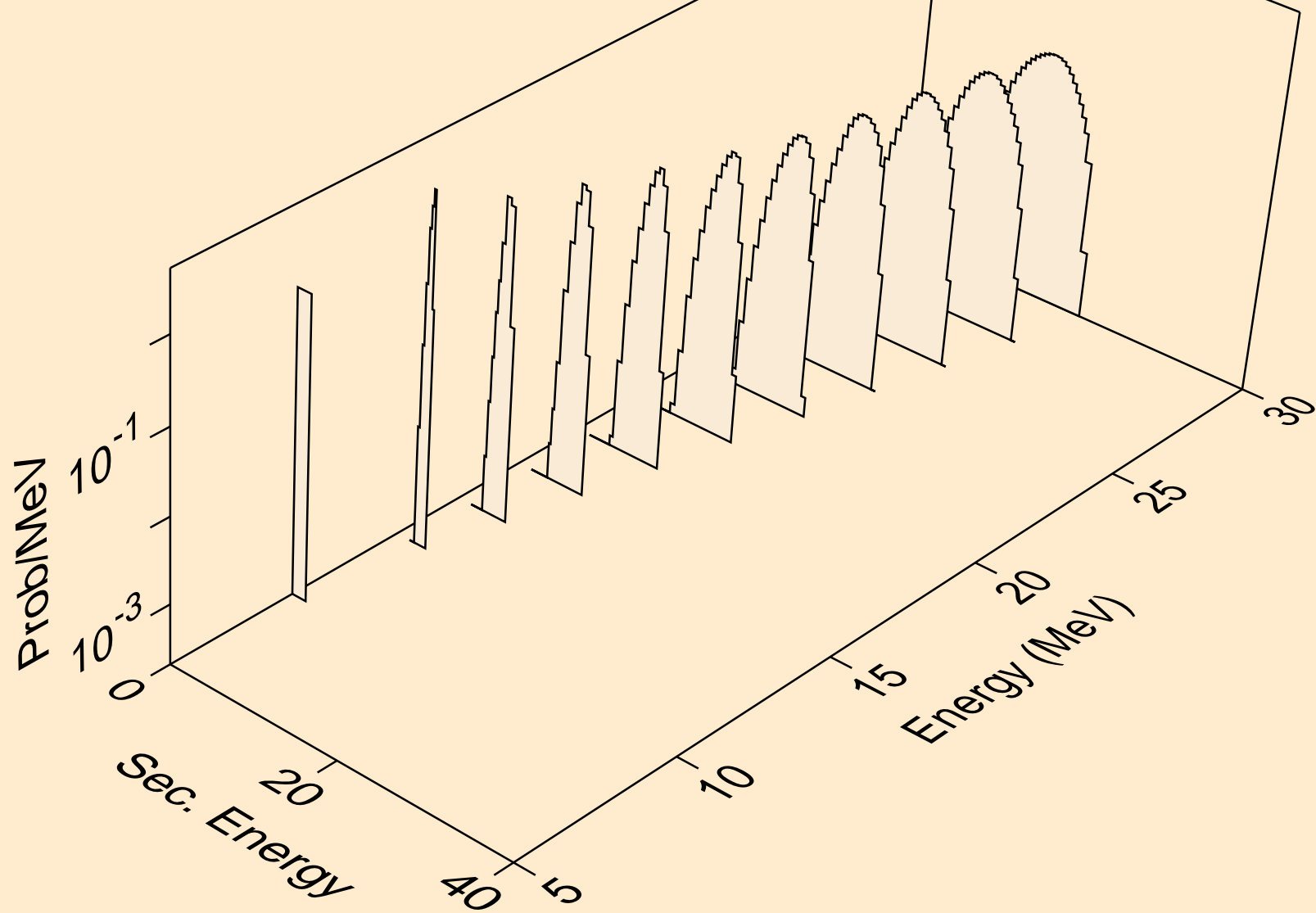

PB191M NEUTRON ACER TENDL-2023 LIBRARY; T=0.K  
deuterons from (n,d)

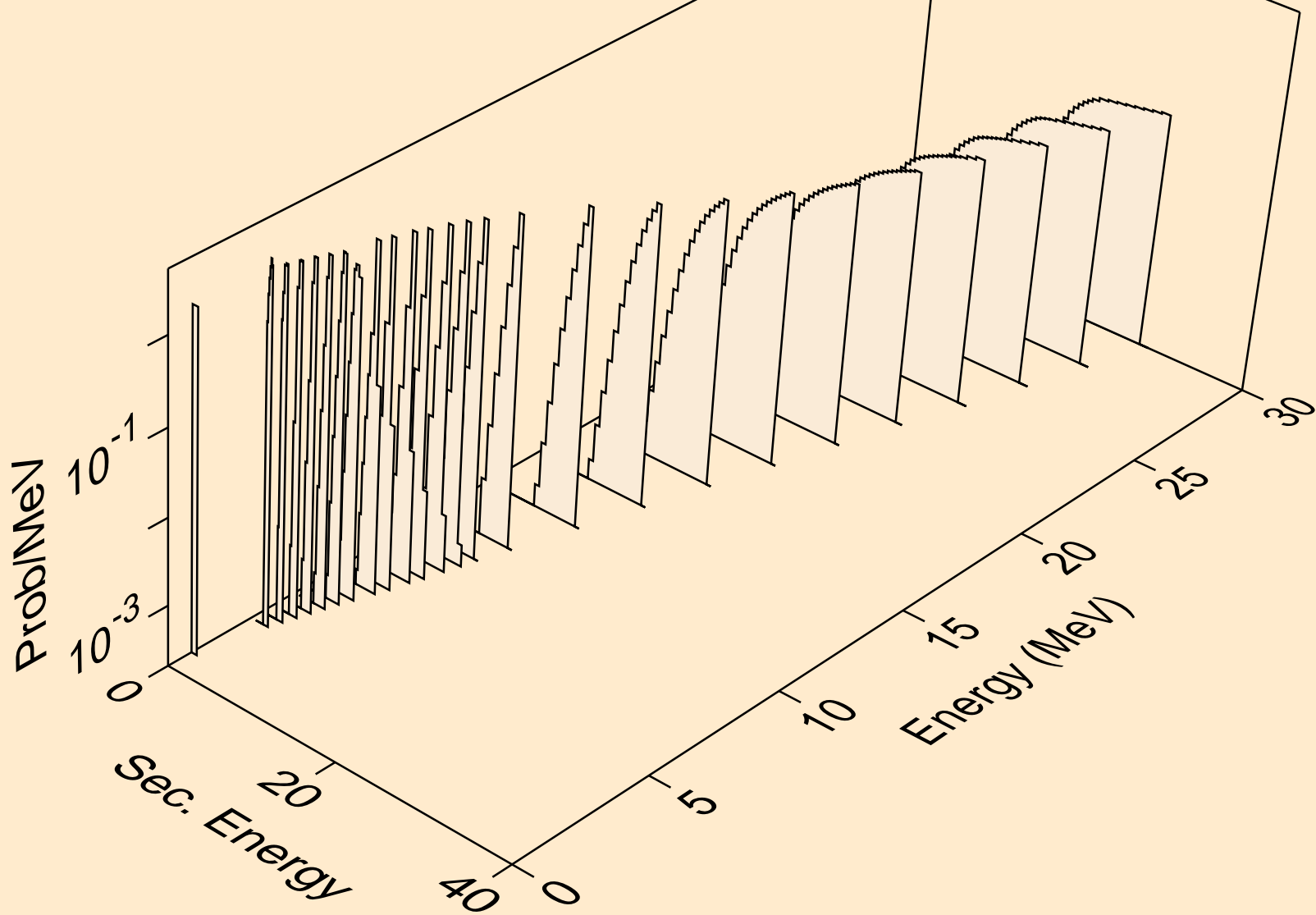

PB191M NEUTRON ACER TENDL-2023 LIBRARY; T=0.K  
deuterons from (n,pd)

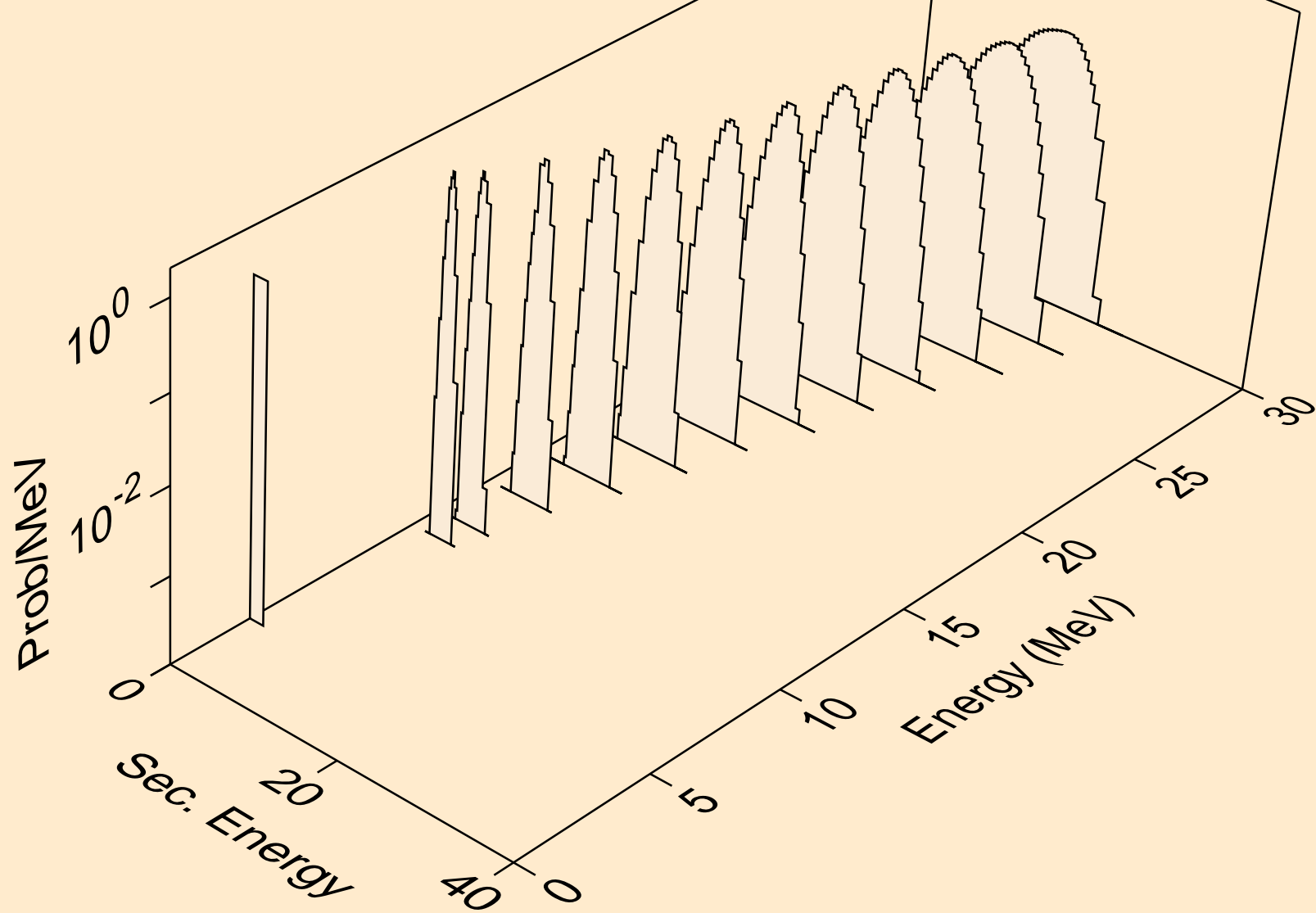

PB191M NEUTRON ACER TENDL-2023 LIBRARY; T=0.K  
deuterons from (n,da)

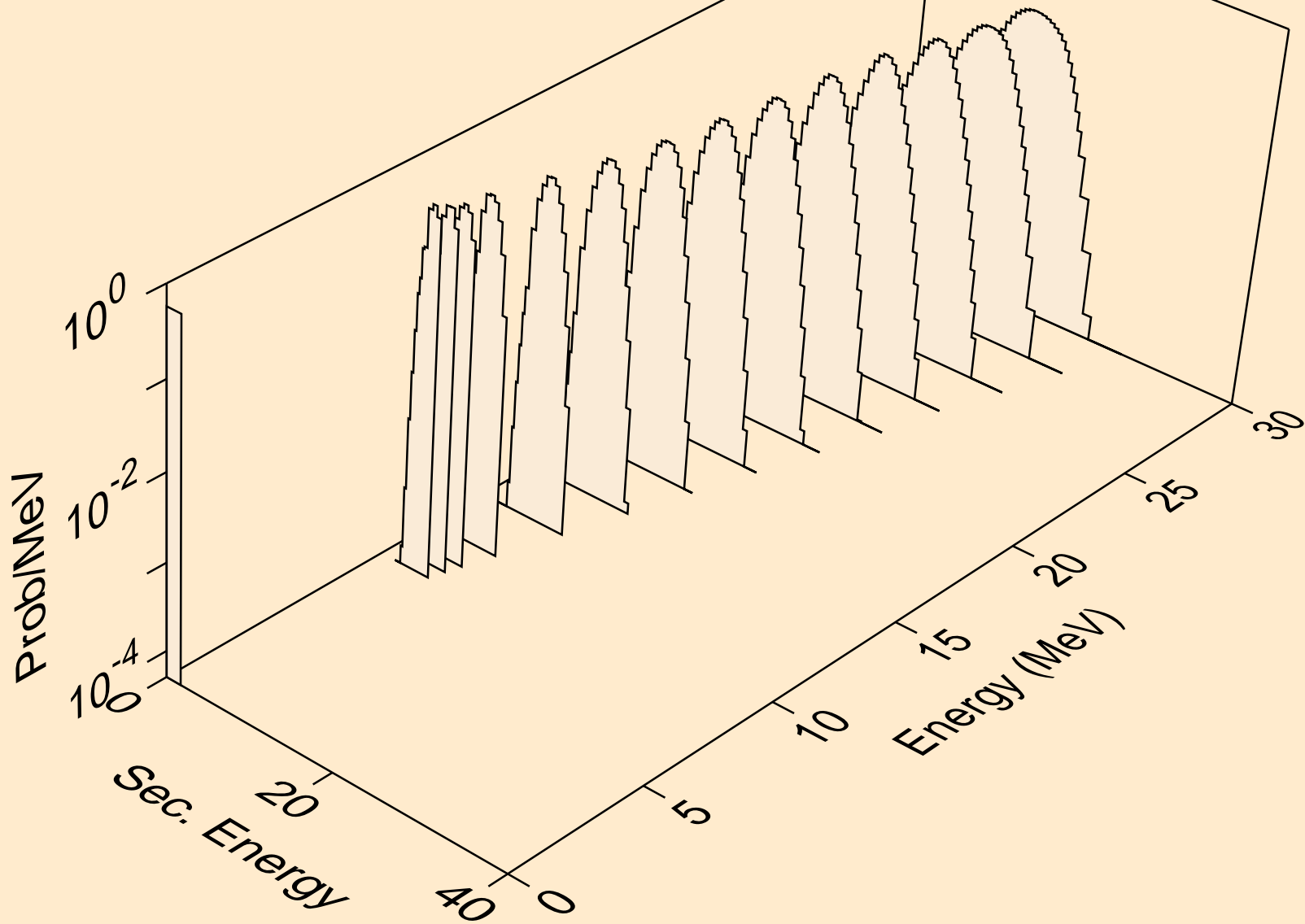

PB191M NEUTRON ACER TENDL-2023 LIBRARY; T=0.K  
tritons from (n,x)

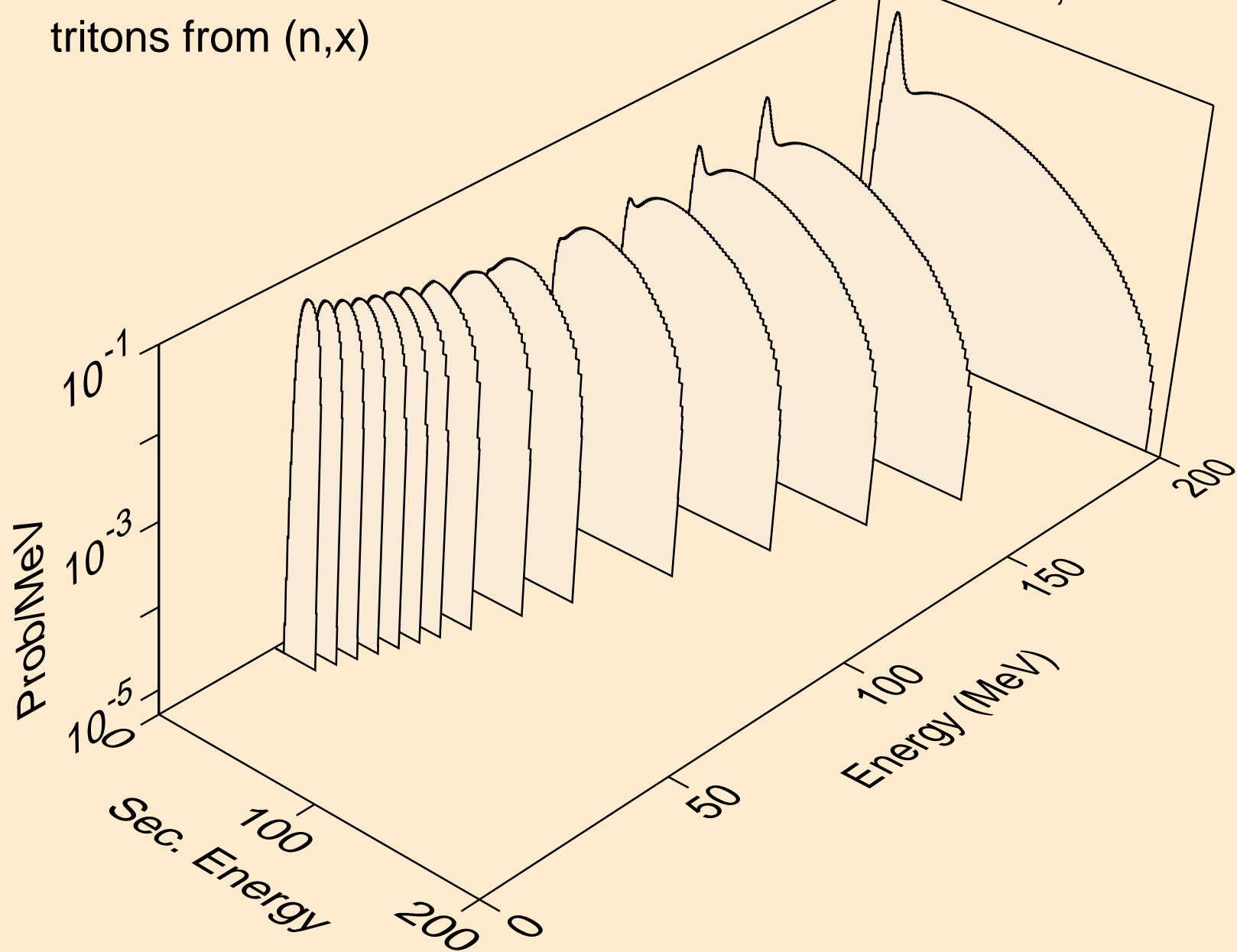

PB191M NEUTRON ACER TENDL-2023 LIBRARY; T=0.K  
tritons from (n,n\*)t

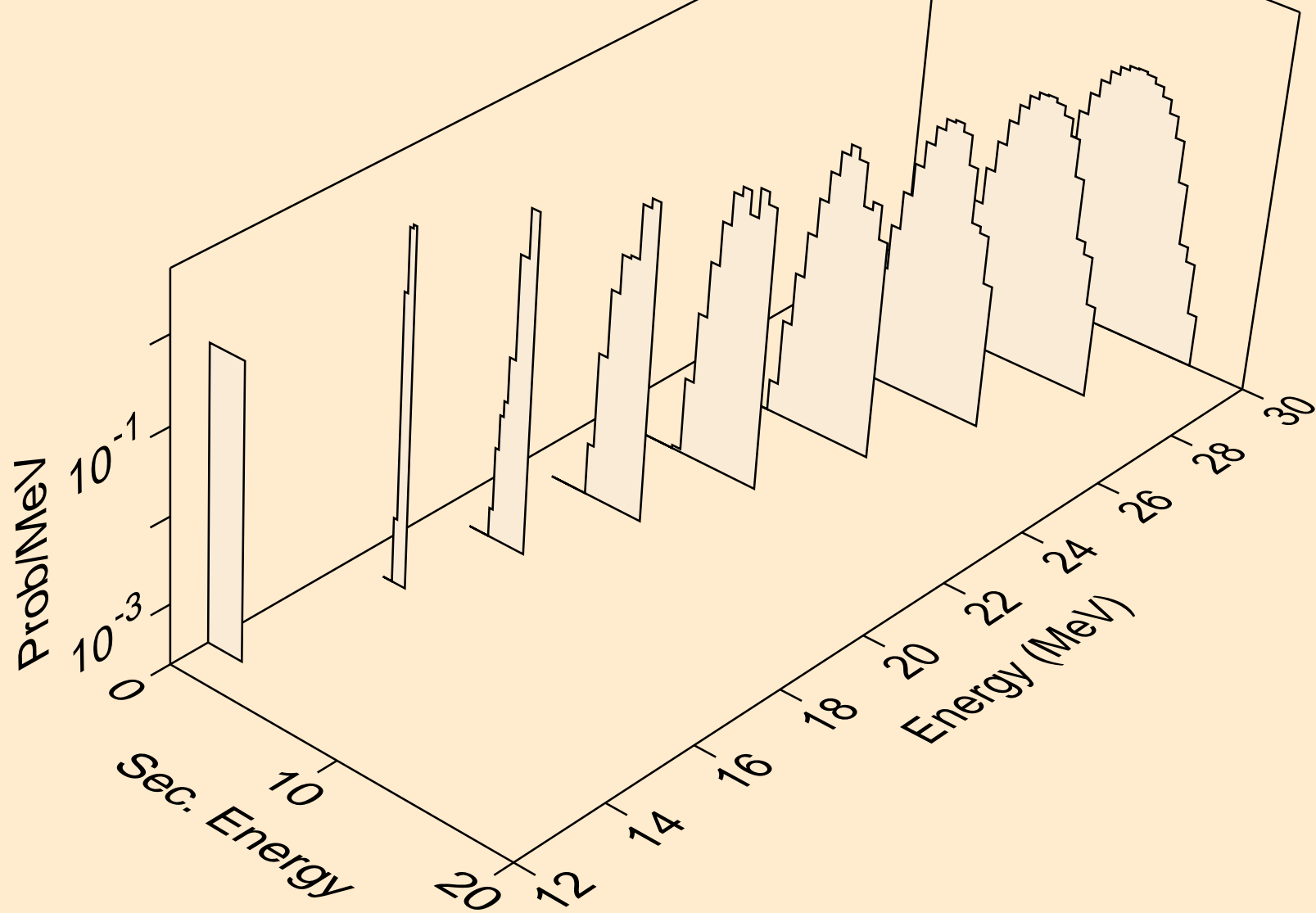

PB191M NEUTRON ACER TENDL-2023 LIBRARY; T=0.K  
tritons from (n,t)

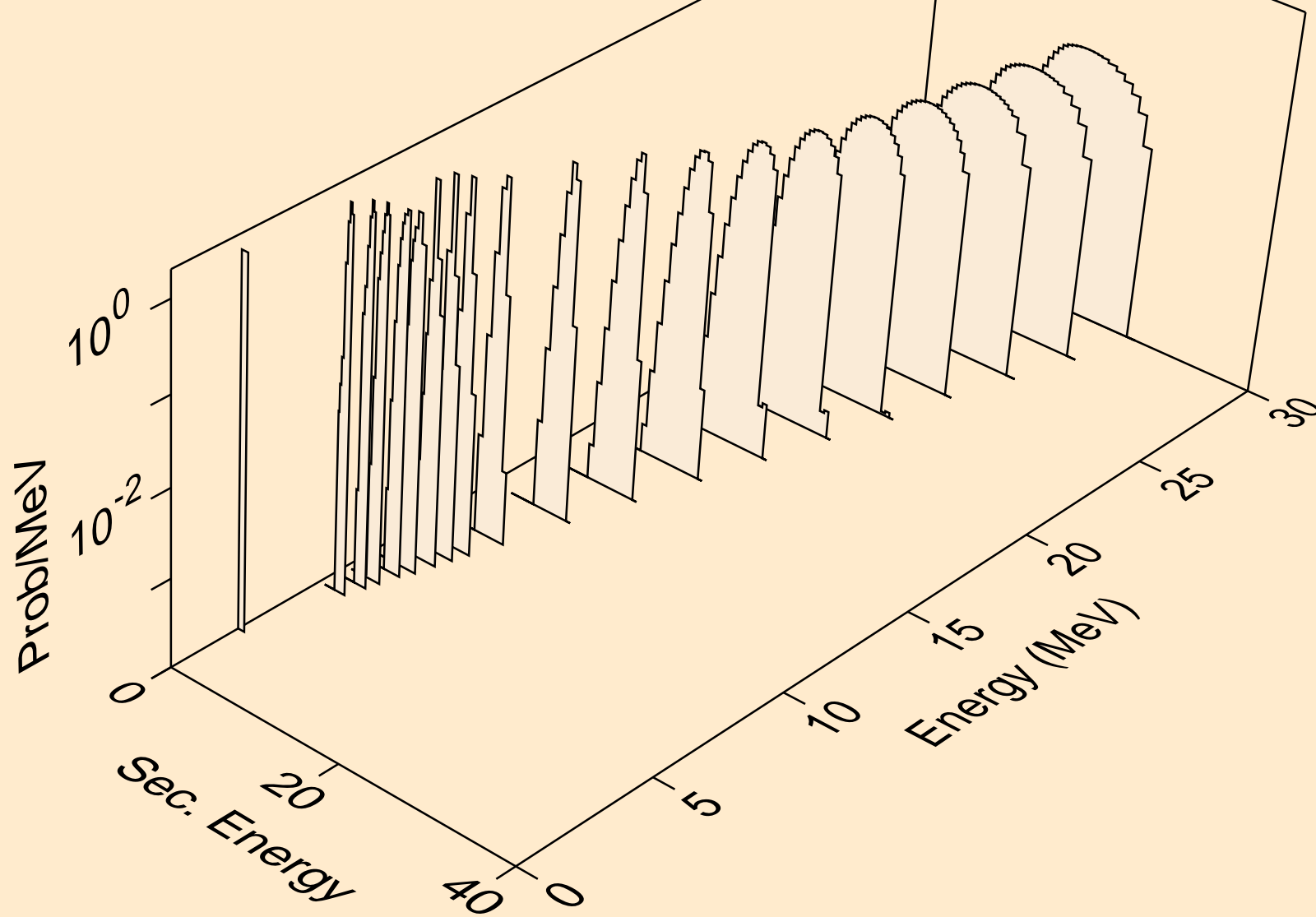

PB191M NEUTRON ACER TENDL-2023 LIBRARY; T=0.K  
tritons from (n,pt)

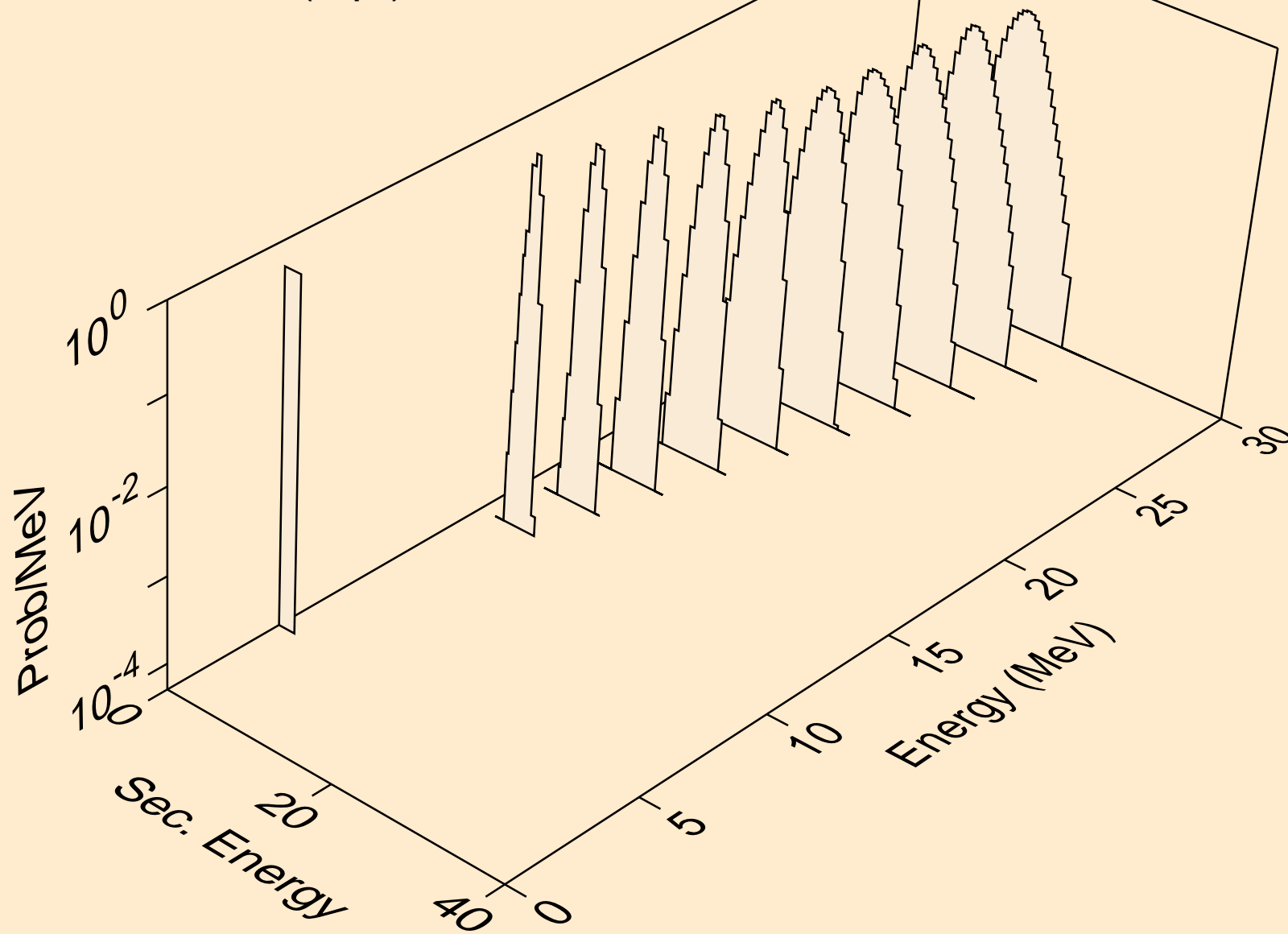

PB191M NEUTRON ACER TENDL-2023 LIBRARY; T=0.K  
he3s from (n,x)

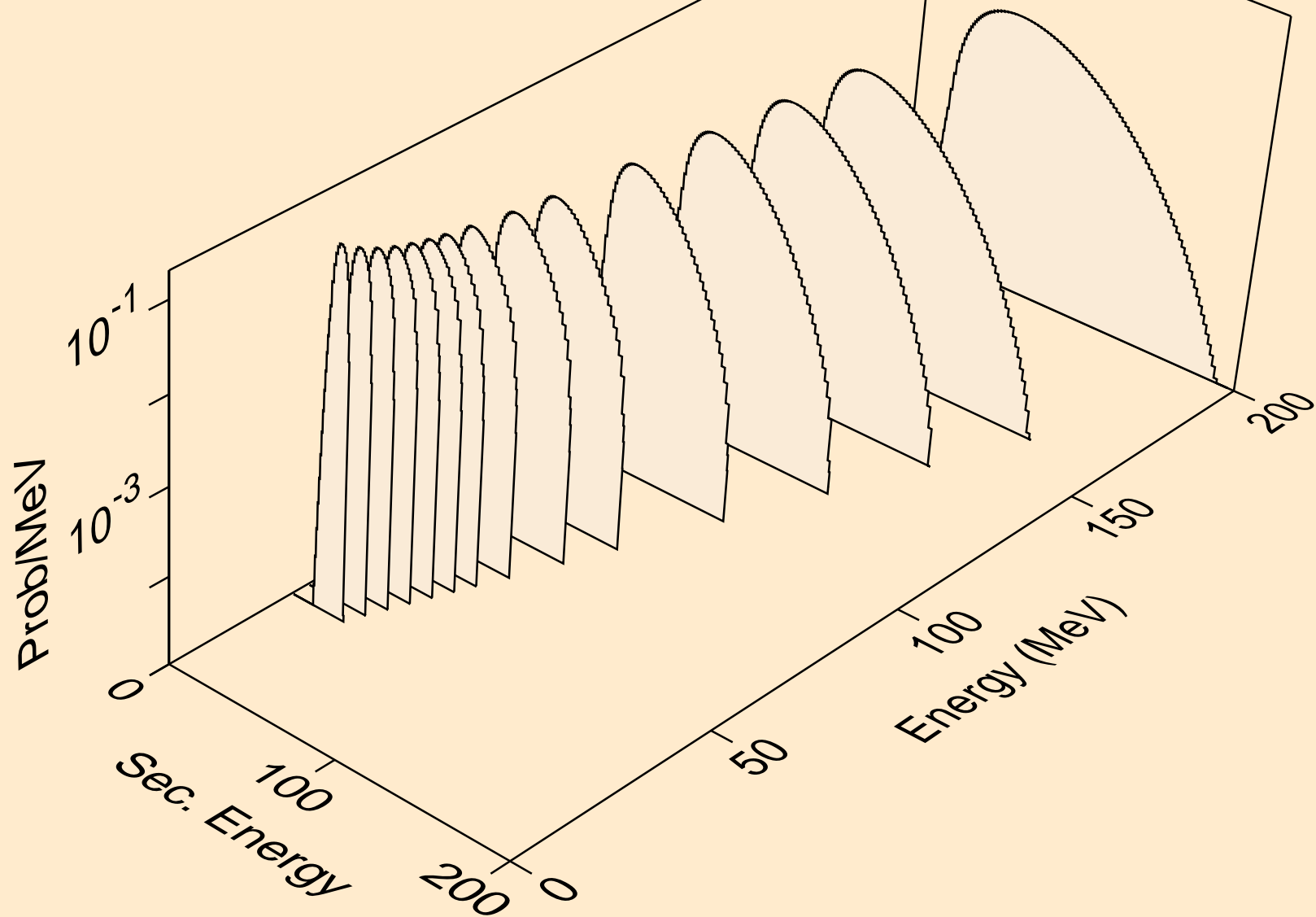

PB191M NEUTRON ACER TENDL-2023 LIBRARY; T=0.K  
he3s from (n,n\*)he3

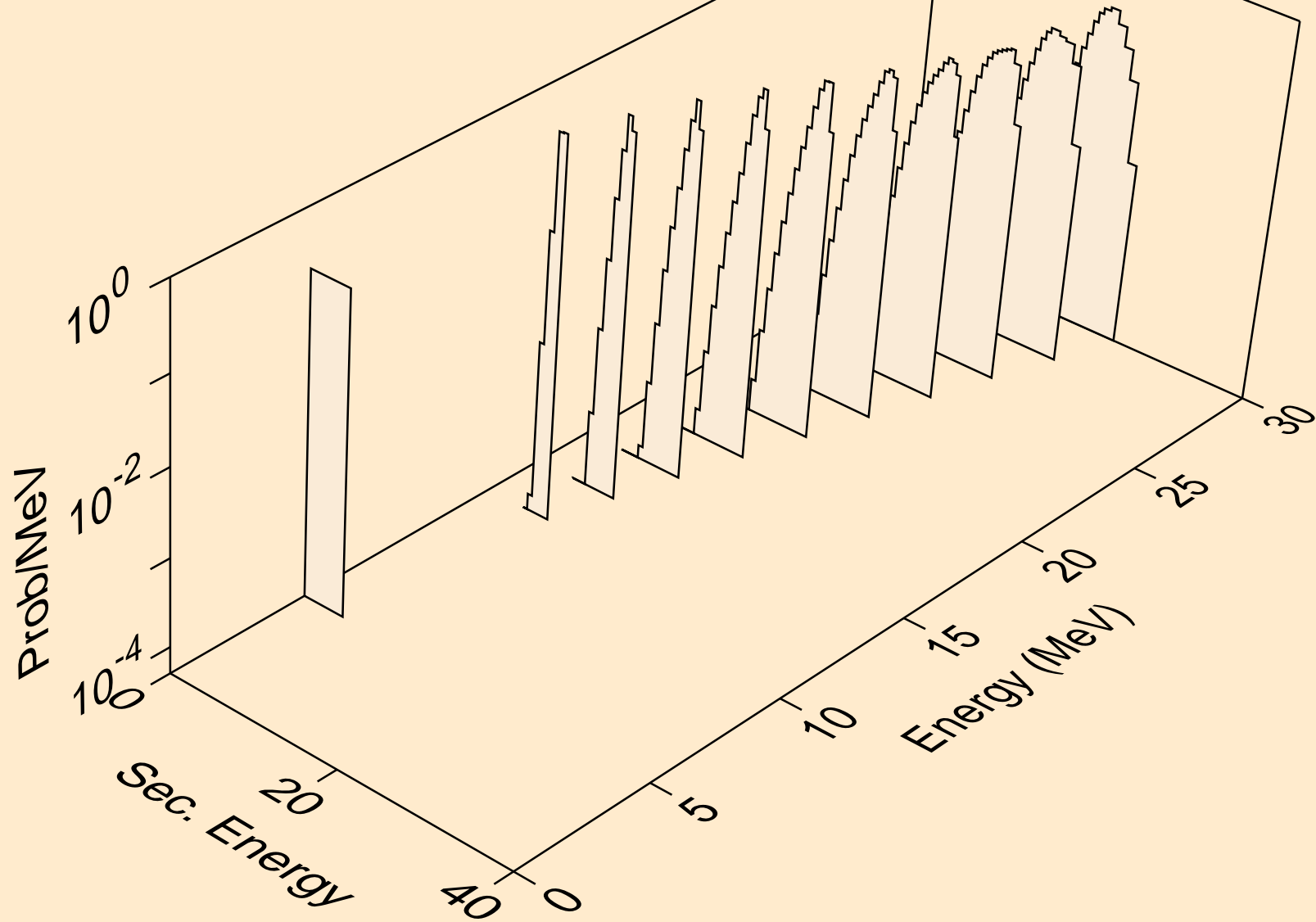

PB191M NEUTRON ACER TENDL-2023 LIBRARY; T=0.K  
he3s from (n,he3)

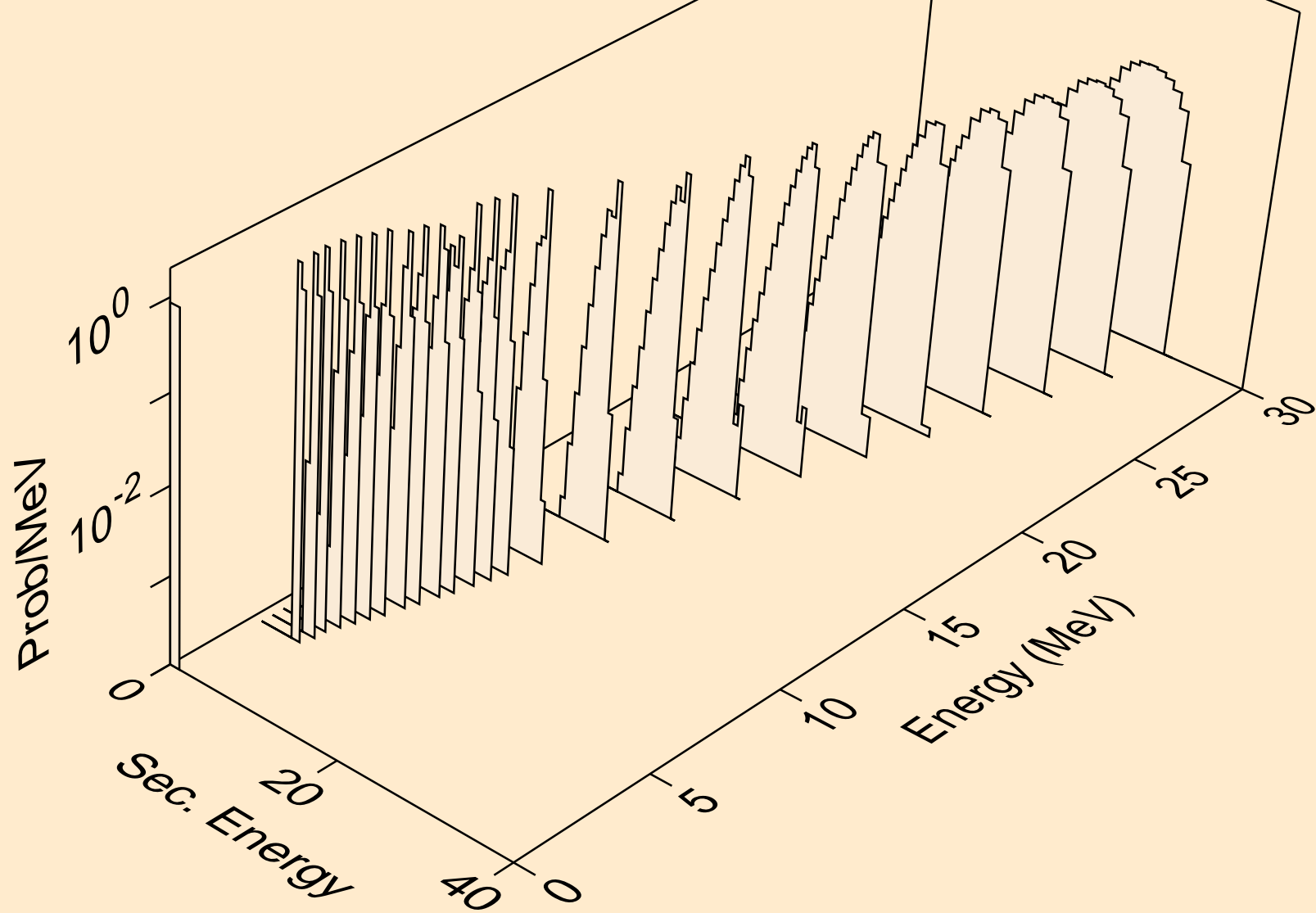

PB191M NEUTRON ACER TENDL-2023 LIBRARY; T=0.K  
alphas from (n,x)

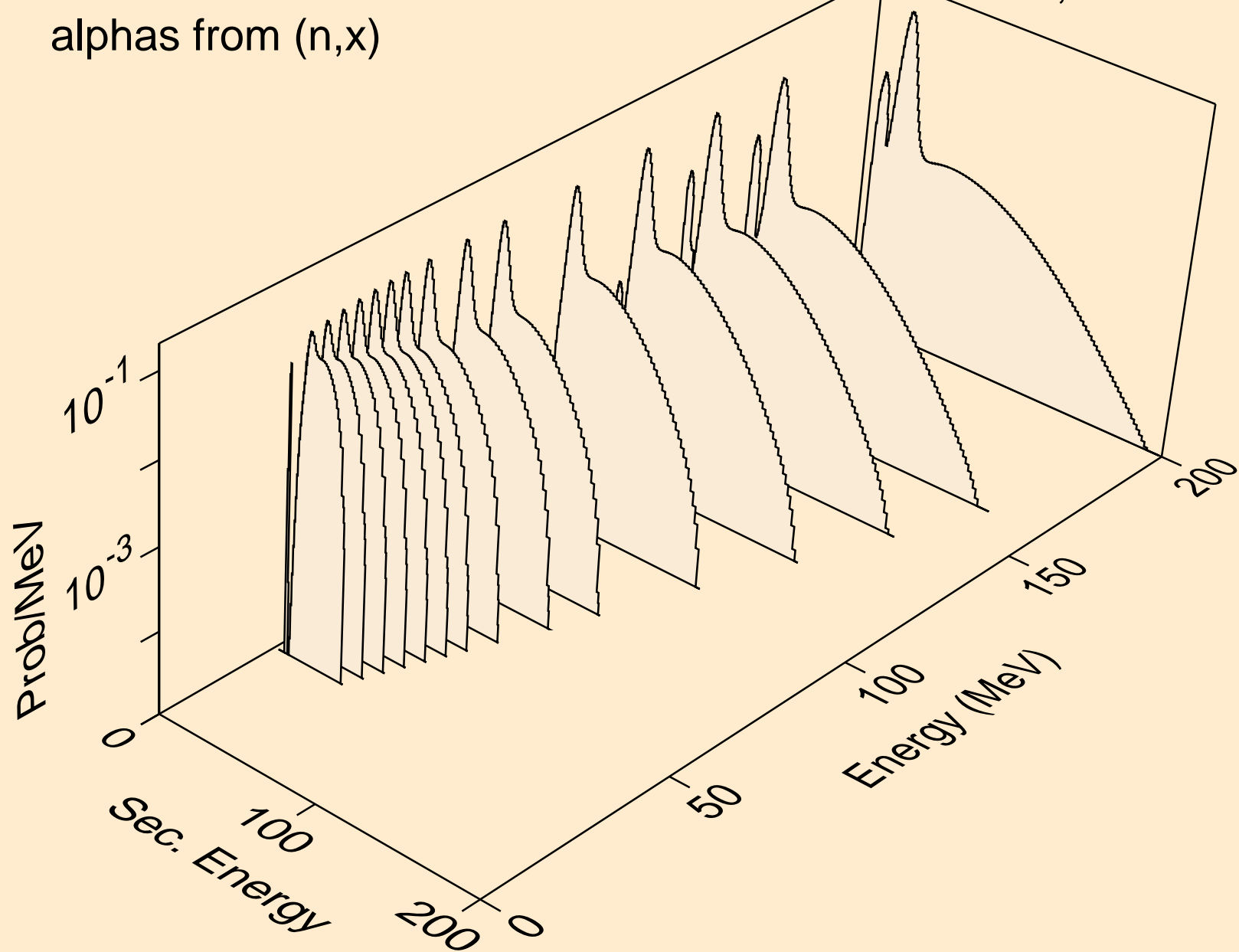

PB191M NEUTRON ACER TENDL-2023 LIBRARY; T=0.K  
alphas from (n,n\*)a

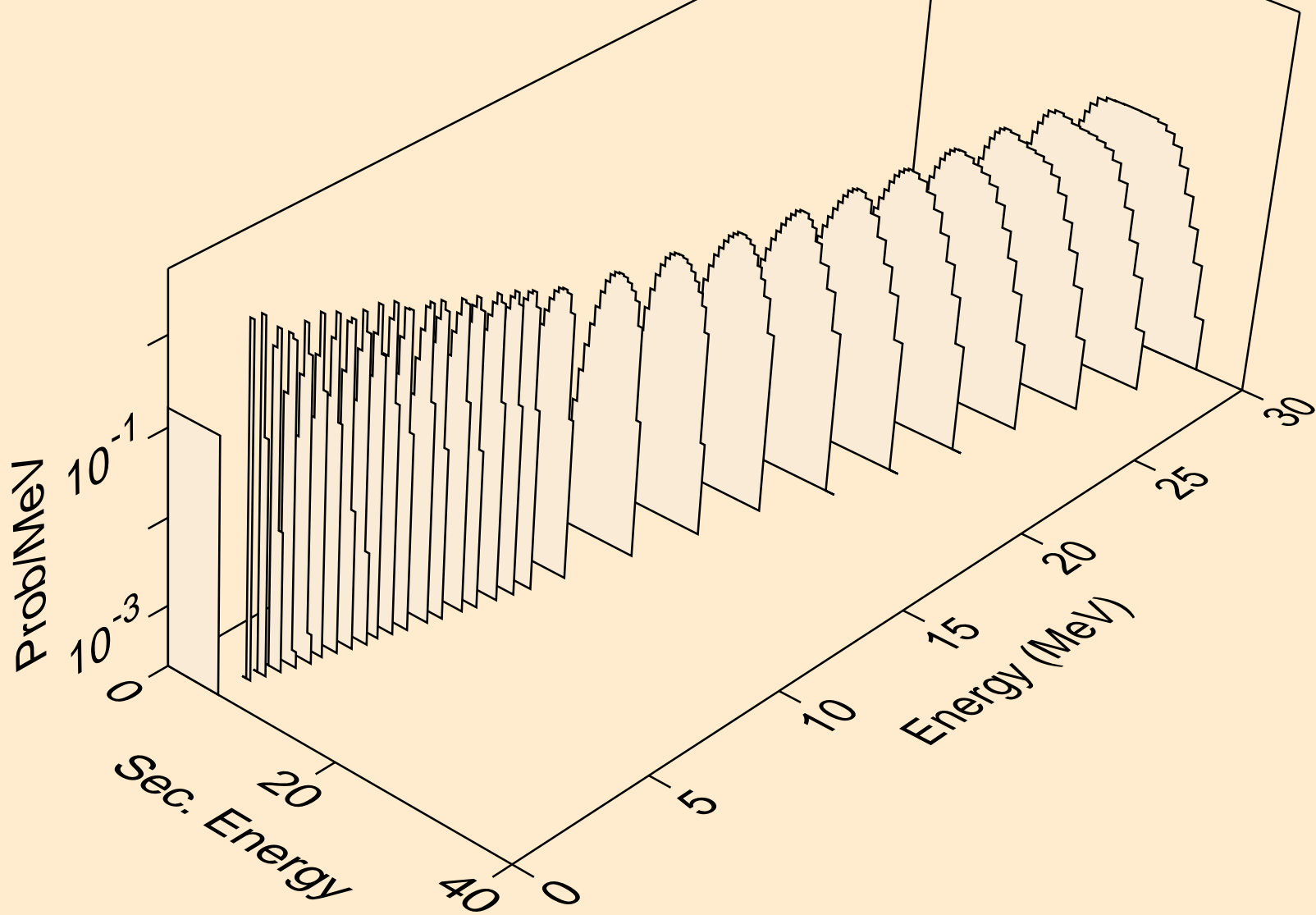

PB191M NEUTRON ACER TENDL-2023 LIBRARY; T=0.K  
alphas from (n,2n)a

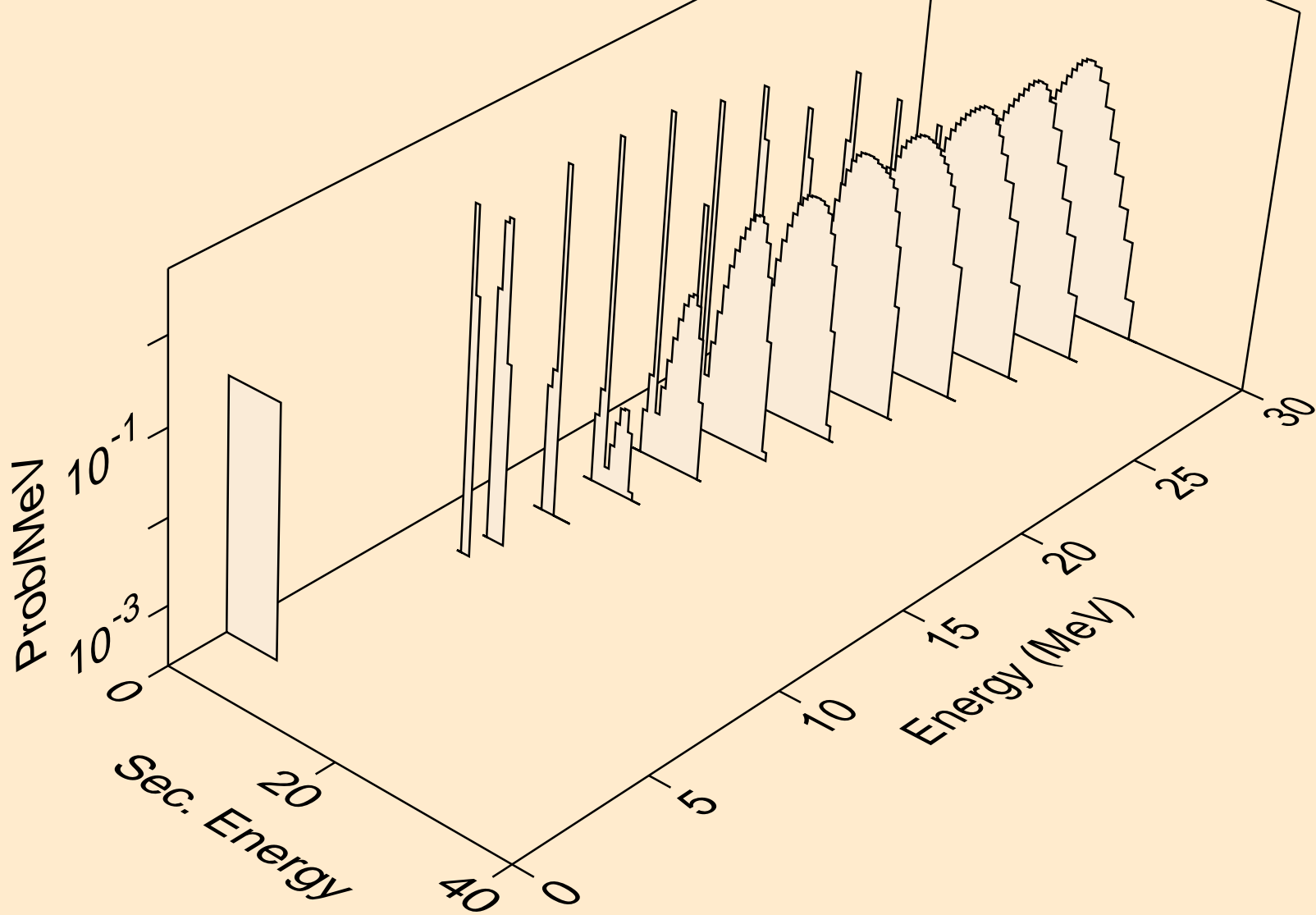

PB191M NEUTRON ACER TENDL-2023 LIBRARY; T=0.K  
alphas from (n,3n)a

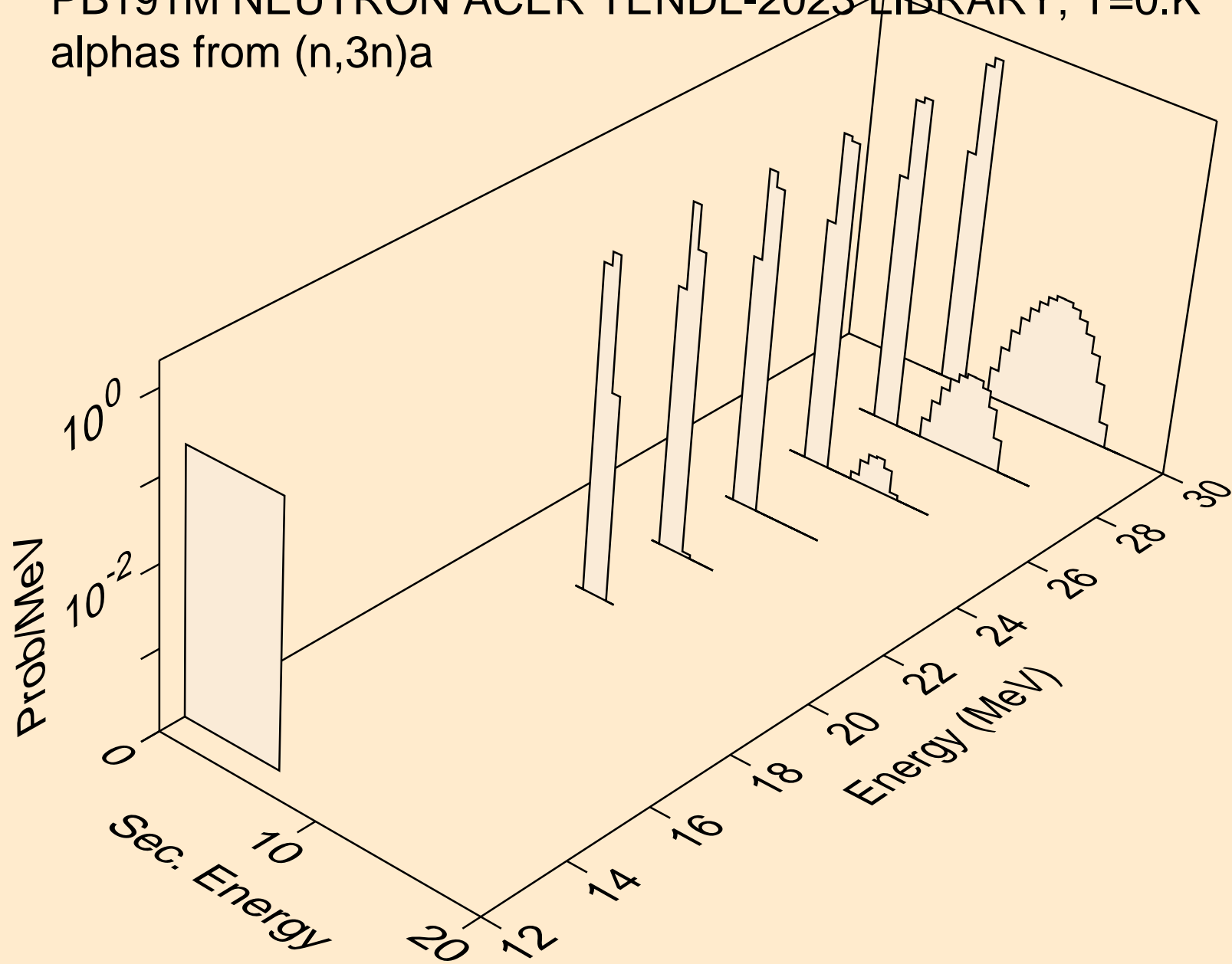

PB191M NEUTRON ACER TENDL-2023 LIBRARY; T=0.K  
alphas from (n,n\*)2a

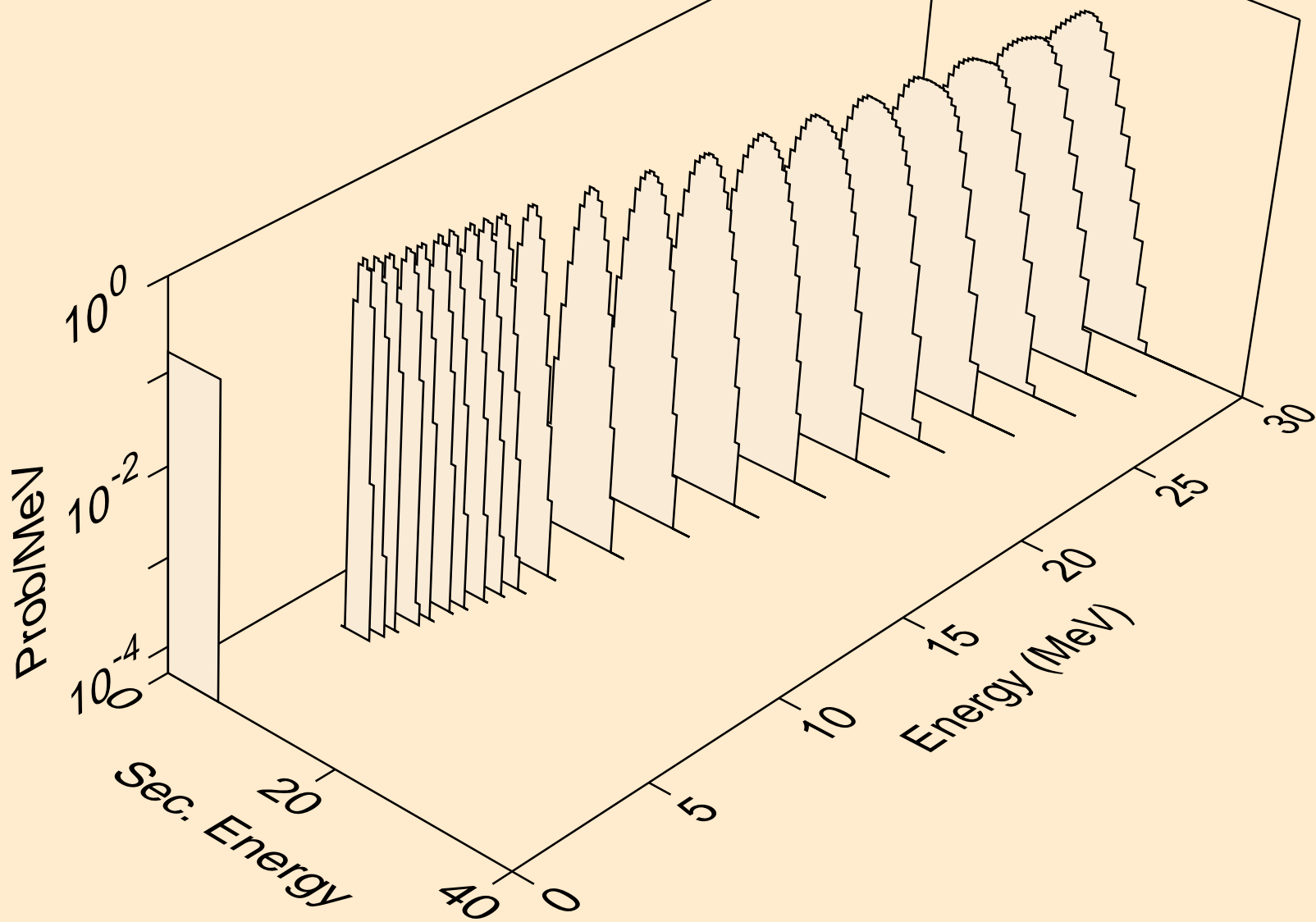

PB191M NEUTRON ACER TENDL-2023 LIBRARY; T=0.K  
alphas from (n,2n)2a

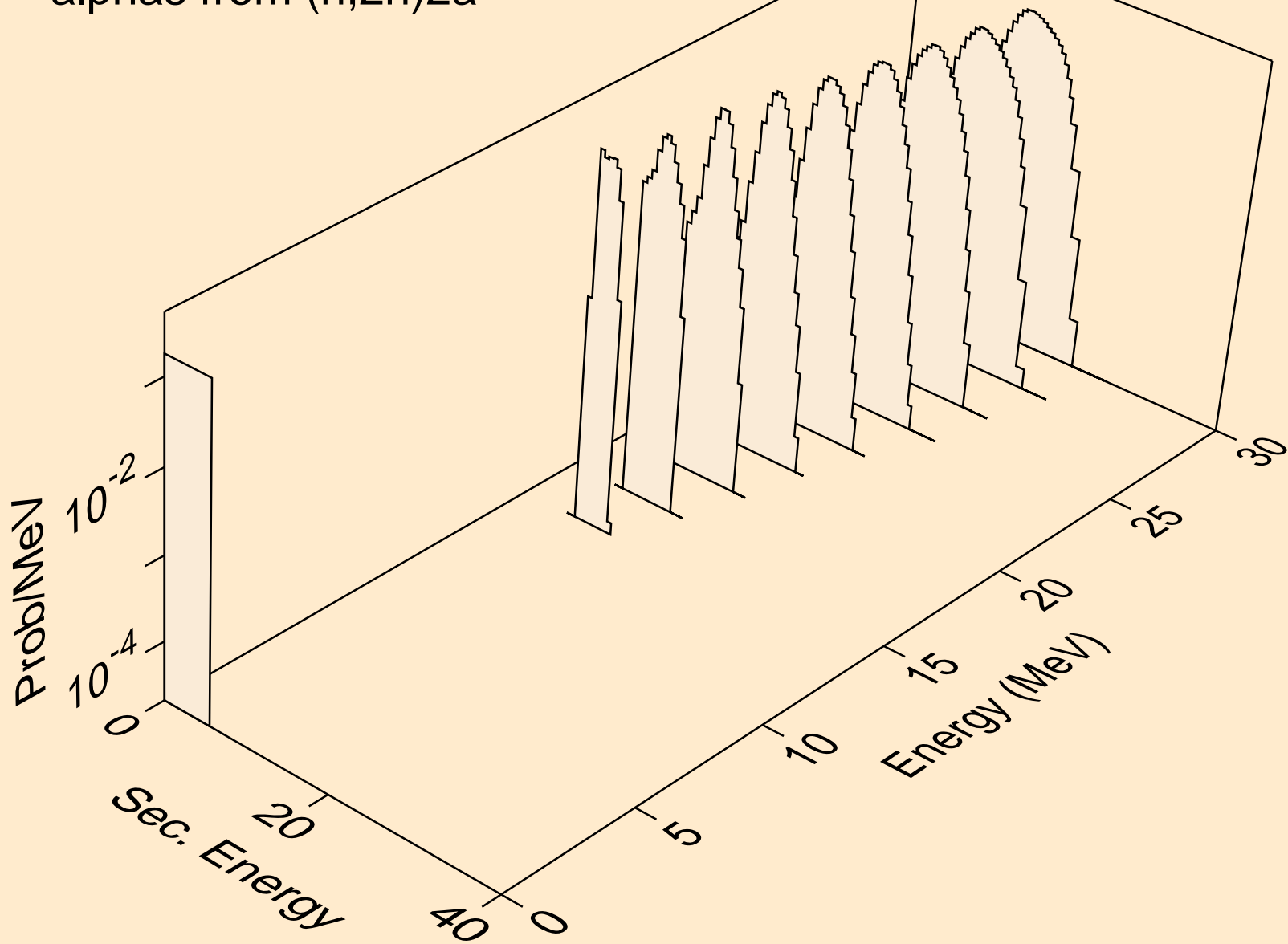

PB191M NEUTRON ACER TENDL-2023 LIBRARY; T=0.K  
alphas from (n,npa)

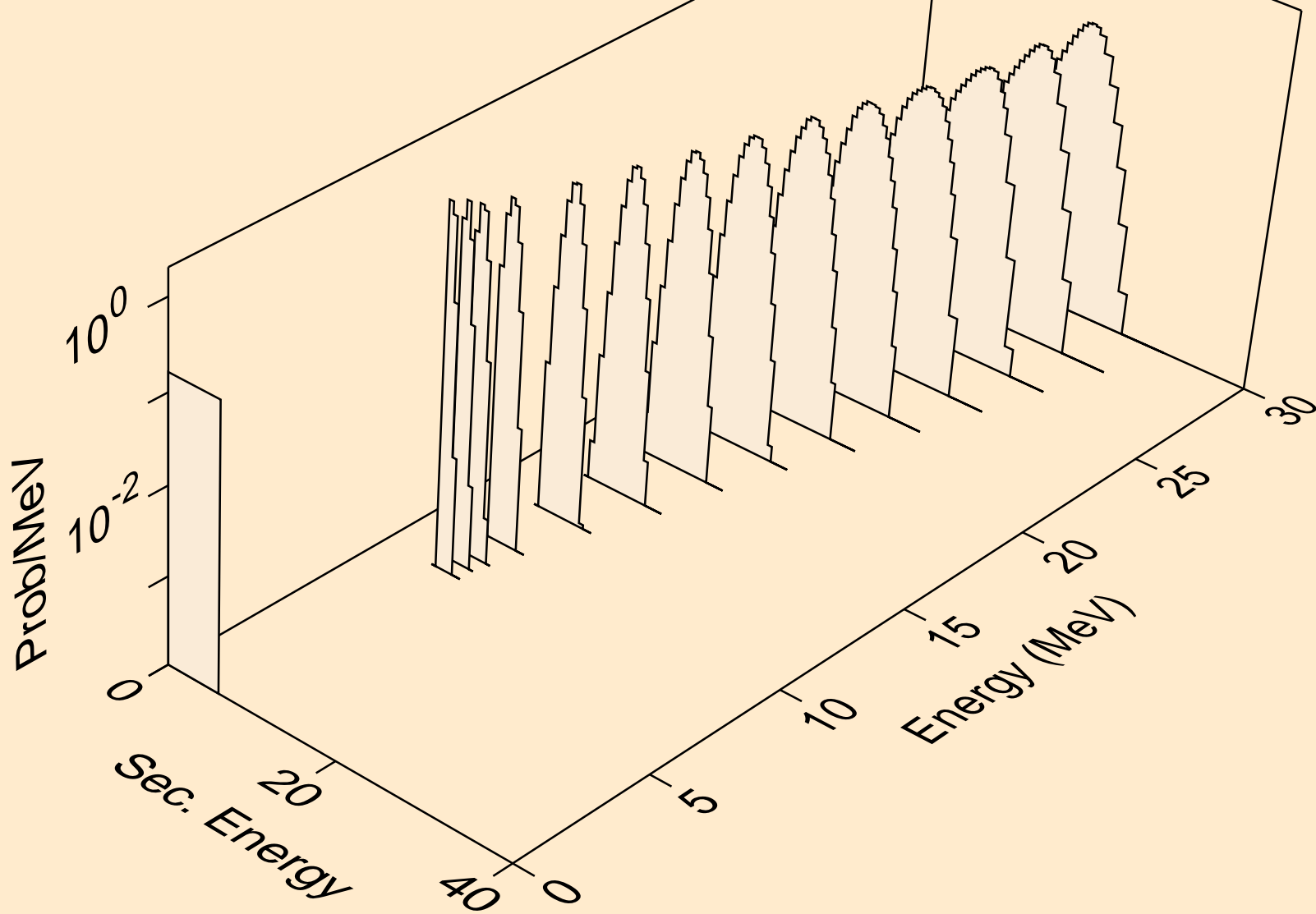

PB191M NEUTRON ACER TENDL-2023 LIBRARY; T=0.K  
alphas from (n,a)

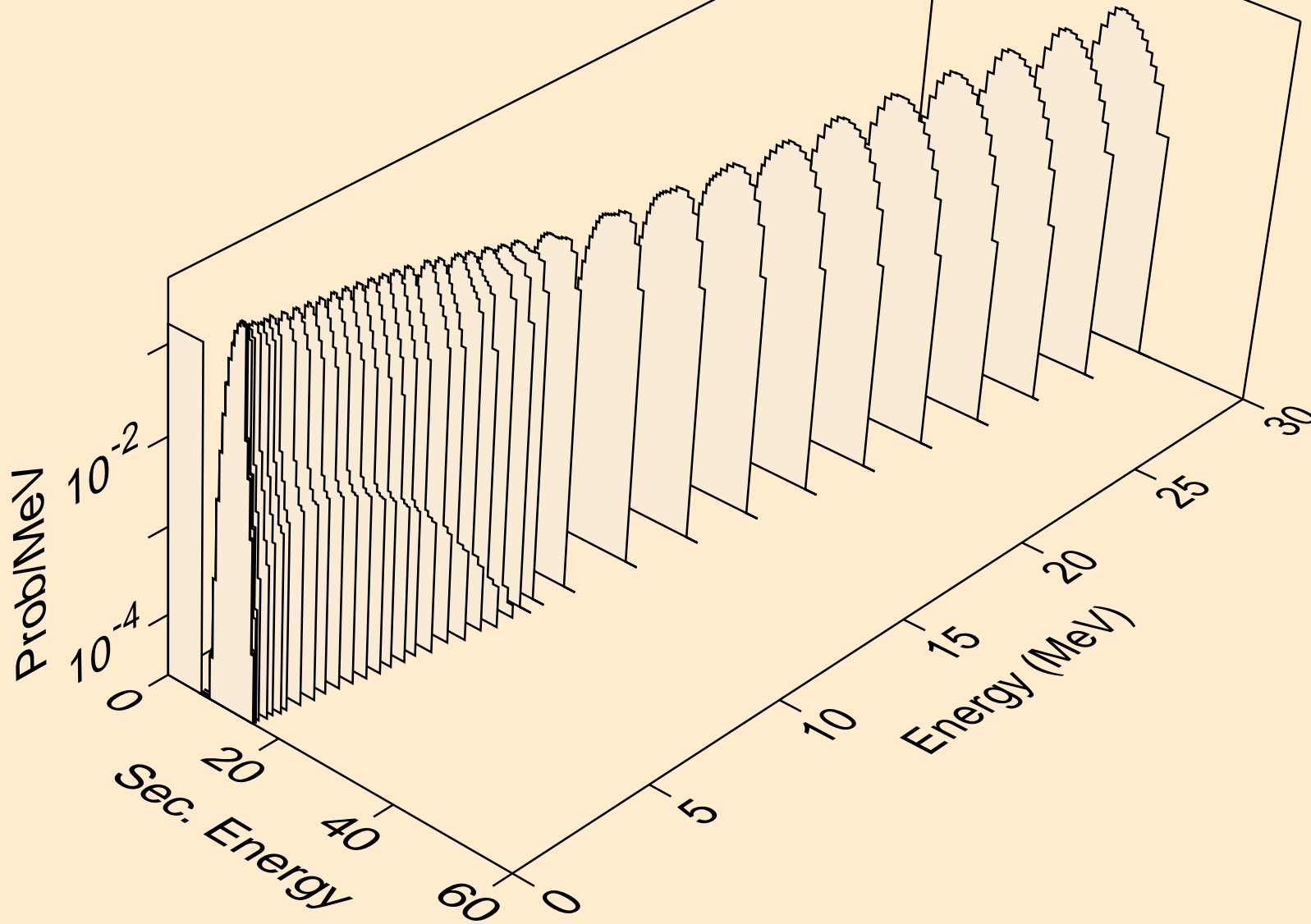

PB191M NEUTRON ACER TENDL-2023 LIBRARY; T=0.K  
alphas from (n,2a)

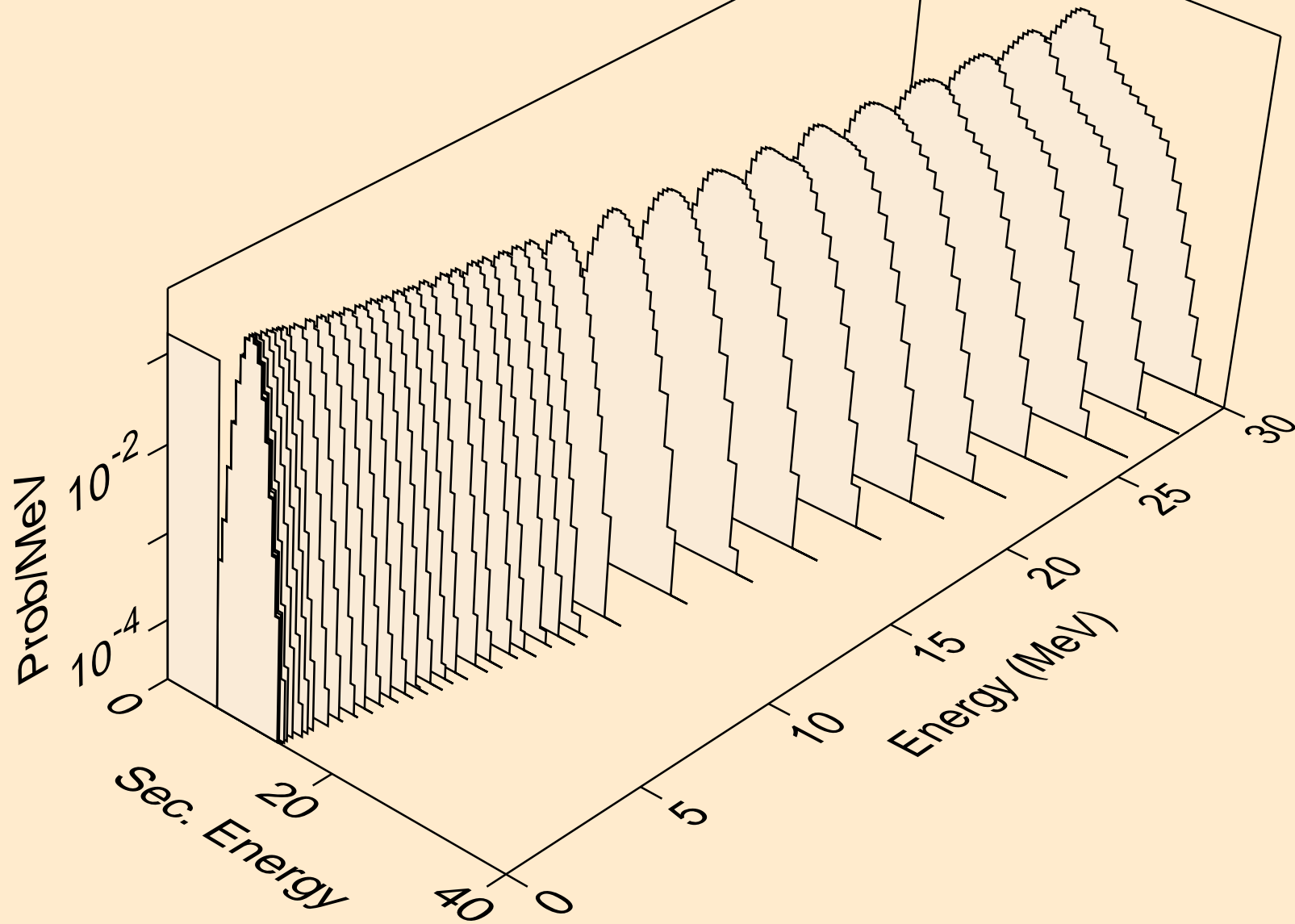

PB191M NEUTRON ACER TENDL-2023 LIBRARY; T=0.K  
alphas from (n,3a)

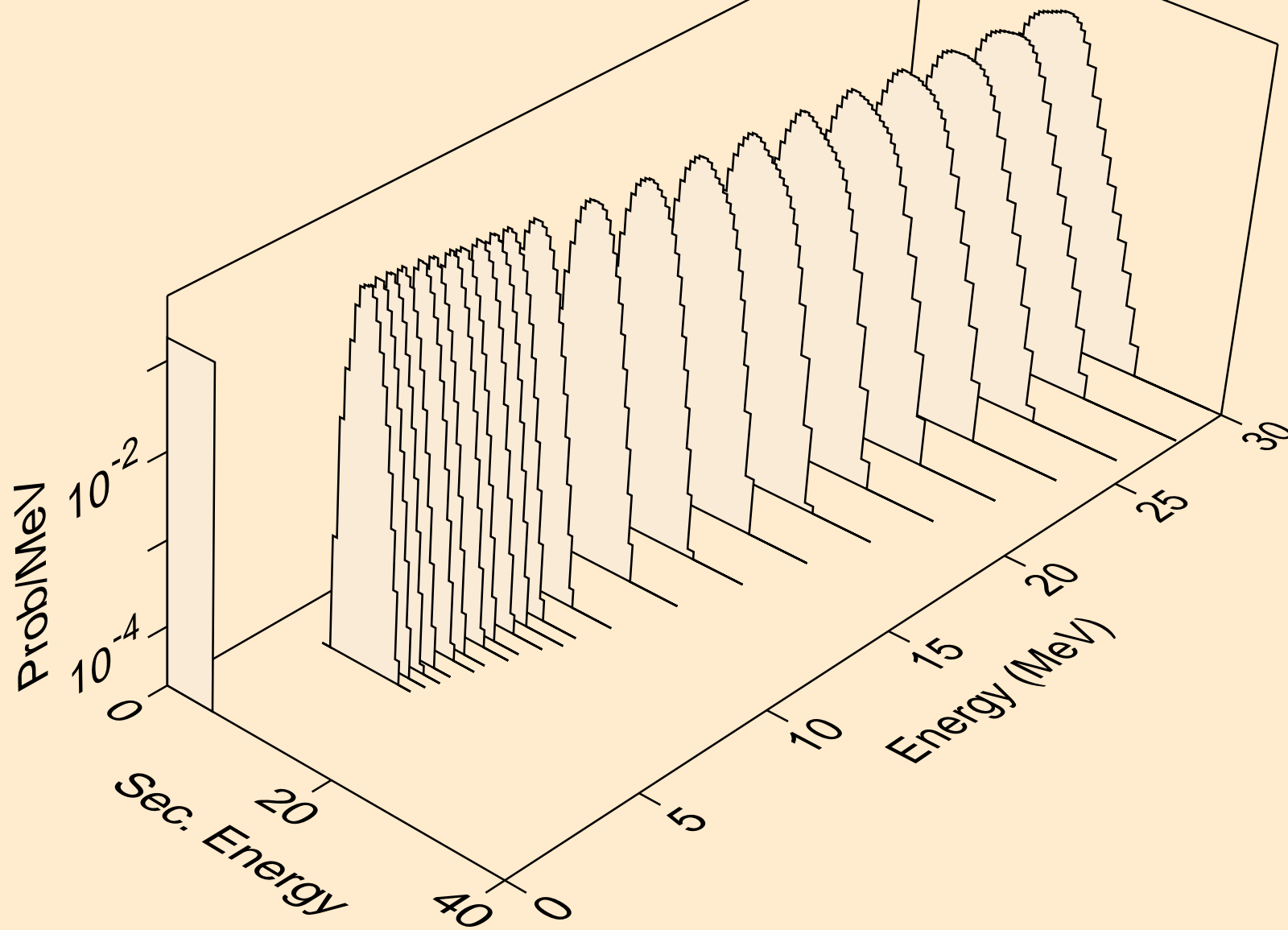

PB191M NEUTRON ACER TENDL-2023 LIBRARY; T=0.K  
alphas from (n,pa)

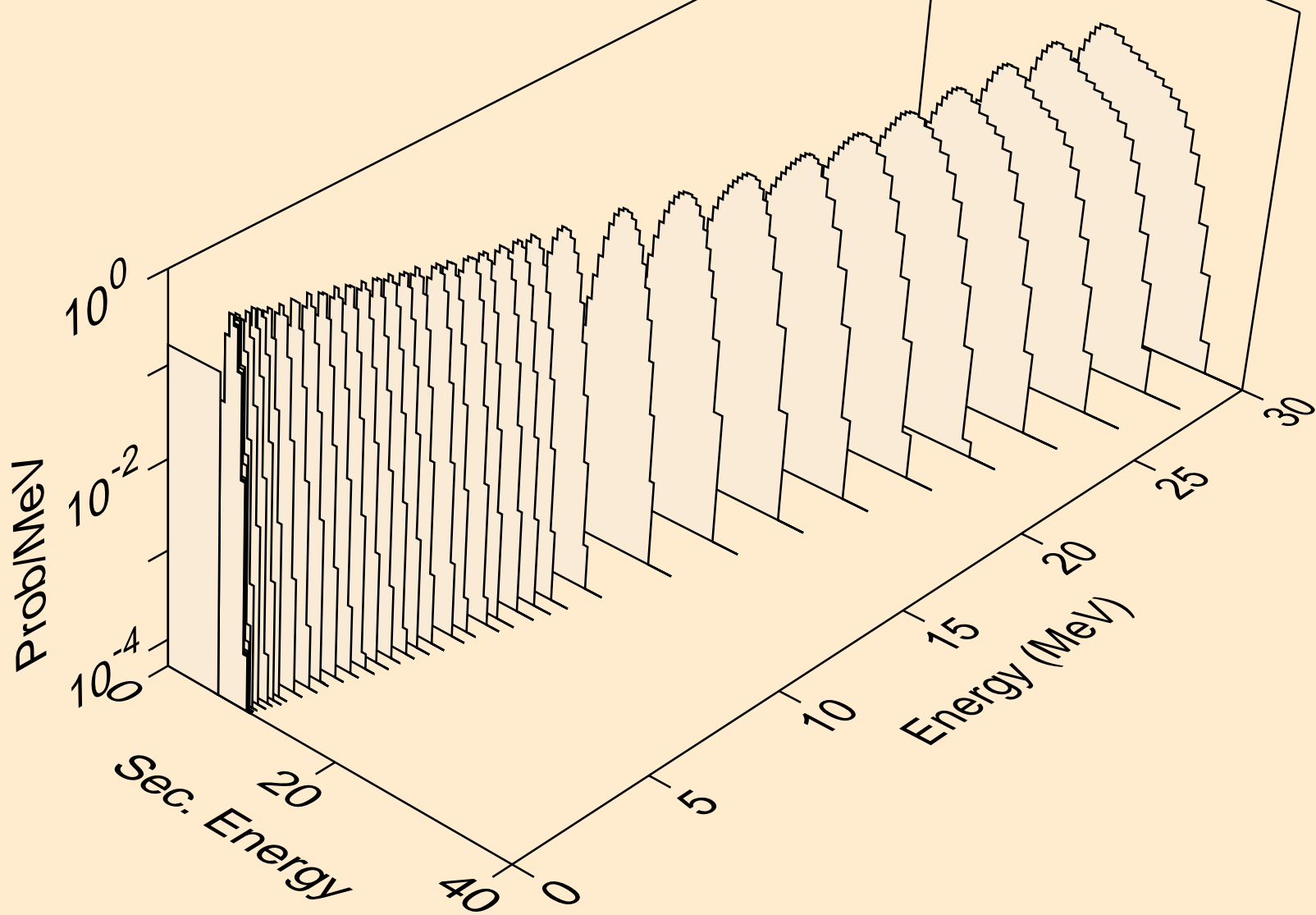

PB191M NEUTRON ACER TENDL-2023 LIBRARY; T=0.K  
alphas from (n,da)

