

# PM154 NEUTRON ACER TENDL-2023 LIBRARY; T=0.K

## Principal cross sections

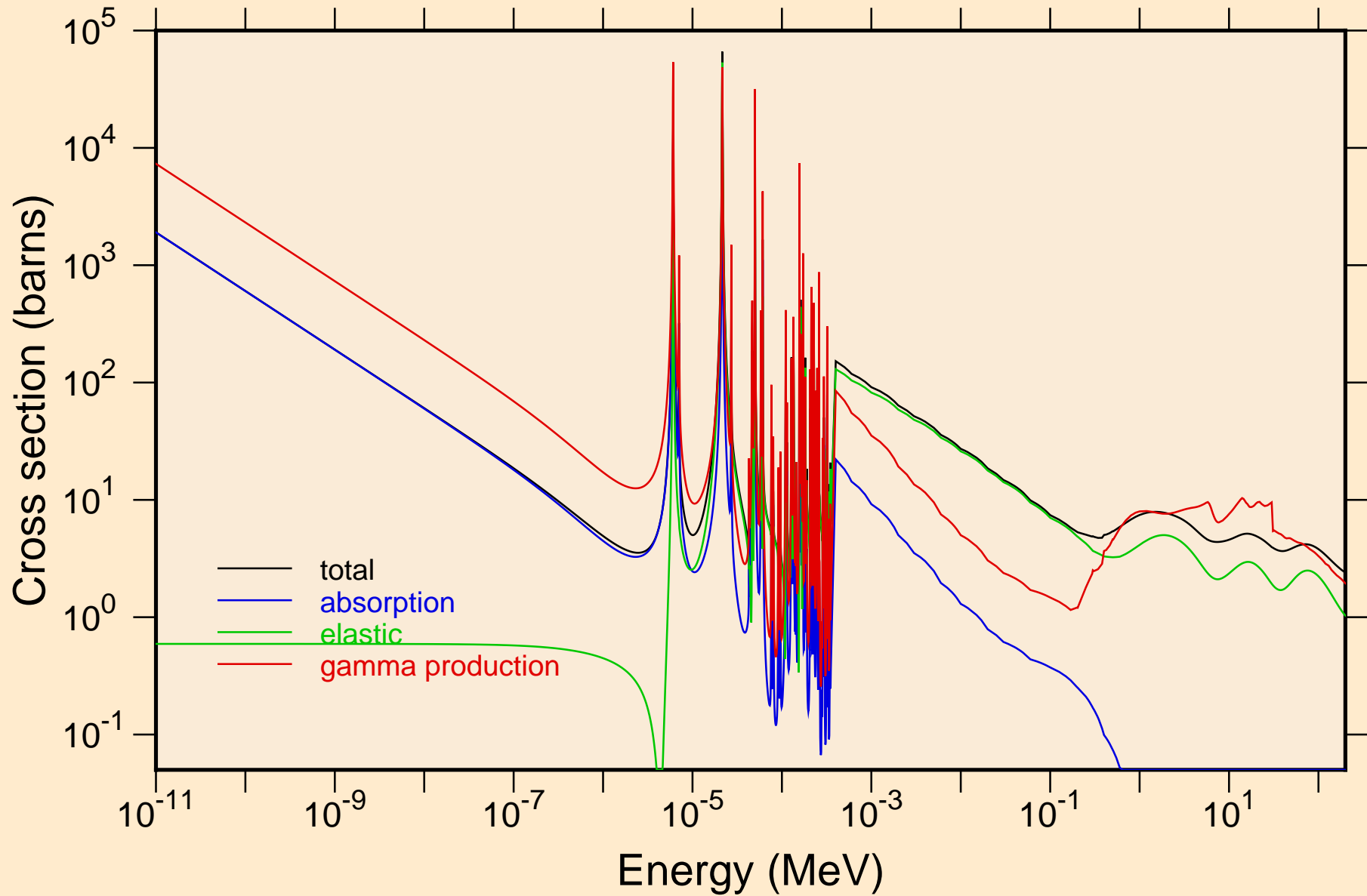

PM154 NEUTRON ACER TENDL-2023 LIBRARY; T=0.K  
resonance total cross section

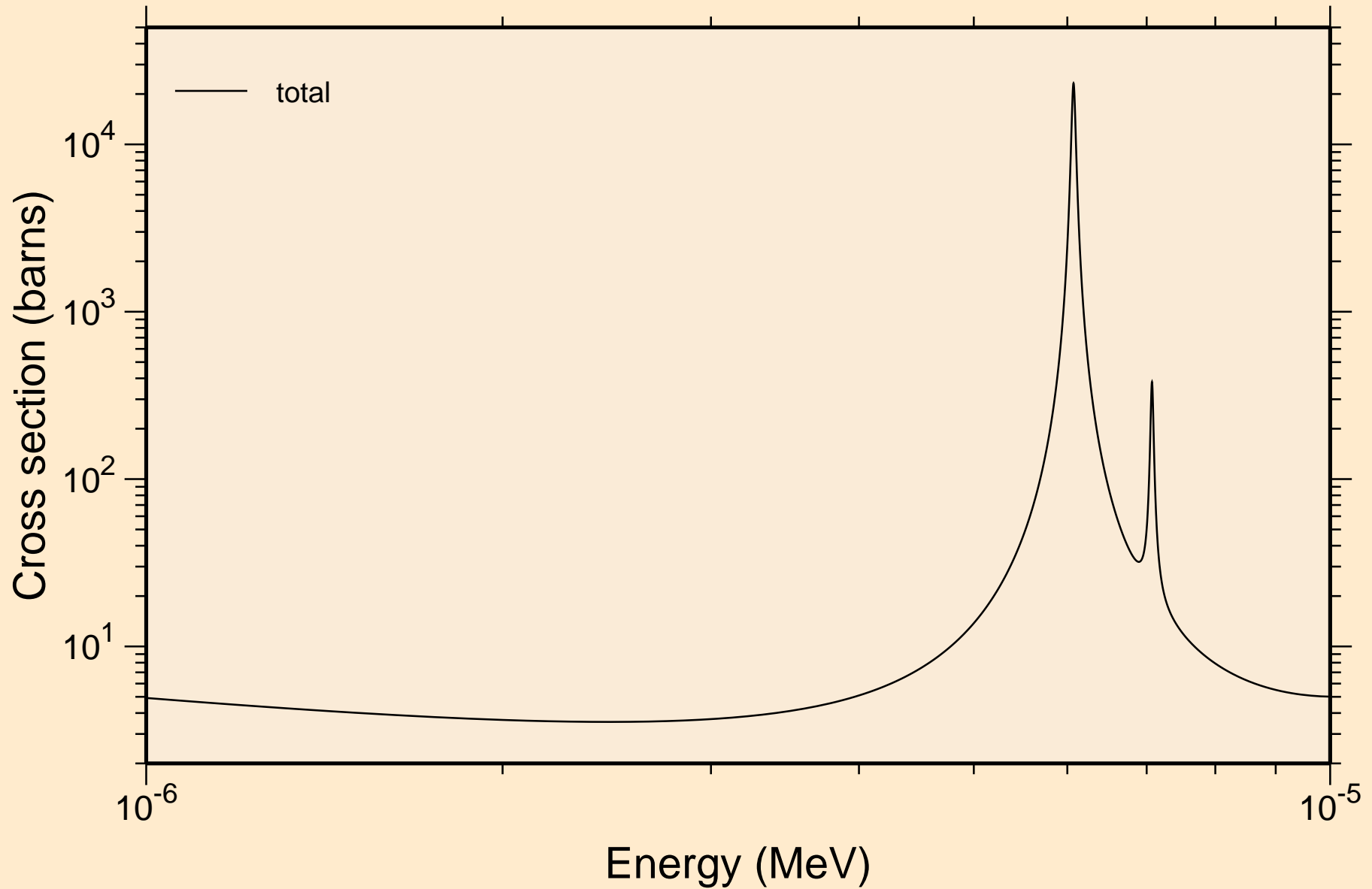

PM154 NEUTRON ACER TENDL-2023 LIBRARY; T=0.K  
resonance total cross section

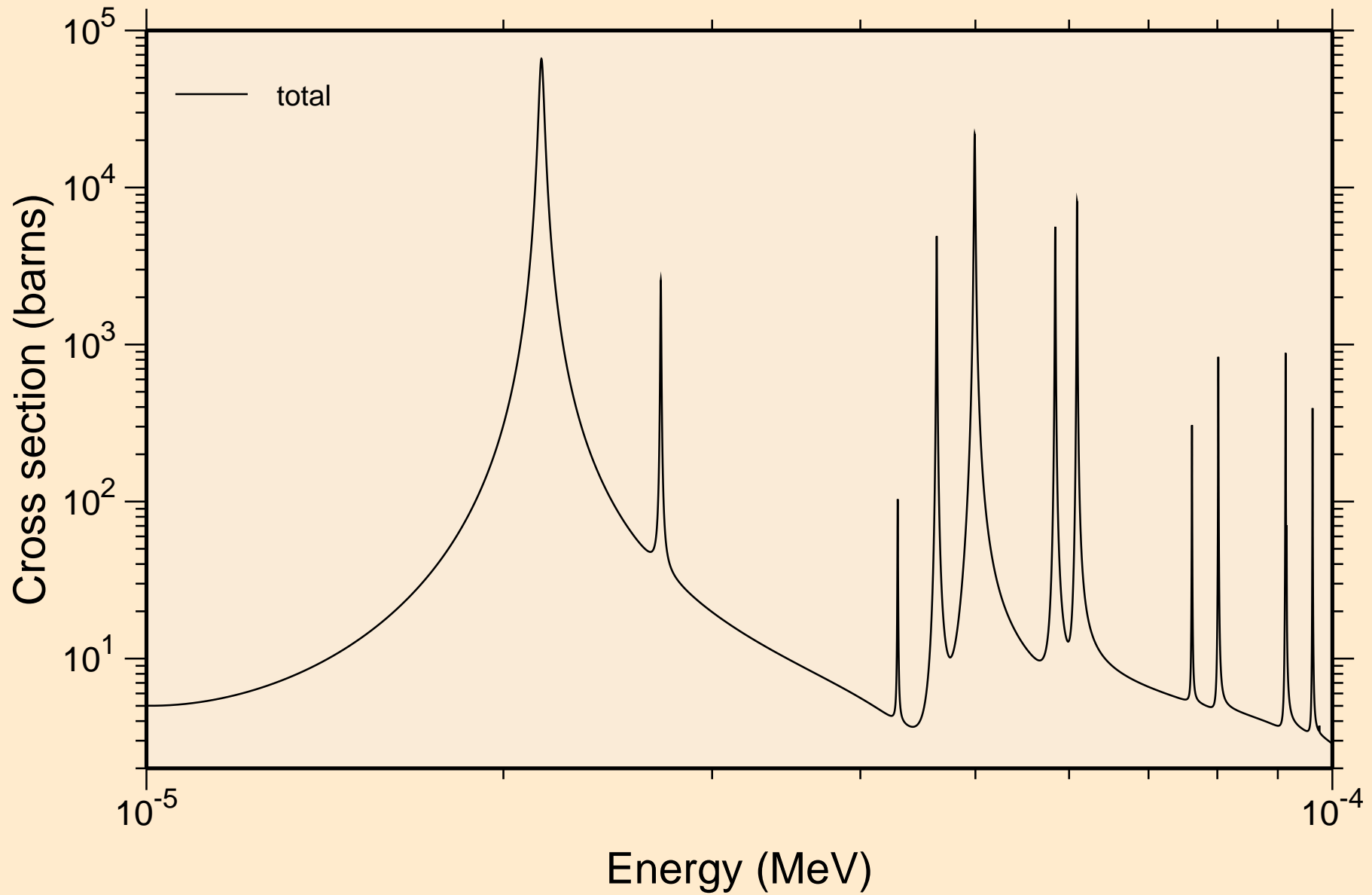

PM154 NEUTRON ACER TENDL-2023 LIBRARY; T=0.K  
resonance total cross section

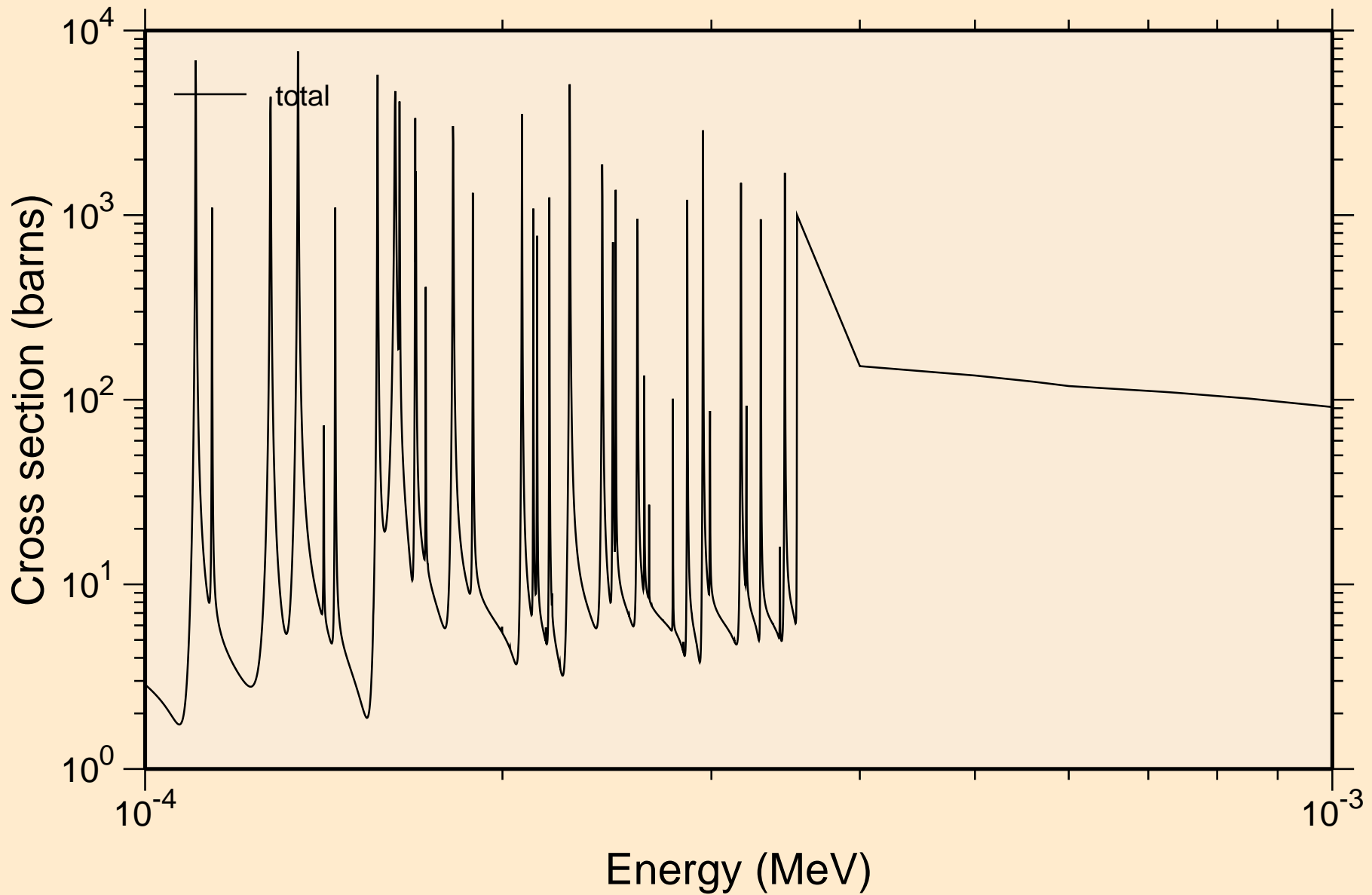

PM154 NEUTRON ACER TENDL-2023 LIBRARY; T=0.K  
resonance total cross section

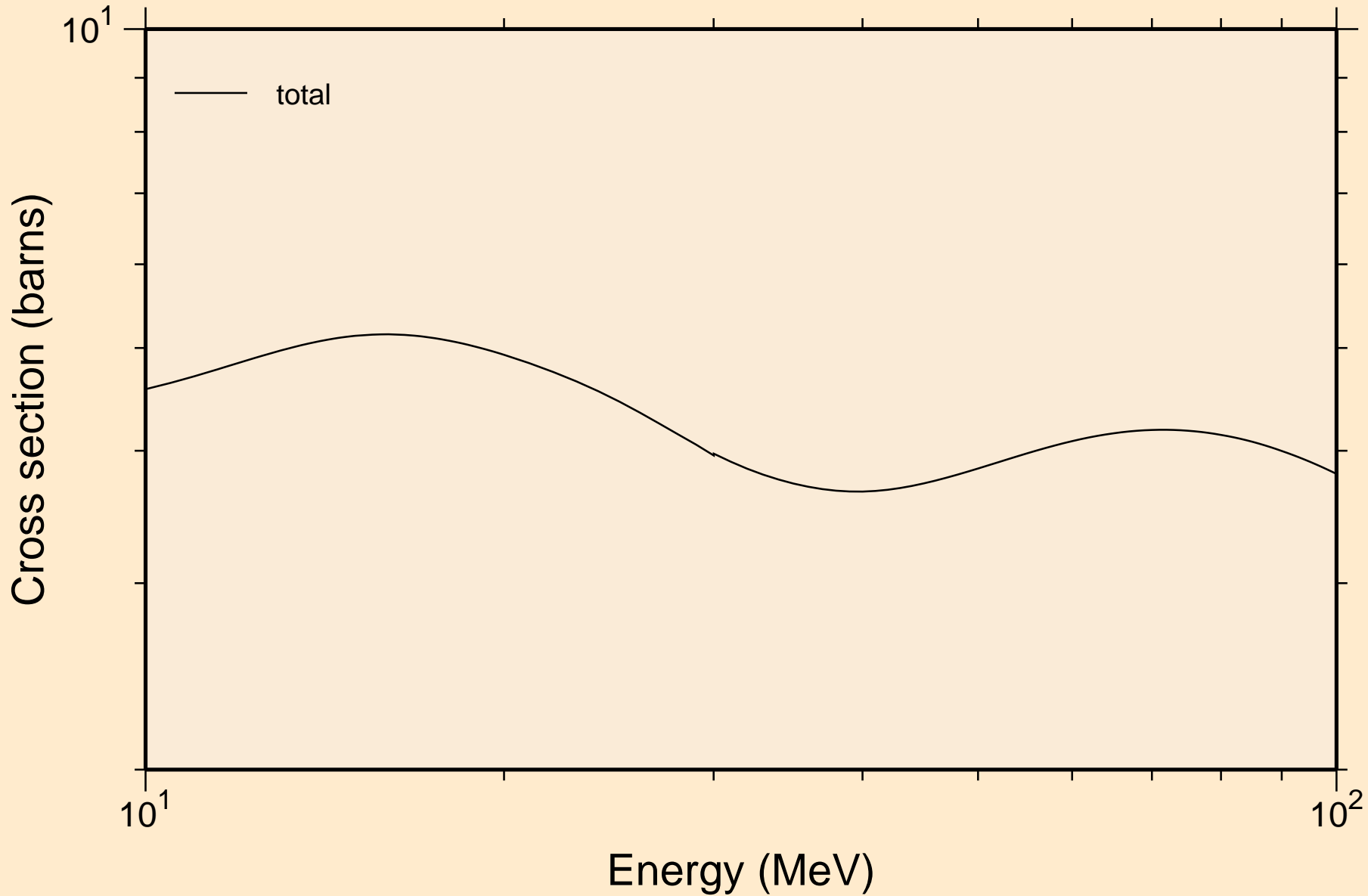

PM154 NEUTRON ACER TENDL-2023 LIBRARY; T=0.K  
resonance absorption cross sections

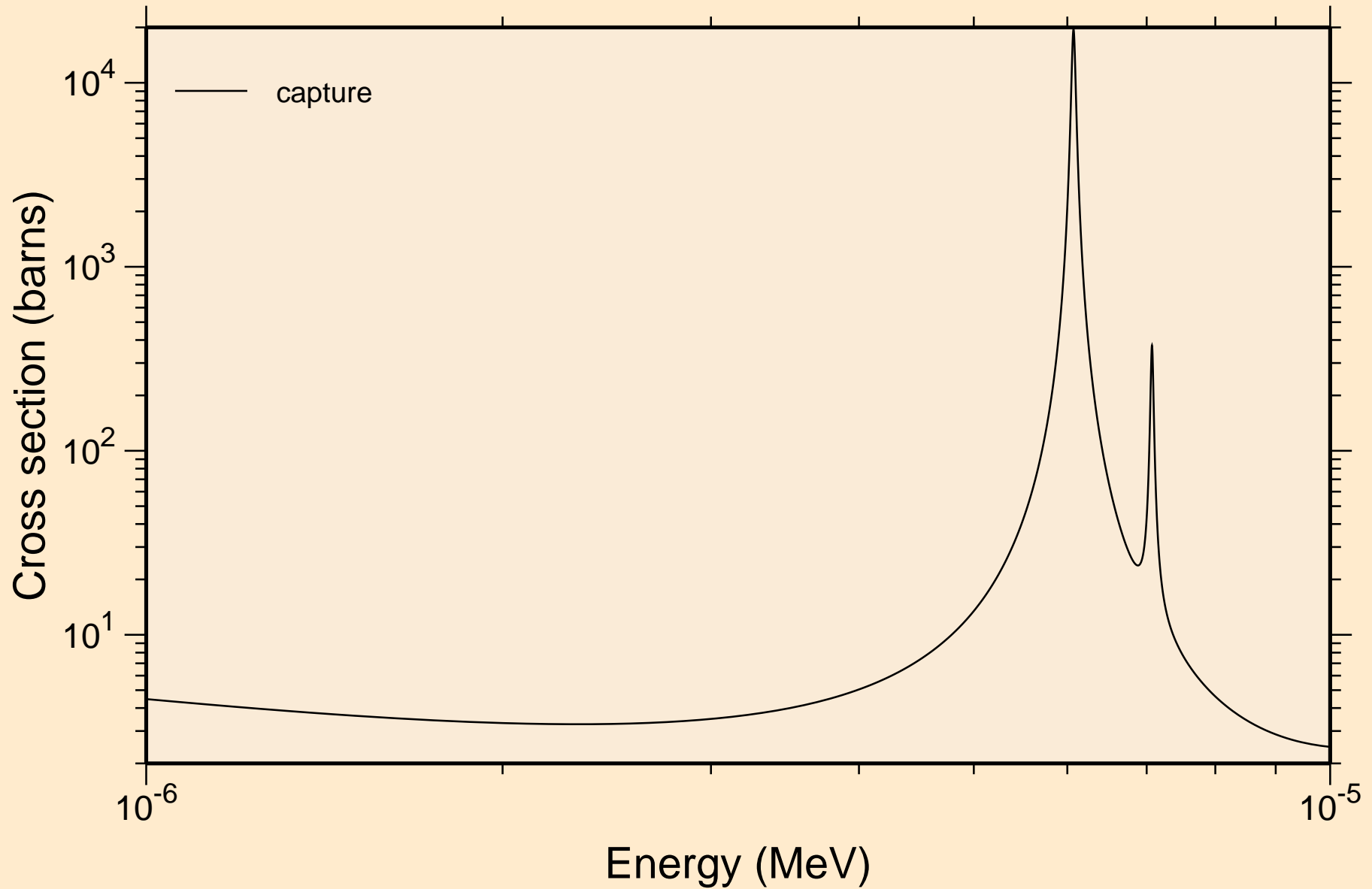

PM154 NEUTRON ACER TENDL-2023 LIBRARY; T=0.K  
resonance absorption cross sections

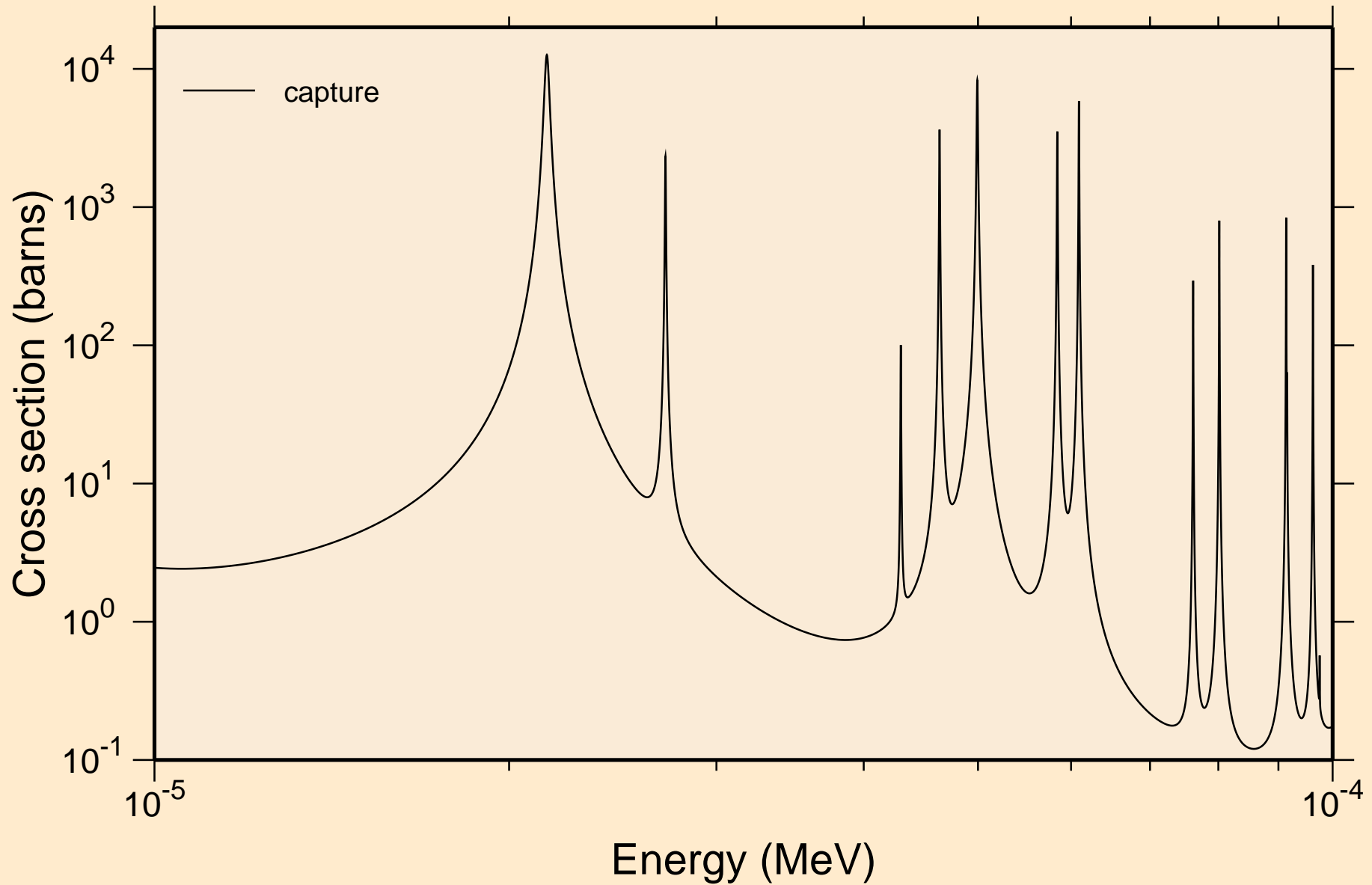

PM154 NEUTRON ACER TENDL-2023 LIBRARY; T=0.K  
resonance absorption cross sections

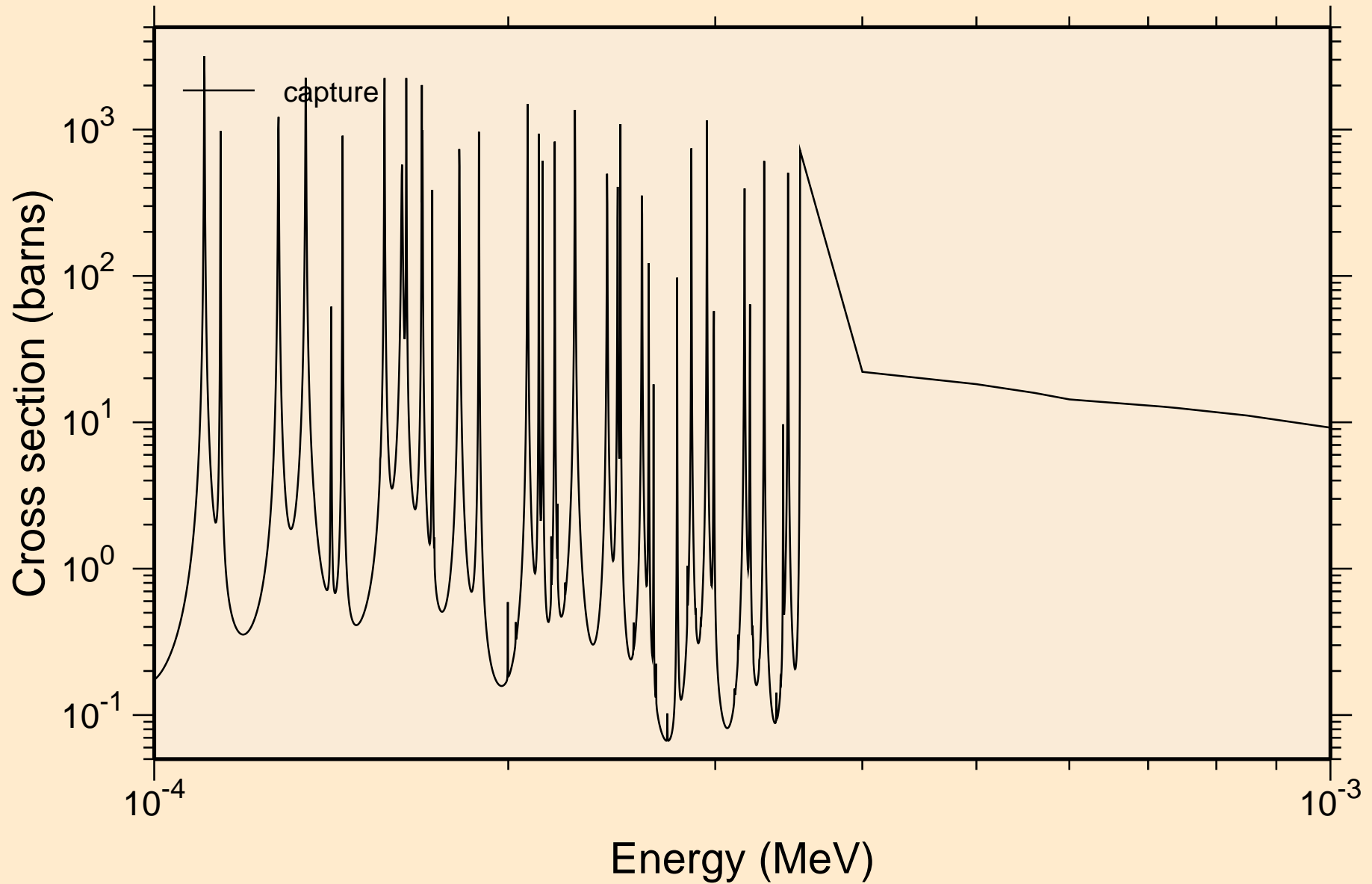

PM154 NEUTRON ACER TENDL-2023 LIBRARY; T=0.K  
resonance absorption cross sections

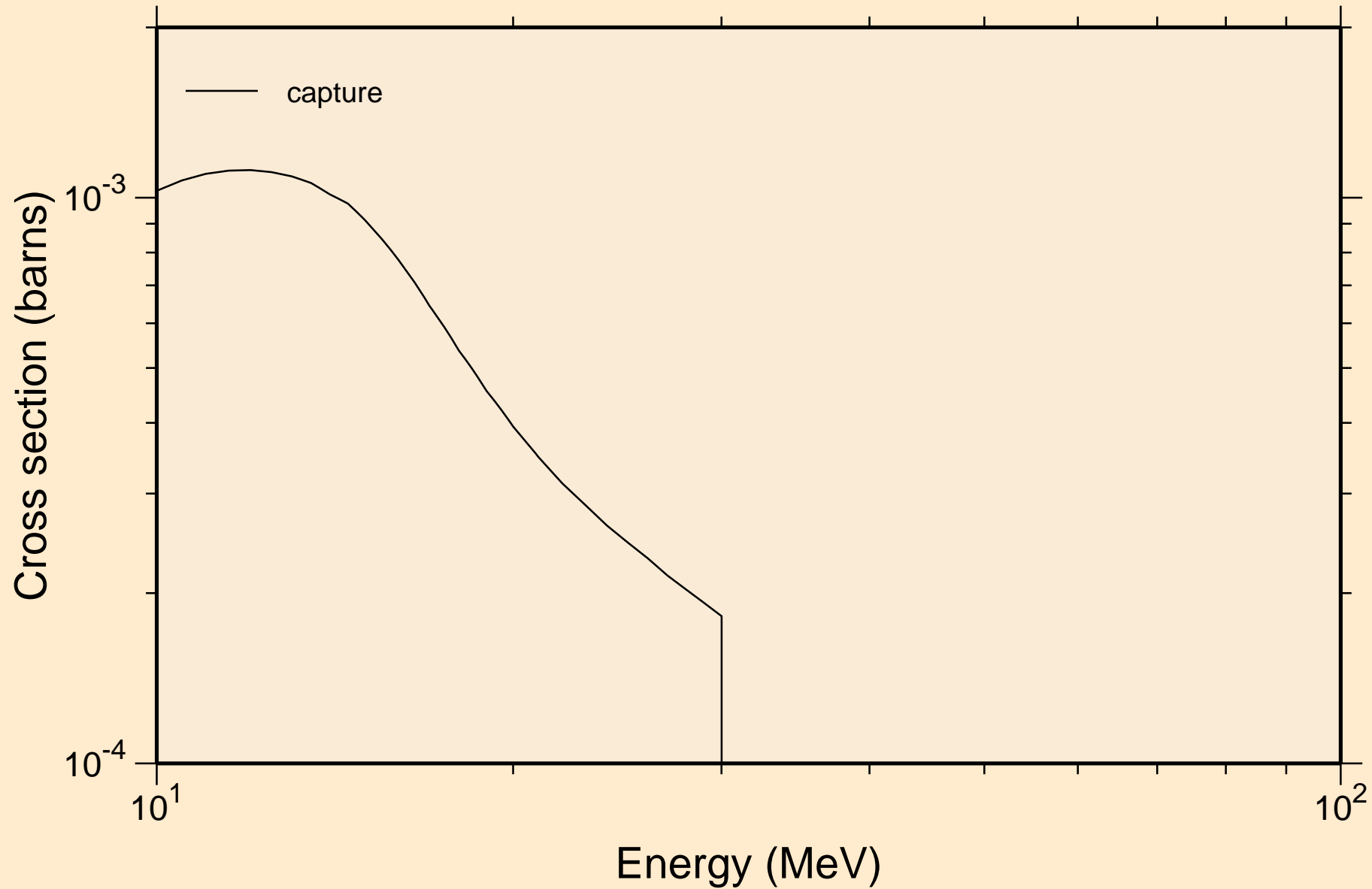

PM154 NEUTRON ACER TENDL-2023 LIBRARY; T=0.K  
Heating

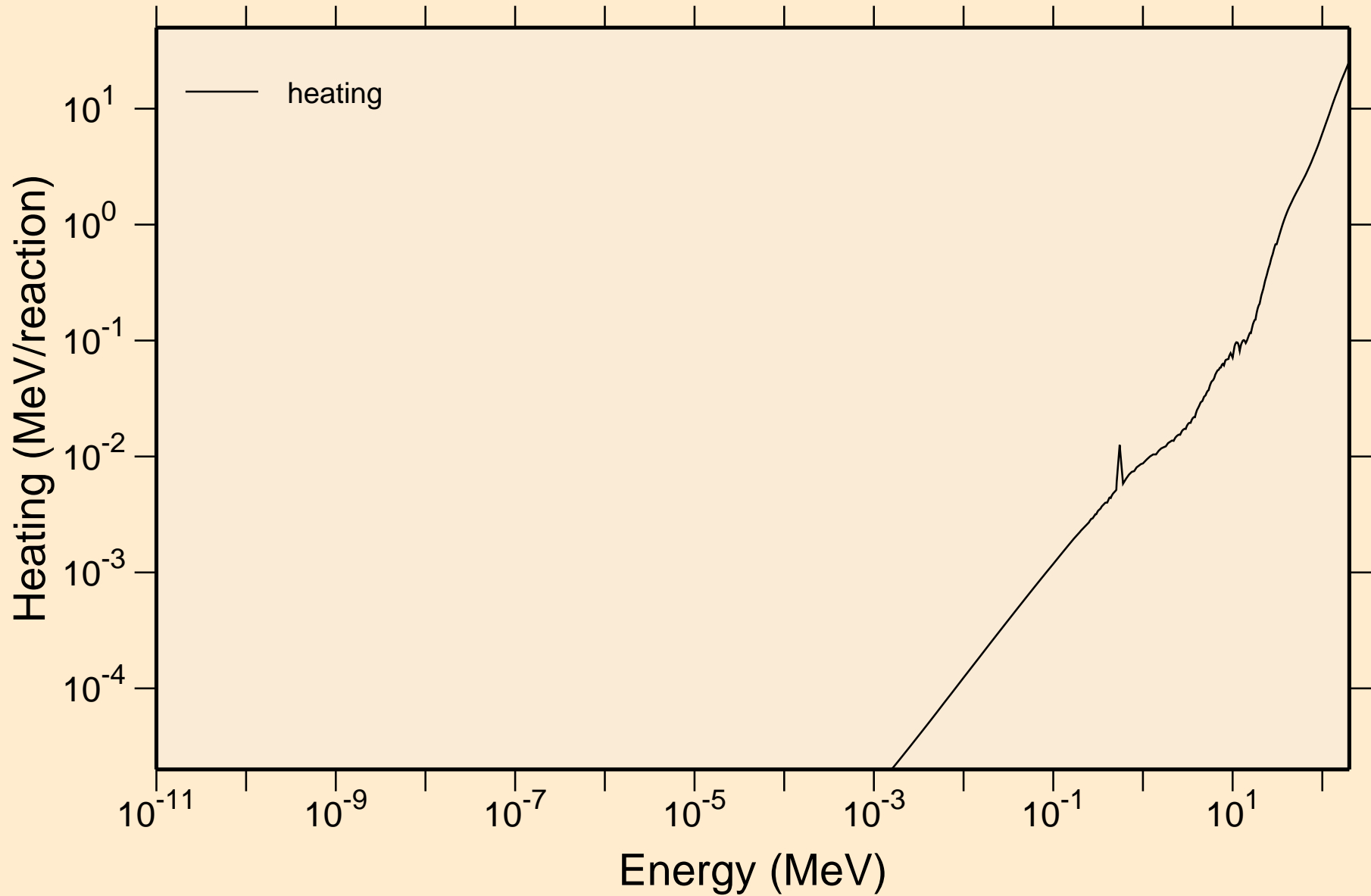

PM154 NEUTRON ACER TENDL-2023 LIBRARY; T=0.K  
Damage

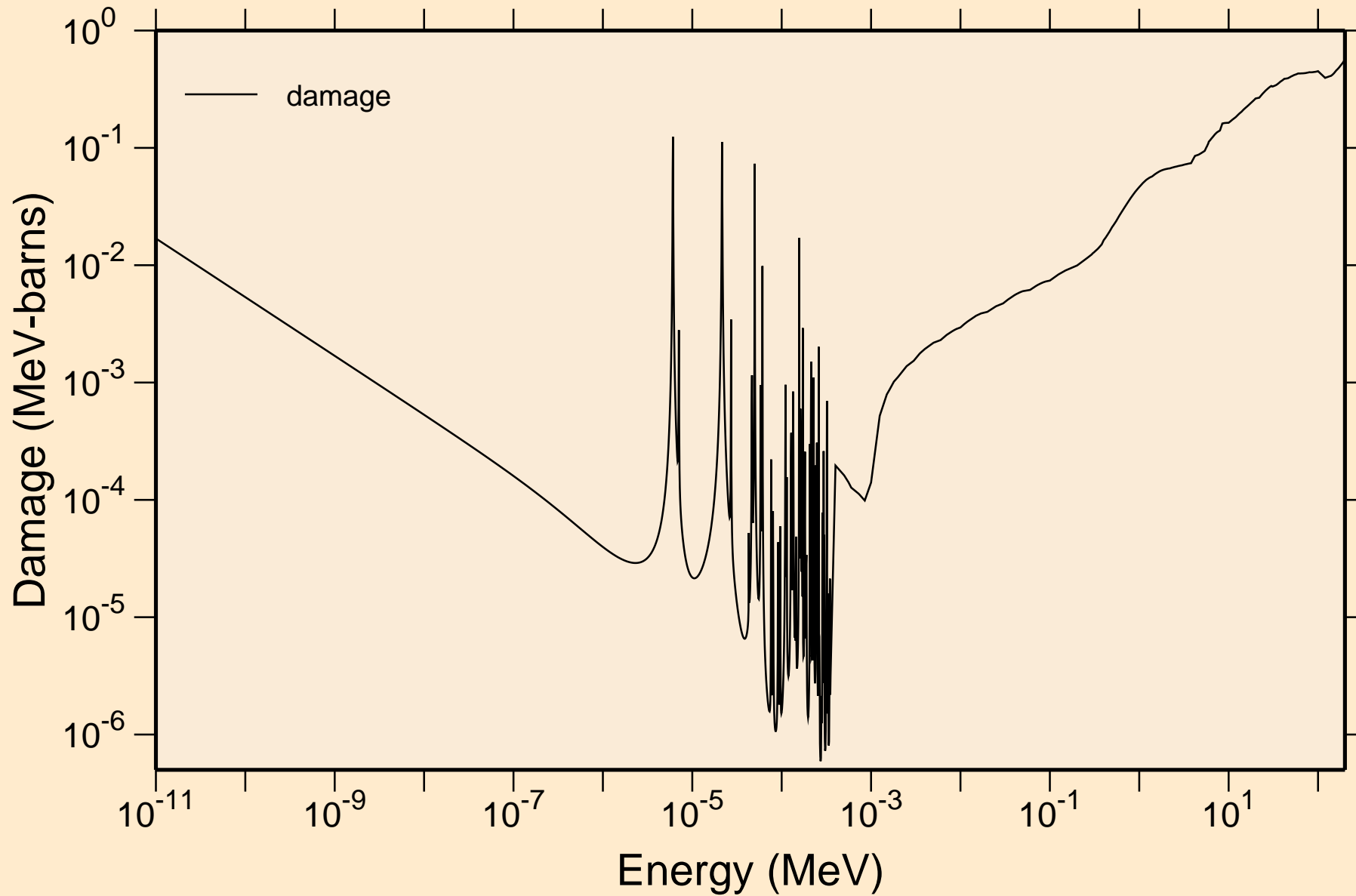

PM154 NEUTRON ACER TENDL-2023 LIBRARY; T=0.K  
Non-threshold reactions

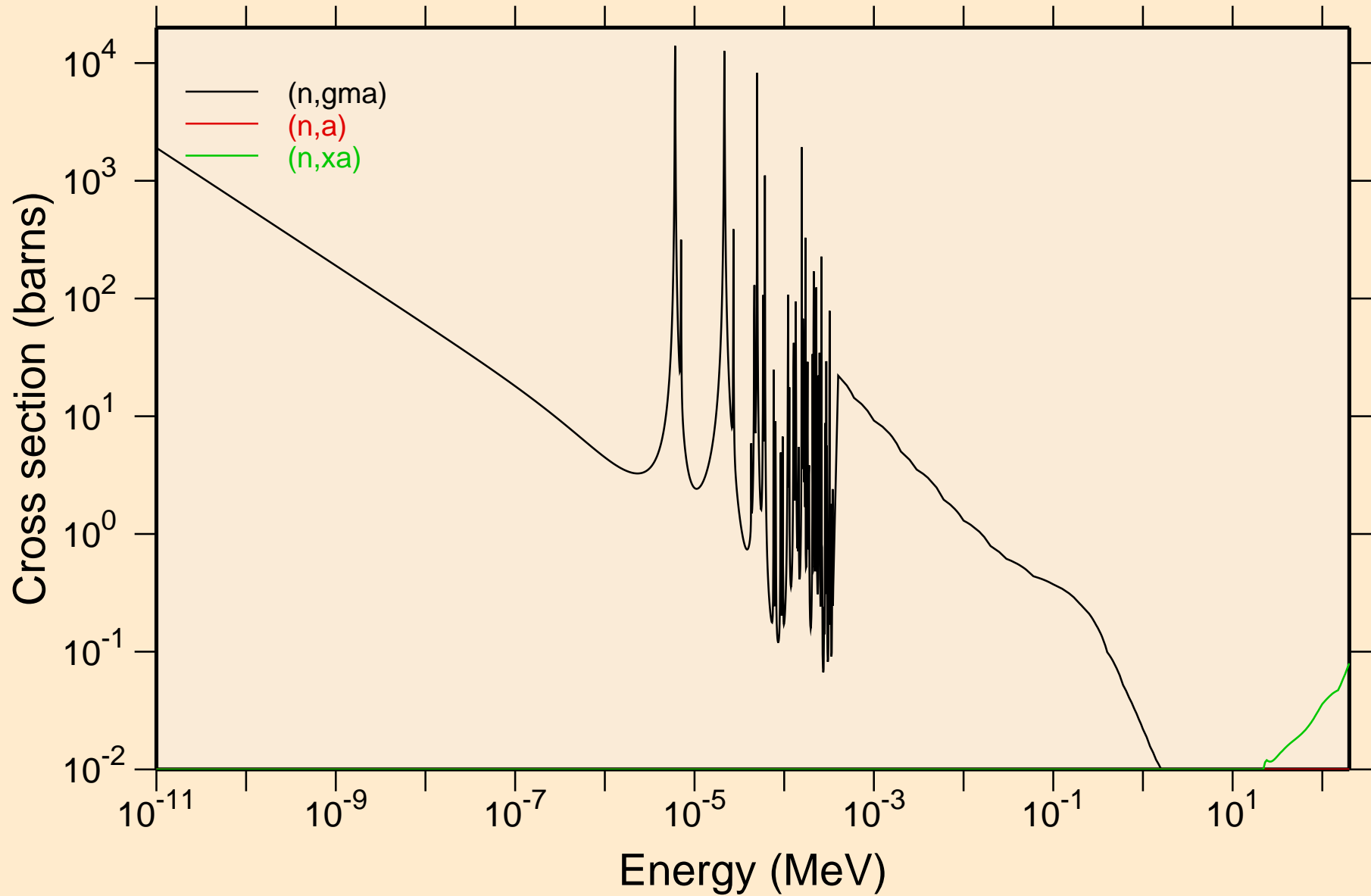

PM154 NEUTRON ACER TENDL-2023 LIBRARY; T=0.K  
Principal cross sections

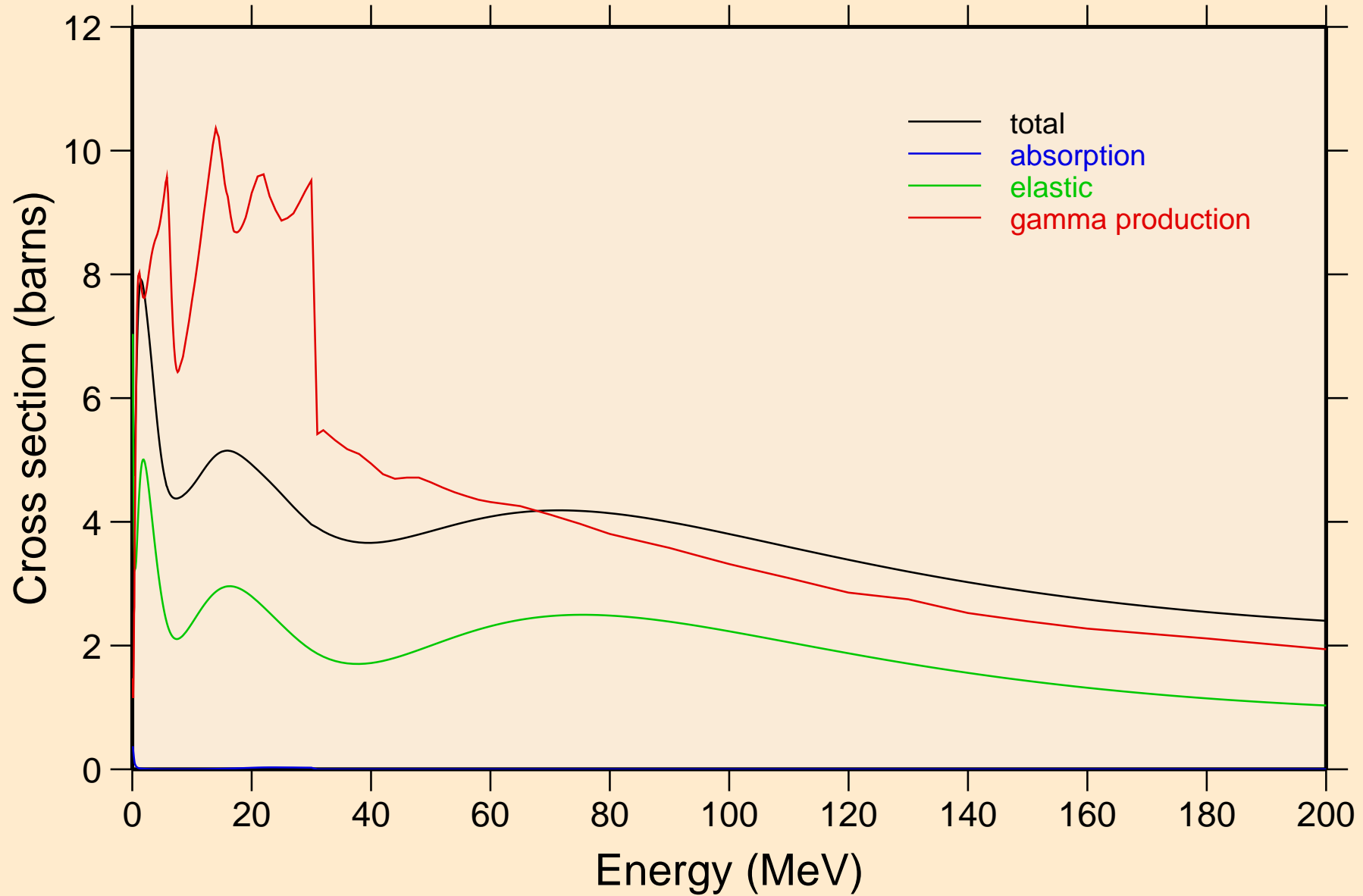

# PM154 NEUTRON ACER TENDL-2023 LIBRARY; T=0.K

## Heating

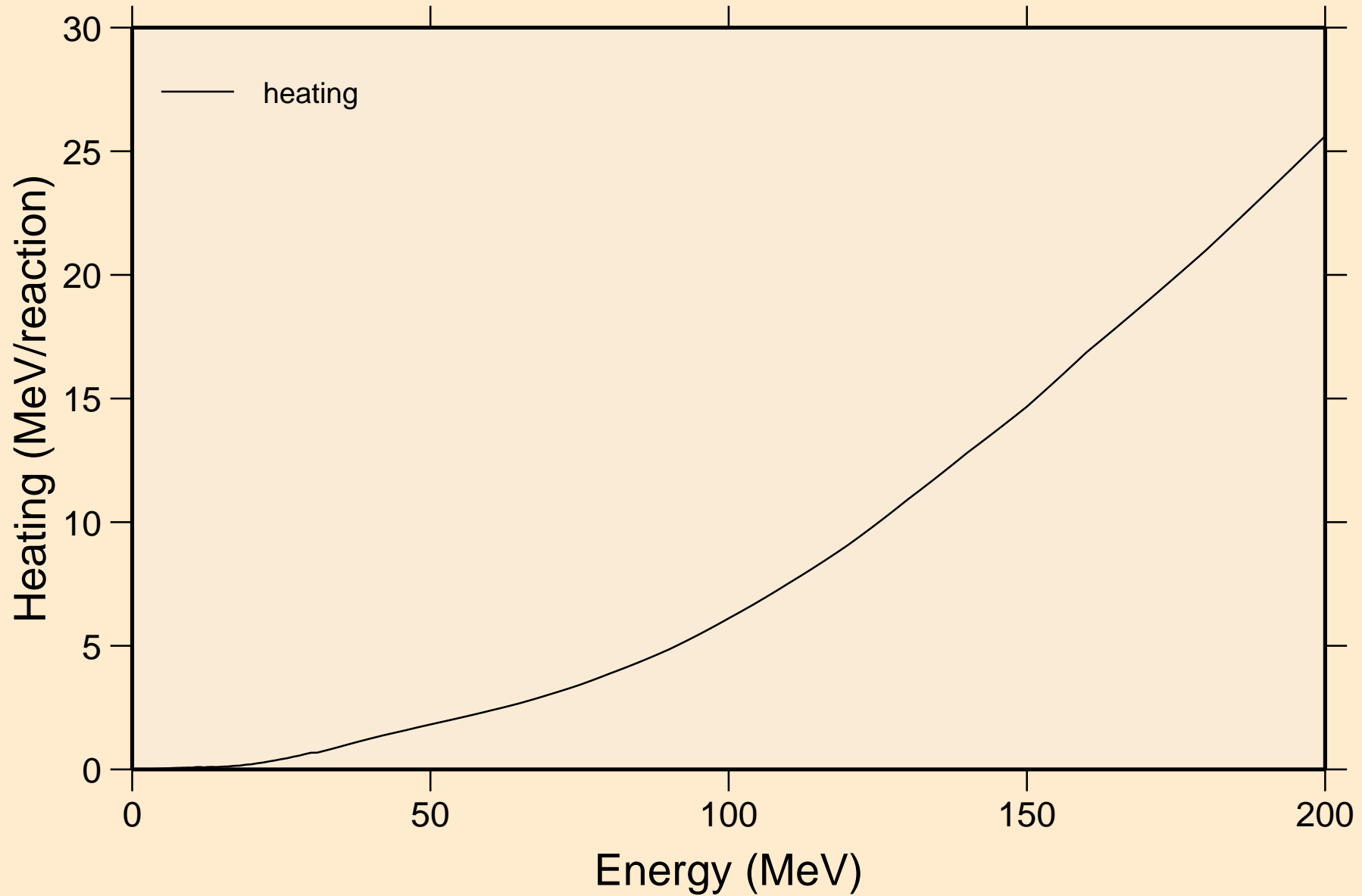

PM154 NEUTRON ACER TENDL-2023 LIBRARY; T=0.K  
Damage

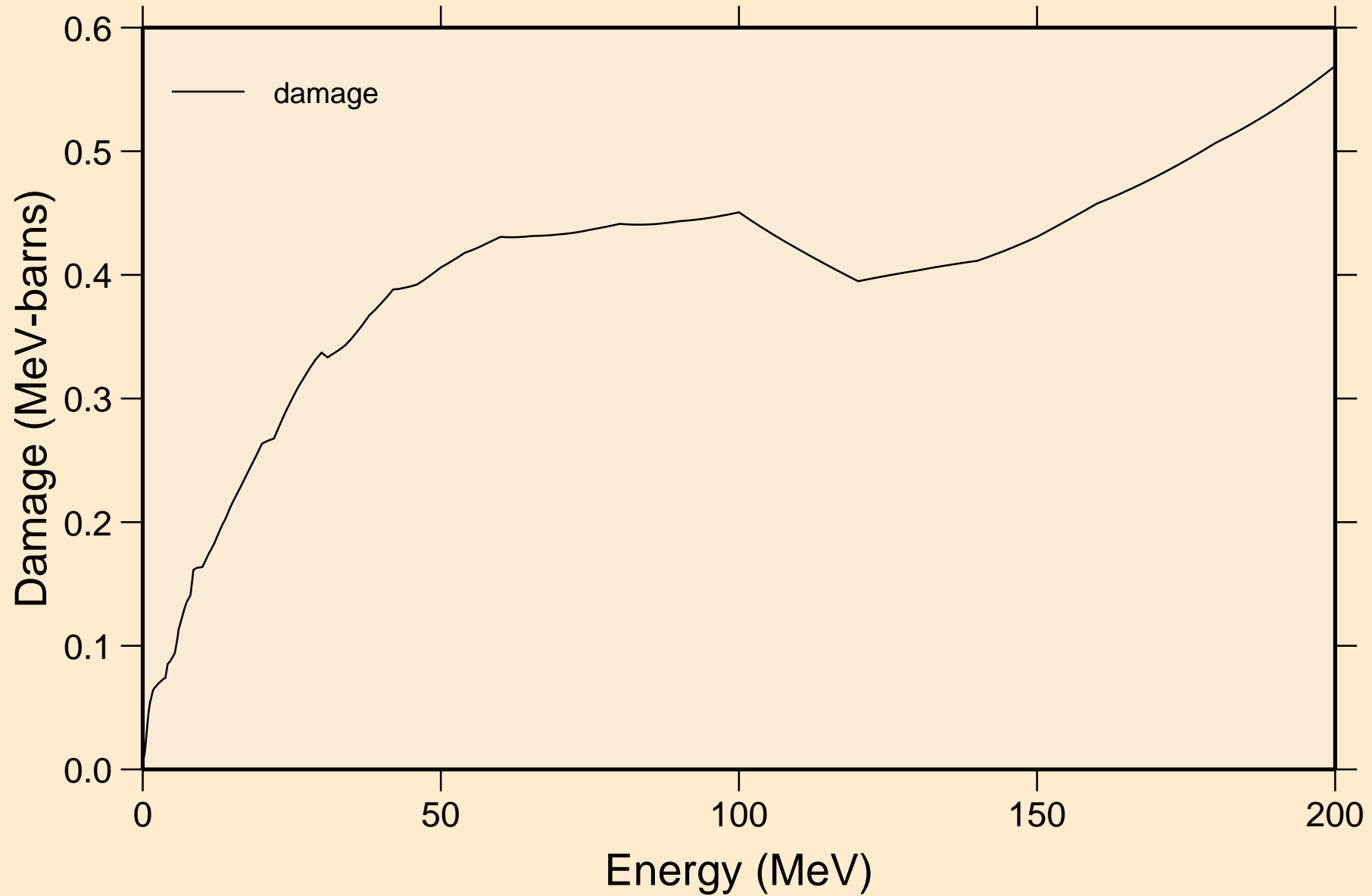

PM154 NEUTRON ACER TENDL-2023 LIBRARY; T=0.K  
Non-threshold reactions

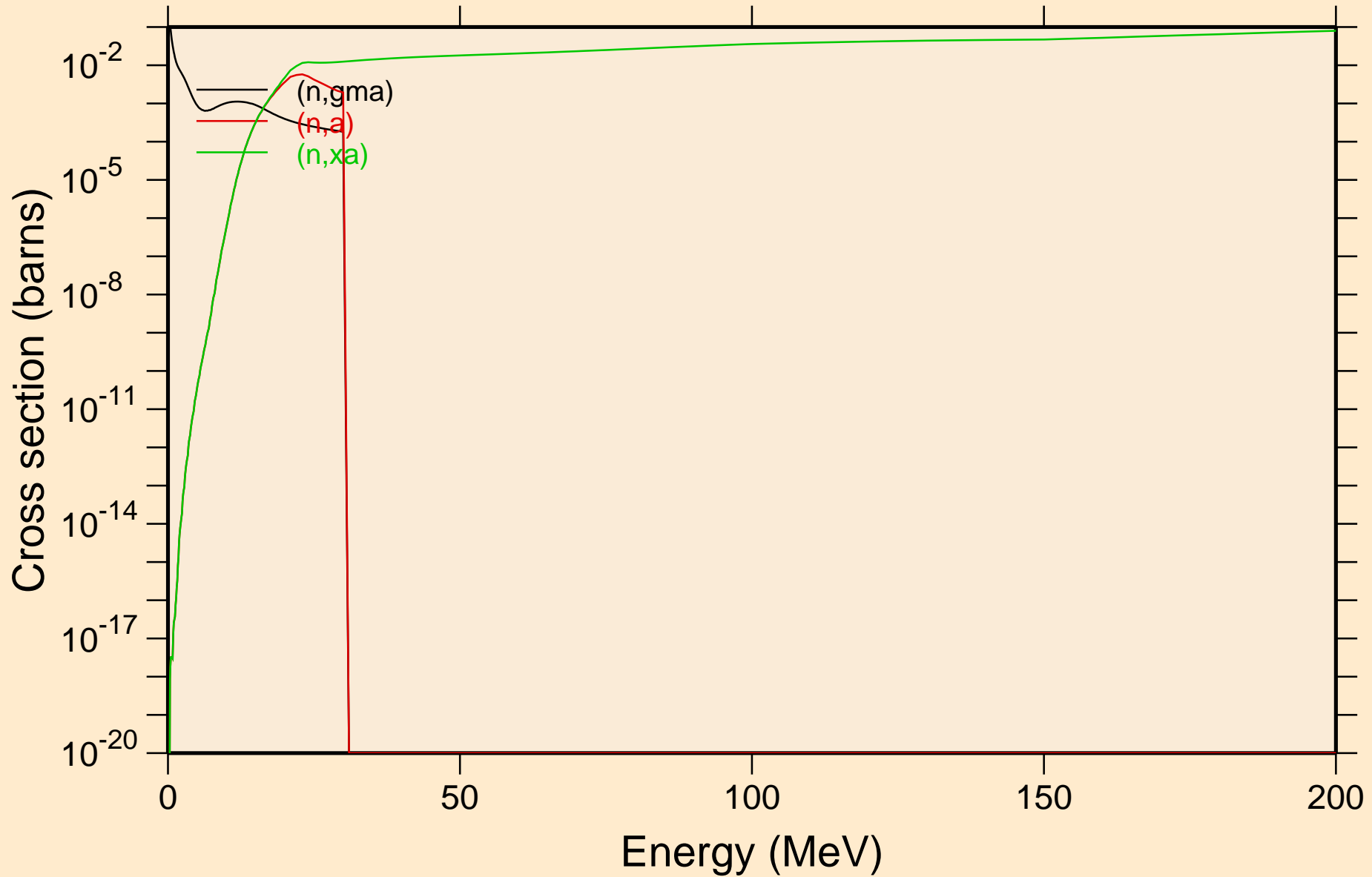

PM154 NEUTRON ACER TENDL-2023 LIBRARY; T=0.K  
Inelastic levels

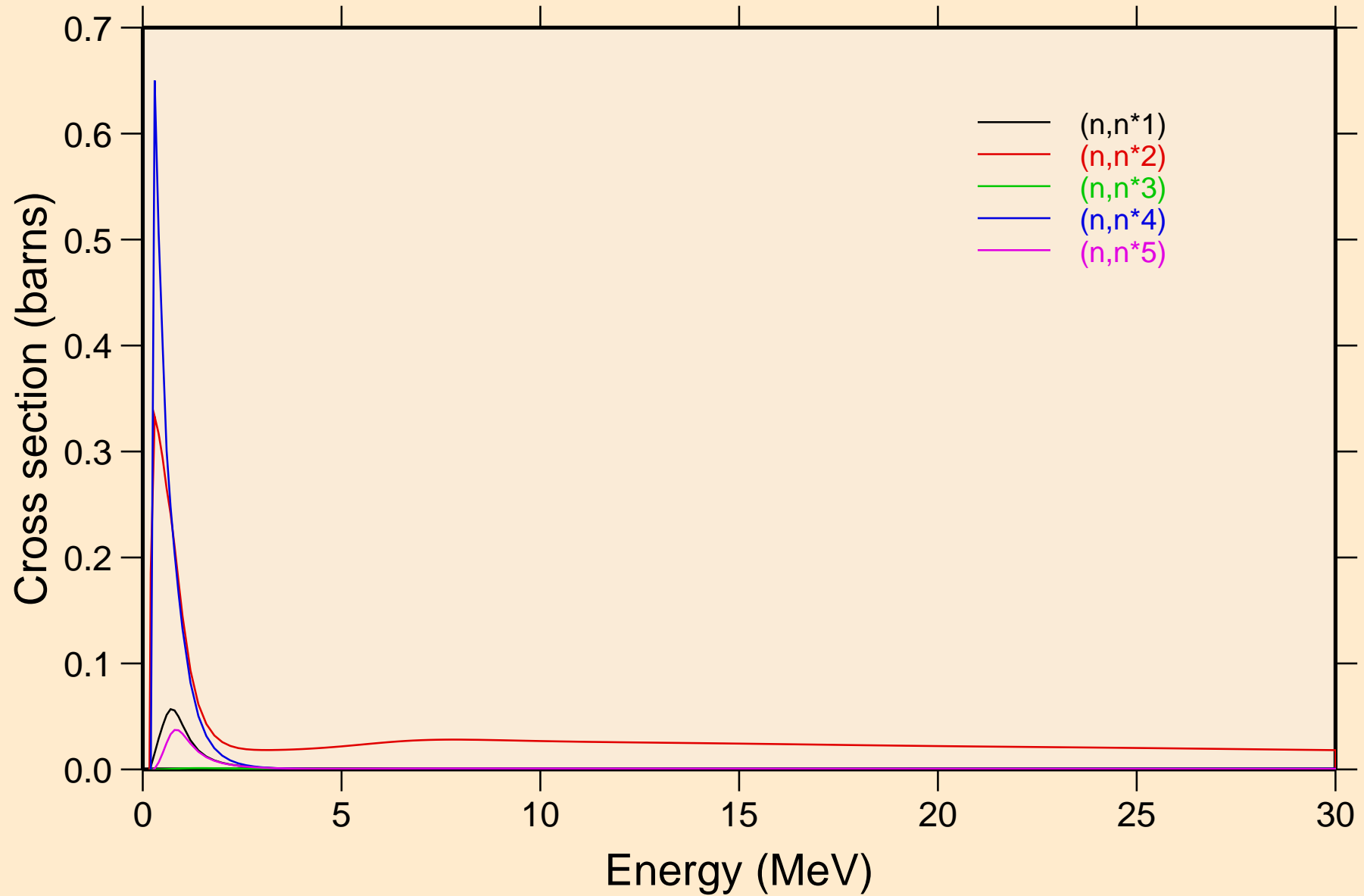

PM154 NEUTRON ACER TENDL-2023 LIBRARY; T=0.K  
Inelastic levels

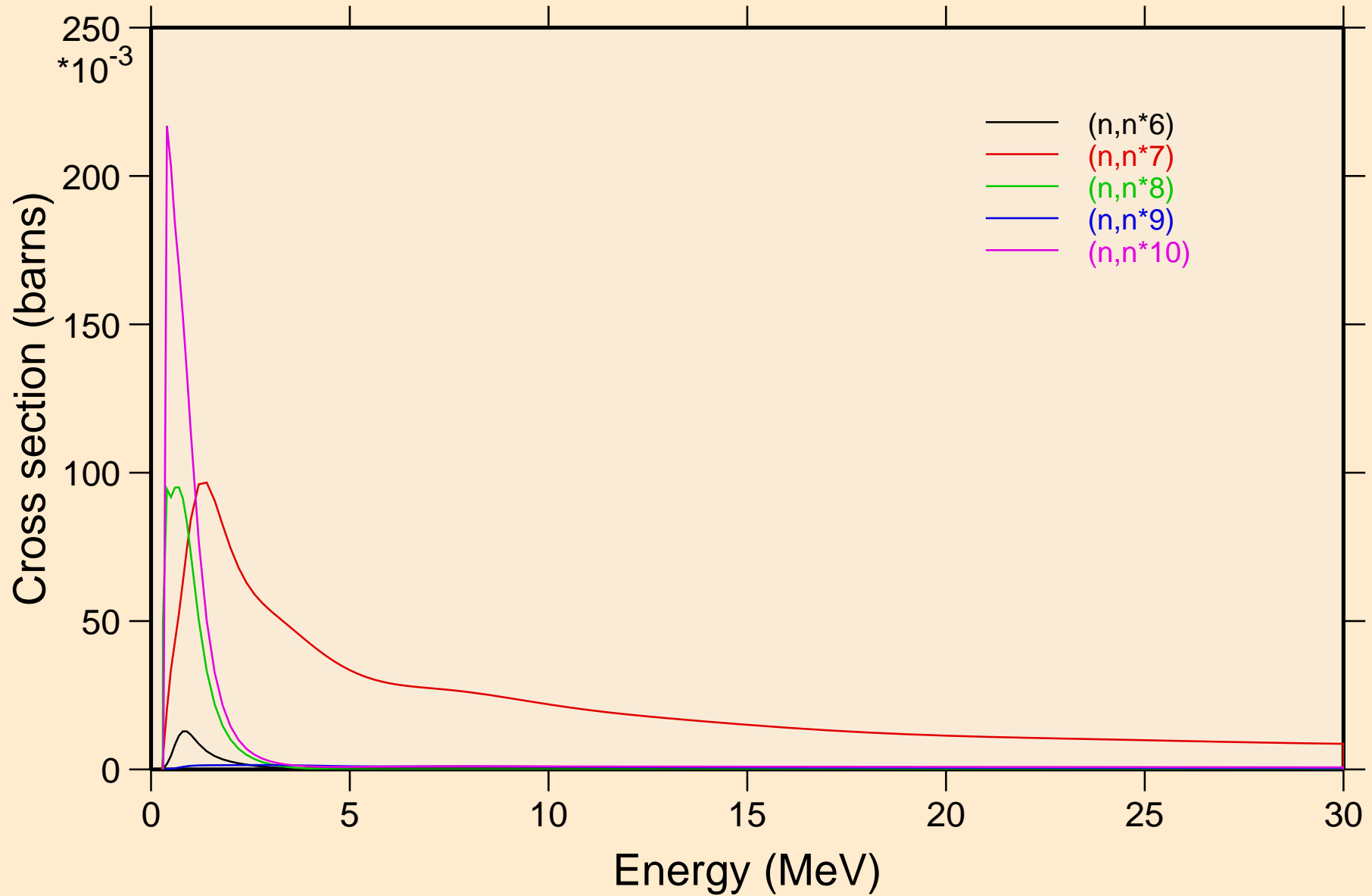

PM154 NEUTRON ACER TENDL-2023 LIBRARY; T=0.K  
Inelastic levels

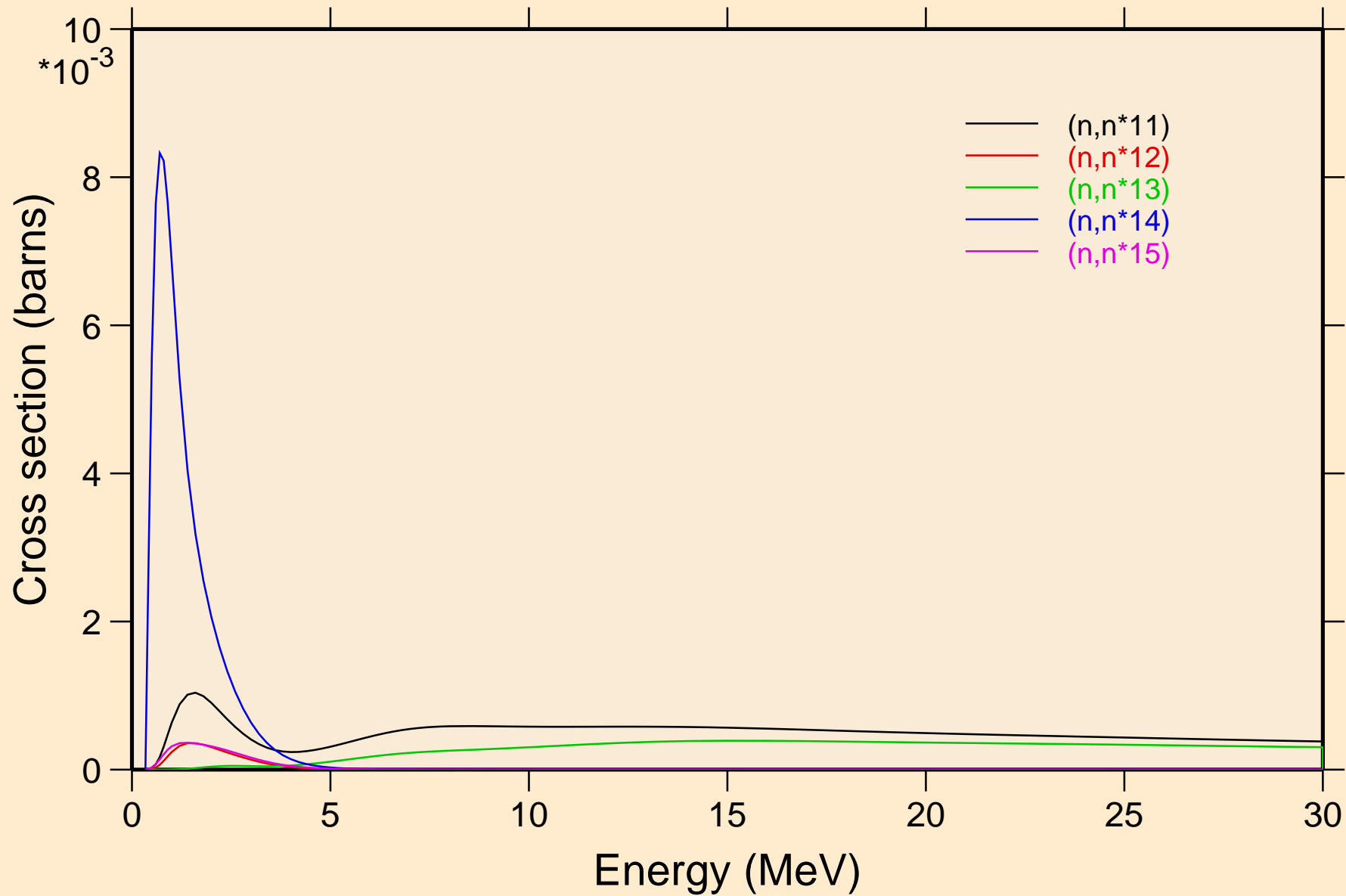

PM154 NEUTRON ACER TENDL-2023 LIBRARY; T=0.K  
Inelastic levels

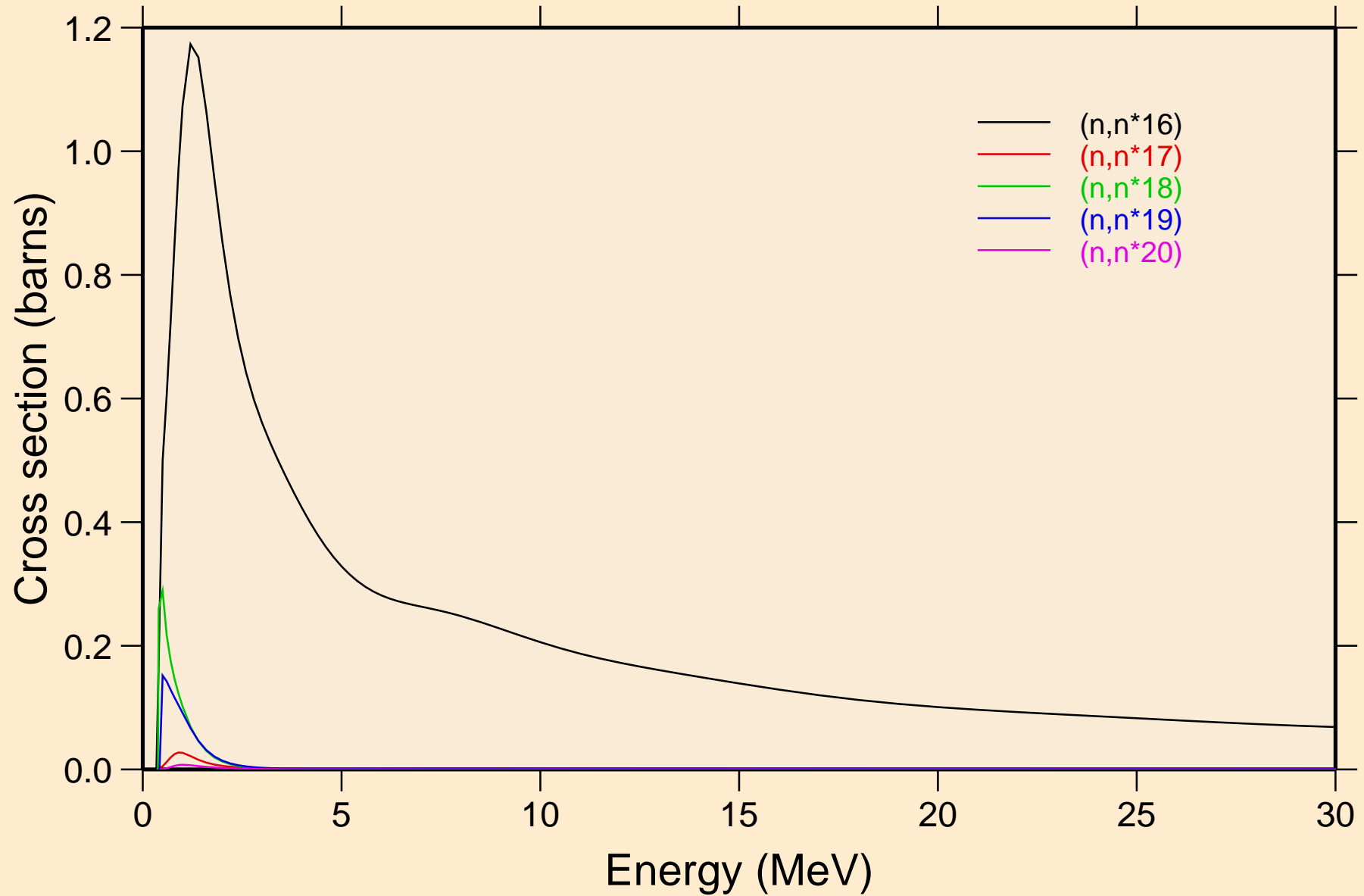

PM154 NEUTRON ACER TENDL-2023 LIBRARY; T=0.K  
Inelastic levels

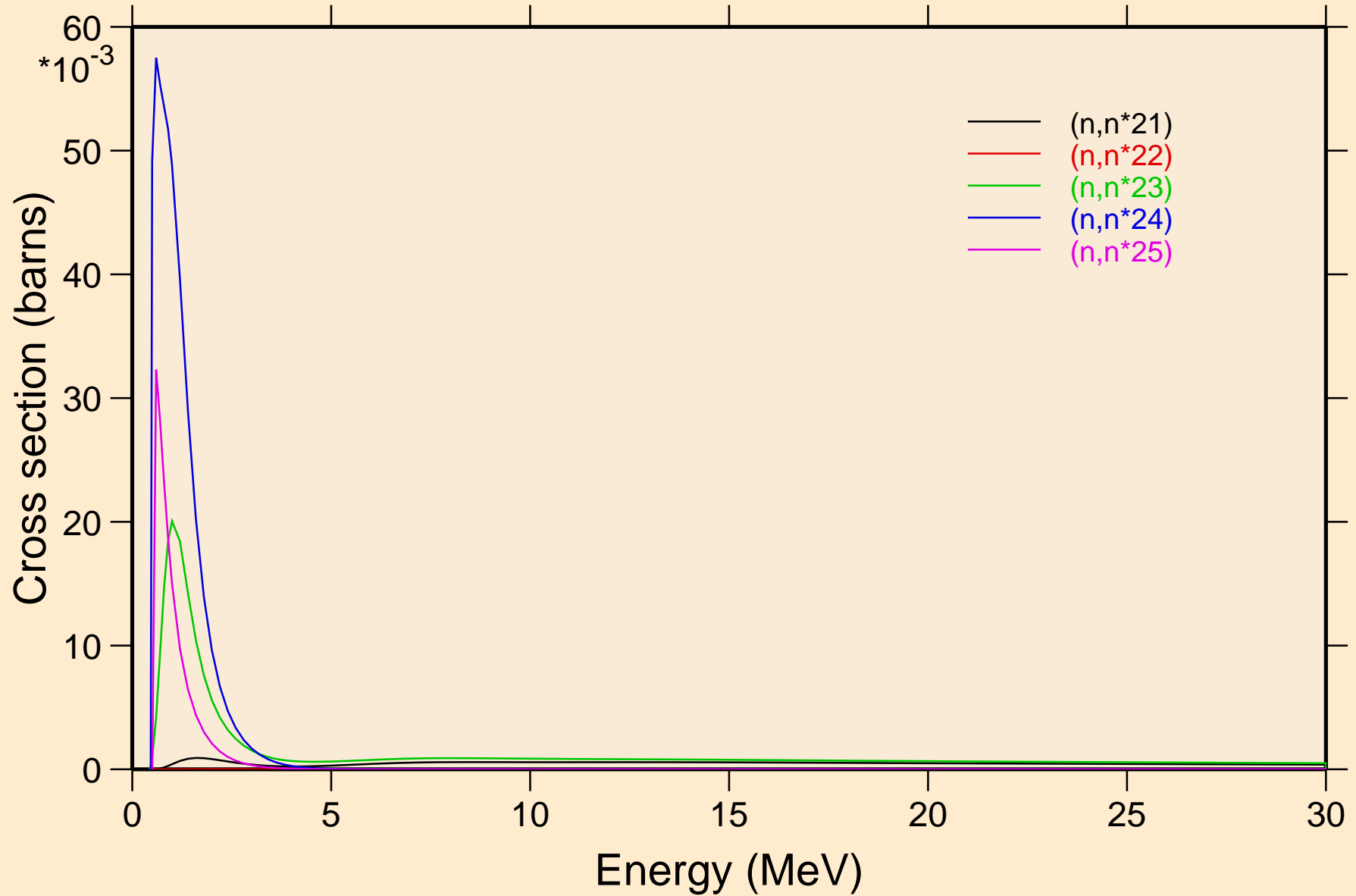

PM154 NEUTRON ACER TENDL-2023 LIBRARY; T=0.K  
Inelastic levels

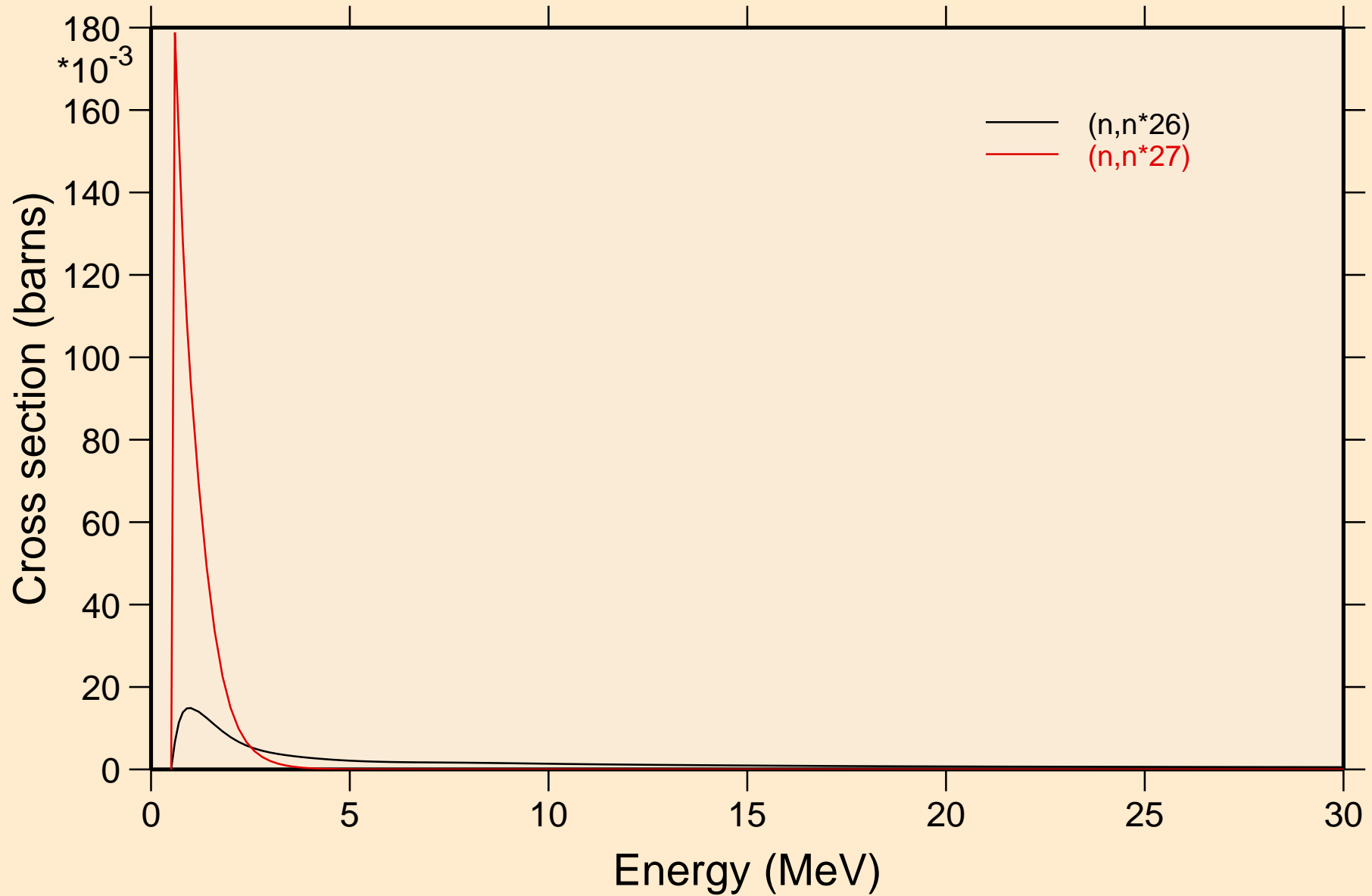

PM154 NEUTRON ACER TENDL-2023 LIBRARY; T=0.K  
Threshold reactions

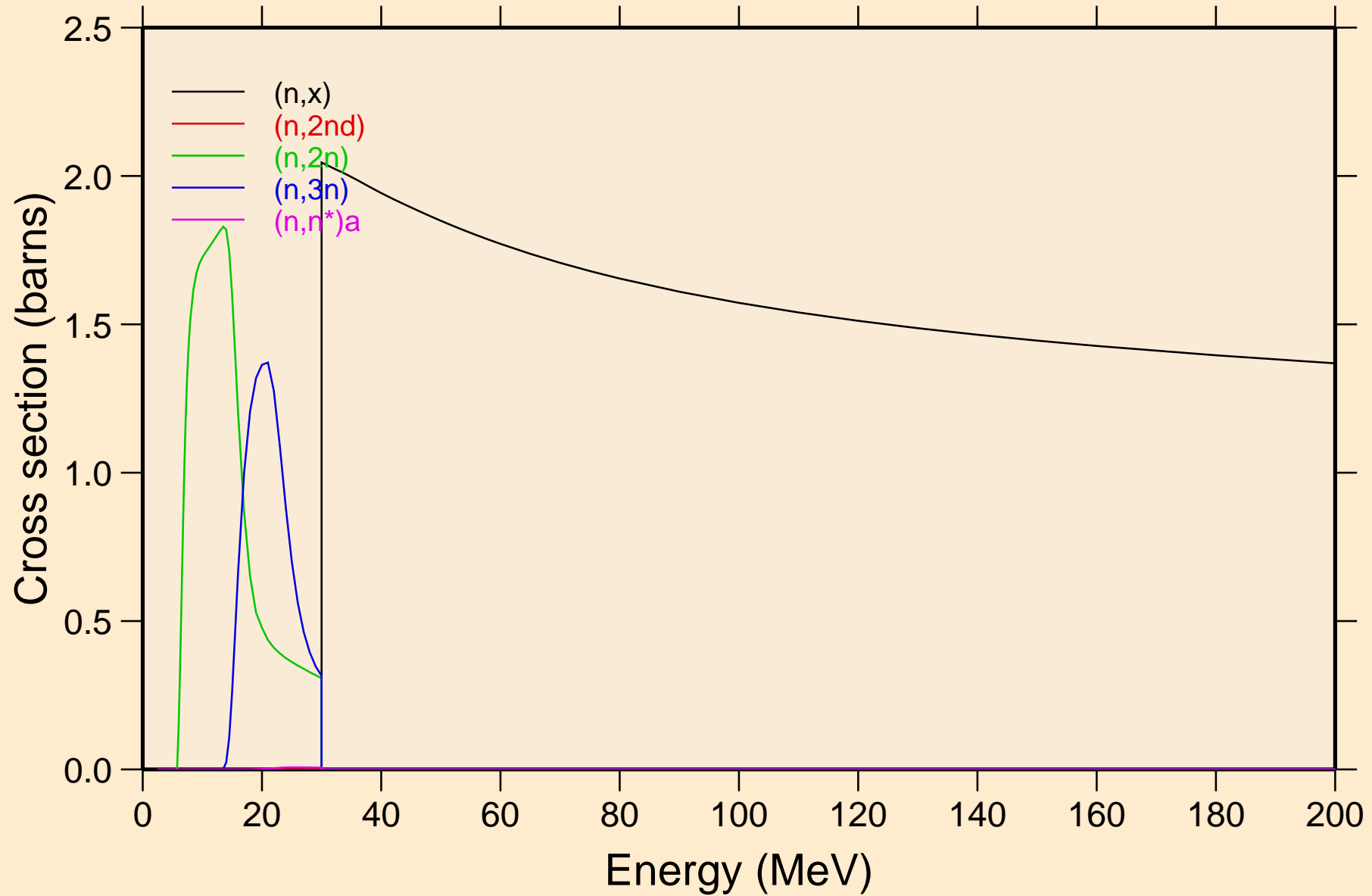

PM154 NEUTRON ACER TENDL-2023 LIBRARY; T=0.K  
Threshold reactions

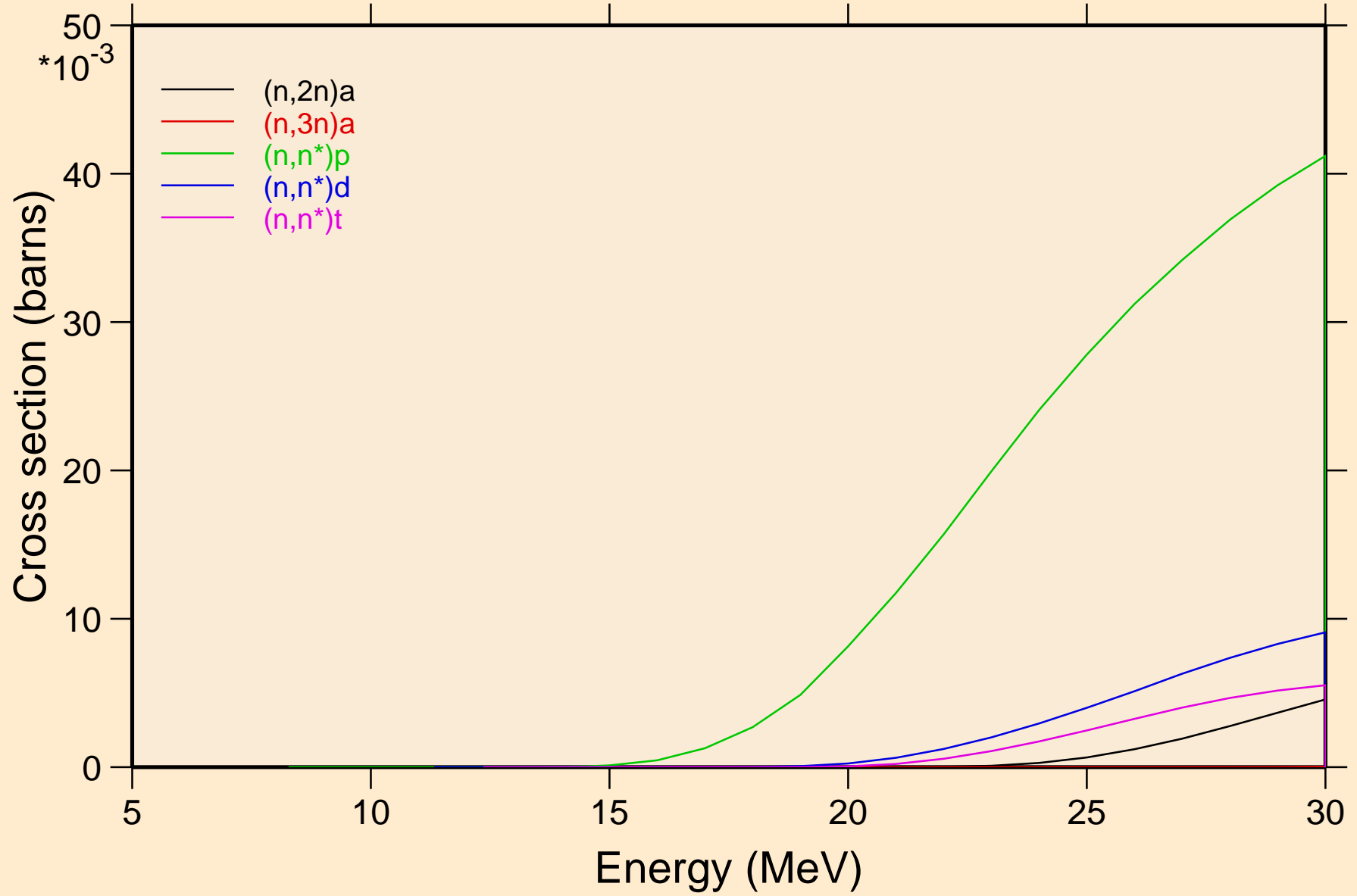

PM154 NEUTRON ACER TENDL-2023 LIBRARY; T=0.K  
Threshold reactions

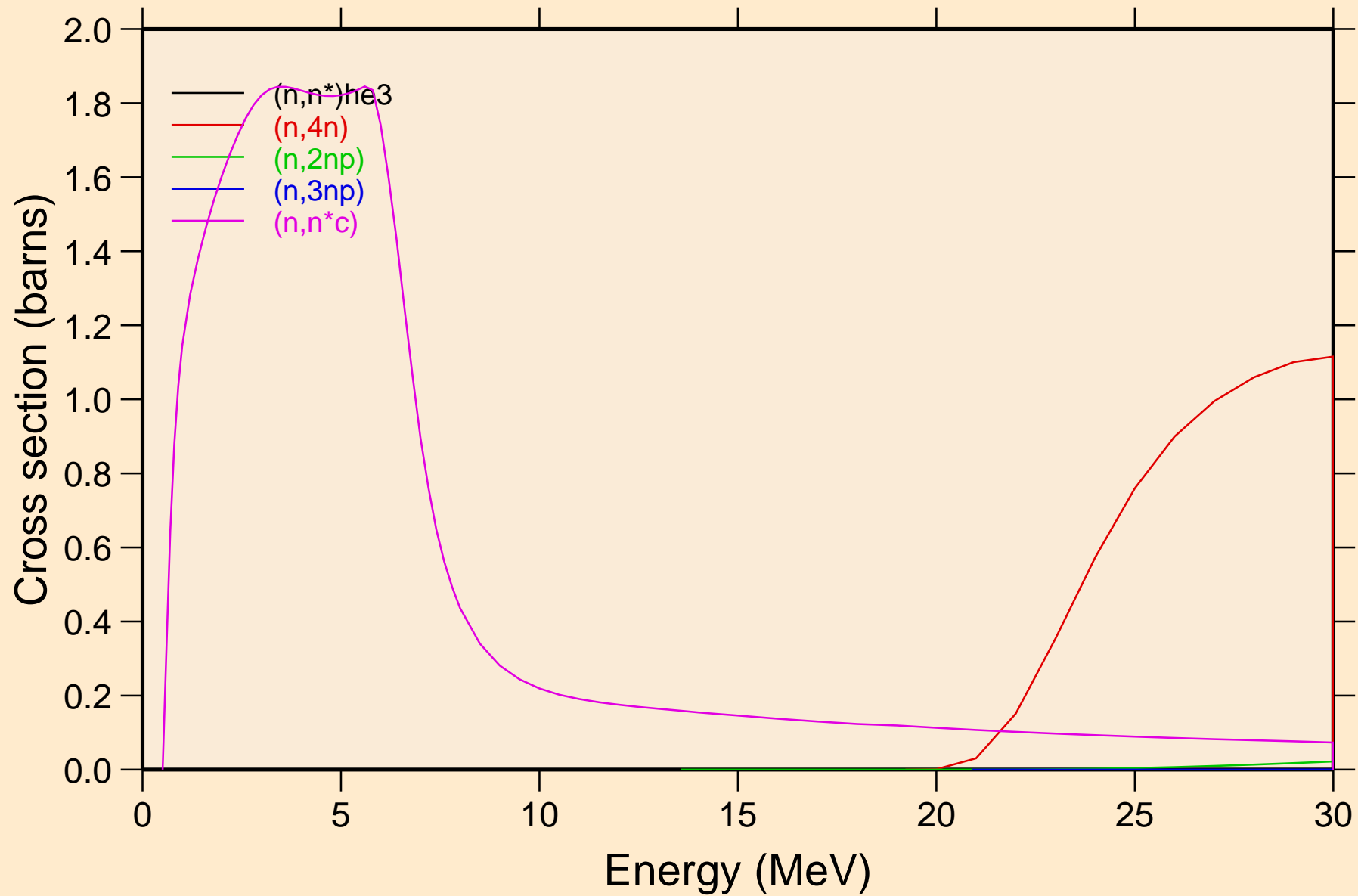

PM154 NEUTRON ACER TENDL-2023 LIBRARY; T=0.K  
Threshold reactions

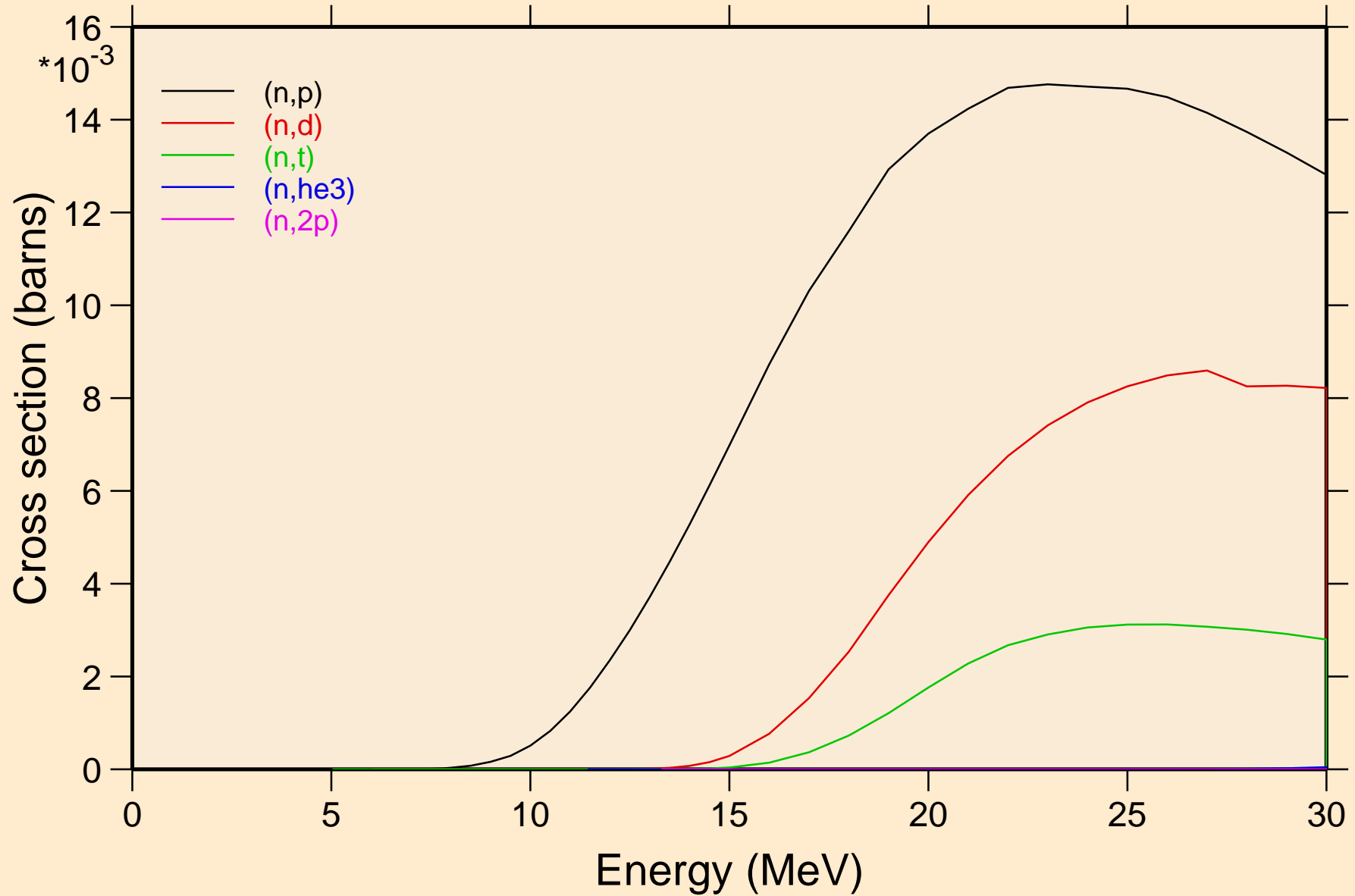

PM154 NEUTRON ACER TENDL-2023 LIBRARY; T=0.K  
Threshold reactions

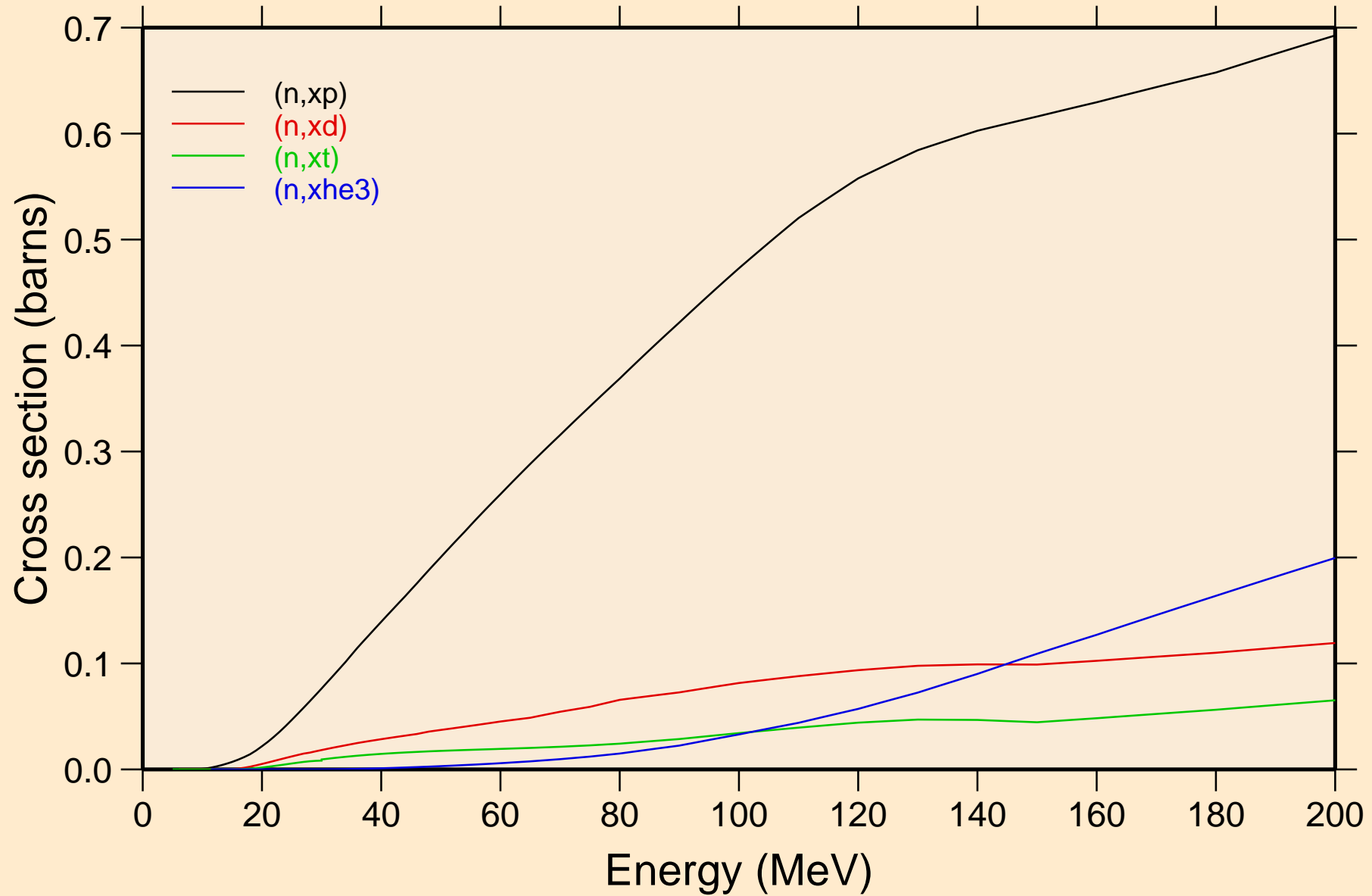

PM154 NEUTRON ACER TENDL-2023 LIBRARY; T=0.K  
angular distribution for elastic

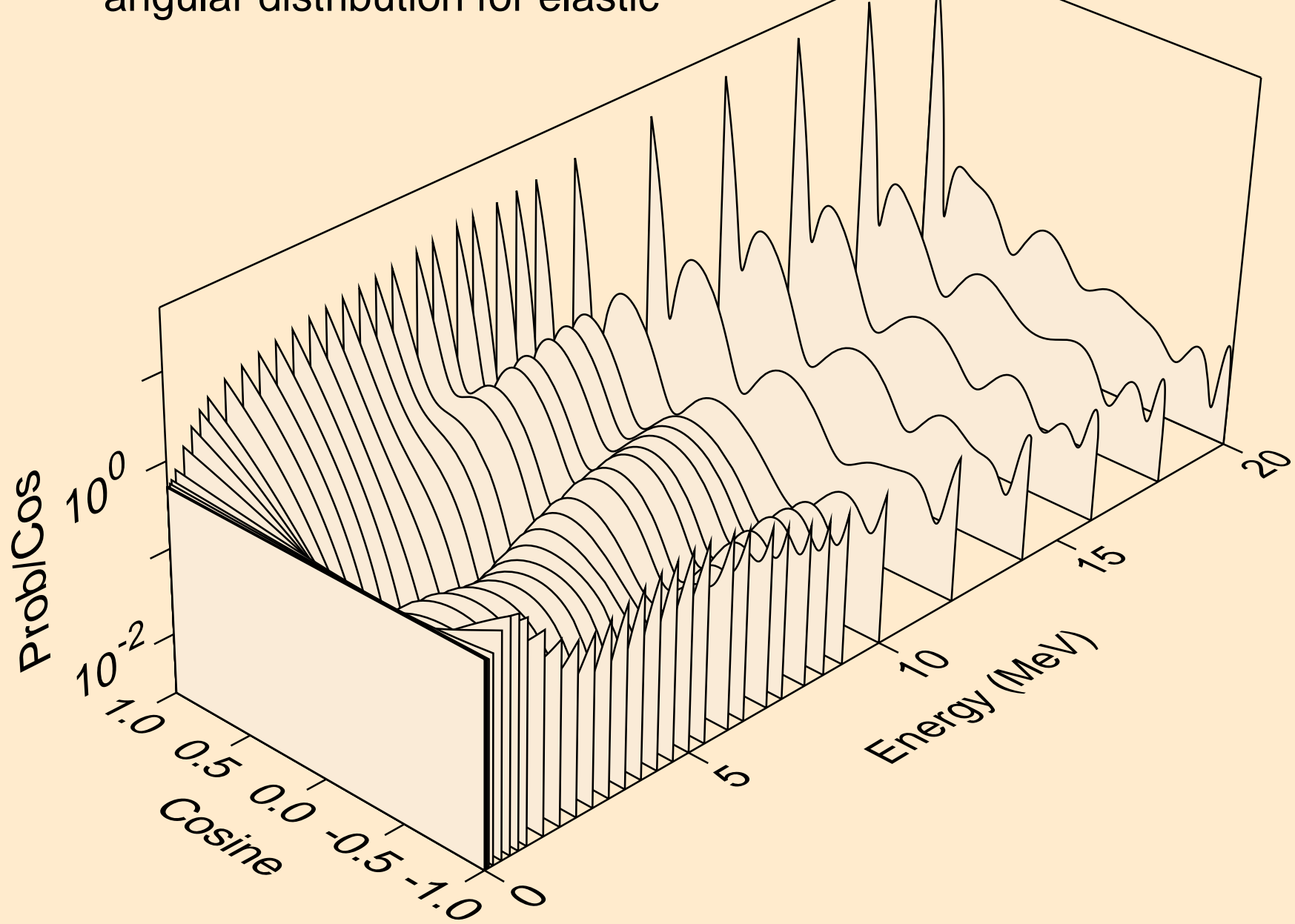

PM154 NEUTRON ACER TENDL-2023 LIBRARY; T=0.K  
angular distribution for elastic

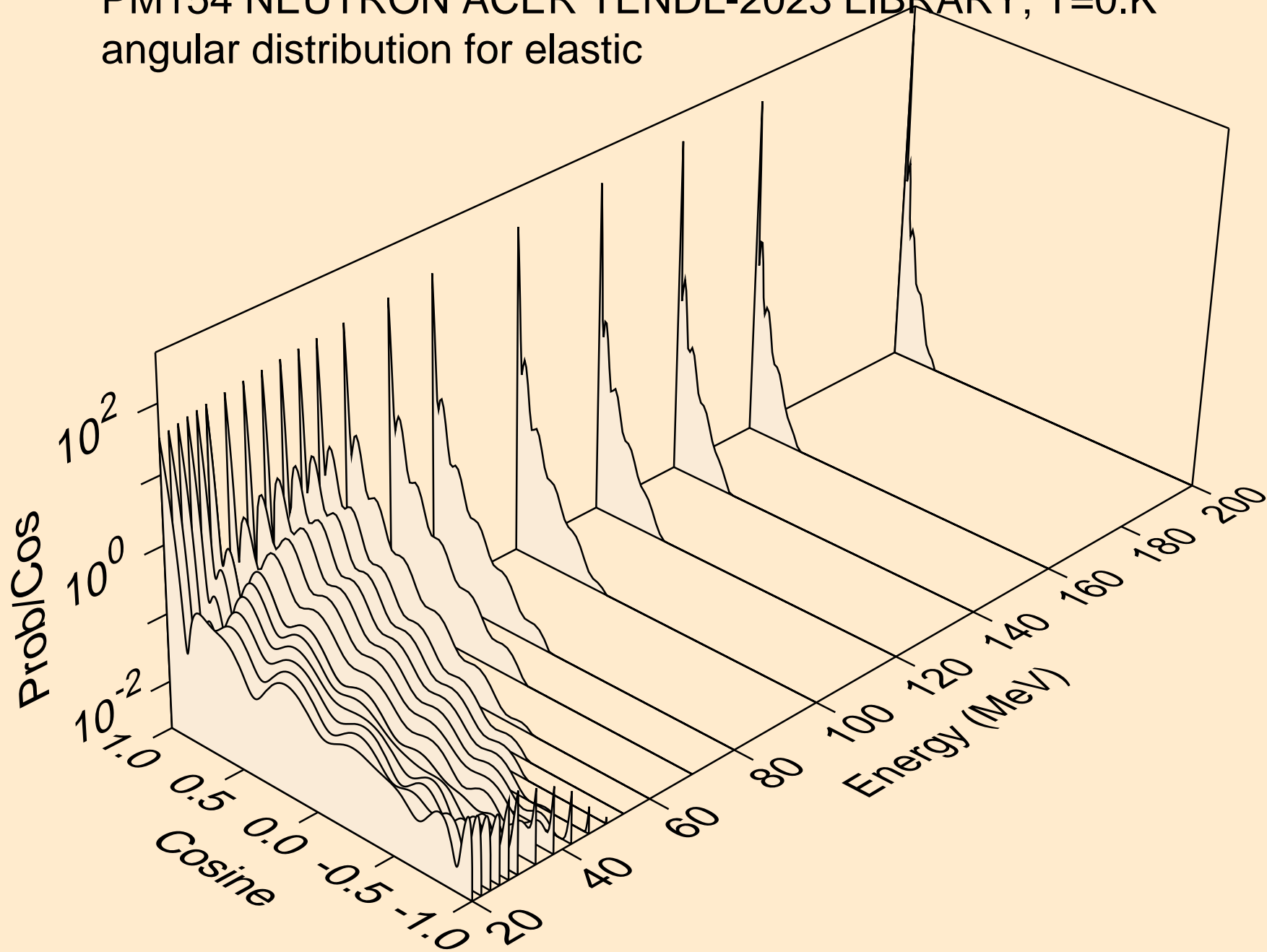

PM154 NEUTRON ACER TENDL-2023 LIBRARY; T=0.K  
angular distribution for (n,n\*1)

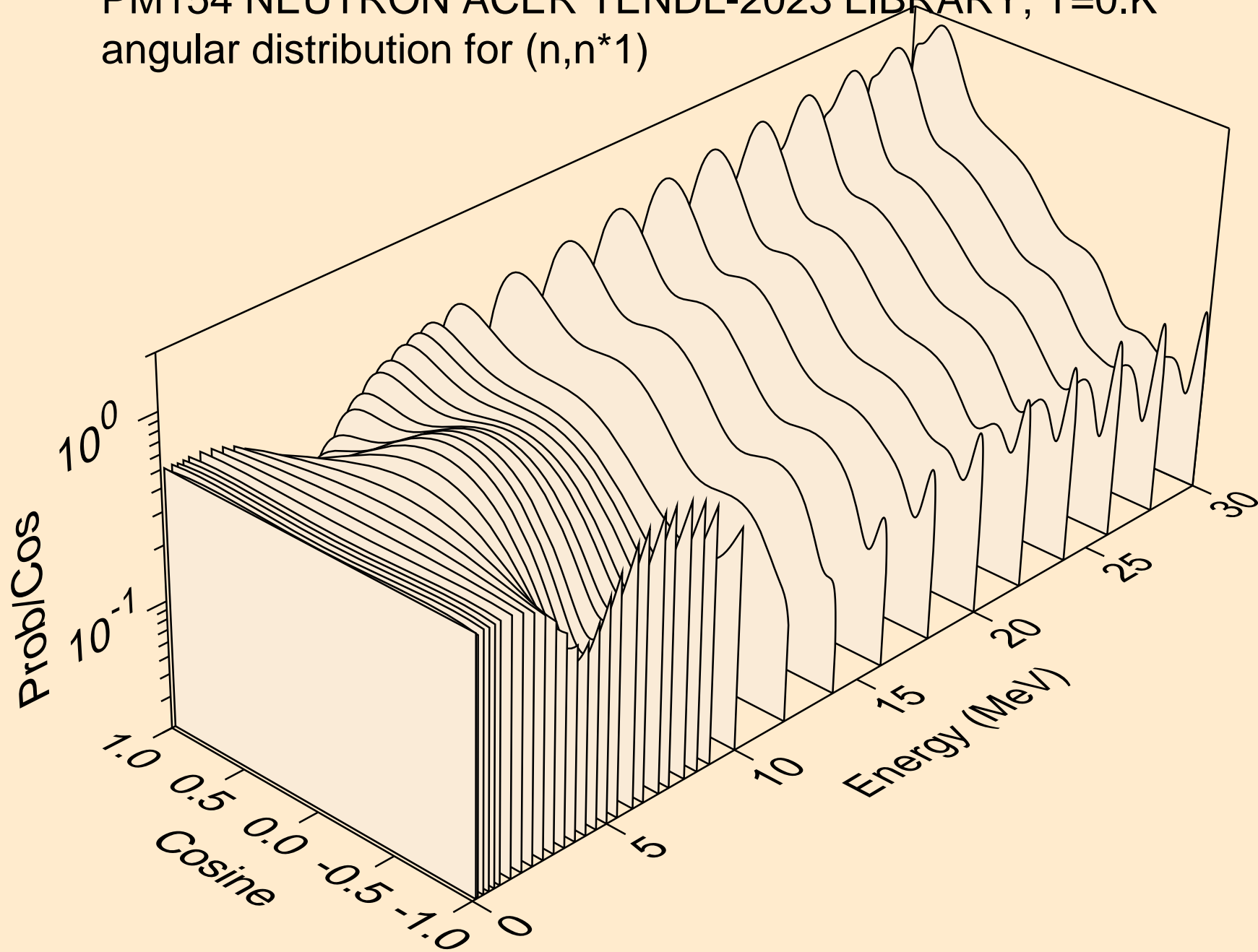

PM154 NEUTRON ACER TENDL-2023 LIBRARY; T=0.K  
angular distribution for (n,n\*2)

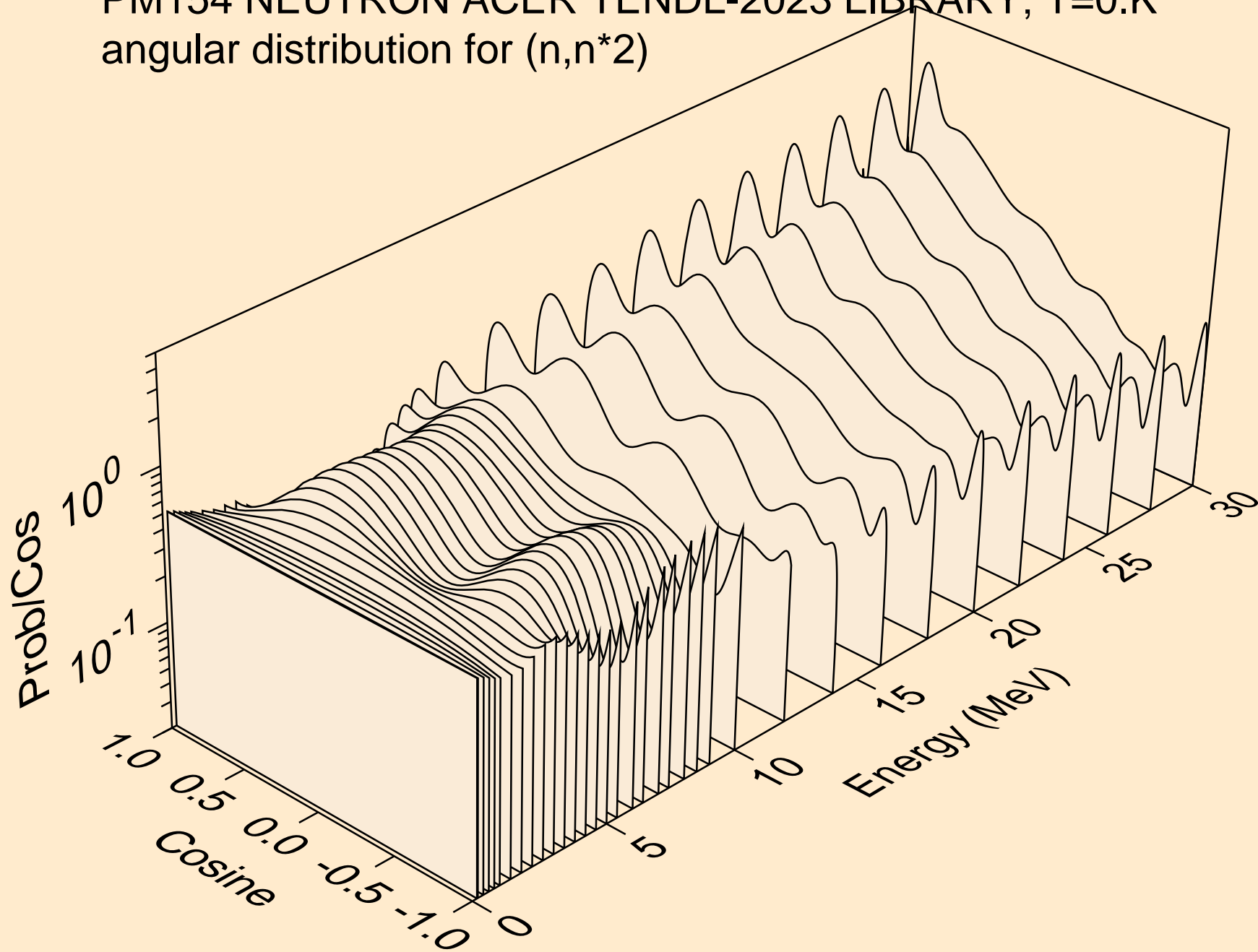

PM154 NEUTRON ACER TENDL-2023 LIBRARY; T=0.K  
angular distribution for (n,n\*3)

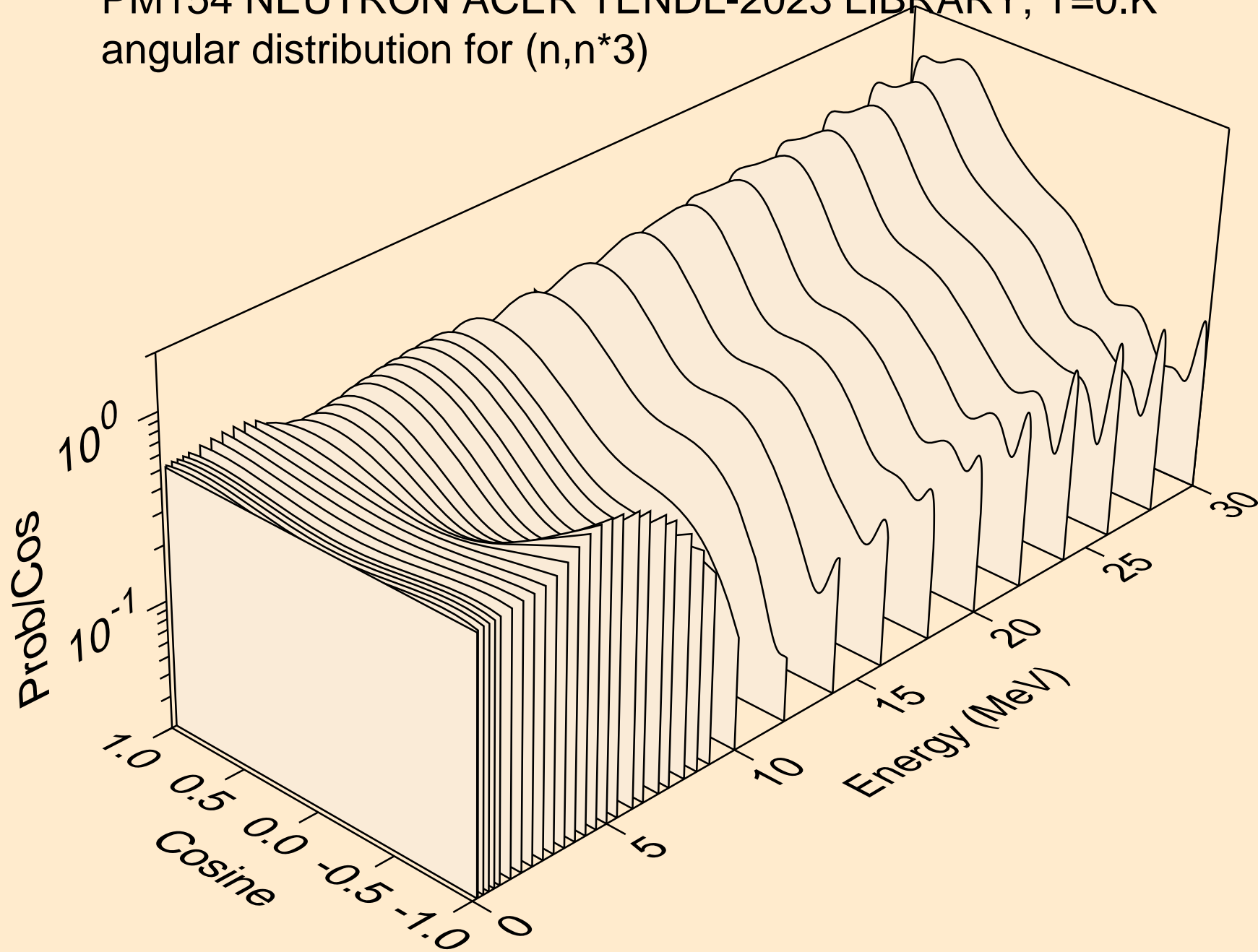

PM154 NEUTRON ACER TENDL-2023 LIBRARY; T=0.K  
angular distribution for (n,n\*4)

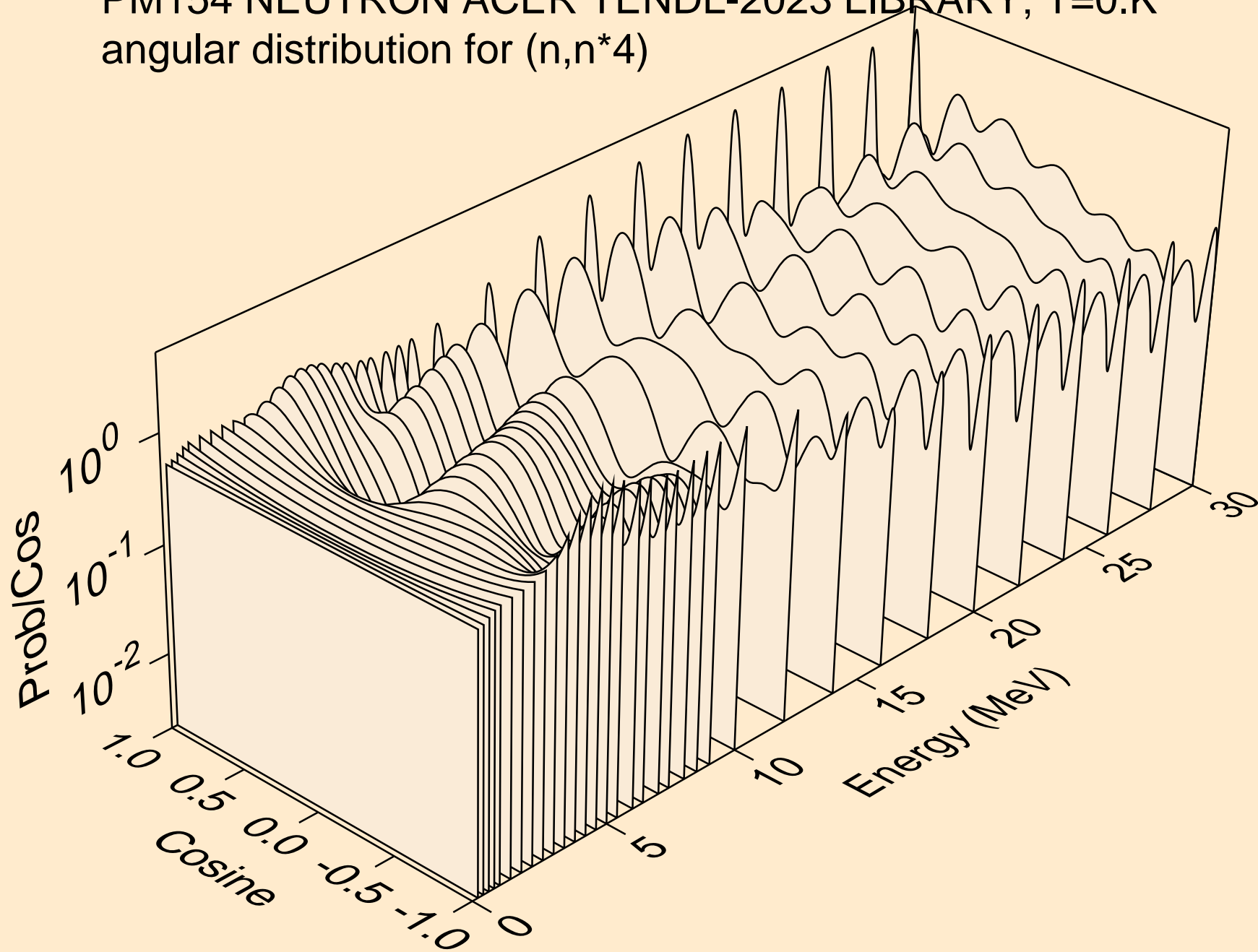

PM154 NEUTRON ACER TENDL-2023 LIBRARY; T=0.K  
angular distribution for (n,n\*5)

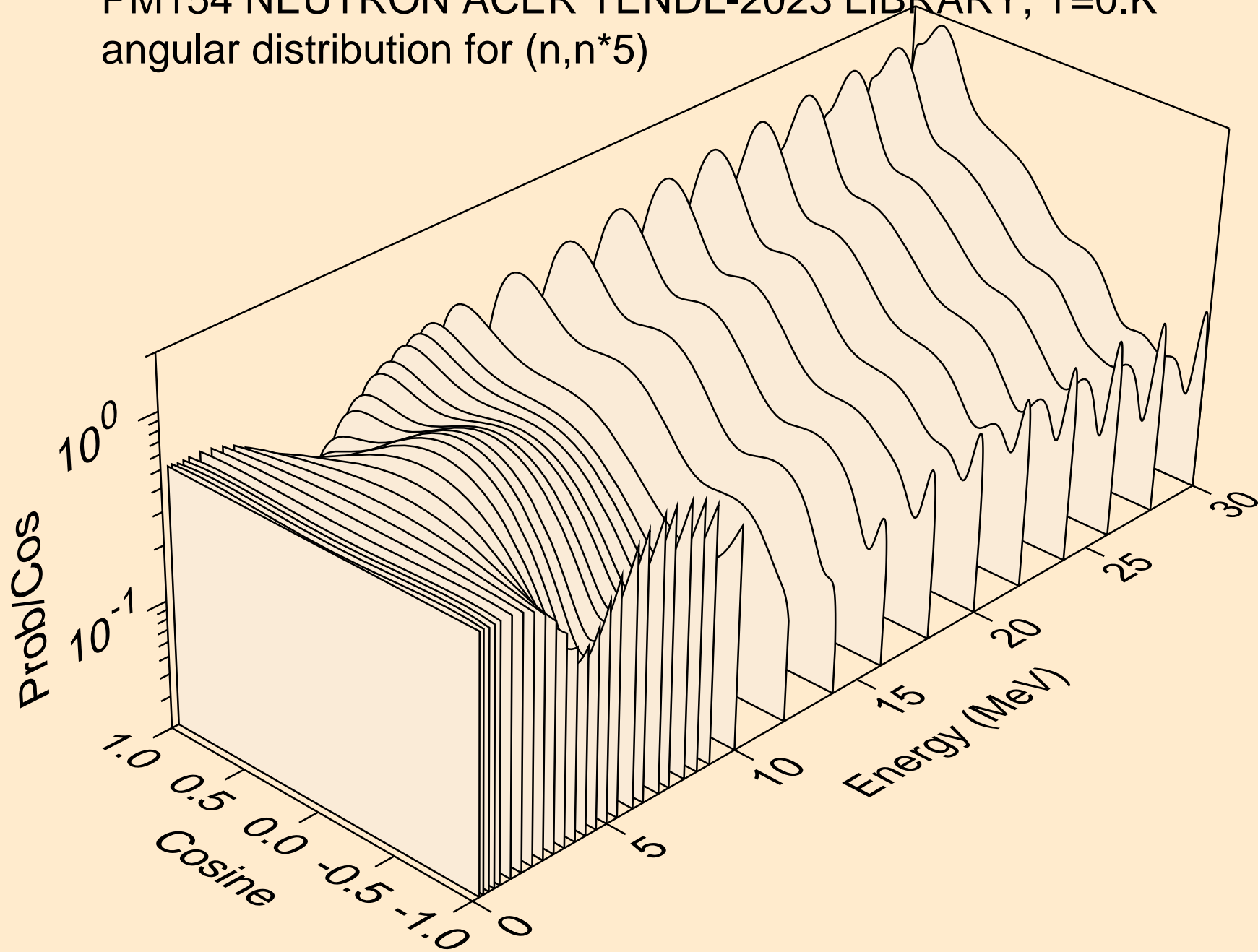

PM154 NEUTRON ACER TENDL-2023 LIBRARY; T=0.K  
angular distribution for (n,n\*6)

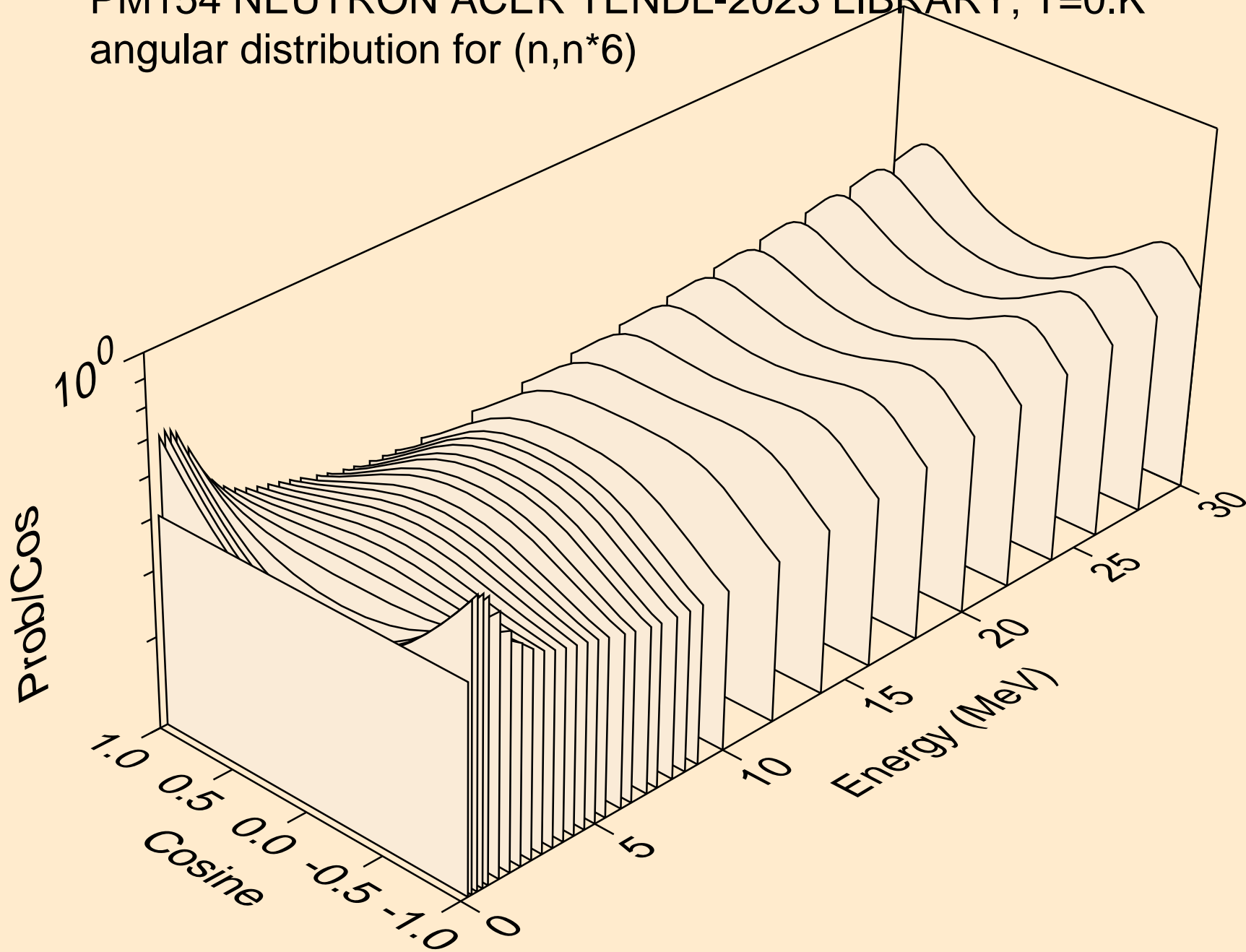

PM154 NEUTRON ACER TENDL-2023 LIBRARY; T=0.K  
angular distribution for (n,n\*7)

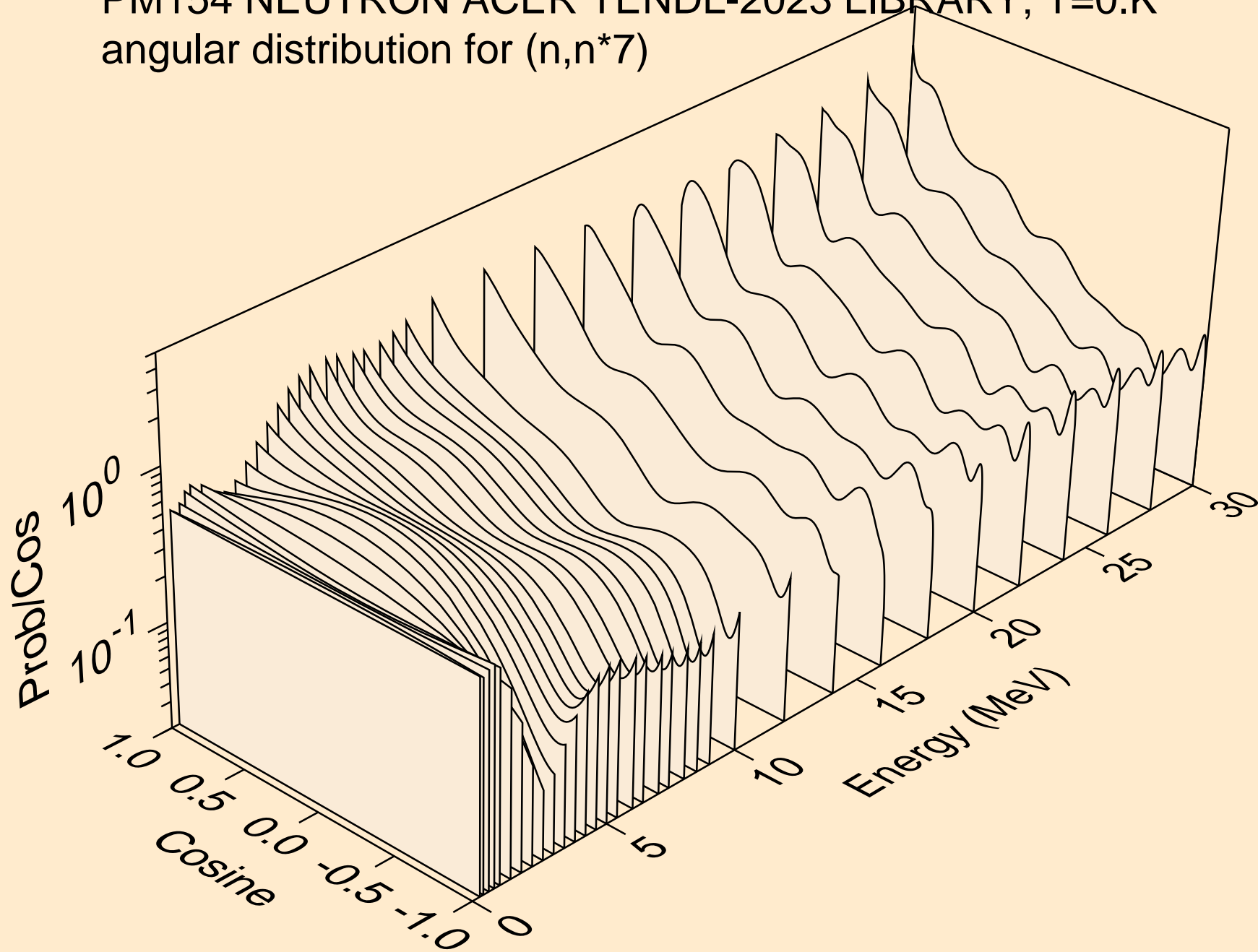

PM154 NEUTRON ACER TENDL-2023 LIBRARY; T=0.K  
angular distribution for (n,n\*8)

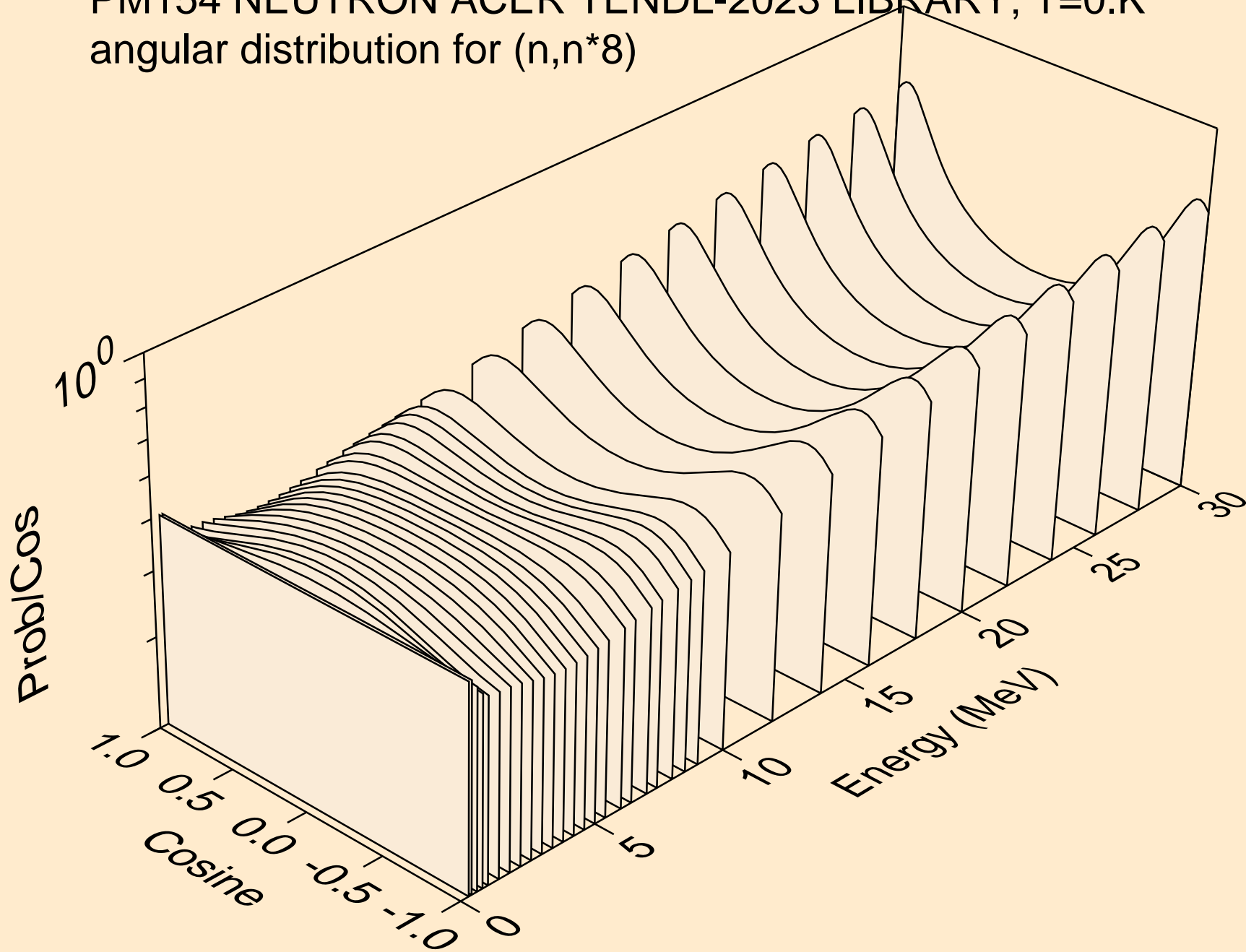

PM154 NEUTRON ACER TENDL-2023 LIBRARY; T=0.K  
angular distribution for (n,n\*9)

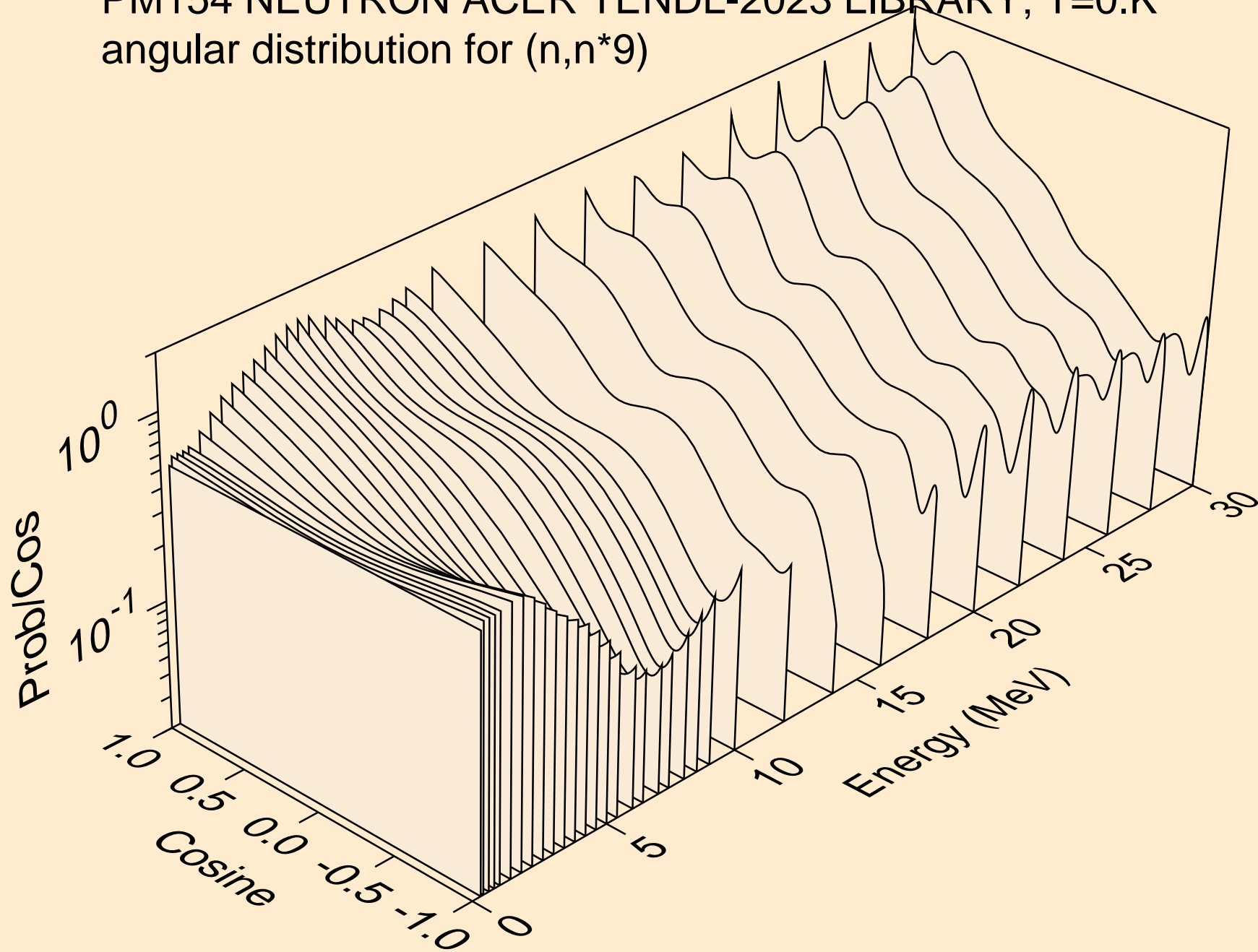

PM154 NEUTRON ACER TENDL-2023 LIBRARY; T=0.K  
angular distribution for (n,n\*10)

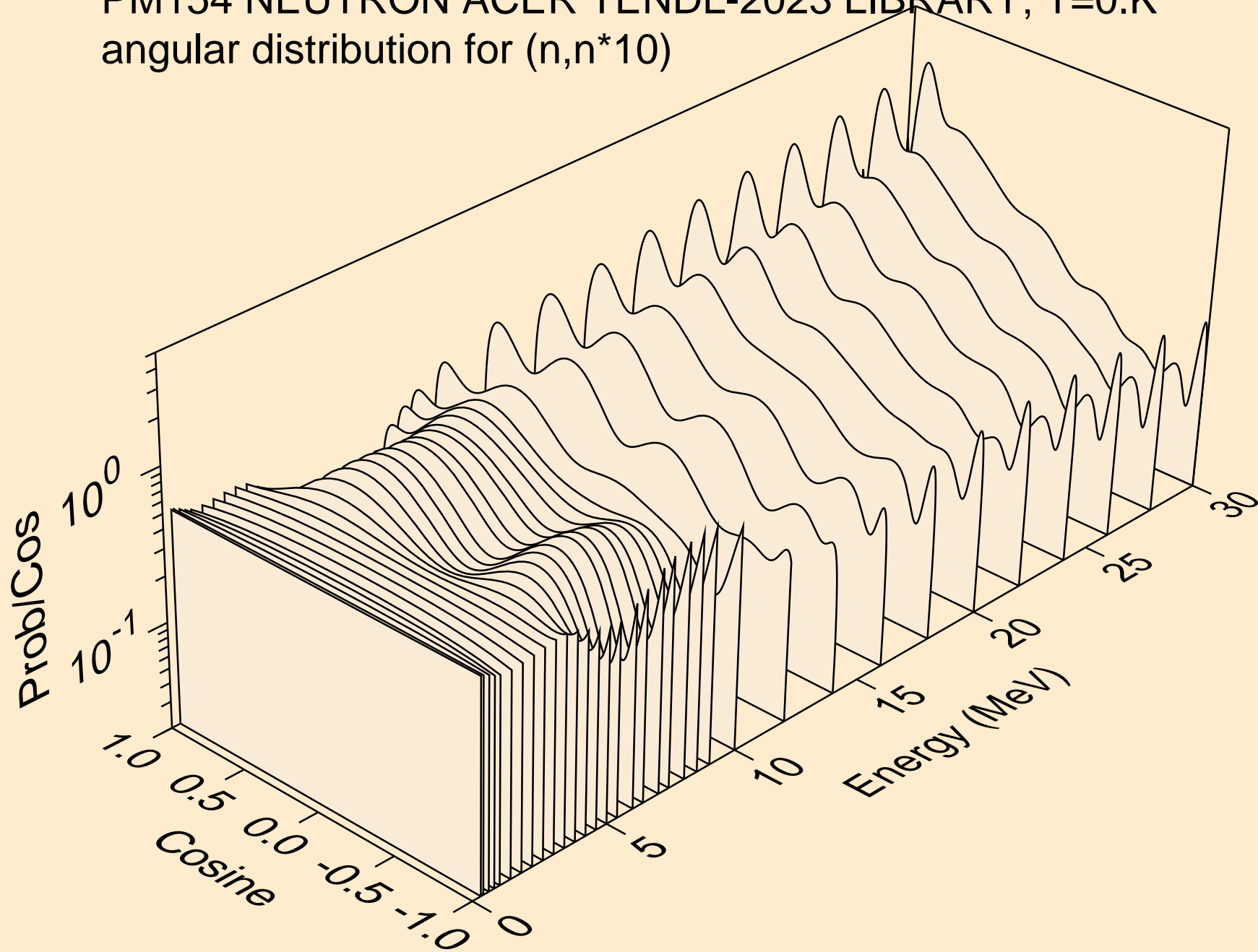

PM154 NEUTRON ACER TENDL-2023 LIBRARY; T=0.K  
angular distribution for (n,n\*11)

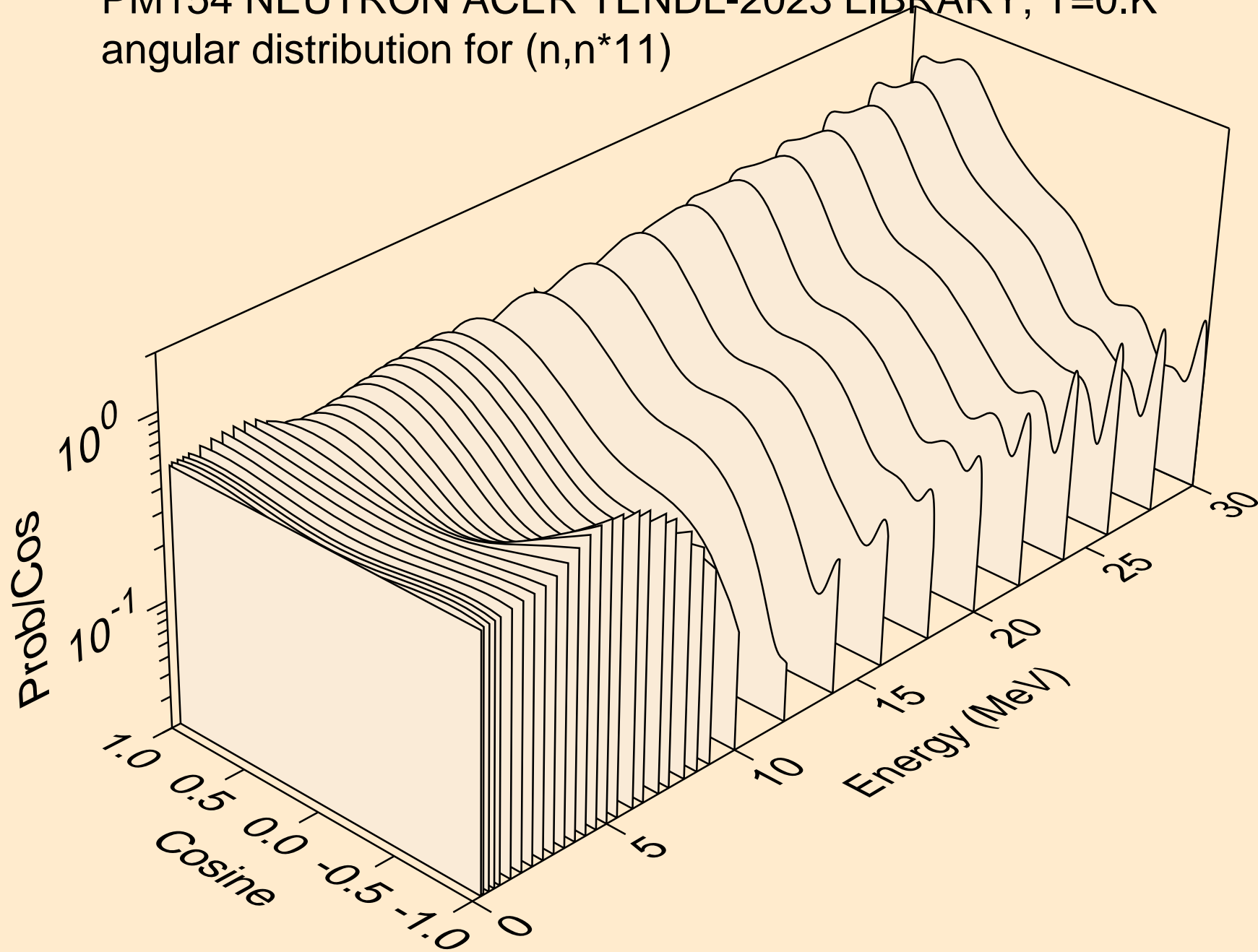

PM154 NEUTRON ACER TENDL-2023 LIBRARY; T=0.K  
angular distribution for (n,n\*12)

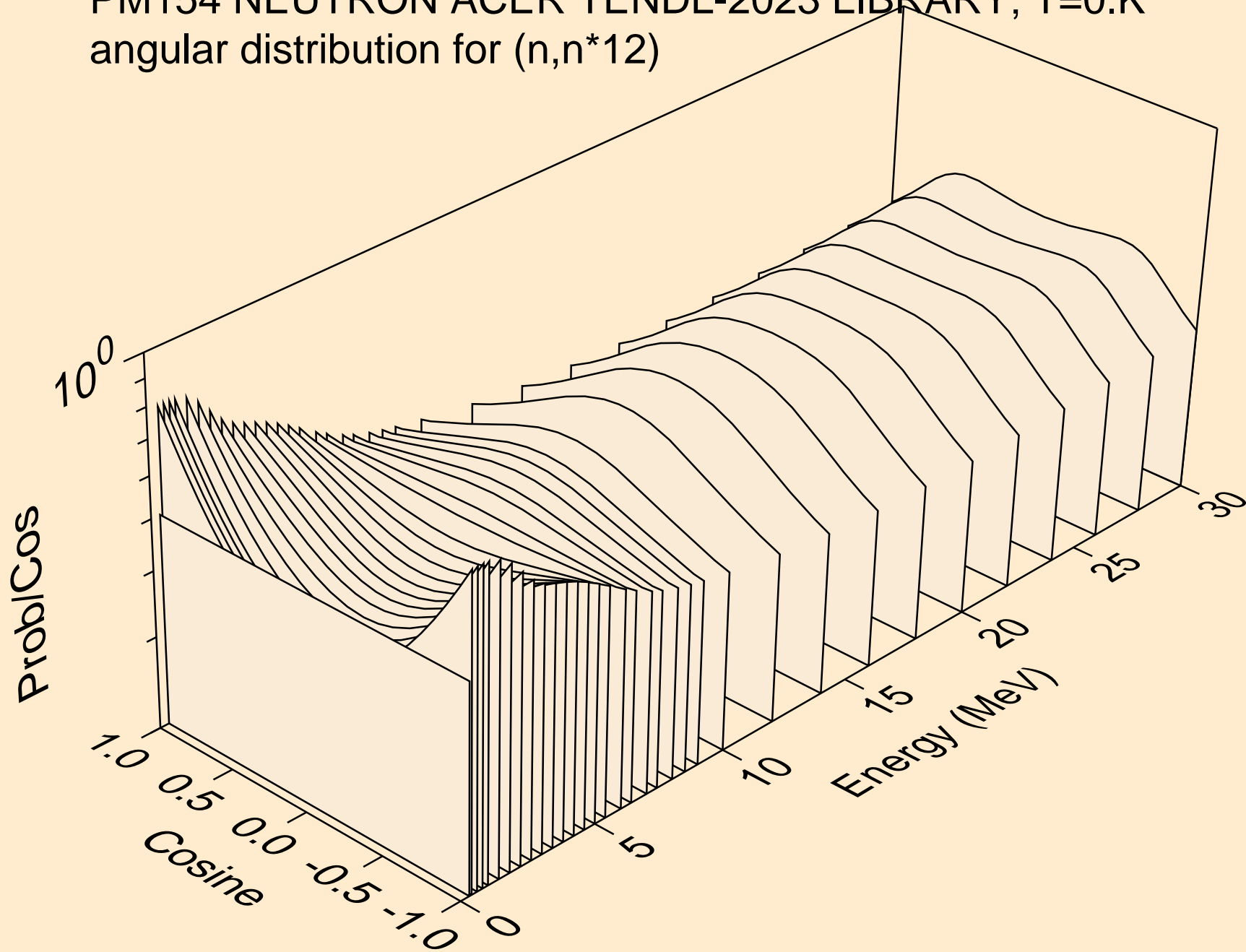

PM154 NEUTRON ACER TENDL-2023 LIBRARY; T=0.K  
angular distribution for (n,n\*13)

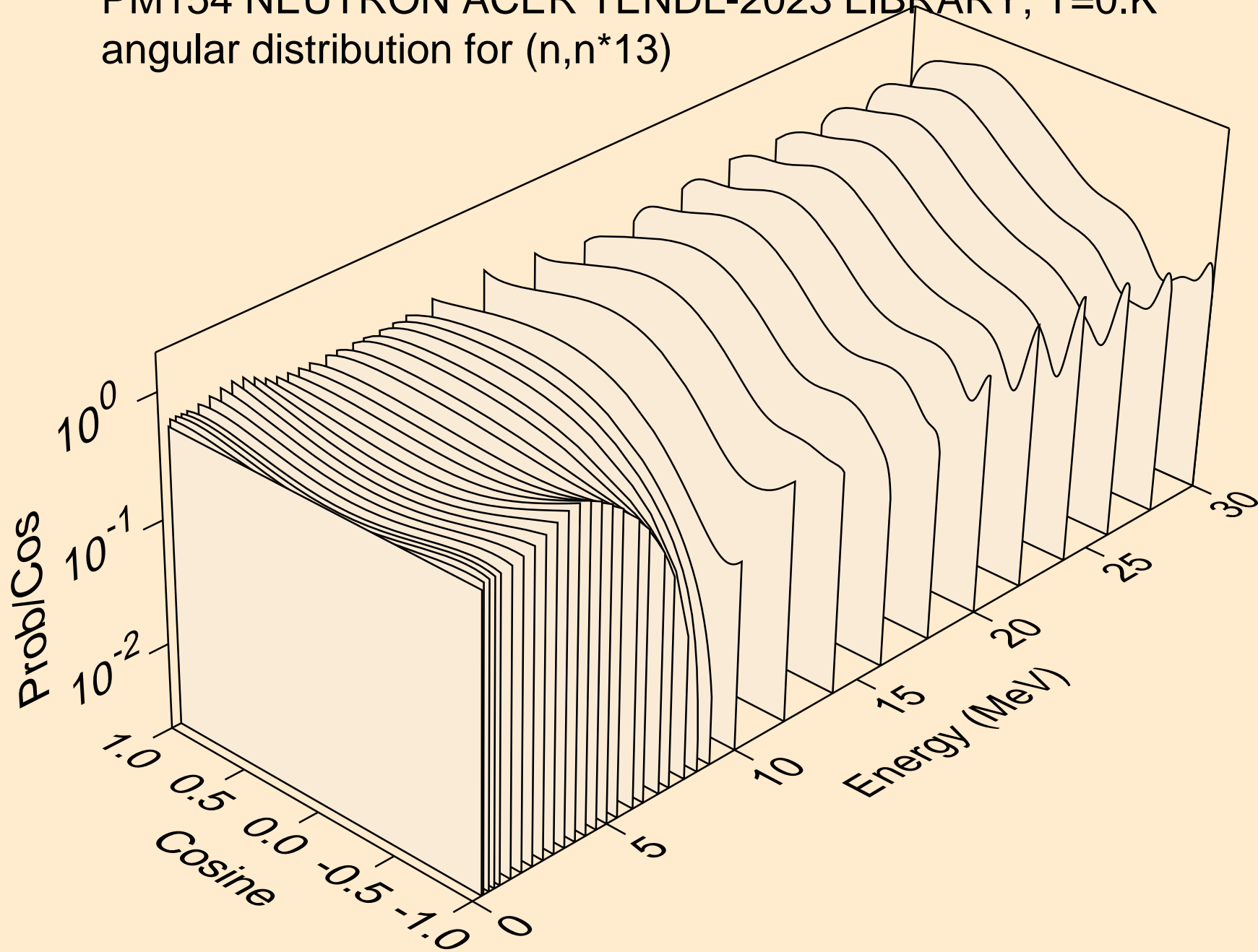

PM154 NEUTRON ACER TENDL-2023 LIBRARY; T=0.K  
angular distribution for (n,n\*14)

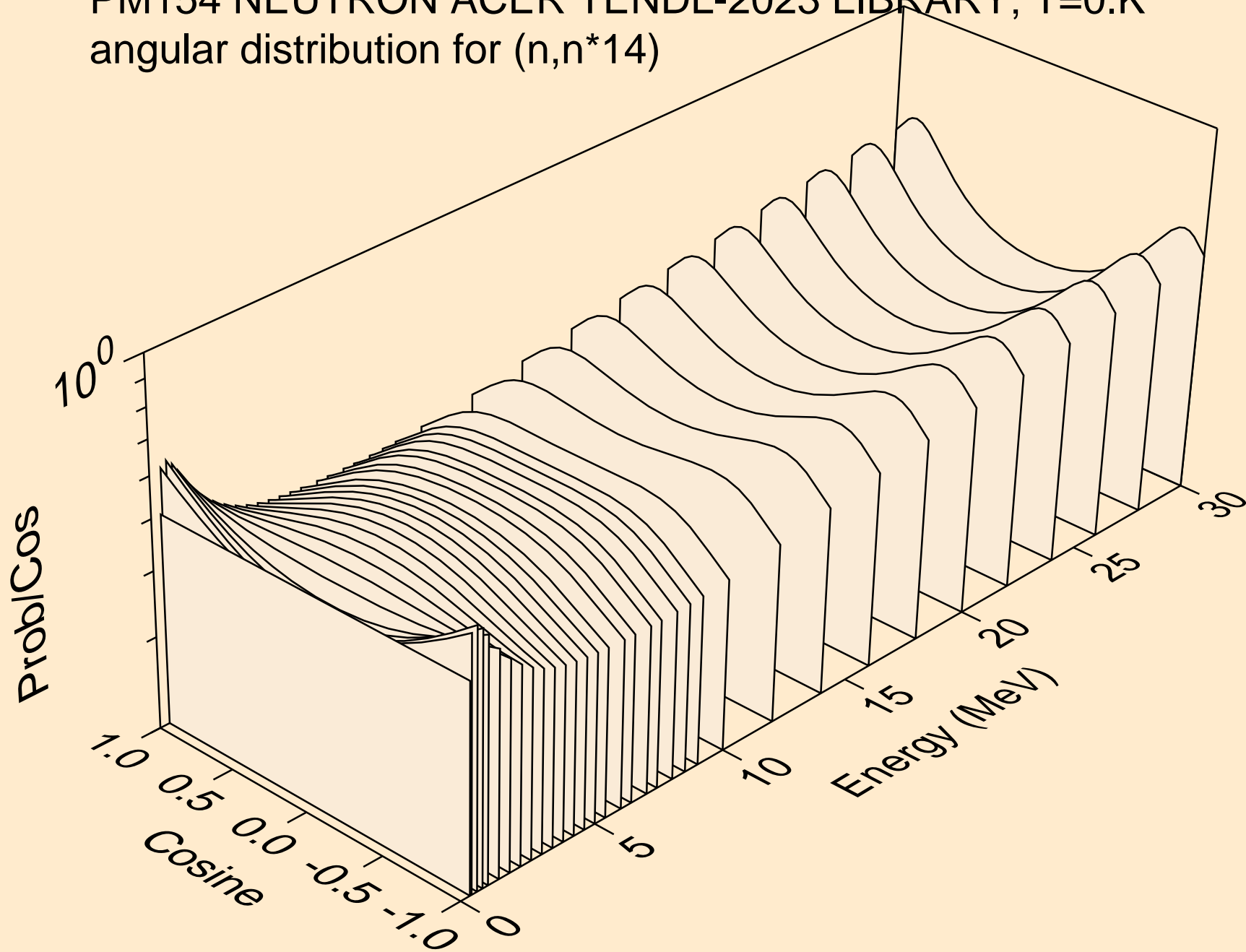

PM154 NEUTRON ACER TENDL-2023 LIBRARY; T=0.K  
angular distribution for (n,n\*15)

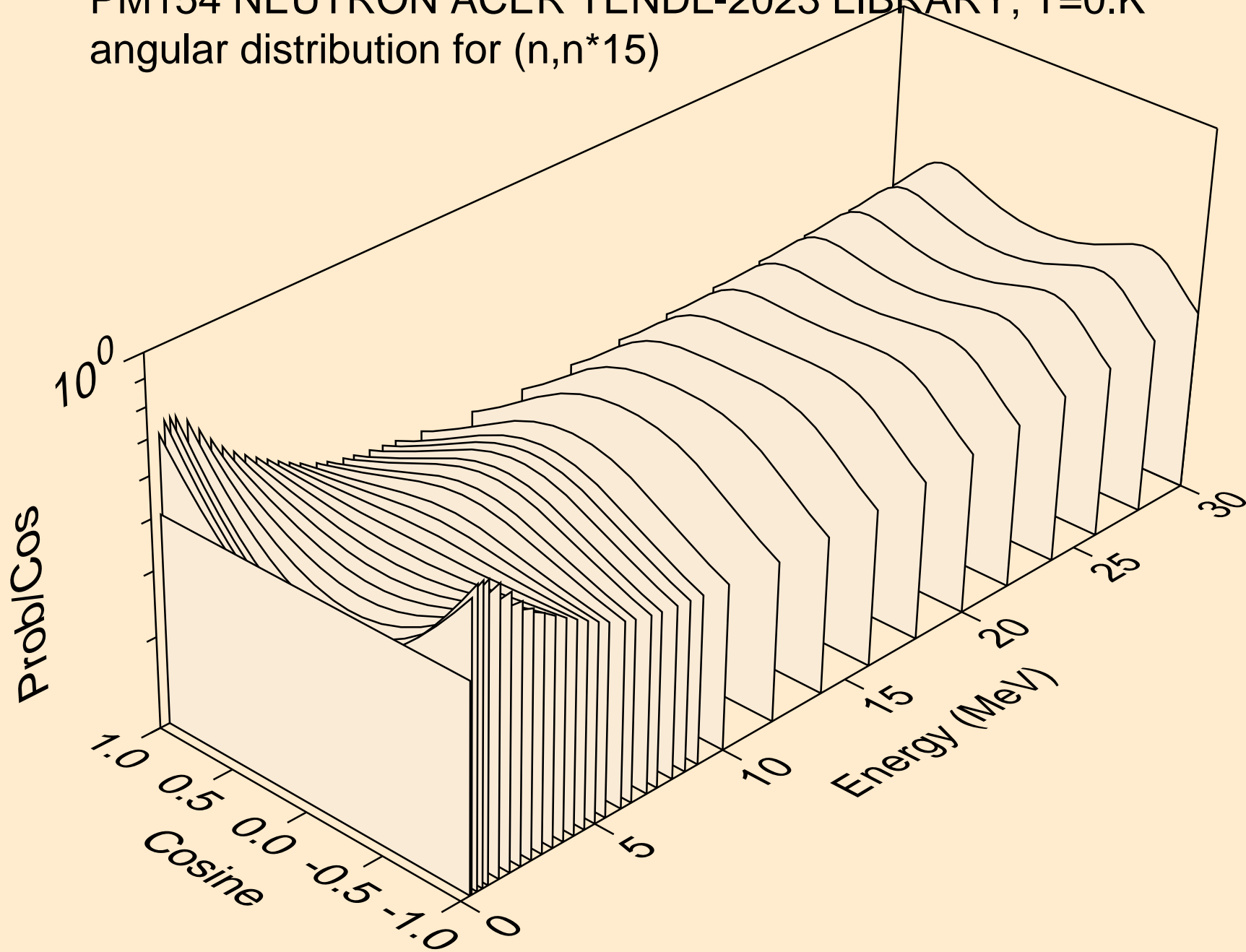

PM154 NEUTRON ACER TENDL-2023 LIBRARY; T=0.K  
angular distribution for (n,n\*16)

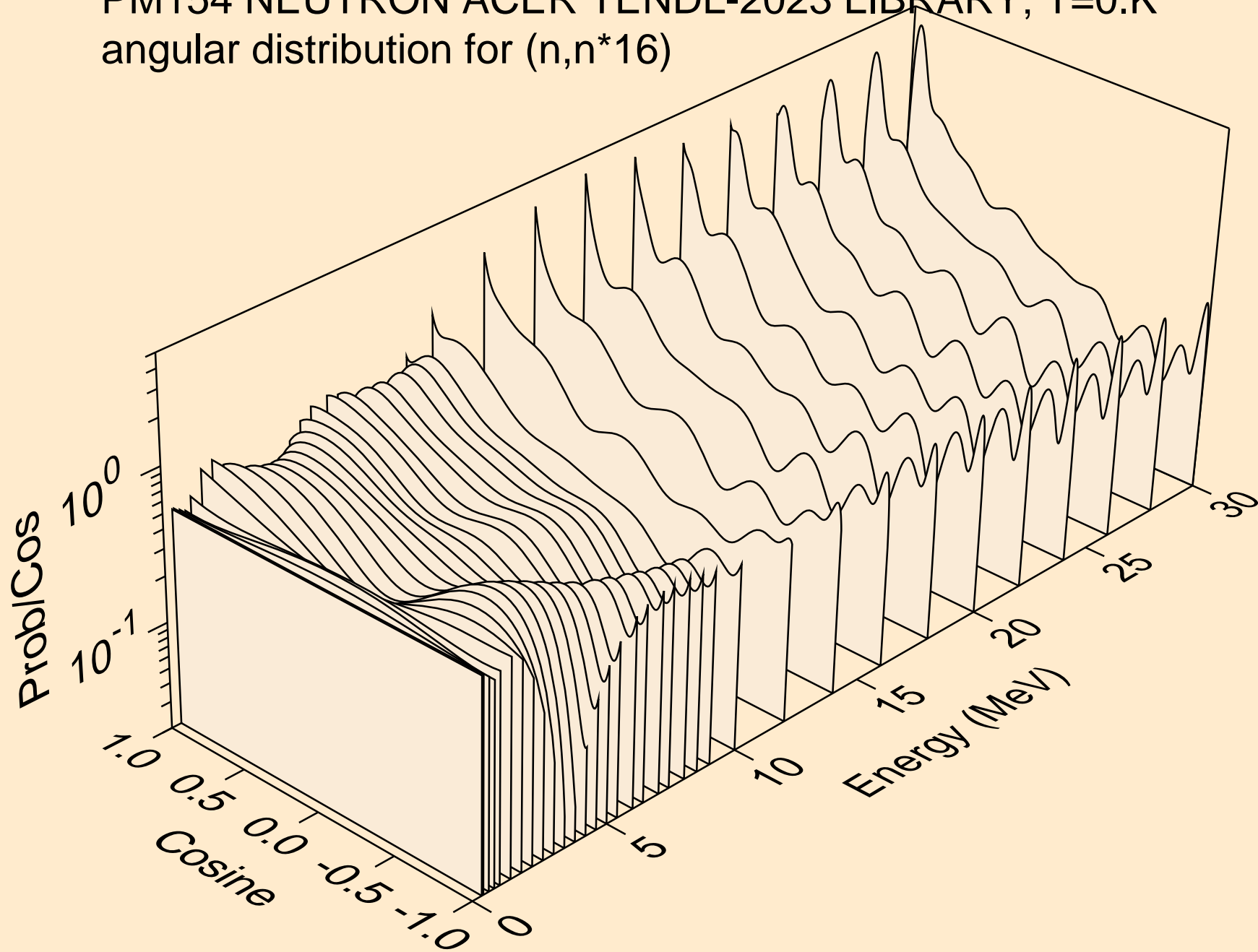

PM154 NEUTRON ACER TENDL-2023 LIBRARY; T=0.K  
angular distribution for (n,n\*17)

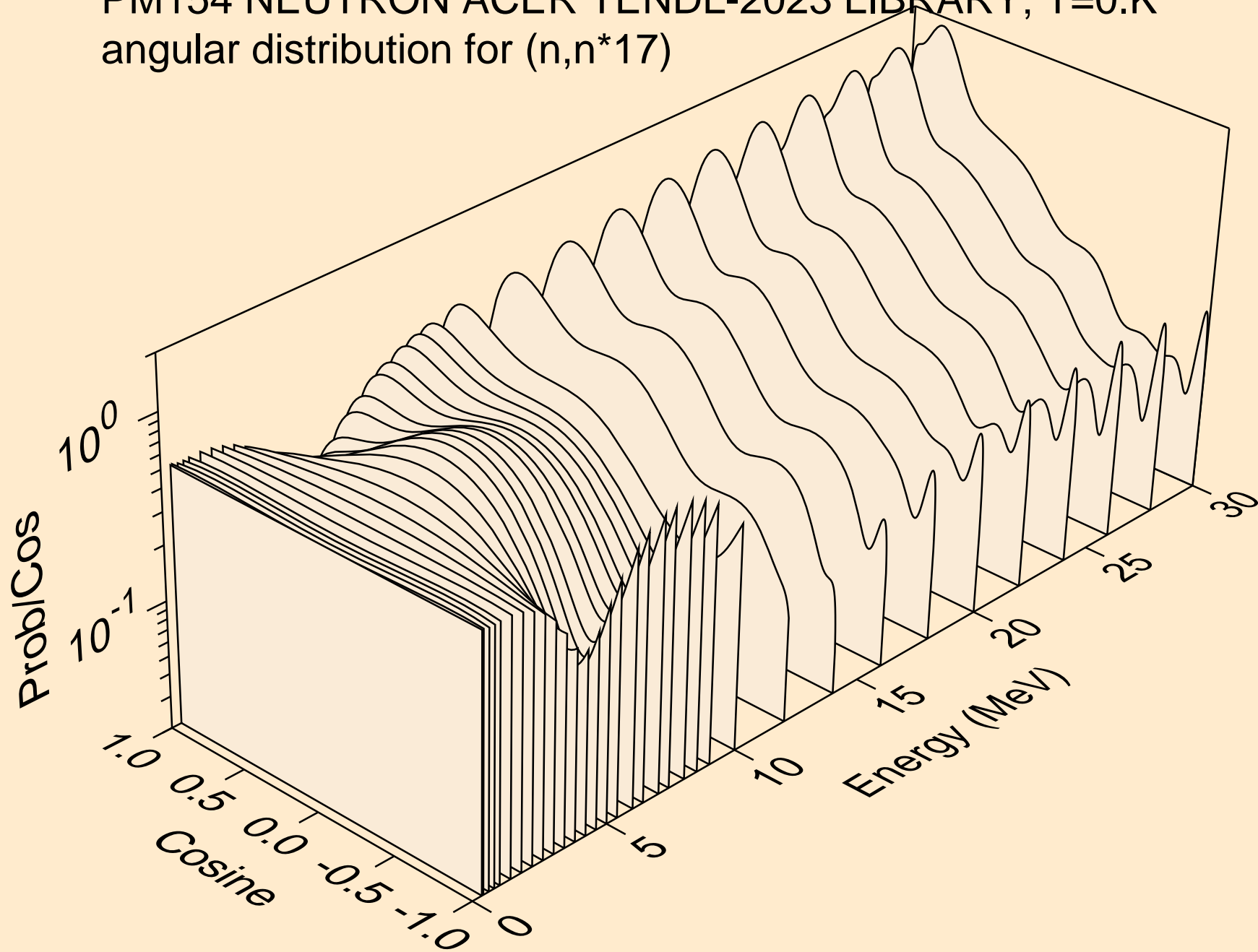

PM154 NEUTRON ACER TENDL-2023 LIBRARY; T=0.K  
angular distribution for (n,n\*18)

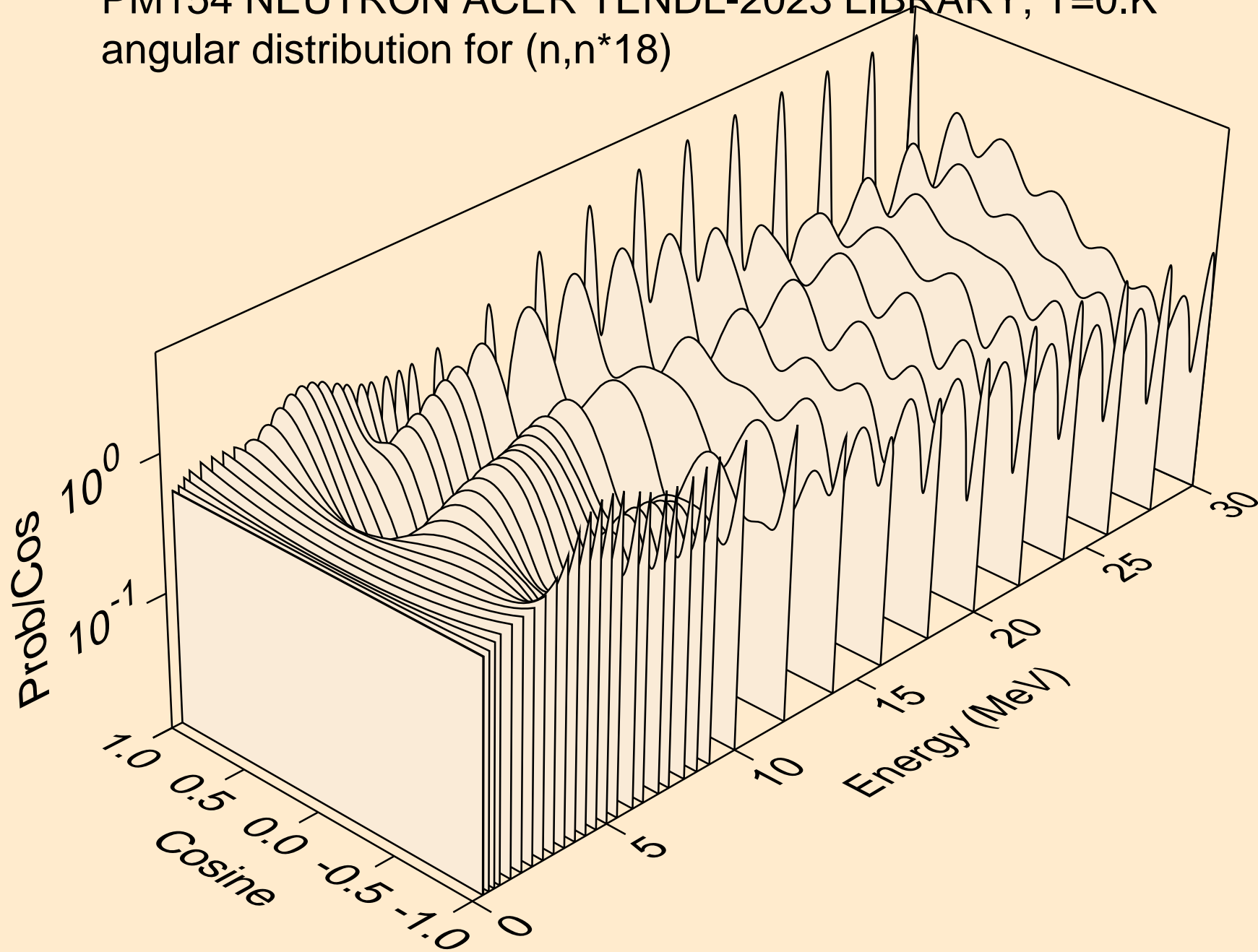

PM154 NEUTRON ACER TENDL-2023 LIBRARY; T=0.K  
angular distribution for (n,n\*19)

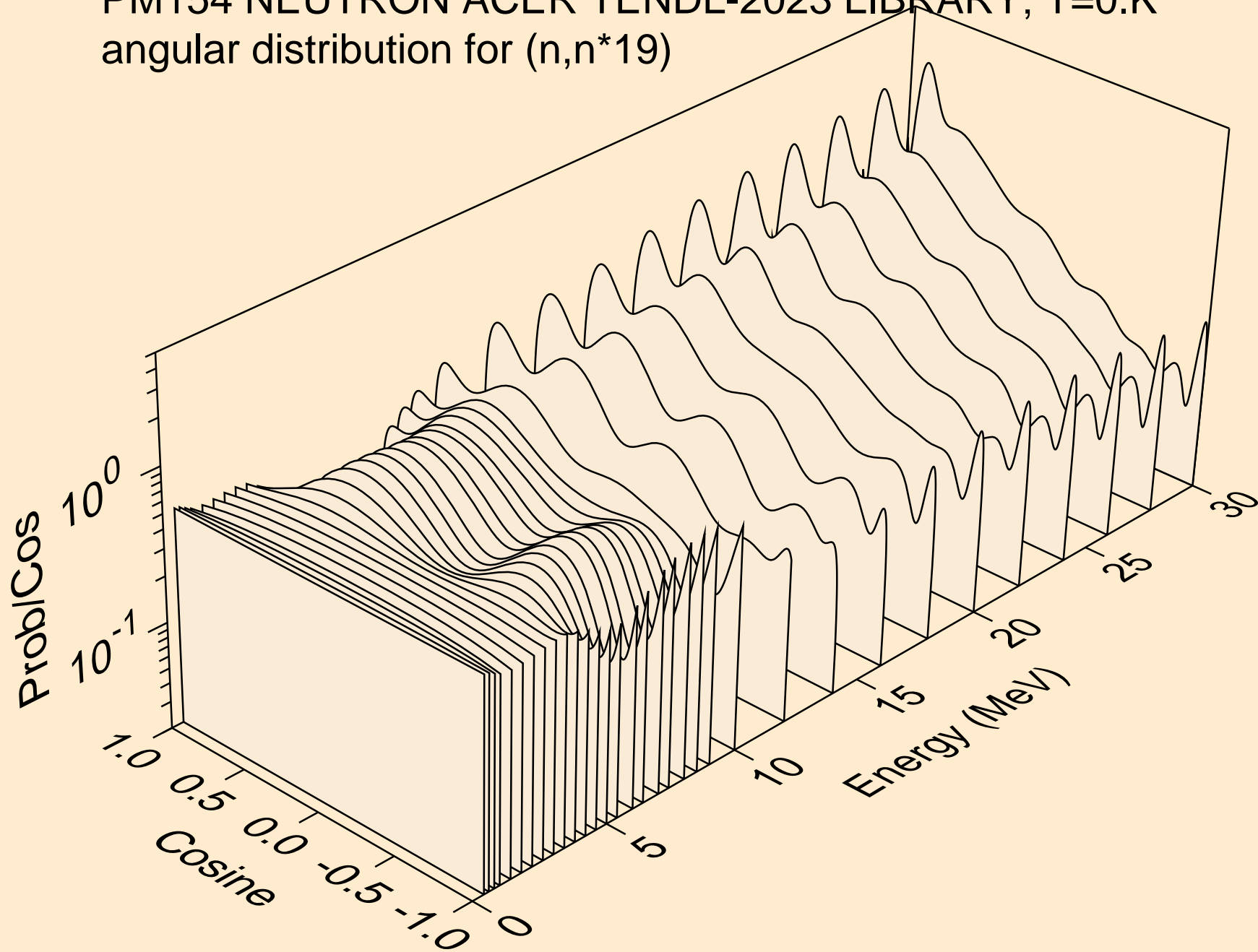

PM154 NEUTRON ACER TENDL-2023 LIBRARY; T=0.K  
angular distribution for (n,n\*20)

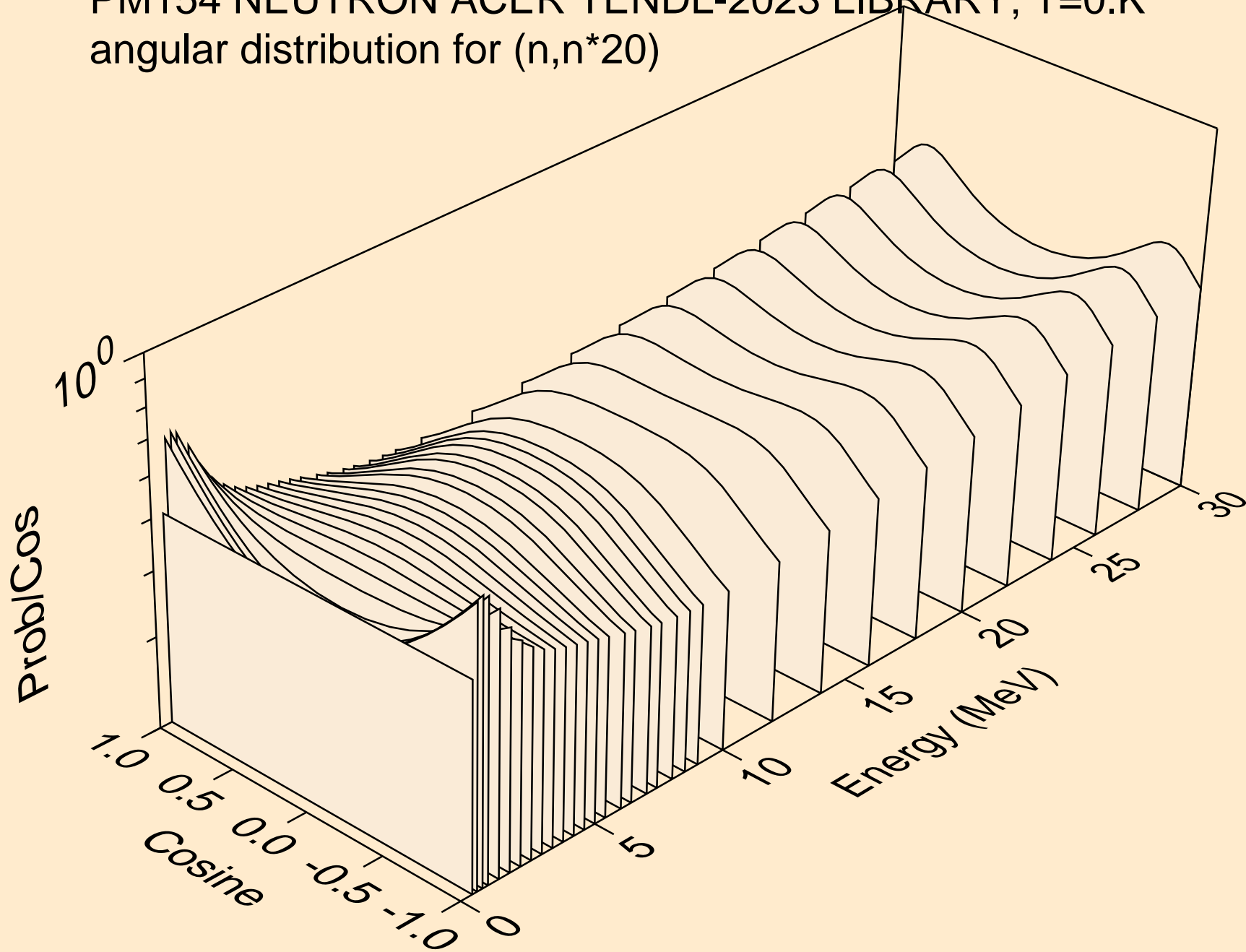

PM154 NEUTRON ACER TENDL-2023 LIBRARY; T=0.K  
angular distribution for (n,n\*21)

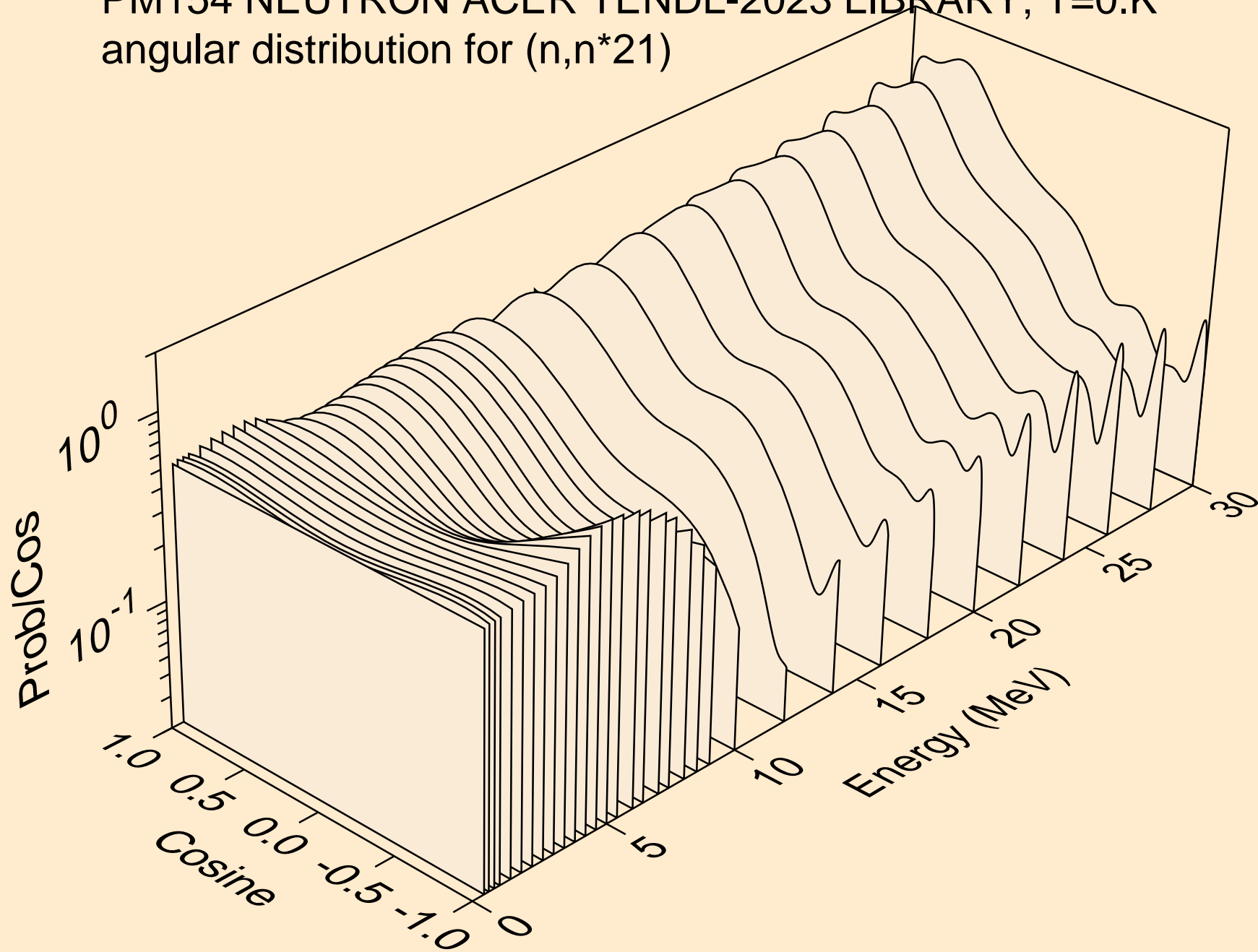

PM154 NEUTRON ACER TENDL-2023 LIBRARY; T=0.K  
angular distribution for (n,n\*22)

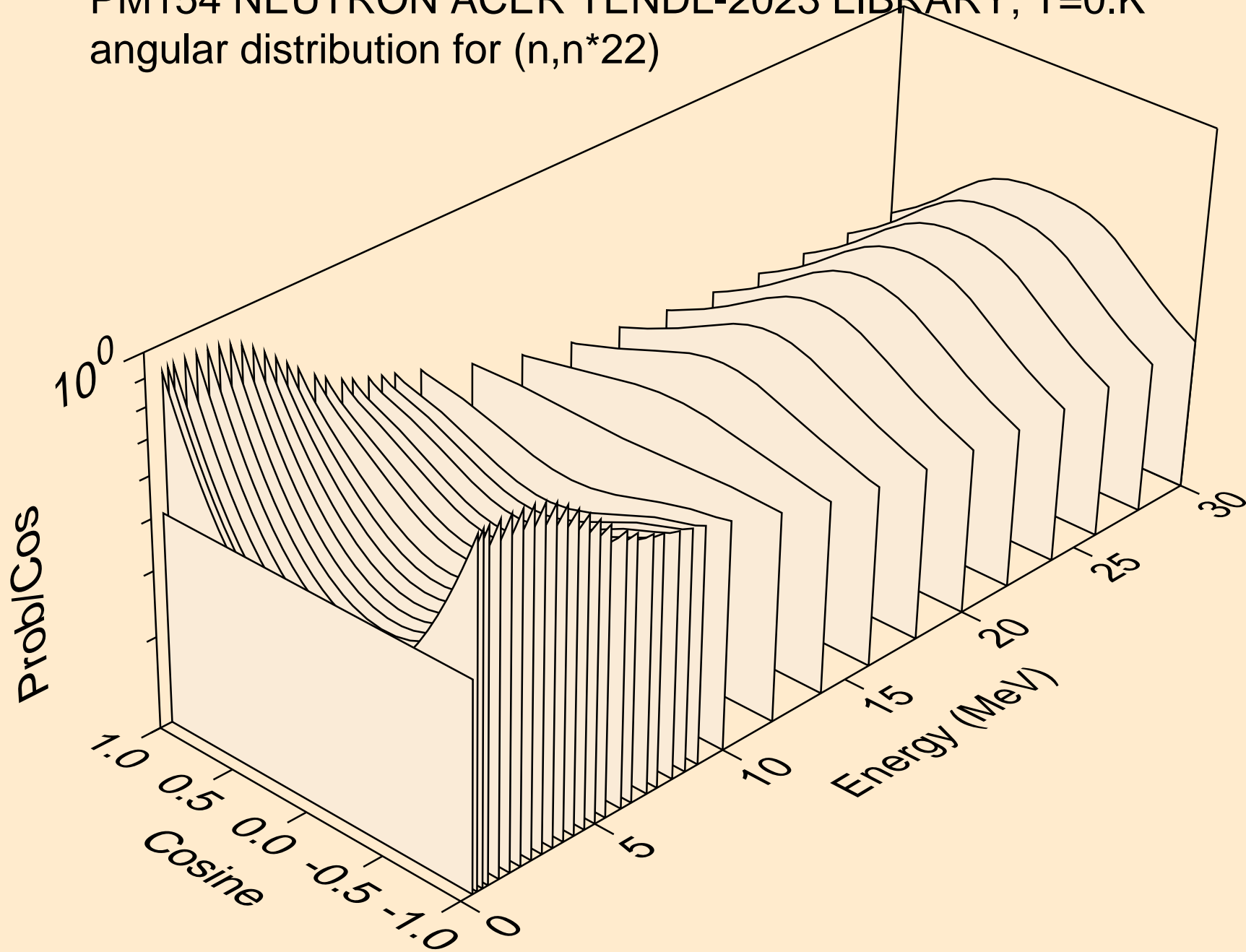

PM154 NEUTRON ACER TENDL-2023 LIBRARY; T=0.K  
angular distribution for (n,n\*23)

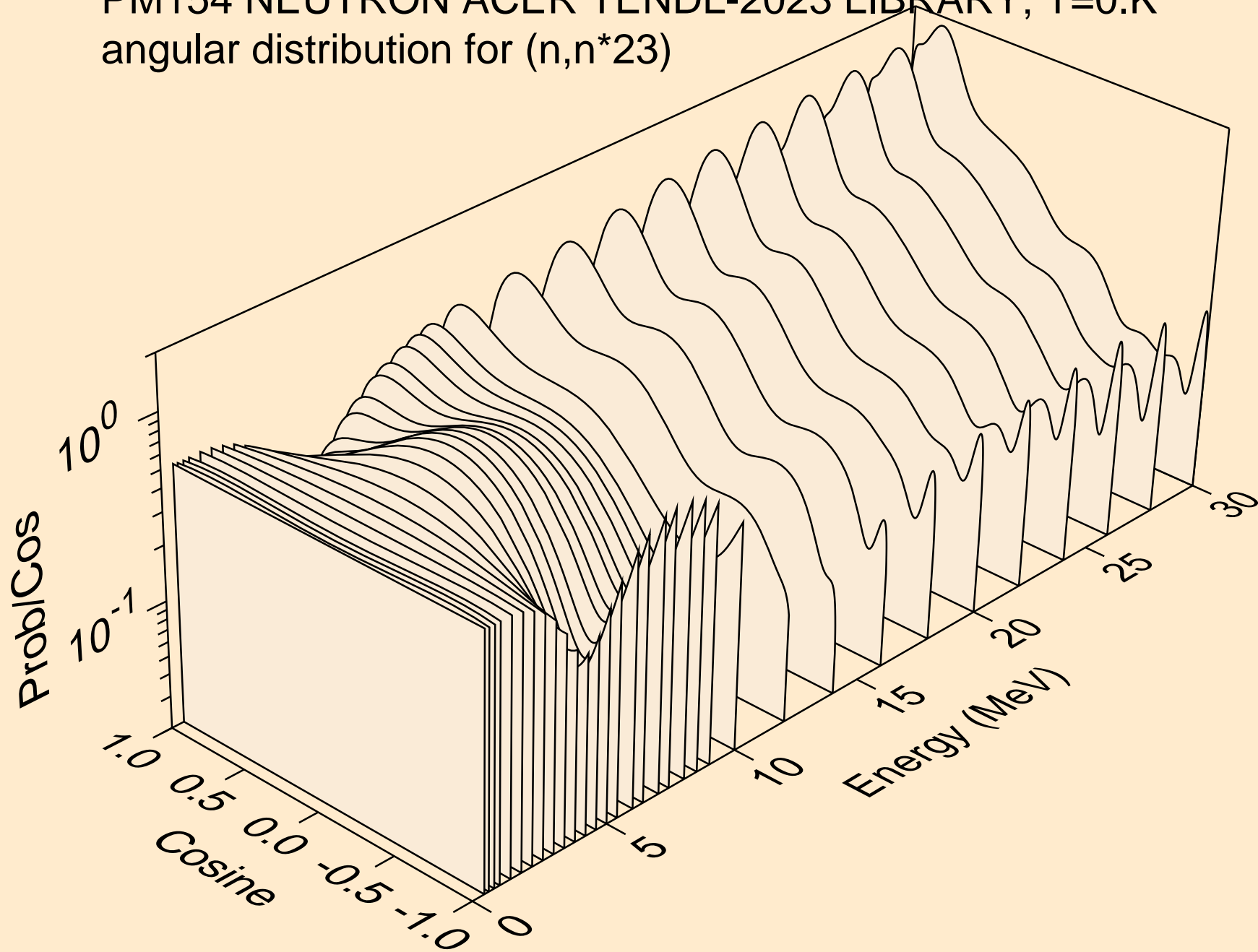

PM154 NEUTRON ACER TENDL-2023 LIBRARY; T=0.K  
angular distribution for (n,n\*24)

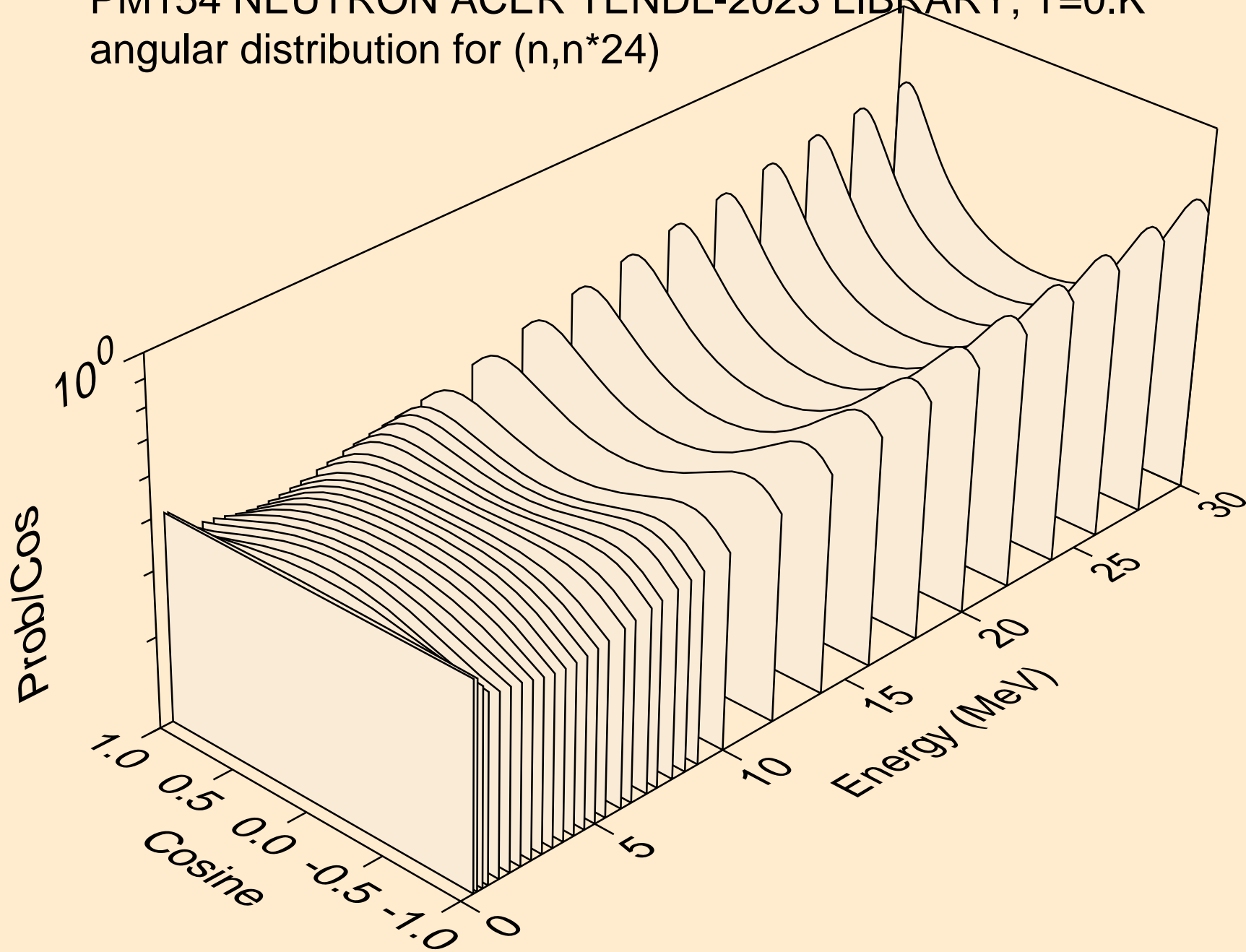

PM154 NEUTRON ACER TENDL-2023 LIBRARY; T=0.K  
angular distribution for (n,n\*25)

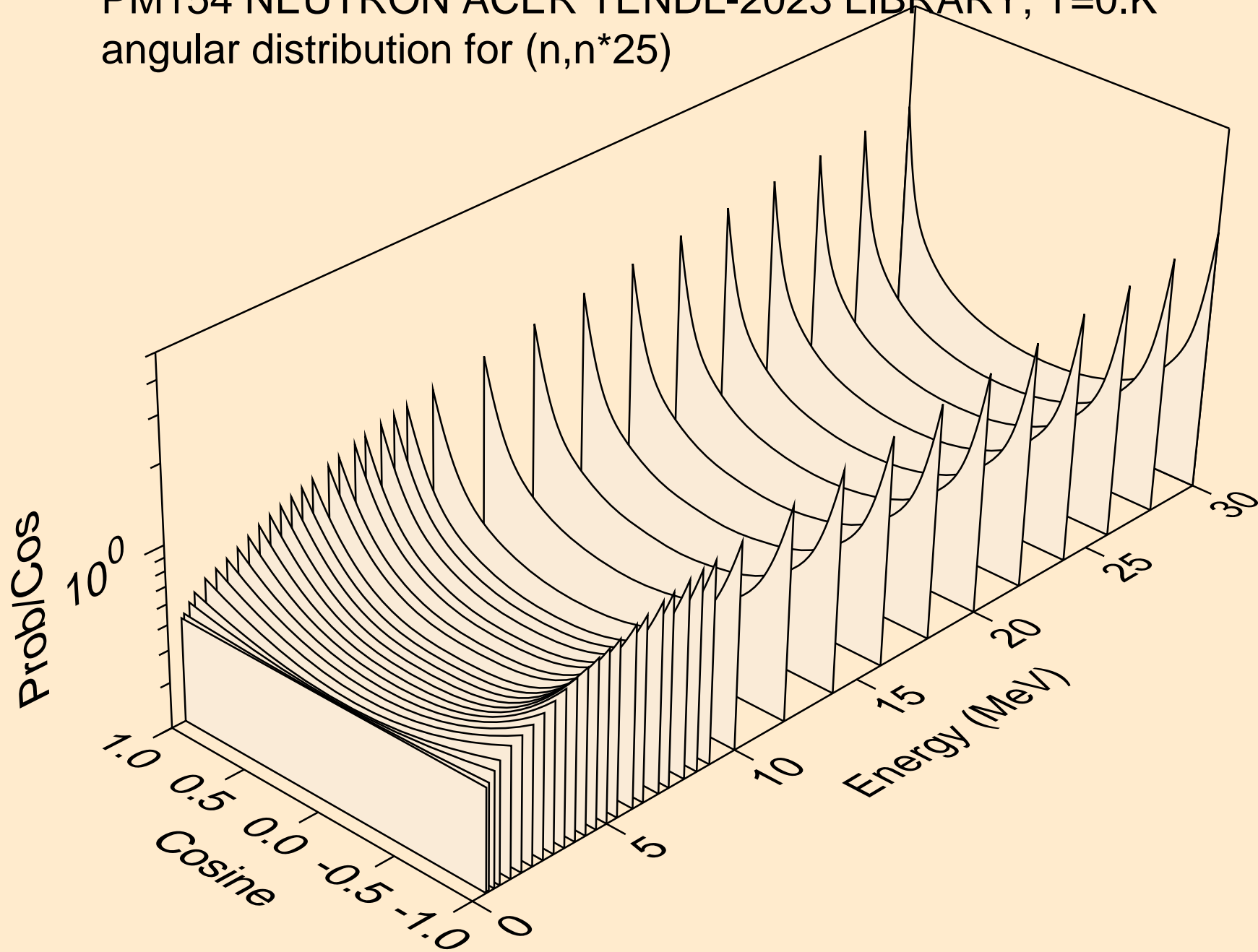

PM154 NEUTRON ACER TENDL-2023 LIBRARY; T=0.K  
angular distribution for (n,n\*26)

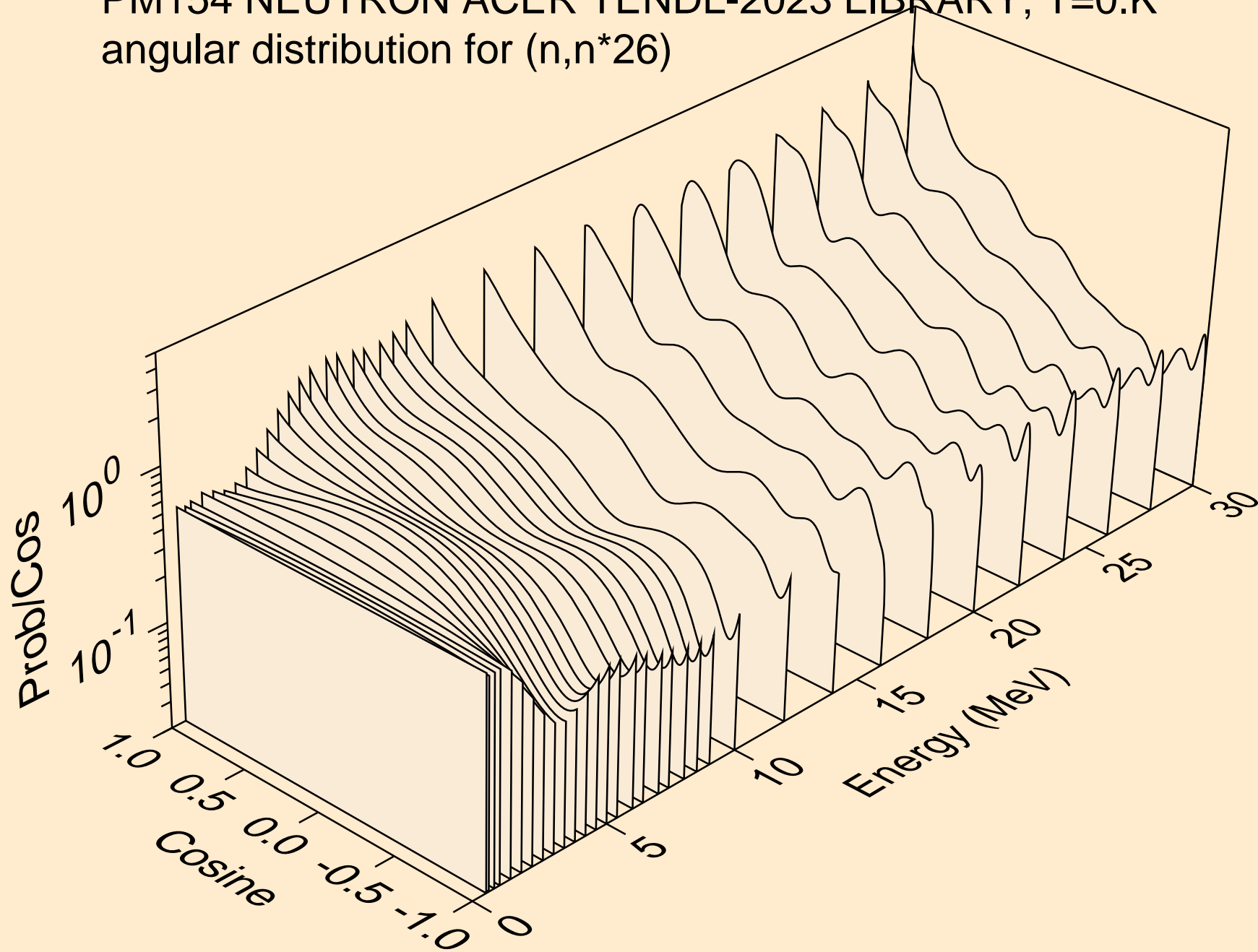

PM154 NEUTRON ACER TENDL-2023 LIBRARY; T=0.K  
angular distribution for (n,n\*27)

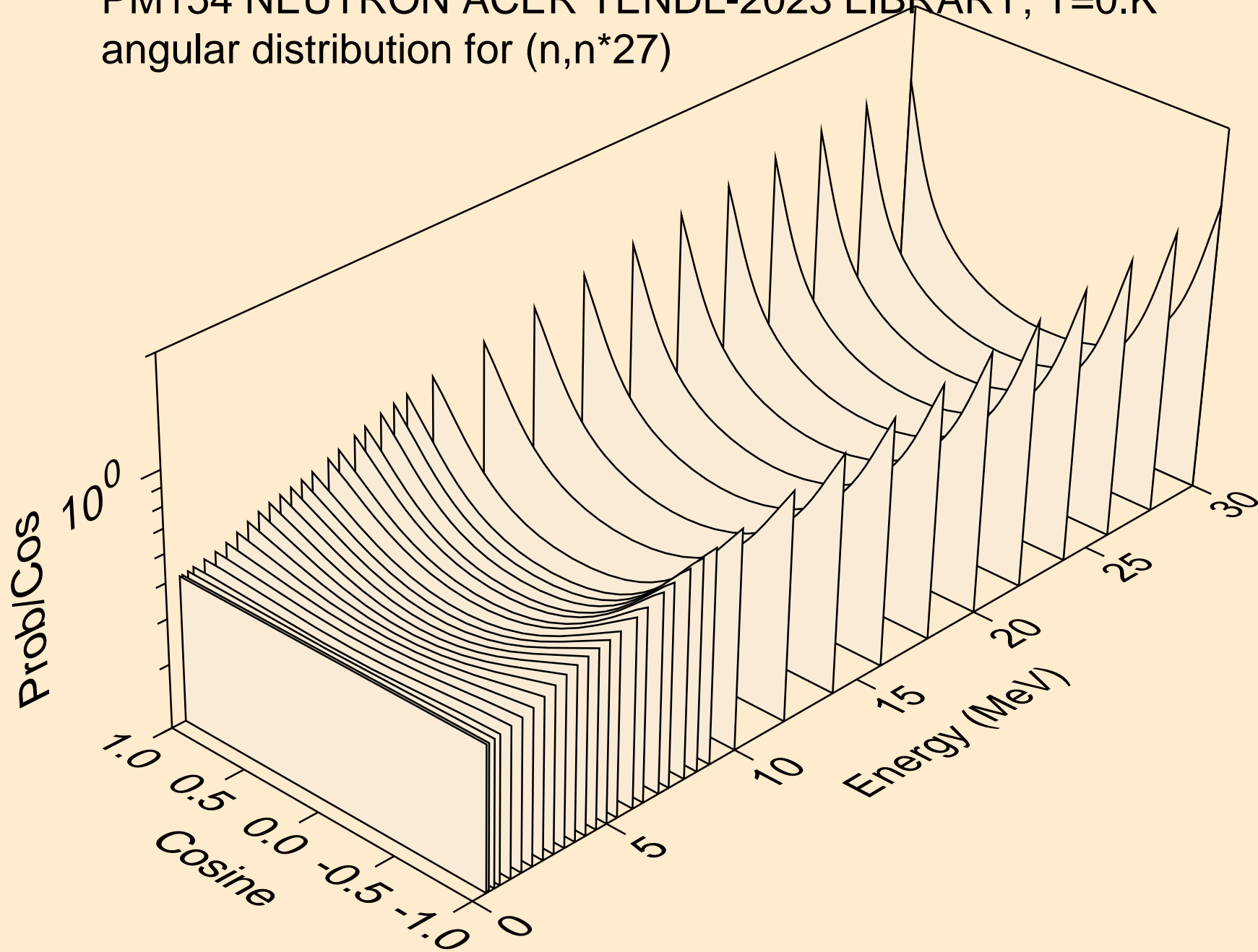

PM154 NEUTRON ACER TENDL-2023 LIBRARY; T=0.K  
Neutron emission for (n,x)

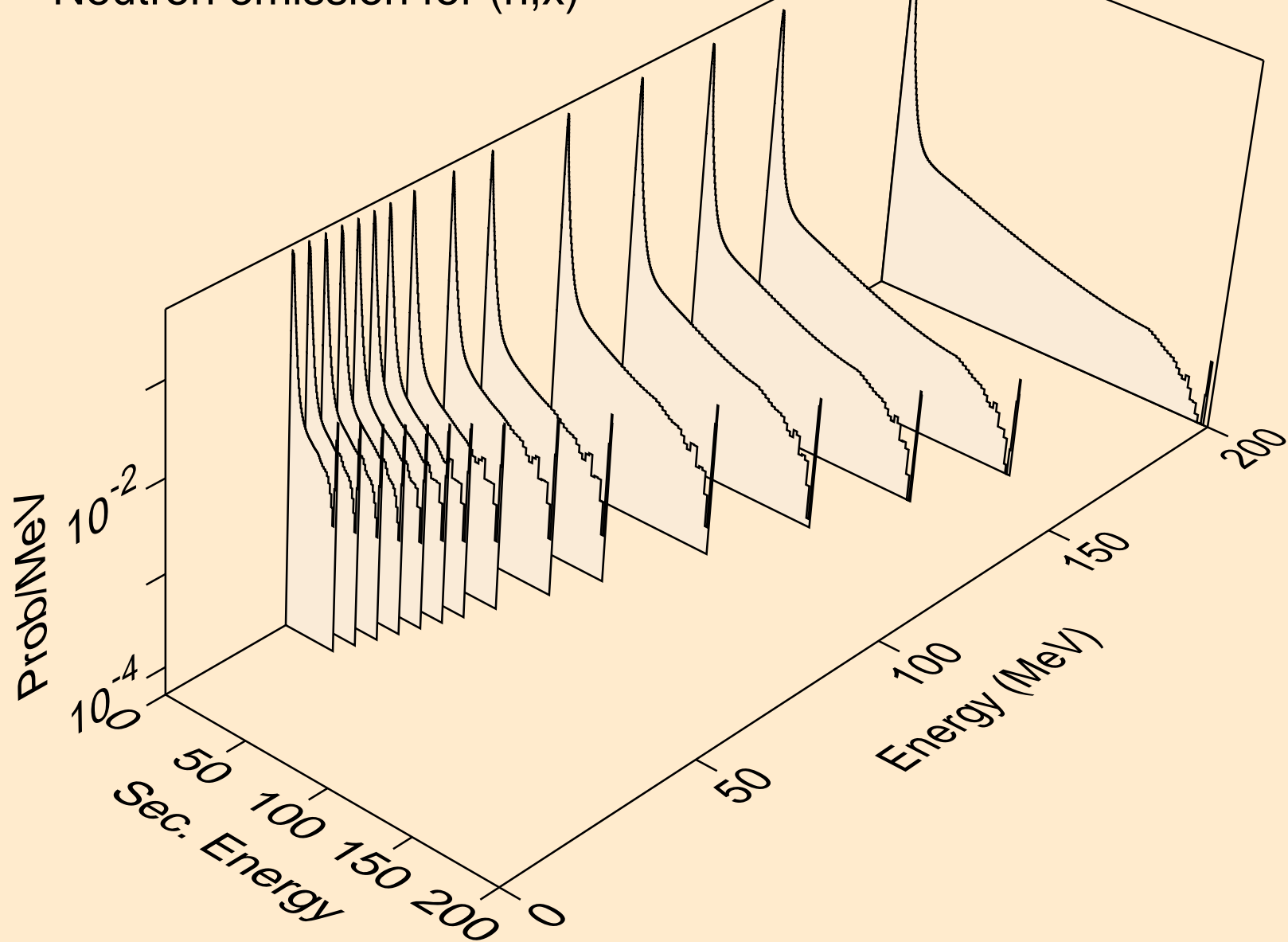

PM154 NEUTRON ACER TENDL-2023 LIBRARY; T=0.K  
Neutron emission for (n,2nd)

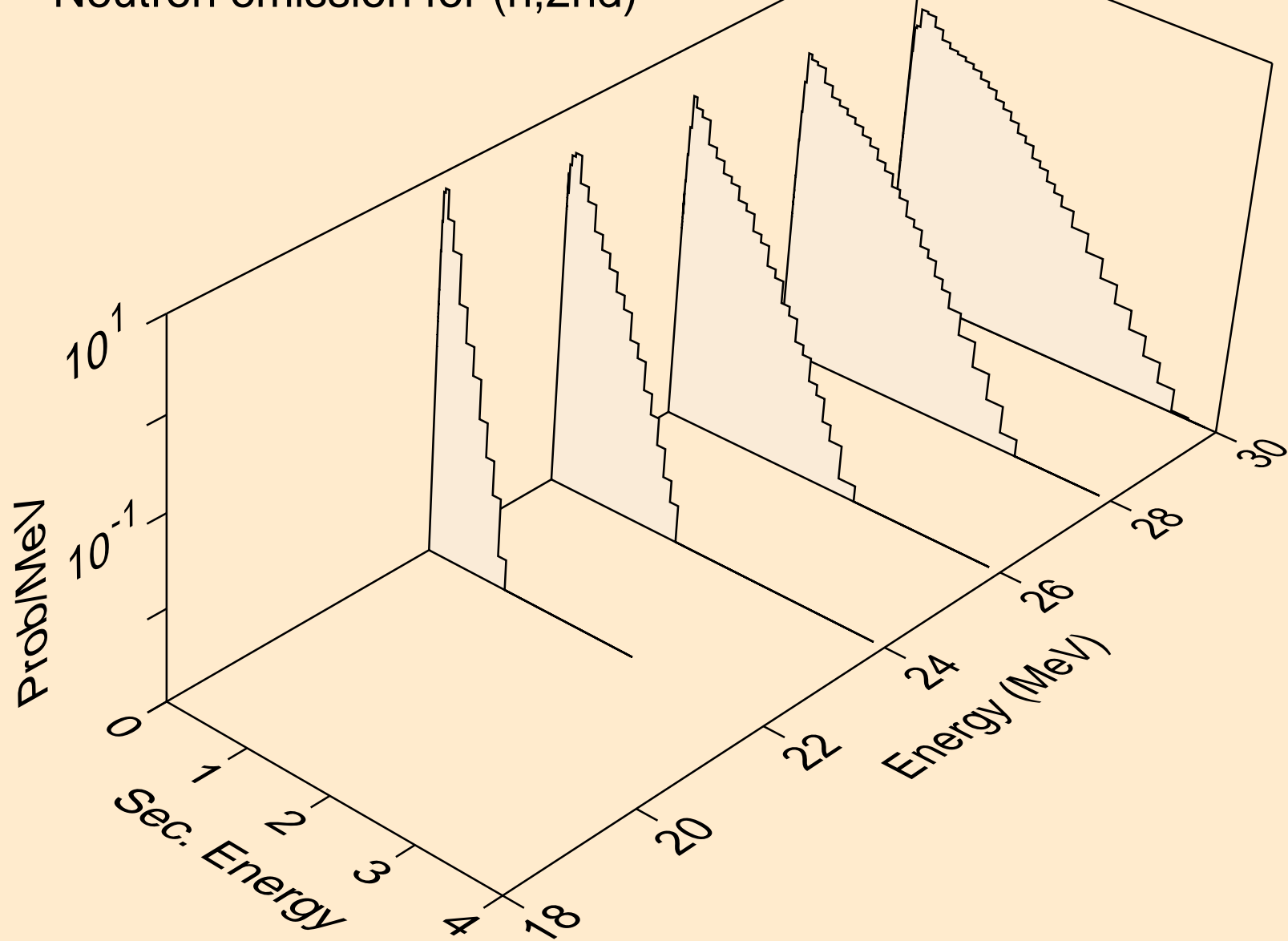

PM154 NEUTRON ACER TENDL-2023 LIBRARY; T=0.K  
Neutron emission for (n,2n)

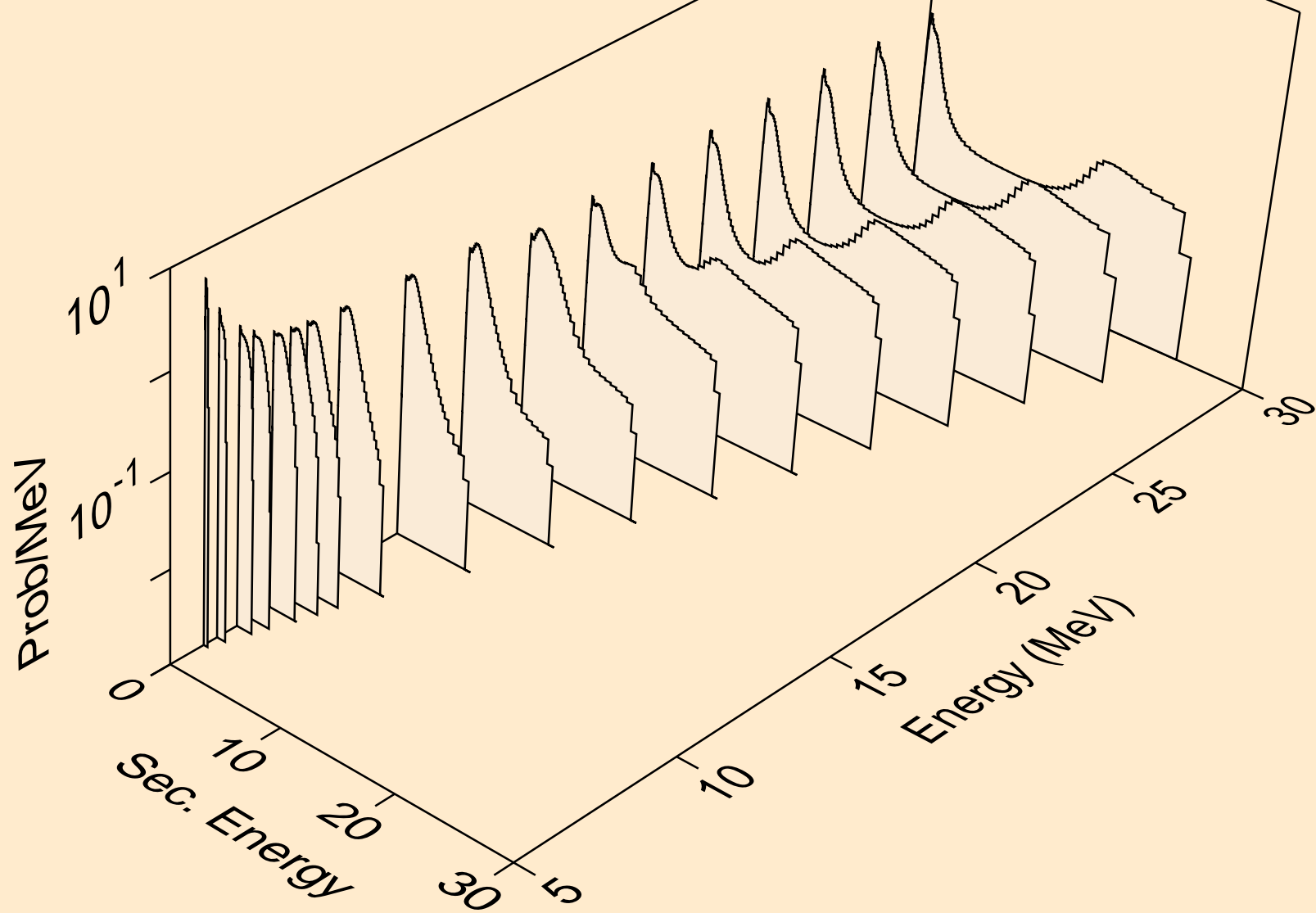

PM154 NEUTRON ACER TENDL-2023 LIBRARY; T=0.K  
Neutron emission for (n,3n)

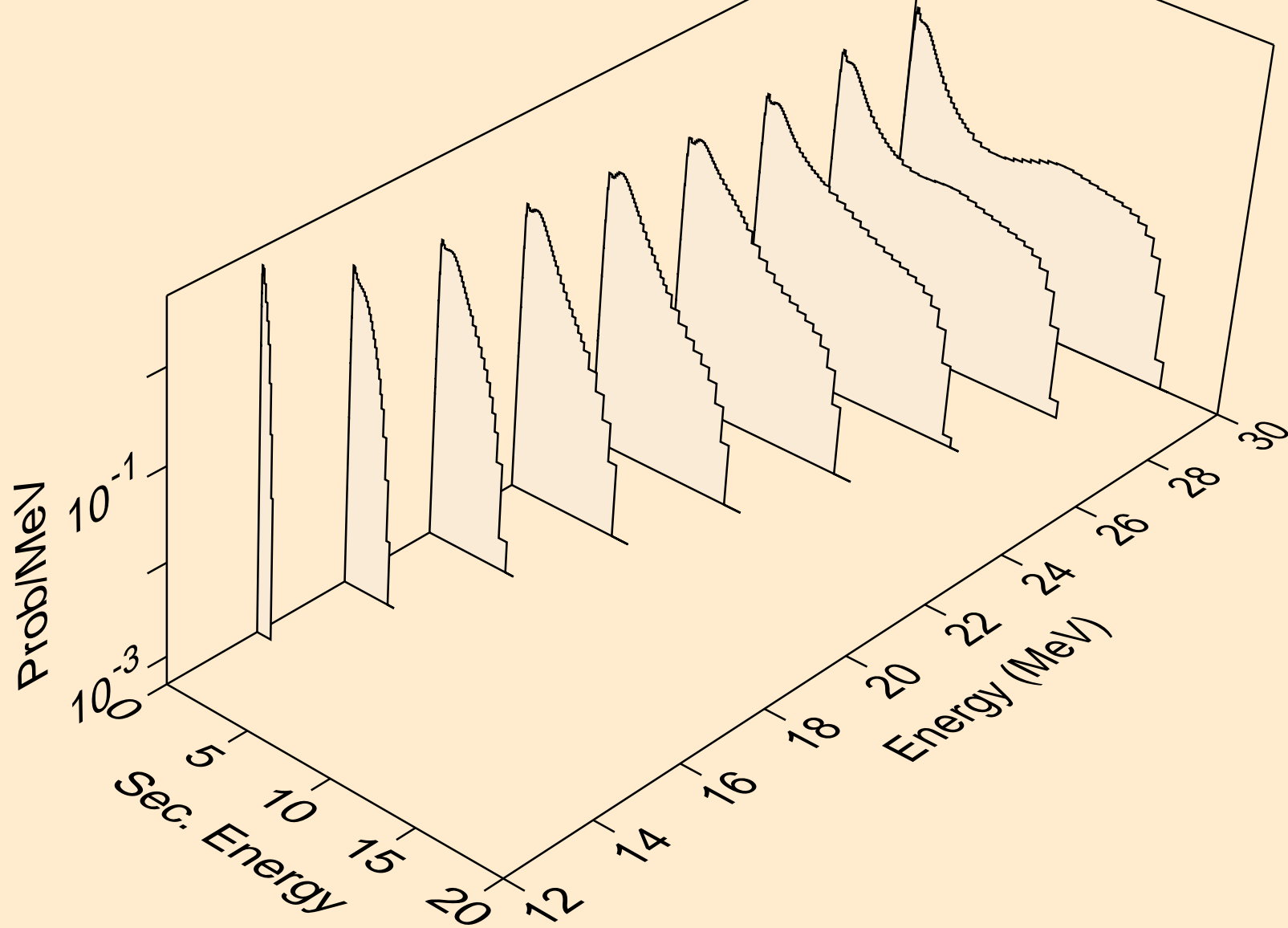

PM154 NEUTRON ACER TENDL-2023 LIBRARY; T=0.K  
Neutron emission for (n,n\*)a

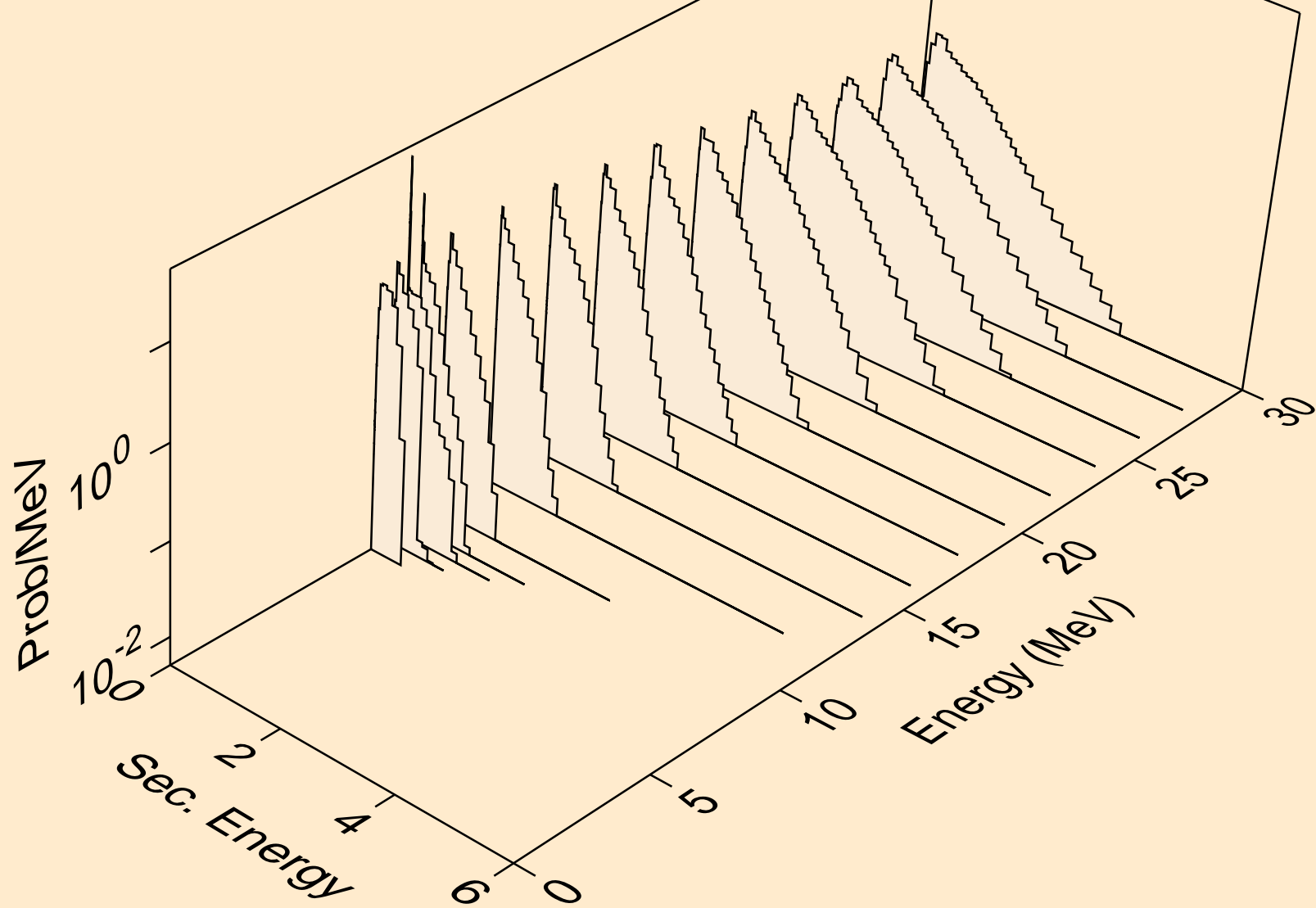

PM154 NEUTRON ACER TENDL-2023 LIBRARY; T=0.K  
Neutron emission for (n,2n)a

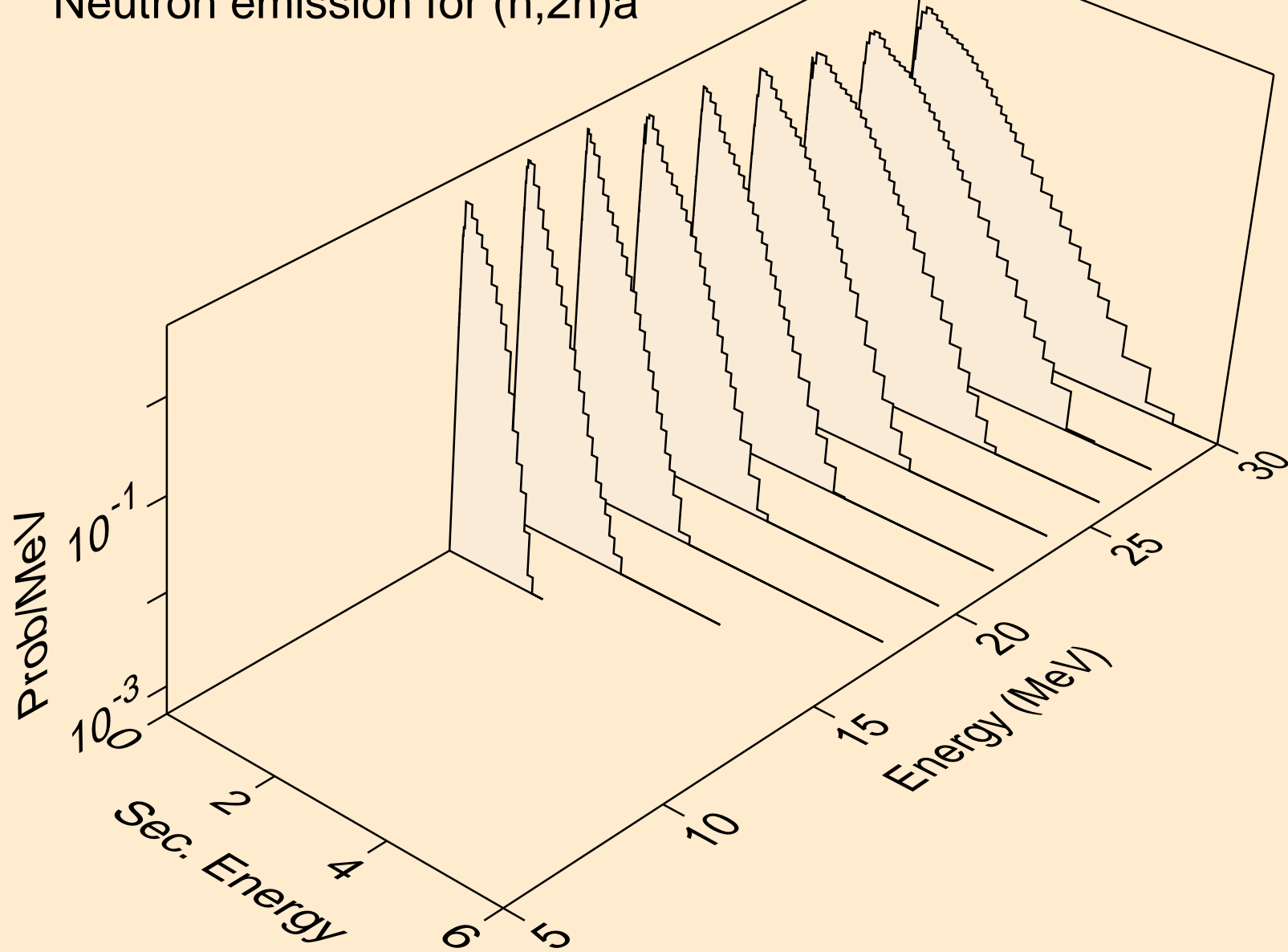

PM154 NEUTRON ACER TENDL-2023 LIBRARY; T=0.K  
Neutron emission for (n,3n)a

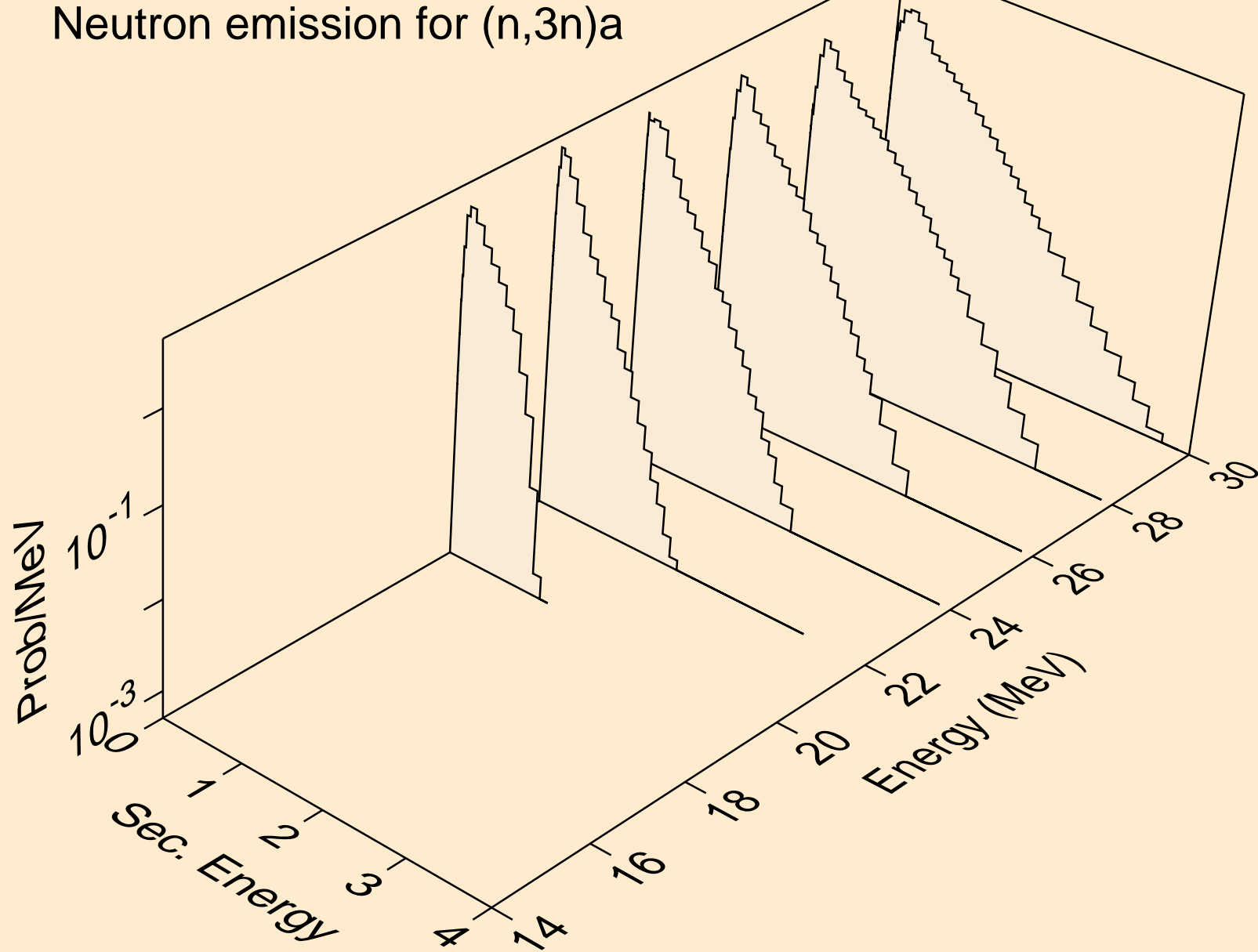

PM154 NEUTRON ACER TENDL-2023 LIBRARY; T=0.K  
Neutron emission for (n,n\*)p

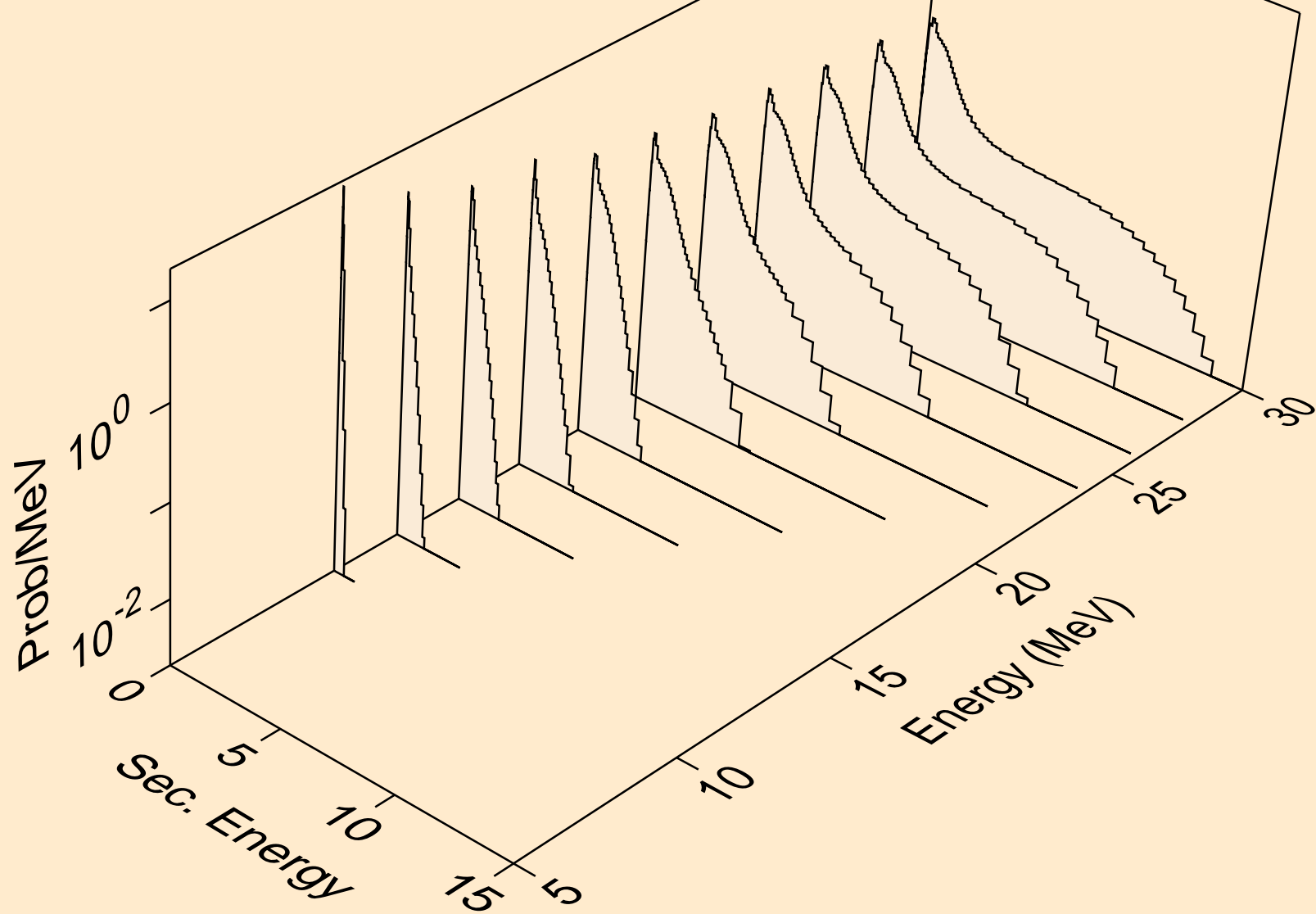

PM154 NEUTRON ACER TENDL-2023 LIBRARY; T=0.K  
Neutron emission for (n,n\*)d

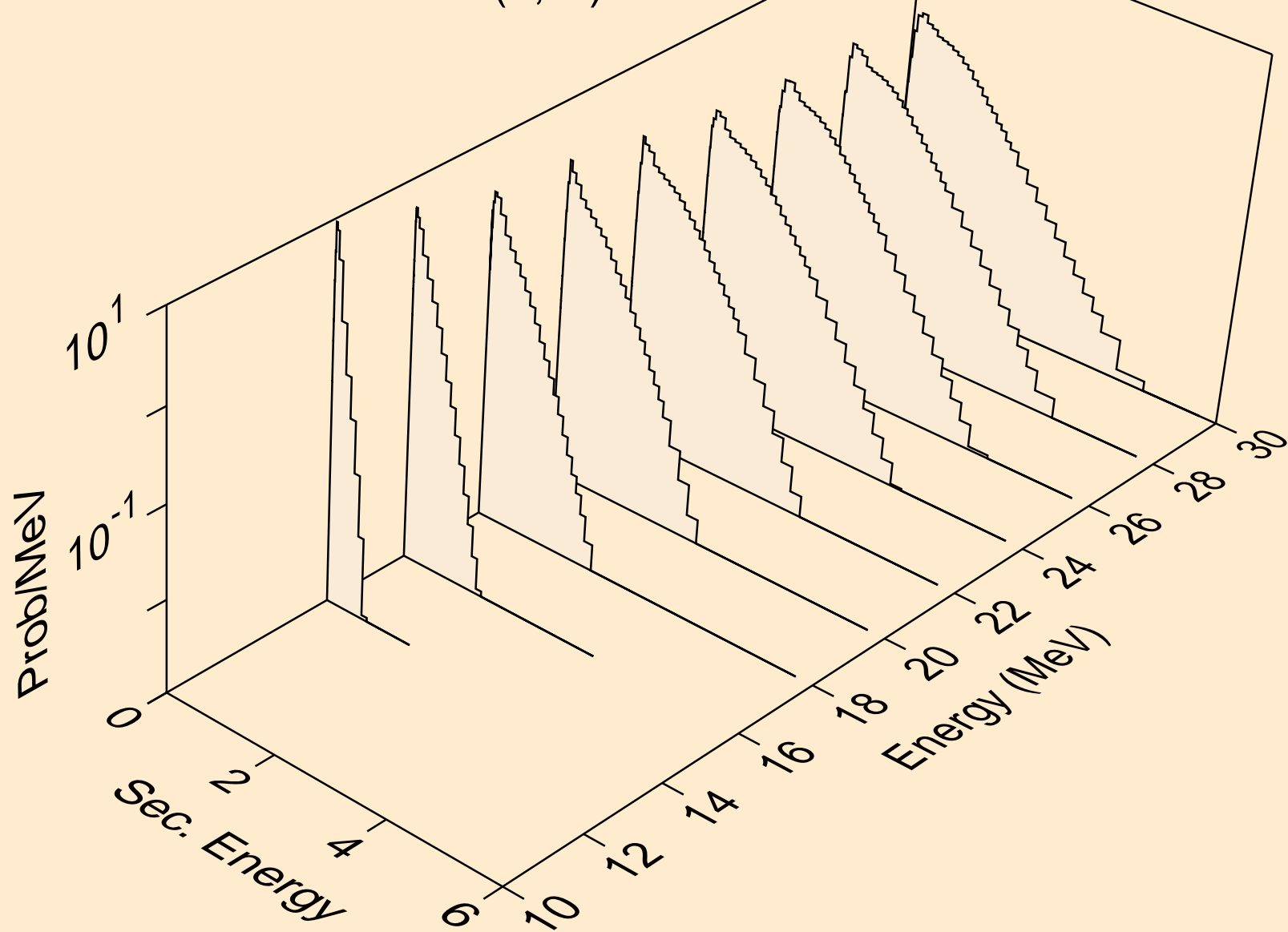

PM154 NEUTRON ACER TENDL-2023 LIBRARY; T=0.K  
Neutron emission for (n,n\*)t

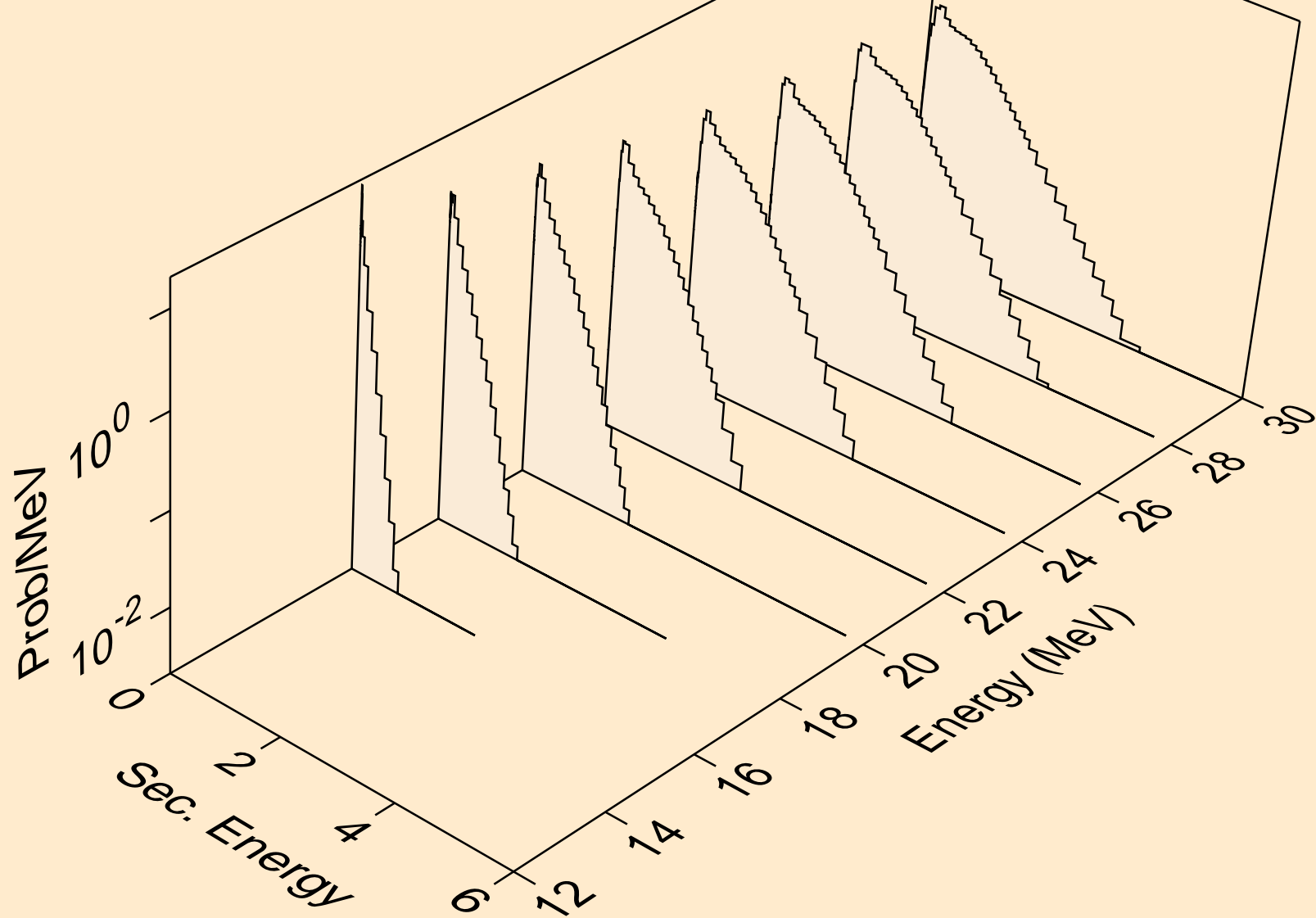

PM154 NEUTRON ACER TENDL-2023 LIBRARY; T=0.K  
Neutron emission for (n,n\*)he3

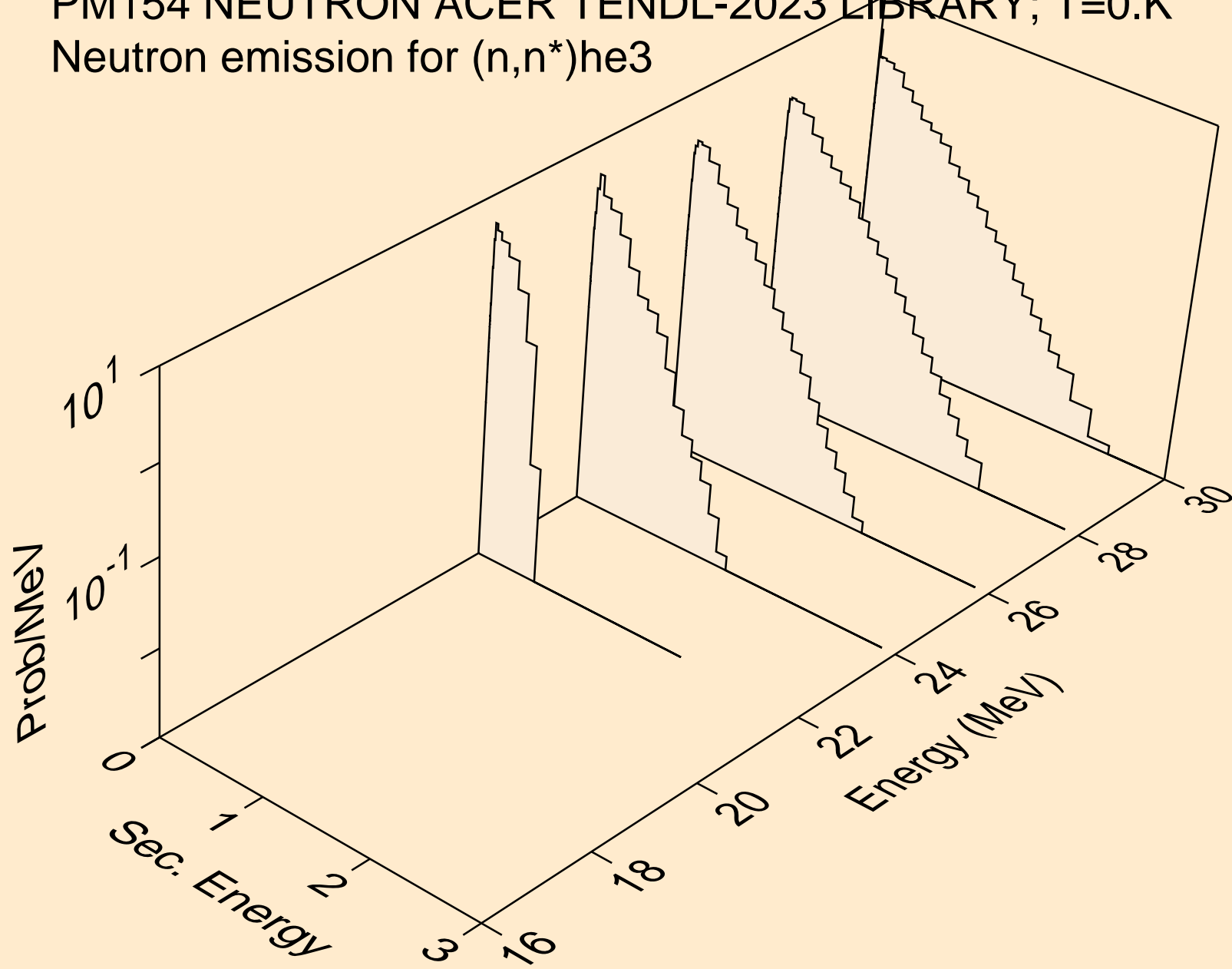

PM154 NEUTRON ACER TENDL-2023 LIBRARY; T=0.K  
Neutron emission for (n,4n)

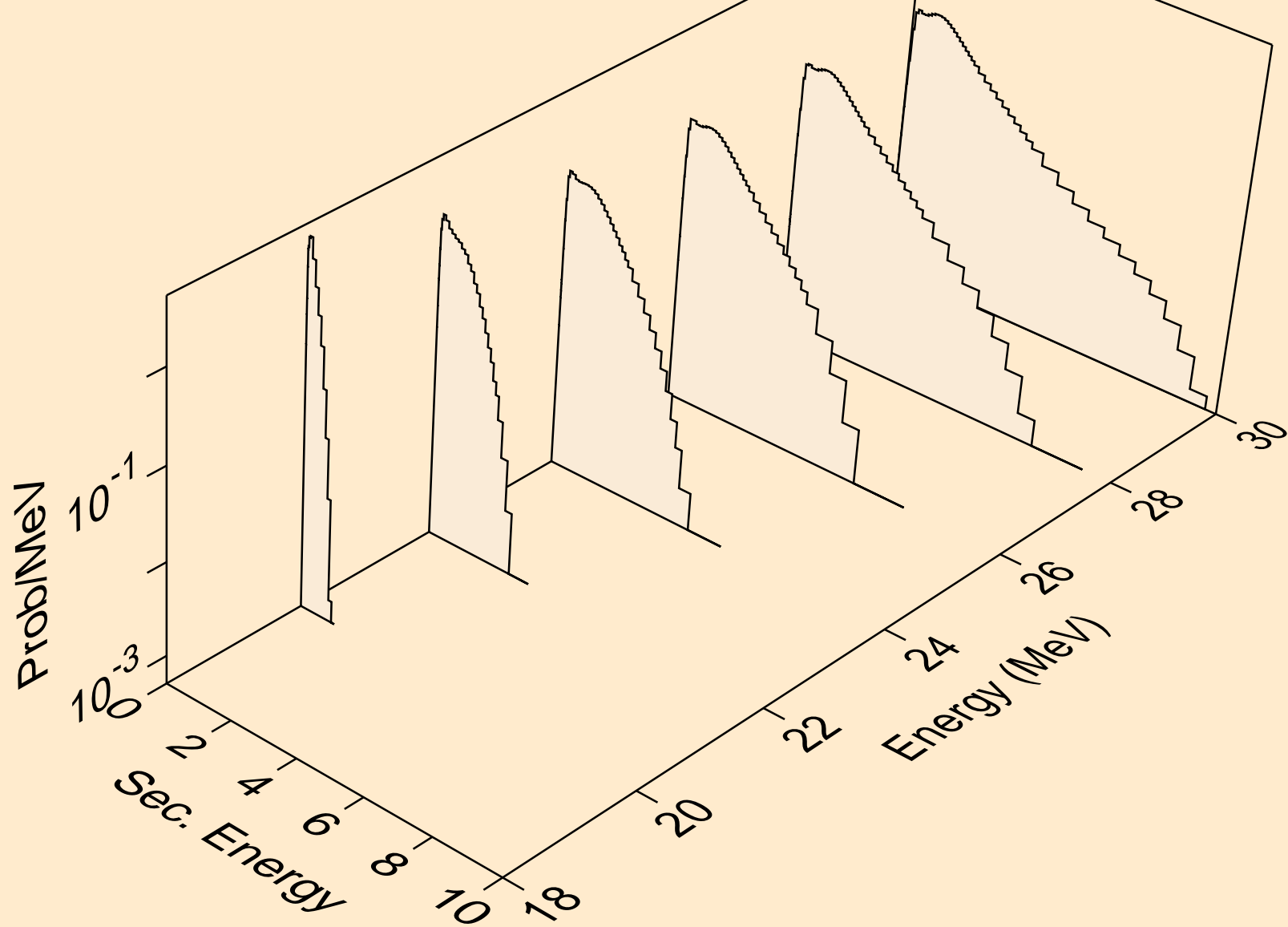

PM154 NEUTRON ACER TENDL-2023 LIBRARY; T=0.K  
Neutron emission for (n,2np)

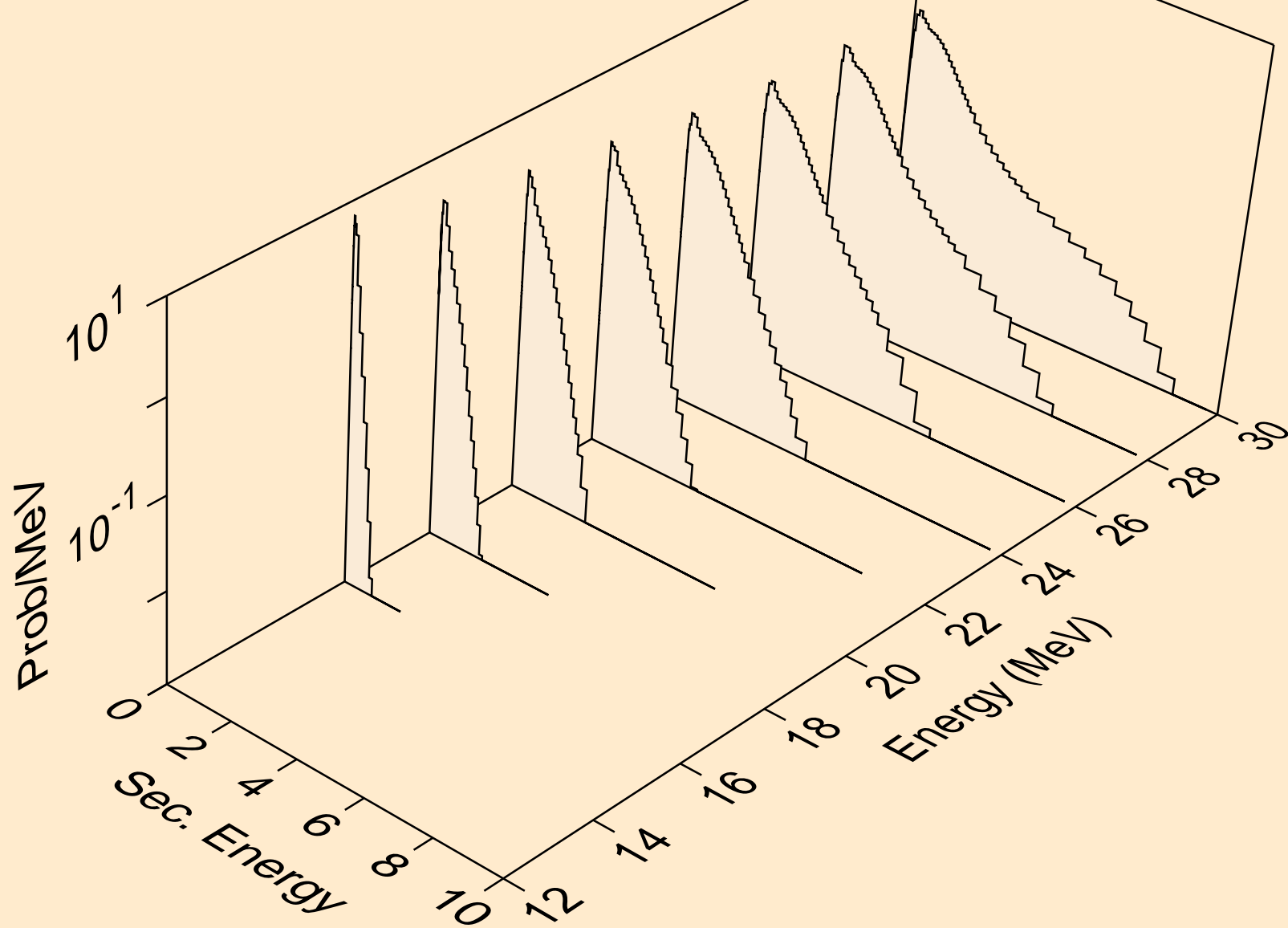

PM154 NEUTRON ACER TENDL-2023 LIBRARY; T=0.K  
Neutron emission for (n,3np)

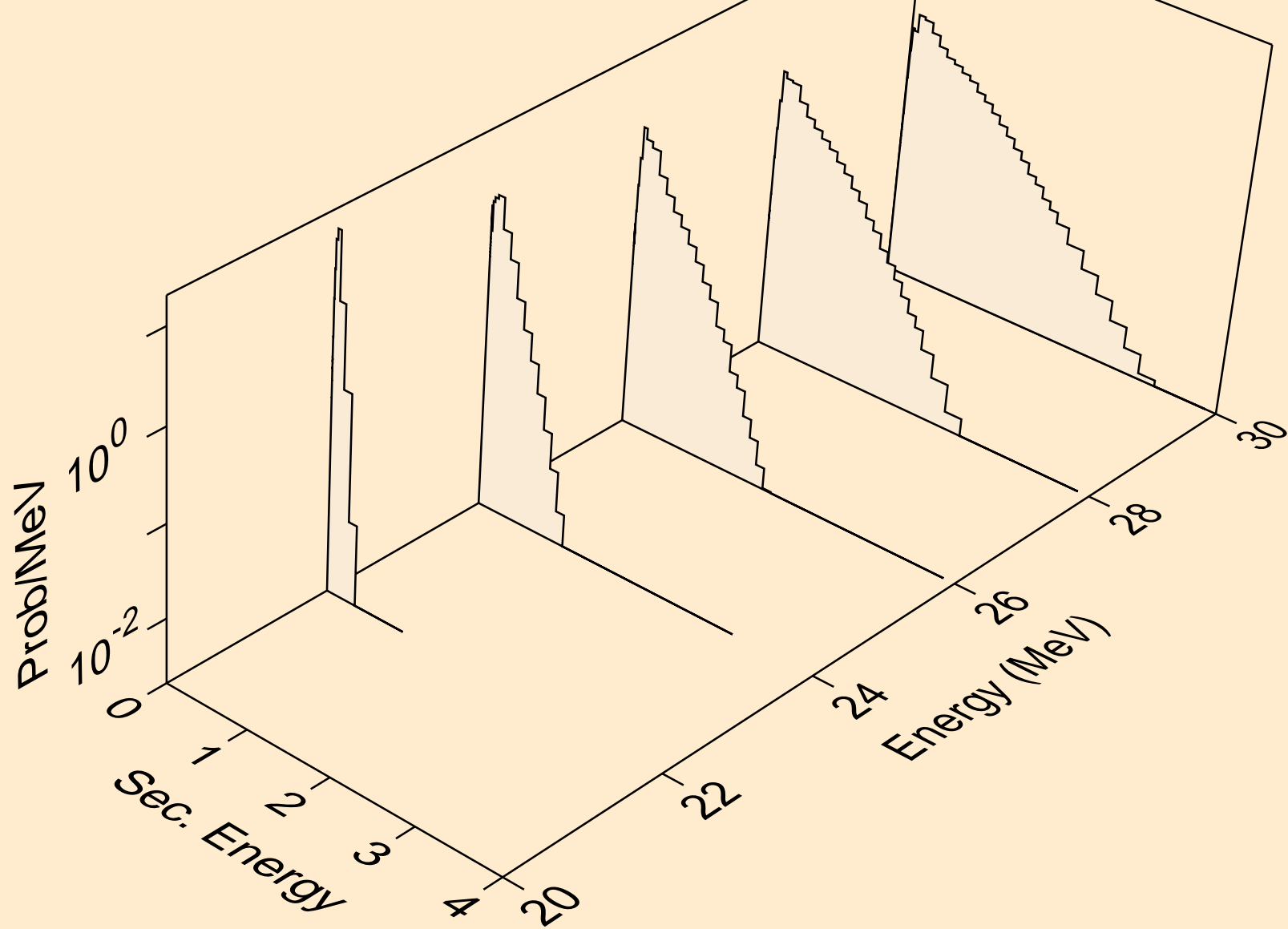

PM154 NEUTRON ACER TENDL-2023 LIBRARY; T=0.K  
Neutron emission for (n,n\*c)

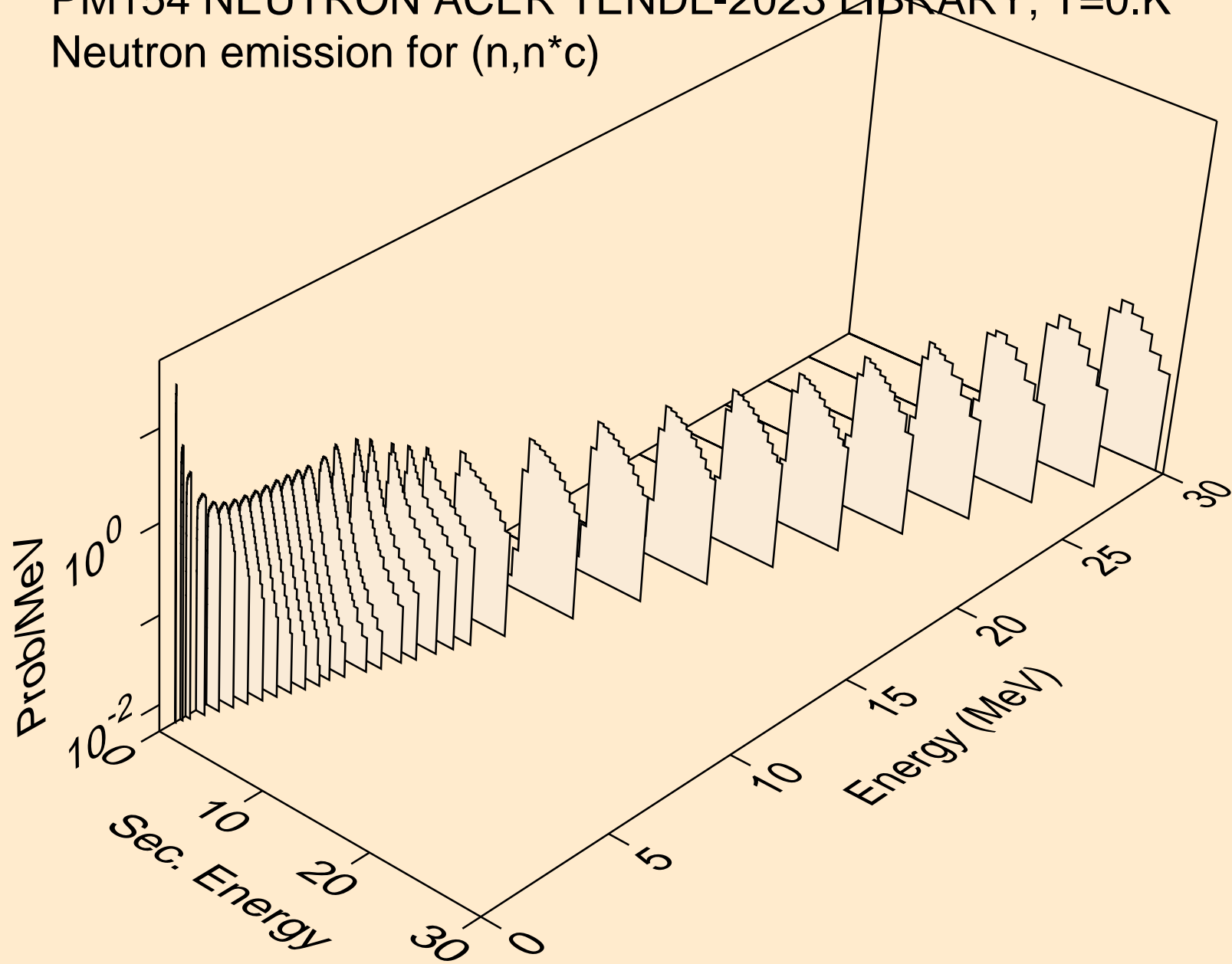

PM154 NEUTRON ACER TENDL-2023 LIBRARY; T=0.K  
Photon emission for (n,x)

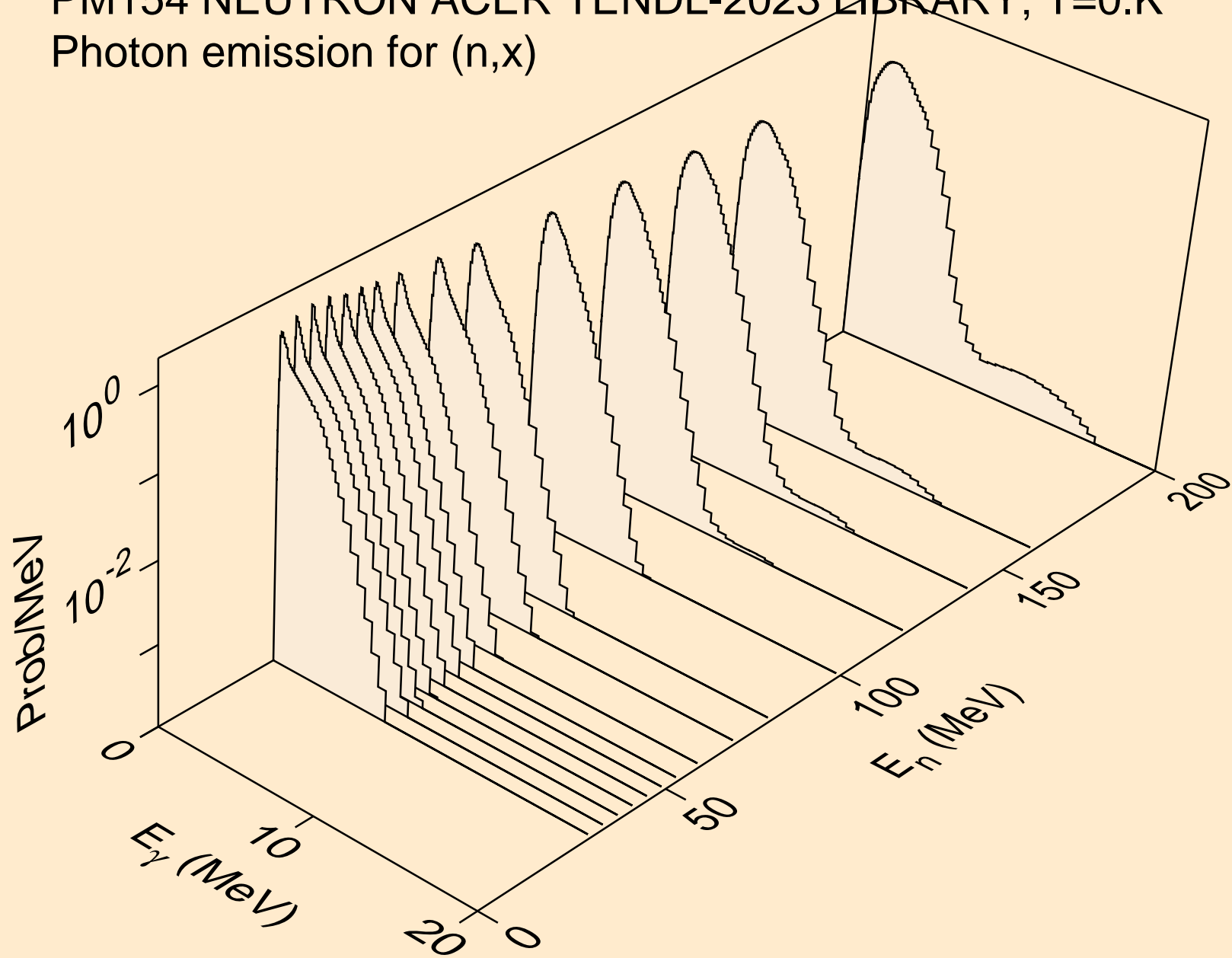

PM154 NEUTRON ACER TENDL-2023 LIBRARY; T=0.K  
Photon emission for (n,2nd)

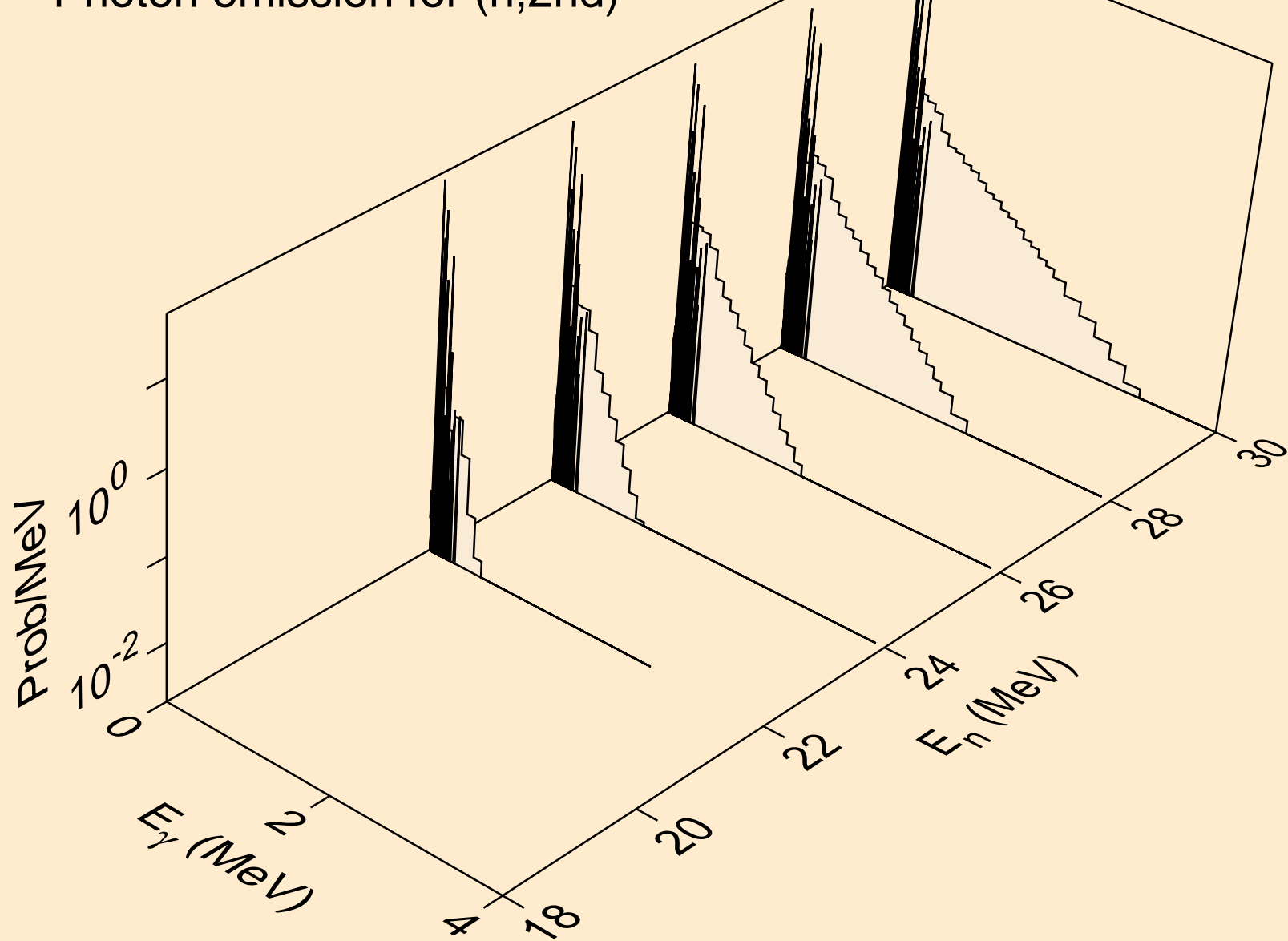

PM154 NEUTRON ACER TENDL-2023 LIBRARY; T=0.K  
Photon emission for (n,2n)

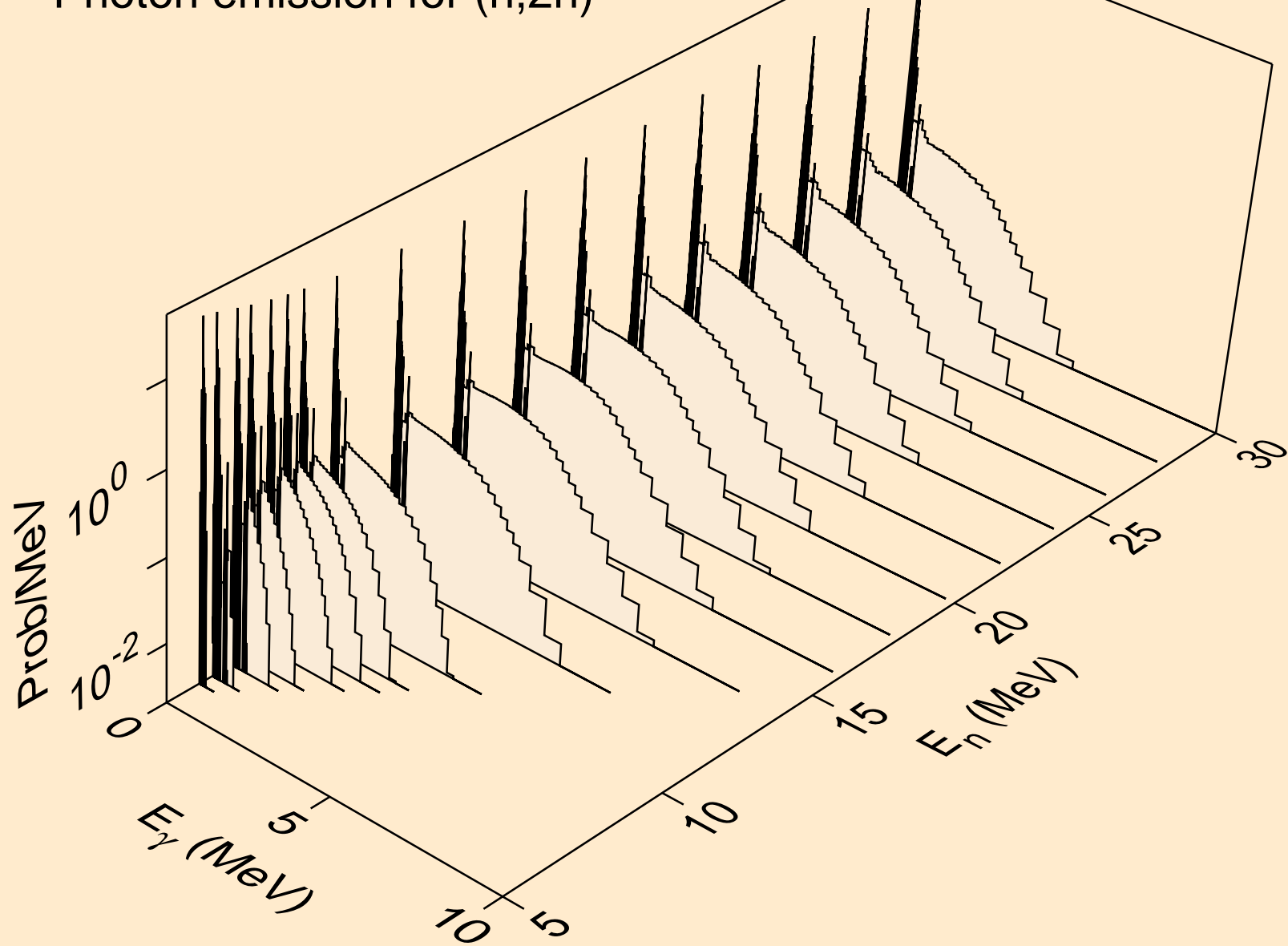

PM154 NEUTRON ACER TENDL-2023 LIBRARY; T=0.K  
Photon emission for (n,3n)

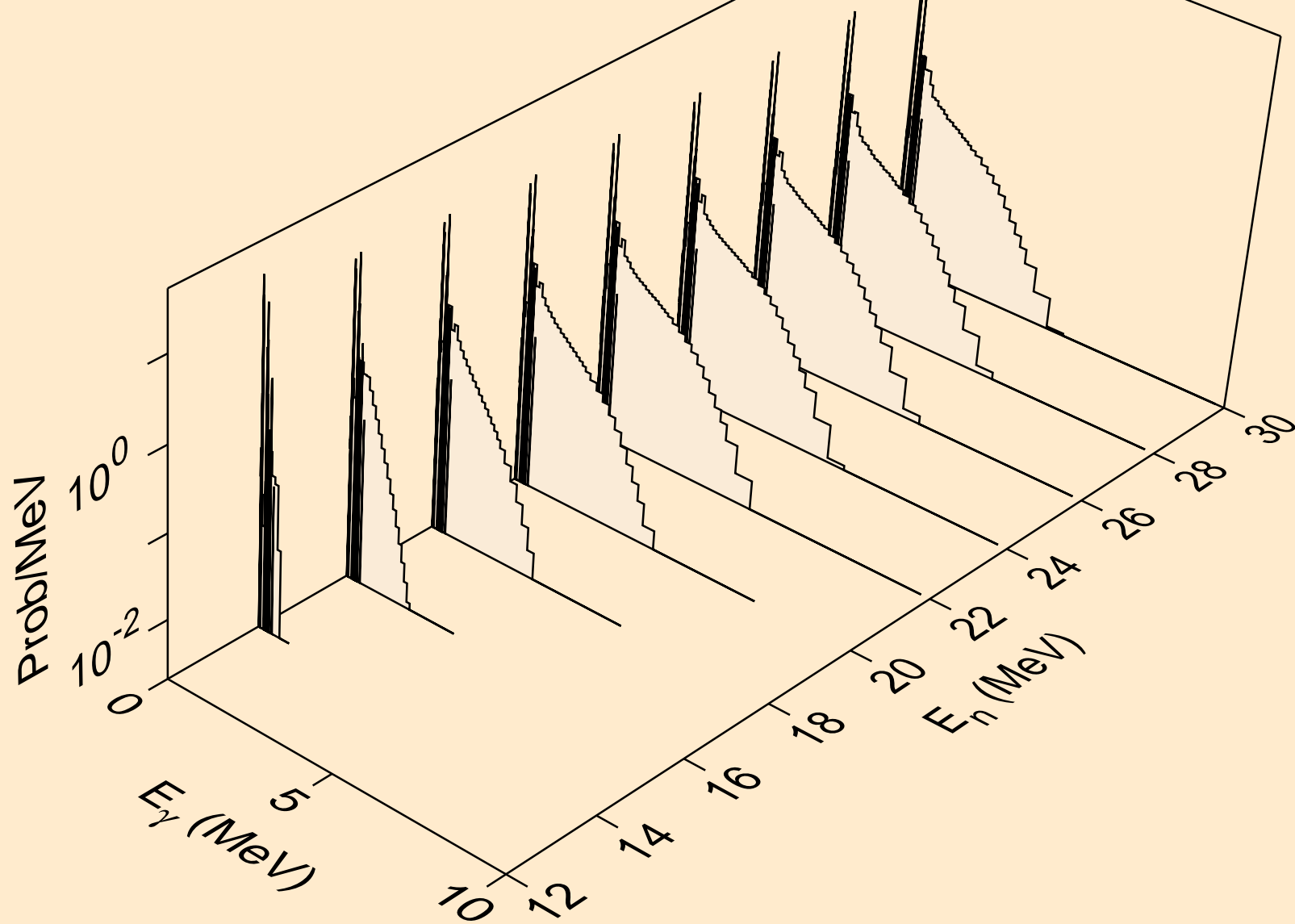

PM154 NEUTRON ACER TENDL-2023 LIBRARY; T=0.K  
Photon emission for (n,n\*)a

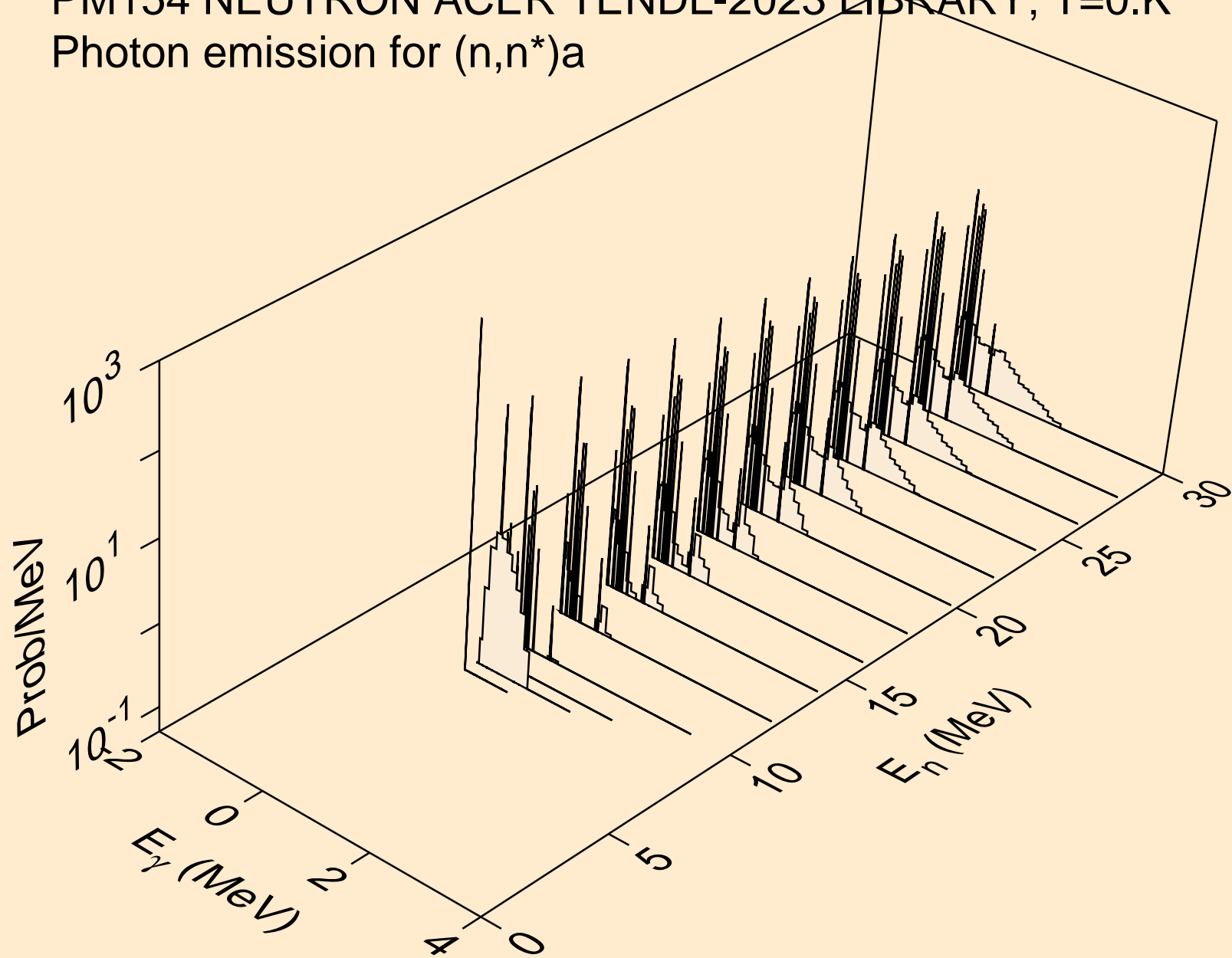

PM154 NEUTRON ACER TENDL-2023 LIBRARY; T=0.K  
Photon emission for (n,2n)a

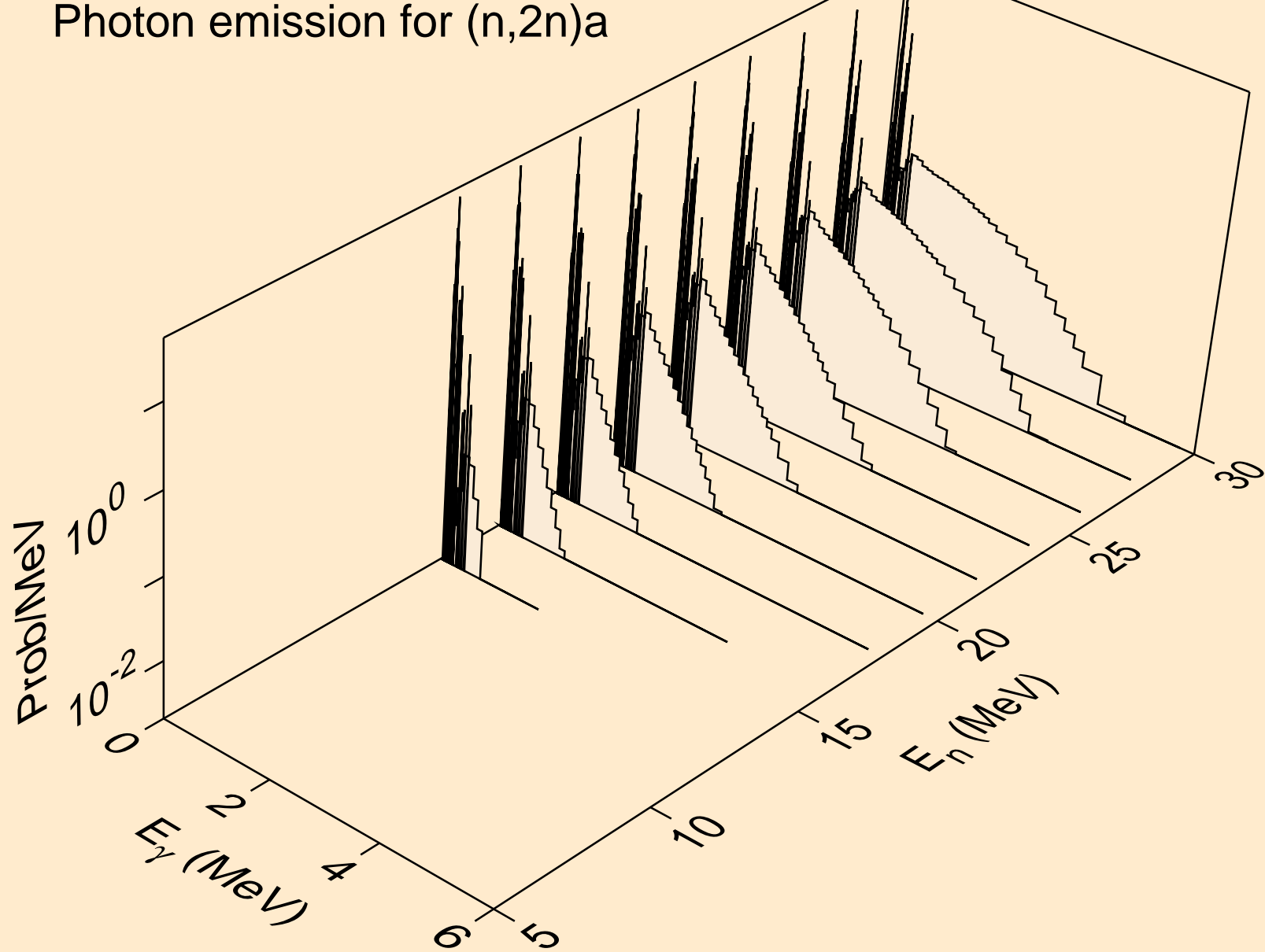

PM154 NEUTRON ACER TENDL-2023 LIBRARY; T=0.K  
Photon emission for (n,3n)a

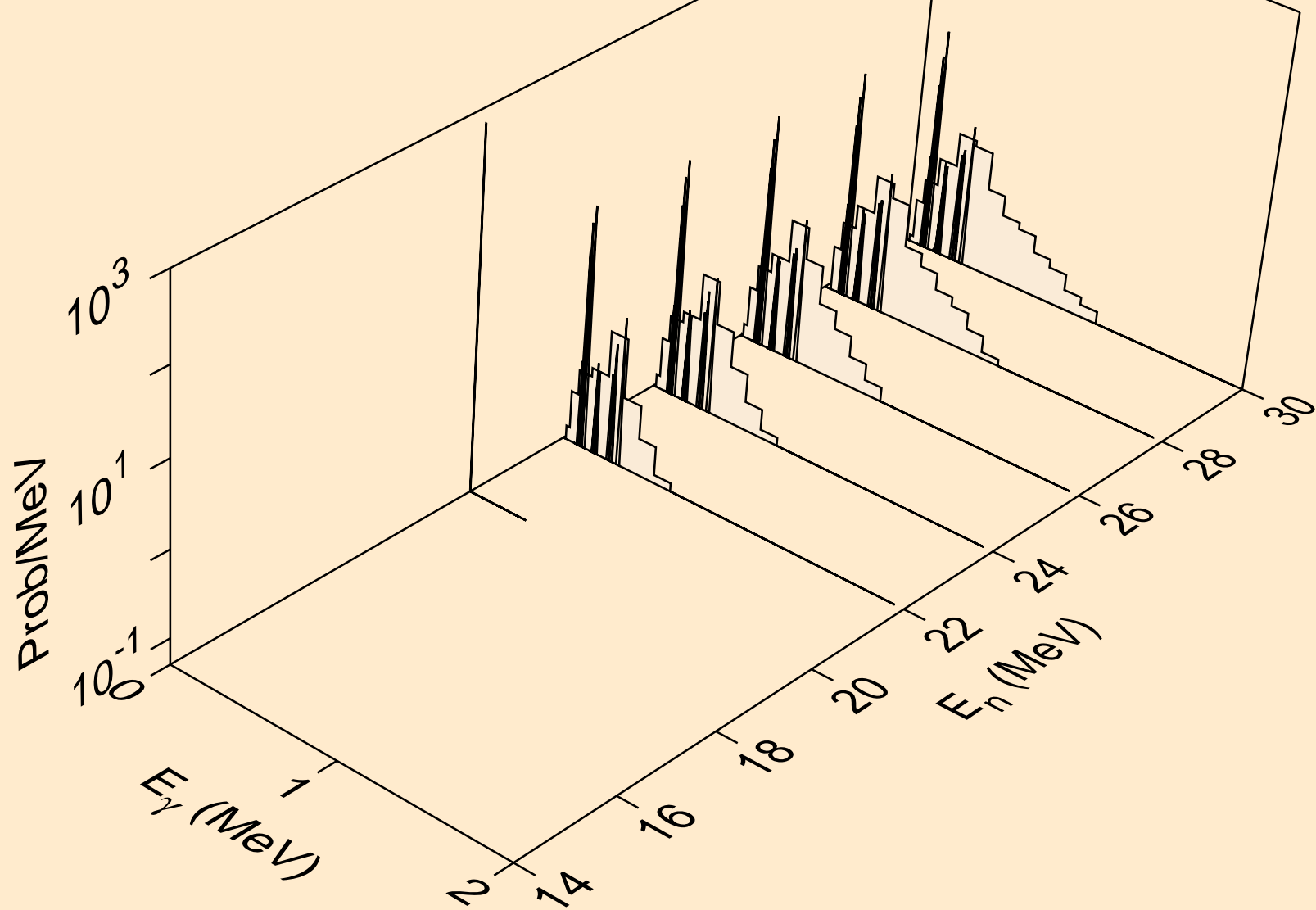

PM154 NEUTRON ACER TENDL-2023 LIBRARY; T=0.K  
Photon emission for (n,n\*)p

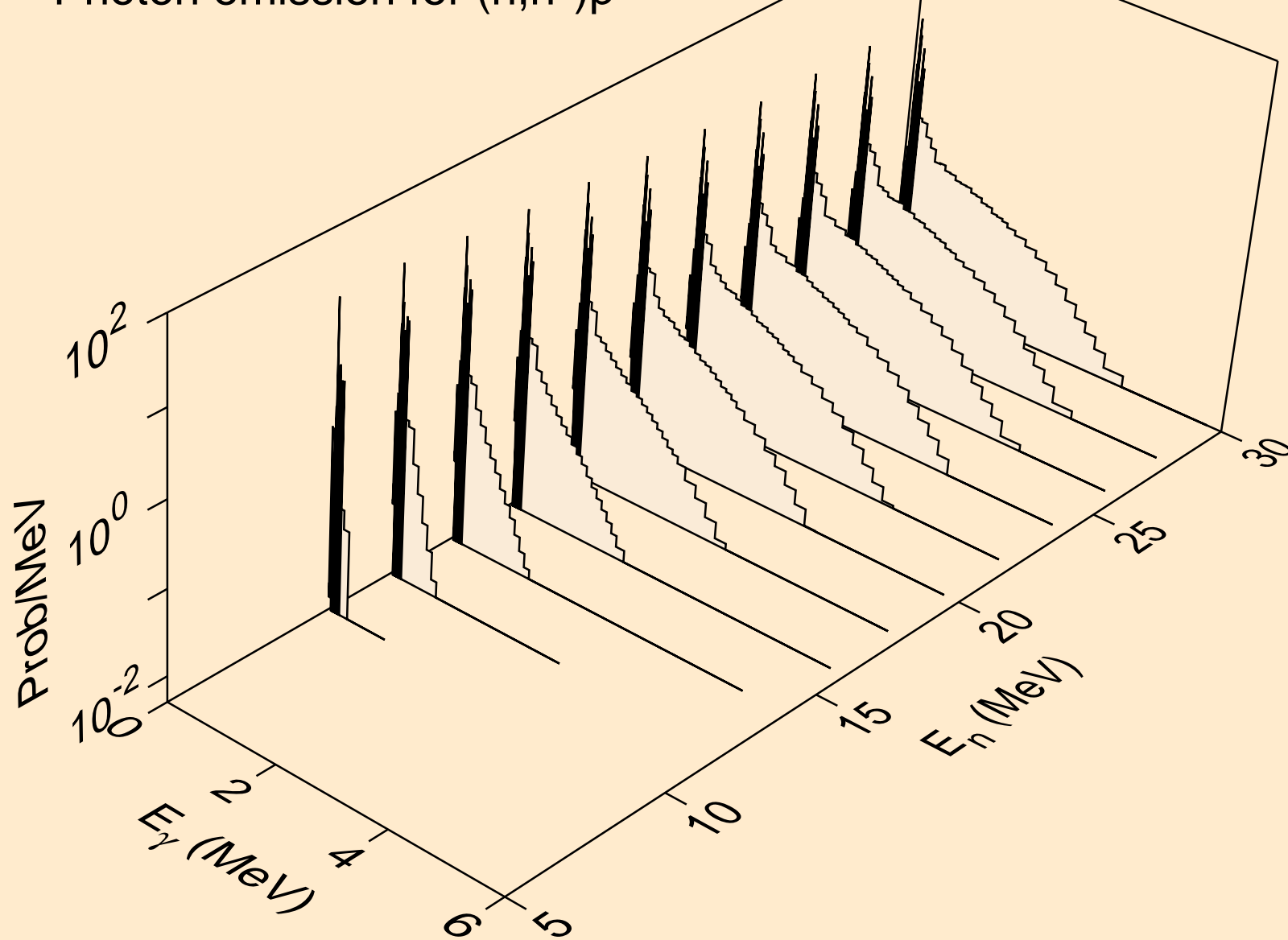

PM154 NEUTRON ACER TENDL-2023 LIBRARY; T=0.K  
Photon emission for (n,n\*)d

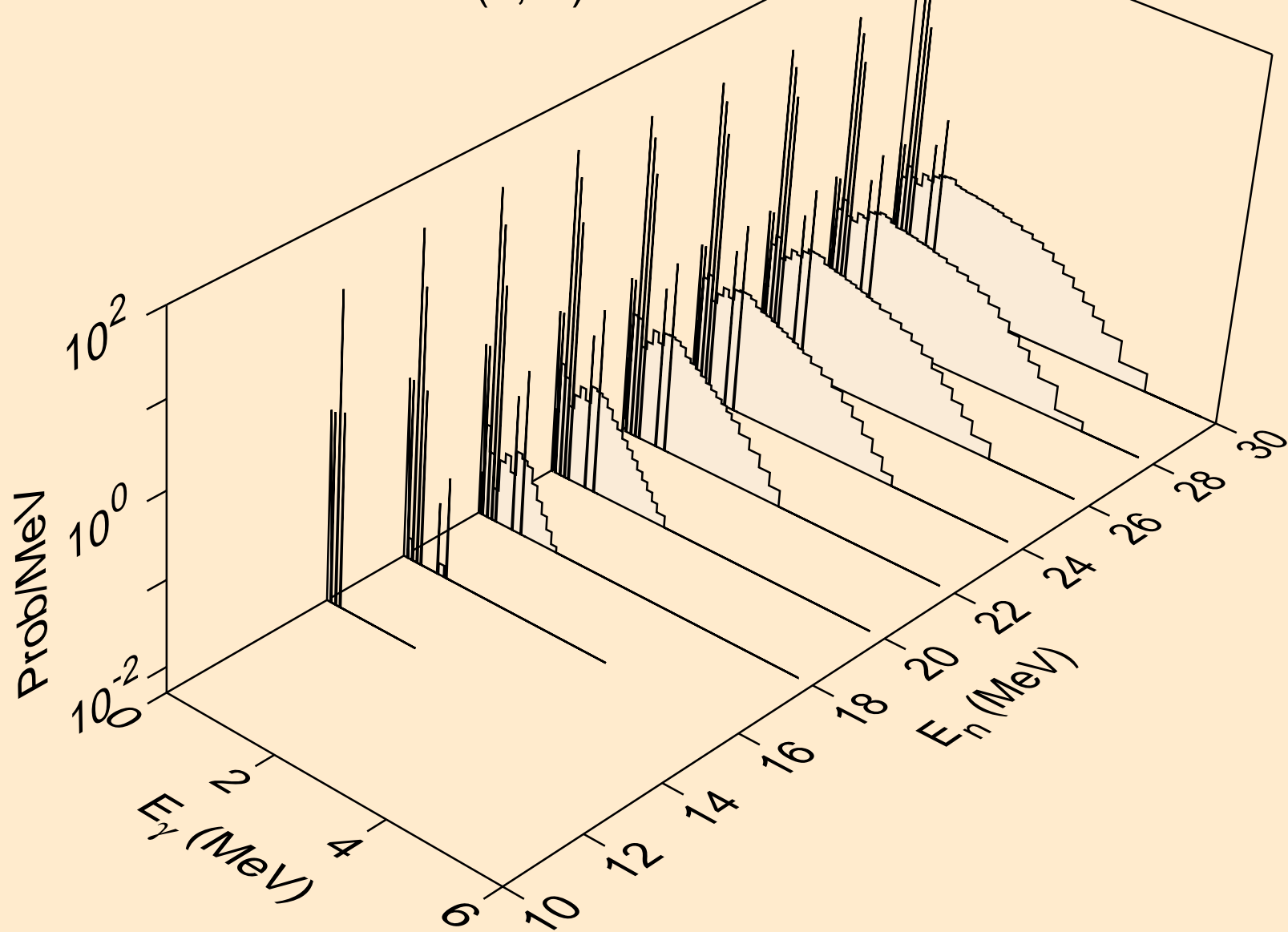

PM154 NEUTRON ACER TENDL-2023 LIBRARY; T=0.K  
Photon emission for (n,n\*)t

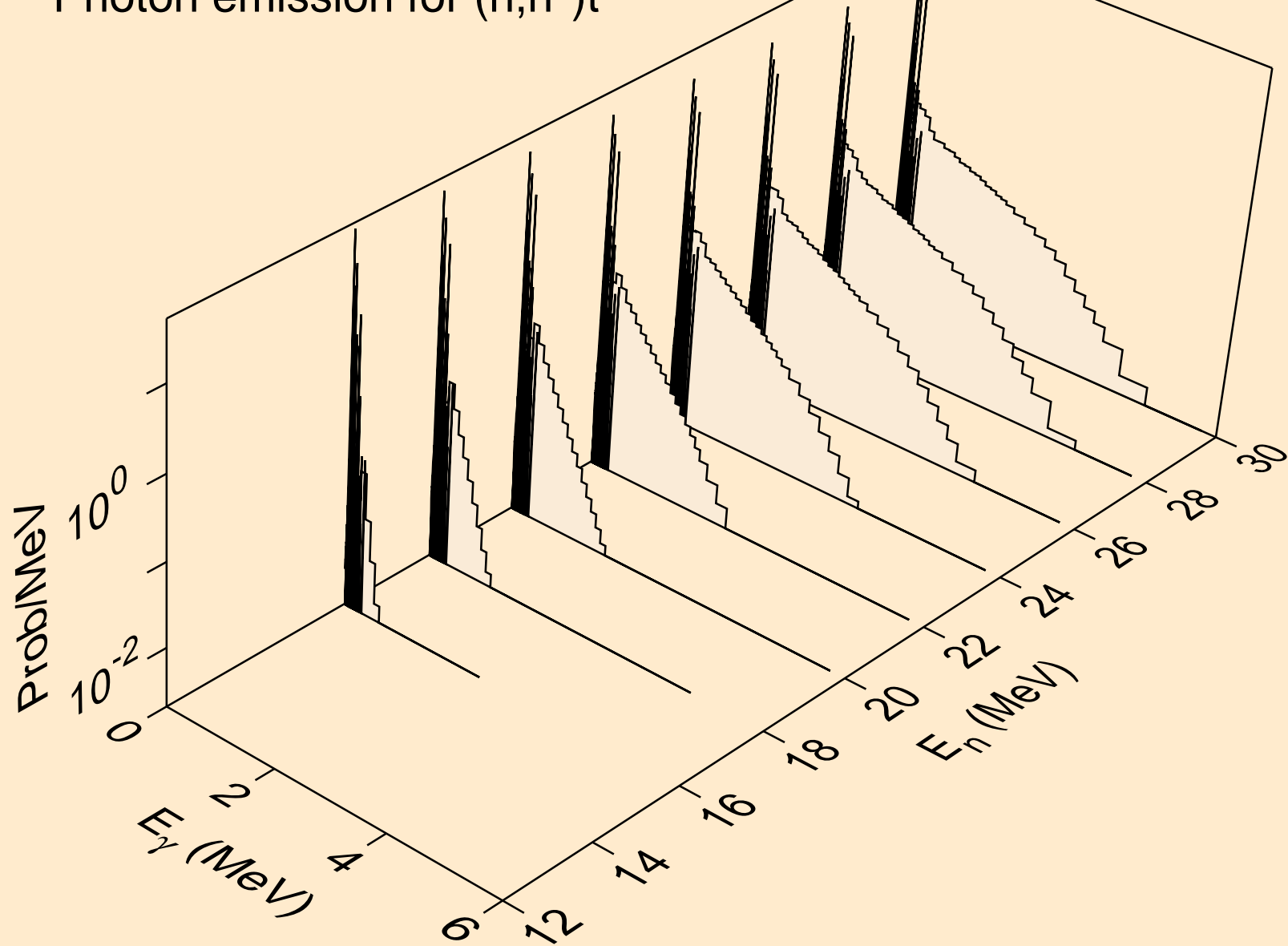

PM154 NEUTRON ACER TENDL-2023 LIBRARY; T=0.K  
Photon emission for (n,n\*)he3



PM154 NEUTRON ACER TENDL-2023 LIBRARY; T=0.K  
Photon emission for (n,4n)

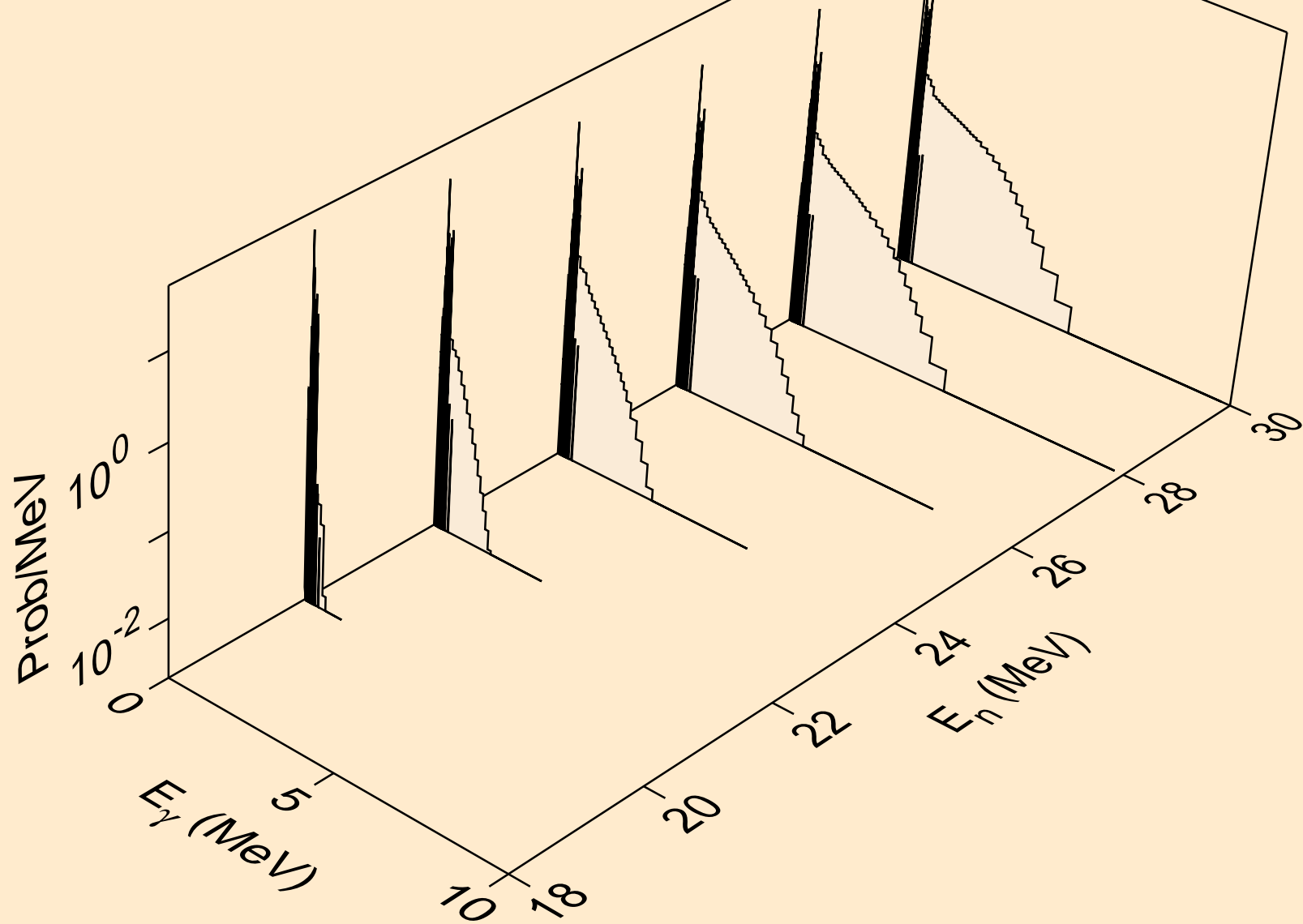

PM154 NEUTRON ACER TENDL-2023 LIBRARY; T=0.K  
Photon emission for (n,2np)

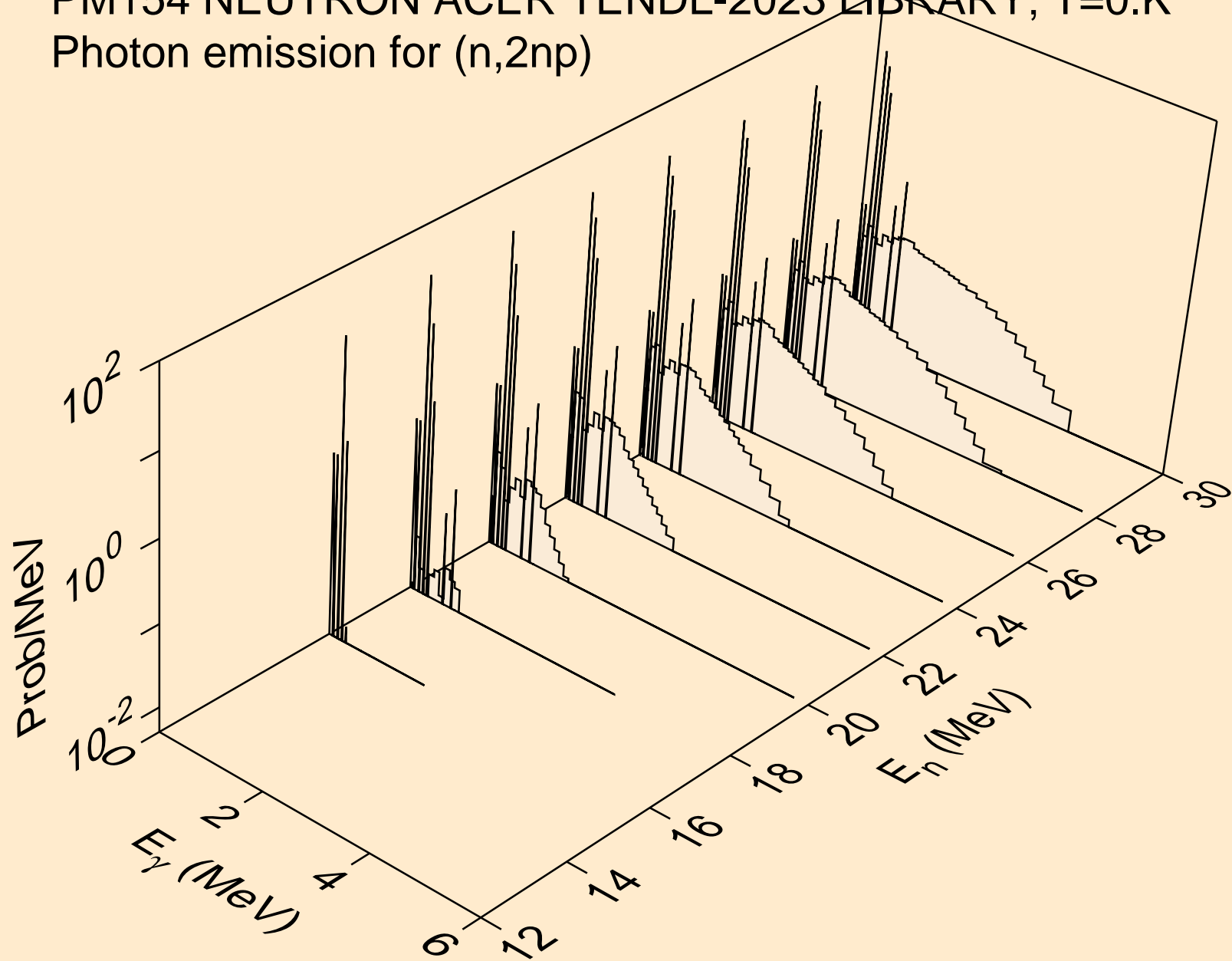

PM154 NEUTRON ACER TENDL-2023 LIBRARY; T=0.K  
Photon emission for (n,3np)

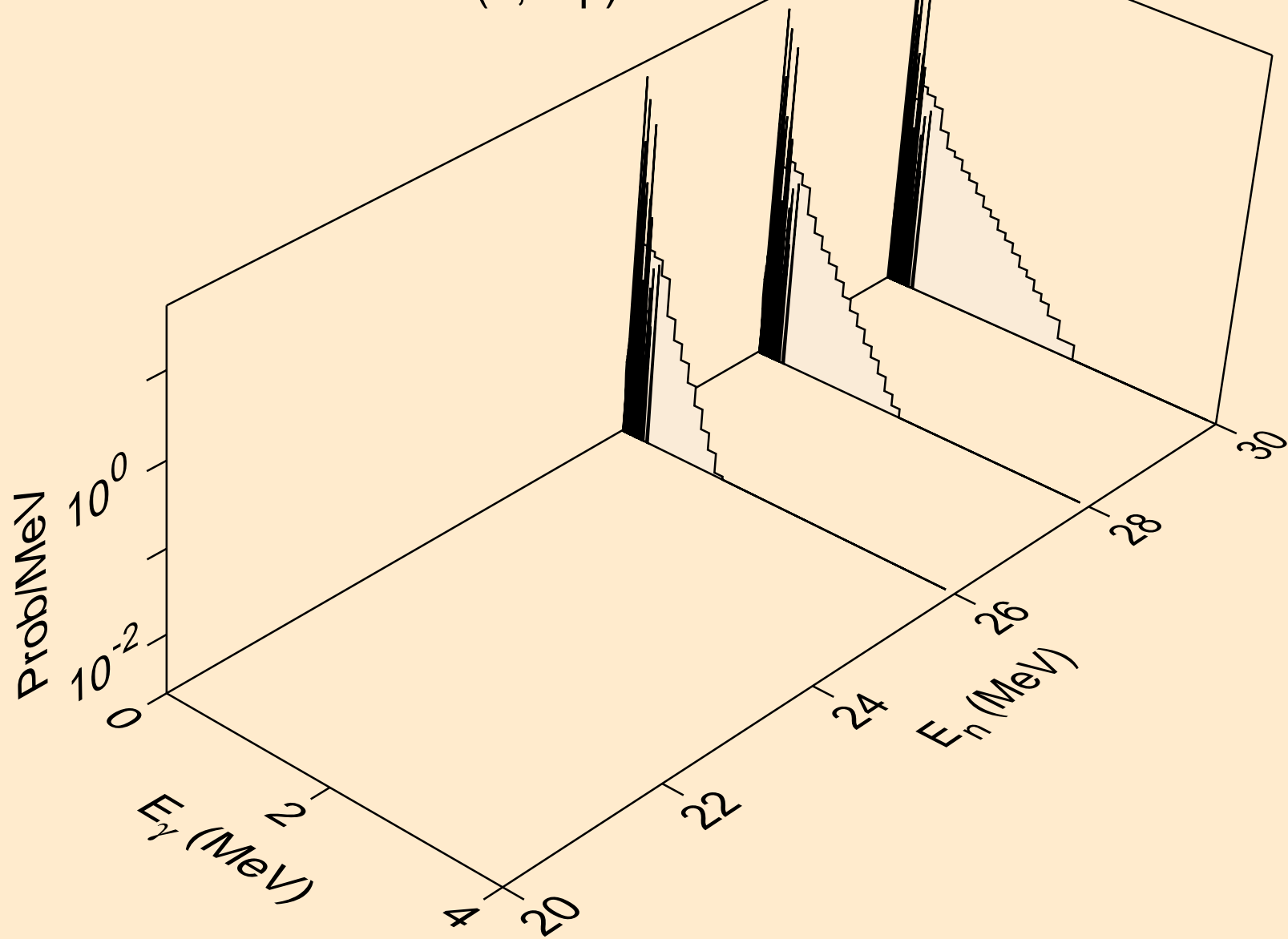

PM154 NEUTRON ACER TENDL-2023 LIBRARY; T=0.K  
Photon emission for (n,n\*c)

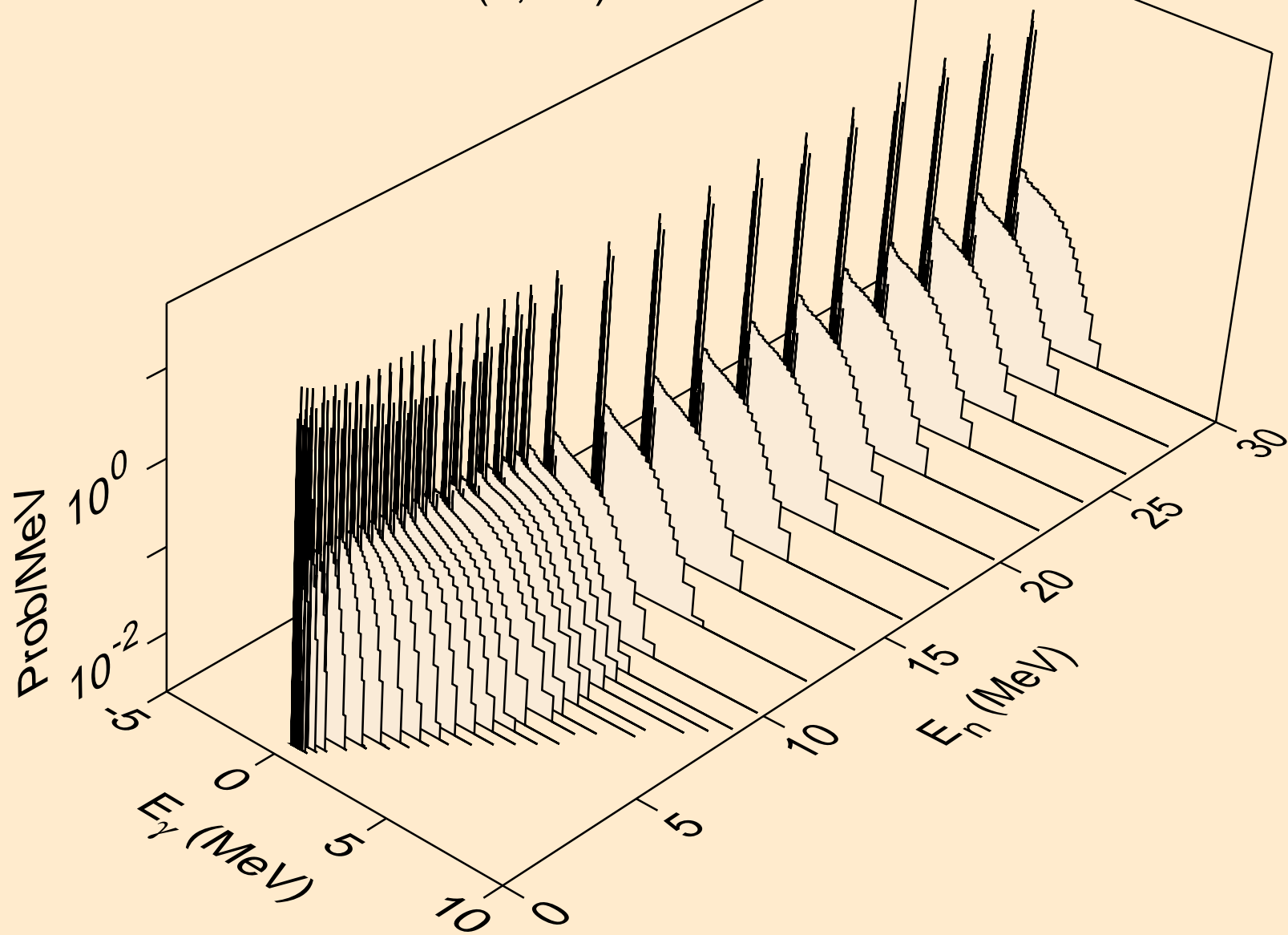

PM154 NEUTRON ACER TENDL-2023 LIBRARY; T=0.K  
Photon emission for (n,gma)

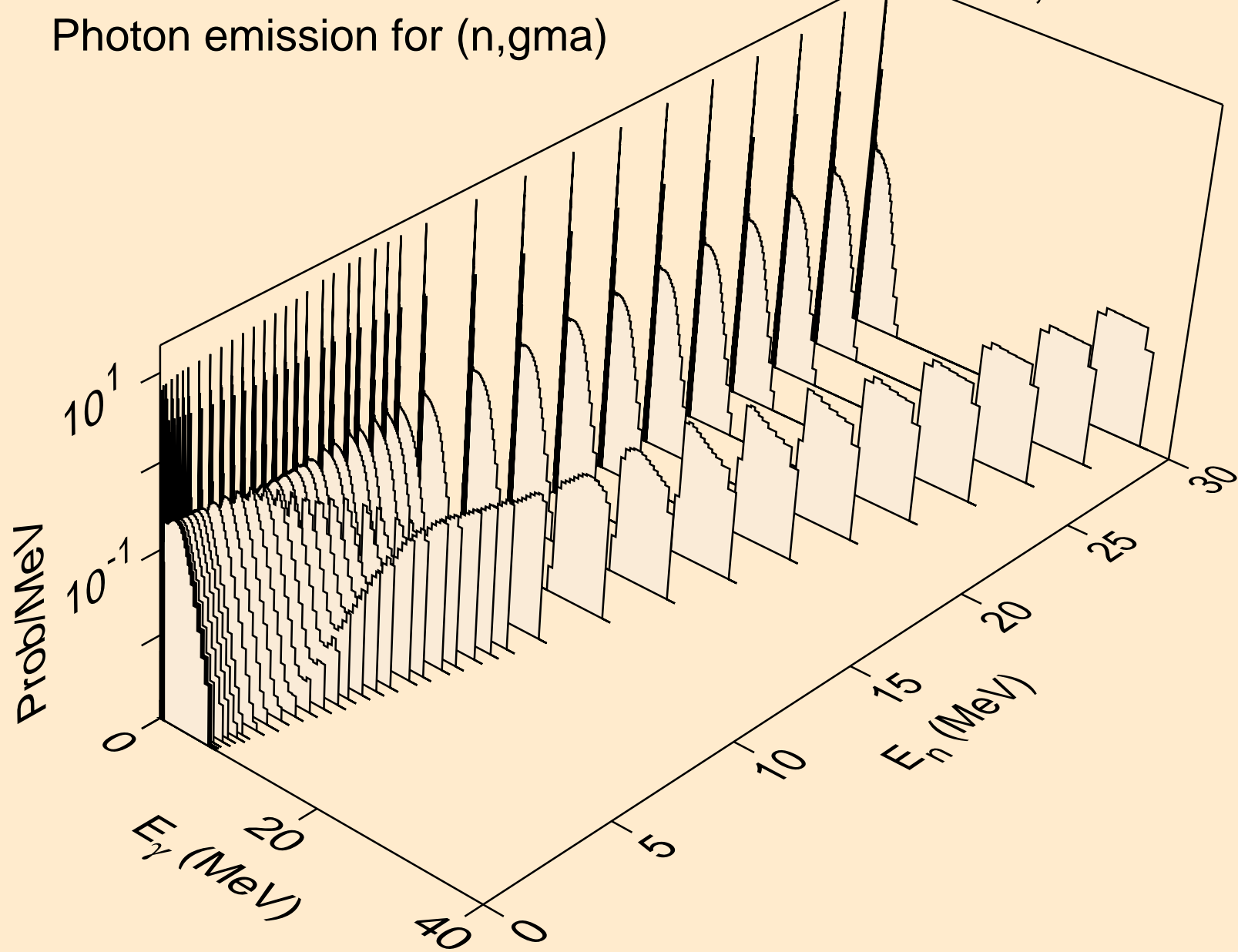

PM154 NEUTRON ACER TENDL-2023 LIBRARY; T=0.K  
Photon emission for (n,p)

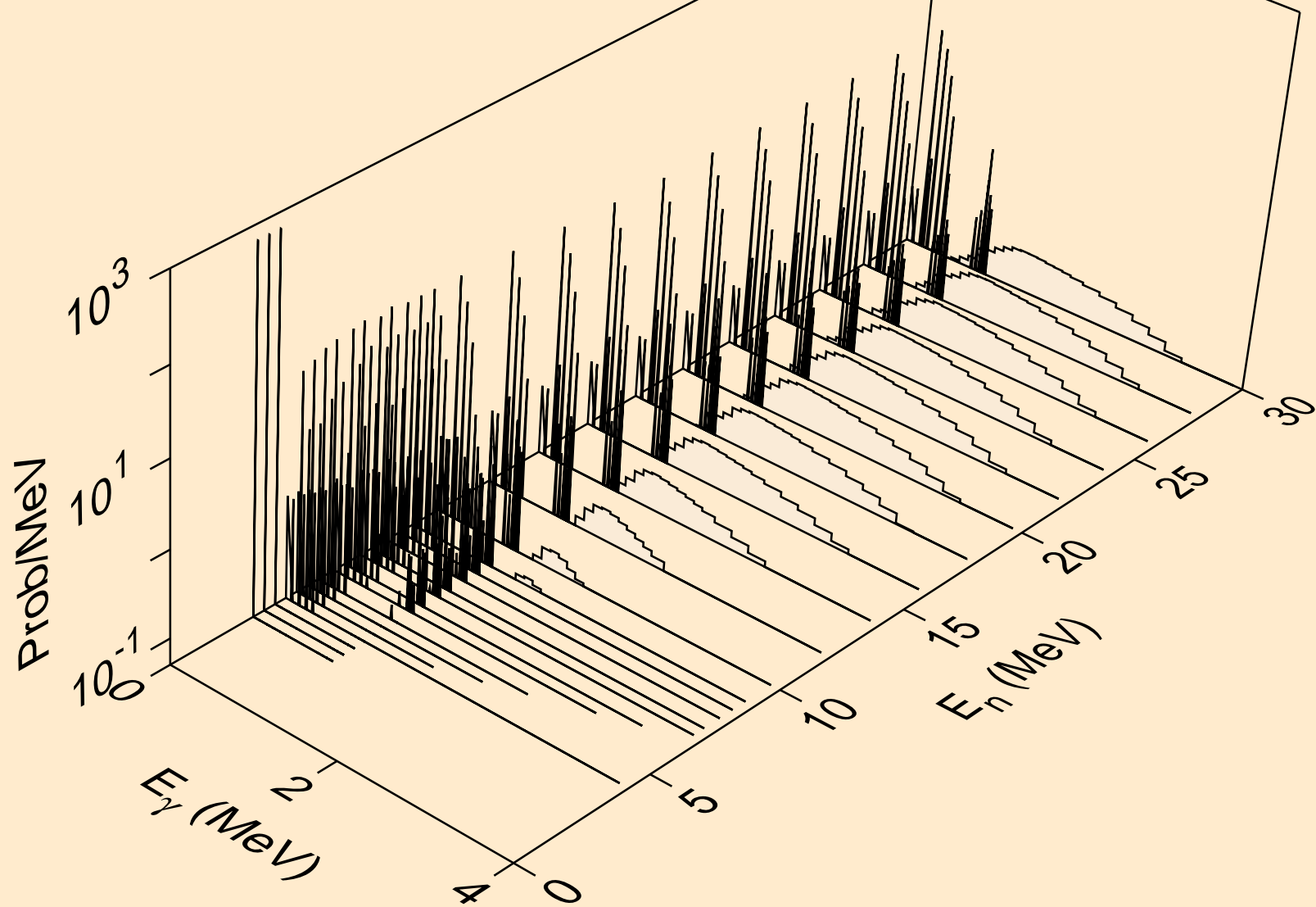

PM154 NEUTRON ACER TENDL-2023 LIBRARY; T=0.K  
Photon emission for (n,d)

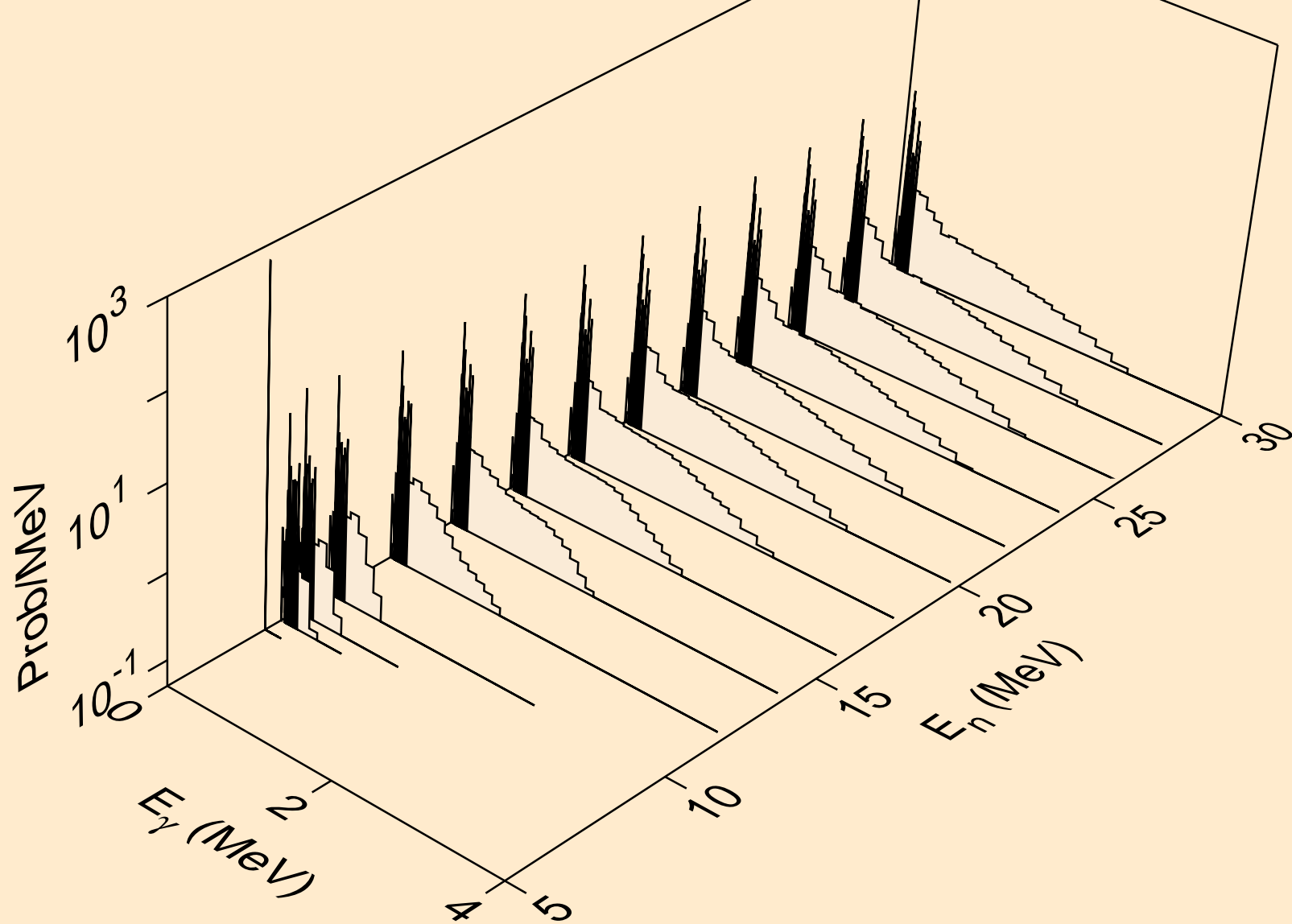

PM154 NEUTRON ACER TENDL-2023 LIBRARY; T=0.K  
Photon emission for (n,t)

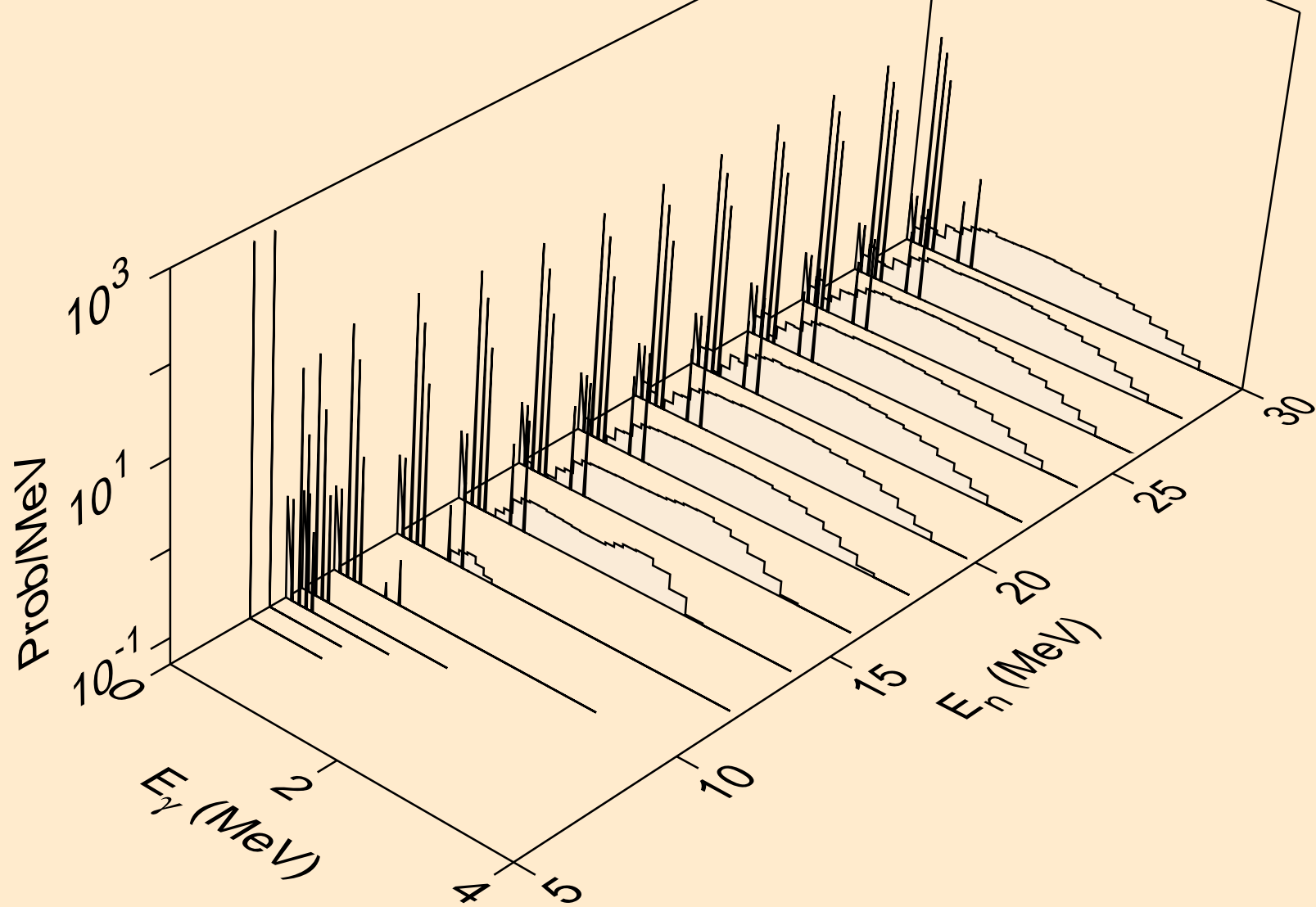

PM154 NEUTRON ACER TENDL-2023 LIBRARY; T=0.K  
Photon emission for (n,he3)

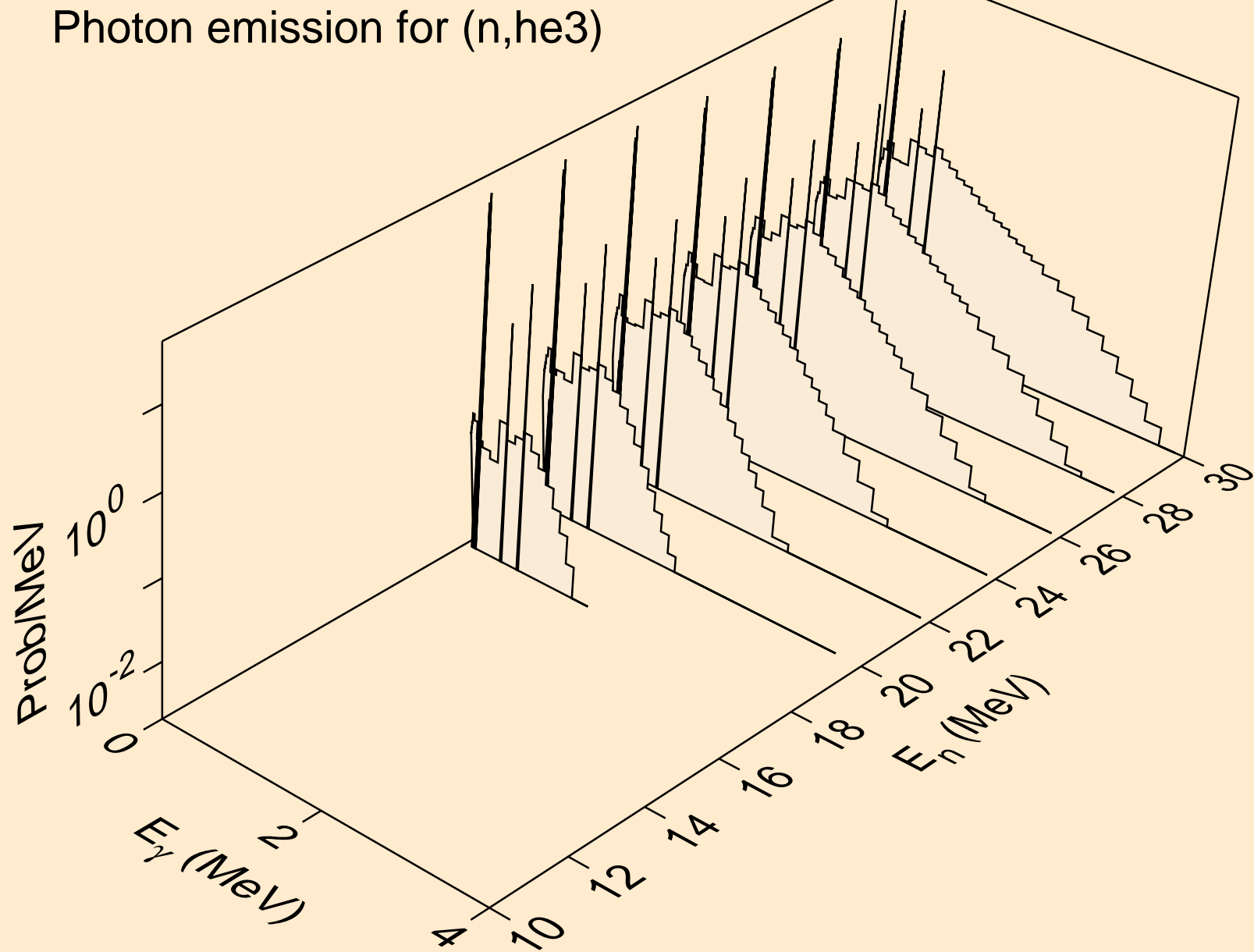

PM154 NEUTRON ACER TENDL-2023 LIBRARY; T=0.K  
Photon emission for (n,a)

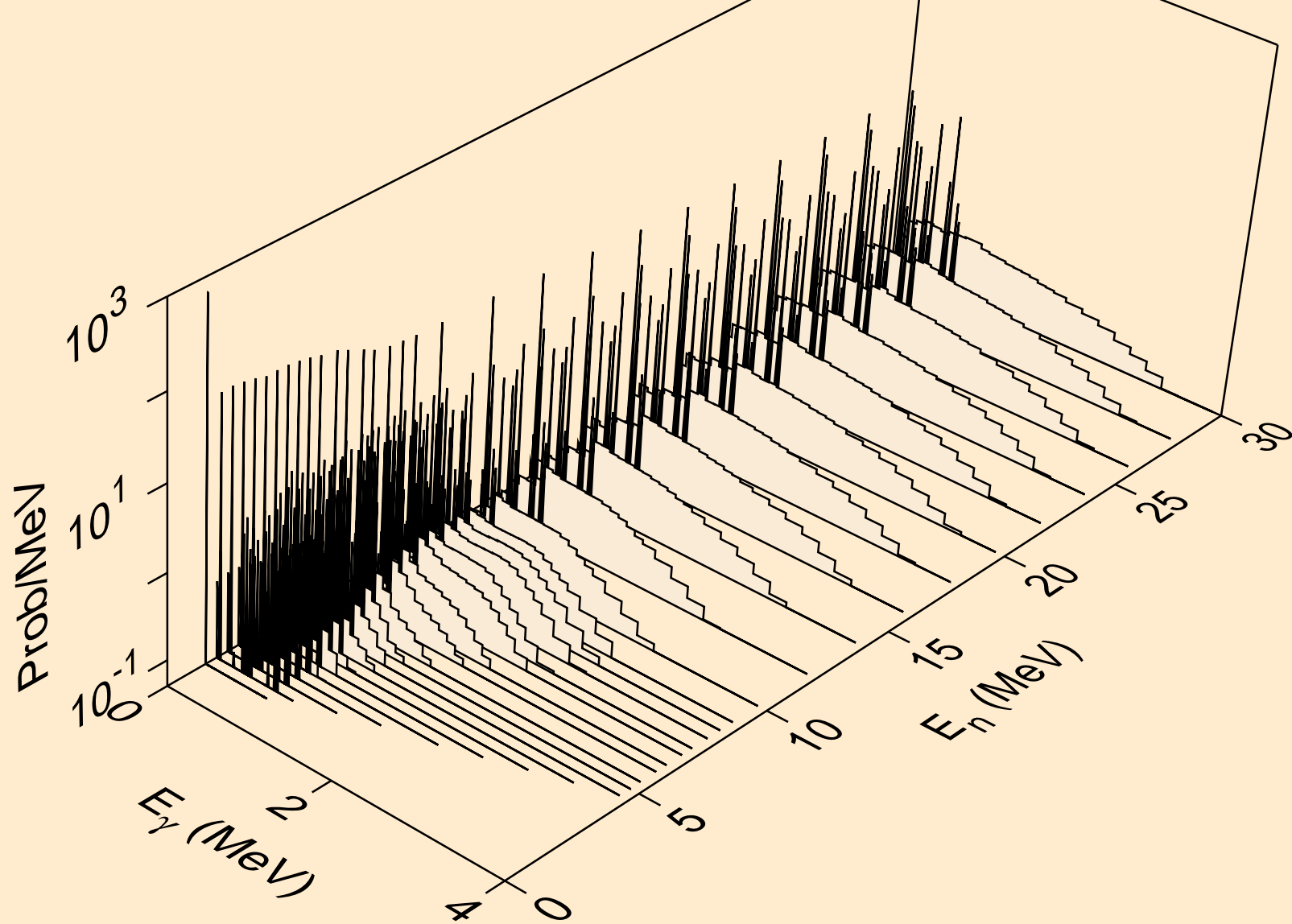

PM154 NEUTRON ACER TENDL-2023 LIBRARY; T=0.K  
Photon emission for (n,2p)

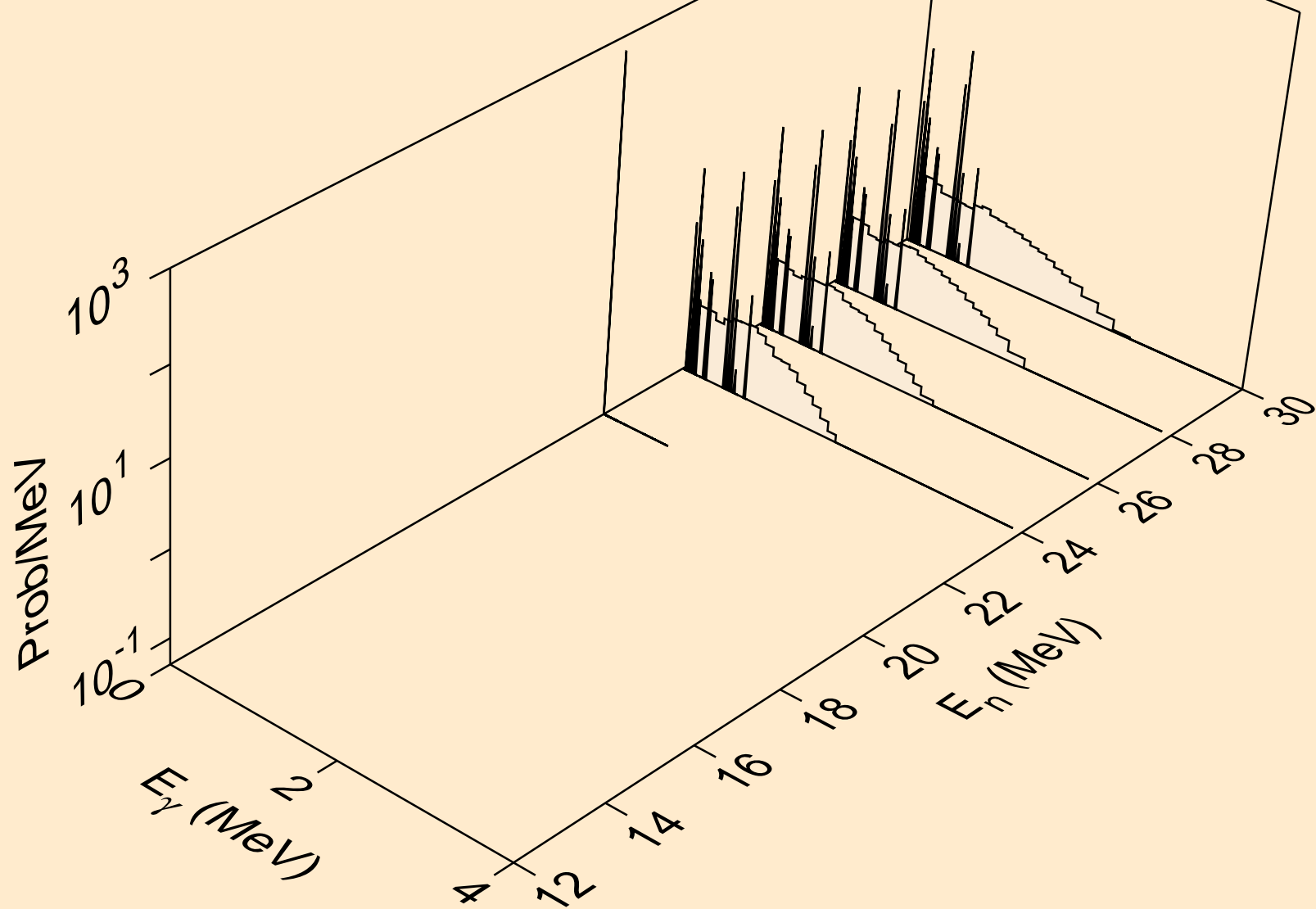

PM154 NEUTRON ACER TENDL-2023 LIBRARY; T=0.K  
thermal capture photon spectrum

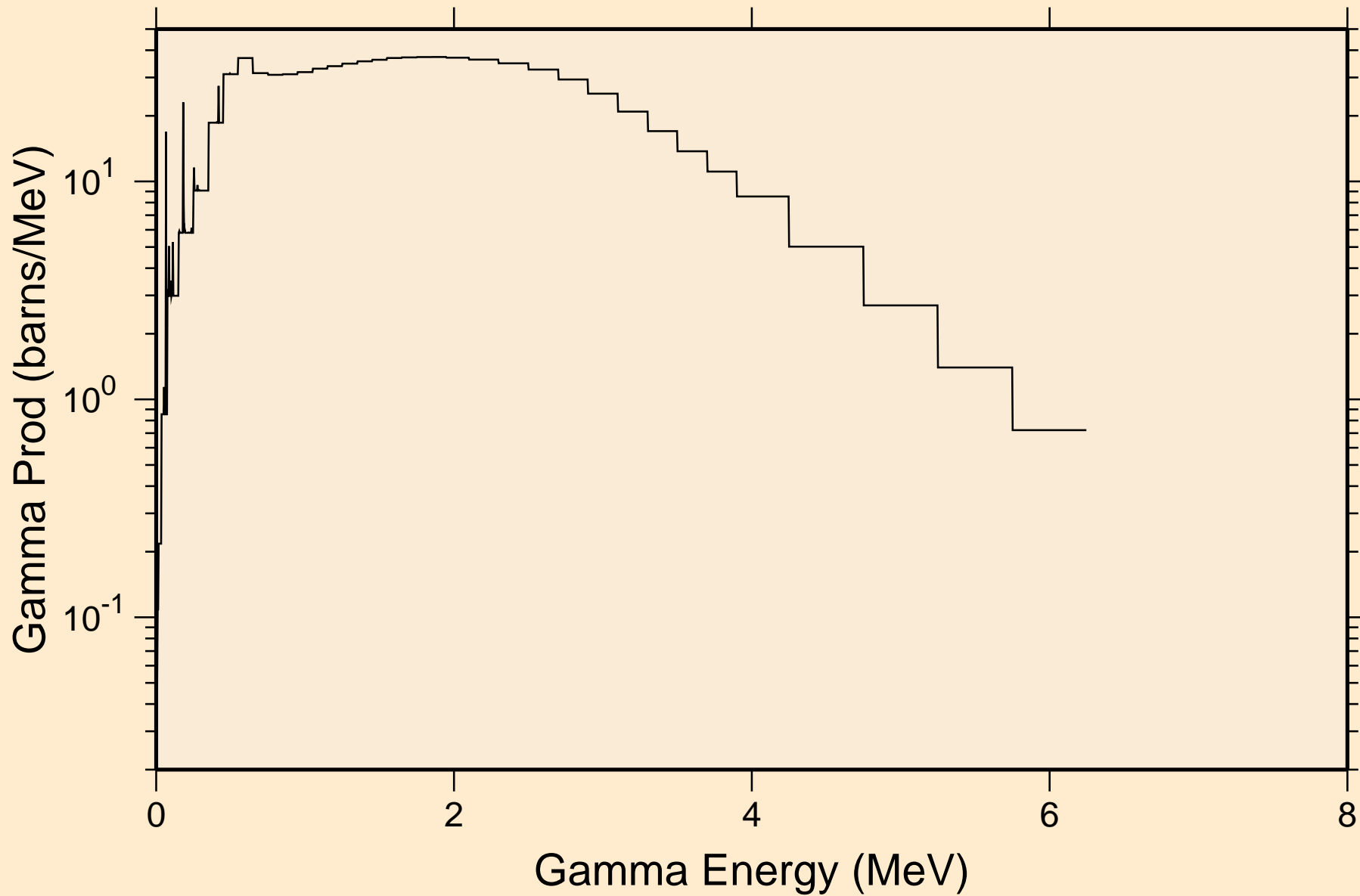

PM154 NEUTRON ACER TENDL-2023 LIBRARY; T=0.K  
14 MeV photon spectrum

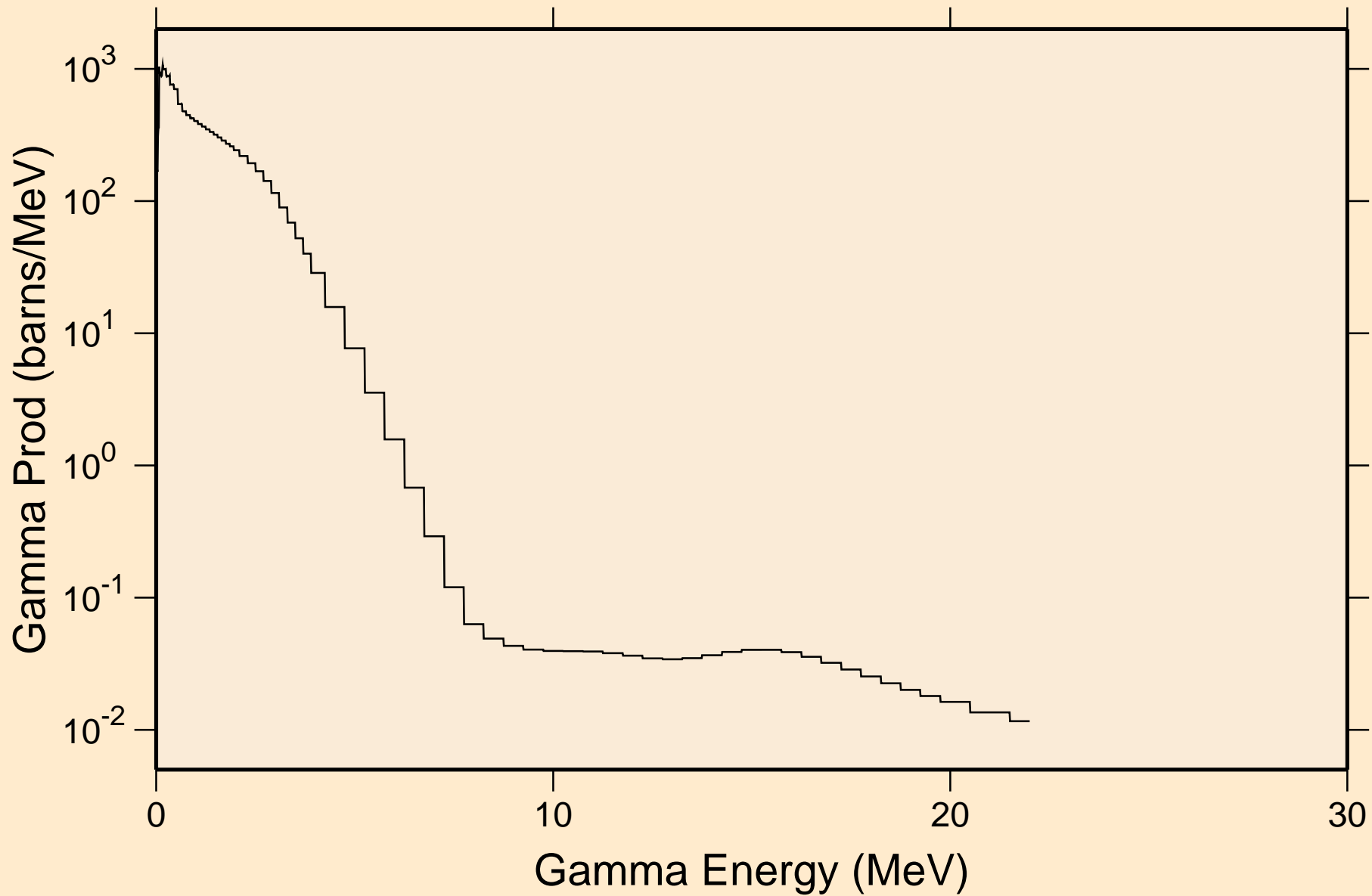

PM154 NEUTRON ACER TENDL-2023 LIBRARY; T=0.K  
Particle heating contributions

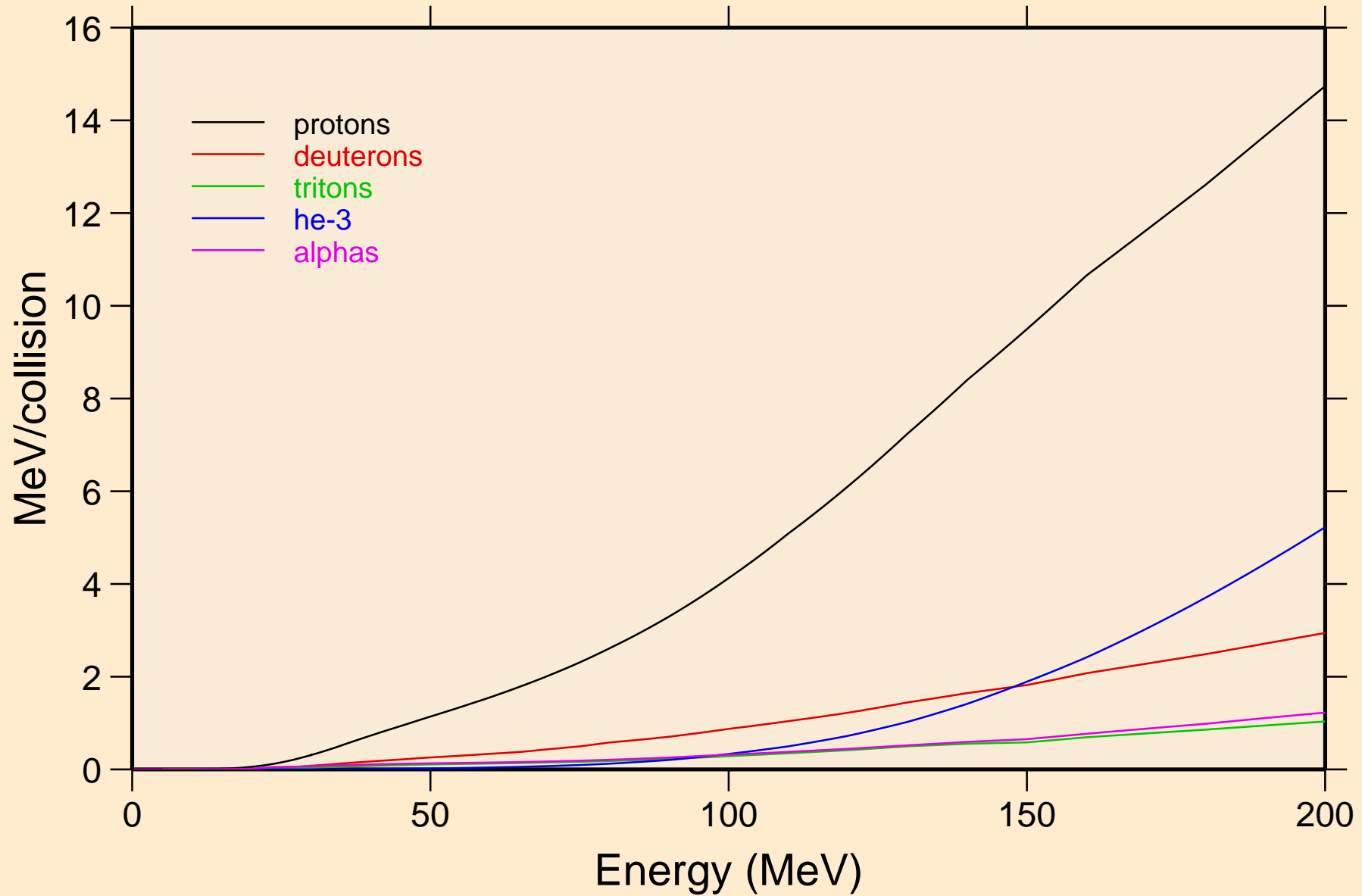

PM154 NEUTRON ACER TENDL-2023 LIBRARY; T=0.K  
Recoil Heating

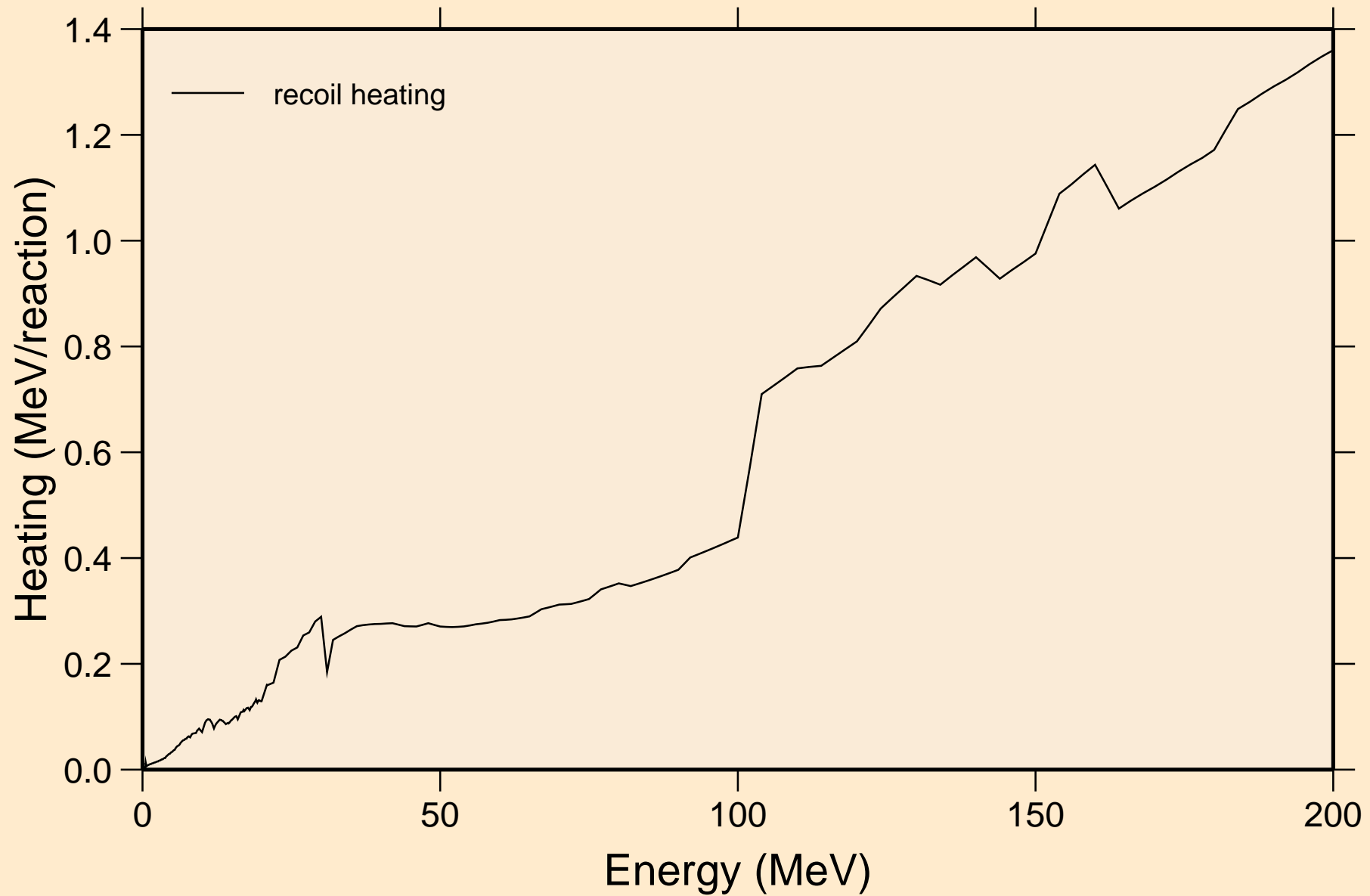

PM154 NEUTRON ACER TENDL-2023 LIBRARY; T=0.K  
Particle production cross sections

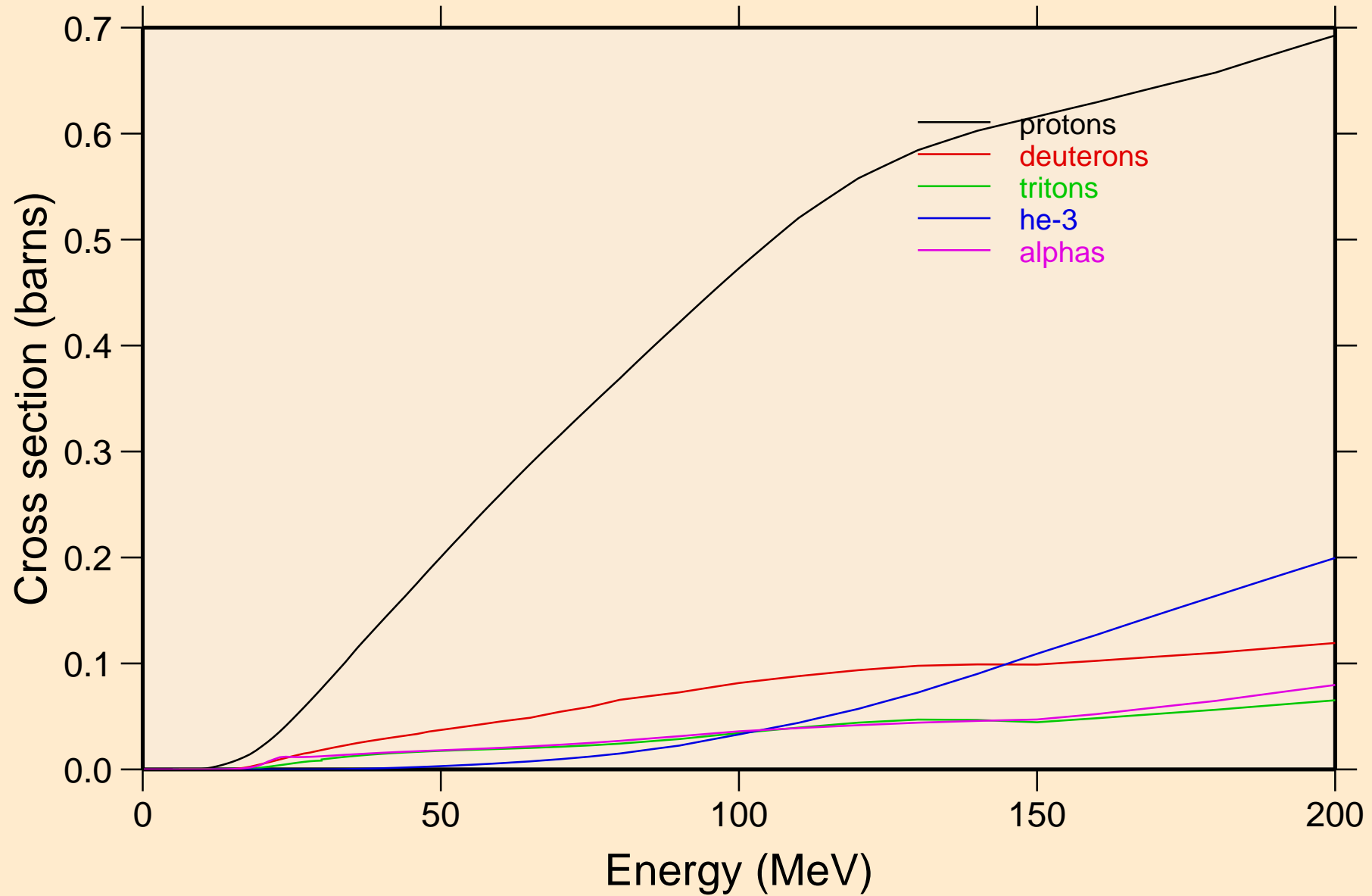

PM154 NEUTRON ACER TENDL-2023 LIBRARY; T=0.K  
protons from (n,x)

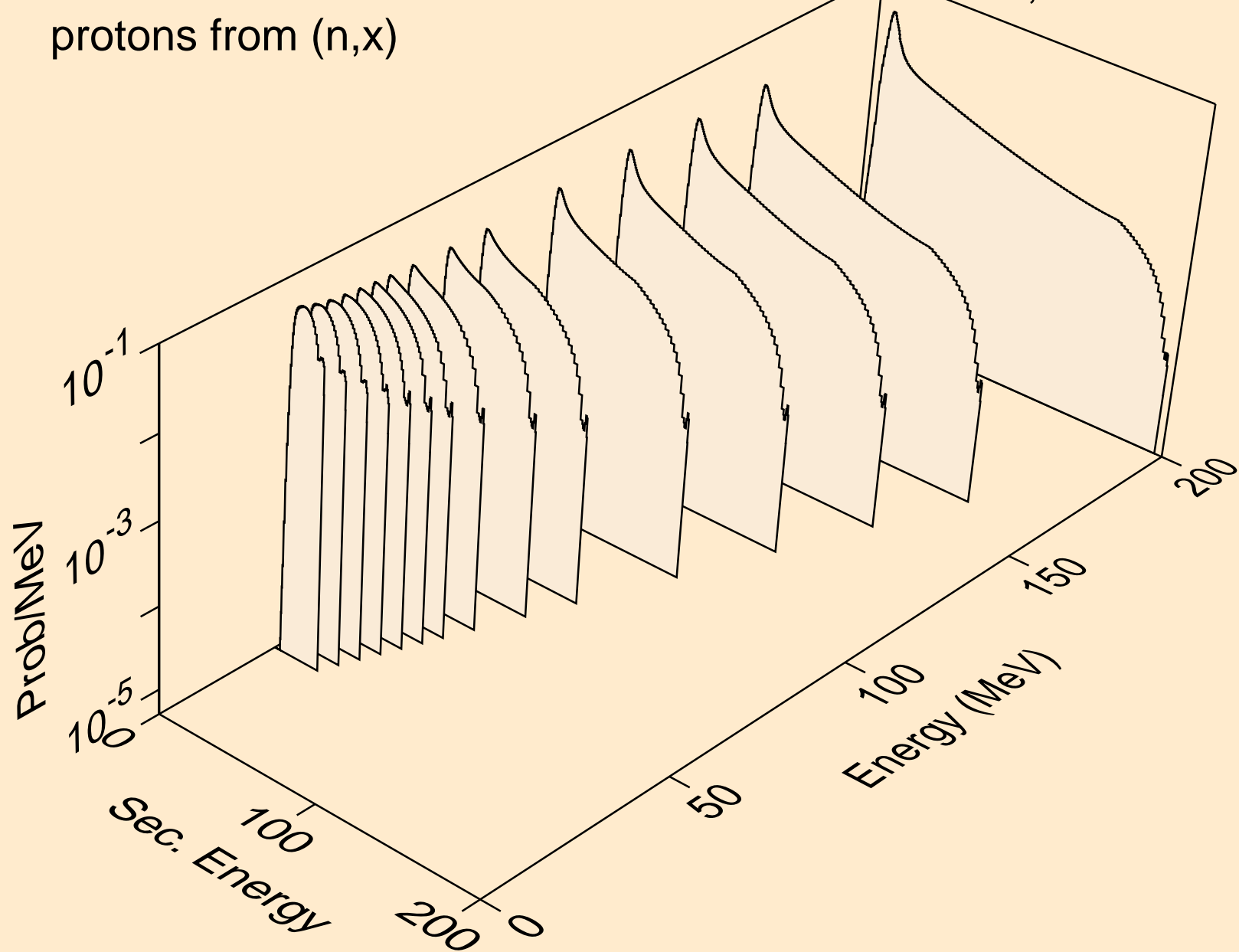

PM154 NEUTRON ACER TENDL-2023 LIBRARY; T=0.K  
protons from (n,n\*)p

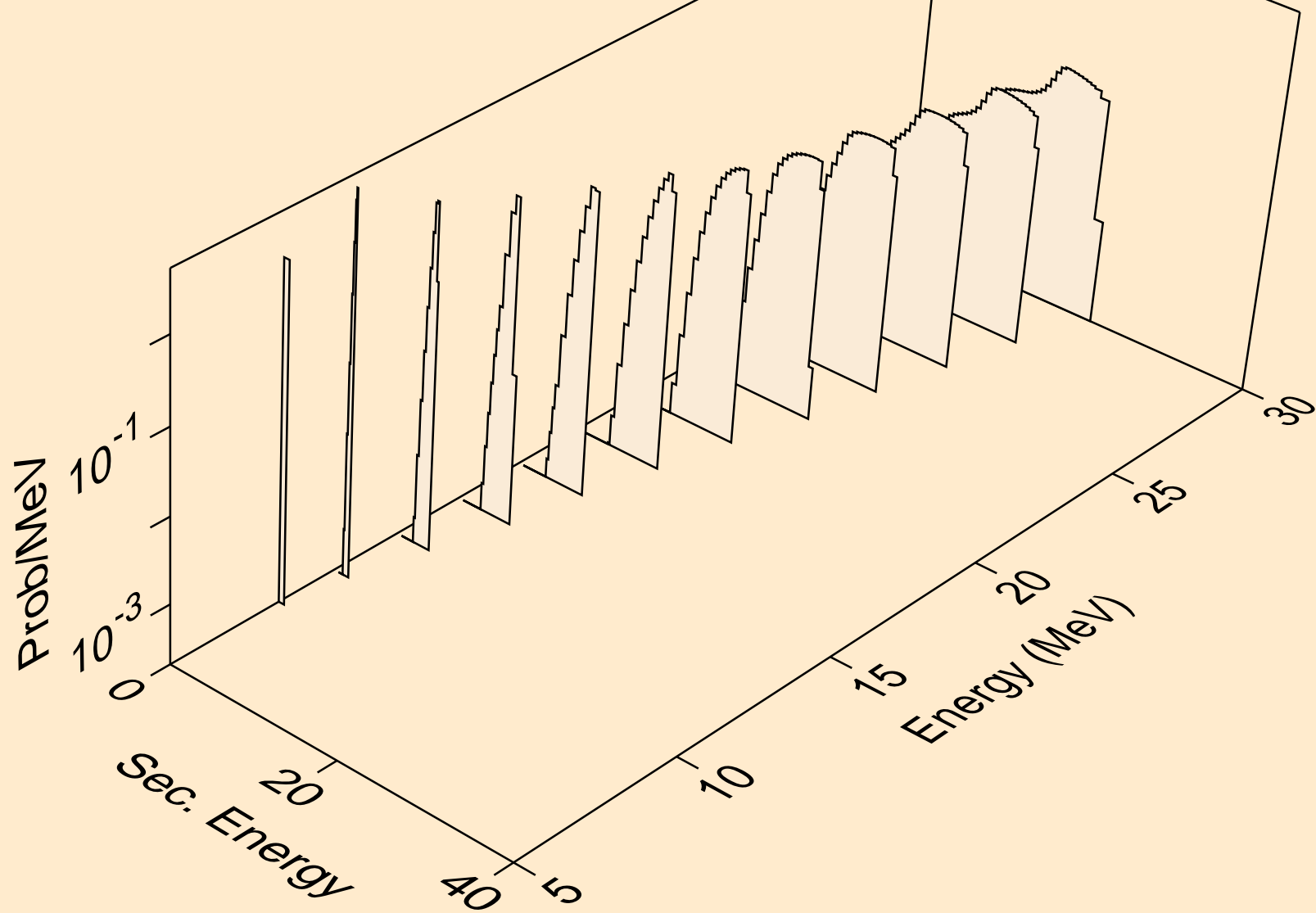

PM154 NEUTRON ACER TENDL-2023 LIBRARY; T=0.K  
protons from (n,2np)

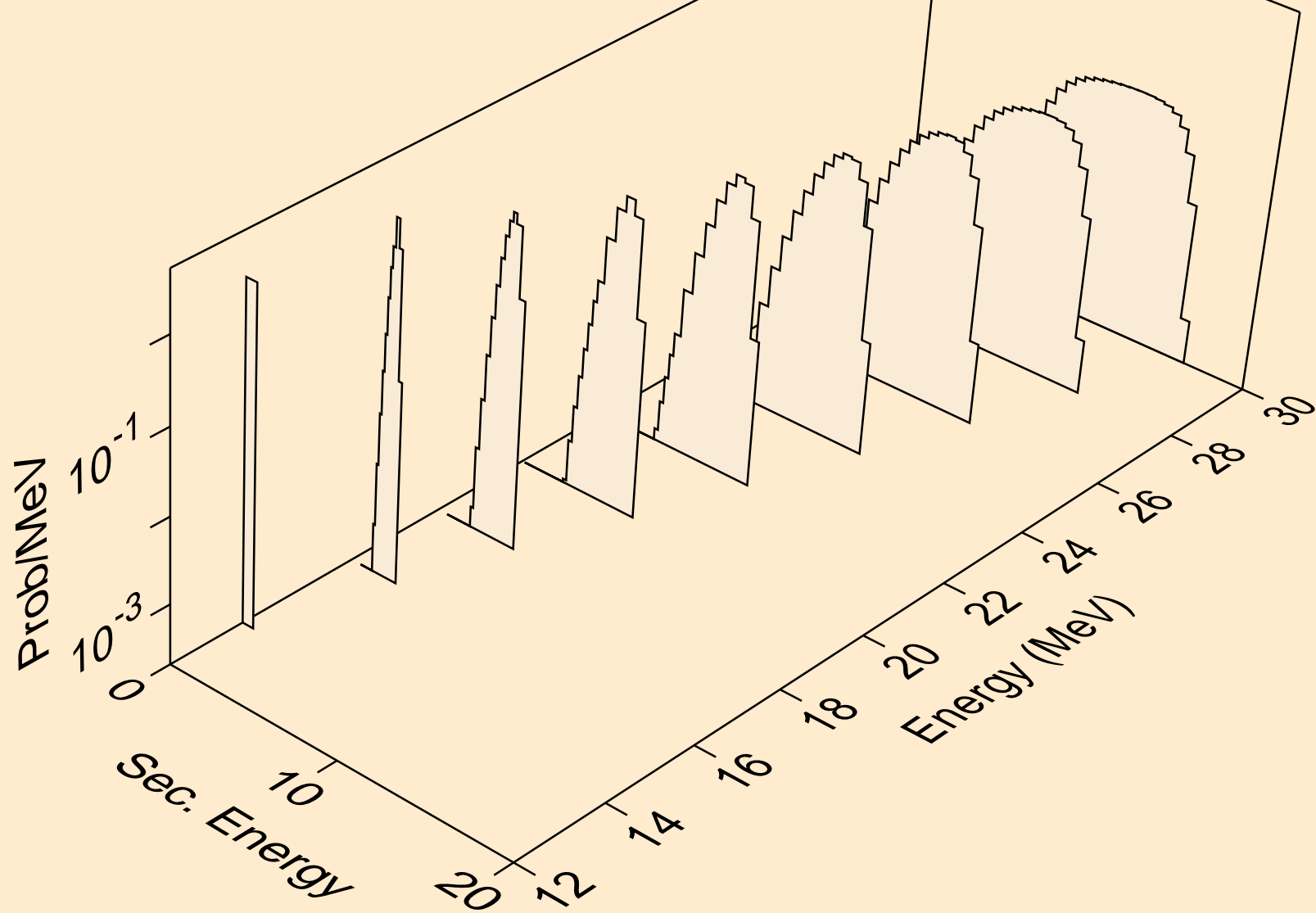

PM154 NEUTRON ACER TENDL-2023 LIBRARY; T=0.K  
protons from (n,3np)

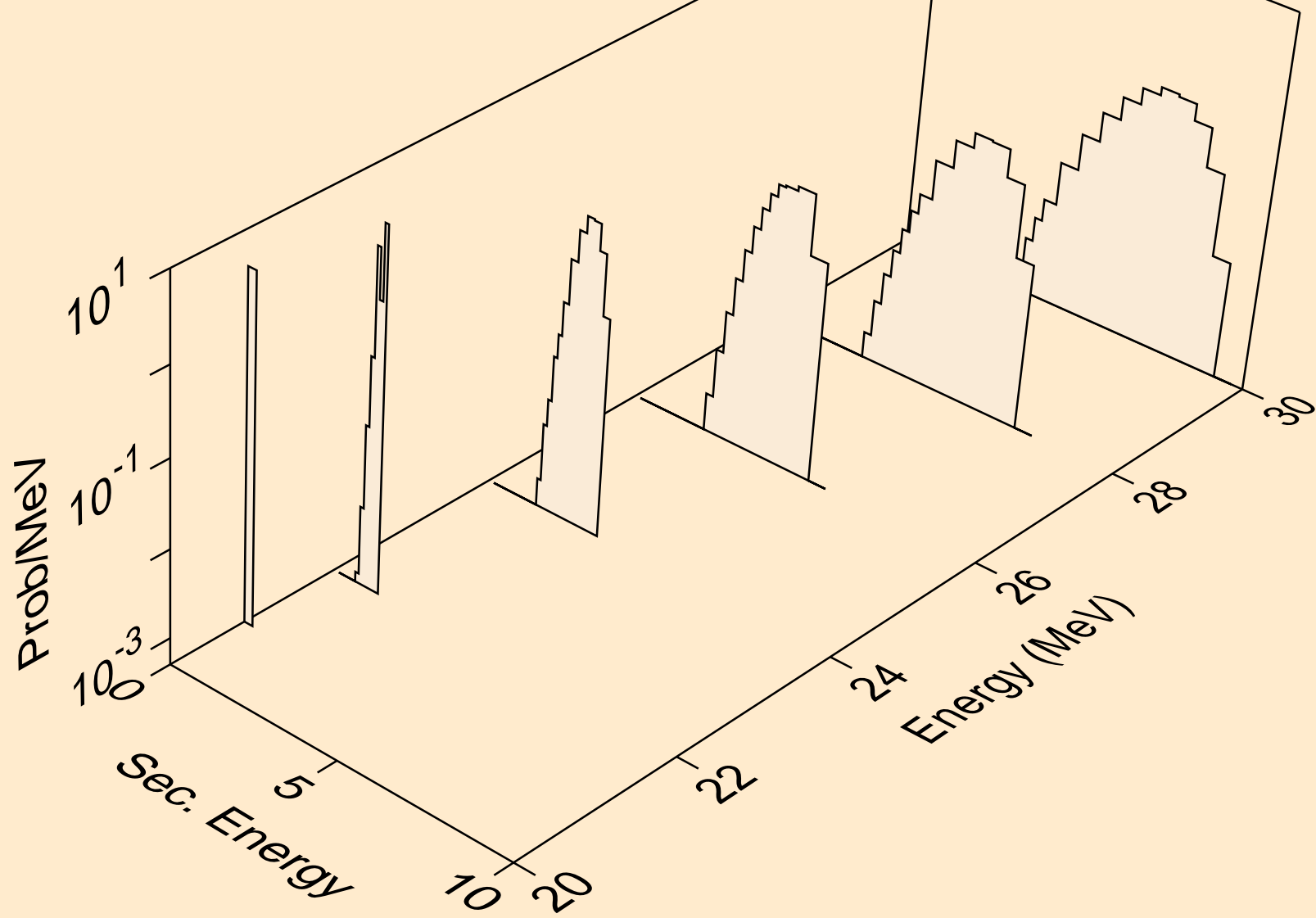

PM154 NEUTRON ACER TENDL-2023 LIBRARY; T=0.K  
protons from (n,p)

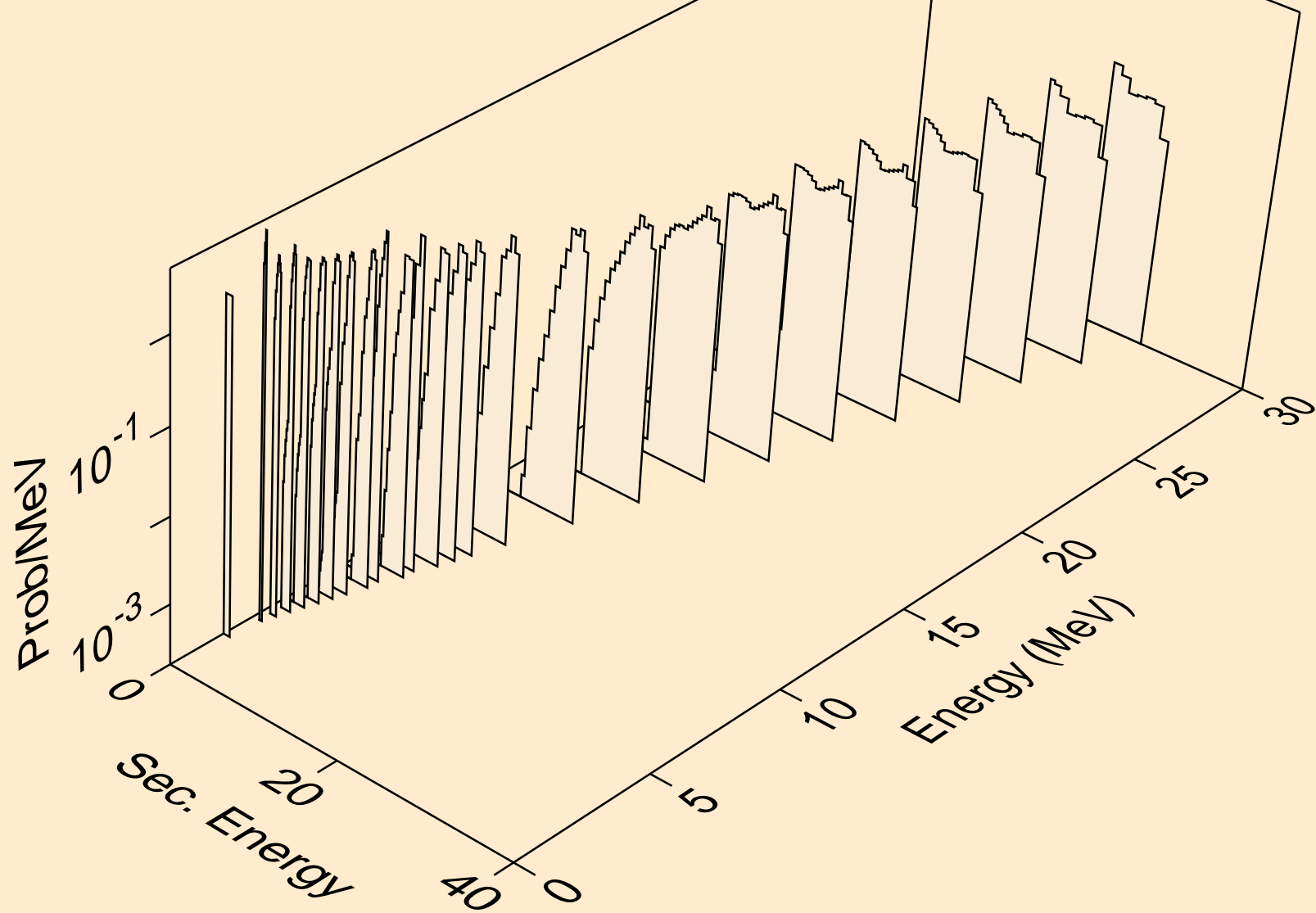

PM154 NEUTRON ACER TENDL-2023 LIBRARY; T=0.K  
protons from (n,2p)

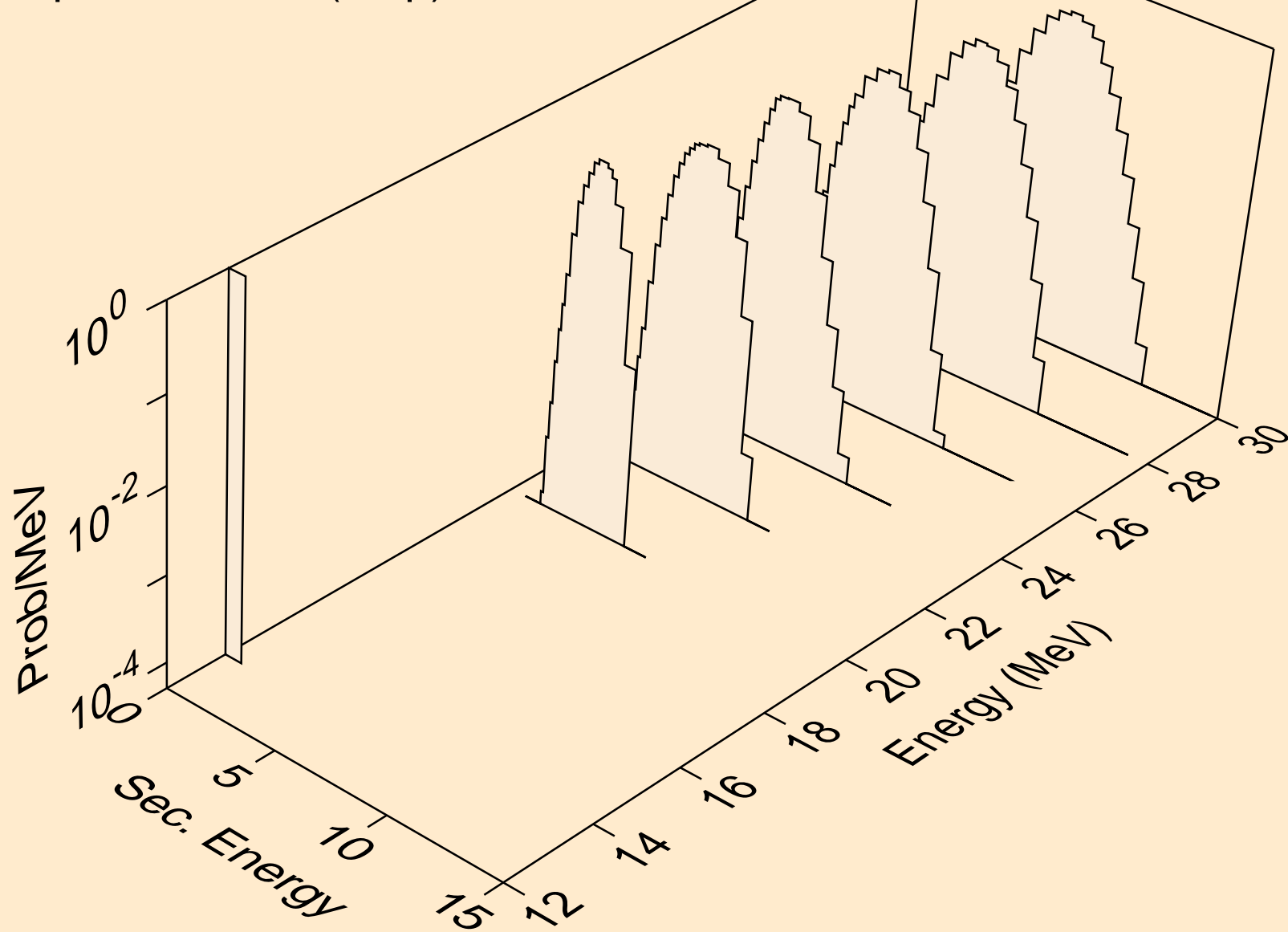

PM154 NEUTRON ACER TENDL-2023 LIBRARY; T=0.K  
deuterons from (n,x)

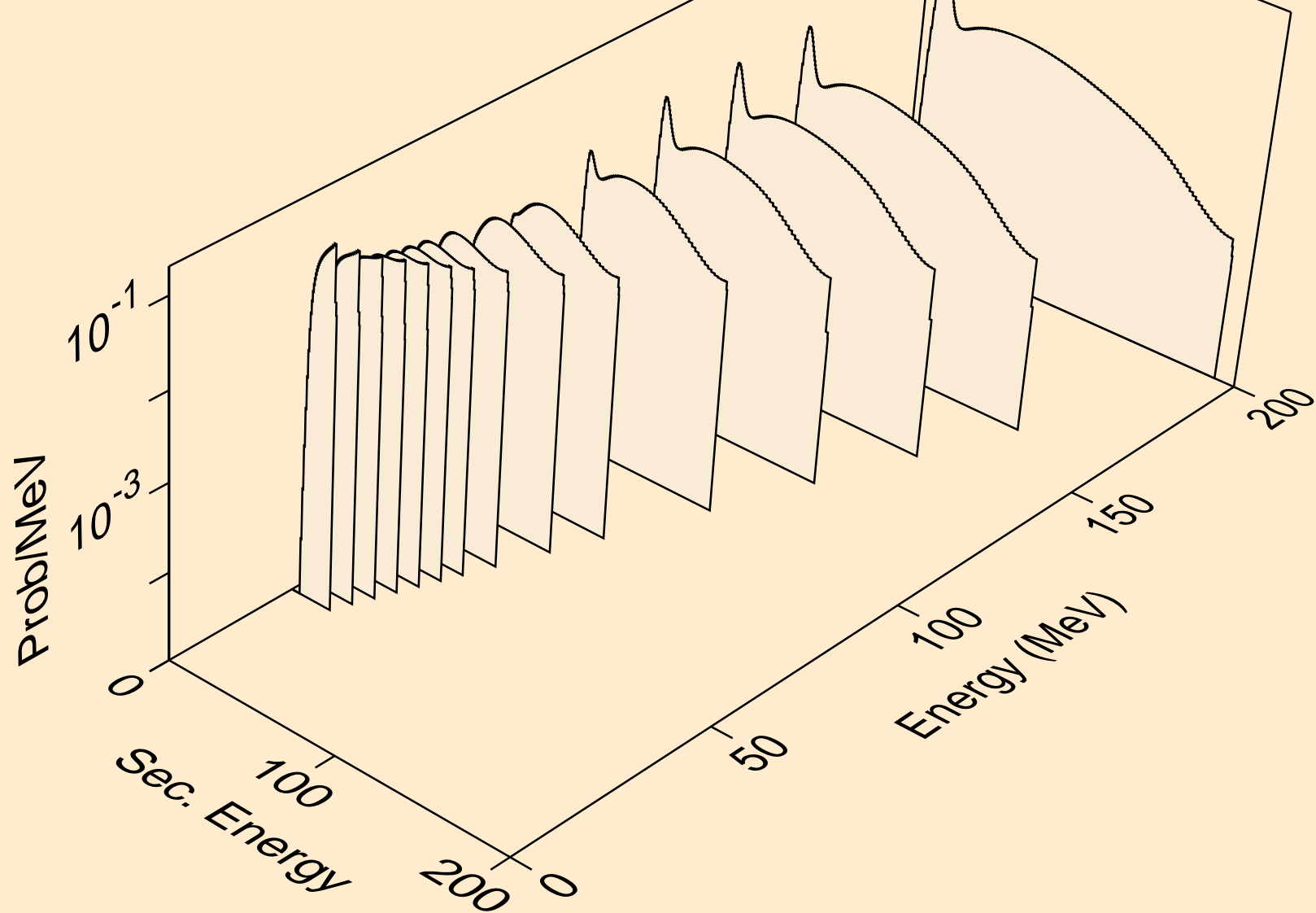

PM154 NEUTRON ACER TENDL-2023 LIBRARY; T=0.K  
deuterons from (n,2nd)

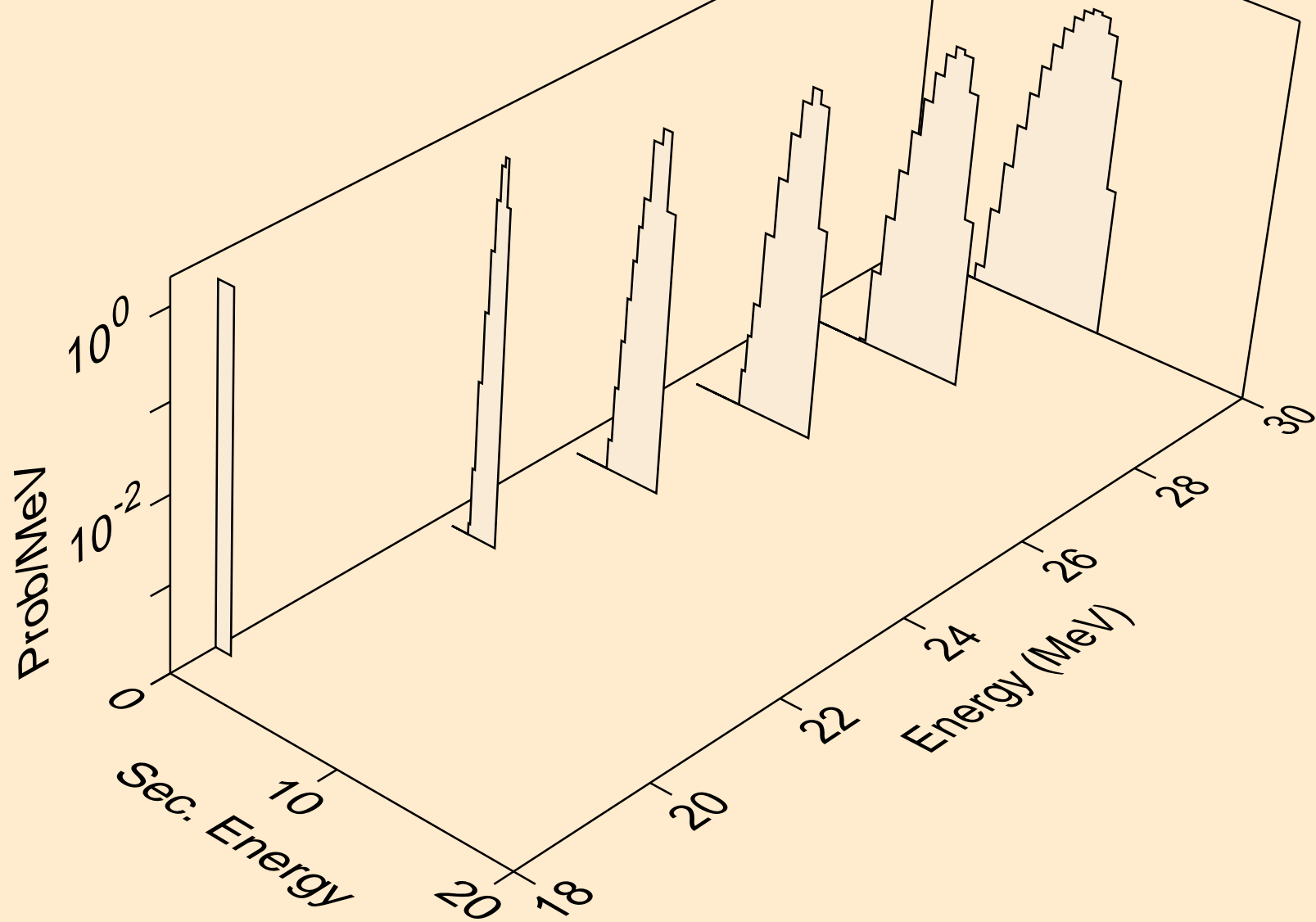

PM154 NEUTRON ACER TENDL-2023 LIBRARY; T=0.K  
deuterons from (n,n\*)d

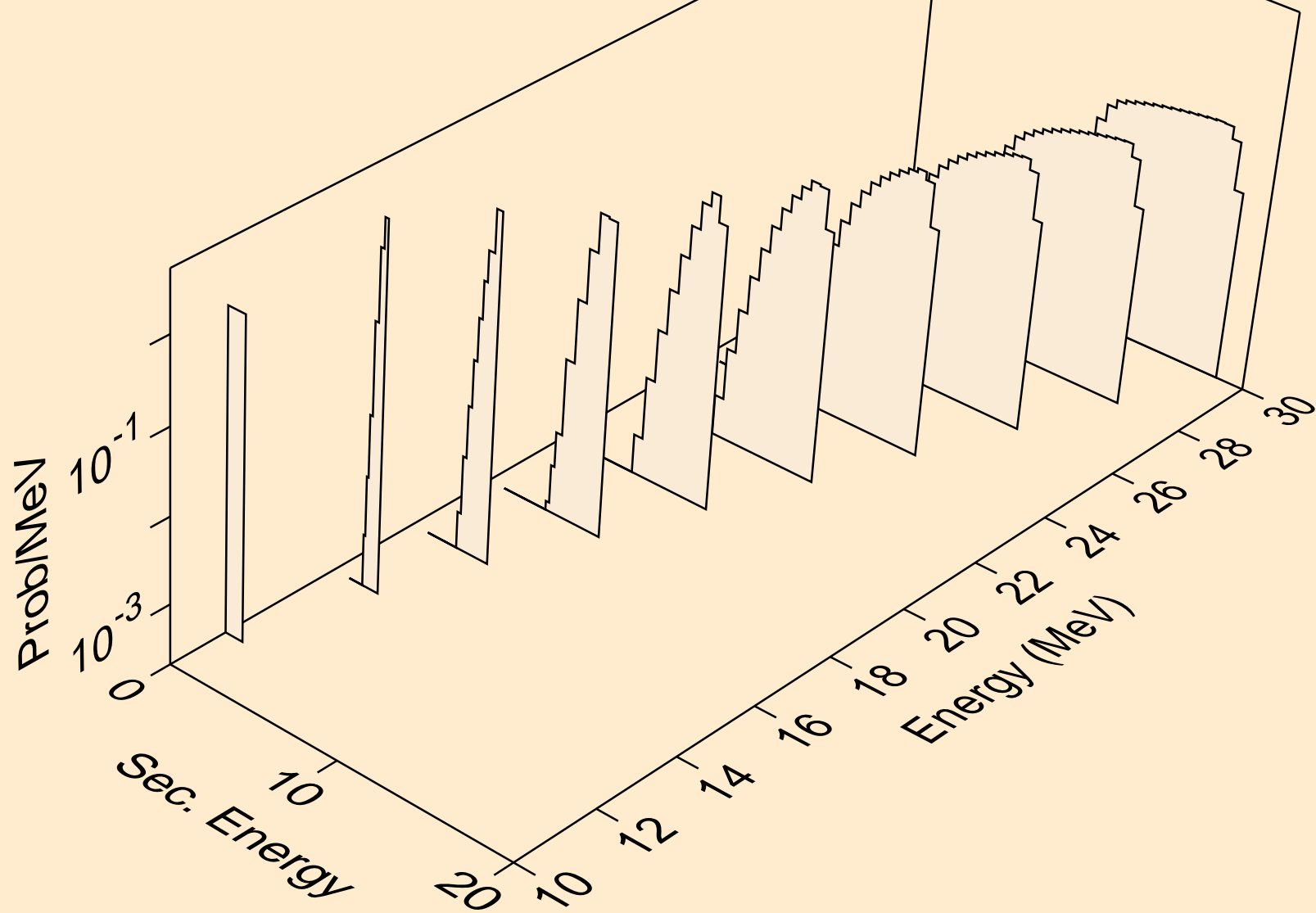

PM154 NEUTRON ACER TENDL-2023 LIBRARY; T=0.K  
deuterons from (n,d)

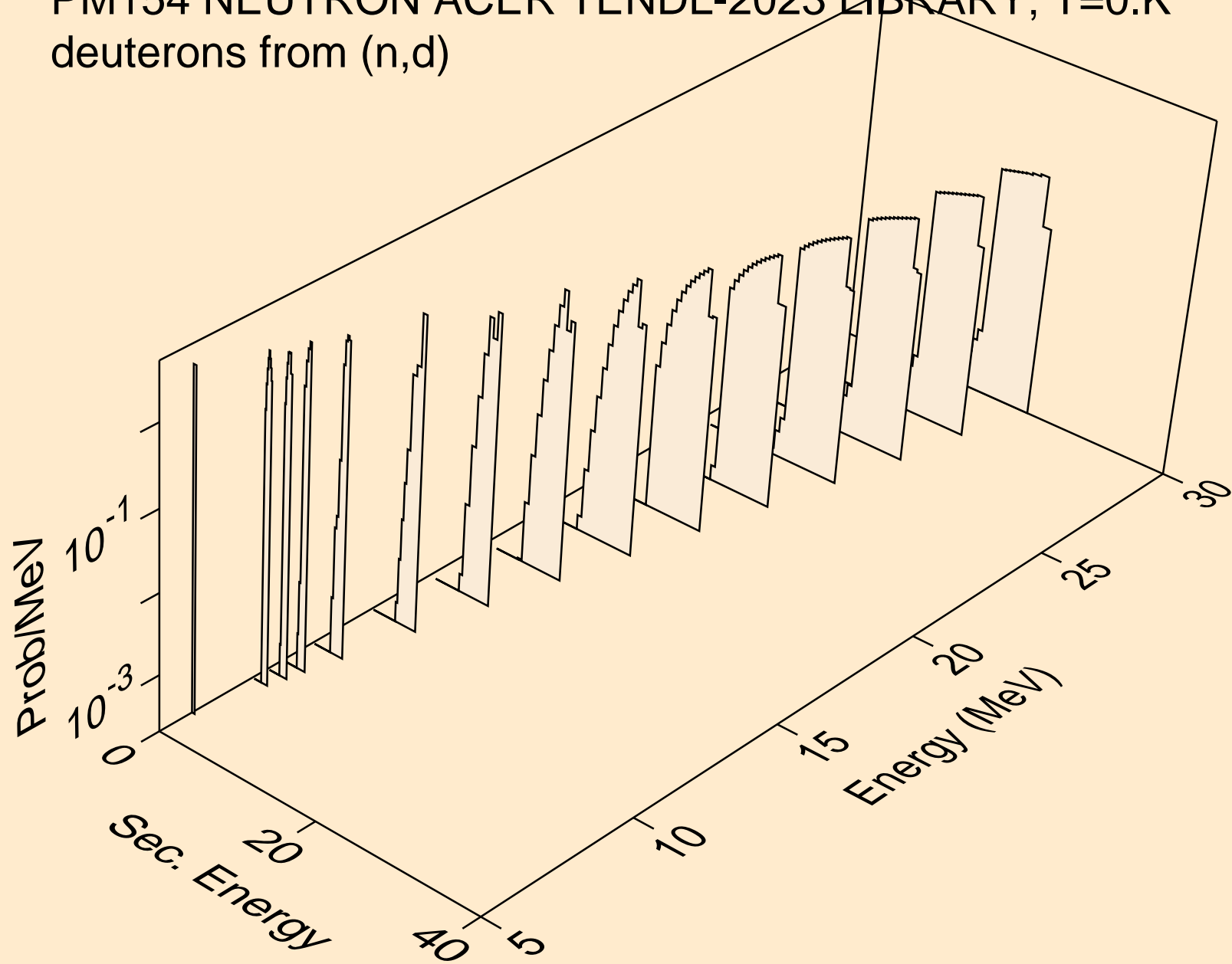

PM154 NEUTRON ACER TENDL-2023 LIBRARY; T=0.K  
tritons from (n,x)

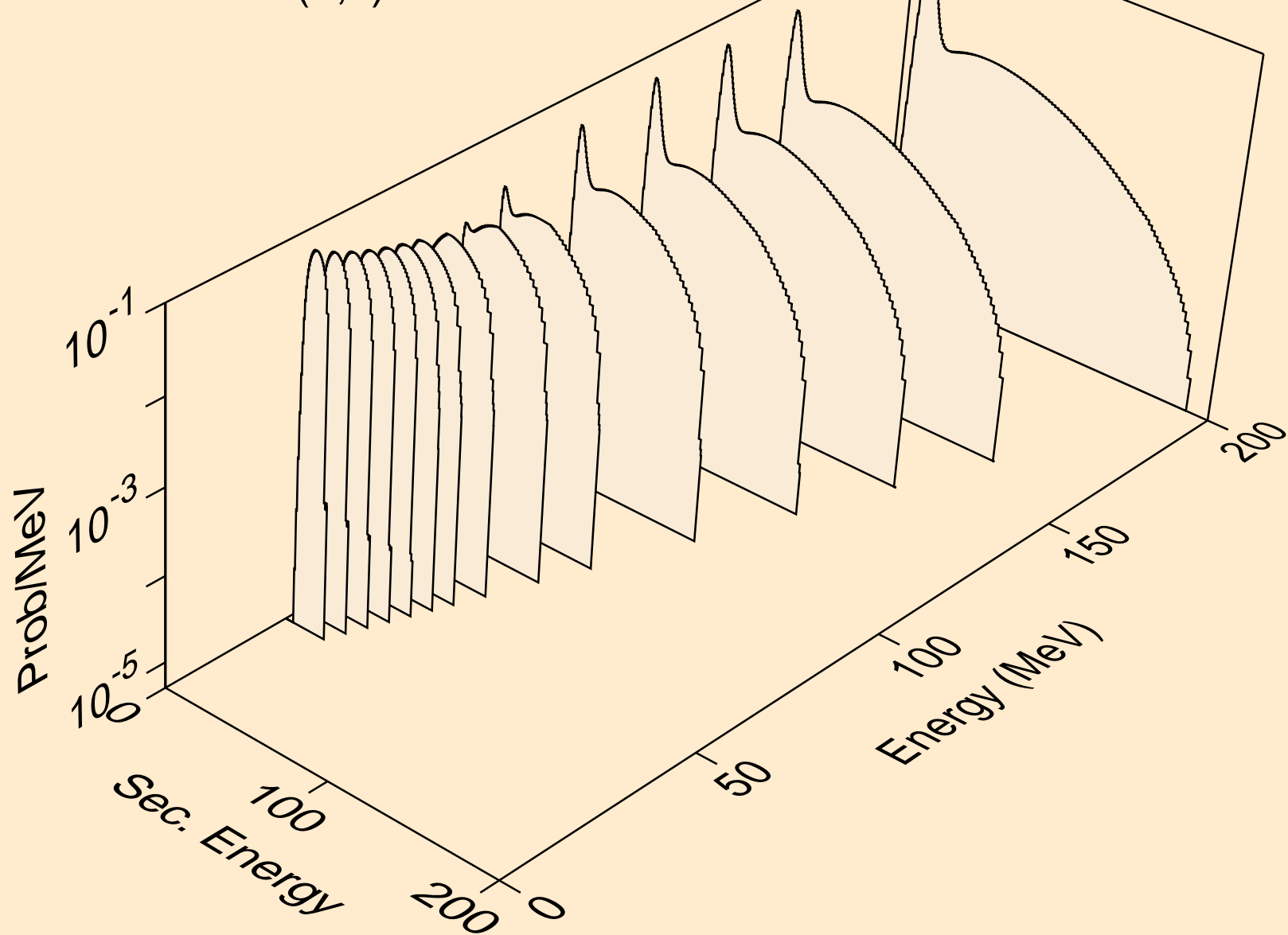

PM154 NEUTRON ACER TENDL-2023 LIBRARY; T=0.K  
tritons from (n,n\*)t

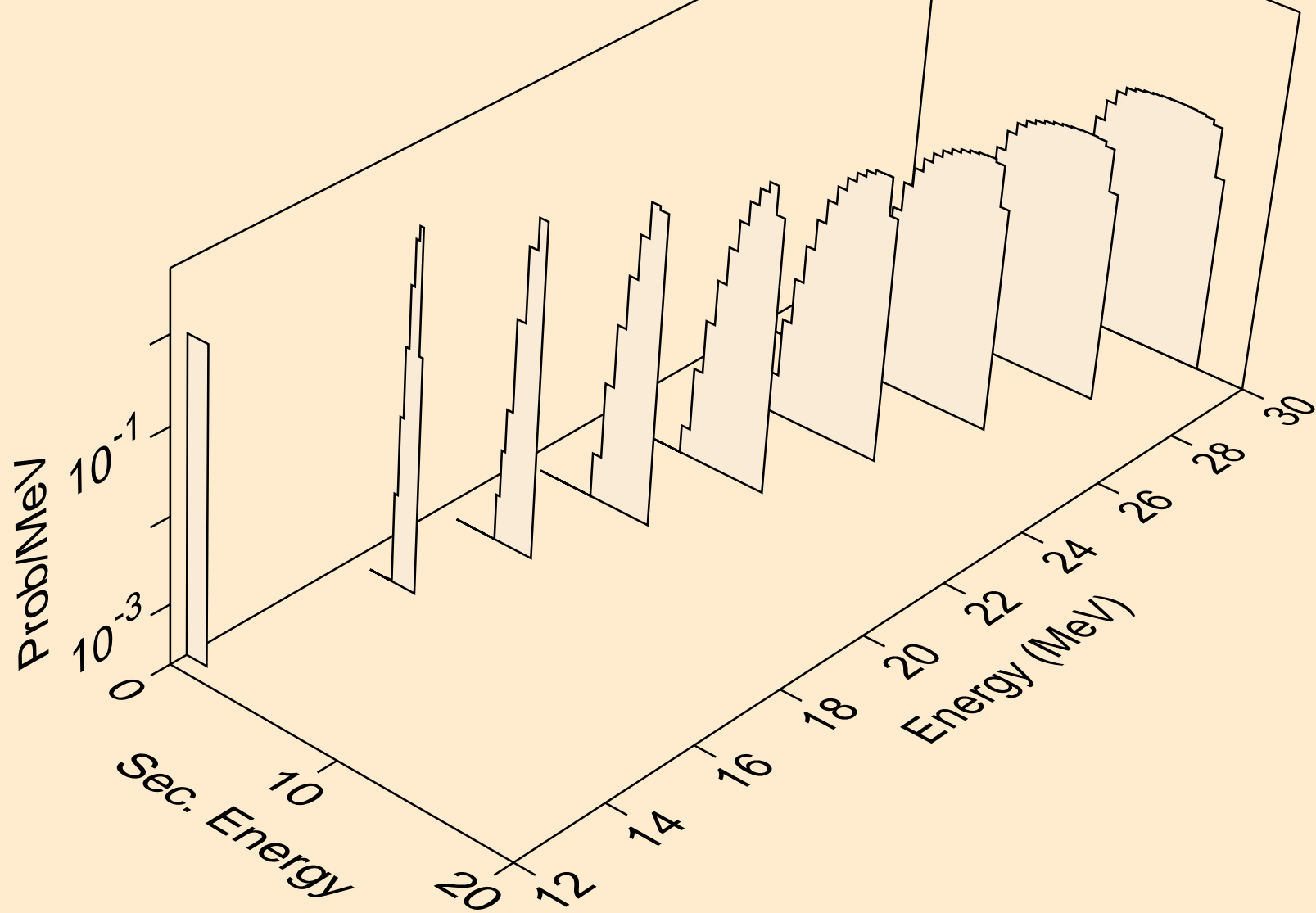

PM154 NEUTRON ACER TENDL-2023 LIBRARY; T=0.K  
tritons from (n,t)

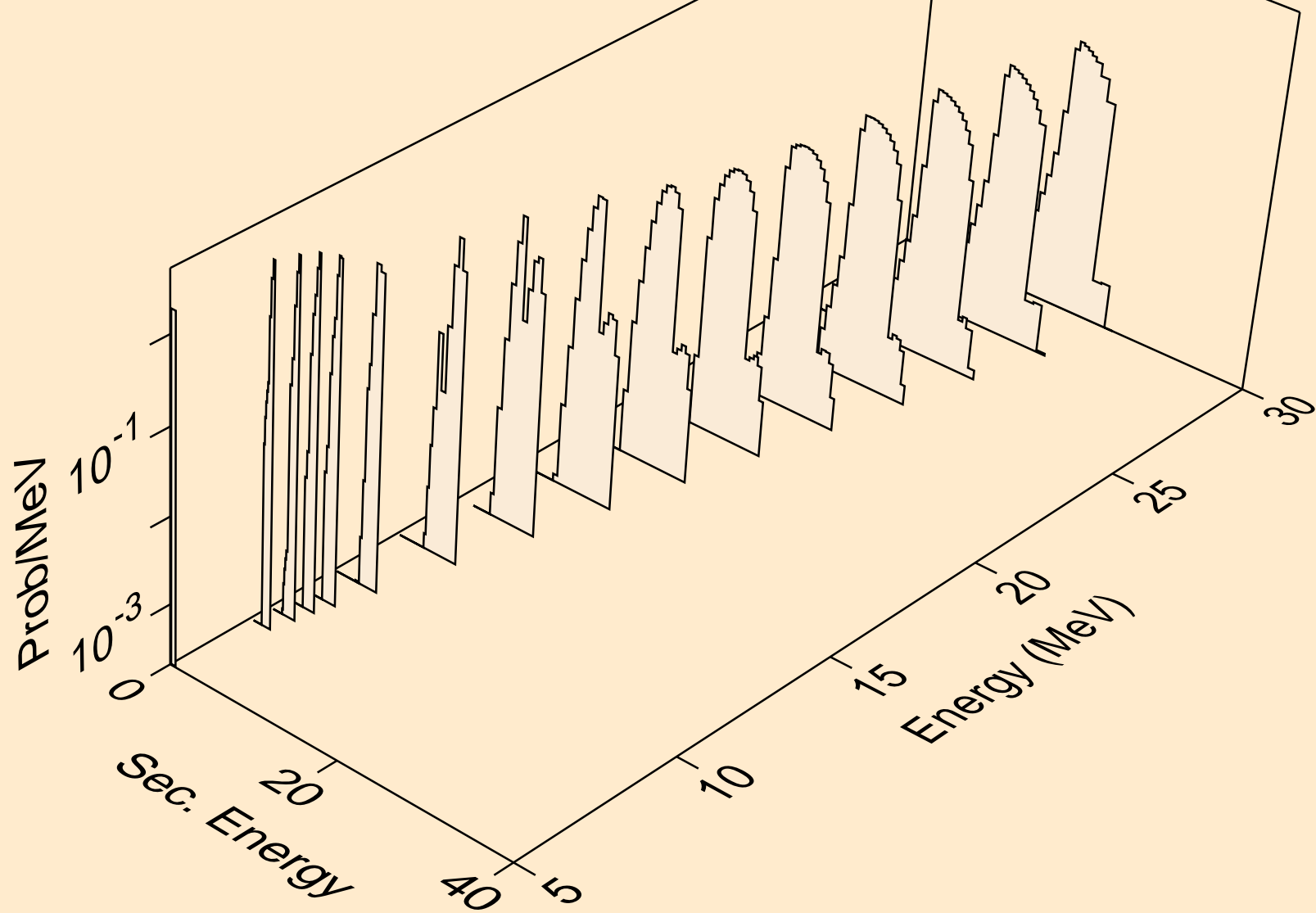

PM154 NEUTRON ACER TENDL-2023 LIBRARY; T=0.K  
he3s from (n,x)

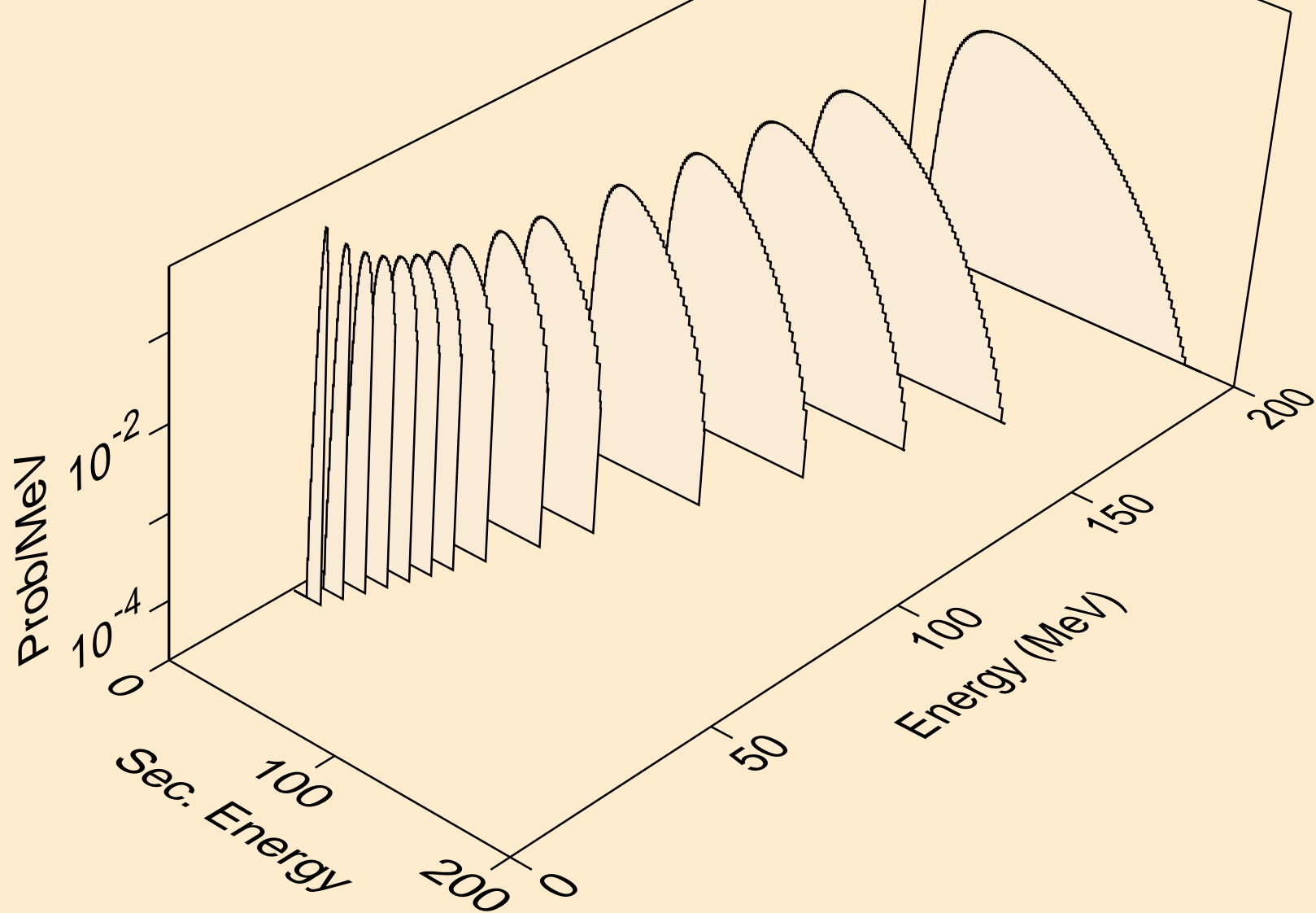

PM154 NEUTRON ACER TENDL-2023 LIBRARY; T=0.K  
he3s from (n,n\*)he3

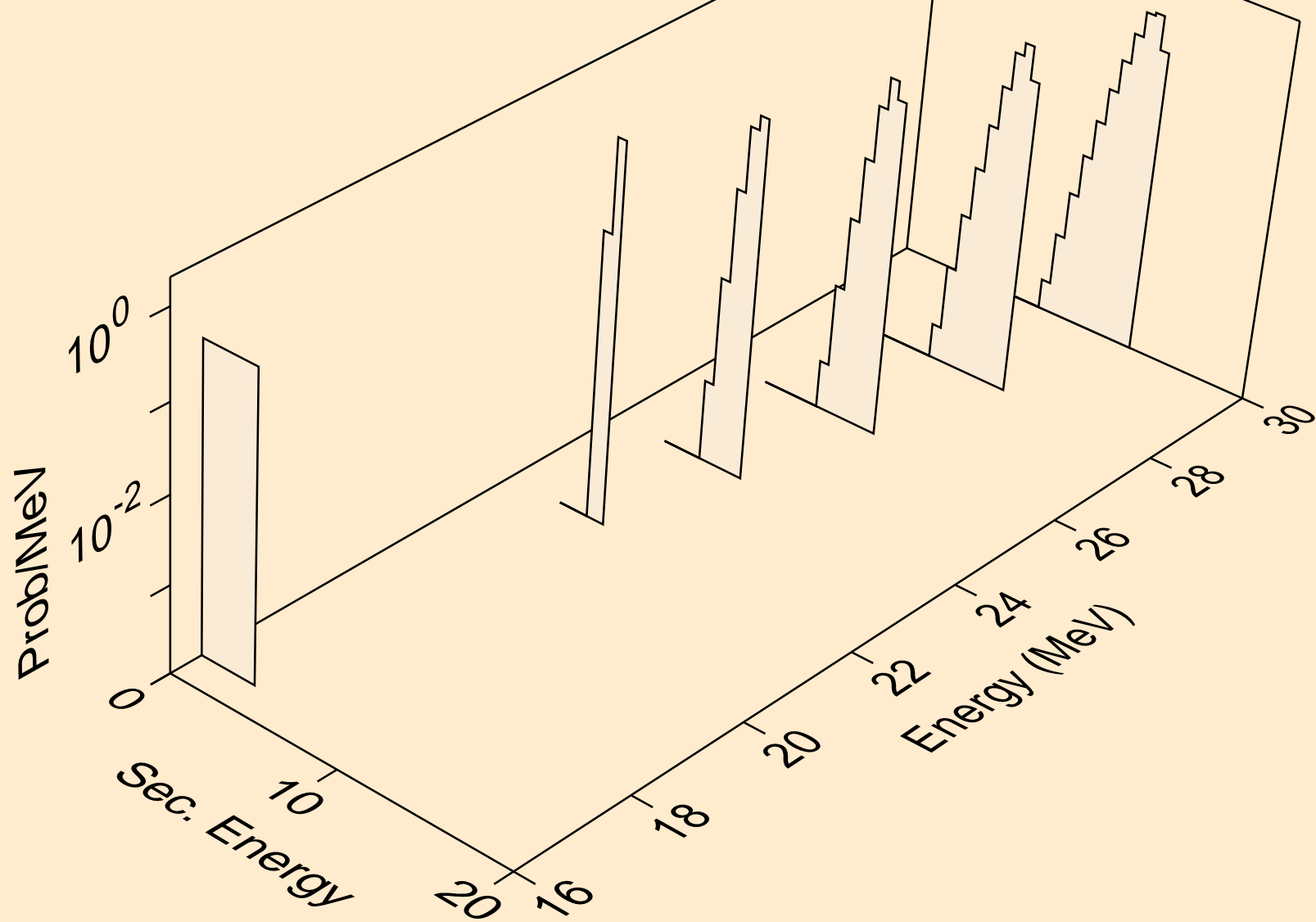

PM154 NEUTRON ACER TENDL-2023 LIBRARY; T=0.K  
he3s from (n,he3)

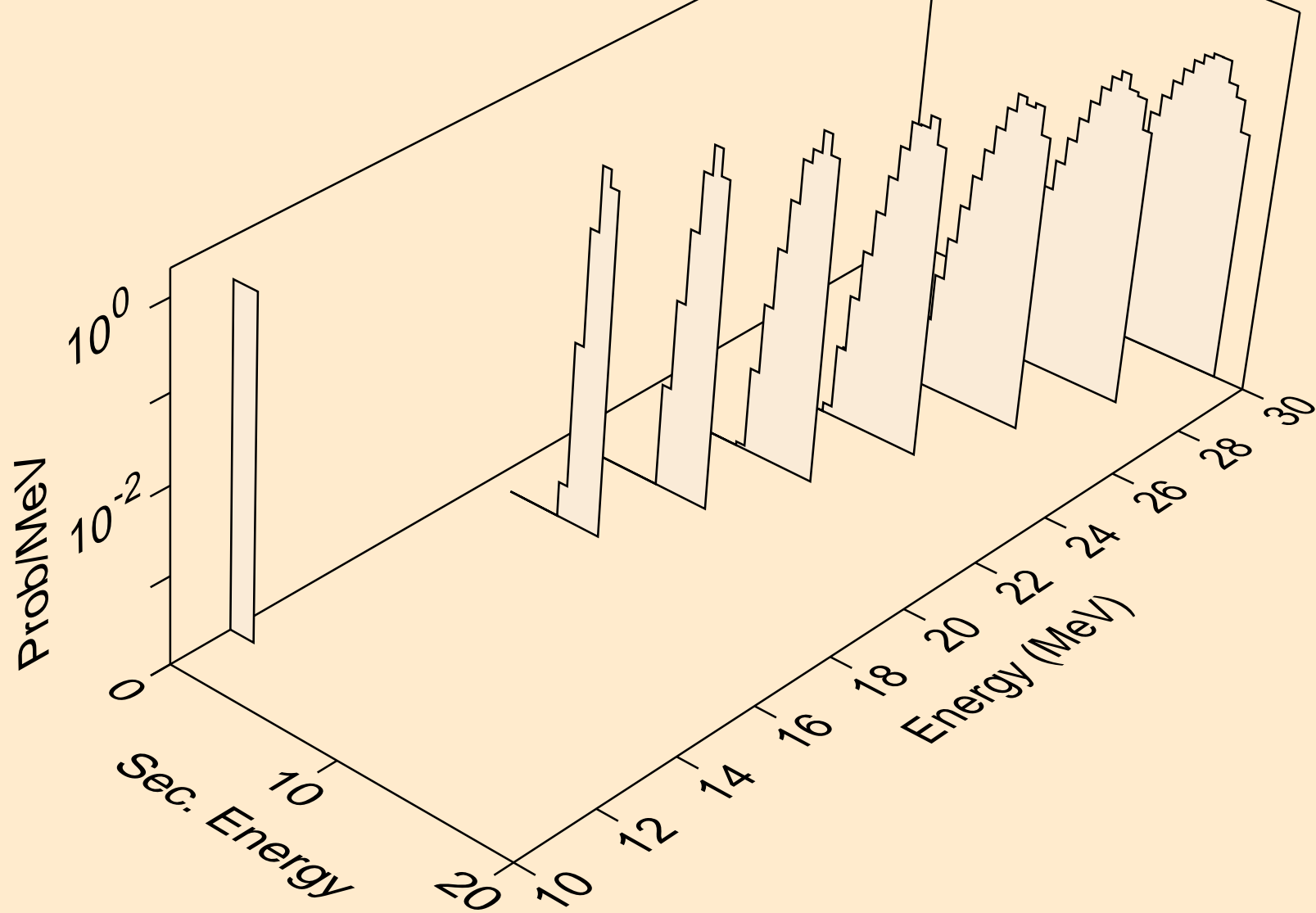

PM154 NEUTRON ACER TENDL-2023 LIBRARY; T=0.K  
alphas from (n,x)

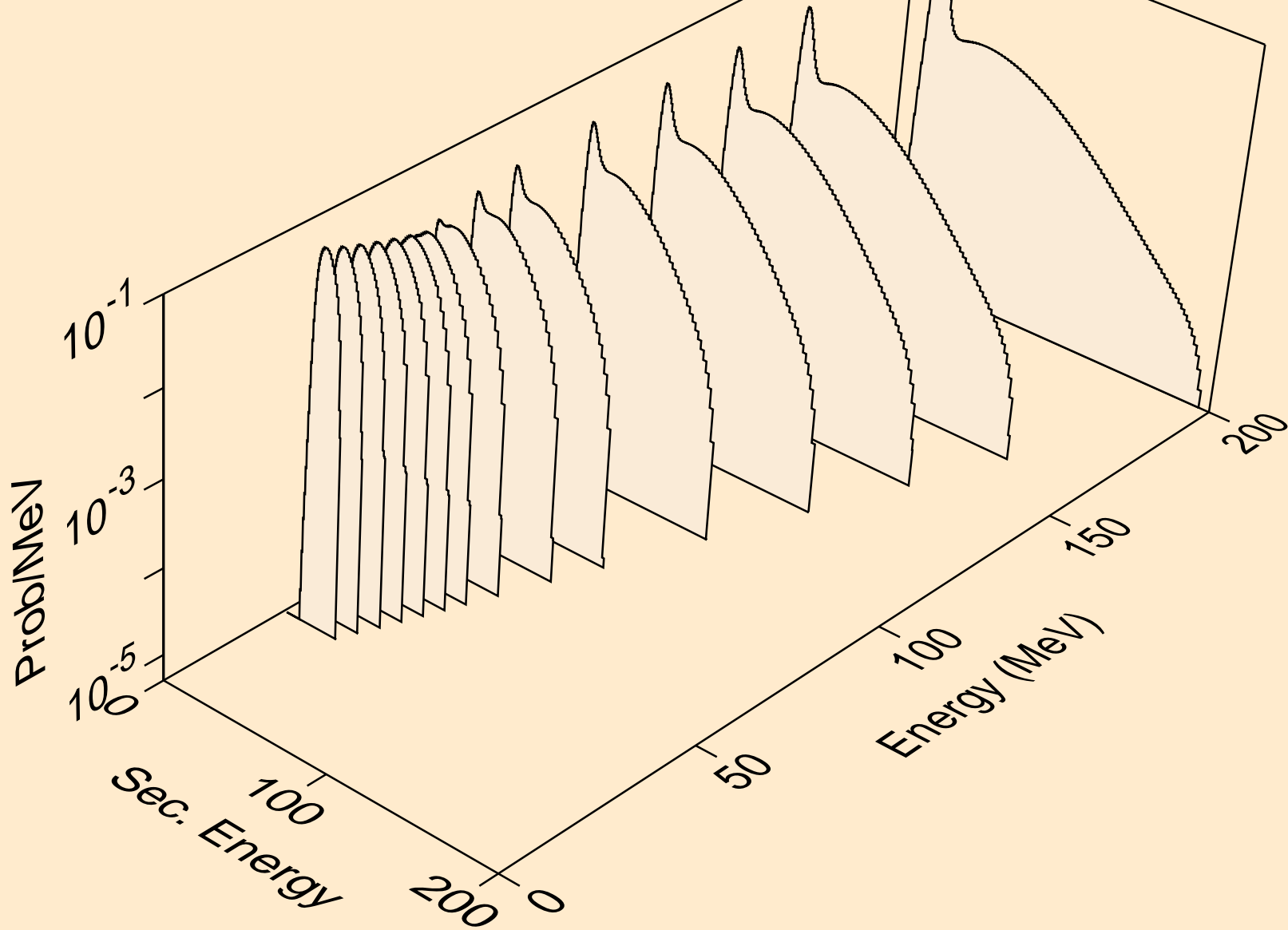

PM154 NEUTRON ACER TENDL-2023 LIBRARY; T=0.K  
alphas from (n,n\*)a

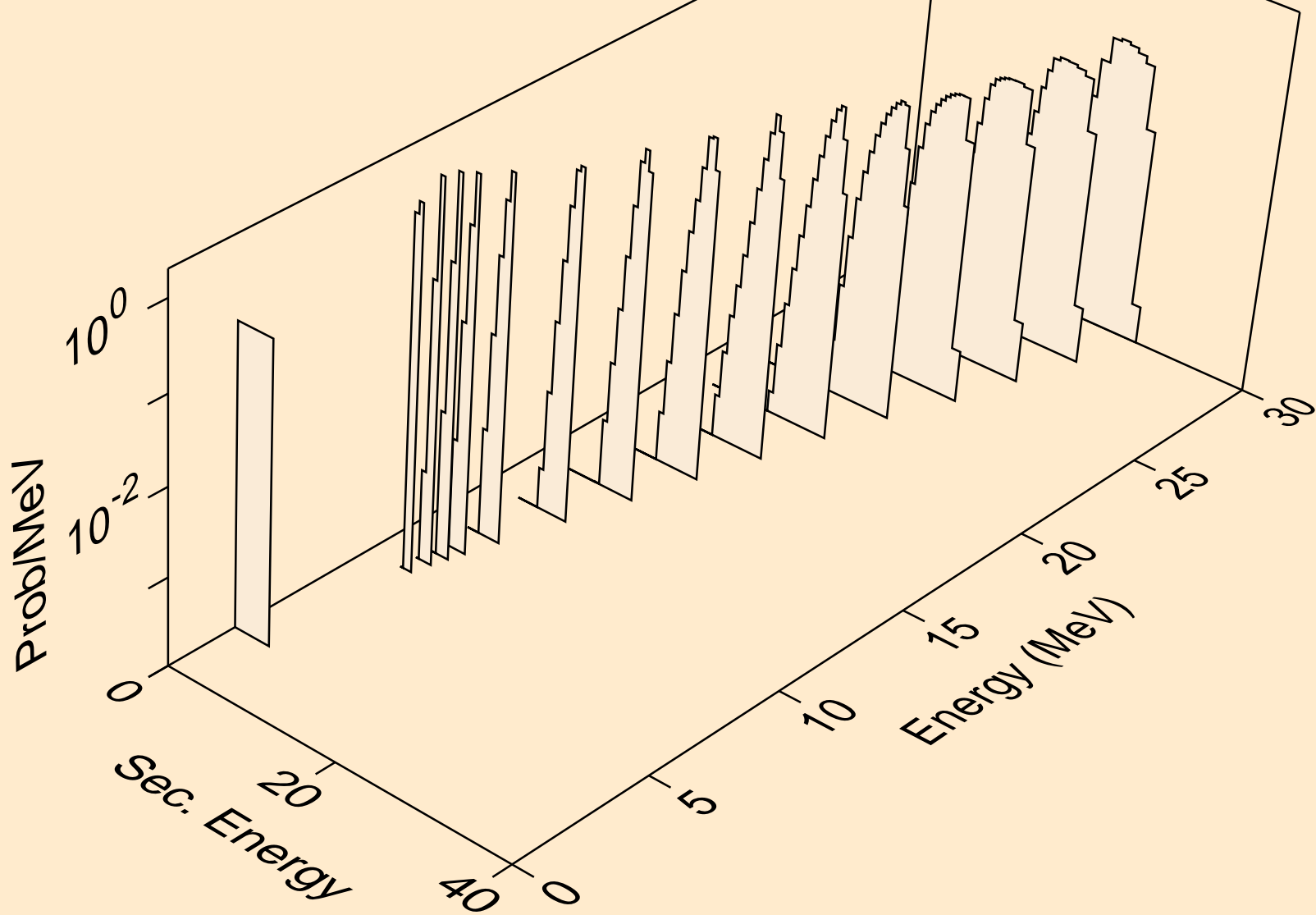

PM154 NEUTRON ACER TENDL-2023 LIBRARY; T=0.K  
alphas from (n,2n)a

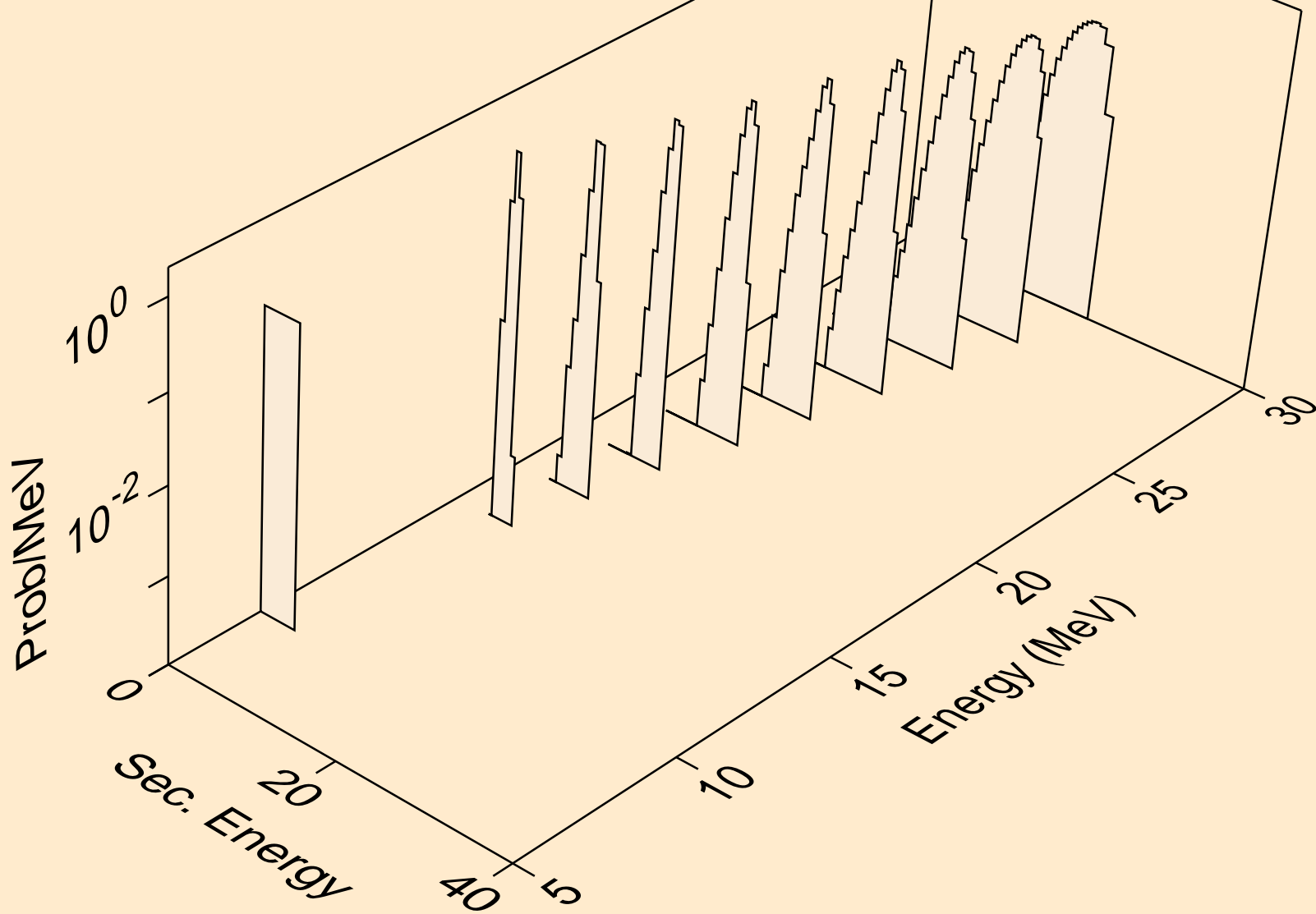

PM154 NEUTRON ACER TENDL-2023 LIBRARY; T=0.K  
alphas from (n,3n)a

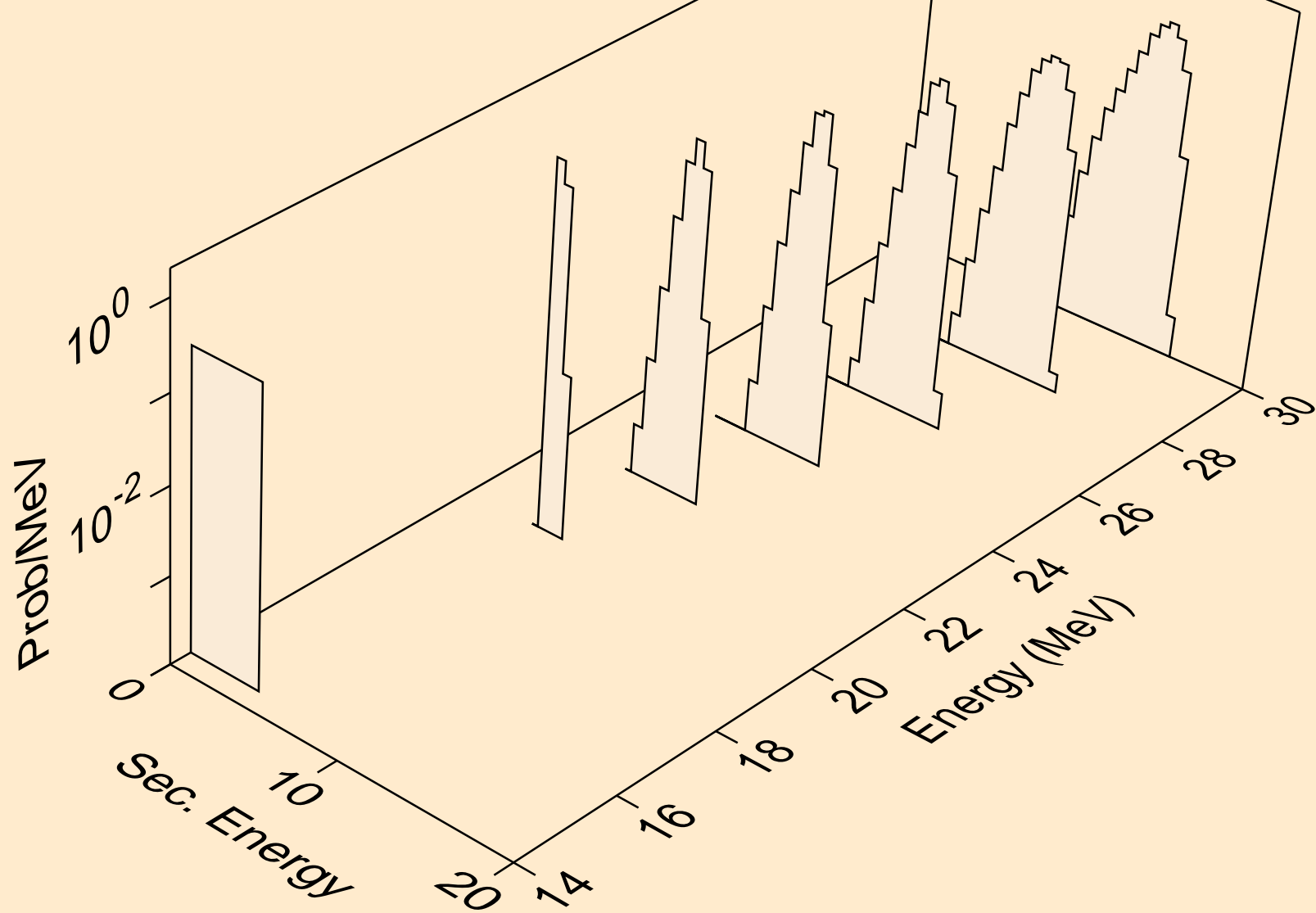

PM154 NEUTRON ACER TENDL-2023 LIBRARY; T=0.K  
alphas from (n,a)

