

RE165 NEUTRON ACER TENDL-2023 LIBRARY; T=0.K  
Principal cross sections

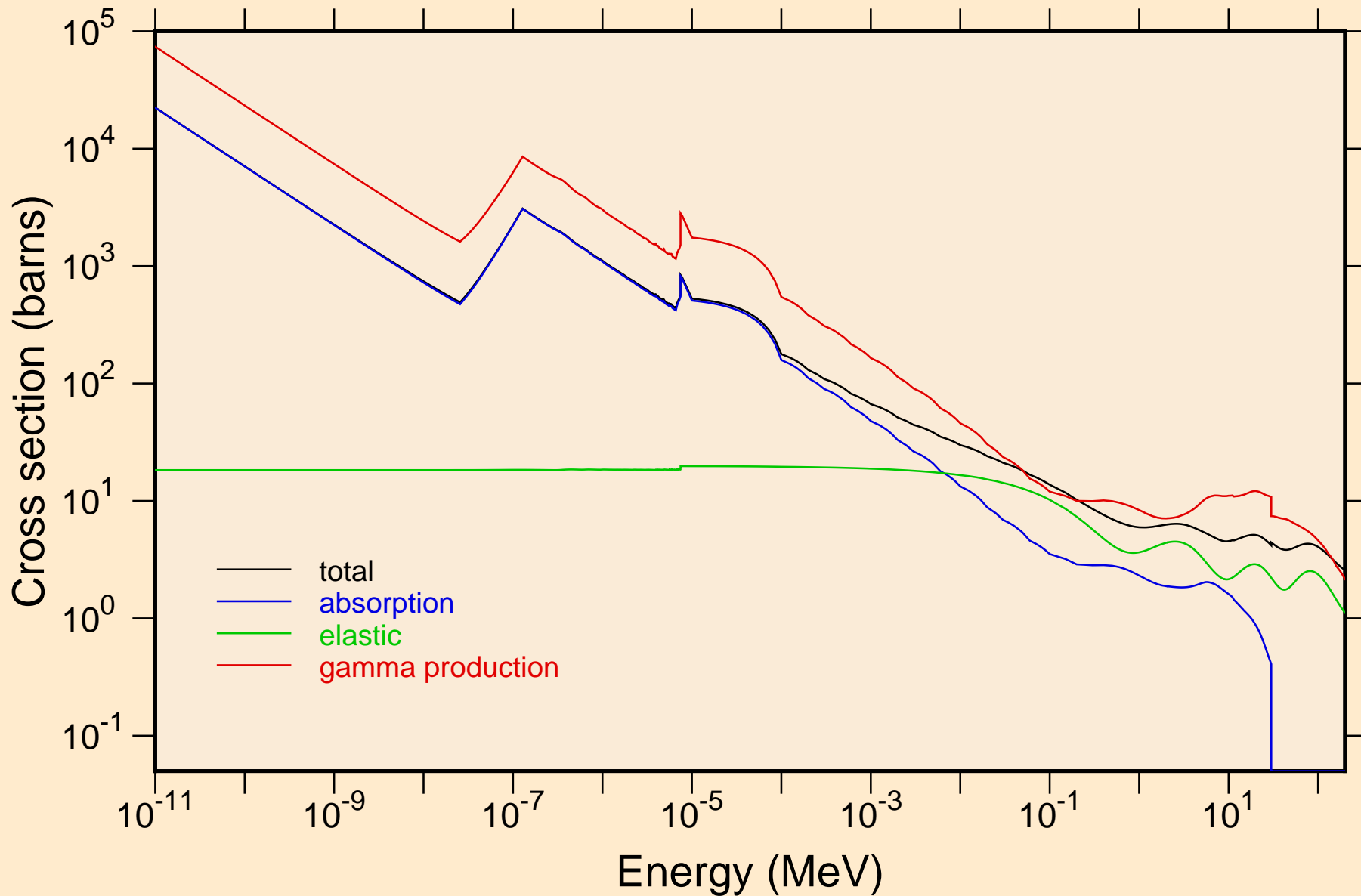

RE165 NEUTRON ACER TENDL-2023 LIBRARY; T=0.K  
resonance total cross section

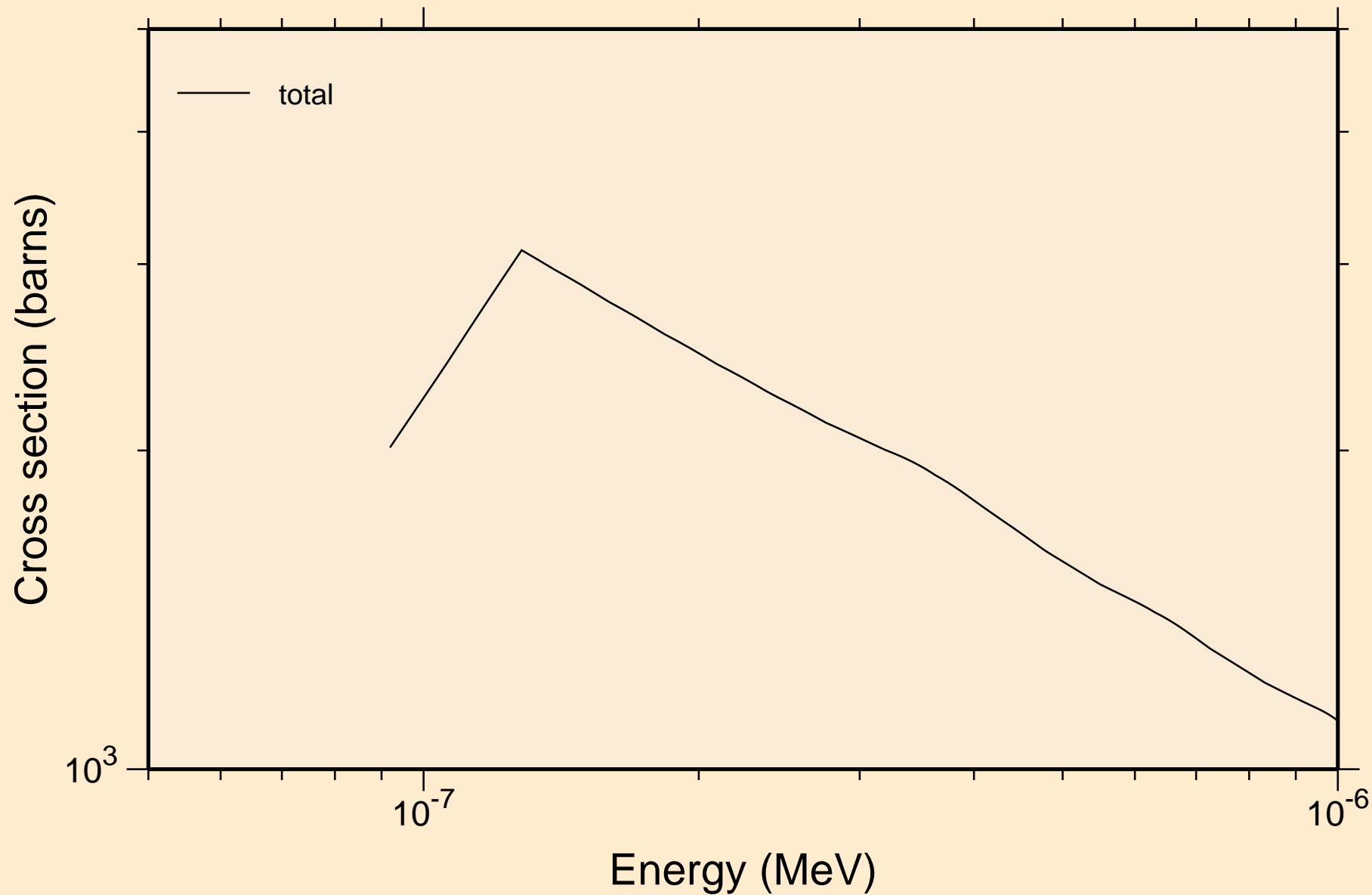

RE165 NEUTRON ACER TENDL-2023 LIBRARY; T=0.K  
resonance total cross section

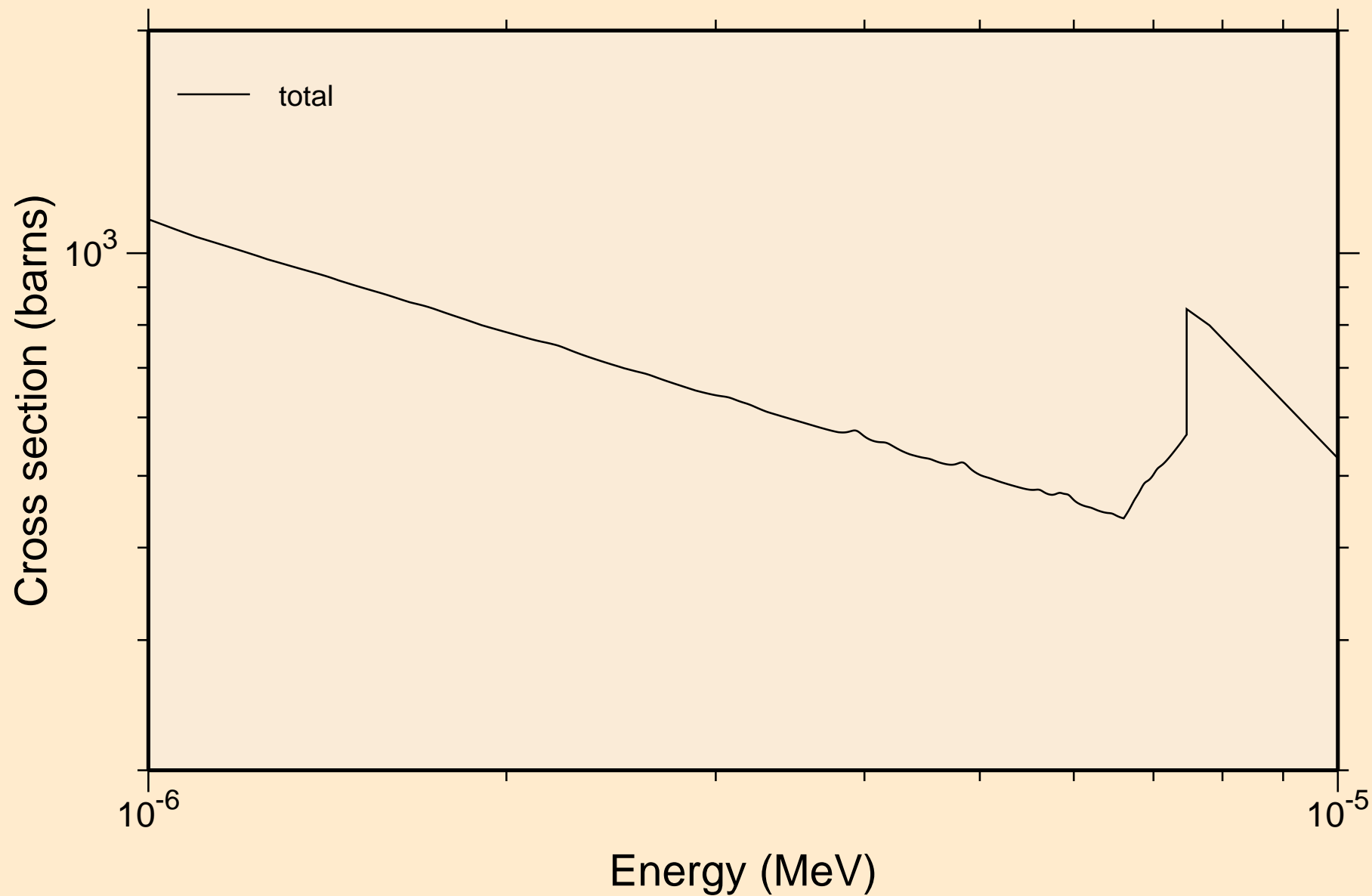

RE165 NEUTRON ACER TENDL-2023 LIBRARY; T=0.K  
resonance total cross section

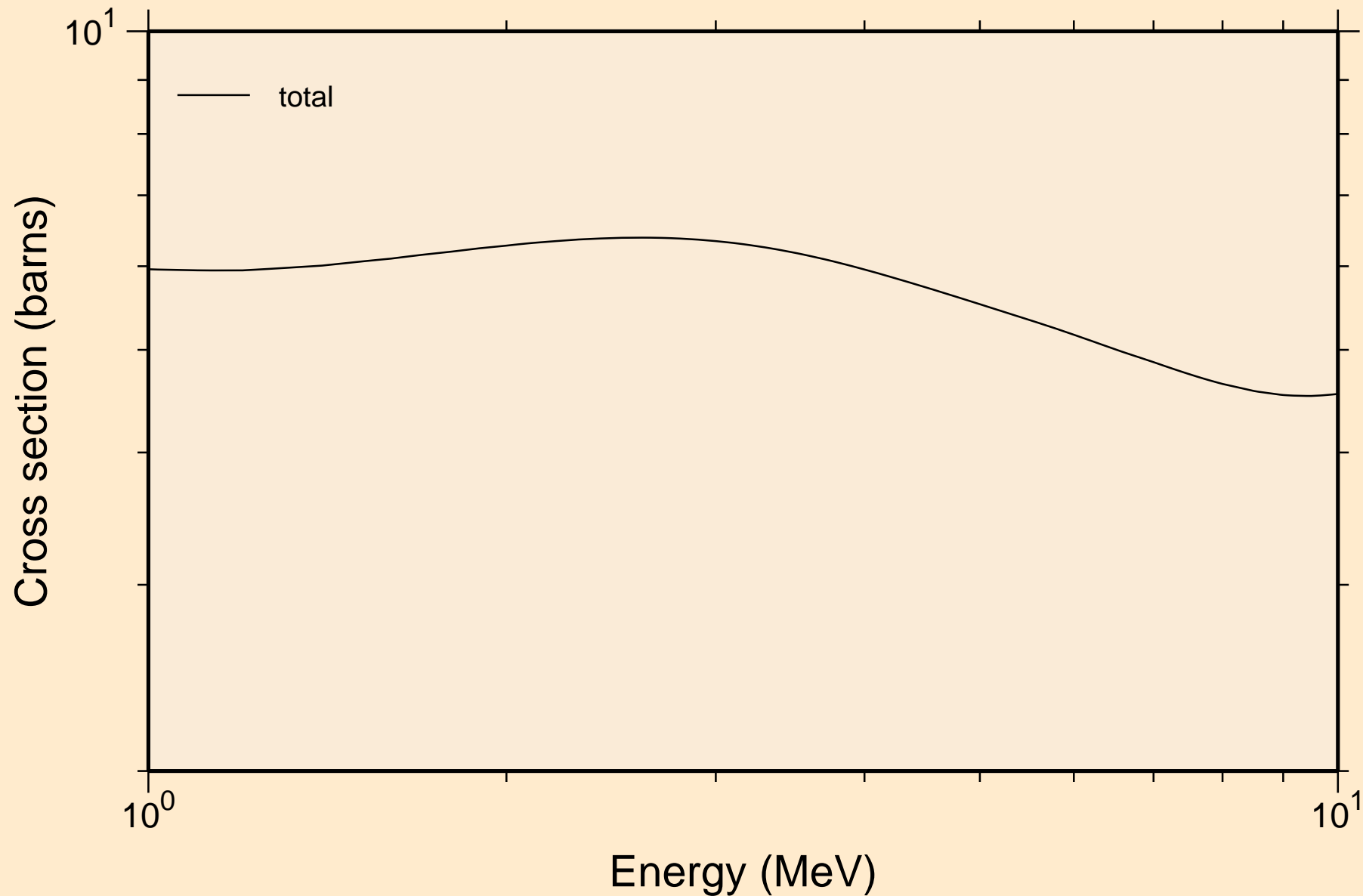

RE165 NEUTRON ACER TENDL-2023 LIBRARY; T=0.K  
resonance absorption cross sections

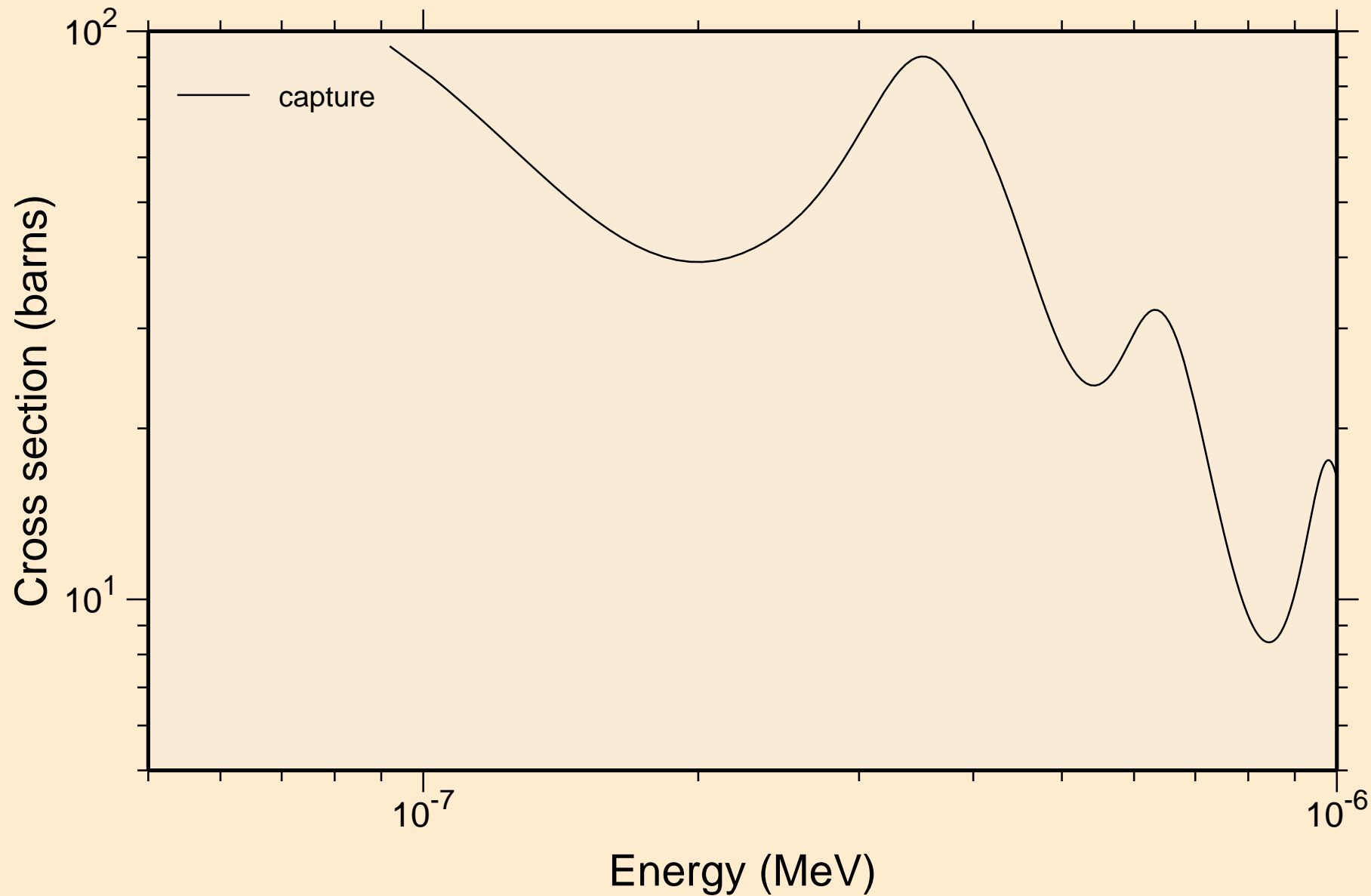

RE165 NEUTRON ACER TENDL-2023 LIBRARY; T=0.K  
resonance absorption cross sections

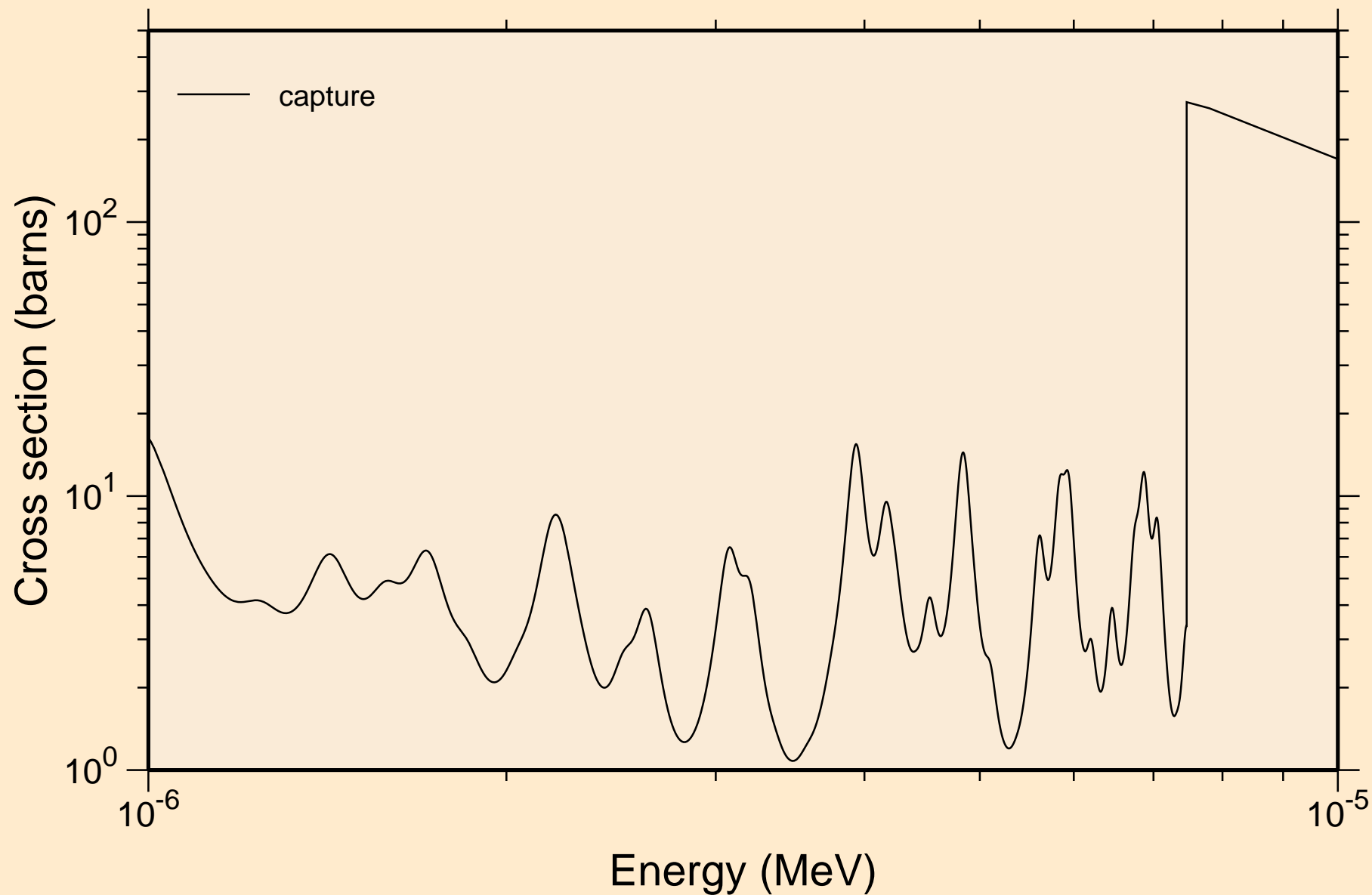

RE165 NEUTRON ACER TENDL-2023 LIBRARY; T=0.K  
resonance absorption cross sections

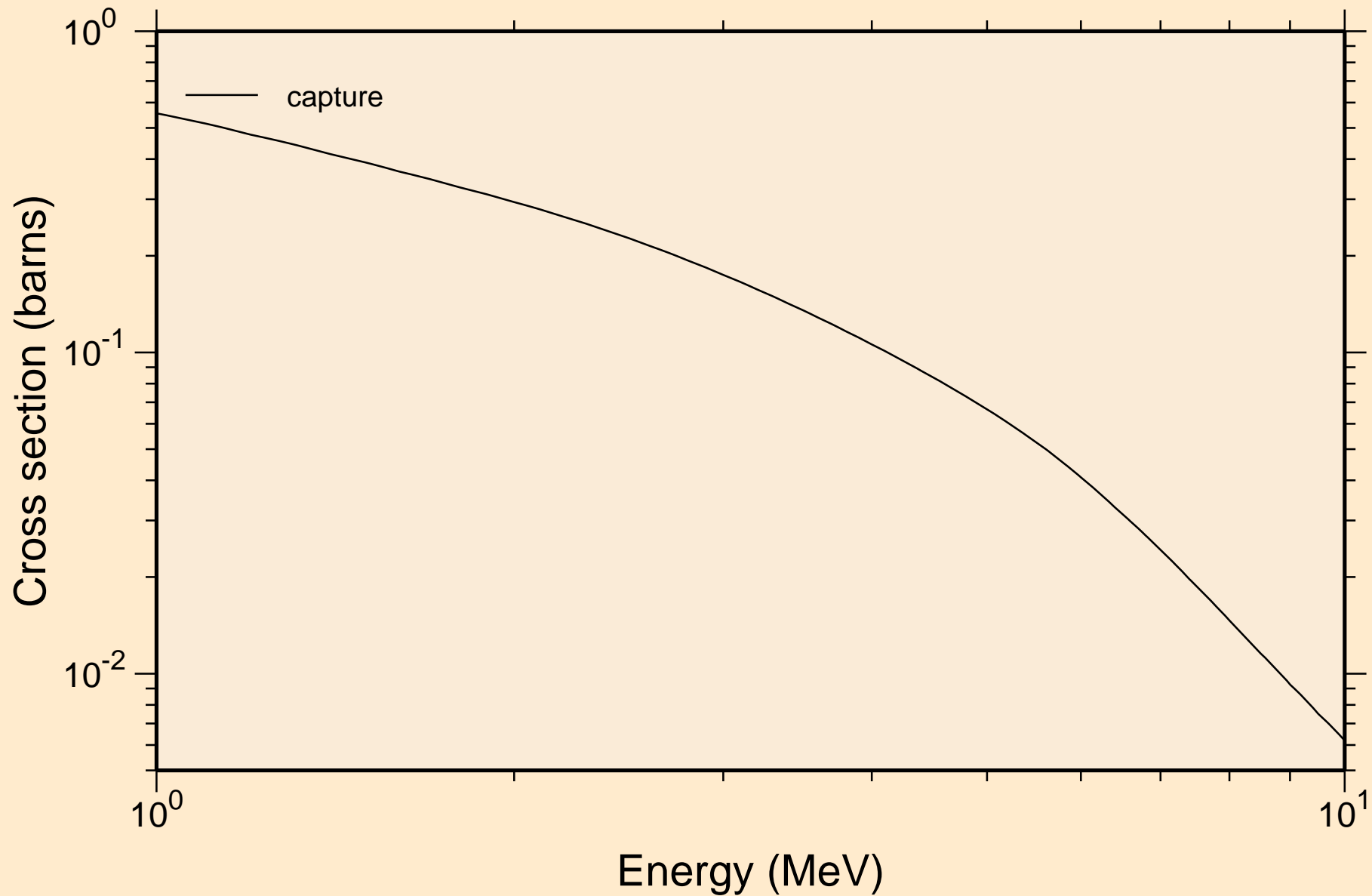

RE165 NEUTRON ACER TENDL-2023 LIBRARY; T=0.K  
Heating

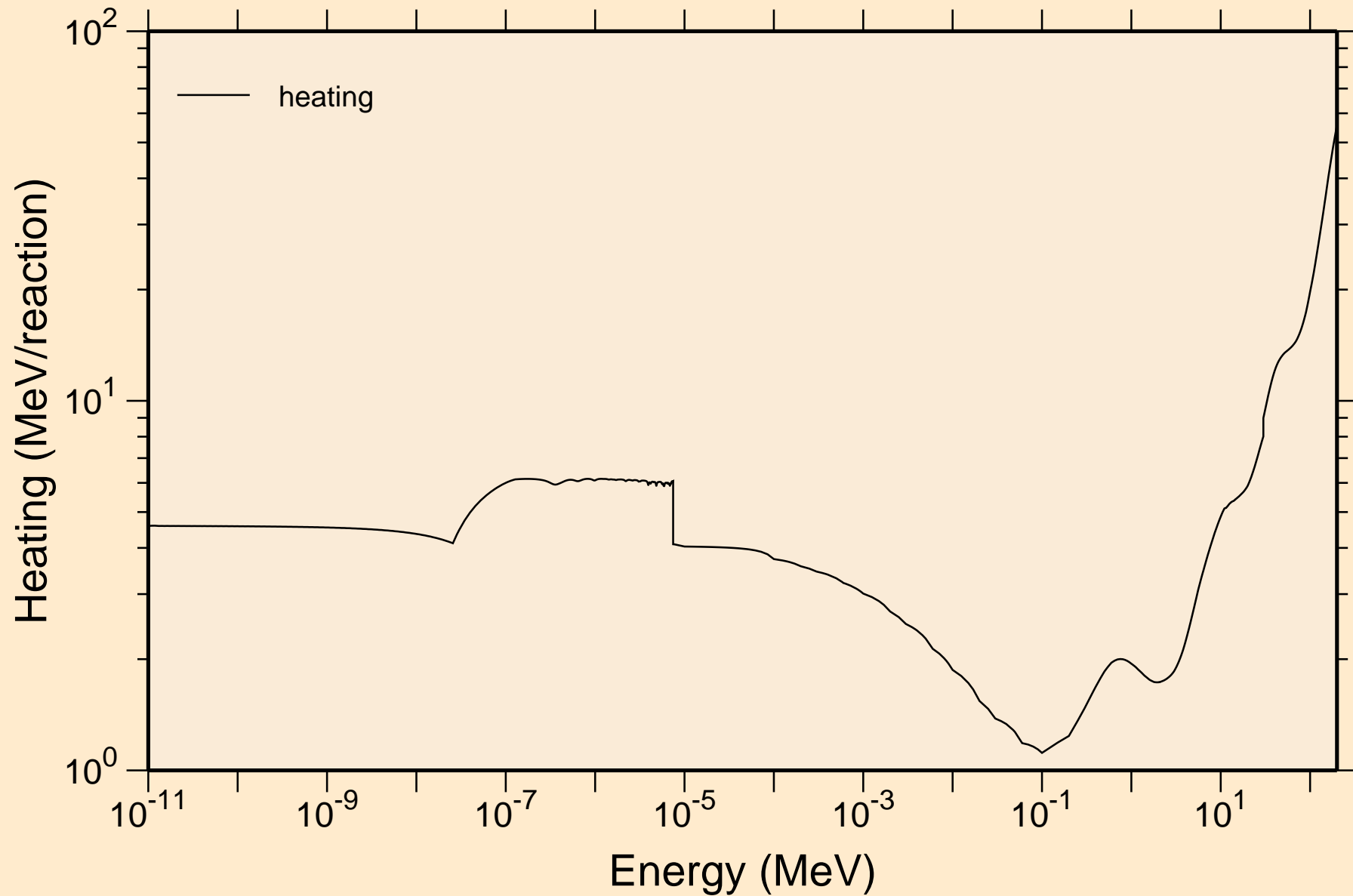

RE165 NEUTRON ACER TENDL-2023 LIBRARY; T=0.K  
Damage

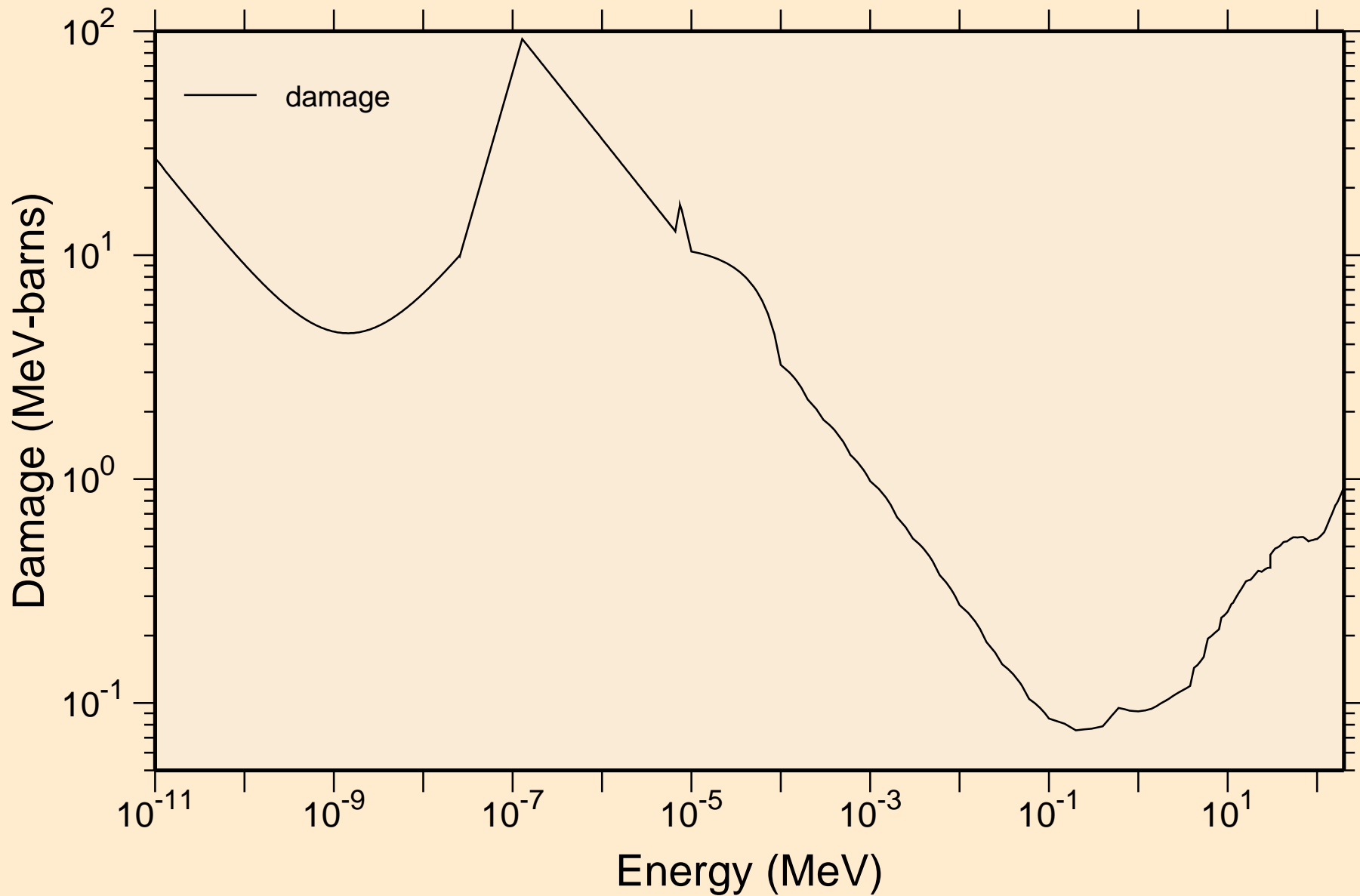

RE165 NEUTRON ACER TENDL-2023 LIBRARY; T=0.K  
Non-threshold reactions

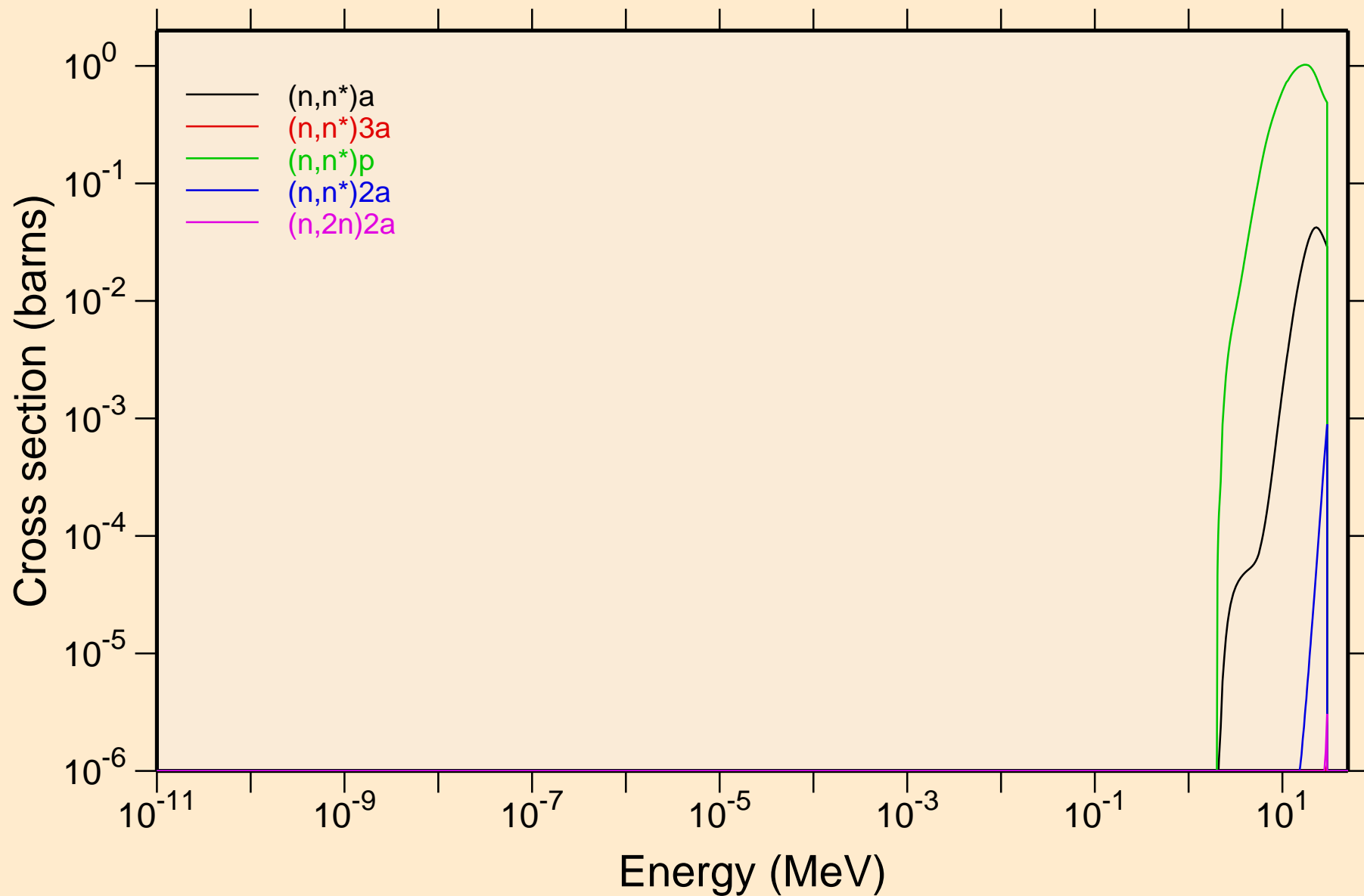

RE165 NEUTRON ACER TENDL-2023 LIBRARY; T=0.K  
Non-threshold reactions

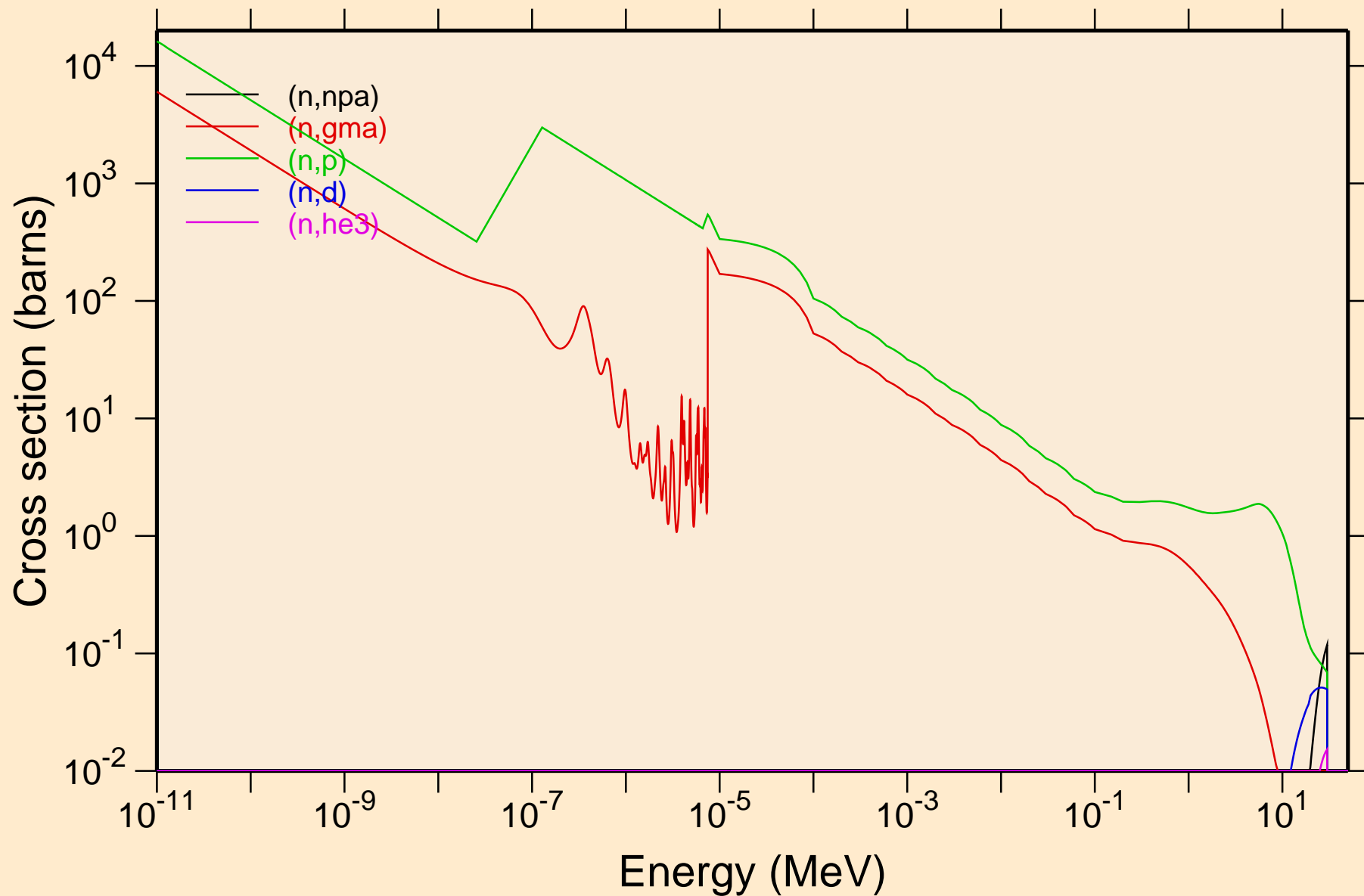

RE165 NEUTRON ACER TENDL-2023 LIBRARY; T=0.K  
Non-threshold reactions

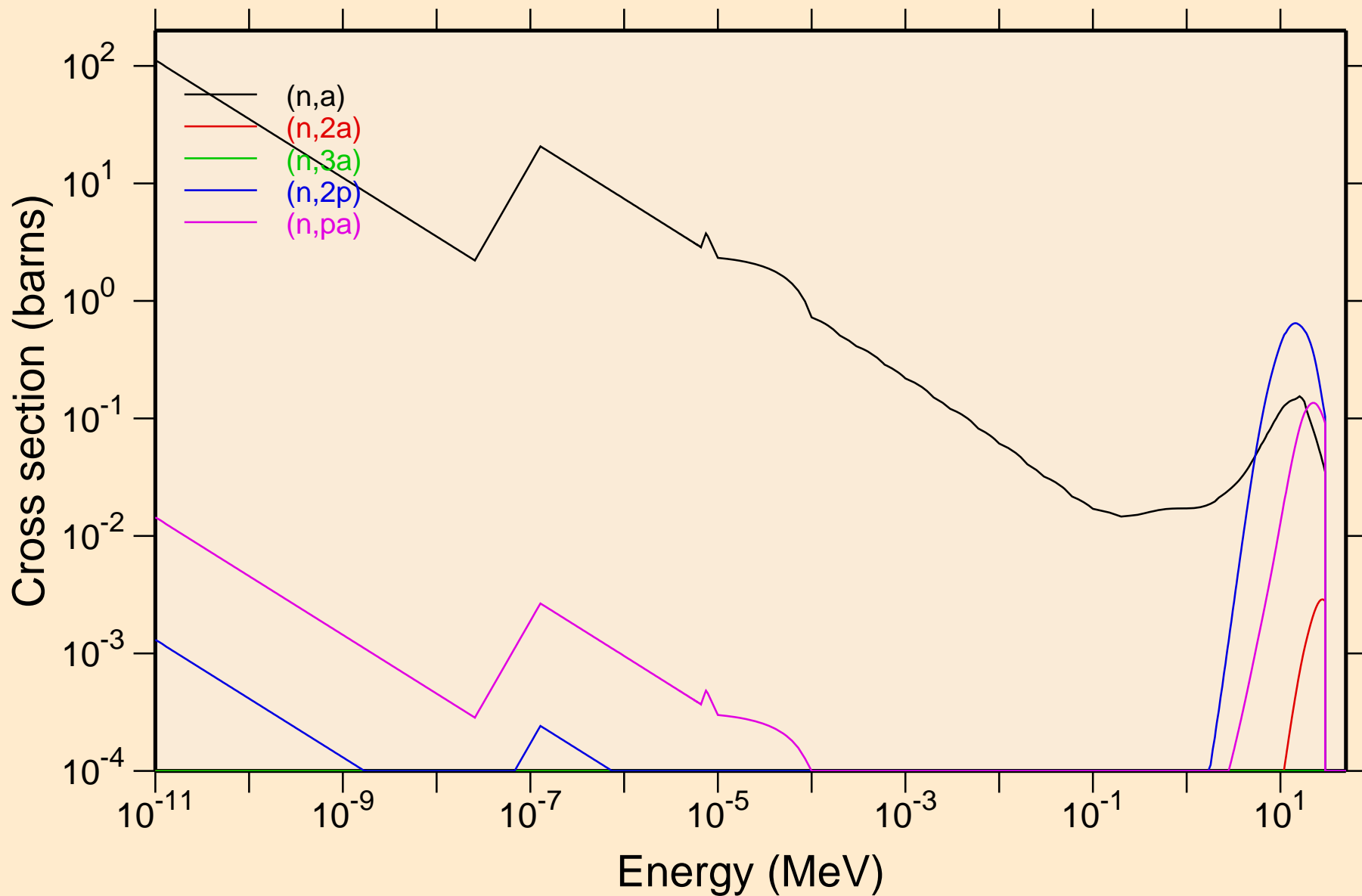

RE165 NEUTRON ACER TENDL-2023 LIBRARY; T=0.K  
Non-threshold reactions

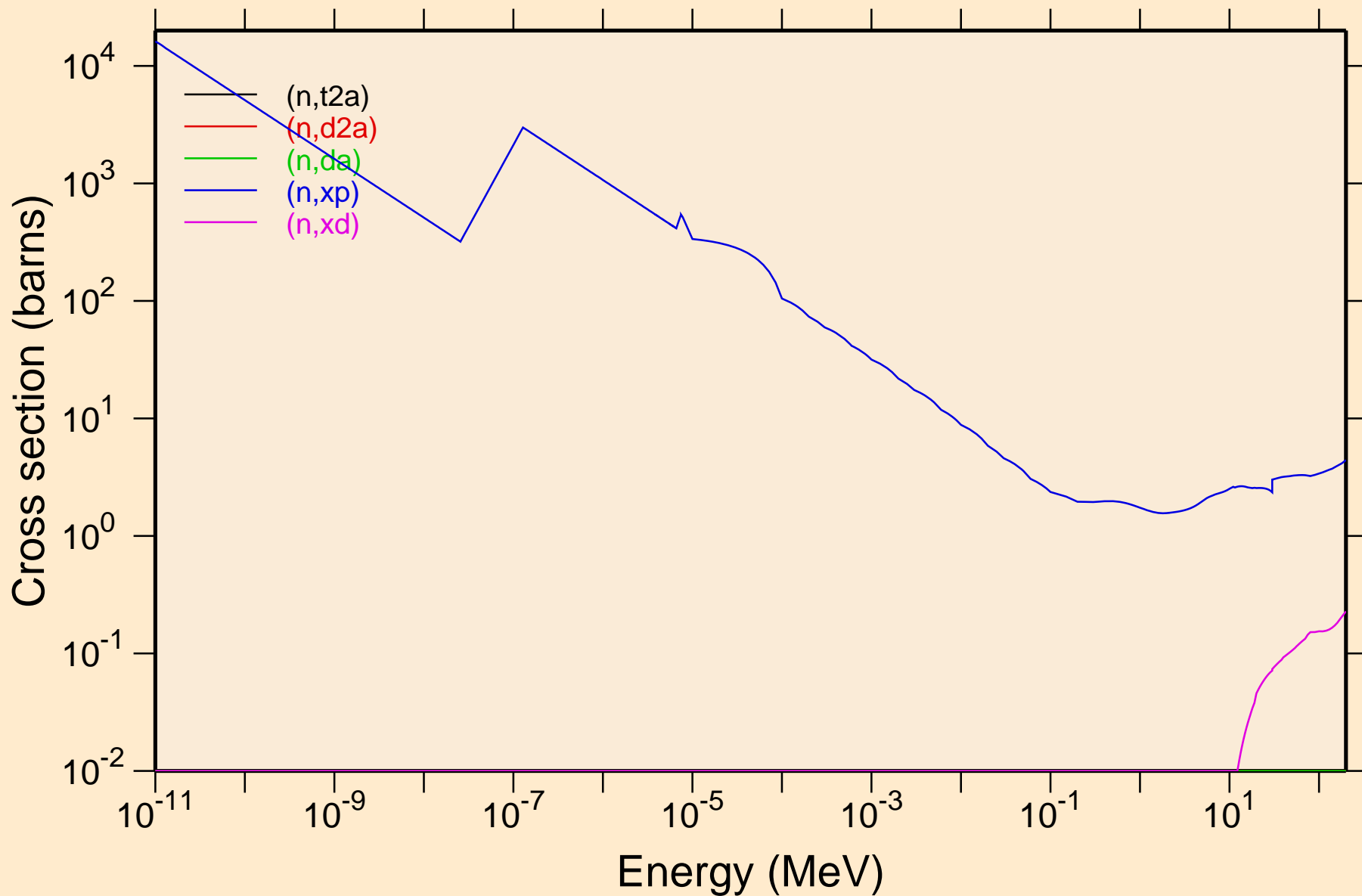

RE165 NEUTRON ACER TENDL-2023 LIBRARY; T=0.K  
Non-threshold reactions

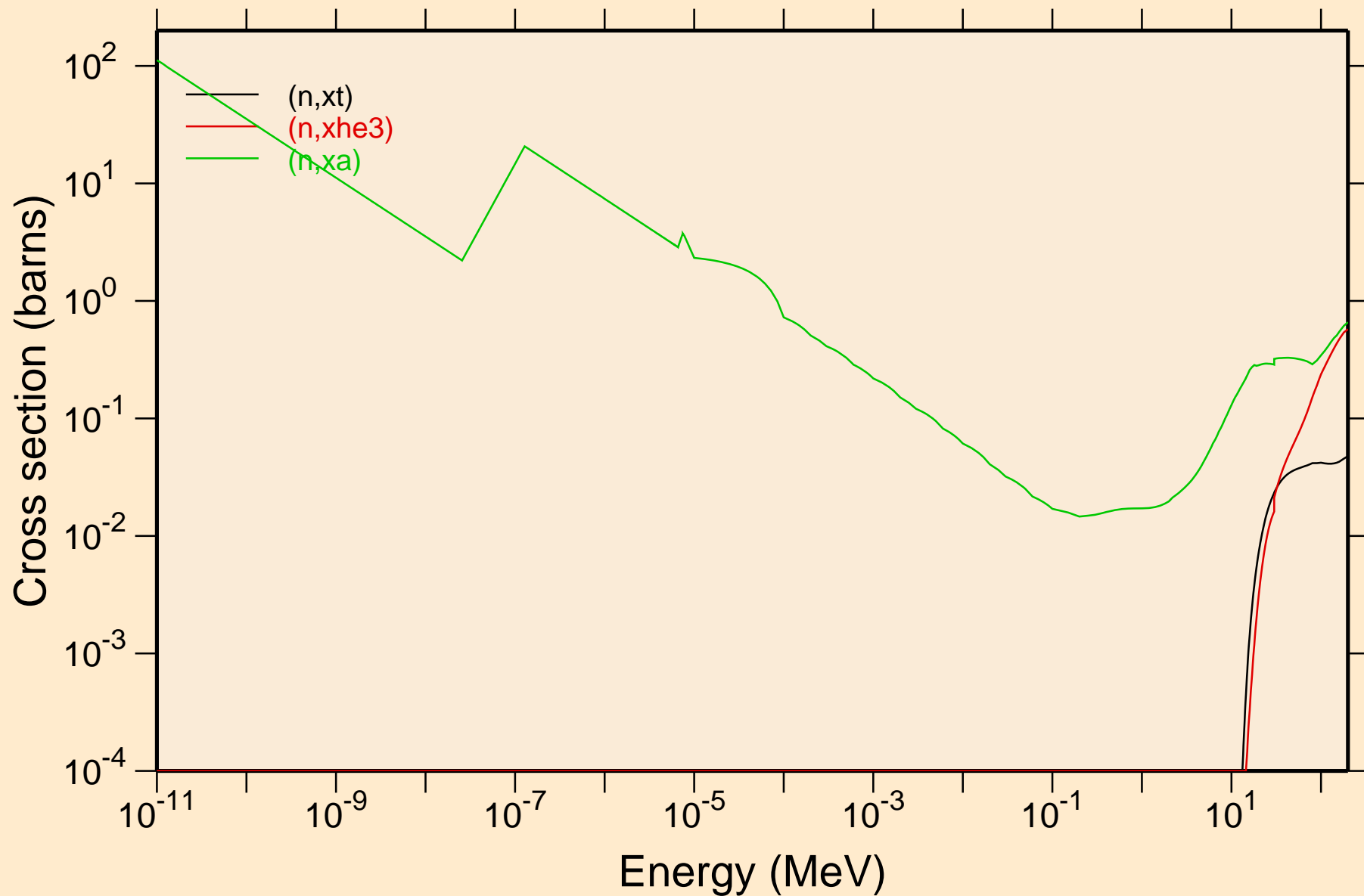

RE165 NEUTRON ACER TENDL-2023 LIBRARY; T=0.K  
Principal cross sections

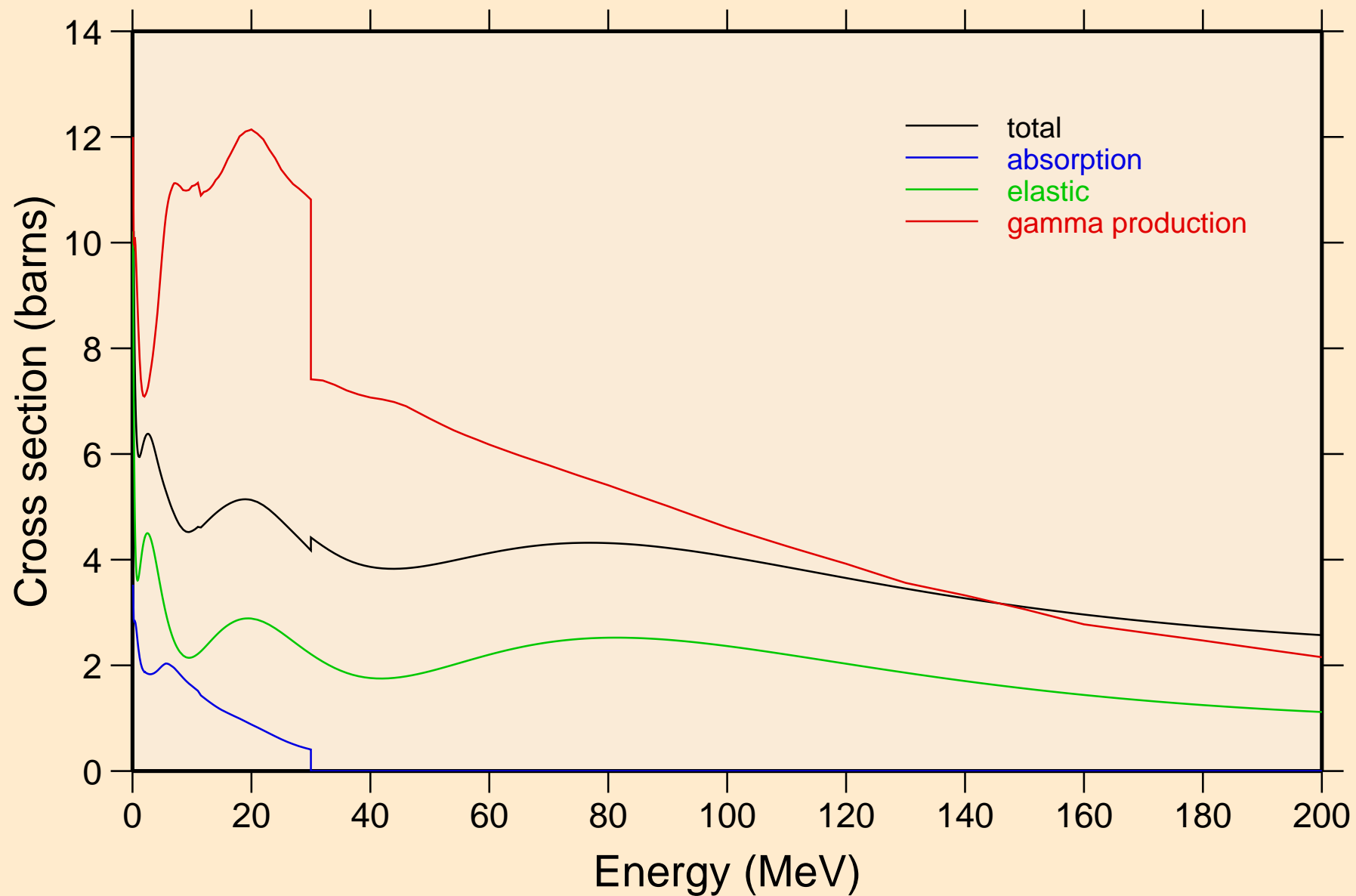

RE165 NEUTRON ACER TENDL-2023 LIBRARY; T=0.K  
Heating

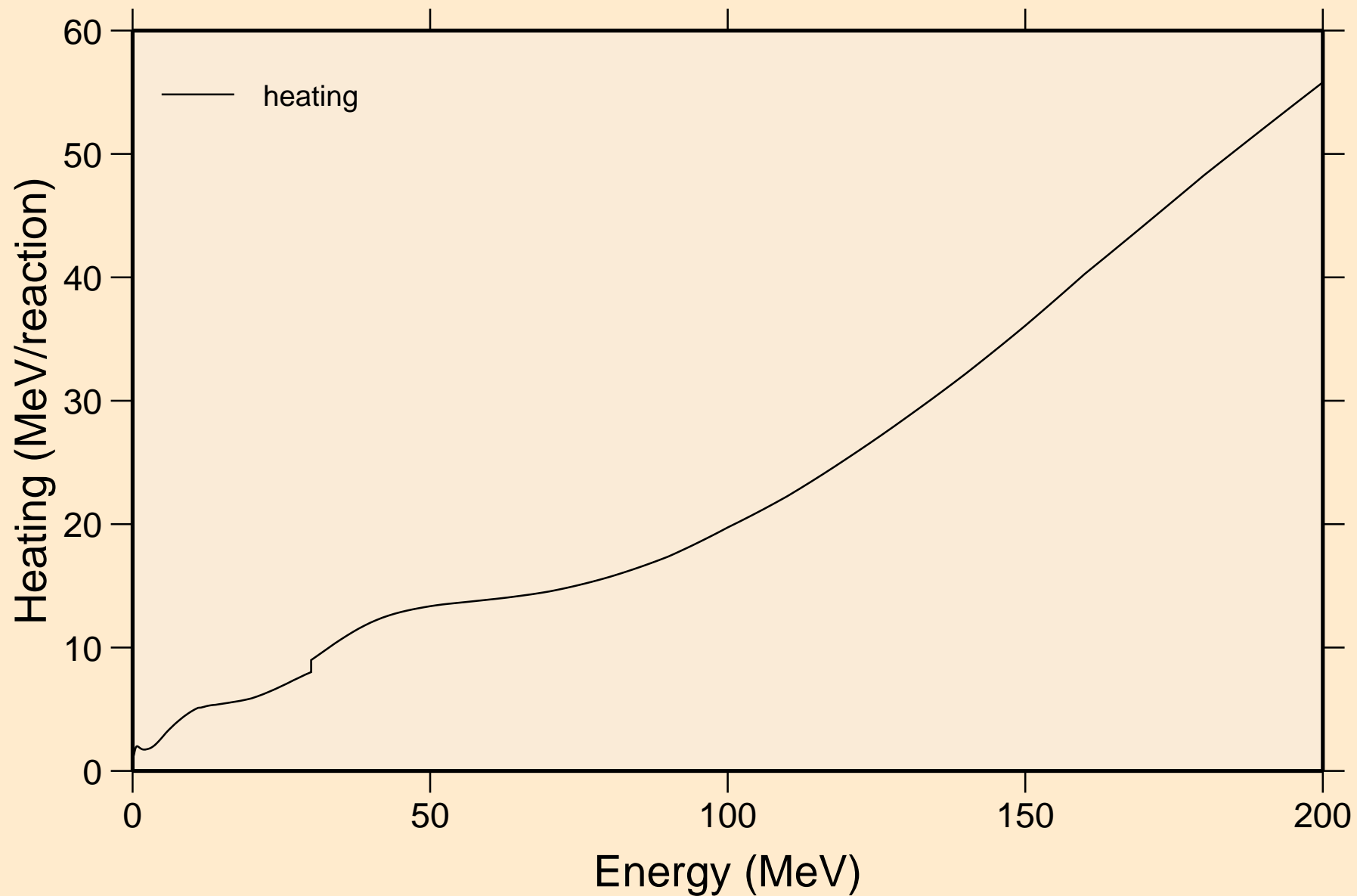

RE165 NEUTRON ACER TENDL-2023 LIBRARY; T=0.K  
Damage

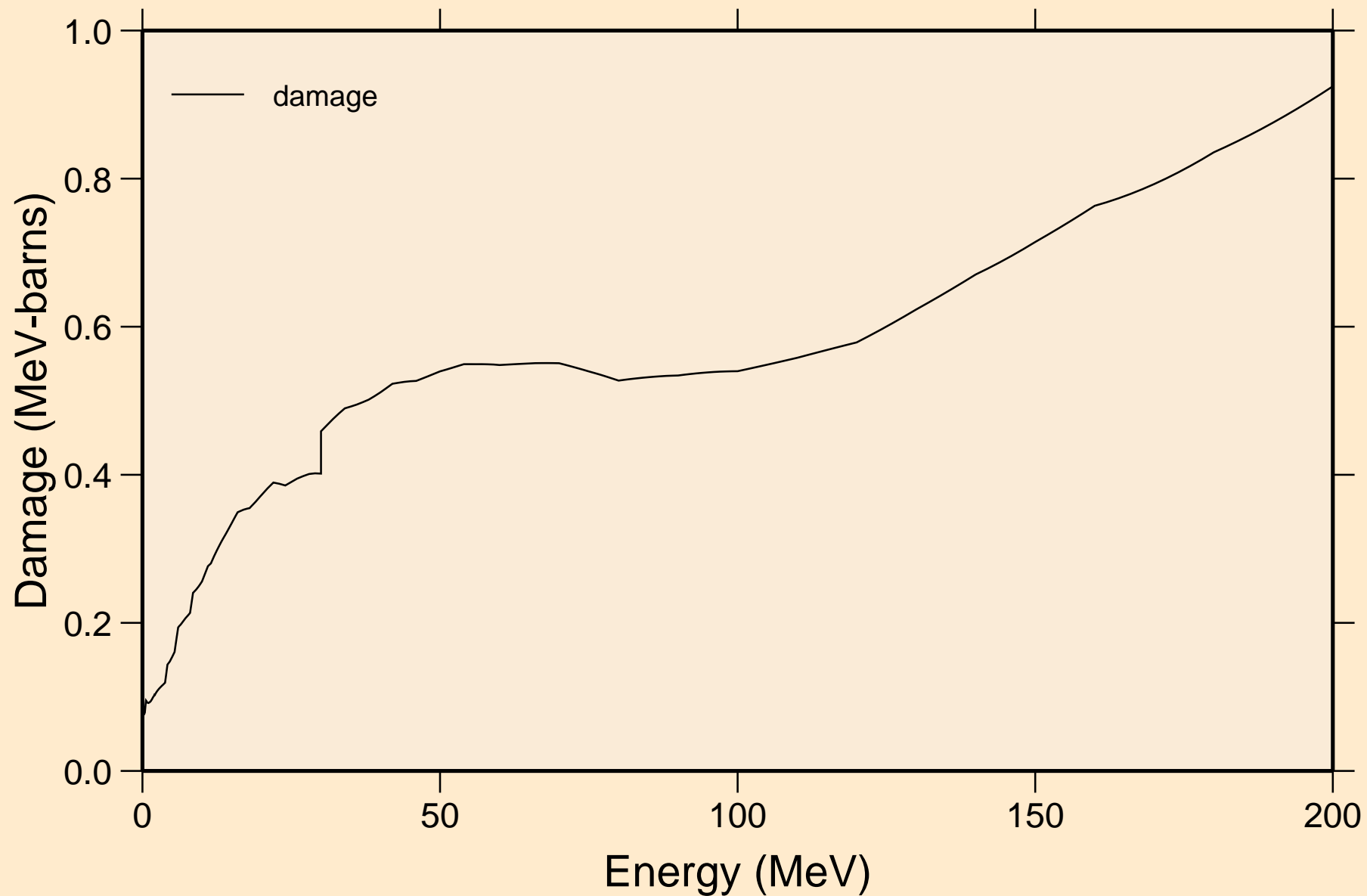

RE165 NEUTRON ACER TENDL-2023 LIBRARY; T=0.K  
Non-threshold reactions

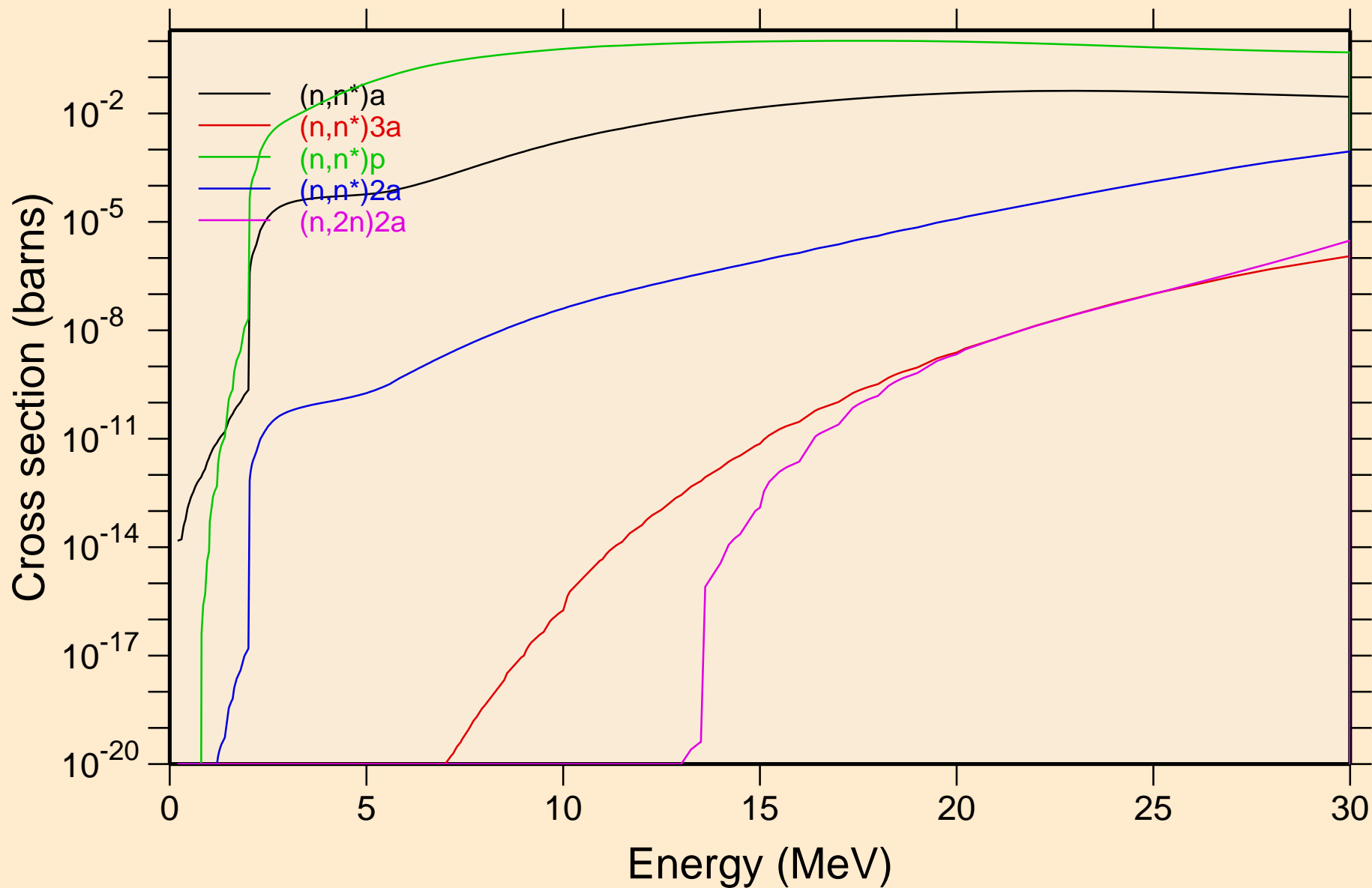

RE165 NEUTRON ACER TENDL-2023 LIBRARY; T=0.K  
Non-threshold reactions

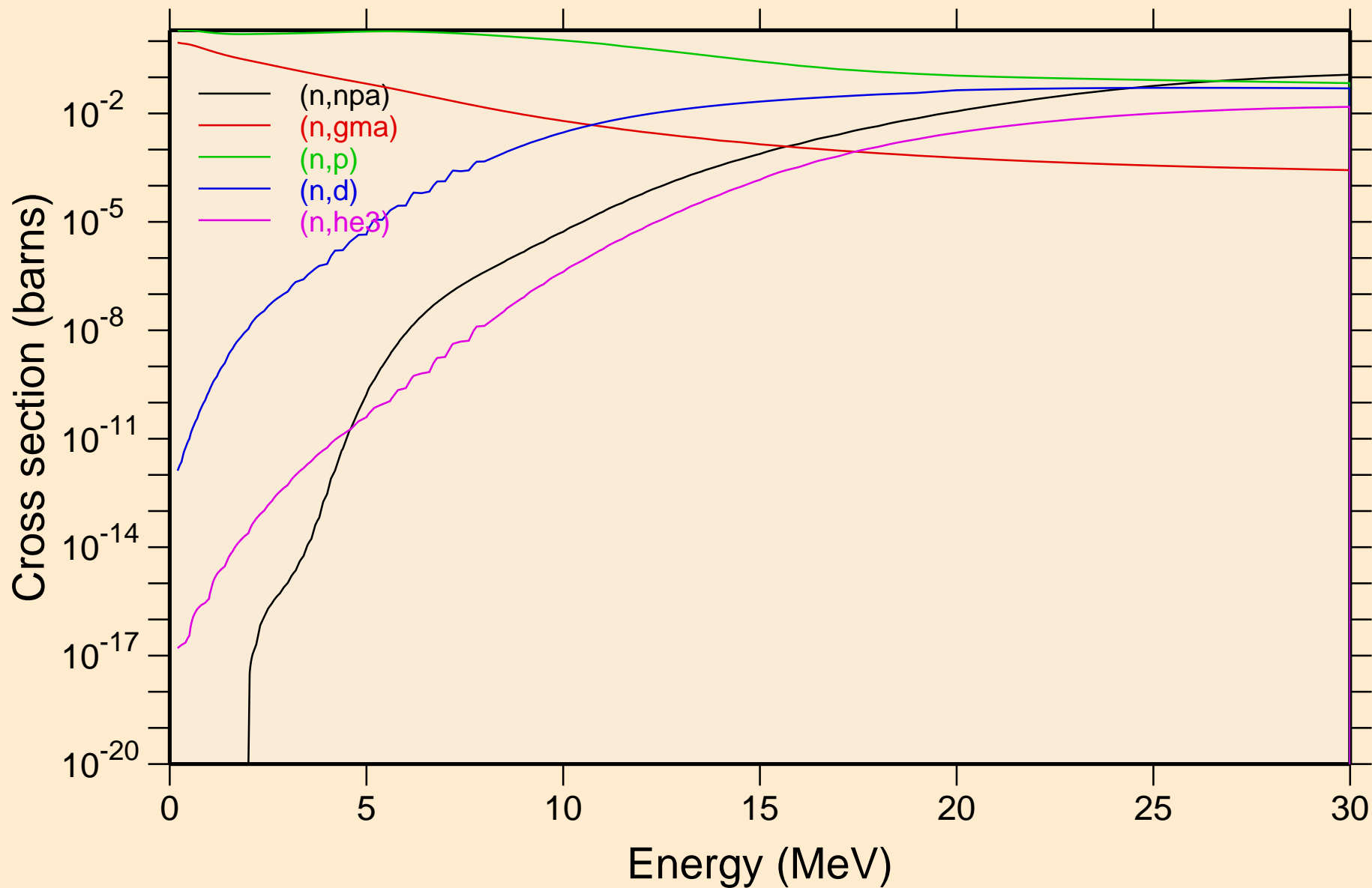

RE165 NEUTRON ACER TENDL-2023 LIBRARY; T=0.K  
Non-threshold reactions

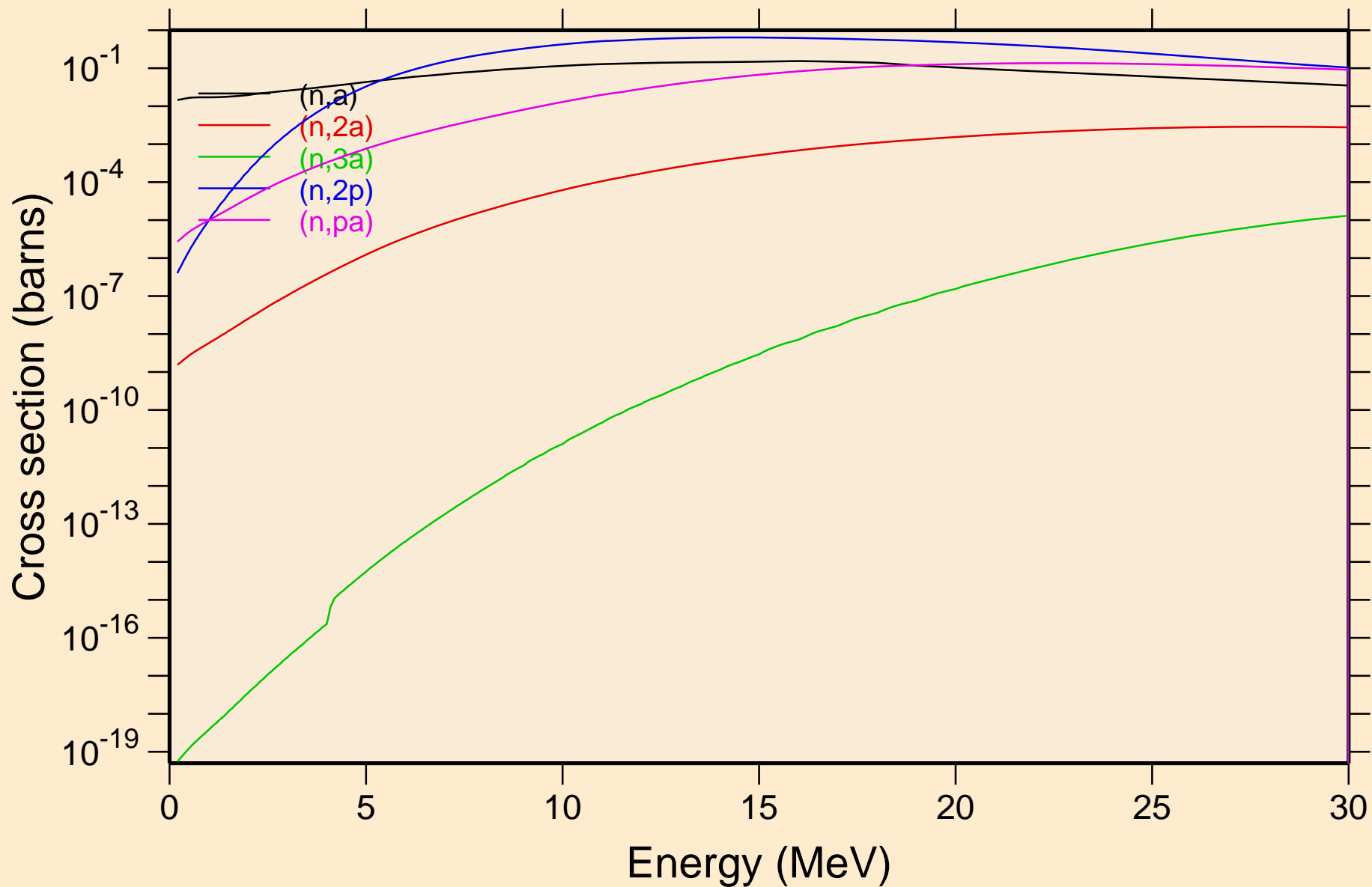

RE165 NEUTRON ACER TENDL-2023 LIBRARY; T=0.K  
Non-threshold reactions

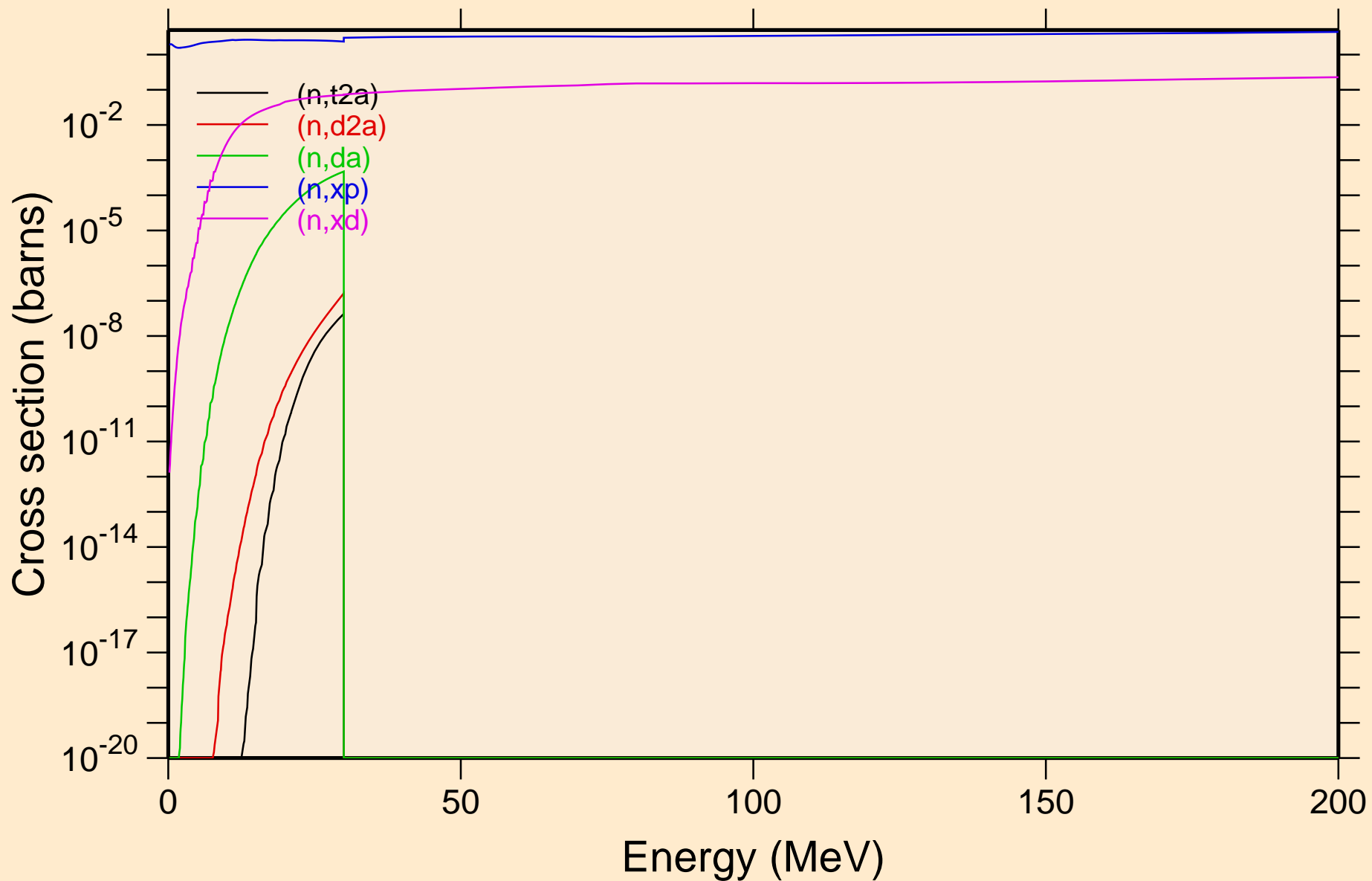

RE165 NEUTRON ACER TENDL-2023 LIBRARY; T=0.K  
Non-threshold reactions

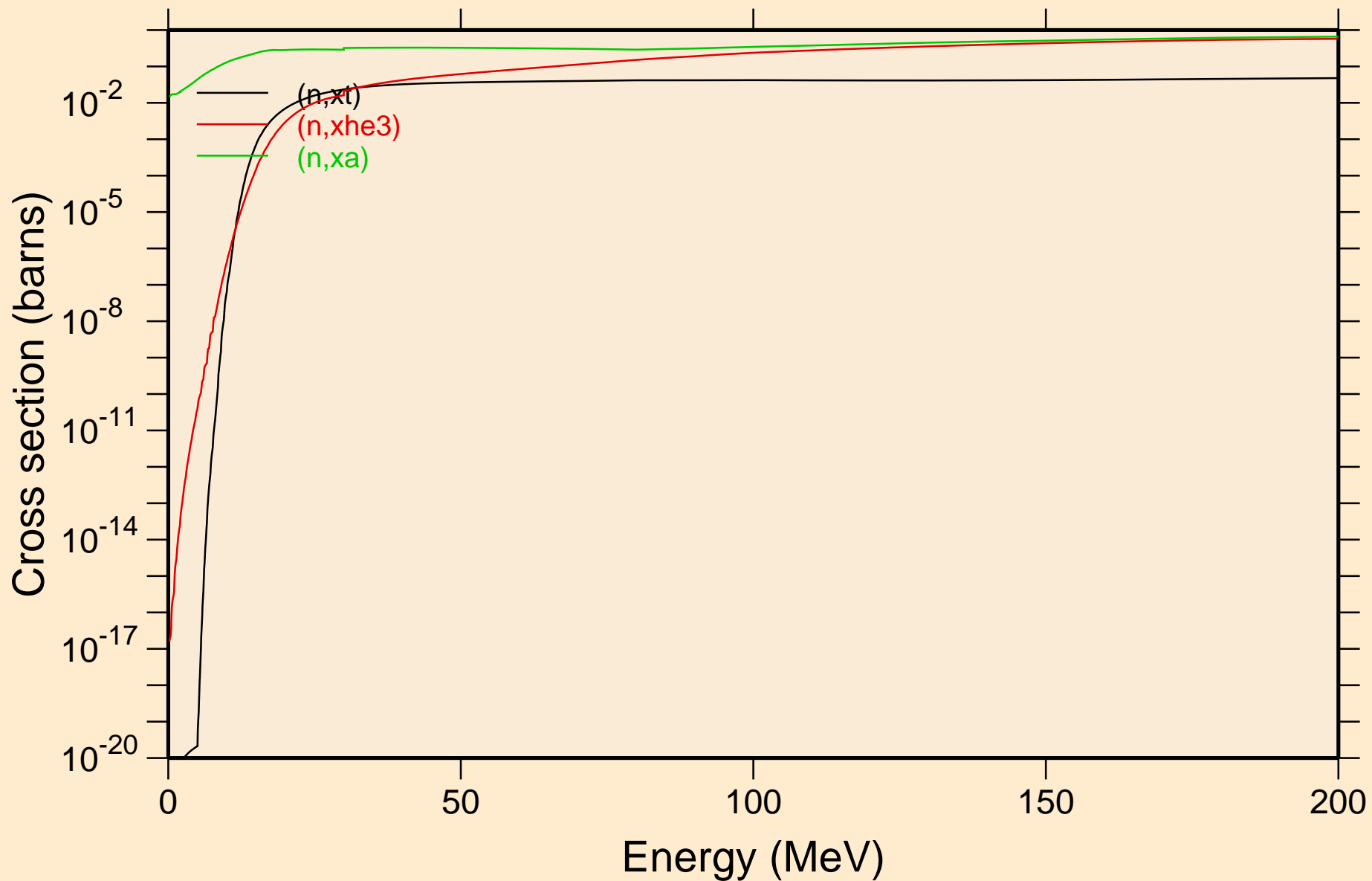

RE165 NEUTRON ACER TENDL-2023 LIBRARY; T=0.K  
Inelastic levels

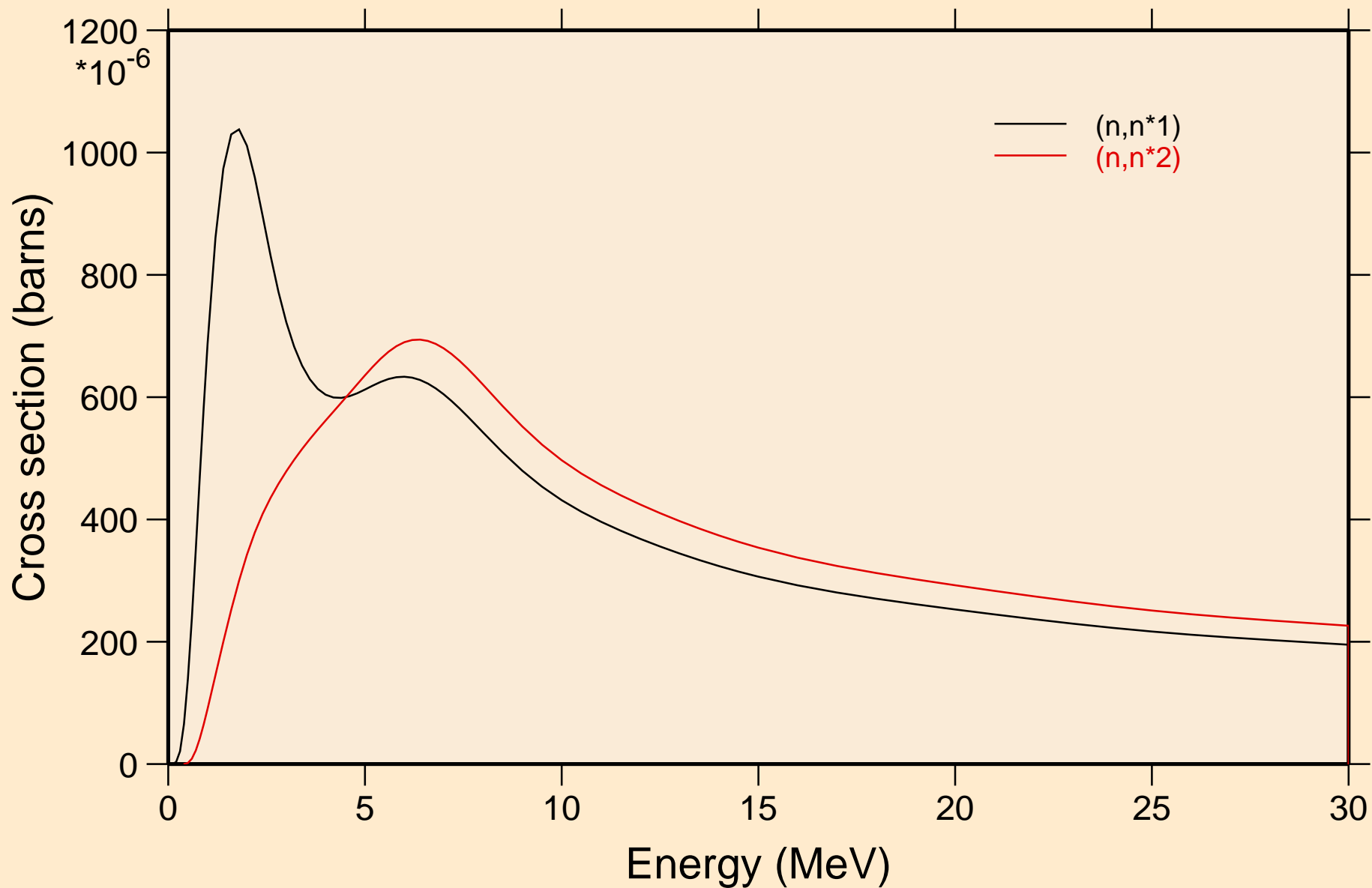

RE165 NEUTRON ACER TENDL-2023 LIBRARY; T=0.K  
Threshold reactions

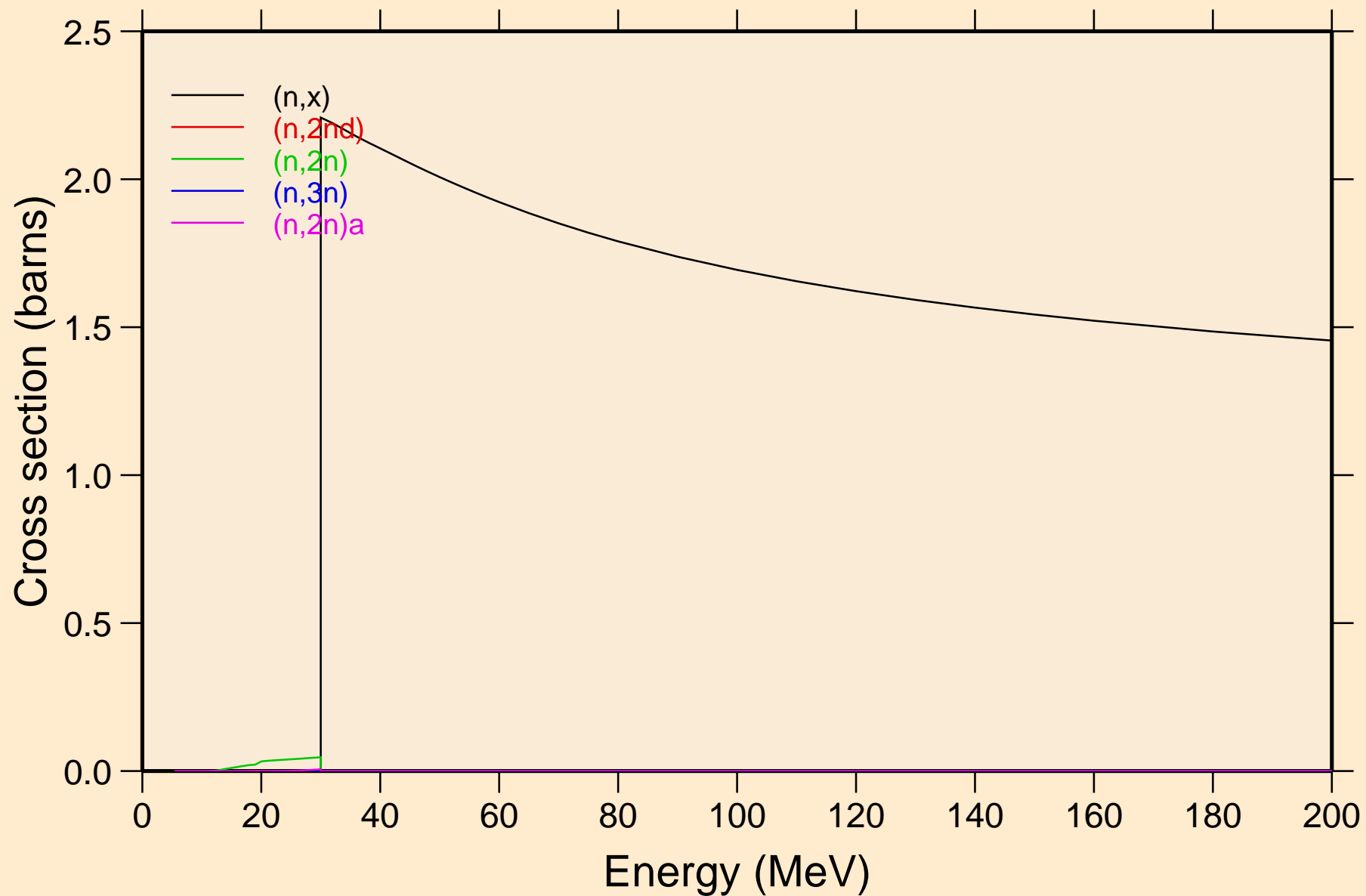

RE165 NEUTRON ACER TENDL-2023 LIBRARY; T=0.K  
Threshold reactions

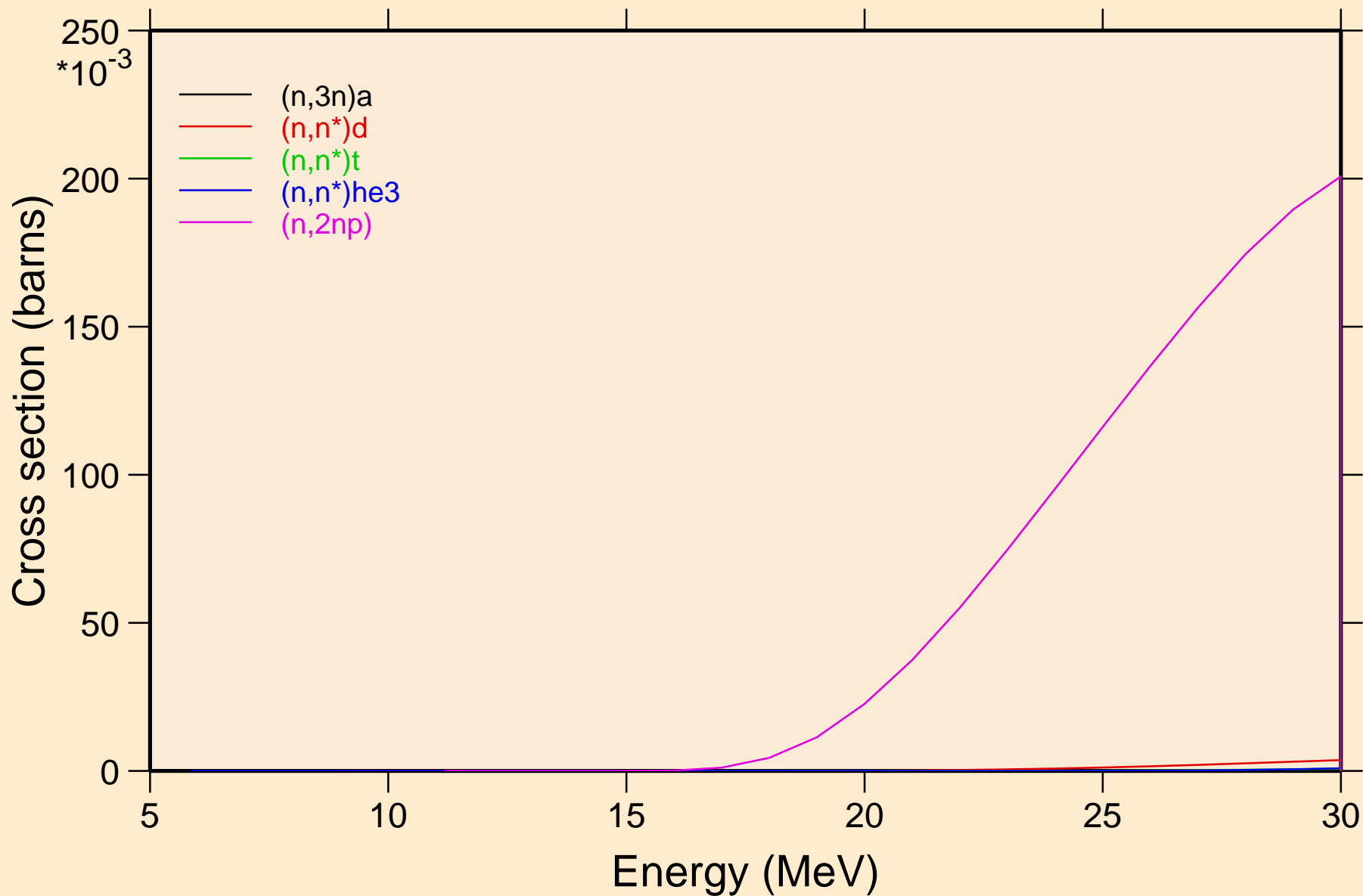

RE165 NEUTRON ACER TENDL-2023 LIBRARY; T=0.K  
Threshold reactions

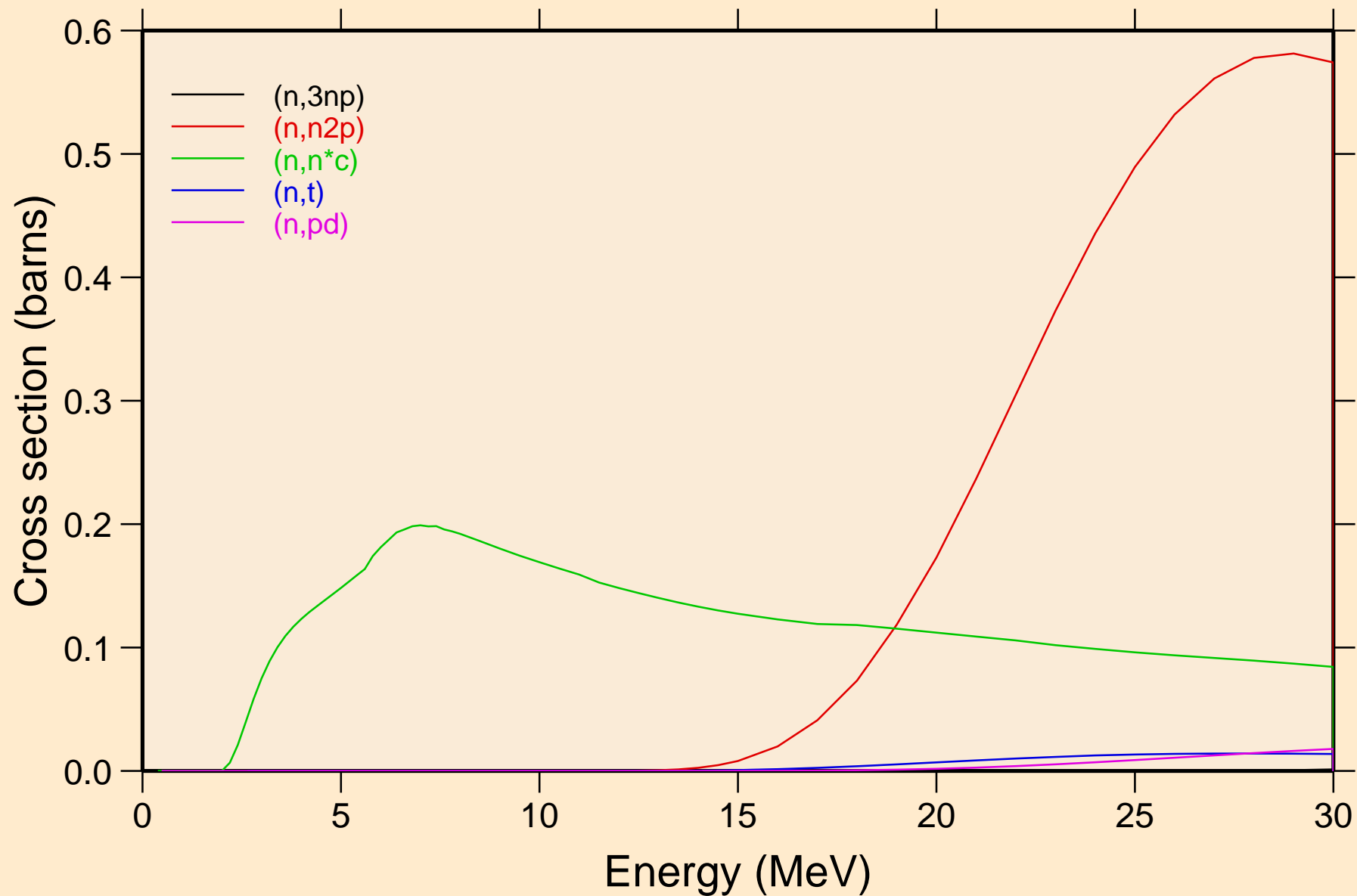

RE165 NEUTRON ACER TENDL-2023 LIBRARY; T=0.K  
Threshold reactions

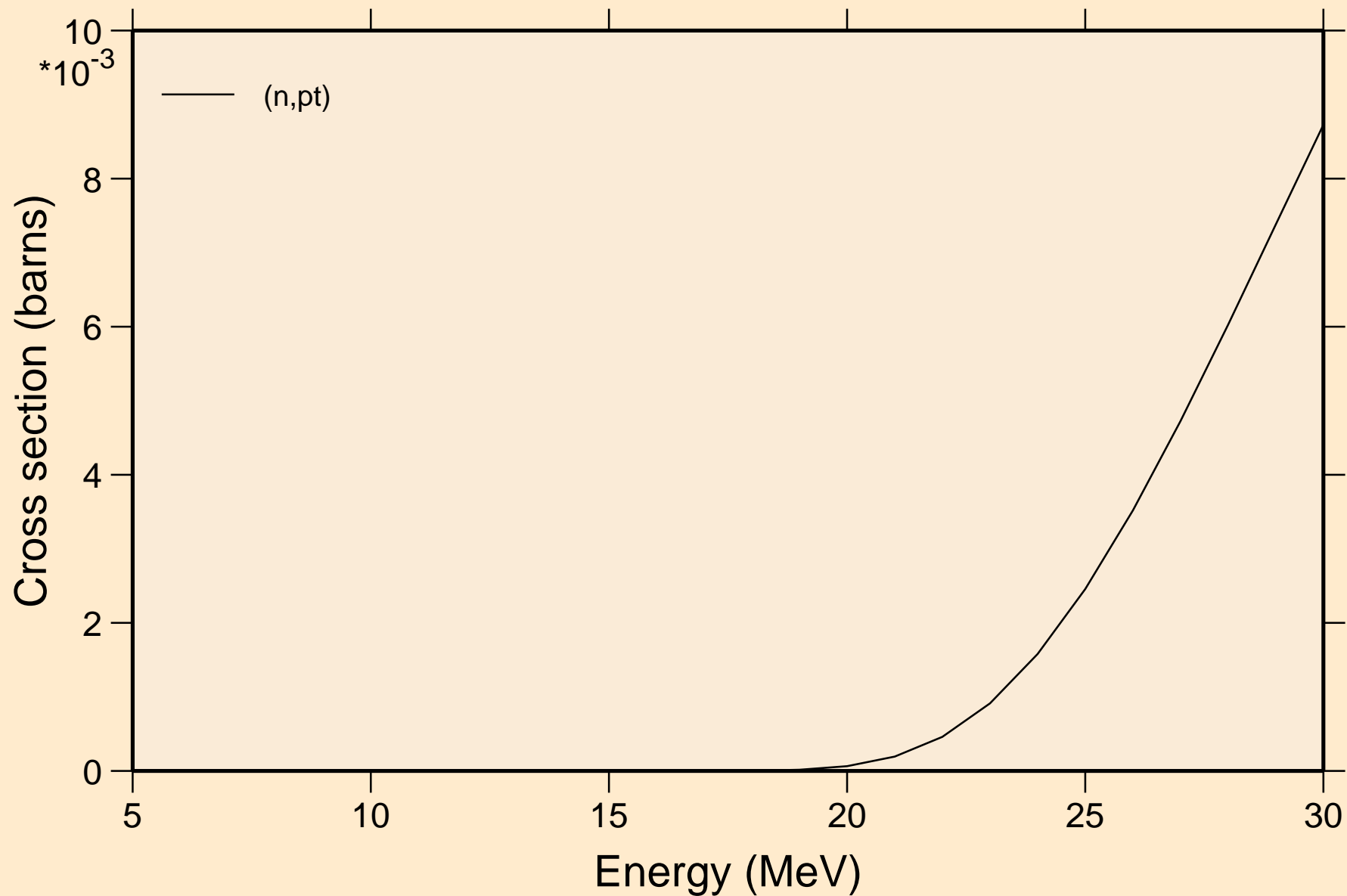

RE165 NEUTRON ACER TENDL-2023 LIBRARY; T=0.K  
angular distribution for elastic

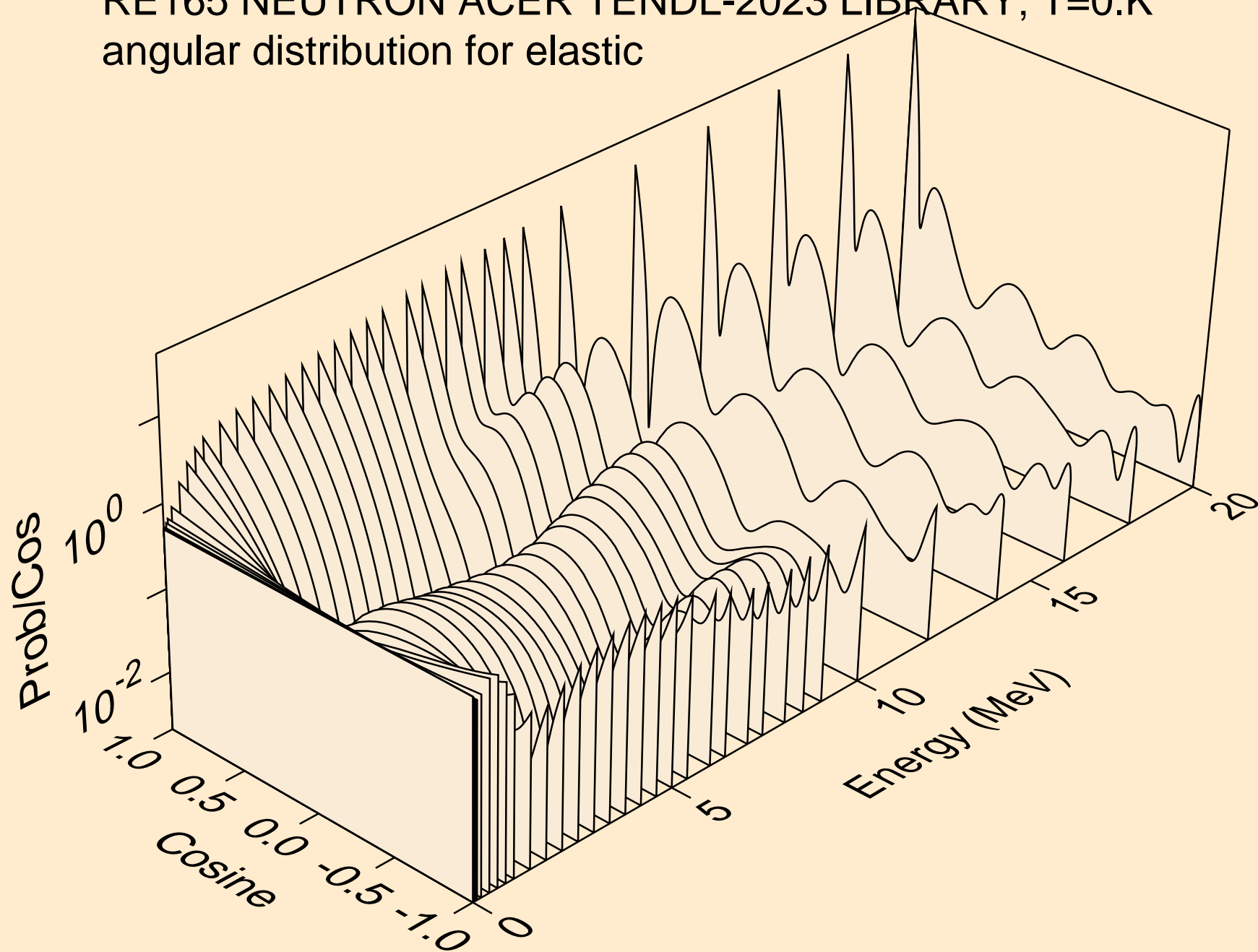

RE165 NEUTRON ACER TENDL-2023 LIBRARY; T=0.K  
angular distribution for elastic

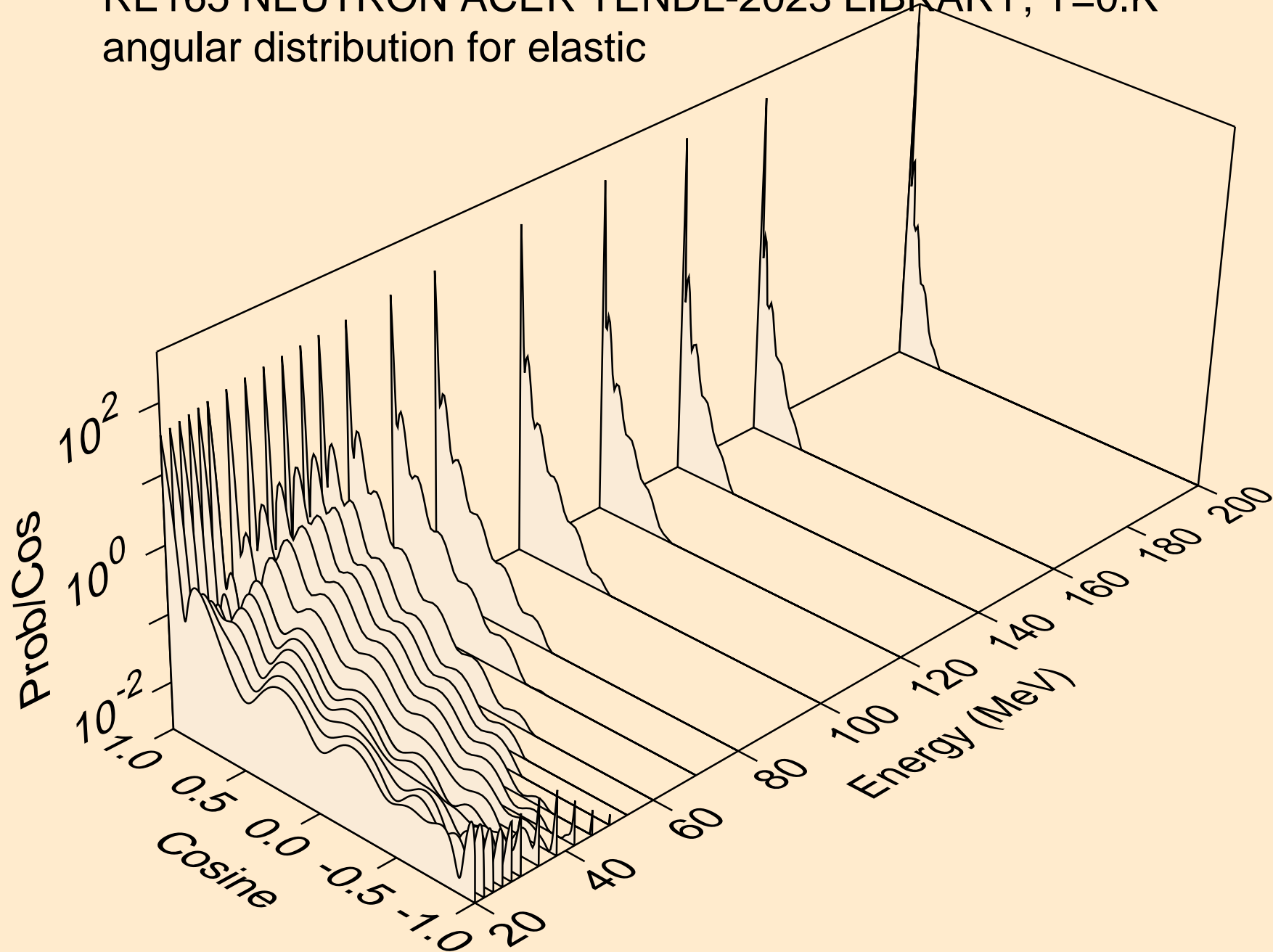

RE165 NEUTRON ACER TENDL-2023 LIBRARY; T=0.K  
angular distribution for (n,n\*1)

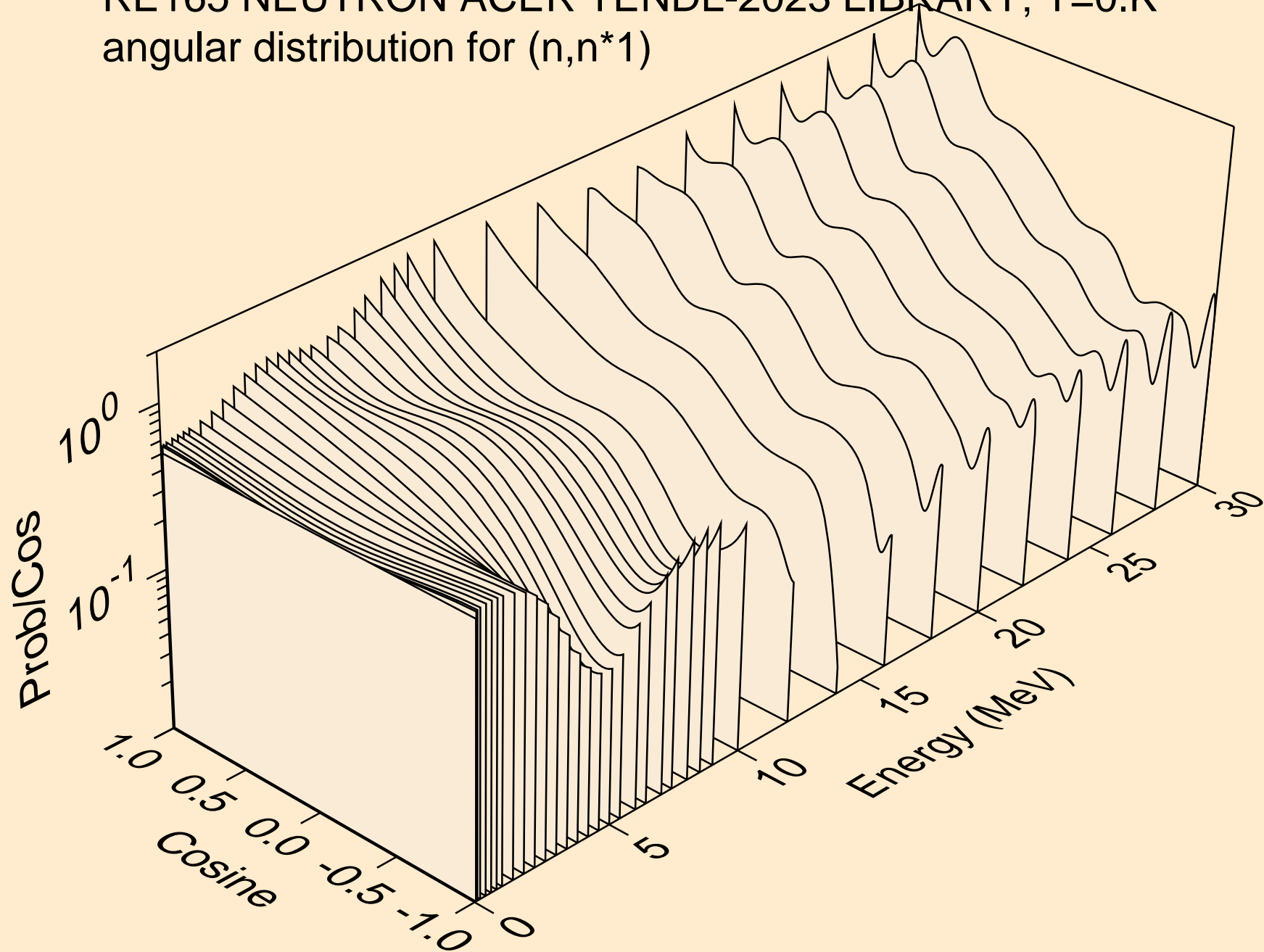

RE165 NEUTRON ACER TENDL-2023 LIBRARY; T=0.K  
angular distribution for (n,n\*2)

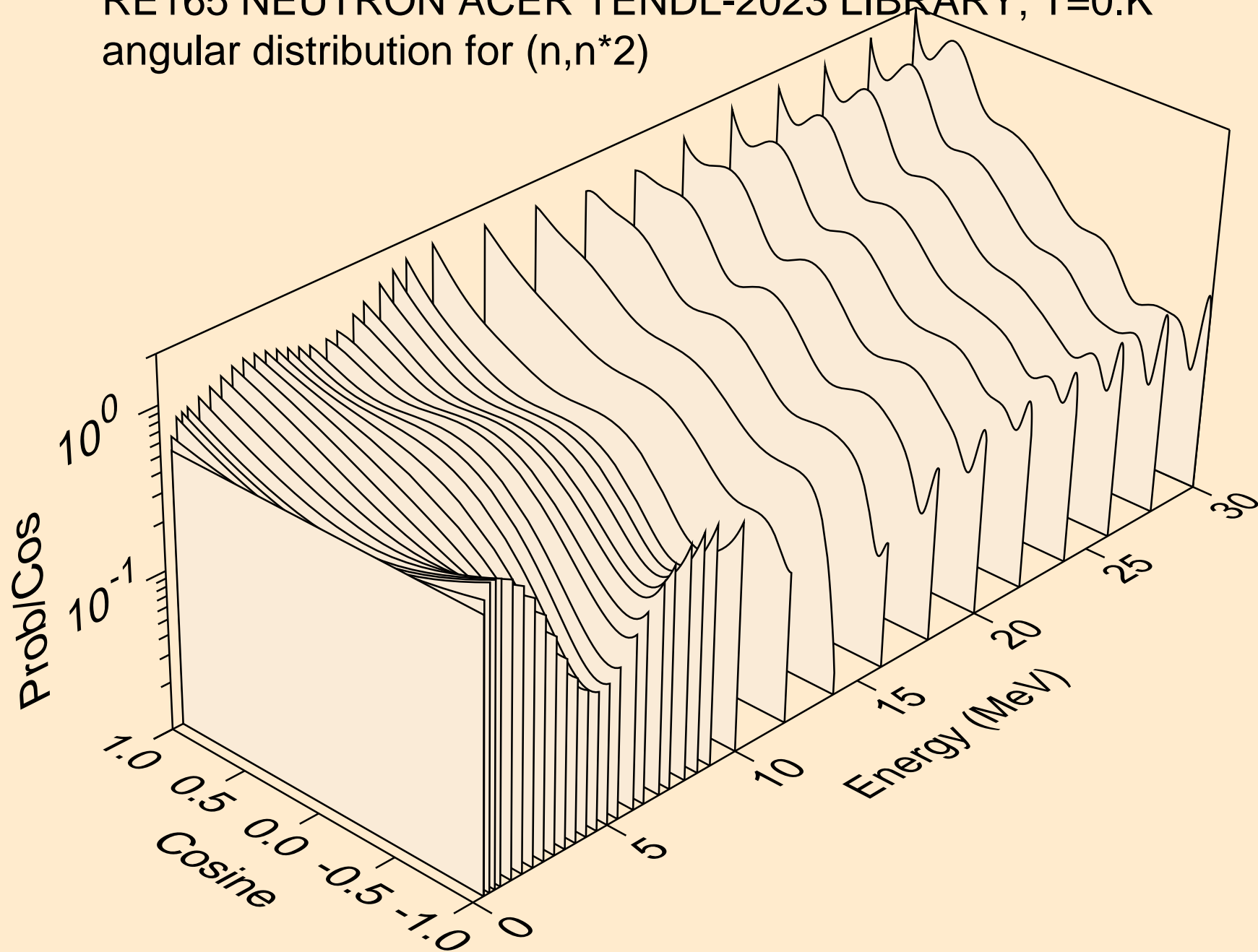

RE165 NEUTRON ACER TENDL-2023 LIBRARY; T=0.K  
Neutron emission for (n,x)

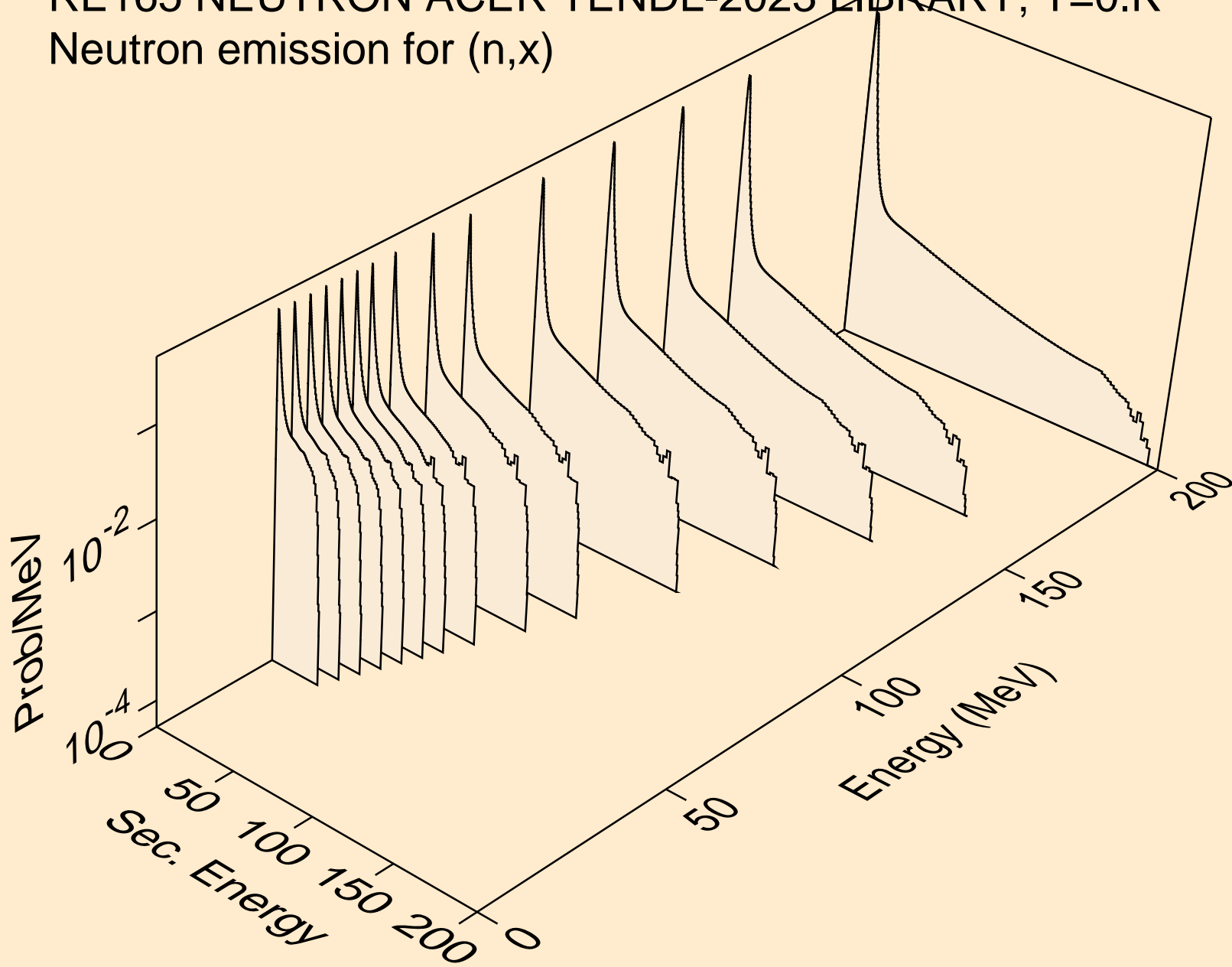

RE165 NEUTRON ACER TENDL-2023 LIBRARY; T=0.K  
Neutron emission for (n,2nd)

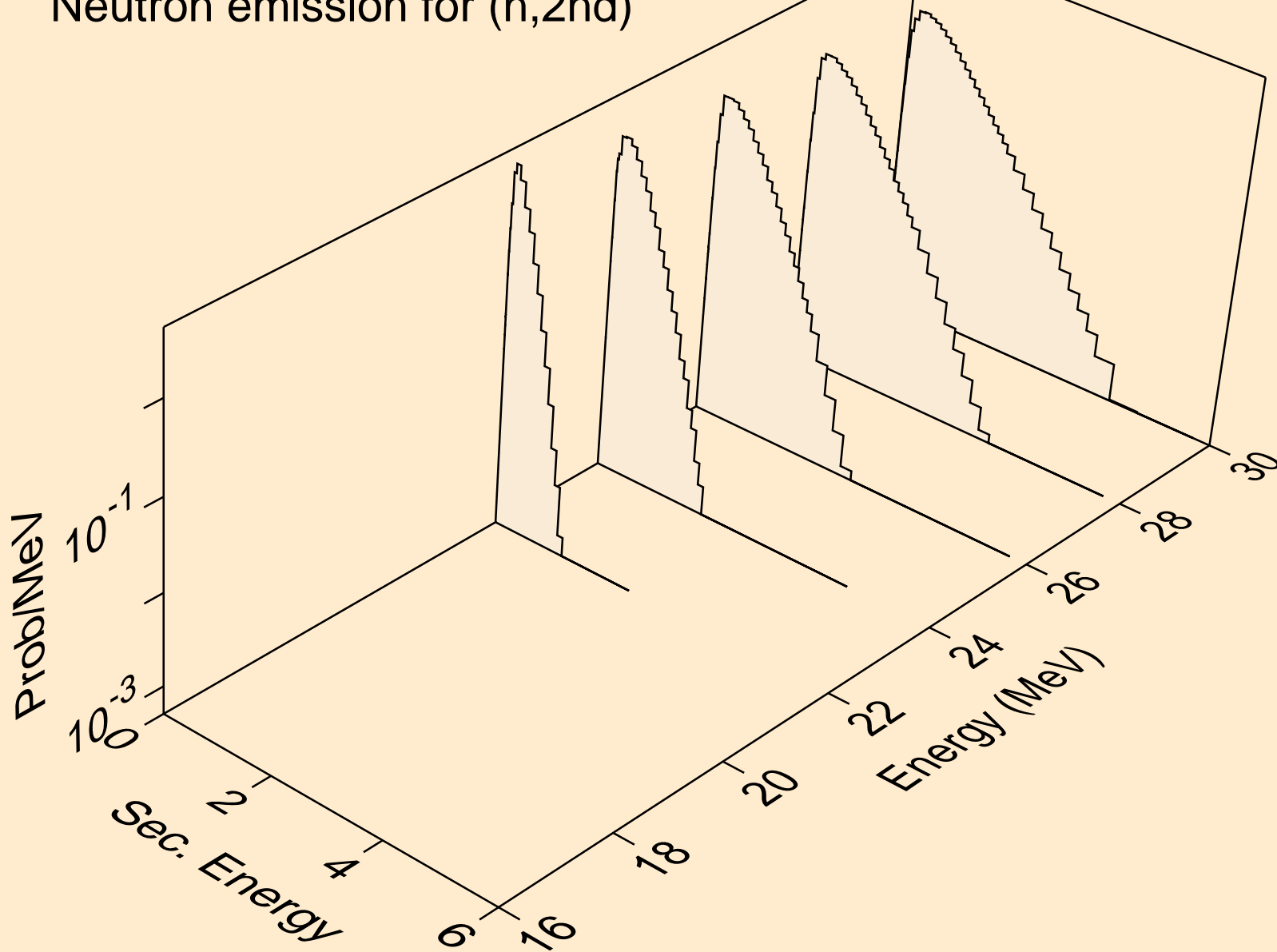

RE165 NEUTRON ACER TENDL-2023 LIBRARY; T=0.K  
Neutron emission for (n,2n)

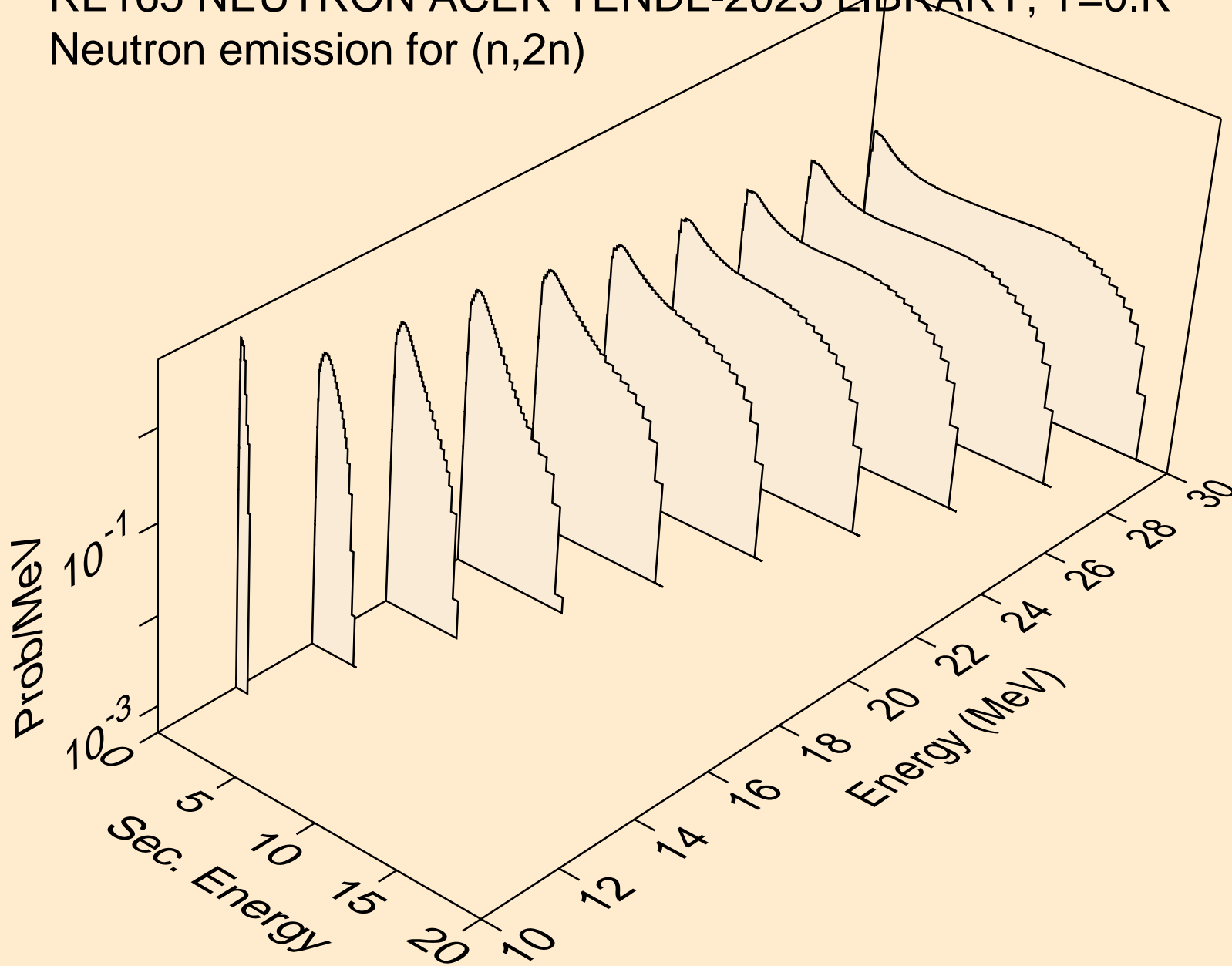

RE165 NEUTRON ACER TENDL-2023 LIBRARY; T=0.K  
Neutron emission for (n,3n)

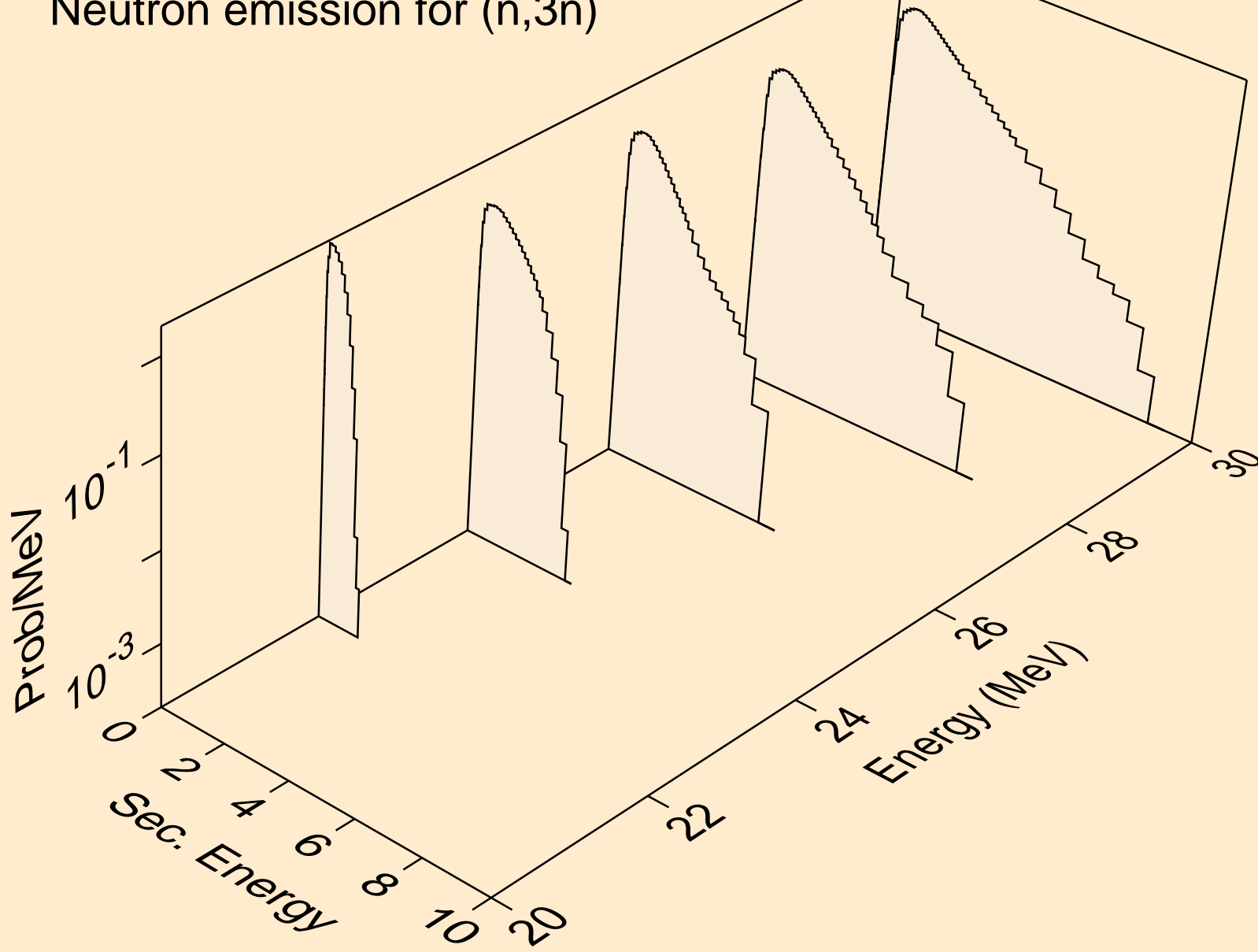

RE165 NEUTRON ACER TENDL-2023 LIBRARY; T=0.K  
Neutron emission for (n,n\*)a

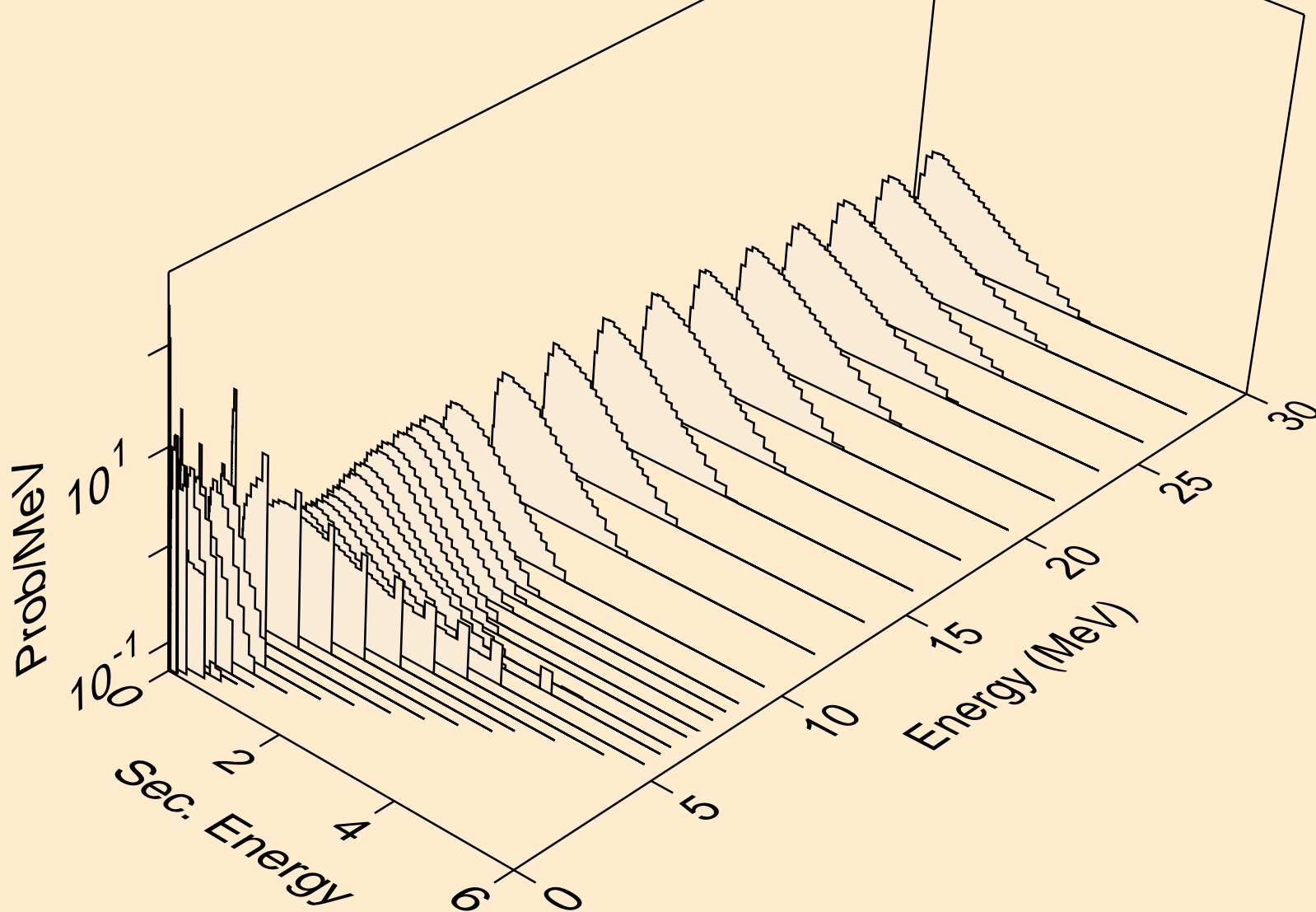

RE165 NEUTRON ACER TENDL-2023 LIBRARY; T=0.K  
Neutron emission for (n,n\*)3a

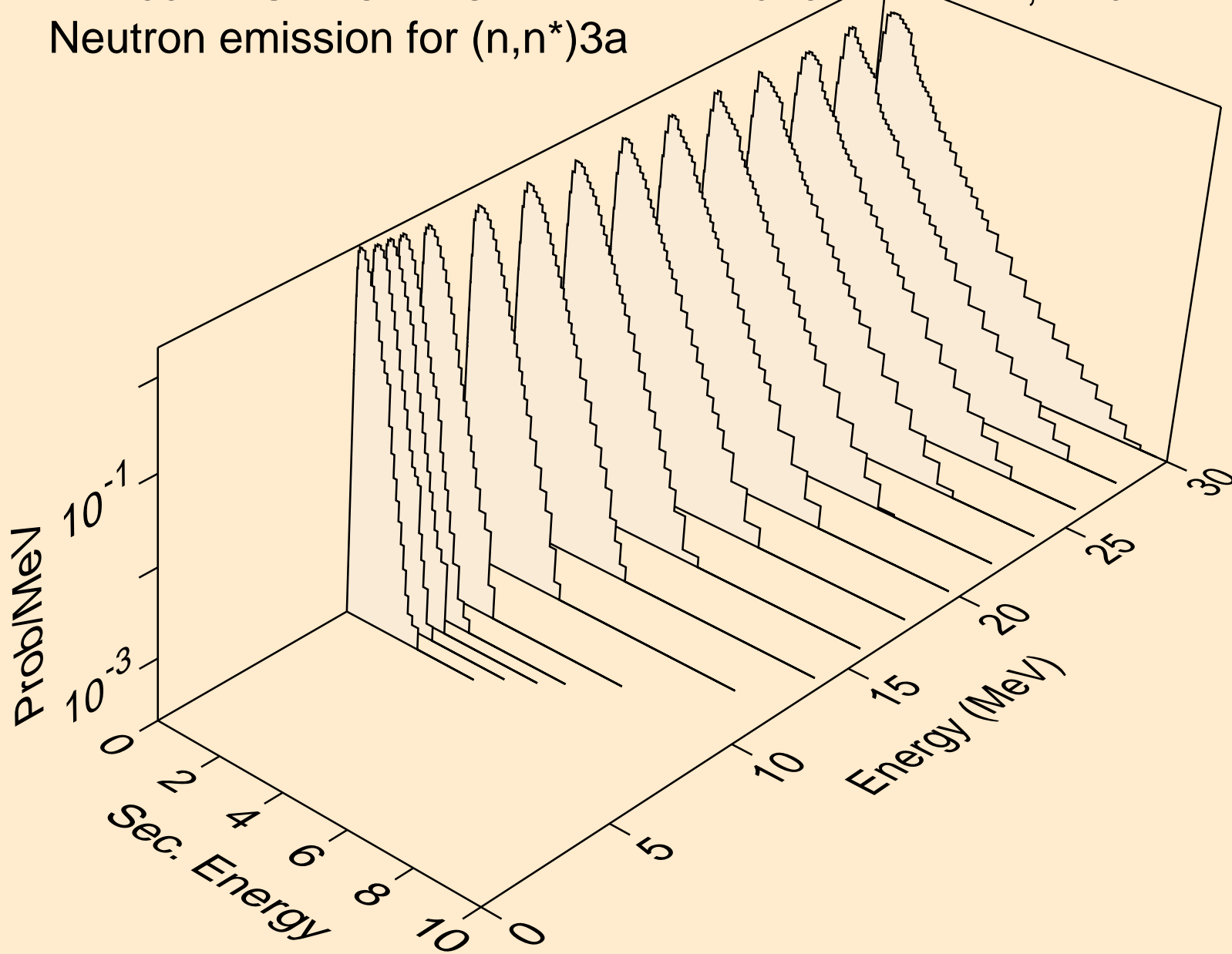

RE165 NEUTRON ACER TENDL-2023 LIBRARY; T=0.K  
Neutron emission for (n,2n)a

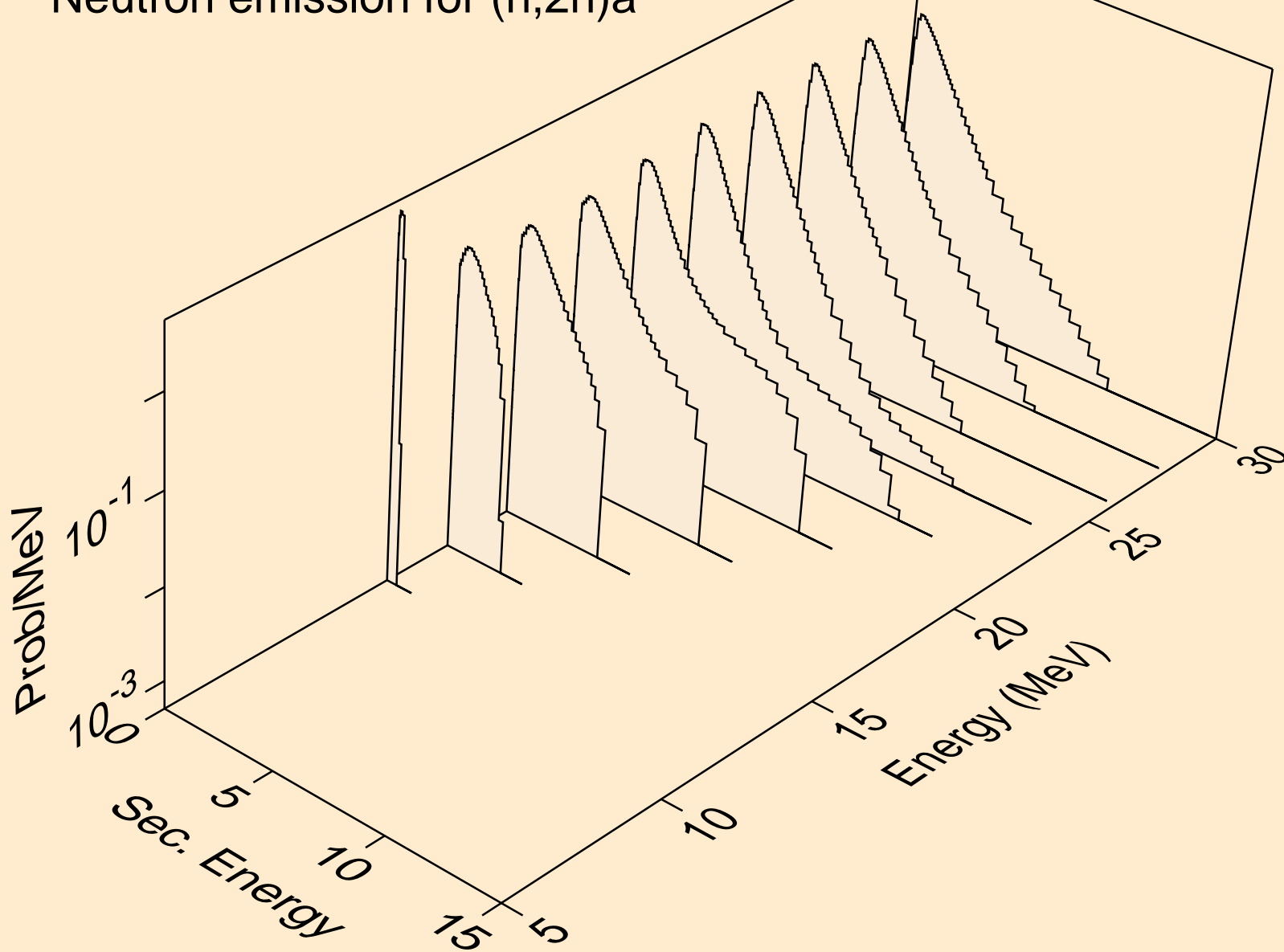

RE165 NEUTRON ACER TENDL-2023 LIBRARY; T=0.K  
Neutron emission for (n,3n)a

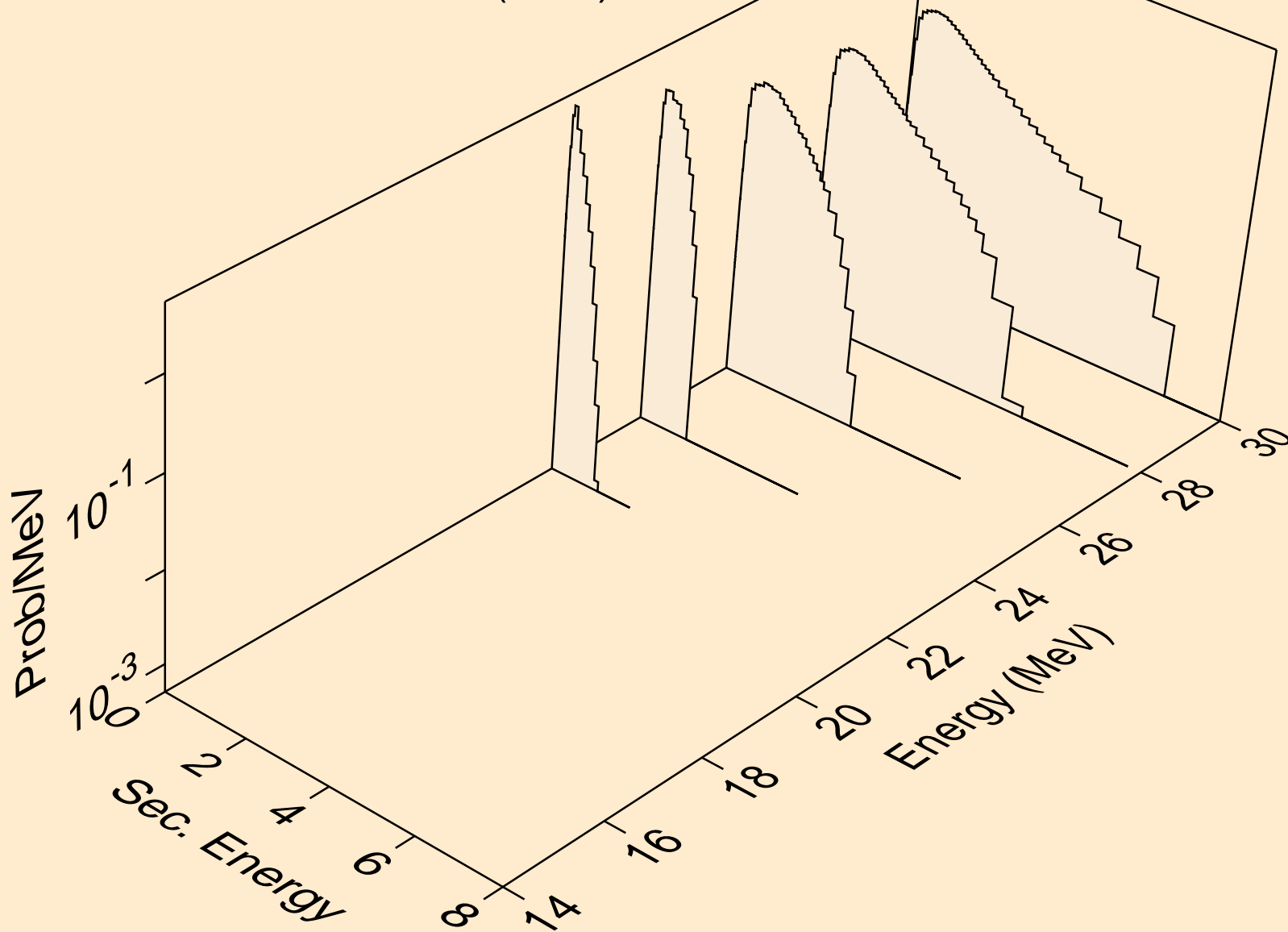

RE165 NEUTRON ACER TENDL-2023 LIBRARY; T=0.K  
Neutron emission for (n,n\*)p

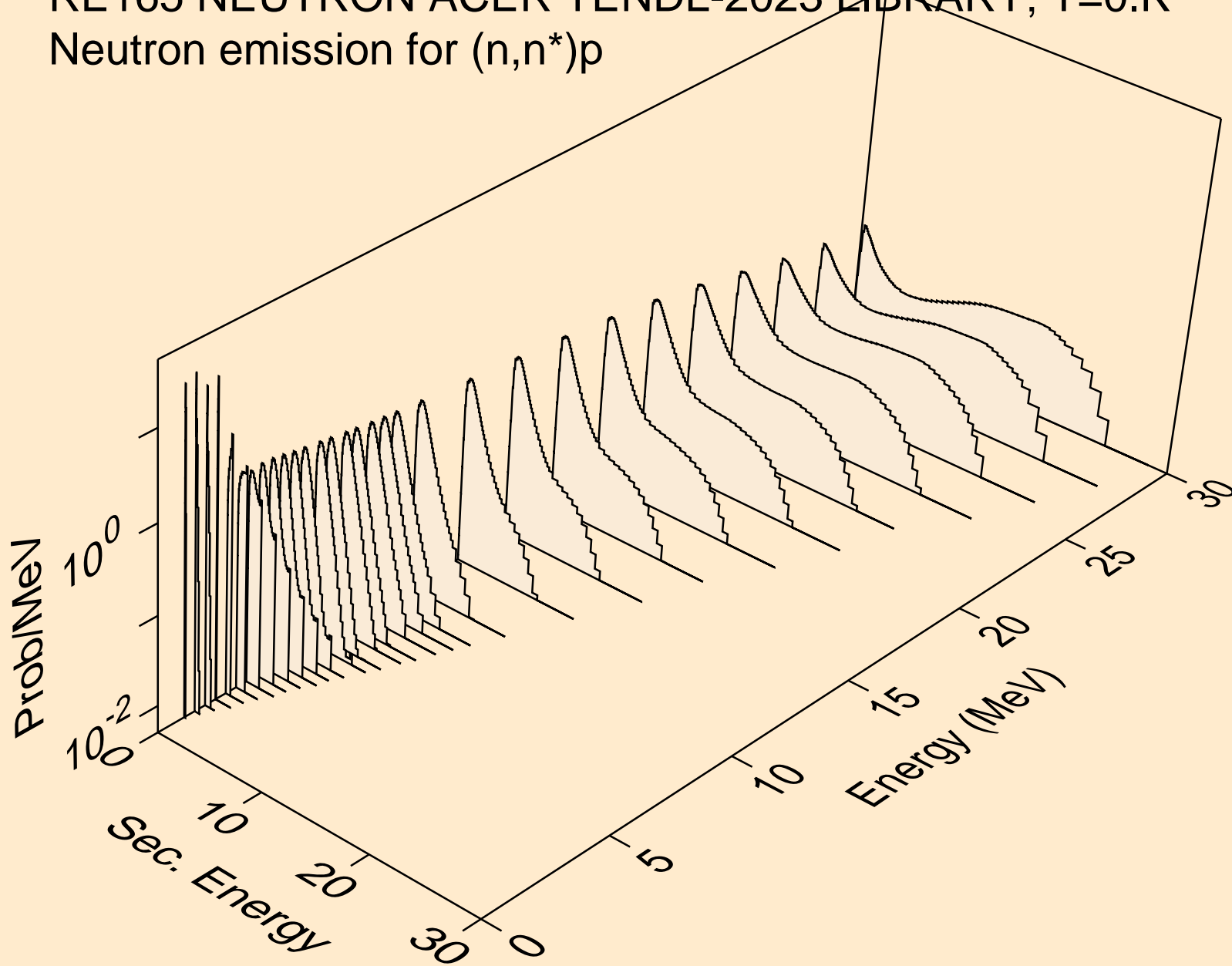

RE165 NEUTRON ACER TENDL-2023 LIBRARY; T=0.K  
Neutron emission for (n,n\*)2a

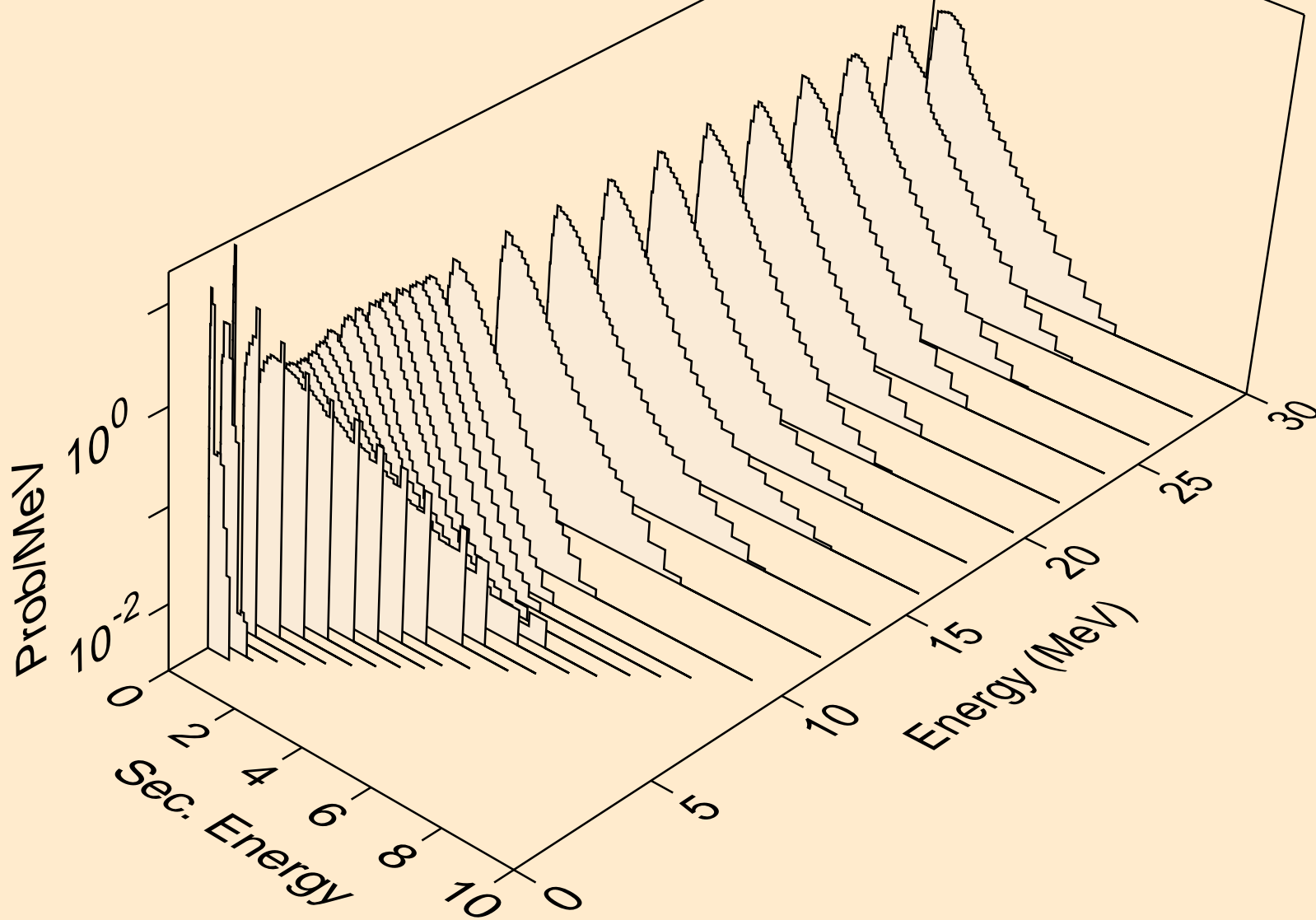

RE165 NEUTRON ACER TENDL-2023 LIBRARY; T=0.K  
Neutron emission for (n,2n)2a

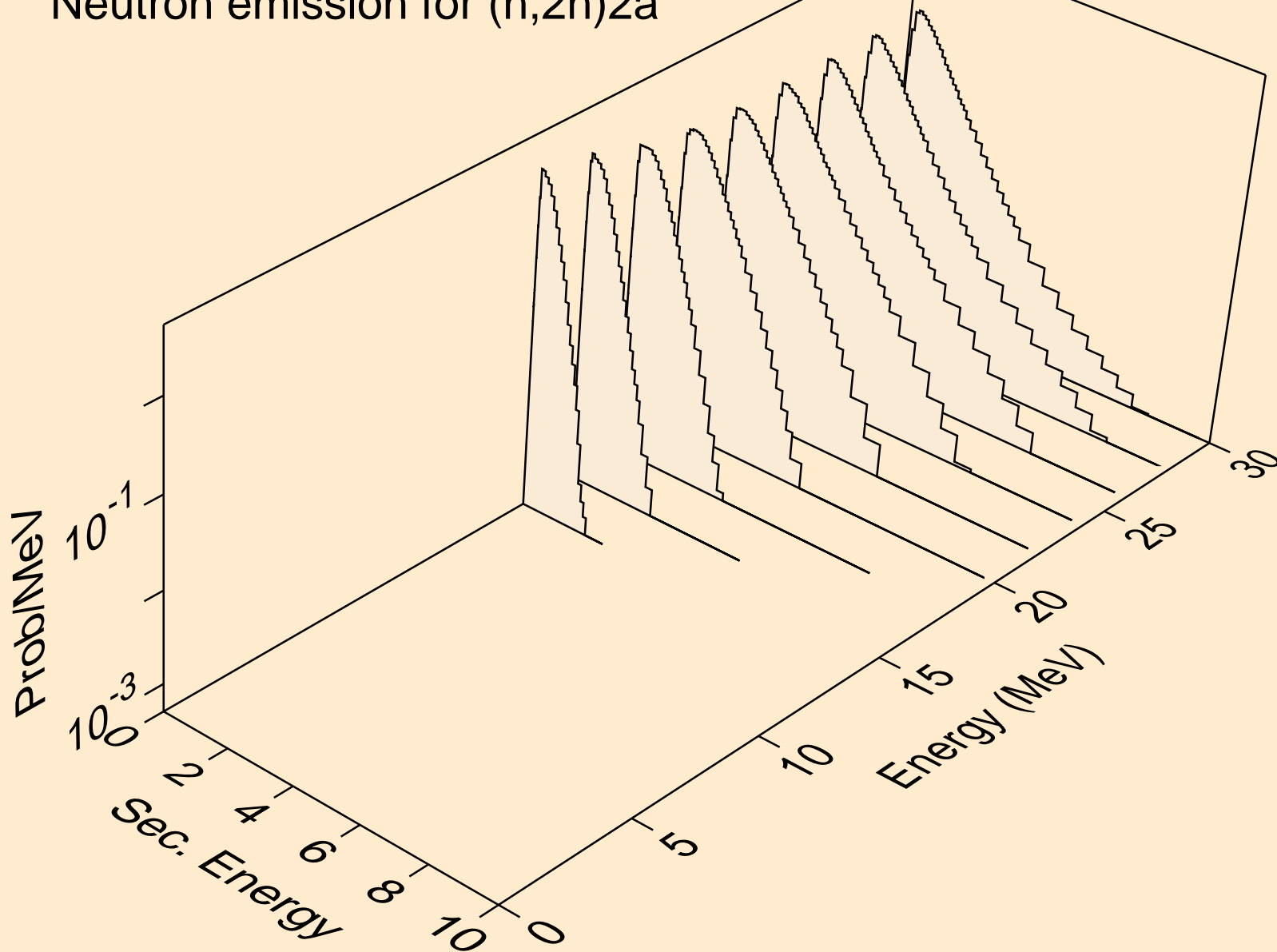

RE165 NEUTRON ACER TENDL-2023 LIBRARY; T=0.K  
Neutron emission for (n,n\*)d

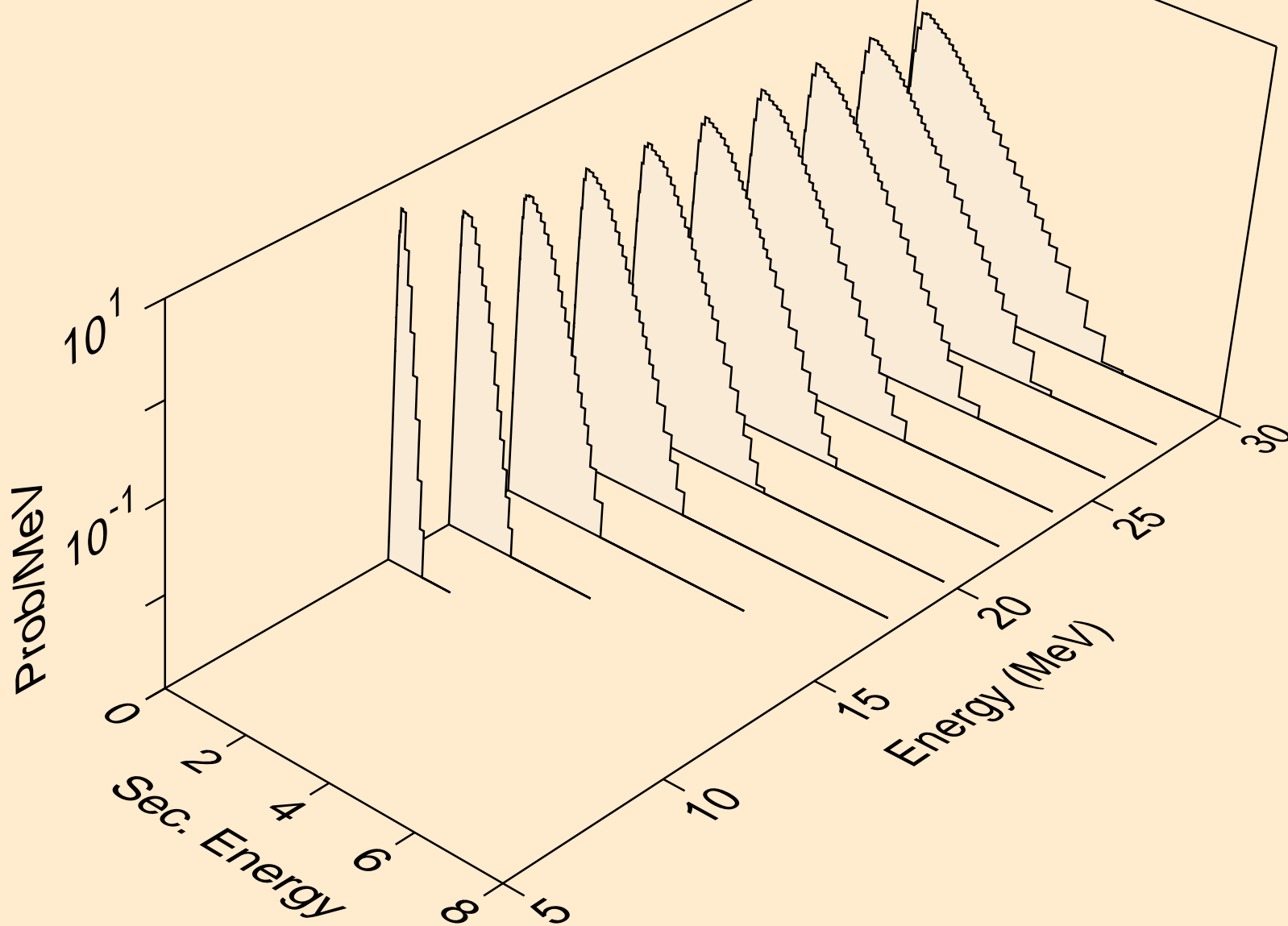

RE165 NEUTRON ACER TENDL-2023 LIBRARY; T=0.K  
Neutron emission for (n,n\*)t

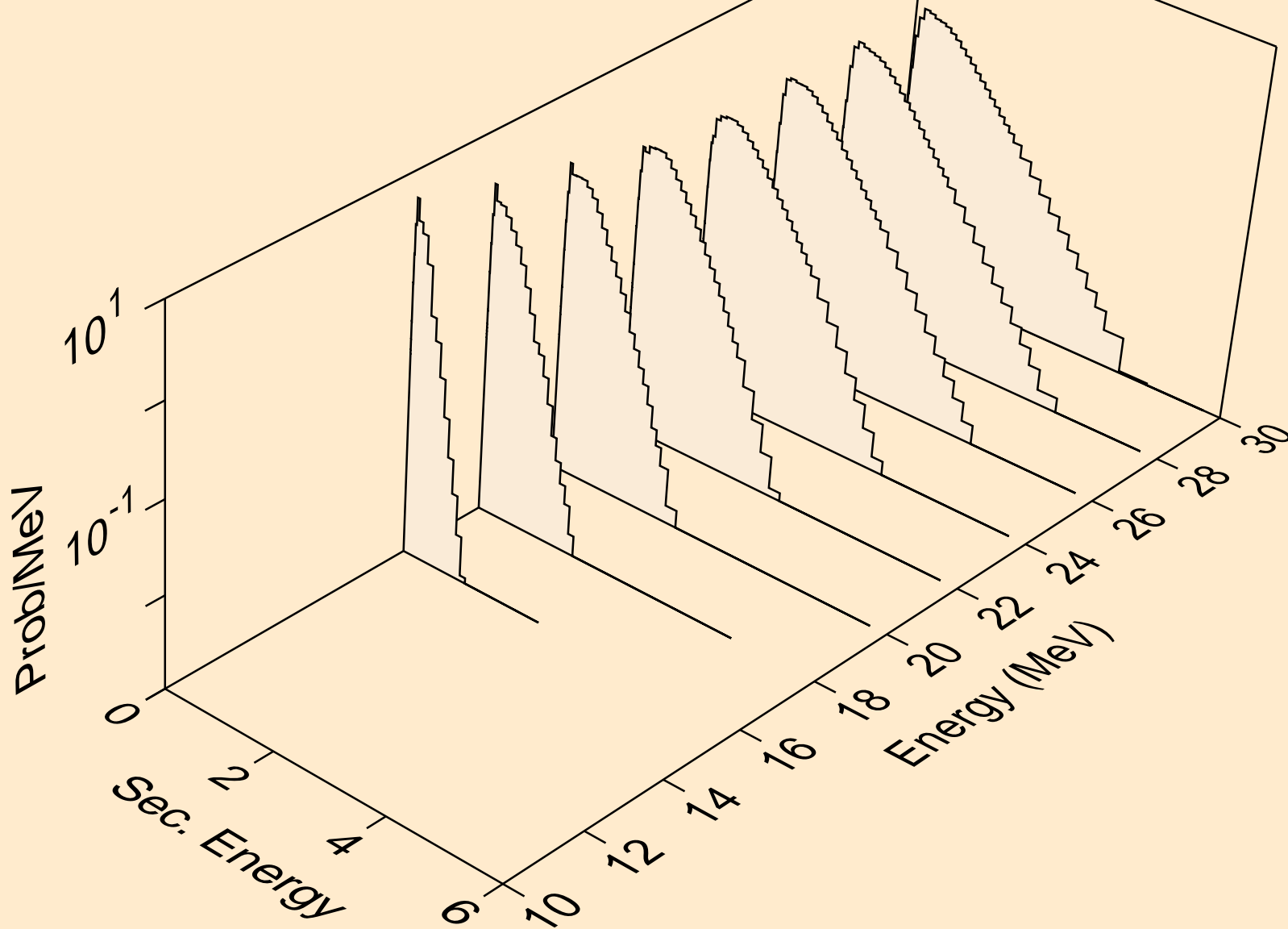

RE165 NEUTRON ACER TENDL-2023 LIBRARY; T=0.K  
Neutron emission for (n,n\*)he3

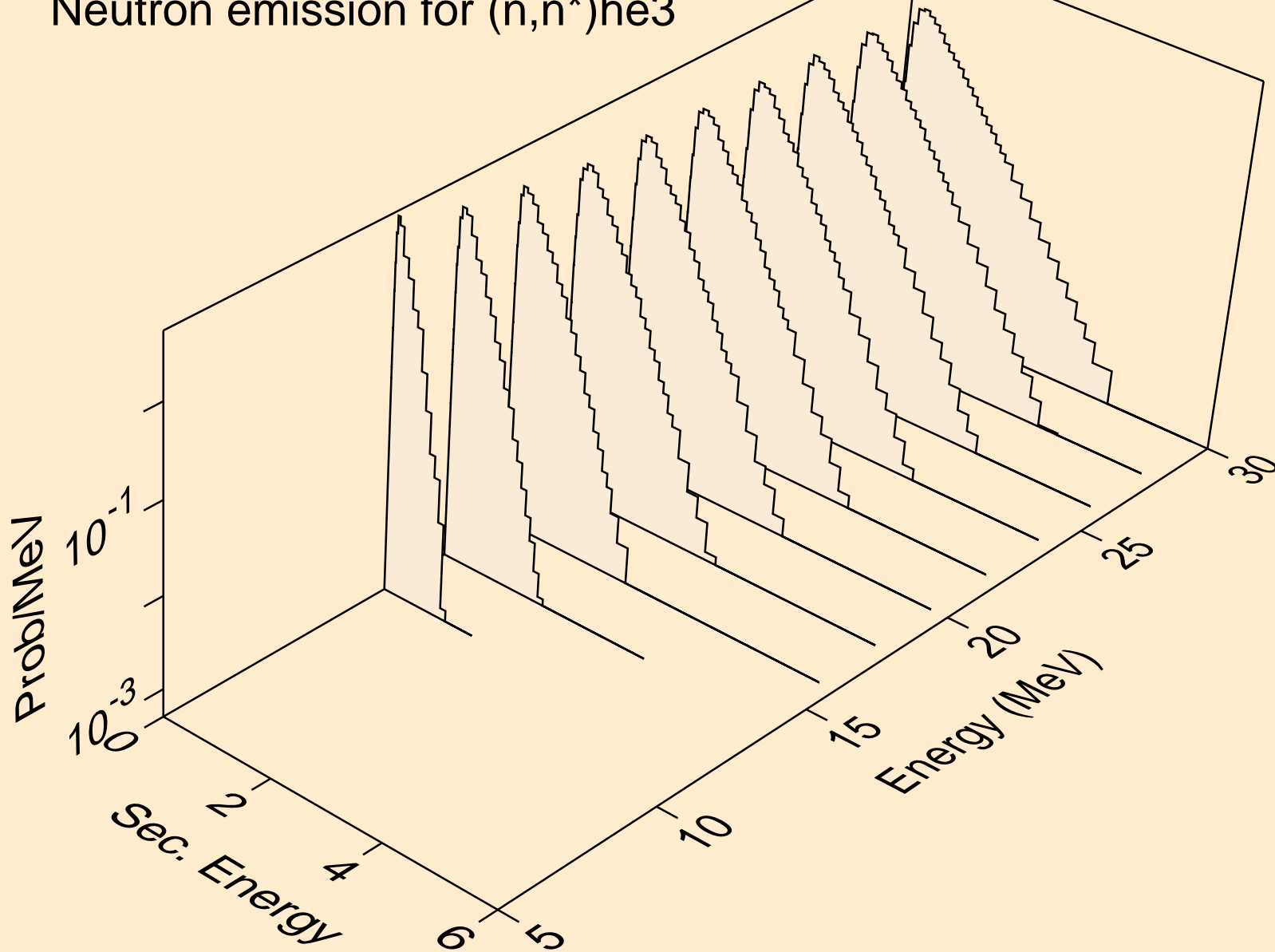

RE165 NEUTRON ACER TENDL-2023 LIBRARY; T=0.K  
Neutron emission for (n,2np)

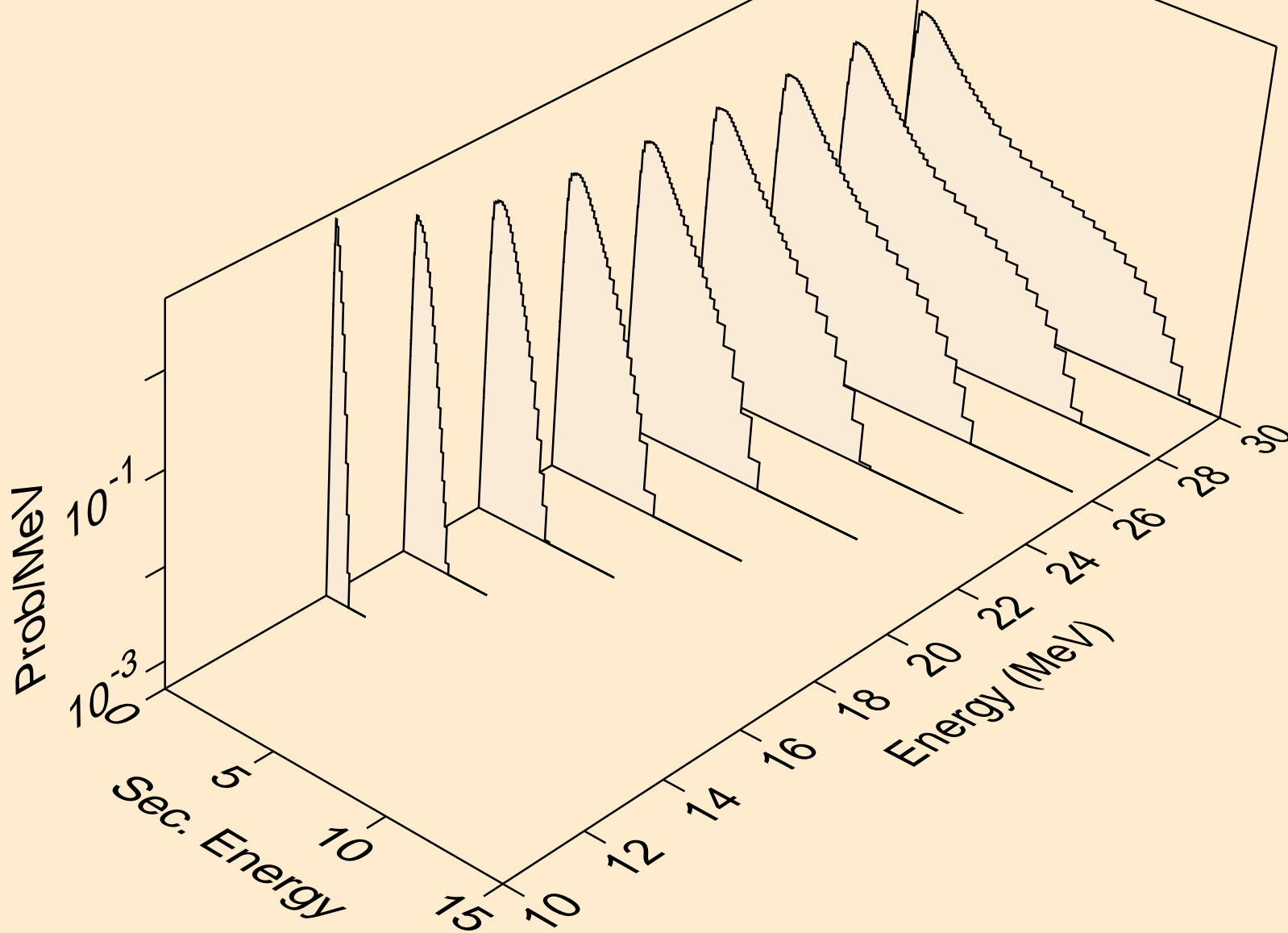

RE165 NEUTRON ACER TENDL-2023 LIBRARY; T=0.K  
Neutron emission for (n,3np)

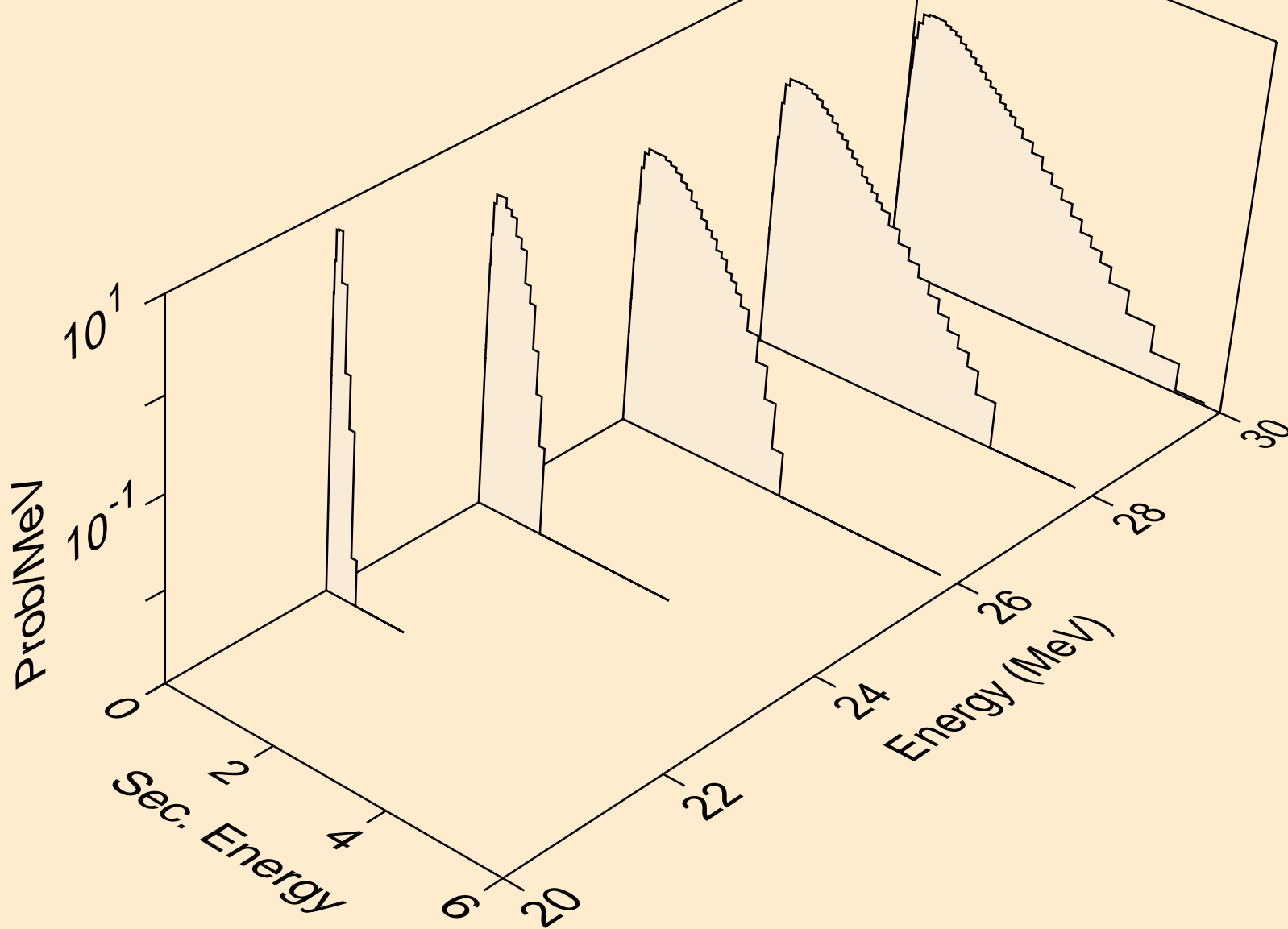

RE165 NEUTRON ACER TENDL-2023 LIBRARY; T=0.K  
Neutron emission for (n,n2p)

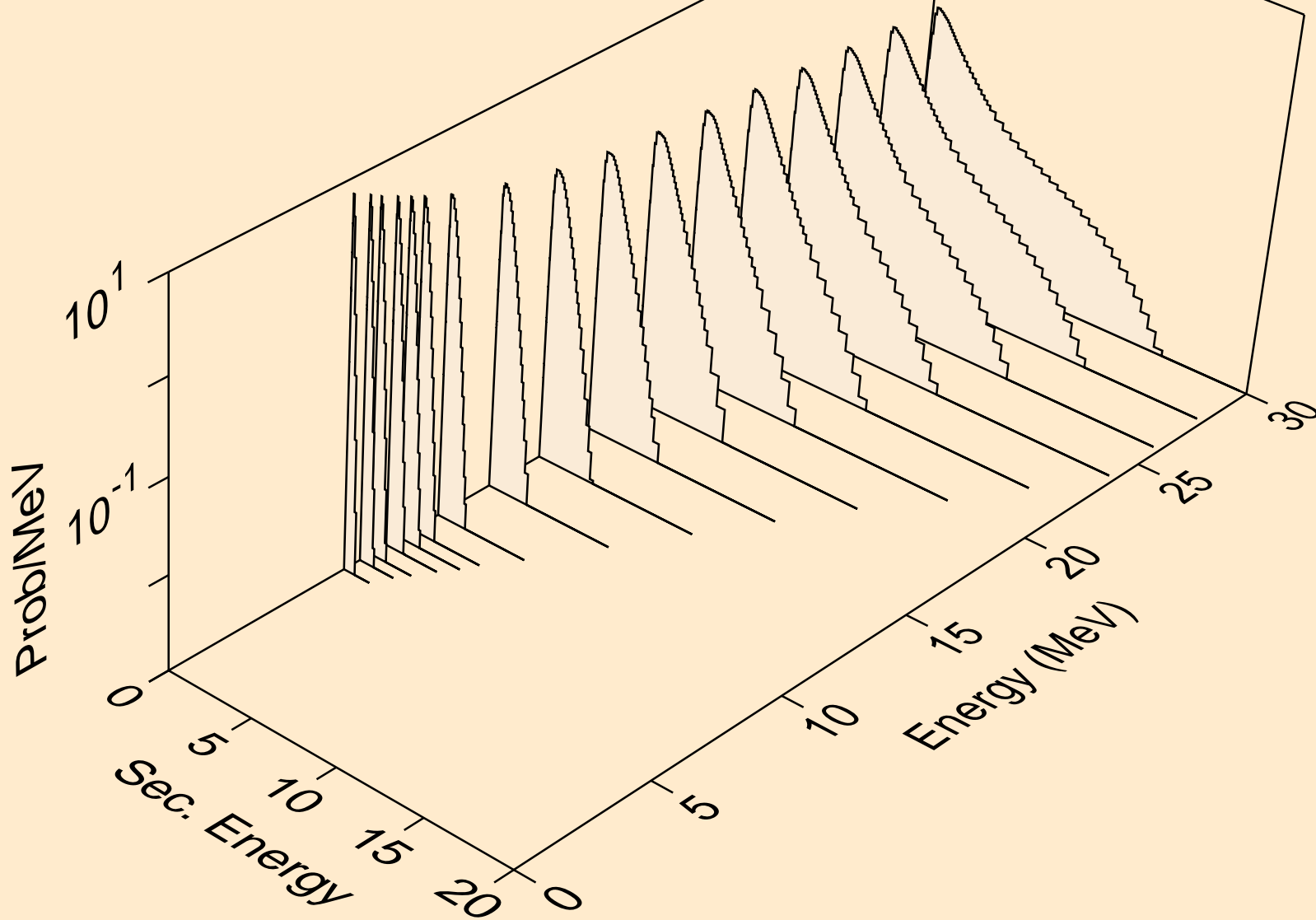

RE165 NEUTRON ACER TENDL-2023 LIBRARY; T=0.K  
Neutron emission for (n,npa)

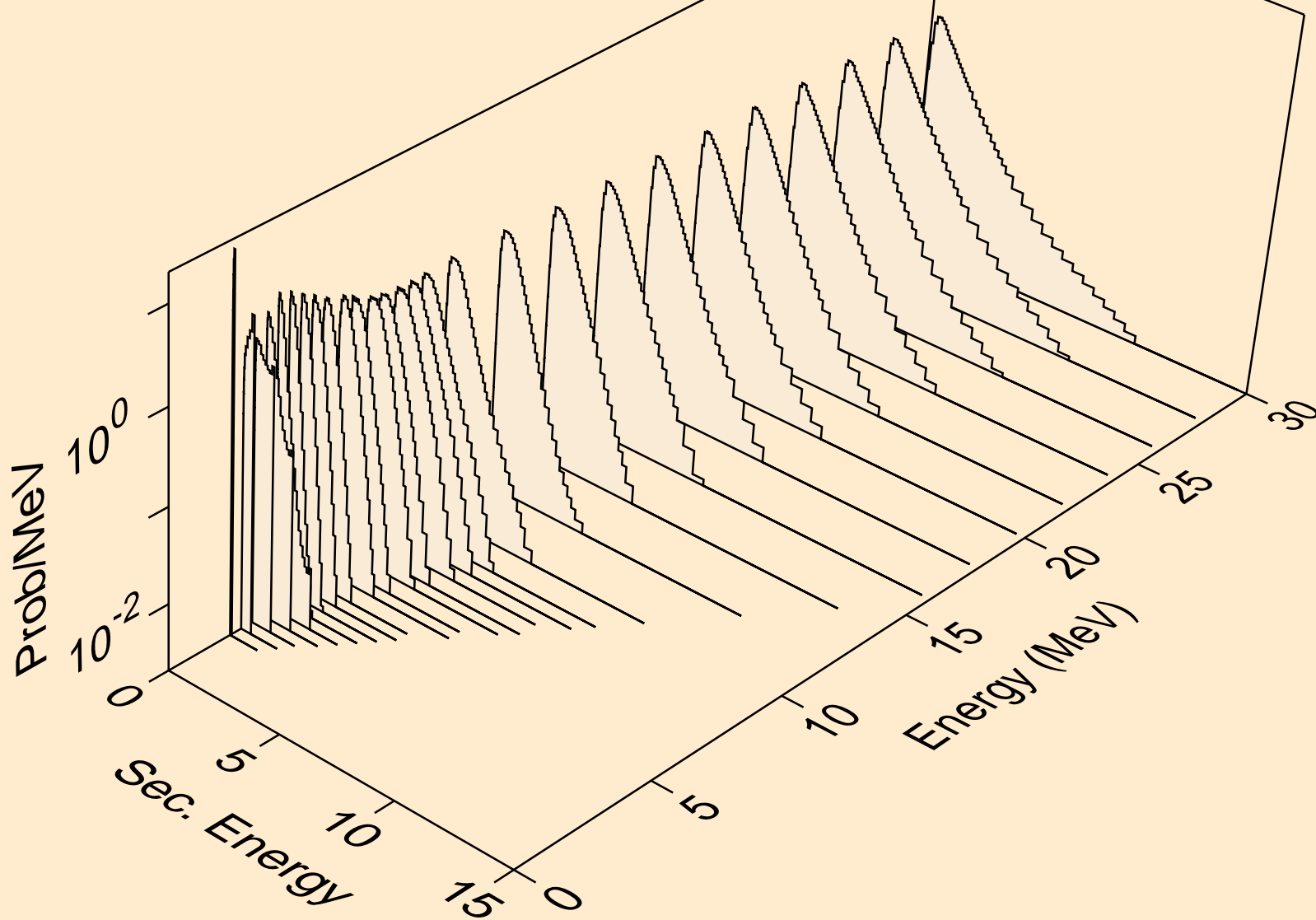

RE165 NEUTRON ACER TENDL-2023 LIBRARY; T=0.K  
Neutron emission for (n,n\*c)

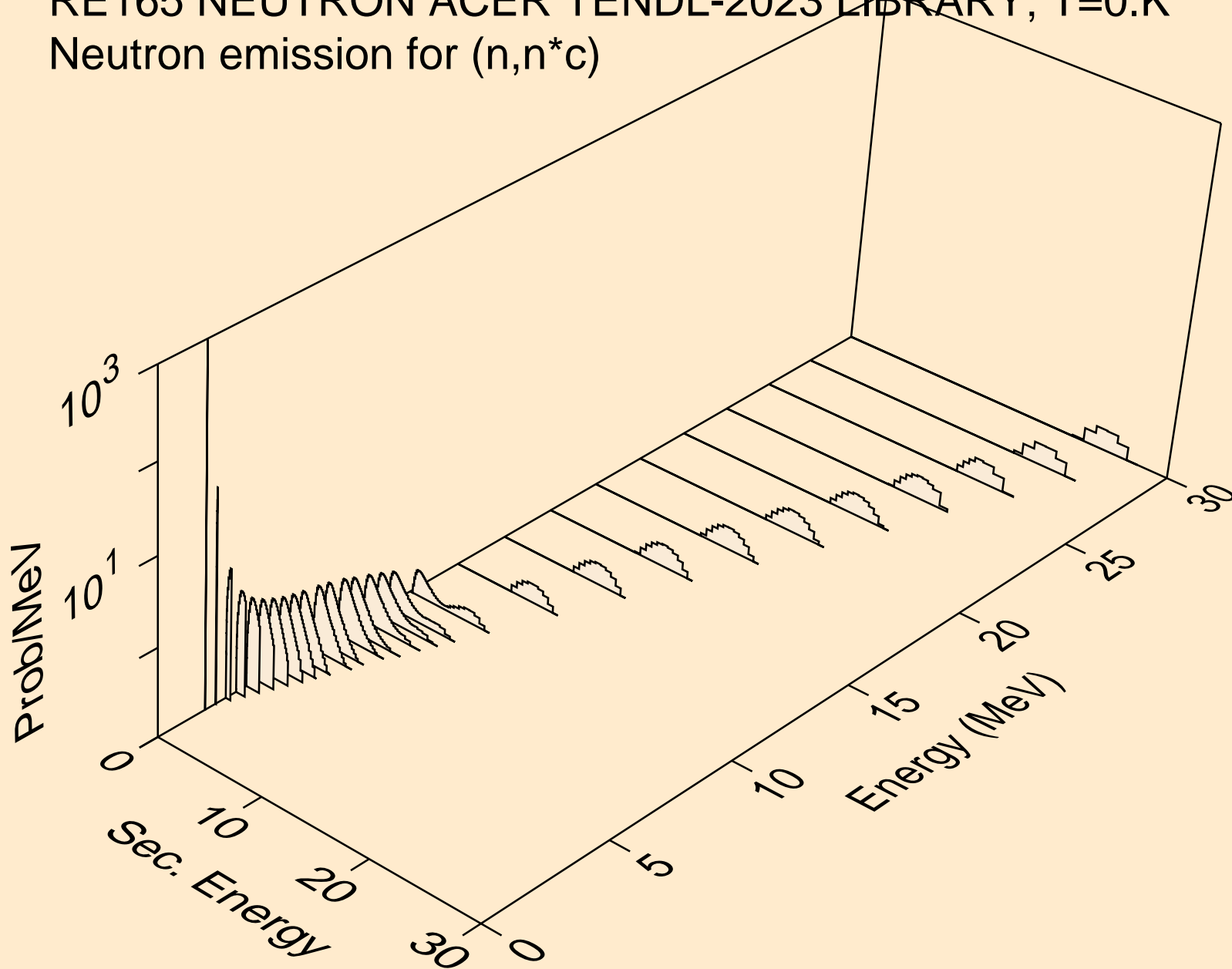

RE165 NEUTRON ACER TENDL-2023 LIBRARY; T=0.K  
Photon emission for (n,x)

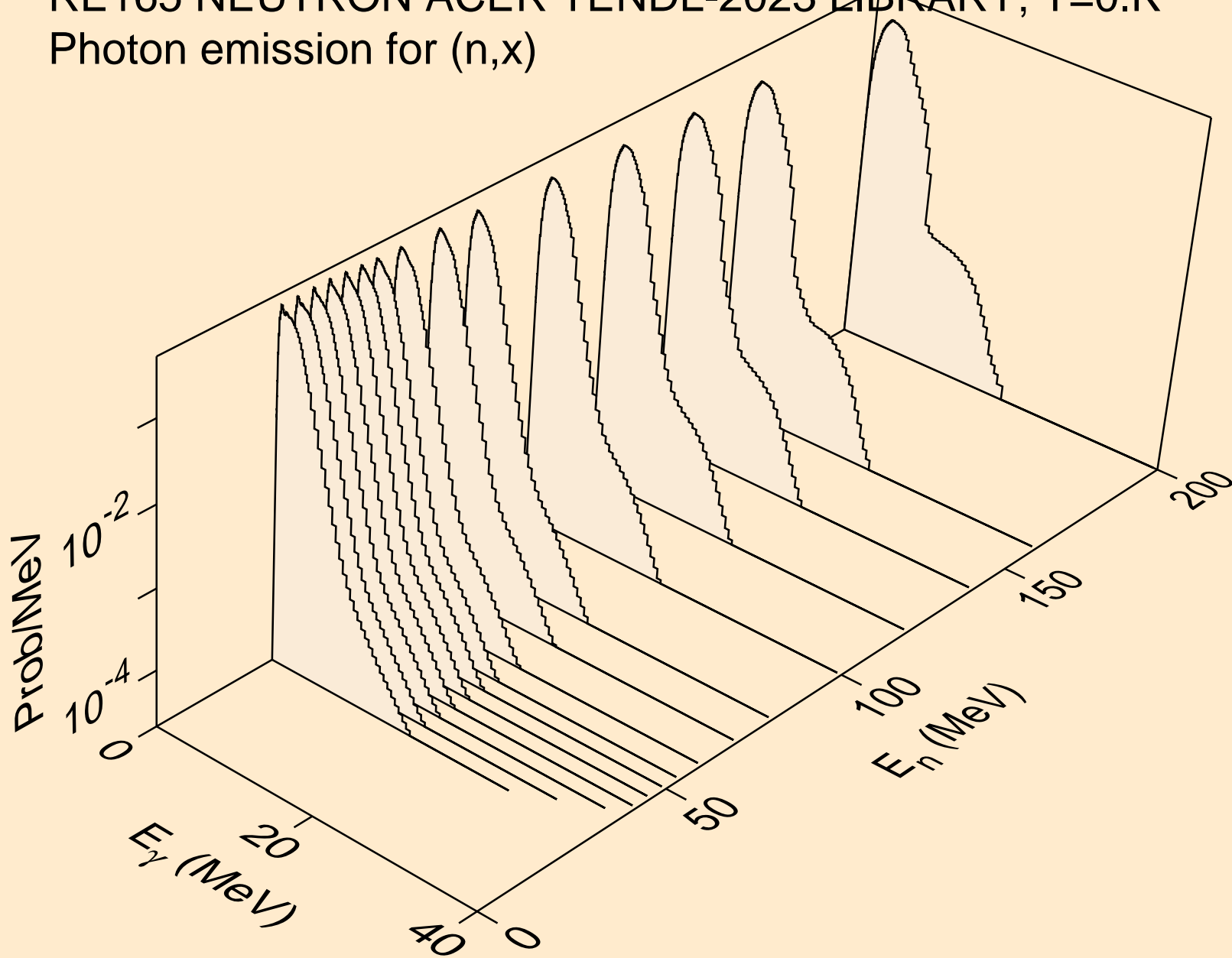

RE165 NEUTRON ACER TENDL-2023 LIBRARY; T=0.K  
Photon emission for (n,2nd)

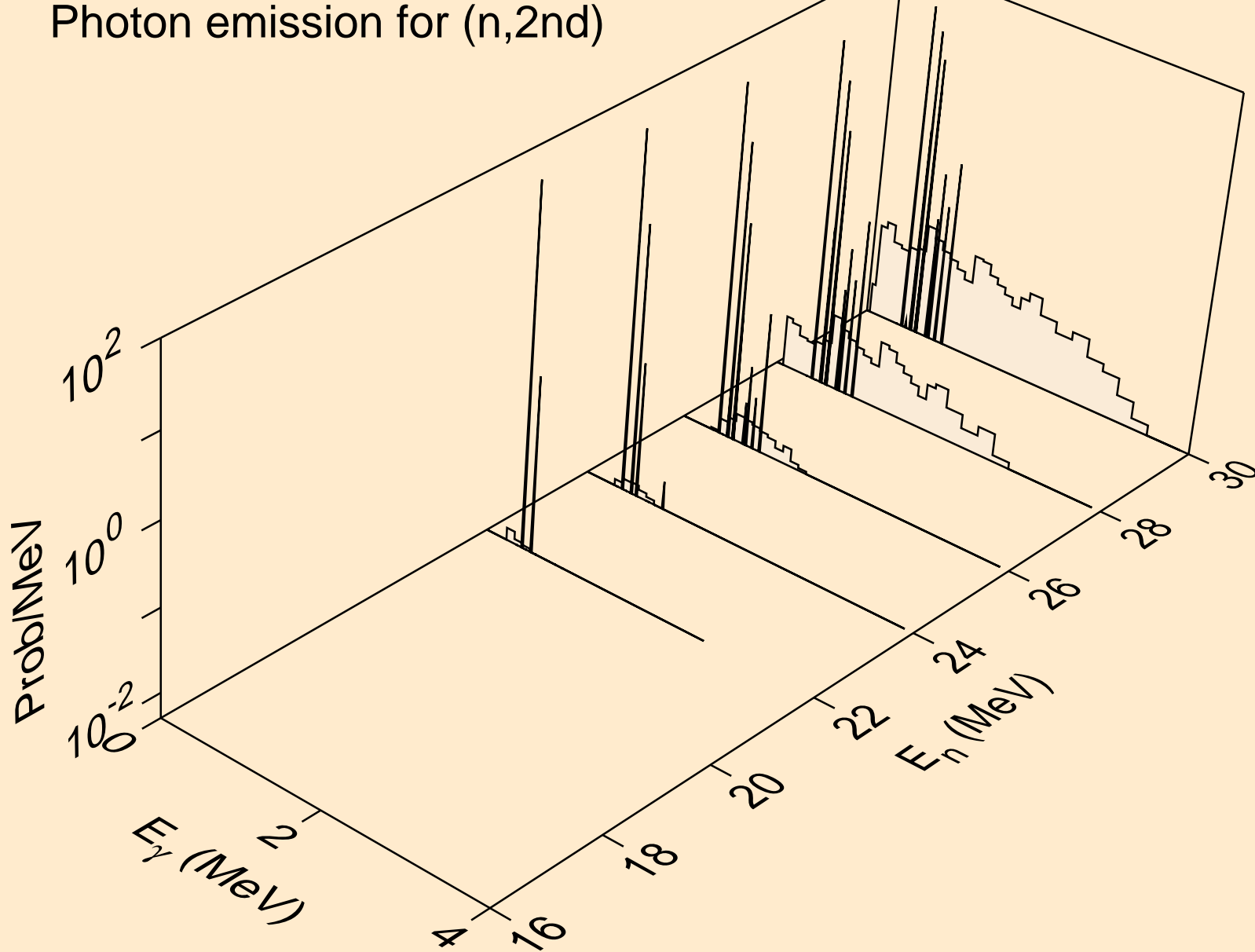

RE165 NEUTRON ACER TENDL-2023 LIBRARY; T=0.K  
Photon emission for (n,2n)

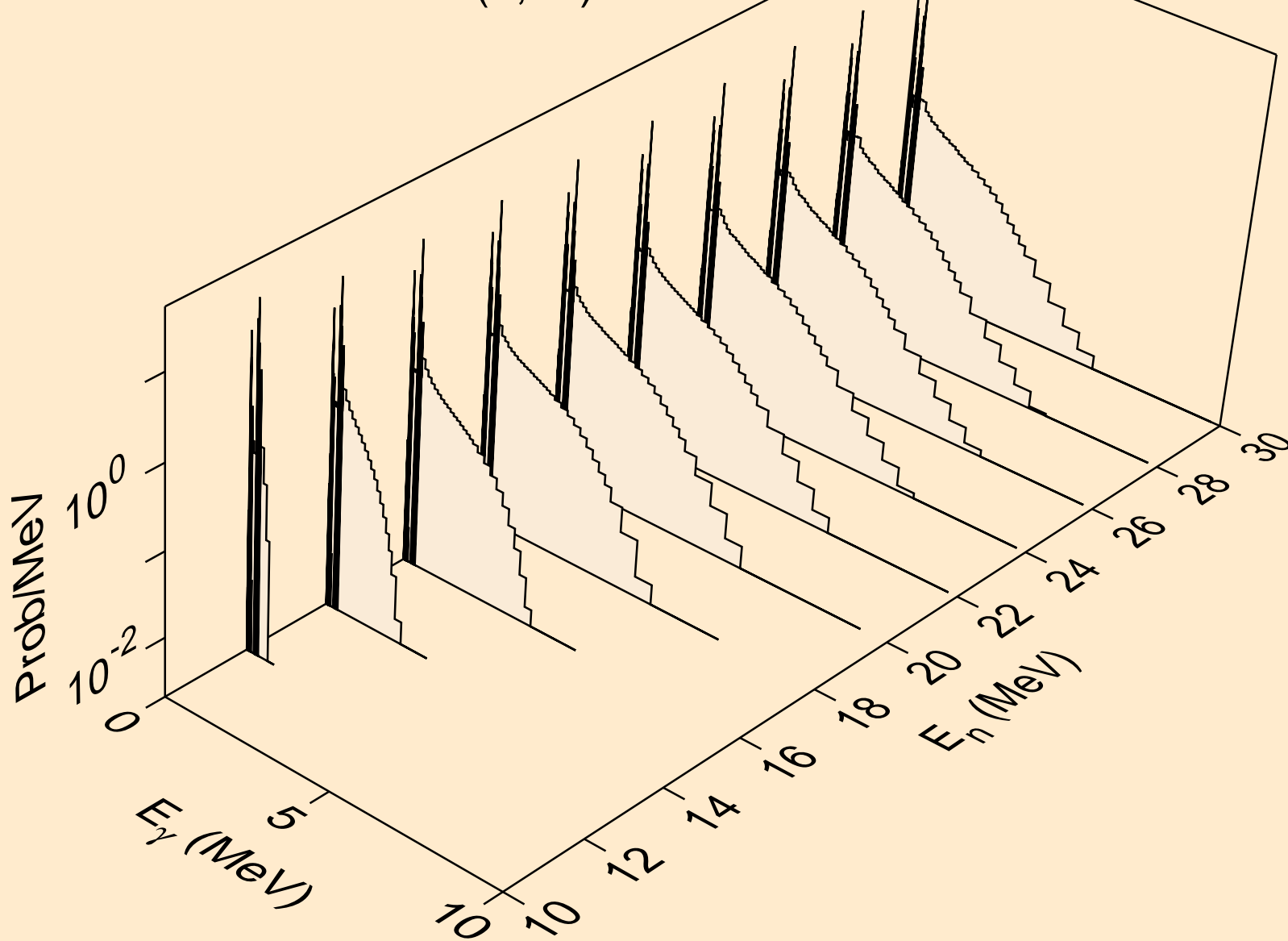

RE165 NEUTRON ACER TENDL-2023 LIBRARY; T=0.K  
Photon emission for (n,3n)

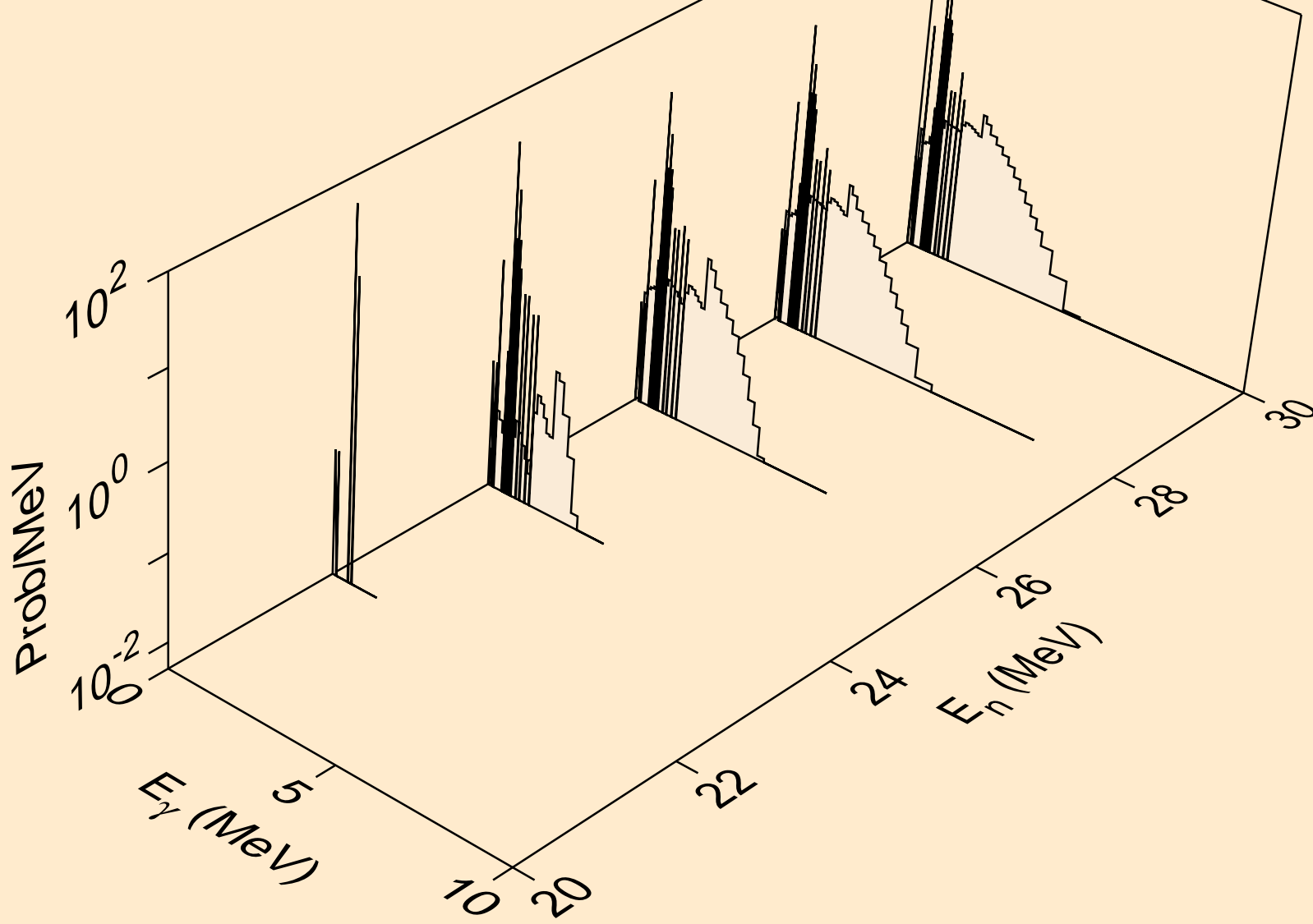

RE165 NEUTRON ACER TENDL-2023 LIBRARY; T=0.K  
Photon emission for (n,n\*)a

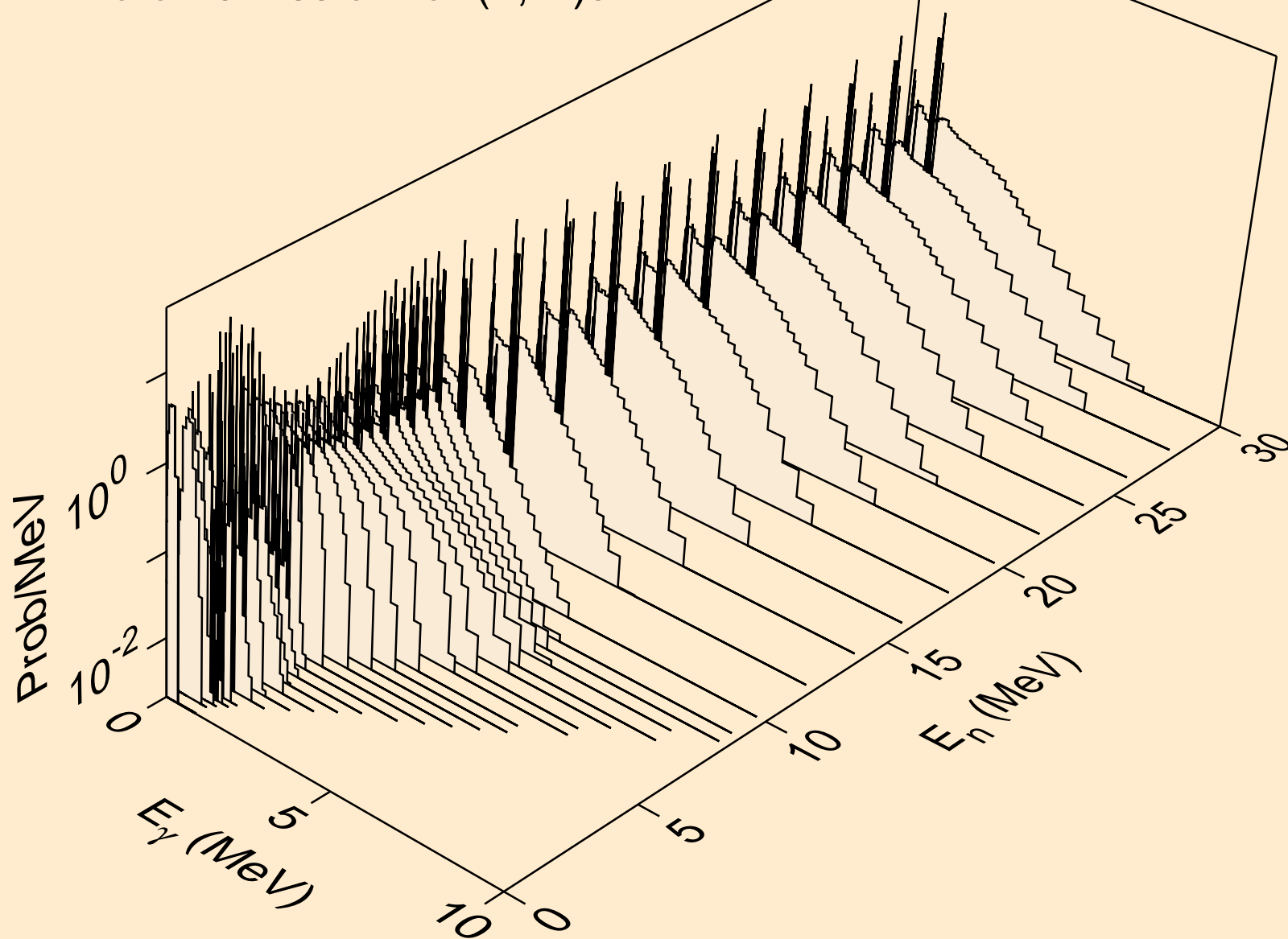

RE165 NEUTRON ACER TENDL-2023 LIBRARY; T=0.K  
Photon emission for (n,n\*)3a

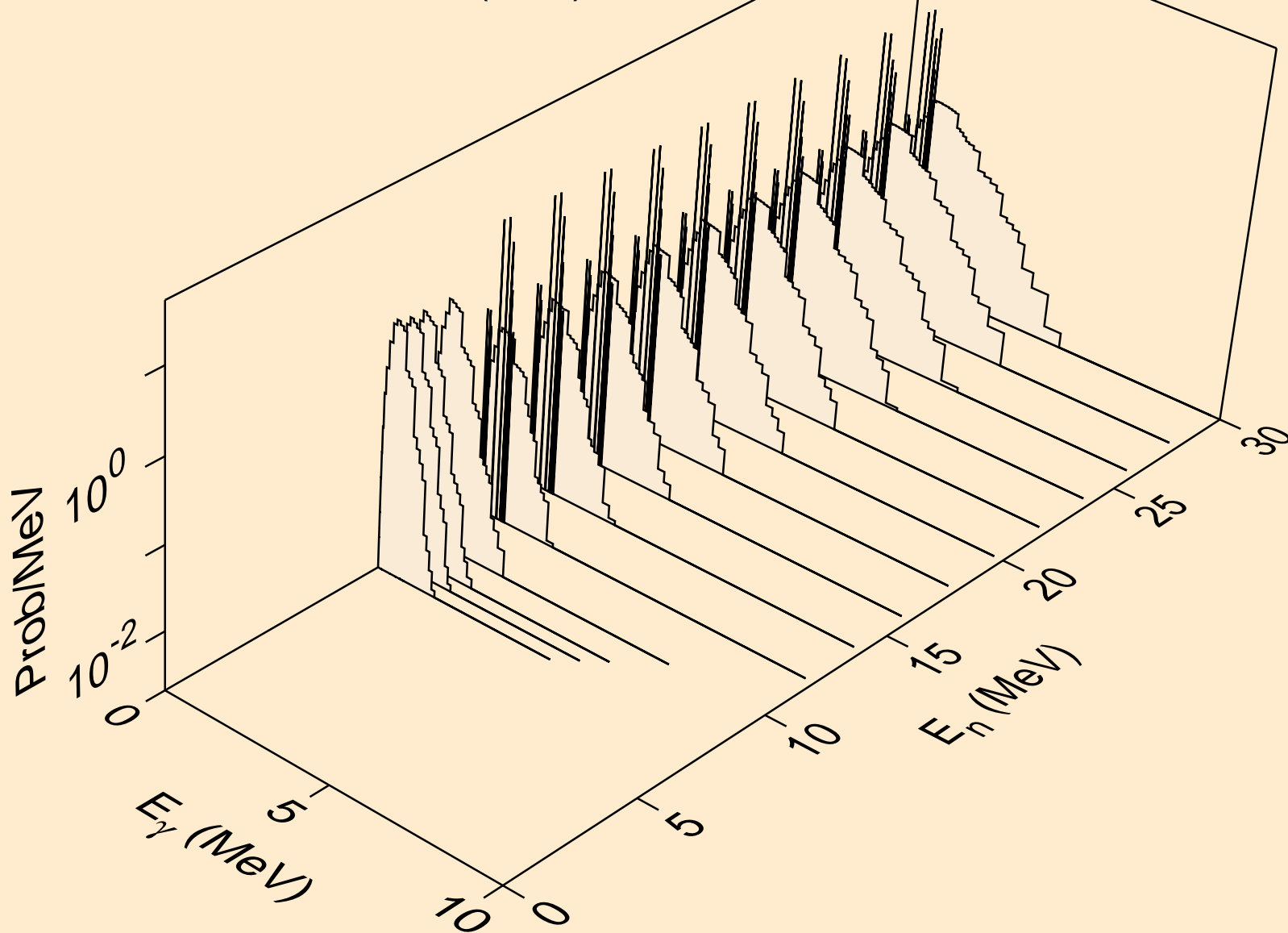

RE165 NEUTRON ACER TENDL-2023 LIBRARY; T=0.K  
Photon emission for (n,2n)a

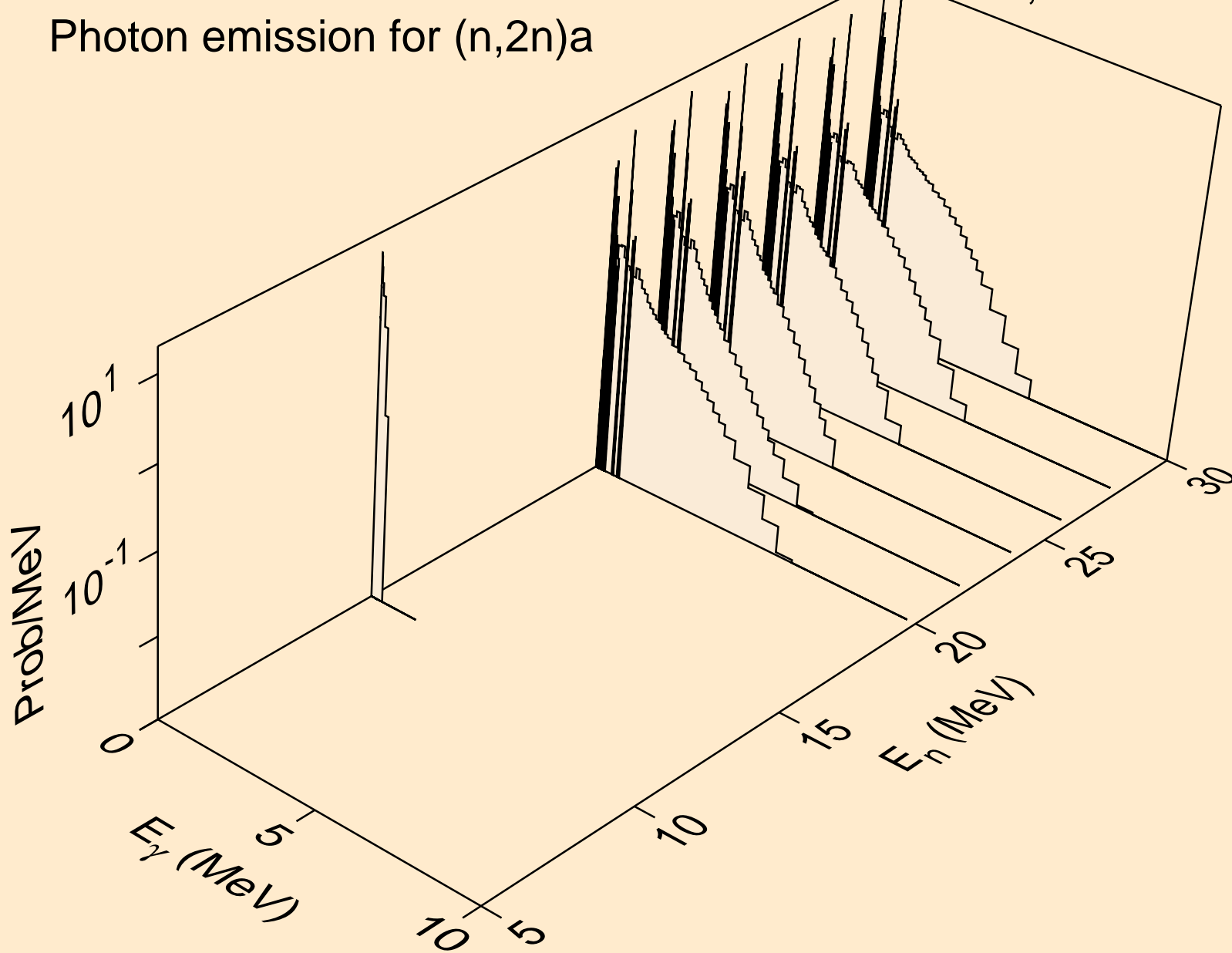

RE165 NEUTRON ACER TENDL-2023 LIBRARY; T=0.K  
Photon emission for (n,3n)a

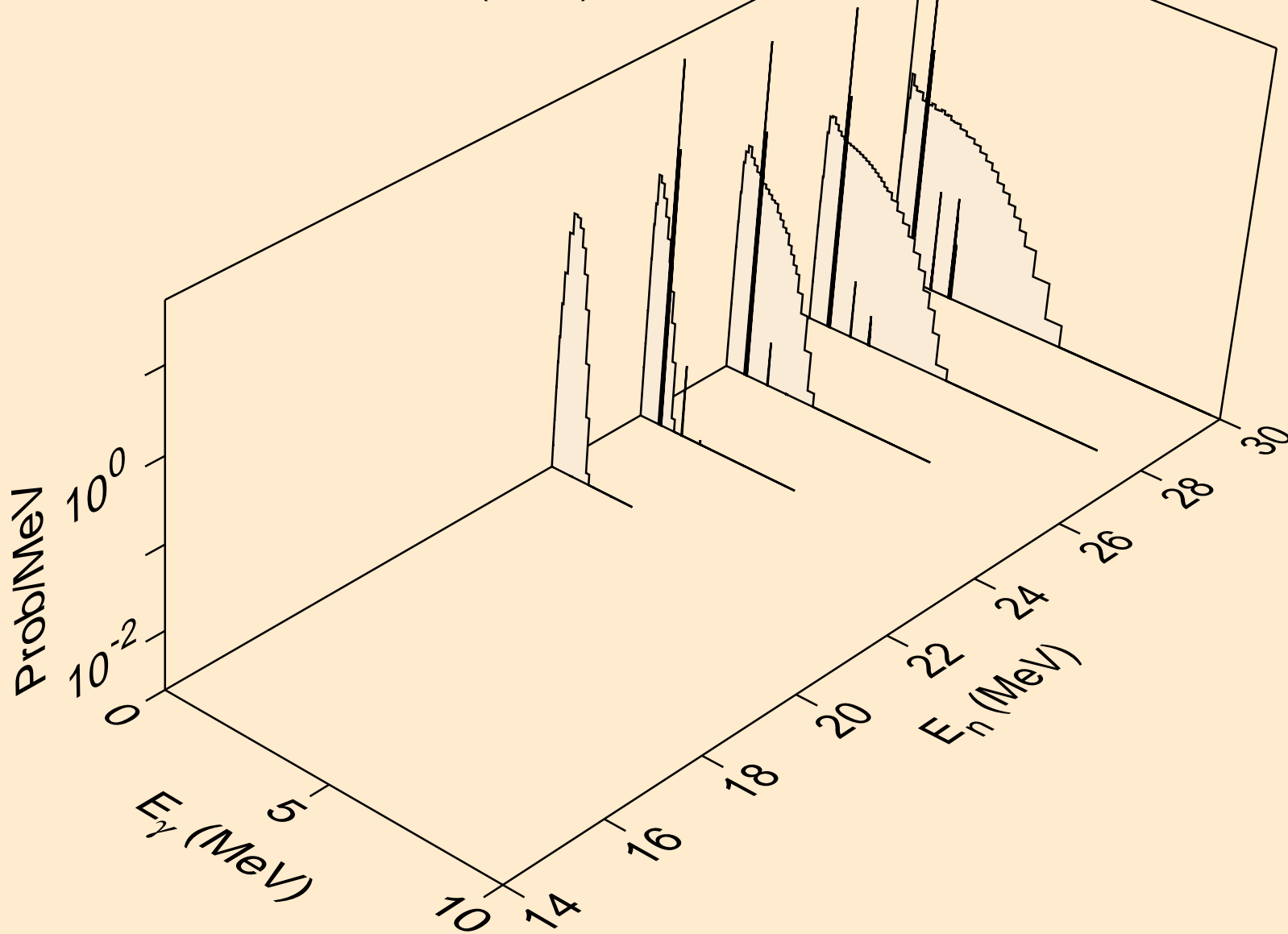

RE165 NEUTRON ACER TENDL-2023 LIBRARY; T=0.K  
Photon emission for (n,n\*)p

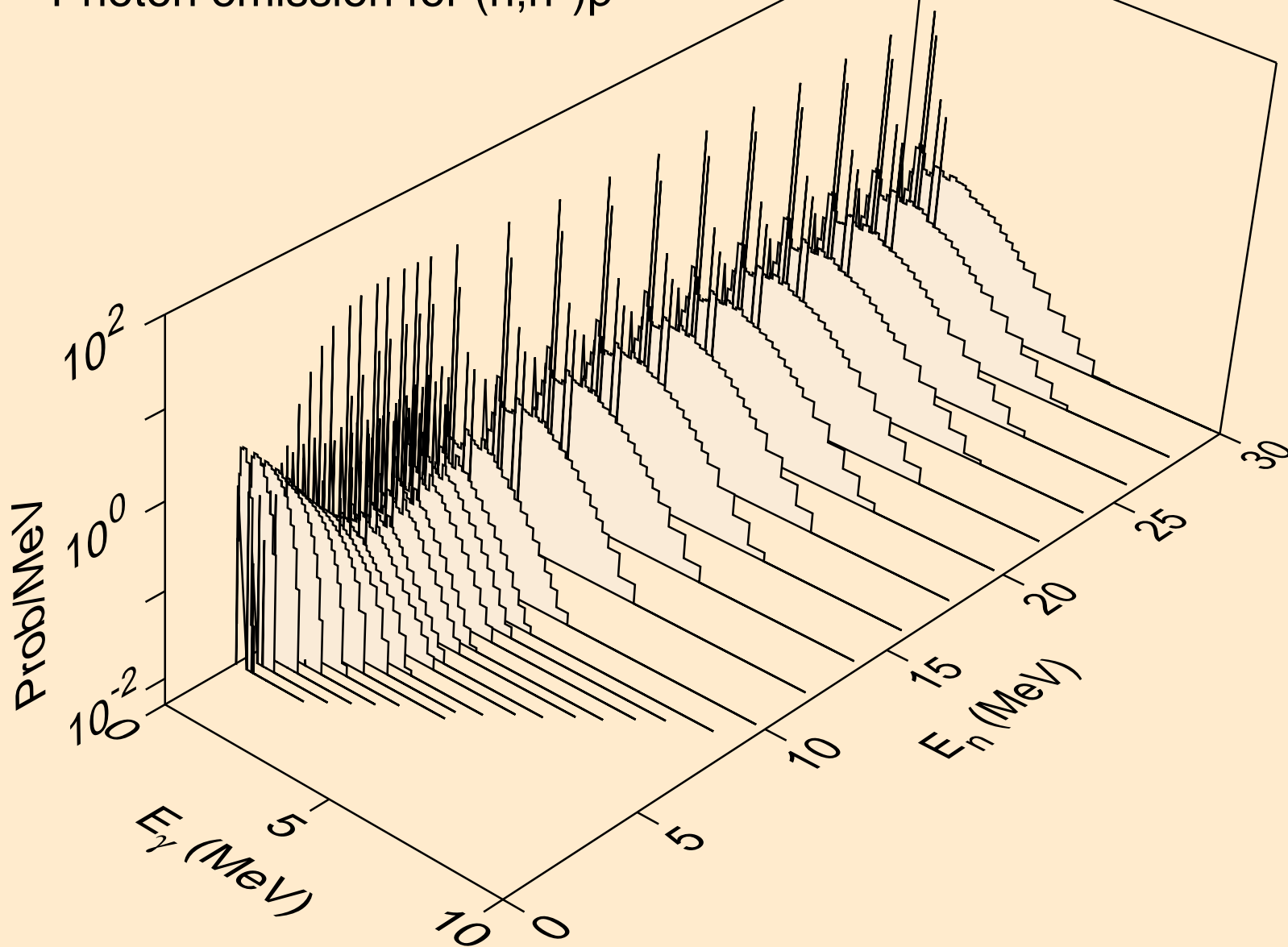

RE165 NEUTRON ACER TENDL-2023 LIBRARY; T=0.K  
Photon emission for (n,n\*)2a

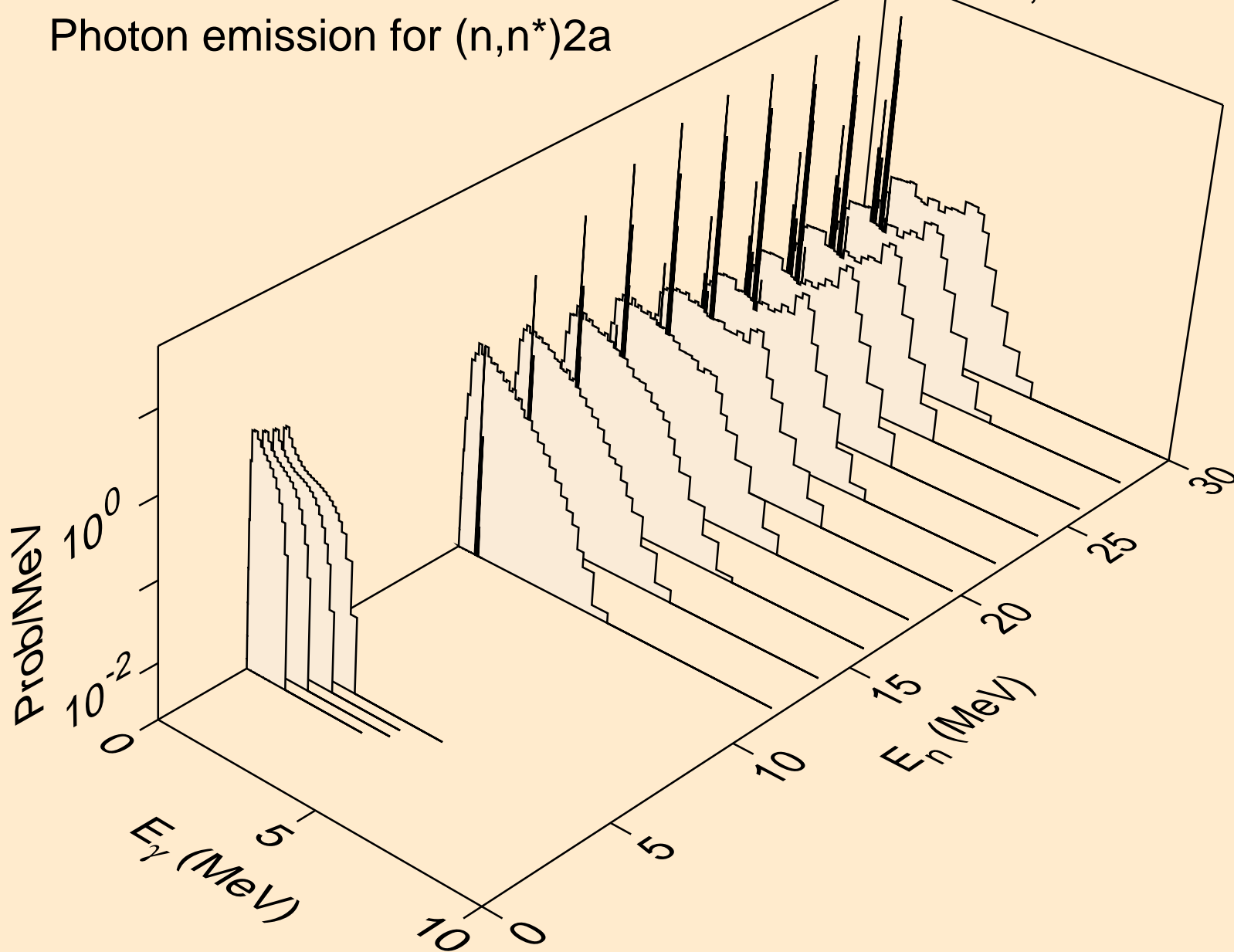

RE165 NEUTRON ACER TENDL-2023 LIBRARY; T=0.K  
Photon emission for (n,2n)2a

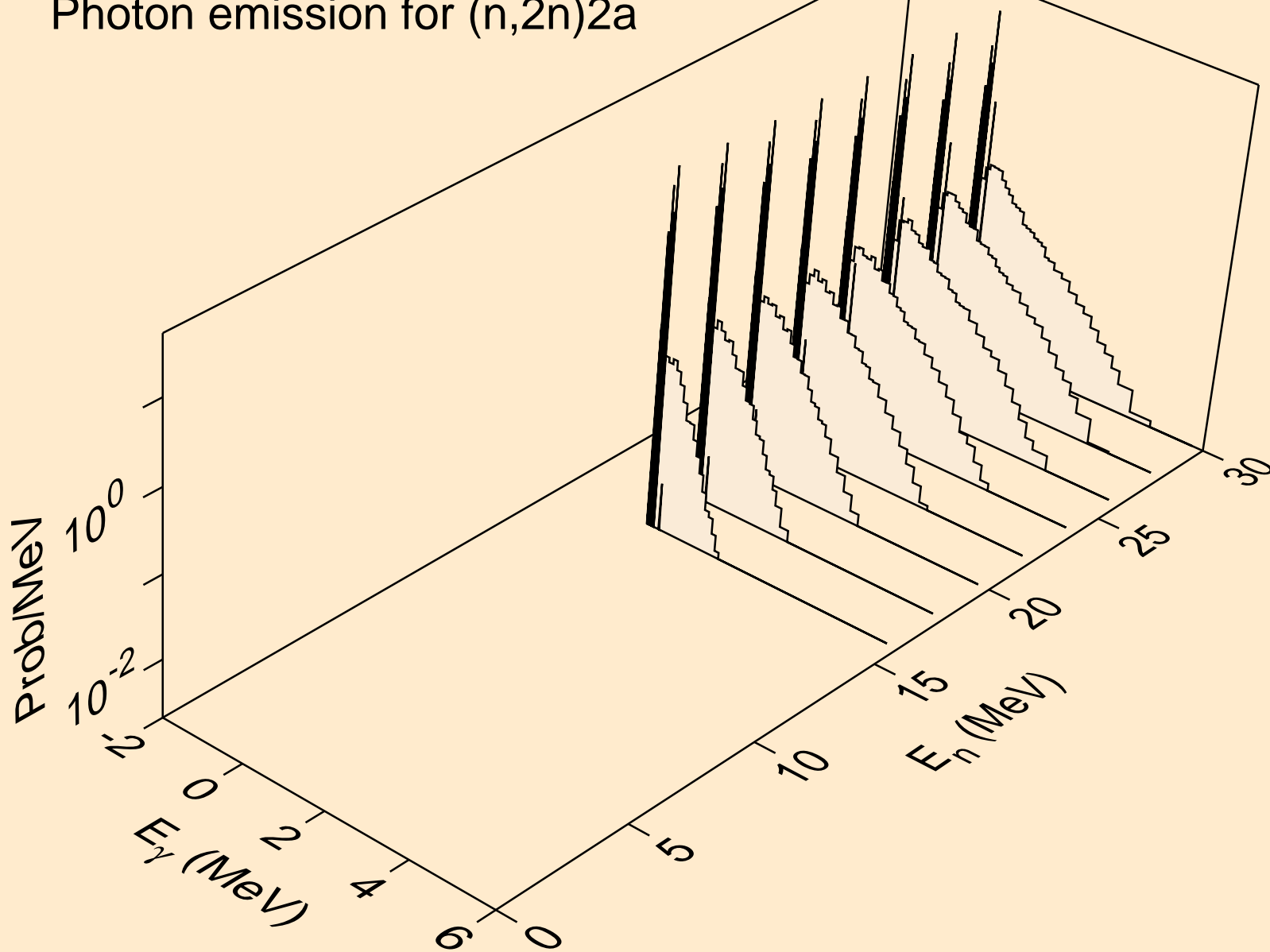

RE165 NEUTRON ACER TENDL-2023 LIBRARY; T=0.K  
Photon emission for (n,n\*)d

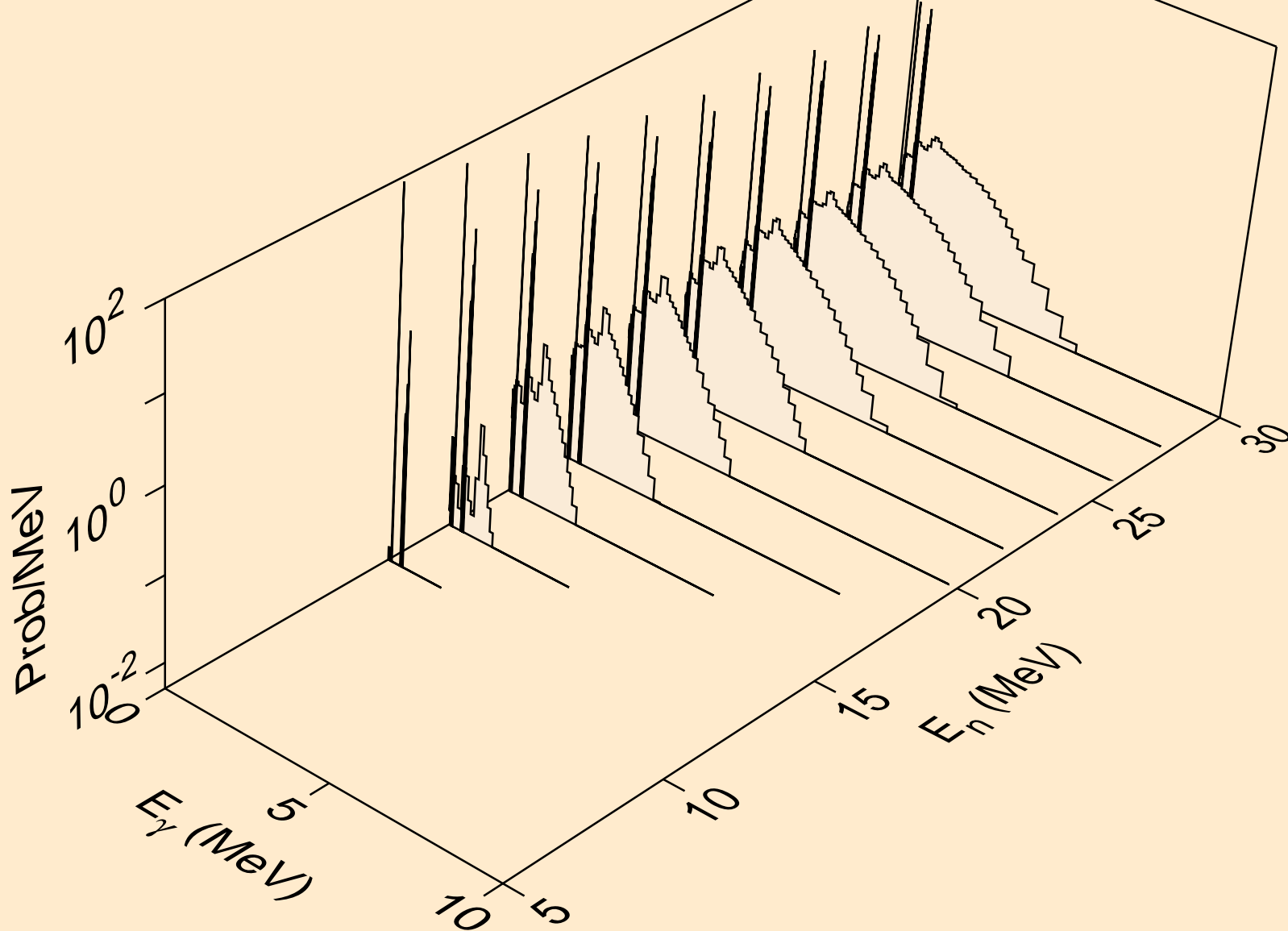

RE165 NEUTRON ACER TENDL-2023 LIBRARY; T=0.K  
Photon emission for (n,n\*)t

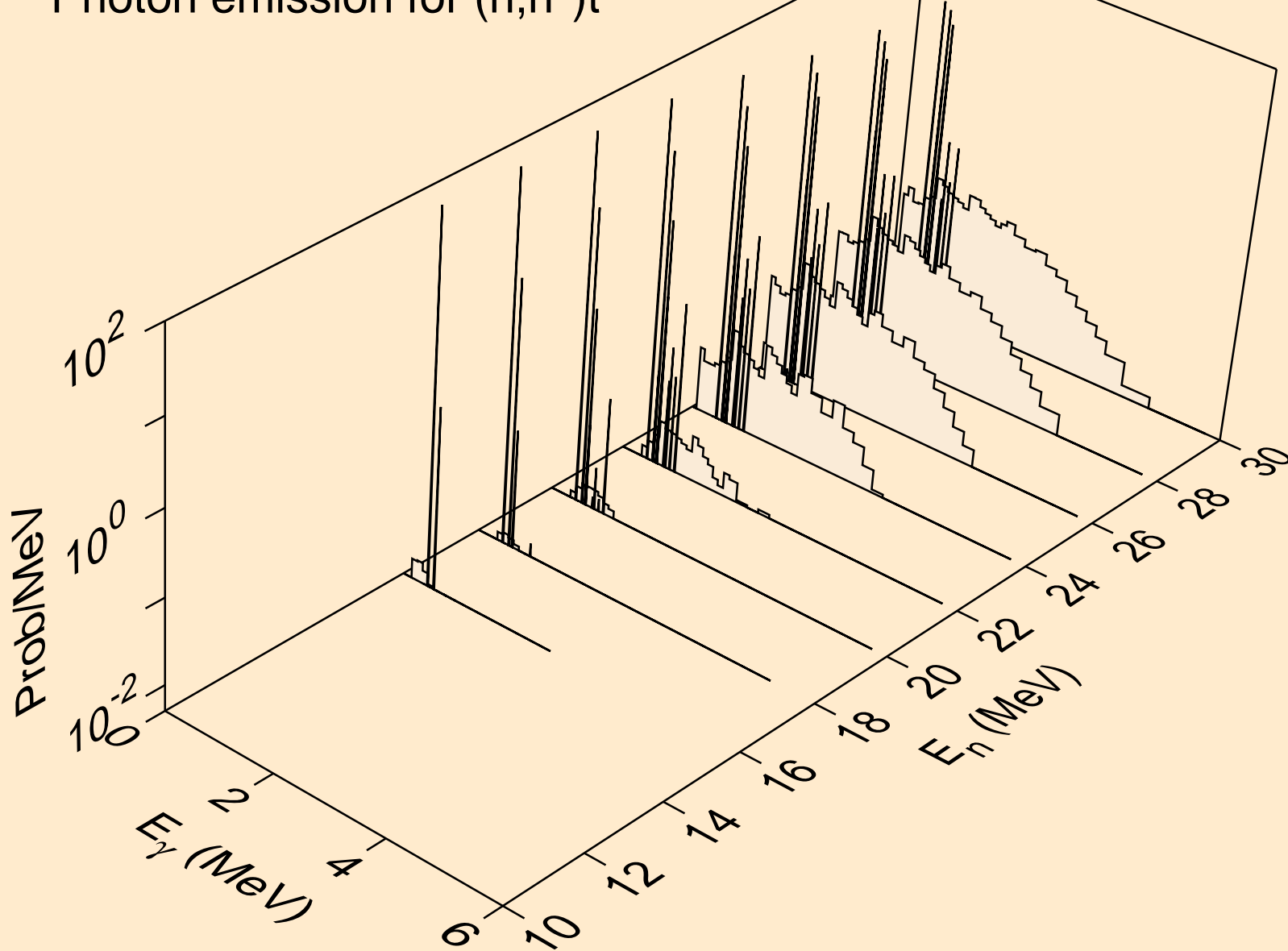

RE165 NEUTRON ACER TENDL-2023 LIBRARY; T=0.K  
Photon emission for (n,n\*)he3

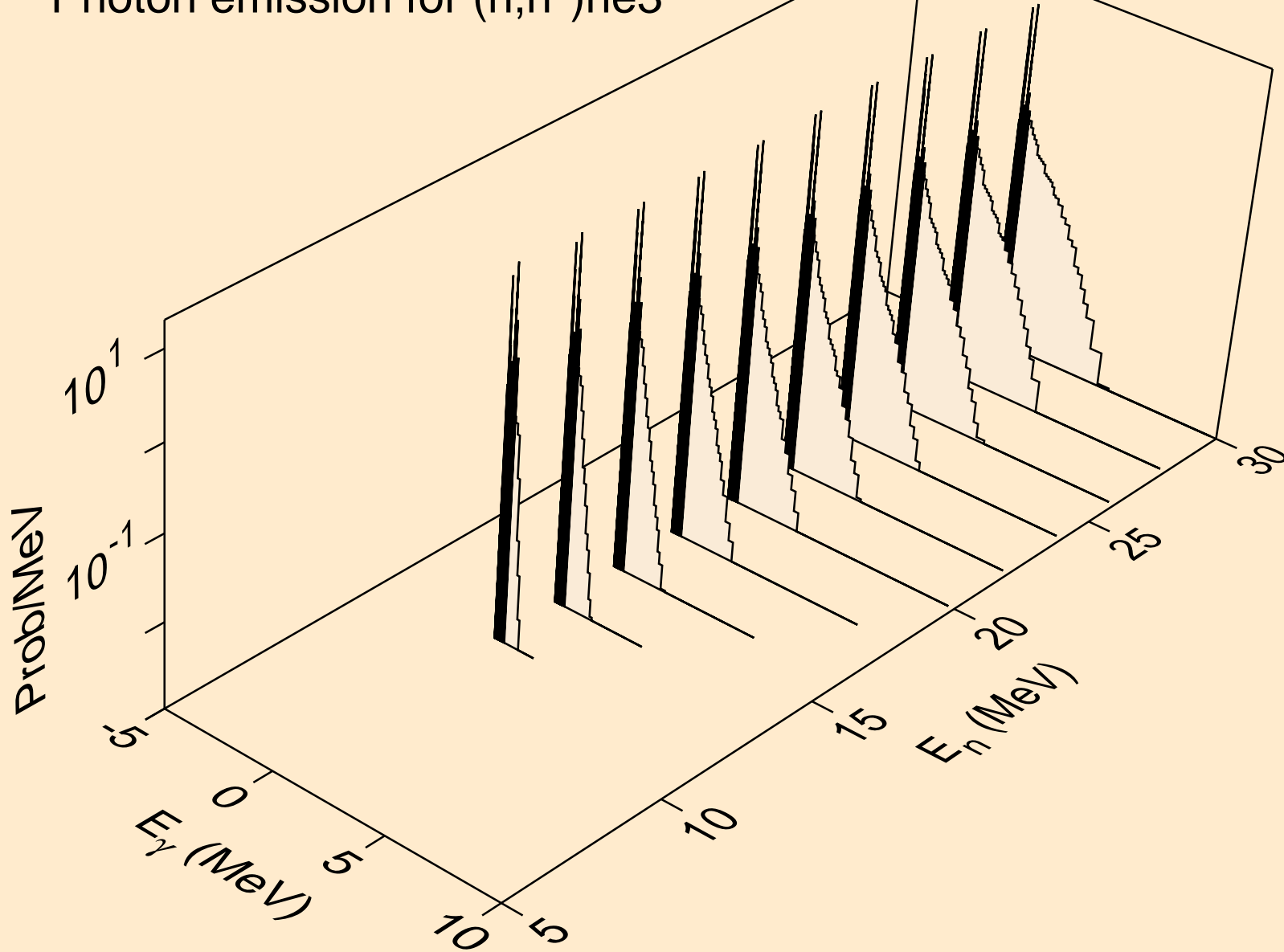

RE165 NEUTRON ACER TENDL-2023 LIBRARY; T=0.K  
Photon emission for (n,2np)

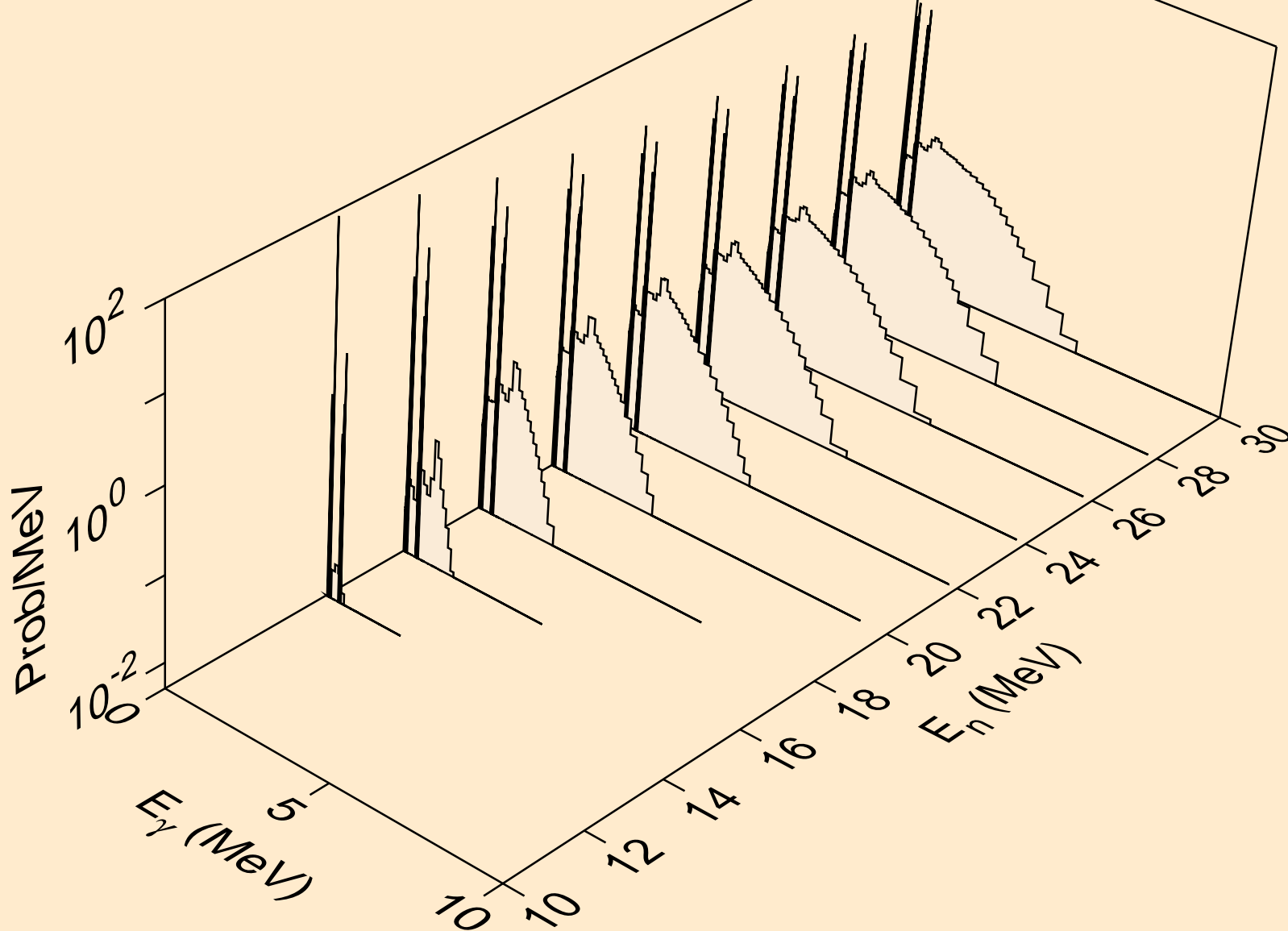

RE165 NEUTRON ACER TENDL-2023 LIBRARY; T=0.K  
Photon emission for (n,3np)

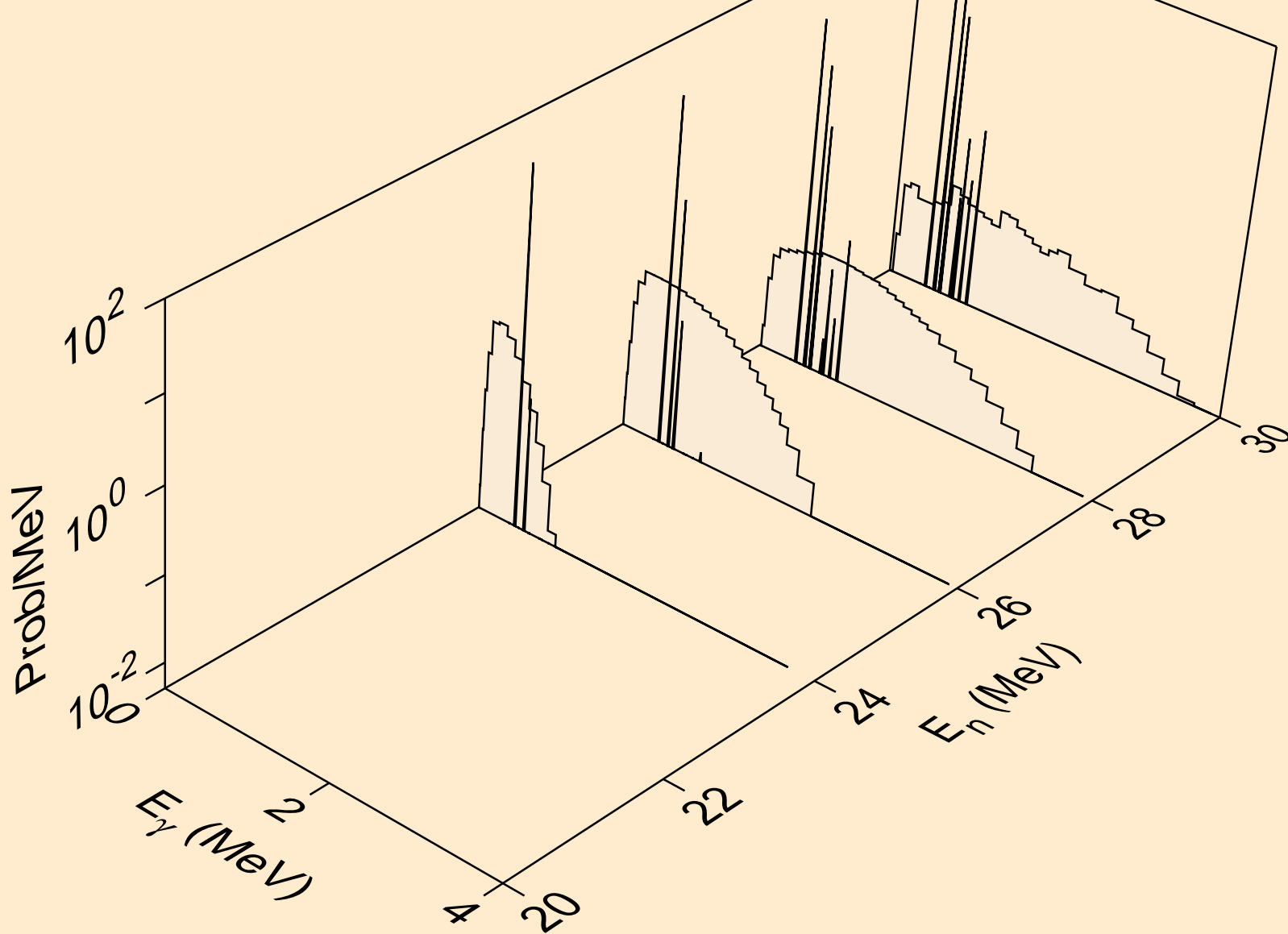

RE165 NEUTRON ACER TENDL-2023 LIBRARY; T=0.K  
Photon emission for (n,n2p)

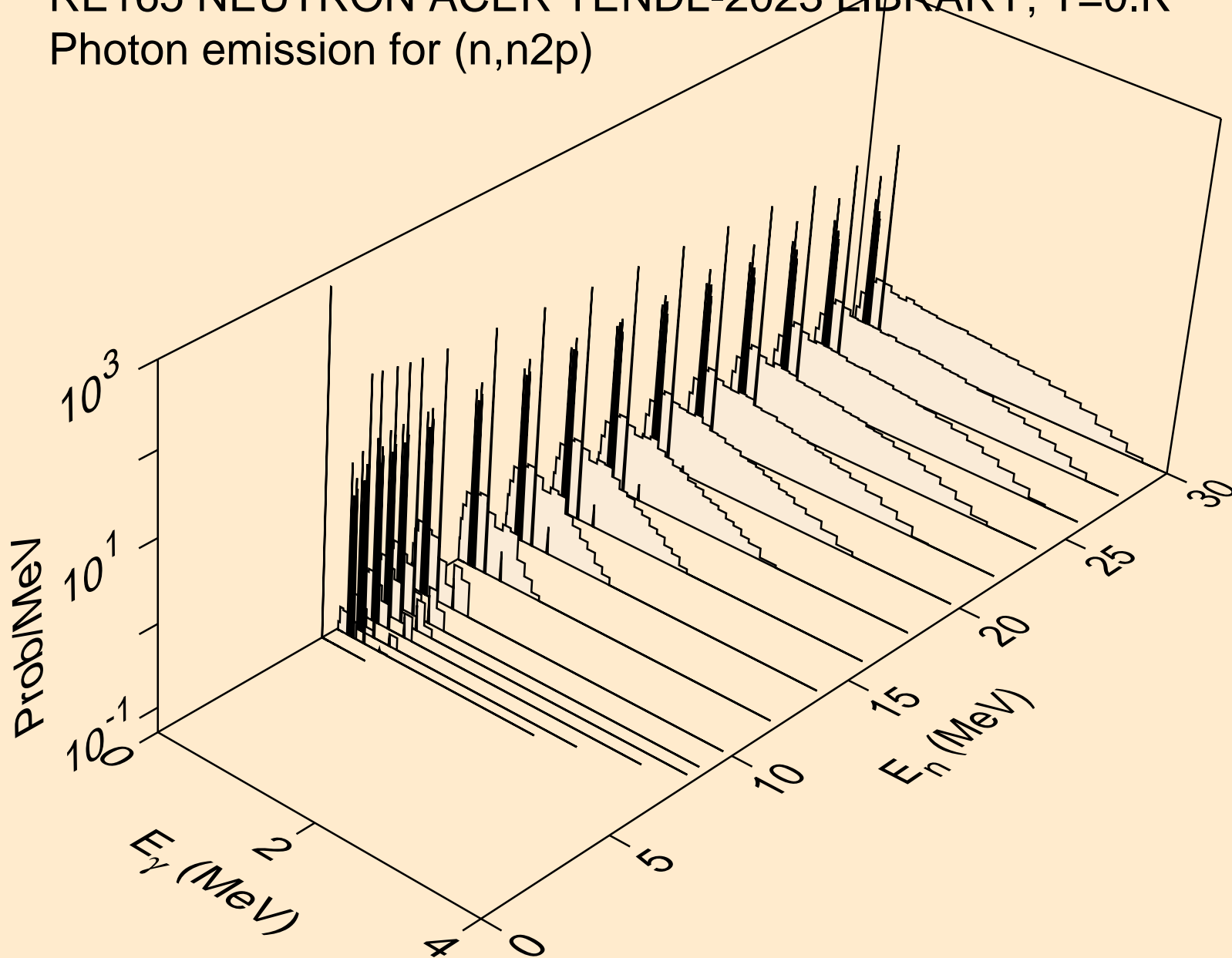

RE165 NEUTRON ACER TENDL-2023 LIBRARY; T=0.K  
Photon emission for (n,npa)

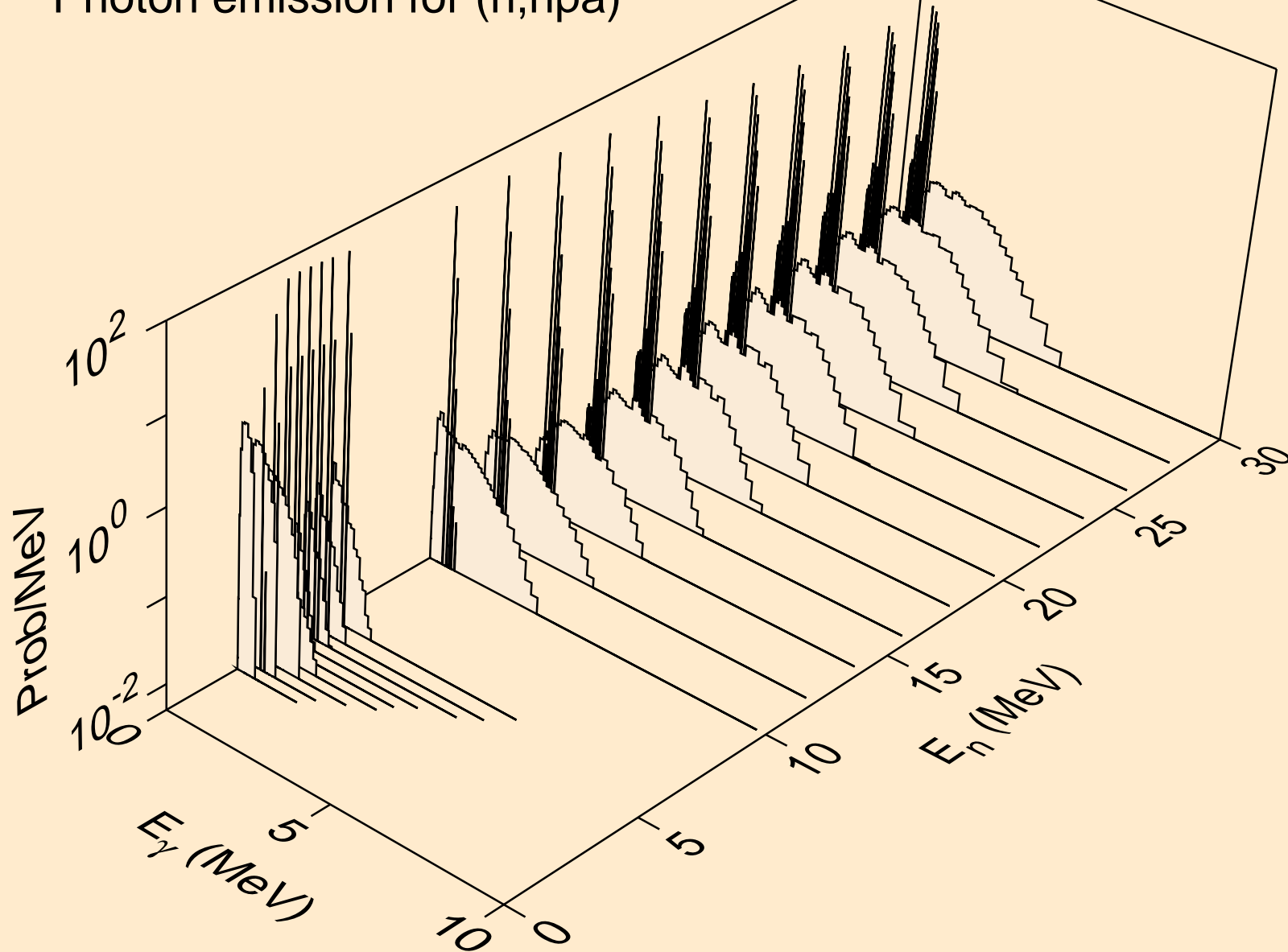

RE165 NEUTRON ACER TENDL-2023 LIBRARY; T=0.K  
Photon emission for (n,n\*c)

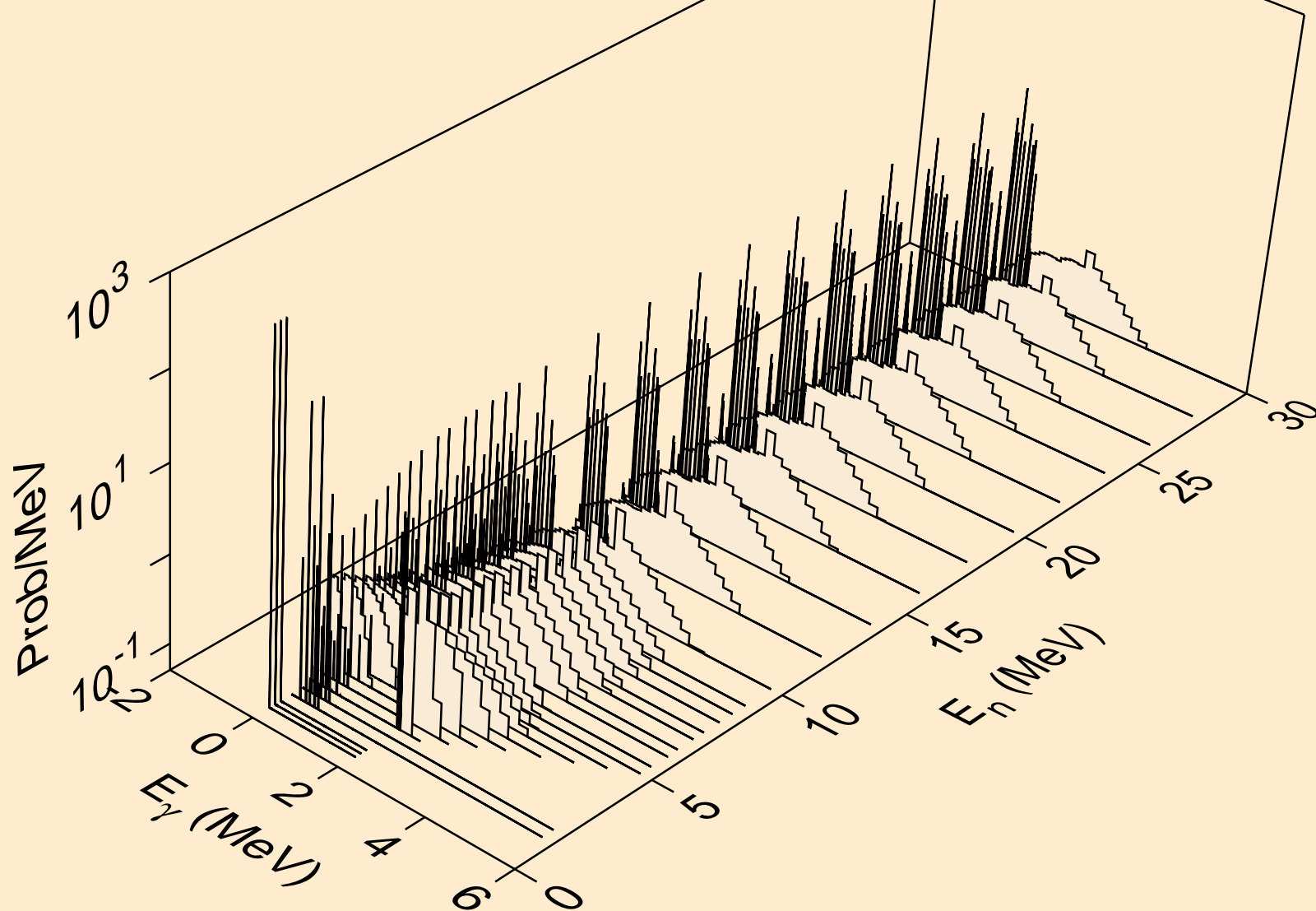

RE165 NEUTRON ACER TENDL-2023 LIBRARY; T=0.K  
Photon emission for (n,gma)

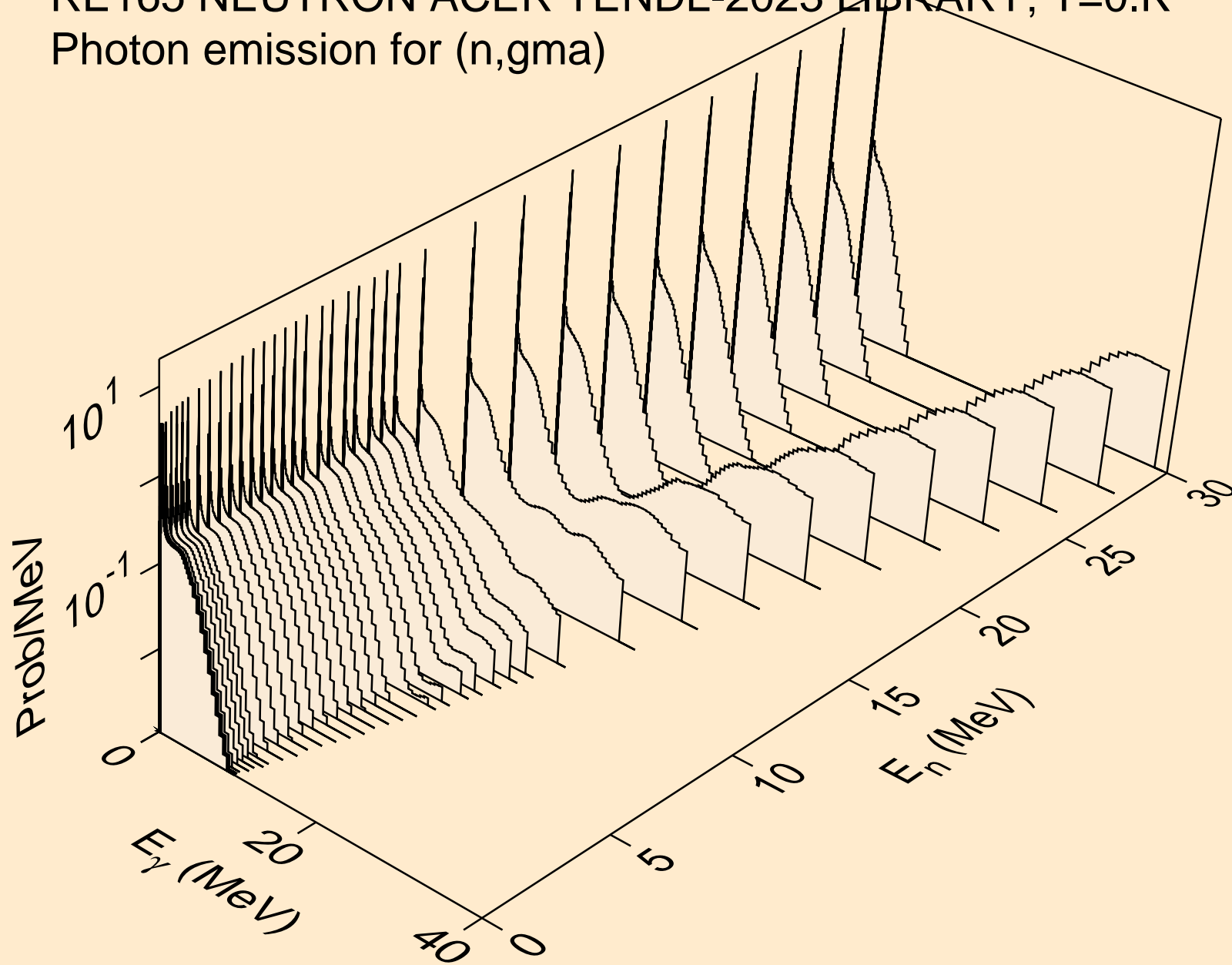

RE165 NEUTRON ACER TENDL-2023 LIBRARY; T=0.K  
Photon emission for (n,p)

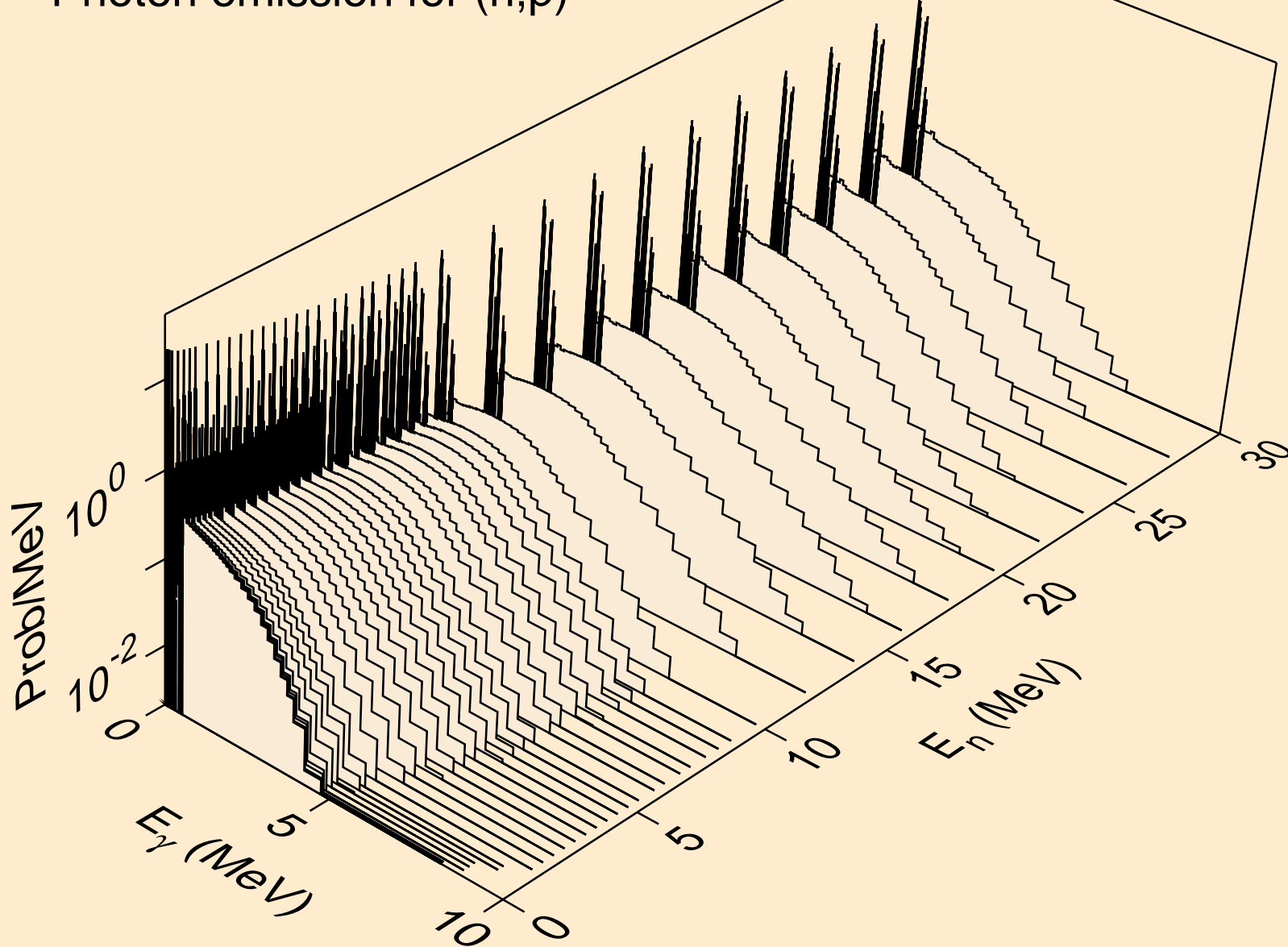

RE165 NEUTRON ACER TENDL-2023 LIBRARY; T=0.K  
Photon emission for (n,d)

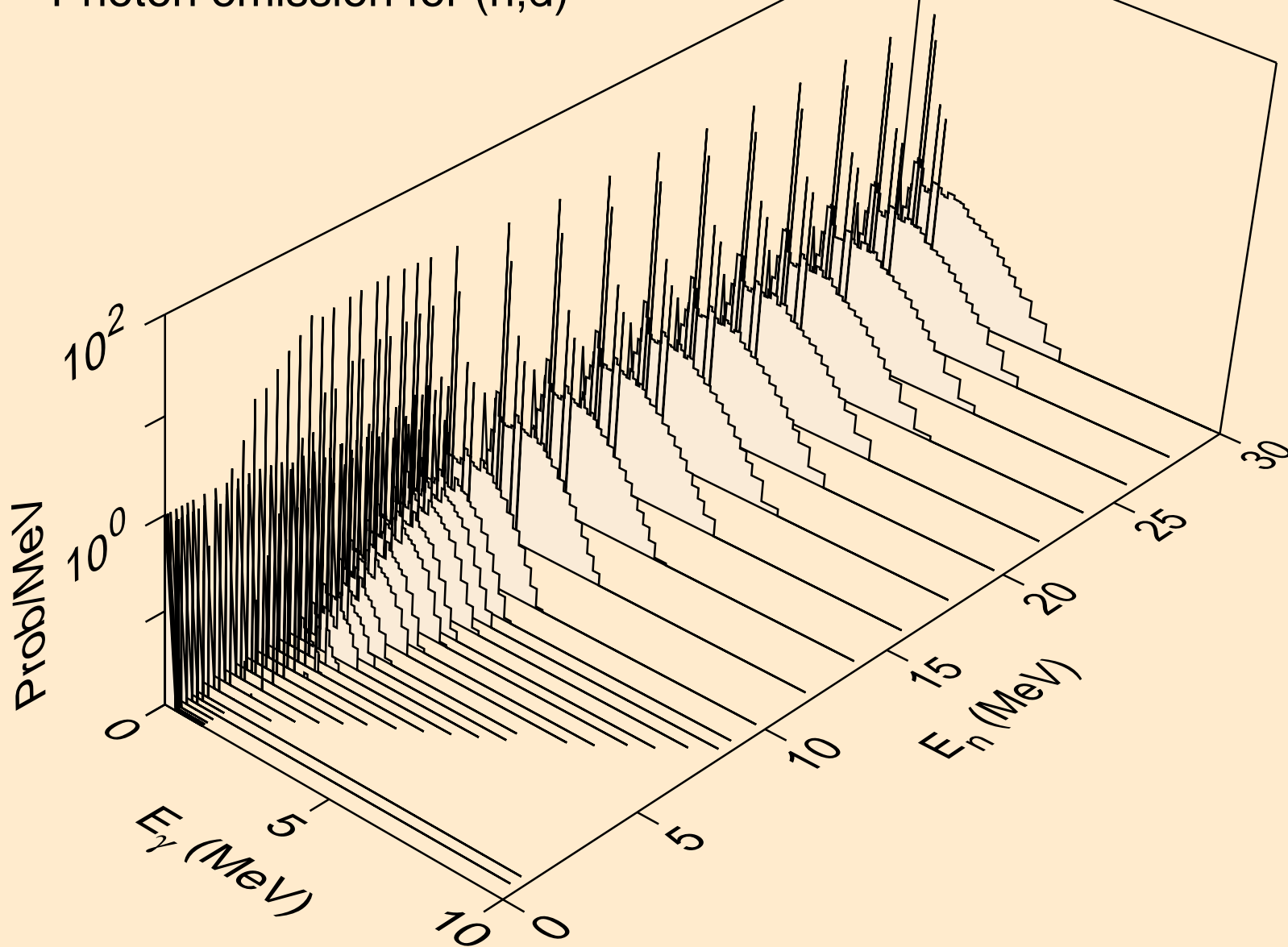

RE165 NEUTRON ACER TENDL-2023 LIBRARY; T=0.K  
Photon emission for (n,t)

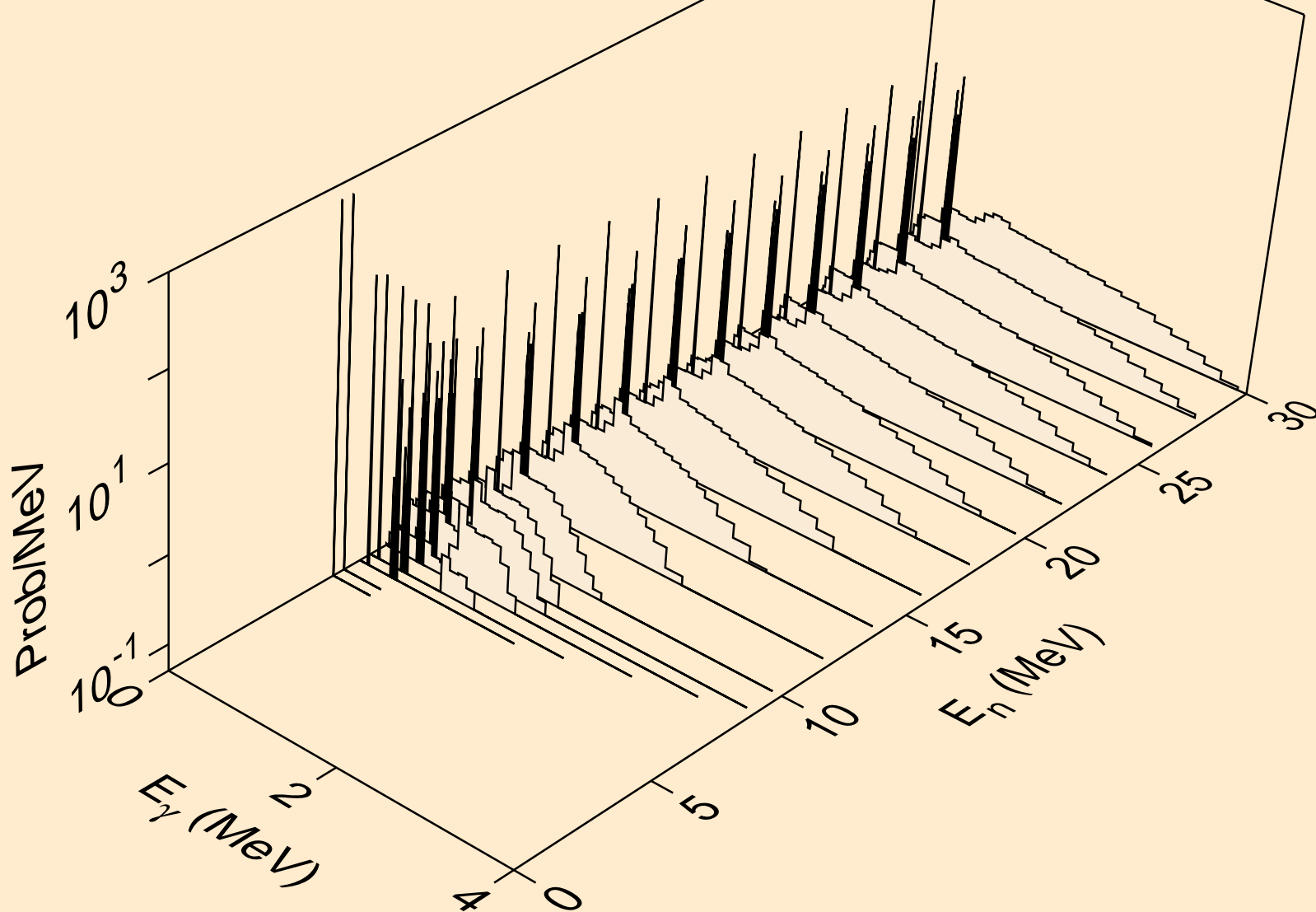

RE165 NEUTRON ACER TENDL-2023 LIBRARY; T=0.K  
Photon emission for (n,he3)

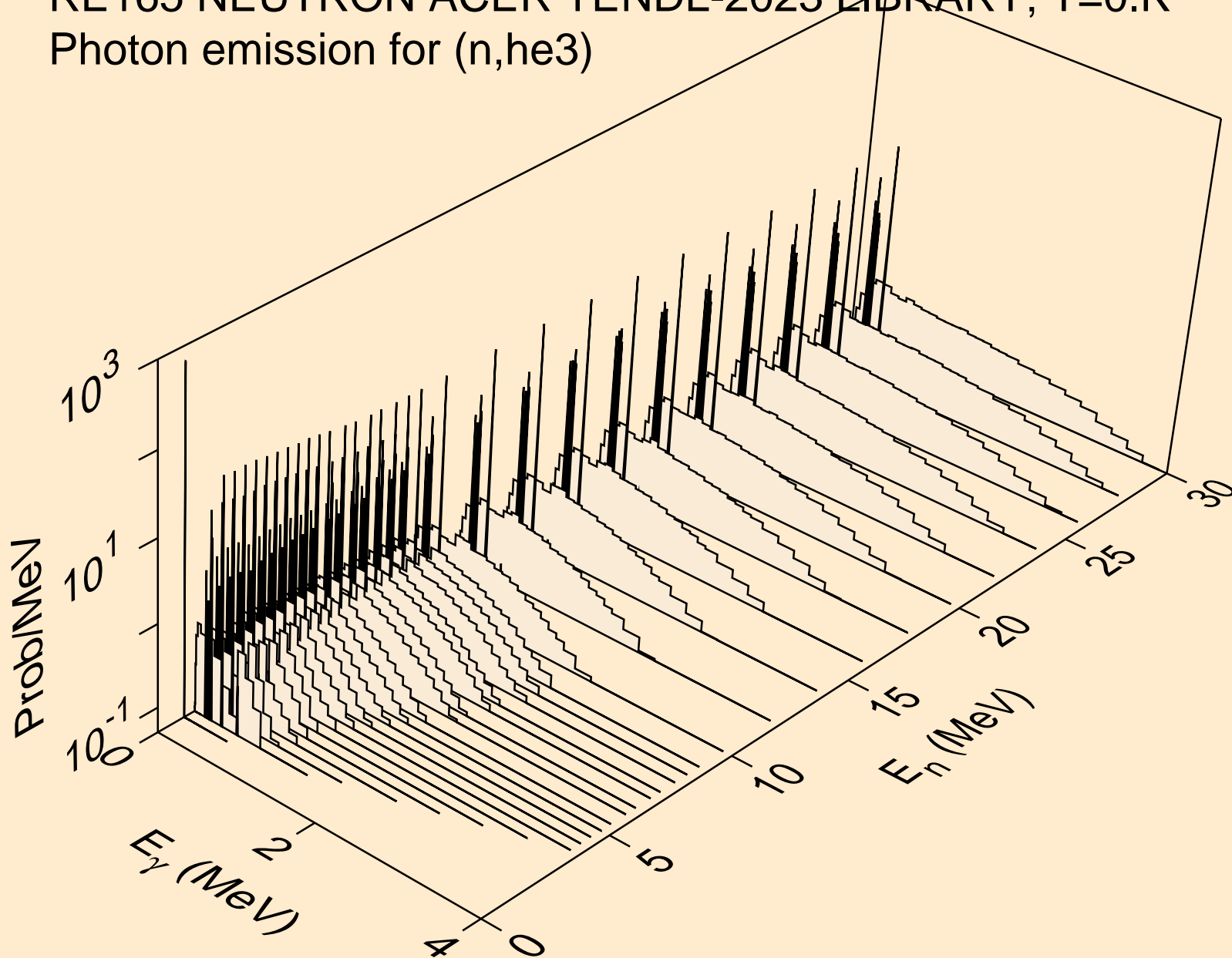

RE165 NEUTRON ACER TENDL-2023 LIBRARY; T=0.K  
Photon emission for (n,a)

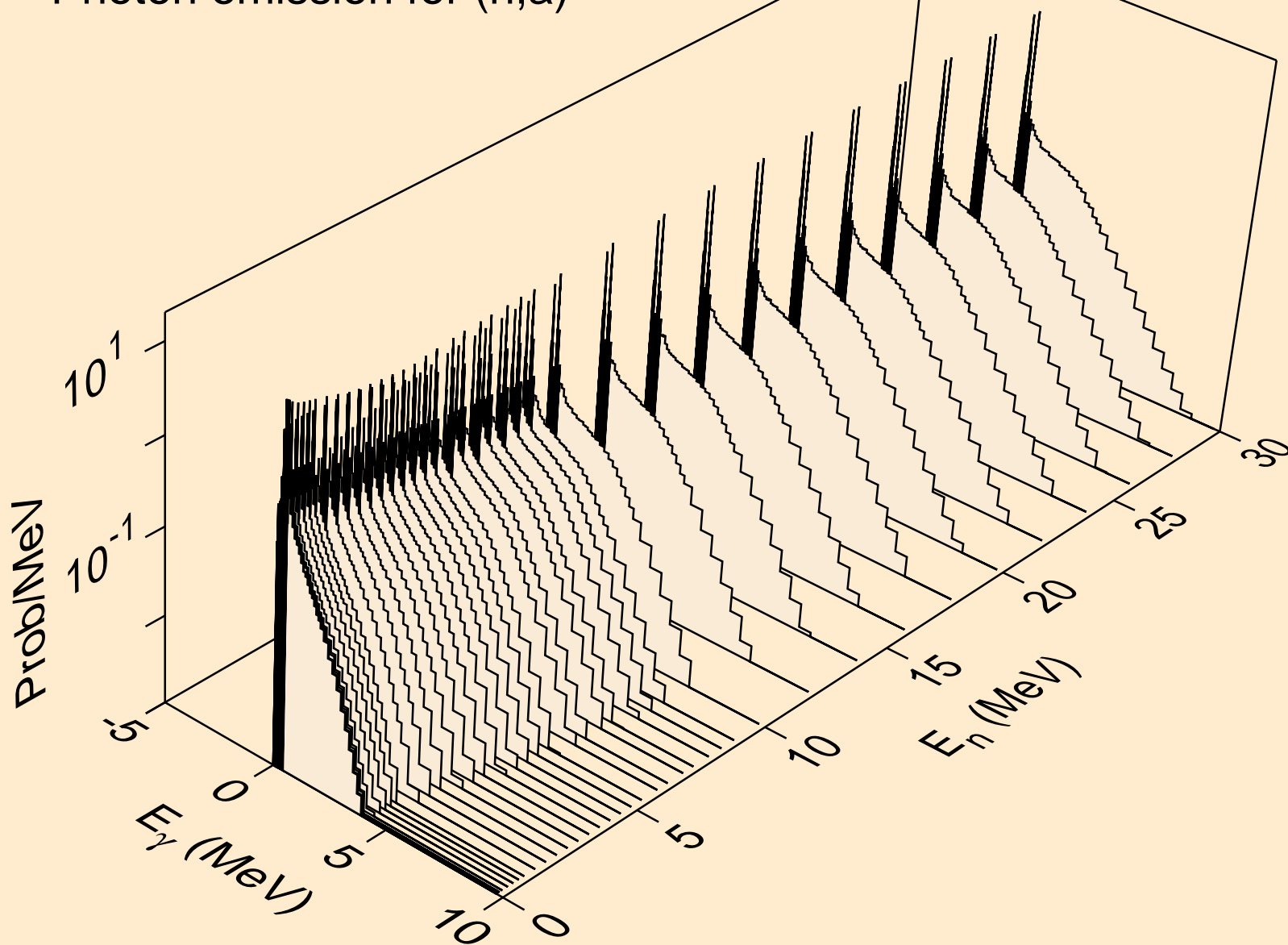

RE165 NEUTRON ACER TENDL-2023 LIBRARY; T=0.K  
Photon emission for (n,2a)

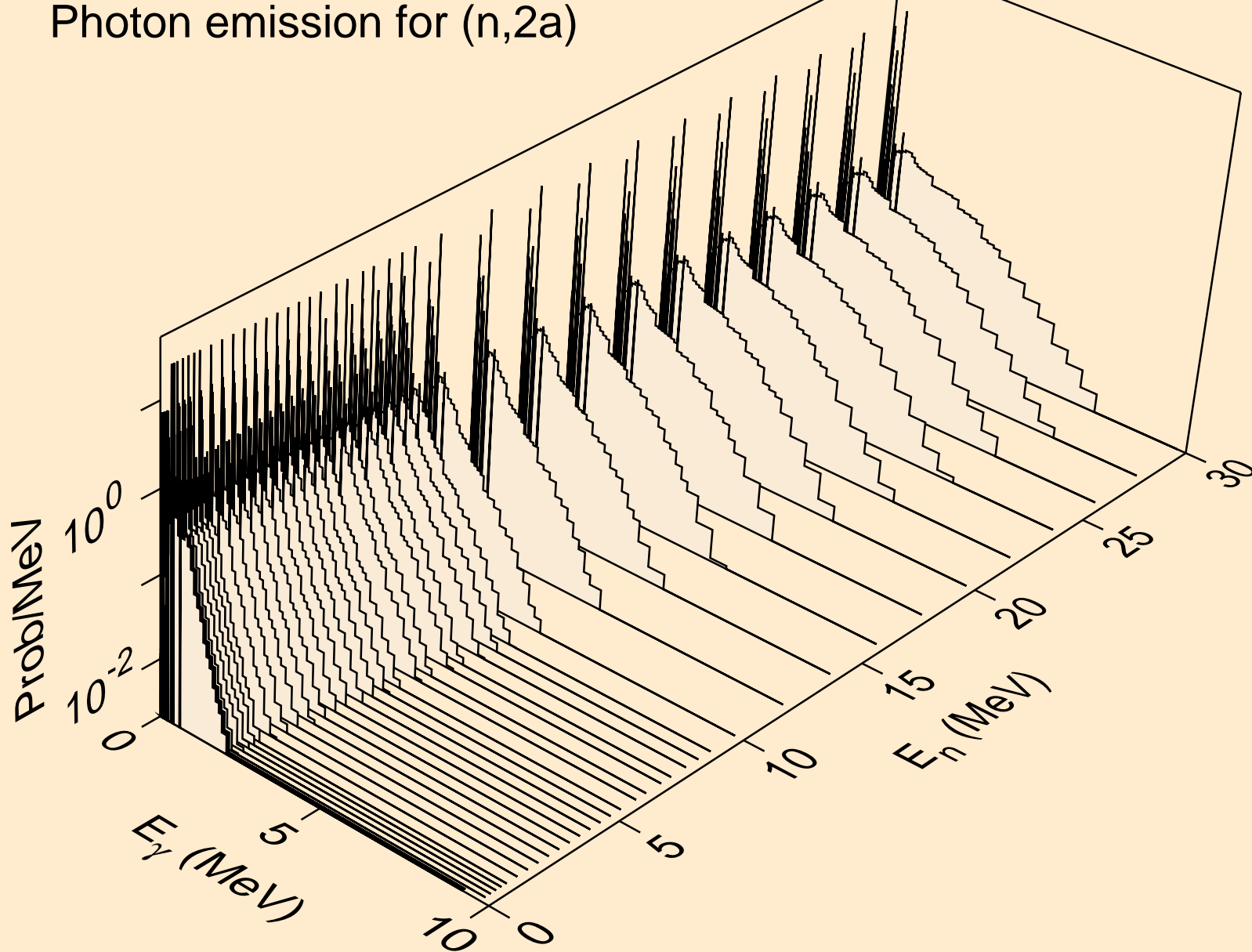

RE165 NEUTRON ACER TENDL-2023 LIBRARY; T=0.K  
Photon emission for (n,3a)

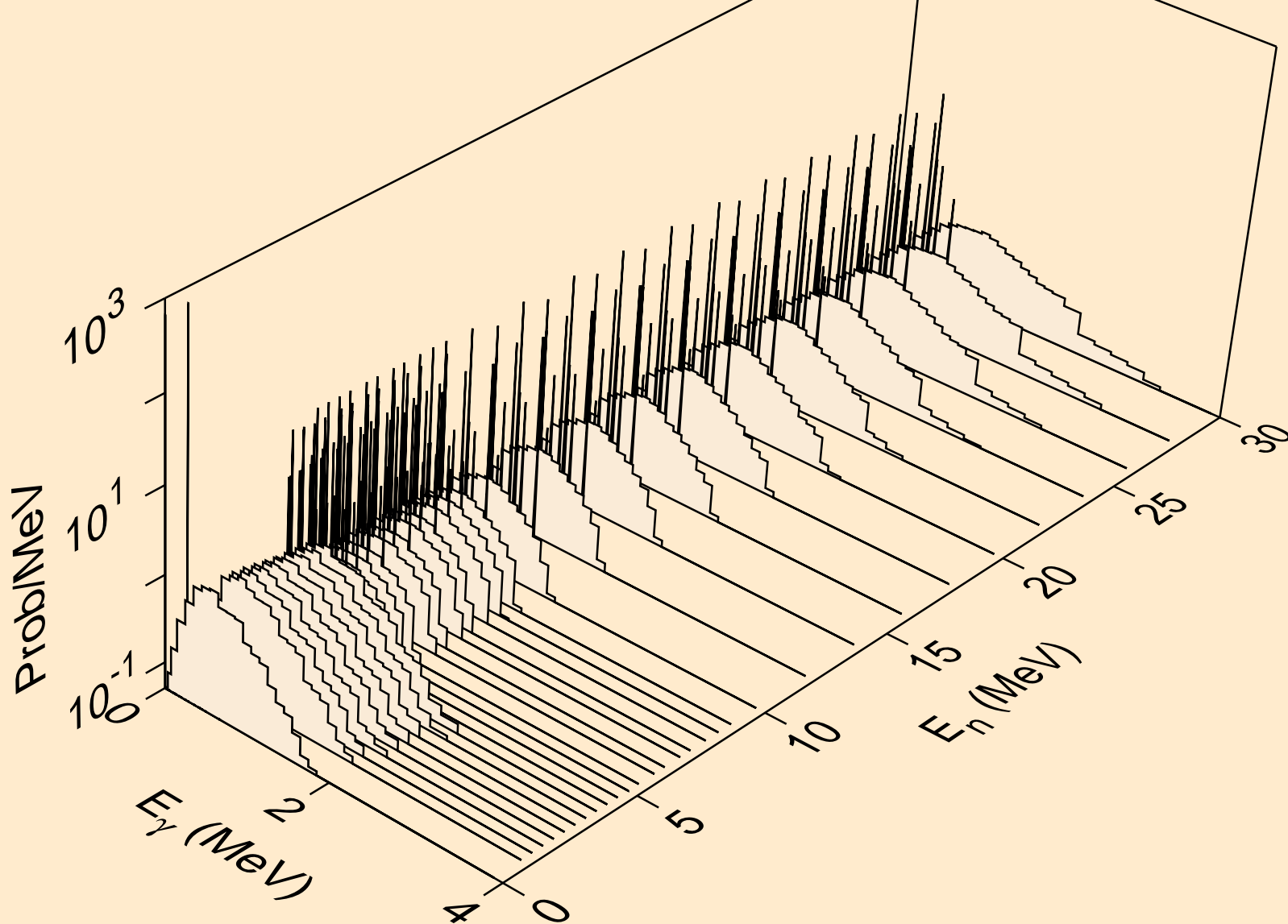

RE165 NEUTRON ACER TENDL-2023 LIBRARY; T=0.K  
Photon emission for (n,2p)

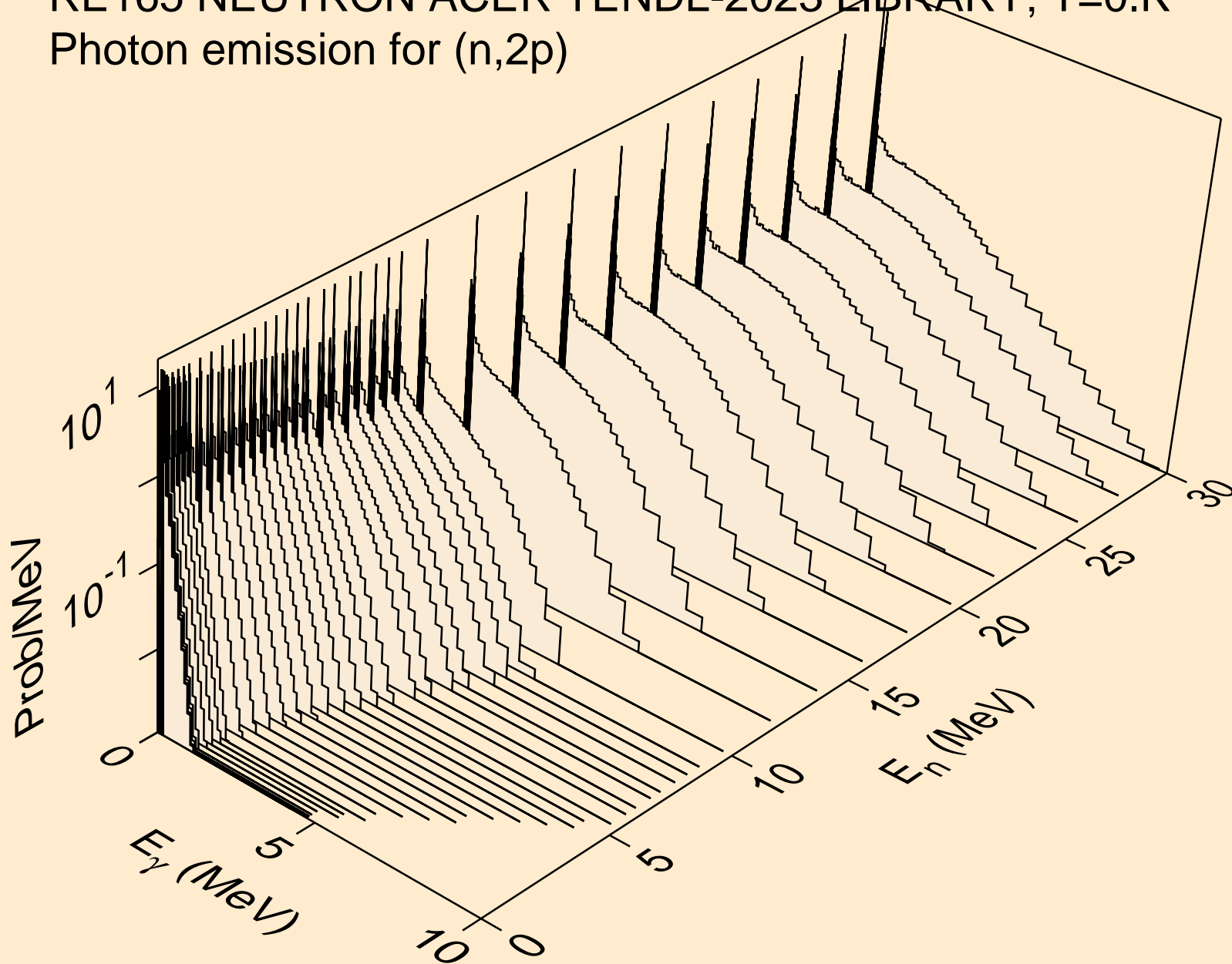

RE165 NEUTRON ACER TENDL-2023 LIBRARY; T=0.K  
Photon emission for (n,p $\alpha$ )

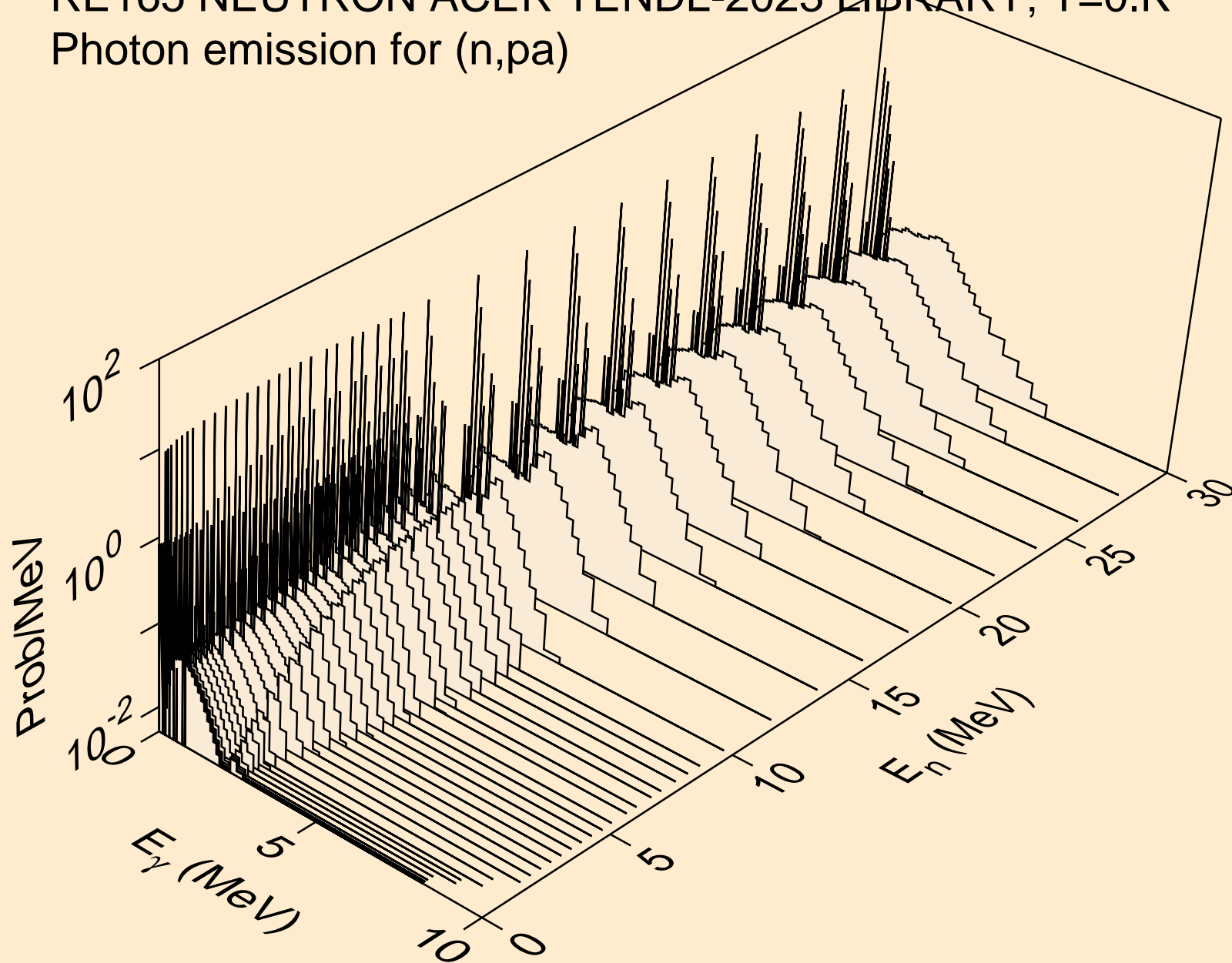

RE165 NEUTRON ACER TENDL-2023 LIBRARY; T=0.K  
Photon emission for (n,t2a)

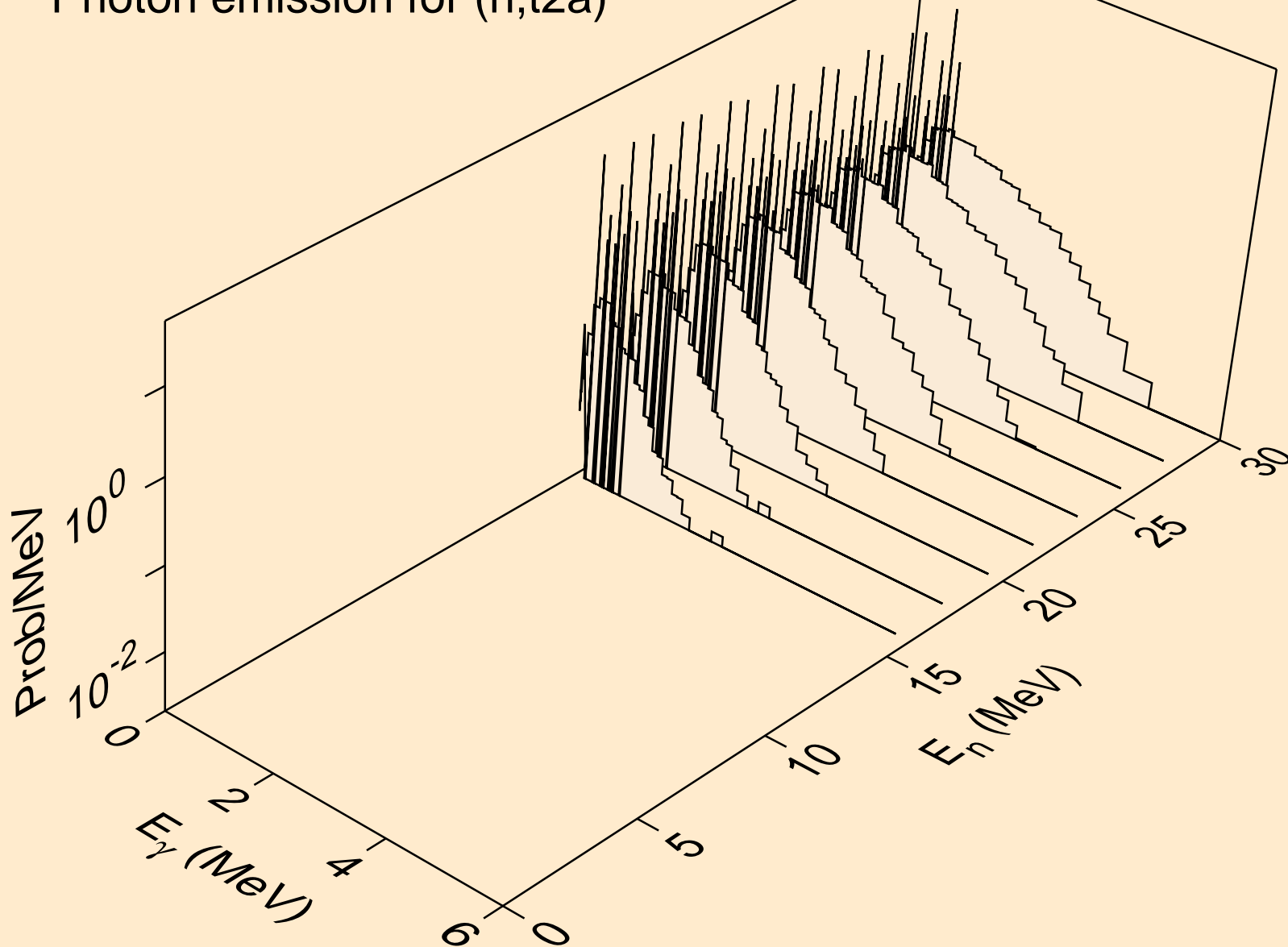

RE165 NEUTRON ACER TENDL-2023 LIBRARY; T=0.K  
Photon emission for (n,d2a)

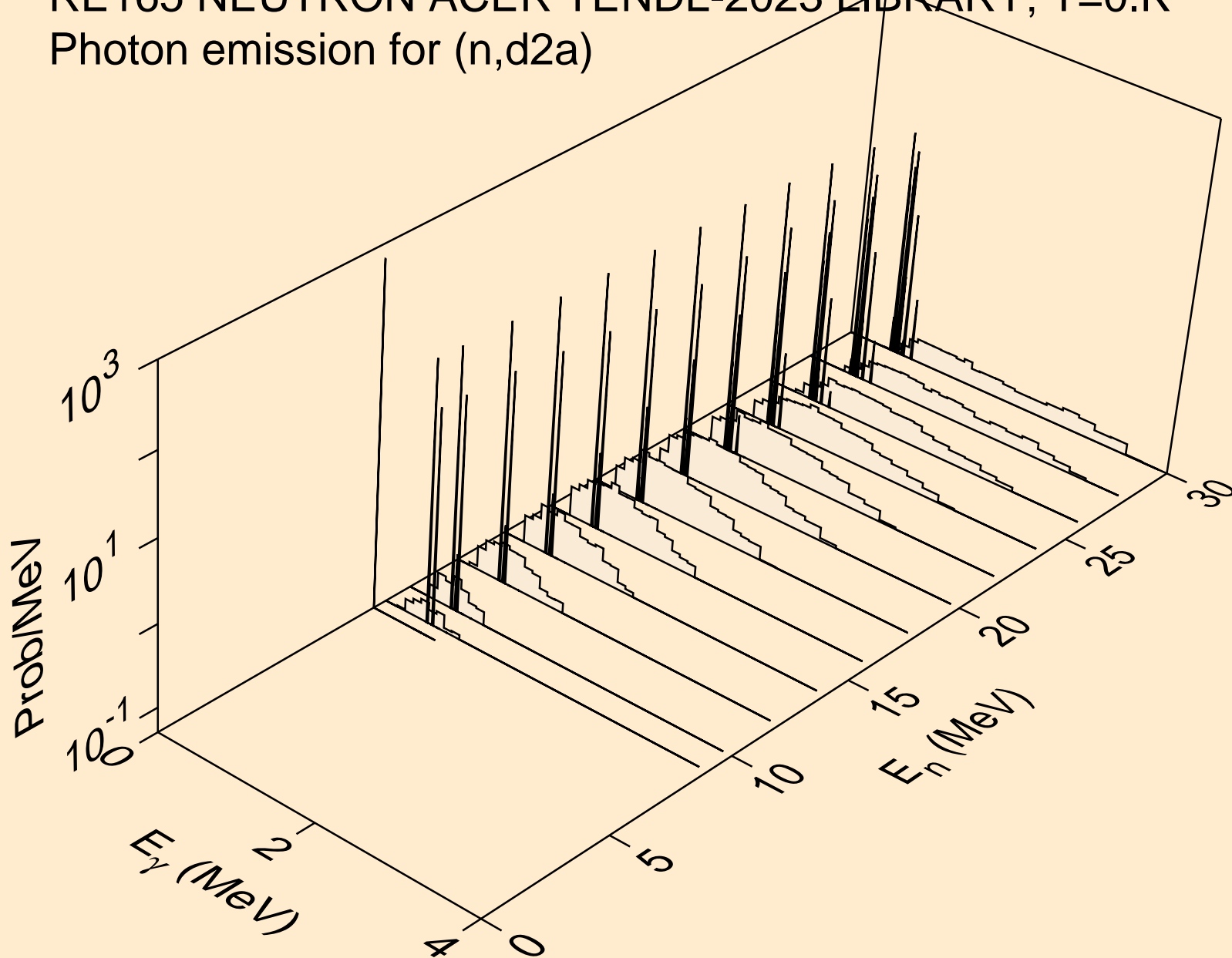

RE165 NEUTRON ACER TENDL-2023 LIBRARY; T=0.K  
Photon emission for (n,pd)

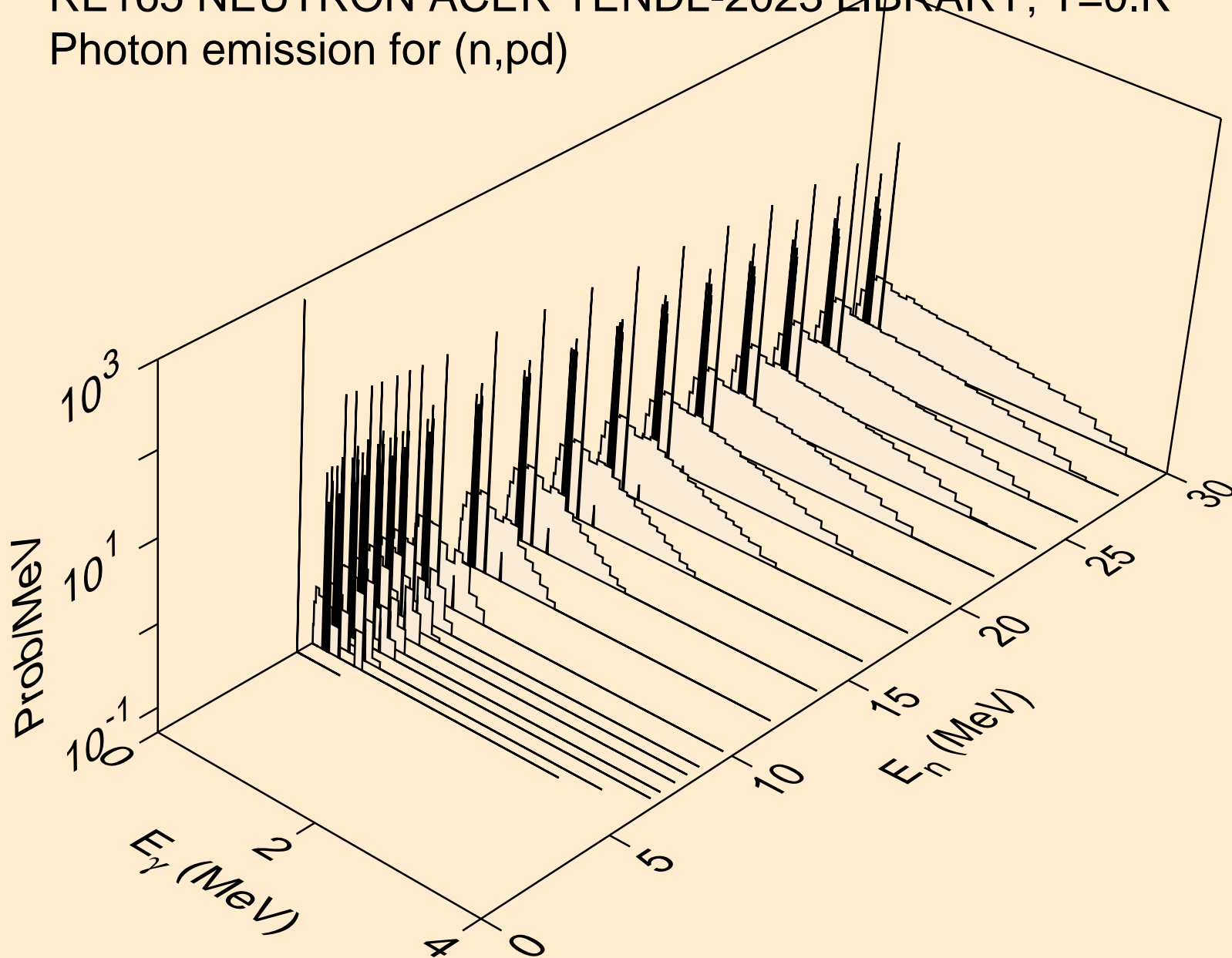

RE165 NEUTRON ACER TENDL-2023 LIBRARY; T=0.K  
Photon emission for (n,pt)

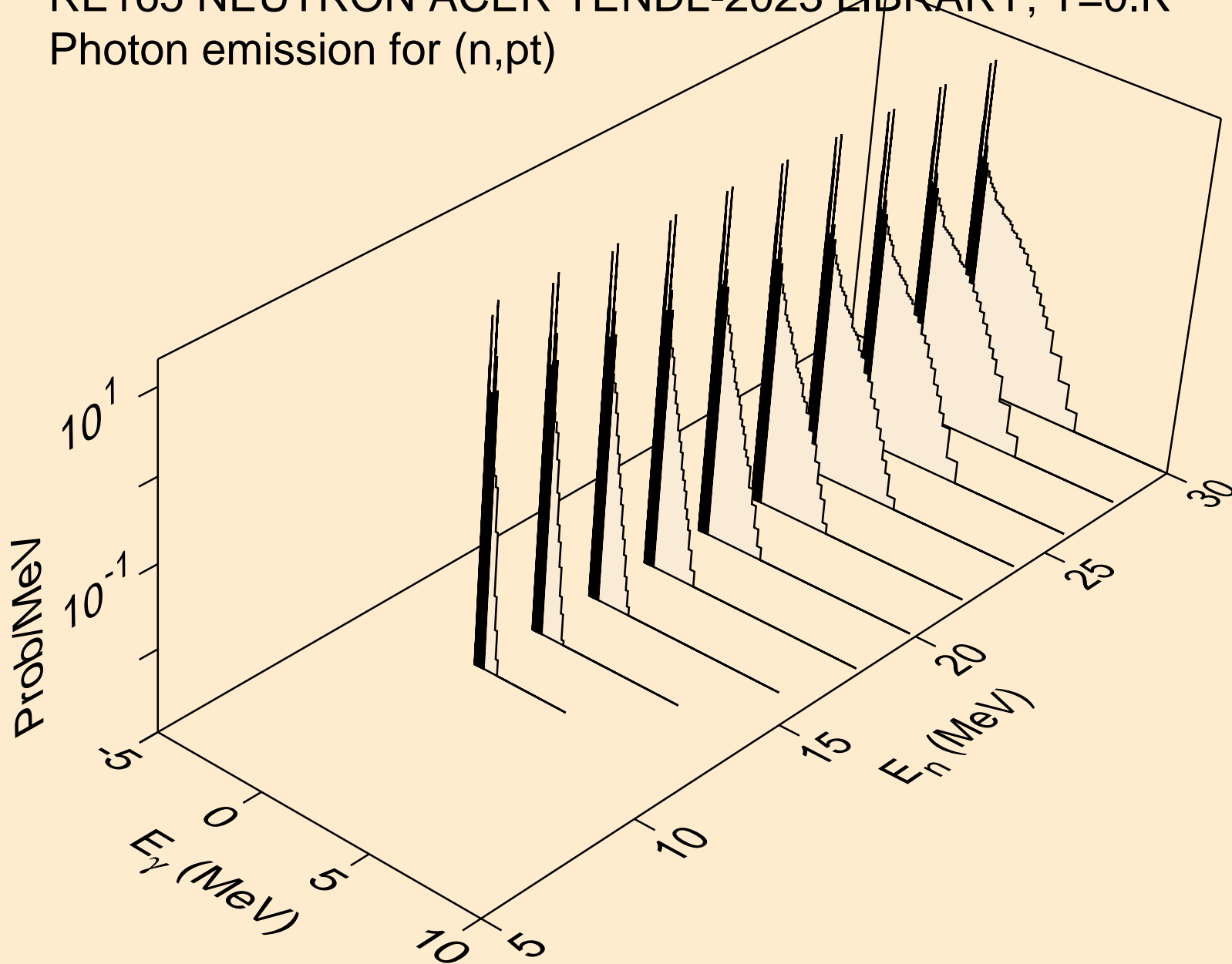

RE165 NEUTRON ACER TENDL-2023 LIBRARY; T=0.K  
Photon emission for (n,da)

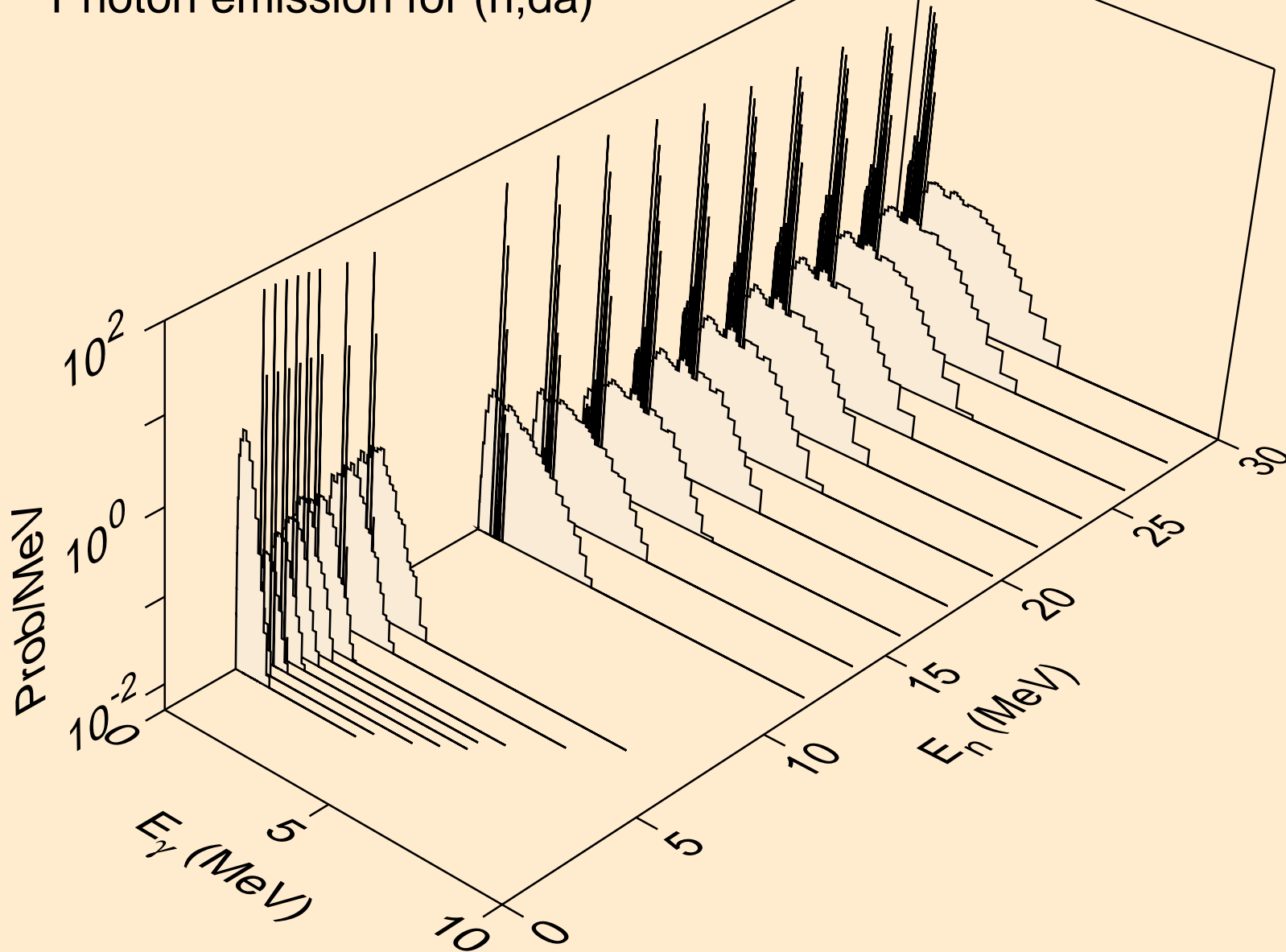

RE165 NEUTRON ACER TENDL-2023 LIBRARY; T=0.K  
thermal capture photon spectrum

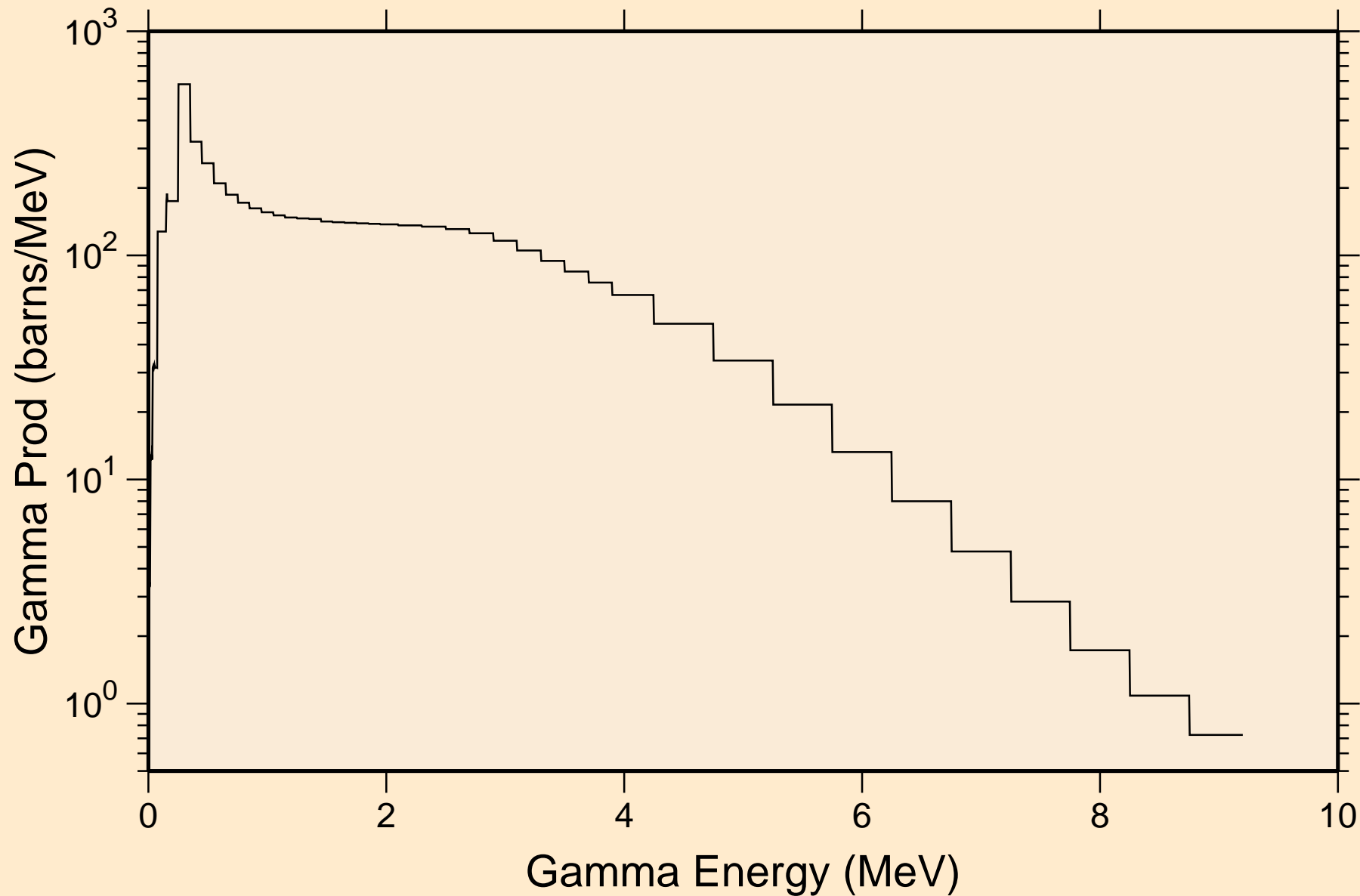

RE165 NEUTRON ACER TENDL-2023 LIBRARY; T=0.K  
14 MeV photon spectrum

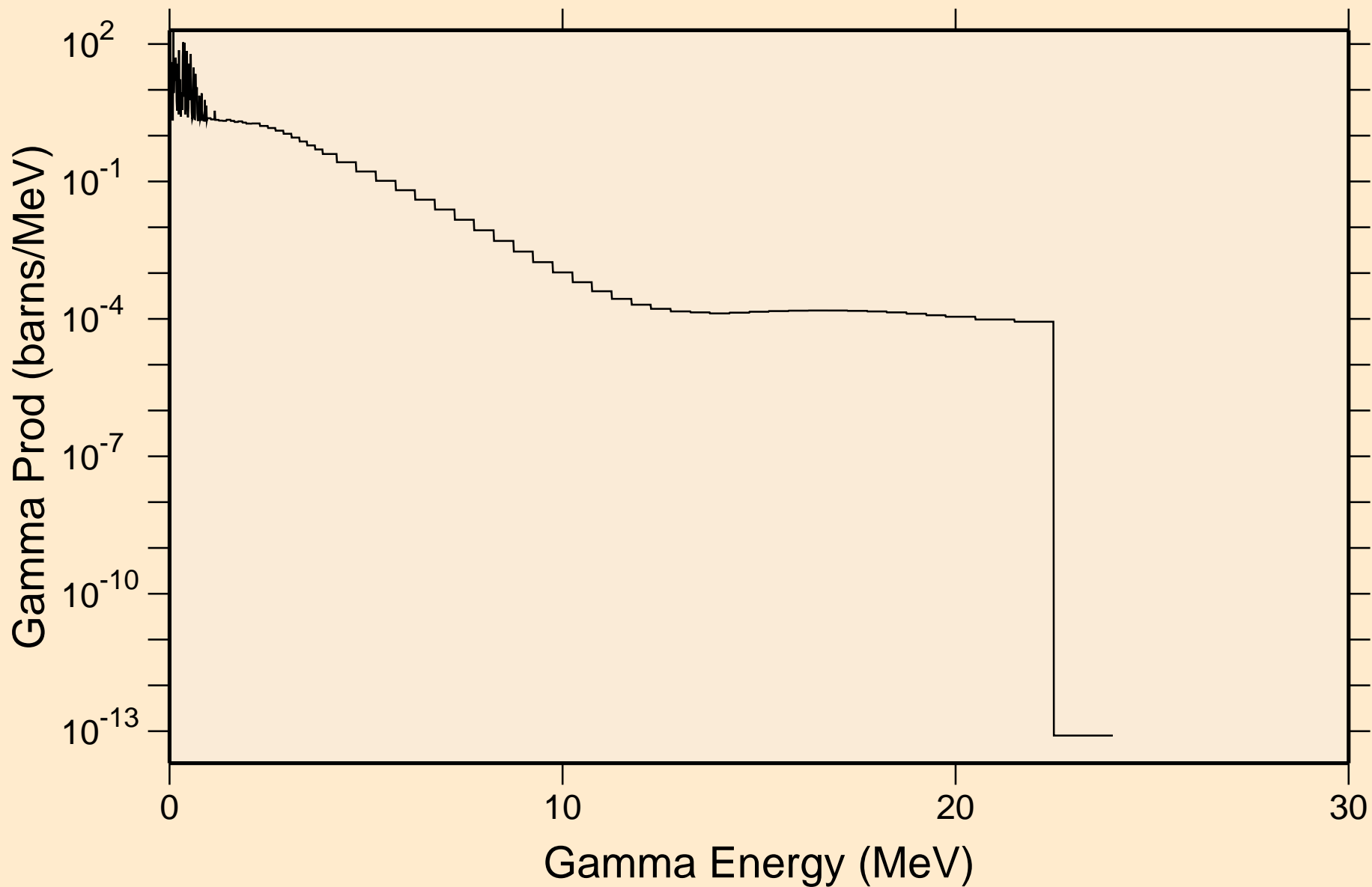

# RE165 NEUTRON ACER TENDL-2023 LIBRARY; T=0.K

## Particle heating contributions

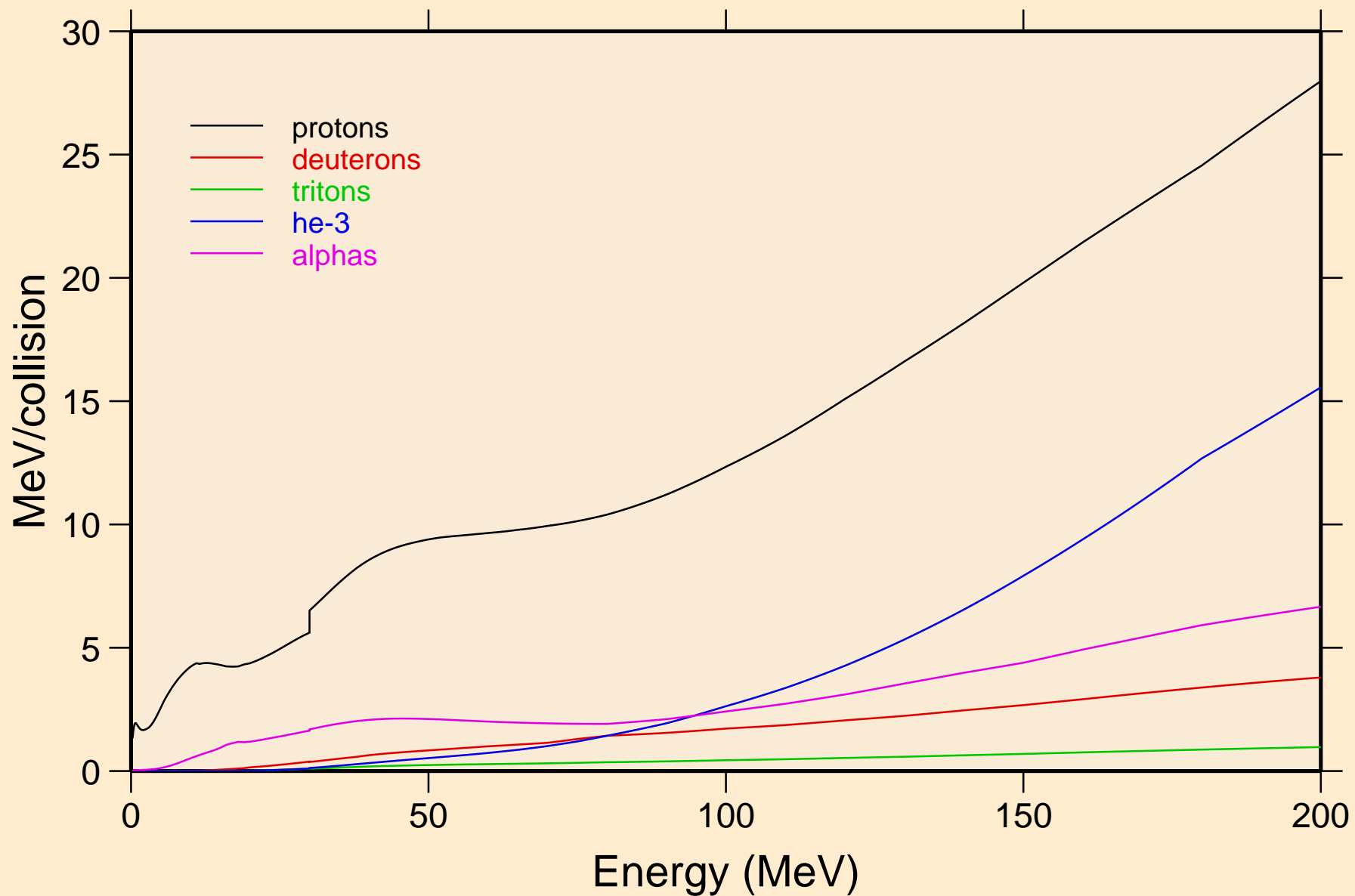

RE165 NEUTRON ACER TENDL-2023 LIBRARY; T=0.K  
Recoil Heating

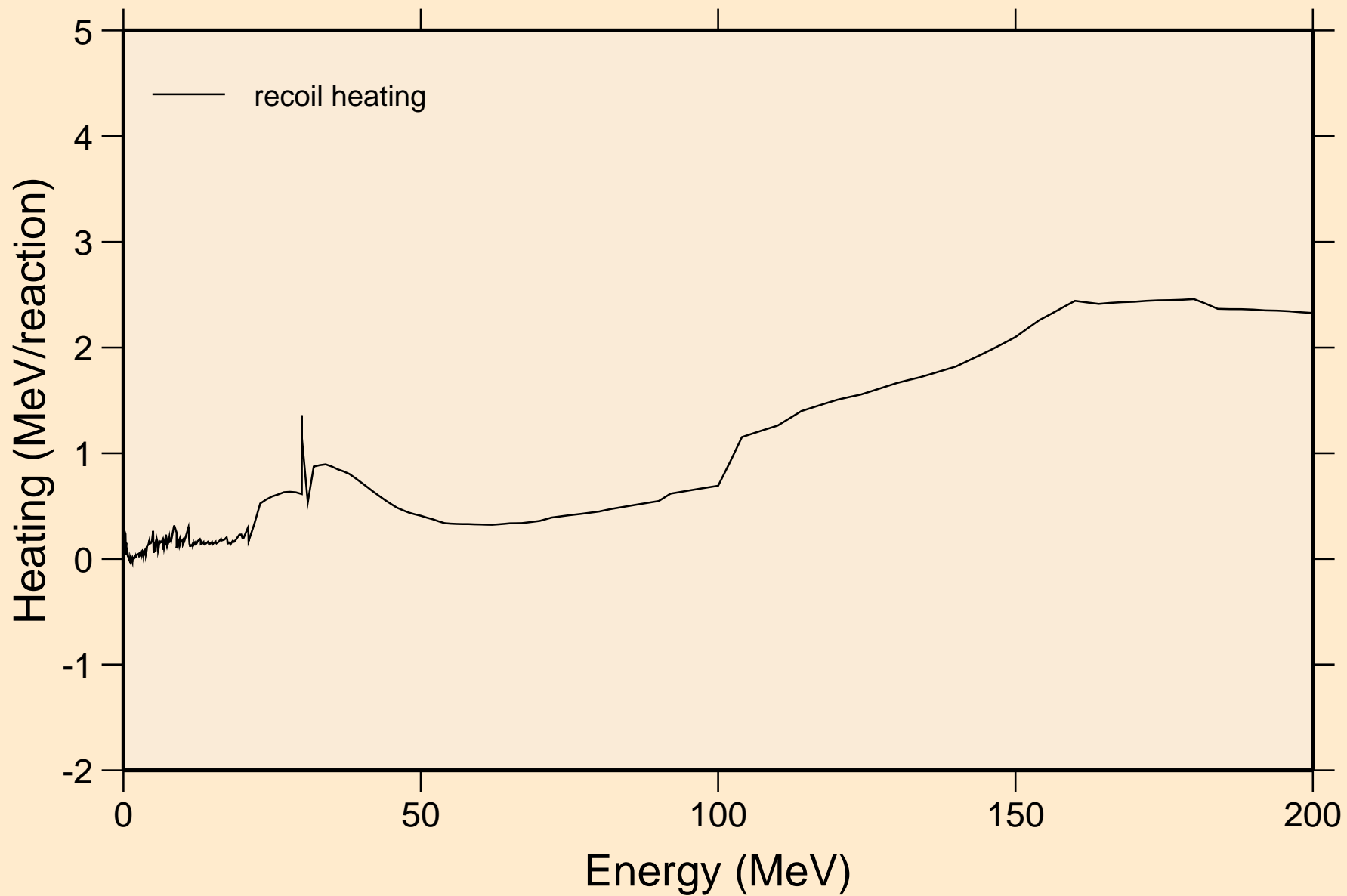

RE165 NEUTRON ACER TENDL-2023 LIBRARY; T=0.K  
Particle production cross sections

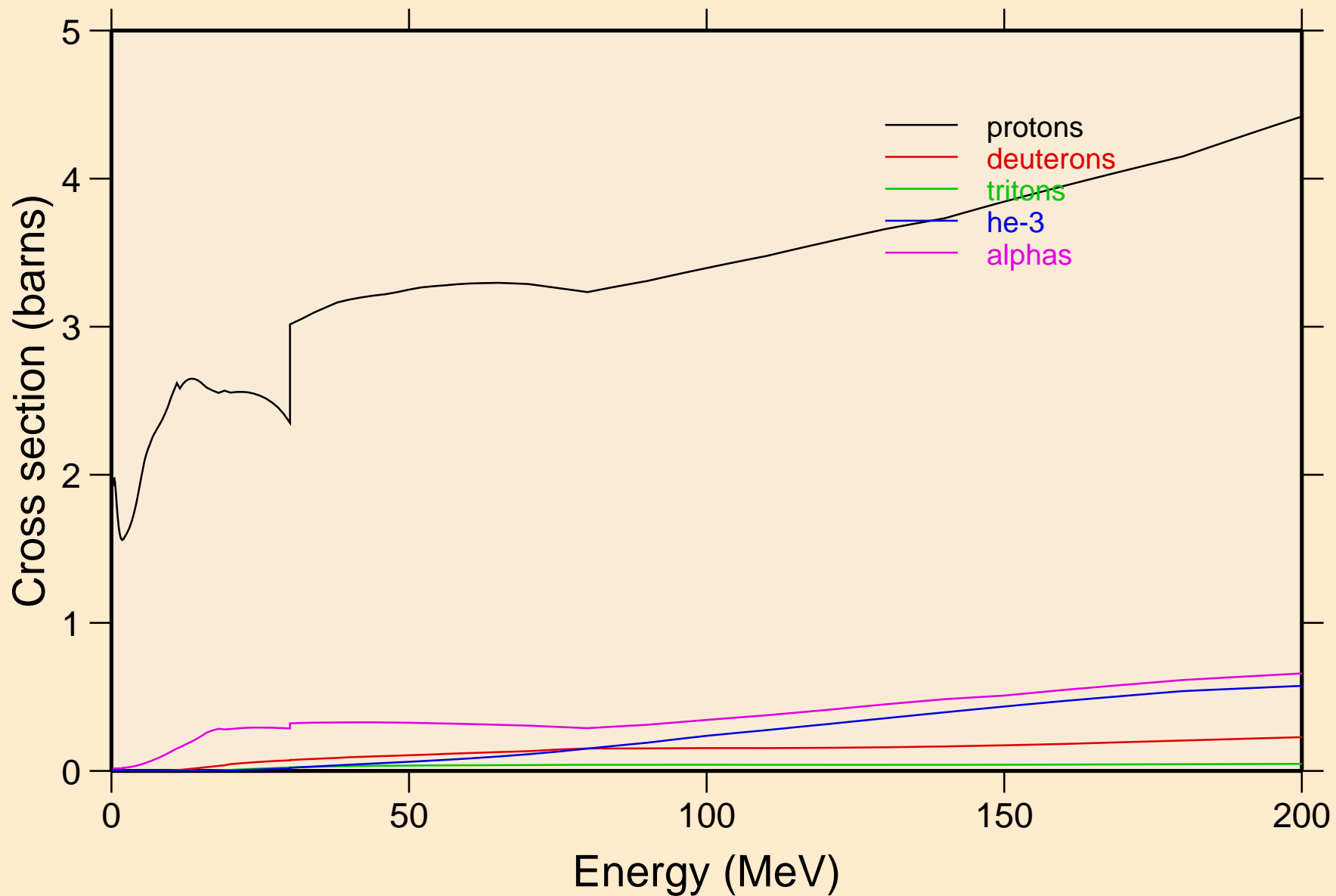

RE165 NEUTRON ACER TENDL-2023 LIBRARY; T=0.K  
protons from (n,x)

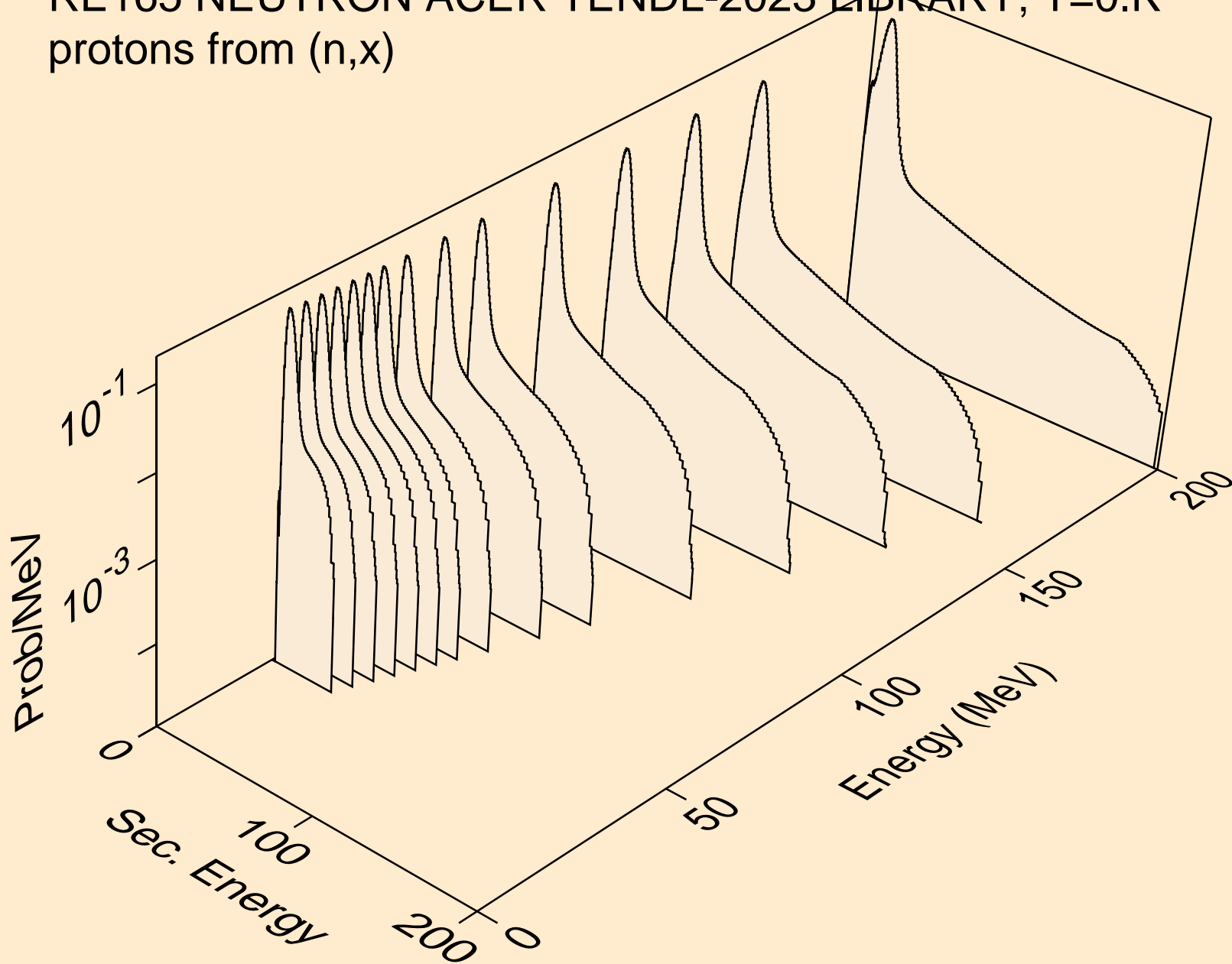

RE165 NEUTRON ACER TENDL-2023 LIBRARY; T=0.K  
protons from (n,n\*)p

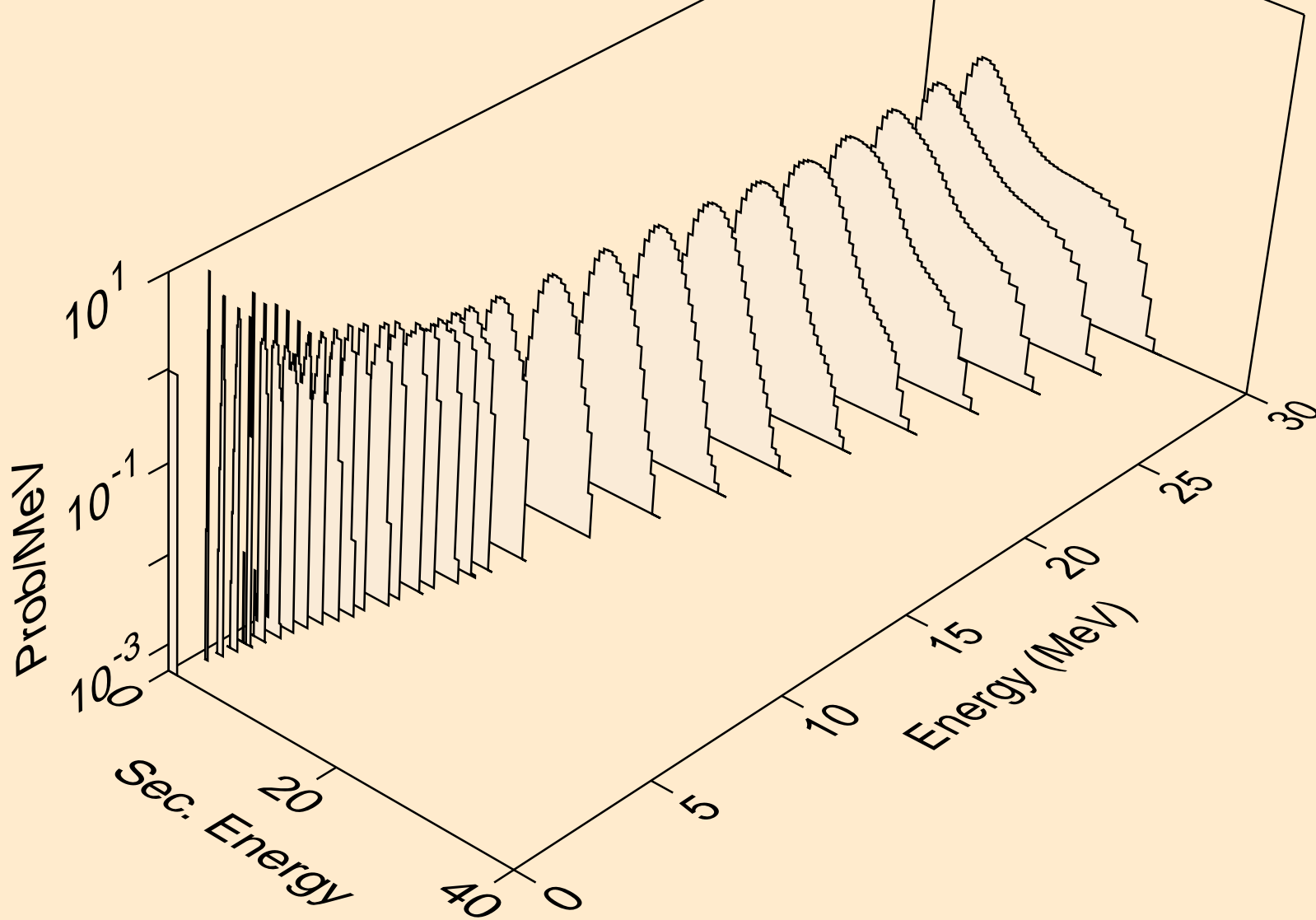

RE165 NEUTRON ACER TENDL-2023 LIBRARY; T=0.K  
protons from (n,2np)

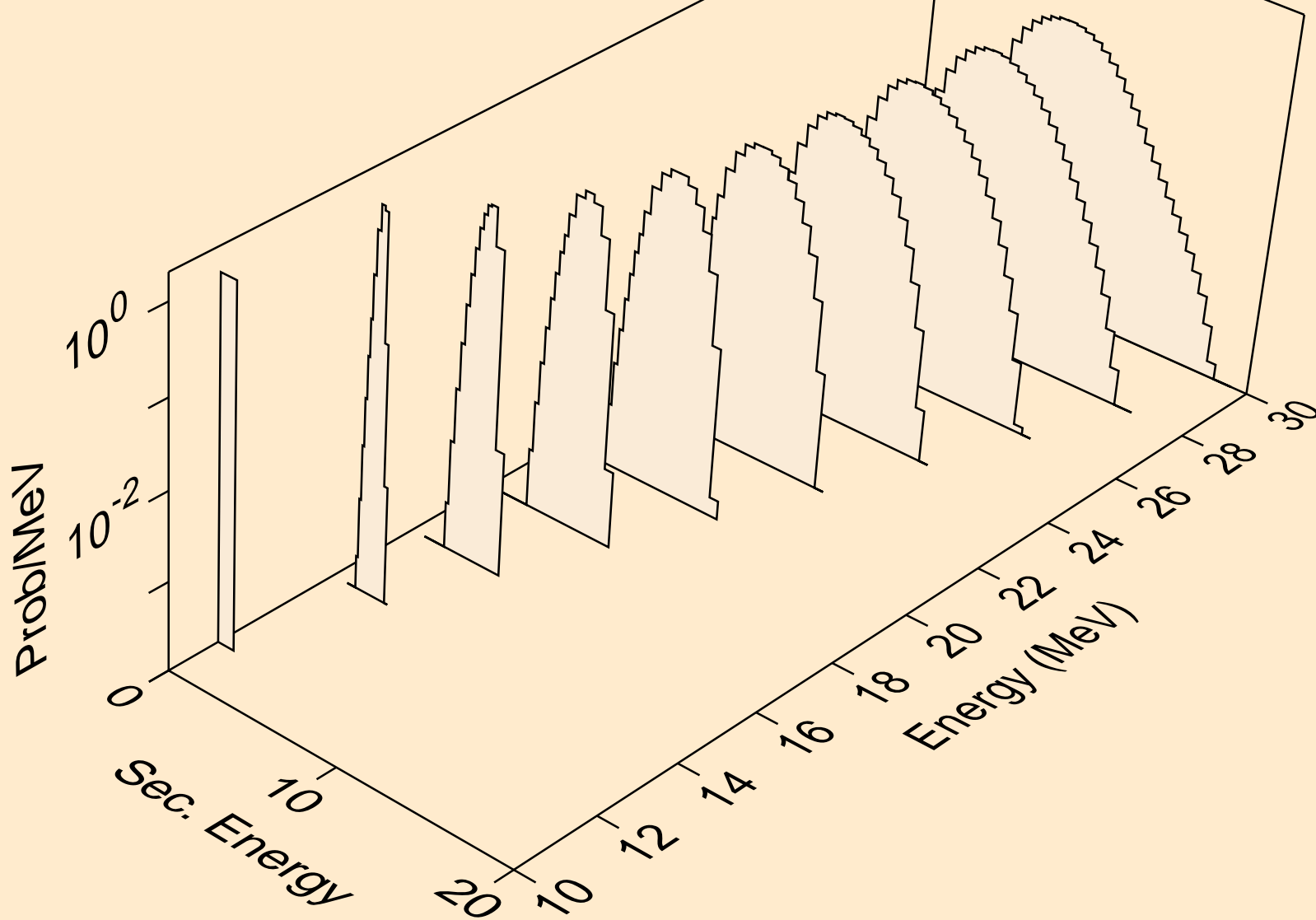

RE165 NEUTRON ACER TENDL-2023 LIBRARY; T=0.K  
protons from (n,3np)

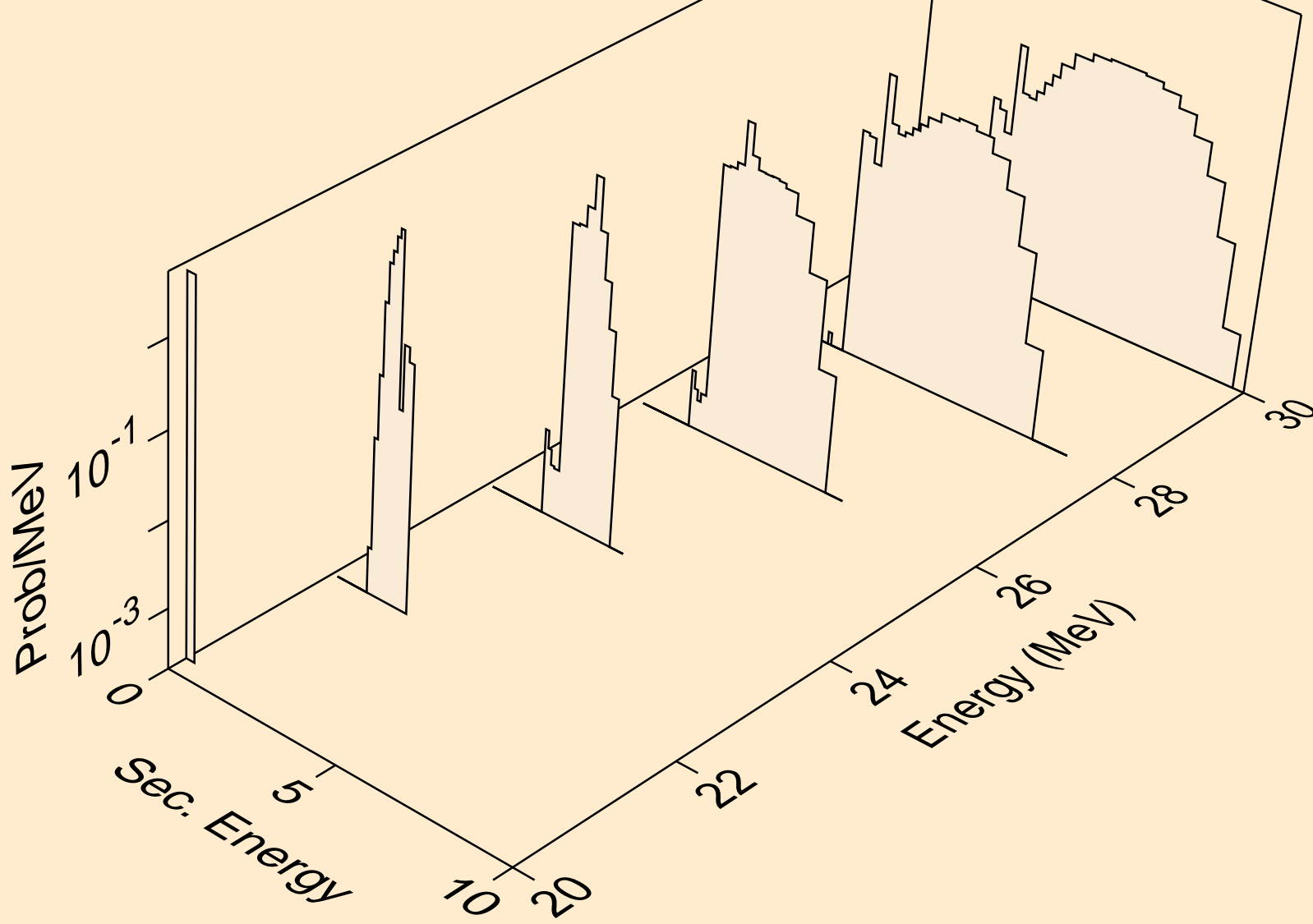

RE165 NEUTRON ACER TENDL-2023 LIBRARY; T=0.K  
protons from (n,n2p)

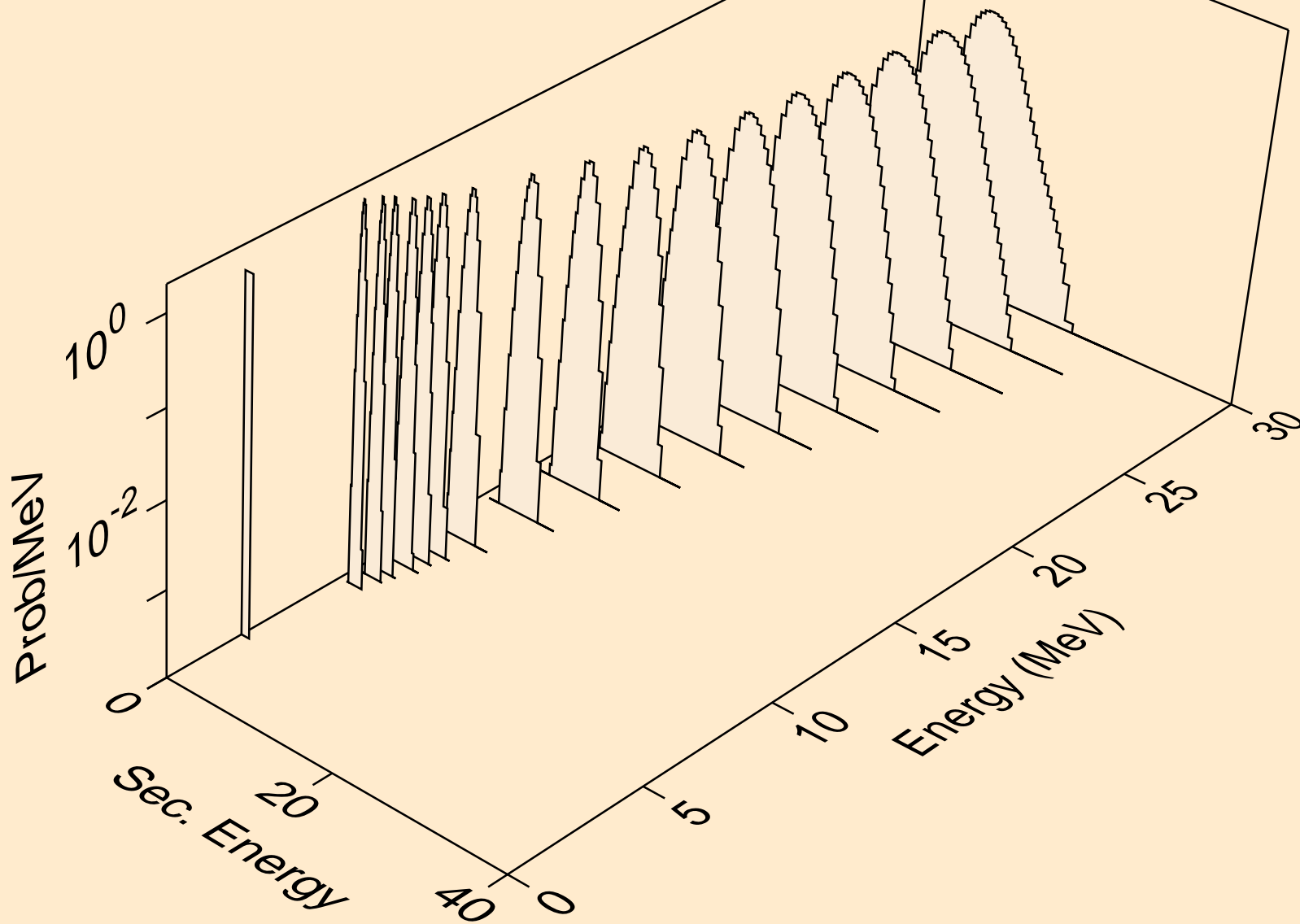

RE165 NEUTRON ACER TENDL-2023 LIBRARY; T=0.K  
protons from (n,npa)

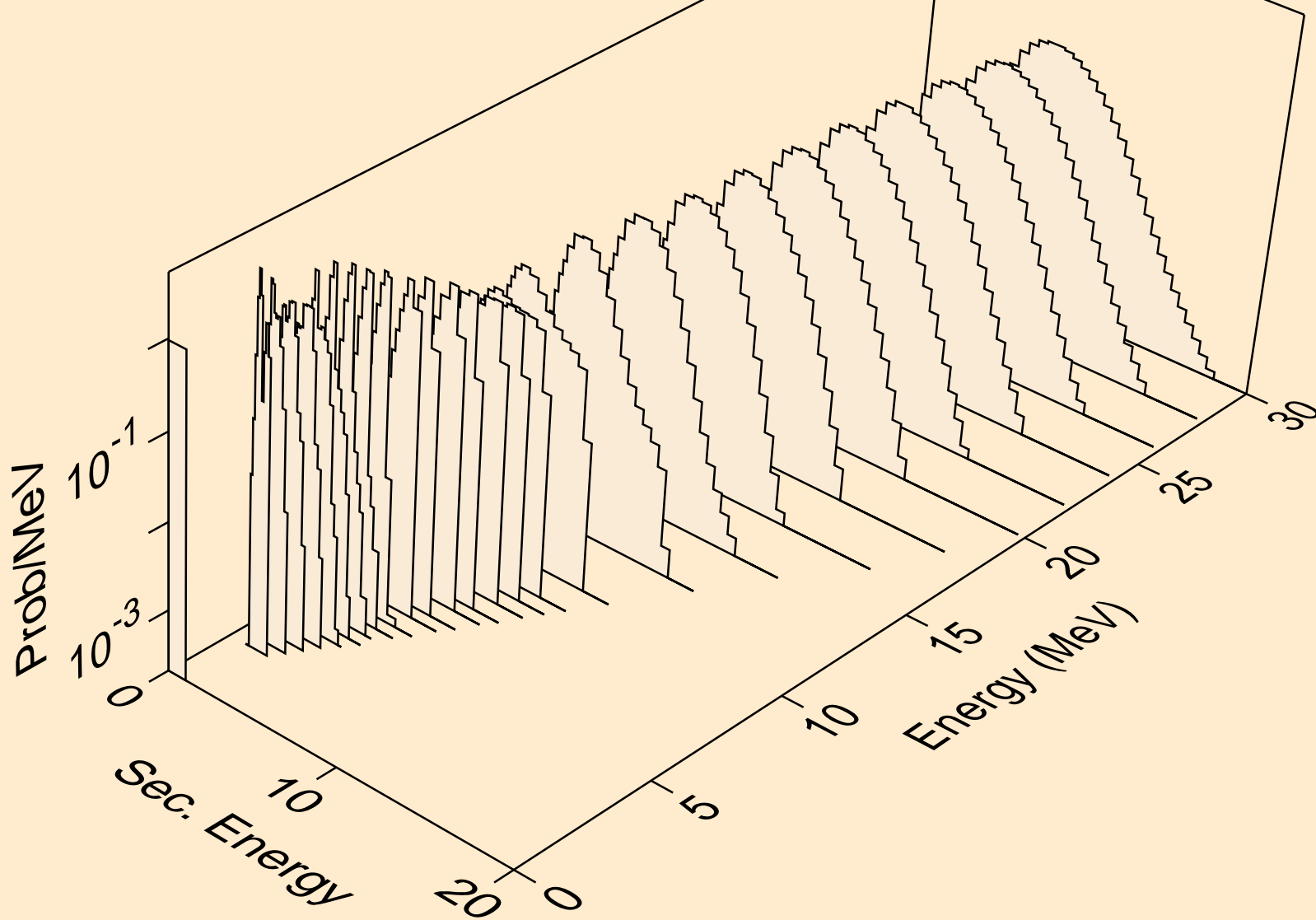

RE165 NEUTRON ACER TENDL-2023 LIBRARY; T=0.K  
protons from (n,p)

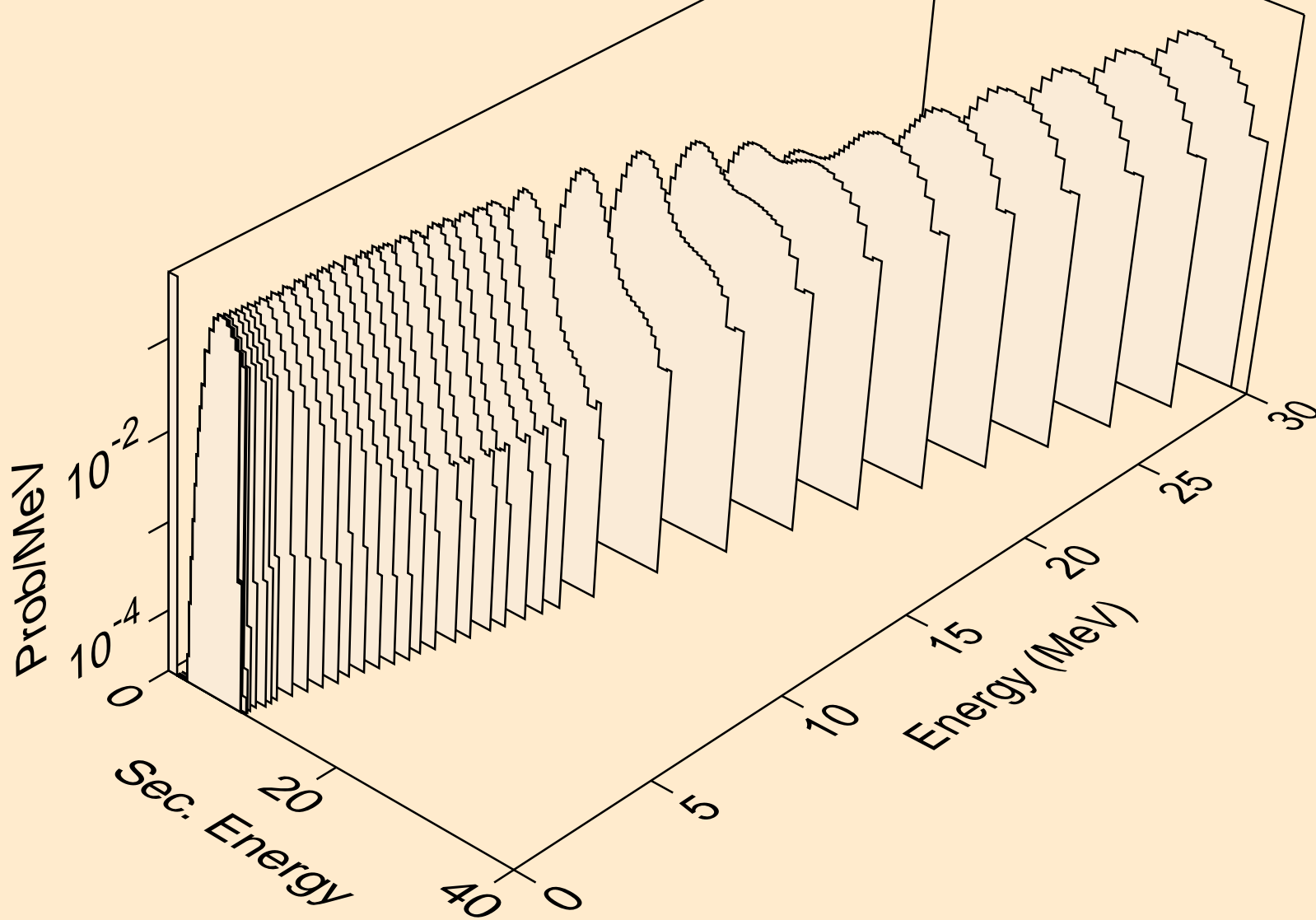

RE165 NEUTRON ACER TENDL-2023 LIBRARY; T=0.K  
protons from (n,2p)

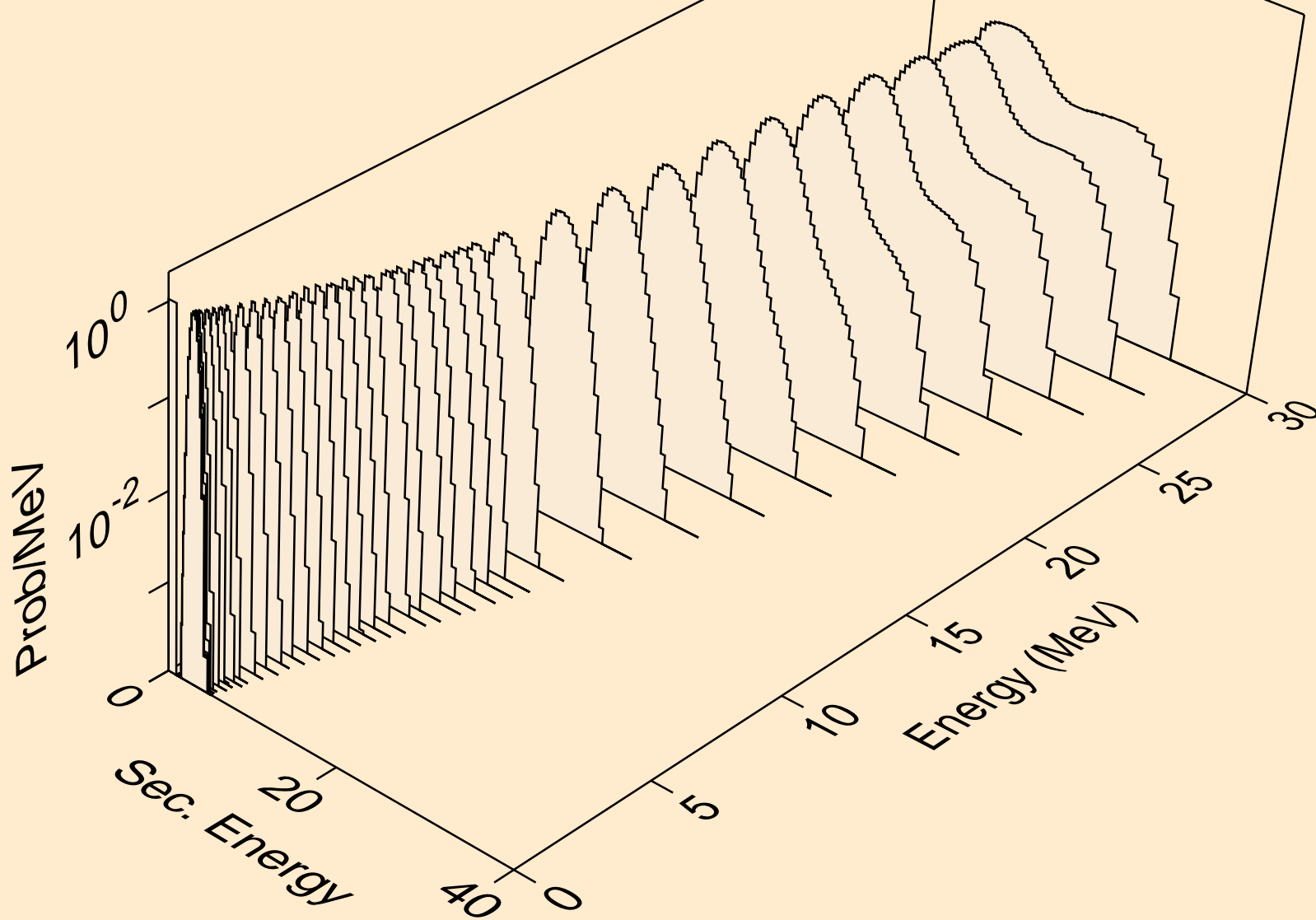

RE165 NEUTRON ACER TENDL-2023 LIBRARY; T=0.K  
protons from (n,p)

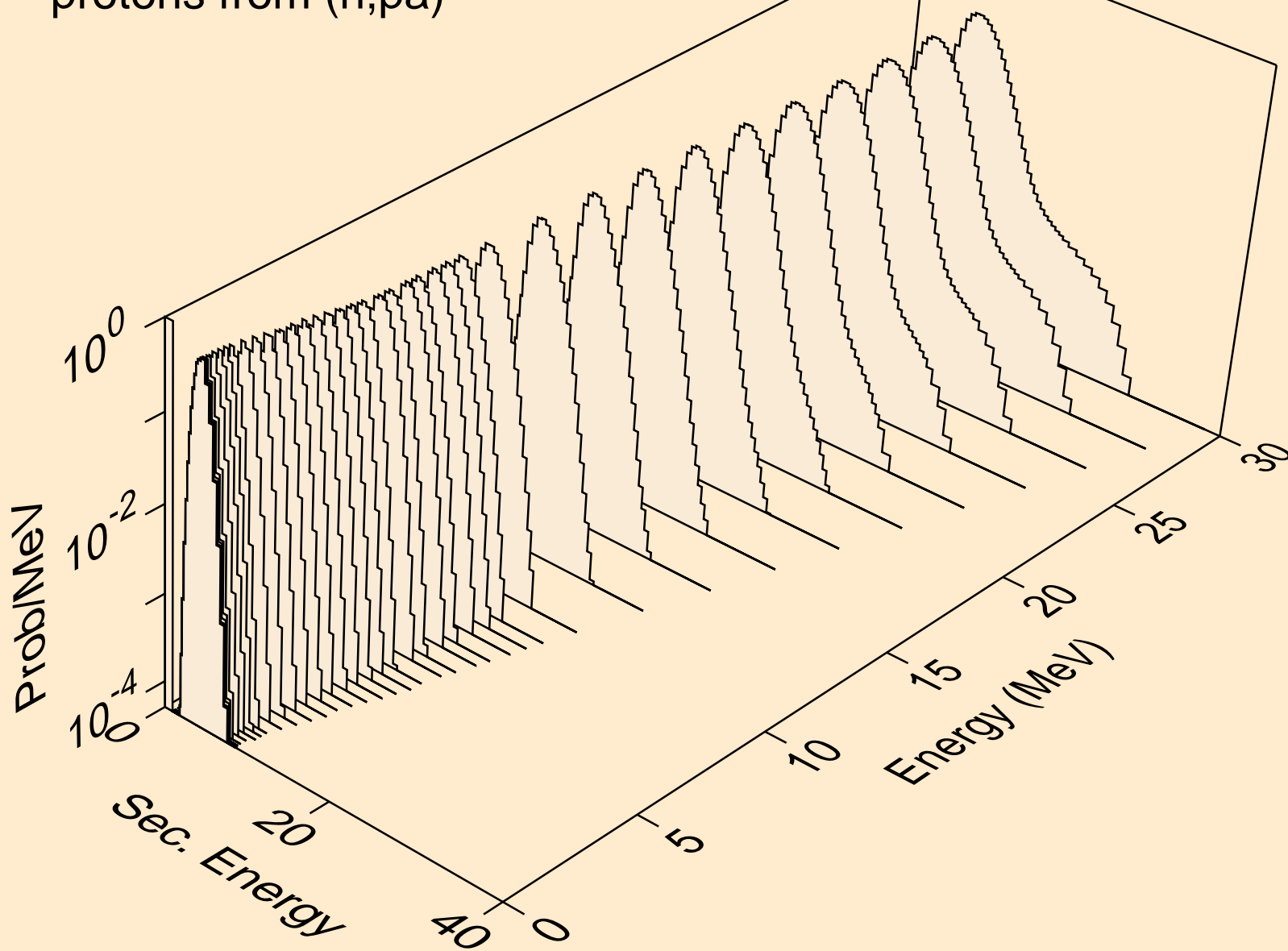

RE165 NEUTRON ACER TENDL-2023 LIBRARY; T=0.K  
protons from (n,pd)

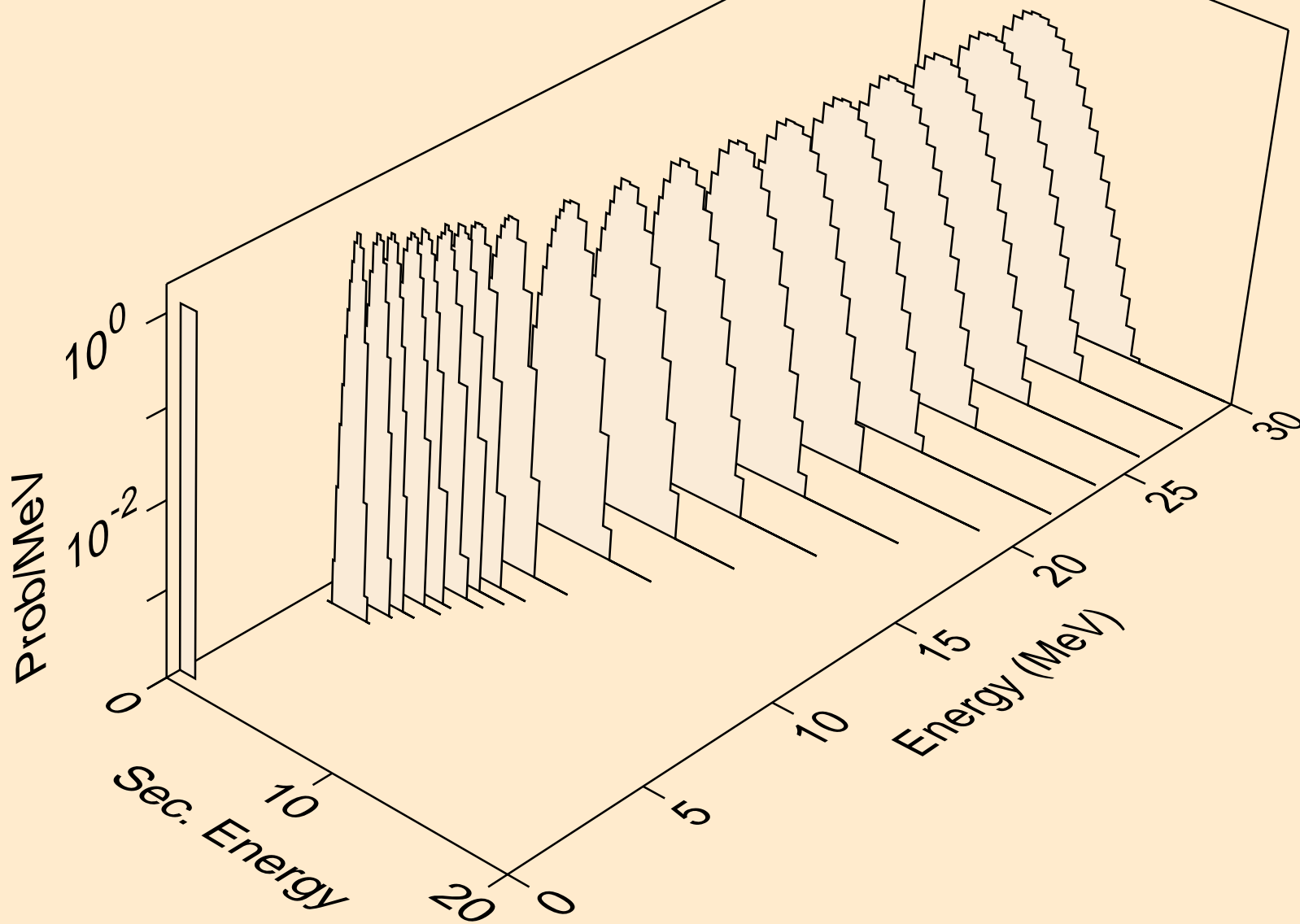

RE165 NEUTRON ACER TENDL-2023 LIBRARY; T=0.K  
protons from (n,pt)

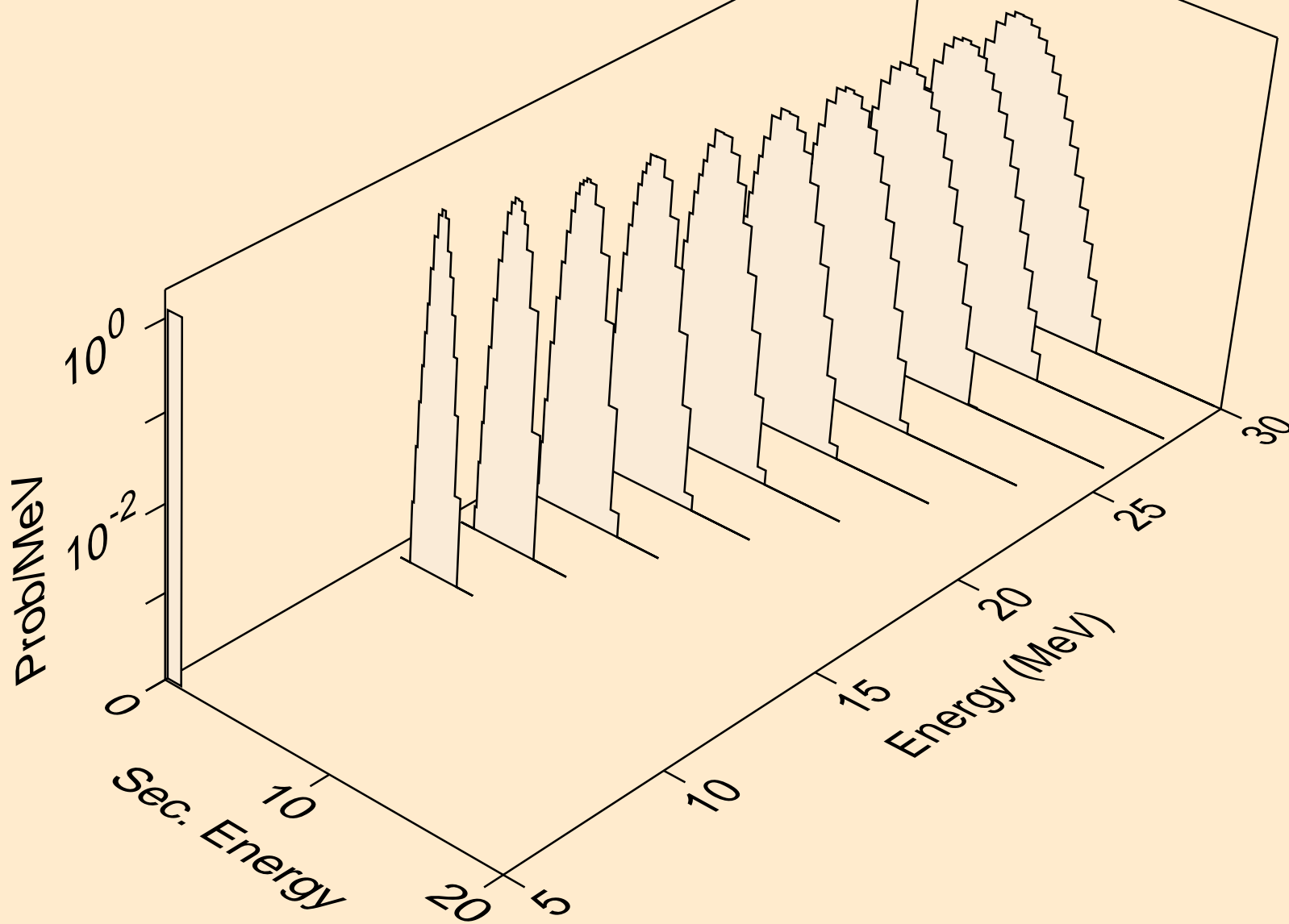

RE165 NEUTRON ACER TENDL-2023 LIBRARY; T=0.K  
deuterons from (n,x)

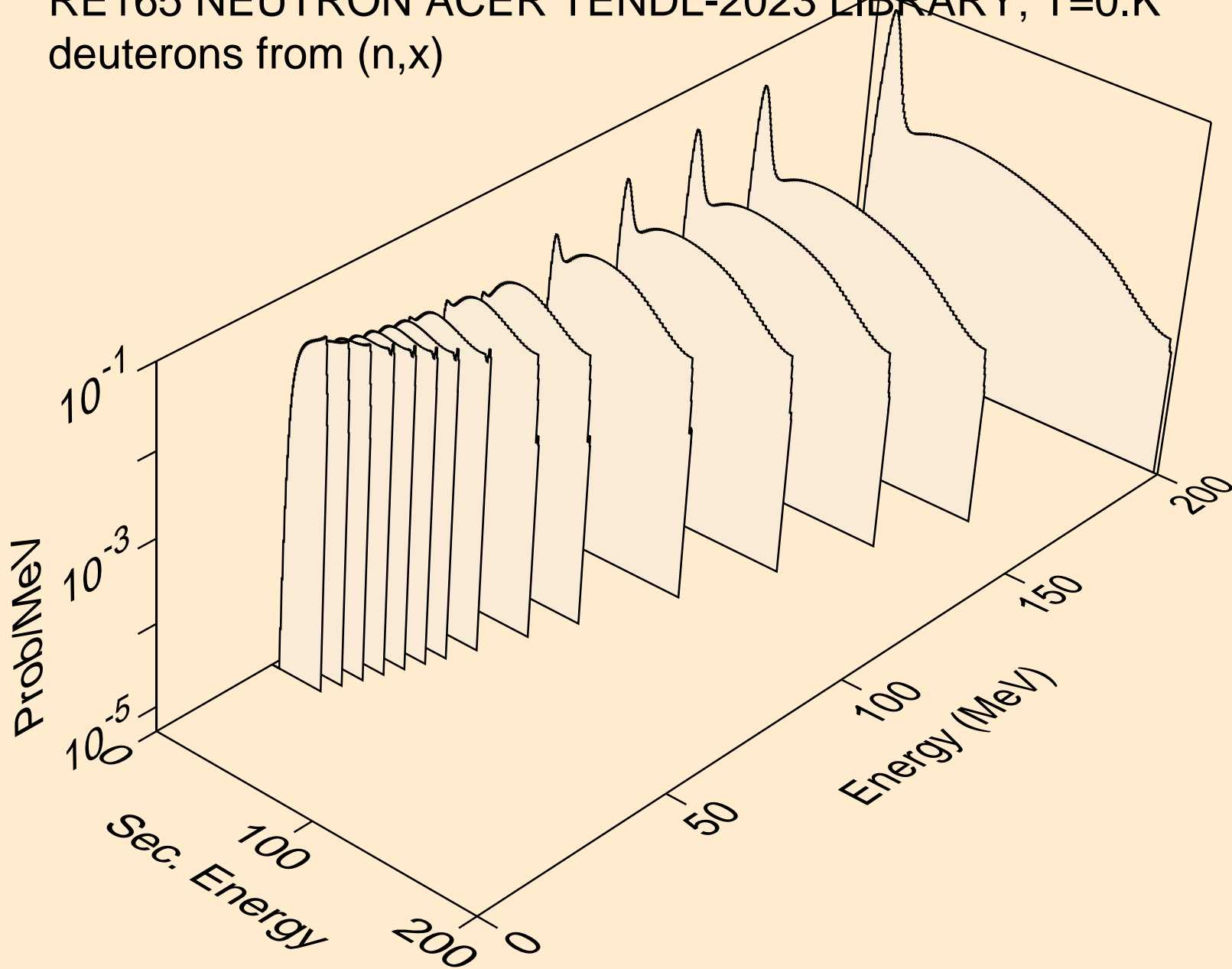

RE165 NEUTRON ACER TENDL-2023 LIBRARY; T=0.K  
deuterons from (n,2nd)

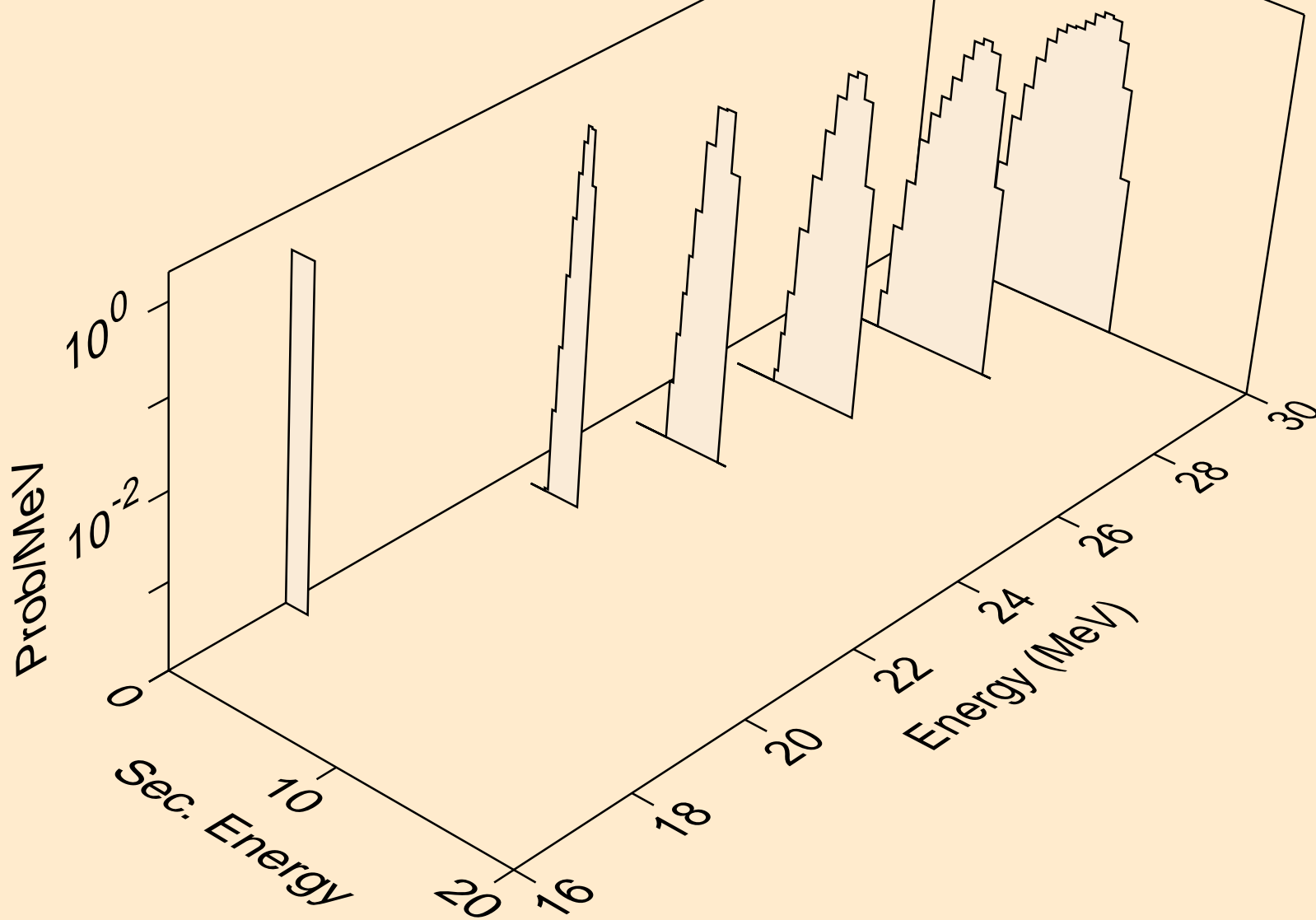

RE165 NEUTRON ACER TENDL-2023 LIBRARY; T=0.K  
deuterons from (n,n\*)d

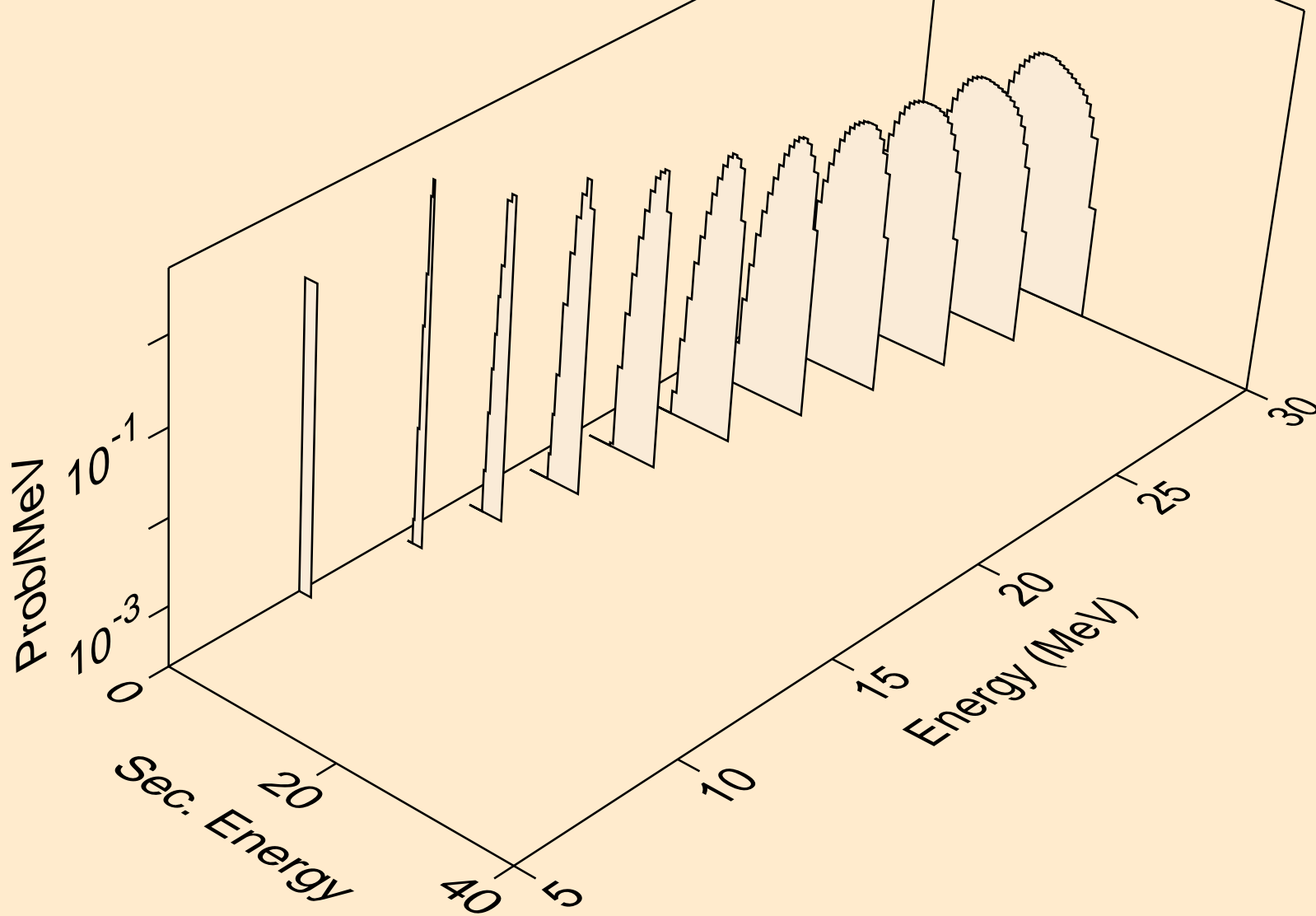

RE165 NEUTRON ACER TENDL-2023 LIBRARY; T=0.K  
deuterons from (n,d)

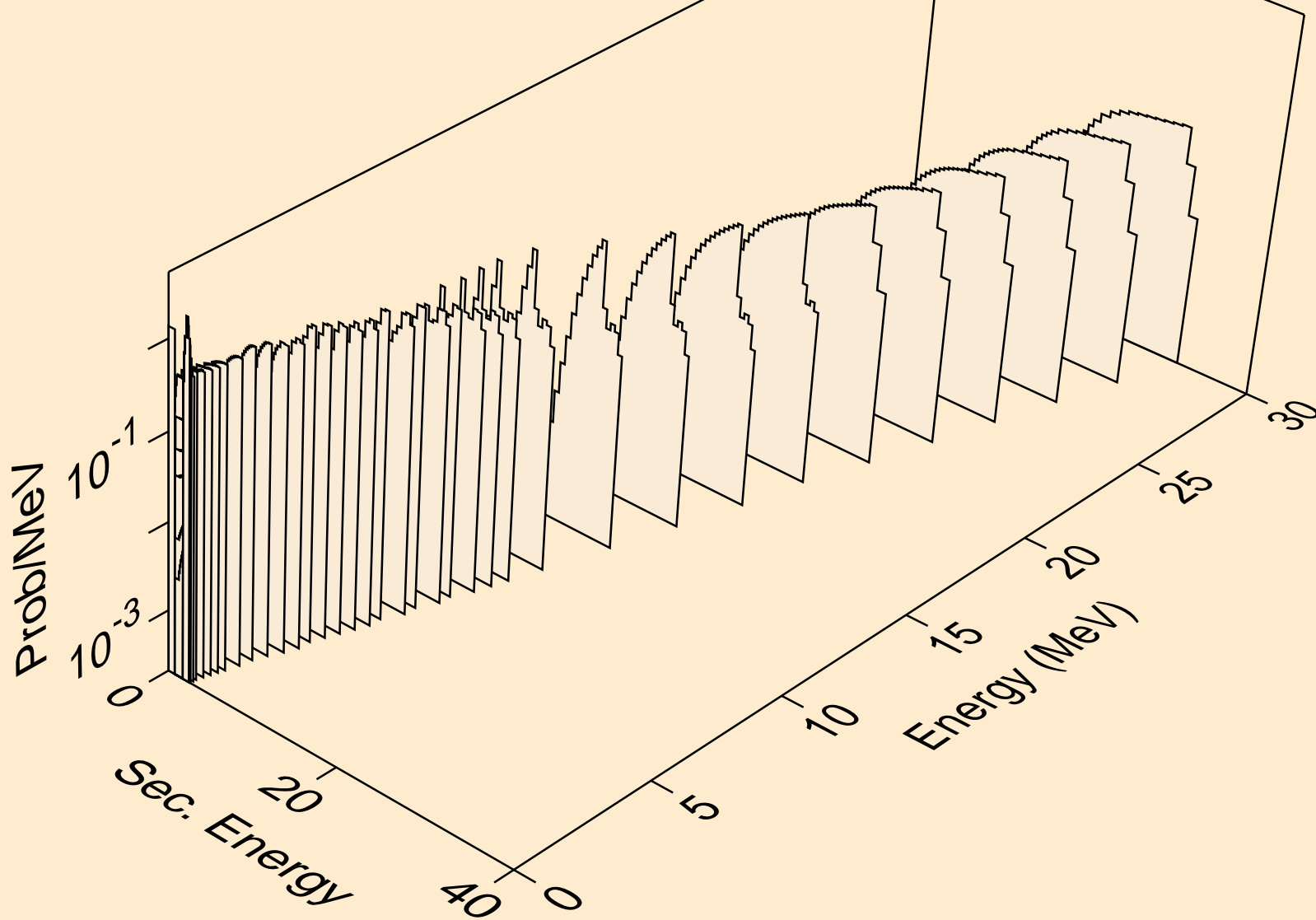

RE165 NEUTRON ACER TENDL-2023 LIBRARY; T=0.K  
deuterons from (n,d2a)

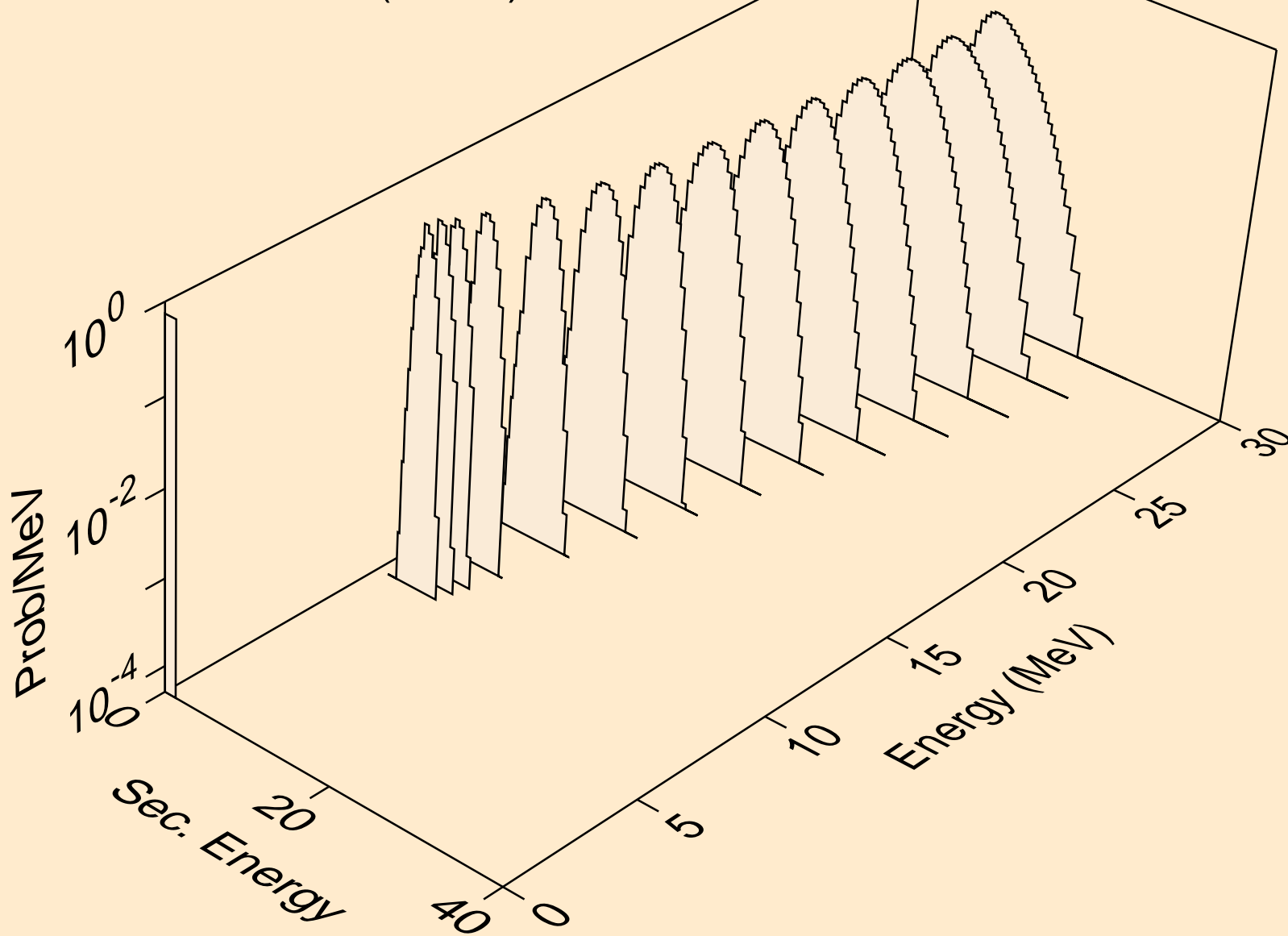

RE165 NEUTRON ACER TENDL-2023 LIBRARY; T=0.K  
deuterons from (n,pd)

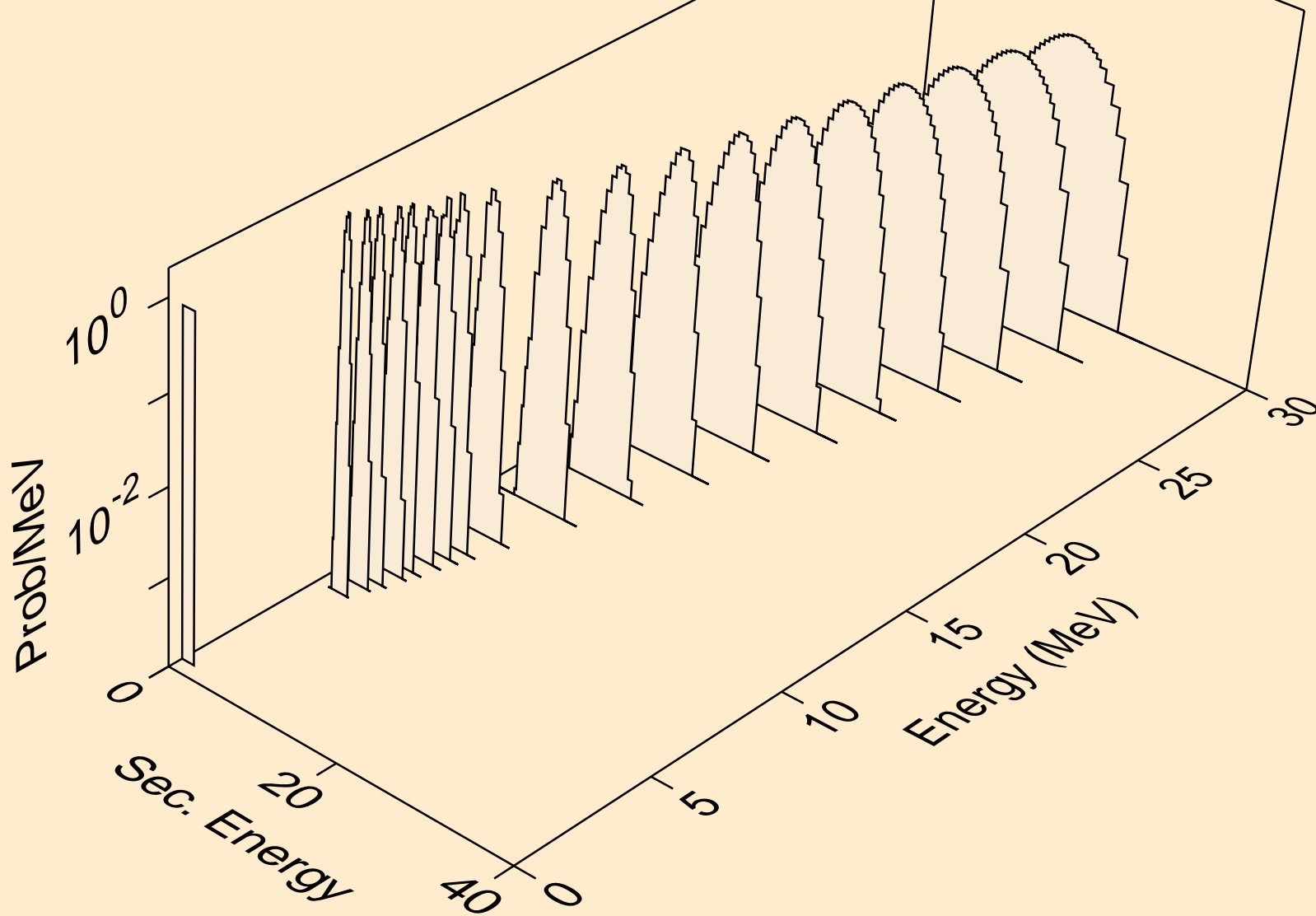

RE165 NEUTRON ACER TENDL-2023 LIBRARY; T=0.K  
deuterons from (n,da)

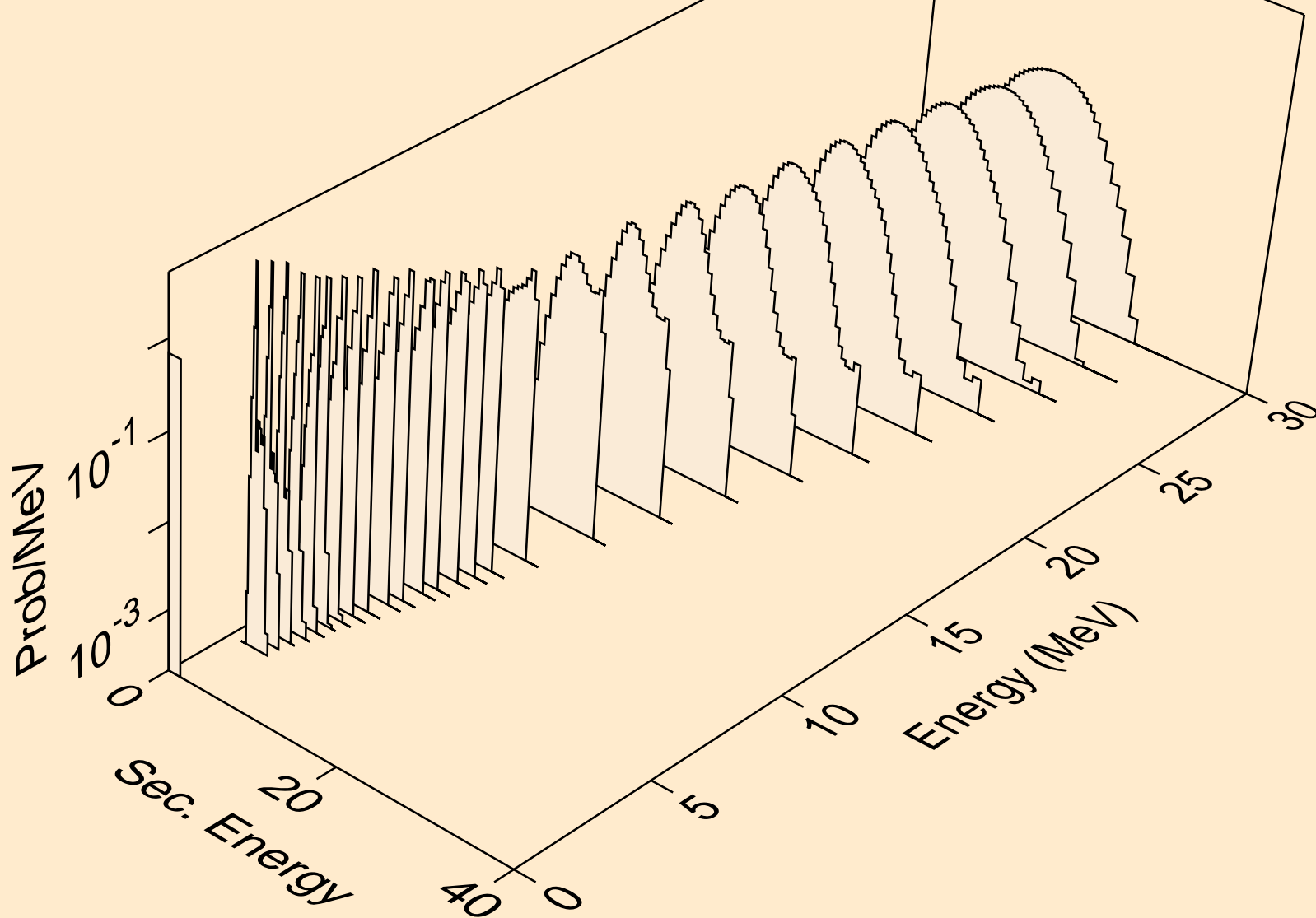

RE165 NEUTRON ACER TENDL-2023 LIBRARY; T=0.K  
tritons from (n,x)

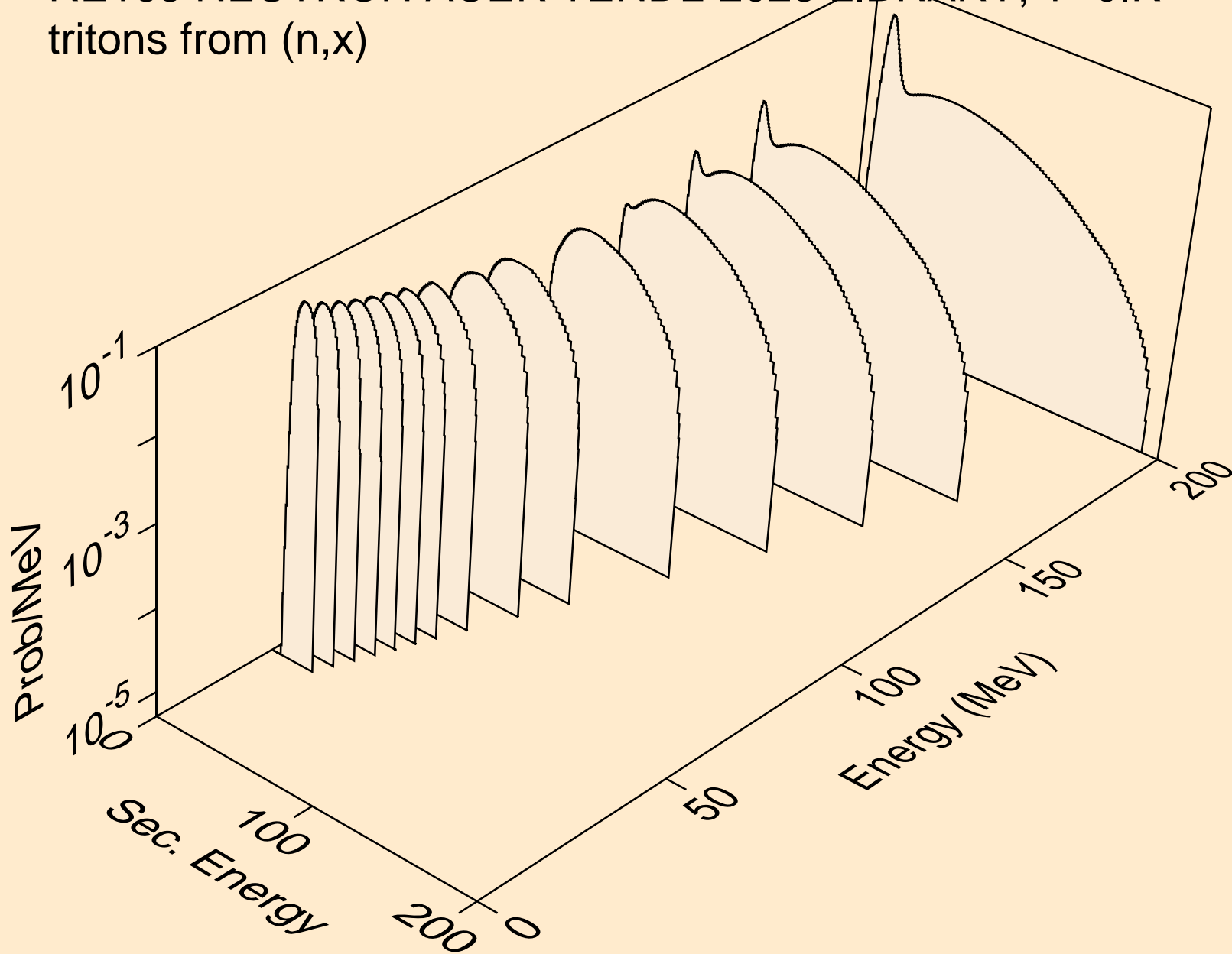

RE165 NEUTRON ACER TENDL-2023 LIBRARY; T=0.K  
tritons from (n,n\*)t

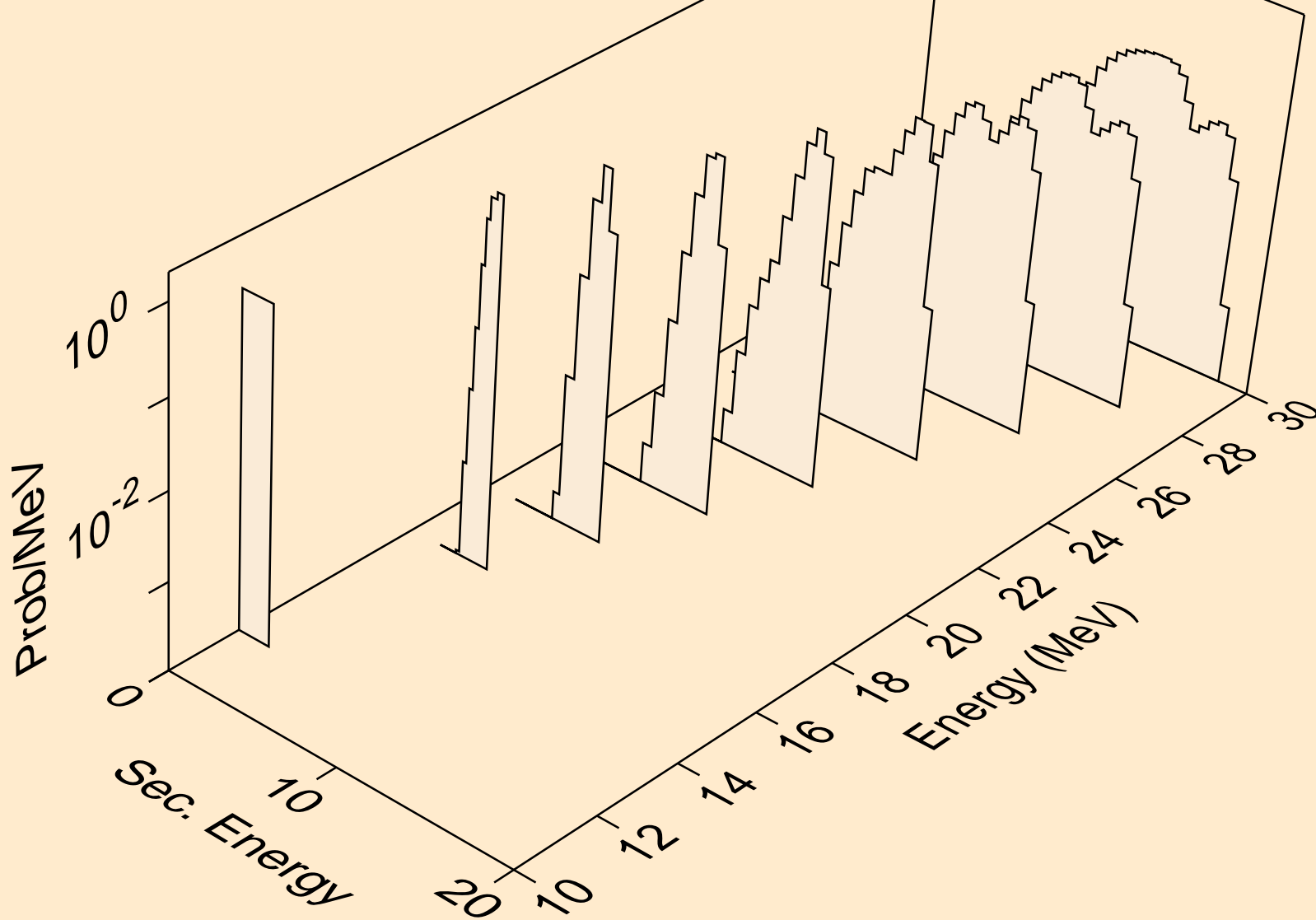

RE165 NEUTRON ACER TENDL-2023 LIBRARY; T=0.K  
tritons from (n,t)

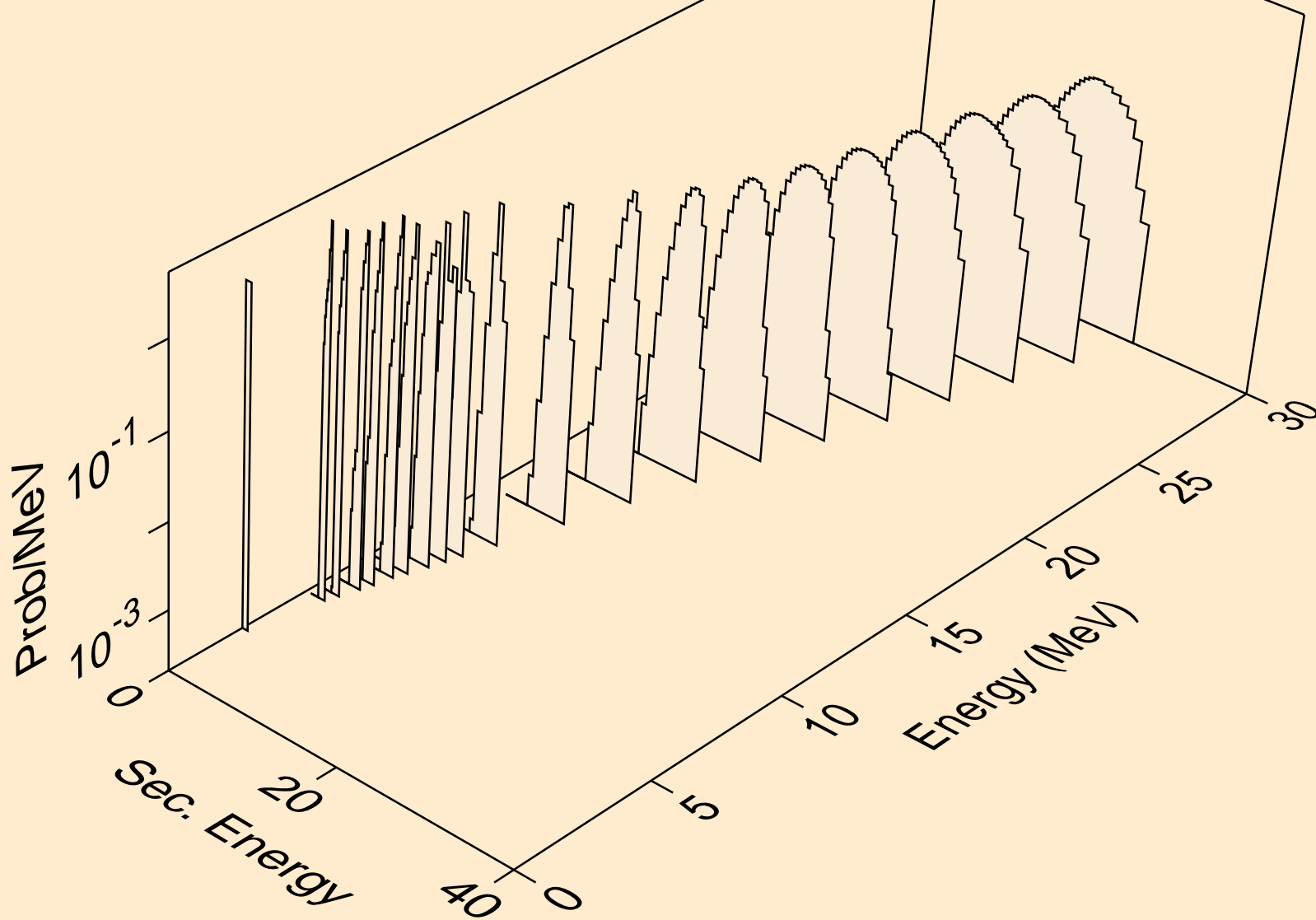

RE165 NEUTRON ACER TENDL-2023 LIBRARY; T=0.K  
tritons from (n,t2a)

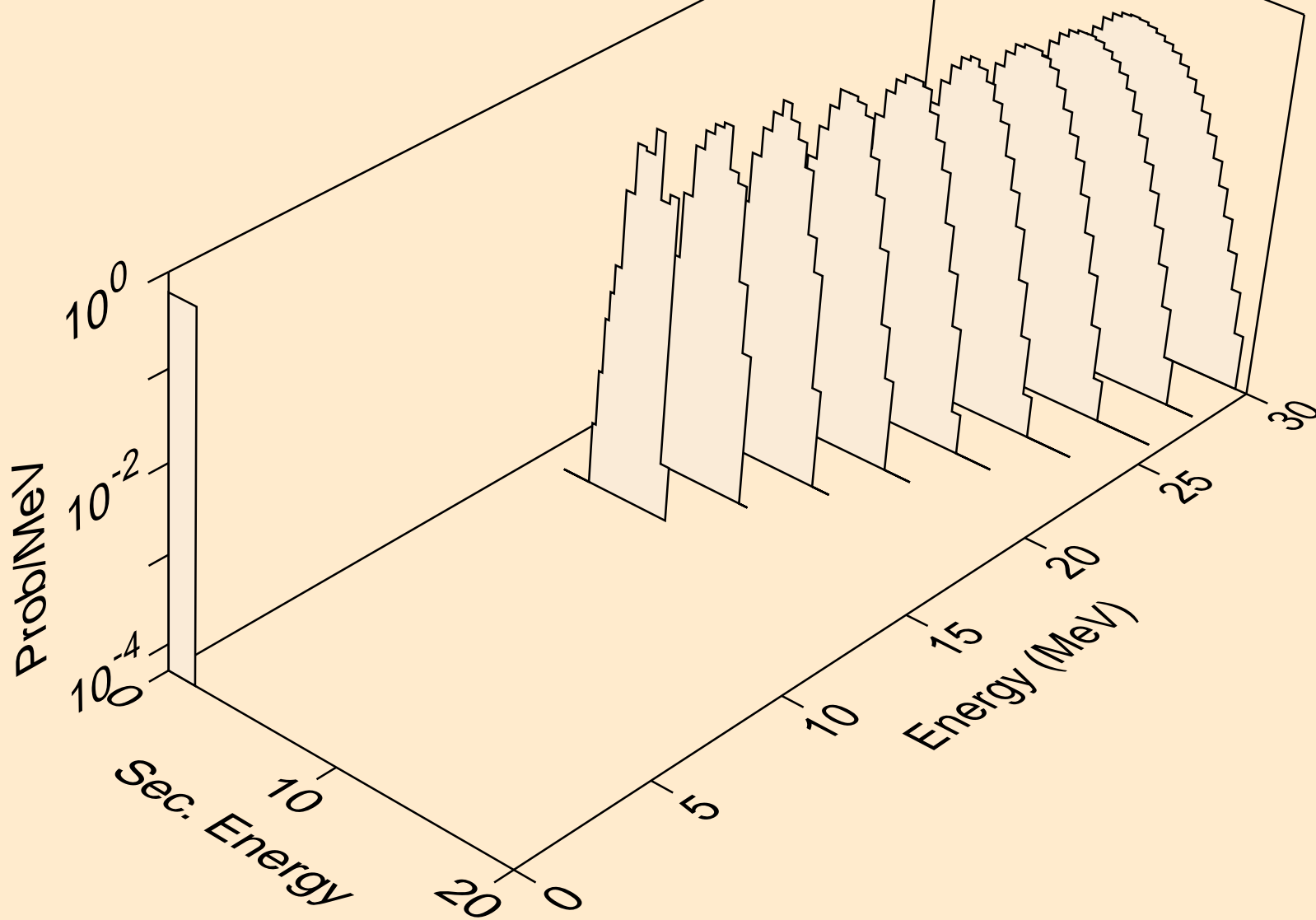

RE165 NEUTRON ACER TENDL-2023 LIBRARY; T=0.K  
tritons from (n,pt)

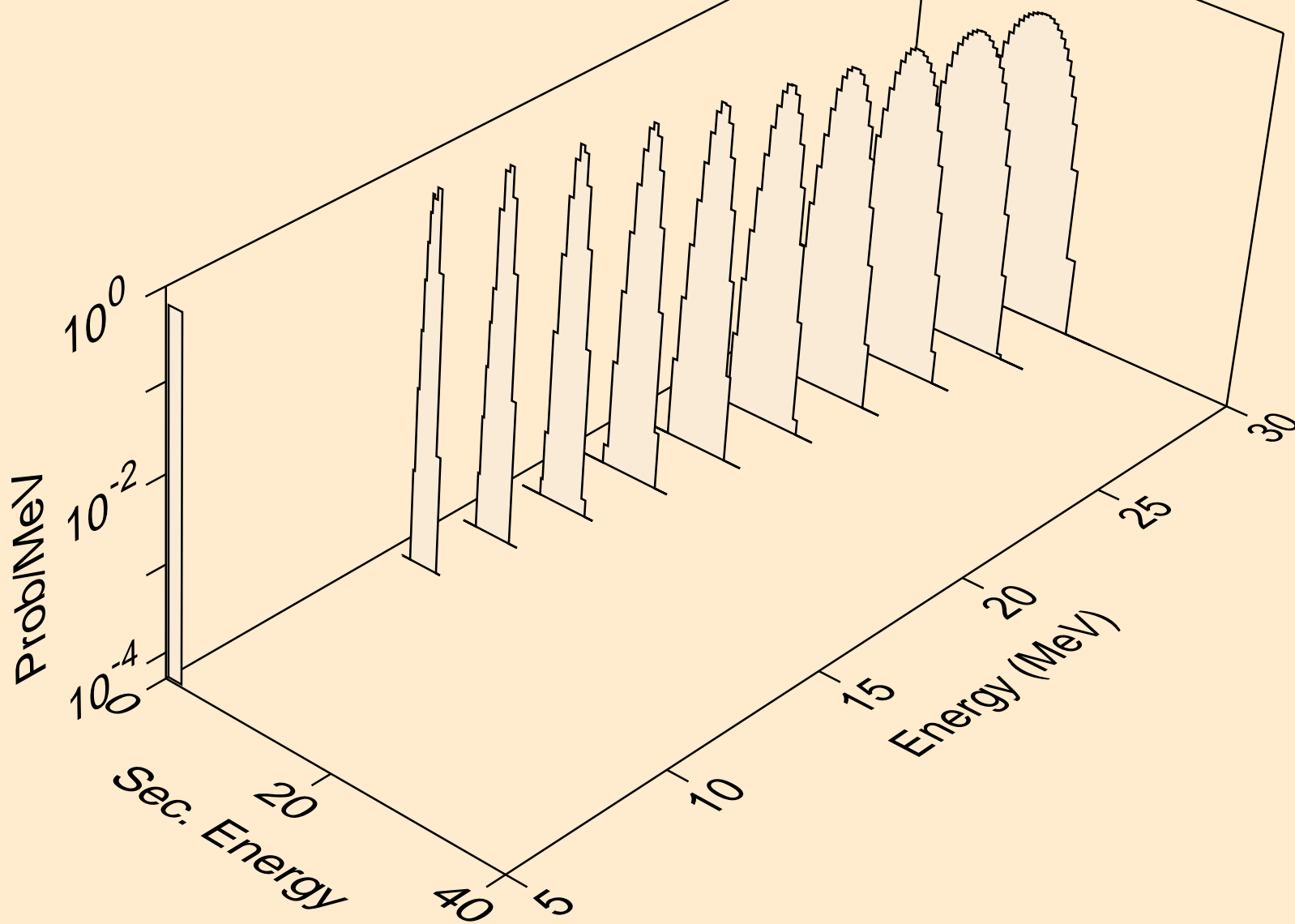

RE165 NEUTRON ACER TENDL-2023 LIBRARY; T=0.K  
he3s from (n,x)

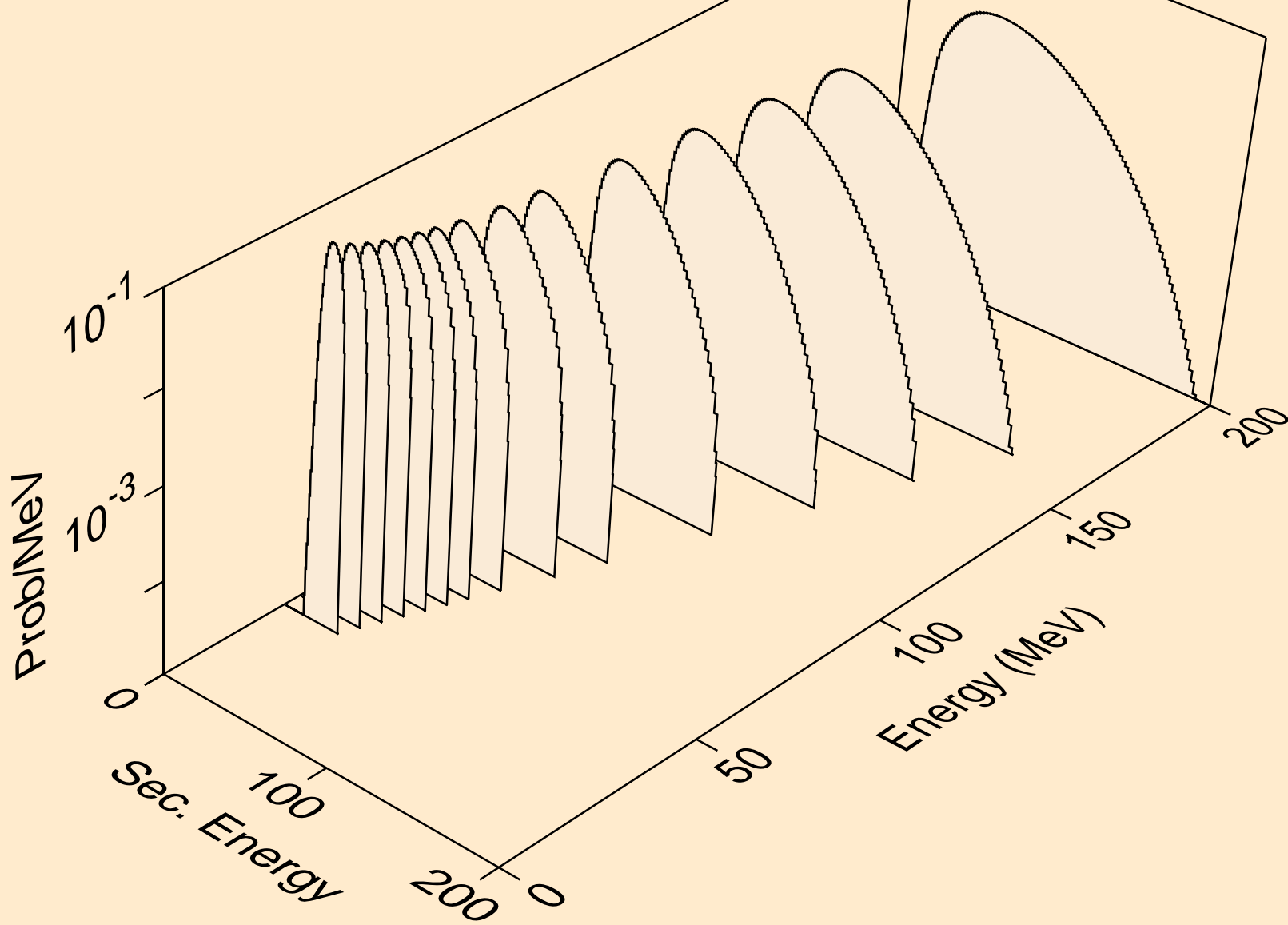

RE165 NEUTRON ACER TENDL-2023 LIBRARY; T=0.K  
he3s from (n,n\*)he3

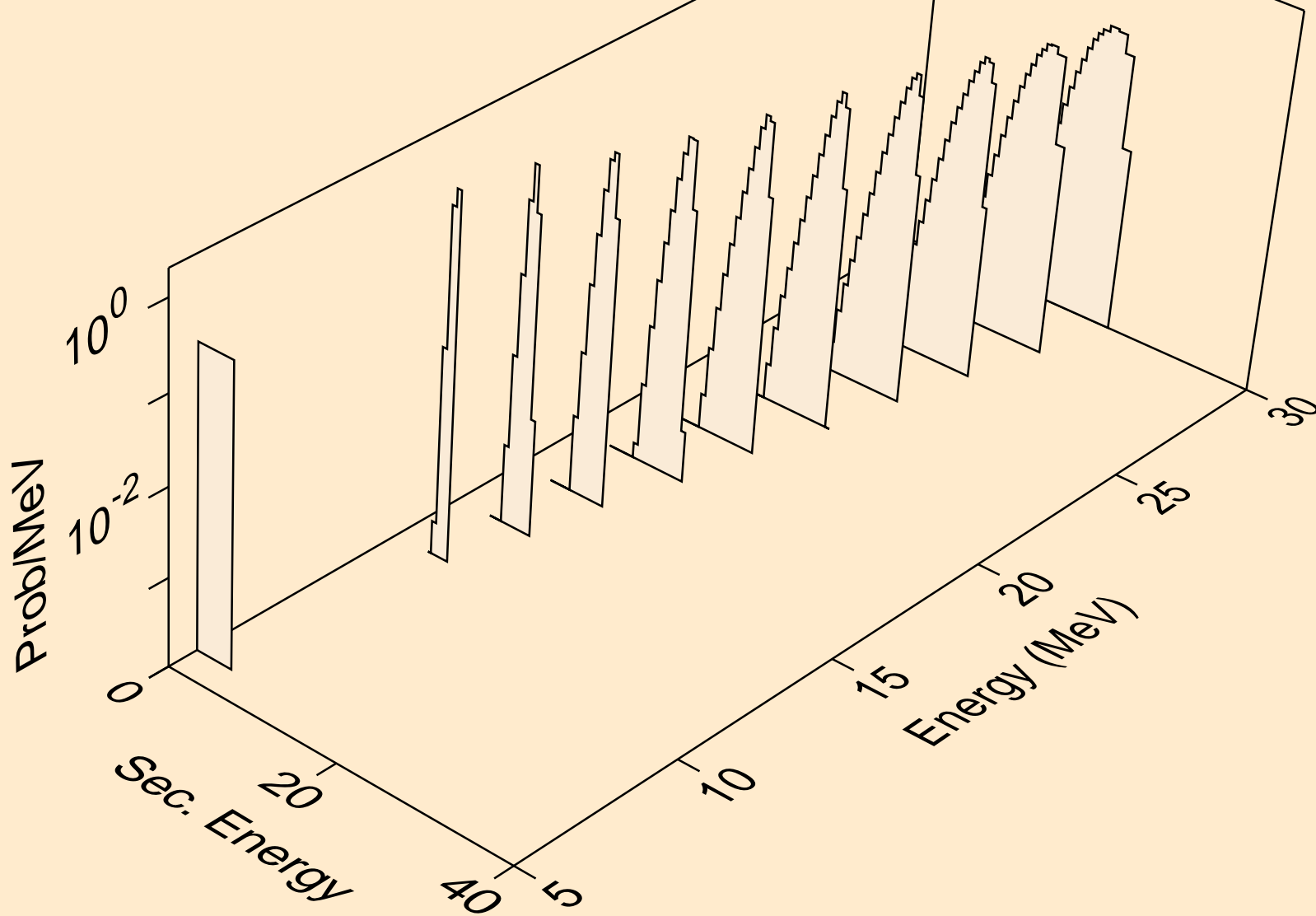

RE165 NEUTRON ACER TENDL-2023 LIBRARY; T=0.K  
he3s from (n,he3)

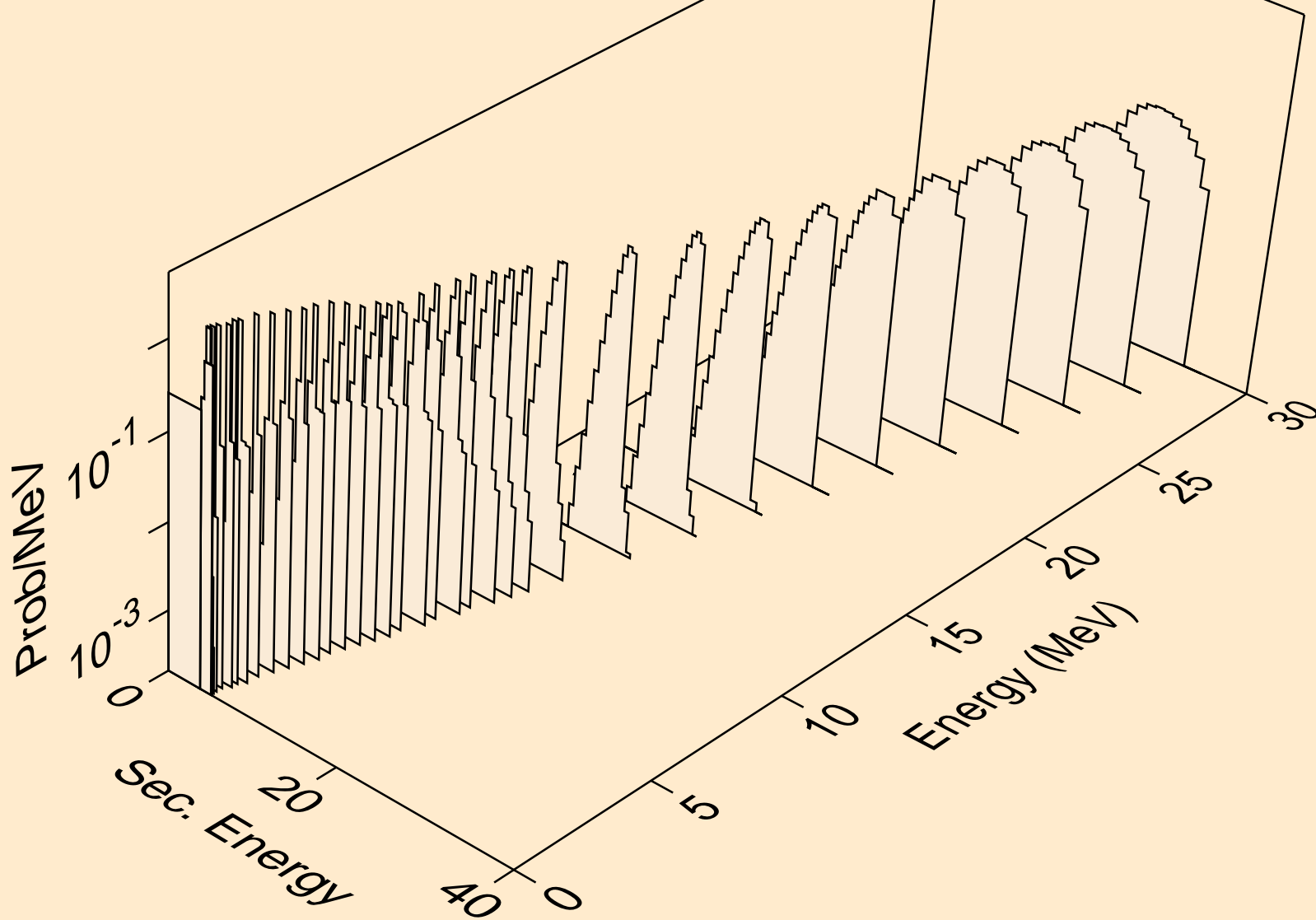

RE165 NEUTRON ACER TENDL-2023 LIBRARY; T=0.K  
alphas from (n,x)

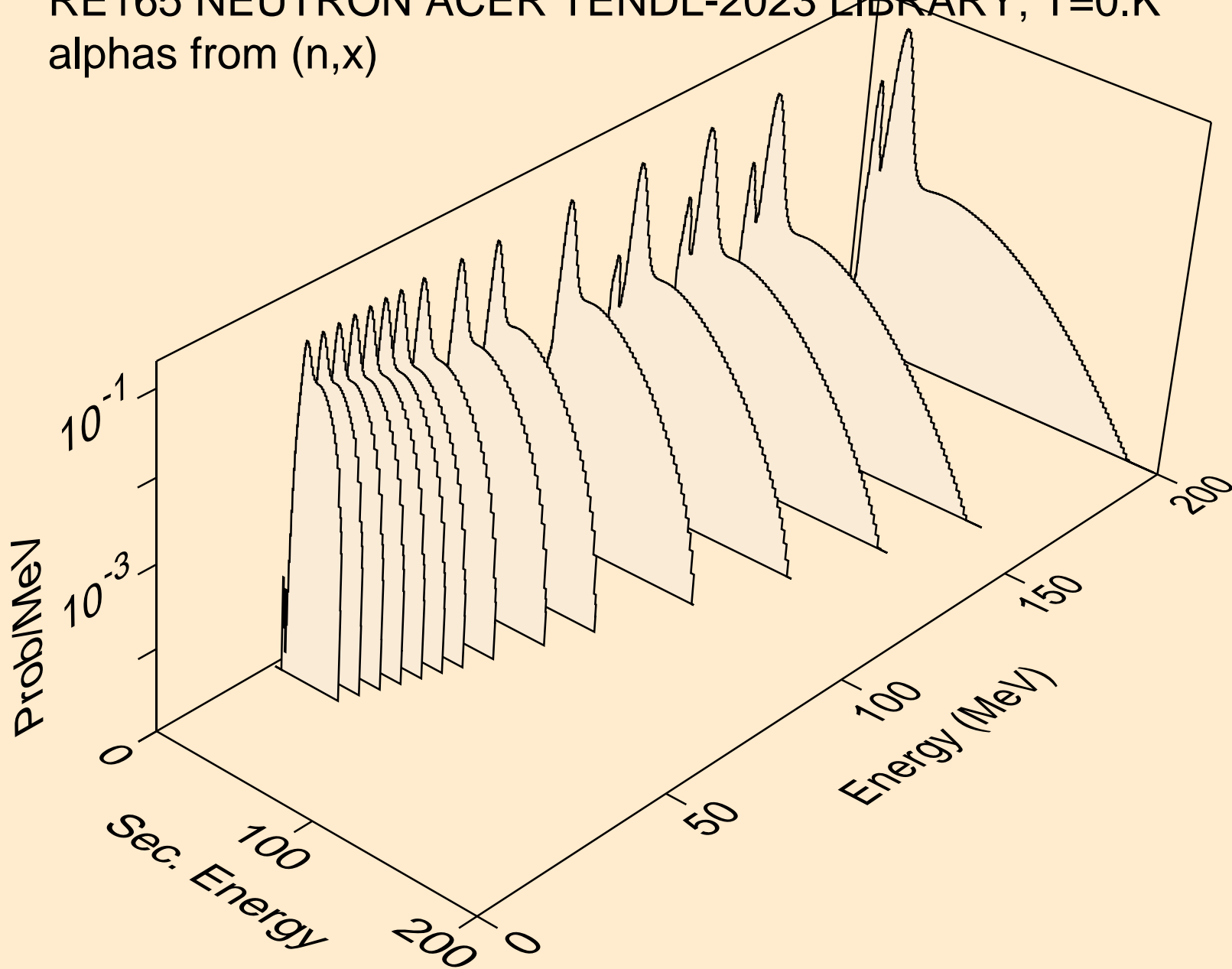

RE165 NEUTRON ACER TENDL-2023 LIBRARY; T=0.K  
alphas from (n,n\*)a

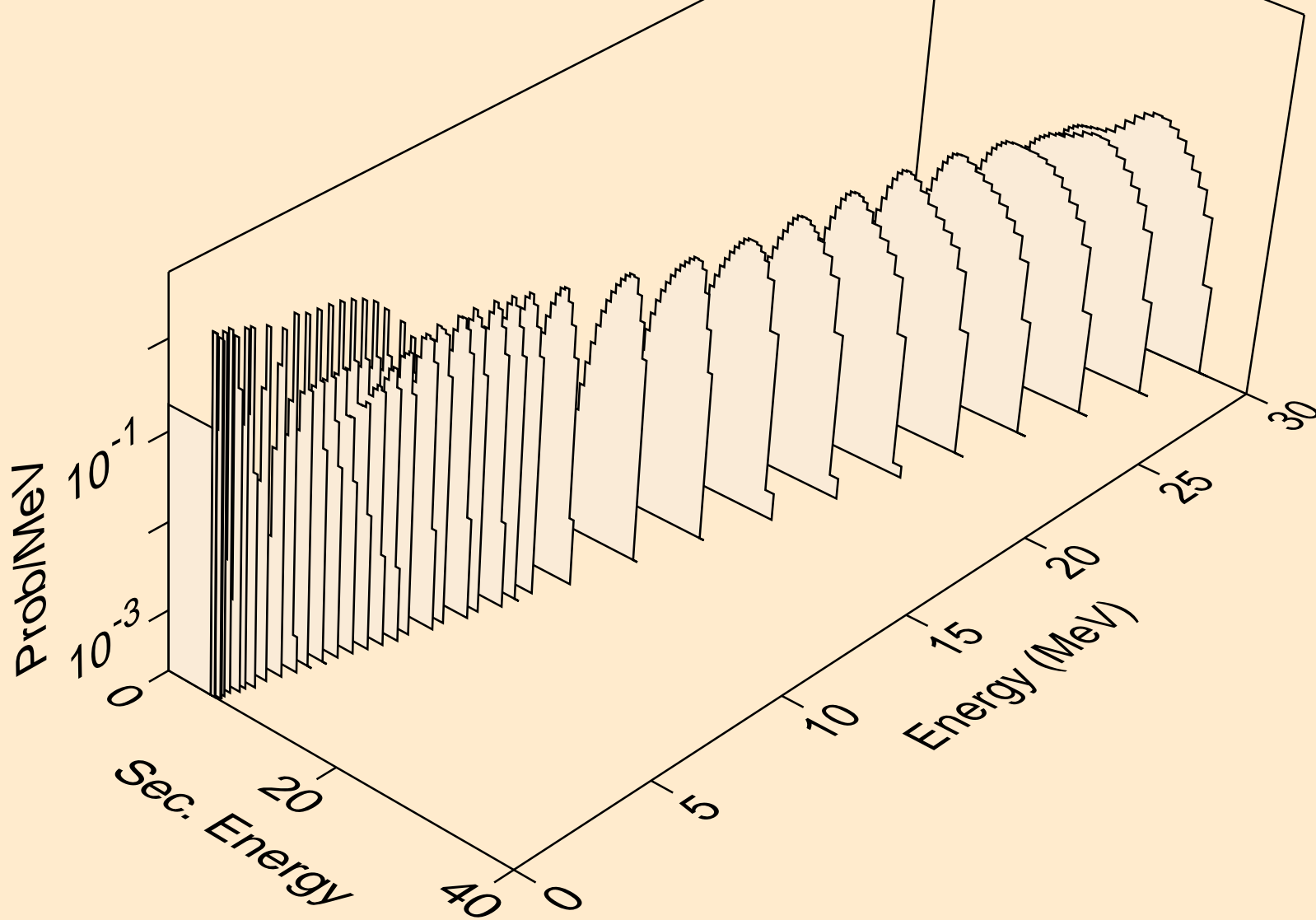

RE165 NEUTRON ACER TENDL-2023 LIBRARY; T=0.K  
alphas from (n,n\*)3a

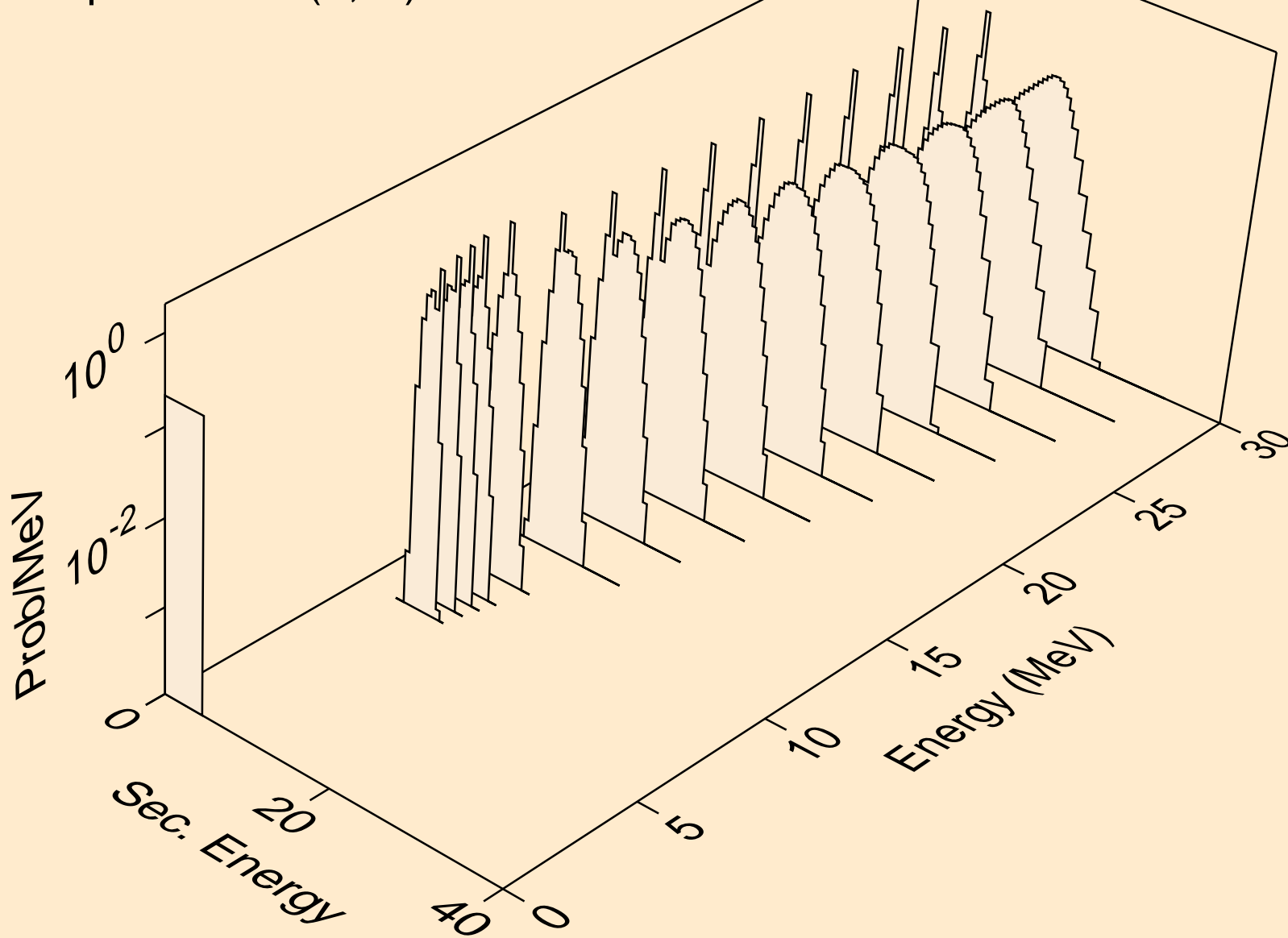

RE165 NEUTRON ACER TENDL-2023 LIBRARY; T=0.K  
alphas from (n,2n)a

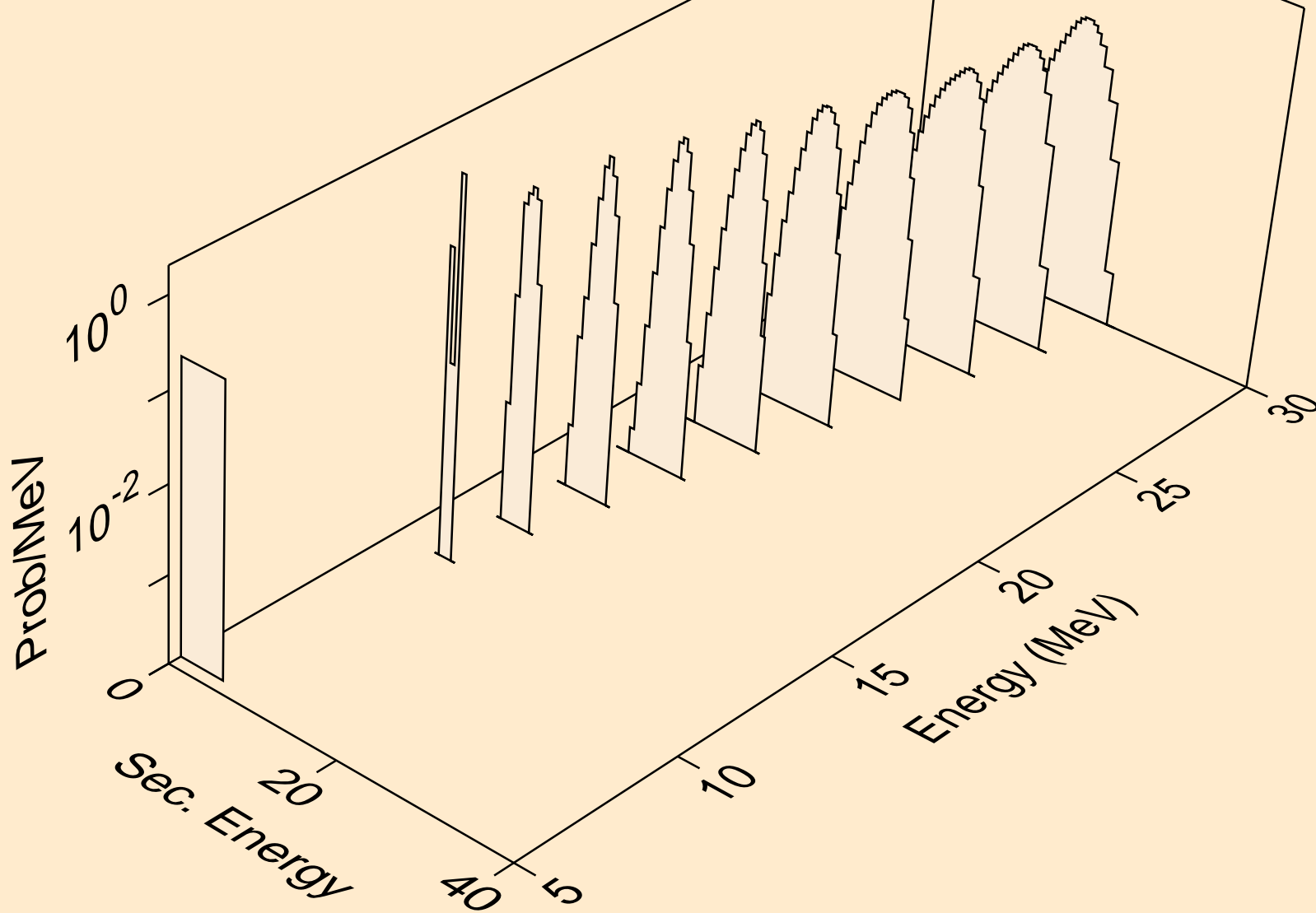

RE165 NEUTRON ACER TENDL-2023 LIBRARY; T=0.K  
alphas from (n,3n)a

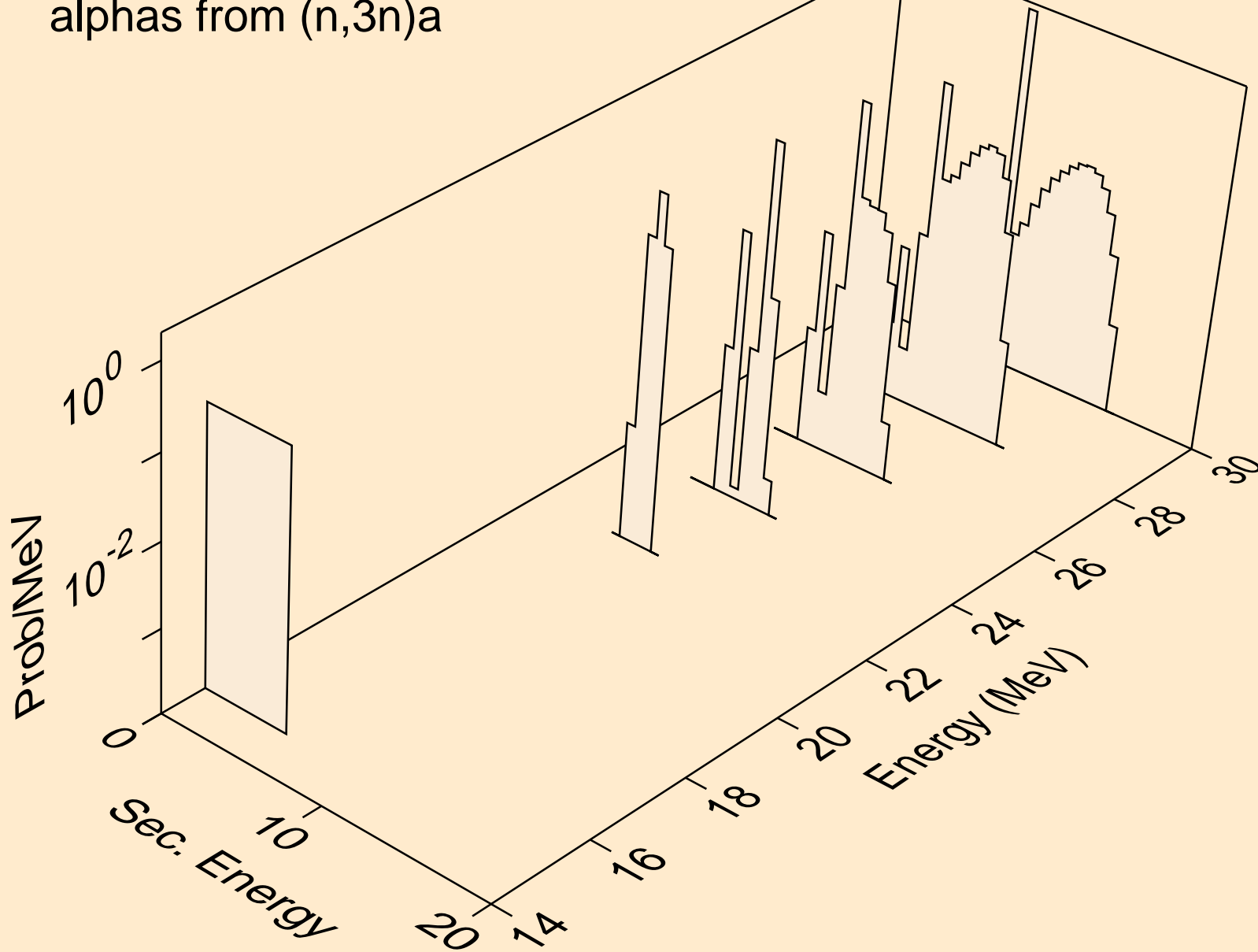

RE165 NEUTRON ACER TENDL-2023 LIBRARY; T=0.K  
alphas from (n,n\*)2a

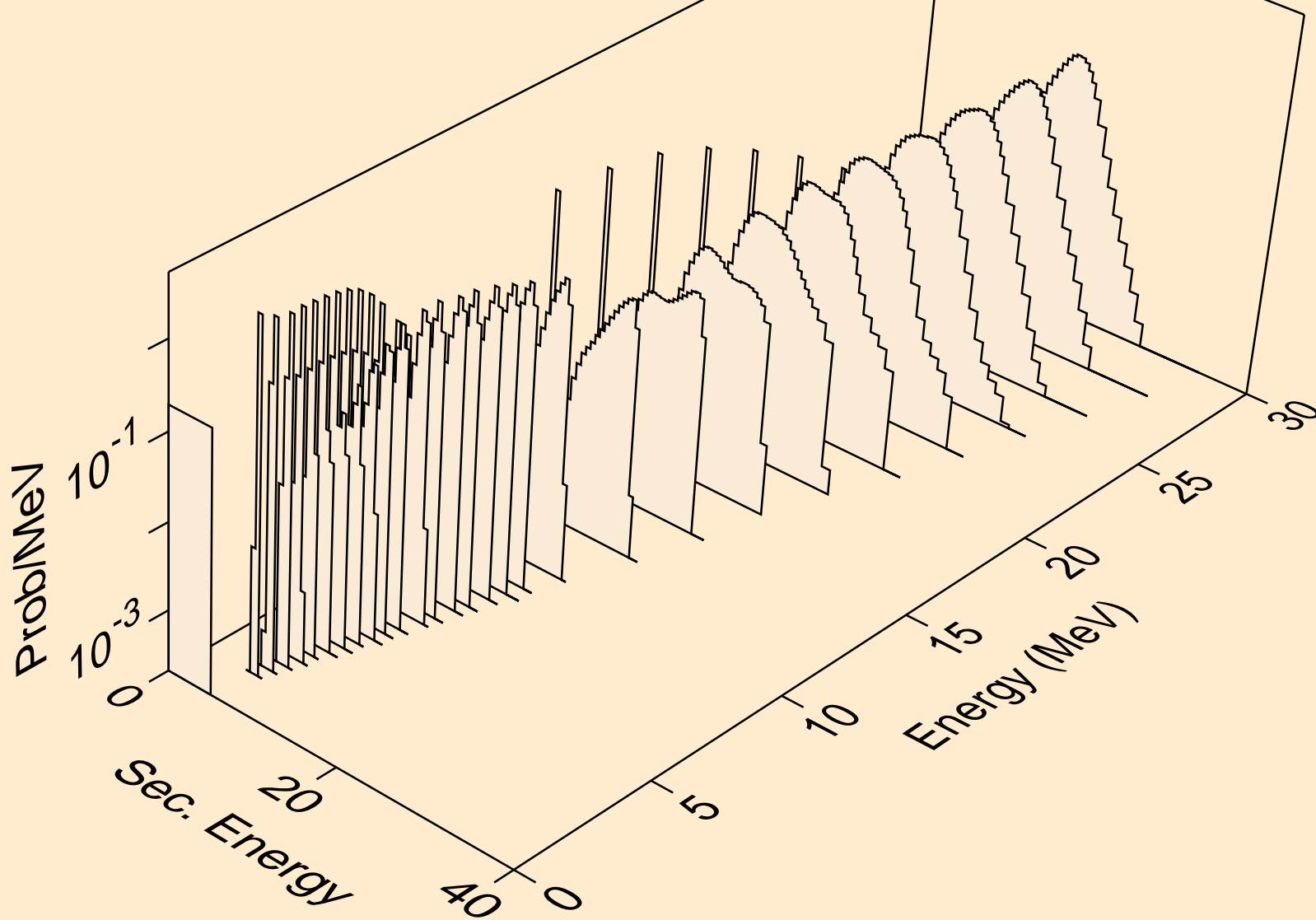

RE165 NEUTRON ACER TENDL-2023 LIBRARY; T=0.K  
alphas from (n,2n)2a

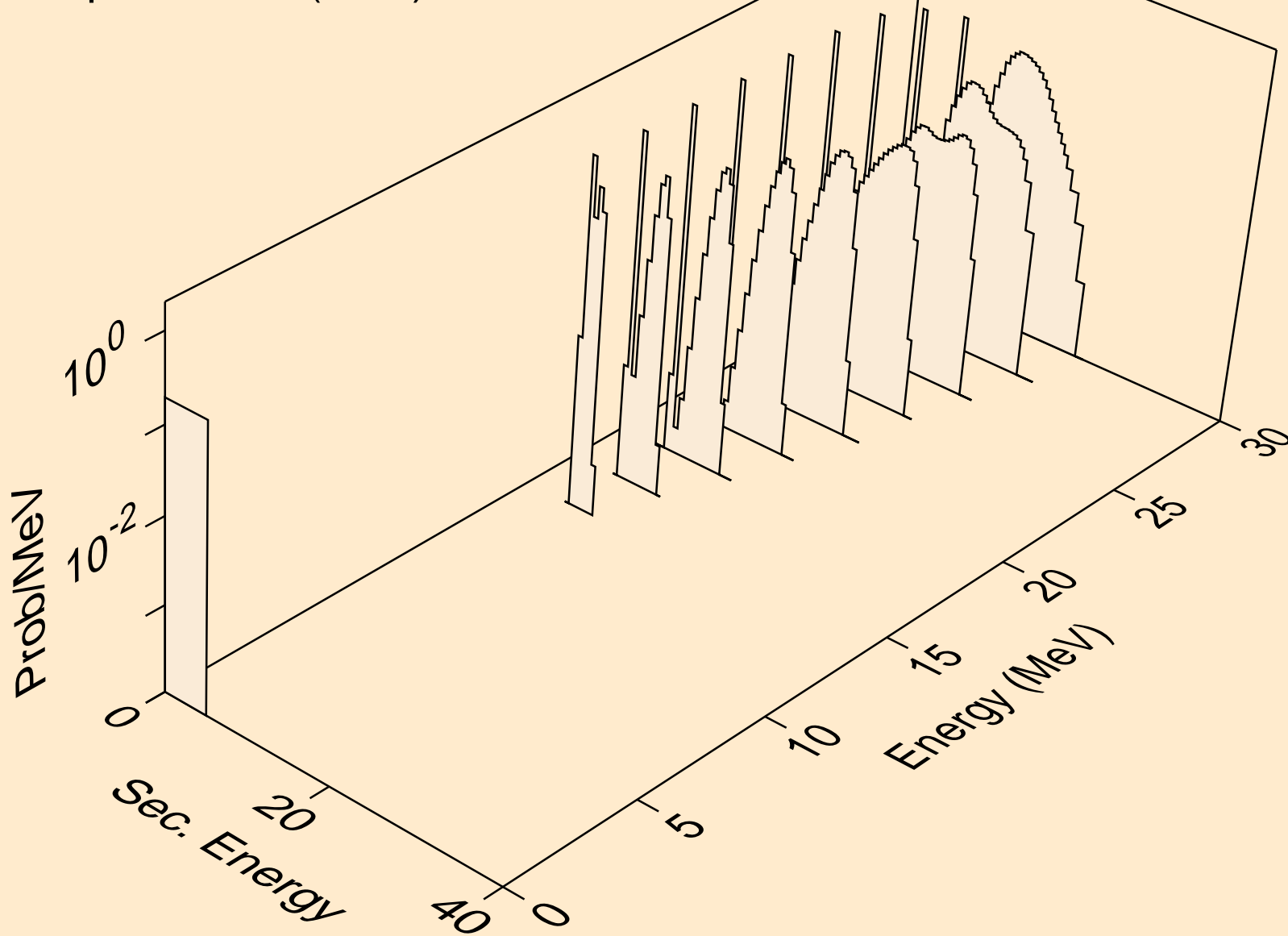

RE165 NEUTRON ACER TENDL-2023 LIBRARY; T=0.K  
alphas from (n,npa)

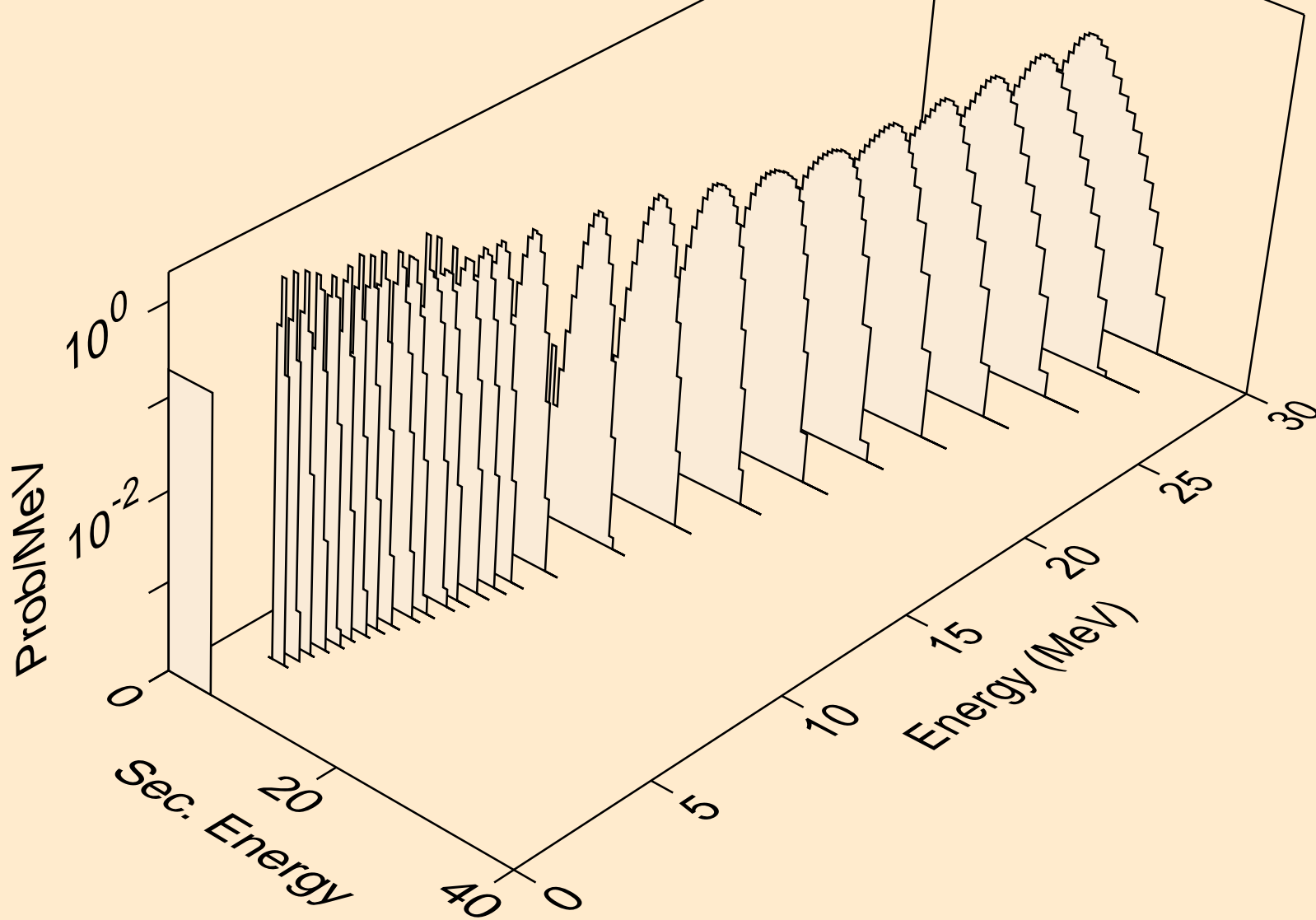

RE165 NEUTRON ACER TENDL-2023 LIBRARY; T=0.K  
alphas from (n,a)

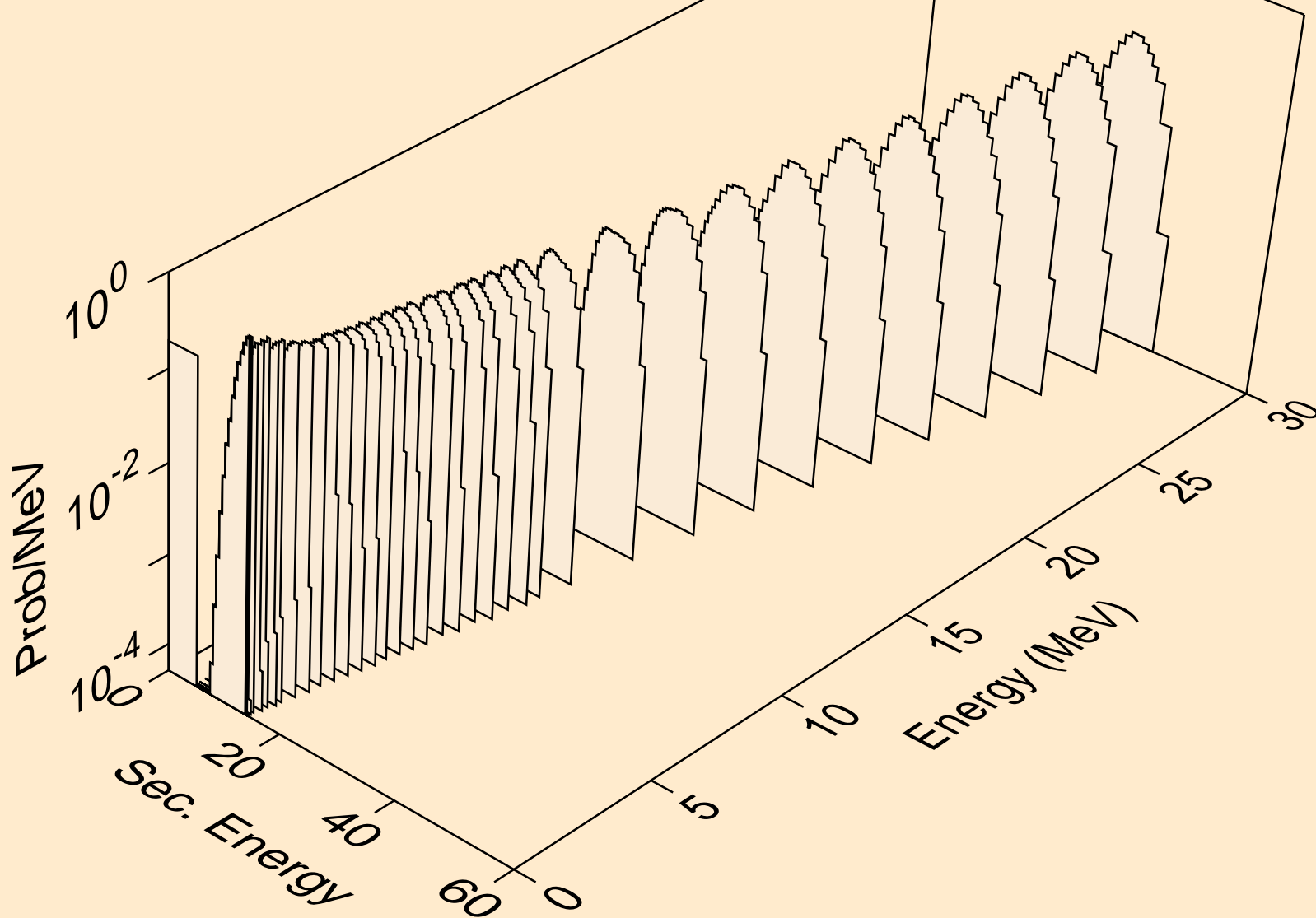

RE165 NEUTRON ACER TENDL-2023 LIBRARY; T=0.K  
alphas from (n,2a)

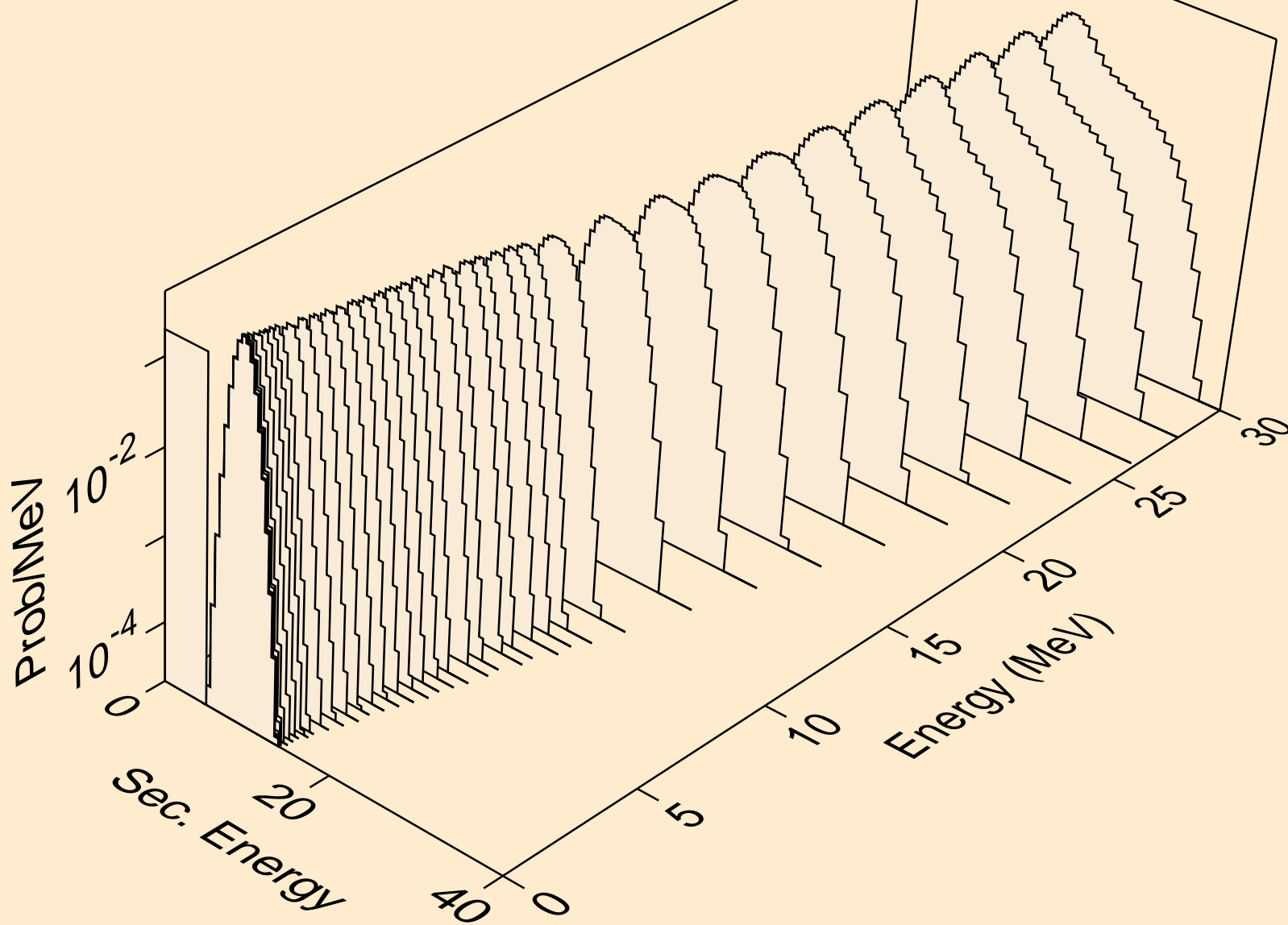

RE165 NEUTRON ACER TENDL-2023 LIBRARY; T=0.K  
alphas from (n,3a)

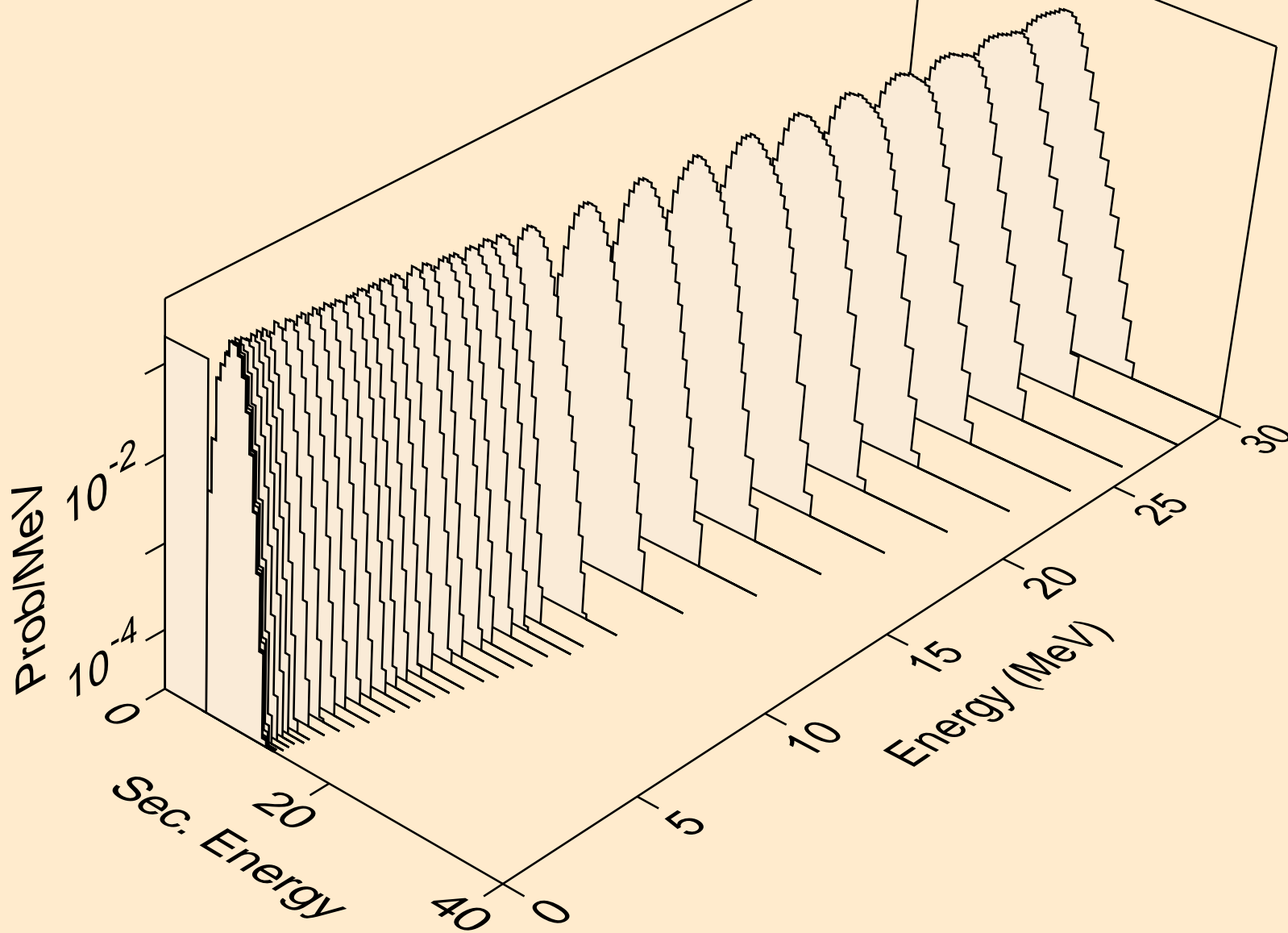

RE165 NEUTRON ACER TENDL-2023 LIBRARY; T=0.K  
alphas from (n,pa)

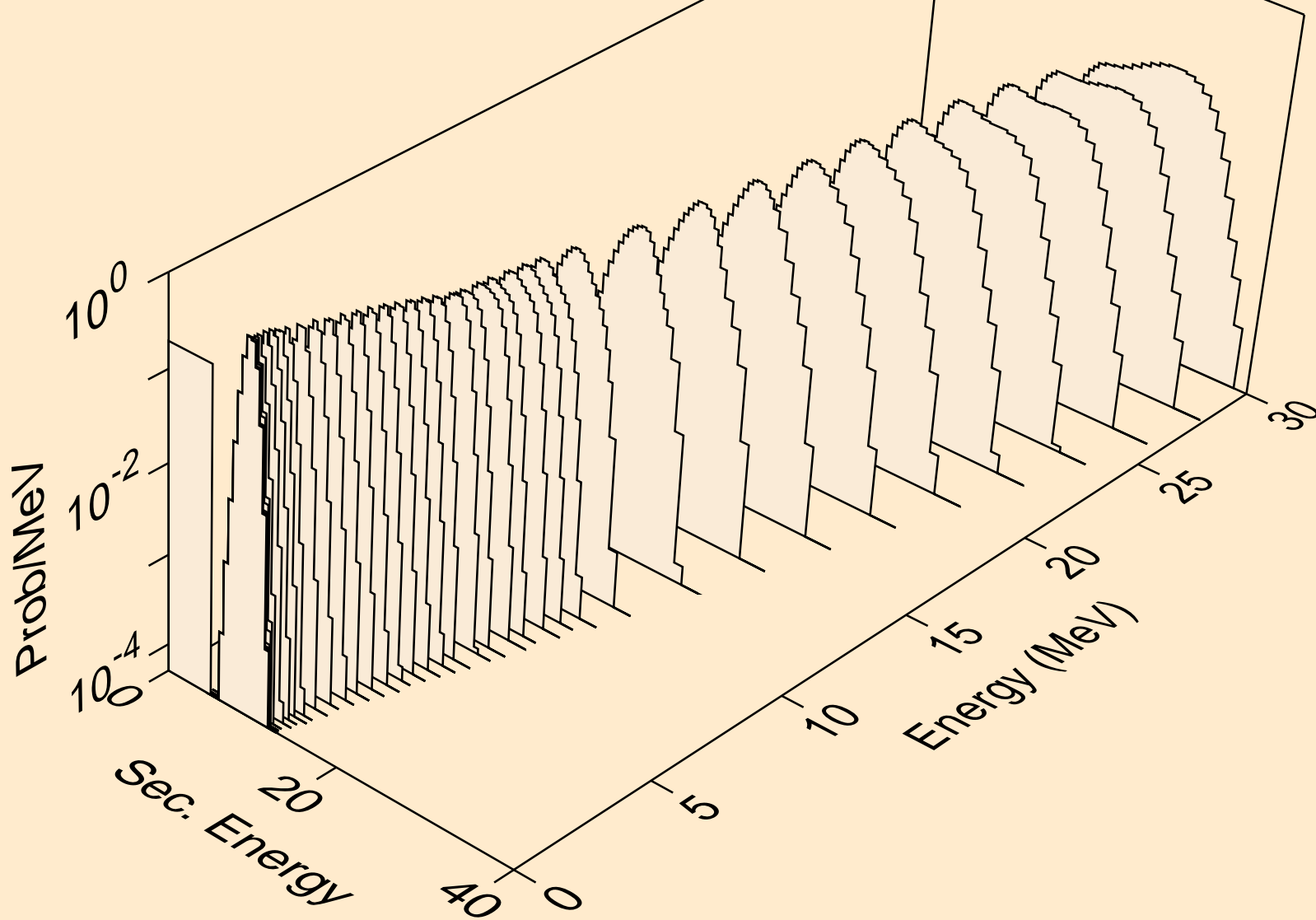

RE165 NEUTRON ACER TENDL-2023 LIBRARY; T=0.K  
alphas from (n,t2a)

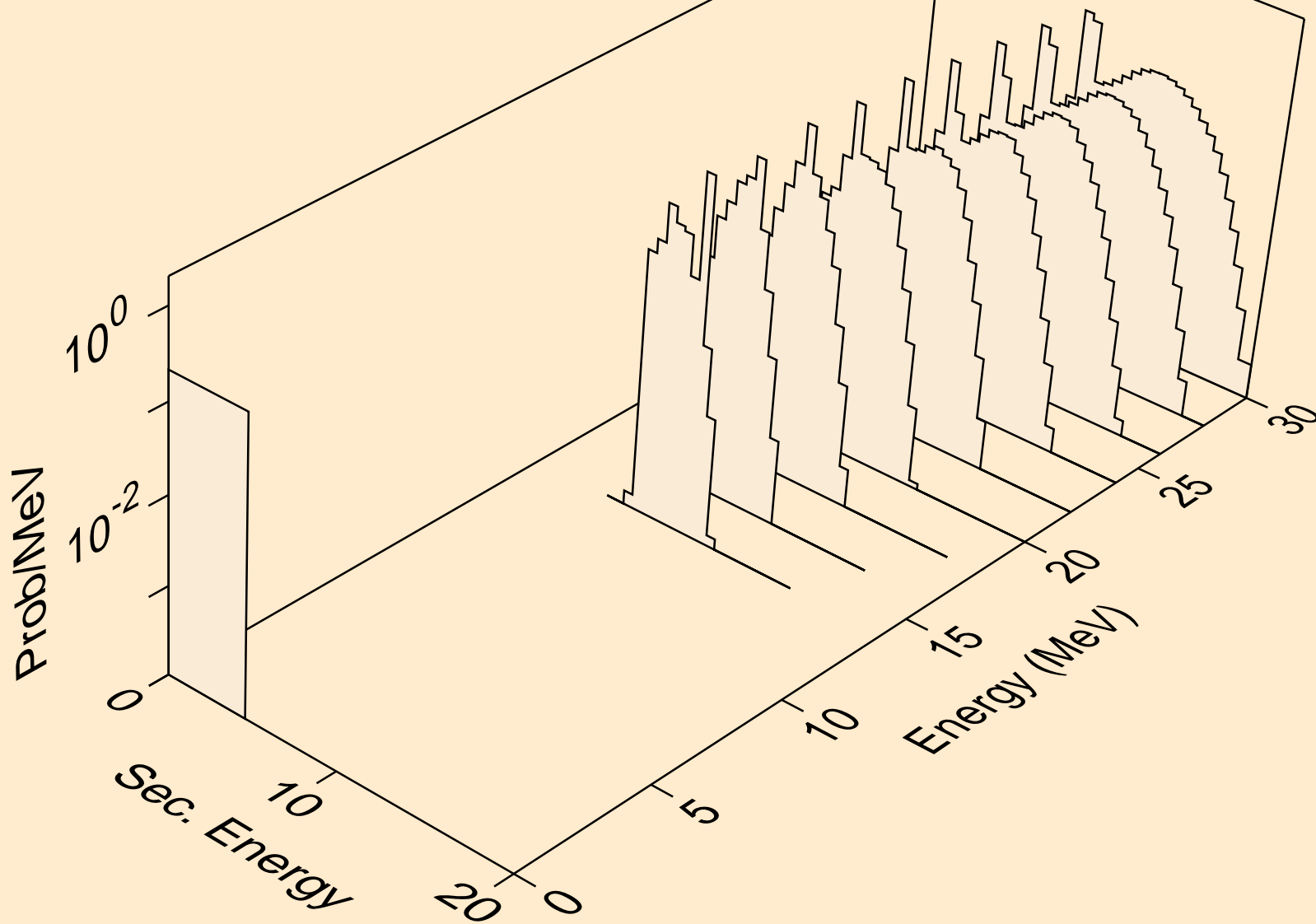

RE165 NEUTRON ACER TENDL-2023 LIBRARY; T=0.K  
alphas from (n,d2a)

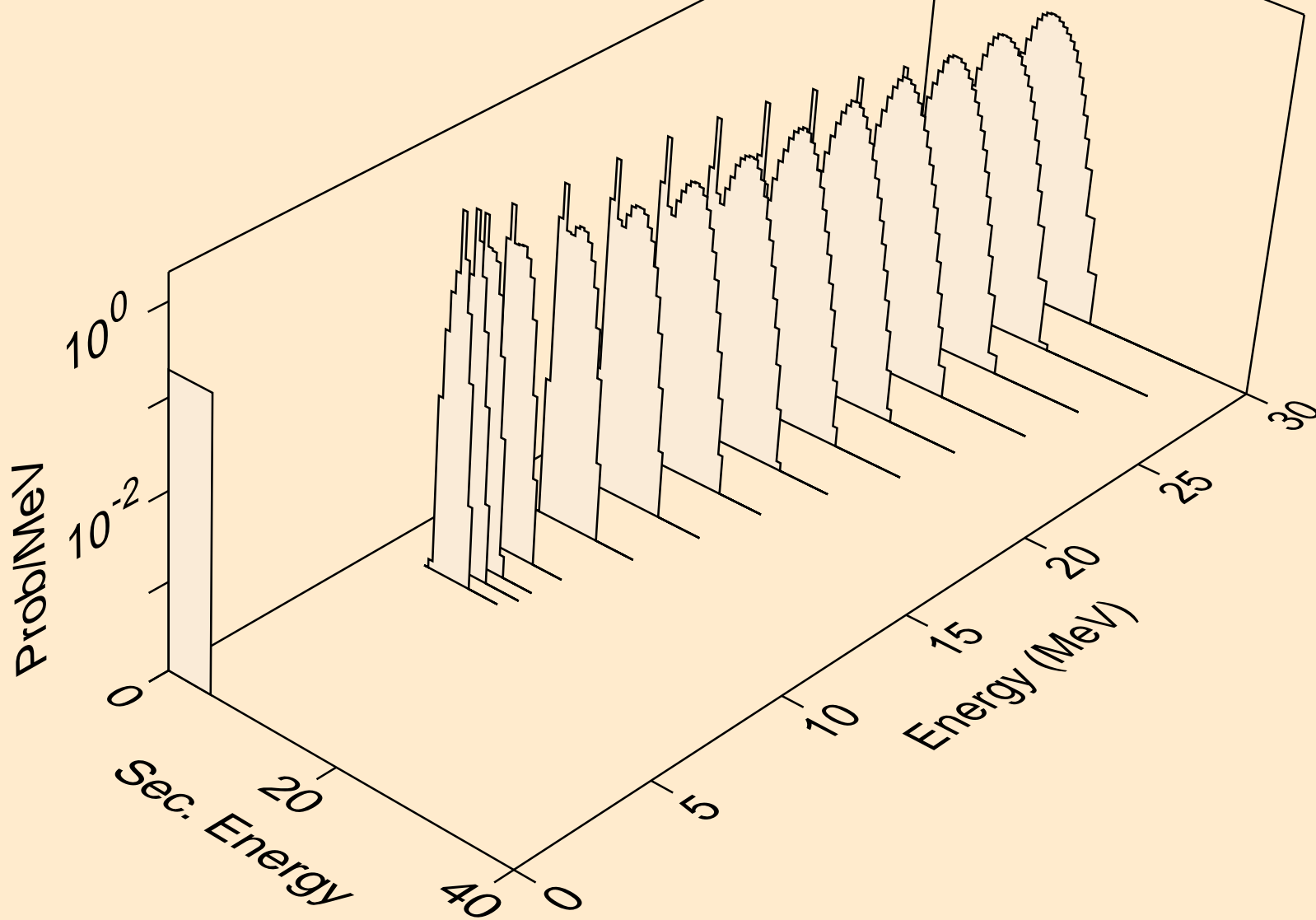

RE165 NEUTRON ACER TENDL-2023 LIBRARY; T=0.K  
alphas from (n,da)

