

# RU101 NEUTRON ACER TENDL-2023 LIBRARY; T=0.K

## Principal cross sections

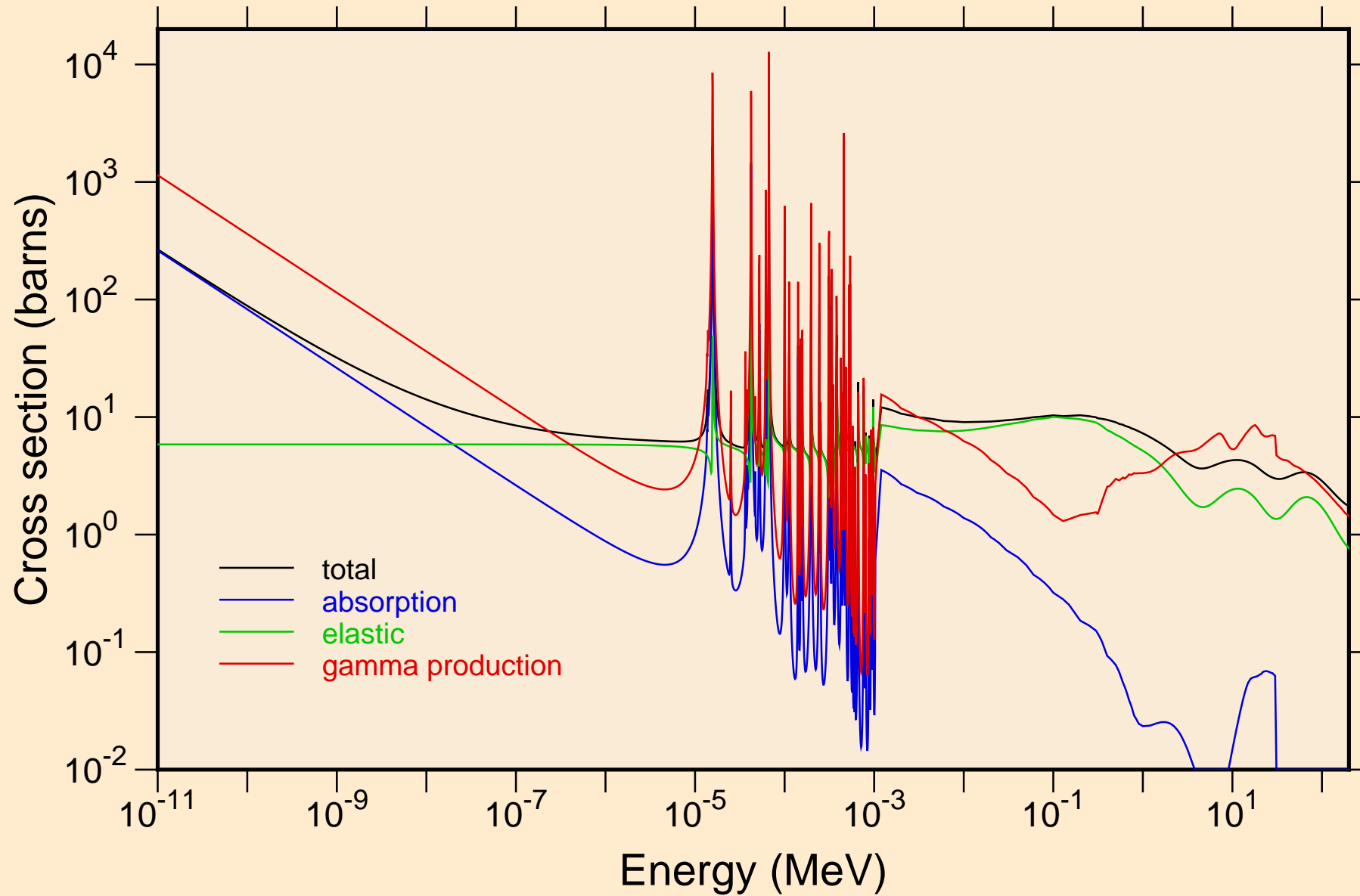

RU101 NEUTRON ACER TENDL-2023 LIBRARY; T=0.K  
resonance total cross section

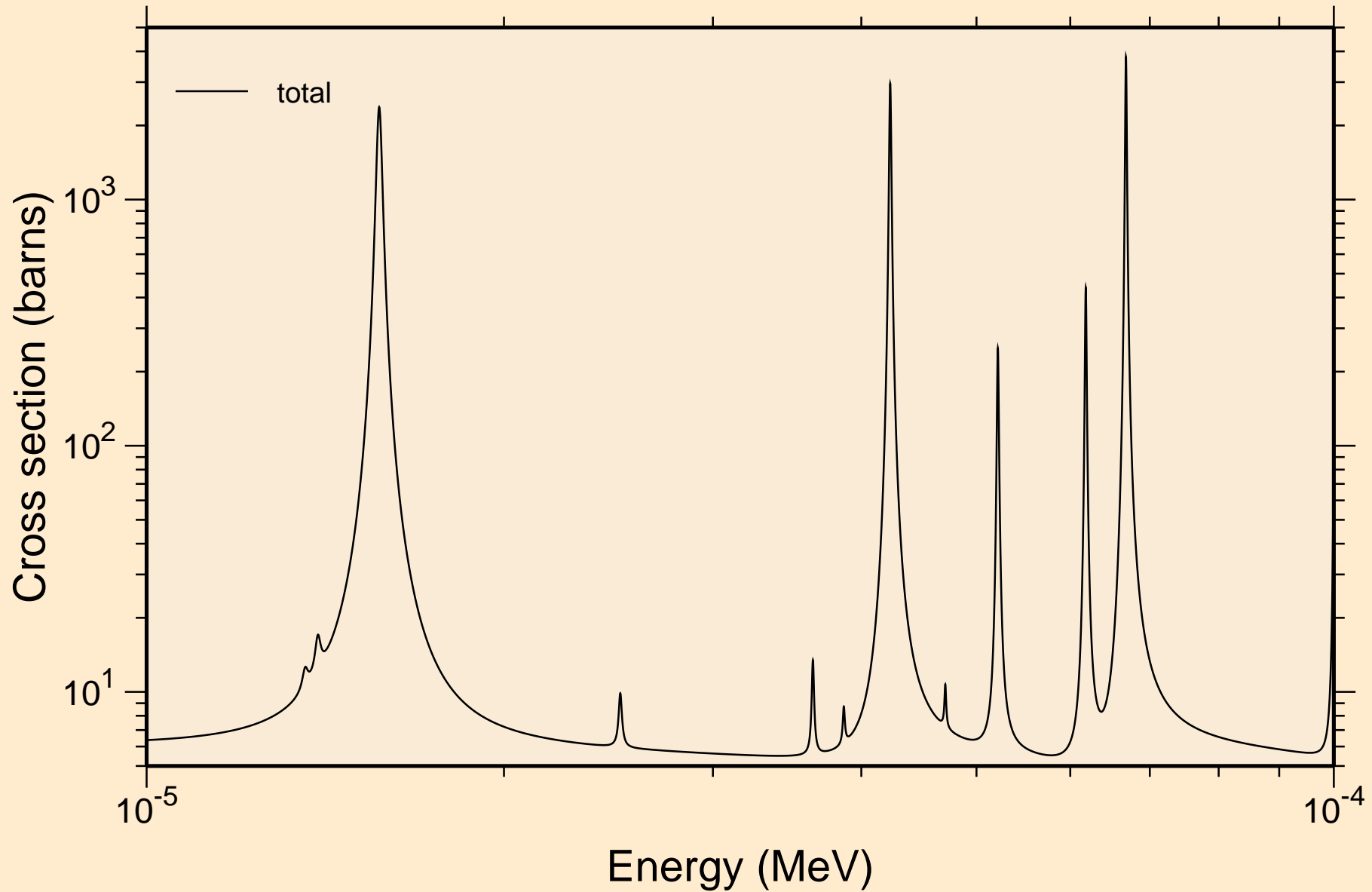

RU101 NEUTRON ACER TENDL-2023 LIBRARY; T=0.K  
resonance total cross section

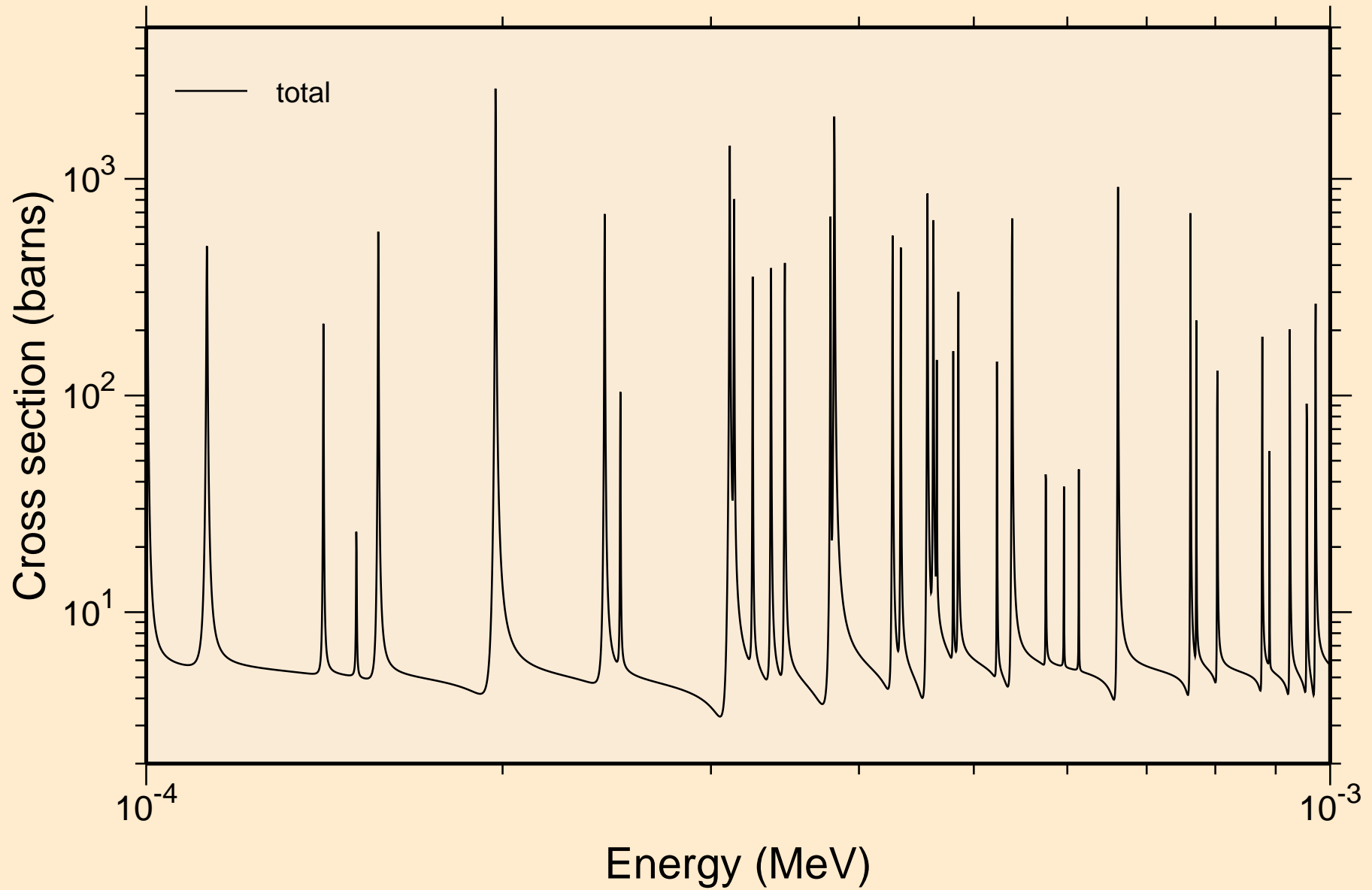

RU101 NEUTRON ACER TENDL-2023 LIBRARY; T=0.K  
resonance total cross section

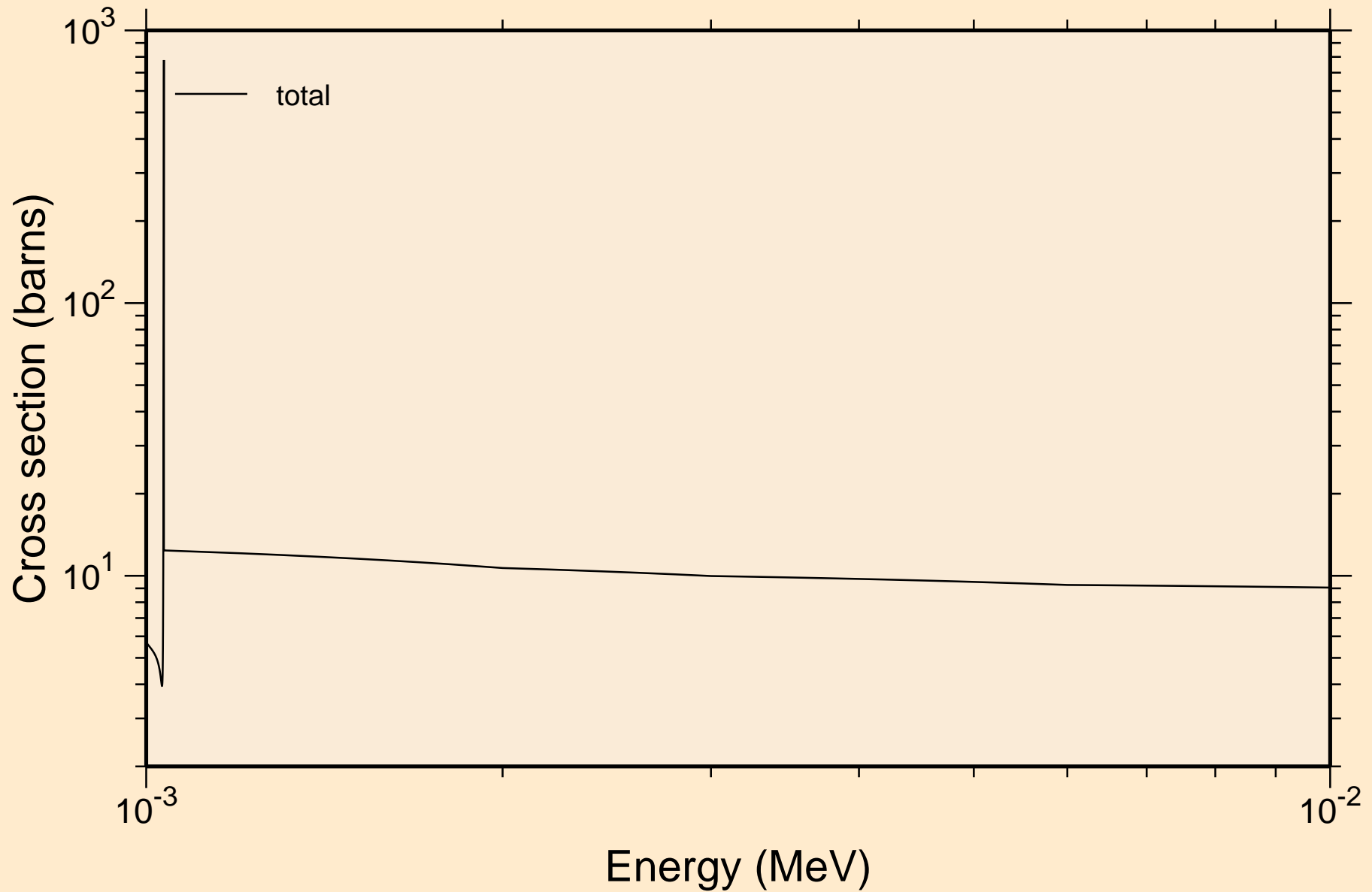

RŪ101 NEUTRON ACER TENDL-2023 LIBRARY; T=0.K  
resonance total cross section

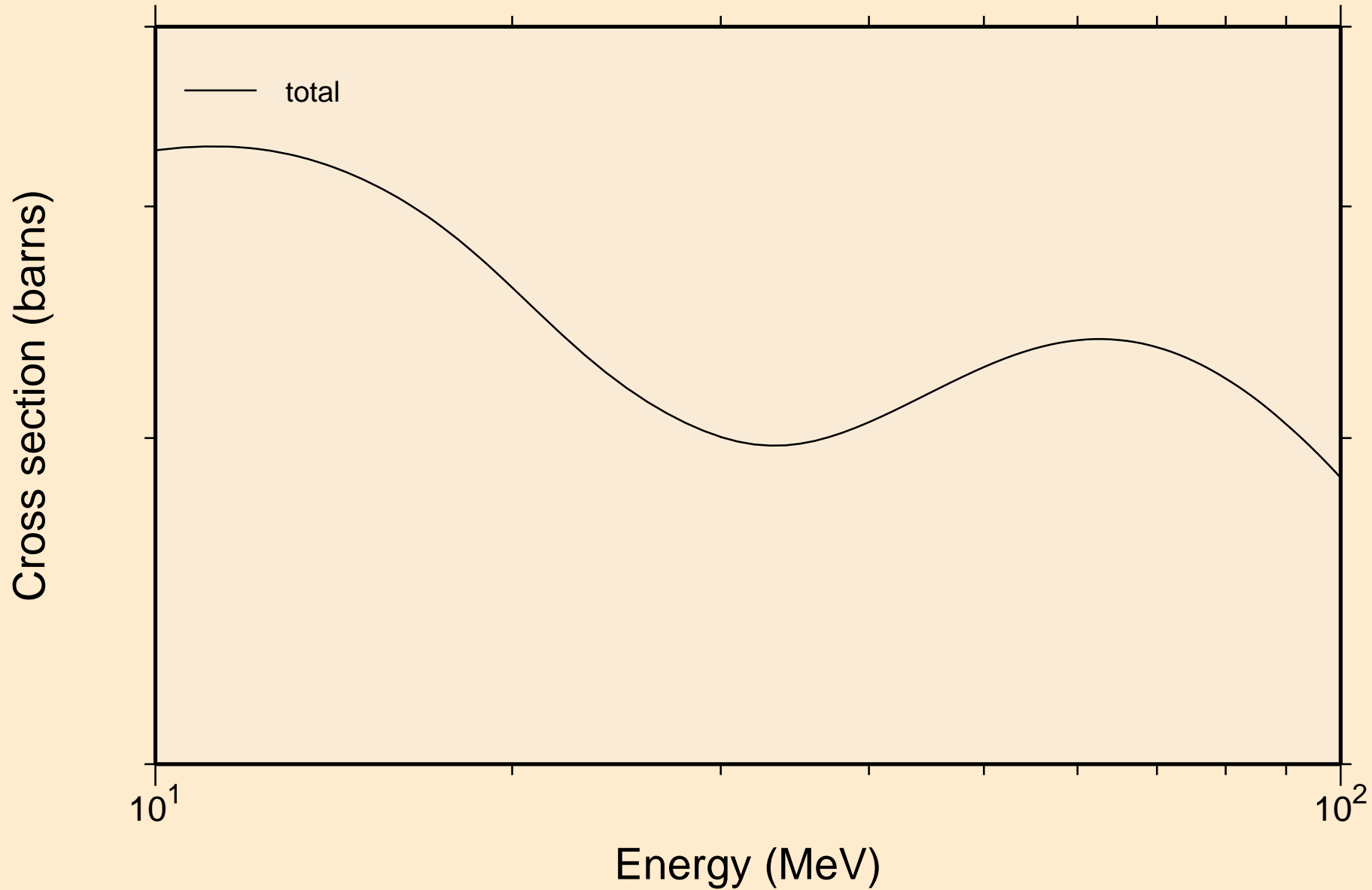

RU101 NEUTRON ACER TENDL-2023 LIBRARY; T=0.K  
resonance absorption cross sections

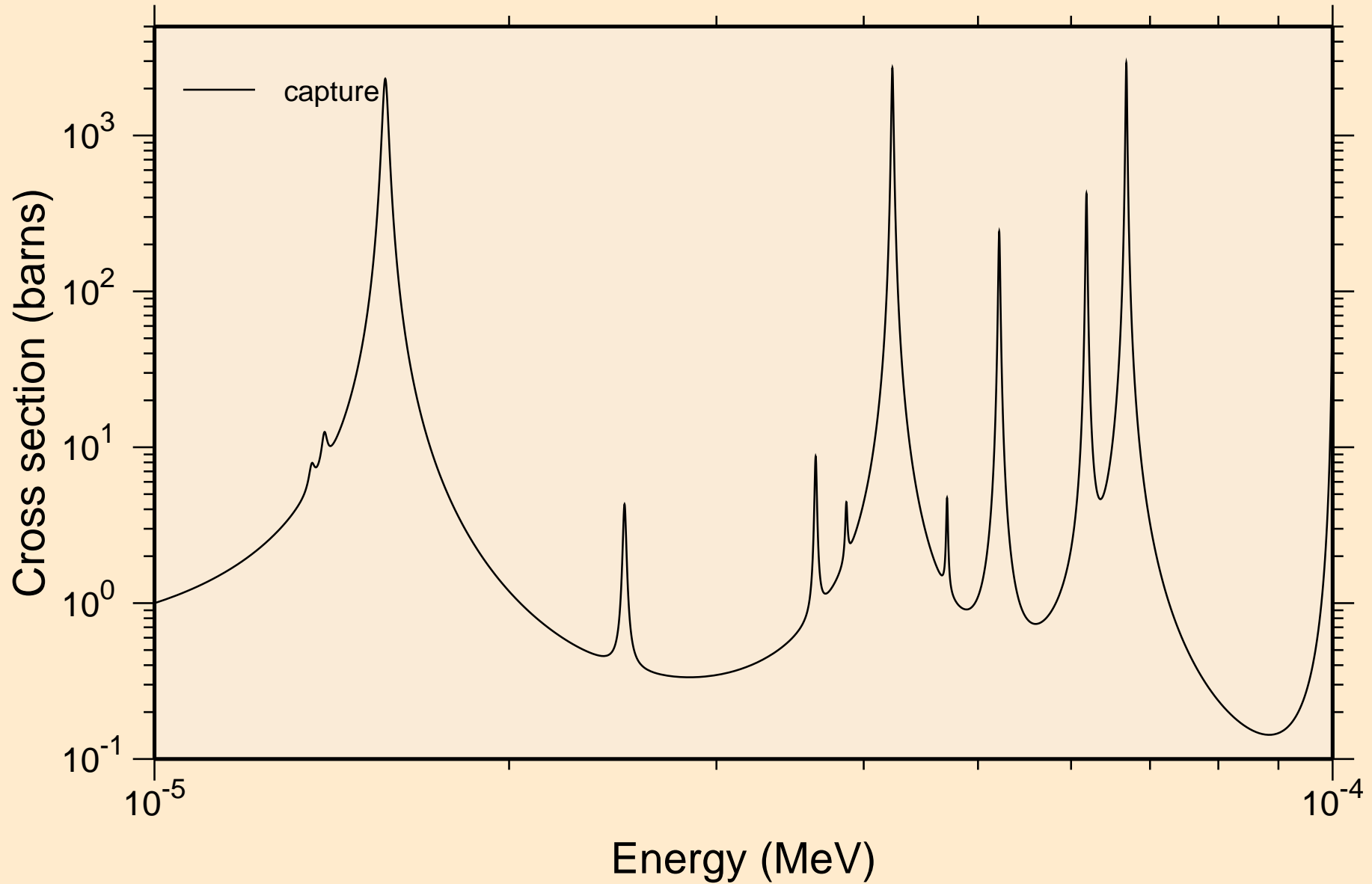

RU101 NEUTRON ACER TENDL-2023 LIBRARY; T=0.K  
resonance absorption cross sections

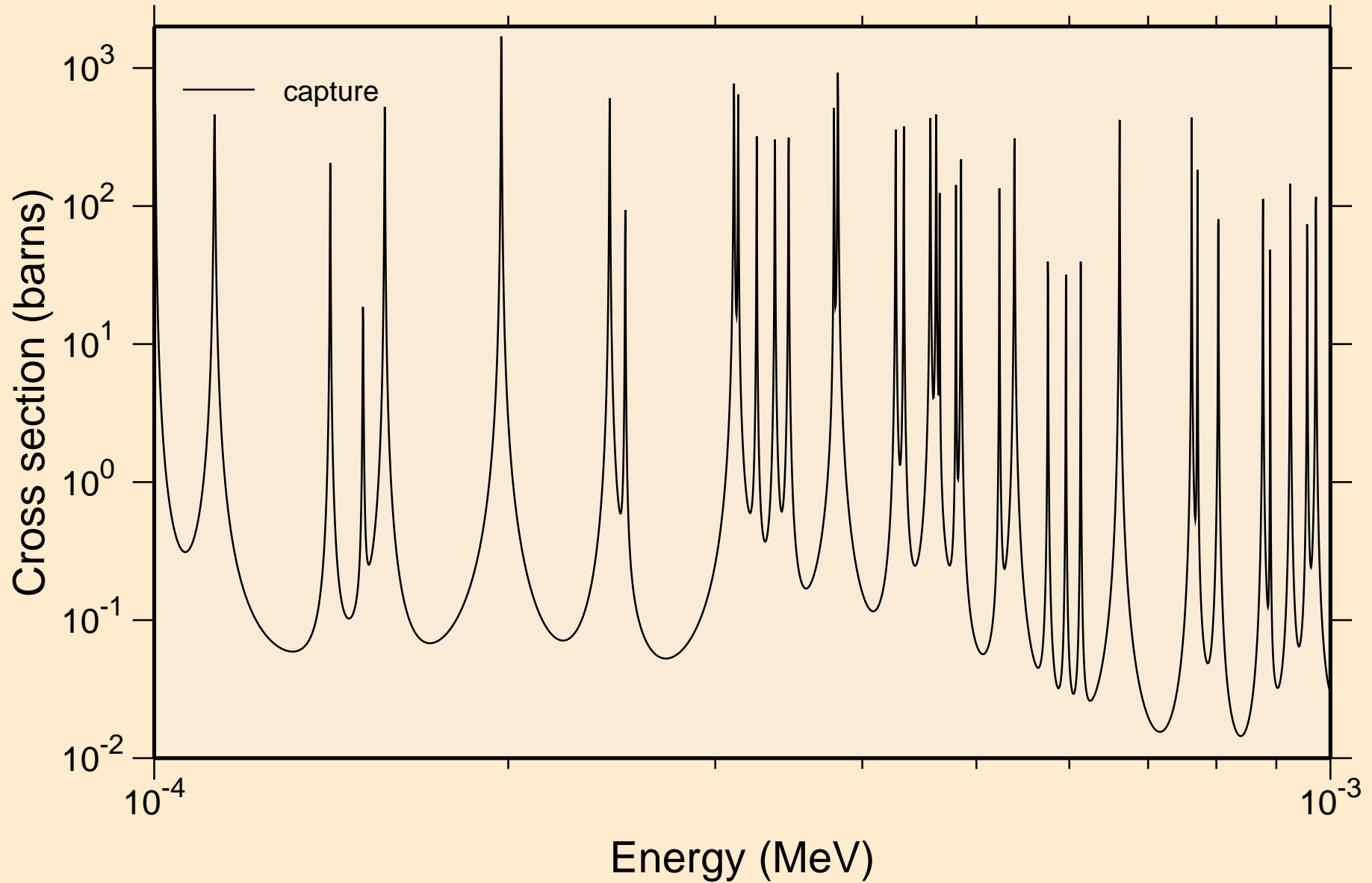

RU101 NEUTRON ACER TENDL-2023 LIBRARY; T=0.K  
resonance absorption cross sections

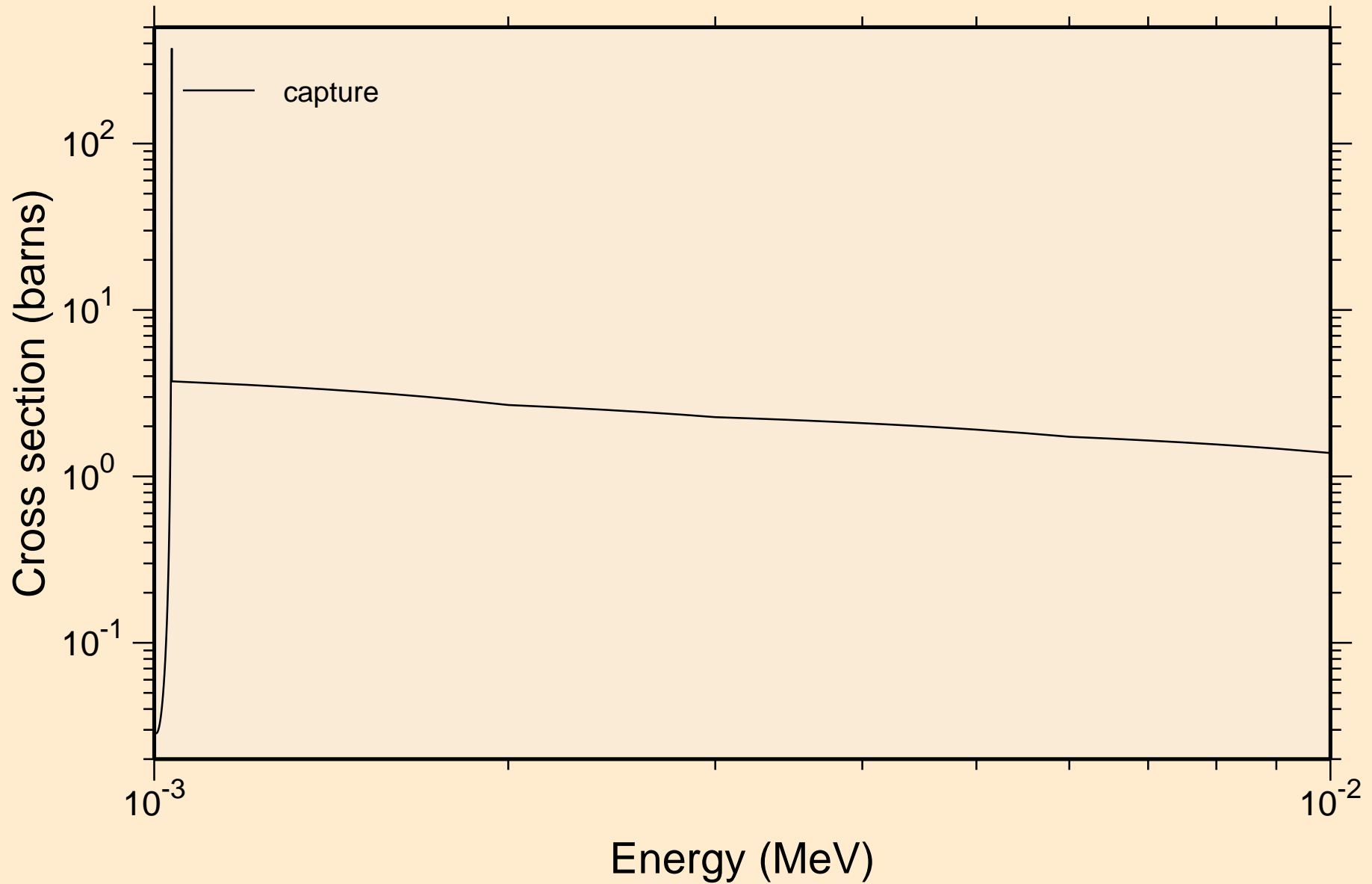

RU101 NEUTRON ACER TENDL-2023 LIBRARY; T=0.K  
resonance absorption cross sections

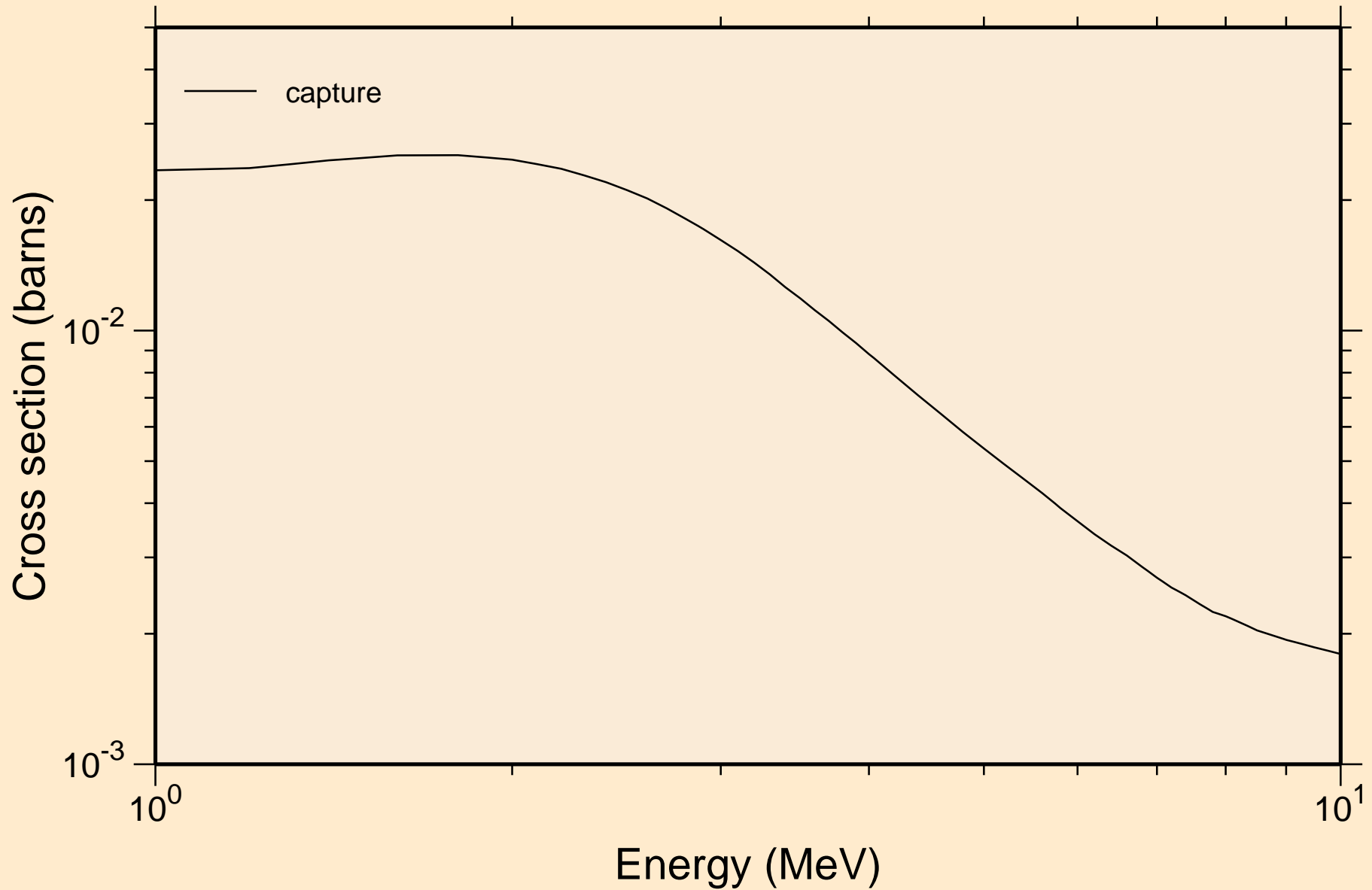

RU101 NEUTRON ACER TENDL-2023 LIBRARY; T=0.K  
Heating

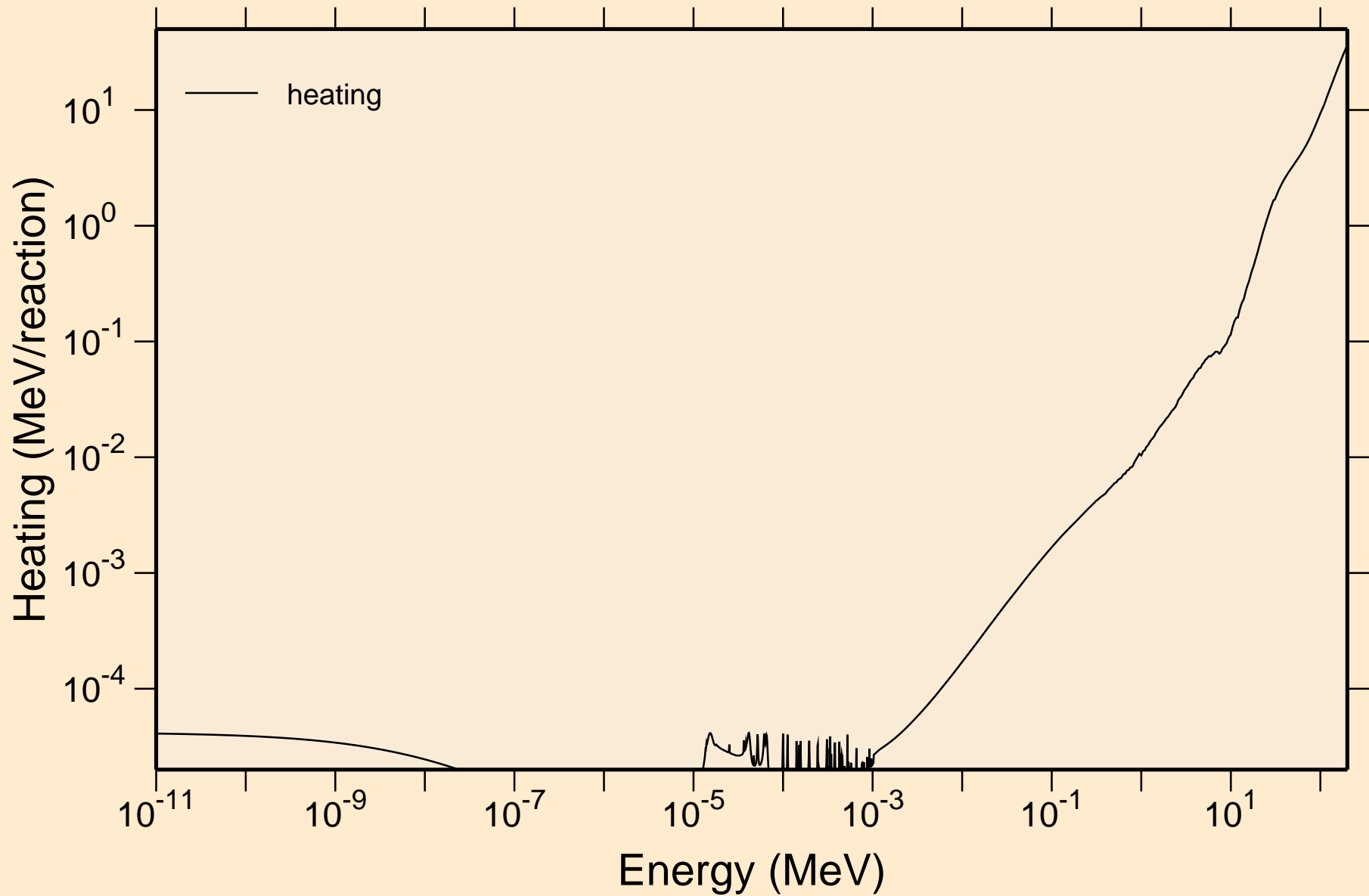

# RU101 NEUTRON ACER TENDL-2023 LIBRARY; T=0.K

## Damage

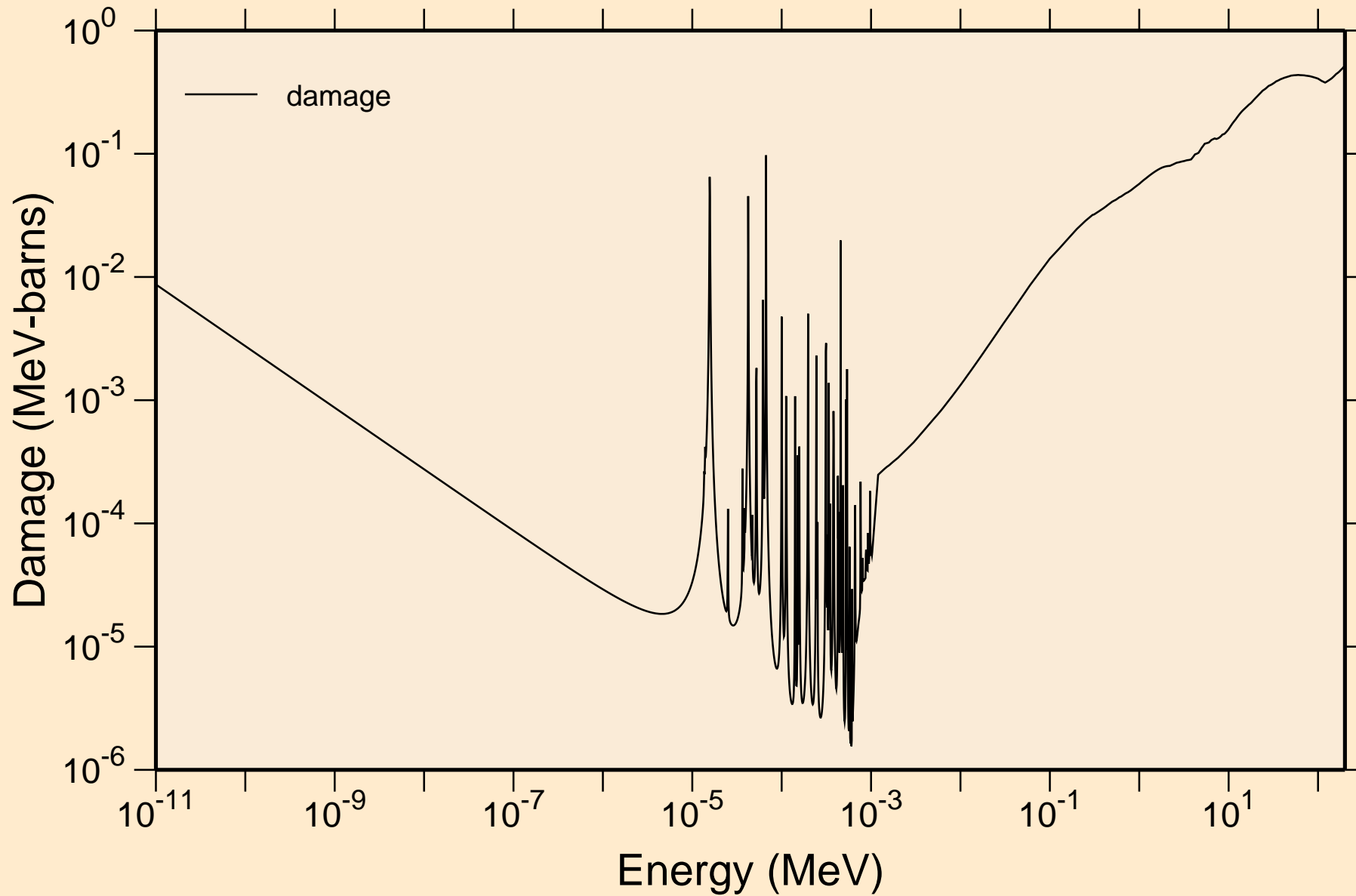

RU101 NEUTRON ACER TENDL-2023 LIBRARY; T=0.K  
Non-threshold reactions

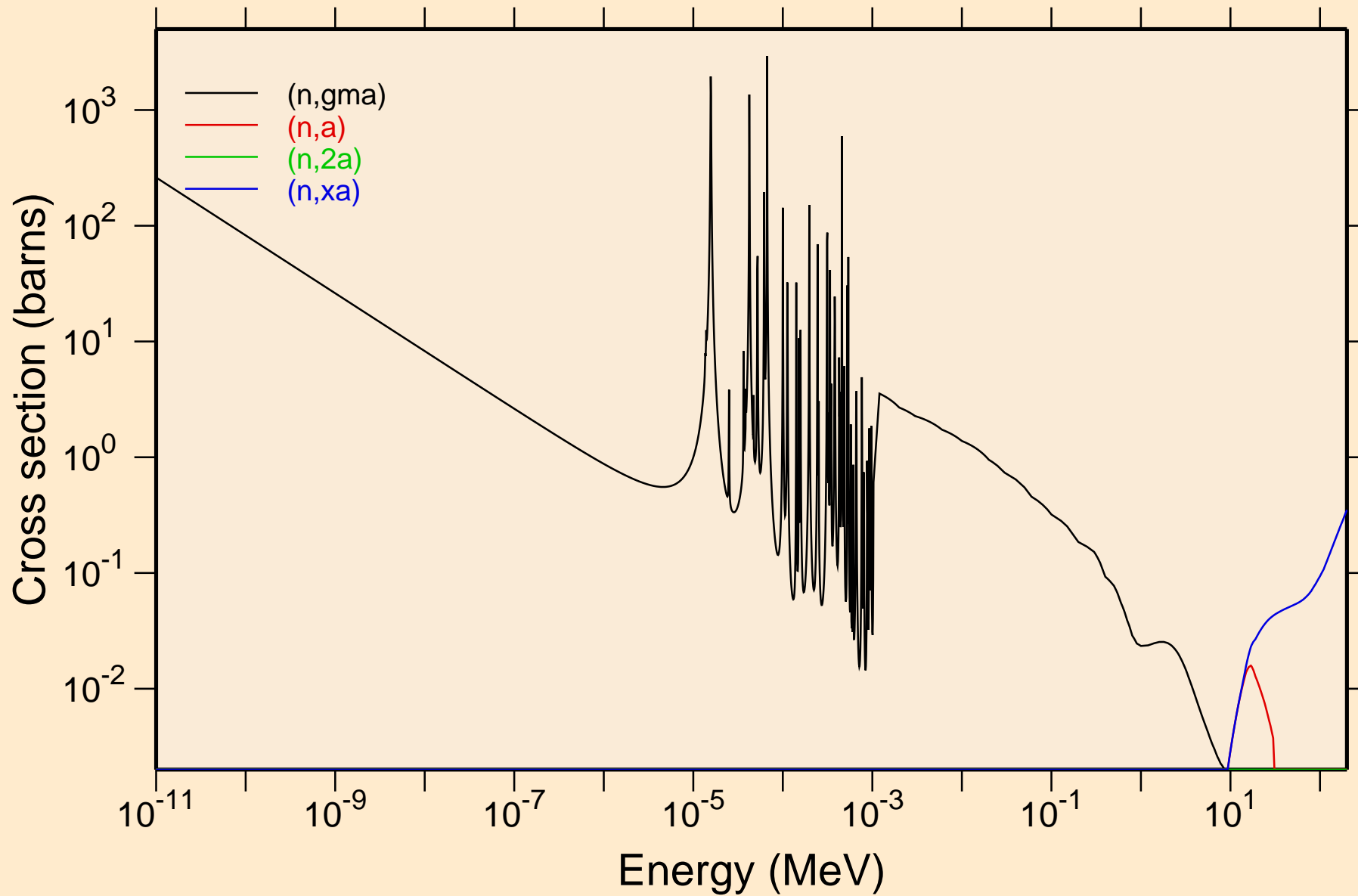

RU101 NEUTRON ACER TENDL-2023 LIBRARY; T=0.K  
Principal cross sections

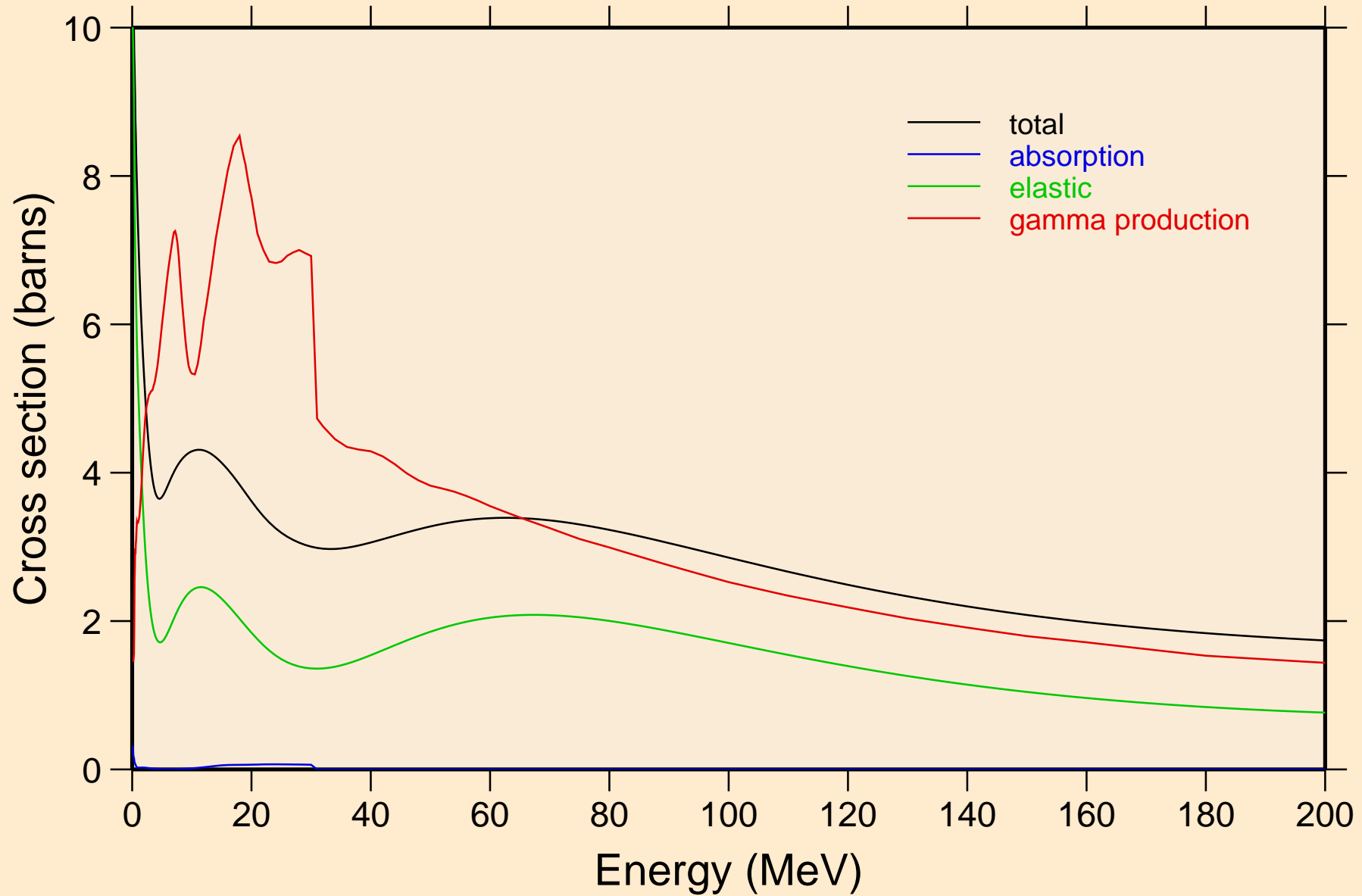

# RU101 NEUTRON ACER TENDL-2023 LIBRARY; T=0.K

## Heating

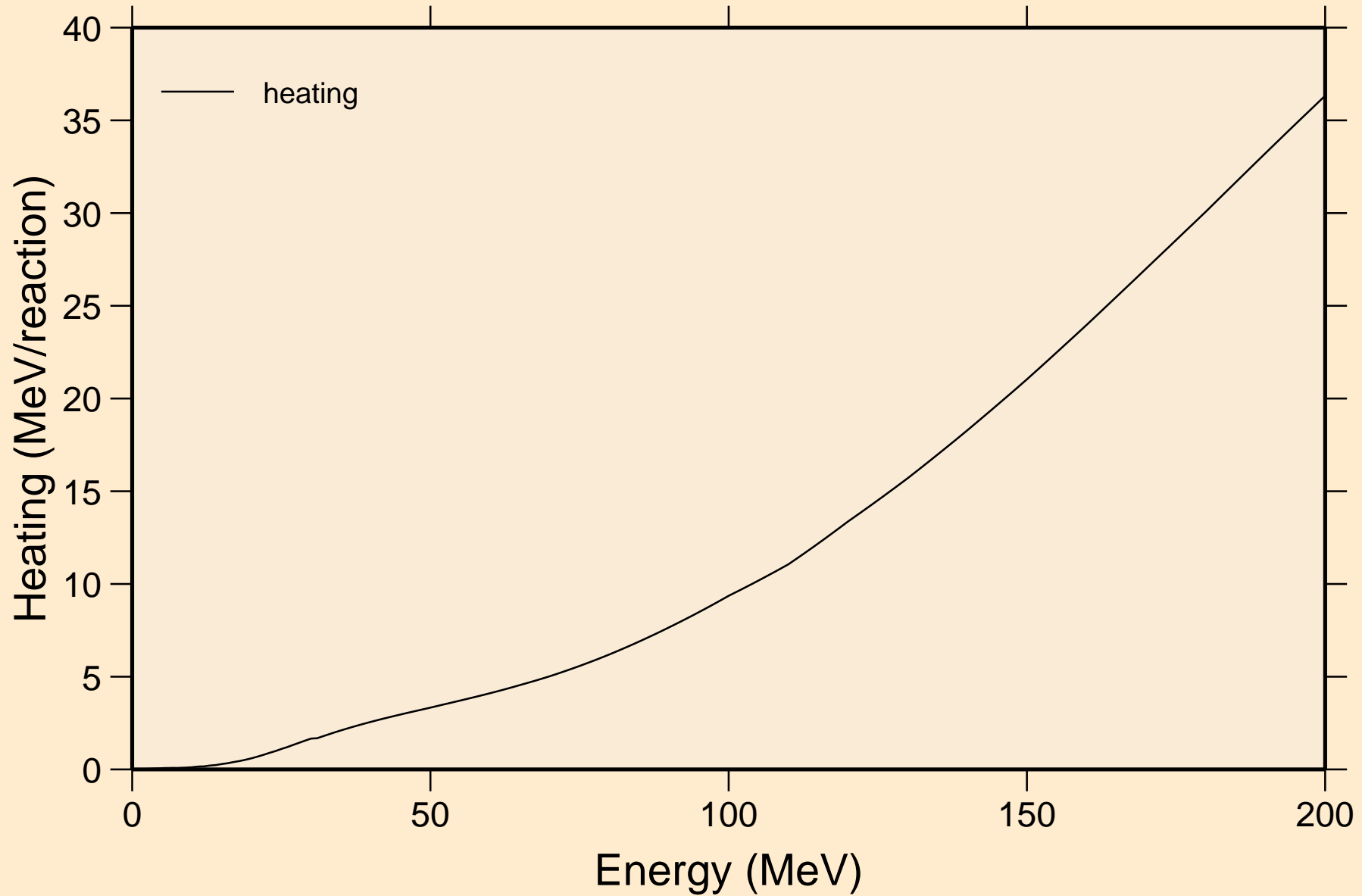

RU101 NEUTRON ACER TENDL-2023 LIBRARY; T=0.K  
Damage

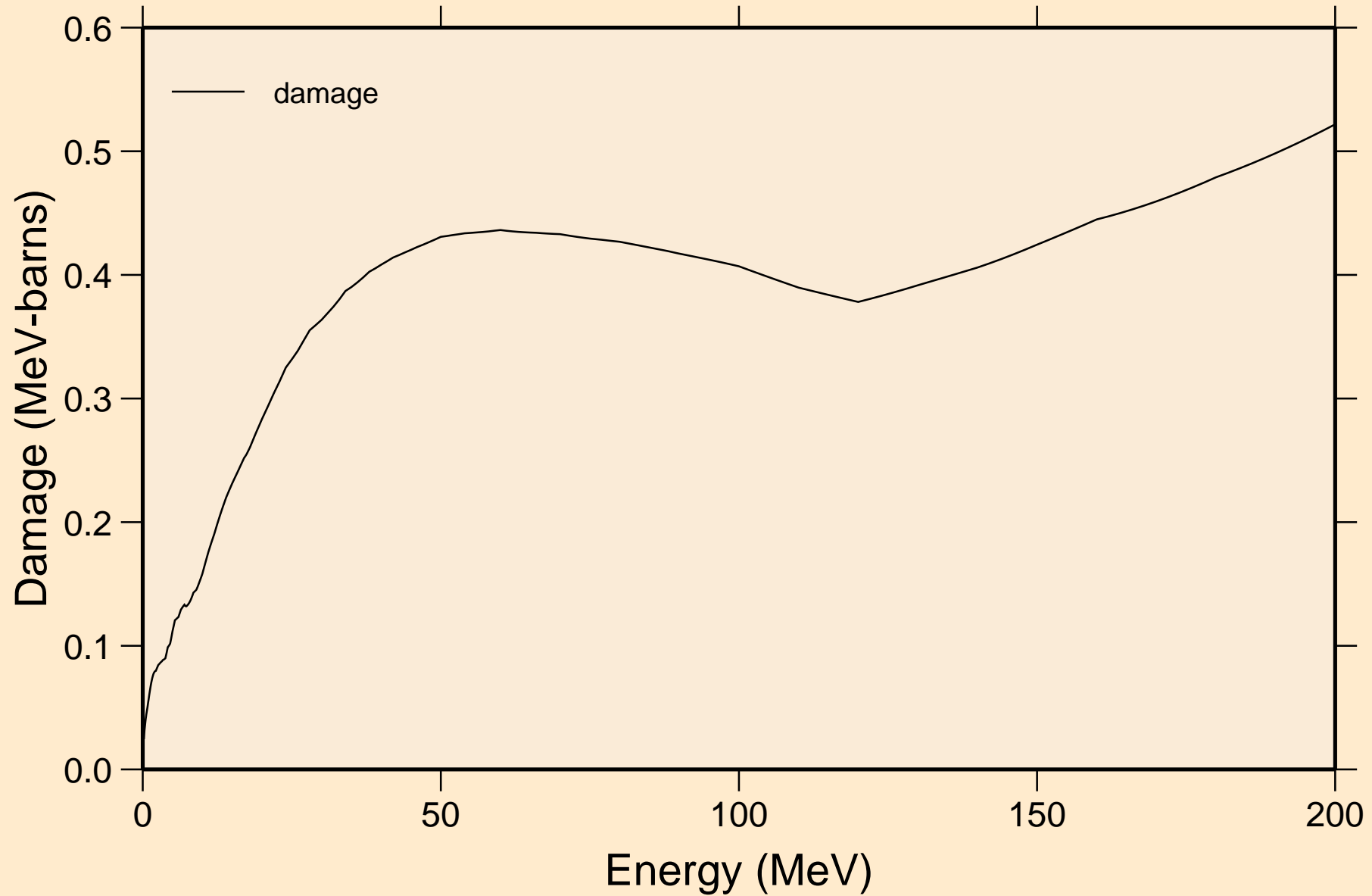

RU101 NEUTRON ACER TENDL-2023 LIBRARY; T=0.K  
Non-threshold reactions

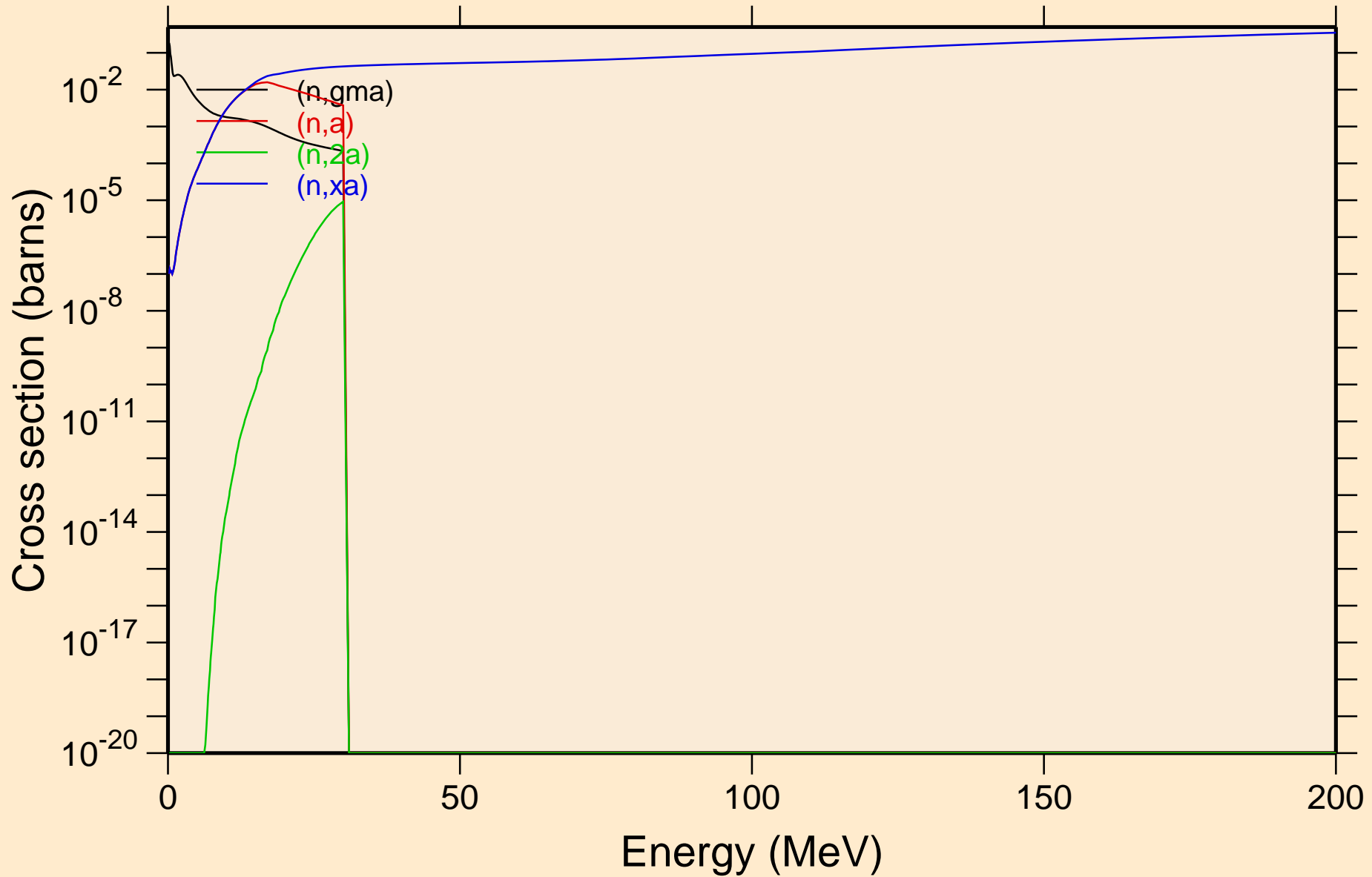

RU101 NEUTRON ACER TENDL-2023 LIBRARY; T=0.K  
Inelastic levels

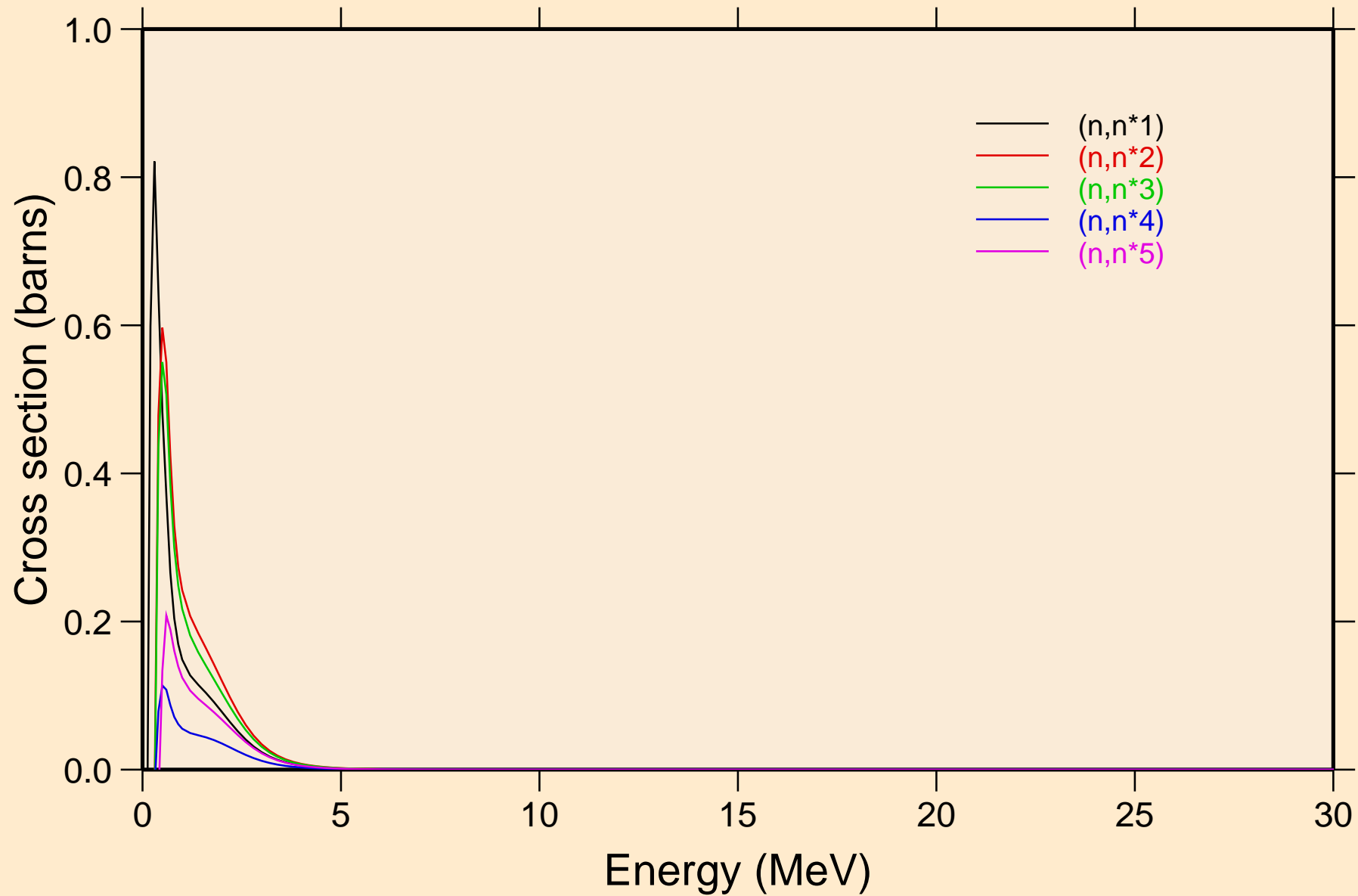

RU101 NEUTRON ACER TENDL-2023 LIBRARY; T=0.K  
Inelastic levels

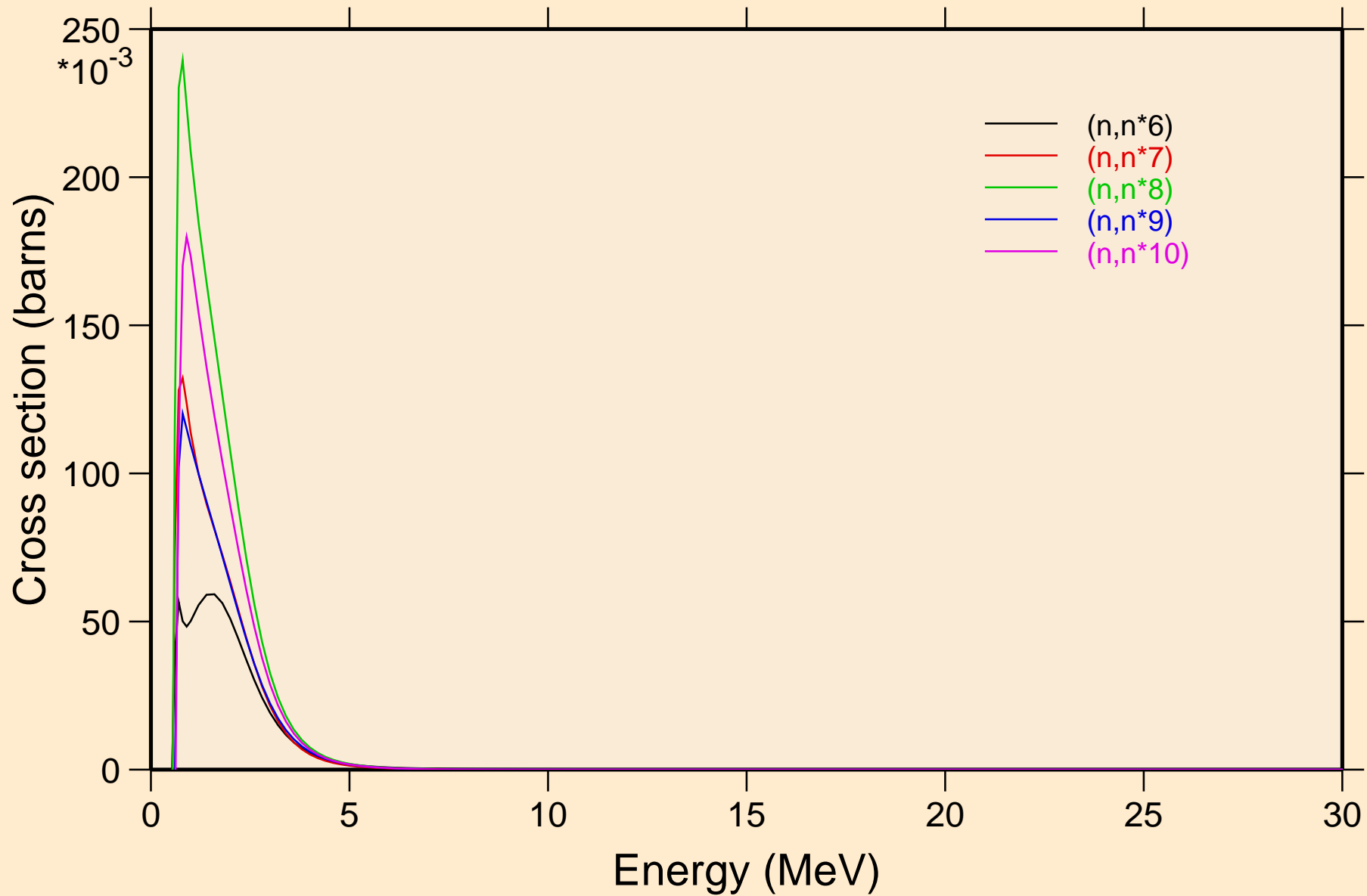

RU101 NEUTRON ACER TENDL-2023 LIBRARY; T=0.K  
Inelastic levels

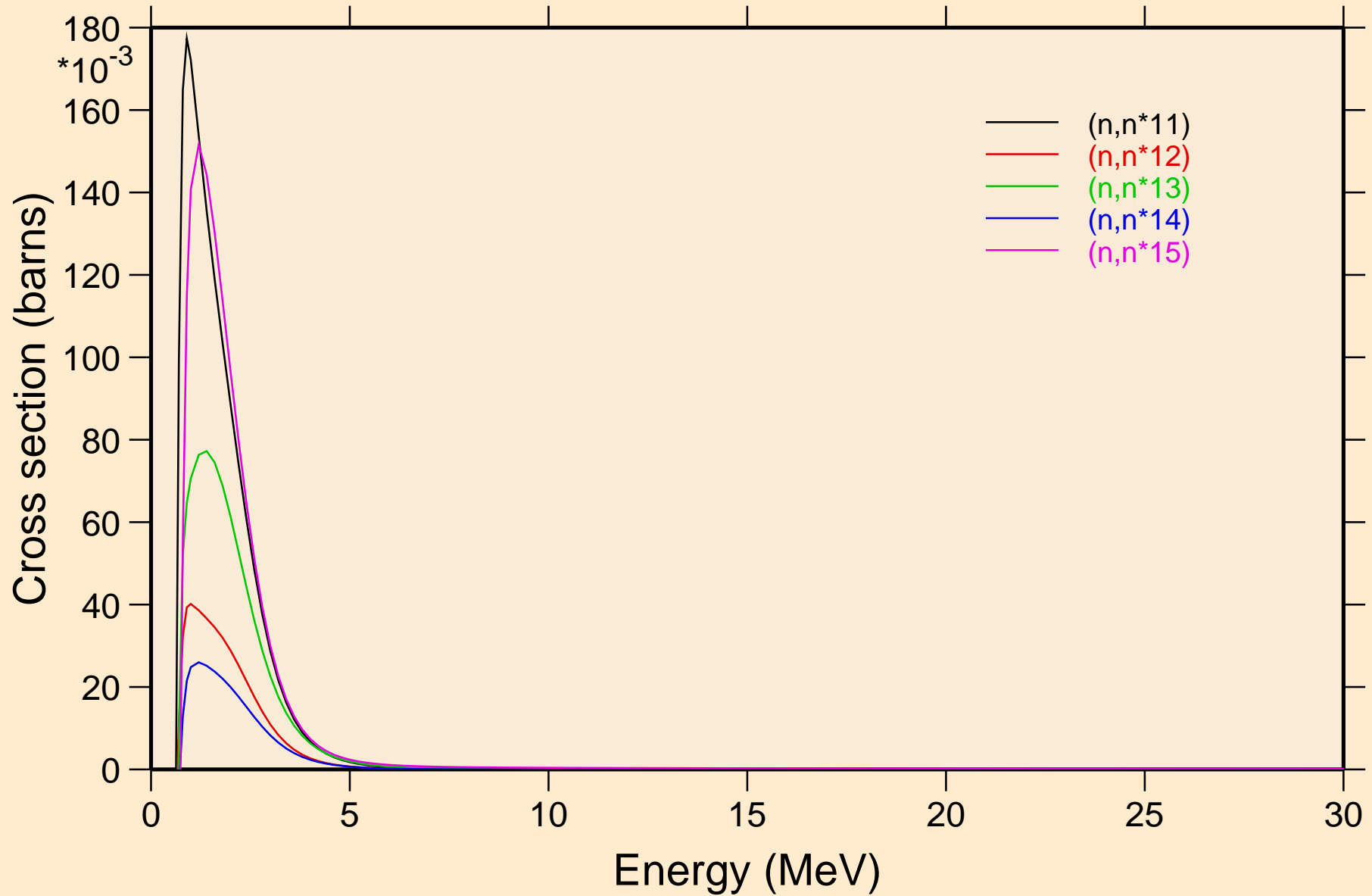

RU101 NEUTRON ACER TENDL-2023 LIBRARY; T=0.K  
Inelastic levels

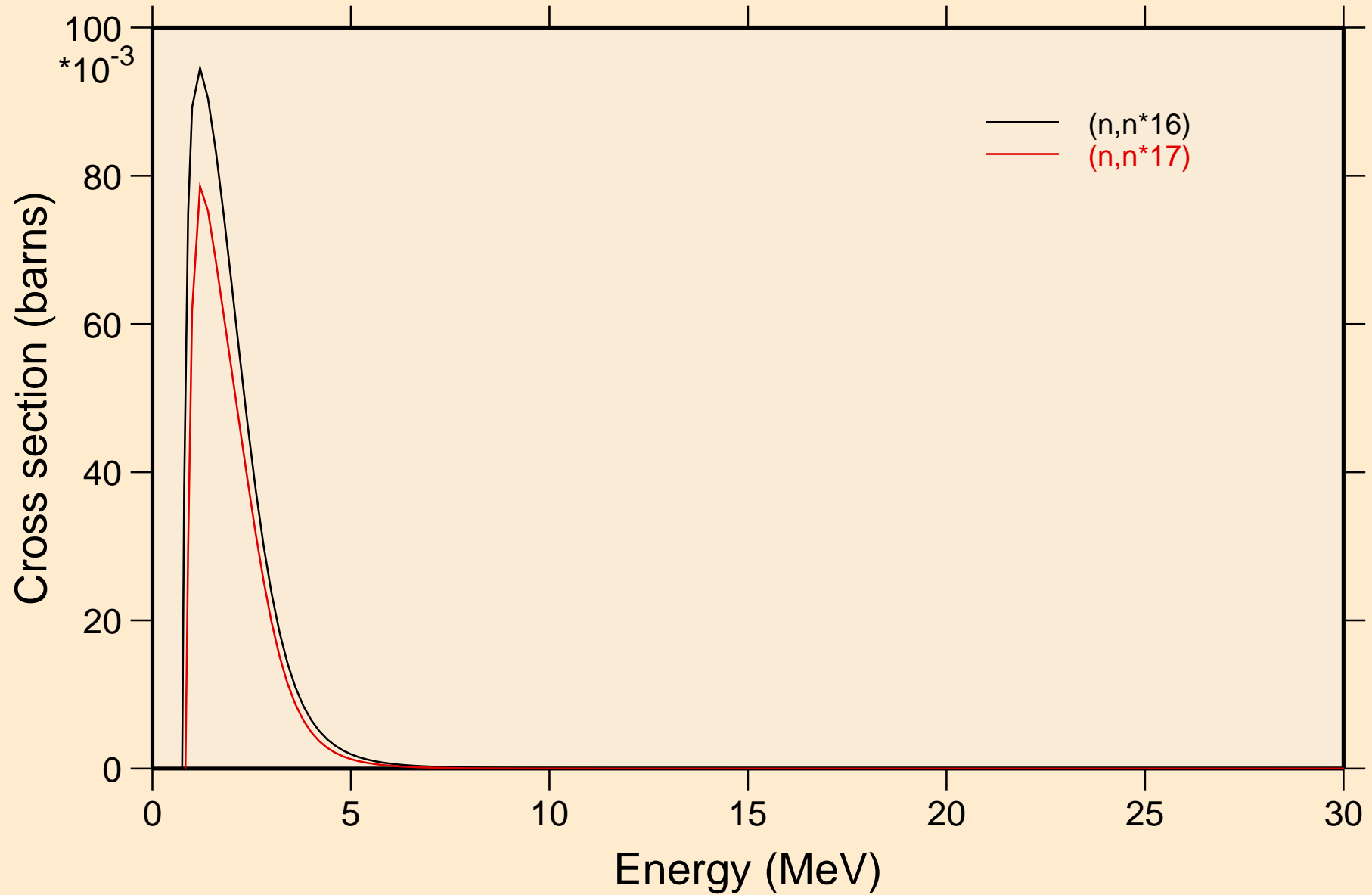

RU101 NEUTRON ACER TENDL-2023 LIBRARY; T=0.K  
Threshold reactions

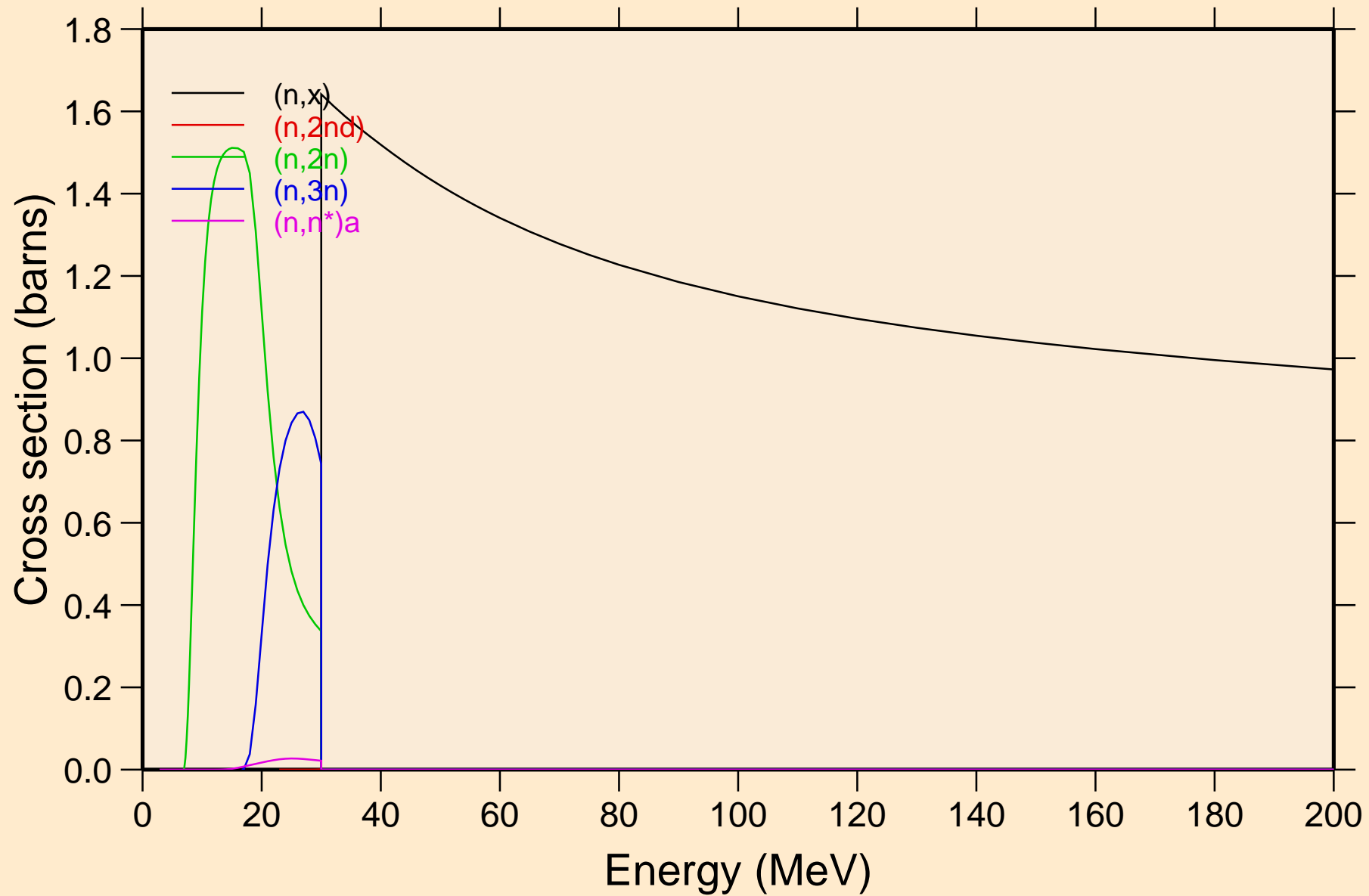

RU101 NEUTRON ACER TENDL-2023 LIBRARY; T=0.K  
Threshold reactions

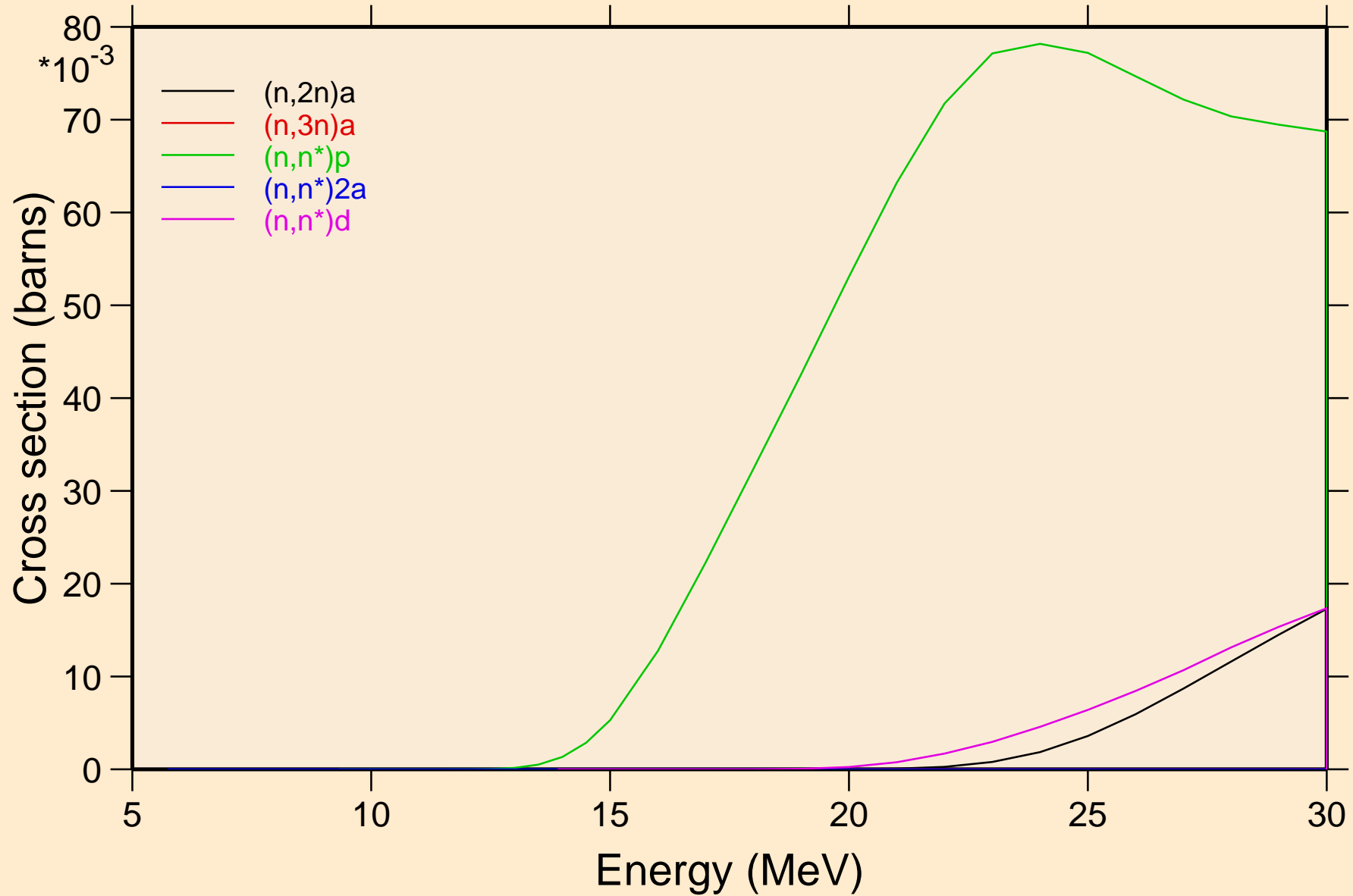

# RU101 NEUTRON ACER TENDL-2023 LIBRARY; T=0.K

## Threshold reactions

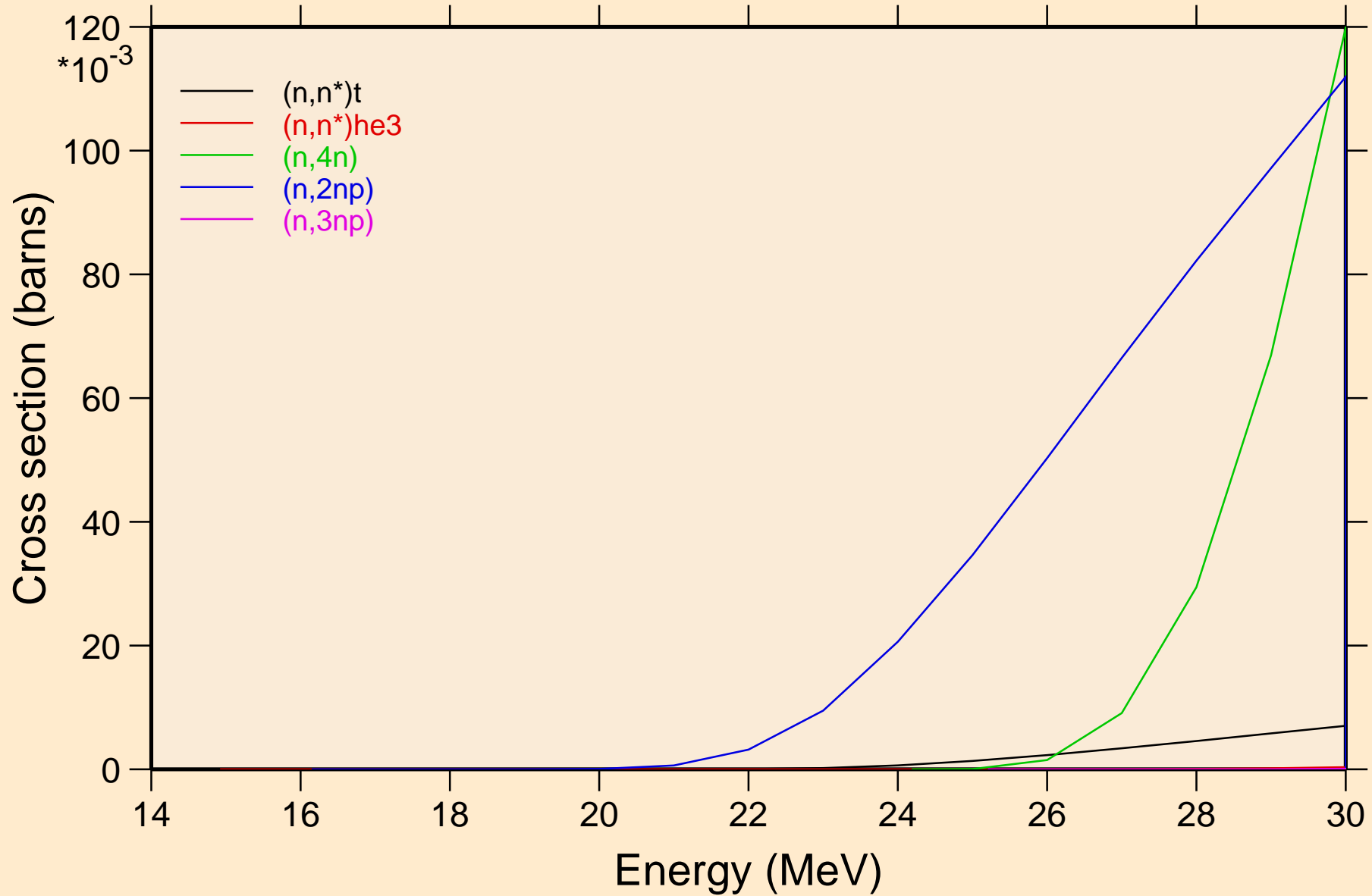

RU101 NEUTRON ACER TENDL-2023 LIBRARY; T=0.K  
Threshold reactions

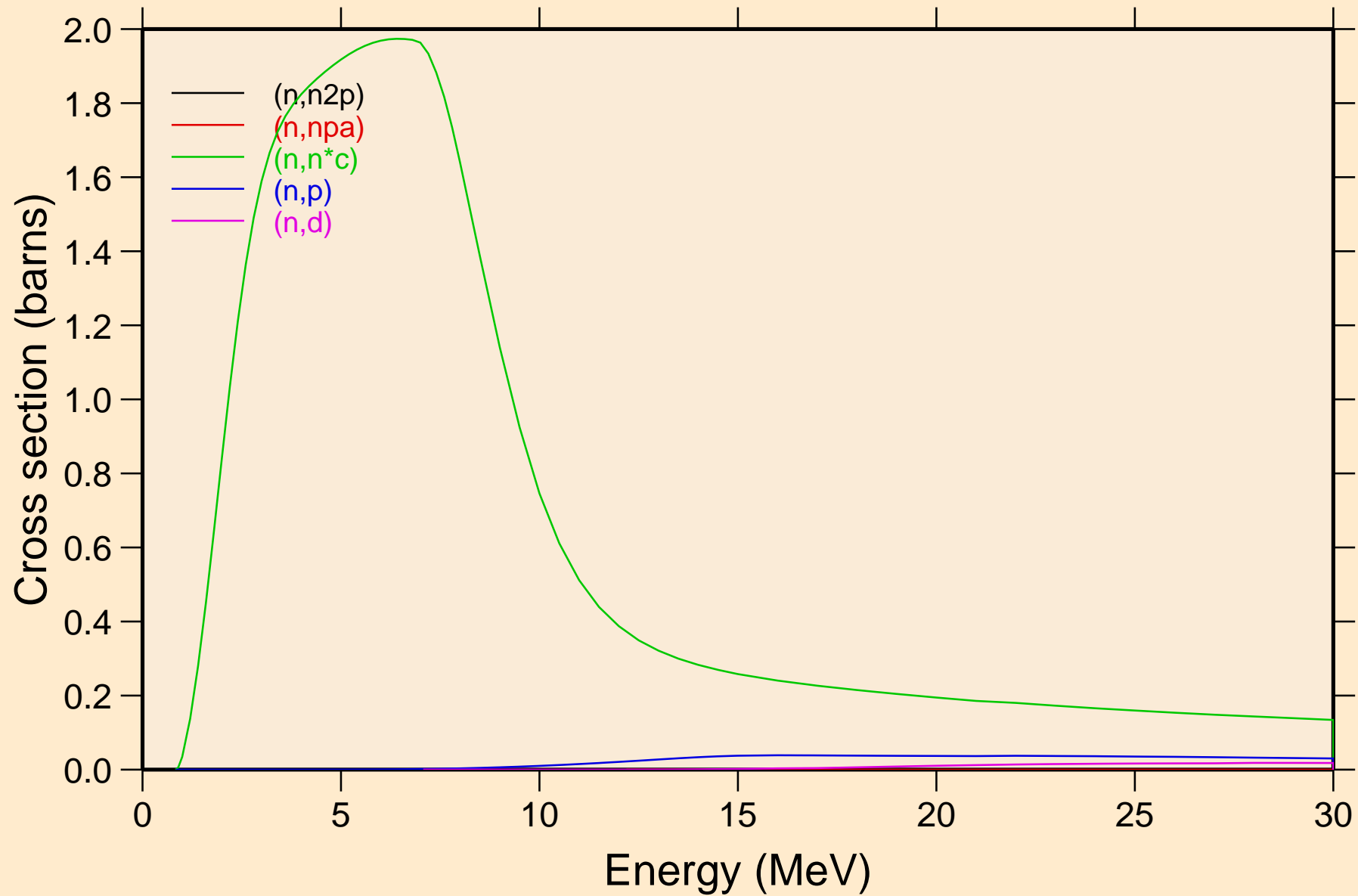

RU101 NEUTRON ACER TENDL-2023 LIBRARY; T=0.K  
Threshold reactions

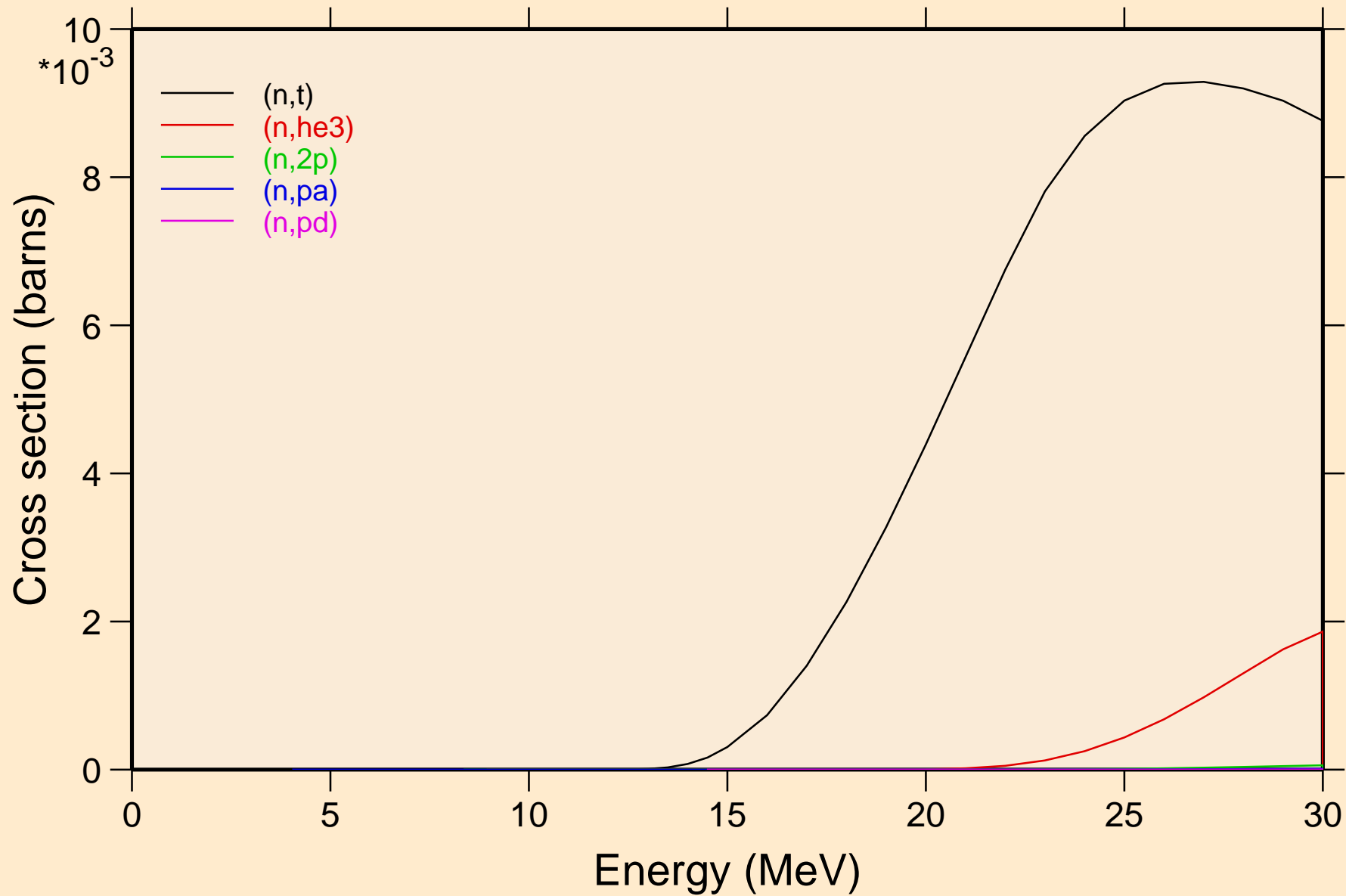

# RU101 NEUTRON ACER TENDL-2023 LIBRARY; T=0.K

## Threshold reactions

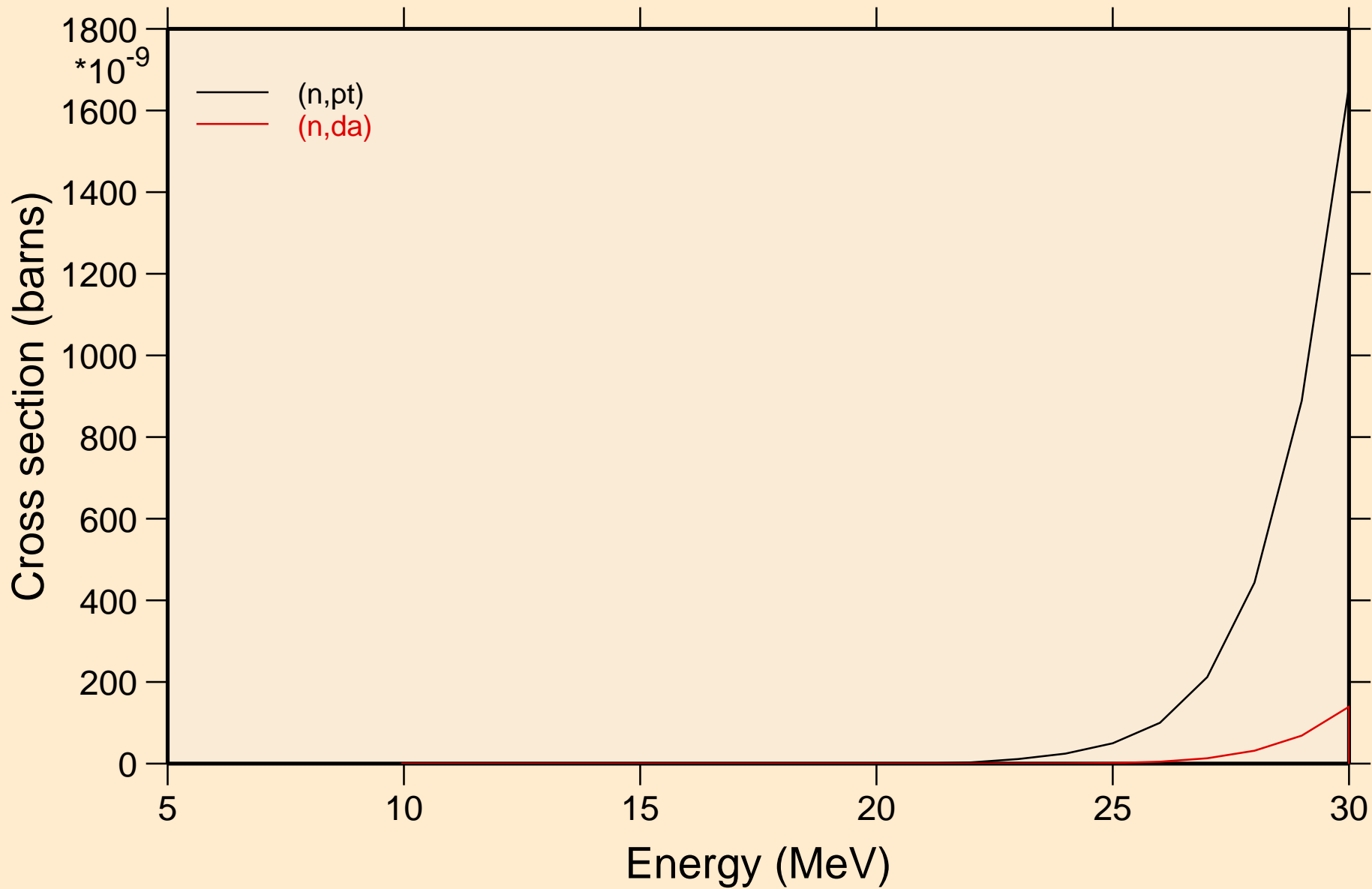

RU101 NEUTRON ACER TENDL-2023 LIBRARY; T=0.K  
Threshold reactions

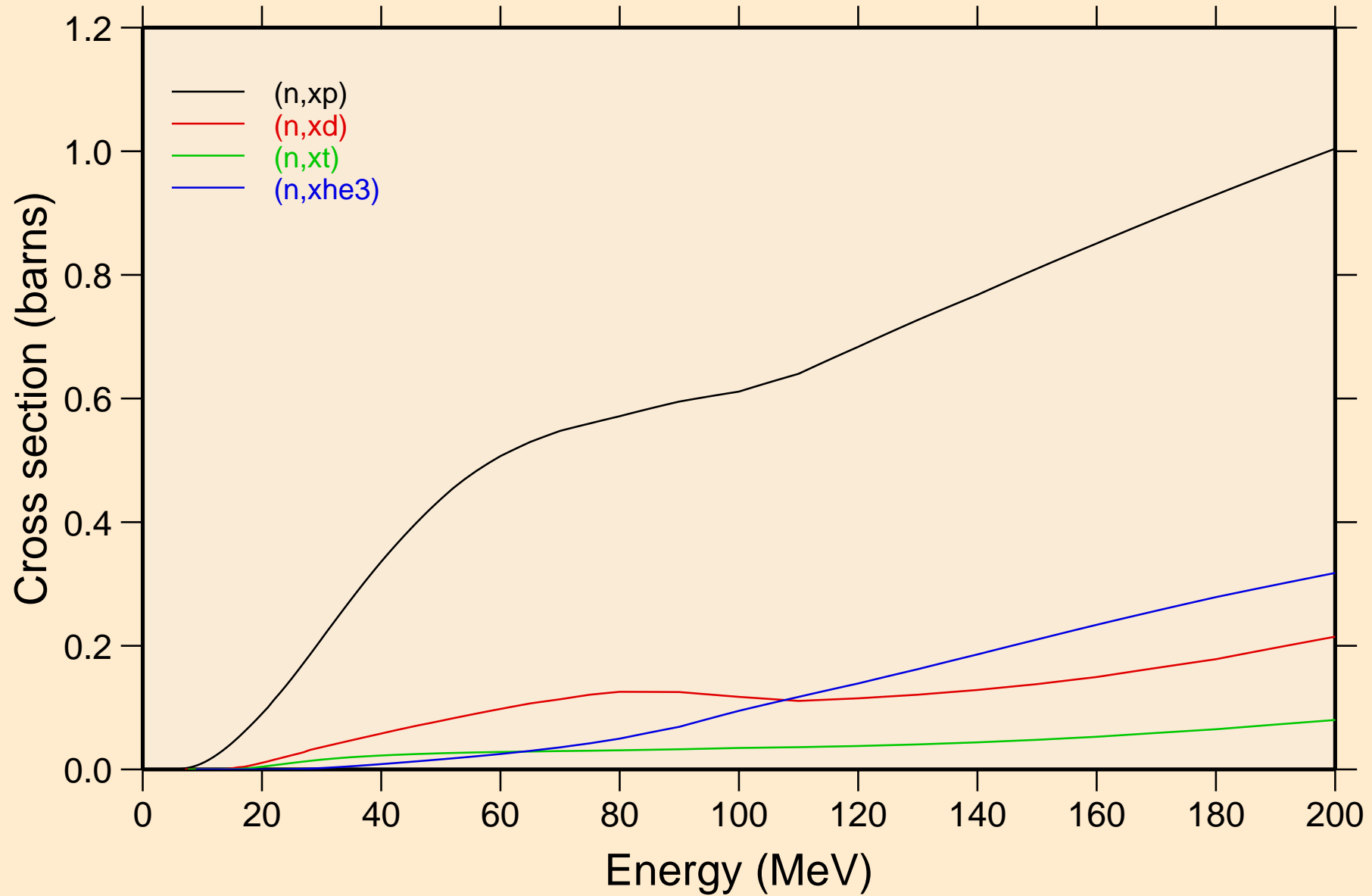

RU101 NEUTRON ACER TENDL-2023 LIBRARY; T=0.K  
angular distribution for elastic

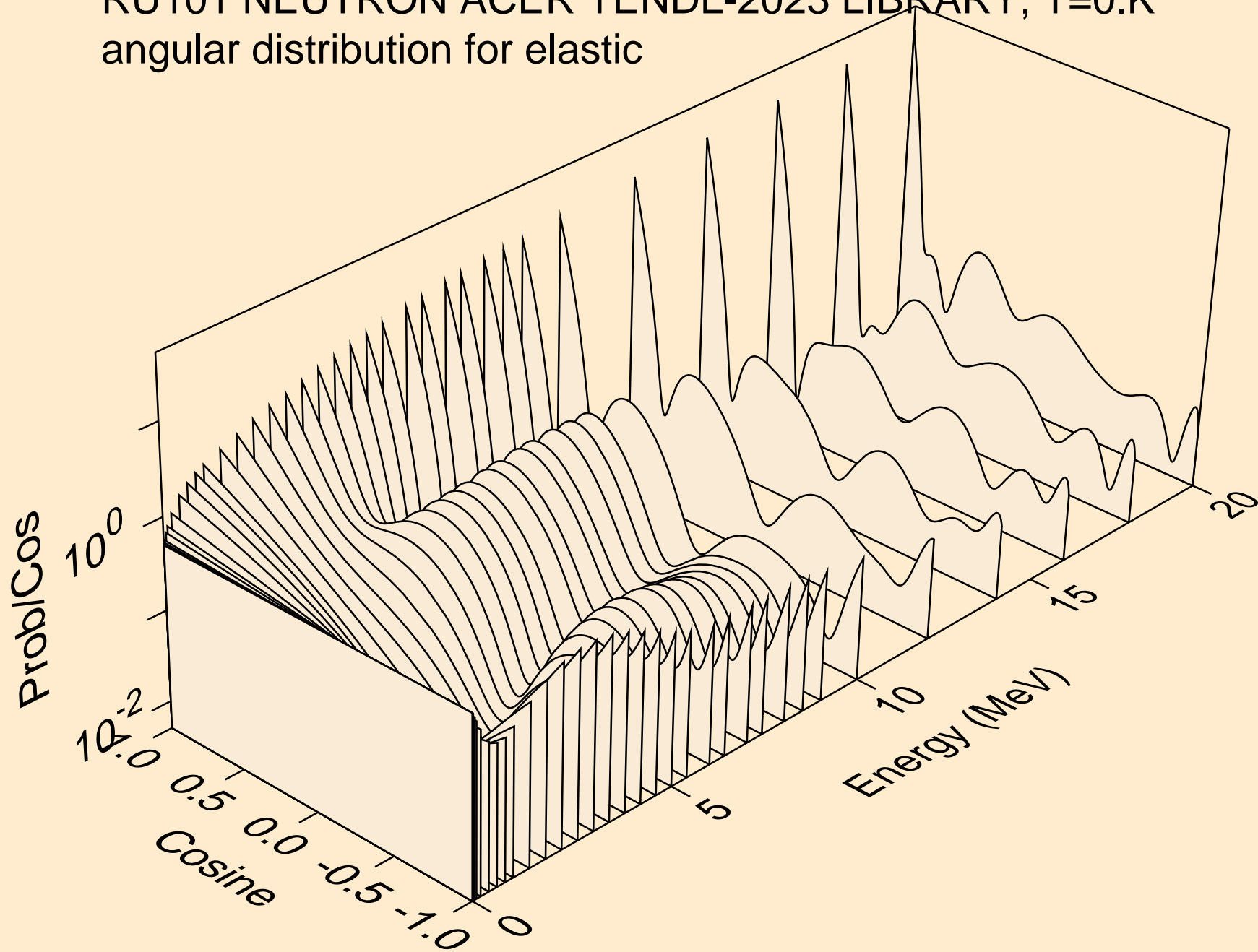

RU101 NEUTRON ACER TENDL-2023 LIBRARY; T=0.K  
angular distribution for elastic

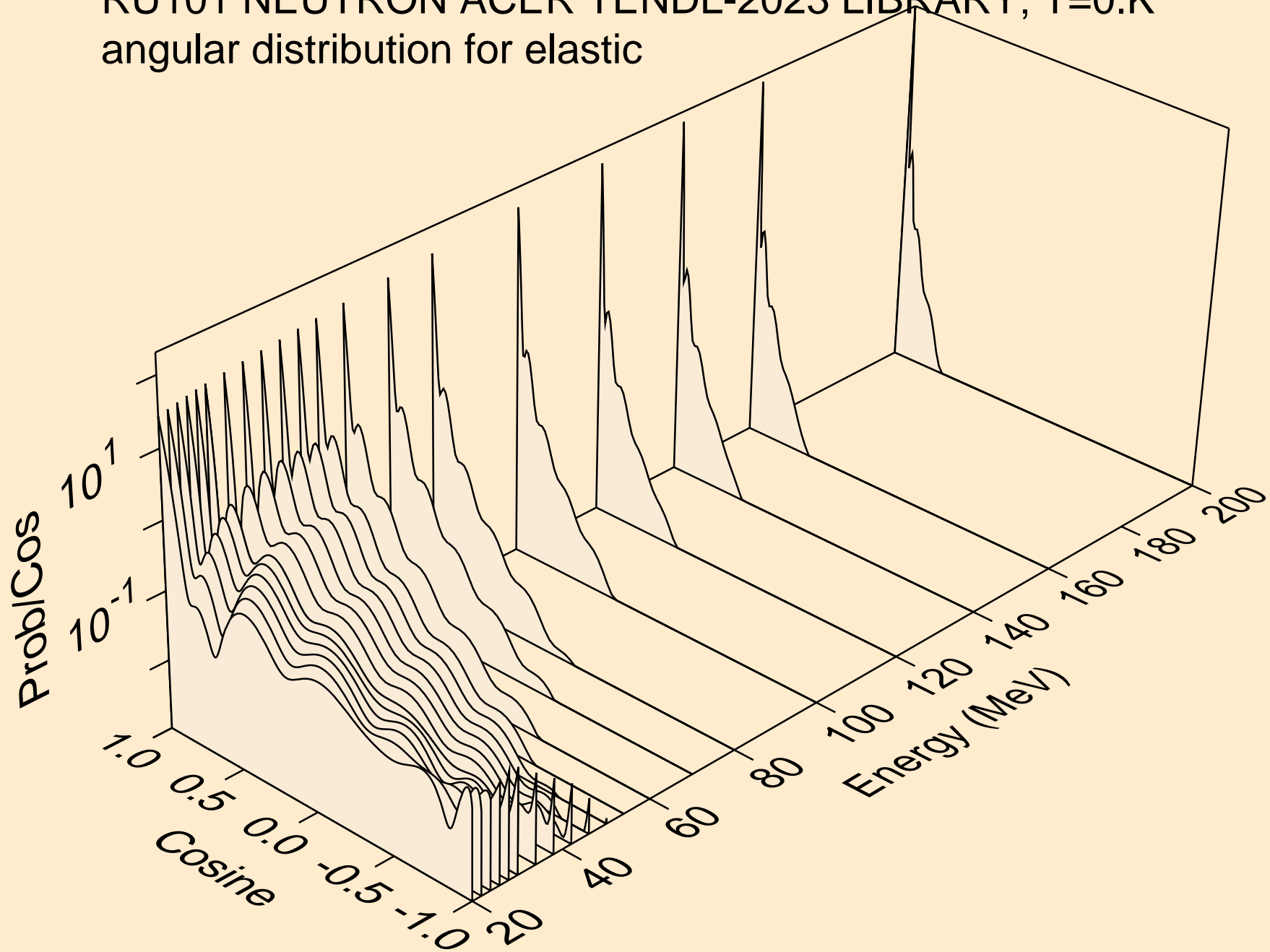

RU101 NEUTRON ACER TENDL-2023 LIBRARY; T=0.K  
angular distribution for (n,n\*1)

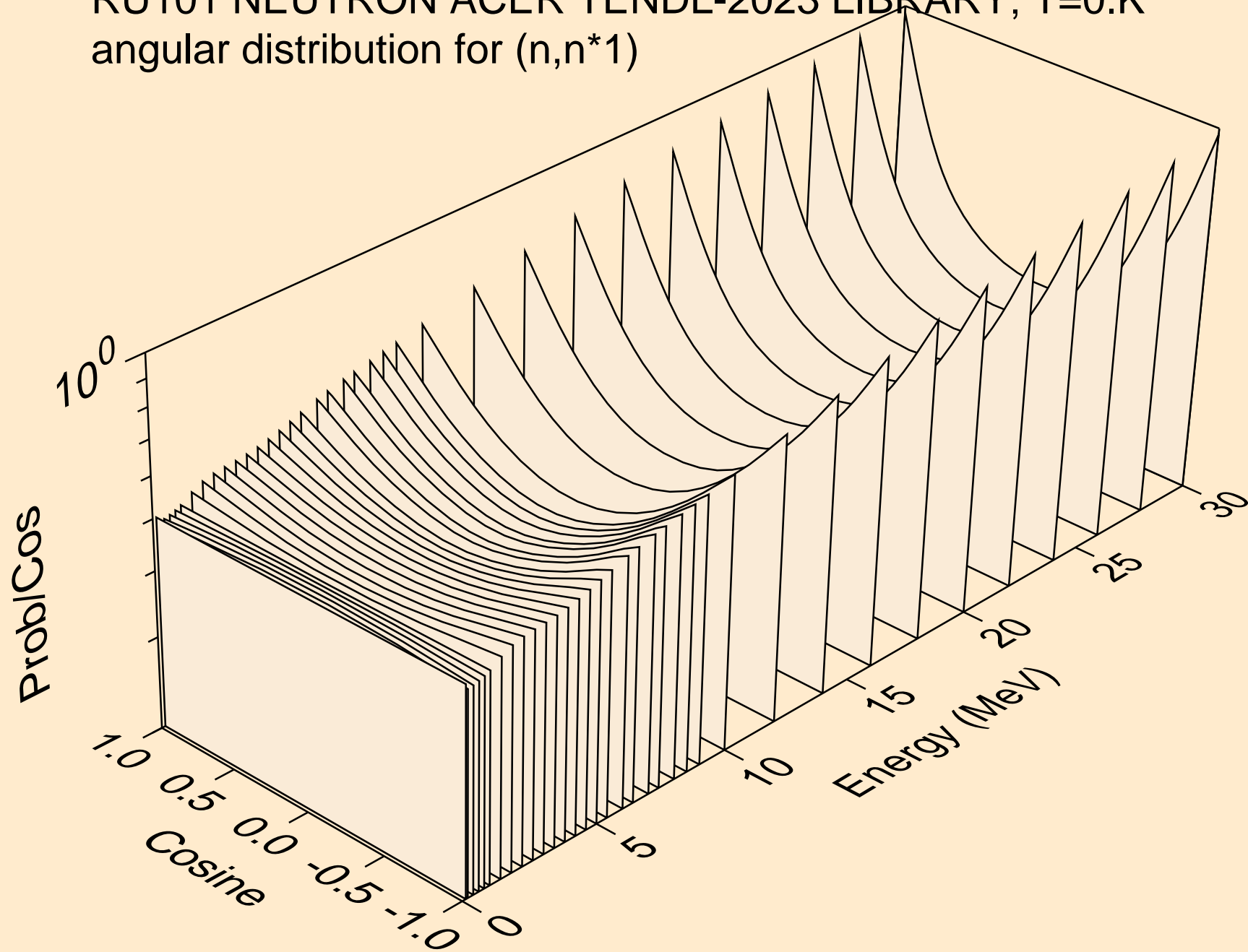

RU101 NEUTRON ACER TENDL-2023 LIBRARY; T=0.K  
angular distribution for (n,n\*2)

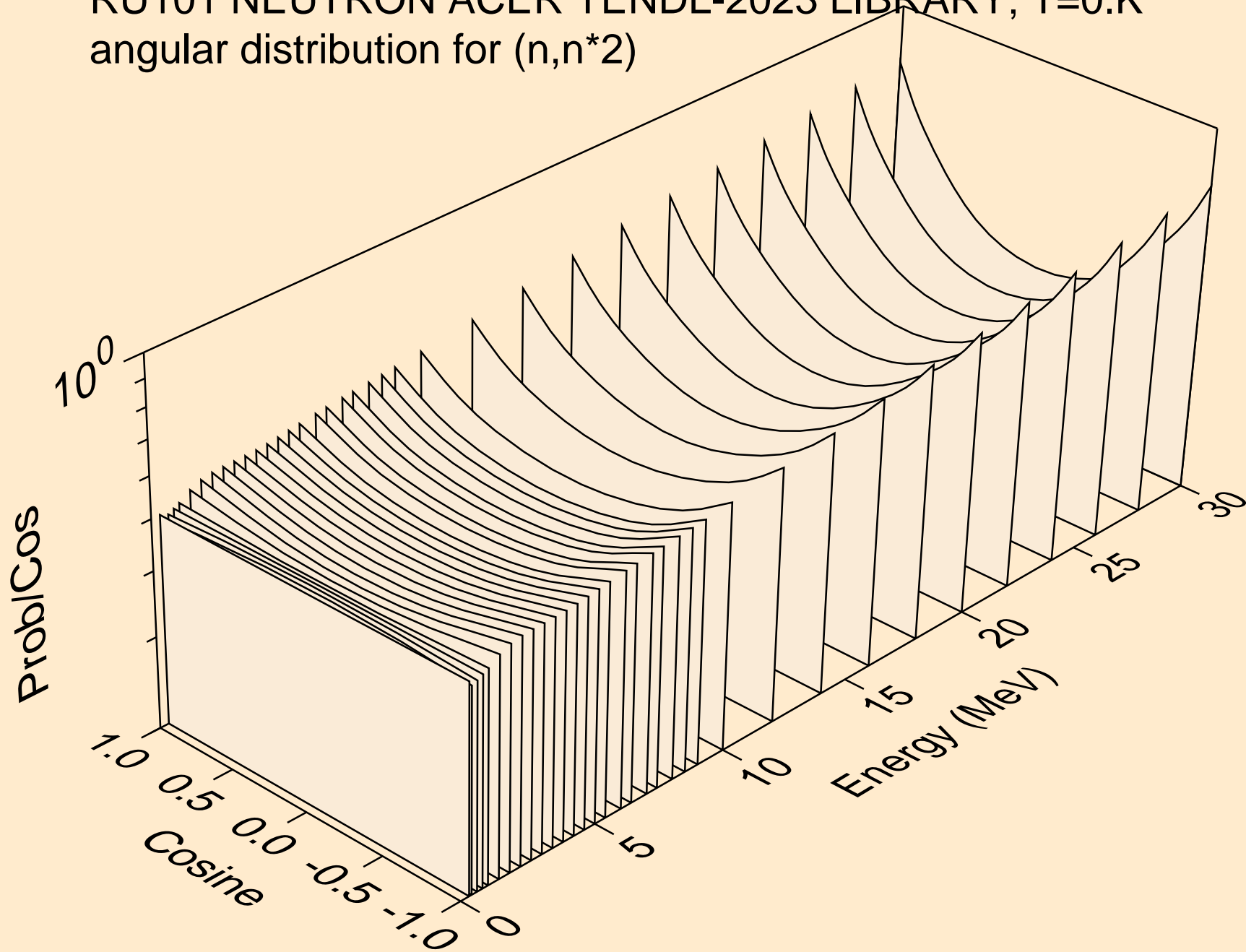

RU101 NEUTRON ACER TENDL-2023 LIBRARY; T=0.K  
angular distribution for (n,n\*3)

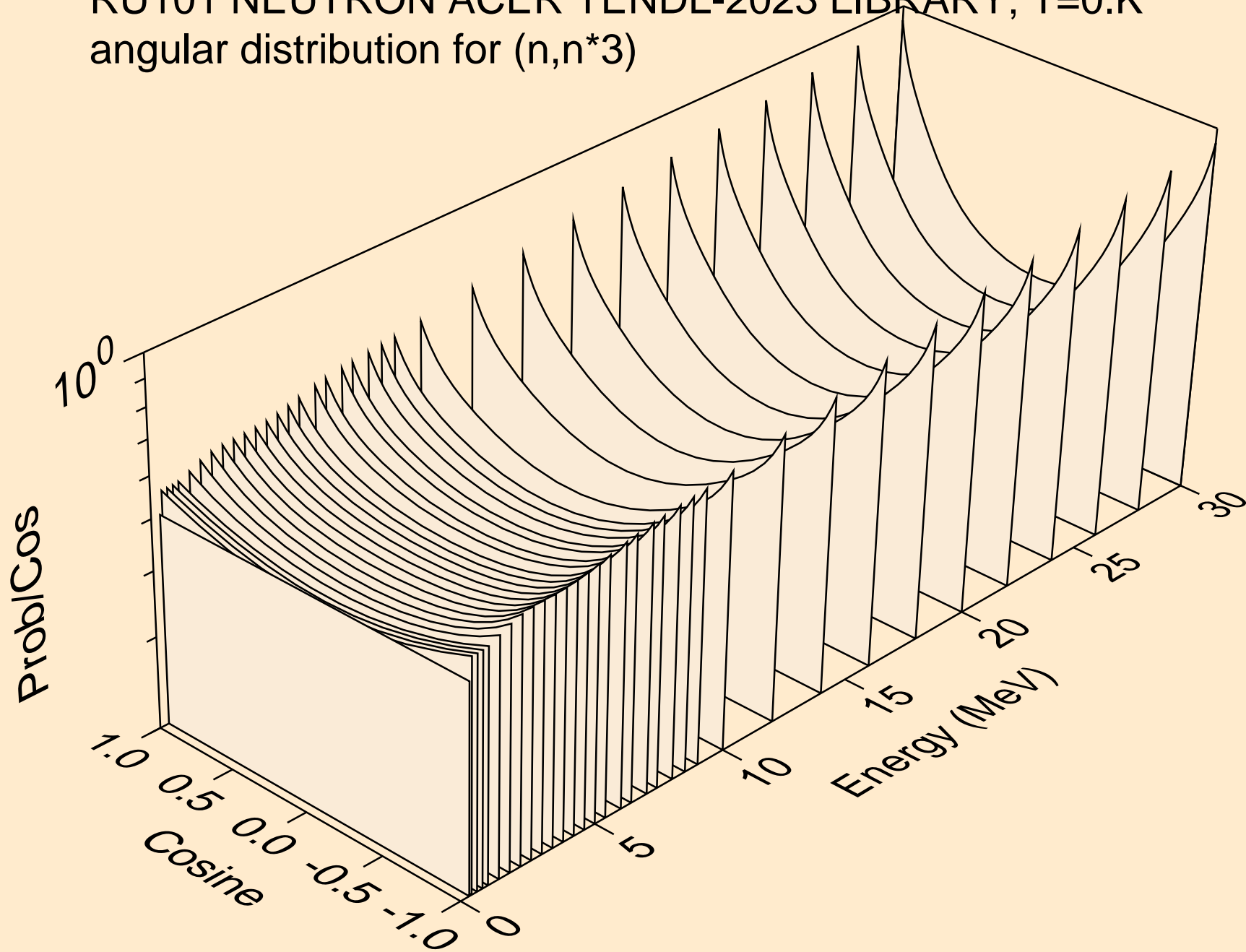

RU101 NEUTRON ACER TENDL-2023 LIBRARY; T=0.K  
angular distribution for (n,n\*4)

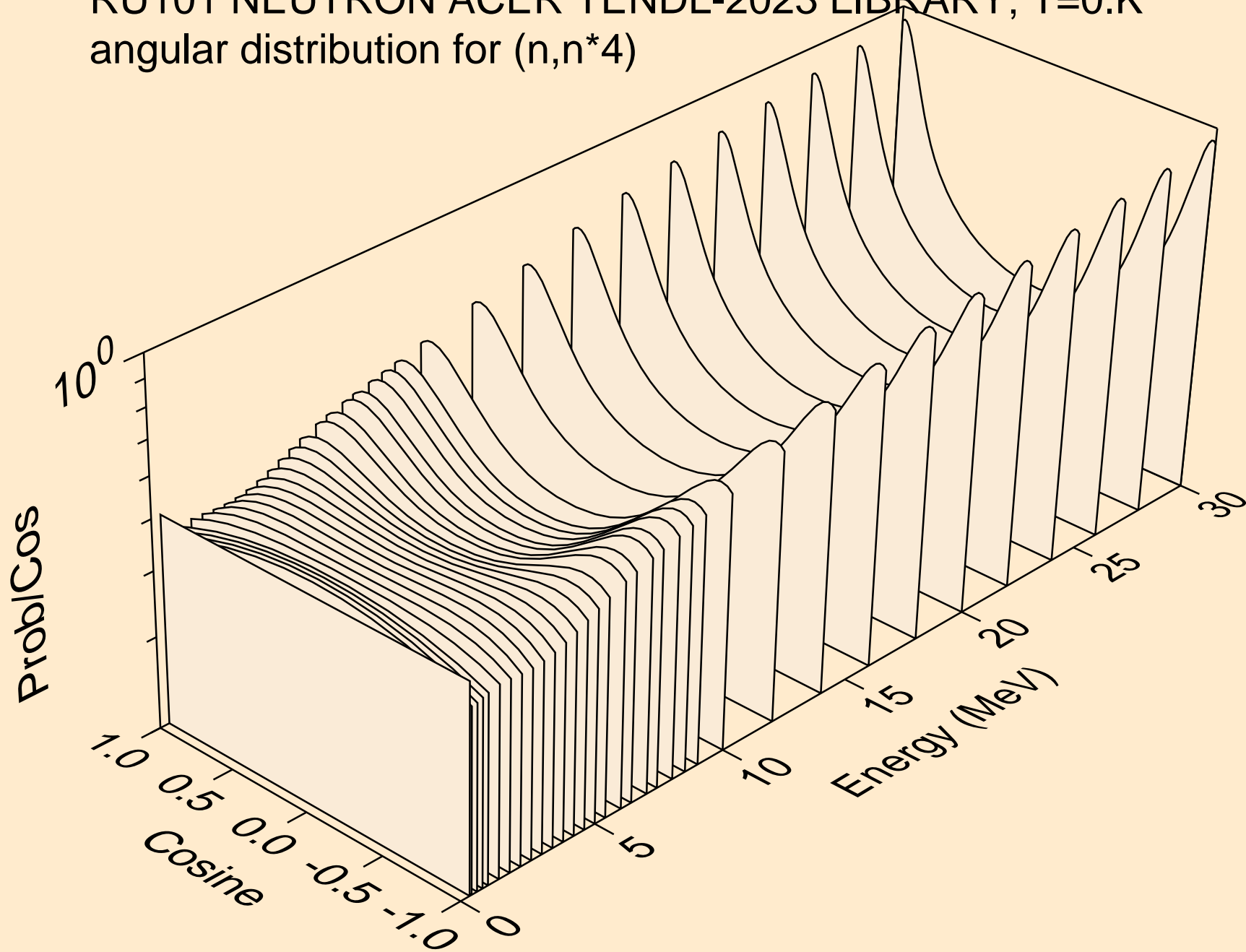

RU101 NEUTRON ACER TENDL-2023 LIBRARY; T=0.K  
angular distribution for (n,n\*5)

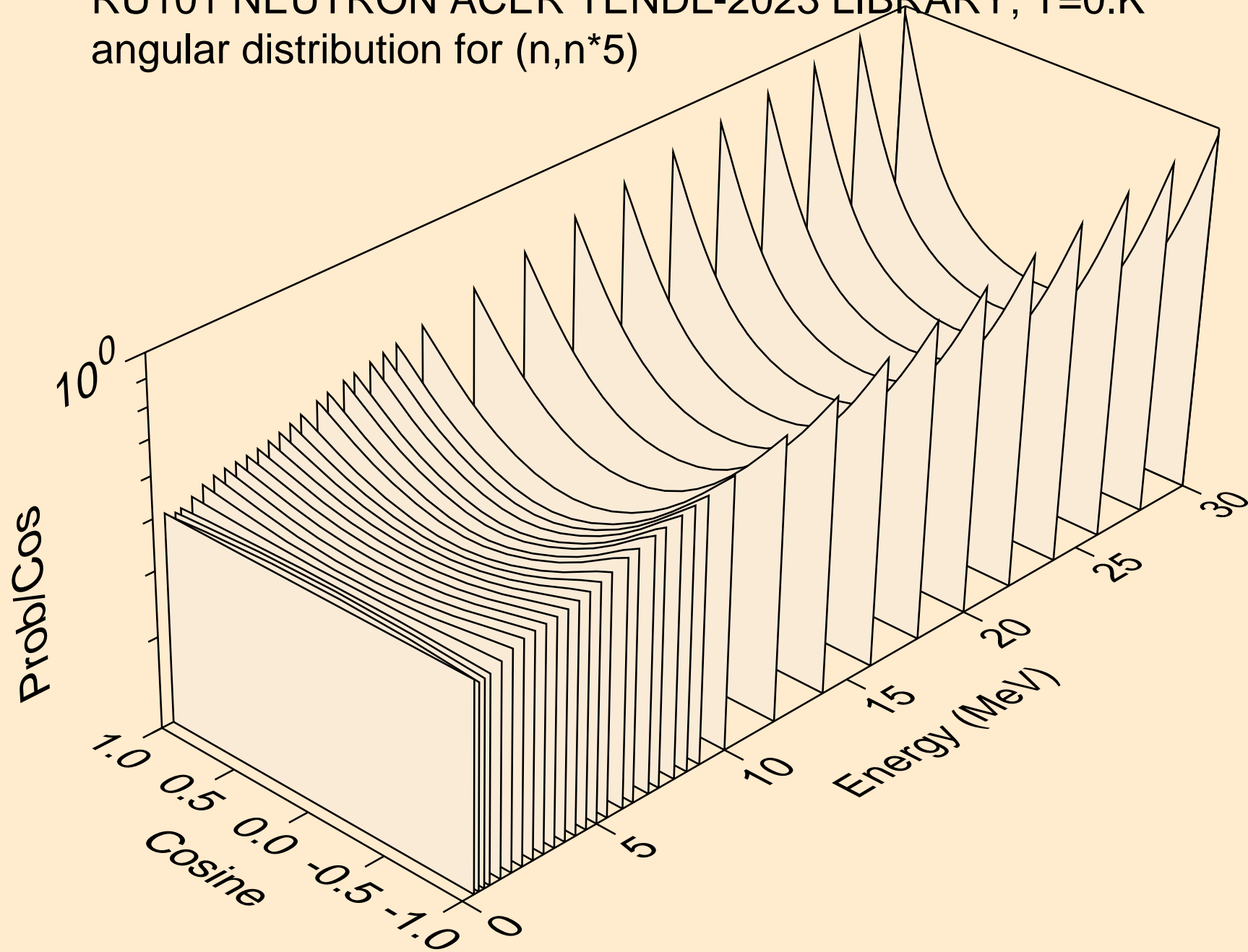

RU101 NEUTRON ACER TENDL-2023 LIBRARY; T=0.K  
angular distribution for (n,n\*6)

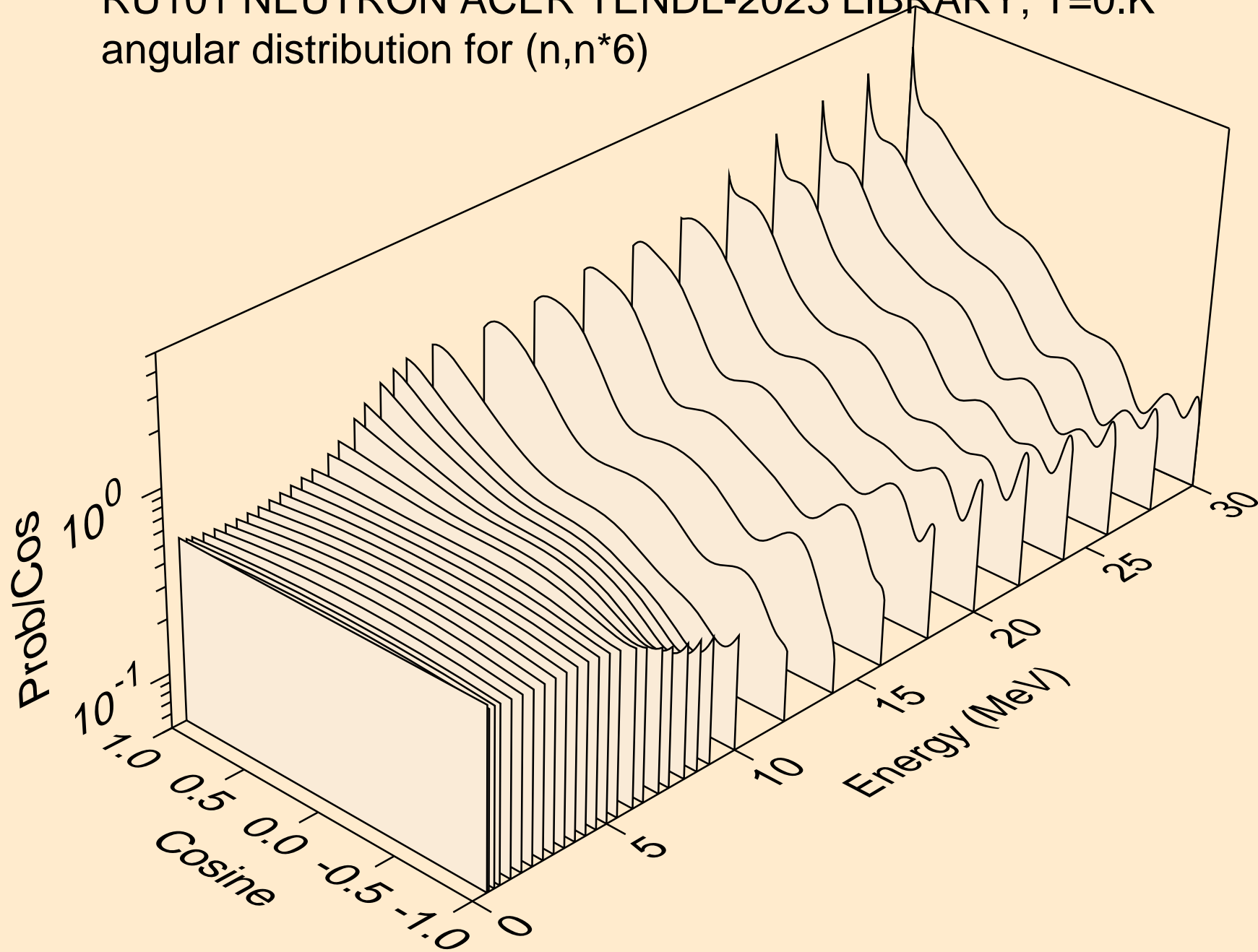

RU101 NEUTRON ACER TENDL-2023 LIBRARY; T=0.K  
angular distribution for (n,n\*7)

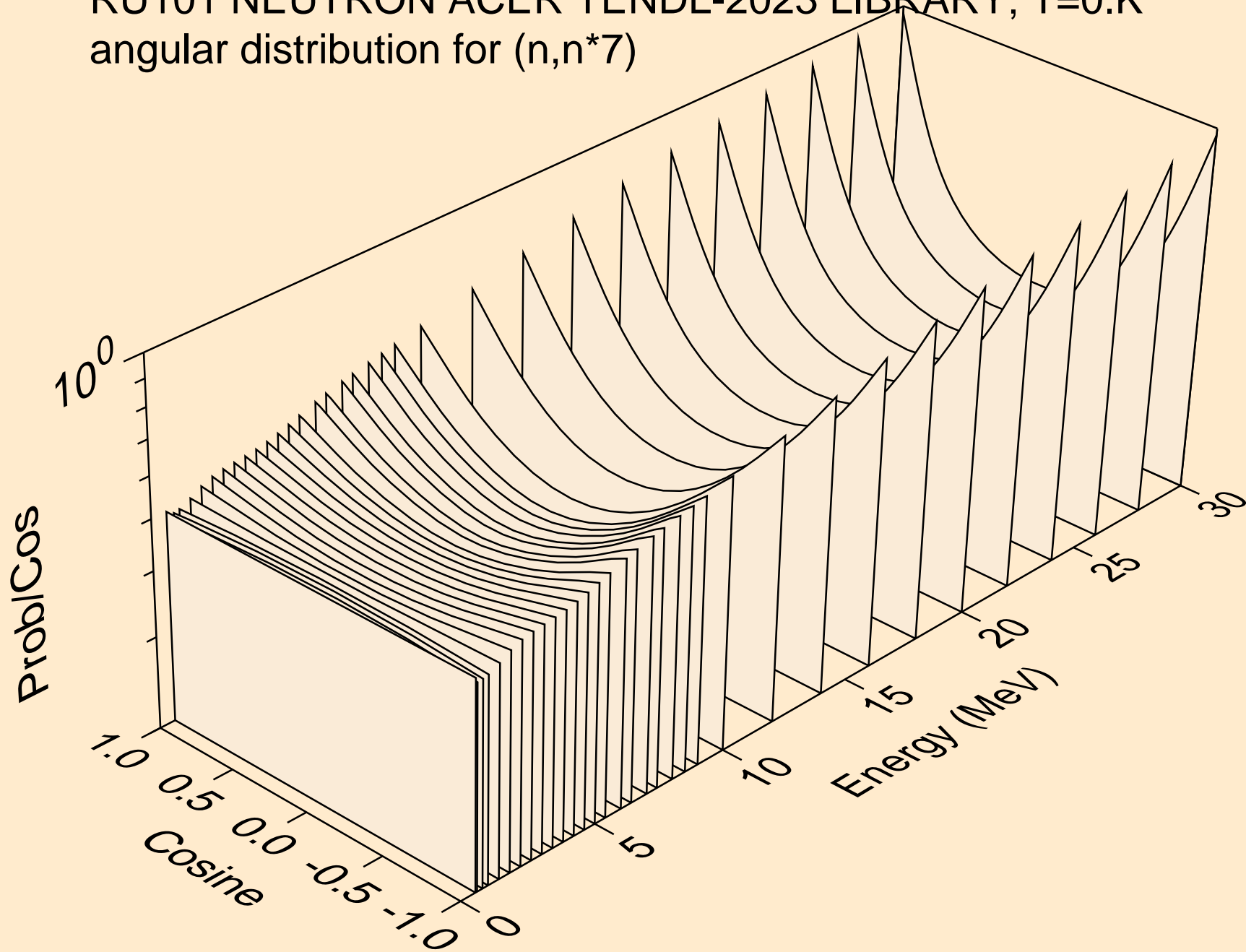

RU101 NEUTRON ACER TENDL-2023 LIBRARY; T=0.K  
angular distribution for (n,n\*8)

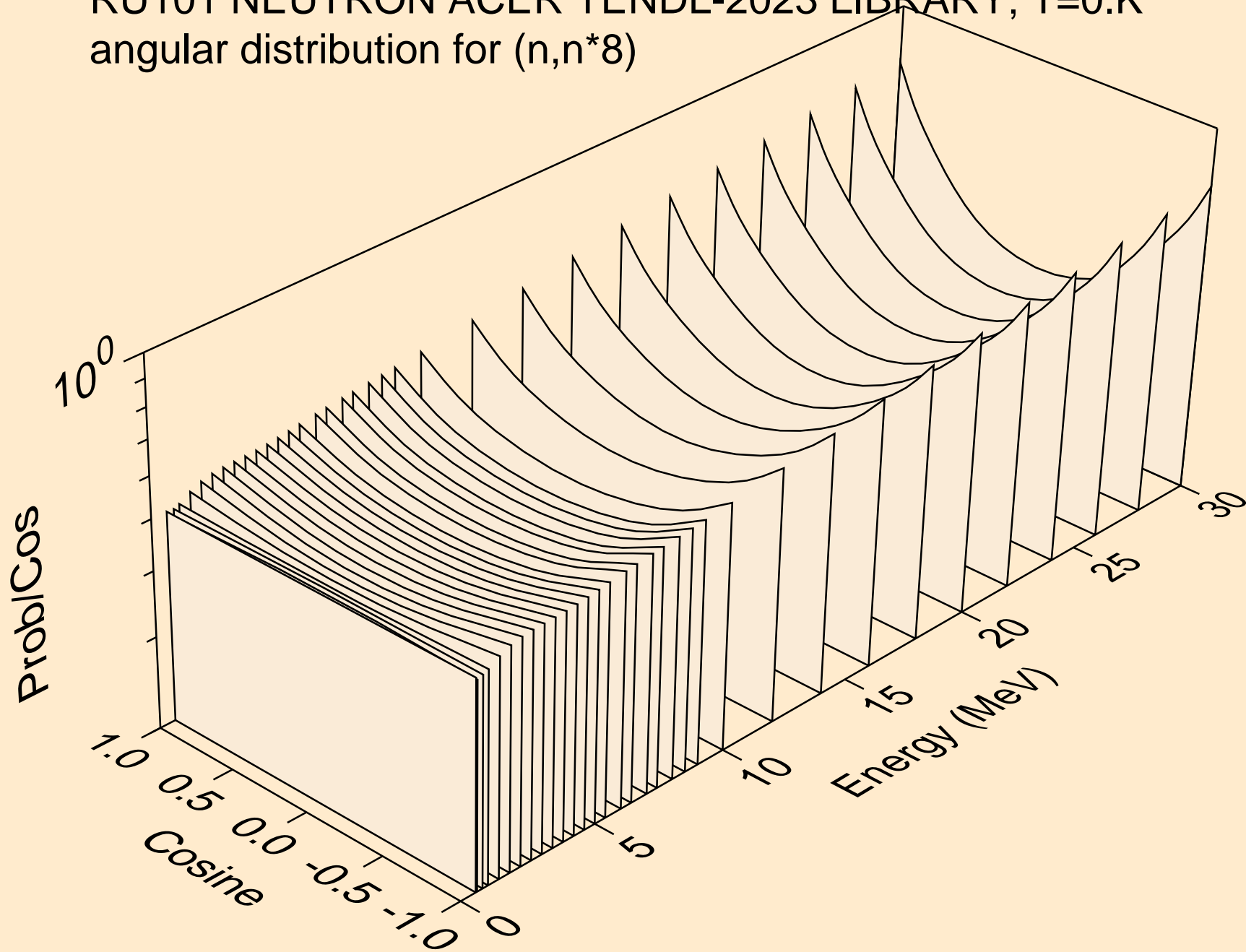

RU101 NEUTRON ACER TENDL-2023 LIBRARY; T=0.K  
angular distribution for (n,n\*9)

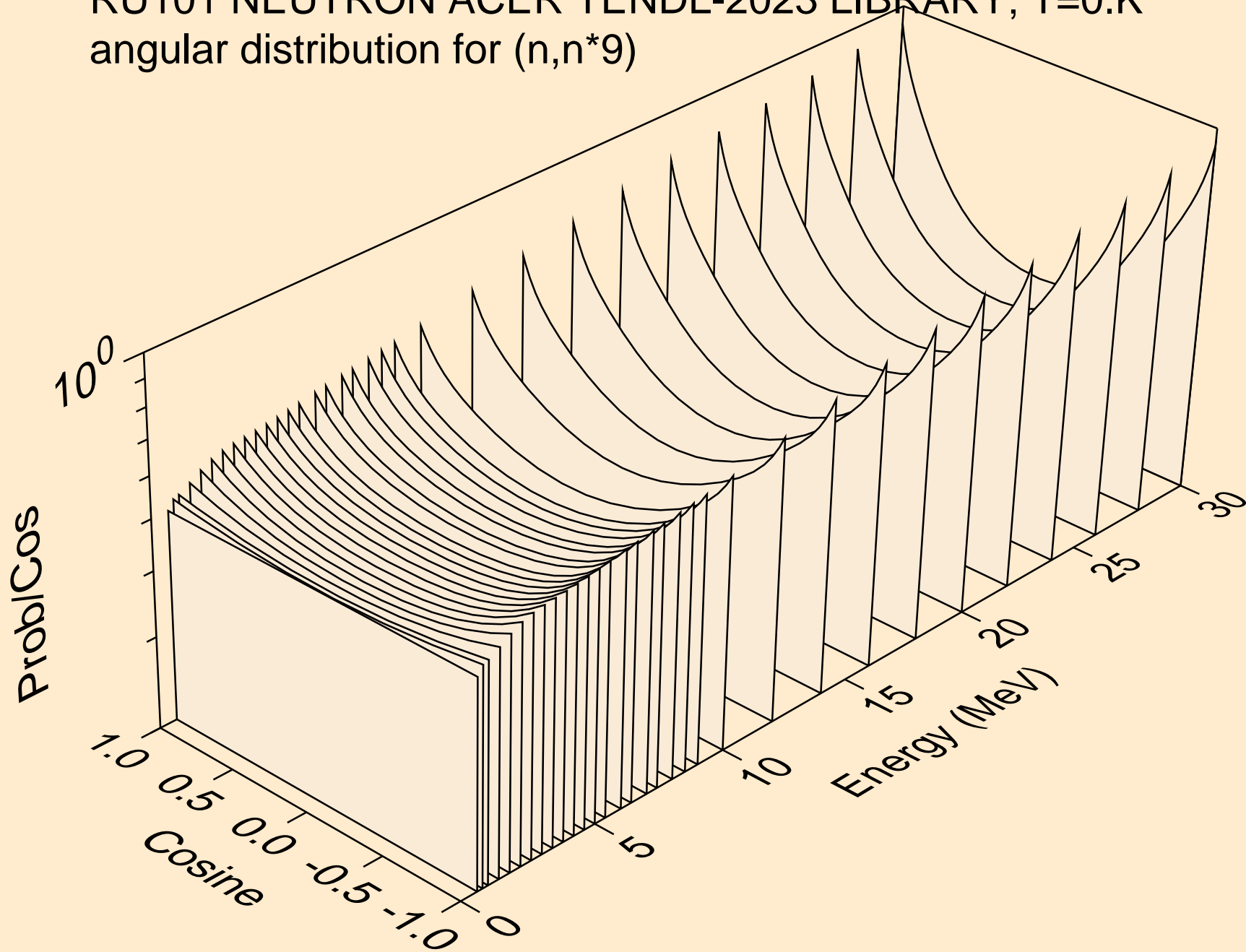

RU101 NEUTRON ACER TENDL-2023 LIBRARY; T=0.K  
angular distribution for (n,n\*10)

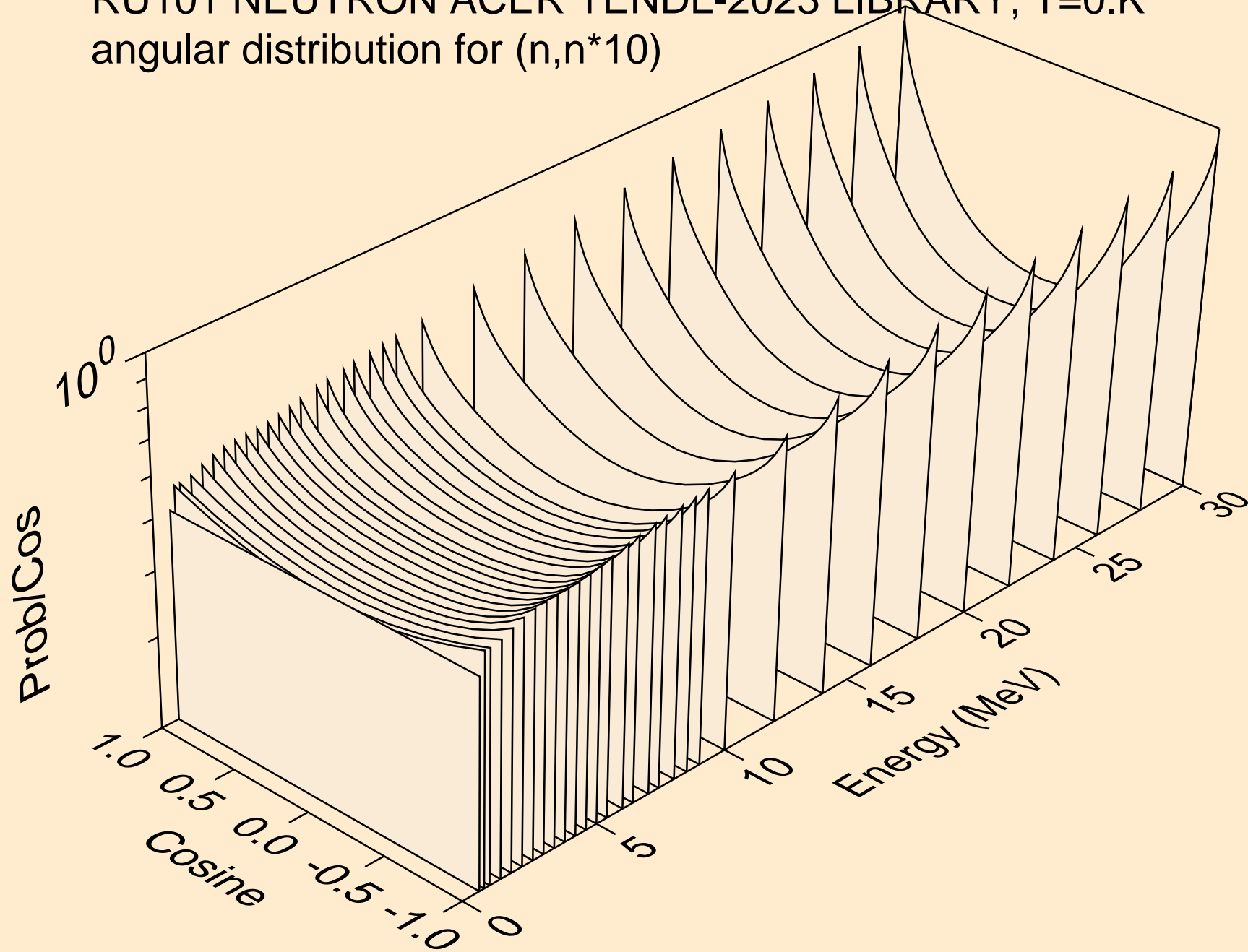

RU101 NEUTRON ACER TENDL-2023 LIBRARY; T=0.K  
angular distribution for (n,n\*11)

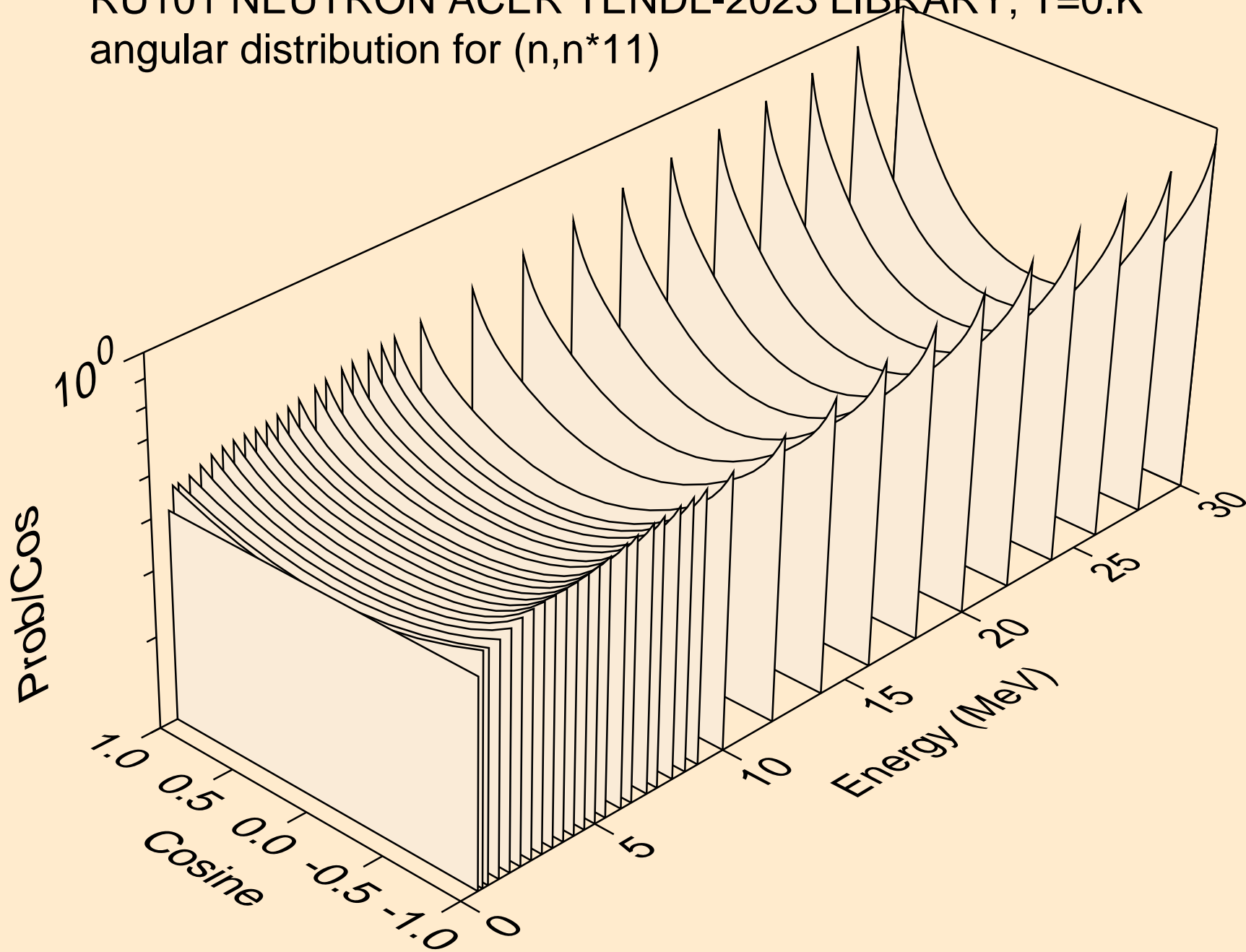

RU101 NEUTRON ACER TENDL-2023 LIBRARY; T=0.K  
angular distribution for (n,n\*12)

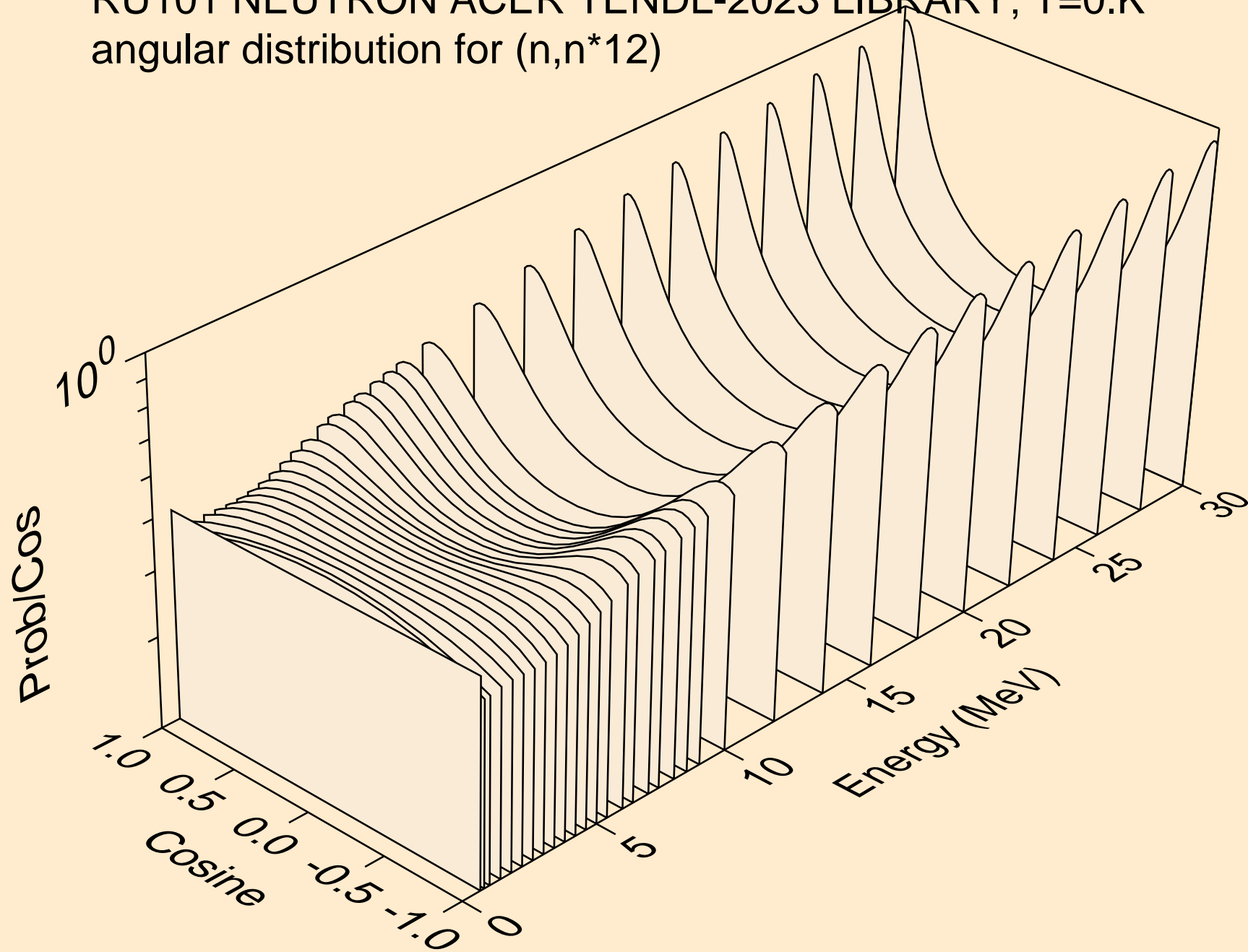

RU101 NEUTRON ACER TENDL-2023 LIBRARY; T=0.K  
angular distribution for (n,n\*13)

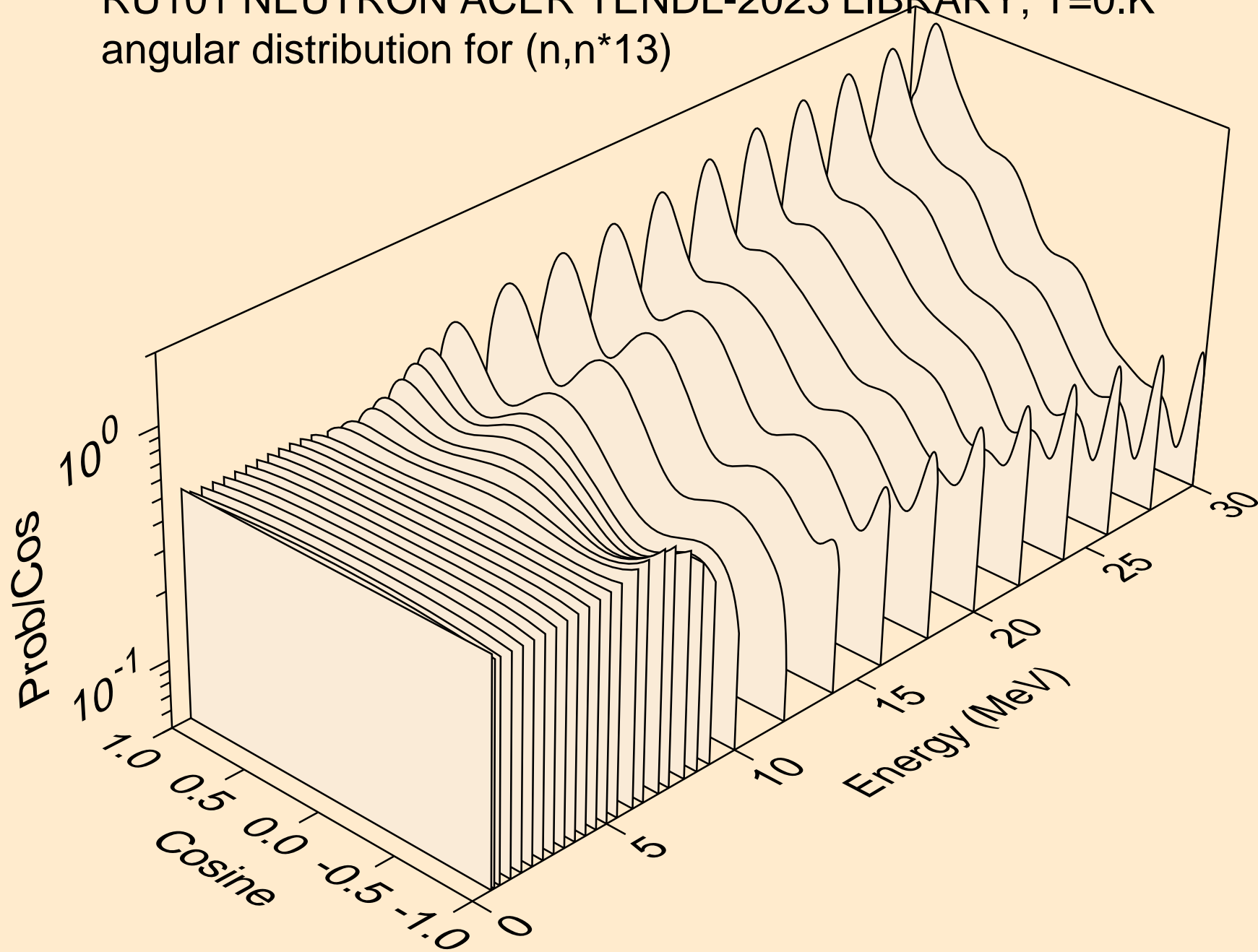

RU101 NEUTRON ACER TENDL-2023 LIBRARY; T=0.K  
angular distribution for (n,n\*14)

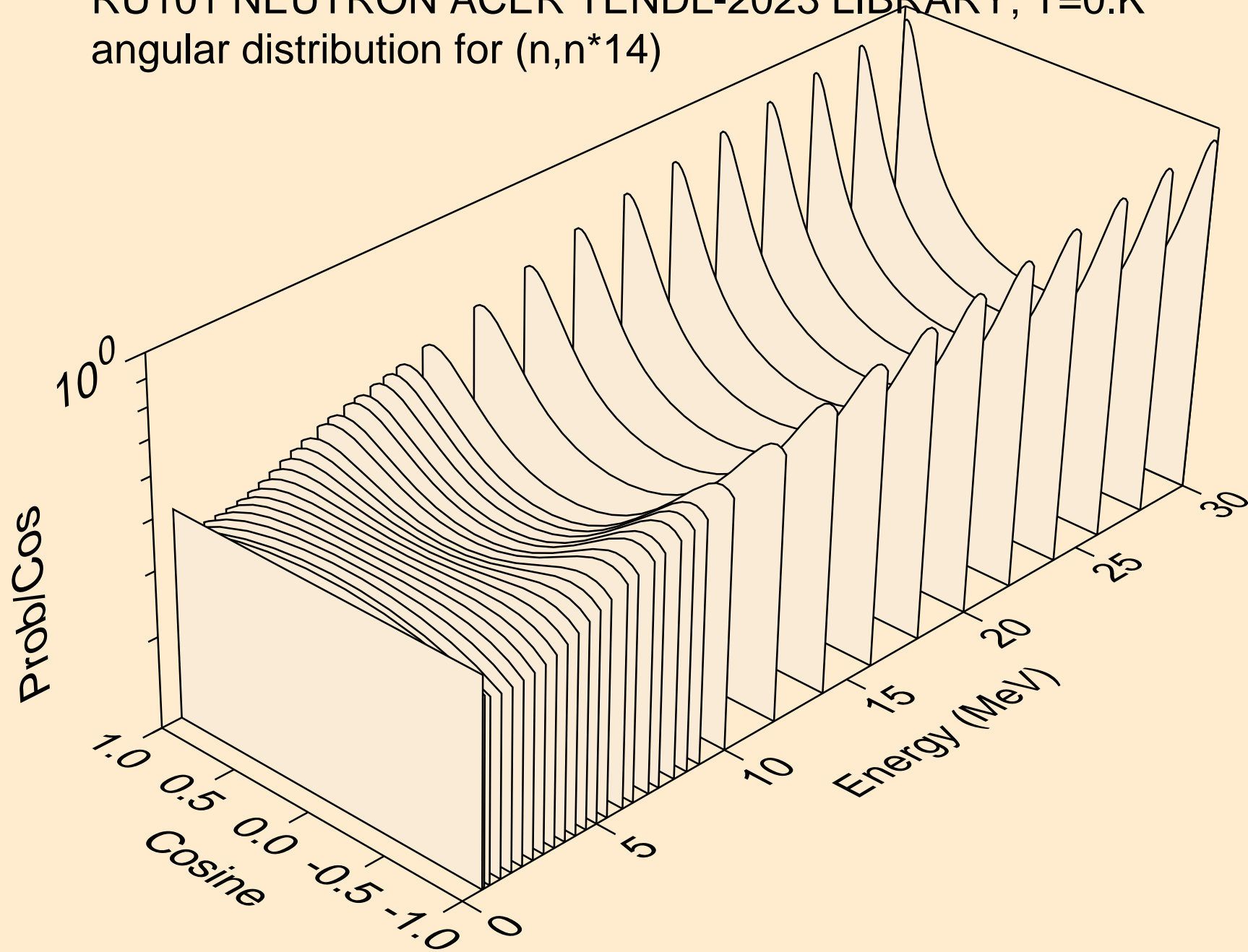

RU101 NEUTRON ACER TENDL-2023 LIBRARY; T=0.K  
angular distribution for (n,n\*15)

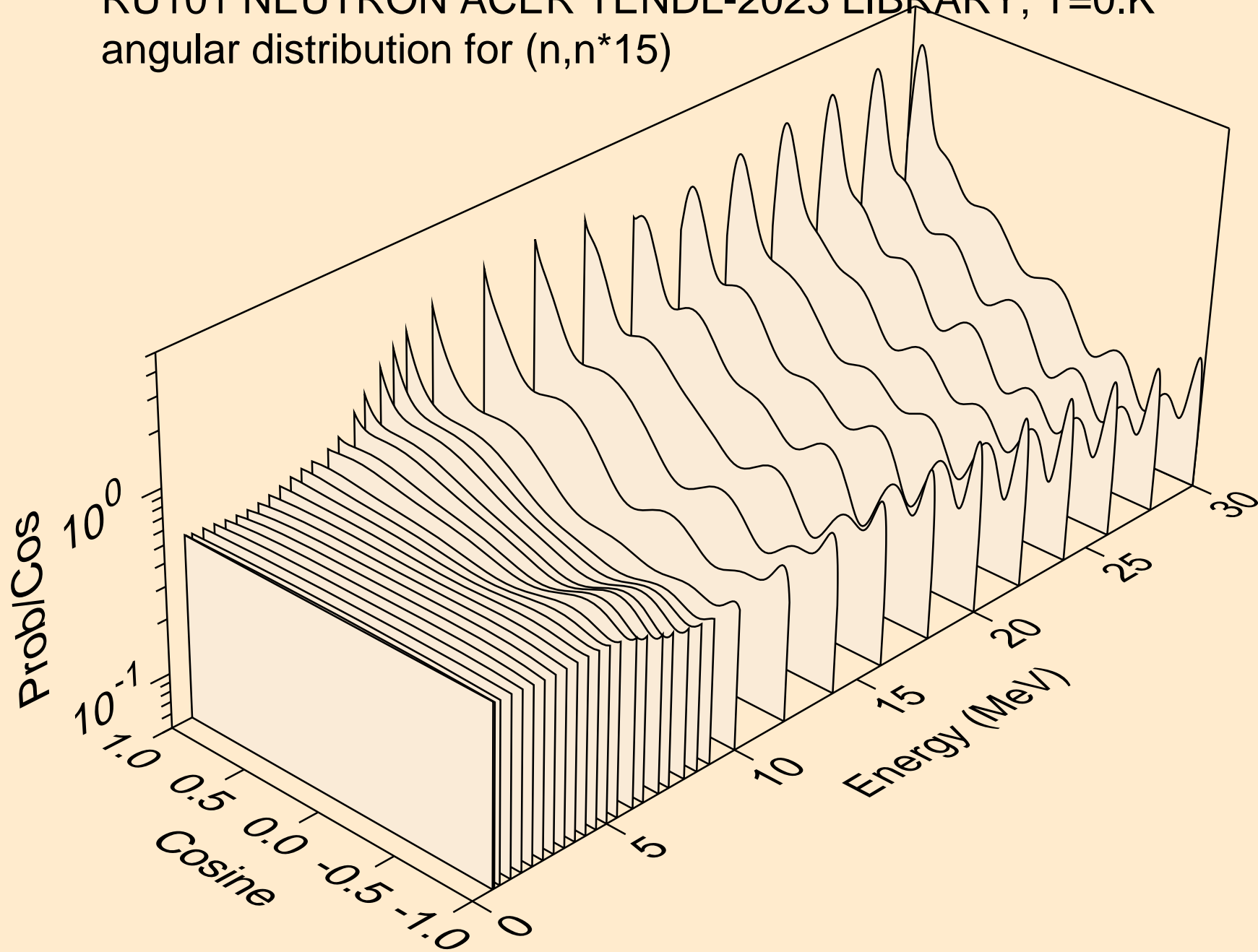

RU101 NEUTRON ACER TENDL-2023 LIBRARY; T=0.K  
angular distribution for (n,n\*16)

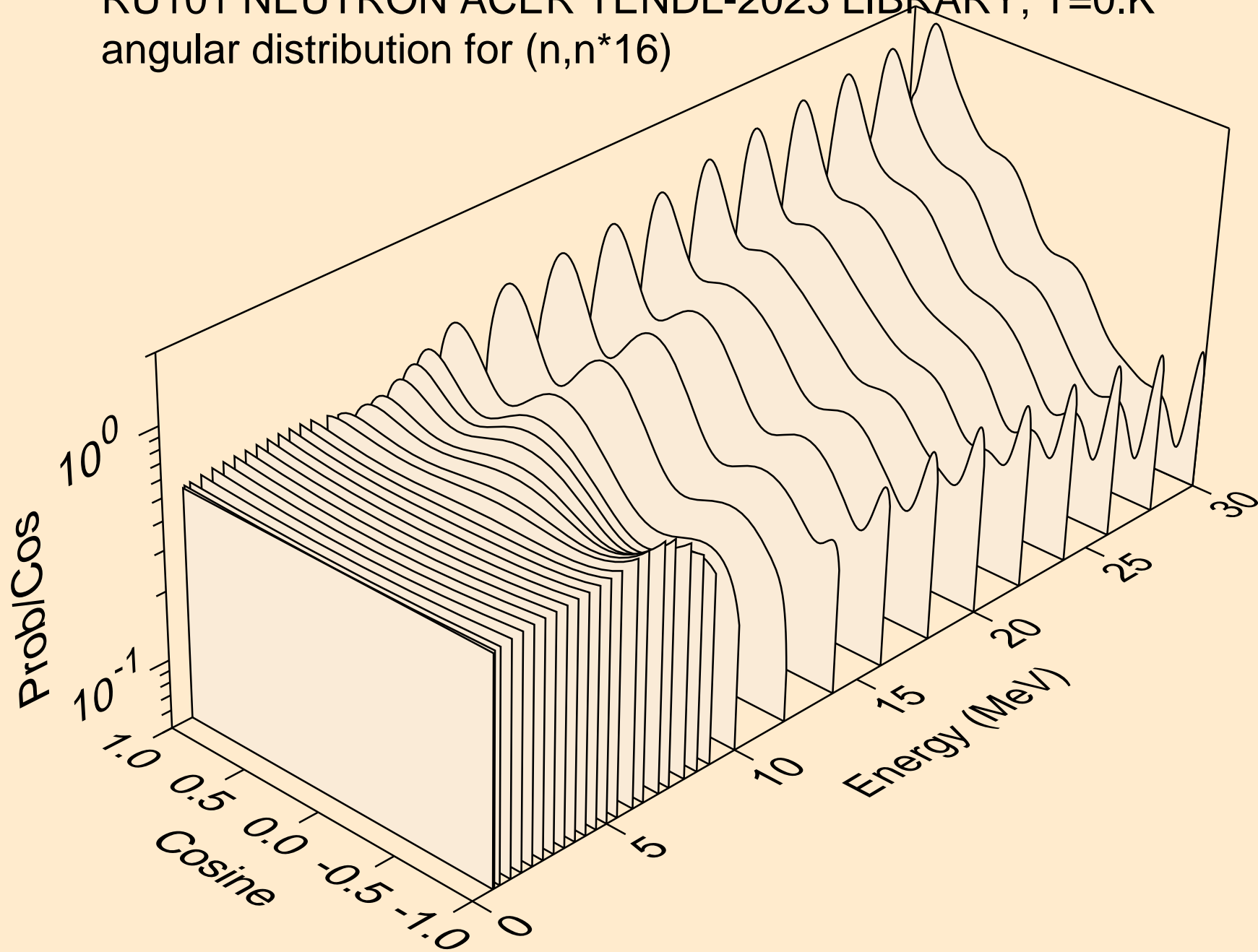

RU101 NEUTRON ACER TENDL-2023 LIBRARY; T=0.K  
angular distribution for (n,n\*17)

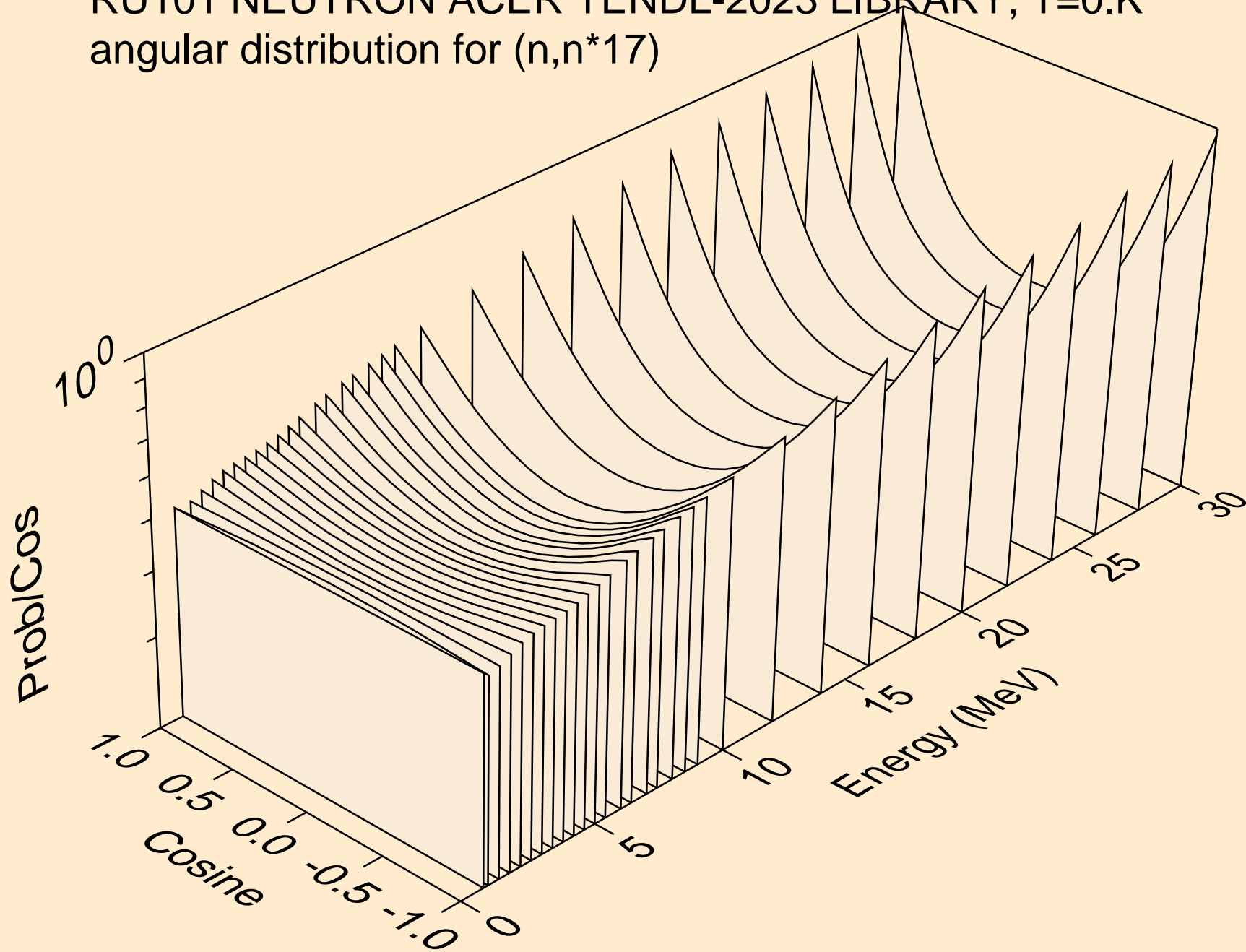

RU101 NEUTRON ACER TENDL-2023 LIBRARY; T=0.K  
Neutron emission for (n,x)

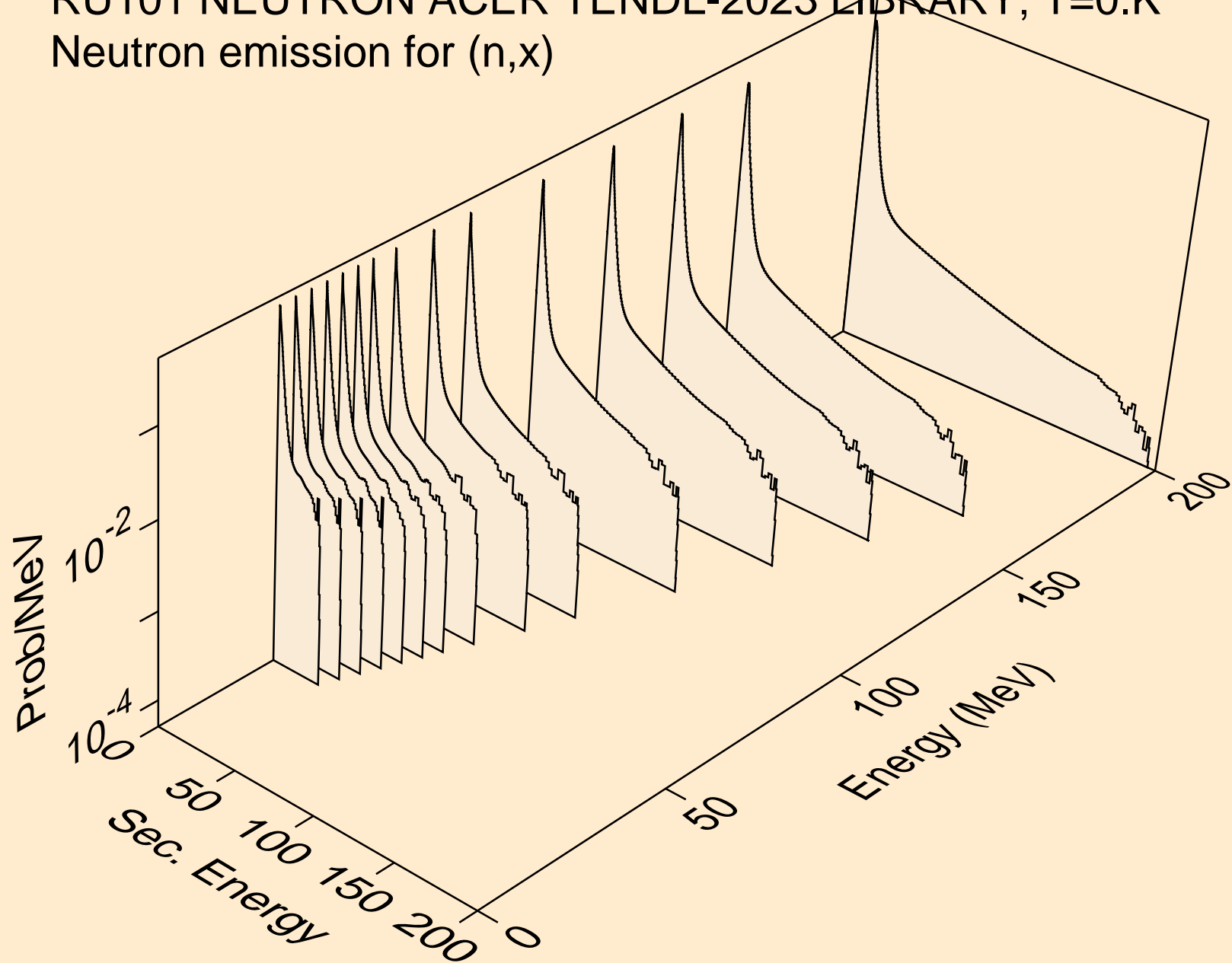

RU101 NEUTRON ACER TENDL-2023 LIBRARY; T=0.K  
Neutron emission for (n,2nd)

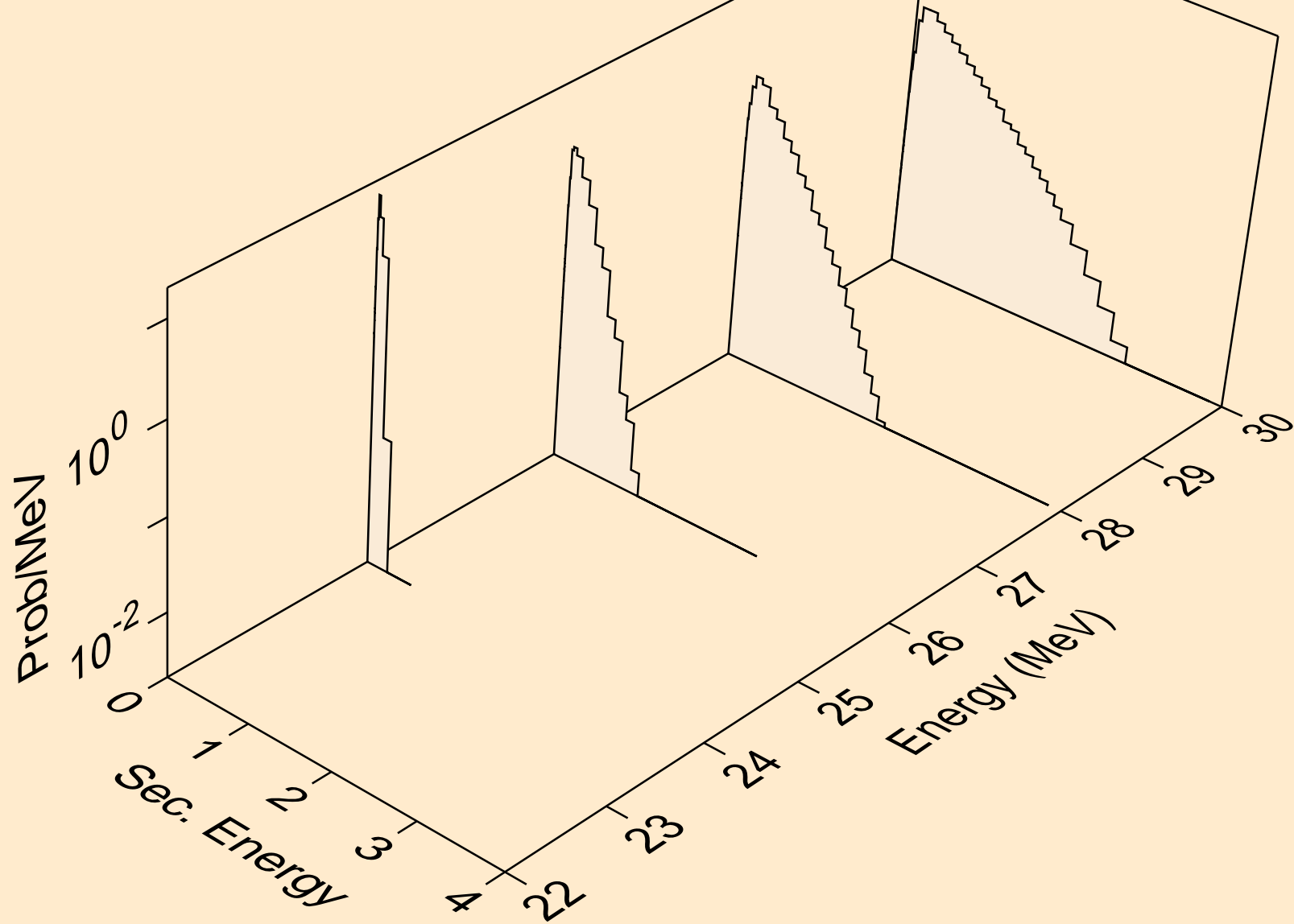

RU101 NEUTRON ACER TENDL-2023 LIBRARY; T=0.K  
Neutron emission for (n,2n)

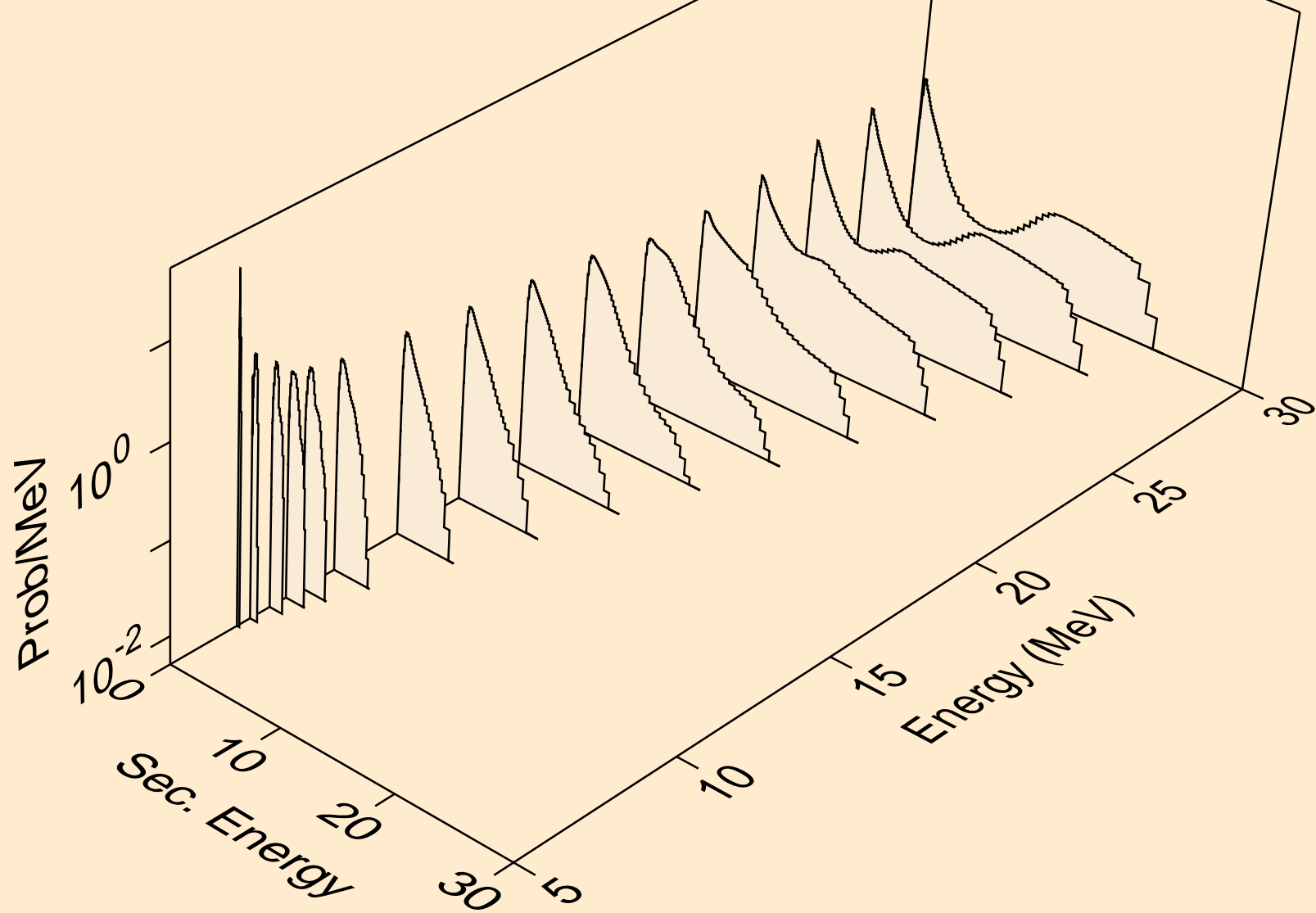

RU101 NEUTRON ACER TENDL-2023 LIBRARY; T=0.K  
Neutron emission for (n,3n)

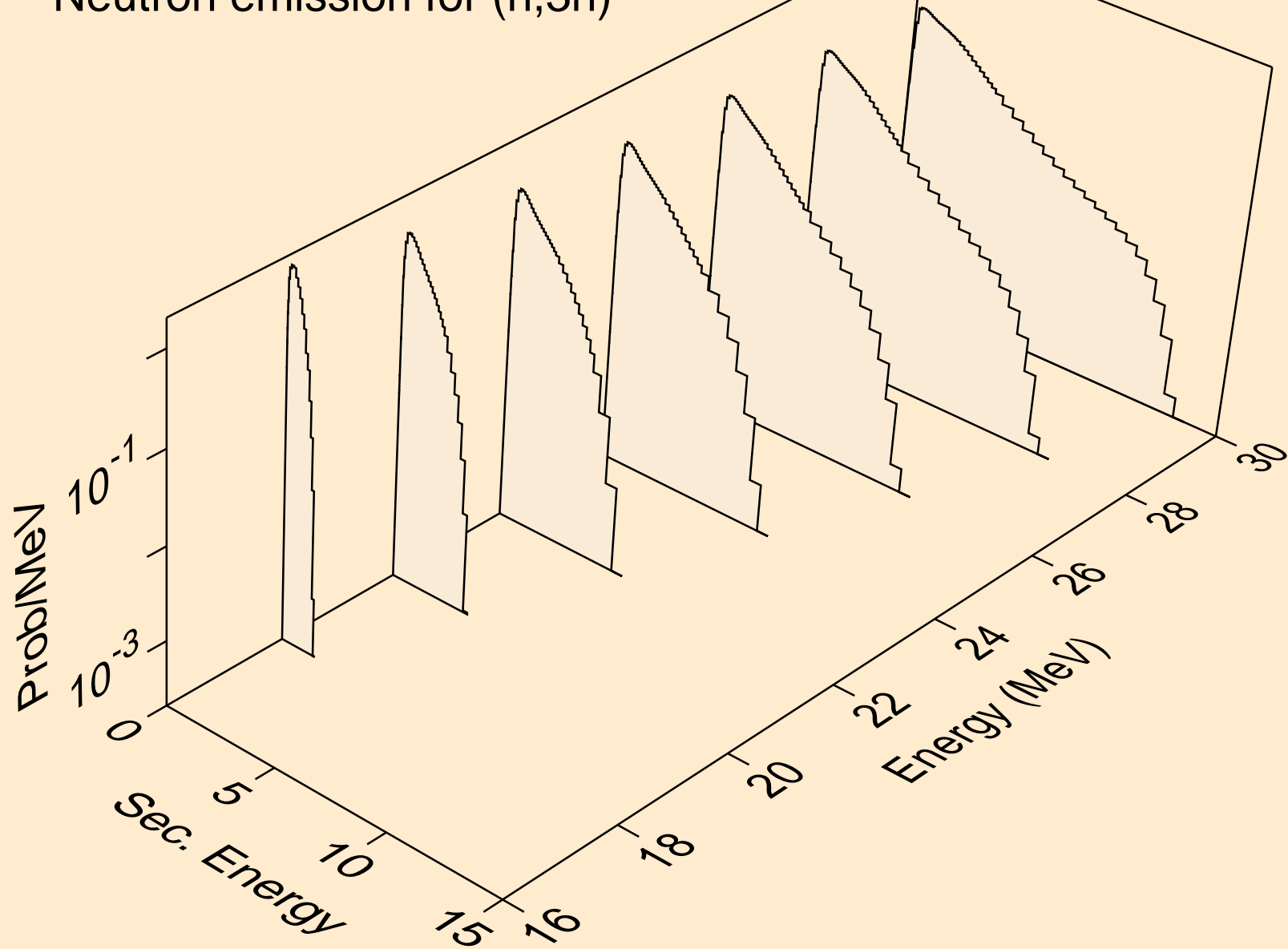

RU101 NEUTRON ACER TENDL-2023 LIBRARY; T=0.K  
Neutron emission for (n,n\*)a

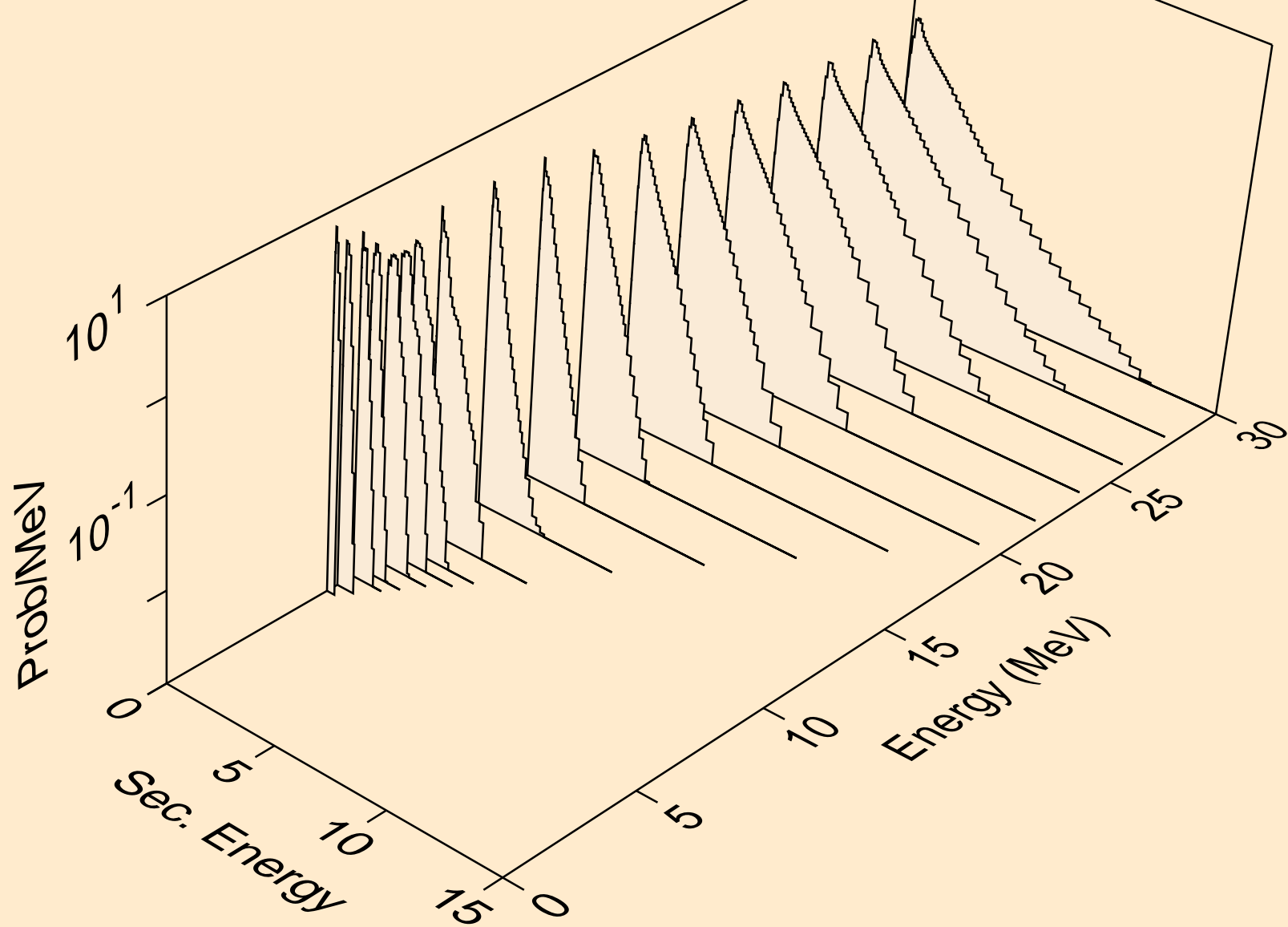

RU101 NEUTRON ACER TENDL-2023 LIBRARY; T=0.K  
Neutron emission for (n,2n)a

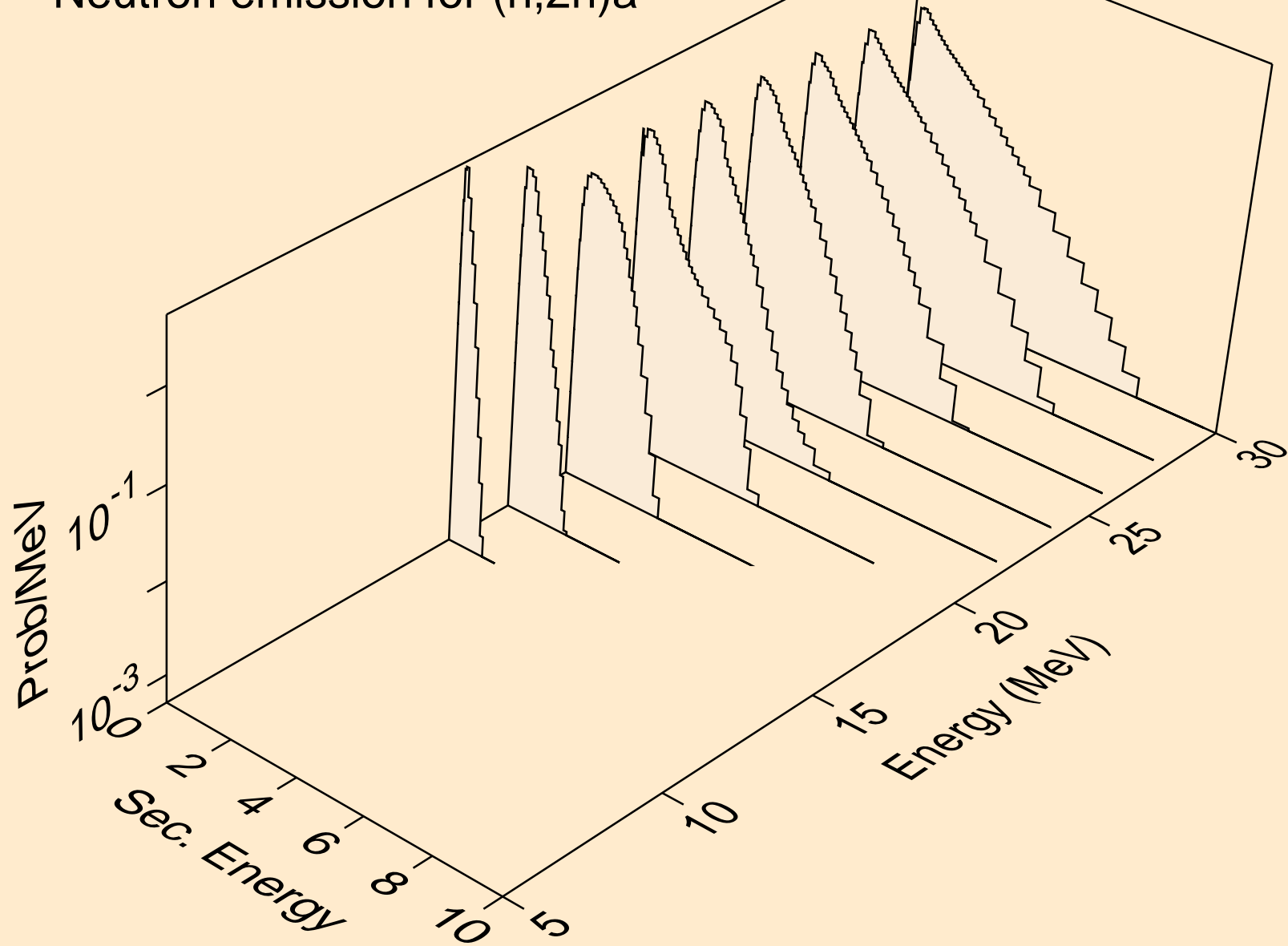

RU101 NEUTRON ACER TENDL-2023 LIBRARY; T=0.K  
Neutron emission for (n,3n)a

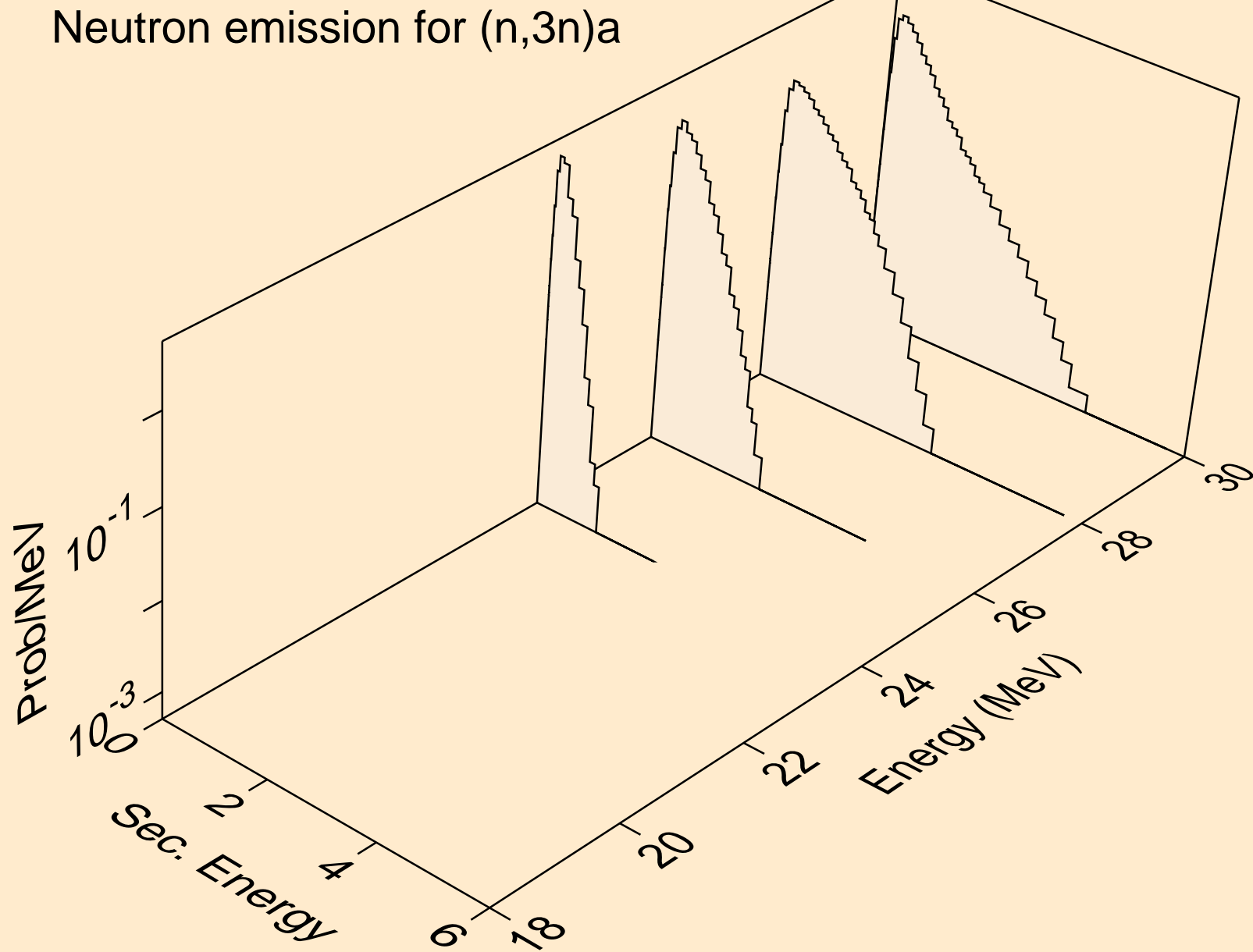

RU101 NEUTRON ACER TENDL-2023 LIBRARY; T=0.K  
Neutron emission for (n,n\*)p

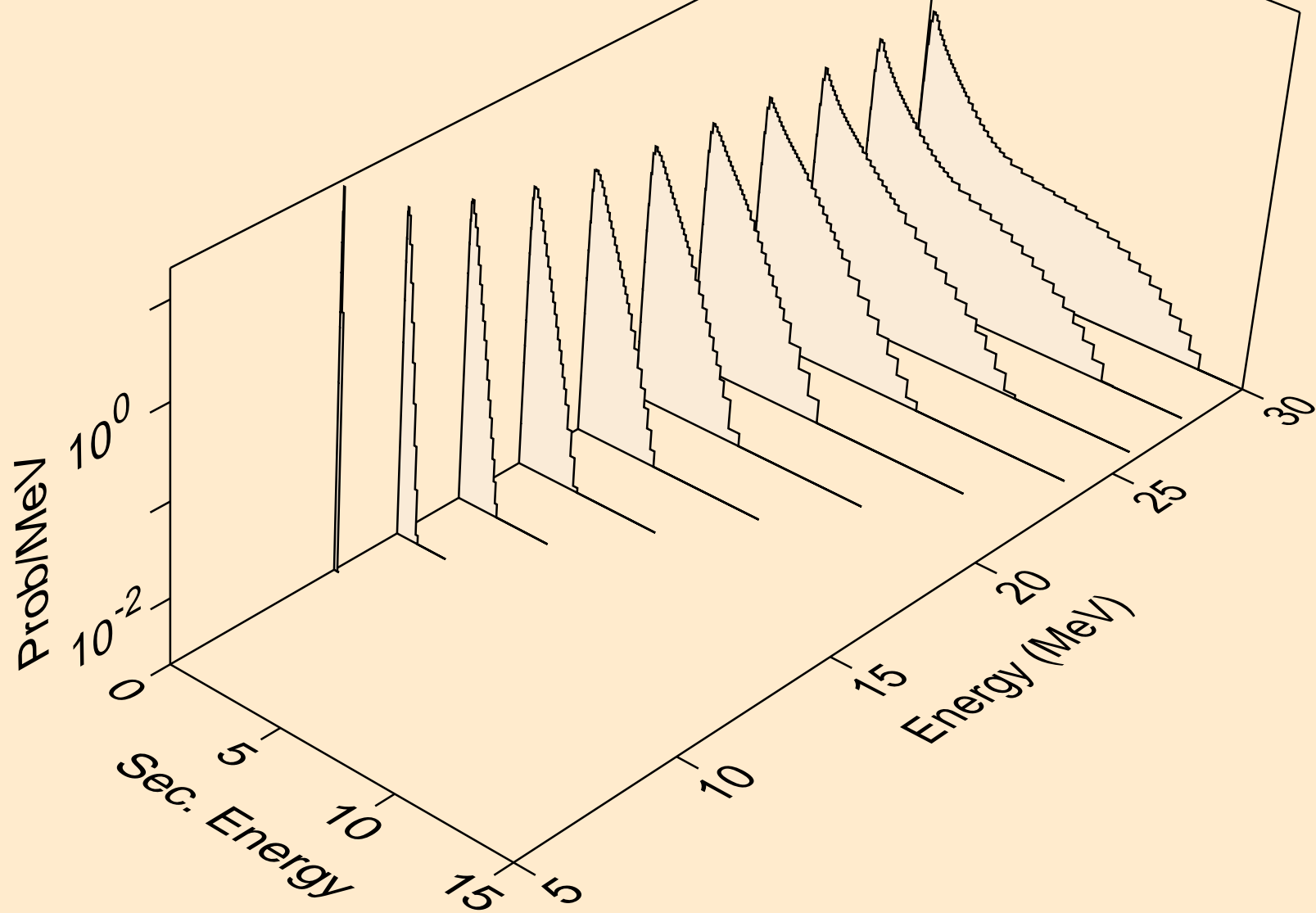

RU101 NEUTRON ACER TENDL-2023 LIBRARY; T=0.K  
Neutron emission for (n,n\*)2a

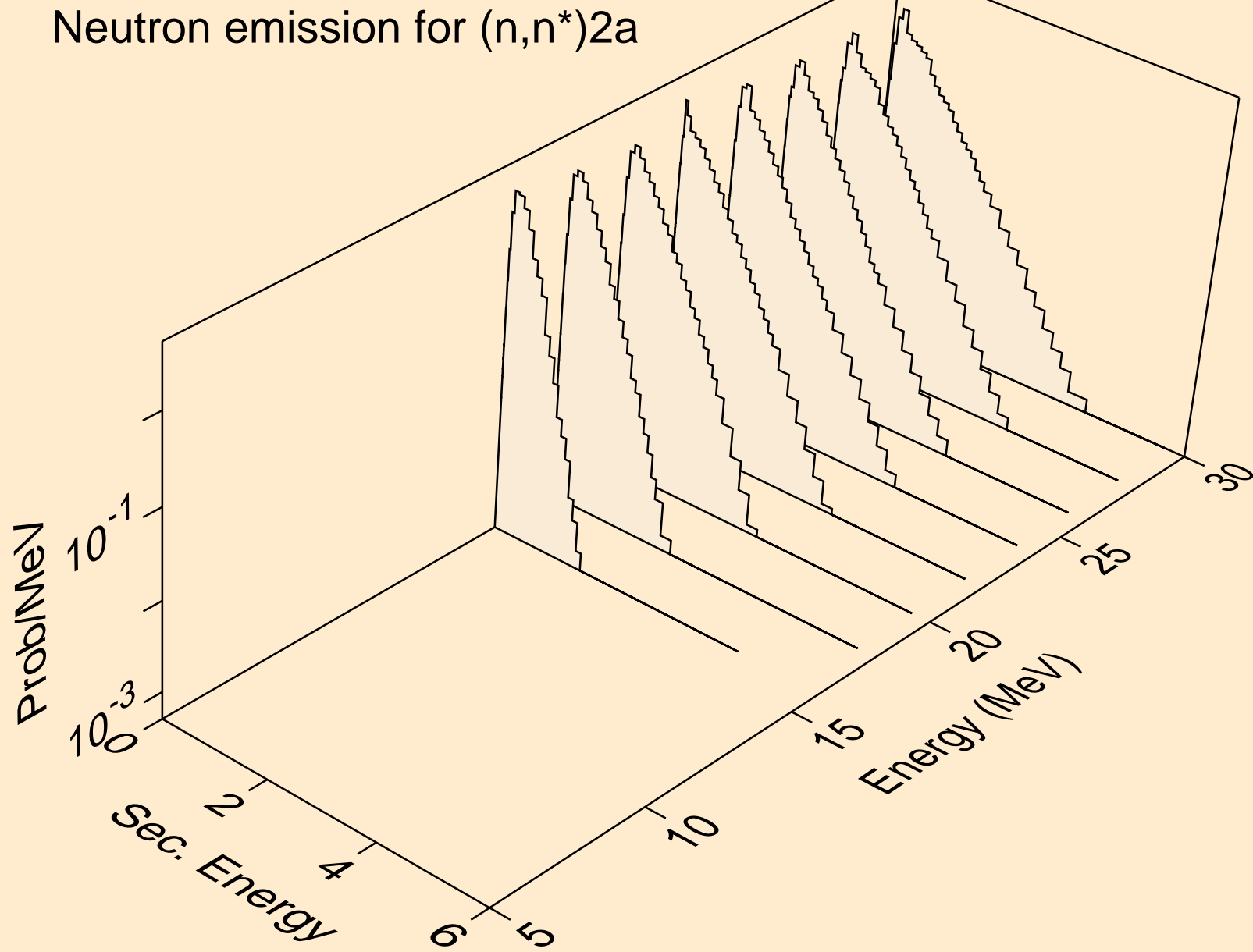

RU101 NEUTRON ACER TENDL-2023 LIBRARY; T=0.K  
Neutron emission for (n,n\*)d

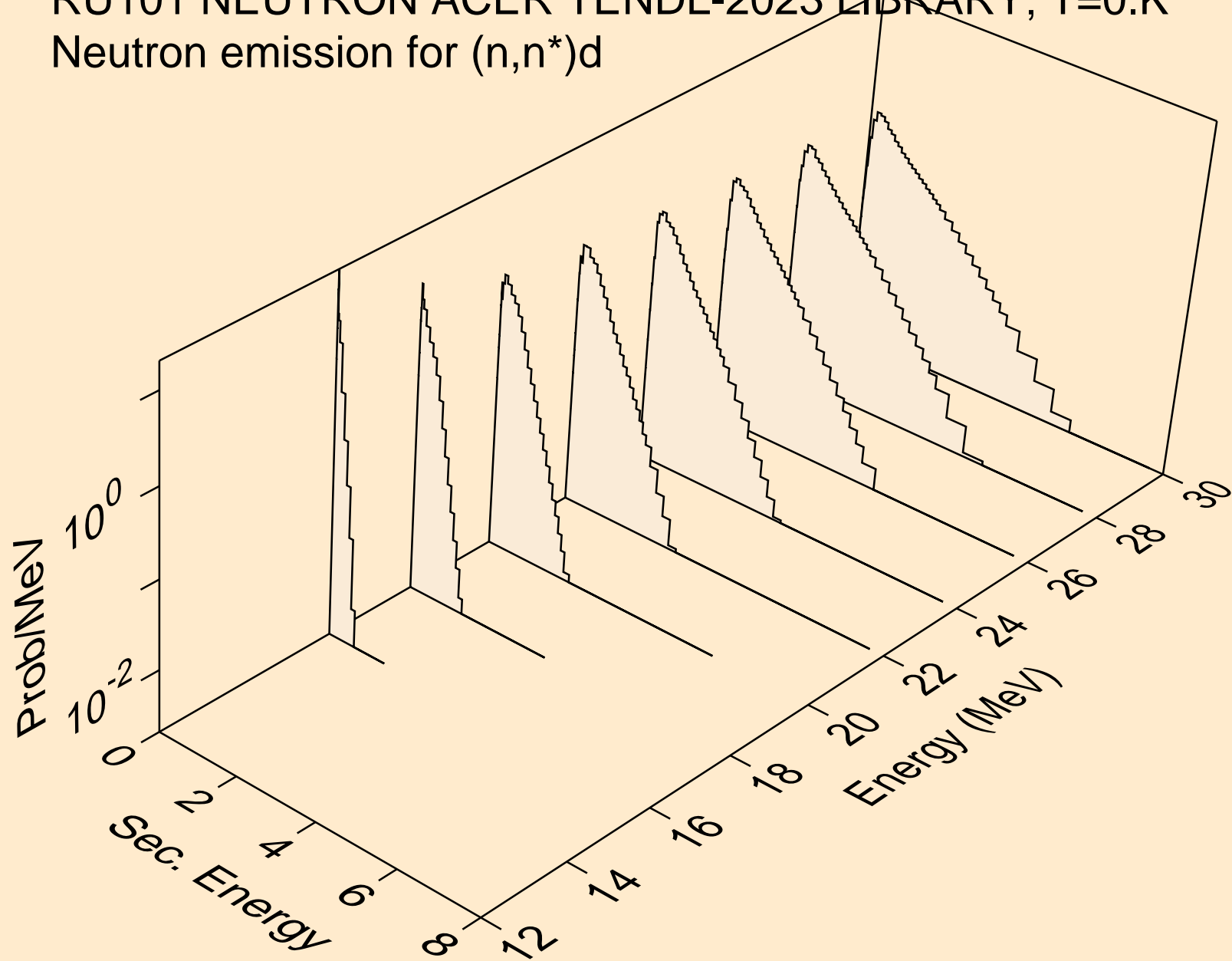

RU101 NEUTRON ACER TENDL-2023 LIBRARY; T=0.K  
Neutron emission for (n,n\*)t

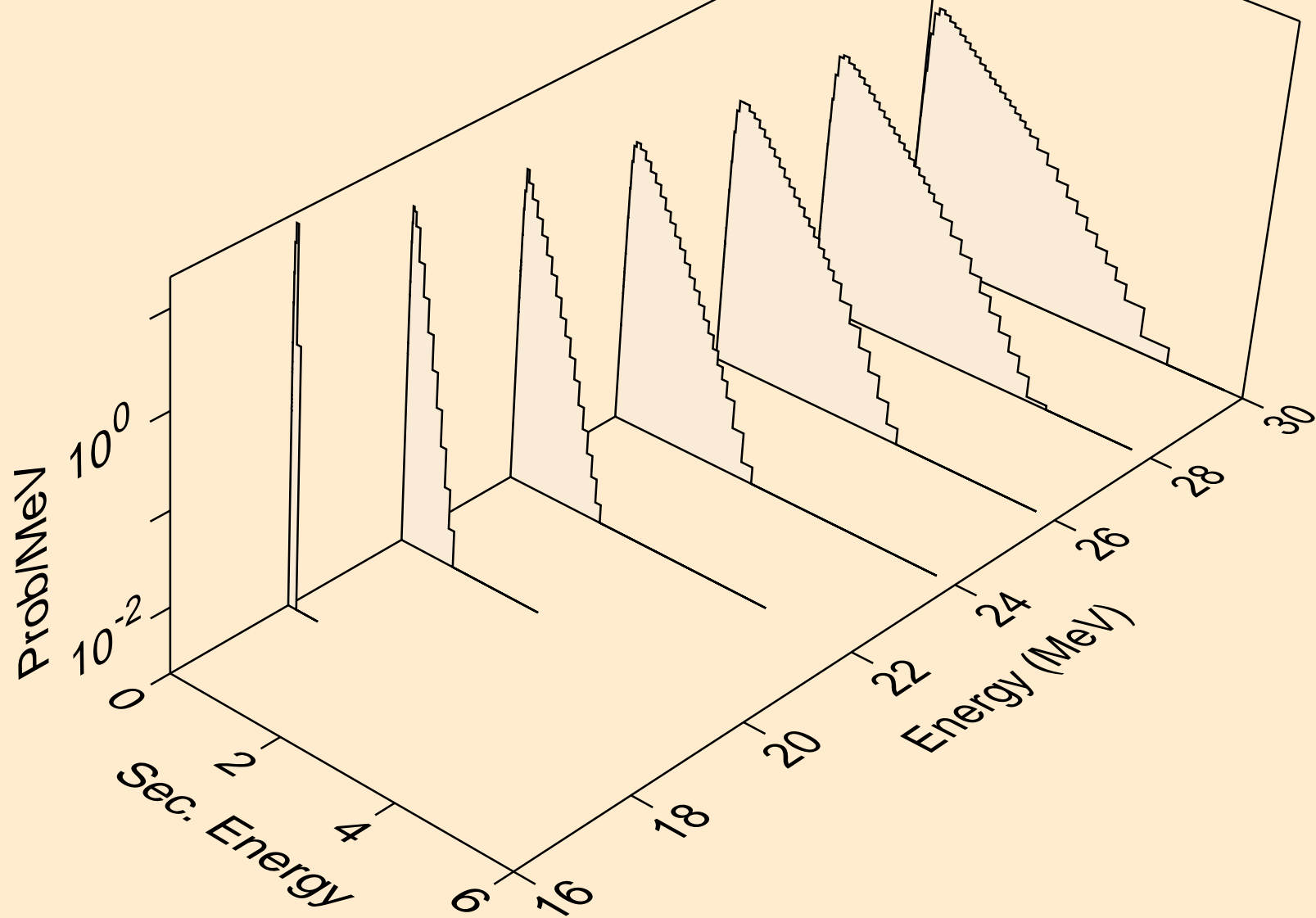

RU101 NEUTRON ACER TENDL-2023 LIBRARY; T=0.K  
Neutron emission for (n,n\*)he3

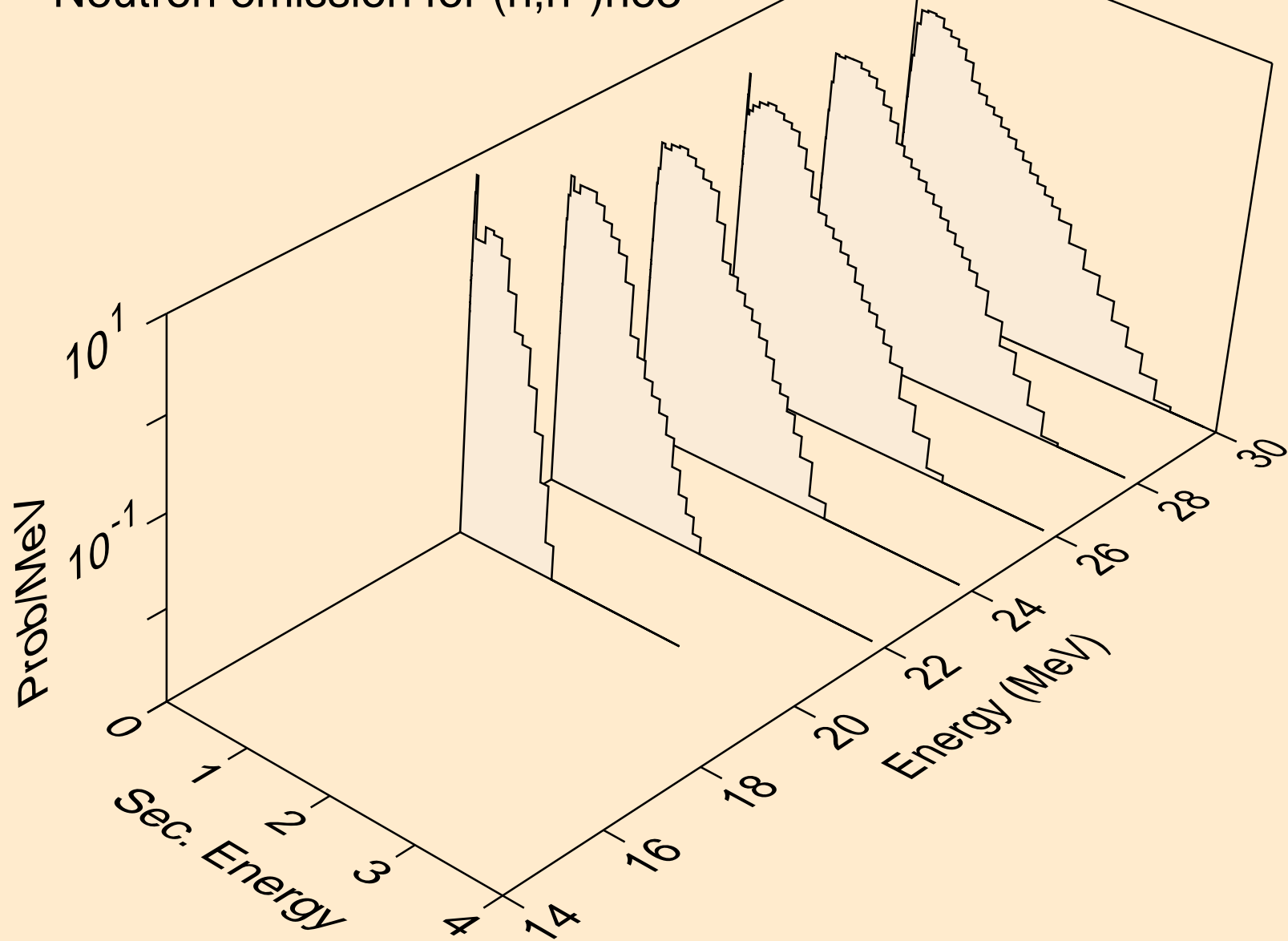

RU101 NEUTRON ACER TENDL-2023 LIBRARY; T=0.K  
Neutron emission for (n,4n)

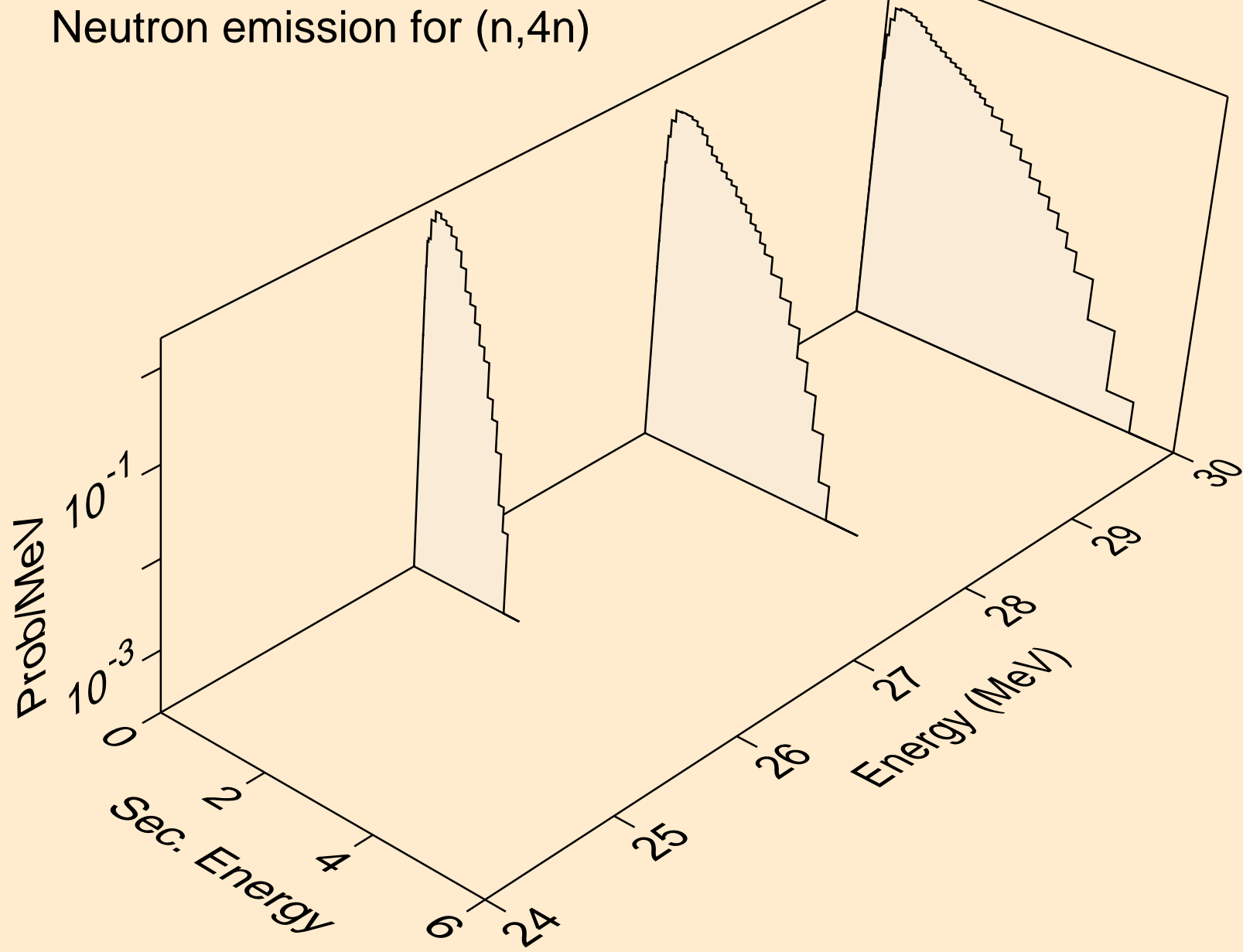

RU101 NEUTRON ACER TENDL-2023 LIBRARY; T=0.K  
Neutron emission for (n,2np)

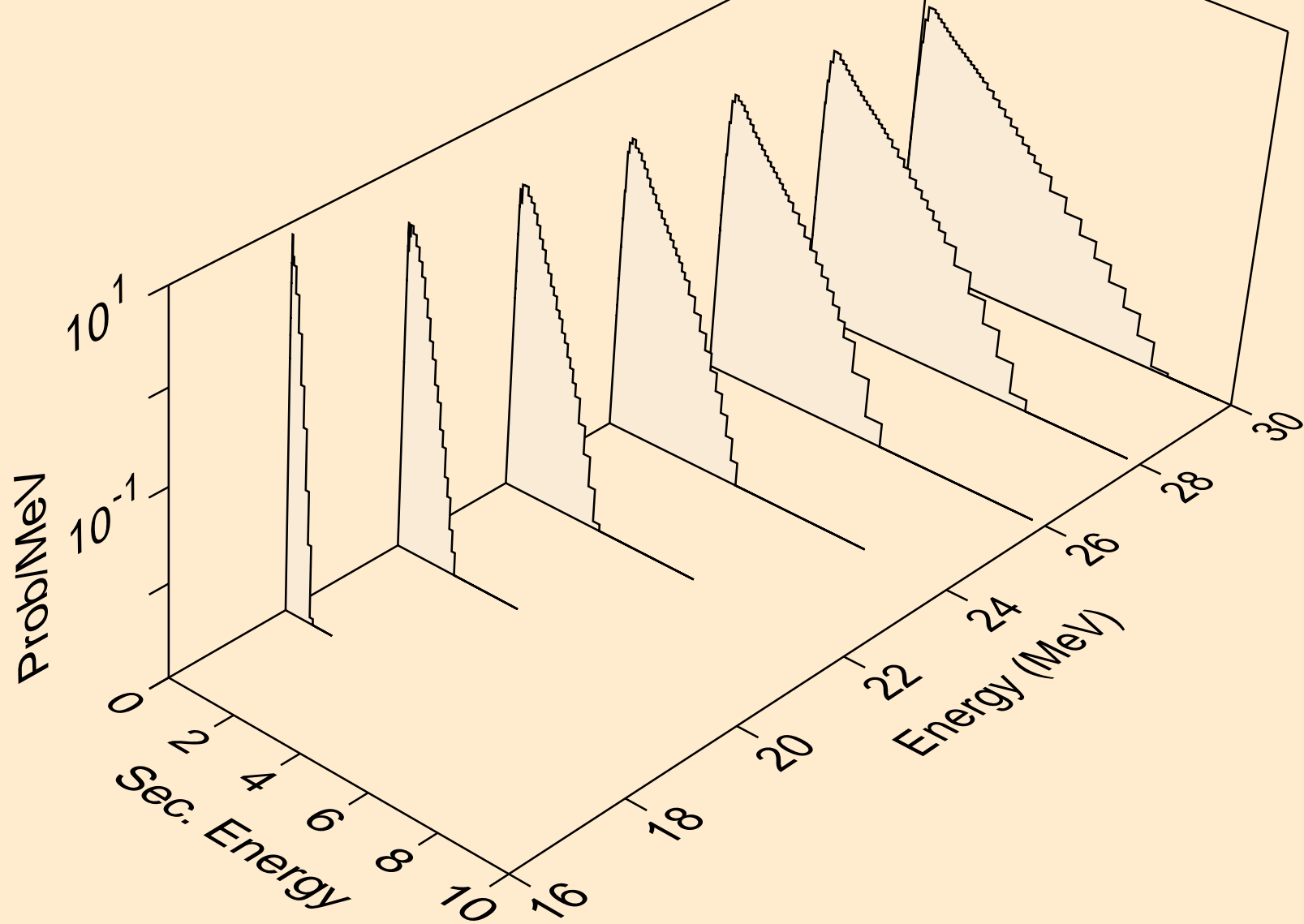

RU101 NEUTRON ACER TENDL-2023 LIBRARY; T=0.K  
Neutron emission for (n,3np)

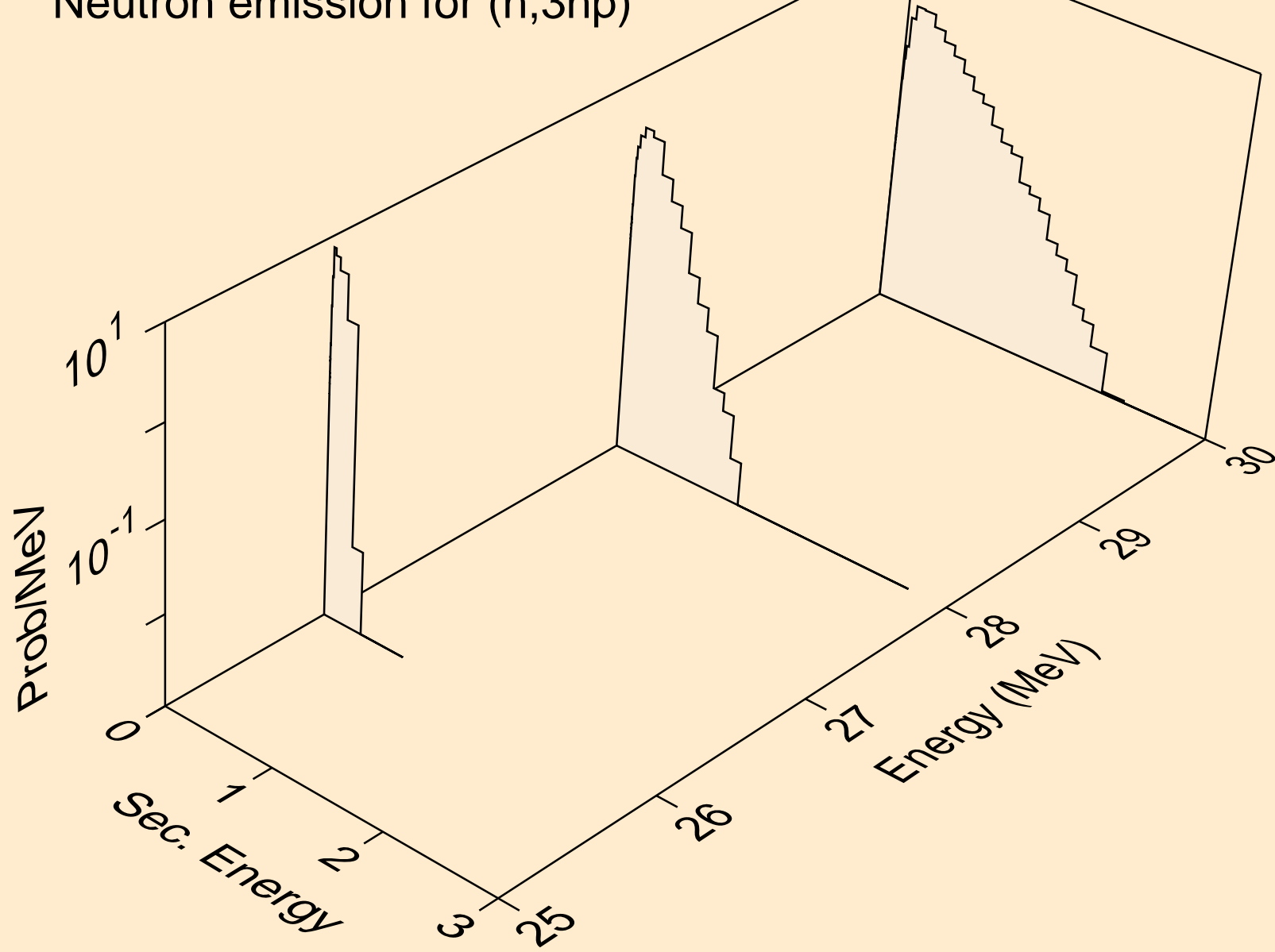

RU101 NEUTRON ACER TENDL-2023 LIBRARY; T=0.K  
Neutron emission for (n,n2p)

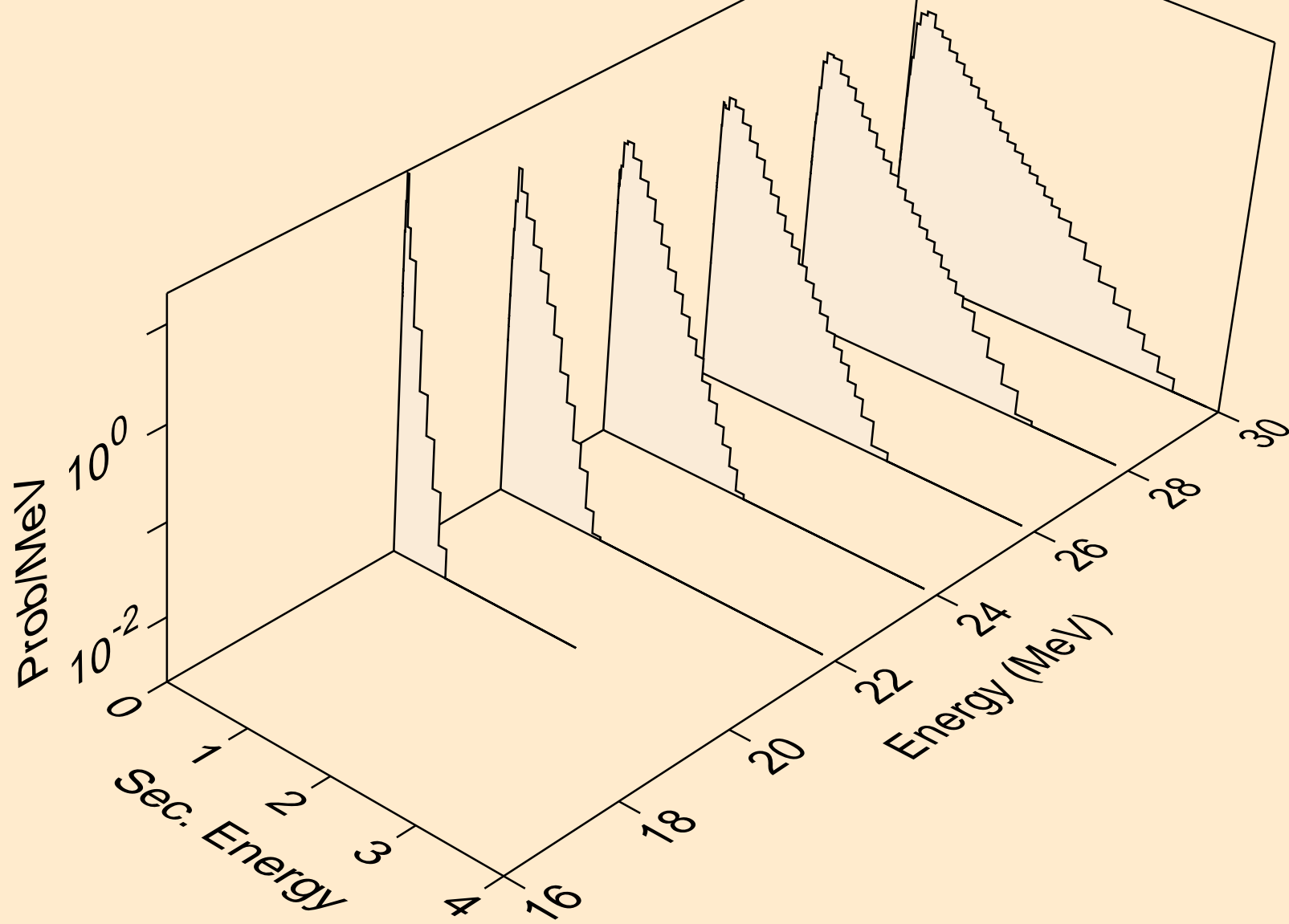

RU101 NEUTRON ACER TENDL-2023 LIBRARY; T=0.K  
Neutron emission for (n,npa)

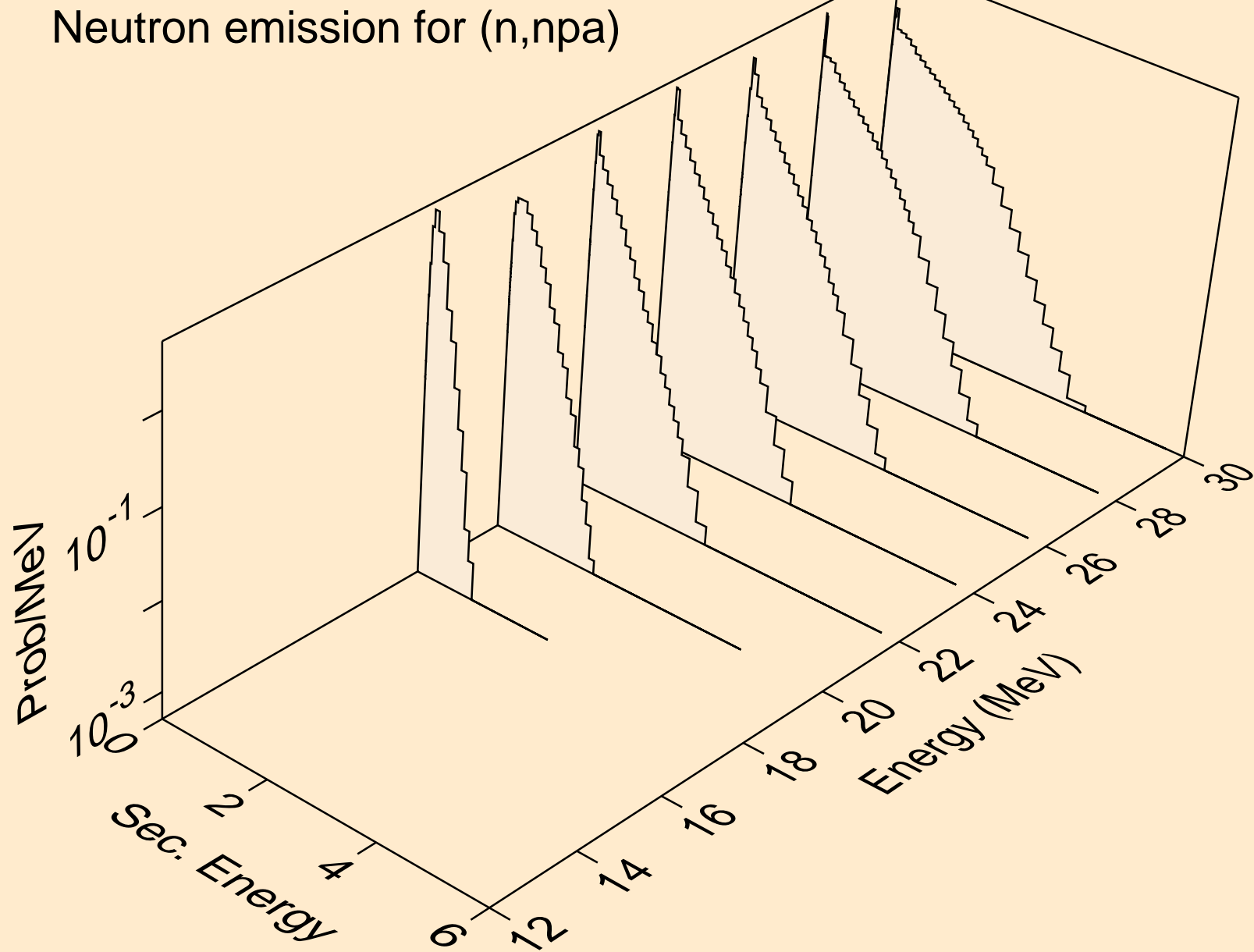

RU101 NEUTRON ACER TENDL-2023 LIBRARY; T=0.K  
Neutron emission for (n,n\*c)

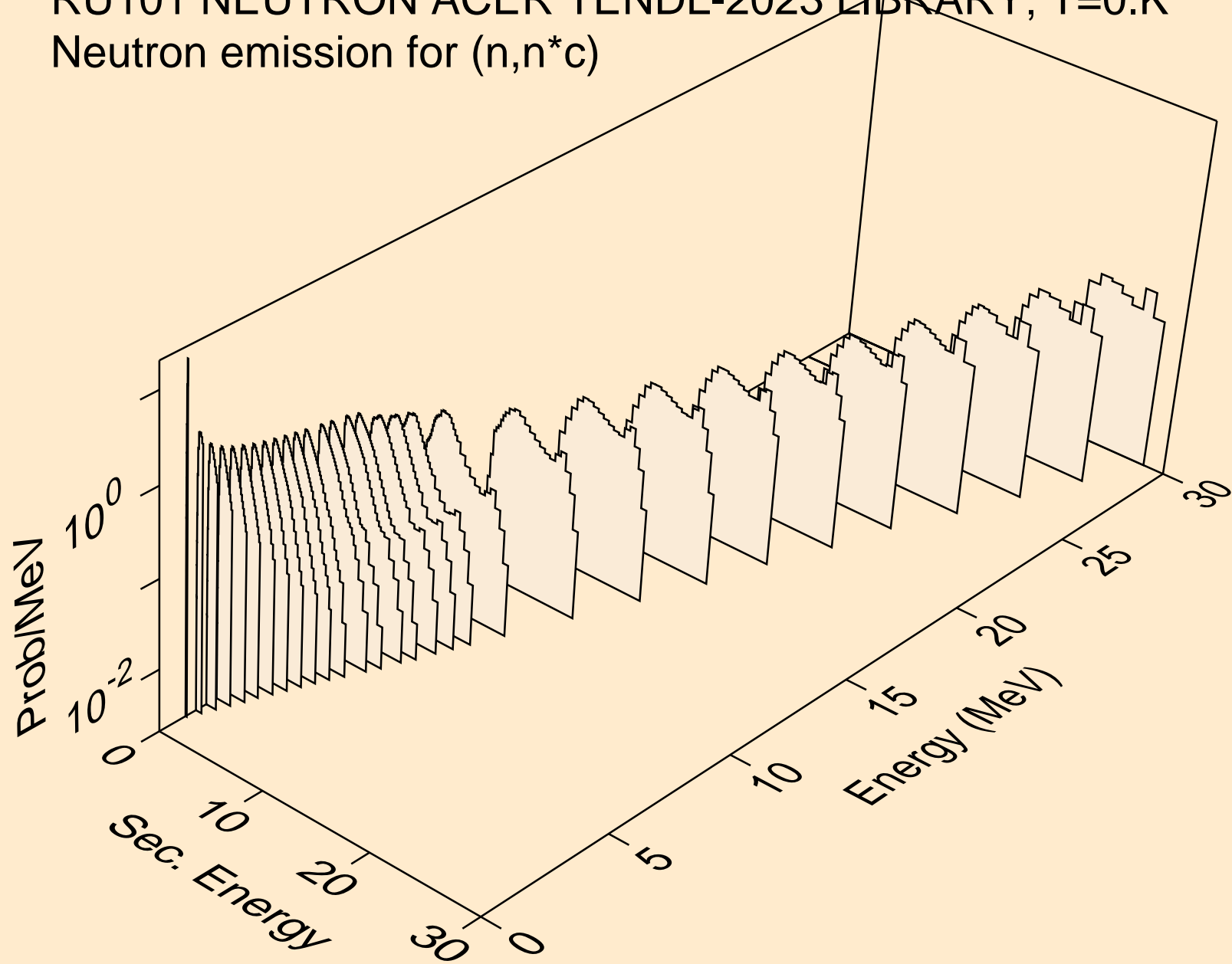

RU101 NEUTRON ACER TENDL-2023 LIBRARY; T=0.K  
Photon emission for (n,x)

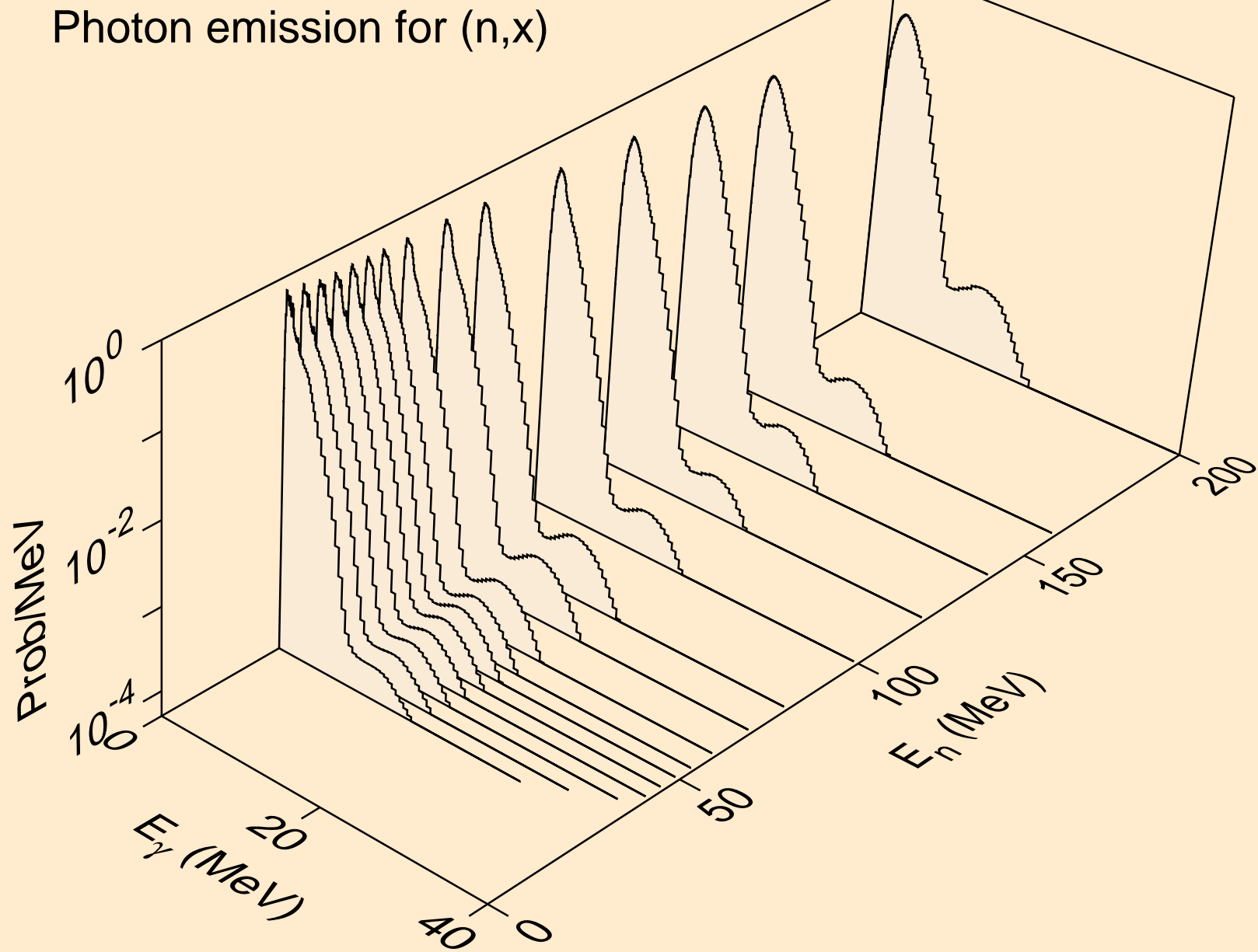

RU101 NEUTRON ACER TENDL-2023 LIBRARY; T=0.K  
Photon emission for (n,2nd)

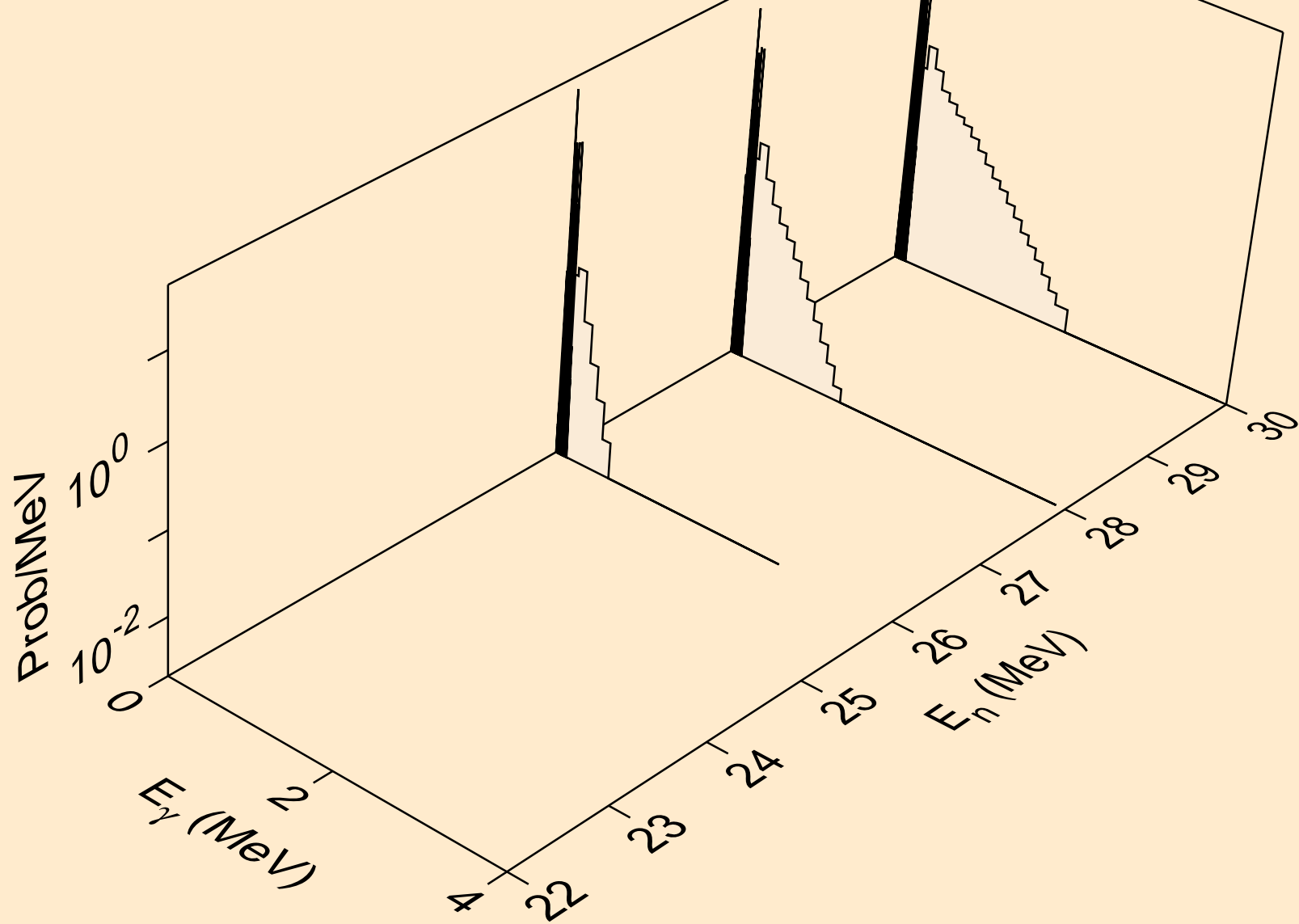

RU101 NEUTRON ACER TENDL-2023 LIBRARY; T=0.K  
Photon emission for (n,2n)

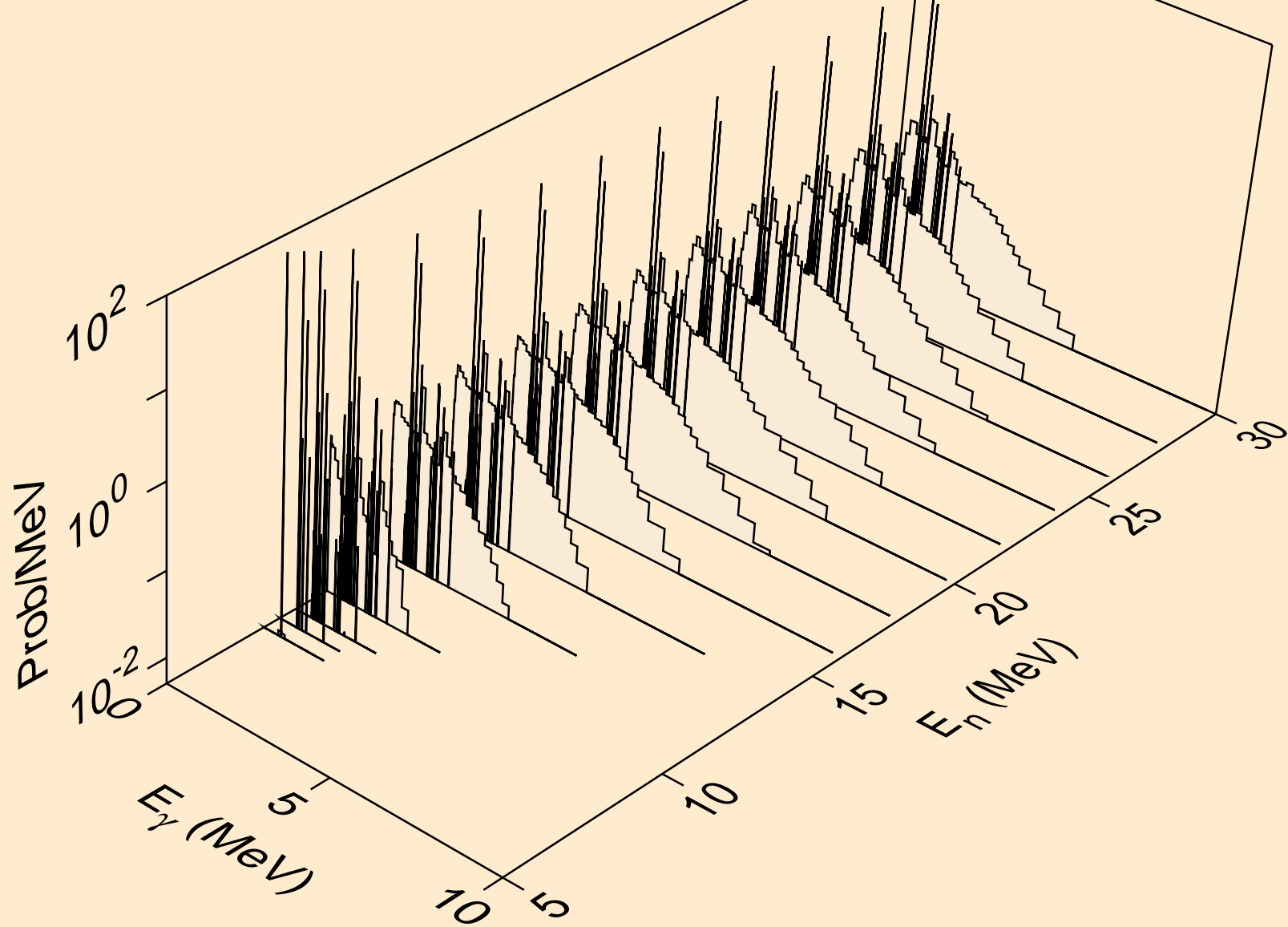

RU101 NEUTRON ACER TENDL-2023 LIBRARY; T=0.K  
Photon emission for (n,3n)

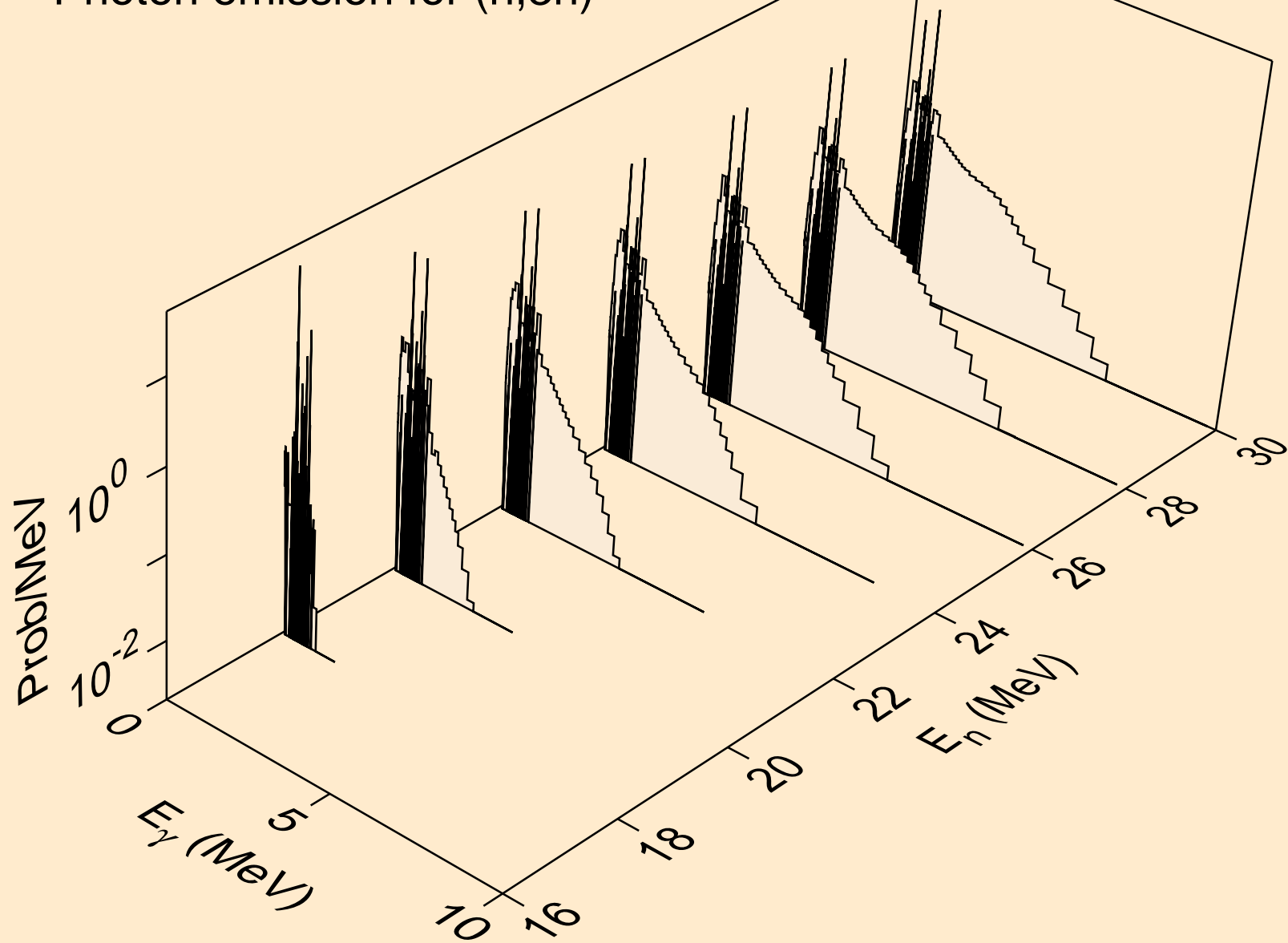

RU101 NEUTRON ACER TENDL-2023 LIBRARY; T=0.K  
Photon emission for (n,n\*)a

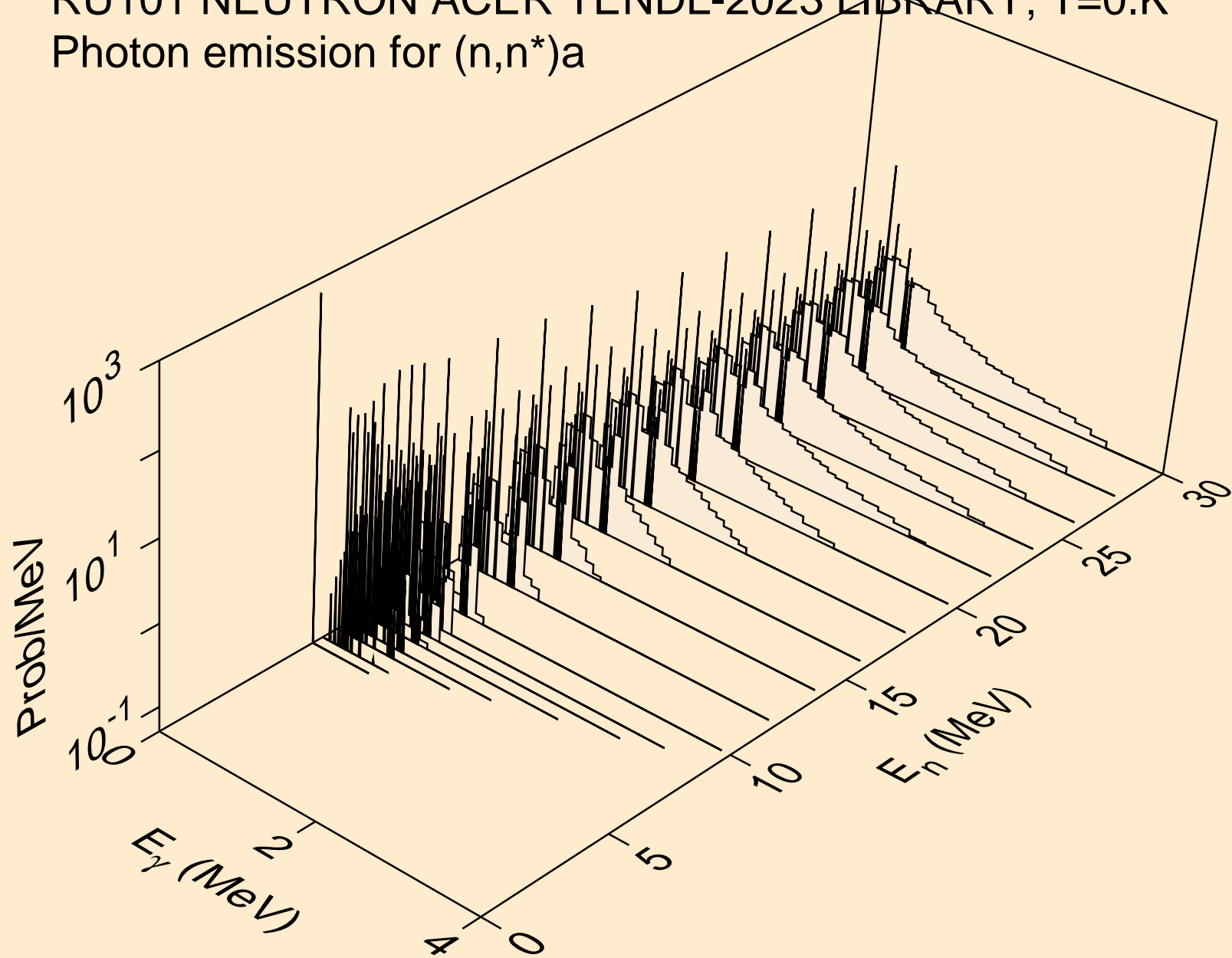

RU101 NEUTRON ACER TENDL-2023 LIBRARY; T=0.K  
Photon emission for (n,2n)a

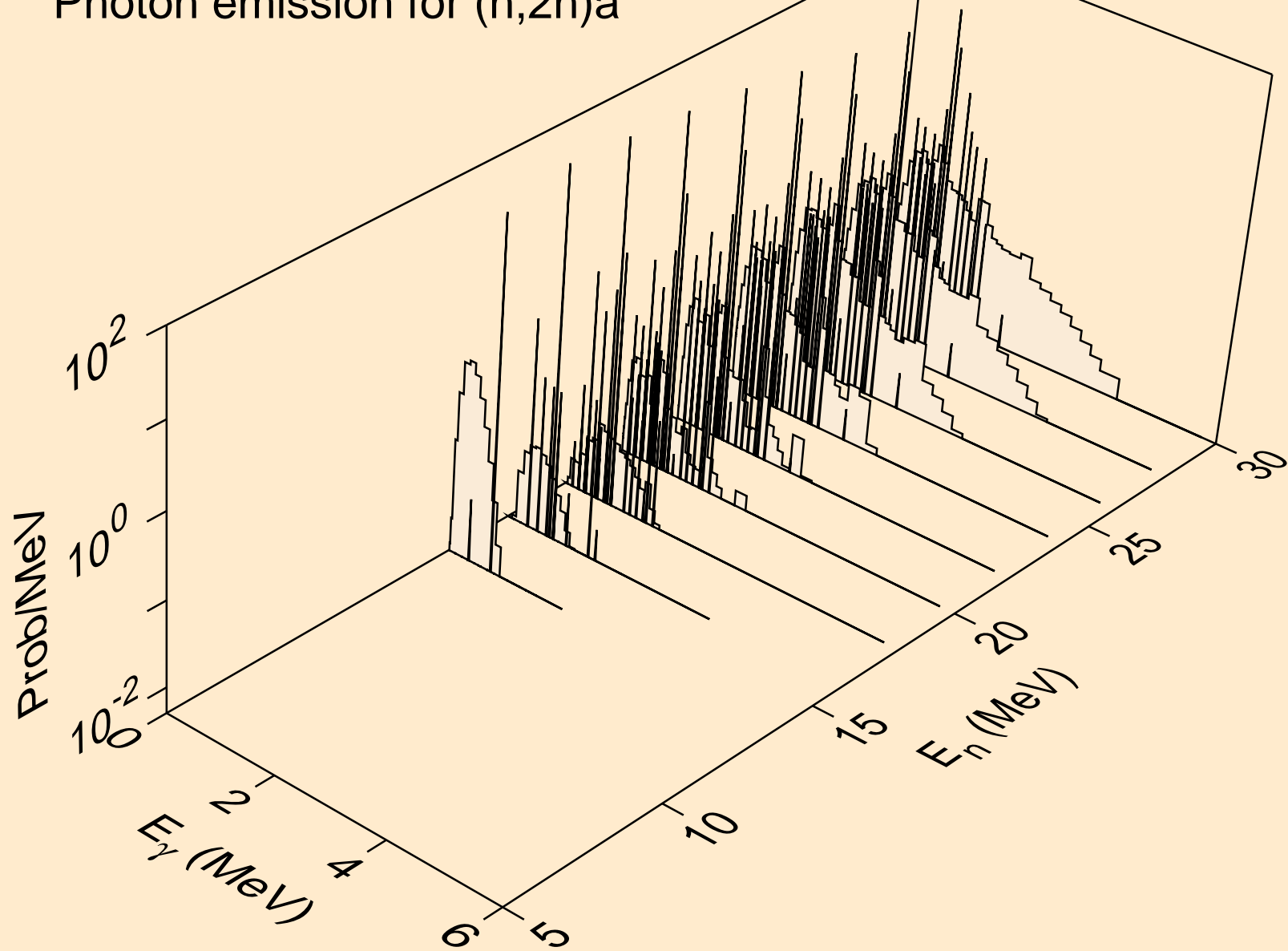

RU101 NEUTRON ACER TENDL-2023 LIBRARY; T=0.K  
Photon emission for (n,3n)a

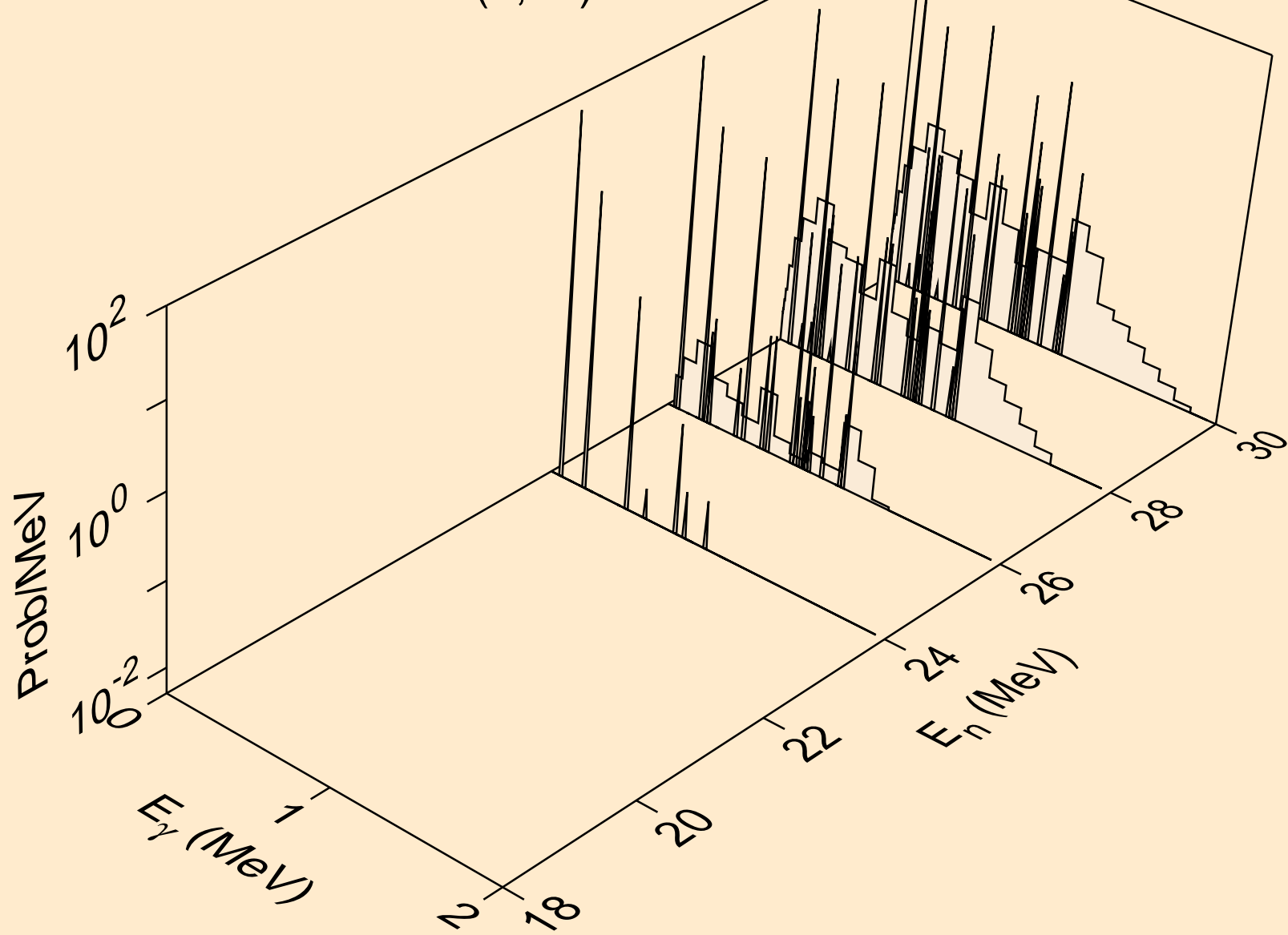

RU101 NEUTRON ACER TENDL-2023 LIBRARY; T=0.K  
Photon emission for (n,n\*)p

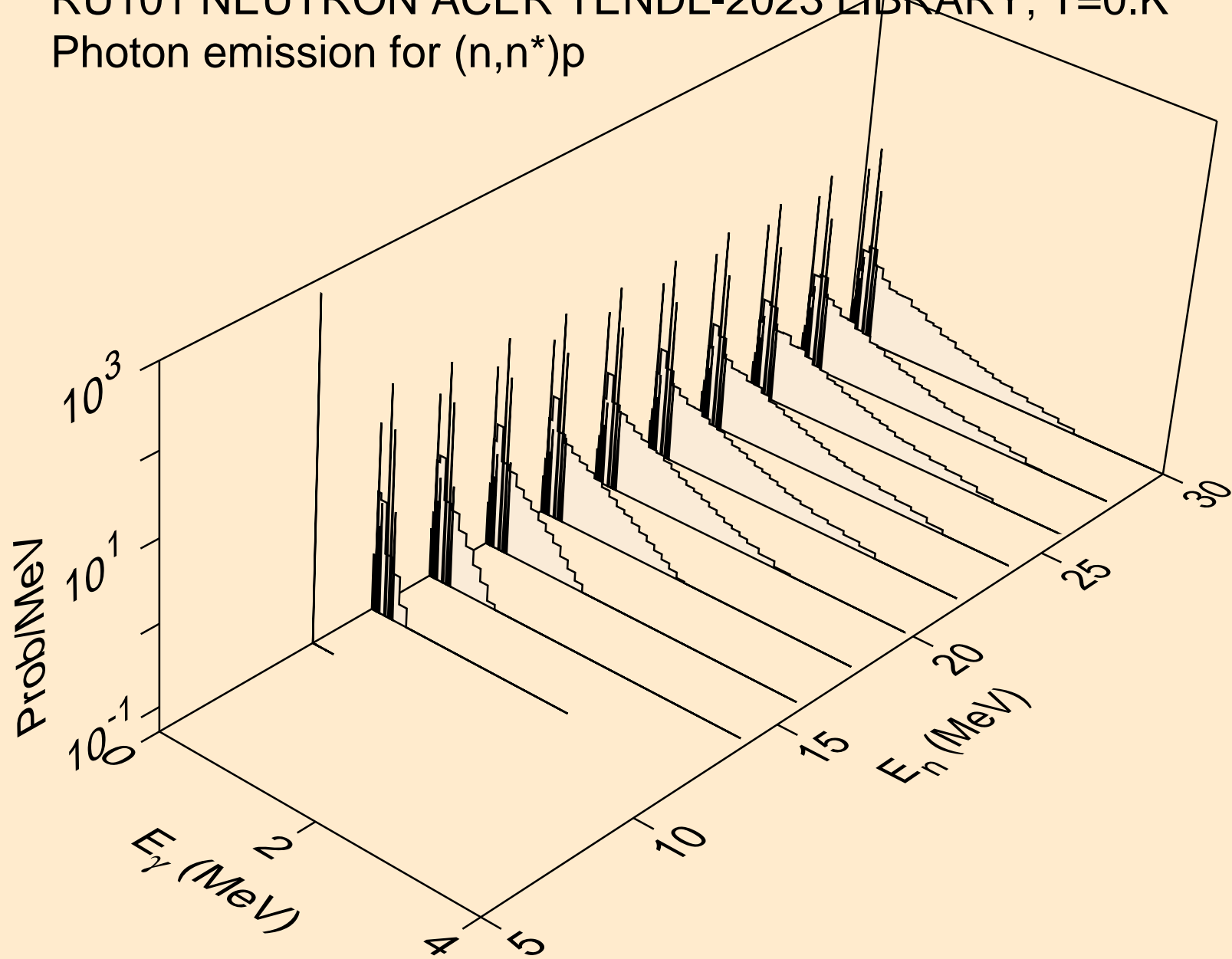

RU101 NEUTRON ACER TENDL-2023 LIBRARY; T=0.K  
Photon emission for (n,n\*)2a

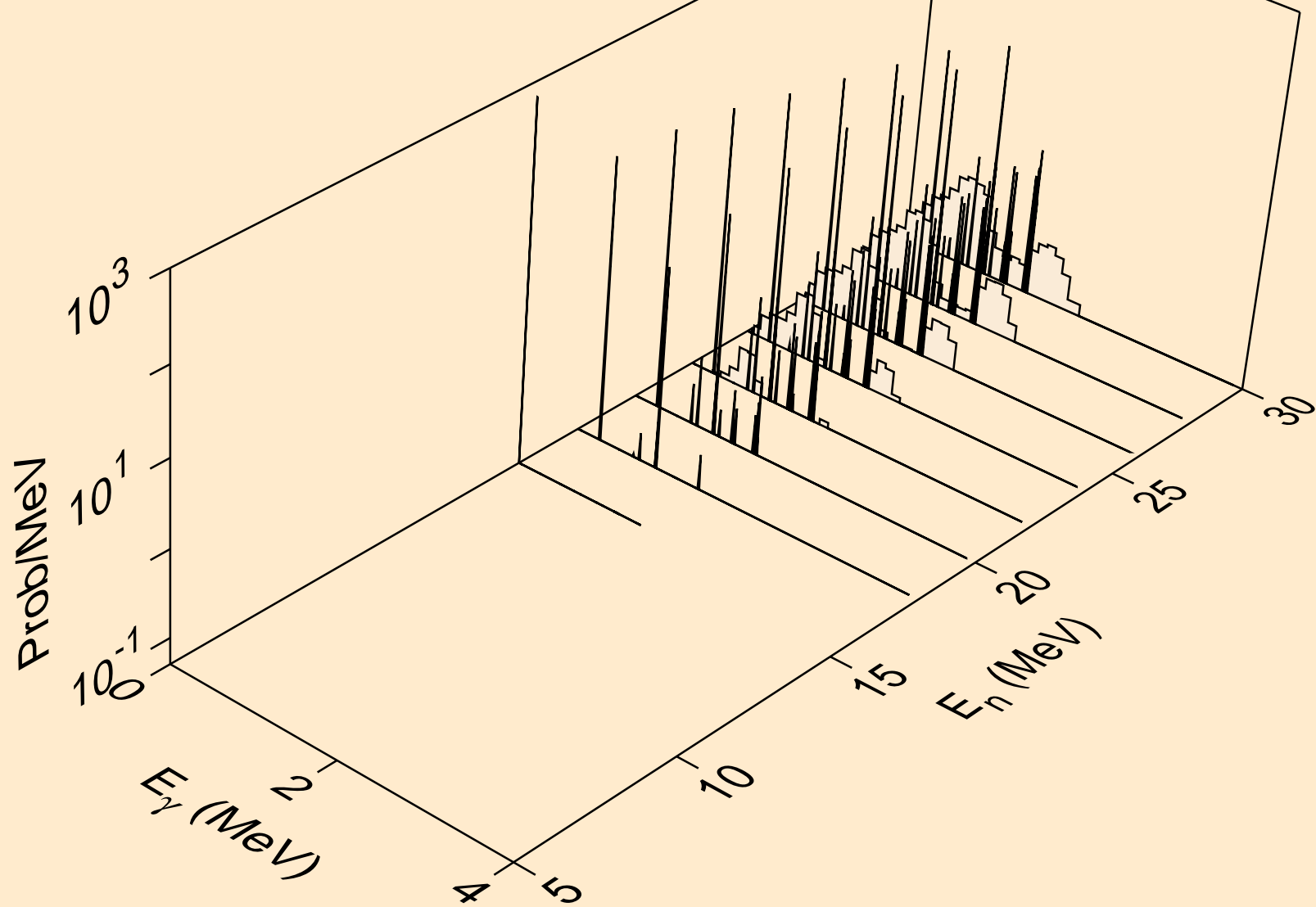

RU101 NEUTRON ACER TENDL-2023 LIBRARY; T=0.K  
Photon emission for (n,n\*)d

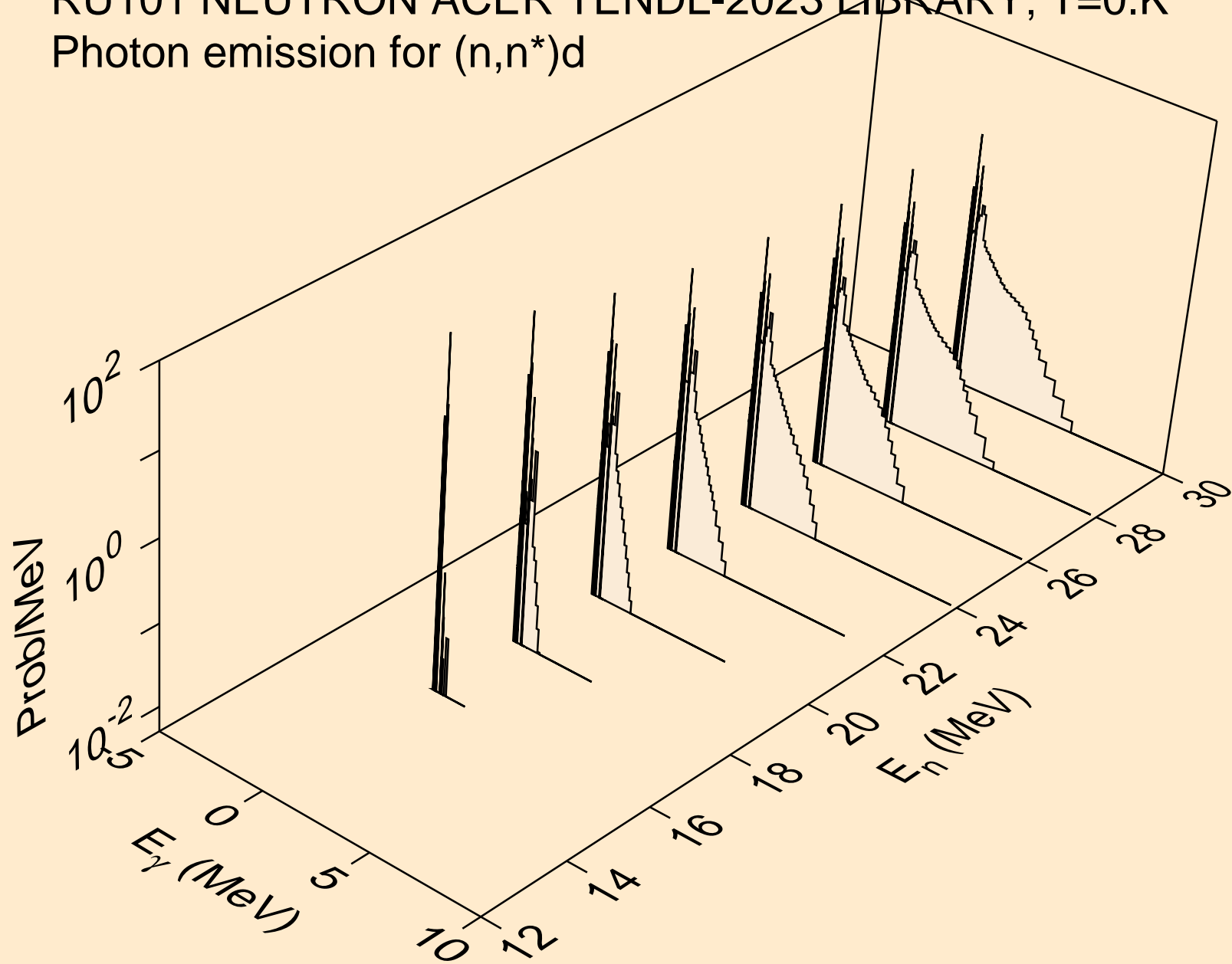

RU101 NEUTRON ACER TENDL-2023 LIBRARY; T=0.K  
Photon emission for (n,n\*)t

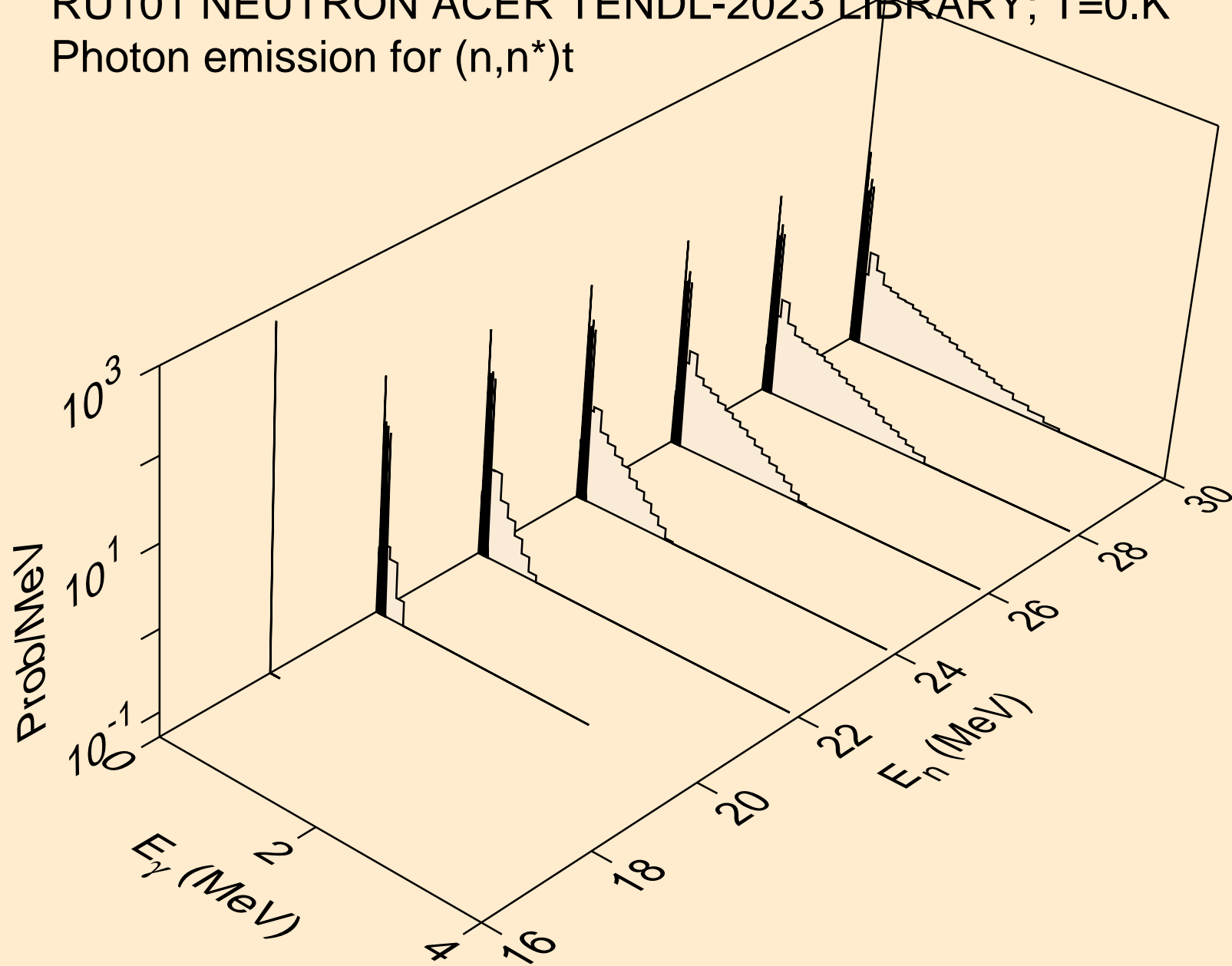

RU101 NEUTRON ACER TENDL-2023 LIBRARY; T=0.K  
Photon emission for (n,n\*)he3

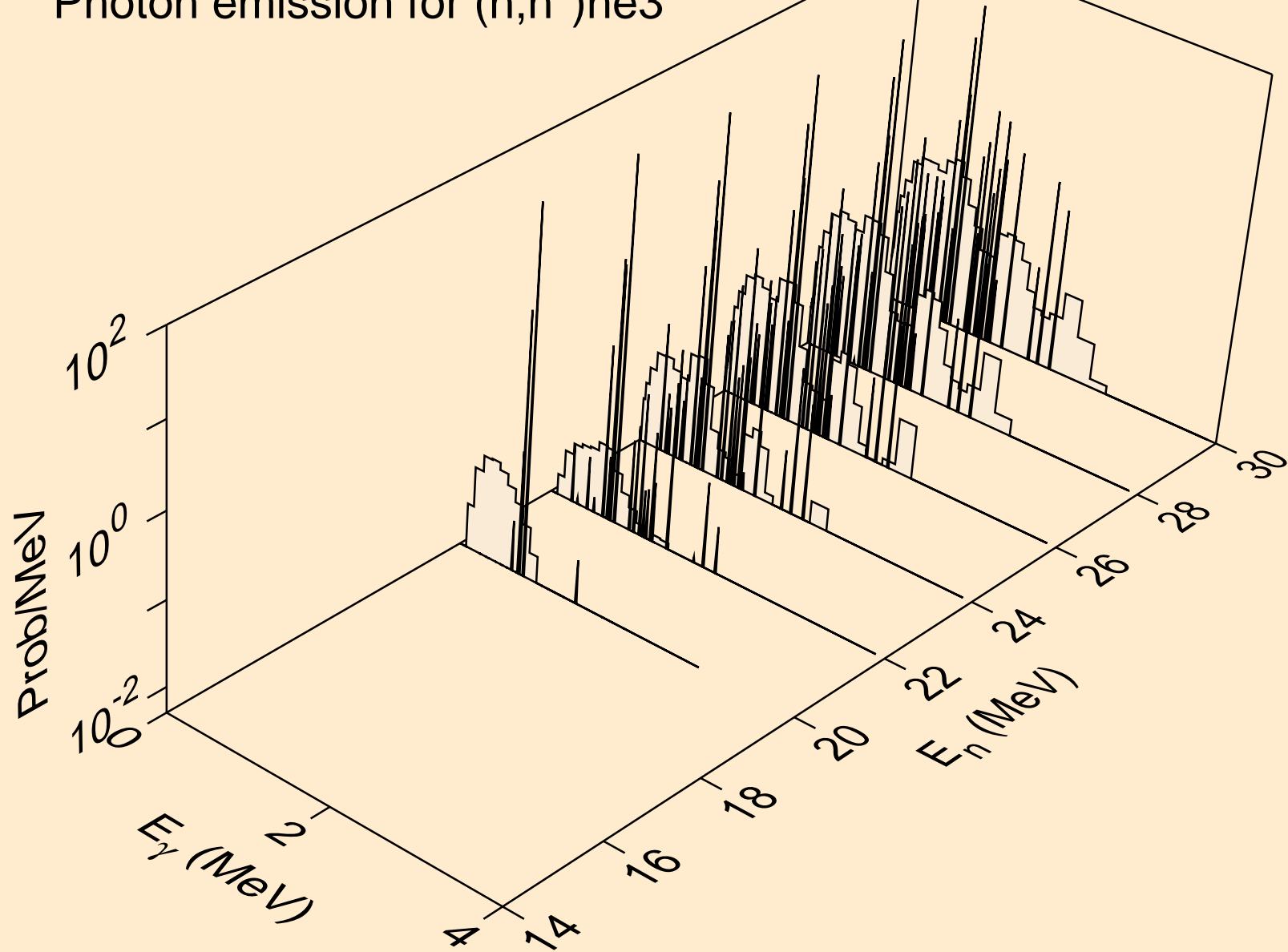

RU101 NEUTRON ACER TENDL-2023 LIBRARY; T=0.K  
Photon emission for (n,4n)

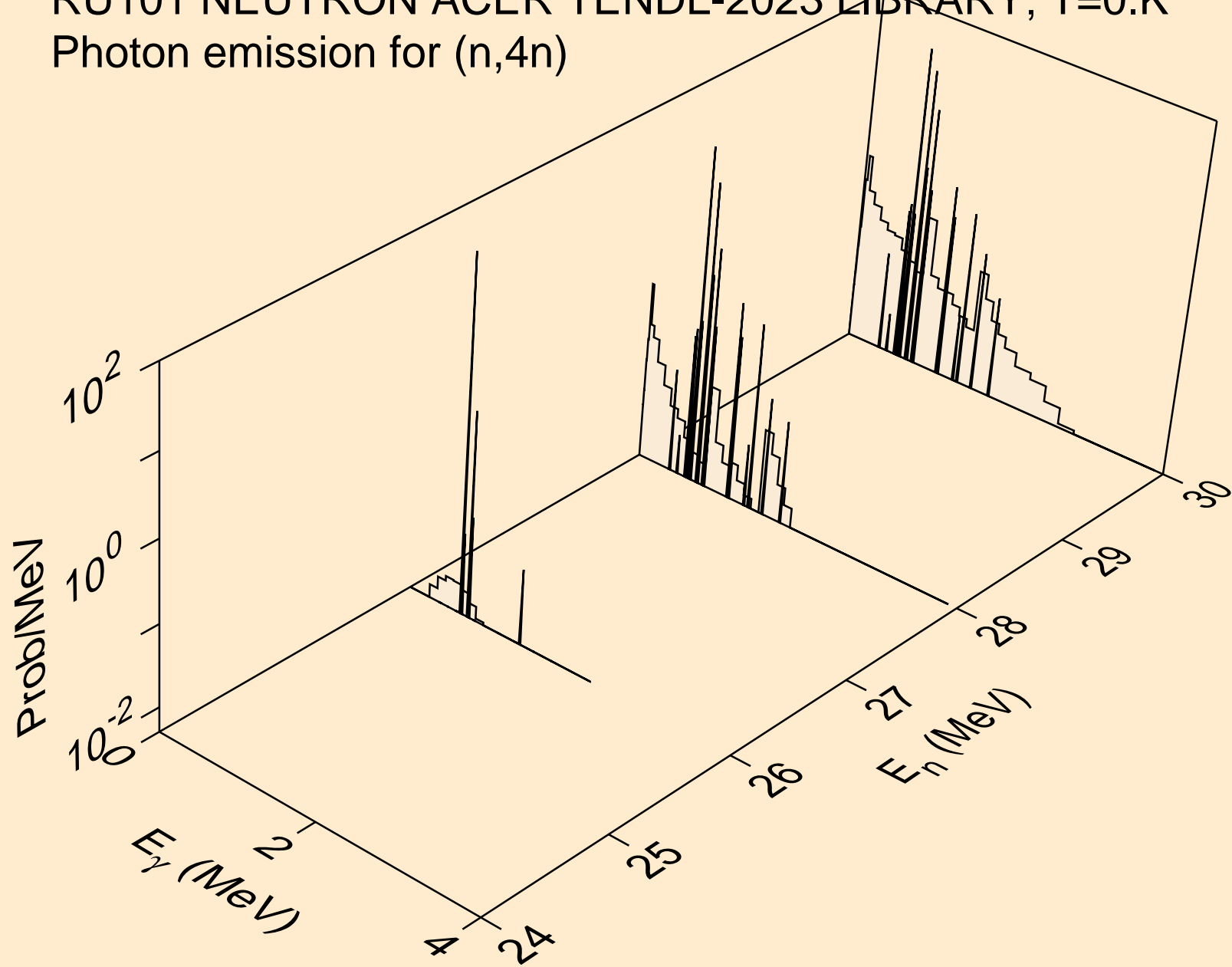

RU101 NEUTRON ACER TENDL-2023 LIBRARY; T=0.K  
Photon emission for (n,2np)

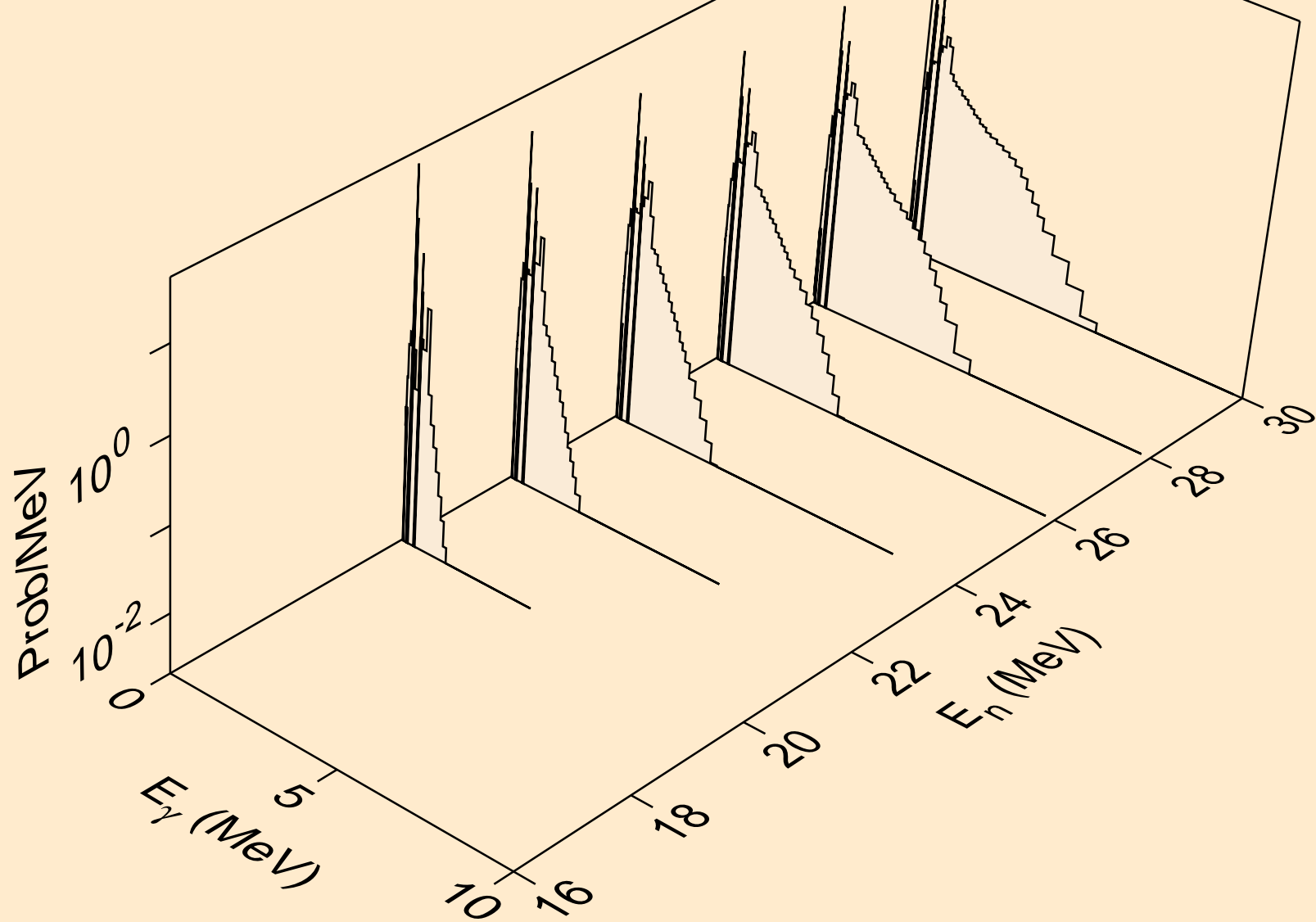

RU101 NEUTRON ACER TENDL-2023 LIBRARY; T=0.K  
Photon emission for (n,3np)

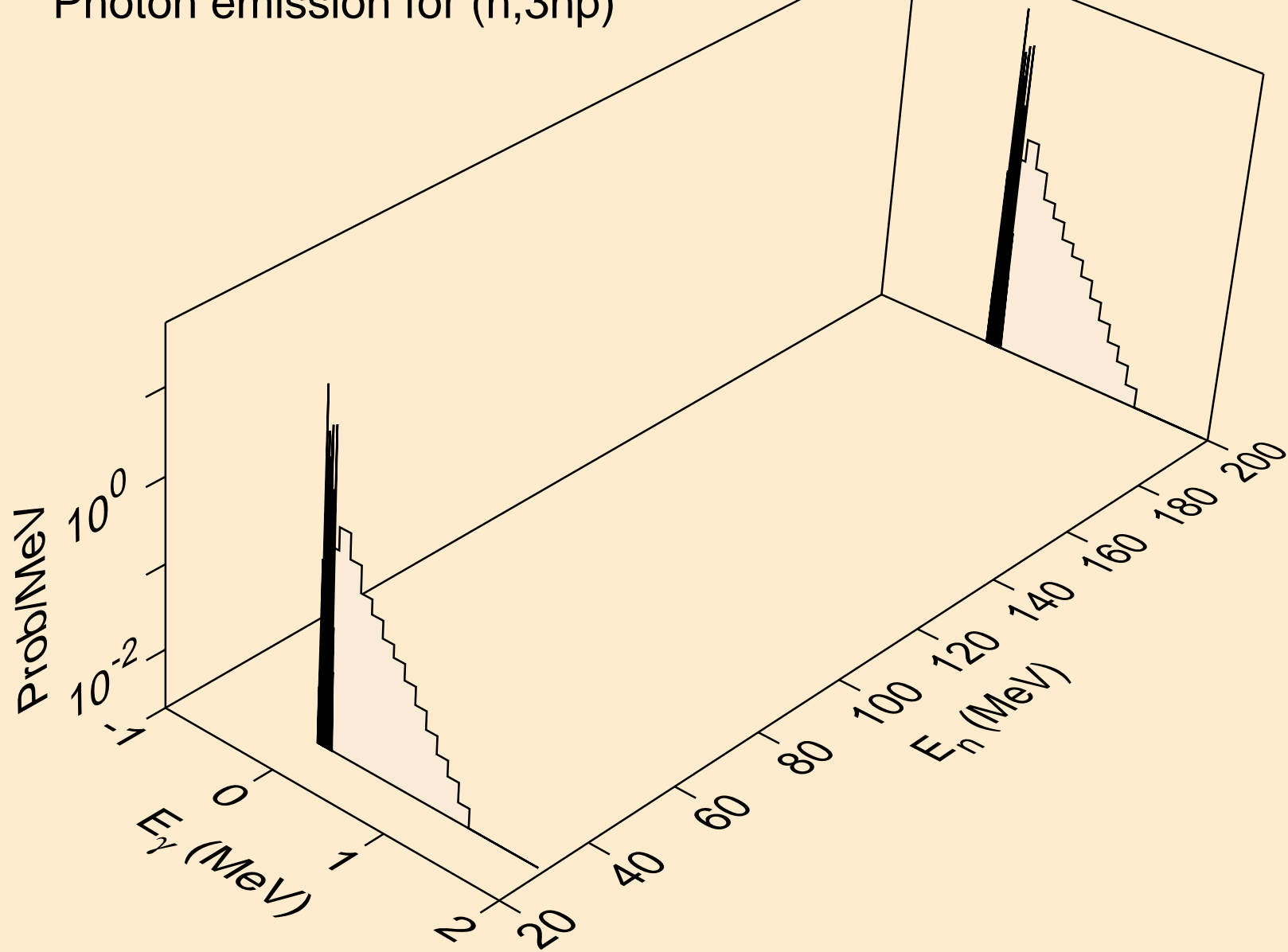

RU101 NEUTRON ACER TENDL-2023 LIBRARY; T=0.K  
Photon emission for (n,n2p)

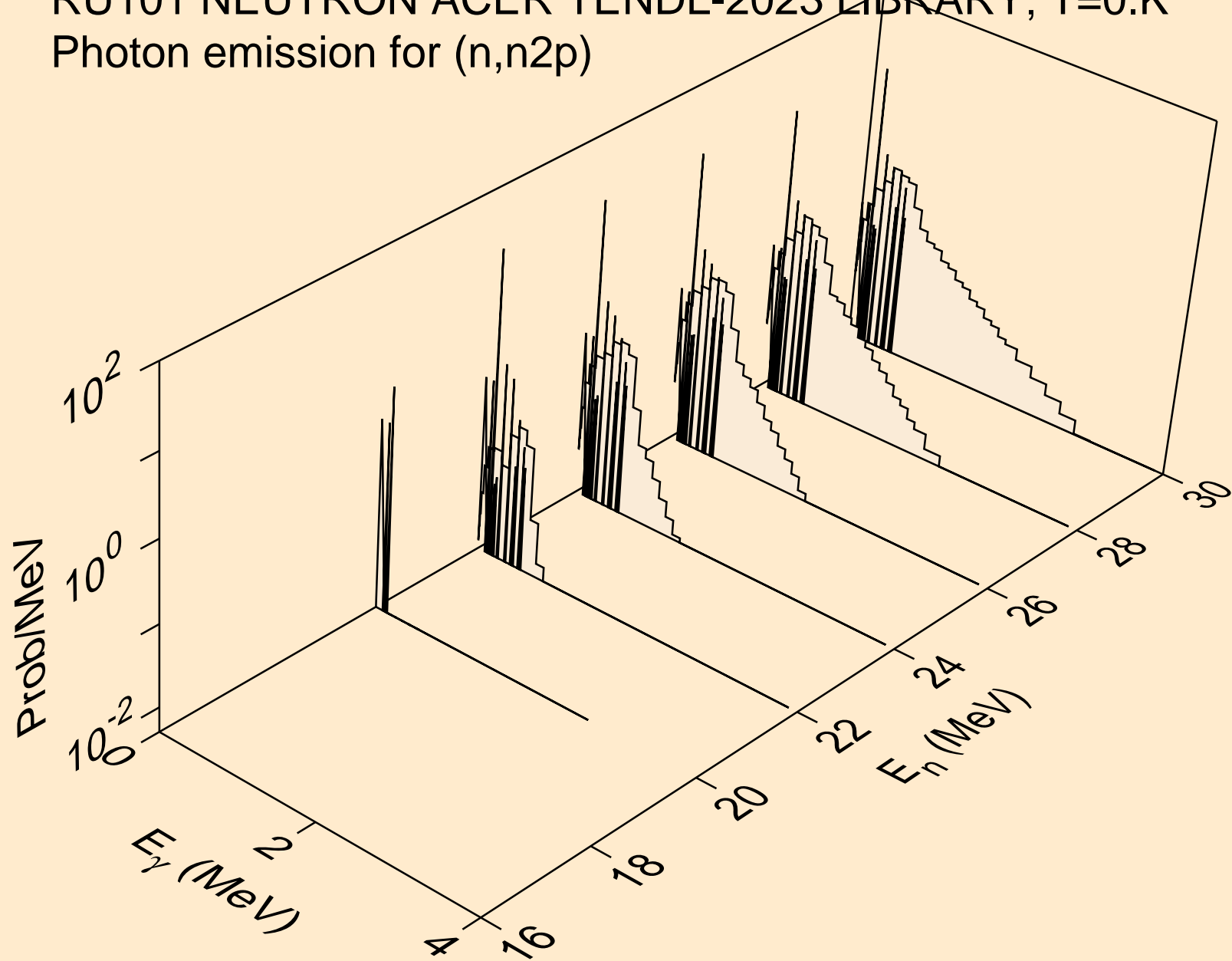

RU101 NEUTRON ACER TENDL-2023 LIBRARY; T=0.K  
Photon emission for (n,npa)

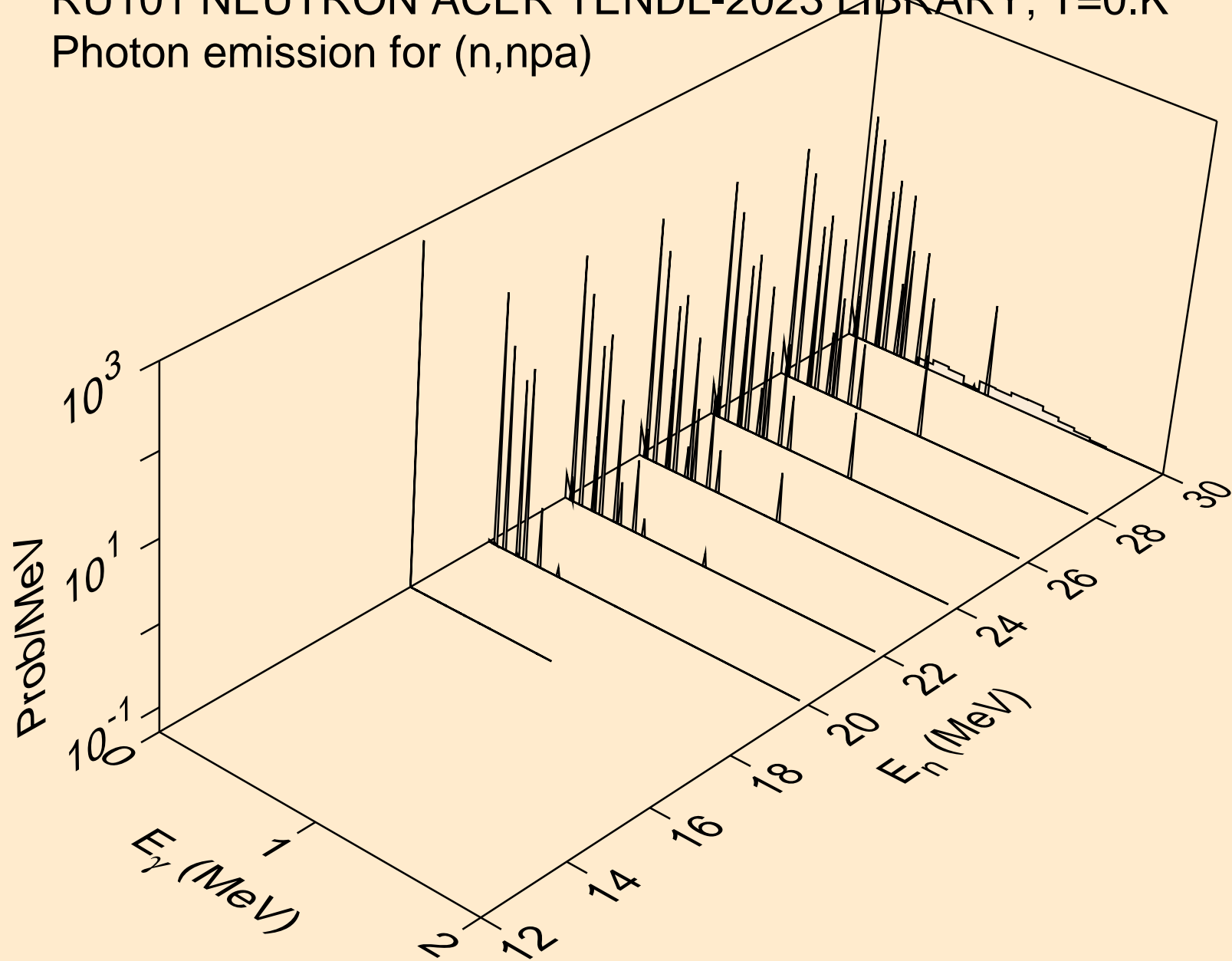

RU101 NEUTRON ACER TENDL-2023 LIBRARY; T=0.K  
Photon emission for (n,n\*c)

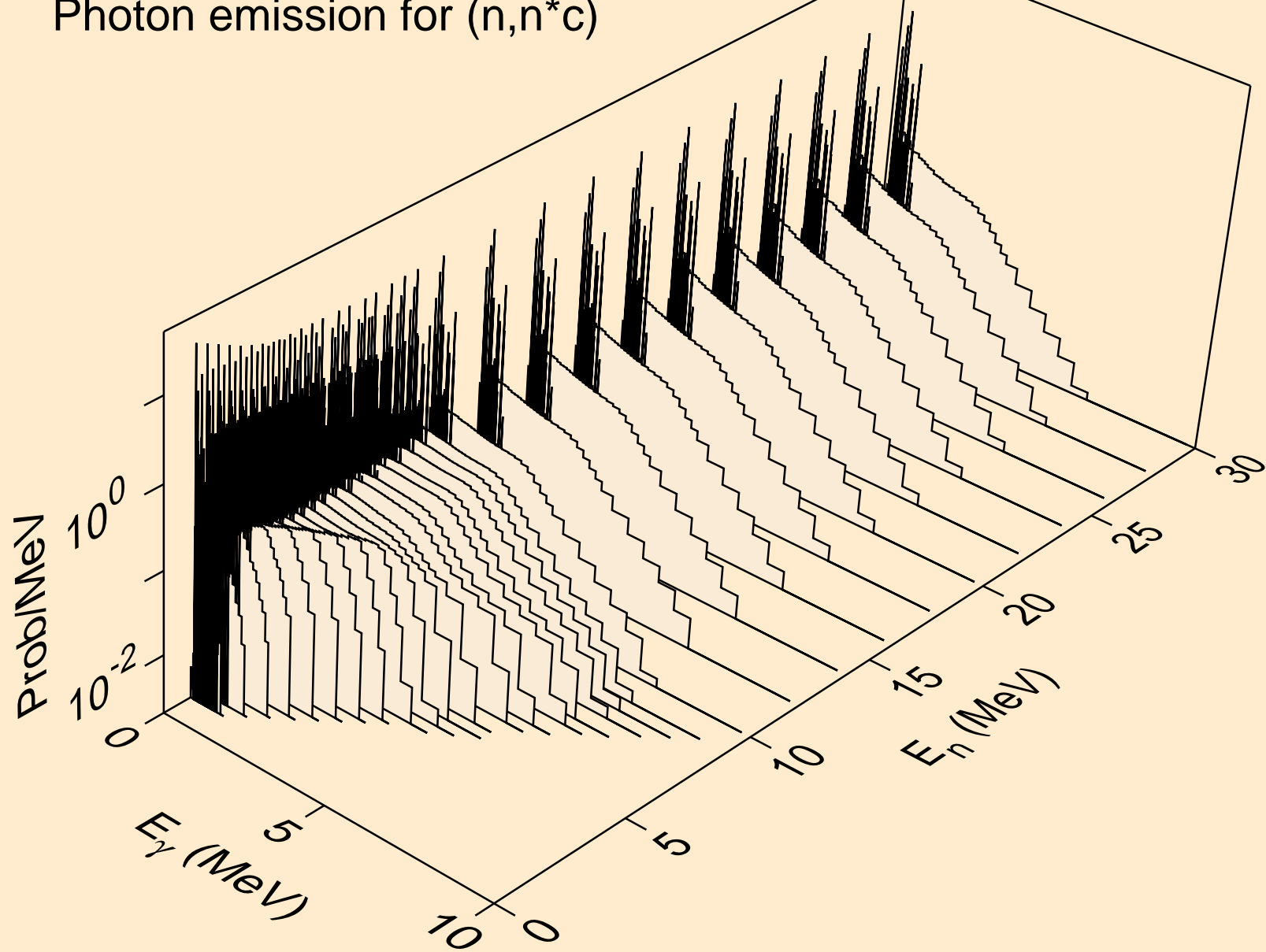

RU101 NEUTRON ACER TENDL-2023 LIBRARY; T=0.K  
Photon emission for (n,gma)

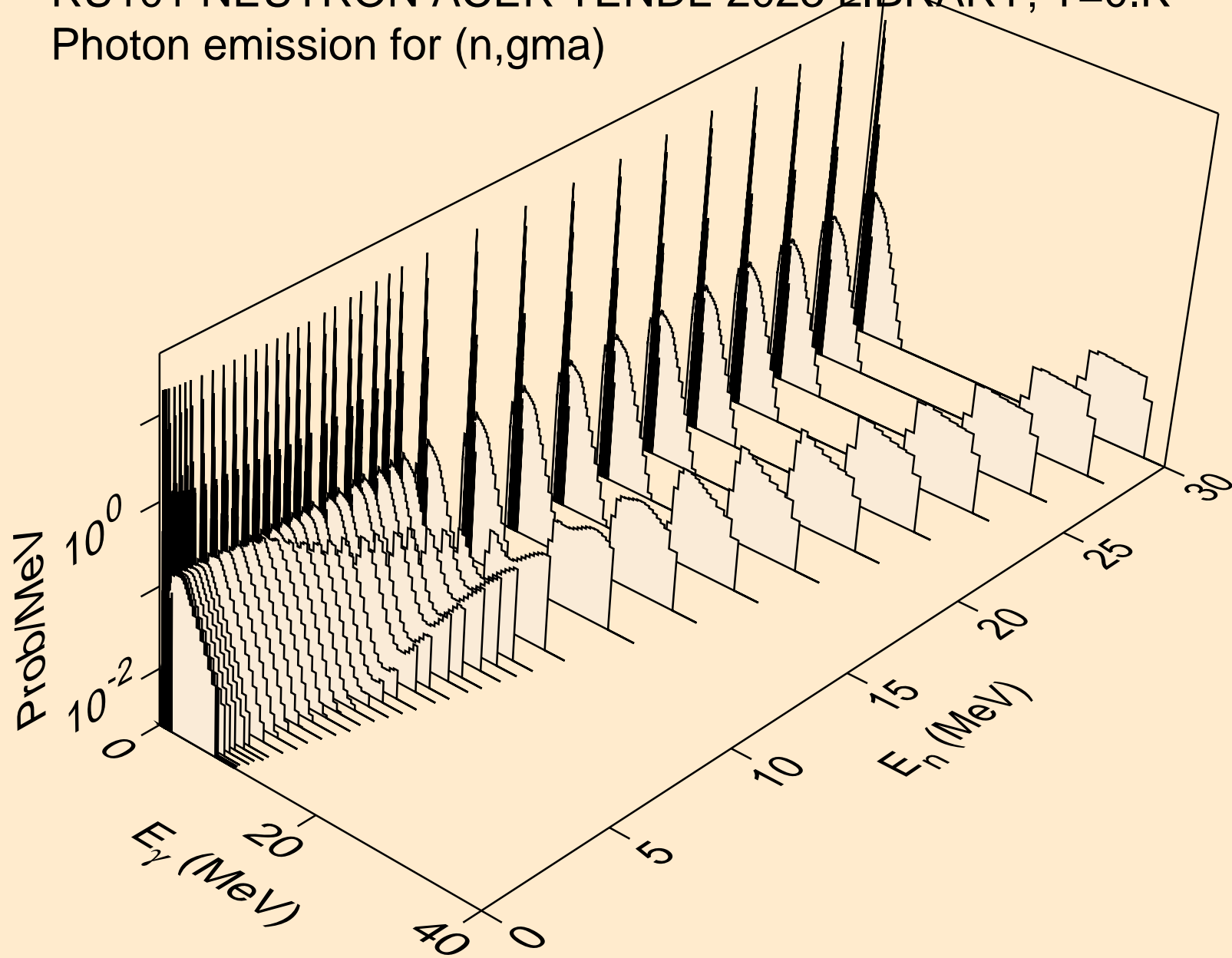

RU101 NEUTRON ACER TENDL-2023 LIBRARY; T=0.K  
Photon emission for (n,p)

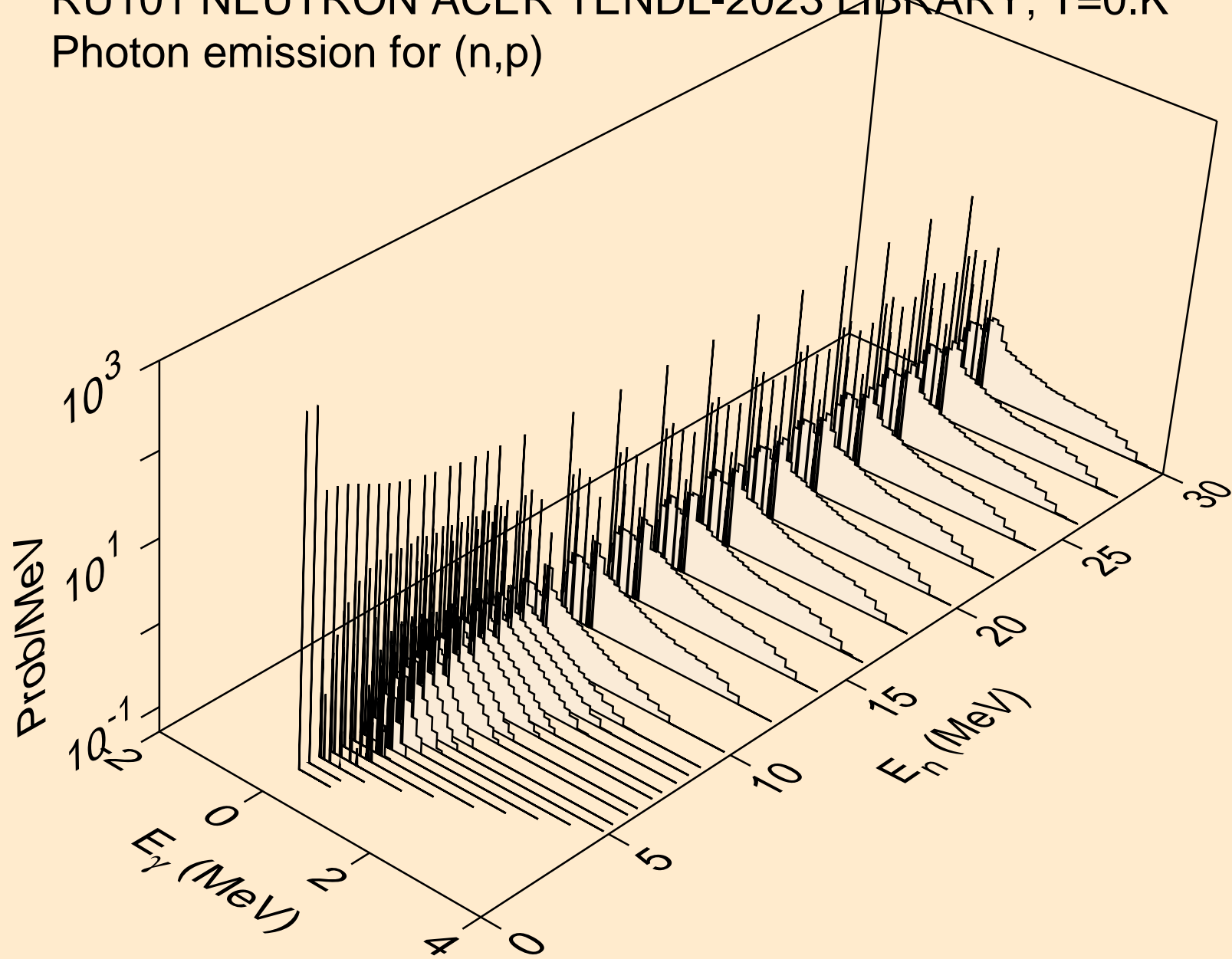

RU101 NEUTRON ACER TENDL-2023 LIBRARY; T=0.K  
Photon emission for (n,d)

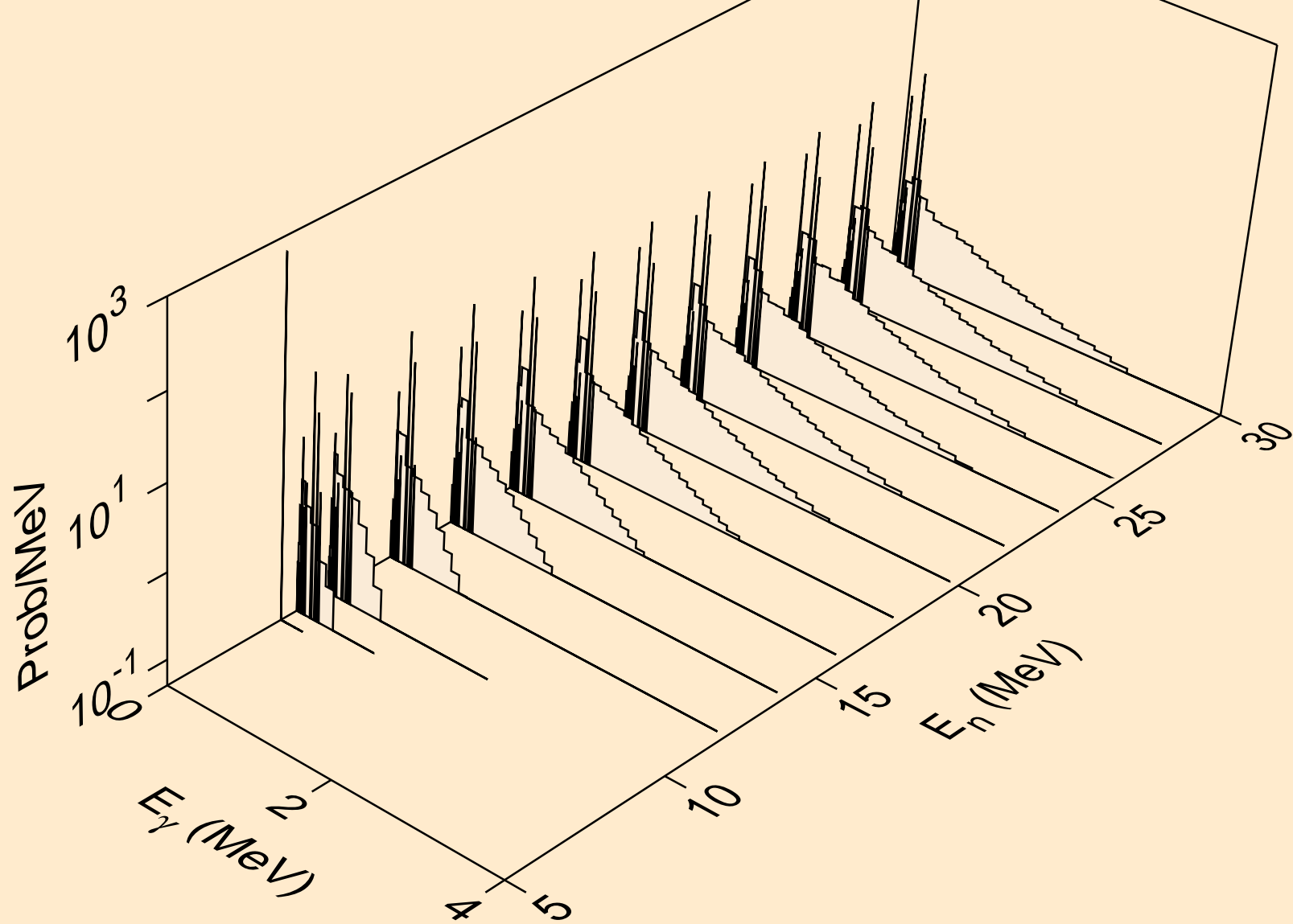

RU101 NEUTRON ACER TENDL-2023 LIBRARY; T=0.K  
Photon emission for (n,t)

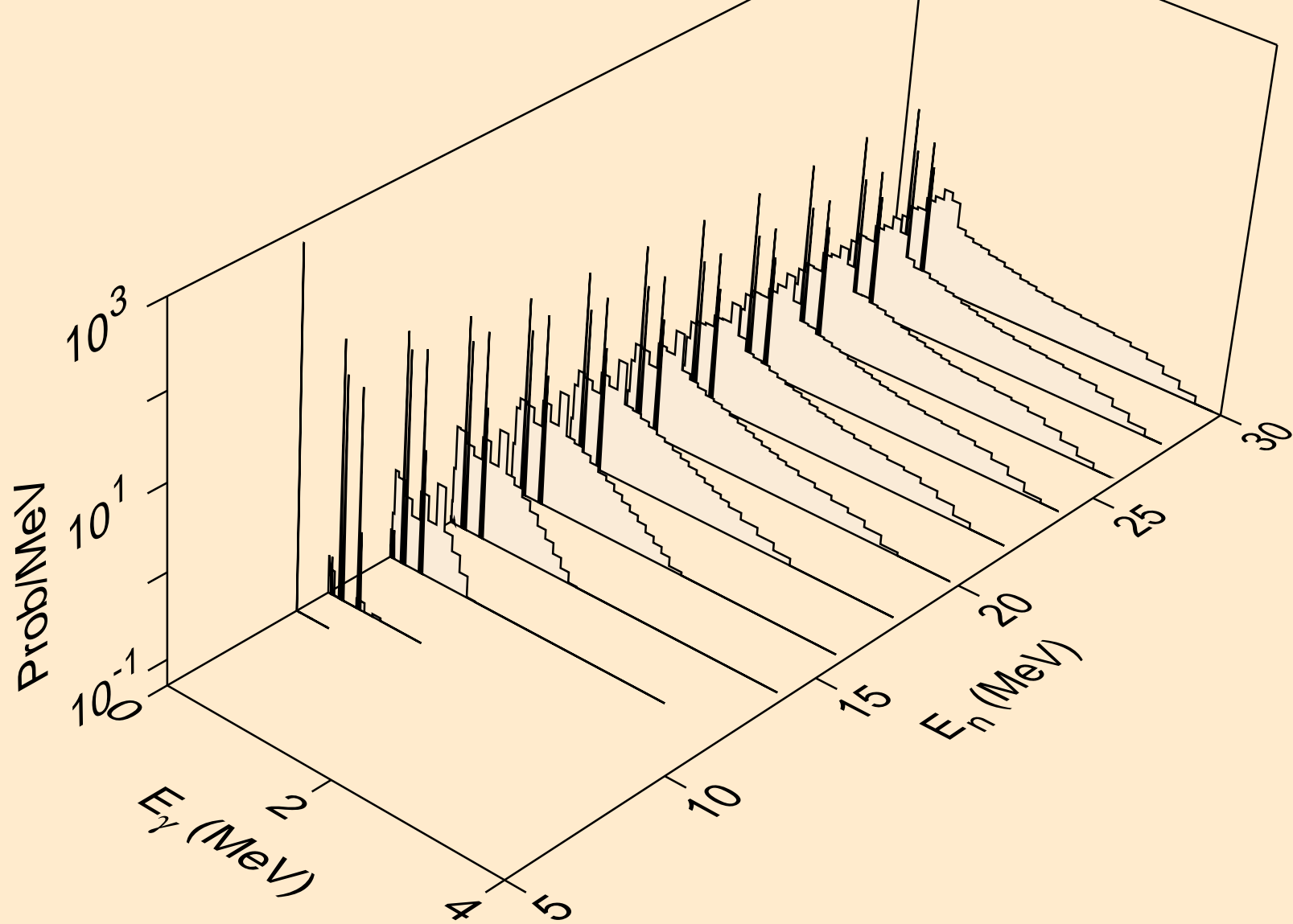

RU101 NEUTRON ACER TENDL-2023 LIBRARY; T=0.K  
Photon emission for (n,he3)

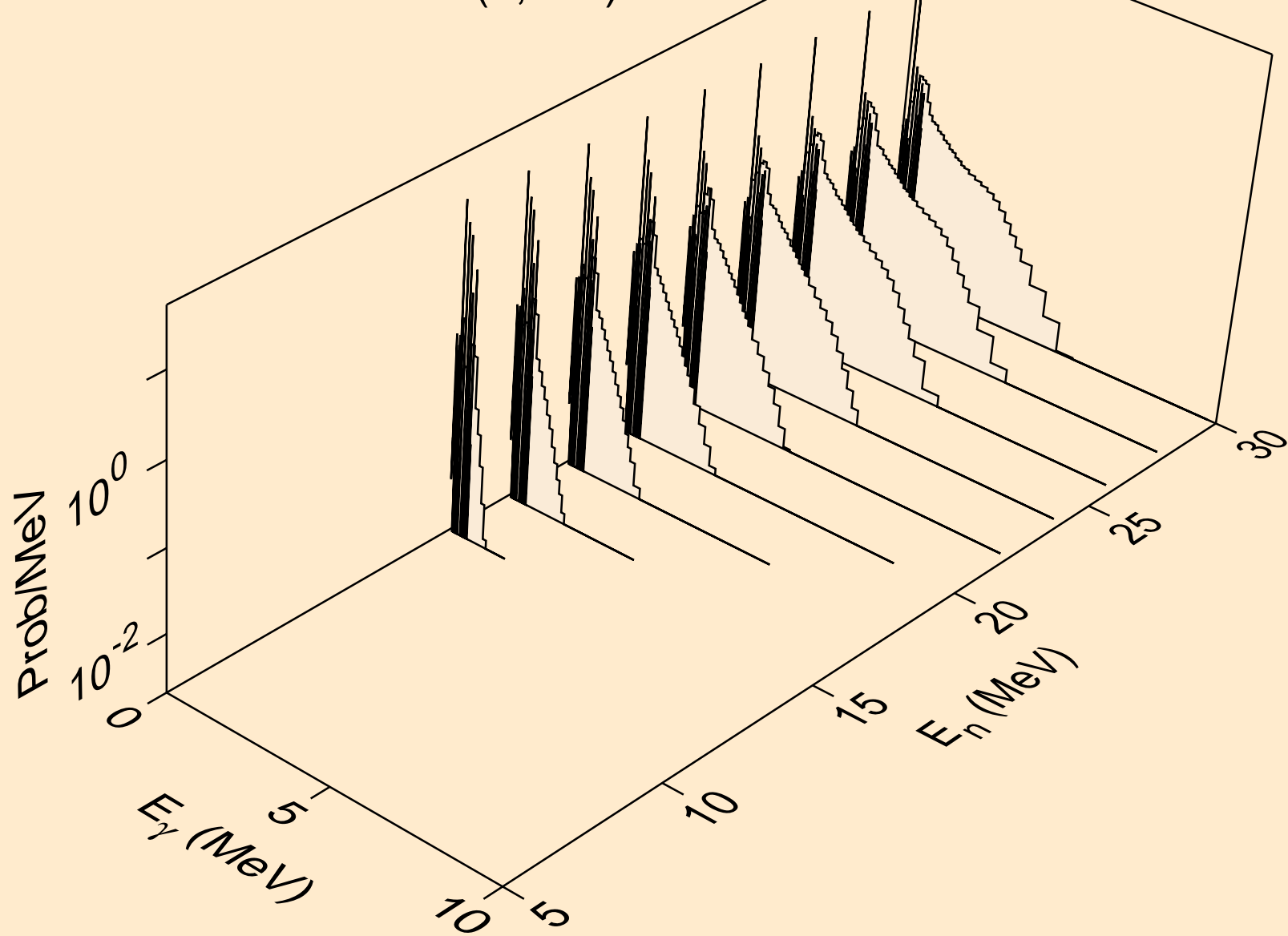

RU101 NEUTRON ACER TENDL-2023 LIBRARY; T=0.K  
Photon emission for (n,a)

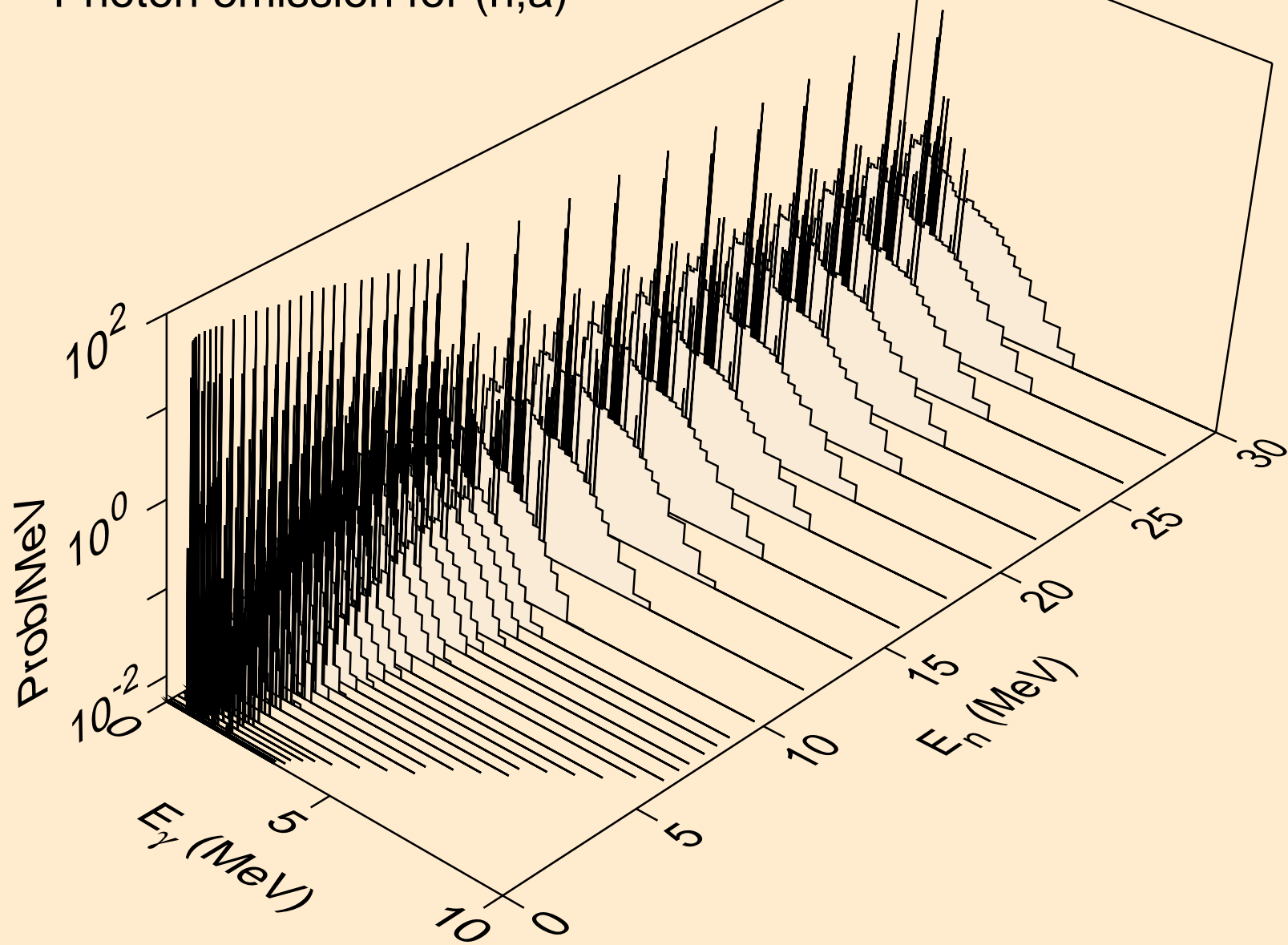

RU101 NEUTRON ACER TENDL-2023 LIBRARY; T=0.K  
Photon emission for (n,2a)

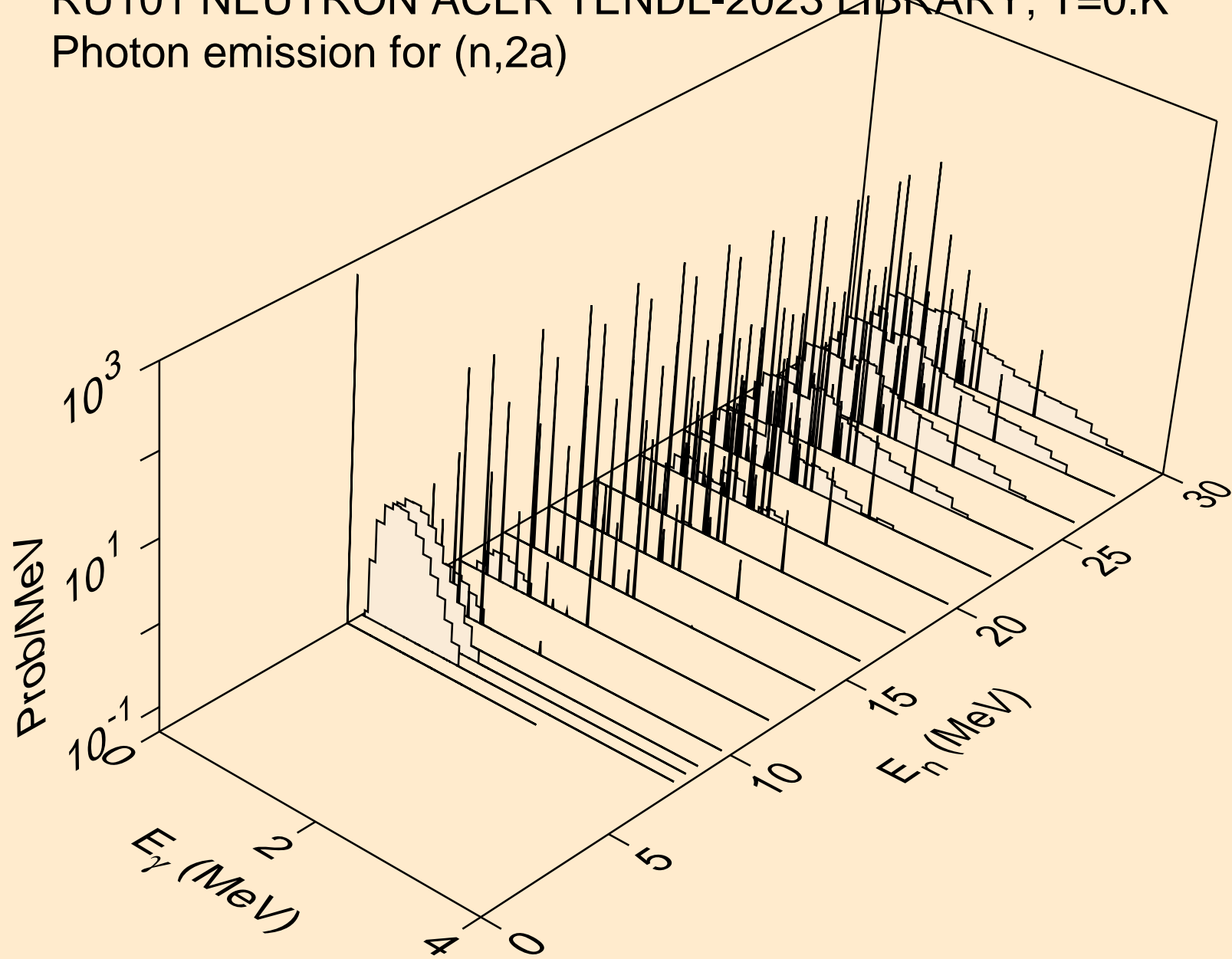

RU101 NEUTRON ACER TENDL-2023 LIBRARY; T=0.K  
Photon emission for (n,2p)

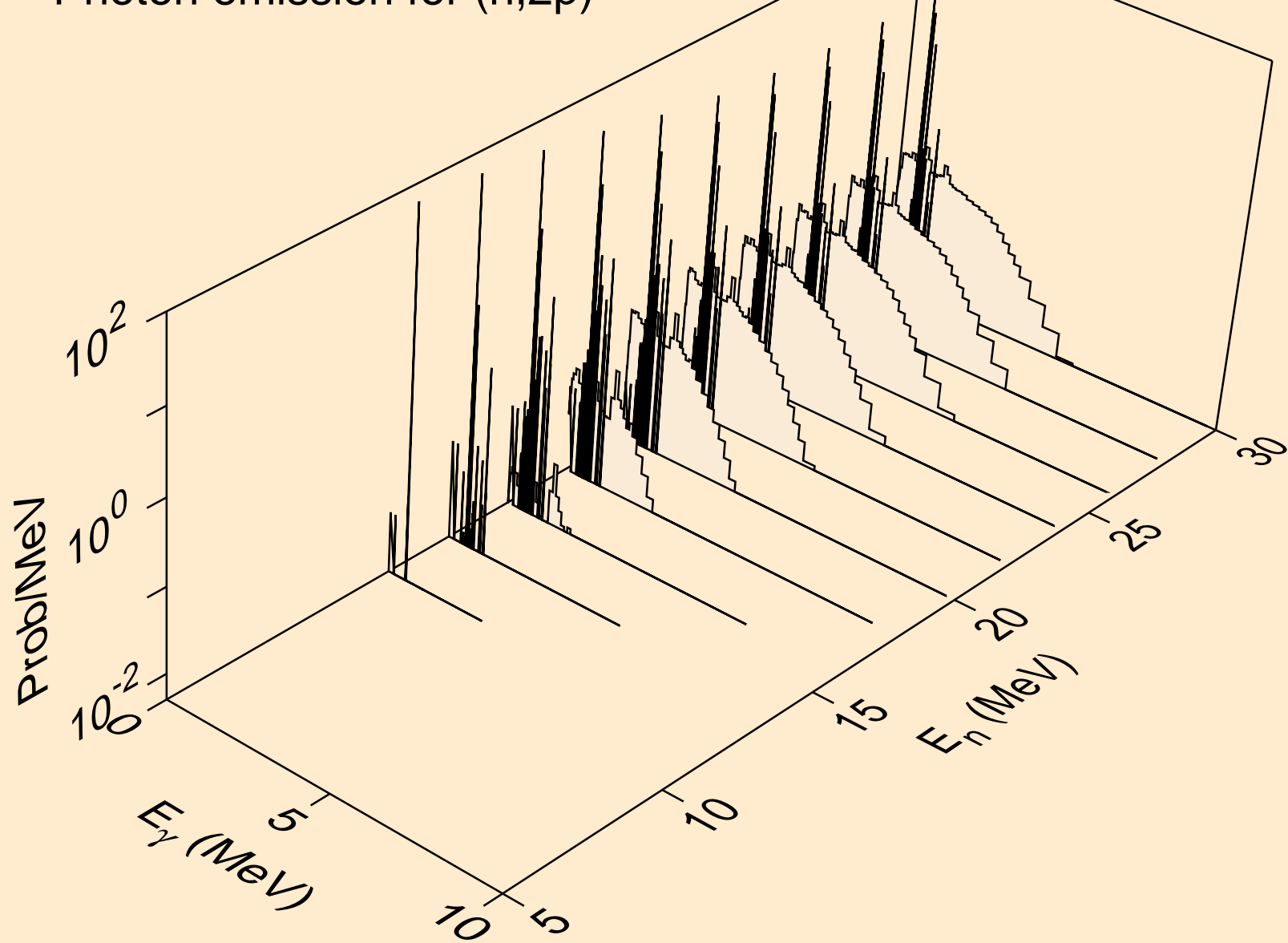

RU101 NEUTRON ACER TENDL-2023 LIBRARY; T=0.K  
Photon emission for (n,p)

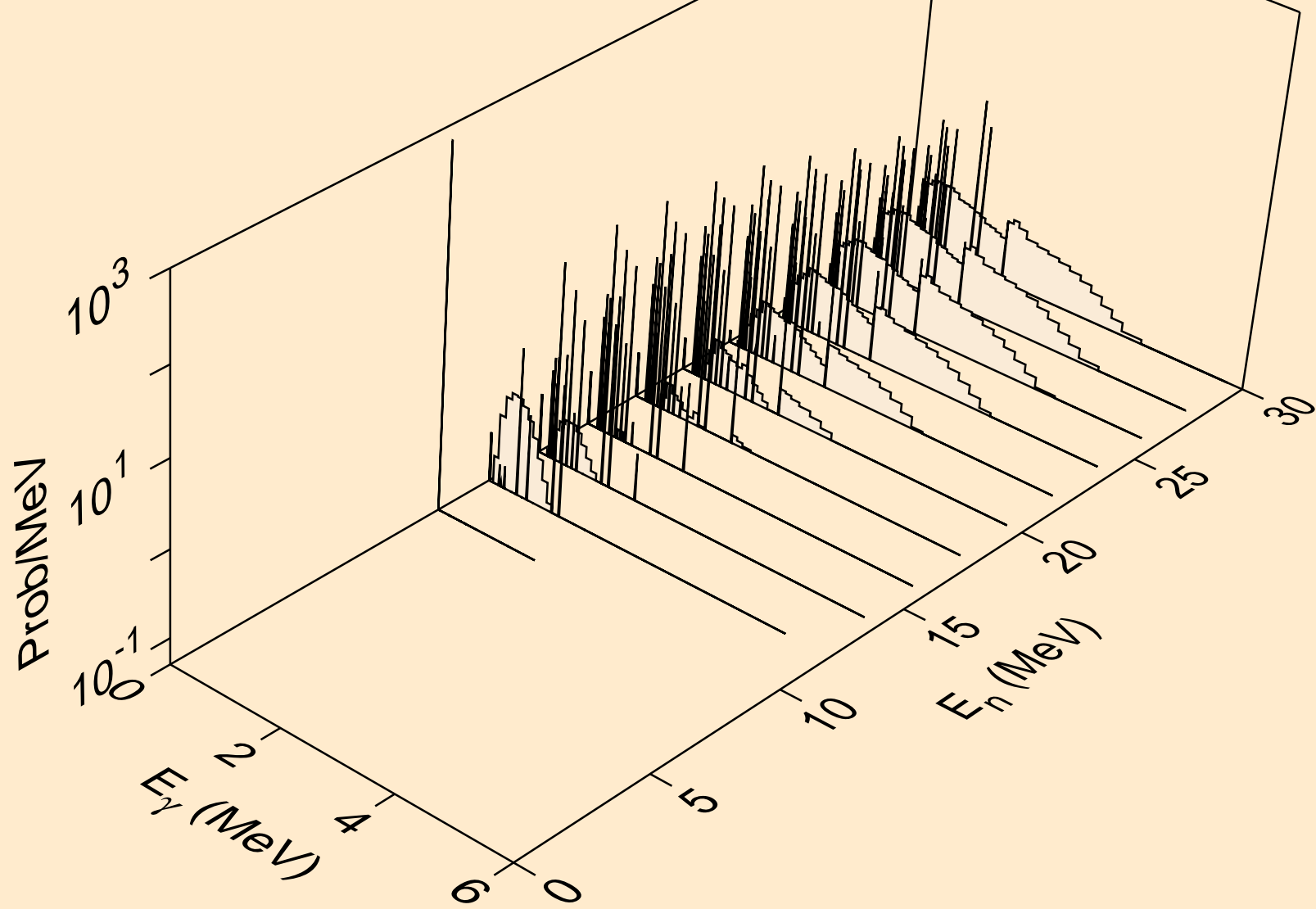

RU101 NEUTRON ACER TENDL-2023 LIBRARY; T=0.K  
Photon emission for (n,pd)

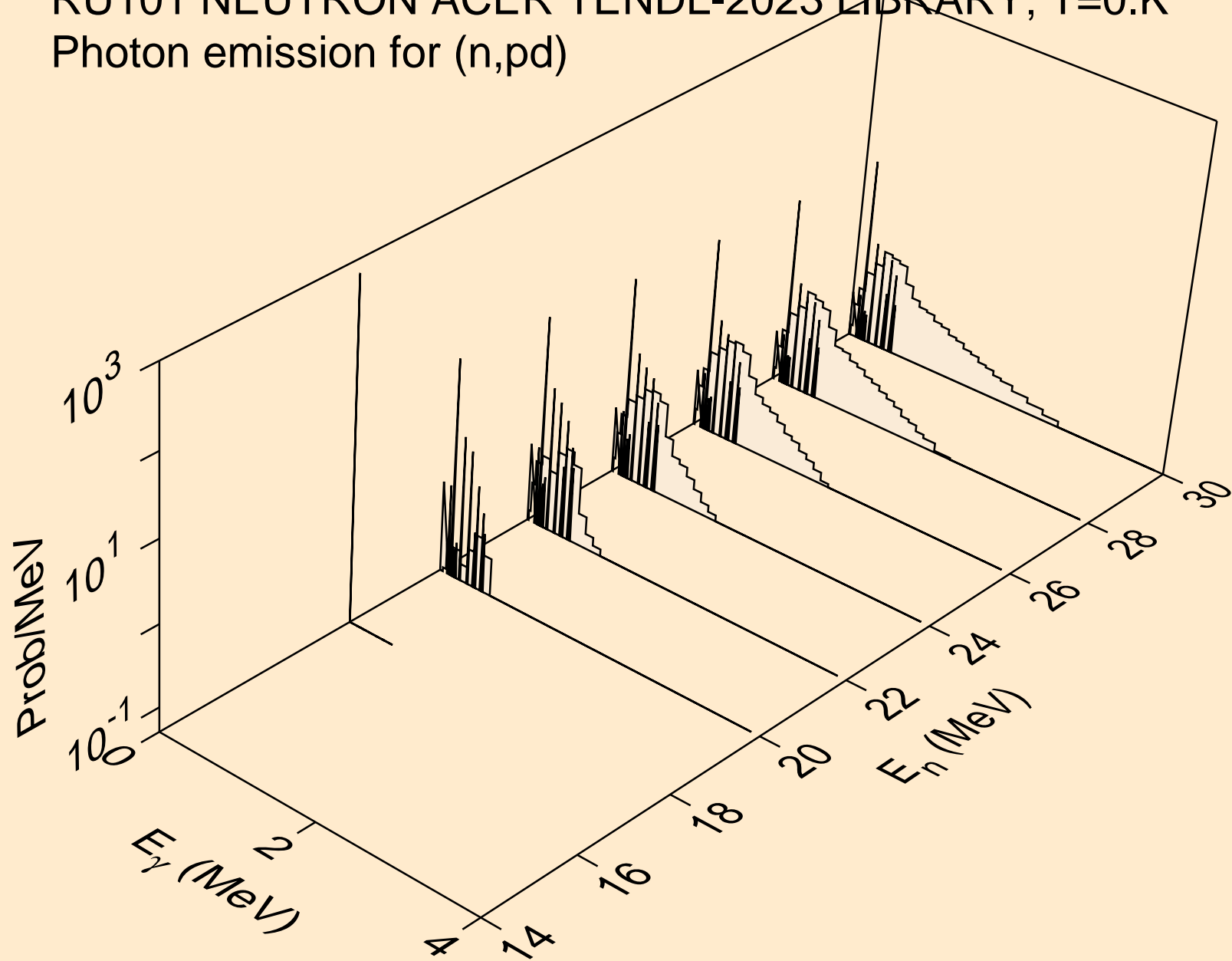

RU101 NEUTRON ACER TENDL-2023 LIBRARY; T=0.K  
Photon emission for (n,pt)

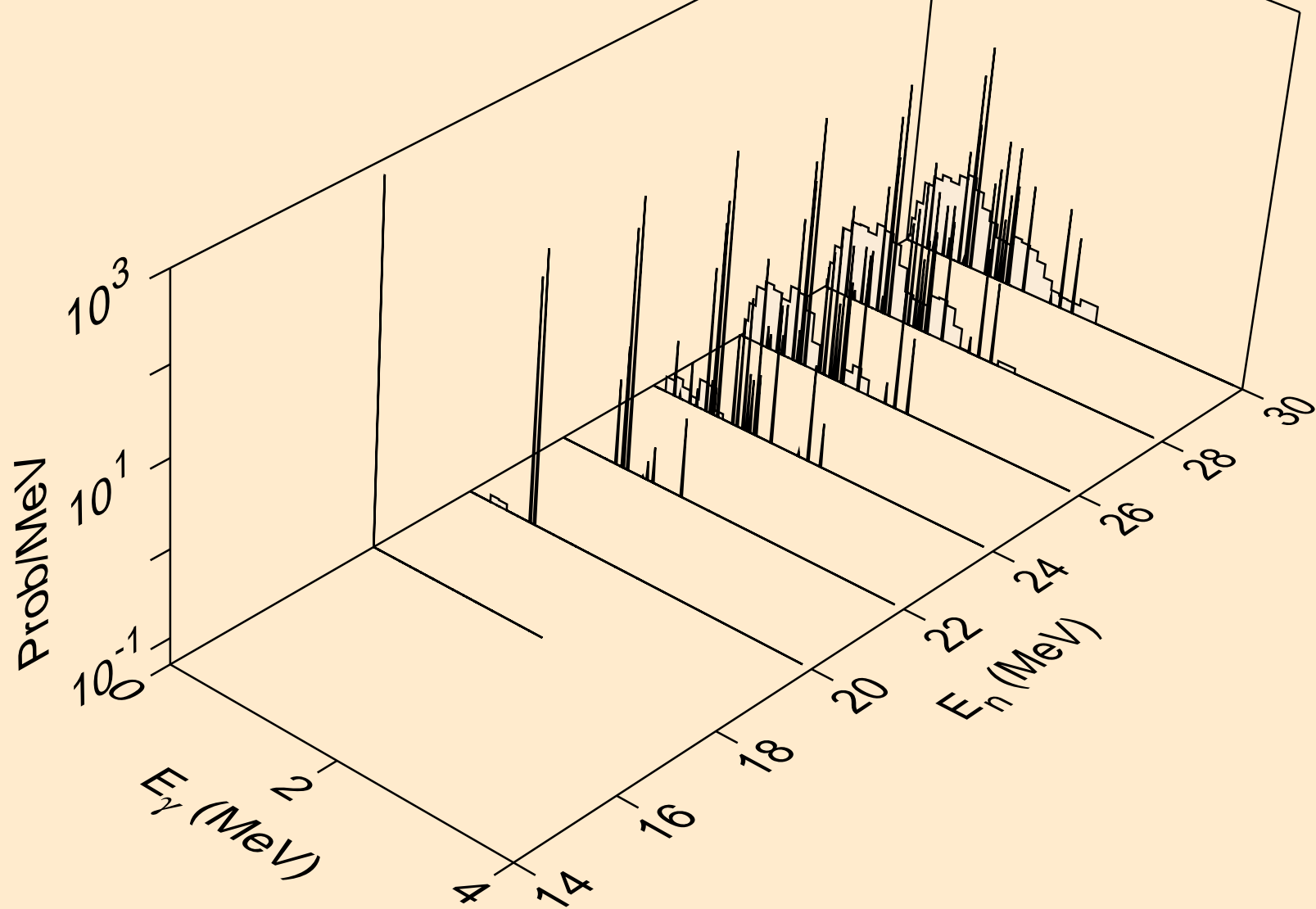

RU101 NEUTRON ACER TENDL-2023 LIBRARY; T=0.K  
Photon emission for (n,da)

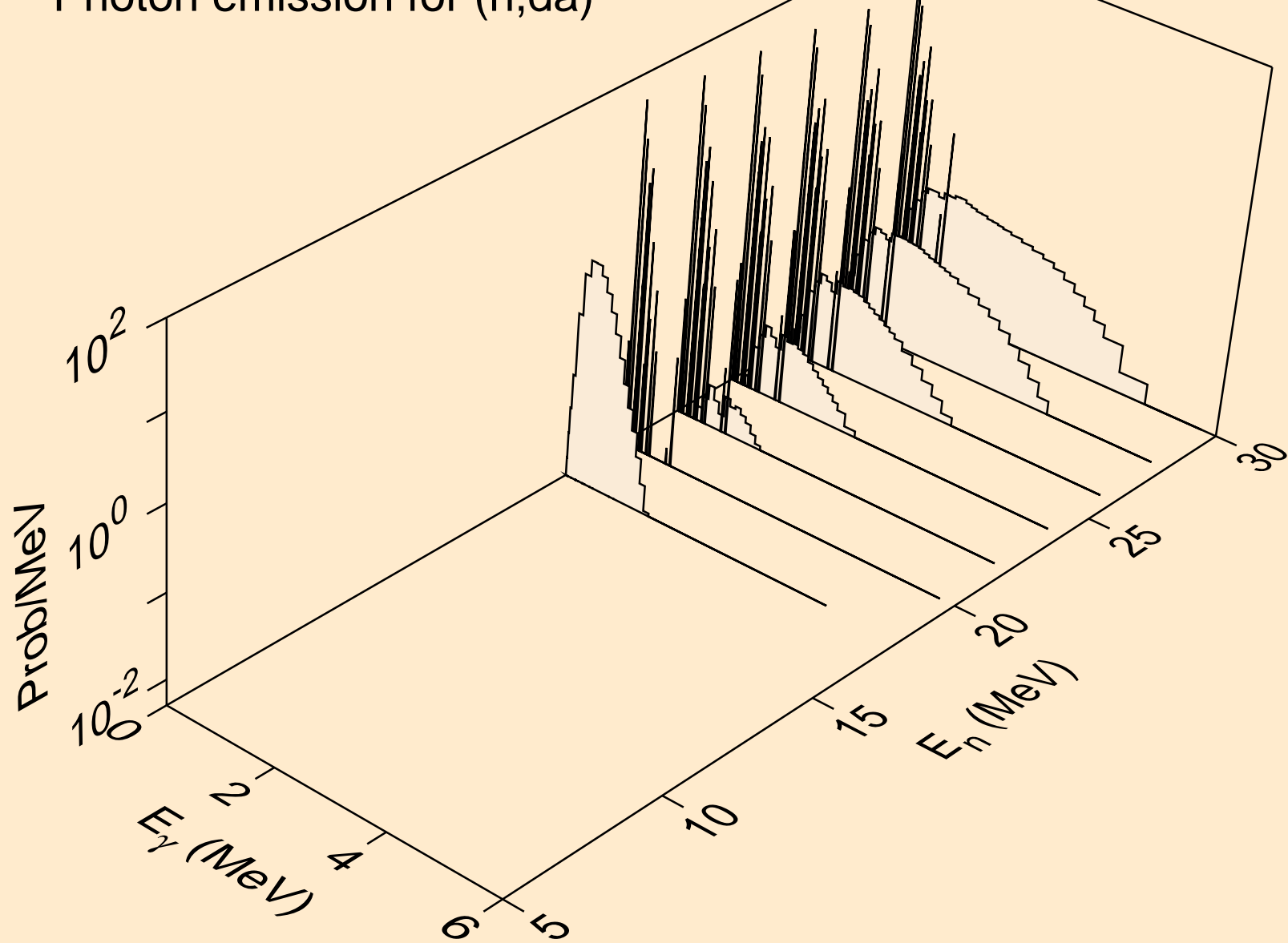

RU101 NEUTRON ACER TENDL-2023 LIBRARY; T=0.K  
thermal capture photon spectrum

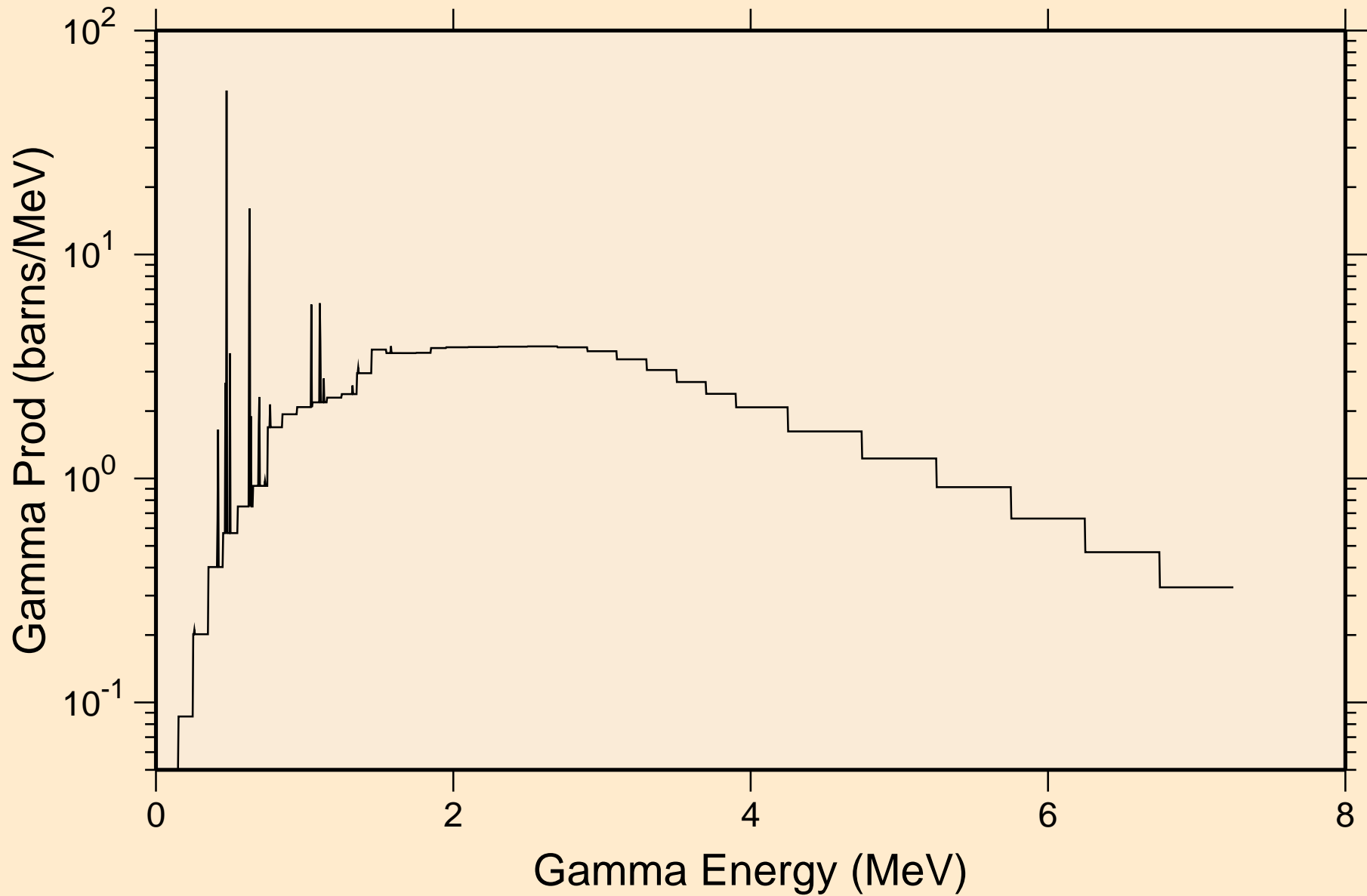

RU101 NEUTRON ACER TENDL-2023 LIBRARY; T=0.K  
14 MeV photon spectrum

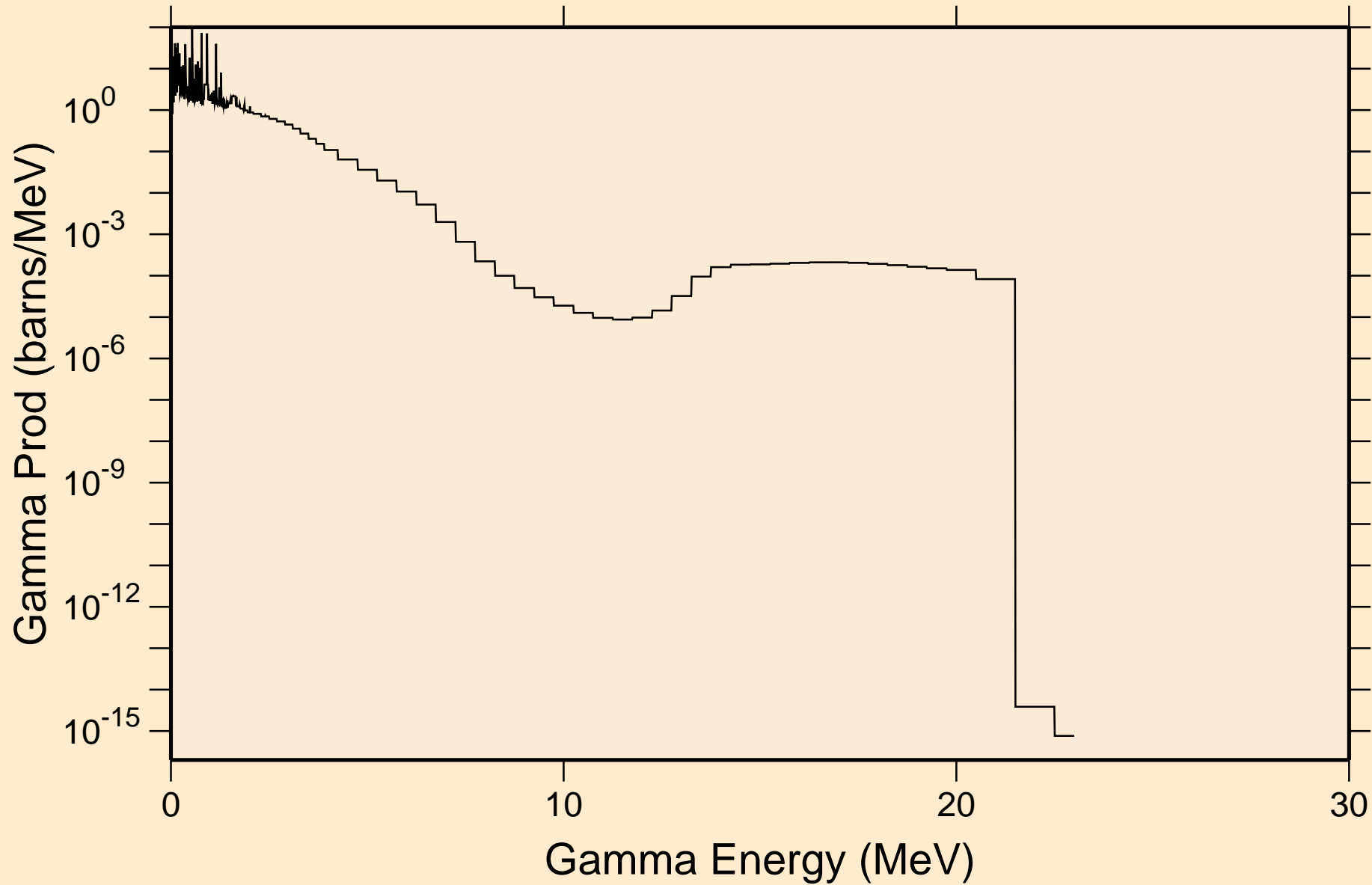

RU101 NEUTRON ACER TENDL-2023 LIBRARY; T=0.K  
Particle heating contributions

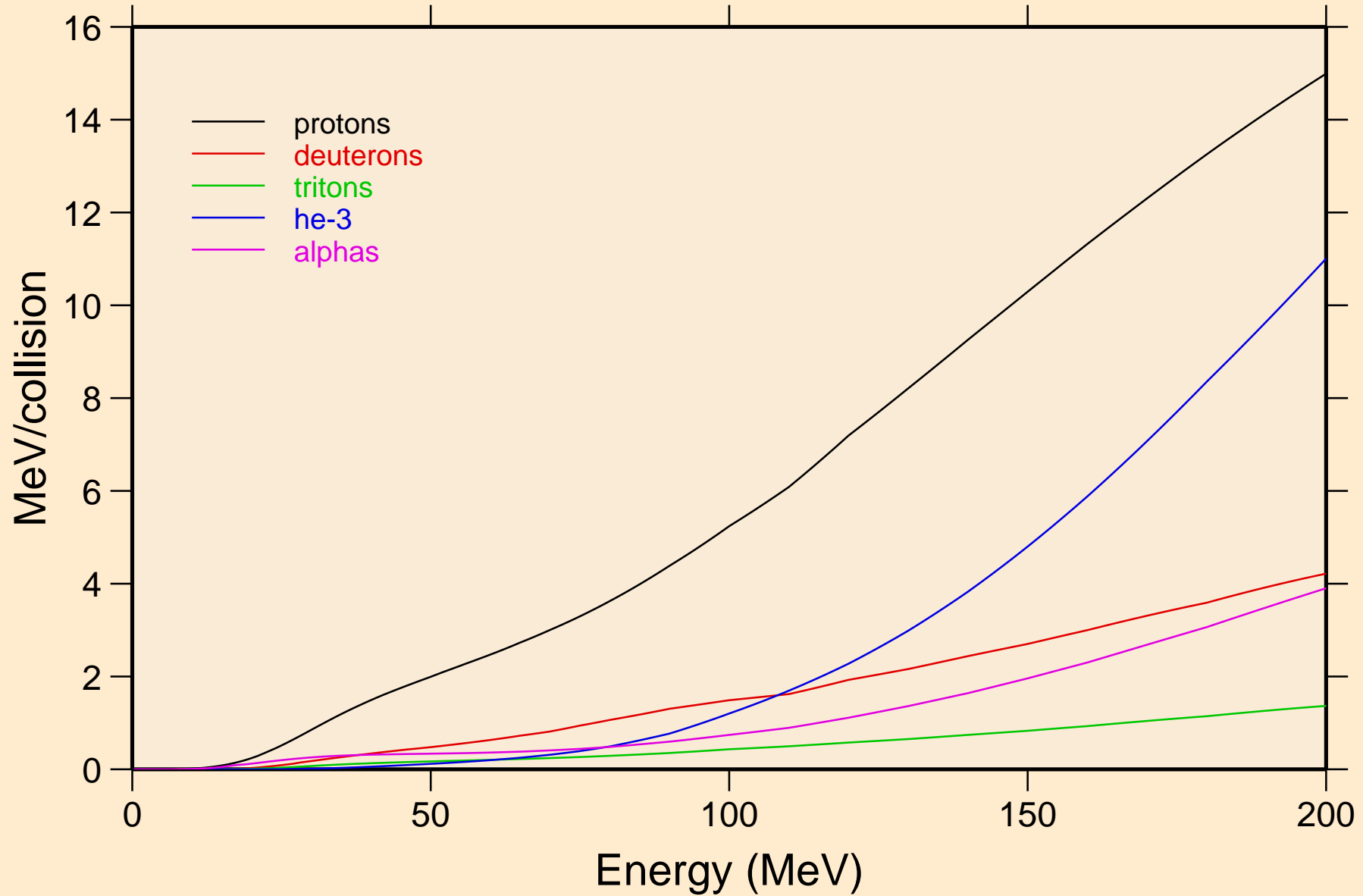

RU101 NEUTRON ACER TENDL-2023 LIBRARY; T=0.K  
Recoil Heating

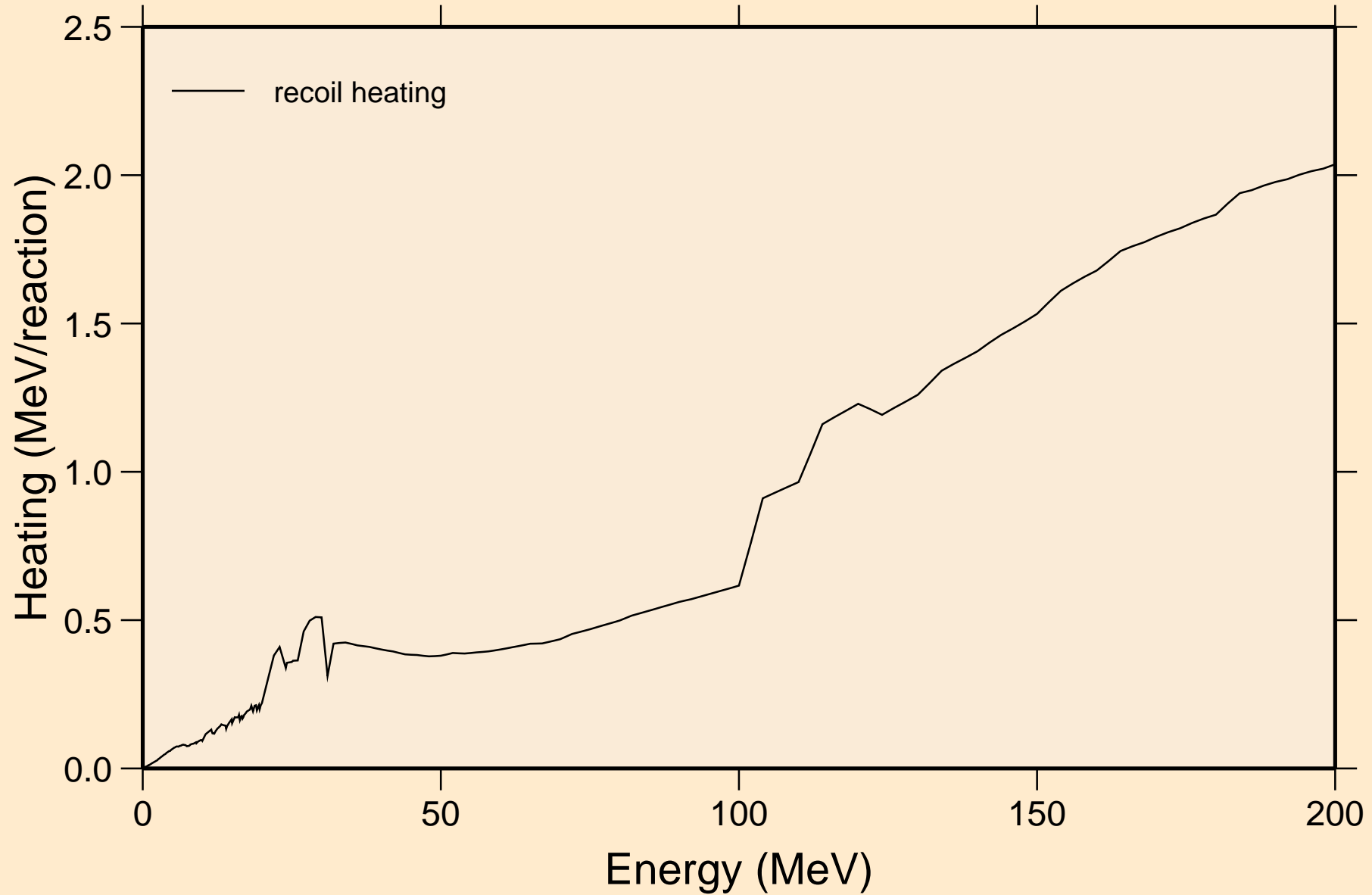

RU101 NEUTRON ACER TENDL-2023 LIBRARY; T=0.K  
Particle production cross sections

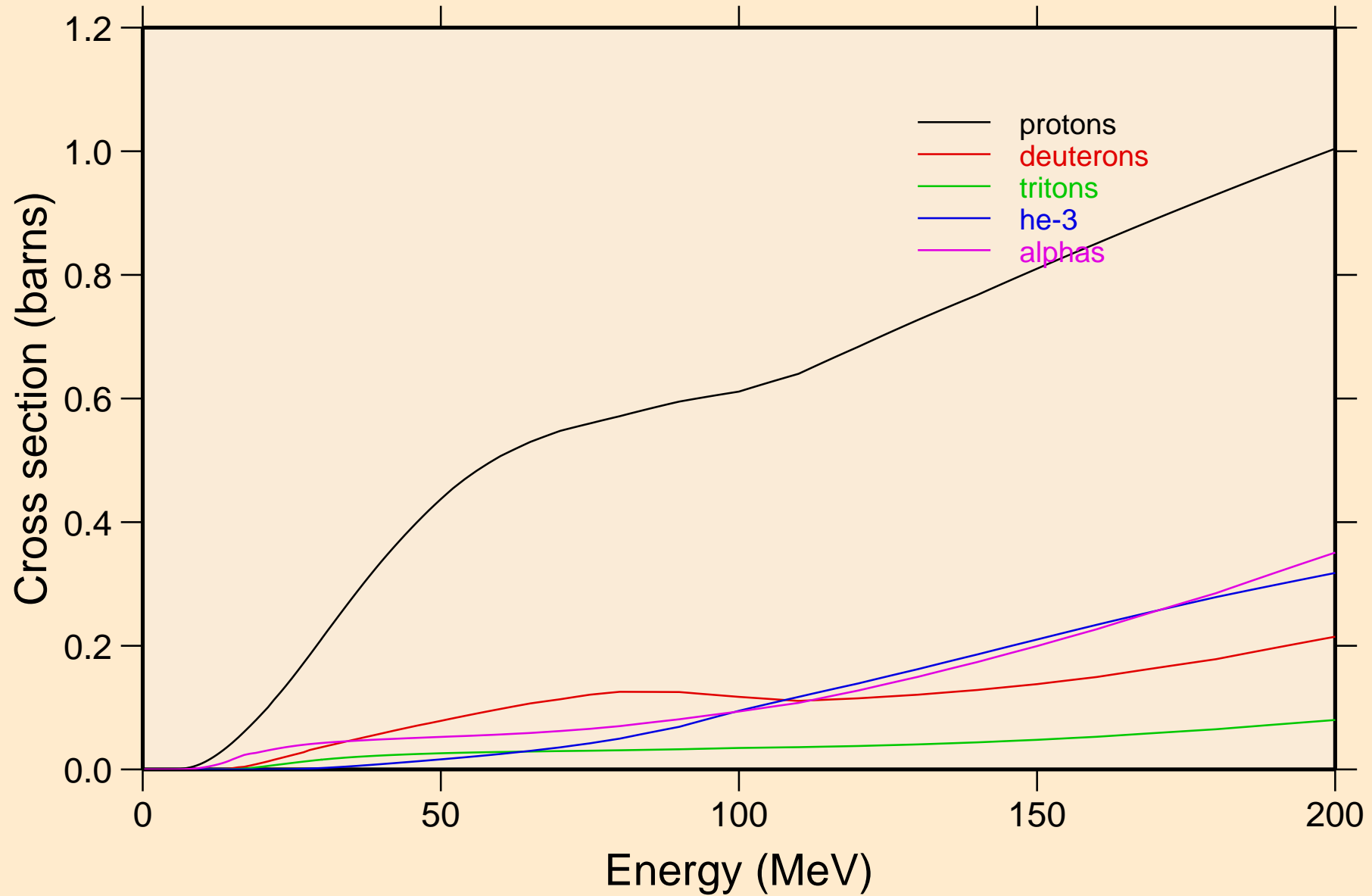

RU101 NEUTRON ACER TENDL-2023 LIBRARY; T=0.K  
protons from (n,x)

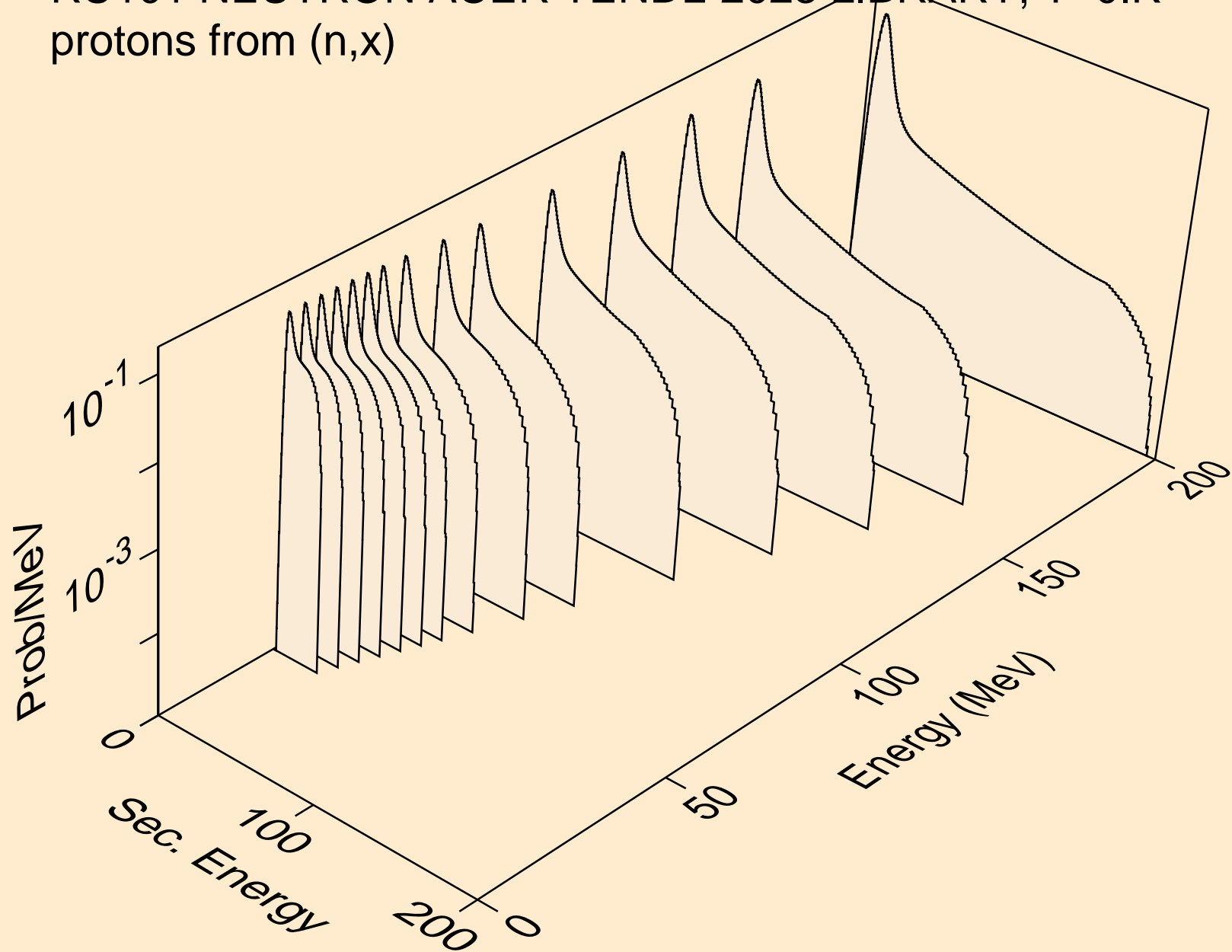

RU101 NEUTRON ACER TENDL-2023 LIBRARY; T=0.K  
protons from (n,n\*)p

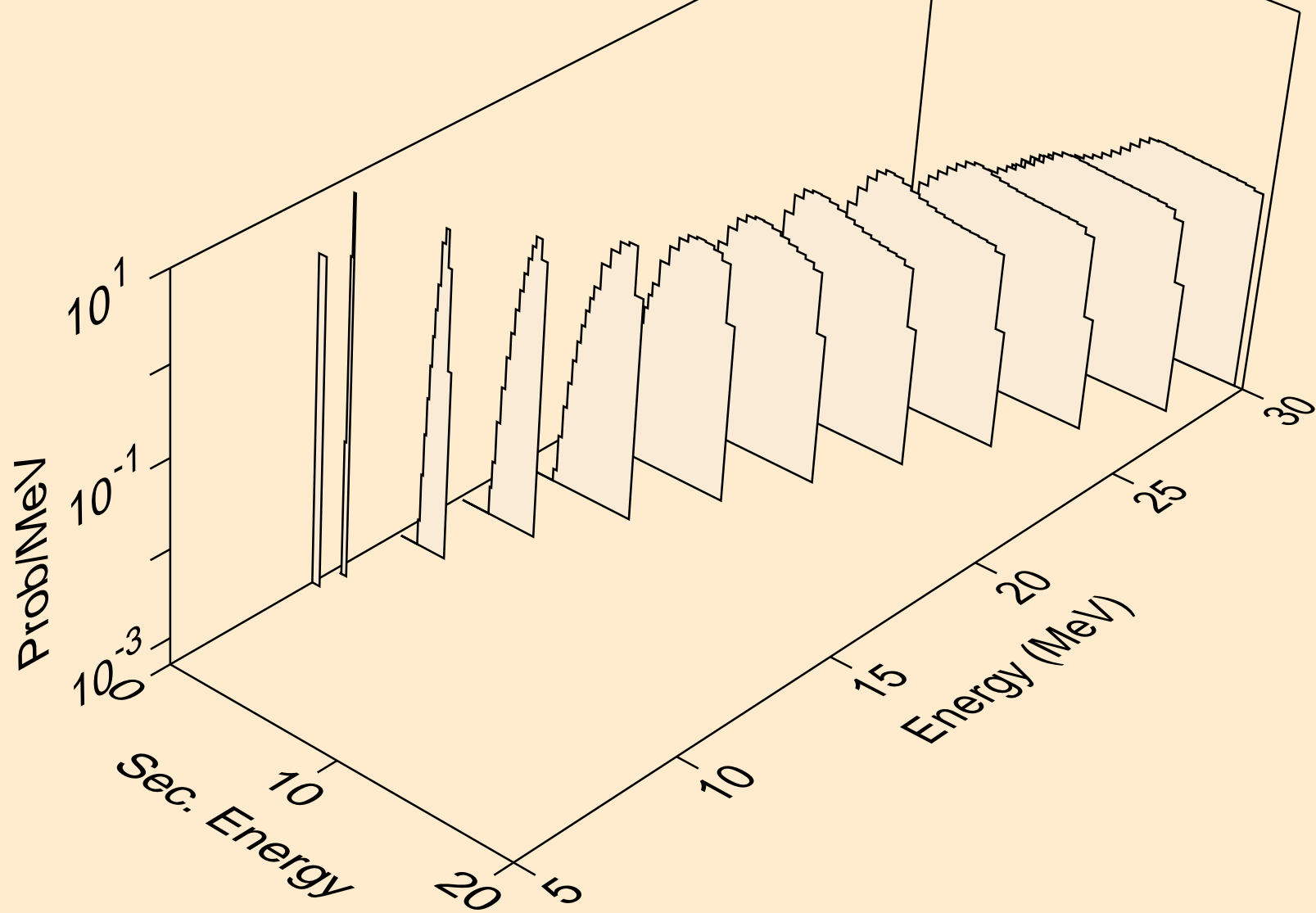

RU101 NEUTRON ACER TENDL-2023 LIBRARY; T=0.K  
protons from (n,2np)

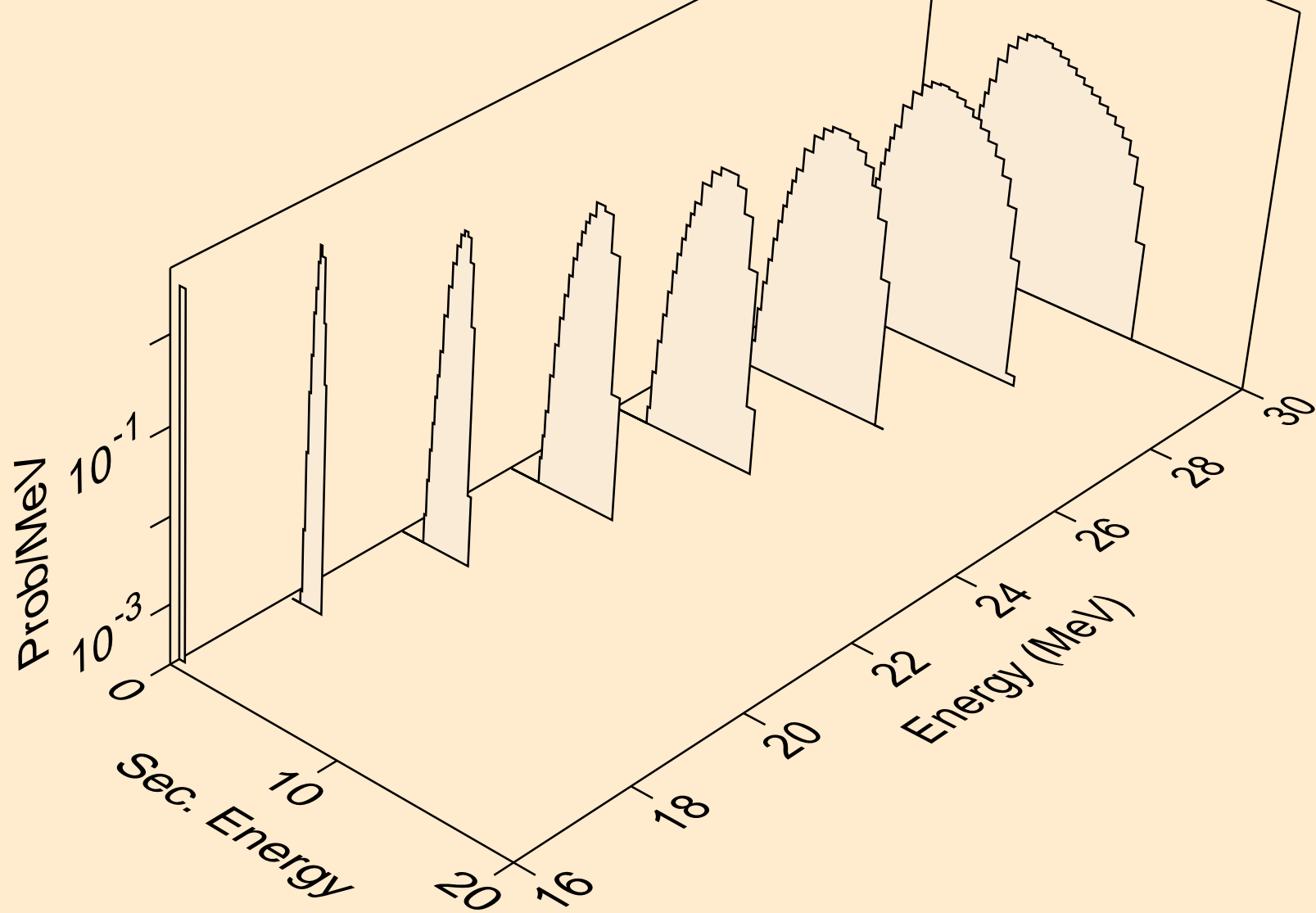

RU101 NEUTRON ACER TENDL-2023 LIBRARY; T=0.K  
protons from (n,3np)

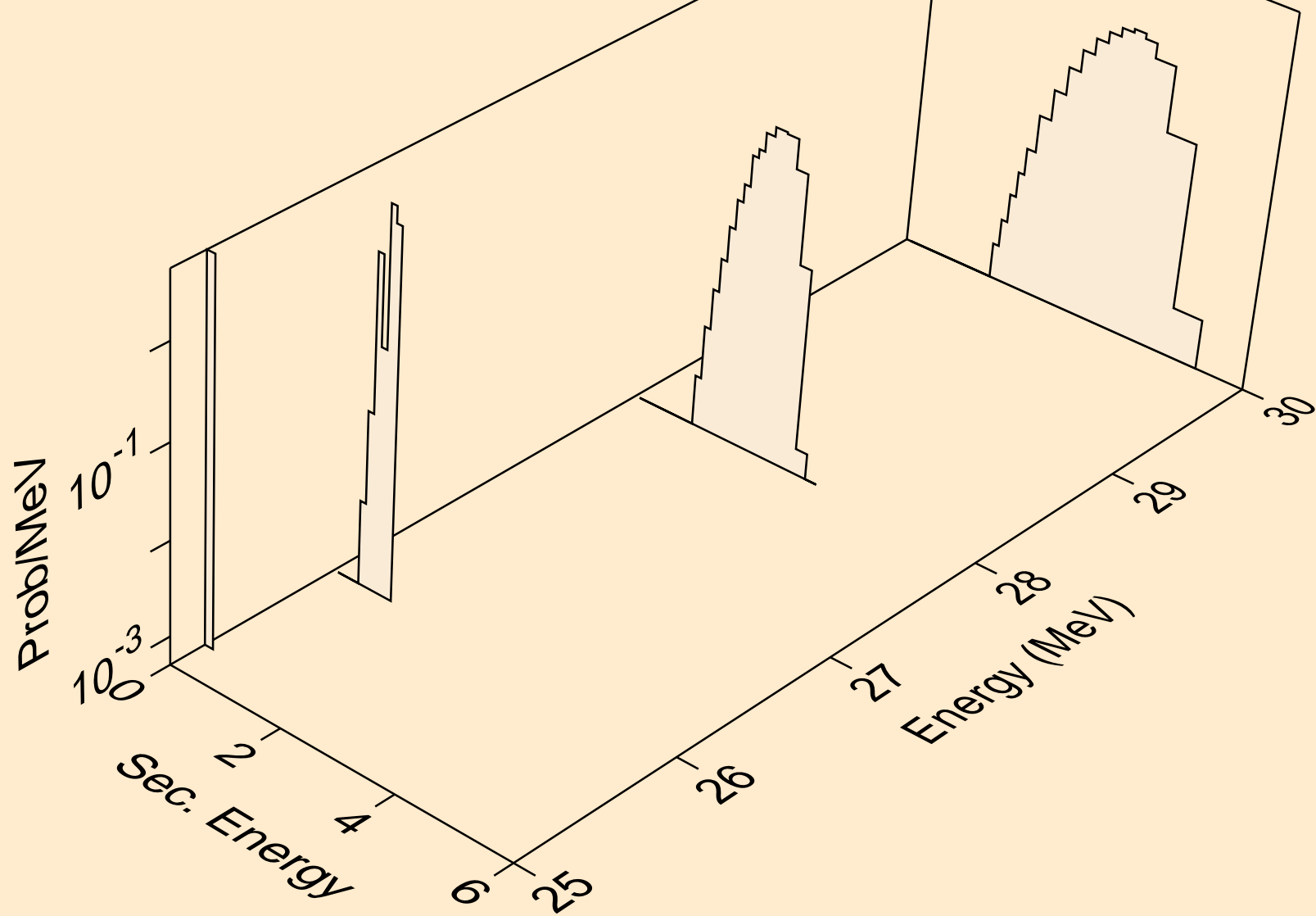

RU101 NEUTRON ACER TENDL-2023 LIBRARY; T=0.K  
protons from (n,n2p)

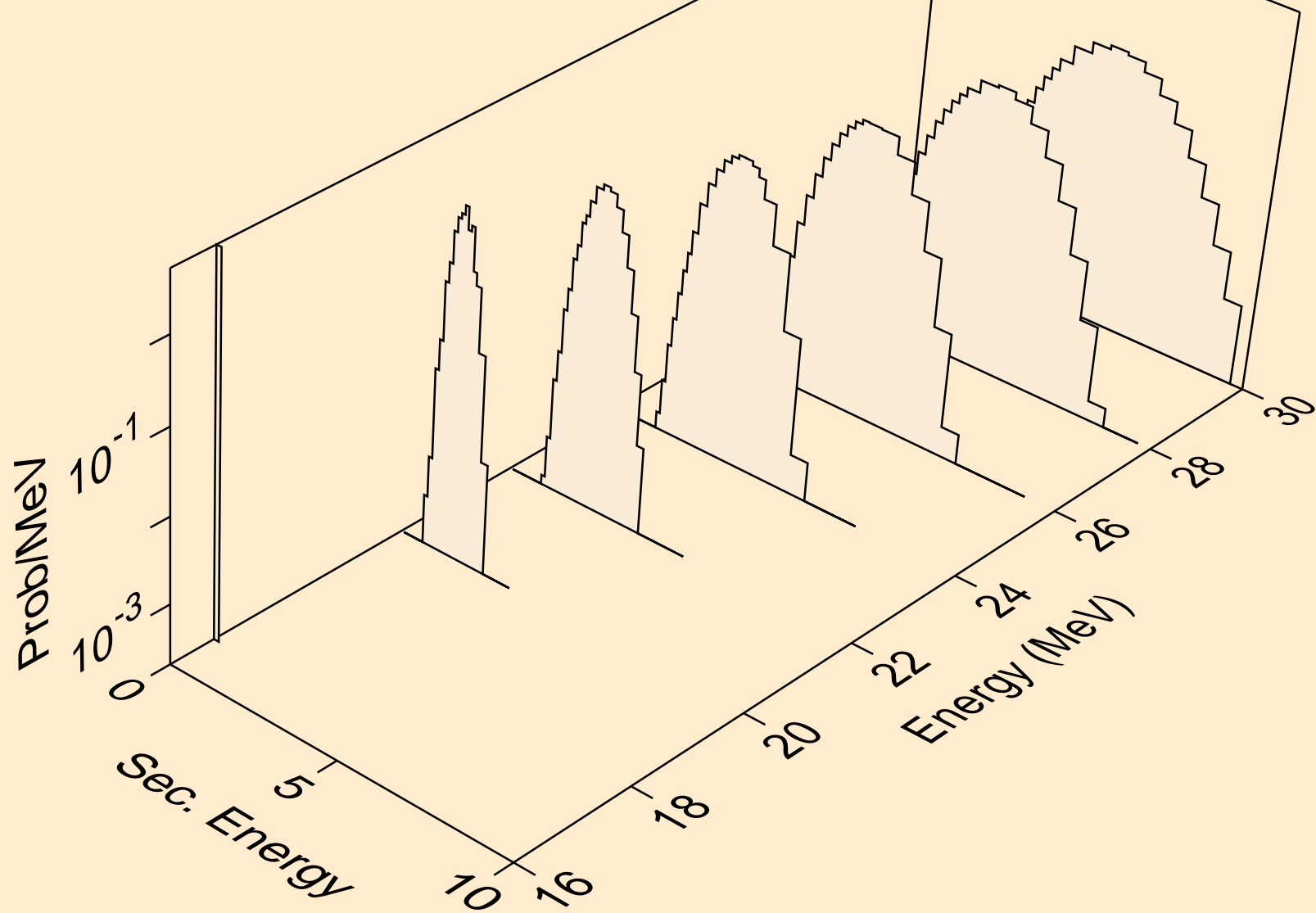

RU101 NEUTRON ACER TENDL-2023 LIBRARY; T=0.K  
protons from (n,npa)

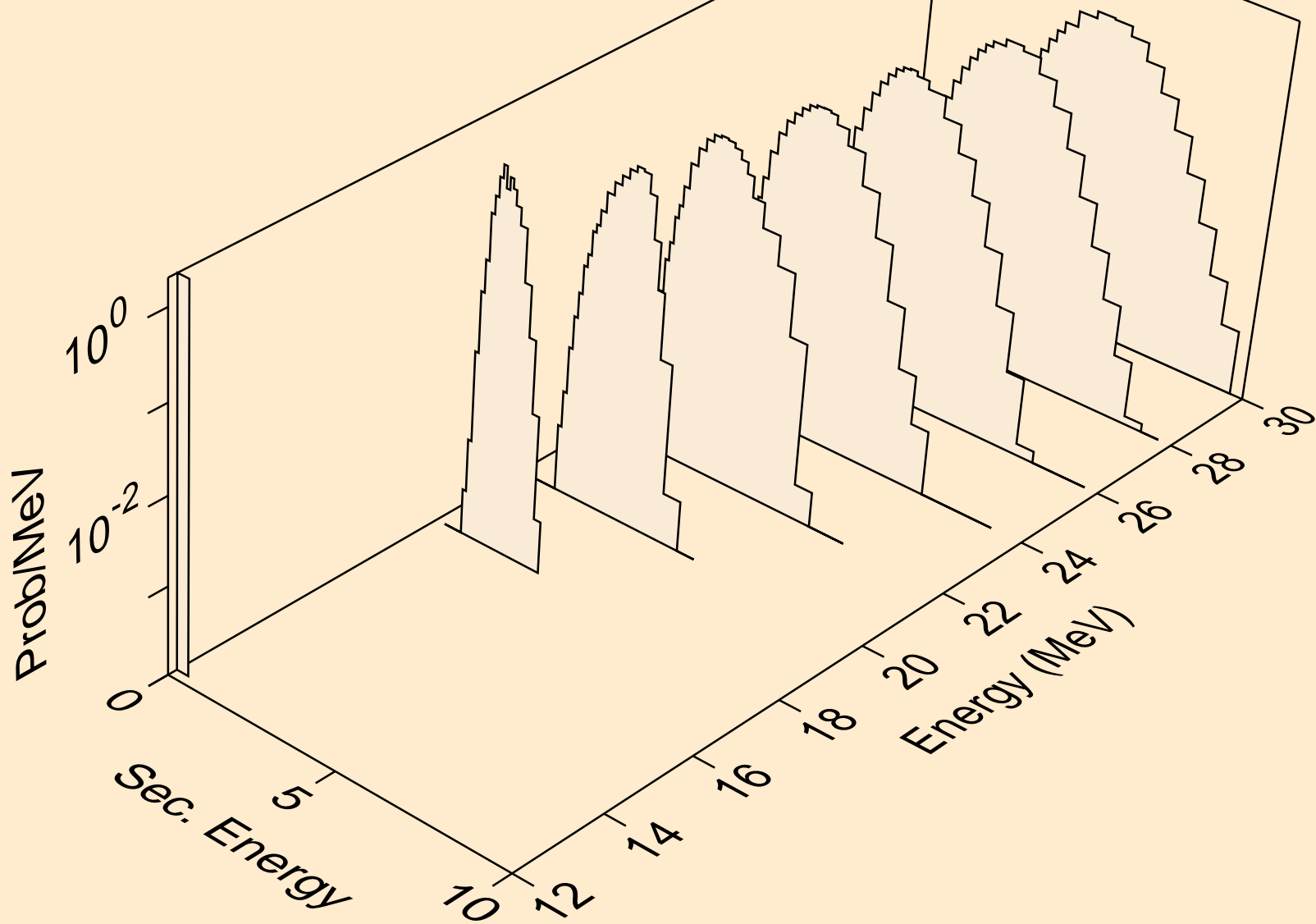

RU101 NEUTRON ACER TENDL-2023 LIBRARY; T=0.K  
protons from (n,p)

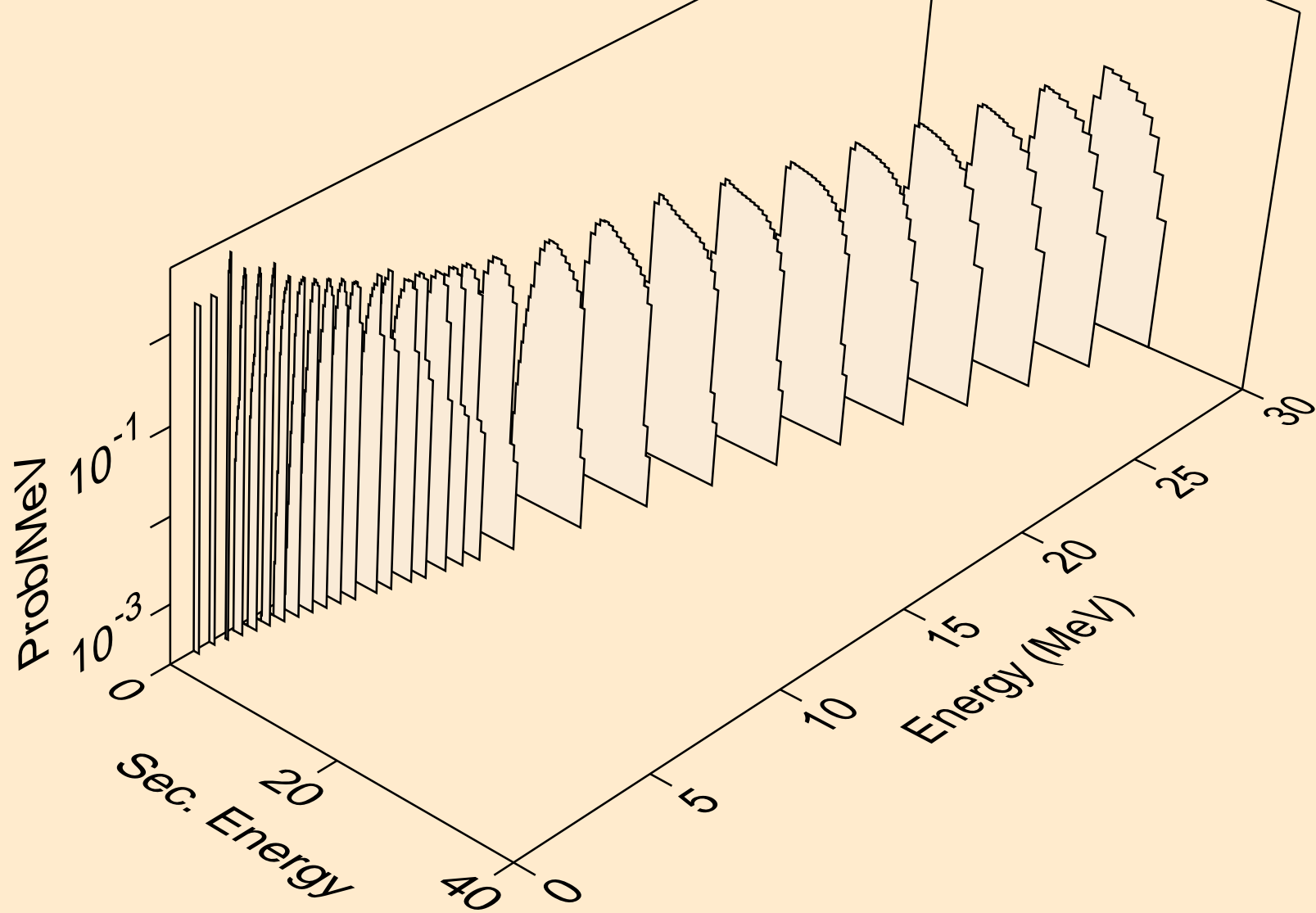

RU101 NEUTRON ACER TENDL-2023 LIBRARY; T=0.K  
protons from (n,2p)

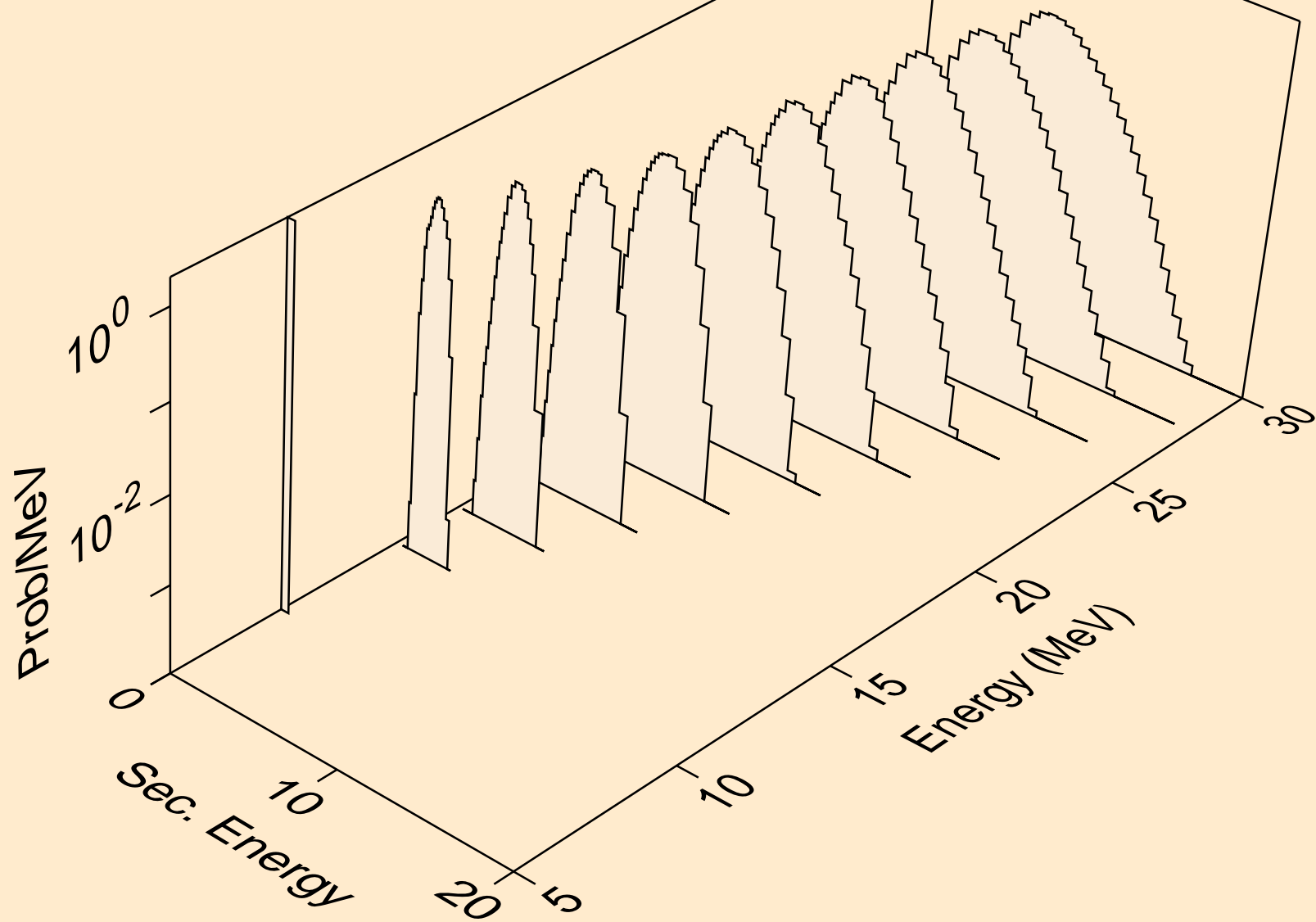

RU101 NEUTRON ACER TENDL-2023 LIBRARY; T=0.K  
protons from (n,p)

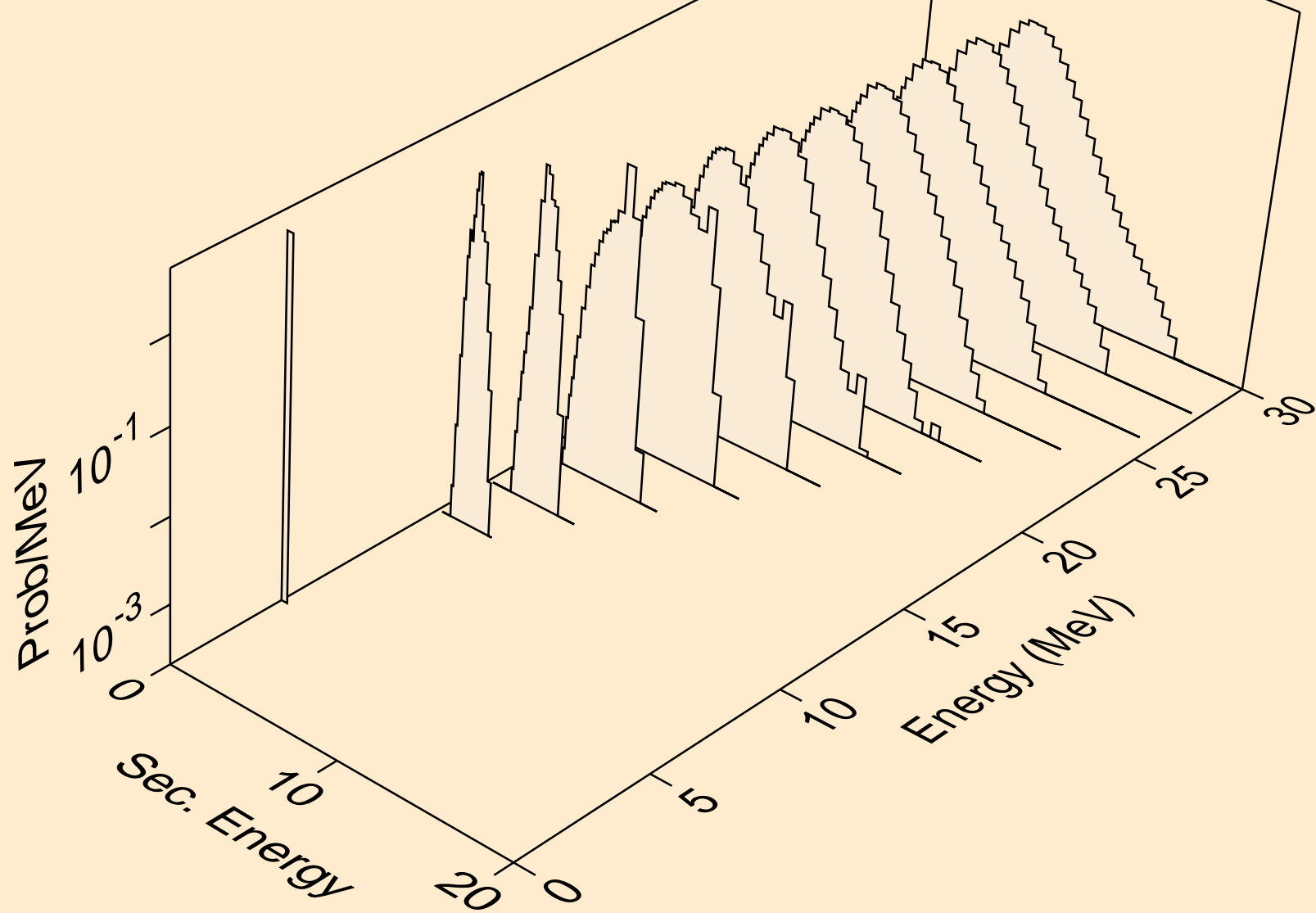

RU101 NEUTRON ACER TENDL-2023 LIBRARY; T=0.K  
protons from (n,pd)

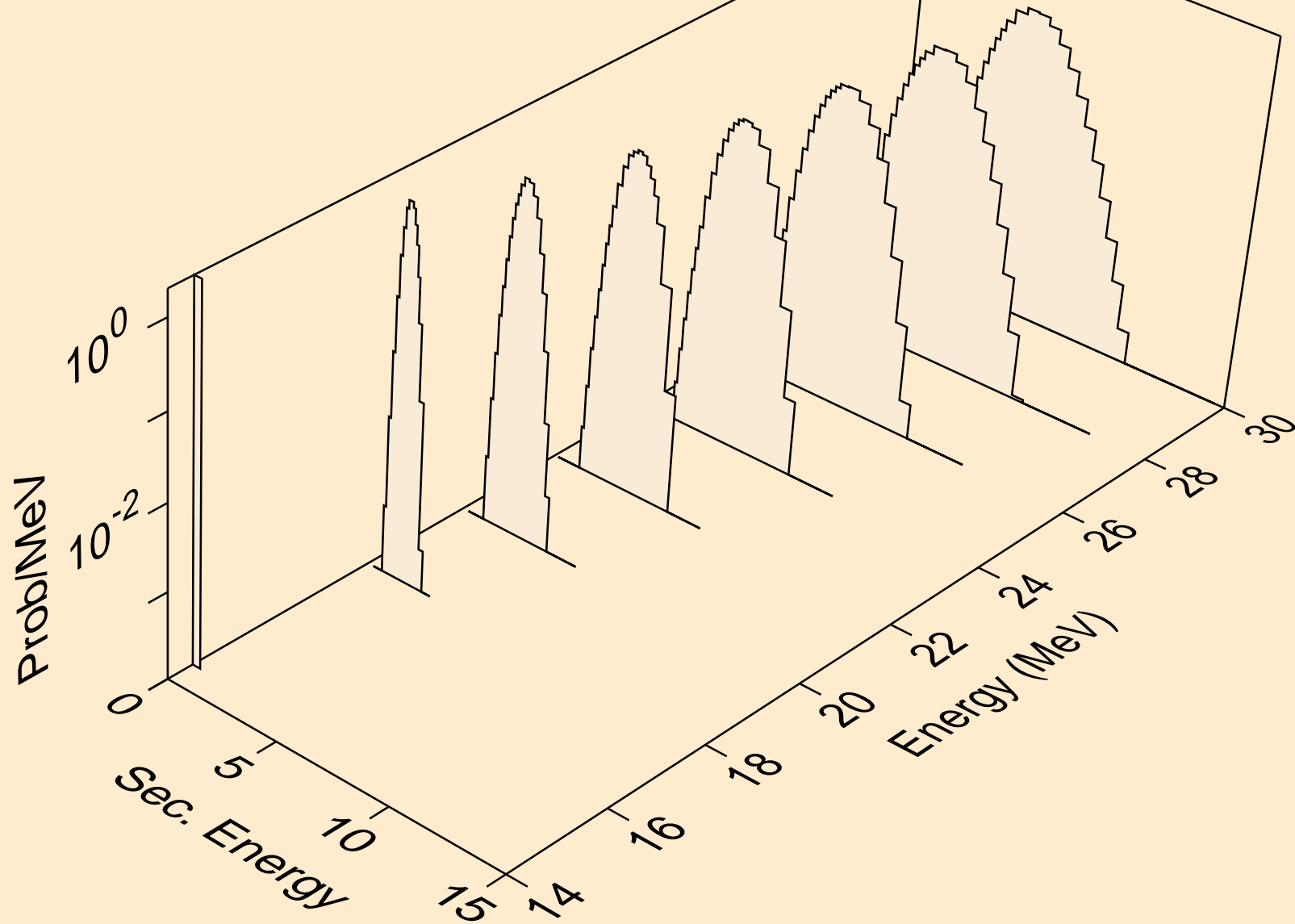

RU101 NEUTRON ACER TENDL-2023 LIBRARY; T=0.K  
protons from (n,pt)

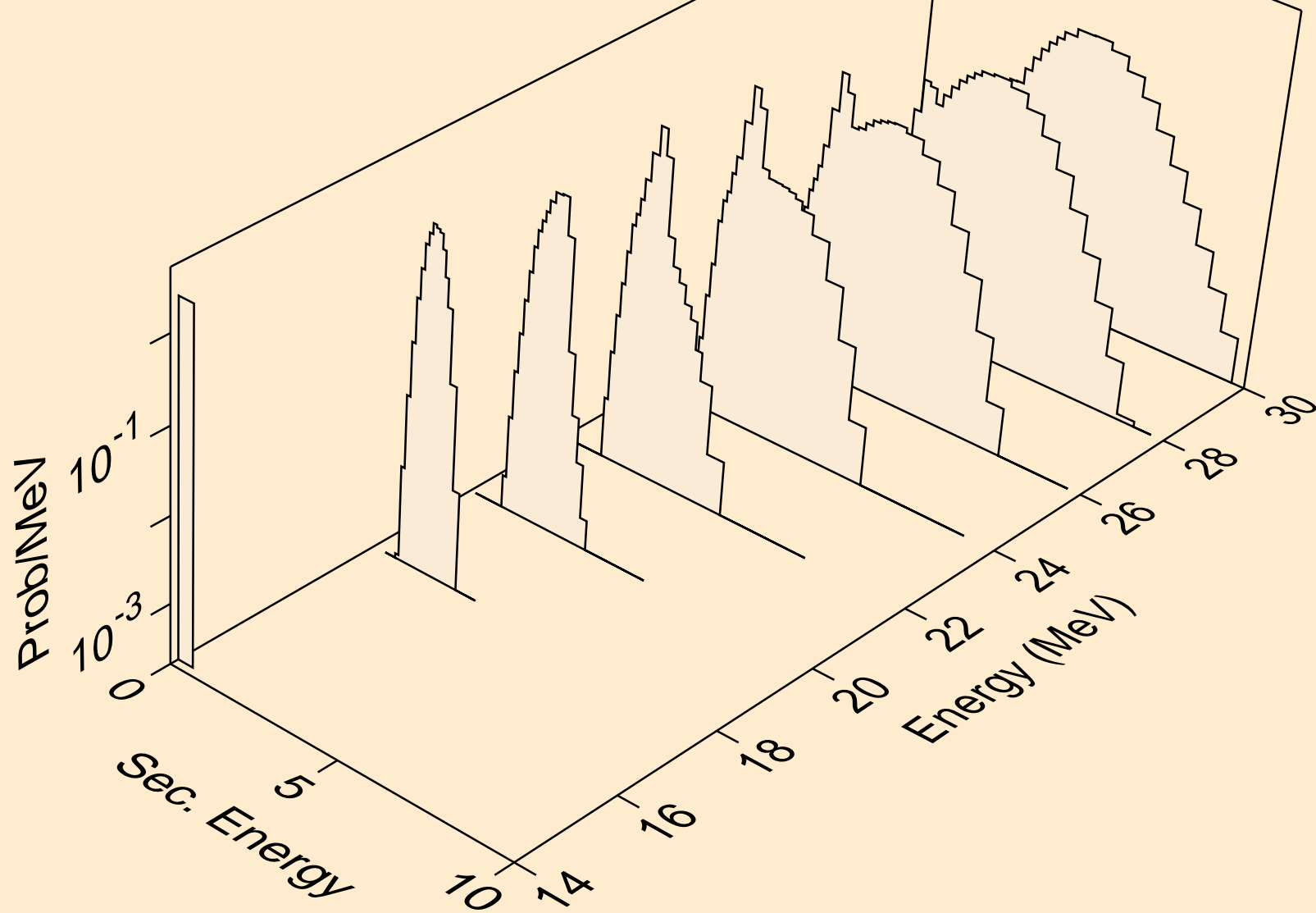

RU101 NEUTRON ACER TENDL-2023 LIBRARY; T=0.K  
deuterons from (n,x)

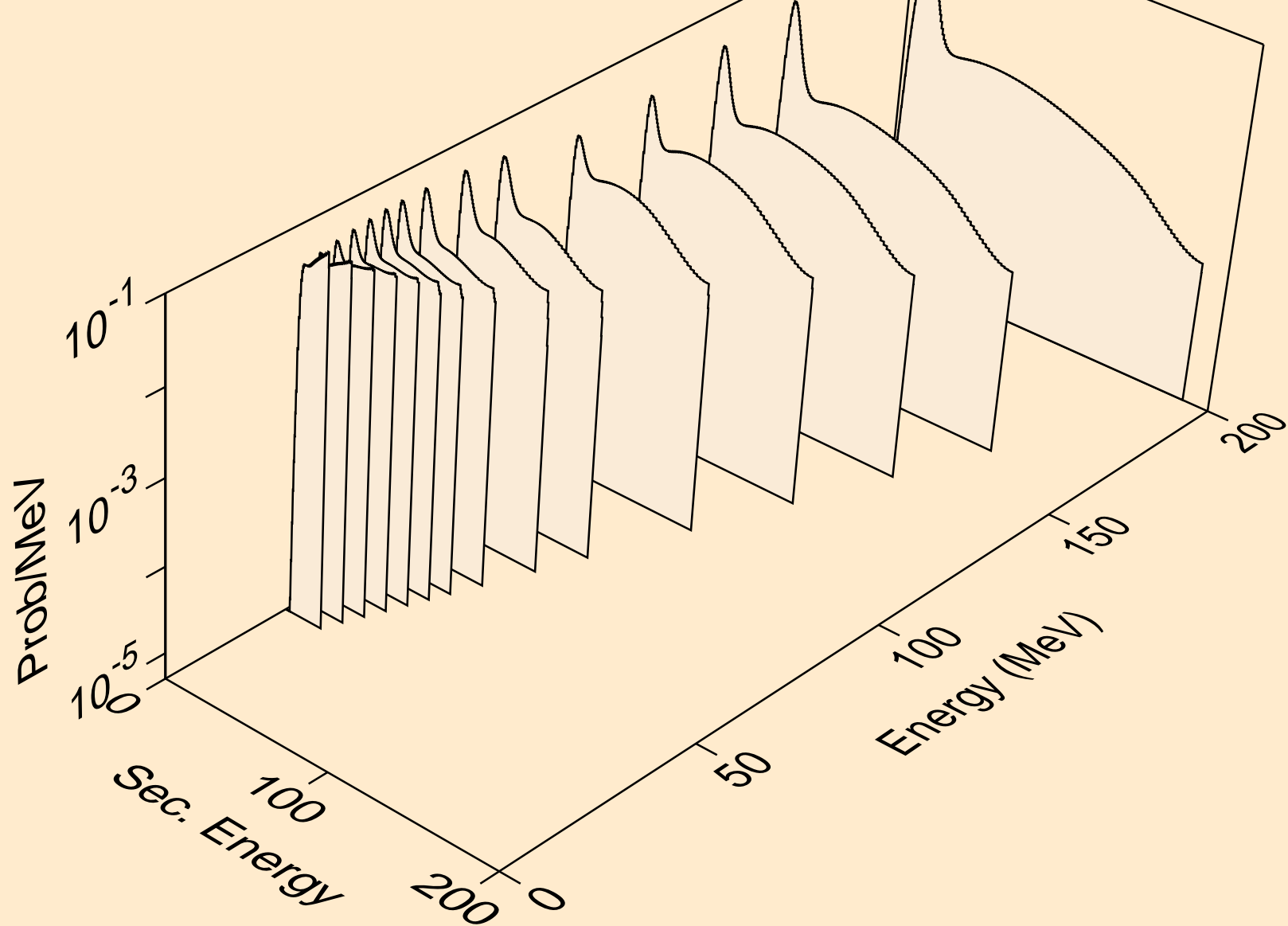

RU101 NEUTRON ACER TENDL-2023 LIBRARY; T=0.K  
deuterons from (n,2nd)

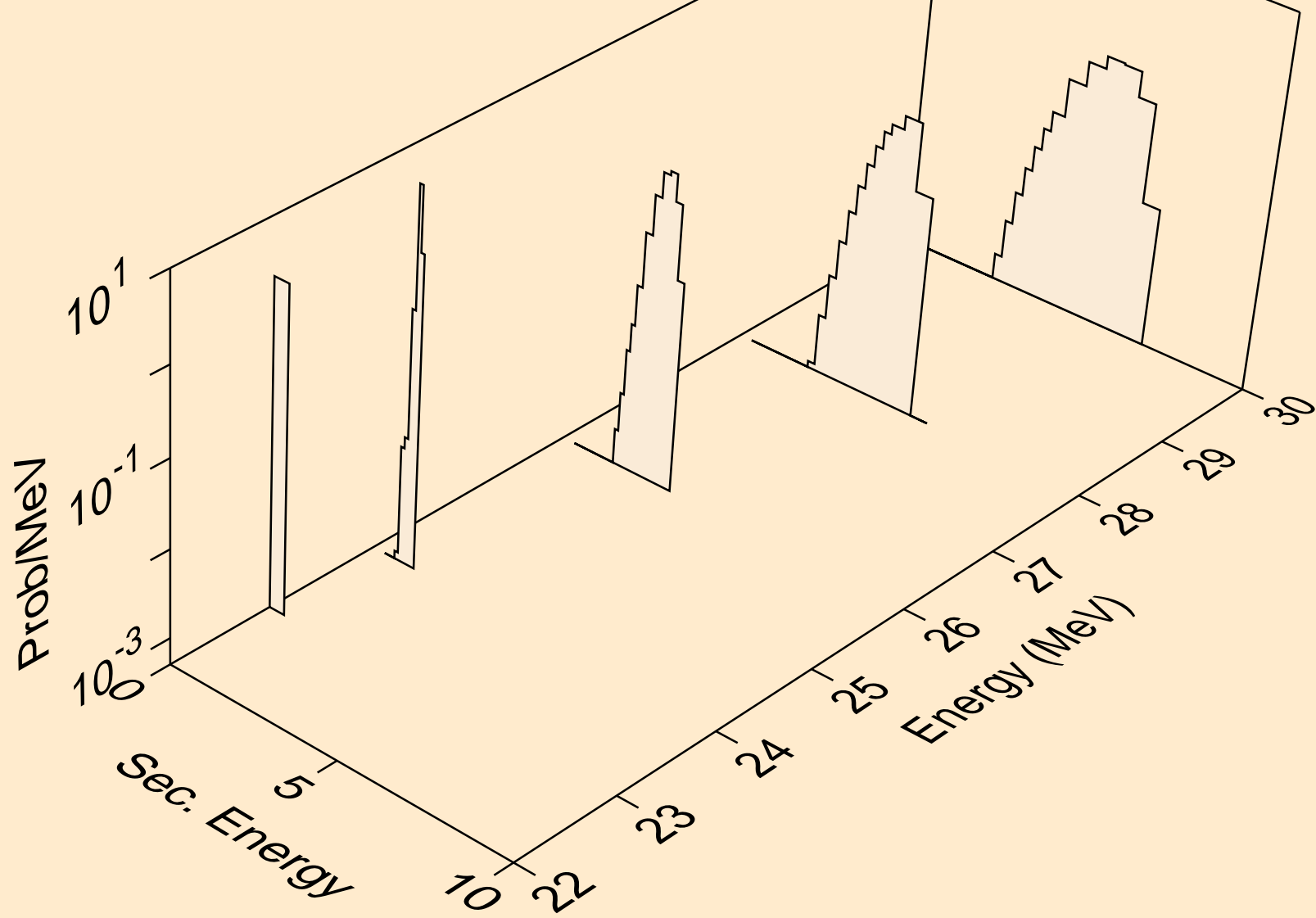

RU101 NEUTRON ACER TENDL-2023 LIBRARY; T=0.K  
deuterons from (n,n\*)d

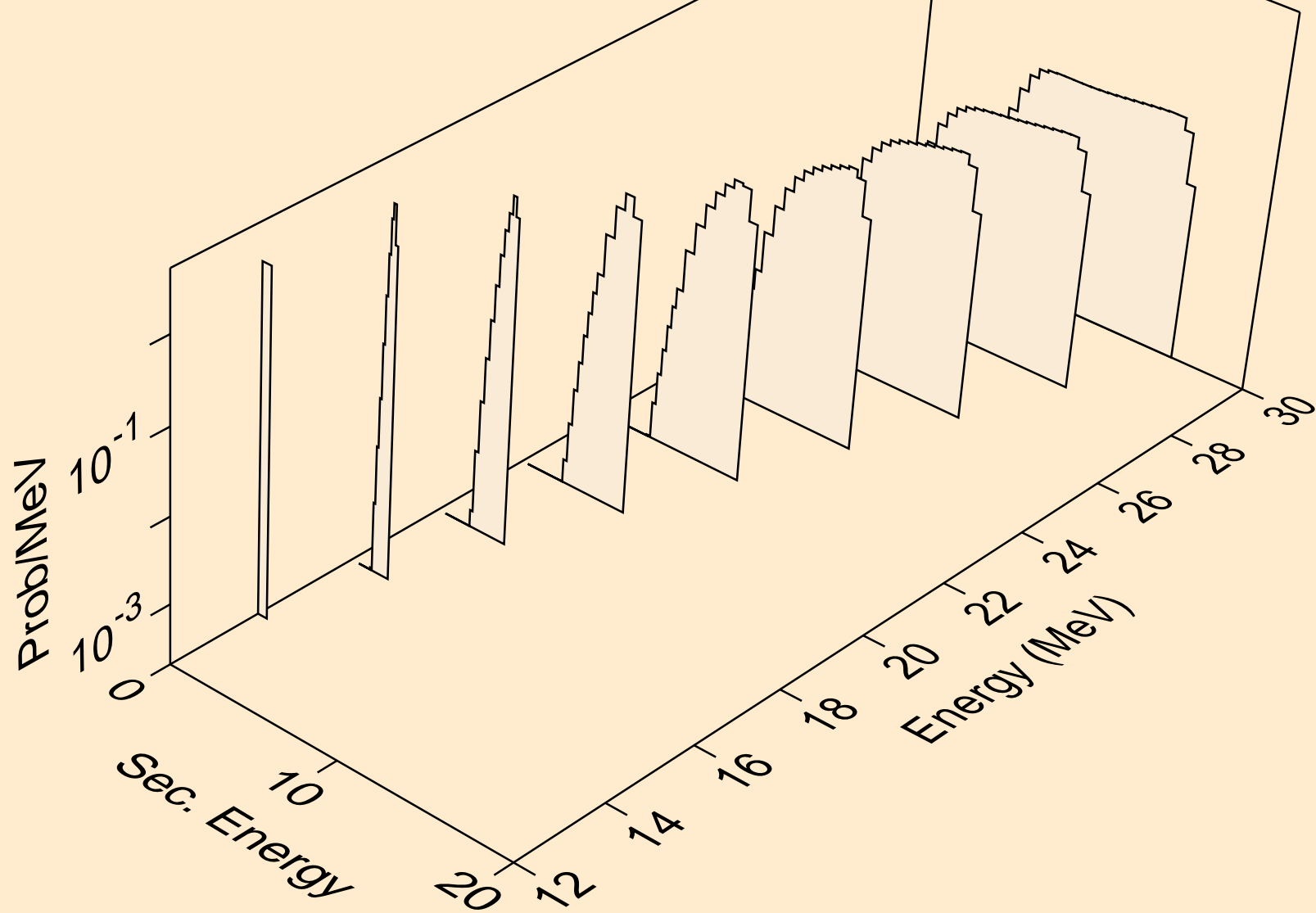

RU101 NEUTRON ACER TENDL-2023 LIBRARY; T=0.K  
deuterons from (n,d)

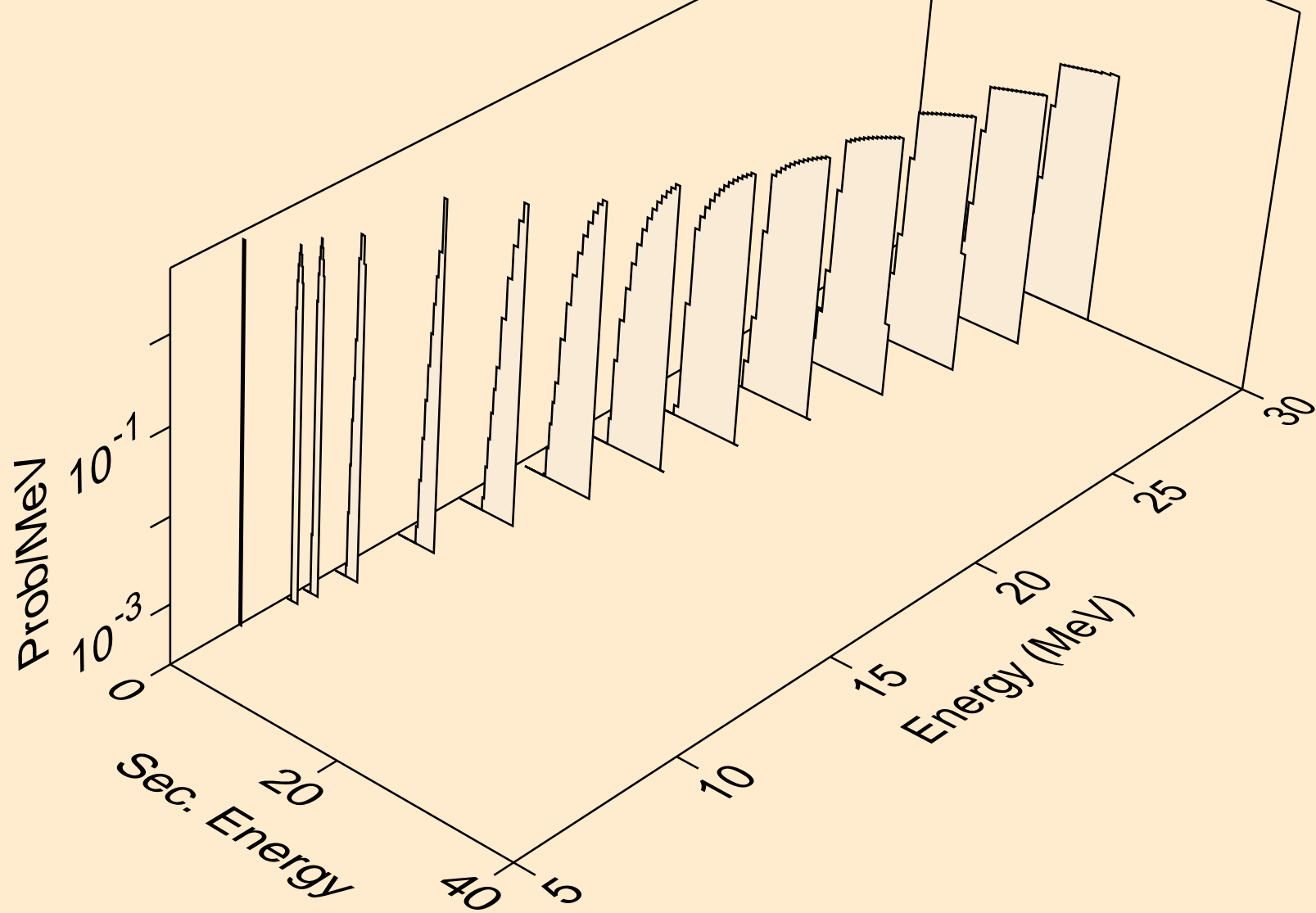

RU101 NEUTRON ACER TENDL-2023 LIBRARY; T=0.K  
deuterons from (n,pd)

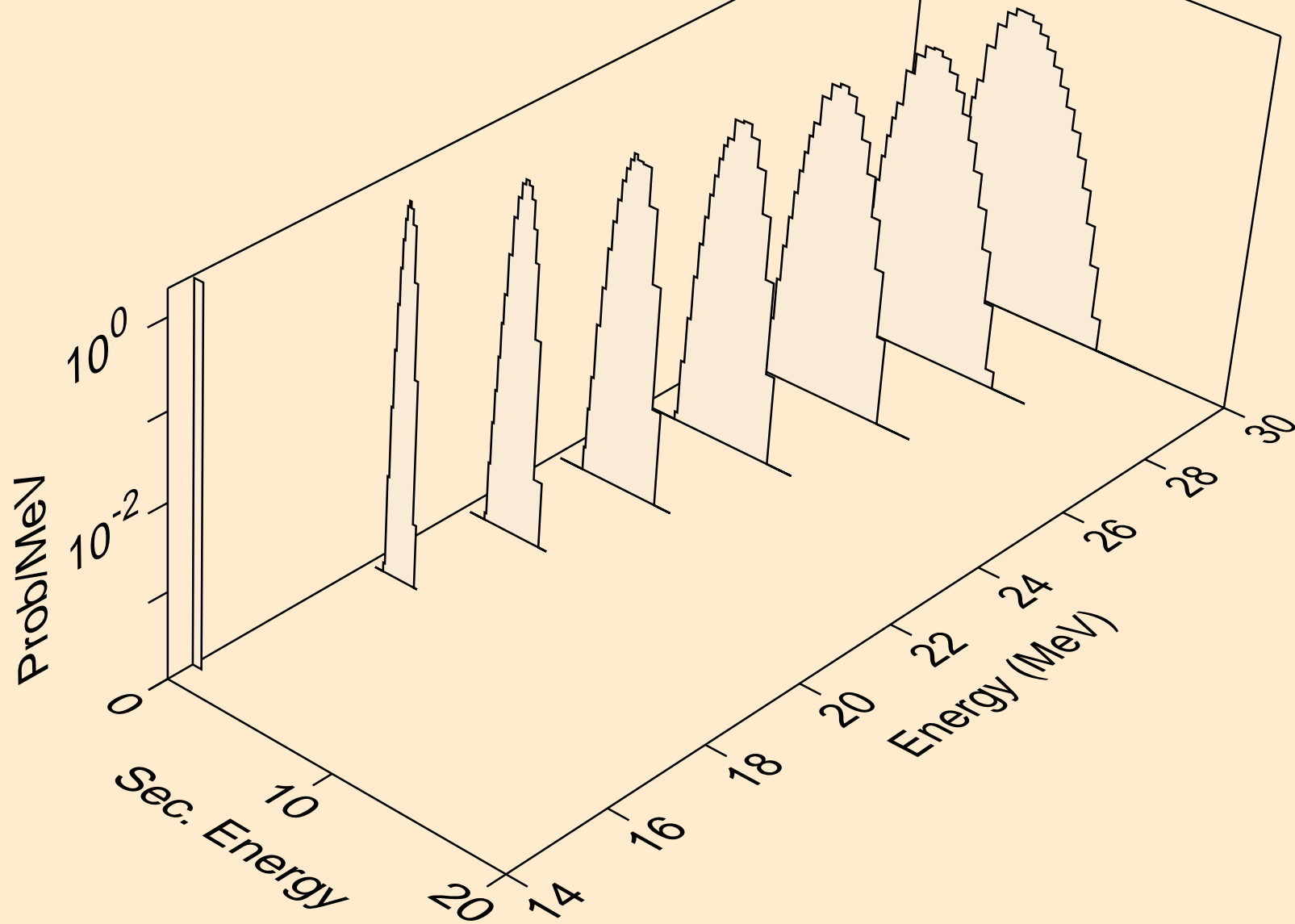

RU101 NEUTRON ACER TENDL-2023 LIBRARY; T=0.K  
deuterons from (n,da)

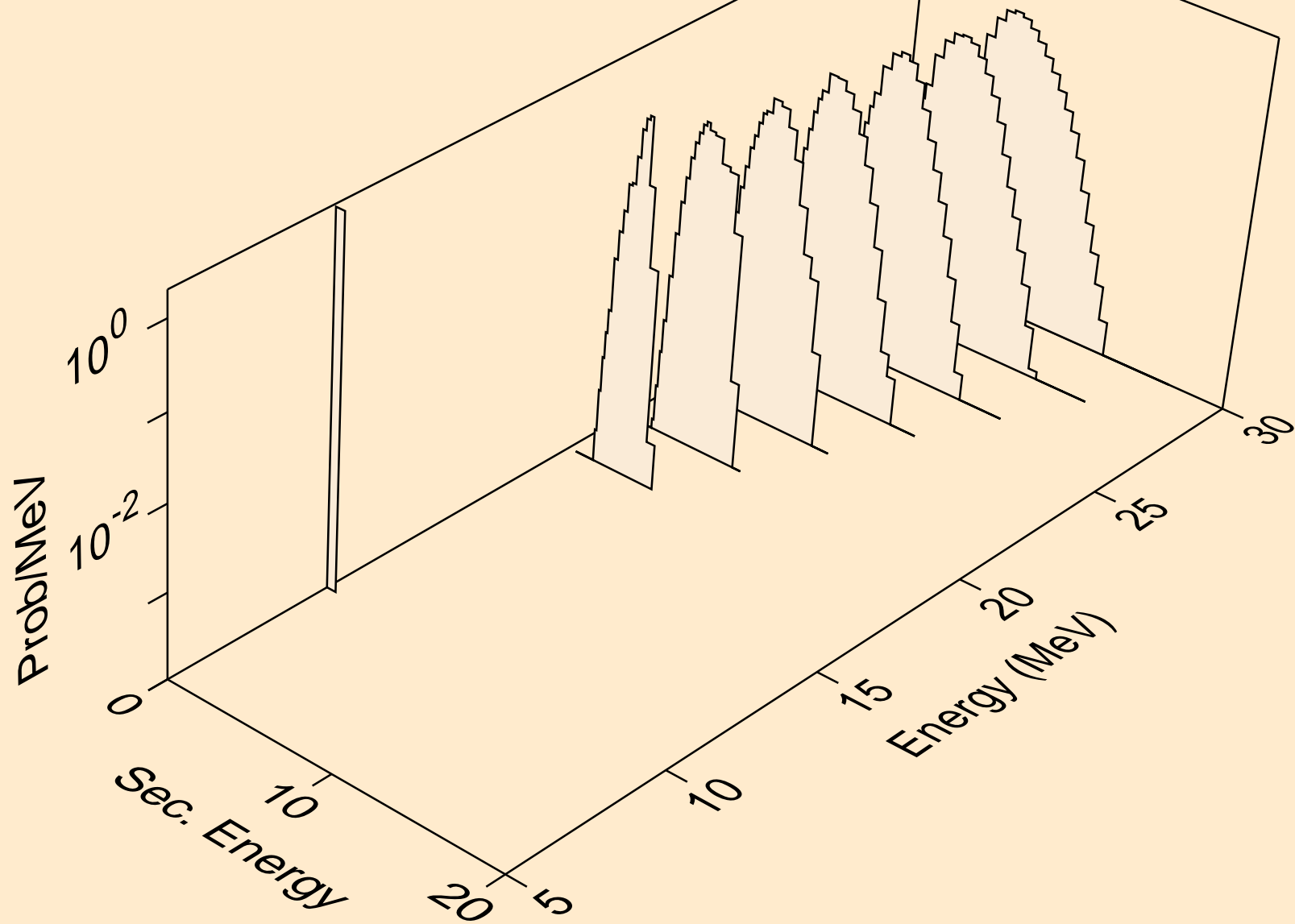

RU101 NEUTRON ACER TENDL-2023 LIBRARY; T=0.K  
tritons from (n,x)

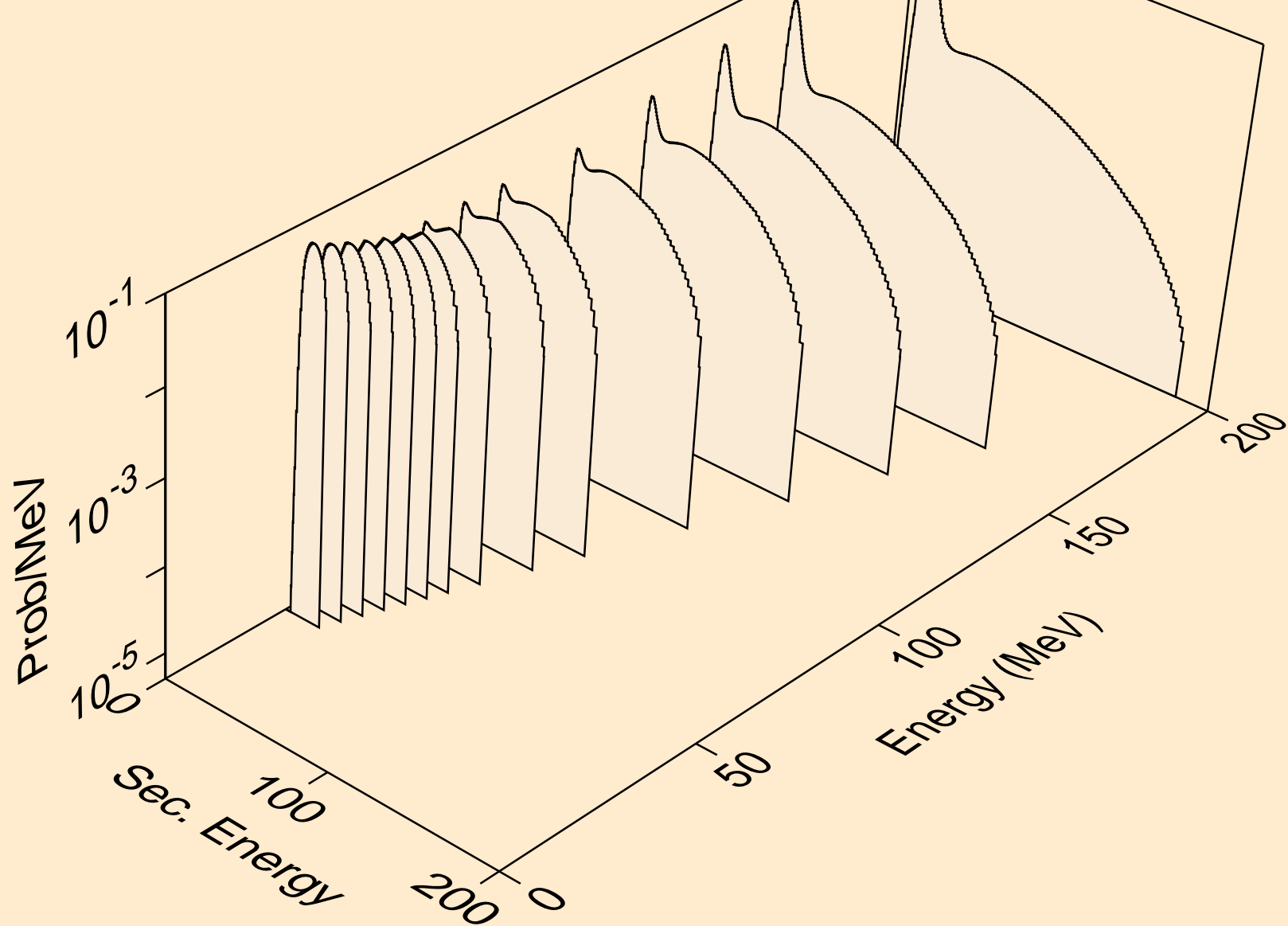

RU101 NEUTRON ACER TENDL-2023 LIBRARY; T=0.K  
tritons from (n,n\*)t

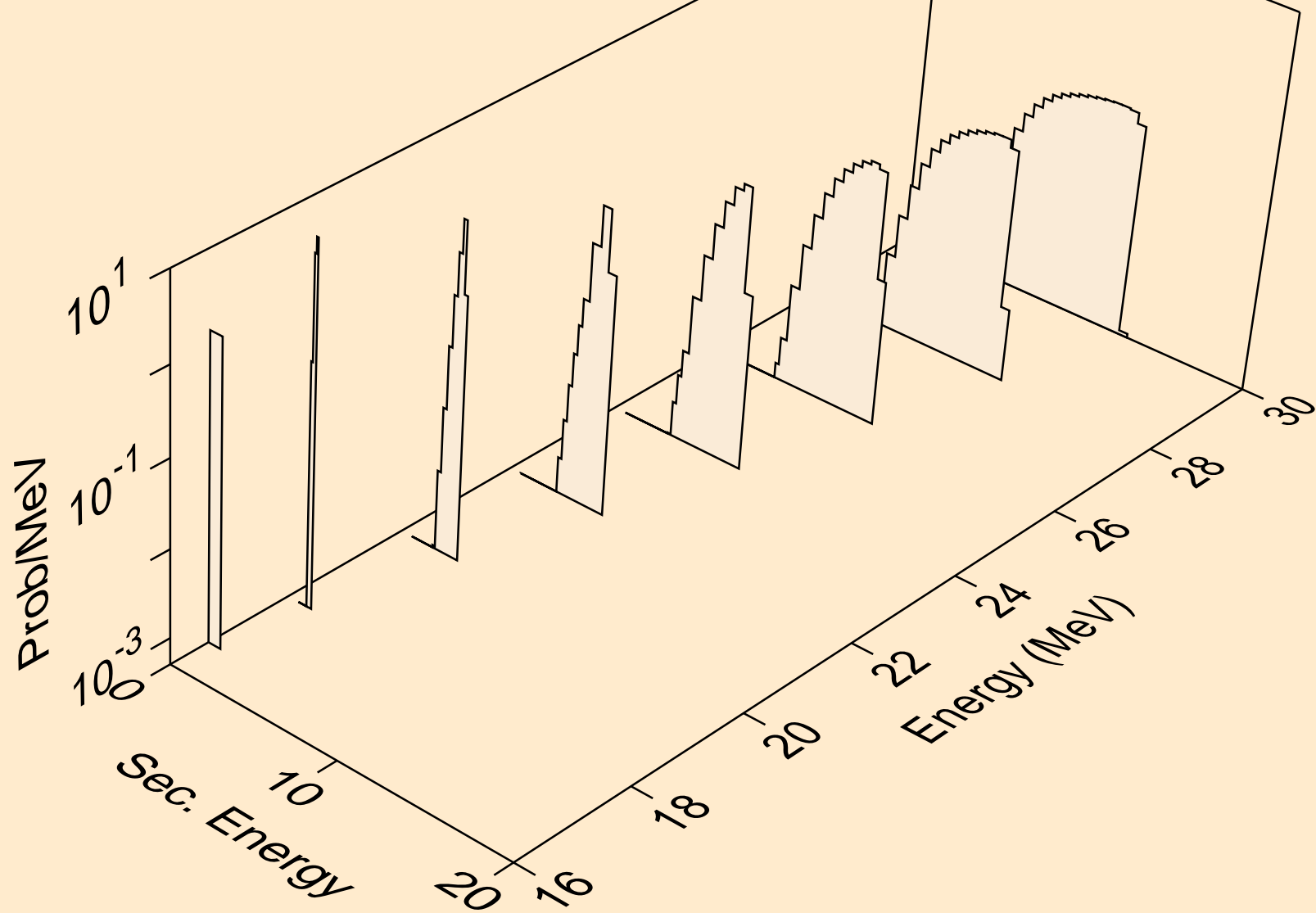

RU101 NEUTRON ACER TENDL-2023 LIBRARY; T=0.K  
tritons from (n,t)

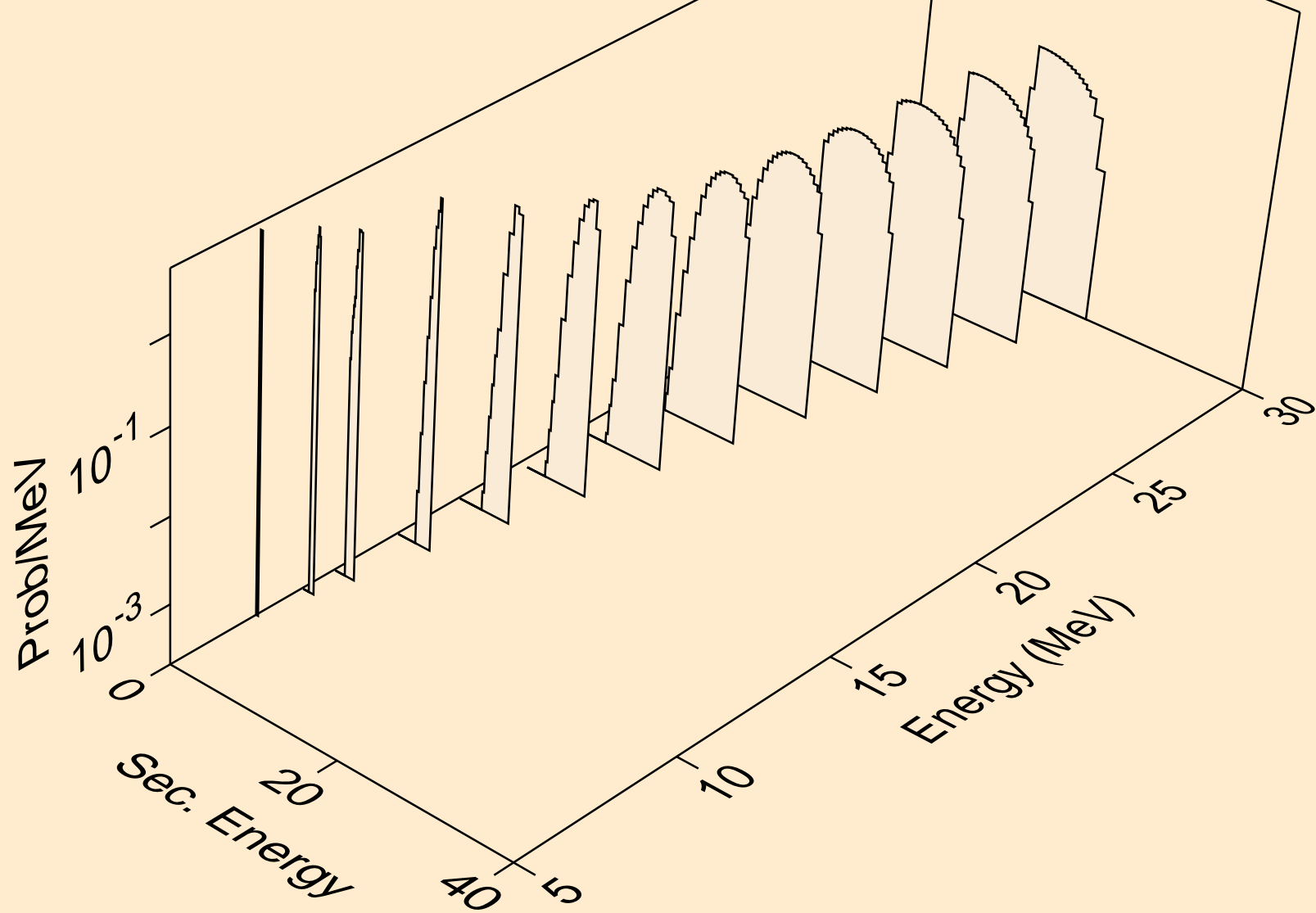

RU101 NEUTRON ACER TENDL-2023 LIBRARY; T=0.K  
tritons from (n,pt)

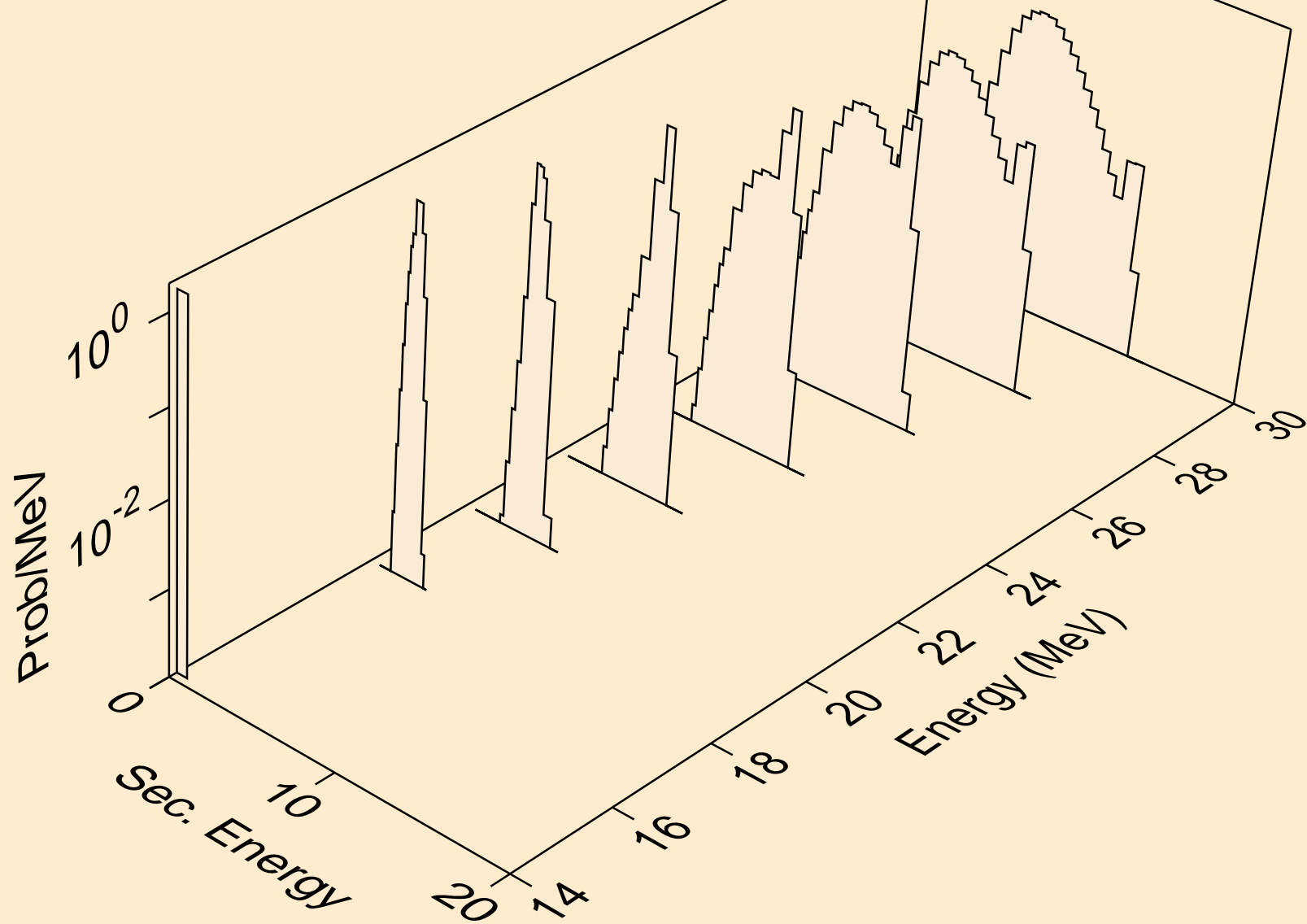

RU101 NEUTRON ACER TENDL-2023 LIBRARY; T=0.K  
he3s from (n,x)

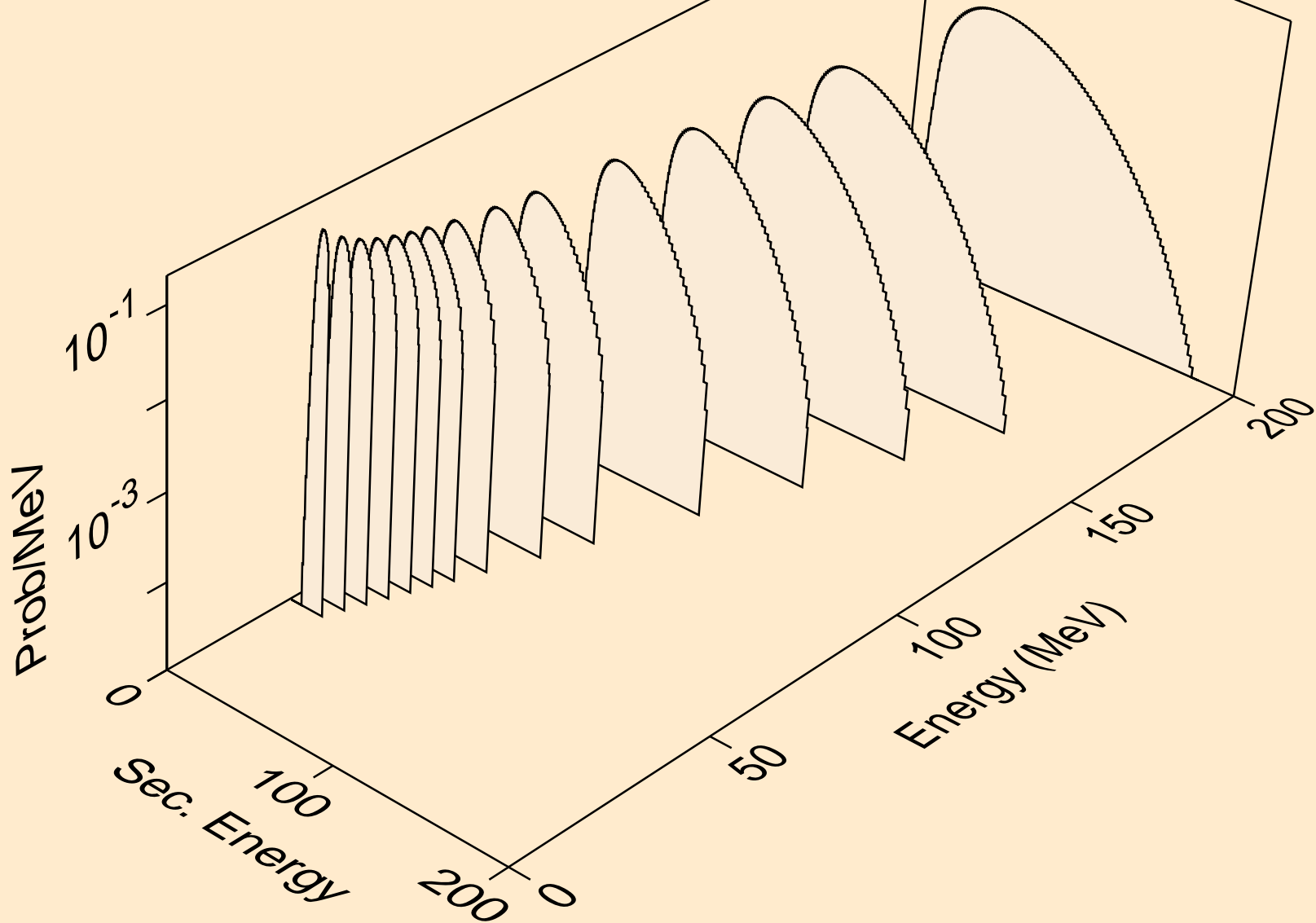

RU101 NEUTRON ACER TENDL-2023 LIBRARY; T=0.K  
he3s from (n,n\*)he3

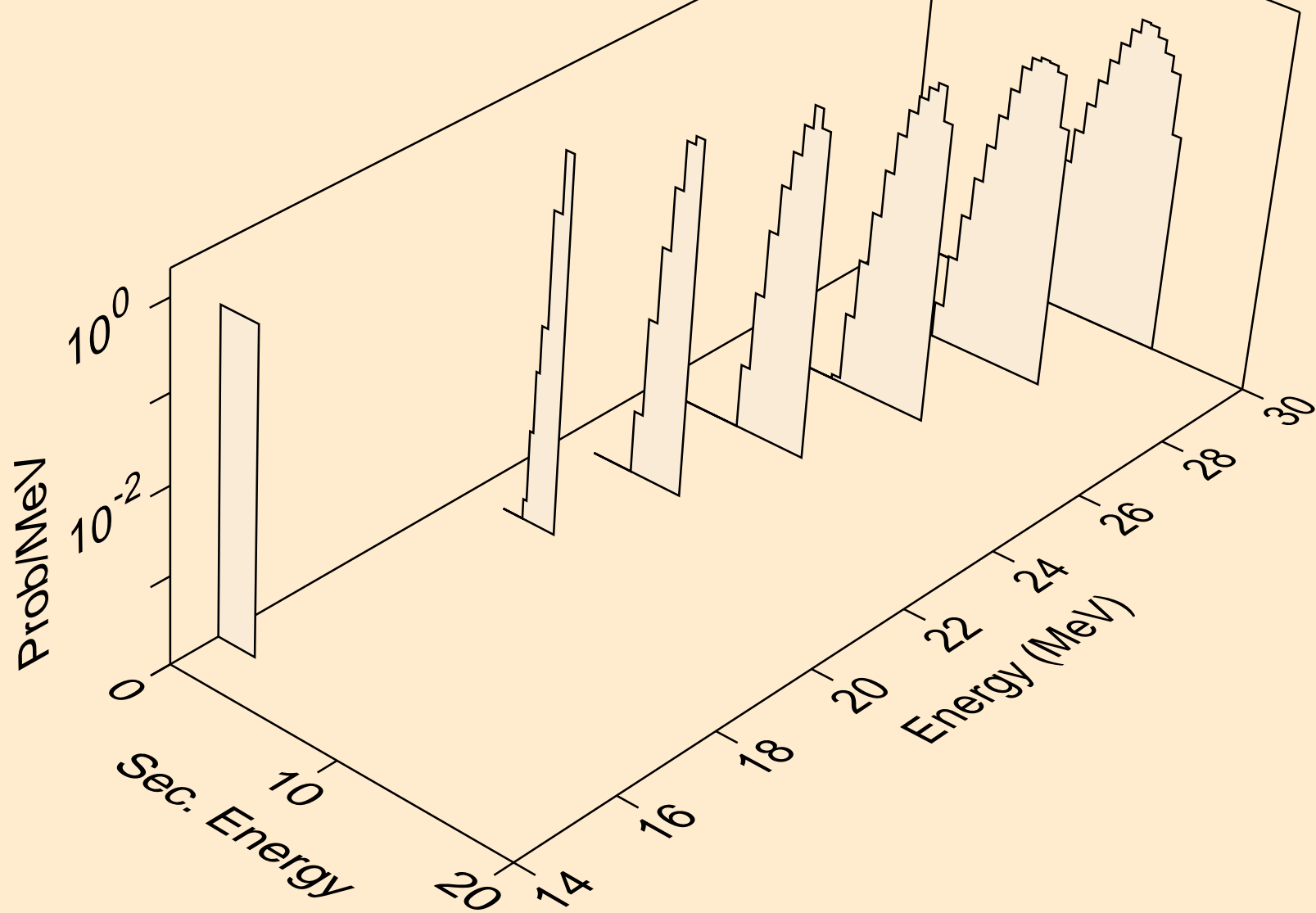

RU101 NEUTRON ACER TENDL-2023 LIBRARY; T=0.K  
he3s from (n,he3)

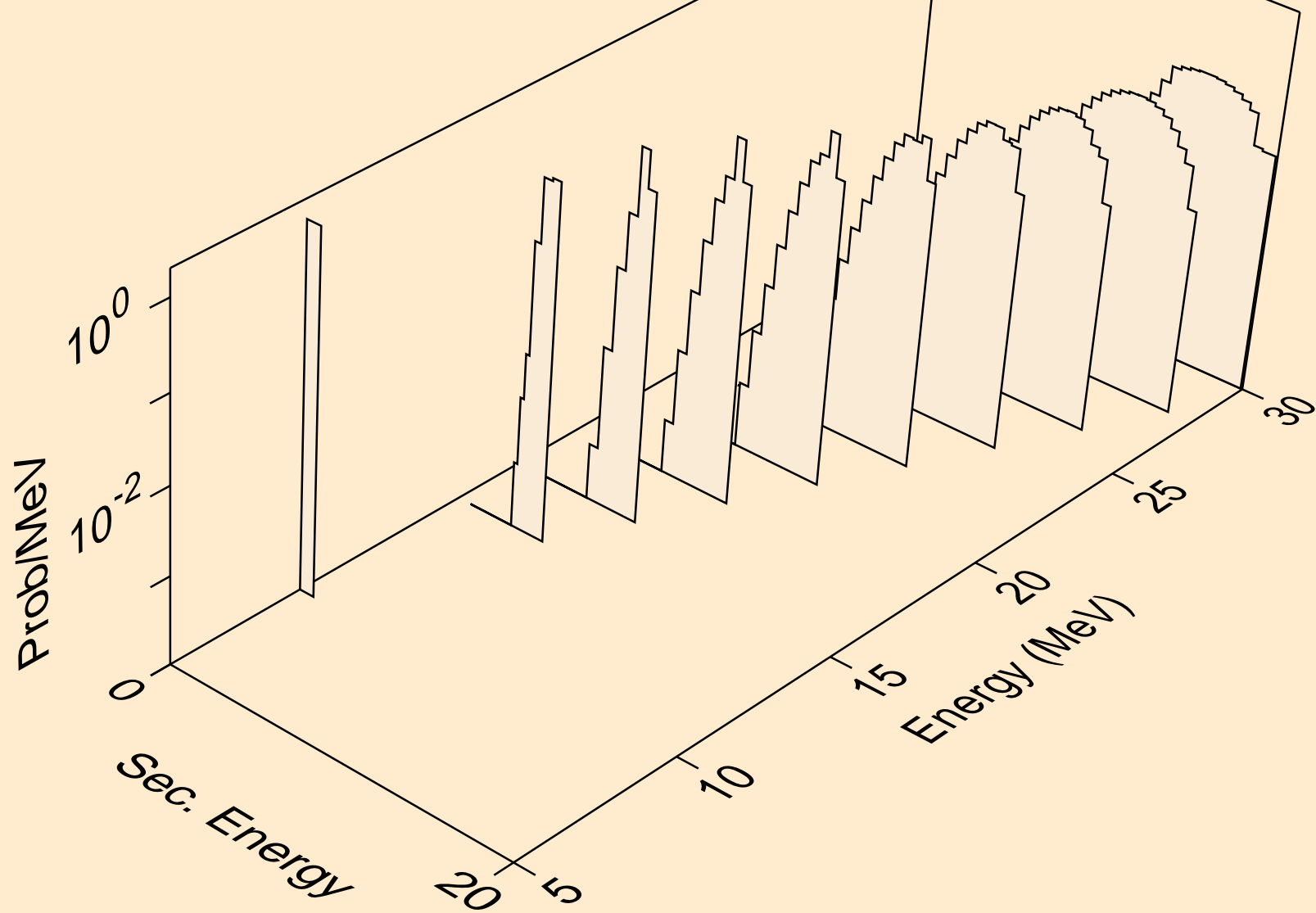

RU101 NEUTRON ACER TENDL-2023 LIBRARY; T=0.K  
alphas from (n,x)

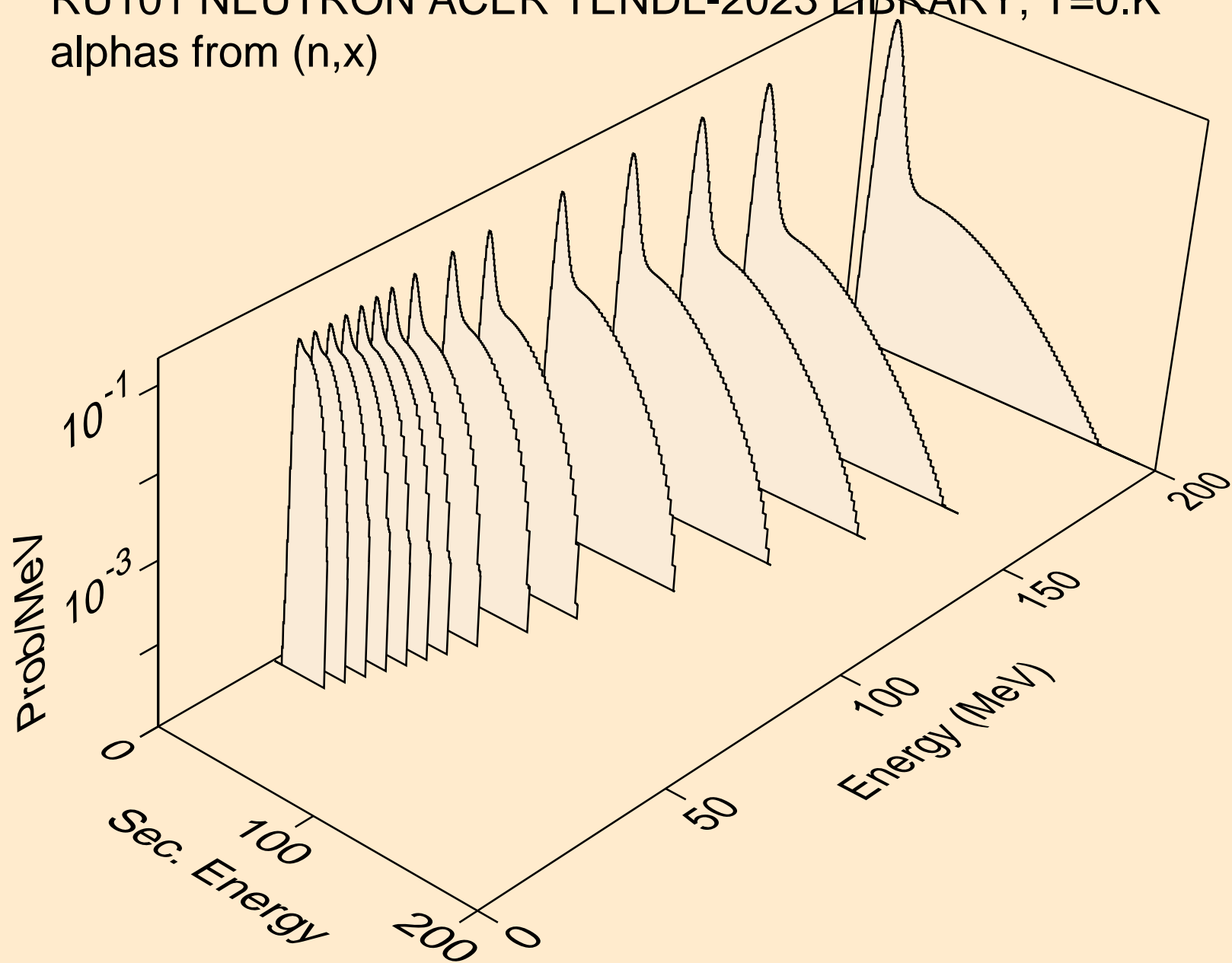

RU101 NEUTRON ACER TENDL-2023 LIBRARY; T=0.K  
alphas from (n,n\*)a

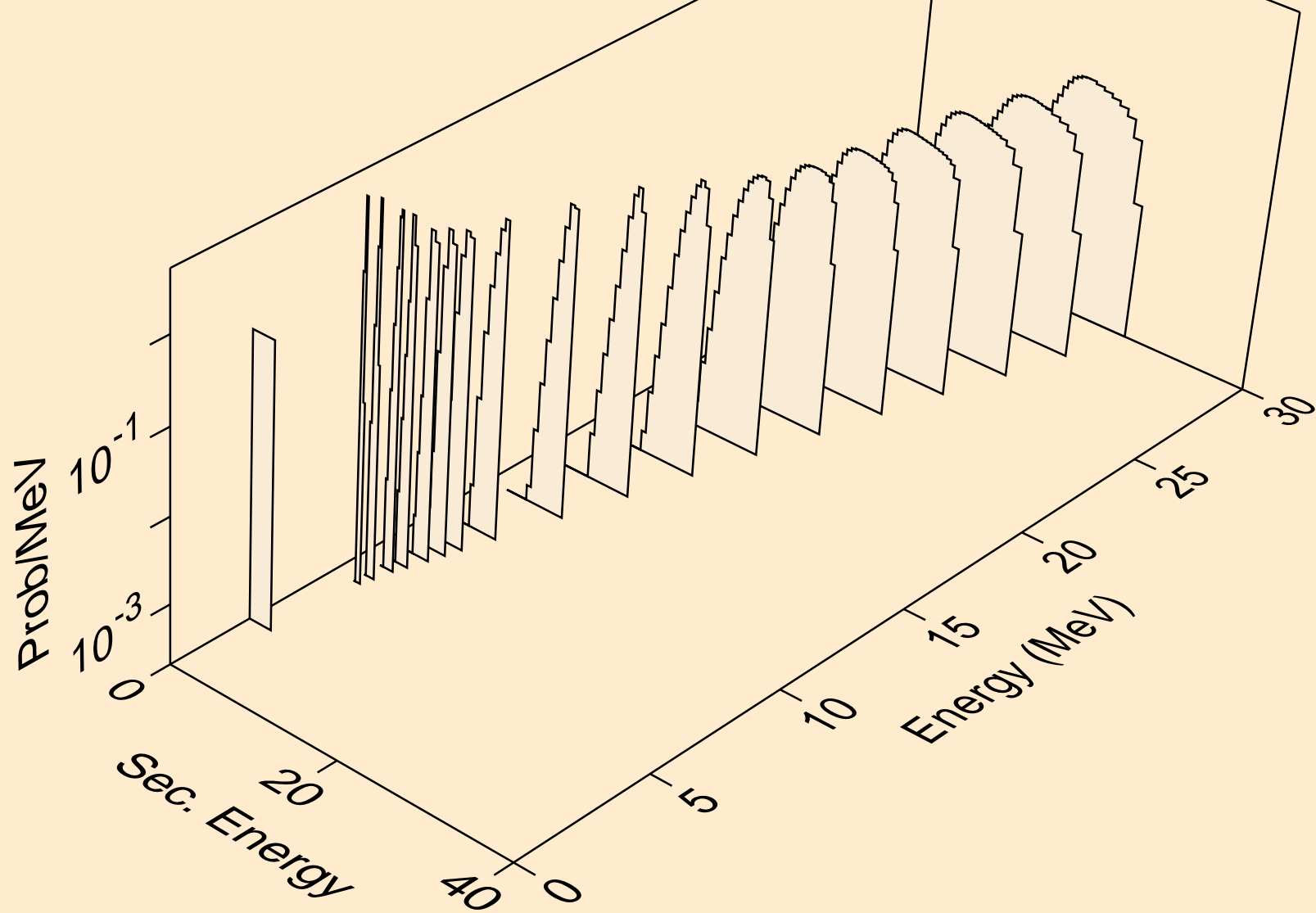

RU101 NEUTRON ACER TENDL-2023 LIBRARY; T=0.K  
alphas from (n,2n)a

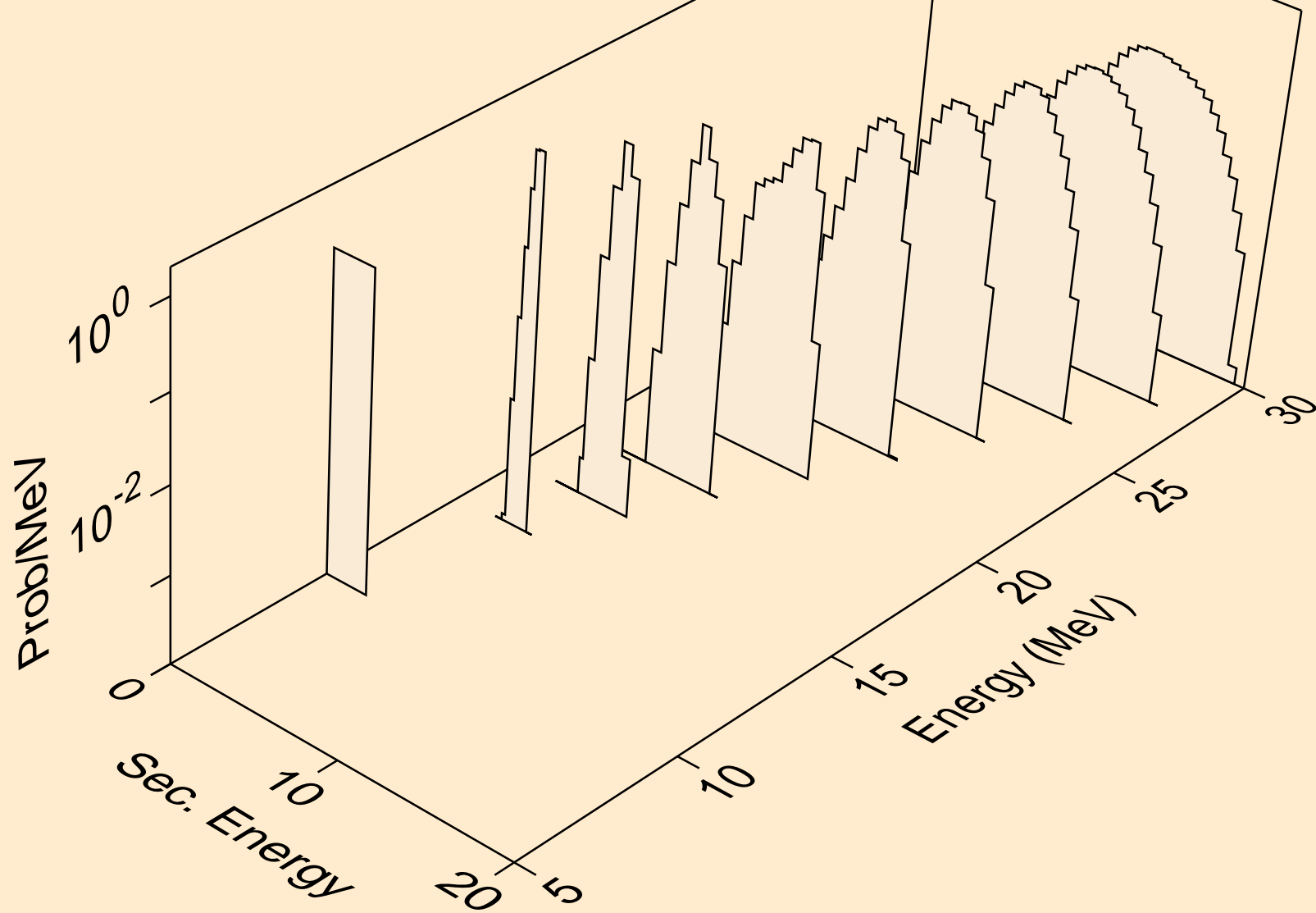

RU101 NEUTRON ACER TENDL-2023 LIBRARY; T=0.K  
alphas from (n,3n)a

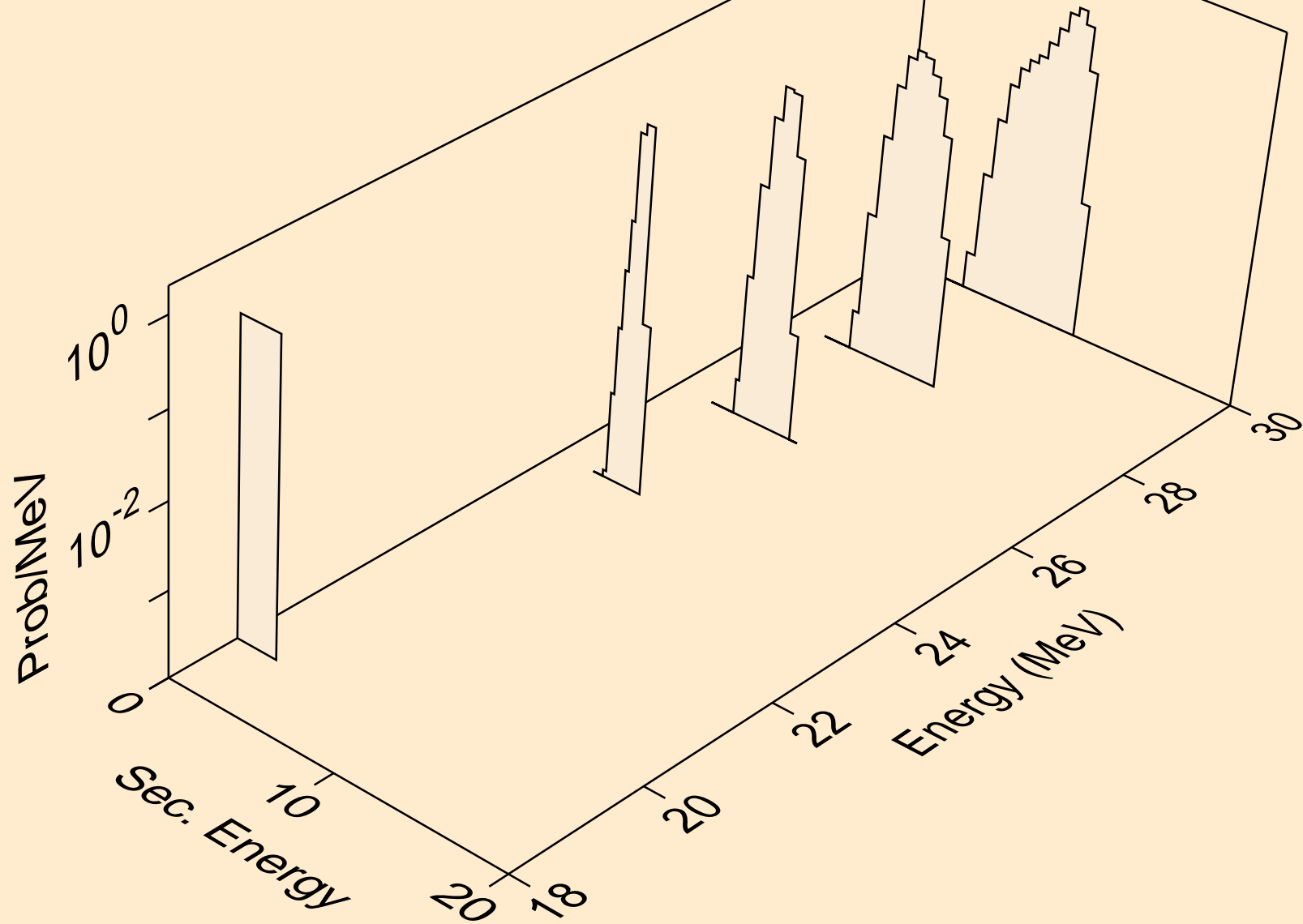

RU101 NEUTRON ACER TENDL-2023 LIBRARY; T=0.K  
alphas from (n,n\*)2a

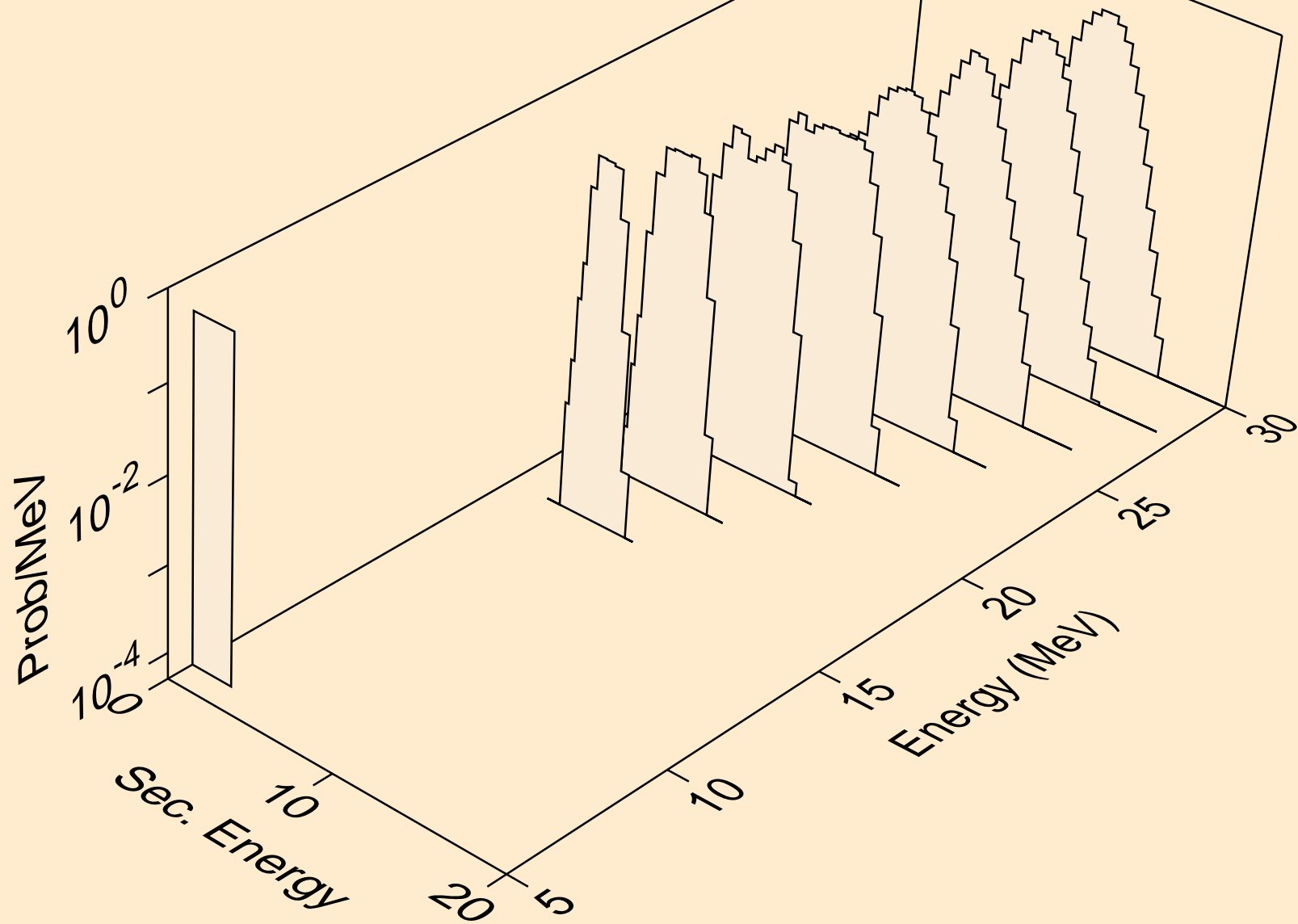

RU101 NEUTRON ACER TENDL-2023 LIBRARY; T=0.K  
alphas from (n,npa)

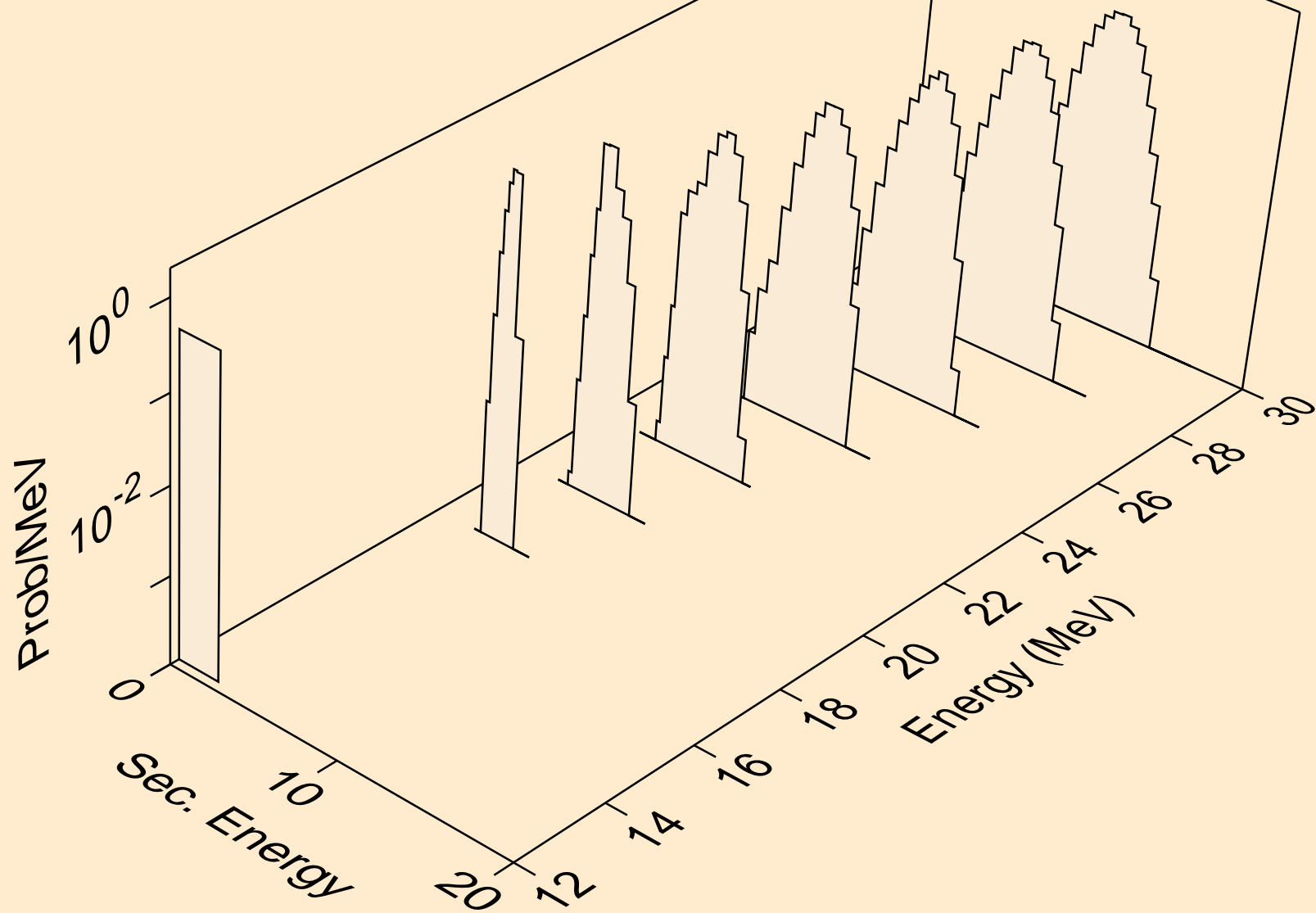

RU101 NEUTRON ACER TENDL-2023 LIBRARY; T=0.K  
alphas from (n,a)

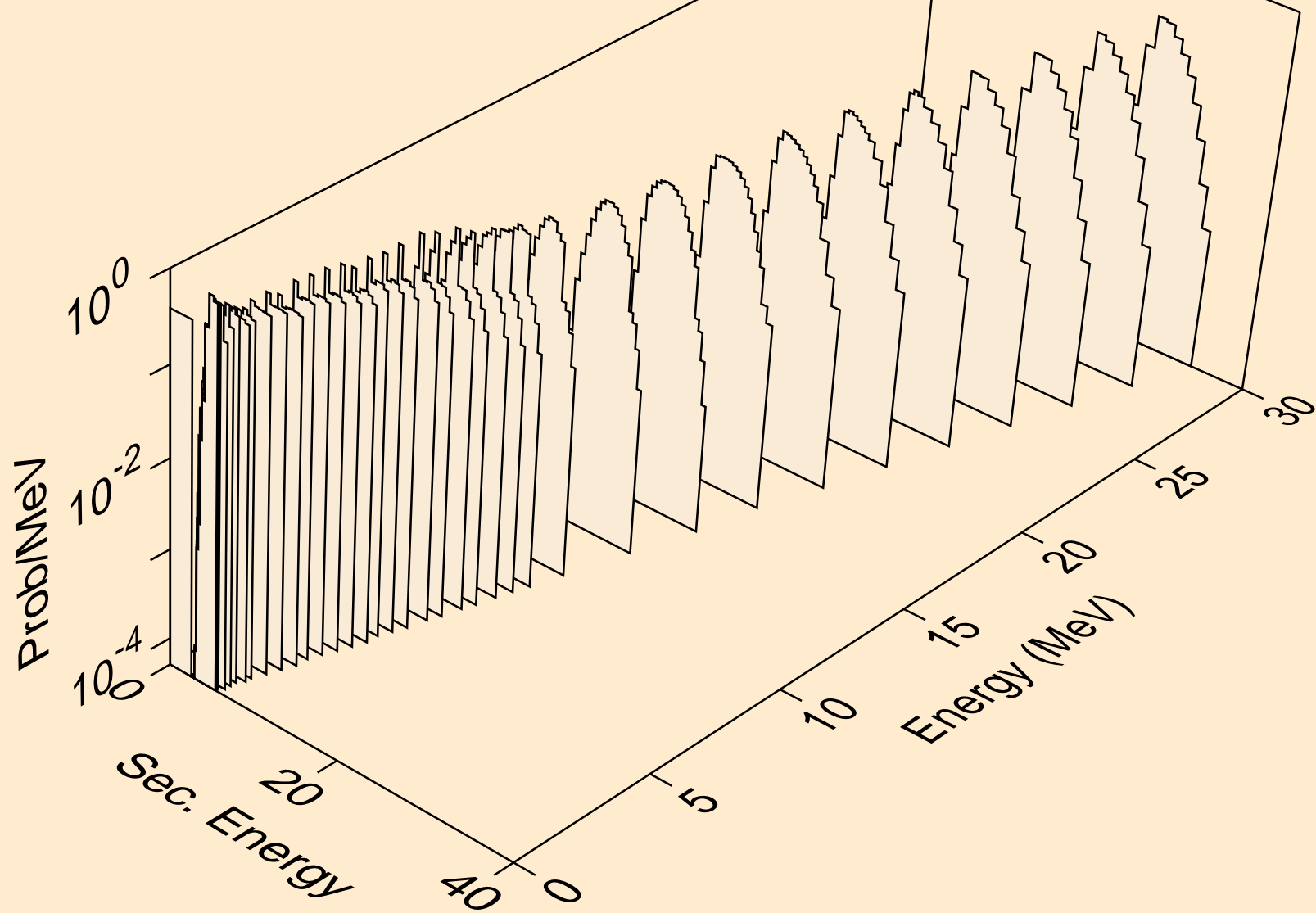

RU101 NEUTRON ACER TENDL-2023 LIBRARY; T=0.K  
alphas from (n,2a)

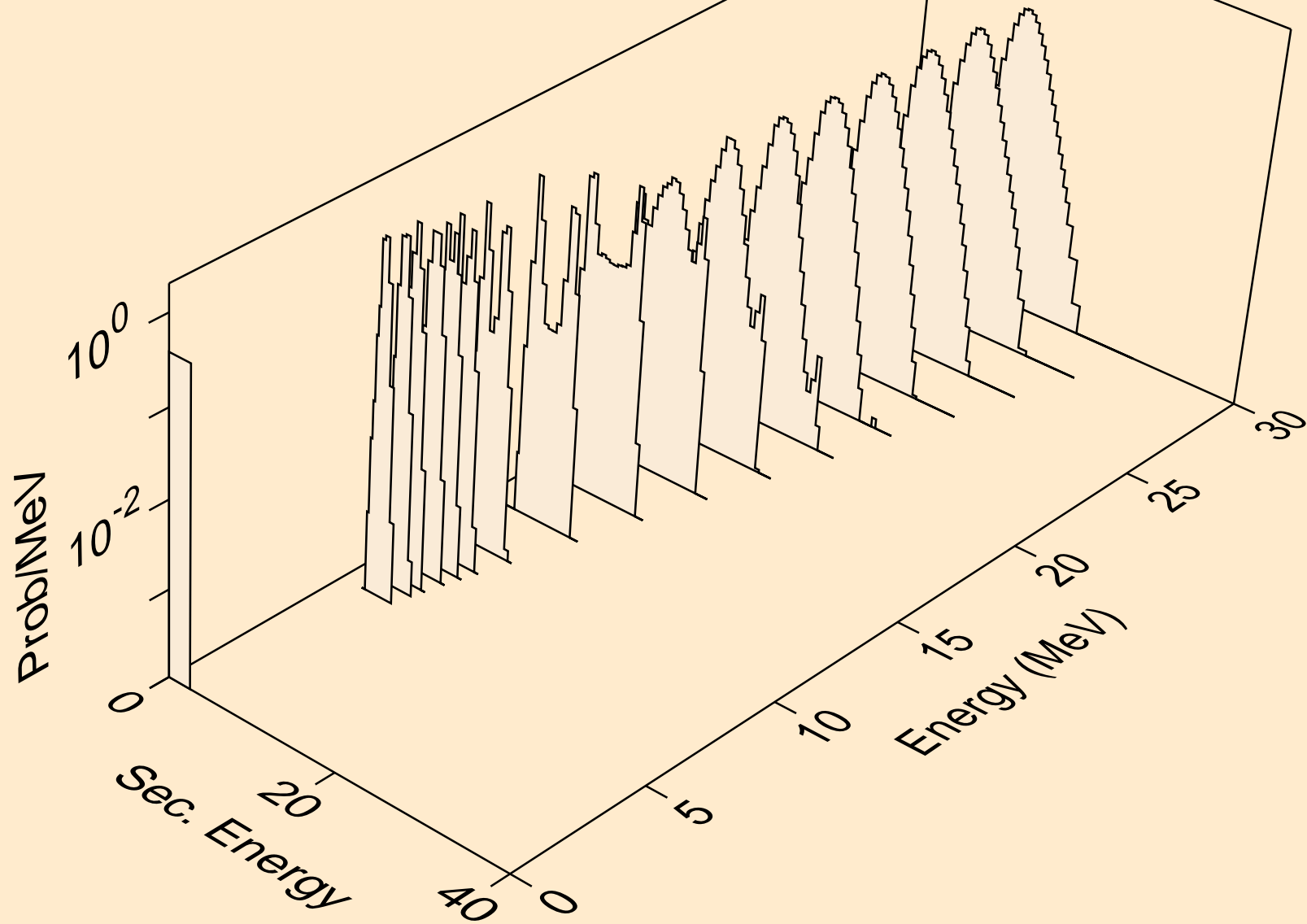

RU101 NEUTRON ACER TENDL-2023 LIBRARY; T=0.K  
alphas from (n,pa)

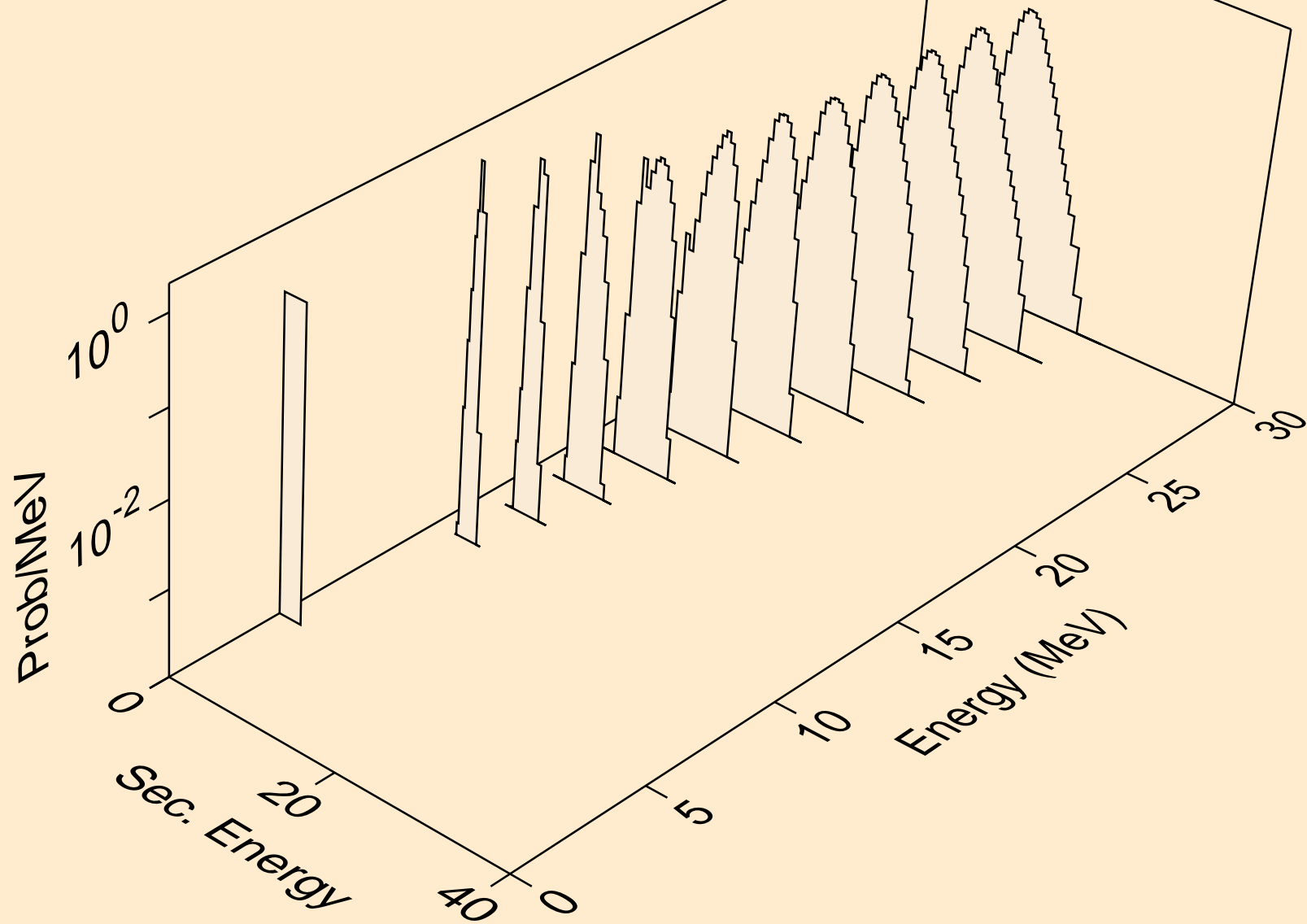

RU101 NEUTRON ACER TENDL-2023 LIBRARY; T=0.K  
alphas from (n,da)

