

# SI034 NEUTRON ACER TENDL-2023 LIBRARY; T=0.K

## Principal cross sections

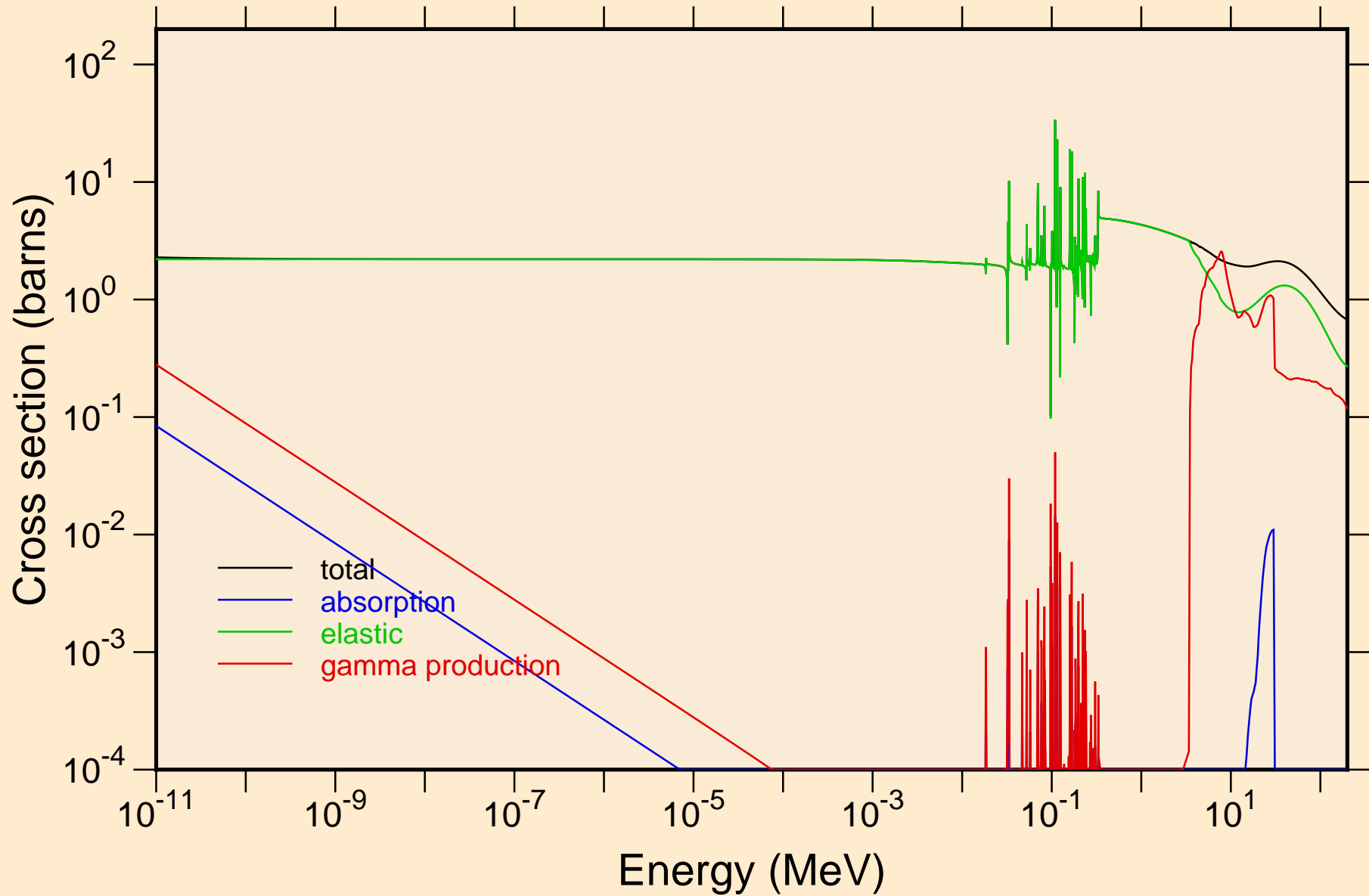

SI034 NEUTRON ACER TENDL-2023 LIBRARY; T=0.K  
resonance total cross section

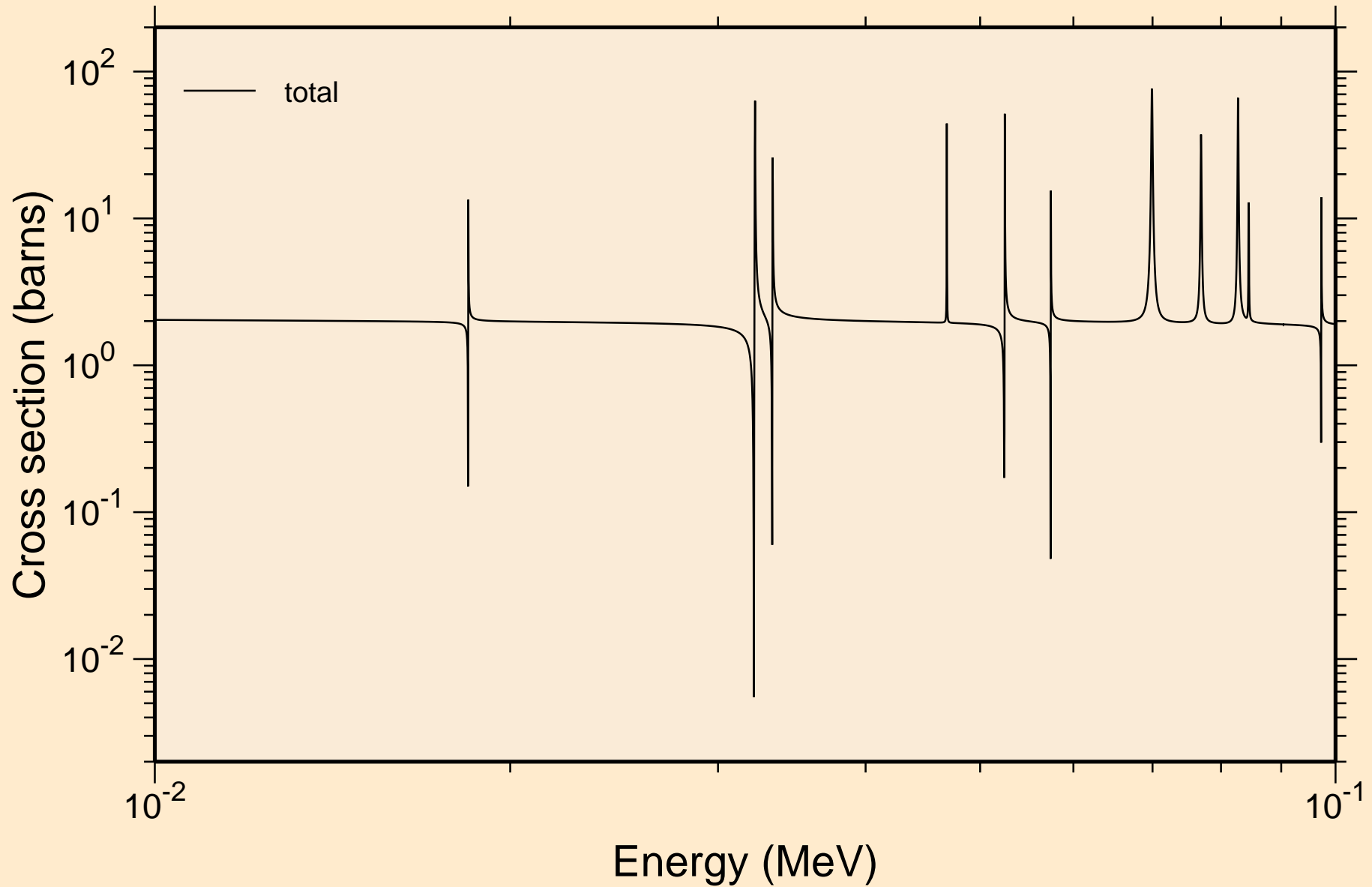

SI034 NEUTRON ACER TENDL-2023 LIBRARY; T=0.K  
resonance total cross section

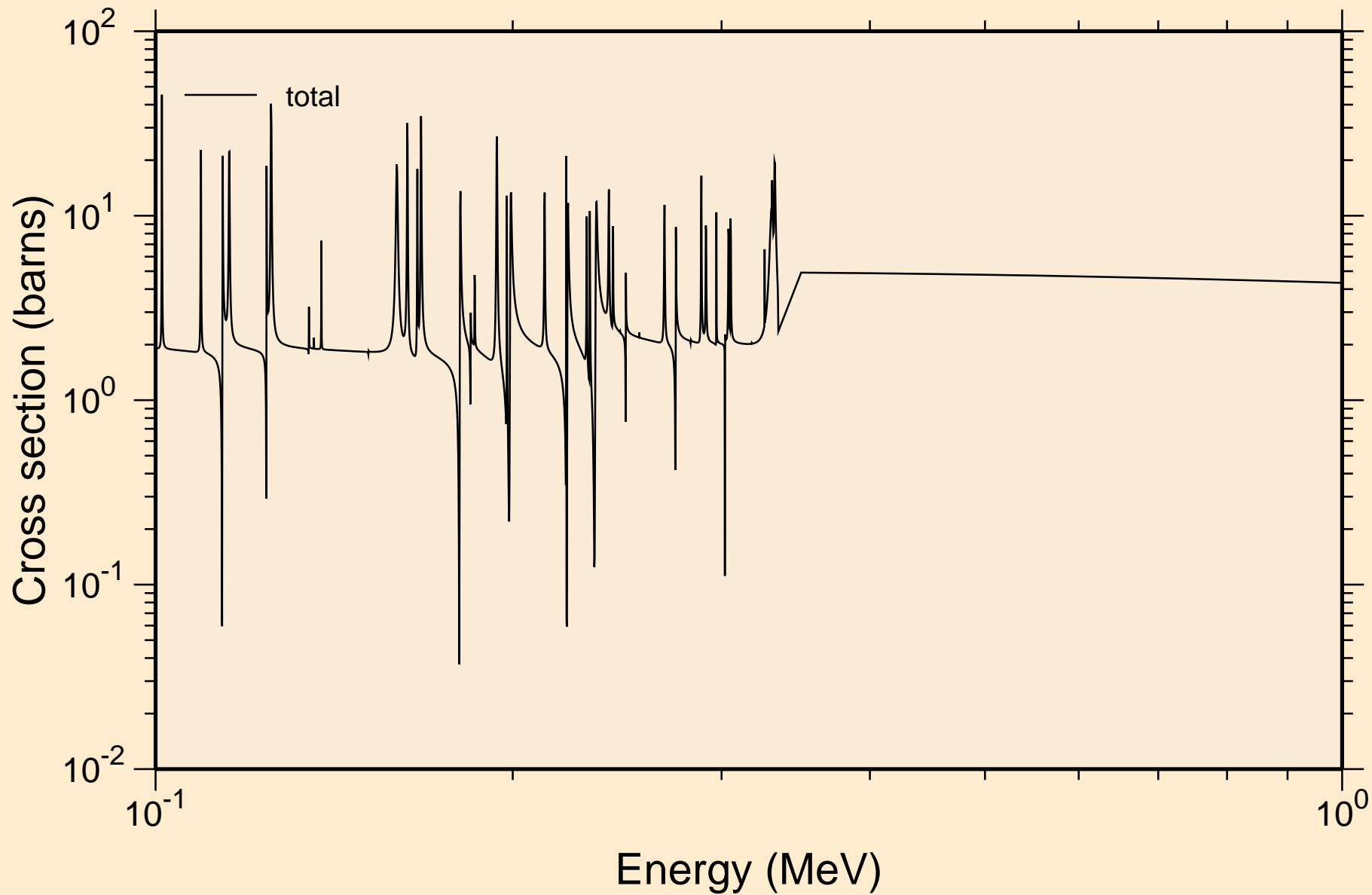

SI034 NEUTRON ACER TENDL-2023 LIBRARY; T=0.K  
resonance total cross section

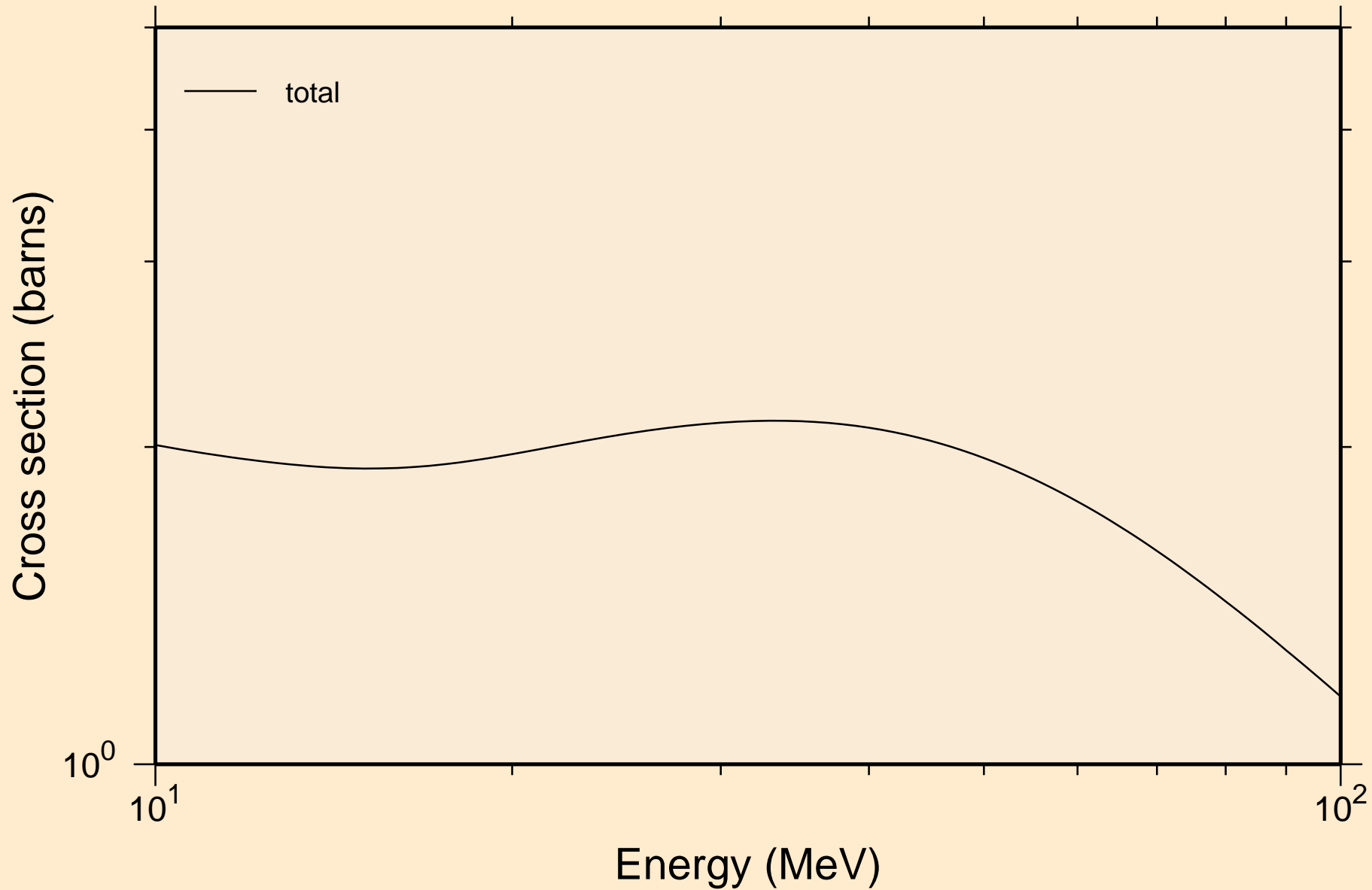

SI034 NEUTRON ACER TENDL-2023 LIBRARY; T=0.K  
resonance absorption cross sections

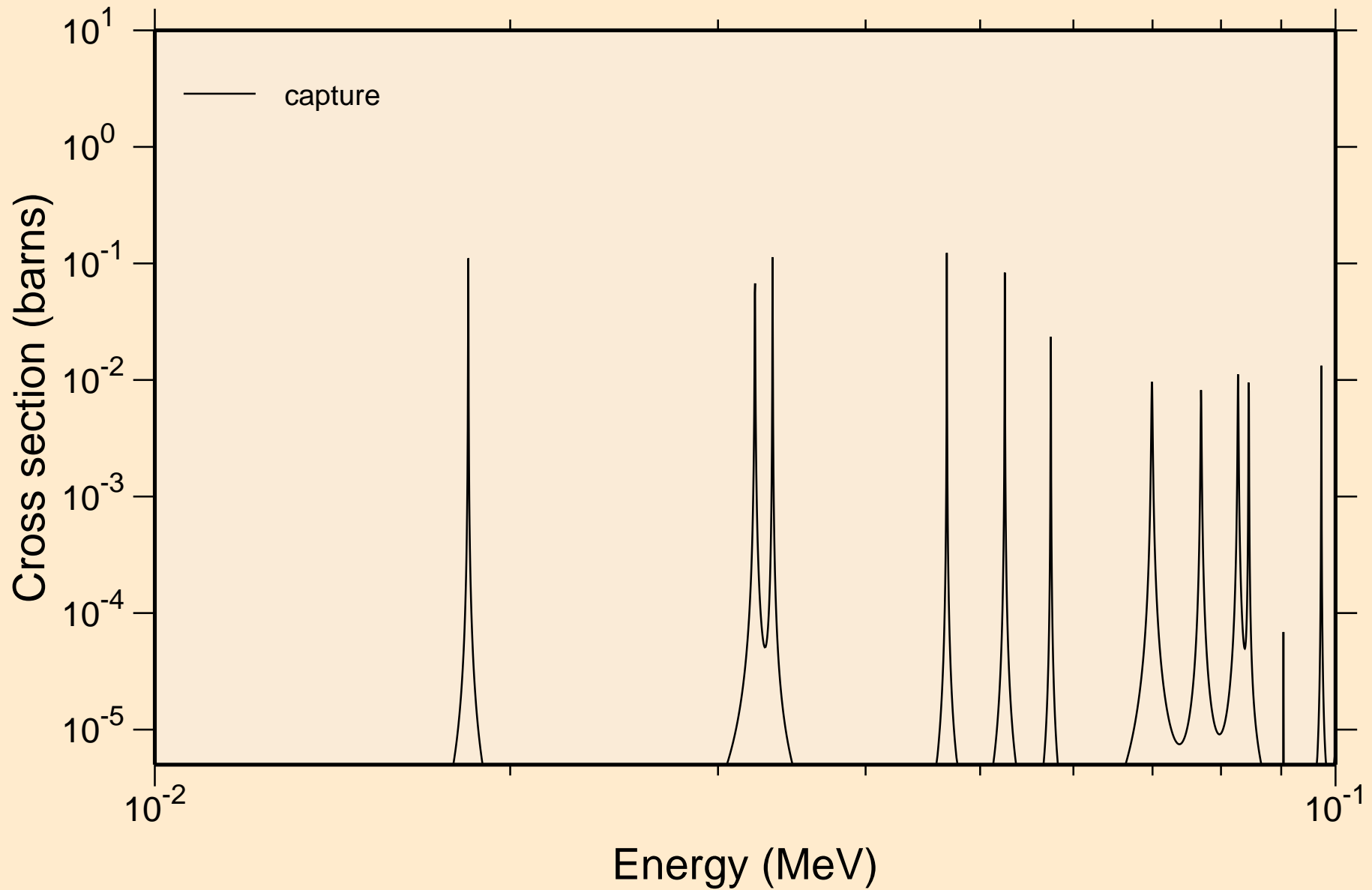

SI034 NEUTRON ACER TENDL-2023 LIBRARY; T=0.K  
resonance absorption cross sections

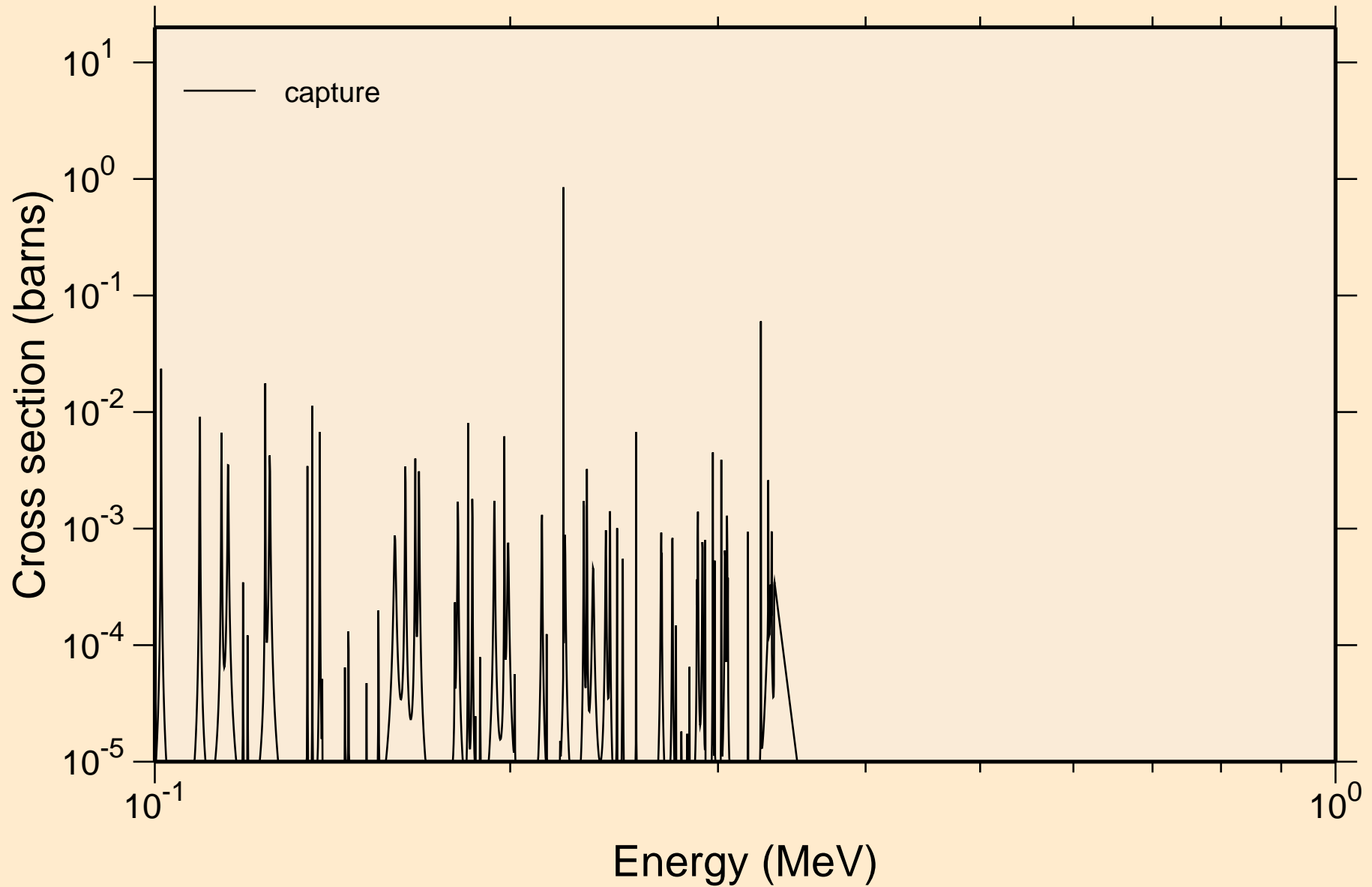

SI034 NEUTRON ACER TENDL-2023 LIBRARY; T=0.K  
resonance absorption cross sections

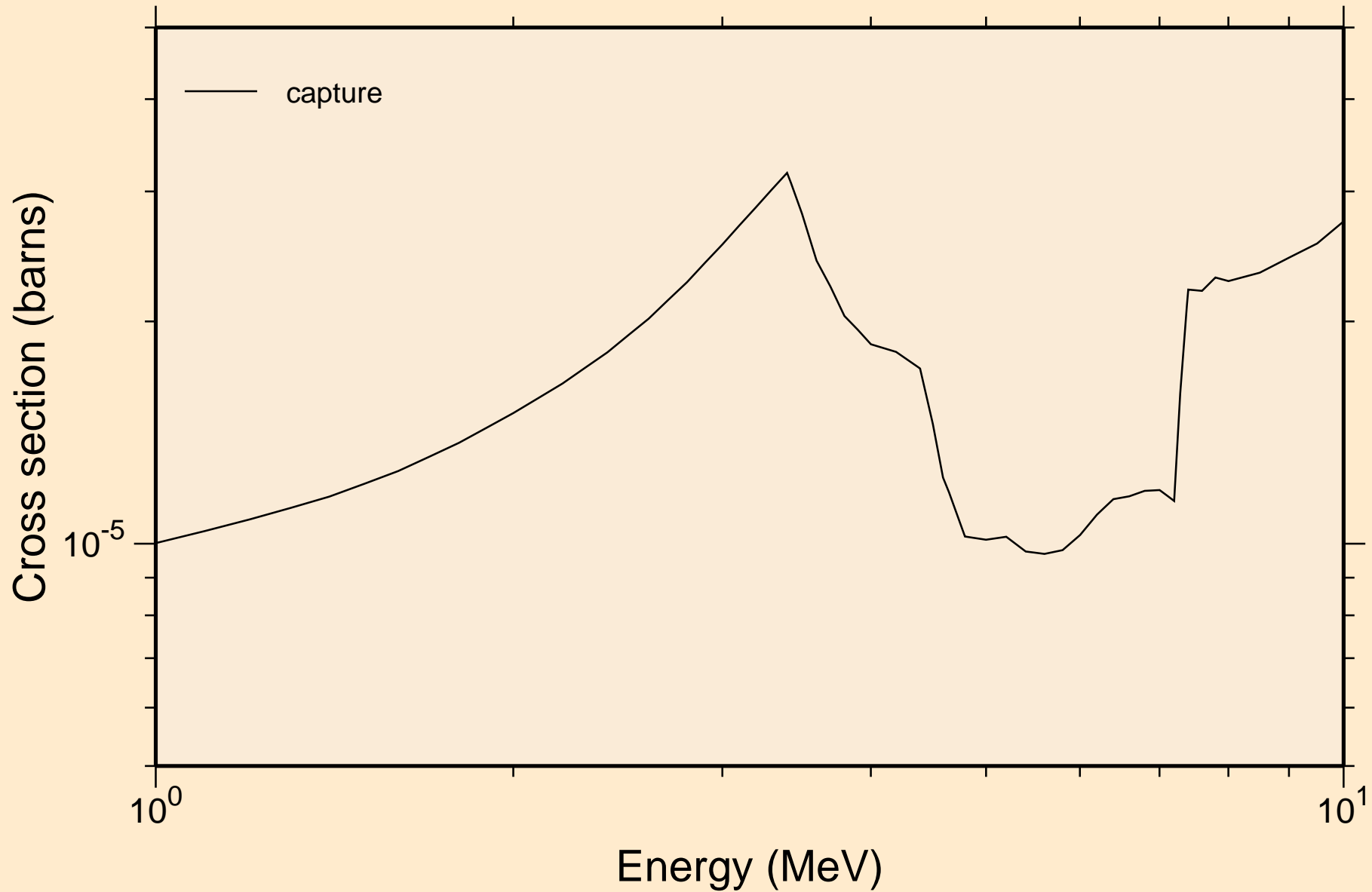

# SI034 NEUTRON ACER TENDL-2023 LIBRARY; T=0.K

## Heating

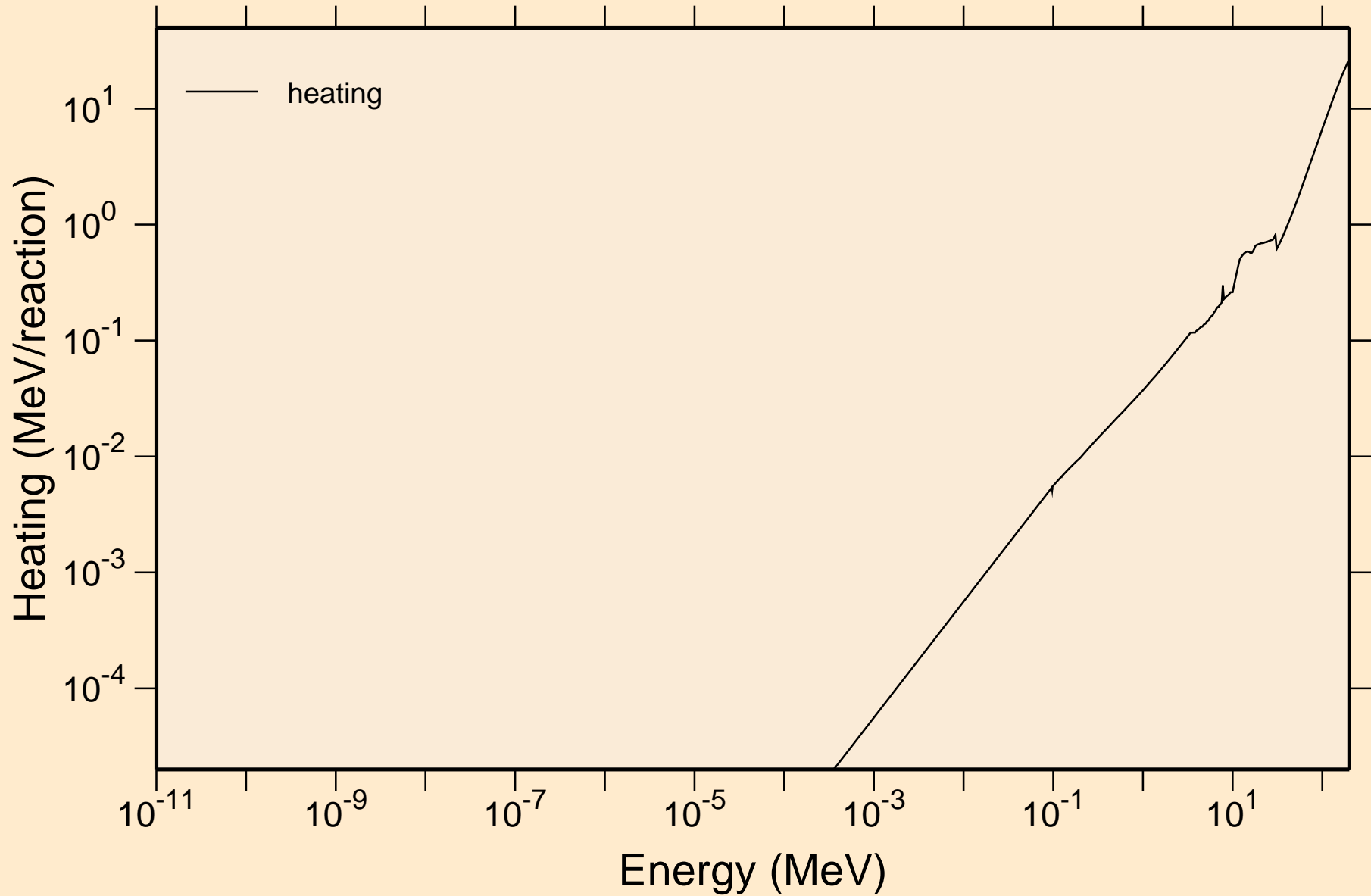

SI034 NEUTRON ACER TENDL-2023 LIBRARY; T=0.K  
Damage

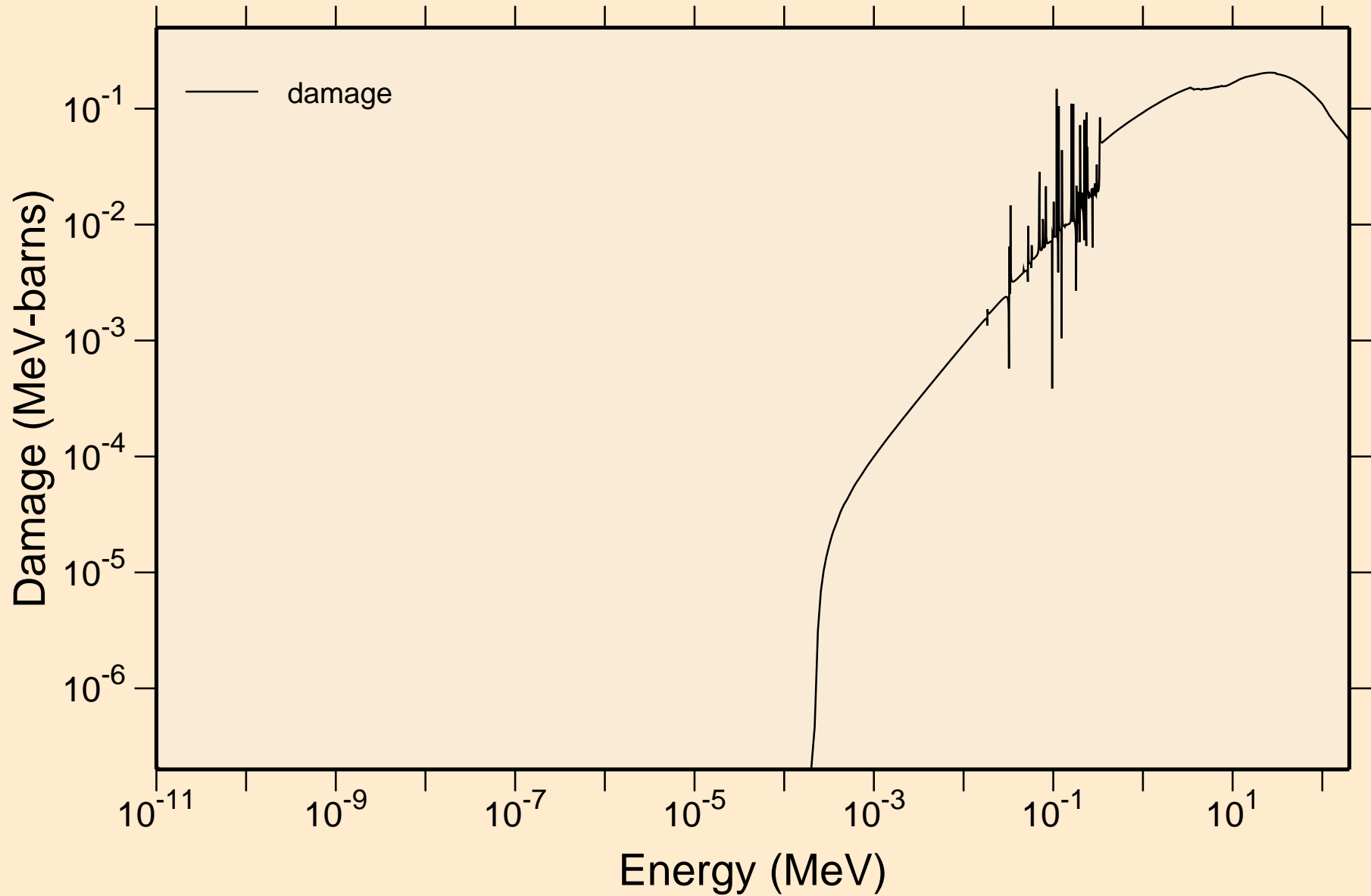

SI034 NEUTRON ACER TENDL-2023 LIBRARY; T=0.K  
Non-threshold reactions

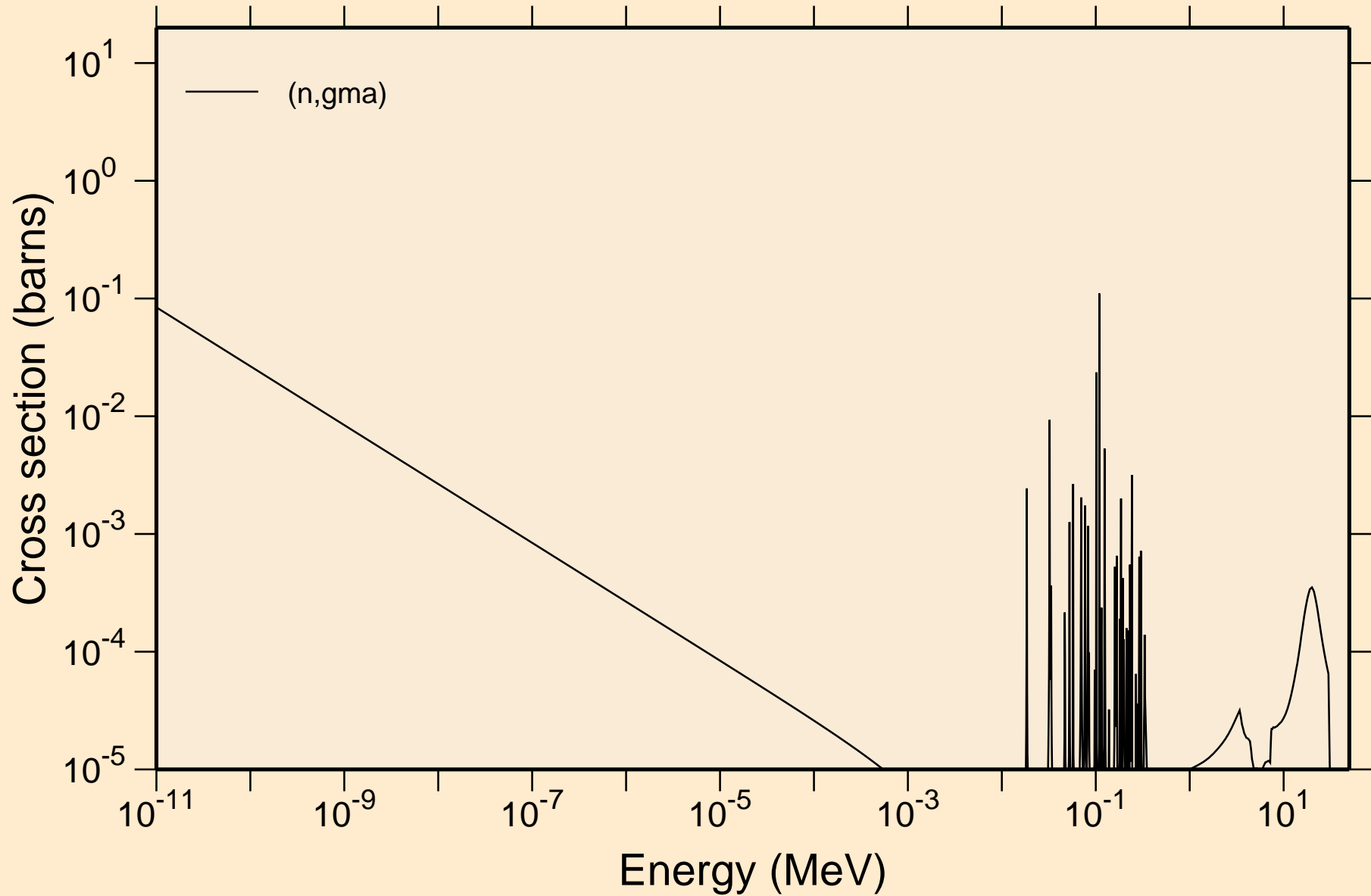

# SI034 NEUTRON ACER TENDL-2023 LIBRARY; T=0.K

## Principal cross sections

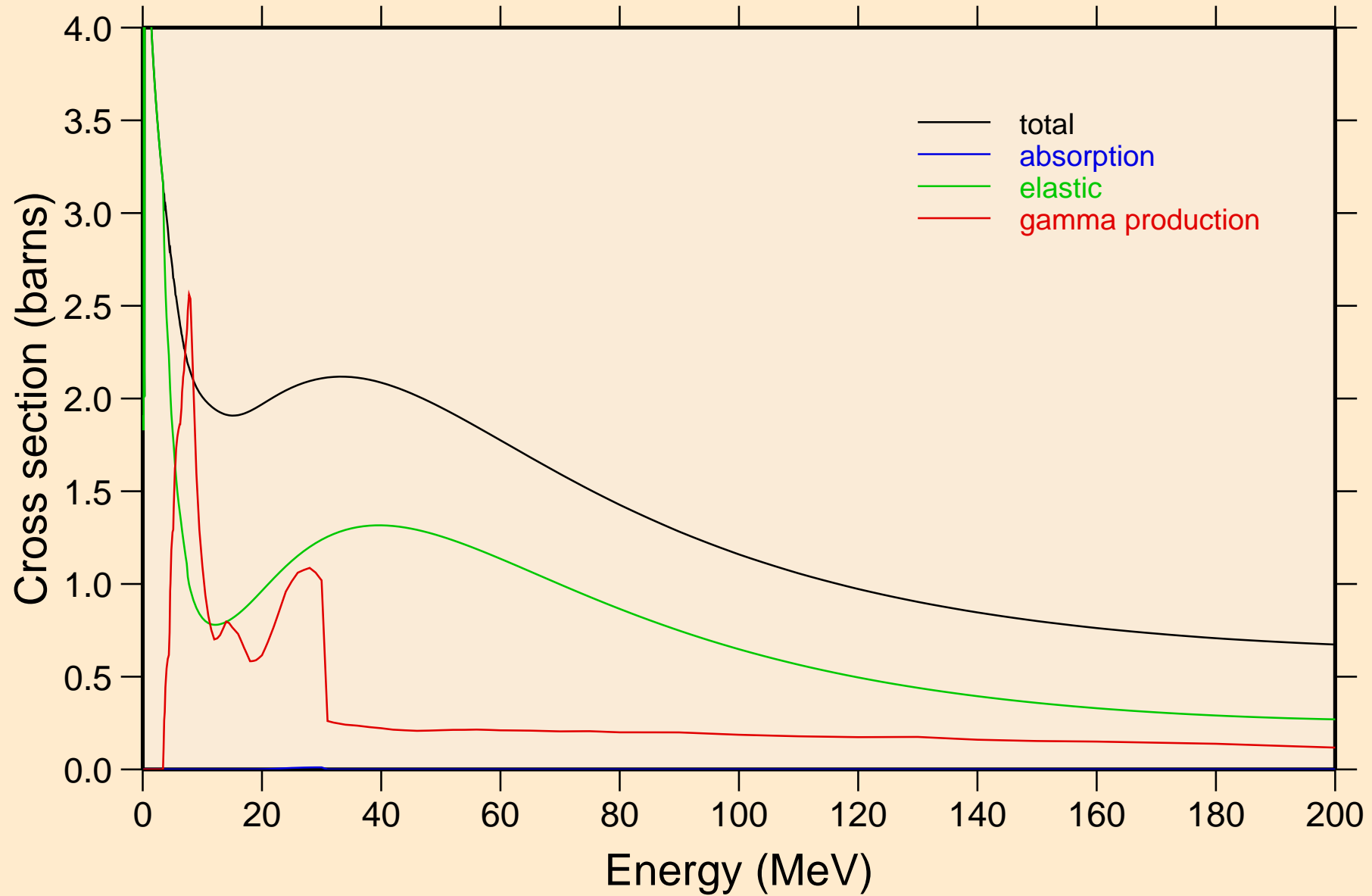

# SI034 NEUTRON ACER TENDL-2023 LIBRARY; T=0.K

## Heating

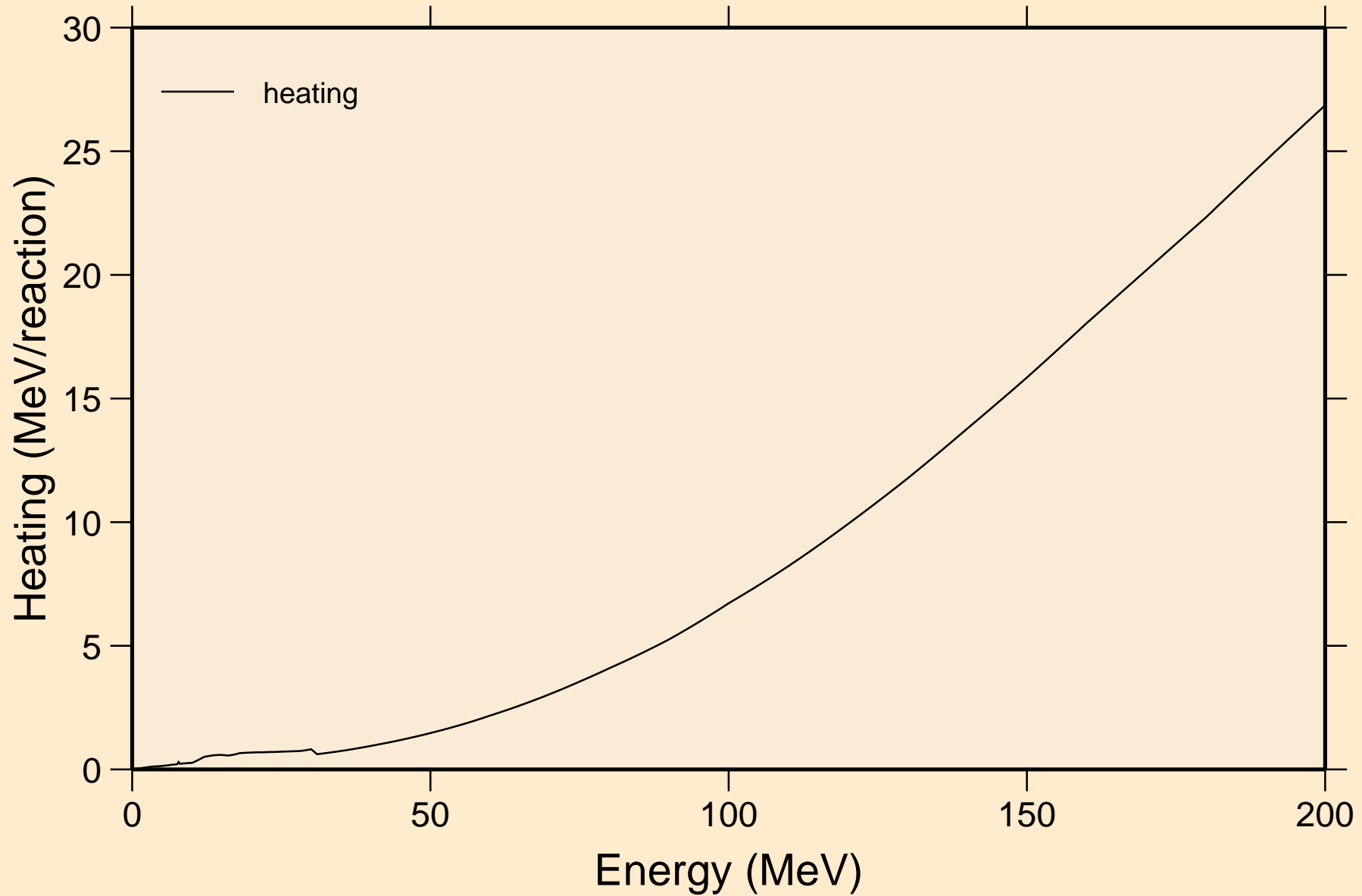

# SI034 NEUTRON ACER TENDL-2023 LIBRARY; T=0.K

## Damage

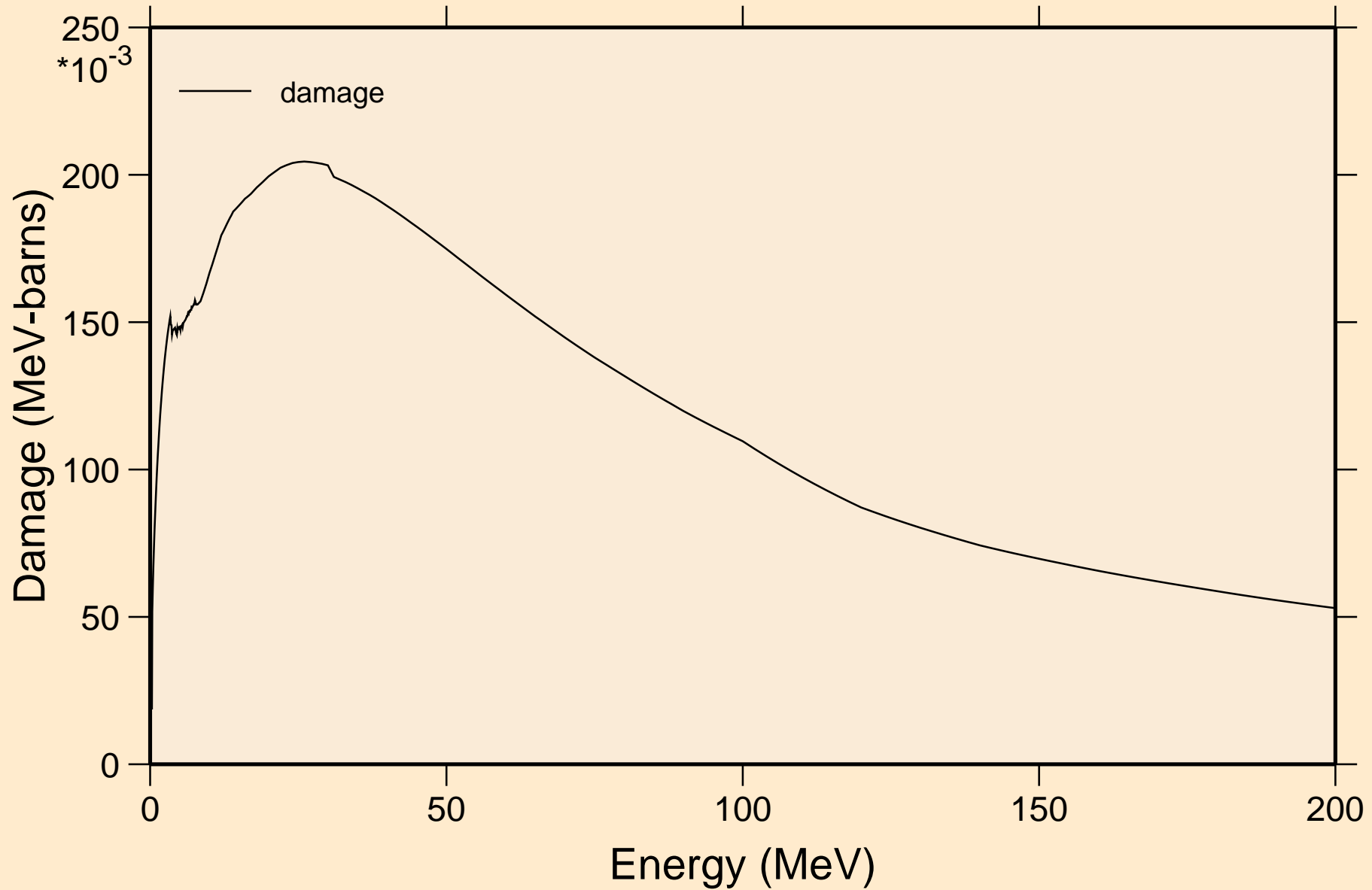

SI034 NEUTRON ACER TENDL-2023 LIBRARY; T=0.K  
Non-threshold reactions

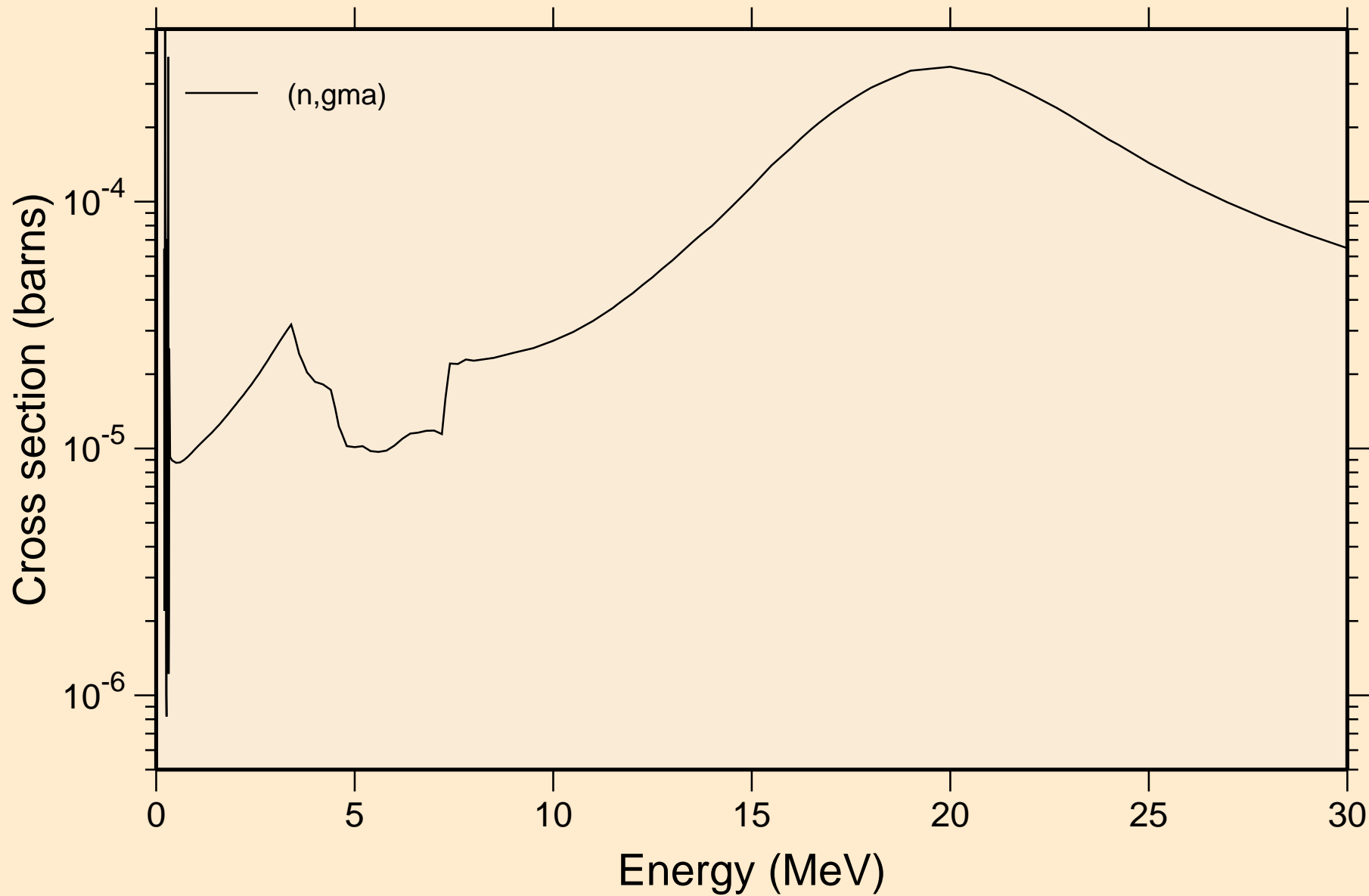

# SI034 NEUTRON ACER TENDL-2023 LIBRARY; T=0.K

## Inelastic levels

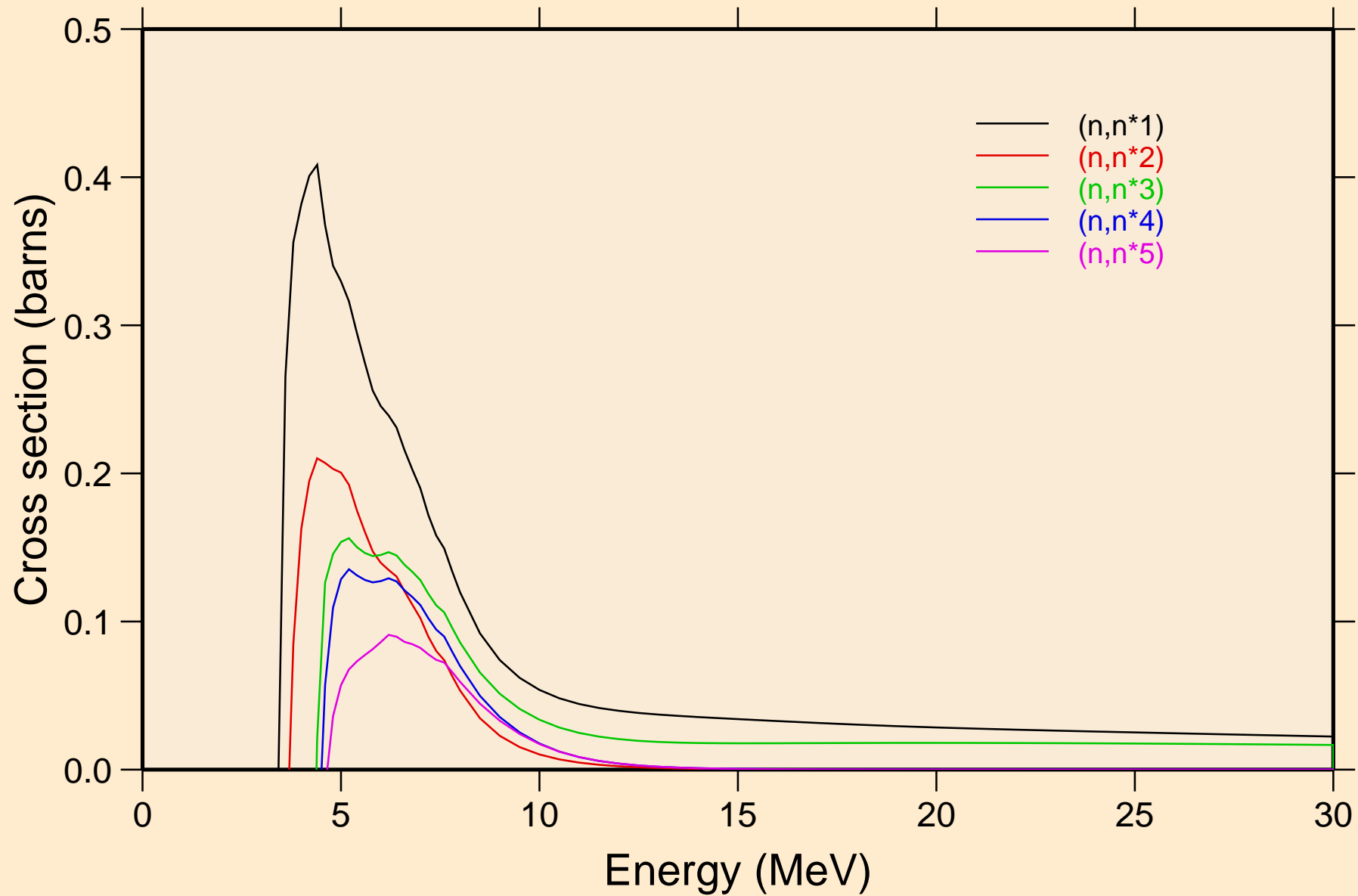

SI034 NEUTRON ACER TENDL-2023 LIBRARY; T=0.K  
Inelastic levels

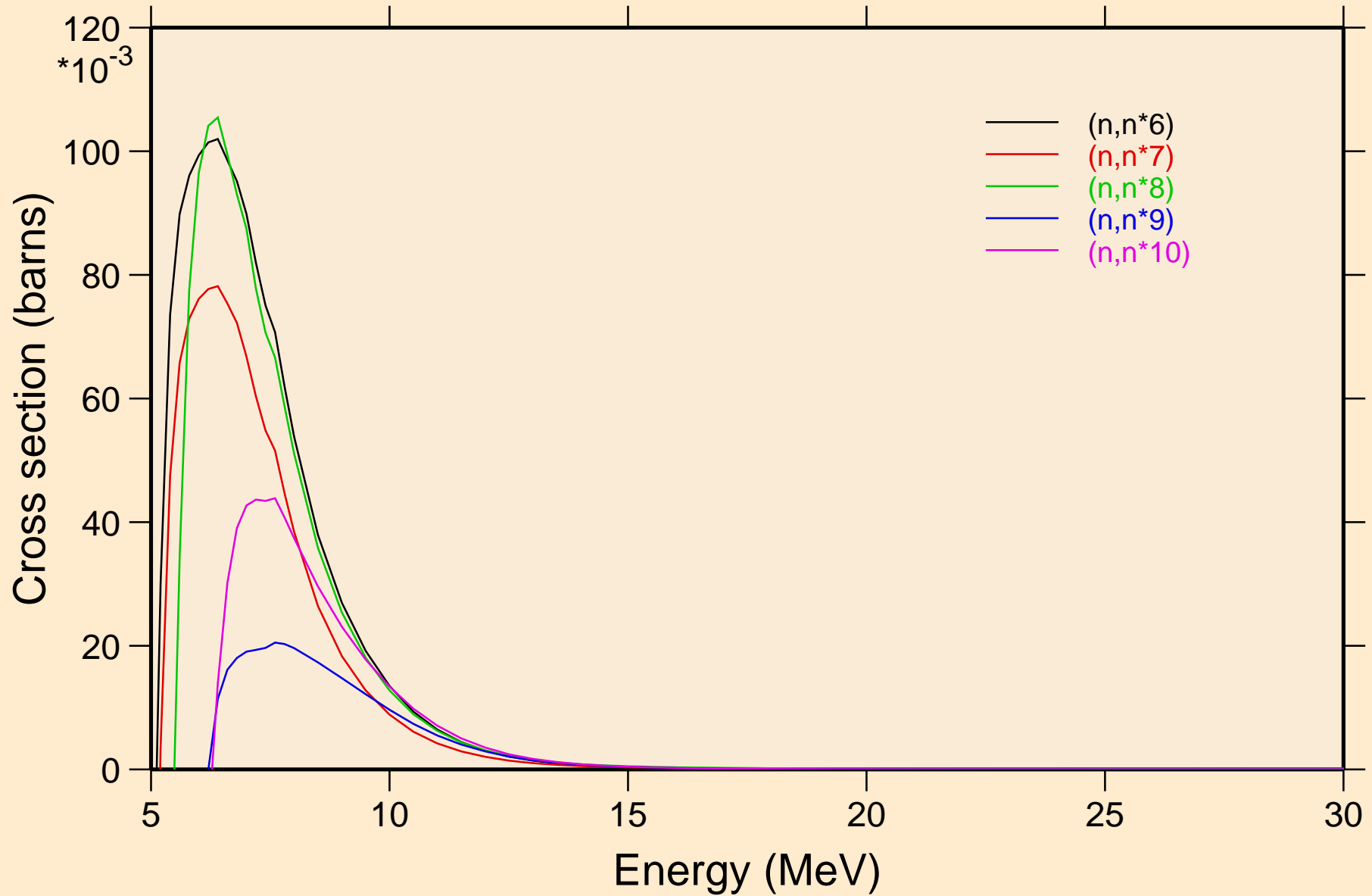

SI034 NEUTRON ACER TENDL-2023 LIBRARY; T=0.K  
Inelastic levels

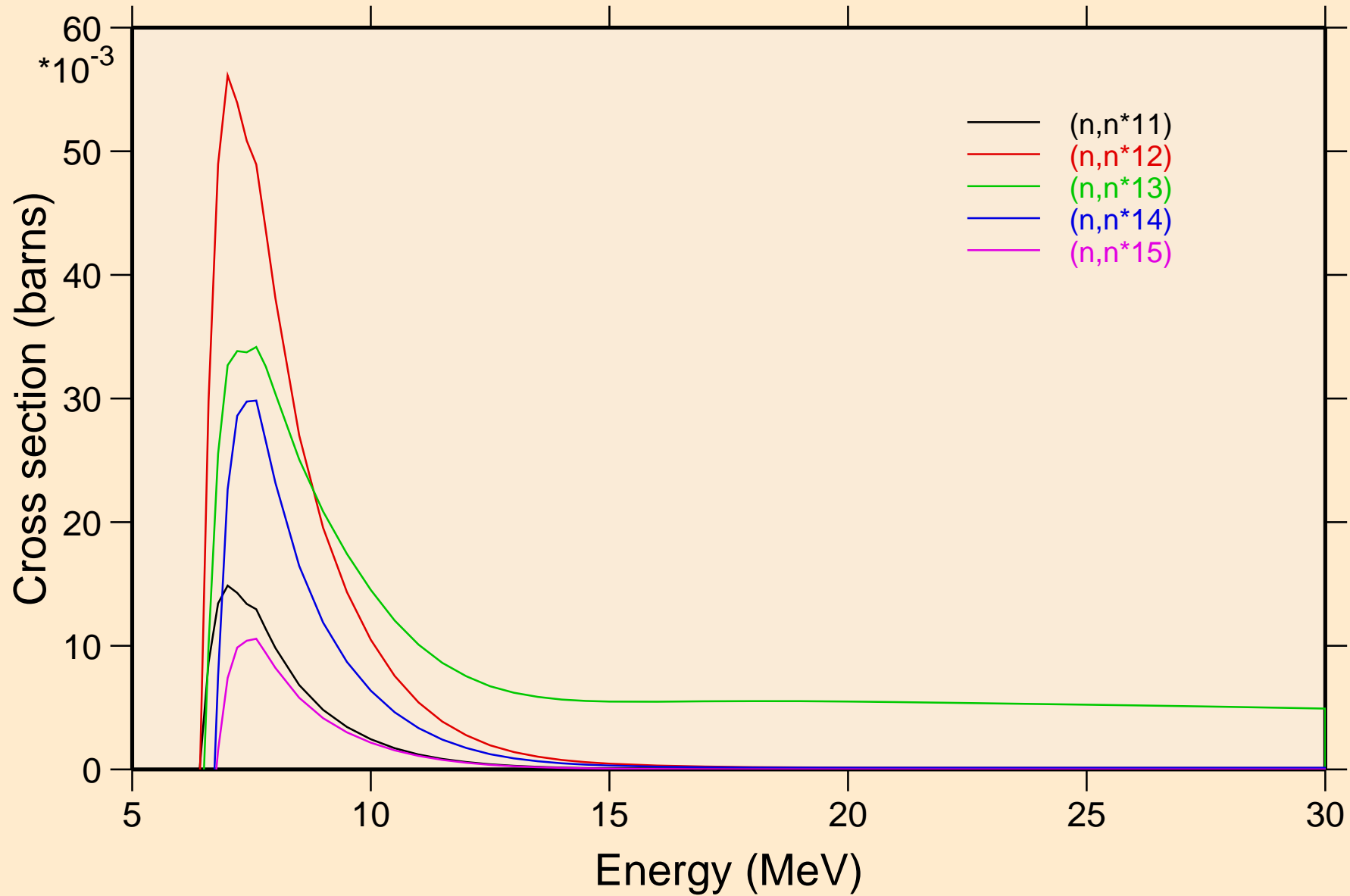

SI034 NEUTRON ACER TENDL-2023 LIBRARY; T=0.K  
Inelastic levels

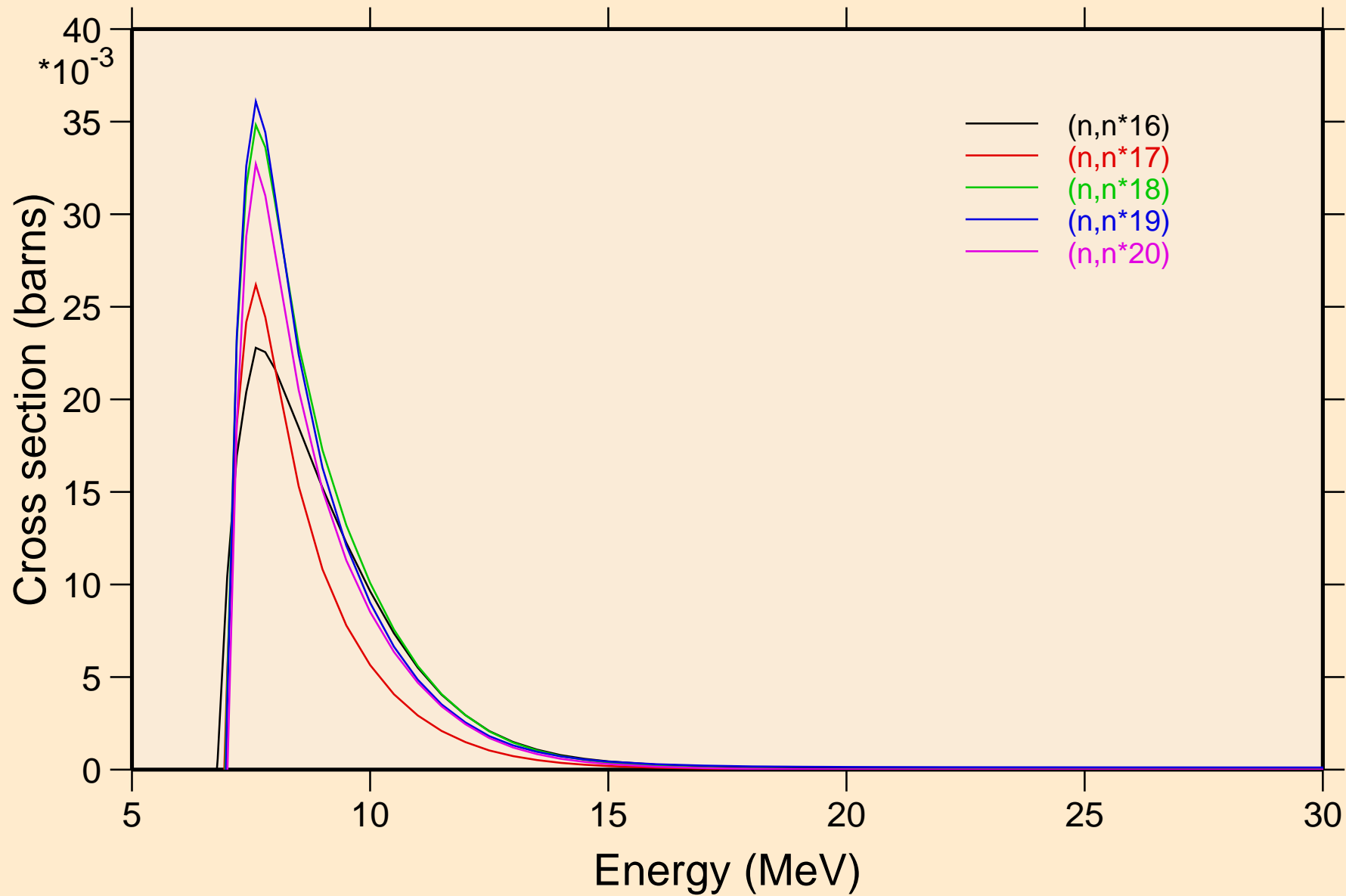

SI034 NEUTRON ACER TENDL-2023 LIBRARY; T=0.K  
Inelastic levels

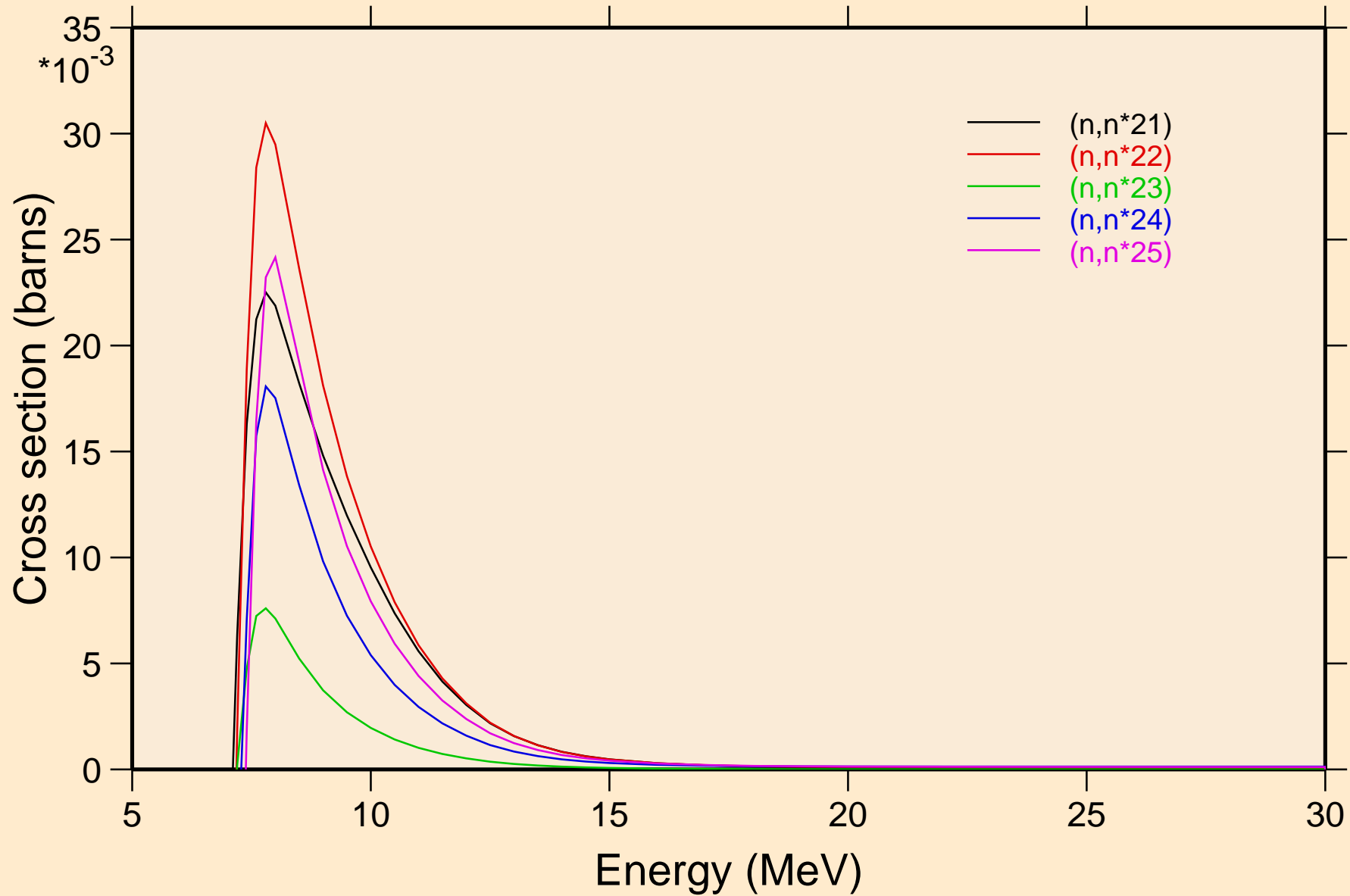

SI034 NEUTRON ACER TENDL-2023 LIBRARY; T=0.K  
Inelastic levels

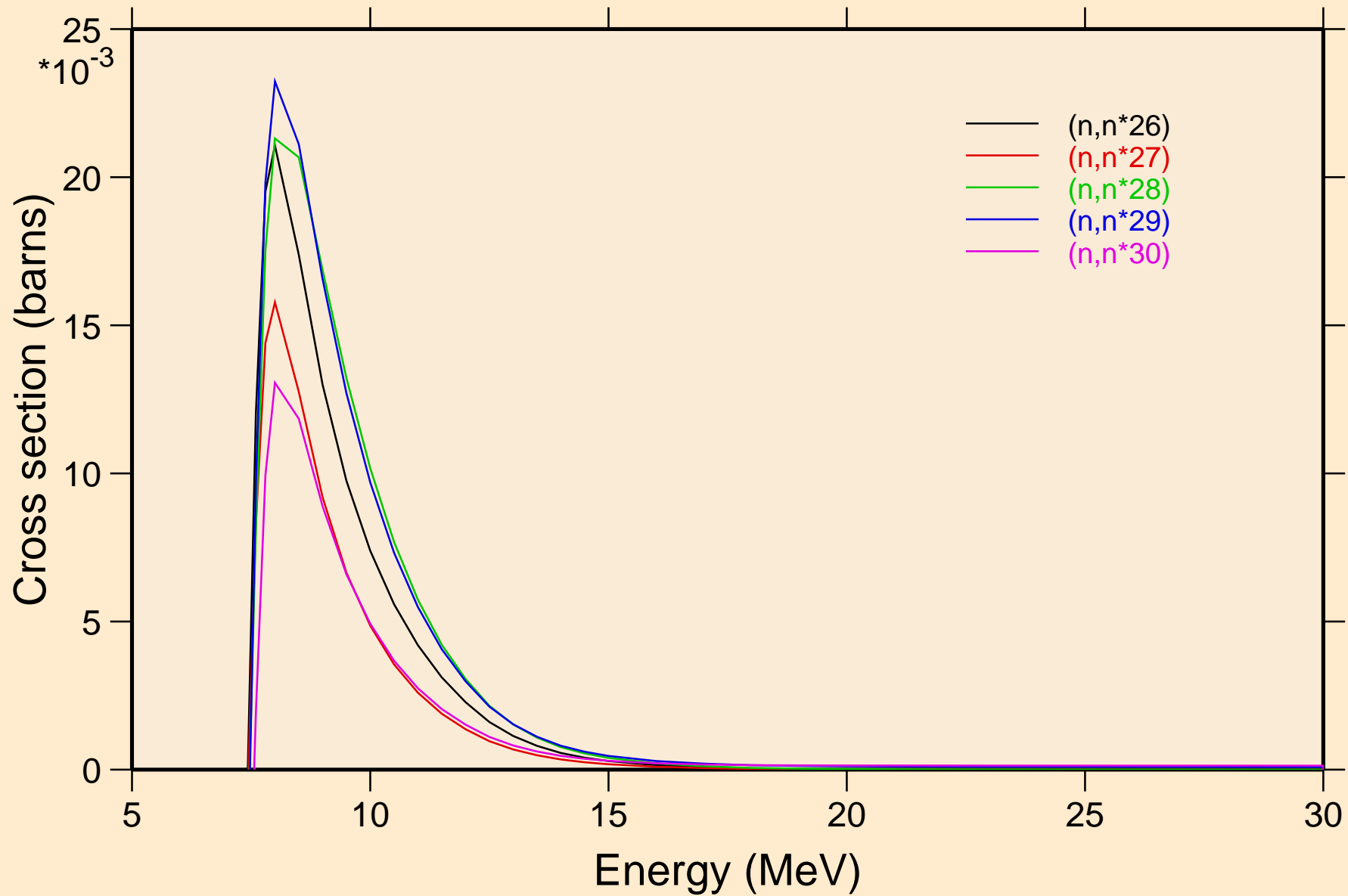

# SI034 NEUTRON ACER TENDL-2023 LIBRARY; T=0.K

## Threshold reactions

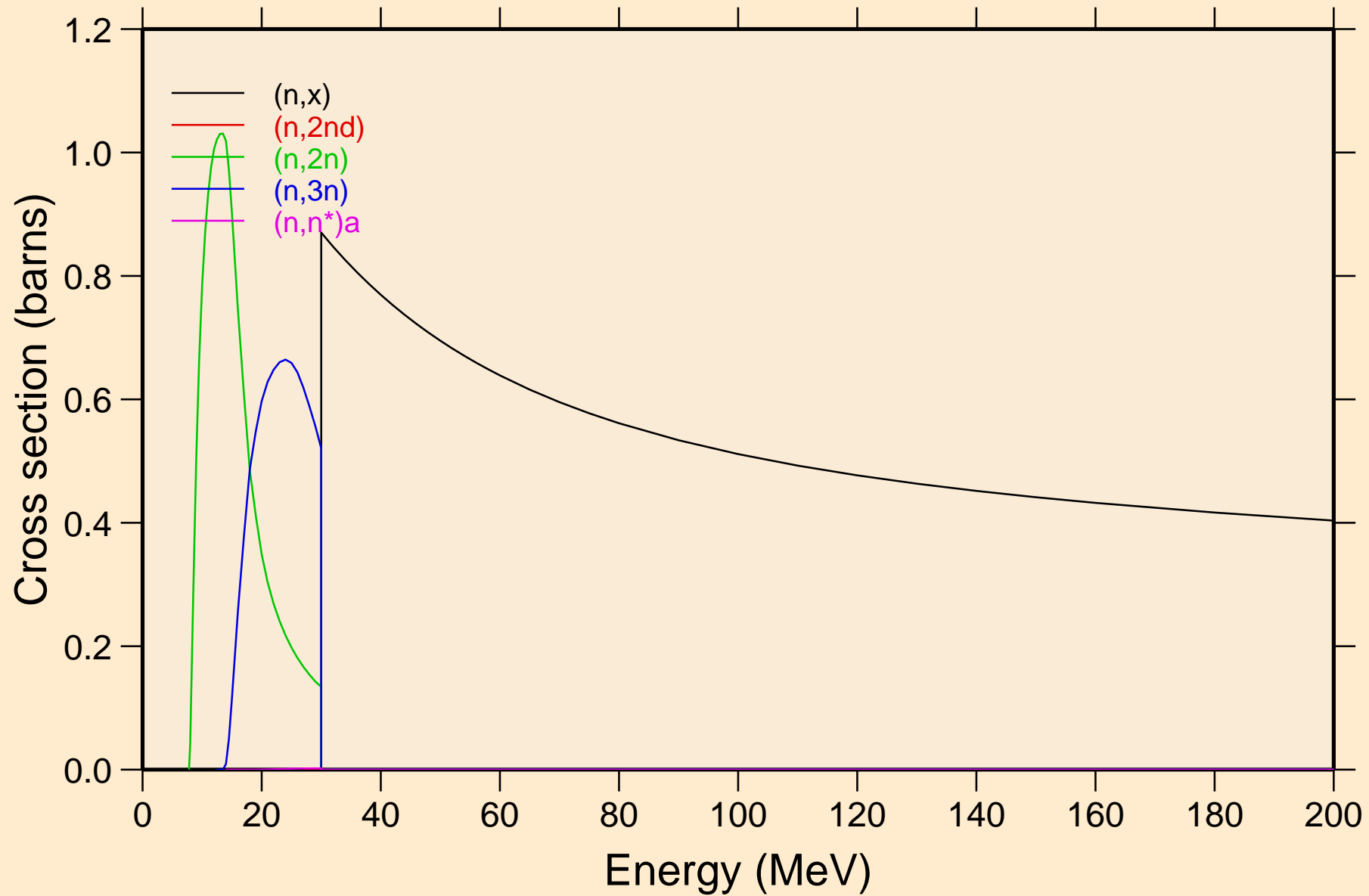

SI034 NEUTRON ACER TENDL-2023 LIBRARY; T=0.K  
Threshold reactions

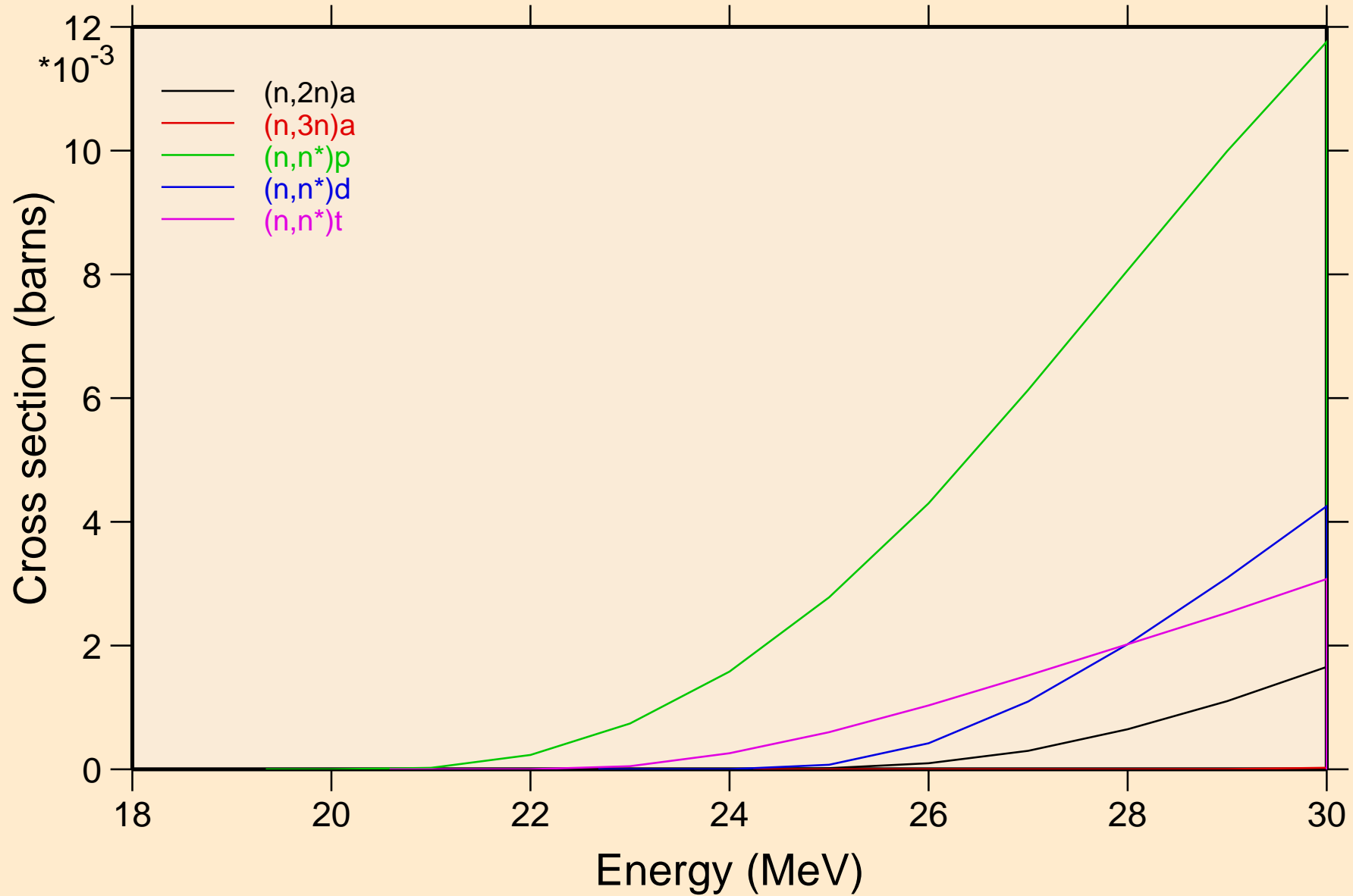

# SI034 NEUTRON ACER TENDL-2023 LIBRARY; T=0.K

## Threshold reactions

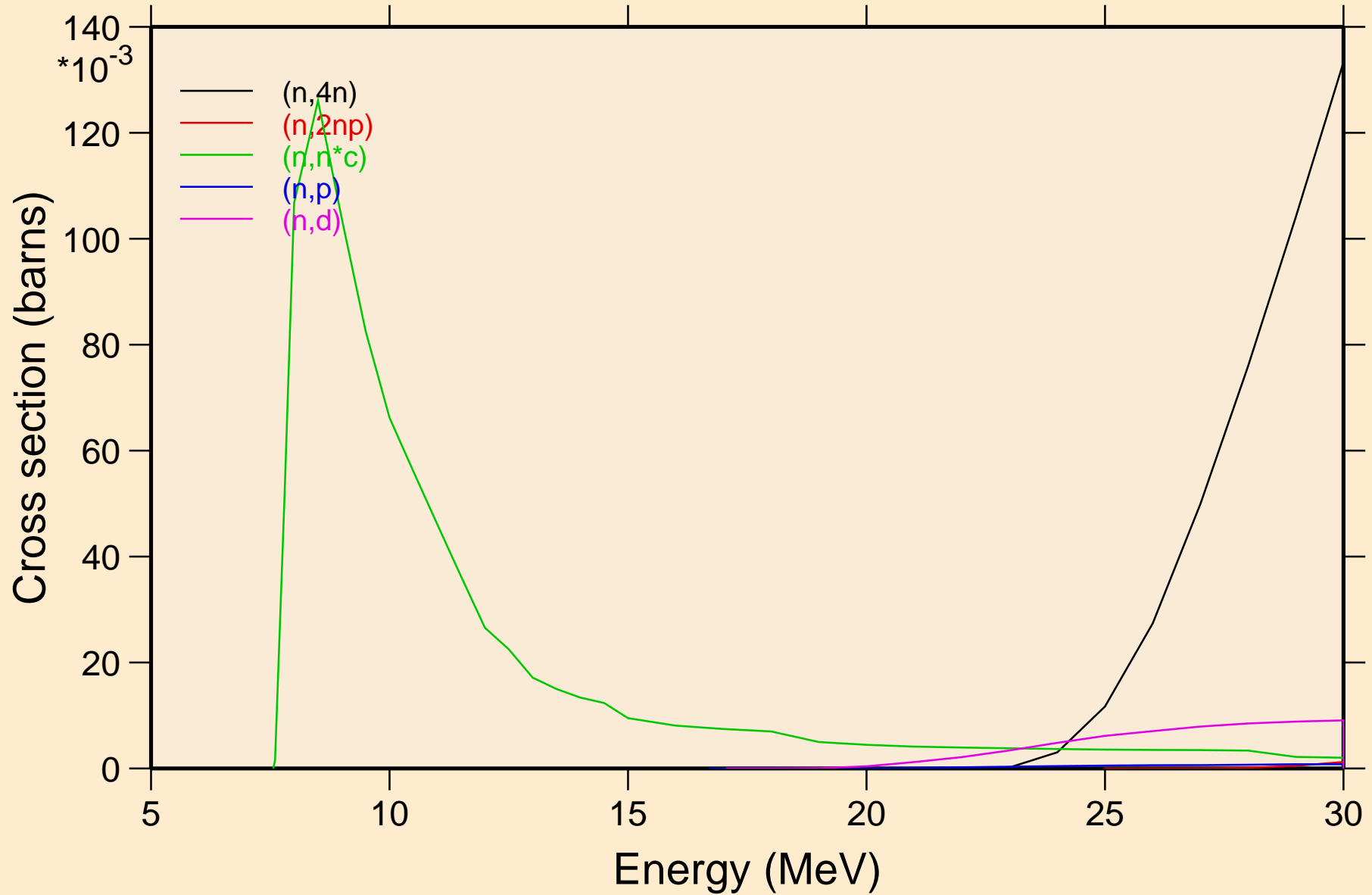

SI034 NEUTRON ACER TENDL-2023 LIBRARY; T=0.K  
Threshold reactions

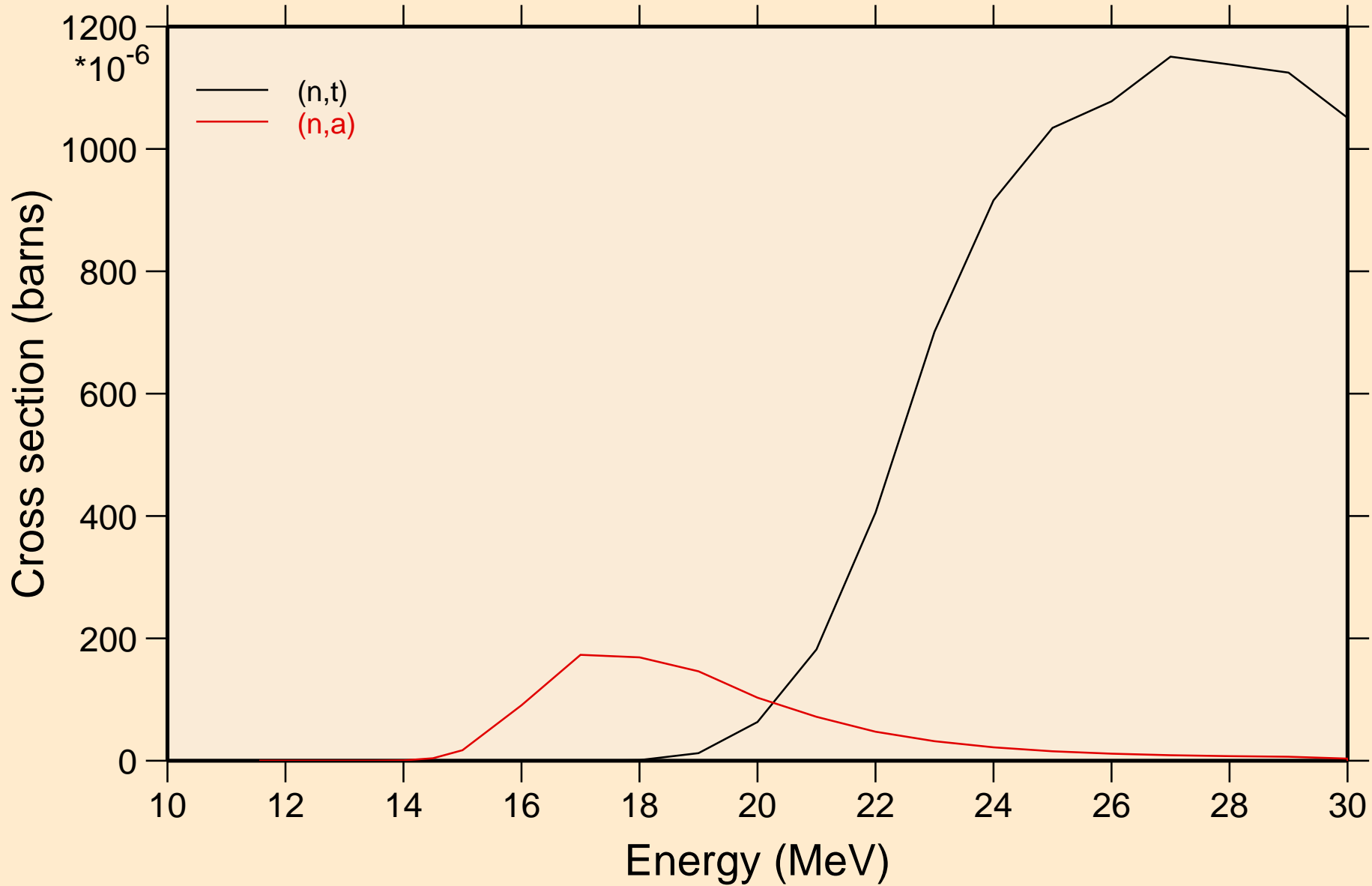

# SI034 NEUTRON ACER TENDL-2023 LIBRARY; T=0.K

## Threshold reactions

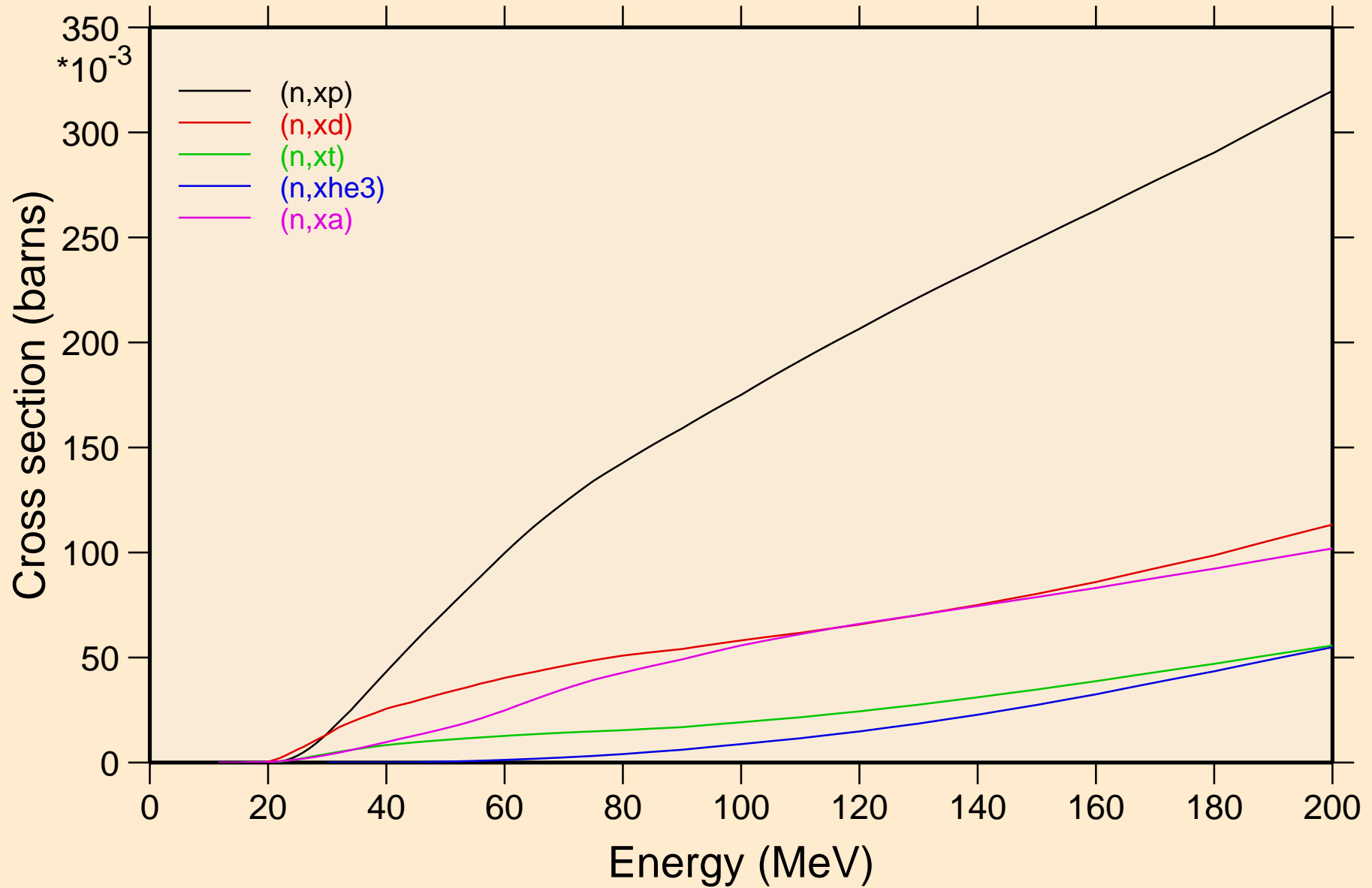

SI034 NEUTRON ACER TENDL-2023 LIBRARY; T=0.K  
angular distribution for elastic

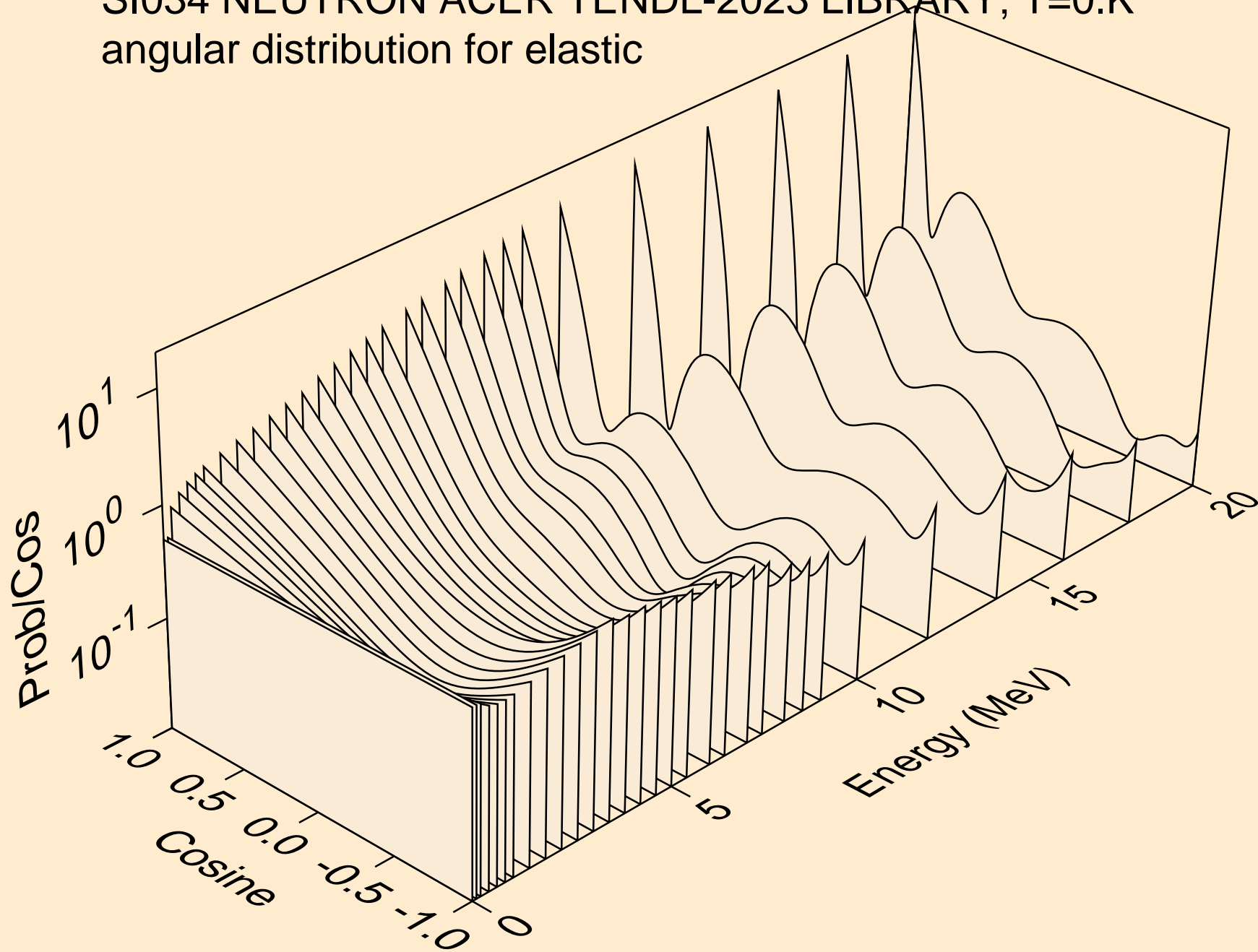

SI034 NEUTRON ACER TENDL-2023 LIBRARY; T=0.K  
angular distribution for elastic

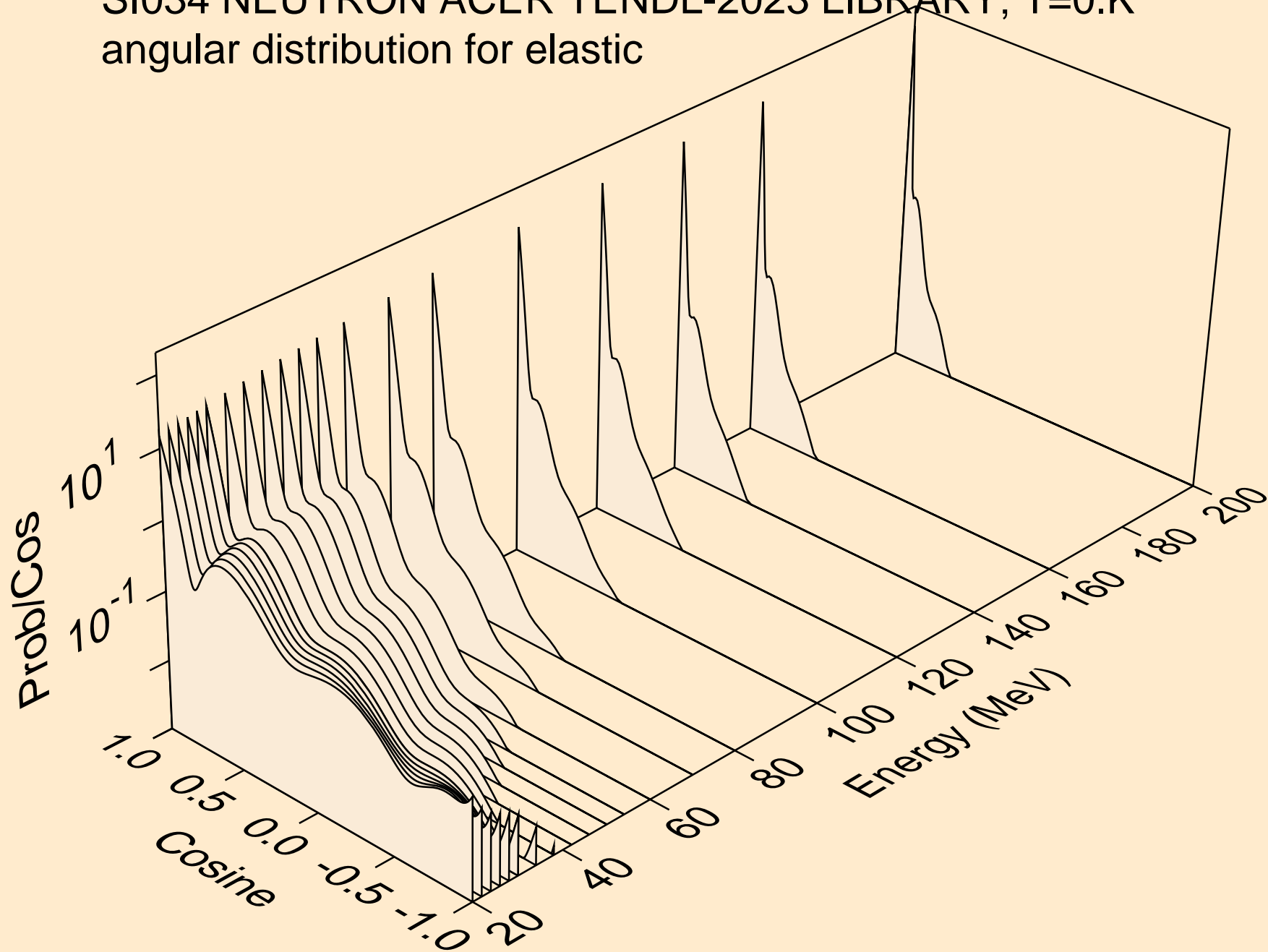

SI034 NEUTRON ACER TENDL-2023 LIBRARY; T=0.K  
angular distribution for (n,n\*1)

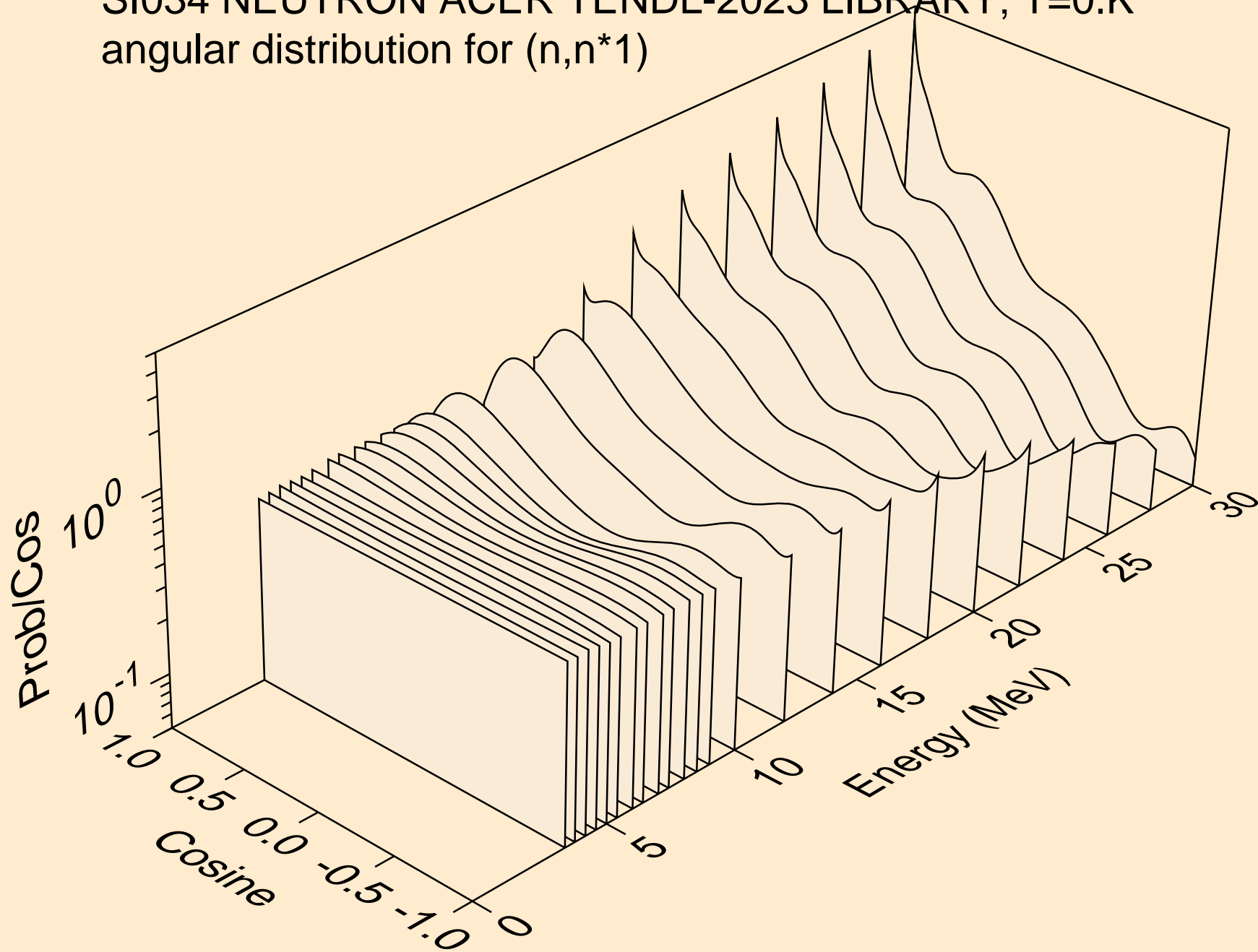

SI034 NEUTRON ACER TENDL-2023 LIBRARY; T=0.K  
angular distribution for (n,n\*2)

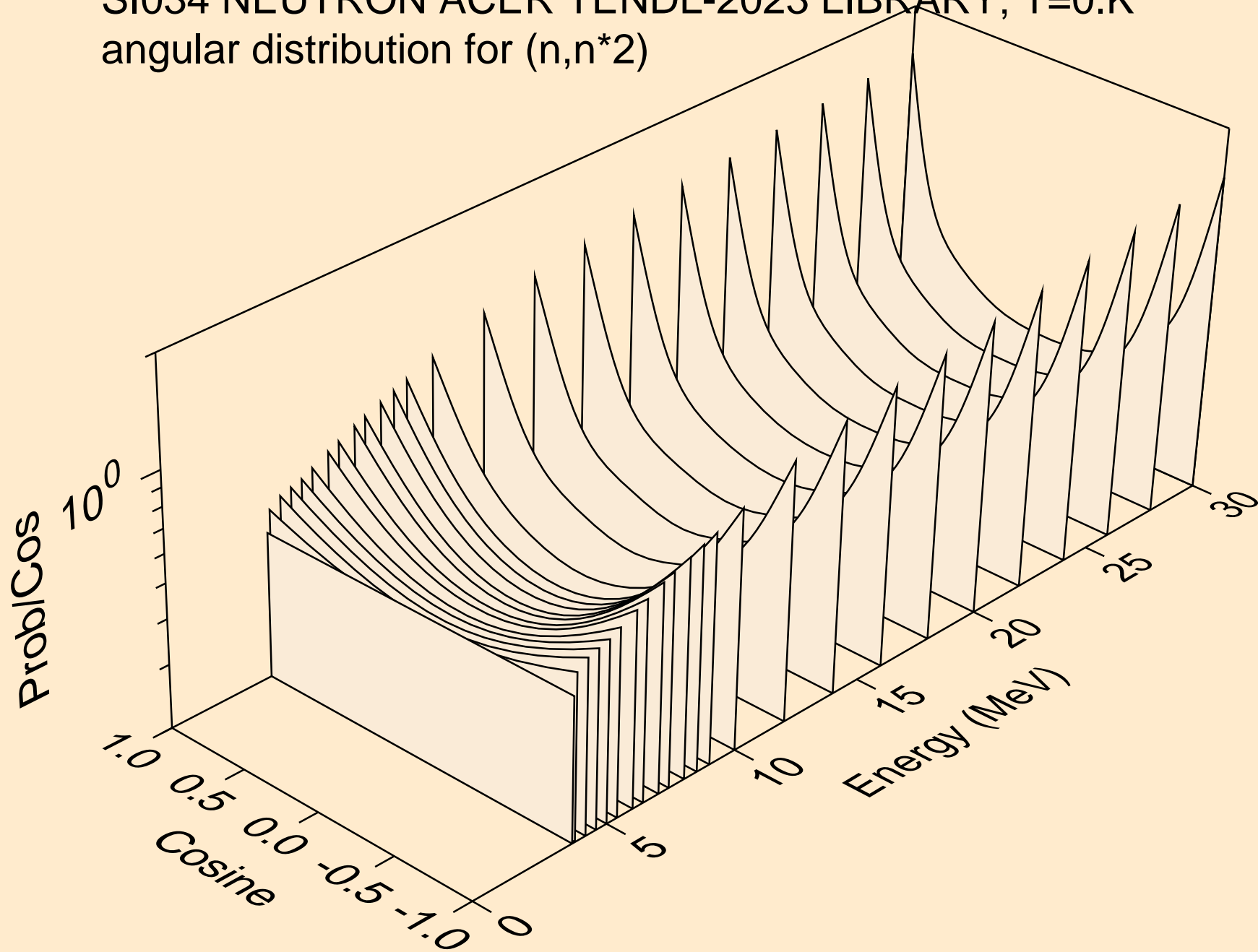

SI034 NEUTRON ACER TENDL-2023 LIBRARY; T=0.K  
angular distribution for (n,n\*3)

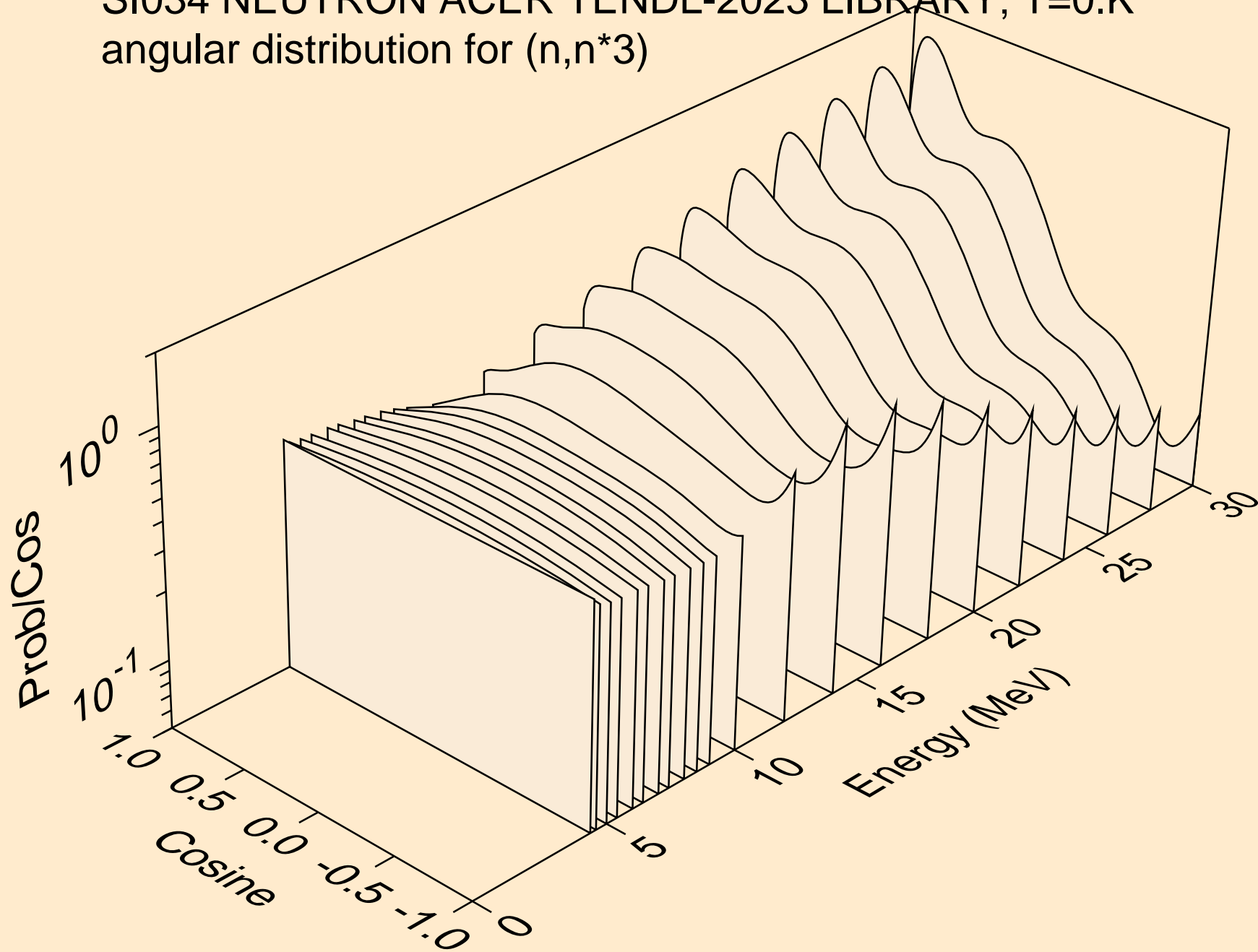

SI034 NEUTRON ACER TENDL-2023 LIBRARY; T=0.K  
angular distribution for (n,n\*4)

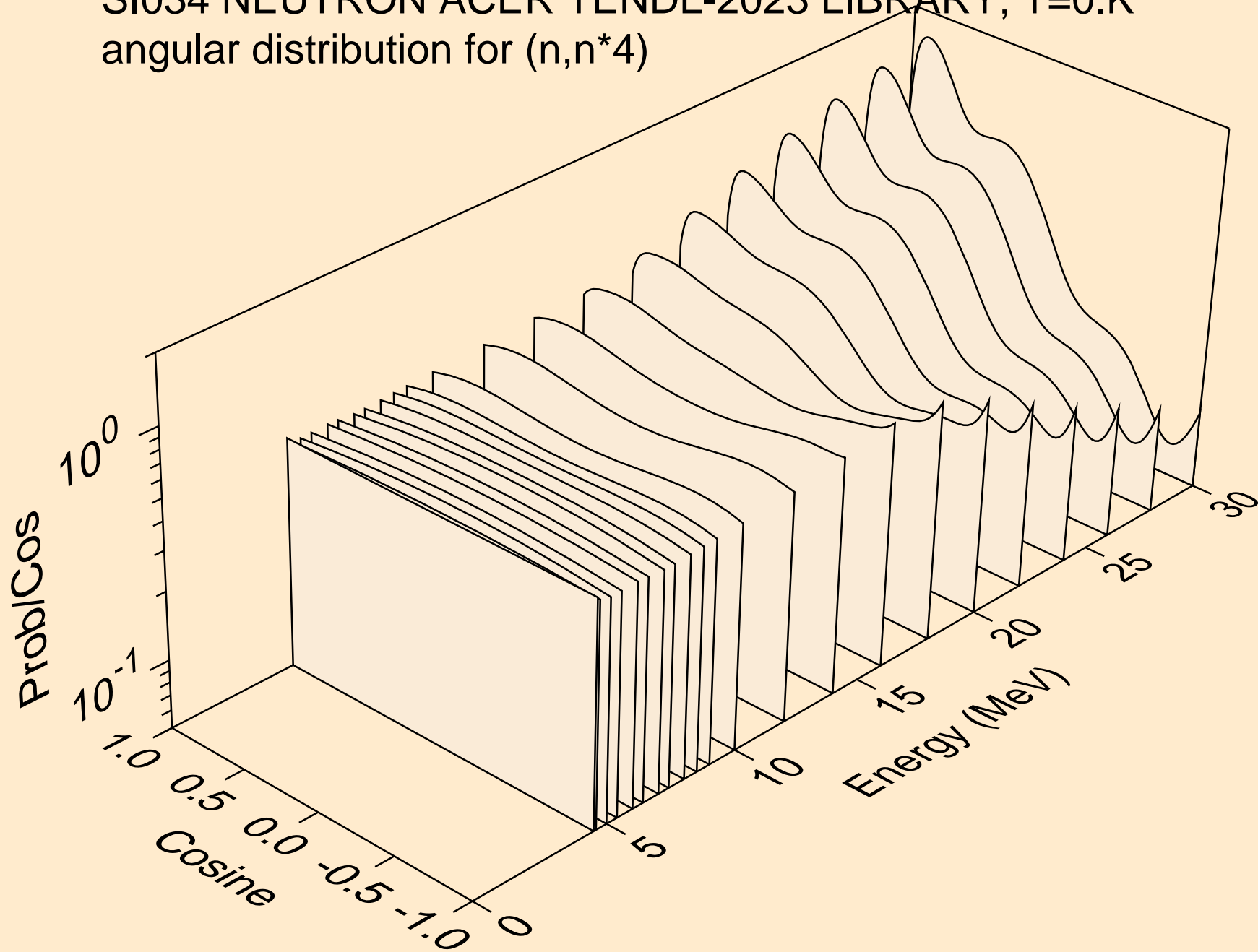

SI034 NEUTRON ACER TENDL-2023 LIBRARY; T=0.K  
angular distribution for (n,n\*5)

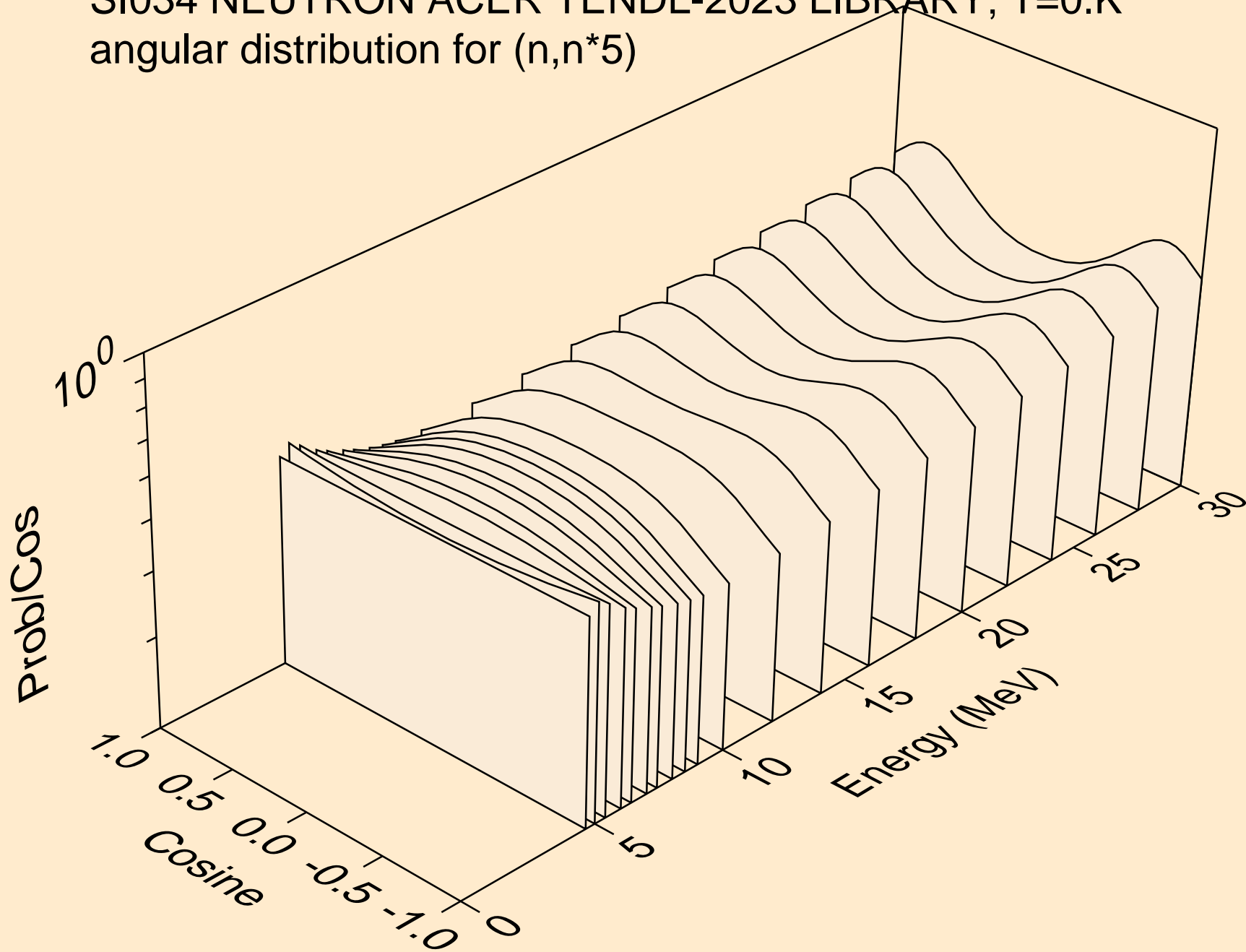

SI034 NEUTRON ACER TENDL-2023 LIBRARY; T=0.K  
angular distribution for (n,n\*6)

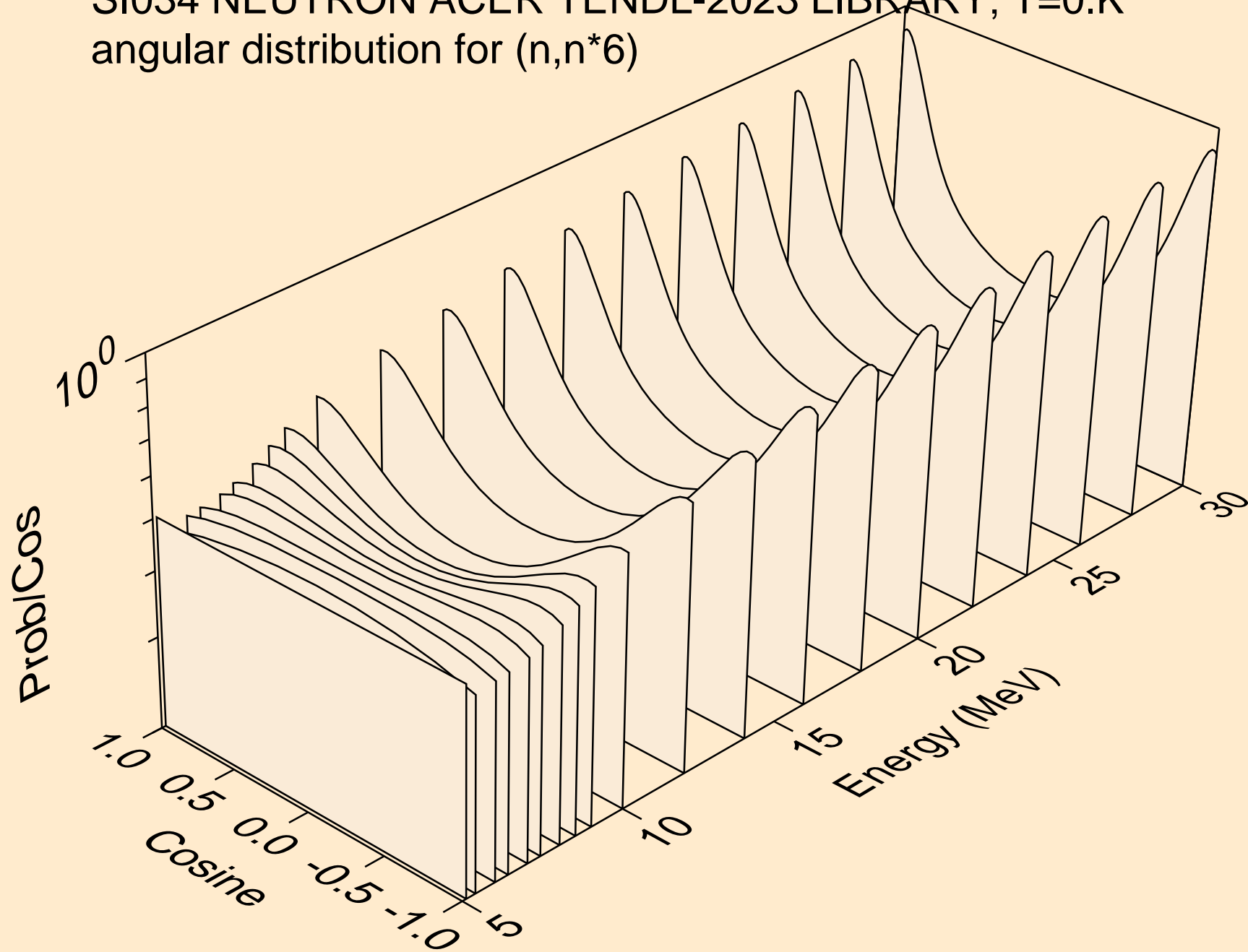

SI034 NEUTRON ACER TENDL-2023 LIBRARY; T=0.K  
angular distribution for (n,n\*7)

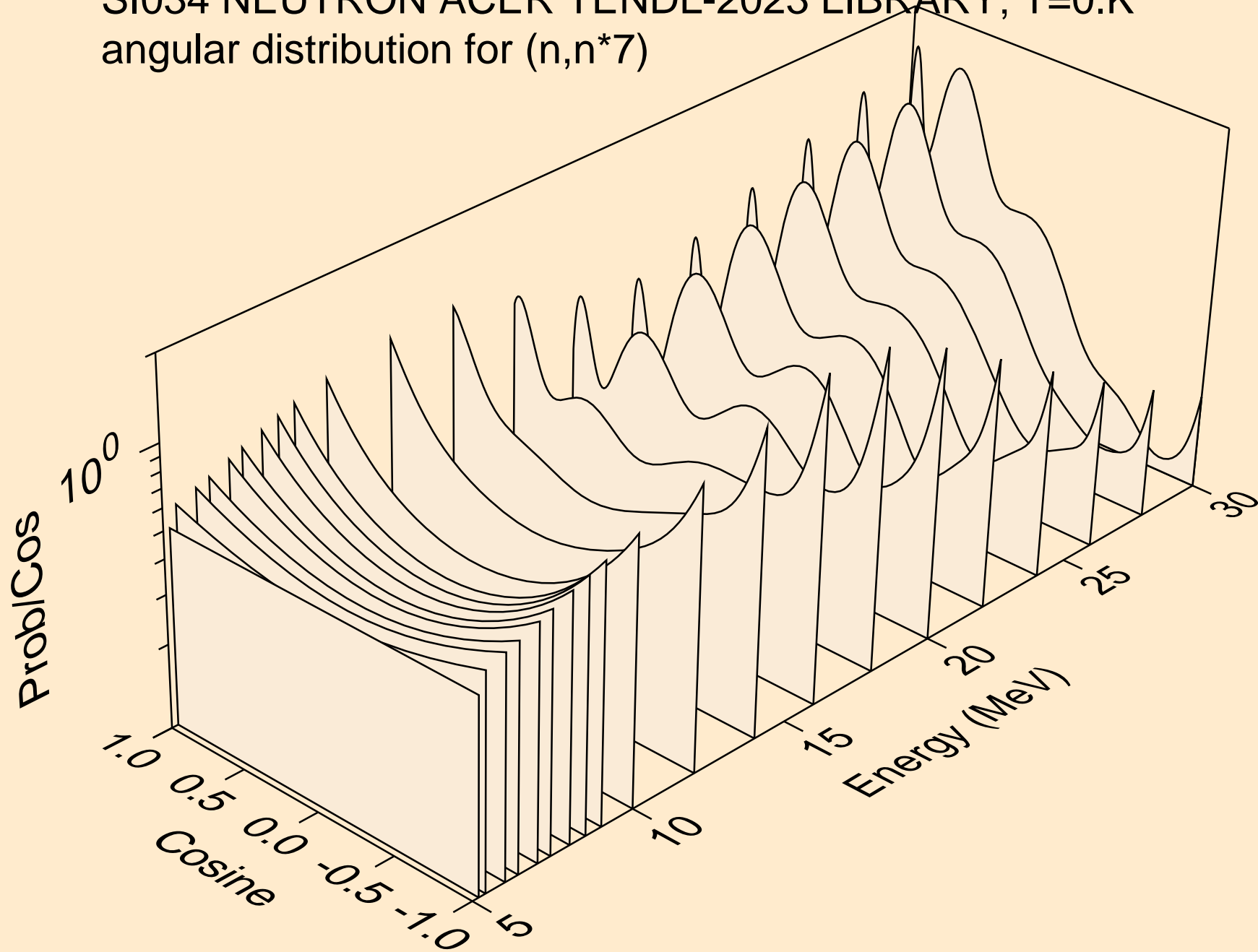

SI034 NEUTRON ACER TENDL-2023 LIBRARY; T=0.K  
angular distribution for (n,n\*8)

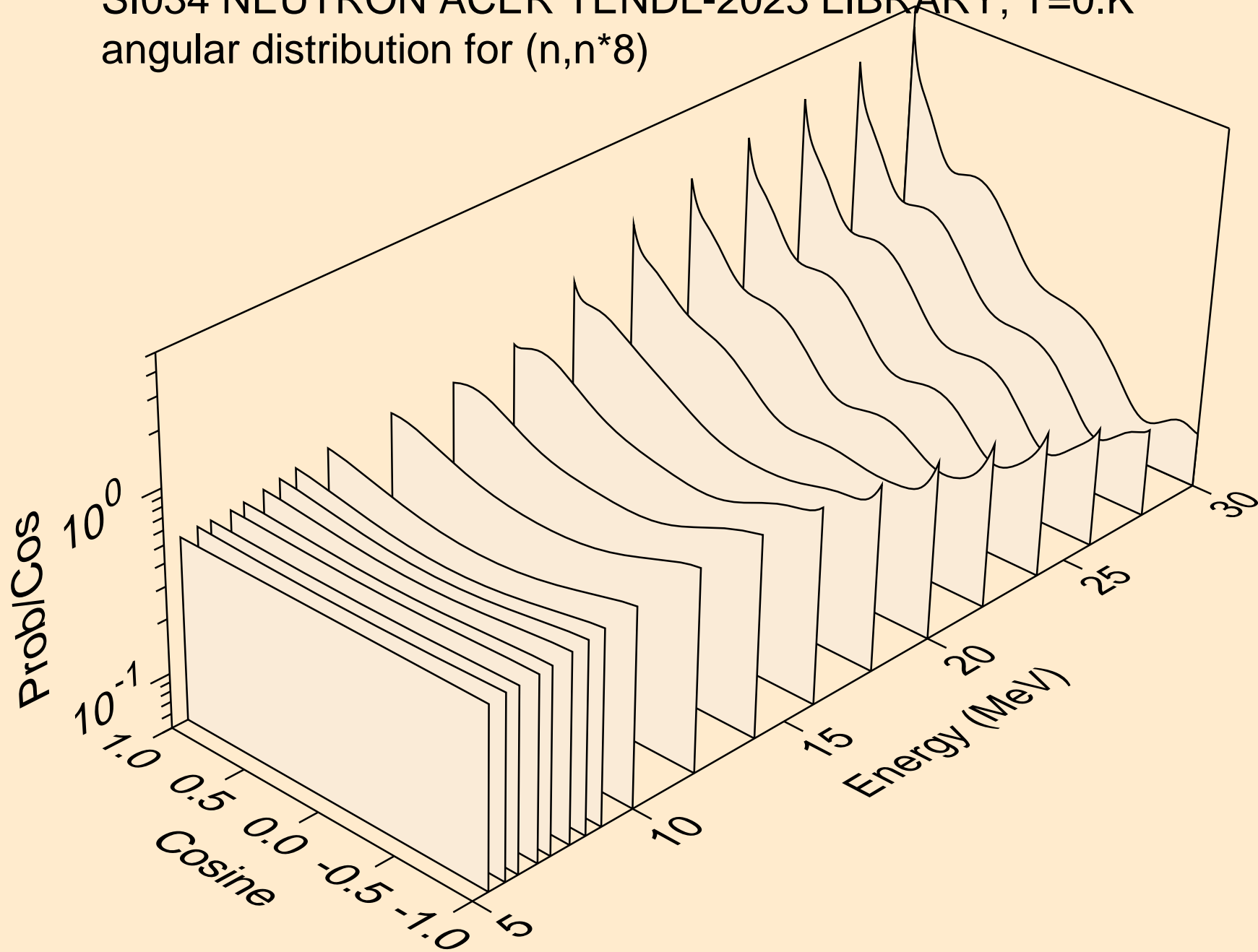

SI034 NEUTRON ACER TENDL-2023 LIBRARY; T=0.K  
angular distribution for (n,n\*9)

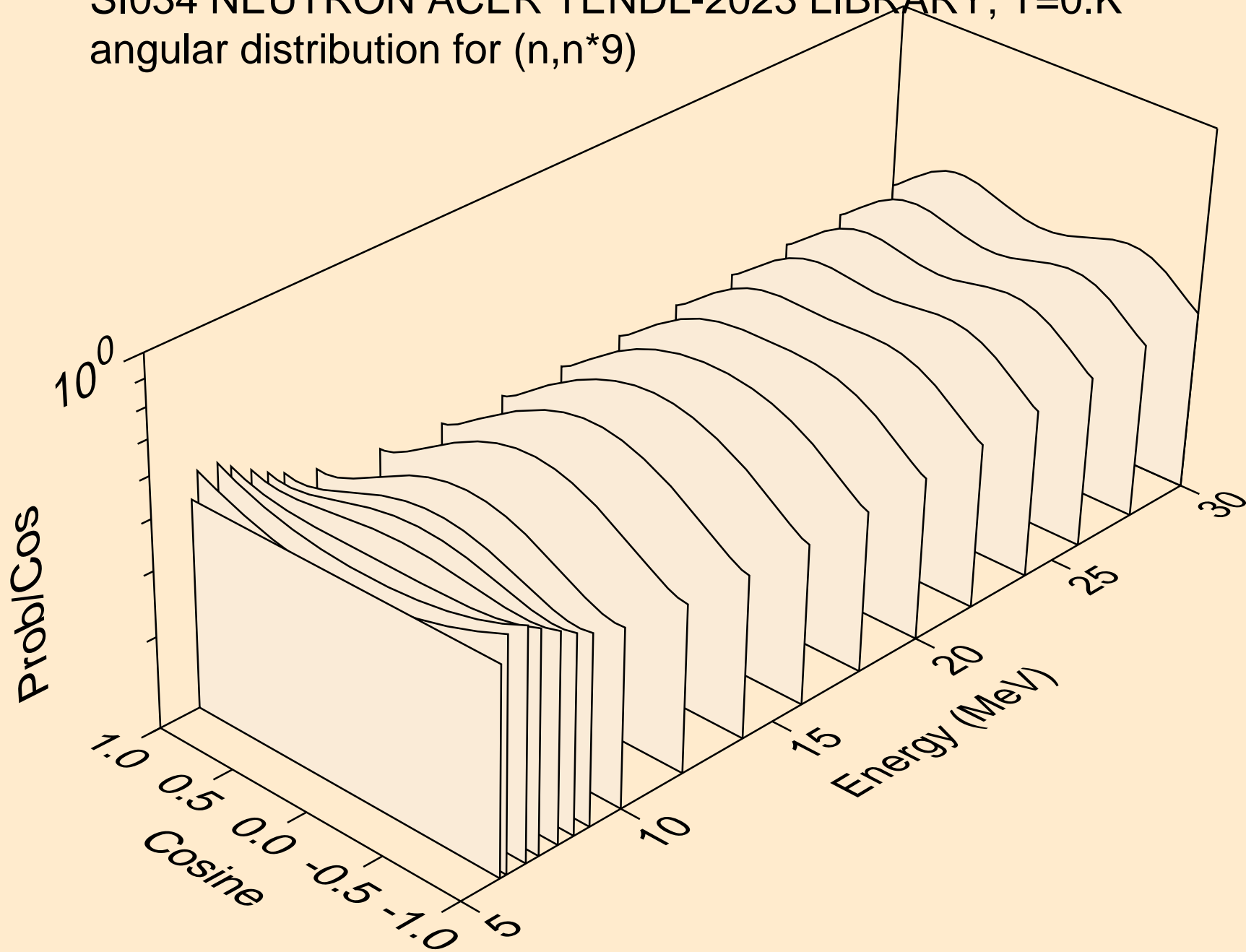

SI034 NEUTRON ACER TENDL-2023 LIBRARY; T=0.K  
angular distribution for (n,n\*10)

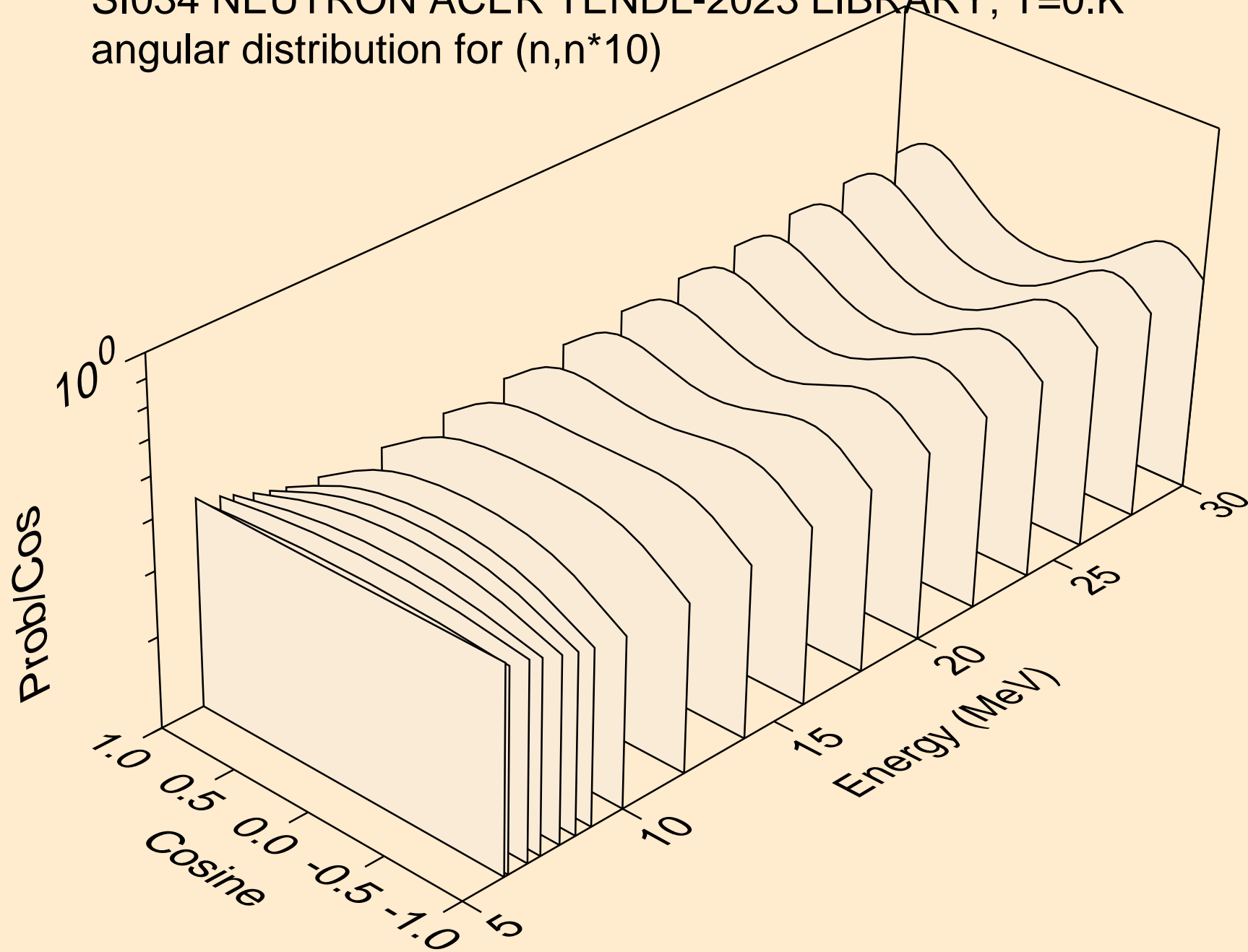

SI034 NEUTRON ACER TENDL-2023 LIBRARY; T=0.K  
angular distribution for (n,n\*11)

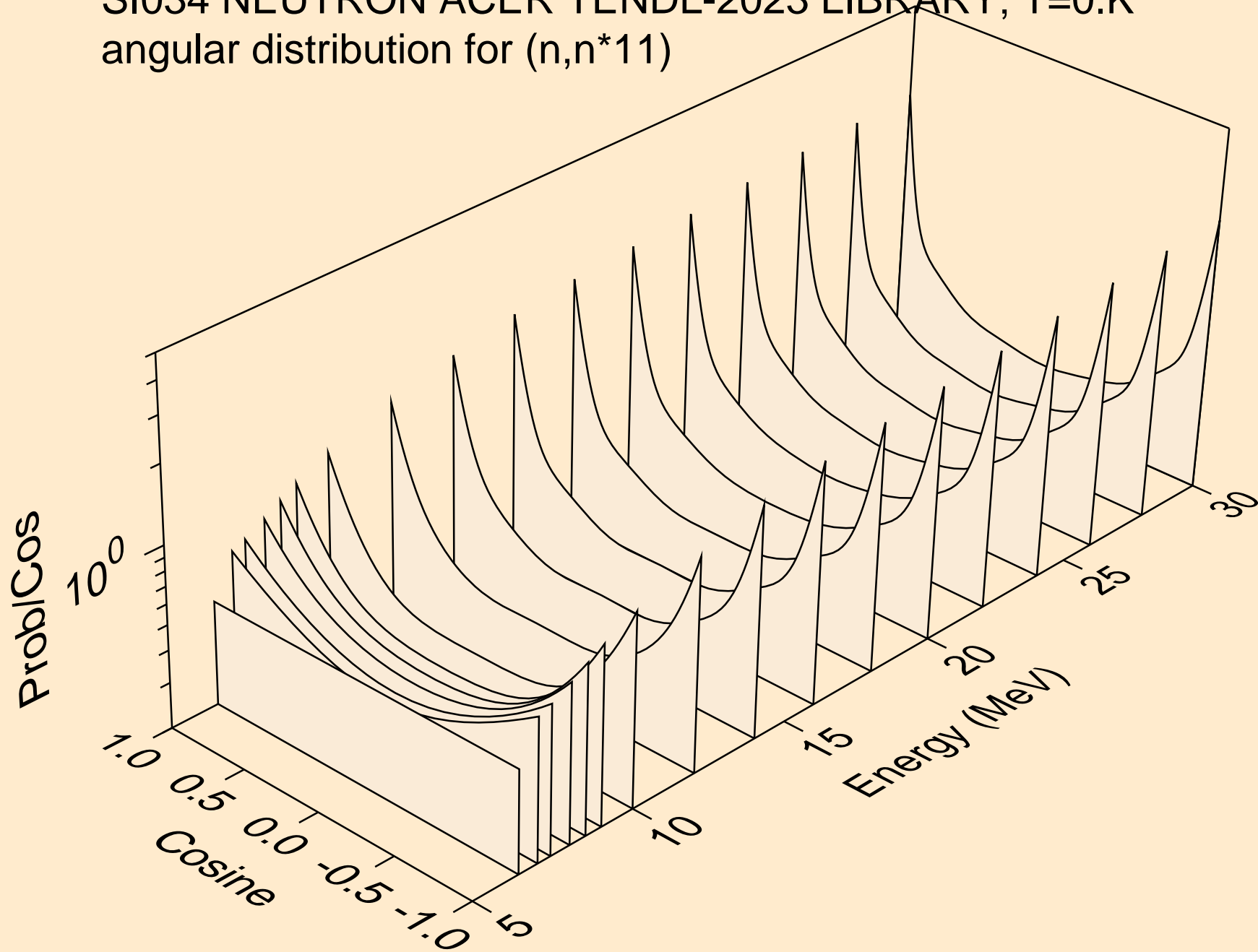

SI034 NEUTRON ACER TENDL-2023 LIBRARY; T=0.K  
angular distribution for (n,n\*12)

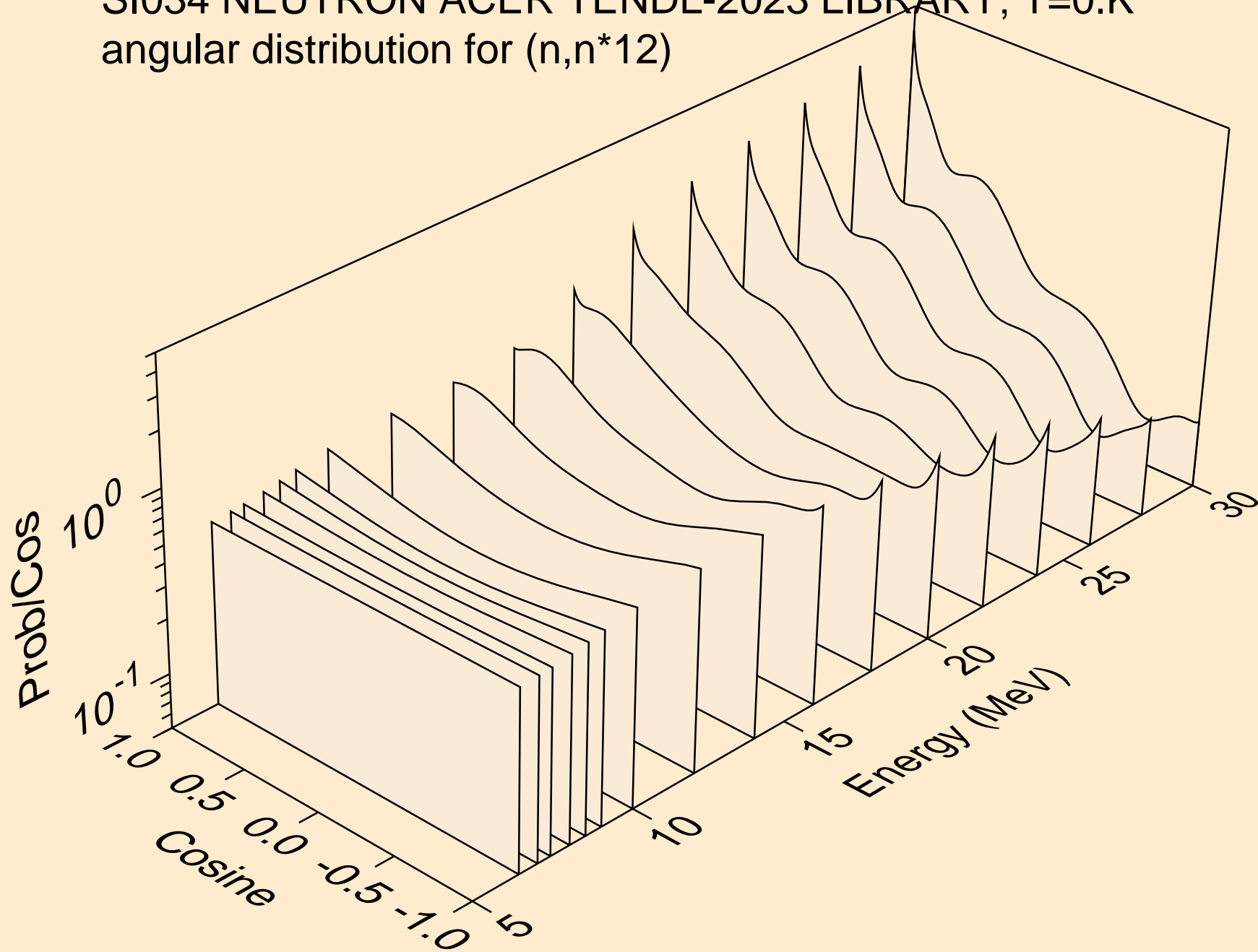

SI034 NEUTRON ACER TENDL-2023 LIBRARY; T=0.K  
angular distribution for (n,n\*13)

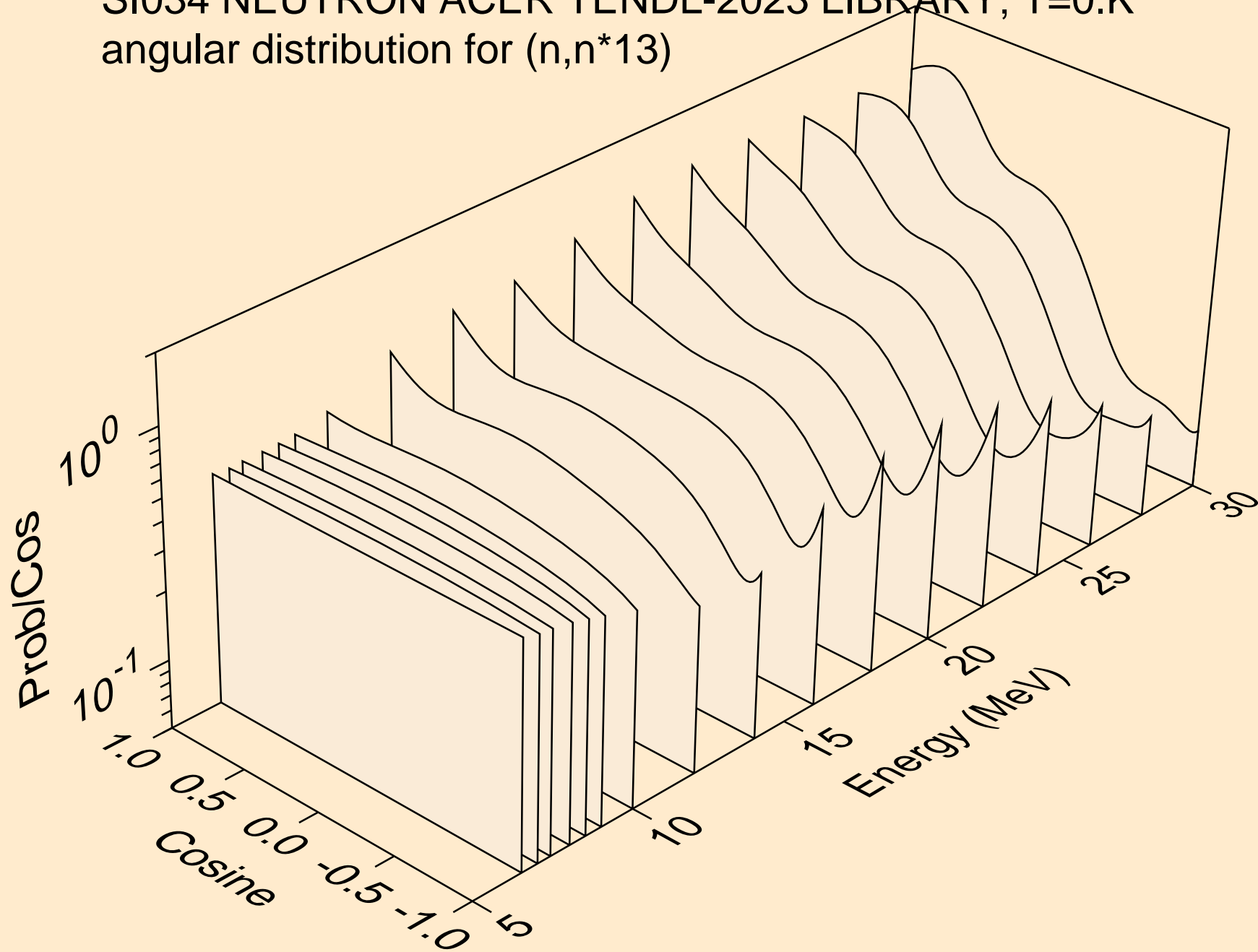

SI034 NEUTRON ACER TENDL-2023 LIBRARY; T=0.K  
angular distribution for (n,n\*14)

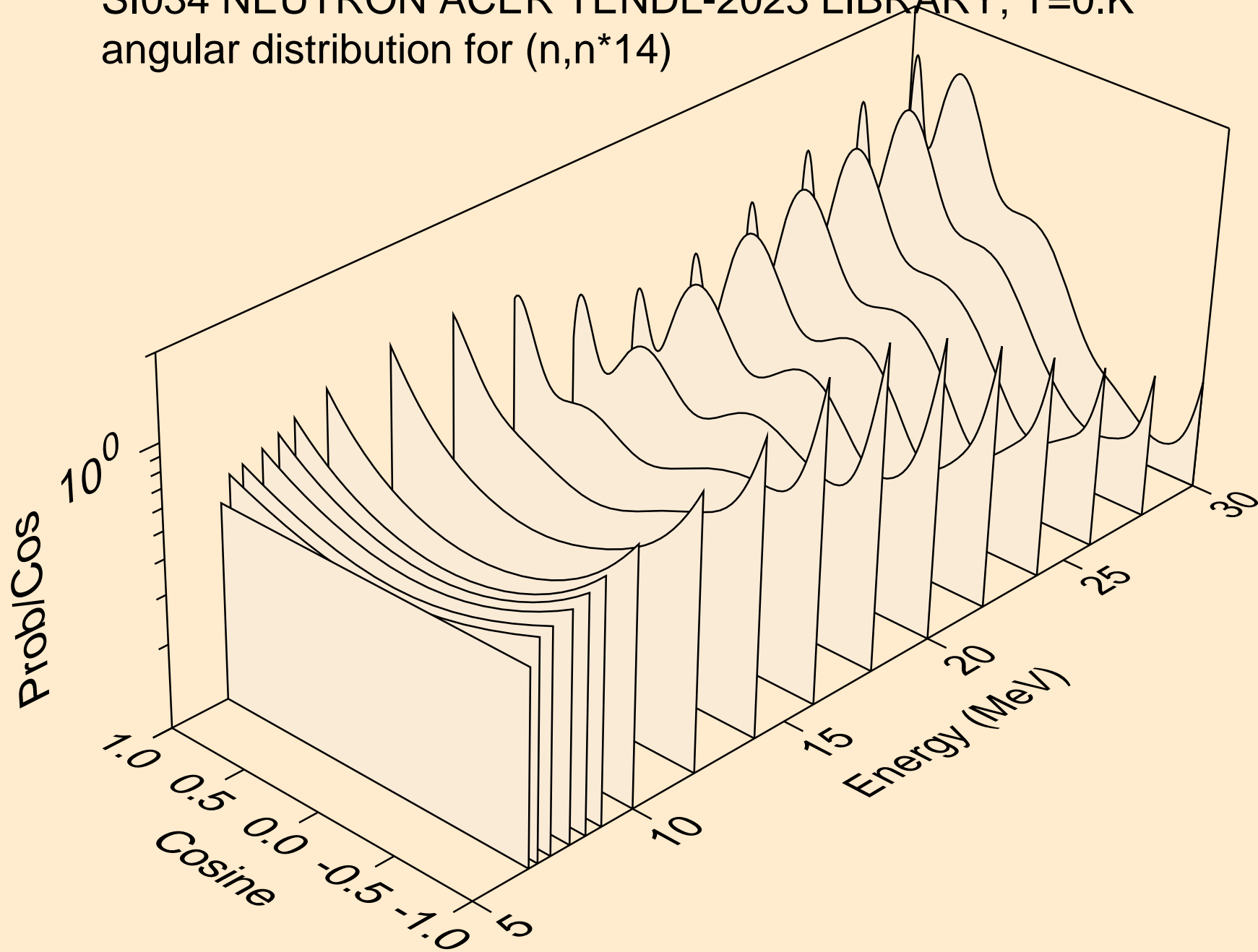

SI034 NEUTRON ACER TENDL-2023 LIBRARY; T=0.K  
angular distribution for (n,n\*15)

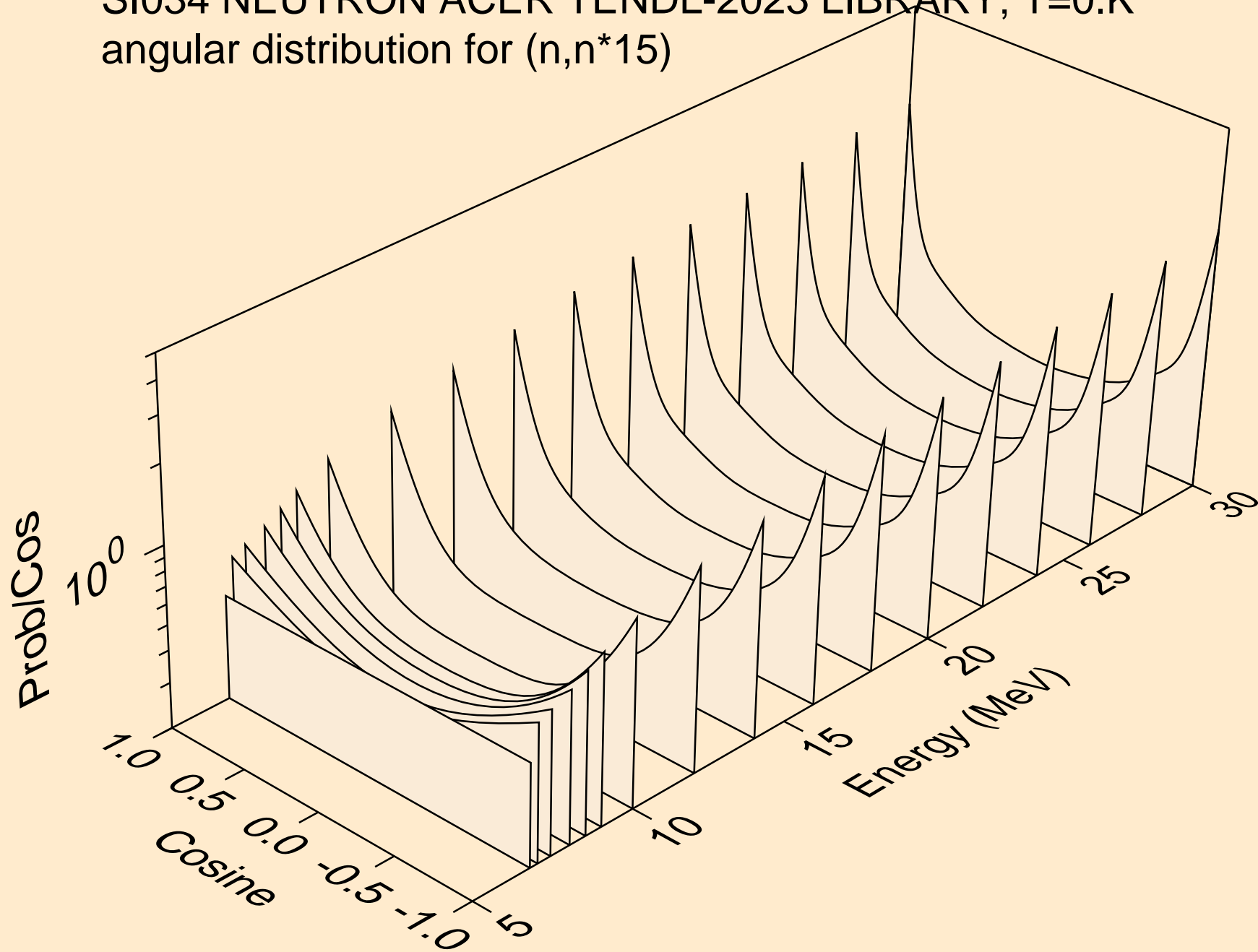

SI034 NEUTRON ACER TENDL-2023 LIBRARY; T=0.K  
angular distribution for (n,n\*16)

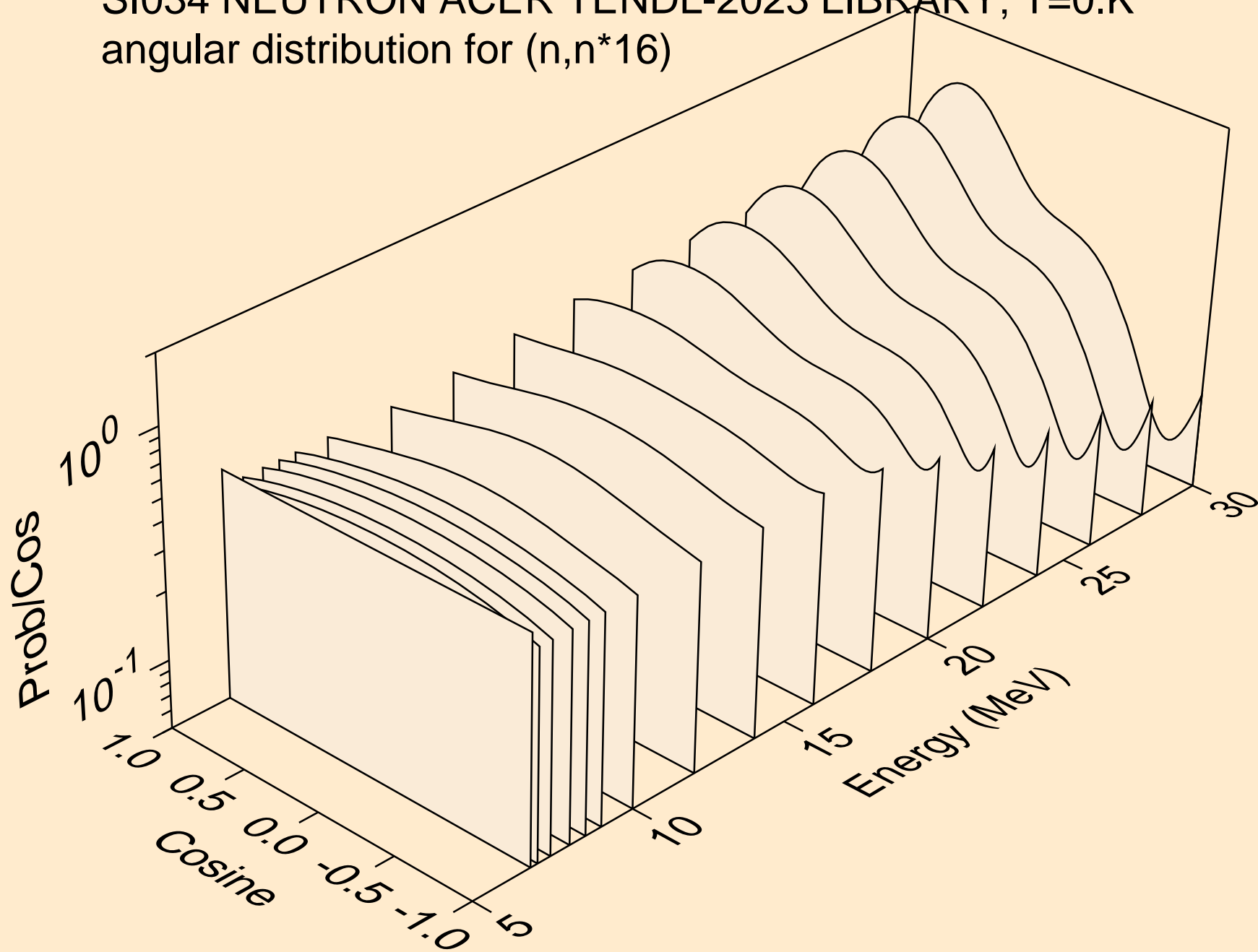

SI034 NEUTRON ACER TENDL-2023 LIBRARY; T=0.K  
angular distribution for (n,n\*17)

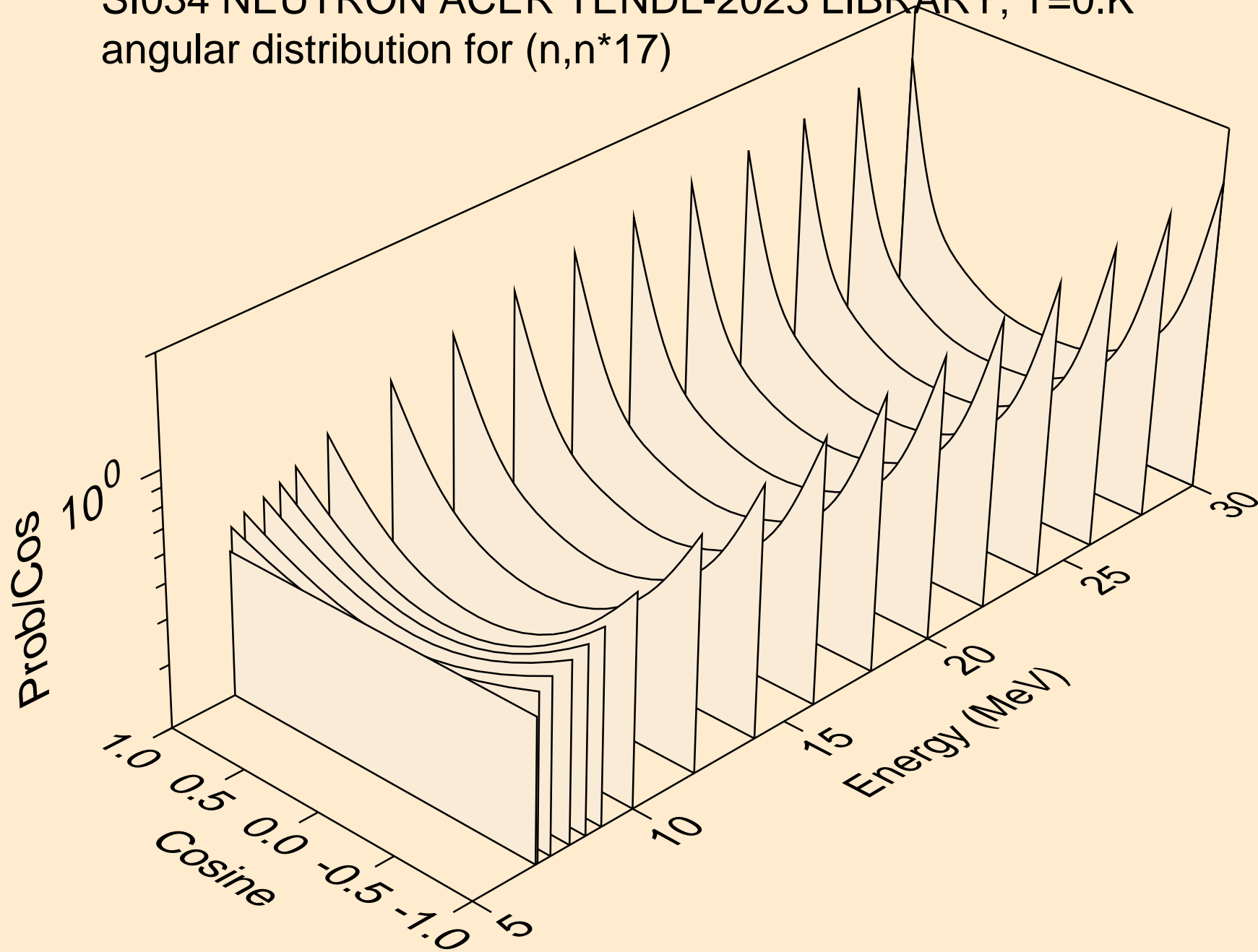

SI034 NEUTRON ACER TENDL-2023 LIBRARY; T=0.K  
angular distribution for (n,n\*18)

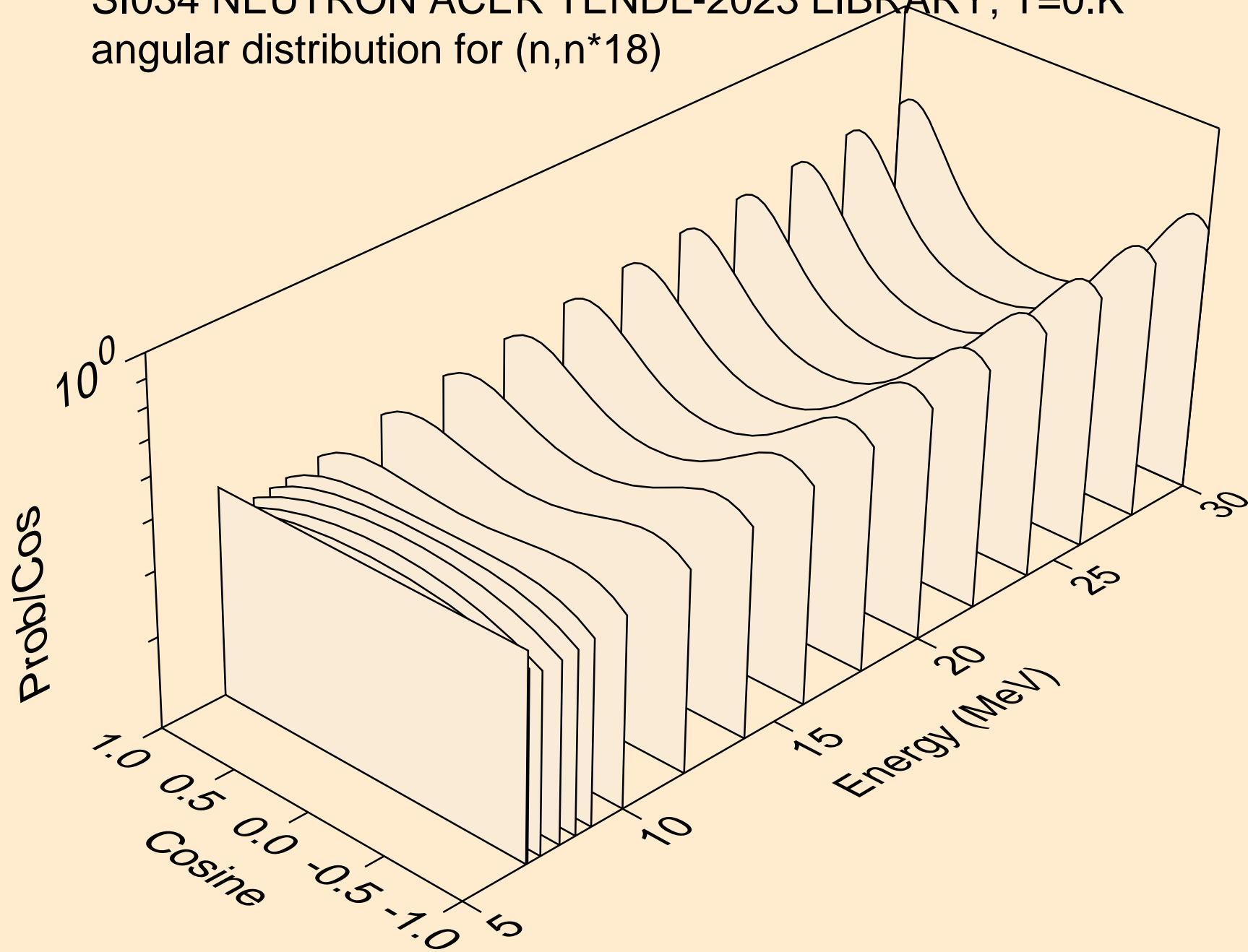

SI034 NEUTRON ACER TENDL-2023 LIBRARY; T=0.K  
angular distribution for (n,n\*19)

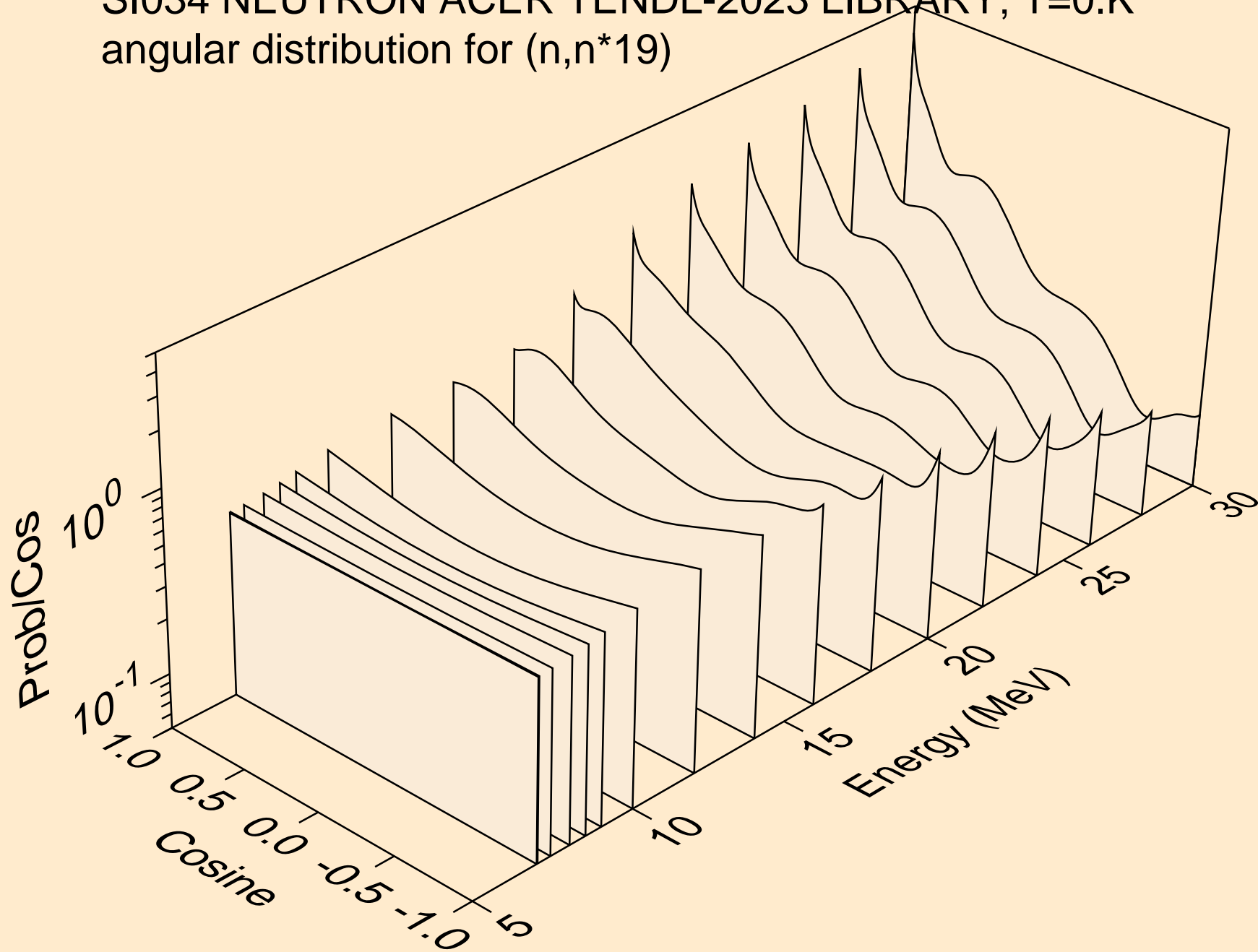

SI034 NEUTRON ACER TENDL-2023 LIBRARY; T=0.K  
angular distribution for (n,n\*20)

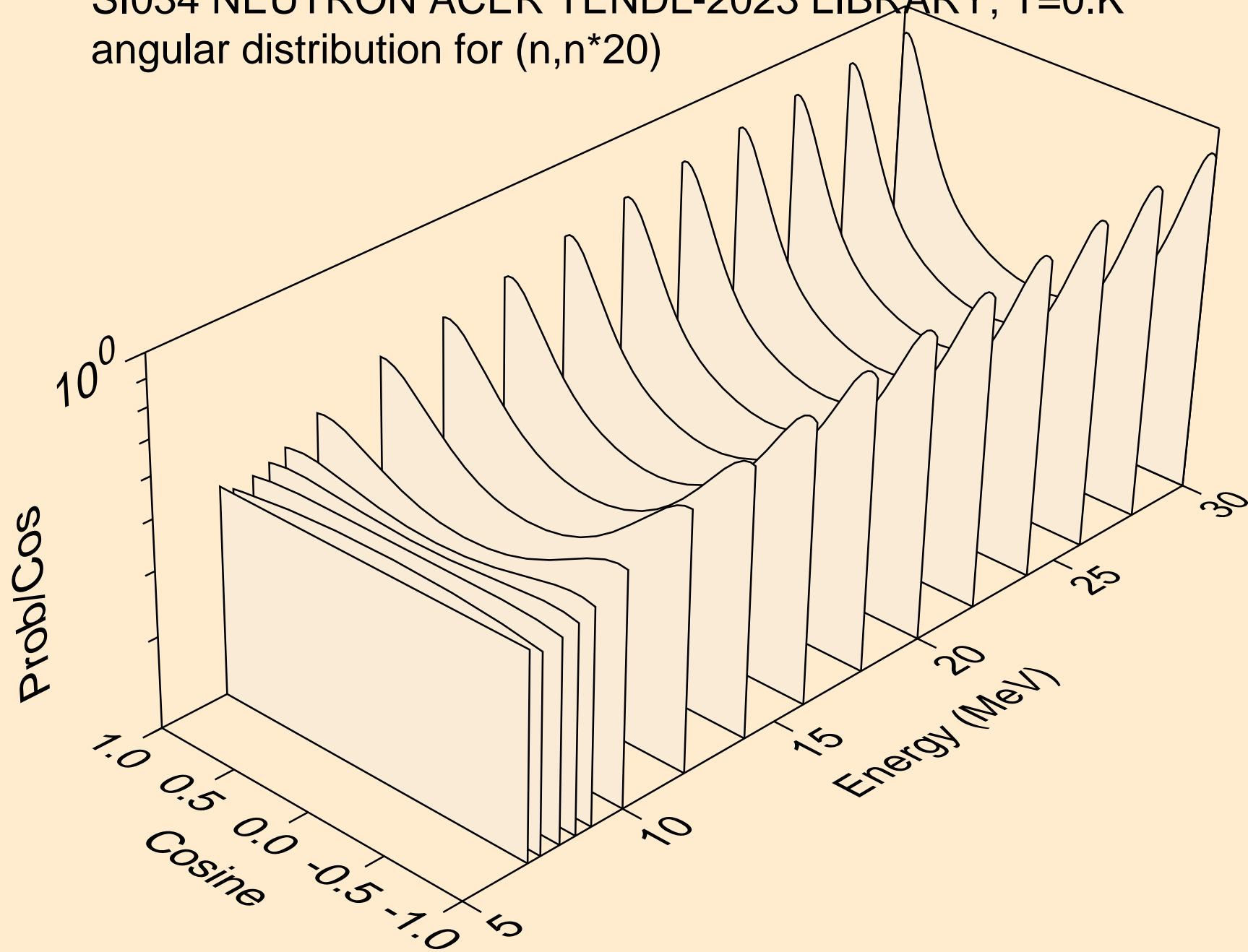

SI034 NEUTRON ACER TENDL-2023 LIBRARY; T=0.K  
angular distribution for (n,n\*21)

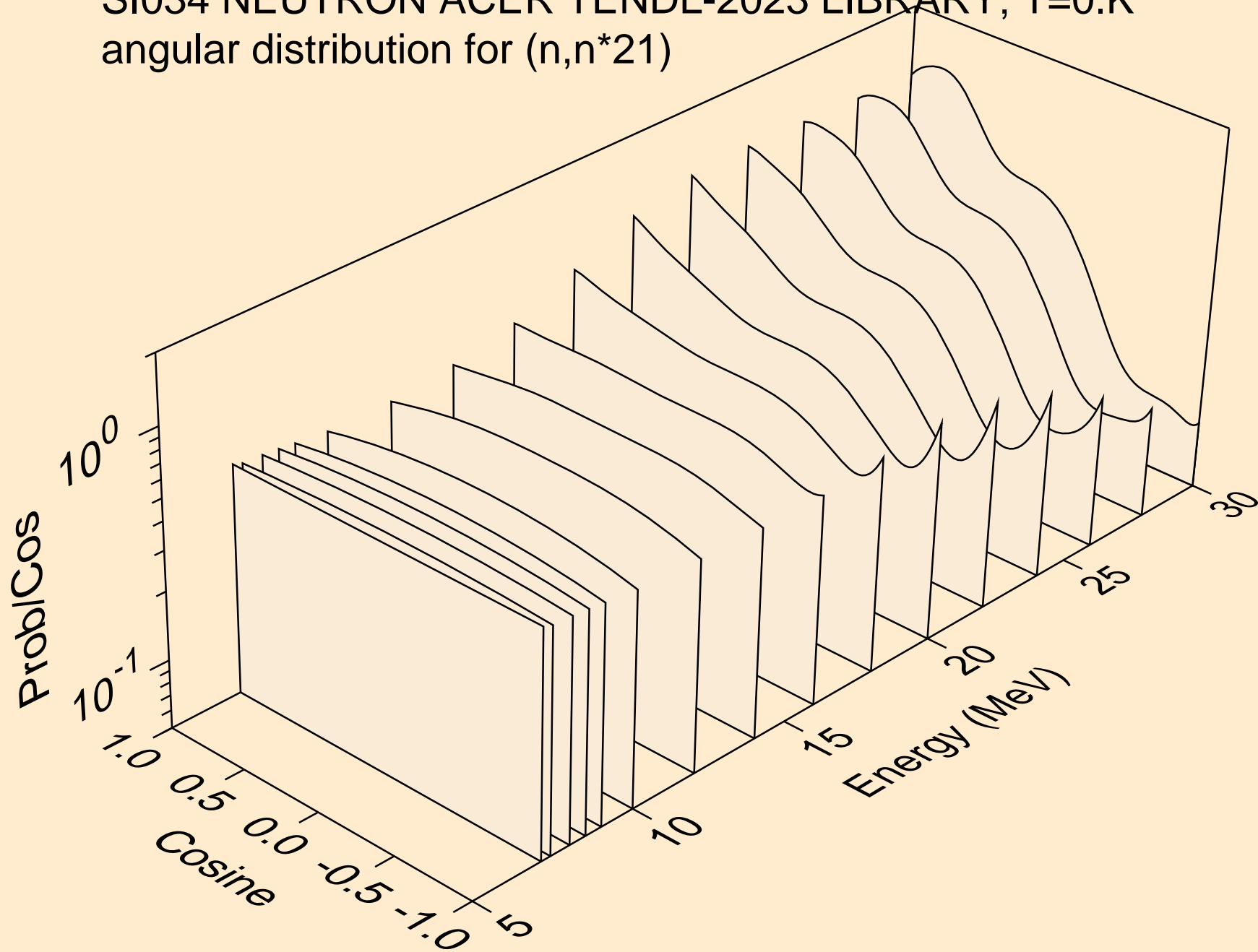

SI034 NEUTRON ACER TENDL-2023 LIBRARY; T=0.K  
angular distribution for (n,n\*22)

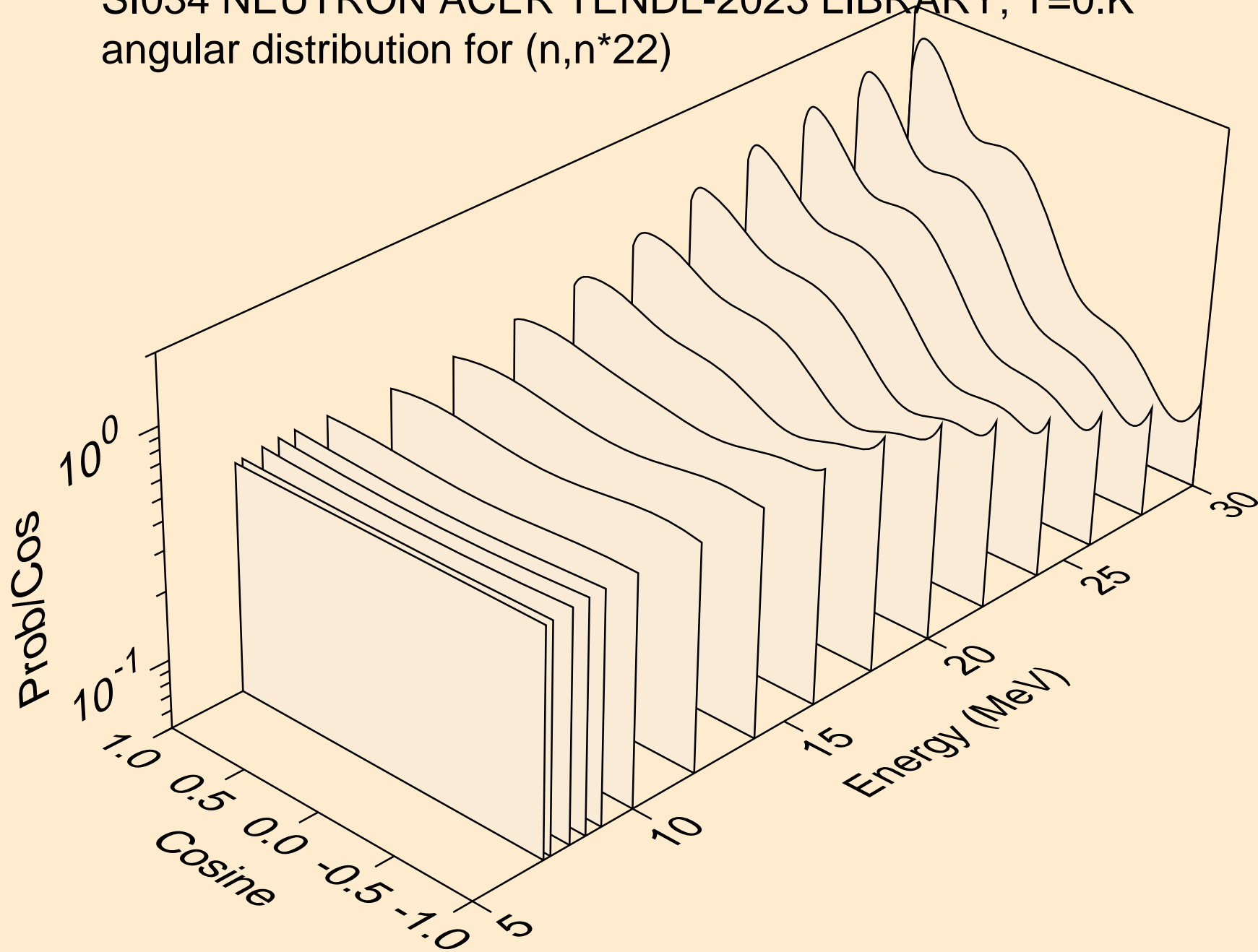

SI034 NEUTRON ACER TENDL-2023 LIBRARY; T=0.K  
angular distribution for (n,n\*23)

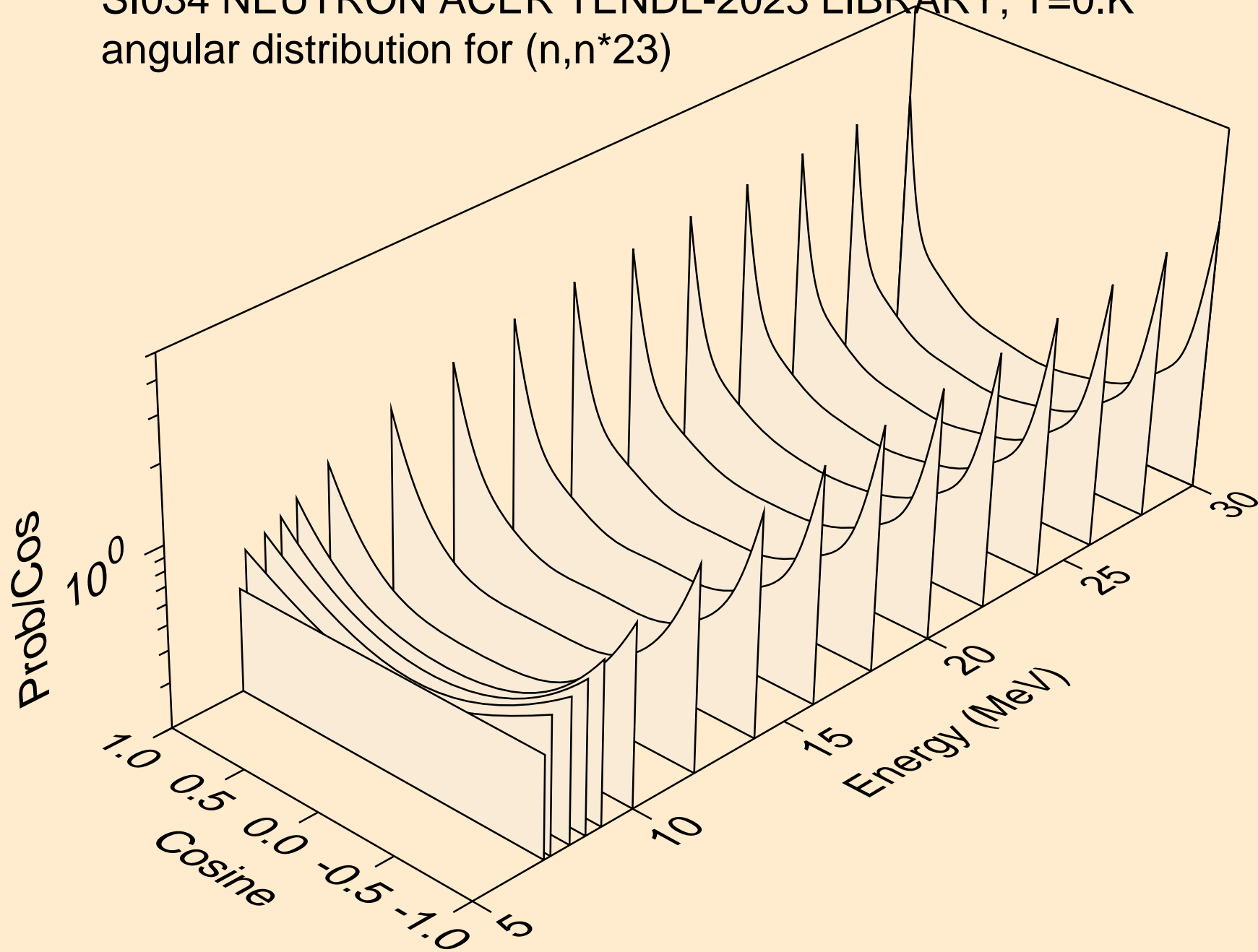

SI034 NEUTRON ACER TENDL-2023 LIBRARY; T=0.K  
angular distribution for (n,n\*24)

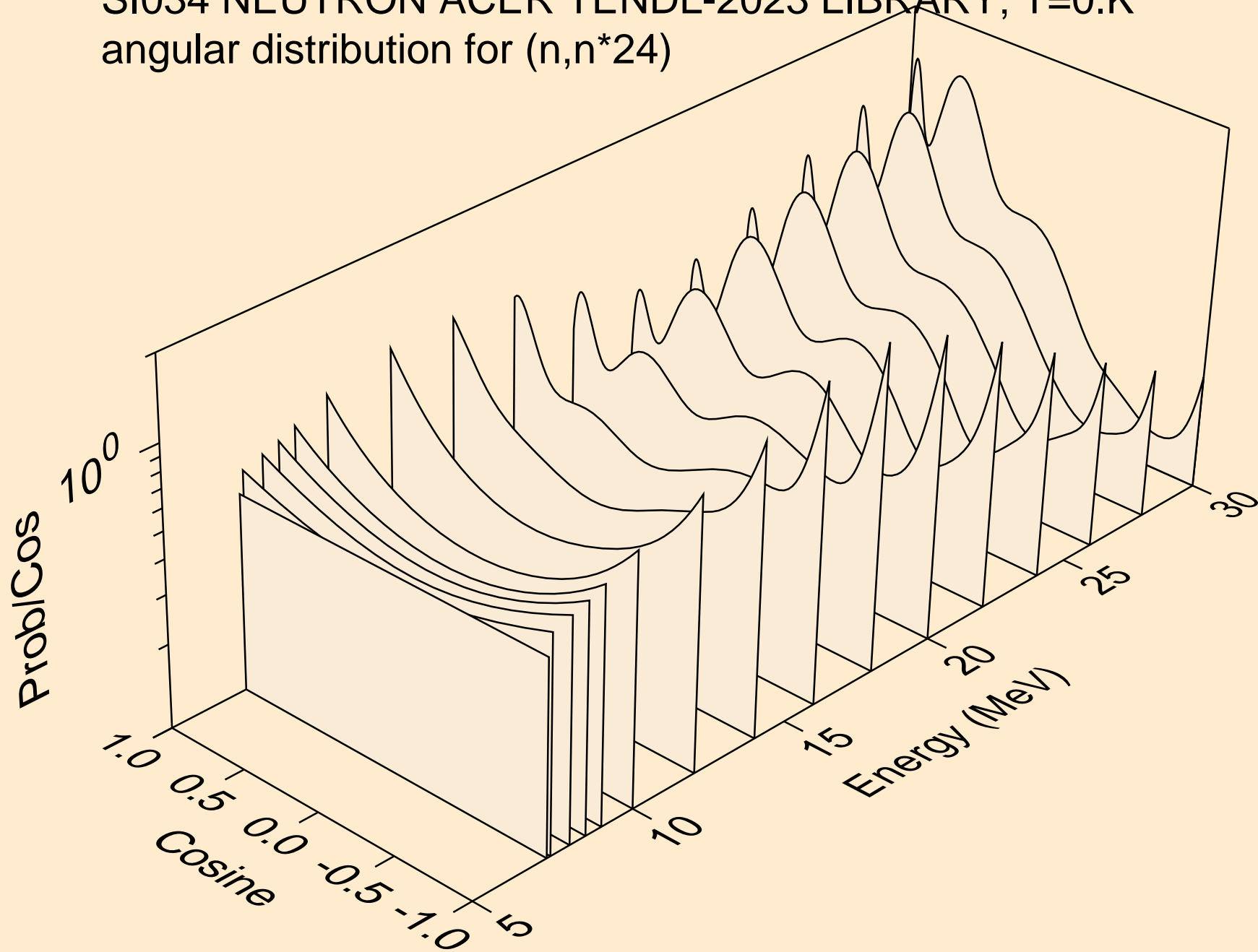

SI034 NEUTRON ACER TENDL-2023 LIBRARY; T=0.K  
angular distribution for (n,n\*25)

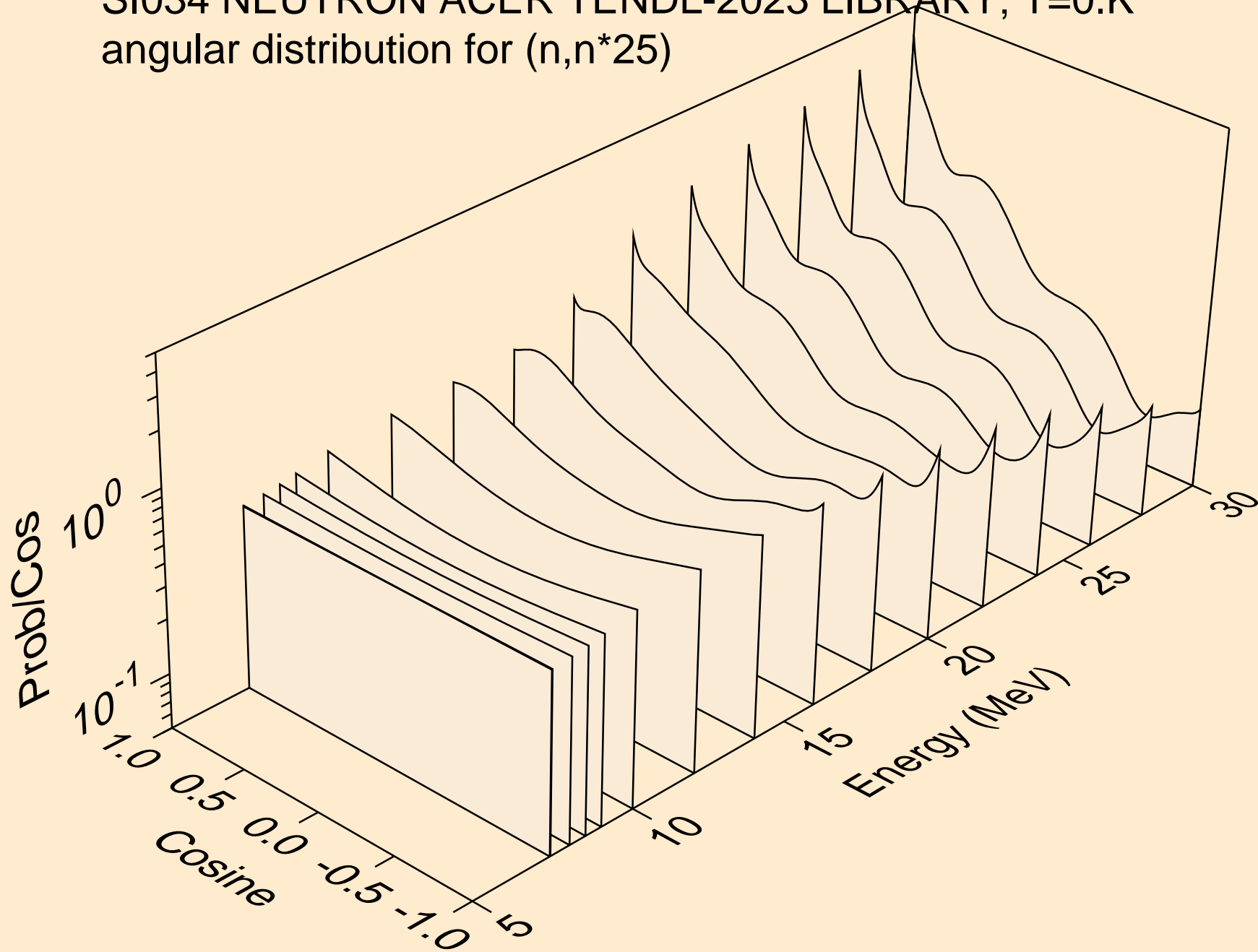

SI034 NEUTRON ACER TENDL-2023 LIBRARY; T=0.K  
angular distribution for (n,n\*26)

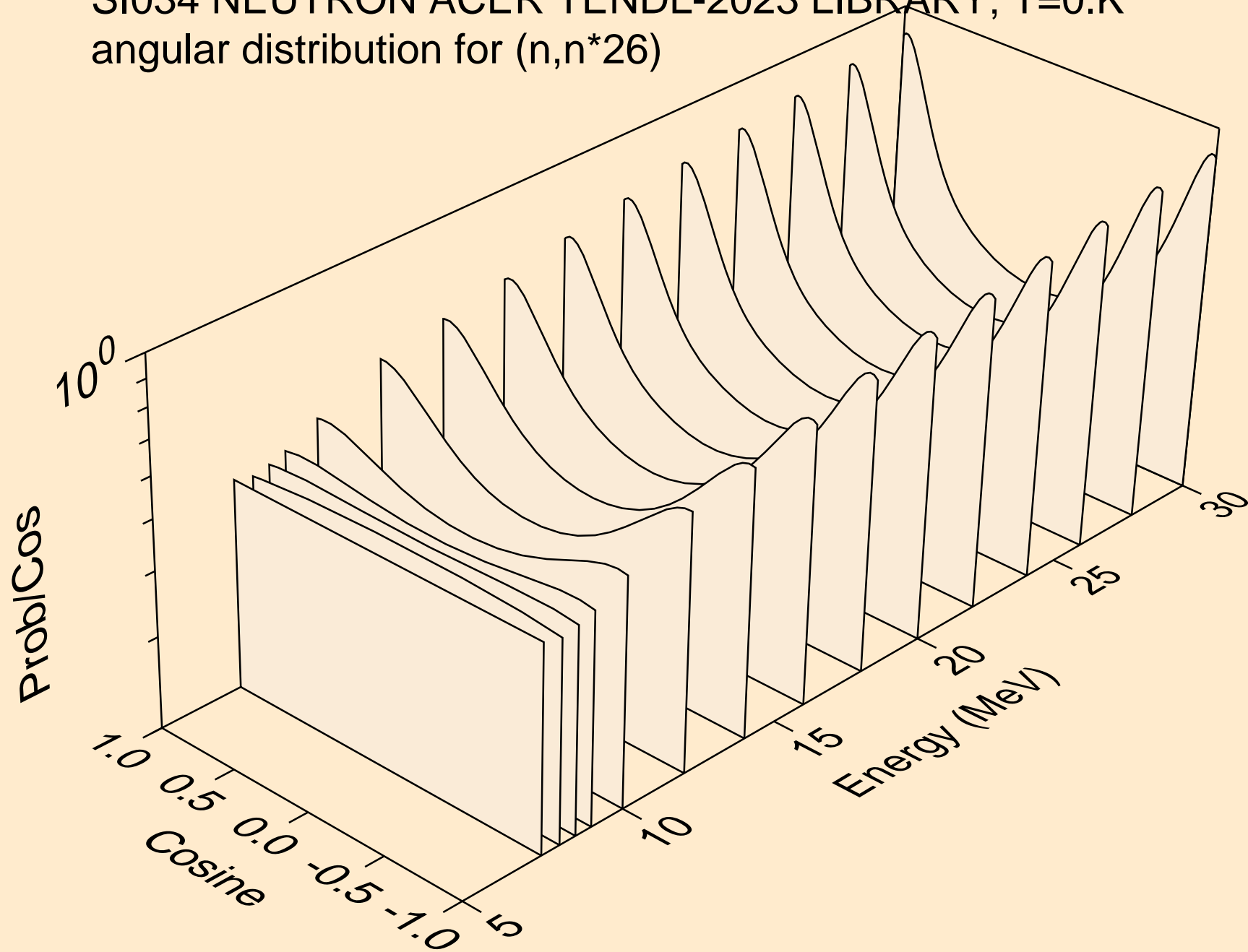

SI034 NEUTRON ACER TENDL-2023 LIBRARY; T=0.K  
angular distribution for (n,n\*27)

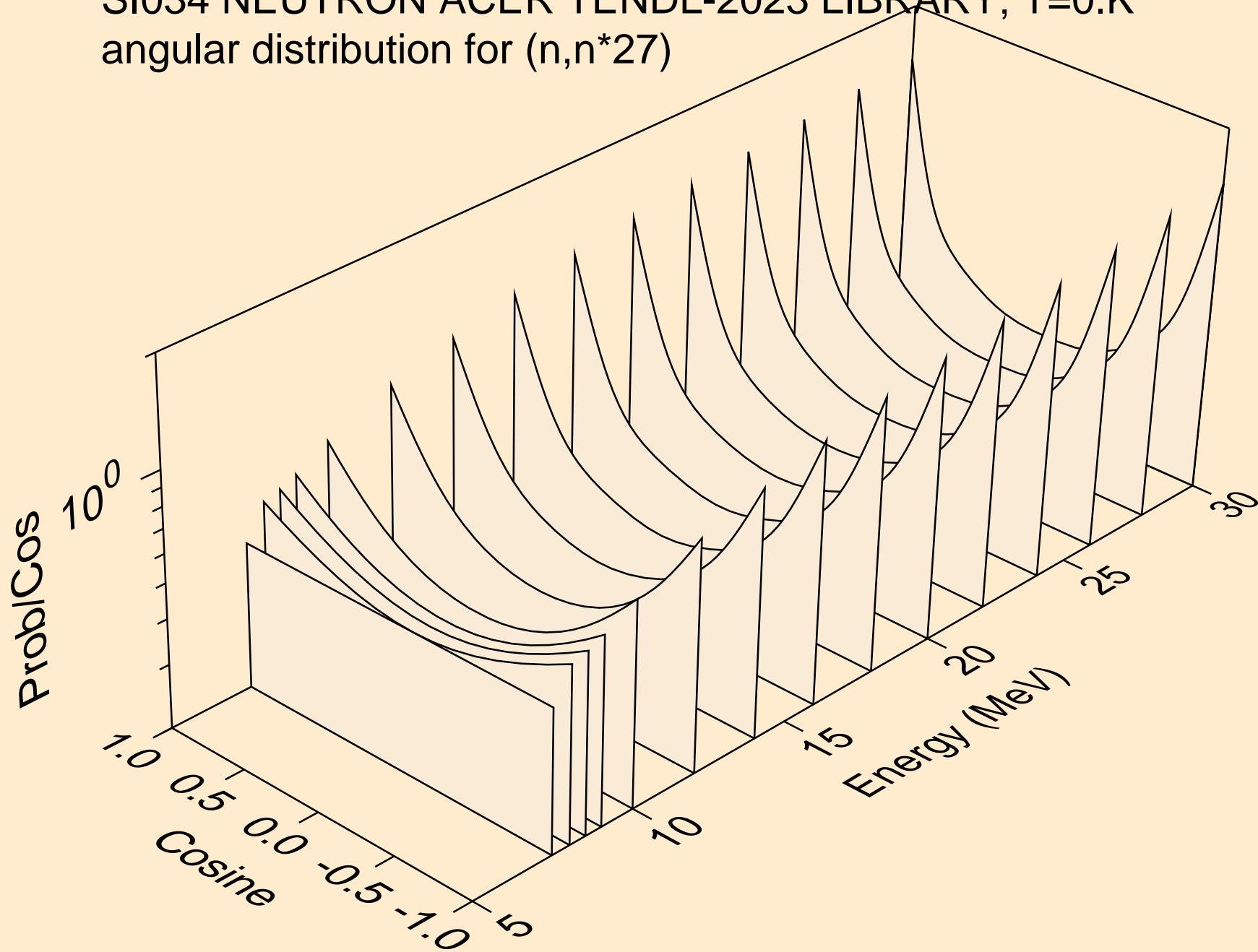

SI034 NEUTRON ACER TENDL-2023 LIBRARY; T=0.K  
angular distribution for (n,n\*28)

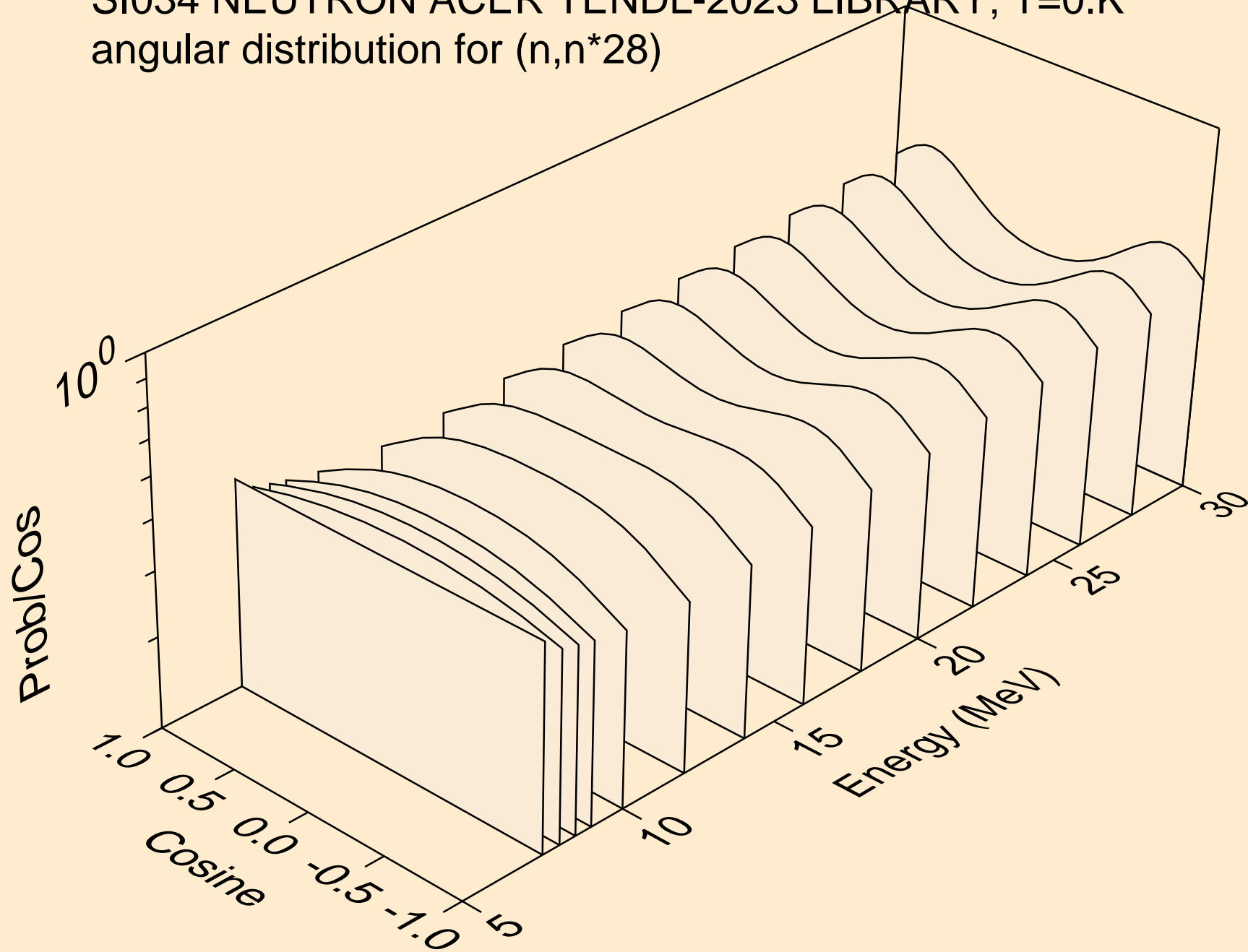

SI034 NEUTRON ACER TENDL-2023 LIBRARY; T=0.K  
angular distribution for (n,n\*29)

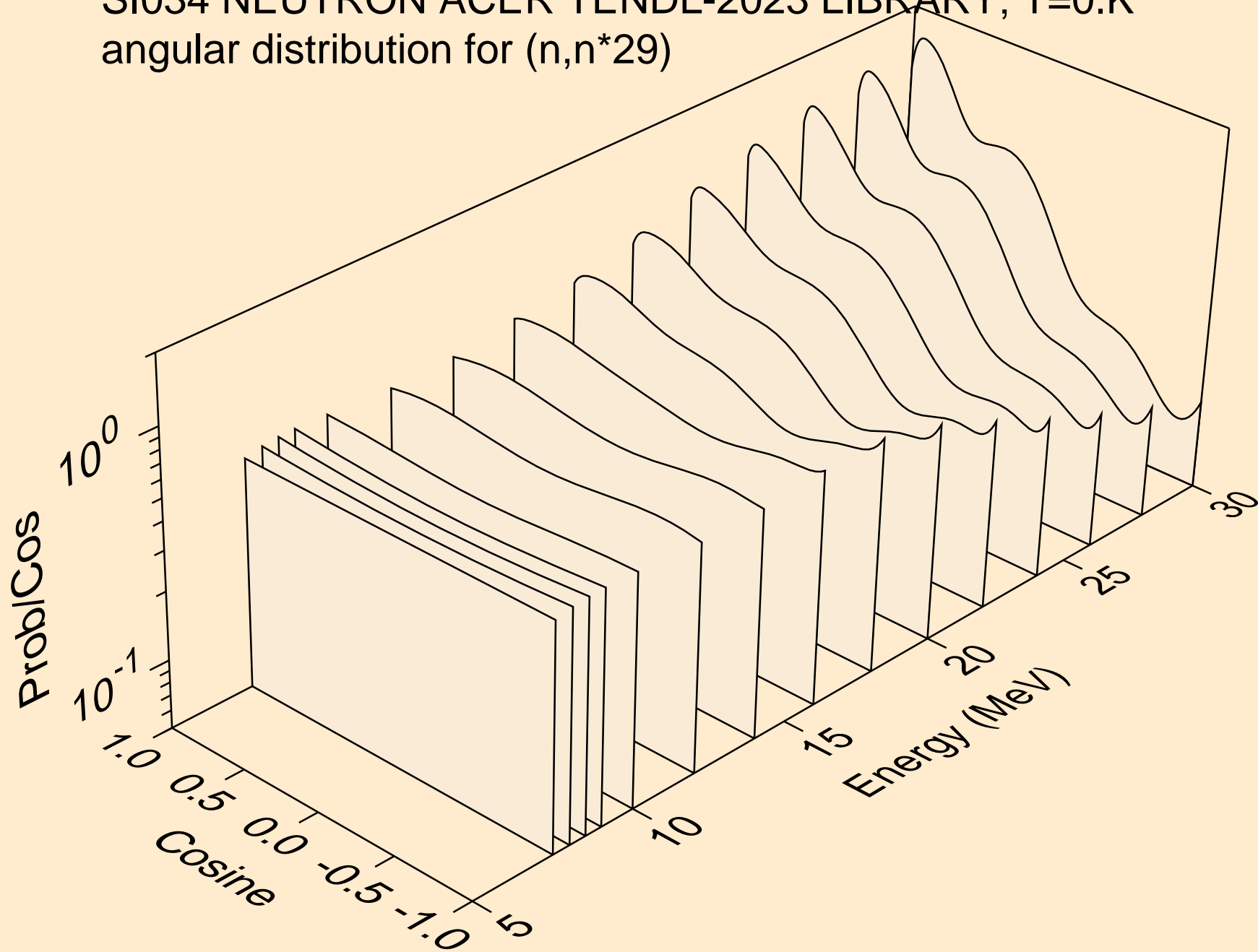

SI034 NEUTRON ACER TENDL-2023 LIBRARY; T=0.K  
angular distribution for (n,n\*30)

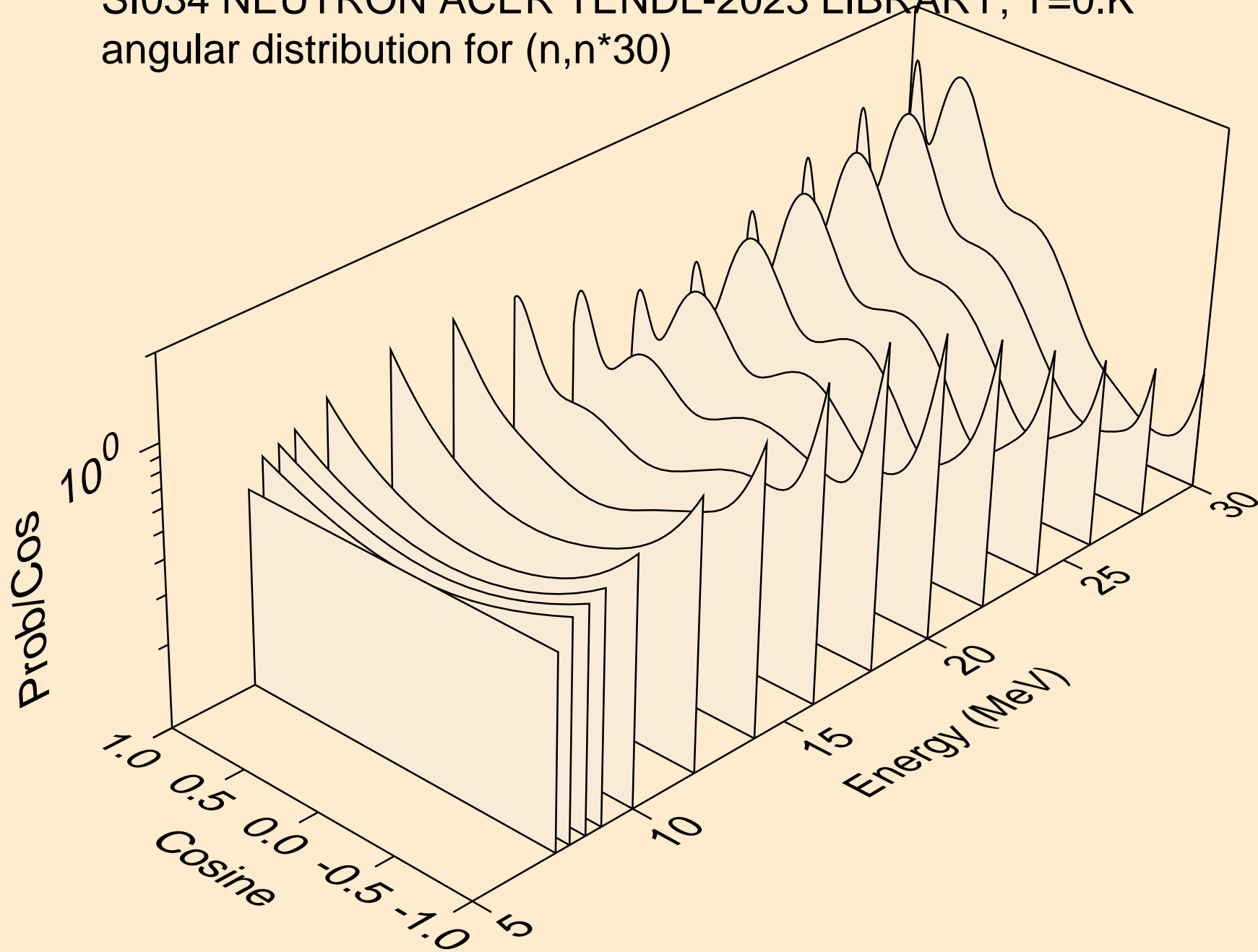

SI034 NEUTRON ACER TENDL-2023 LIBRARY; T=0.K  
Neutron emission for (n,x)

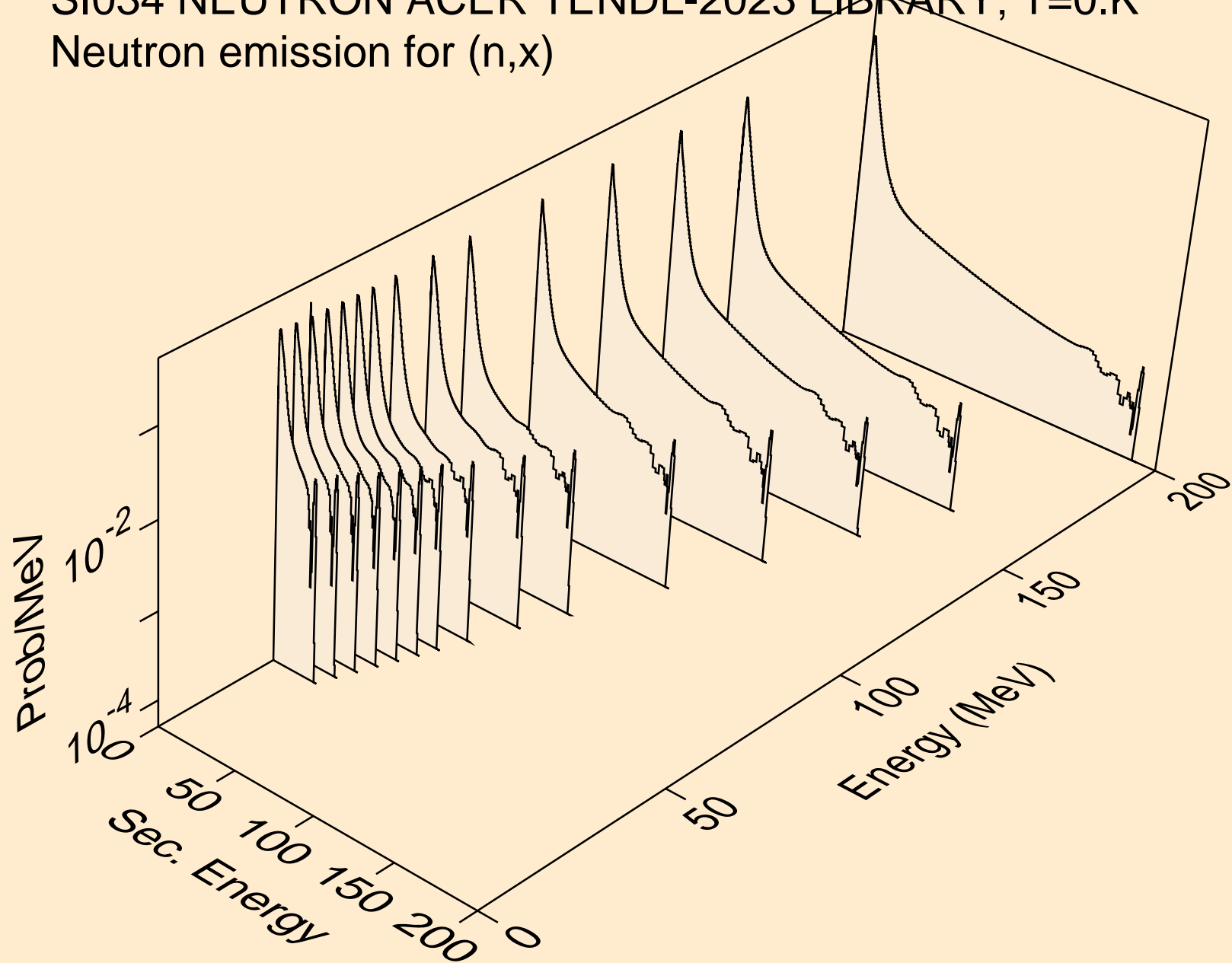

SI034 NEUTRON ACER TENDL-2023 LIBRARY; T=0.K  
Neutron emission for (n,2nd)

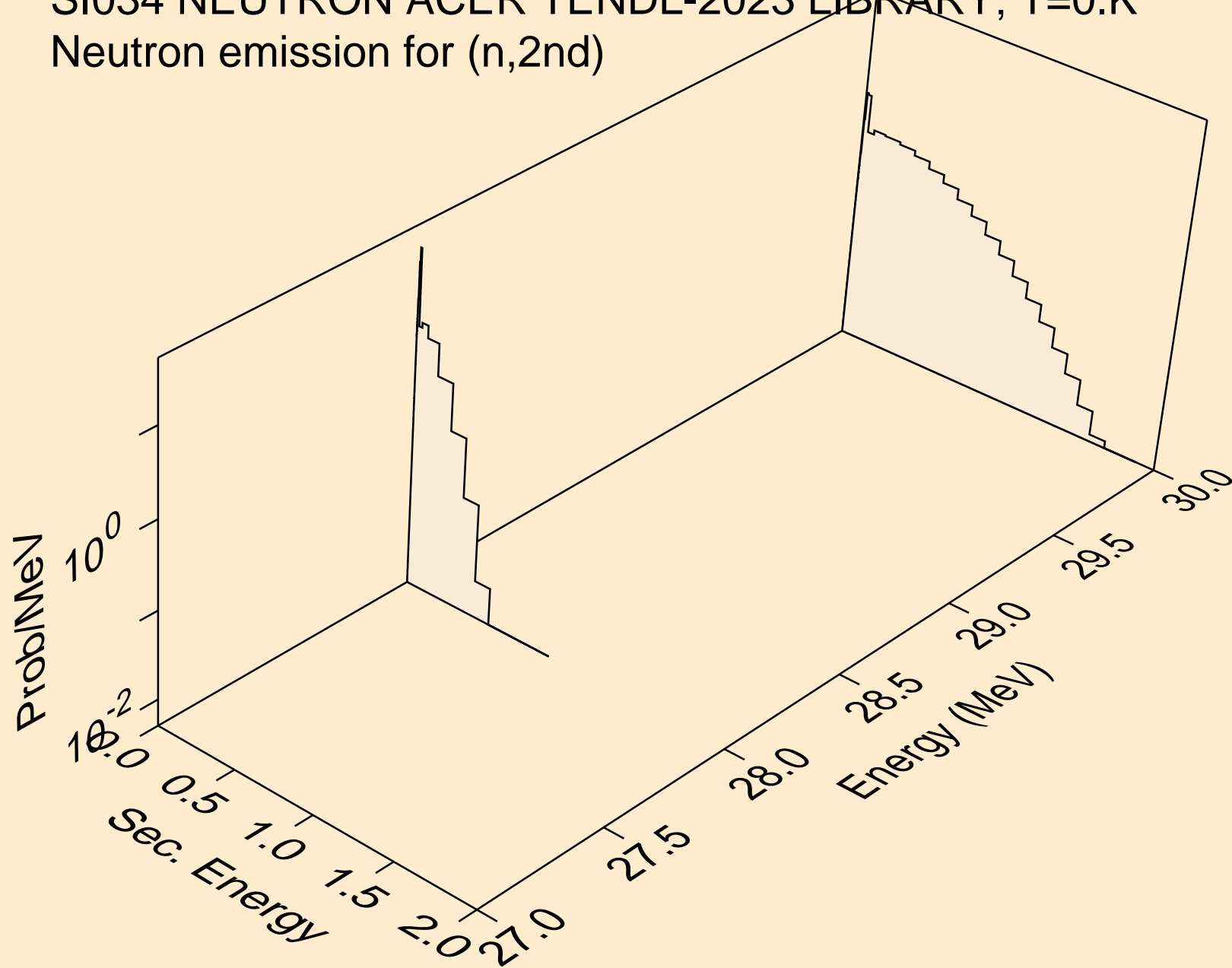

SI034 NEUTRON ACER TENDL-2023 LIBRARY; T=0.K  
Neutron emission for (n,2n)

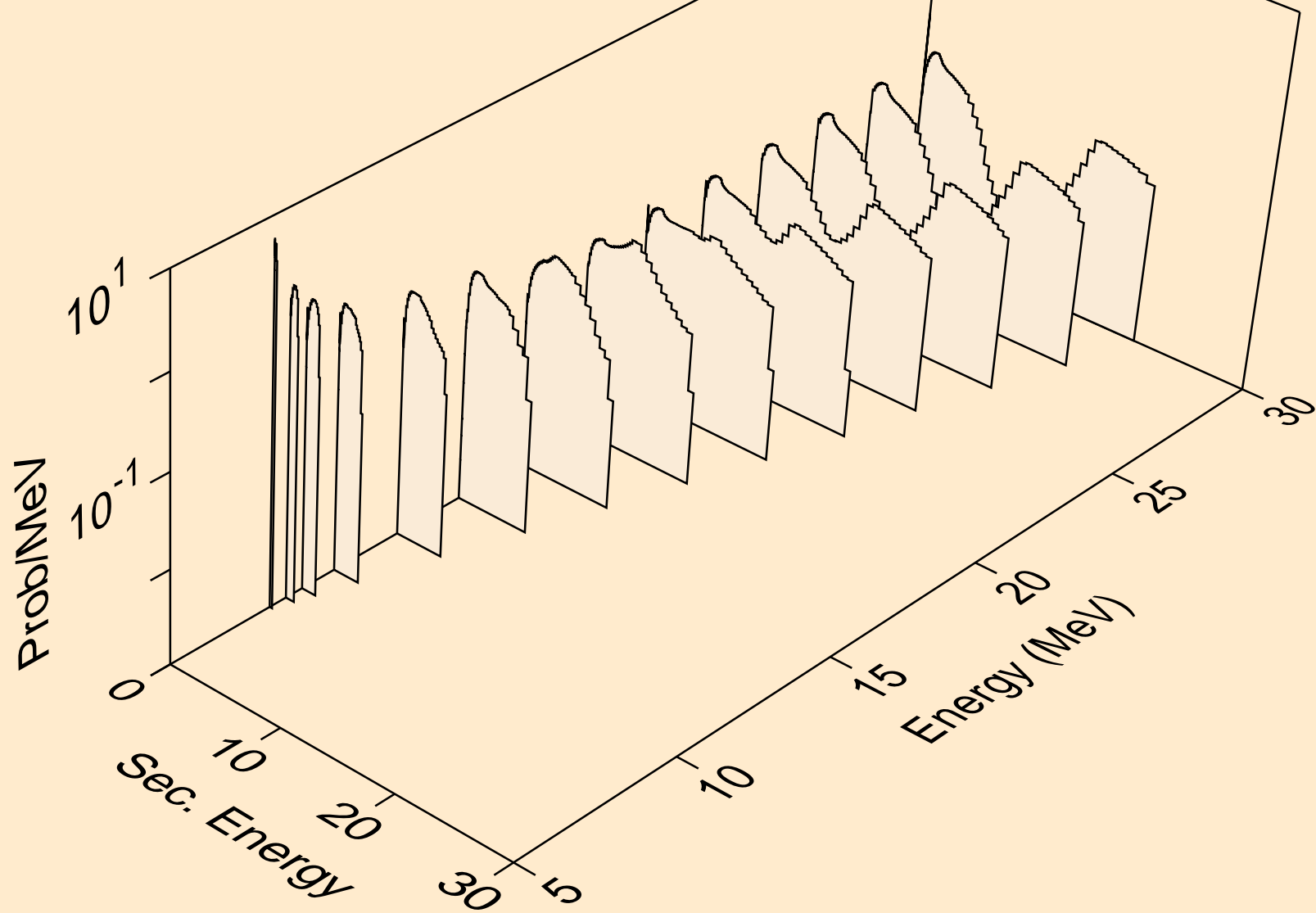

SI034 NEUTRON ACER TENDL-2023 LIBRARY; T=0.K  
Neutron emission for (n,3n)

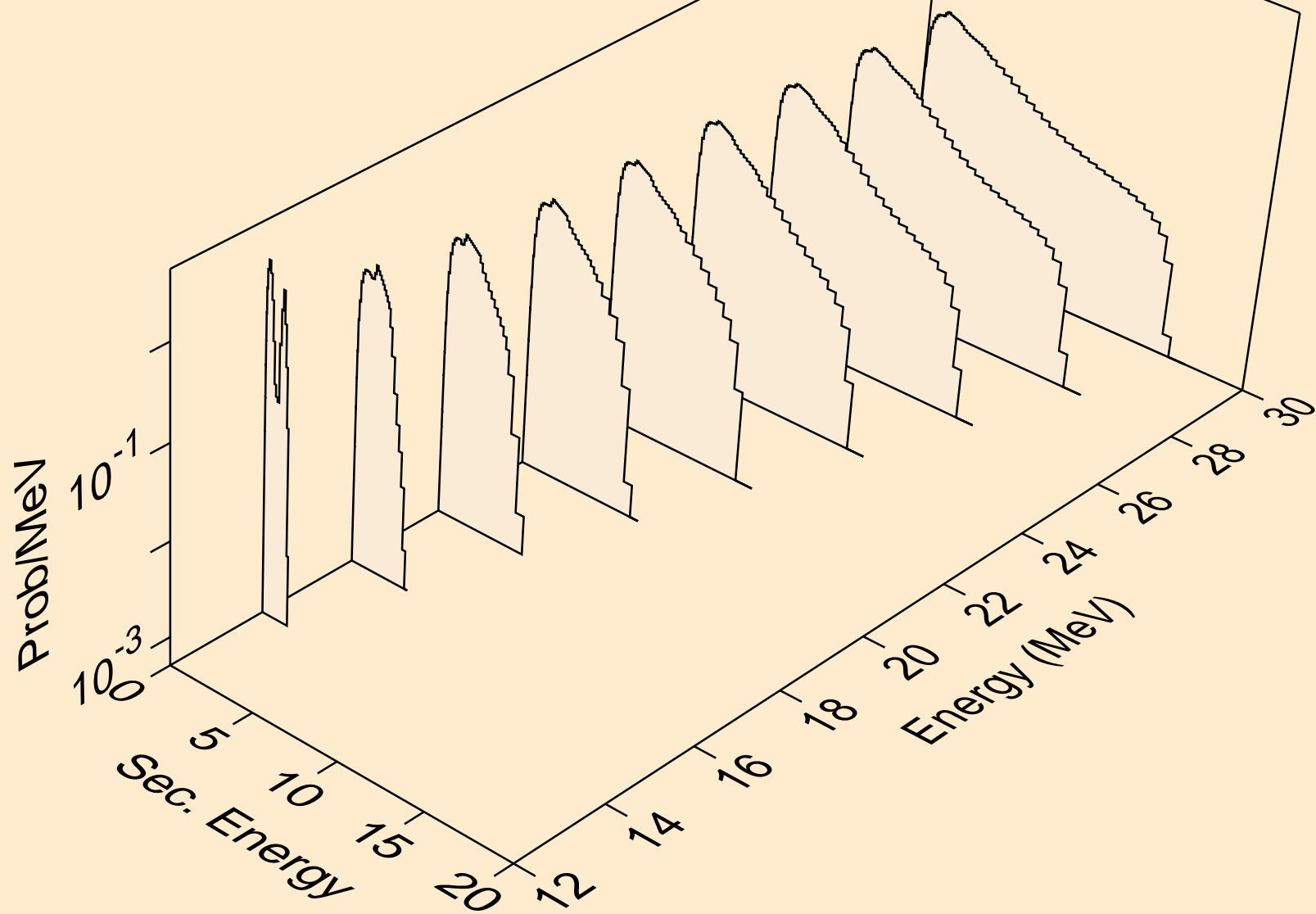

SI034 NEUTRON ACER TENDL-2023 LIBRARY; T=0.K  
Neutron emission for (n,n\*)a

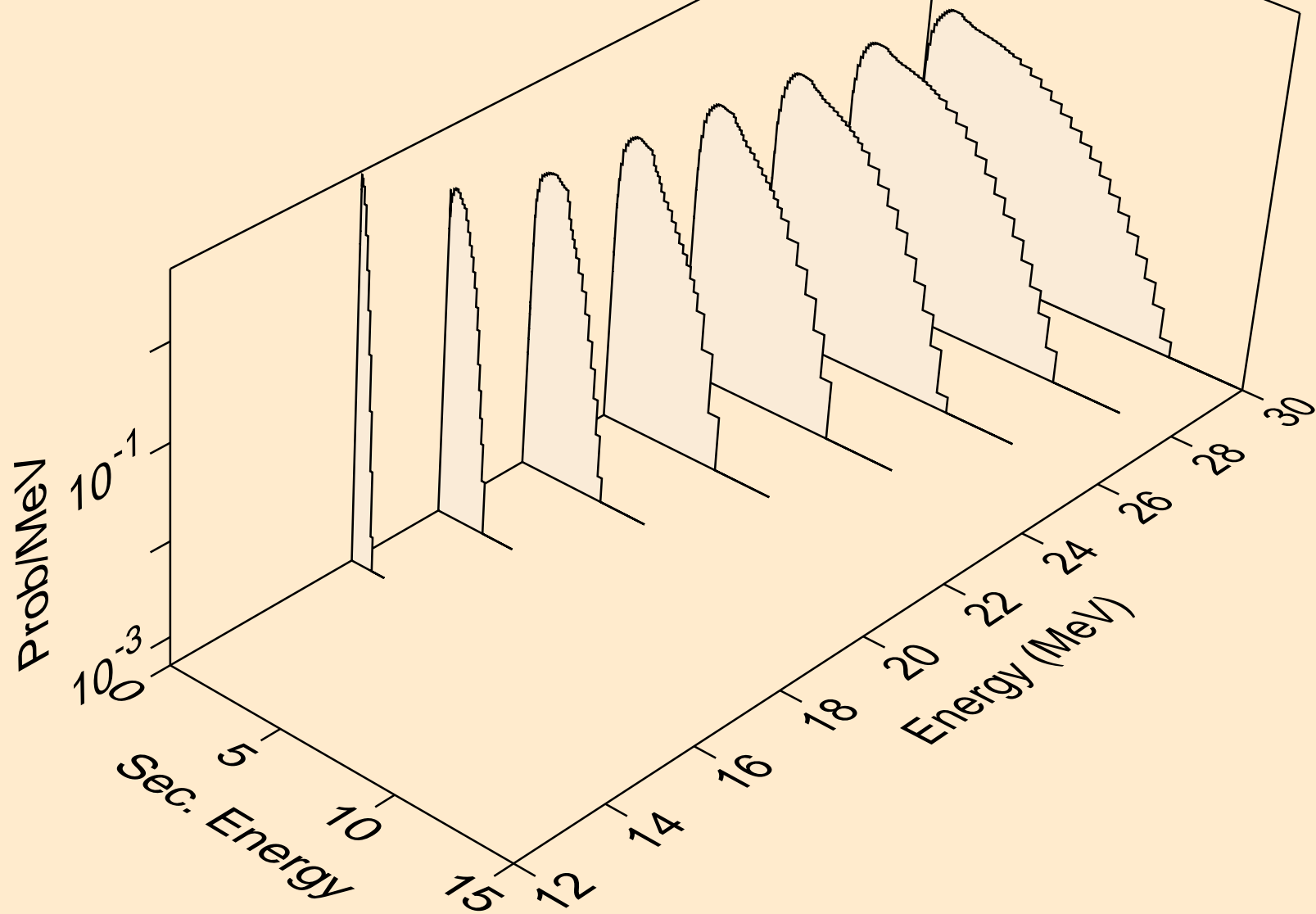

SI034 NEUTRON ACER TENDL-2023 LIBRARY; T=0.K  
Neutron emission for (n,2n)a

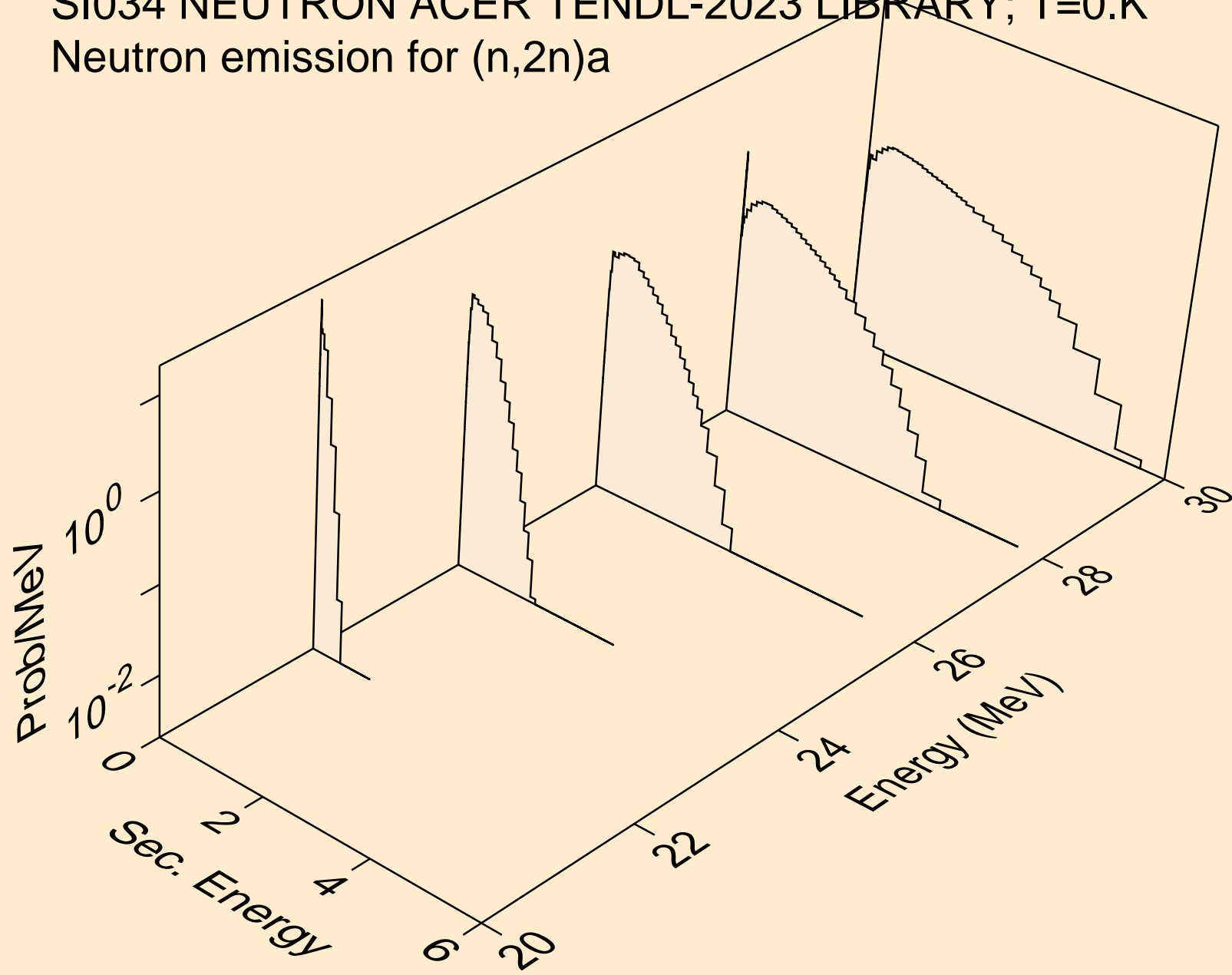

SI034 NEUTRON ACER TENDL-2023 LIBRARY; T=0.K  
Neutron emission for (n,3n)a

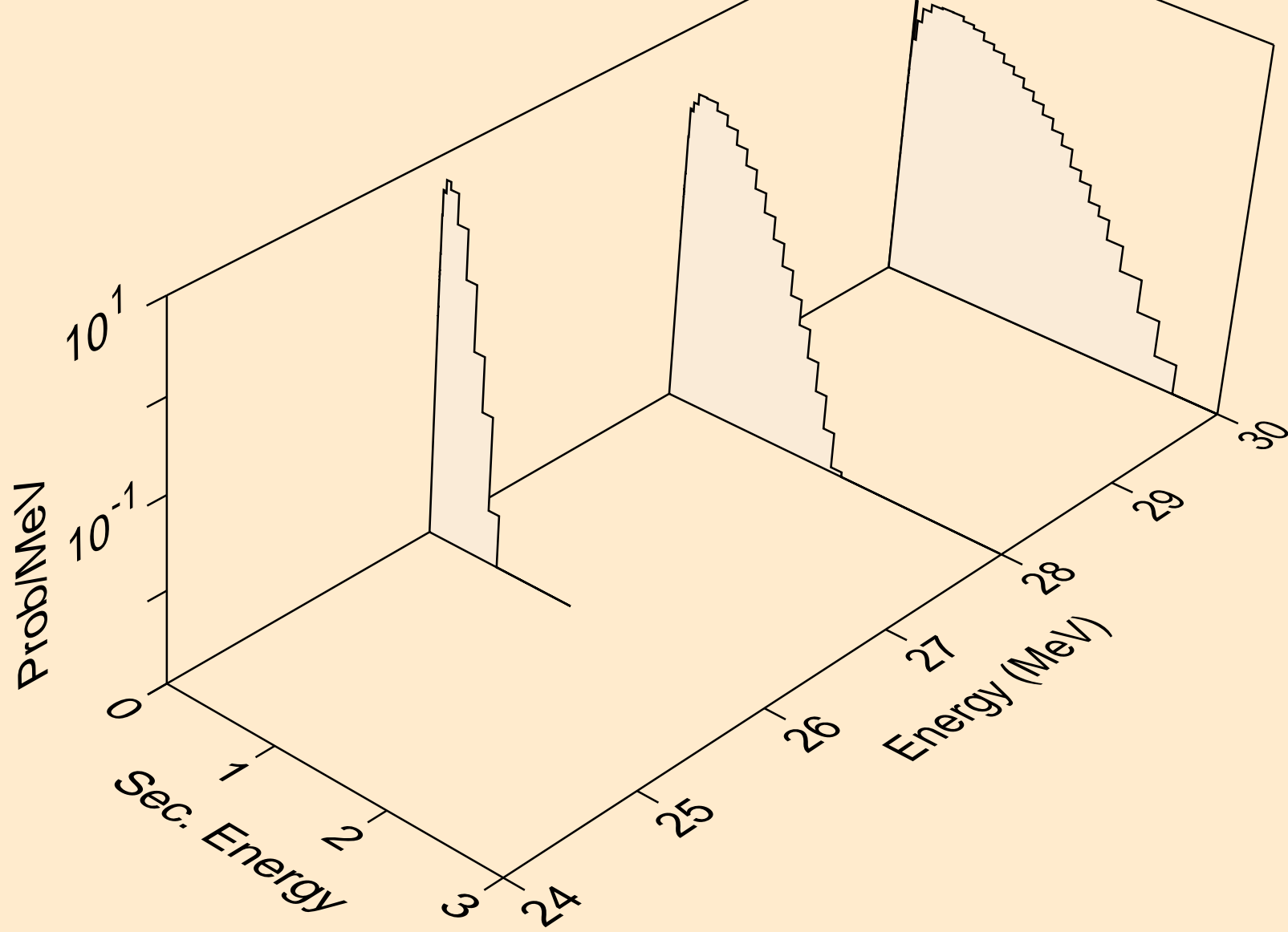

SI034 NEUTRON ACER TENDL-2023 LIBRARY; T=0.K  
Neutron emission for (n,n\*)p

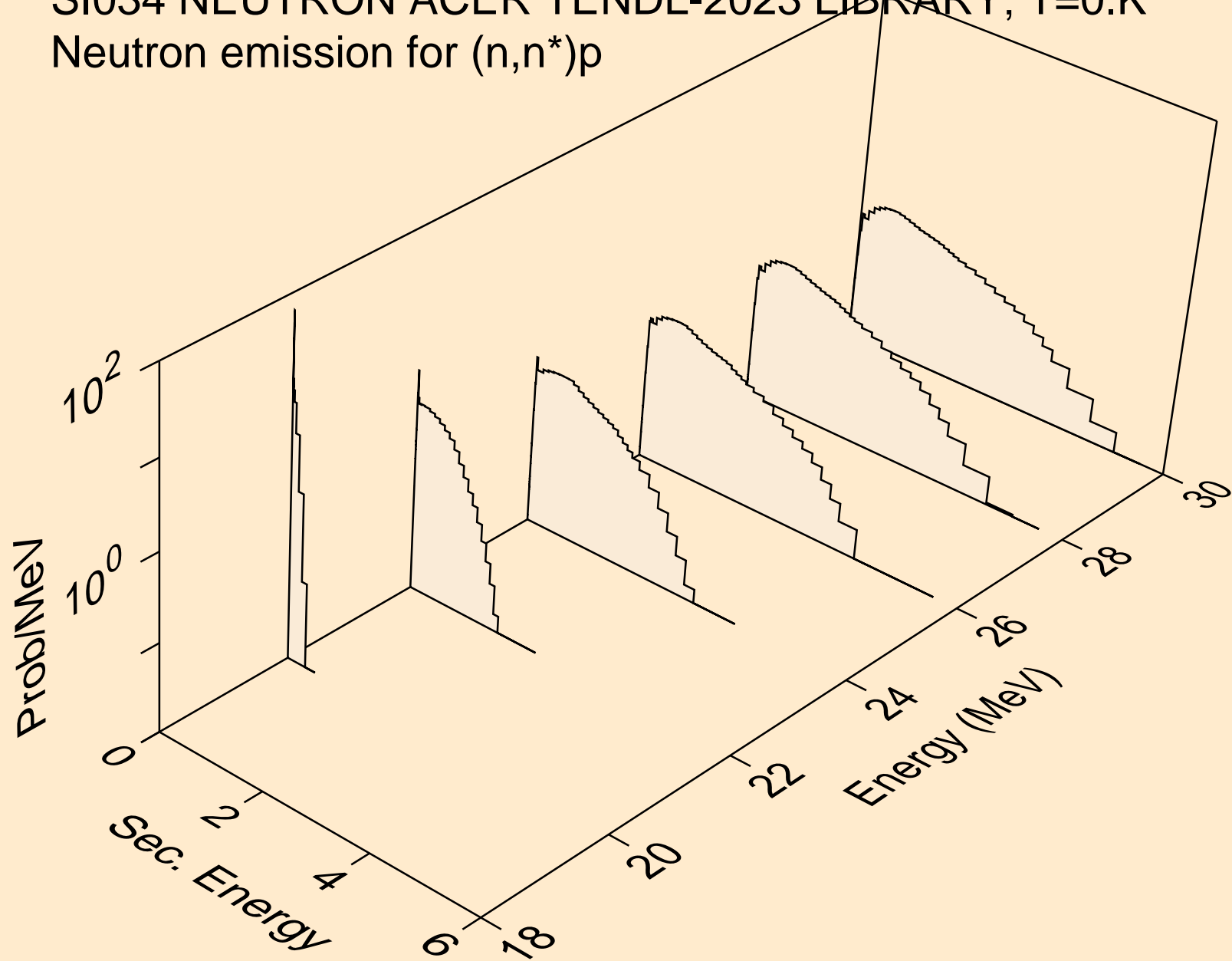

SI034 NEUTRON ACER TENDL-2023 LIBRARY; T=0.K  
Neutron emission for (n,n\*)d

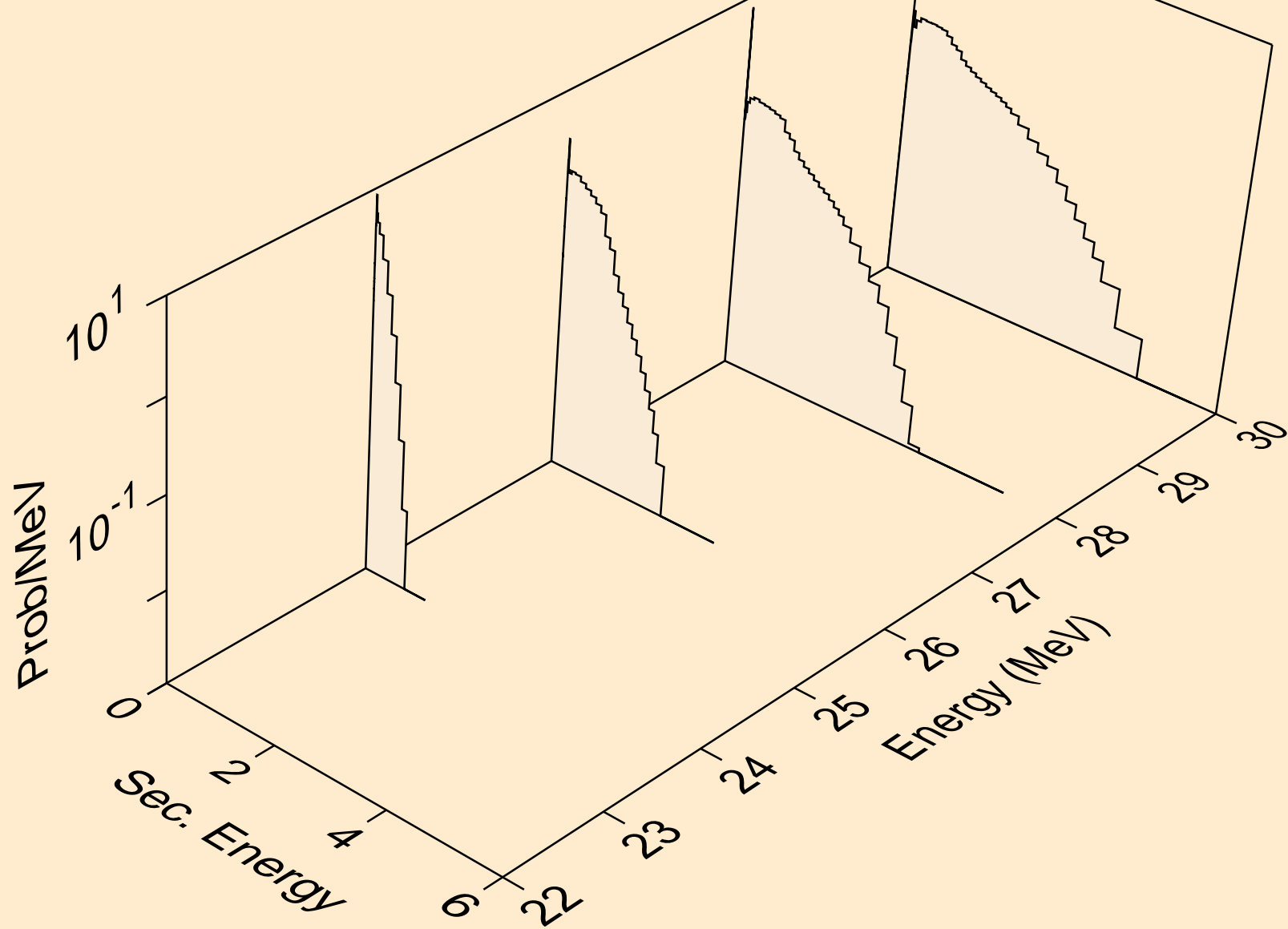

SI034 NEUTRON ACER TENDL-2023 LIBRARY; T=0.K  
Neutron emission for (n,n\*)t

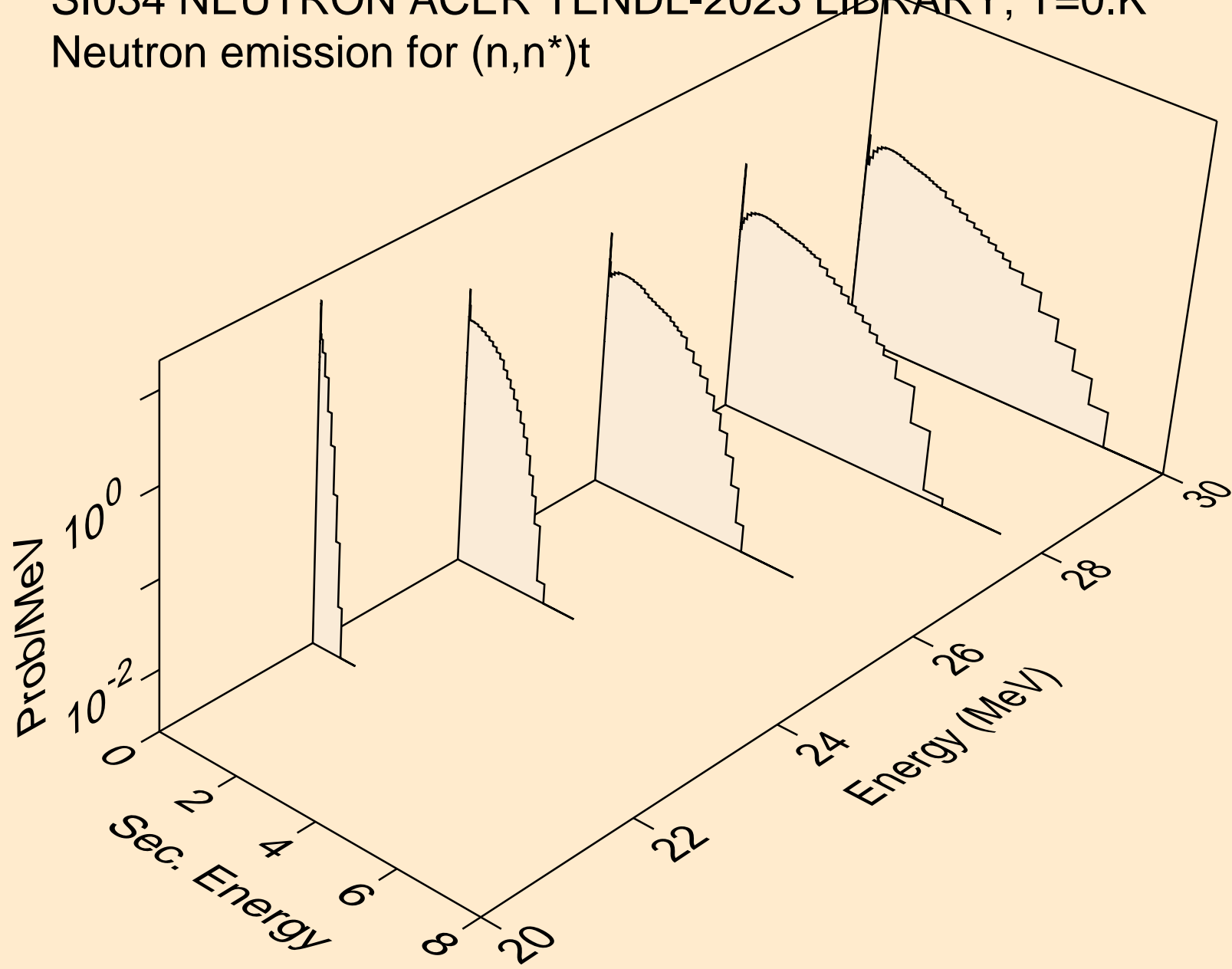

SI034 NEUTRON ACER TENDL-2023 LIBRARY; T=0.K  
Neutron emission for (n,4n)

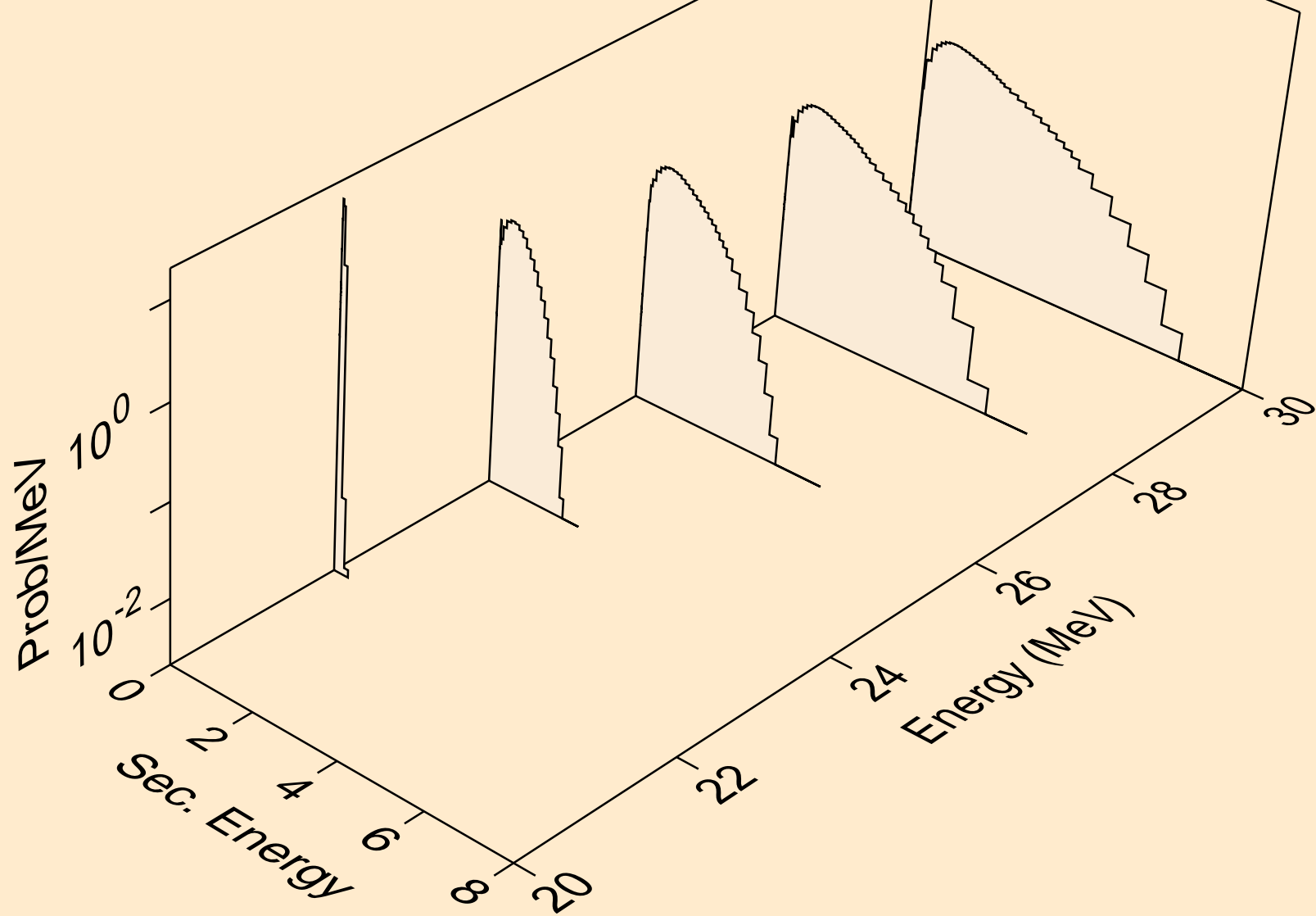

SI034 NEUTRON ACER TENDL-2023 LIBRARY; T=0.K  
Neutron emission for (n,2np)

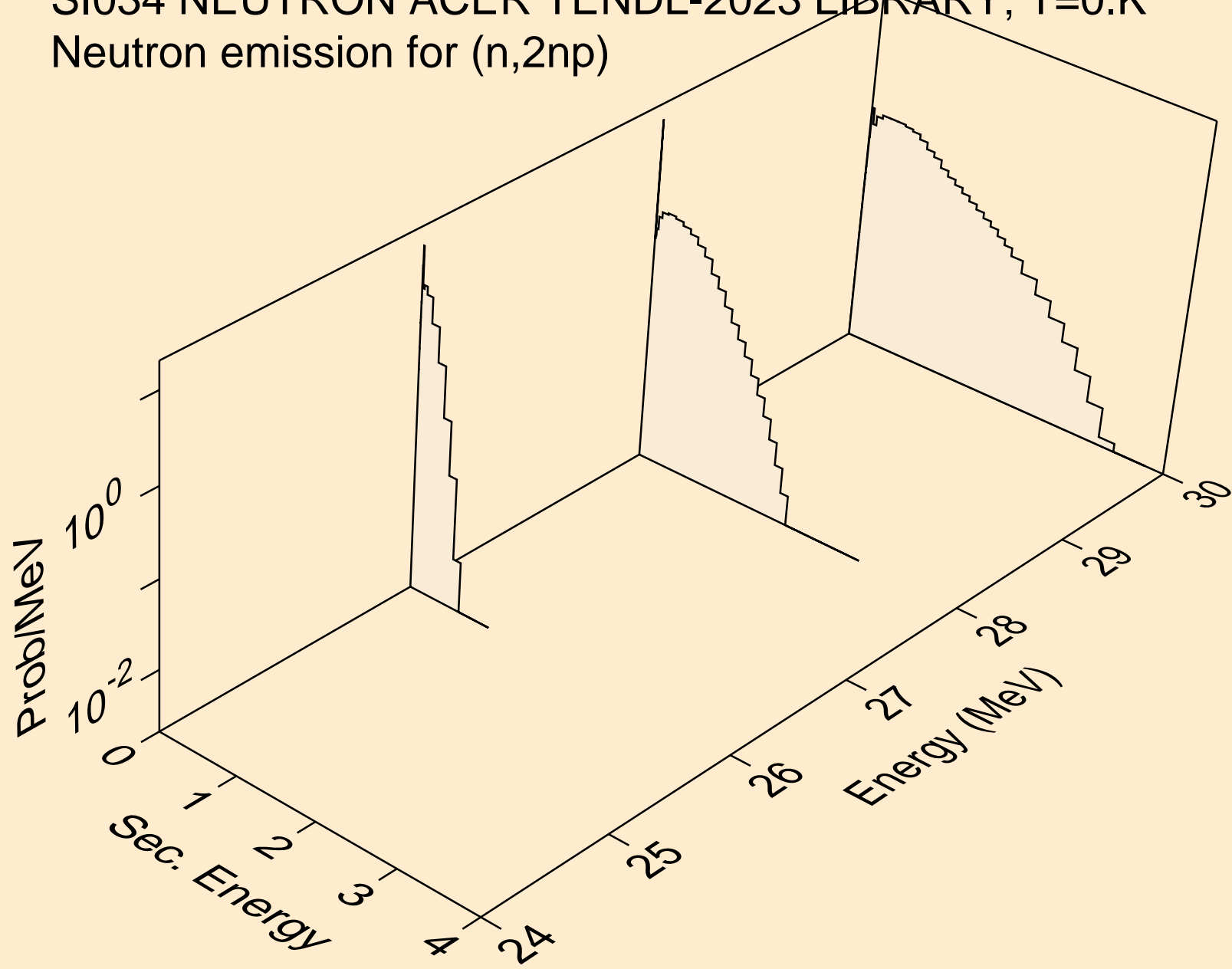

SI034 NEUTRON ACER TENDL-2023 LIBRARY; T=0.K  
Neutron emission for (n,n\*c)

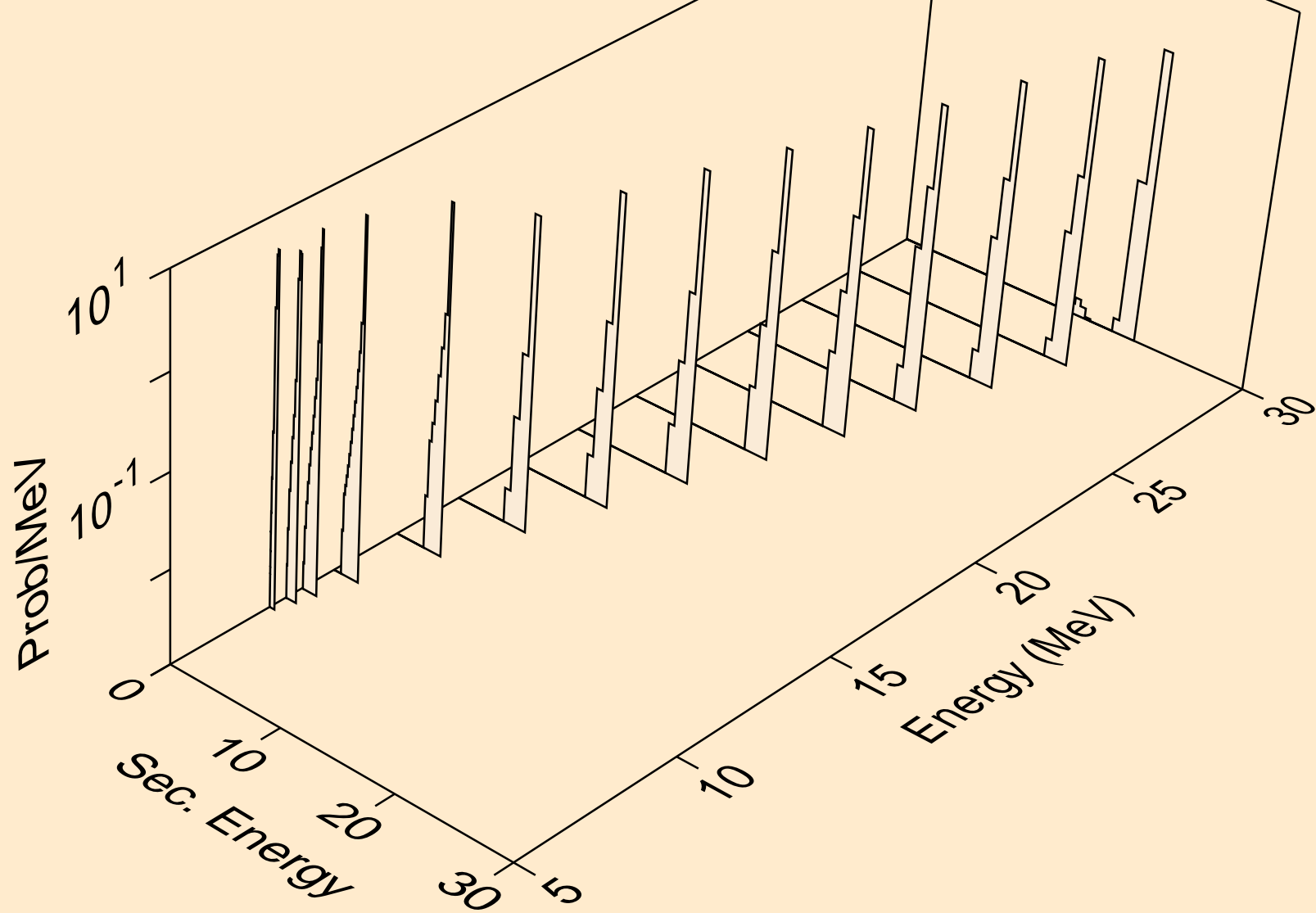

SI034 NEUTRON ACER TENDL-2023 LIBRARY; T=0.K  
Photon emission for (n,x)

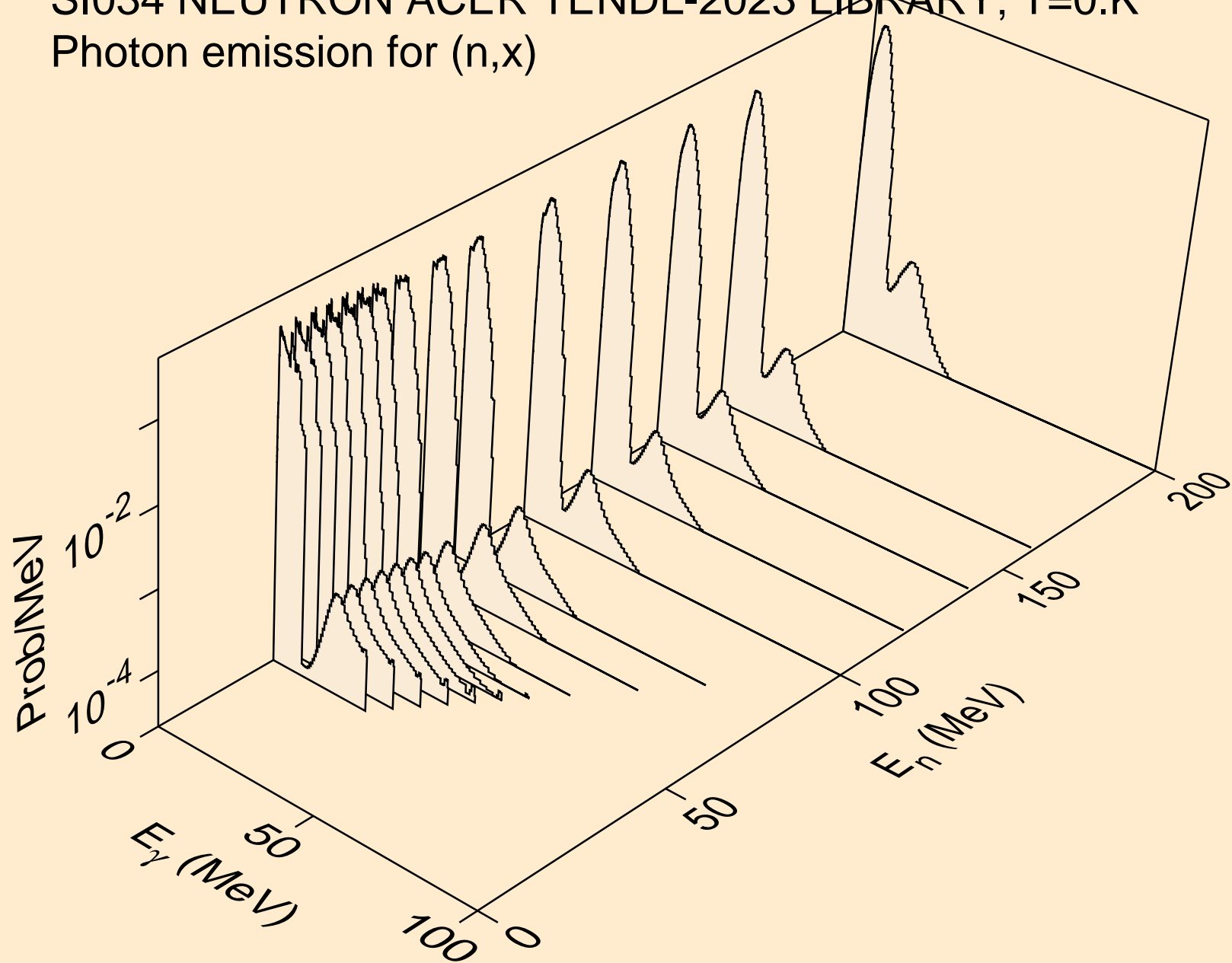

SI034 NEUTRON ACER TENDL-2023 LIBRARY; T=0.K  
Photon emission for (n,2nd)

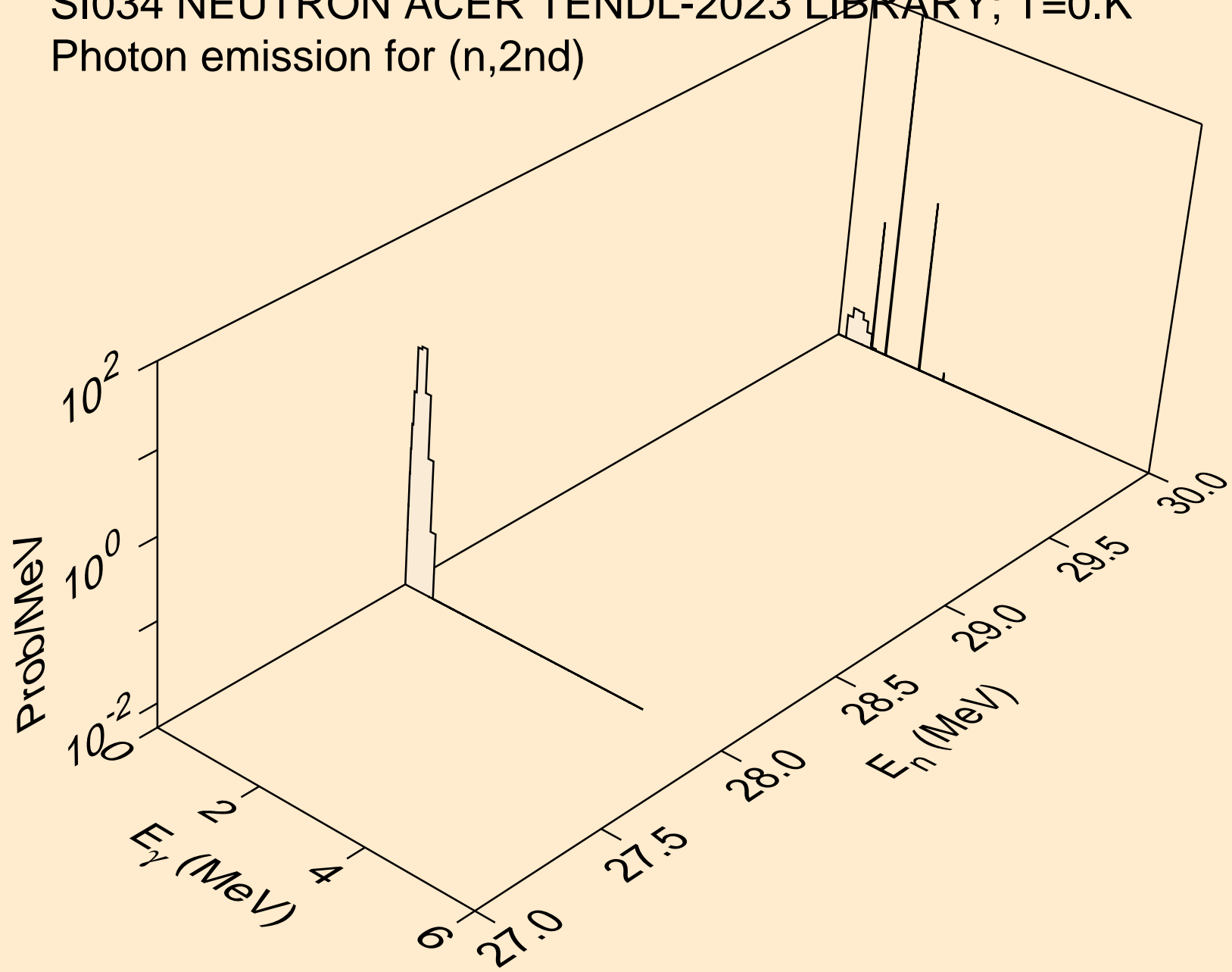

SI034 NEUTRON ACER TENDL-2023 LIBRARY; T=0.K  
Photon emission for (n,2n)

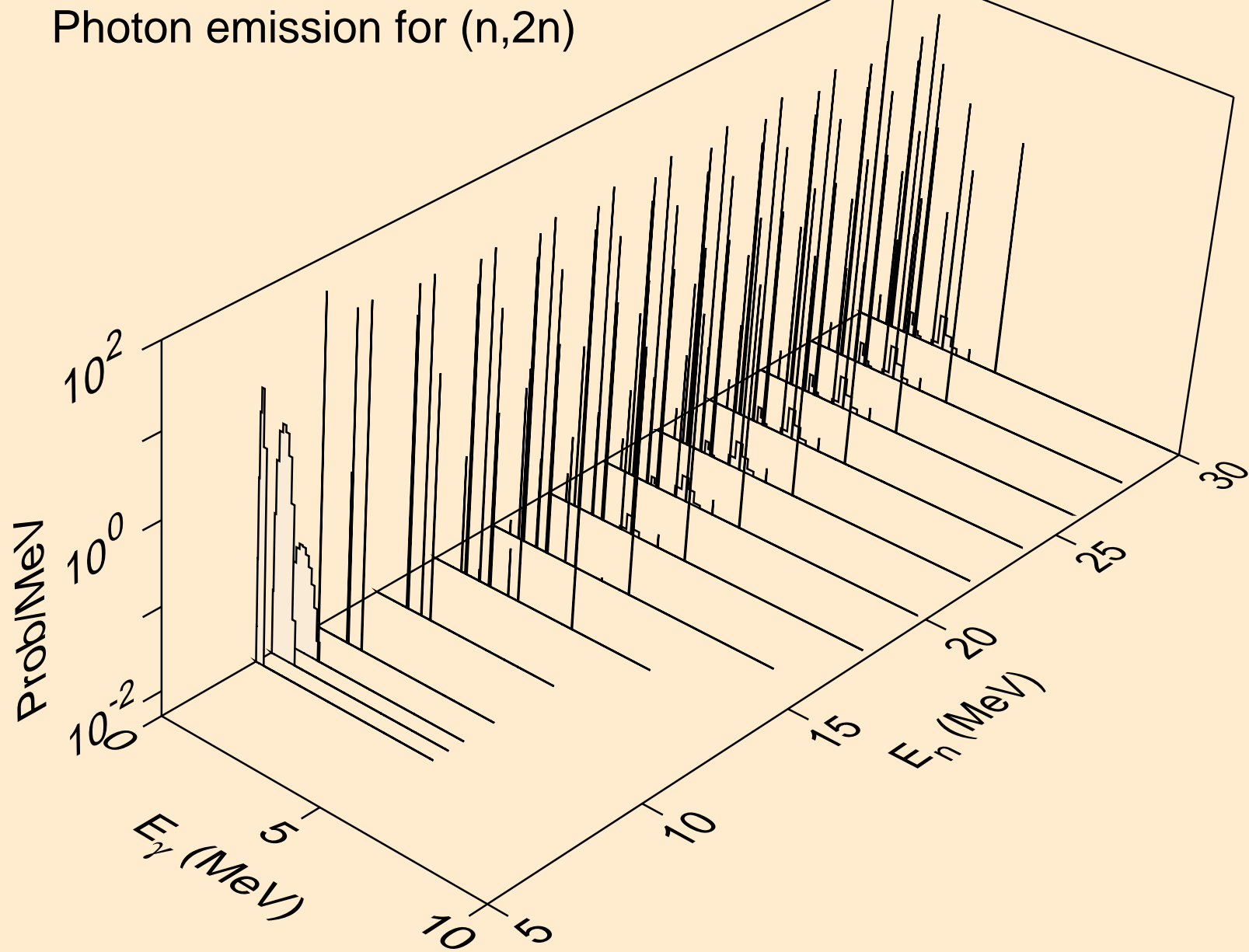

SI034 NEUTRON ACER TENDL-2023 LIBRARY; T=0.K  
Photon emission for (n,3n)

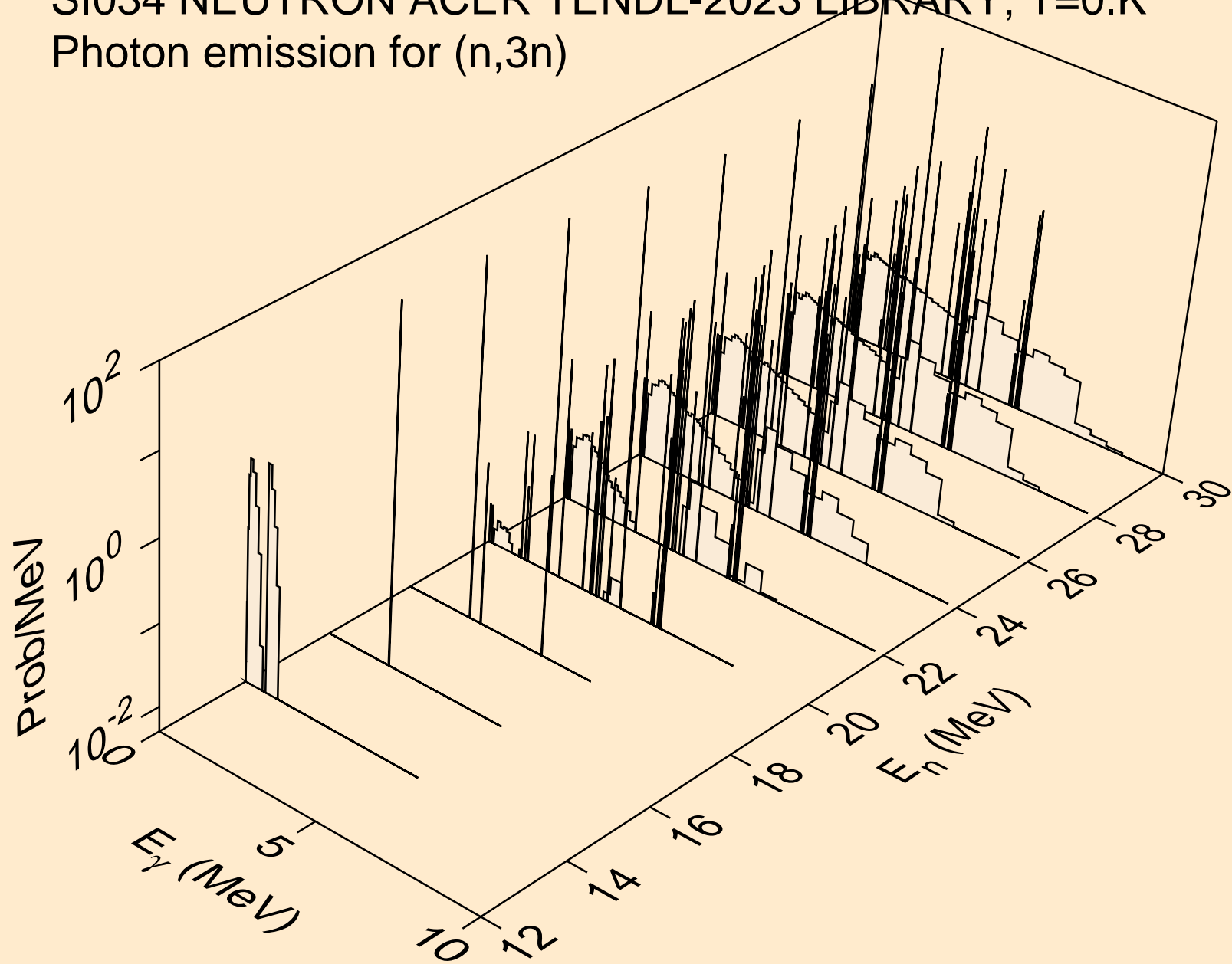

SI034 NEUTRON ACER TENDL-2023 LIBRARY; T=0.K  
Photon emission for (n,n\*)a

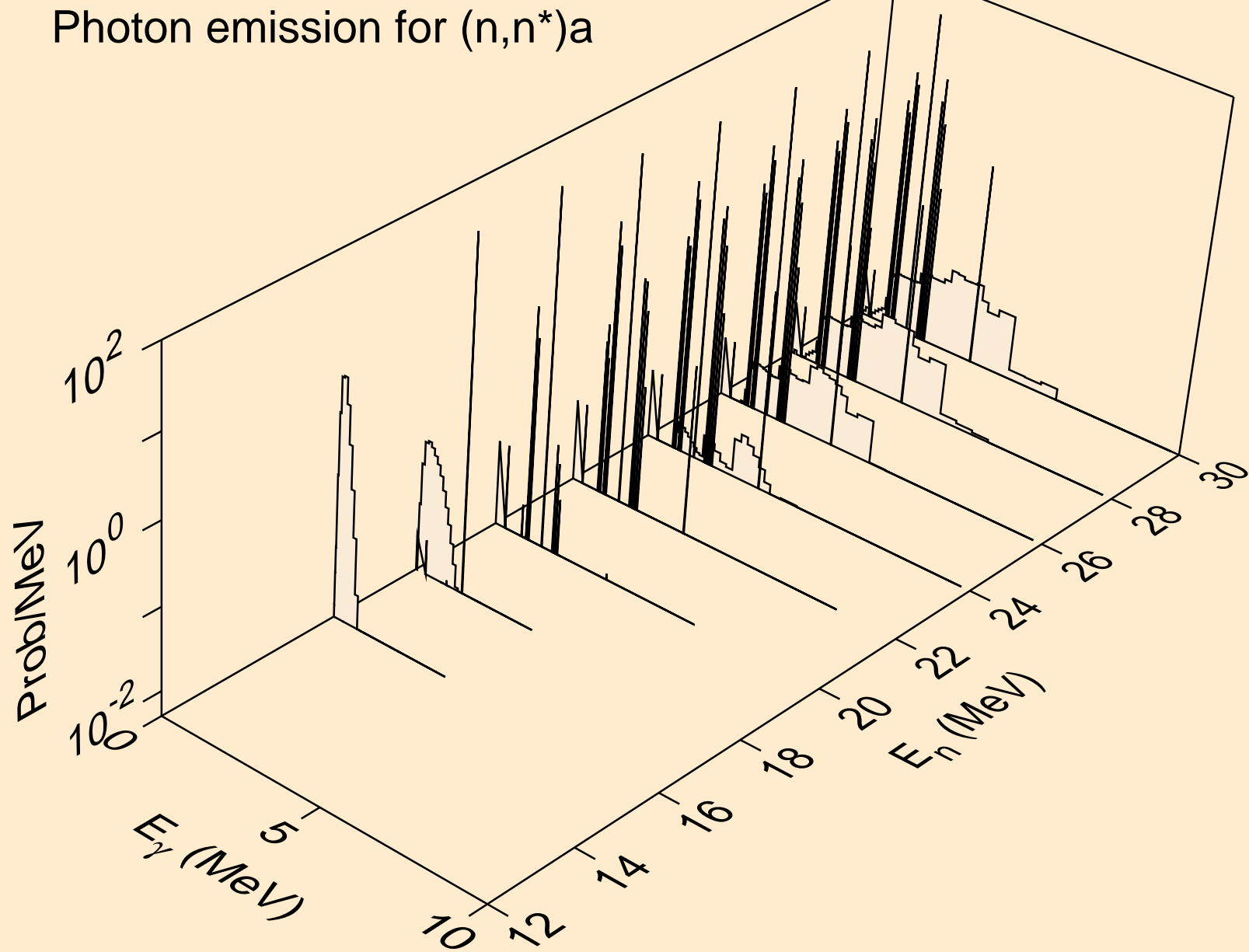

SI034 NEUTRON ACER TENDL-2023 LIBRARY; T=0.K  
Photon emission for (n,2n)a

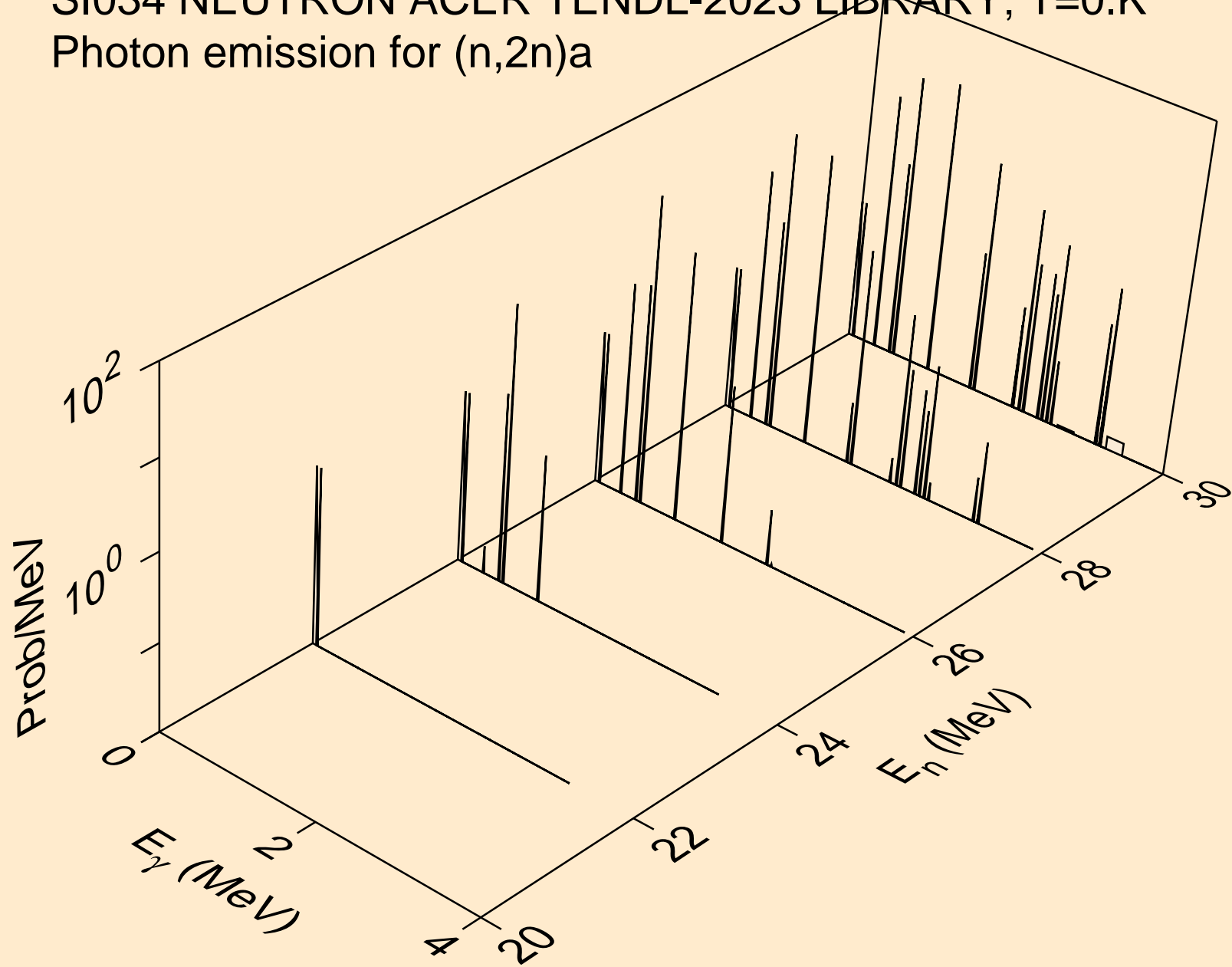

SI034 NEUTRON ACER TENDL-2023 LIBRARY; T=0.K  
Photon emission for (n,3n)a

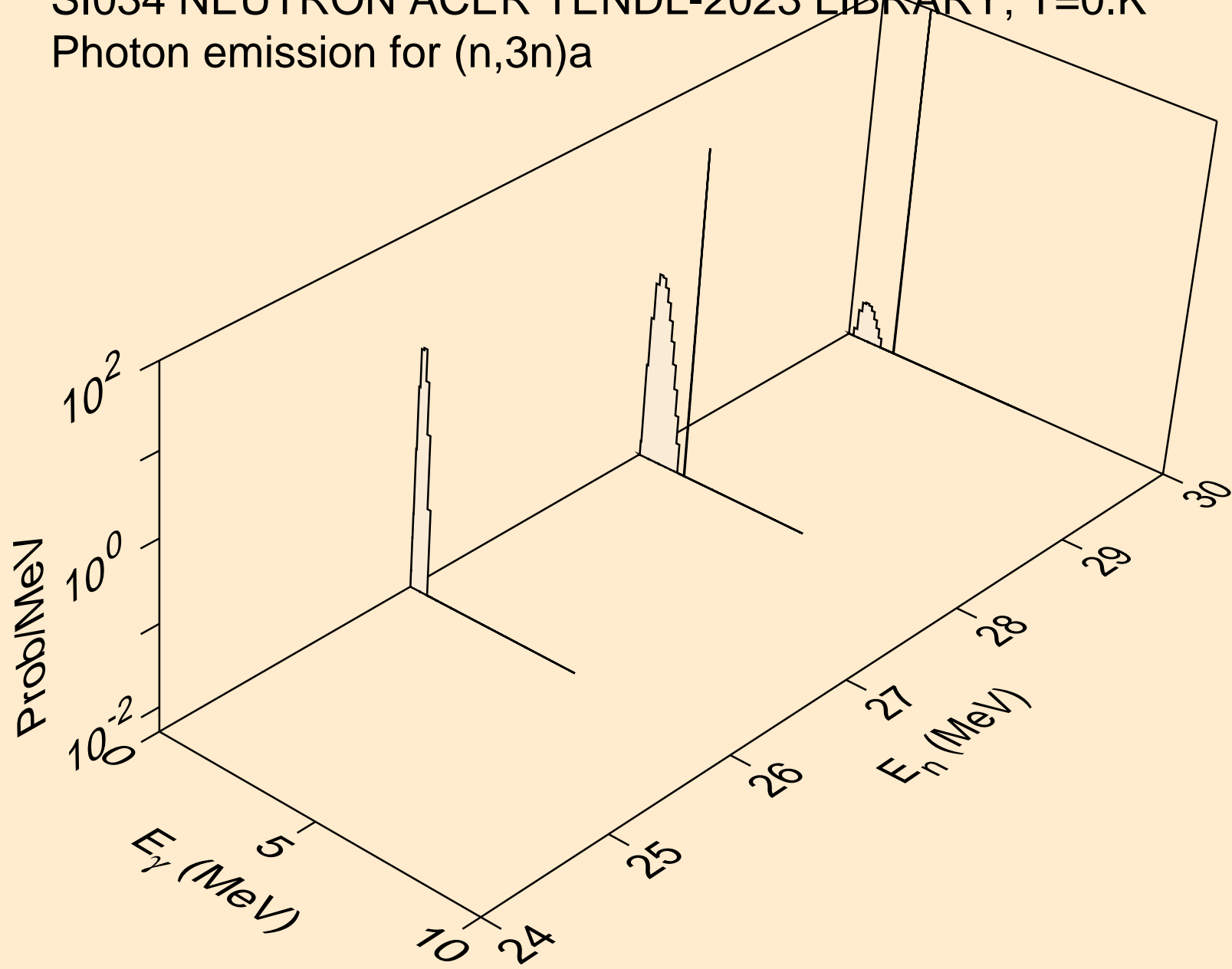

SI034 NEUTRON ACER TENDL-2023 LIBRARY; T=0.K  
Photon emission for (n,n\*)p

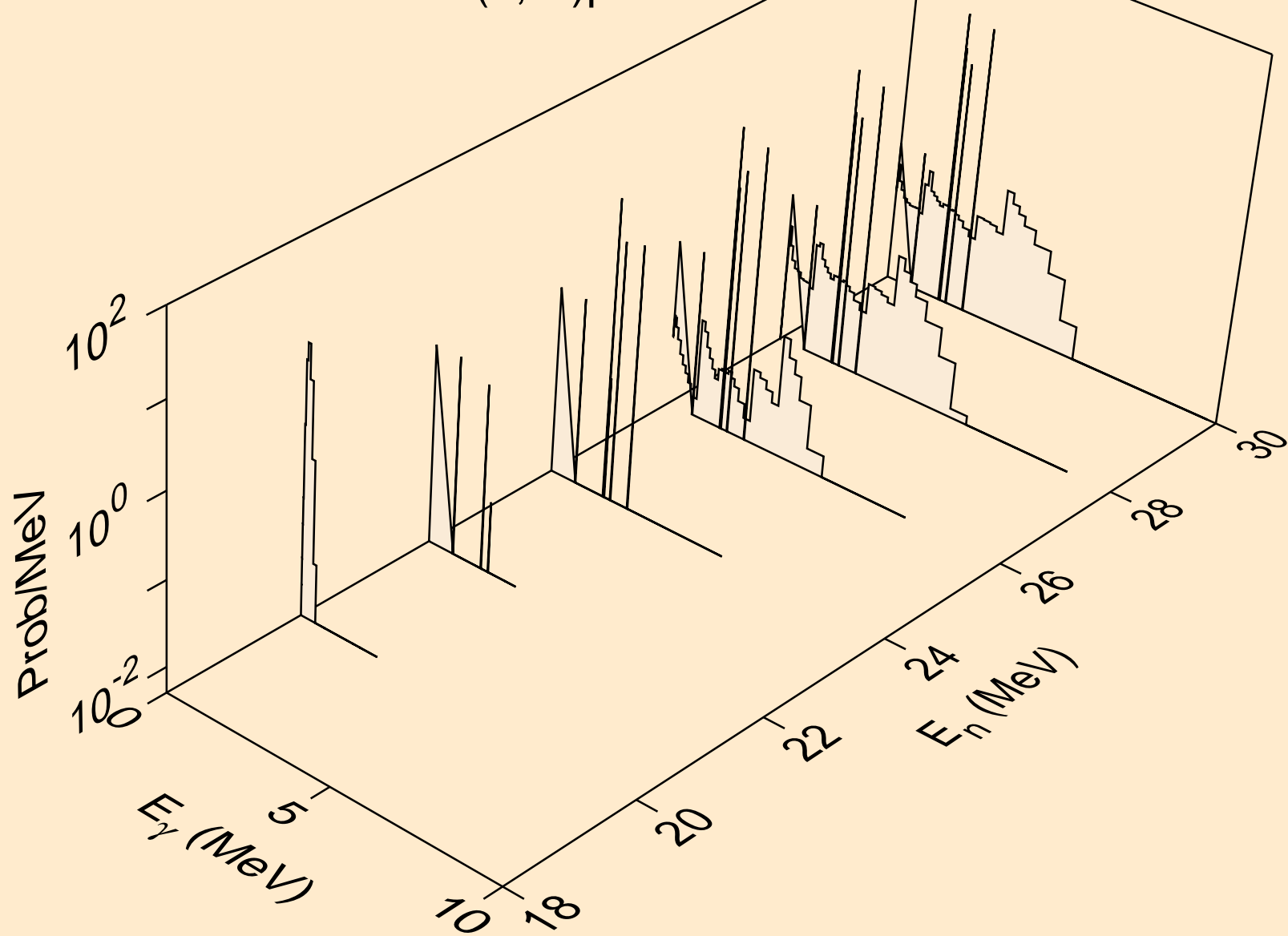

SI034 NEUTRON ACER TENDL-2023 LIBRARY; T=0.K  
Photon emission for (n,n\*)d

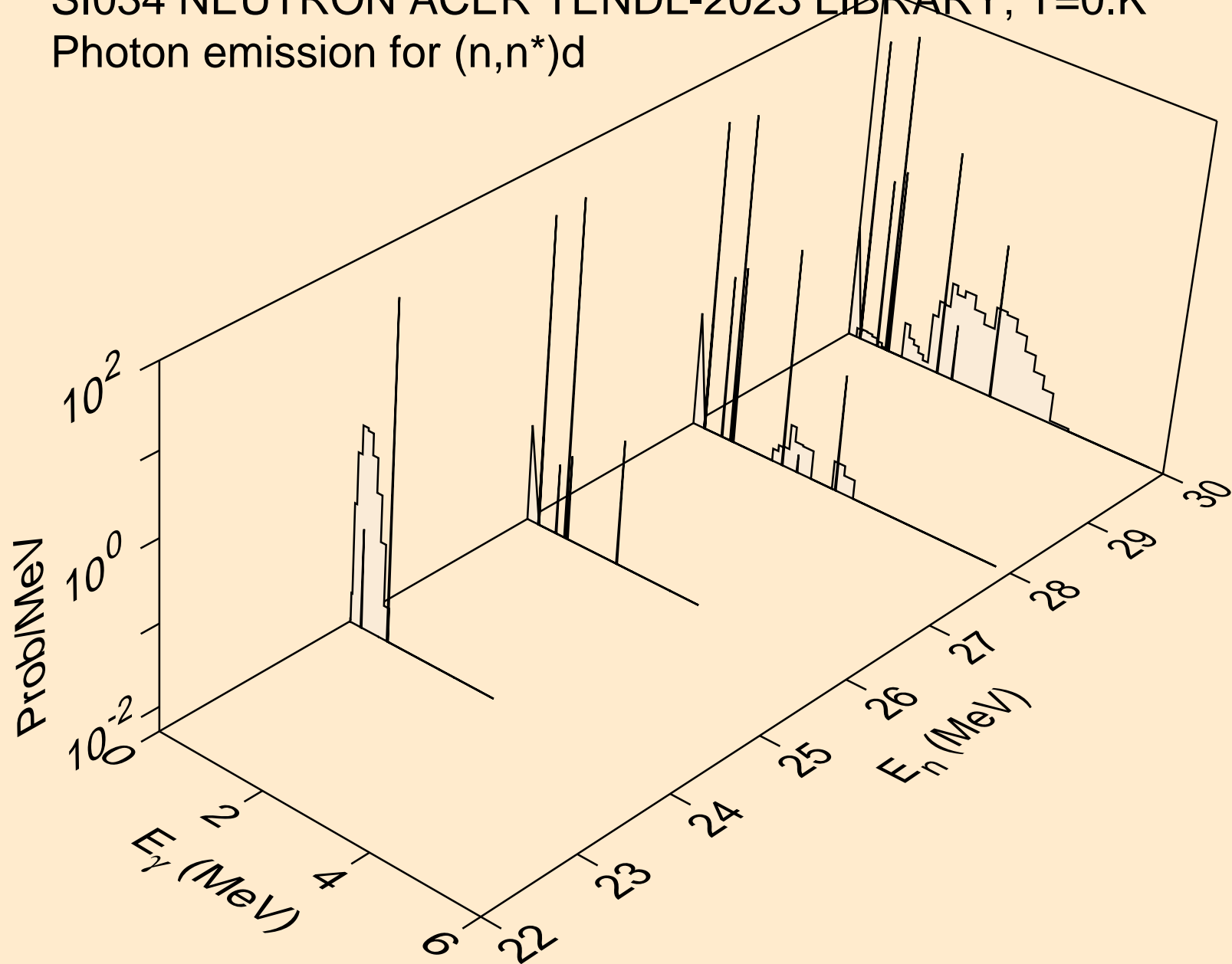

SI034 NEUTRON ACER TENDL-2023 LIBRARY; T=0.K  
Photon emission for (n,n\*)t

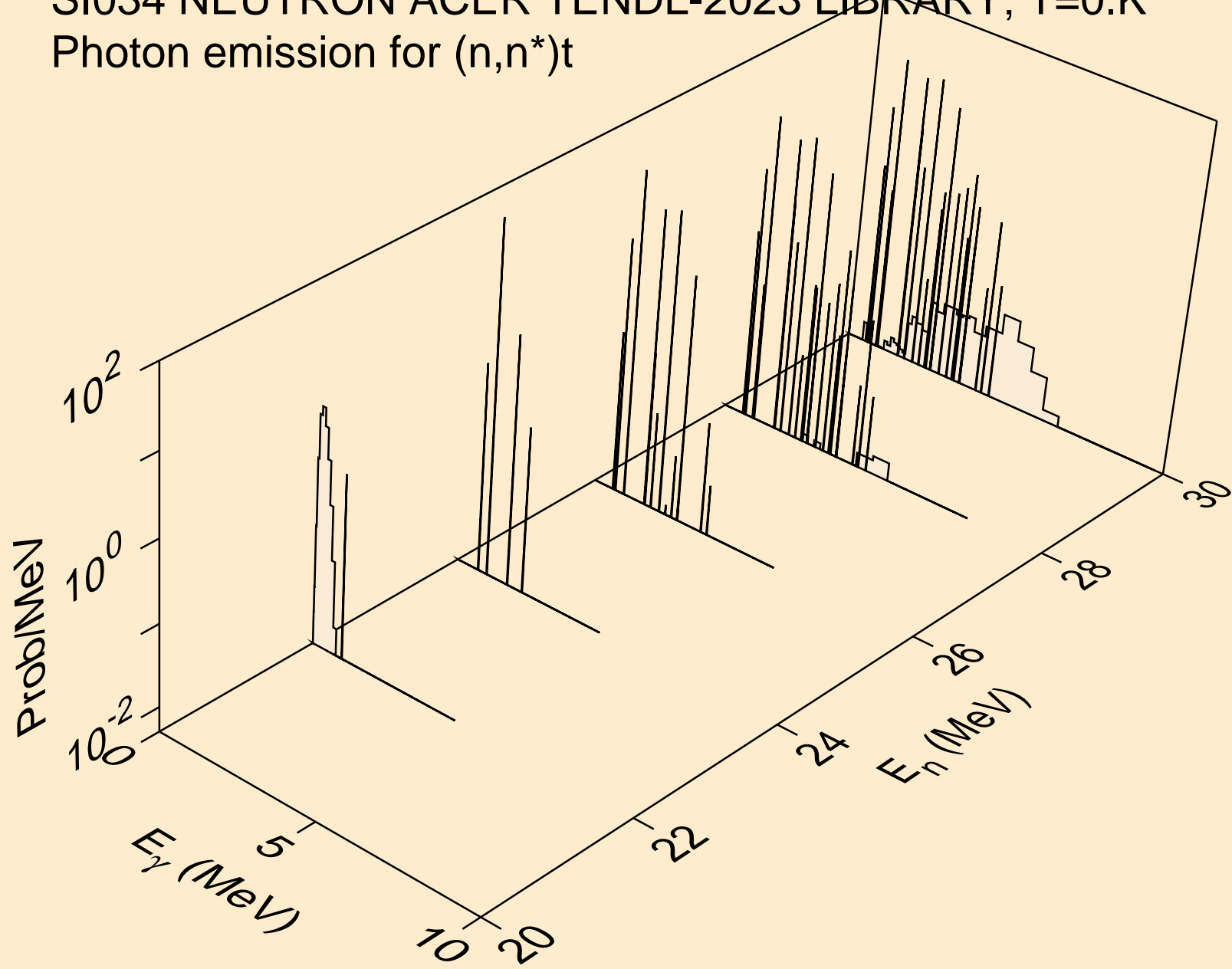

SI034 NEUTRON ACER TENDL-2023 LIBRARY; T=0.K  
Photon emission for (n,4n)

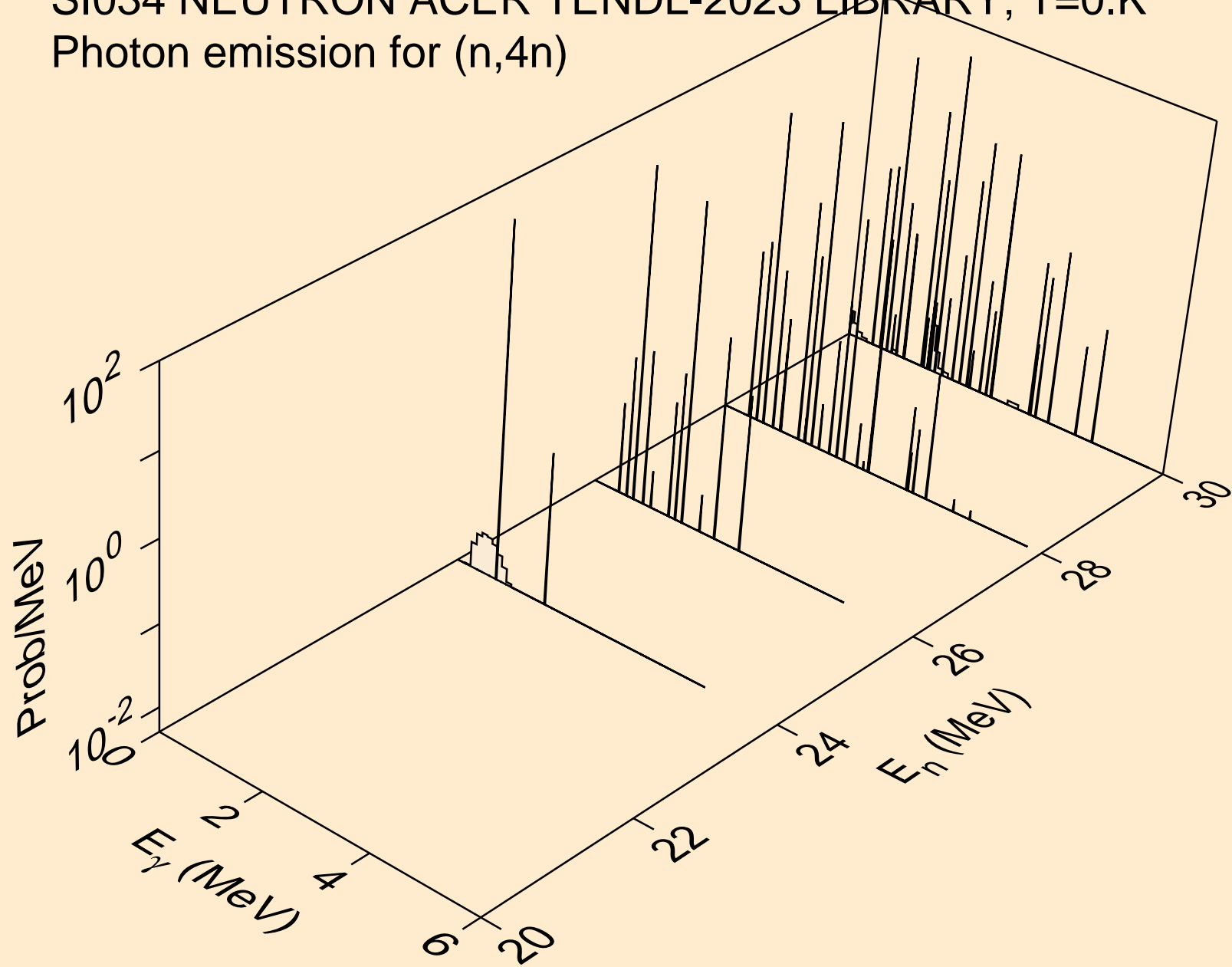

SI034 NEUTRON ACER TENDL-2023 LIBRARY; T=0.K  
Photon emission for (n,2np)

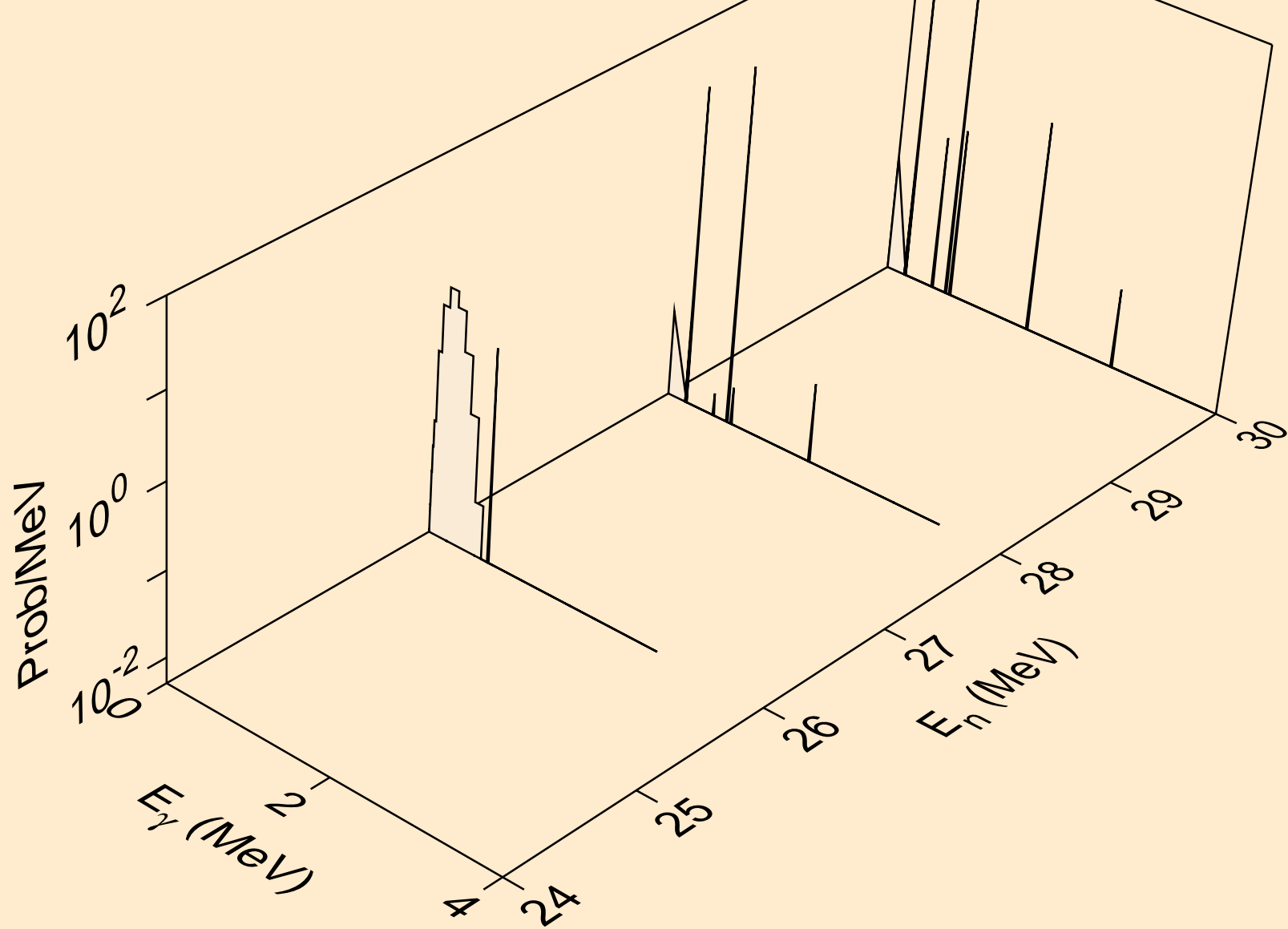

SI034 NEUTRON ACER TENDL-2023 LIBRARY; T=0.K  
Photon emission for (n,n\*c)

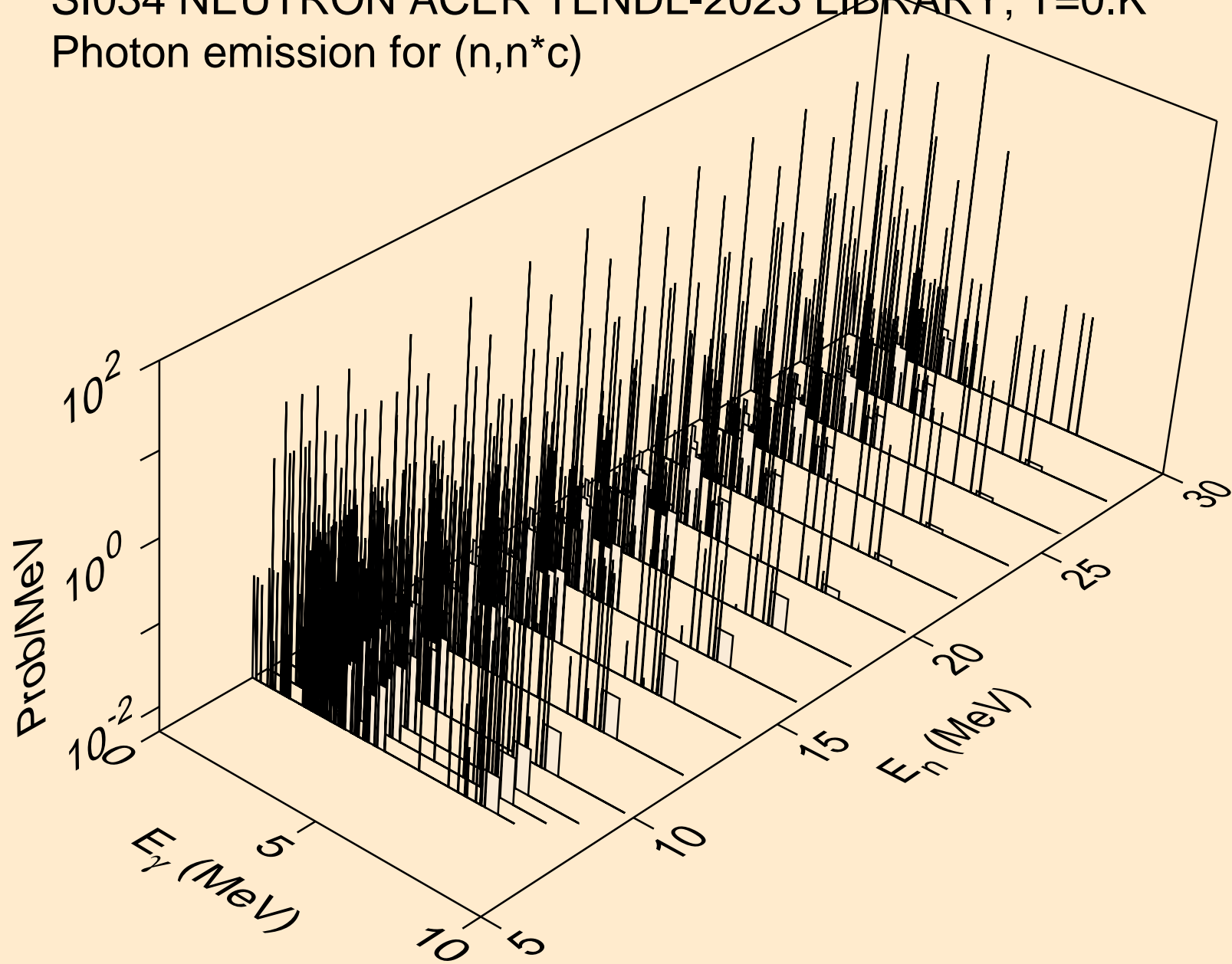

SI034 NEUTRON ACER TENDL-2023 LIBRARY; T=0.K  
Photon emission for (n,gma)

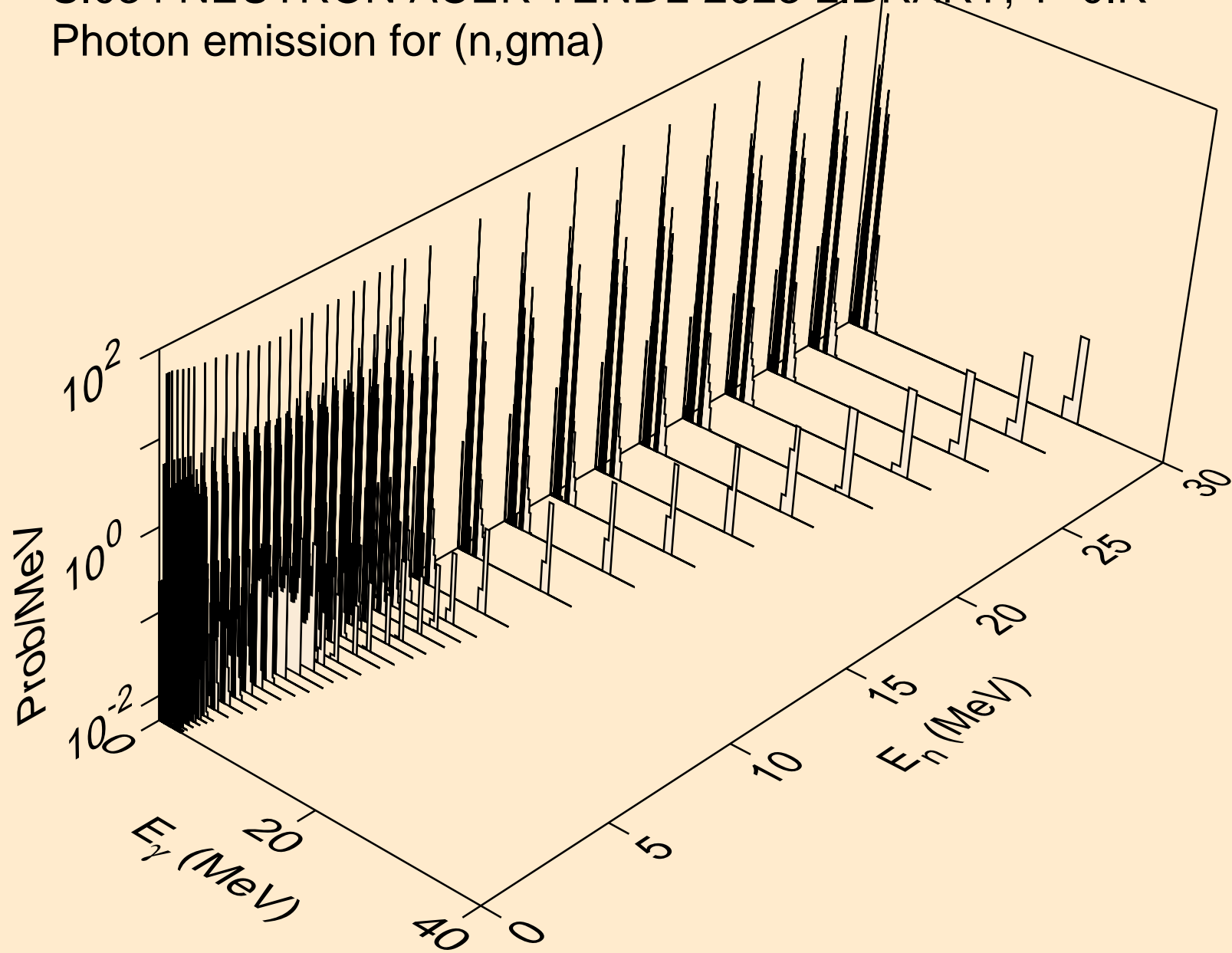

SI034 NEUTRON ACER TENDL-2023 LIBRARY; T=0.K  
Photon emission for (n,p)

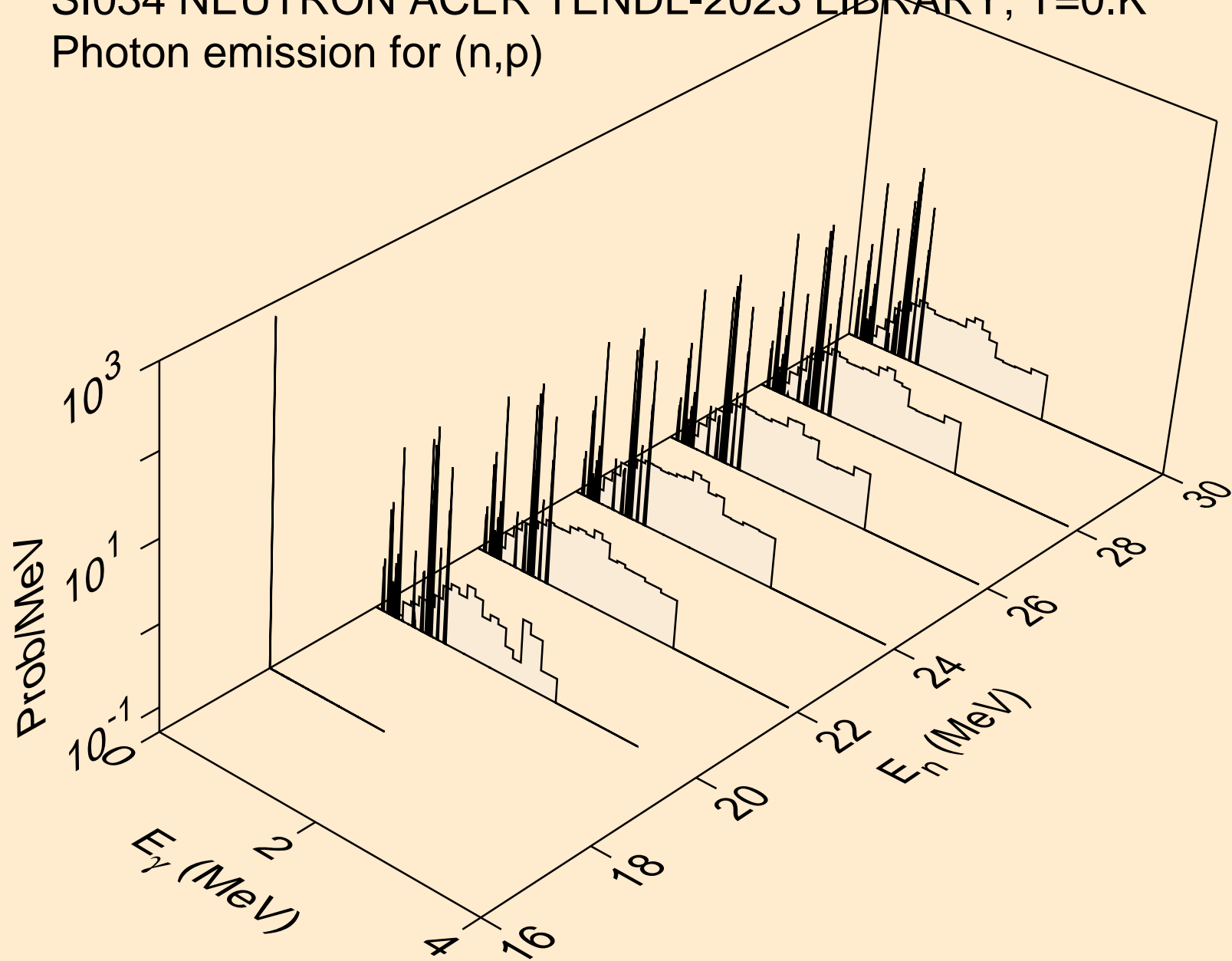

SI034 NEUTRON ACER TENDL-2023 LIBRARY; T=0.K  
Photon emission for (n,d)

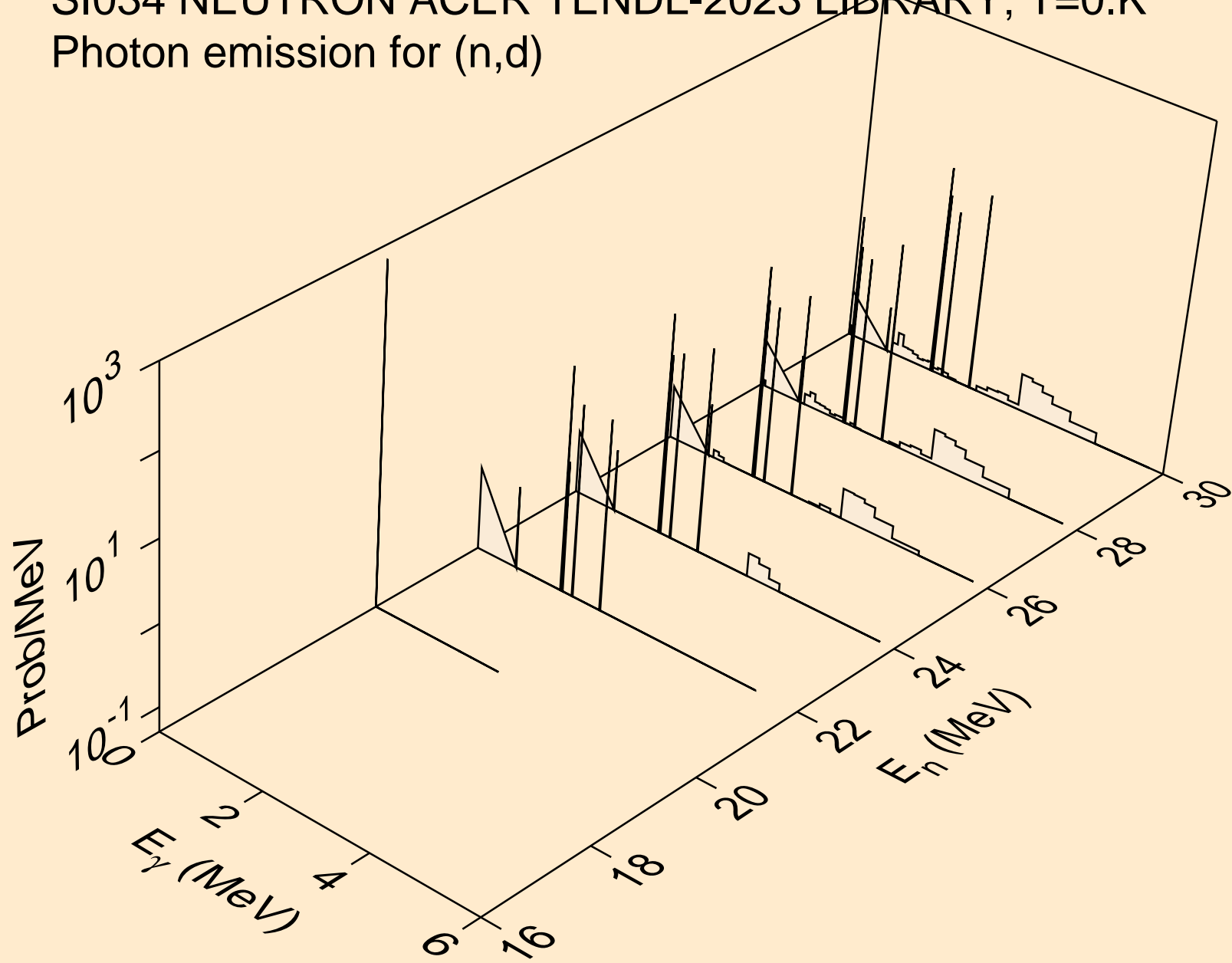

SI034 NEUTRON ACER TENDL-2023 LIBRARY; T=0.K  
Photon emission for (n,t)

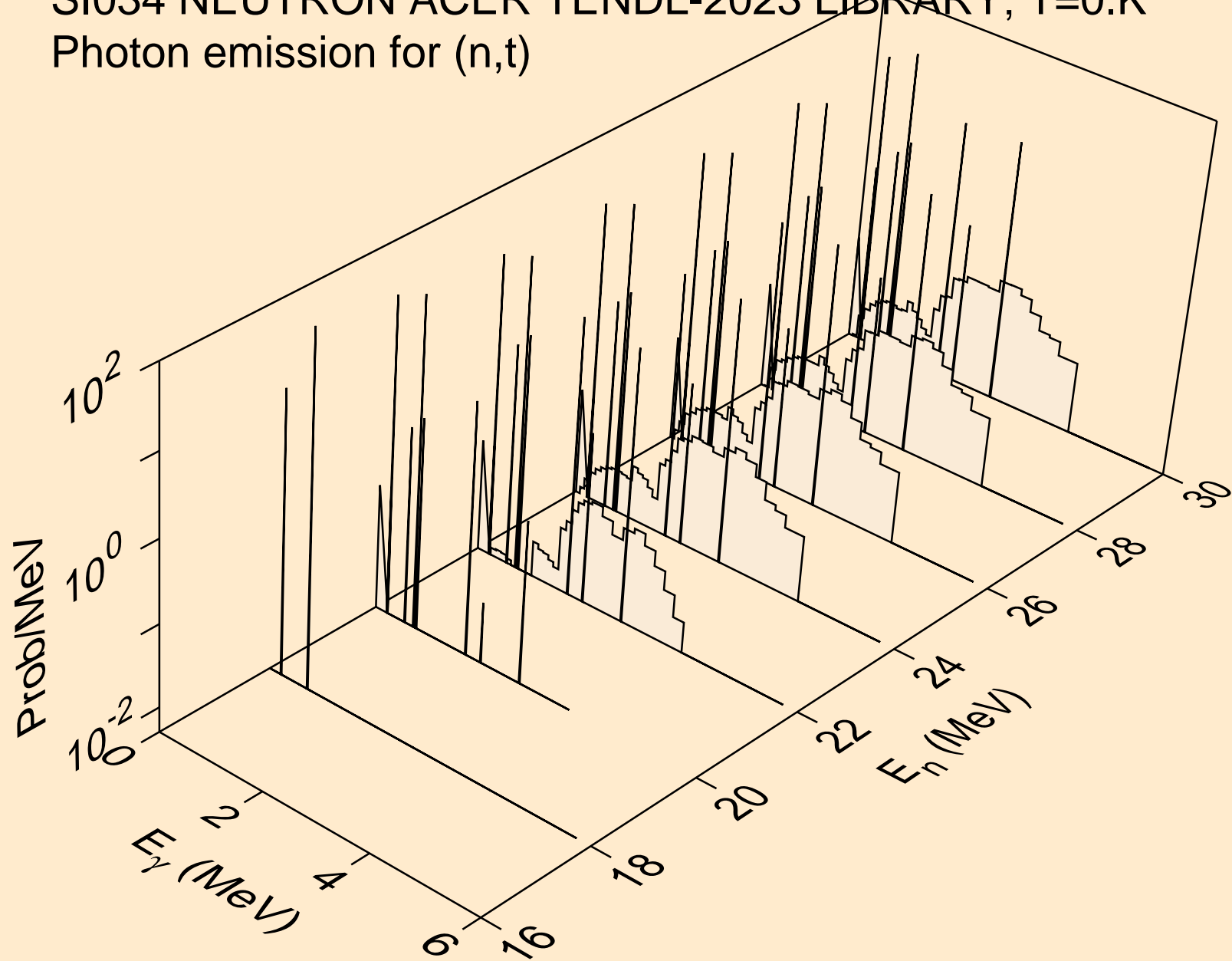

SI034 NEUTRON ACER TENDL-2023 LIBRARY; T=0.K  
Photon emission for (n,a)

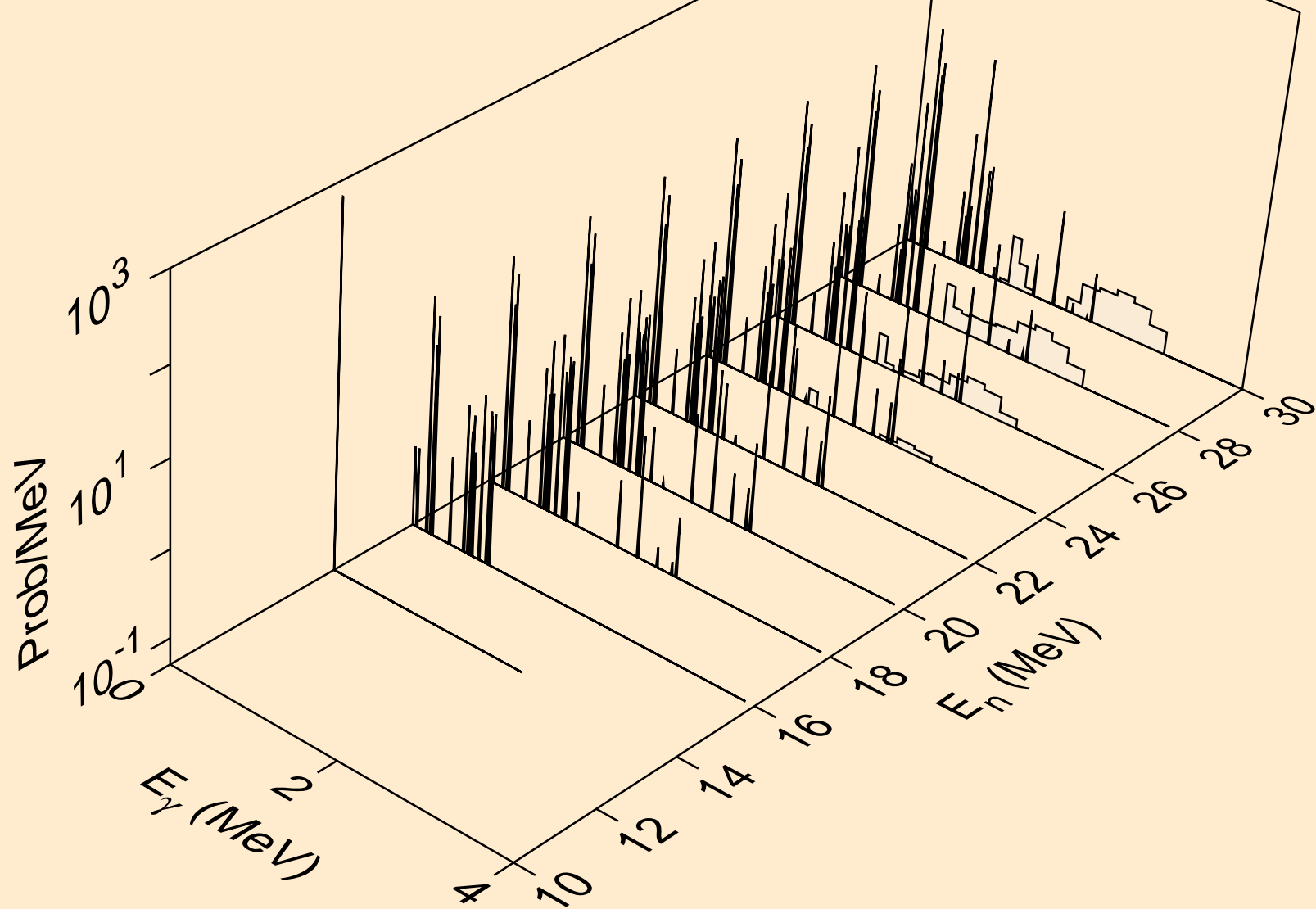

SI034 NEUTRON ACER TENDL-2023 LIBRARY; T=0.K  
thermal capture photon spectrum

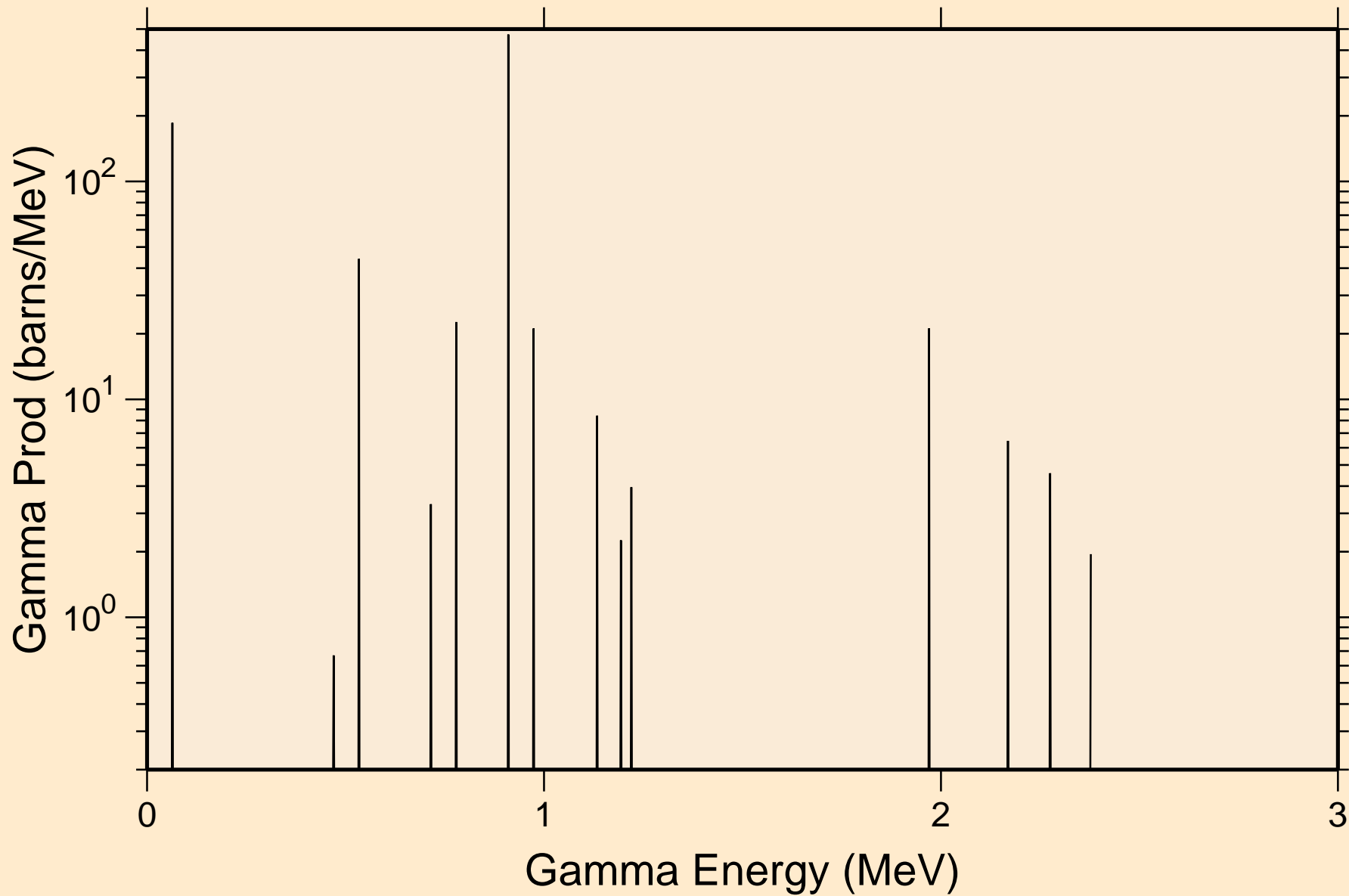

SI034 NEUTRON ACER TENDL-2023 LIBRARY; T=0.K  
14 MeV photon spectrum

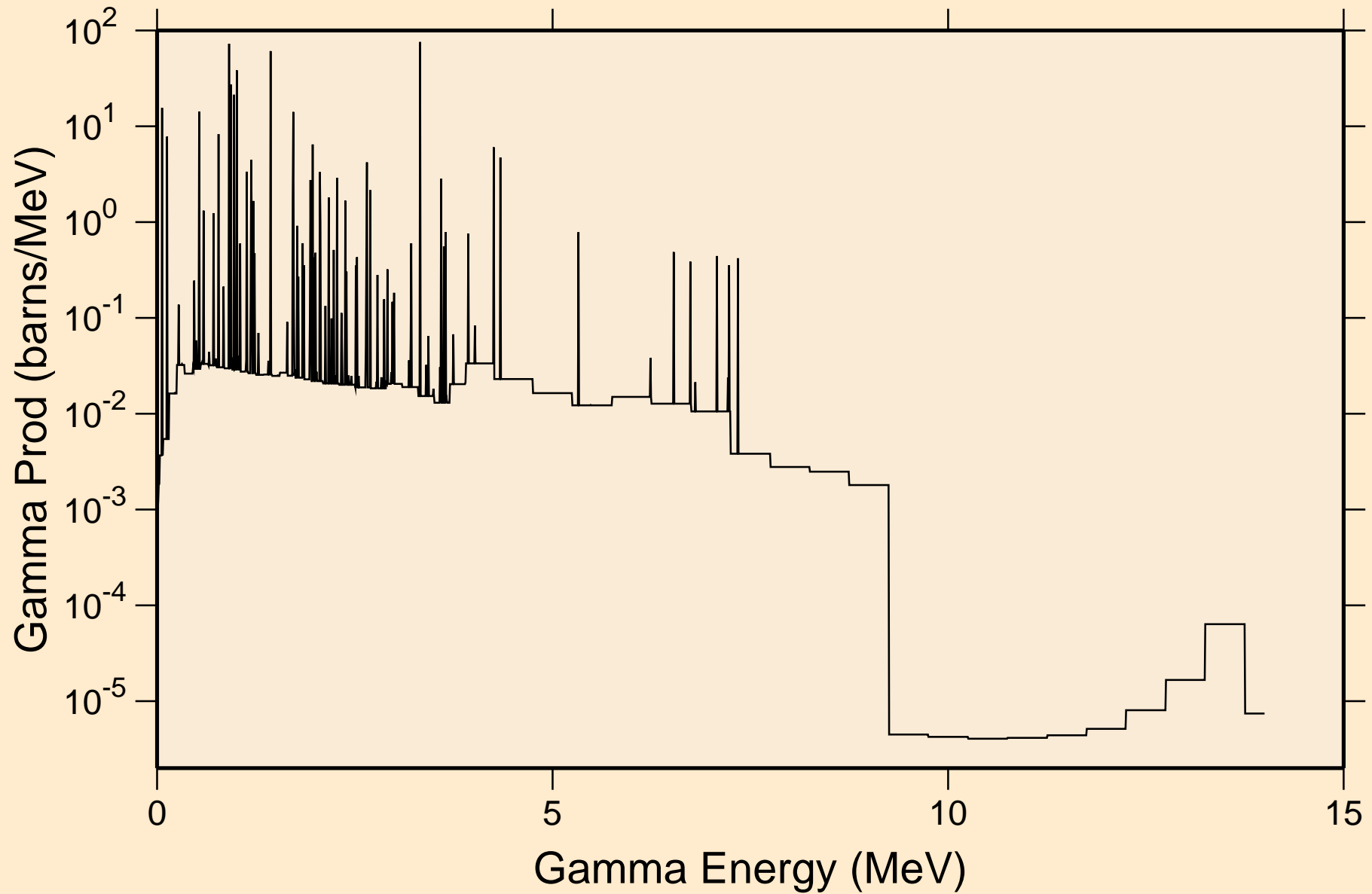

SI034 NEUTRON ACER TENDL-2023 LIBRARY; T=0.K  
Particle heating contributions

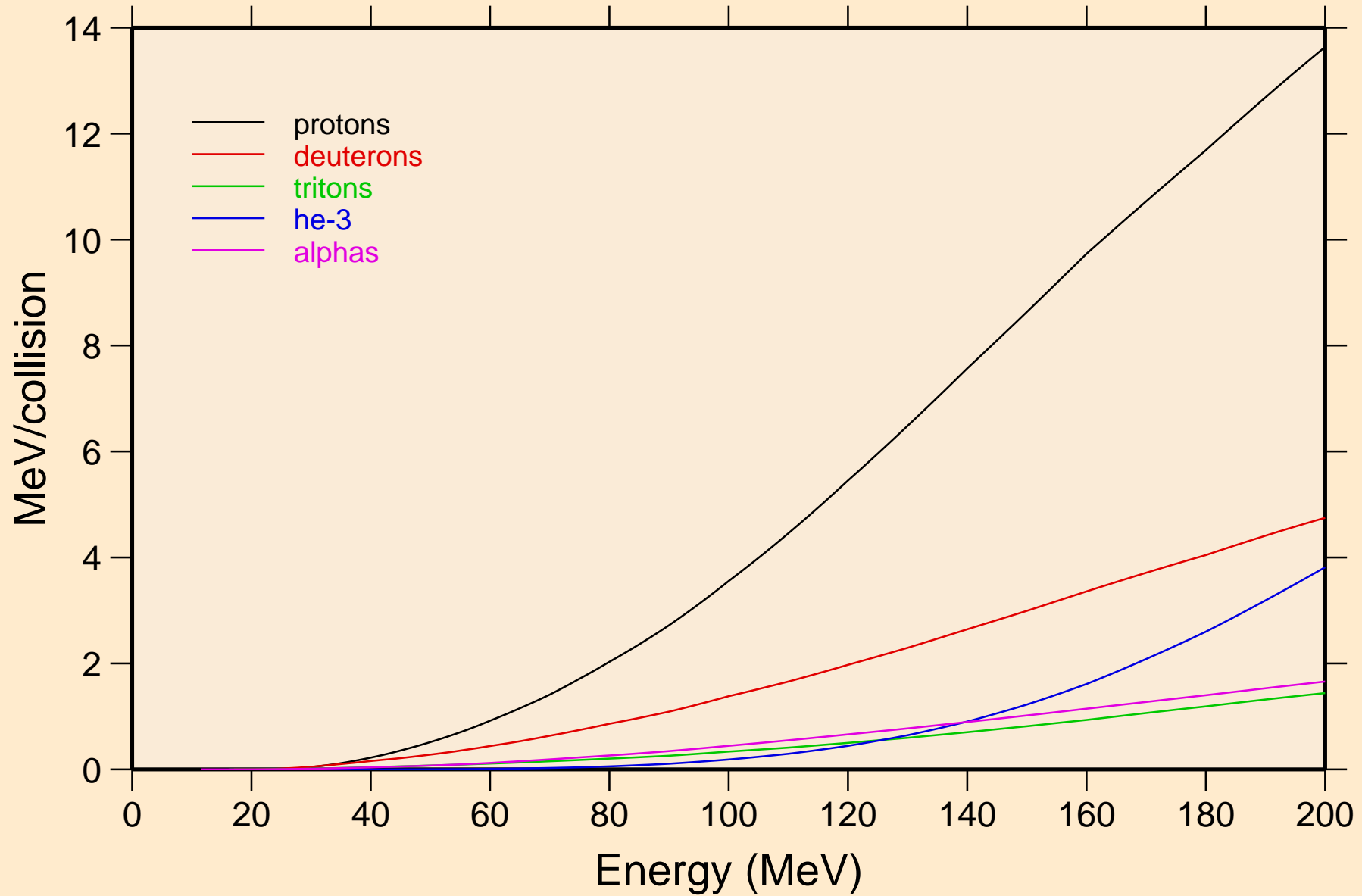

SI034 NEUTRON ACER TENDL-2023 LIBRARY; T=0.K  
Recoil Heating

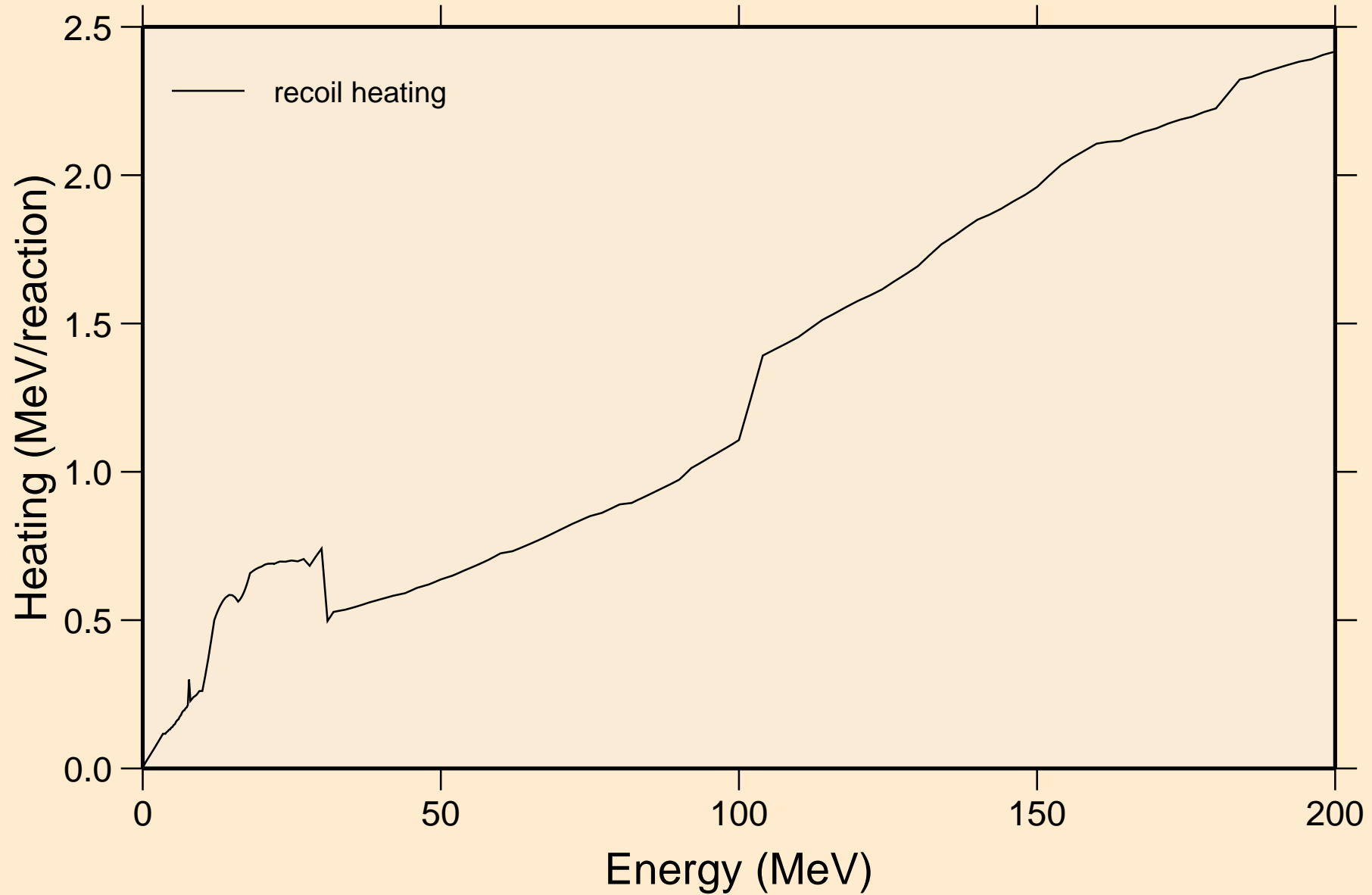

# SI034 NEUTRON ACER TENDL-2023 LIBRARY; T=0.K

## Particle production cross sections

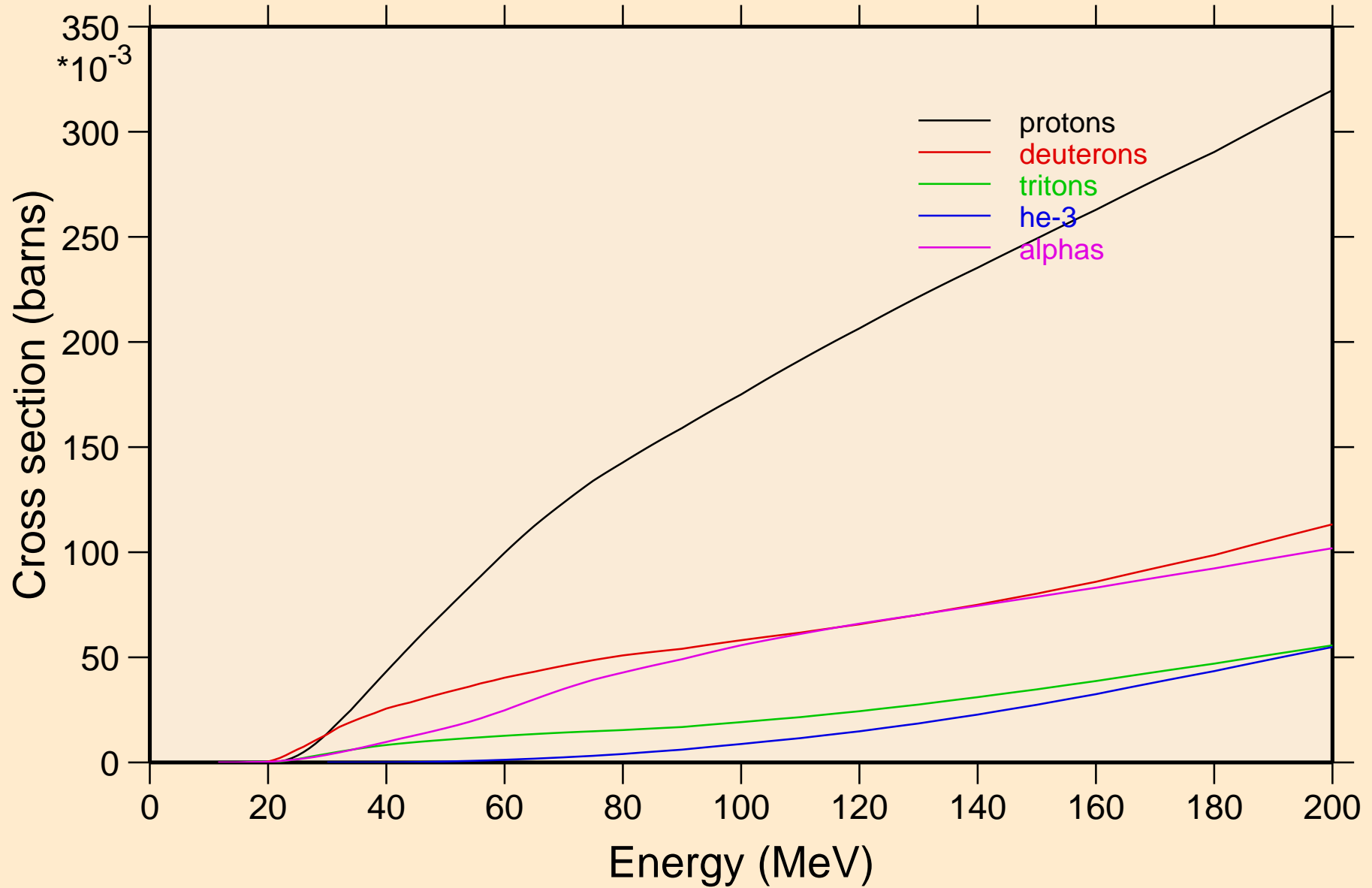

SI034 NEUTRON ACER TENDL-2023 LIBRARY; T=0.K  
protons from (n,x)

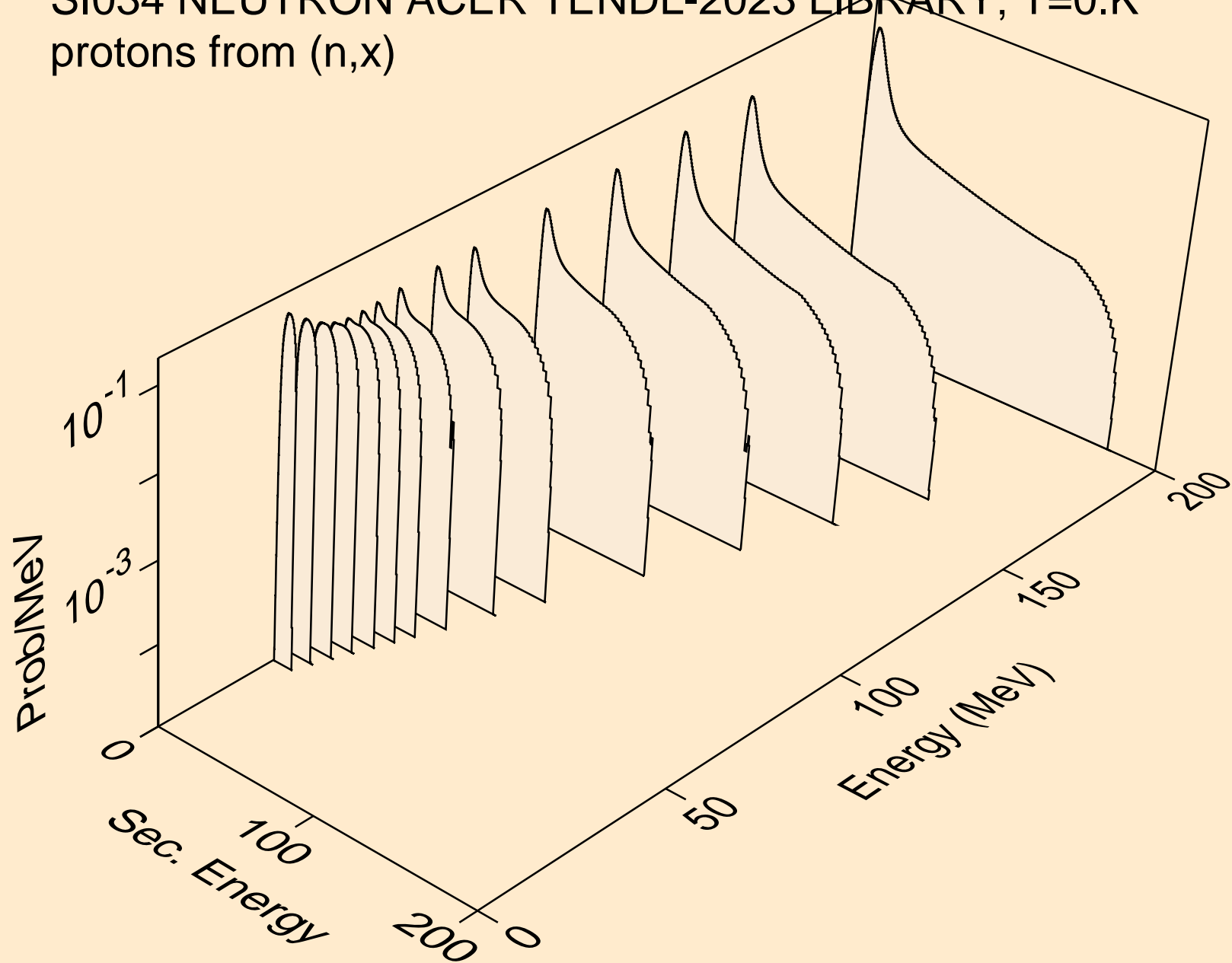

SI034 NEUTRON ACER TENDL-2023 LIBRARY; T=0.K  
protons from (n,n\*)p

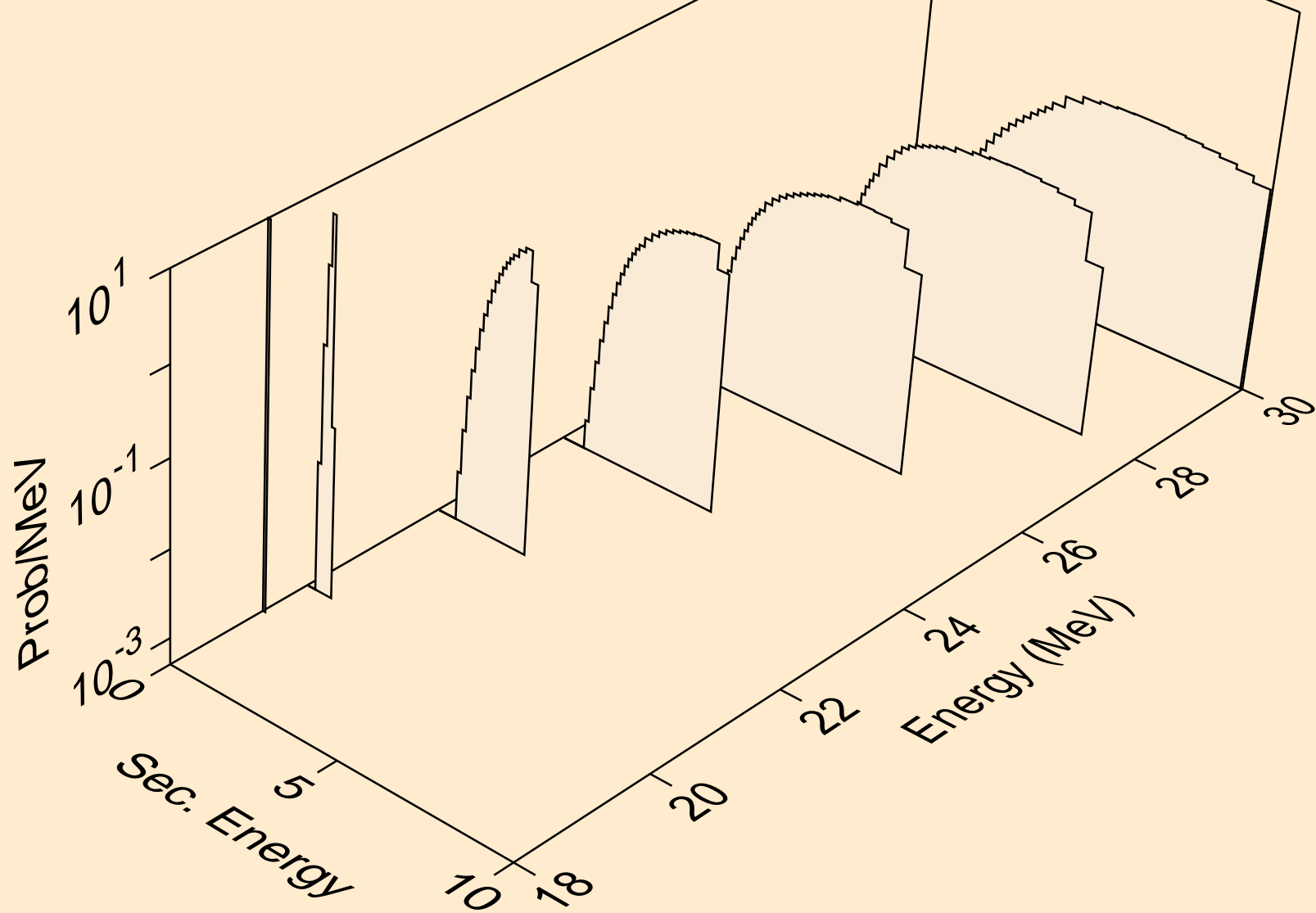

SI034 NEUTRON ACER TENDL-2023 LIBRARY; T=0.K  
protons from (n,2np)

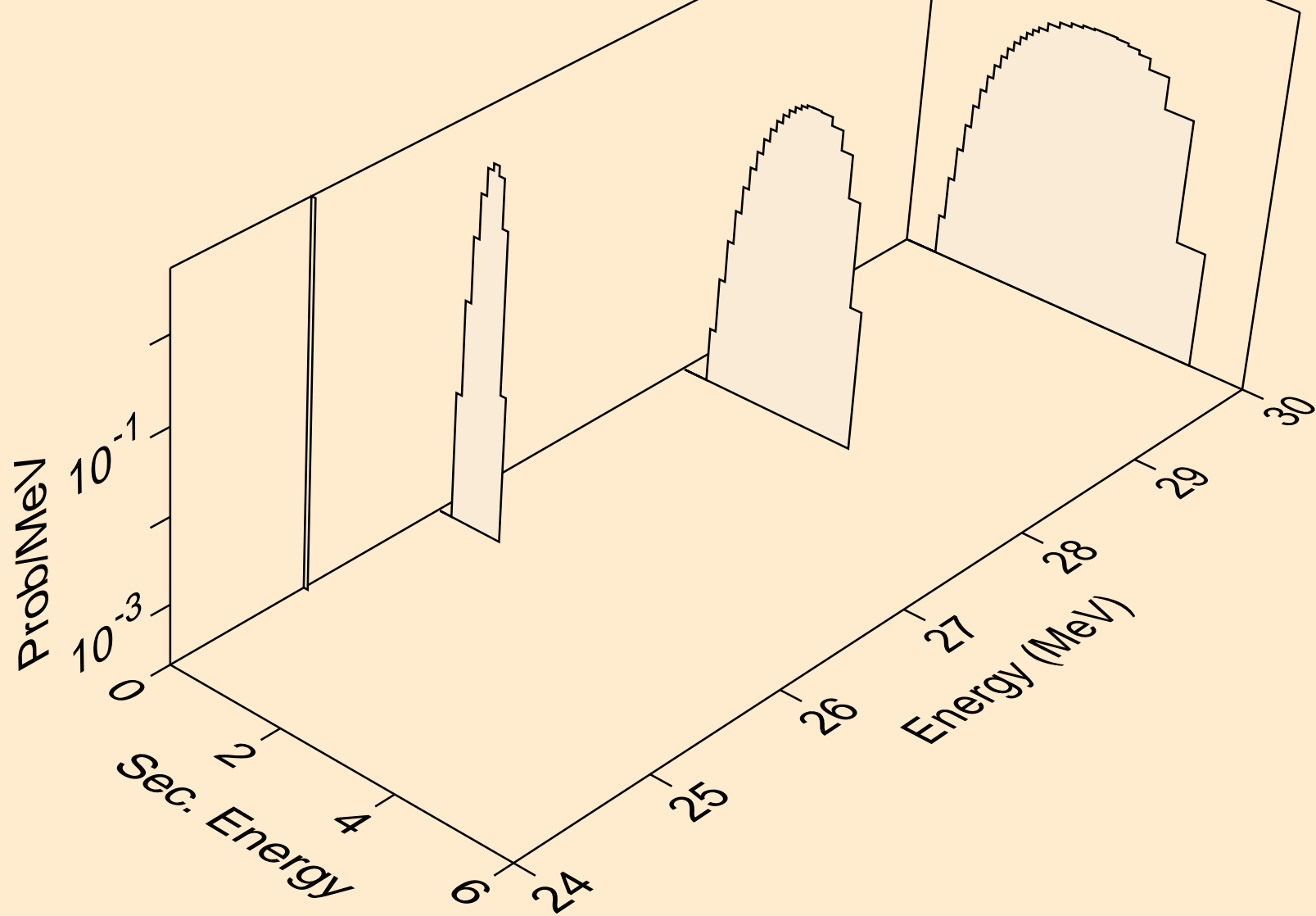

SI034 NEUTRON ACER TENDL-2023 LIBRARY; T=0.K  
protons from (n,p)

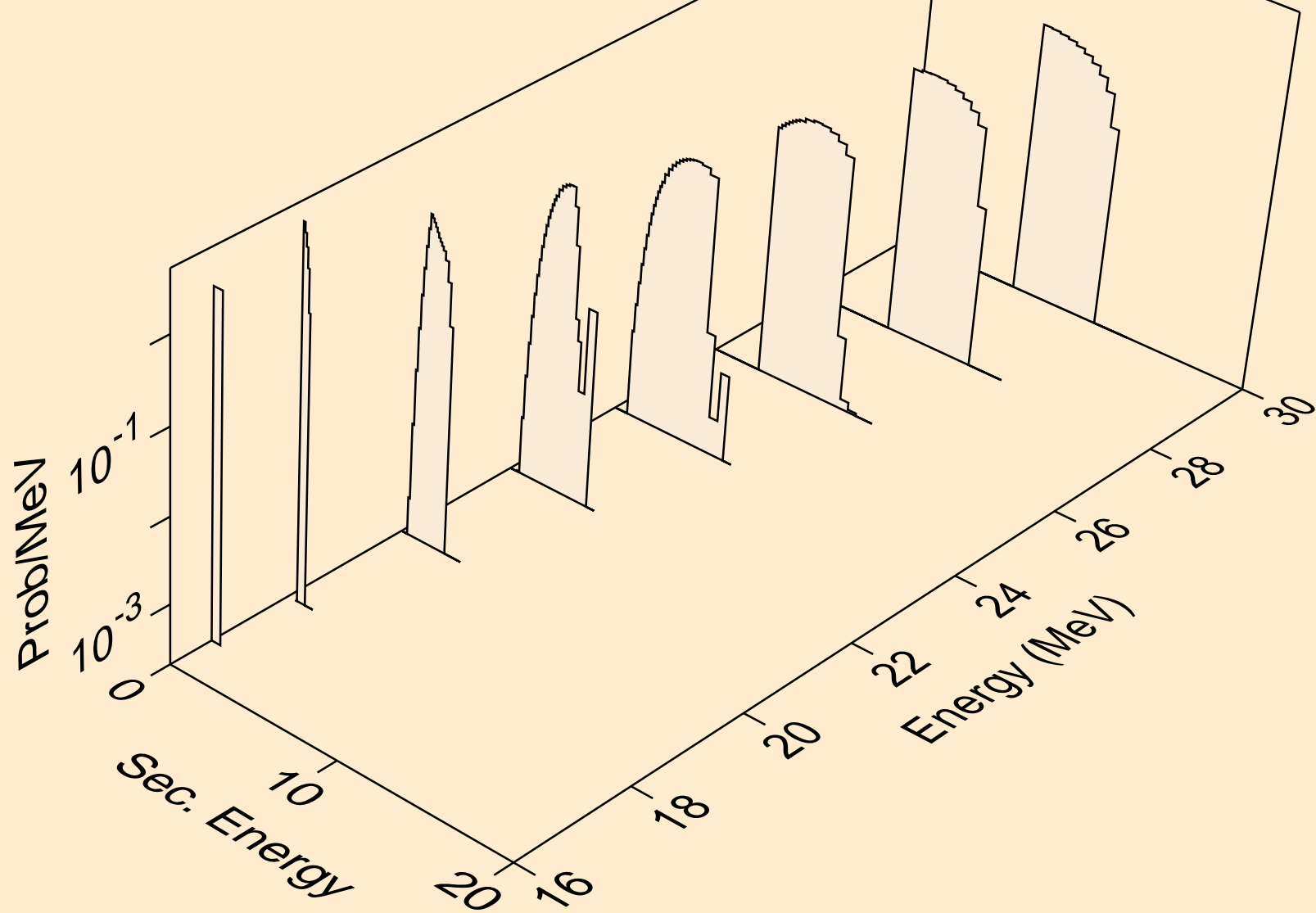

SI034 NEUTRON ACER TENDL-2023 LIBRARY; T=0.K  
deuterons from (n,x)

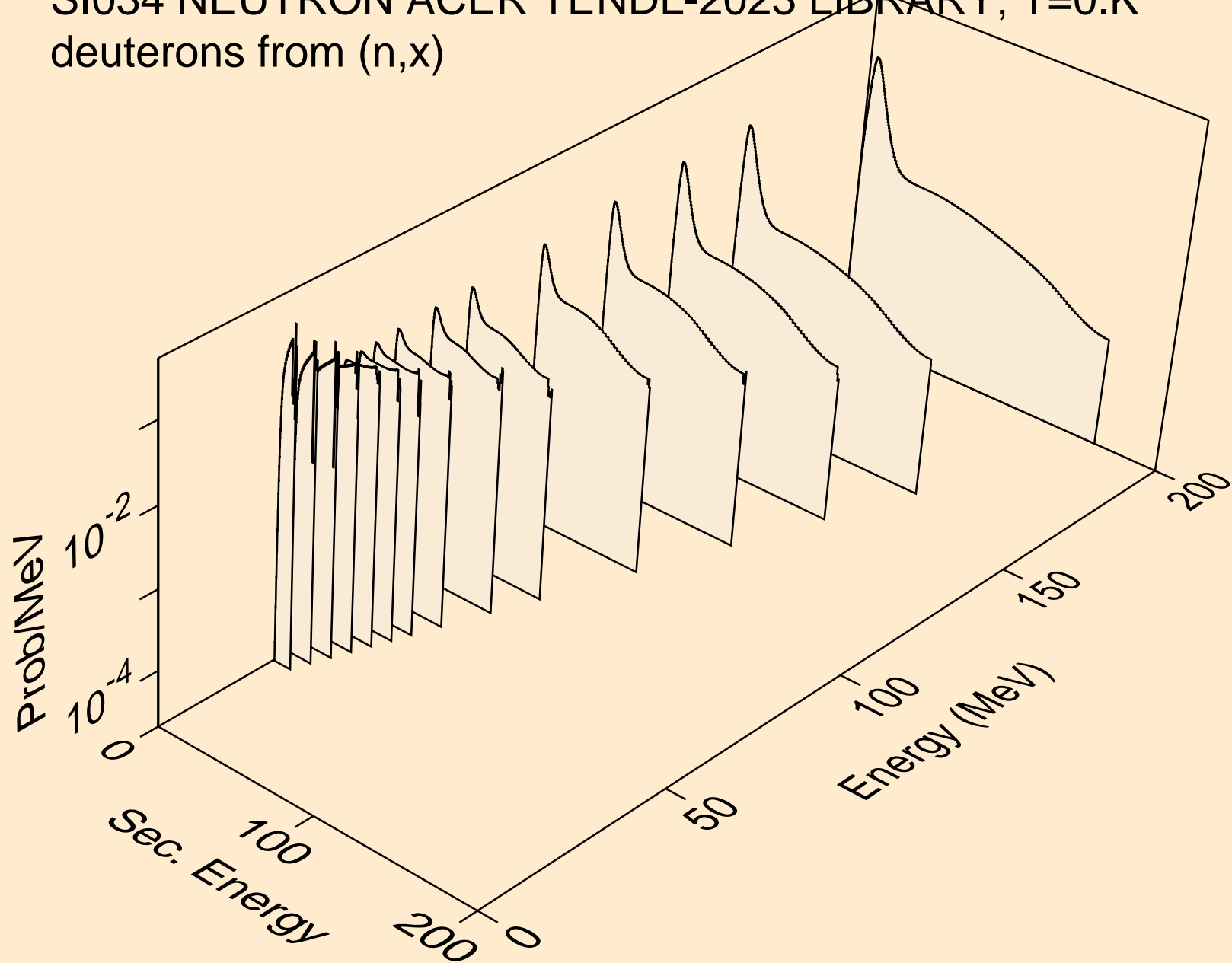

SI034 NEUTRON ACER TENDL-2023 LIBRARY; T=0.K  
deuterons from (n,2nd)

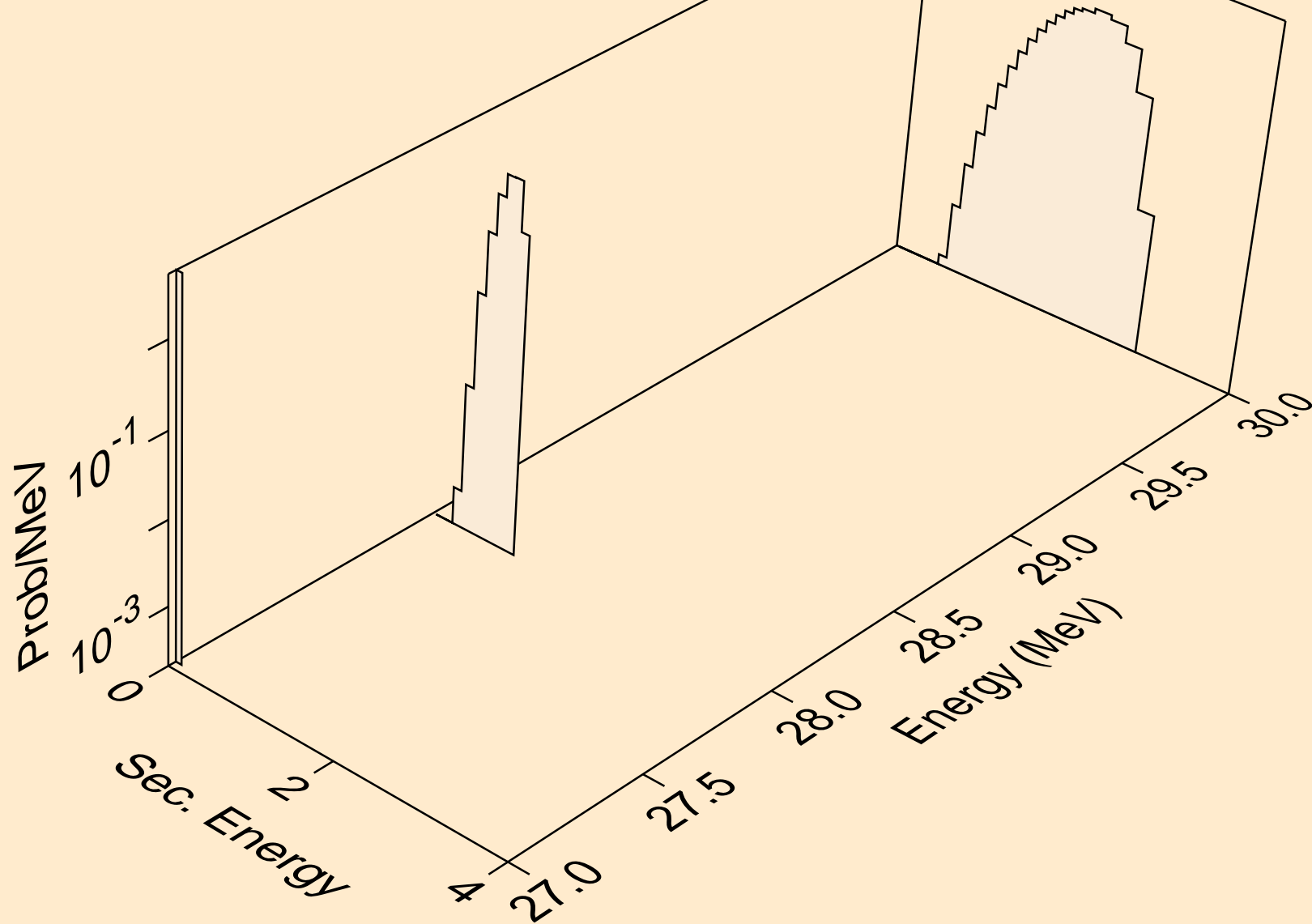

SI034 NEUTRON ACER TENDL-2023 LIBRARY; T=0.K  
deuterons from (n,n\*)d

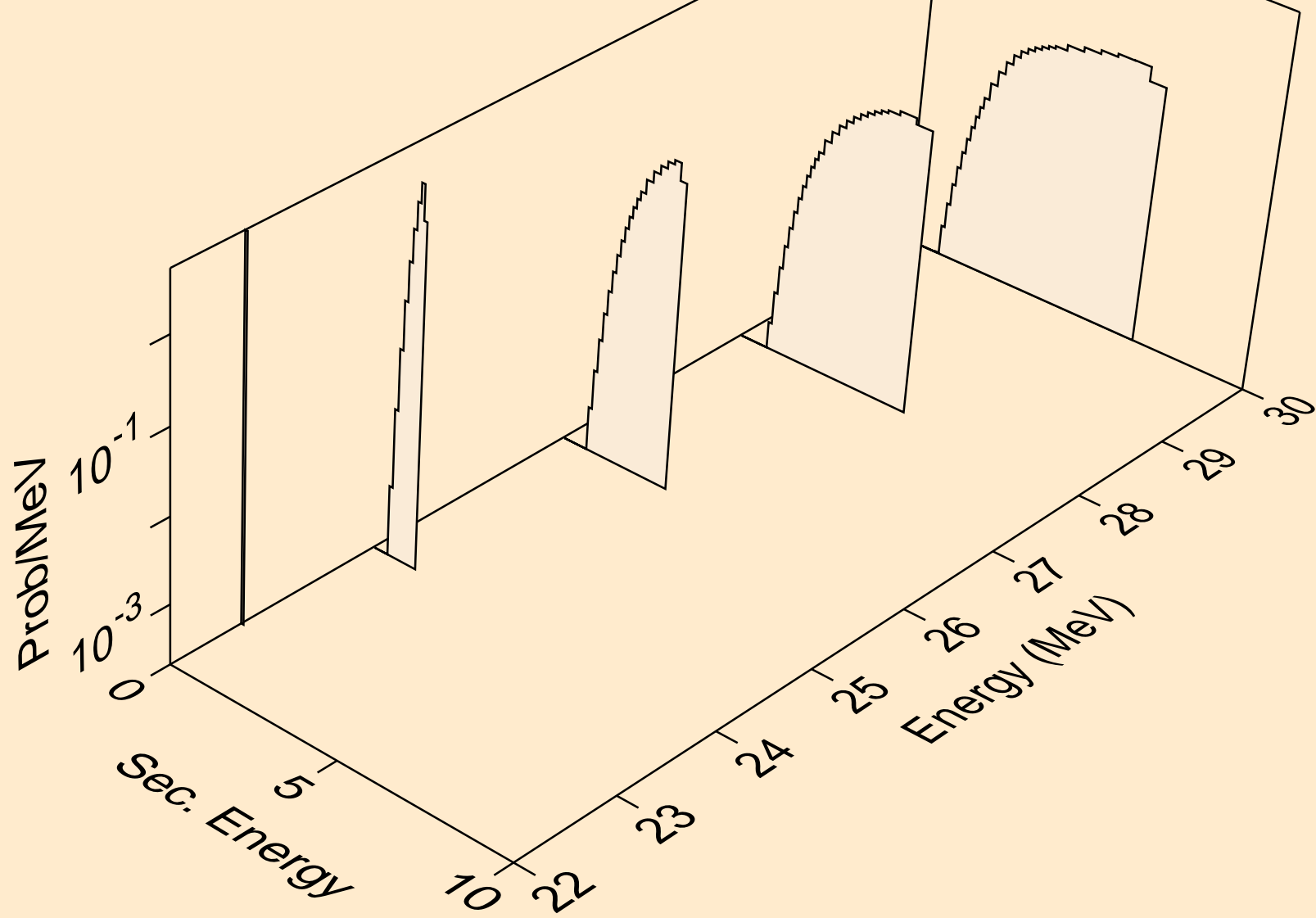

SI034 NEUTRON ACER TENDL-2023 LIBRARY; T=0.K  
deuterons from (n,d)

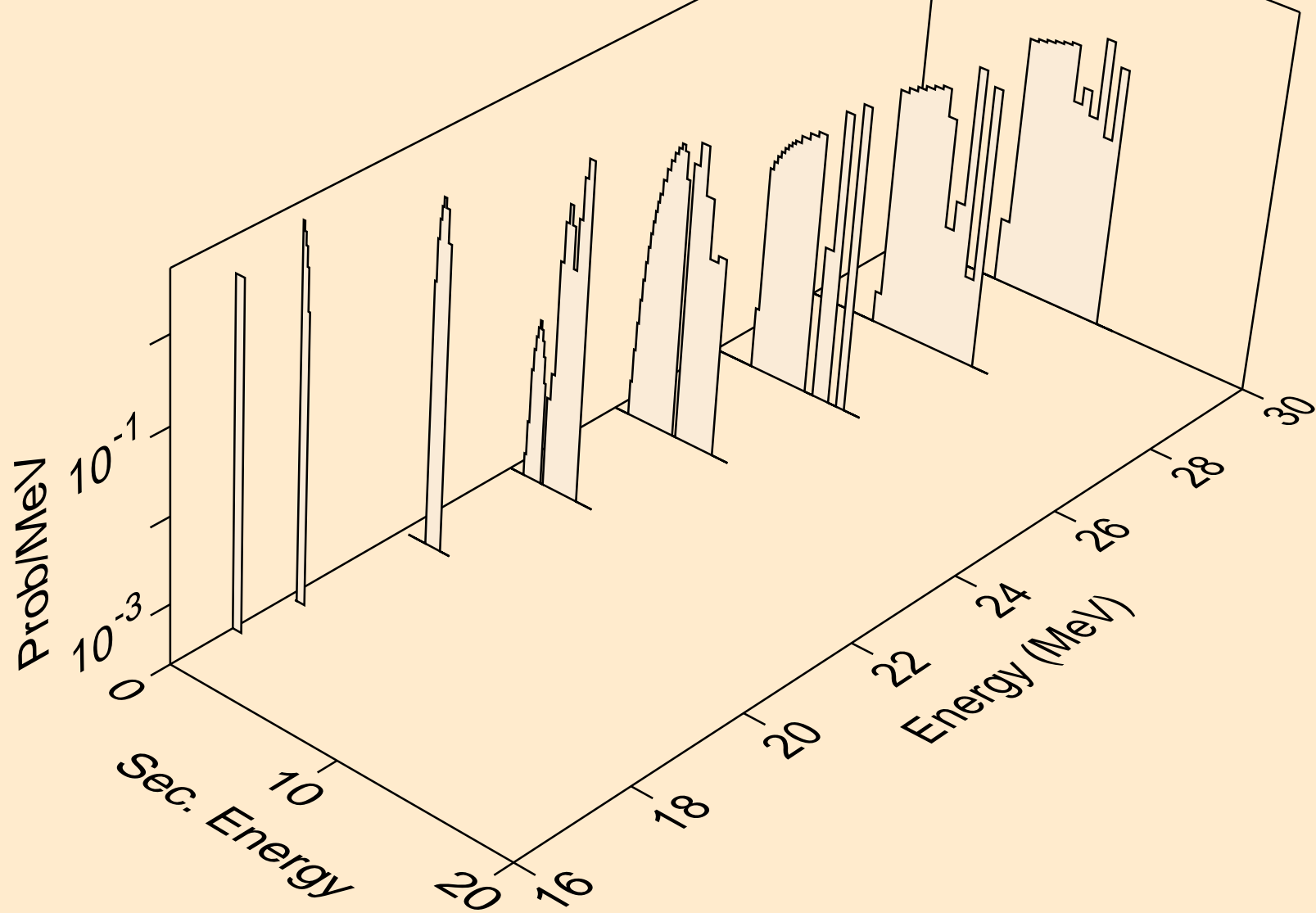

SI034 NEUTRON ACER TENDL-2023 LIBRARY; T=0.K  
tritons from (n,x)

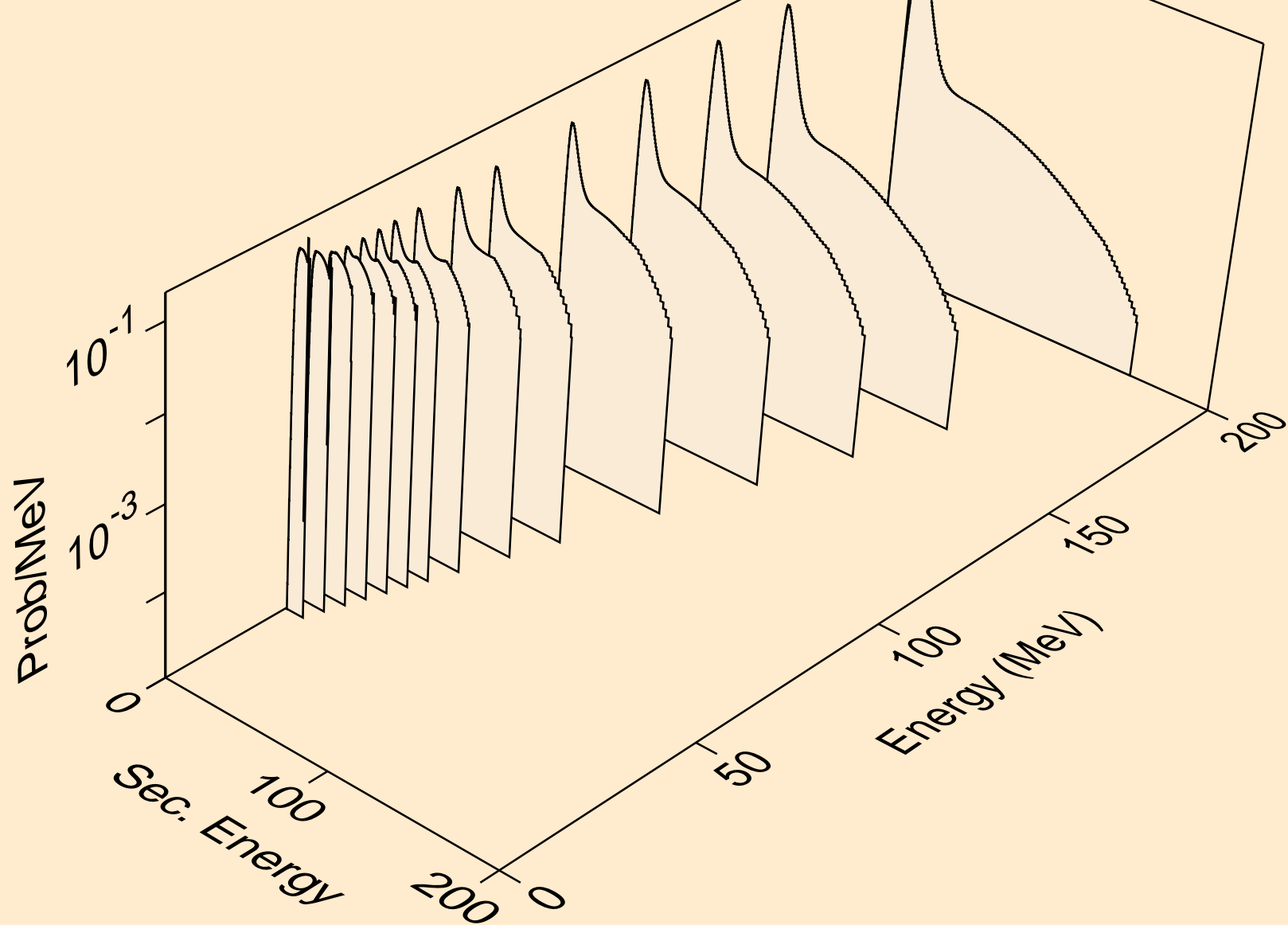

SI034 NEUTRON ACER TENDL-2023 LIBRARY; T=0.K  
tritons from (n,n\*)t

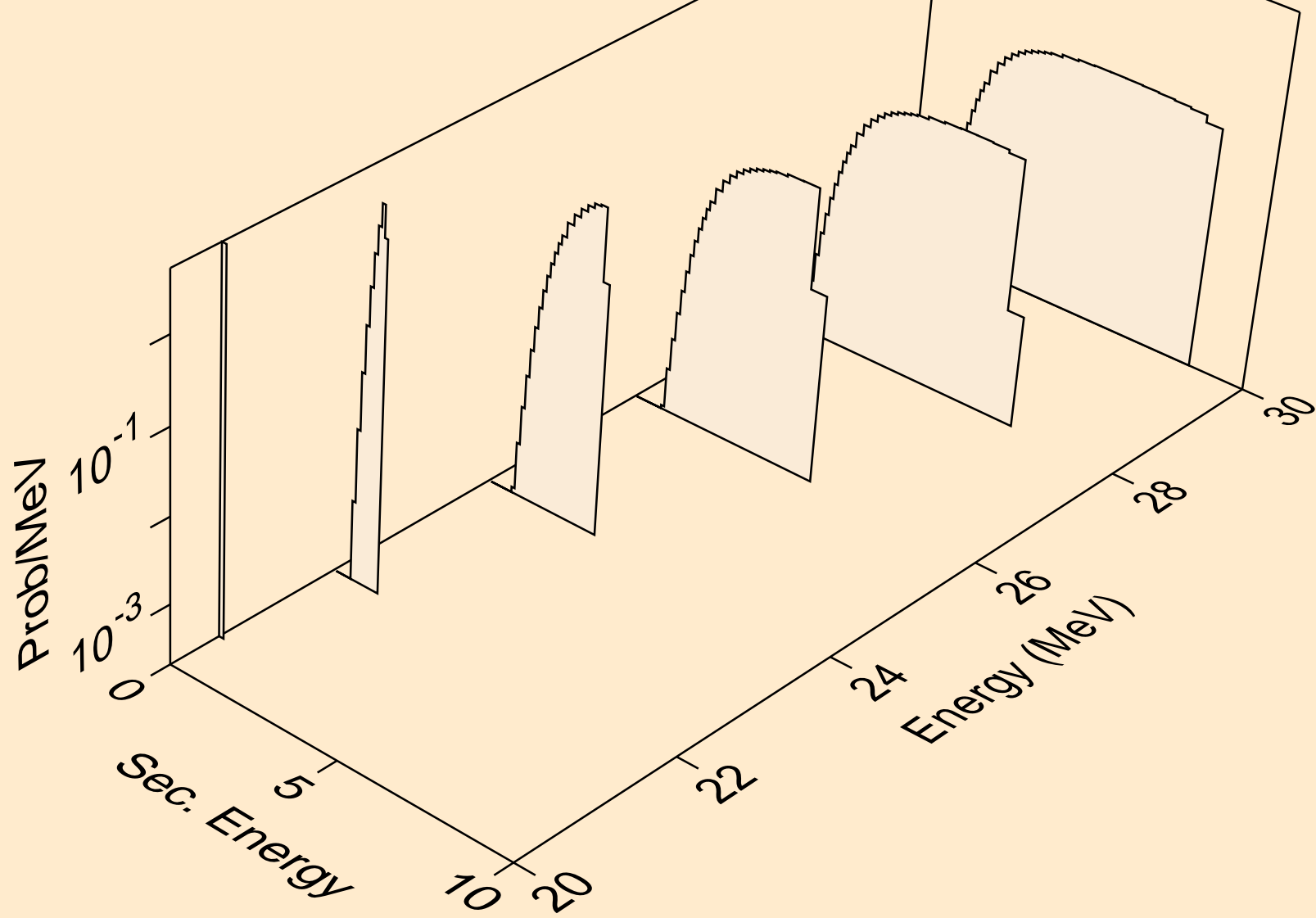

SI034 NEUTRON ACER TENDL-2023 LIBRARY; T=0.K  
tritons from (n,t)

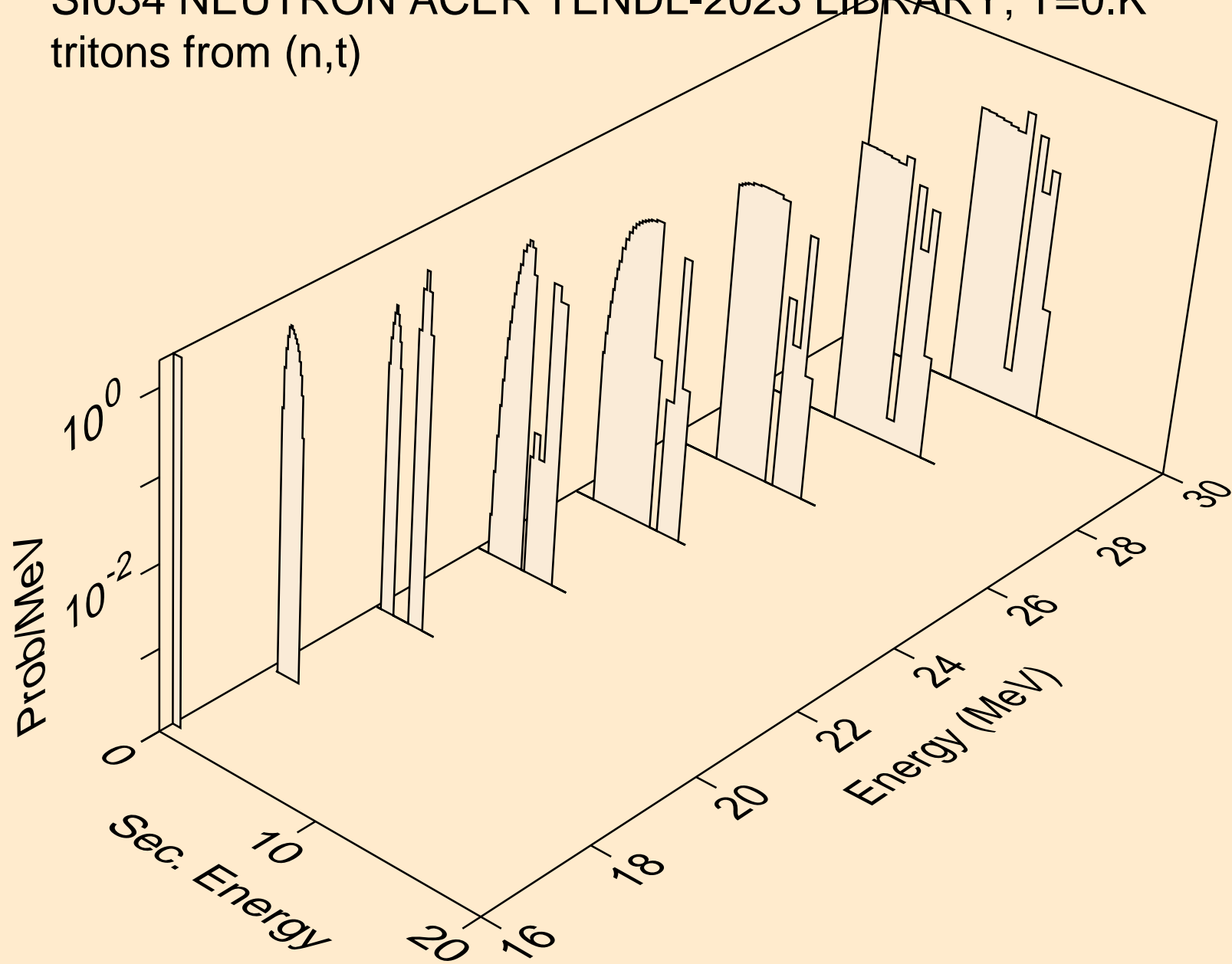

SI034 NEUTRON ACER TENDL-2023 LIBRARY; T=0.K  
he3s from (n,x)

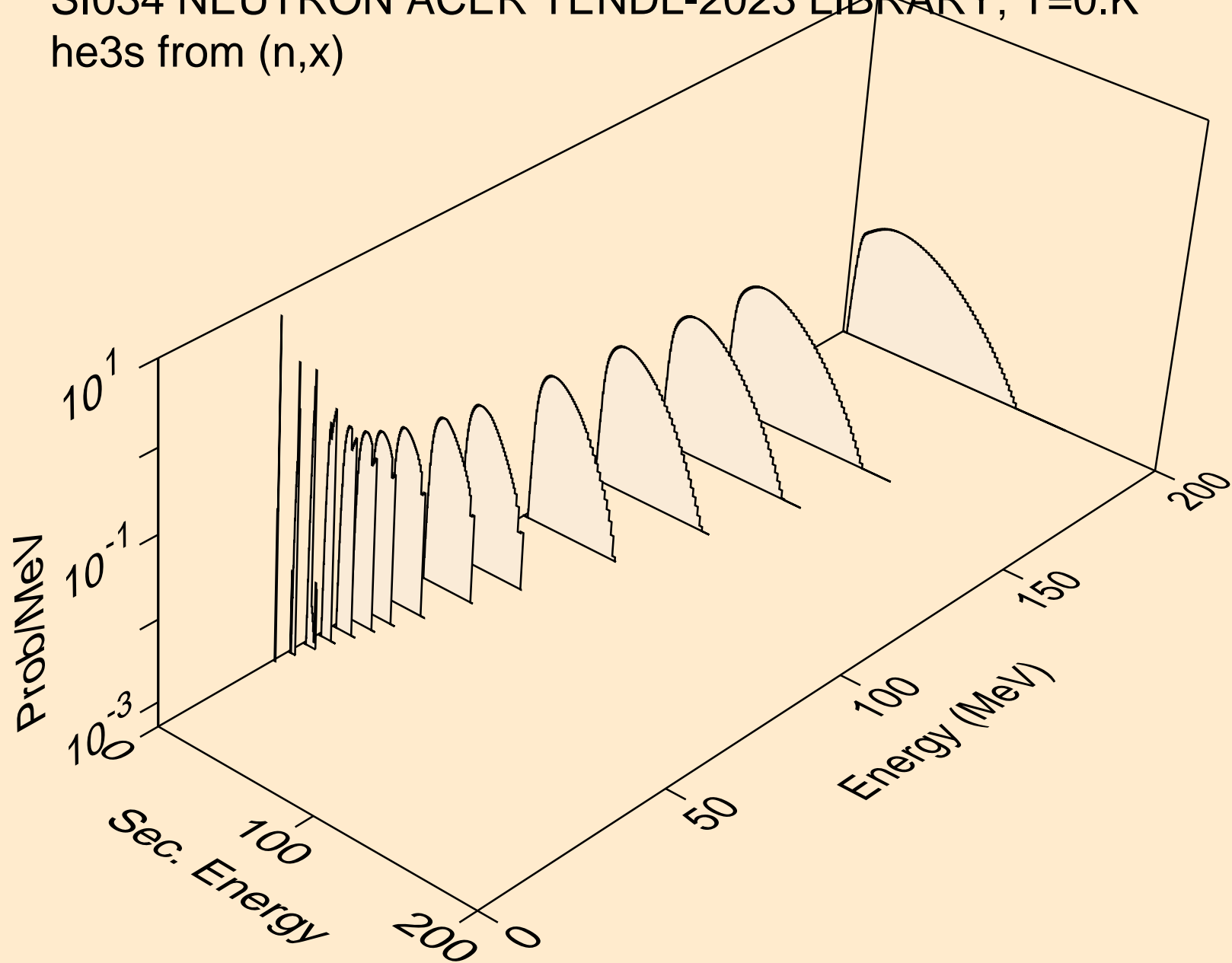

SI034 NEUTRON ACER TENDL-2023 LIBRARY; T=0.K  
alphas from (n,x)

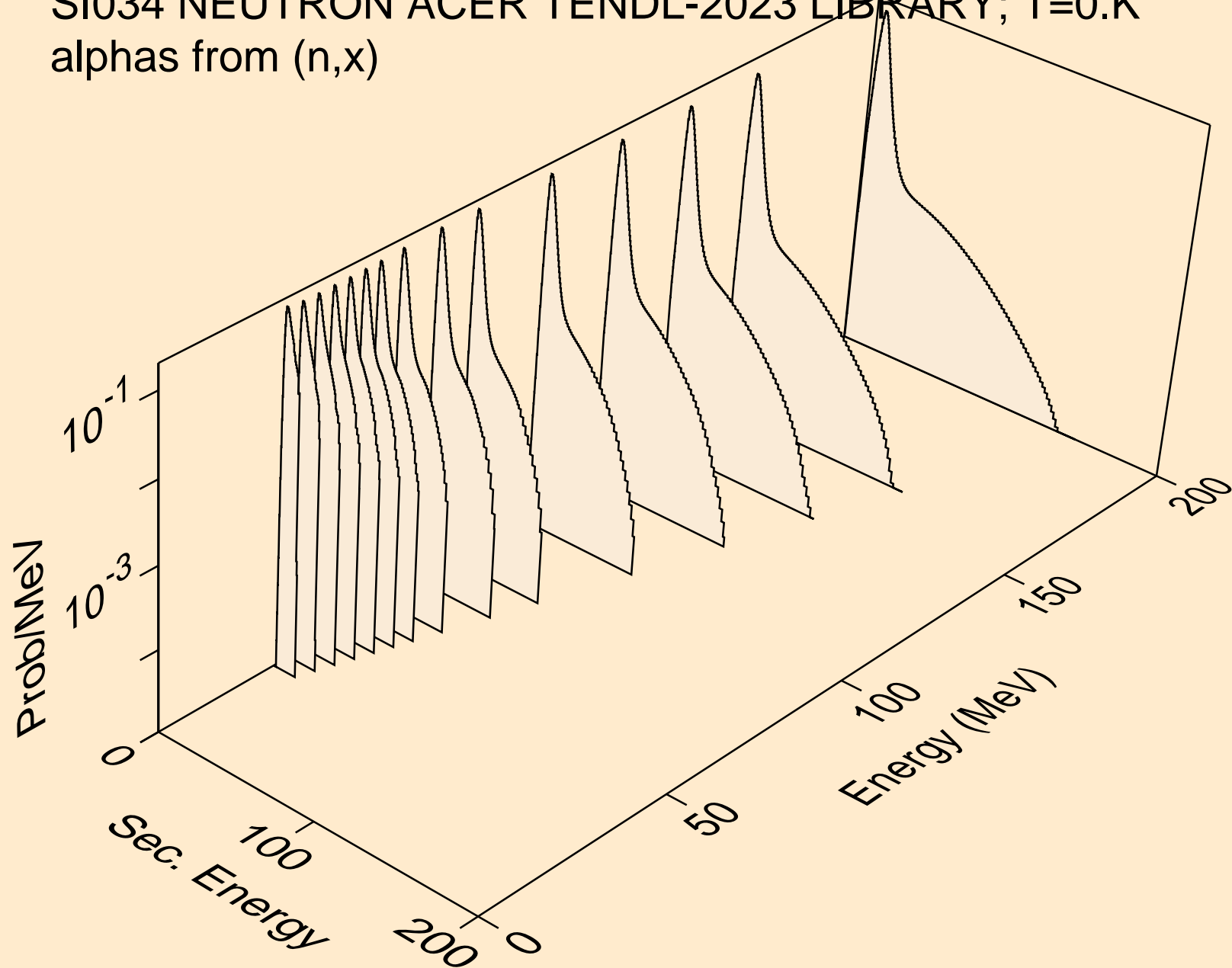

SI034 NEUTRON ACER TENDL-2023 LIBRARY; T=0.K  
alphas from (n,n\*)a

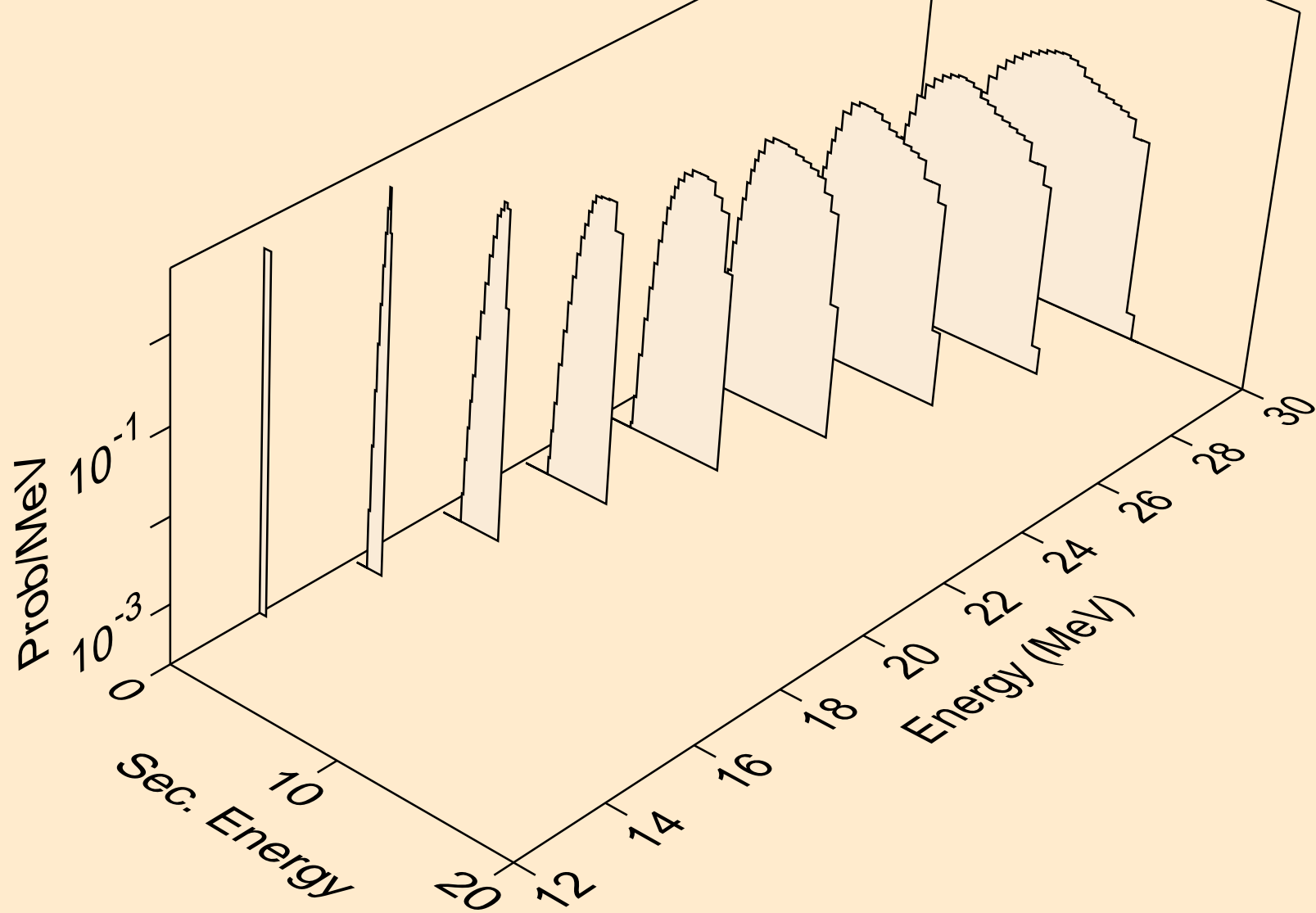

SI034 NEUTRON ACER TENDL-2023 LIBRARY; T=0.K  
alphas from (n,2n)a

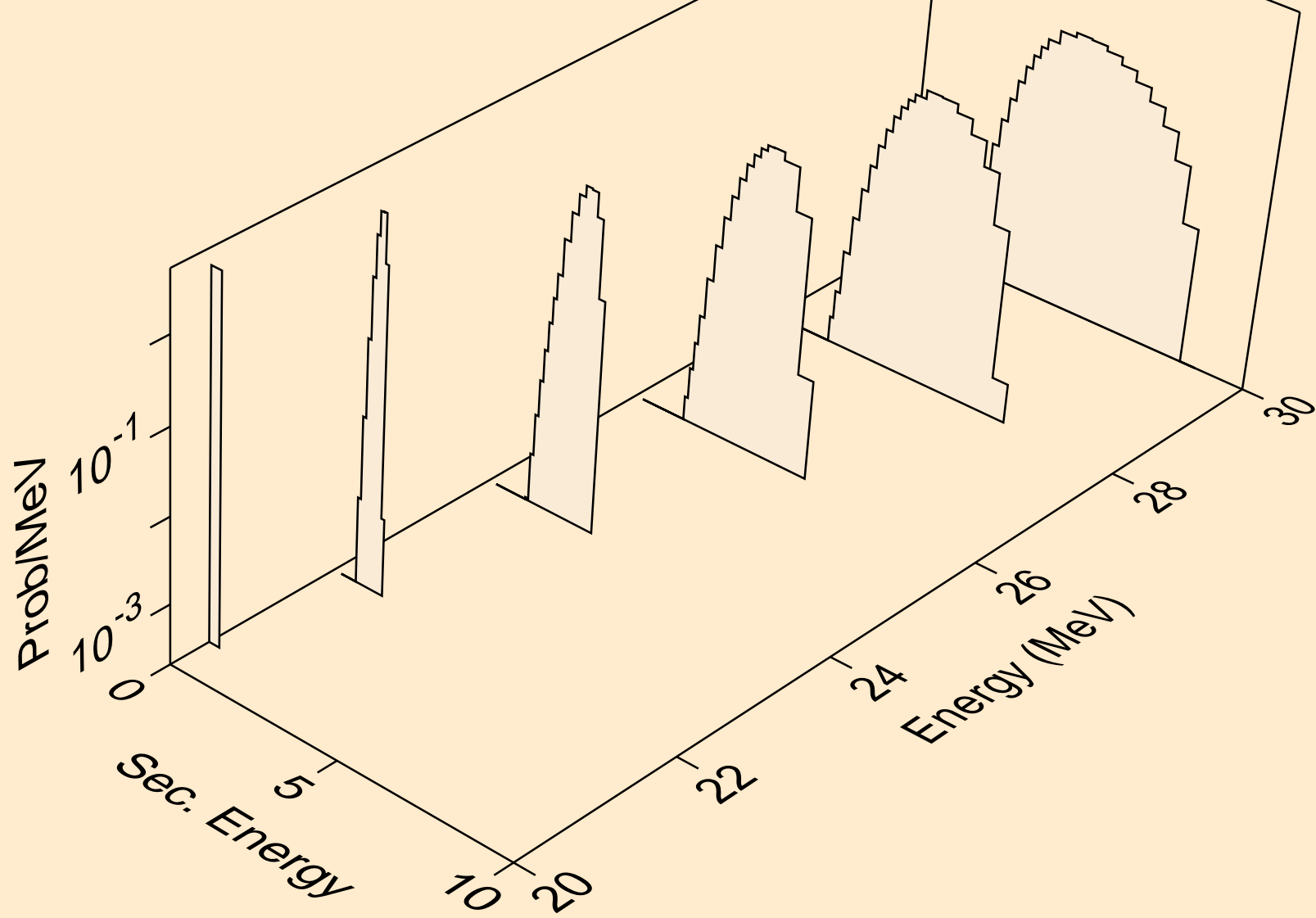

SI034 NEUTRON ACER TENDL-2023 LIBRARY; T=0.K  
alphas from (n,3n)a

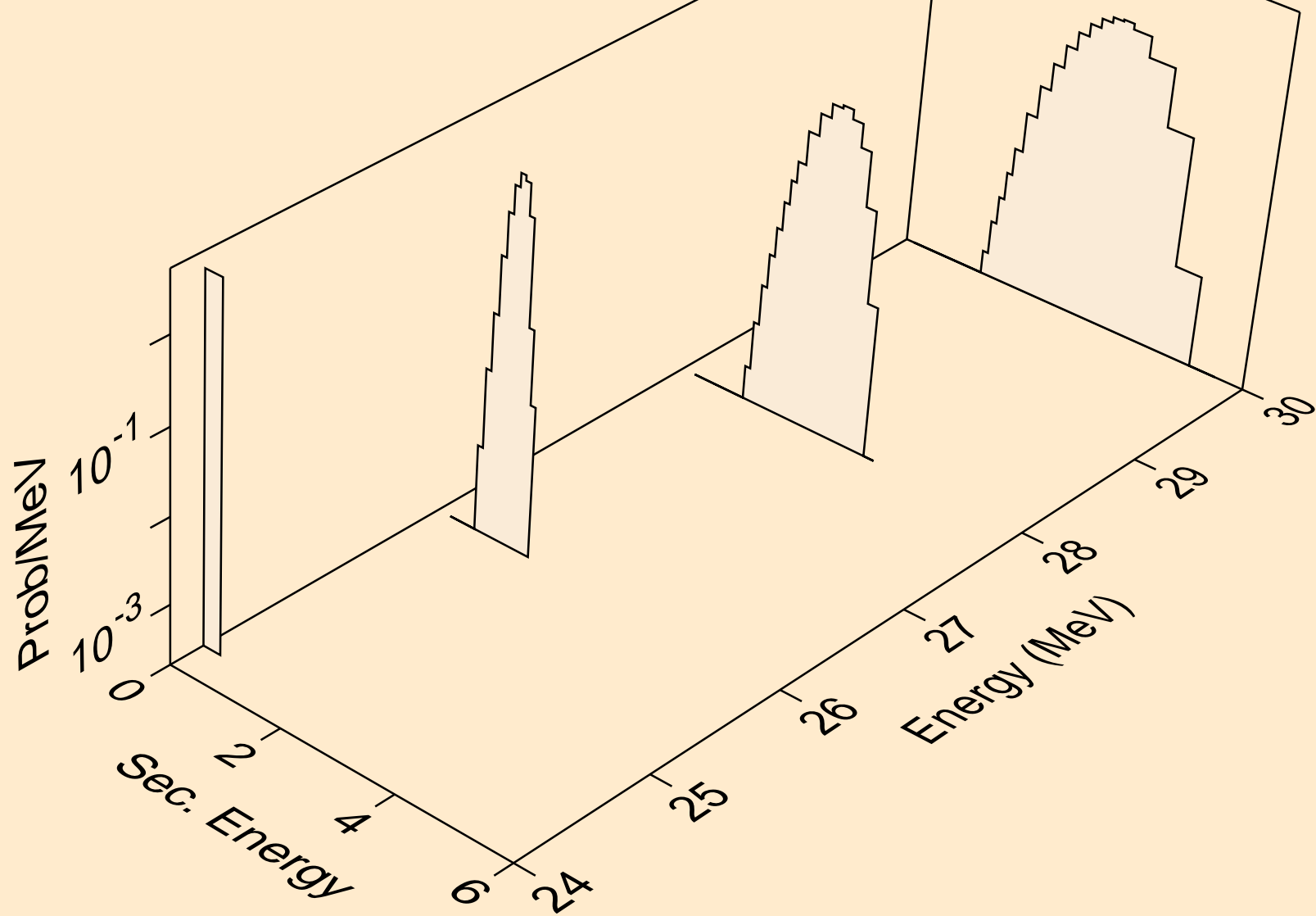

SI034 NEUTRON ACER TENDL-2023 LIBRARY; T=0.K  
alphas from (n,a)

