

TA194 NEUTRON ACER TENDL-2023 LIBRARY; T=0.K
Principal cross sections

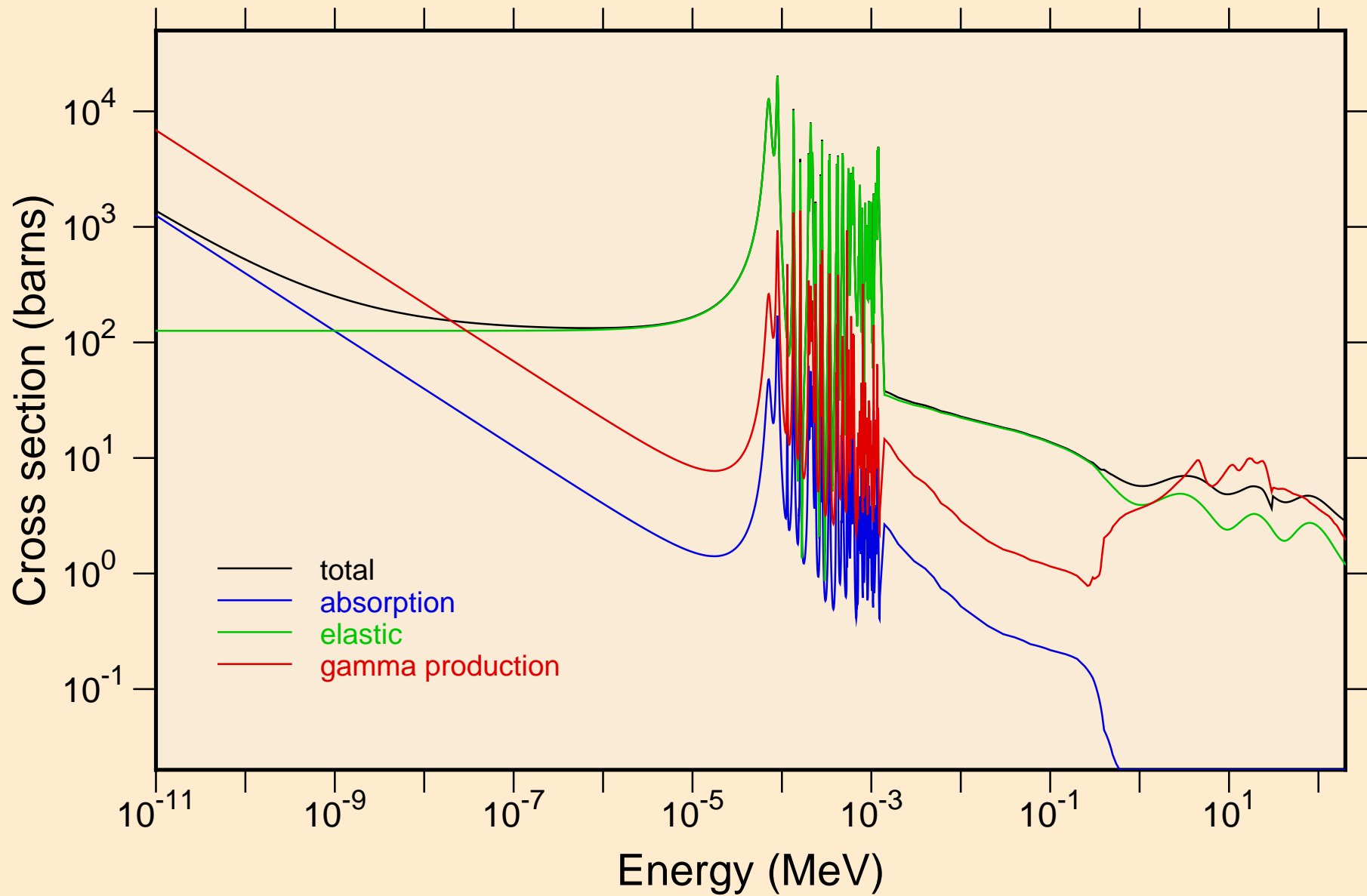

TA194 NEUTRON ACER TENDL-2023 LIBRARY; T=0.K
resonance total cross section

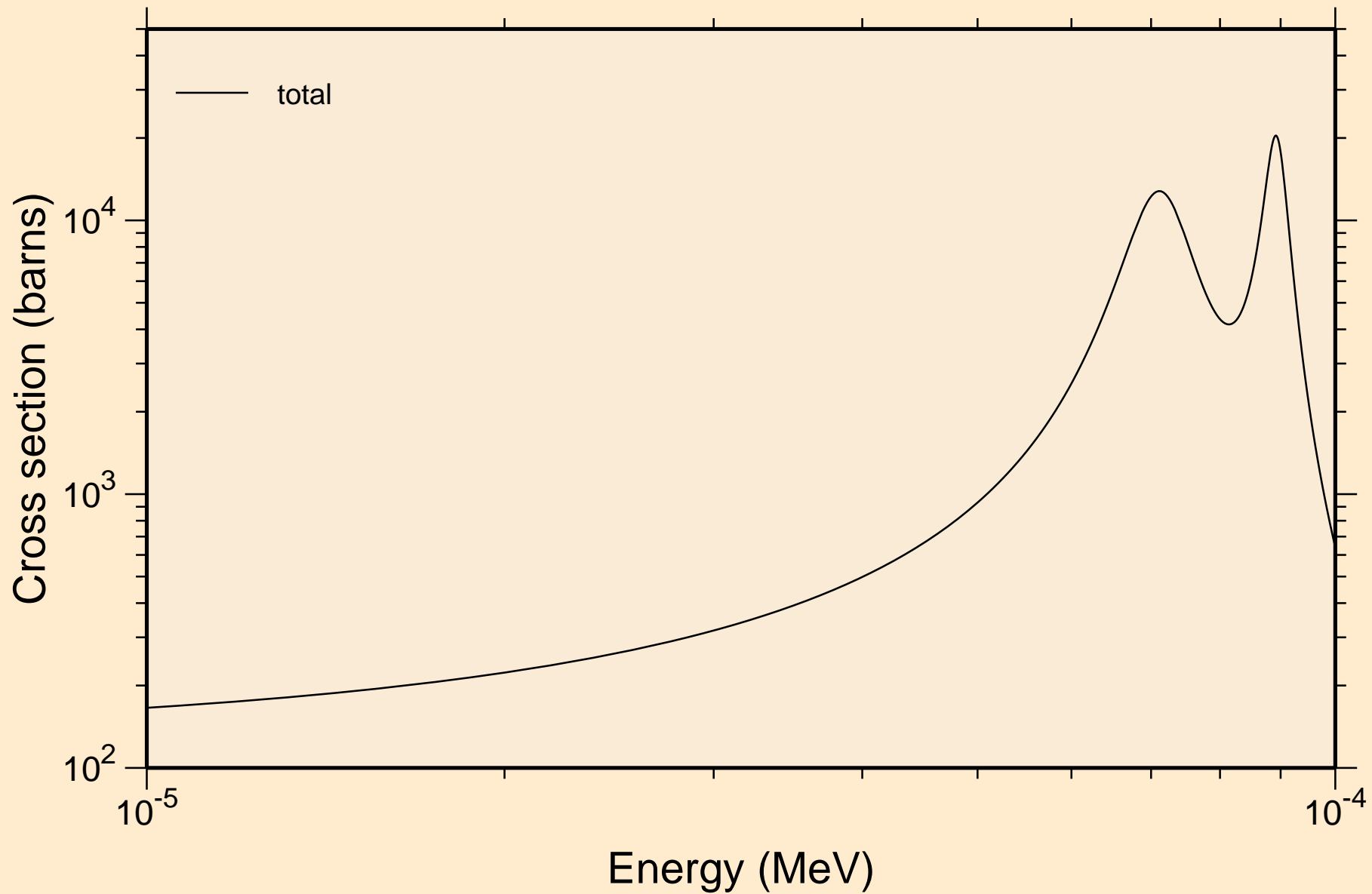

TA194 NEUTRON ACER TENDL-2023 LIBRARY; T=0.K
resonance total cross section

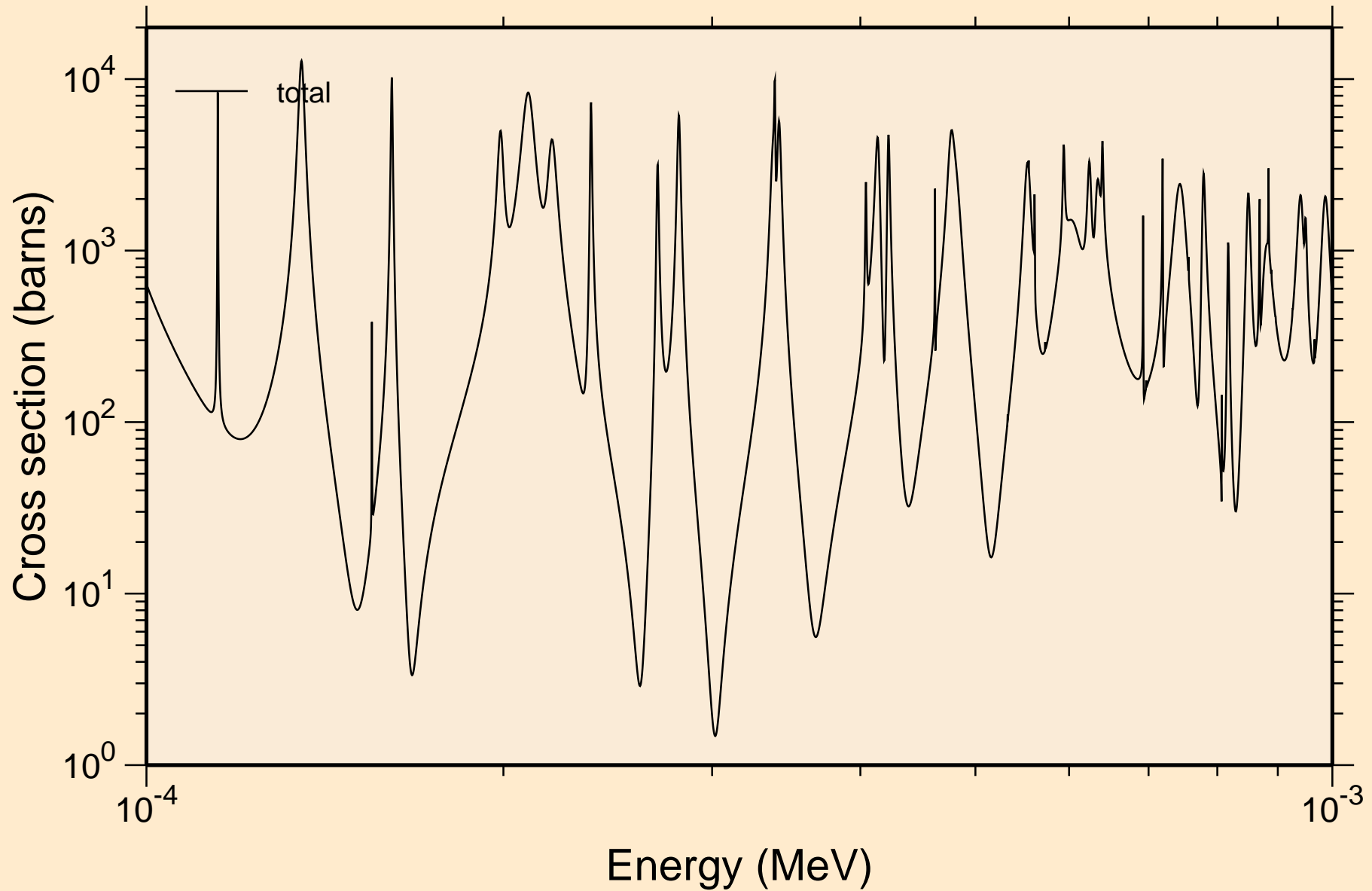

TA194 NEUTRON ACER TENDL-2023 LIBRARY; T=0.K
resonance total cross section

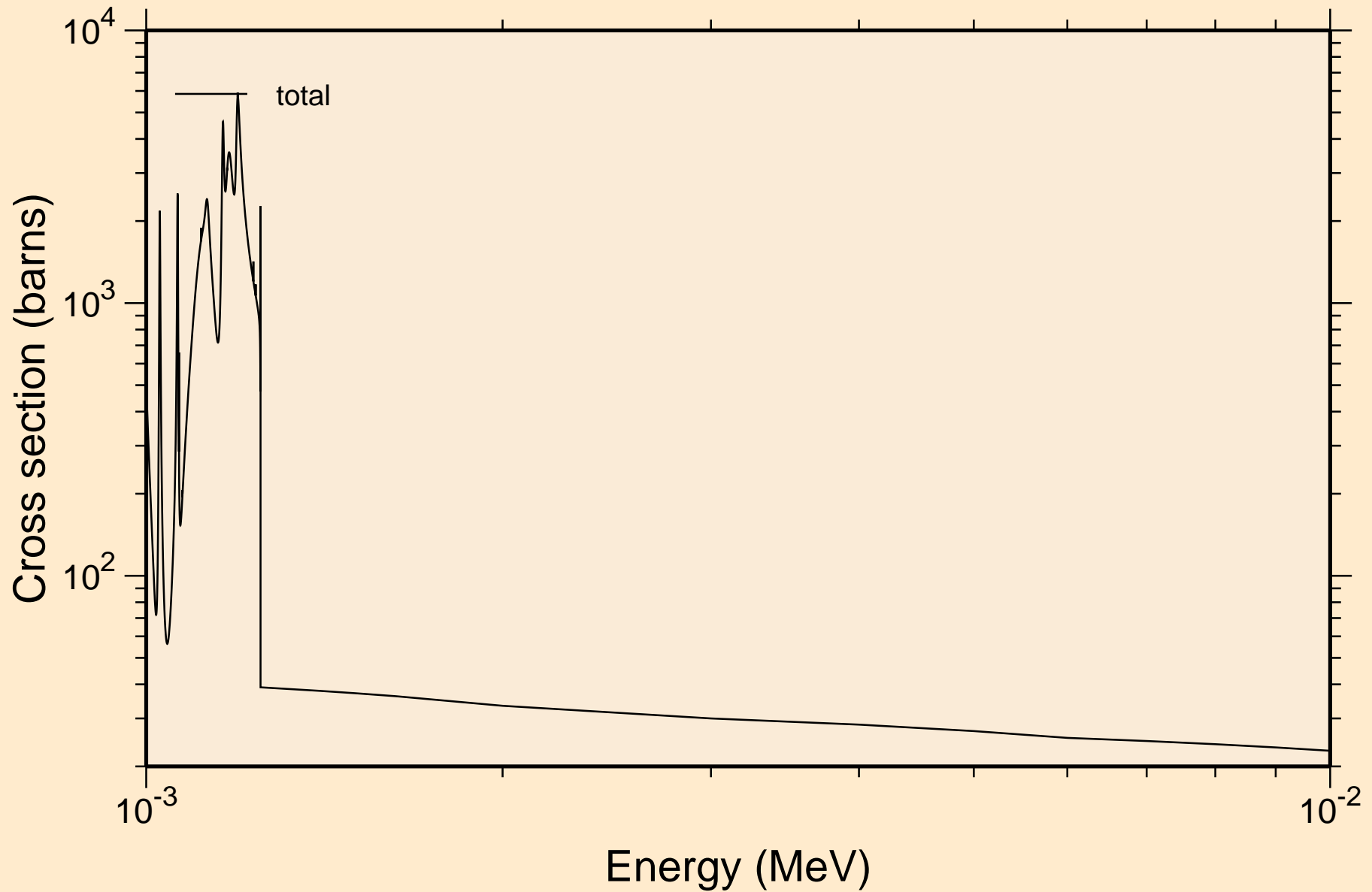

TA194 NEUTRON ACER TENDL-2023 LIBRARY; T=0.K
resonance total cross section

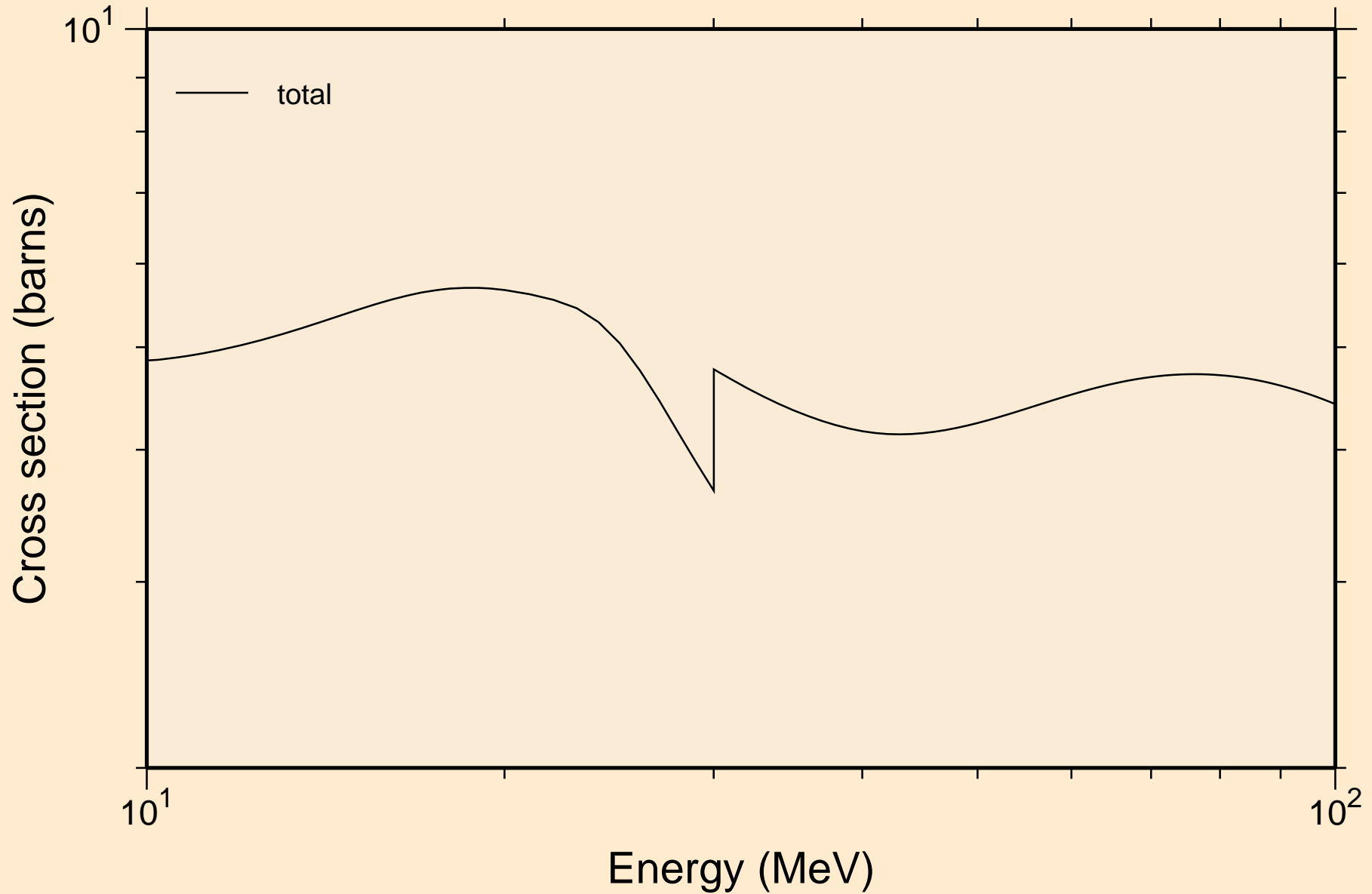

TA194 NEUTRON ACER TENDL-2023 LIBRARY; T=0.K
resonance absorption cross sections

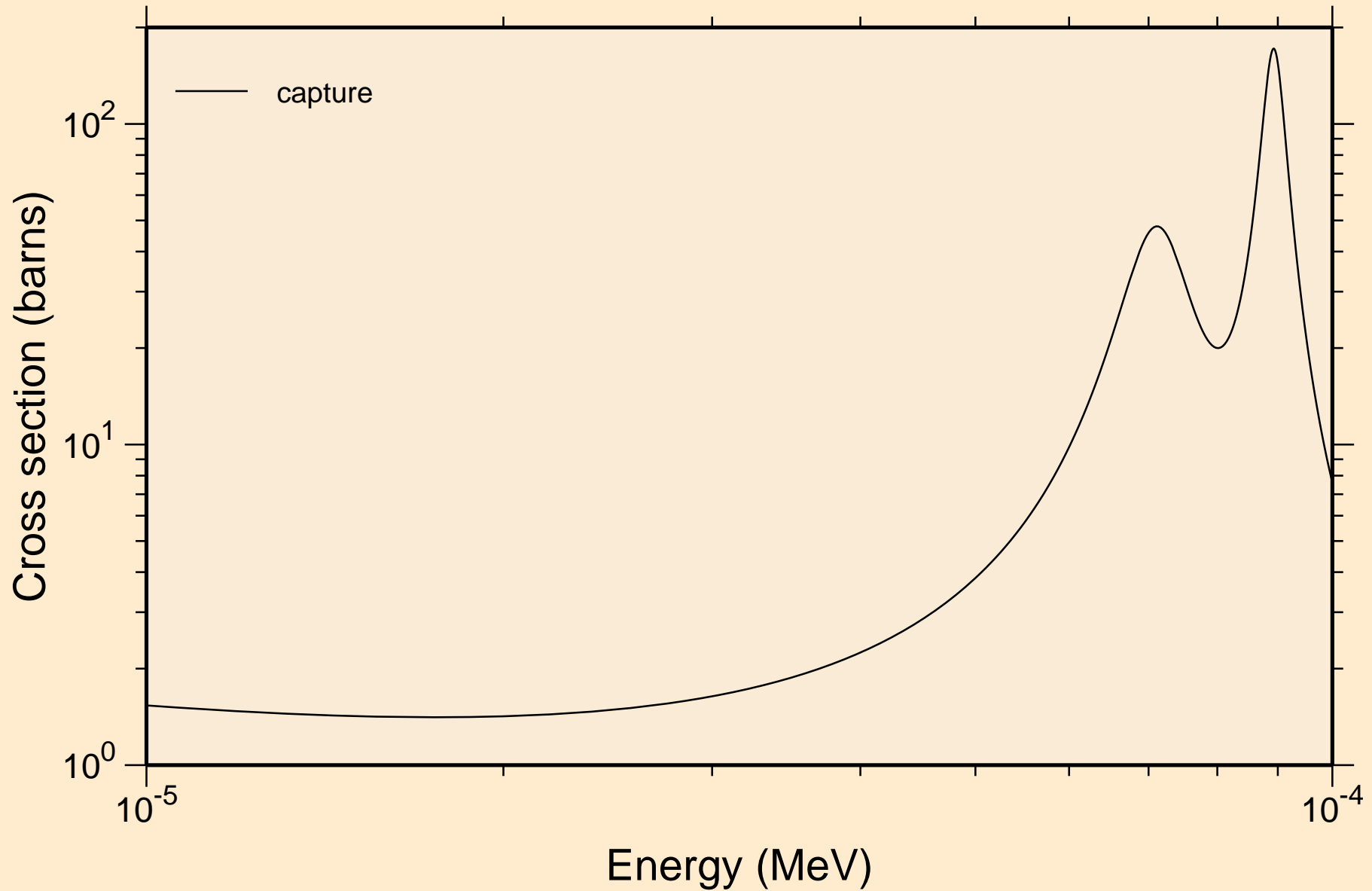

TA194 NEUTRON ACER TENDL-2023 LIBRARY; T=0.K
resonance absorption cross sections

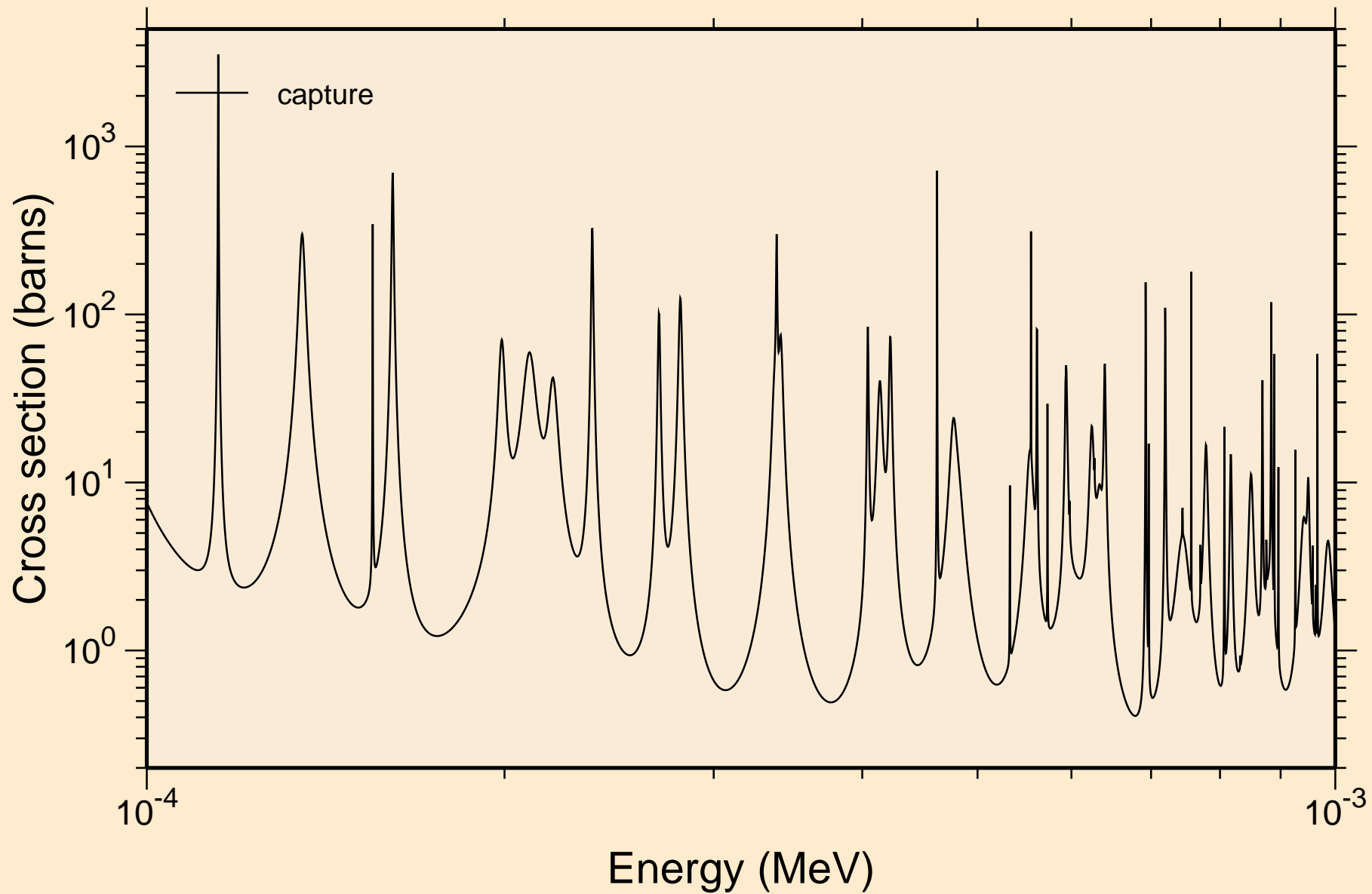

TA194 NEUTRON ACER TENDL-2023 LIBRARY; T=0.K
resonance absorption cross sections

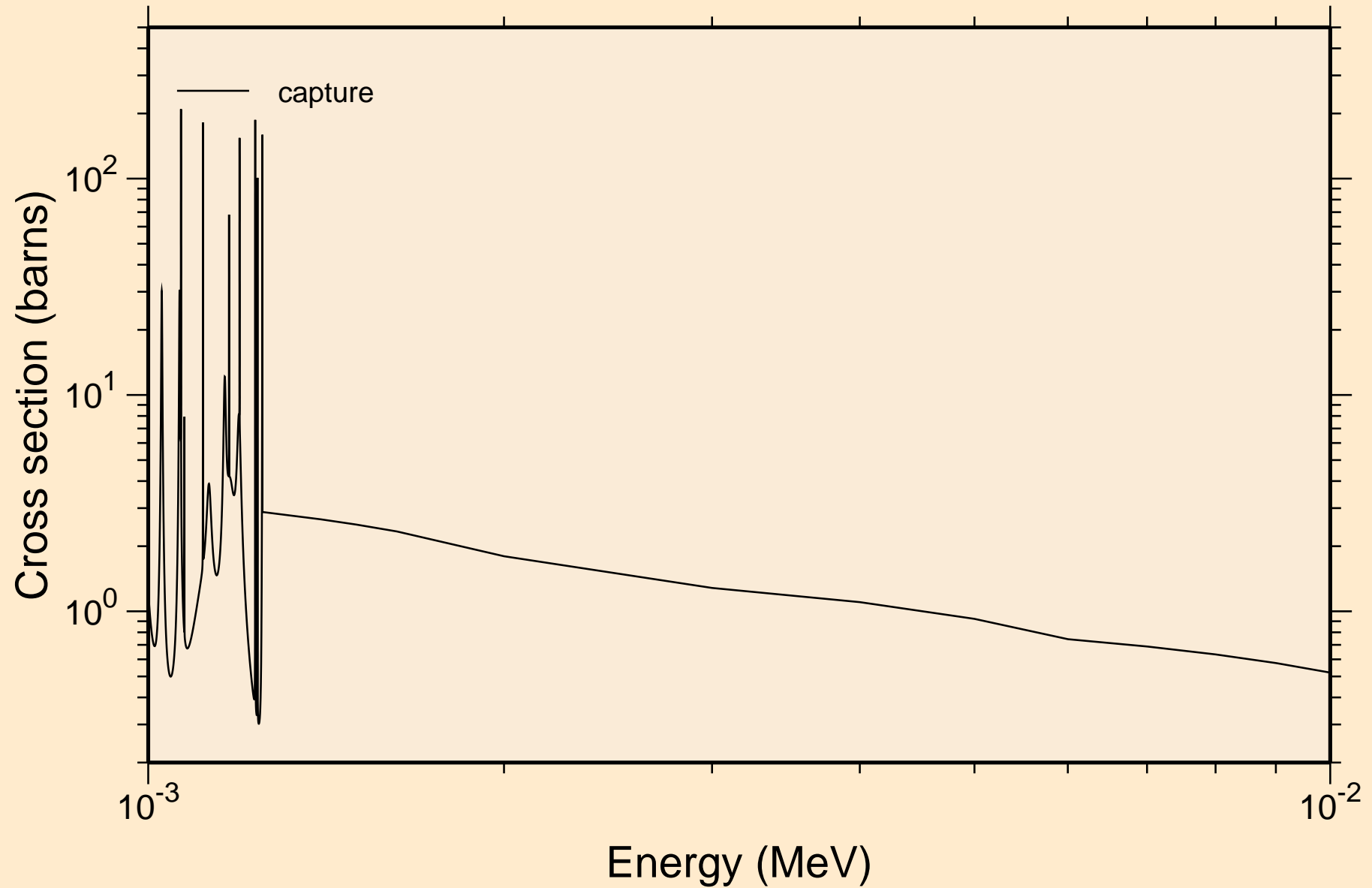

TA194 NEUTRON ACER TENDL-2023 LIBRARY; T=0.K
resonance absorption cross sections

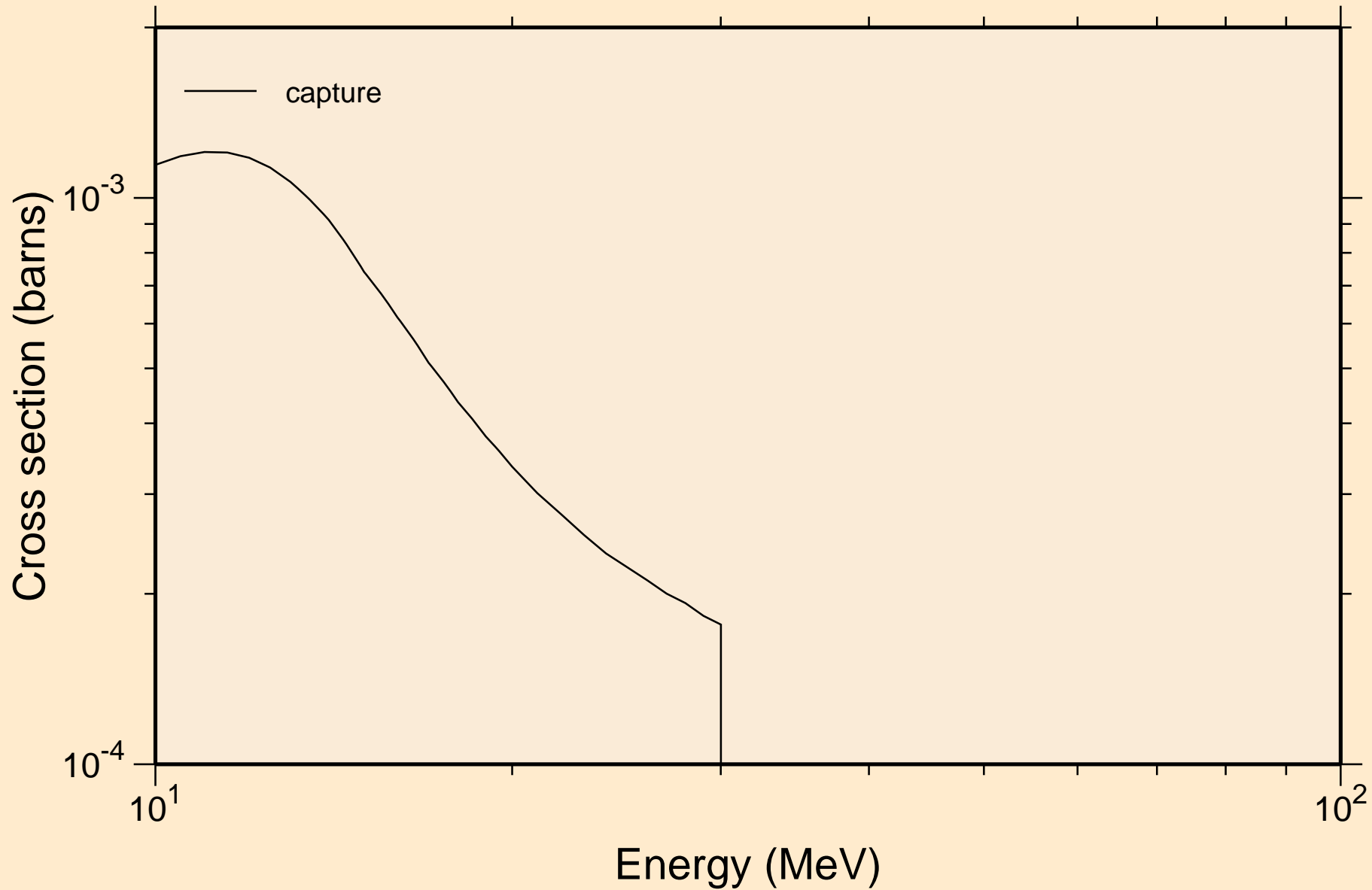

TA194 NEUTRON ACER TENDL-2023 LIBRARY; T=0.K
Heating

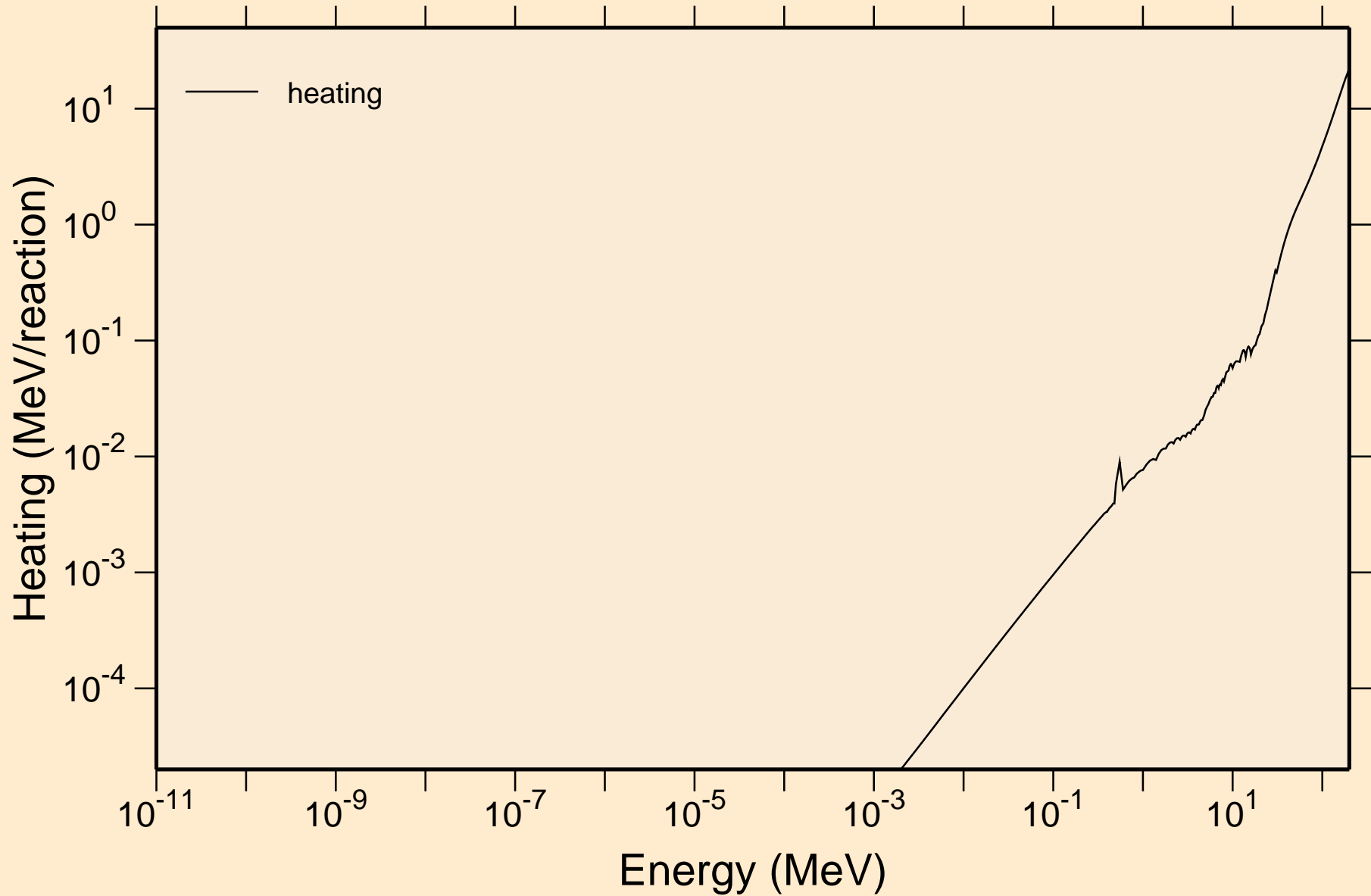

TA194 NEUTRON ACER TENDL-2023 LIBRARY; T=0.K
Damage

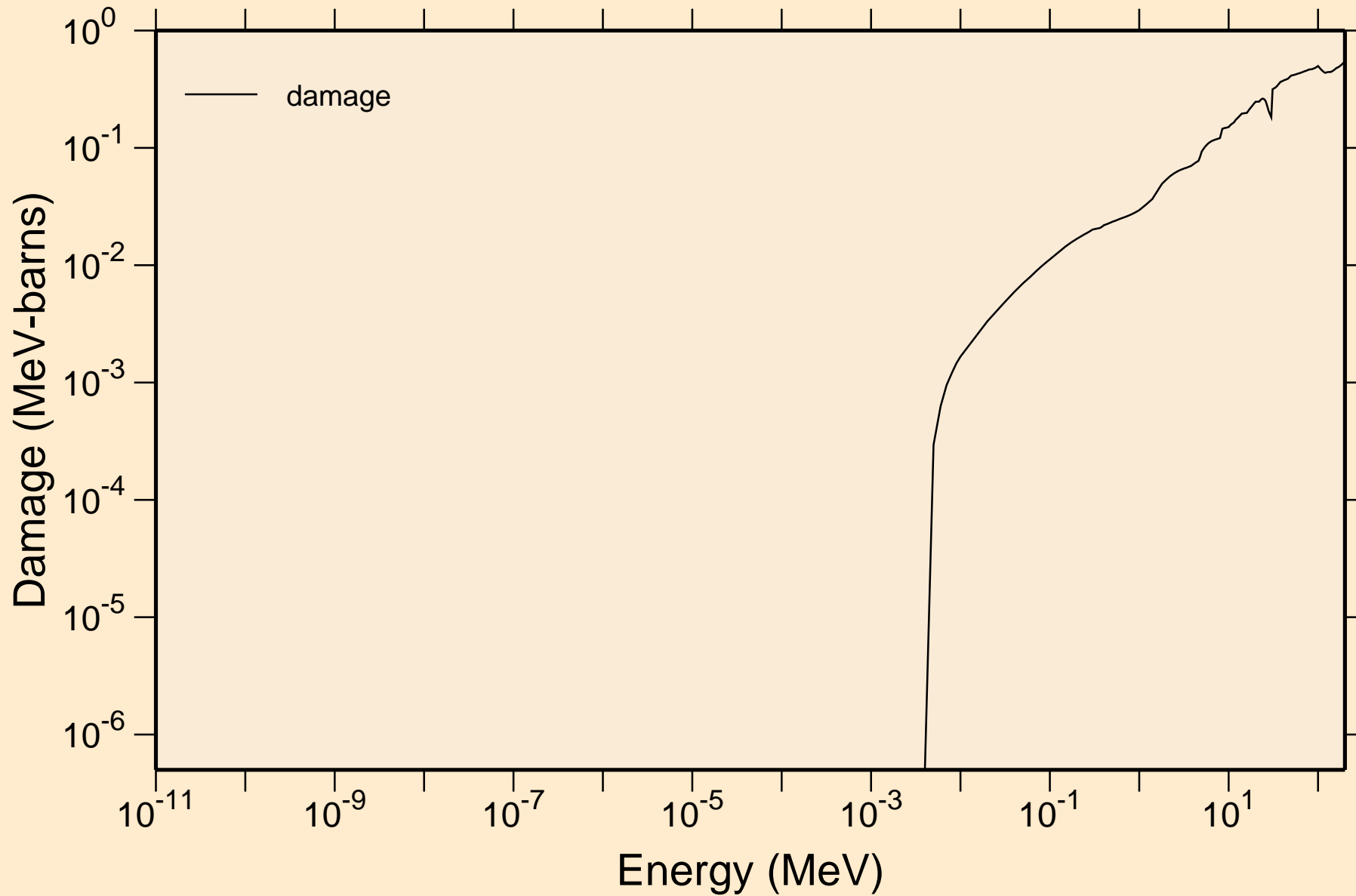

TA194 NEUTRON ACER TENDL-2023 LIBRARY; T=0.K
Non-threshold reactions

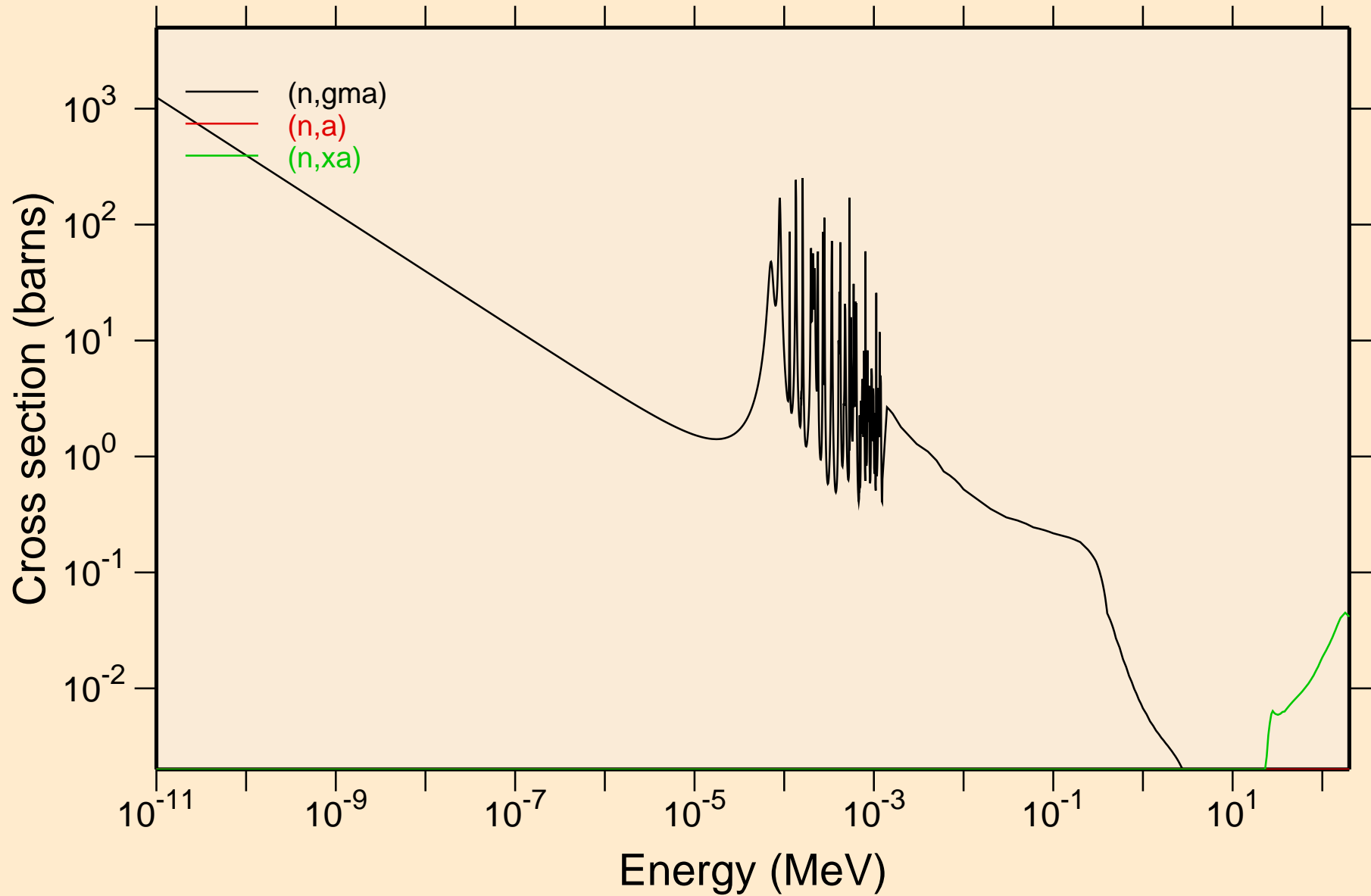

TA194 NEUTRON ACER TENDL-2023 LIBRARY; T=0.K
Principal cross sections

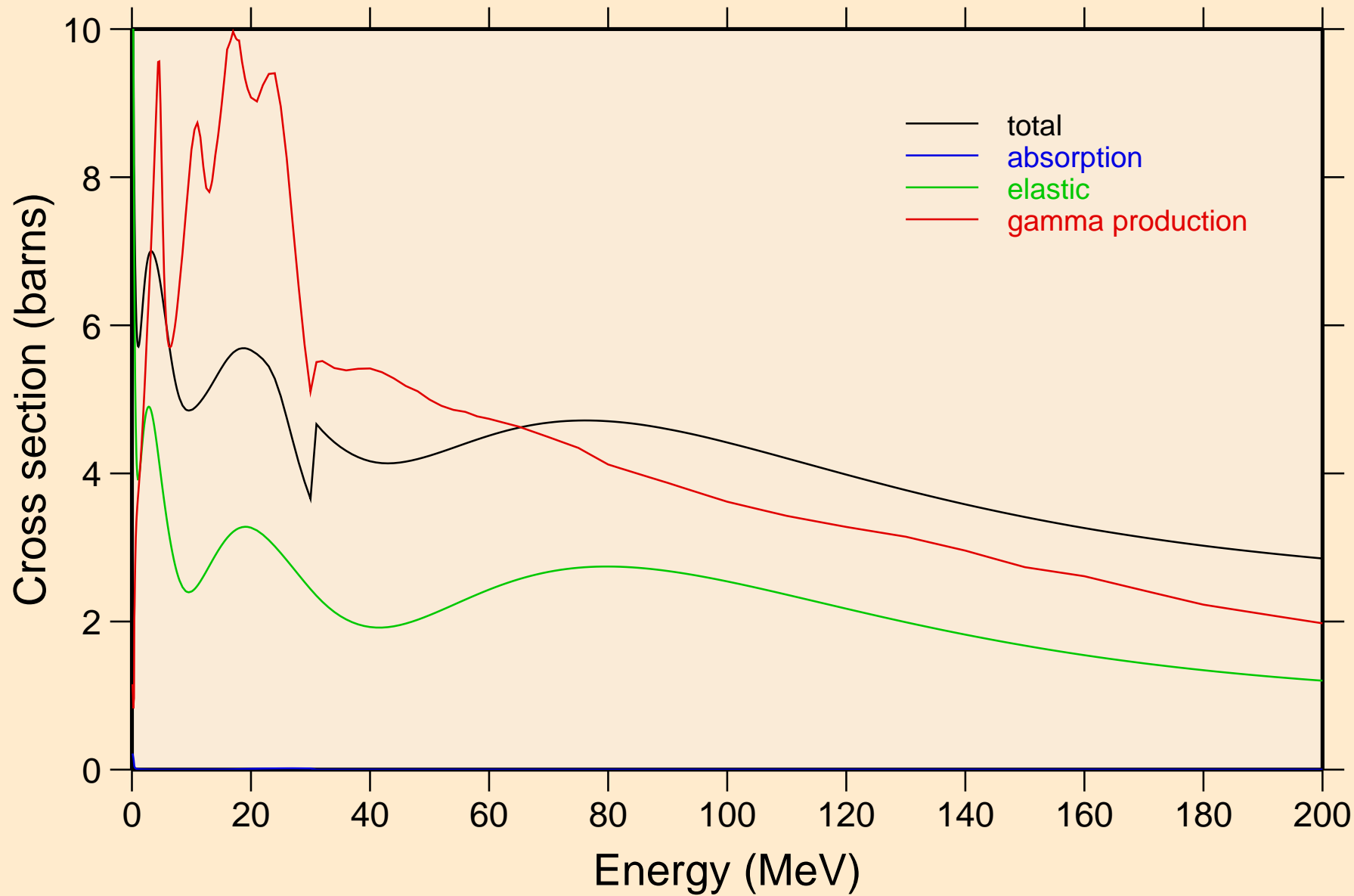

TA194 NEUTRON ACER TENDL-2023 LIBRARY; T=0.K

Heating

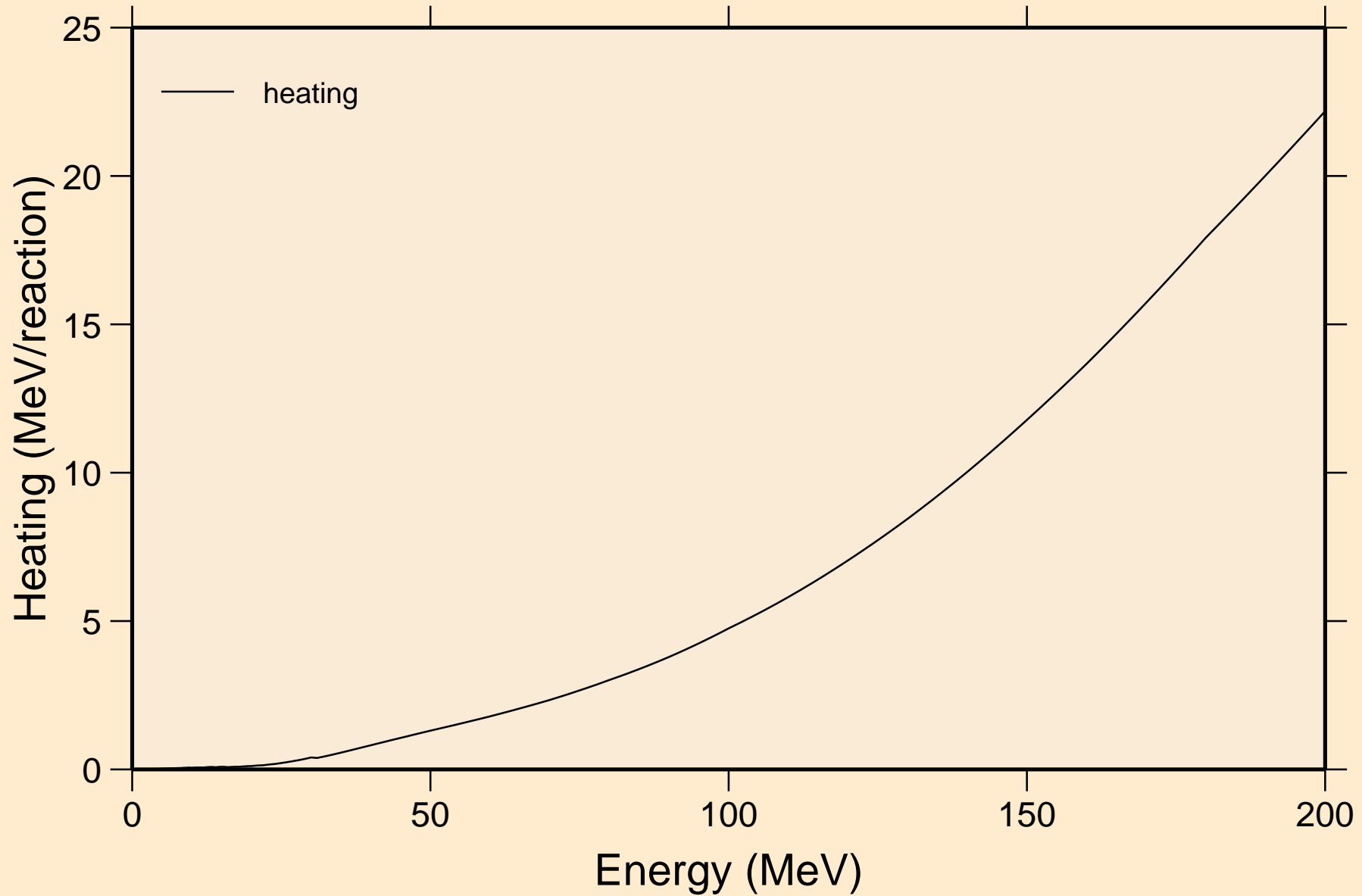

TA194 NEUTRON ACER TENDL-2023 LIBRARY; T=0.K
Damage

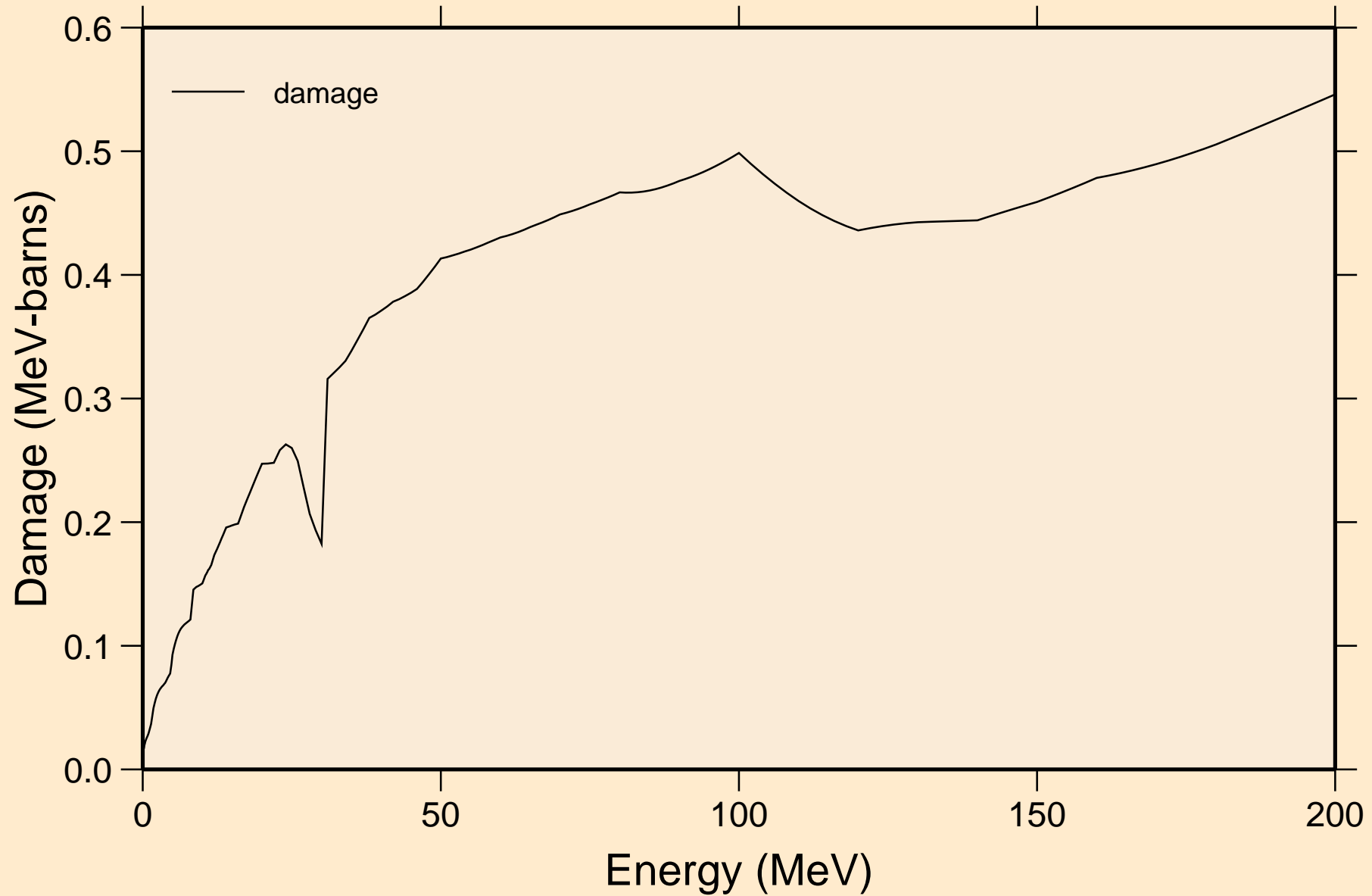

TA194 NEUTRON ACER TENDL-2023 LIBRARY; T=0.K
Non-threshold reactions

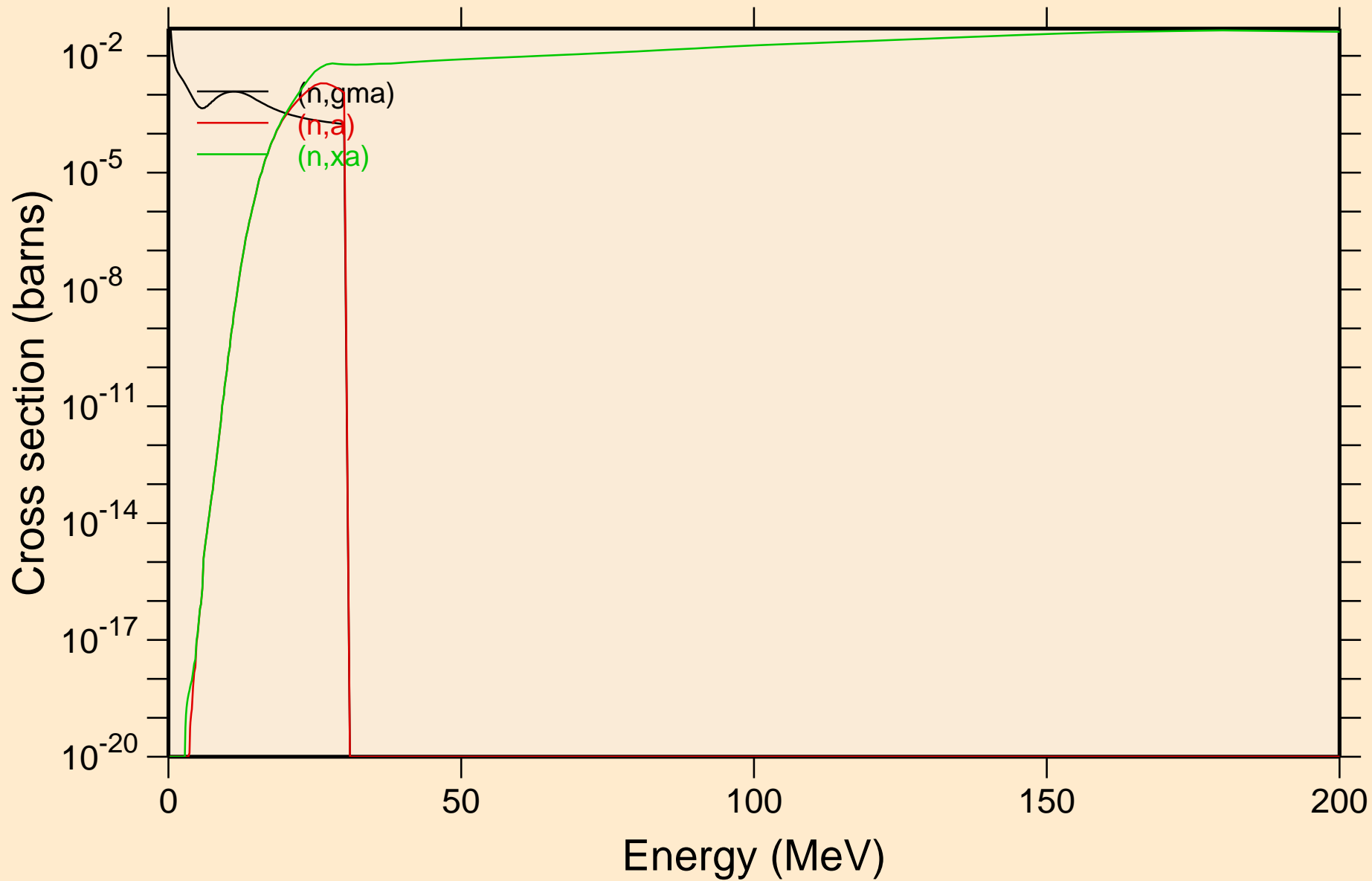

TA194 NEUTRON ACER TENDL-2023 LIBRARY; T=0.K
Inelastic levels

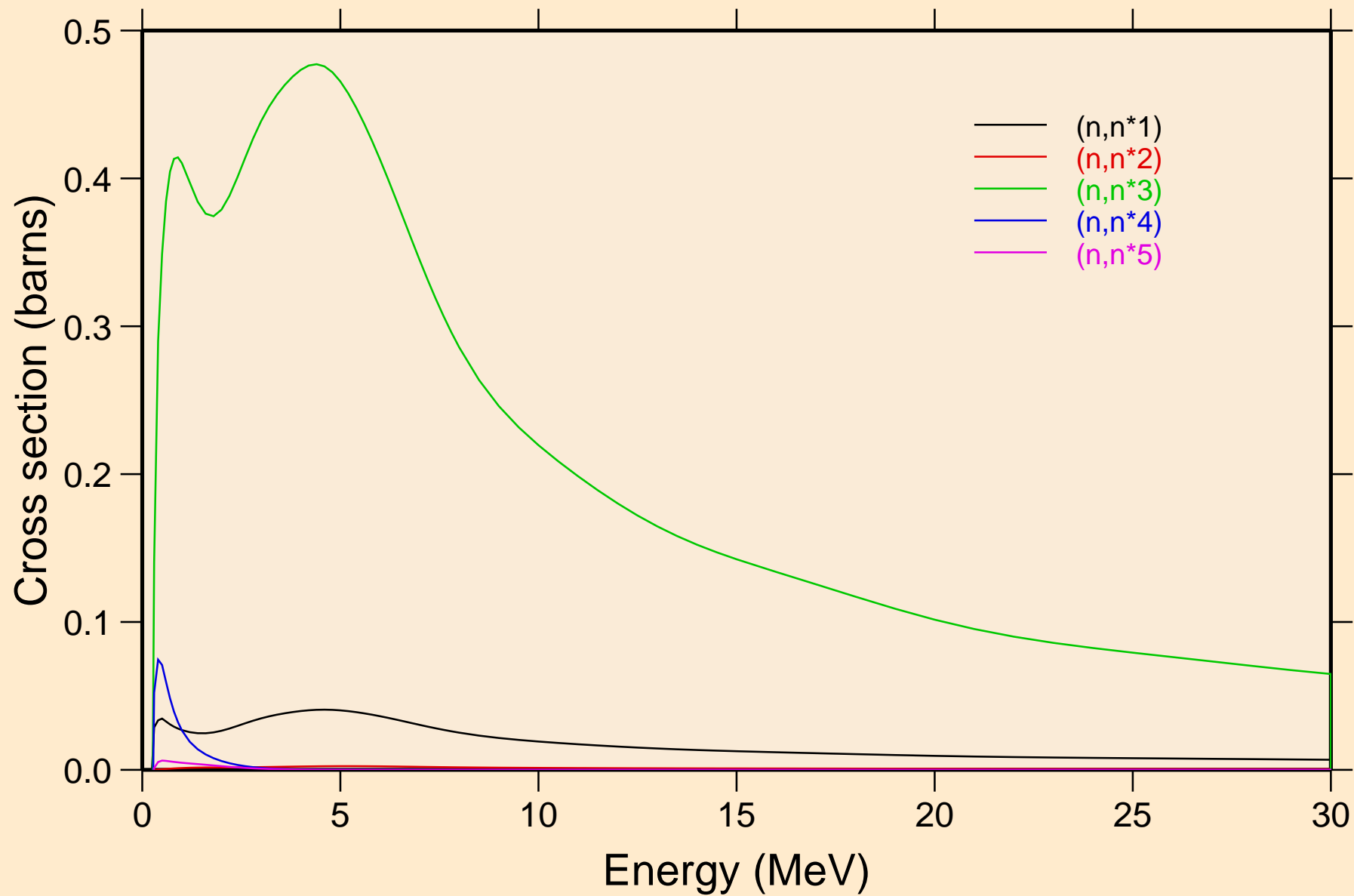

TA194 NEUTRON ACER TENDL-2023 LIBRARY; T=0.K
Inelastic levels

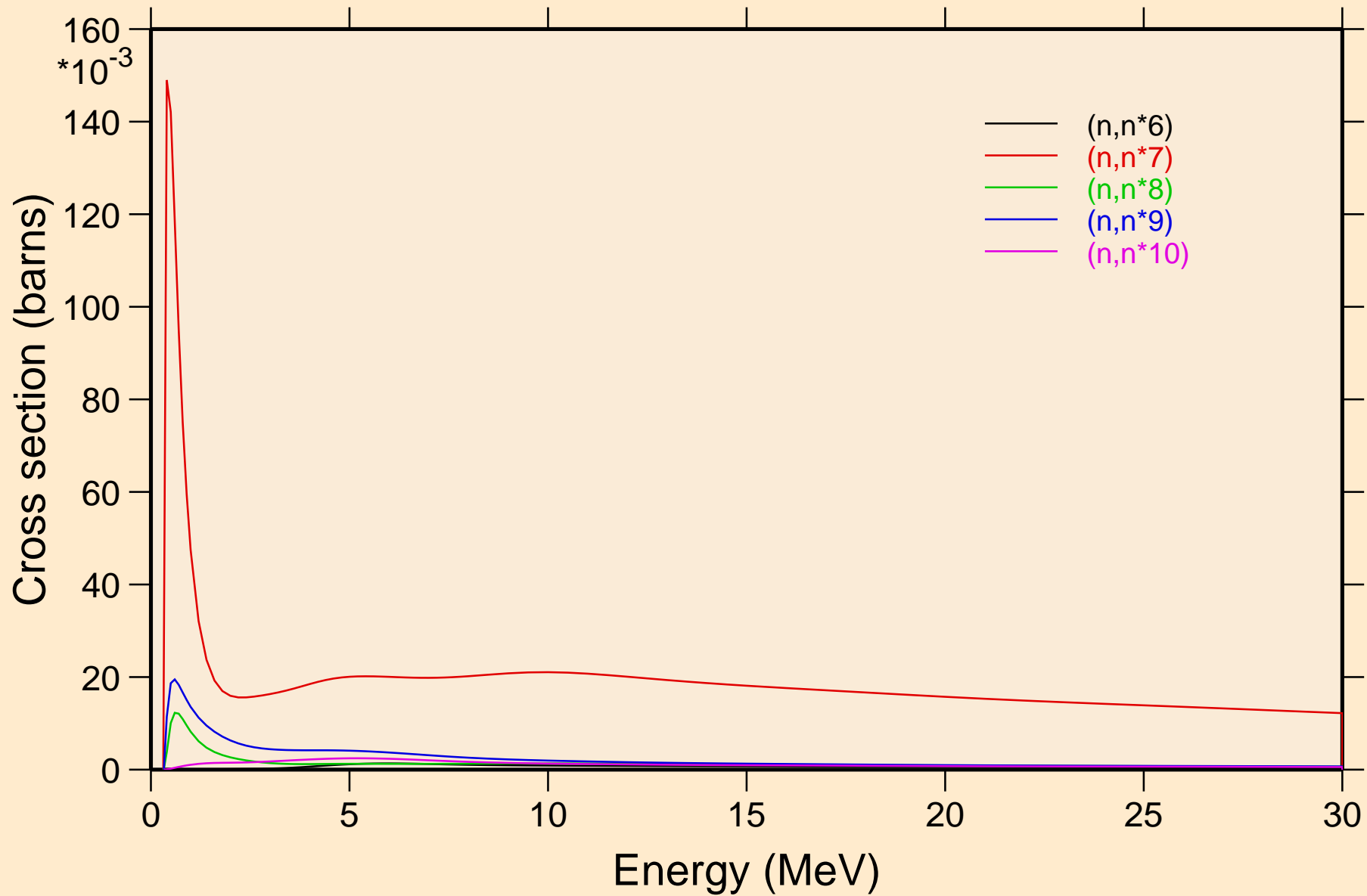

TA194 NEUTRON ACER TENDL-2023 LIBRARY; T=0.K
Inelastic levels

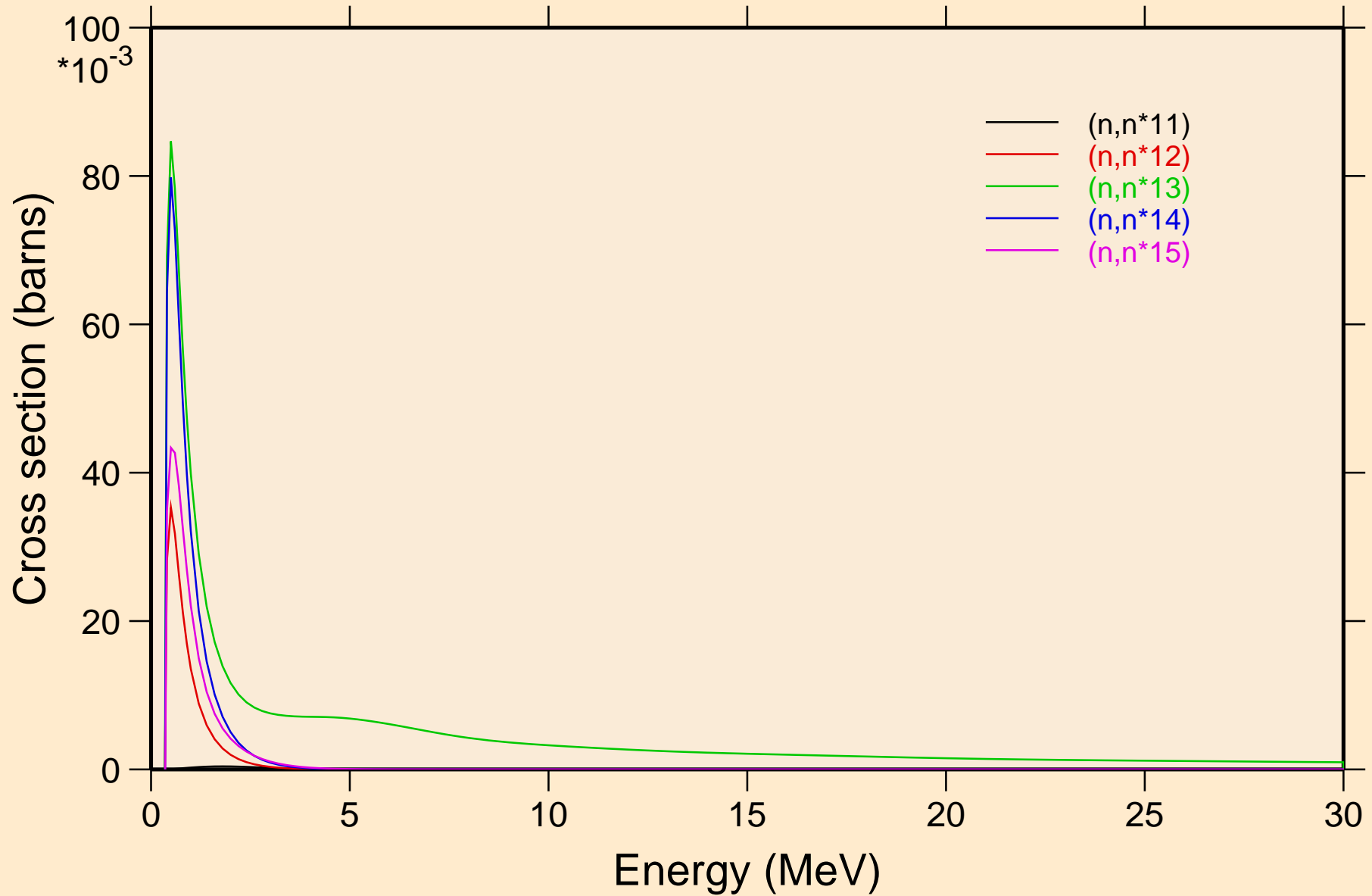

TA194 NEUTRON ACER TENDL-2023 LIBRARY; T=0.K
Inelastic levels

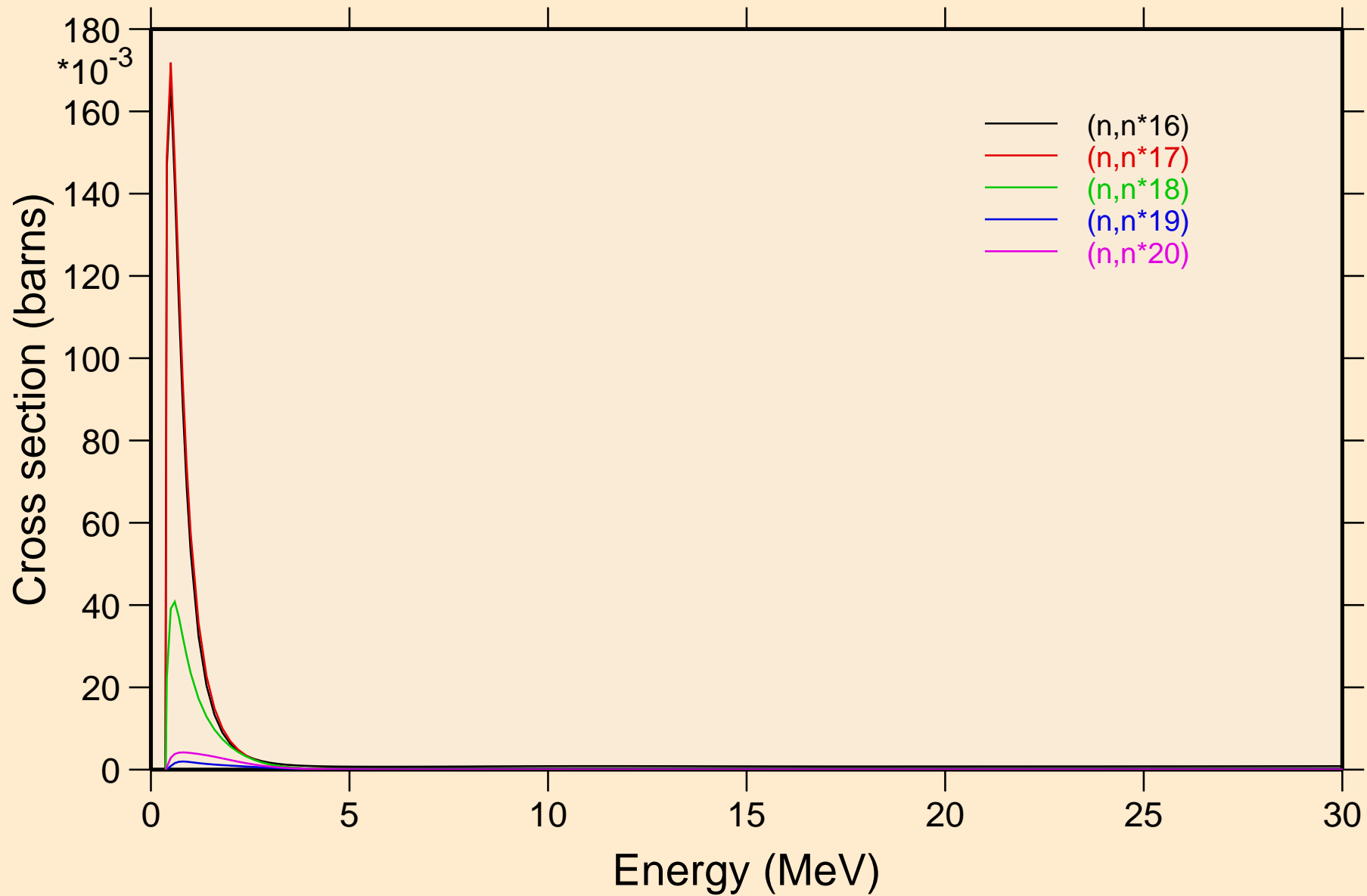

TA194 NEUTRON ACER TENDL-2023 LIBRARY; T=0.K
Inelastic levels

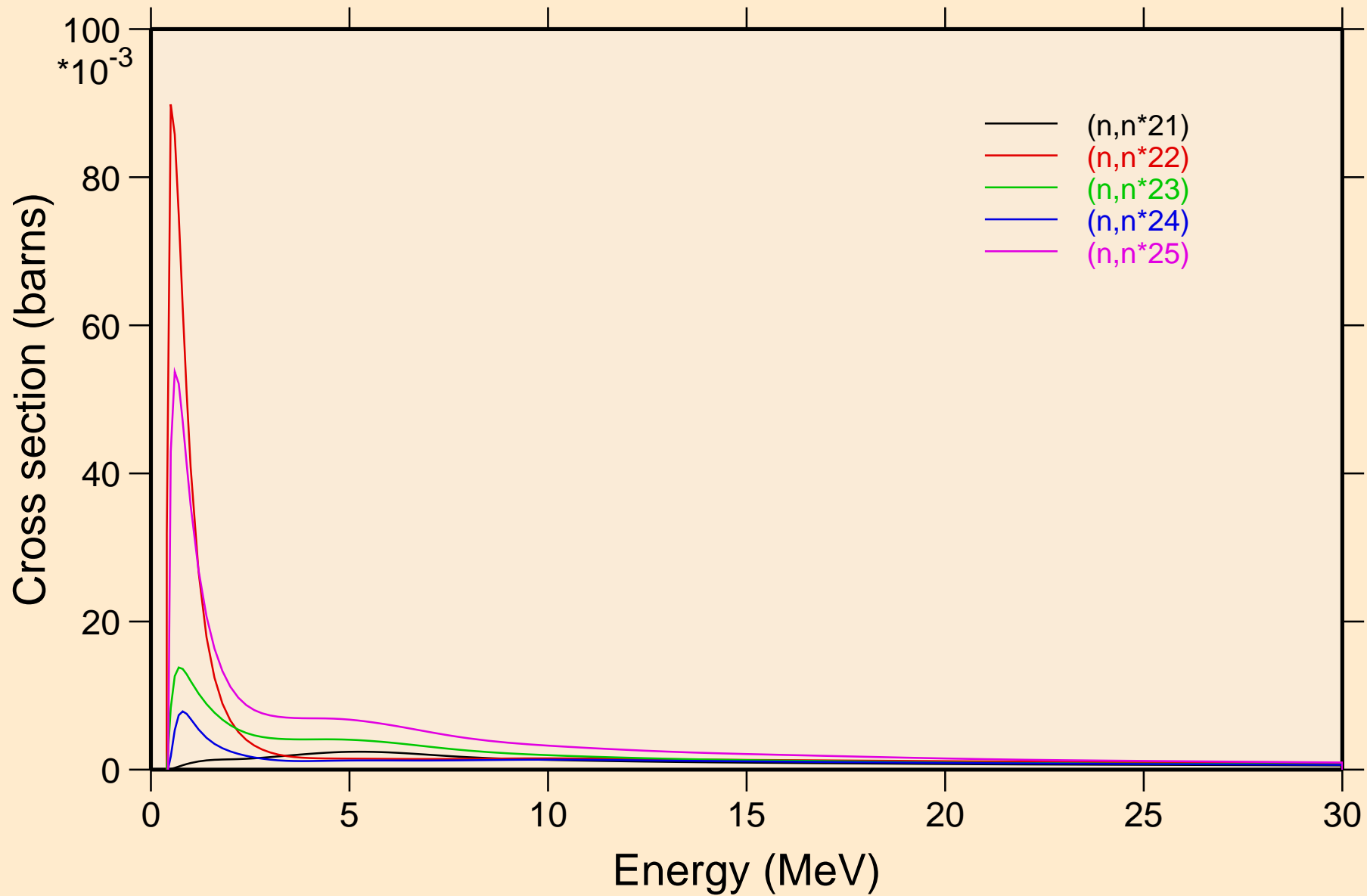

TA194 NEUTRON ACER TENDL-2023 LIBRARY; T=0.K
Inelastic levels

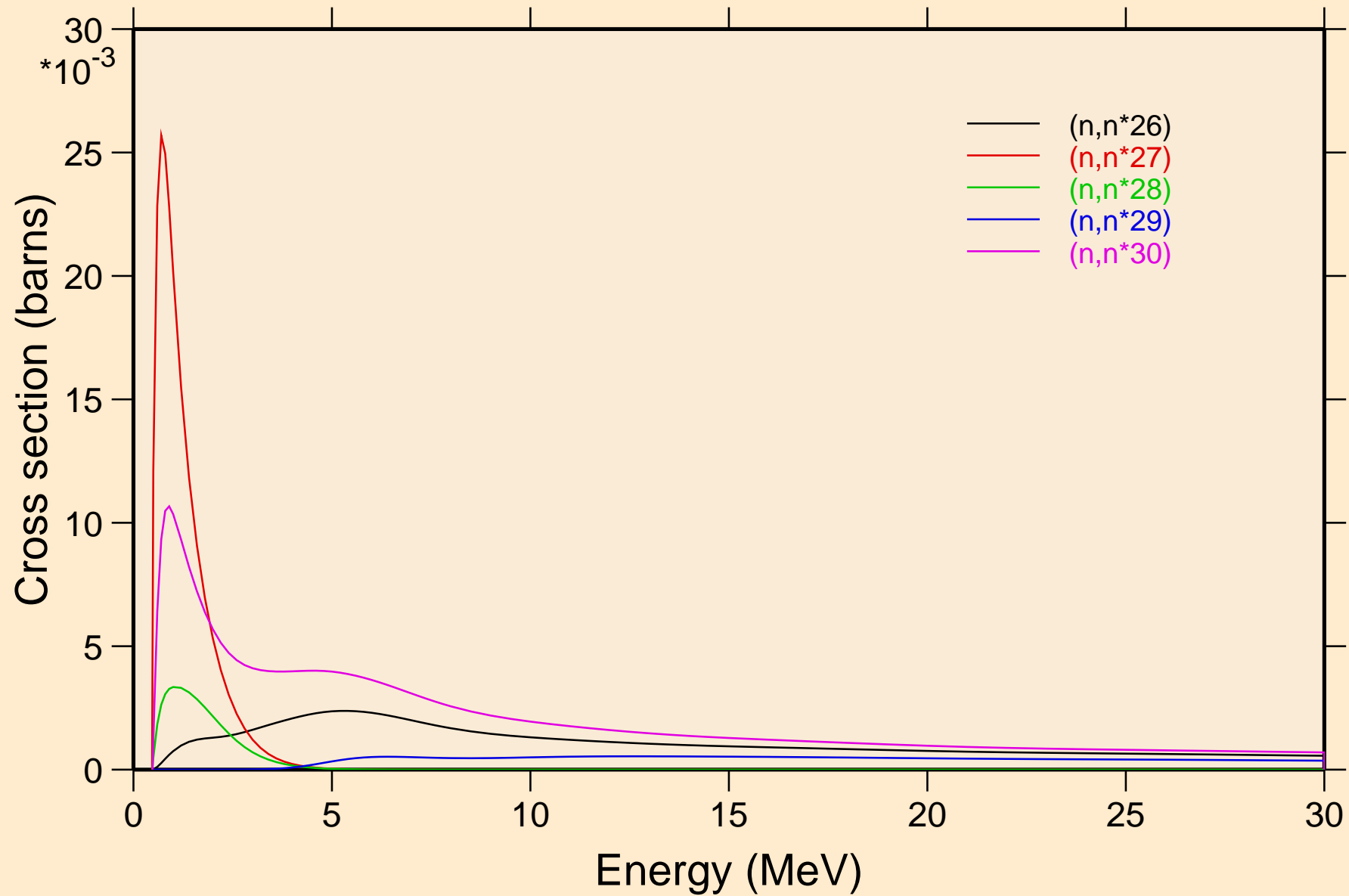

TA194 NEUTRON ACER TENDL-2023 LIBRARY; T=0.K
Threshold reactions

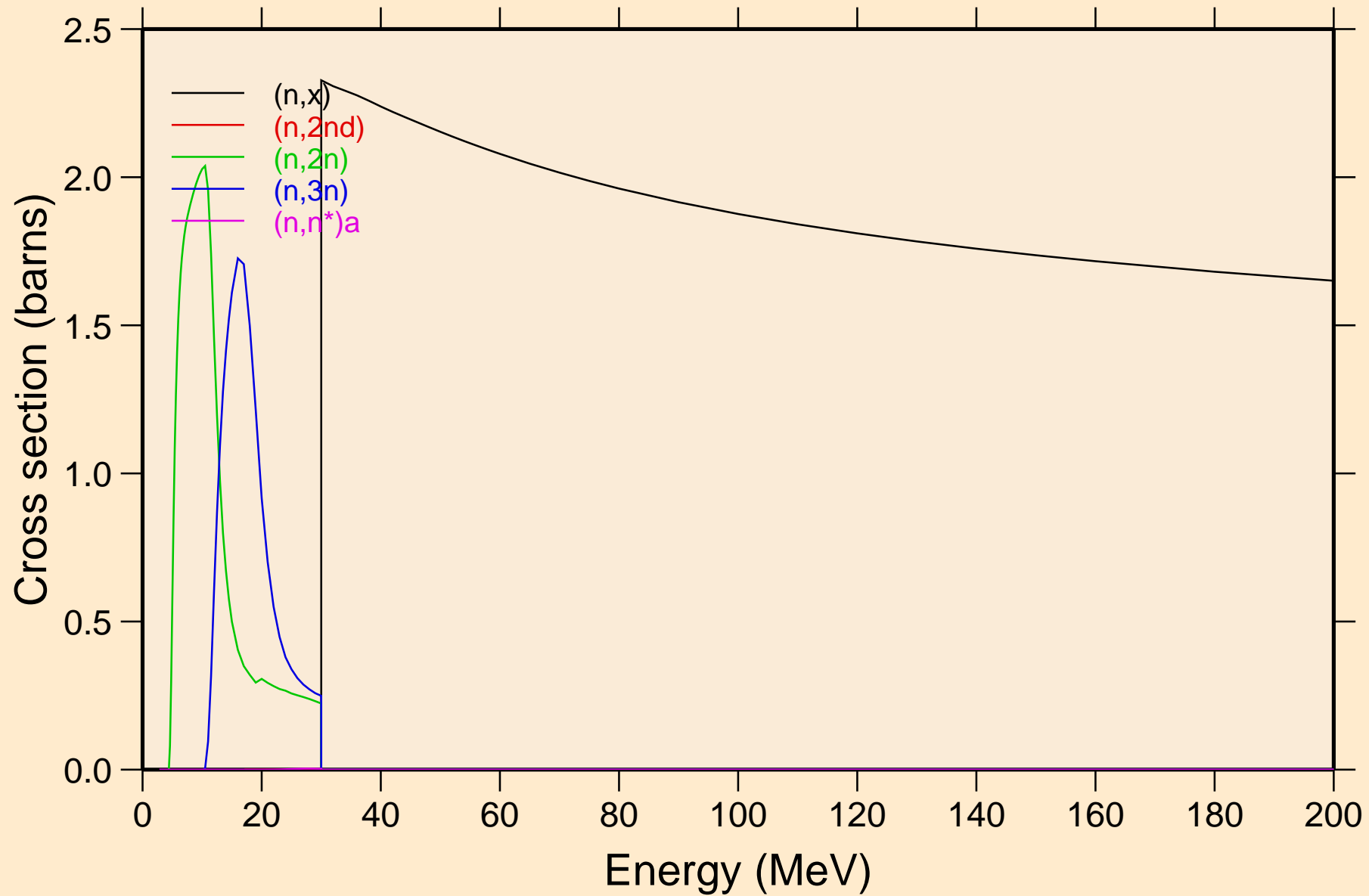

TA194 NEUTRON ACER TENDL-2023 LIBRARY; T=0.K
Threshold reactions

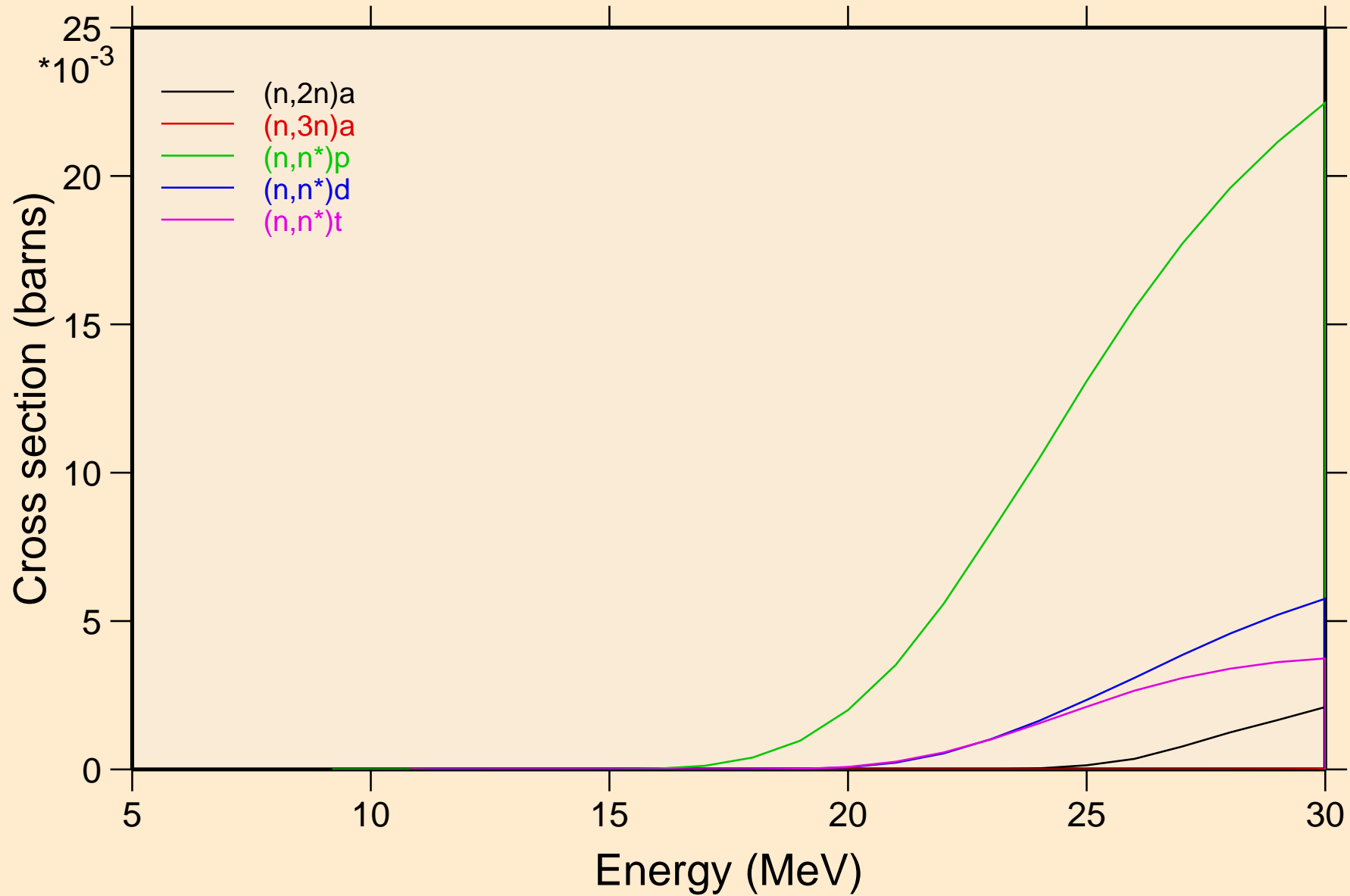

TA194 NEUTRON ACER TENDL-2023 LIBRARY; T=0.K
Threshold reactions

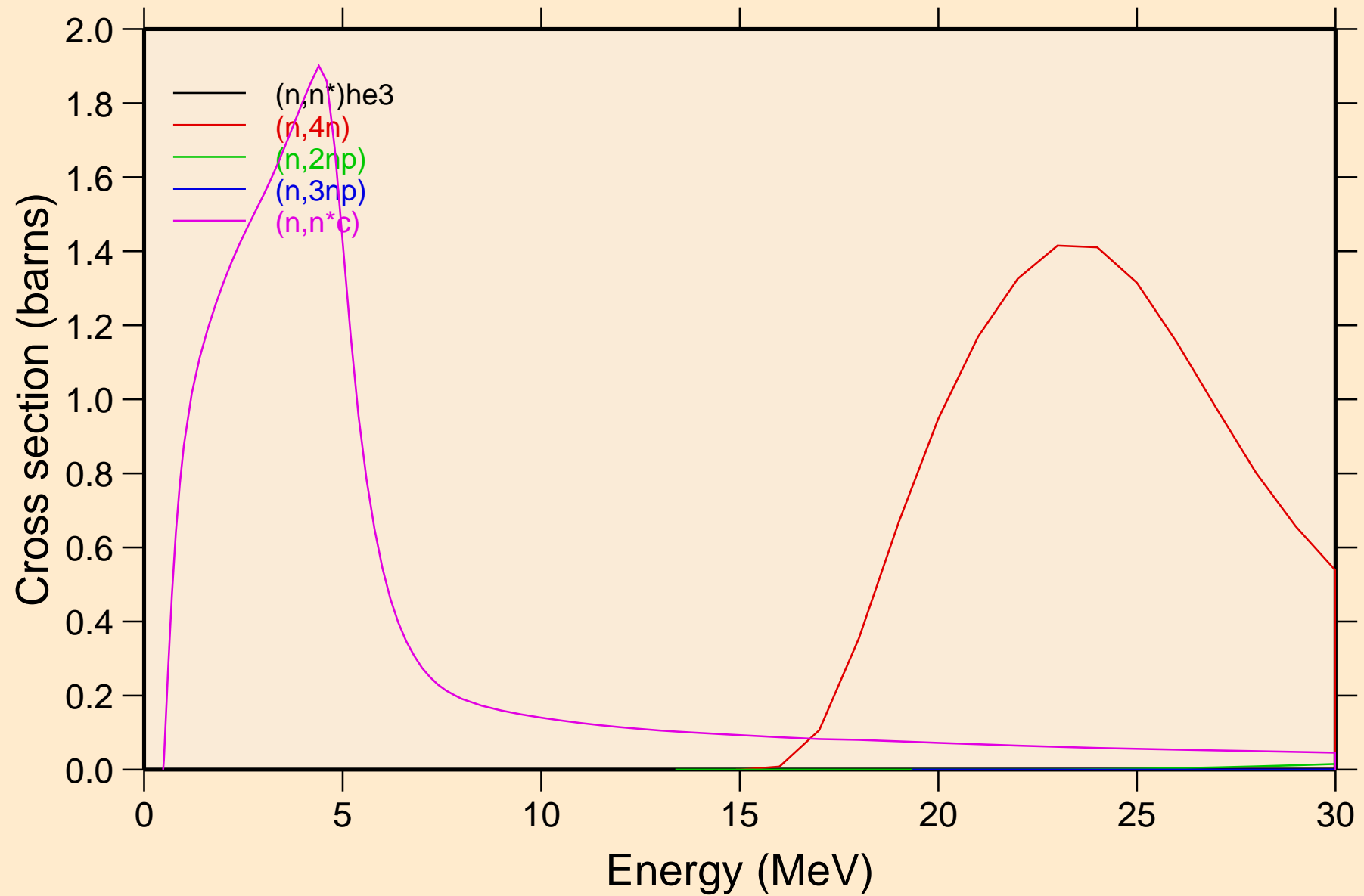

TA194 NEUTRON ACER TENDL-2023 LIBRARY; T=0.K
Threshold reactions

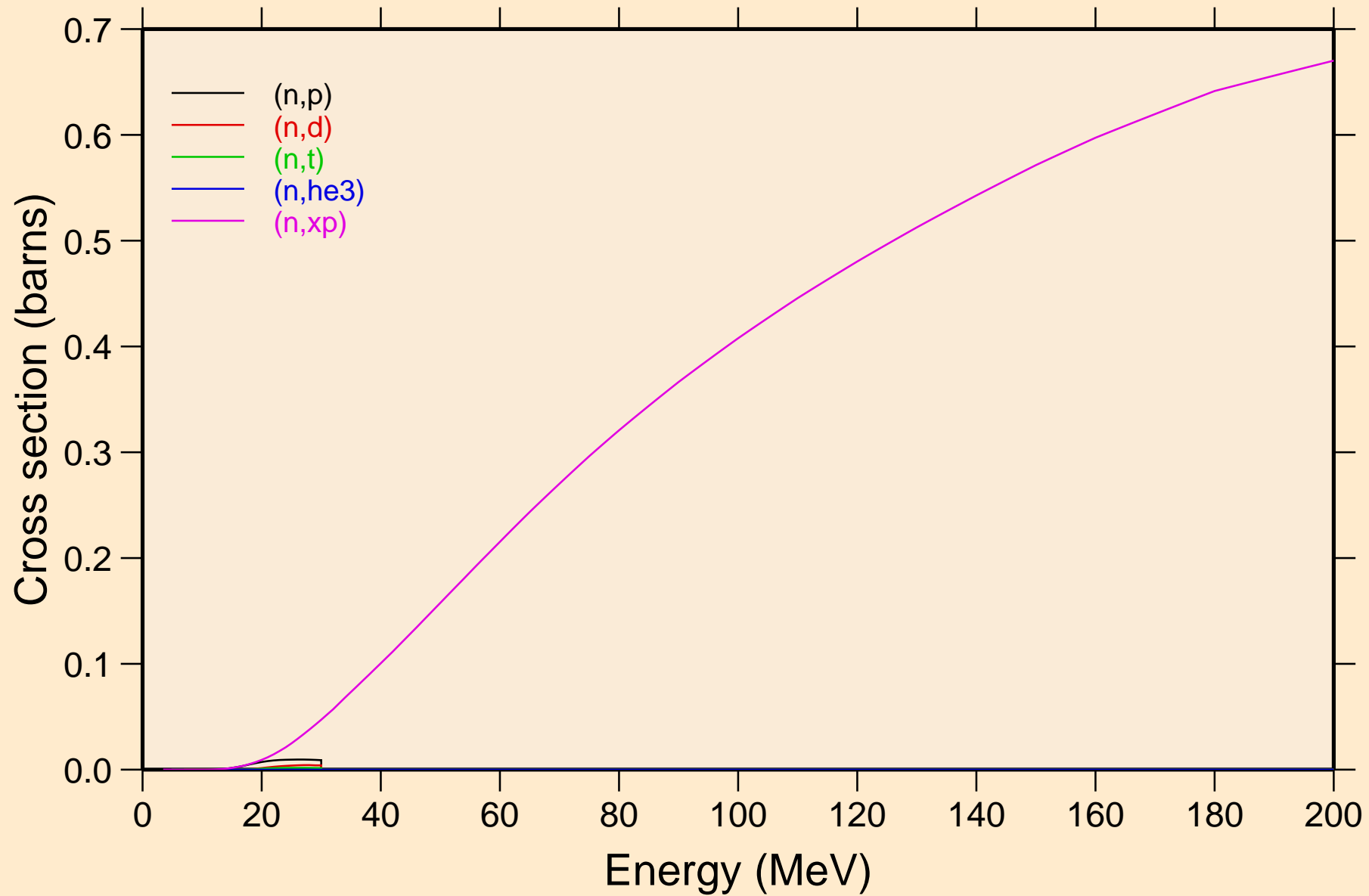

TA194 NEUTRON ACER TENDL-2023 LIBRARY; T=0.K
Threshold reactions

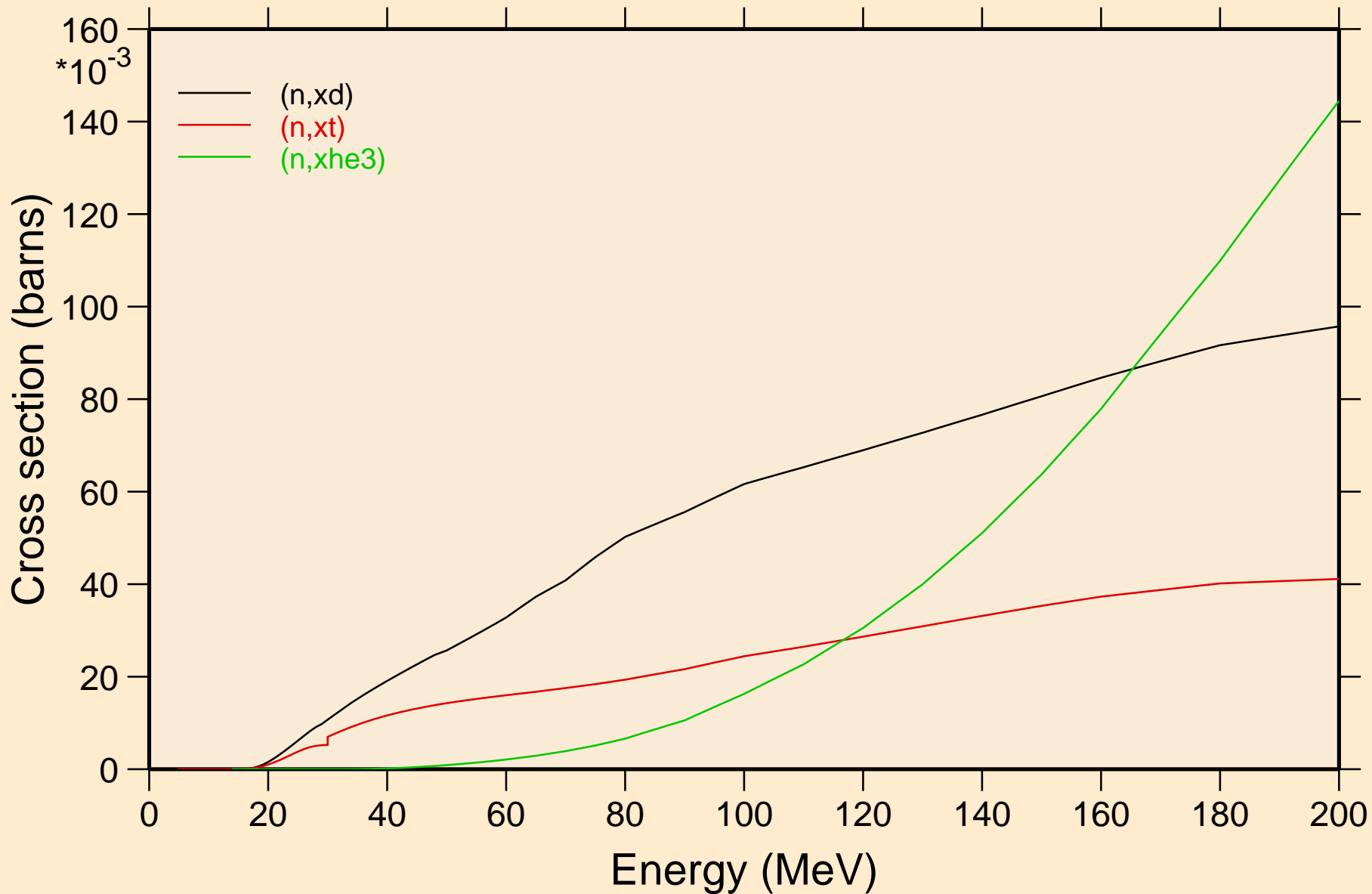

TA194 NEUTRON ACER TENDL-2023 LIBRARY; T=0.K
angular distribution for elastic

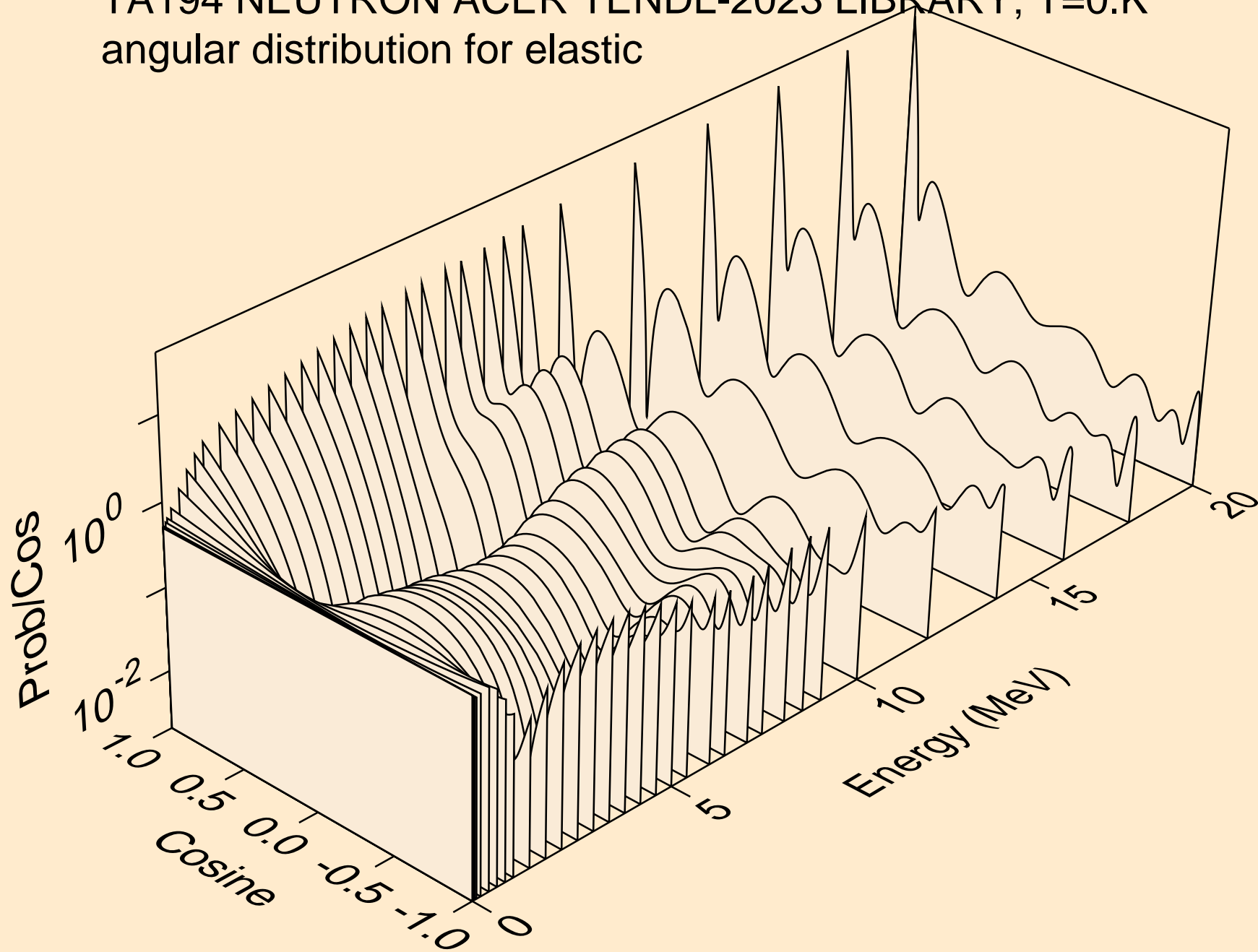

TA194 NEUTRON ACER TENDL-2023 LIBRARY; T=0.K
angular distribution for elastic

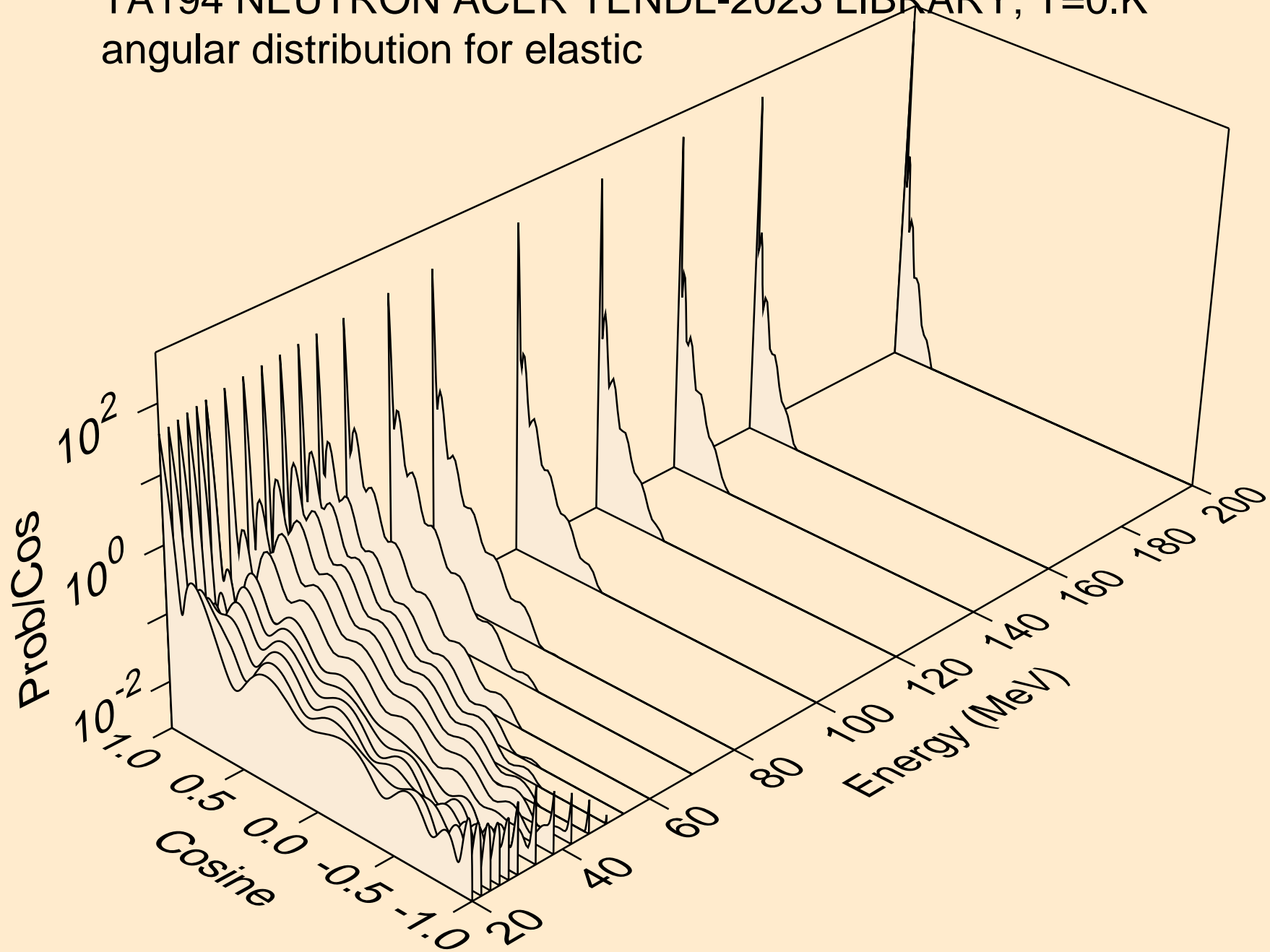

TA194 NEUTRON ACER TENDL-2023 LIBRARY; T=0.K
angular distribution for (n,n*1)

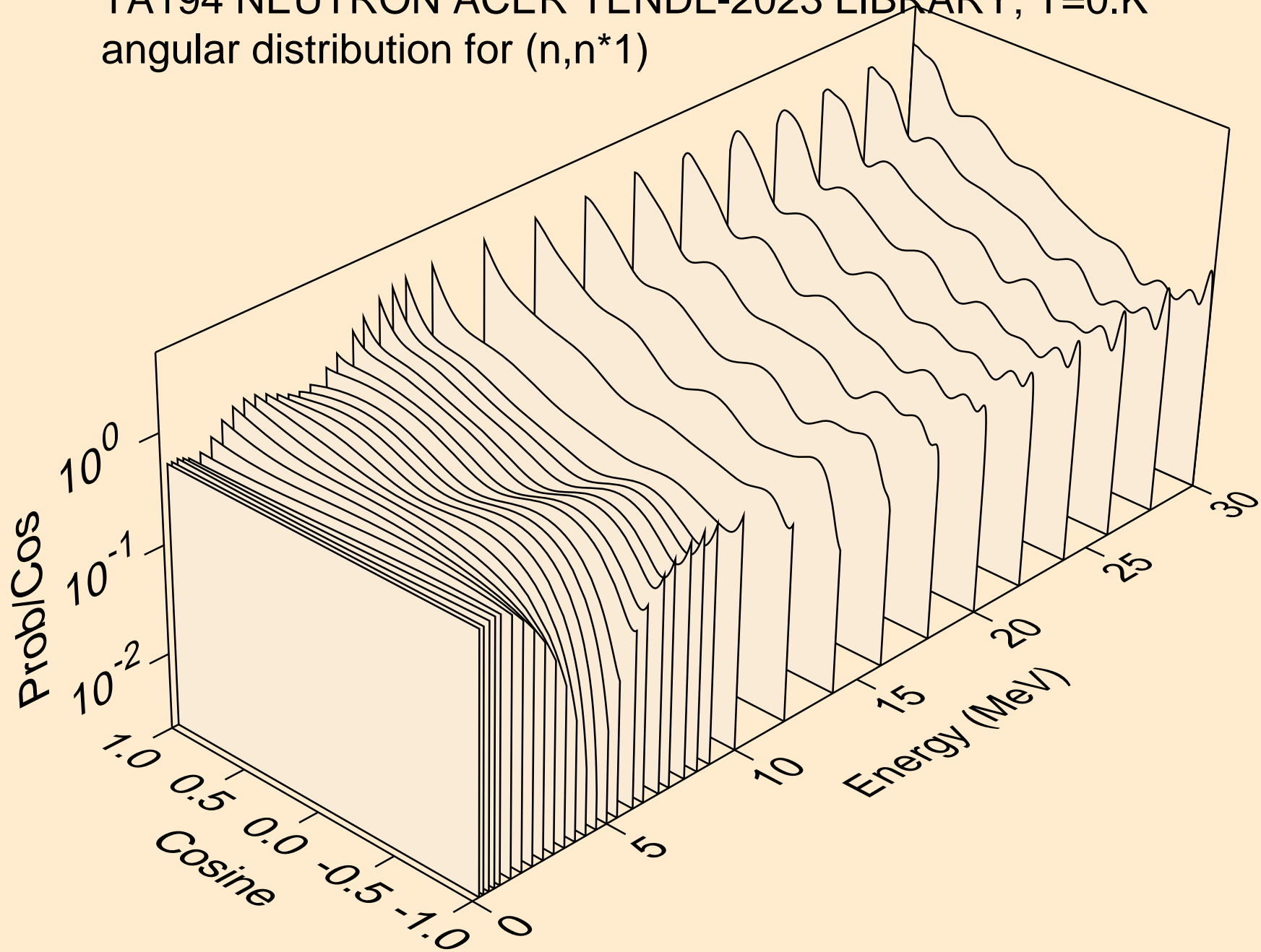

TA194 NEUTRON ACER TENDL-2023 LIBRARY; T=0.K
angular distribution for (n,n*2)

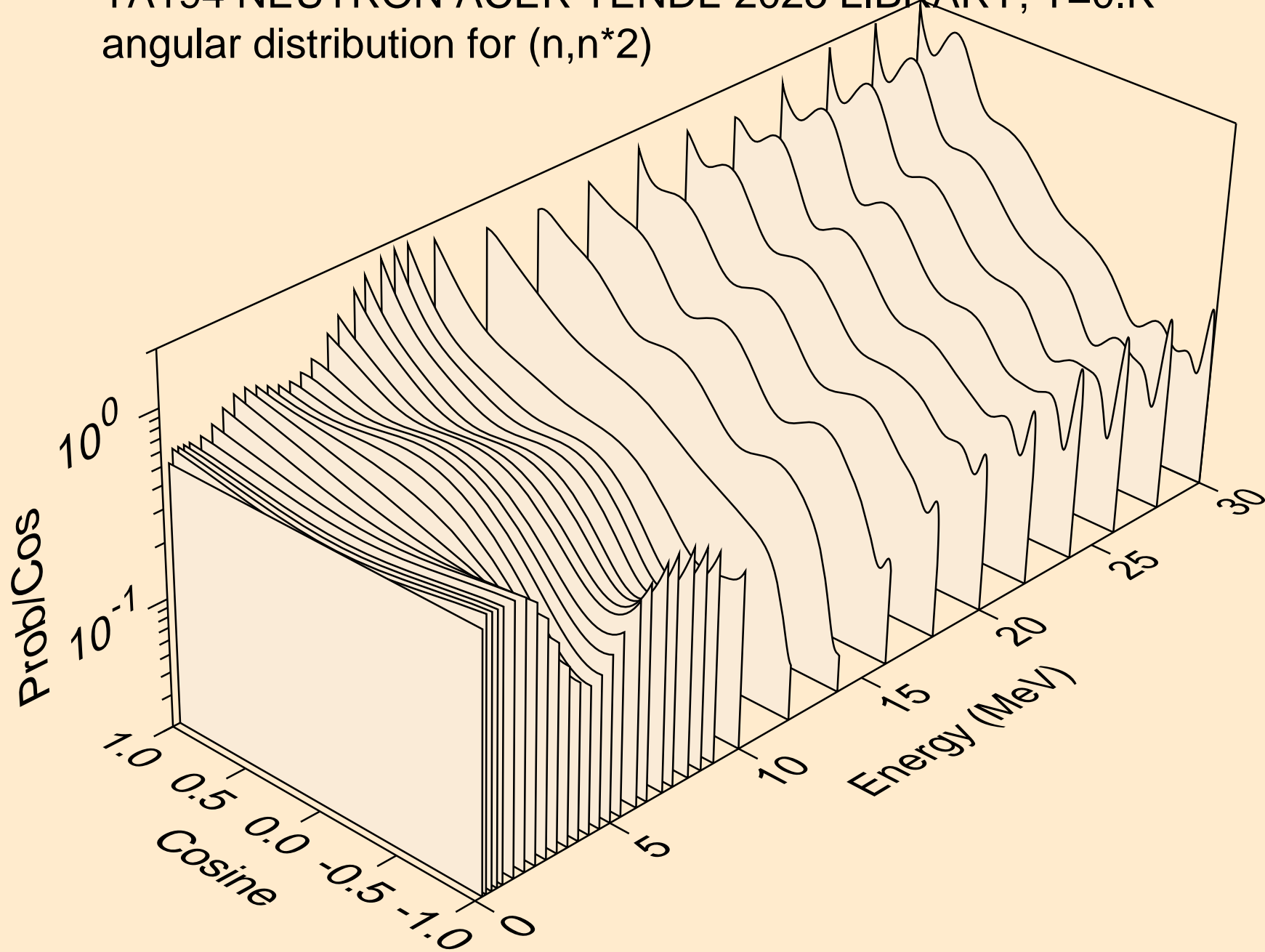

TA194 NEUTRON ACER TENDL-2023 LIBRARY; T=0.K
angular distribution for (n,n*3)

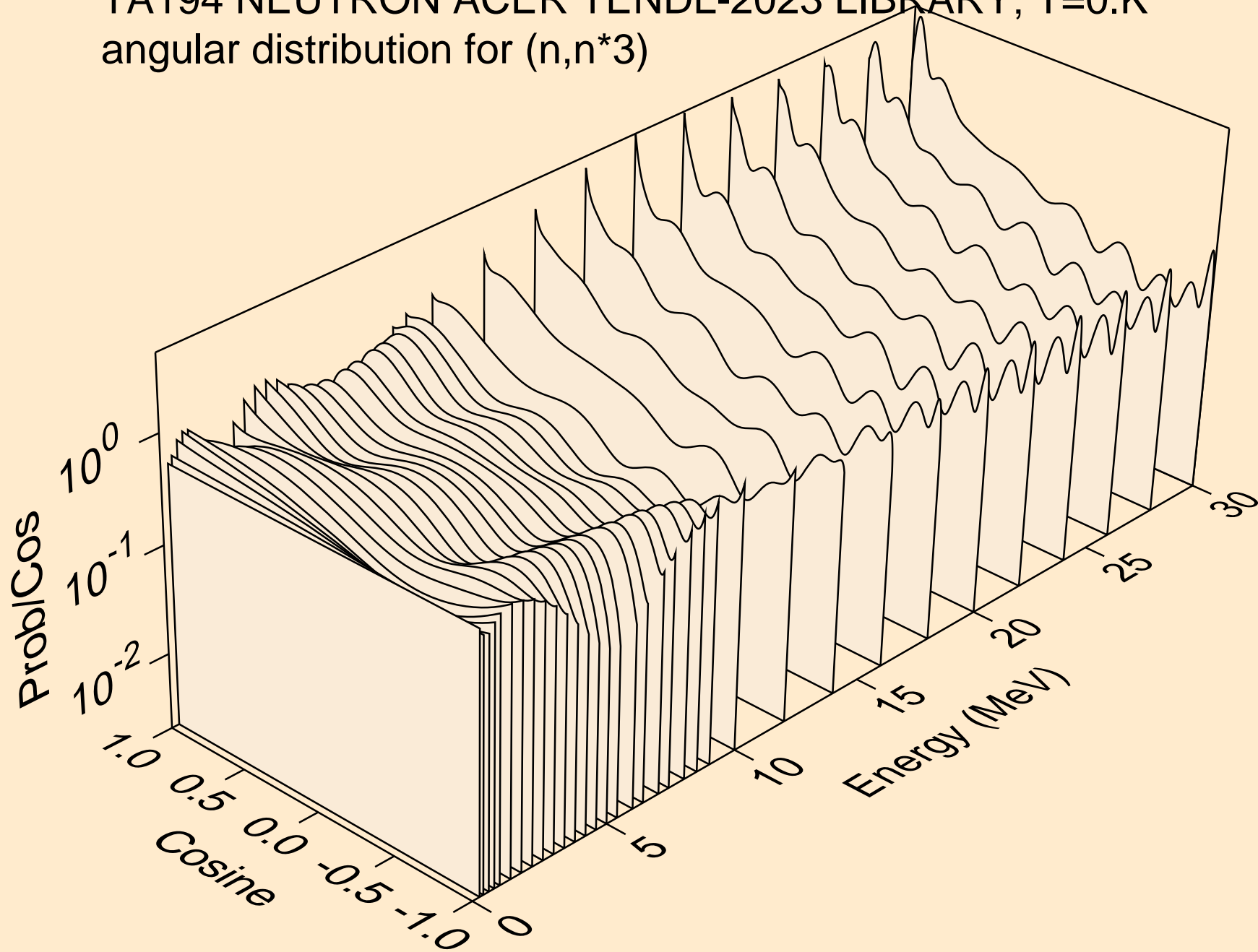

TA194 NEUTRON ACER TENDL-2023 LIBRARY; T=0.K
angular distribution for (n,n*4)

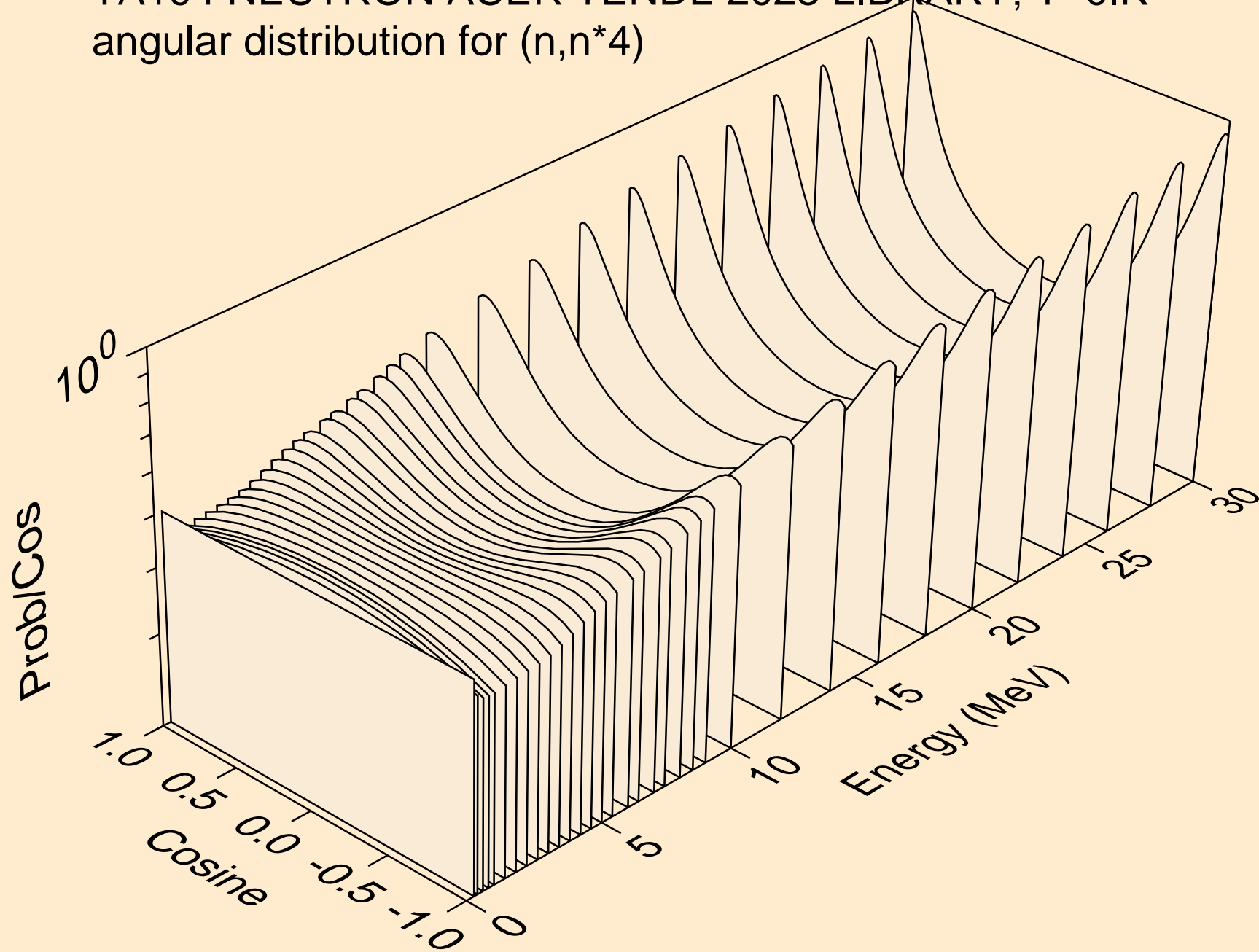

TA194 NEUTRON ACER TENDL-2023 LIBRARY; T=0.K
angular distribution for (n,n*5)

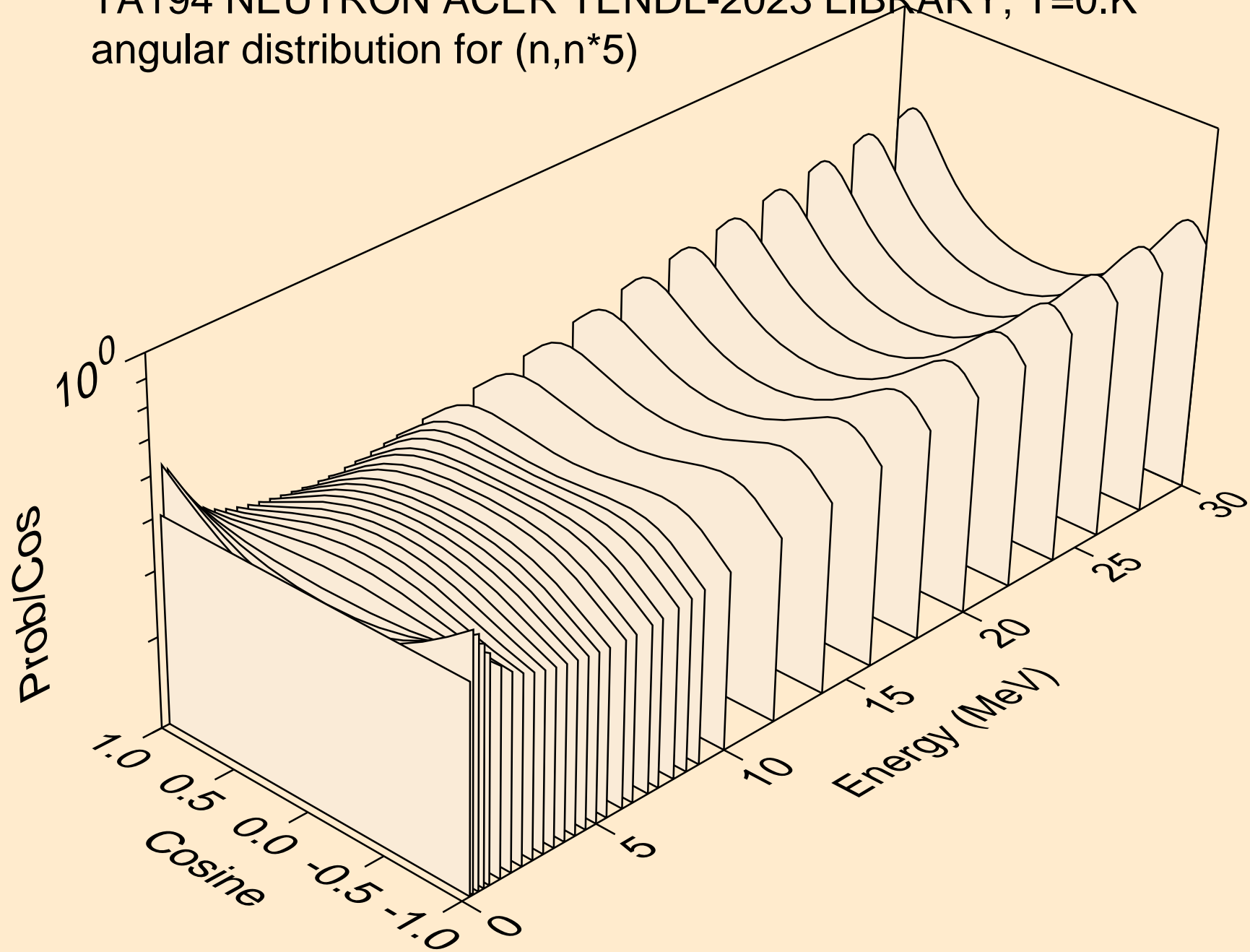

TA194 NEUTRON ACER TENDL-2023 LIBRARY; T=0.K
angular distribution for (n,n*6)

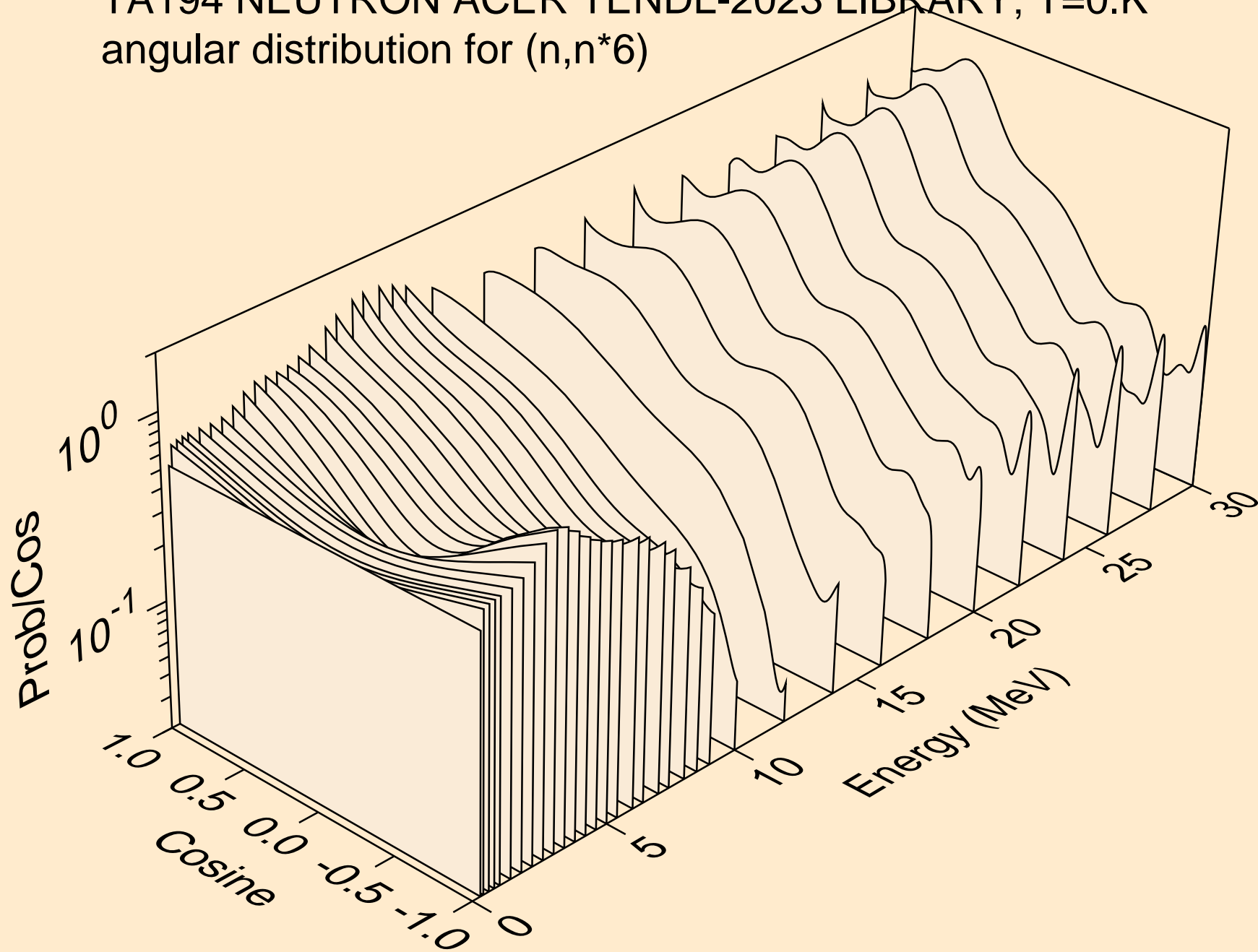

TA194 NEUTRON ACER TENDL-2023 LIBRARY; T=0.K
angular distribution for (n,n*7)

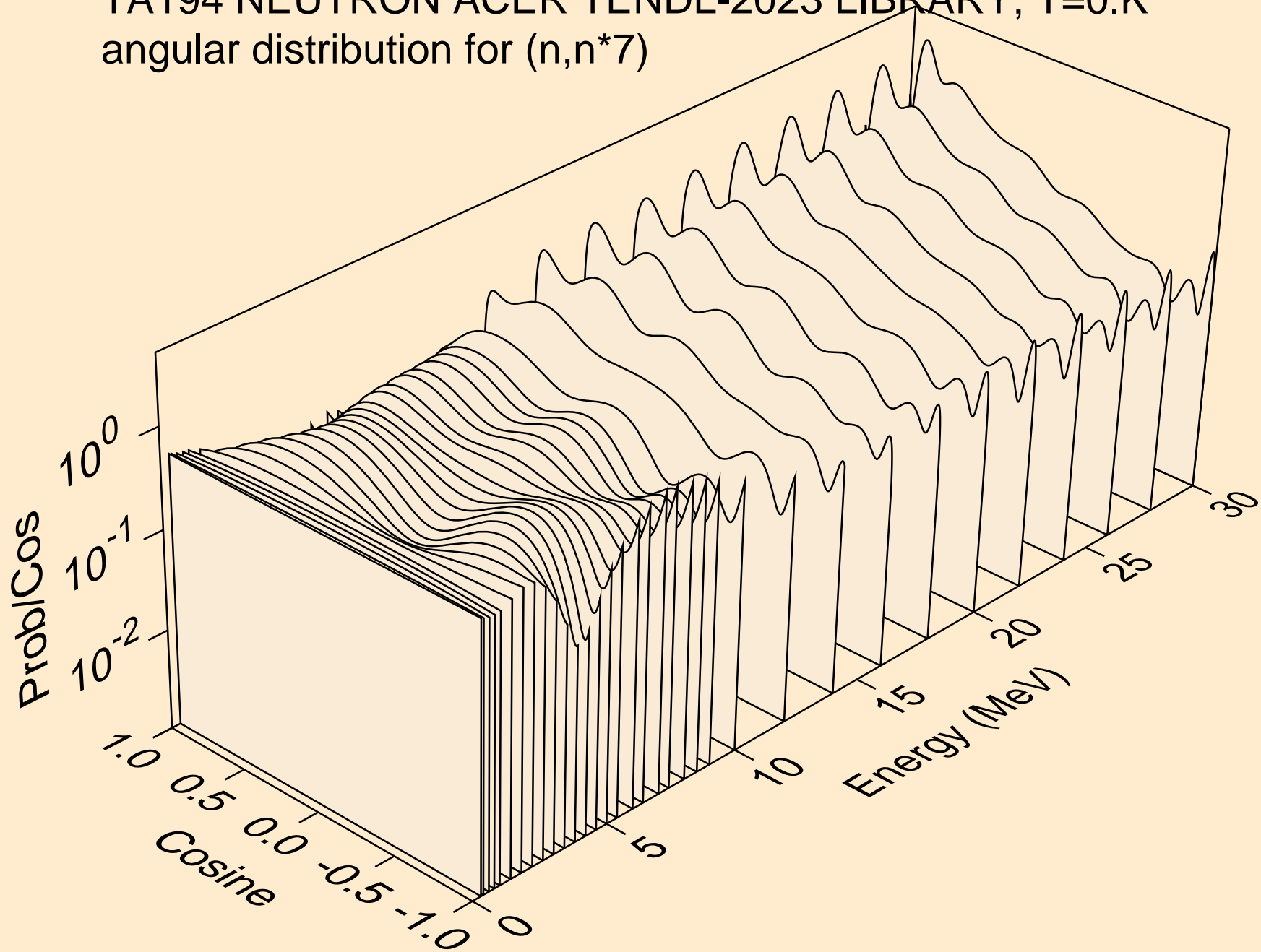

TA194 NEUTRON ACER TENDL-2023 LIBRARY; T=0.K
angular distribution for (n,n*8)

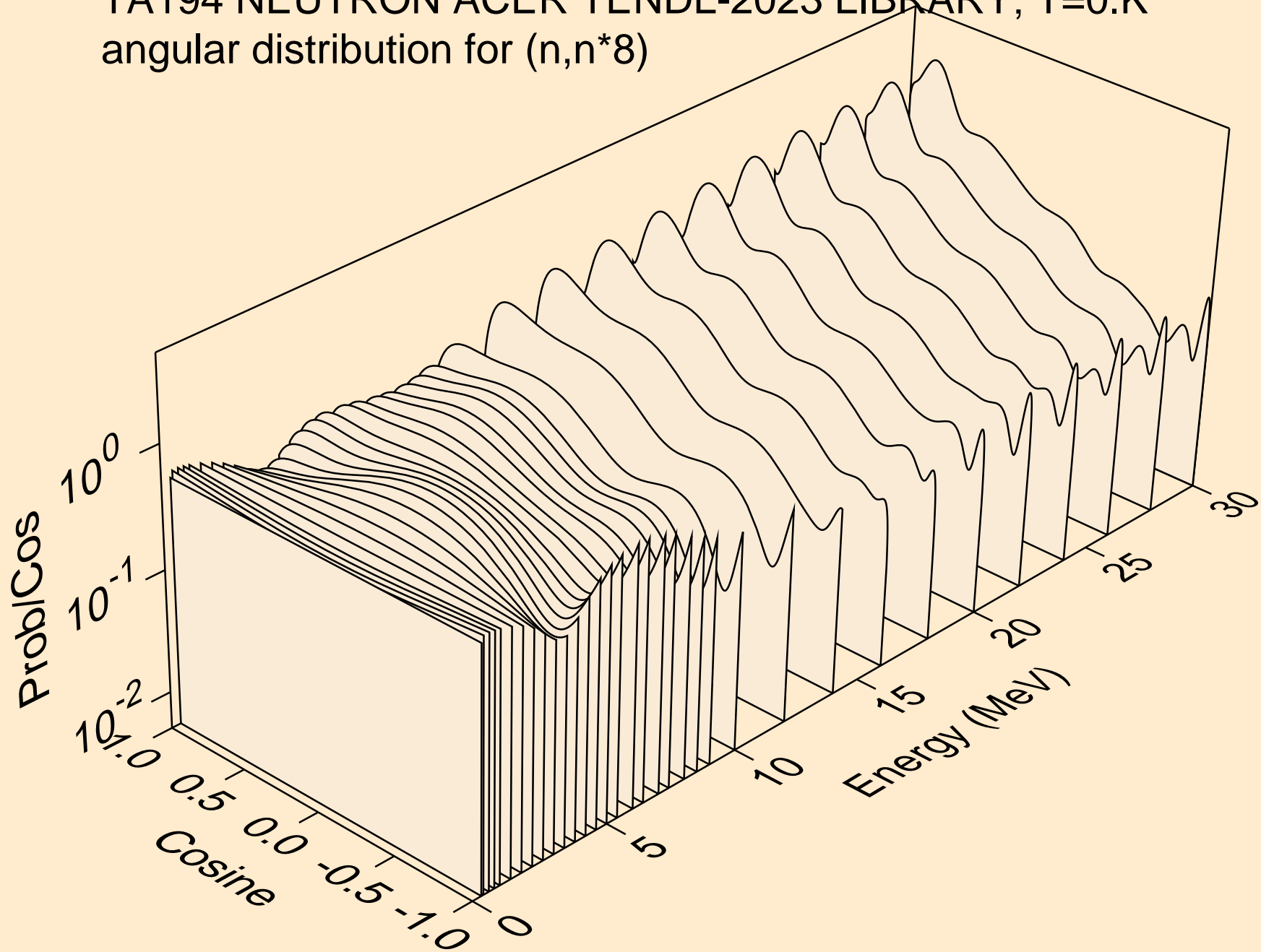

TA194 NEUTRON ACER TENDL-2023 LIBRARY; T=0.K
angular distribution for (n,n*9)

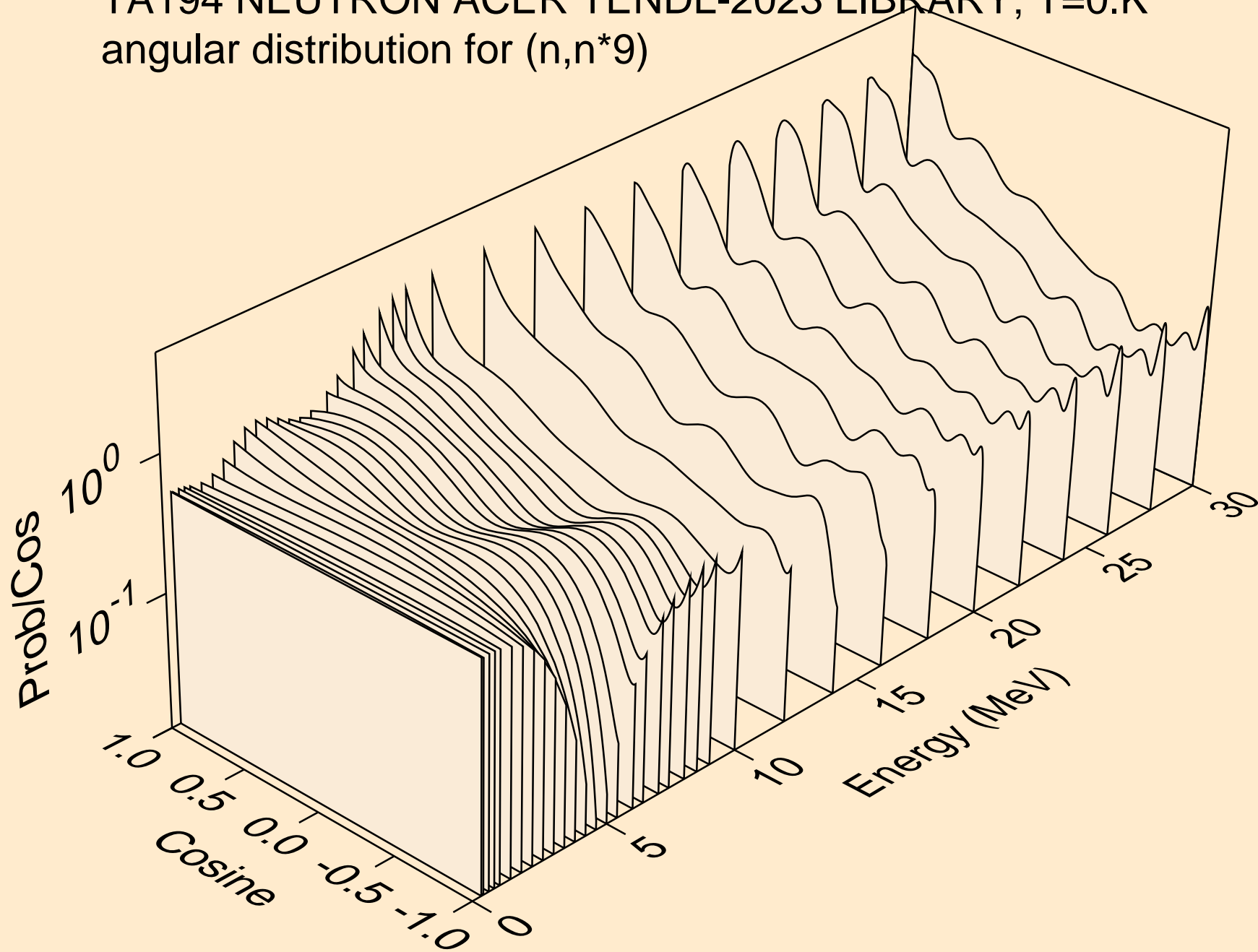

TA194 NEUTRON ACER TENDL-2023 LIBRARY; T=0.K
angular distribution for (n,n*10)

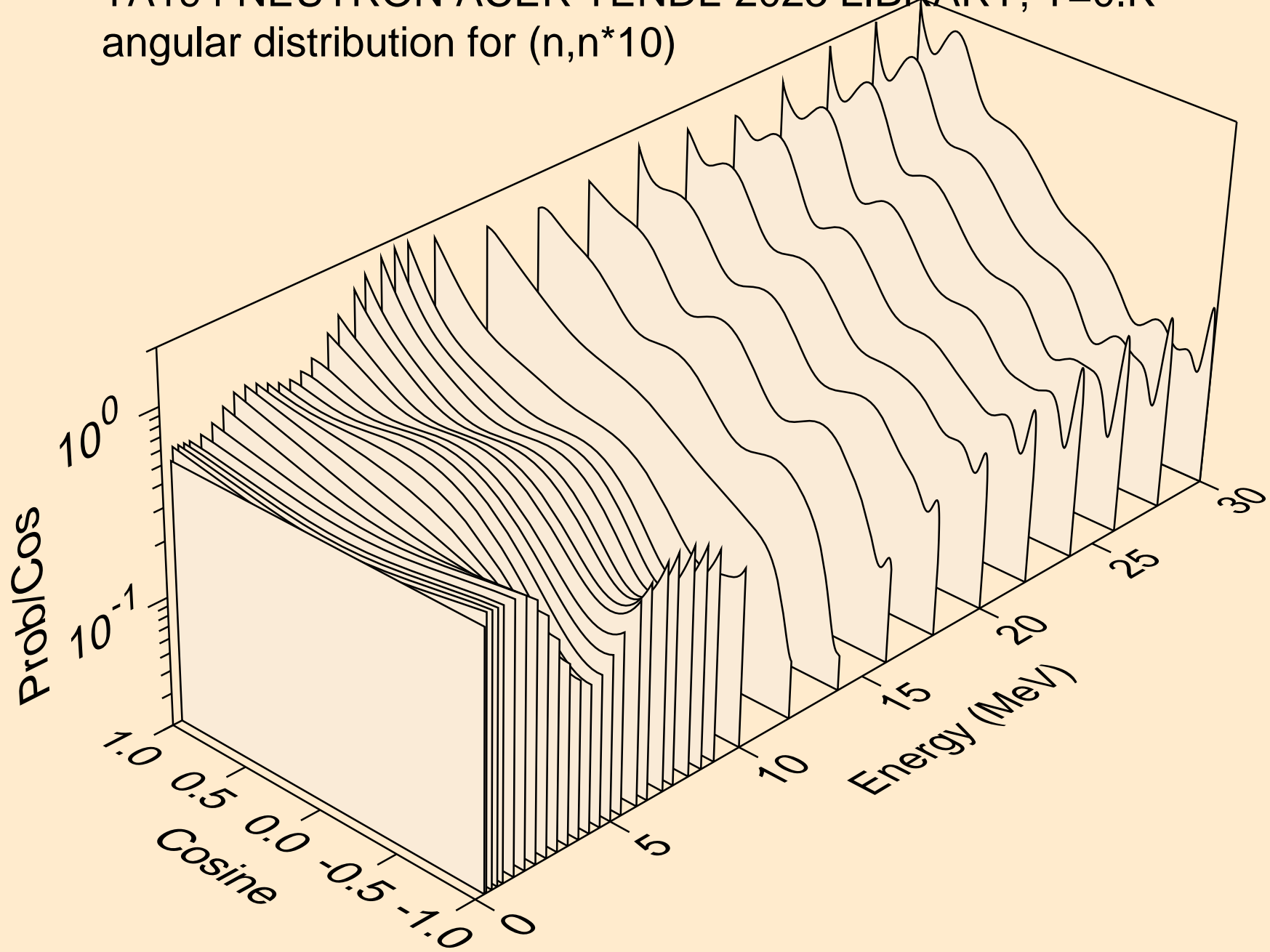

TA194 NEUTRON ACER TENDL-2023 LIBRARY; T=0.K
angular distribution for (n,n*11)

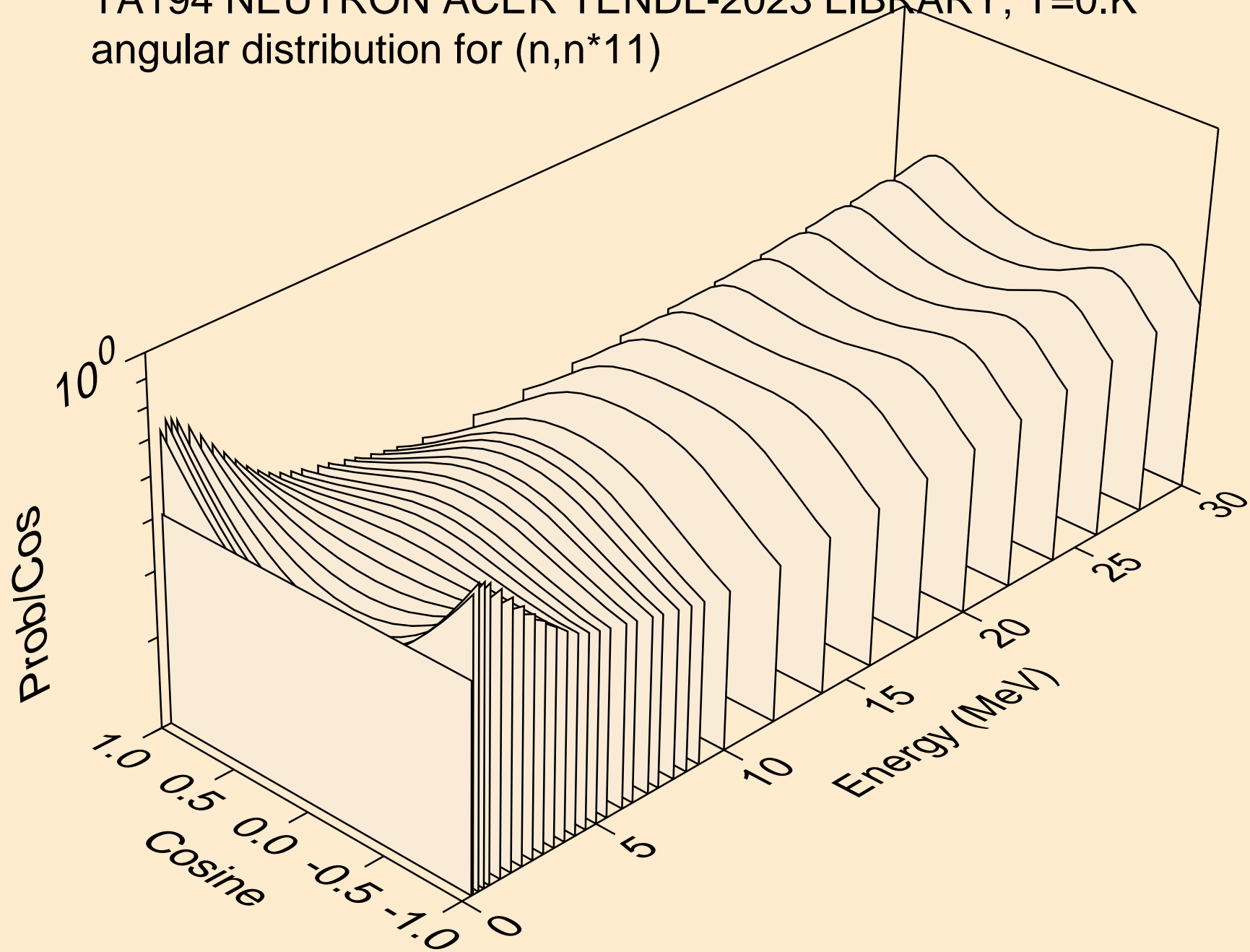

TA194 NEUTRON ACER TENDL-2023 LIBRARY; T=0.K
angular distribution for (n,n*12)

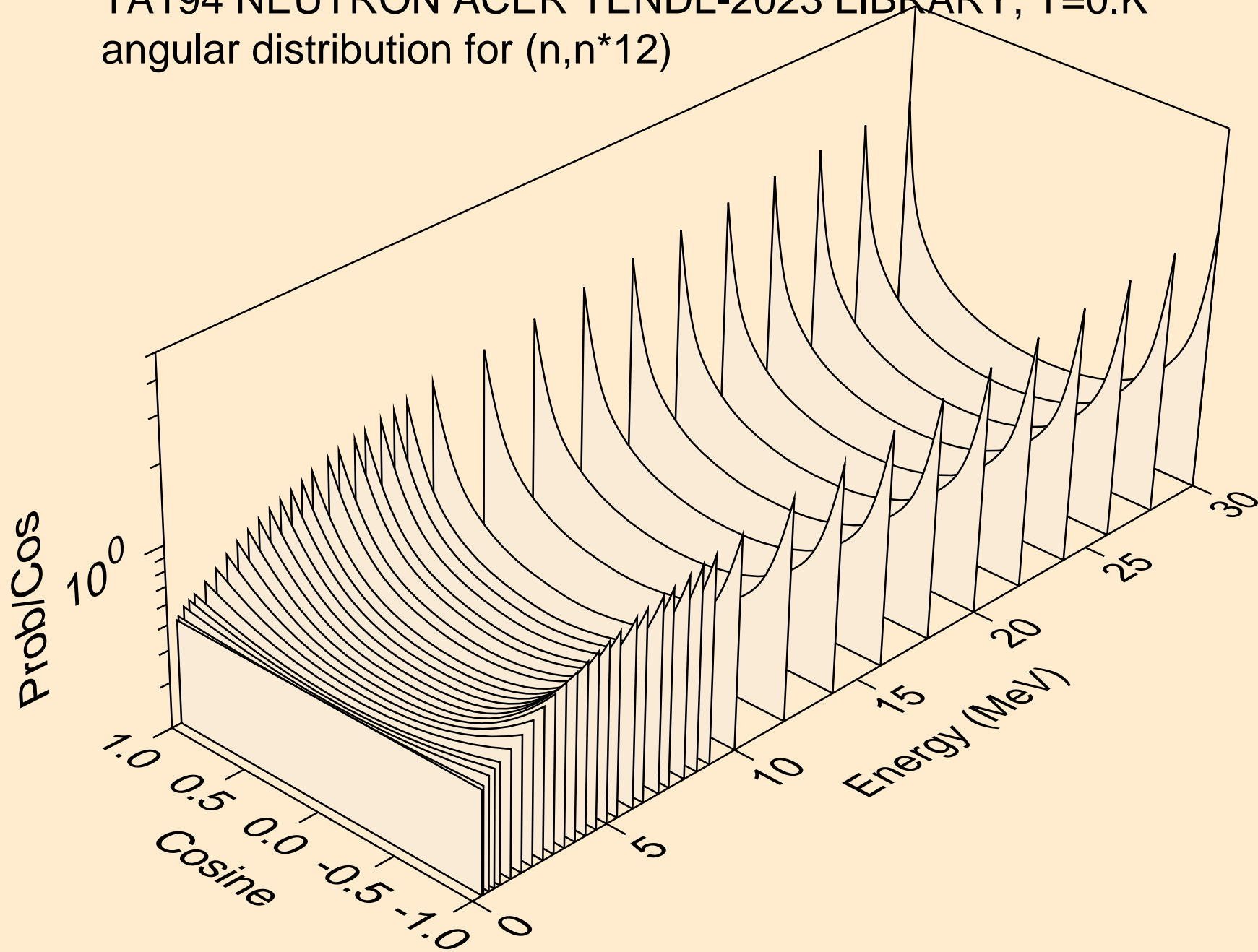

TA194 NEUTRON ACER TENDL-2023 LIBRARY; T=0.K
angular distribution for (n,n*13)

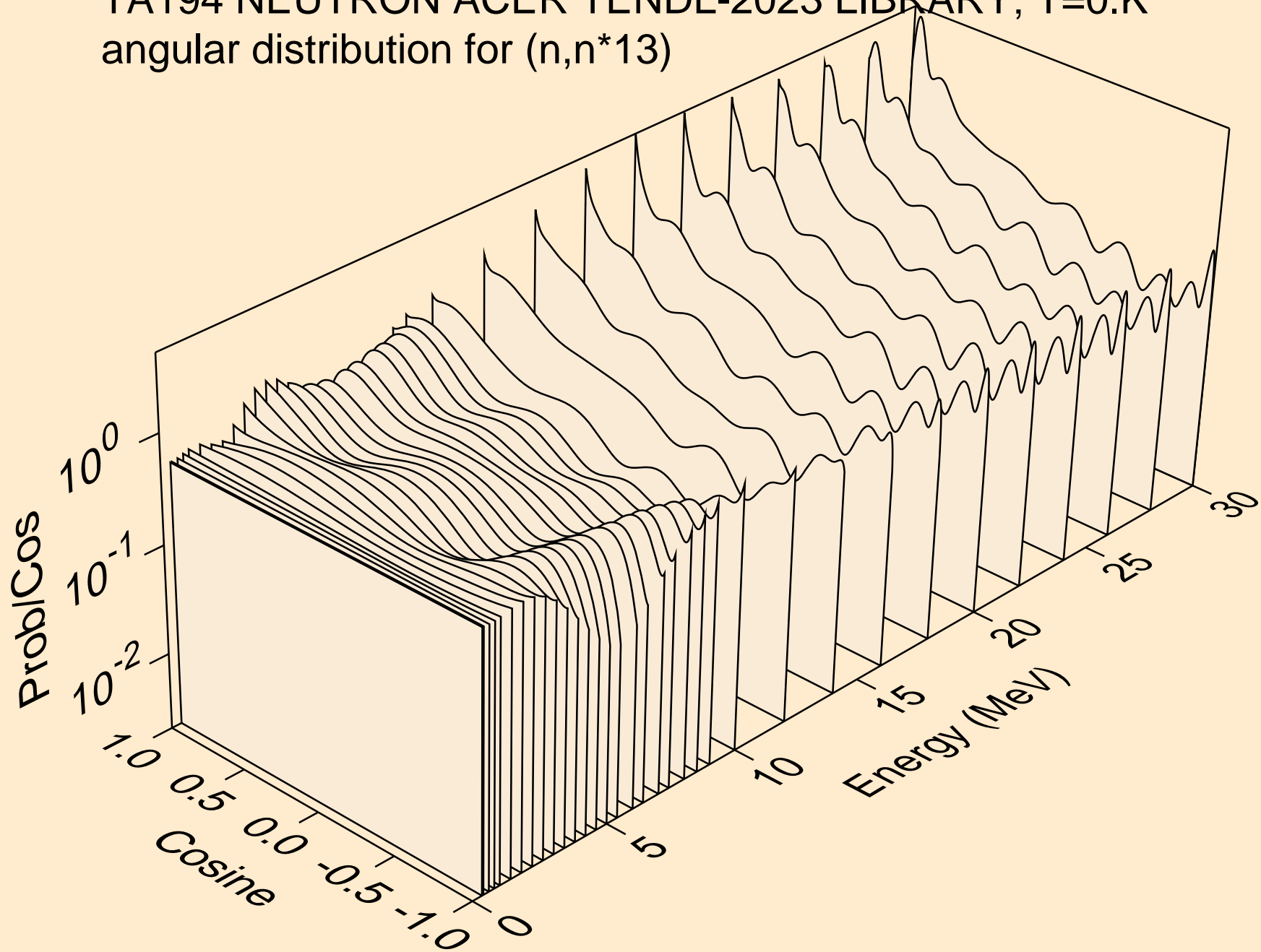

TA194 NEUTRON ACER TENDL-2023 LIBRARY; T=0.K
angular distribution for (n,n*14)

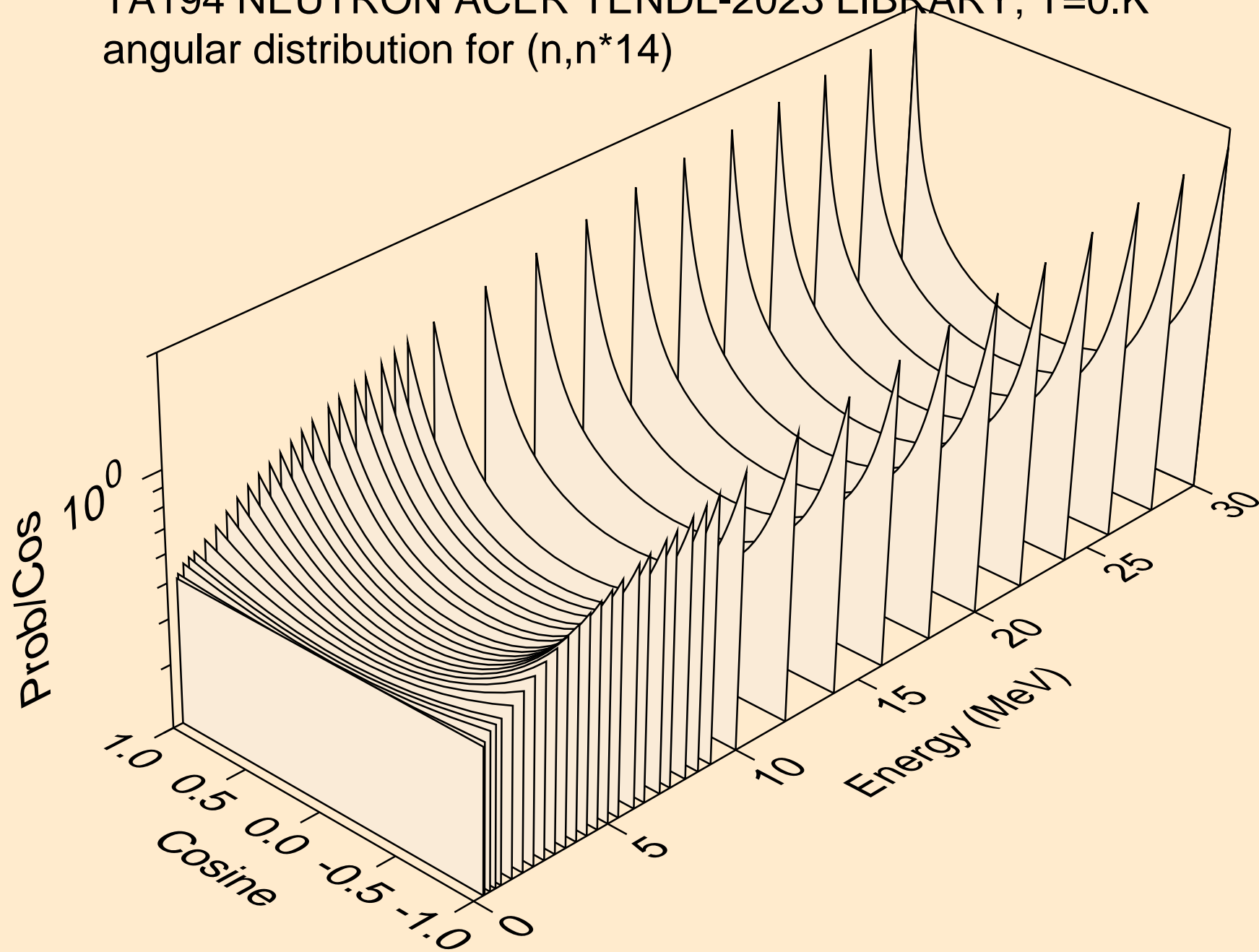

TA194 NEUTRON ACER TENDL-2023 LIBRARY; T=0.K
angular distribution for (n,n*15)

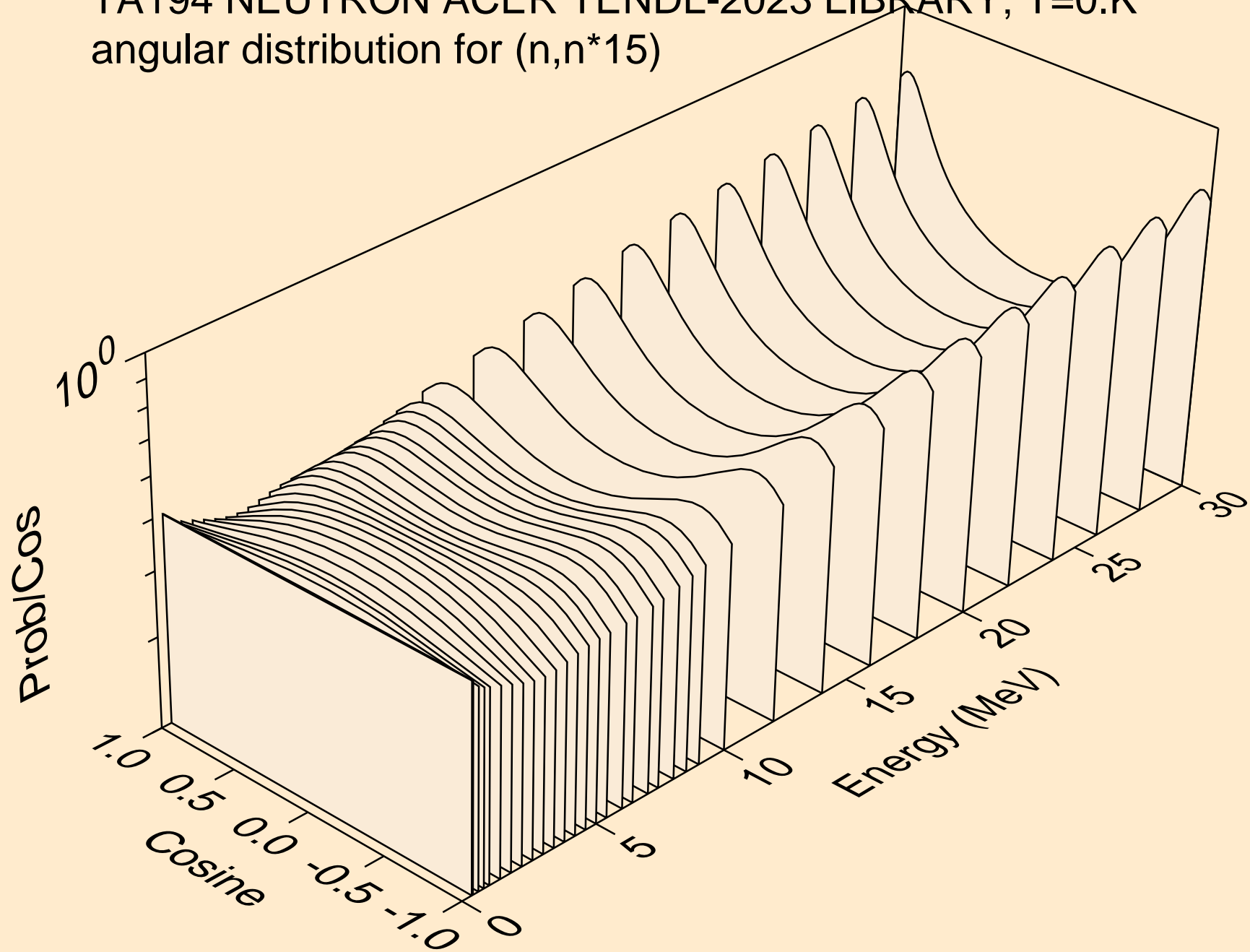

TA194 NEUTRON ACER TENDL-2023 LIBRARY; T=0.K
angular distribution for (n,n*16)

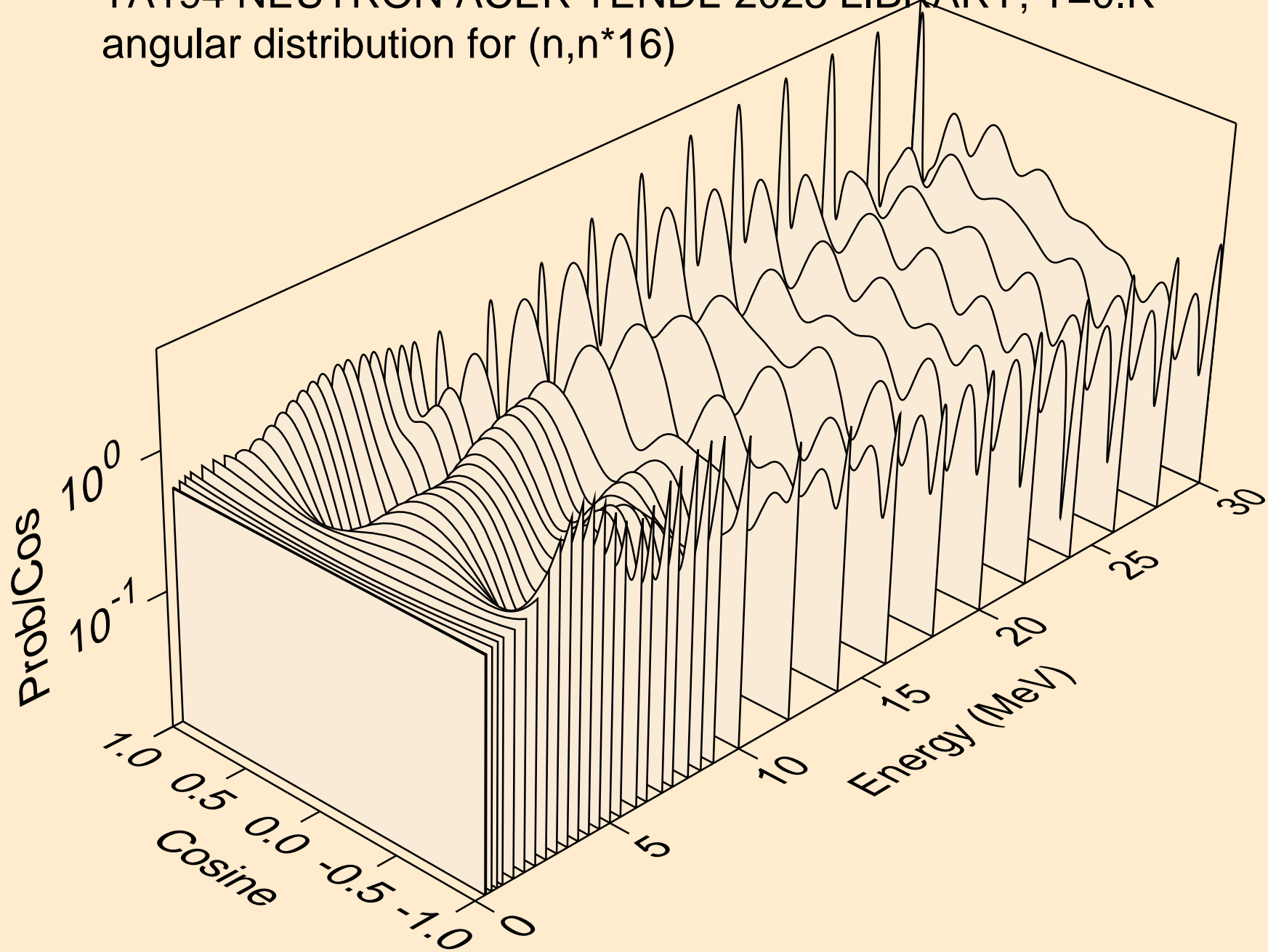

TA194 NEUTRON ACER TENDL-2023 LIBRARY; T=0.K
angular distribution for (n,n*17)

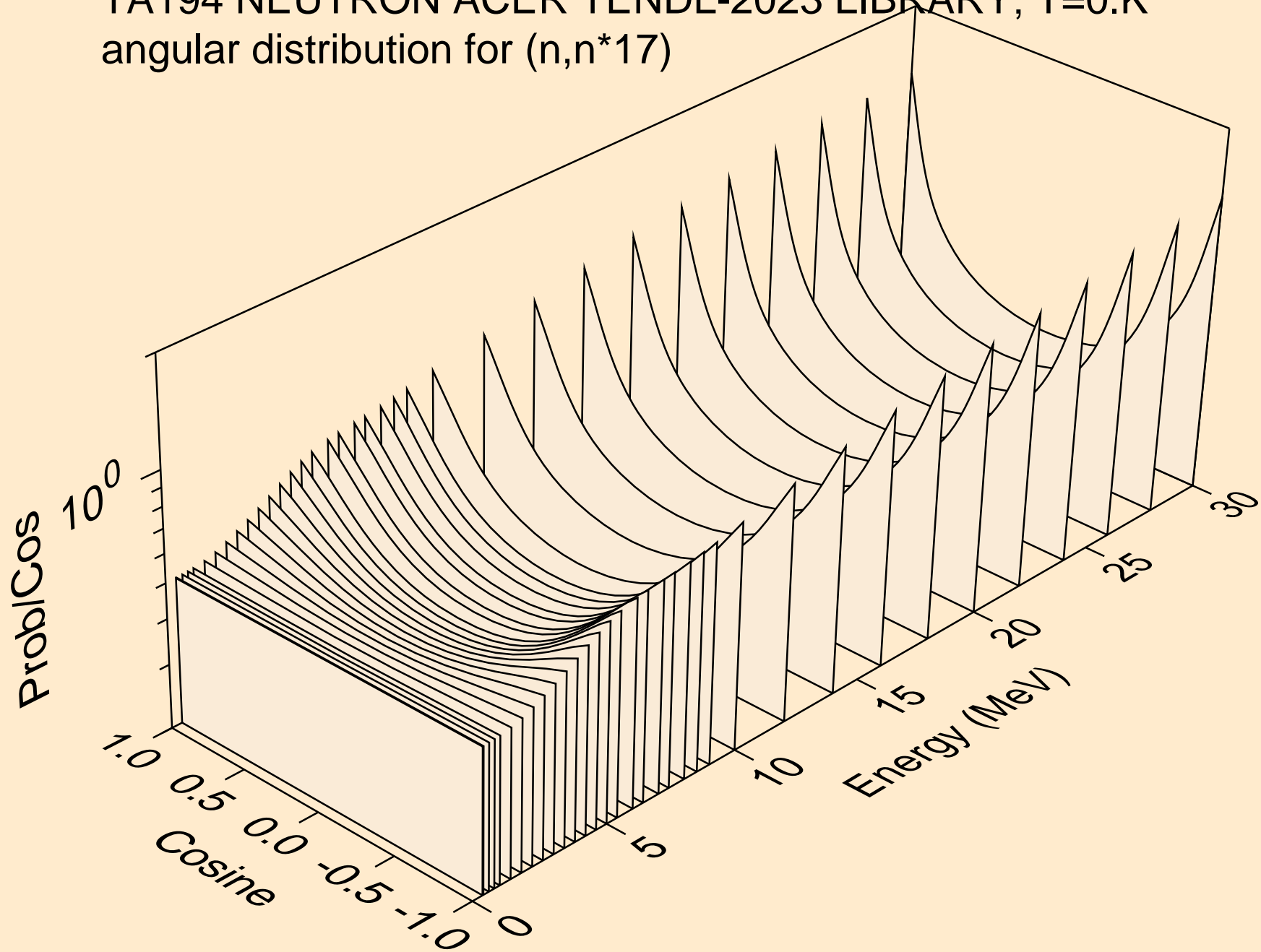

TA194 NEUTRON ACER TENDL-2023 LIBRARY; T=0.K
angular distribution for (n,n*18)

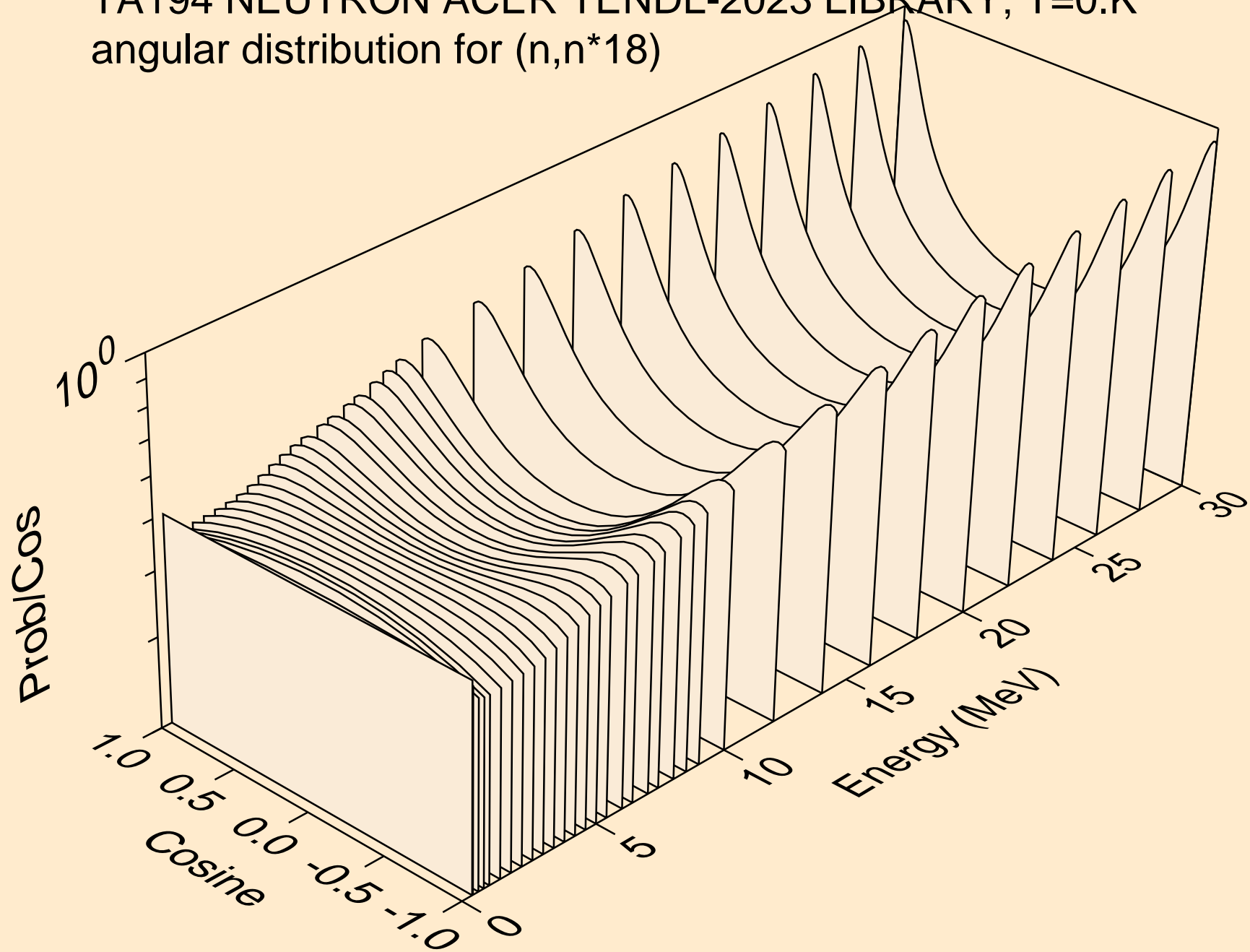

TA194 NEUTRON ACER TENDL-2023 LIBRARY; T=0.K
angular distribution for (n,n*19)

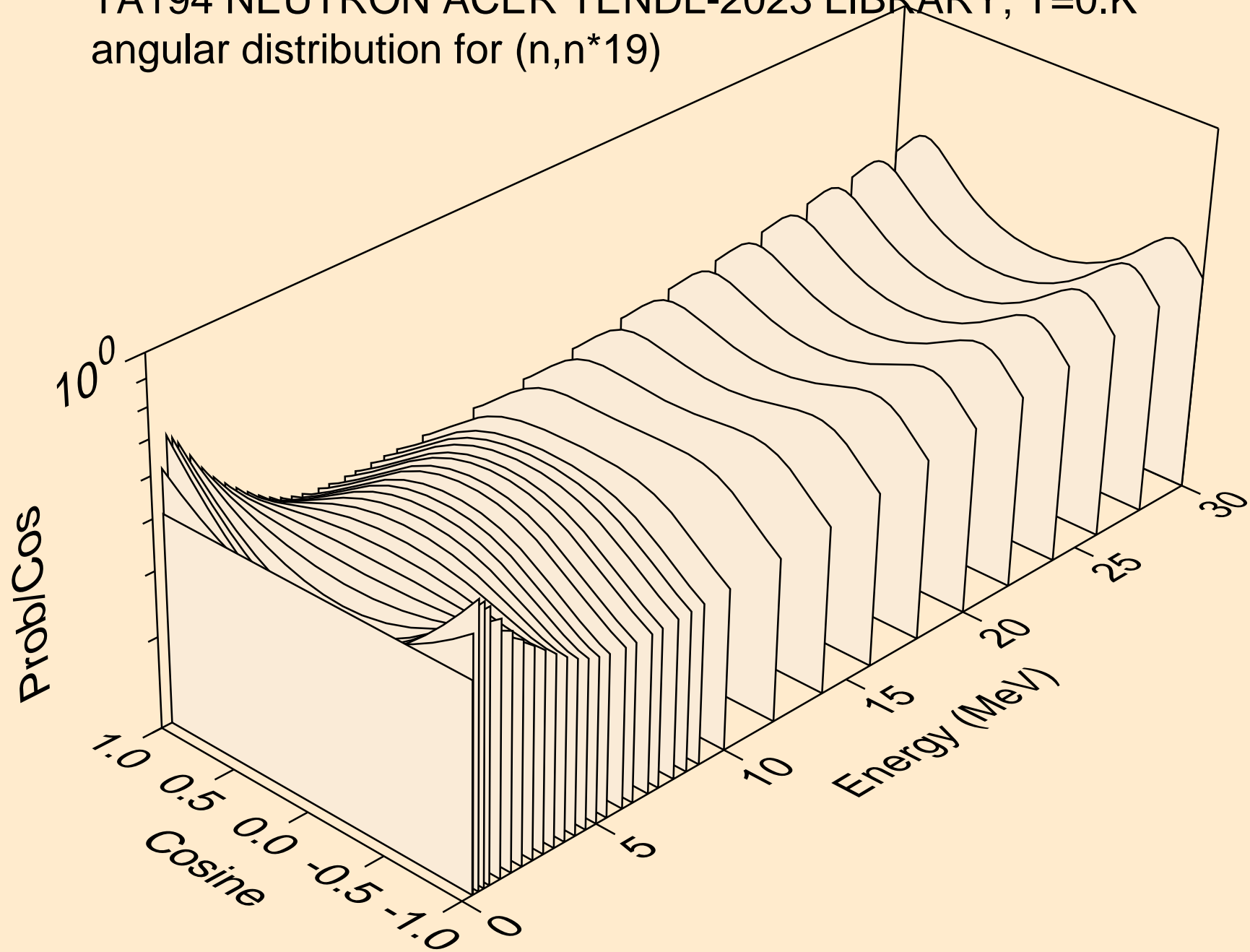

TA194 NEUTRON ACER TENDL-2023 LIBRARY; T=0.K
angular distribution for (n,n*20)

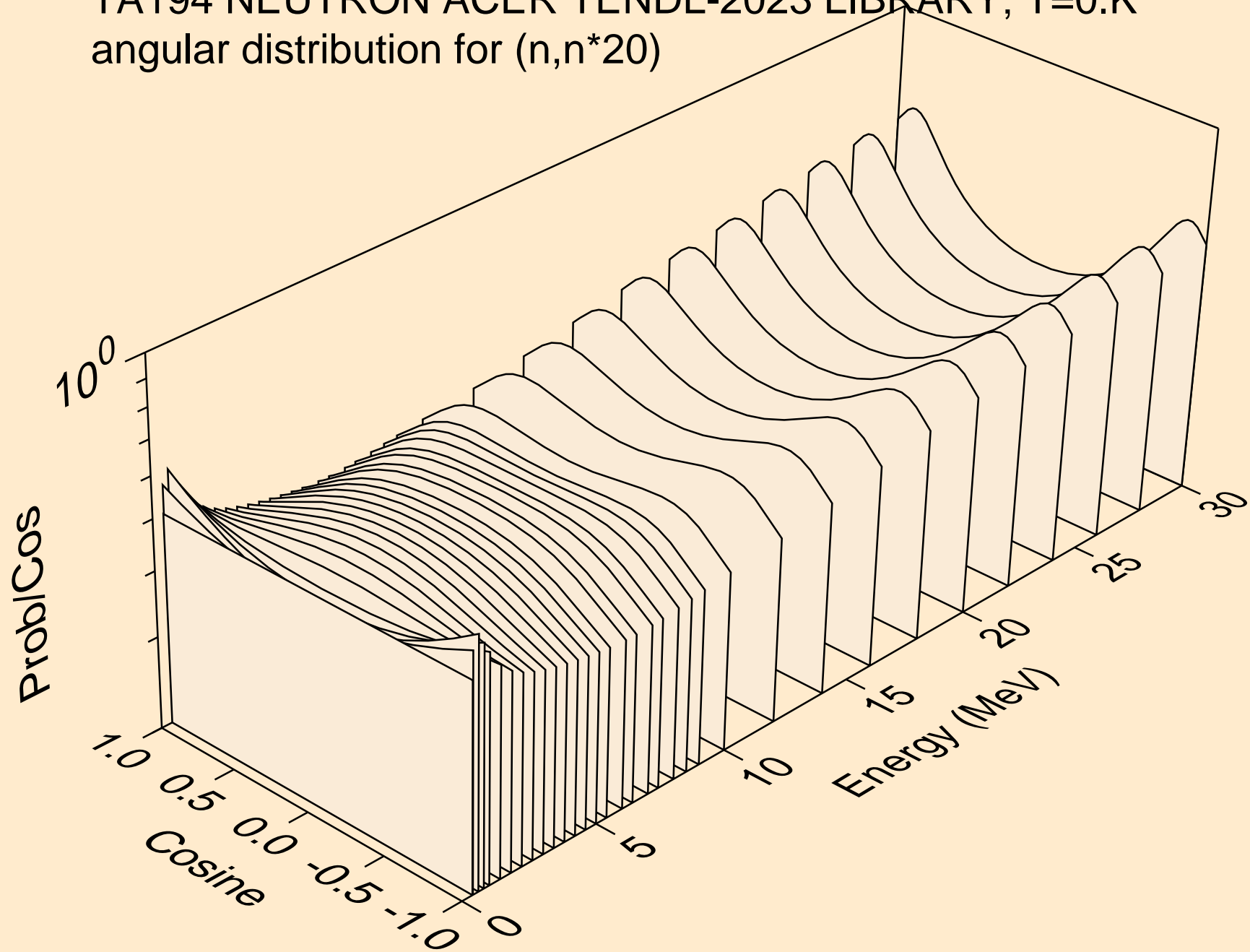

TA194 NEUTRON ACER TENDL-2023 LIBRARY; T=0.K
angular distribution for (n,n*21)

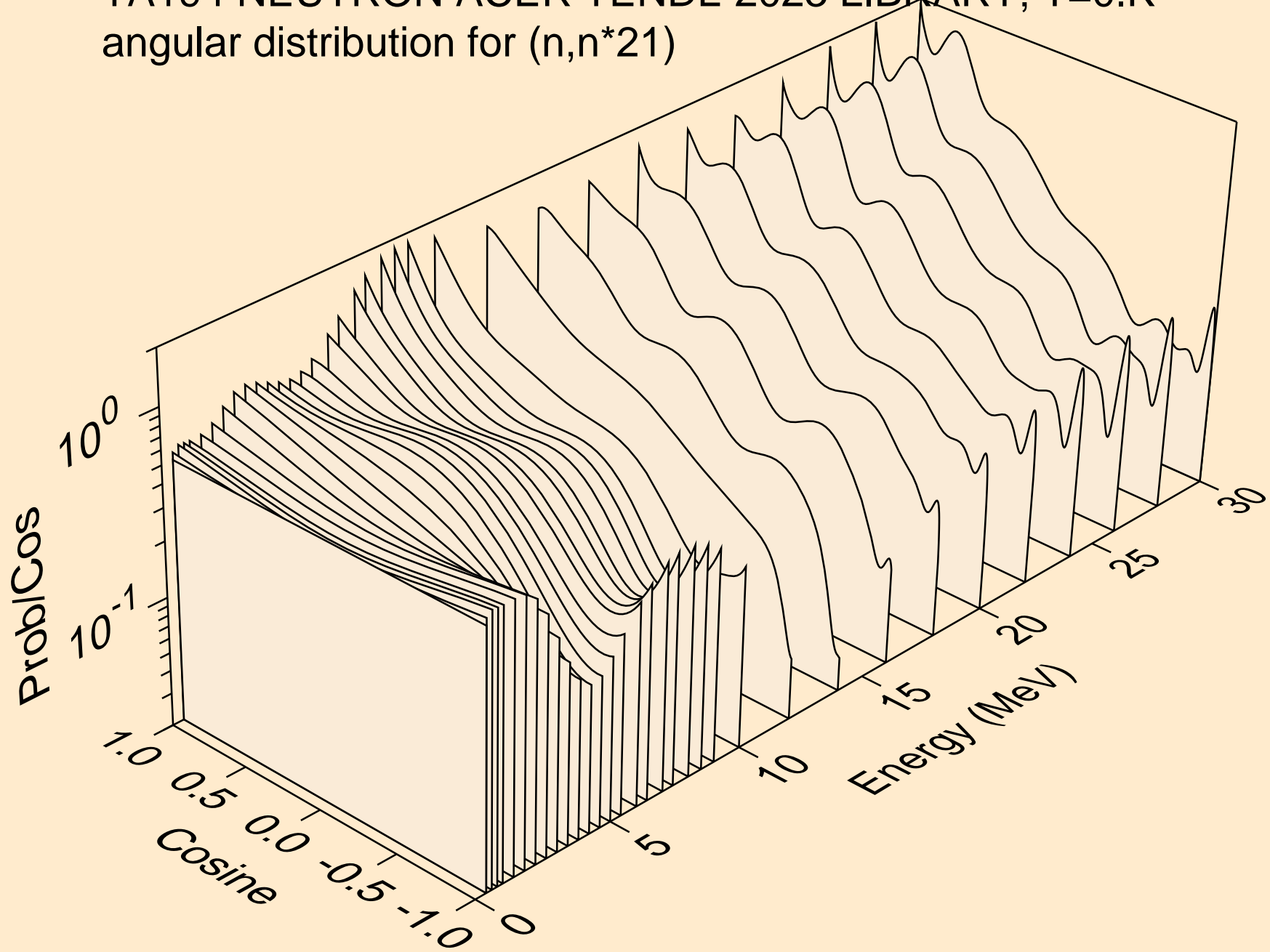

TA194 NEUTRON ACER TENDL-2023 LIBRARY; T=0.K
angular distribution for (n,n*22)

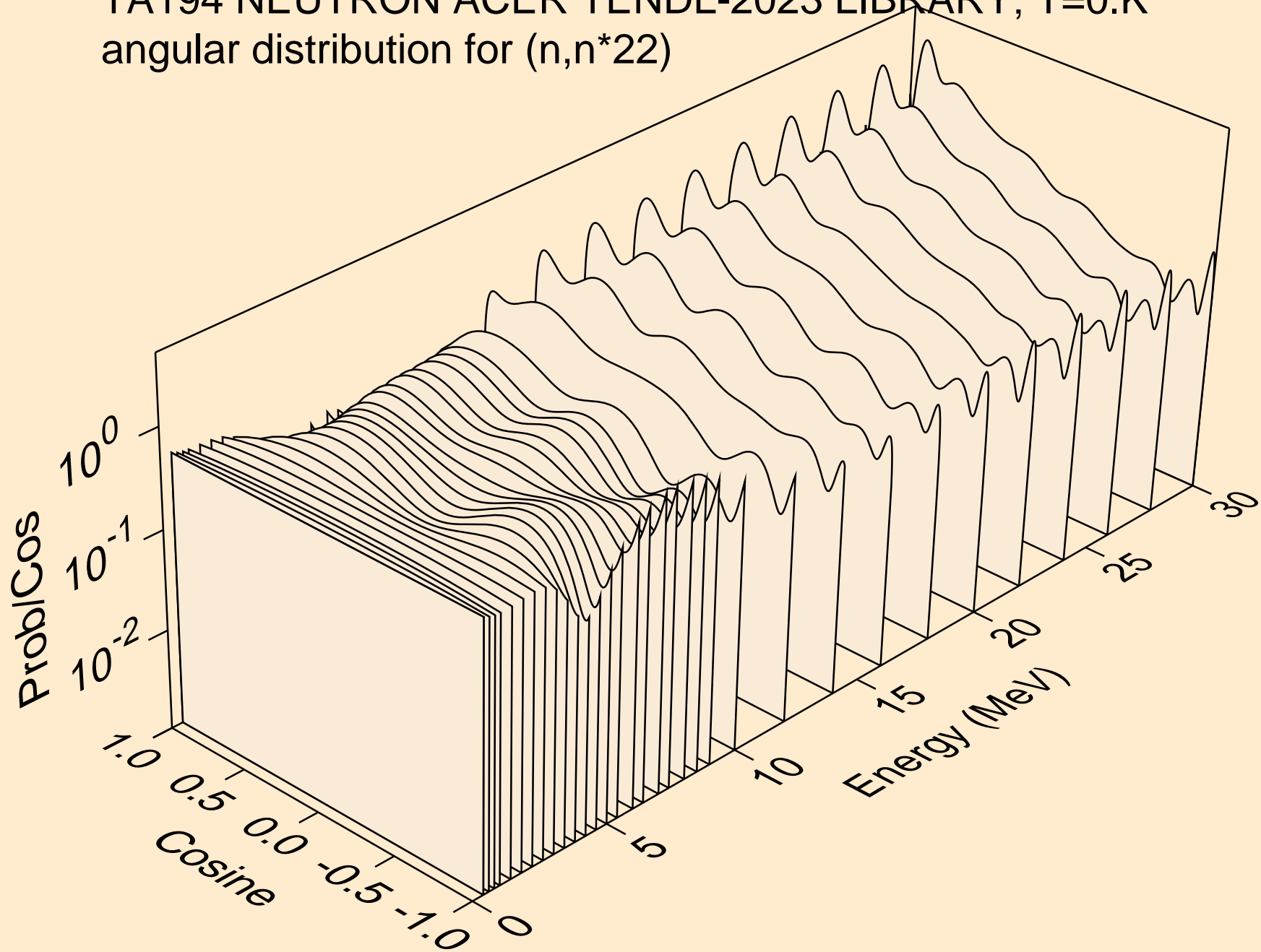

TA194 NEUTRON ACER TENDL-2023 LIBRARY; T=0.K
angular distribution for (n,n*23)

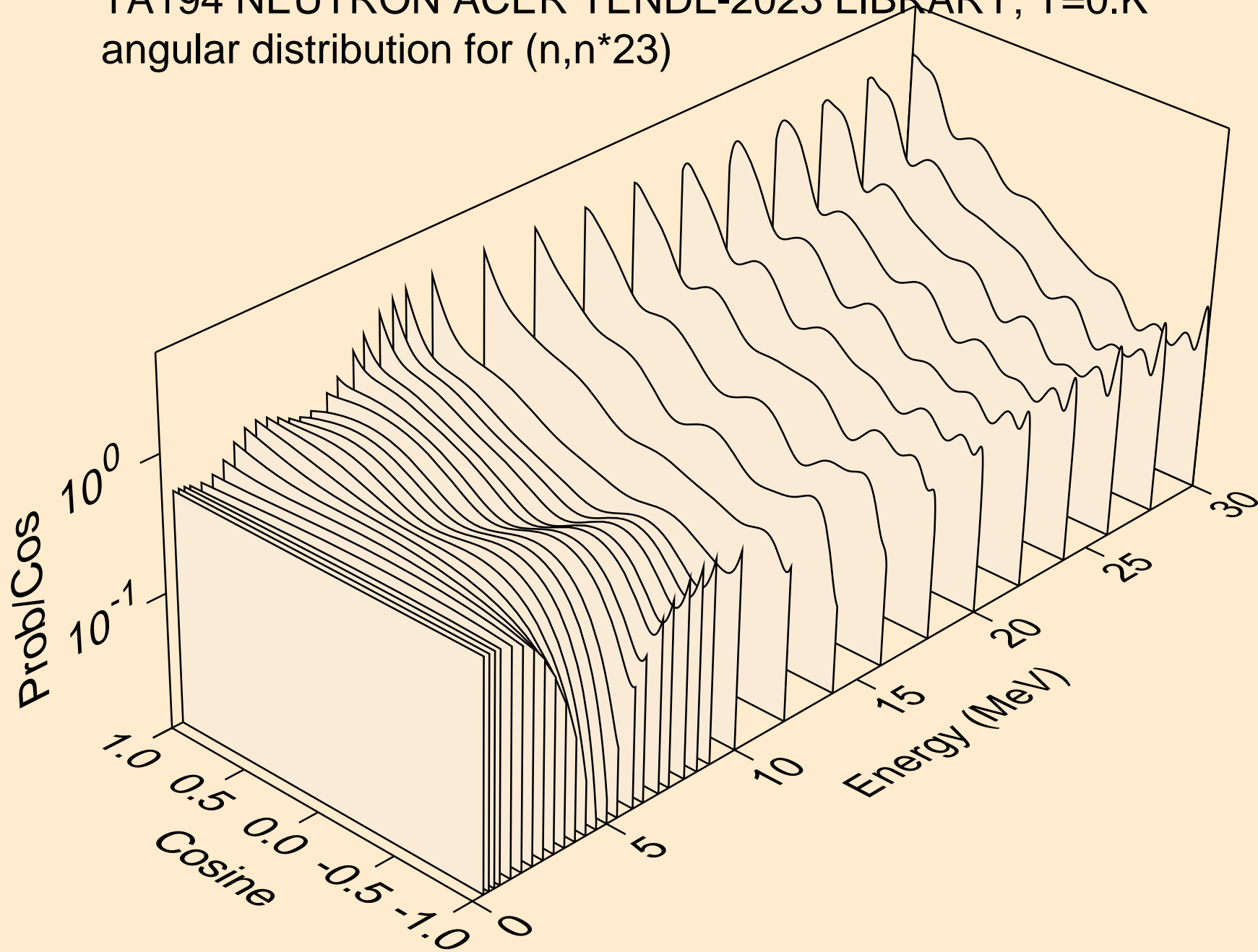

TA194 NEUTRON ACER TENDL-2023 LIBRARY; T=0.K
angular distribution for (n,n*24)

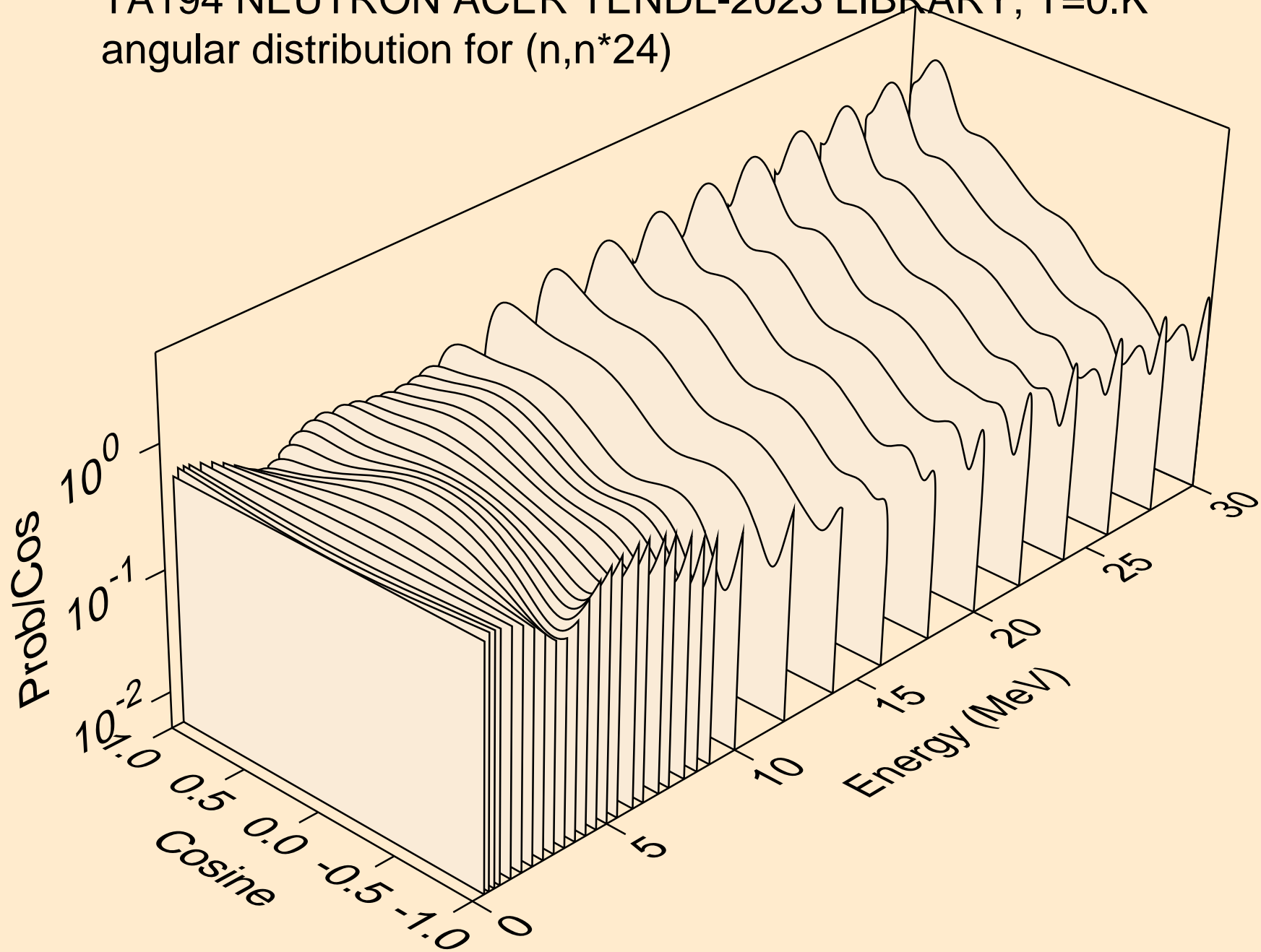

TA194 NEUTRON ACER TENDL-2023 LIBRARY; T=0.K
angular distribution for (n,n*25)

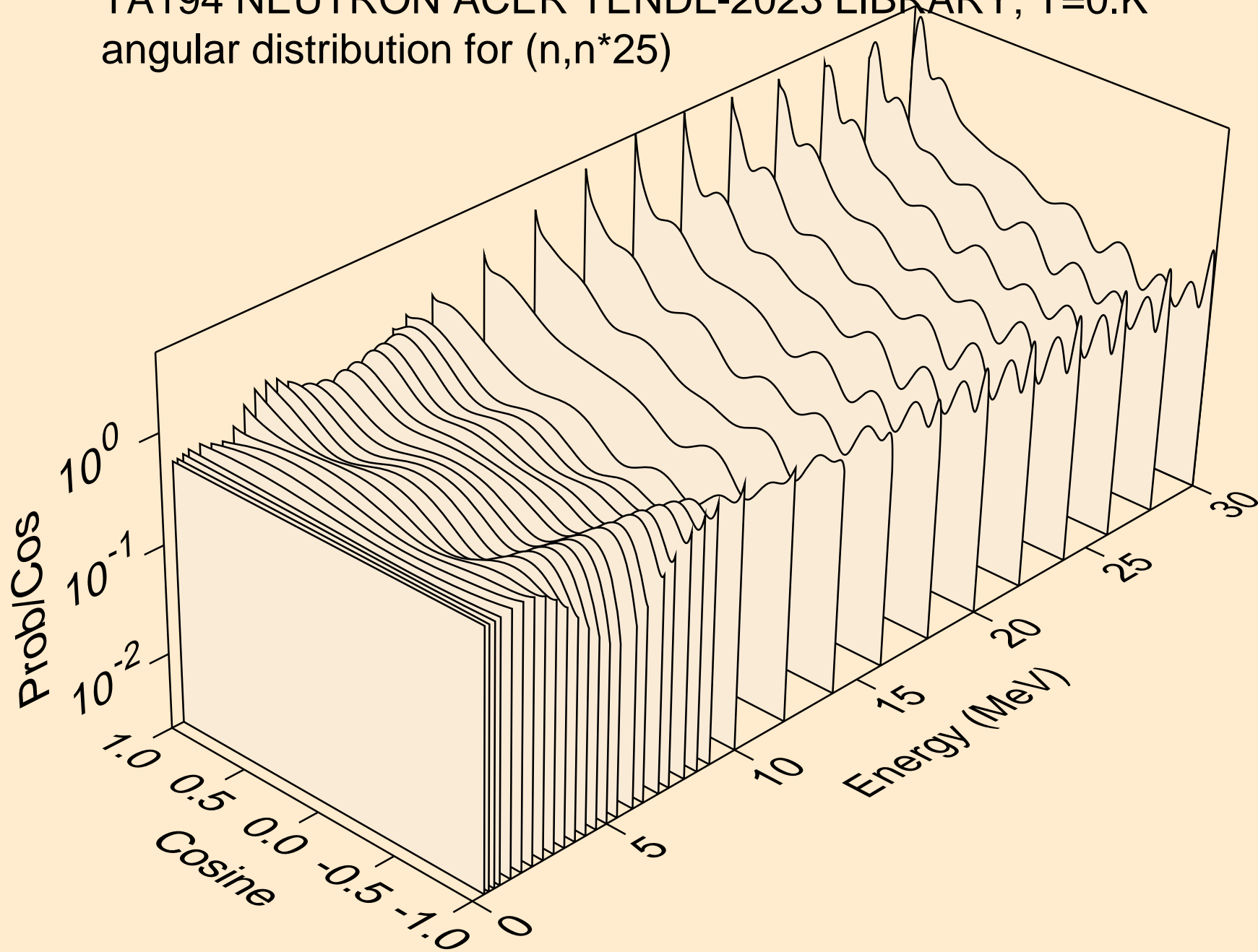

TA194 NEUTRON ACER TENDL-2023 LIBRARY; T=0.K
angular distribution for (n,n*26)

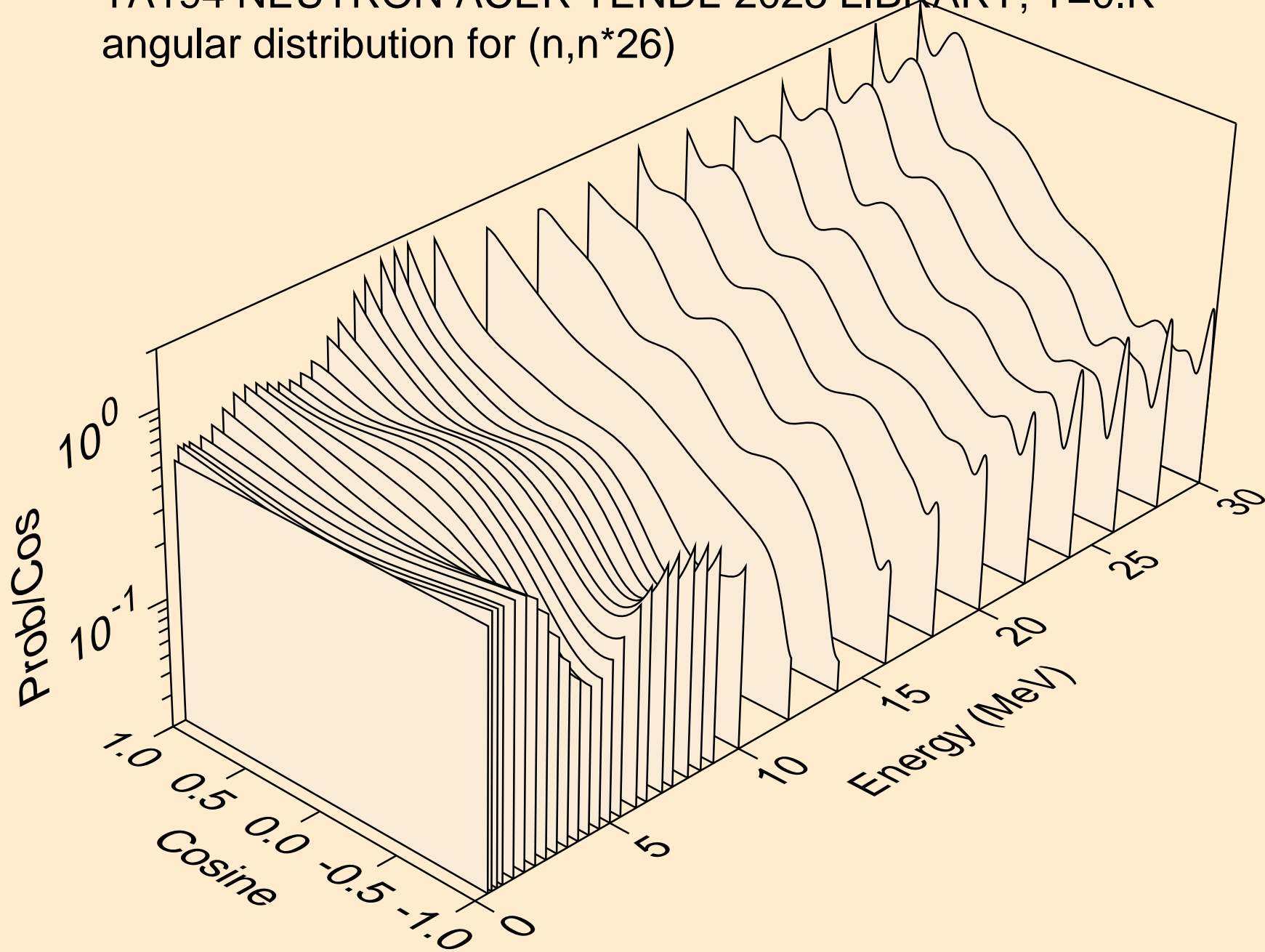

TA194 NEUTRON ACER TENDL-2023 LIBRARY; T=0.K
angular distribution for (n,n*27)

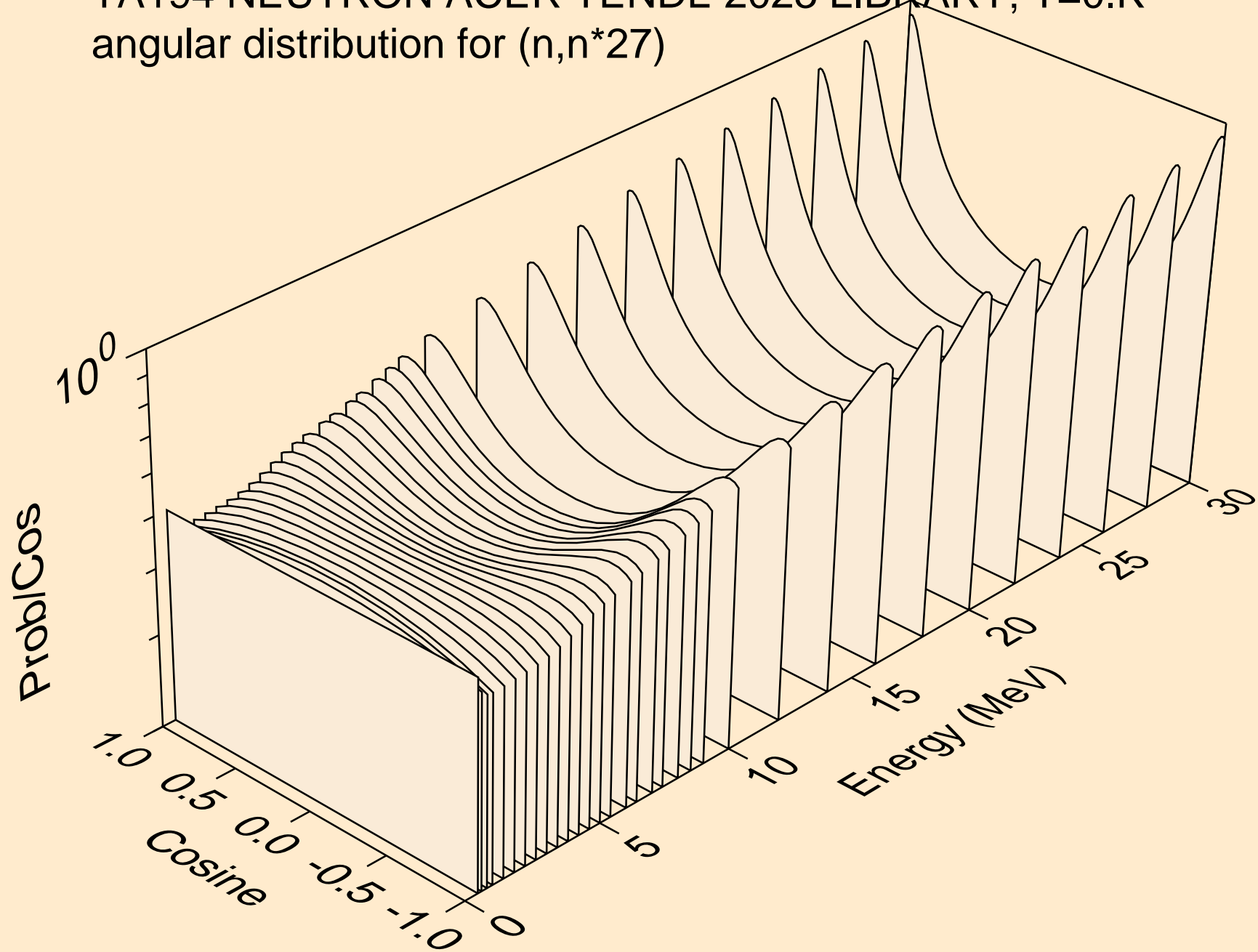

TA194 NEUTRON ACER TENDL-2023 LIBRARY; T=0.K
angular distribution for (n,n*28)

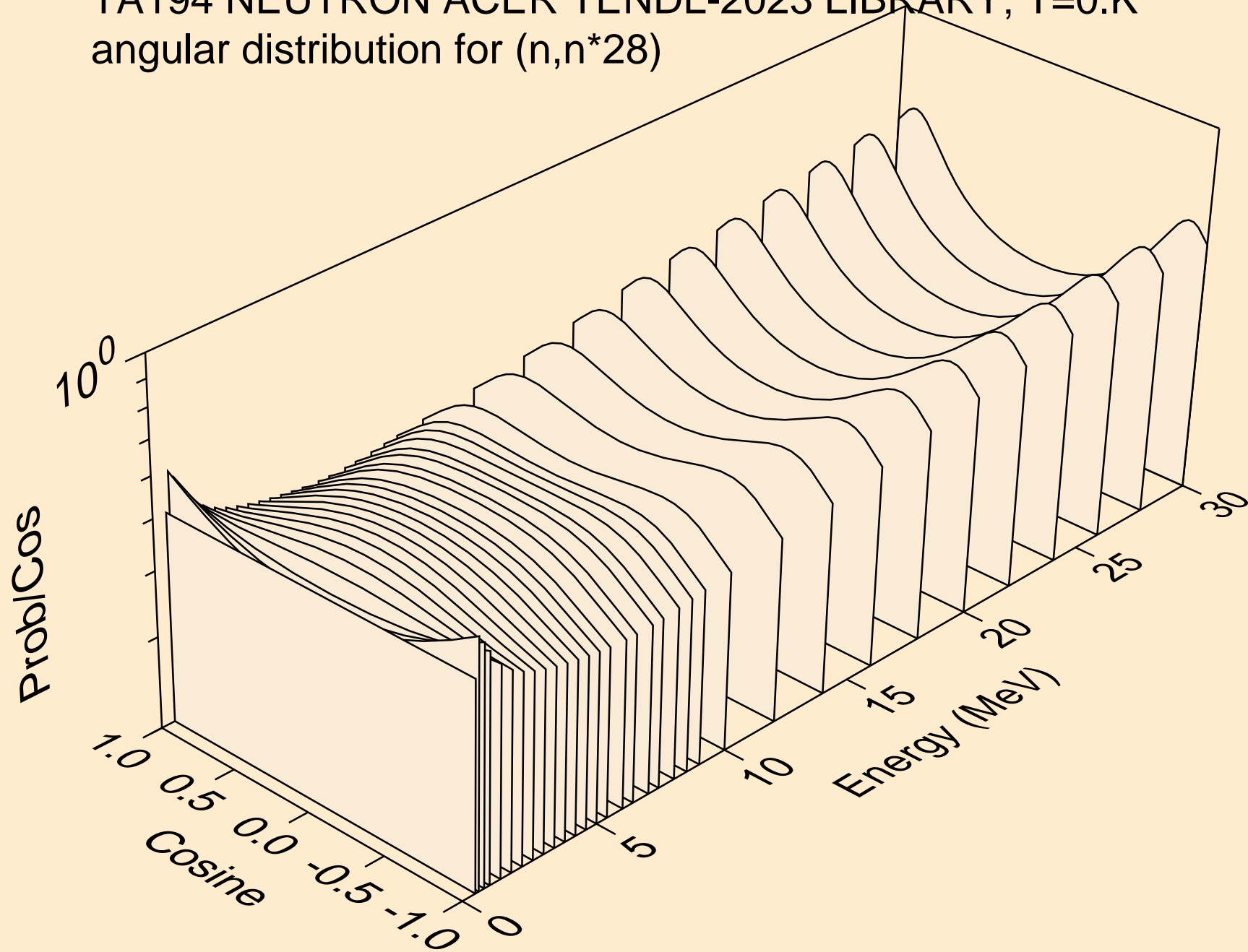

TA194 NEUTRON ACER TENDL-2023 LIBRARY; T=0.K
angular distribution for (n,n*29)

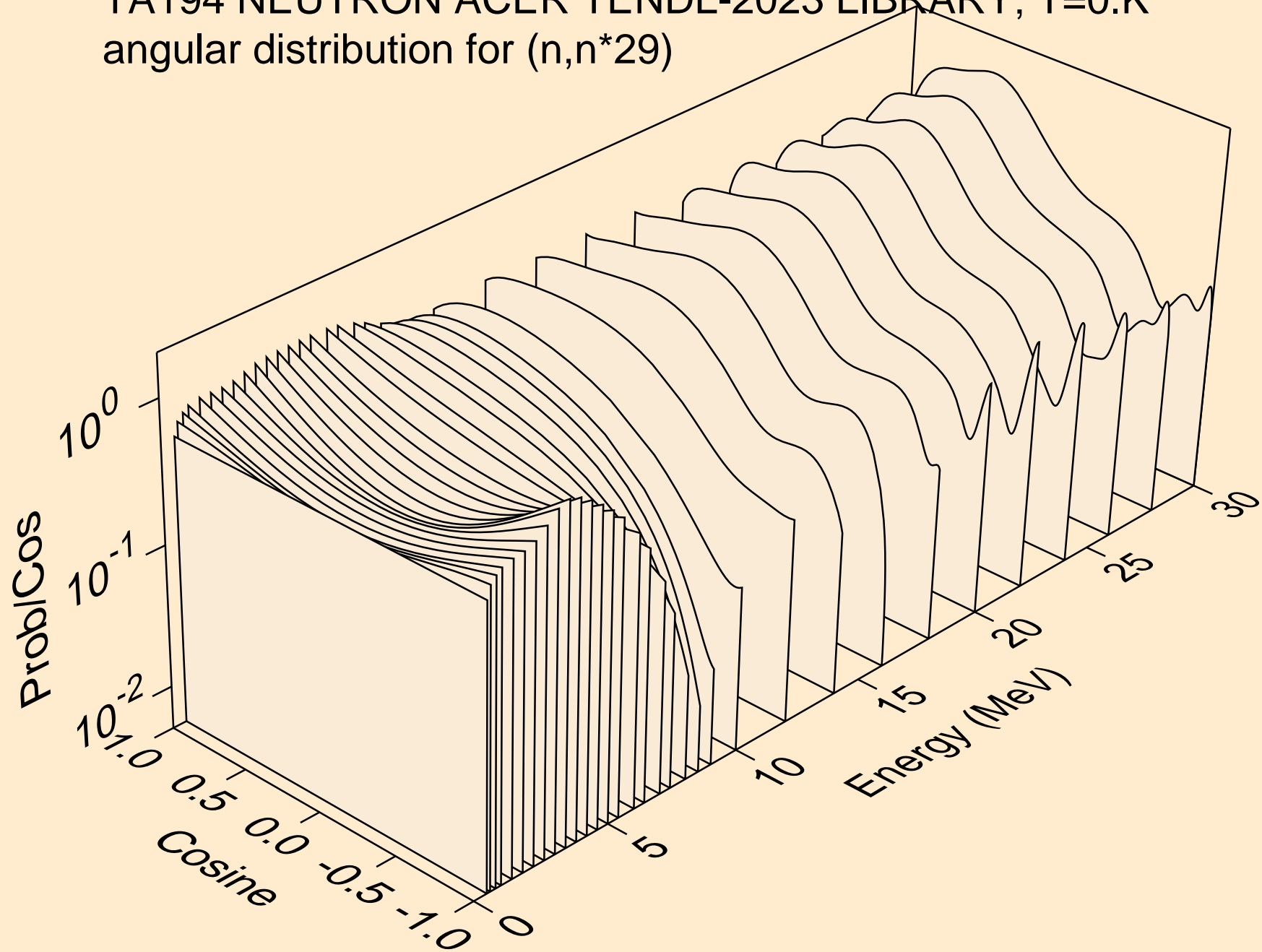

TA194 NEUTRON ACER TENDL-2023 LIBRARY; T=0.K
angular distribution for (n,n*30)

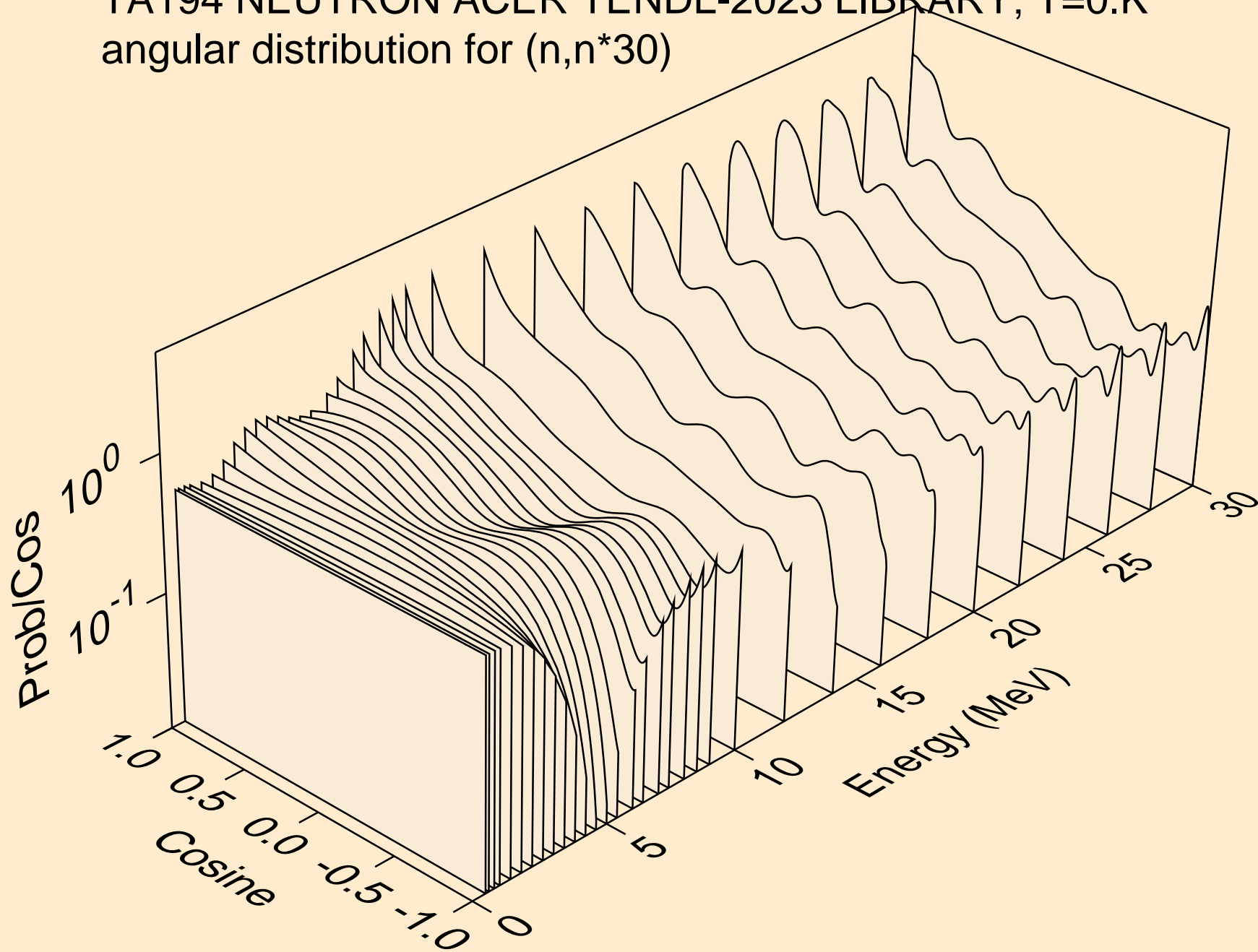

TA194 NEUTRON ACER TENDL-2023 LIBRARY; T=0.K
Neutron emission for (n,x)

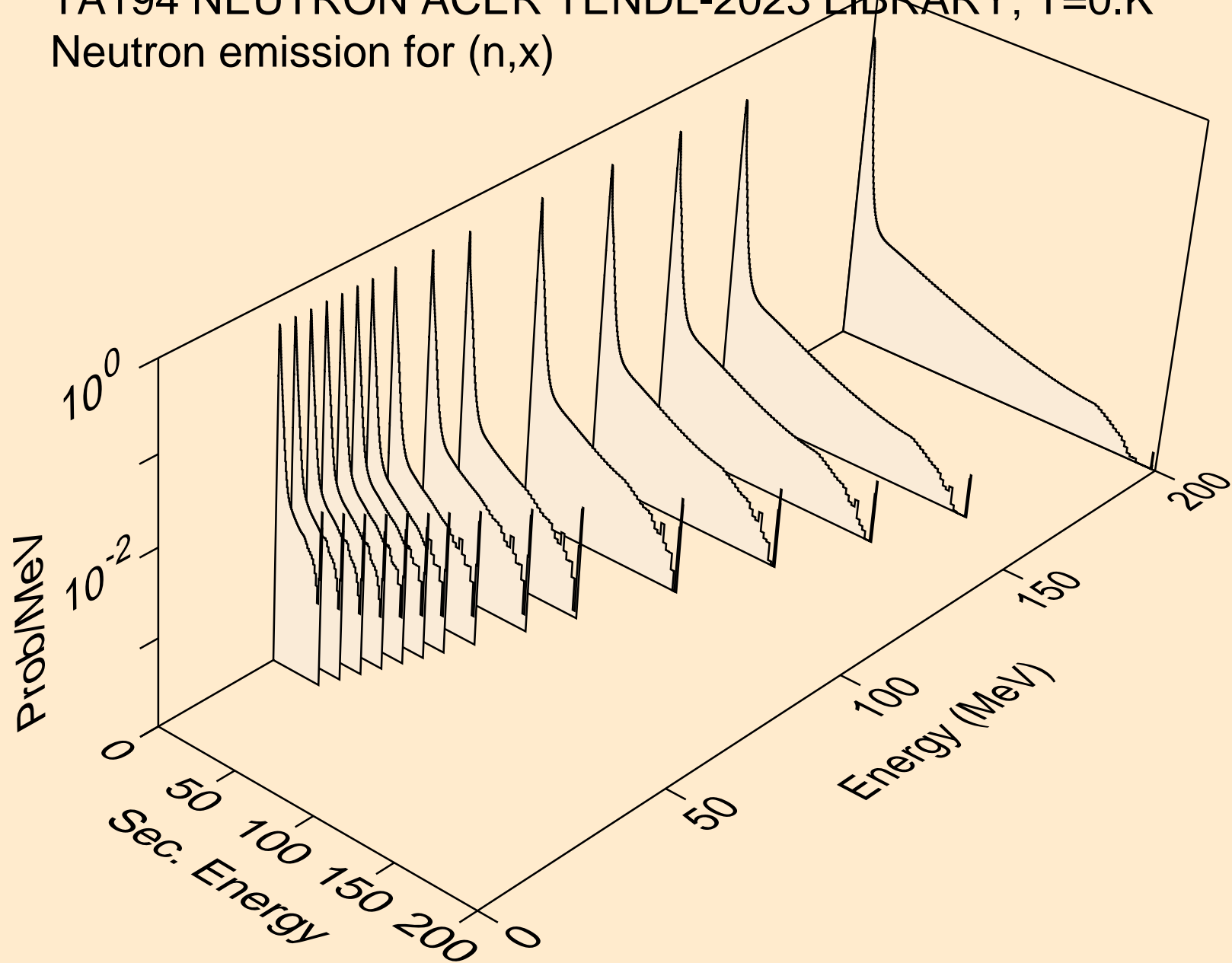

TA194 NEUTRON ACER TENDL-2023 LIBRARY; T=0.K
Neutron emission for (n,2nd)

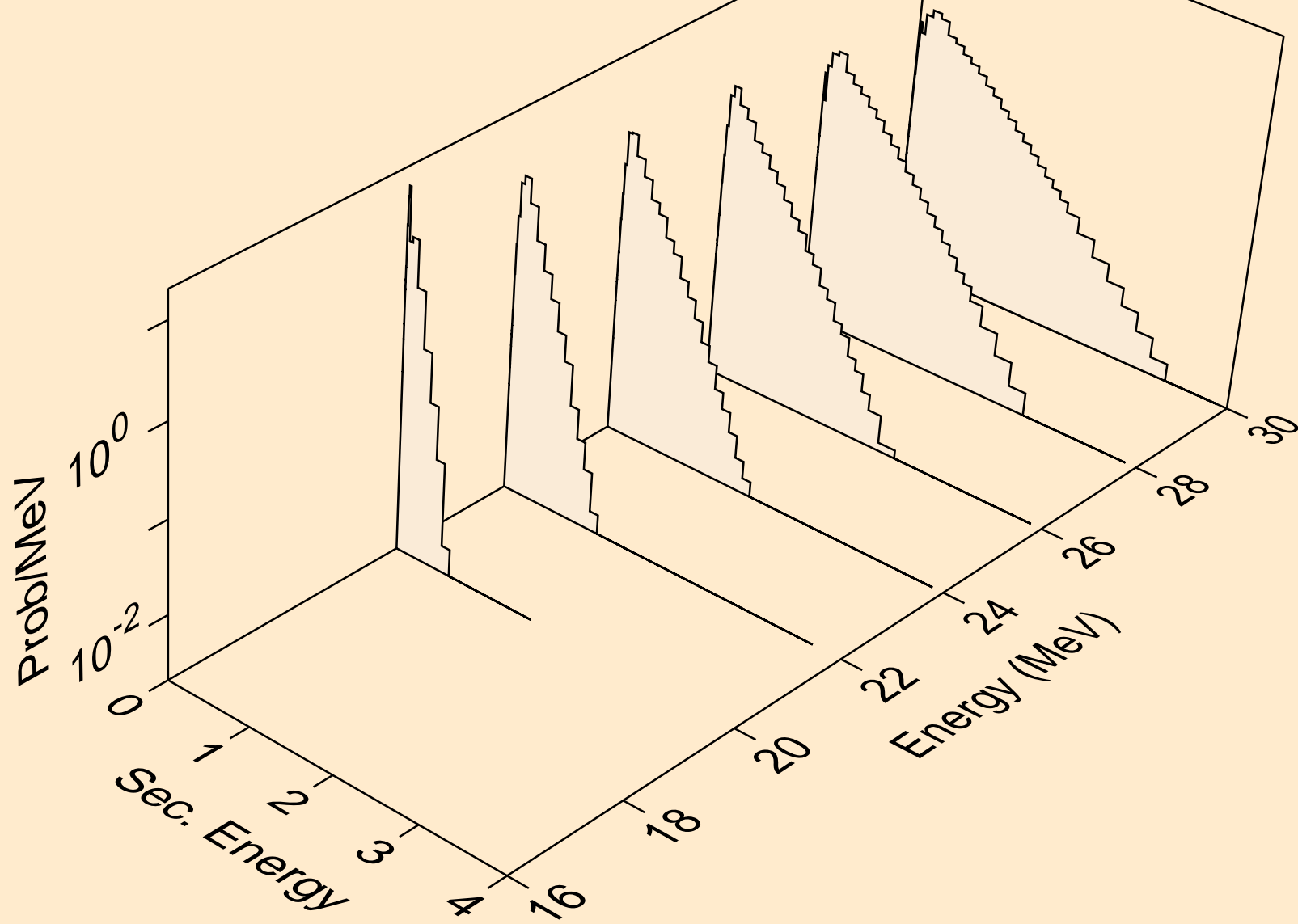

TA194 NEUTRON ACER TENDL-2023 LIBRARY; T=0.K
Neutron emission for (n,2n)

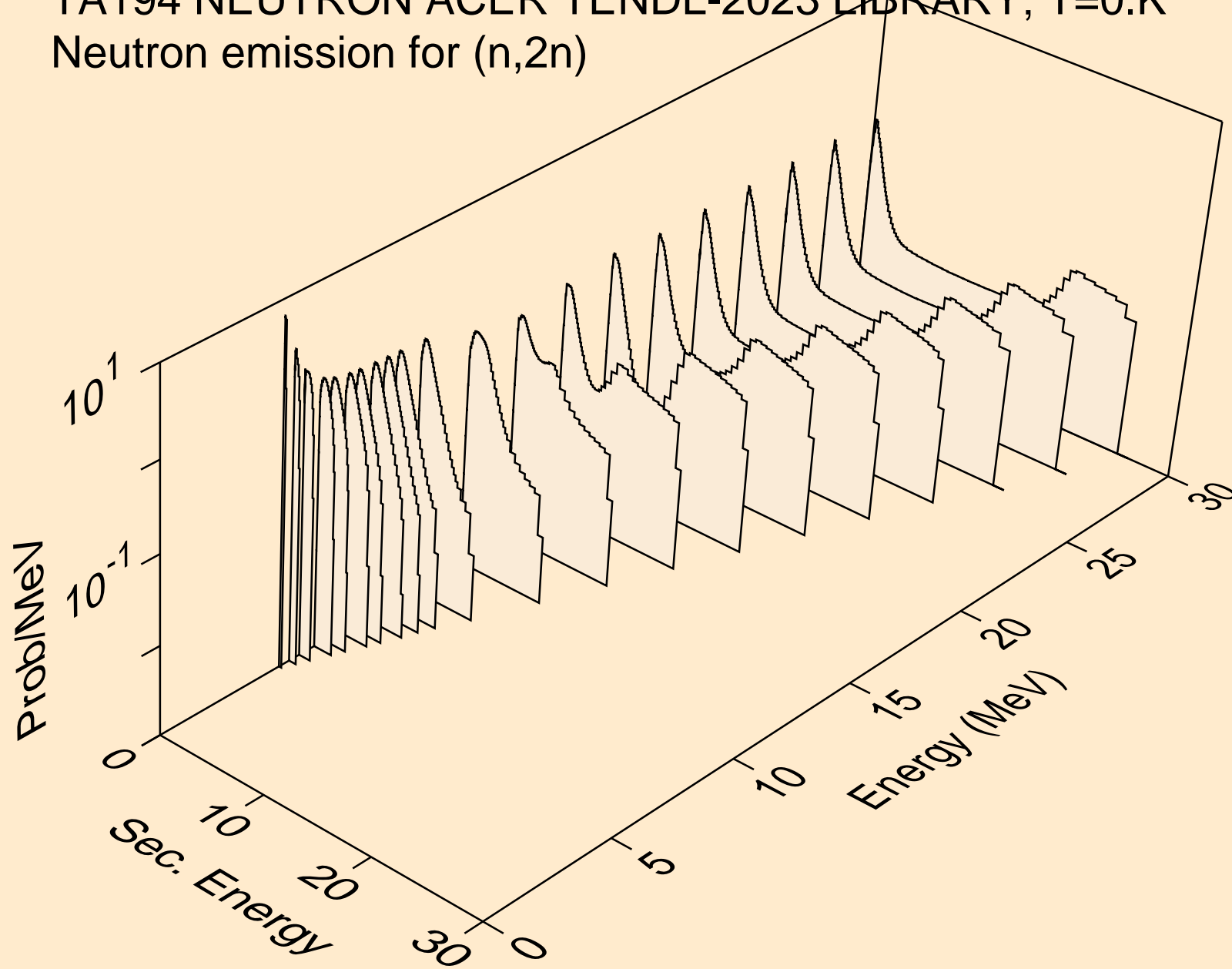

TA194 NEUTRON ACER TENDL-2023 LIBRARY; T=0.K
Neutron emission for (n,3n)

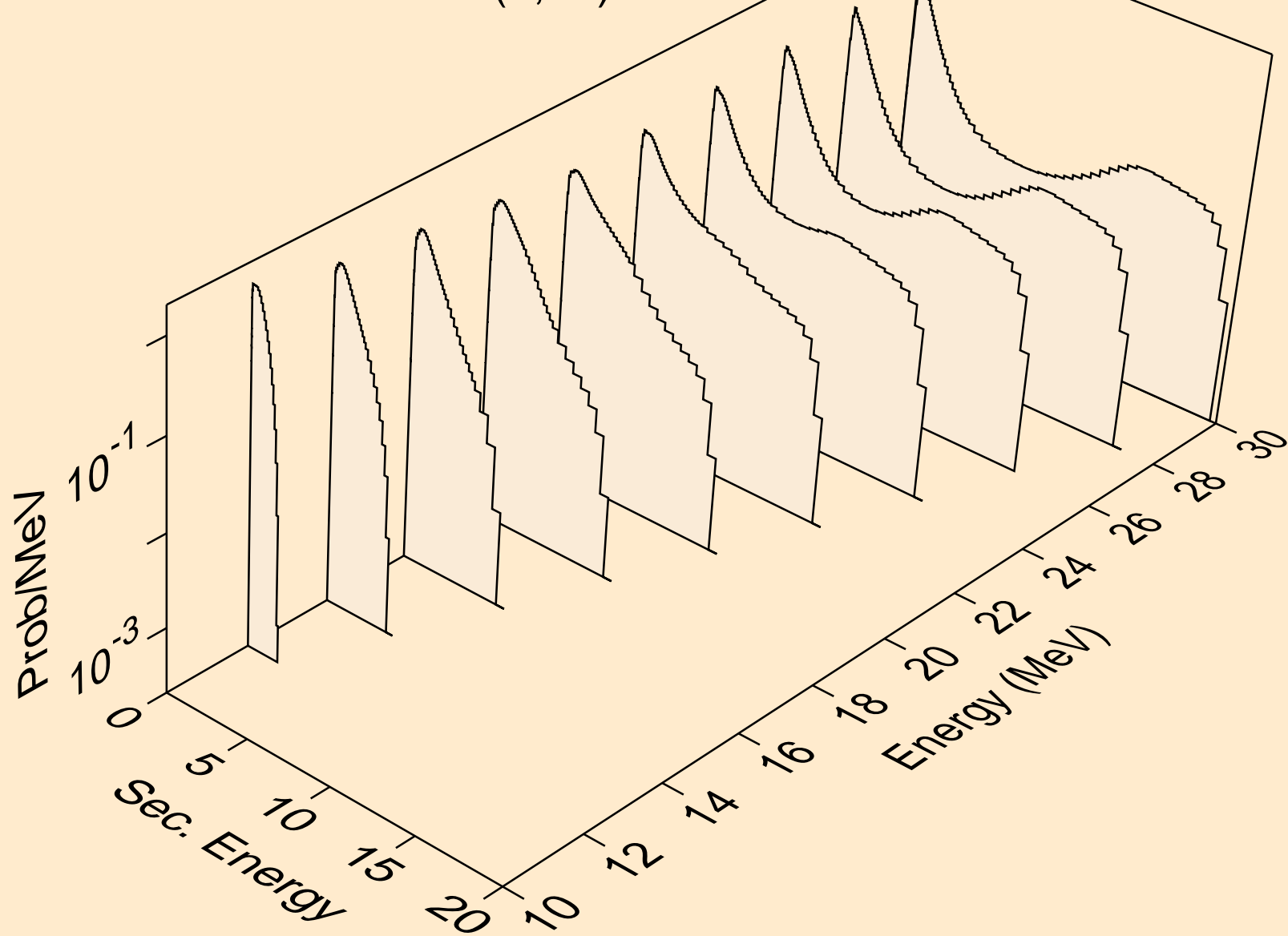

TA194 NEUTRON ACER TENDL-2023 LIBRARY; T=0.K
Neutron emission for (n,n*)a

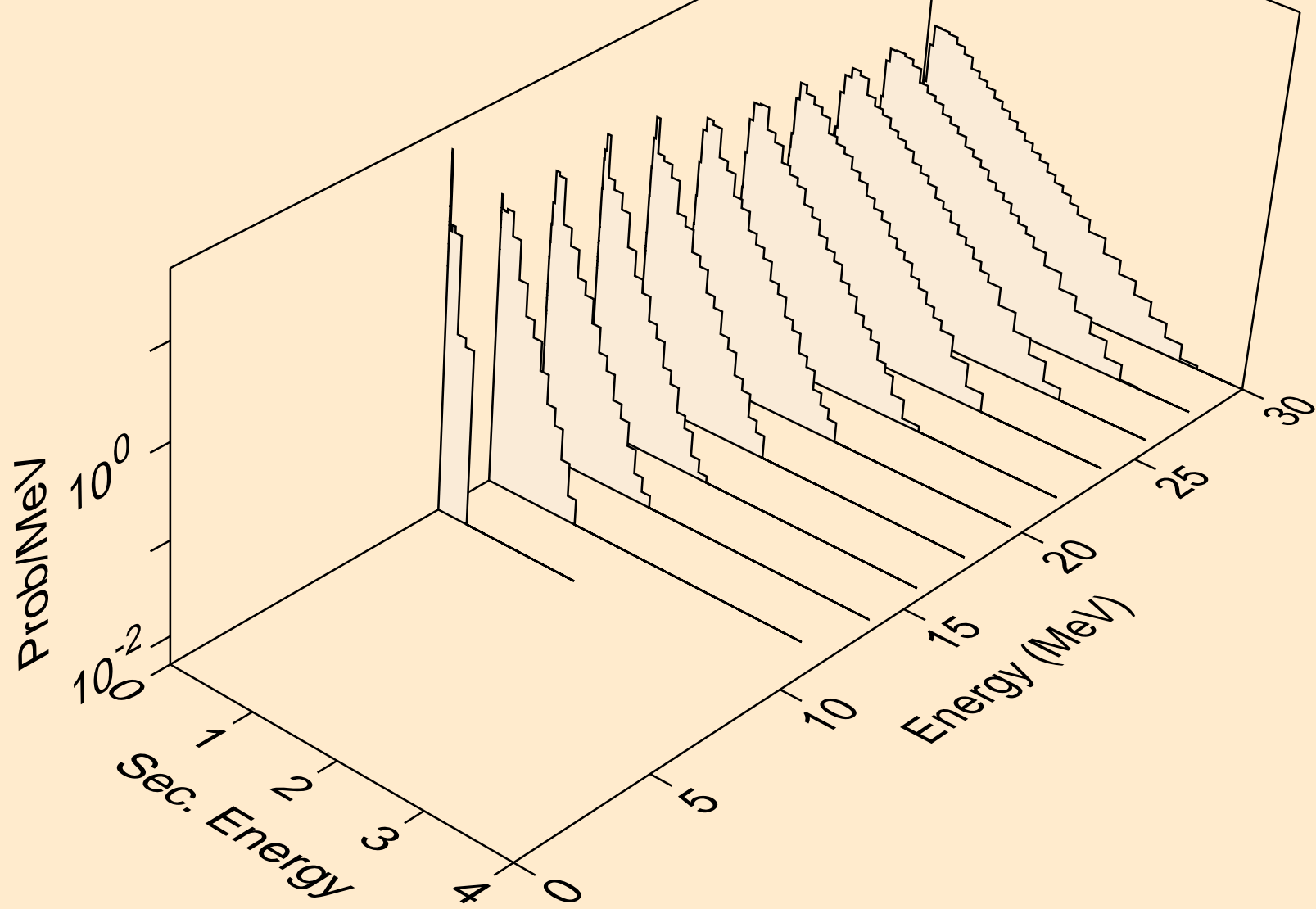

TA194 NEUTRON ACER TENDL-2023 LIBRARY; T=0.K
Neutron emission for (n,2n)a

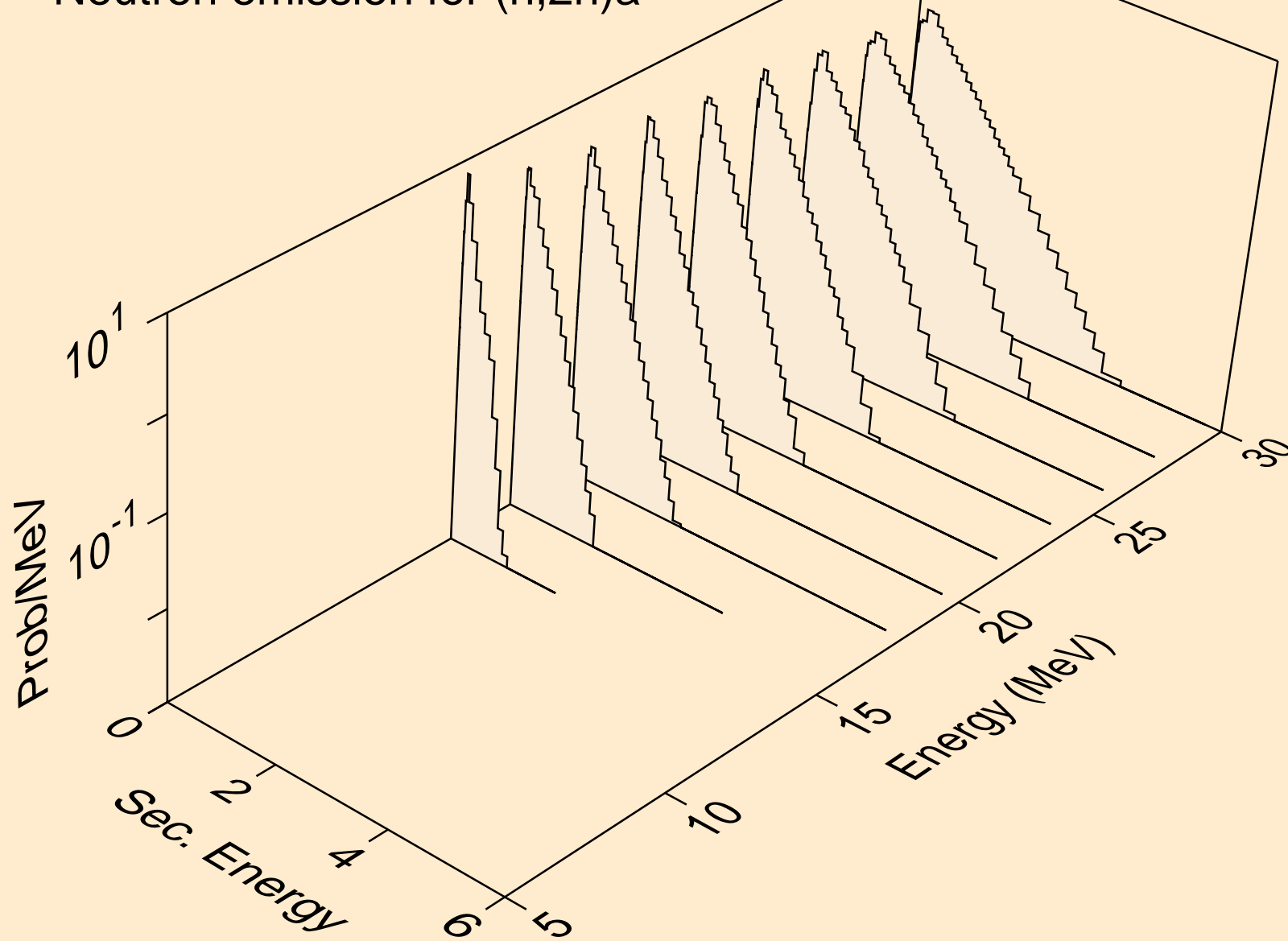

TA194 NEUTRON ACER TENDL-2023 LIBRARY; T=0.K
Neutron emission for (n,3n)a

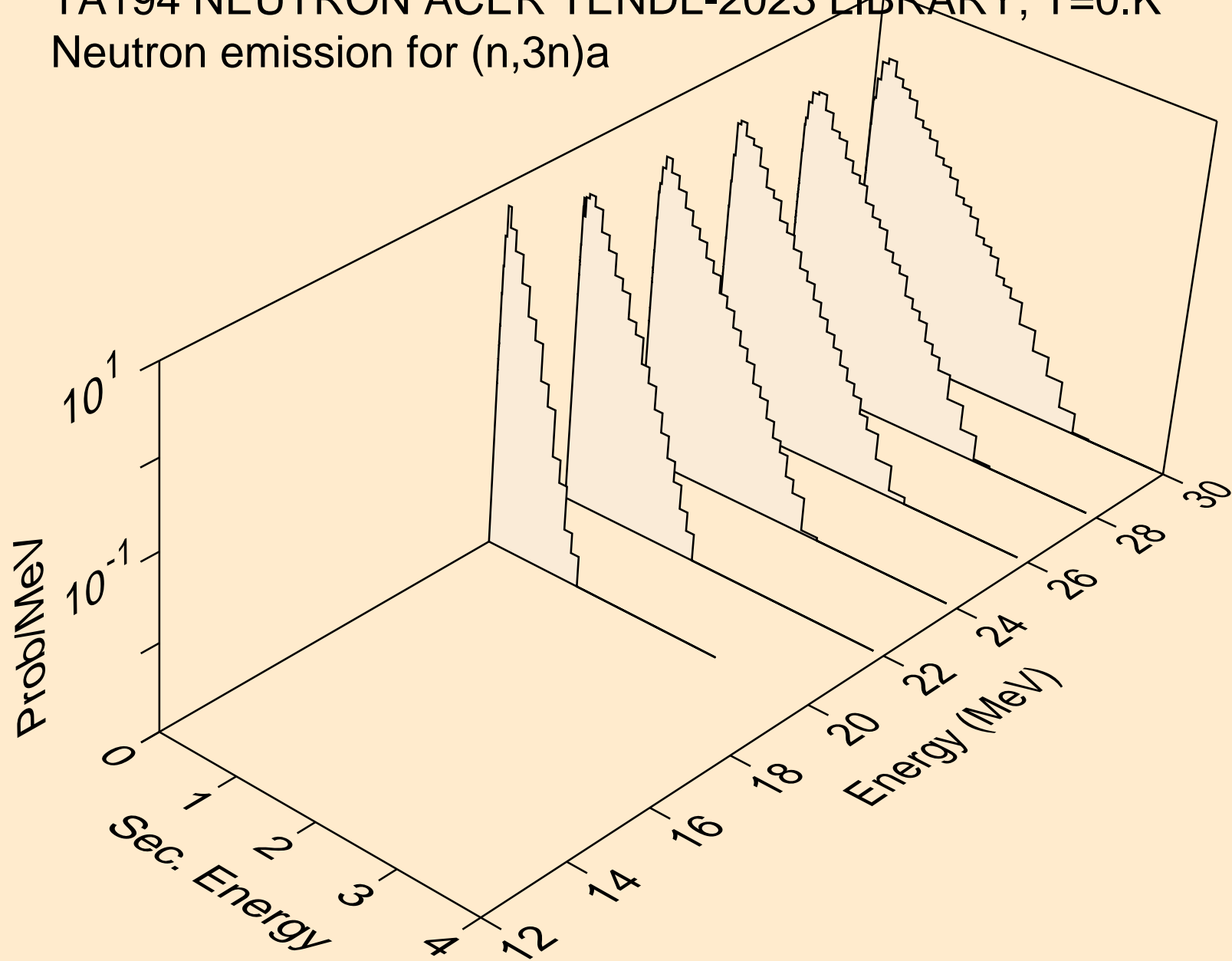

TA194 NEUTRON ACER TENDL-2023 LIBRARY; T=0.K
Neutron emission for (n,n*)p

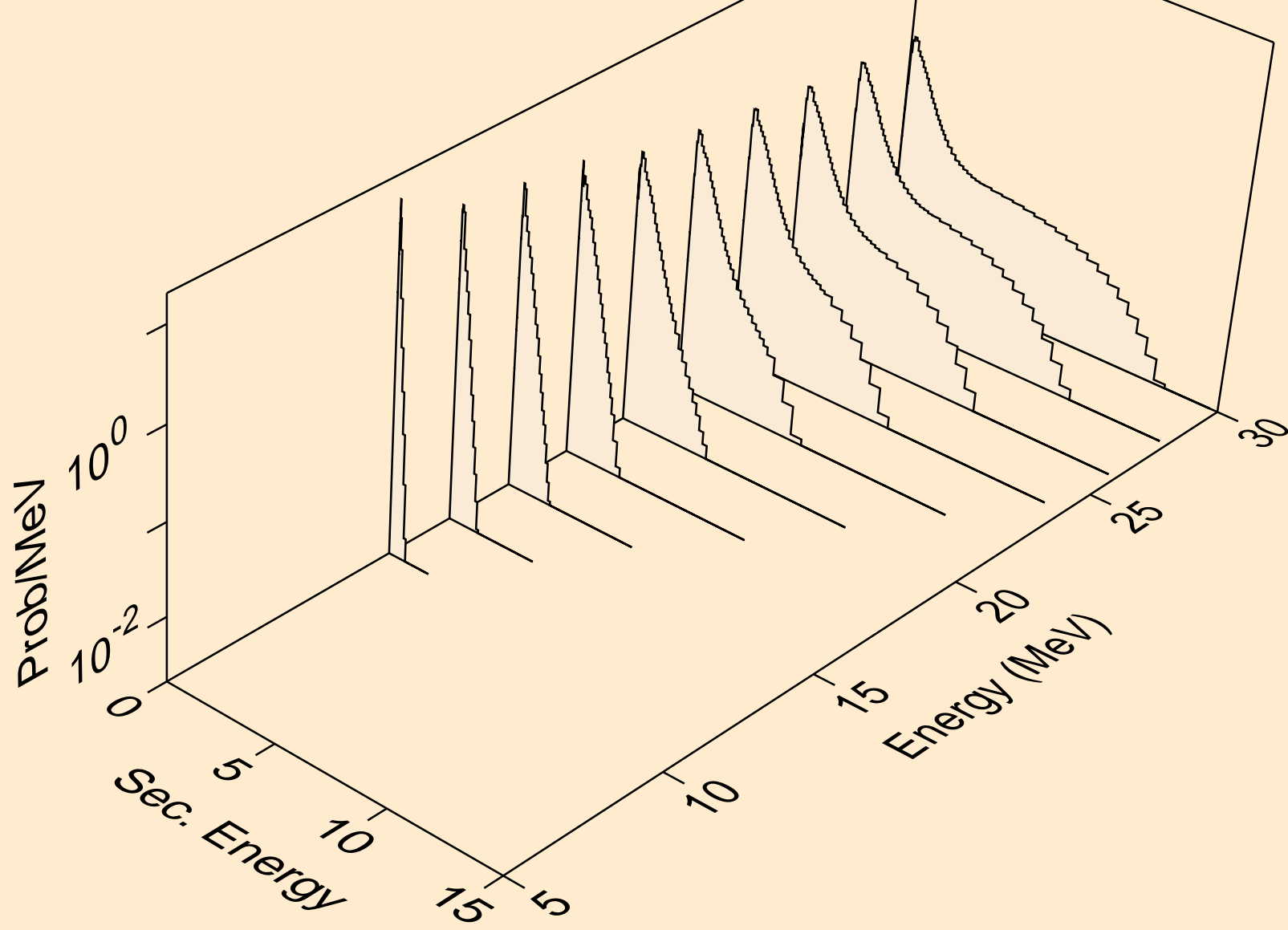

TA194 NEUTRON ACER TENDL-2023 LIBRARY; T=0.K
Neutron emission for (n,n*)d

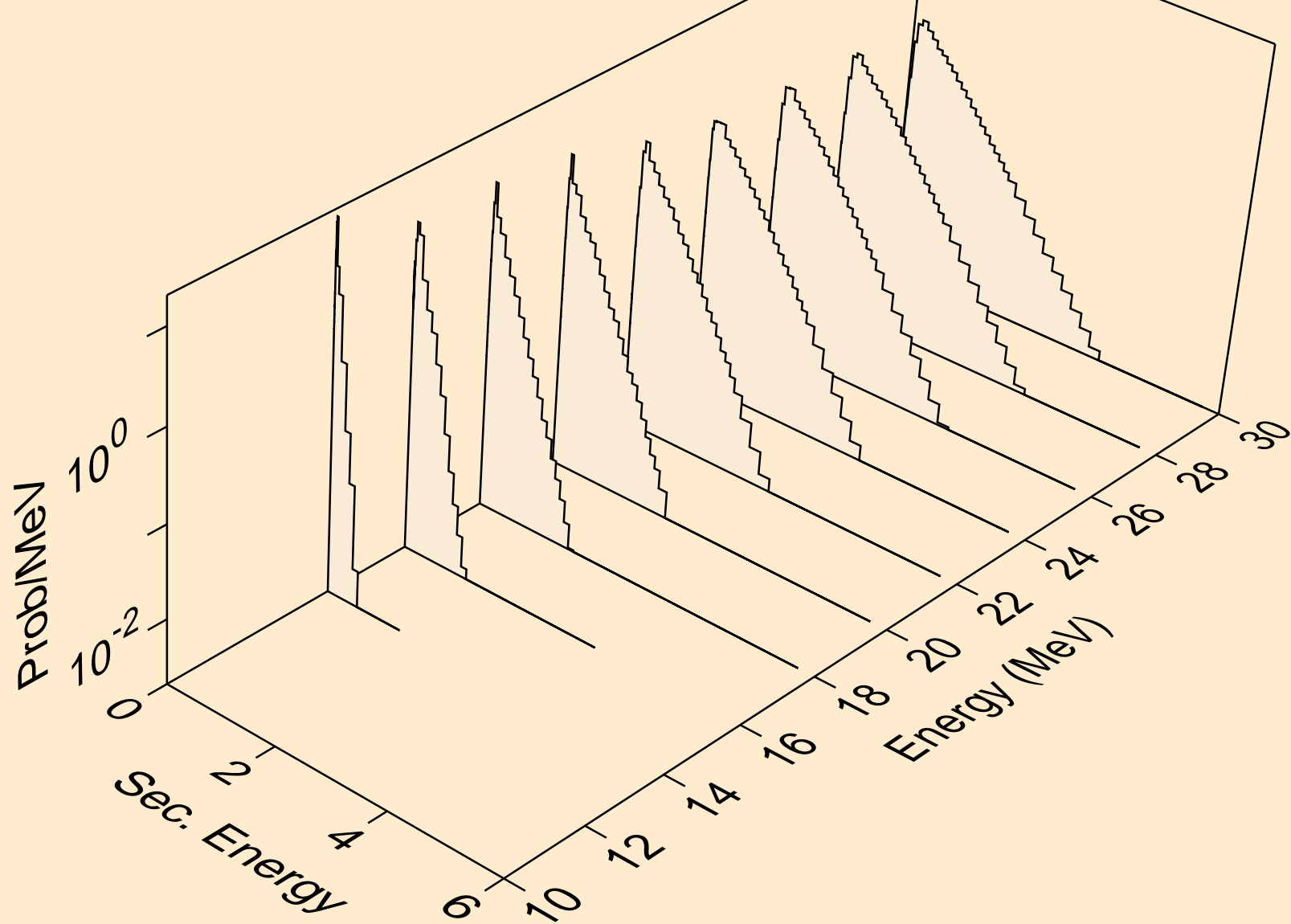

TA194 NEUTRON ACER TENDL-2023 LIBRARY; T=0.K
Neutron emission for (n,n*)t

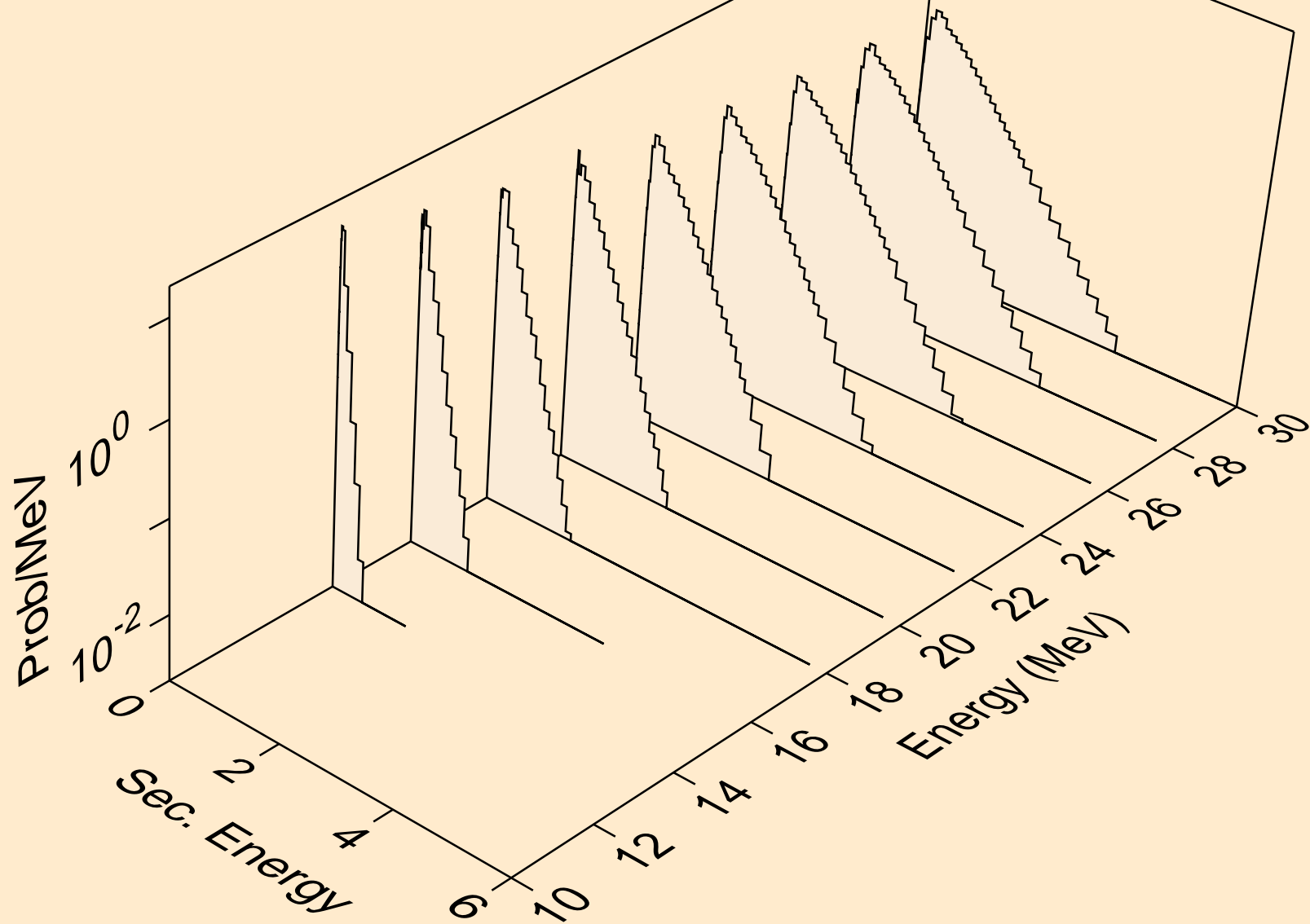

TA194 NEUTRON ACER TENDL-2023 LIBRARY; T=0.K
Neutron emission for (n,n*)he3

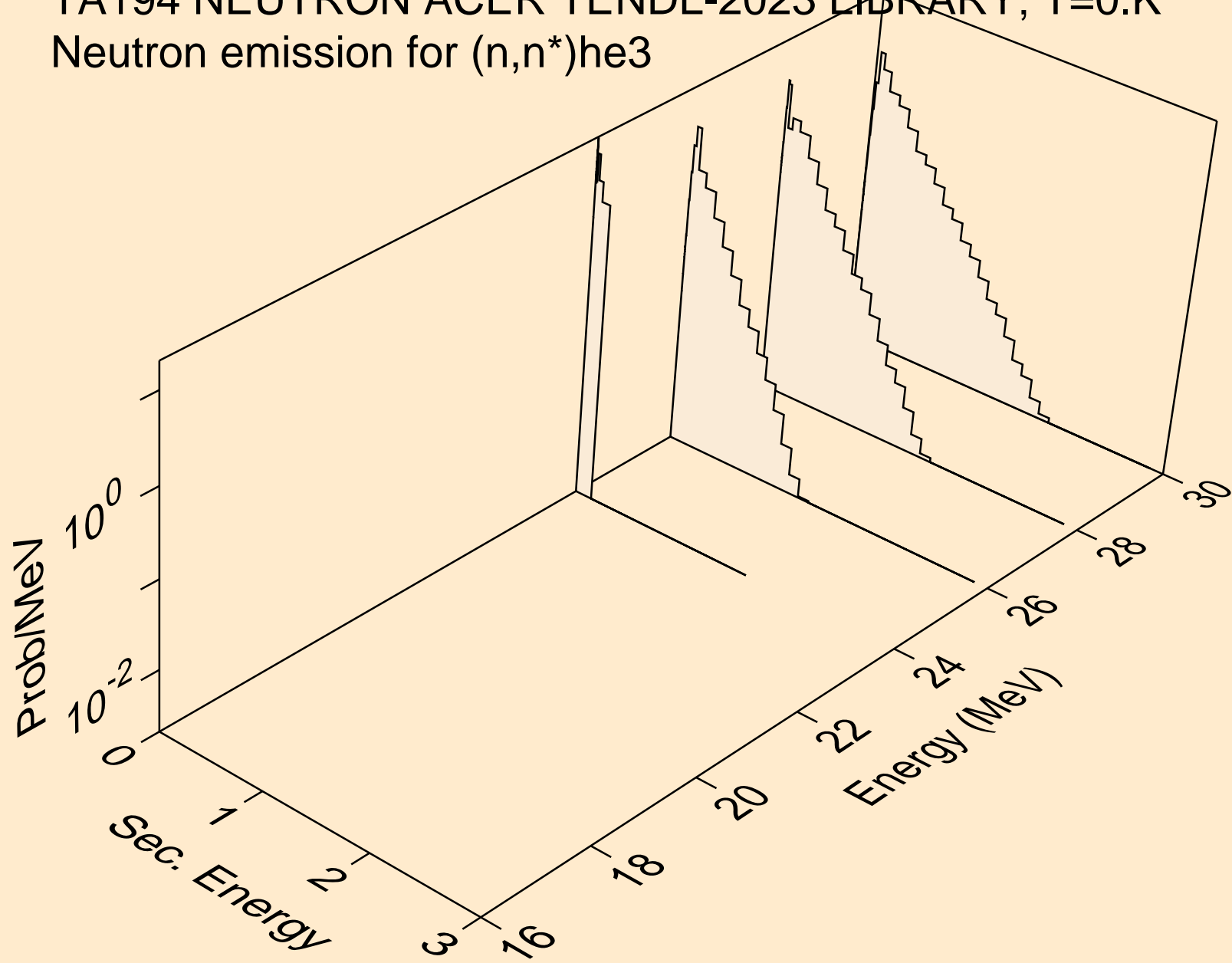

TA194 NEUTRON ACER TENDL-2023 LIBRARY; T=0.K
Neutron emission for (n,4n)

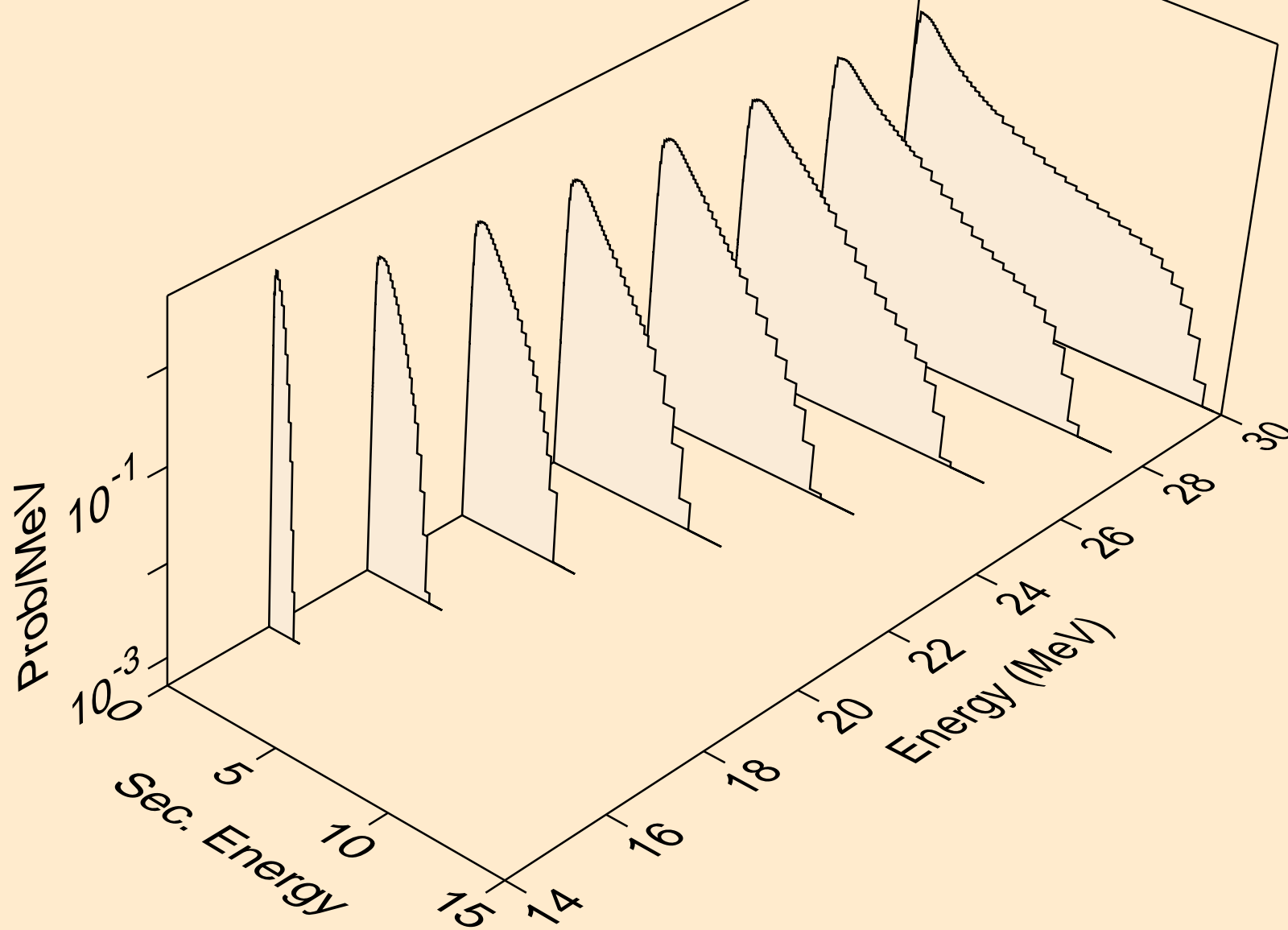

TA194 NEUTRON ACER TENDL-2023 LIBRARY; T=0.K
Neutron emission for (n,2np)

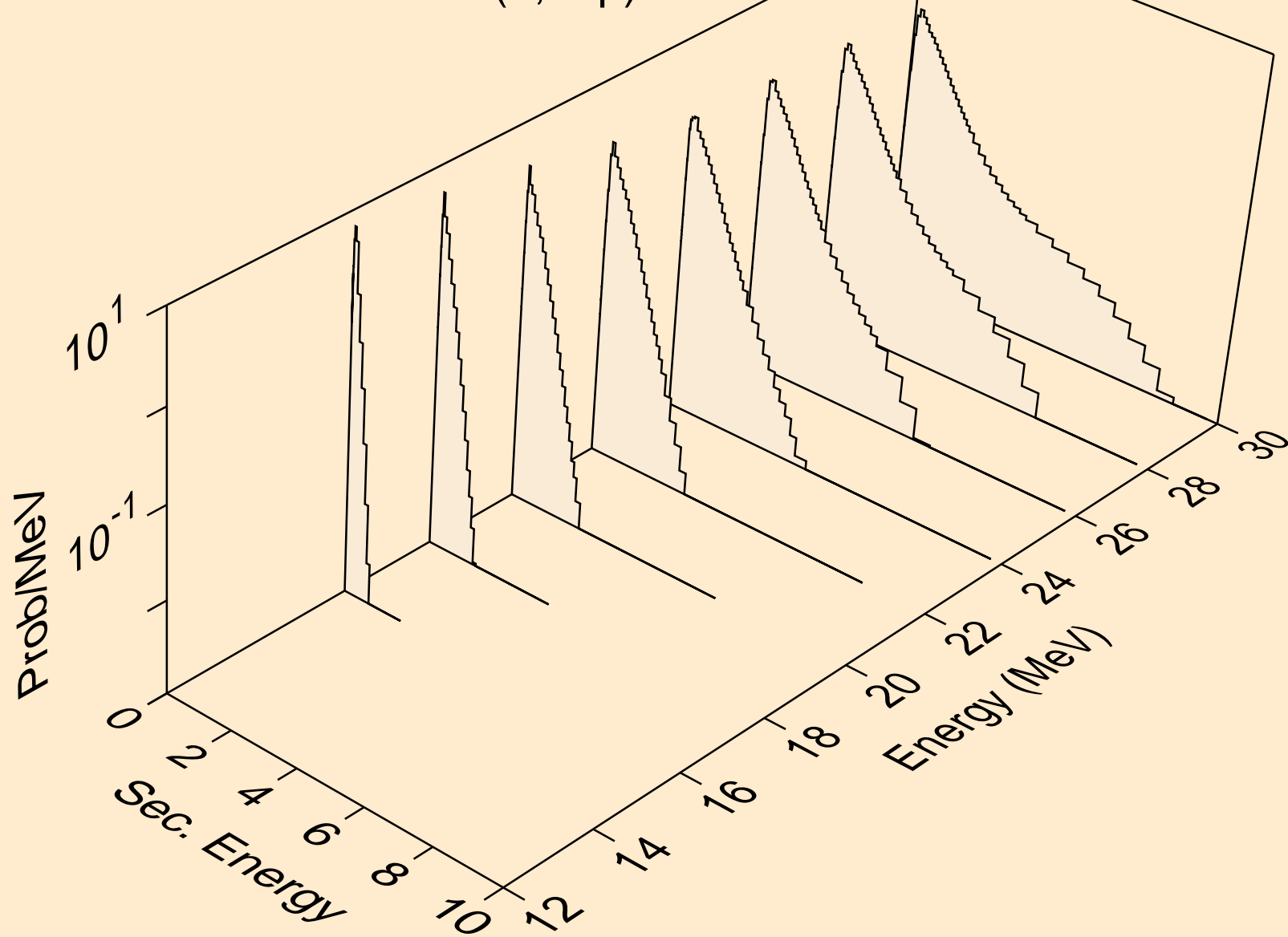

TA194 NEUTRON ACER TENDL-2023 LIBRARY; T=0.K
Neutron emission for (n,3np)

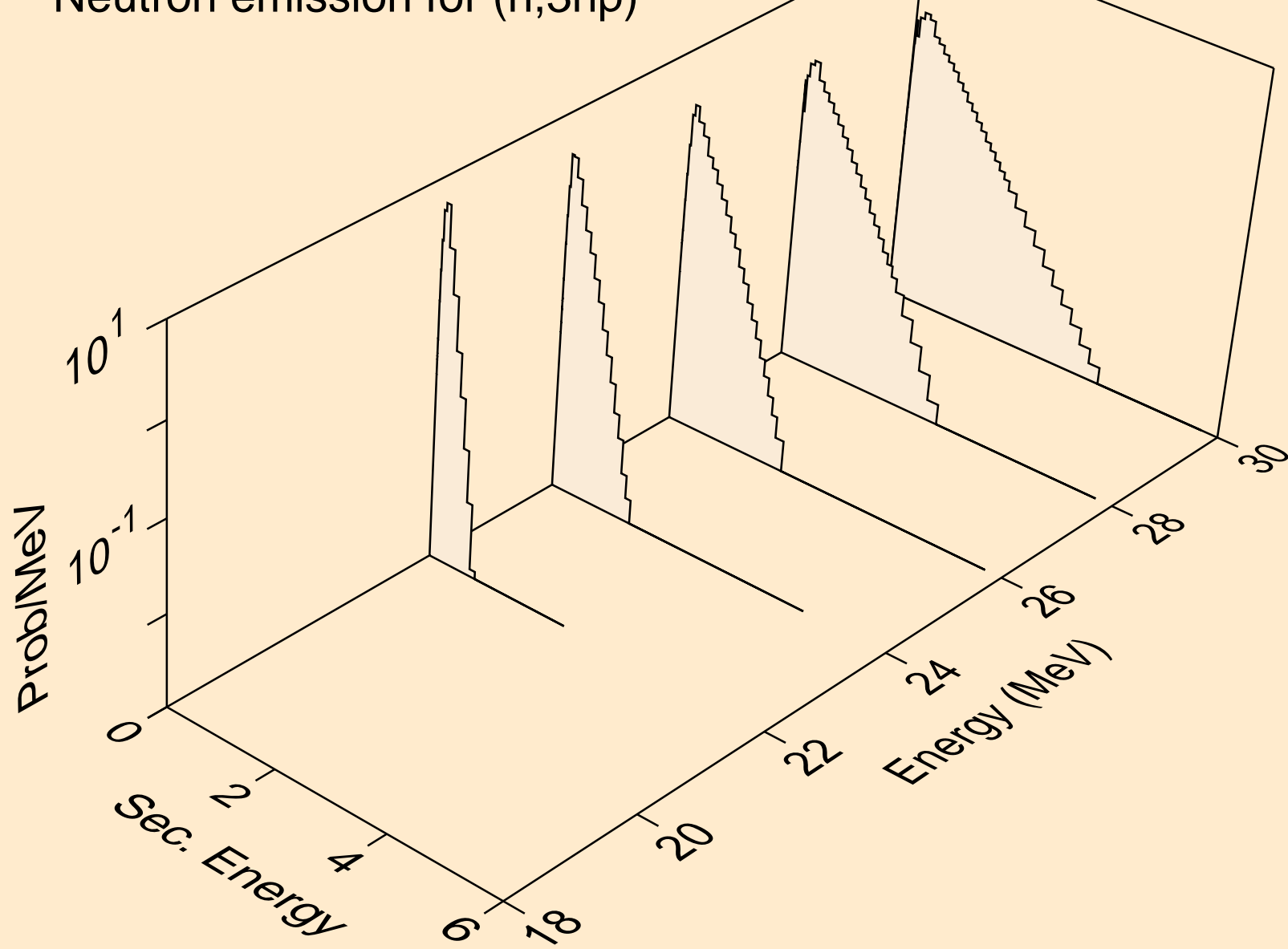

TA194 NEUTRON ACER TENDL-2023 LIBRARY; T=0.K
Neutron emission for (n,n*c)

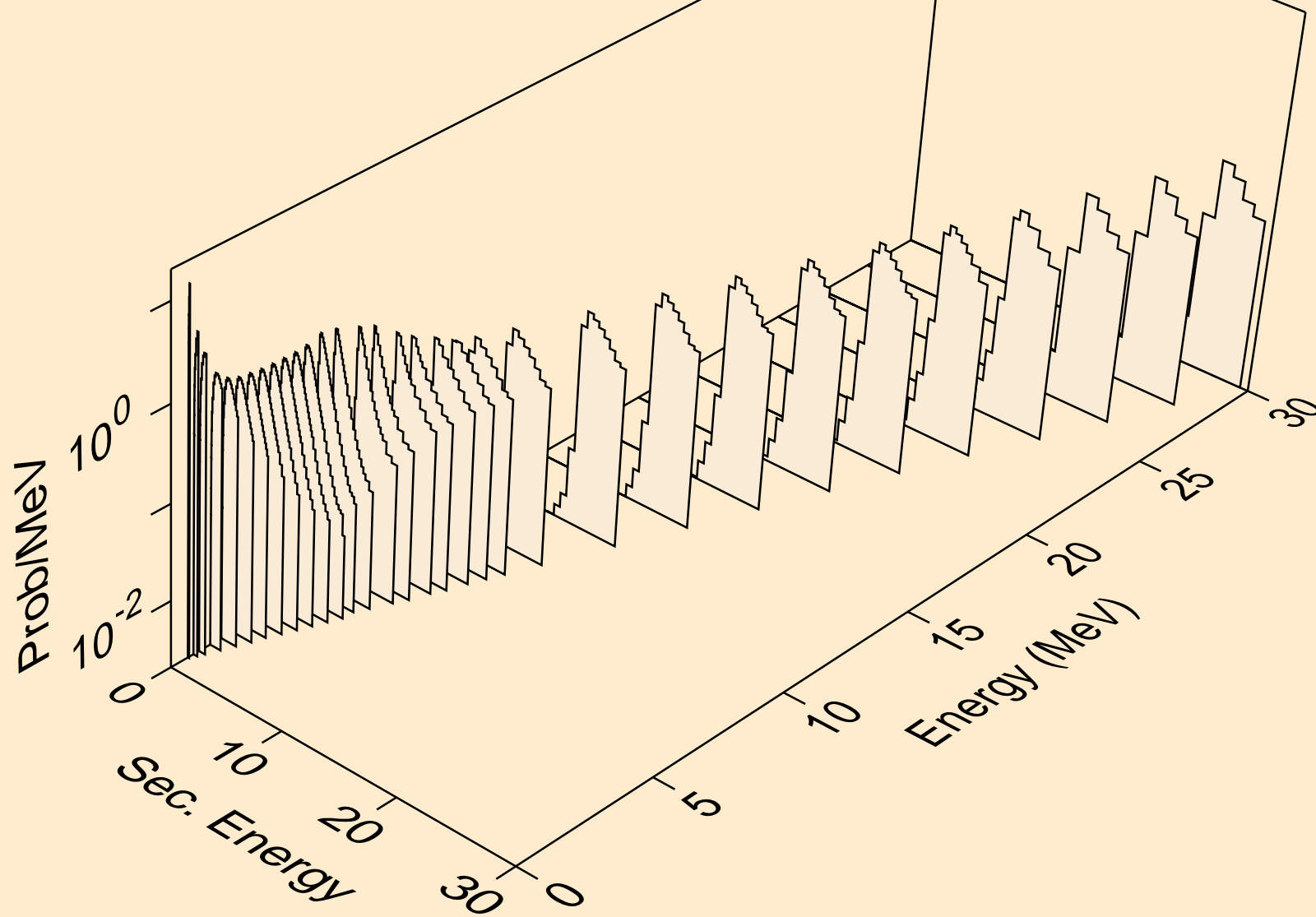

TA194 NEUTRON ACER TENDL-2023 LIBRARY; T=0.K
Photon emission for (n,x)

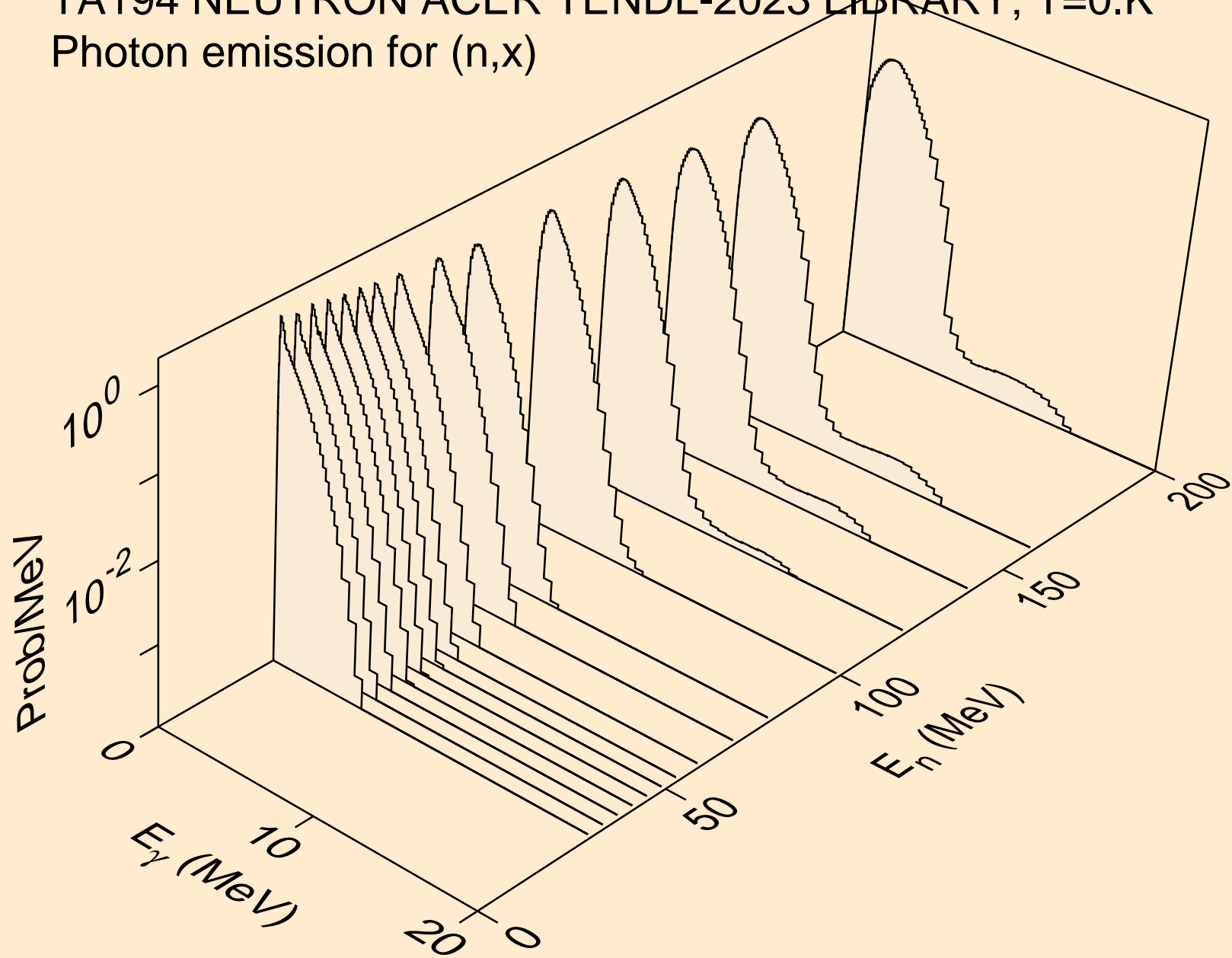

TA194 NEUTRON ACER TENDL-2023 LIBRARY; T=0.K
Photon emission for (n,2nd)

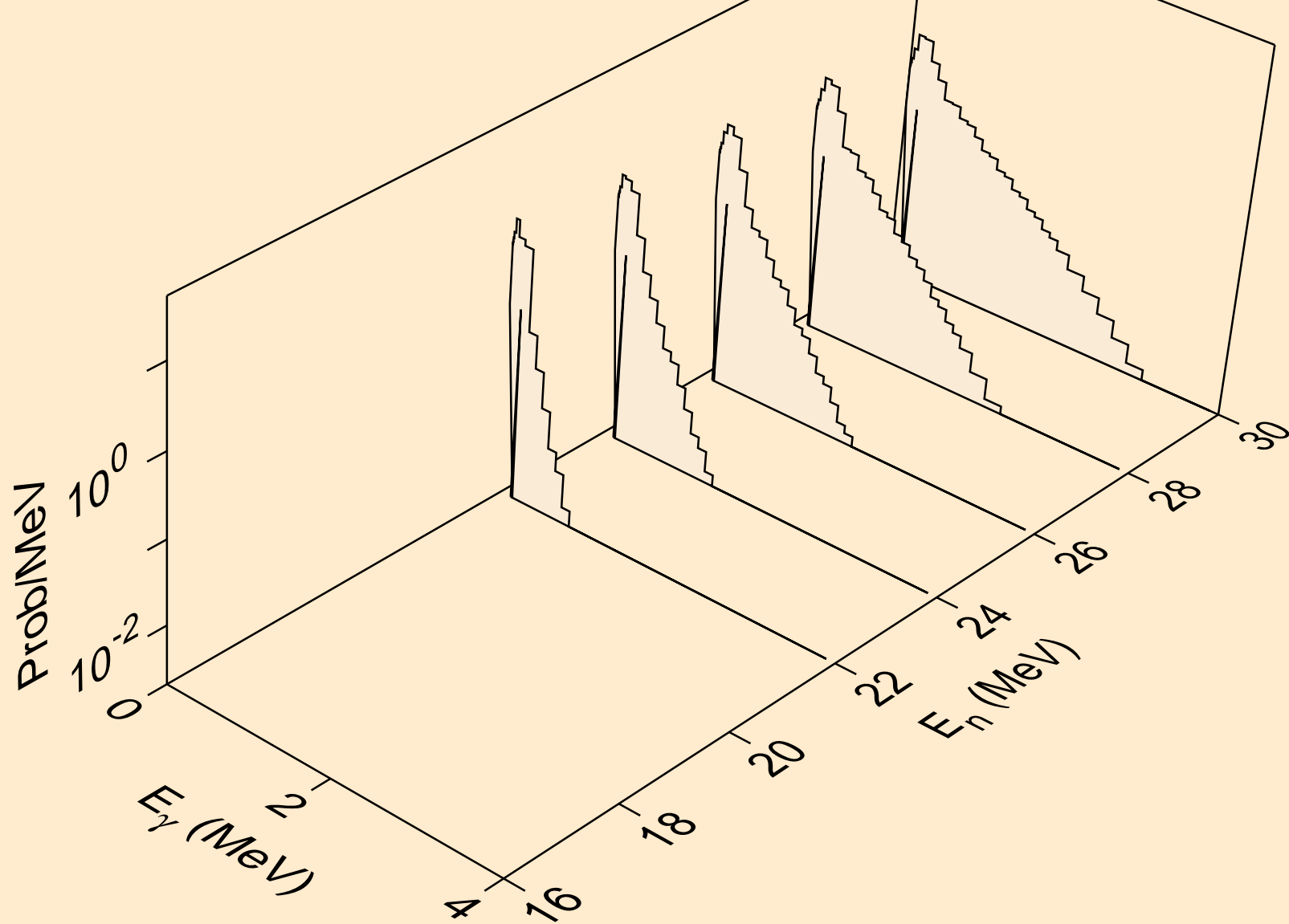

TA194 NEUTRON ACER TENDL-2023 LIBRARY; T=0.K
Photon emission for (n,2n)

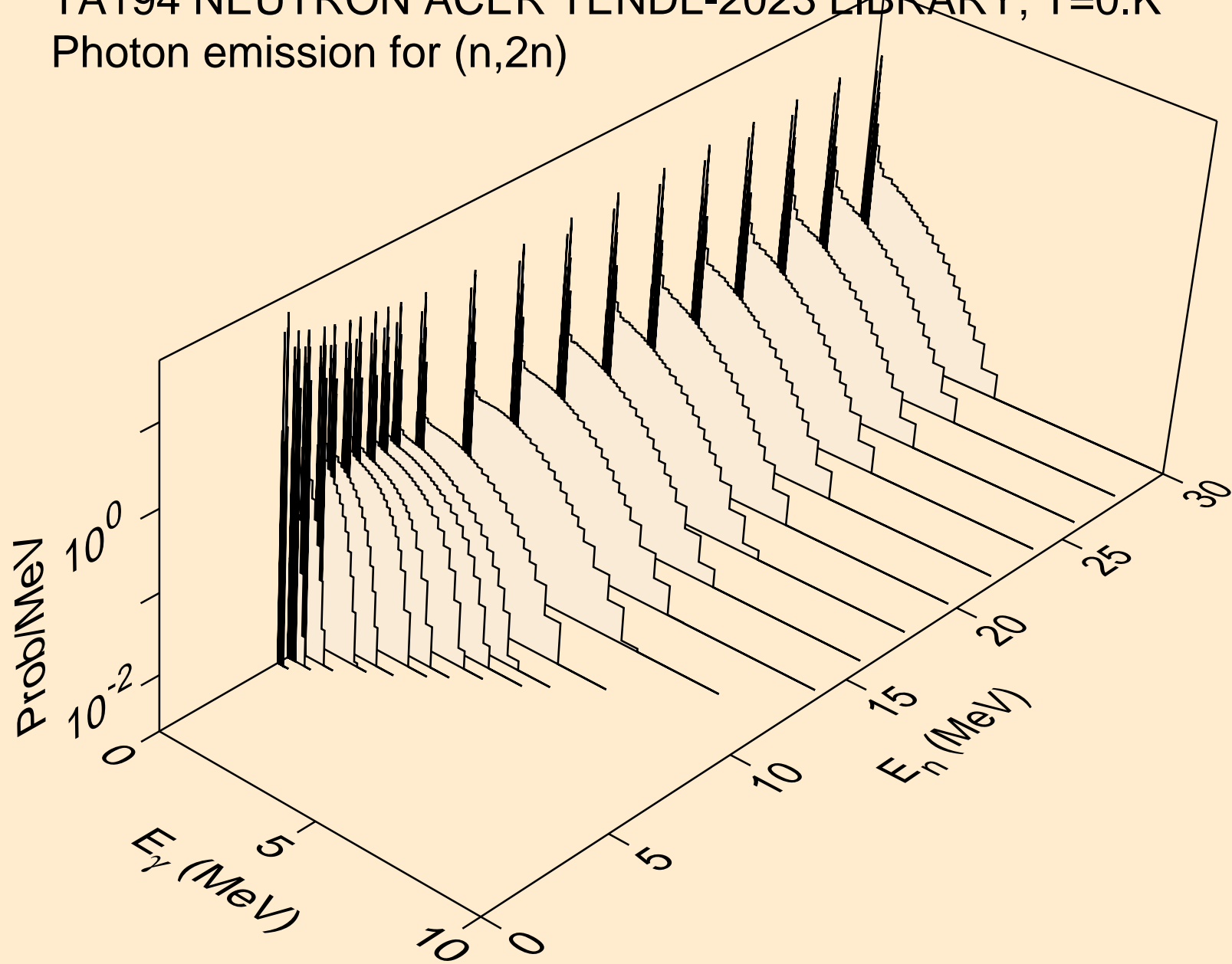

TA194 NEUTRON ACER TENDL-2023 LIBRARY; T=0.K
Photon emission for (n,3n)

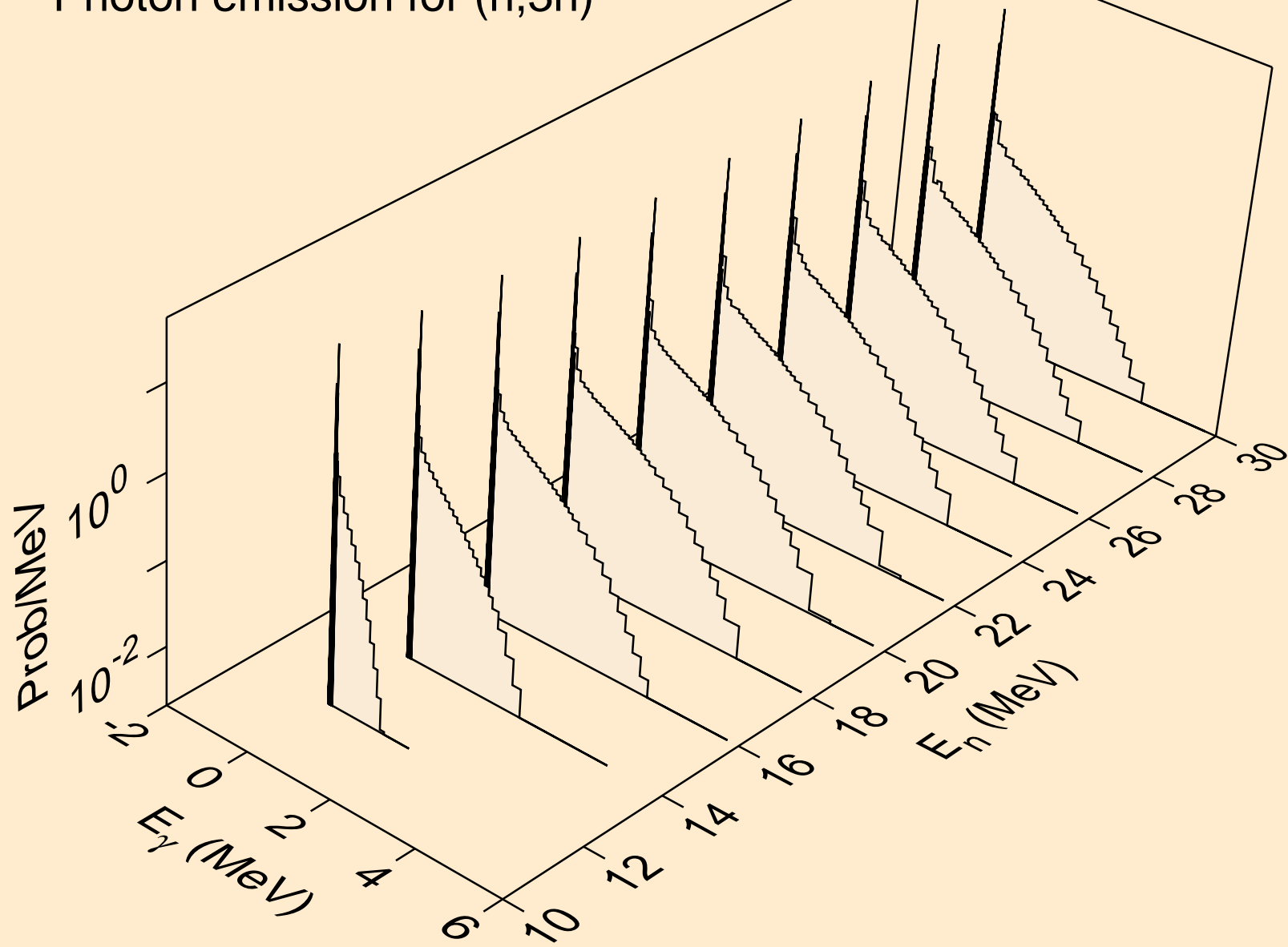

TA194 NEUTRON ACER TENDL-2023 LIBRARY; T=0.K
Photon emission for (n,n*)a

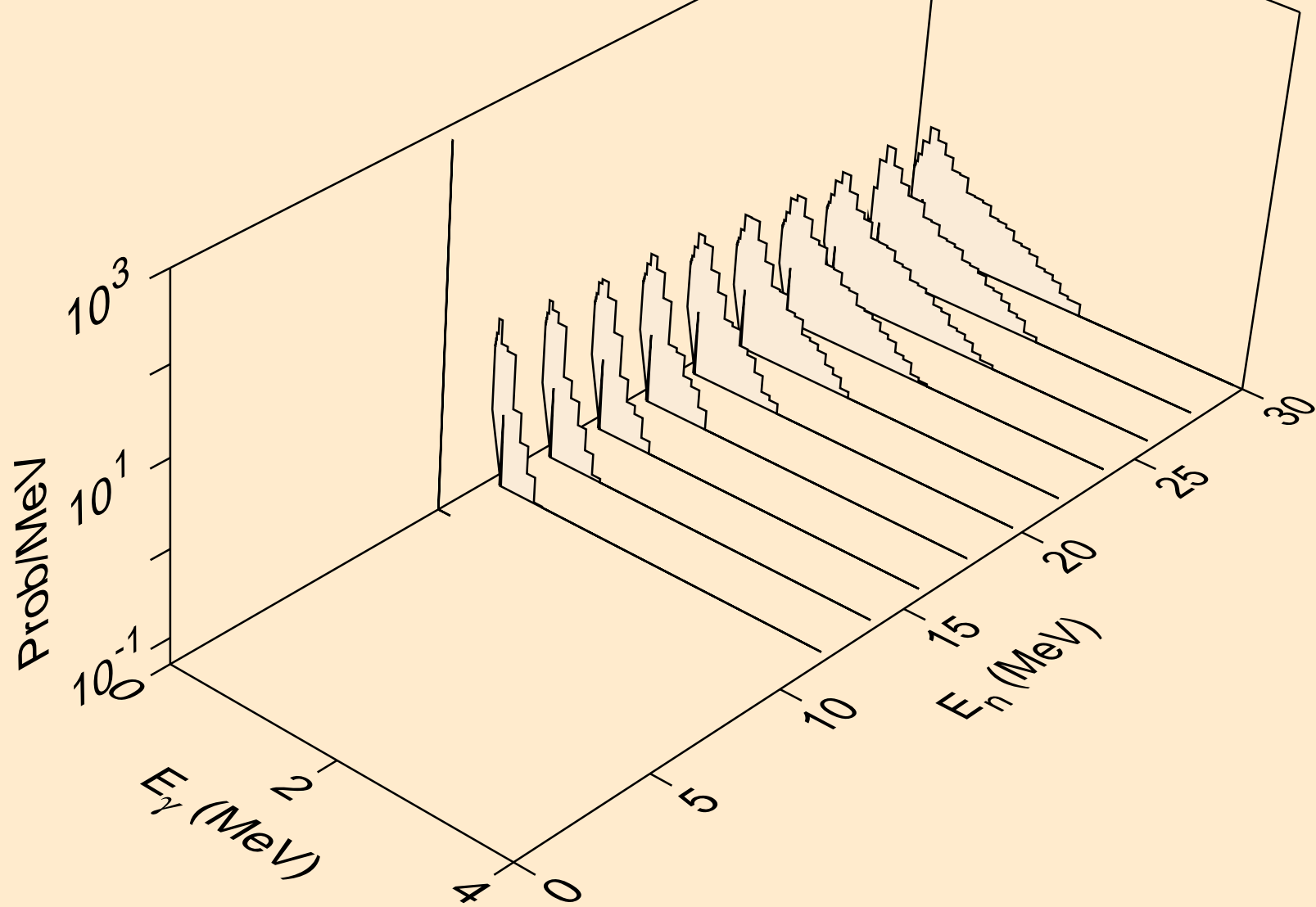

TA194 NEUTRON ACER TENDL-2023 LIBRARY; T=0.K
Photon emission for (n,2n)a

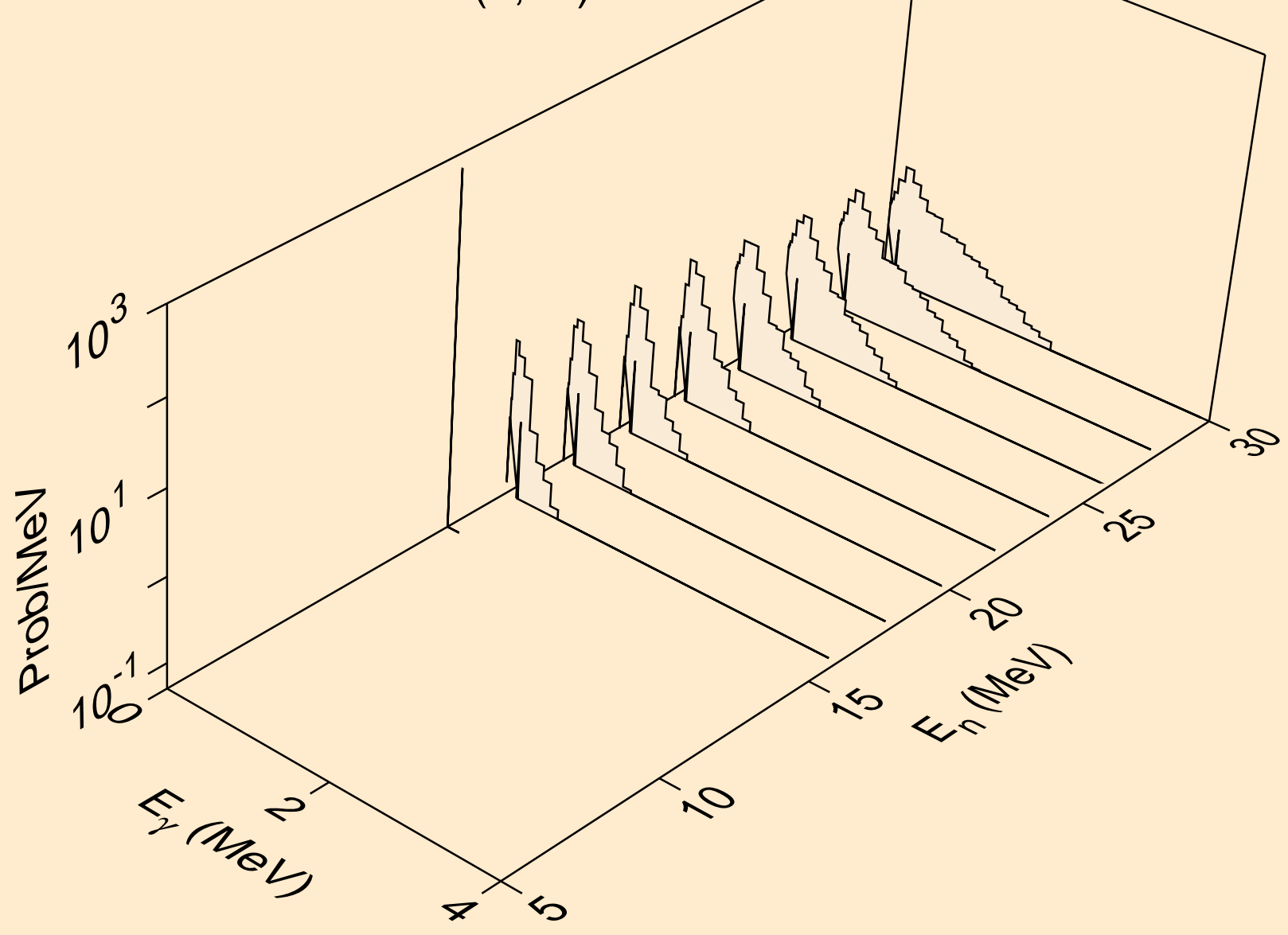

TA194 NEUTRON ACER TENDL-2023 LIBRARY; T=0.K
Photon emission for (n,3n)a

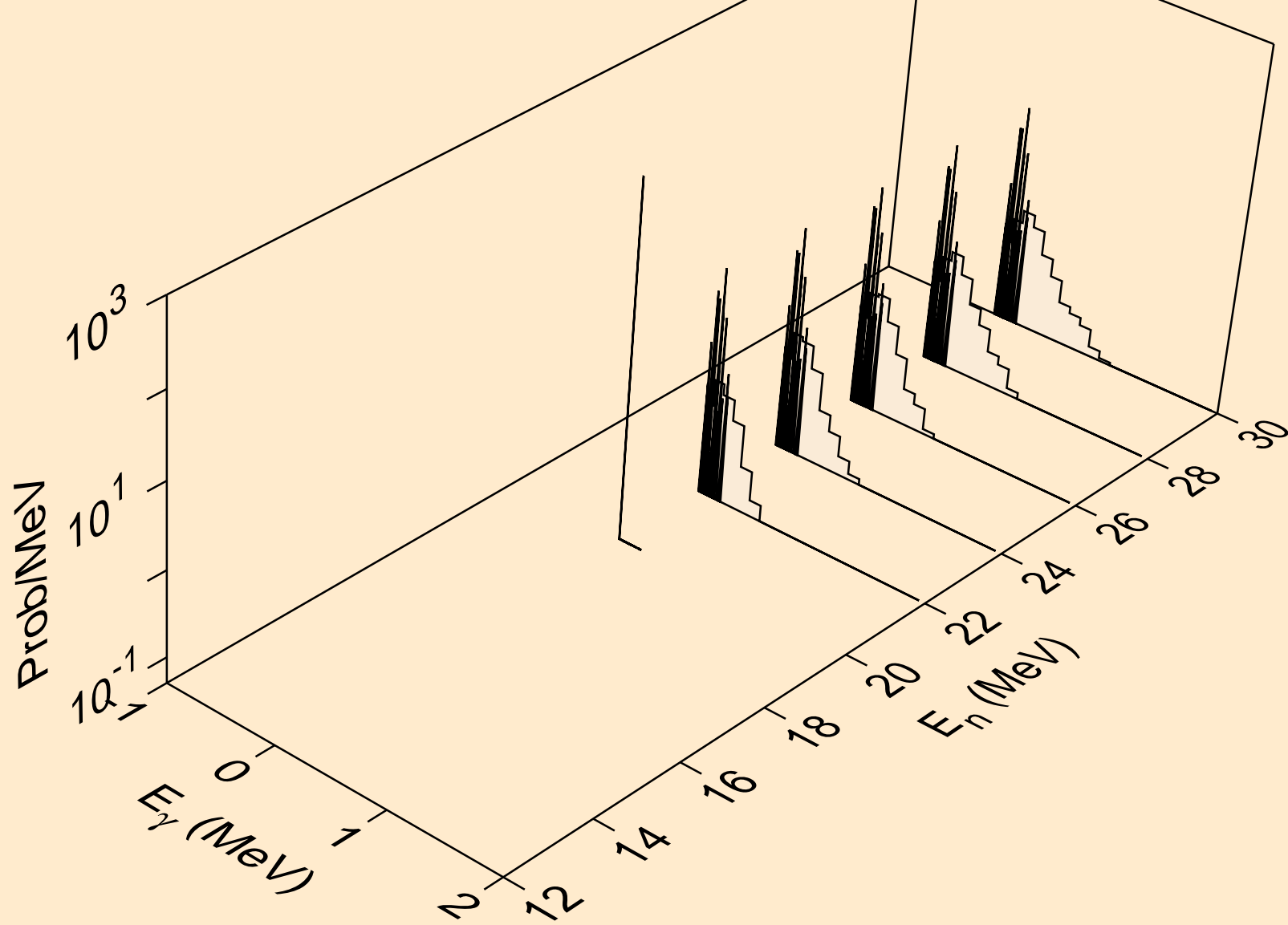

TA194 NEUTRON ACER TENDL-2023 LIBRARY; T=0.K
Photon emission for (n,n*)p

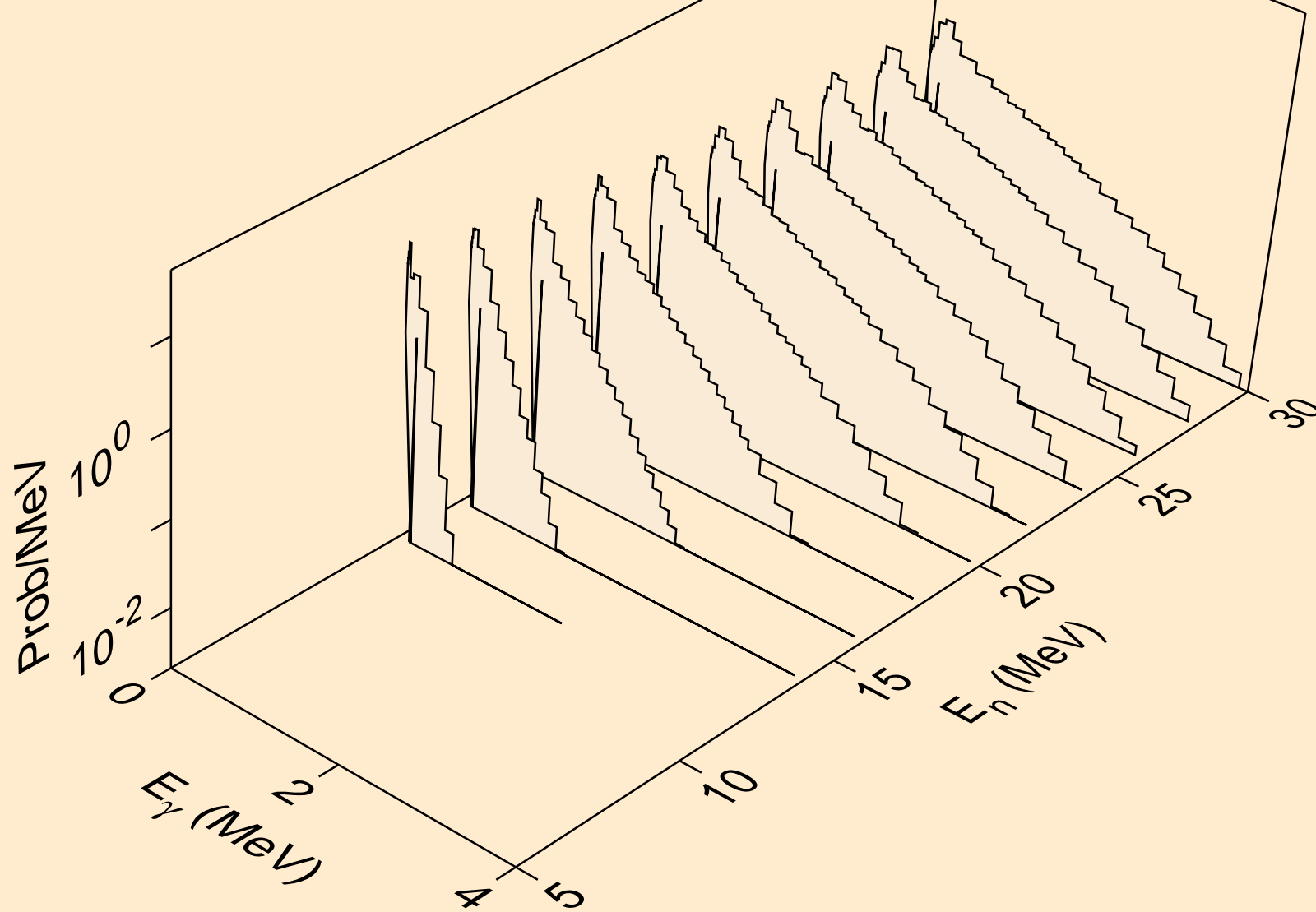

TA194 NEUTRON ACER TENDL-2023 LIBRARY; T=0.K
Photon emission for (n,n*)d

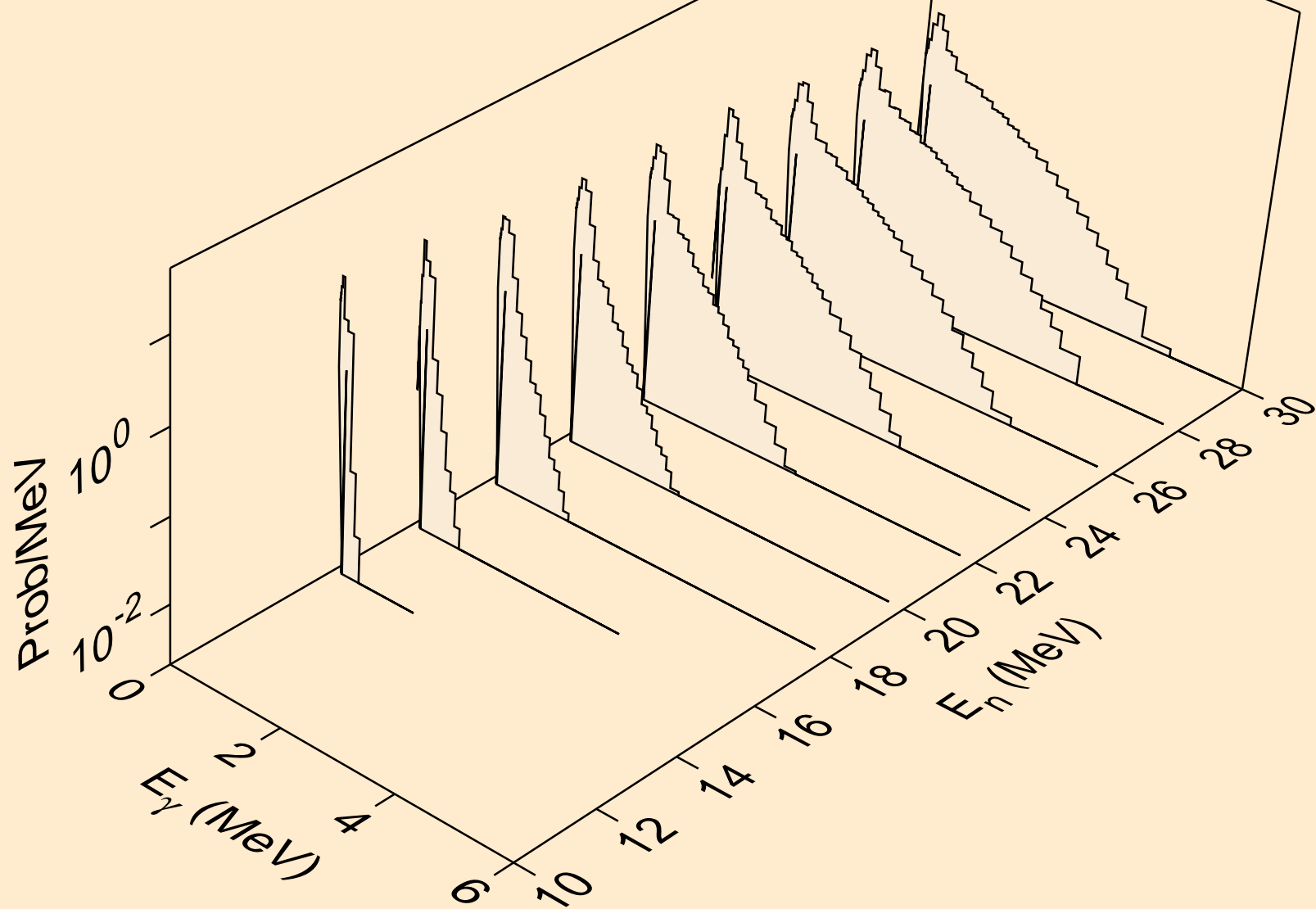

TA194 NEUTRON ACER TENDL-2023 LIBRARY; T=0.K
Photon emission for (n,n*)t

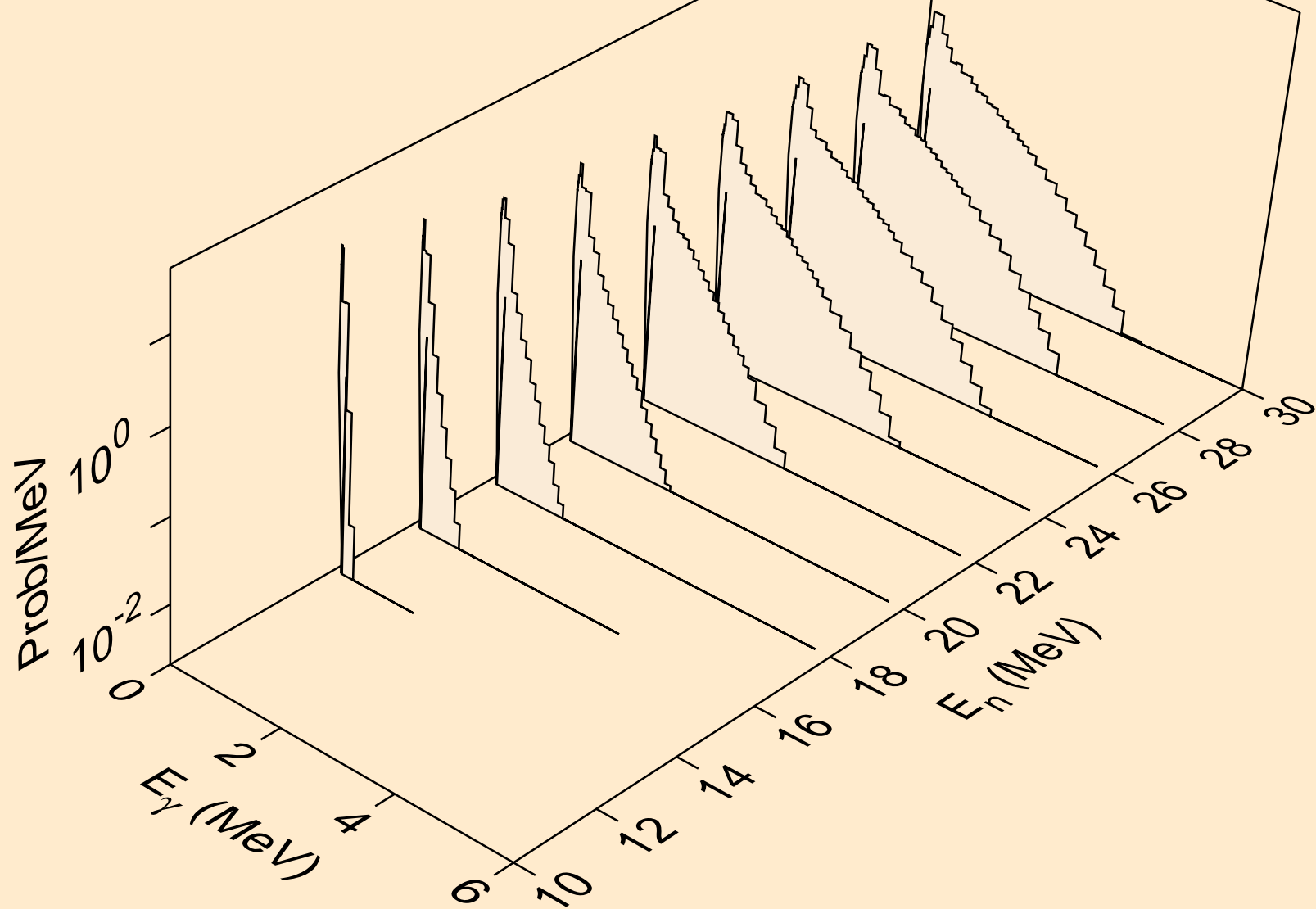

TA194 NEUTRON ACER TENDL-2023 LIBRARY; T=0.K
Photon emission for (n,n*)he3

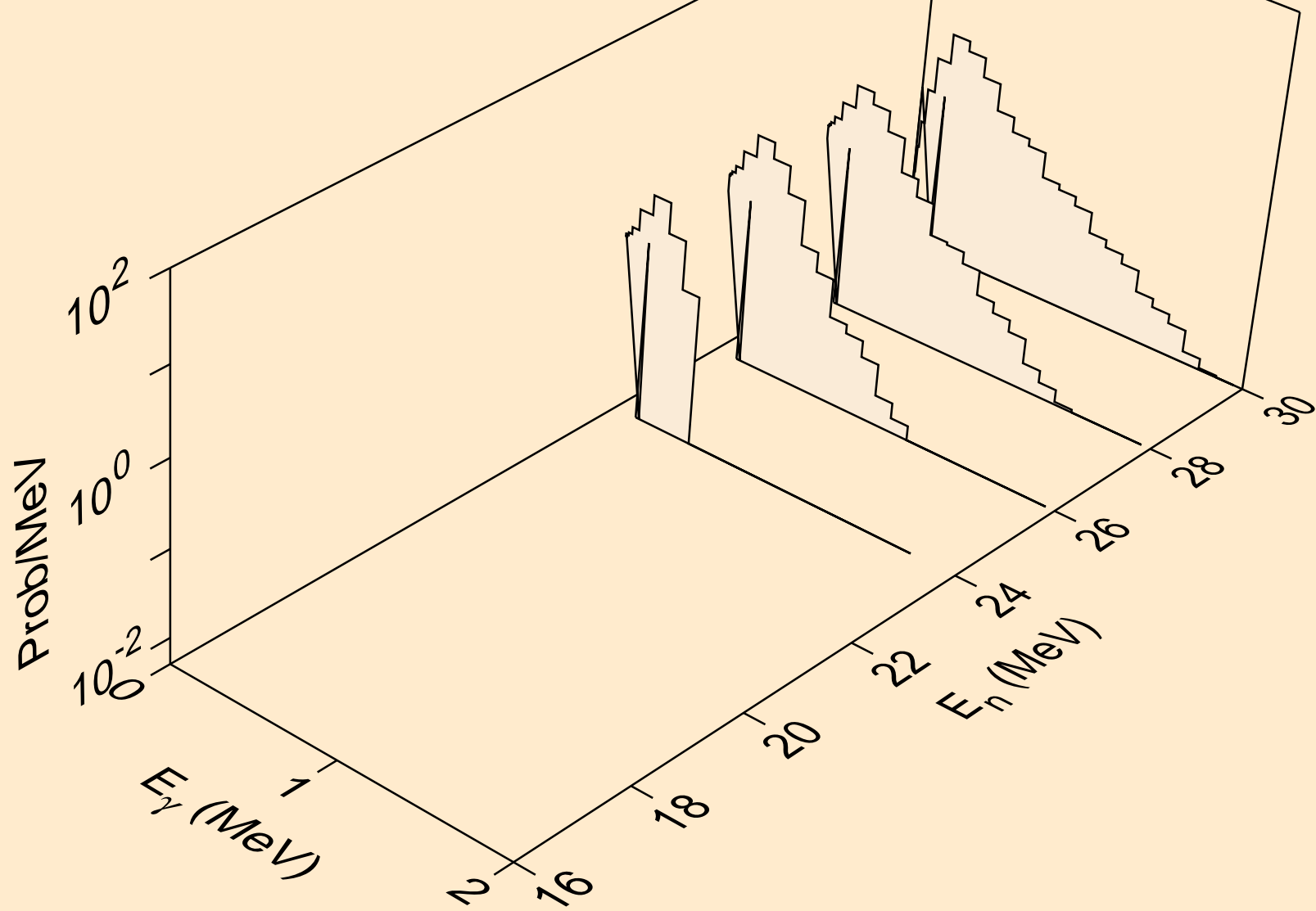

TA194 NEUTRON ACER TENDL-2023 LIBRARY; T=0.K
Photon emission for (n,4n)

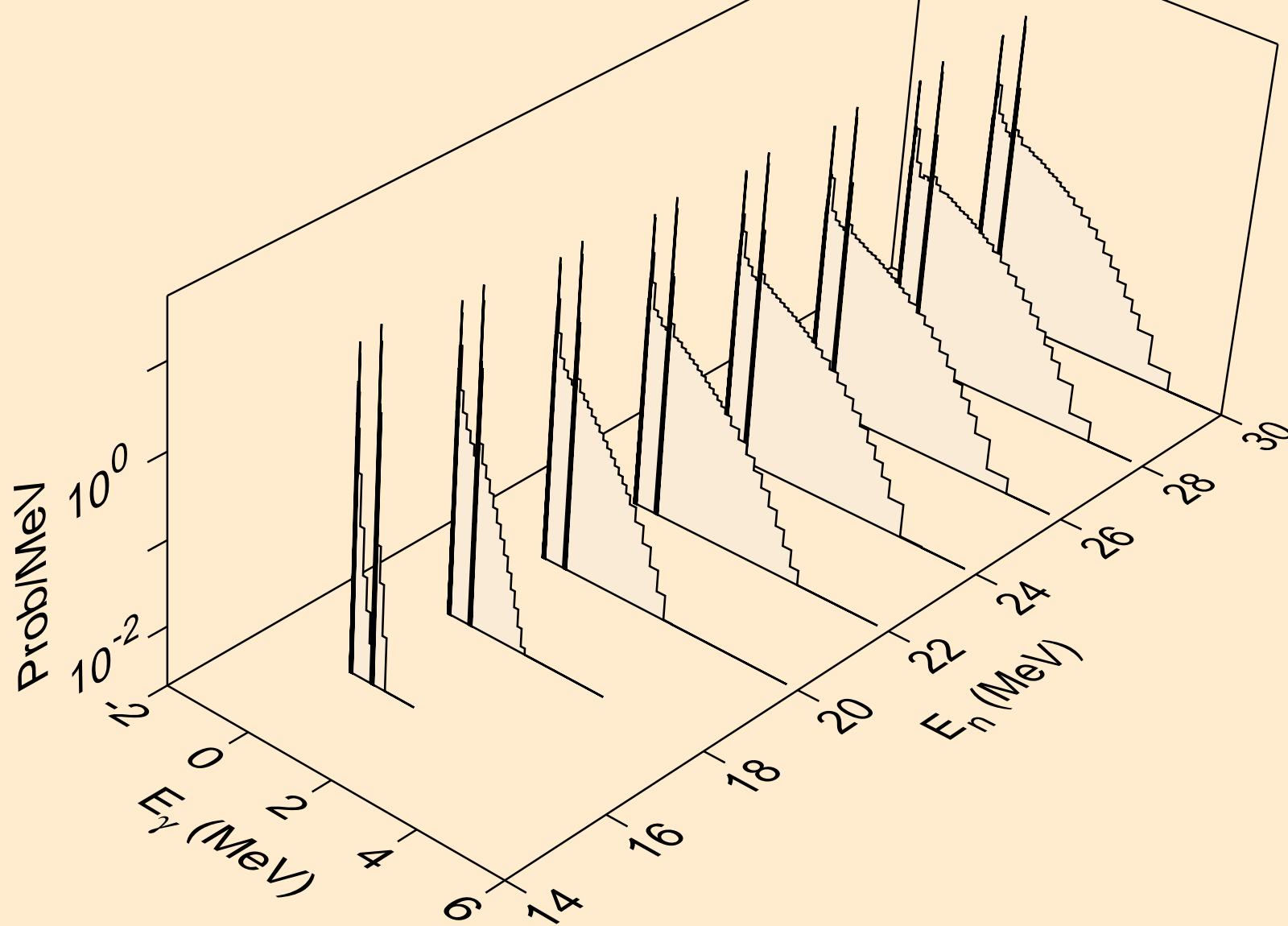

TA194 NEUTRON ACER TENDL-2023 LIBRARY; T=0.K
Photon emission for (n,2np)

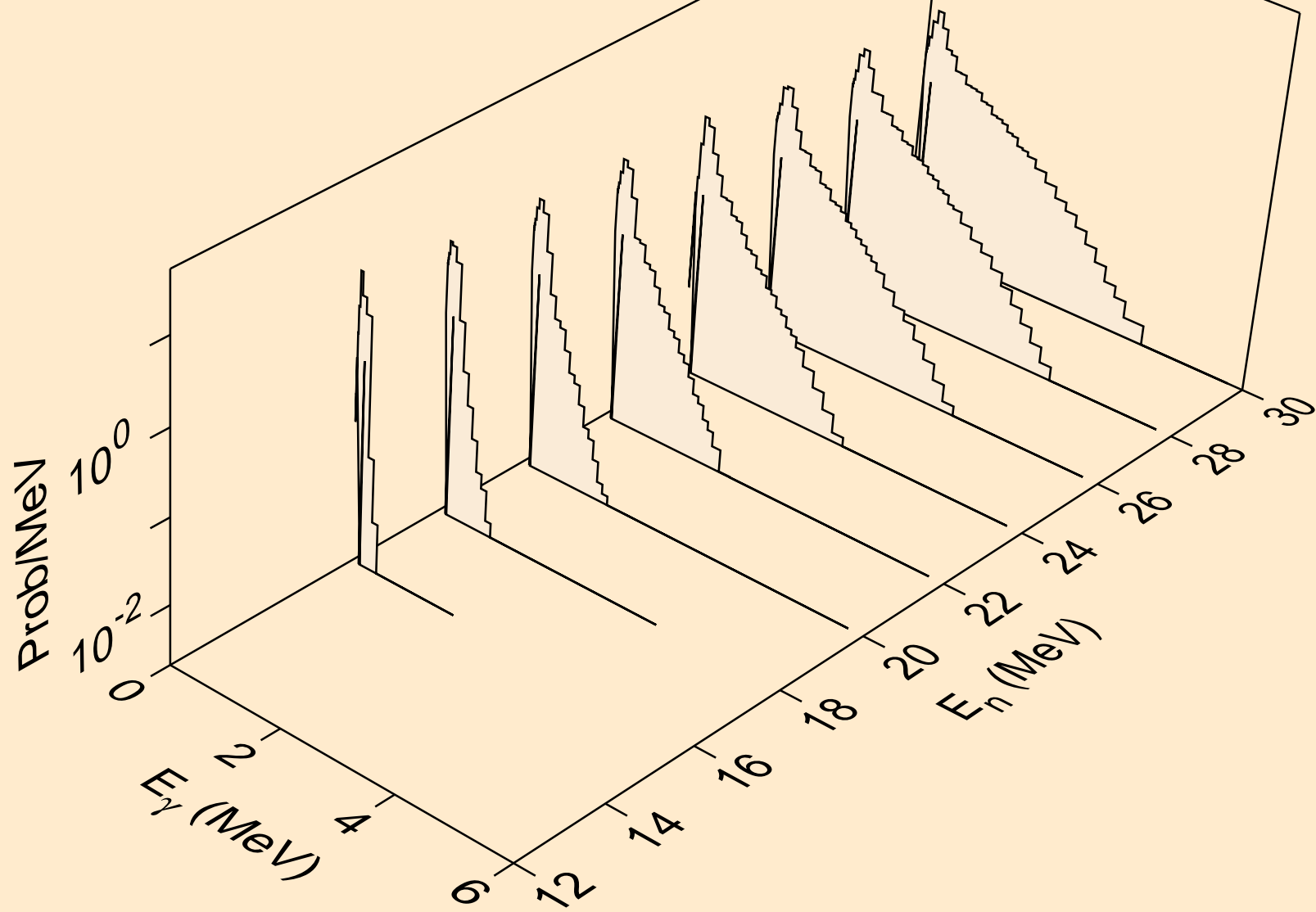

TA194 NEUTRON ACER TENDL-2023 LIBRARY; T=0.K
Photon emission for (n,3np)

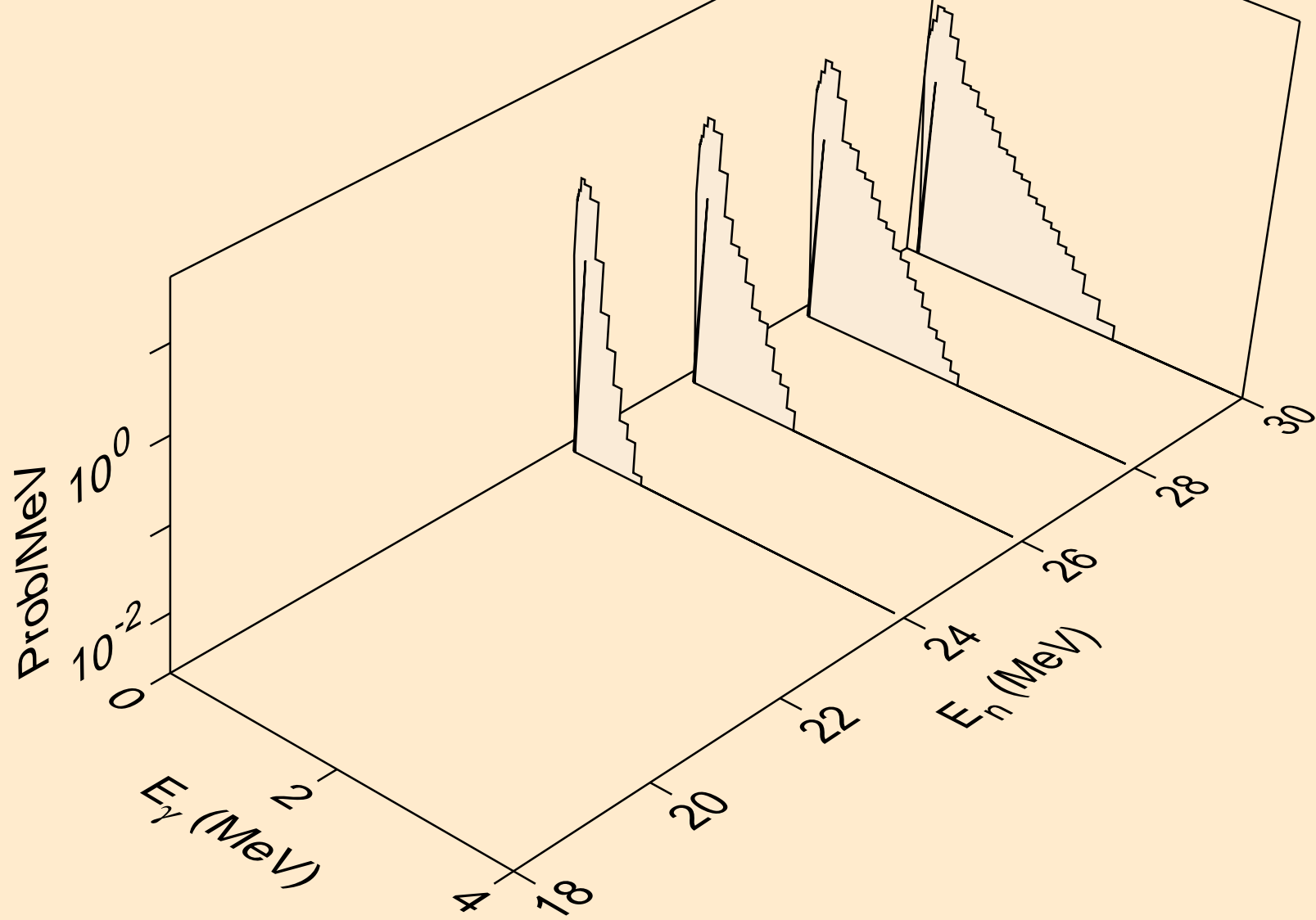

TA194 NEUTRON ACER TENDL-2023 LIBRARY; T=0.K
Photon emission for (n,n*c)

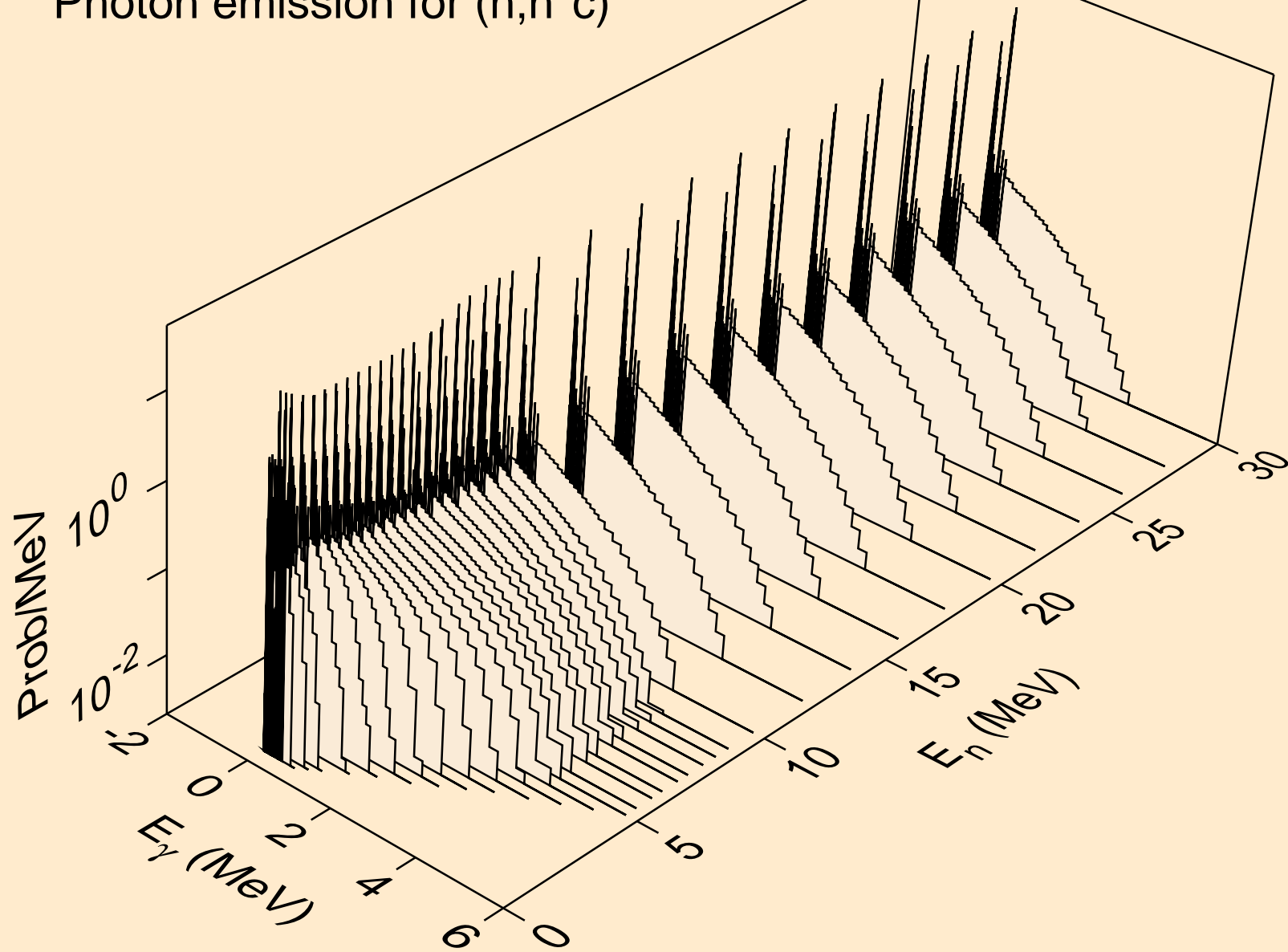

TA194 NEUTRON ACER TENDL-2023 LIBRARY; T=0.K
Photon emission for (n,gma)

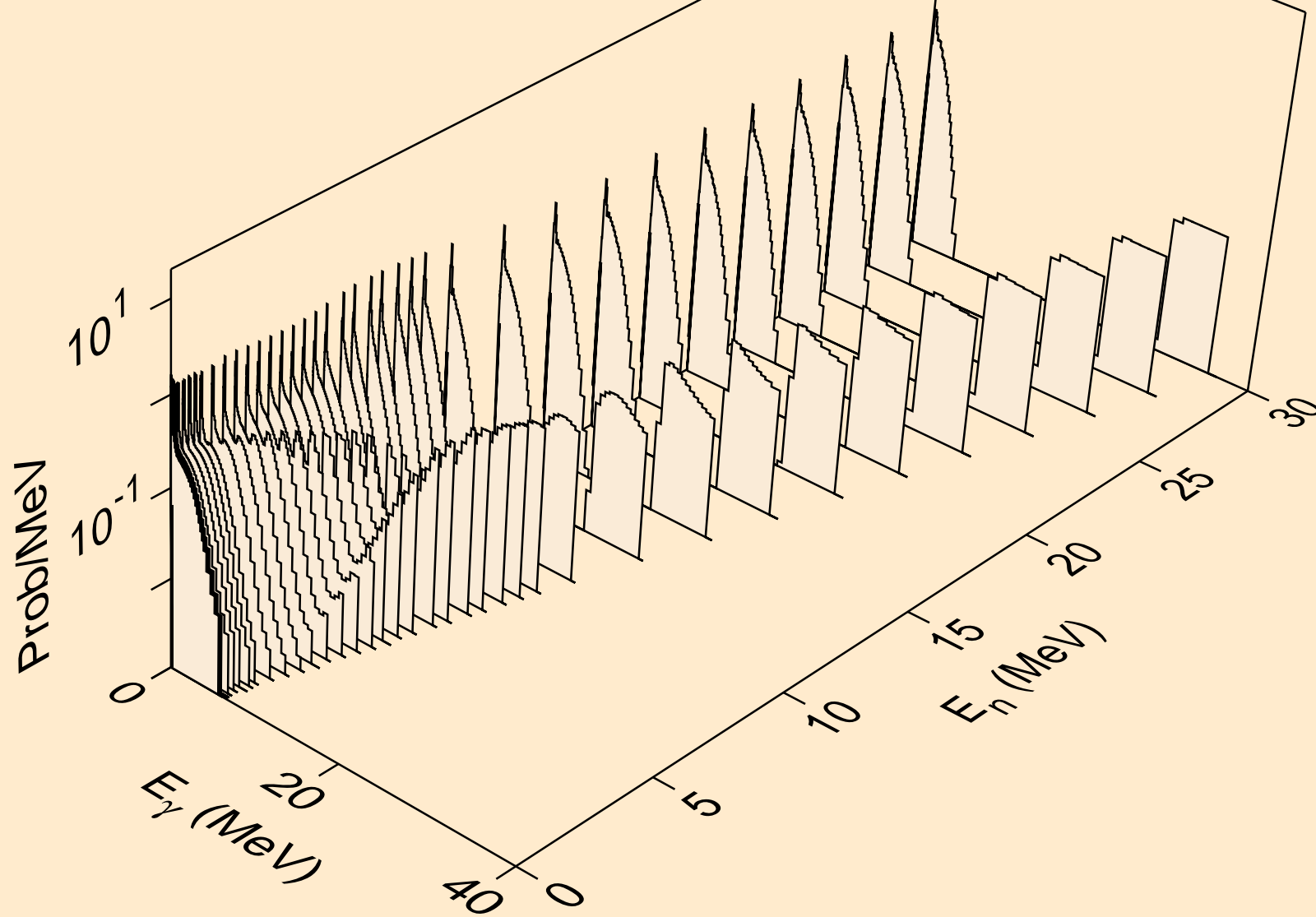

TA194 NEUTRON ACER TENDL-2023 LIBRARY; T=0.K
Photon emission for (n,p)

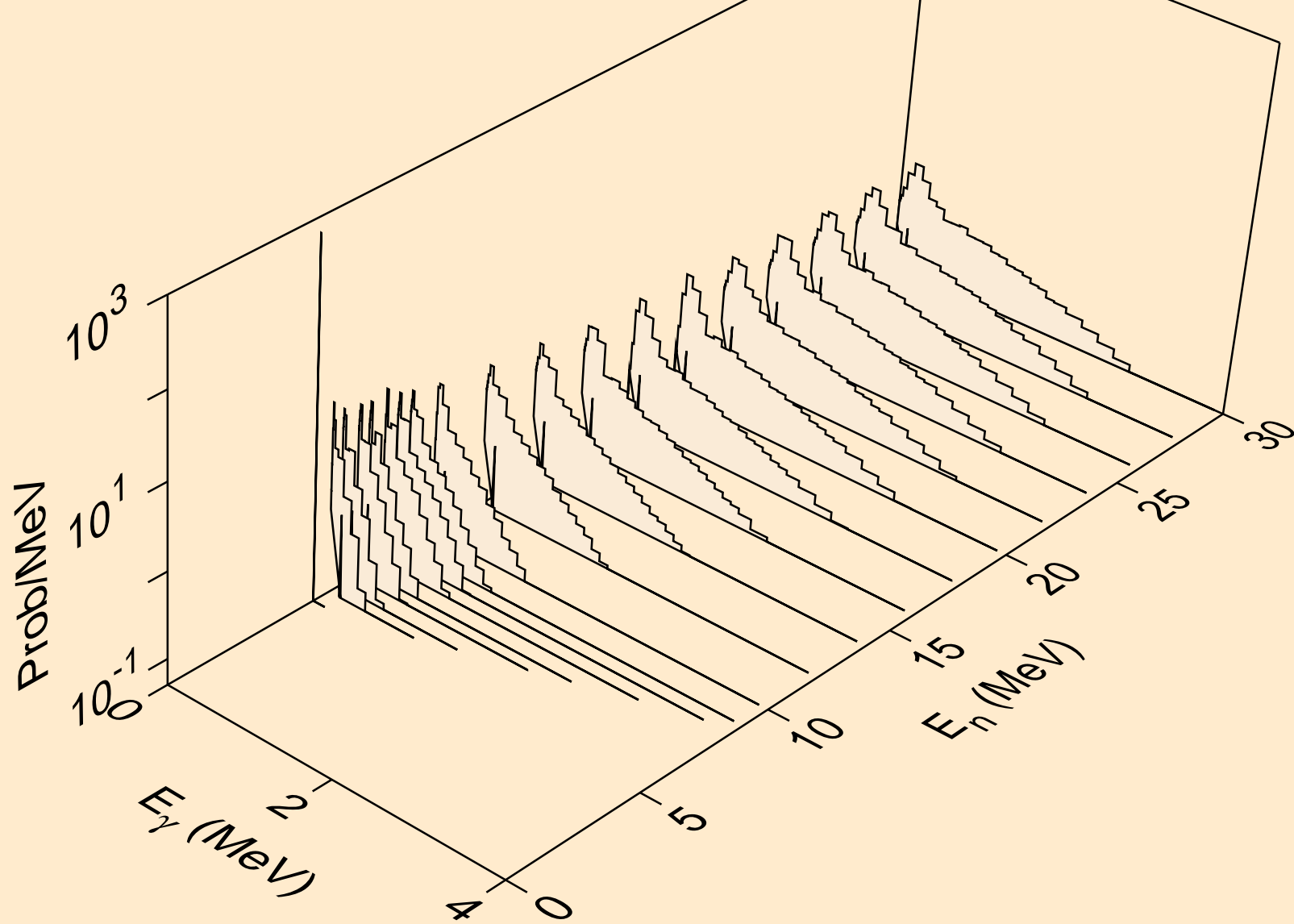

TA194 NEUTRON ACER TENDL-2023 LIBRARY; T=0.K
Photon emission for (n,d)

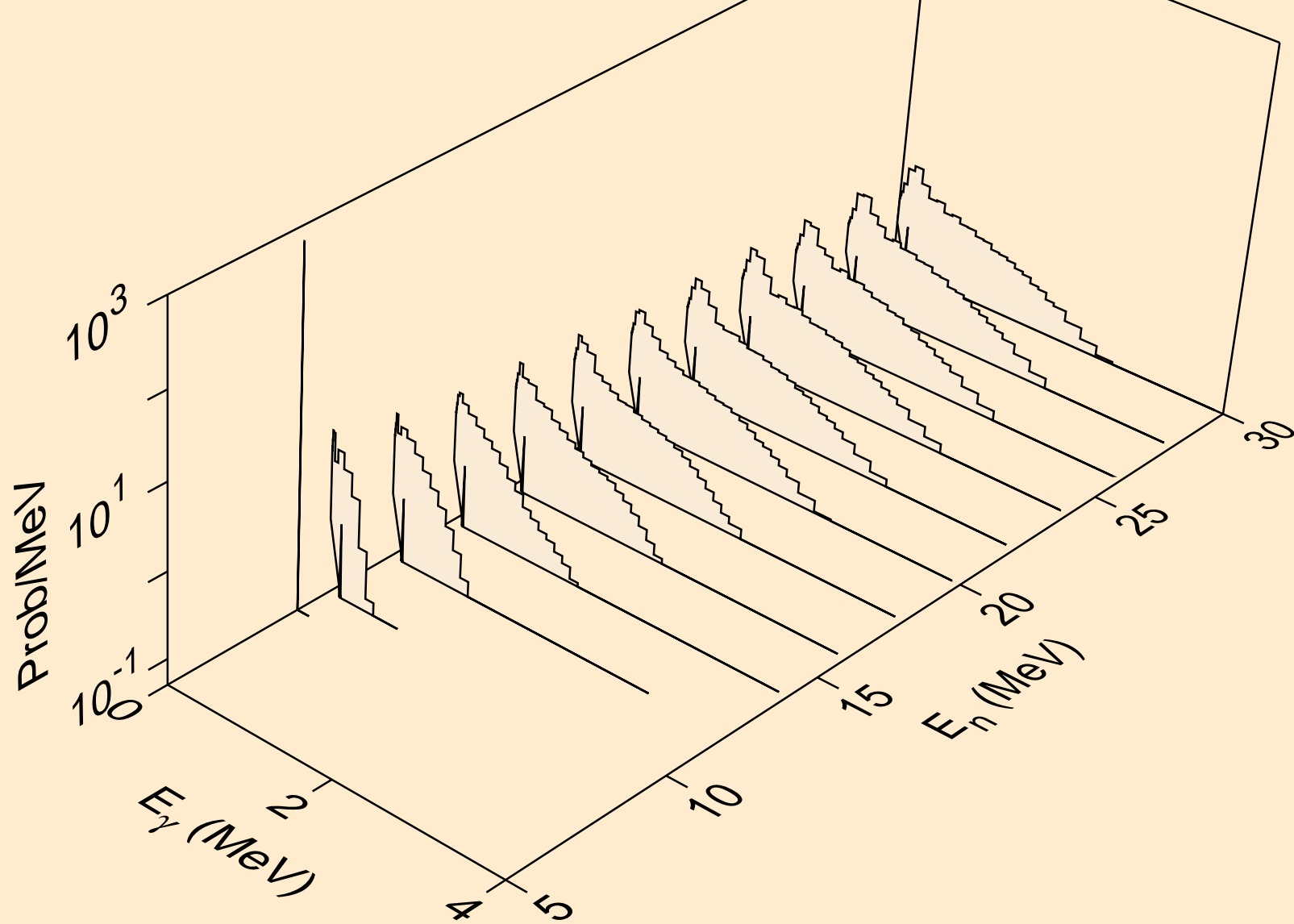

TA194 NEUTRON ACER TENDL-2023 LIBRARY; T=0.K
Photon emission for (n,t)

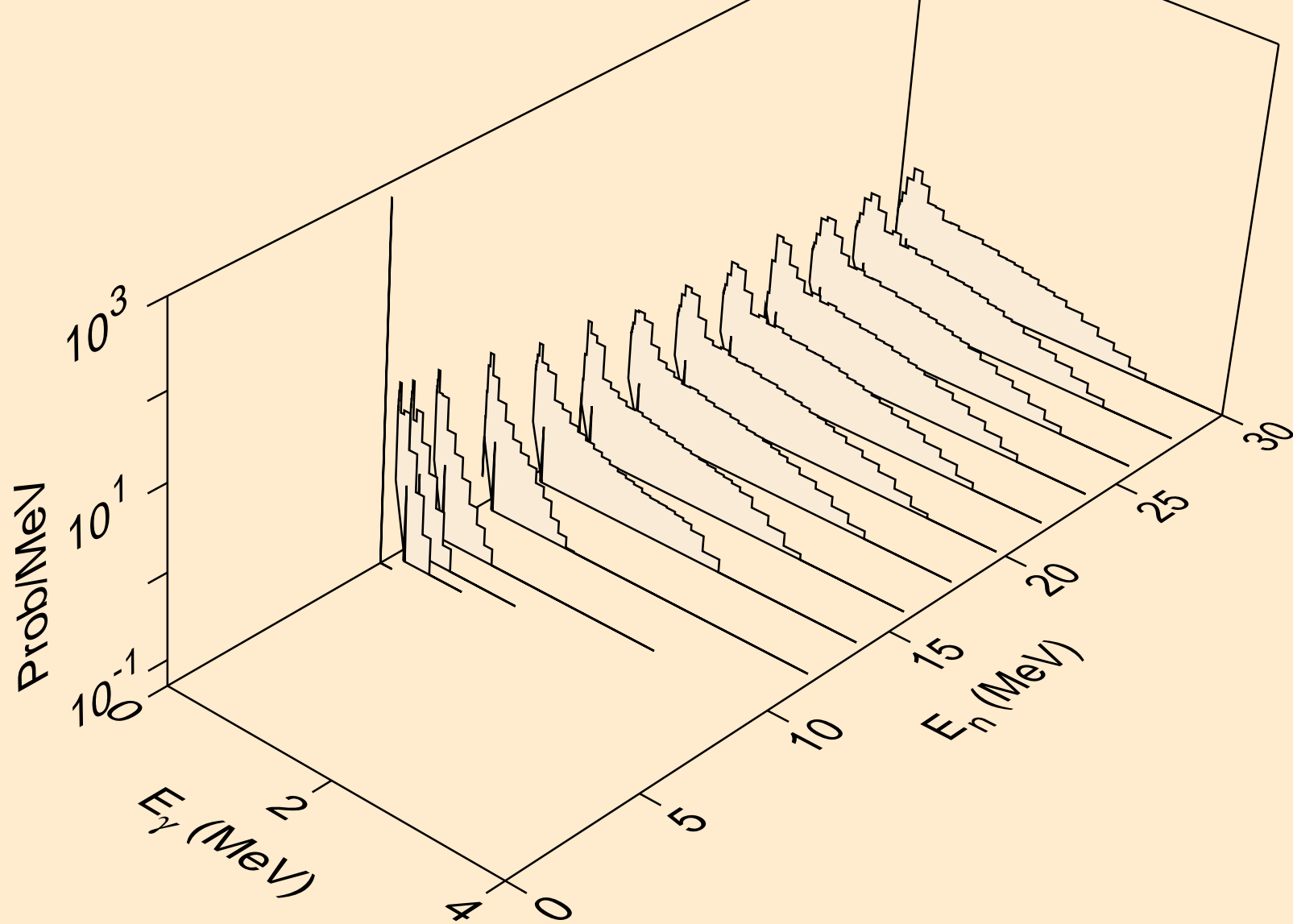

TA194 NEUTRON ACER TENDL-2023 LIBRARY; T=0.K
Photon emission for (n,he3)

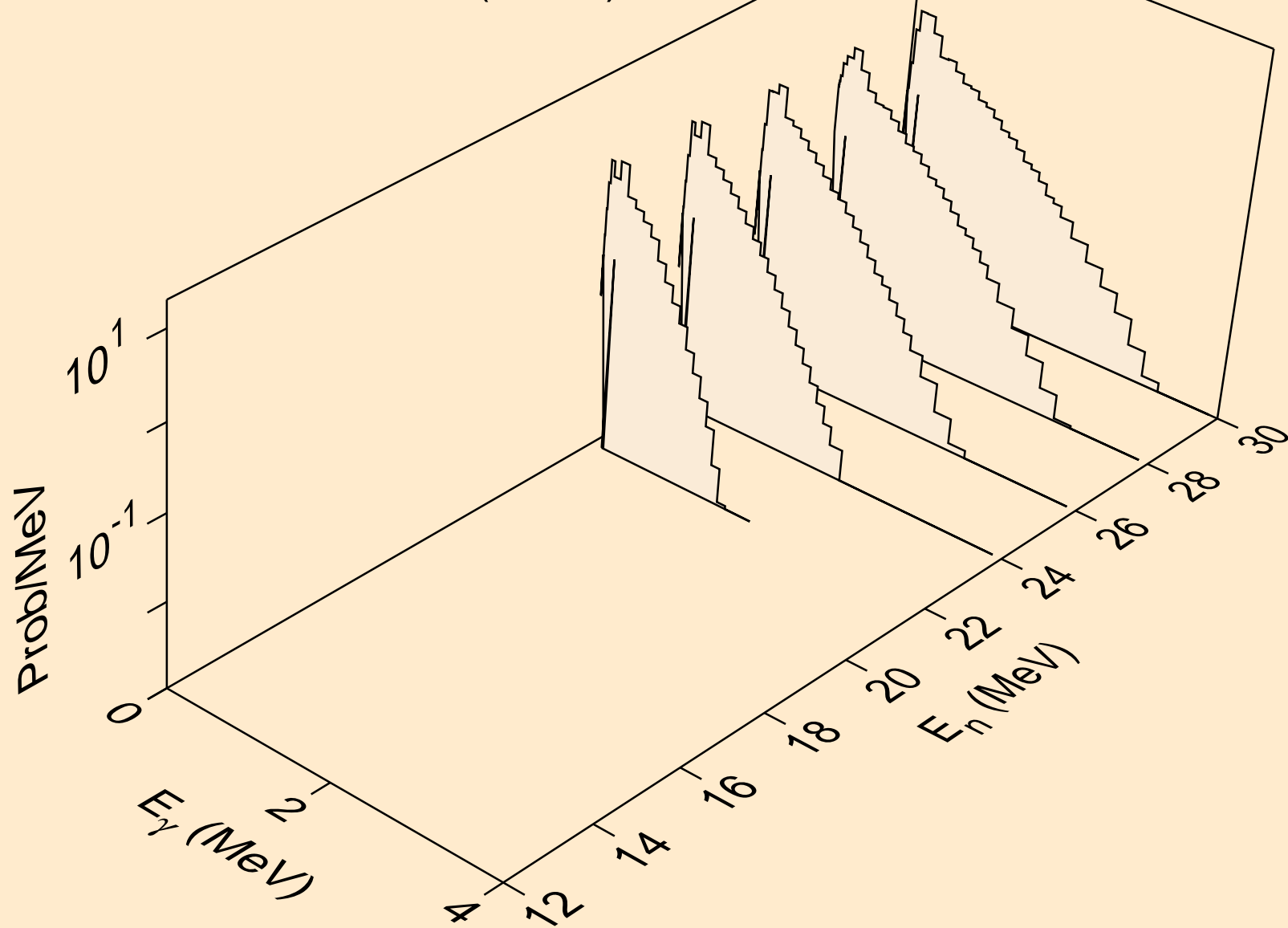

TA194 NEUTRON ACER TENDL-2023 LIBRARY; T=0.K
Photon emission for (n,a)

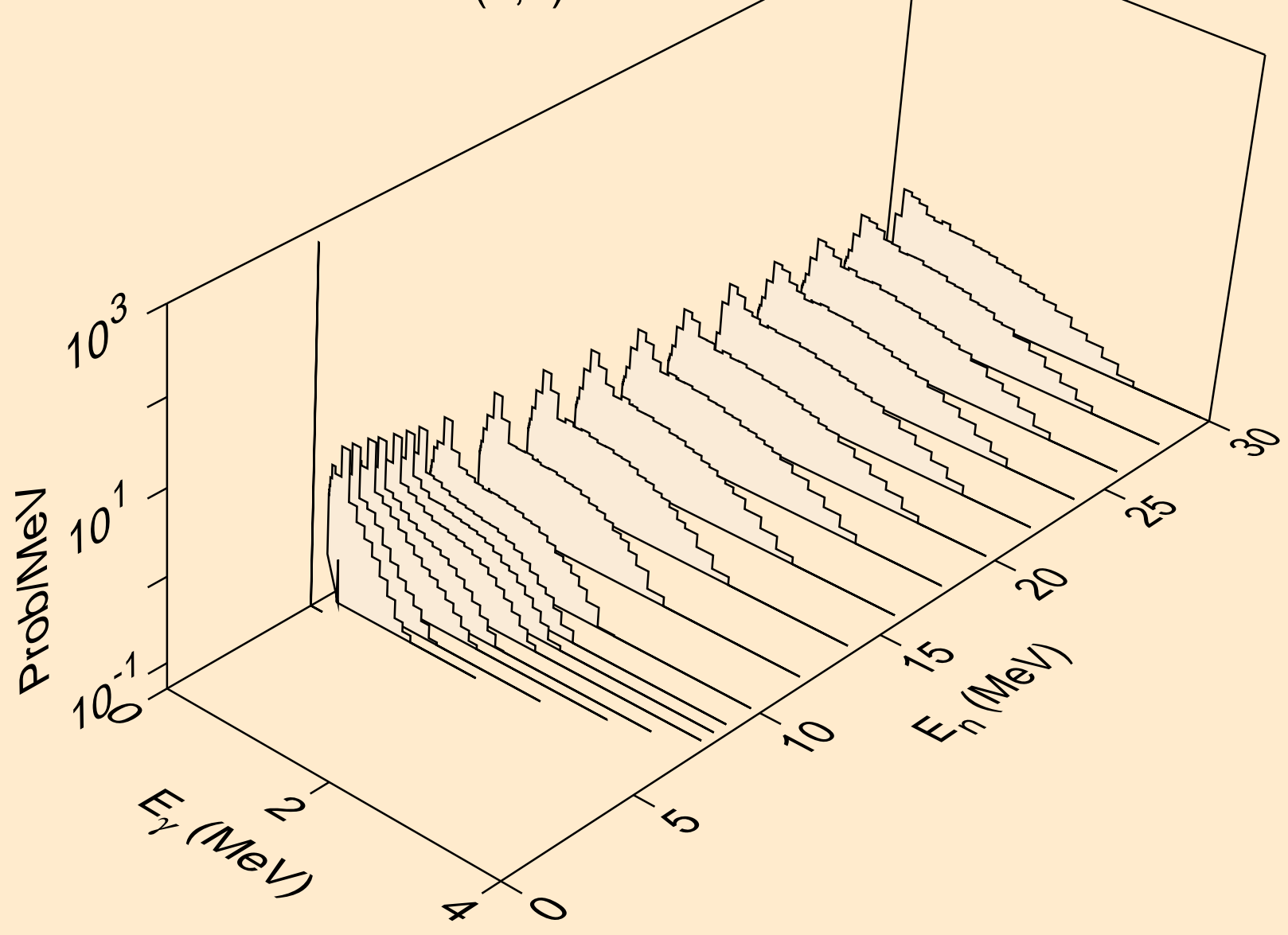

TA194 NEUTRON ACER TENDL-2023 LIBRARY; T=0.K
thermal capture photon spectrum

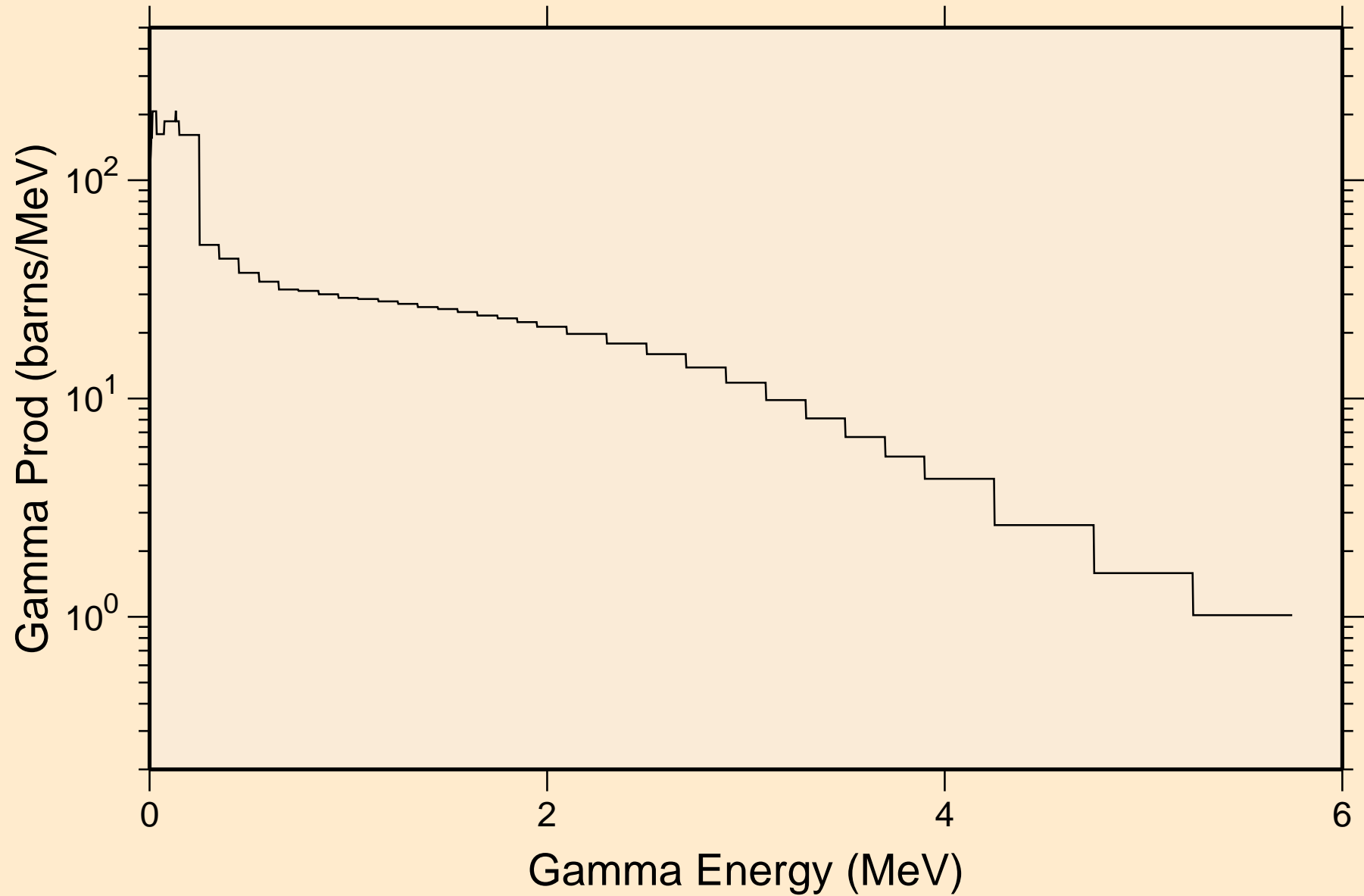

TA194 NEUTRON ACER TENDL-2023 LIBRARY; T=0.K
14 MeV photon spectrum

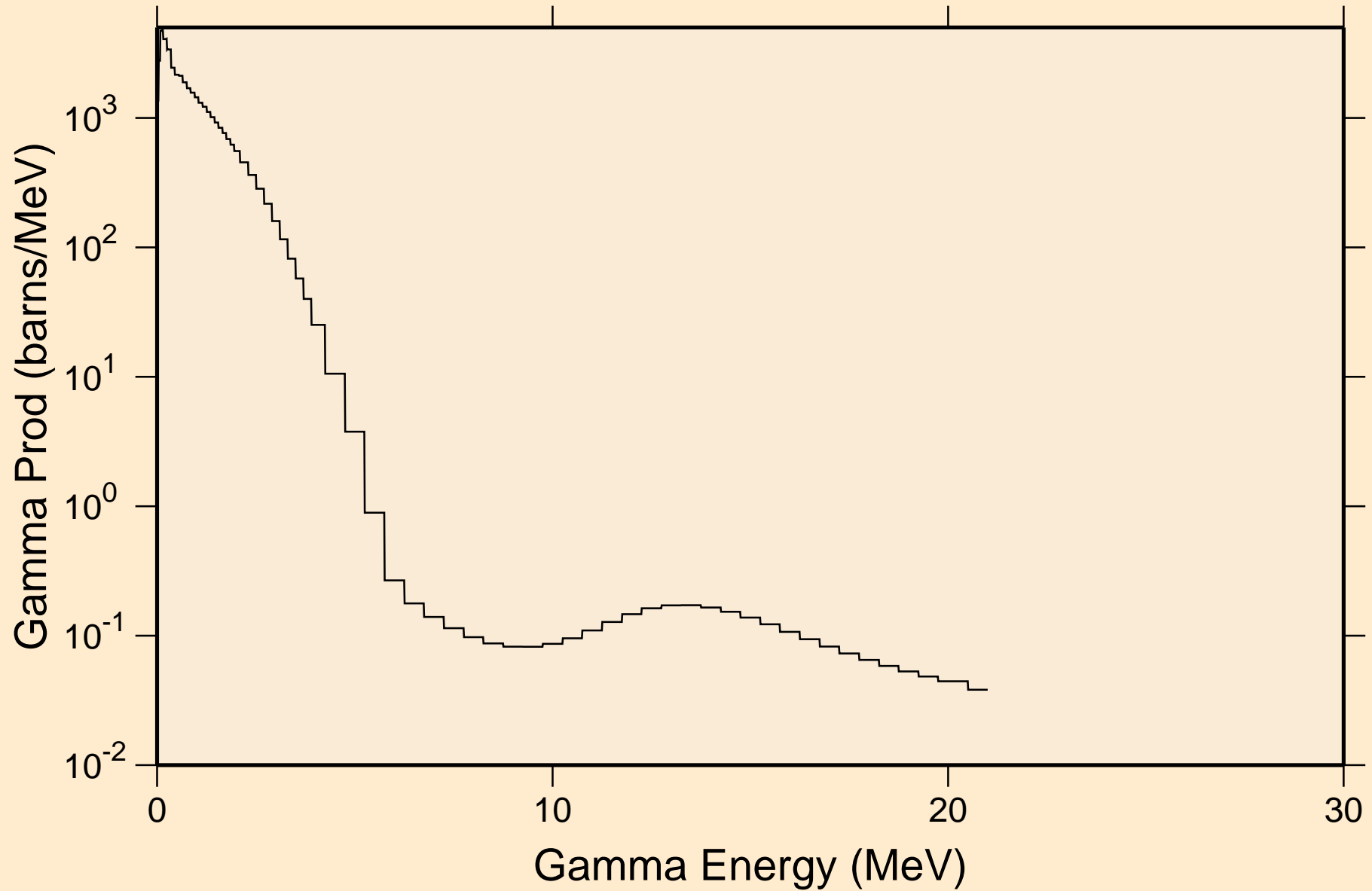

TA194 NEUTRON ACER TENDL-2023 LIBRARY; T=0.K
Particle heating contributions

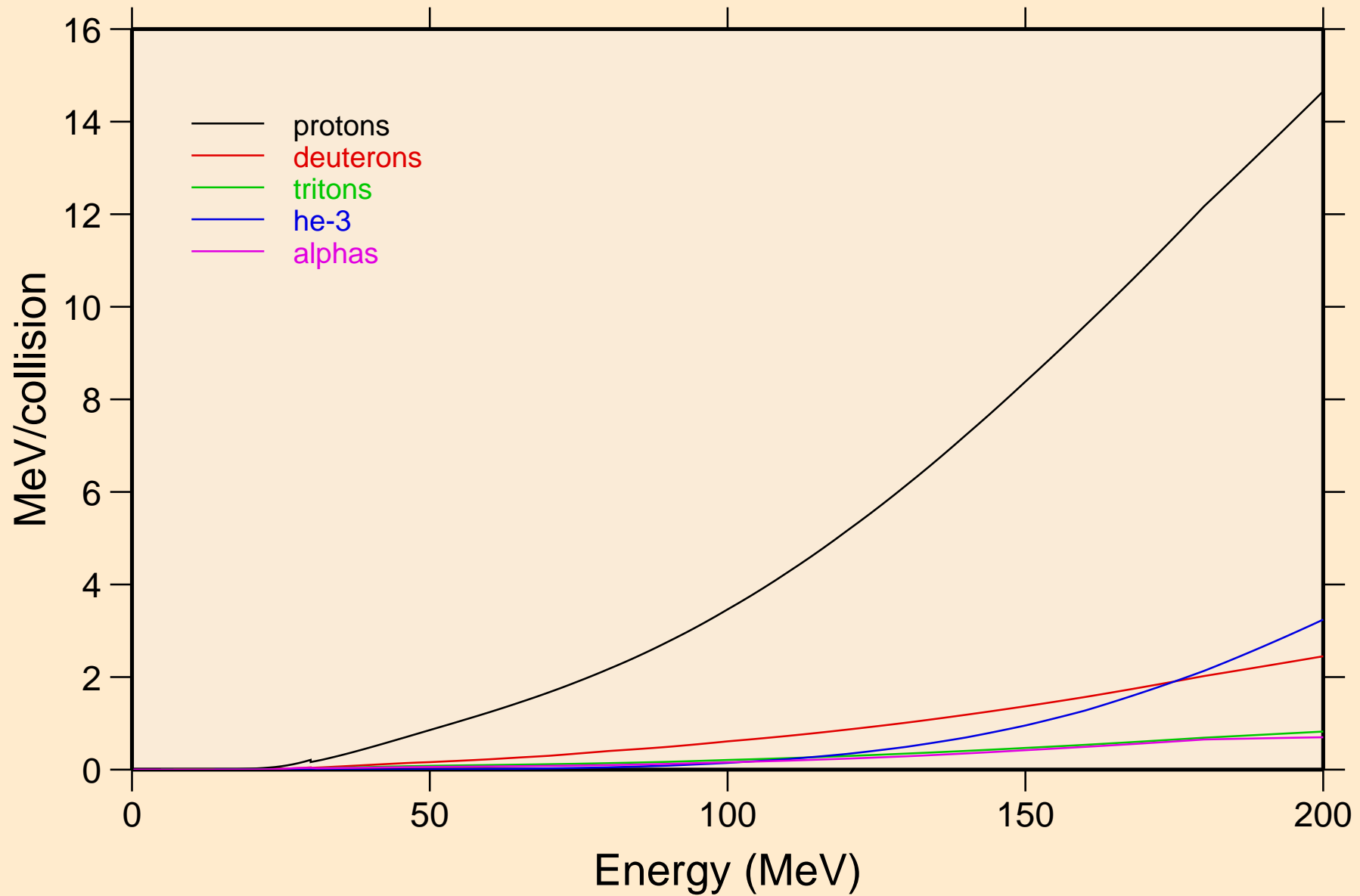

TA194 NEUTRON ACER TENDL-2023 LIBRARY; T=0.K
Recoil Heating

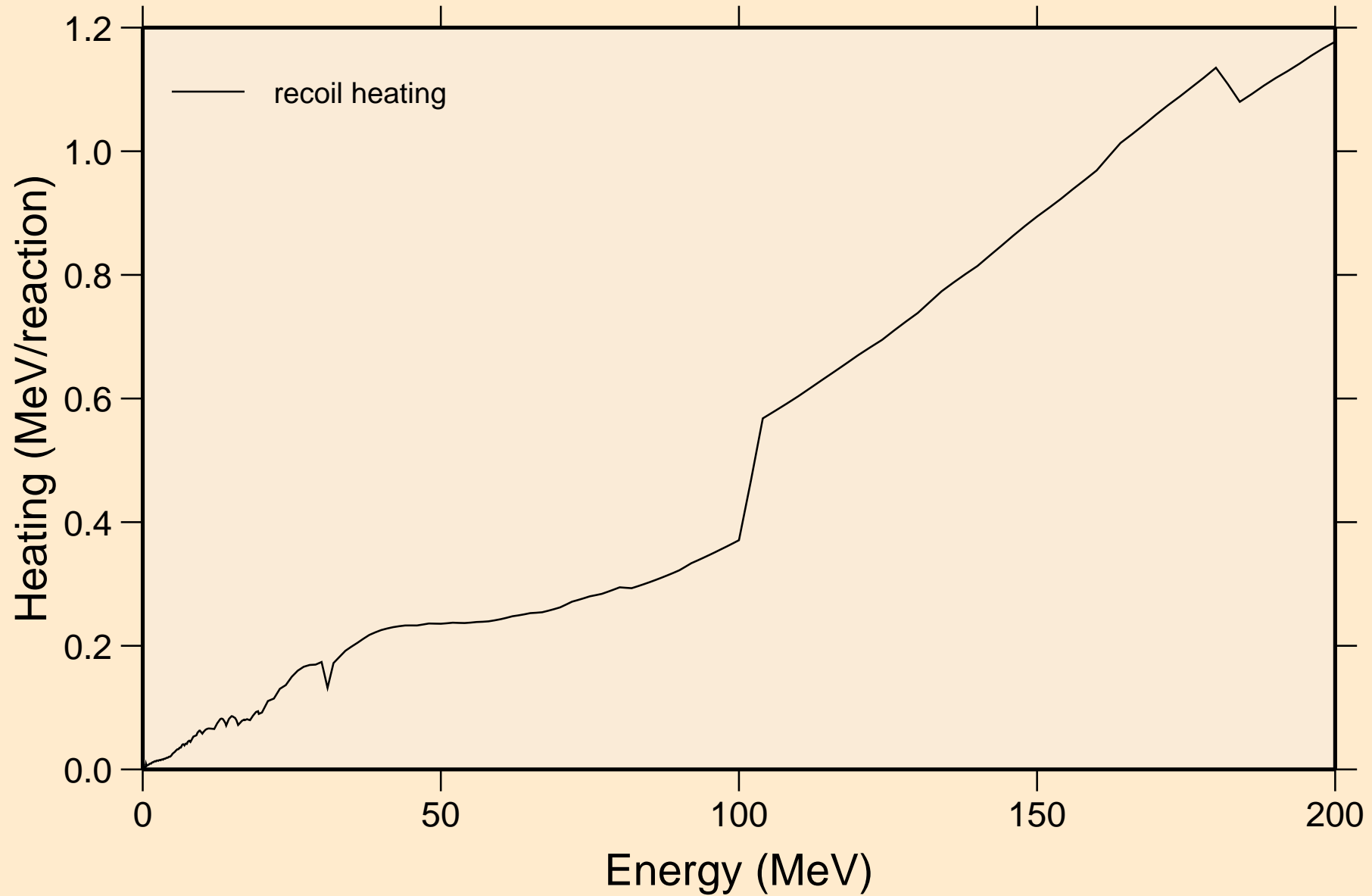

TA194 NEUTRON ACER TENDL-2023 LIBRARY; T=0.K
Particle production cross sections

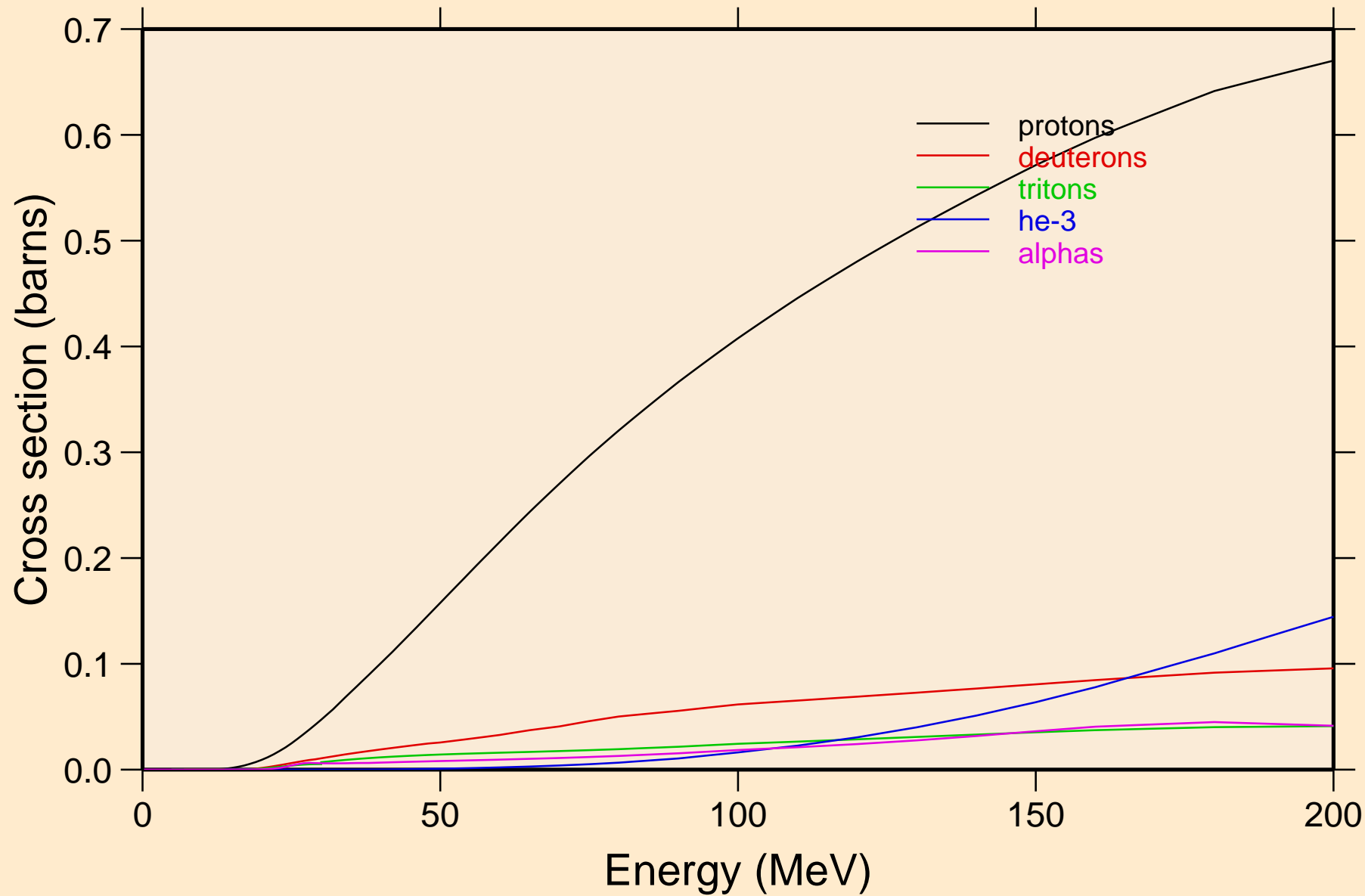

TA194 NEUTRON ACER TENDL-2023 LIBRARY; T=0.K
protons from (n,x)

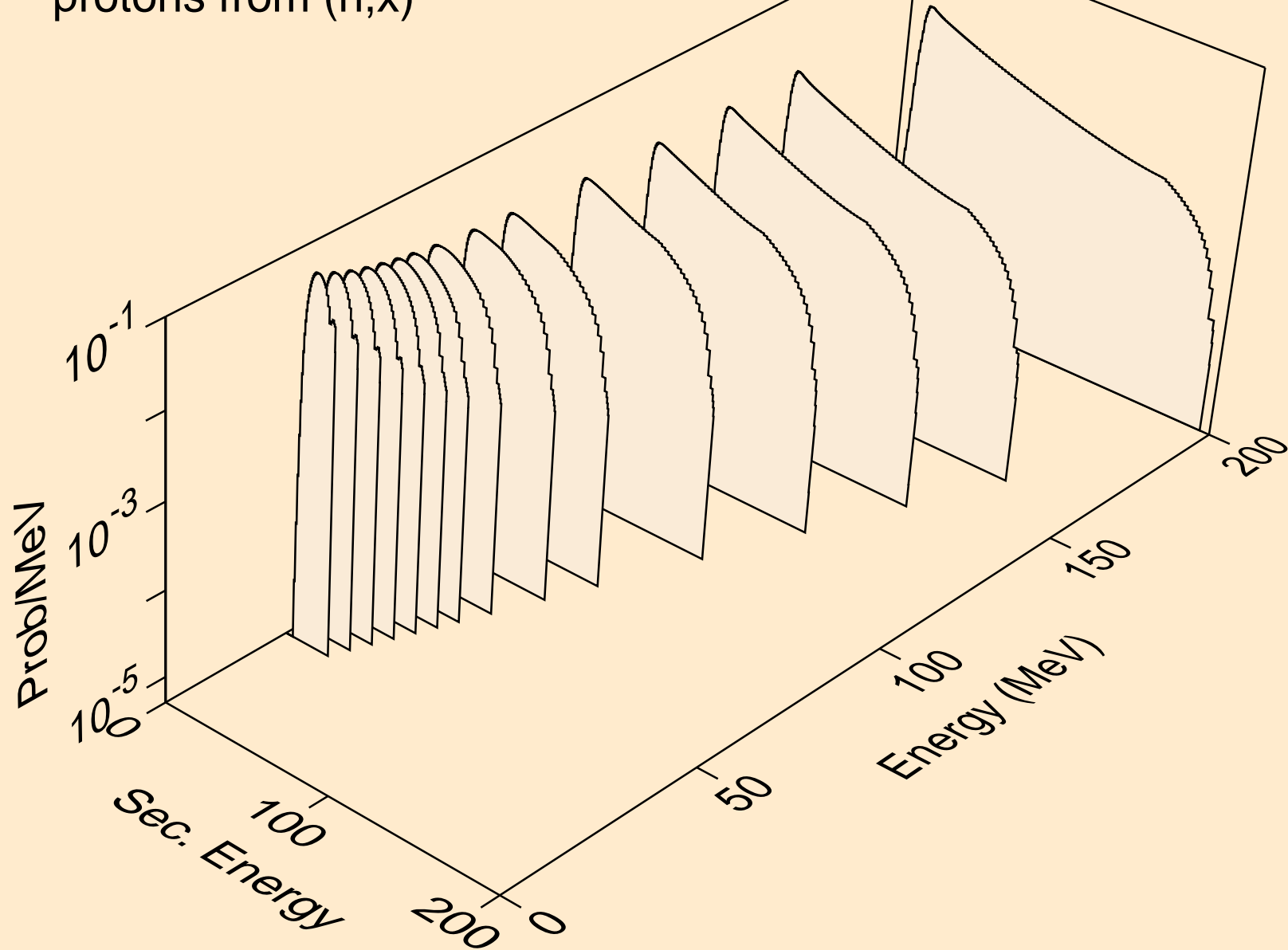

TA194 NEUTRON ACER TENDL-2023 LIBRARY; T=0.K
protons from (n,n*)p

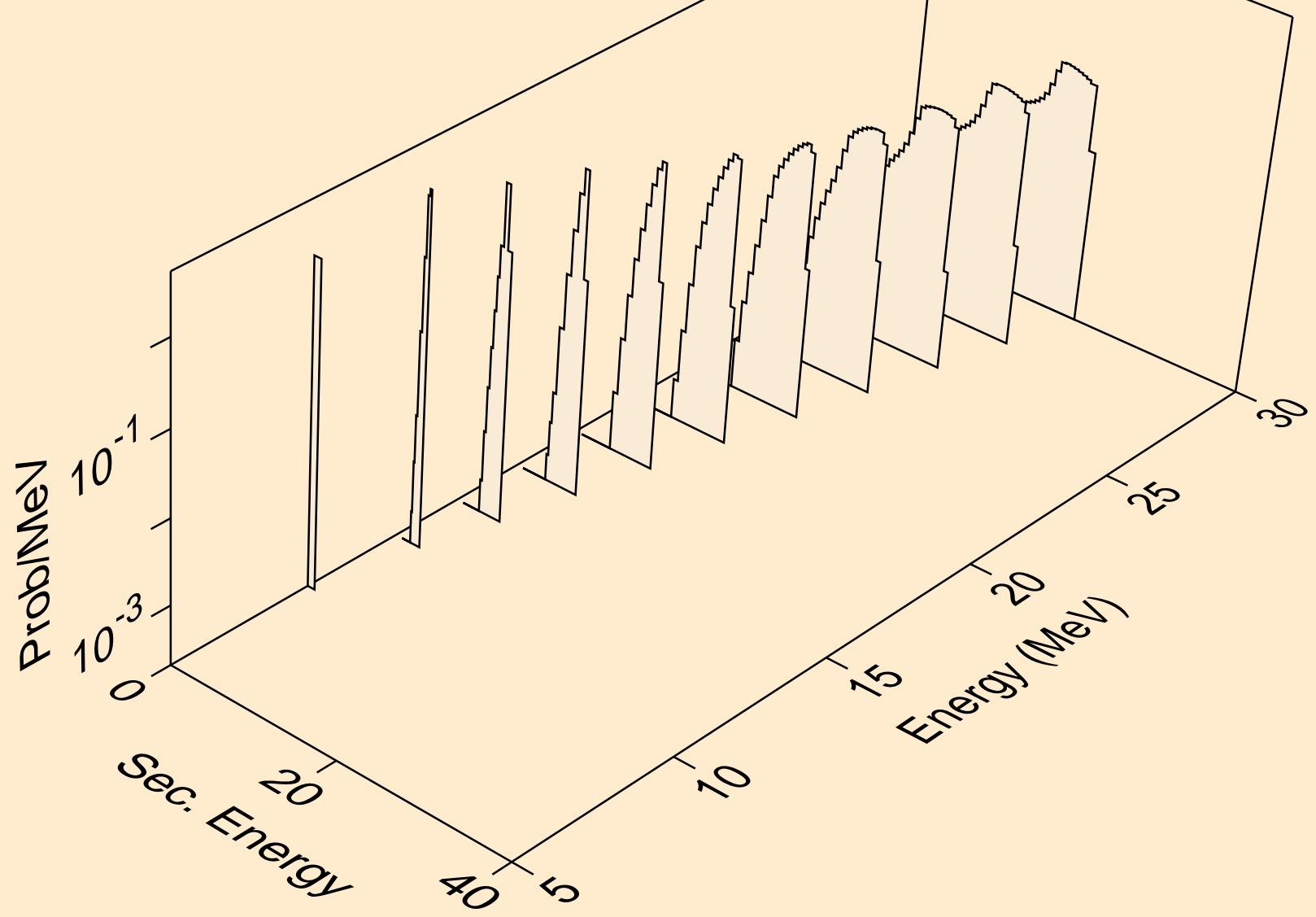

TA194 NEUTRON ACER TENDL-2023 LIBRARY; T=0.K
protons from (n,2np)

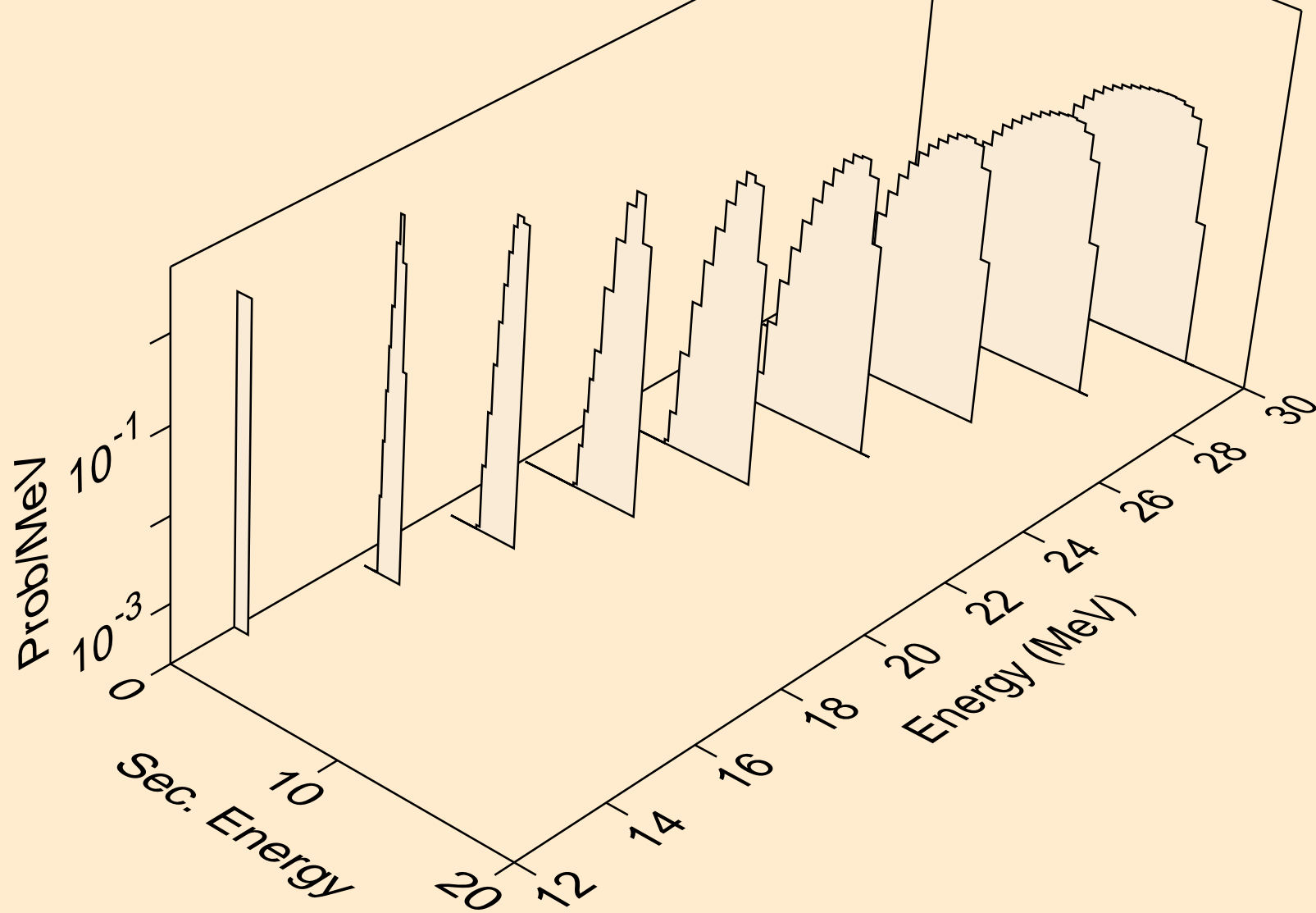

TA194 NEUTRON ACER TENDL-2023 LIBRARY; T=0.K
protons from (n,3np)

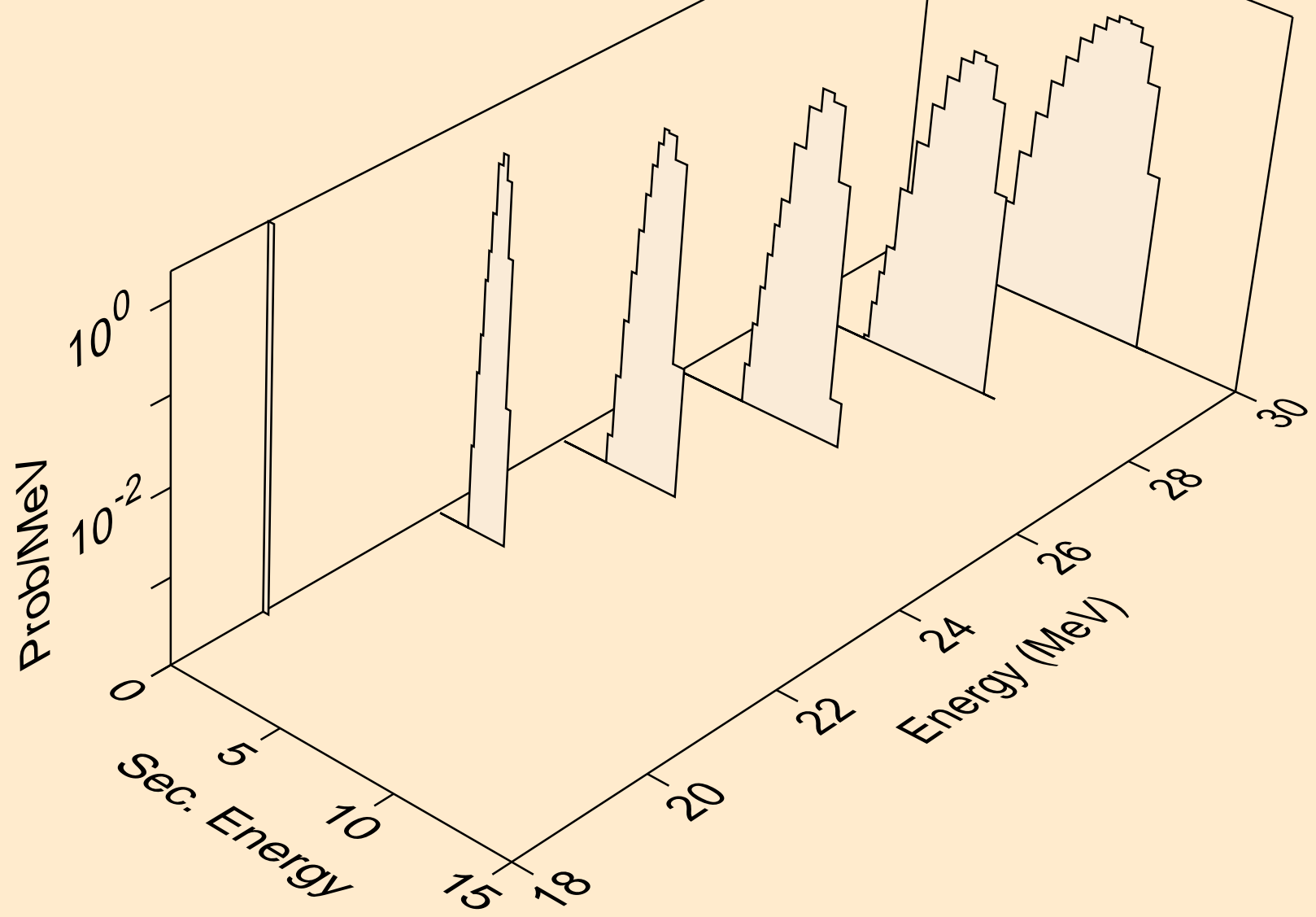

TA194 NEUTRON ACER TENDL-2023 LIBRARY; T=0.K
protons from (n,p)

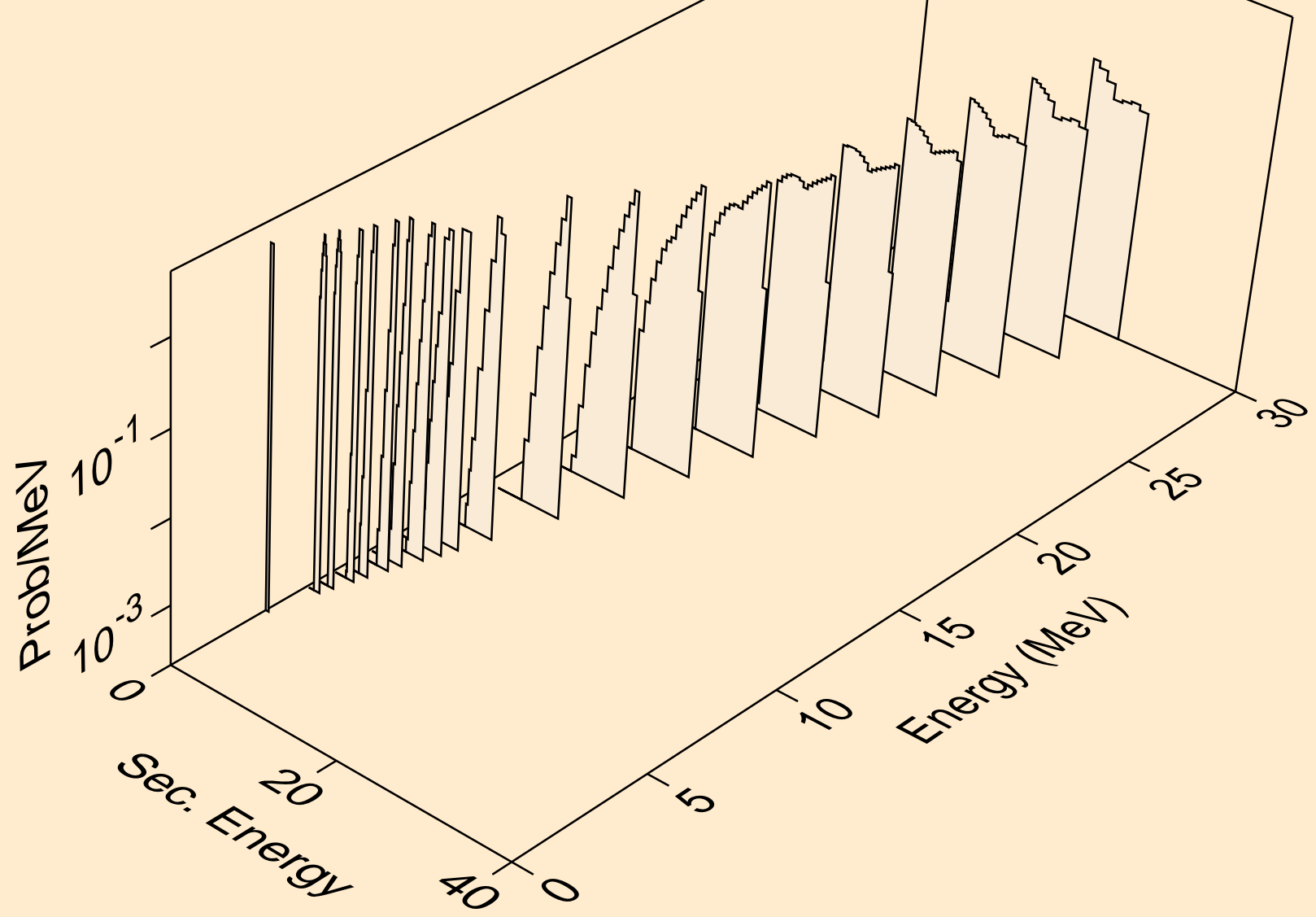

TA194 NEUTRON ACER TENDL-2023 LIBRARY; T=0.K
deuterons from (n,x)

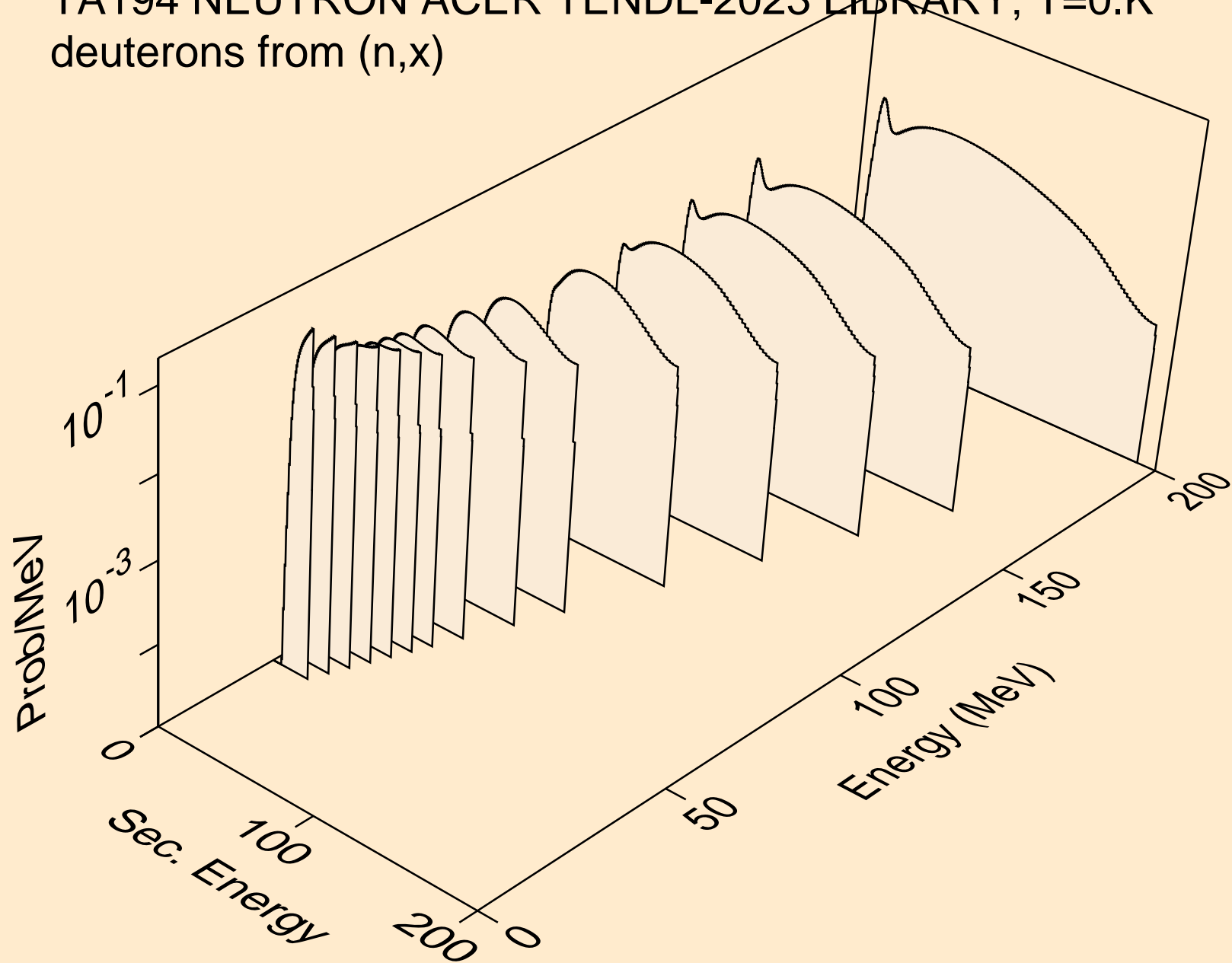

TA194 NEUTRON ACER TENDL-2023 LIBRARY; T=0.K
deuterons from (n,2nd)

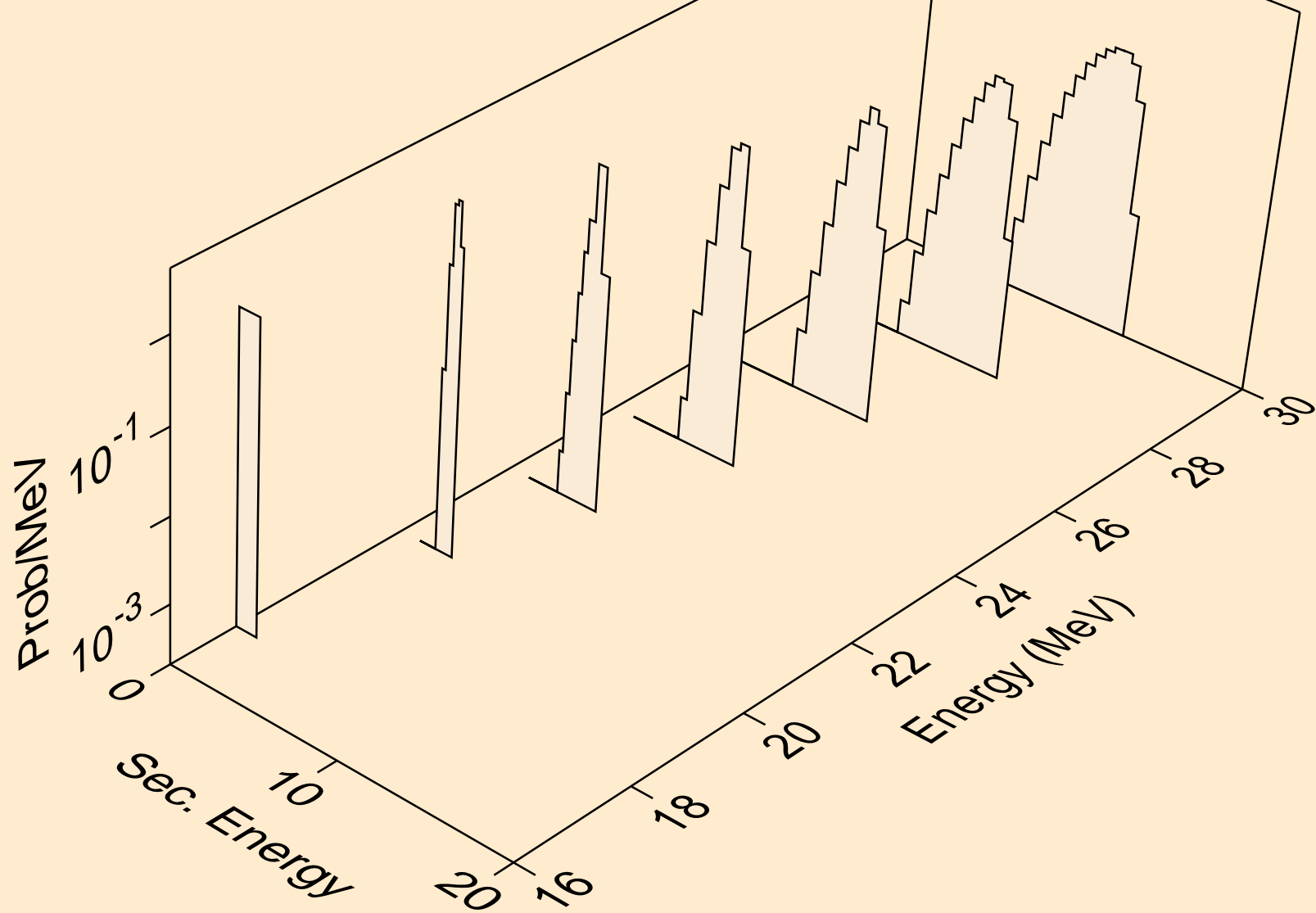

TA194 NEUTRON ACER TENDL-2023 LIBRARY; T=0.K
deuterons from (n,n*)d

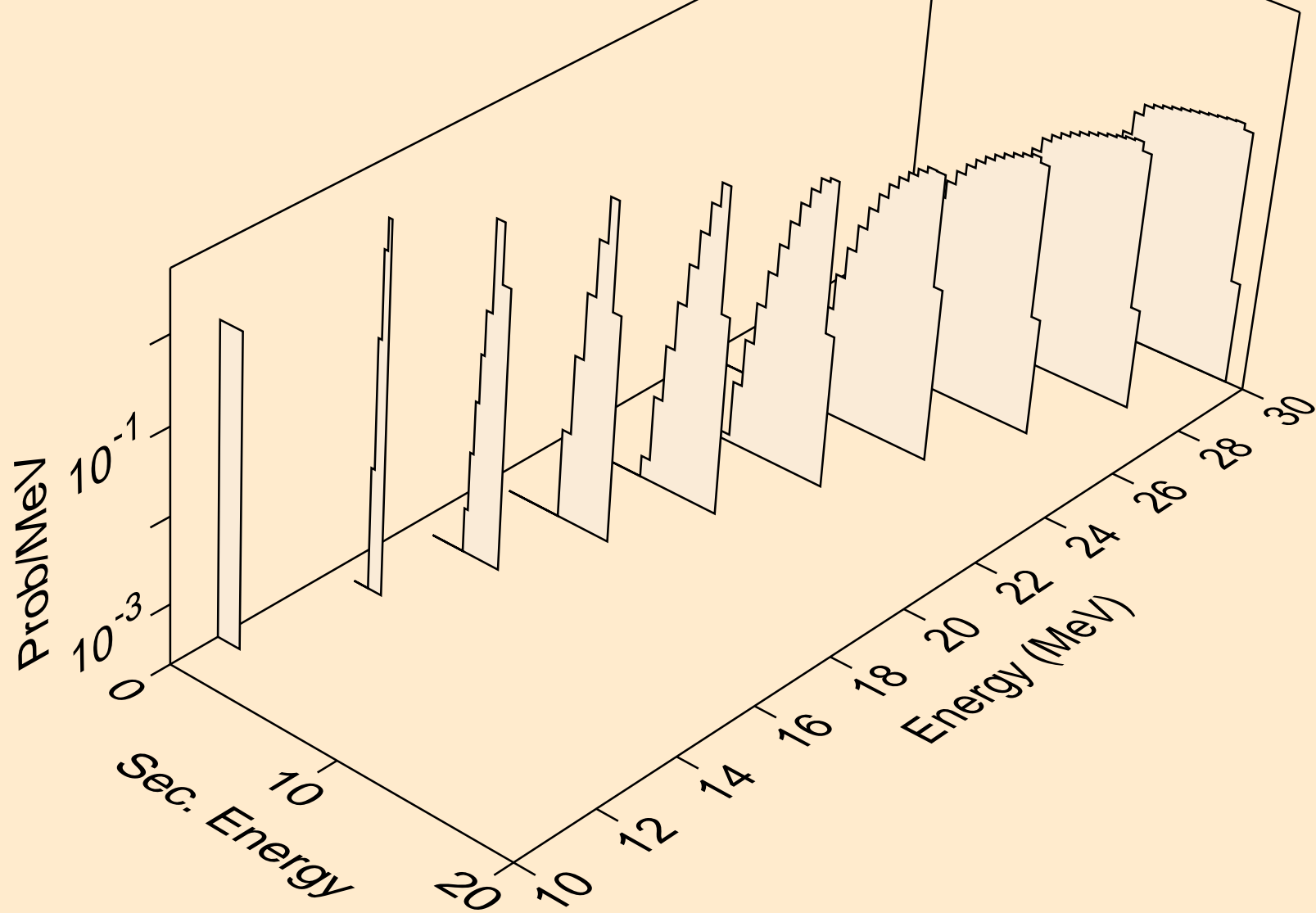

TA194 NEUTRON ACER TENDL-2023 LIBRARY; T=0.K
deuterons from (n,d)

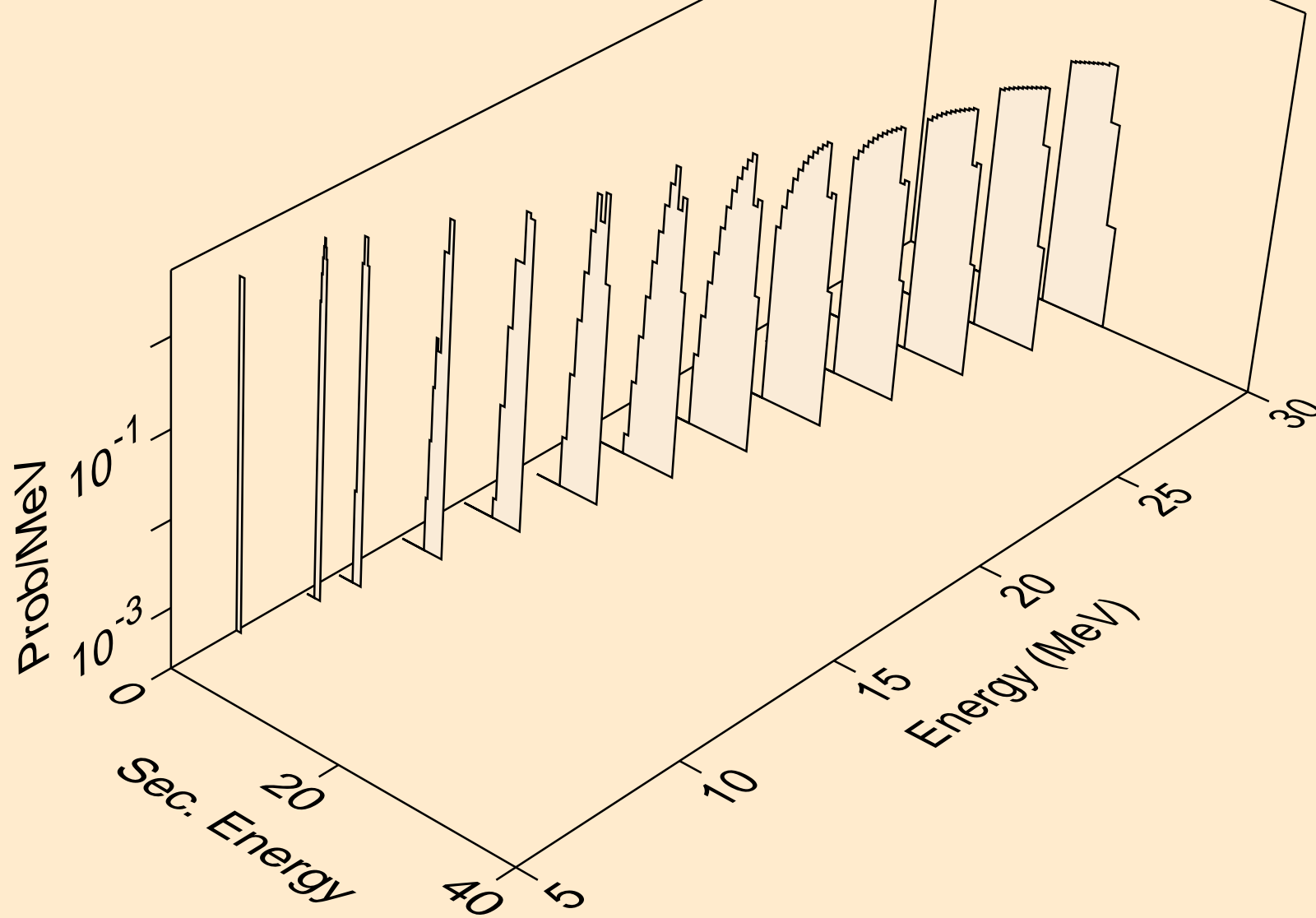

TA194 NEUTRON ACER TENDL-2023 LIBRARY; T=0.K
tritons from (n,x)

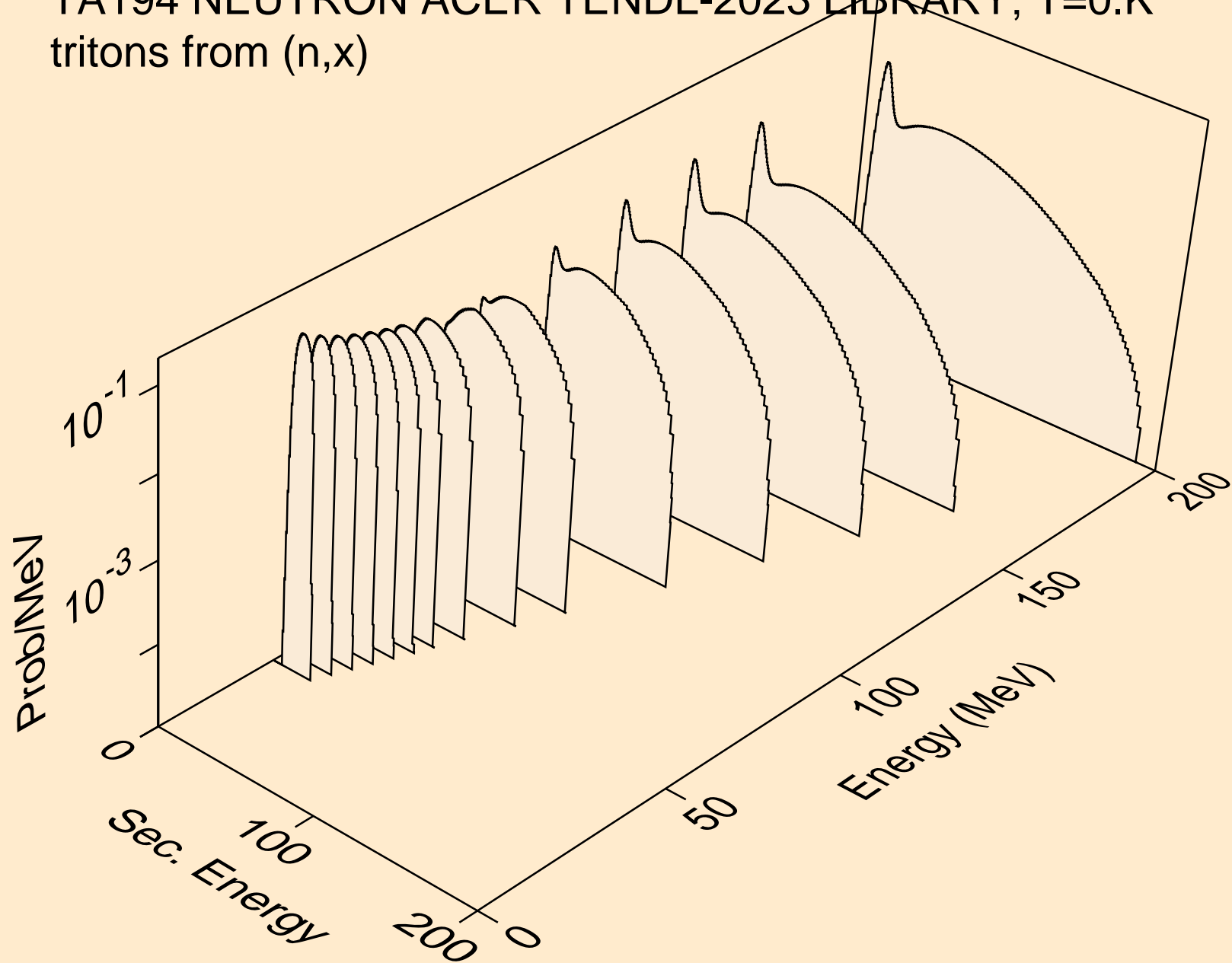

TA194 NEUTRON ACER TENDL-2023 LIBRARY; T=0.K
tritons from (n,n*)t

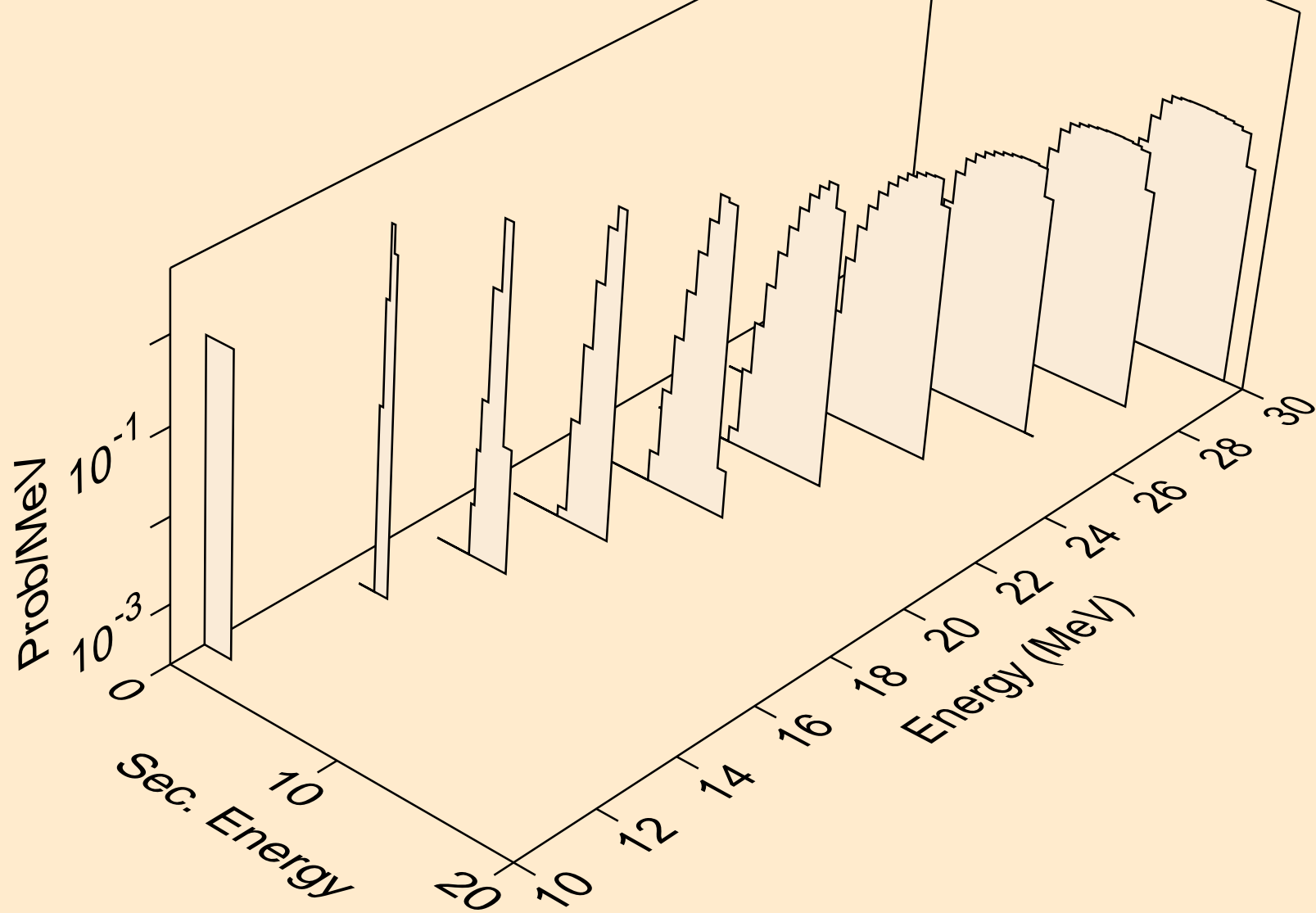

TA194 NEUTRON ACER TENDL-2023 LIBRARY; T=0.K
tritons from (n,t)

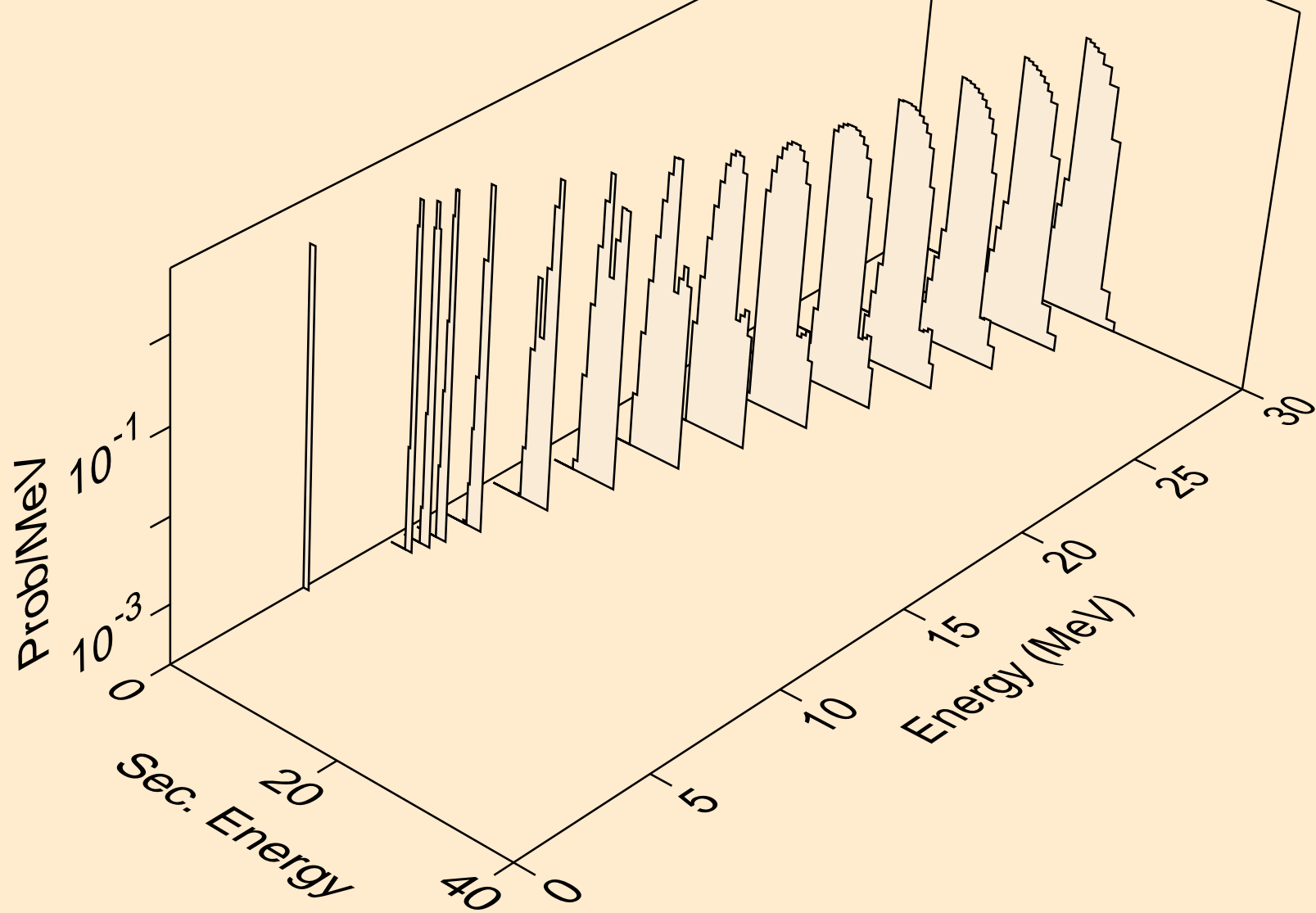

TA194 NEUTRON ACER TENDL-2023 LIBRARY; T=0.K
he3s from (n,x)

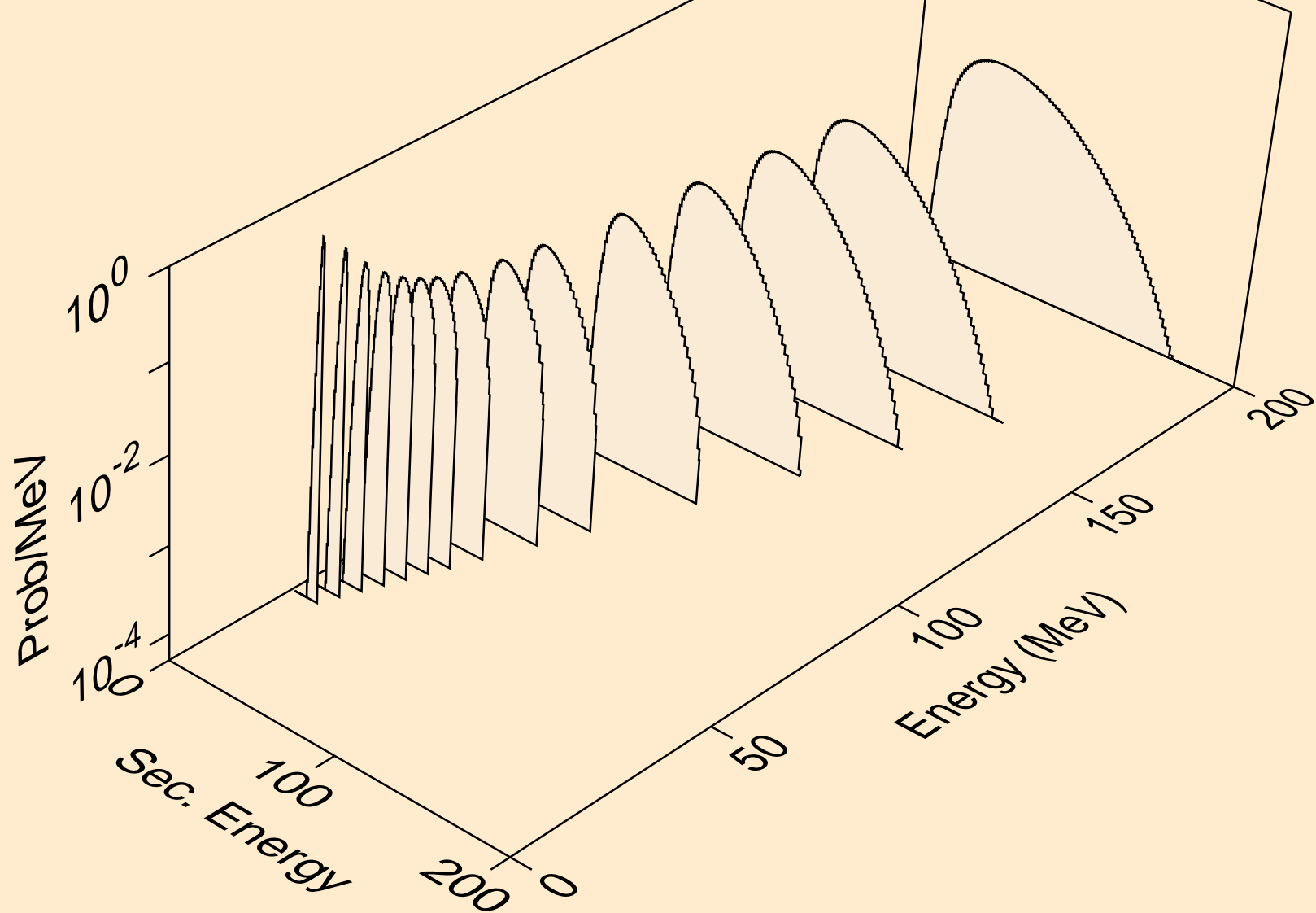

TA194 NEUTRON ACER TENDL-2023 LIBRARY; T=0.K
he3s from (n,n*)he3

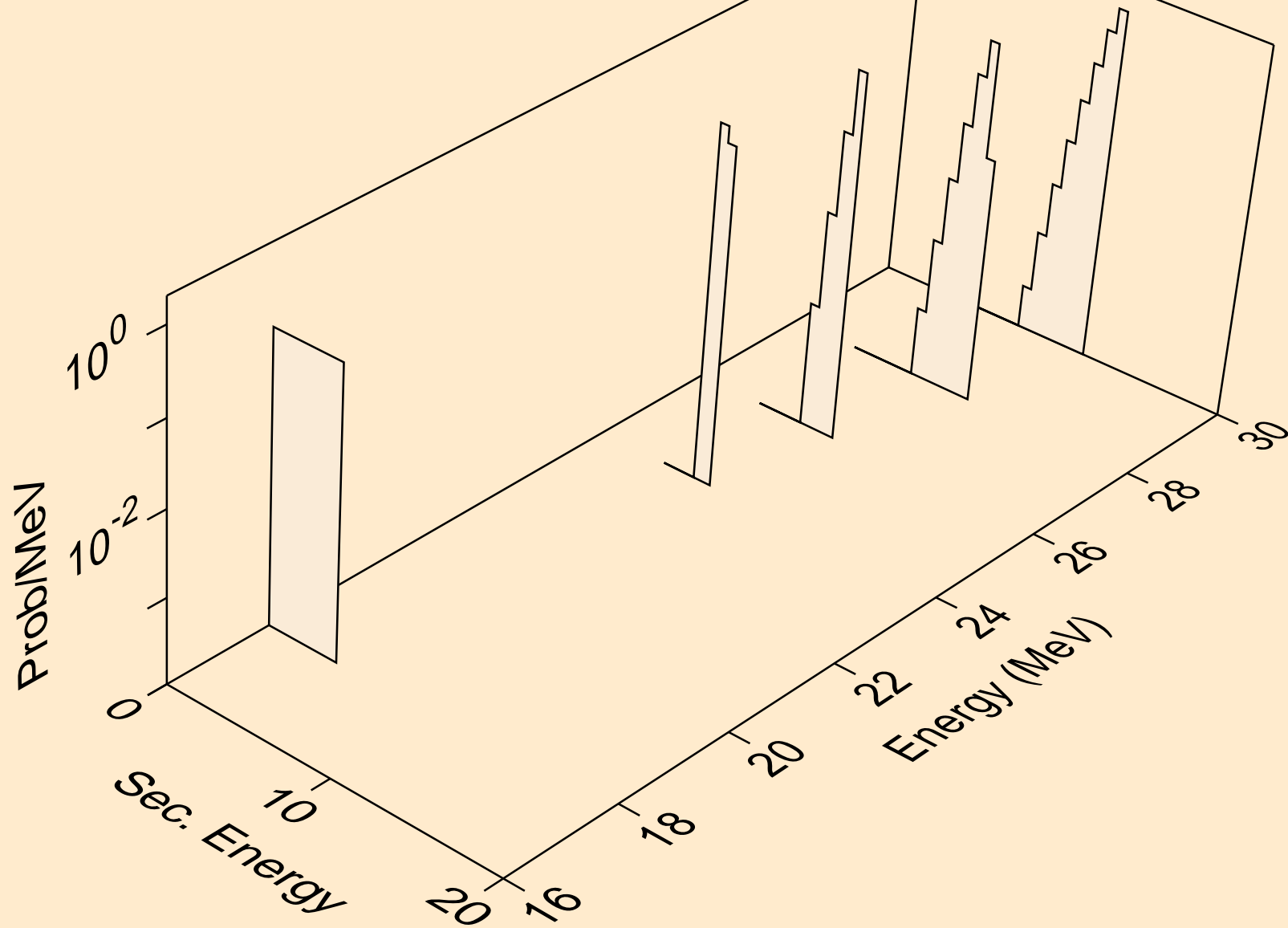

TA194 NEUTRON ACER TENDL-2023 LIBRARY; T=0.K
he3s from (n,he3)

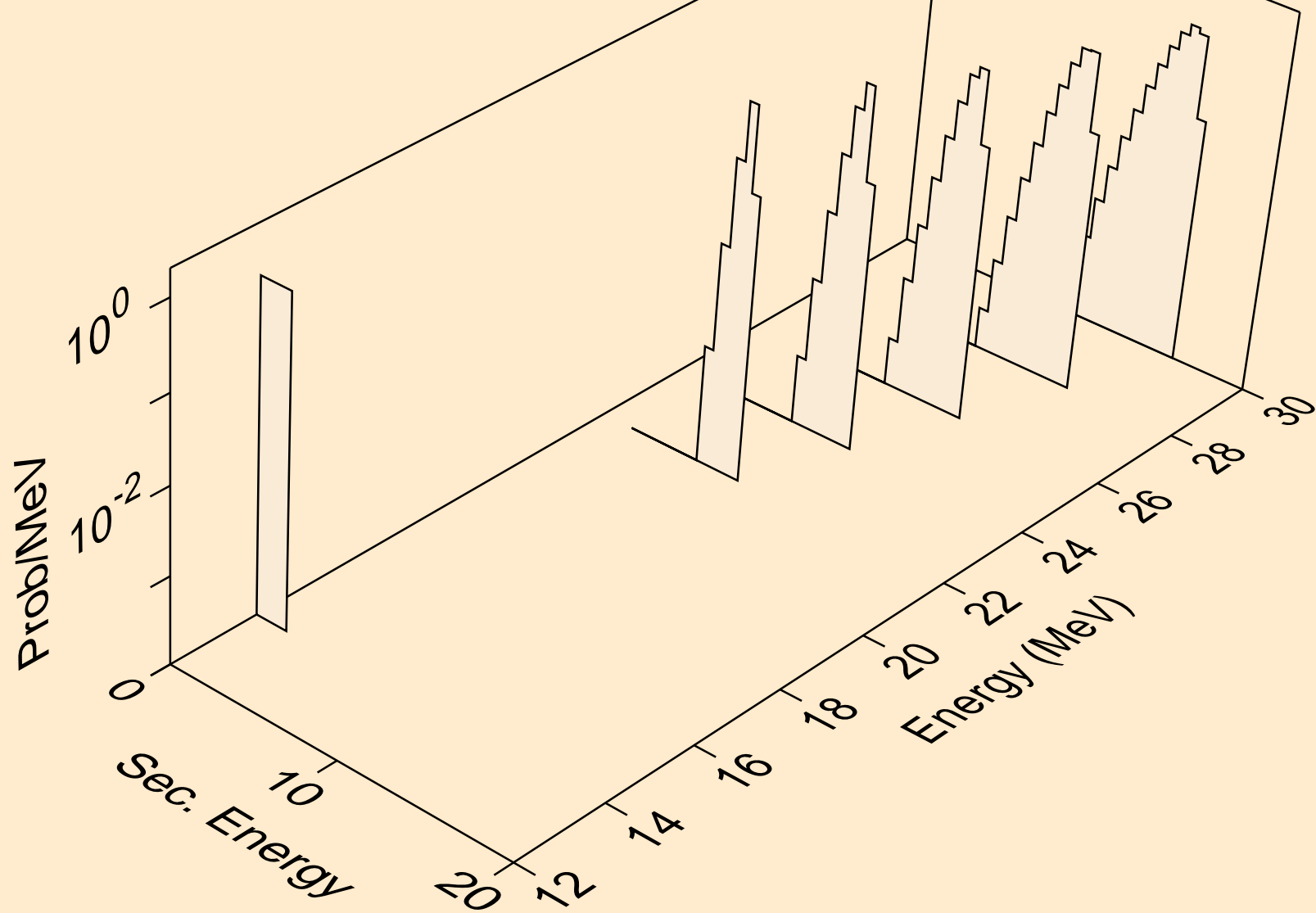

TA194 NEUTRON ACER TENDL-2023 LIBRARY; T=0.K
alphas from (n,x)

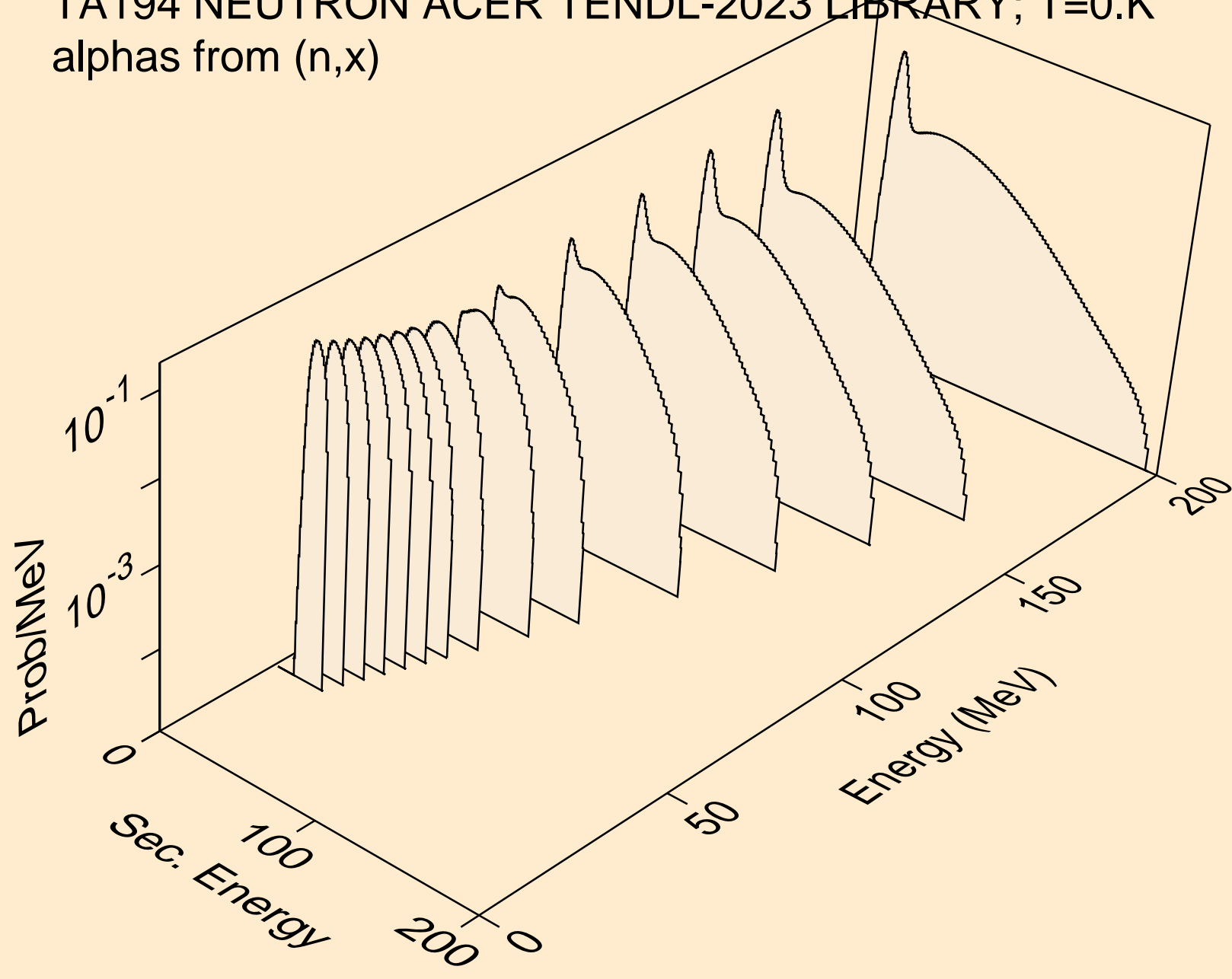

TA194 NEUTRON ACER TENDL-2023 LIBRARY; T=0.K
alphas from (n,n*)a

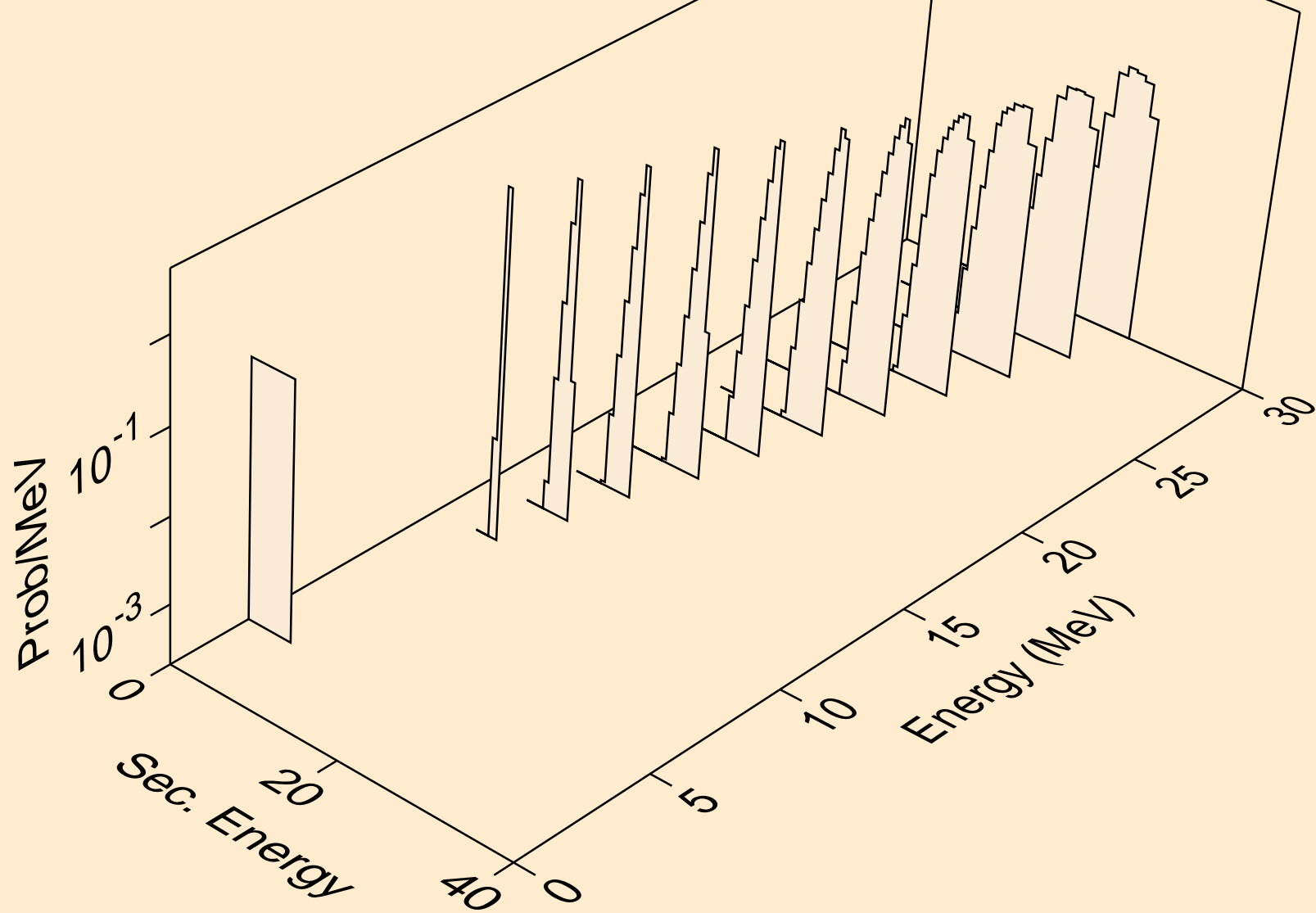

TA194 NEUTRON ACER TENDL-2023 LIBRARY; T=0.K
alphas from (n,2n)a

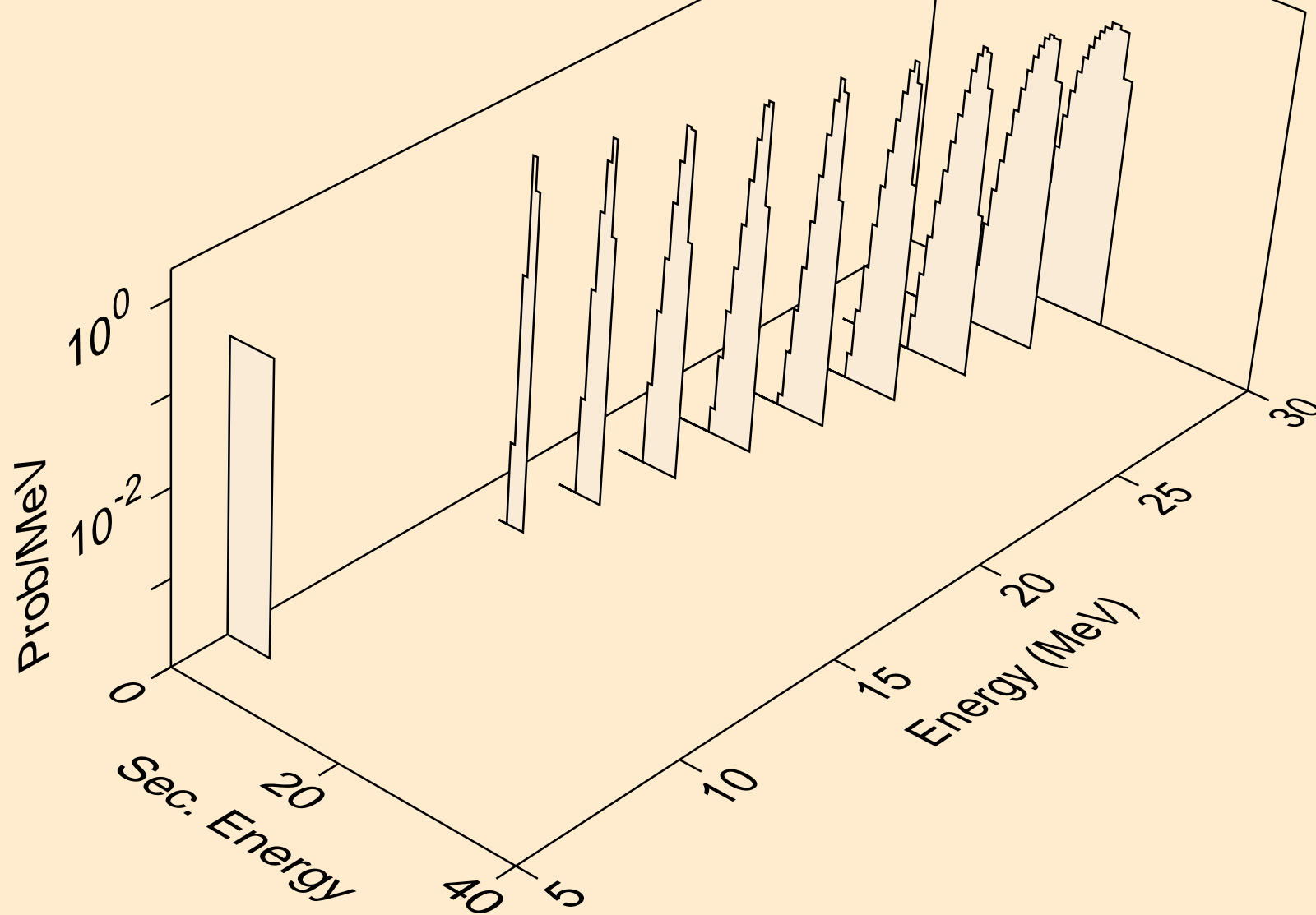

TA194 NEUTRON ACER TENDL-2023 LIBRARY; T=0.K
alphas from (n,3n)a

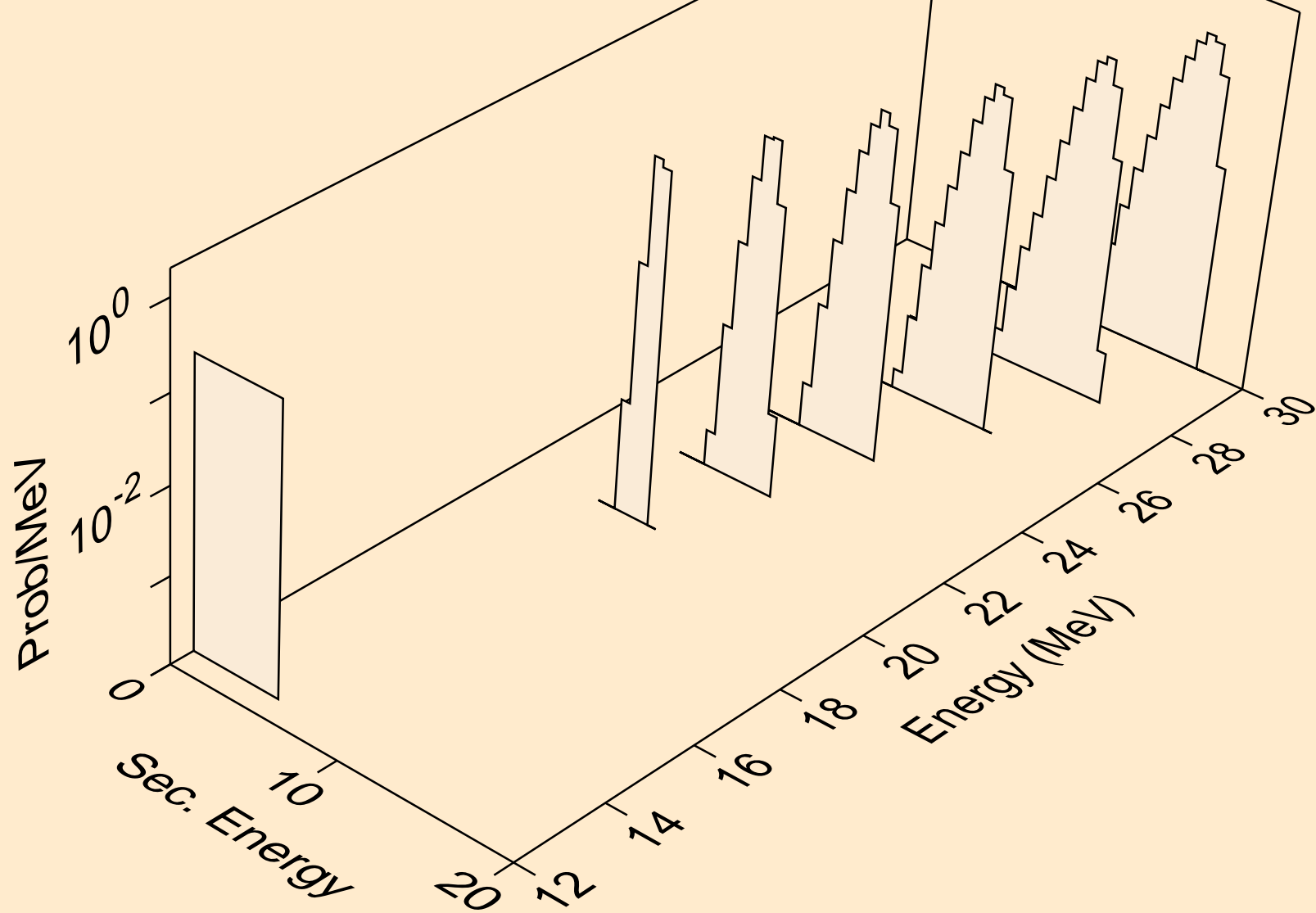

TA194 NEUTRON ACER TENDL-2023 LIBRARY; T=0.K
alphas from (n,a)

