

# TB146 NEUTRON ACER TENDL-2023 LIBRARY; T=0.K

## Principal cross sections

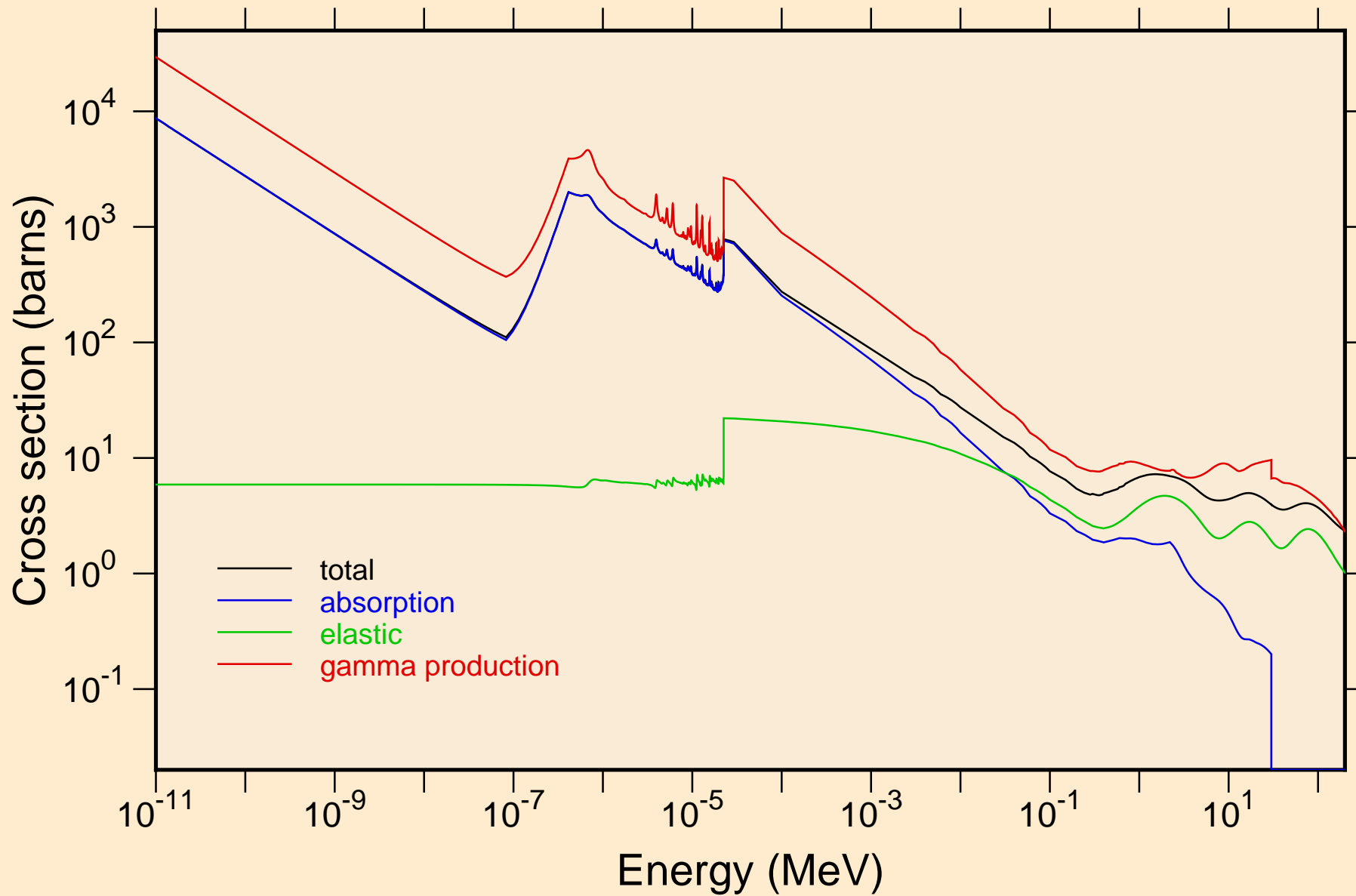

TB146 NEUTRON ACER TENDL-2023 LIBRARY; T=0.K  
resonance total cross section

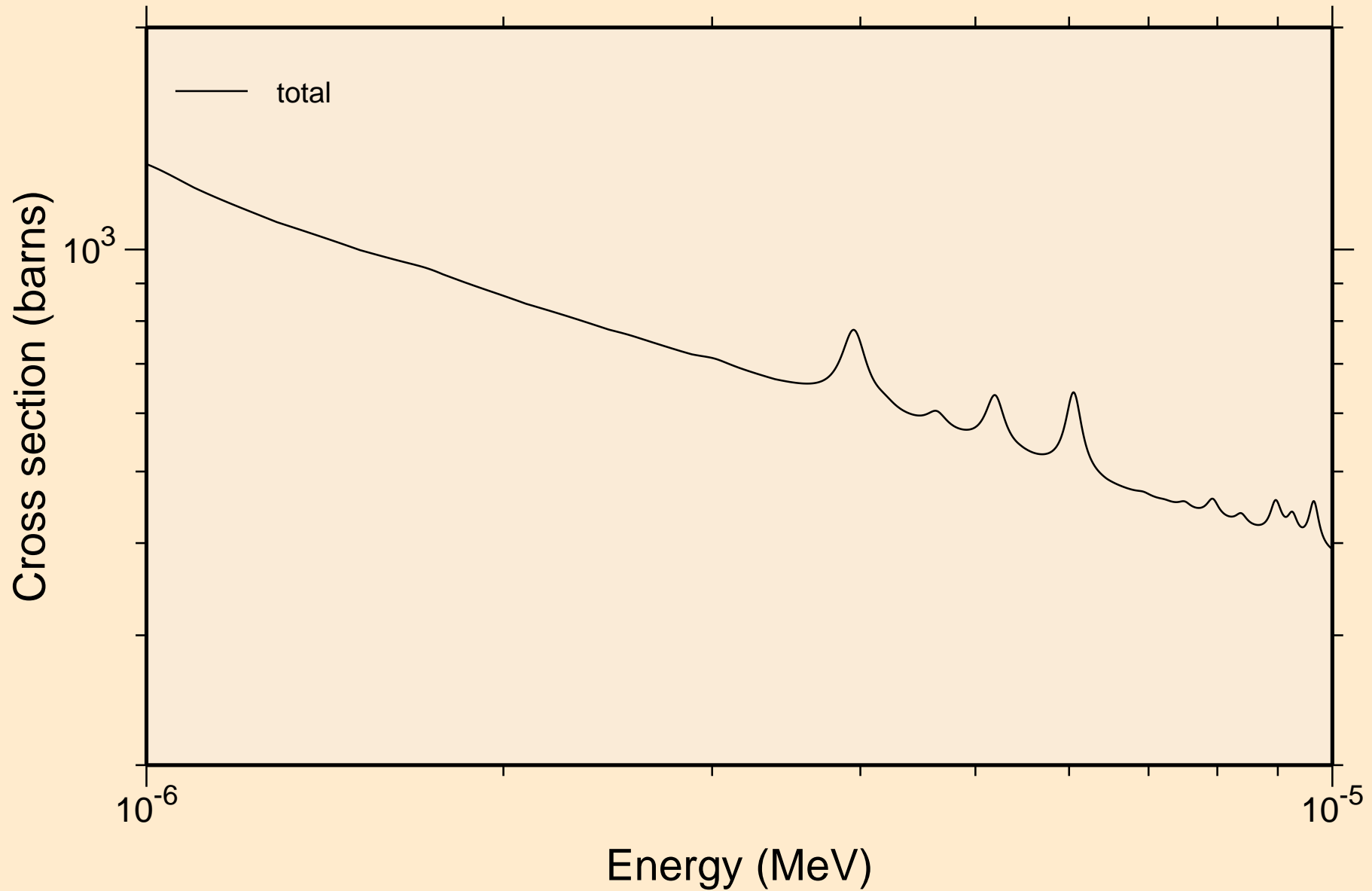

TB146 NEUTRON ACER TENDL-2023 LIBRARY; T=0.K  
resonance total cross section

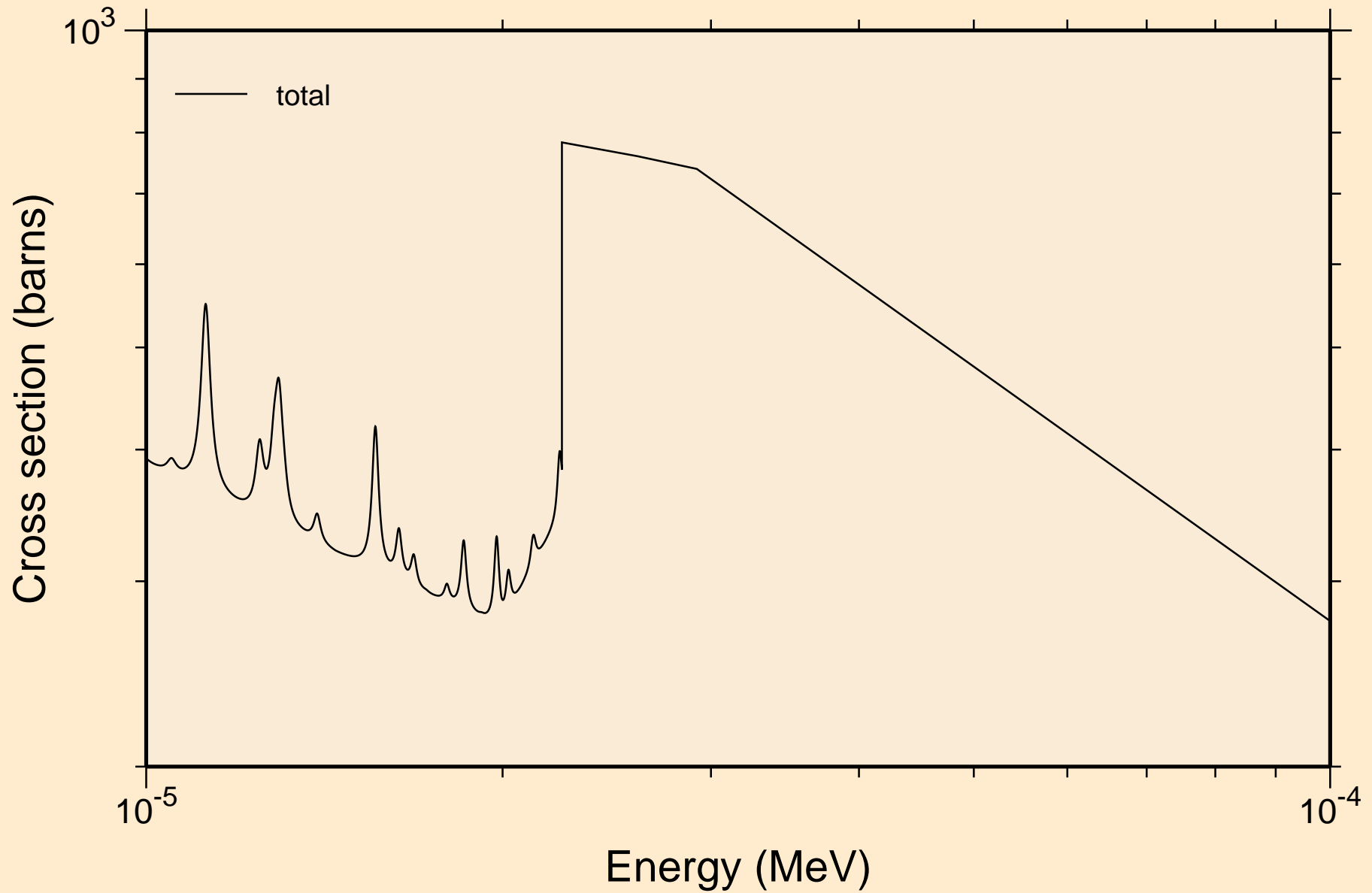

TB146 NEUTRON ACER TENDL-2023 LIBRARY; T=0.K  
resonance total cross section

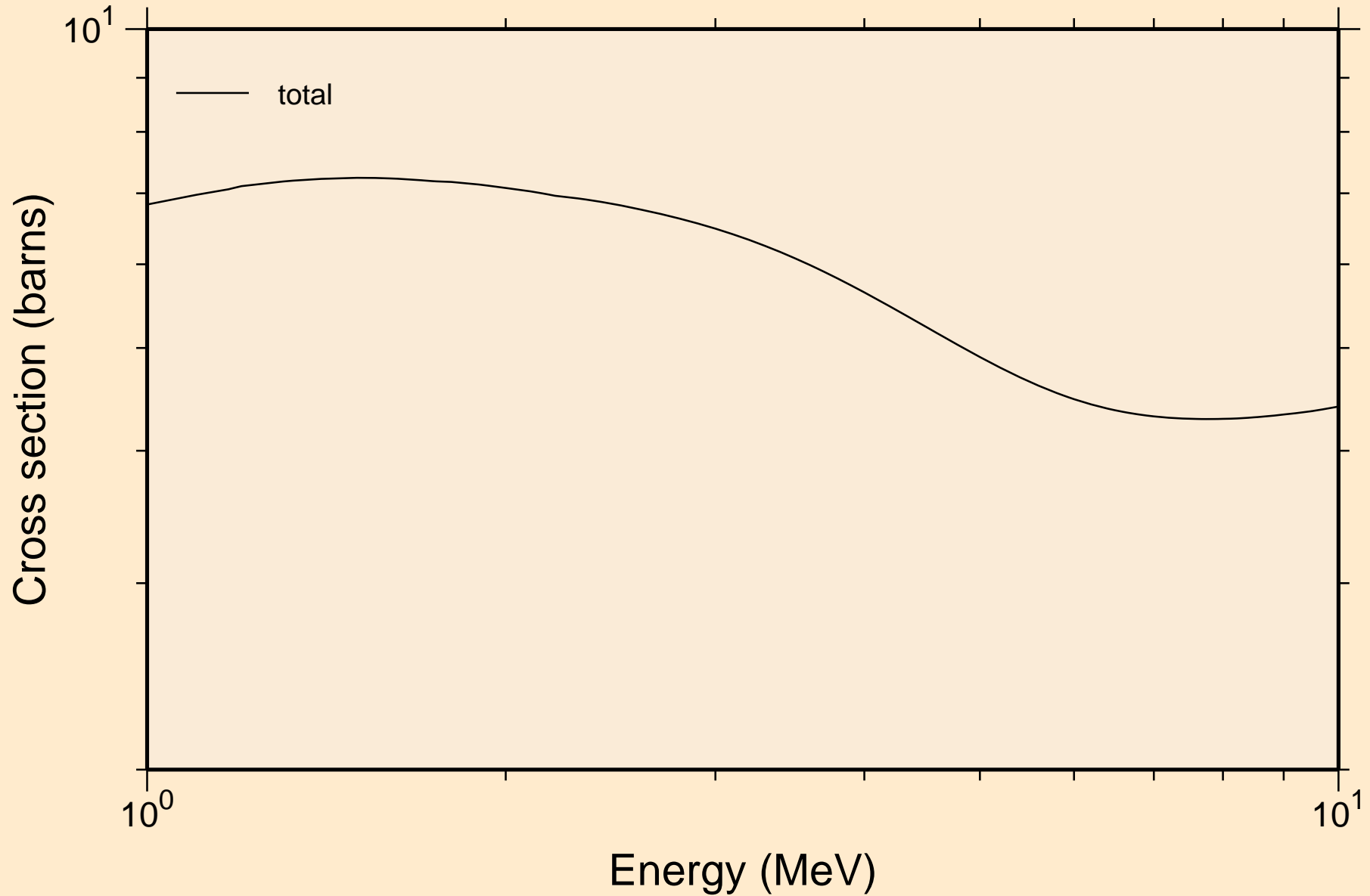

TB146 NEUTRON ACER TENDL-2023 LIBRARY; T=0.K  
resonance absorption cross sections

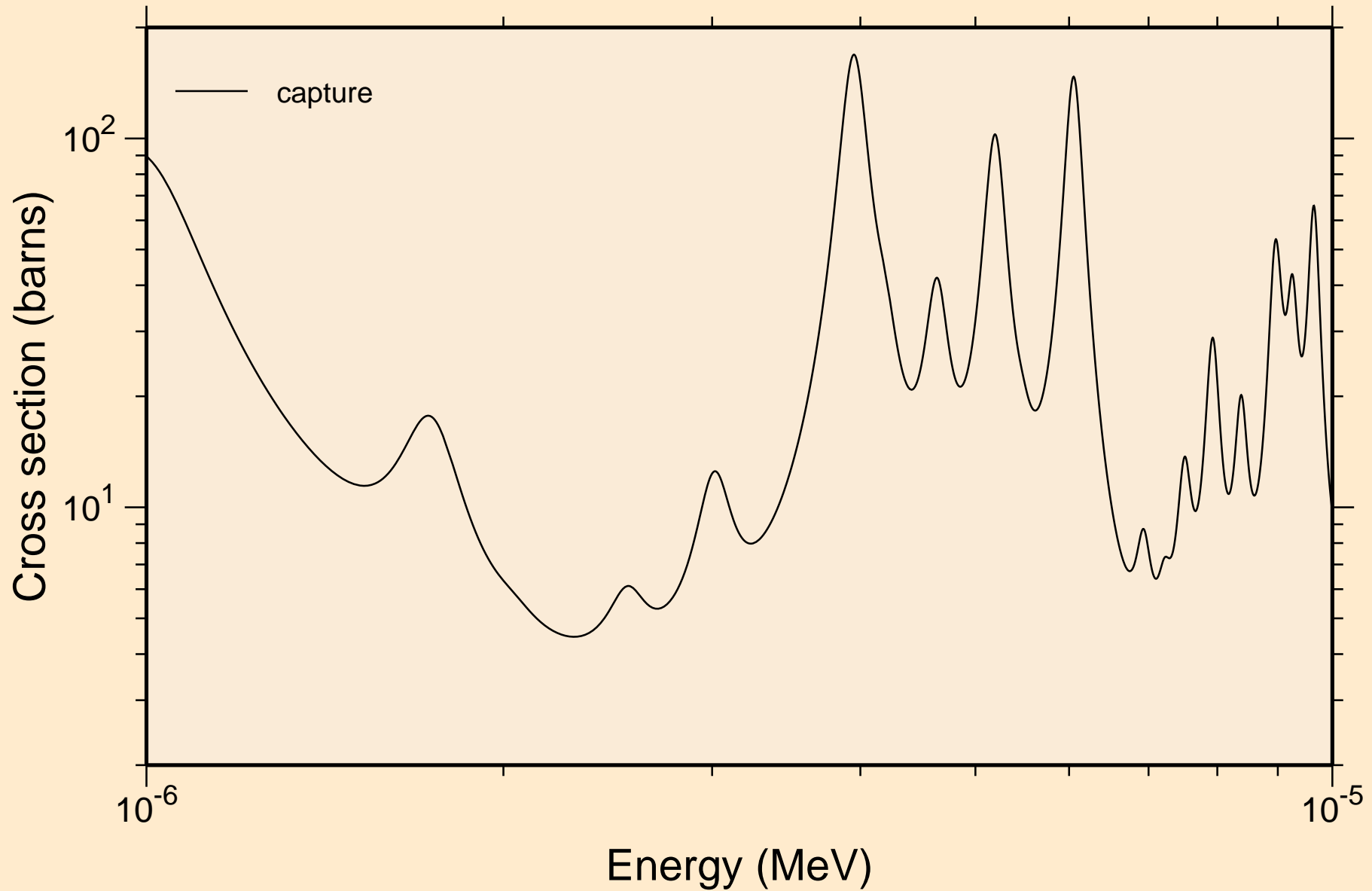

TB146 NEUTRON ACER TENDL-2023 LIBRARY; T=0.K  
resonance absorption cross sections

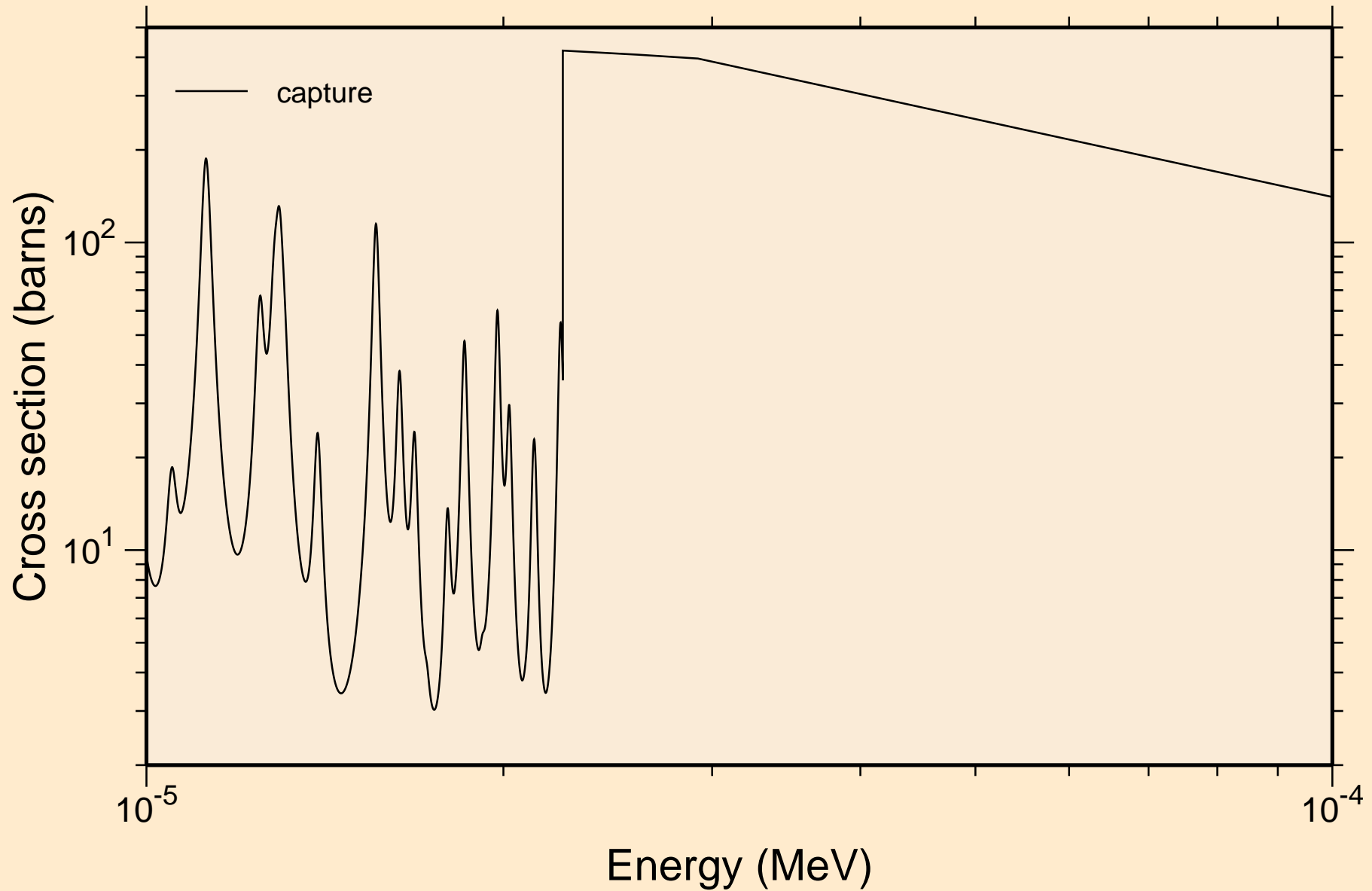

TB146 NEUTRON ACER TENDL-2023 LIBRARY; T=0.K  
resonance absorption cross sections

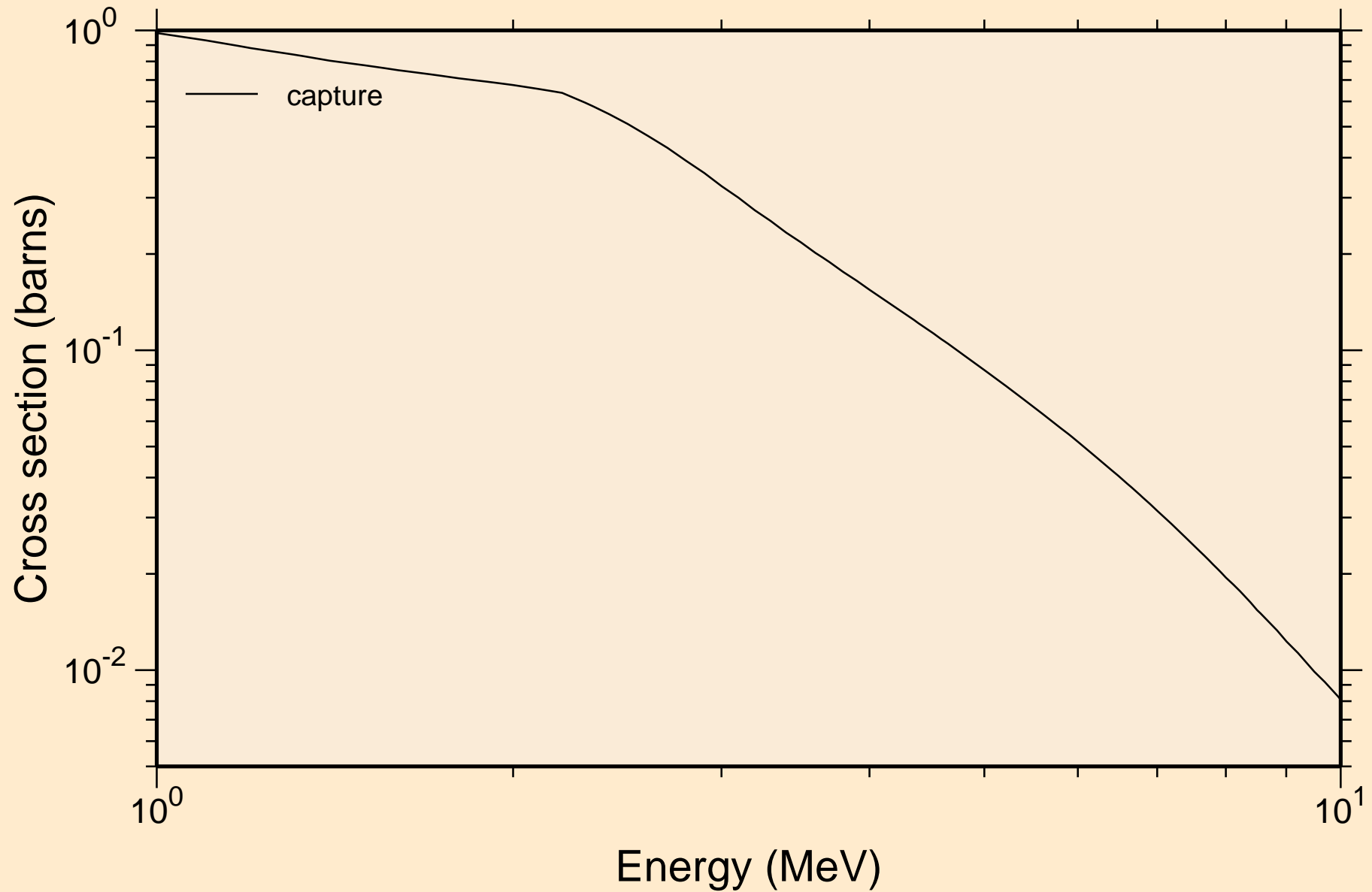

# TB146 NEUTRON ACER TENDL-2023 LIBRARY; T=0.K

## Heating

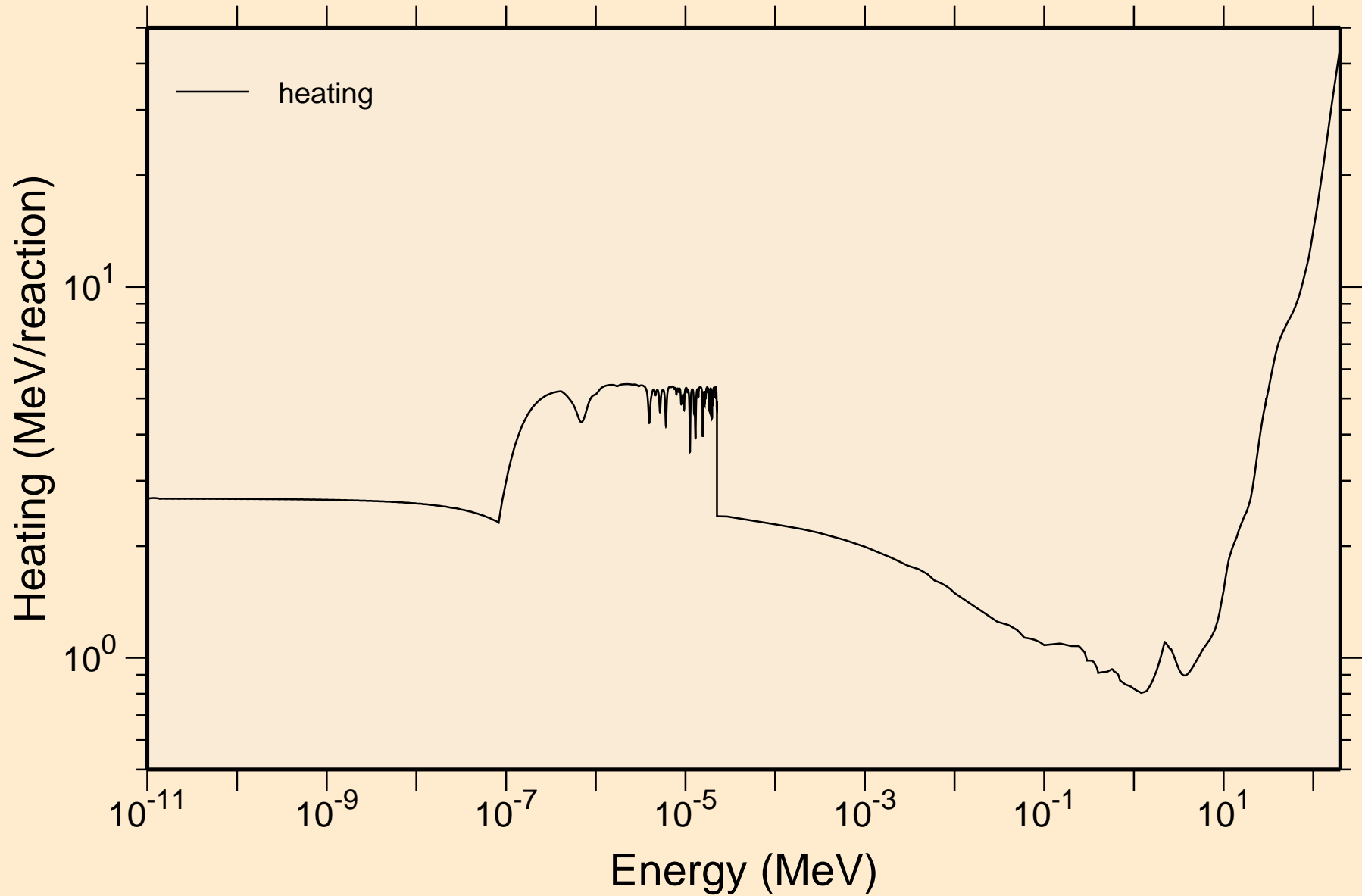

TB146 NEUTRON ACER TENDL-2023 LIBRARY; T=0.K  
Damage

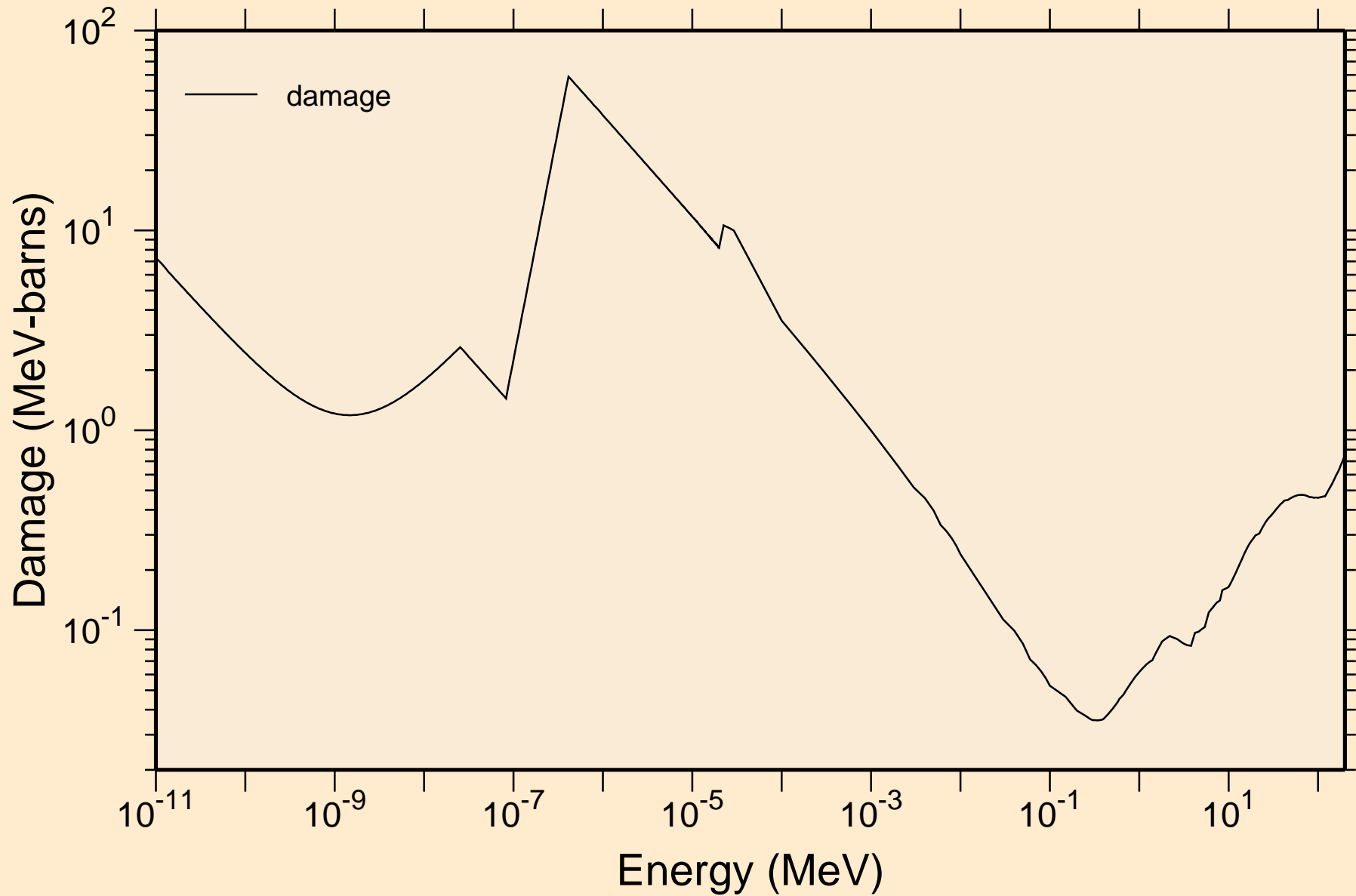

TB146 NEUTRON ACER TENDL-2023 LIBRARY; T=0.K  
Non-threshold reactions

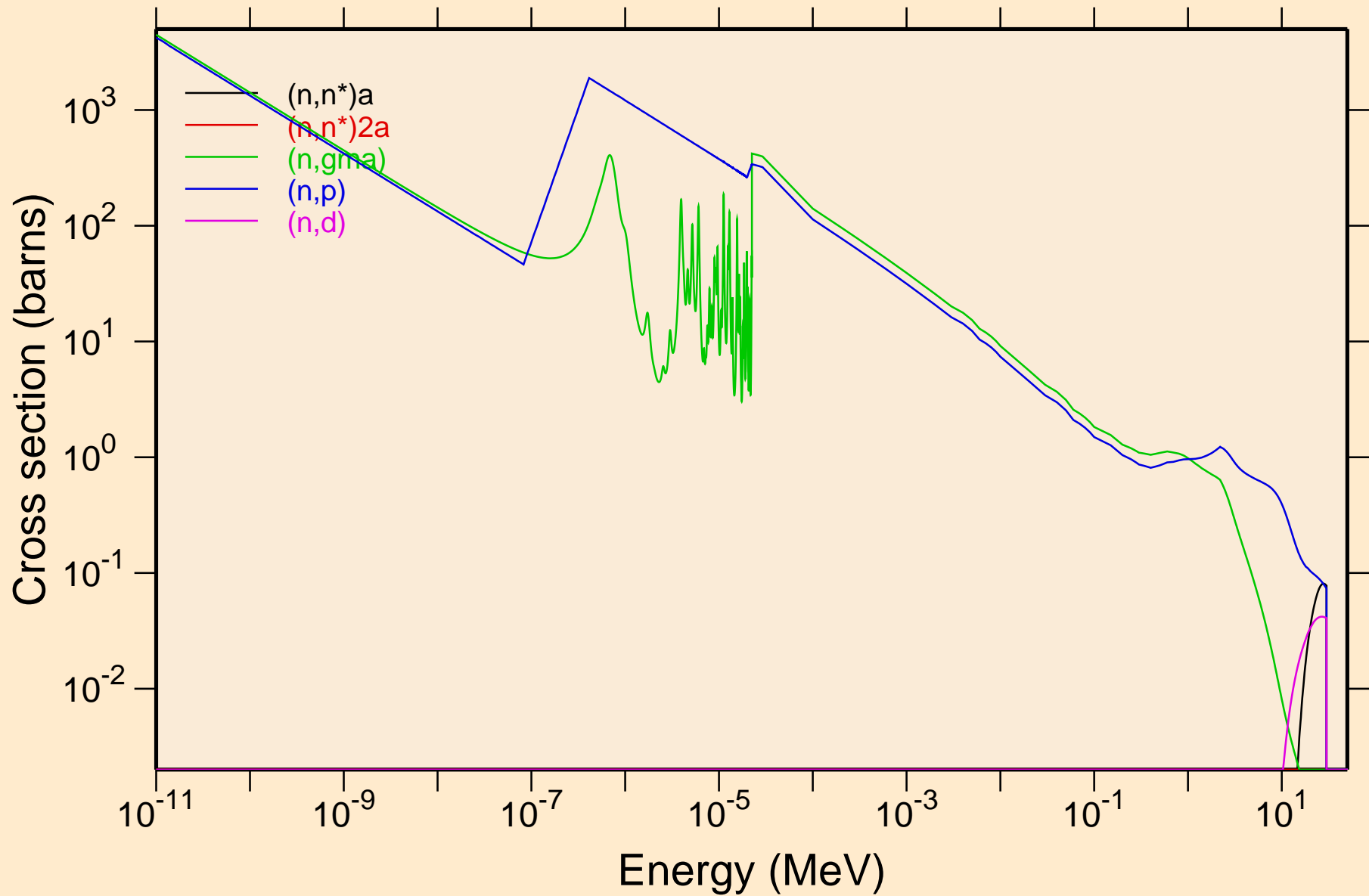

TB146 NEUTRON ACER TENDL-2023 LIBRARY; T=0.K  
Non-threshold reactions

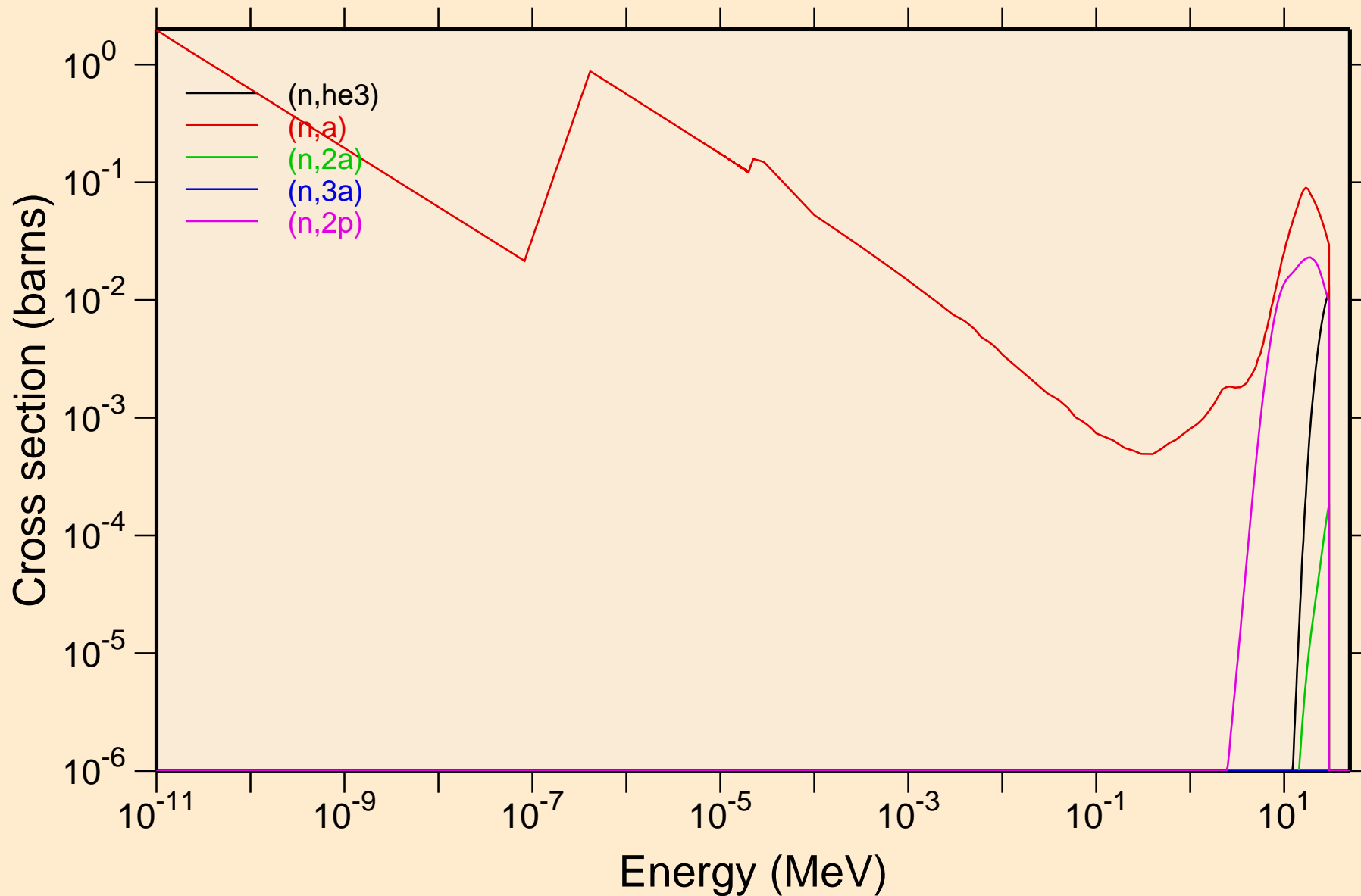

TB146 NEUTRON ACER TENDL-2023 LIBRARY; T=0.K  
Non-threshold reactions

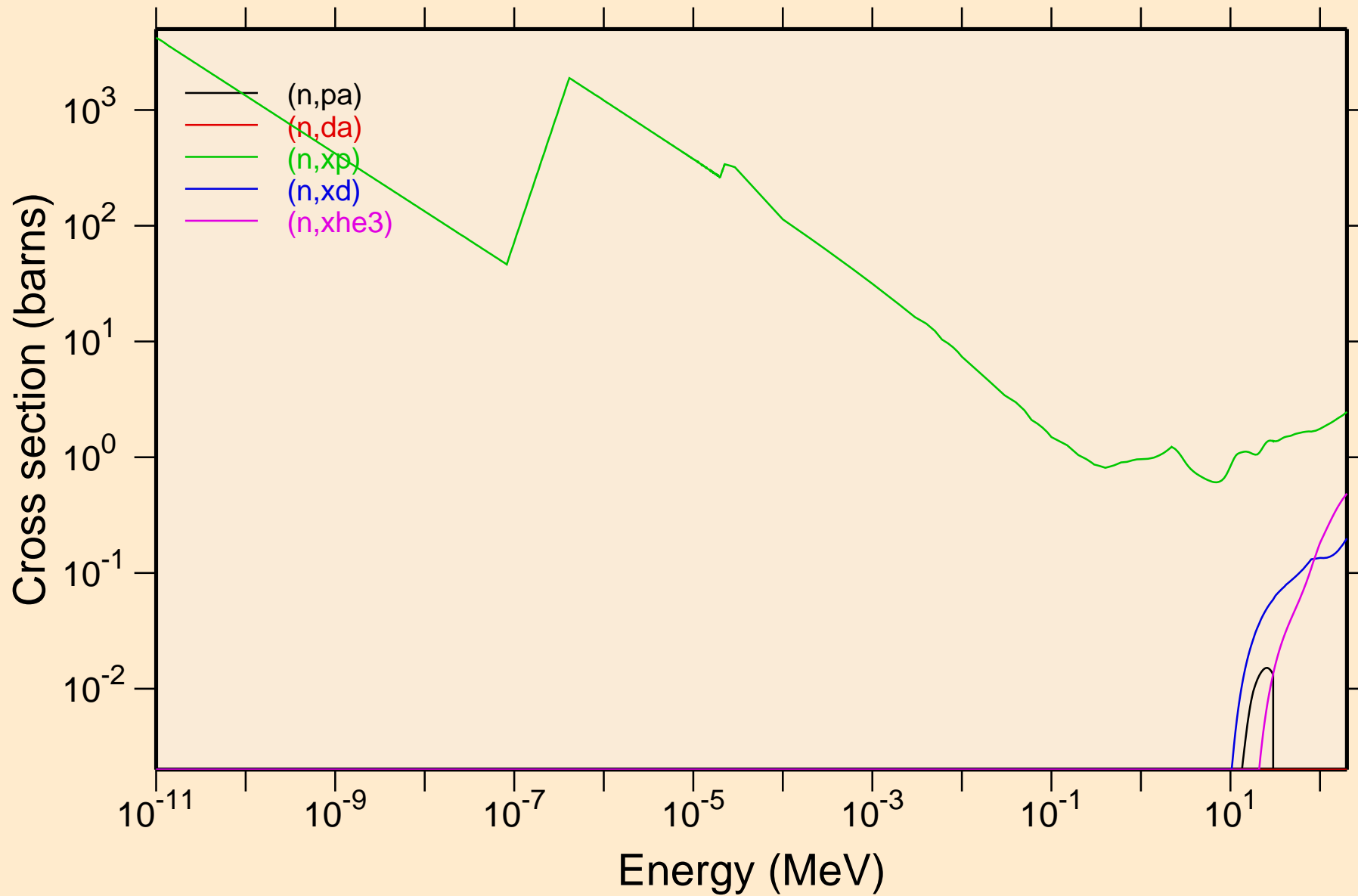

TB146 NEUTRON ACER TENDL-2023 LIBRARY; T=0.K  
Non-threshold reactions

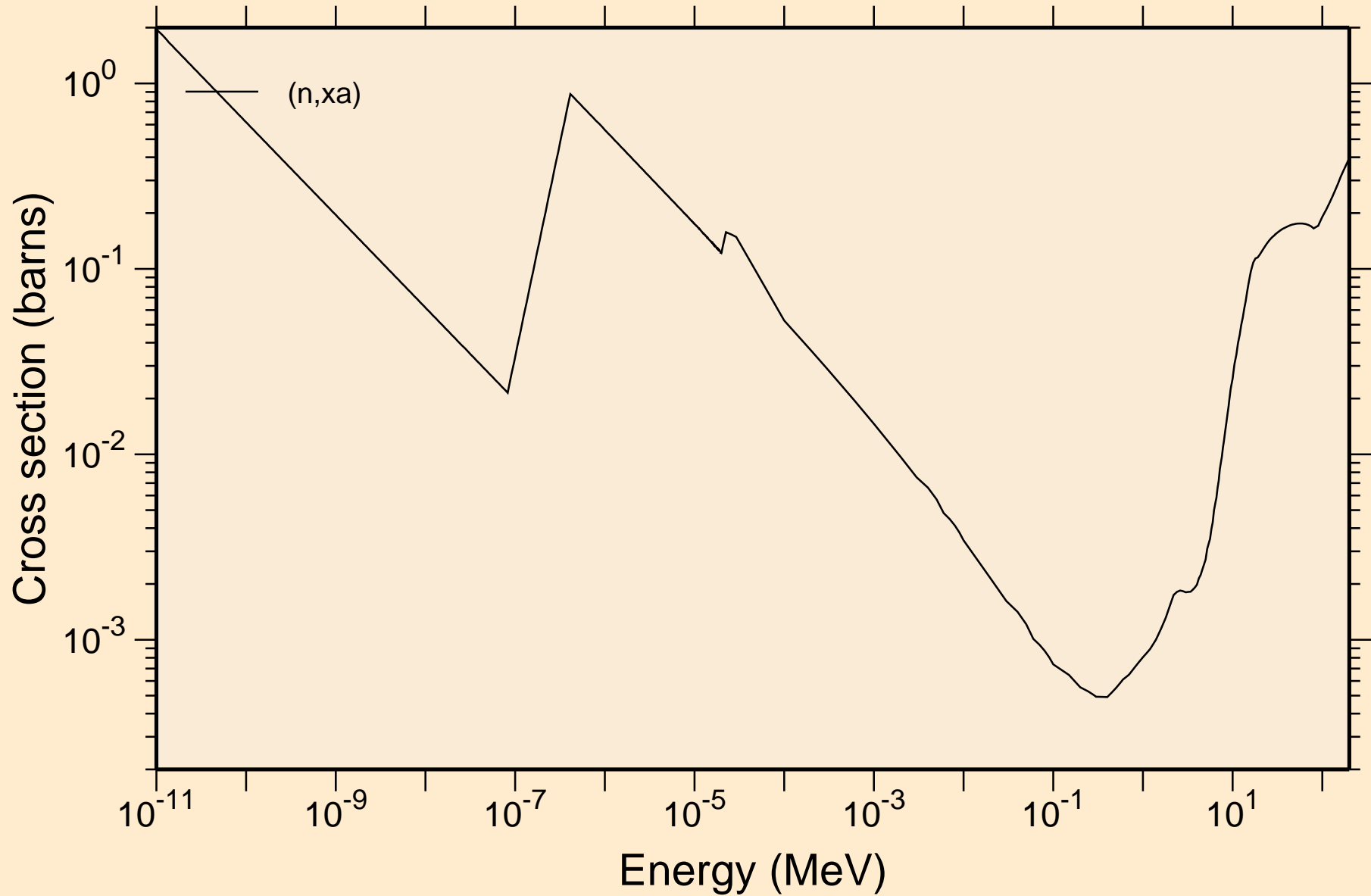

TB146 NEUTRON ACER TENDL-2023 LIBRARY; T=0.K  
Principal cross sections

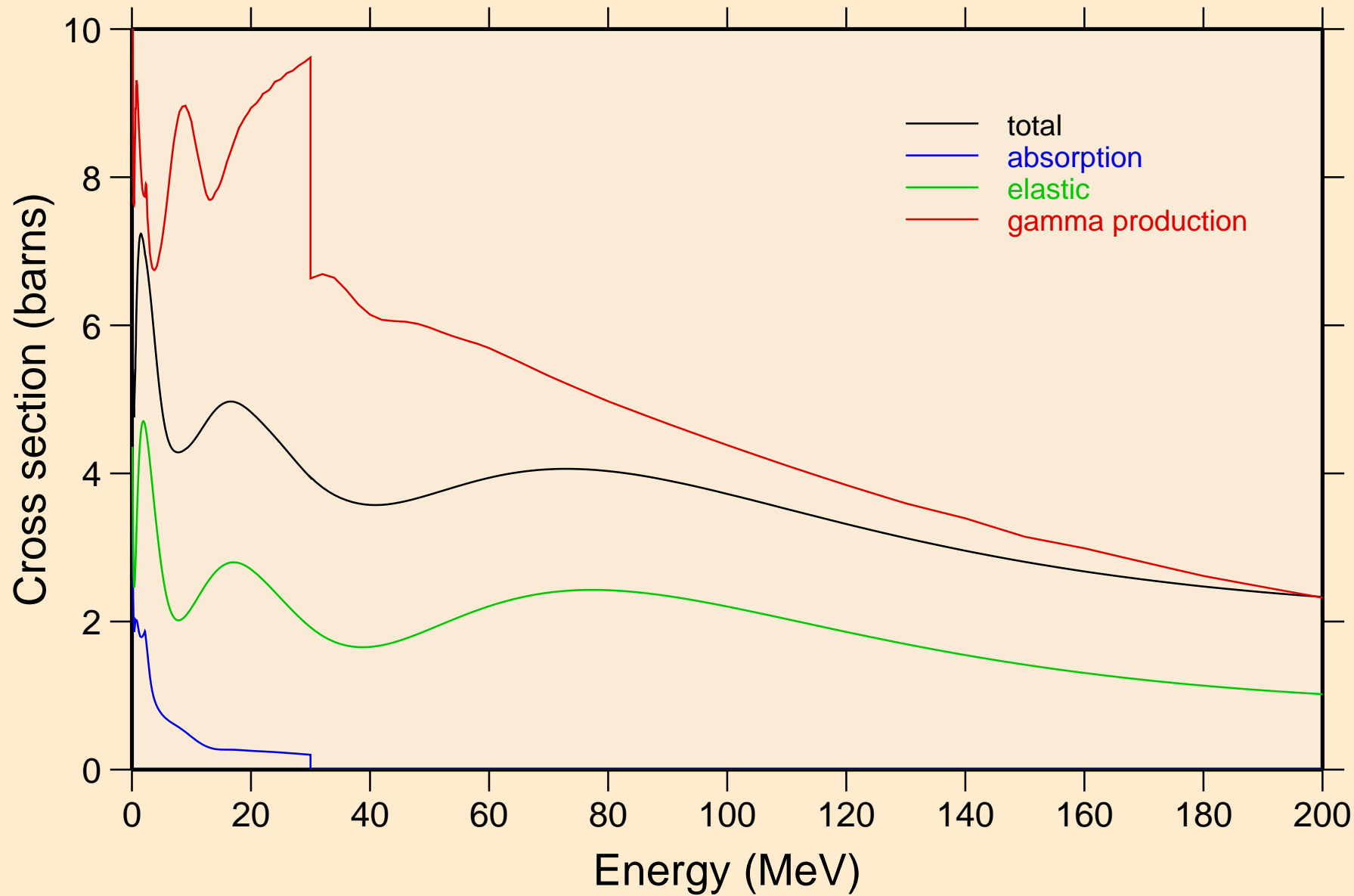

# TB146 NEUTRON ACER TENDL-2023 LIBRARY; T=0.K

## Heating

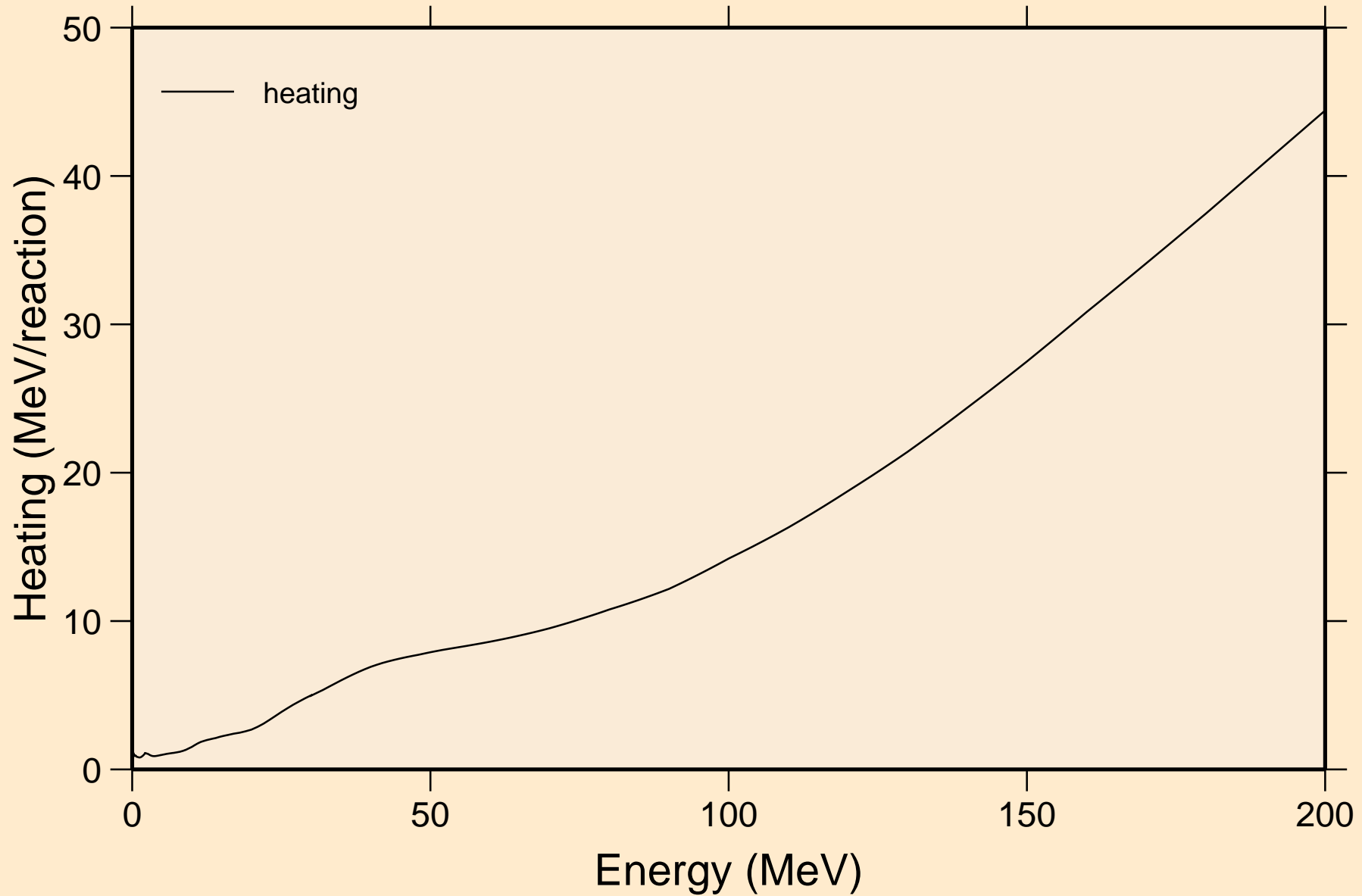

TB146 NEUTRON ACER TENDL-2023 LIBRARY; T=0.K  
Damage

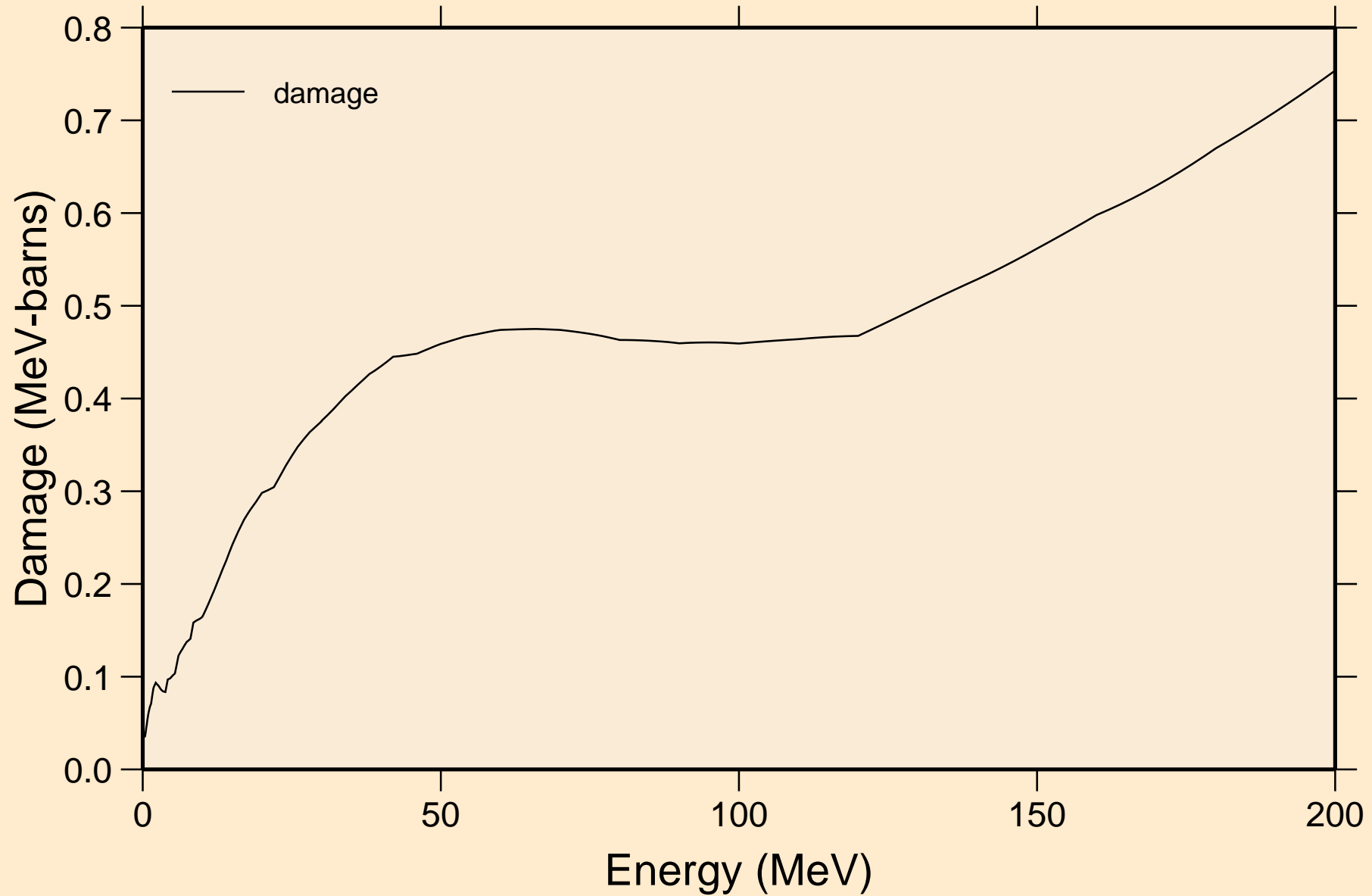

TB146 NEUTRON ACER TENDL-2023 LIBRARY; T=0.K  
Non-threshold reactions

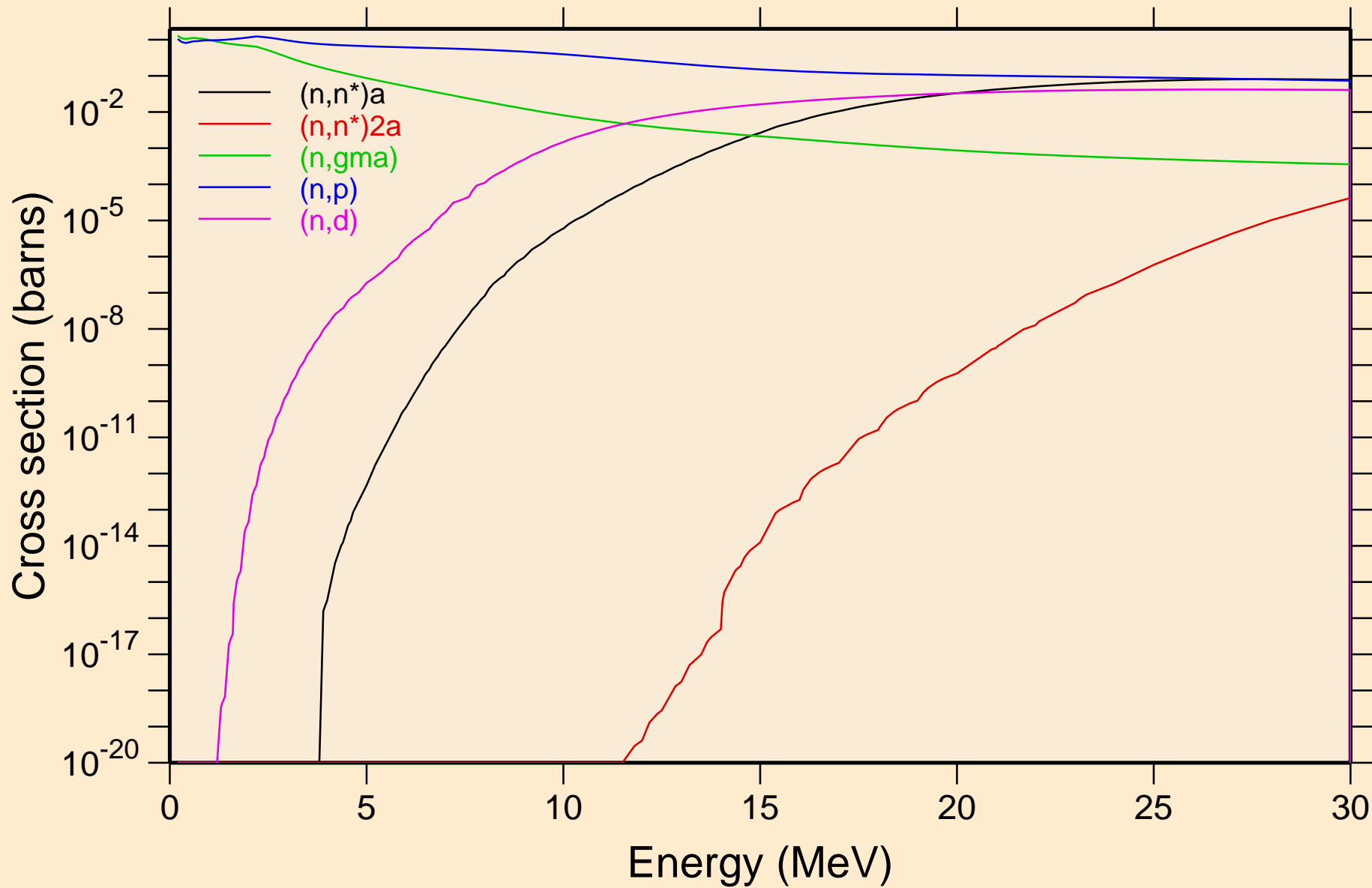

TB146 NEUTRON ACER TENDL-2023 LIBRARY; T=0.K  
Non-threshold reactions

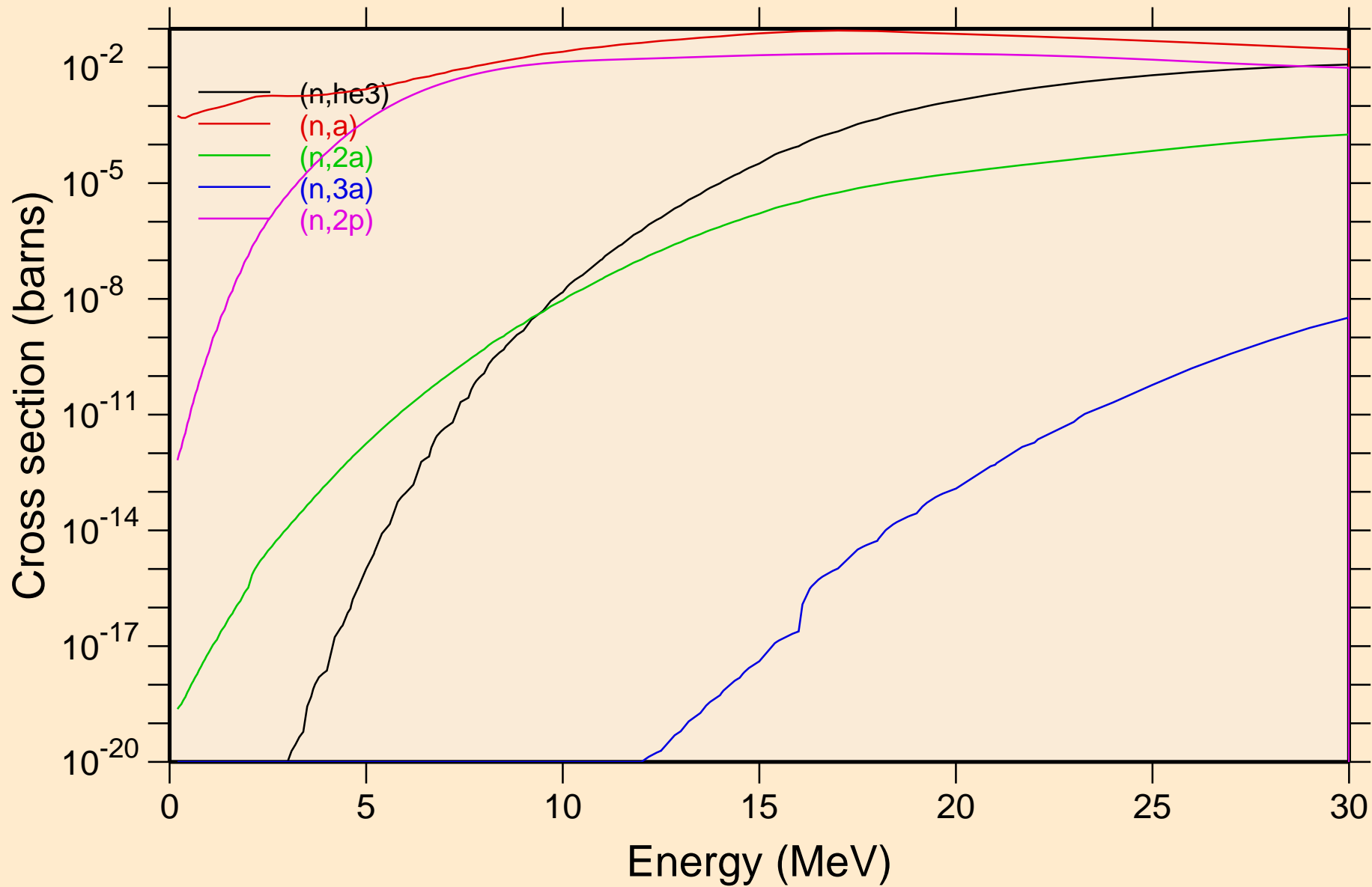

TB146 NEUTRON ACER TENDL-2023 LIBRARY; T=0.K  
Non-threshold reactions

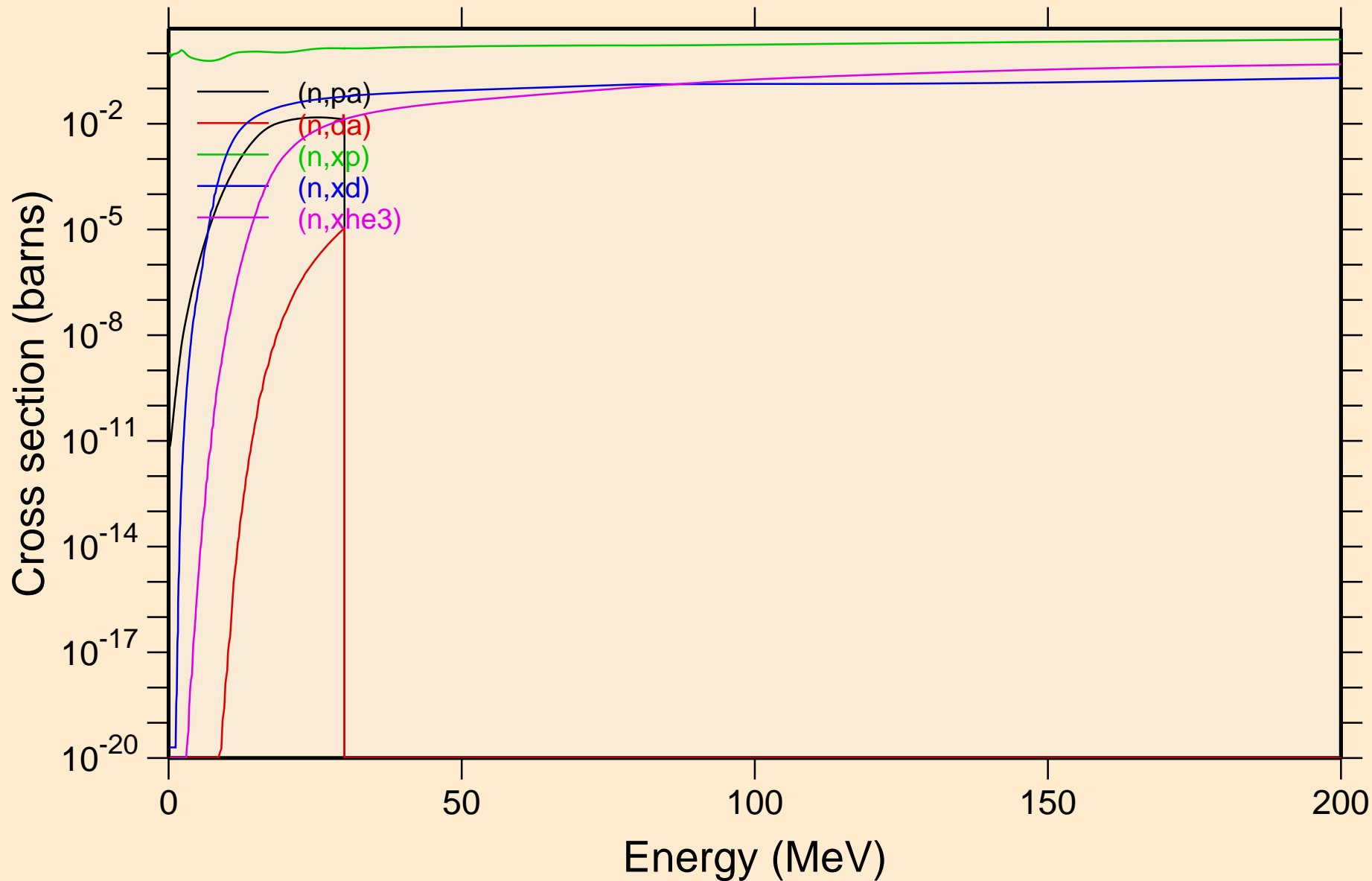

TB146 NEUTRON ACER TENDL-2023 LIBRARY; T=0.K  
Non-threshold reactions

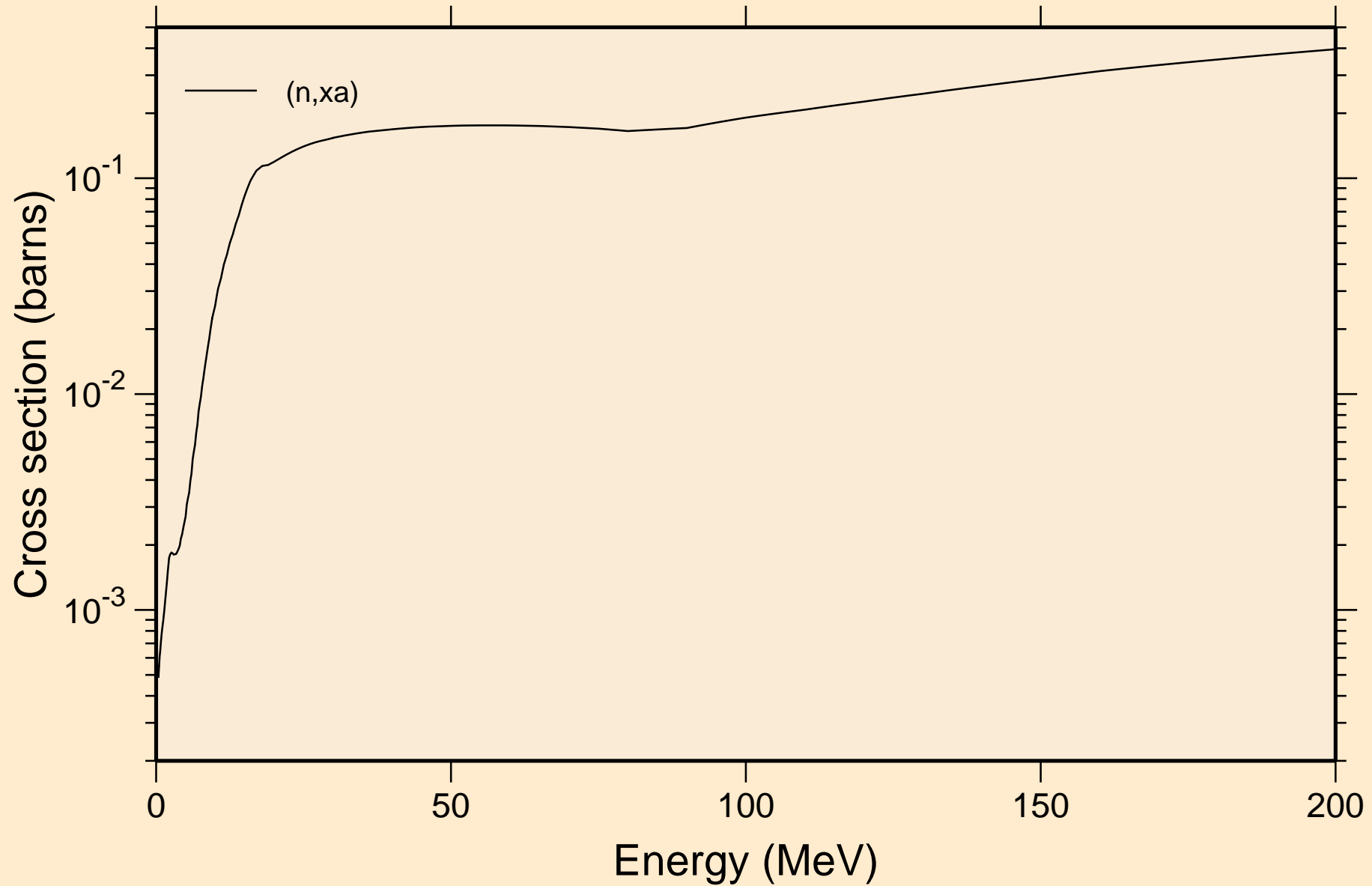

TB146 NEUTRON ACER TENDL-2023 LIBRARY; T=0.K  
Inelastic levels

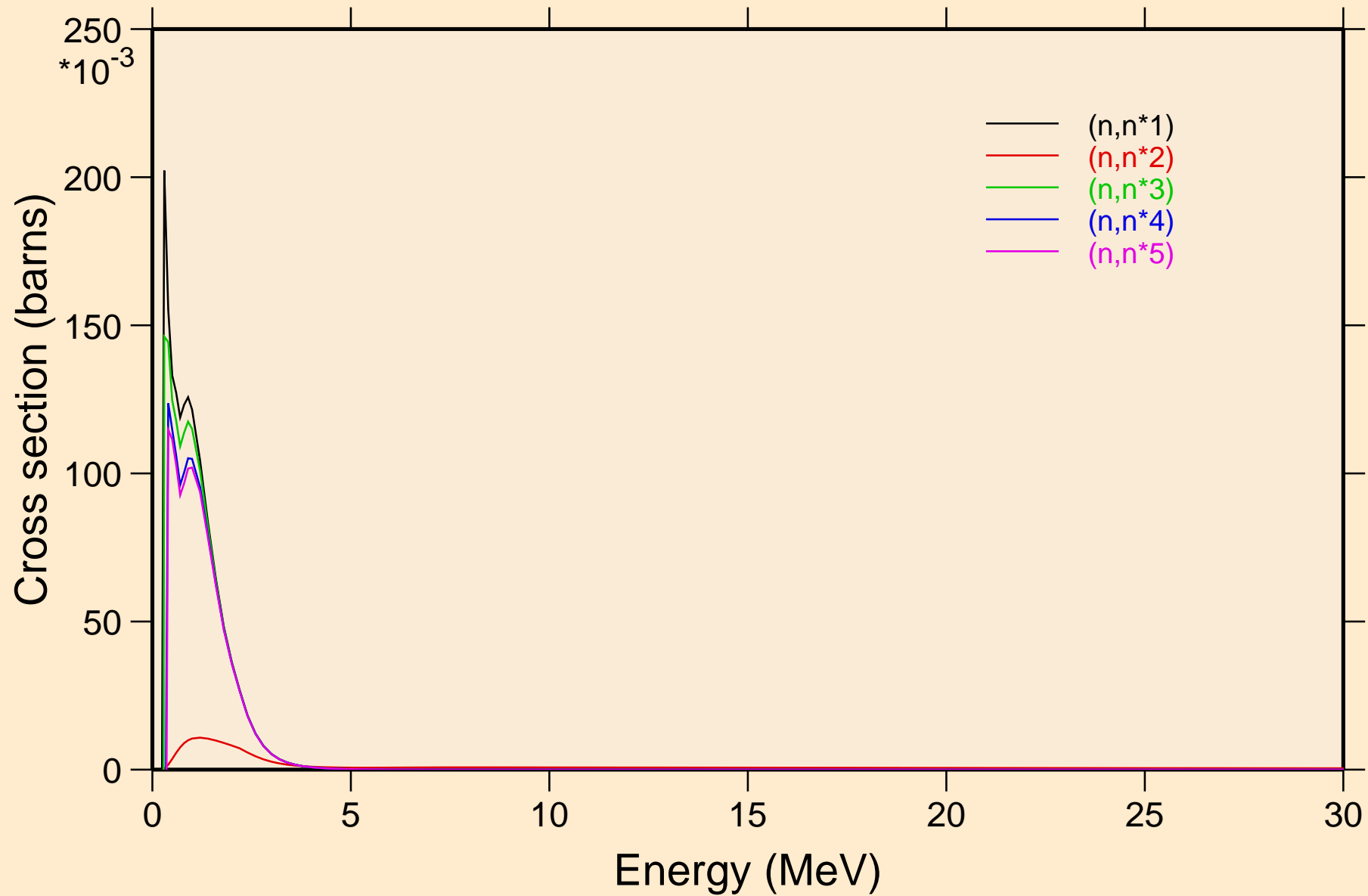

TB146 NEUTRON ACER TENDL-2023 LIBRARY; T=0.K  
Inelastic levels

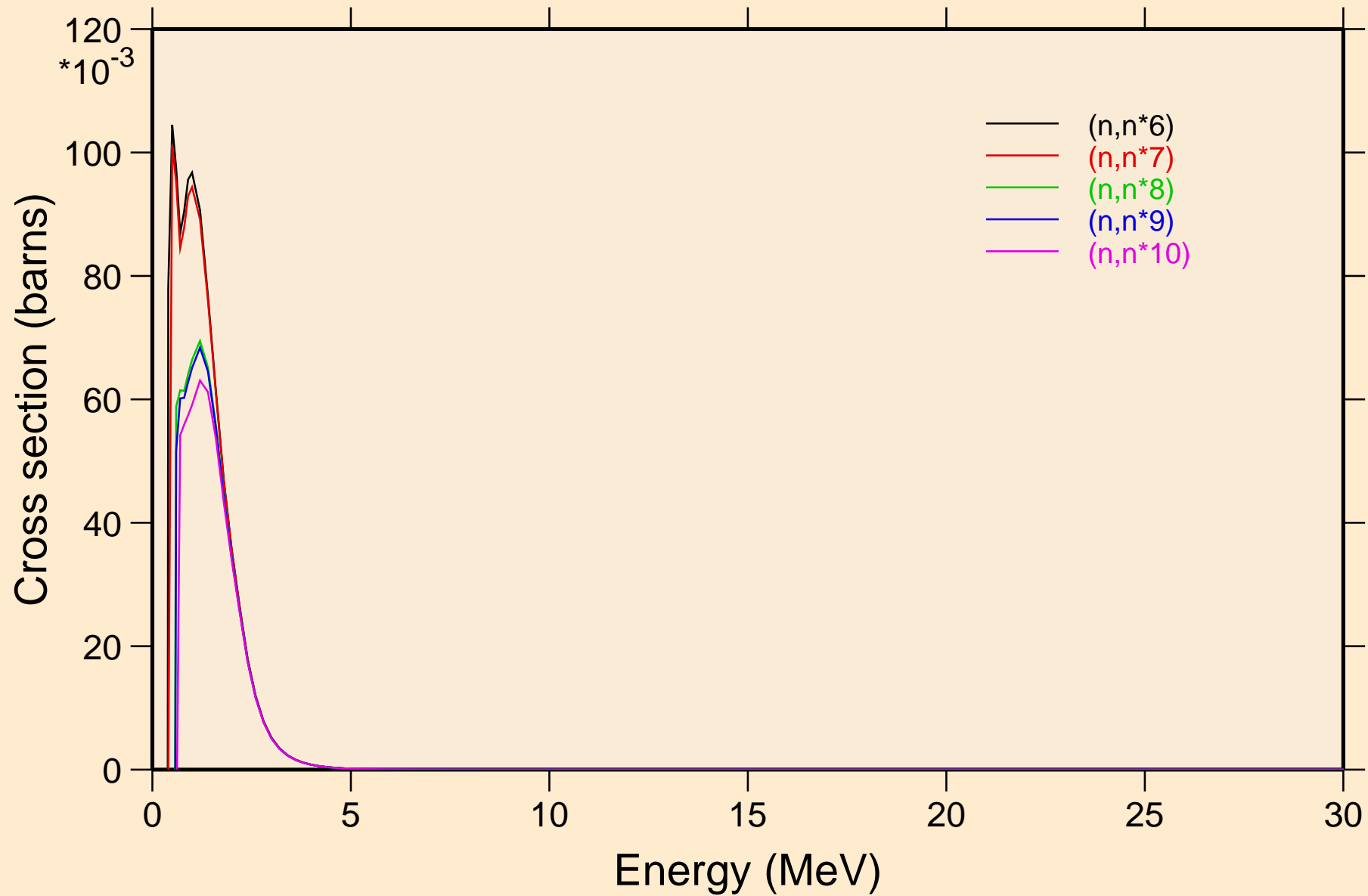

TB146 NEUTRON ACER TENDL-2023 LIBRARY; T=0.K  
Inelastic levels

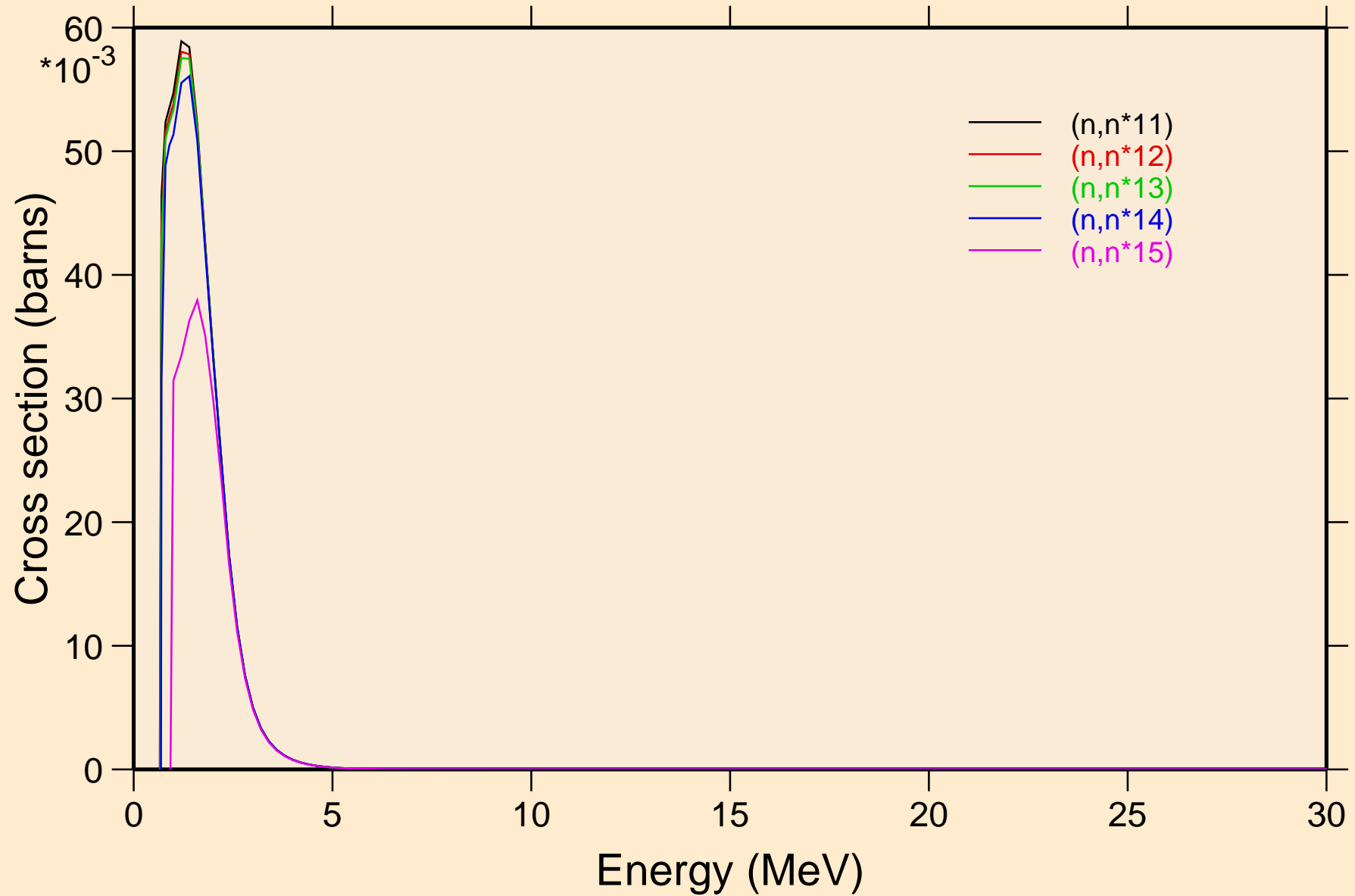

TB146 NEUTRON ACER TENDL-2023 LIBRARY; T=0.K  
Inelastic levels

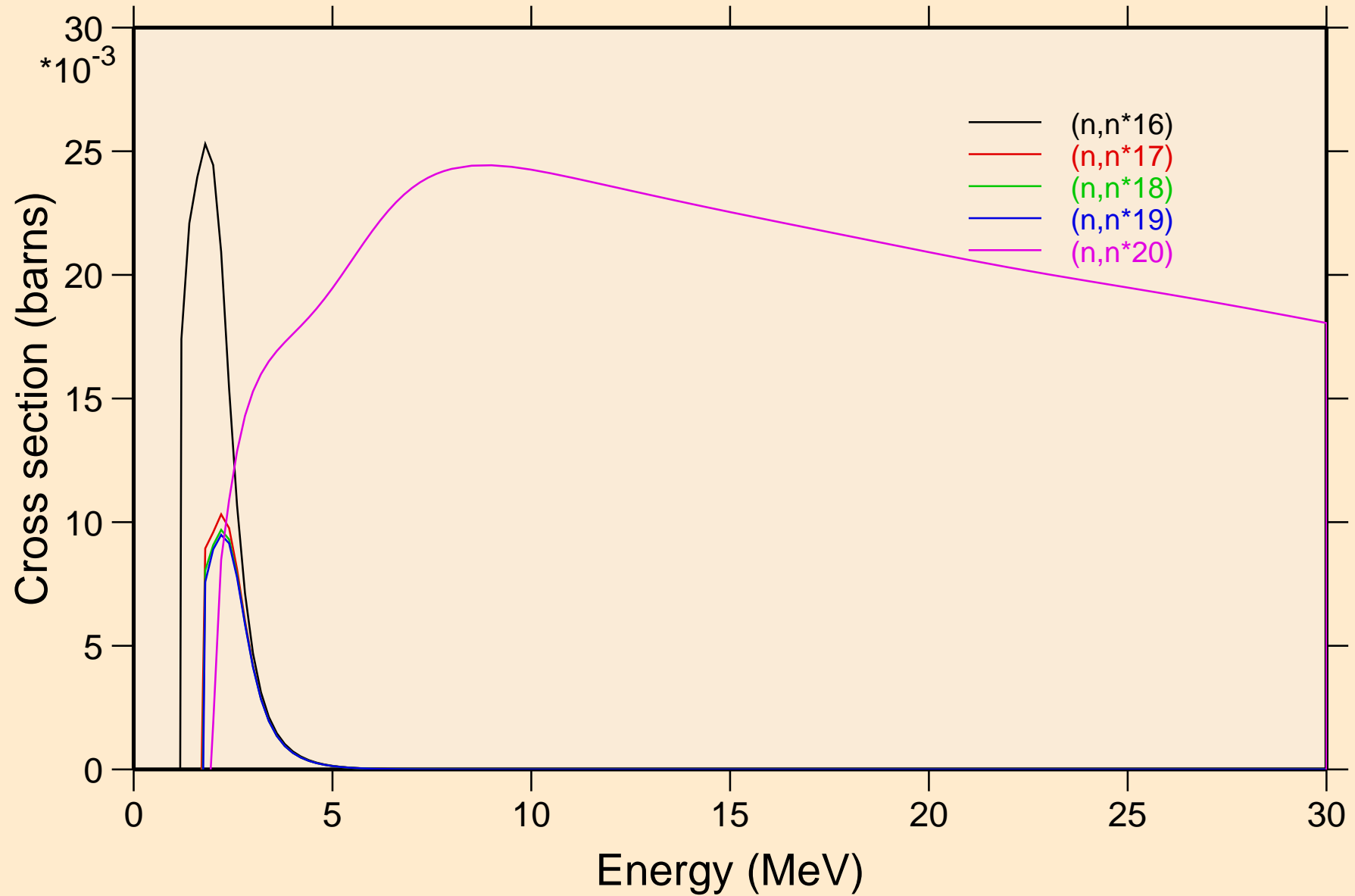

TB146 NEUTRON ACER TENDL-2023 LIBRARY; T=0.K  
Threshold reactions

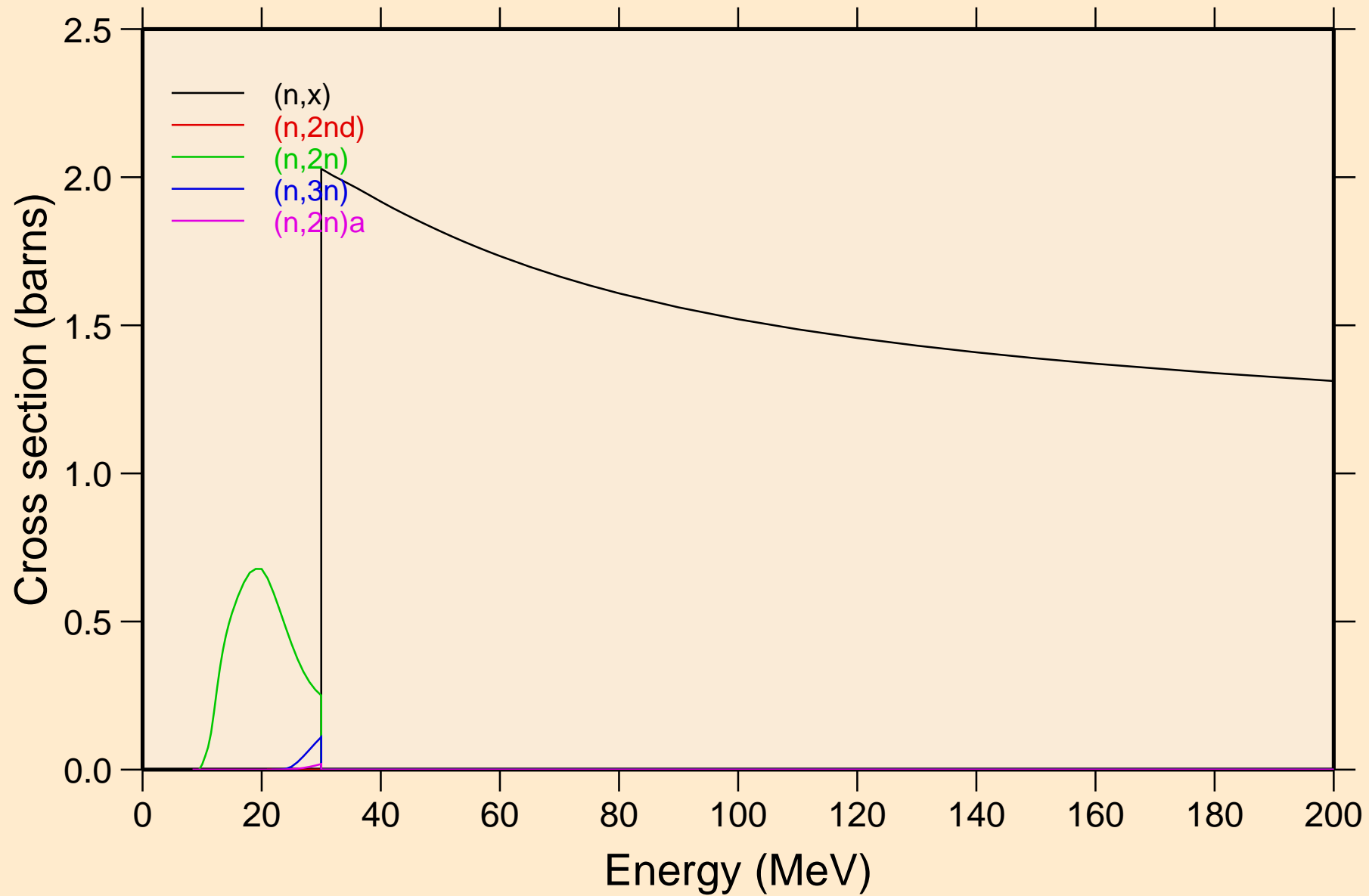

TB146 NEUTRON ACER TENDL-2023 LIBRARY; T=0.K  
Threshold reactions

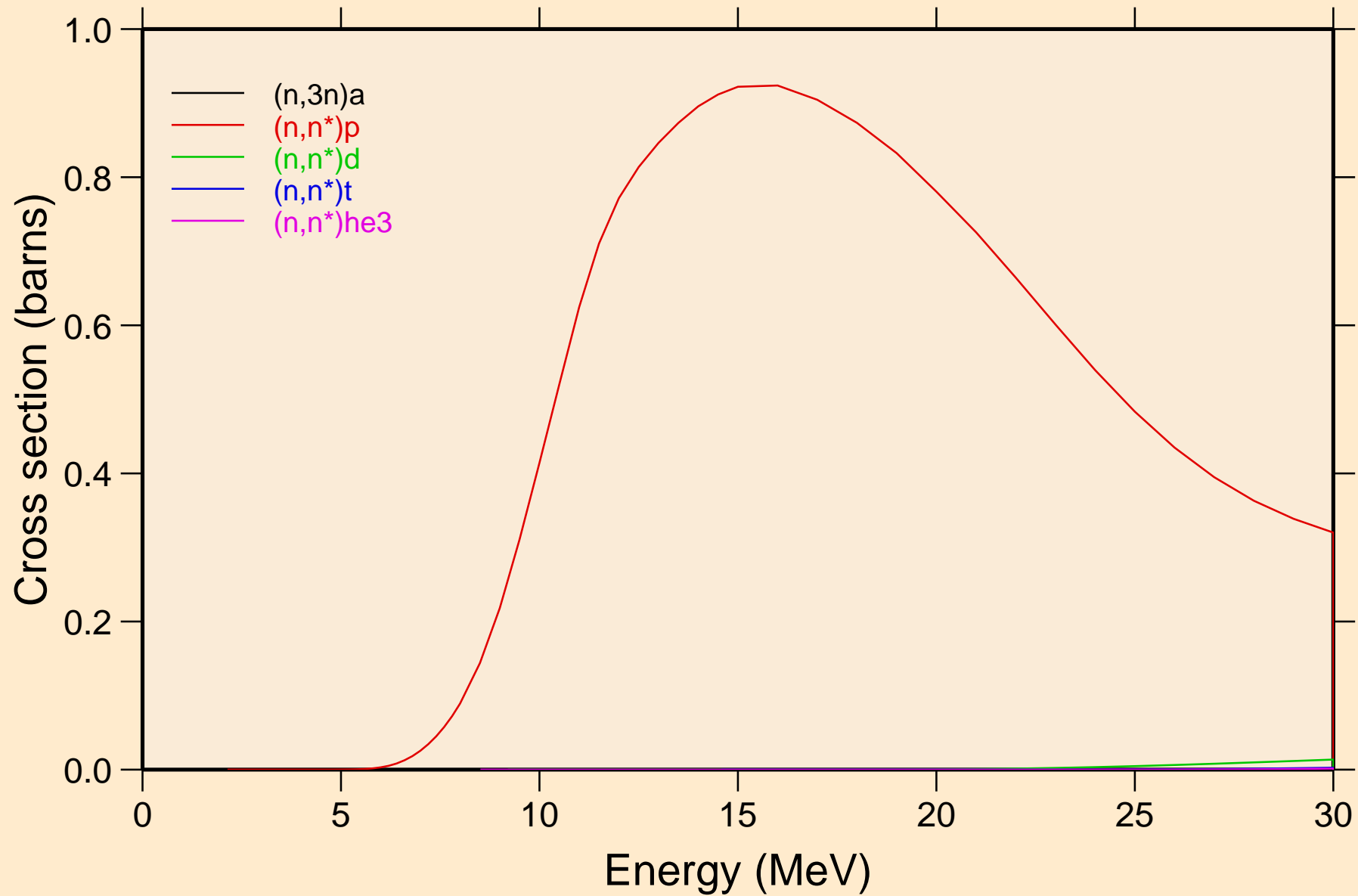

TB146 NEUTRON ACER TENDL-2023 LIBRARY; T=0.K  
Threshold reactions

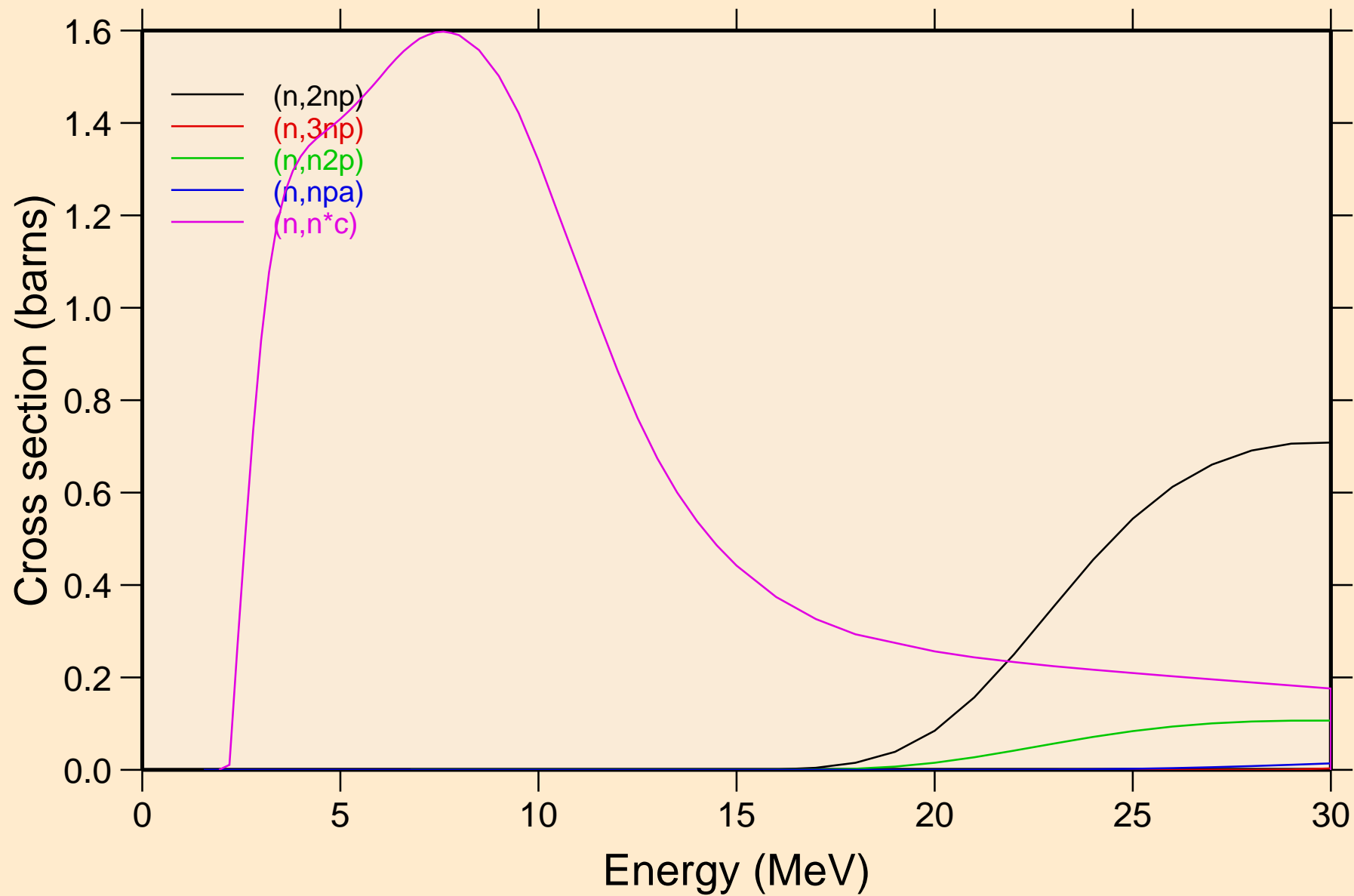

TB146 NEUTRON ACER TENDL-2023 LIBRARY; T=0.K  
Threshold reactions

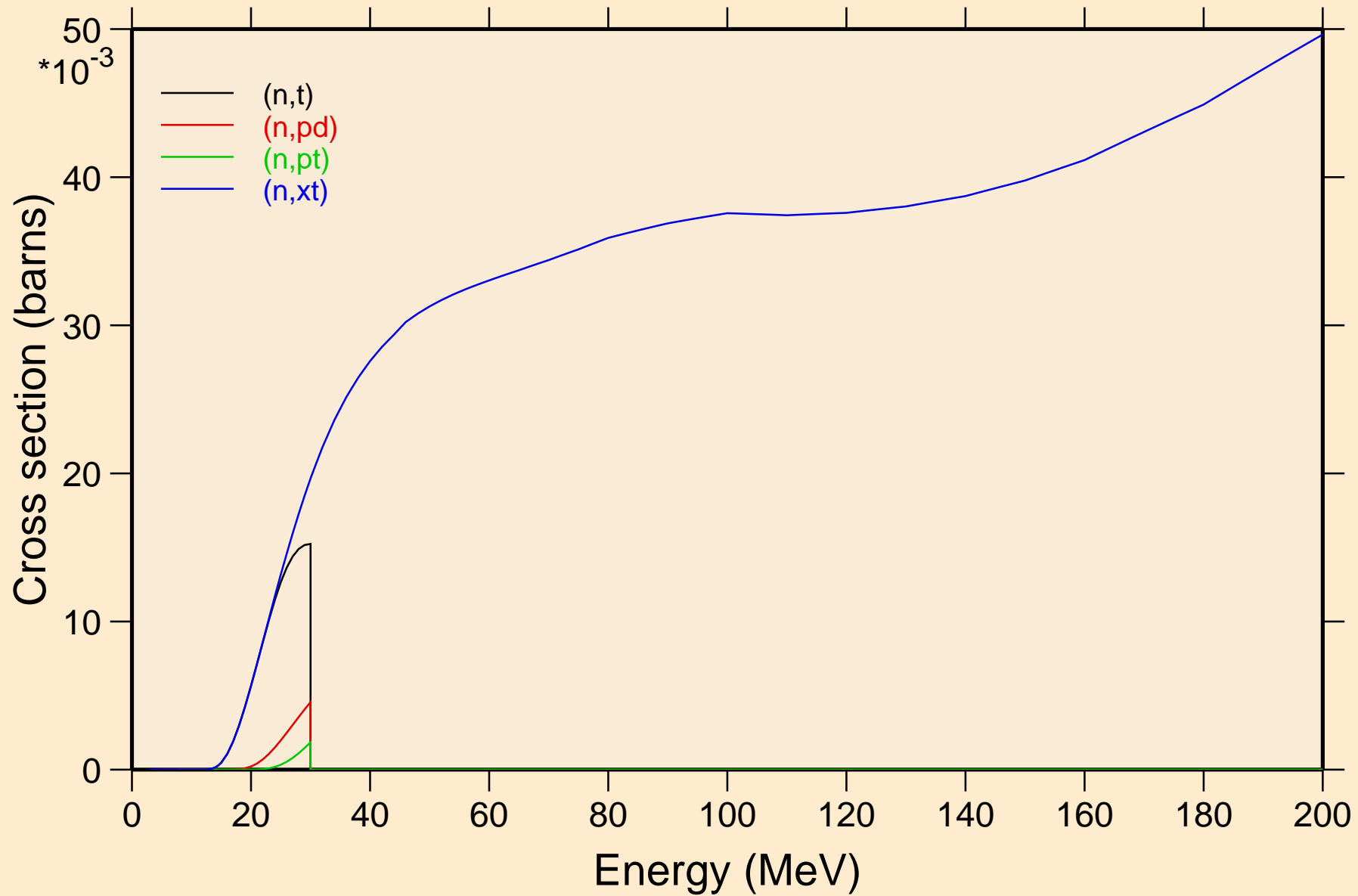

TB146 NEUTRON ACER TENDL-2023 LIBRARY; T=0.K  
angular distribution for elastic

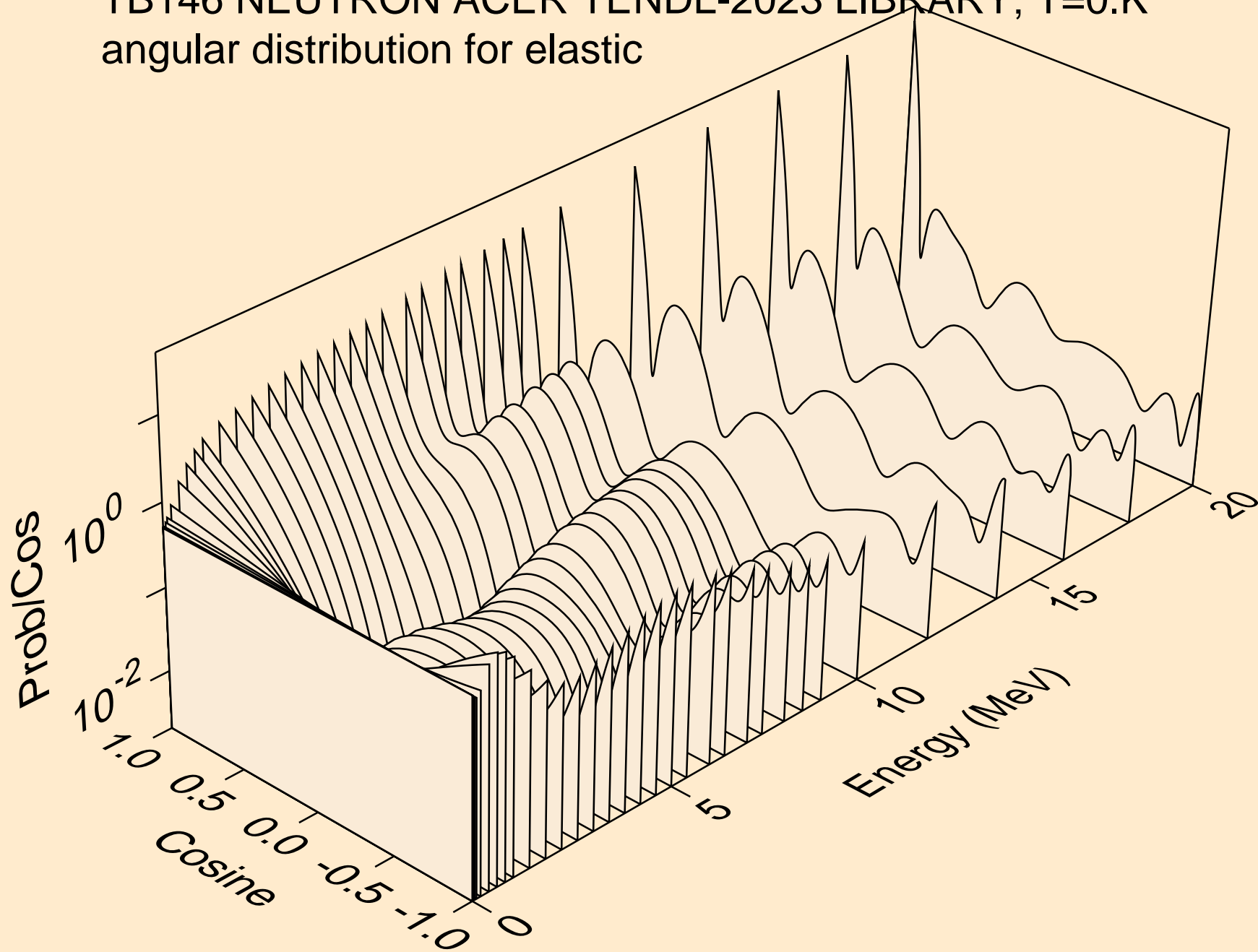

TB146 NEUTRON ACER TENDL-2023 LIBRARY; T=0.K  
angular distribution for elastic

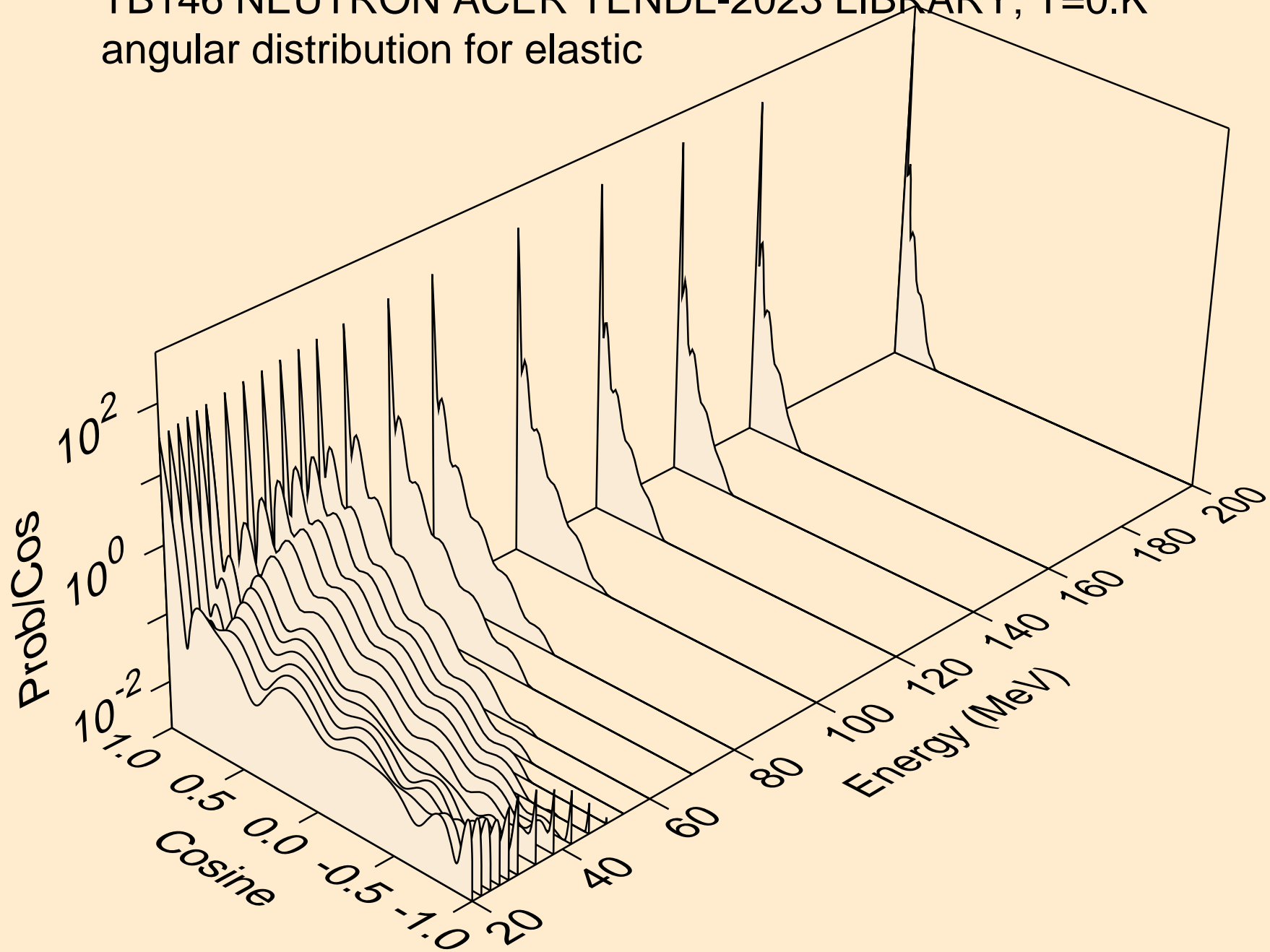

TB146 NEUTRON ACER TENDL-2023 LIBRARY; T=0.K  
angular distribution for (n,n\*1)

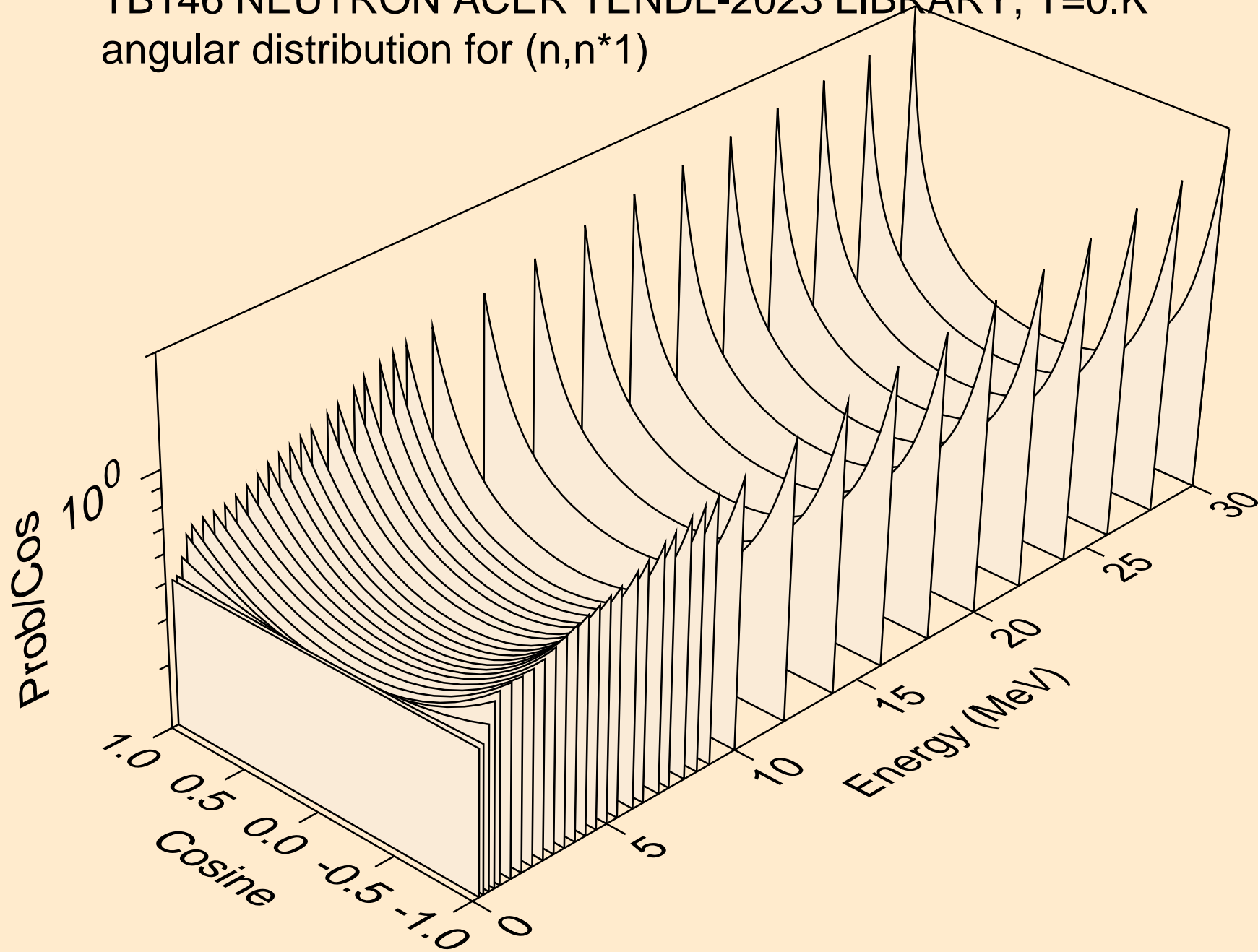

TB146 NEUTRON ACER TENDL-2023 LIBRARY; T=0.K  
angular distribution for (n,n\*2)

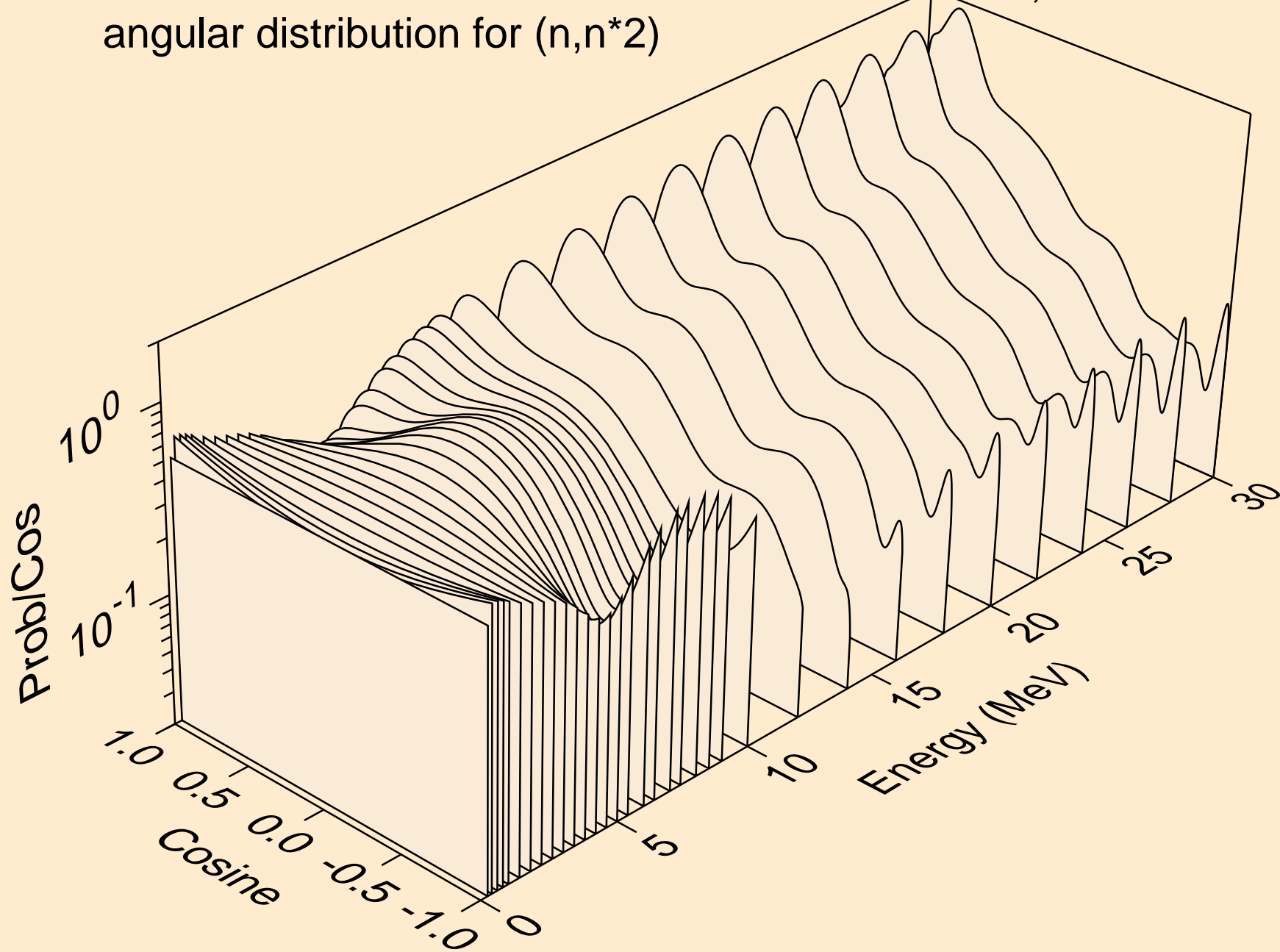

TB146 NEUTRON ACER TENDL-2023 LIBRARY; T=0.K  
angular distribution for (n,n\*3)

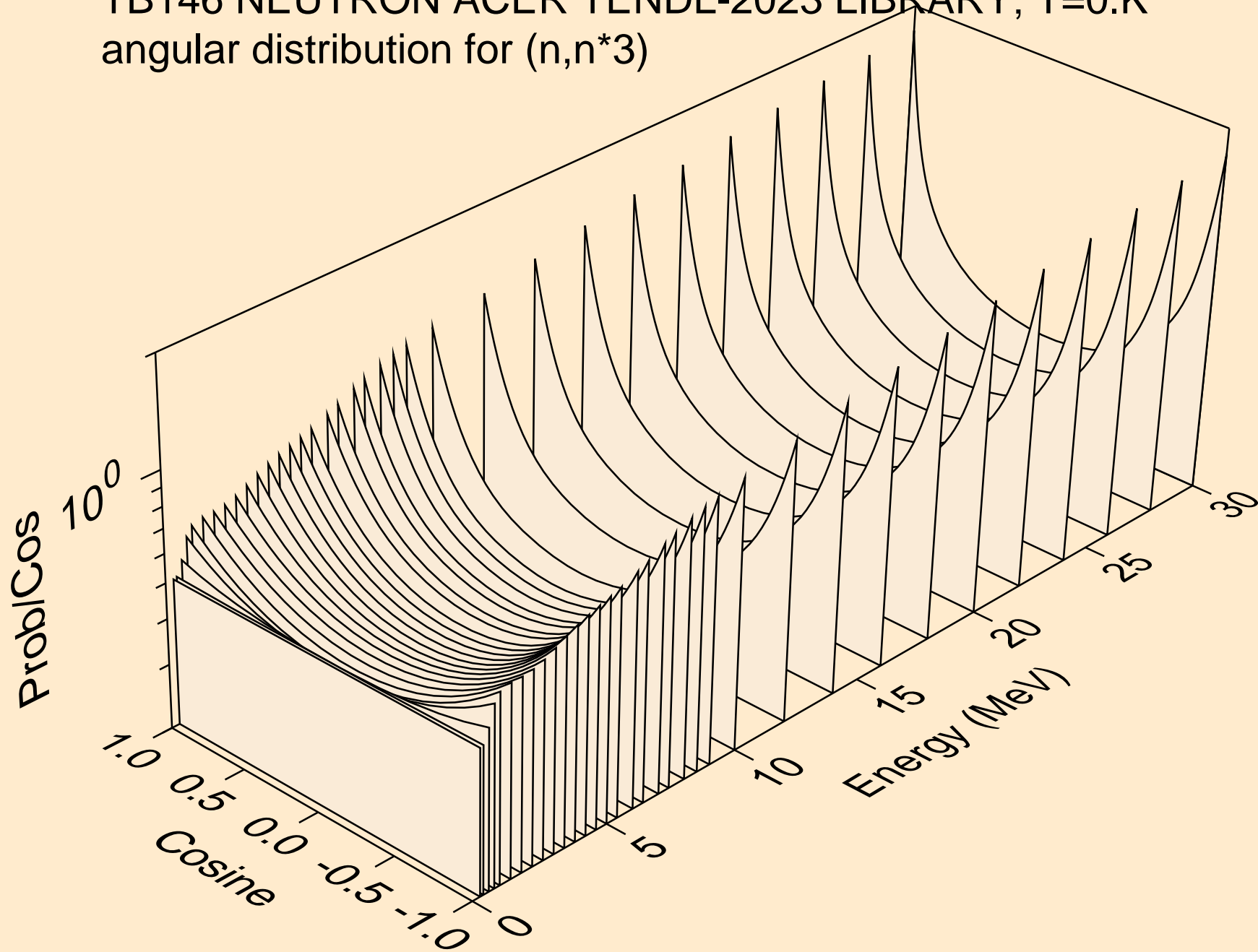

TB146 NEUTRON ACER TENDL-2023 LIBRARY; T=0.K  
angular distribution for (n,n\*4)

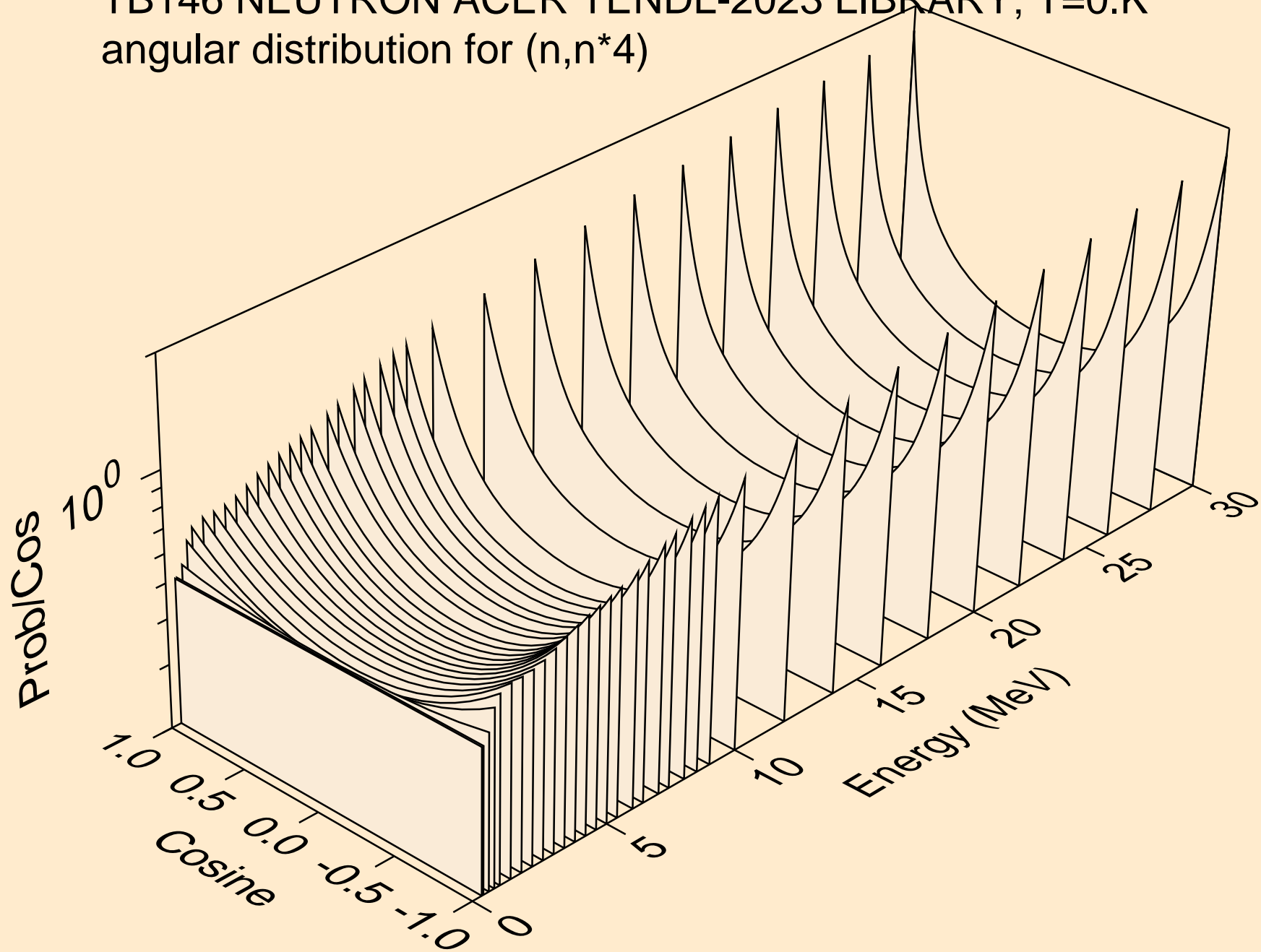

TB146 NEUTRON ACER TENDL-2023 LIBRARY; T=0.K  
angular distribution for (n,n\*5)

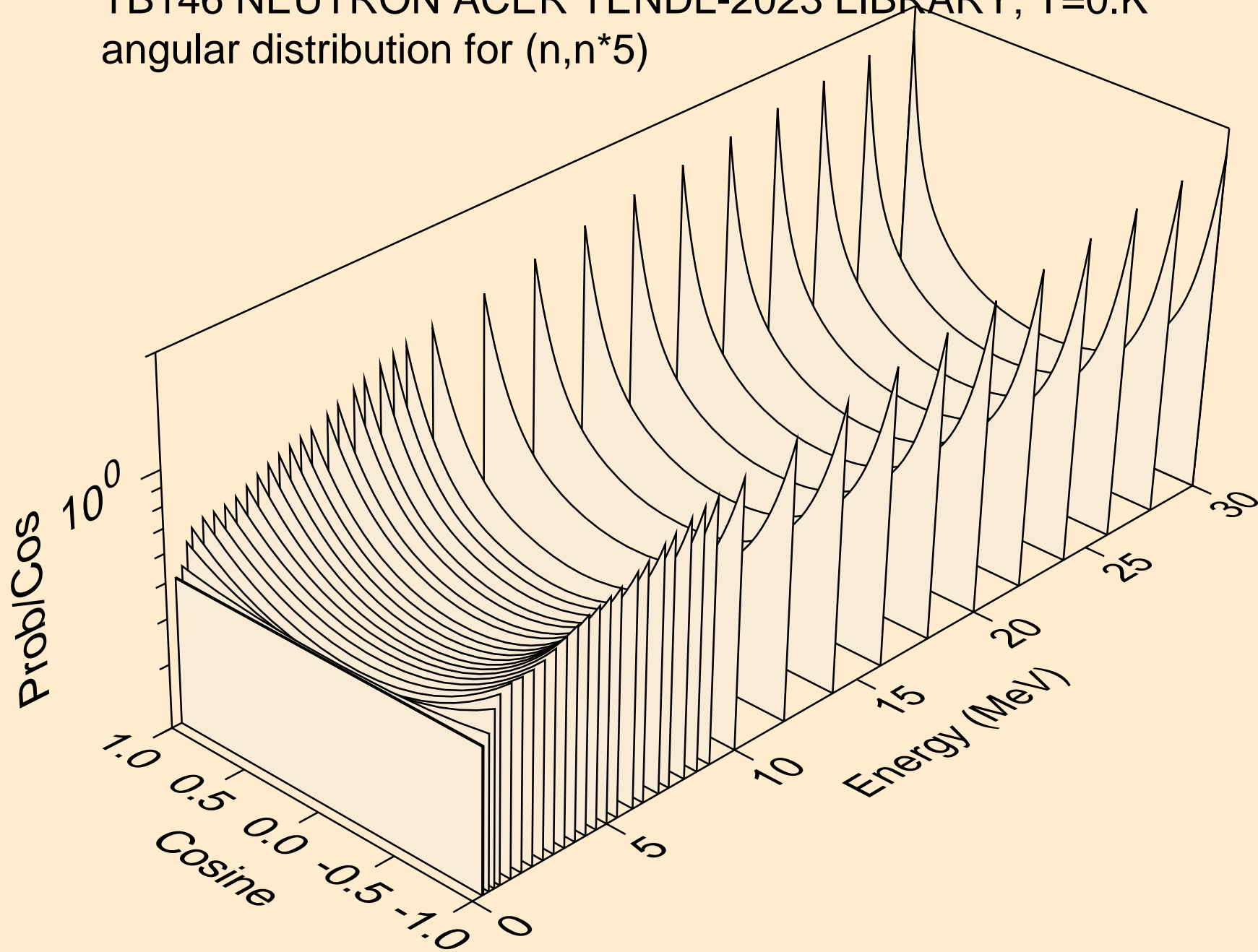

TB146 NEUTRON ACER TENDL-2023 LIBRARY; T=0.K  
angular distribution for (n,n\*6)

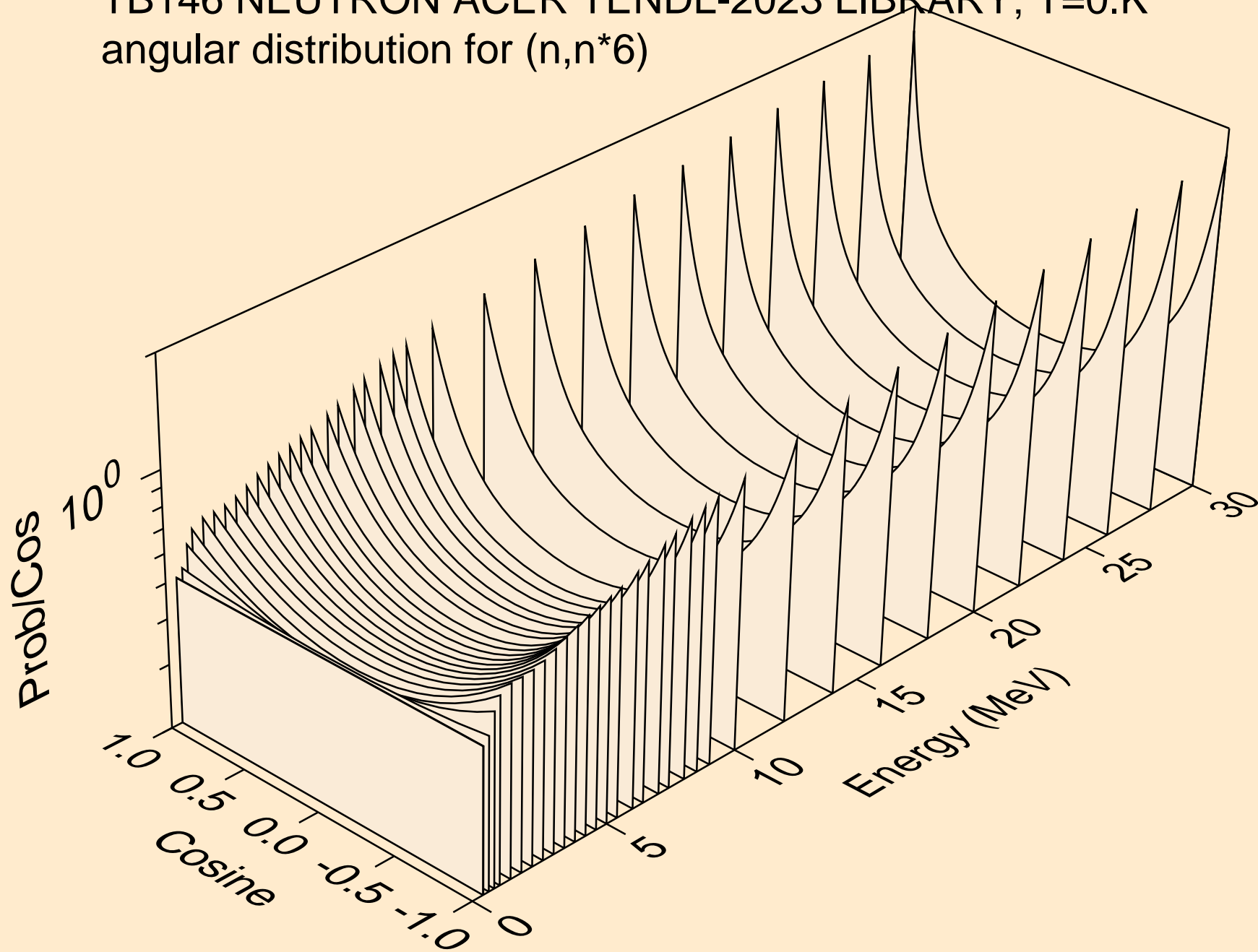

TB146 NEUTRON ACER TENDL-2023 LIBRARY; T=0.K  
angular distribution for (n,n\*7)

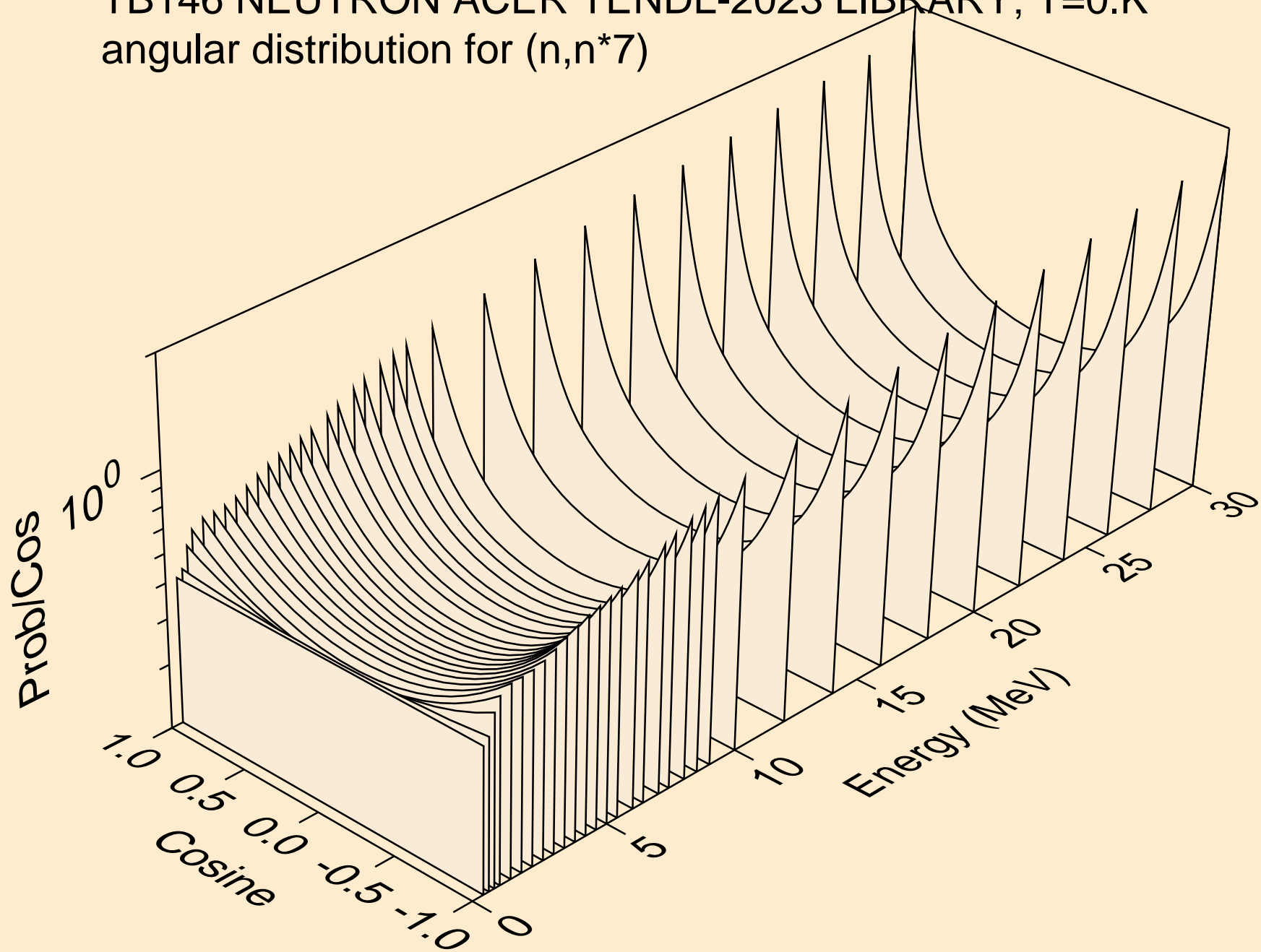

TB146 NEUTRON ACER TENDL-2023 LIBRARY; T=0.K  
angular distribution for (n,n\*8)

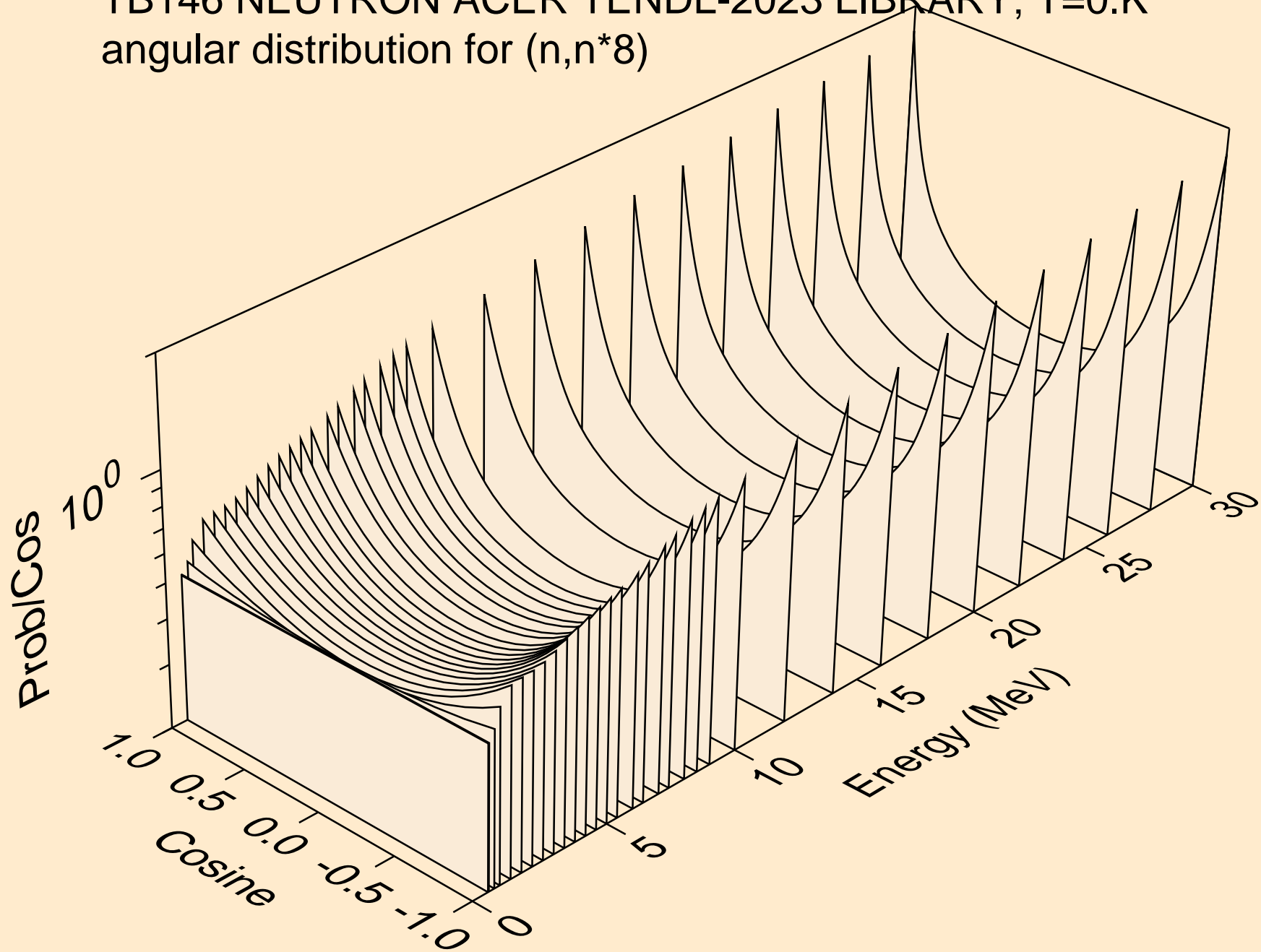

TB146 NEUTRON ACER TENDL-2023 LIBRARY; T=0.K  
angular distribution for (n,n\*9)

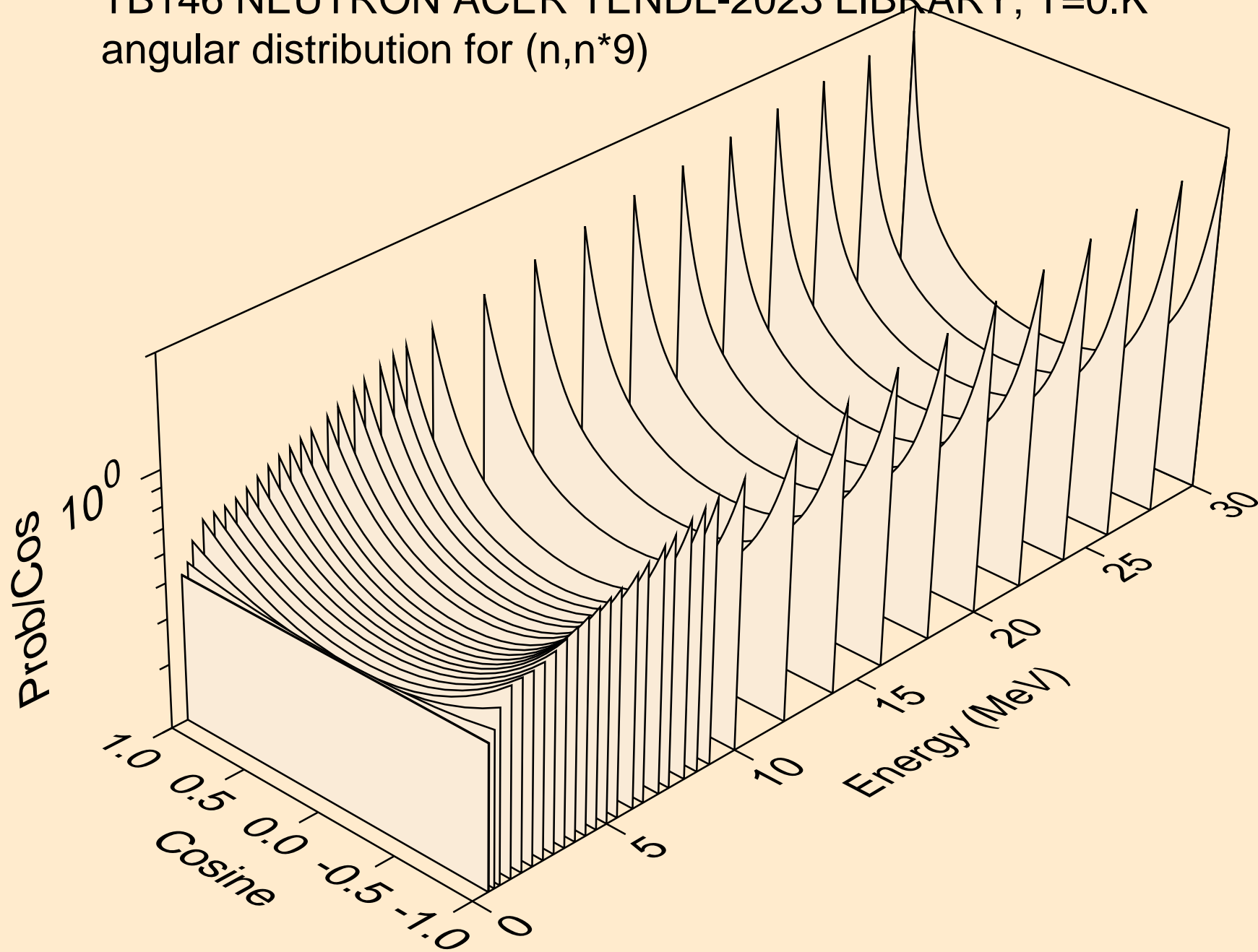

TB146 NEUTRON ACER TENDL-2023 LIBRARY; T=0.K  
angular distribution for (n,n\*10)

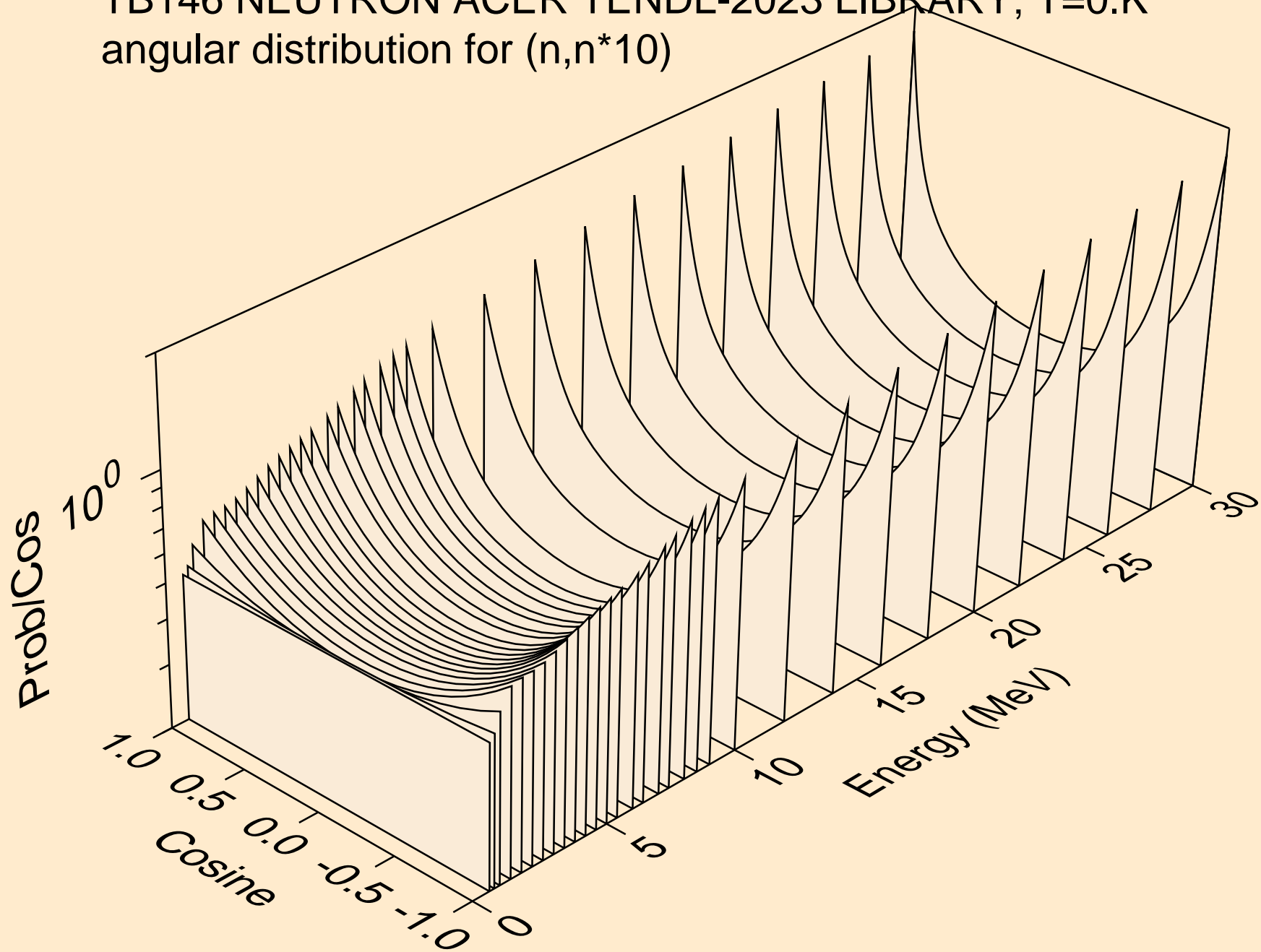

TB146 NEUTRON ACER TENDL-2023 LIBRARY; T=0.K  
angular distribution for (n,n\*11)

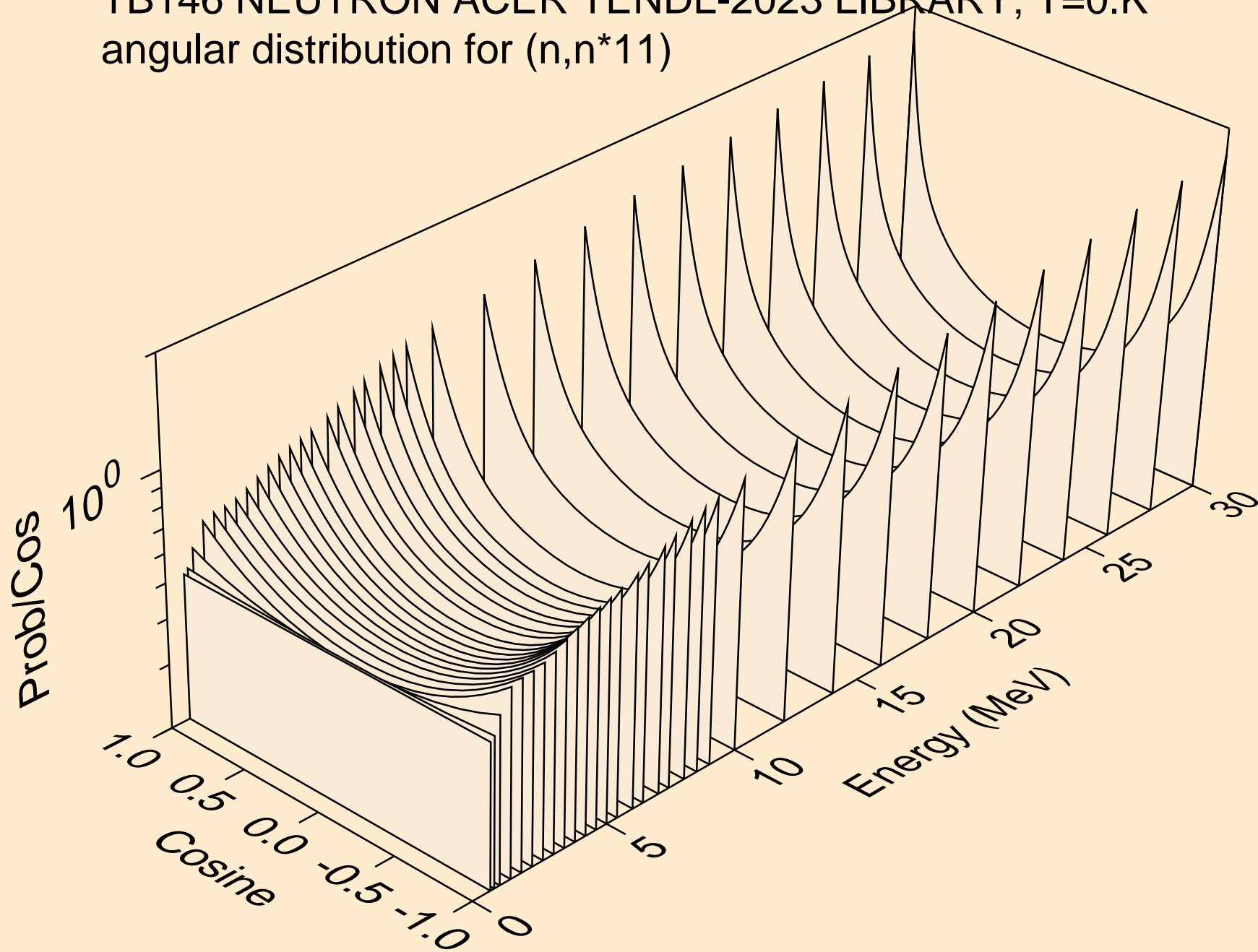

TB146 NEUTRON ACER TENDL-2023 LIBRARY; T=0.K  
angular distribution for (n,n\*12)

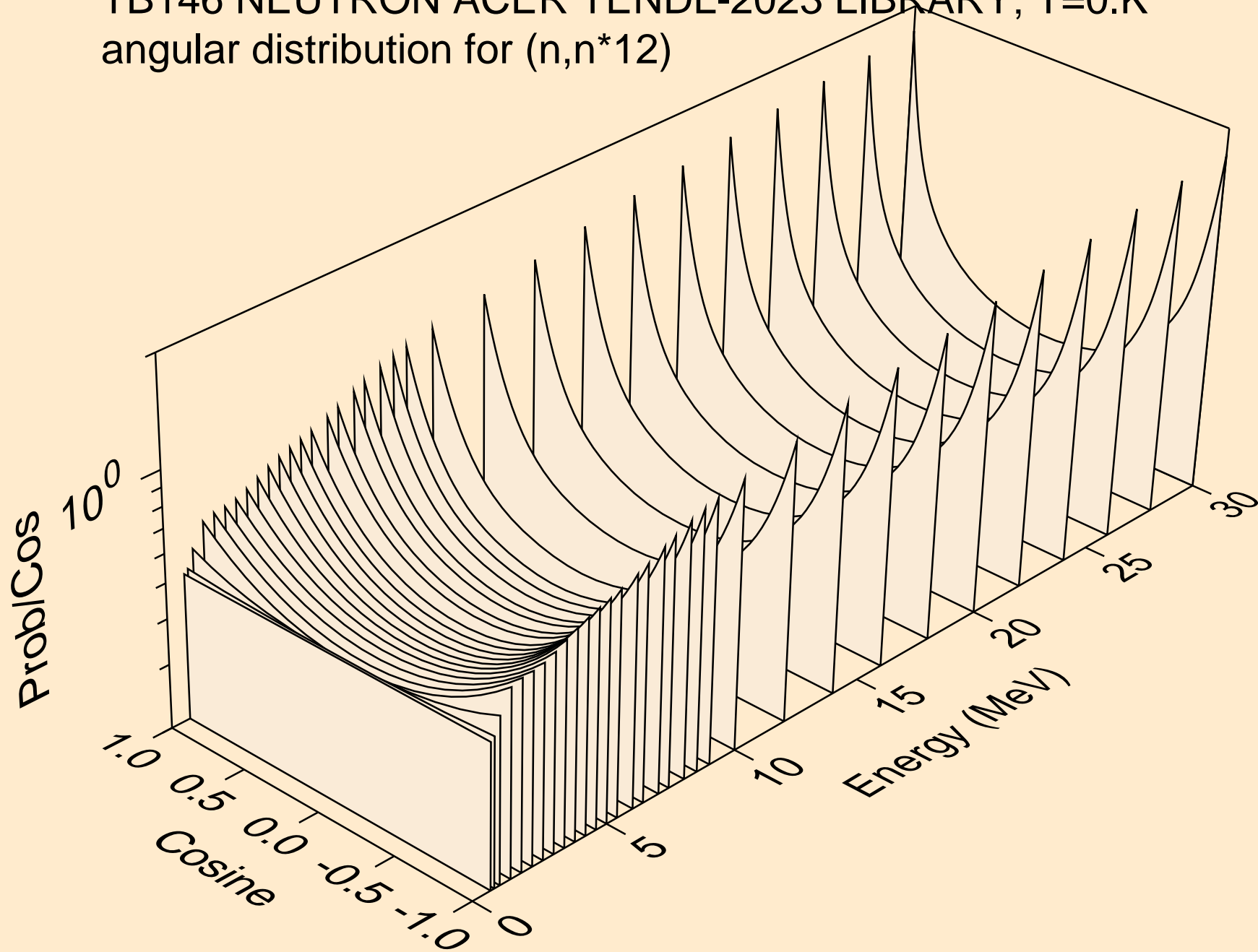

TB146 NEUTRON ACER TENDL-2023 LIBRARY; T=0.K  
angular distribution for (n,n\*13)

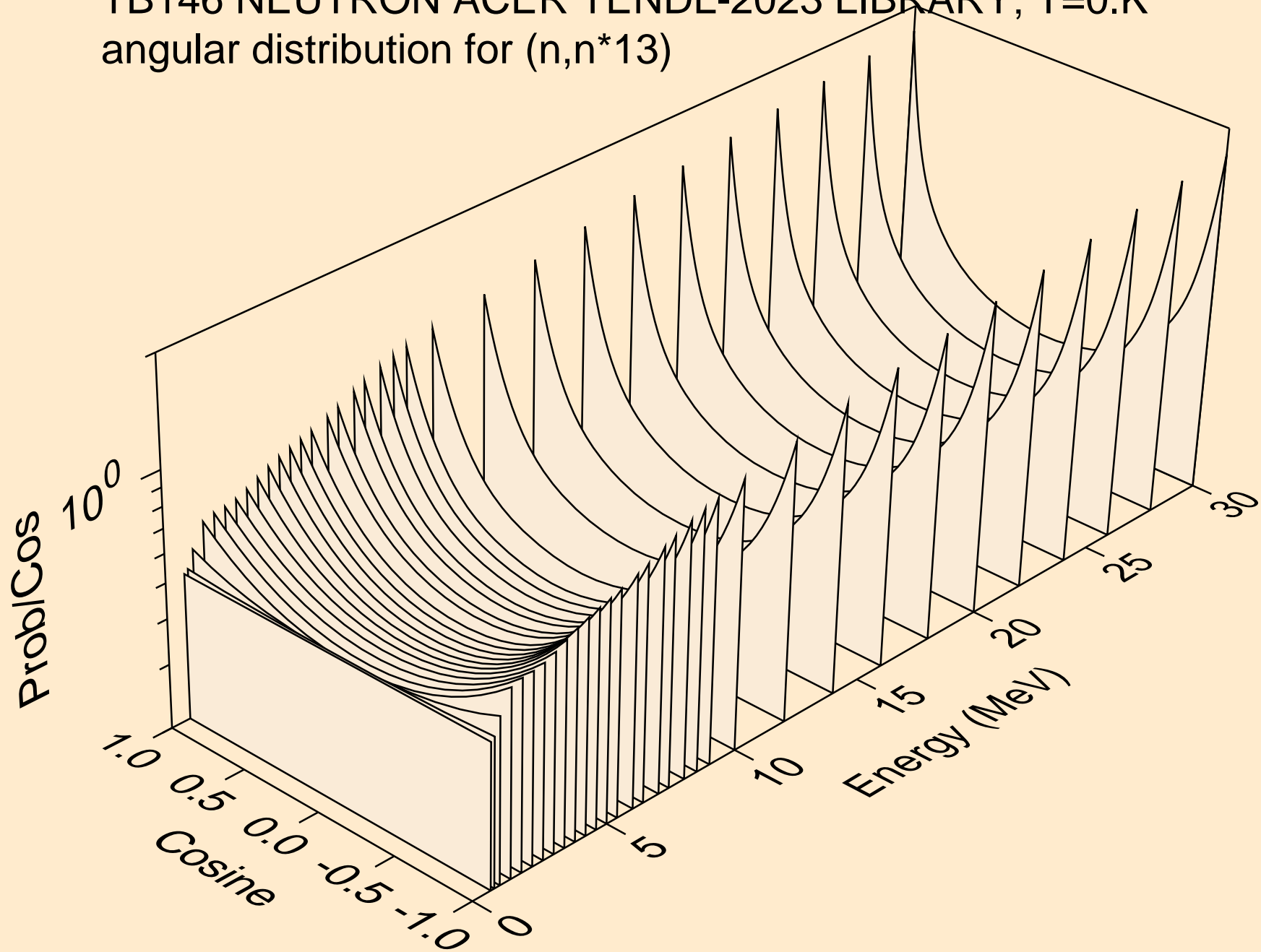

TB146 NEUTRON ACER TENDL-2023 LIBRARY; T=0.K  
angular distribution for (n,n\*14)

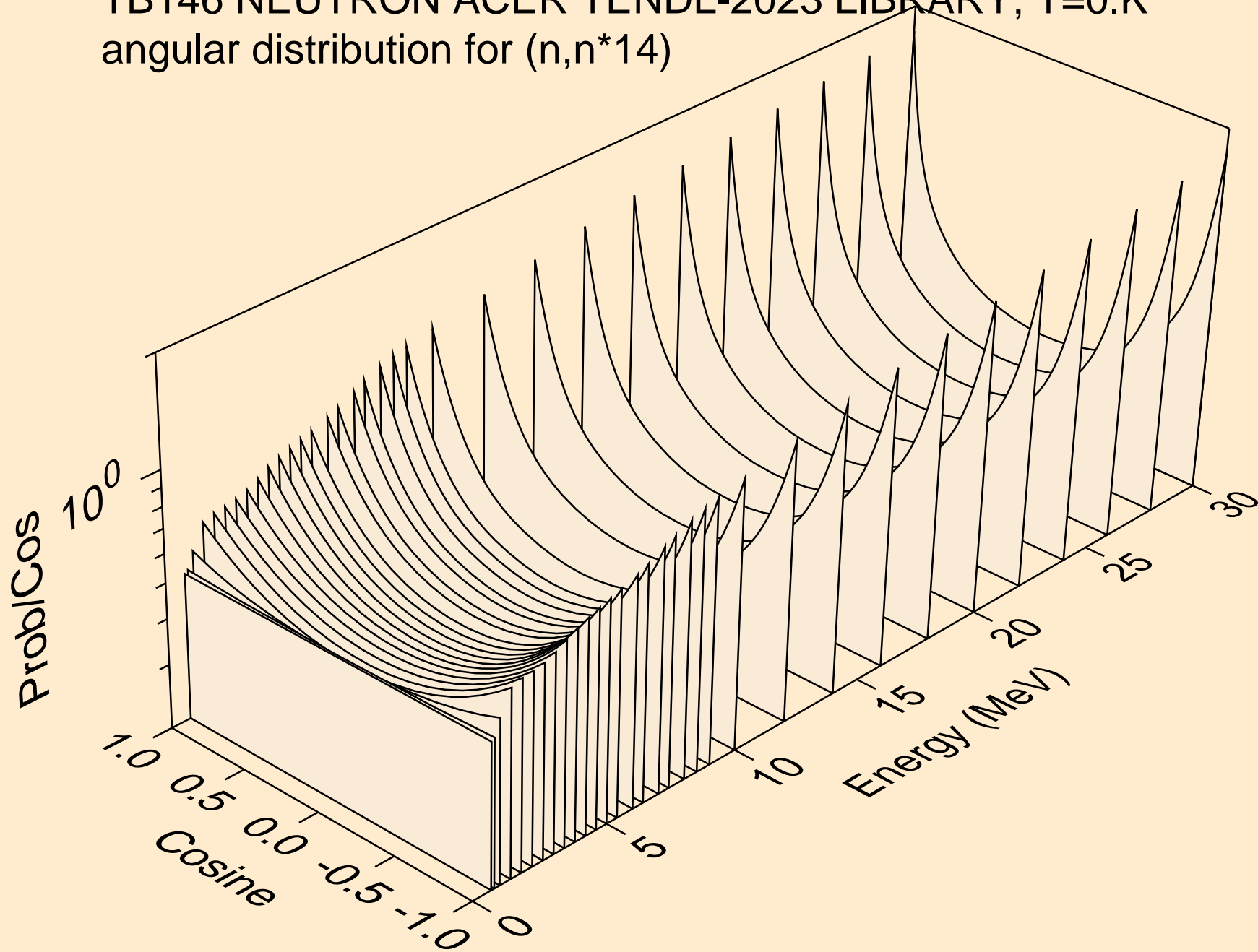

TB146 NEUTRON ACER TENDL-2023 LIBRARY; T=0.K  
angular distribution for (n,n\*15)

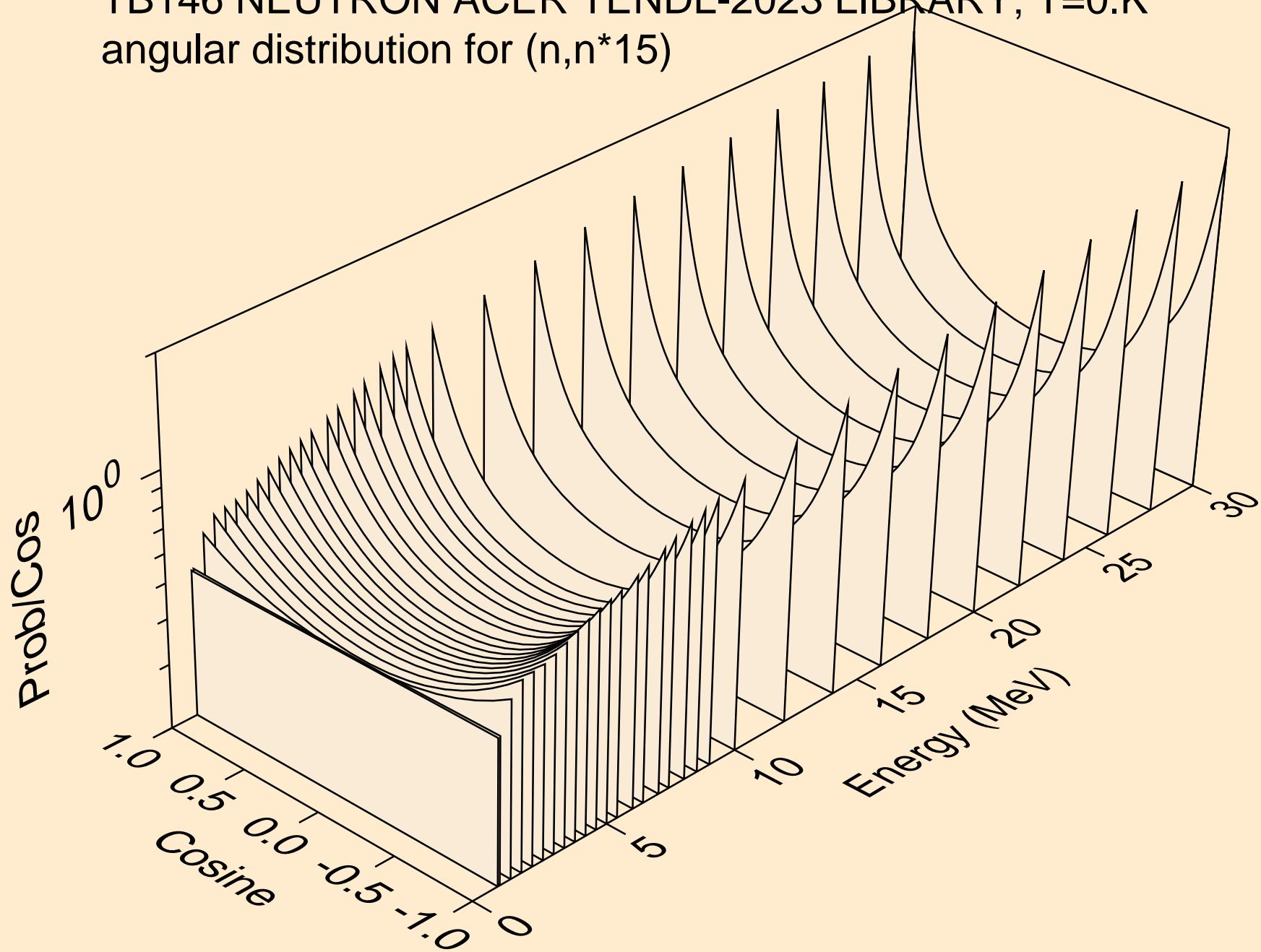

TB146 NEUTRON ACER TENDL-2023 LIBRARY; T=0.K  
angular distribution for (n,n\*16)

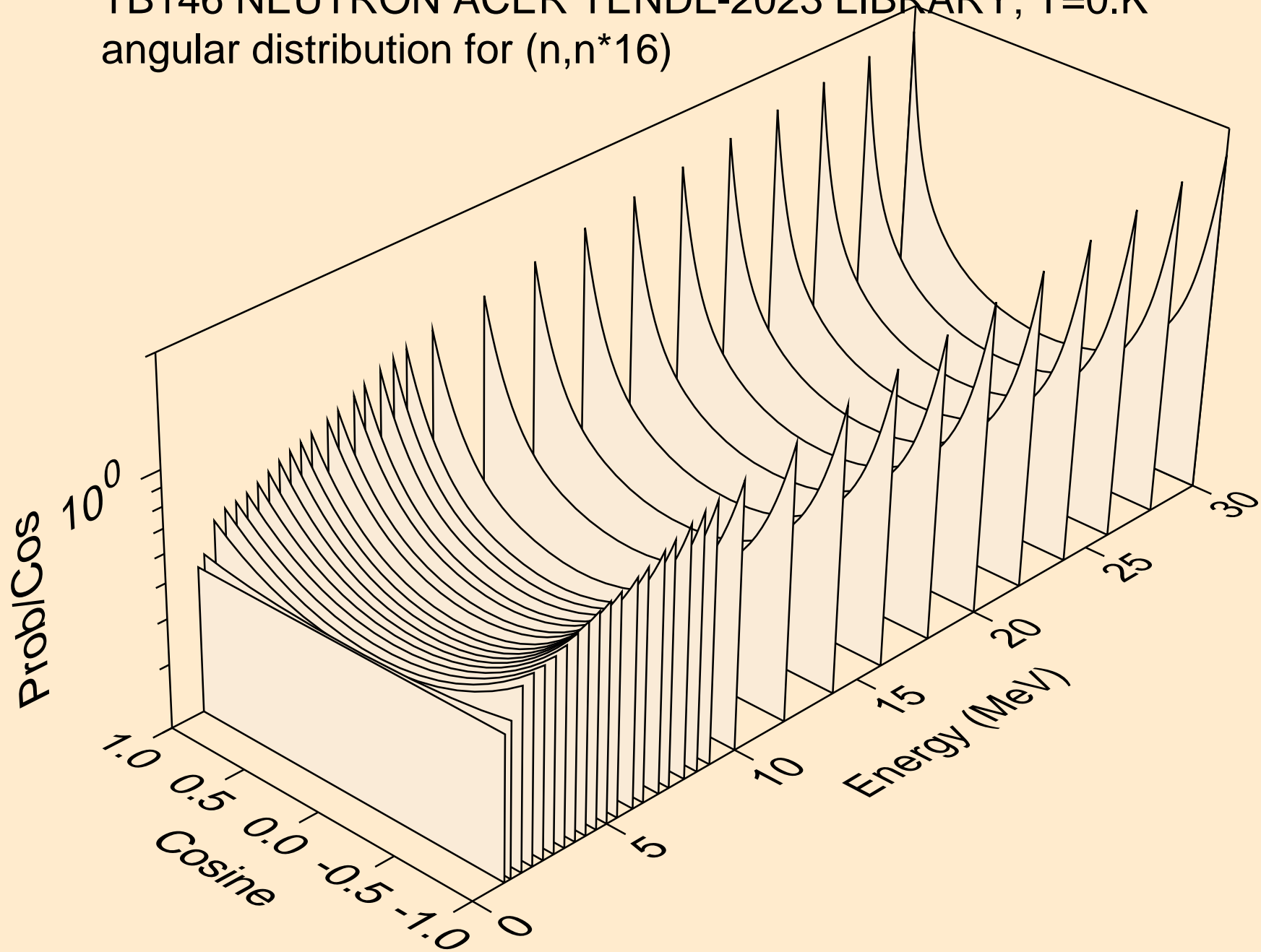

TB146 NEUTRON ACER TENDL-2023 LIBRARY; T=0.K  
angular distribution for (n,n\*17)

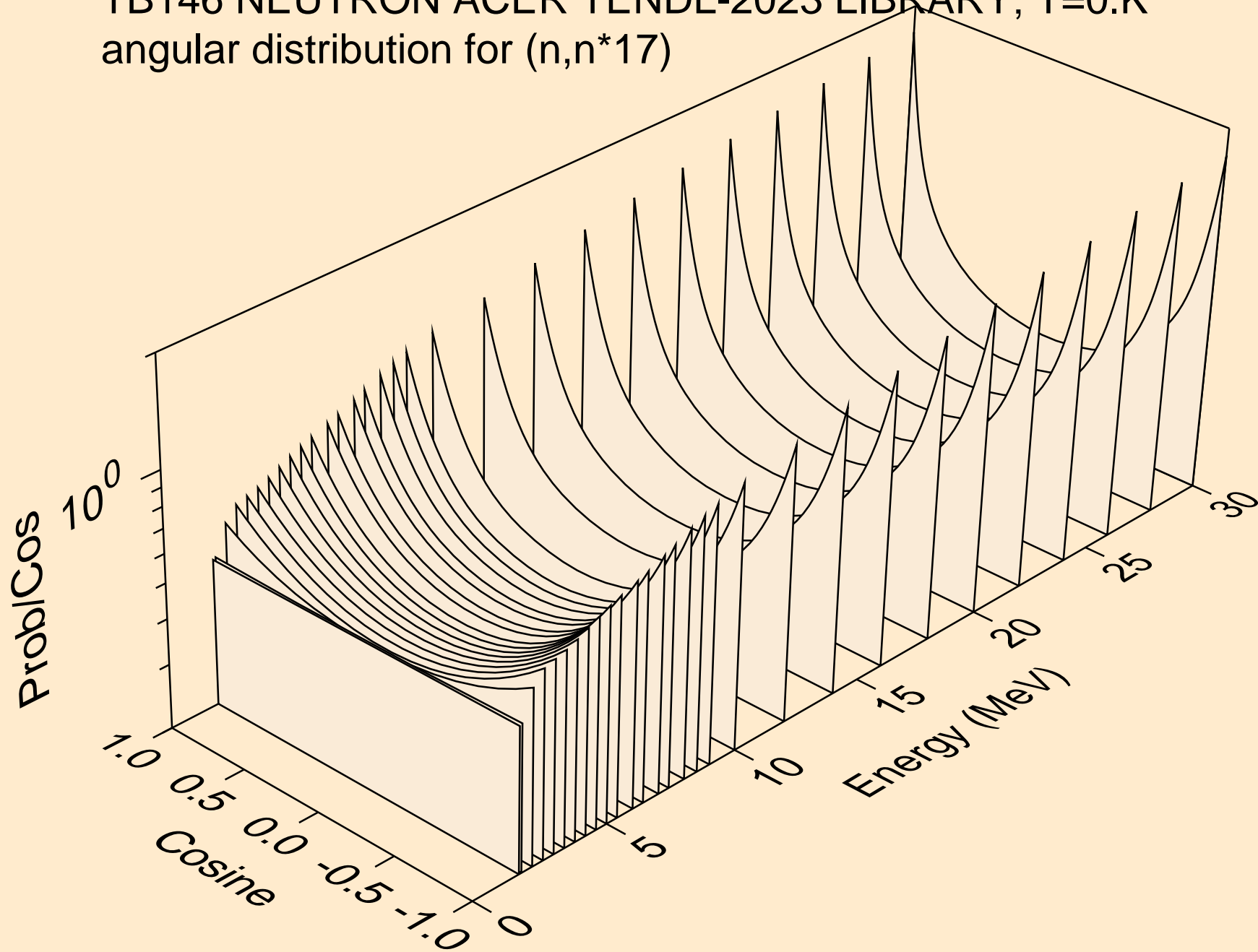

TB146 NEUTRON ACER TENDL-2023 LIBRARY; T=0.K  
angular distribution for (n,n\*18)

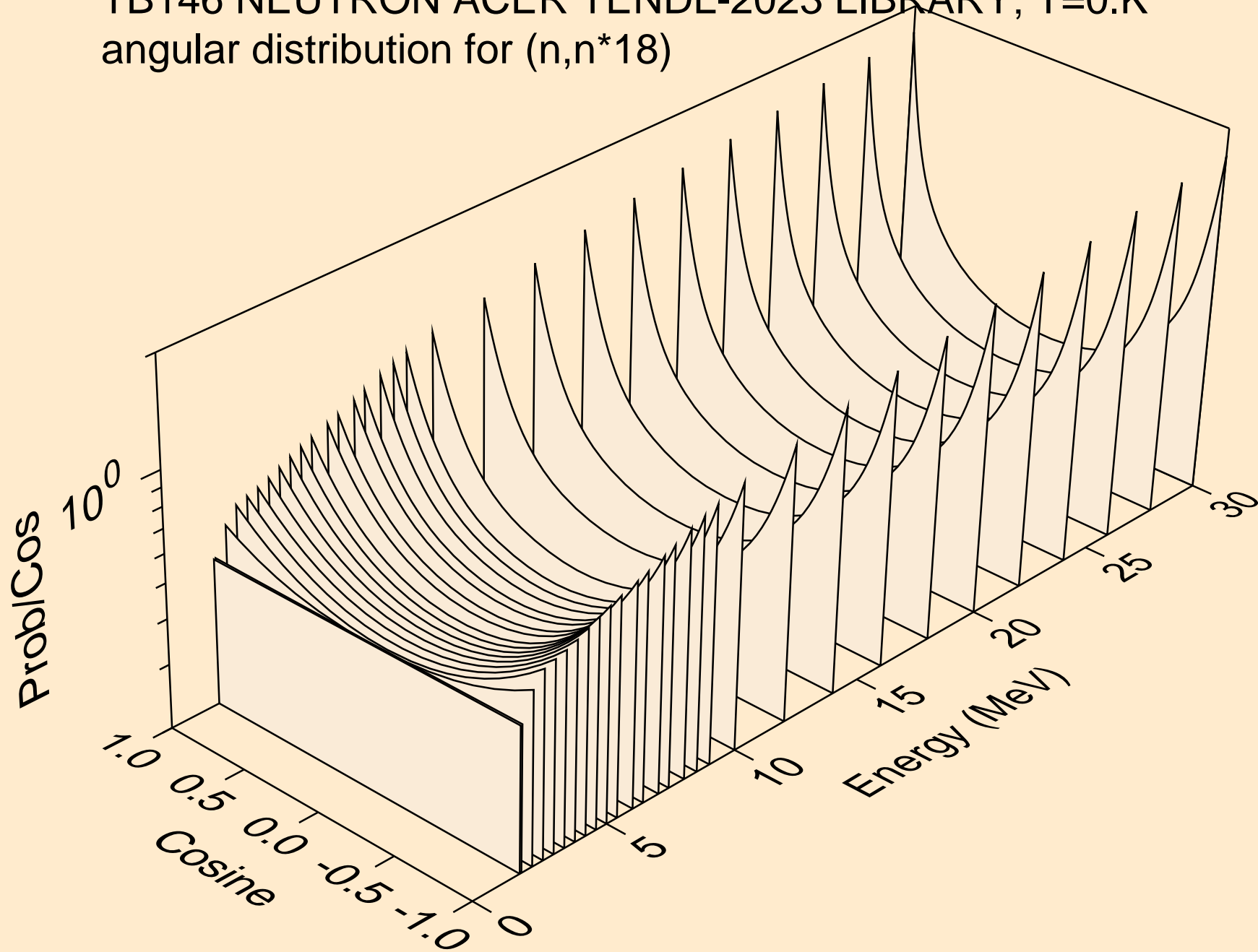

TB146 NEUTRON ACER TENDL-2023 LIBRARY; T=0.K  
angular distribution for (n,n\*19)

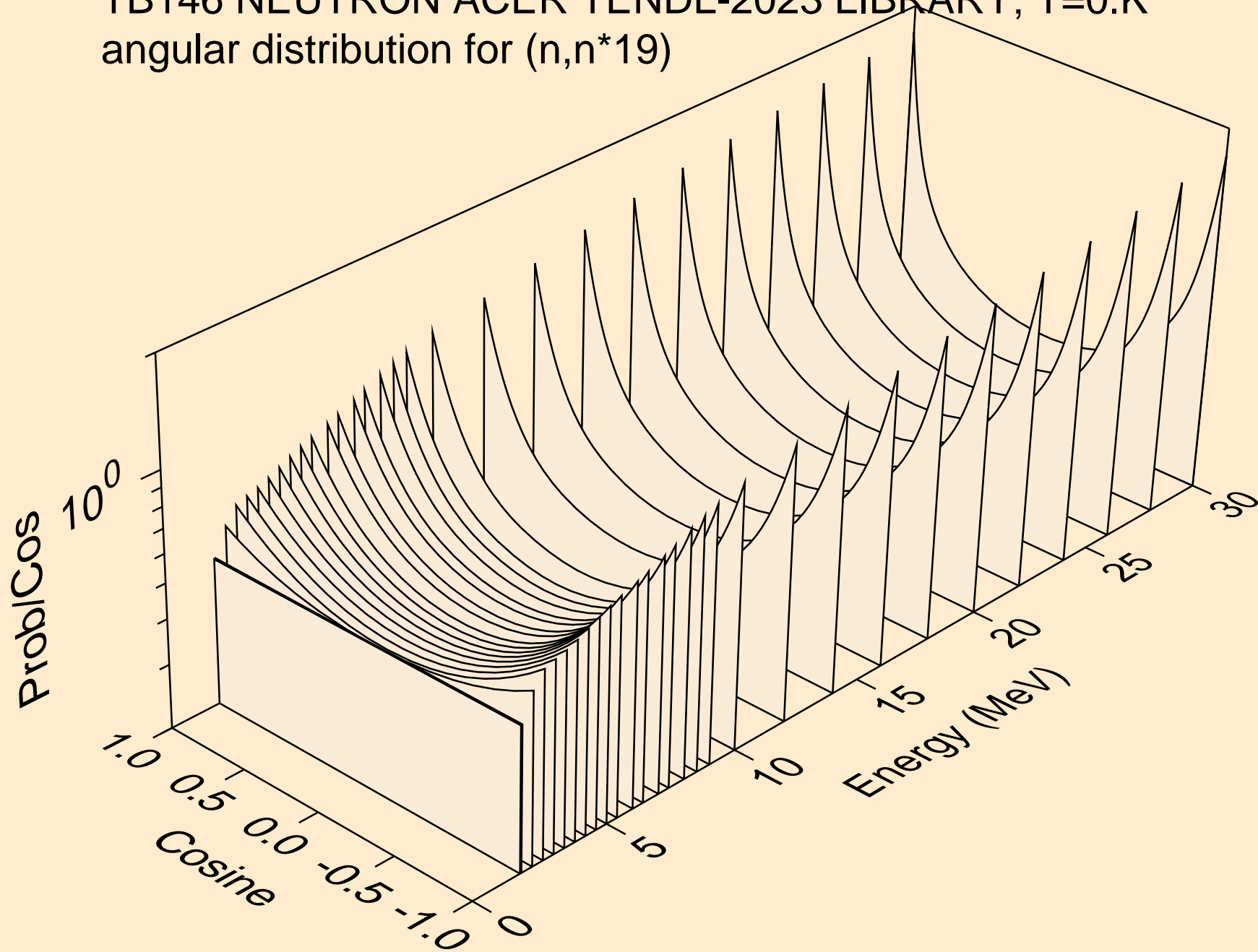

TB146 NEUTRON ACER TENDL-2023 LIBRARY; T=0.K  
angular distribution for (n,n\*20)

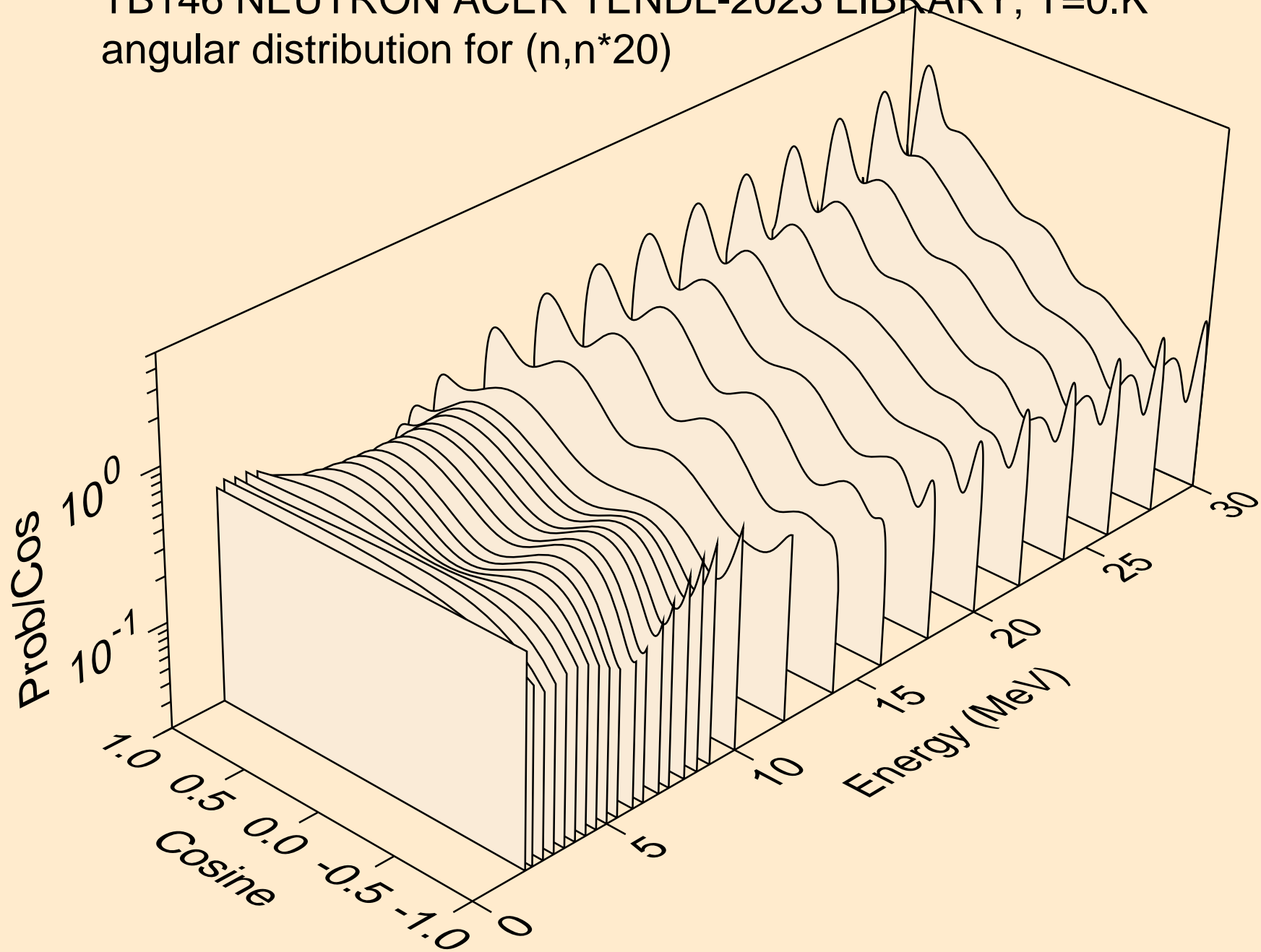

TB146 NEUTRON ACER TENDL-2023 LIBRARY; T=0.K  
Neutron emission for (n,x)

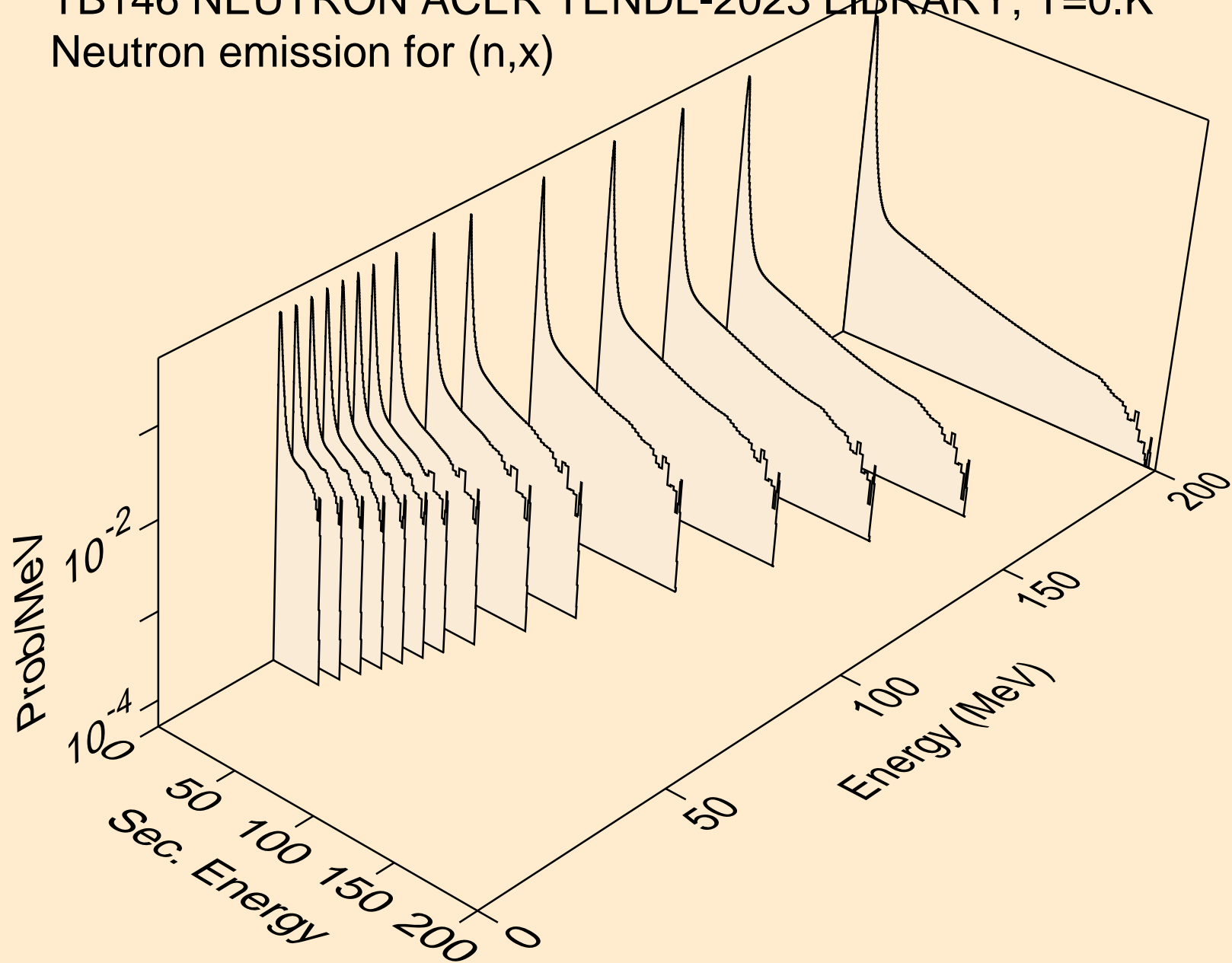

TB146 NEUTRON ACER TENDL-2023 LIBRARY; T=0.K  
Neutron emission for (n,2nd)

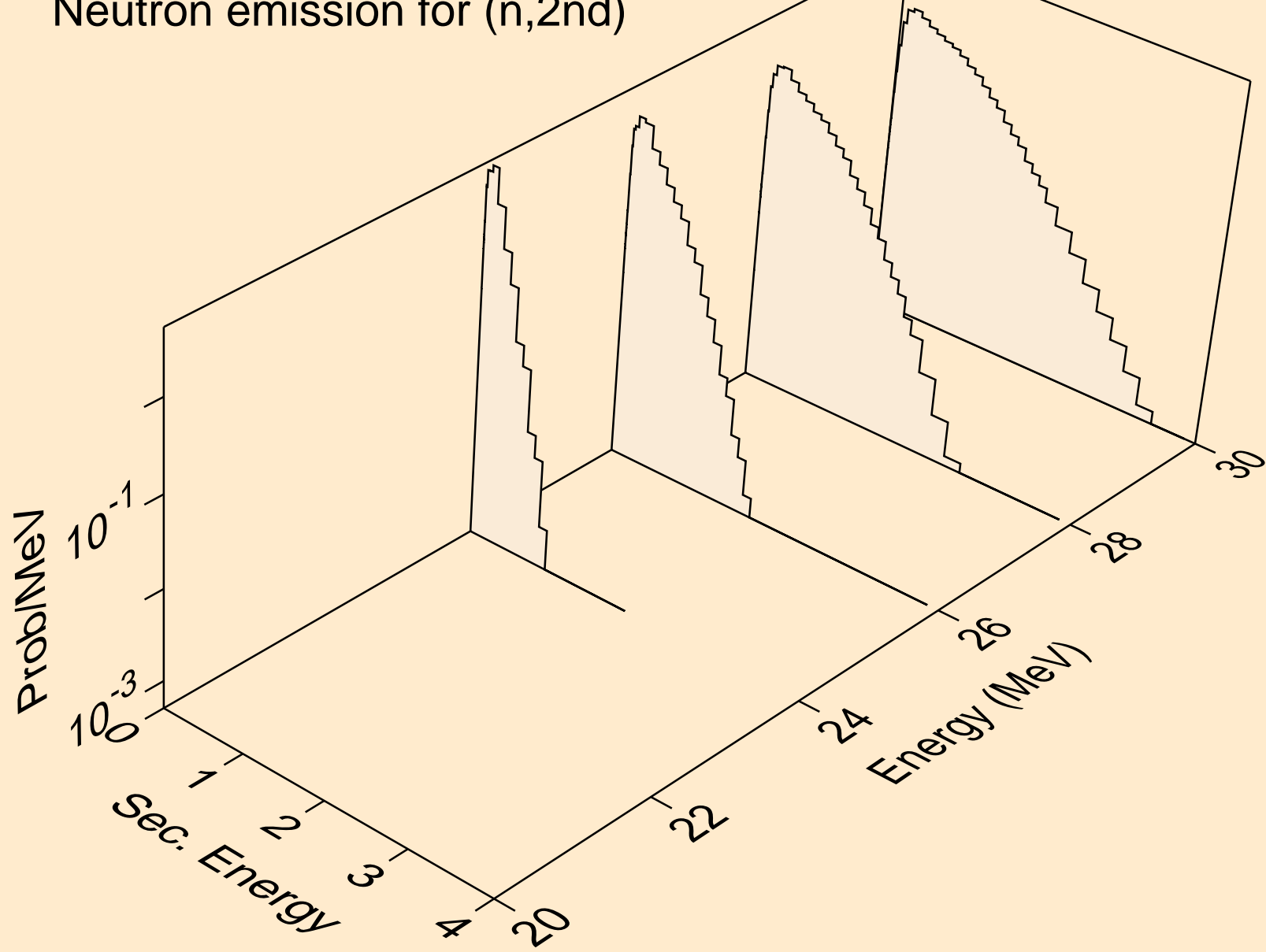

TB146 NEUTRON ACER TENDL-2023 LIBRARY; T=0.K  
Neutron emission for (n,2n)

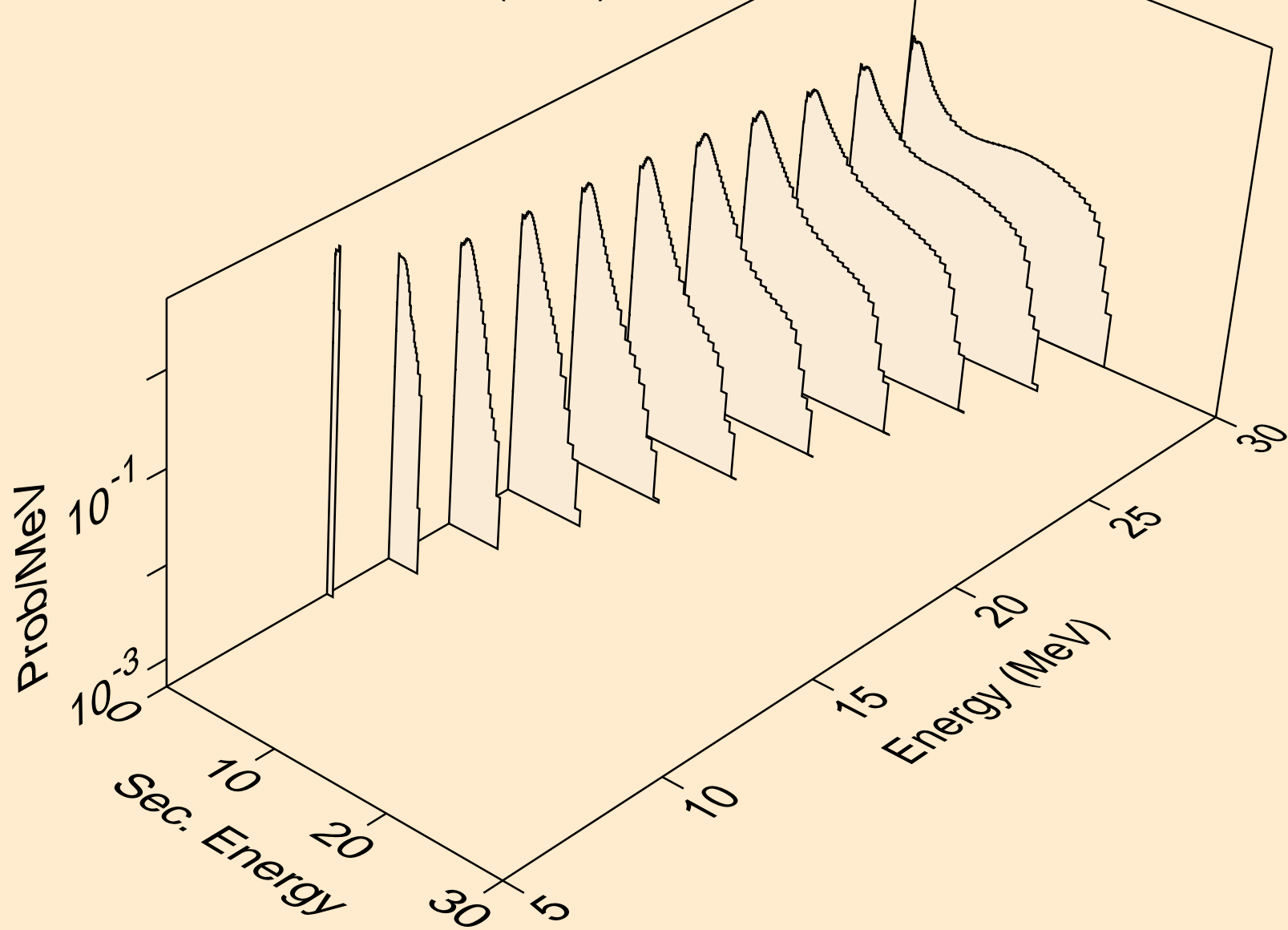

TB146 NEUTRON ACER TENDL-2023 LIBRARY; T=0.K  
Neutron emission for (n,3n)

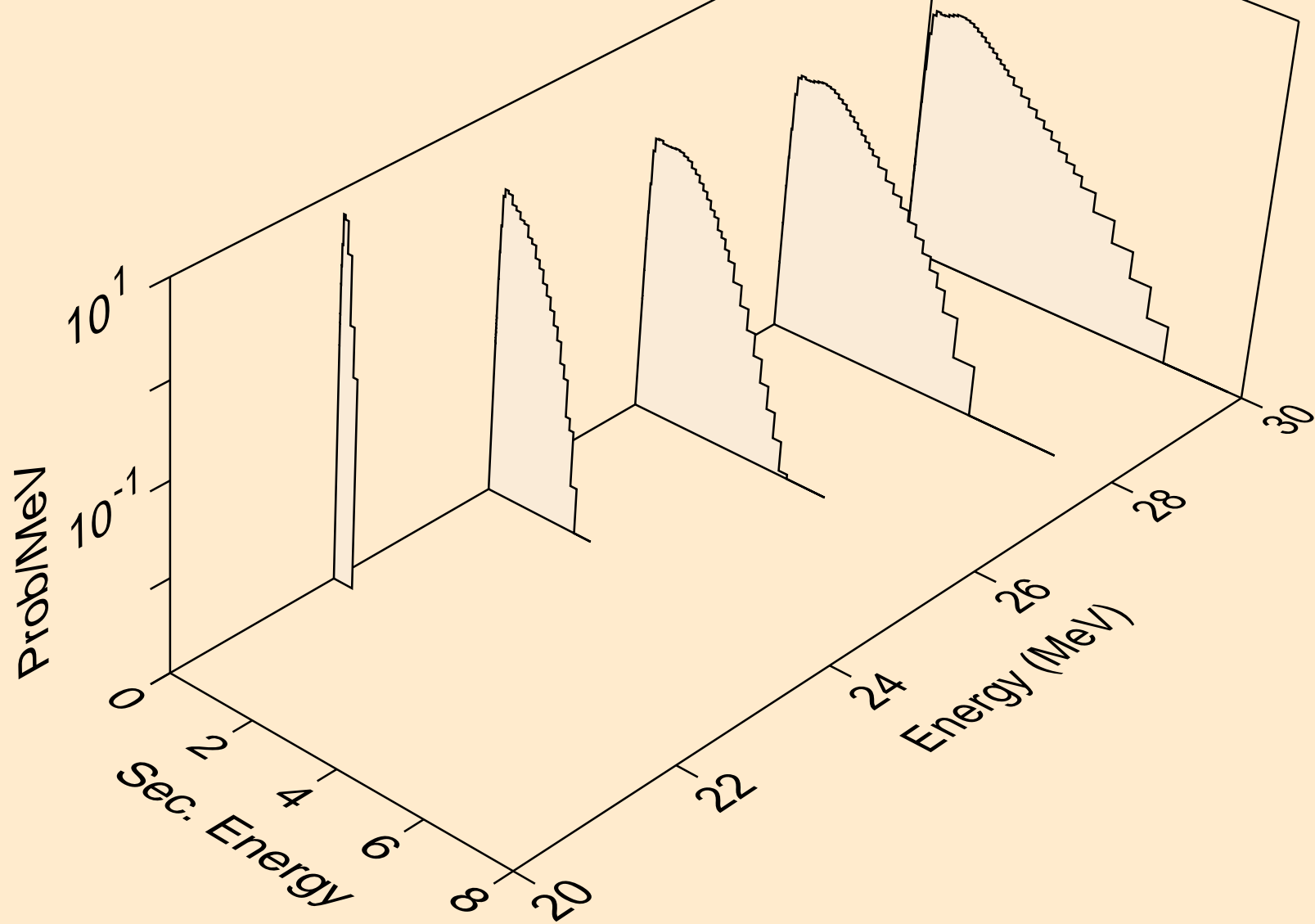

TB146 NEUTRON ACER TENDL-2023 LIBRARY; T=0.K  
Neutron emission for (n,n\*)a

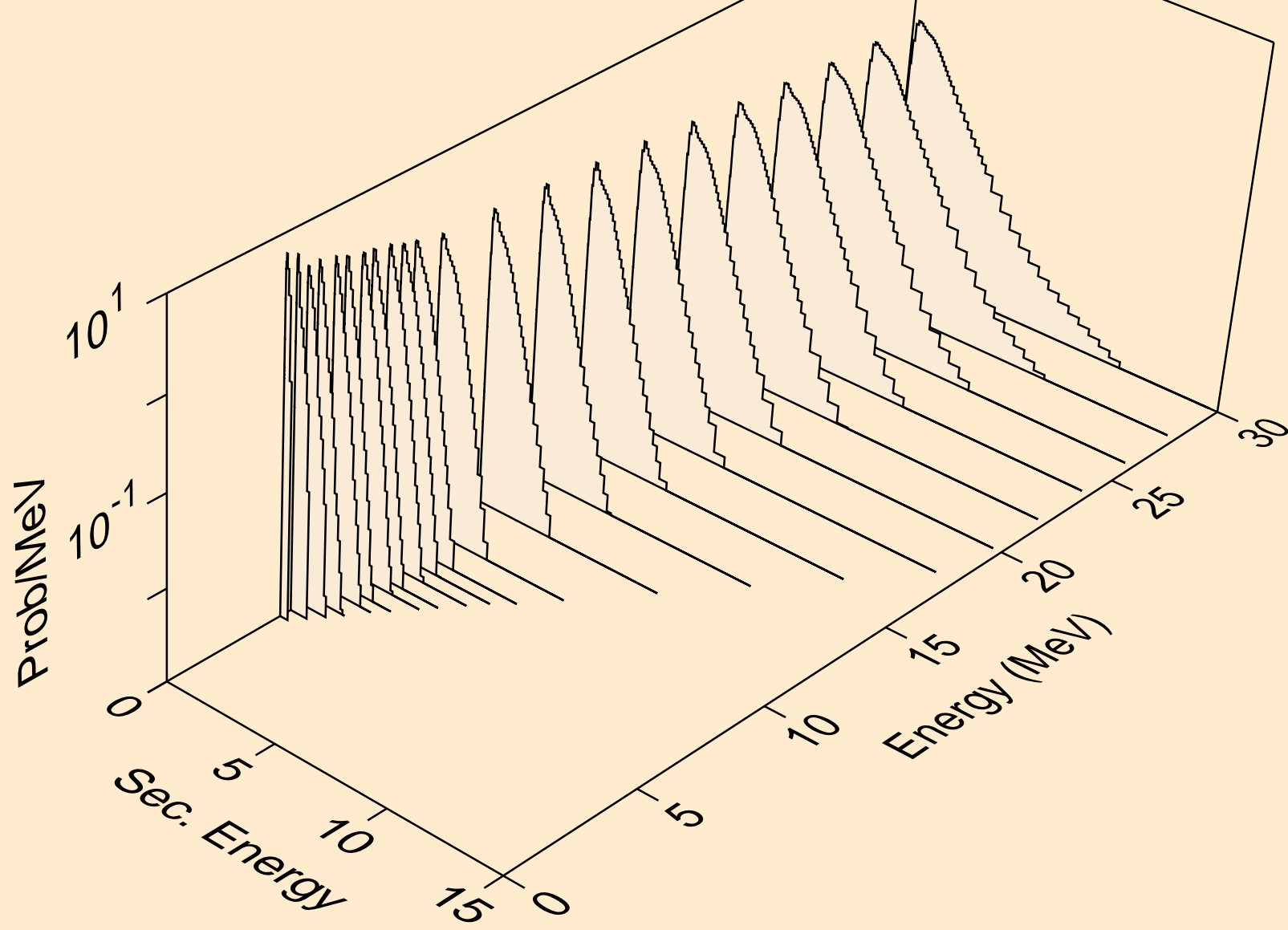

TB146 NEUTRON ACER TENDL-2023 LIBRARY; T=0.K  
Neutron emission for (n,2n)<sub>a</sub>

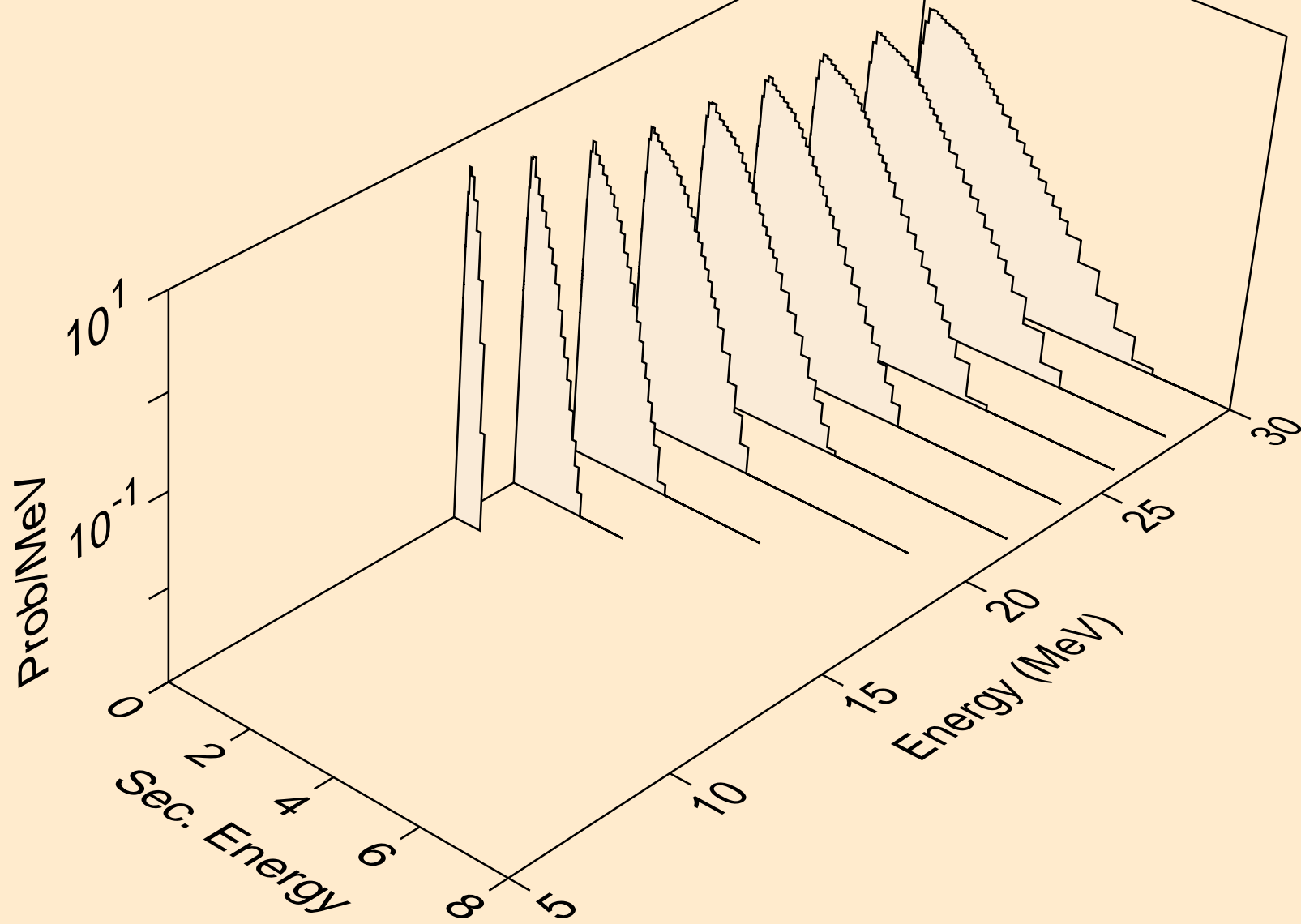

TB146 NEUTRON ACER TENDL-2023 LIBRARY; T=0.K  
Neutron emission for (n,3n)a

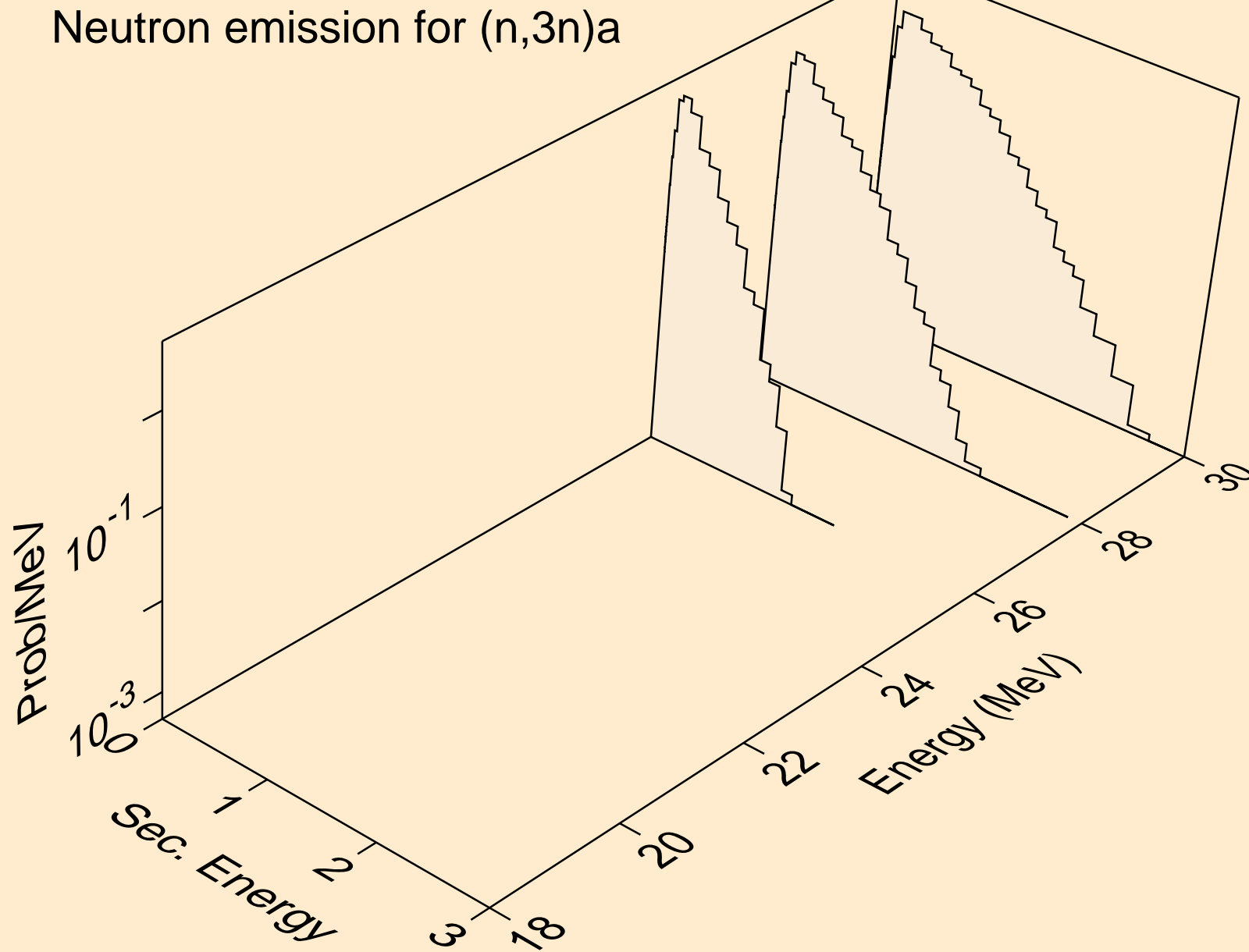

TB146 NEUTRON ACER TENDL-2023 LIBRARY; T=0.K  
Neutron emission for (n,n\*)p

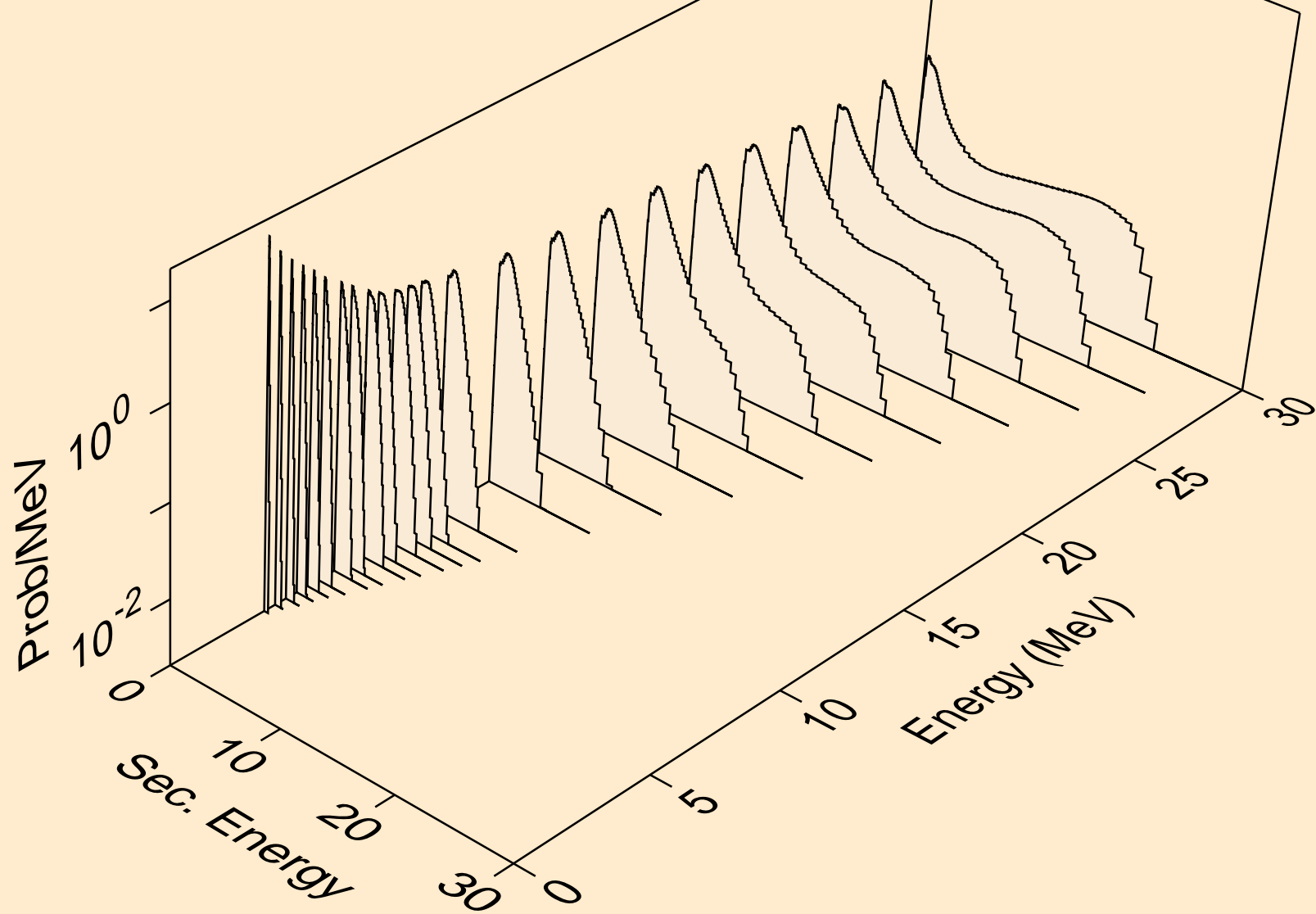

TB146 NEUTRON ACER TENDL-2023 LIBRARY; T=0.K  
Neutron emission for (n,n\*)2a

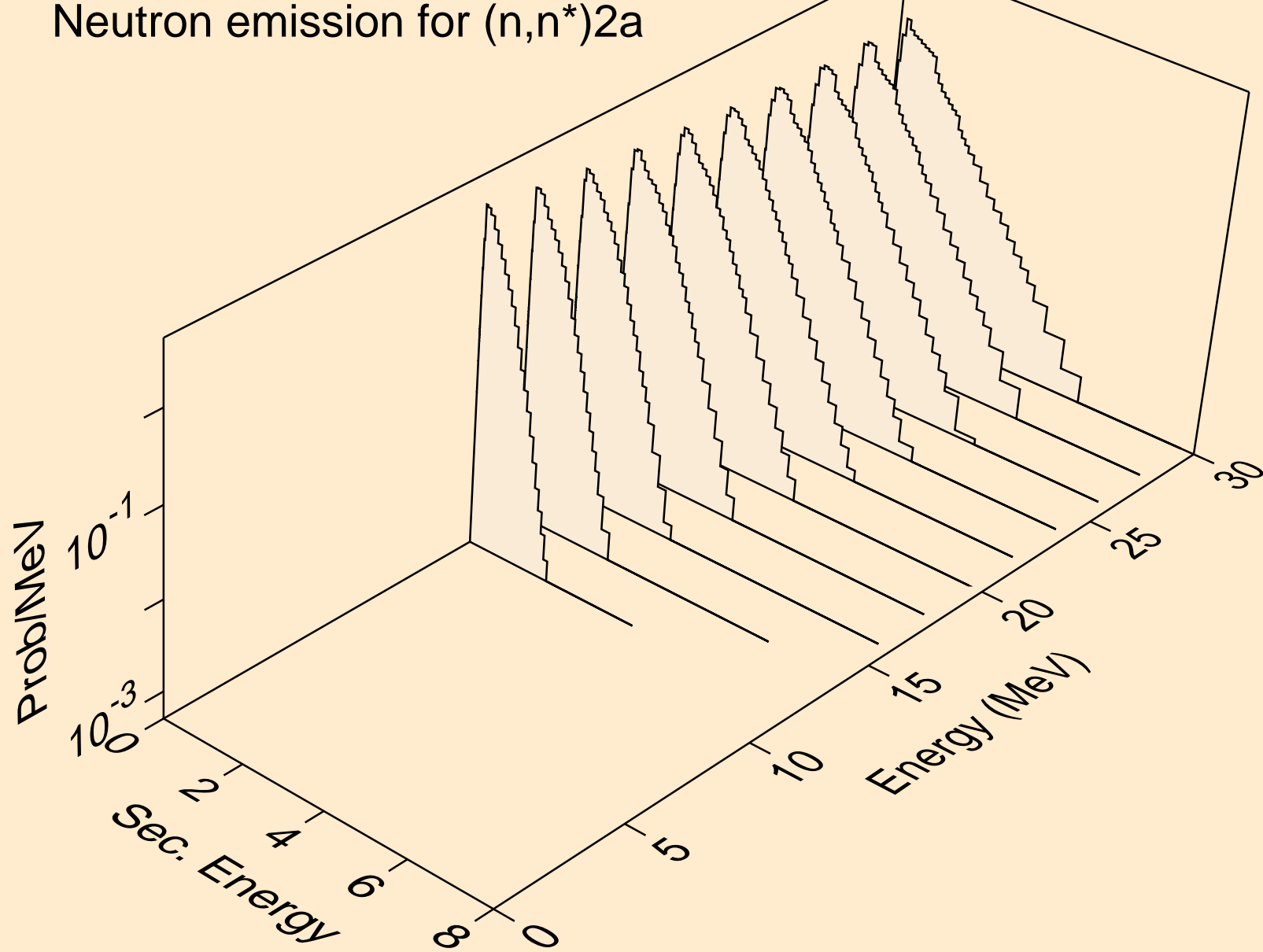

TB146 NEUTRON ACER TENDL-2023 LIBRARY; T=0.K  
Neutron emission for (n,n\*)d

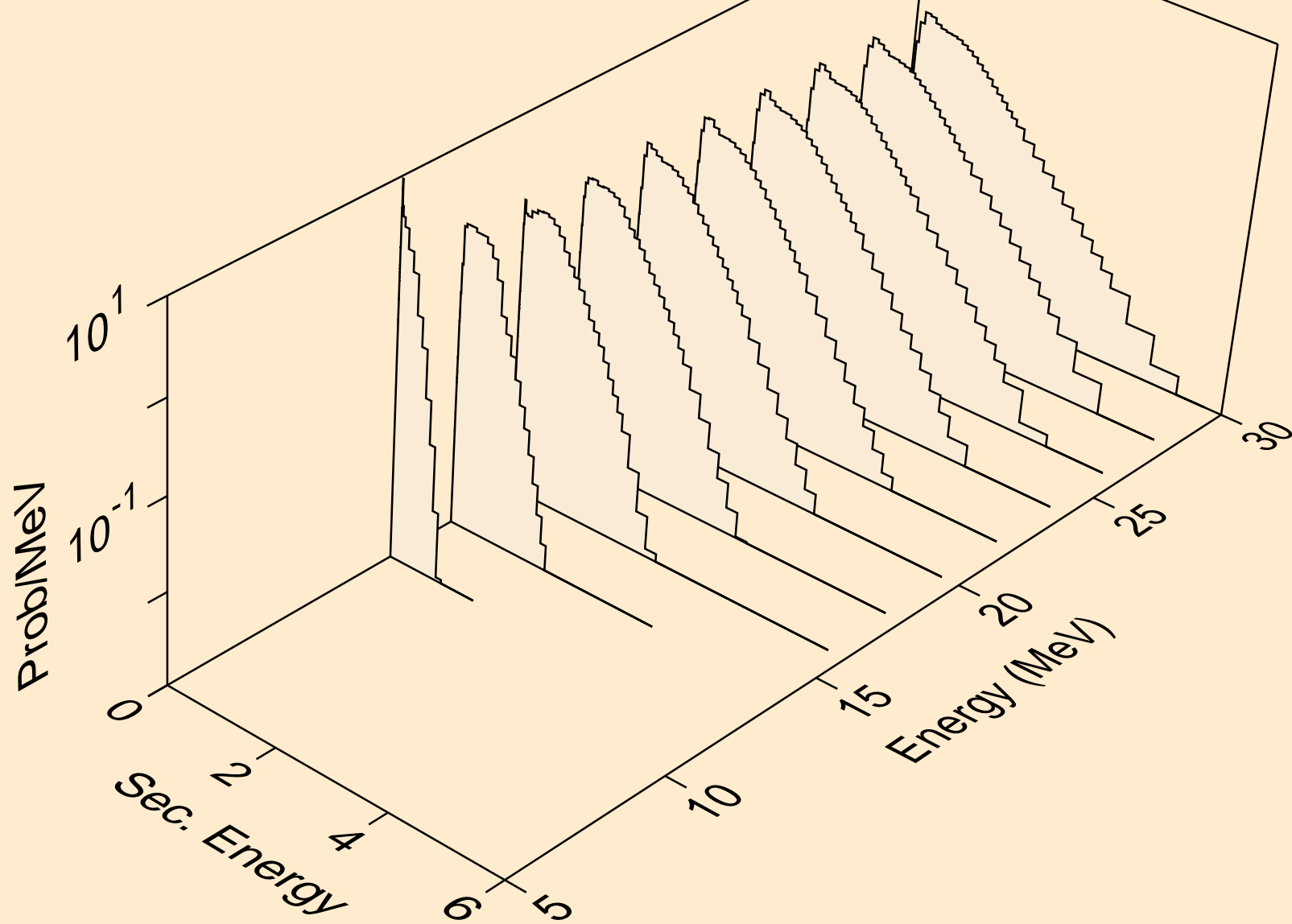

TB146 NEUTRON ACER TENDL-2023 LIBRARY; T=0.K  
Neutron emission for (n,n\*)t

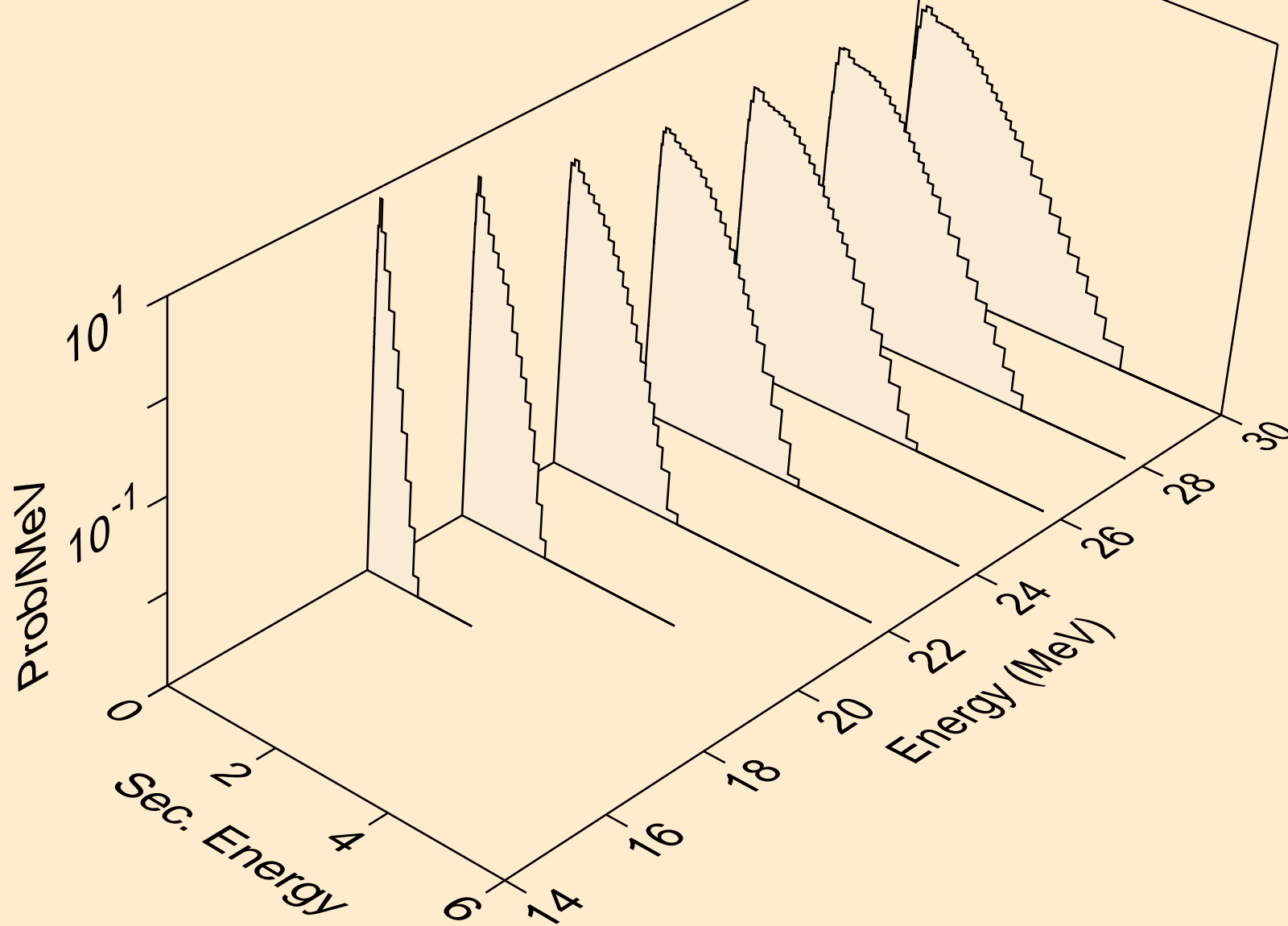

TB146 NEUTRON ACER TENDL-2023 LIBRARY; T=0.K  
Neutron emission for (n,n\*)he3

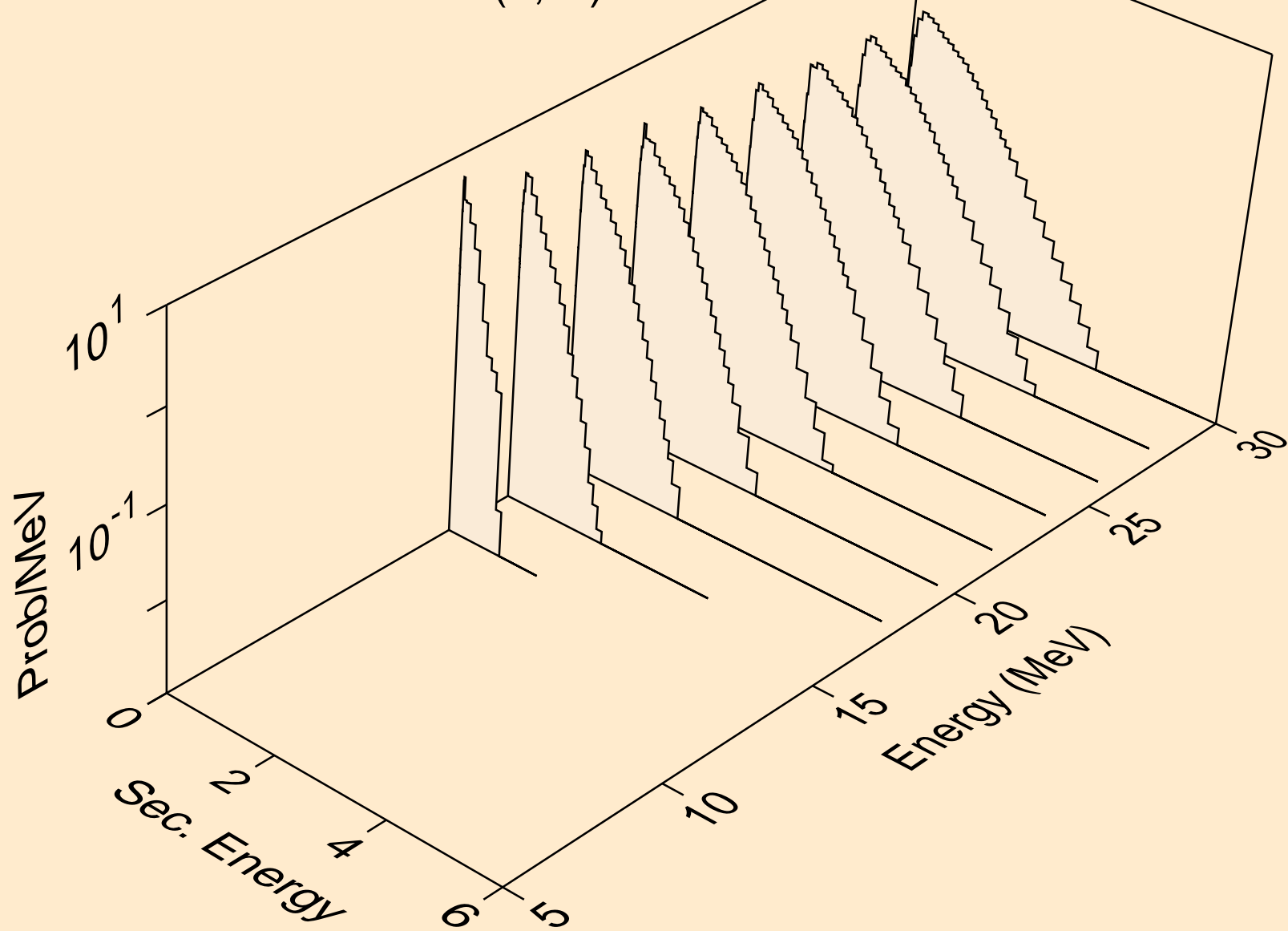

TB146 NEUTRON ACER TENDL-2023 LIBRARY; T=0.K  
Neutron emission for (n,2np)

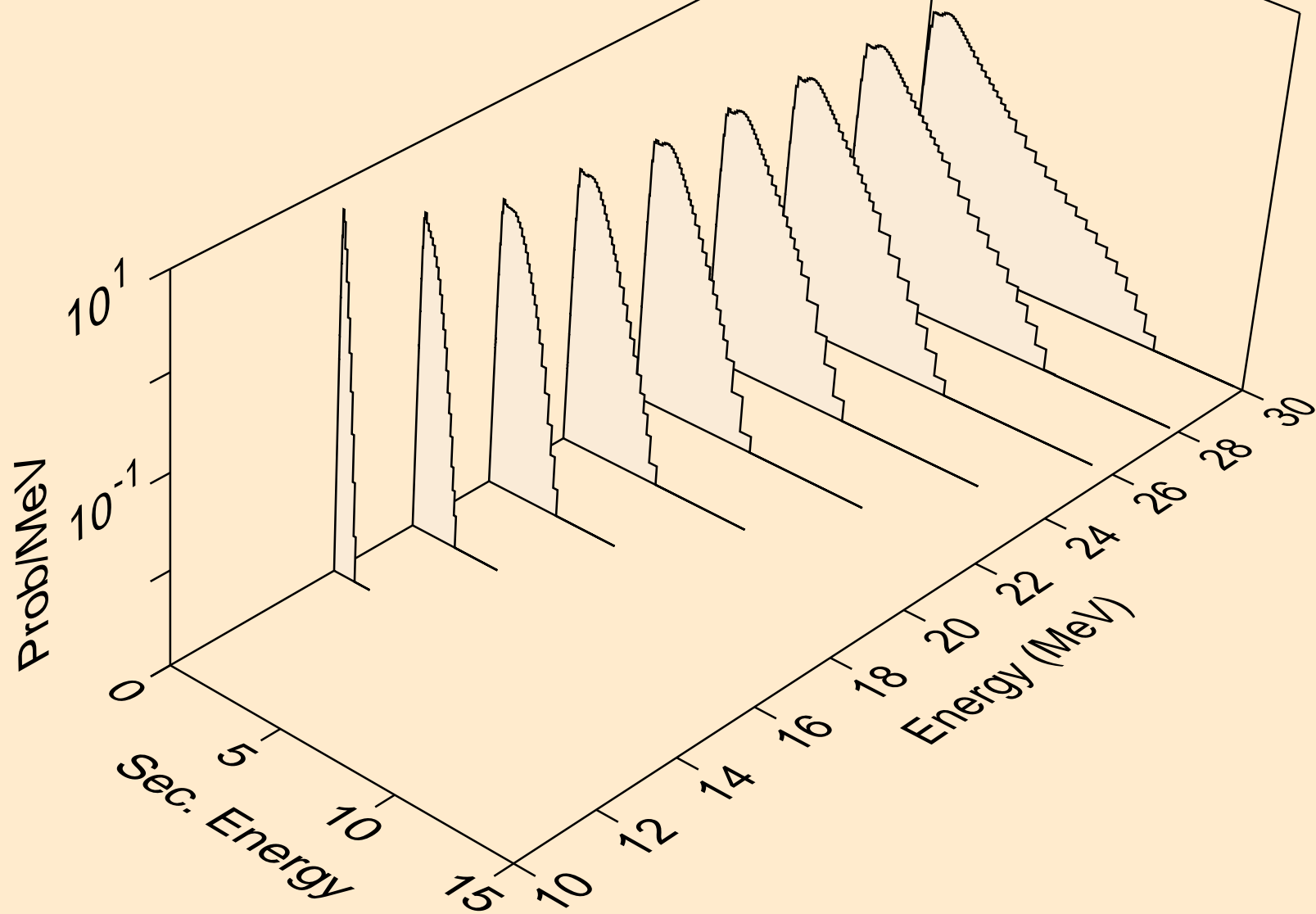

TB146 NEUTRON ACER TENDL-2023 LIBRARY; T=0.K  
Neutron emission for (n,3np)

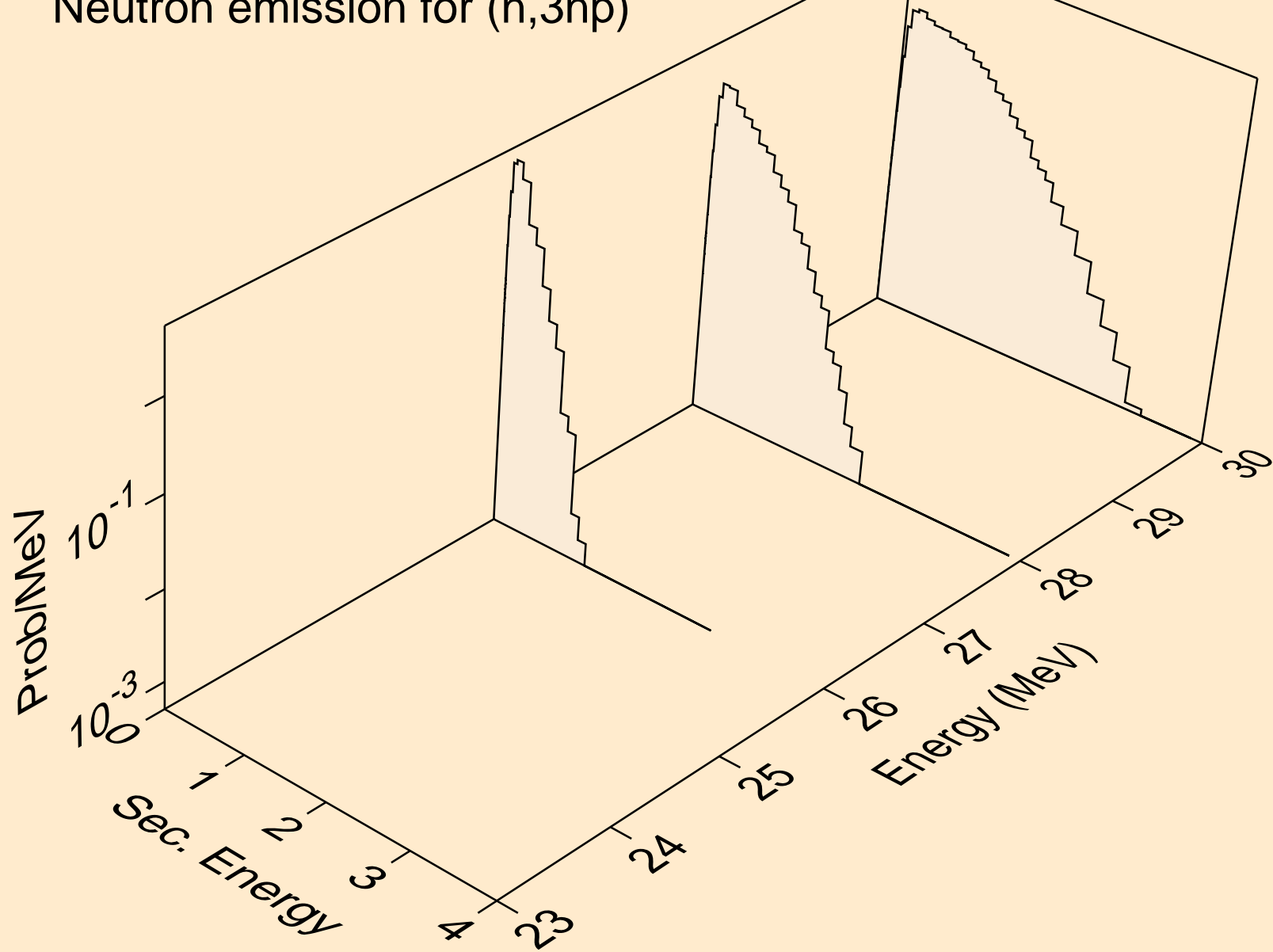

TB146 NEUTRON ACER TENDL-2023 LIBRARY; T=0.K  
Neutron emission for (n,n2p)

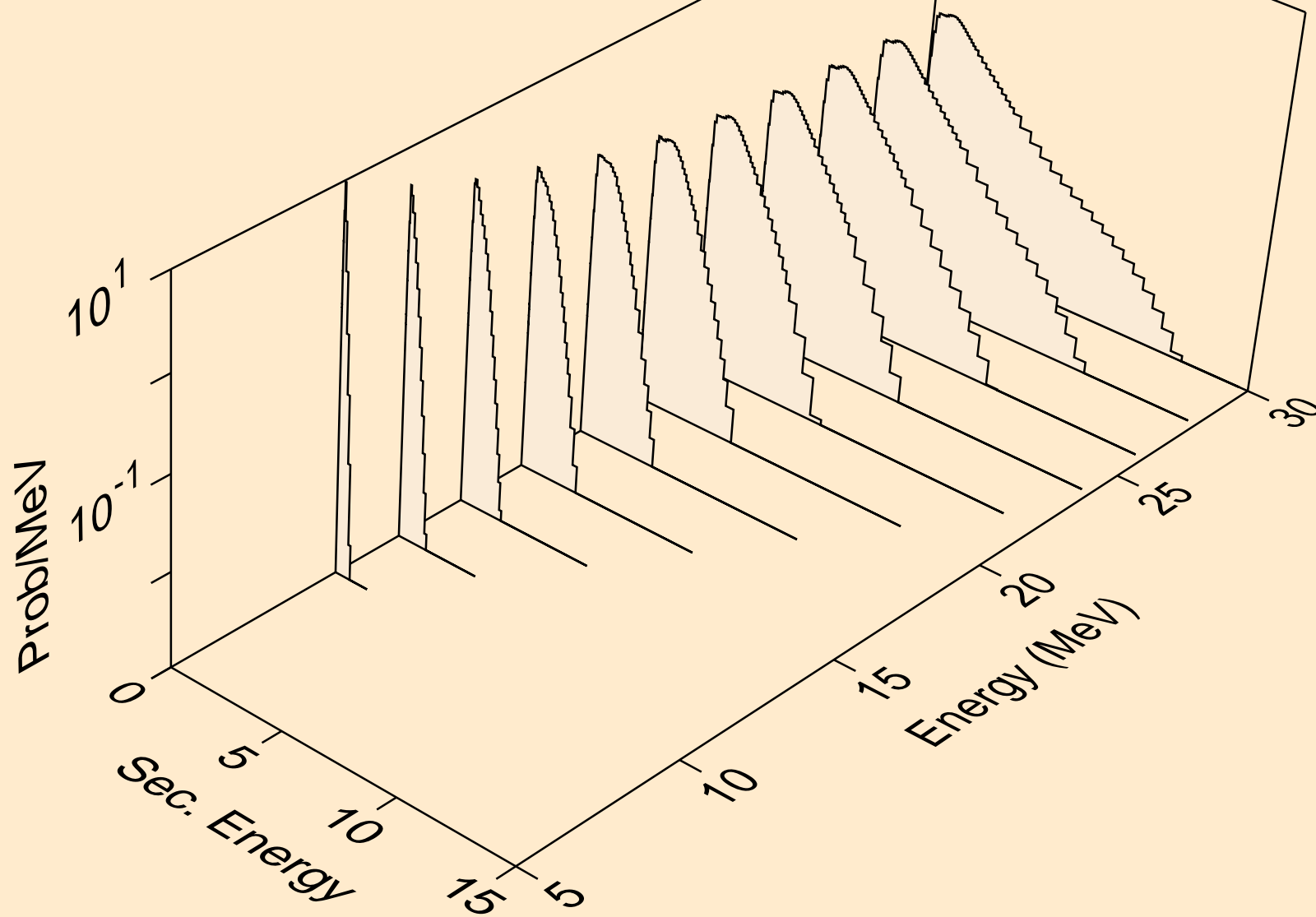

TB146 NEUTRON ACER TENDL-2023 LIBRARY; T=0.K  
Neutron emission for (n,npa)

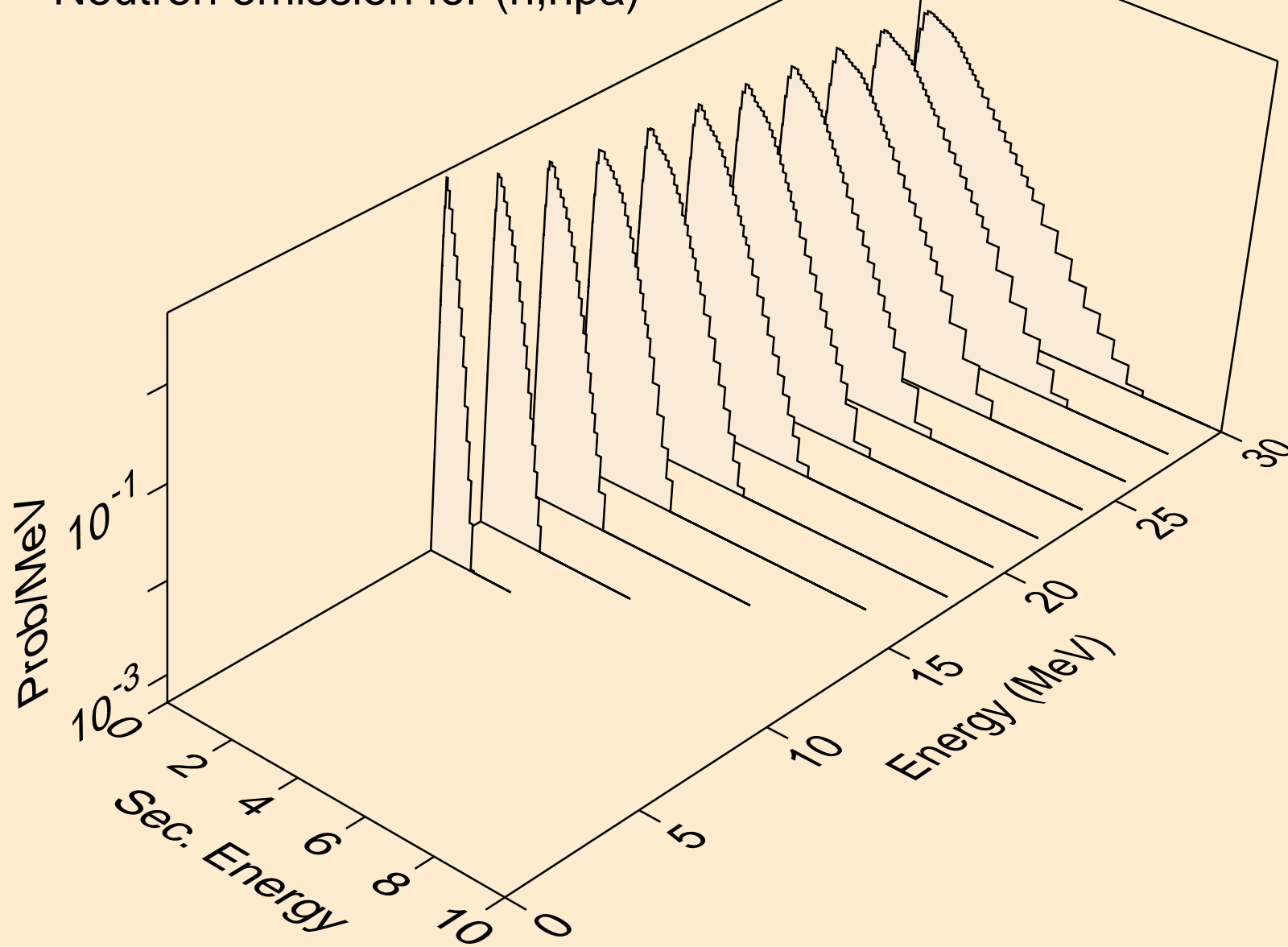

TB146 NEUTRON ACER TENDL-2023 LIBRARY; T=0.K  
Neutron emission for (n,n\*c)

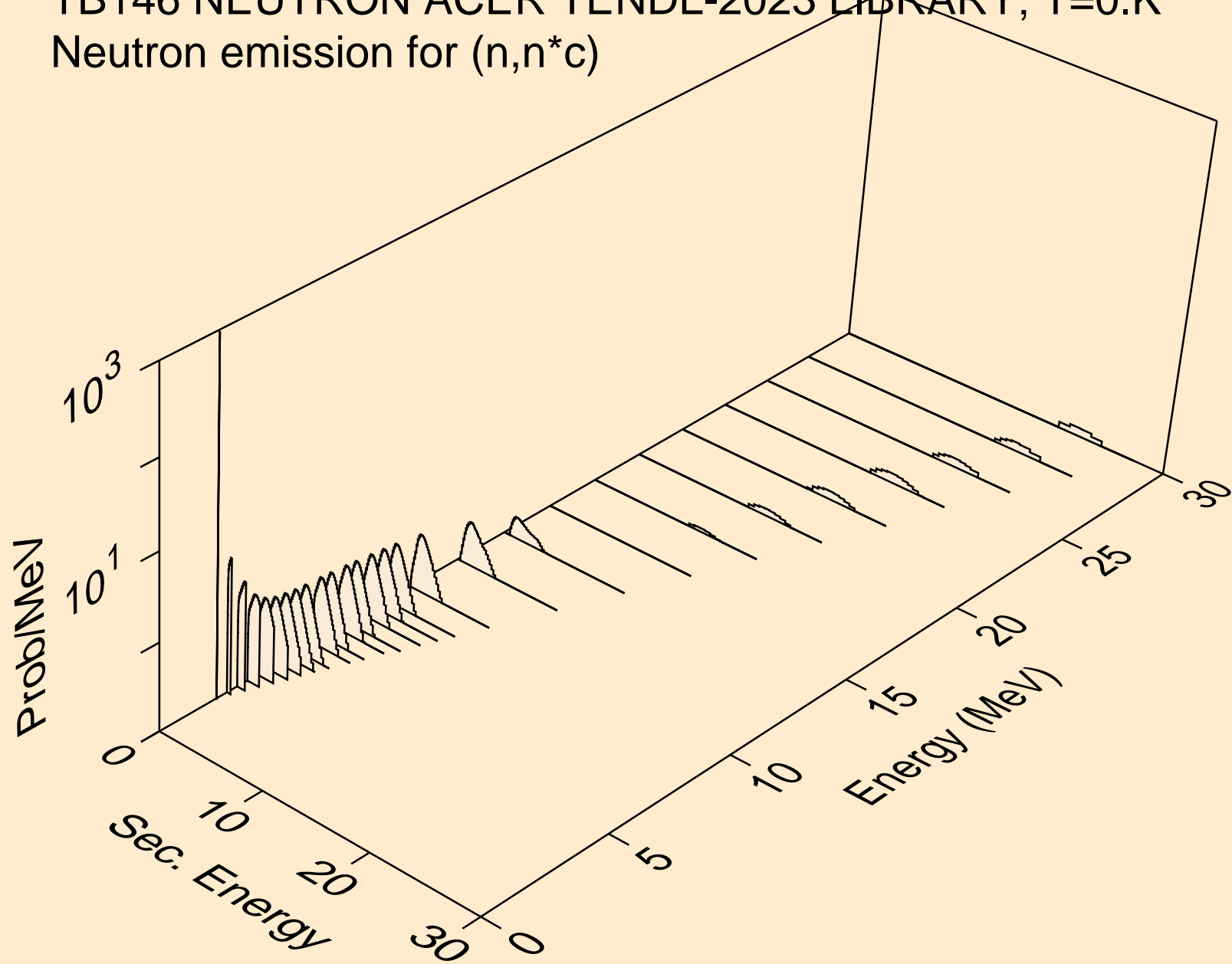

TB146 NEUTRON ACER TENDL-2023 LIBRARY; T=0.K  
Photon emission for (n,x)

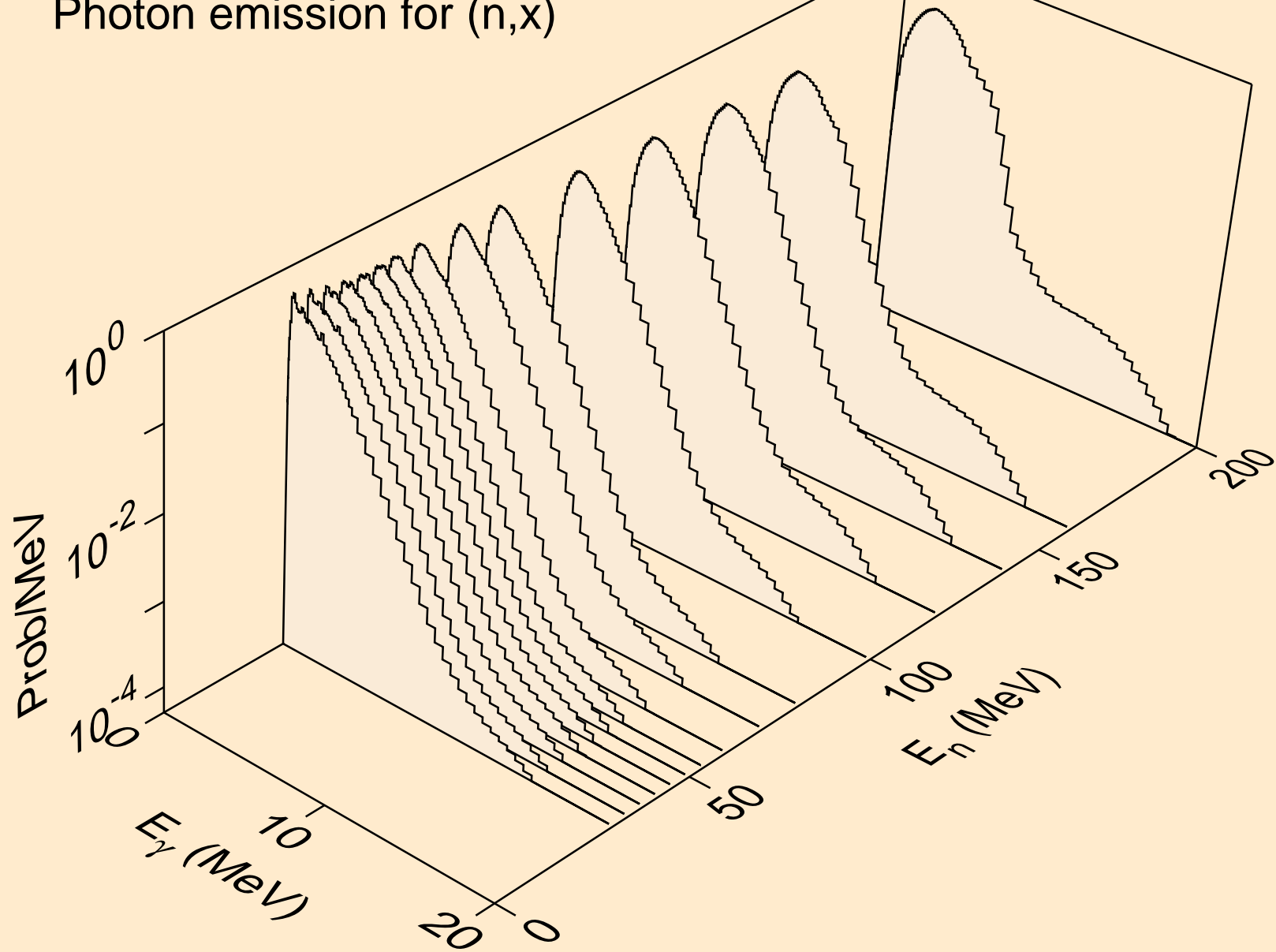

TB146 NEUTRON ACER TENDL-2023 LIBRARY; T=0.K  
Photon emission for (n,2nd)

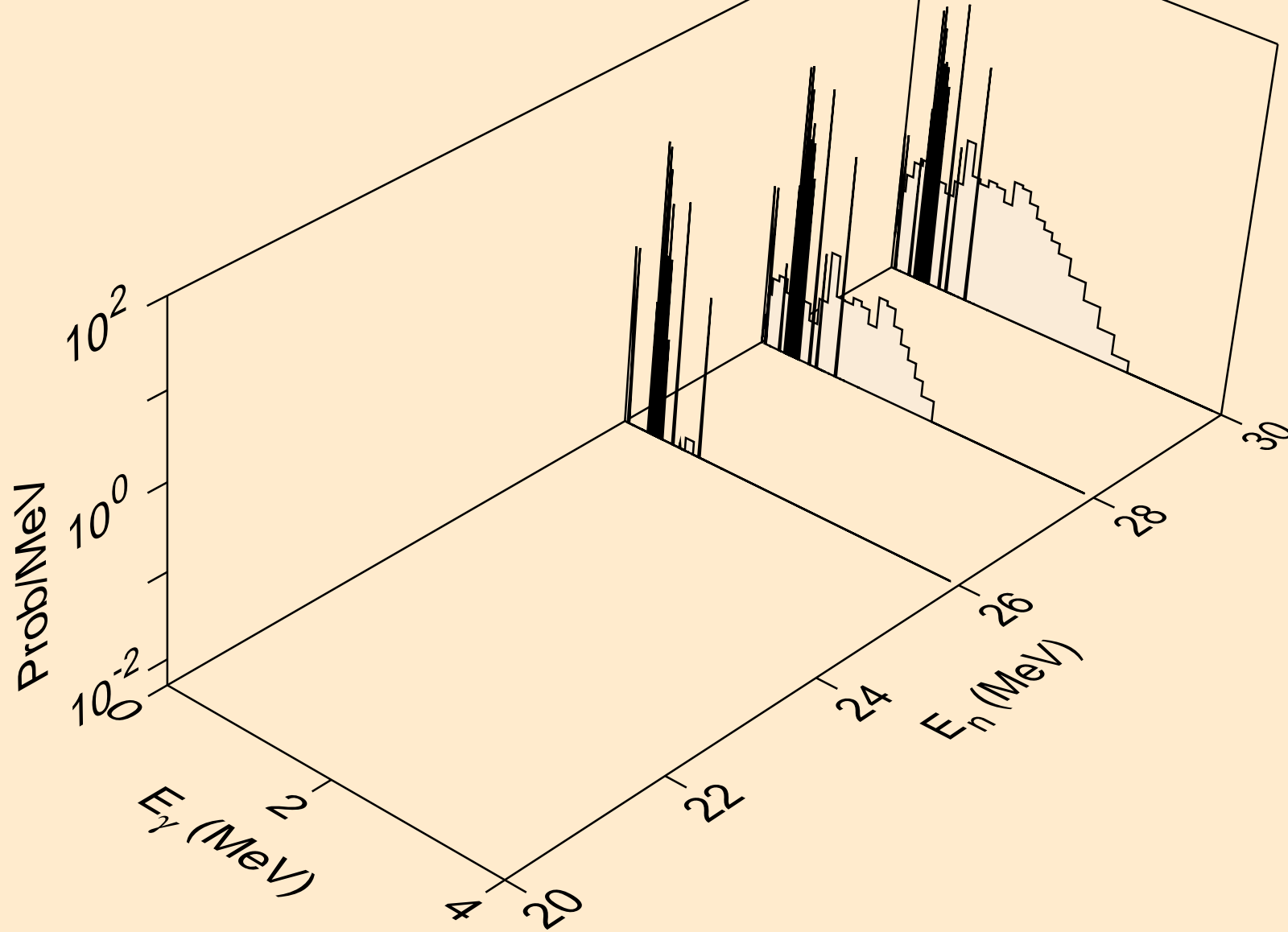

TB146 NEUTRON ACER TENDL-2023 LIBRARY; T=0.K  
Photon emission for (n,2n)

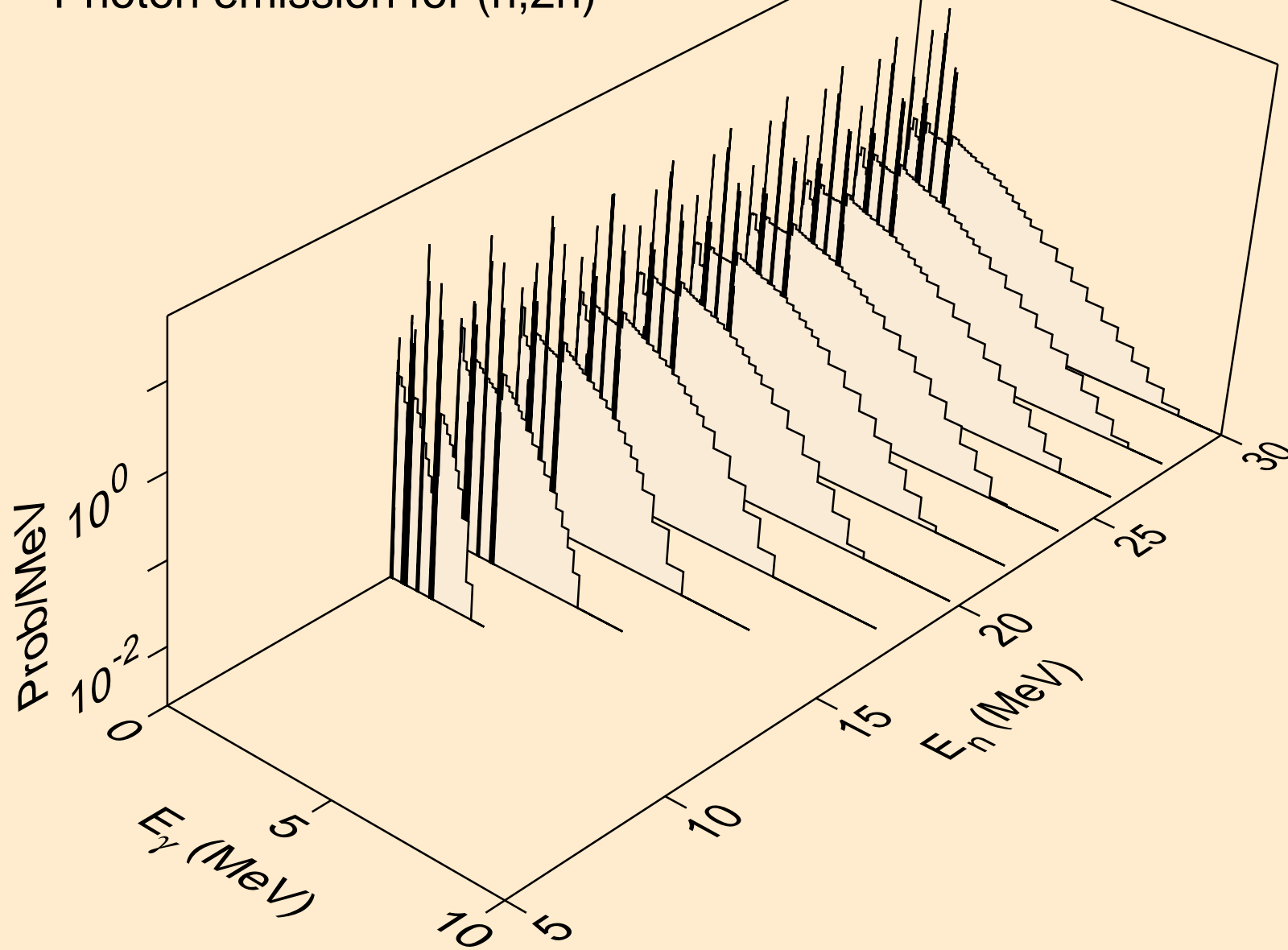

TB146 NEUTRON ACER TENDL-2023 LIBRARY; T=0.K  
Photon emission for (n,3n)

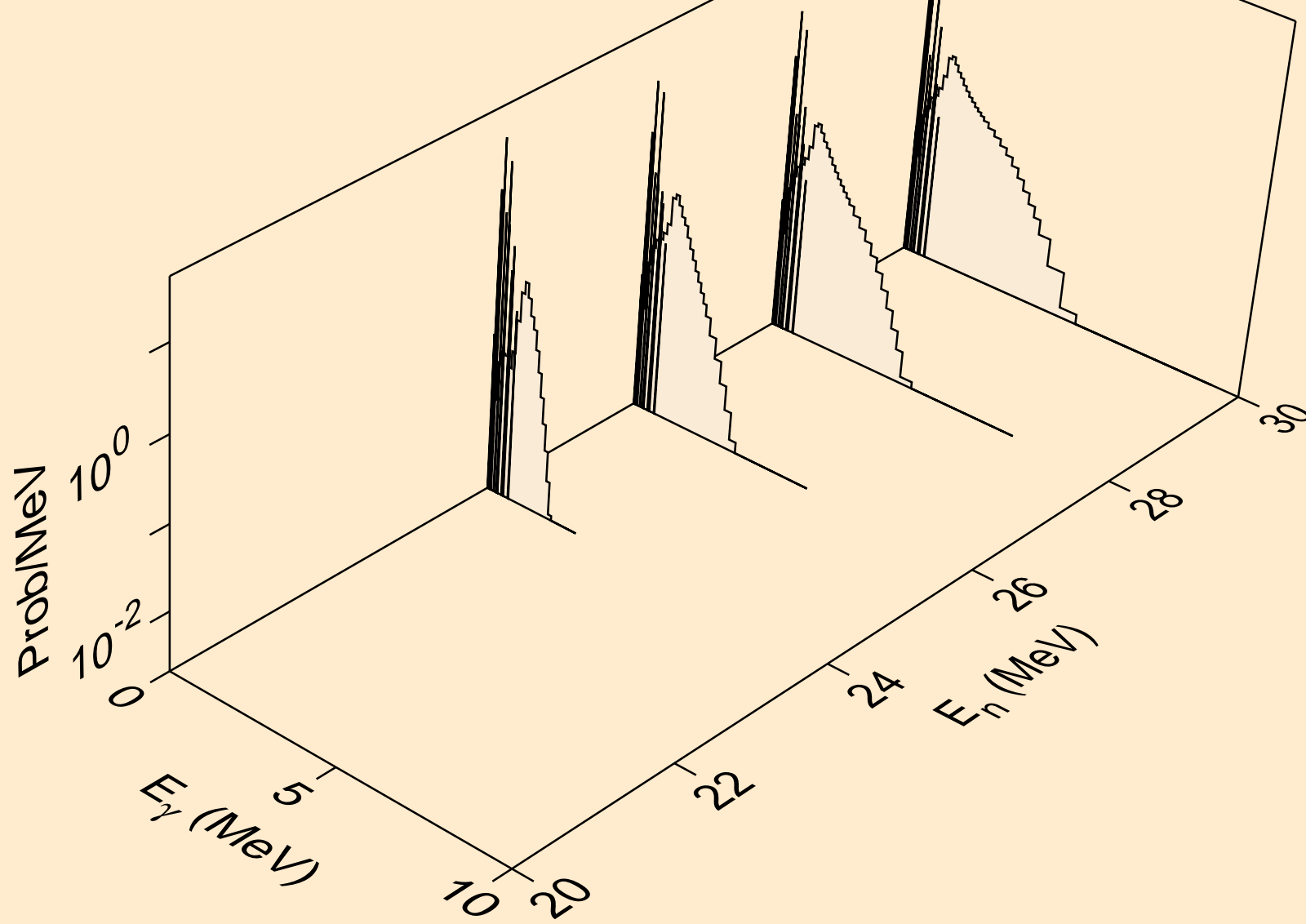

TB146 NEUTRON ACER TENDL-2023 LIBRARY; T=0.K  
Photon emission for (n,n\*)a

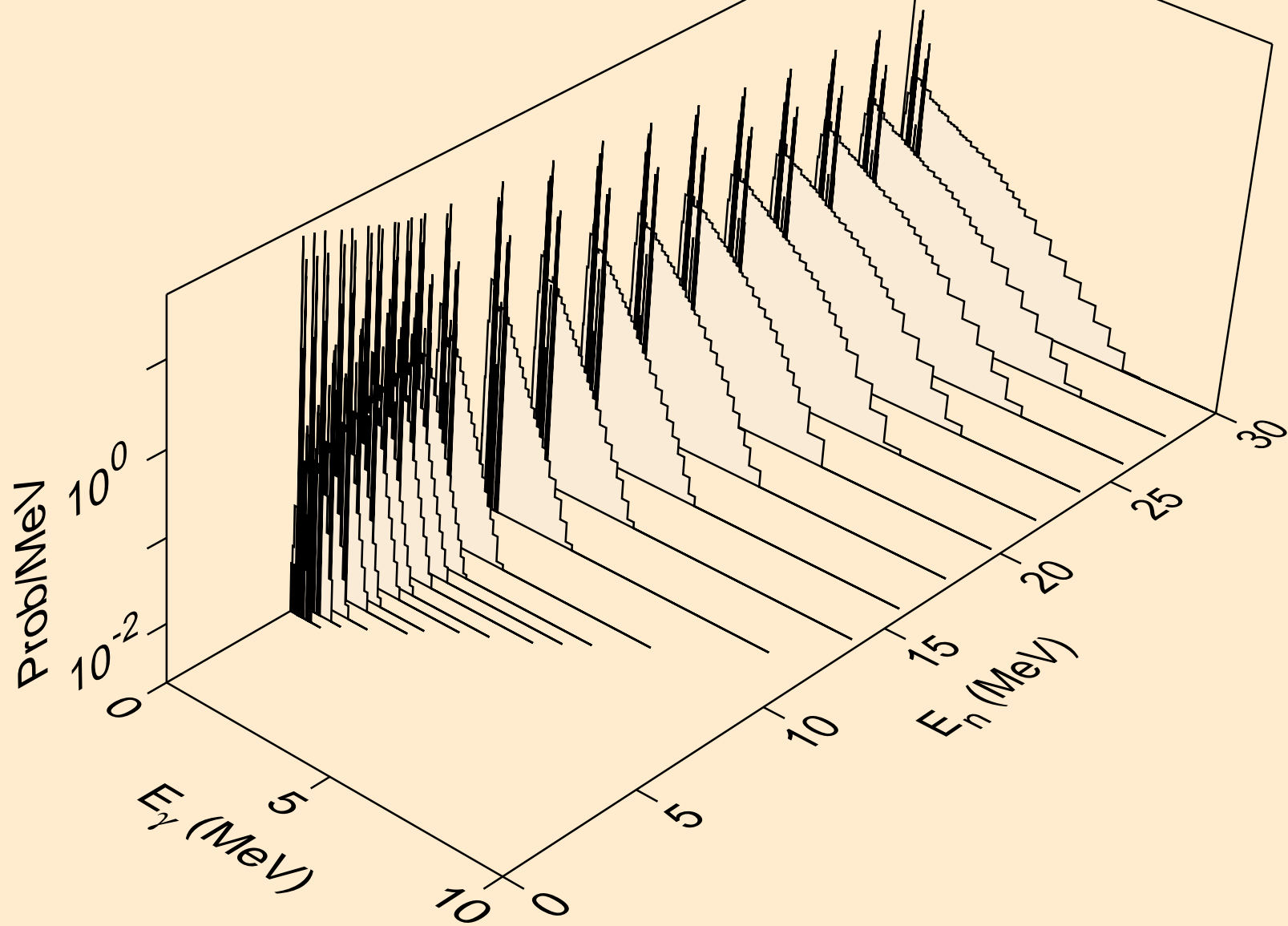

TB146 NEUTRON ACER TENDL-2023 LIBRARY; T=0.K  
Photon emission for (n,2n)a

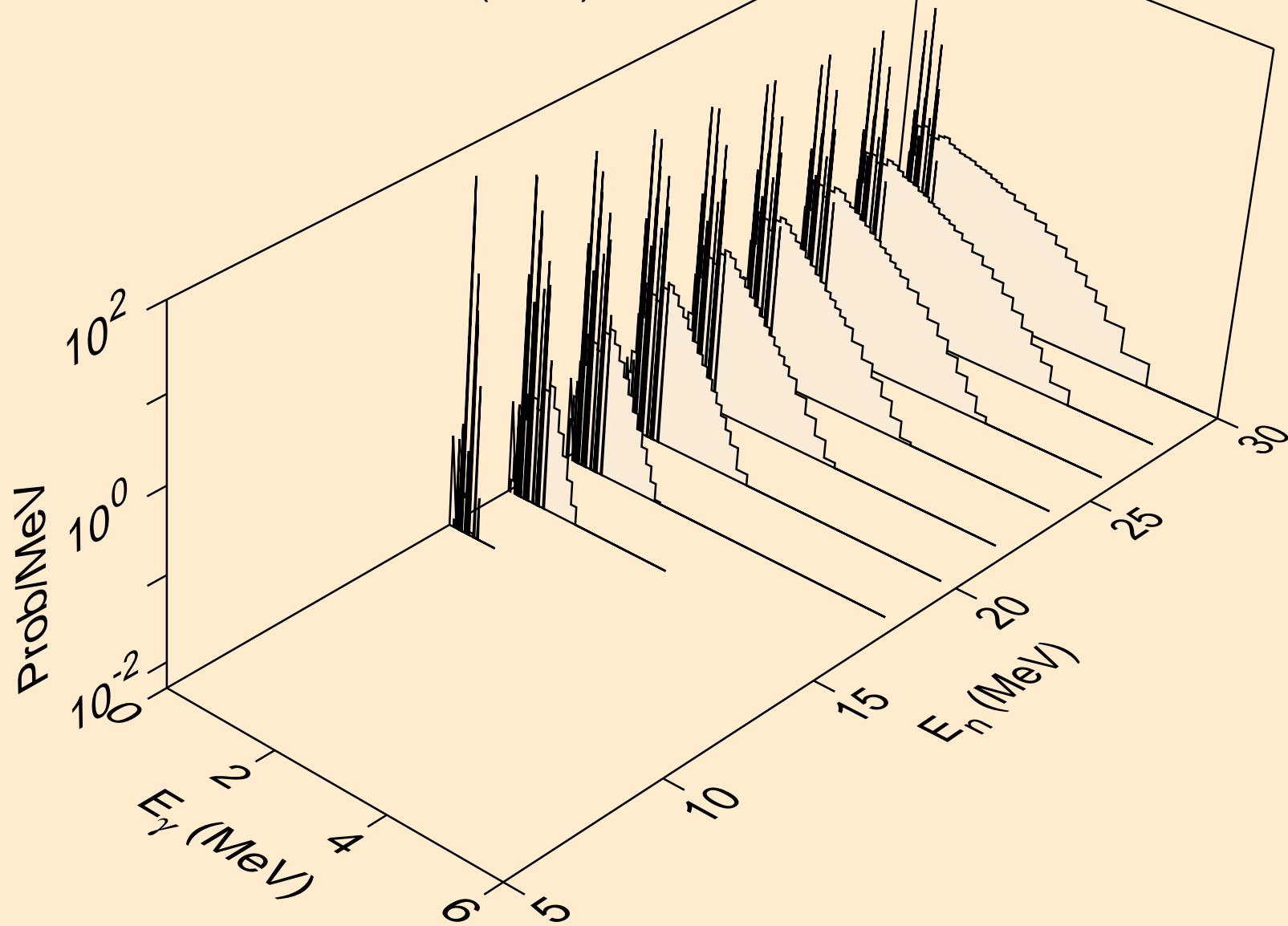

TB146 NEUTRON ACER TENDL-2023 LIBRARY; T=0.K  
Photon emission for (n,3n)a

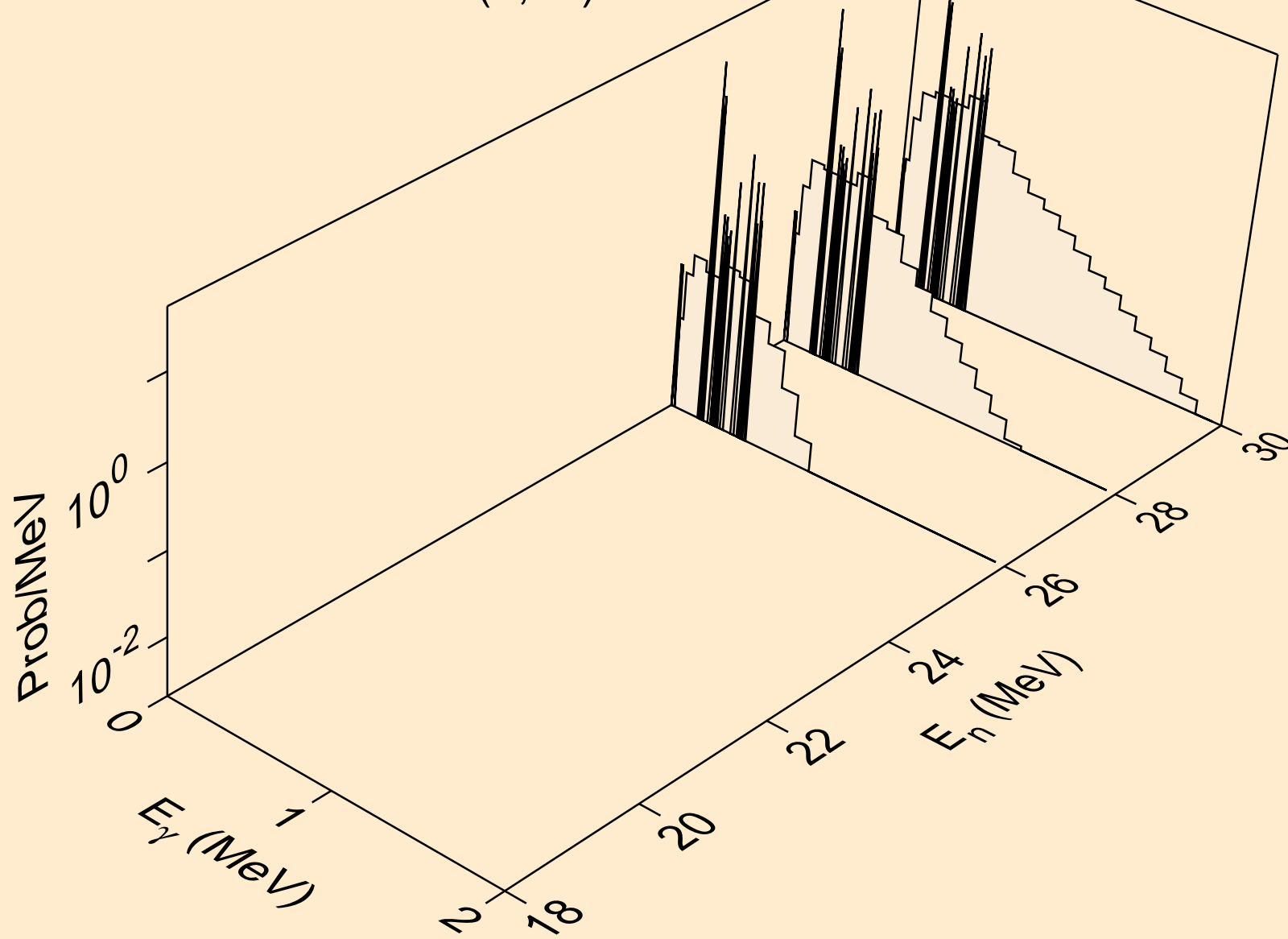

TB146 NEUTRON ACER TENDL-2023 LIBRARY; T=0.K  
Photon emission for (n,n\*)p

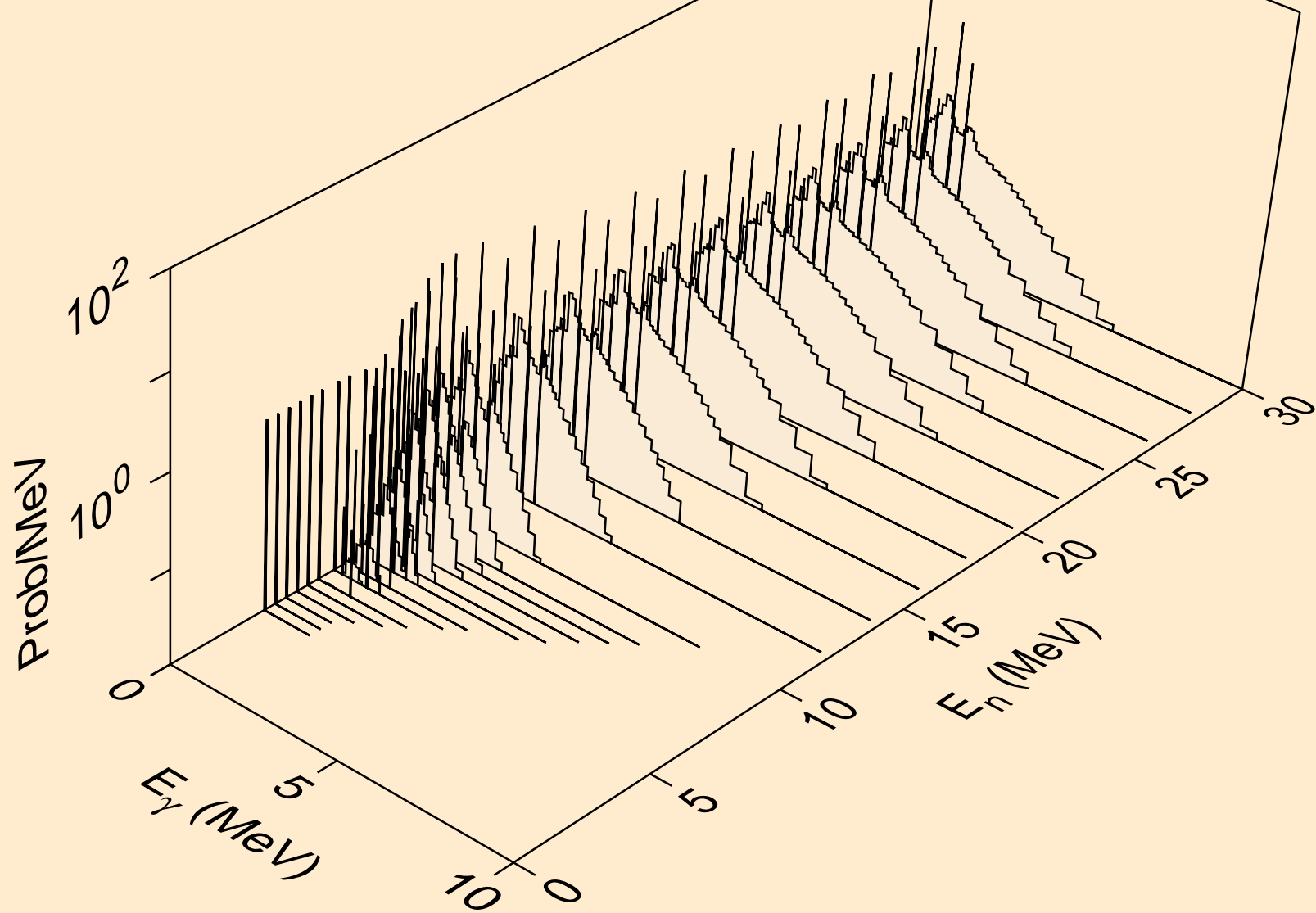

TB146 NEUTRON ACER TENDL-2023 LIBRARY; T=0.K  
Photon emission for (n,n\*)2a

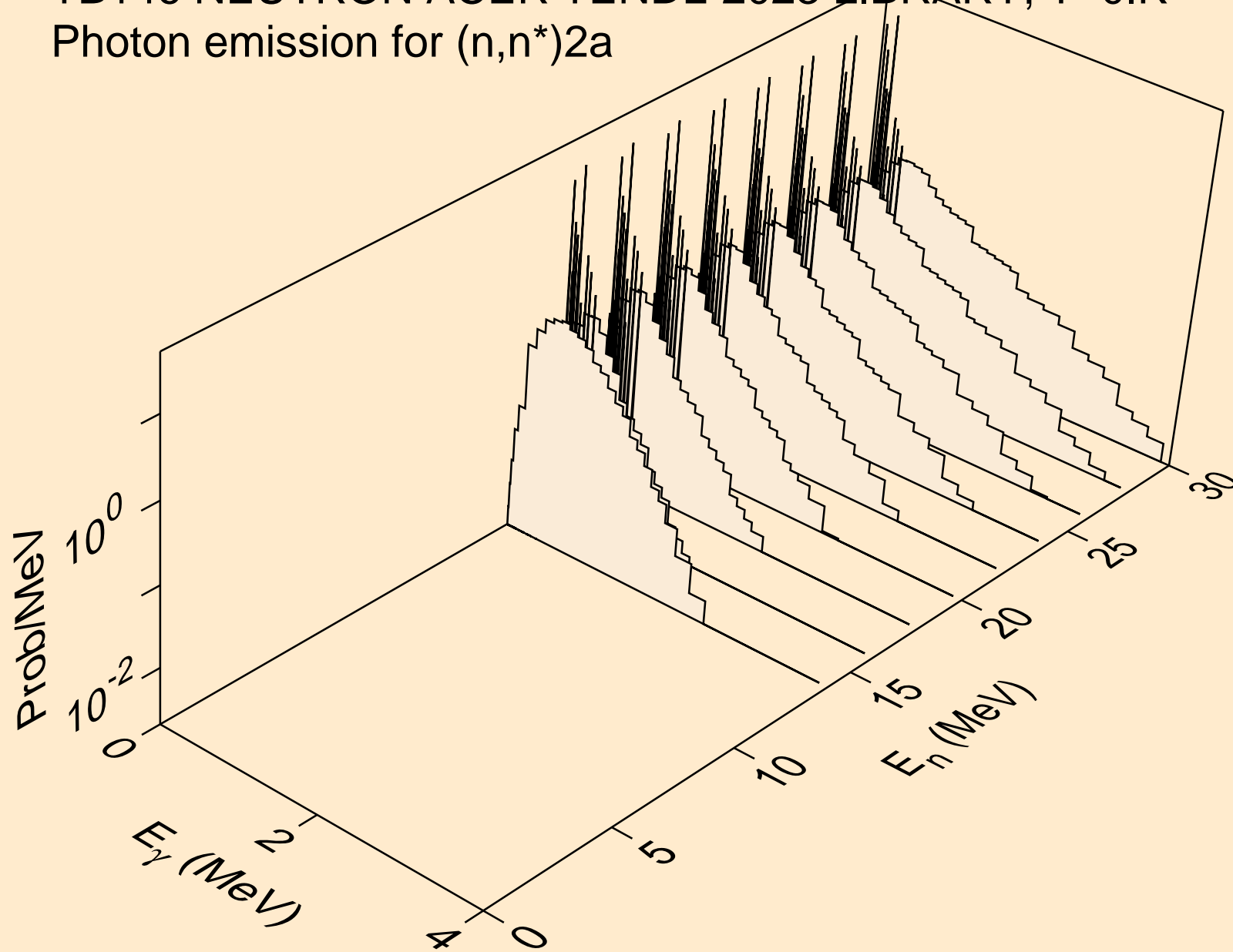

TB146 NEUTRON ACER TENDL-2023 LIBRARY; T=0.K  
Photon emission for (n,n\*)d

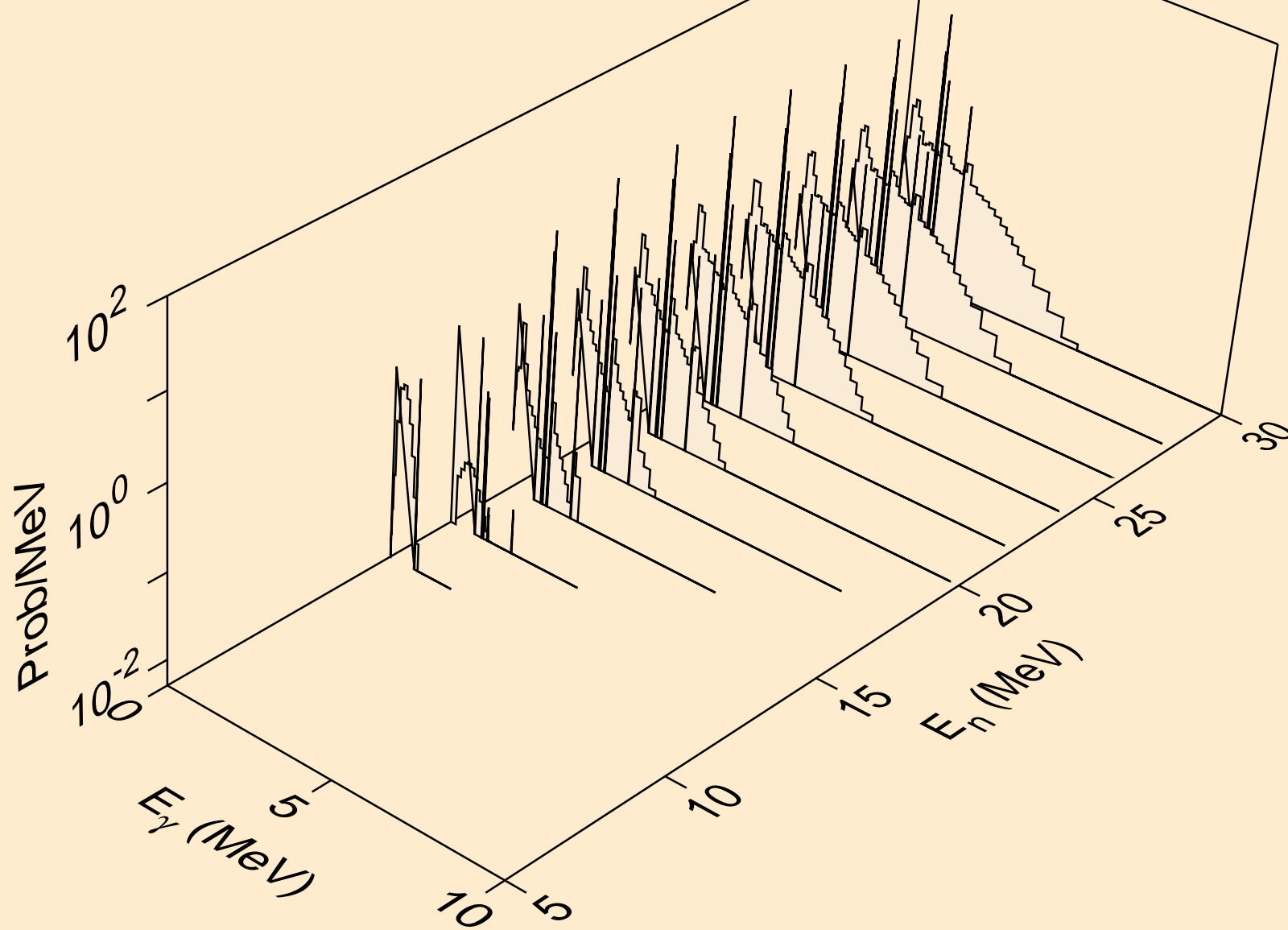

TB146 NEUTRON ACER TENDL-2023 LIBRARY; T=0.K  
Photon emission for (n,n\*)t

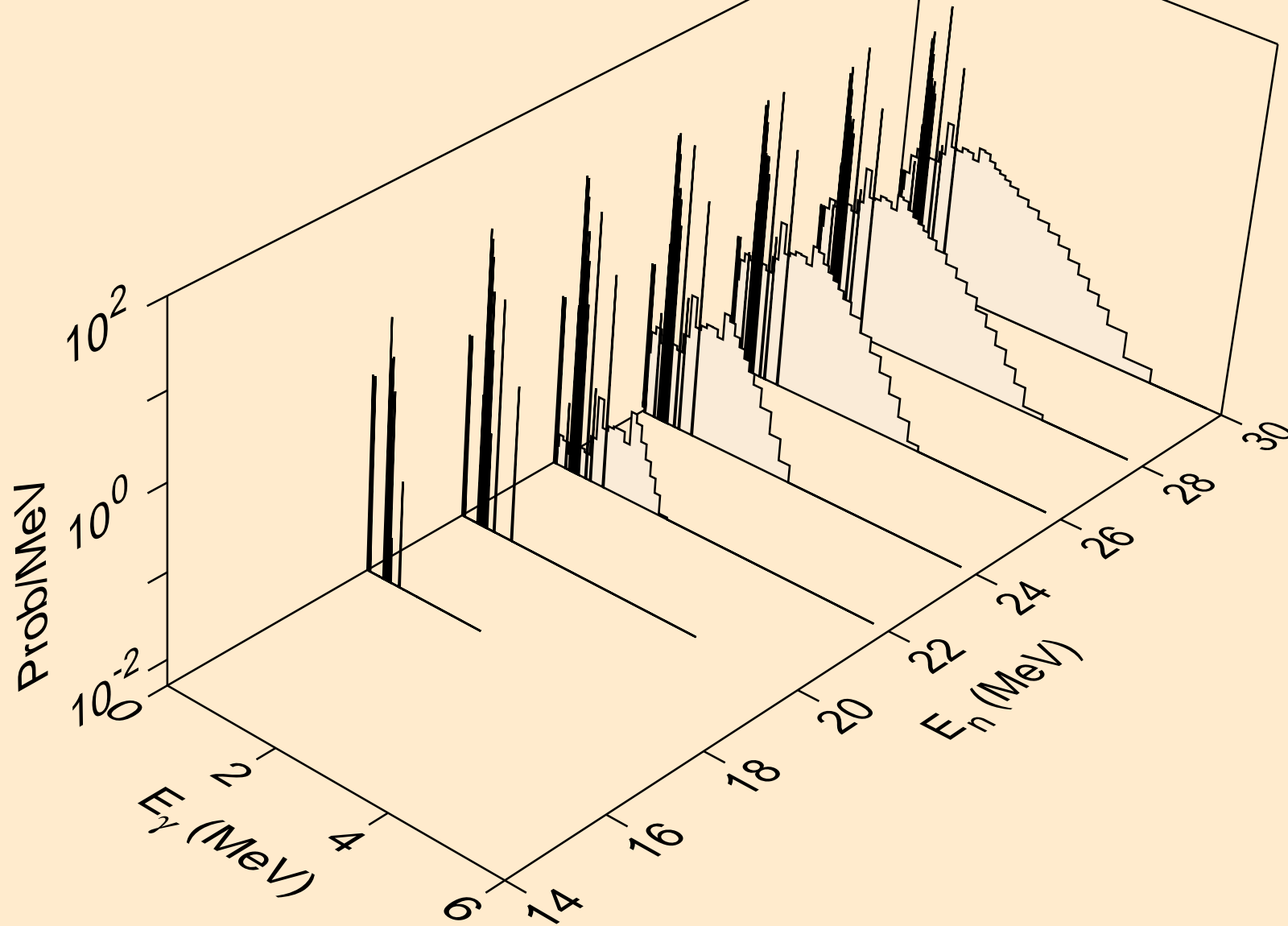

TB146 NEUTRON ACER TENDL-2023 LIBRARY; T=0.K  
Photon emission for (n,n\*)he3

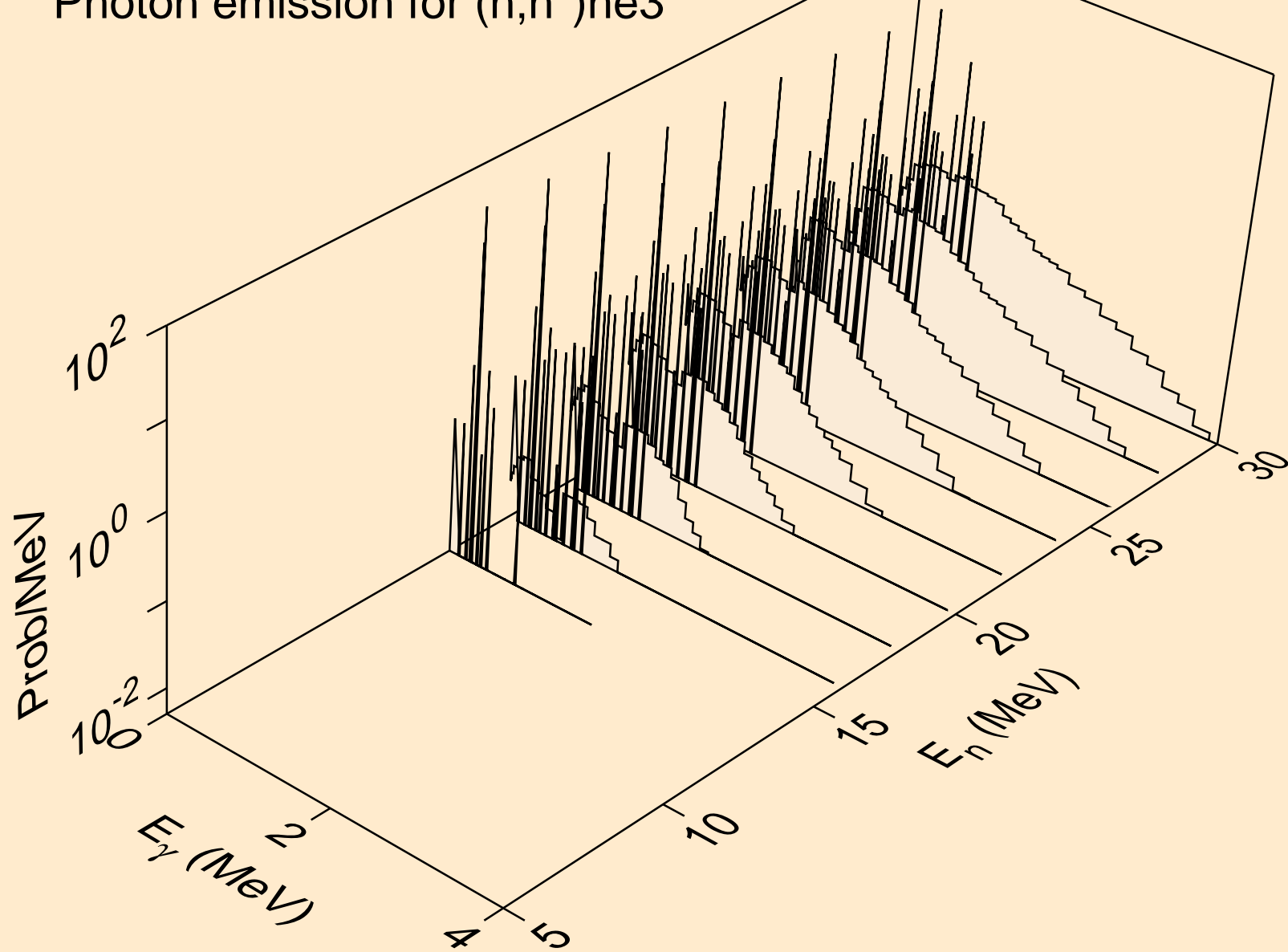

TB146 NEUTRON ACER TENDL-2023 LIBRARY; T=0.K  
Photon emission for (n,2np)

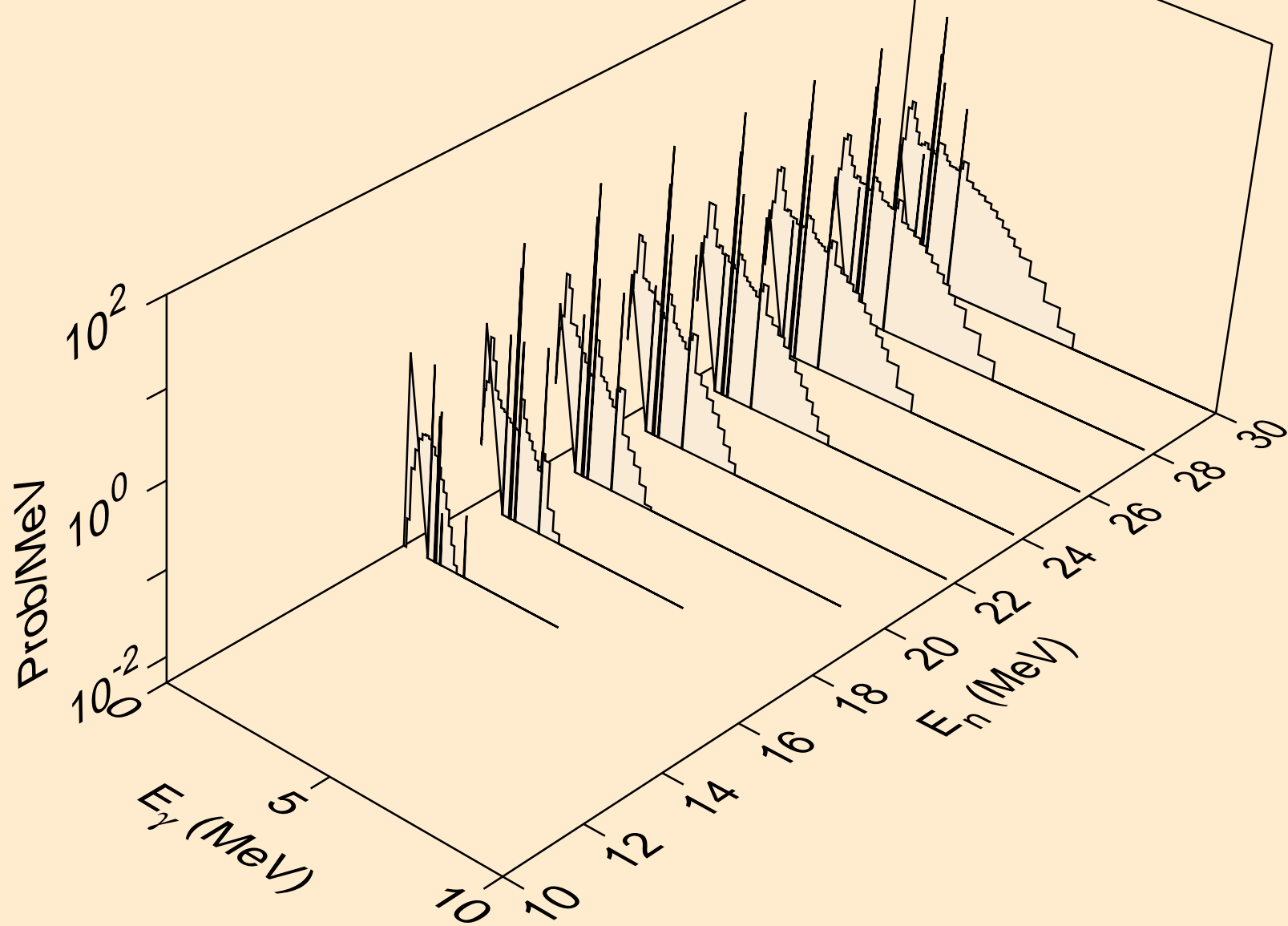

TB146 NEUTRON ACER TENDL-2023 LIBRARY; T=0.K  
Photon emission for (n,3np)

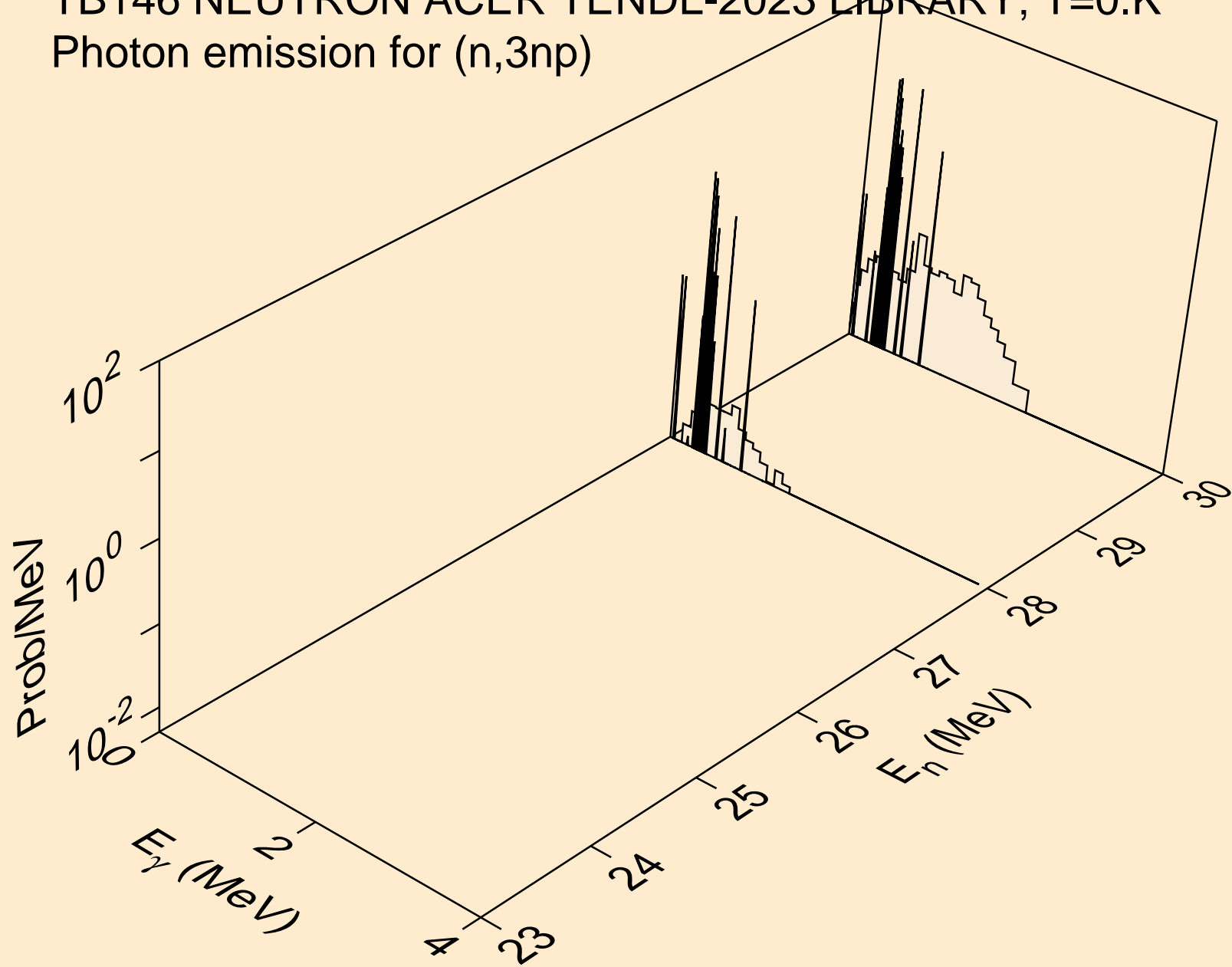

TB146 NEUTRON ACER TENDL-2023 LIBRARY; T=0.K  
Photon emission for (n,n2p)

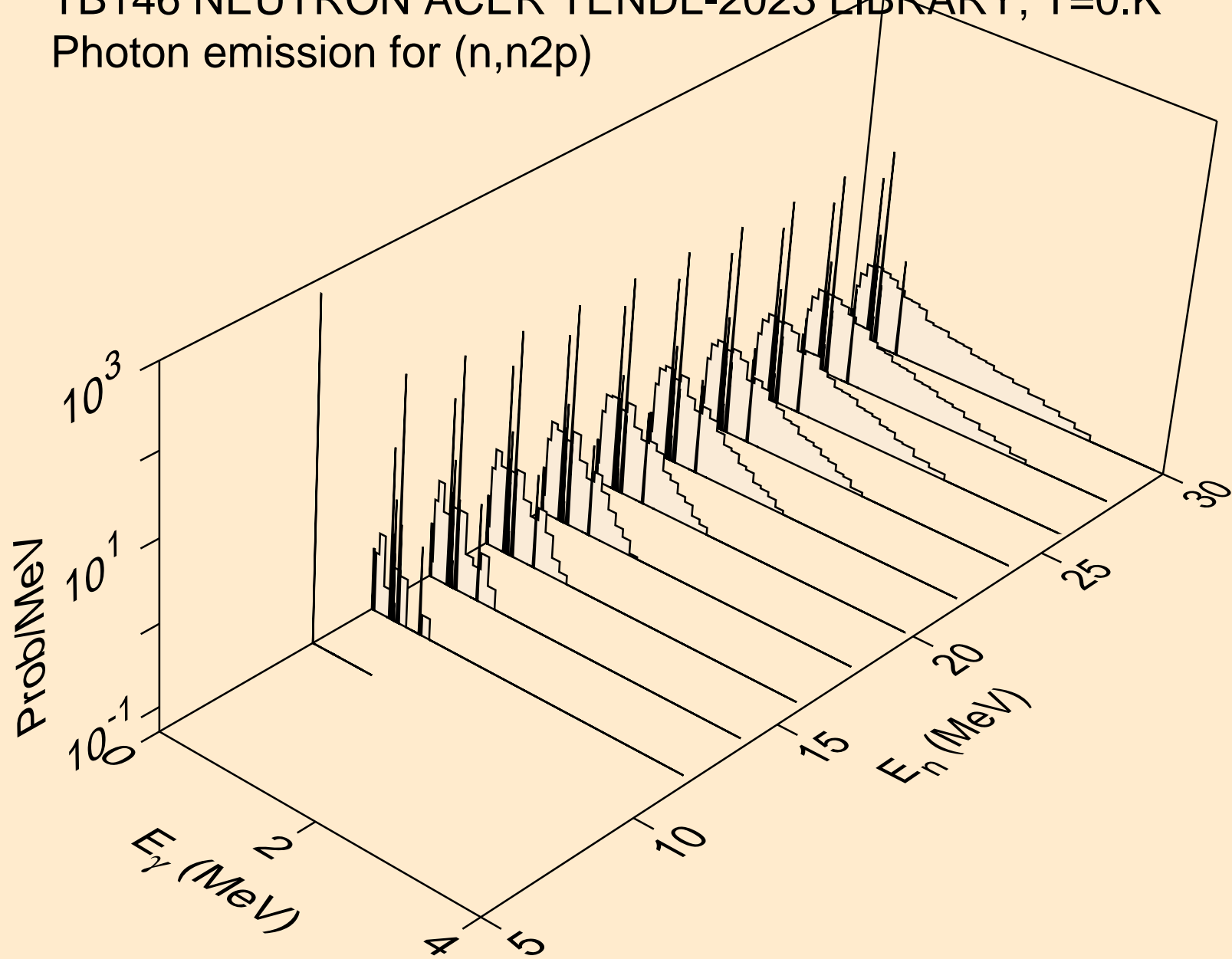

TB146 NEUTRON ACER TENDL-2023 LIBRARY; T=0.K  
Photon emission for (n,npa)

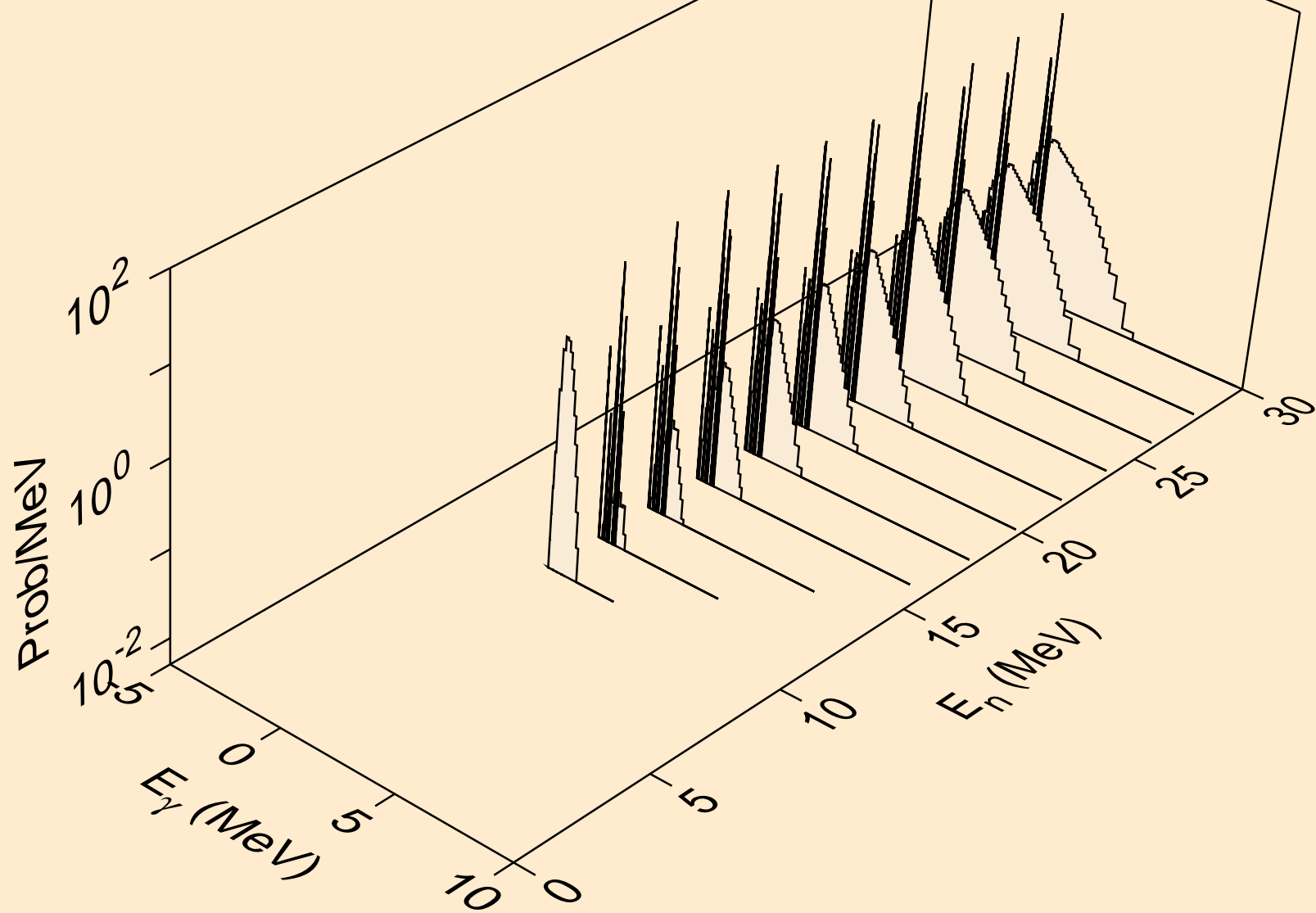

TB146 NEUTRON ACER TENDL-2023 LIBRARY; T=0.K  
Photon emission for (n,n\*c)

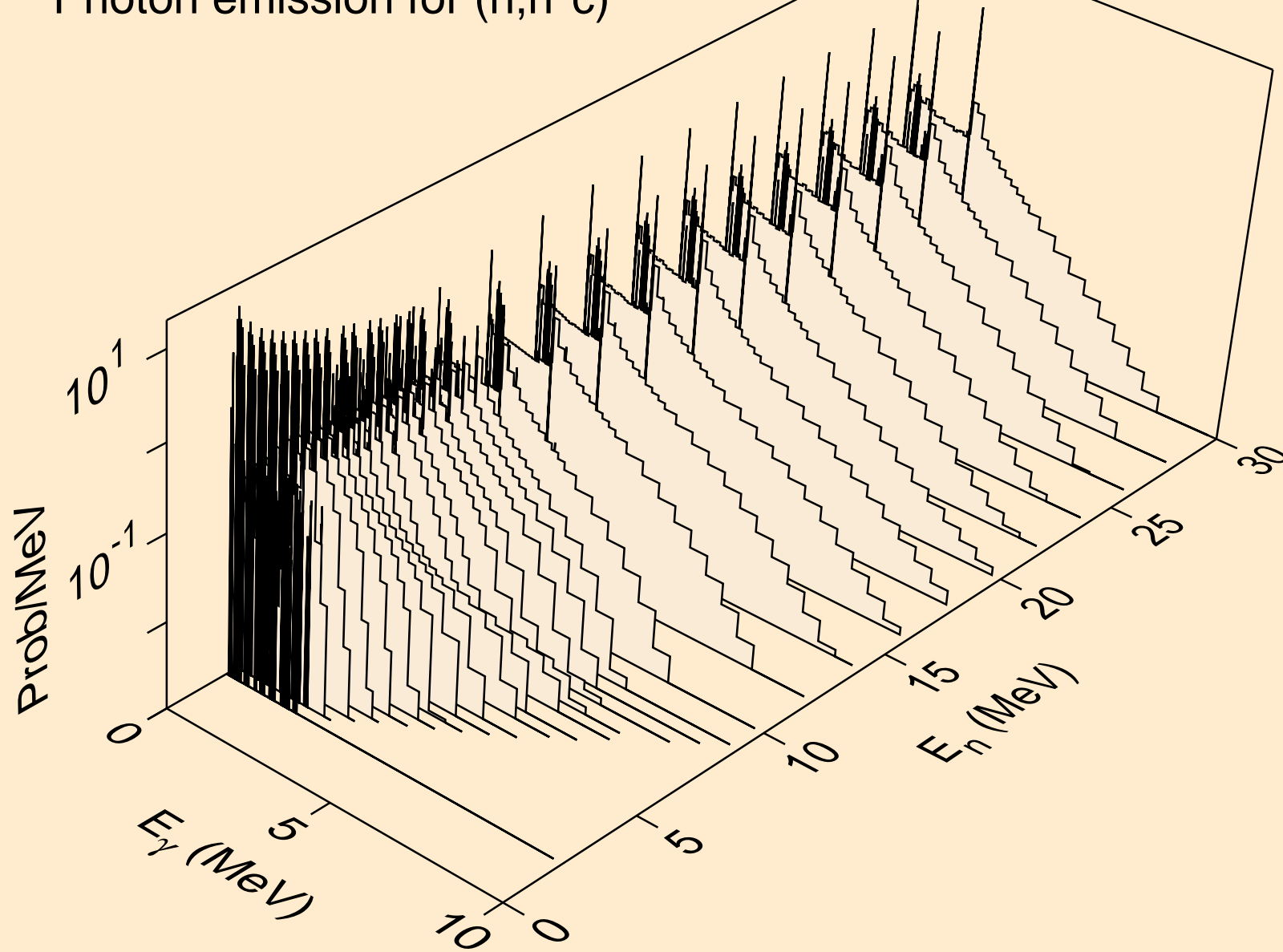

TB146 NEUTRON ACER TENDL-2023 LIBRARY; T=0.K  
Photon emission for (n,gma)

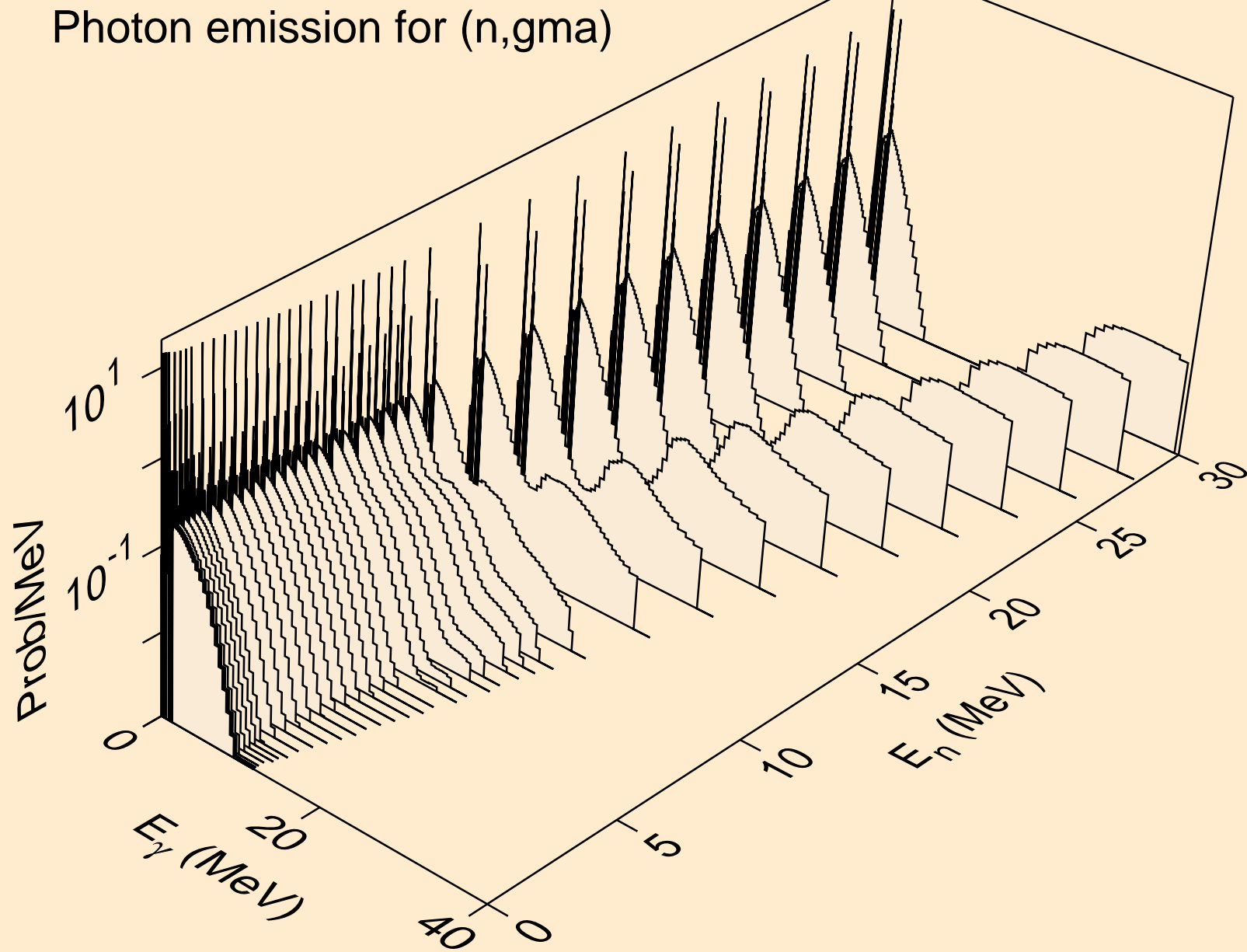

TB146 NEUTRON ACER TENDL-2023 LIBRARY; T=0.K  
Photon emission for (n,p)

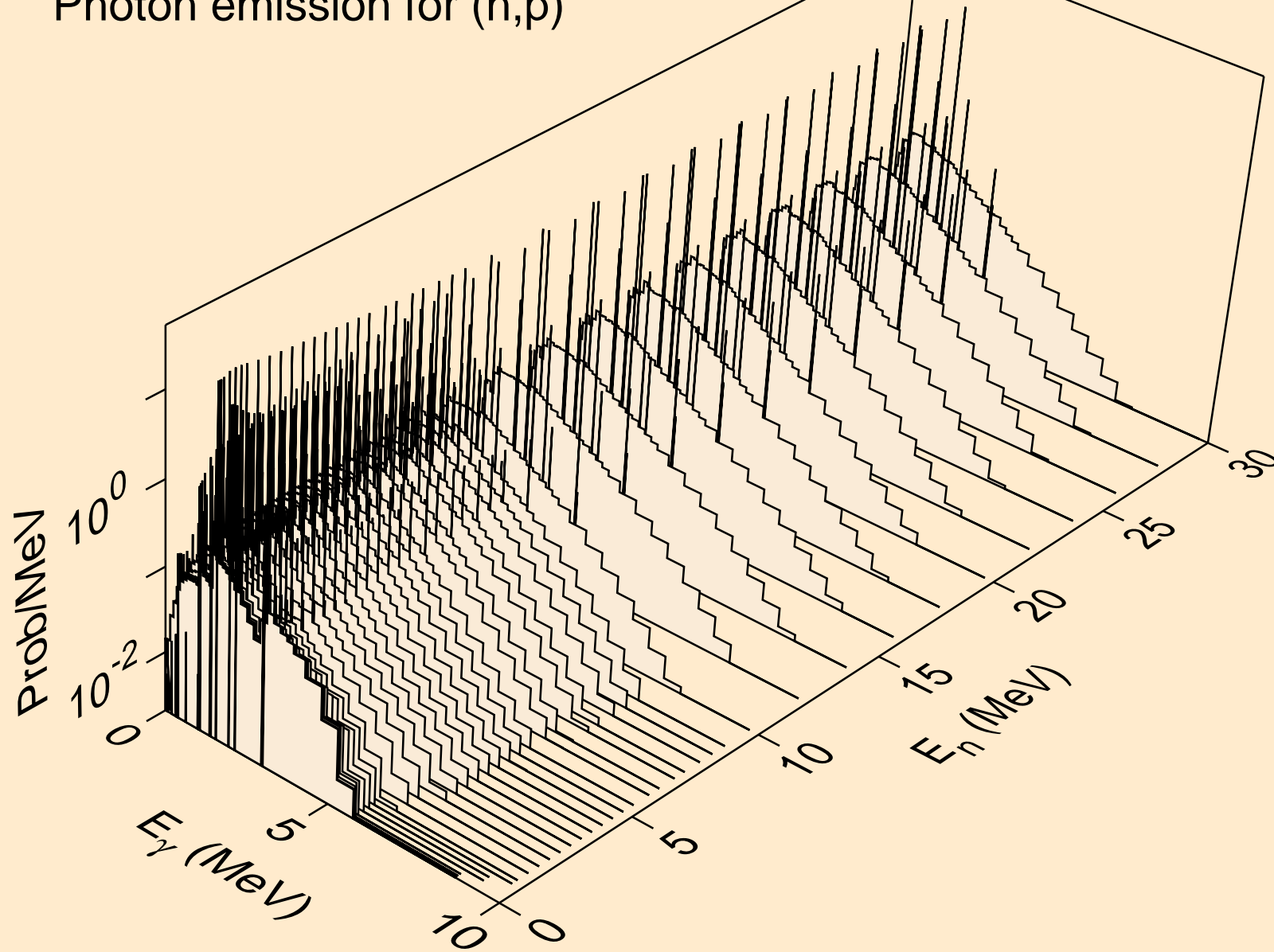

TB146 NEUTRON ACER TENDL-2023 LIBRARY; T=0.K  
Photon emission for (n,d)

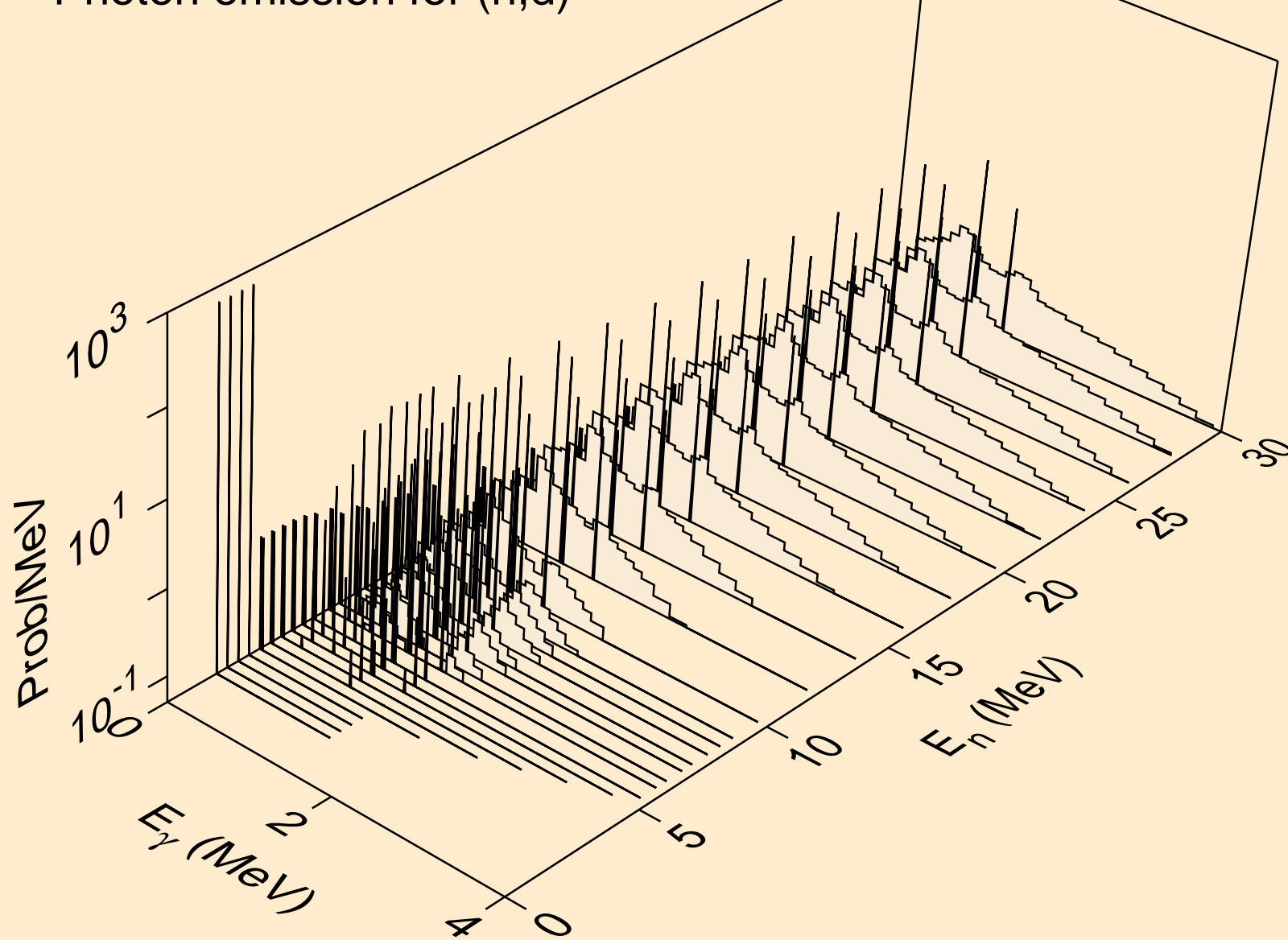

TB146 NEUTRON ACER TENDL-2023 LIBRARY; T=0.K  
Photon emission for (n,t)

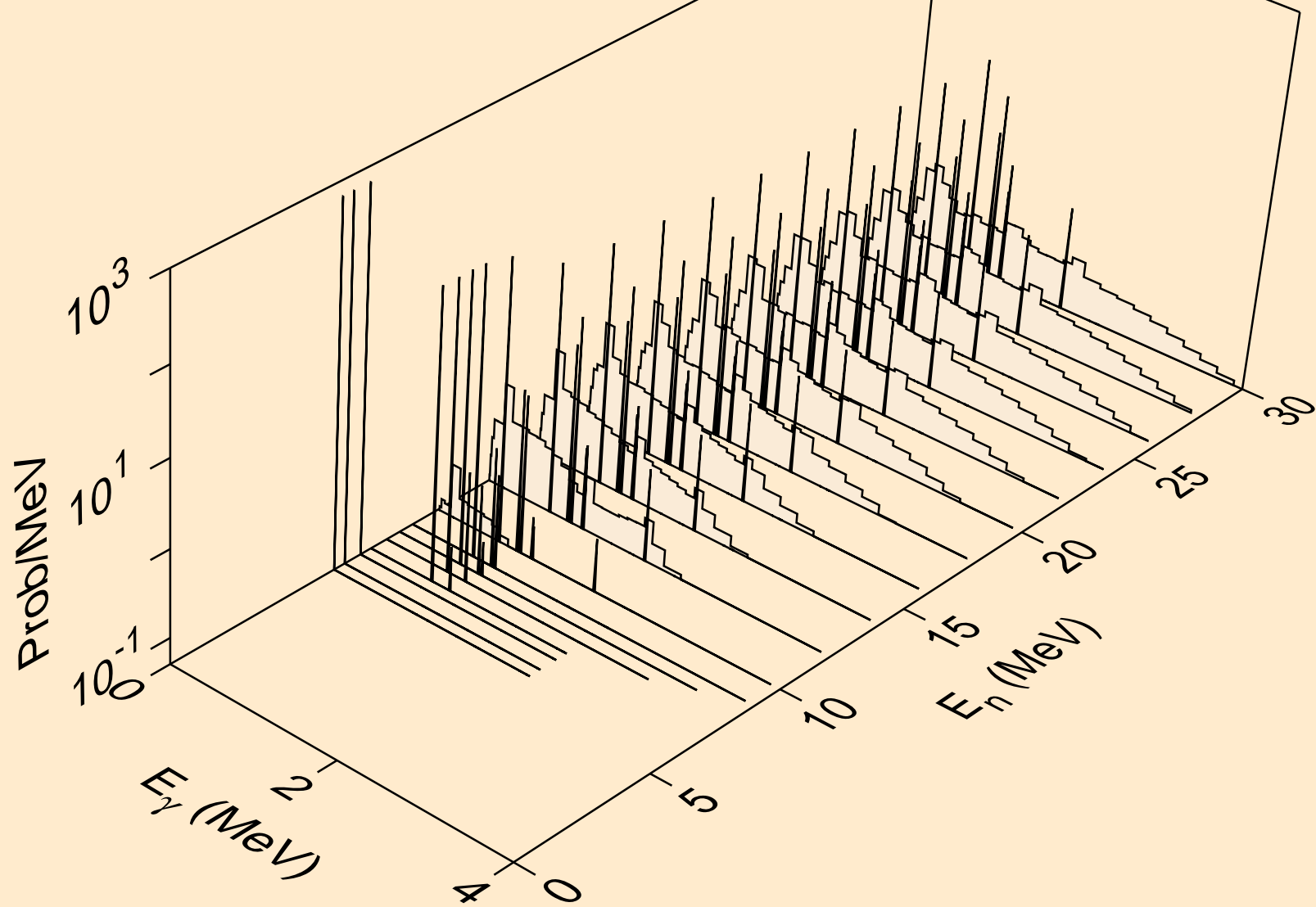

TB146 NEUTRON ACER TENDL-2023 LIBRARY; T=0.K  
Photon emission for (n,he3)

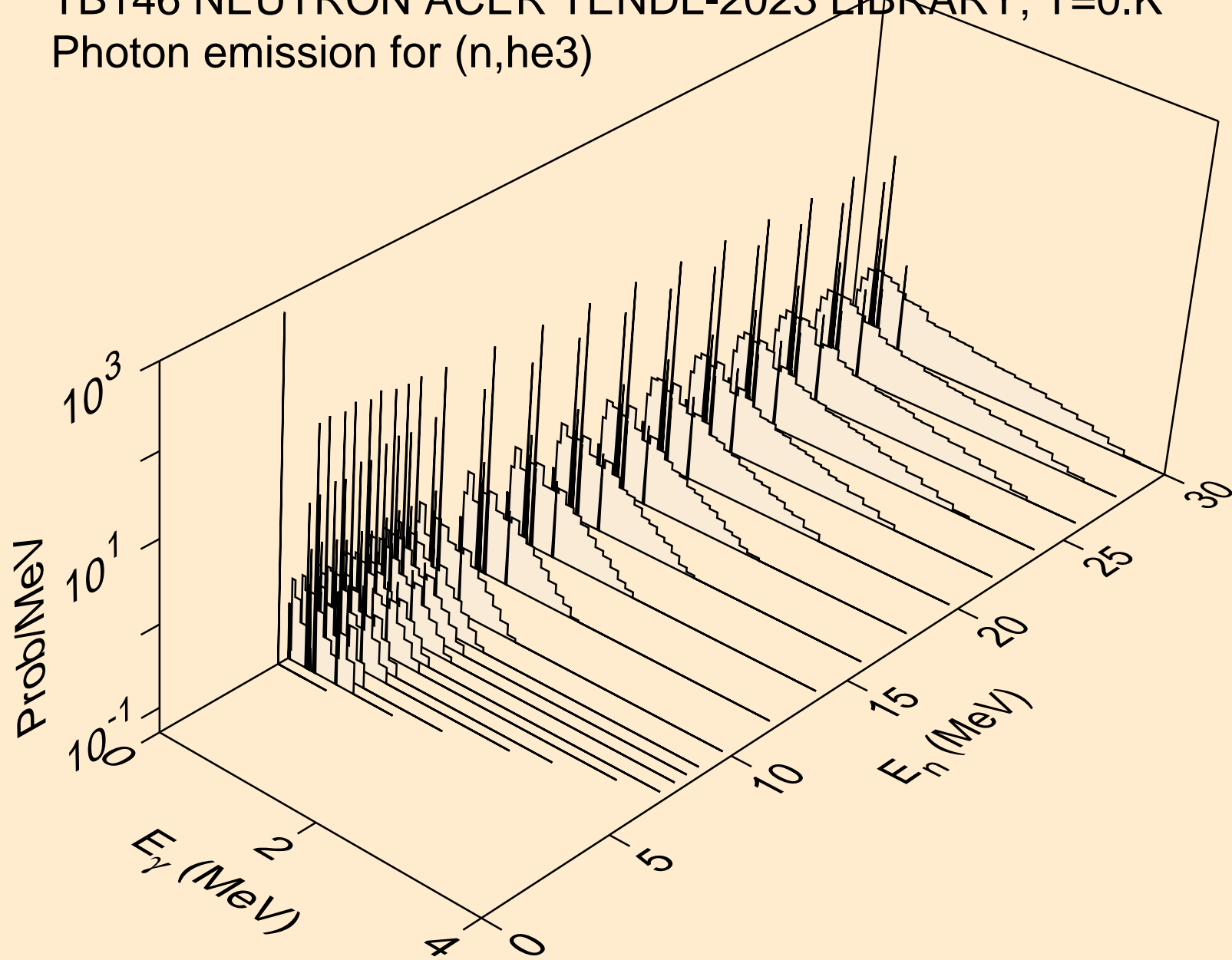

TB146 NEUTRON ACER TENDL-2023 LIBRARY; T=0.K  
Photon emission for (n,a)

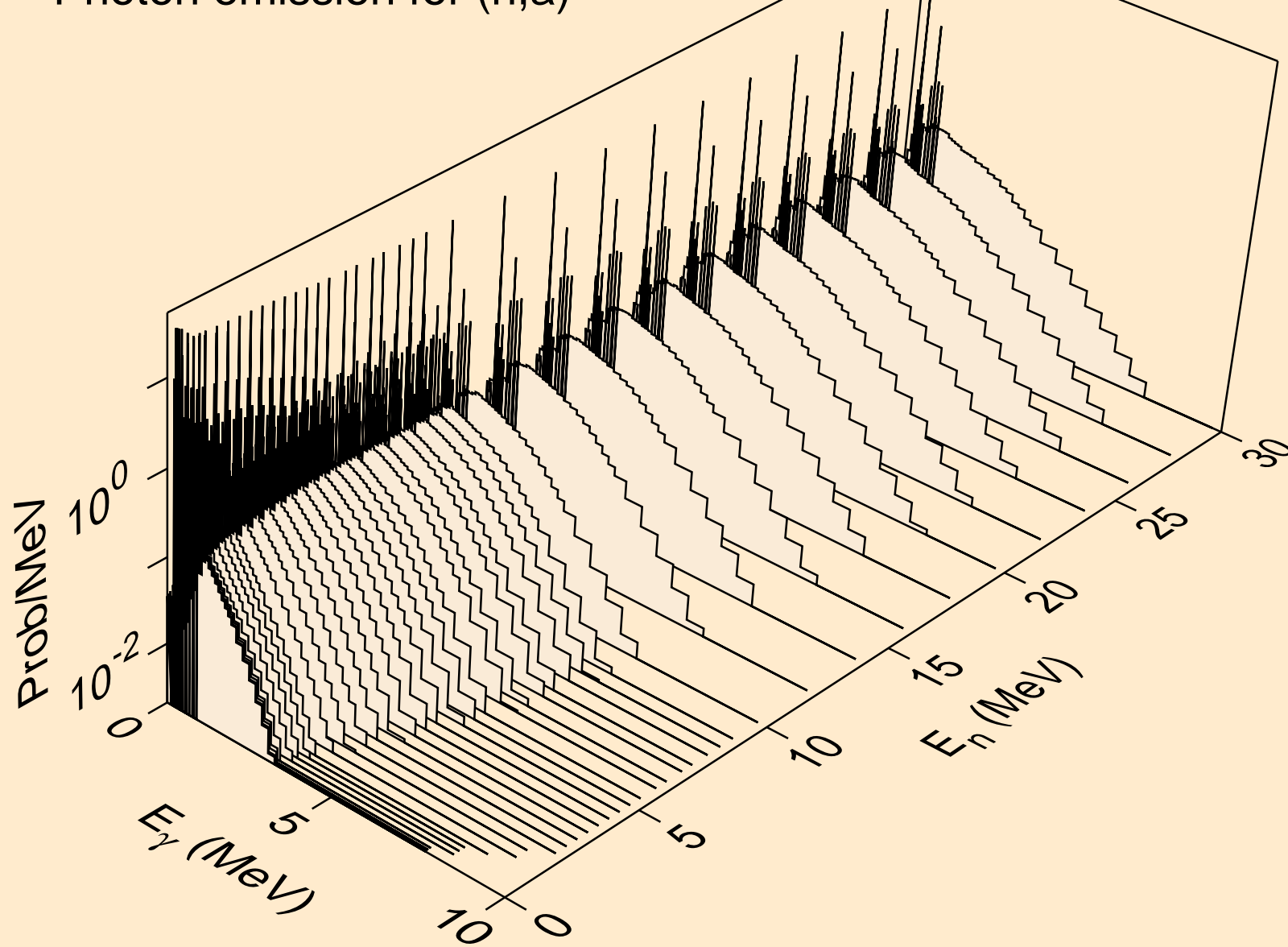

TB146 NEUTRON ACER TENDL-2023 LIBRARY; T=0.K  
Photon emission for (n,2a)

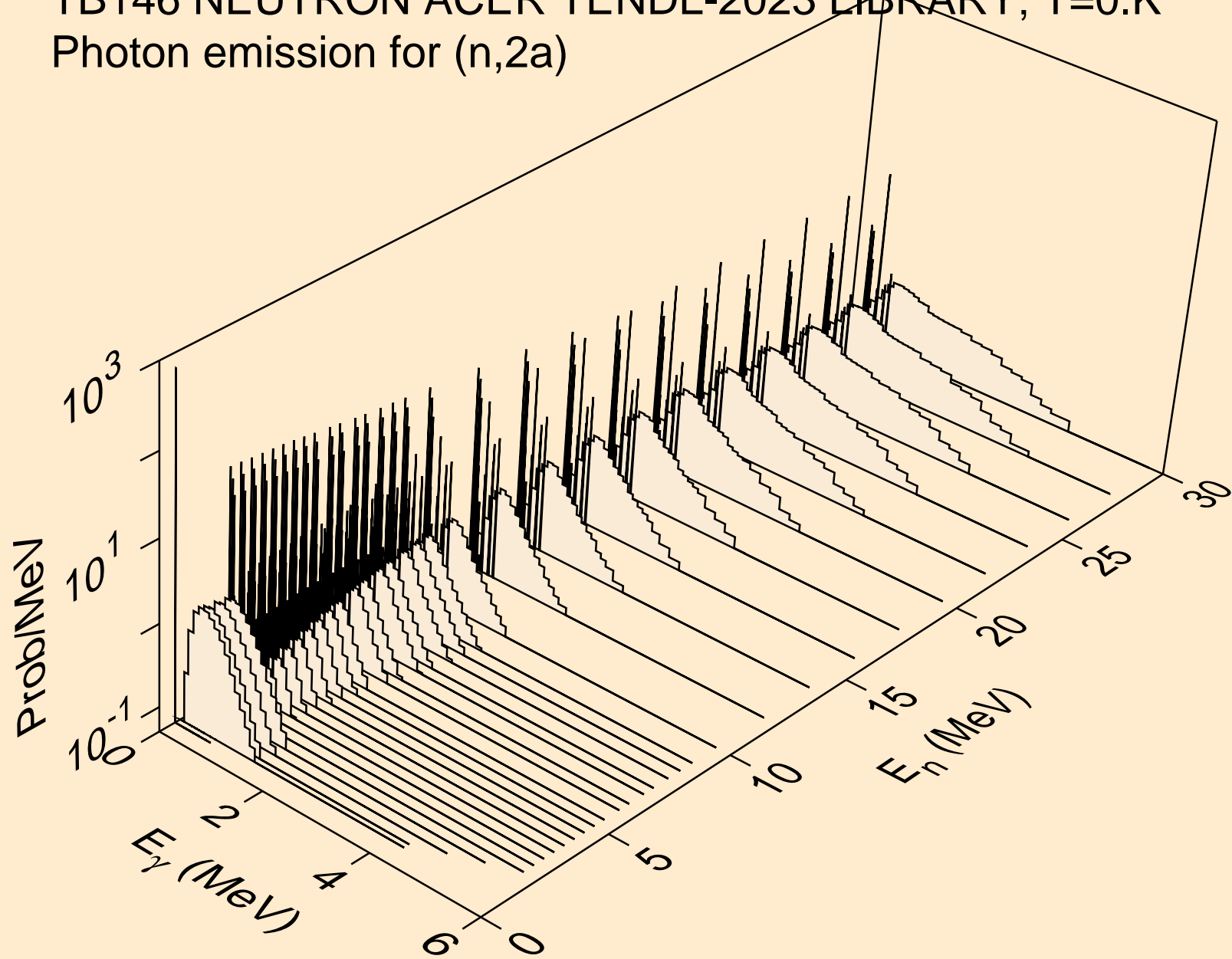

TB146 NEUTRON ACER TENDL-2023 LIBRARY; T=0.K  
Photon emission for (n,3a)

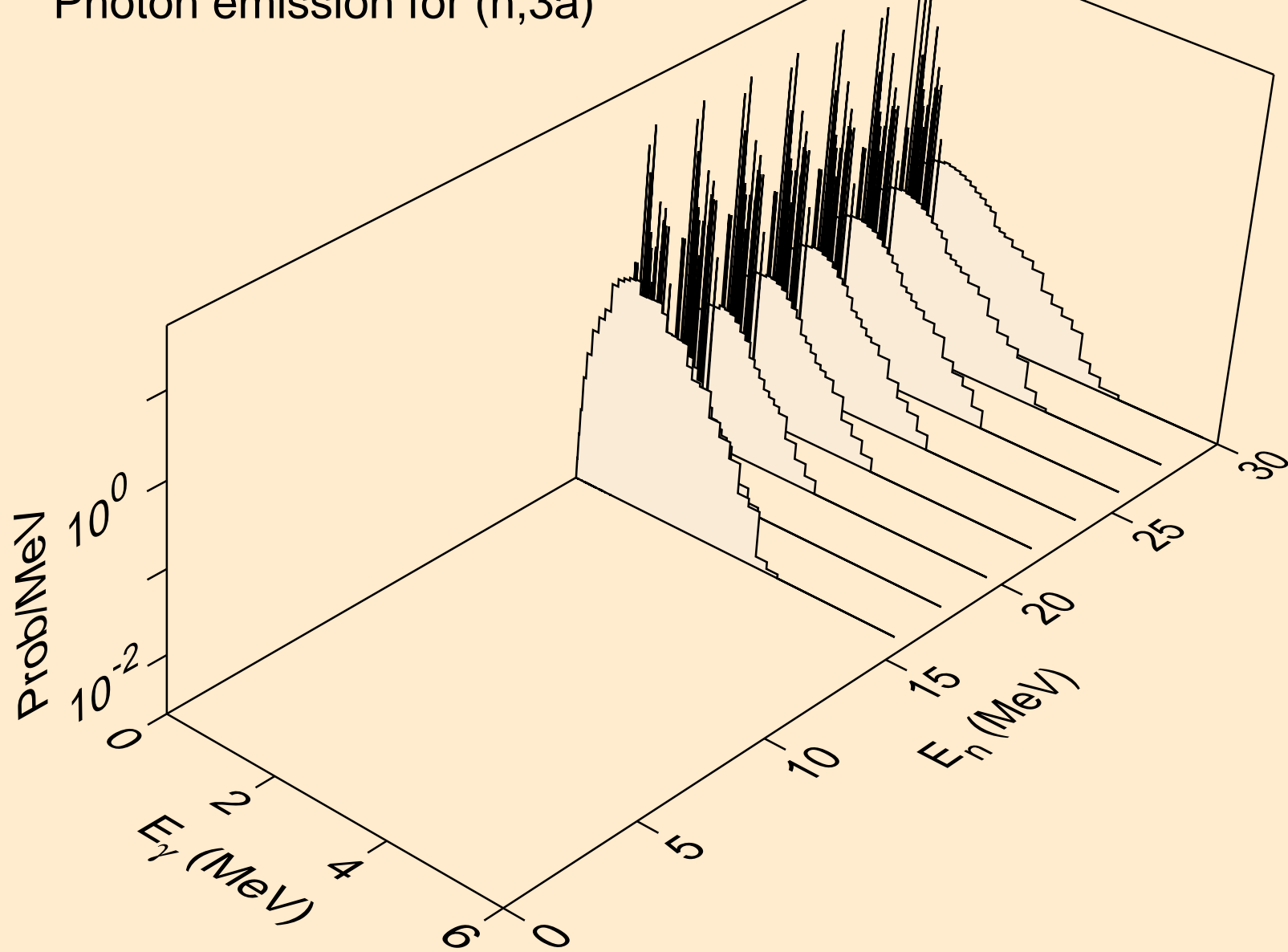

TB146 NEUTRON ACER TENDL-2023 LIBRARY; T=0.K  
Photon emission for (n,2p)

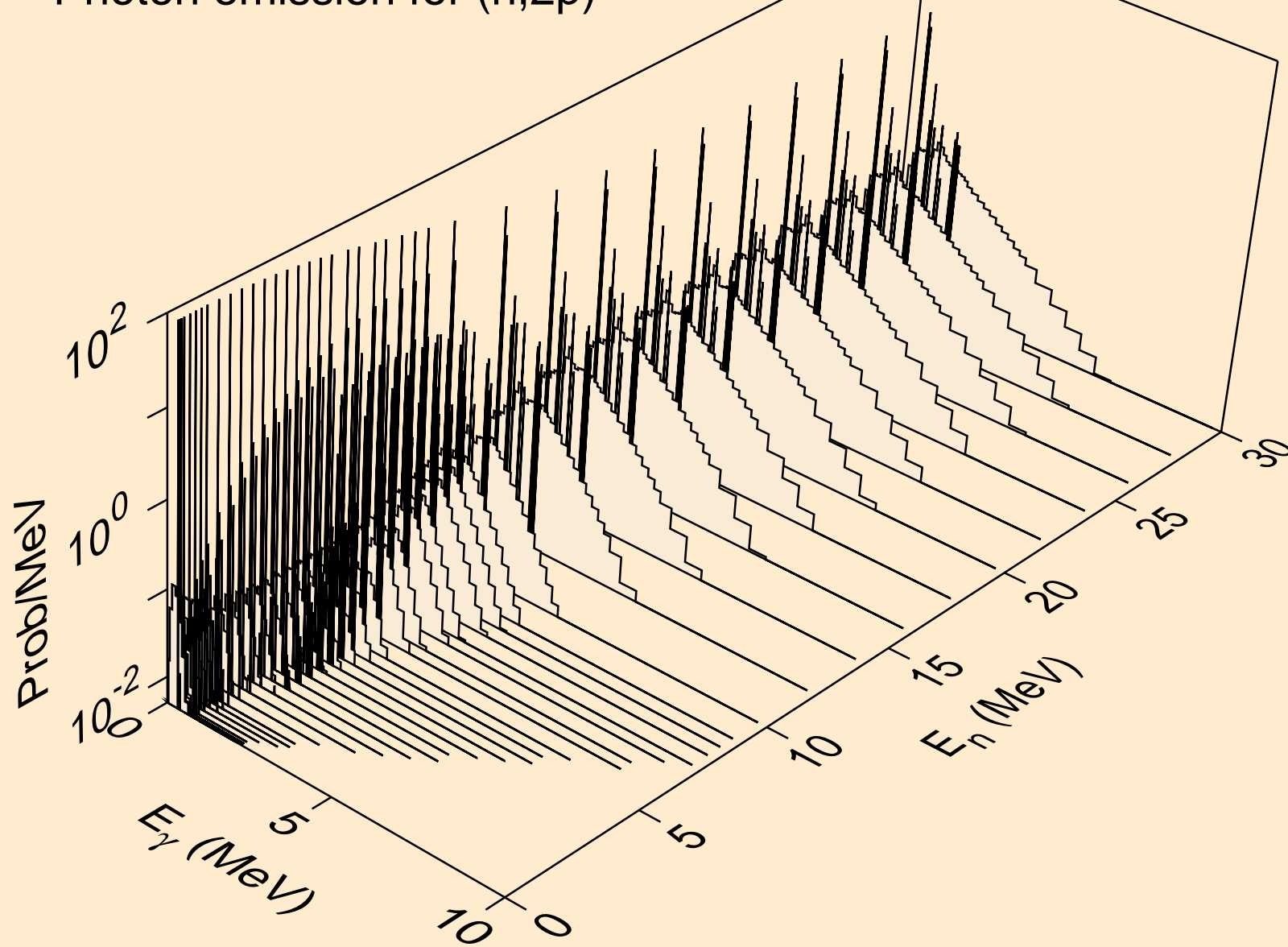

TB146 NEUTRON ACER TENDL-2023 LIBRARY; T=0.K  
Photon emission for (n,p $\alpha$ )

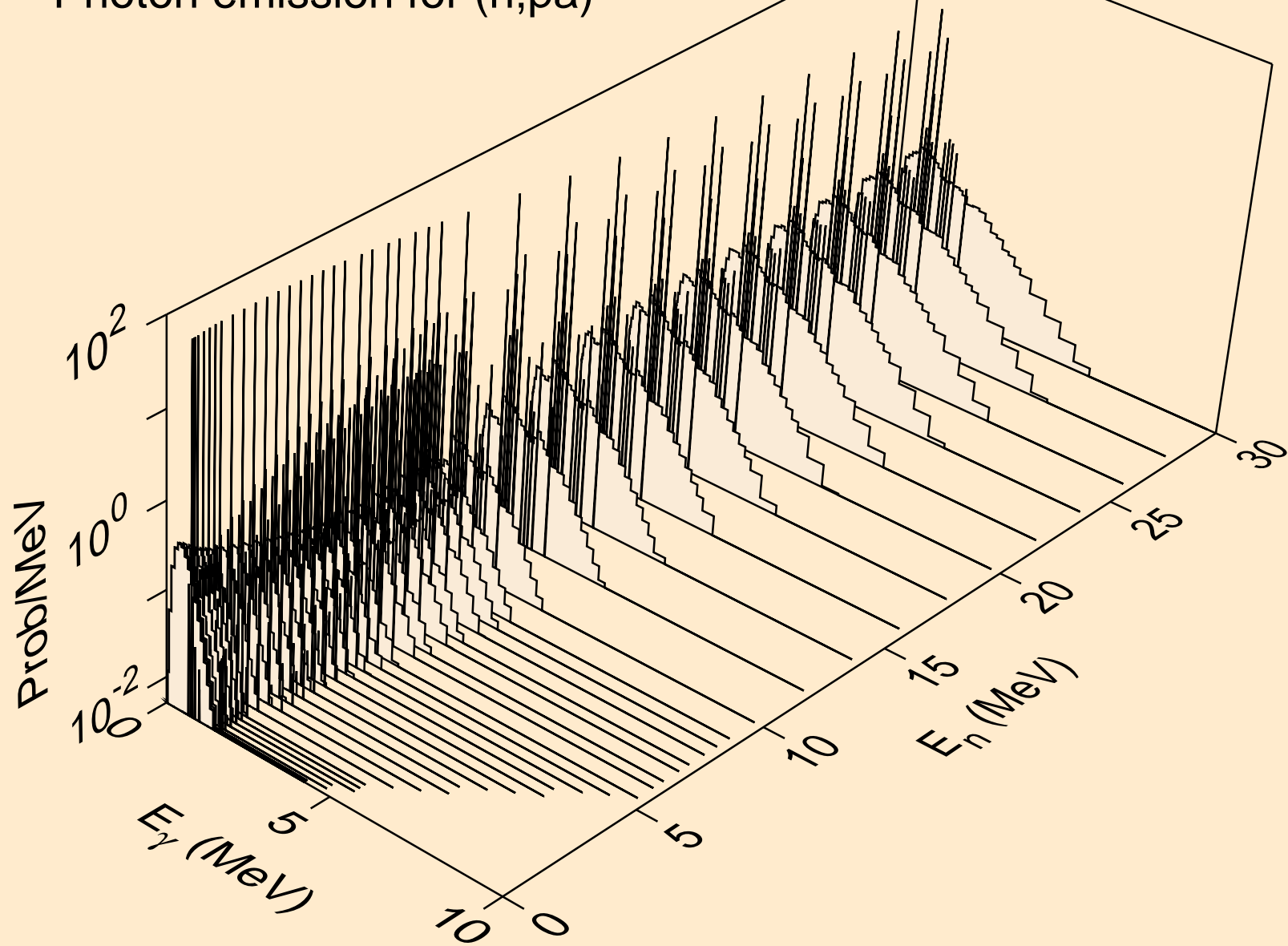

TB146 NEUTRON ACER TENDL-2023 LIBRARY; T=0.K  
Photon emission for (n,pd)

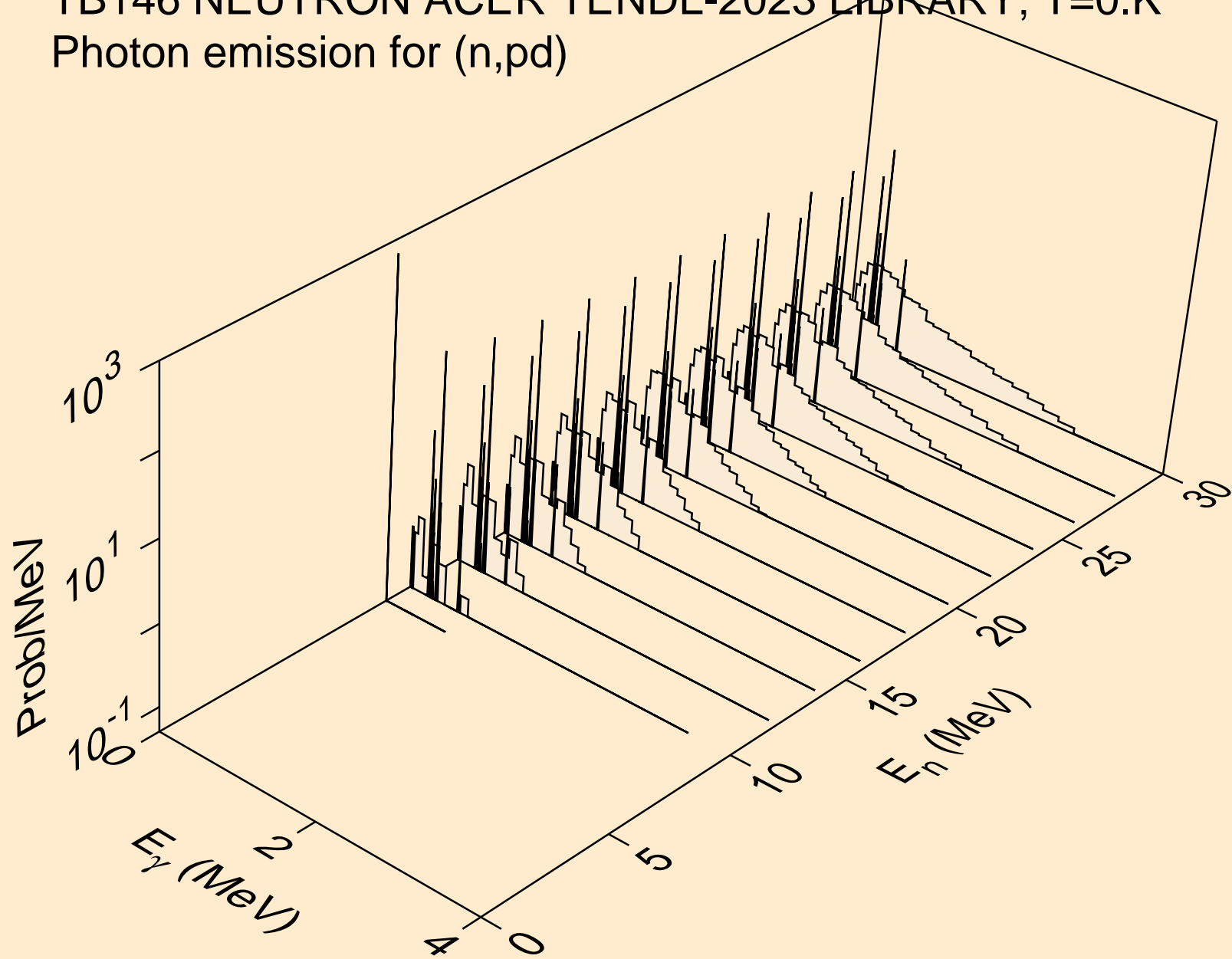

TB146 NEUTRON ACER TENDL-2023 LIBRARY; T=0.K  
Photon emission for (n,pt)

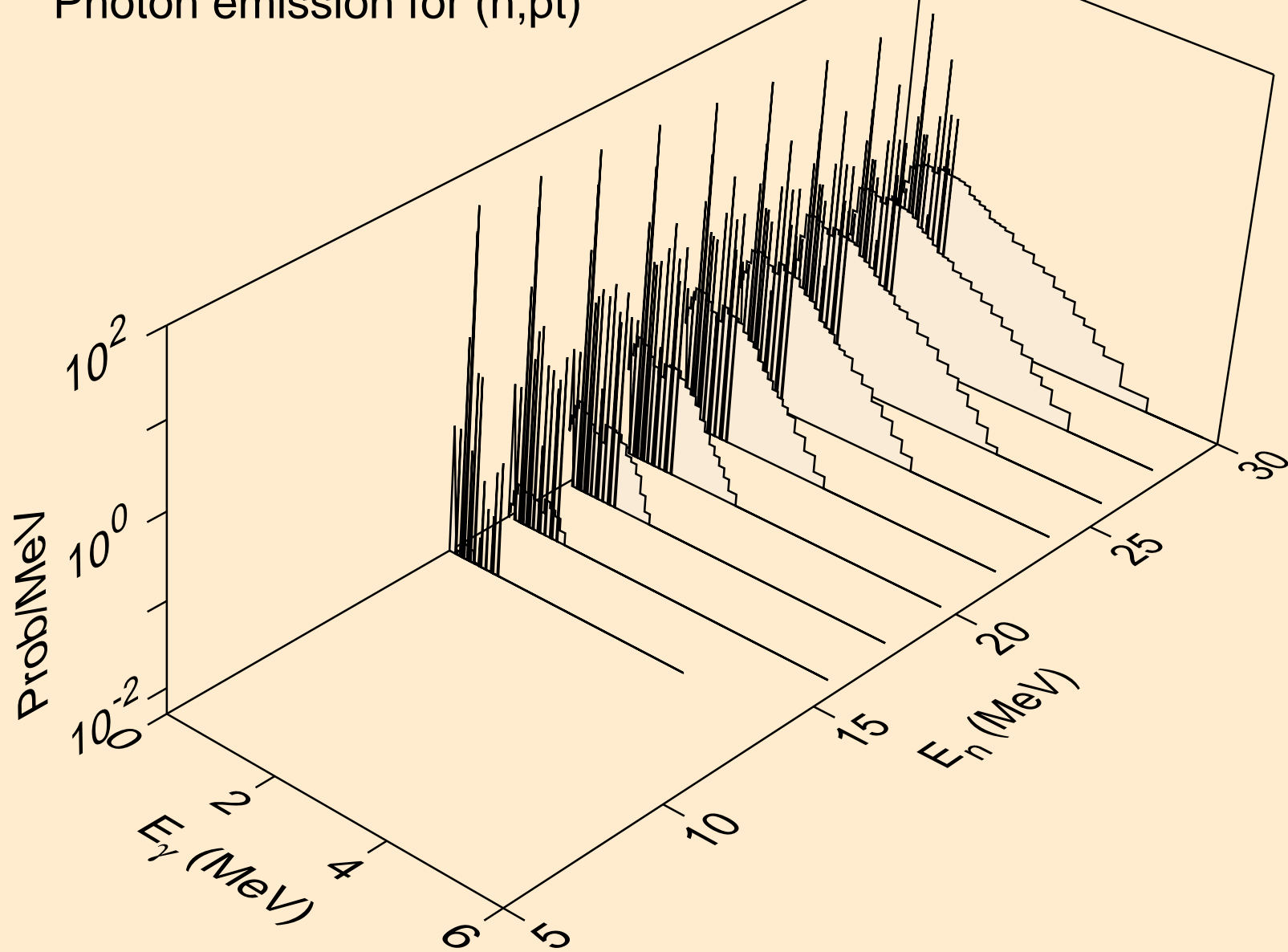

TB146 NEUTRON ACER TENDL-2023 LIBRARY; T=0.K  
Photon emission for (n,da)

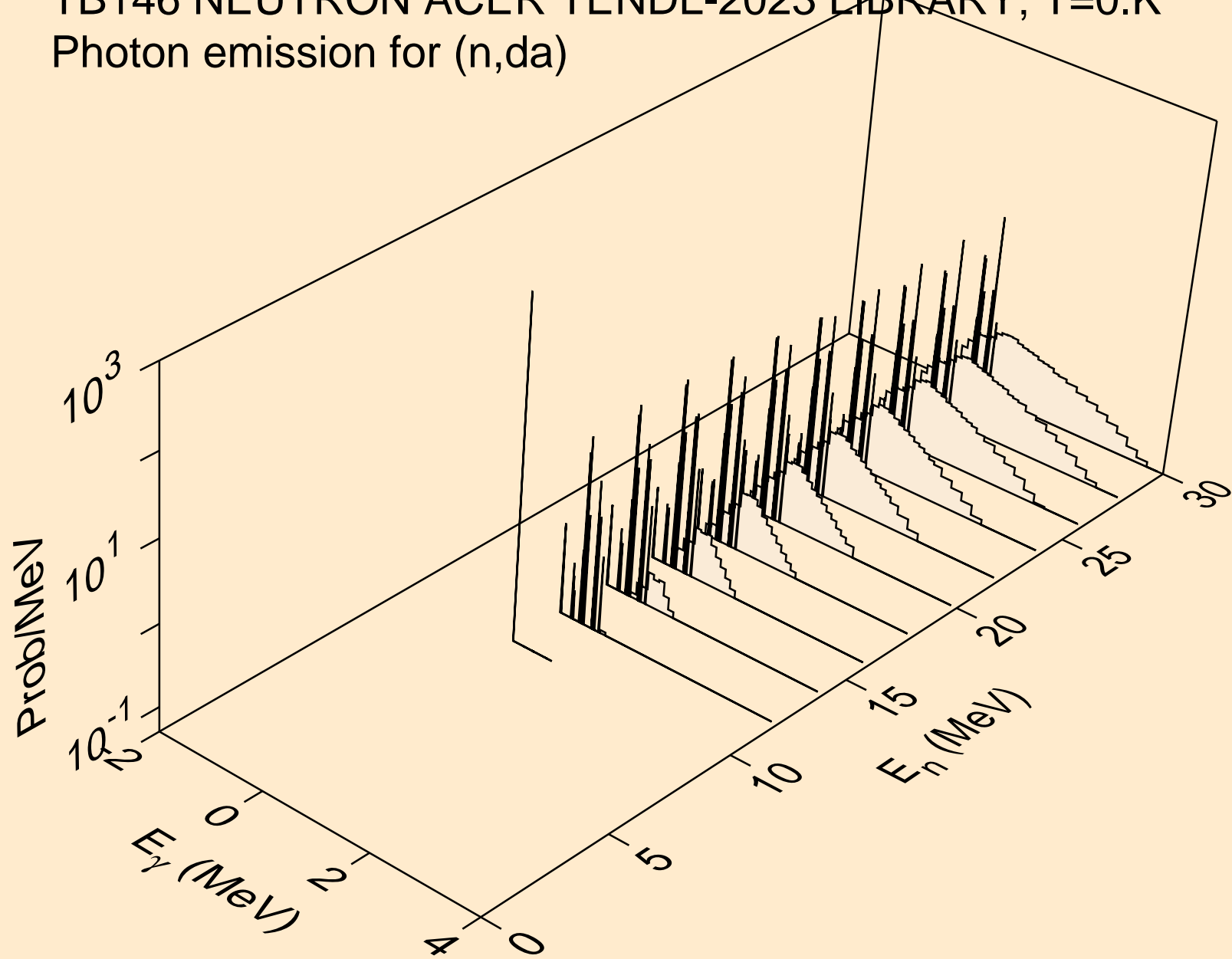

TB146 NEUTRON ACER TENDL-2023 LIBRARY; T=0.K  
thermal capture photon spectrum

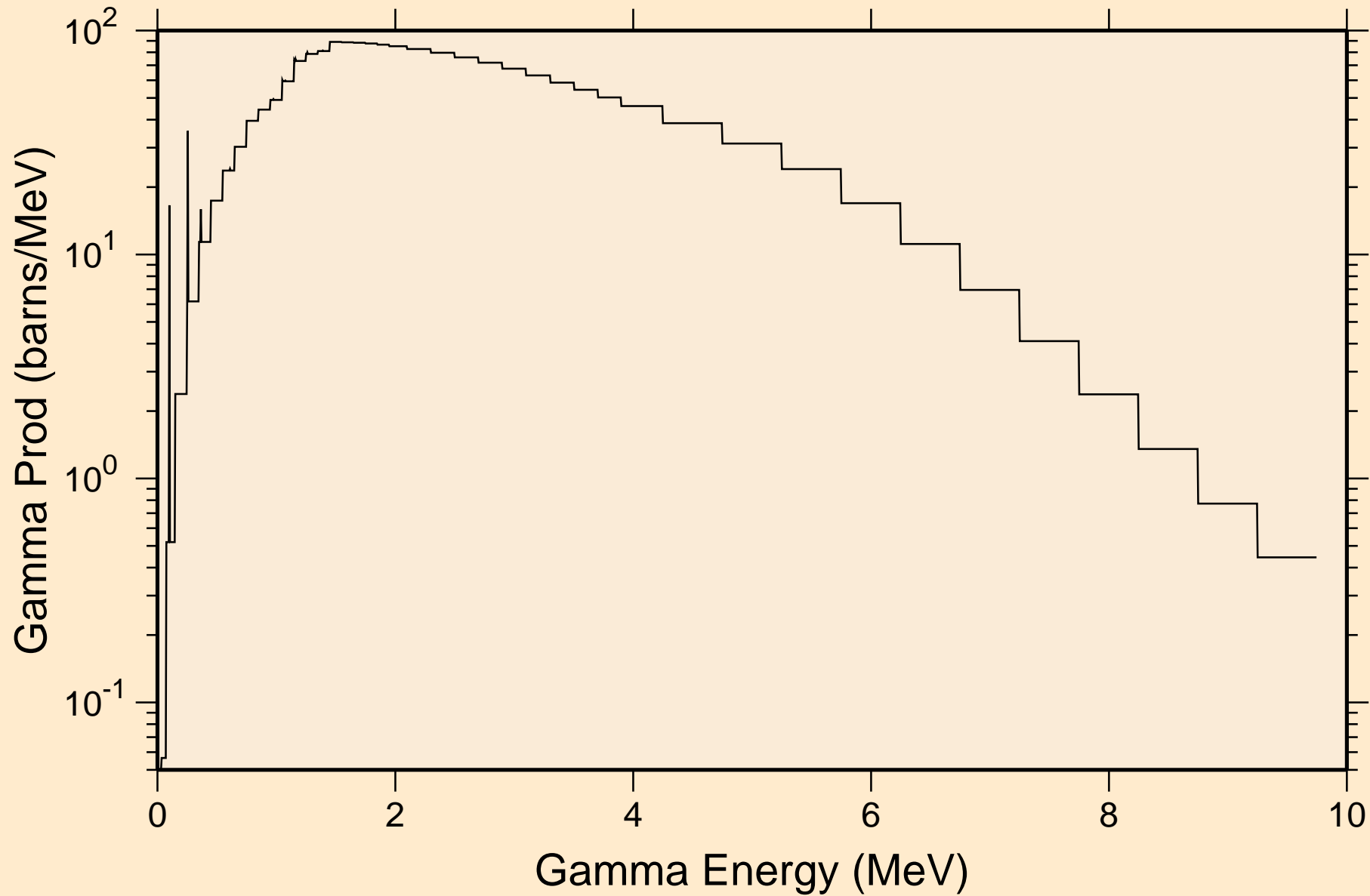

TB146 NEUTRON ACER TENDL-2023 LIBRARY; T=0.K  
14 MeV photon spectrum

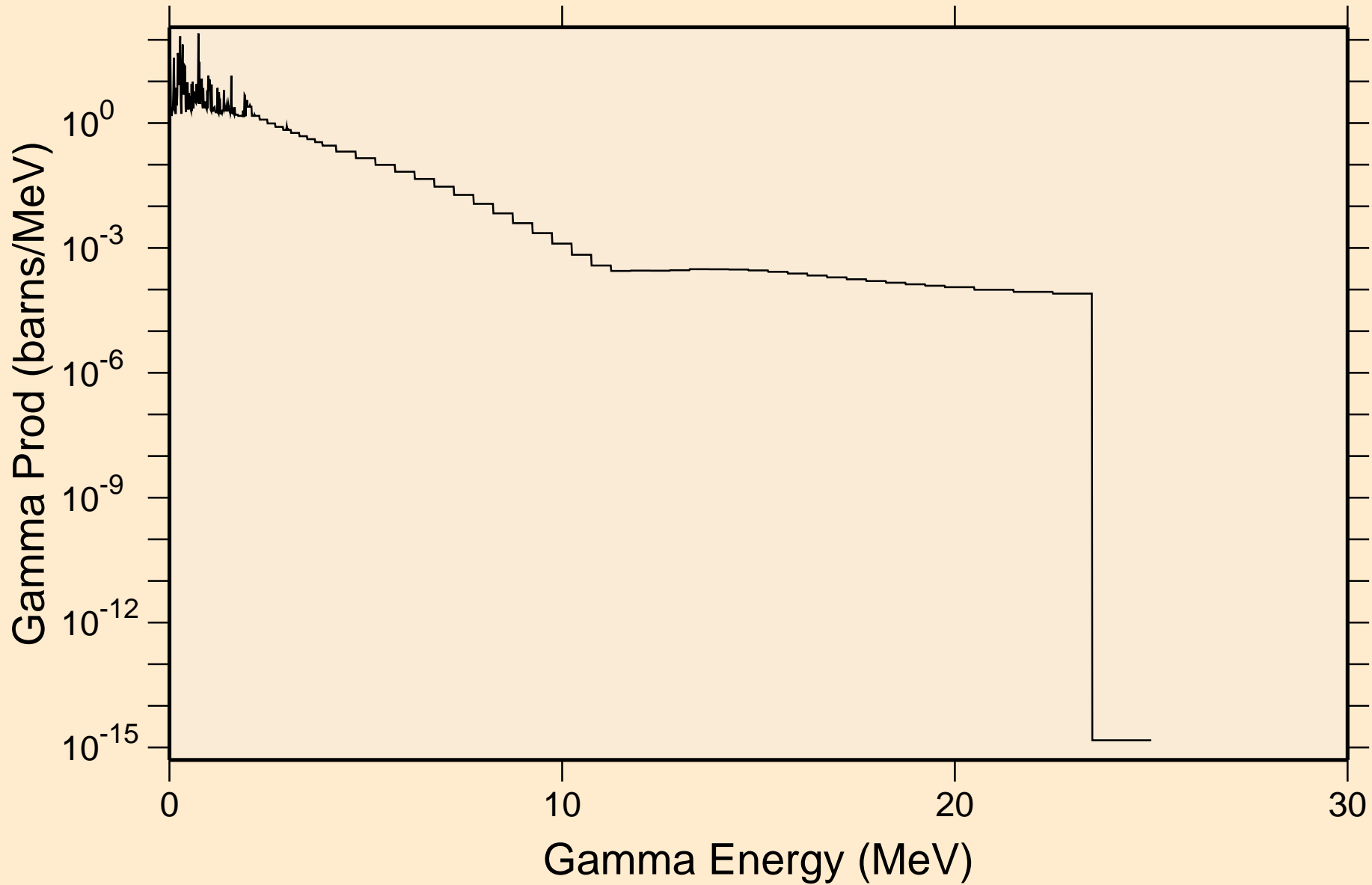

TB146 NEUTRON ACER TENDL-2023 LIBRARY; T=0.K  
Particle heating contributions

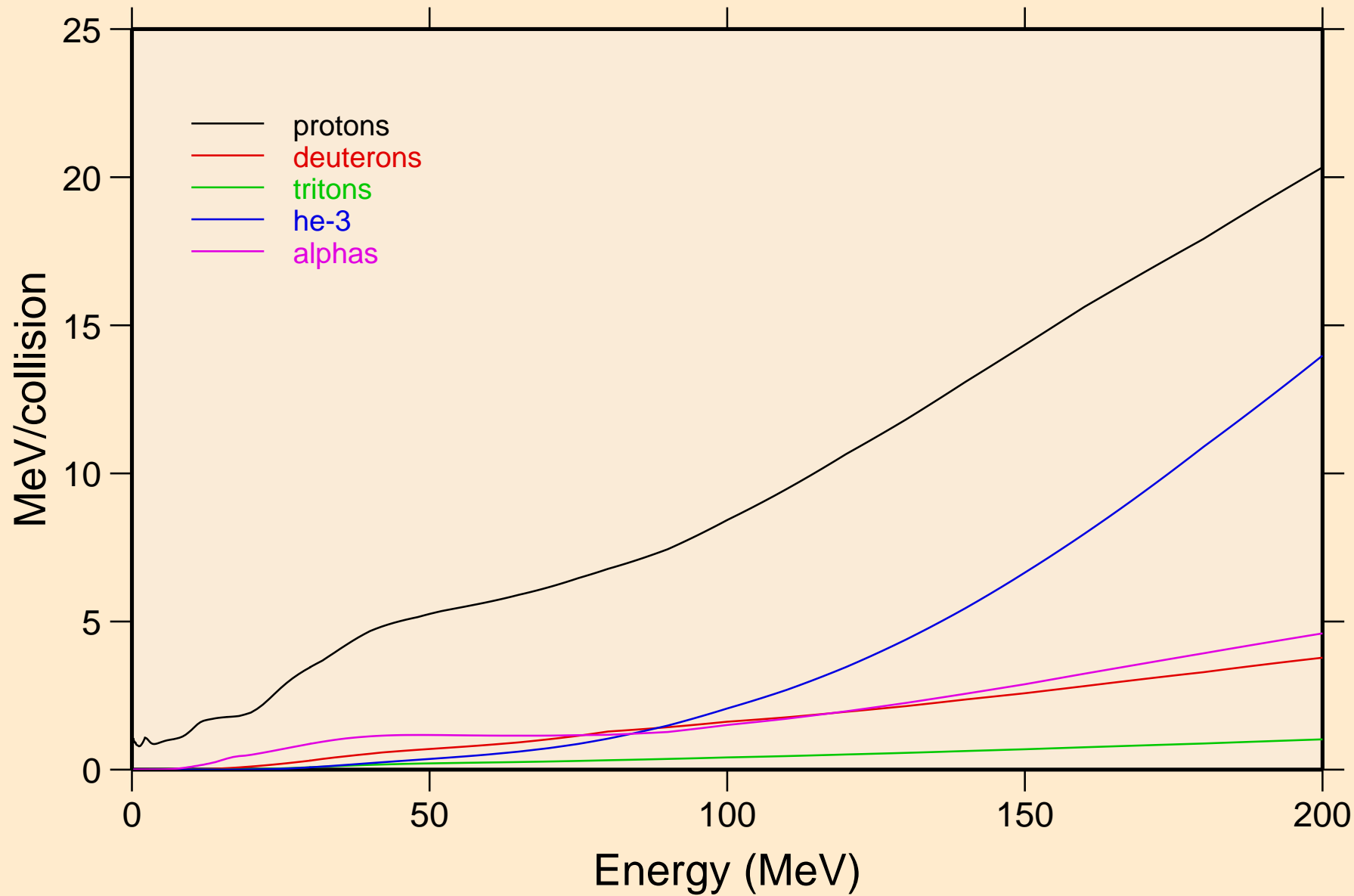

TB146 NEUTRON ACER TENDL-2023 LIBRARY; T=0.K  
Recoil Heating

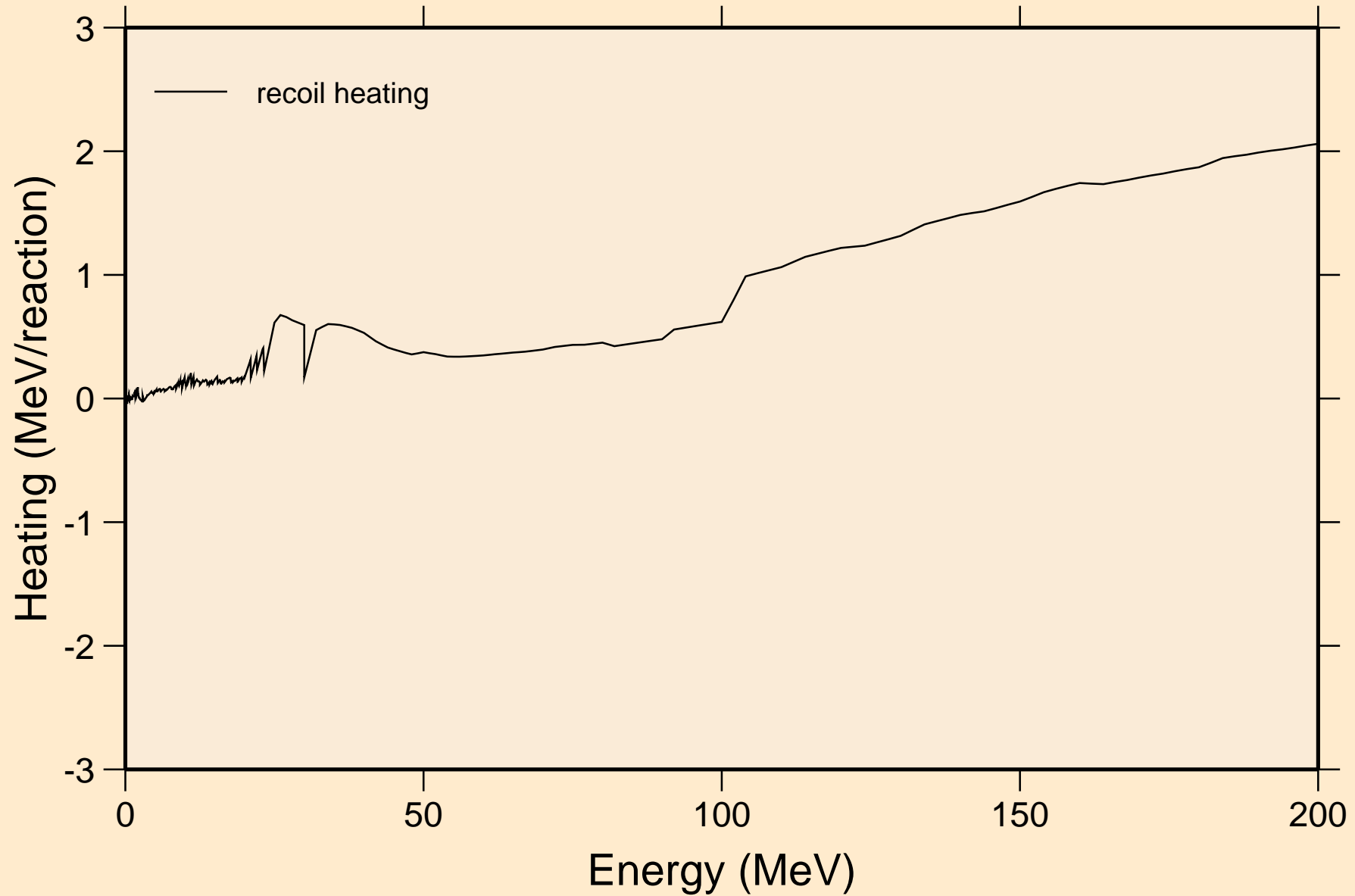

TB146 NEUTRON ACER TENDL-2023 LIBRARY; T=0.K  
Particle production cross sections

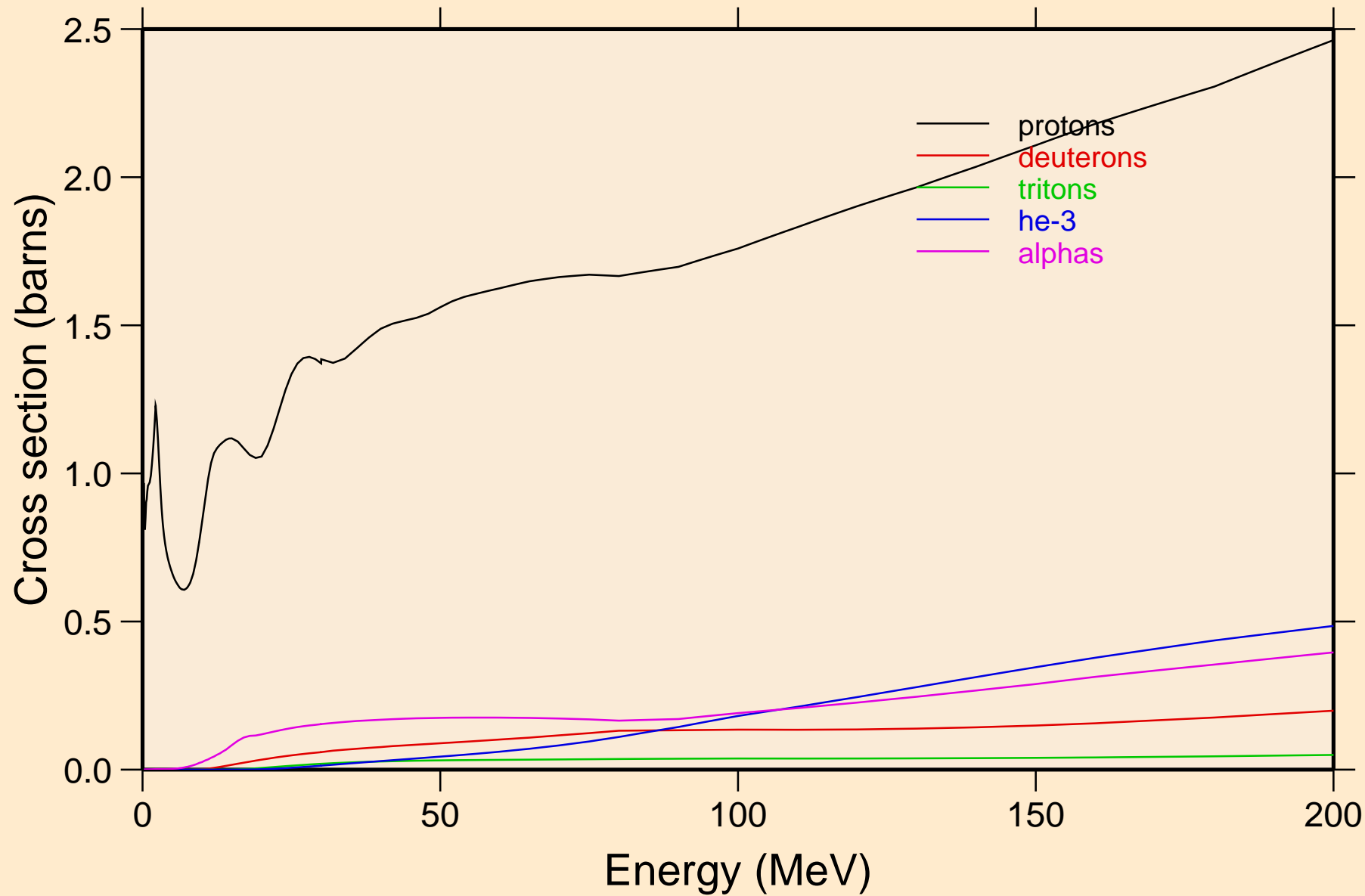

TB146 NEUTRON ACER TENDL-2023 LIBRARY; T=0.K  
protons from (n,x)

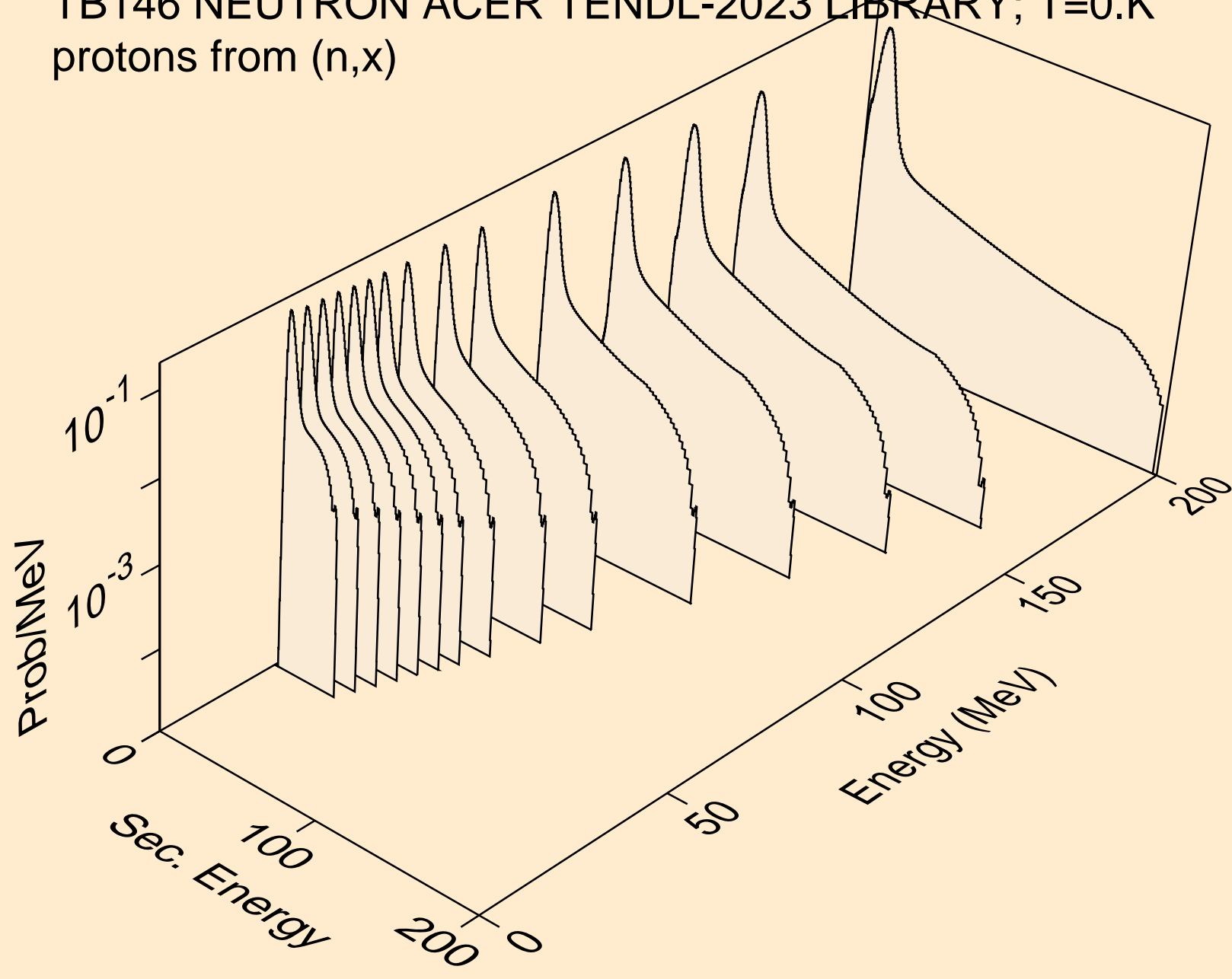

TB146 NEUTRON ACER TENDL-2023 LIBRARY; T=0.K  
protons from (n,n\*)p

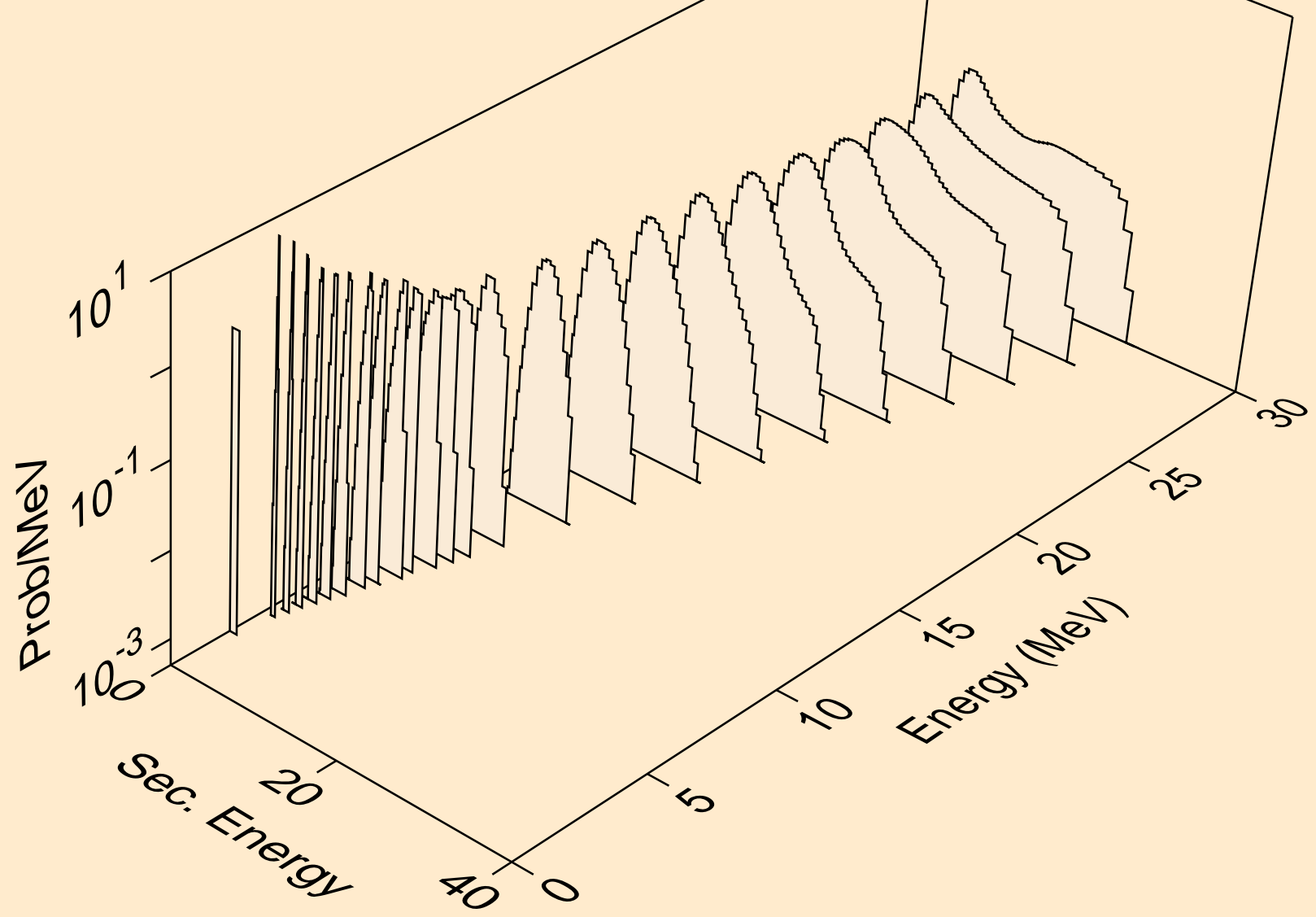

TB146 NEUTRON ACER TENDL-2023 LIBRARY; T=0.K  
protons from (n,2np)

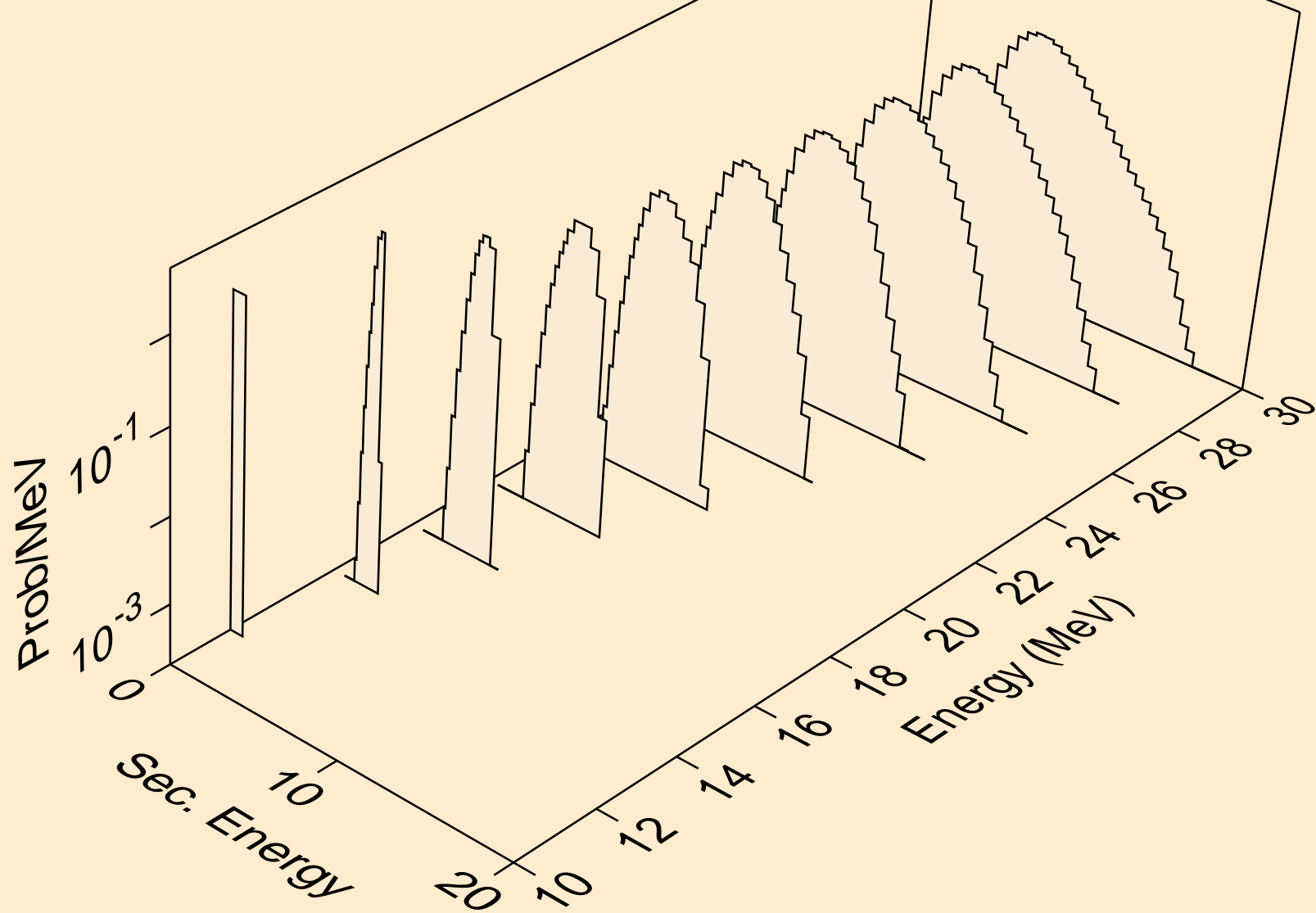

TB146 NEUTRON ACER TENDL-2023 LIBRARY; T=0.K  
protons from (n,3np)

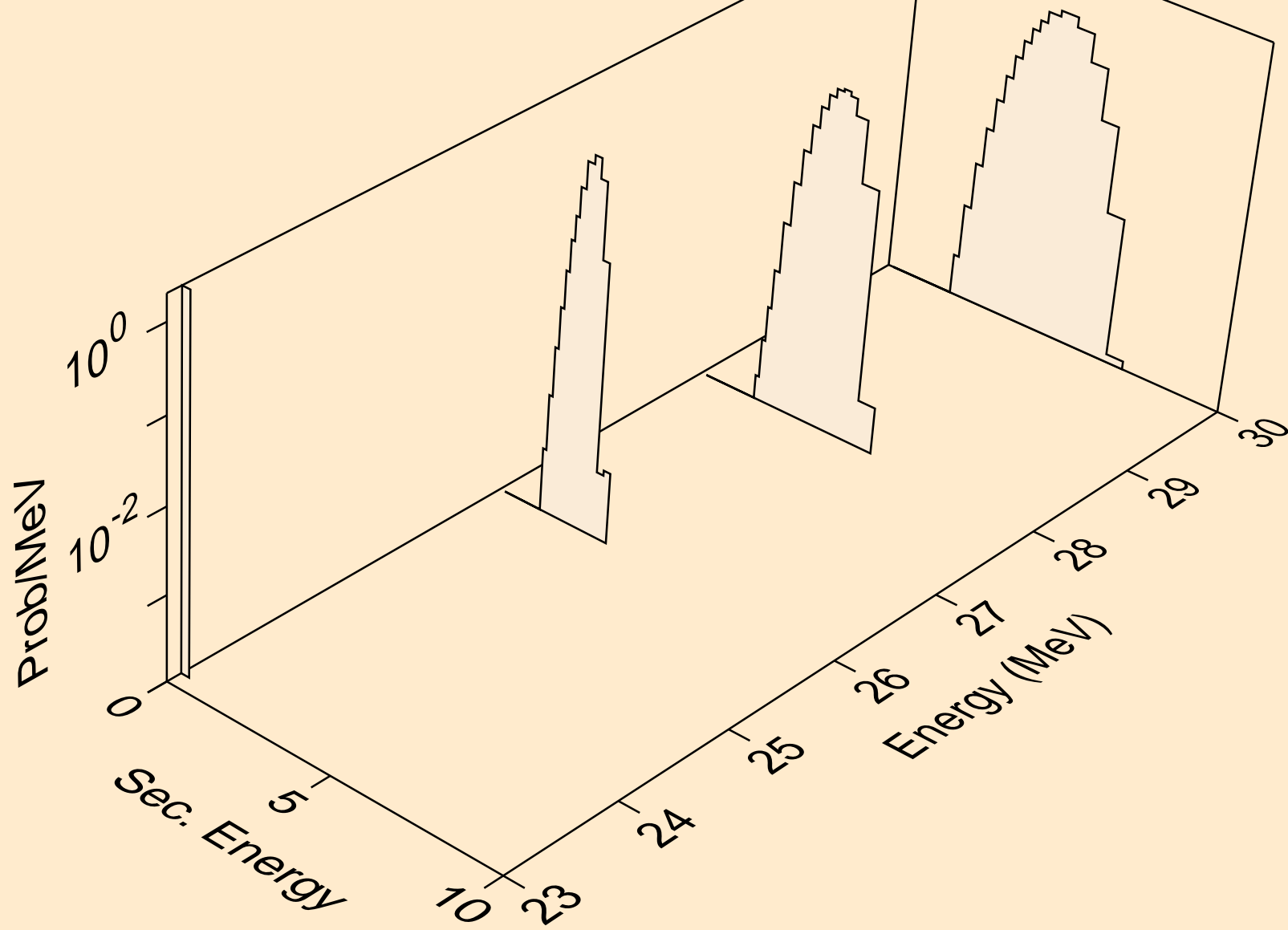

TB146 NEUTRON ACER TENDL-2023 LIBRARY; T=0.K  
protons from (n,n2p)

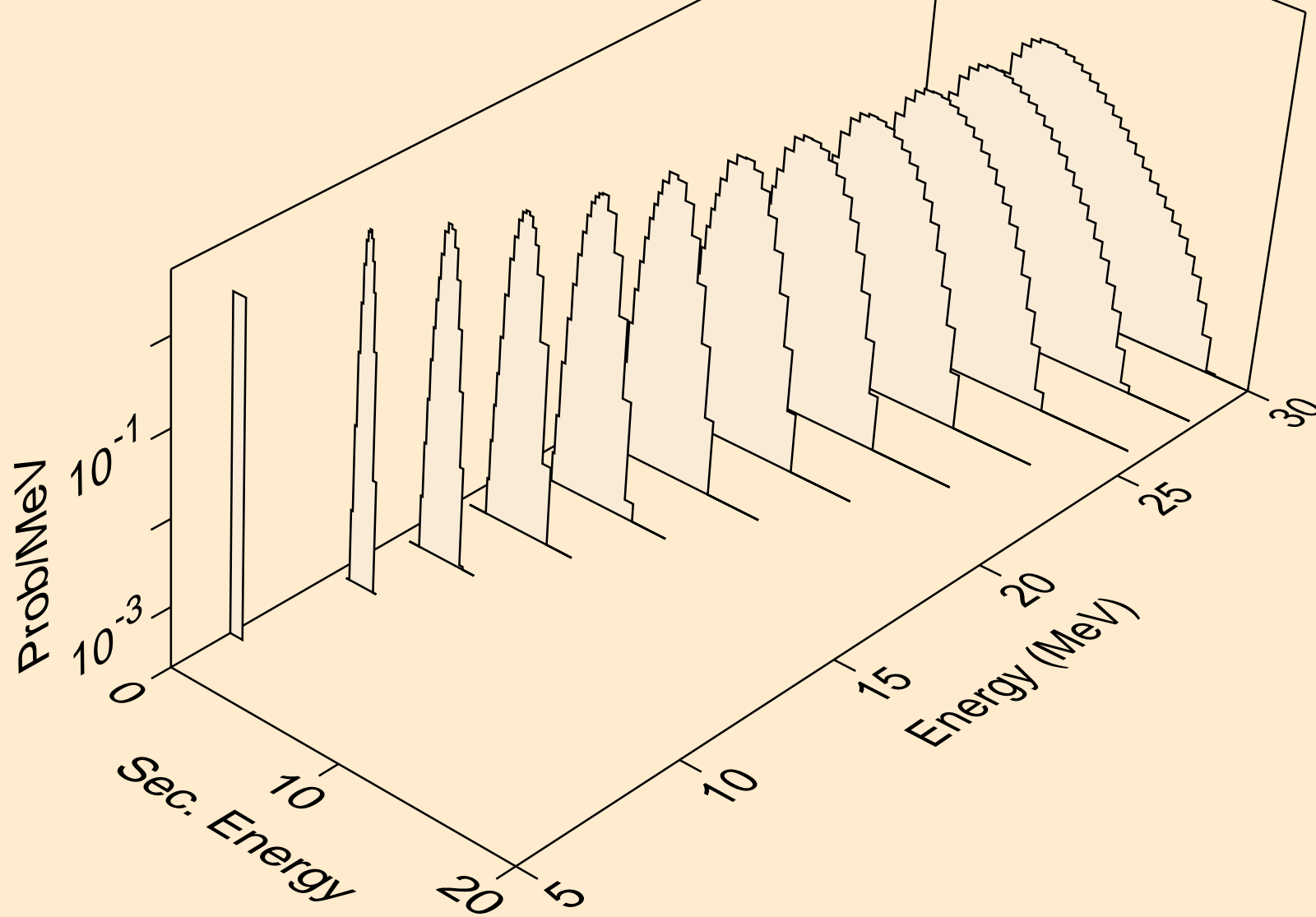

TB146 NEUTRON ACER TENDL-2023 LIBRARY; T=0.K  
protons from (n,npa)

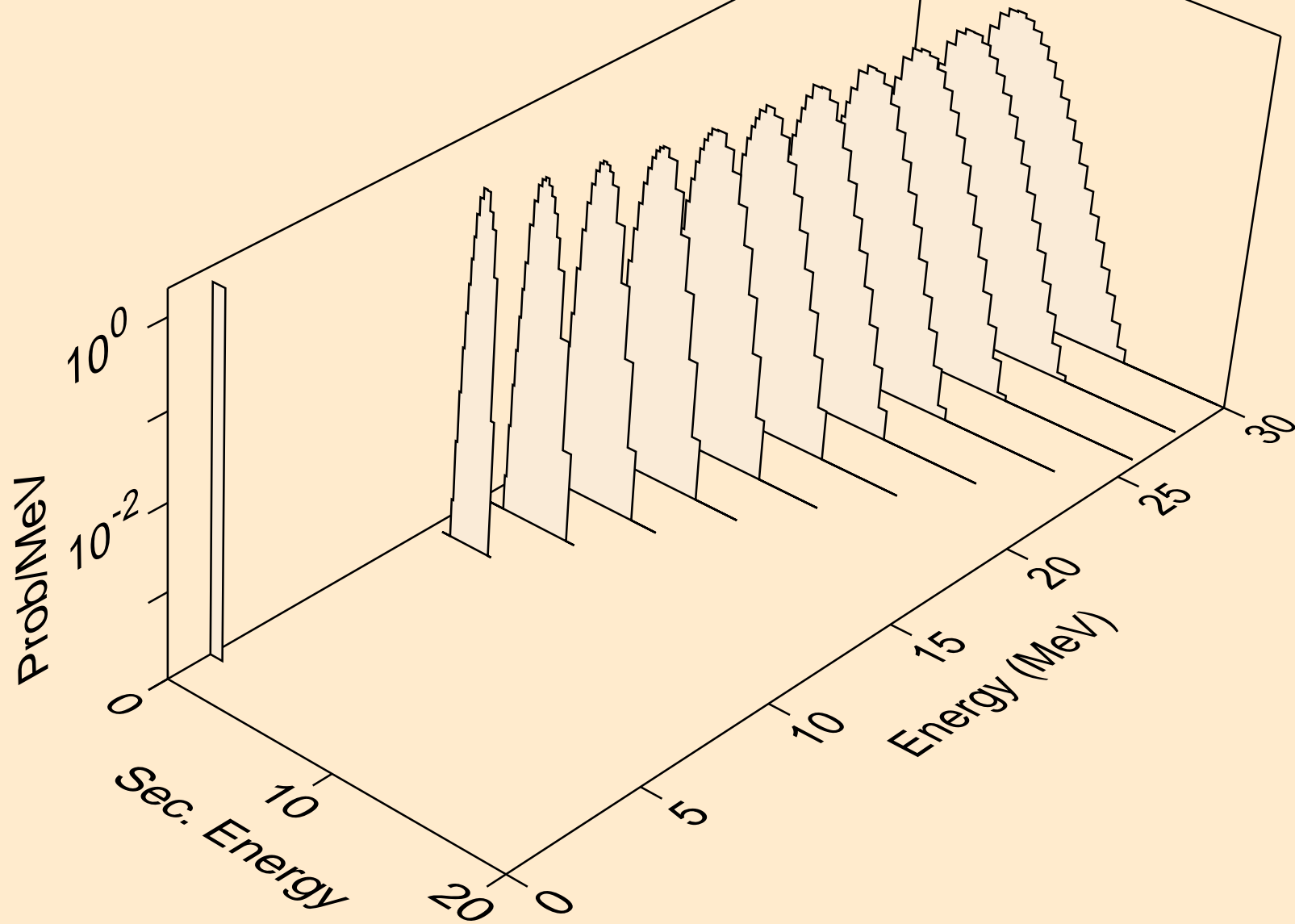

TB146 NEUTRON ACER TENDL-2023 LIBRARY; T=0.K  
protons from (n,p)

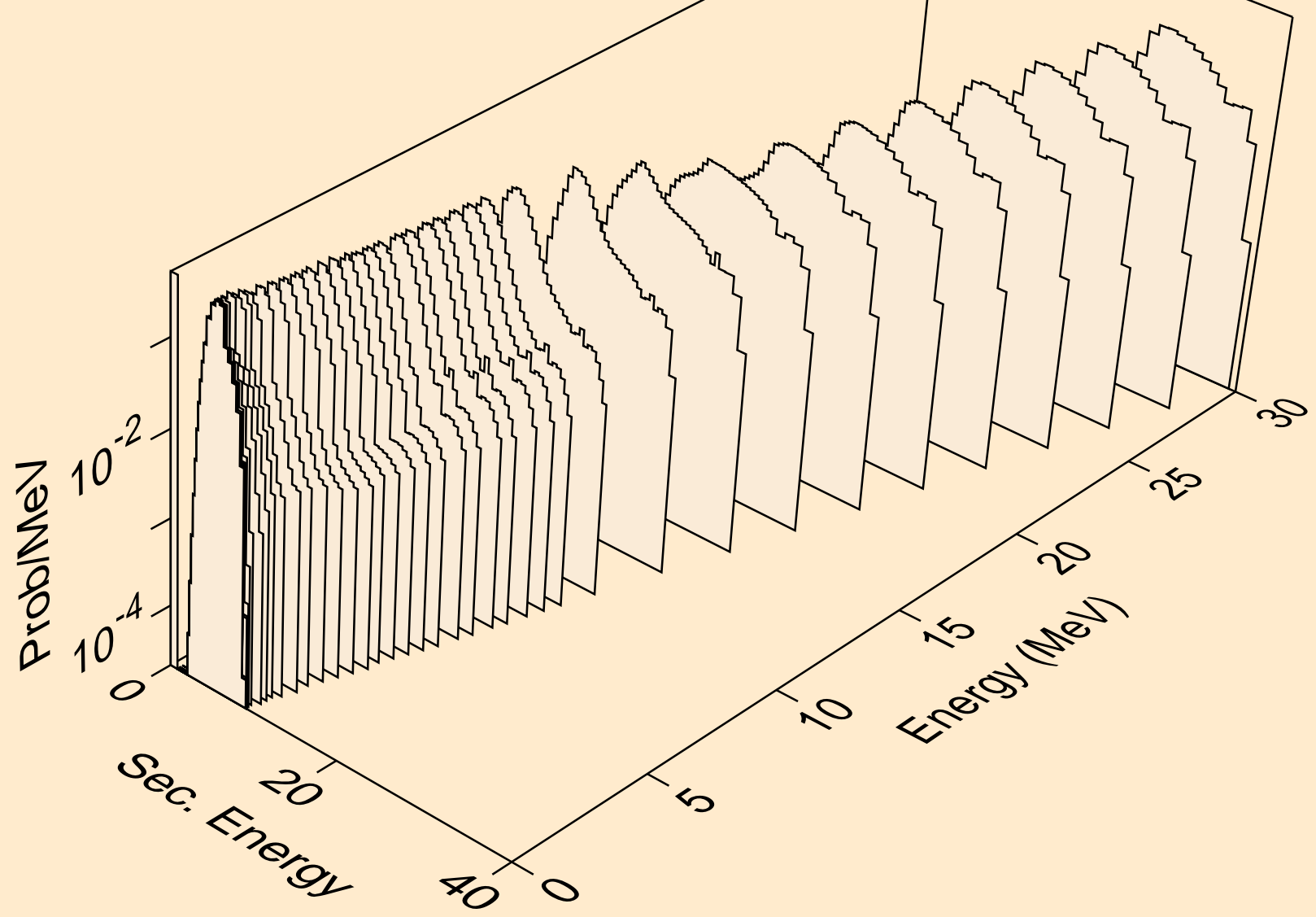

TB146 NEUTRON ACER TENDL-2023 LIBRARY; T=0.K  
protons from (n,2p)

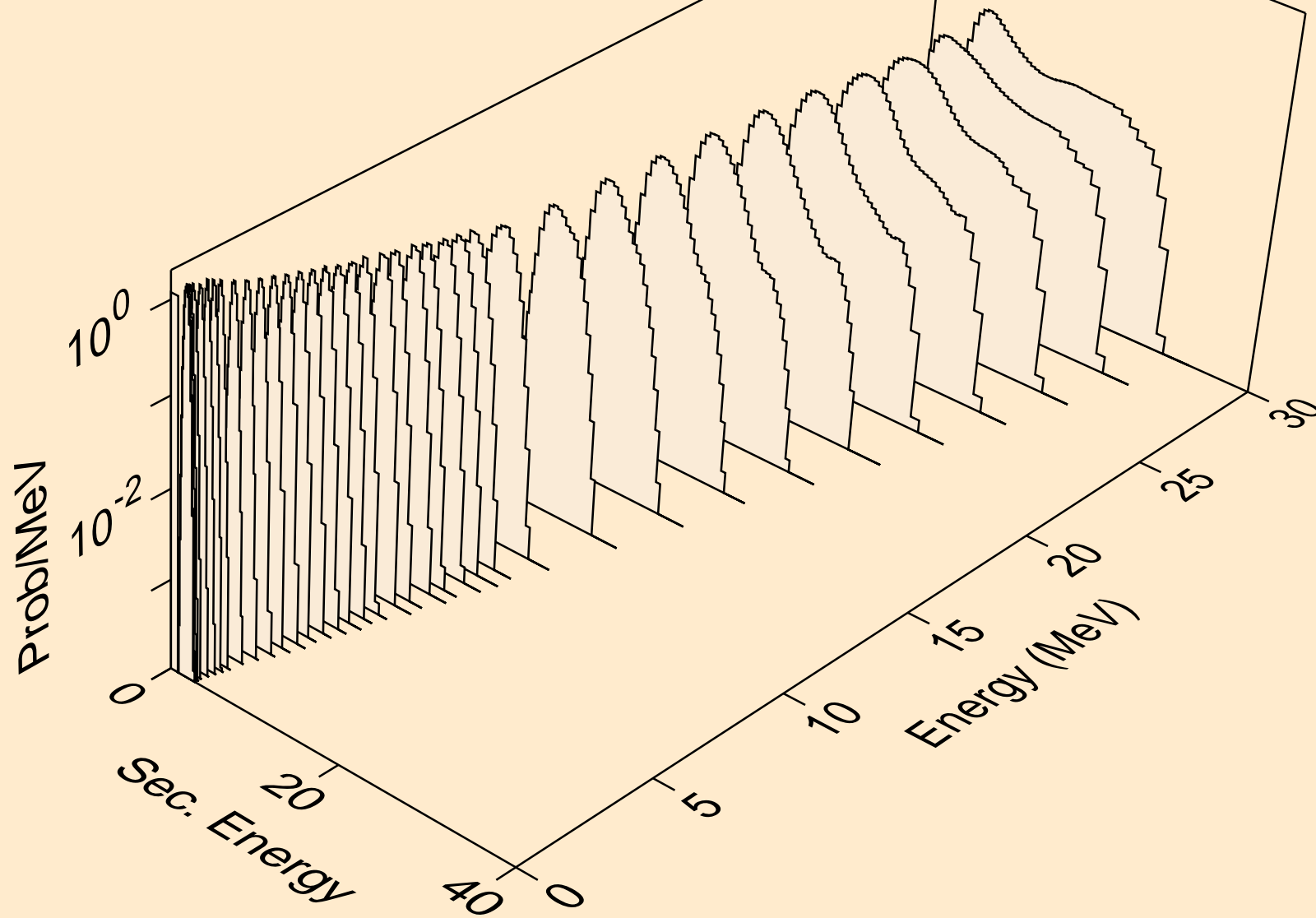

TB146 NEUTRON ACER TENDL-2023 LIBRARY; T=0.K  
protons from (n,p)

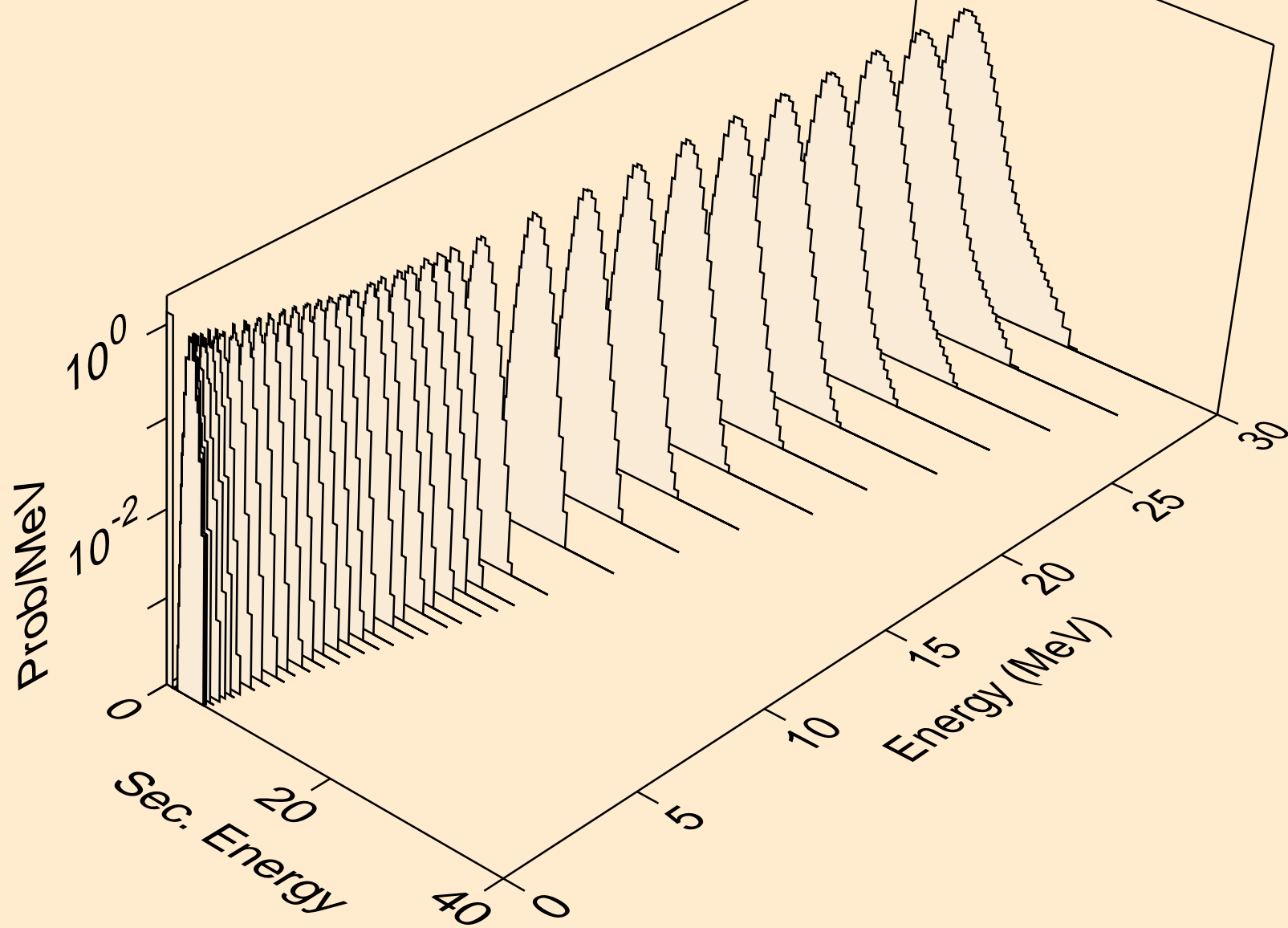

TB146 NEUTRON ACER TENDL-2023 LIBRARY; T=0.K  
protons from (n,pd)

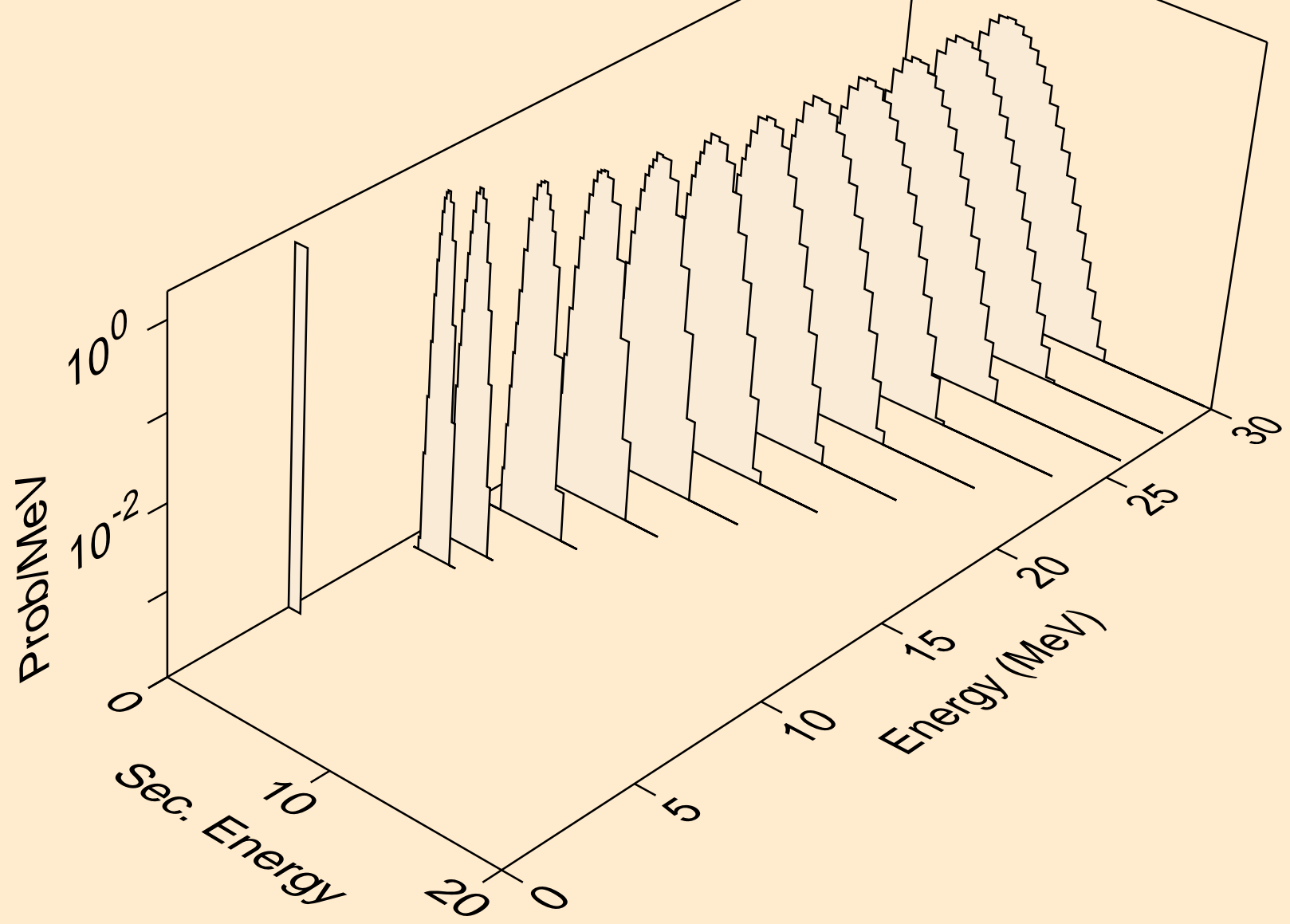

TB146 NEUTRON ACER TENDL-2023 LIBRARY; T=0.K  
protons from (n,pt)

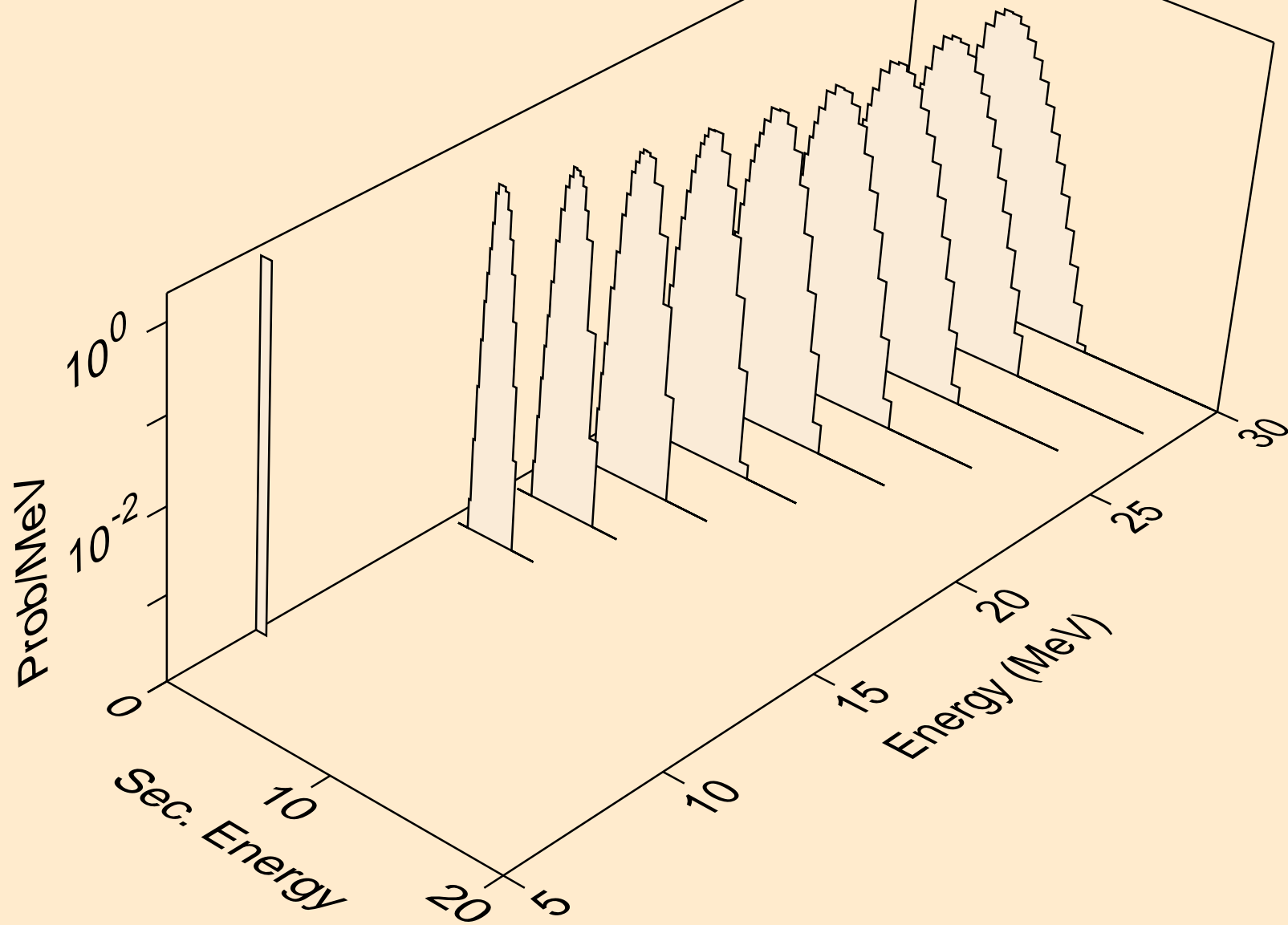

TB146 NEUTRON ACER TENDL-2023 LIBRARY; T=0.K  
deuterons from (n,x)

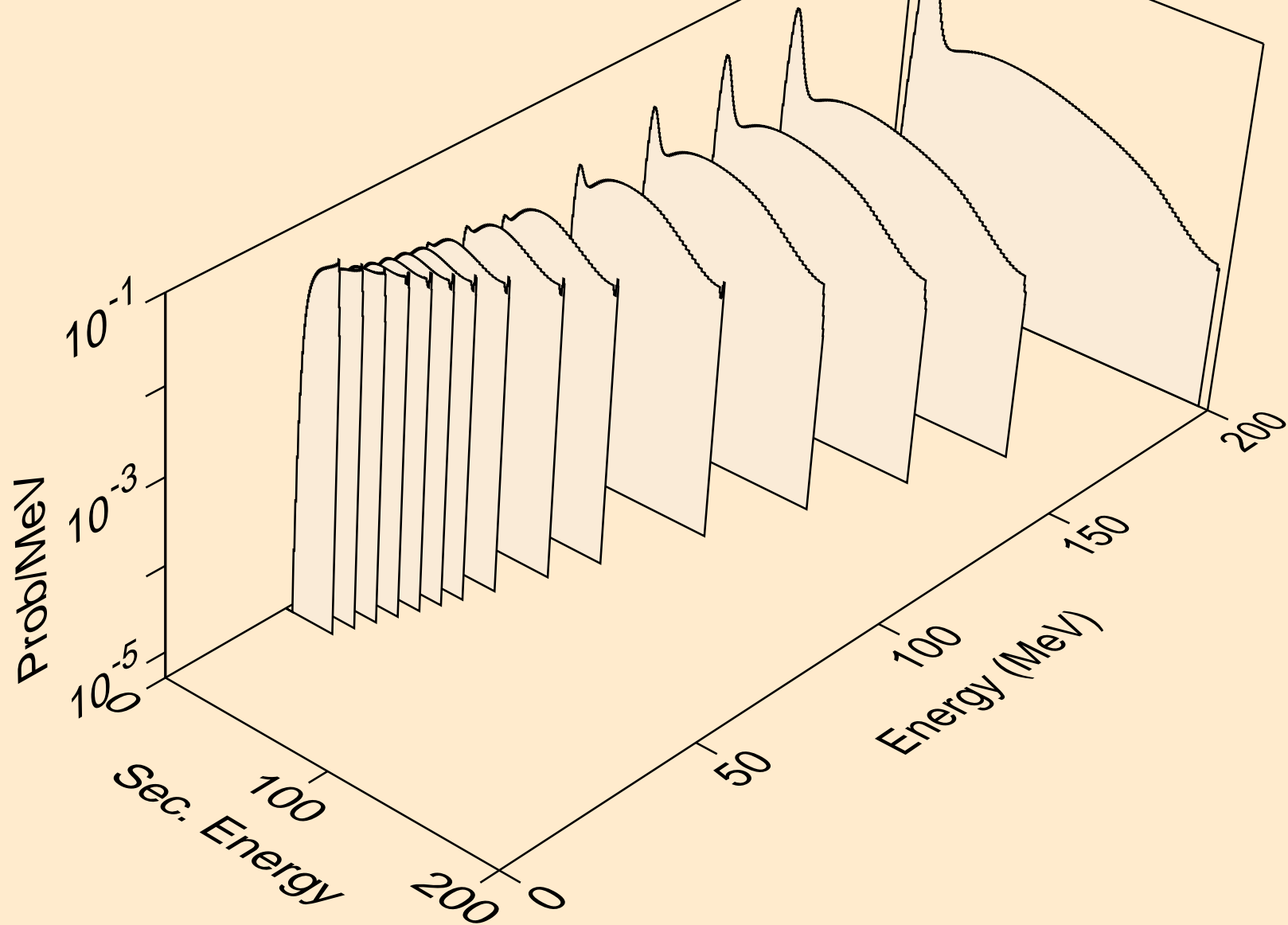

TB146 NEUTRON ACER TENDL-2023 LIBRARY; T=0.K  
deuterons from (n,2nd)

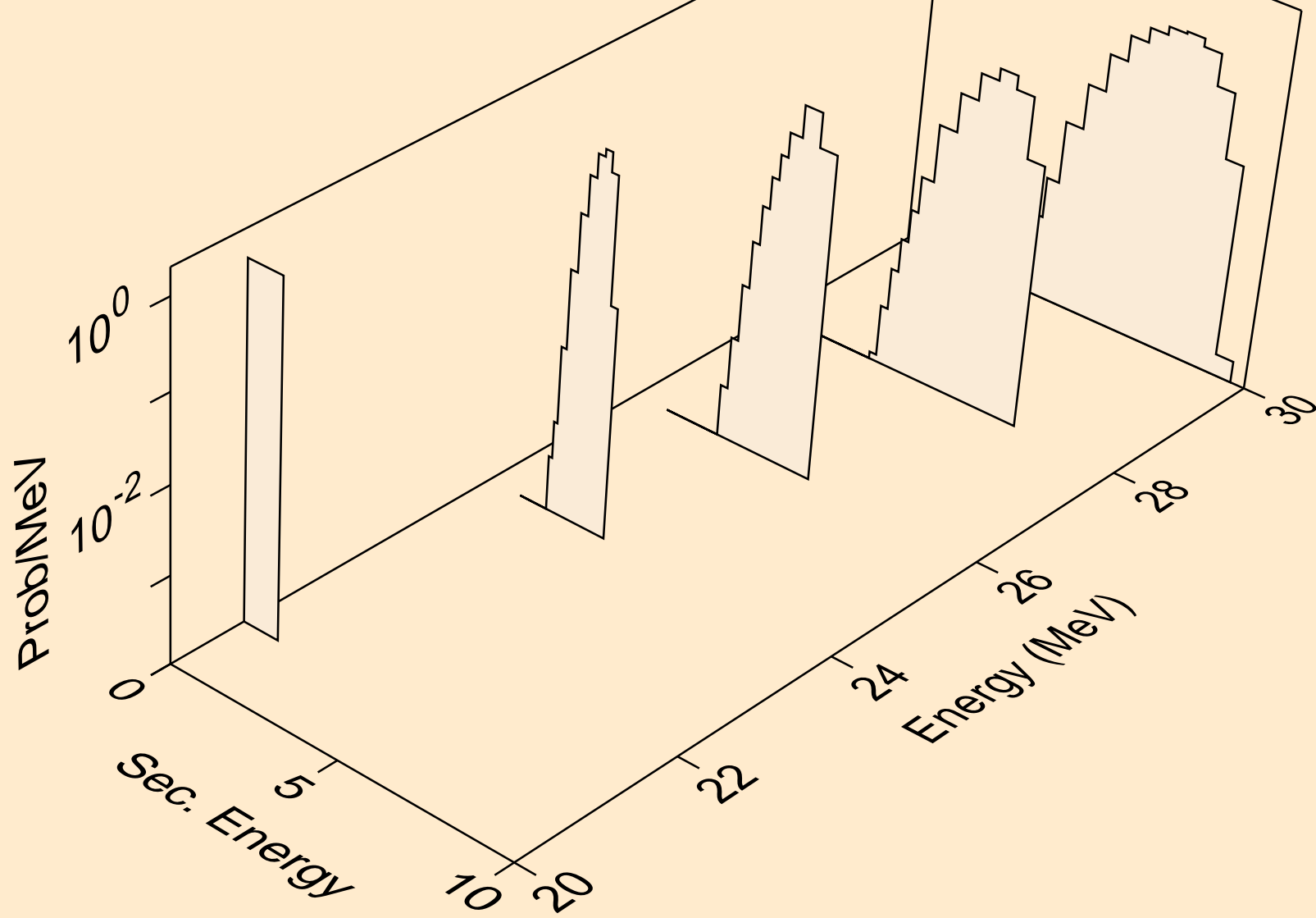

TB146 NEUTRON ACER TENDL-2023 LIBRARY; T=0.K  
deuterons from (n,n\*)d

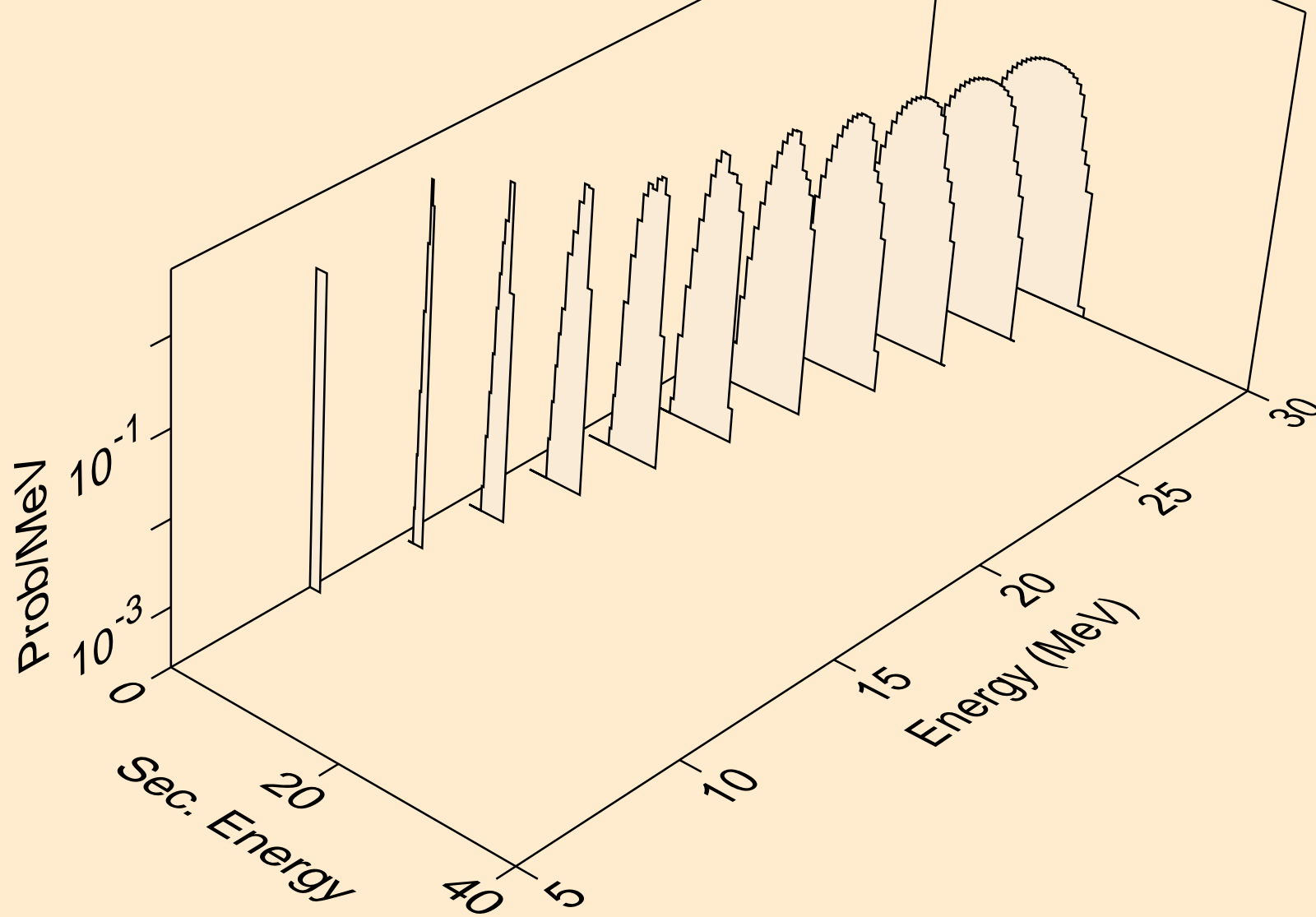

TB146 NEUTRON ACER TENDL-2023 LIBRARY; T=0.K  
deuterons from (n,d)

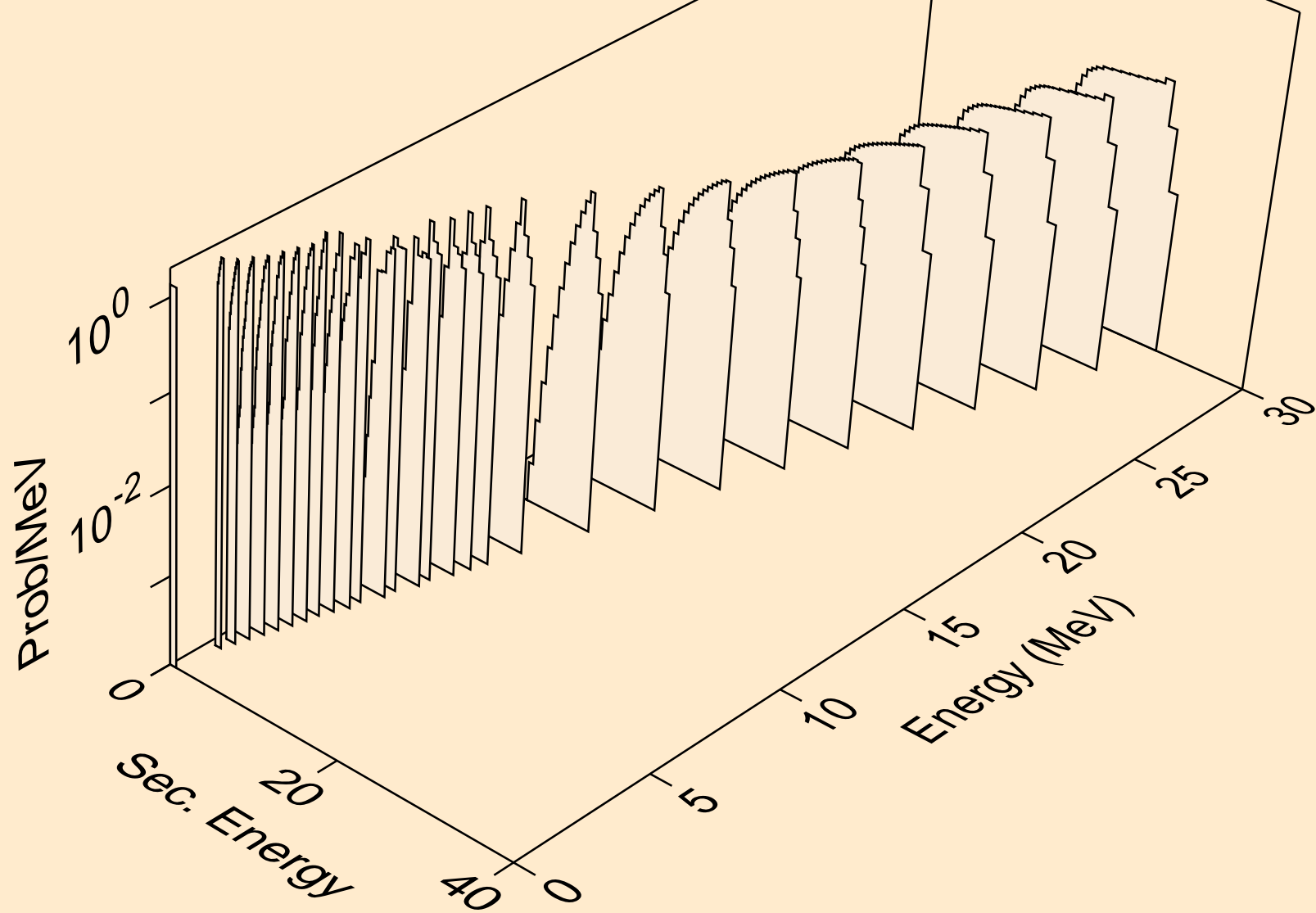

TB146 NEUTRON ACER TENDL-2023 LIBRARY; T=0.K  
deuterons from (n,pd)

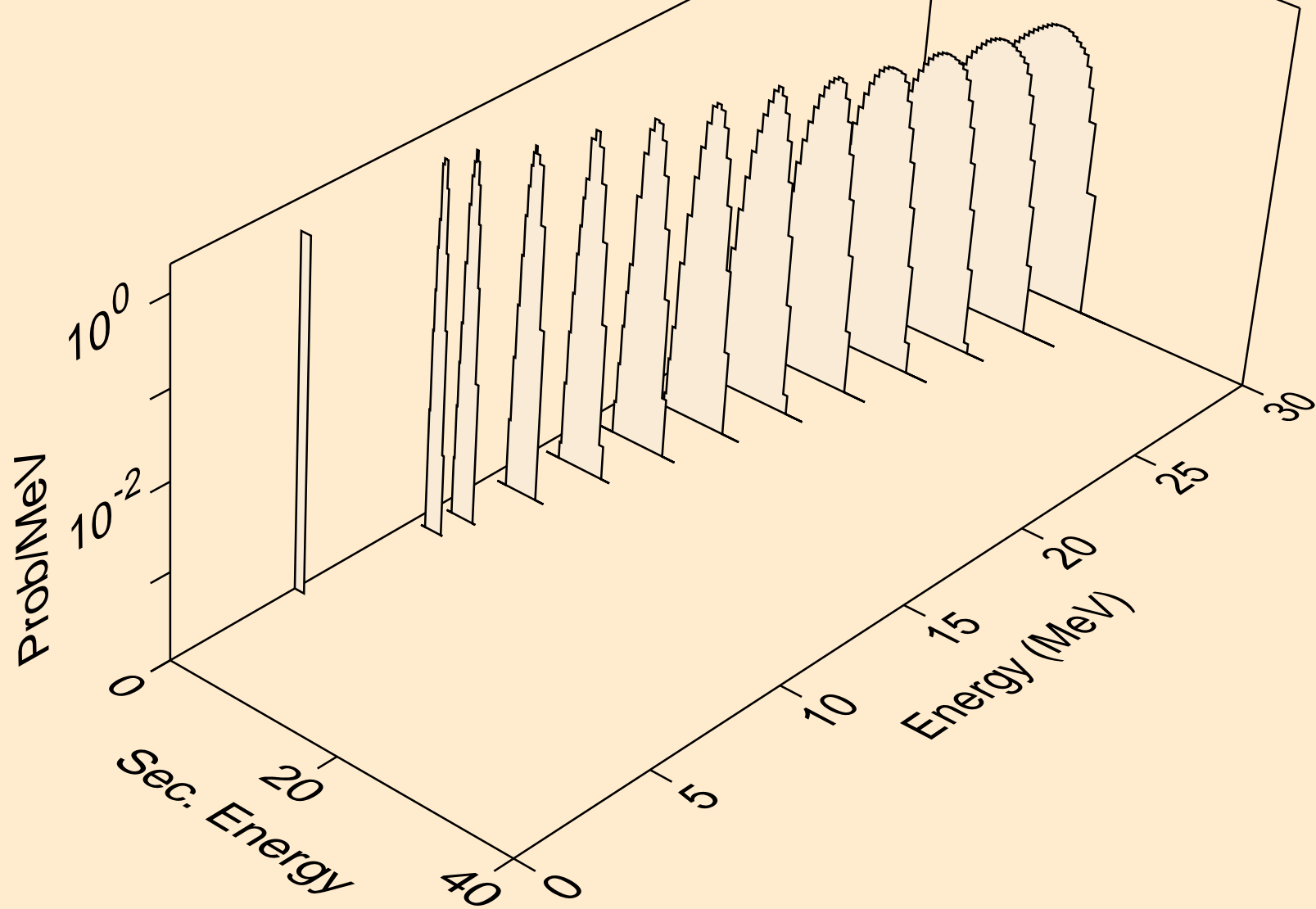

TB146 NEUTRON ACER TENDL-2023 LIBRARY; T=0.K  
deuterons from (n,da)

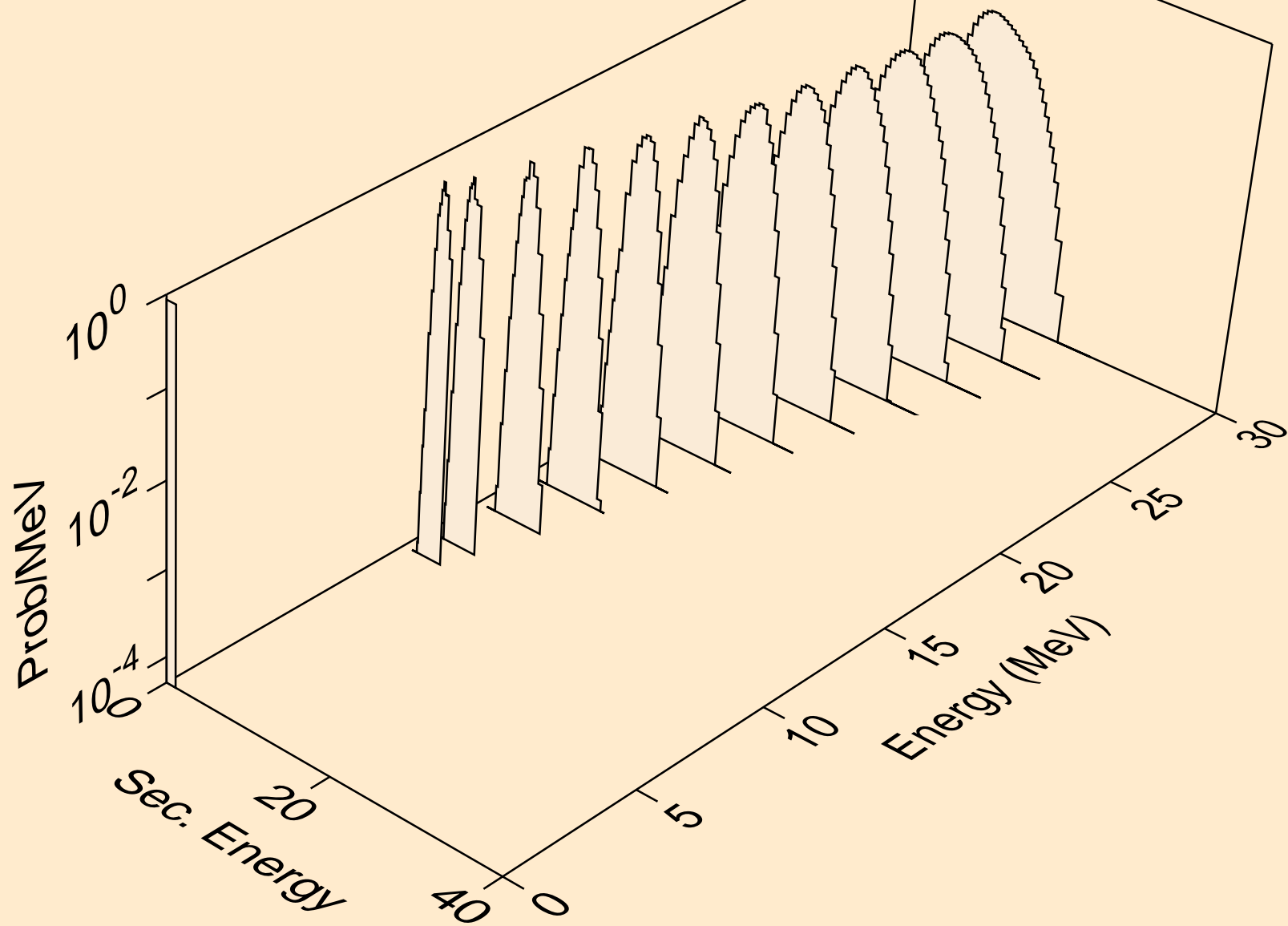

TB146 NEUTRON ACER TENDL-2023 LIBRARY; T=0.K  
tritons from (n,x)

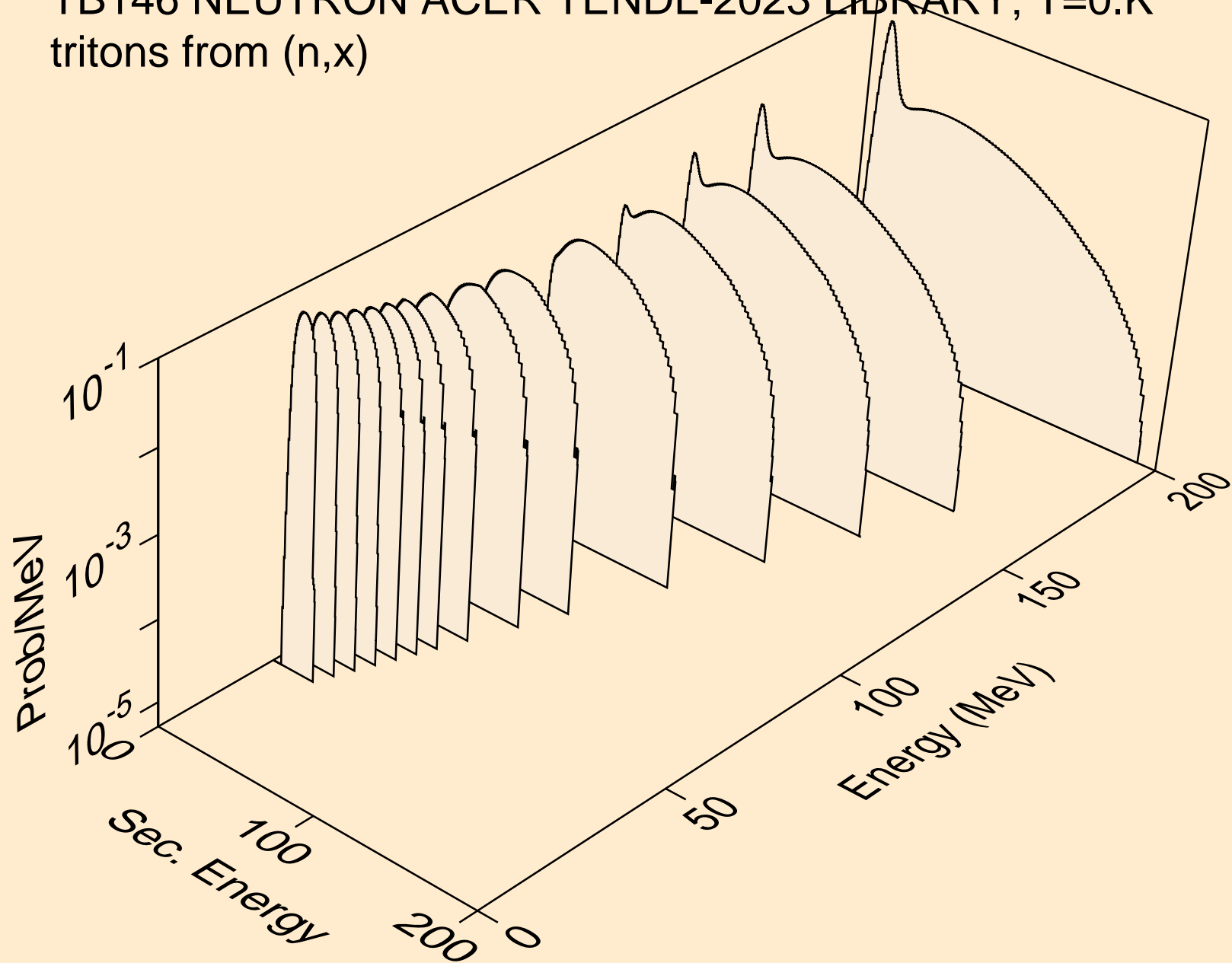

TB146 NEUTRON ACER TENDL-2023 LIBRARY; T=0.K  
tritons from (n,n\*)t

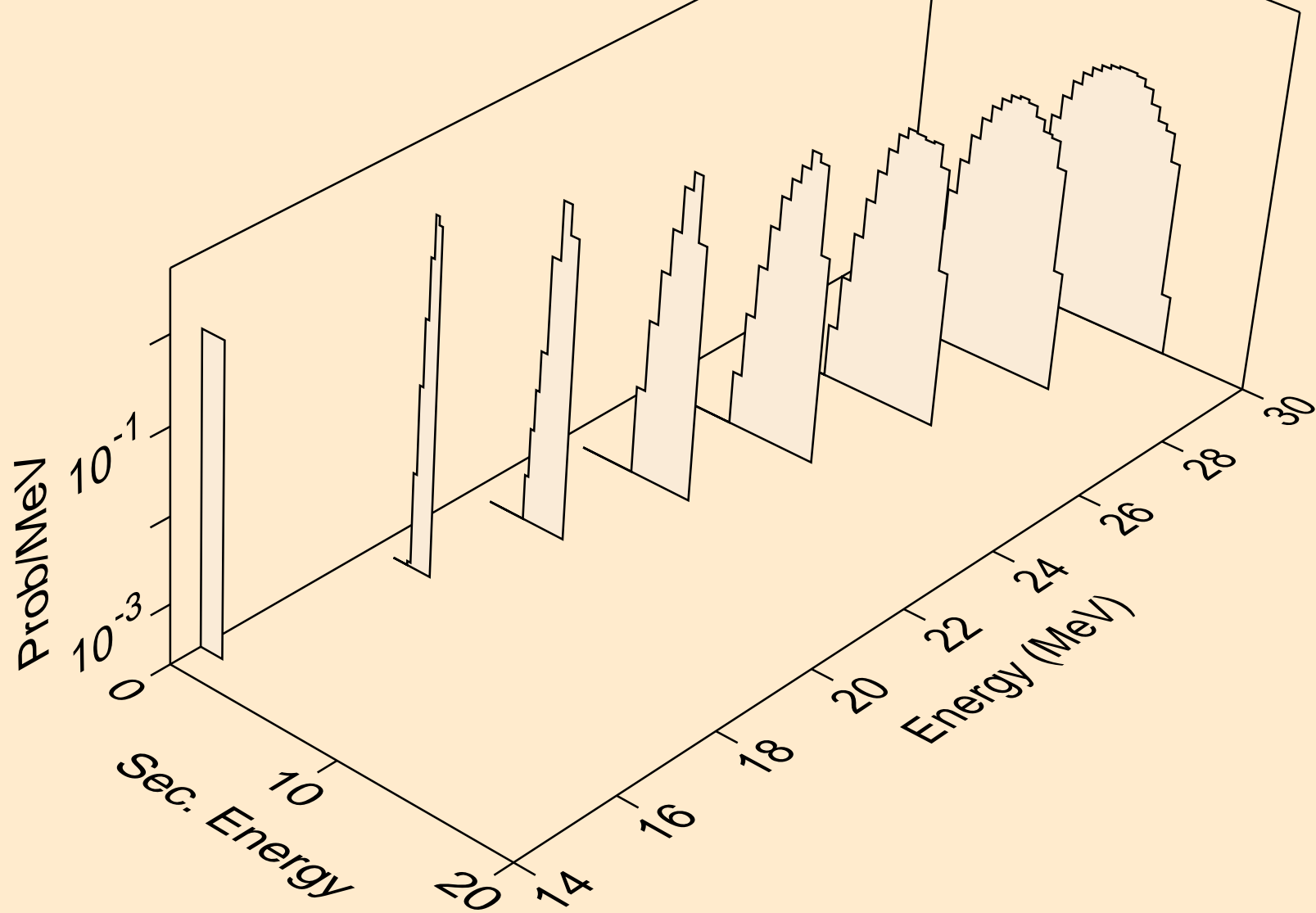

TB146 NEUTRON ACER TENDL-2023 LIBRARY; T=0.K  
tritons from (n,t)

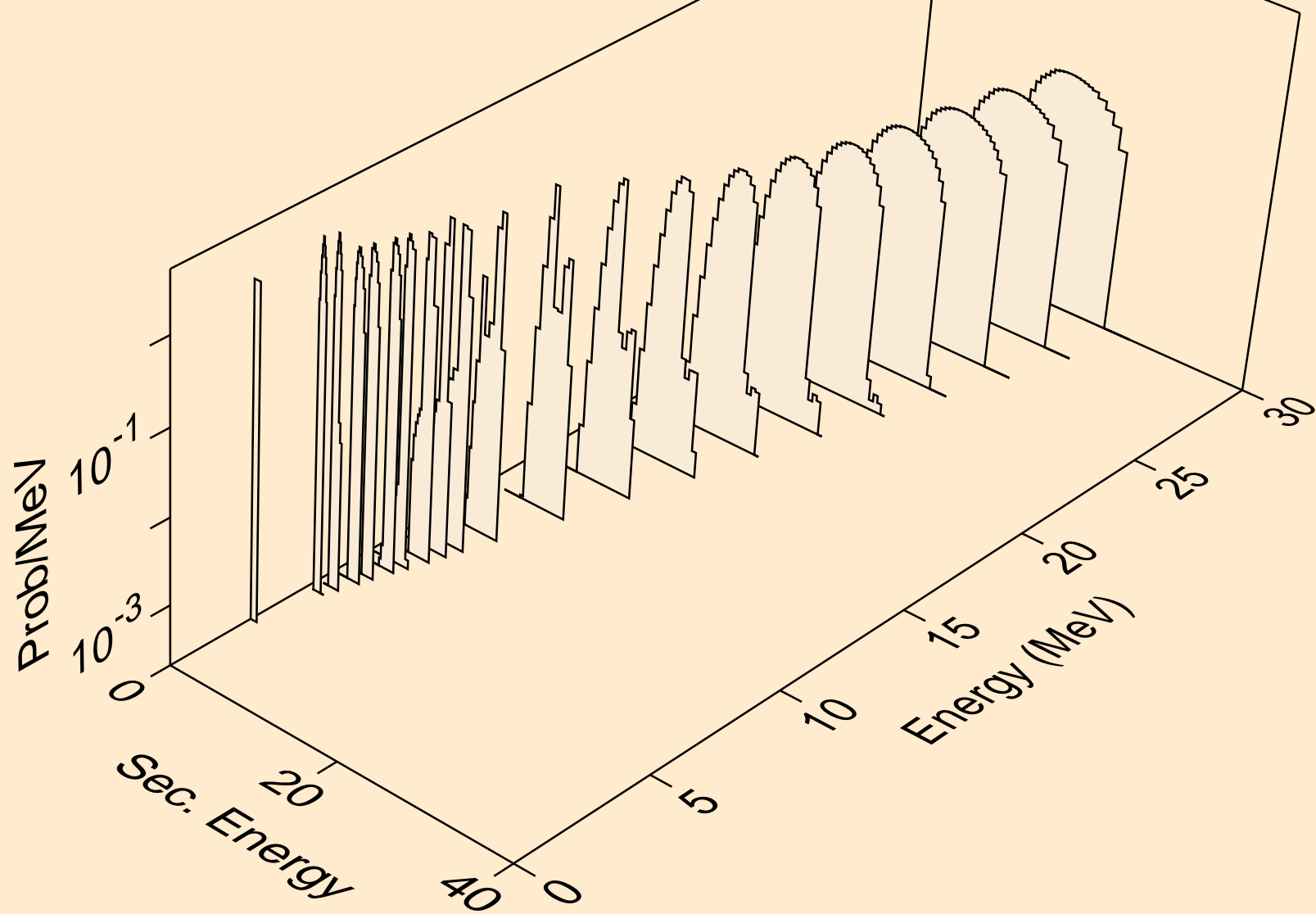

TB146 NEUTRON ACER TENDL-2023 LIBRARY; T=0.K  
tritons from (n,pt)

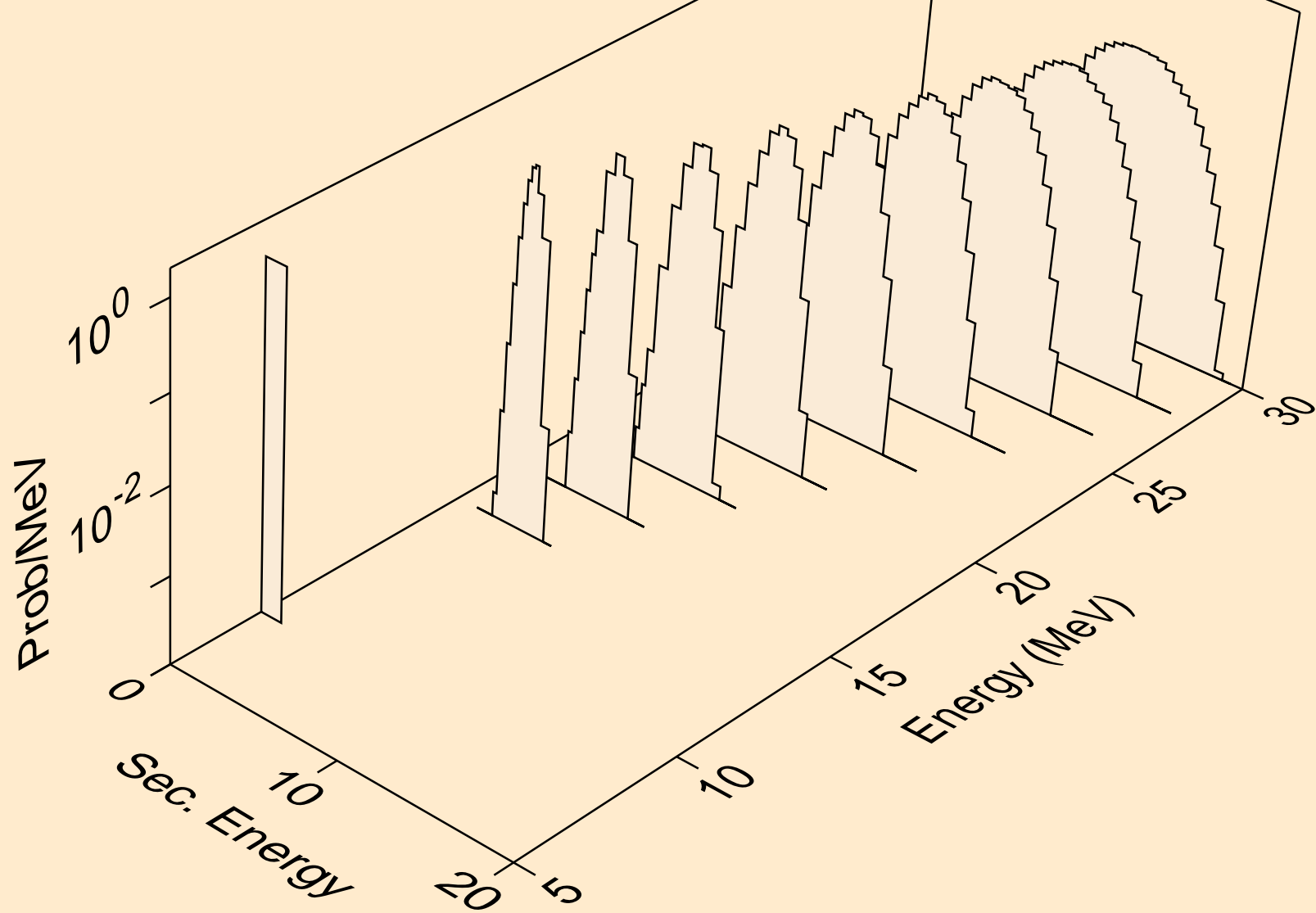

TB146 NEUTRON ACER TENDL-2023 LIBRARY; T=0.K  
he3s from (n,x)

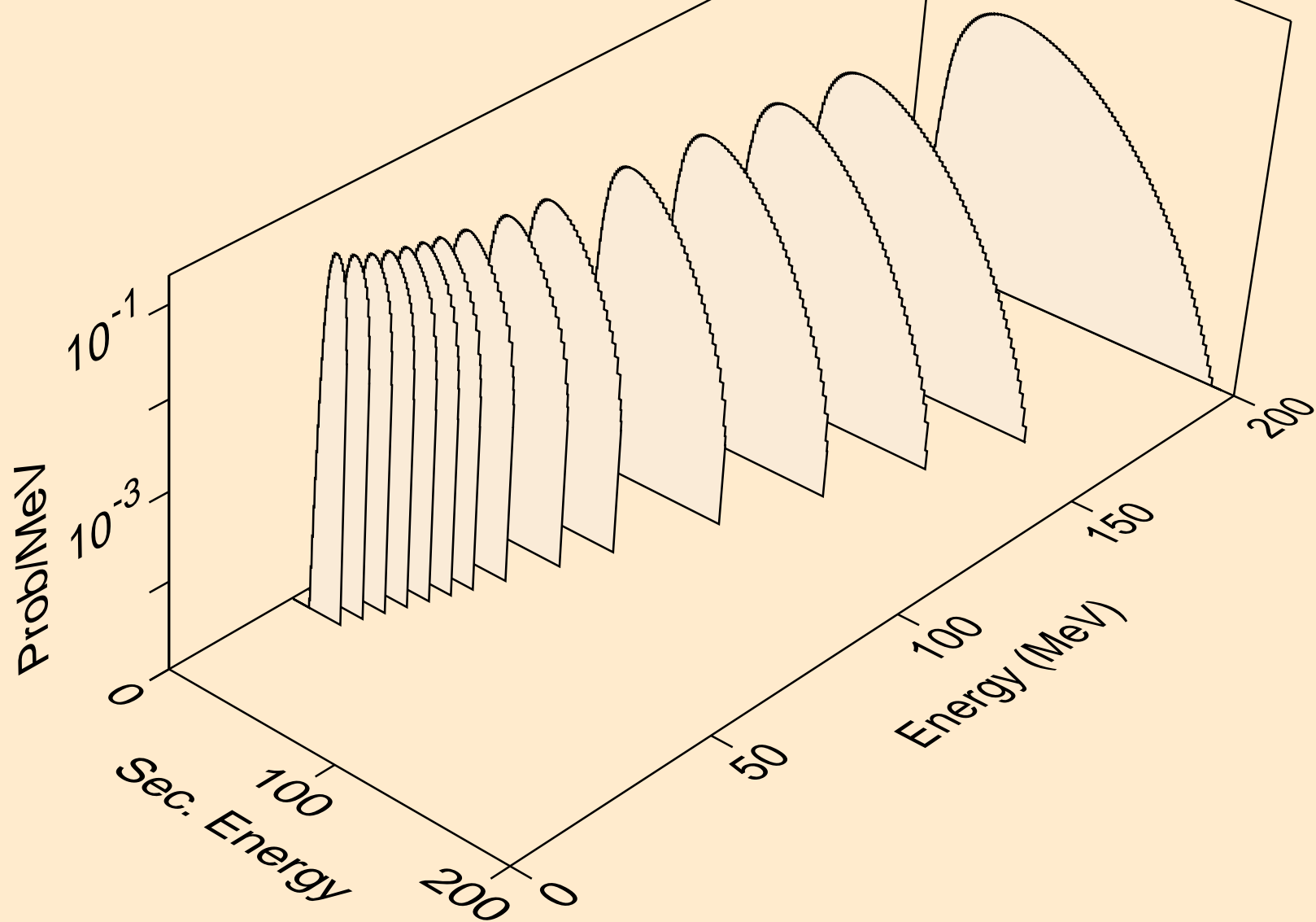

TB146 NEUTRON ACER TENDL-2023 LIBRARY; T=0.K  
he3s from (n,n\*)he3

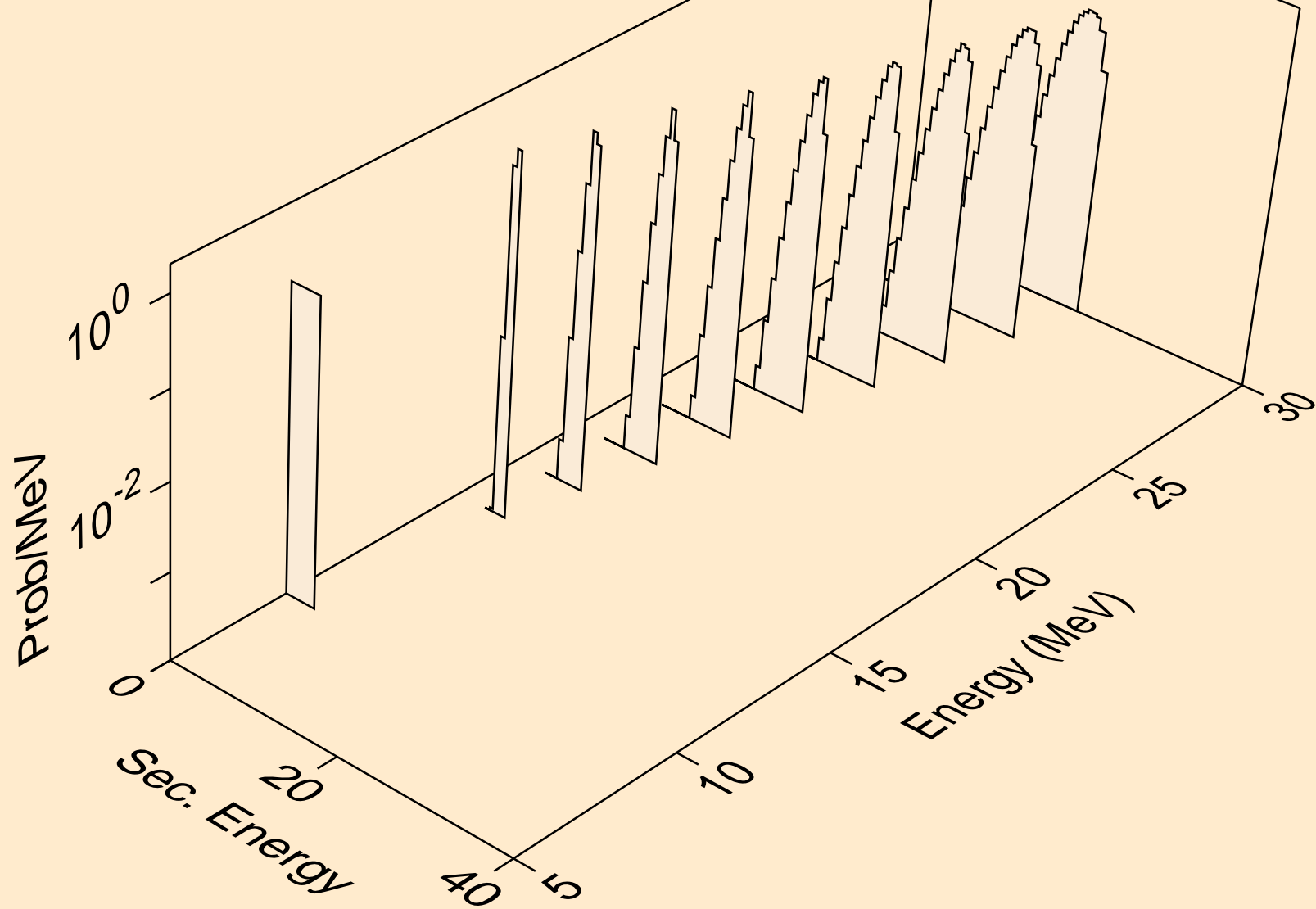

TB146 NEUTRON ACER TENDL-2023 LIBRARY; T=0.K  
he3s from (n,he3)

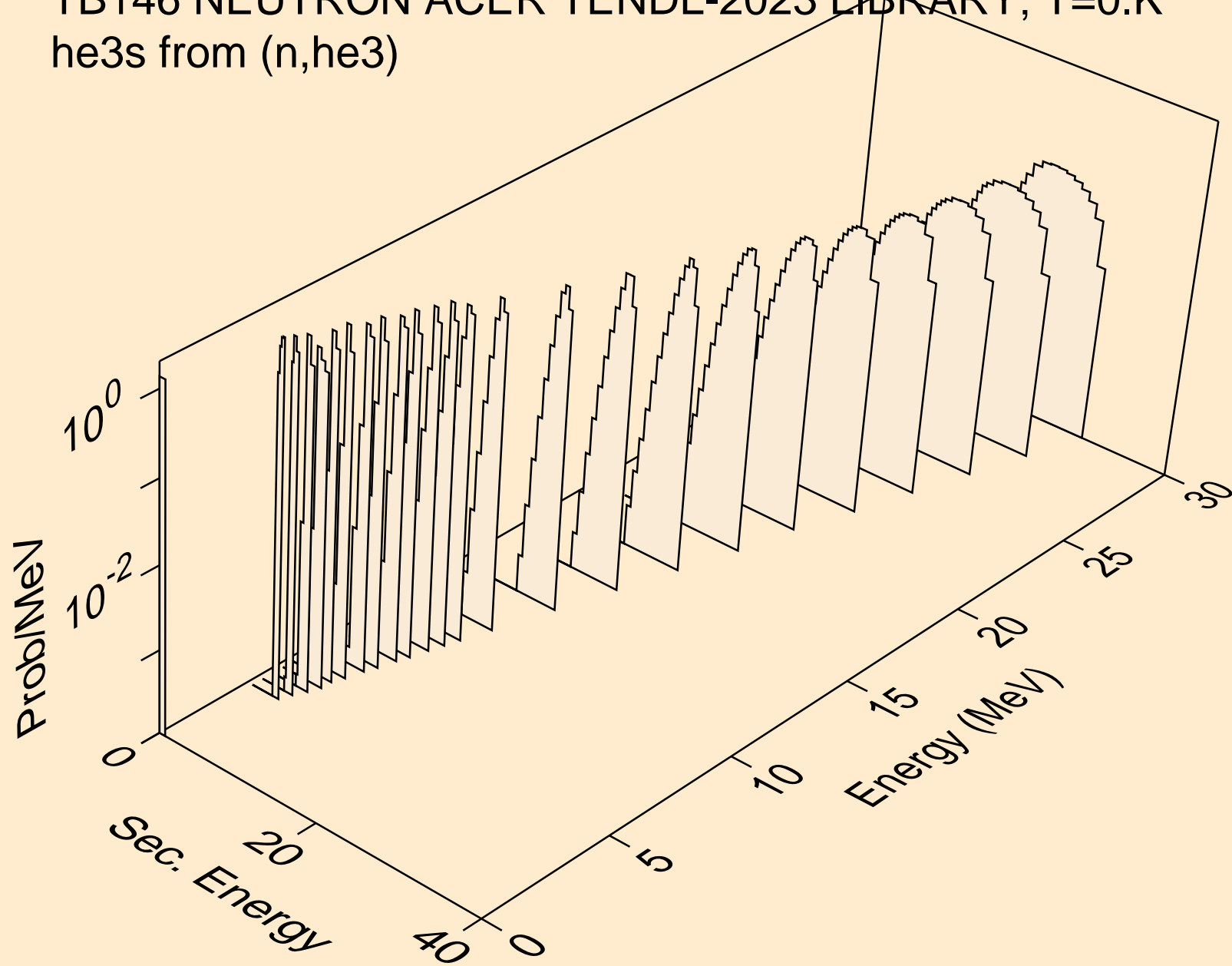

TB146 NEUTRON ACER TENDL-2023 LIBRARY; T=0.K  
alphas from (n,x)

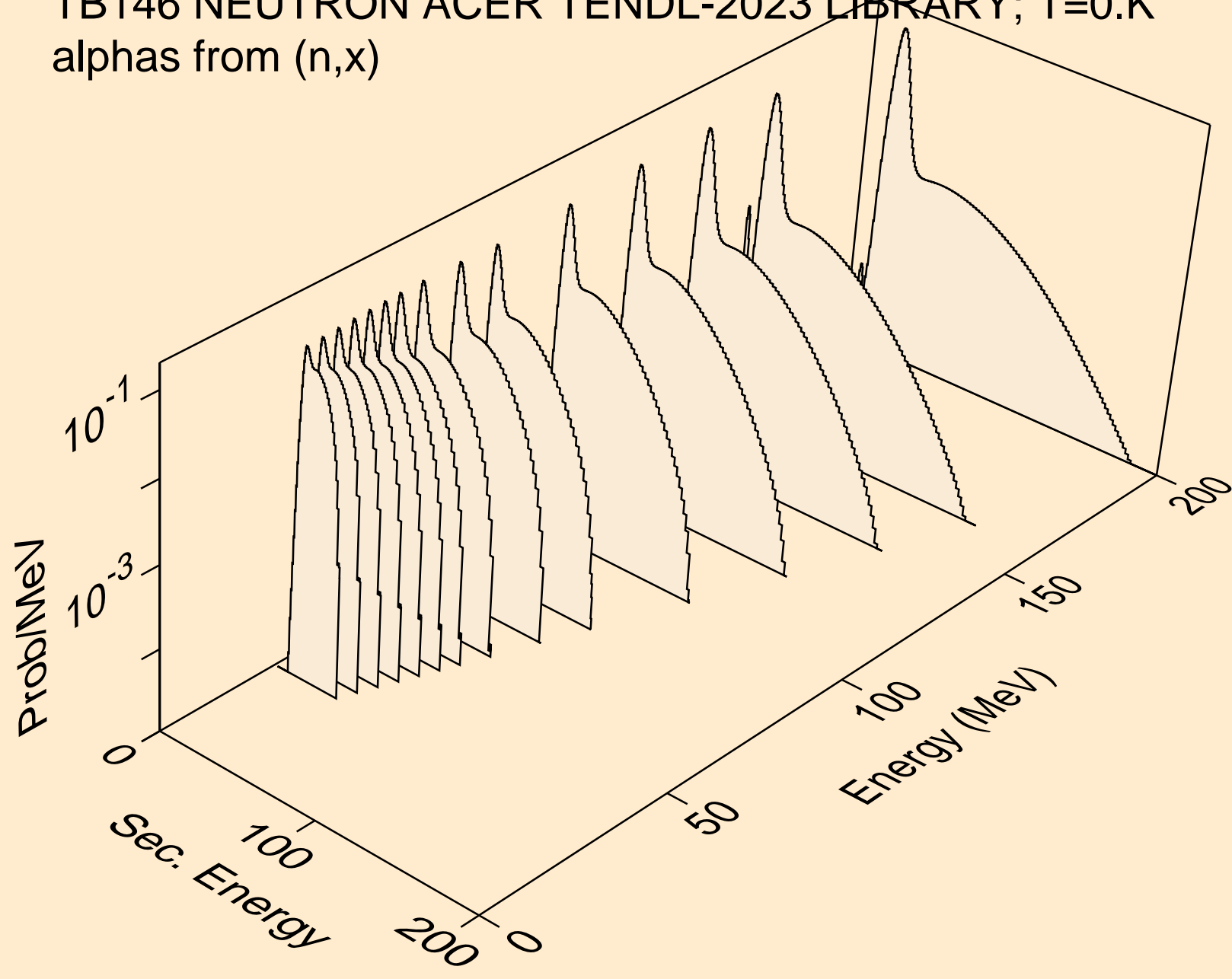

TB146 NEUTRON ACER TENDL-2023 LIBRARY; T=0.K  
alphas from (n,n\*)a

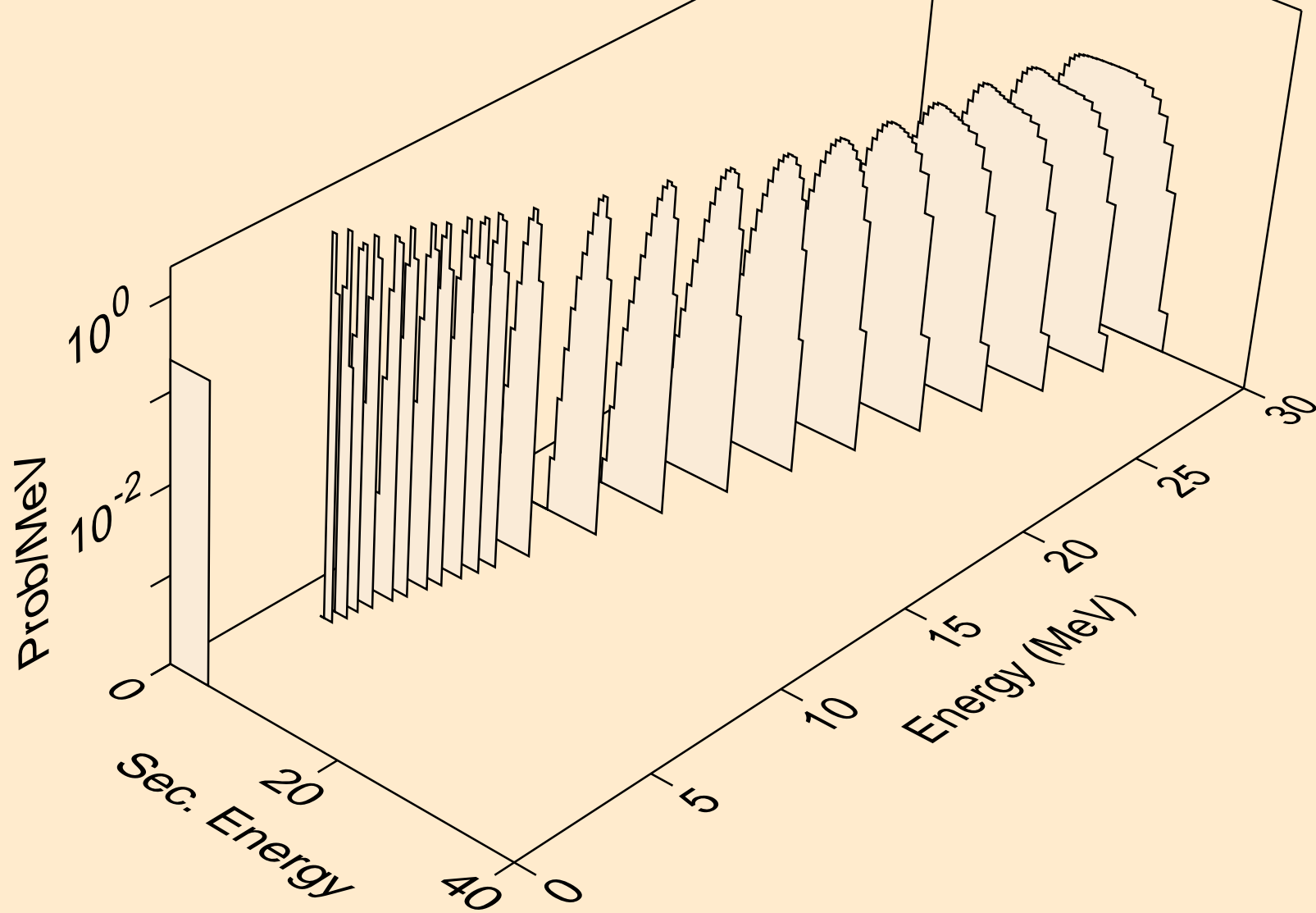

TB146 NEUTRON ACER TENDL-2023 LIBRARY; T=0.K  
alphas from (n,2n)a

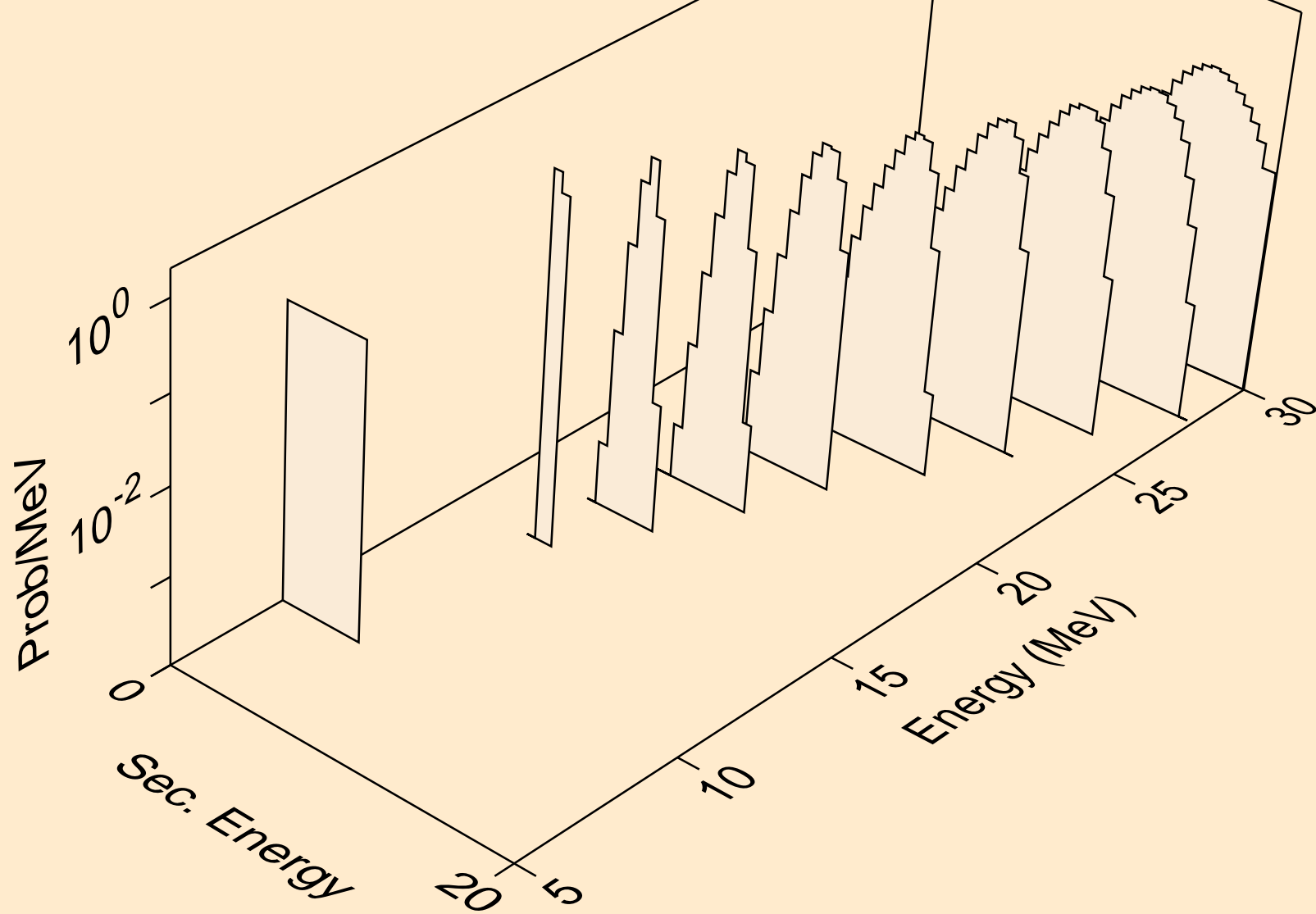

TB146 NEUTRON ACER TENDL-2023 LIBRARY; T=0.K  
alphas from (n,3n)a

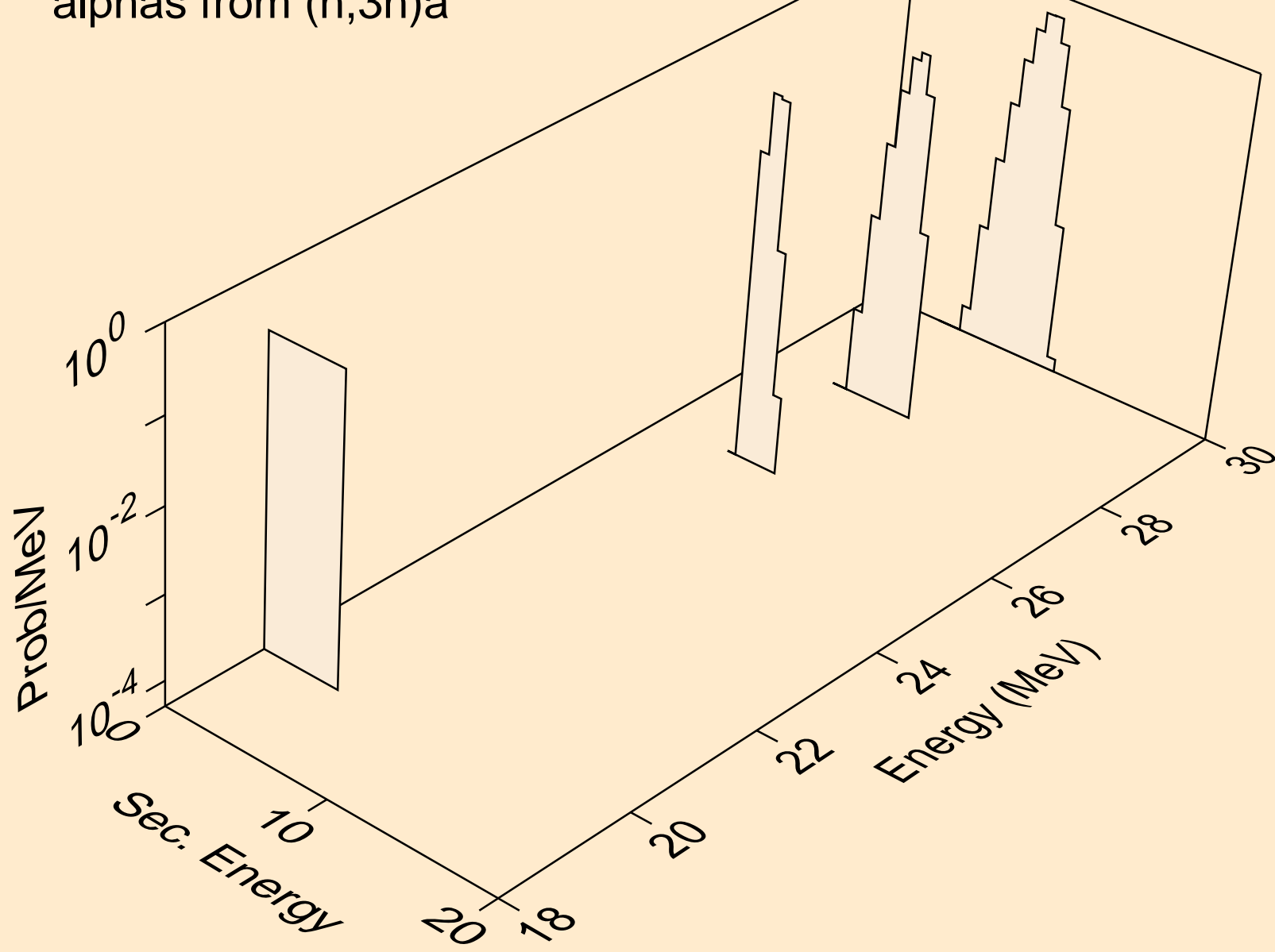

TB146 NEUTRON ACER TENDL-2023 LIBRARY; T=0.K  
alphas from (n,n\*)2a

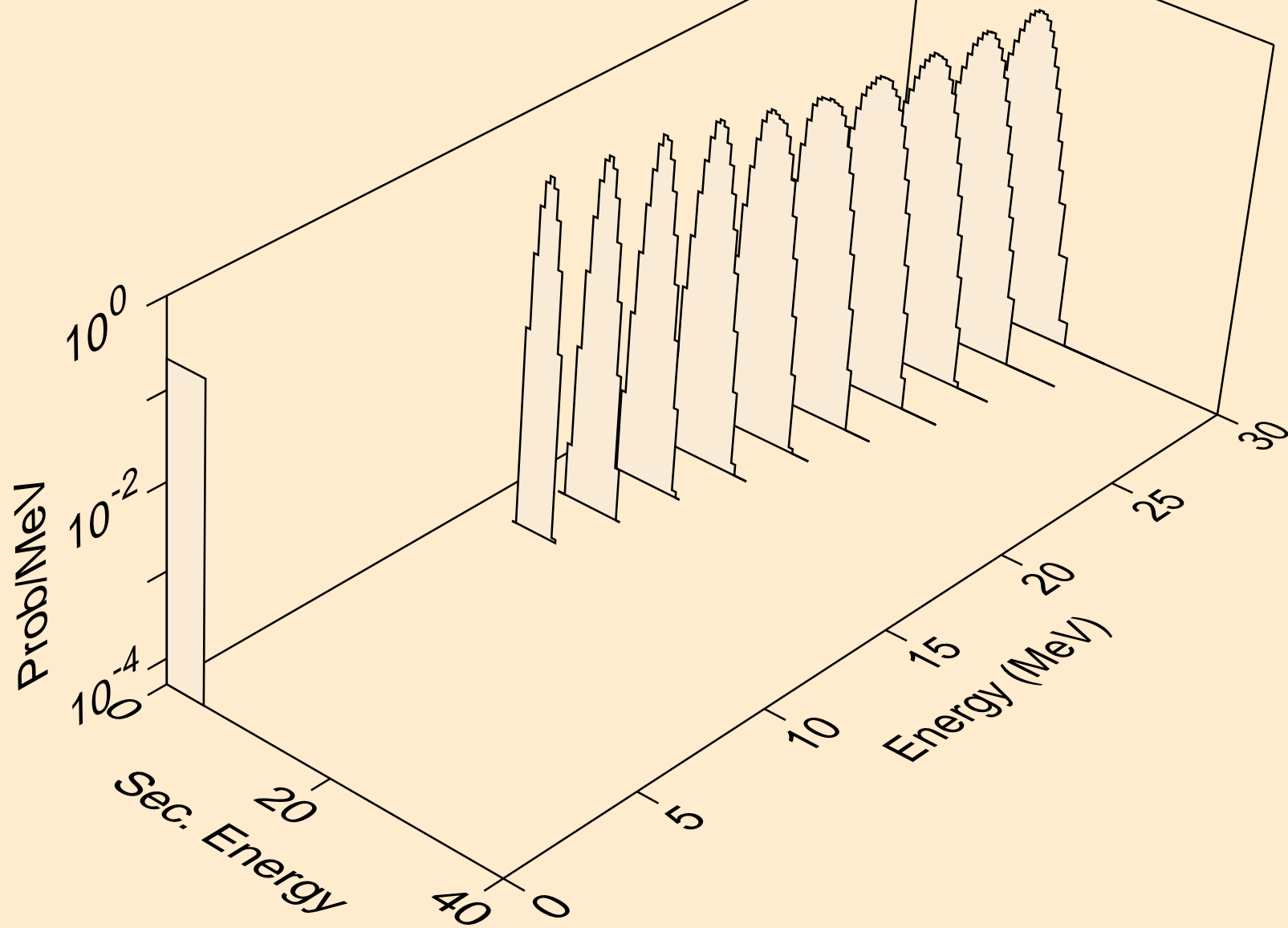

TB146 NEUTRON ACER TENDL-2023 LIBRARY; T=0.K  
alphas from (n,npa)

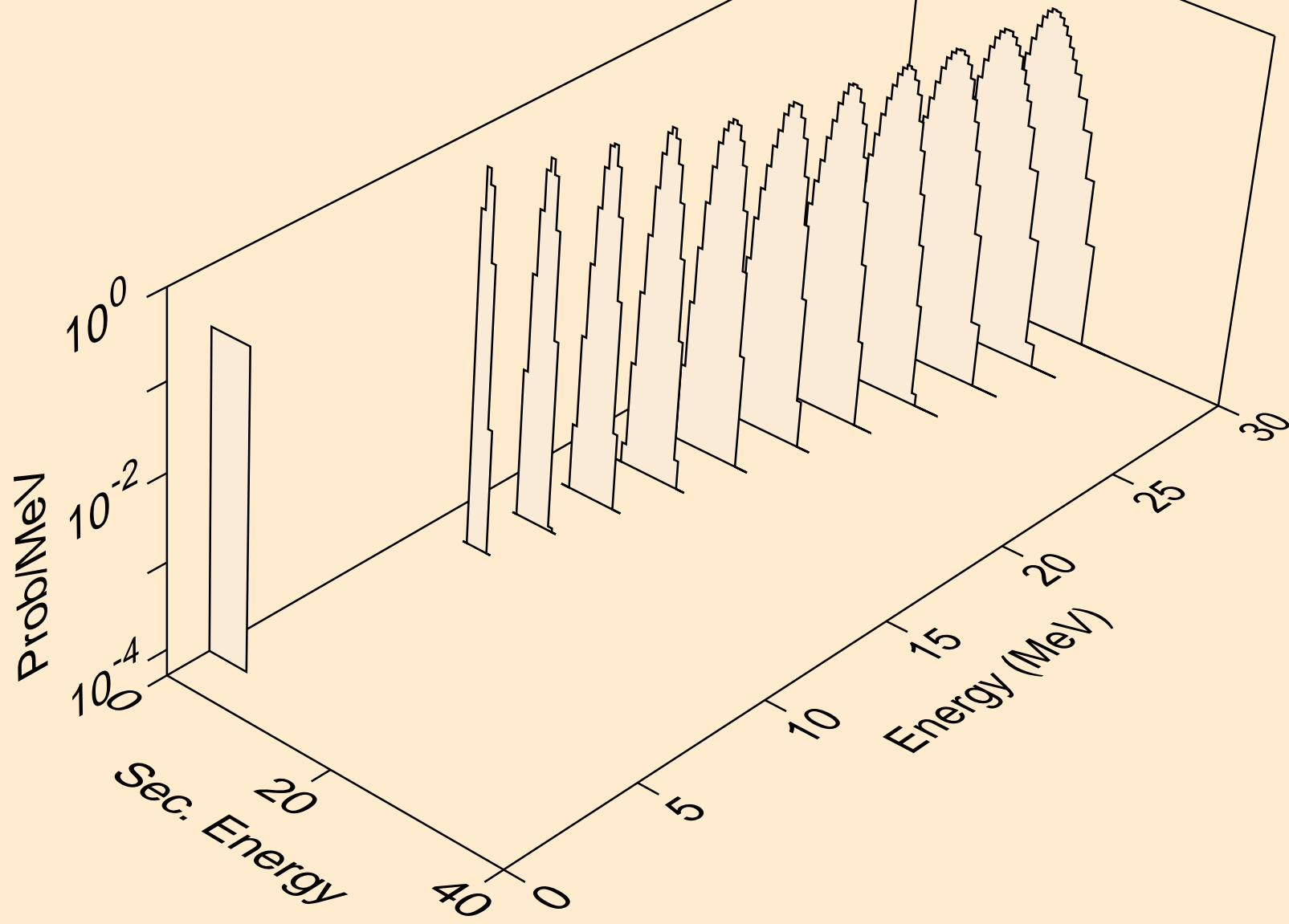

TB146 NEUTRON ACER TENDL-2023 LIBRARY; T=0.K  
alphas from (n,a)

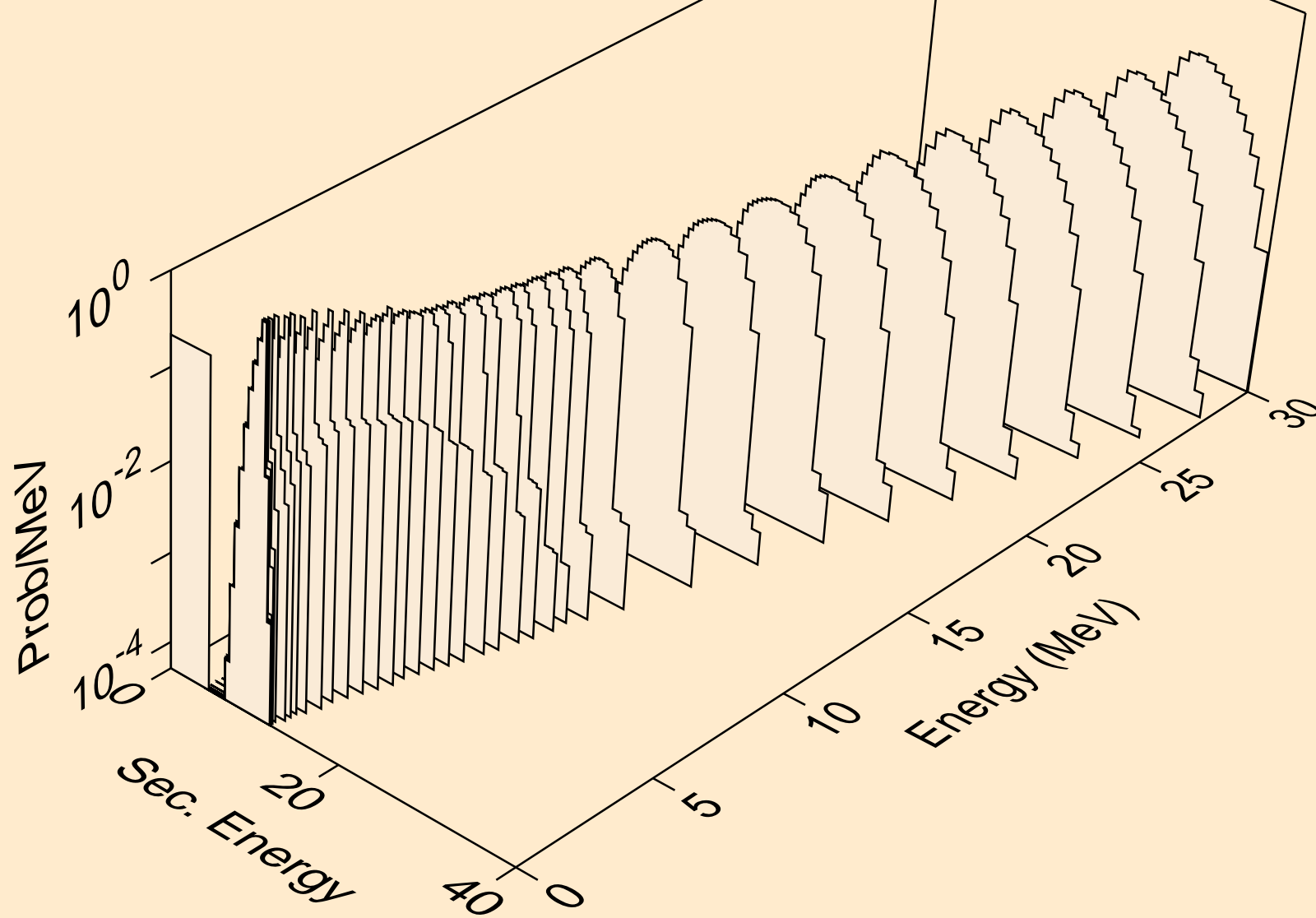

TB146 NEUTRON ACER TENDL-2023 LIBRARY; T=0.K  
alphas from (n,2a)

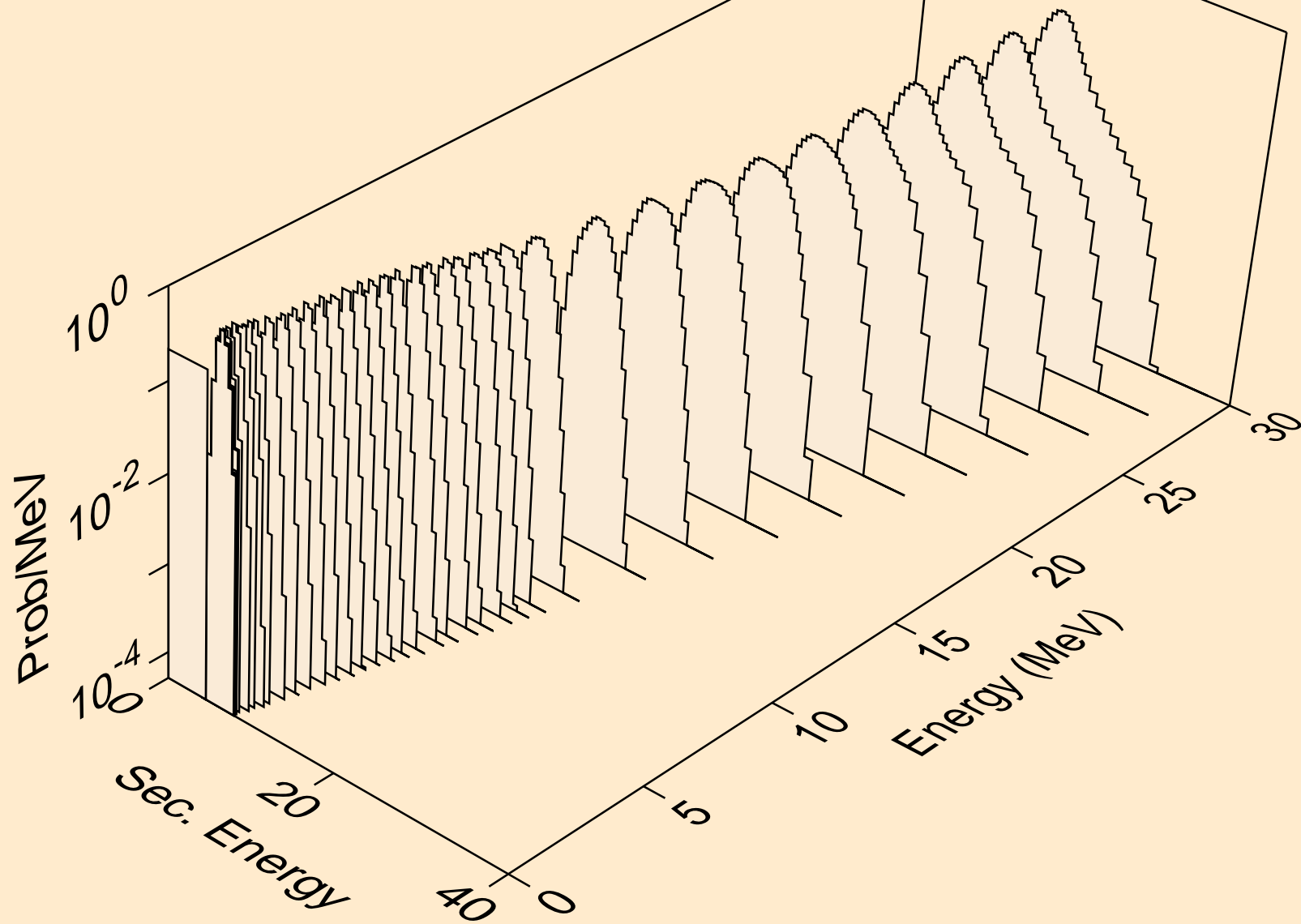

TB146 NEUTRON ACER TENDL-2023 LIBRARY; T=0.K  
alphas from (n,3a)

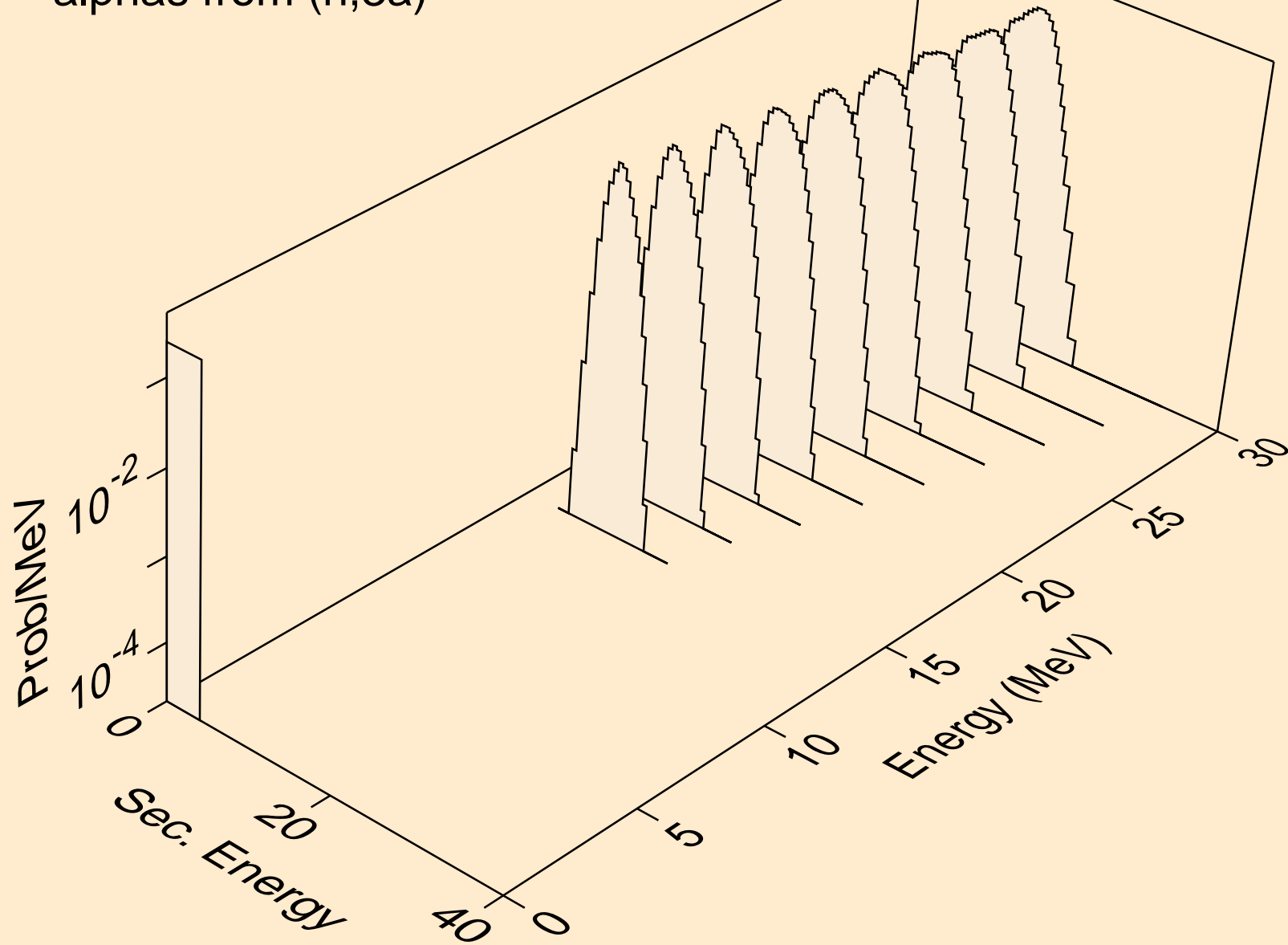

TB146 NEUTRON ACER TENDL-2023 LIBRARY; T=0.K  
alphas from (n,pa)

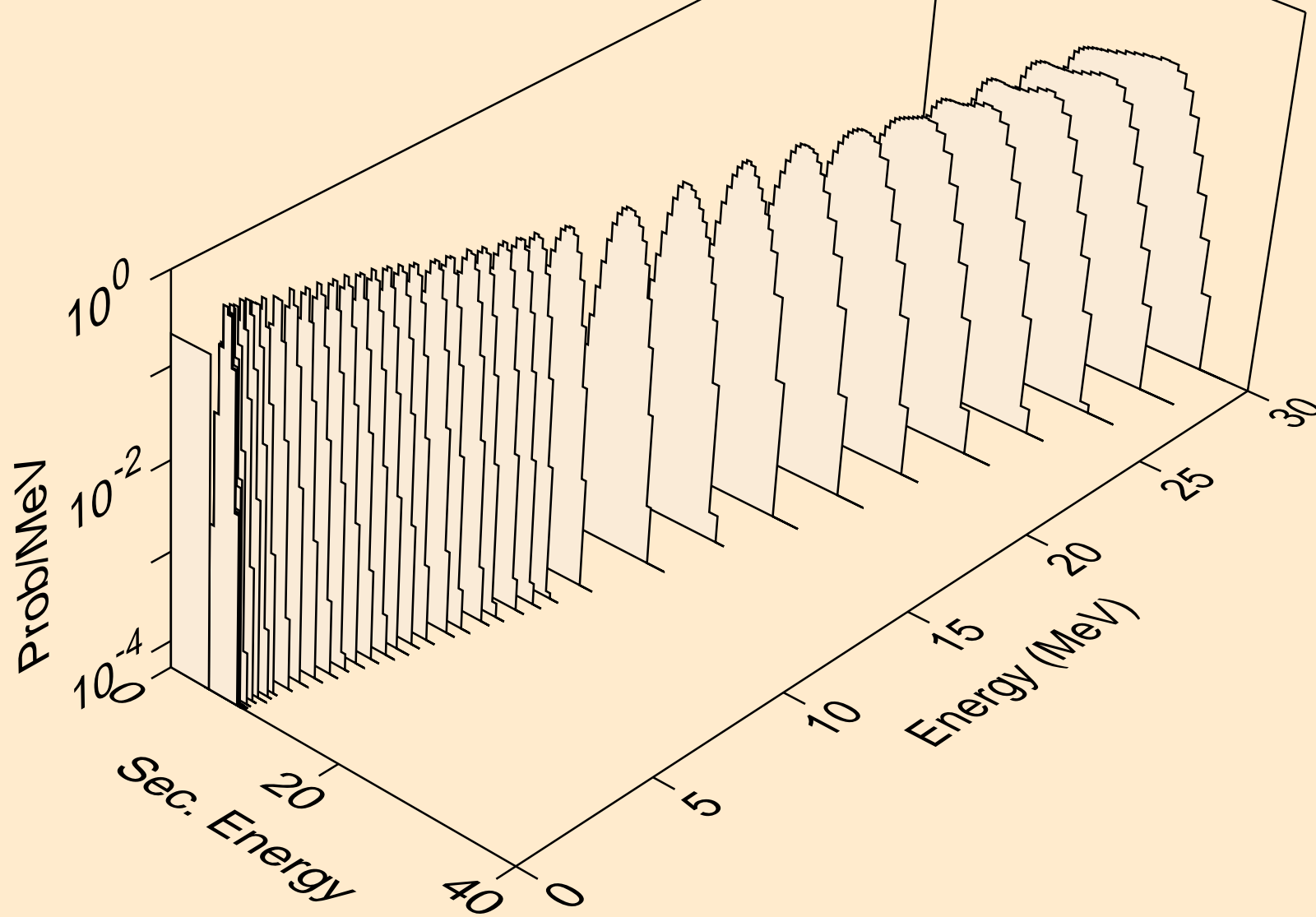

TB146 NEUTRON ACER TENDL-2023 LIBRARY; T=0.K  
alphas from (n,da)

