

TB151M NEUTRON ACER TENDL-2023 LIBRARY; T=0.K

Principal cross sections

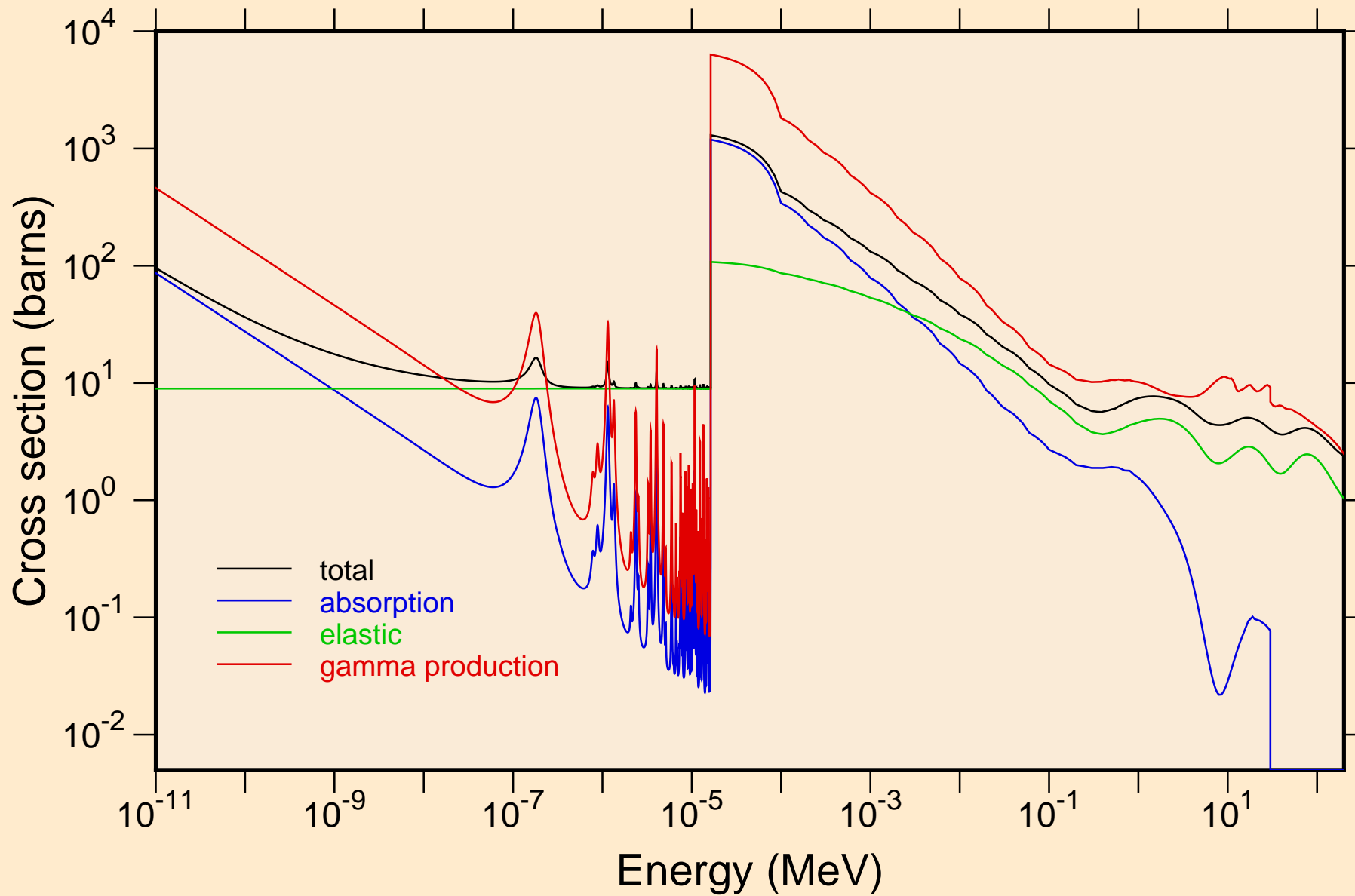

TB151M NEUTRON ACER TENDL-2023 LIBRARY; T=0.K
resonance total cross section

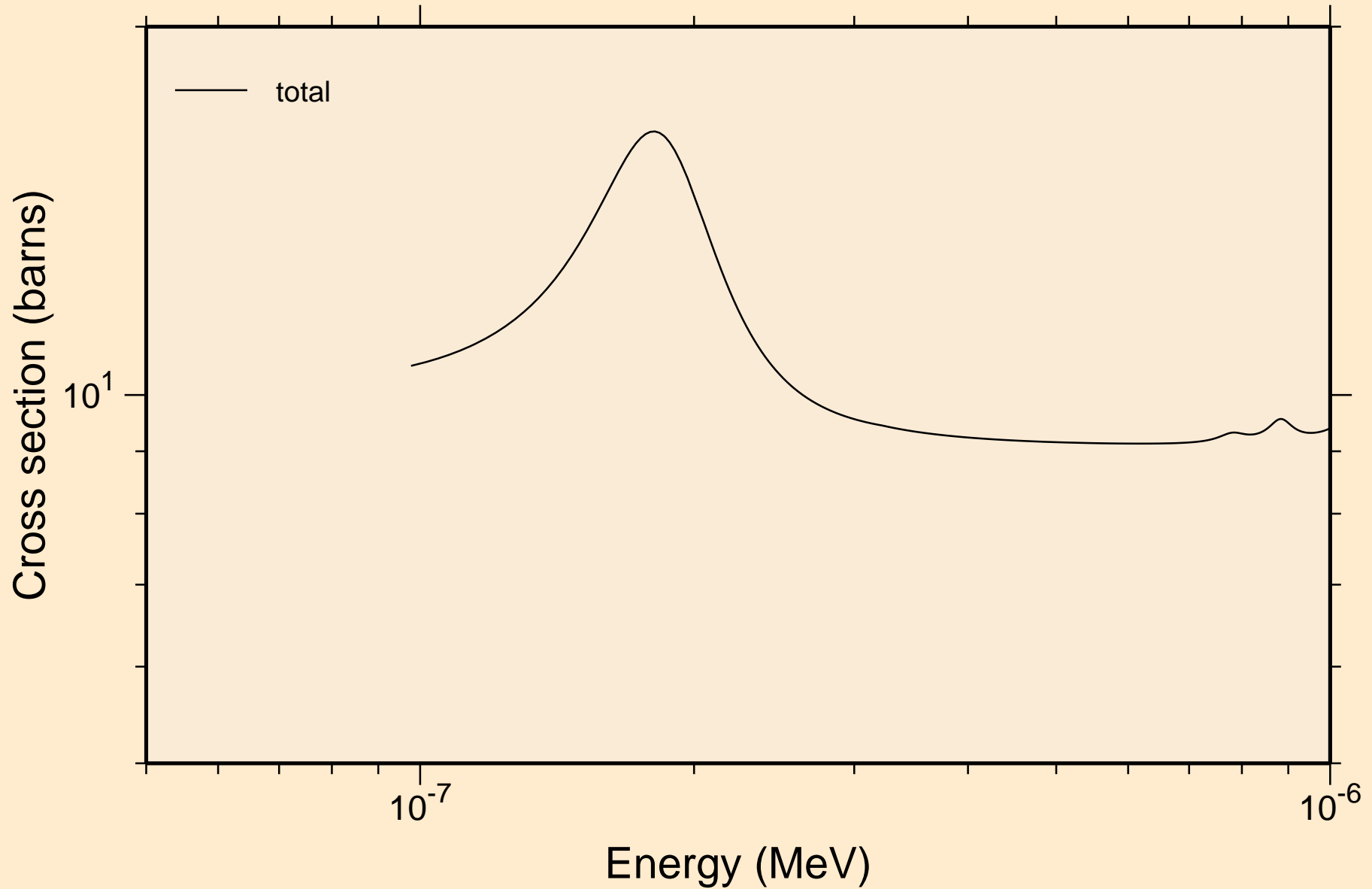

TB151M NEUTRON ACER TENDL-2023 LIBRARY; T=0.K
resonance total cross section

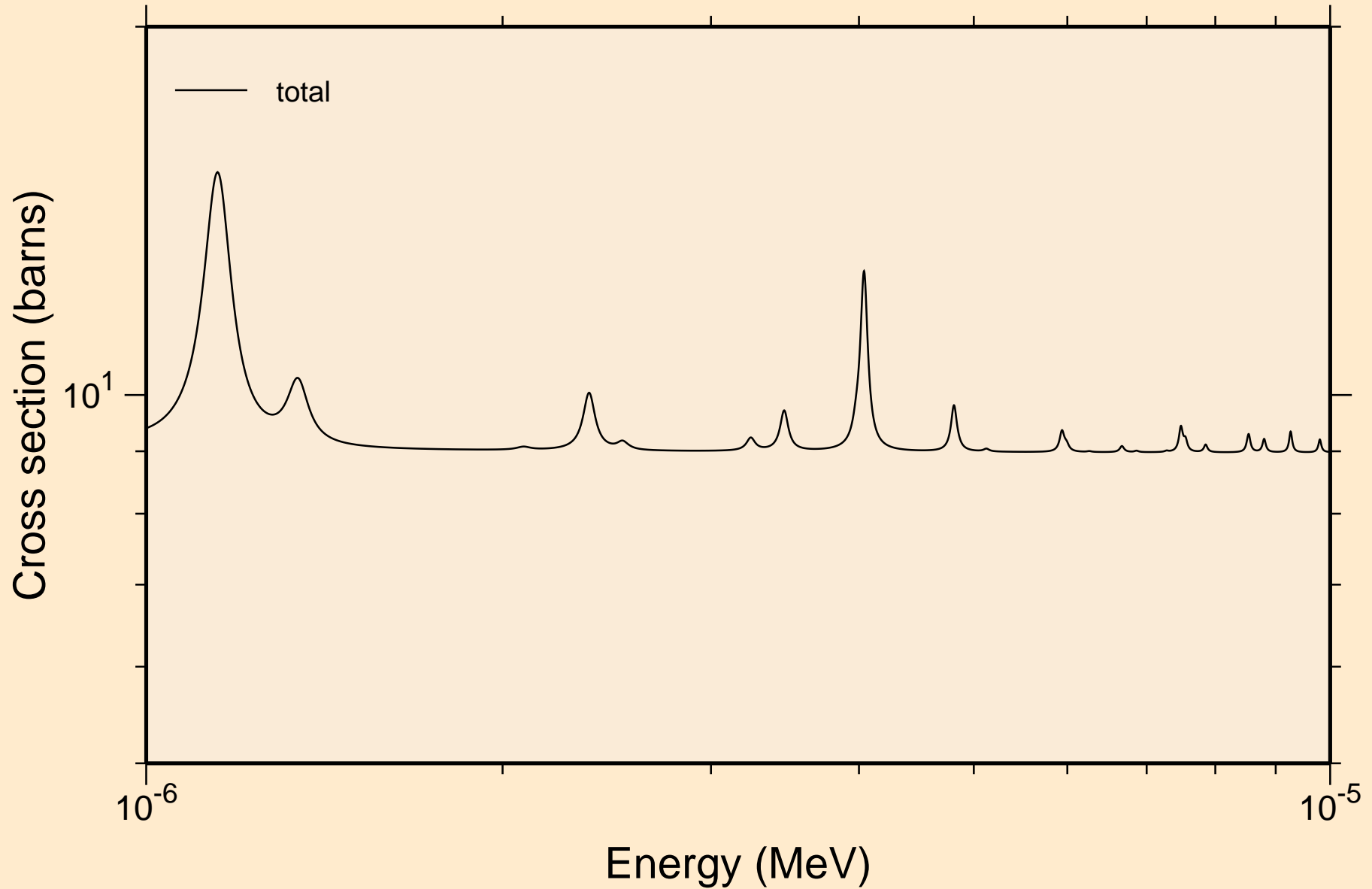

TB151M NEUTRON ACER TENDL-2023 LIBRARY; T=0.K
resonance total cross section

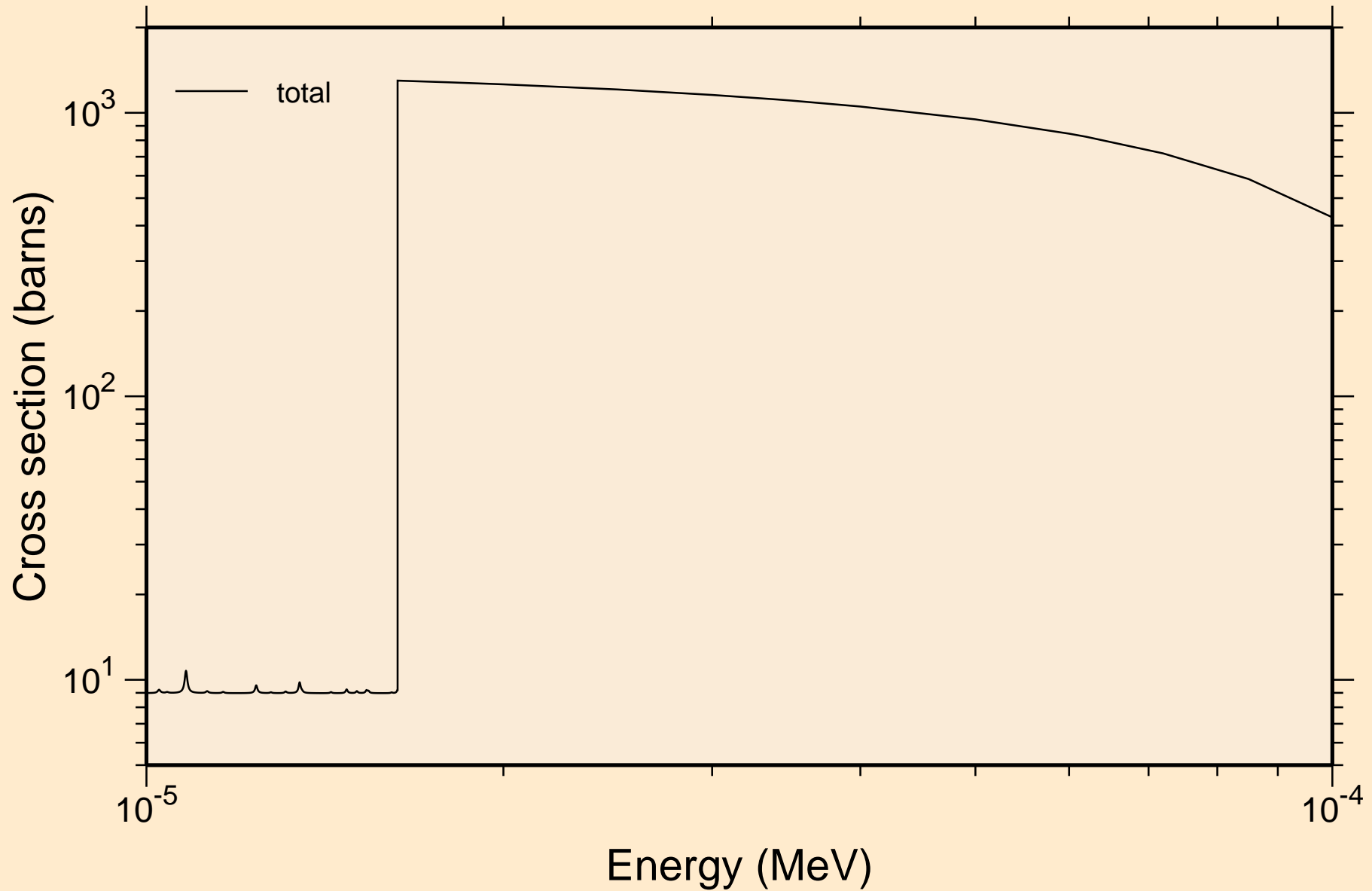

TB151M NEUTRON ACER TENDL-2023 LIBRARY; T=0.K
resonance total cross section

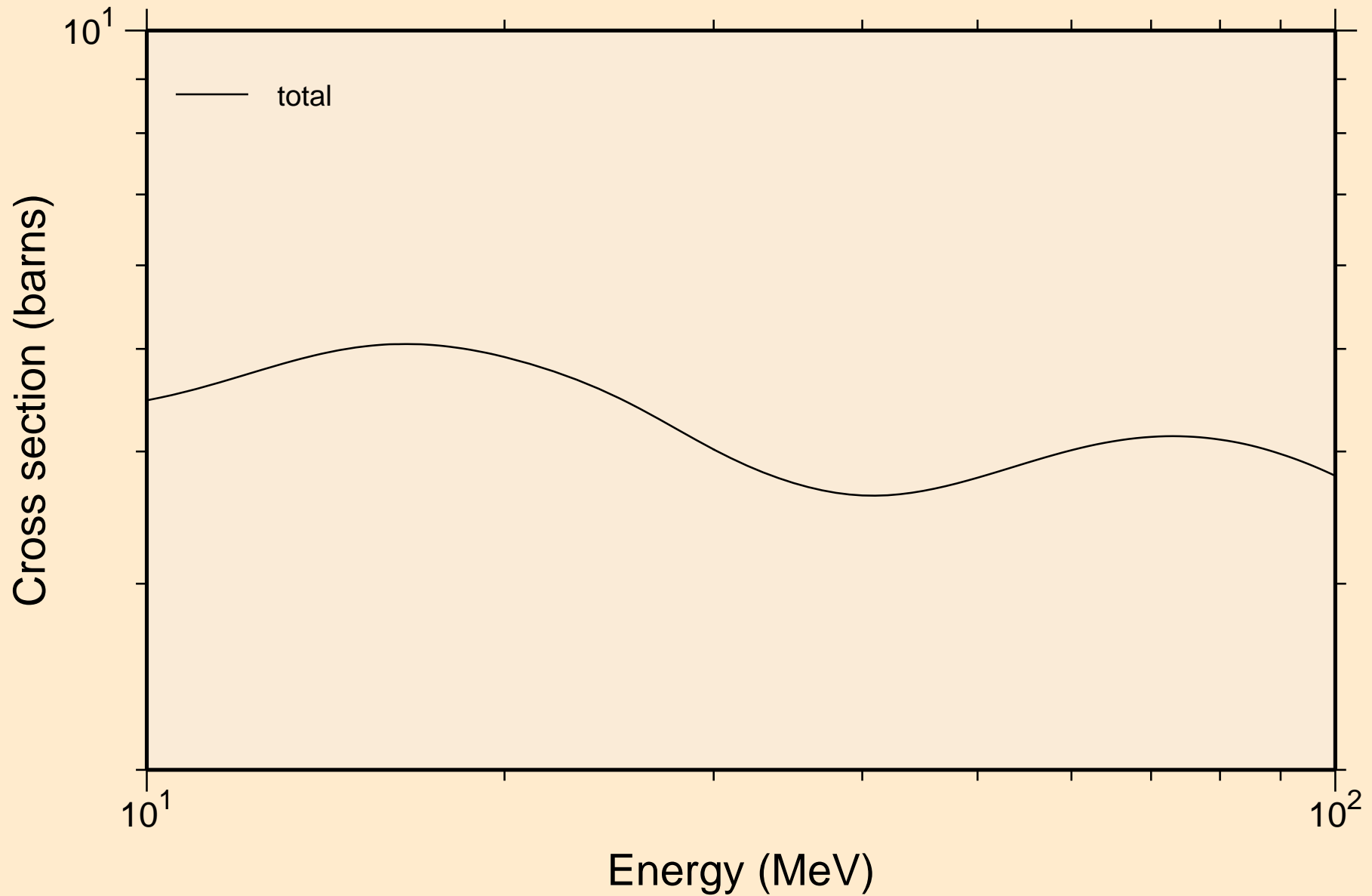

TB151M NEUTRON ACER TENDL-2023 LIBRARY; T=0.K
resonance absorption cross sections

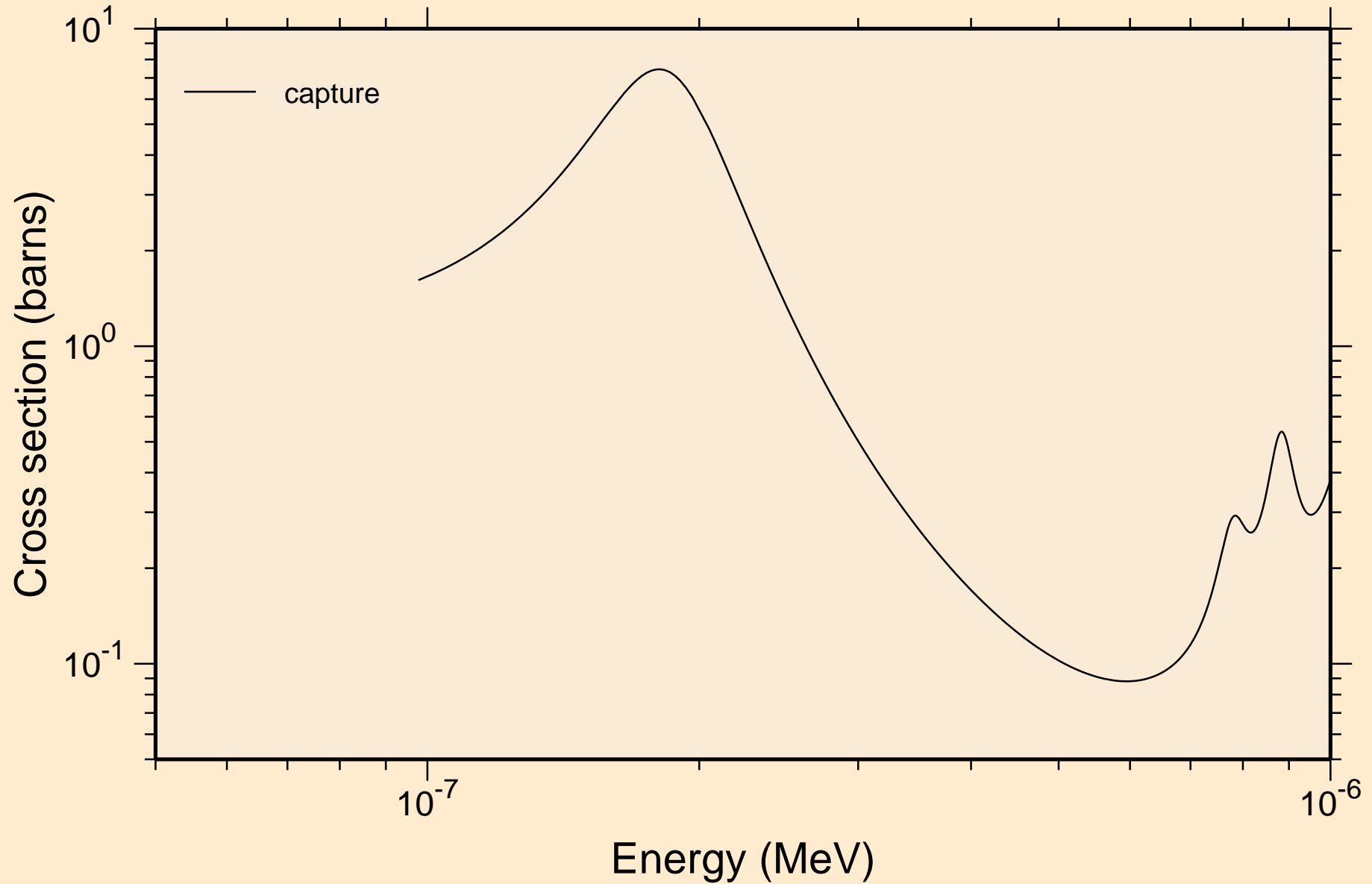

TB151M NEUTRON ACER TENDL-2023 LIBRARY; T=0.K
resonance absorption cross sections

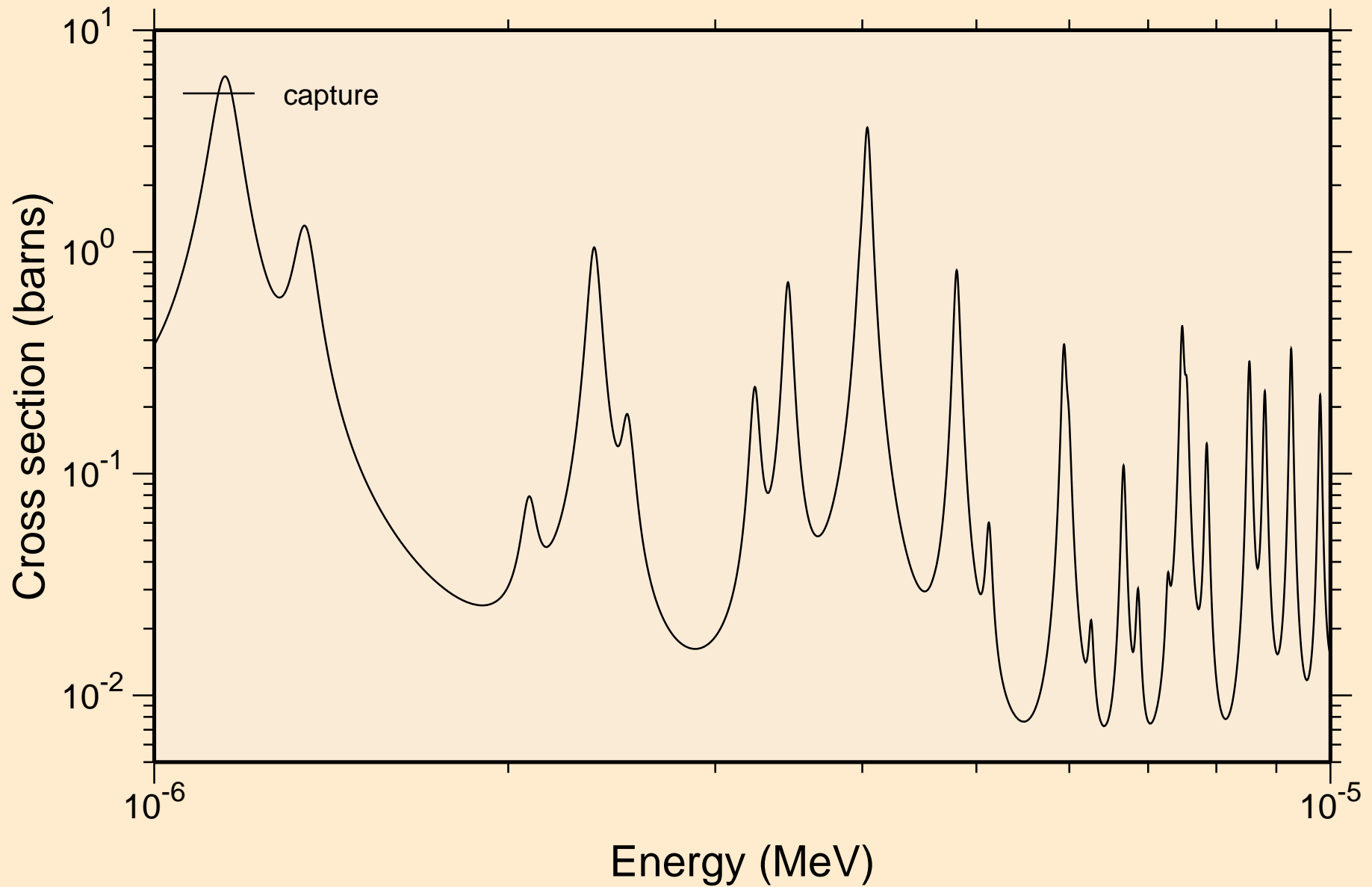

TB151M NEUTRON ACER TENDL-2023 LIBRARY; T=0.K
resonance absorption cross sections

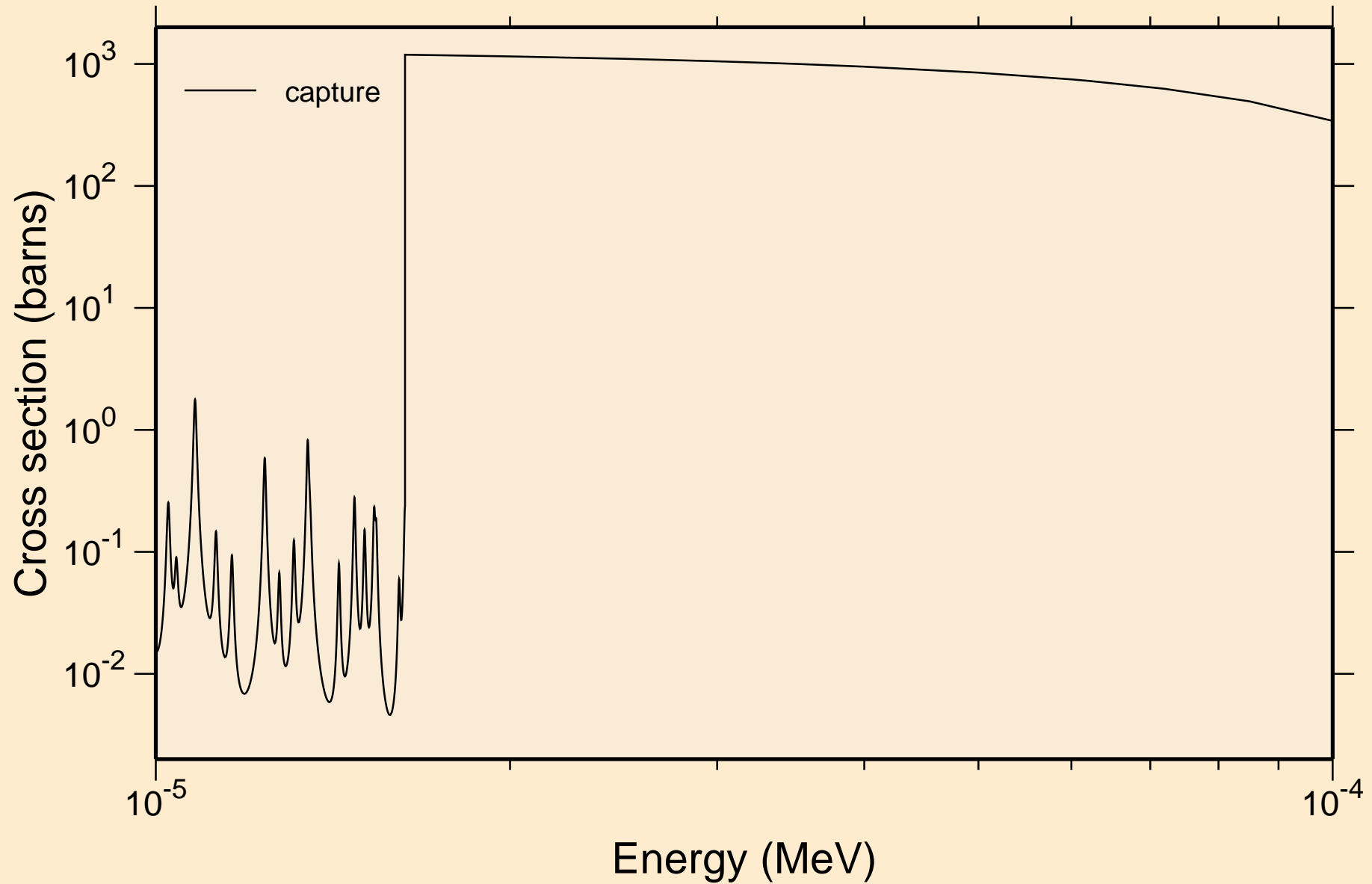

TB151M NEUTRON ACER TENDL-2023 LIBRARY; T=0.K
resonance absorption cross sections

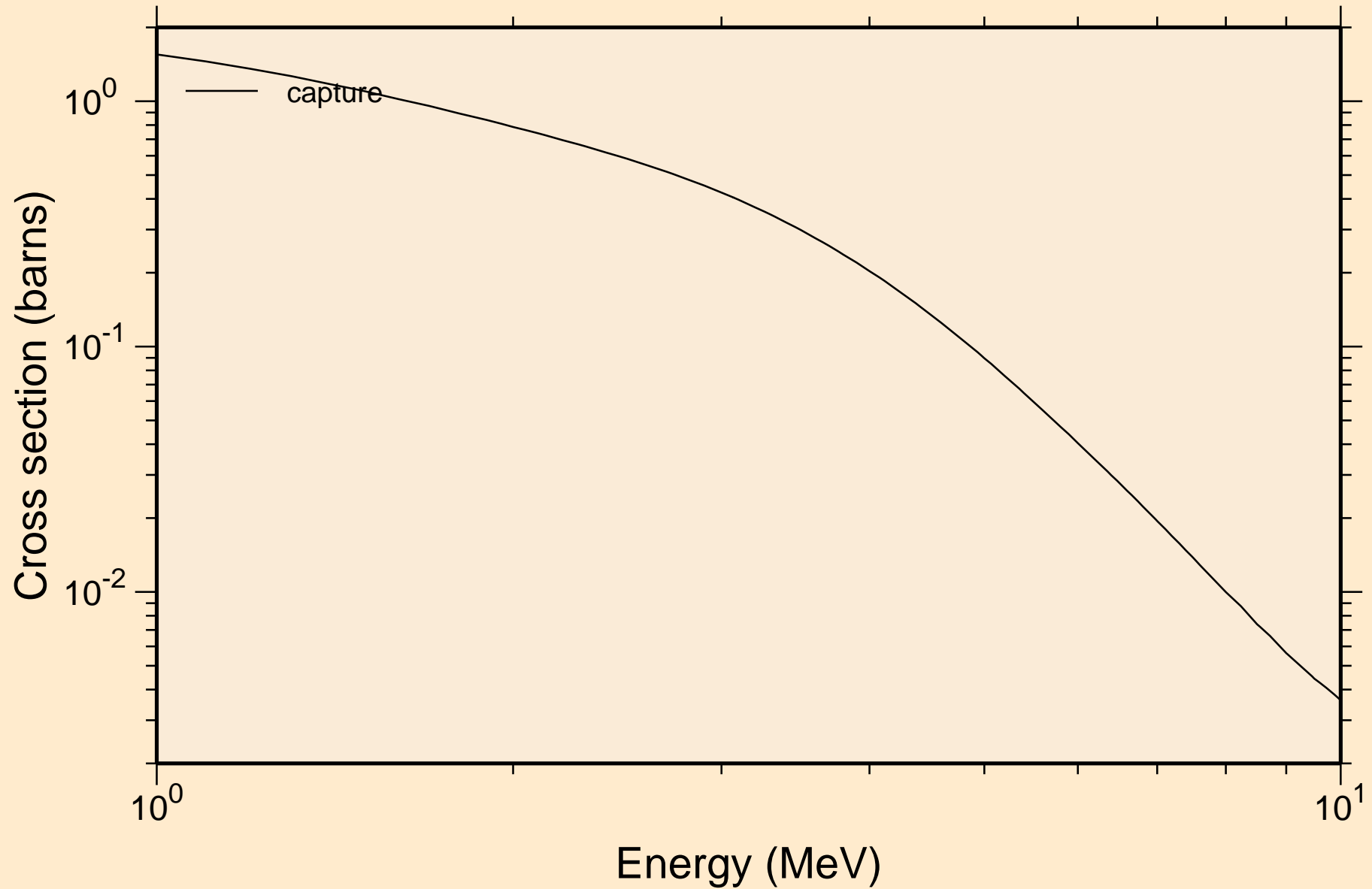

TB151M NEUTRON ACER TENDL-2023 LIBRARY; T=0.K
Heating

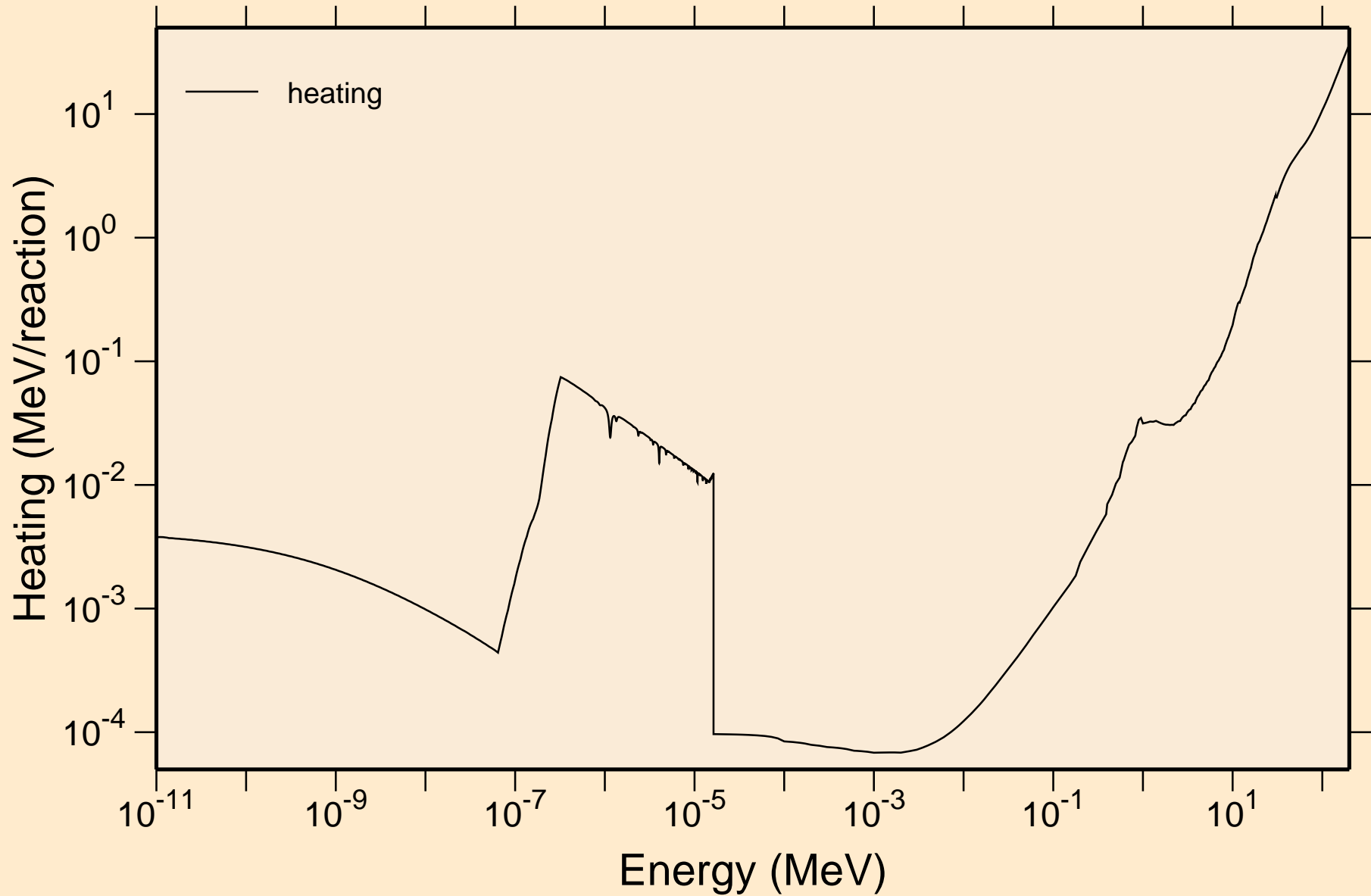

TB151M NEUTRON ACER TENDL-2023 LIBRARY; T=0.K
Damage

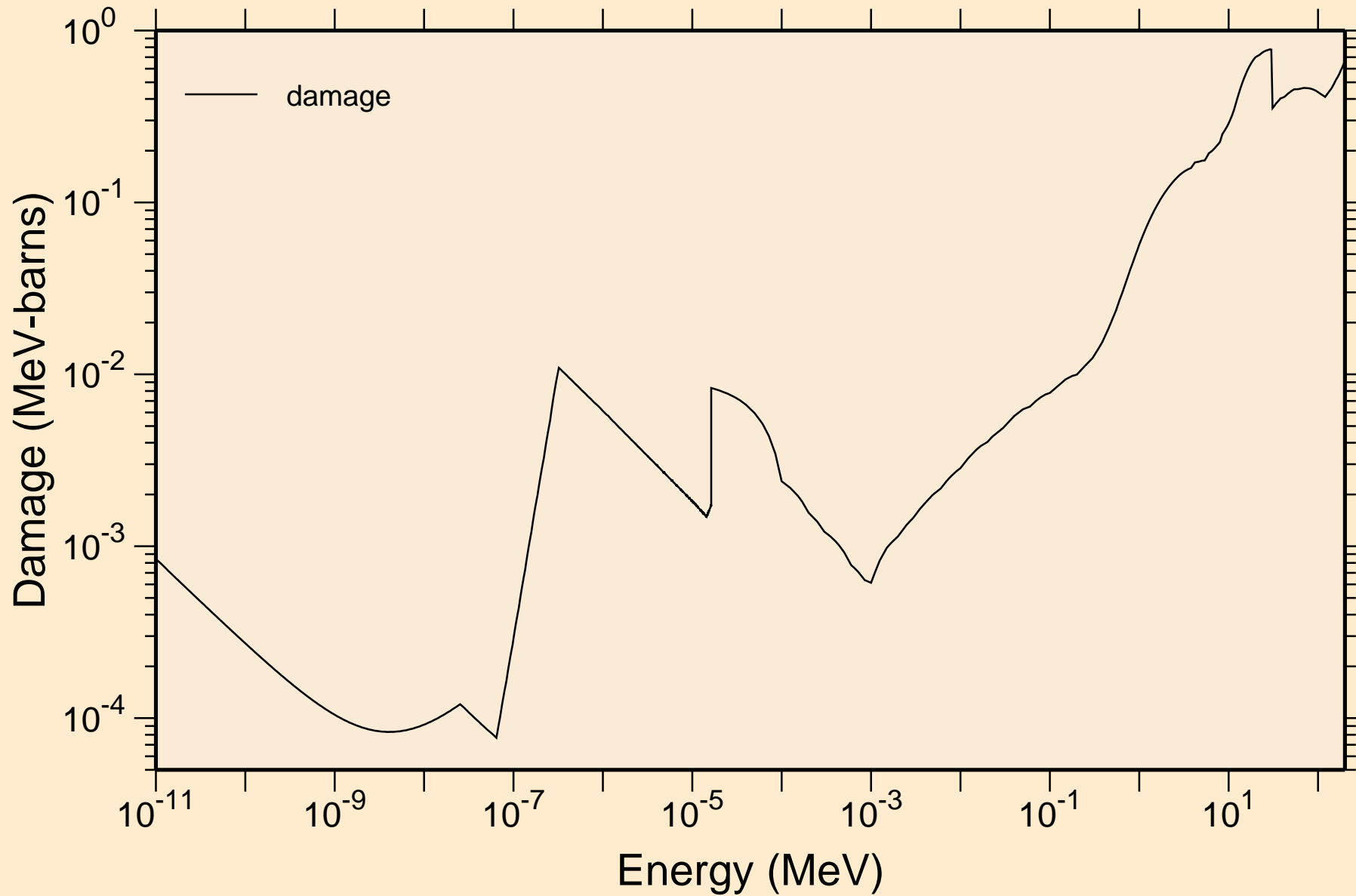

TB151M NEUTRON ACER TENDL-2023 LIBRARY; T=0.K

Non-threshold reactions

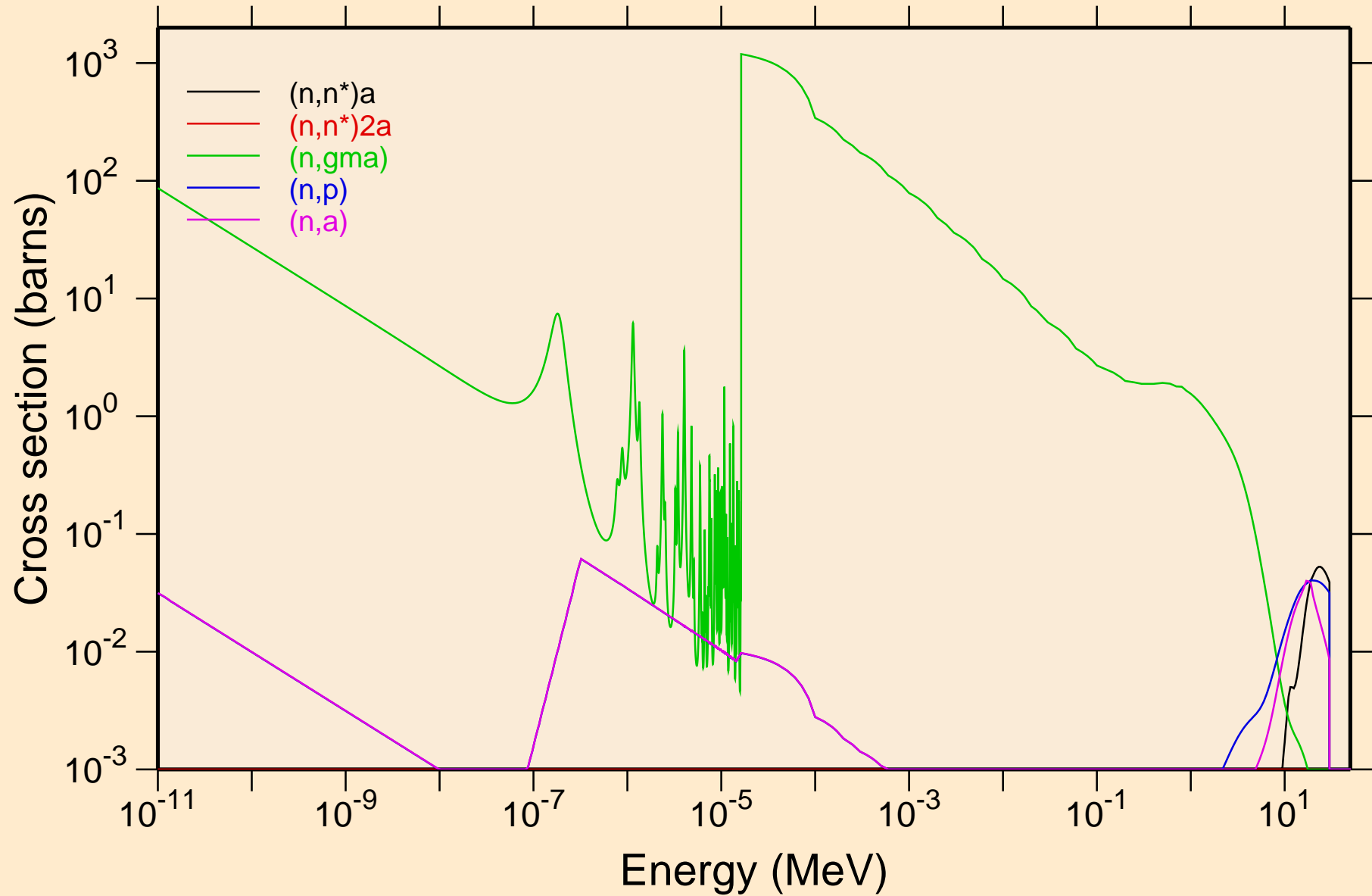

TB151M NEUTRON ACER TENDL-2023 LIBRARY; T=0.K
Non-threshold reactions

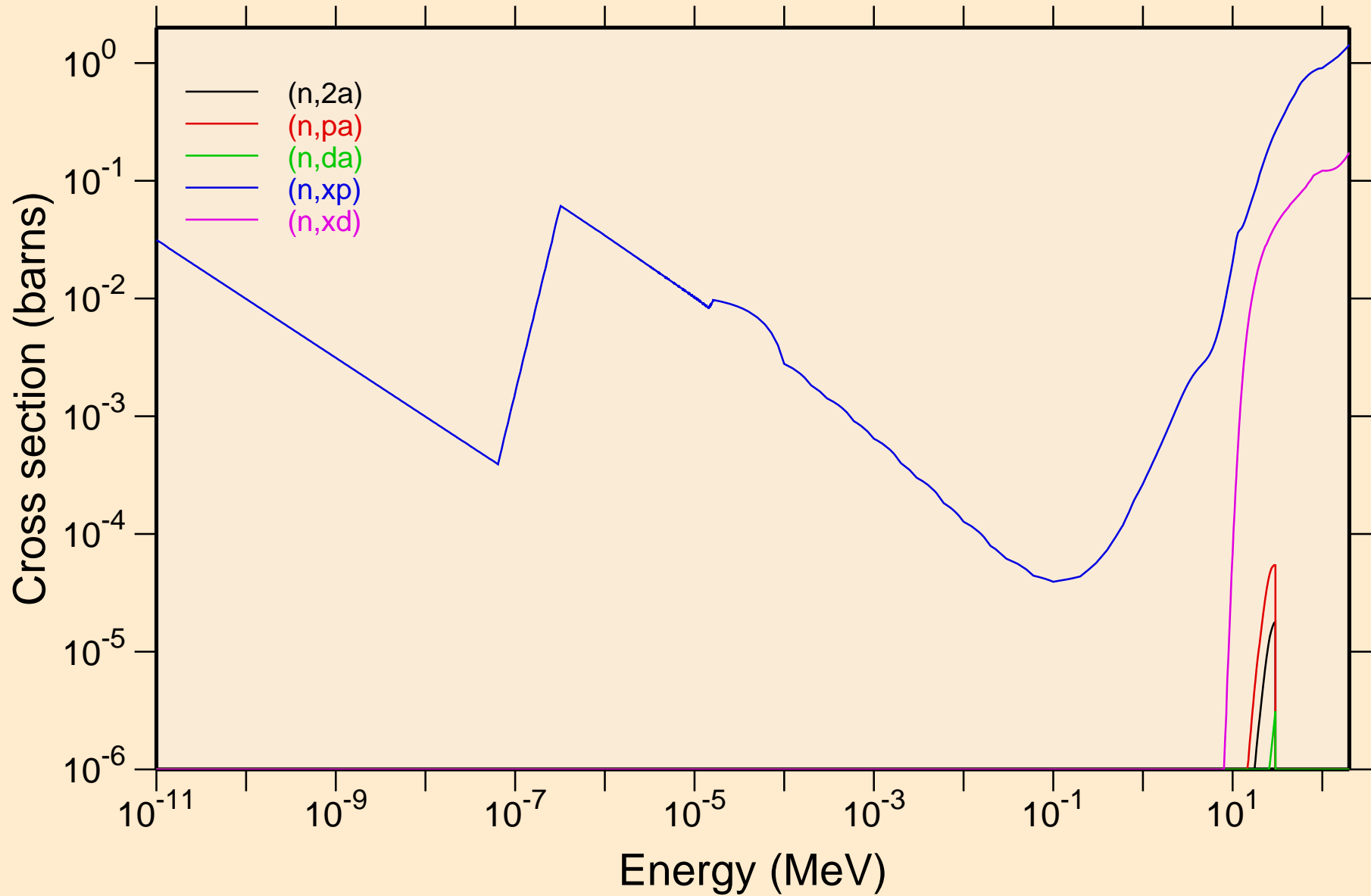

TB151M NEUTRON ACER TENDL-2023 LIBRARY; T=0.K
Non-threshold reactions

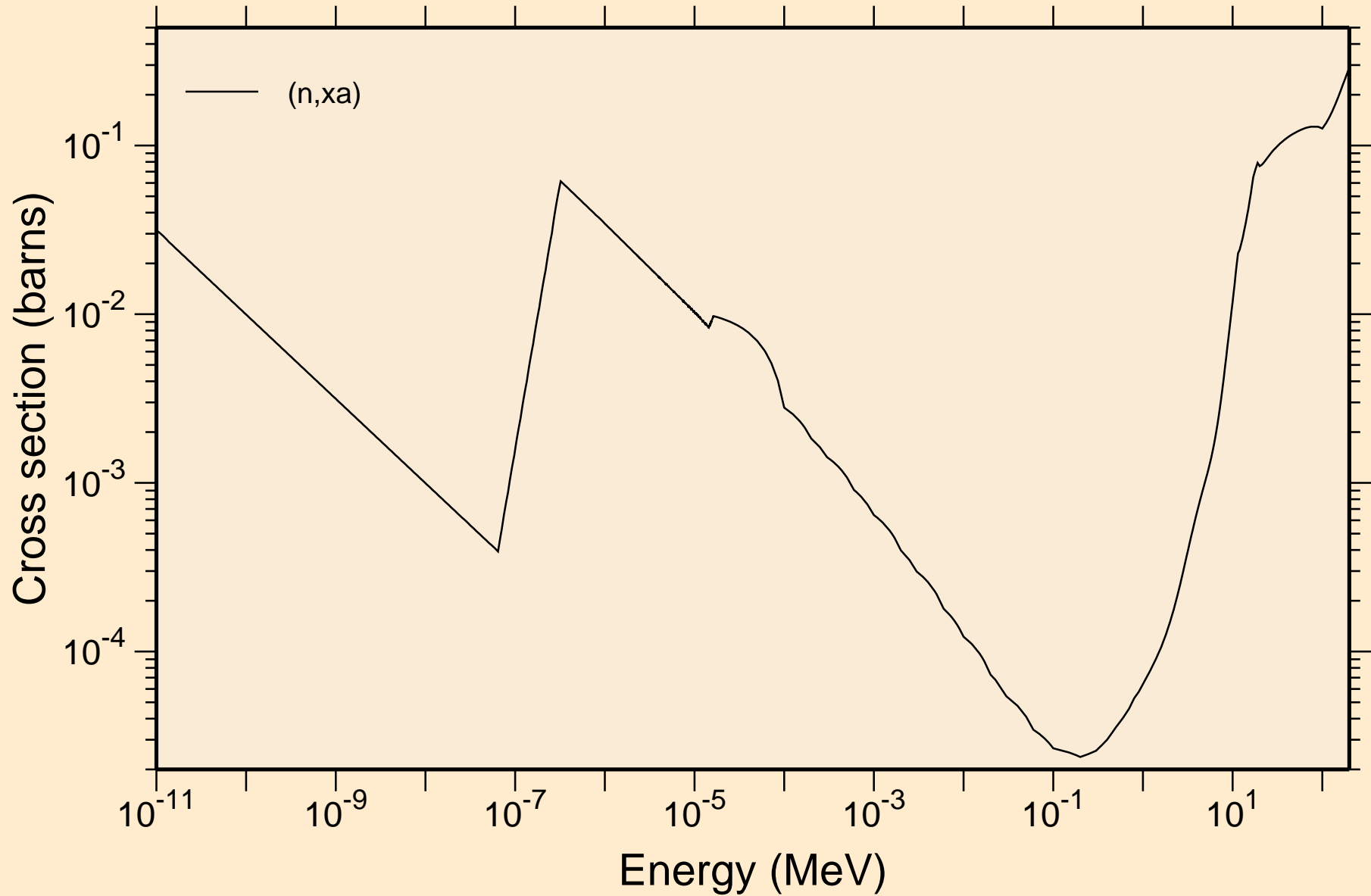

TB151M NEUTRON ACER TENDL-2023 LIBRARY; T=0.K

Principal cross sections

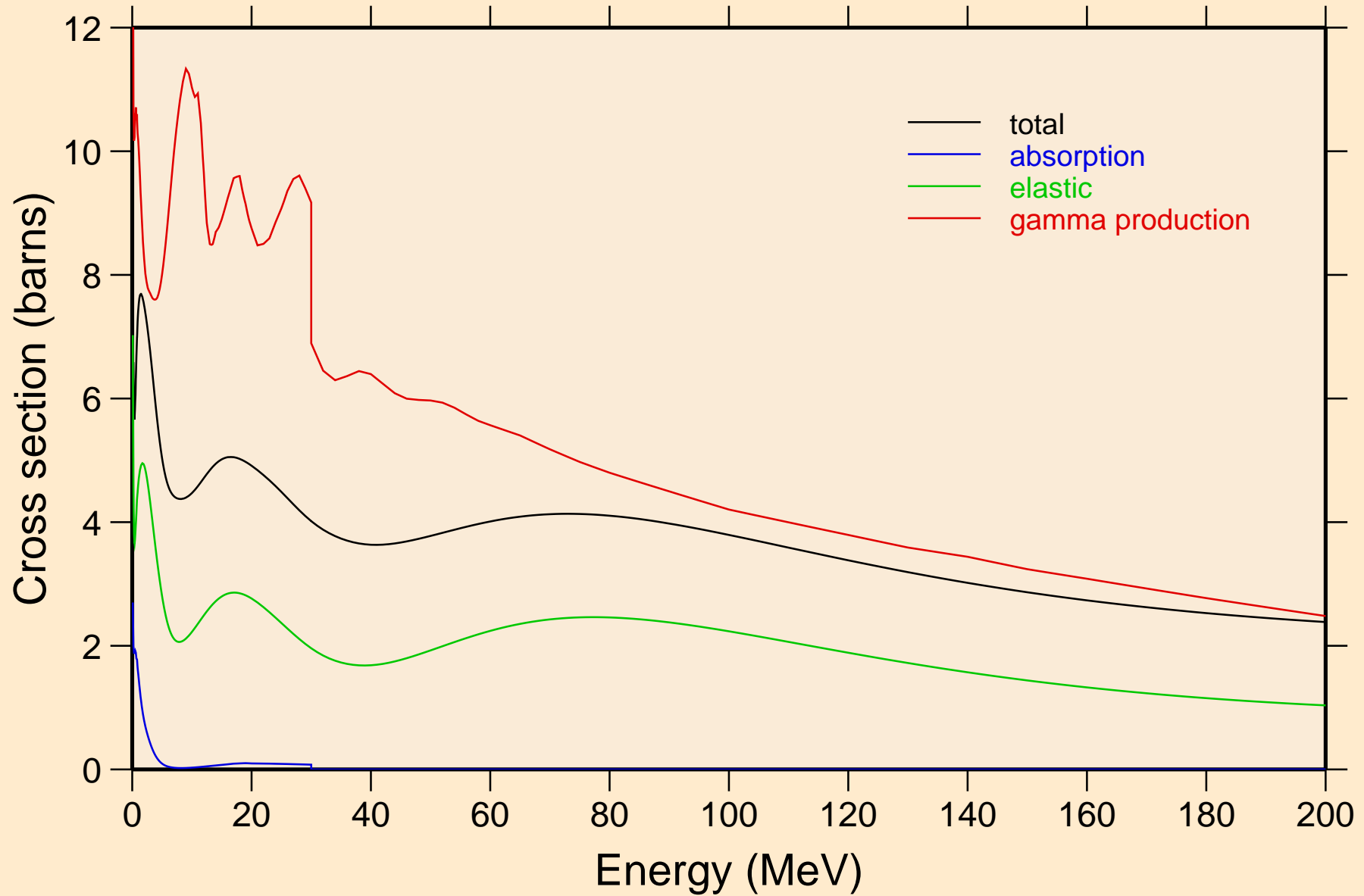

TB151M NEUTRON ACER TENDL-2023 LIBRARY; T=0.K

Heating

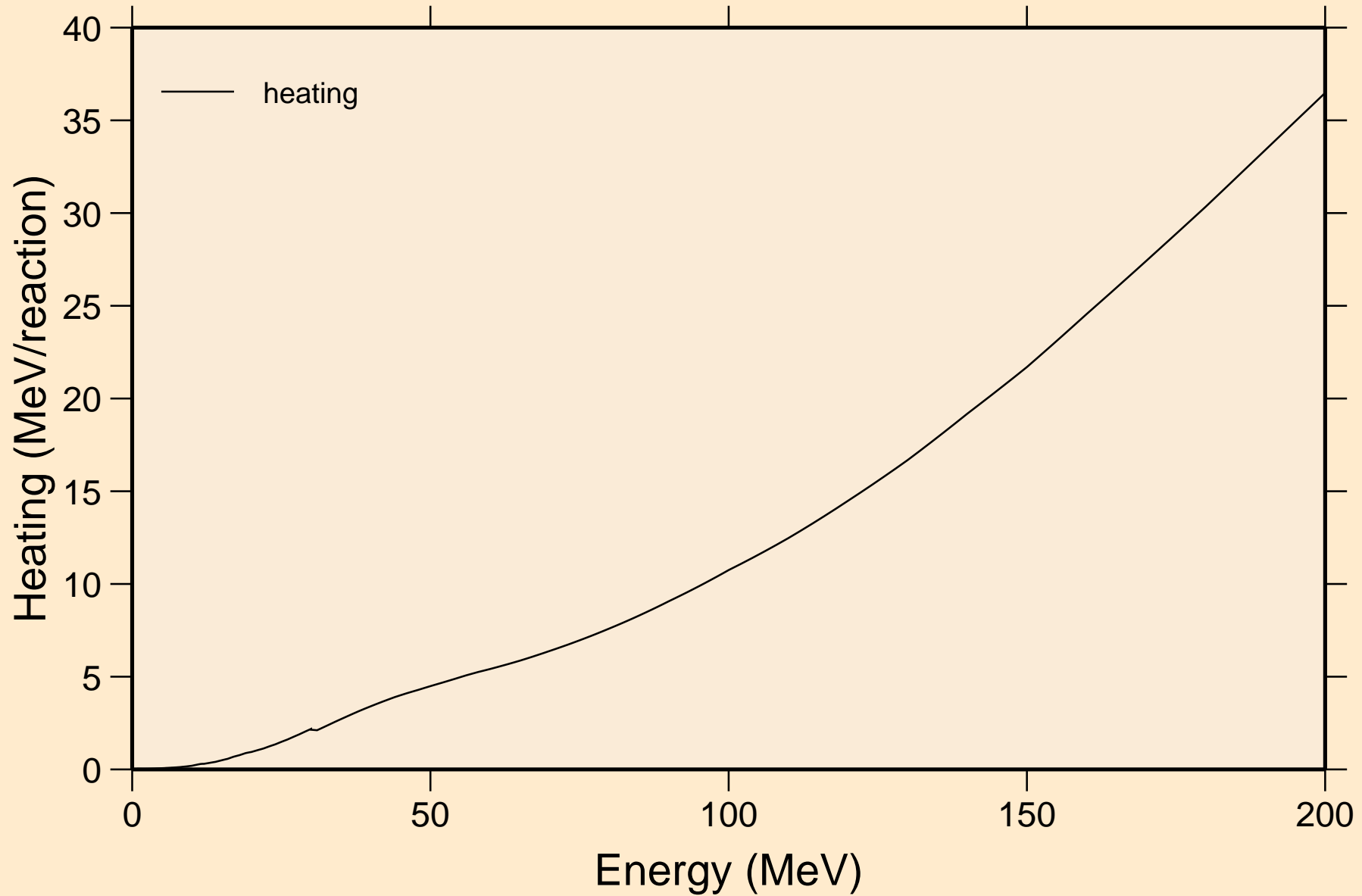

TB151M NEUTRON ACER TENDL-2023 LIBRARY; T=0.K
Damage

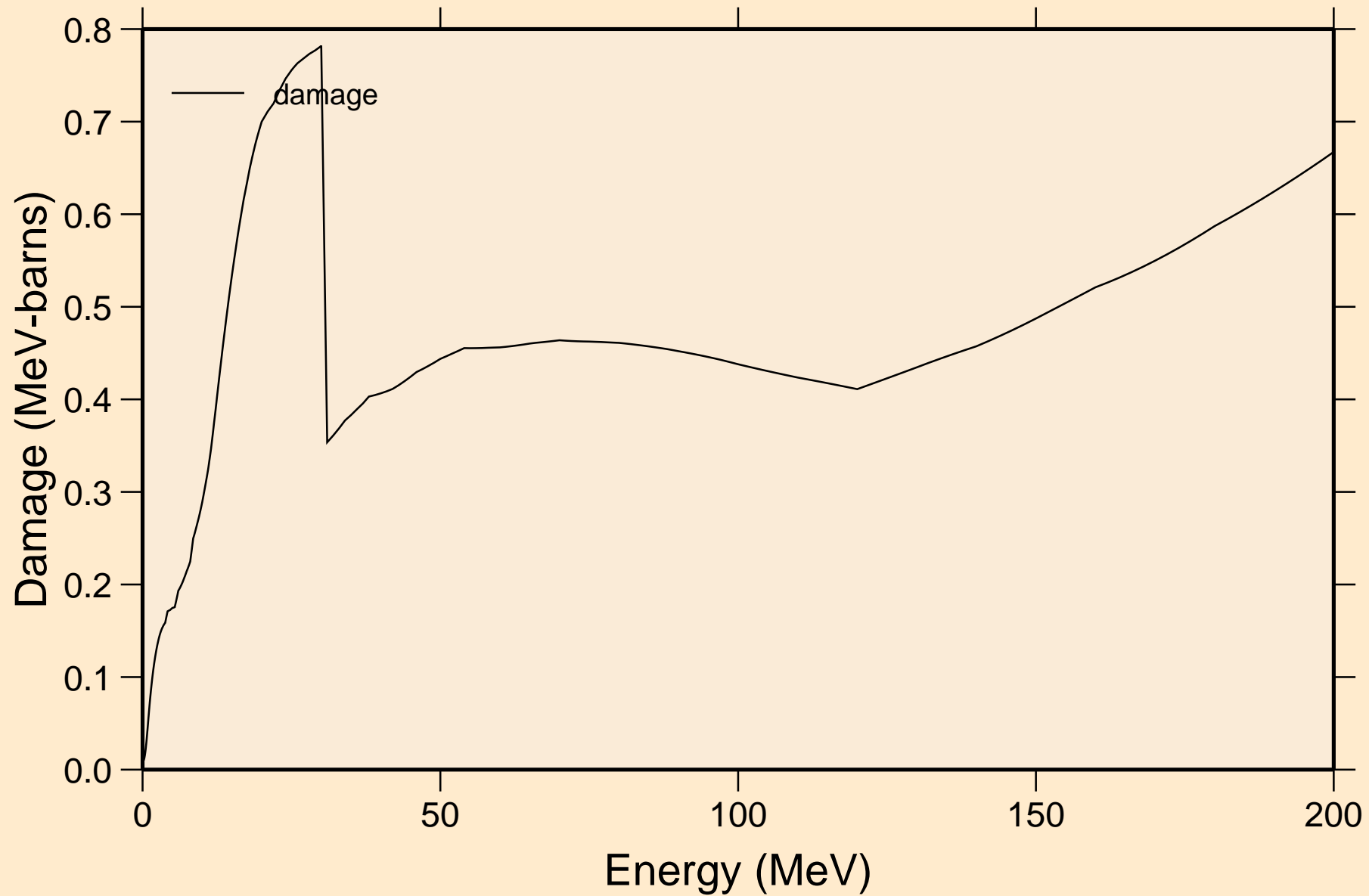

TB151M NEUTRON ACER TENDL-2023 LIBRARY; T=0.K
Non-threshold reactions

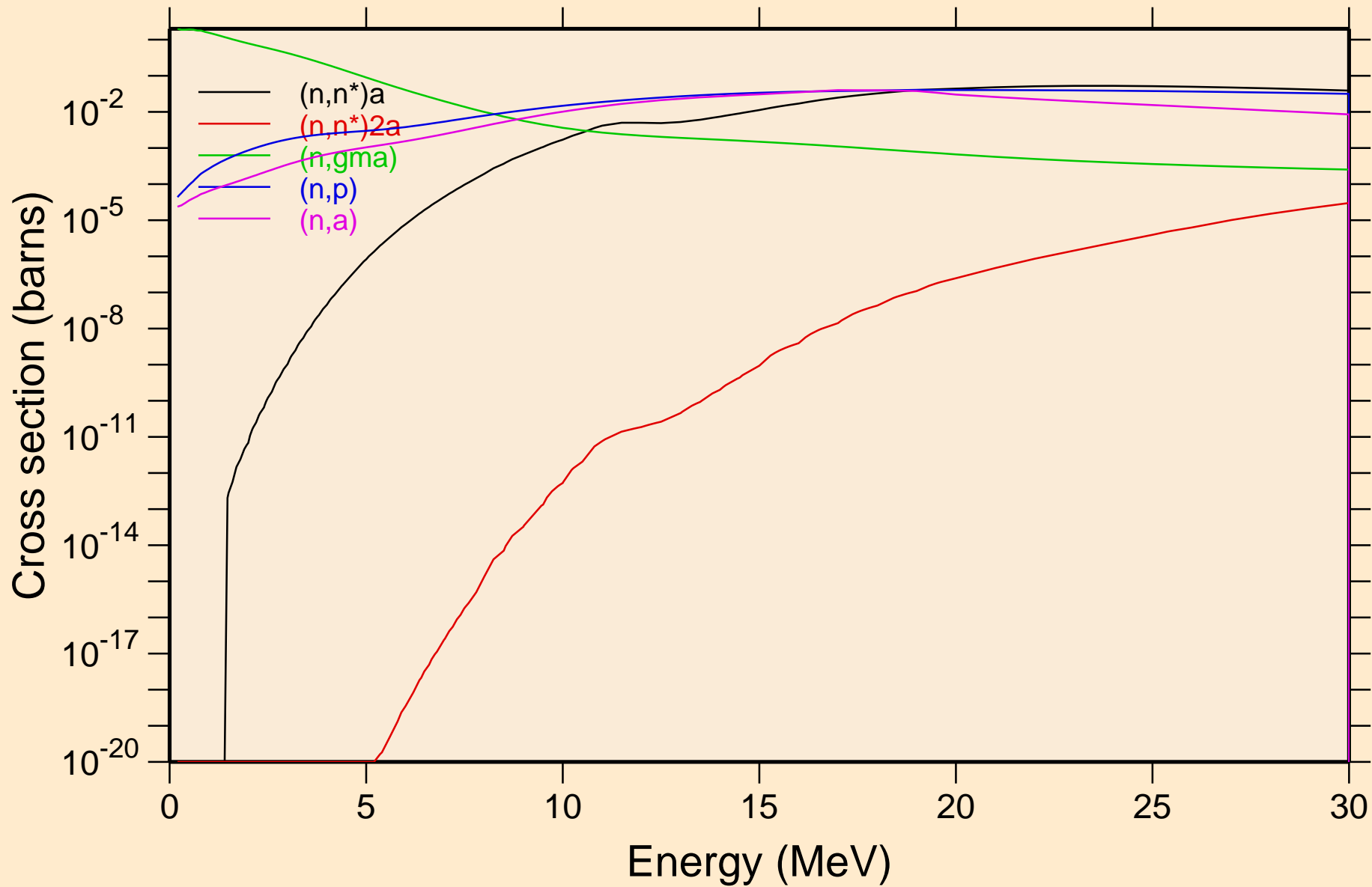

TB151M NEUTRON ACER TENDL-2023 LIBRARY; T=0.K
Non-threshold reactions

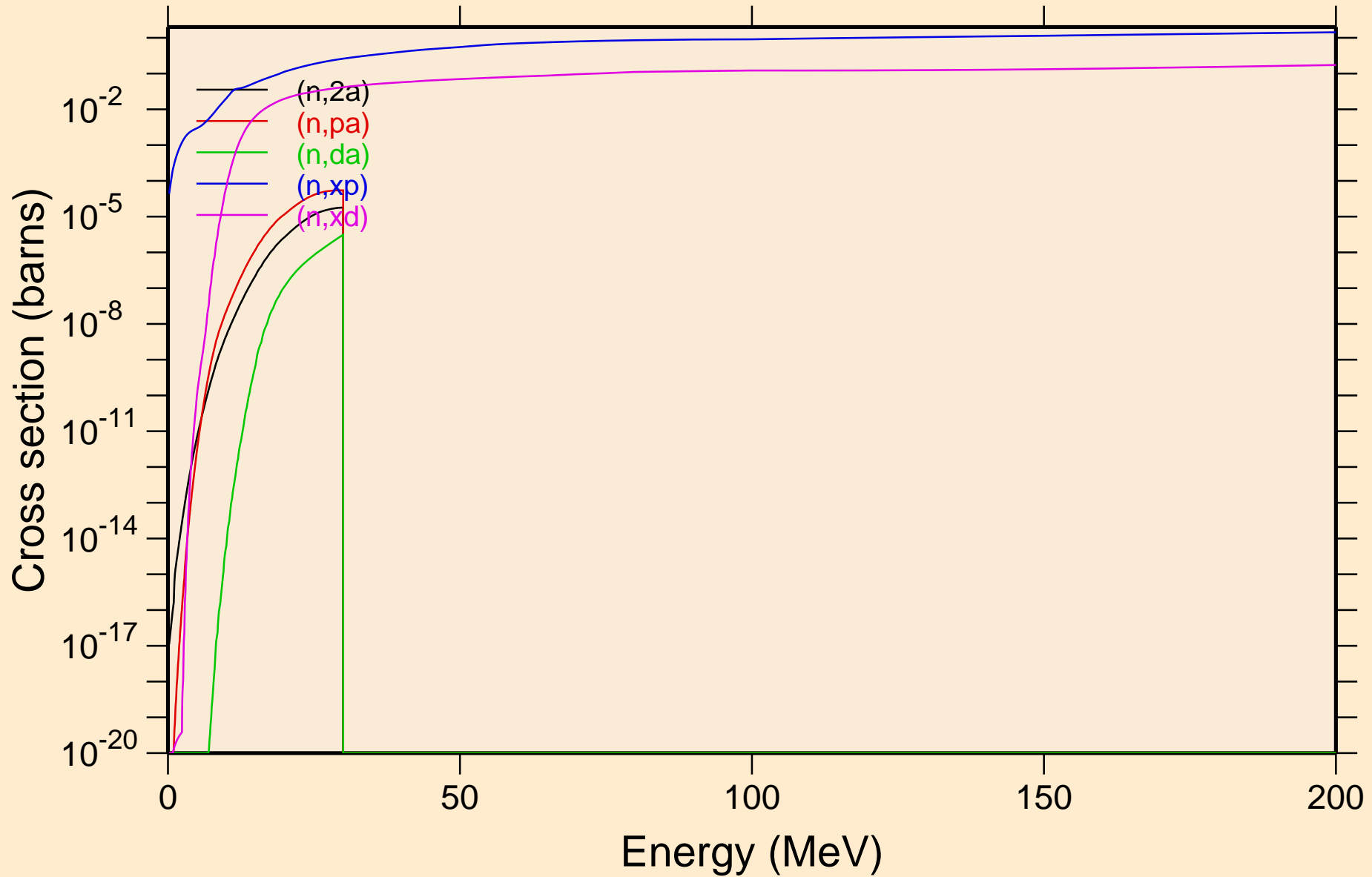

TB151M NEUTRON ACER TENDL-2023 LIBRARY; T=0.K
Non-threshold reactions

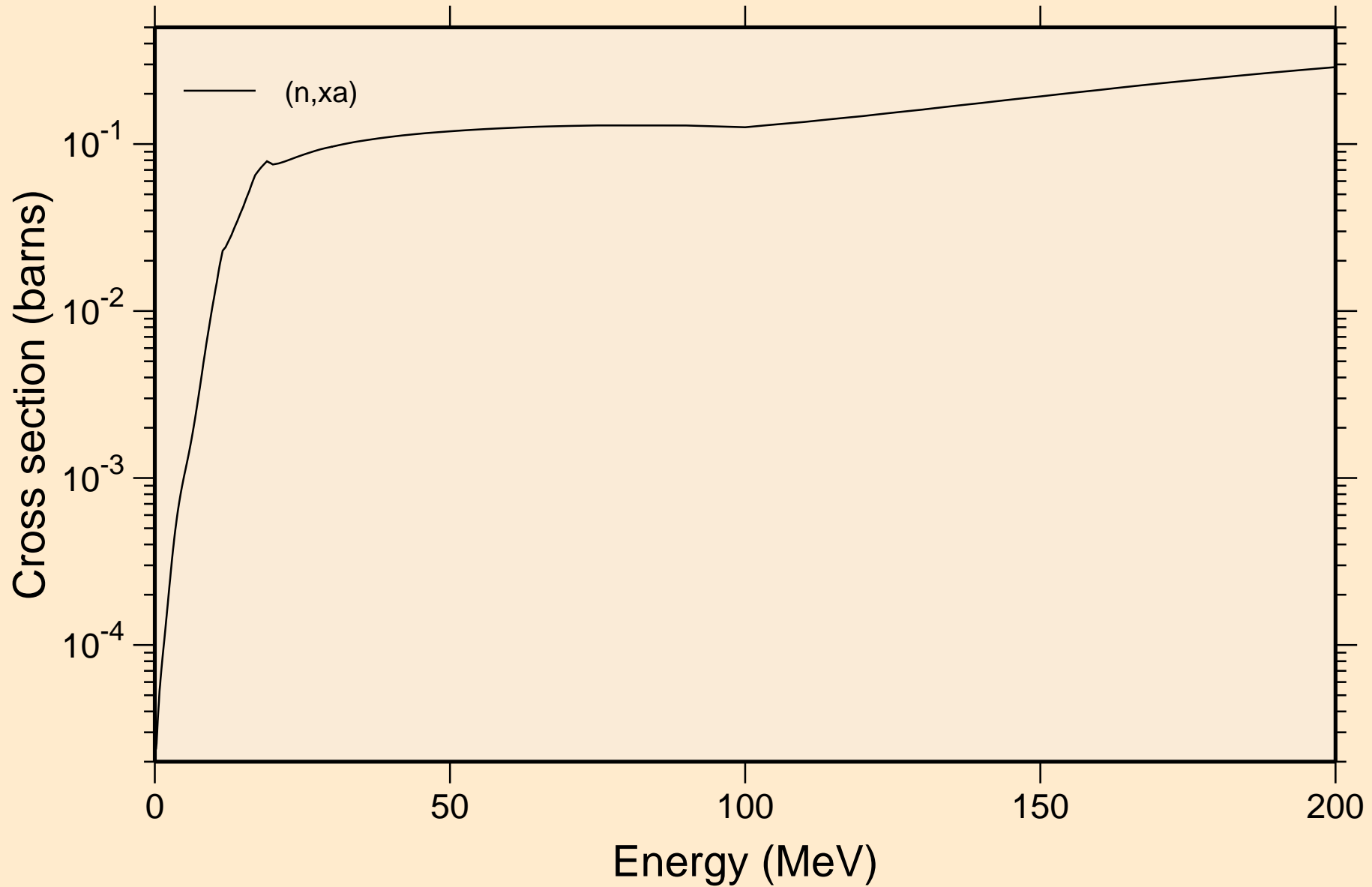

TB151M NEUTRON ACER TENDL-2023 LIBRARY; T=0.K
Inelastic levels

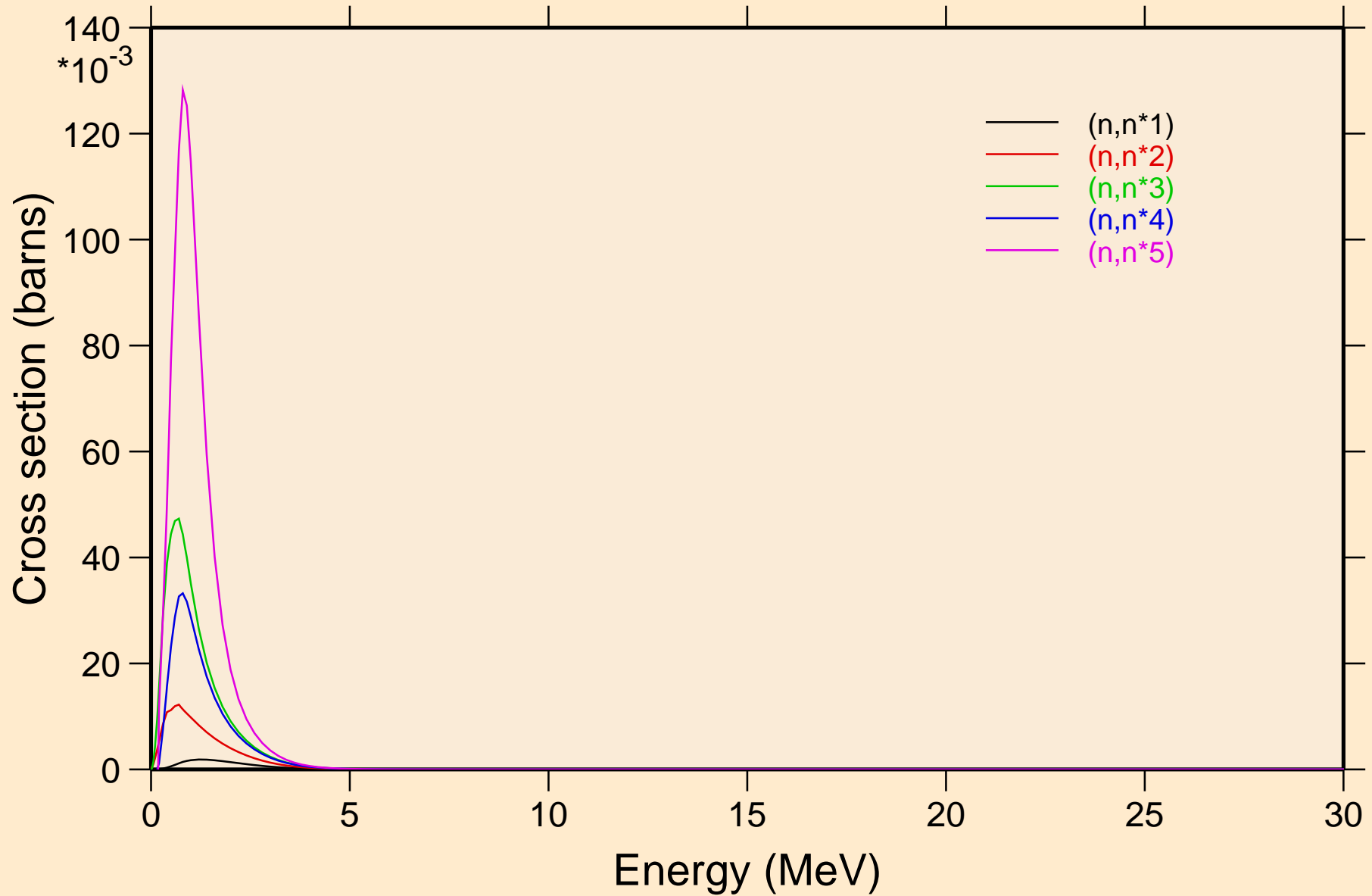

TB151M NEUTRON ACER TENDL-2023 LIBRARY; T=0.K
Inelastic levels

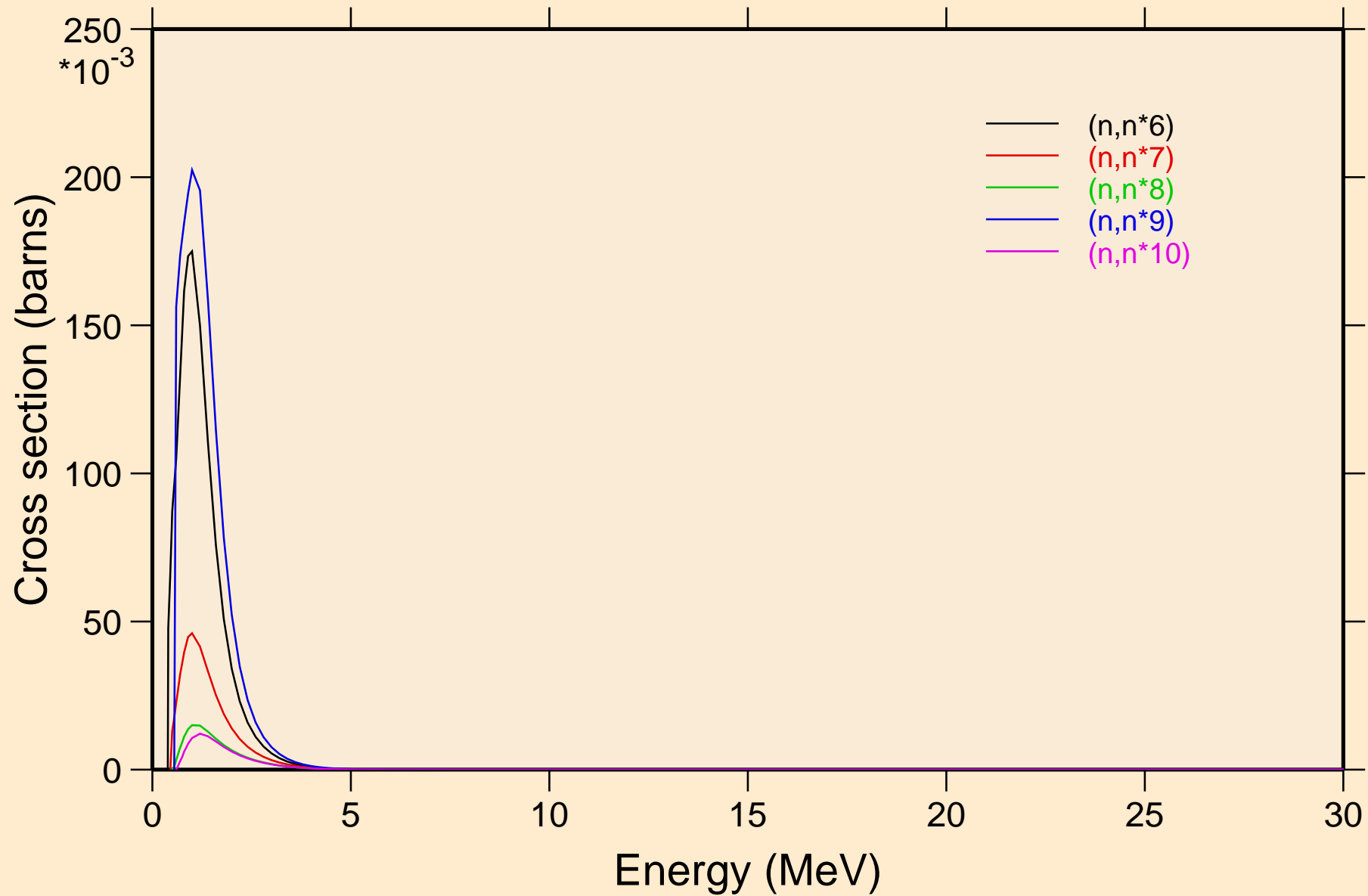

TB151M NEUTRON ACER TENDL-2023 LIBRARY; T=0.K
Inelastic levels

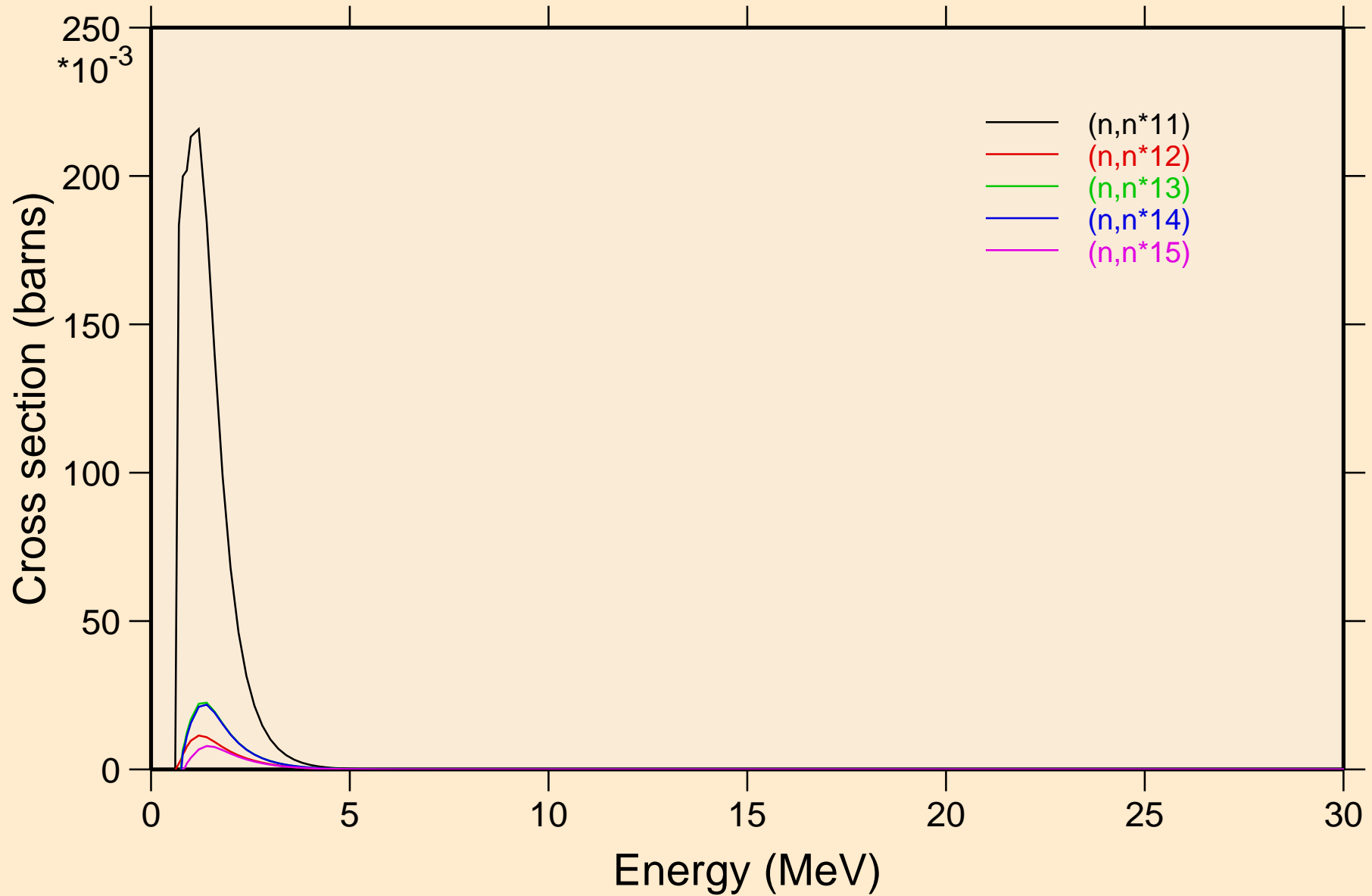

TB151M NEUTRON ACER TENDL-2023 LIBRARY; T=0.K
Inelastic levels

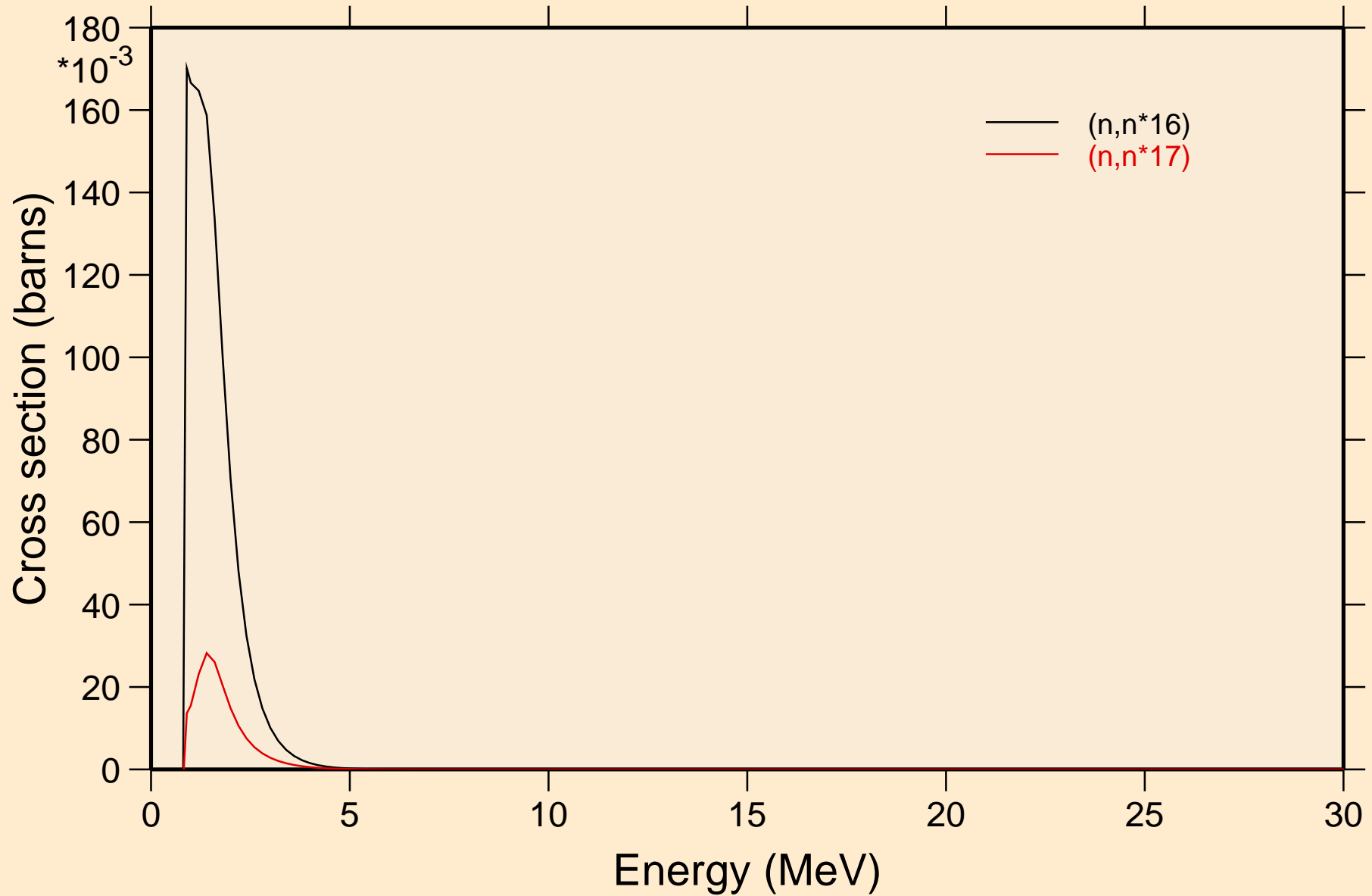

TB151M NEUTRON ACER TENDL-2023 LIBRARY; T=0.K
Threshold reactions

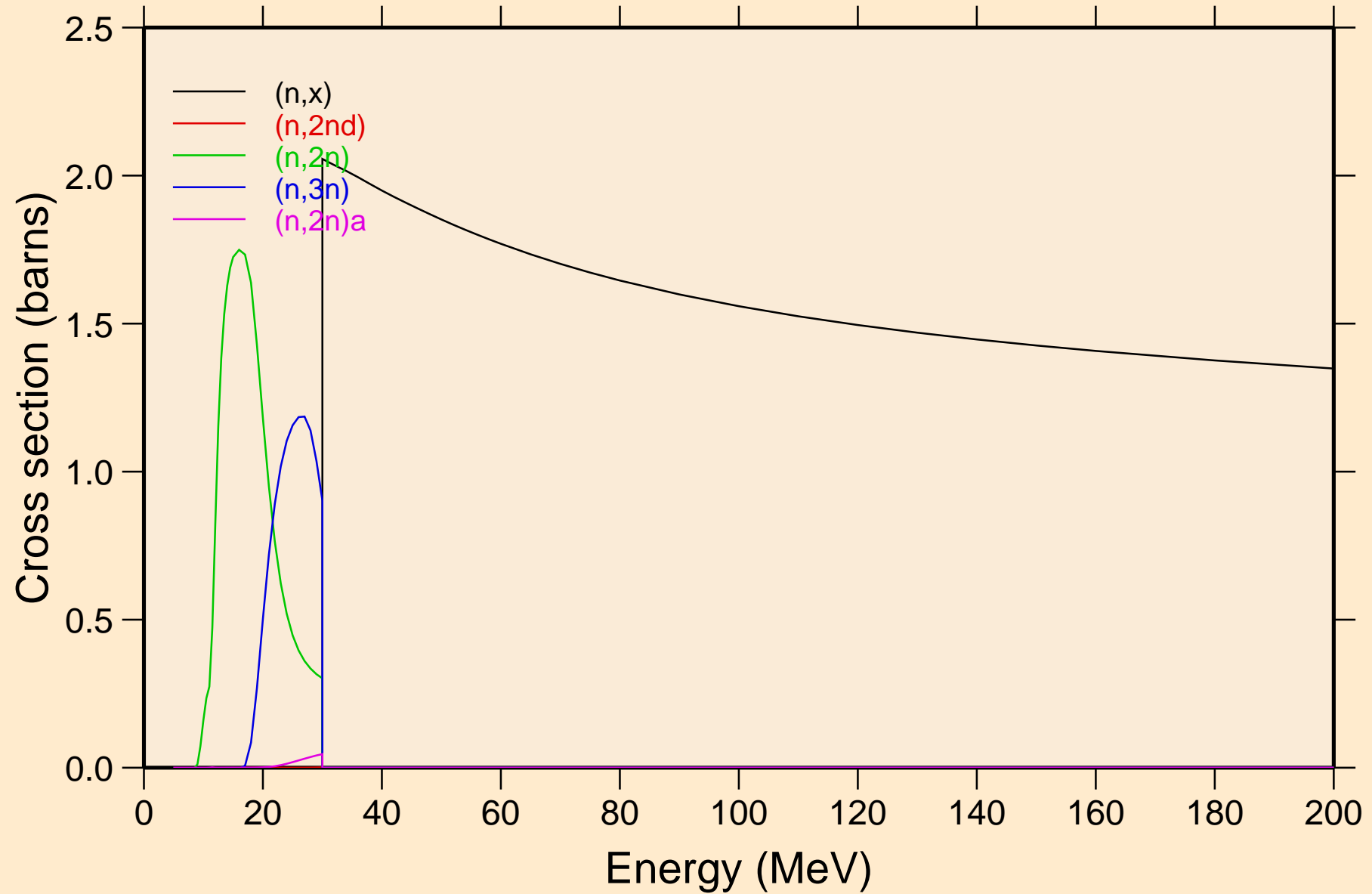

TB151M NEUTRON ACER TENDL-2023 LIBRARY; T=0.K
Threshold reactions

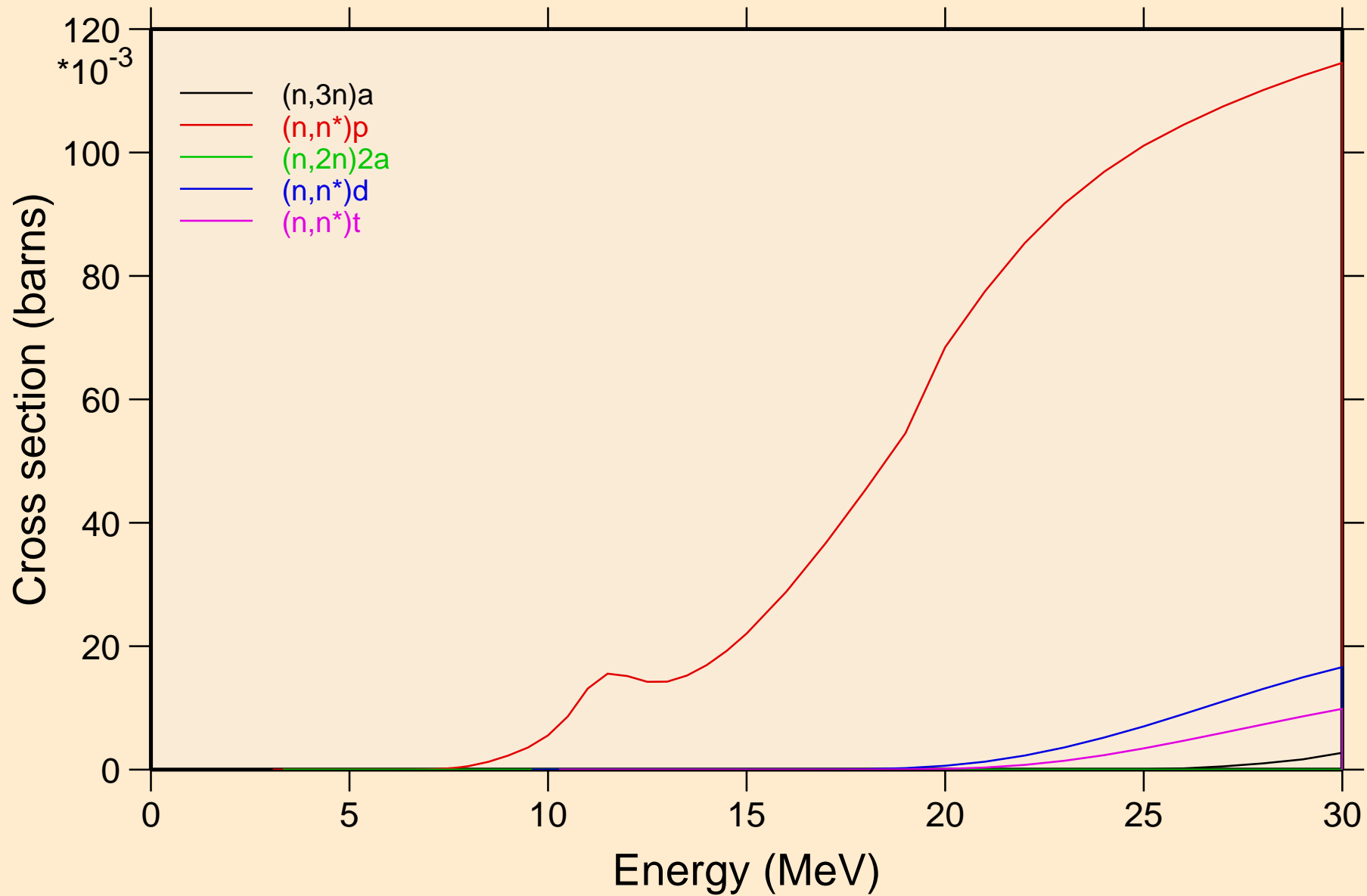

TB151M NEUTRON ACER TENDL-2023 LIBRARY; T=0.K

Threshold reactions

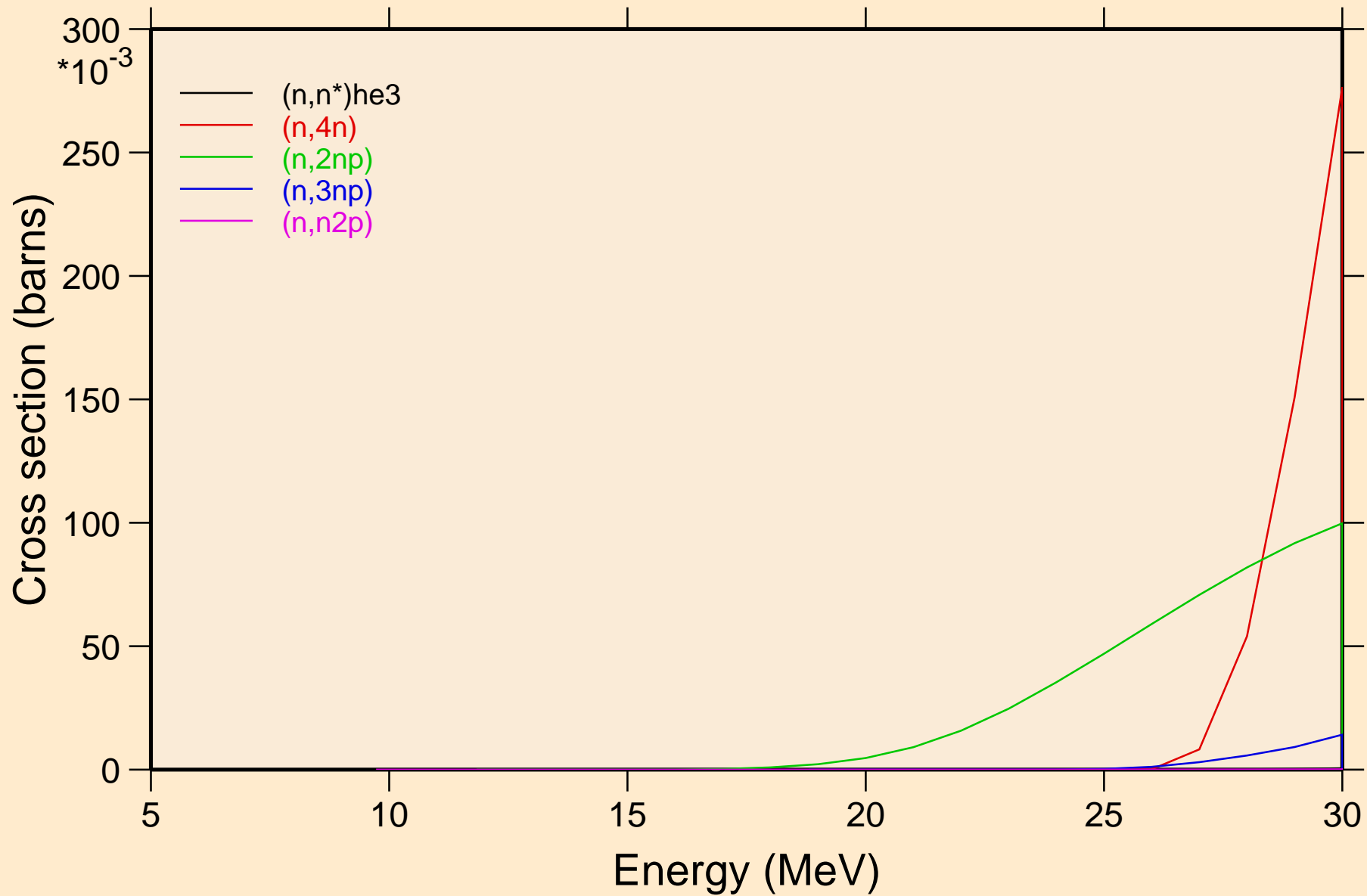

TB151M NEUTRON ACER TENDL-2023 LIBRARY; T=0.K
Threshold reactions

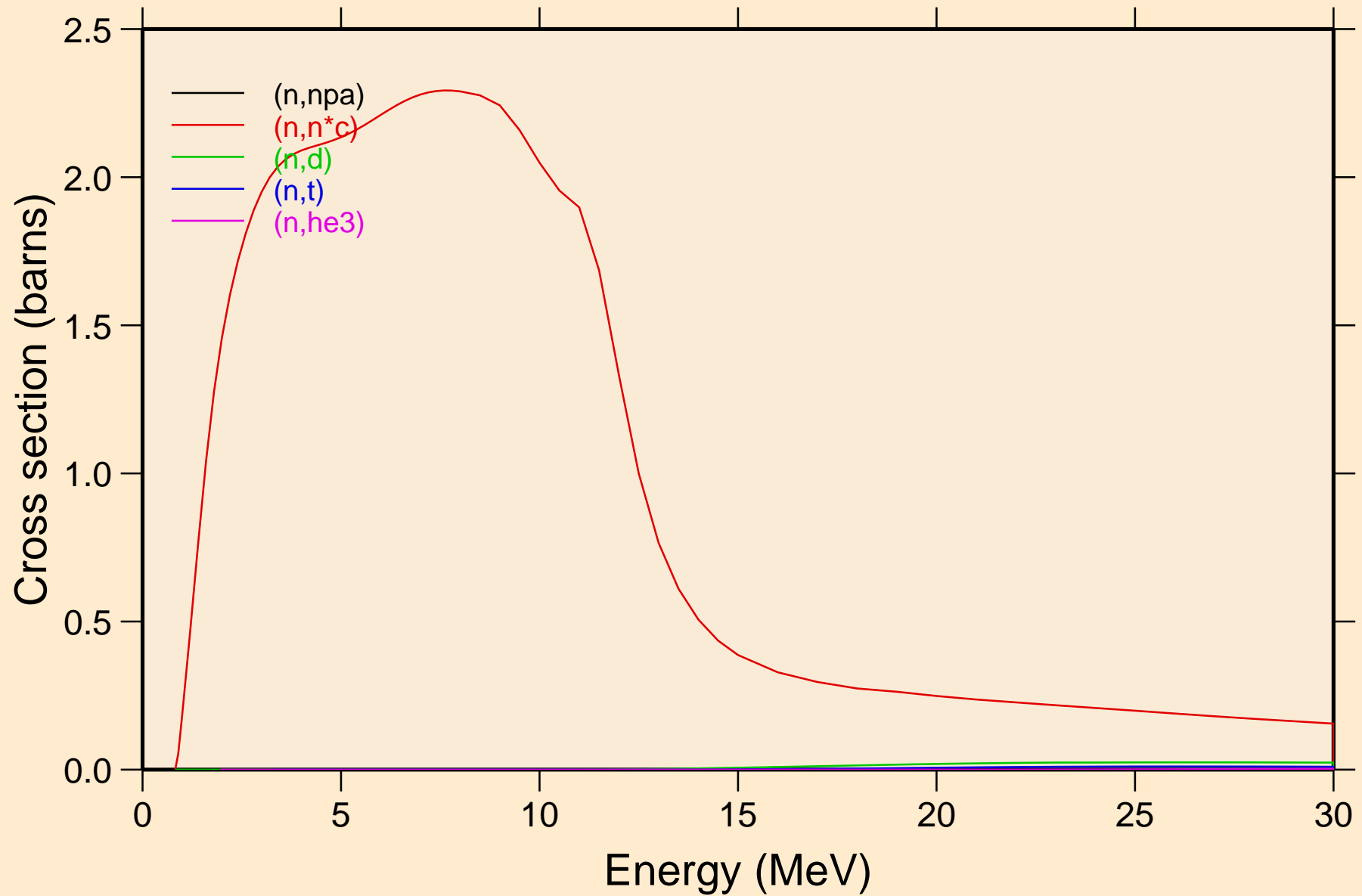

TB151M NEUTRON ACER TENDL-2023 LIBRARY; T=0.K

Threshold reactions

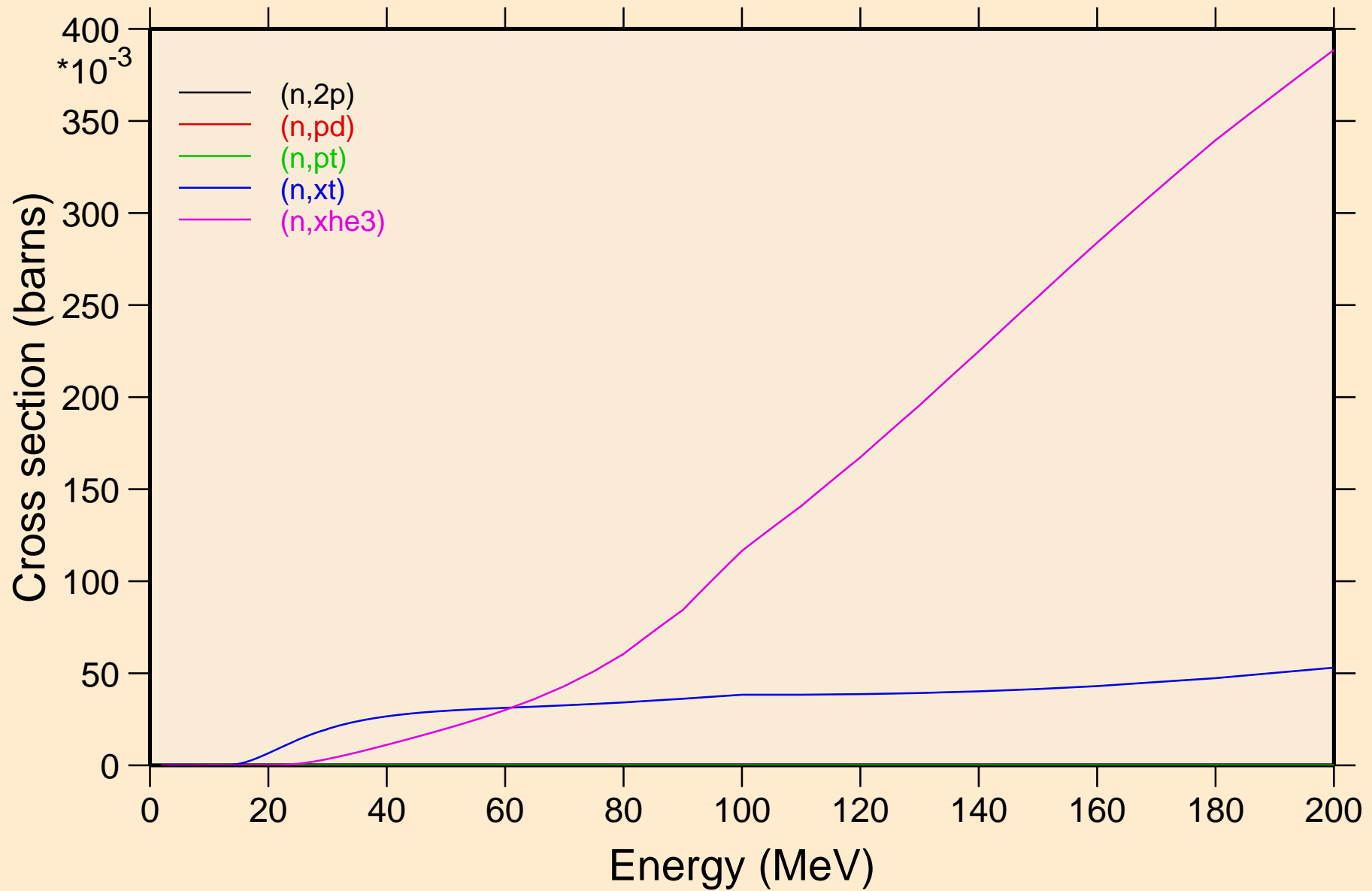

TB151M NEUTRON ACER TENDL-2023 LIBRARY; T=0.K
angular distribution for elastic

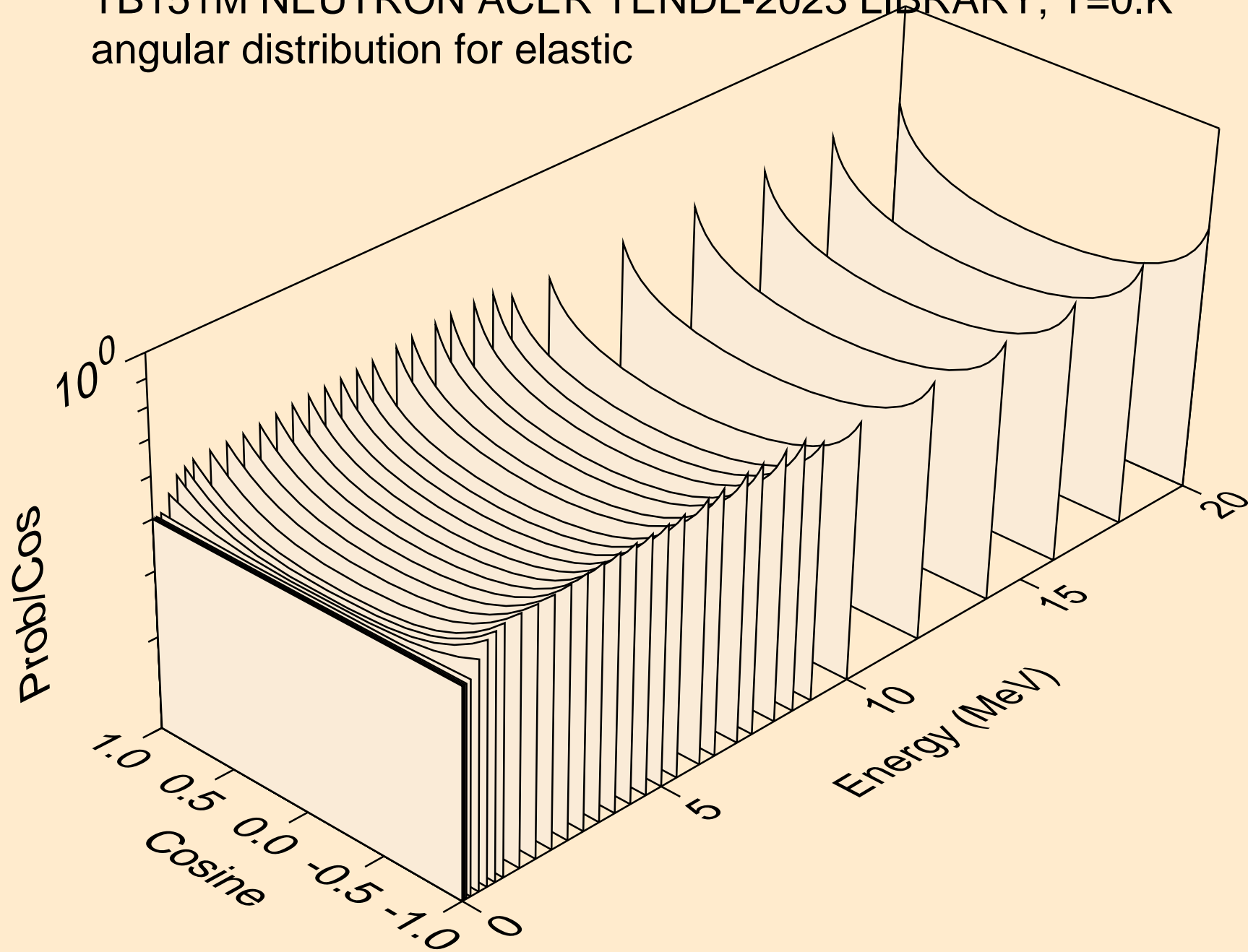

TB151M NEUTRON ACER TENDL-2023 LIBRARY; T=0.K
angular distribution for elastic

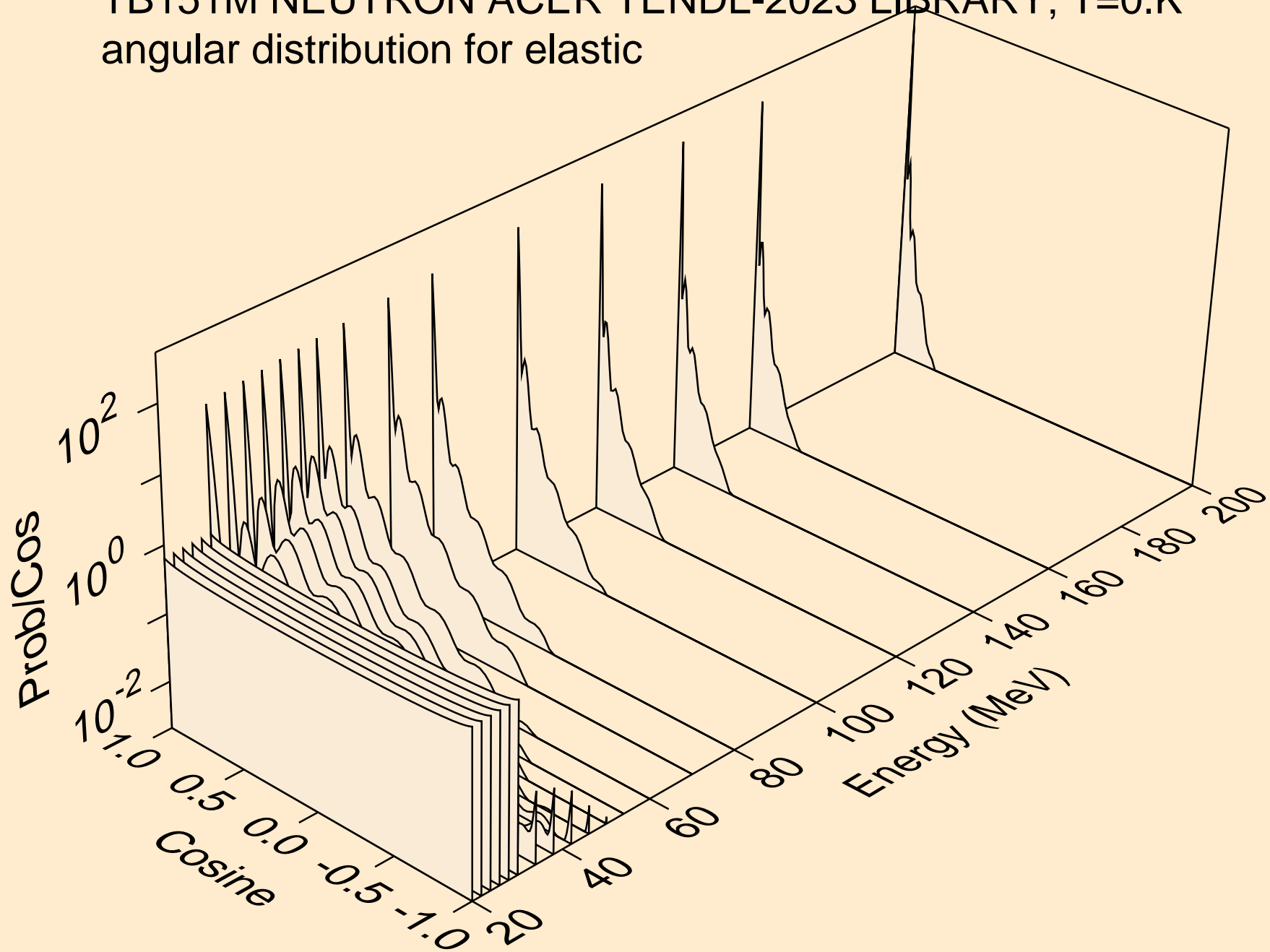

TB151M NEUTRON ACER TENDL-2023 LIBRARY; T=0.K
angular distribution for (n,n*1)

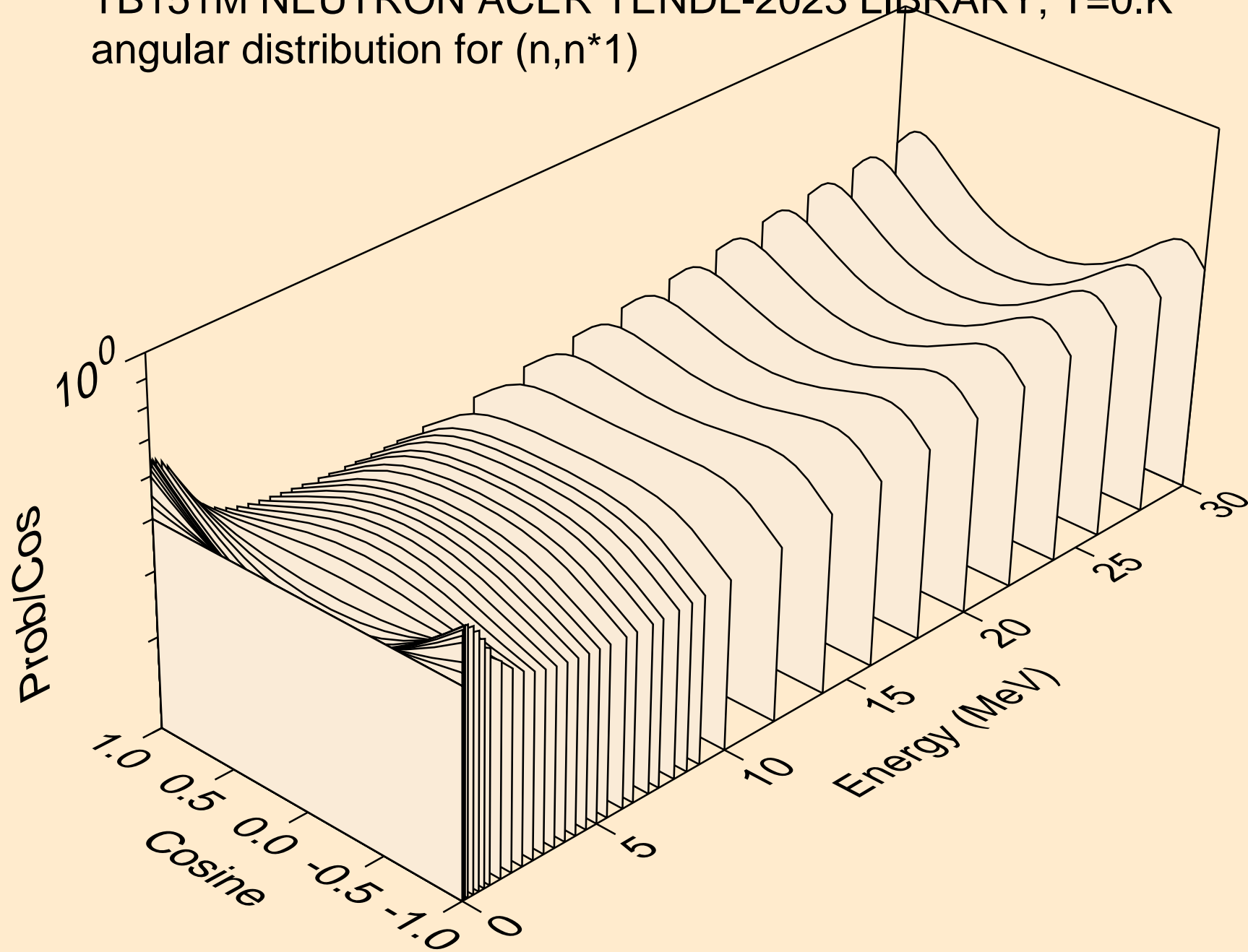

TB151M NEUTRON ACER TENDL-2023 LIBRARY; T=0.K
angular distribution for (n,n*2)

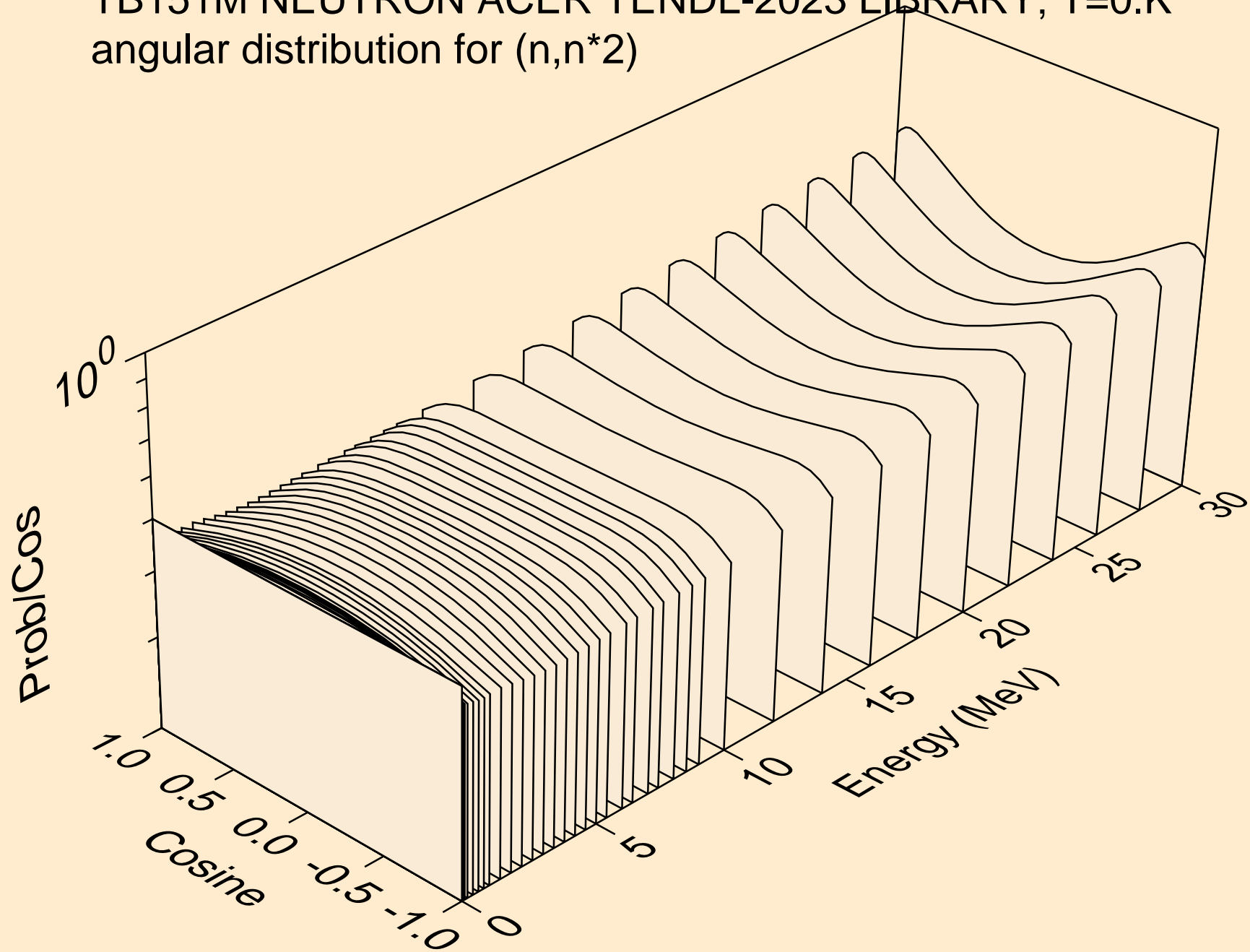

TB151M NEUTRON ACER TENDL-2023 LIBRARY; T=0.K
angular distribution for (n,n*3)

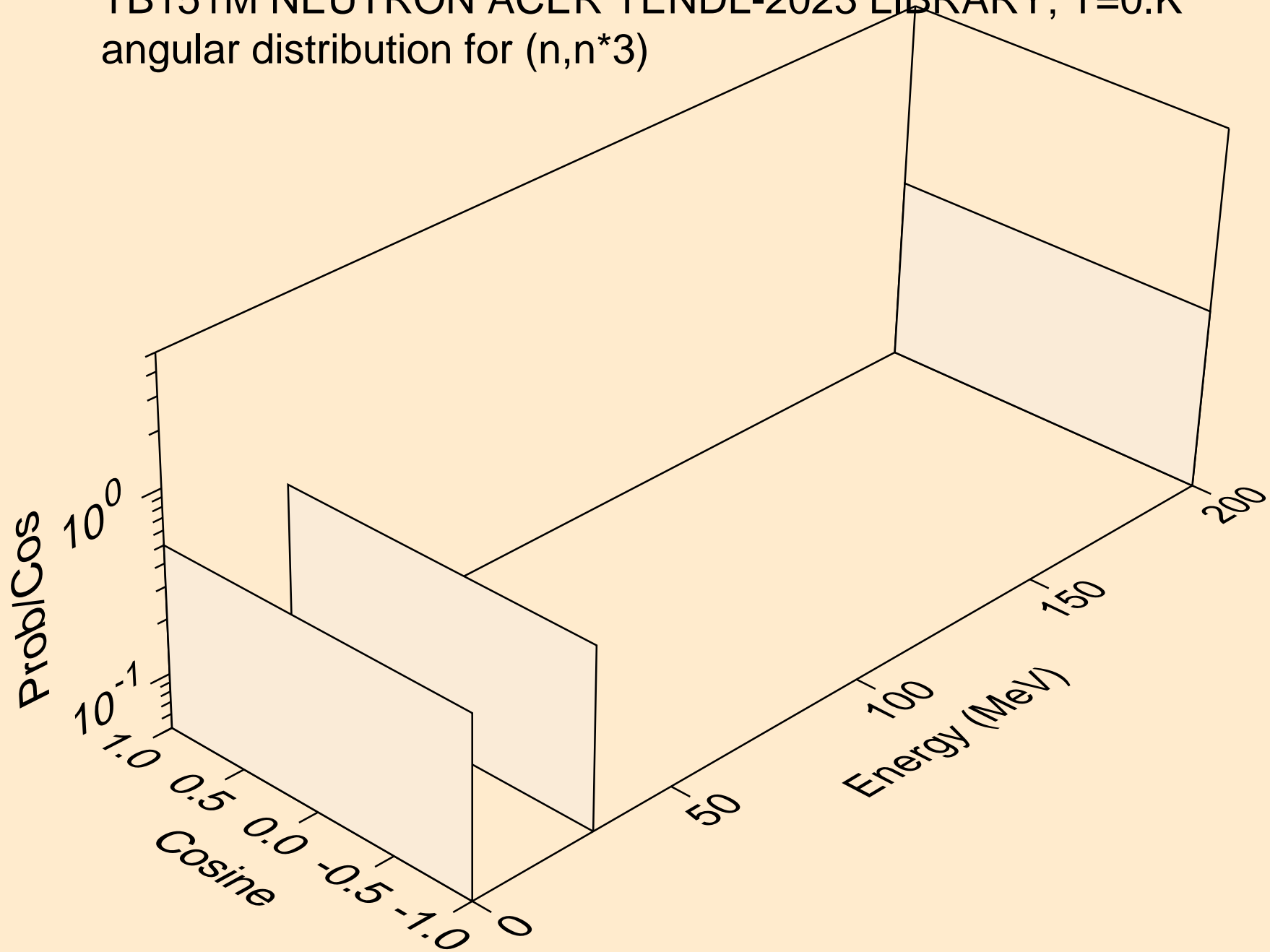

TB151M NEUTRON ACER TENDL-2023 LIBRARY; T=0.K
angular distribution for (n,n*4)

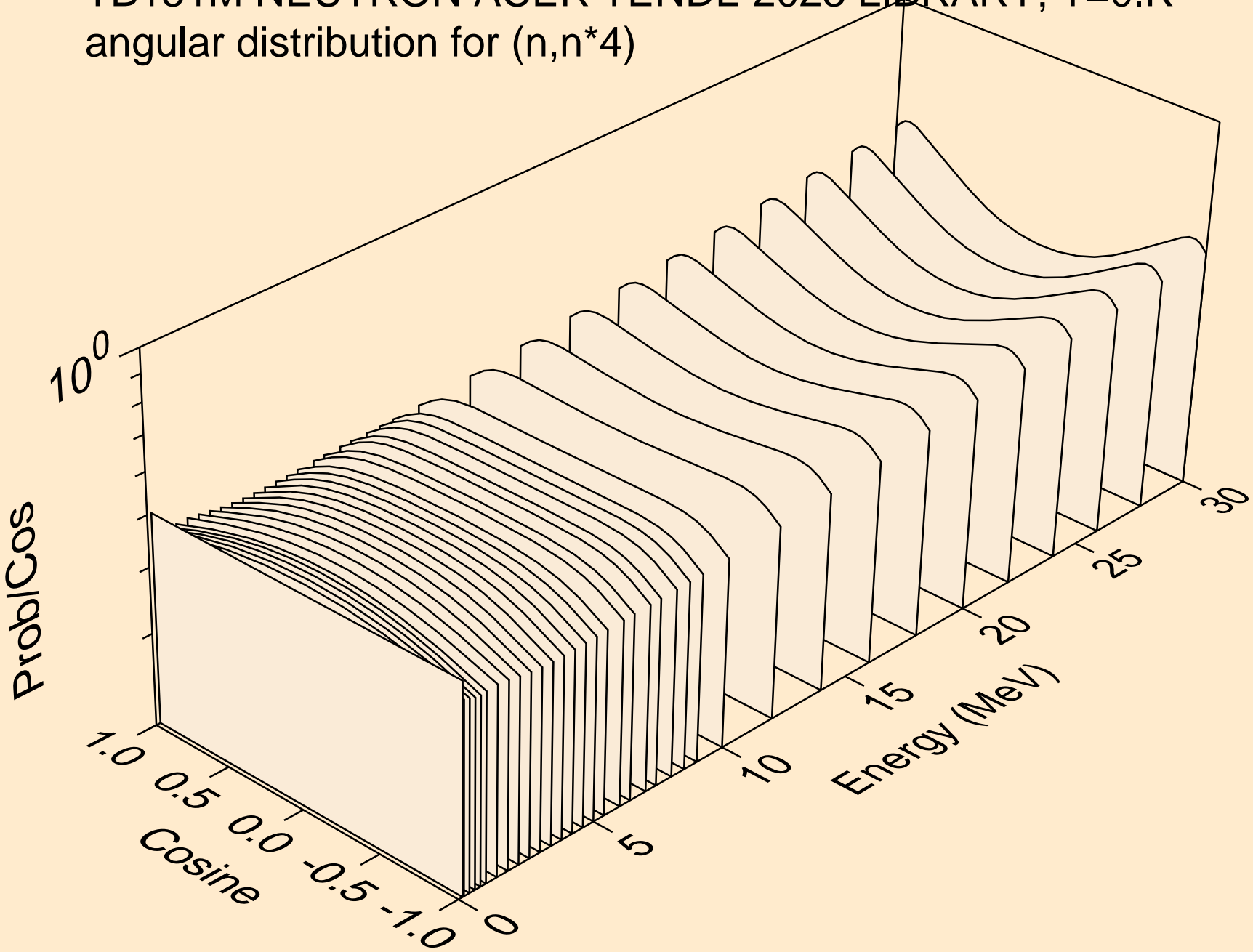

TB151M NEUTRON ACER TENDL-2023 LIBRARY; T=0.K
angular distribution for (n,n*5)

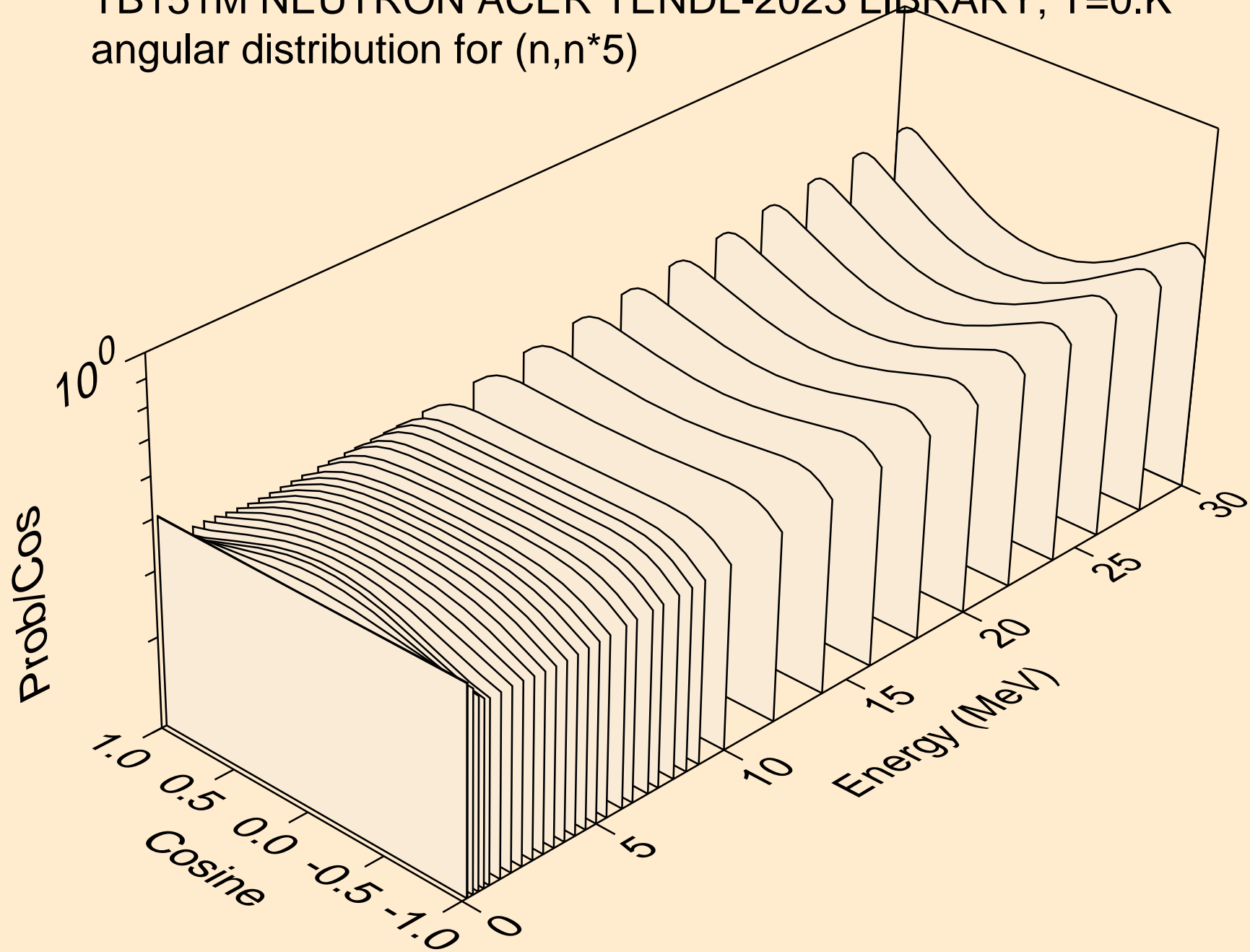

TB151M NEUTRON ACER TENDL-2023 LIBRARY; T=0.K
angular distribution for (n,n*6)

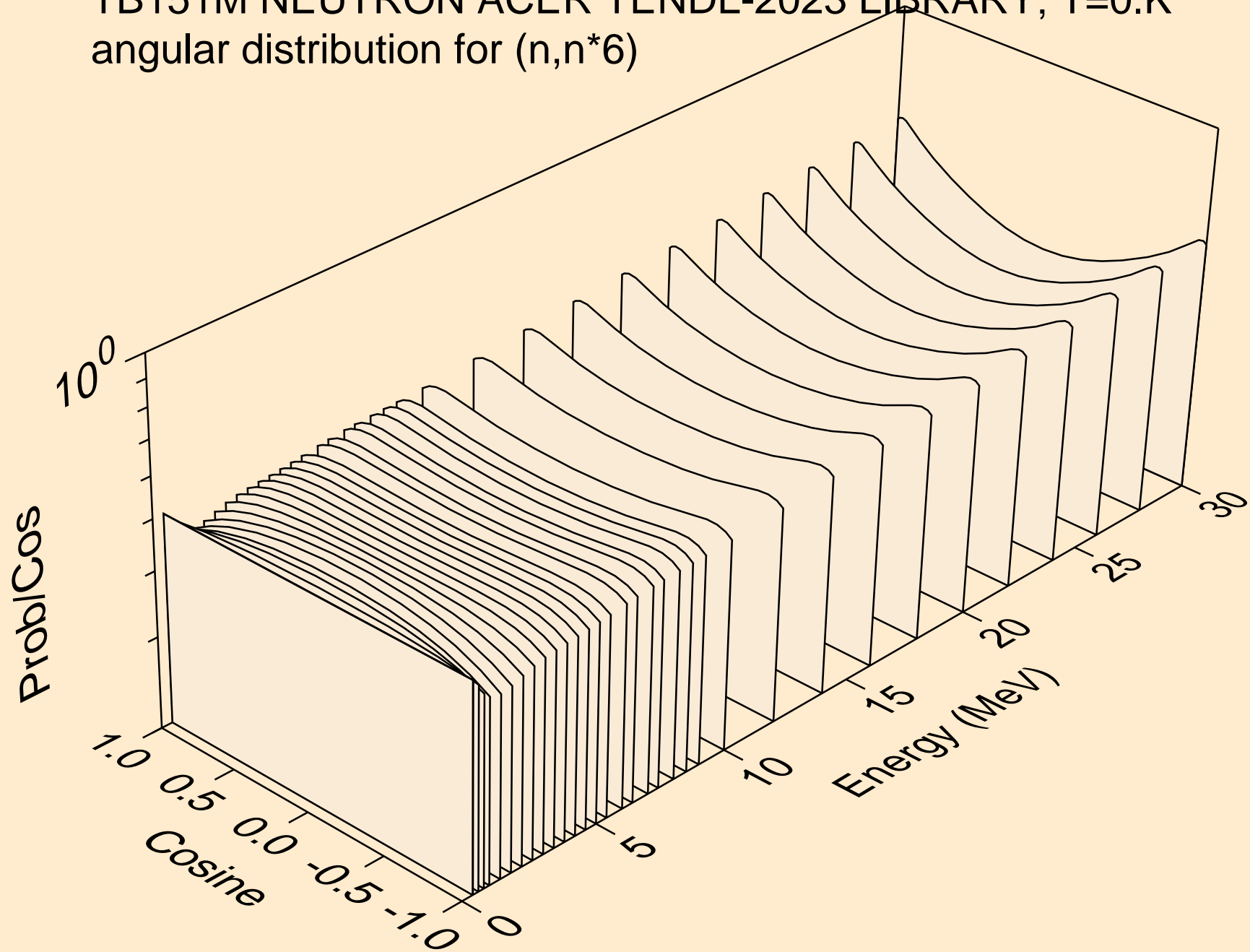

TB151M NEUTRON ACER TENDL-2023 LIBRARY; T=0.K
angular distribution for (n,n*7)

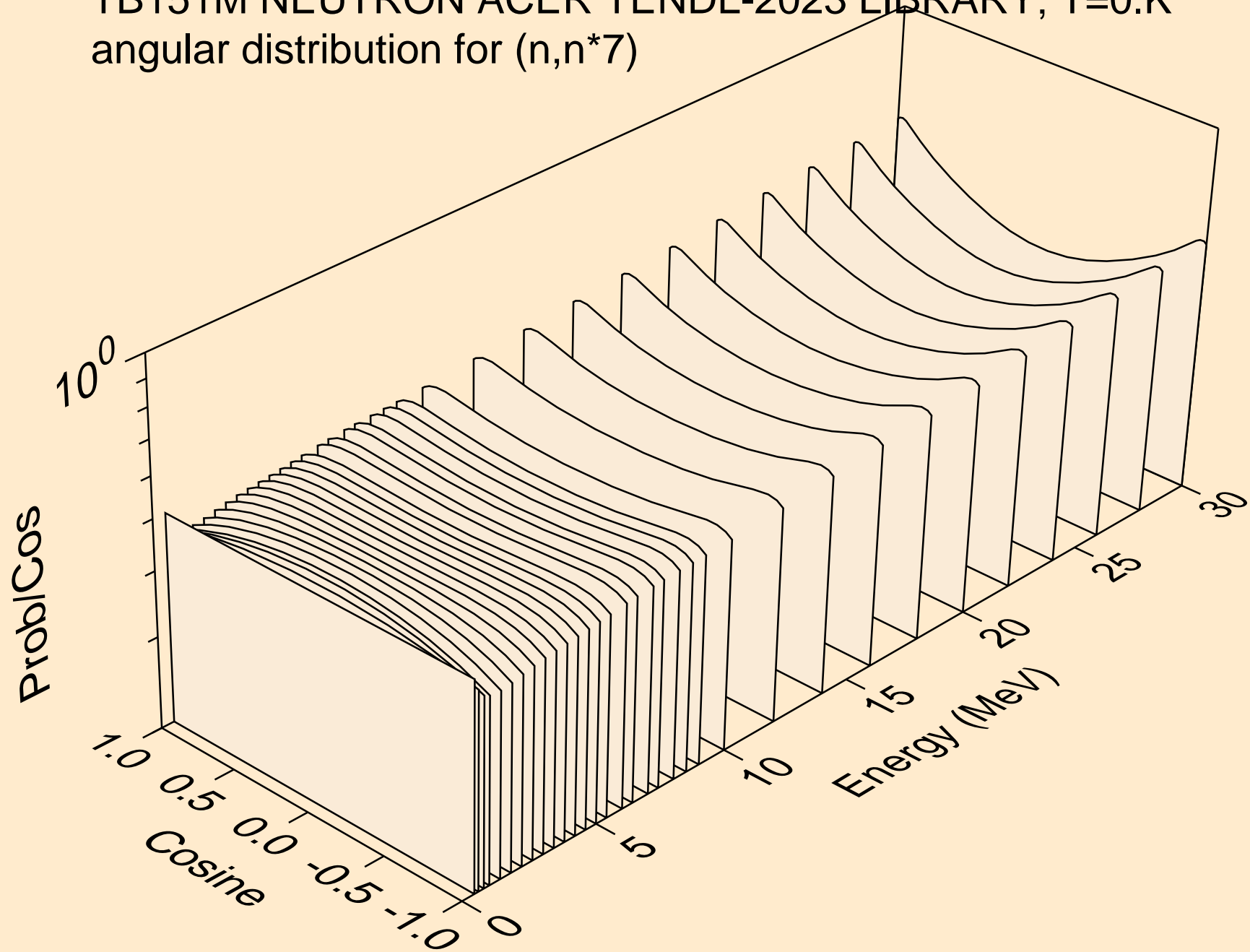

TB151M NEUTRON ACER TENDL-2023 LIBRARY; T=0.K
angular distribution for (n,n*8)

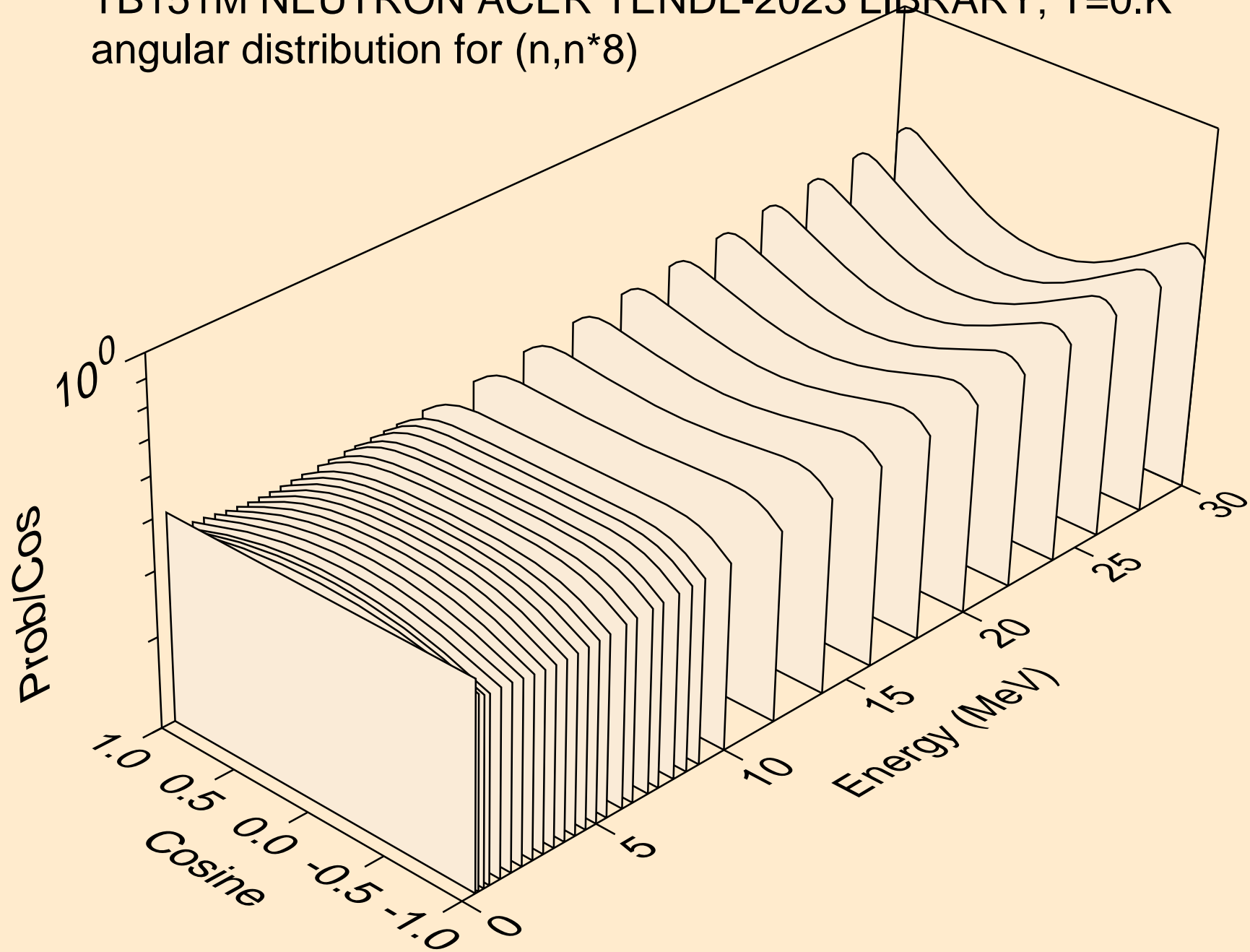

TB151M NEUTRON ACER TENDL-2023 LIBRARY; T=0.K
angular distribution for (n,n*9)

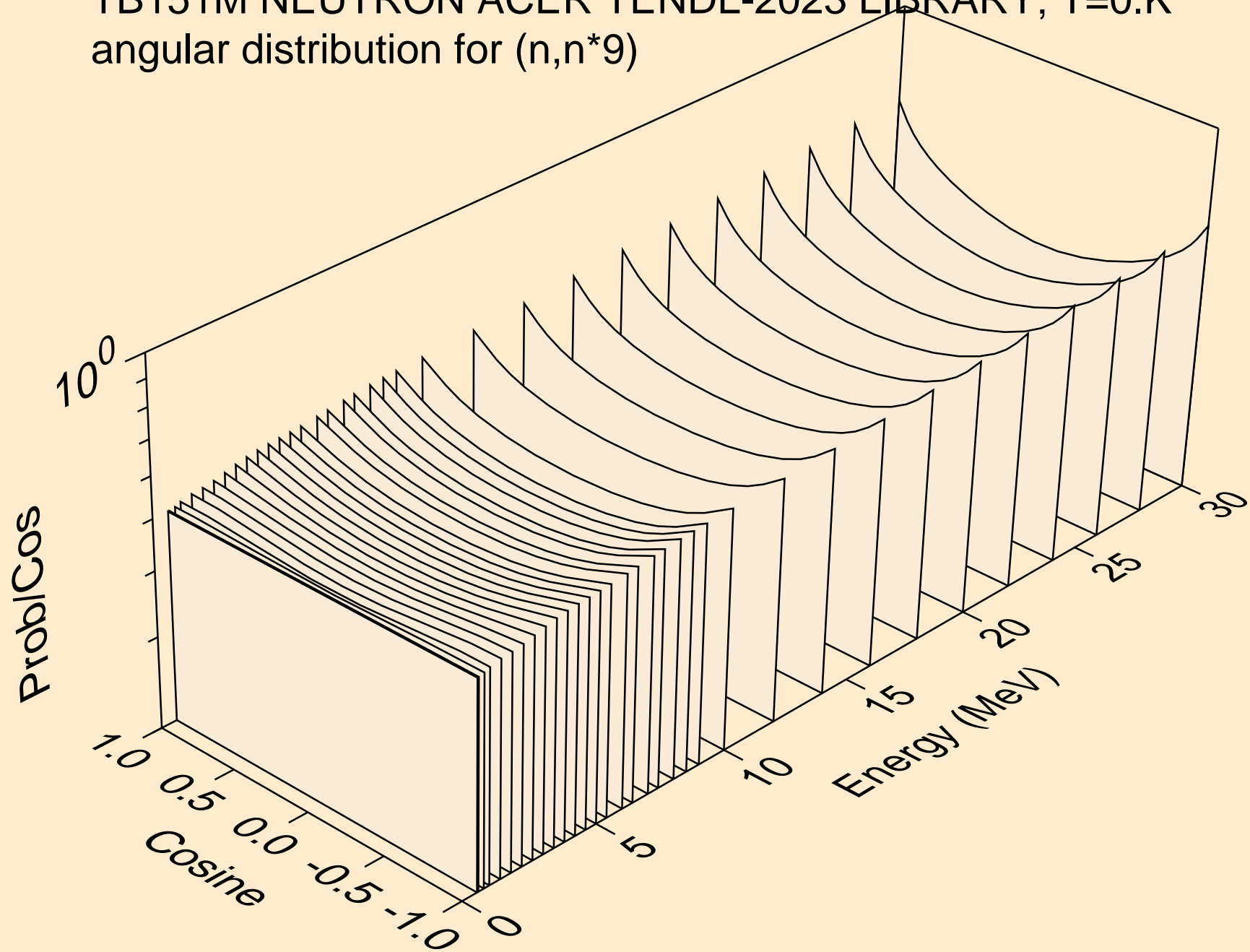

TB151M NEUTRON ACER TENDL-2023 LIBRARY; T=0.K
angular distribution for (n,n*10)

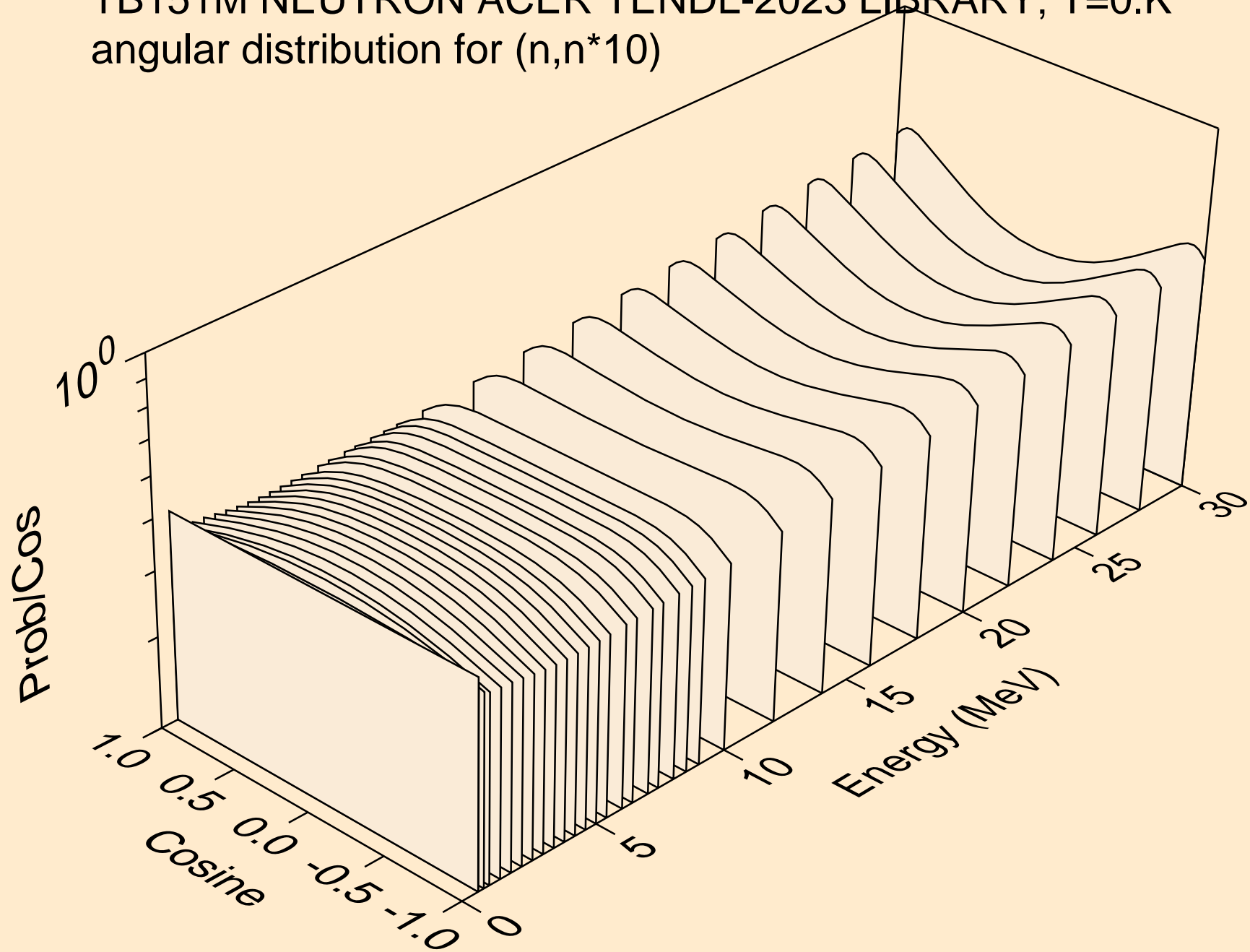

TB151M NEUTRON ACER TENDL-2023 LIBRARY; T=0.K
angular distribution for (n,n*11)

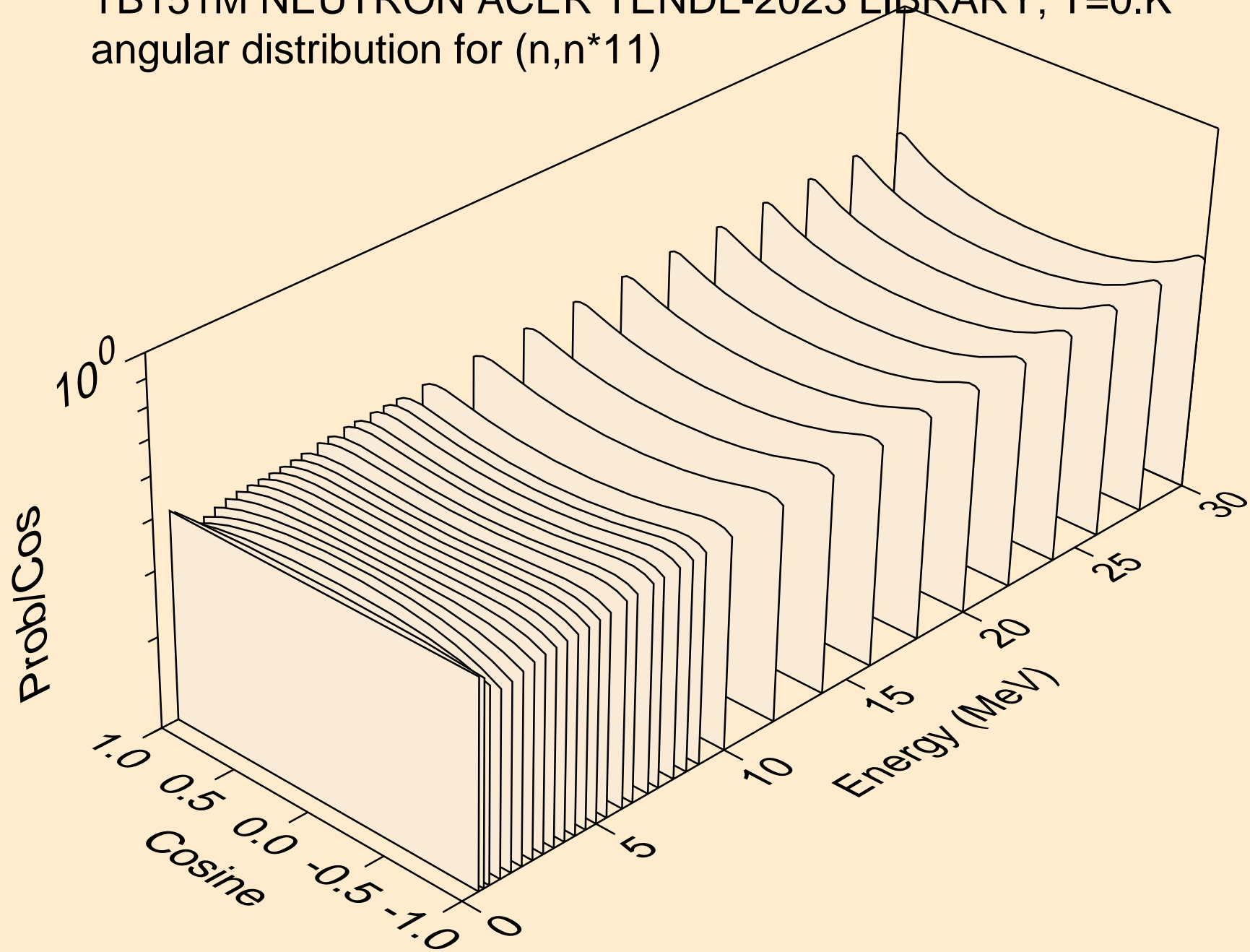

TB151M NEUTRON ACER TENDL-2023 LIBRARY; T=0.K
angular distribution for (n,n*12)

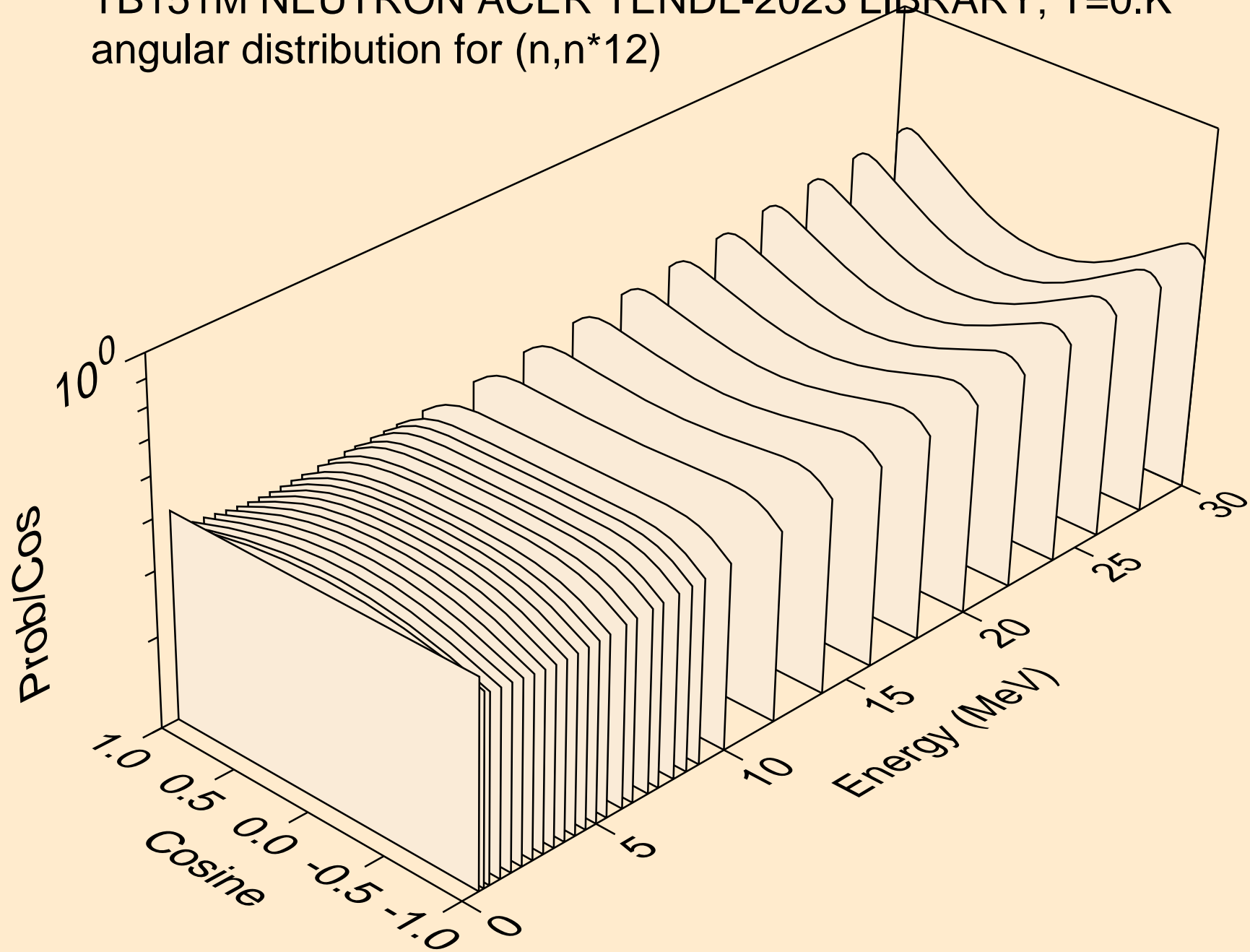

TB151M NEUTRON ACER TENDL-2023 LIBRARY; T=0.K
angular distribution for (n,n*13)

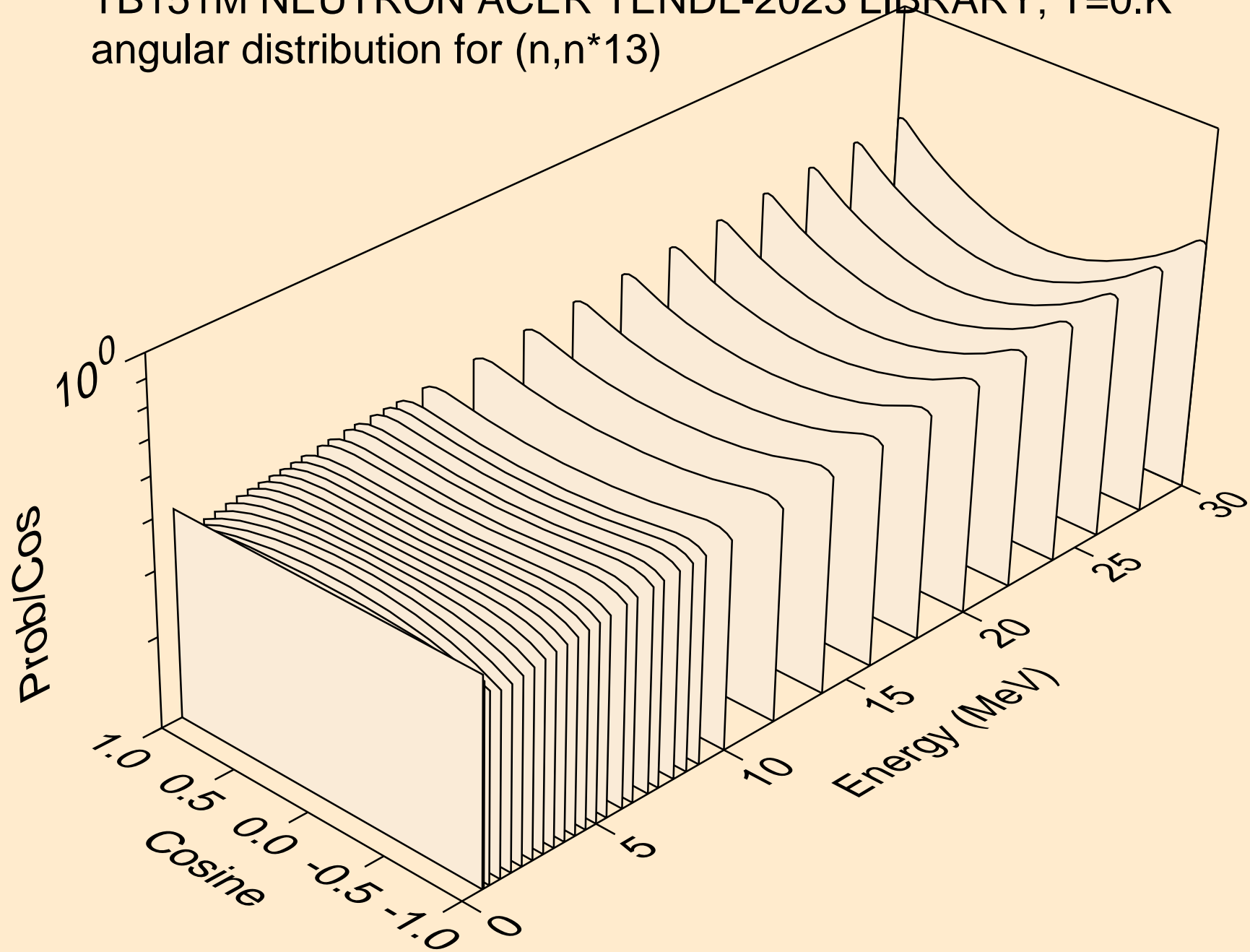

TB151M NEUTRON ACER TENDL-2023 LIBRARY; T=0.K
angular distribution for (n,n*14)

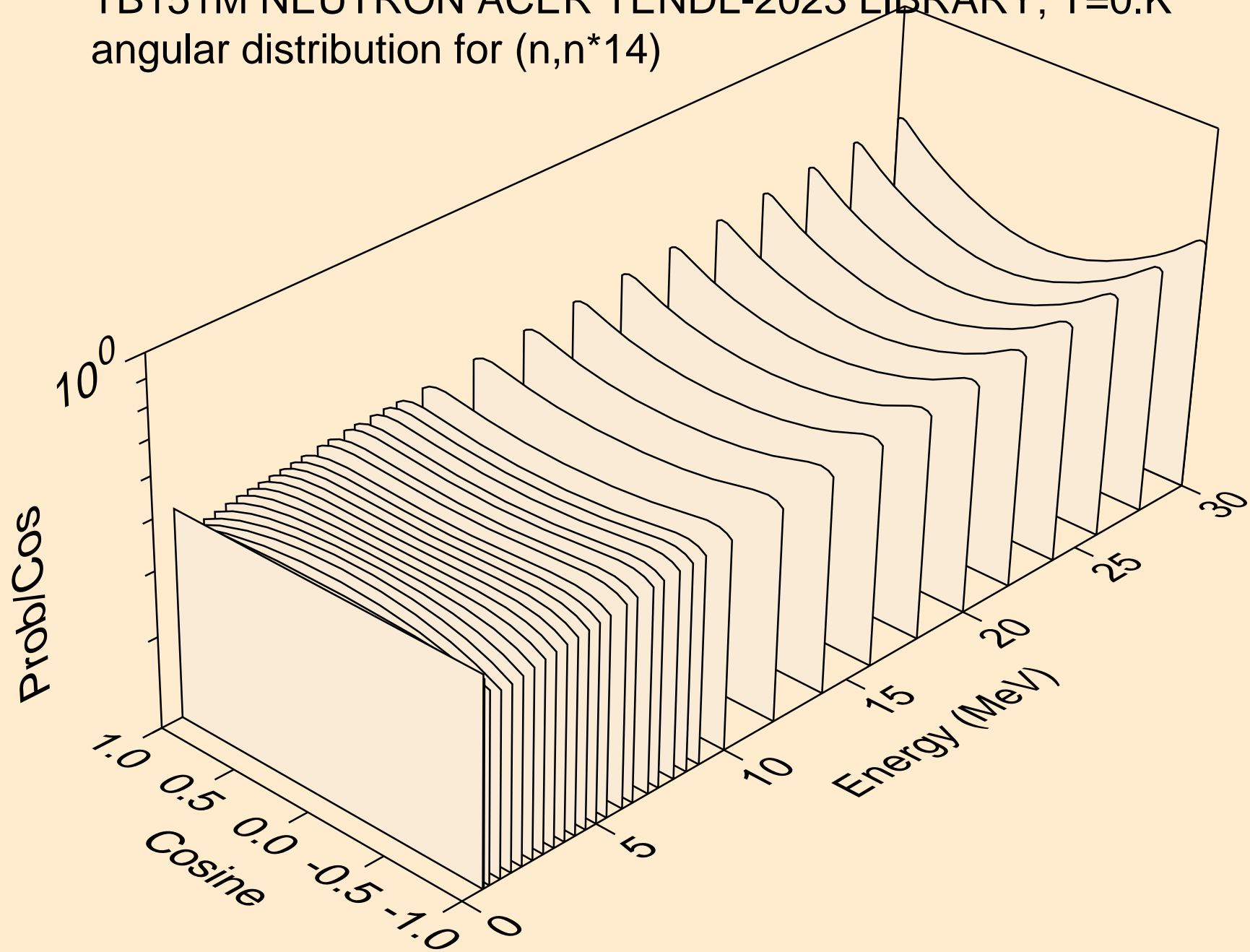

TB151M NEUTRON ACER TENDL-2023 LIBRARY; T=0.K
angular distribution for (n,n*15)

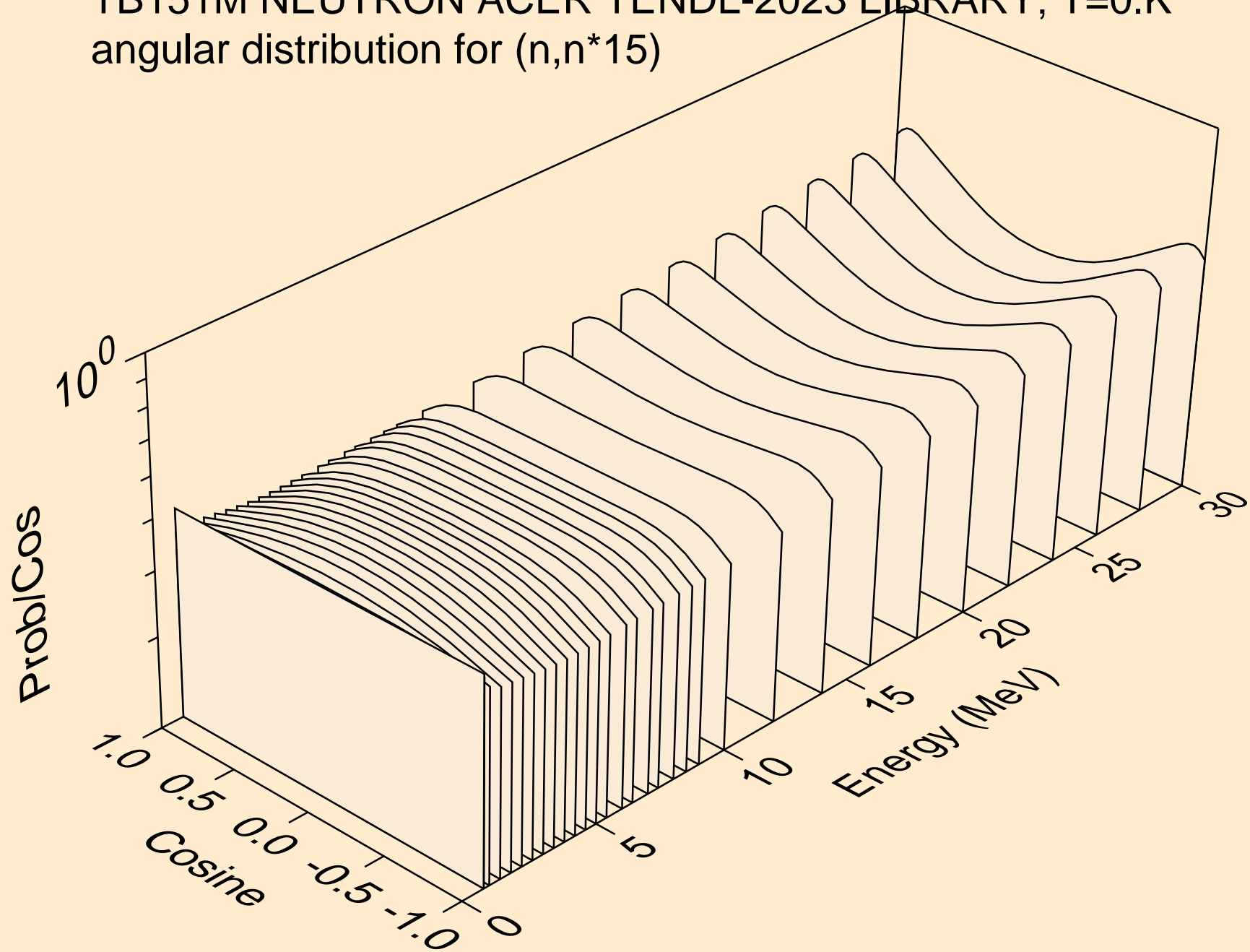

TB151M NEUTRON ACER TENDL-2023 LIBRARY; T=0.K
angular distribution for (n,n*16)

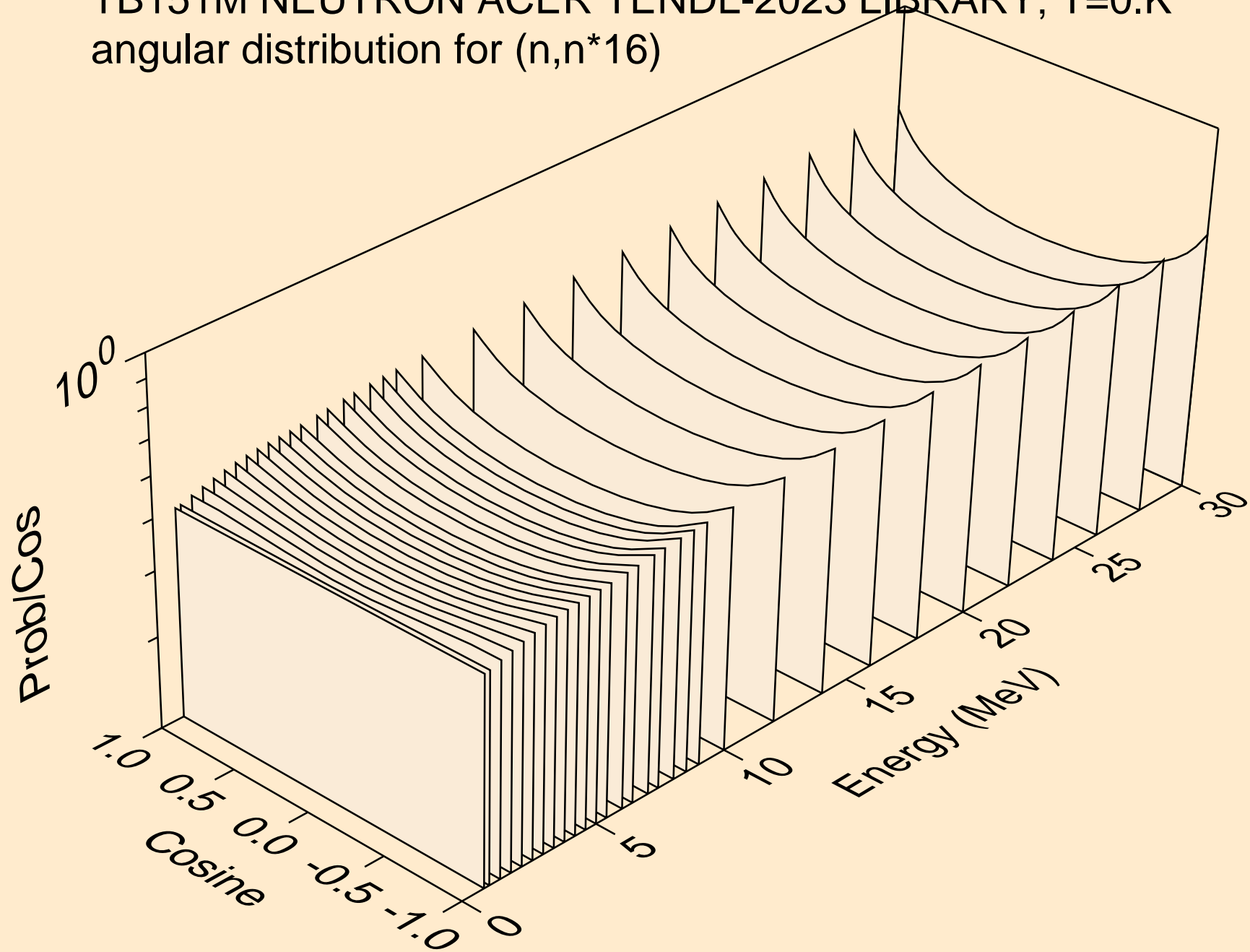

TB151M NEUTRON ACER TENDL-2023 LIBRARY; T=0.K
angular distribution for (n,n*17)

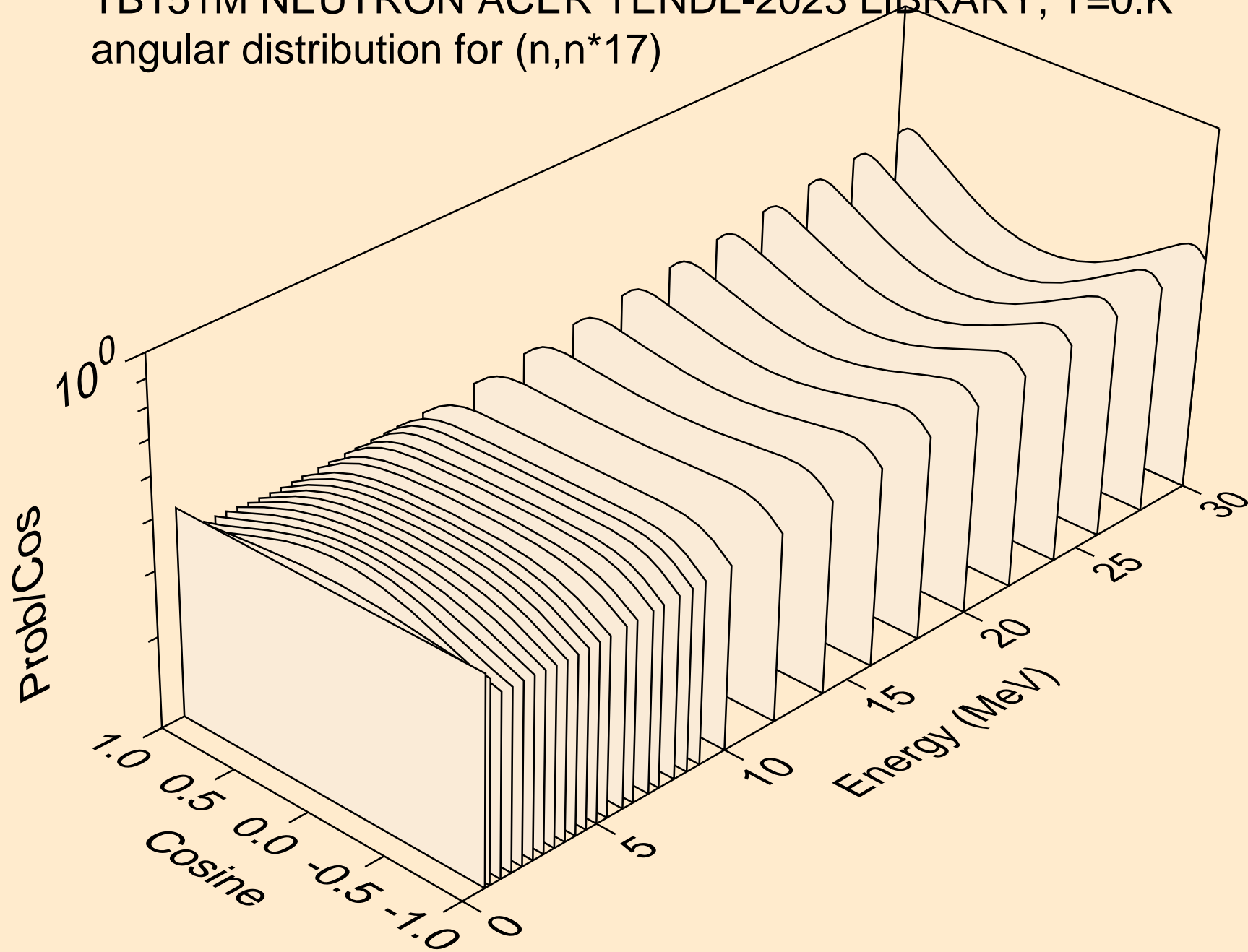

TB151M NEUTRON ACER TENDL-2023 LIBRARY; T=0.K
Neutron emission for (n,x)

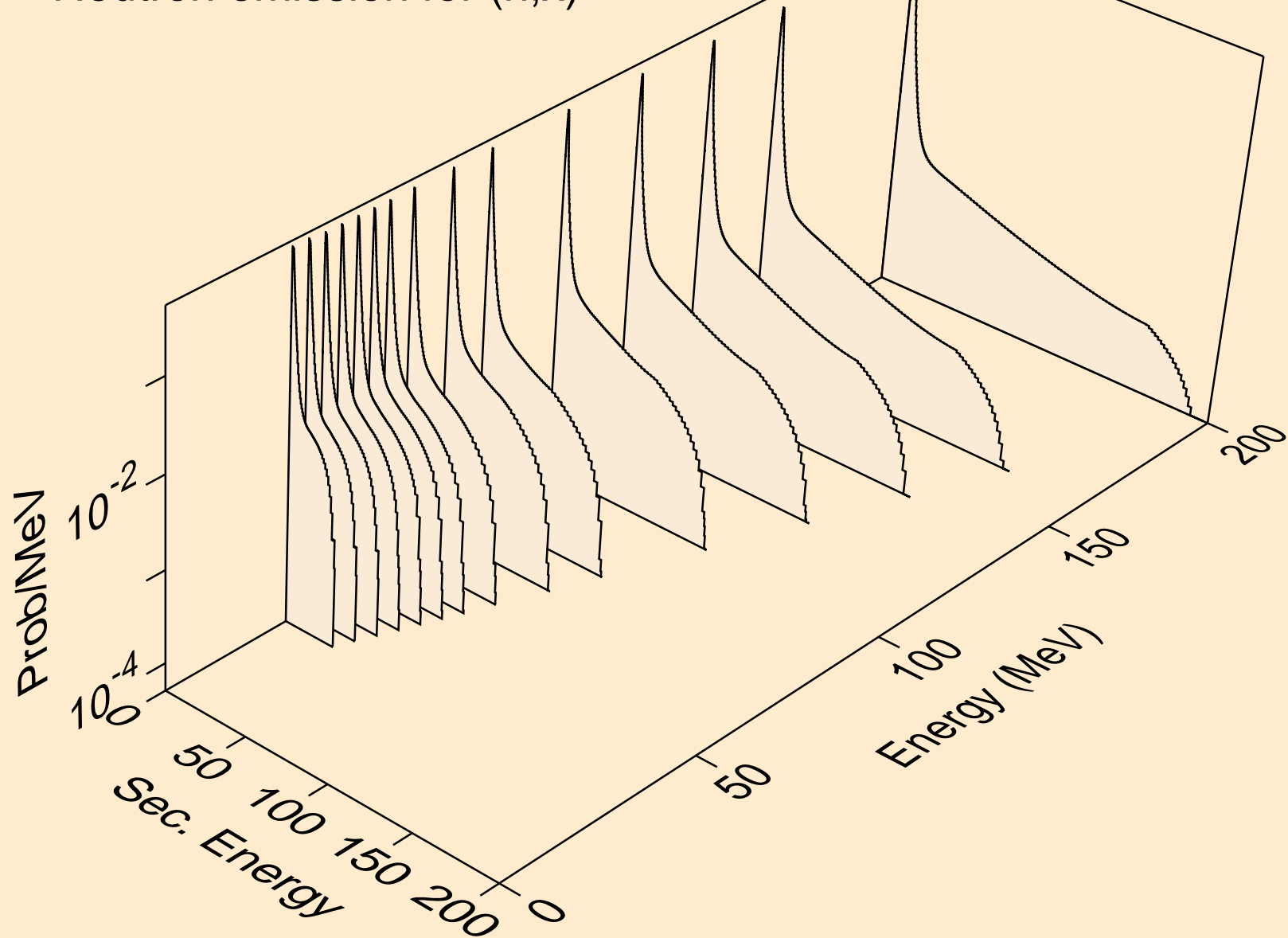

TB151M NEUTRON ACER TENDL-2023 LIBRARY; T=0.K
Neutron emission for (n,2nd)

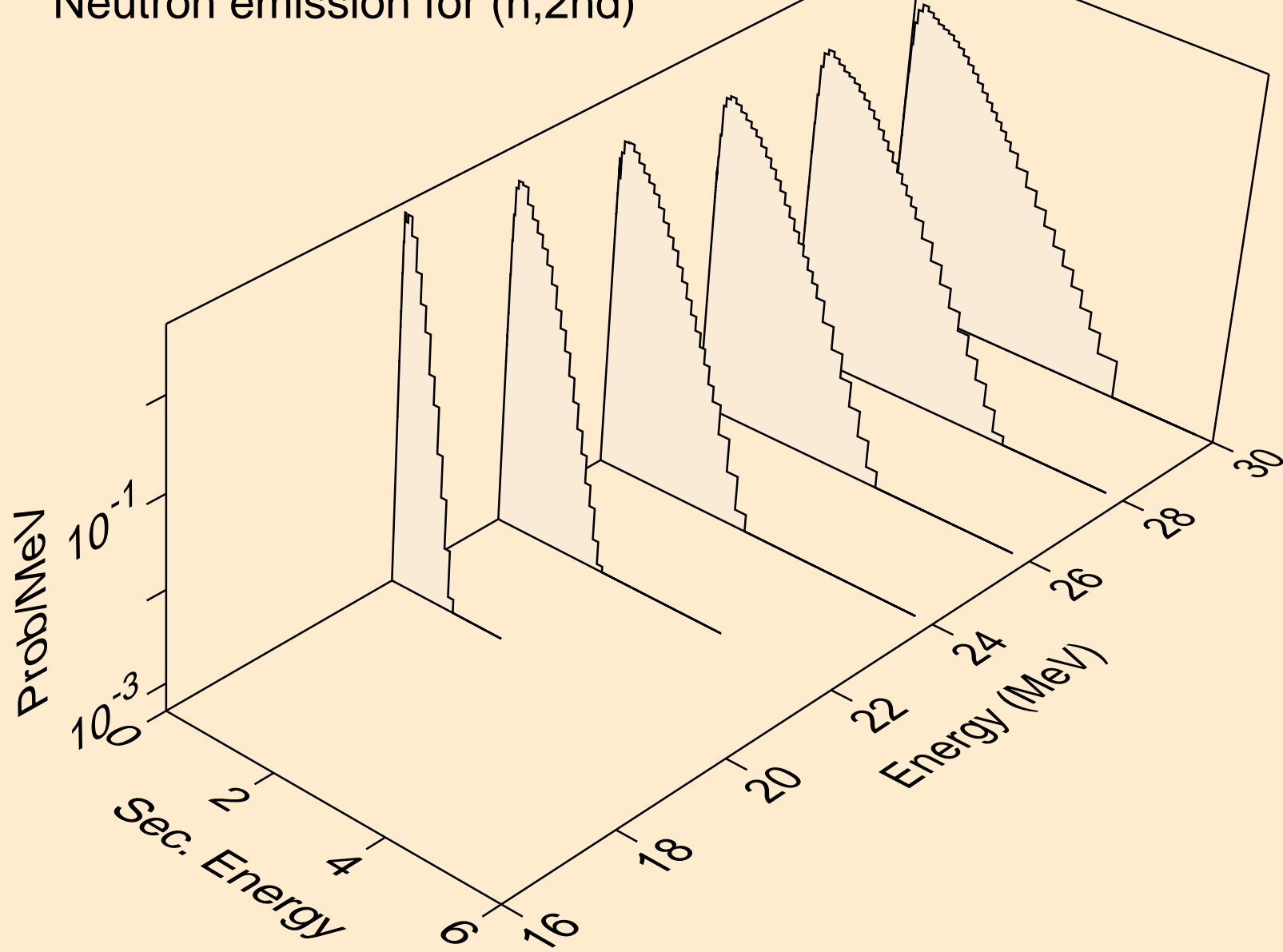

TB151M NEUTRON ACER TENDL-2023 LIBRARY; T=0.K
Neutron emission for (n,2n)

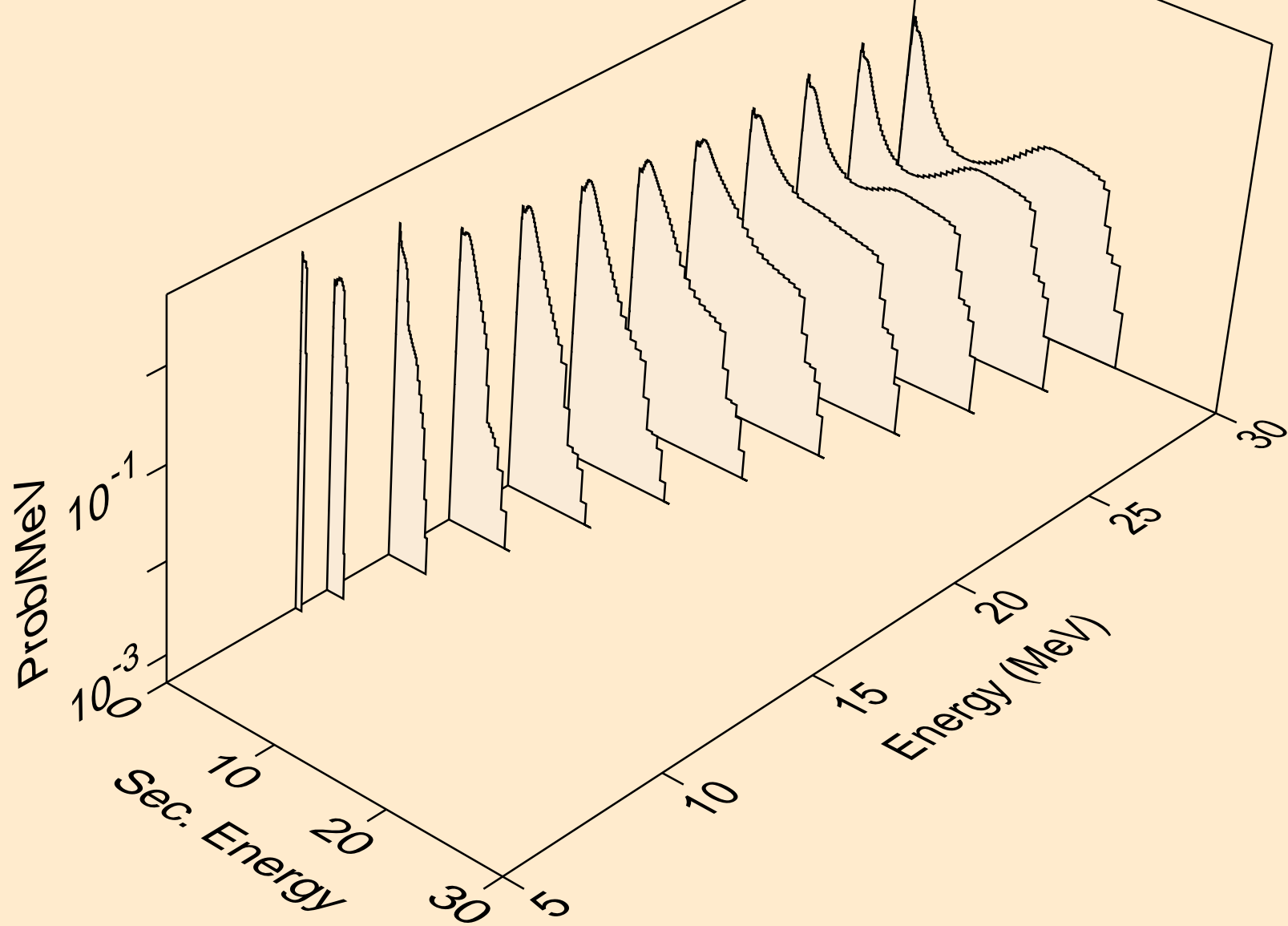

TB151M NEUTRON ACER TENDL-2023 LIBRARY; T=0.K
Neutron emission for (n,3n)

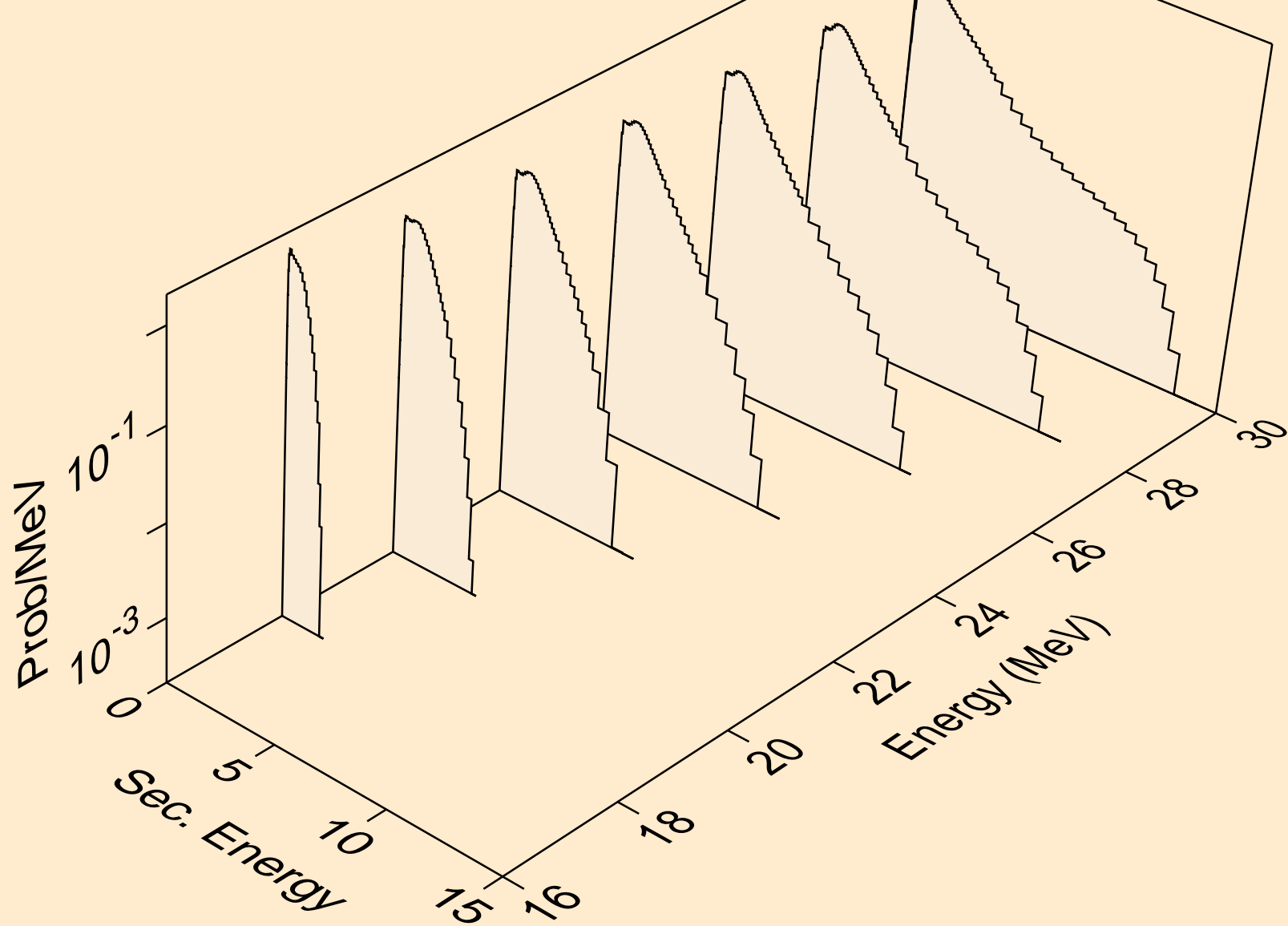

TB151M NEUTRON ACER TENDL-2023 LIBRARY; T=0.K
Neutron emission for (n,n*)a

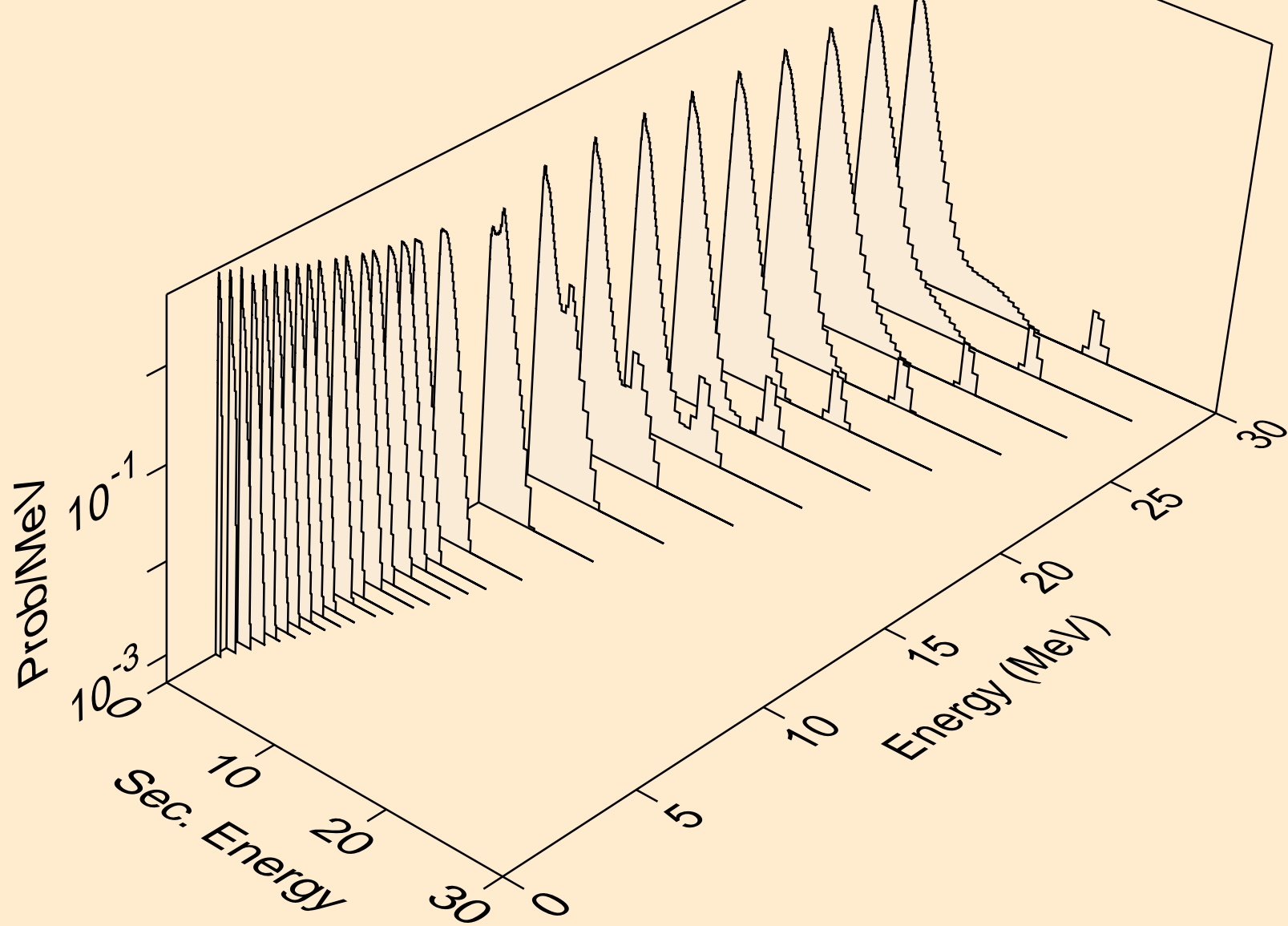

TB151M NEUTRON ACER TENDL-2023 LIBRARY; T=0.K
Neutron emission for (n,2n)a

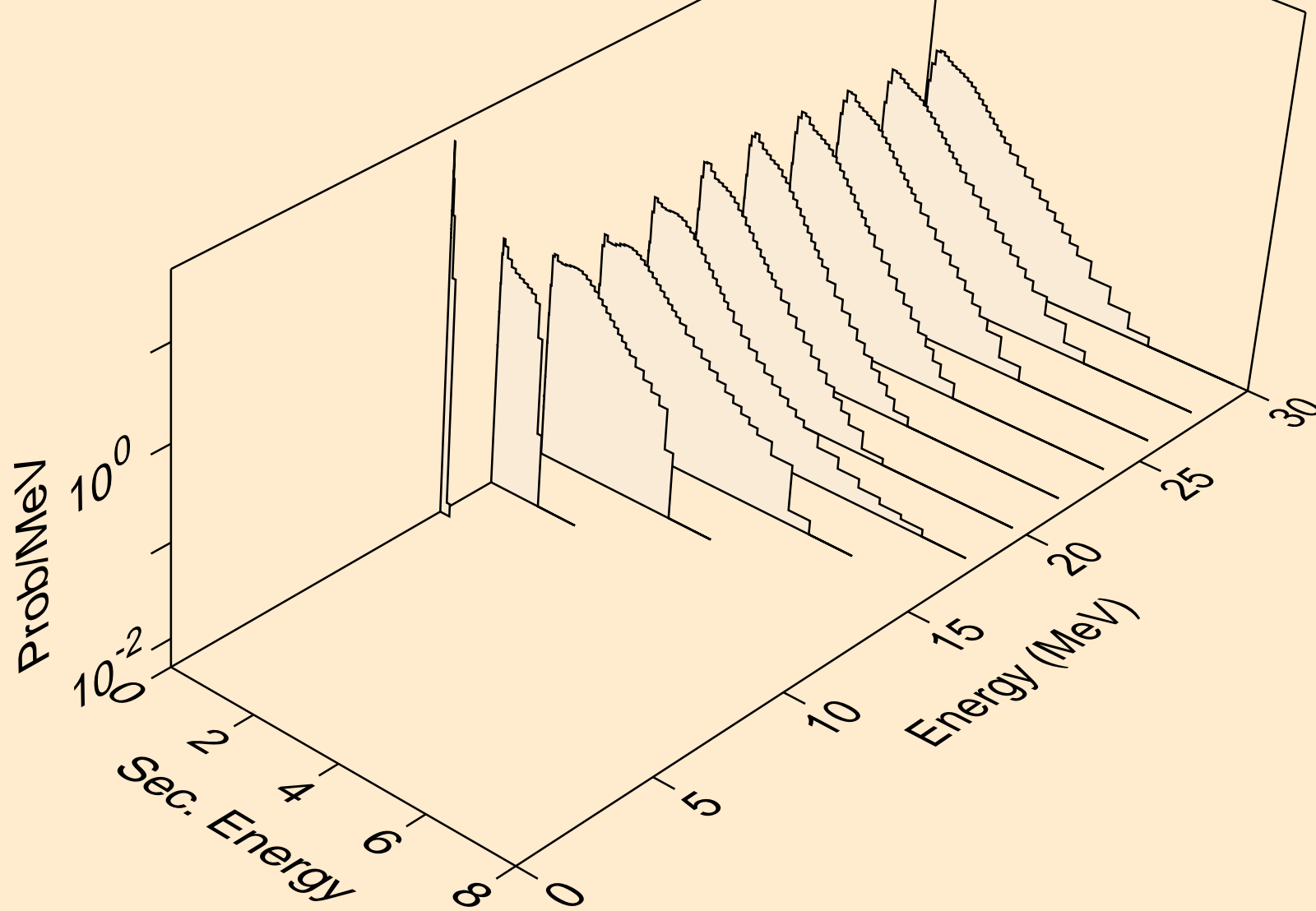

TB151M NEUTRON ACER TENDL-2023 LIBRARY; T=0.K
Neutron emission for (n,3n)a

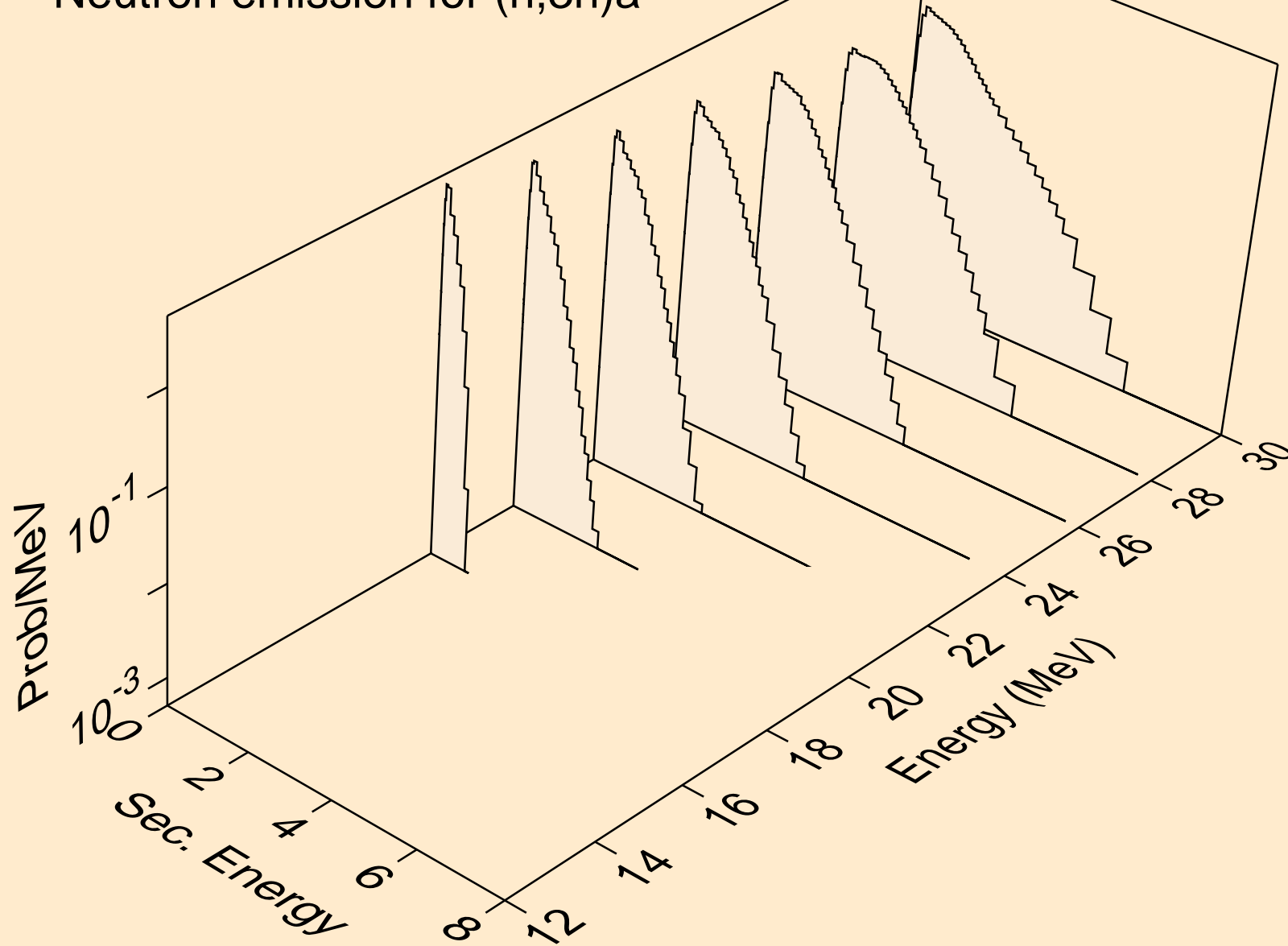

TB151M NEUTRON ACER TENDL-2023 LIBRARY; T=0.K
Neutron emission for (n,n*)p

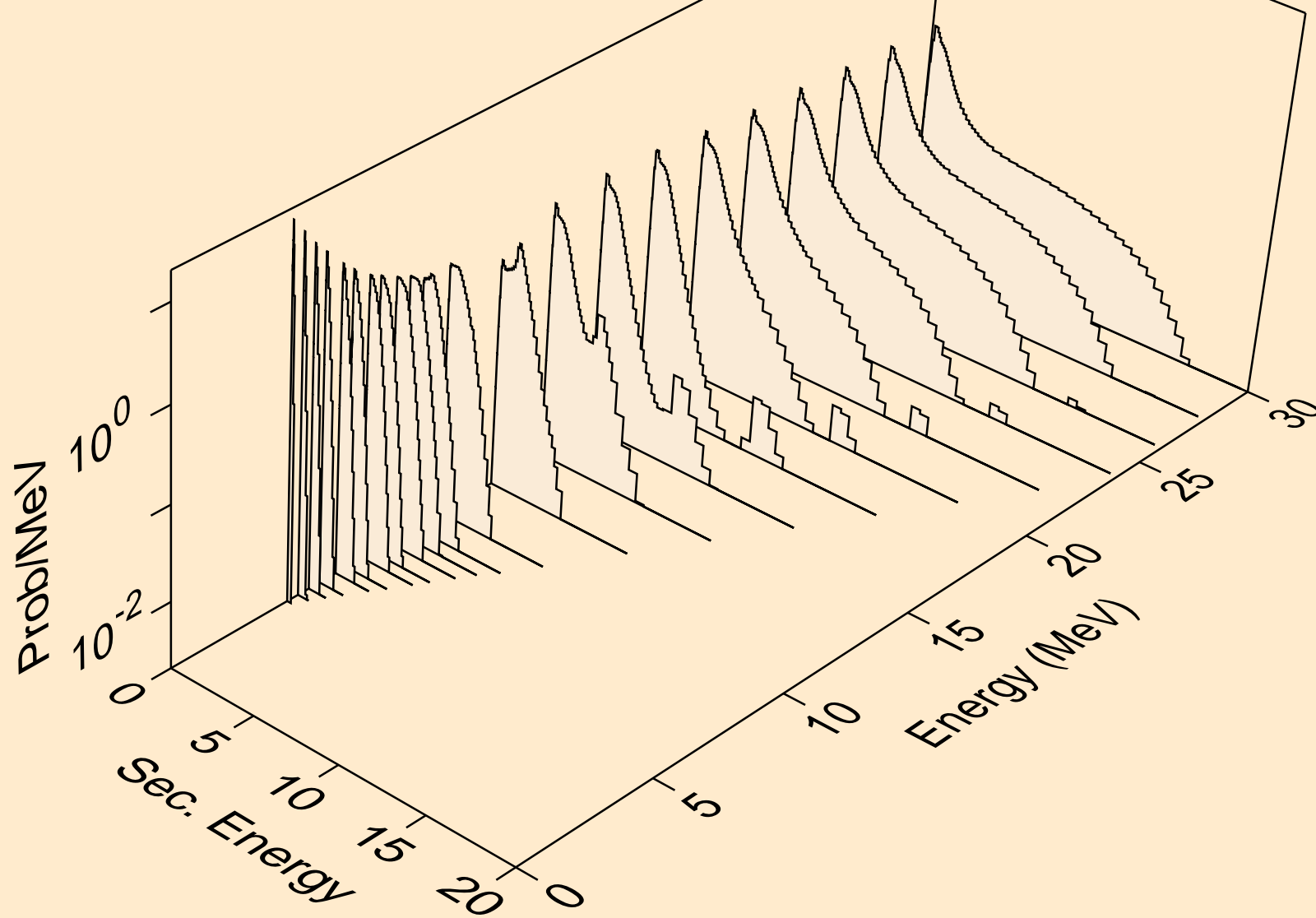

TB151M NEUTRON ACER TENDL-2023 LIBRARY; T=0.K
Neutron emission for (n,n*)2a

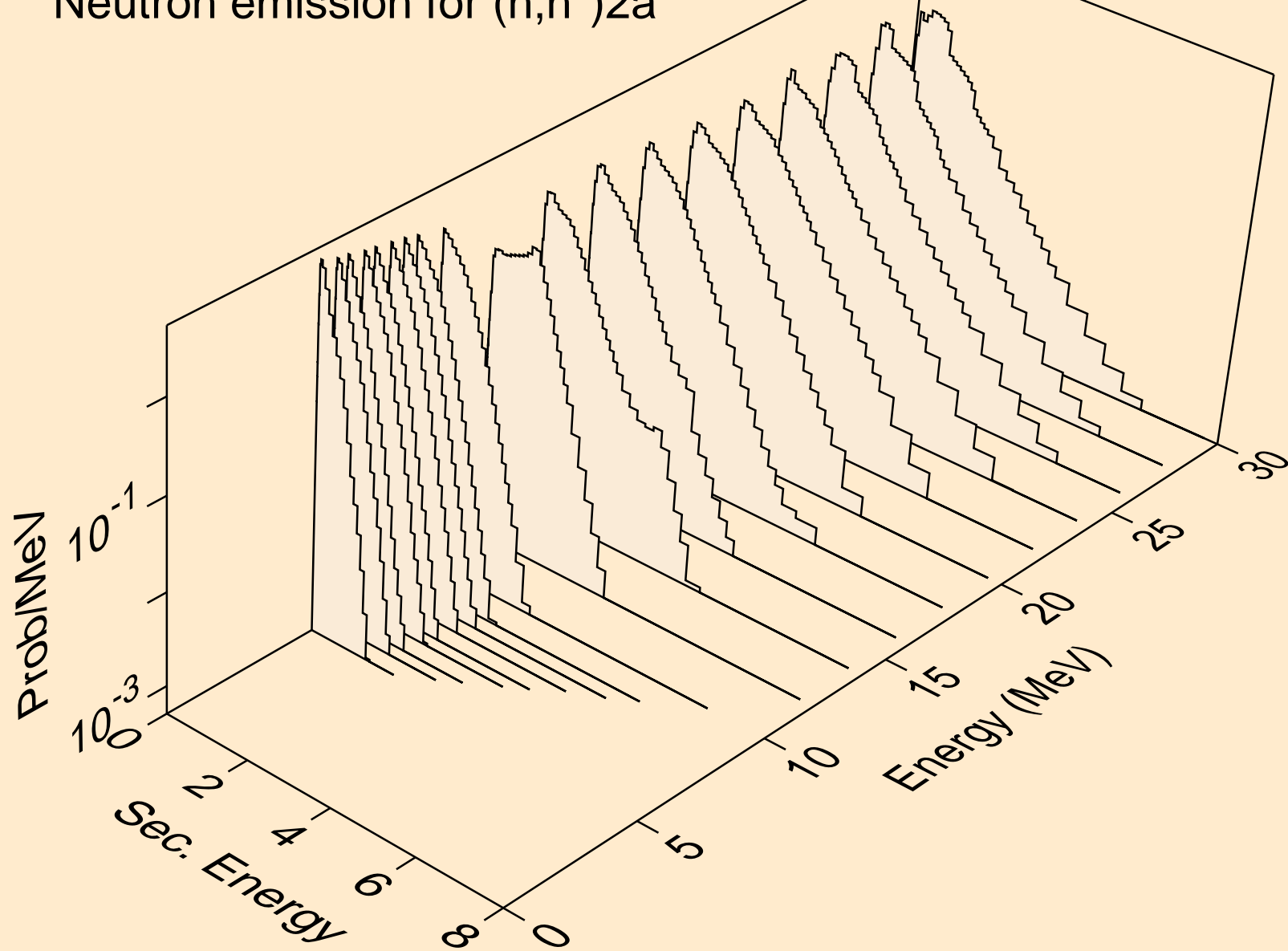

TB151M NEUTRON ACER TENDL-2023 LIBRARY; T=0.K
Neutron emission for (n,2n)2a

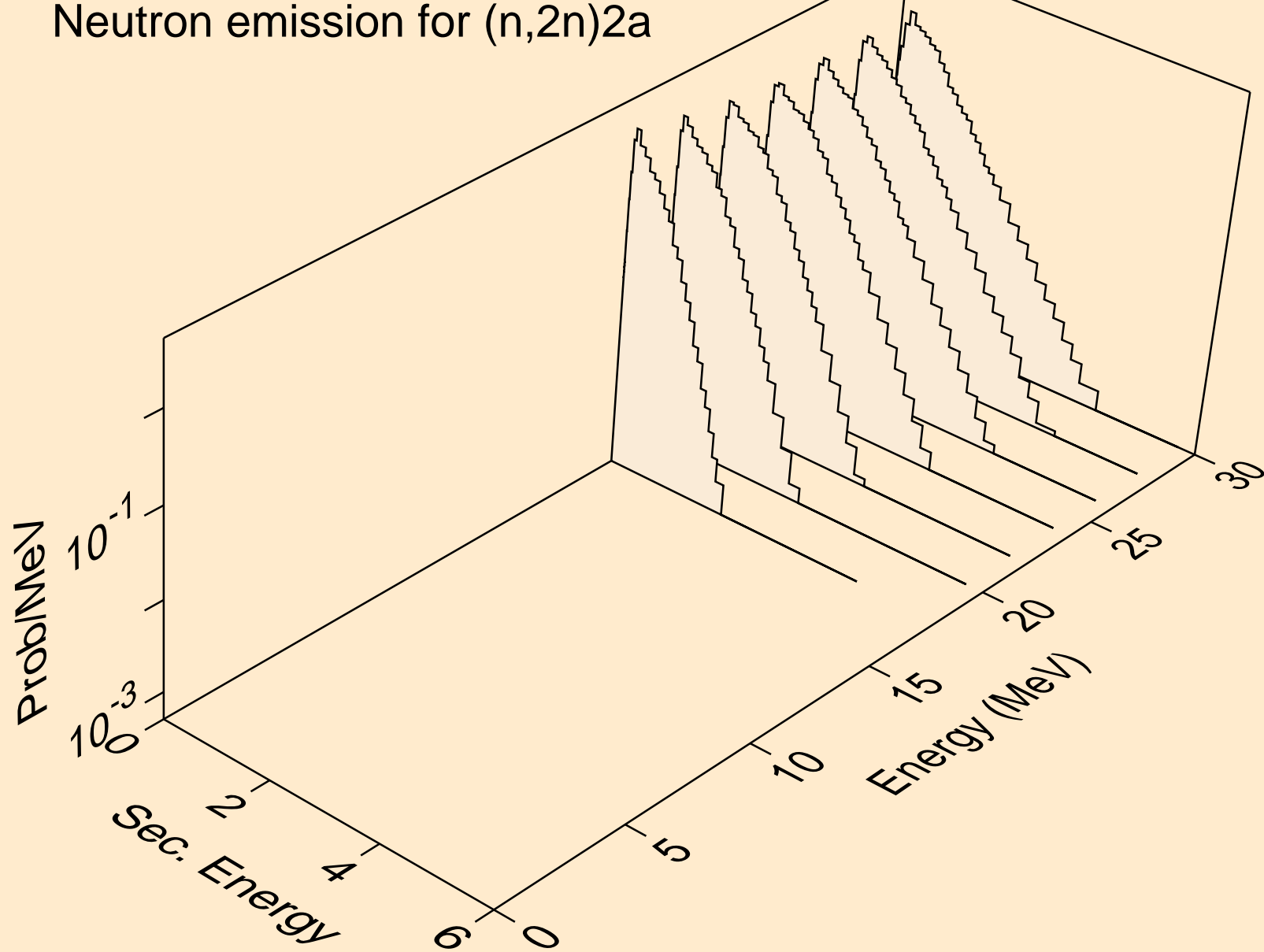

TB151M NEUTRON ACER TENDL-2023 LIBRARY; T=0.K
Neutron emission for (n,n*)d

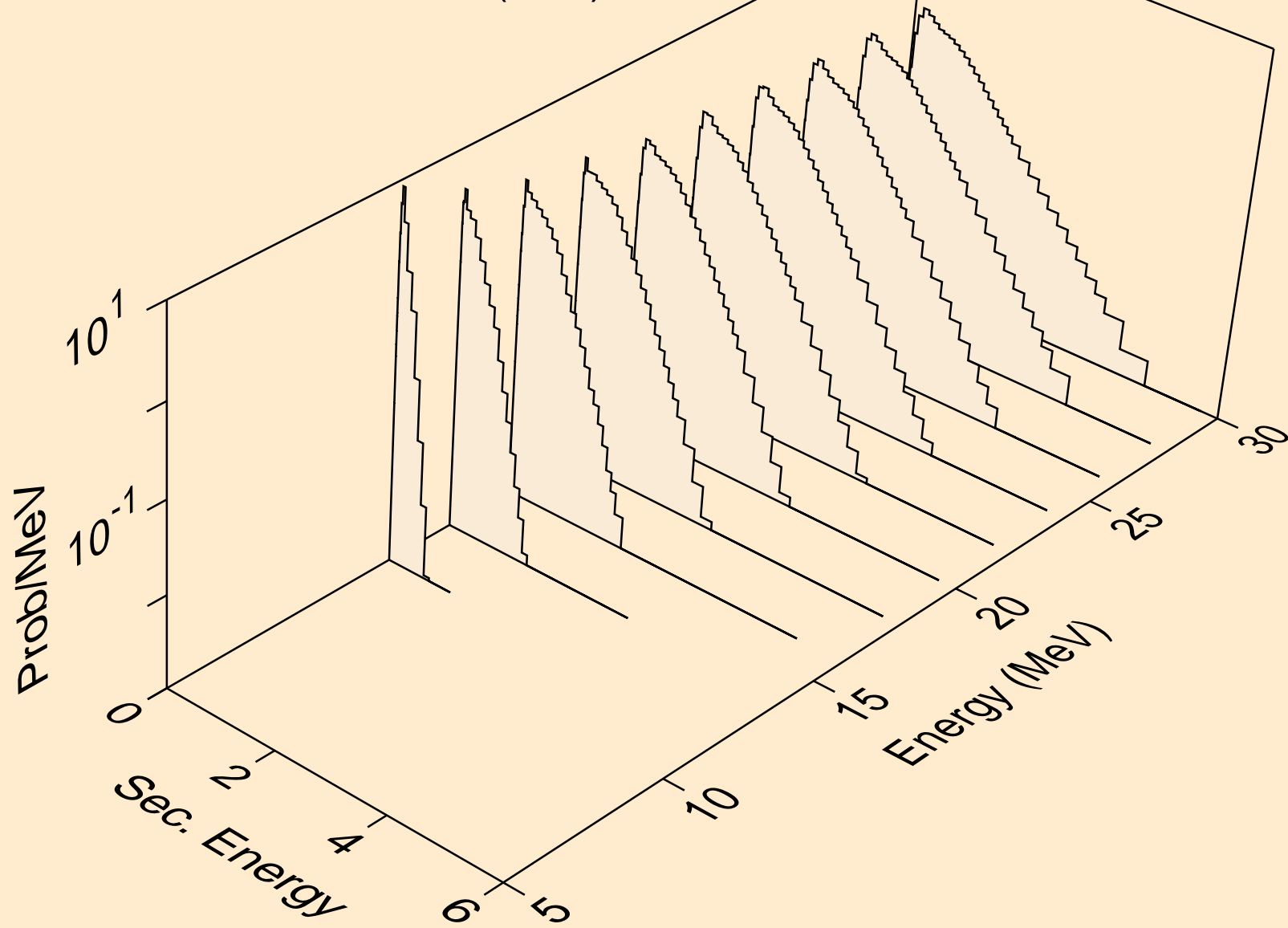

TB151M NEUTRON ACER TENDL-2023 LIBRARY; T=0.K
Neutron emission for (n,n*)t

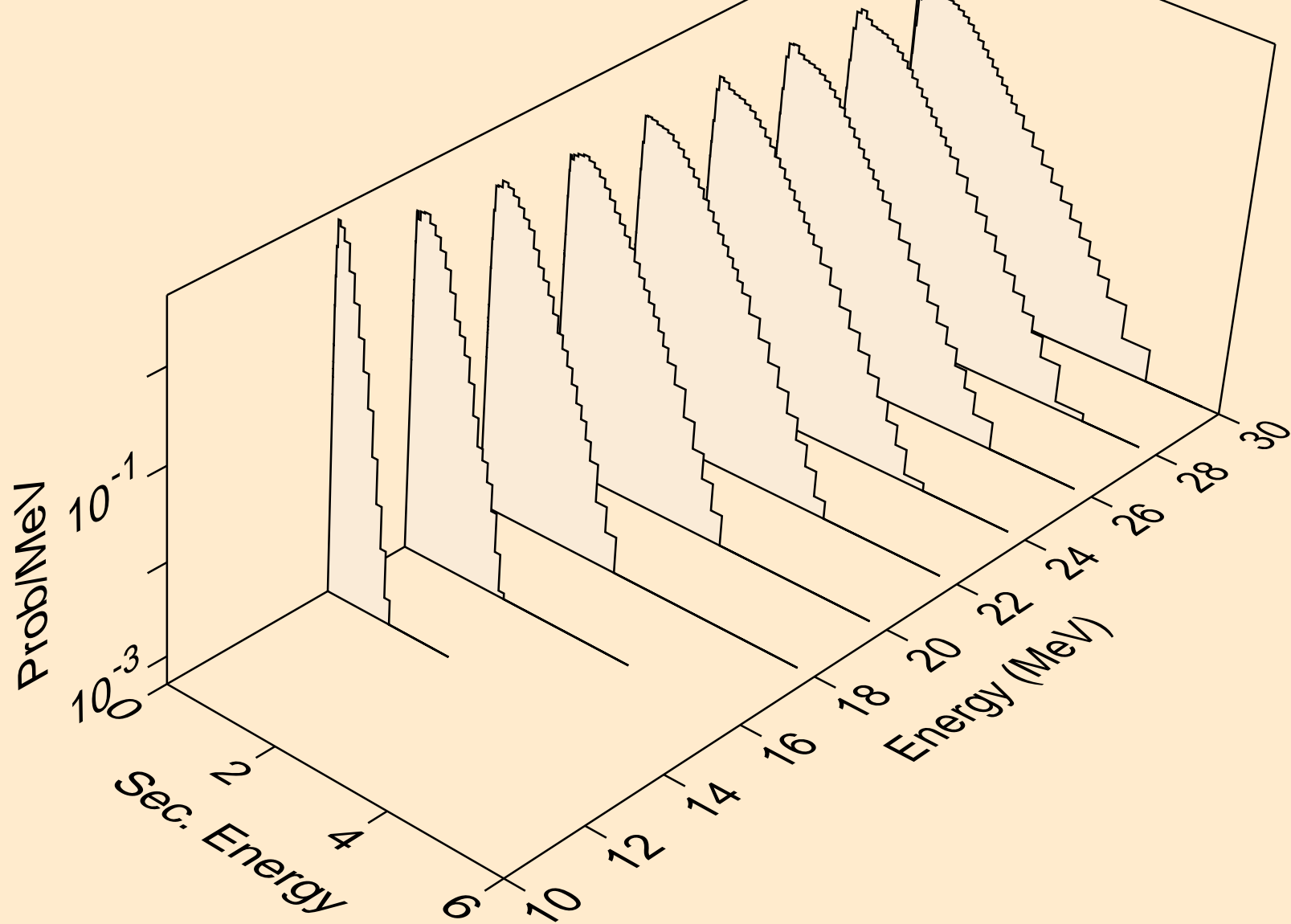

TB151M NEUTRON ACER TENDL-2023 LIBRARY; T=0.K
Neutron emission for (n,n*)he3

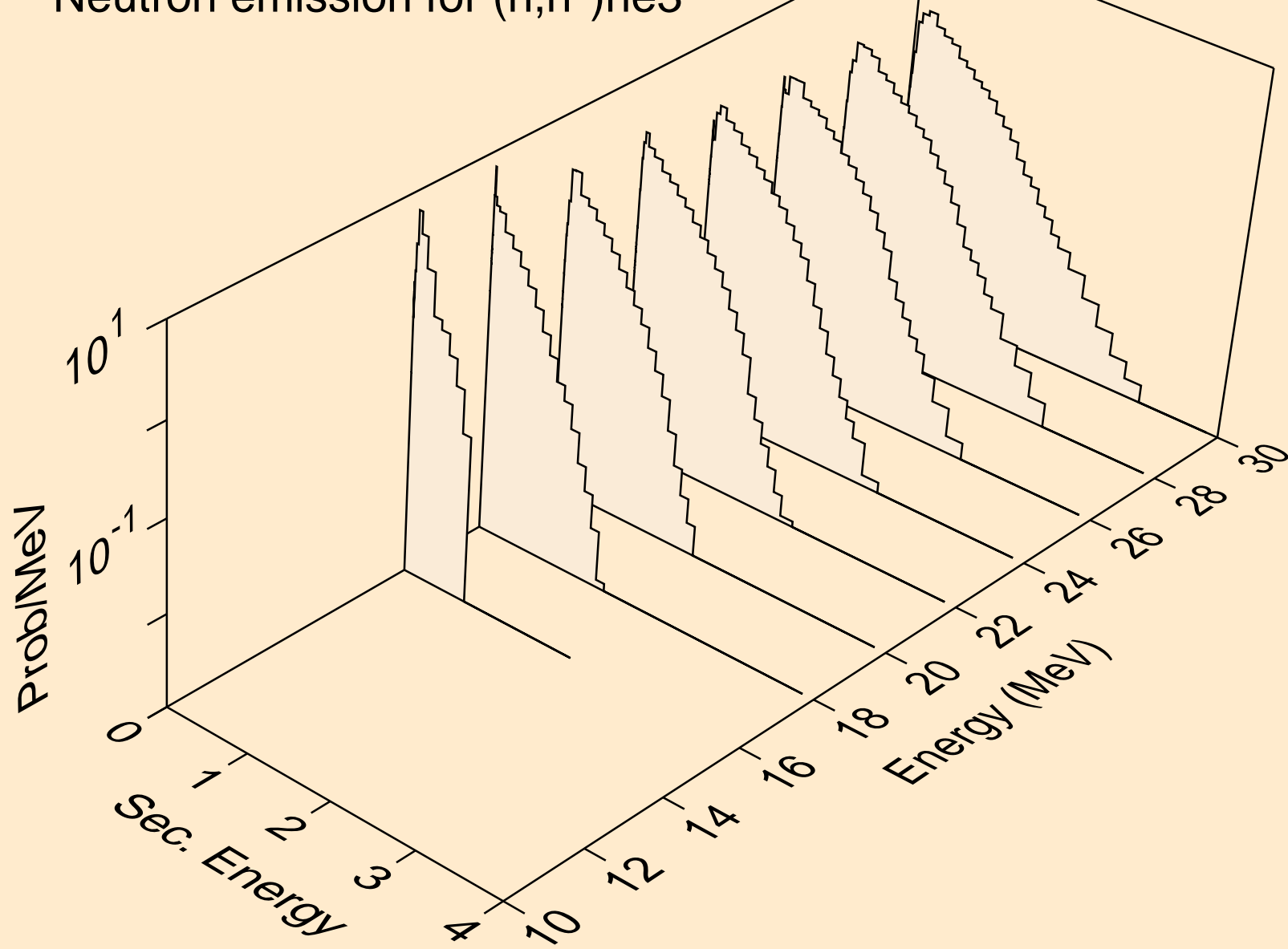

TB151M NEUTRON ACER TENDL-2023 LIBRARY; T=0.K
Neutron emission for (n,4n)

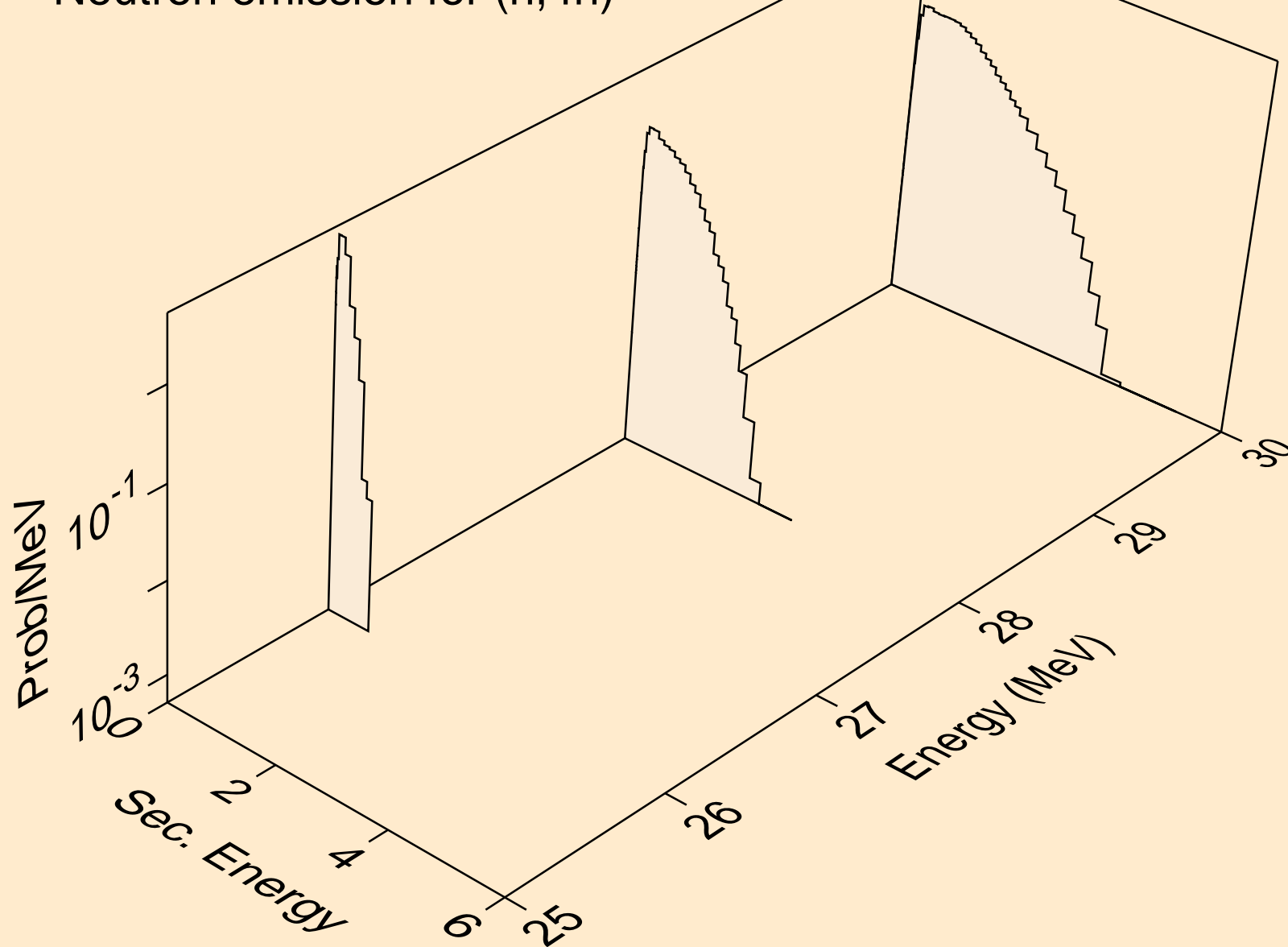

TB151M NEUTRON ACER TENDL-2023 LIBRARY; T=0.K
Neutron emission for (n,2np)

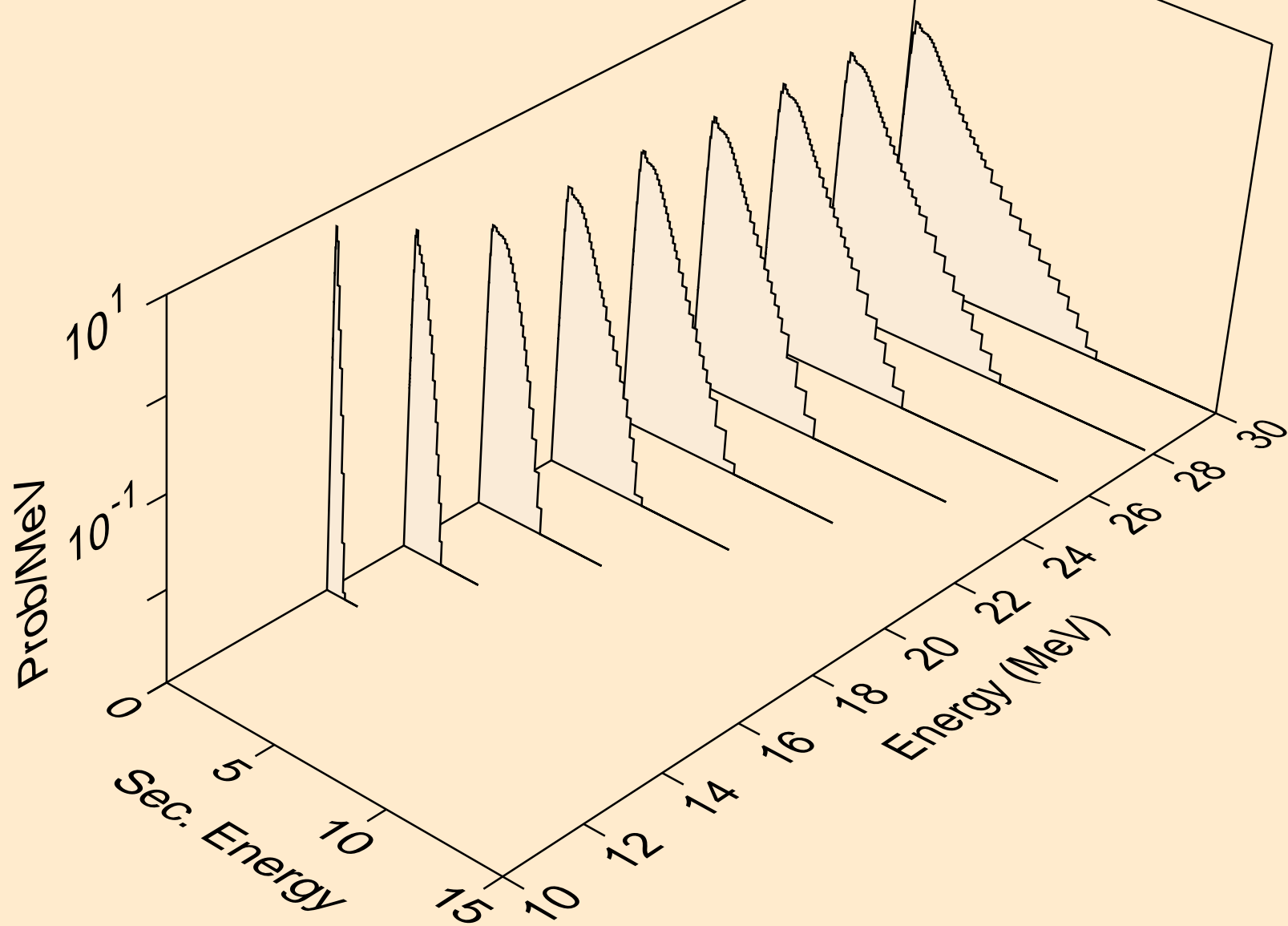

TB151M NEUTRON ACER TENDL-2023 LIBRARY; T=0.K
Neutron emission for (n,3np)

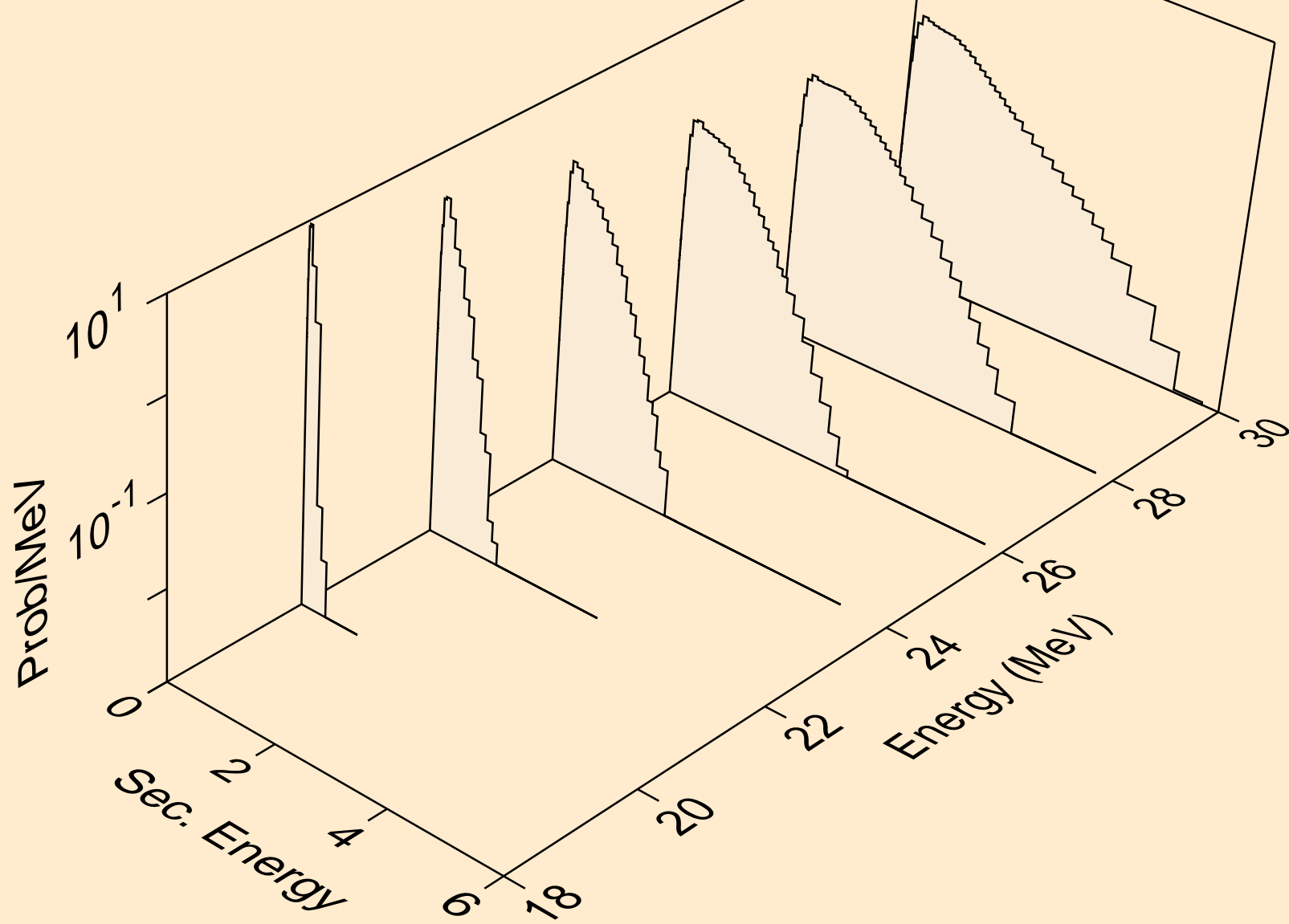

TB151M NEUTRON ACER TENDL-2023 LIBRARY; T=0.K
Neutron emission for (n,n2p)

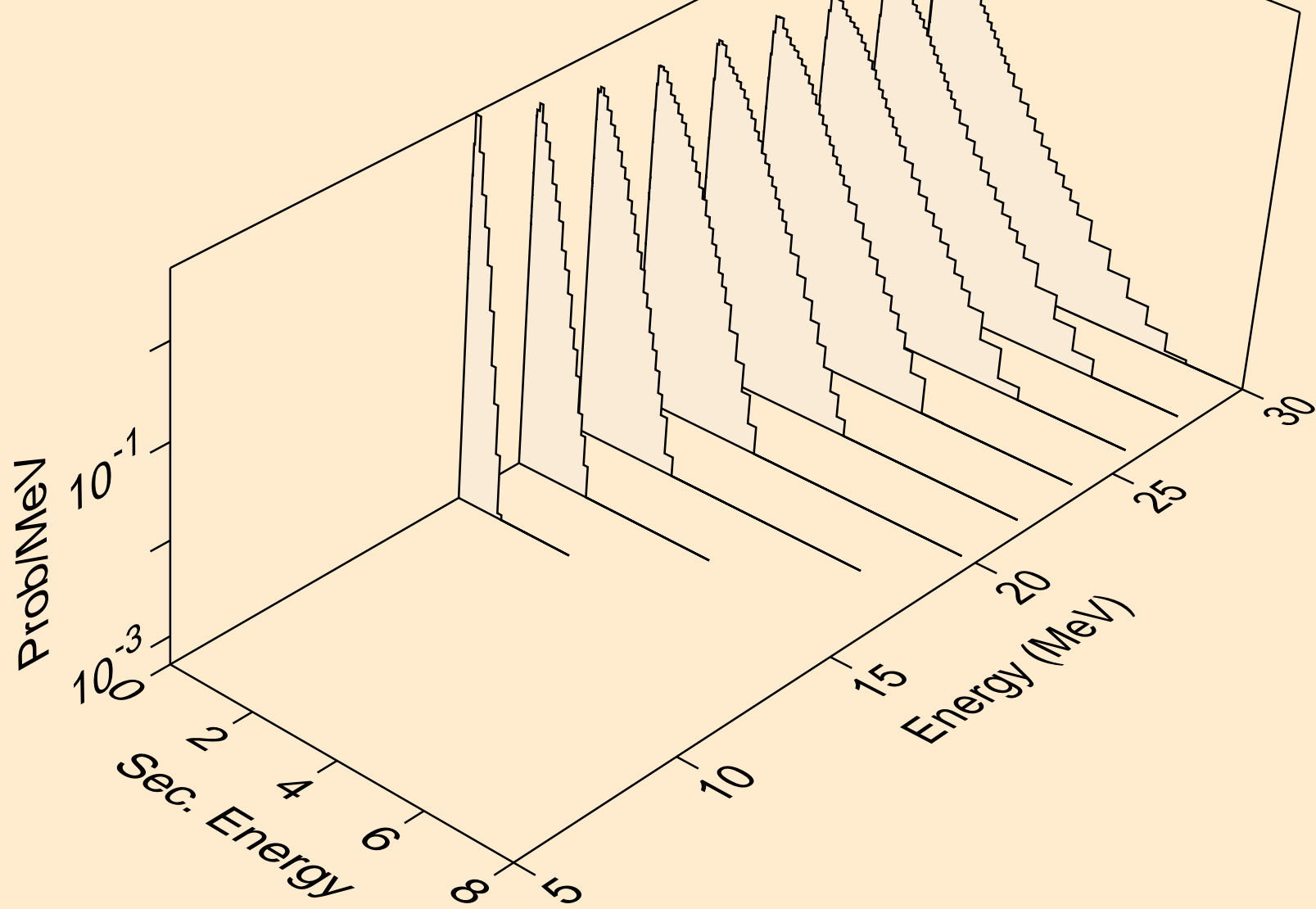

TB151M NEUTRON ACER TENDL-2023 LIBRARY; T=0.K
Neutron emission for (n,npa)

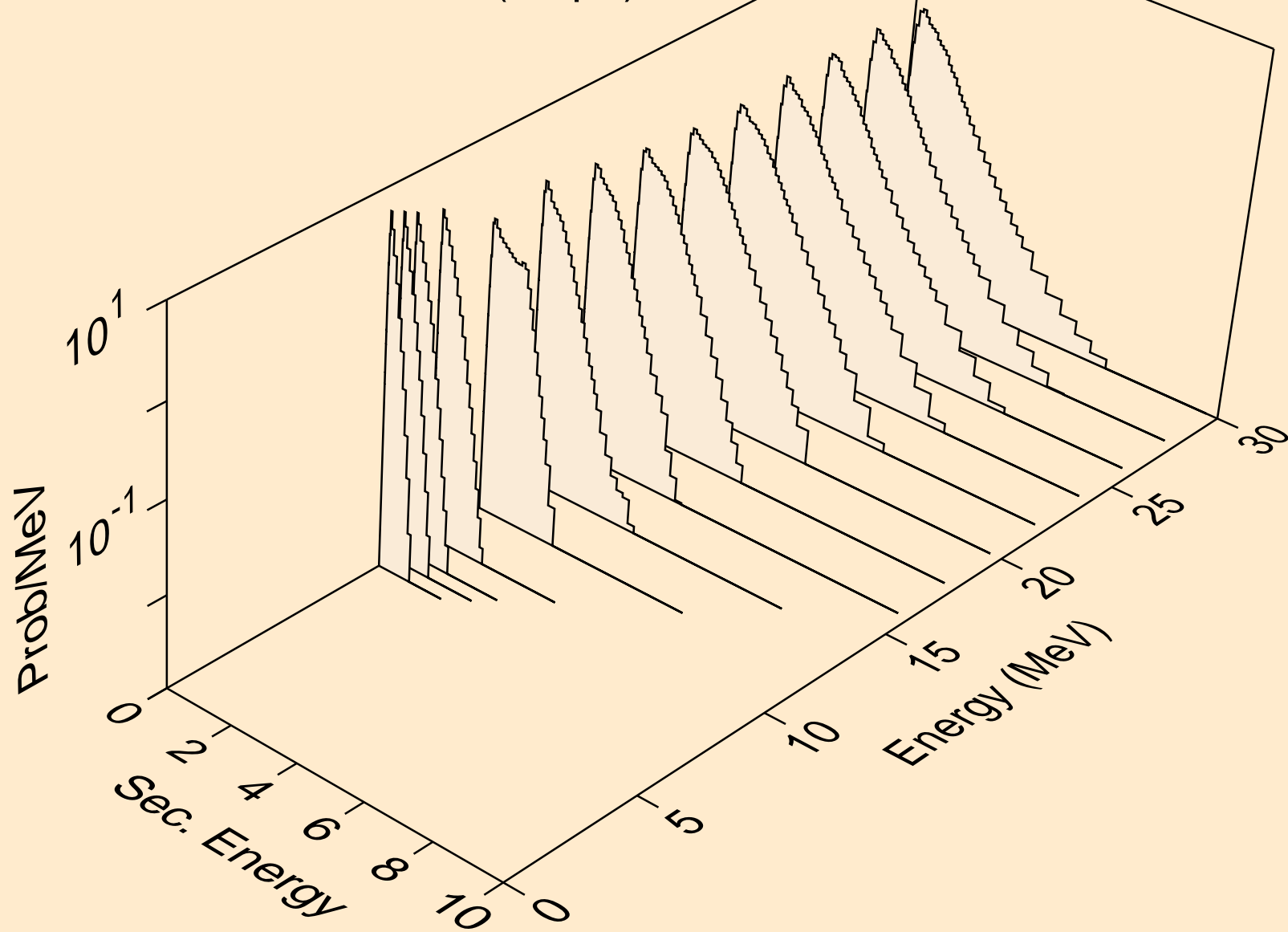

TB151M NEUTRON ACER TENDL-2023 LIBRARY; T=0.K
Neutron emission for (n,n*c)

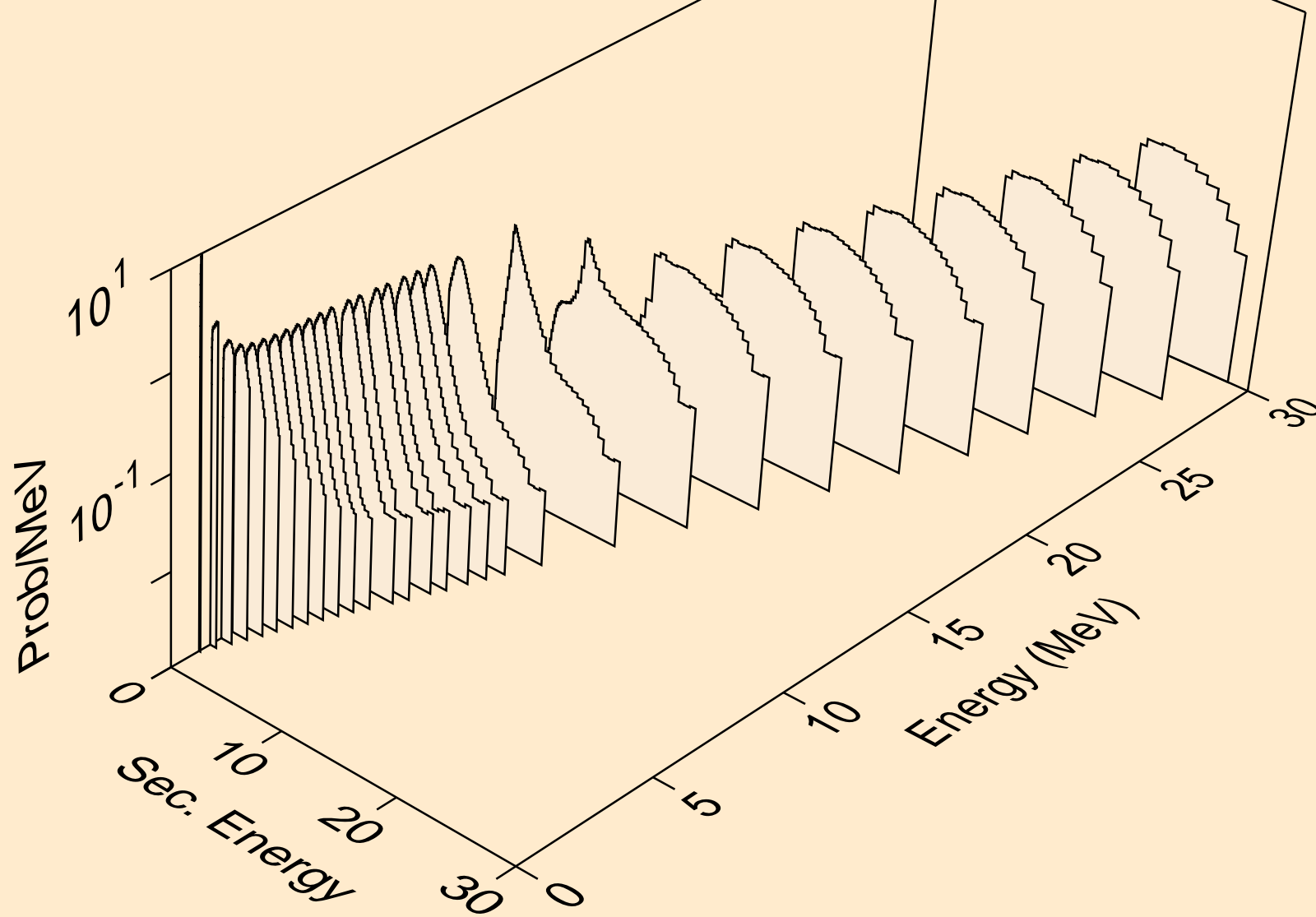

TB151M NEUTRON ACER TENDL-2023 LIBRARY; T=0.K
Photon emission for (n,x)

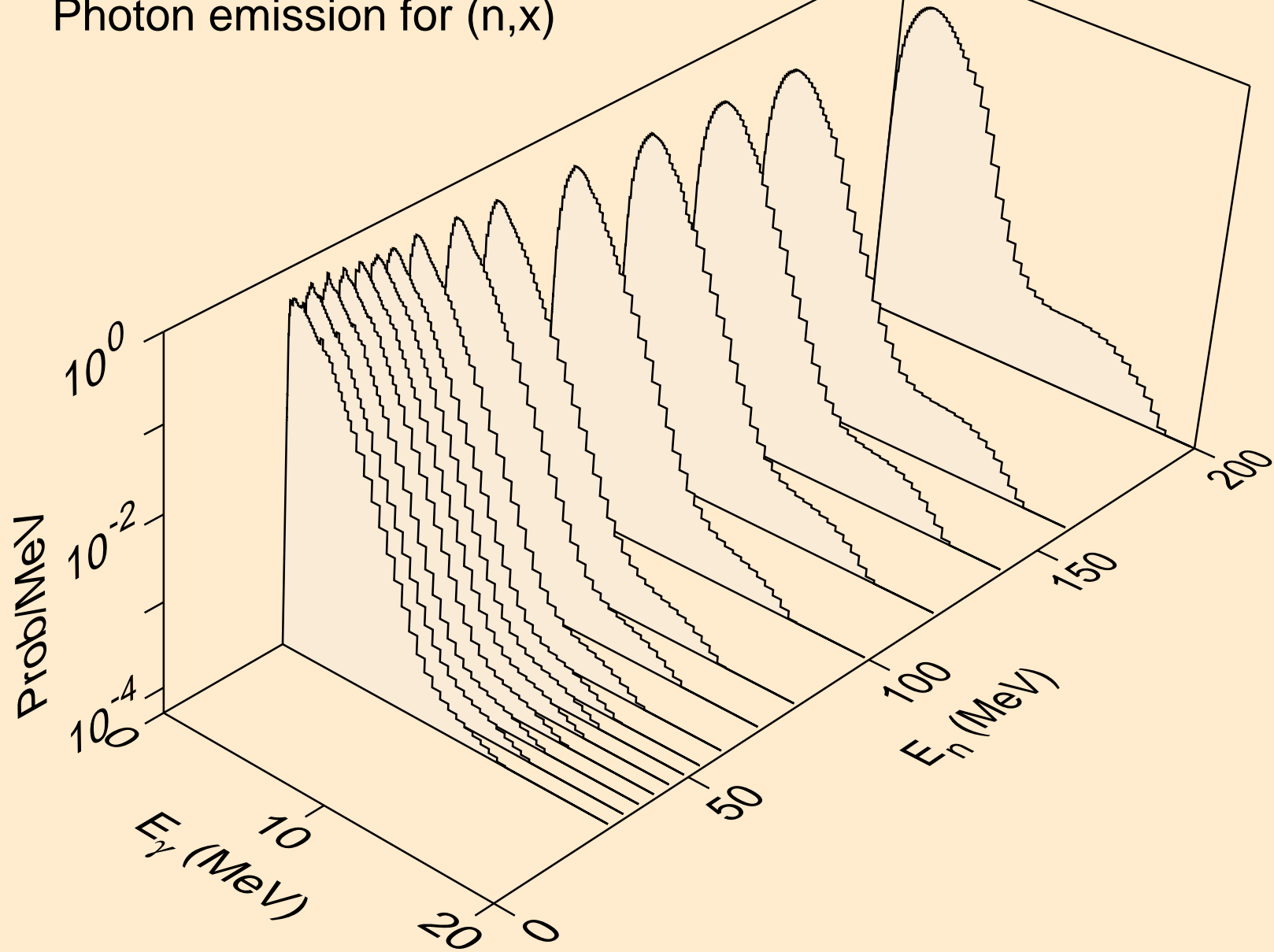

TB151M NEUTRON ACER TENDL-2023 LIBRARY; T=0.K
Photon emission for (n,2nd)

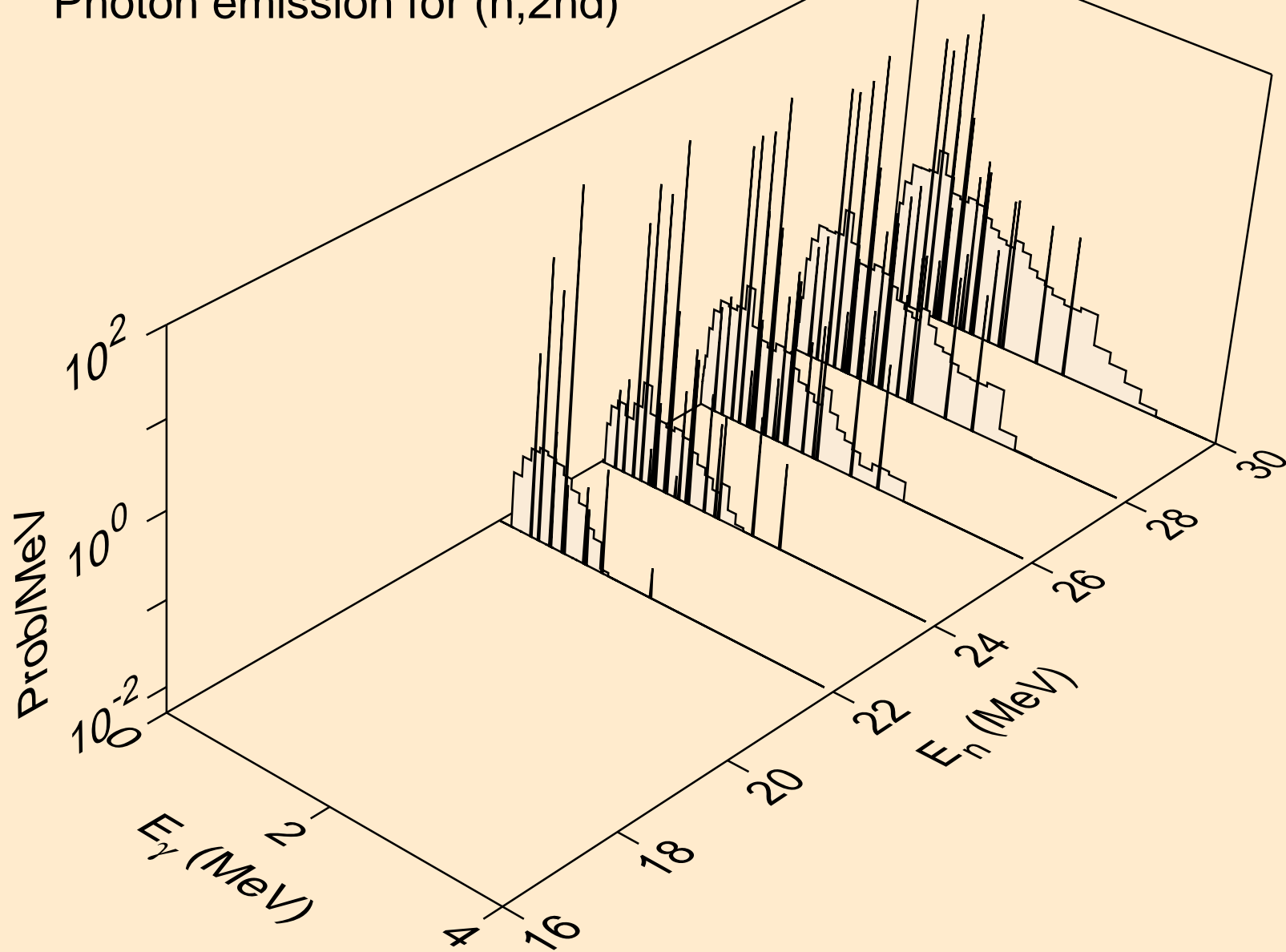

TB151M NEUTRON ACER TENDL-2023 LIBRARY; T=0.K
Photon emission for (n,2n)

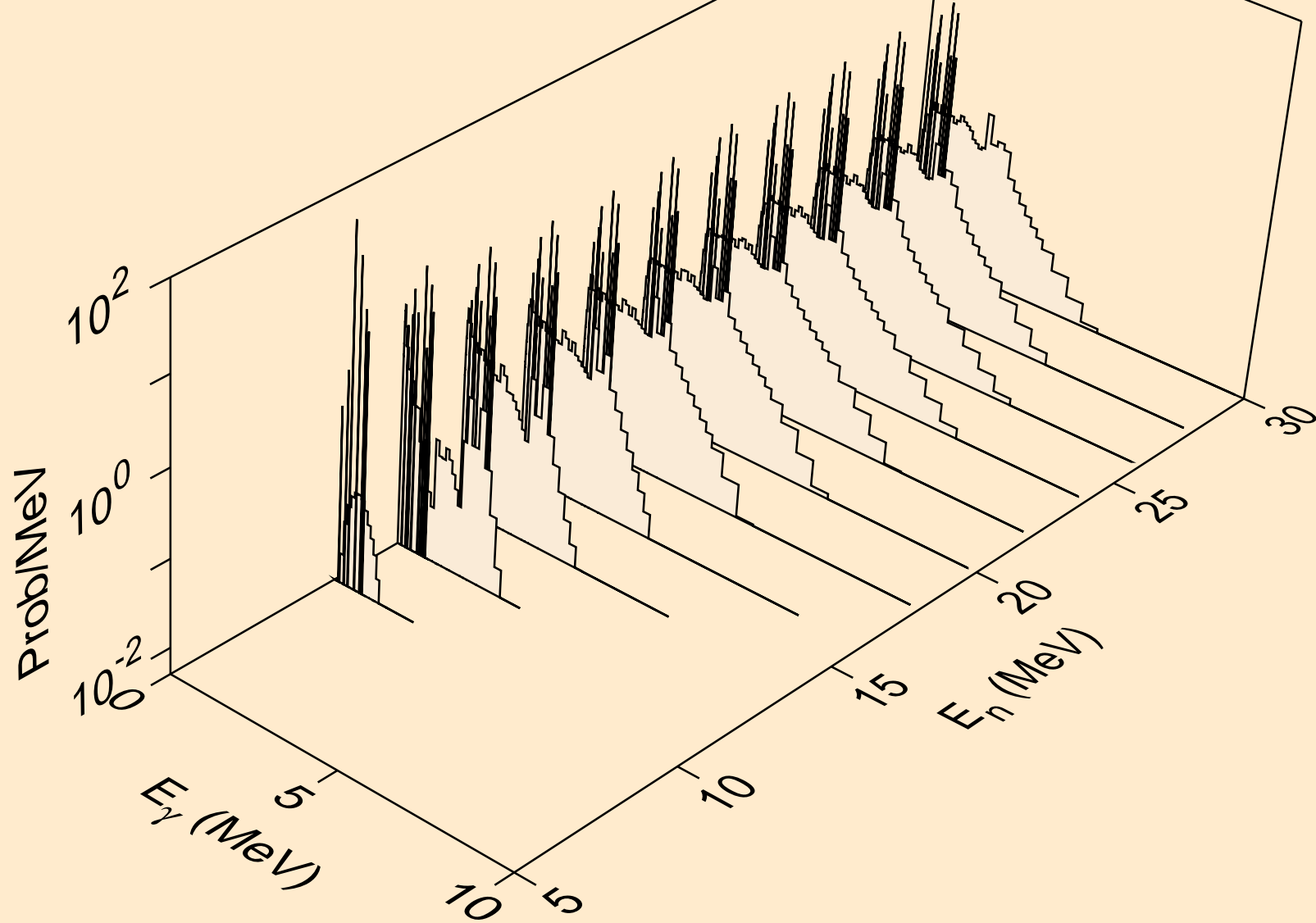

TB151M NEUTRON ACER TENDL-2023 LIBRARY; T=0.K
Photon emission for (n,3n)

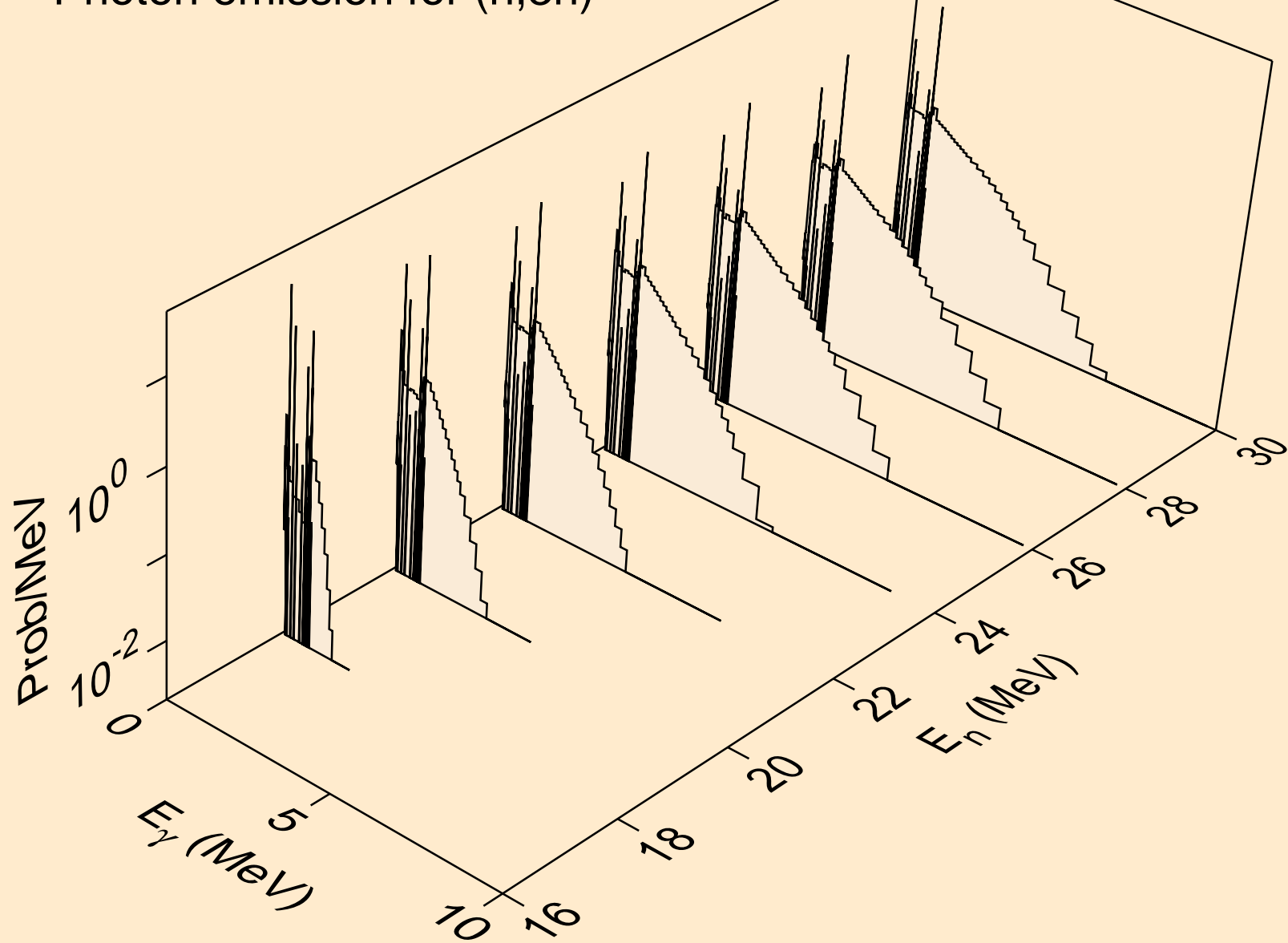

TB151M NEUTRON ACER TENDL-2023 LIBRARY; T=0.K
Photon emission for (n,n*)a

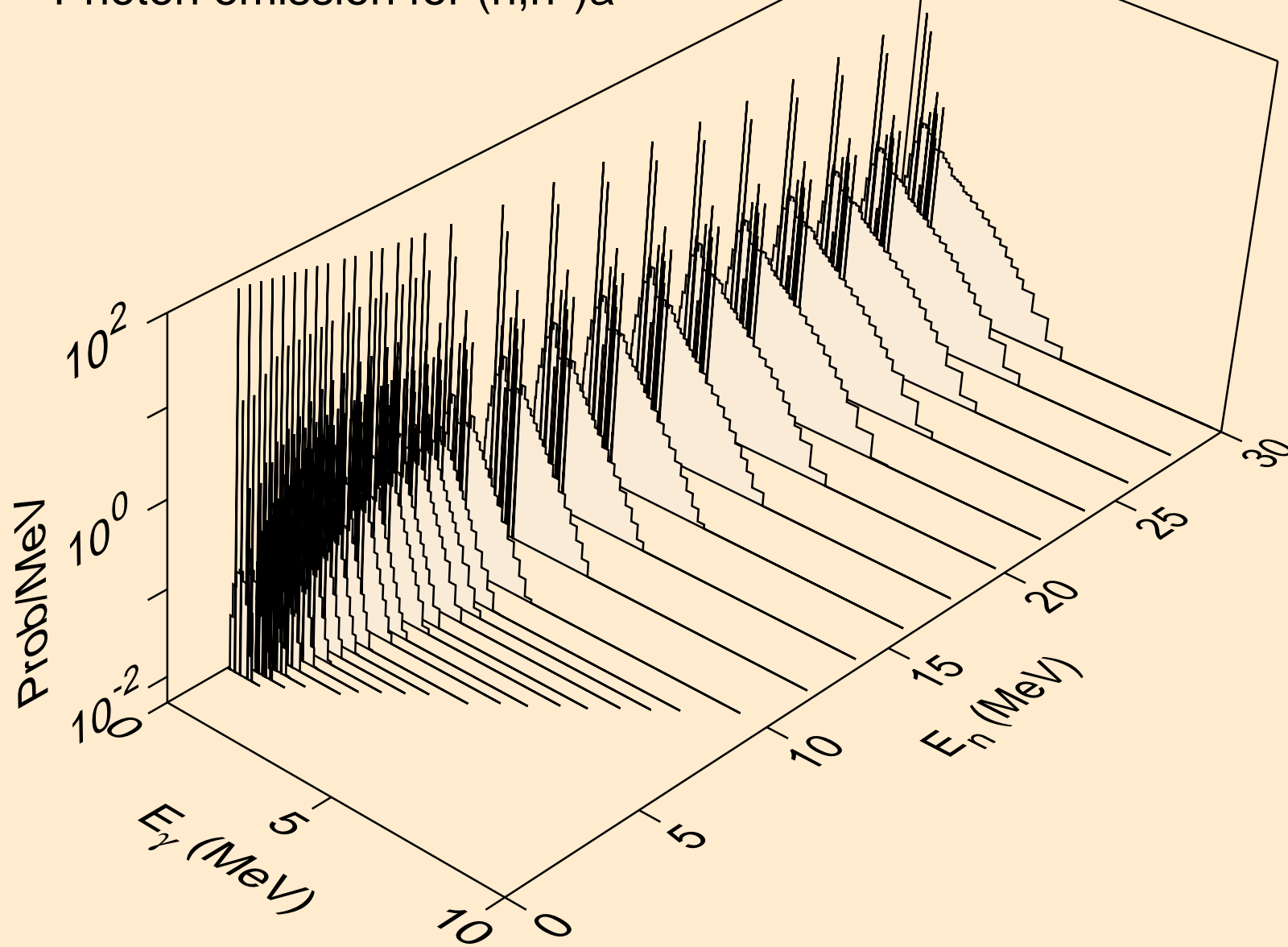

TB151M NEUTRON ACER TENDL-2023 LIBRARY; T=0.K
Photon emission for (n,2n)a

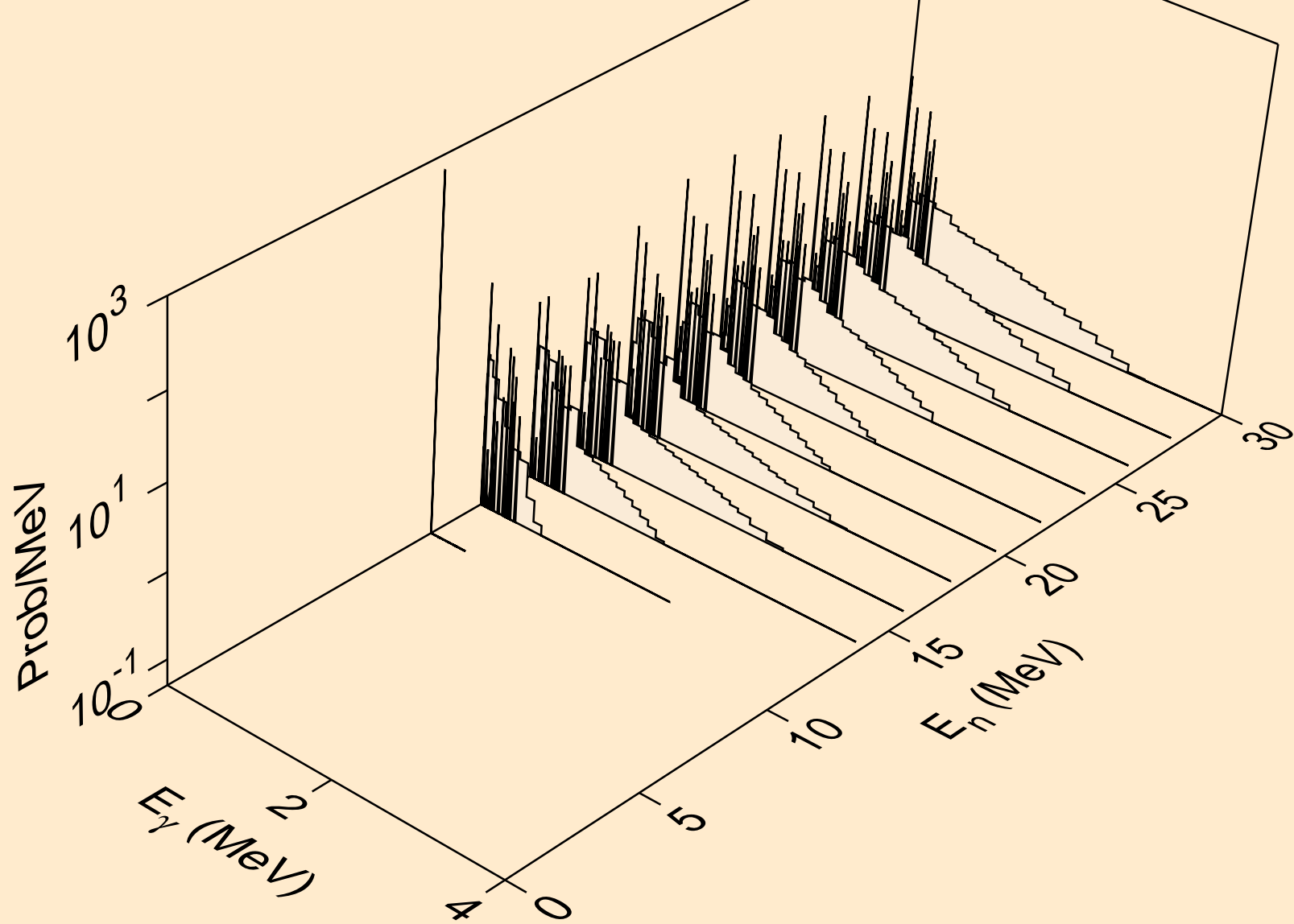

TB151M NEUTRON ACER TENDL-2023 LIBRARY; T=0.K
Photon emission for (n,3n)a

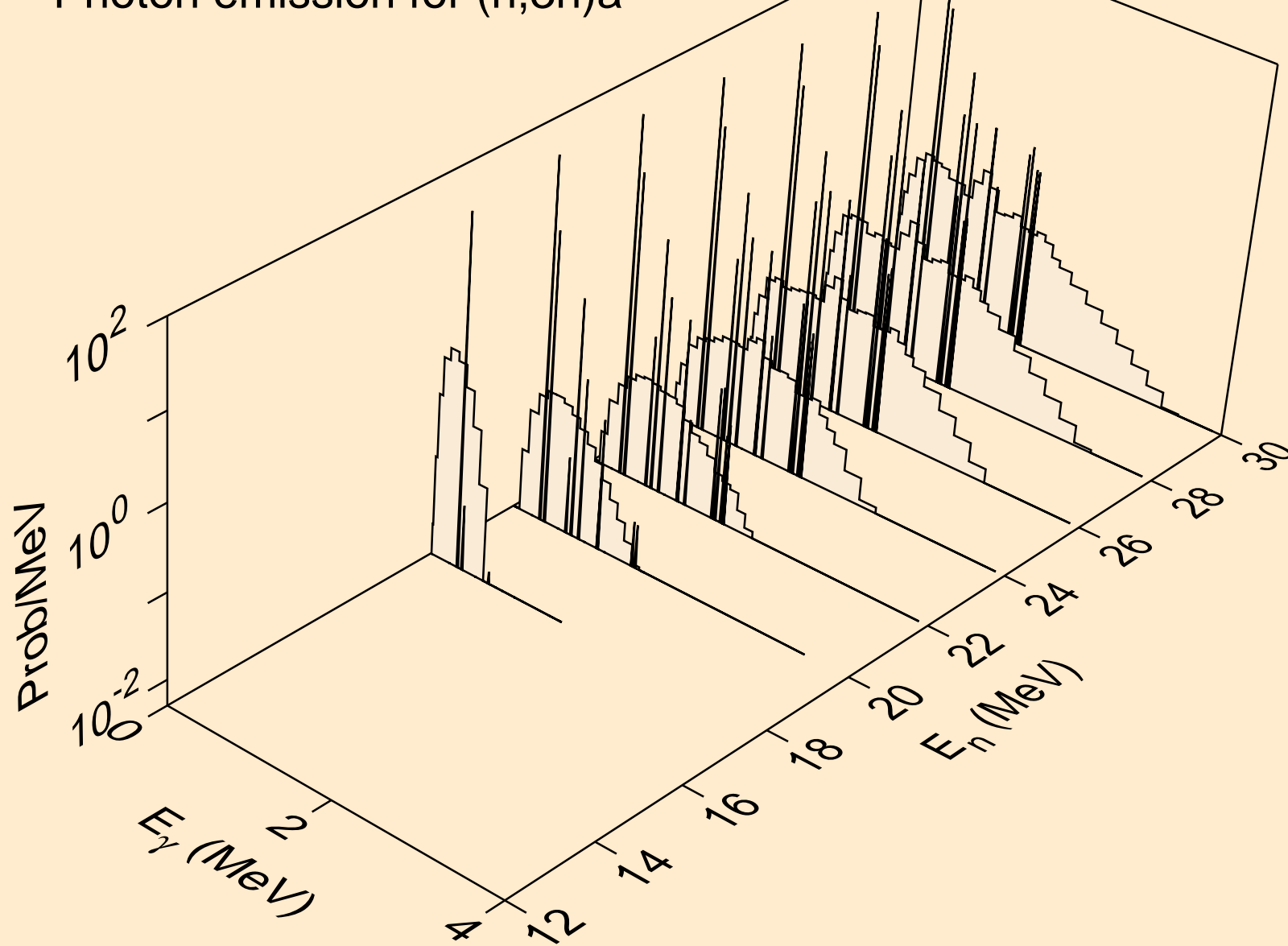

TB151M NEUTRON ACER TENDL-2023 LIBRARY; T=0.K
Photon emission for (n,n*)p

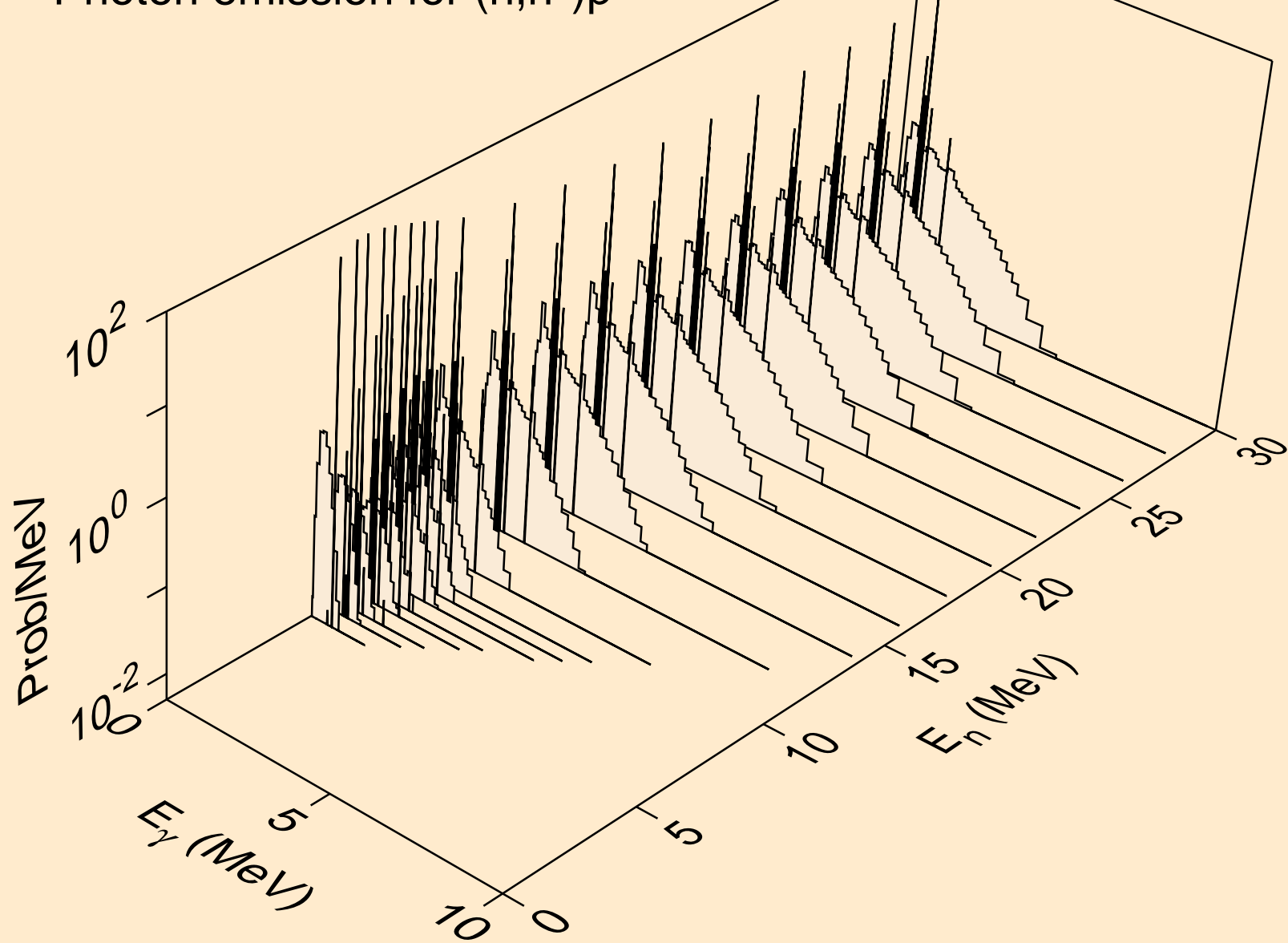

TB151M NEUTRON ACER TENDL-2023 LIBRARY; T=0.K
Photon emission for (n,n*)2a

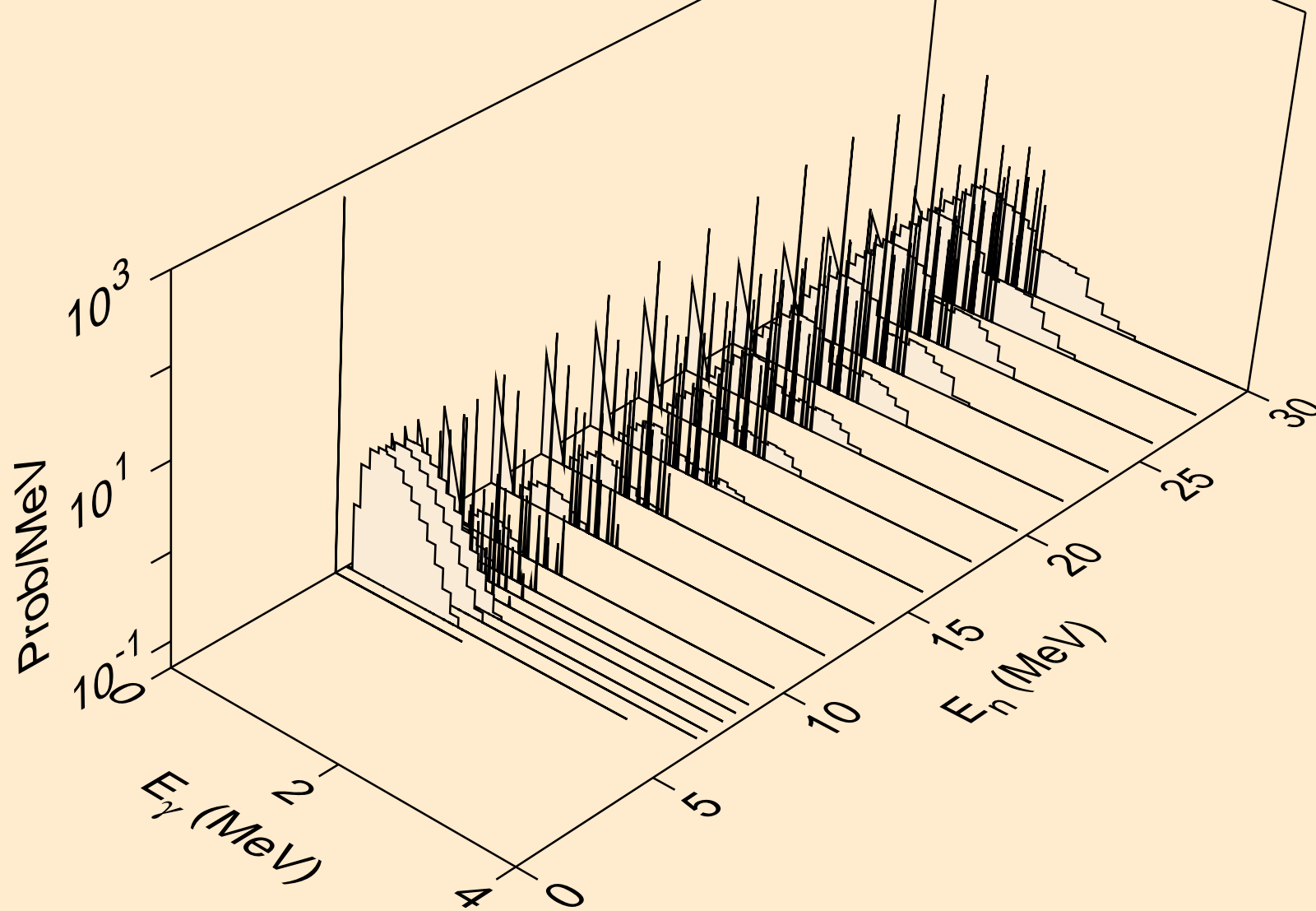

TB151M NEUTRON ACER TENDL-2023 LIBRARY; T=0.K
Photon emission for (n,2n)2a

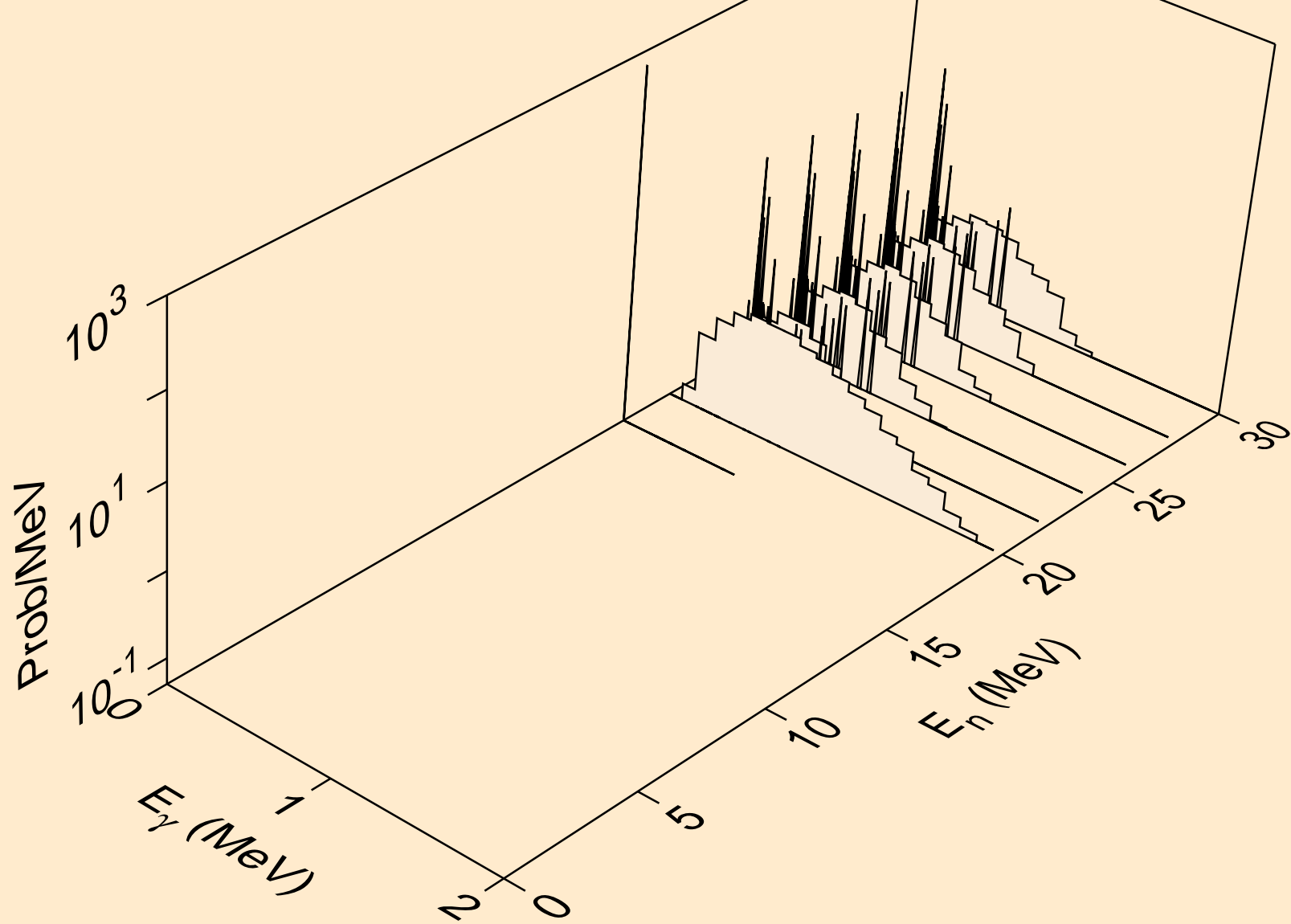

TB151M NEUTRON ACER TENDL-2023 LIBRARY; T=0.K
Photon emission for (n,n*)d

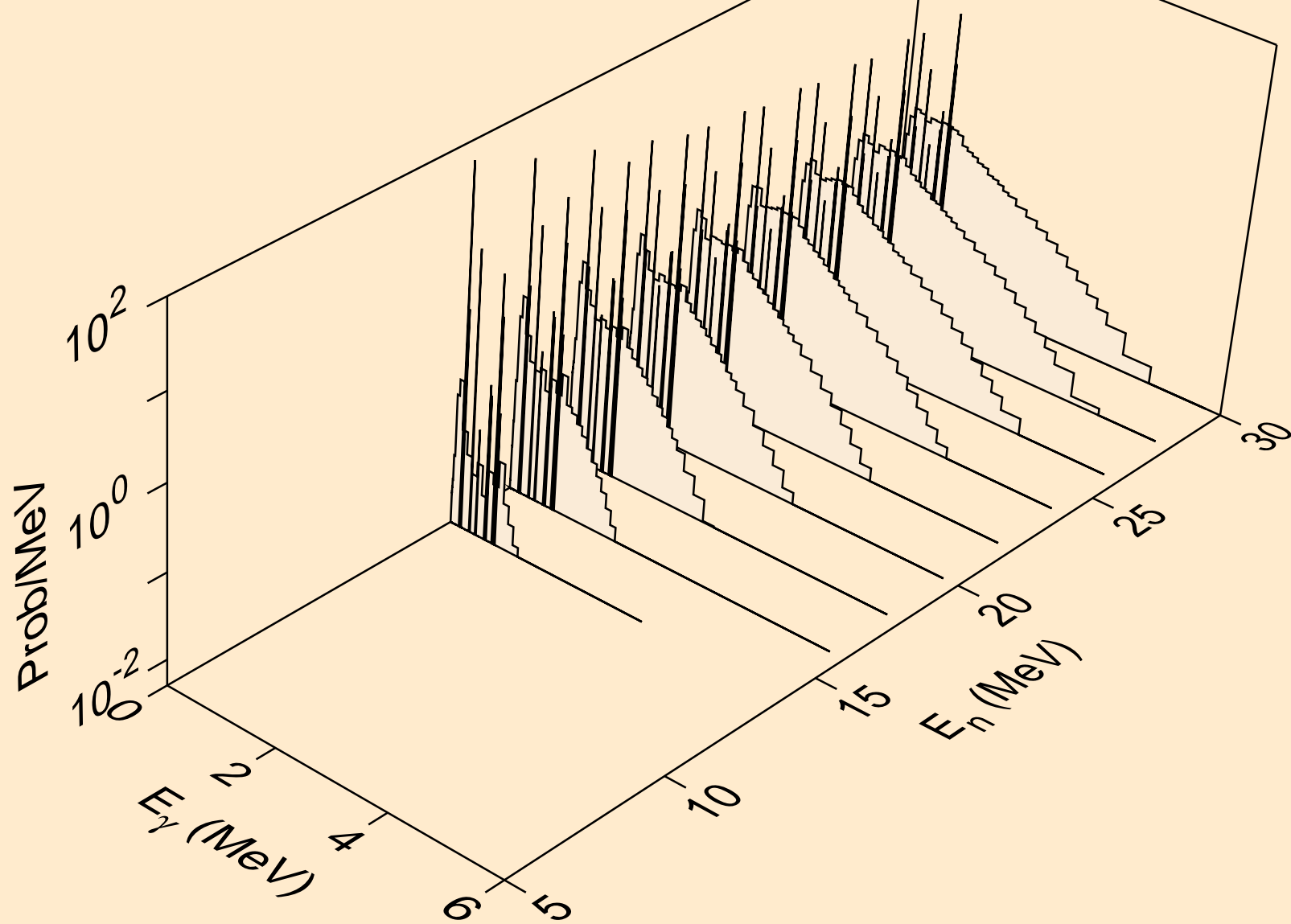

TB151M NEUTRON ACER TENDL-2023 LIBRARY; T=0.K
Photon emission for (n,n*)t

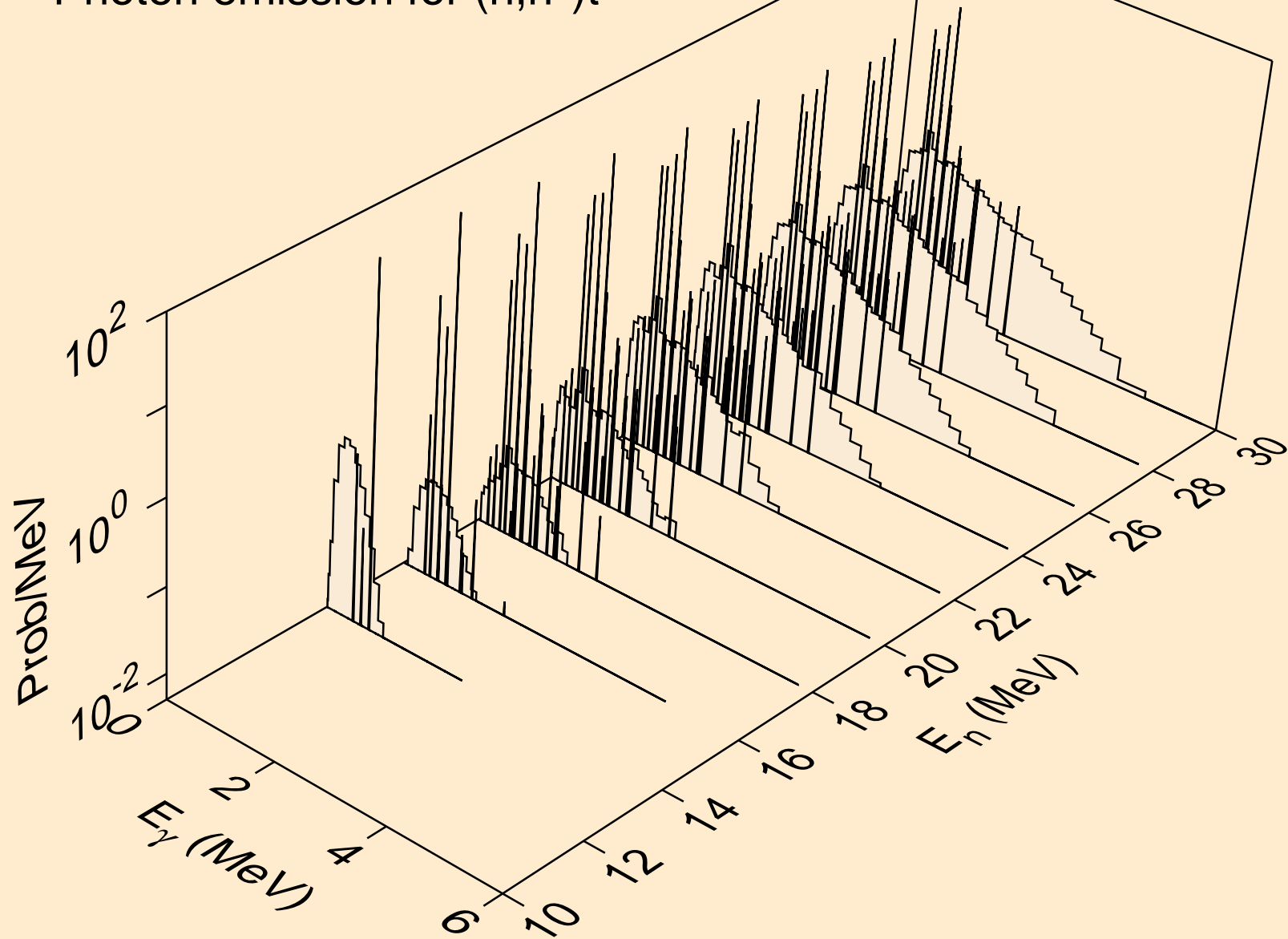

TB151M NEUTRON ACER TENDL-2023 LIBRARY; T=0.K
Photon emission for (n,n*)he3

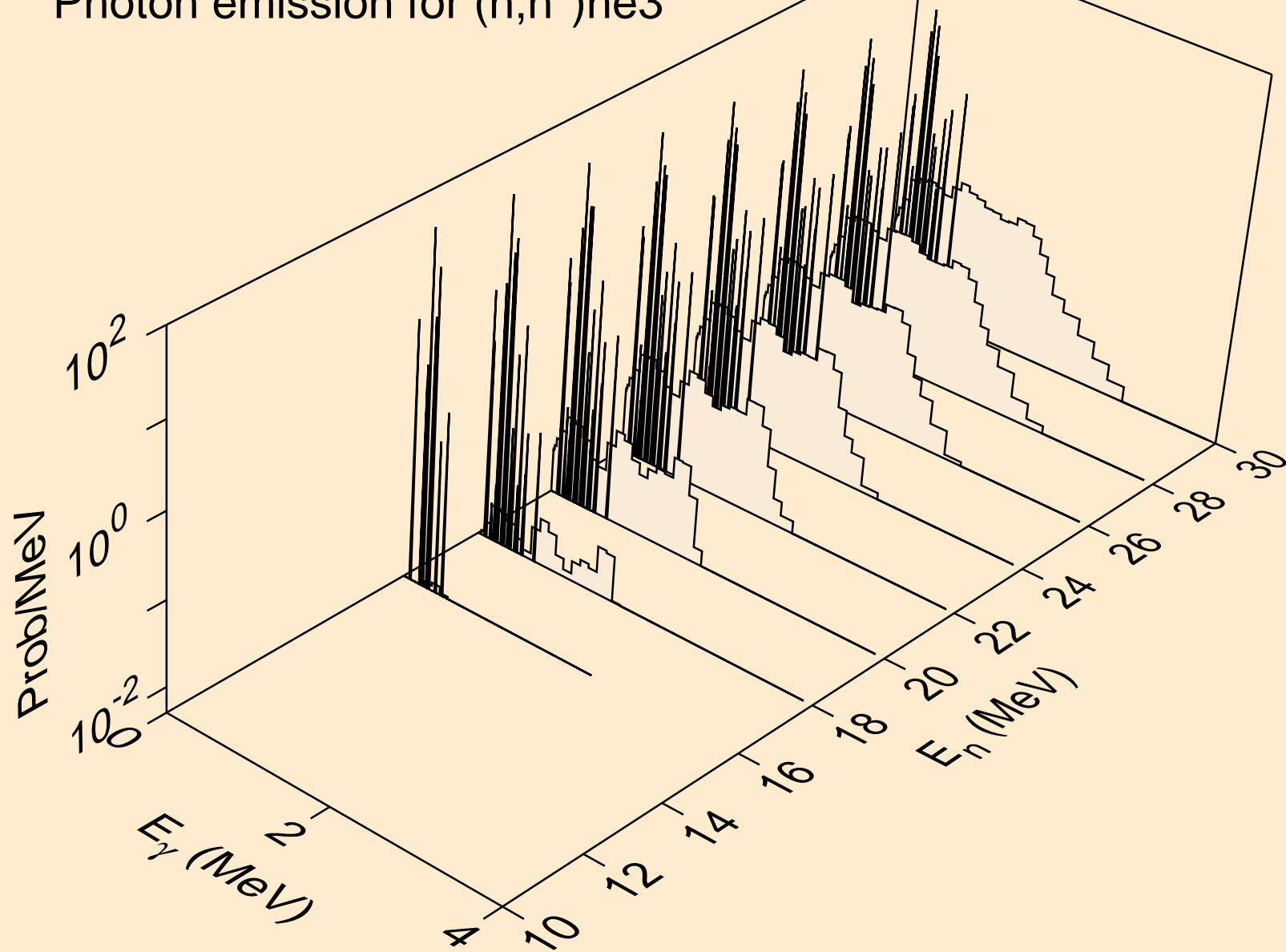

TB151M NEUTRON ACER TENDL-2023 LIBRARY; T=0.K
Photon emission for (n,4n)

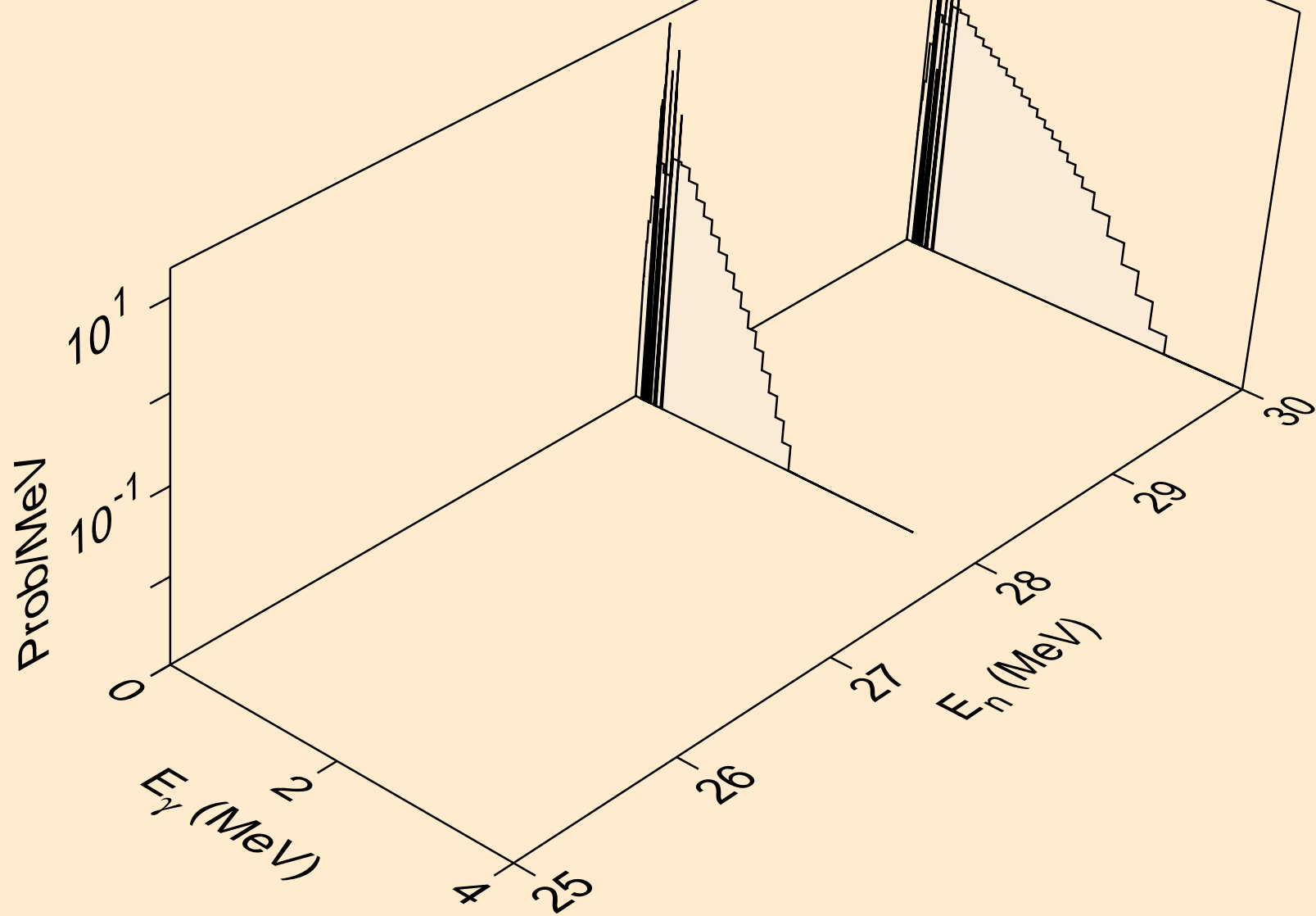

TB151M NEUTRON ACER TENDL-2023 LIBRARY; T=0.K
Photon emission for (n,2np)

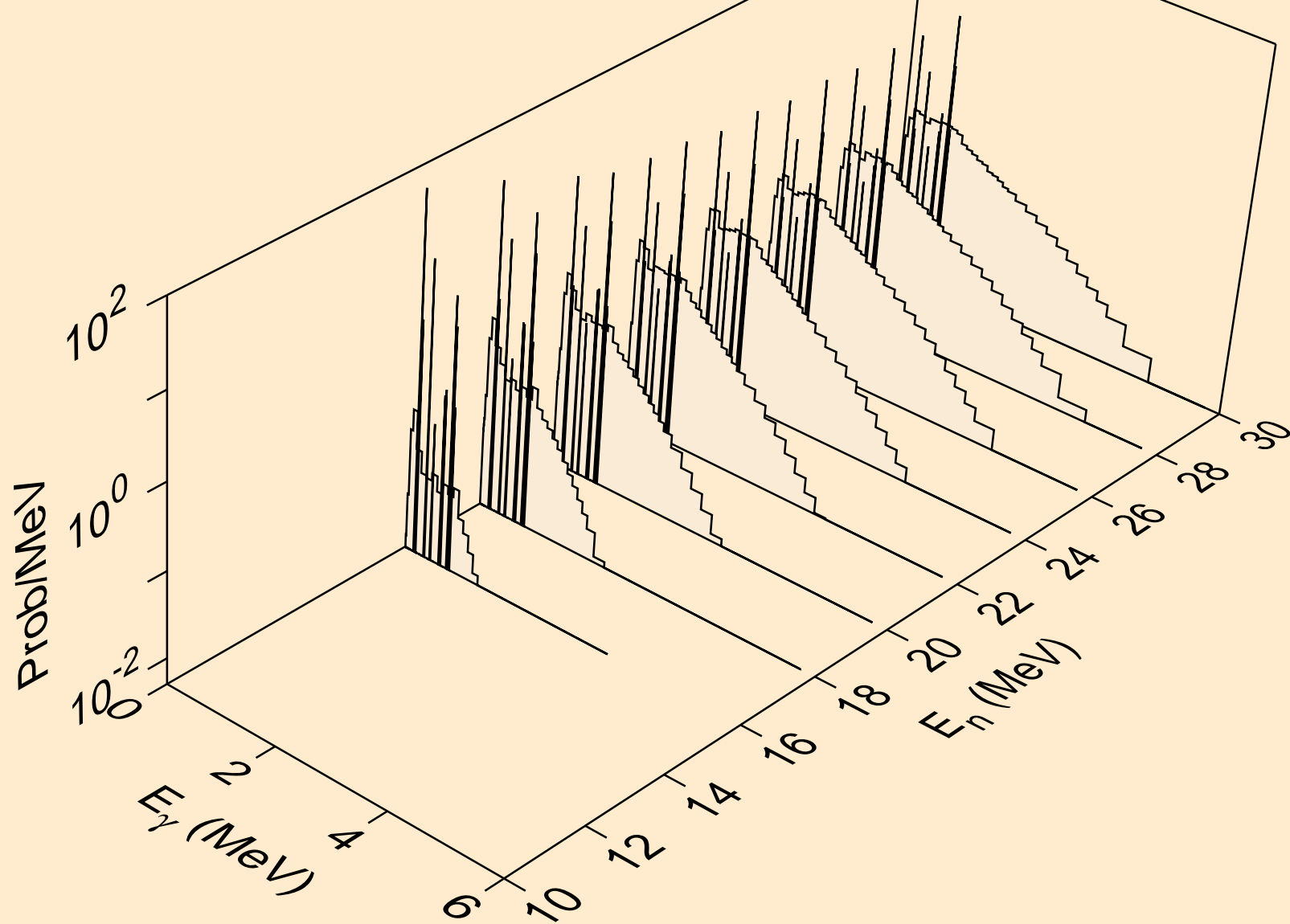

TB151M NEUTRON ACER TENDL-2023 LIBRARY; T=0.K
Photon emission for (n,3np)

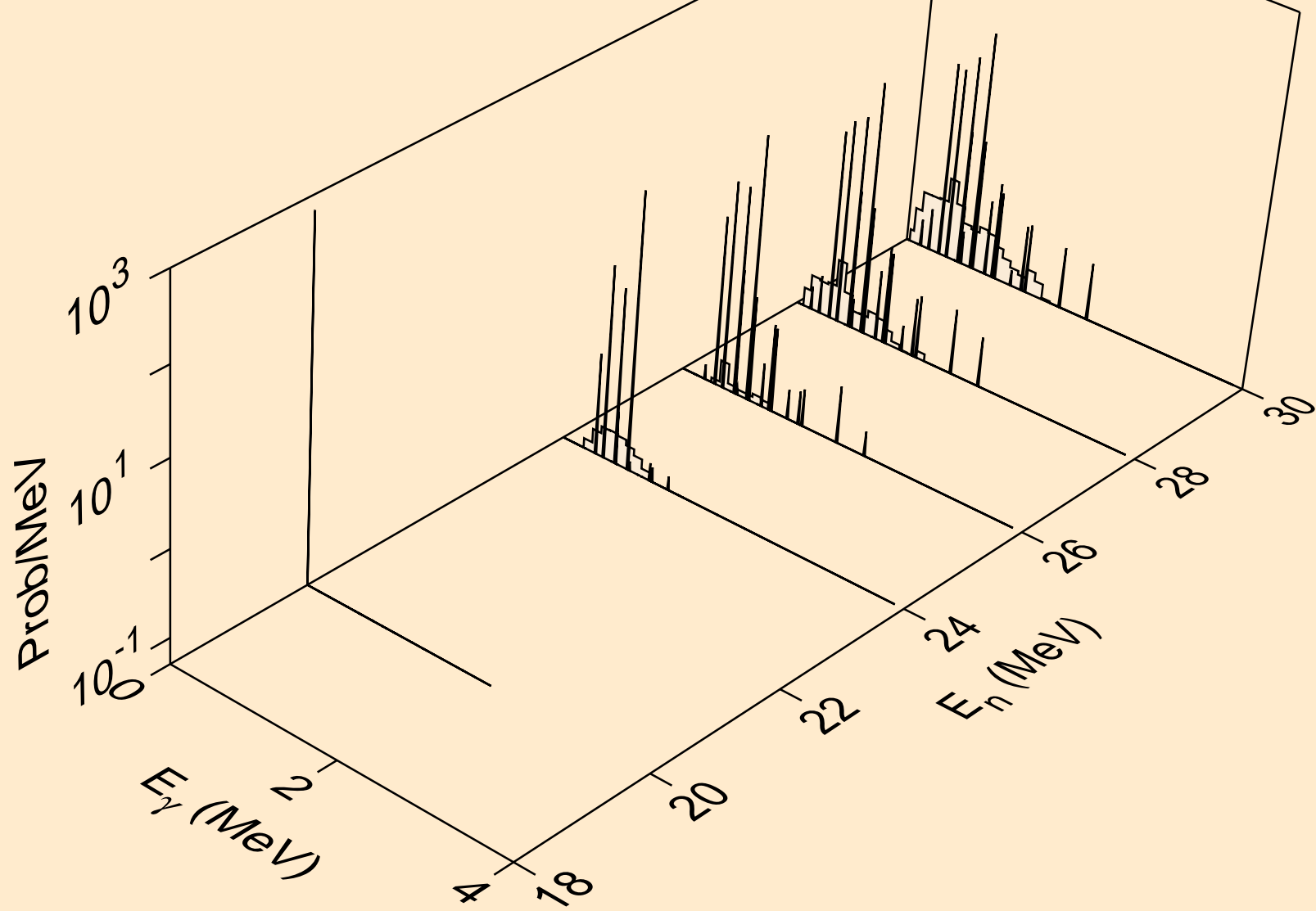

TB151M NEUTRON ACER TENDL-2023 LIBRARY; T=0.K
Photon emission for (n,n2p)

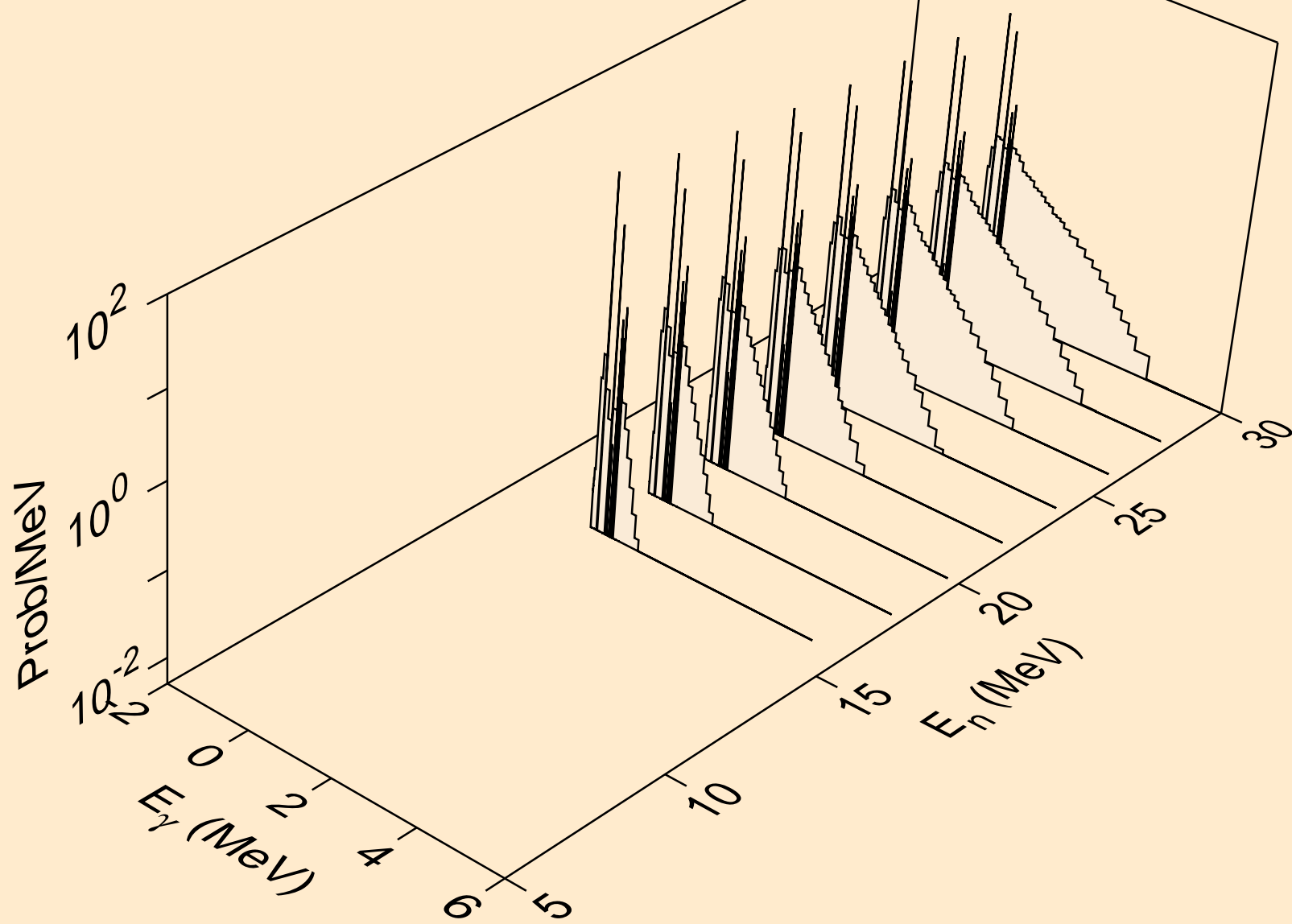

TB151M NEUTRON ACER TENDL-2023 LIBRARY; T=0.K
Photon emission for (n,npa)

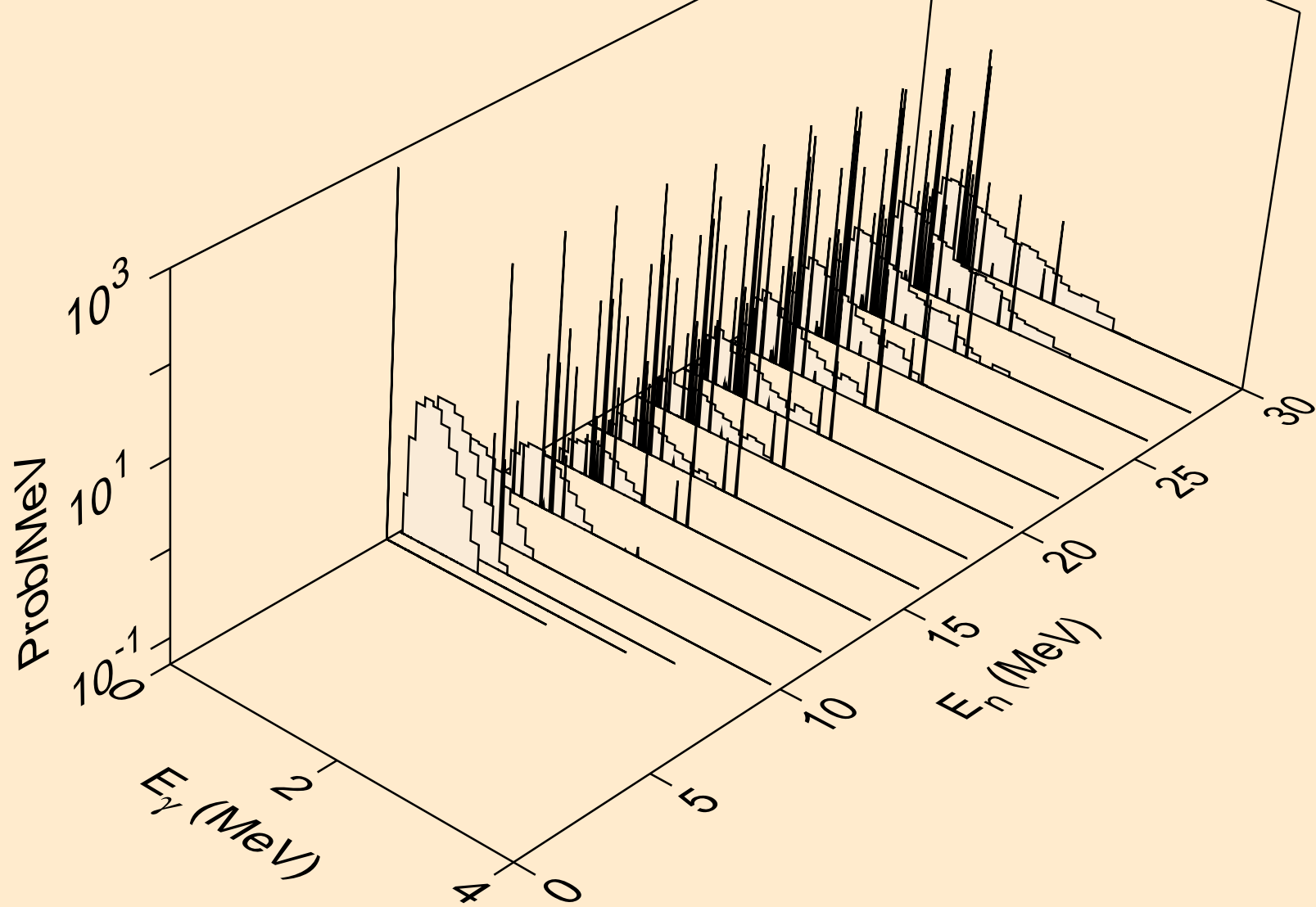

TB151M NEUTRON ACER TENDL-2023 LIBRARY; T=0.K
Photon emission for (n,n*1)

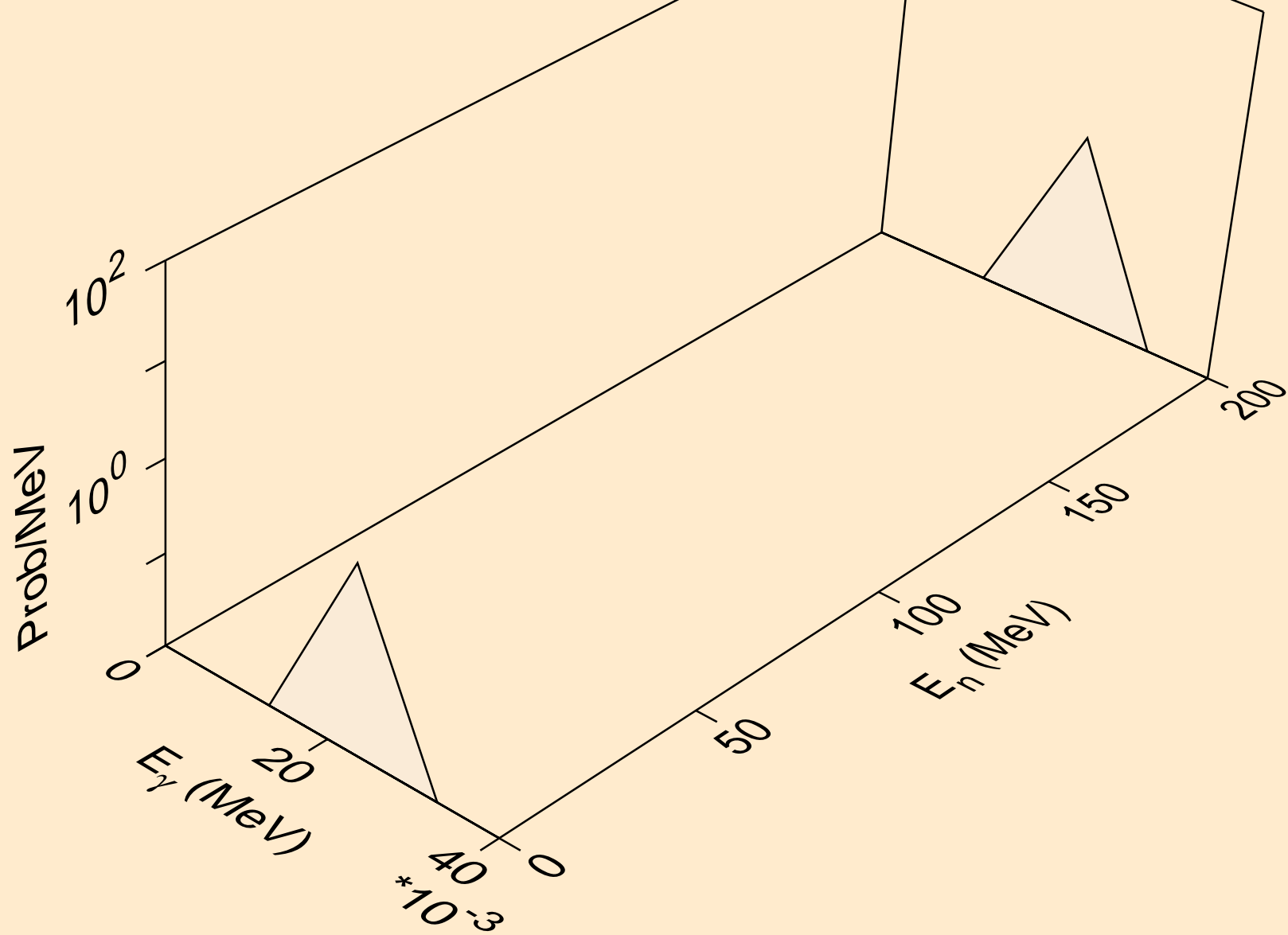

TB151M NEUTRON ACER TENDL-2023 LIBRARY; T=0.K
Photon emission for (n,n*2)

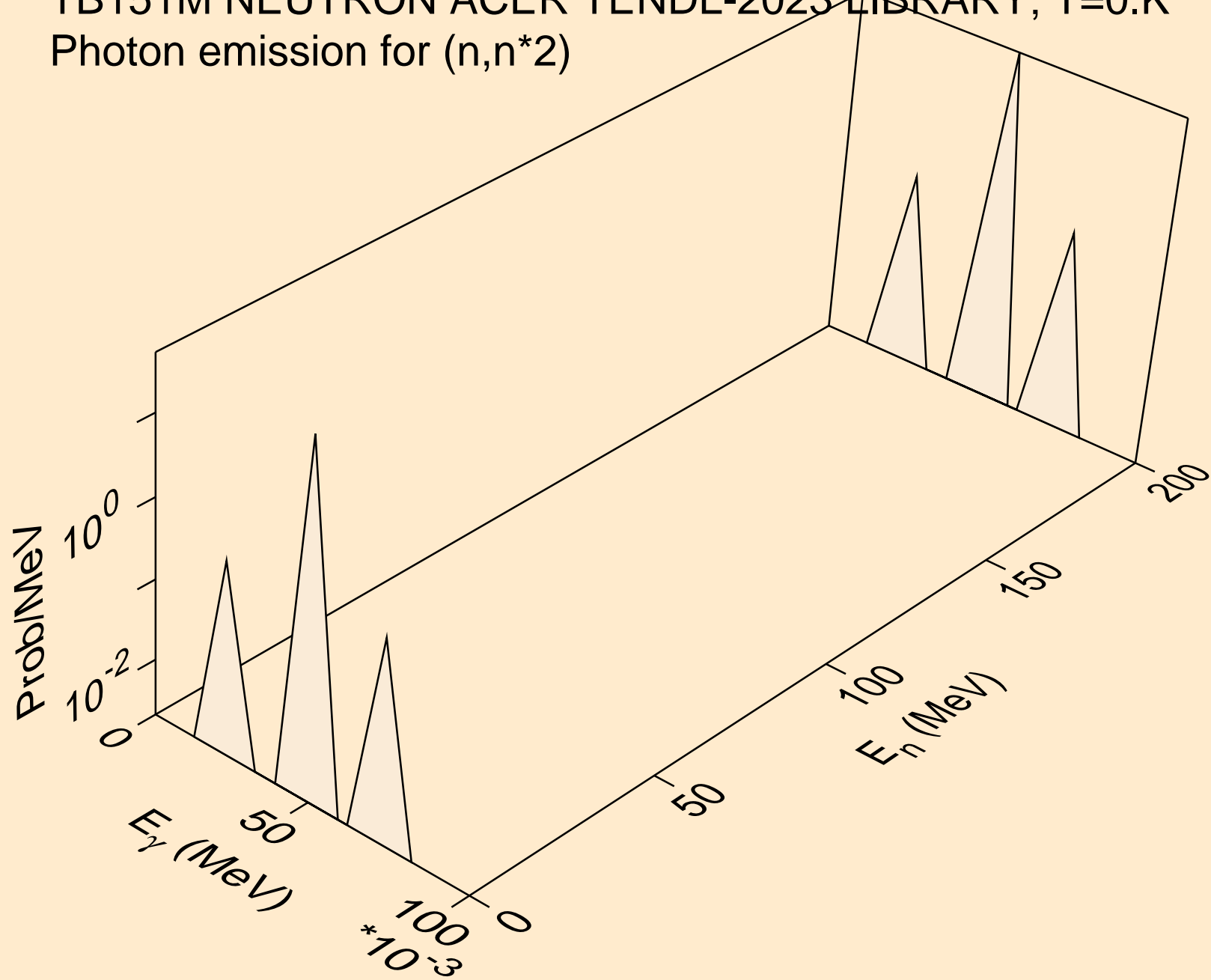

TB151M NEUTRON ACER TENDL-2023 LIBRARY; T=0.K
Photon emission for (n,n*4)

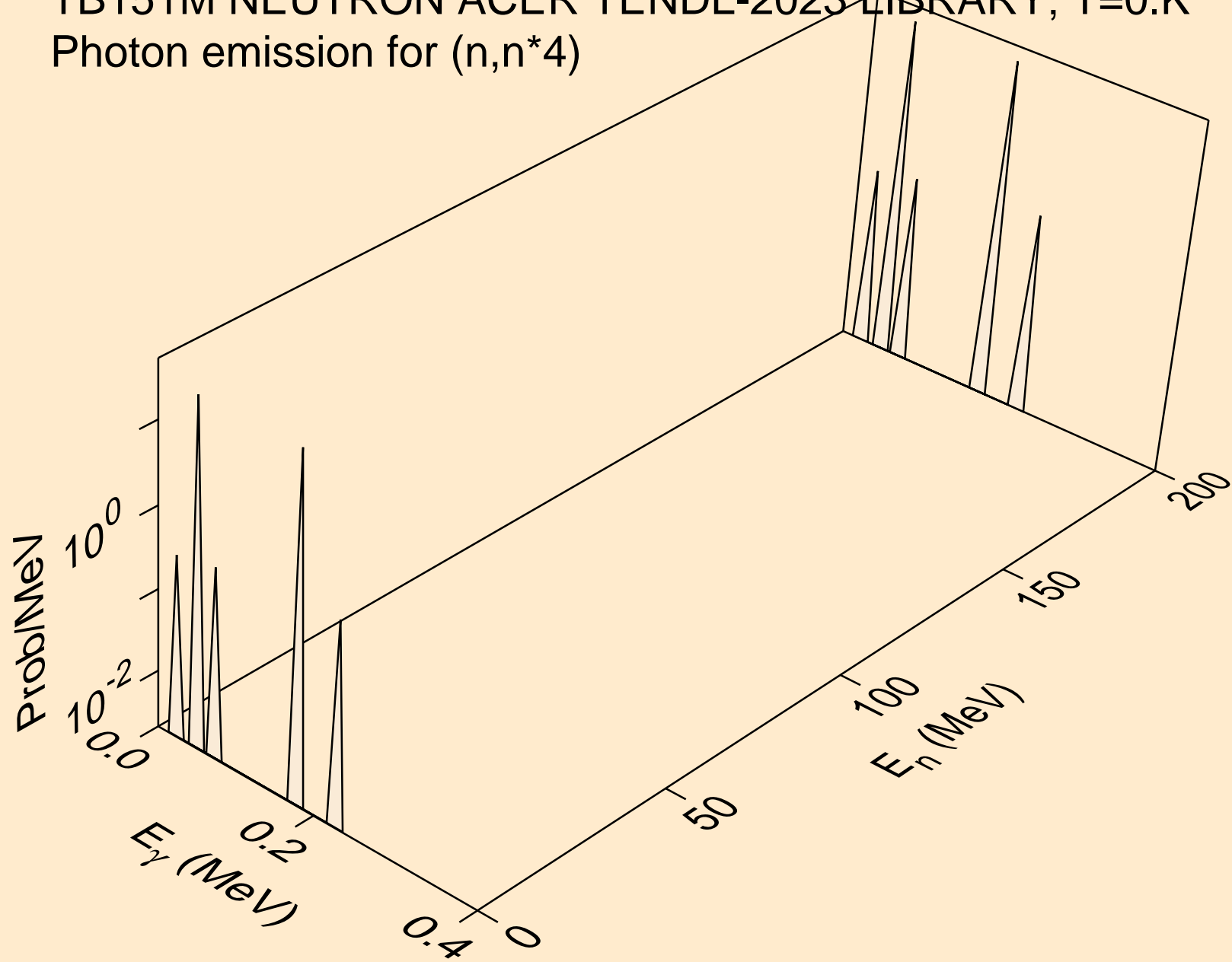

TB151M NEUTRON ACER TENDL-2023 LIBRARY; T=0.K
Photon emission for (n,n*5)

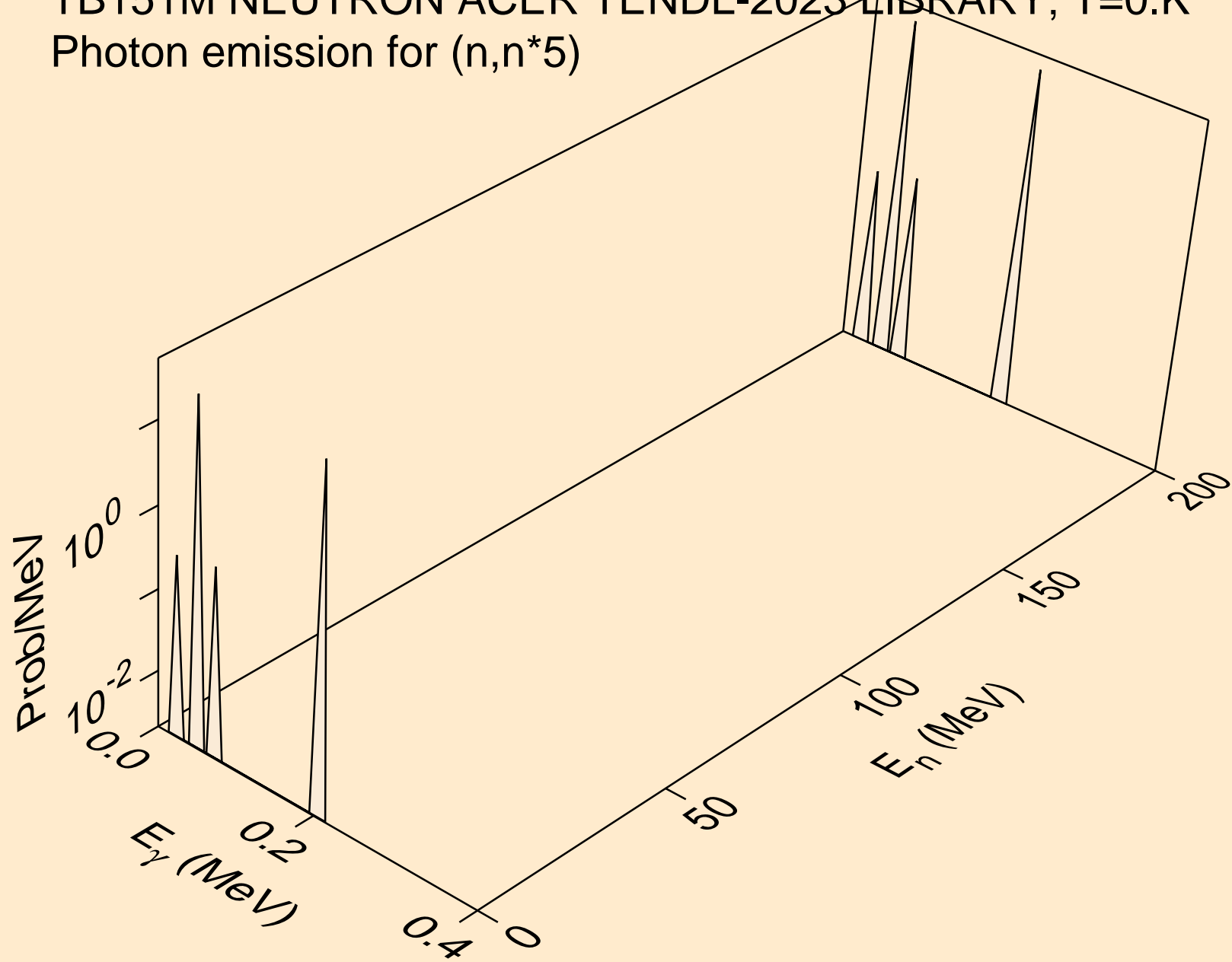

TB151M NEUTRON ACER TENDL-2023 LIBRARY; T=0.K
Photon emission for (n,n*6)

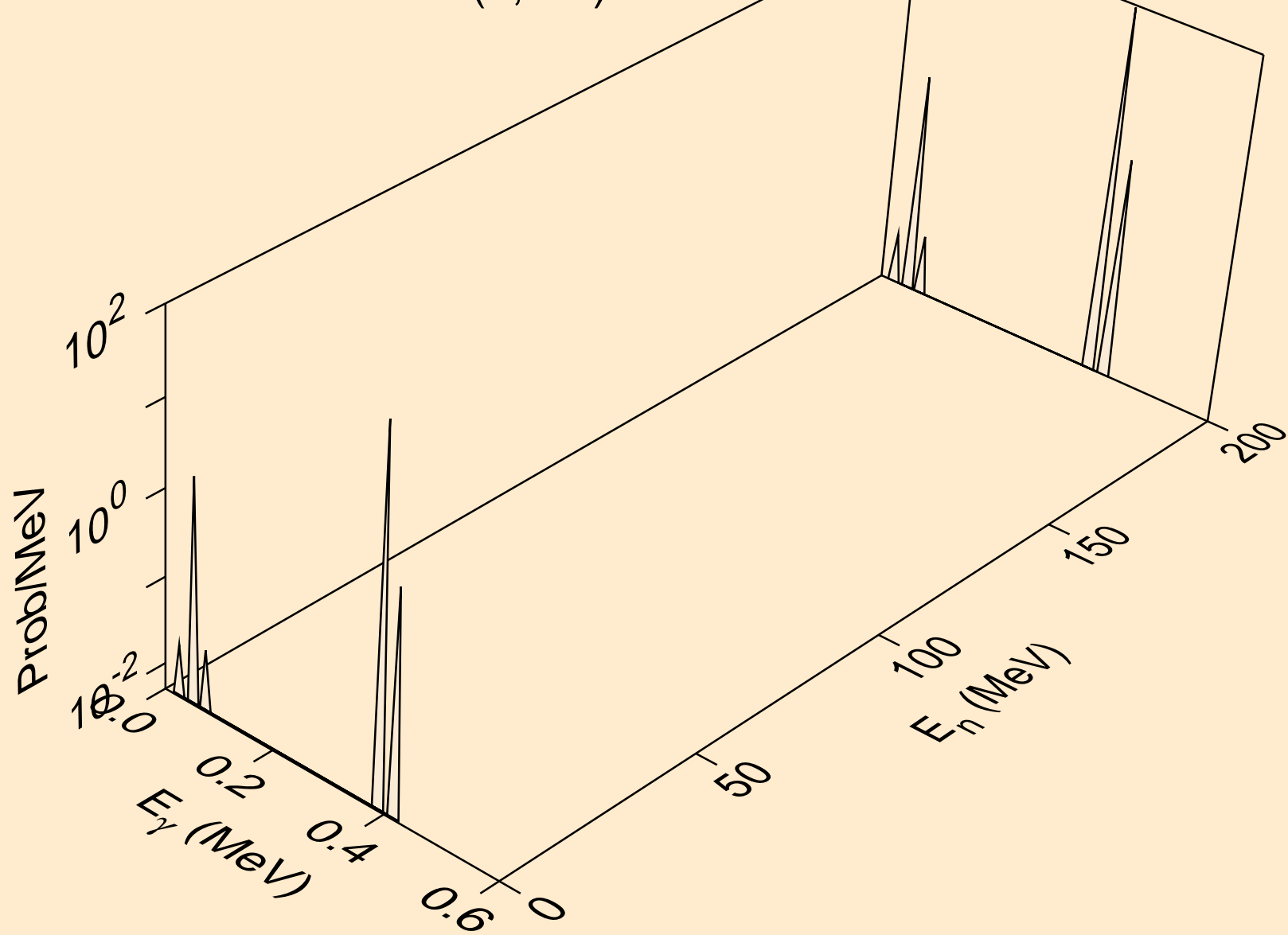

TB151M NEUTRON ACER TENDL-2023 LIBRARY; T=0.K
Photon emission for (n,n*7)

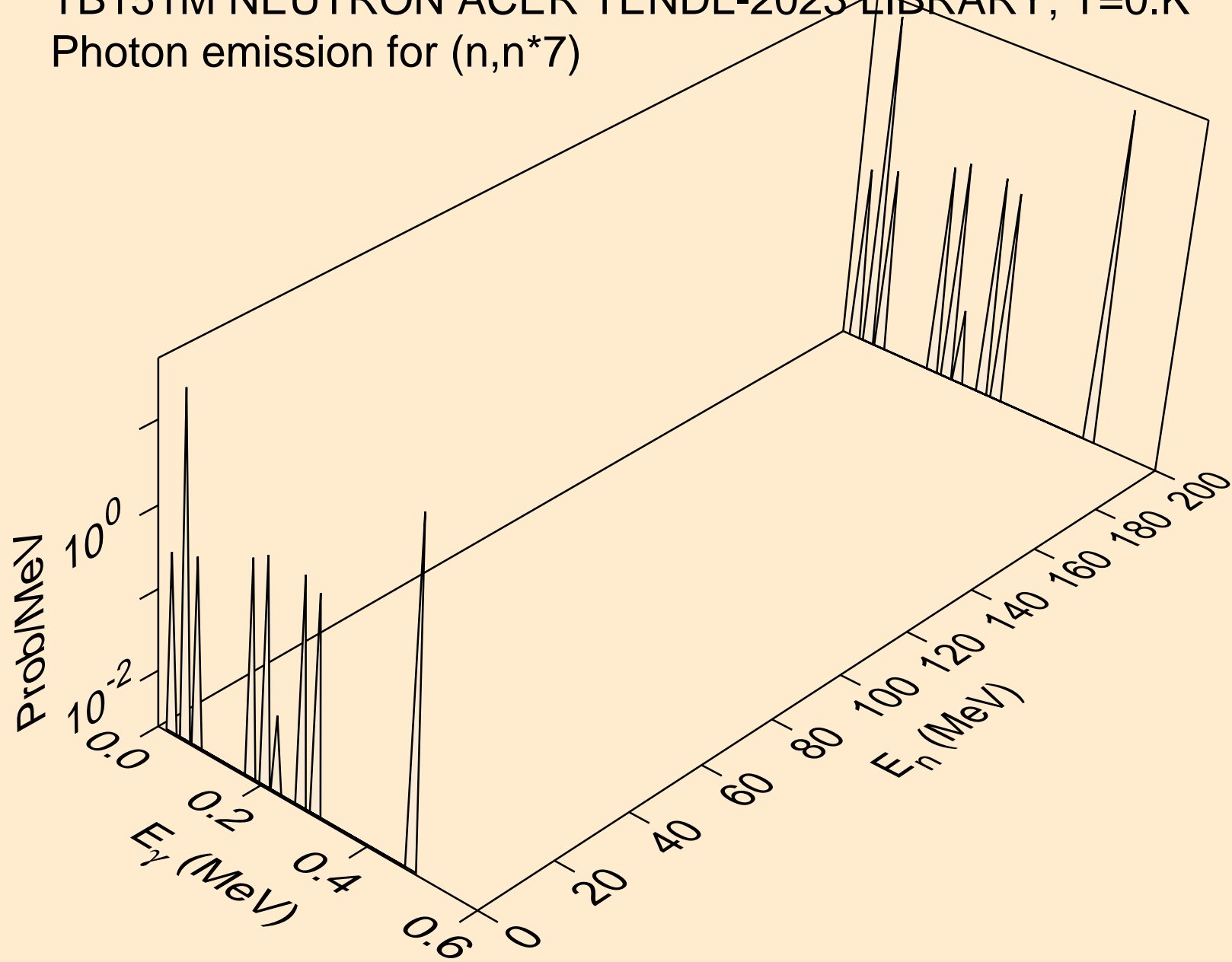

TB151M NEUTRON ACER TENDL-2023 LIBRARY; T=0.K
Photon emission for (n,n*8)

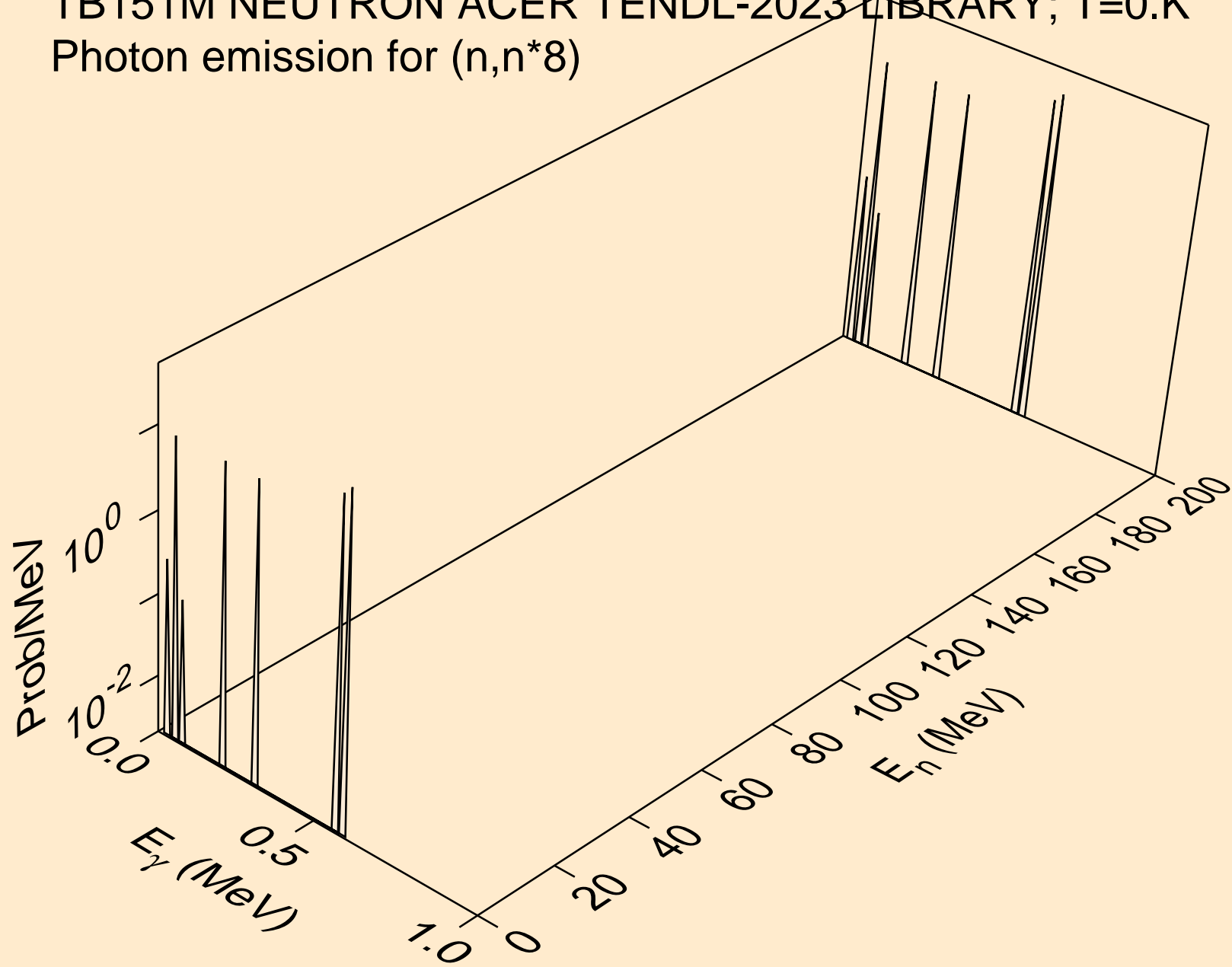

TB151M NEUTRON ACER TENDL-2023 LIBRARY; T=0.K
Photon emission for (n,n*9)

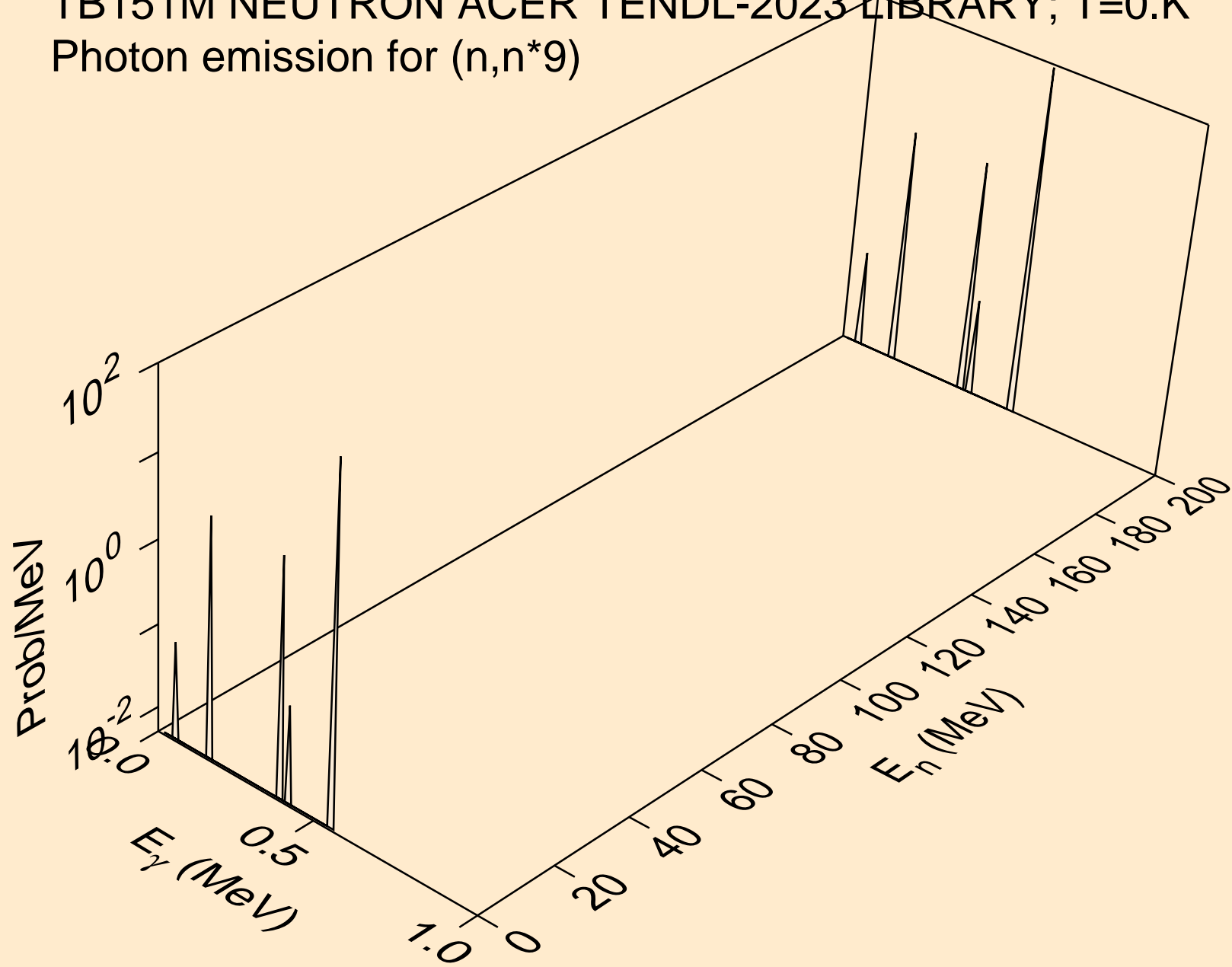

TB151M NEUTRON ACER TENDL-2023 LIBRARY; T=0.K
Photon emission for (n,n*10)

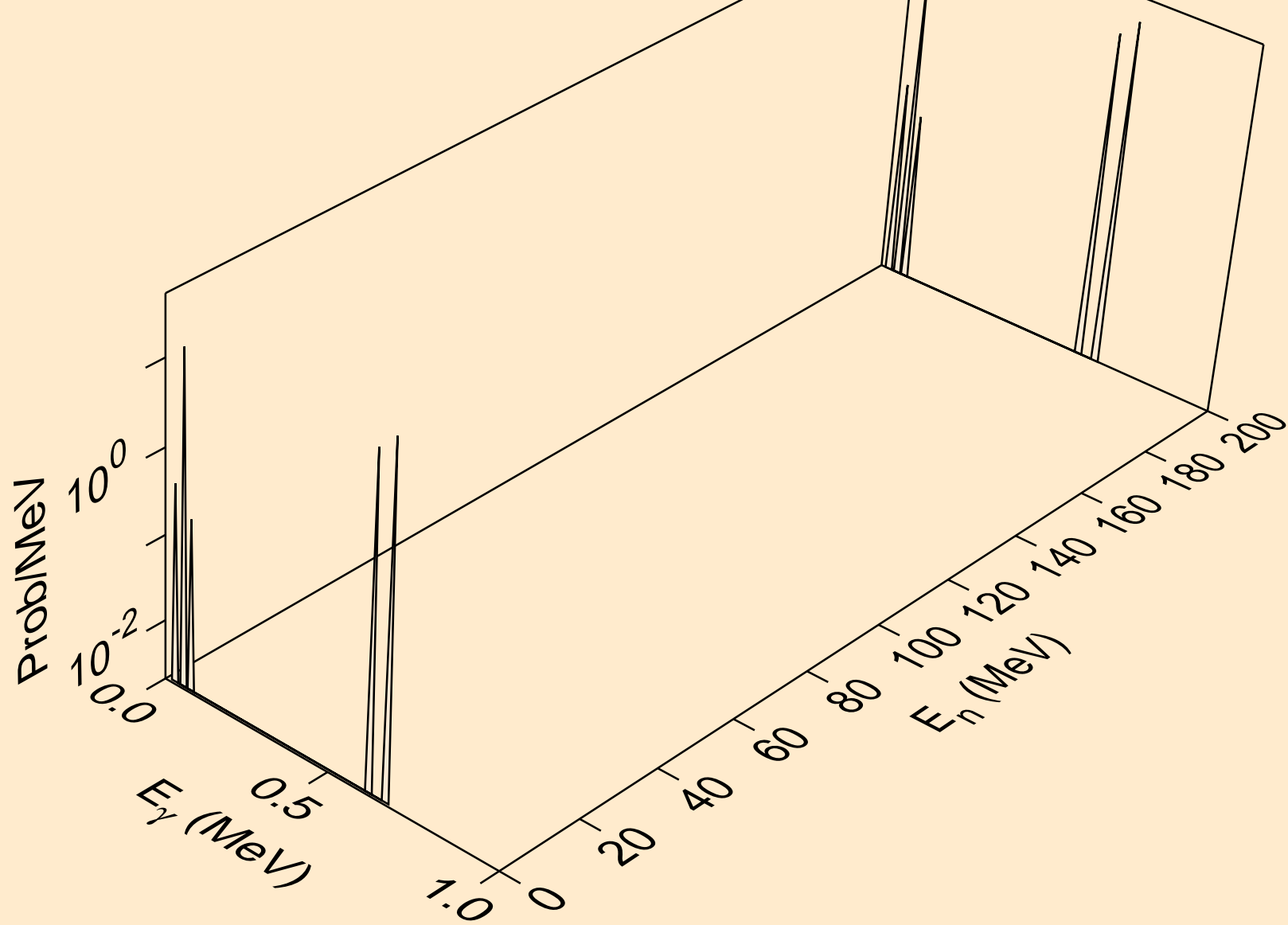

TB151M NEUTRON ACER TENDL-2023 LIBRARY; T=0.K
Photon emission for (n,n*11)

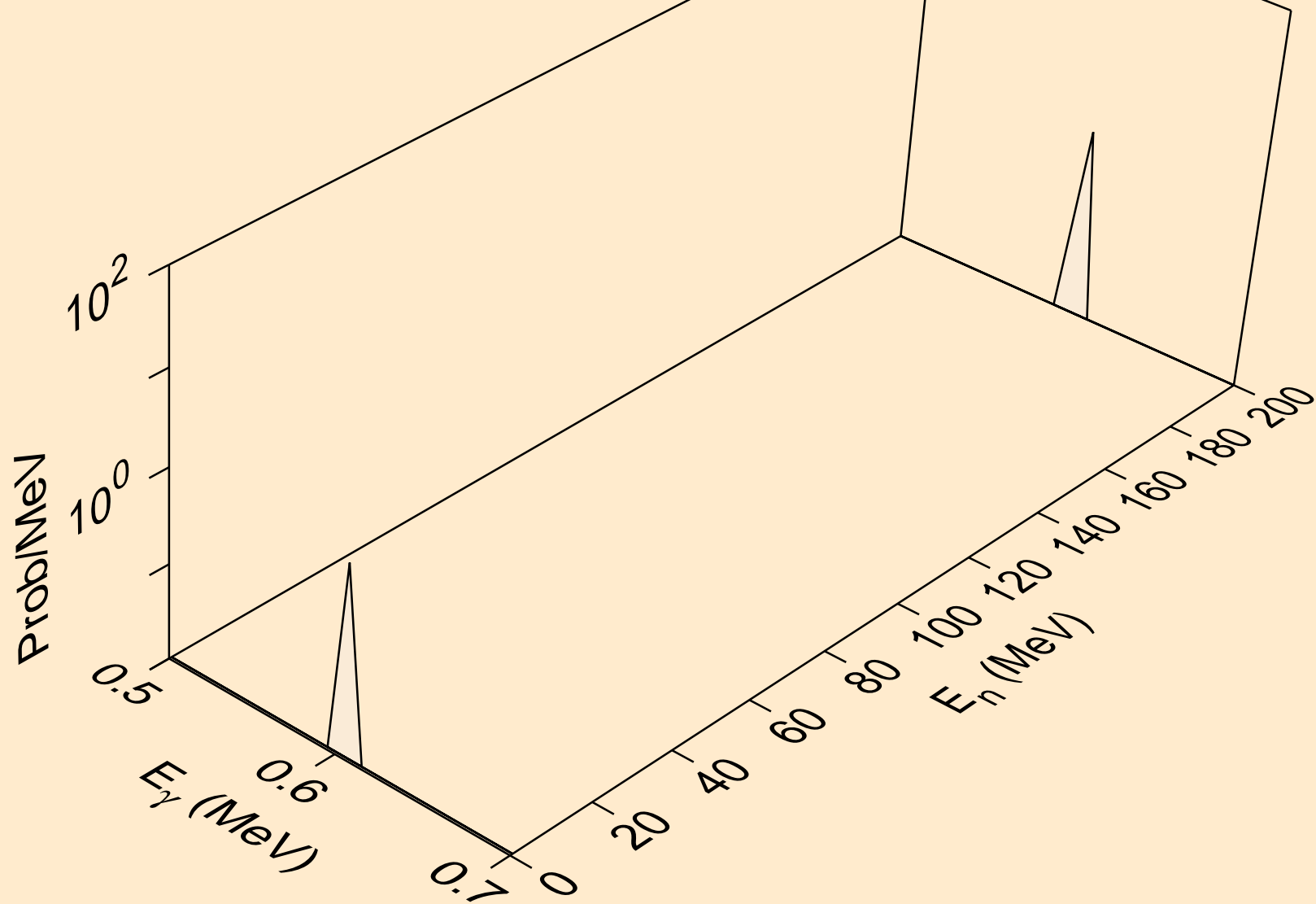

TB151M NEUTRON ACER TENDL-2023 LIBRARY; T=0.K
Photon emission for (n,n*12)

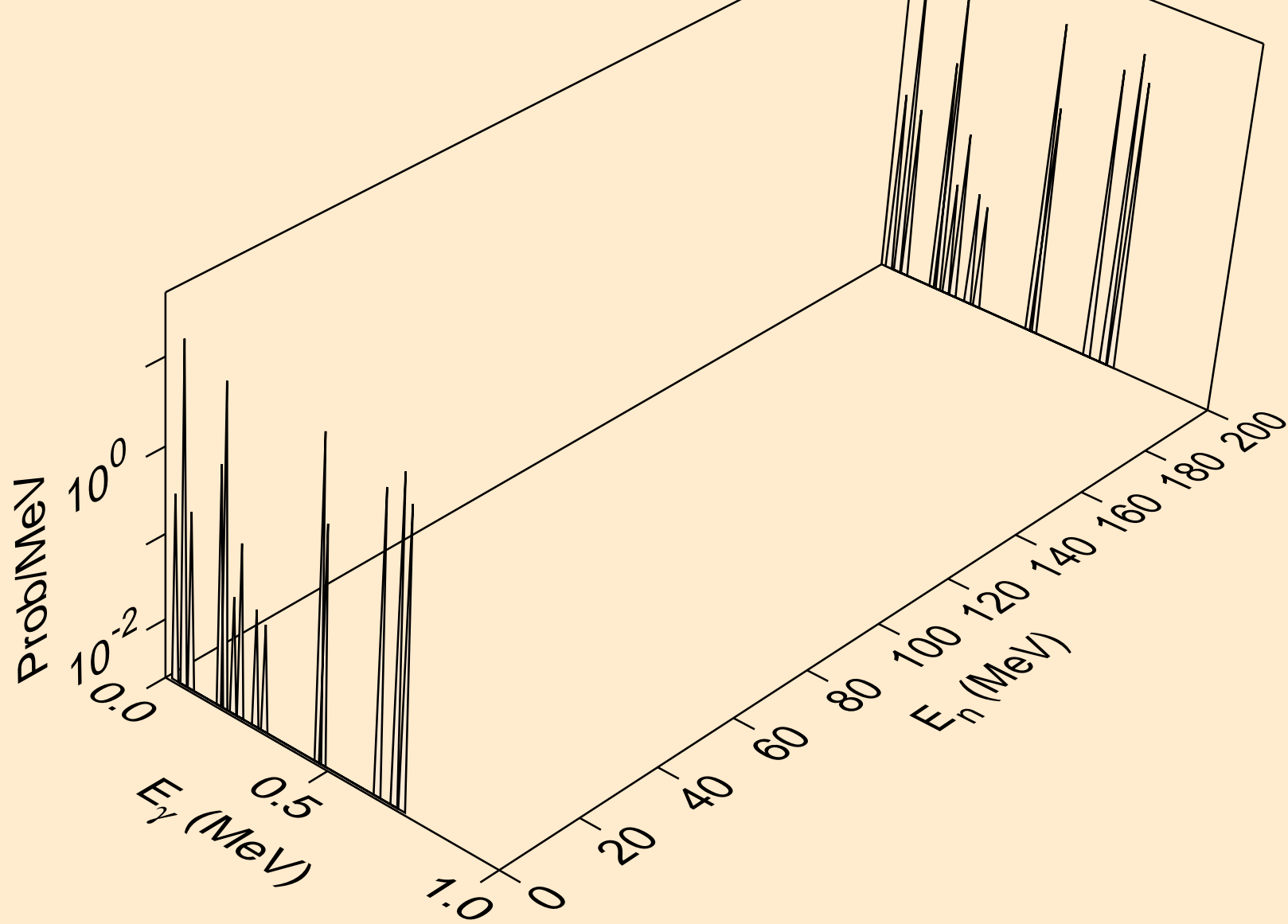

TB151M NEUTRON ACER TENDL-2023 LIBRARY; T=0.K
Photon emission for (n,n*13)

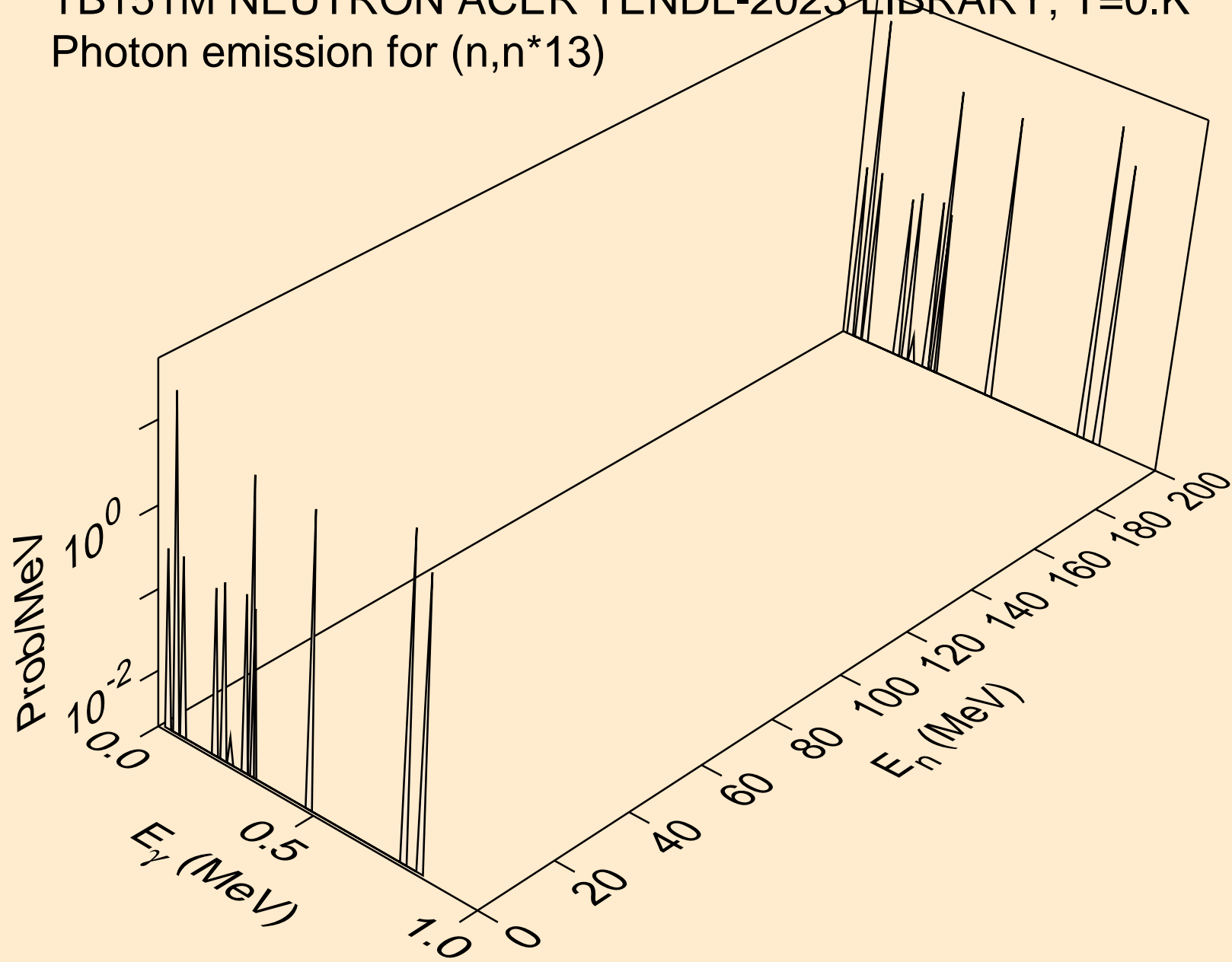

TB151M NEUTRON ACER TENDL-2023 LIBRARY; T=0.K
Photon emission for (n,n*14)

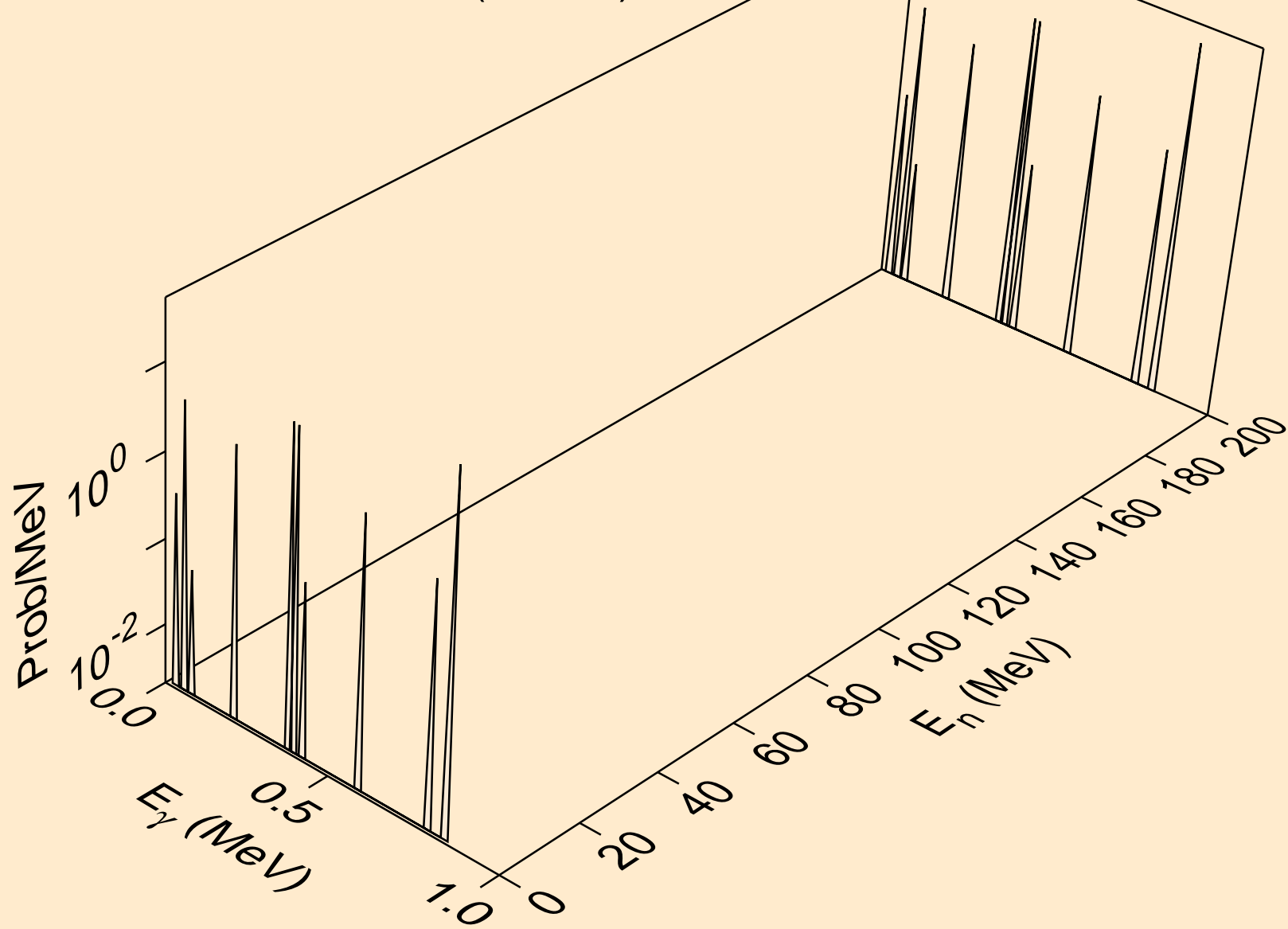

TB151M NEUTRON ACER TENDL-2023 LIBRARY; T=0.K
Photon emission for (n,n*15)

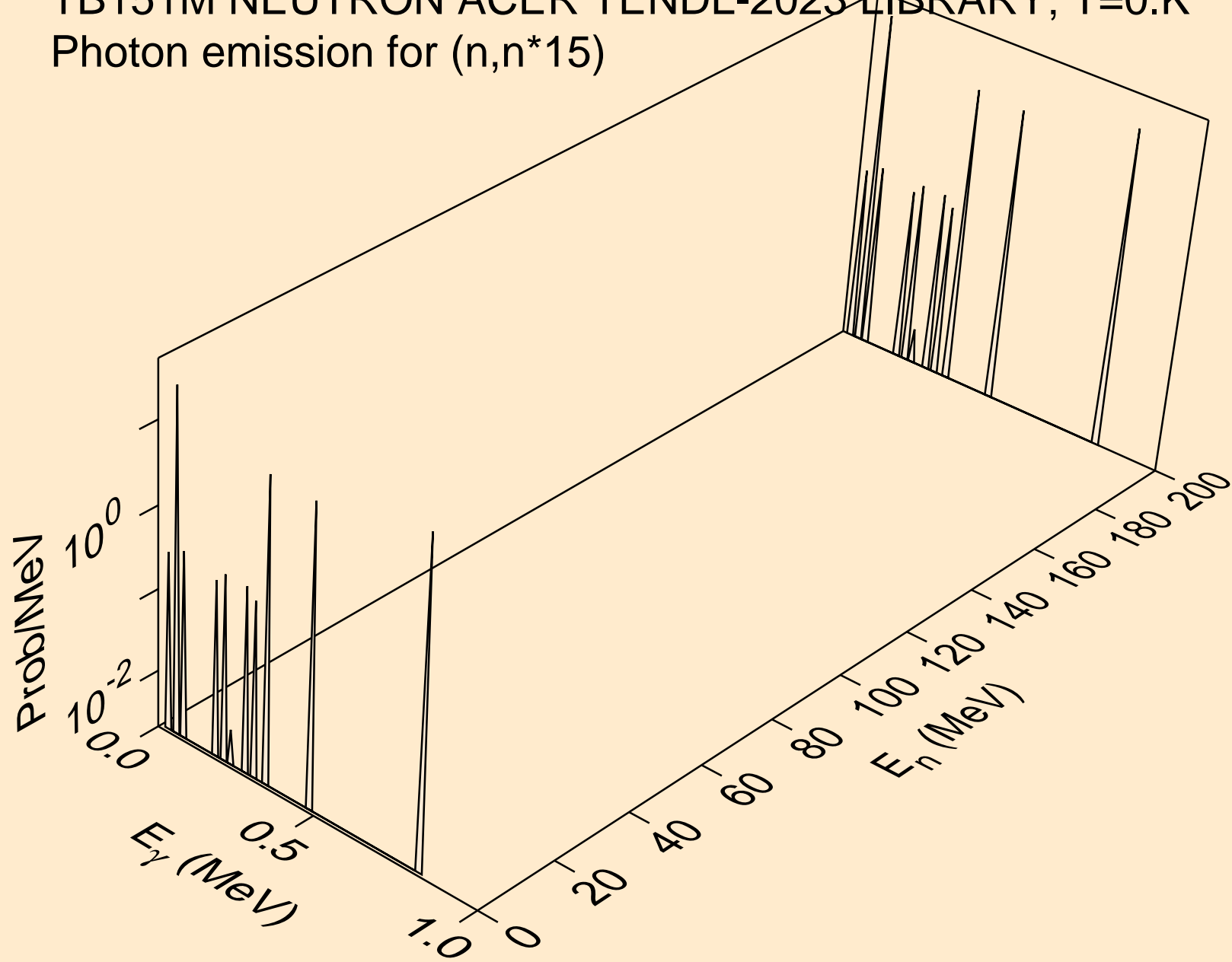

TB151M NEUTRON ACER TENDL-2023 LIBRARY; T=0.K
Photon emission for (n,n*16)

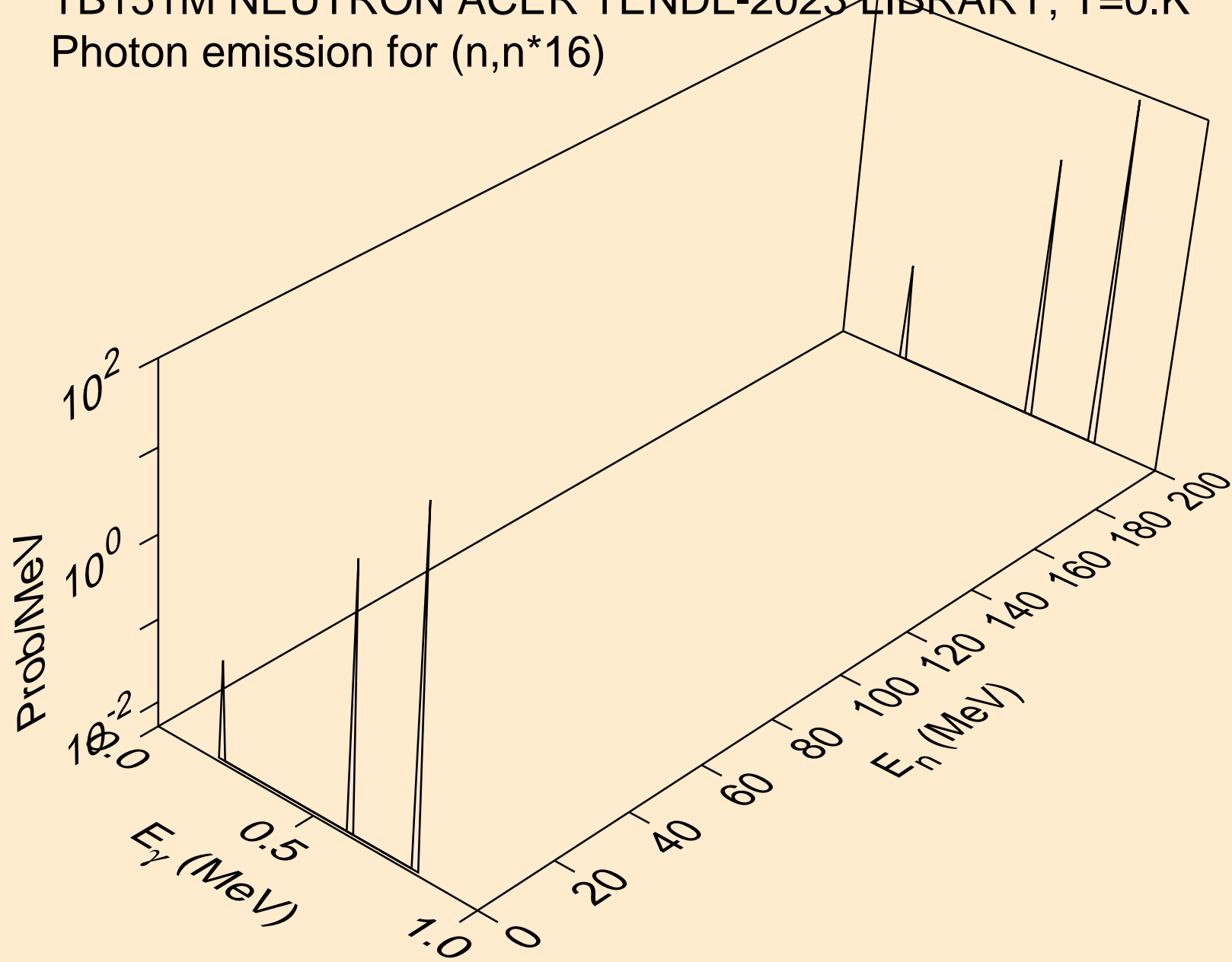

TB151M NEUTRON ACER TENDL-2023 LIBRARY; T=0.K
Photon emission for (n,n*17)

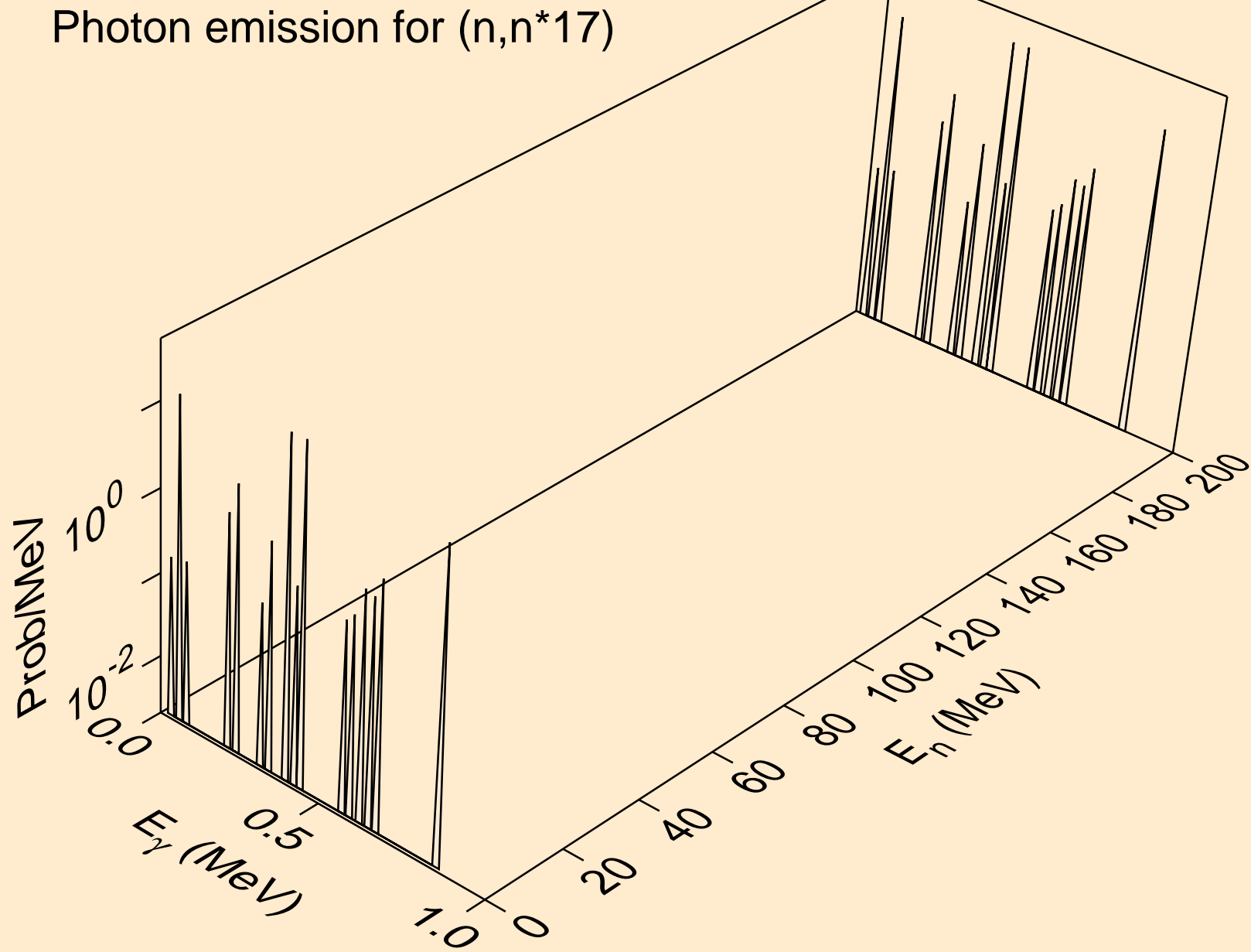

TB151M NEUTRON ACER TENDL-2023 LIBRARY; T=0.K
Photon emission for (n,n*c)

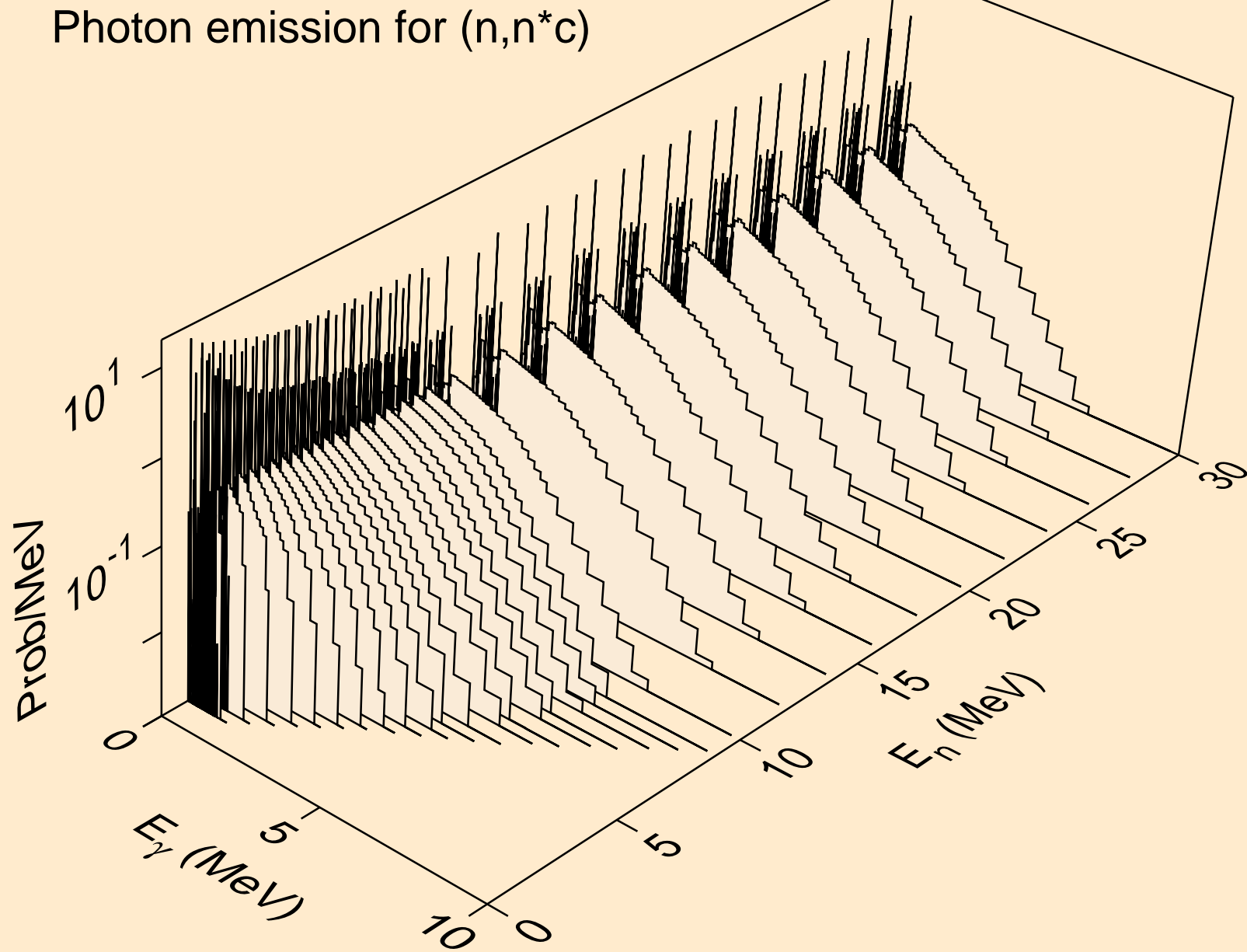

TB151M NEUTRON ACER TENDL-2023 LIBRARY; T=0.K
Photon emission for (n,gma)

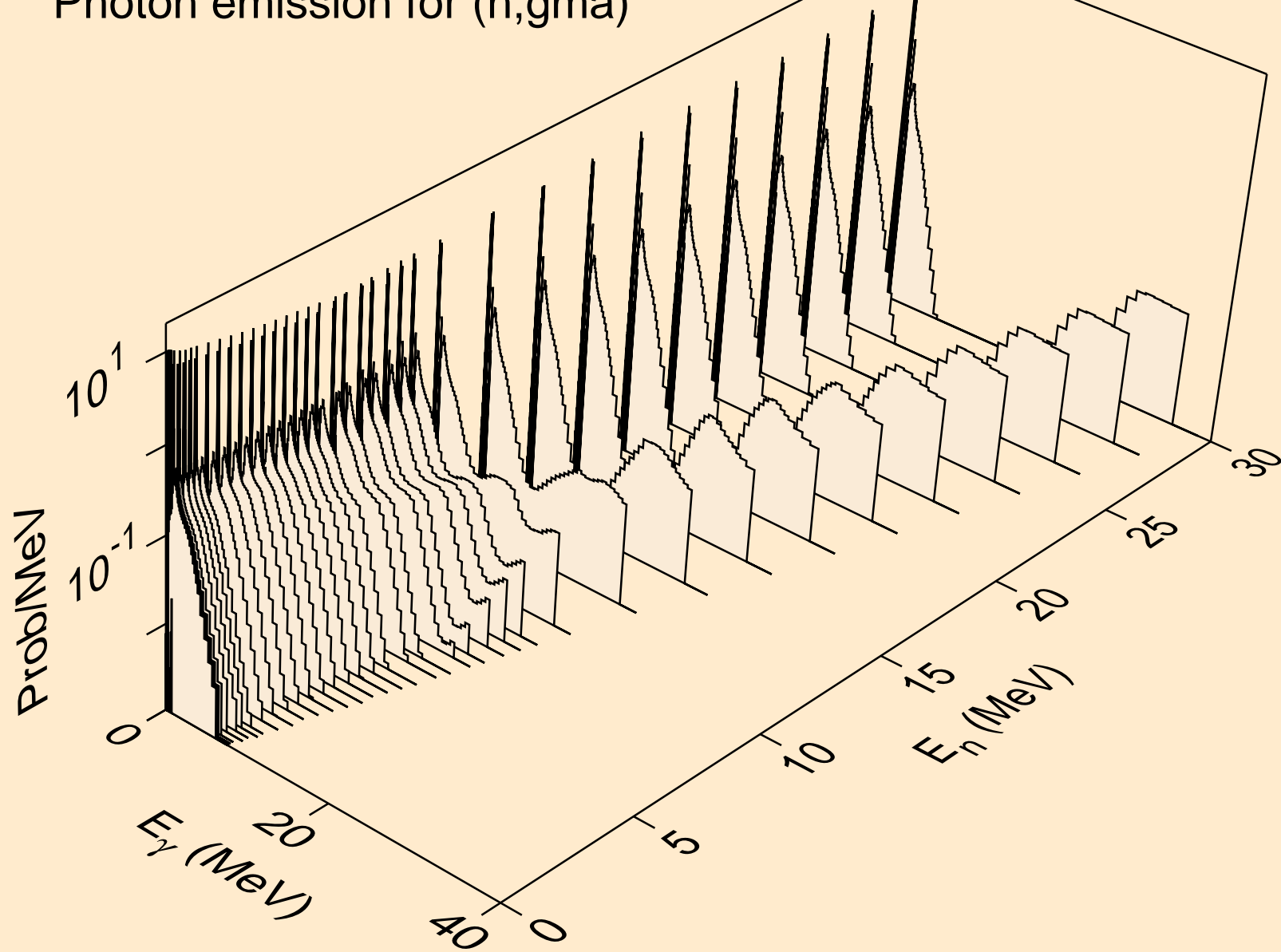

TB151M NEUTRON ACER TENDL-2023 LIBRARY; T=0.K
Photon emission for (n,p)

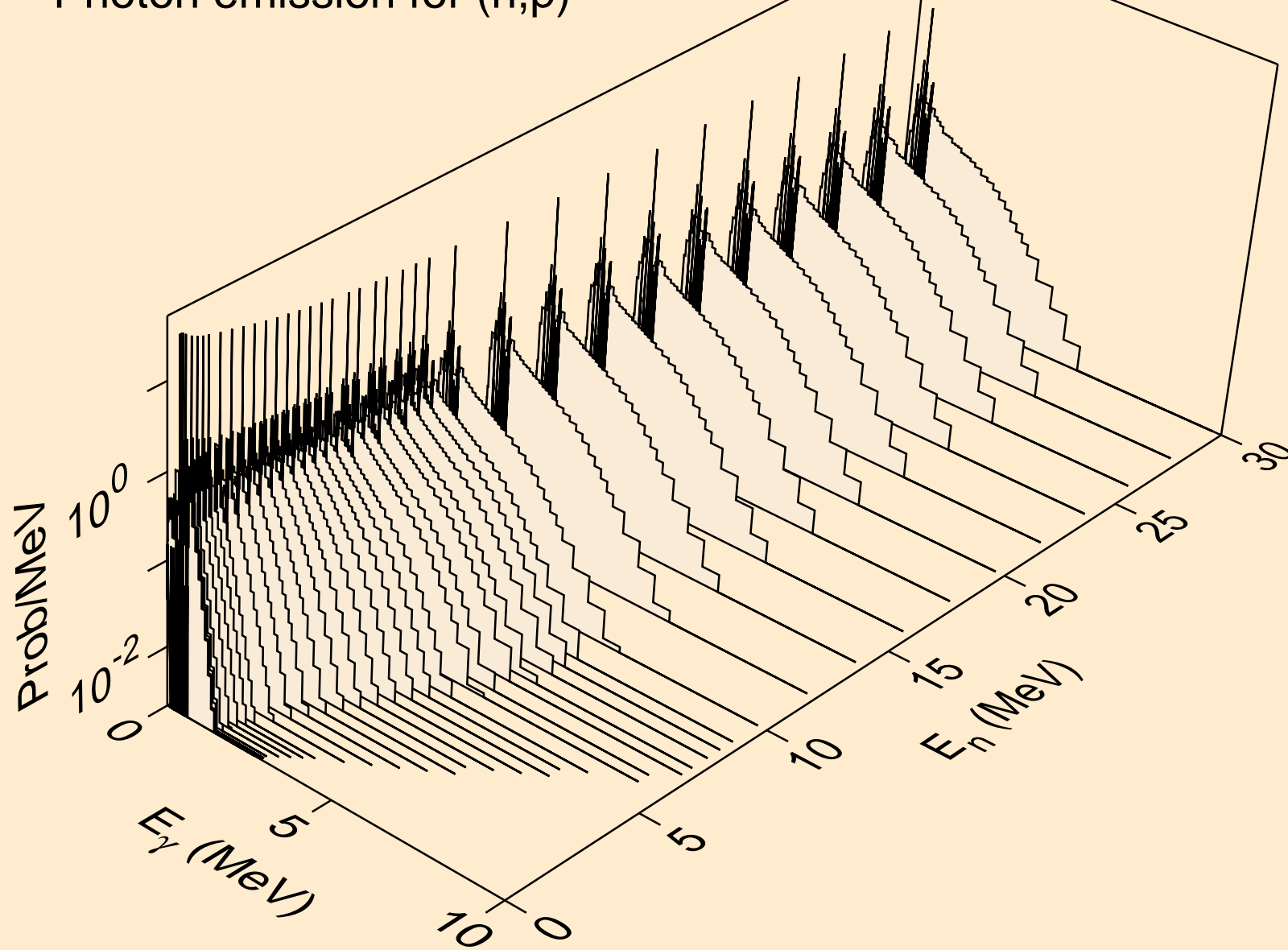

TB151M NEUTRON ACER TENDL-2023 LIBRARY; T=0.K
Photon emission for (n,d)

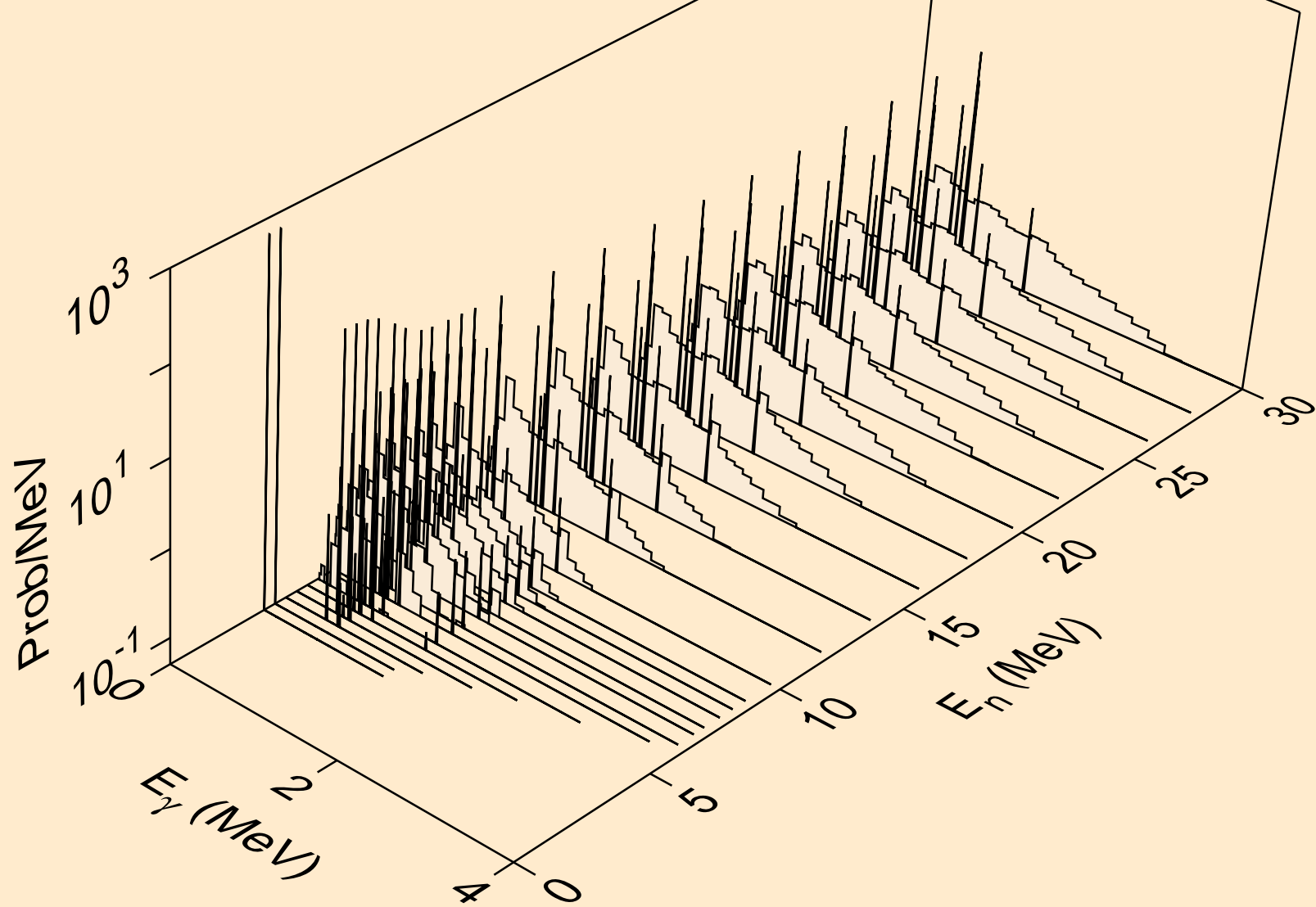

TB151M NEUTRON ACER TENDL-2023 LIBRARY; T=0.K
Photon emission for (n,t)

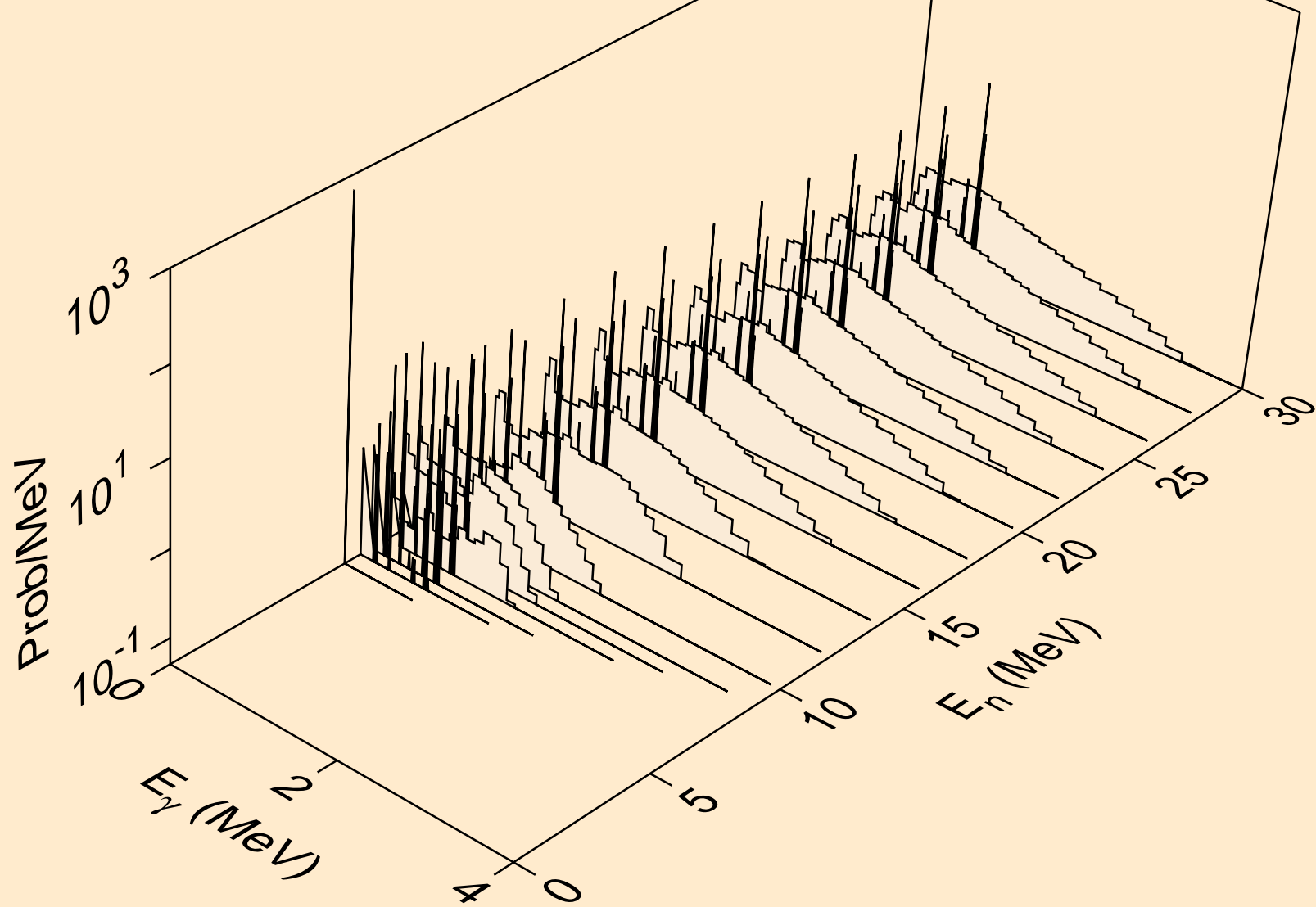

TB151M NEUTRON ACER TENDL-2023 LIBRARY; T=0.K
Photon emission for (n,he3)

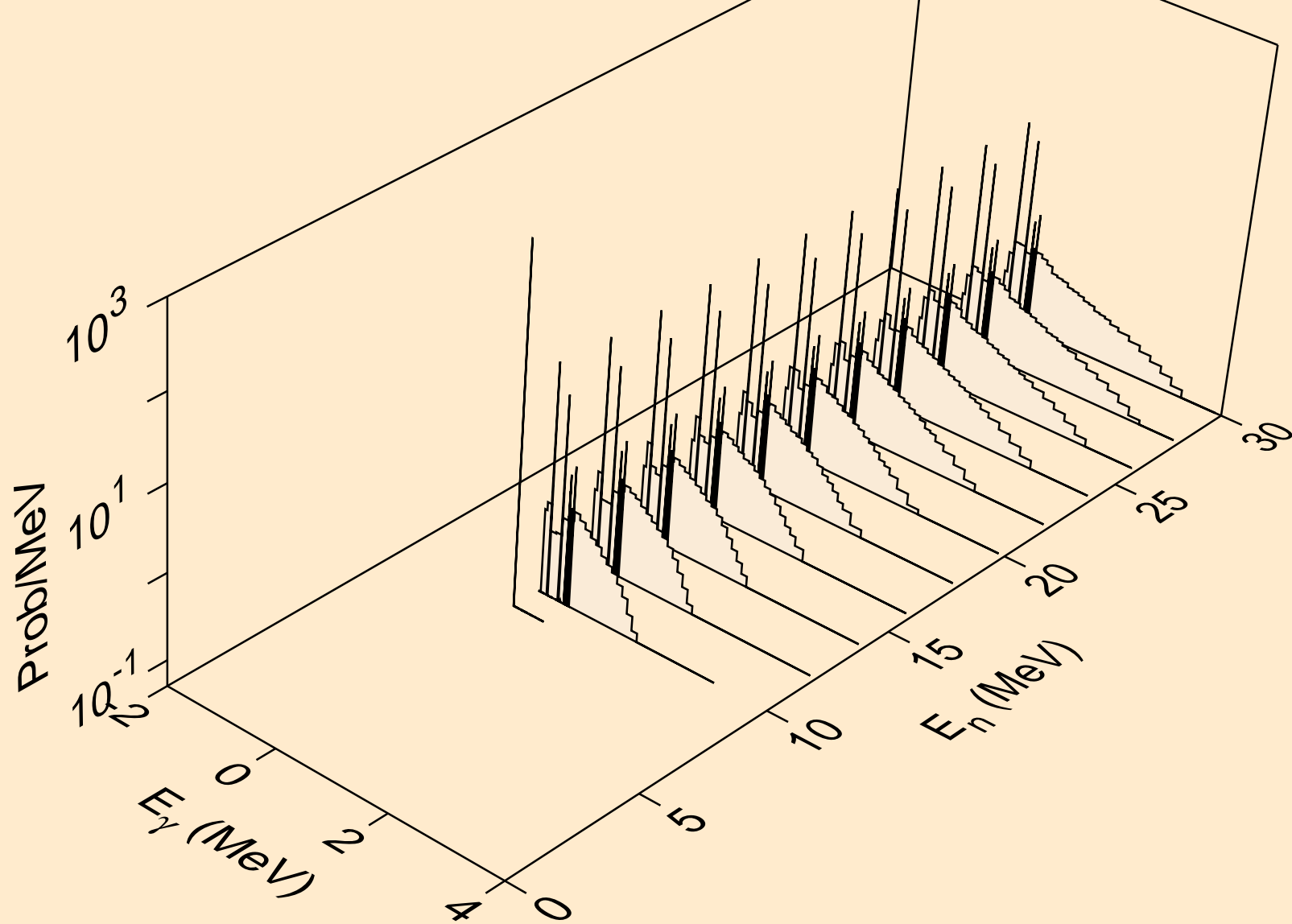

TB151M NEUTRON ACER TENDL-2023 LIBRARY; T=0.K
Photon emission for (n,a)

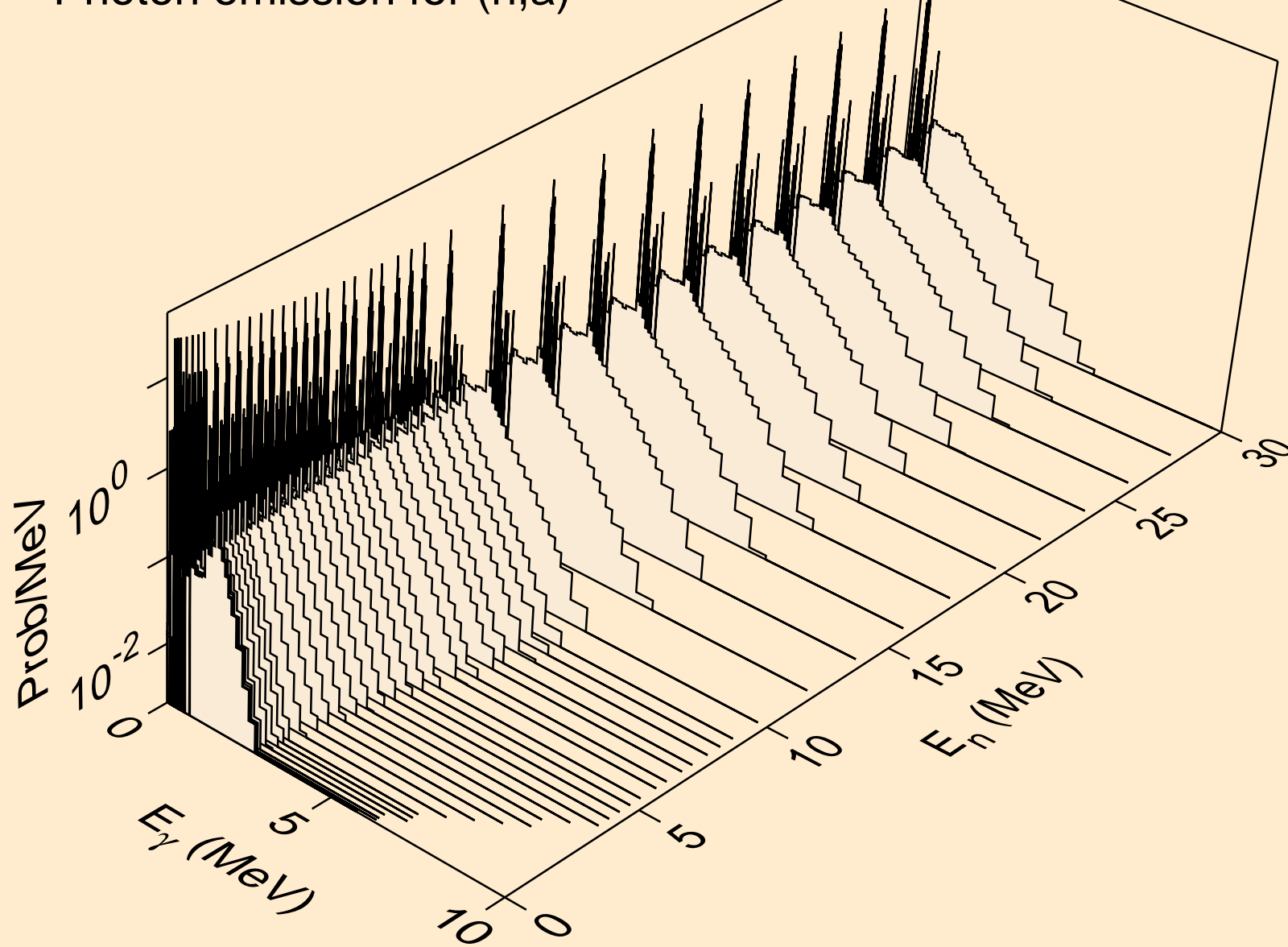

TB151M NEUTRON ACER TENDL-2023 LIBRARY; T=0.K
Photon emission for (n,2a)

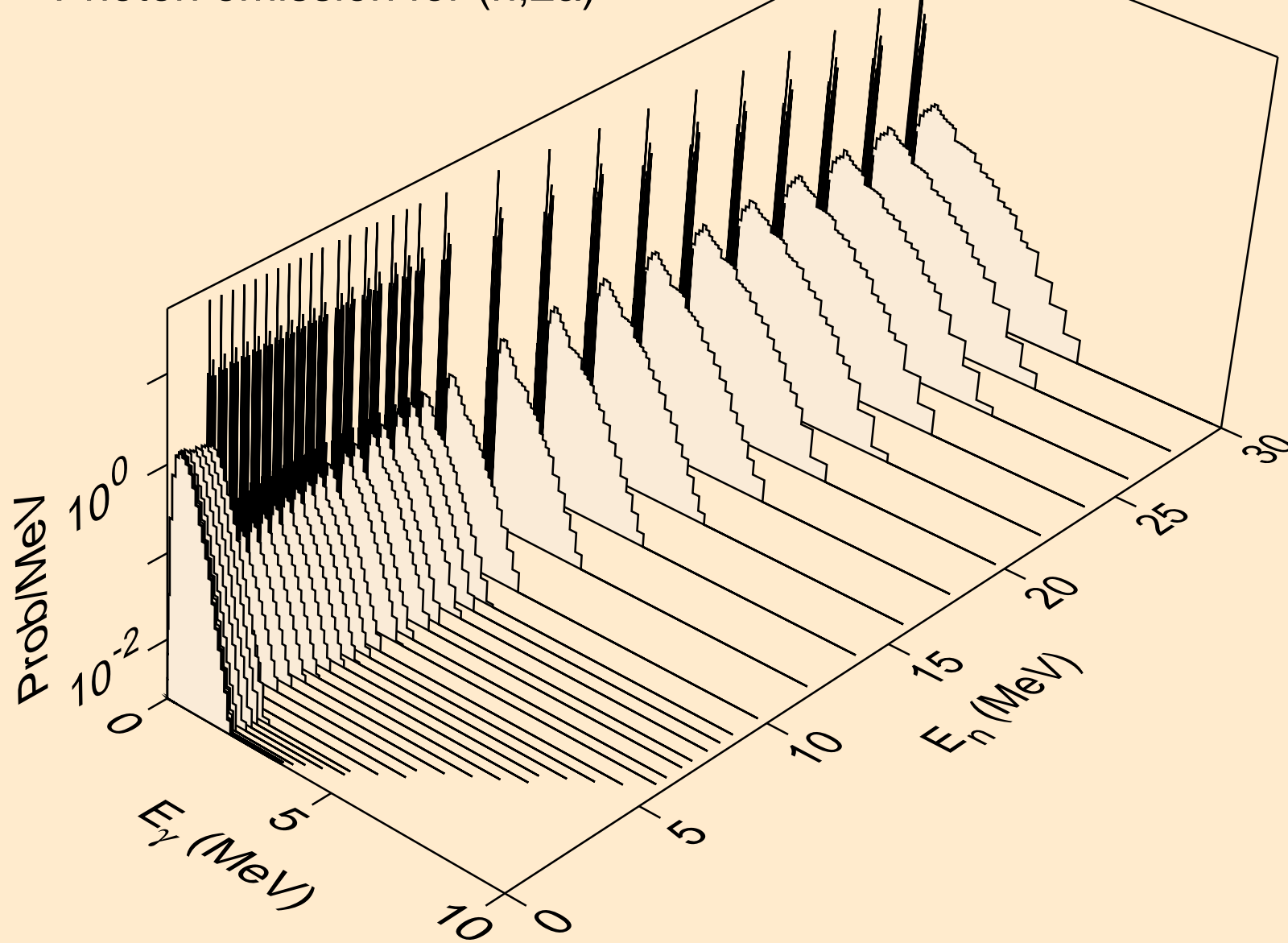

TB151M NEUTRON ACER TENDL-2023 LIBRARY; T=0.K
Photon emission for (n,2p)

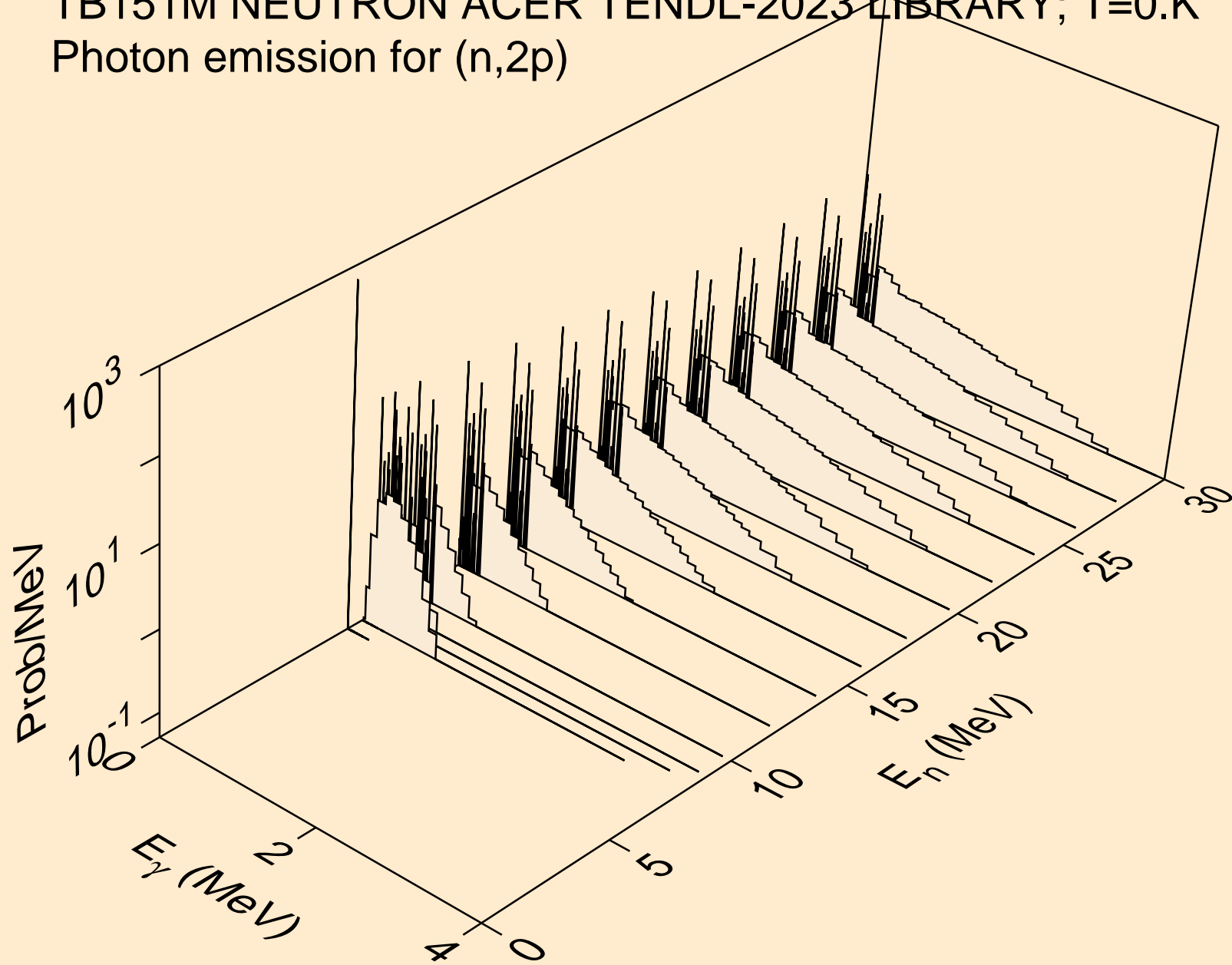

TB151M NEUTRON ACER TENDL-2023 LIBRARY; T=0.K
Photon emission for (n,p α)

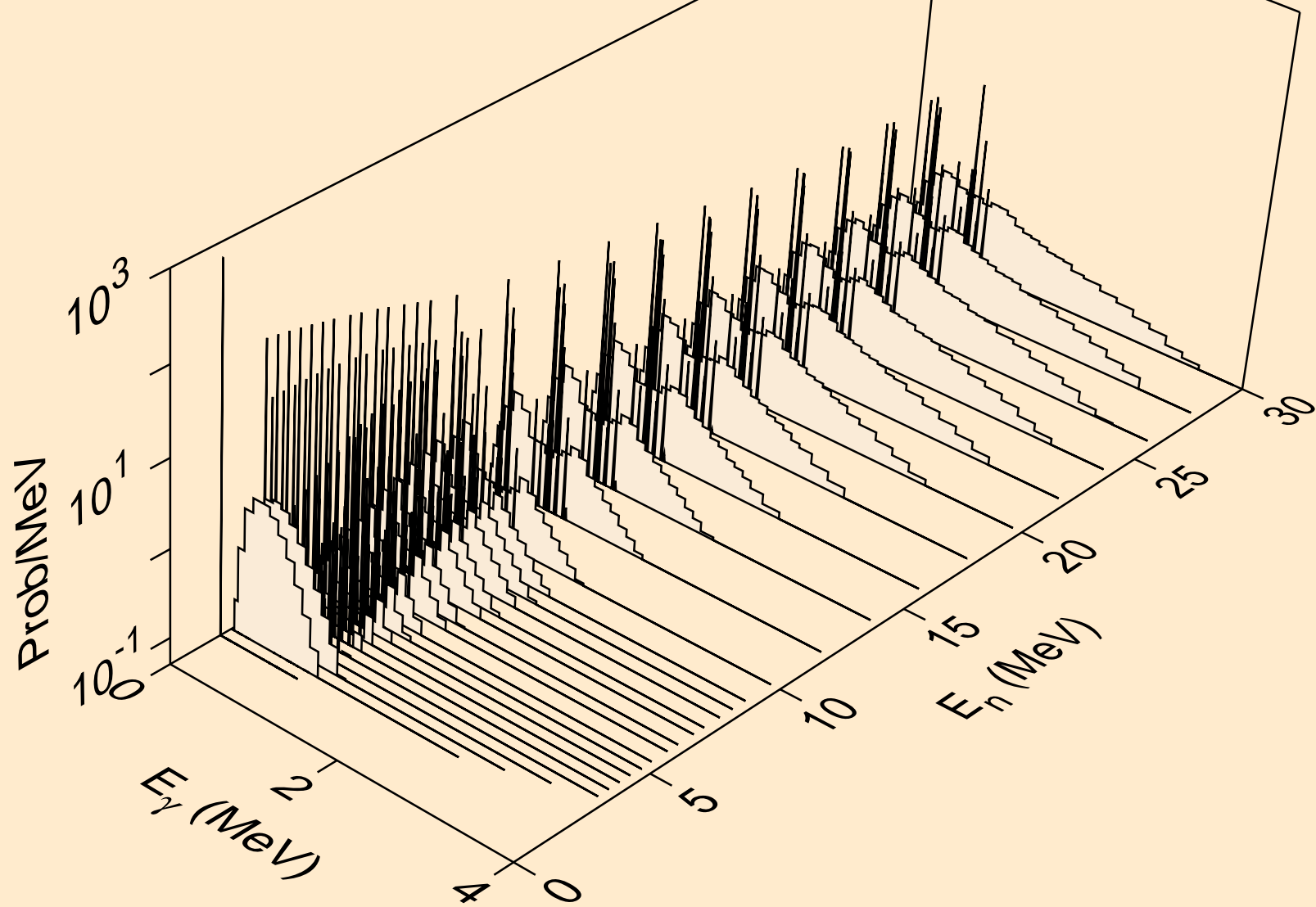

TB151M NEUTRON ACER TENDL-2023 LIBRARY; T=0.K
Photon emission for (n,pd)

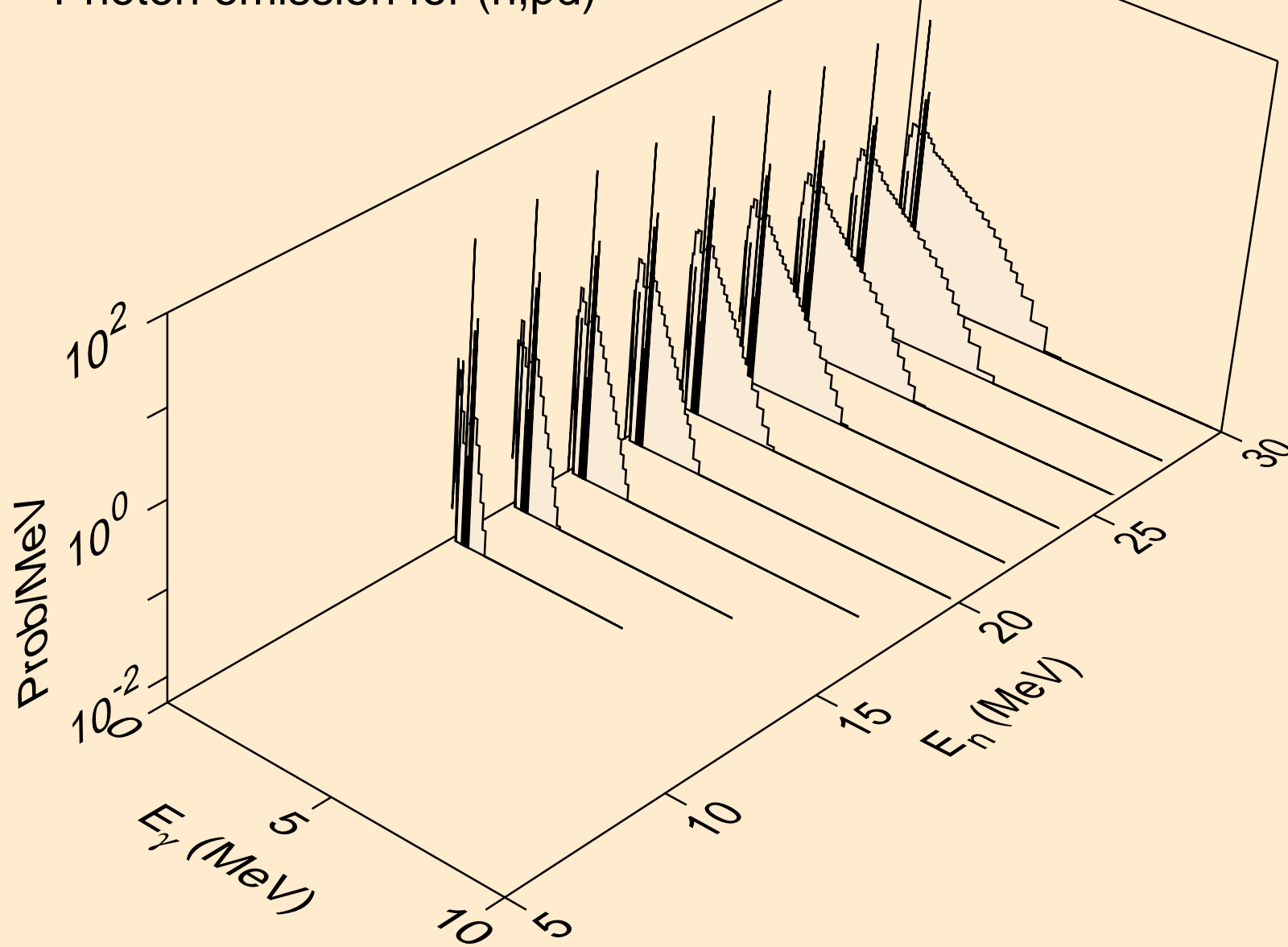

TB151M NEUTRON ACER TENDL-2023 LIBRARY; T=0.K
Photon emission for (n,pt)

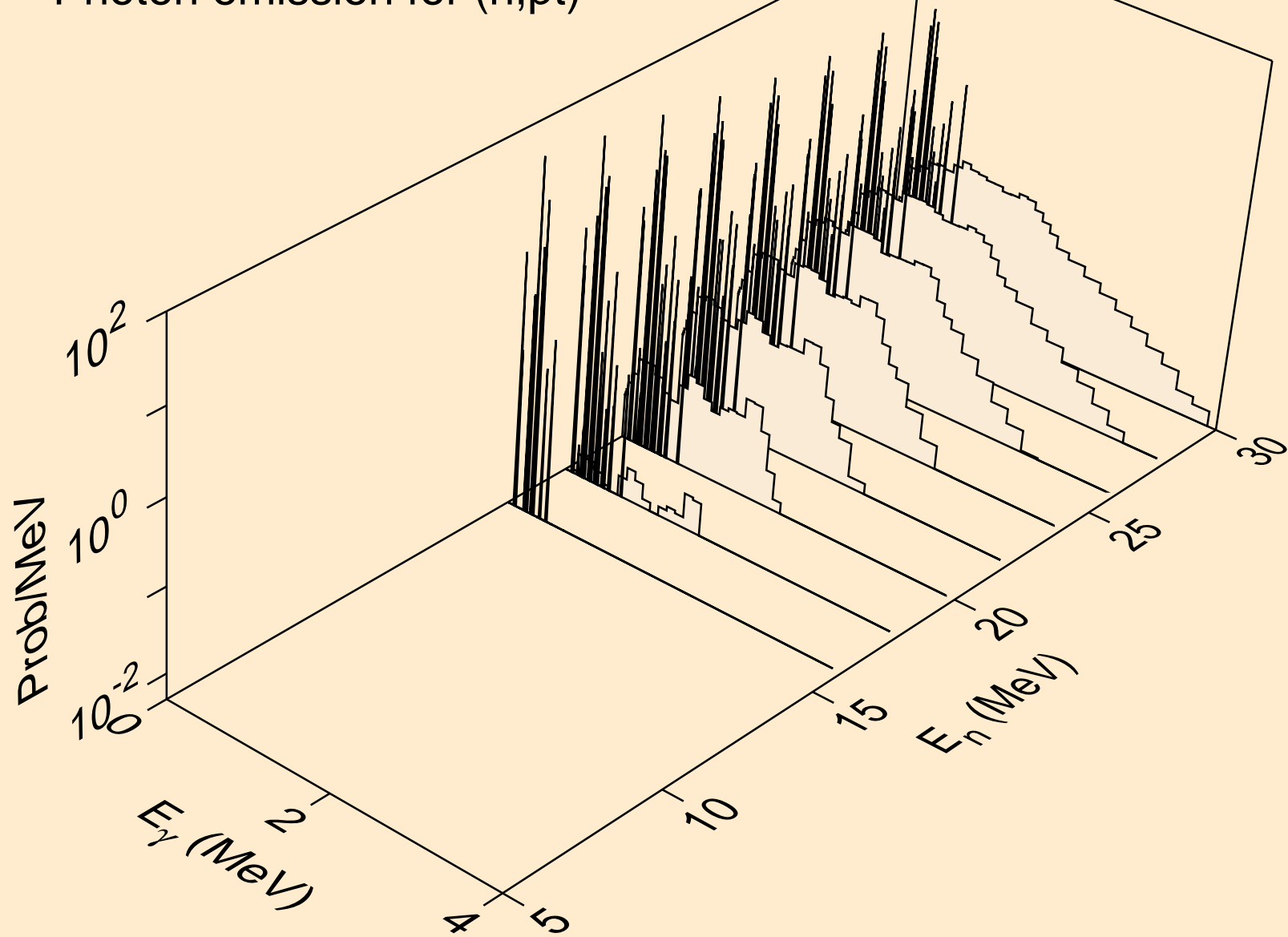

TB151M NEUTRON ACER TENDL-2023 LIBRARY; T=0.K
Photon emission for (n,da)

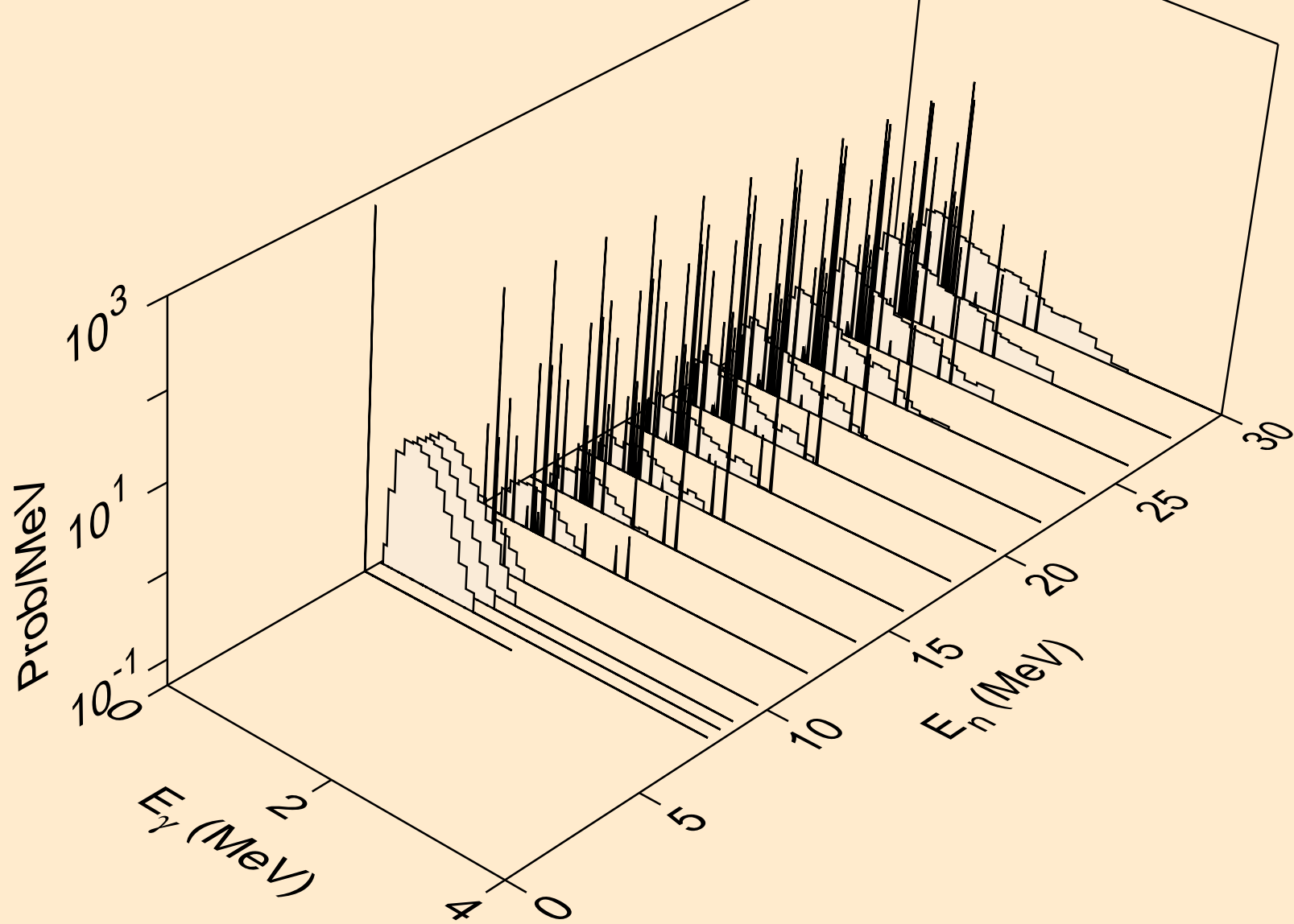

TB151M NEUTRON ACER TENDL-2023 LIBRARY; T=0.K
thermal capture photon spectrum

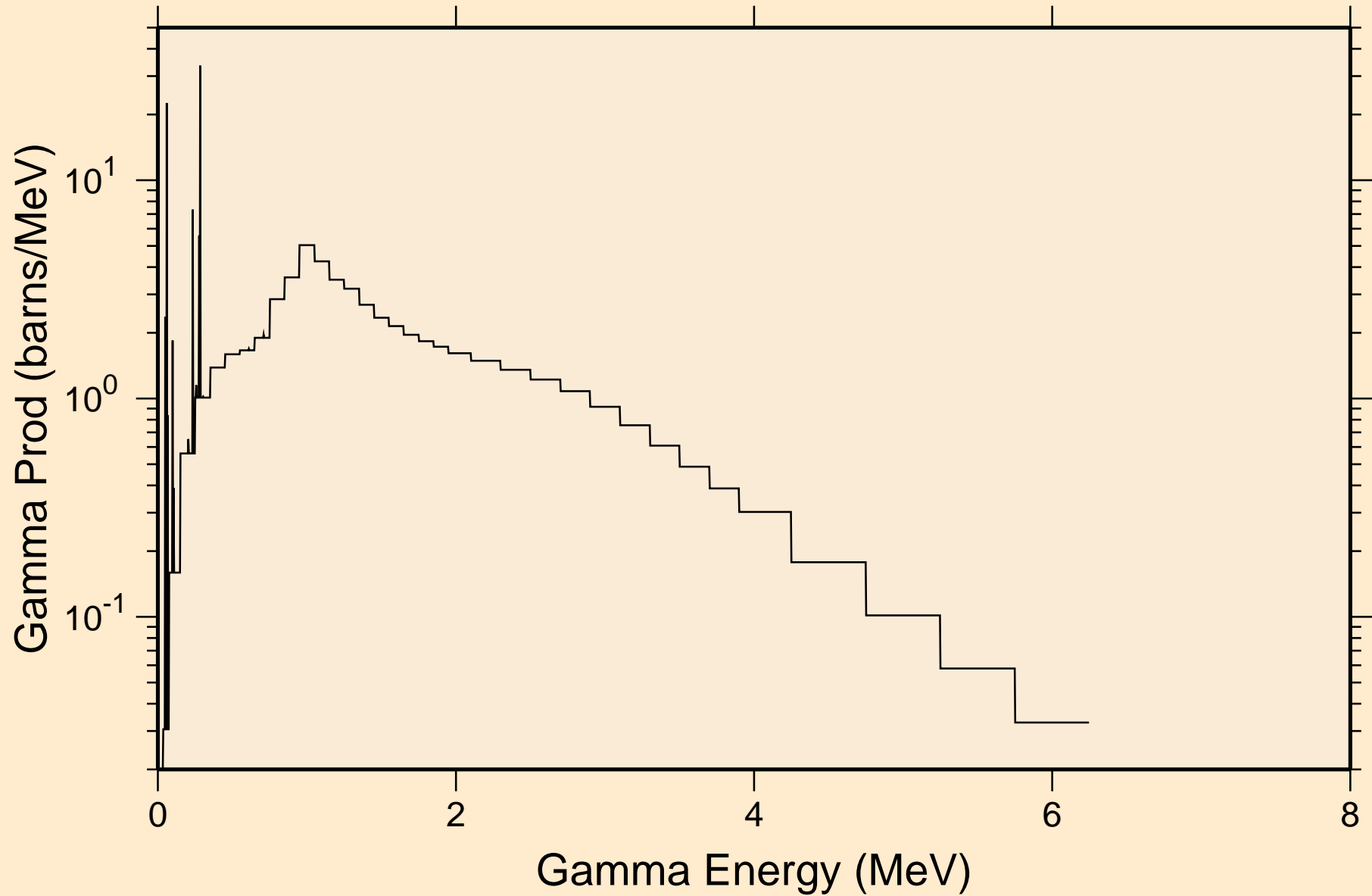

TB151M NEUTRON ACER TENDL-2023 LIBRARY; T=0.K
14 MeV photon spectrum

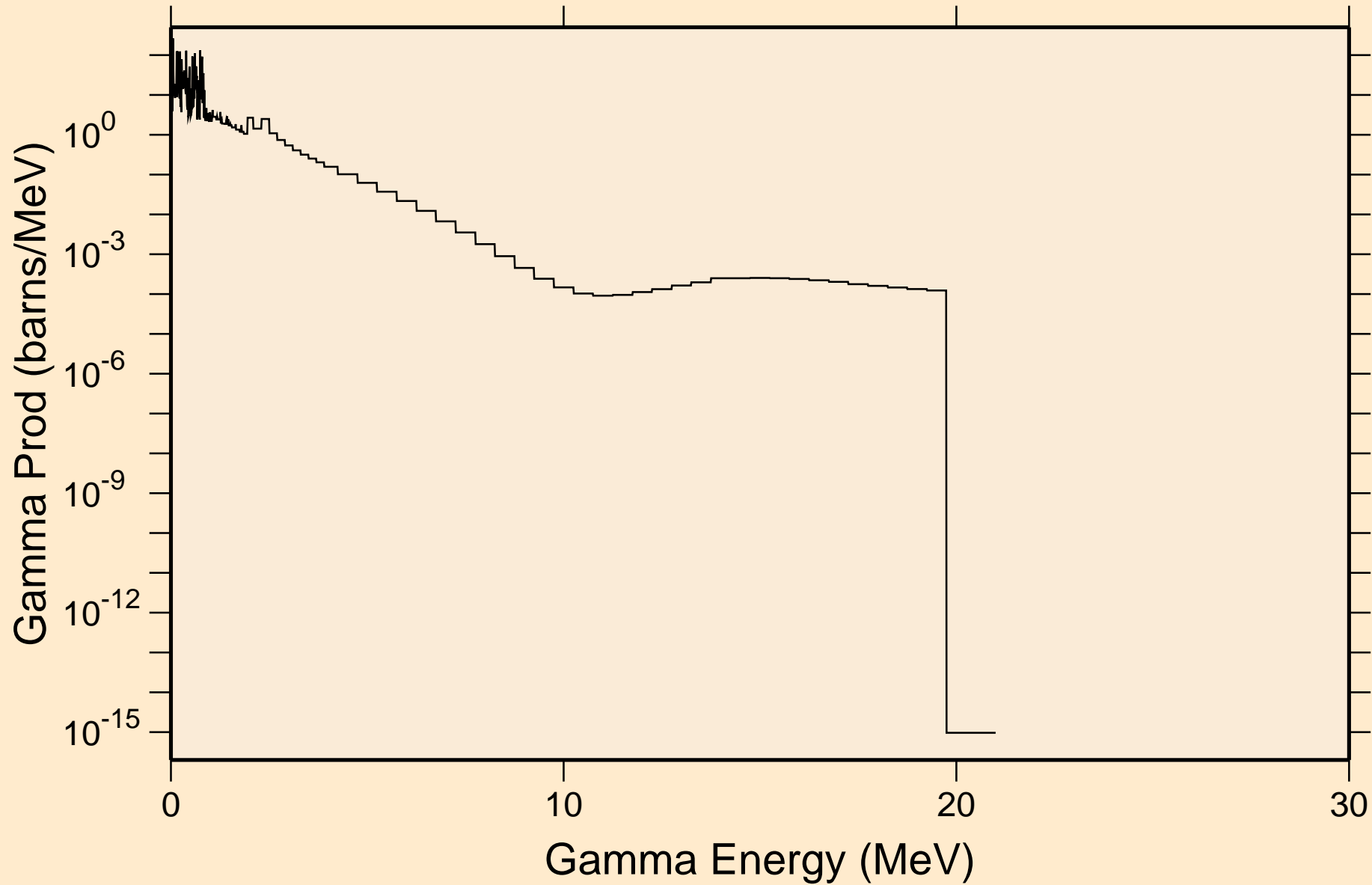

TB151M NEUTRON ACER TENDL-2023 LIBRARY; T=0.K
Particle heating contributions

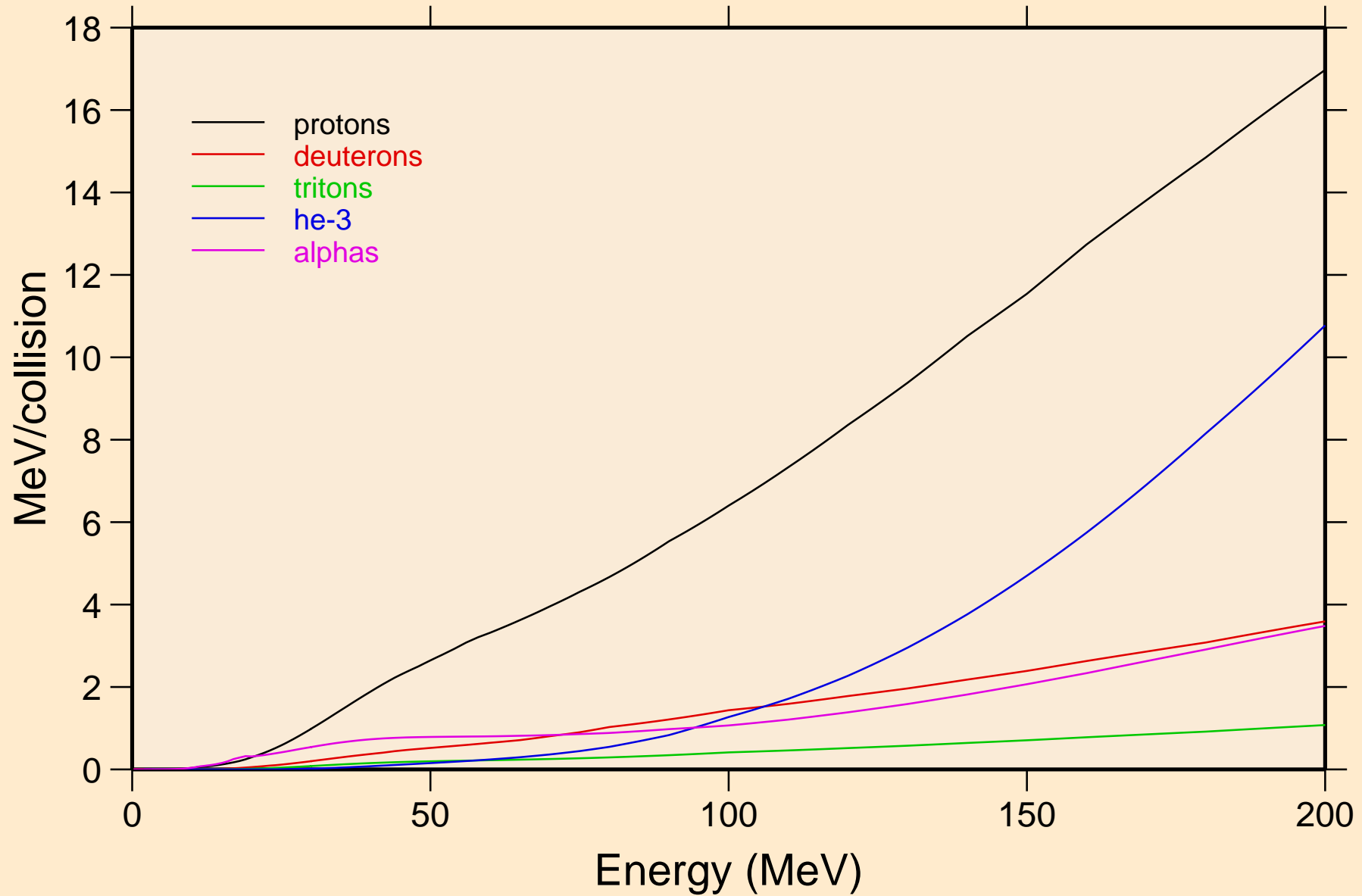

TB151M NEUTRON ACER TENDL-2023 LIBRARY; T=0.K
Recoil Heating

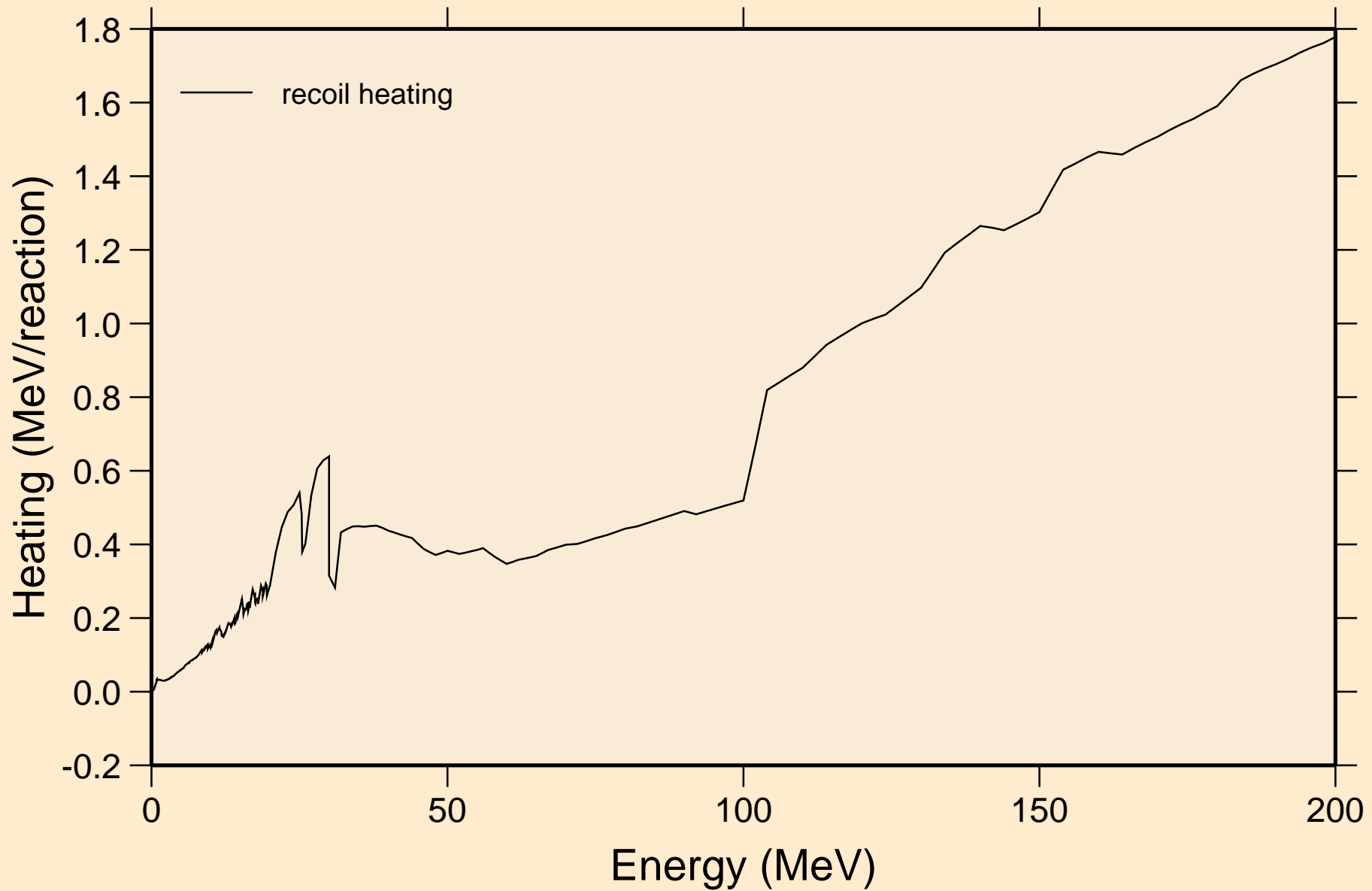

TB151M NEUTRON ACER TENDL-2023 LIBRARY; T=0.K

Particle production cross sections

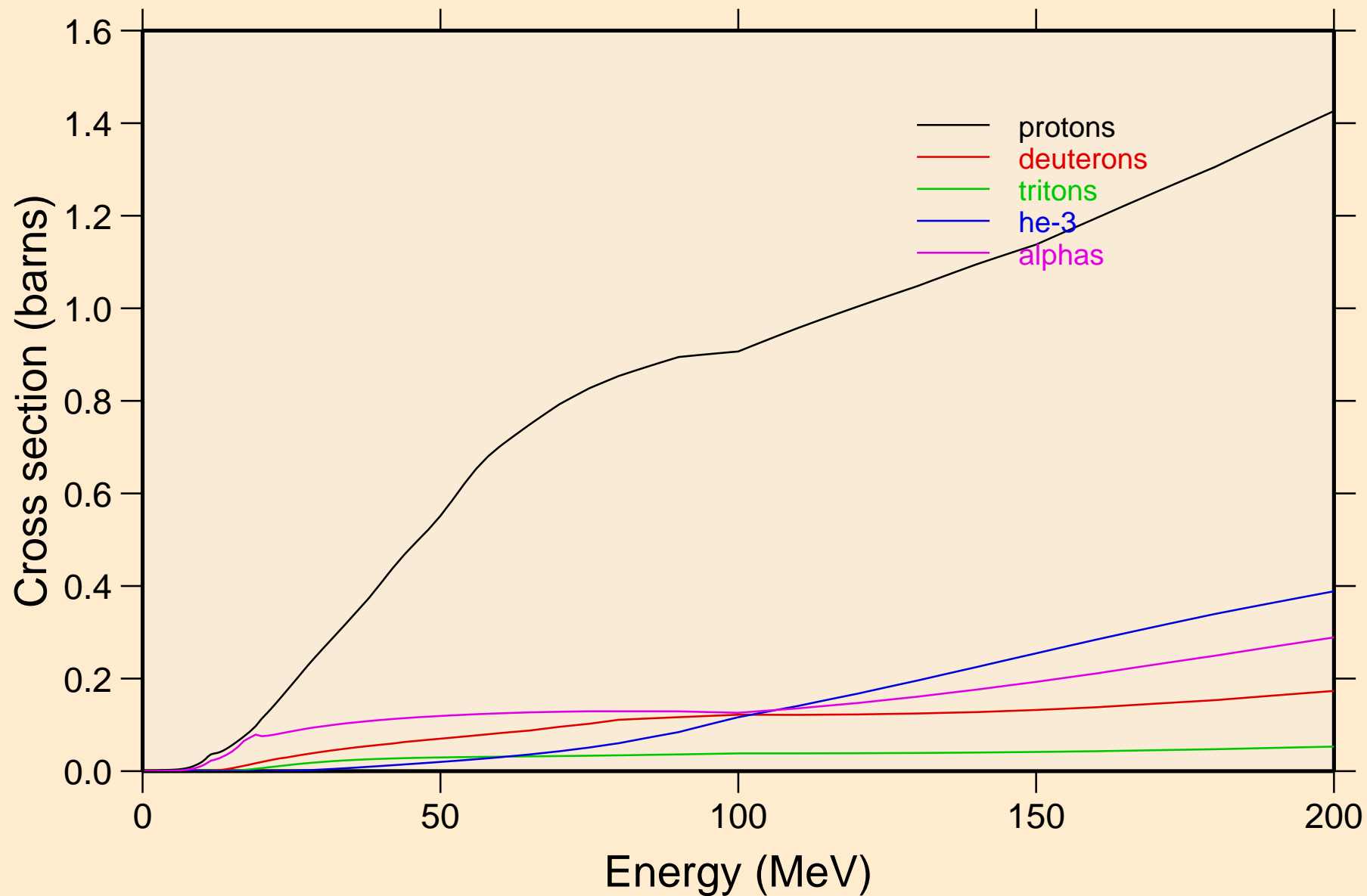

TB151M NEUTRON ACER TENDL-2023 LIBRARY; T=0.K
protons from (n,x)

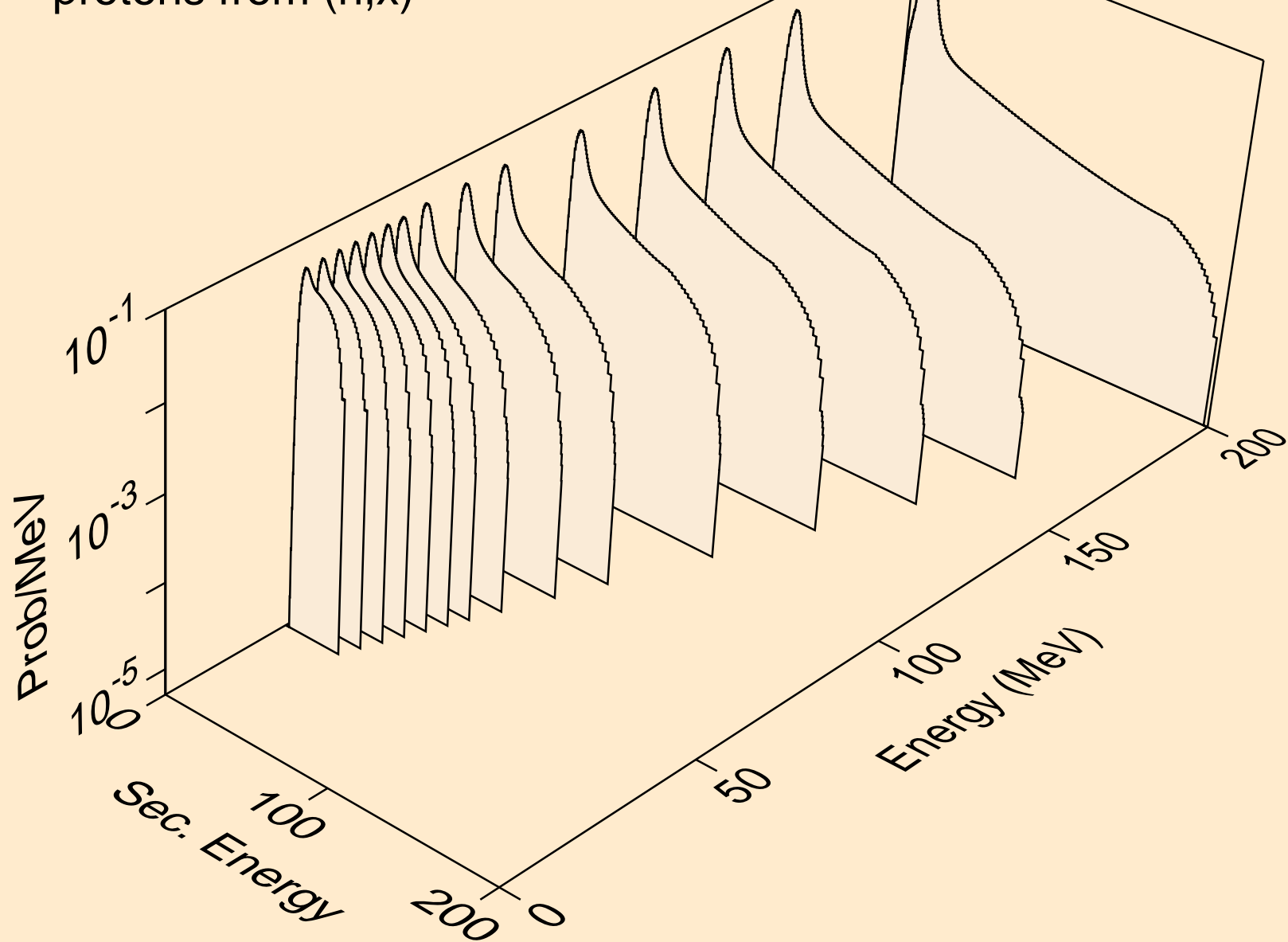

TB151M NEUTRON ACER TENDL-2023 LIBRARY; T=0.K
protons from (n,n*)p

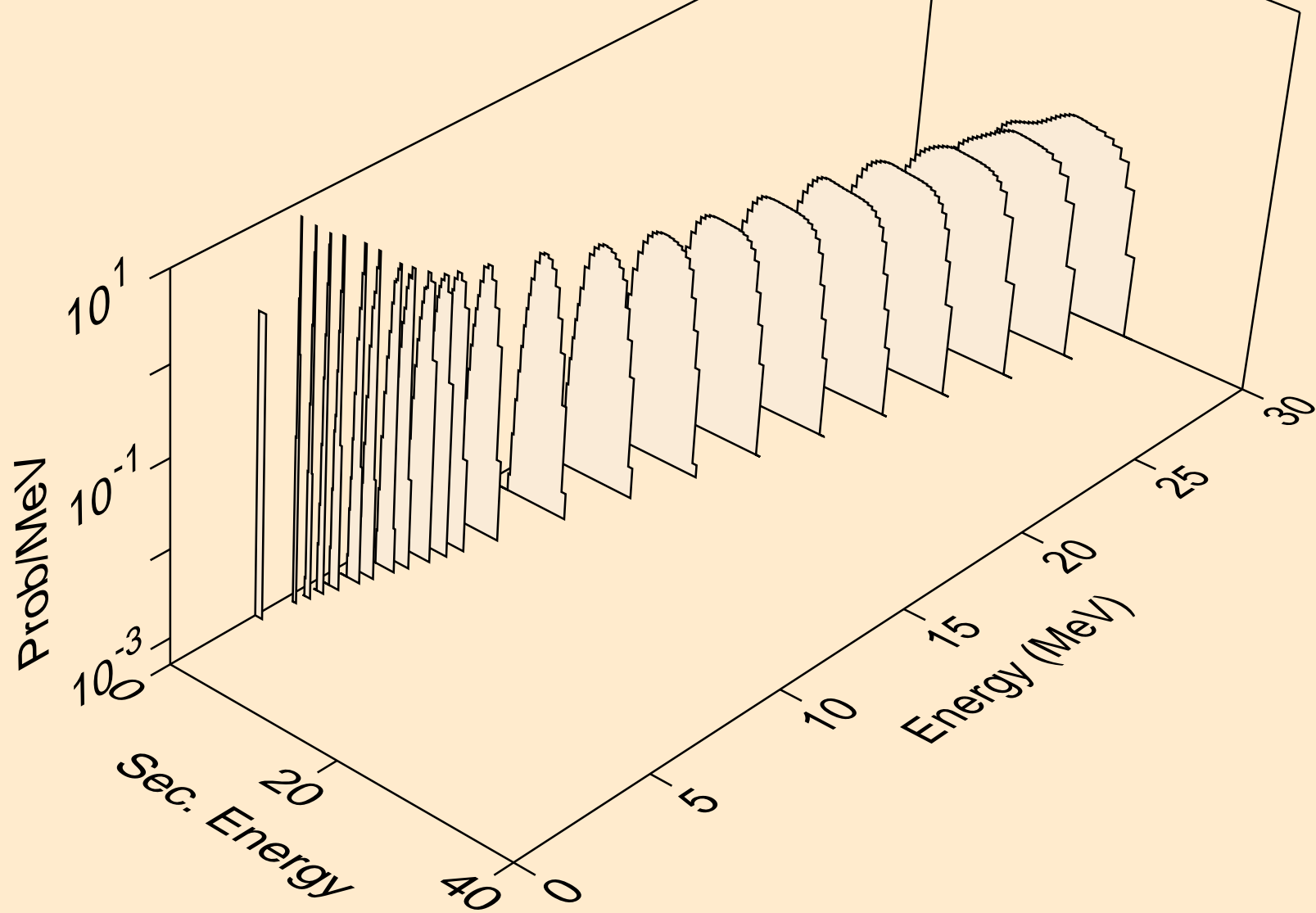

TB151M NEUTRON ACER TENDL-2023 LIBRARY; T=0.K
protons from (n,2np)

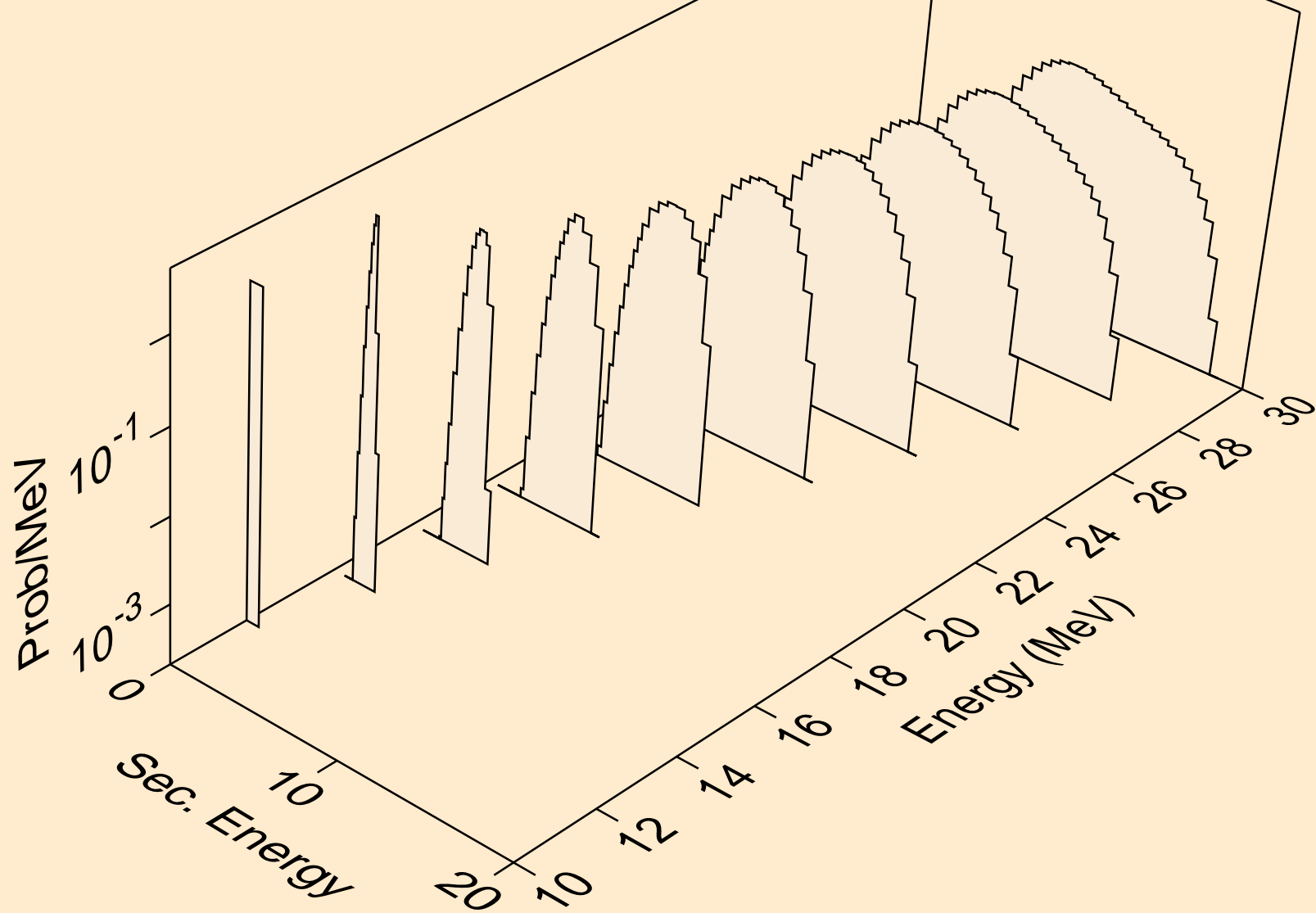

TB151M NEUTRON ACER TENDL-2023 LIBRARY; T=0.K
protons from (n,3np)

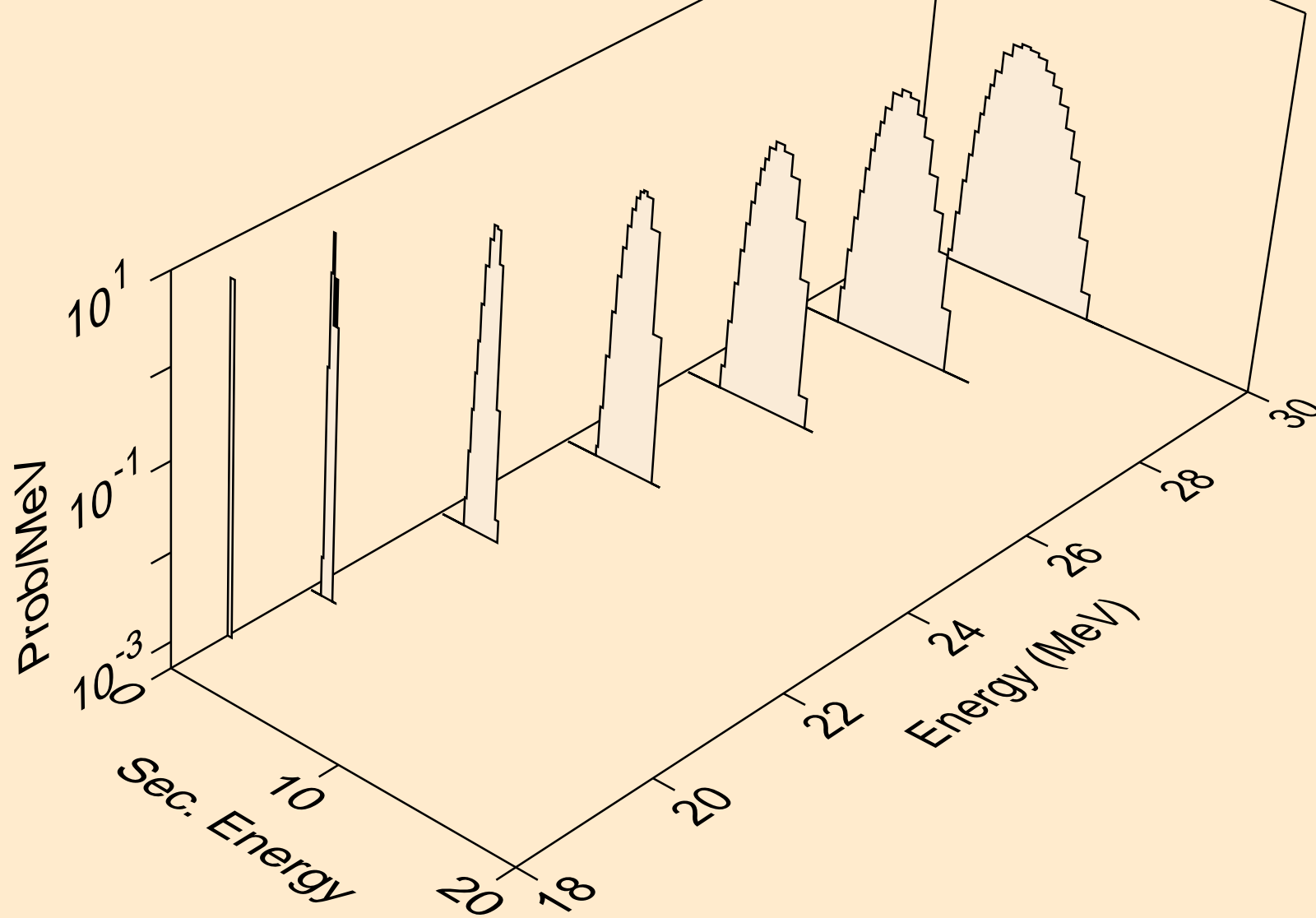

TB151M NEUTRON ACER TENDL-2023 LIBRARY; T=0.K
protons from (n,n2p)

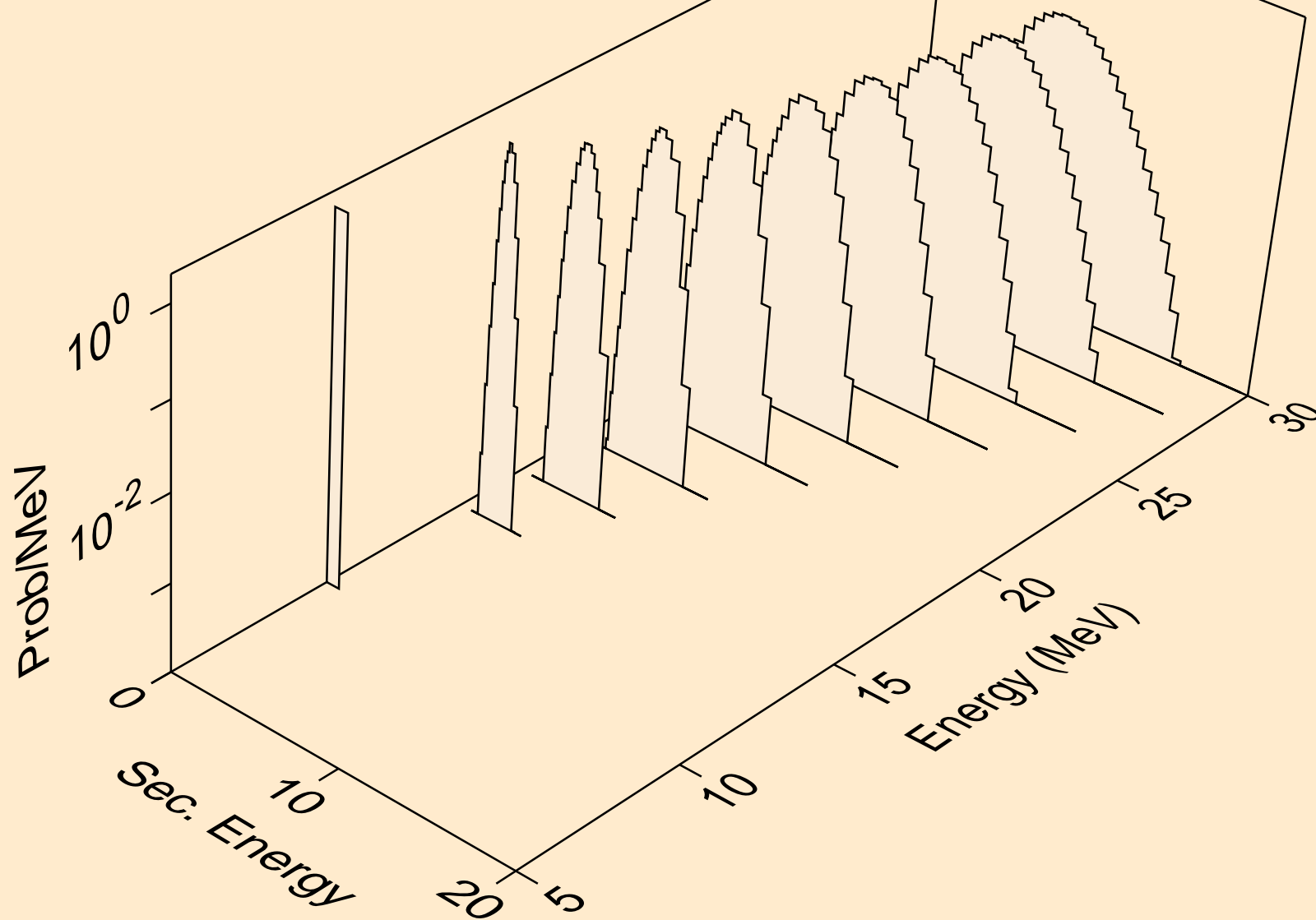

TB151M NEUTRON ACER TENDL-2023 LIBRARY; T=0.K
protons from (n,npa)

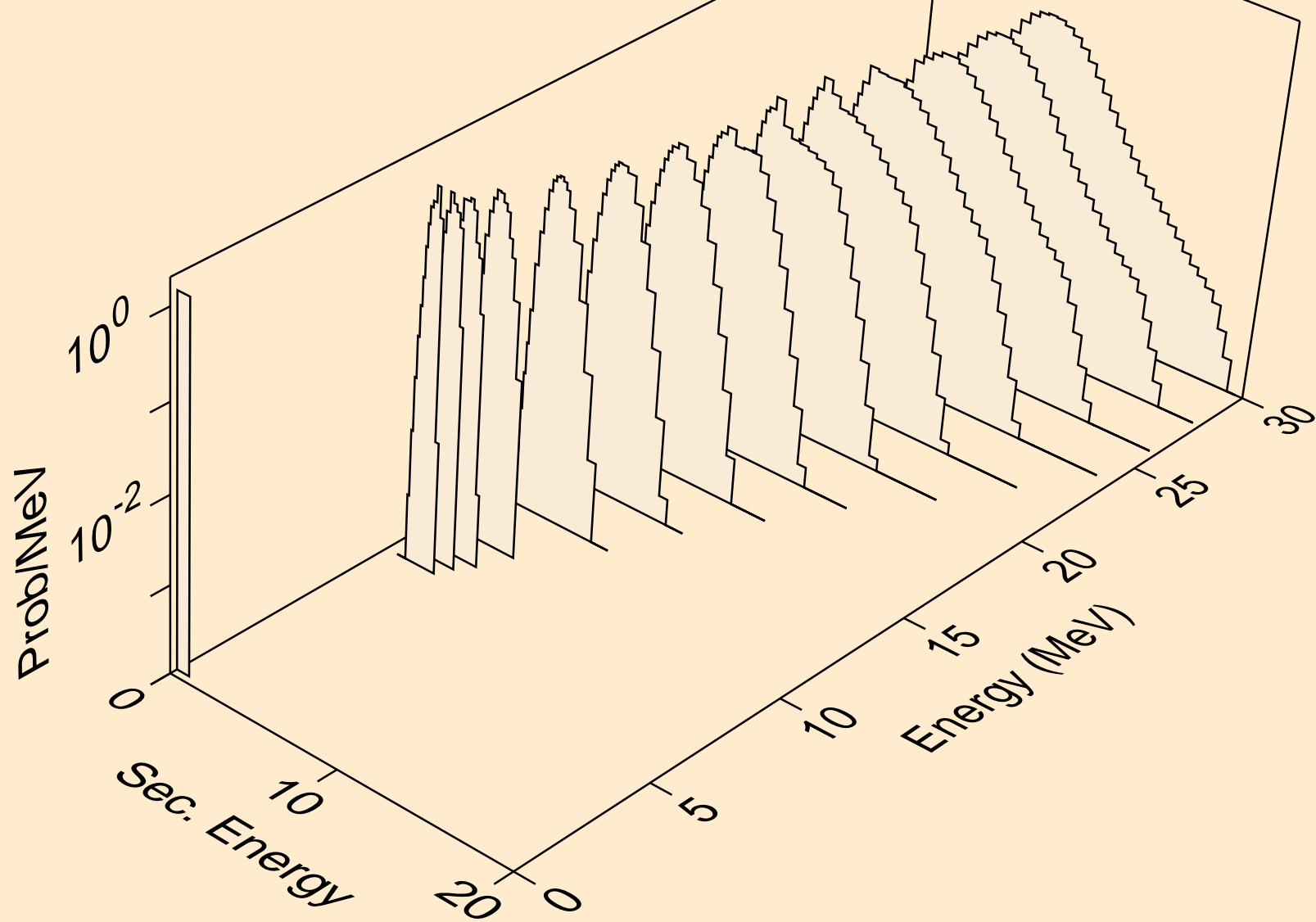

TB151M NEUTRON ACER TENDL-2023 LIBRARY; T=0.K
protons from (n,p)

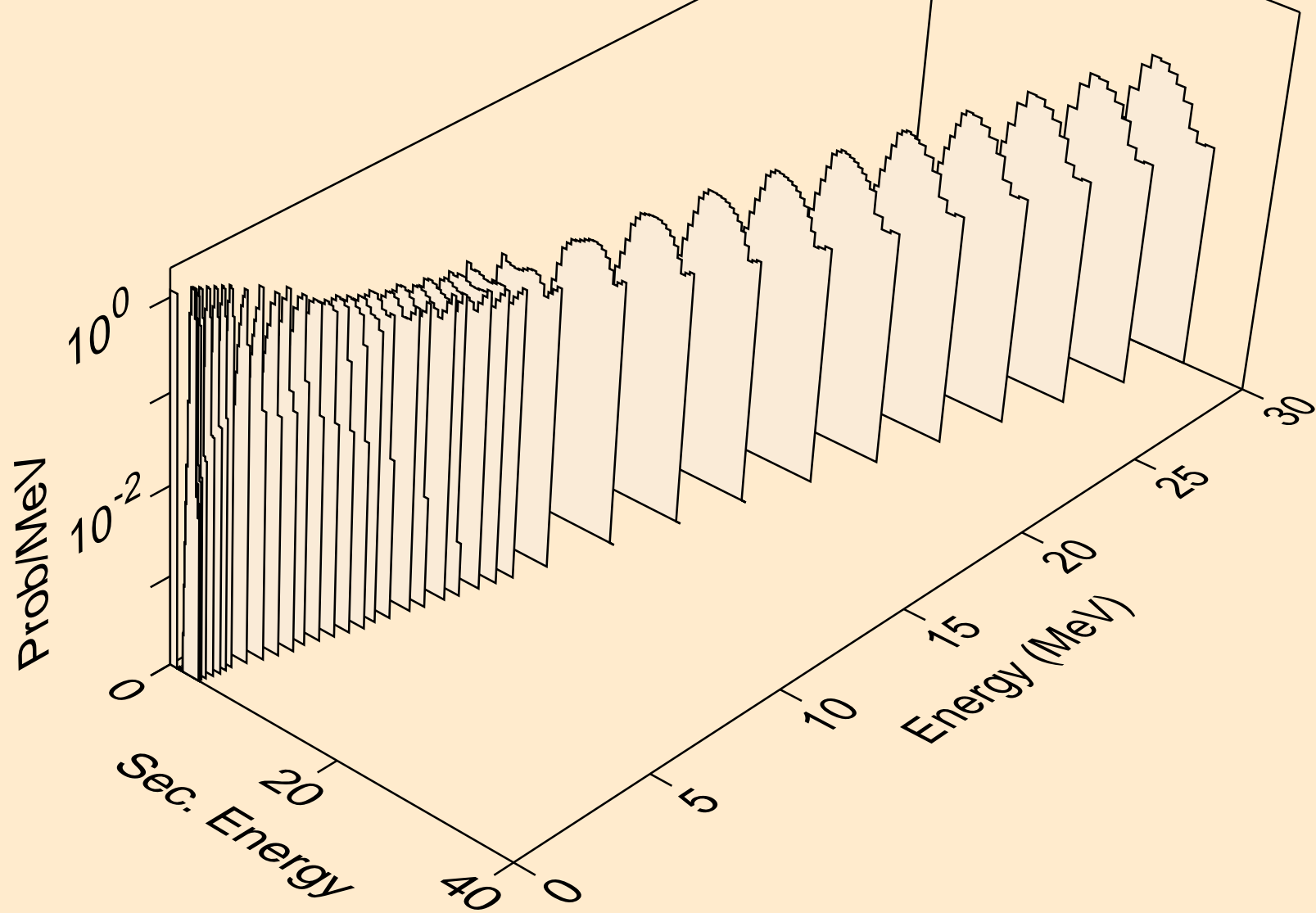

TB151M NEUTRON ACER TENDL-2023 LIBRARY; T=0.K
protons from (n,2p)

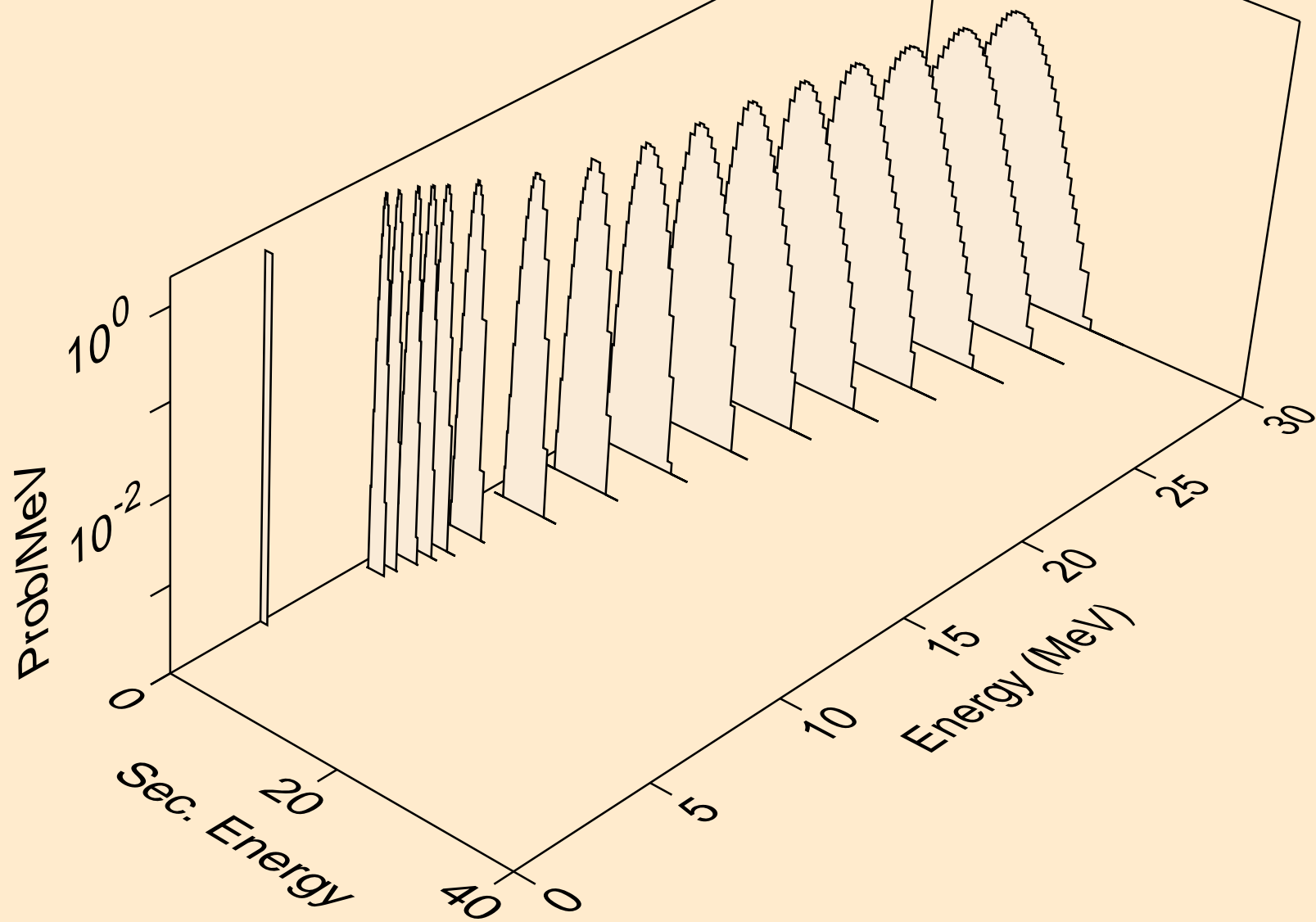

TB151M NEUTRON ACER TENDL-2023 LIBRARY; T=0.K
protons from (n,p)

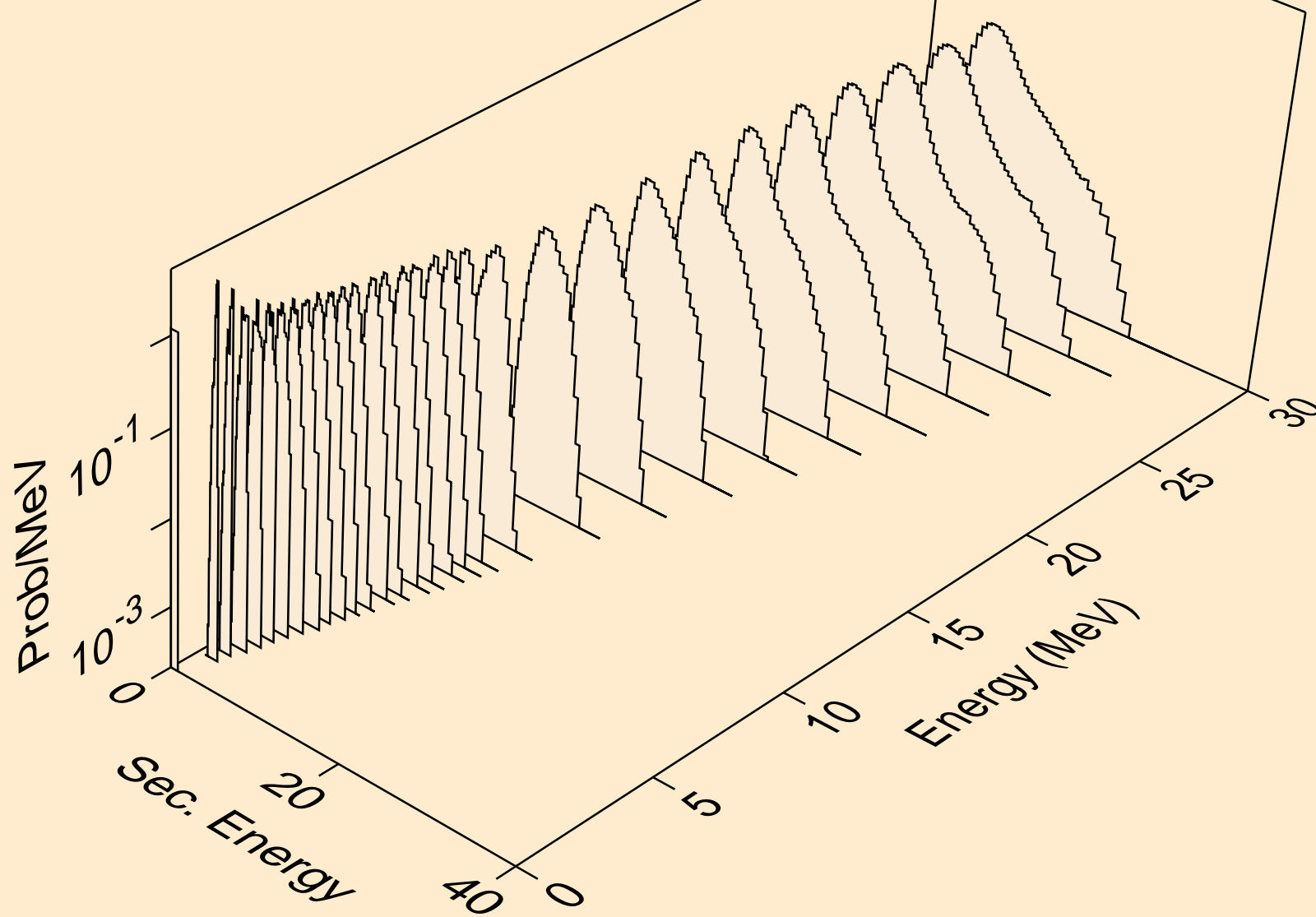

TB151M NEUTRON ACER TENDL-2023 LIBRARY; T=0.K
protons from (n,pd)

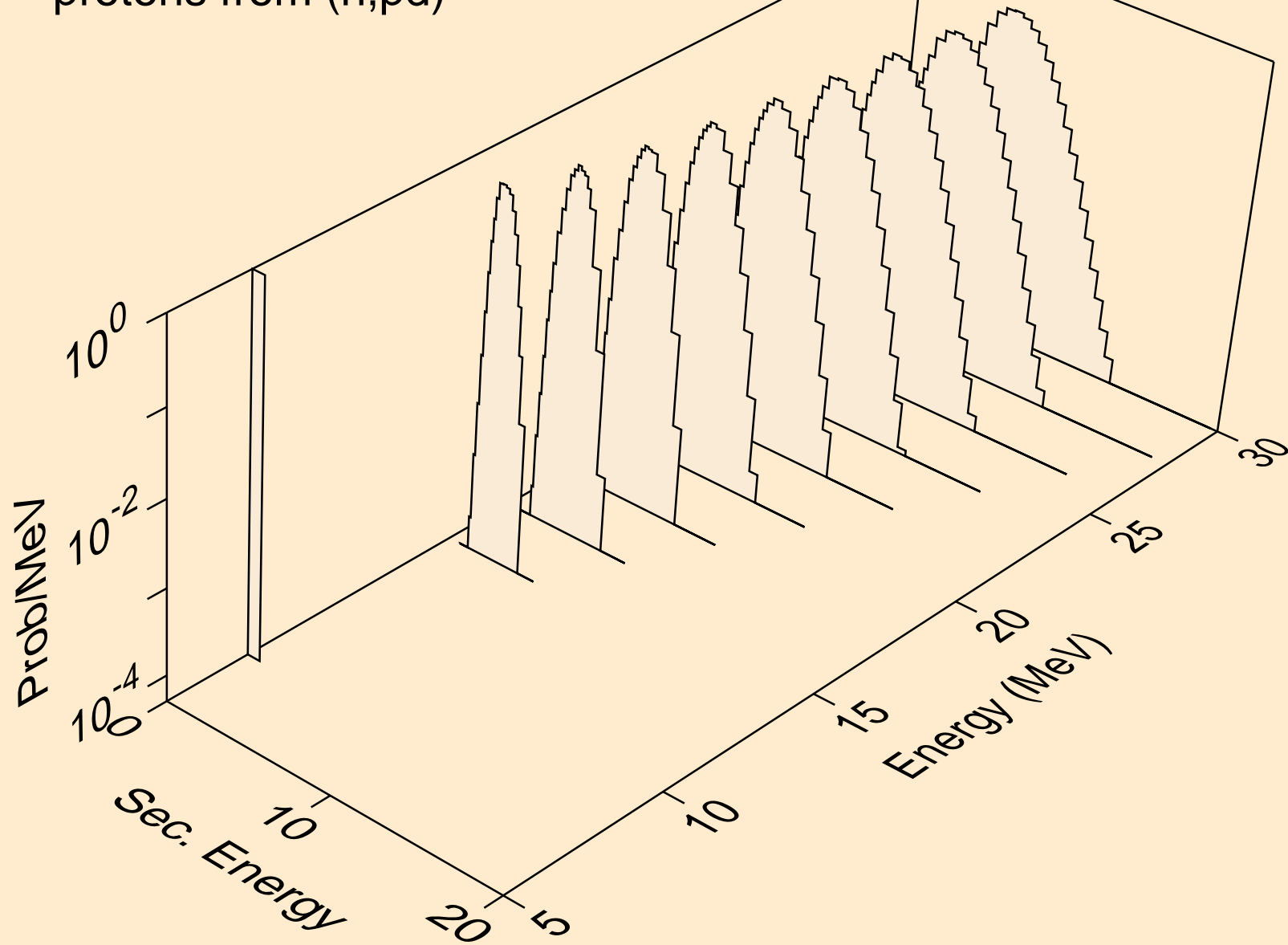

TB151M NEUTRON ACER TENDL-2023 LIBRARY; T=0.K
protons from (n,pt)

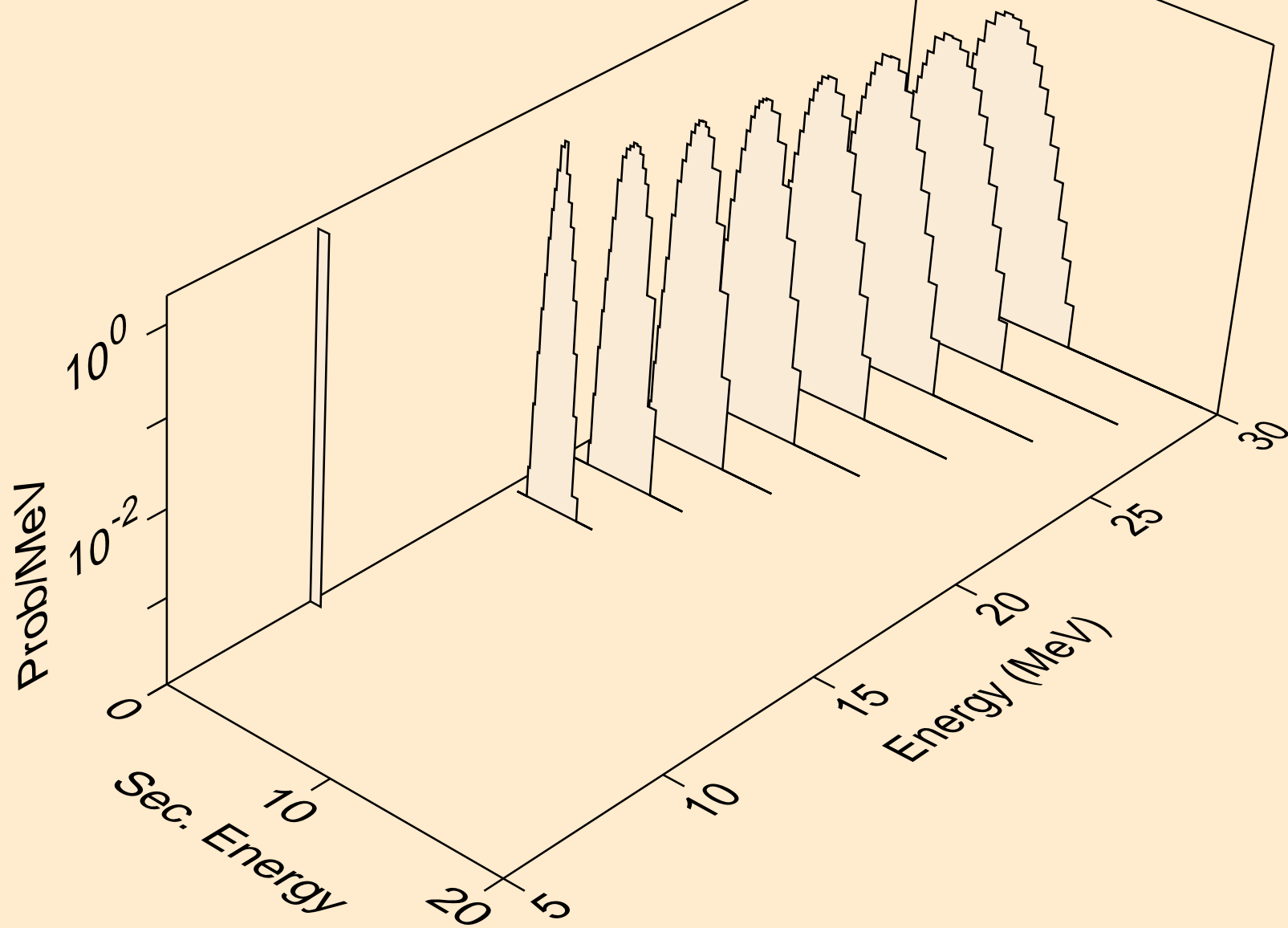

TB151M NEUTRON ACER TENDL-2023 LIBRARY; T=0.K
deuterons from (n,x)

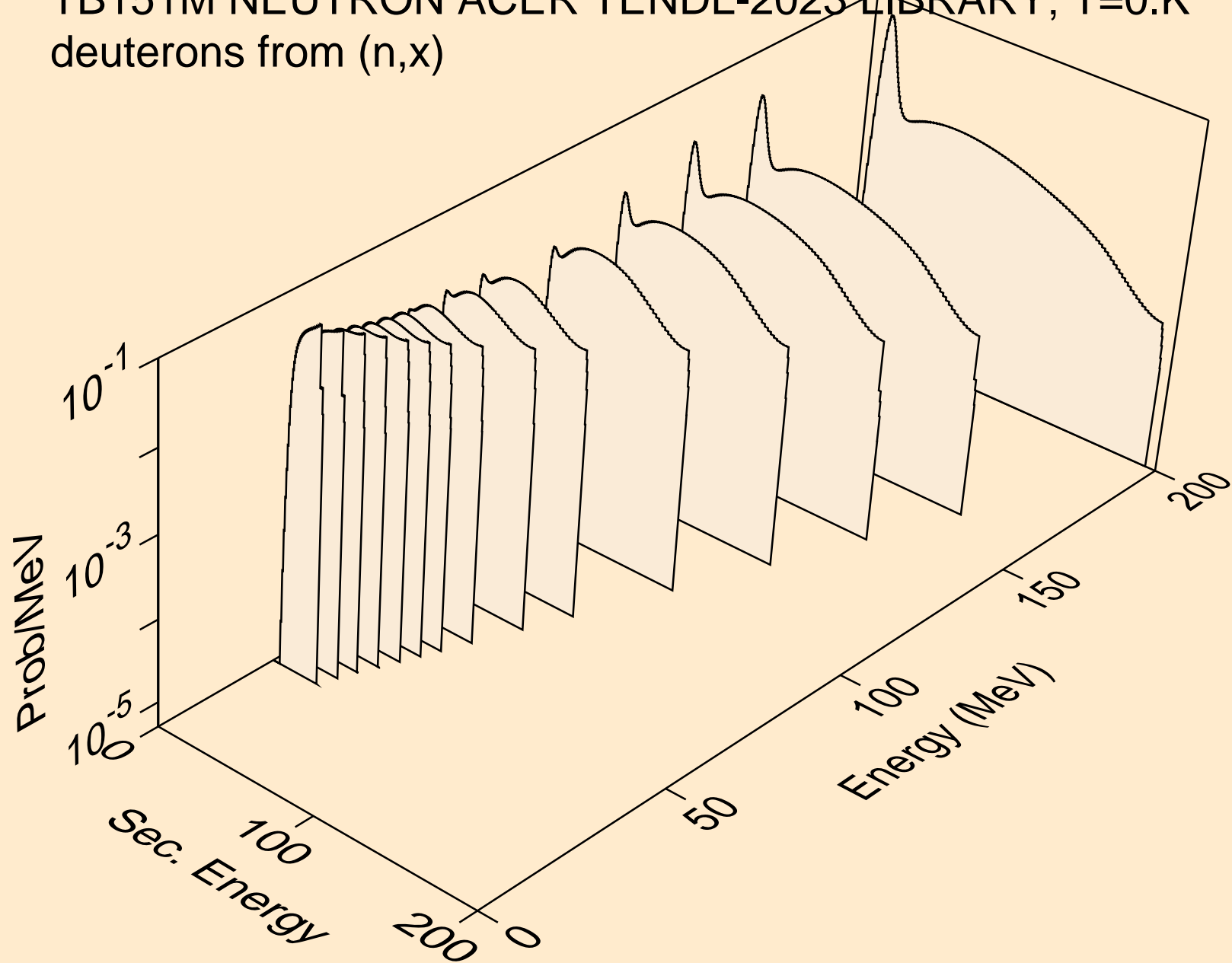

TB151M NEUTRON ACER TENDL-2023 LIBRARY; T=0.K
deuterons from (n,2nd)

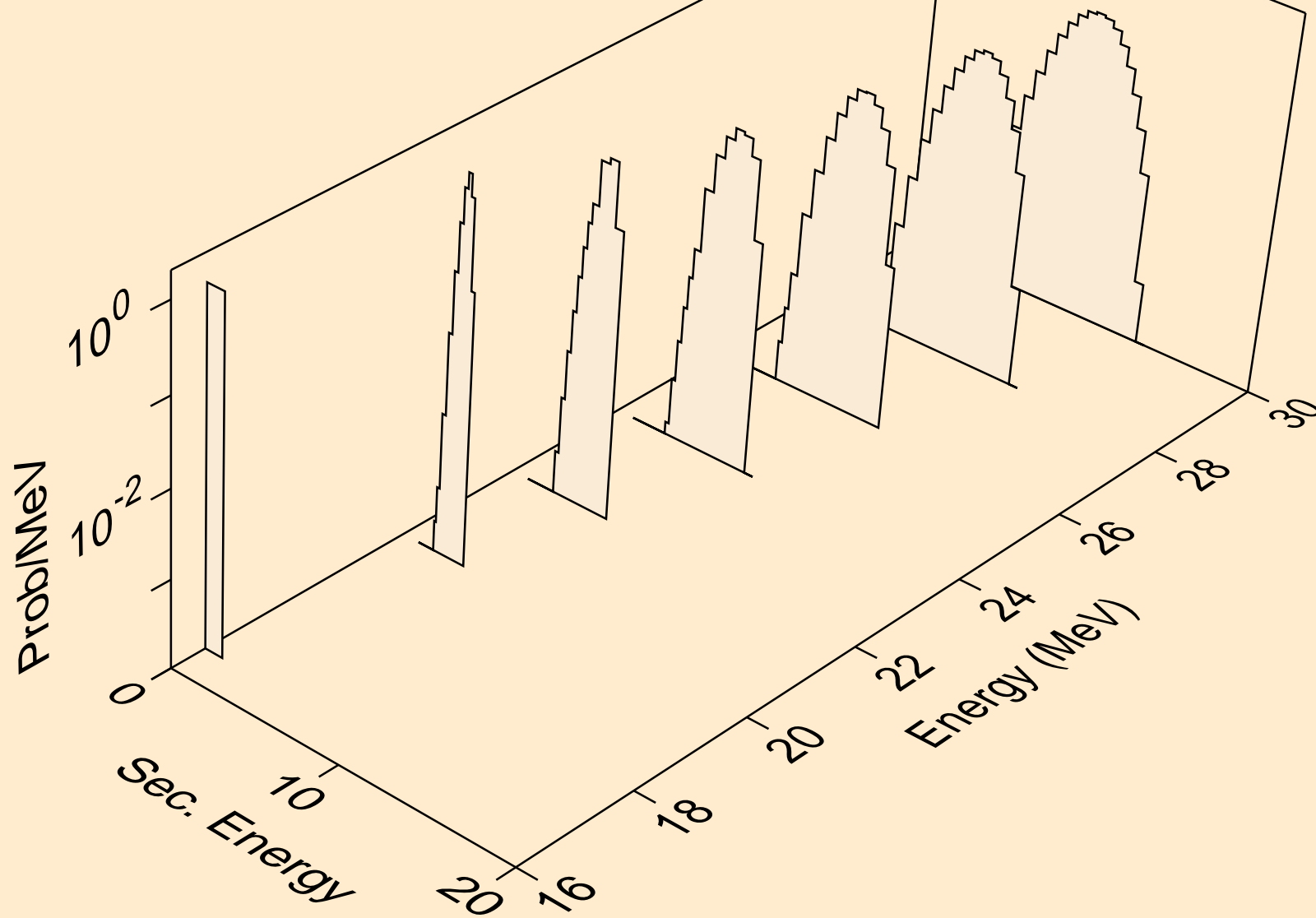

TB151M NEUTRON ACER TENDL-2023 LIBRARY; T=0.K
deuterons from (n,n*)d

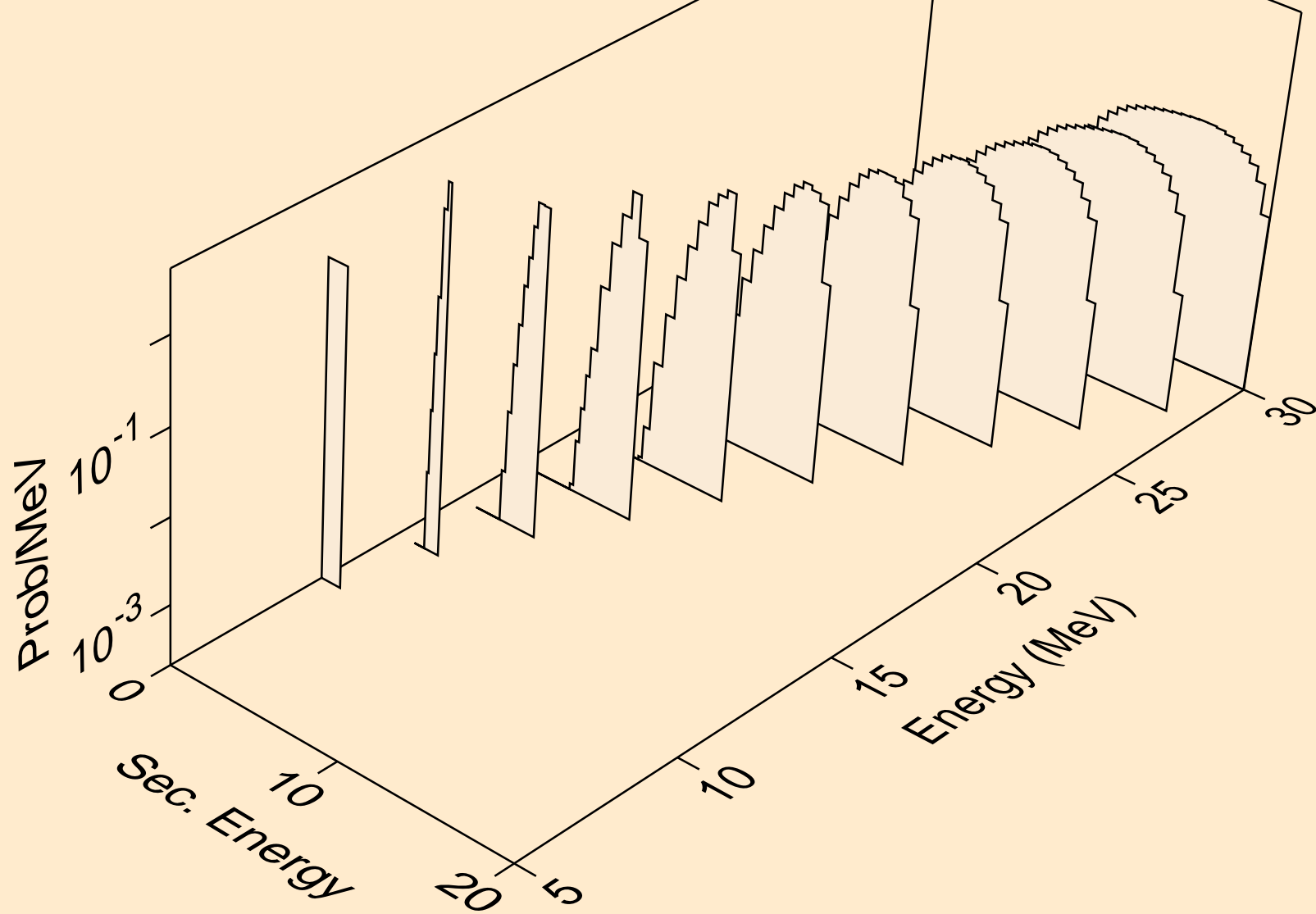

TB151M NEUTRON ACER TENDL-2023 LIBRARY; T=0.K
deuterons from (n,d)

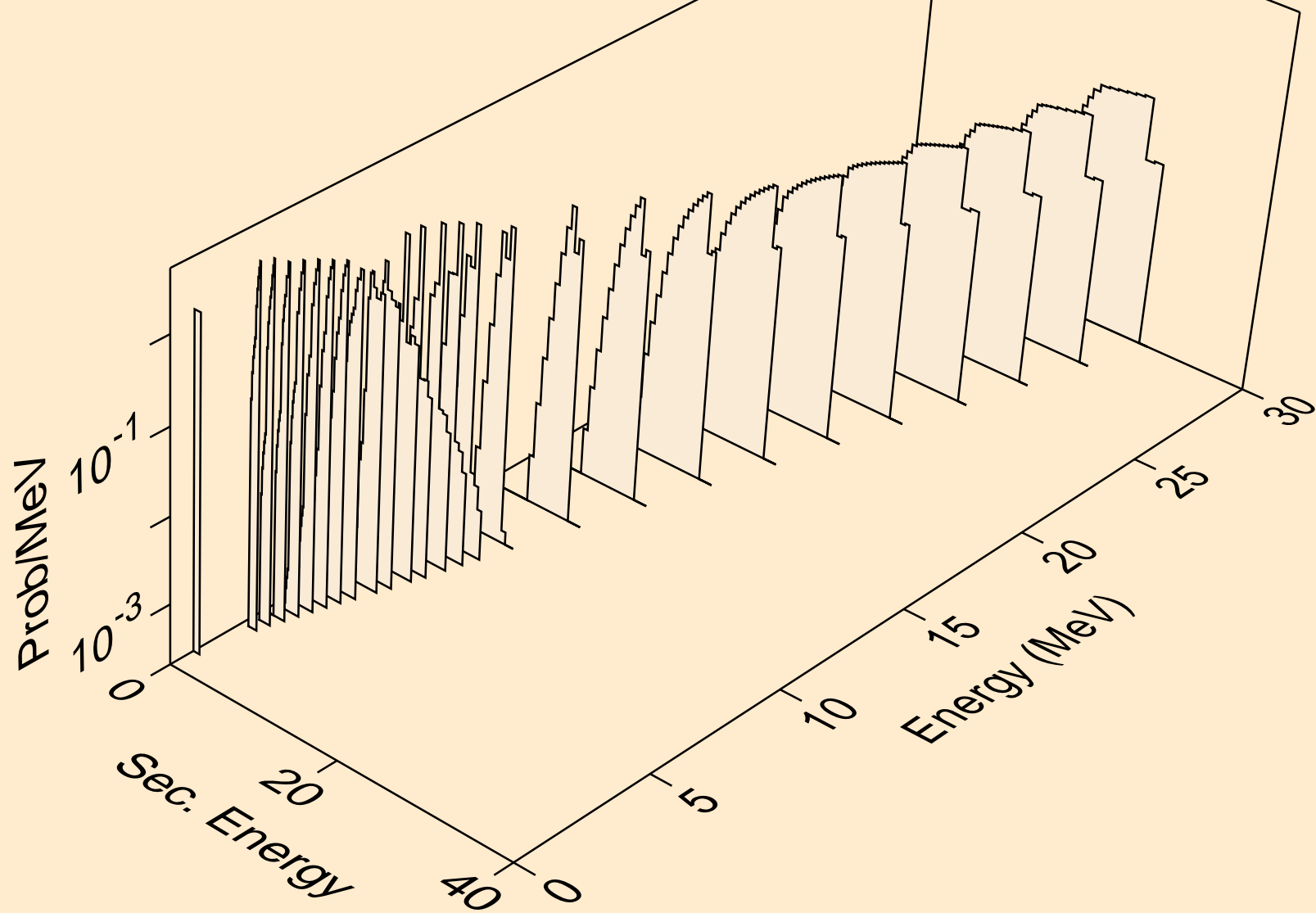

TB151M NEUTRON ACER TENDL-2023 LIBRARY; T=0.K
deuterons from (n,pd)

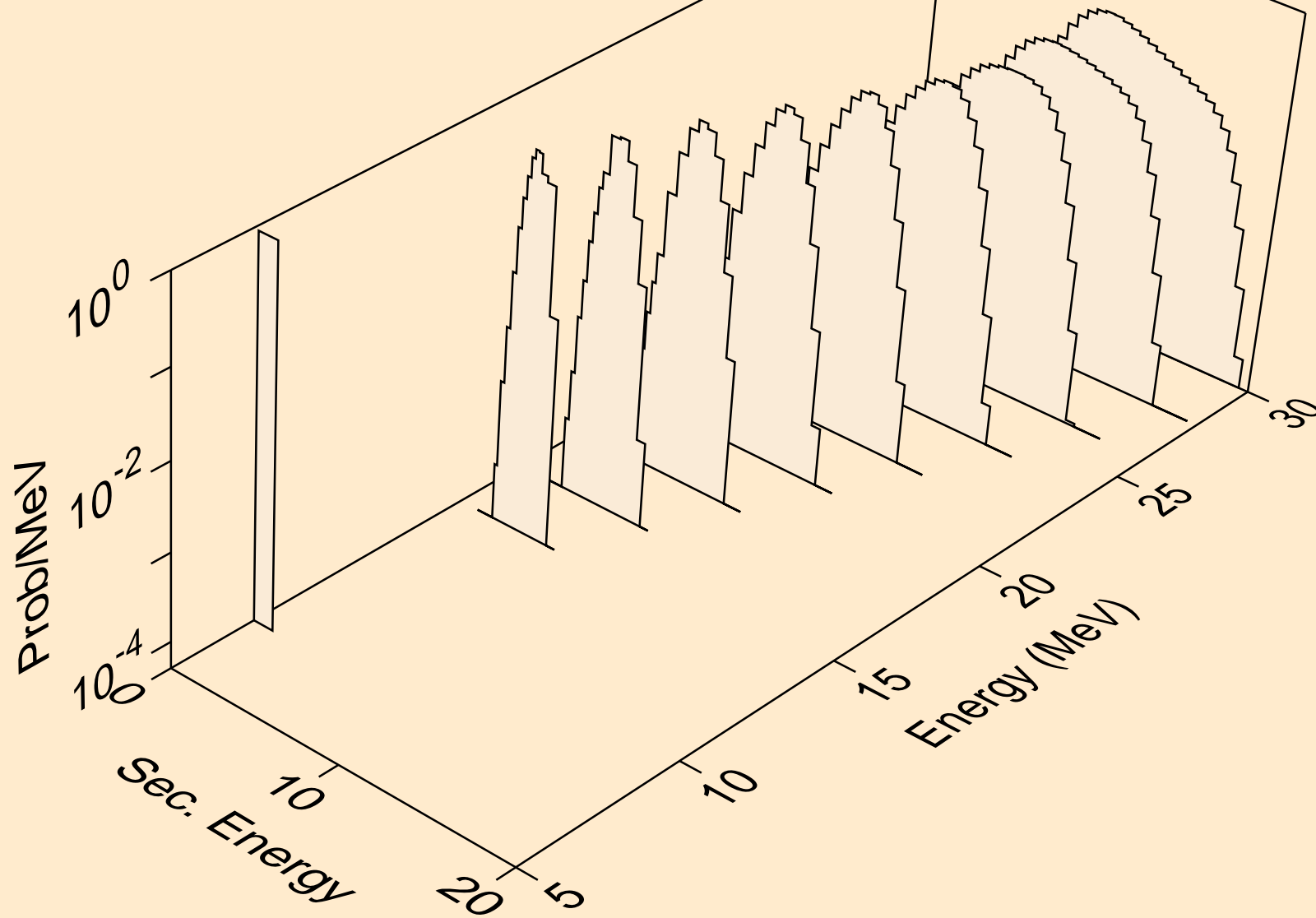

TB151M NEUTRON ACER TENDL-2023 LIBRARY; T=0.K
deuterons from (n,da)

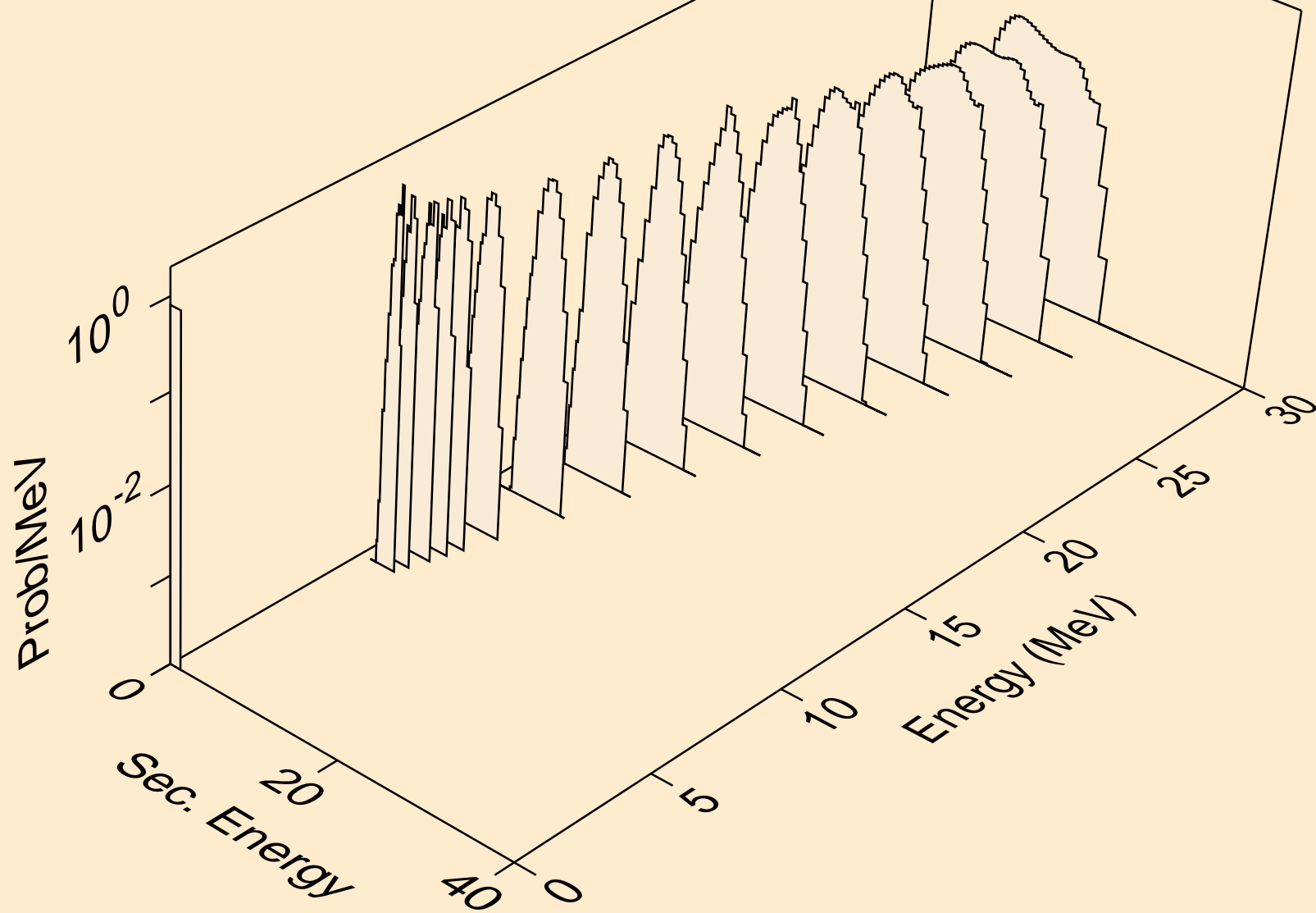

TB151M NEUTRON ACER TENDL-2023 LIBRARY; T=0.K
tritons from (n,x)

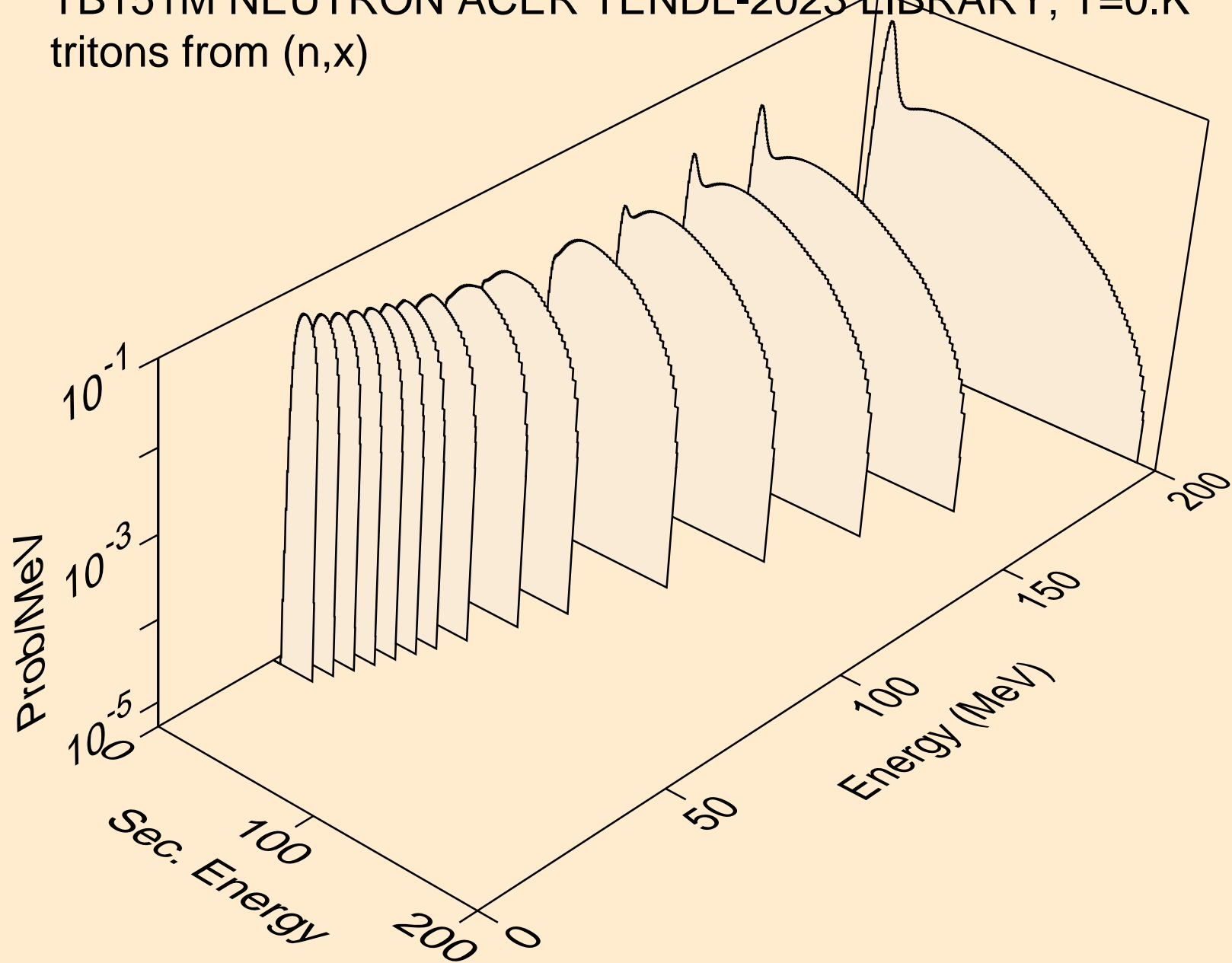

TB151M NEUTRON ACER TENDL-2023 LIBRARY; T=0.K
tritons from (n,n*)t

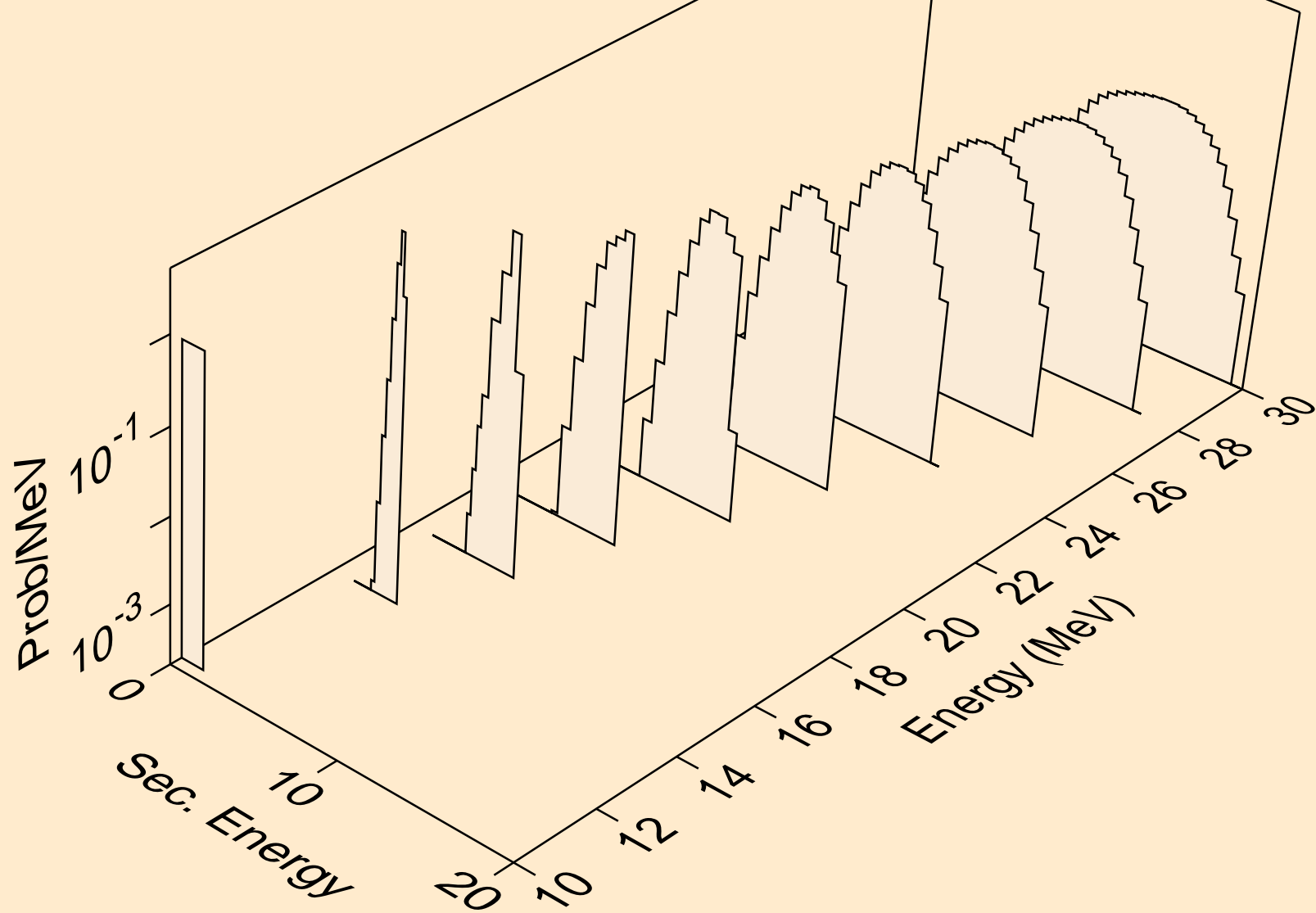

TB151M NEUTRON ACER TENDL-2023 LIBRARY; T=0.K
tritons from (n,t)

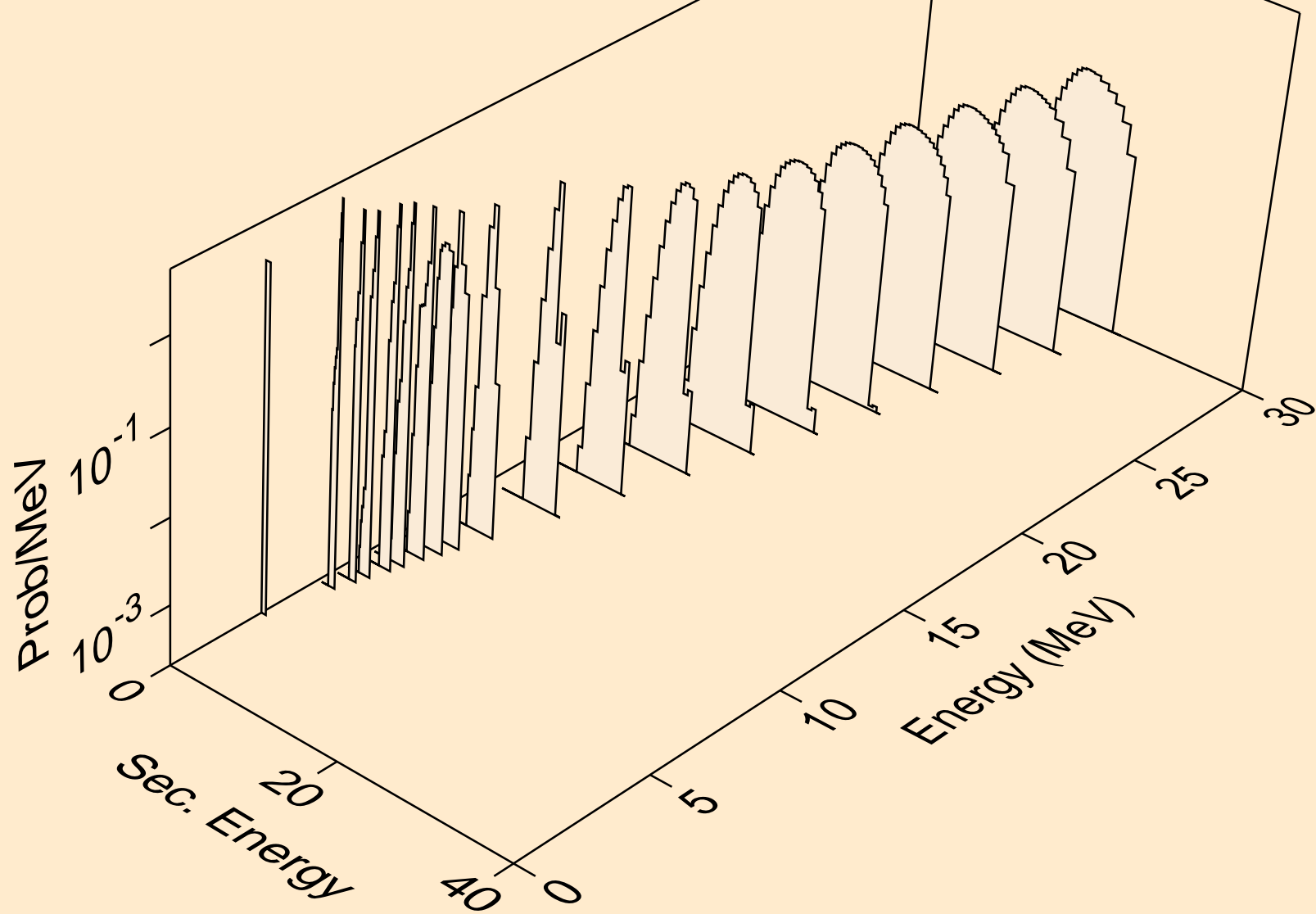

TB151M NEUTRON ACER TENDL-2023 LIBRARY; T=0.K
tritons from (n,pt)

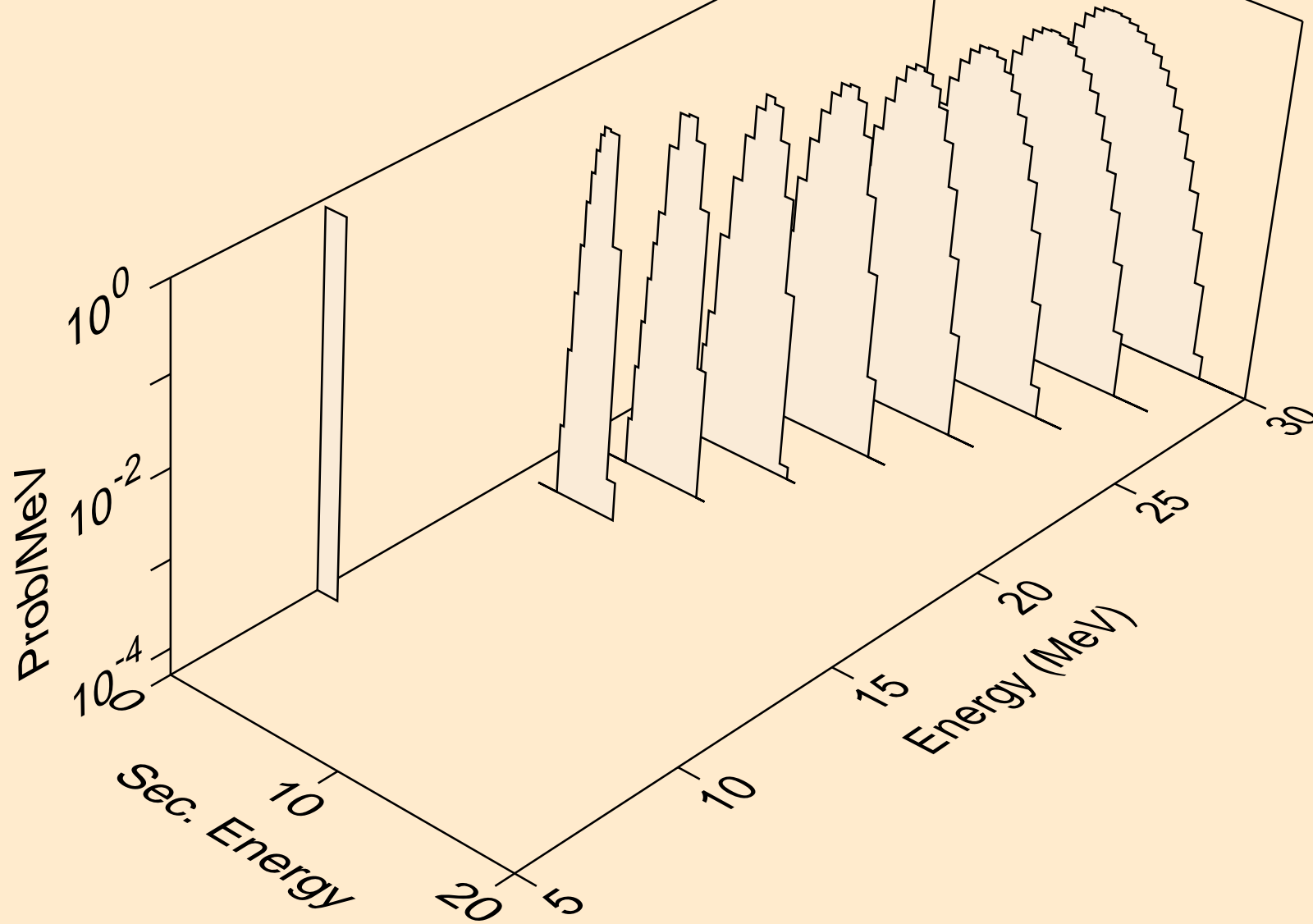

TB151M NEUTRON ACER TENDL-2023 LIBRARY; T=0.K
he3s from (n,x)

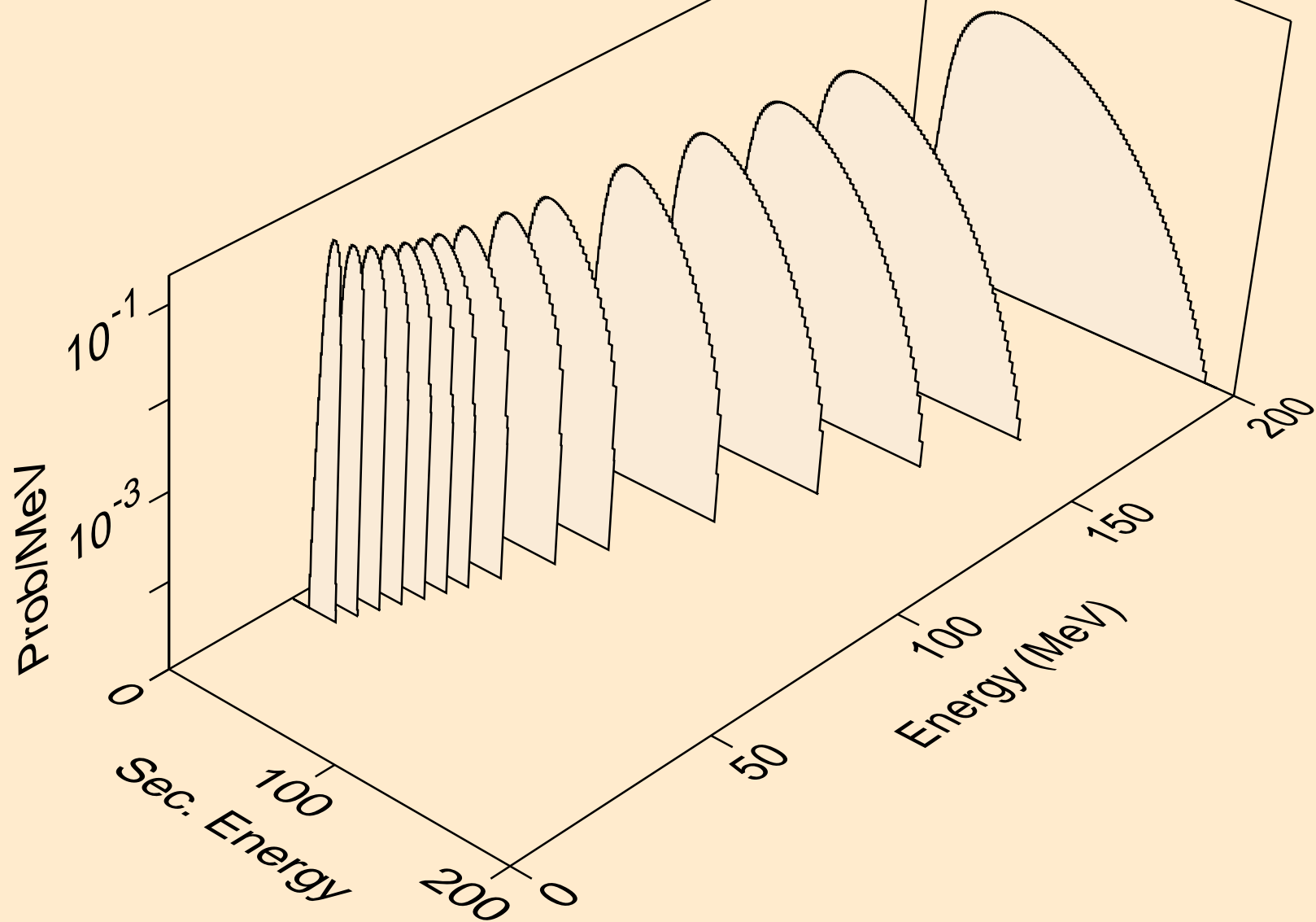

TB151M NEUTRON ACER TENDL-2023 LIBRARY; T=0.K
he3s from (n,n*)he3

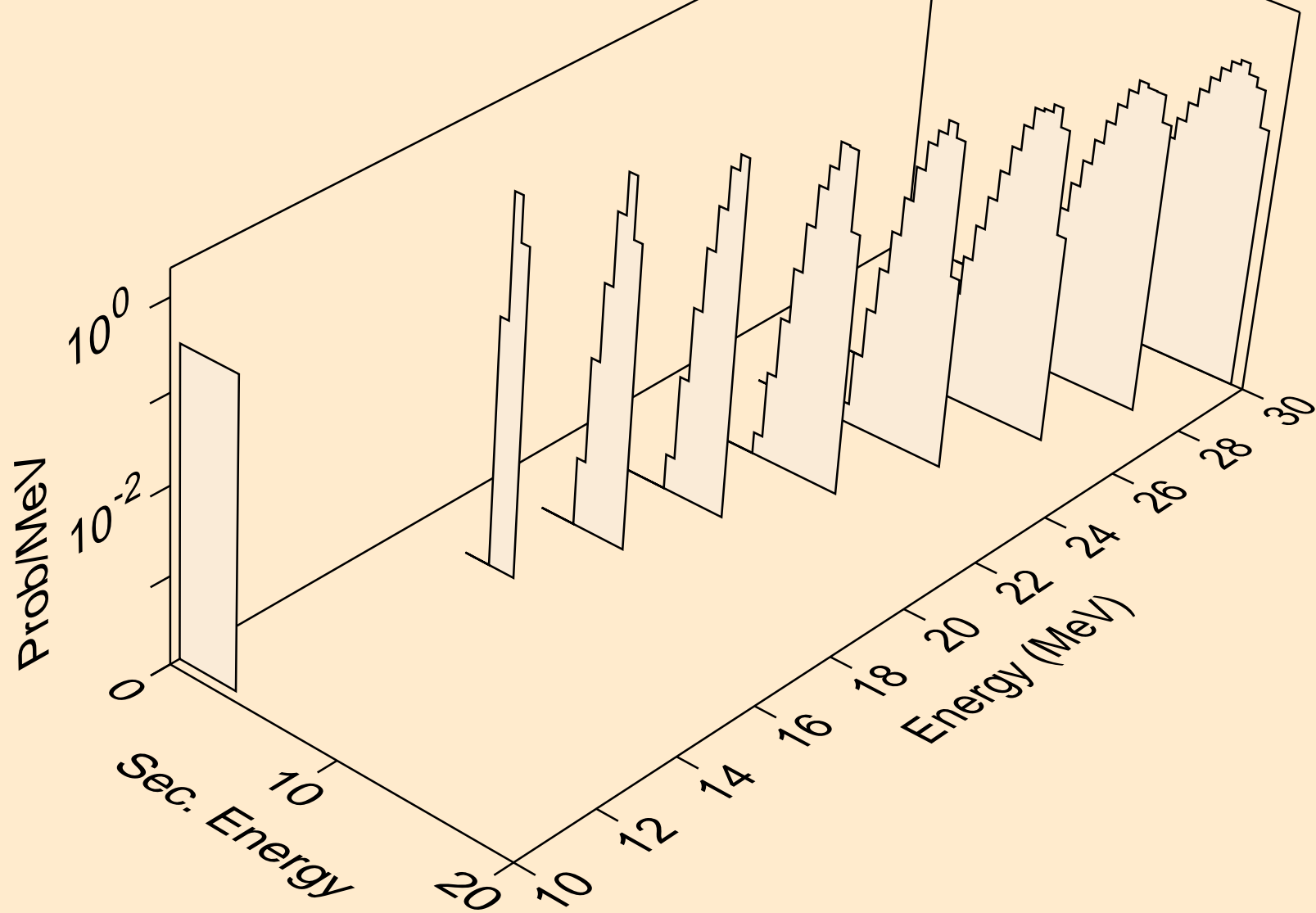

TB151M NEUTRON ACER TENDL-2023 LIBRARY; T=0.K
he3s from (n,he3)

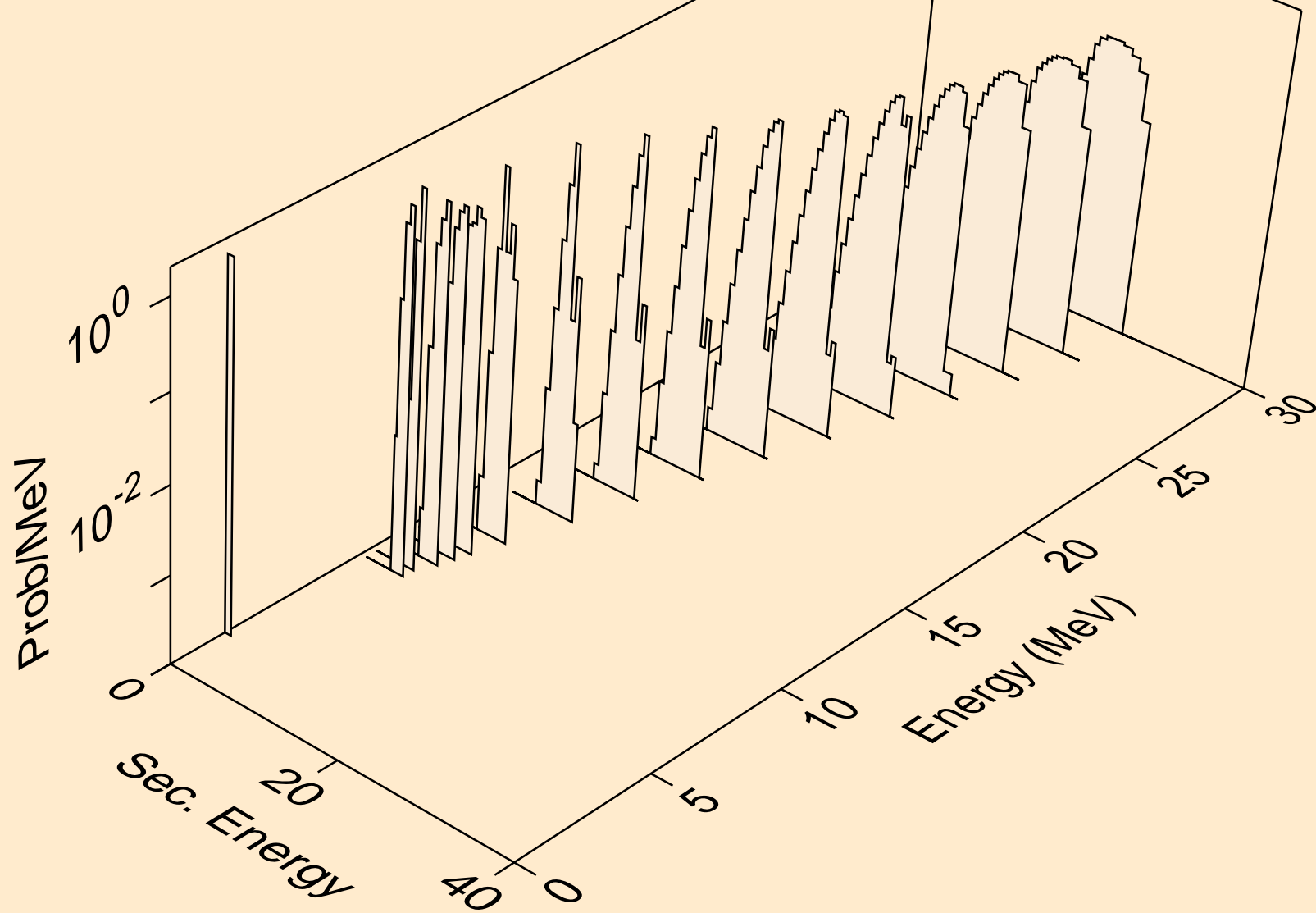

TB151M NEUTRON ACER TENDL-2023 LIBRARY; T=0.K
alphas from (n,x)

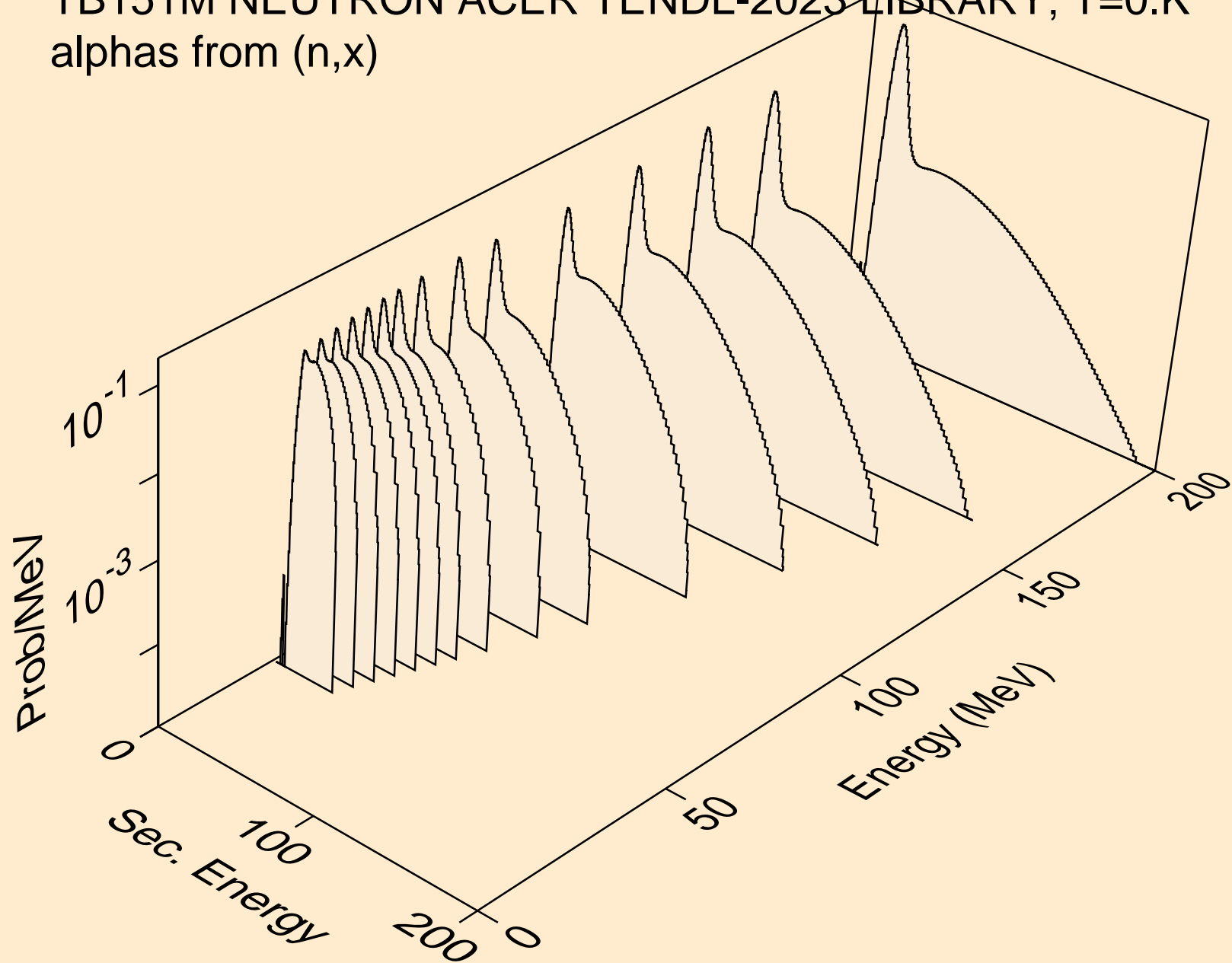

TB151M NEUTRON ACER TENDL-2023 LIBRARY; T=0.K
alphas from (n,n*)a

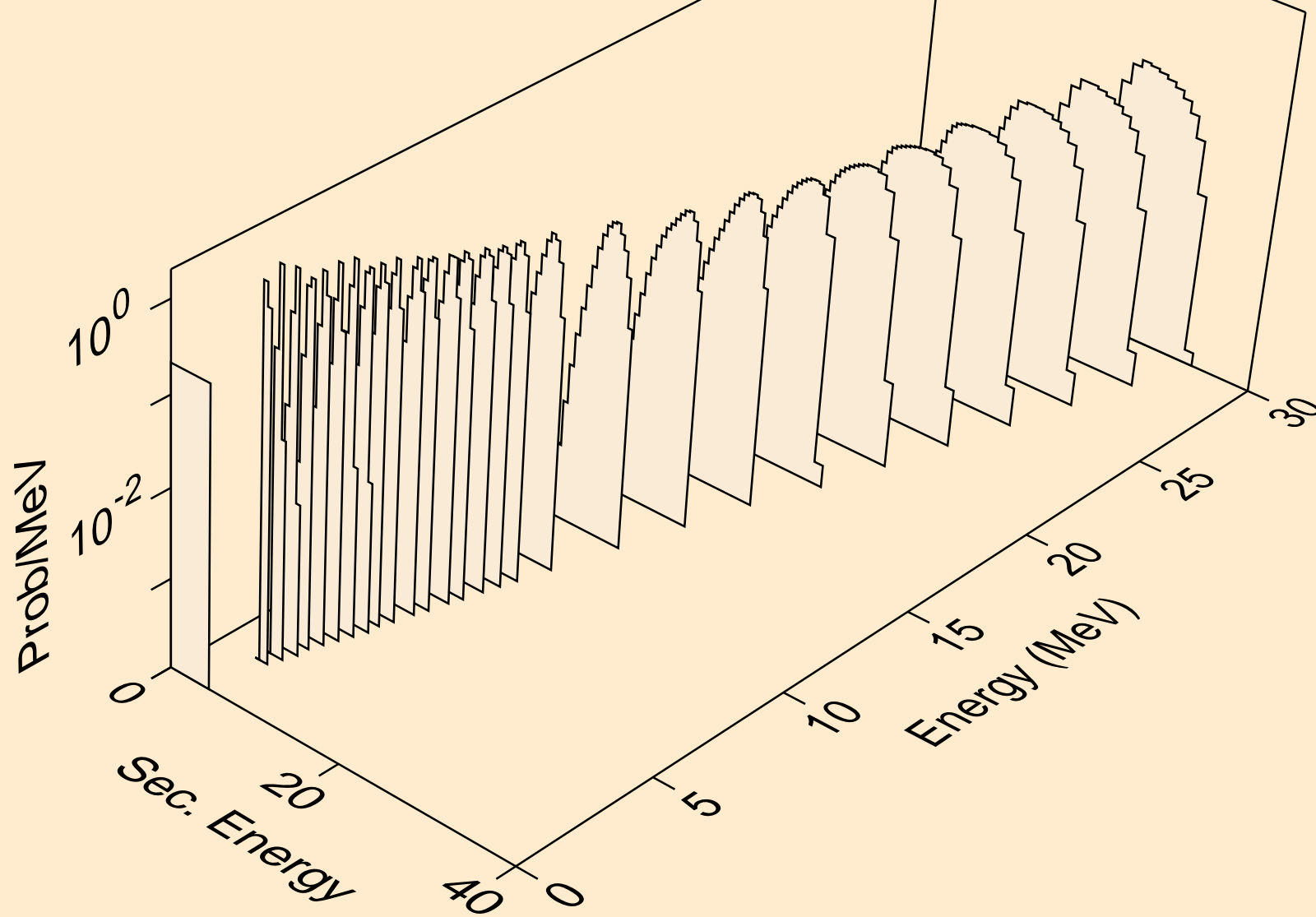

TB151M NEUTRON ACER TENDL-2023 LIBRARY; T=0.K
alphas from (n,2n)a

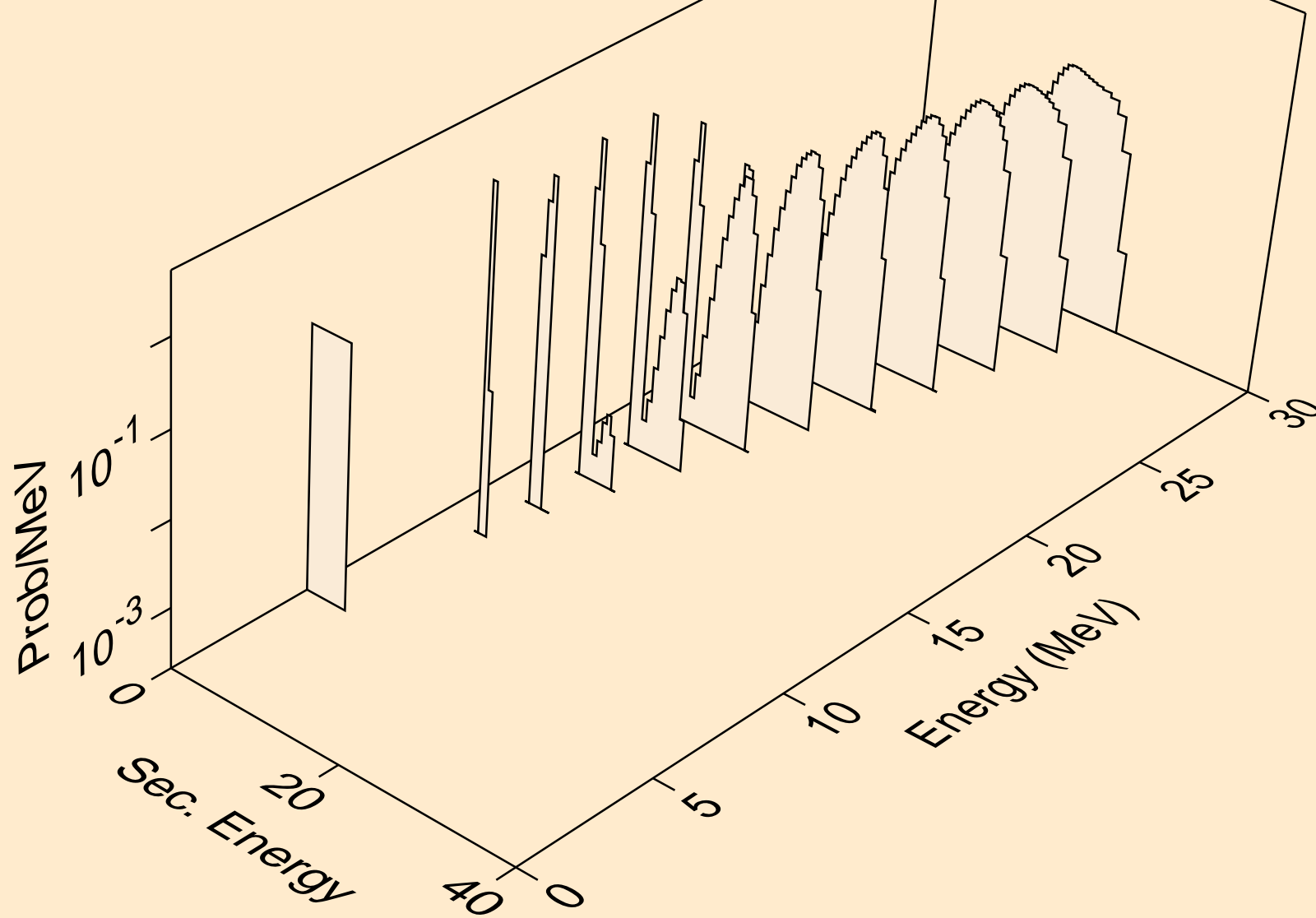

TB151M NEUTRON ACER TENDL-2023 LIBRARY; T=0.K
alphas from (n,3n)a

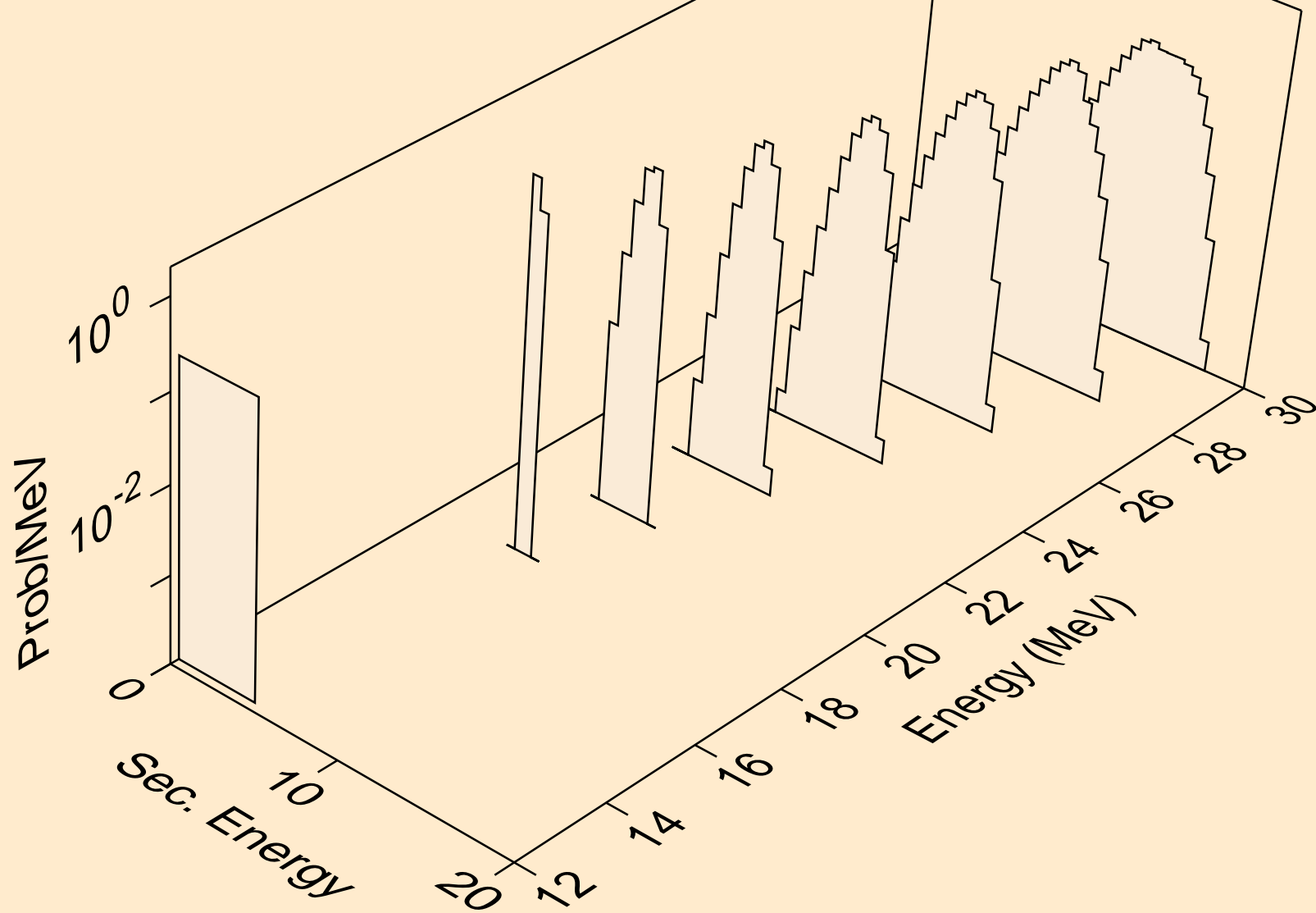

TB151M NEUTRON ACER TENDL-2023 LIBRARY; T=0.K
alphas from (n,n*)2a

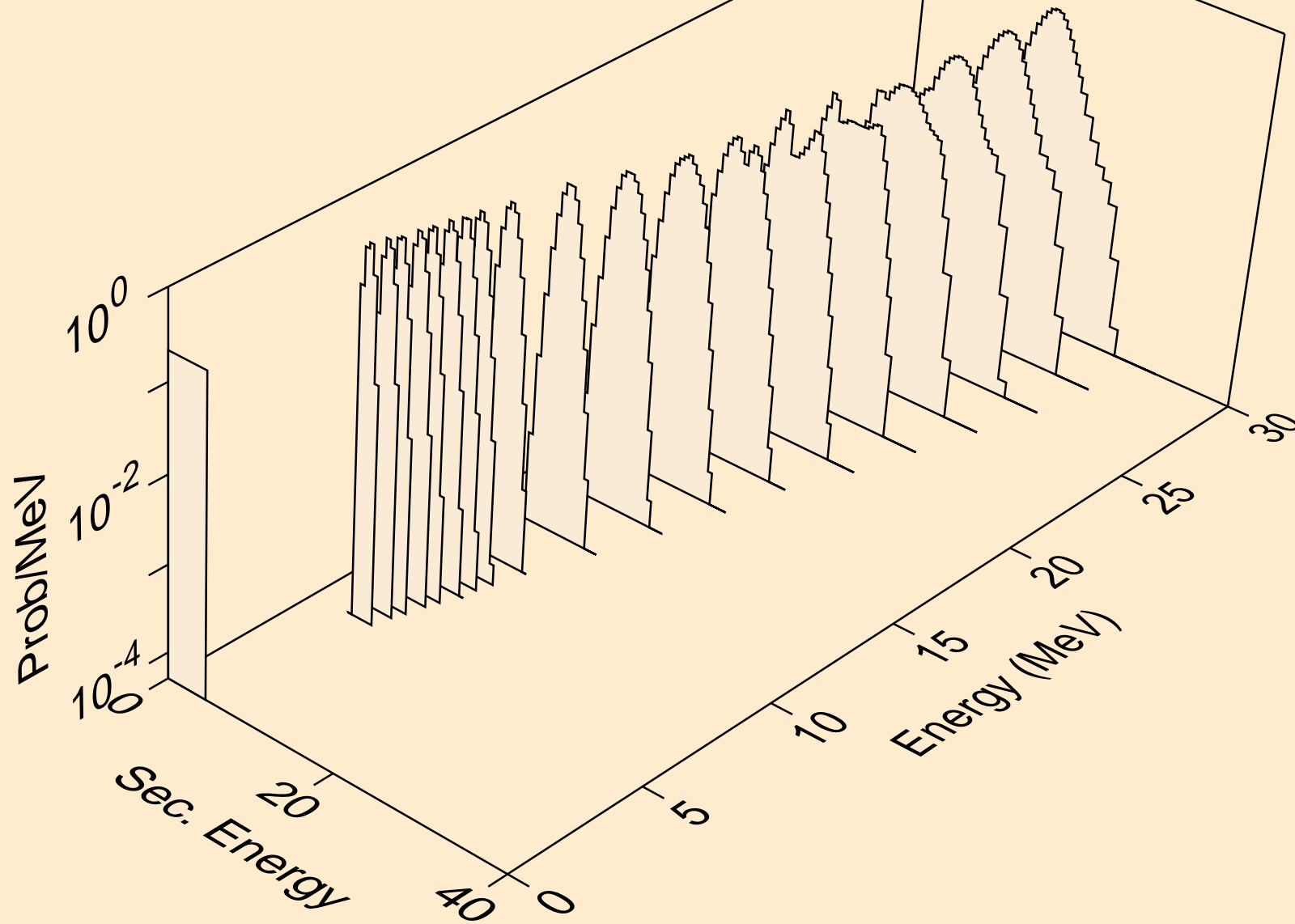

TB151M NEUTRON ACER TENDL-2023 LIBRARY; T=0.K
alphas from (n,2n)2a

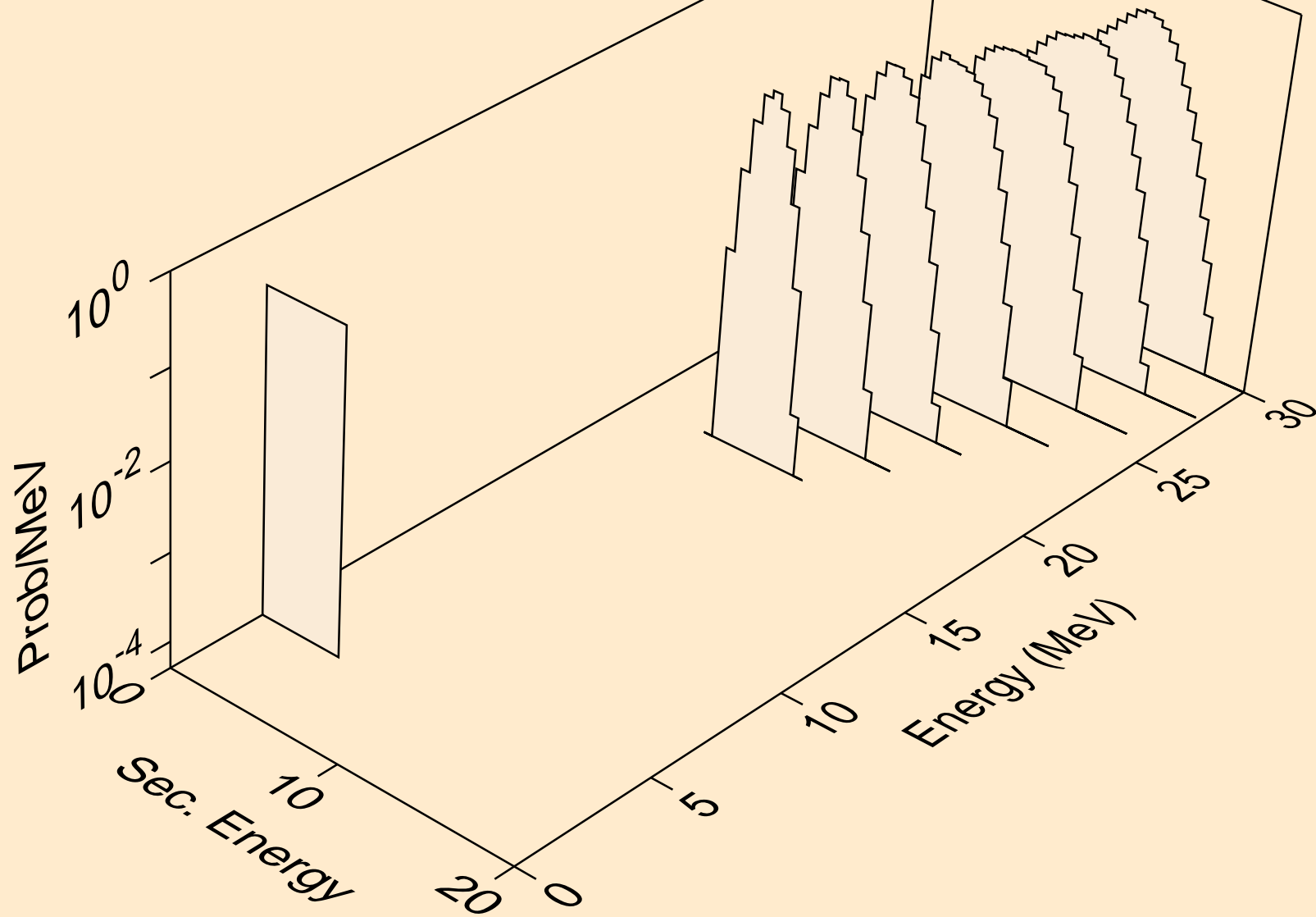

TB151M NEUTRON ACER TENDL-2023 LIBRARY; T=0.K
alphas from (n,npa)

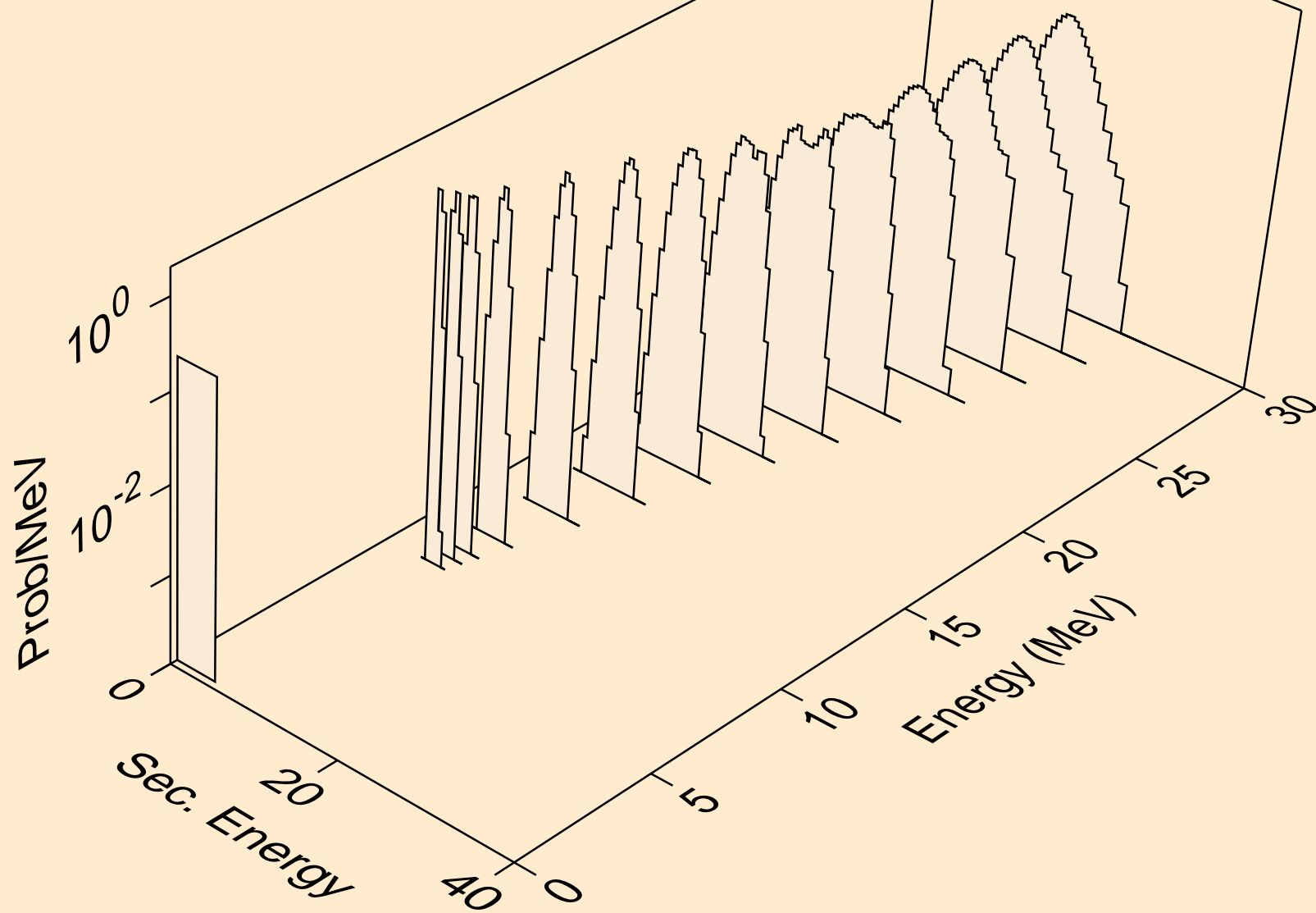

TB151M NEUTRON ACER TENDL-2023 LIBRARY; T=0.K
alphas from (n,a)

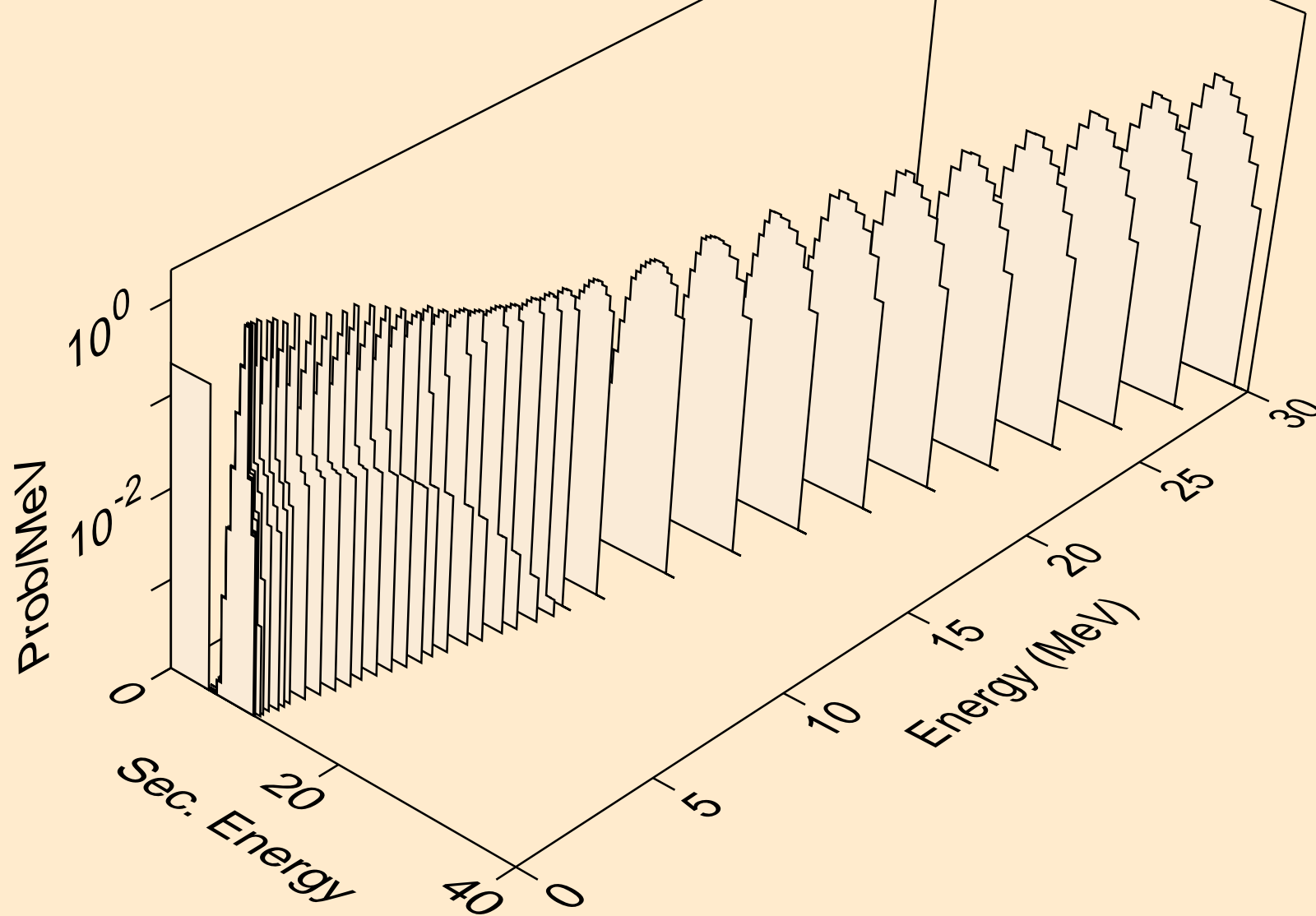

TB151M NEUTRON ACER TENDL-2023 LIBRARY; T=0.K
alphas from (n,2a)

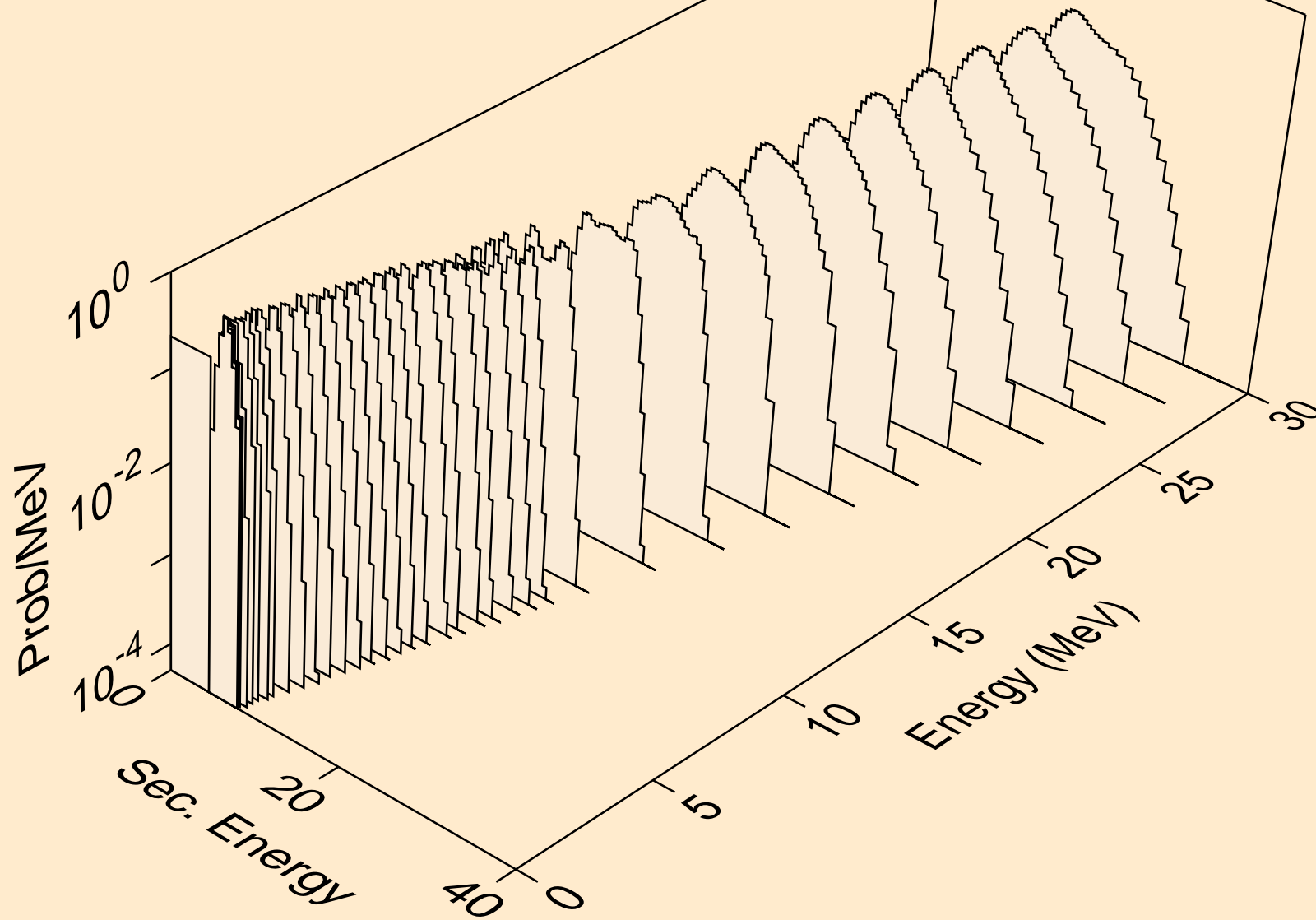

TB151M NEUTRON ACER TENDL-2023 LIBRARY; T=0.K
alphas from (n,pa)

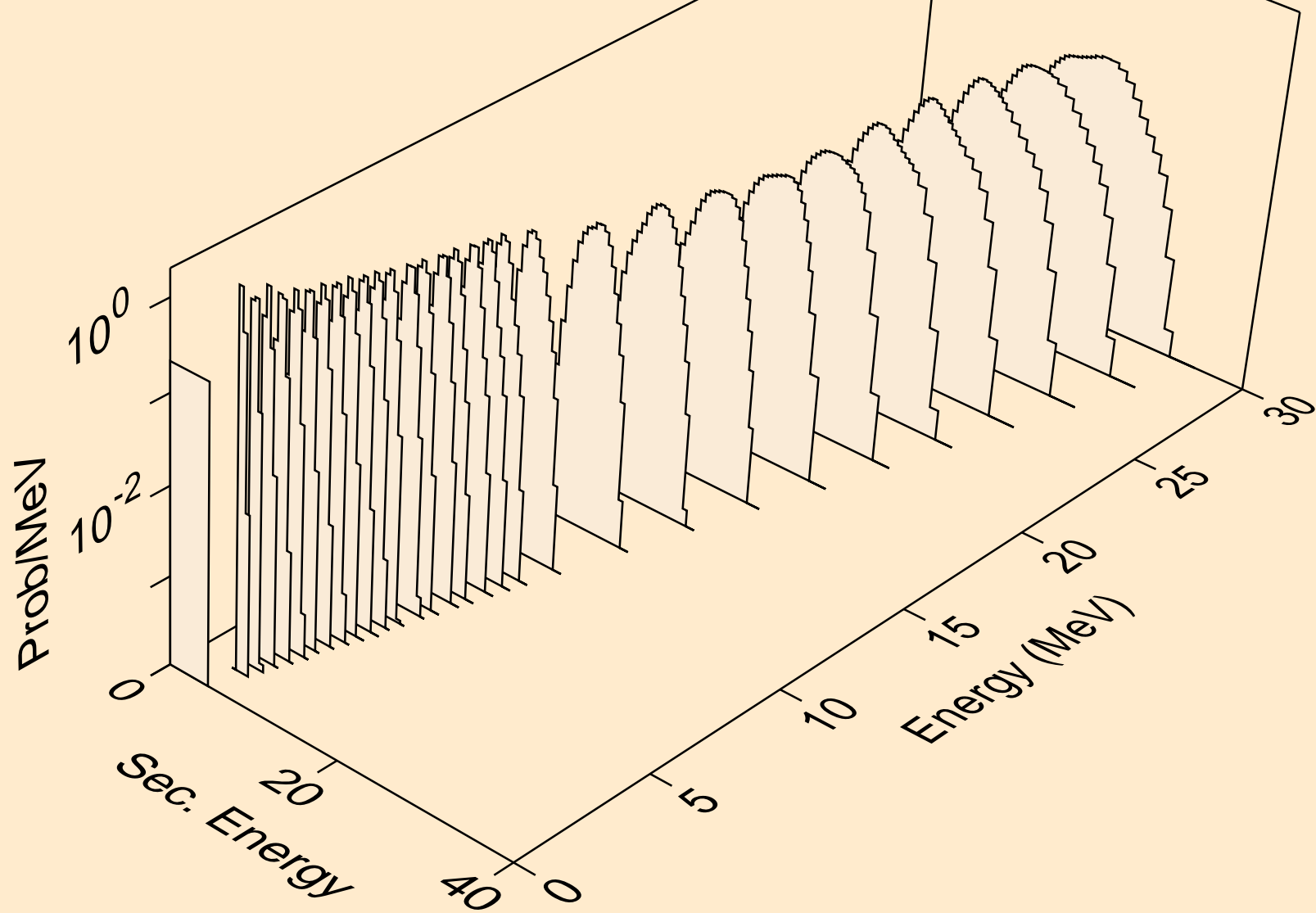

TB151M NEUTRON ACER TENDL-2023 LIBRARY; T=0.K
alphas from (n,da)

