

TB157 NEUTRON ACER TENDL-2023 LIBRARY; T=0.K

Principal cross sections

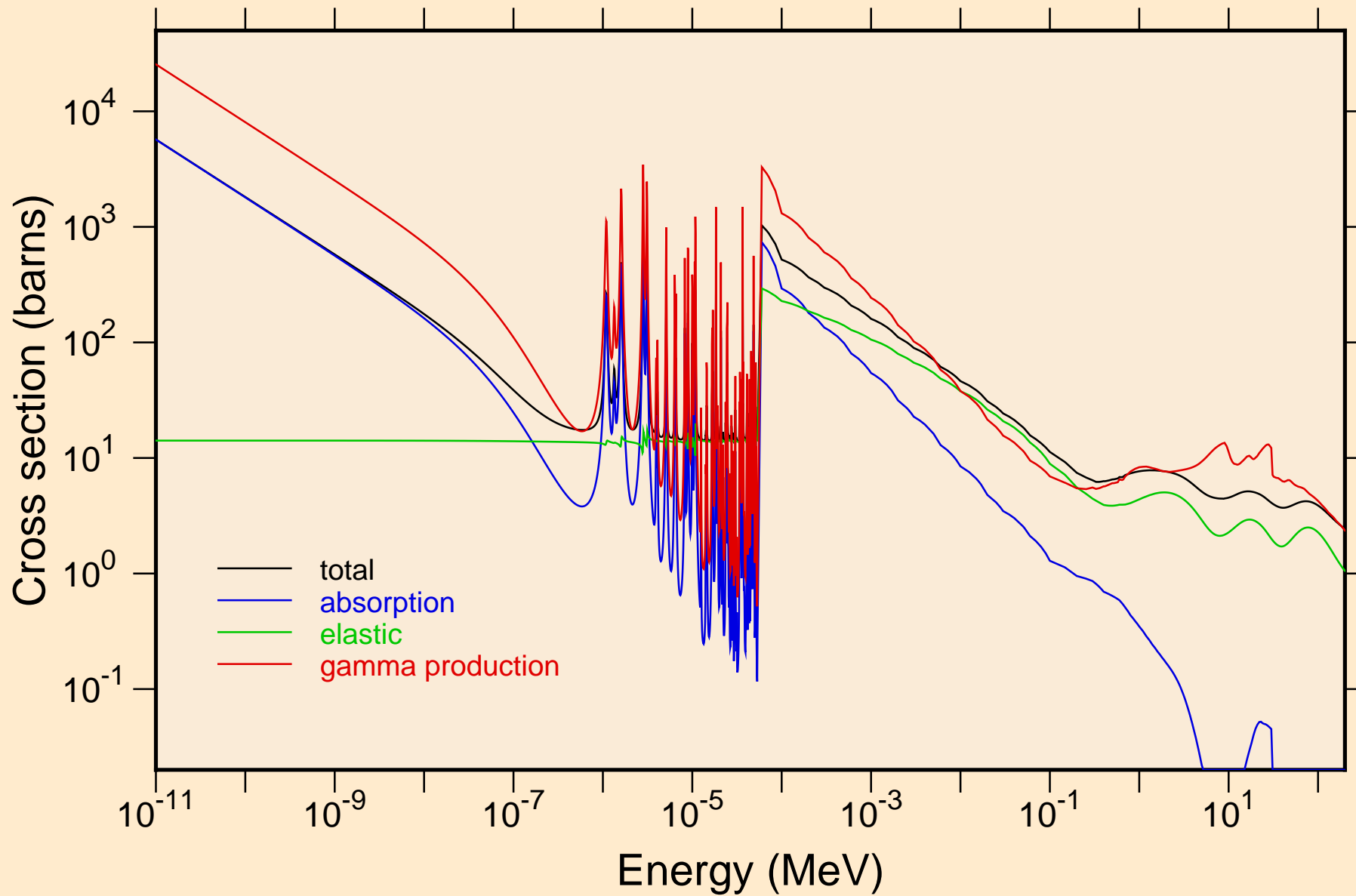

TB157 NEUTRON ACER TENDL-2023 LIBRARY; T=0.K
resonance total cross section

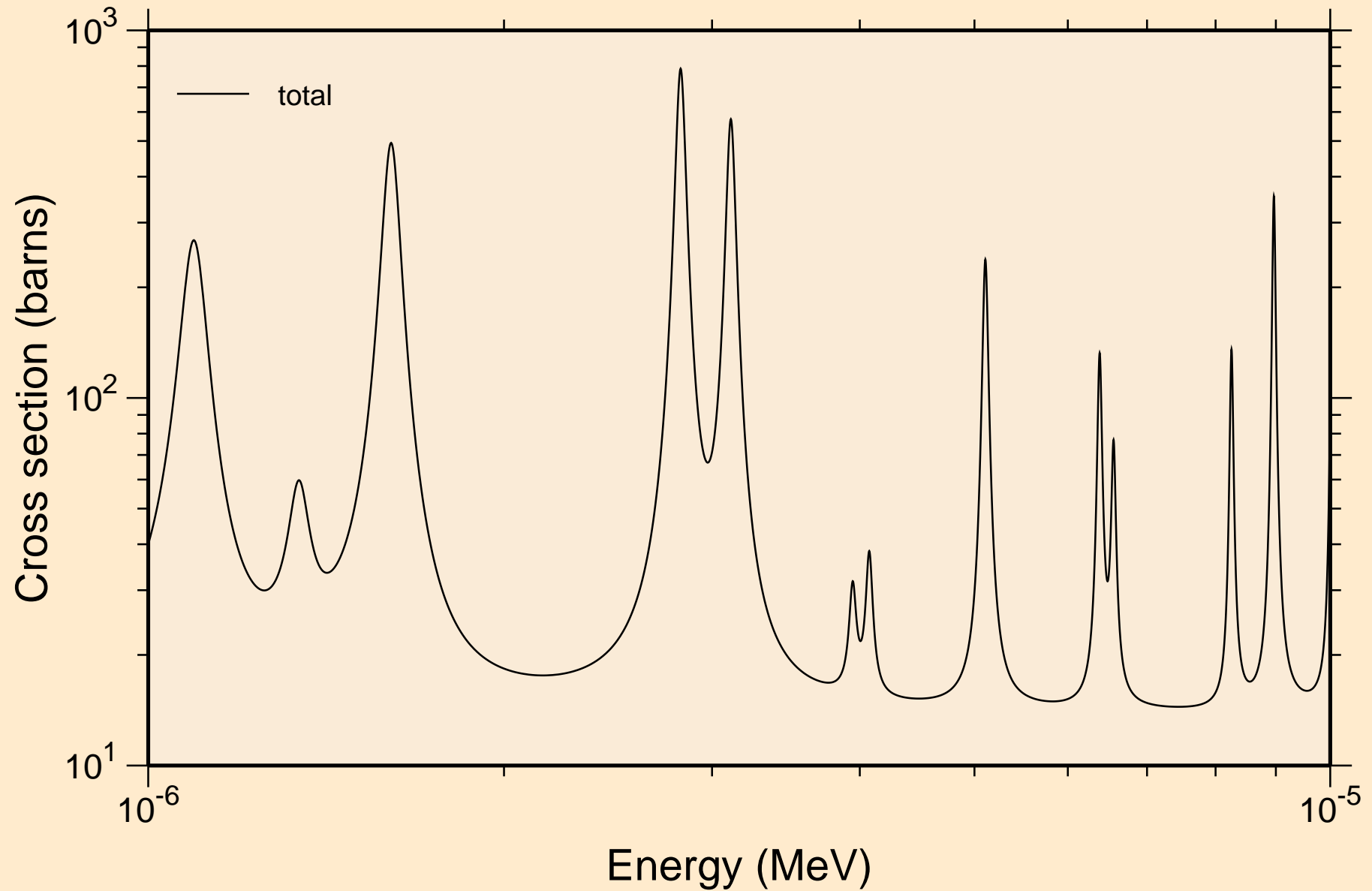

TB157 NEUTRON ACER TENDL-2023 LIBRARY; T=0.K
resonance total cross section

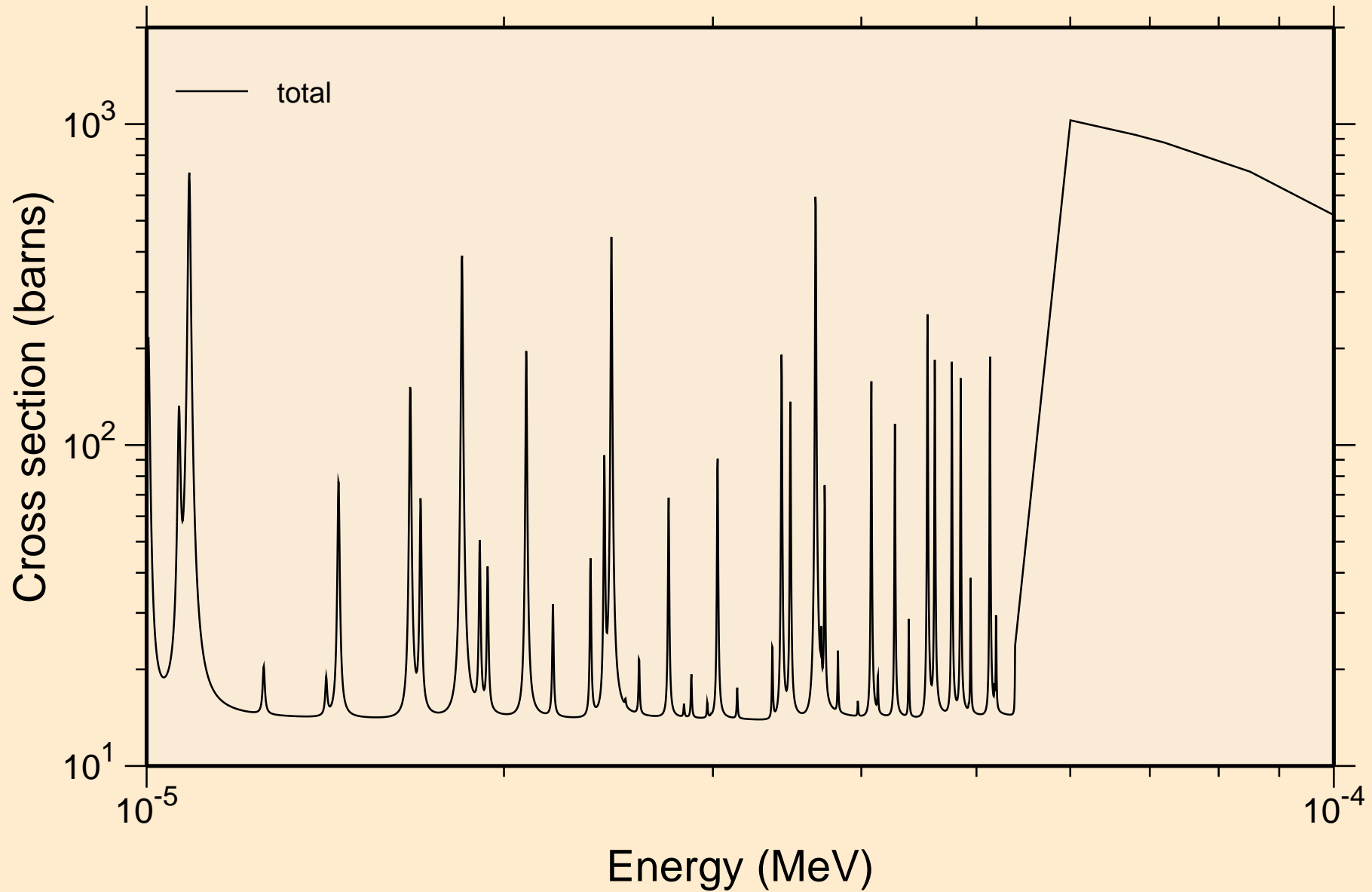

TB157 NEUTRON ACER TENDL-2023 LIBRARY; T=0.K
resonance total cross section

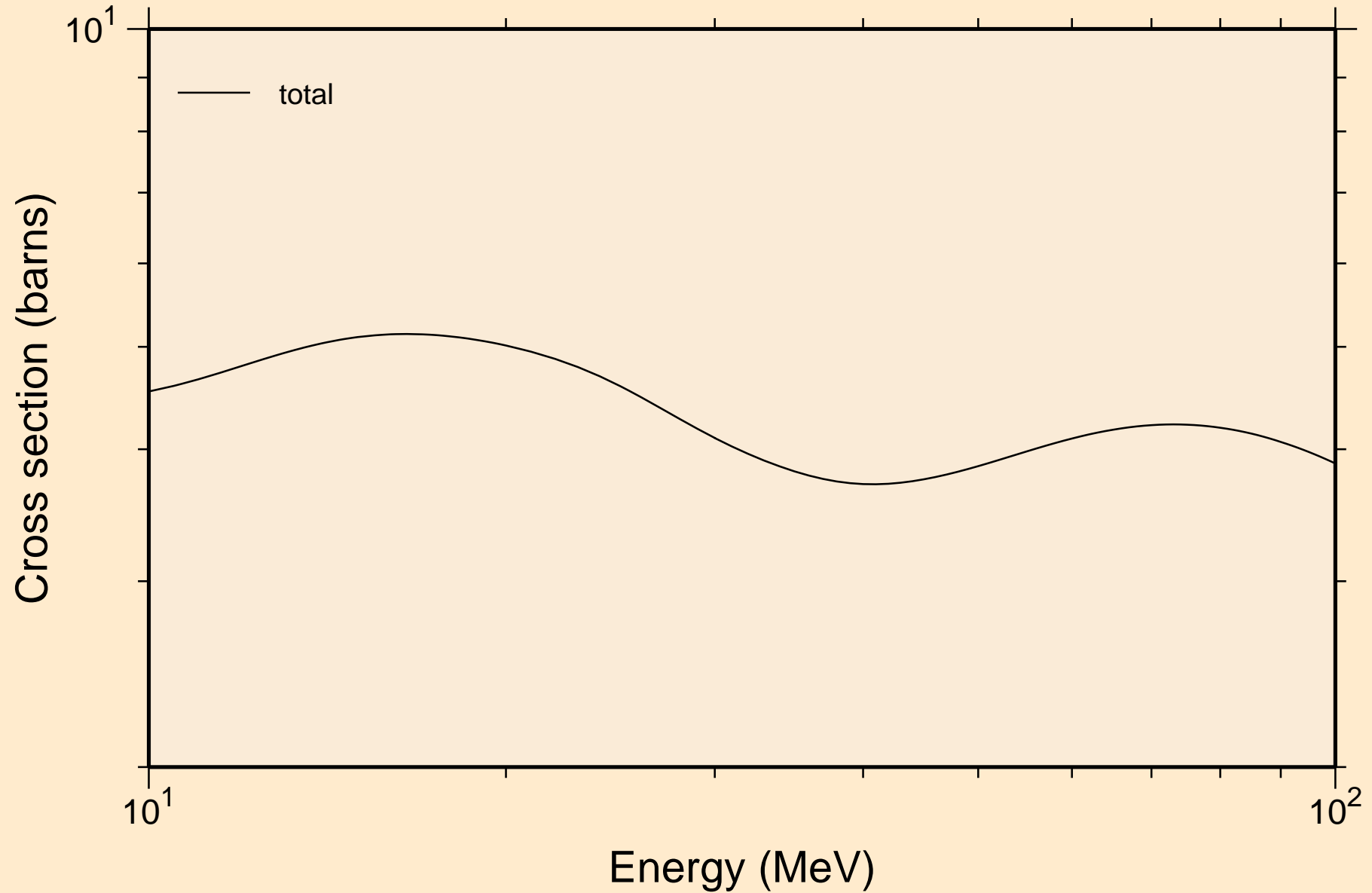

TB157 NEUTRON ACER TENDL-2023 LIBRARY; T=0.K
resonance absorption cross sections

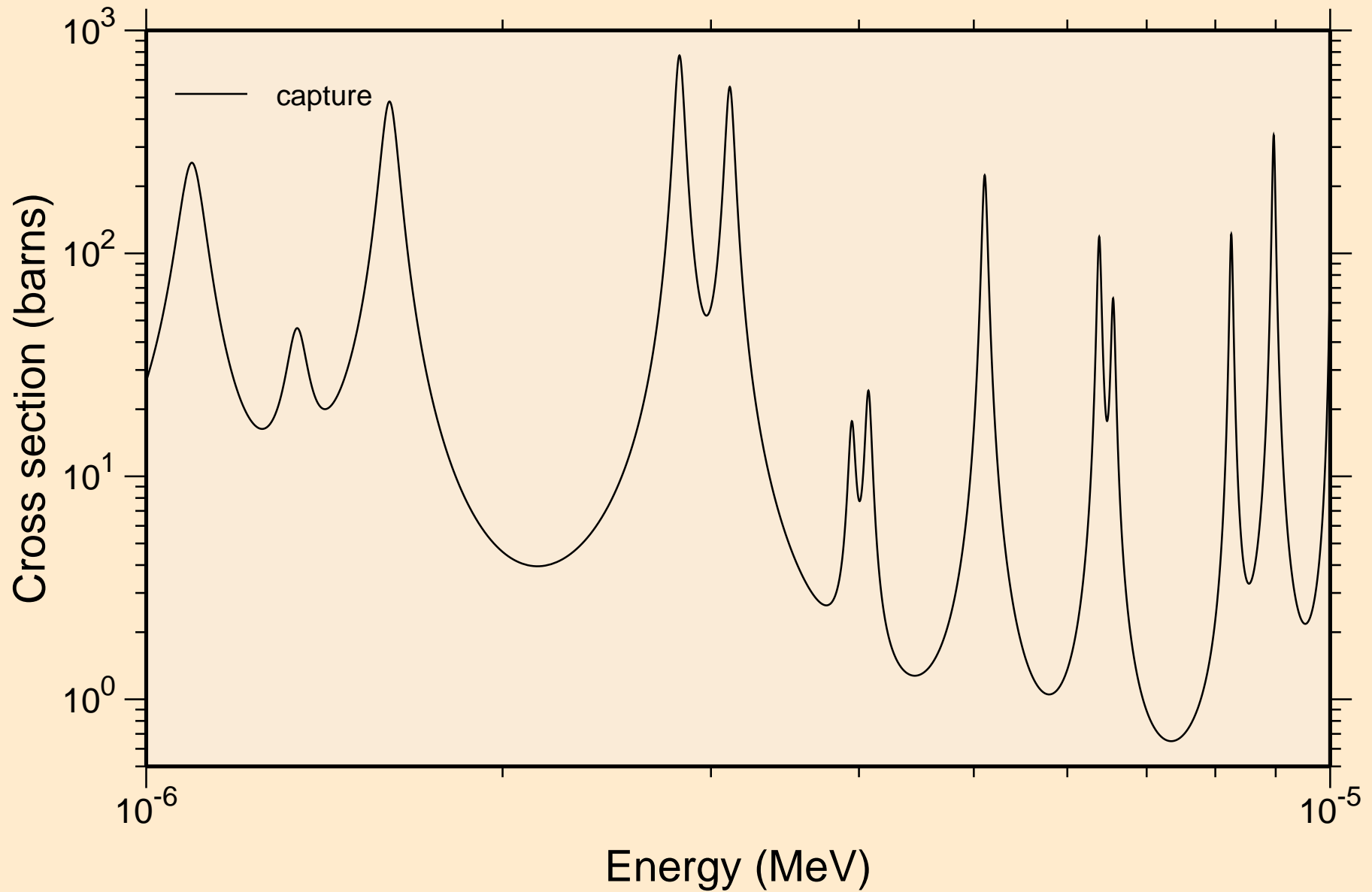

TB157 NEUTRON ACER TENDL-2023 LIBRARY; T=0.K
resonance absorption cross sections

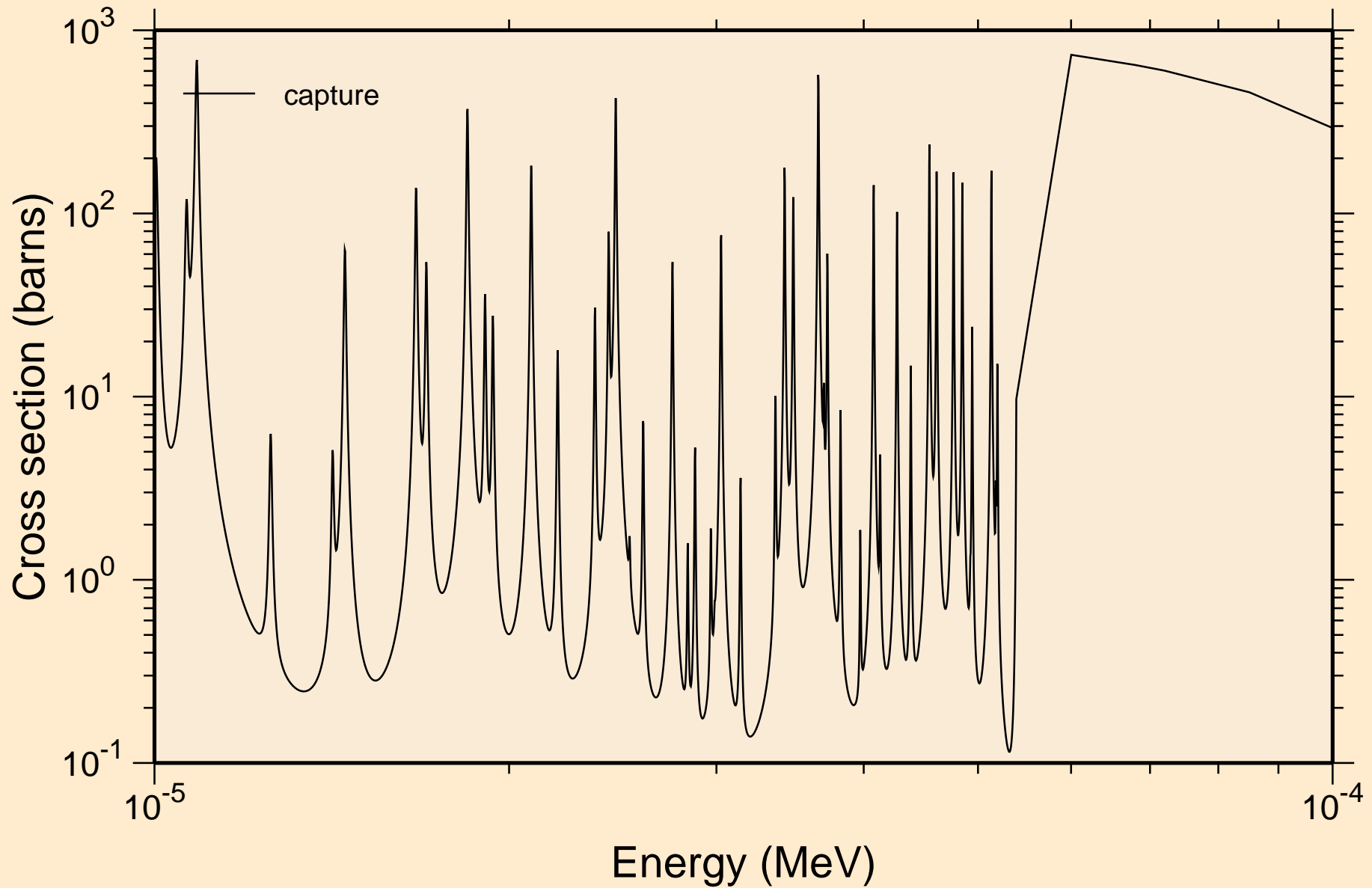

TB157 NEUTRON ACER TENDL-2023 LIBRARY; T=0.K
resonance absorption cross sections

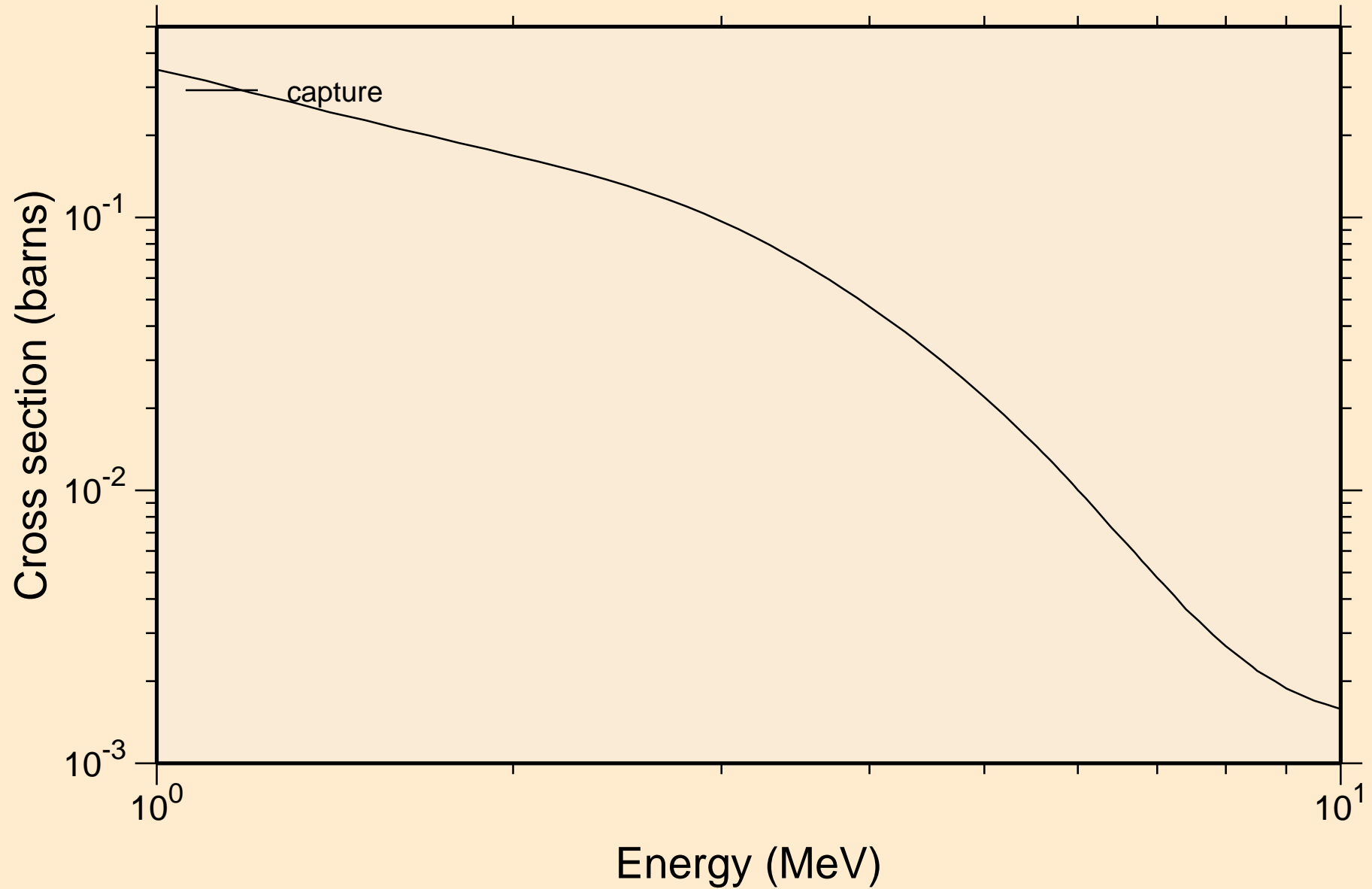

TB157 NEUTRON ACER TENDL-2023 LIBRARY; T=0.K
Heating

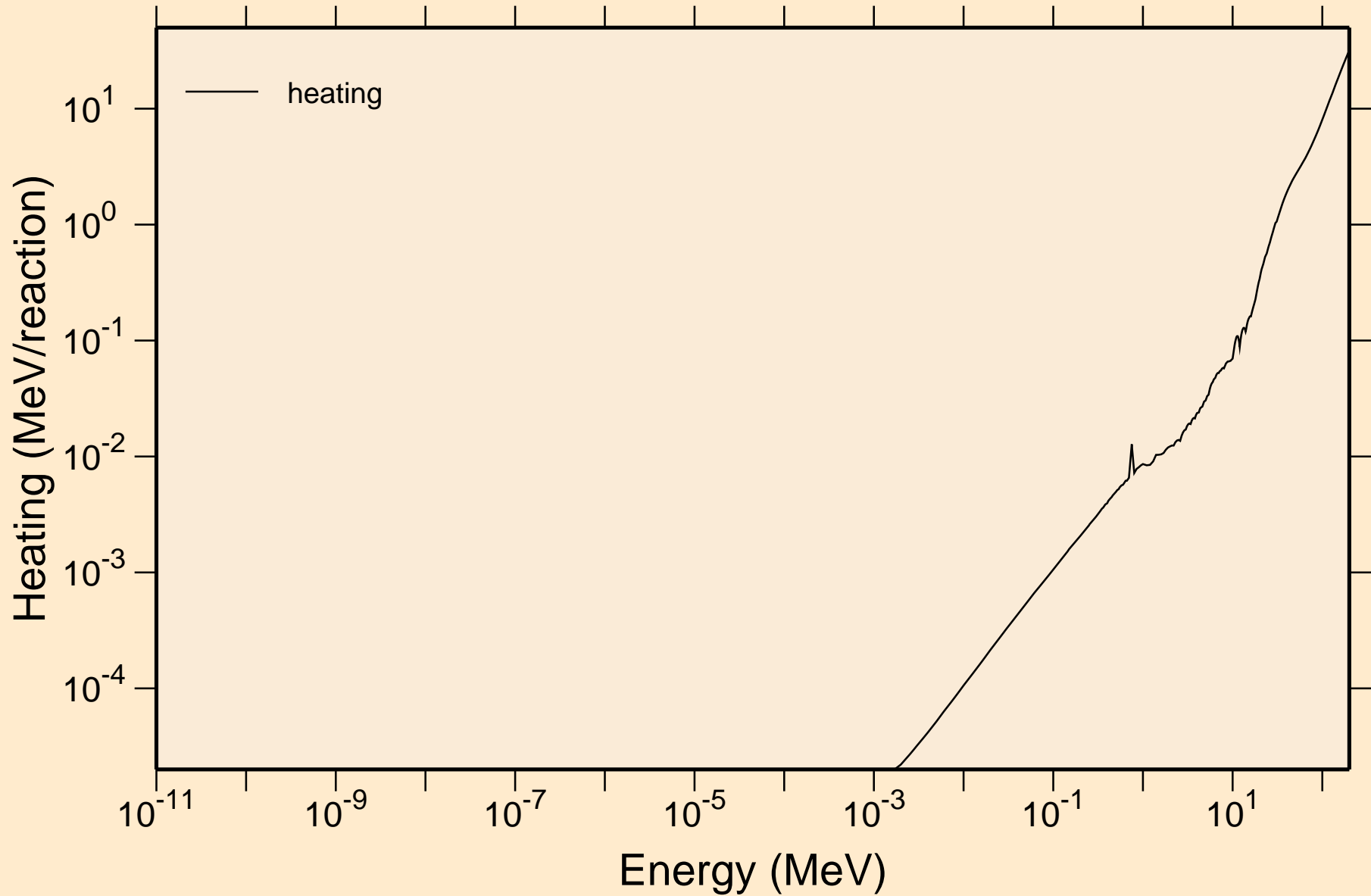

TB157 NEUTRON ACER TENDL-2023 LIBRARY; T=0.K
Damage

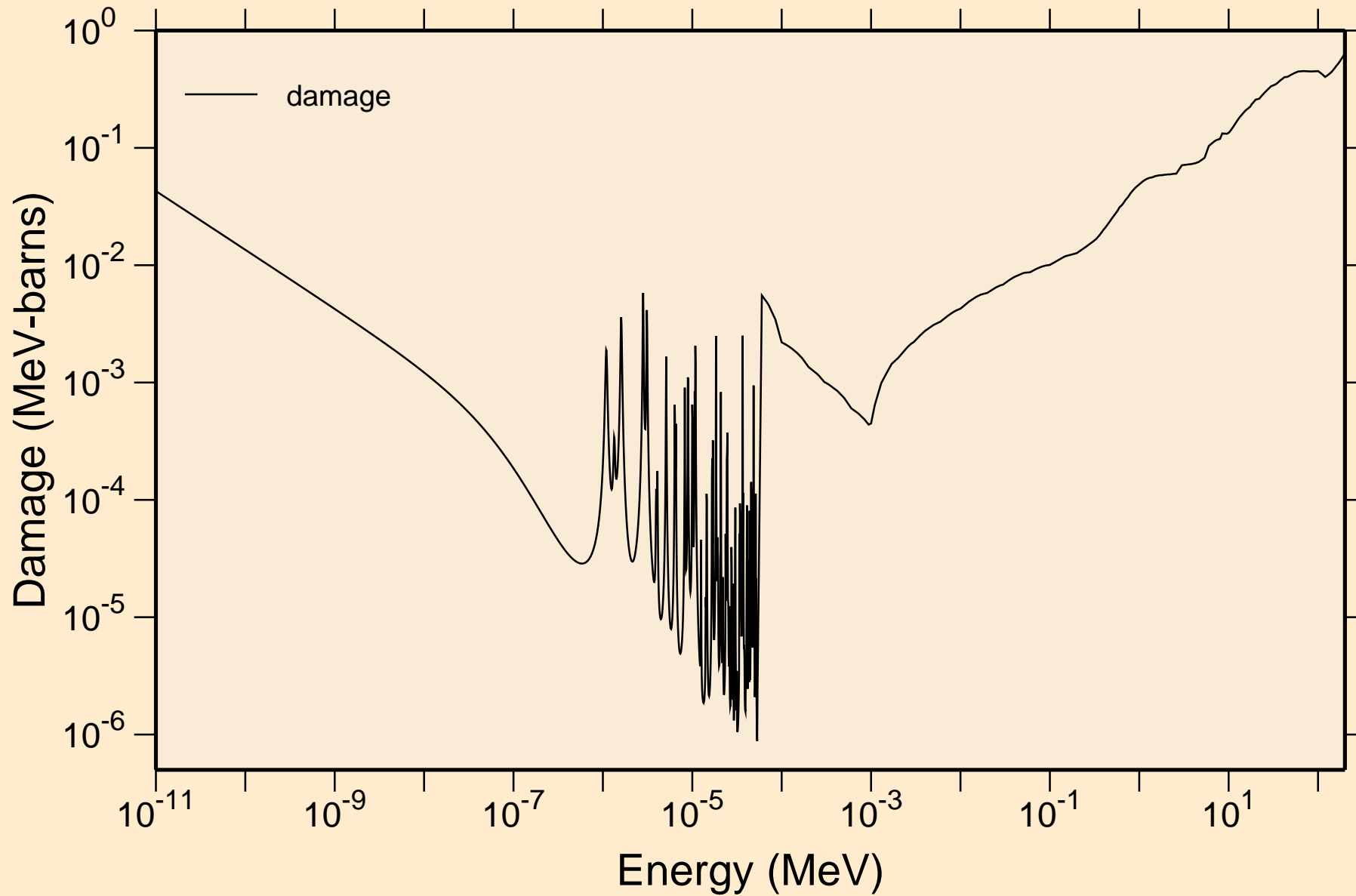

TB157 NEUTRON ACER TENDL-2023 LIBRARY; T=0.K
Non-threshold reactions

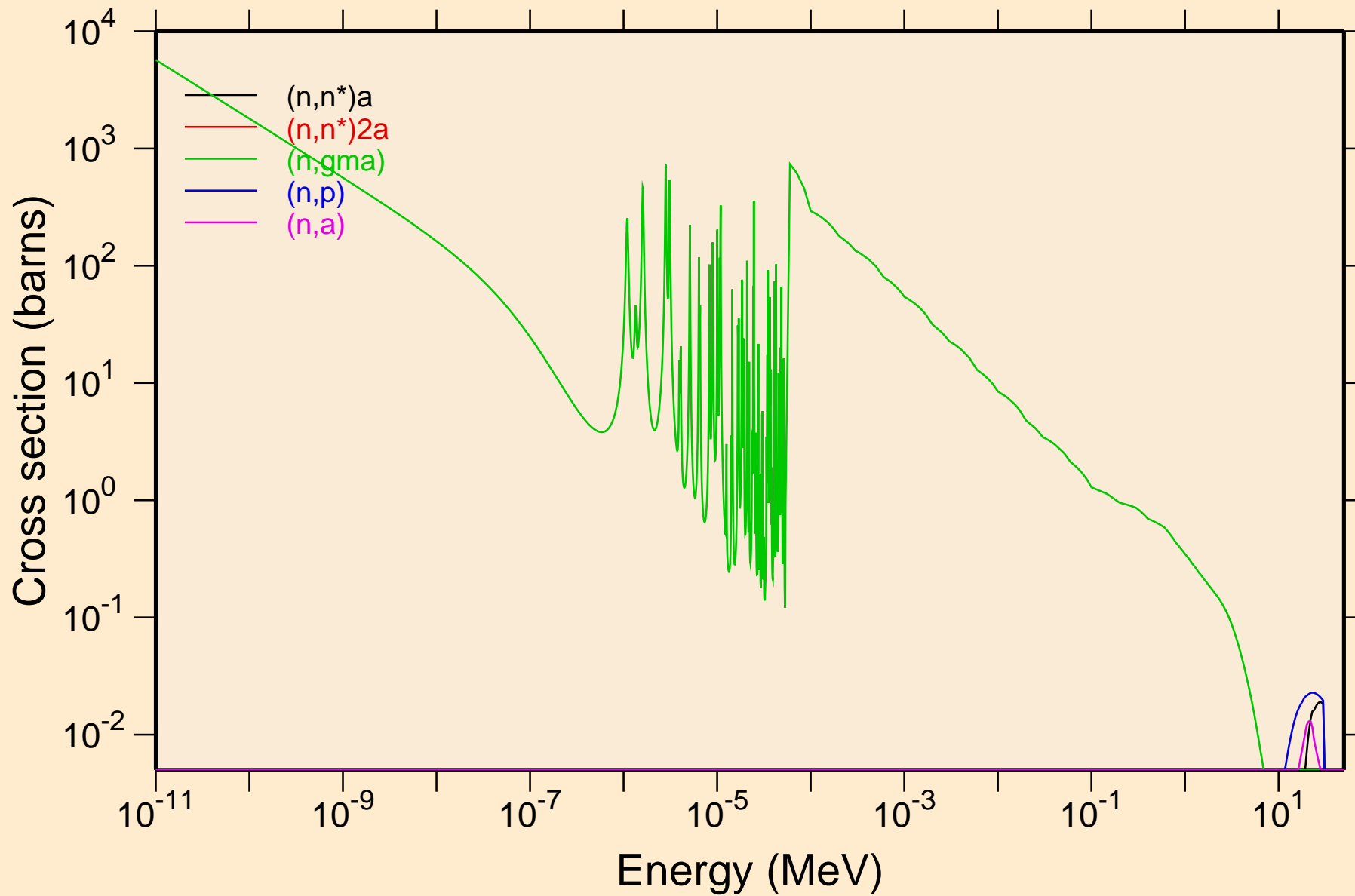

TB157 NEUTRON ACER TENDL-2023 LIBRARY; T=0.K
Non-threshold reactions

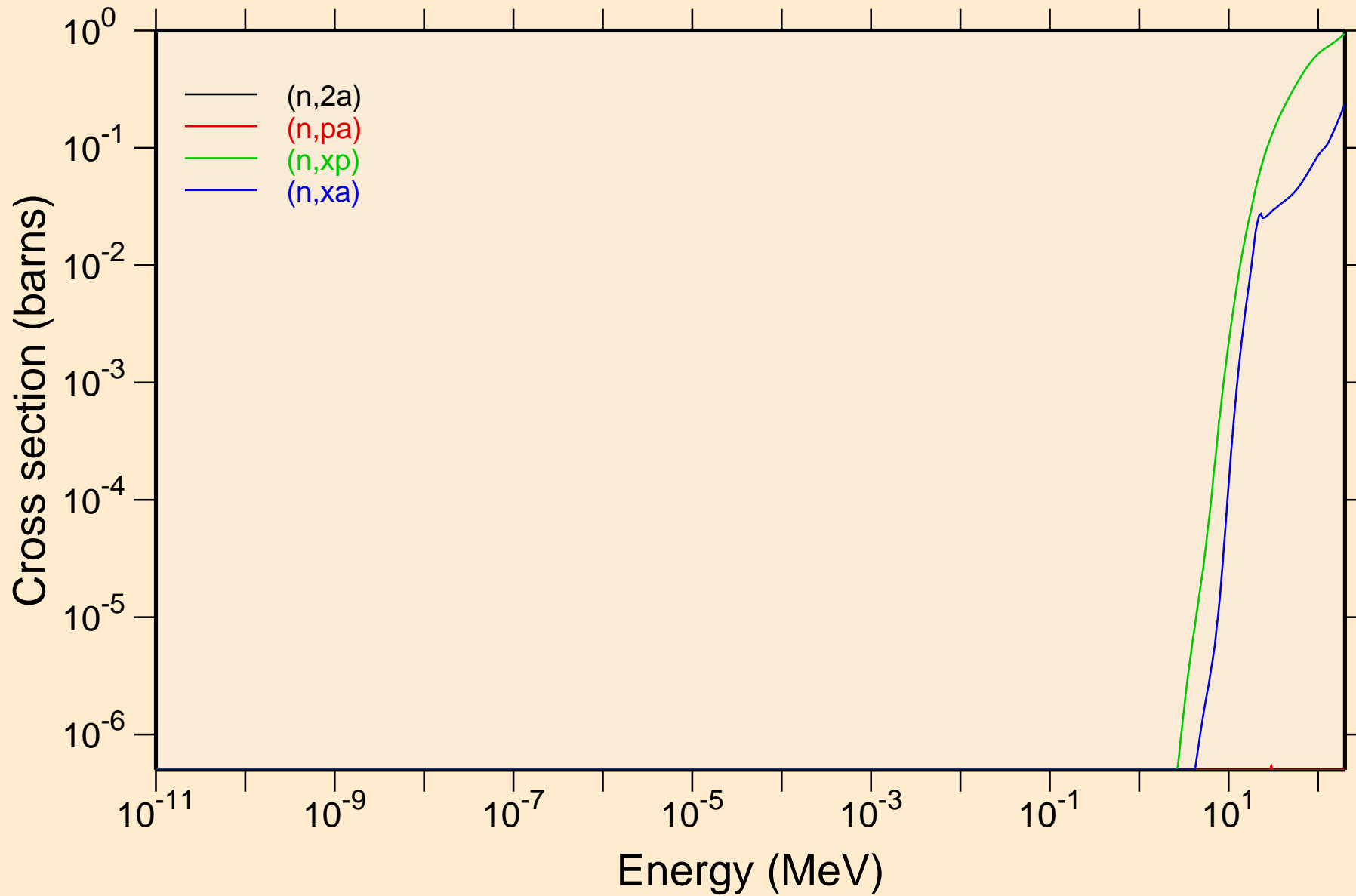

TB157 NEUTRON ACER TENDL-2023 LIBRARY; T=0.K
Principal cross sections

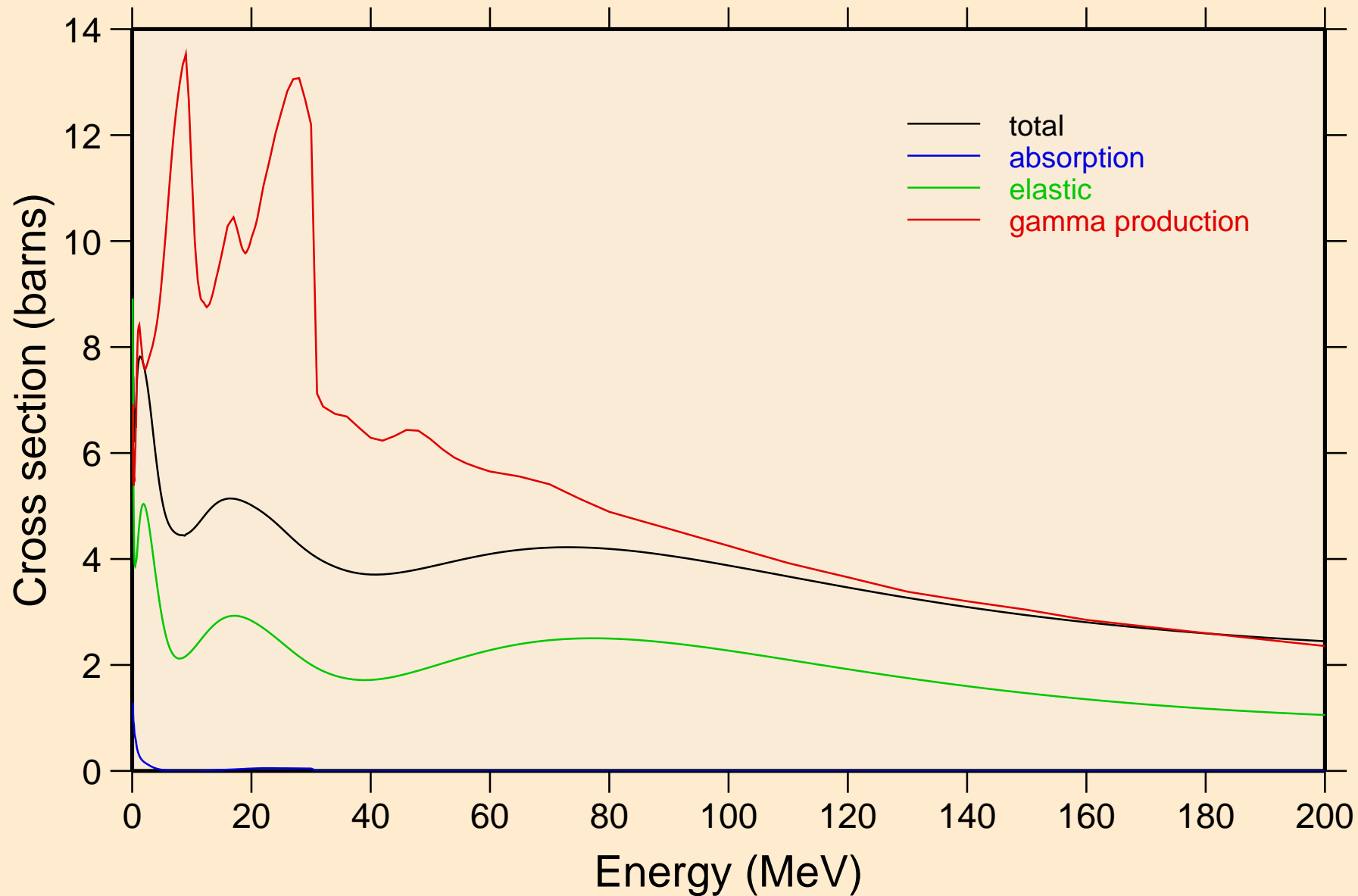

TB157 NEUTRON ACER TENDL-2023 LIBRARY; T=0.K

Heating

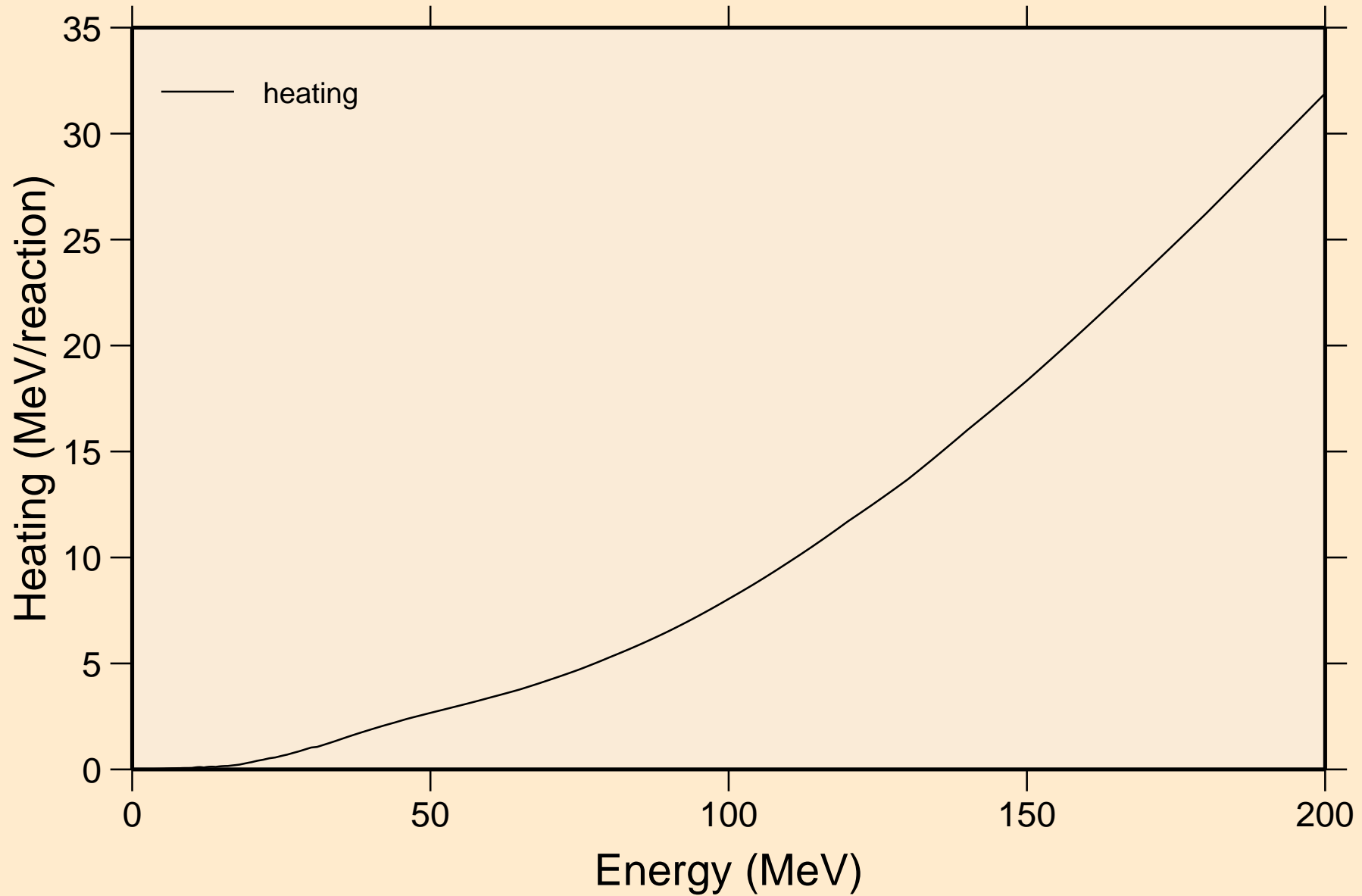

TB157 NEUTRON ACER TENDL-2023 LIBRARY; T=0.K
Damage

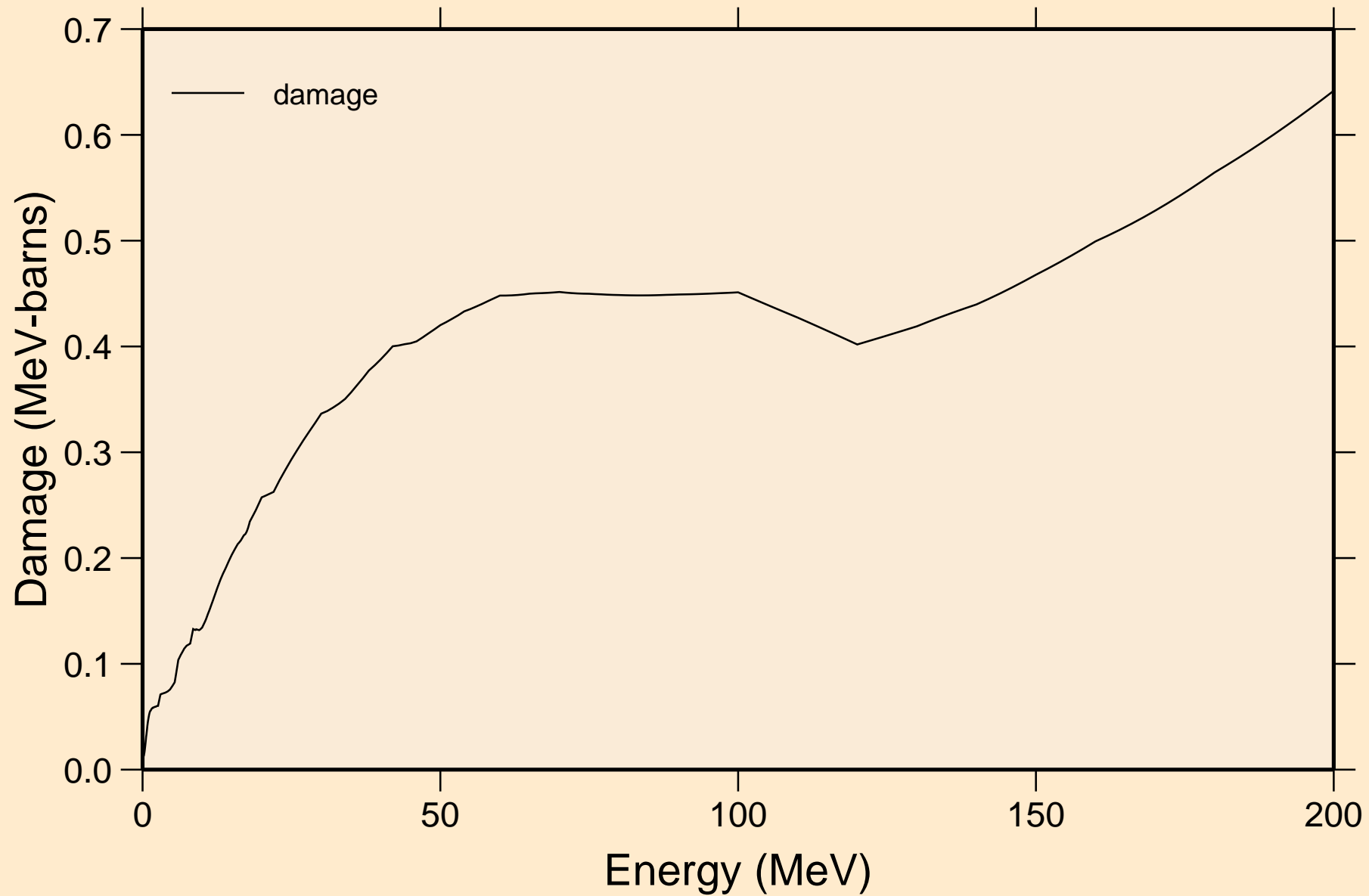

TB157 NEUTRON ACER TENDL-2023 LIBRARY; T=0.K
Non-threshold reactions

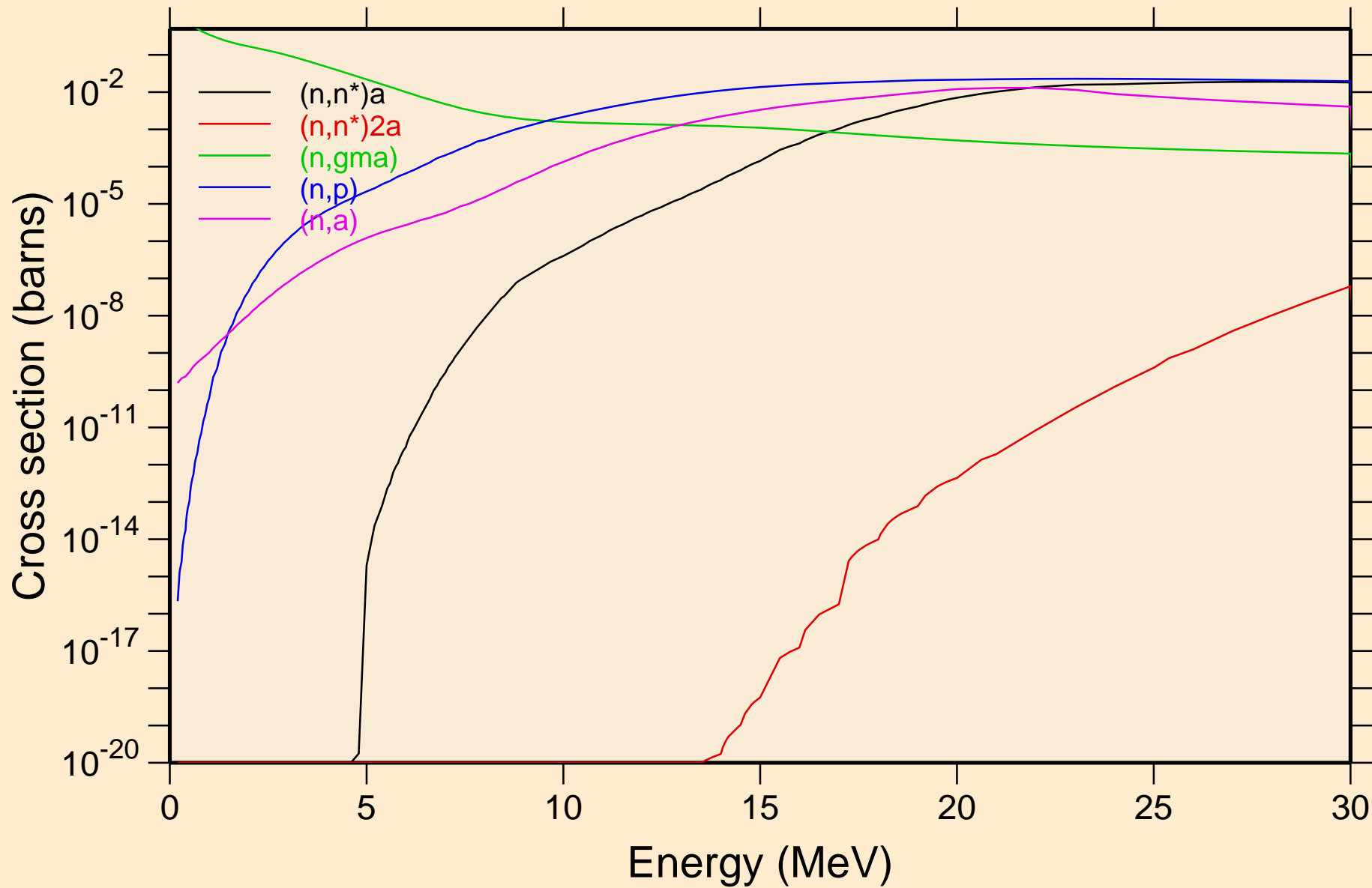

TB157 NEUTRON ACER TENDL-2023 LIBRARY; T=0.K
Non-threshold reactions

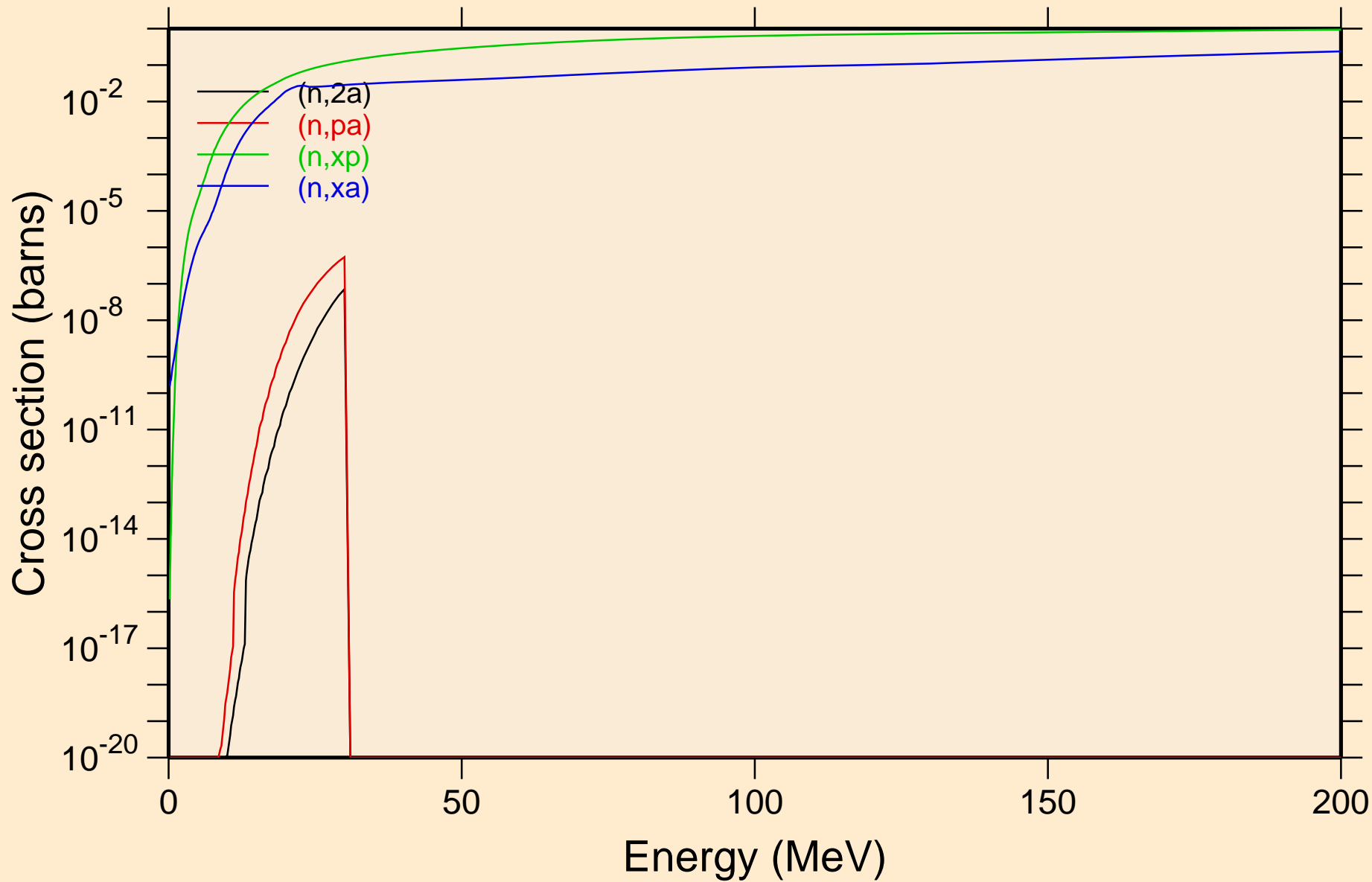

TB157 NEUTRON ACER TENDL-2023 LIBRARY; T=0.K
Inelastic levels

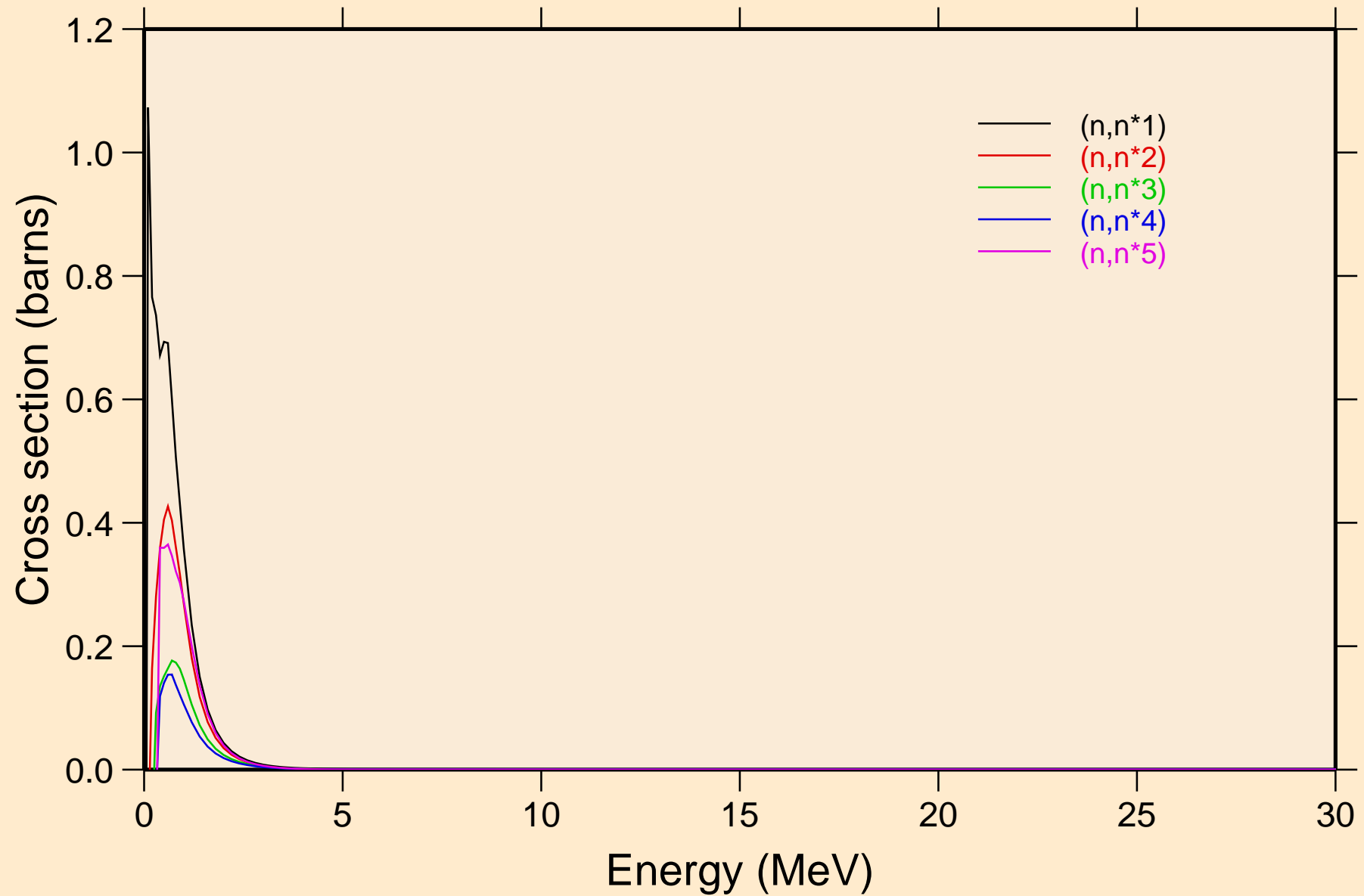

TB157 NEUTRON ACER TENDL-2023 LIBRARY; T=0.K
Inelastic levels

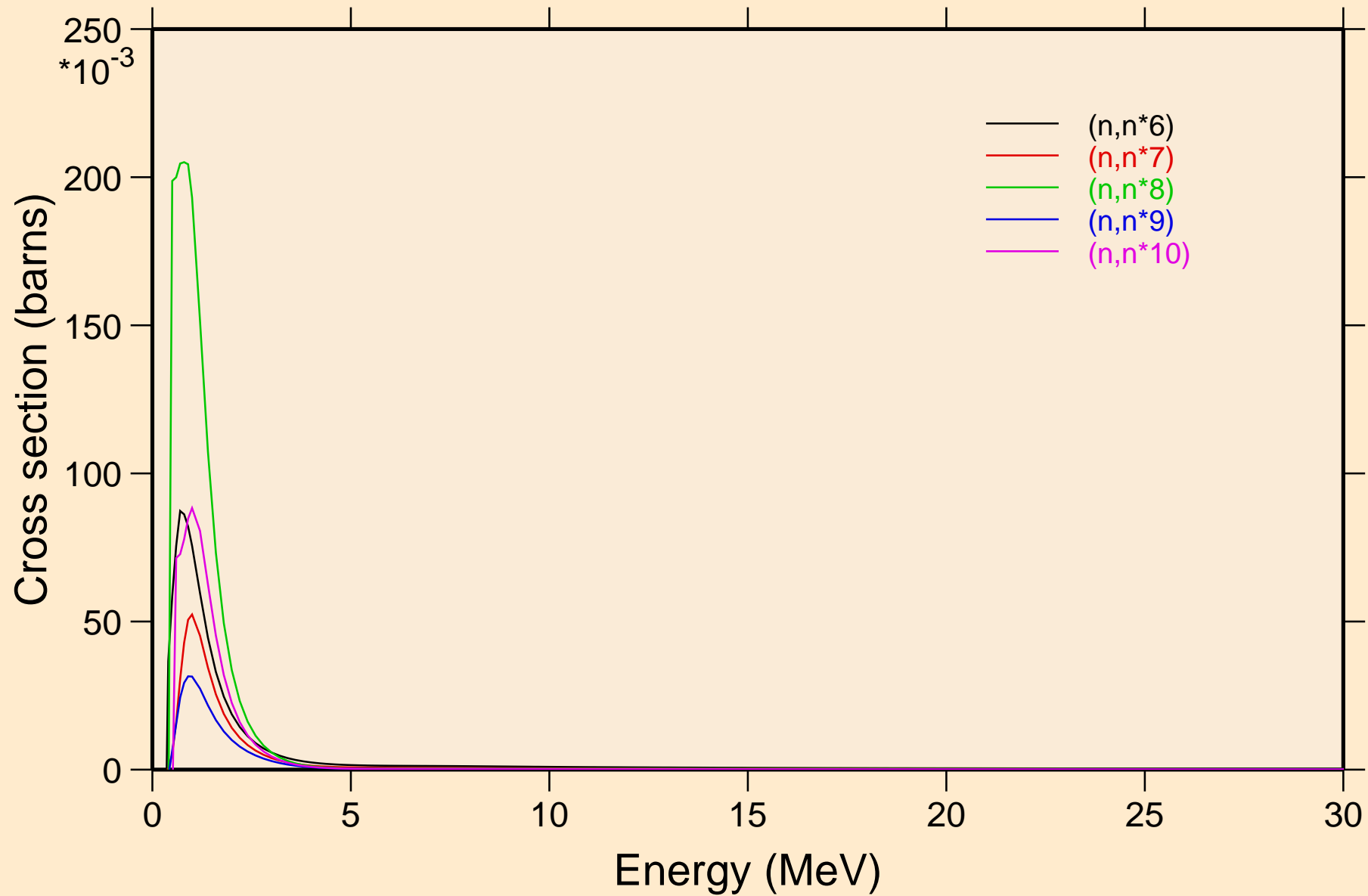

TB157 NEUTRON ACER TENDL-2023 LIBRARY; T=0.K
Inelastic levels

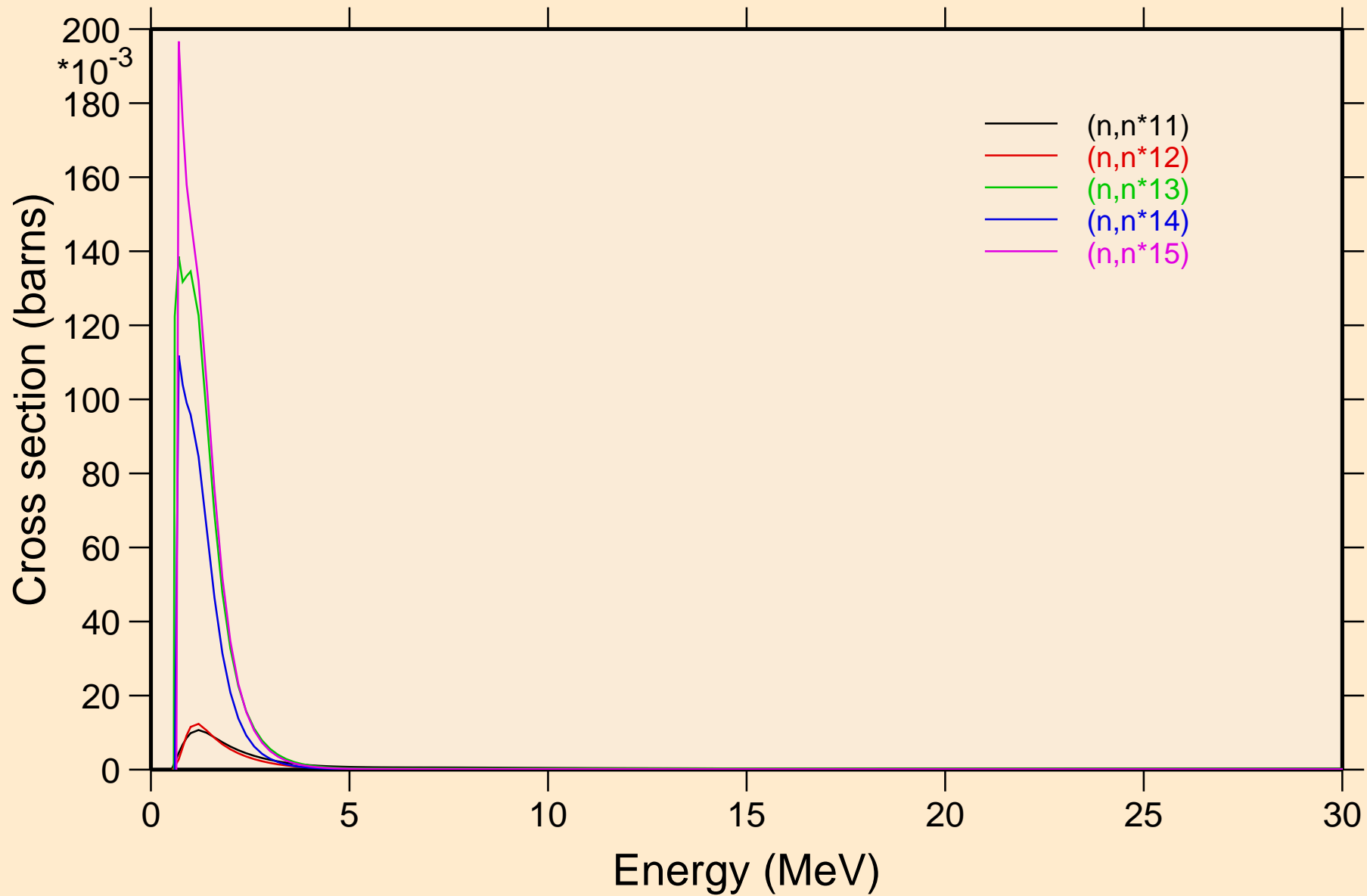

TB157 NEUTRON ACER TENDL-2023 LIBRARY; T=0.K
Inelastic levels

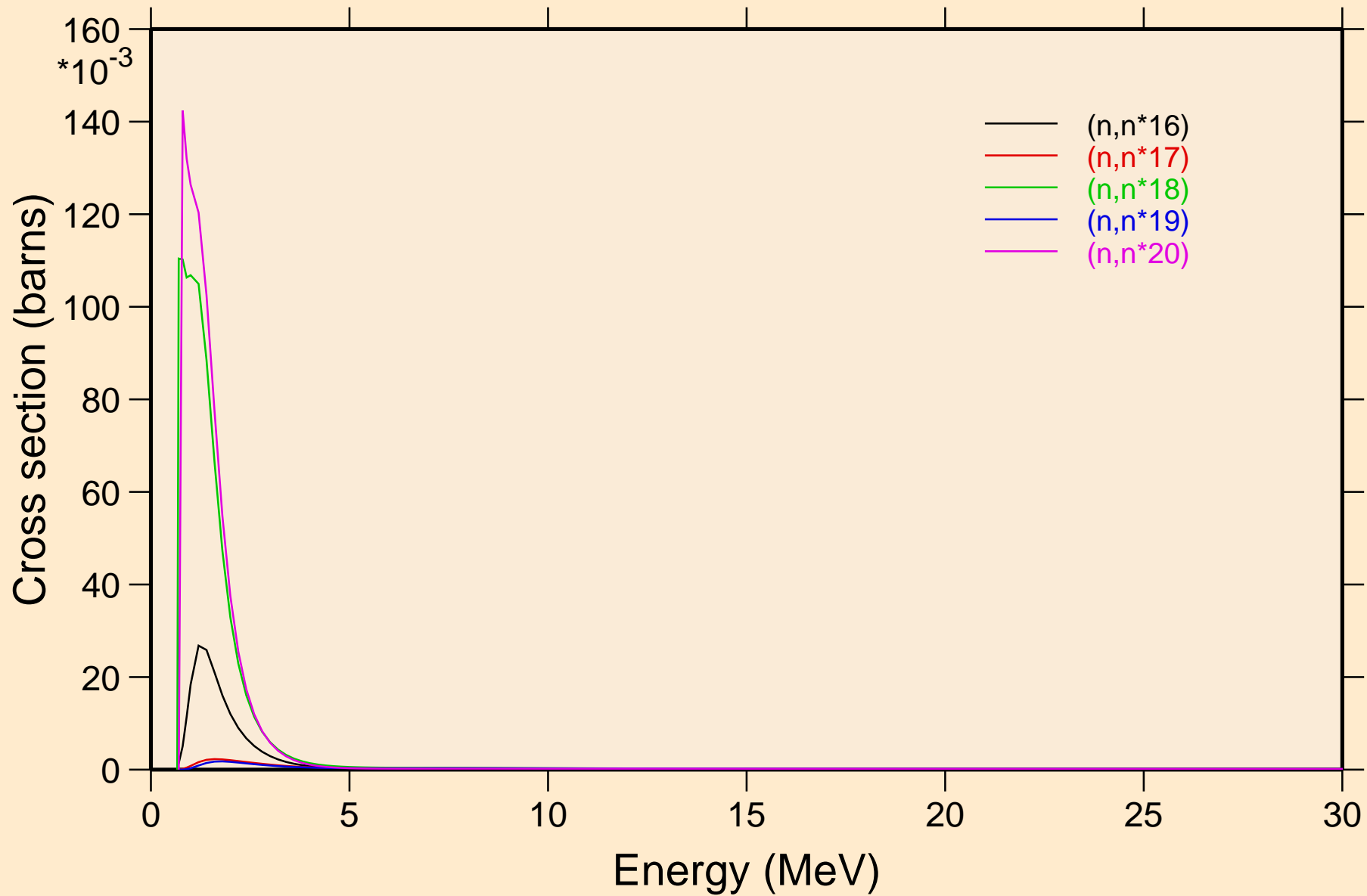

TB157 NEUTRON ACER TENDL-2023 LIBRARY; T=0.K
Threshold reactions

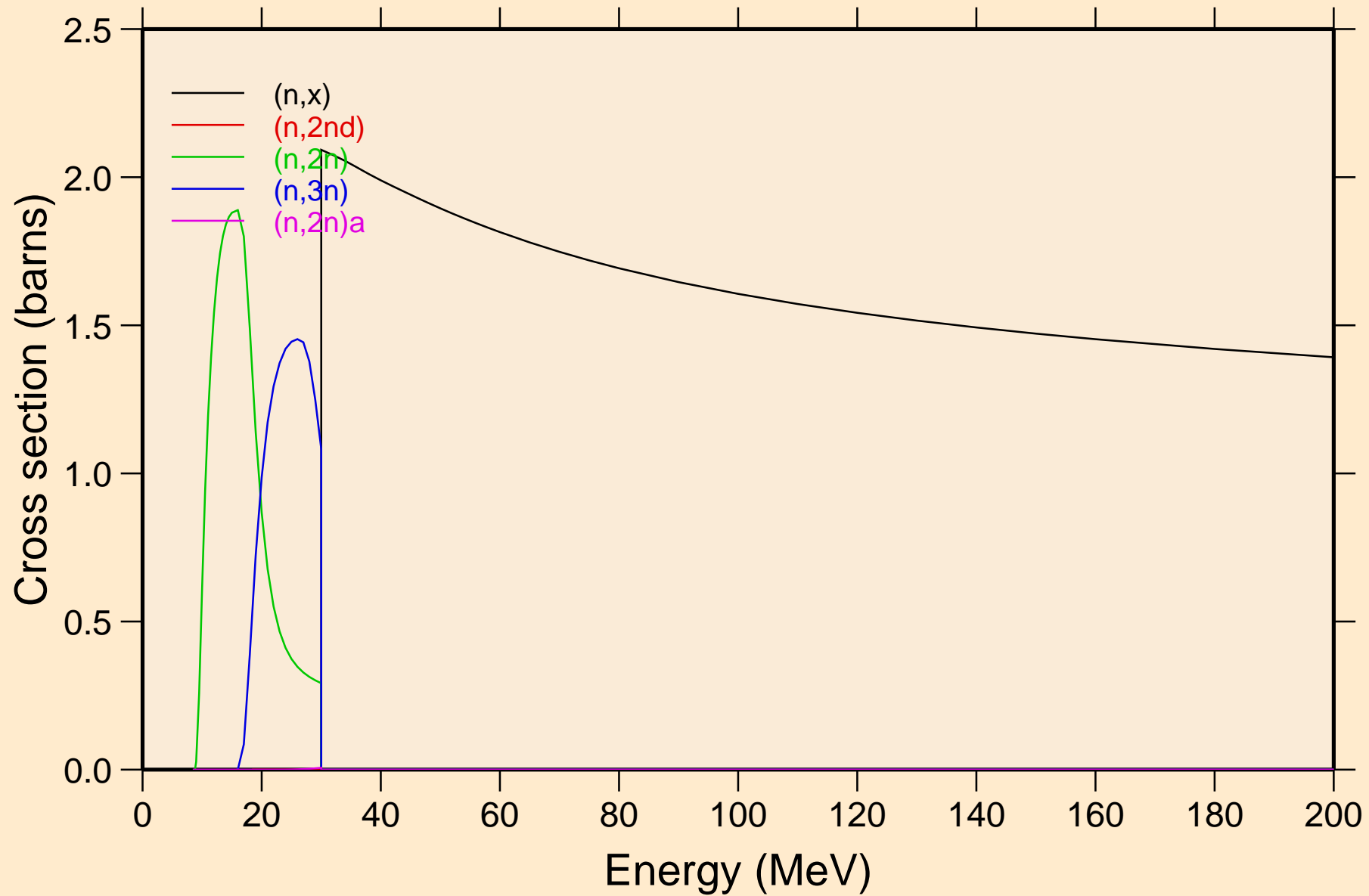

TB157 NEUTRON ACER TENDL-2023 LIBRARY; T=0.K
Threshold reactions

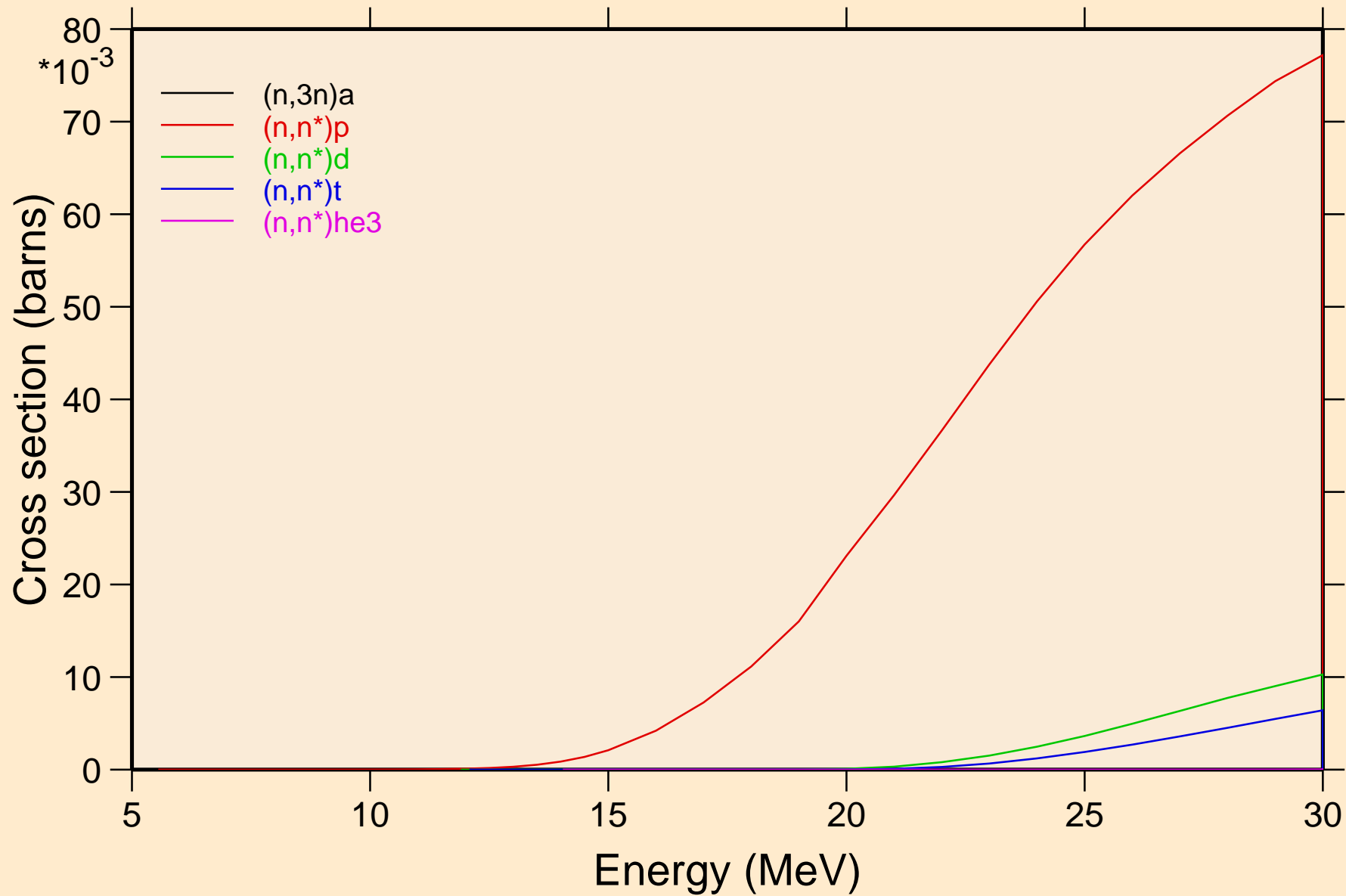

TB157 NEUTRON ACER TENDL-2023 LIBRARY; T=0.K
Threshold reactions

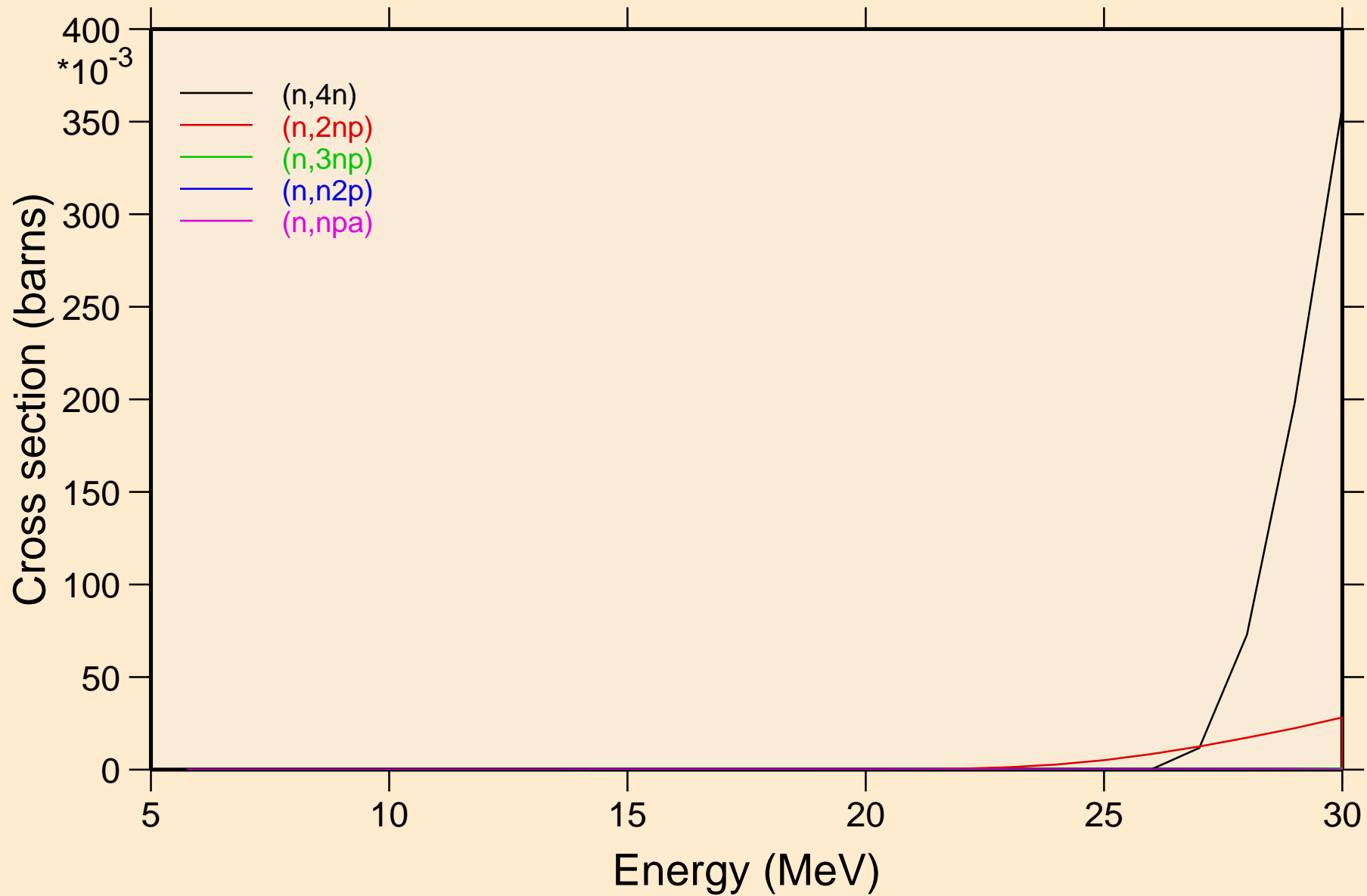

TB157 NEUTRON ACER TENDL-2023 LIBRARY; T=0.K
Threshold reactions

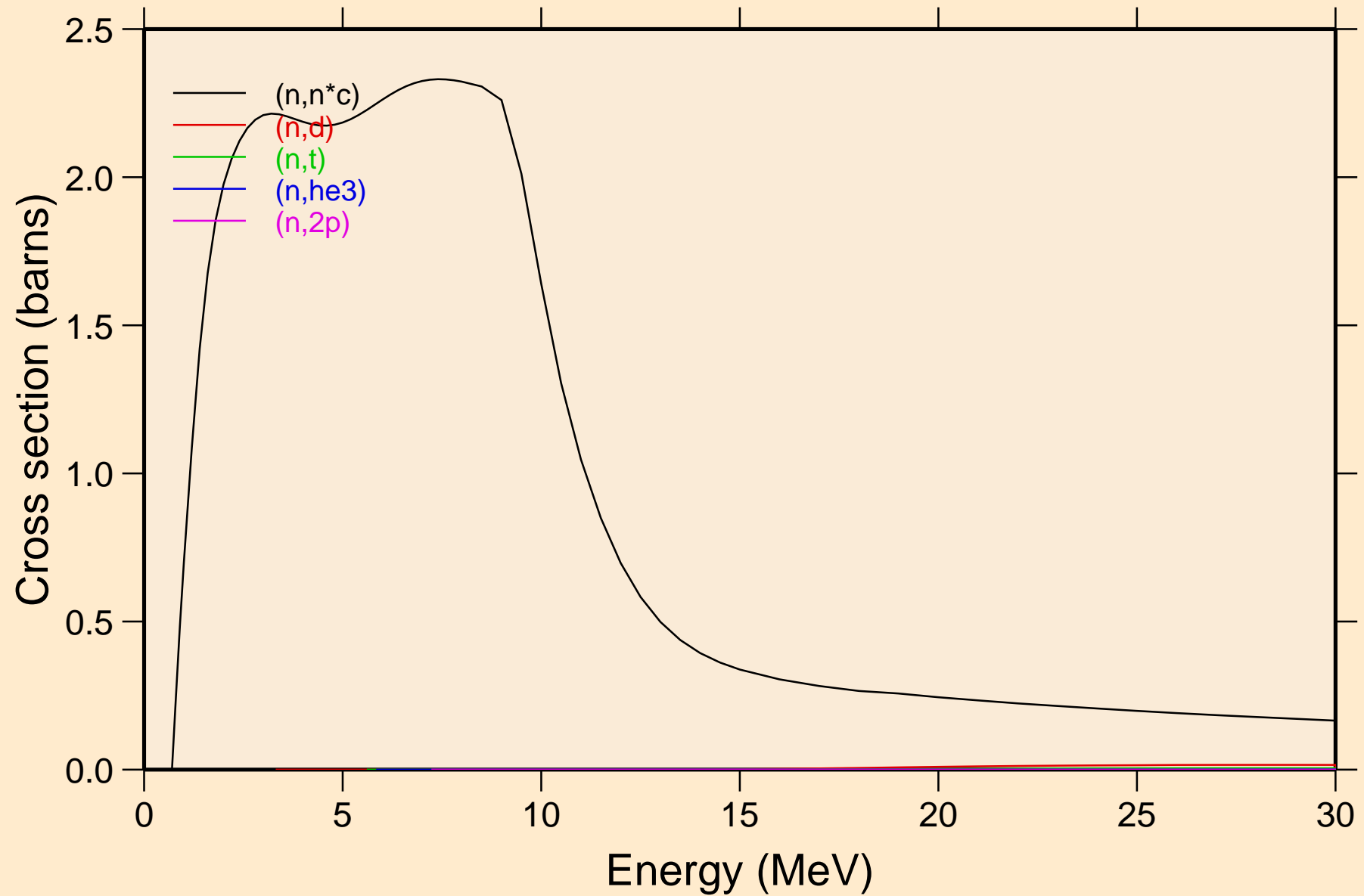

TB157 NEUTRON ACER TENDL-2023 LIBRARY; T=0.K
Threshold reactions

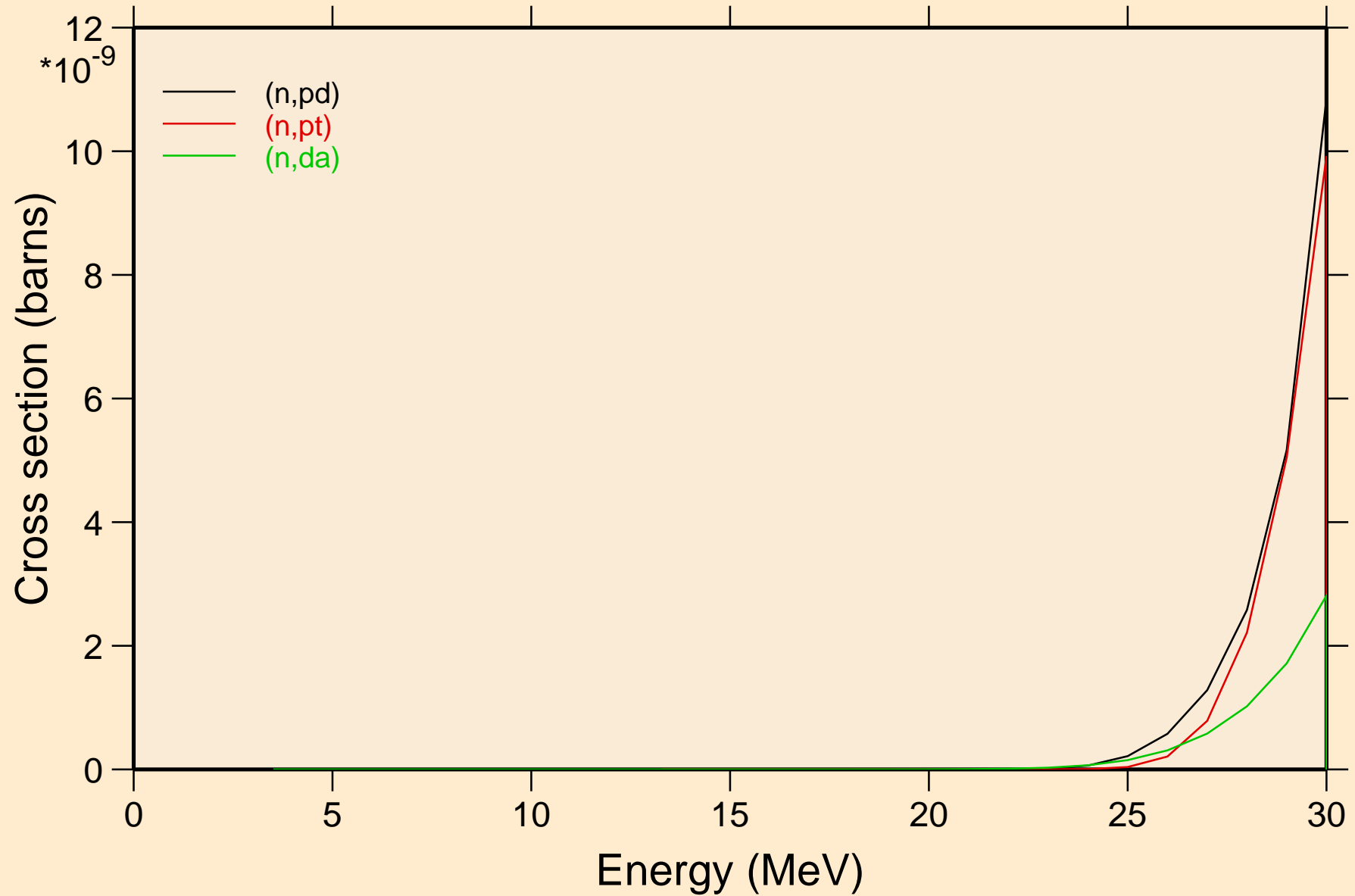

TB157 NEUTRON ACER TENDL-2023 LIBRARY; T=0.K

Threshold reactions

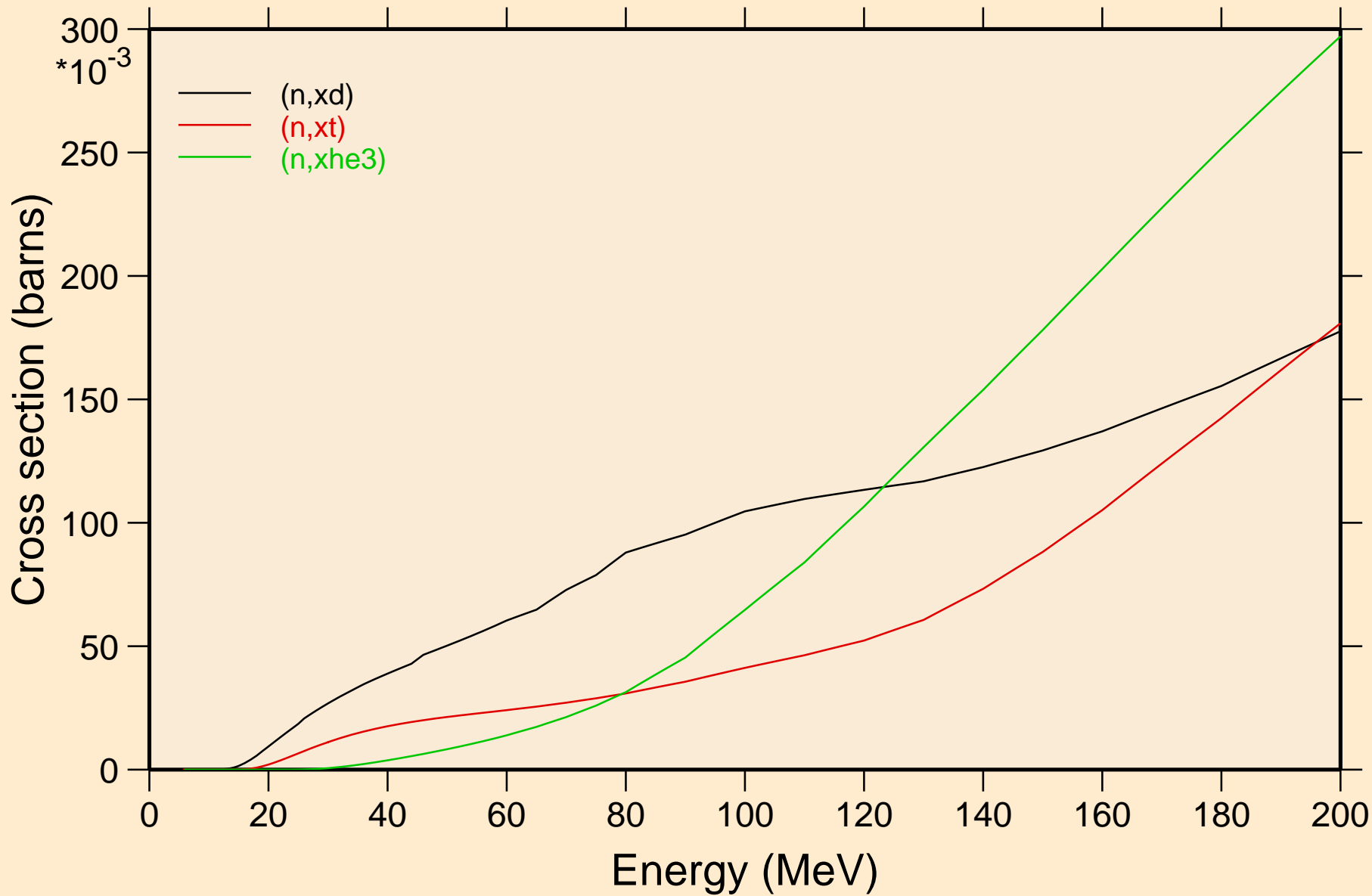

TB157 NEUTRON ACER TENDL-2023 LIBRARY; T=0.K
angular distribution for elastic

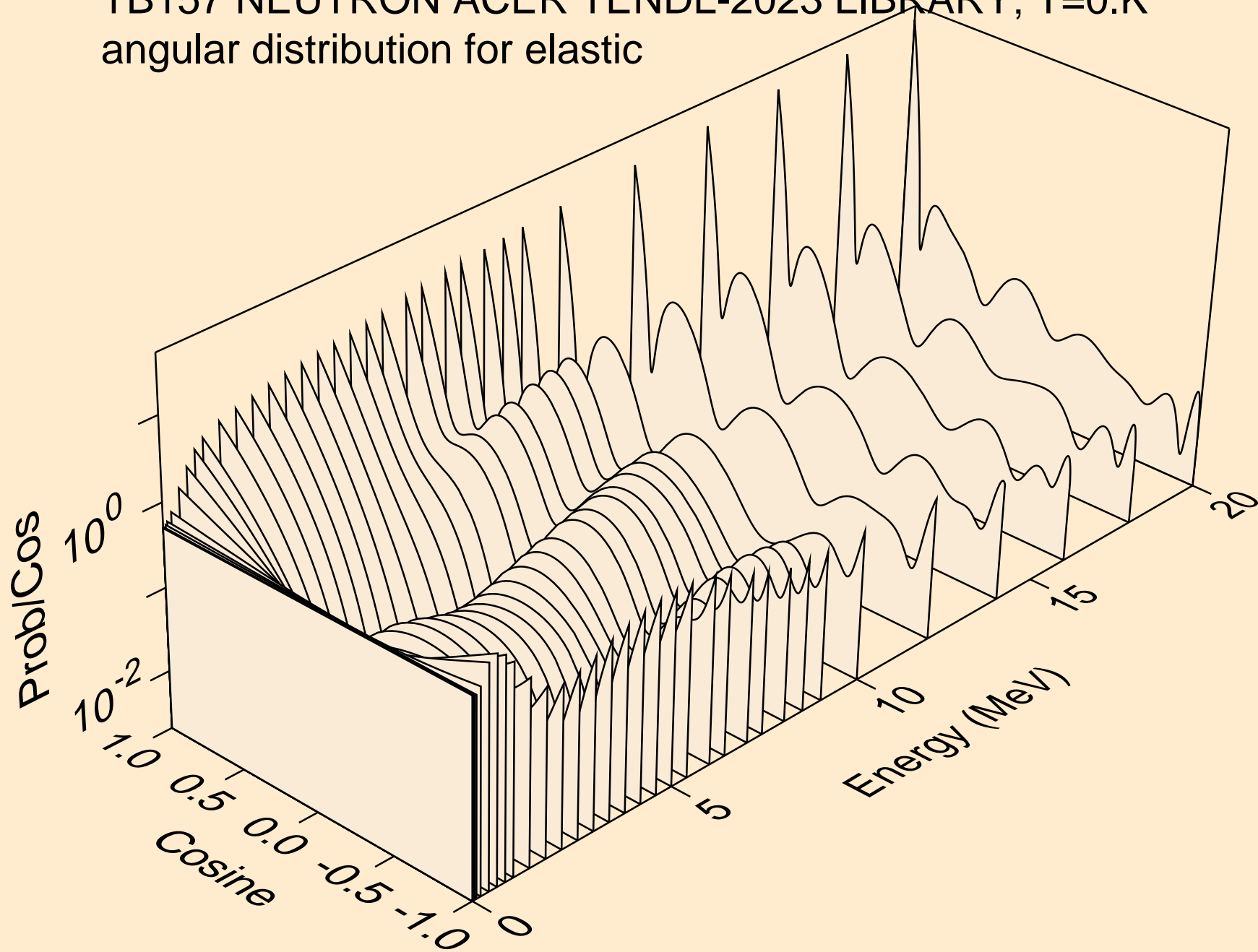

TB157 NEUTRON ACER TENDL-2023 LIBRARY; T=0.K
angular distribution for elastic

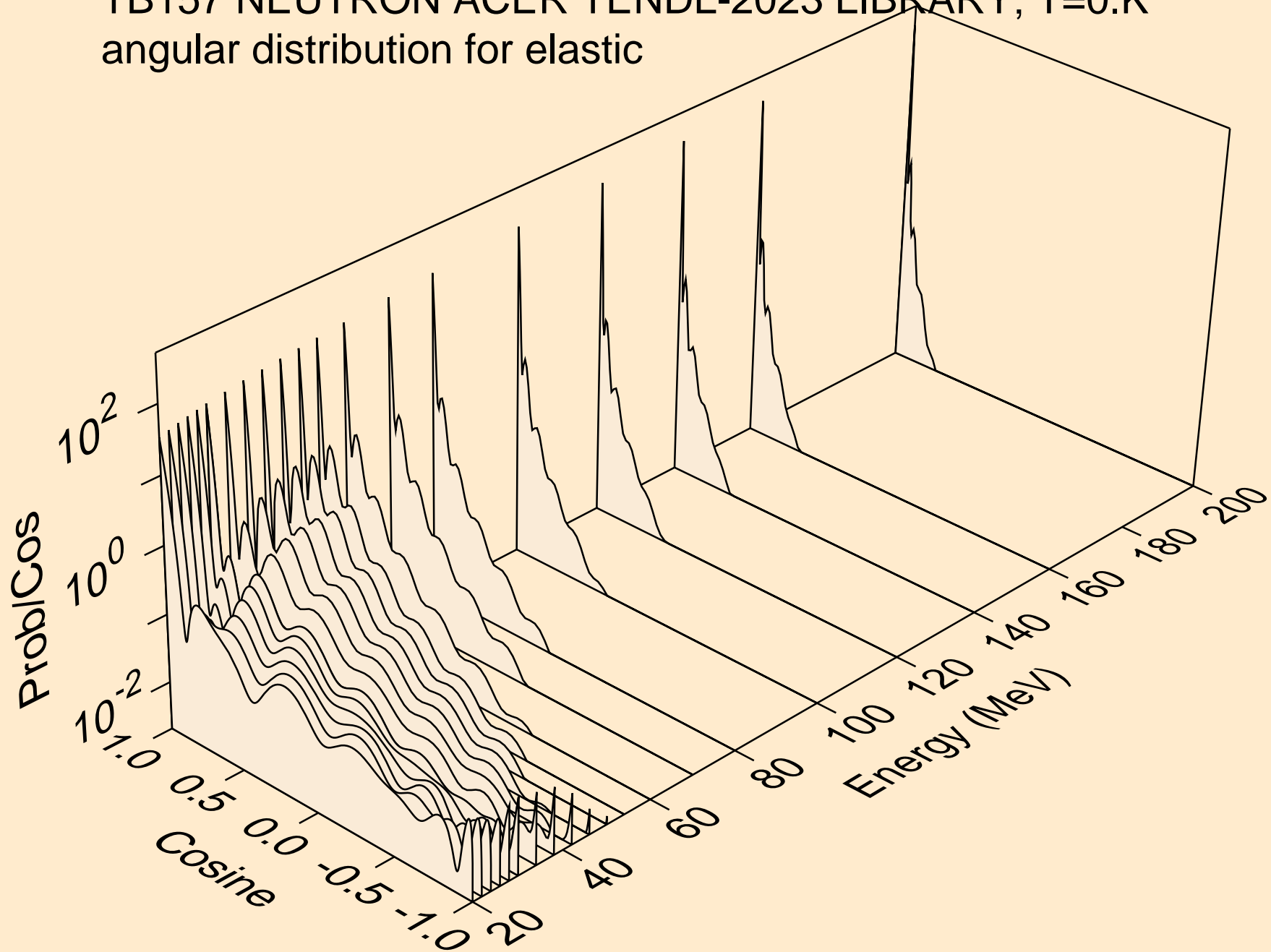

TB157 NEUTRON ACER TENDL-2023 LIBRARY; T=0.K
angular distribution for (n,n*1)

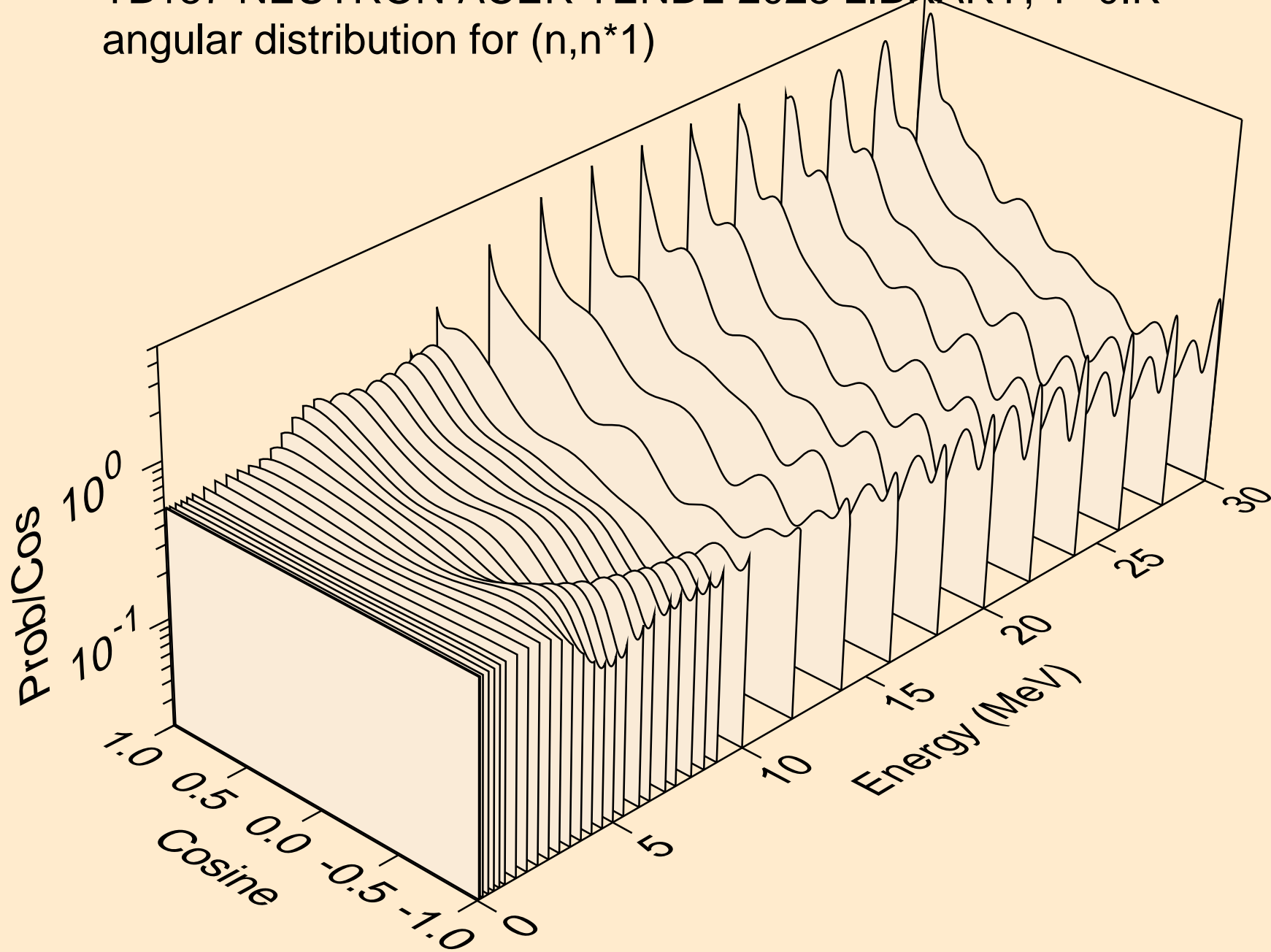

TB157 NEUTRON ACER TENDL-2023 LIBRARY; T=0.K
angular distribution for (n,n*2)

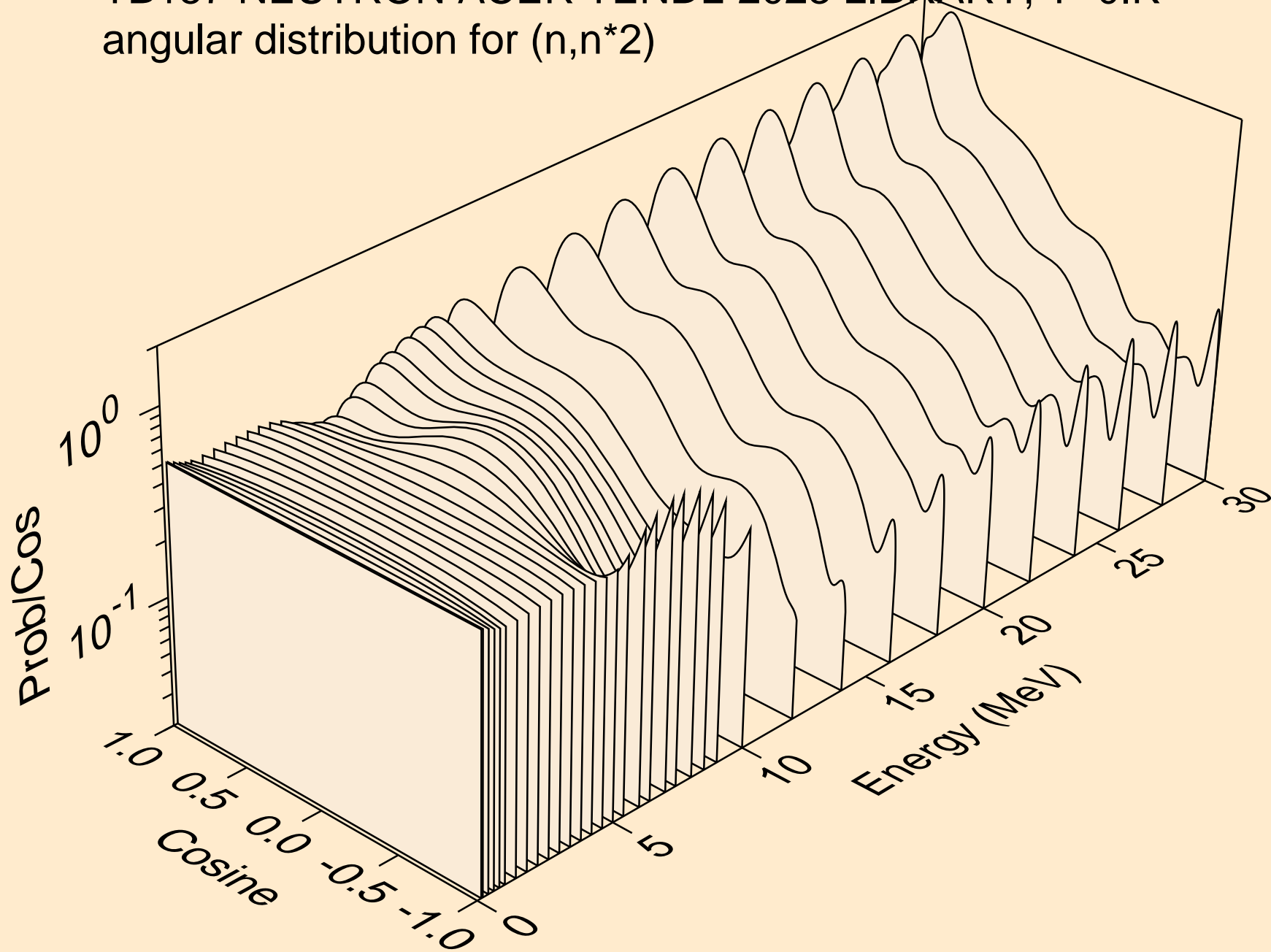

TB157 NEUTRON ACER TENDL-2023 LIBRARY; T=0.K
angular distribution for (n,n*3)

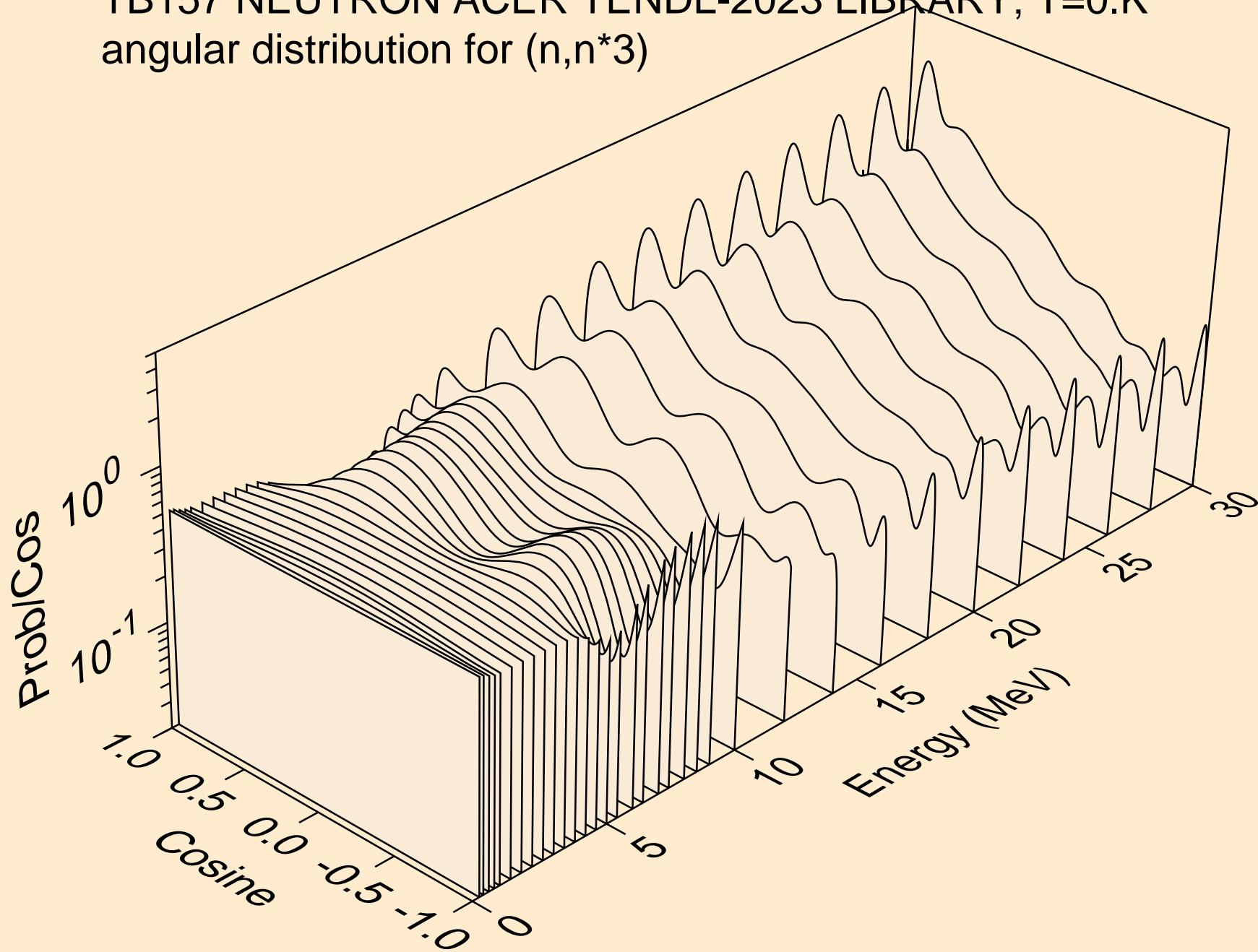

TB157 NEUTRON ACER TENDL-2023 LIBRARY; T=0.K
angular distribution for (n,n*4)

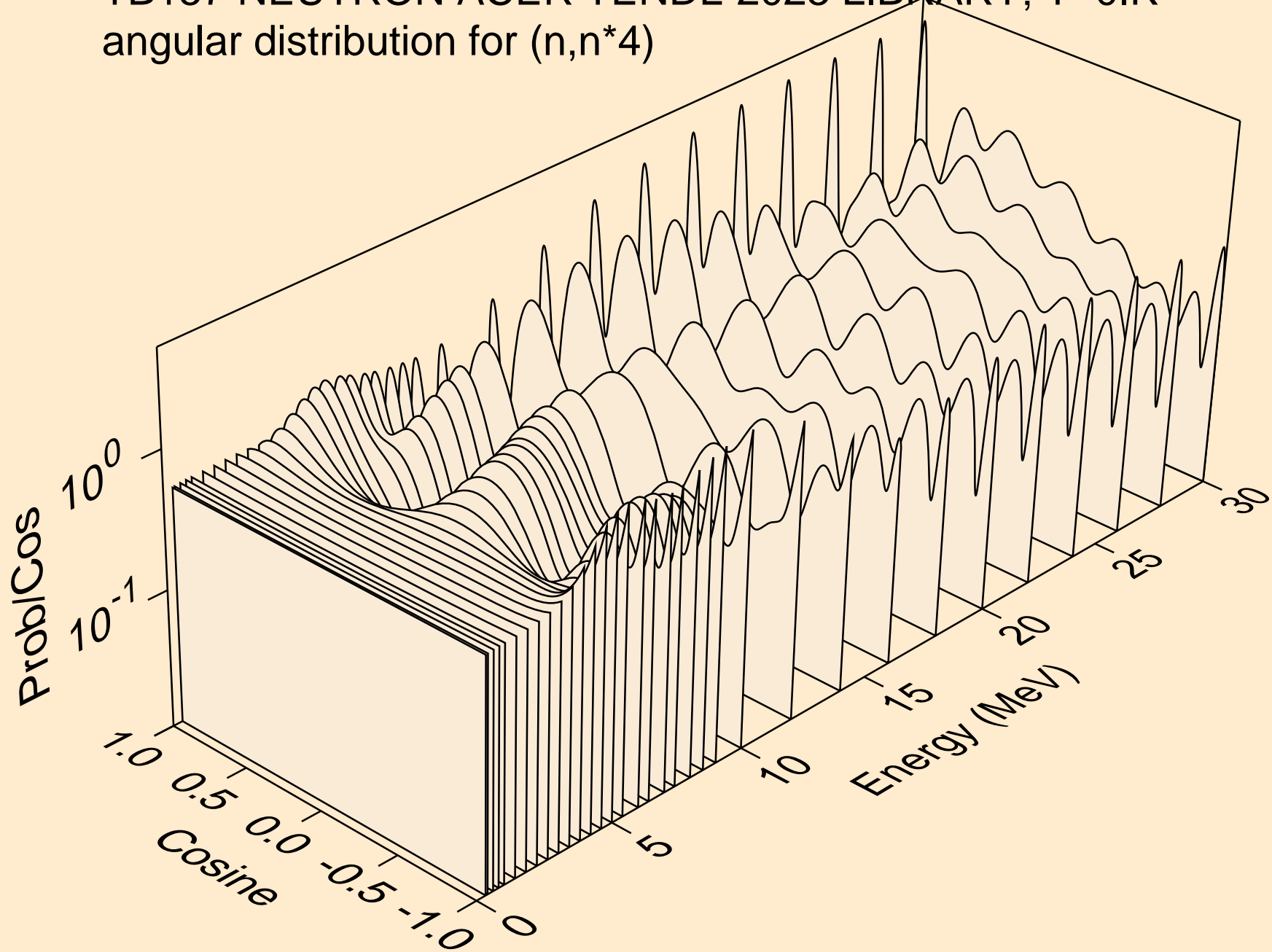

TB157 NEUTRON ACER TENDL-2023 LIBRARY; T=0.K
angular distribution for (n,n*5)

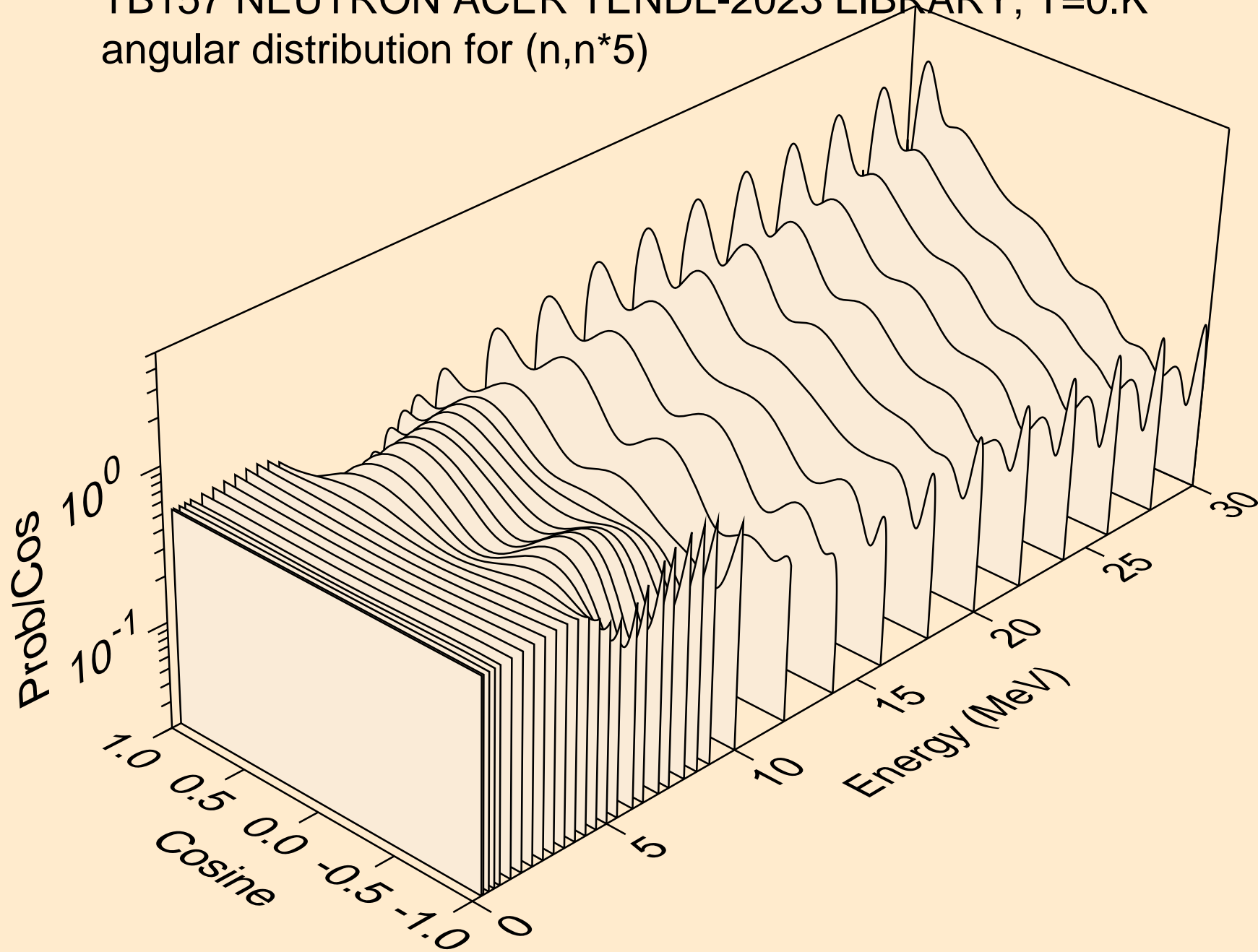

TB157 NEUTRON ACER TENDL-2023 LIBRARY; T=0.K
angular distribution for (n,n*6)

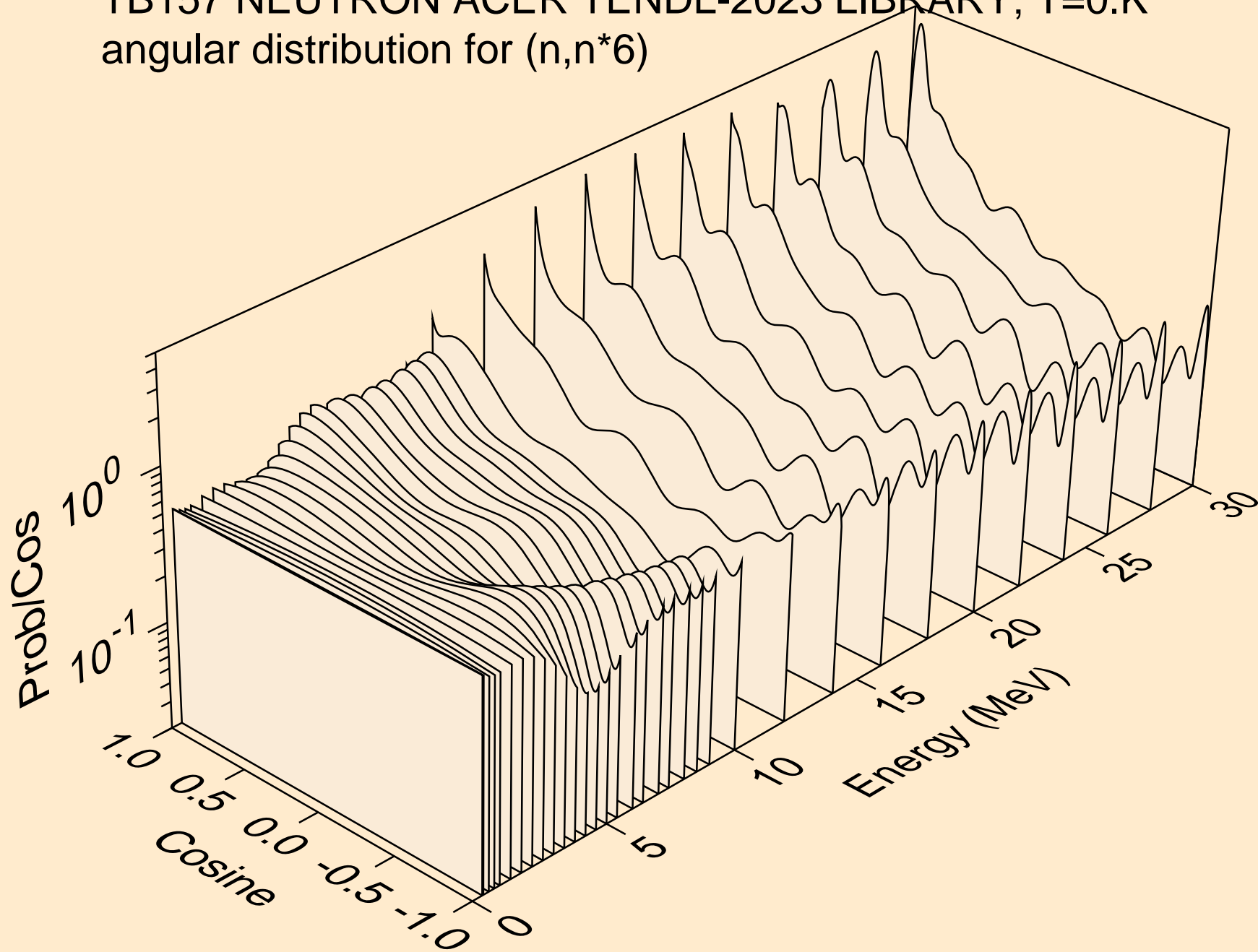

TB157 NEUTRON ACER TENDL-2023 LIBRARY; T=0.K
angular distribution for (n,n*7)

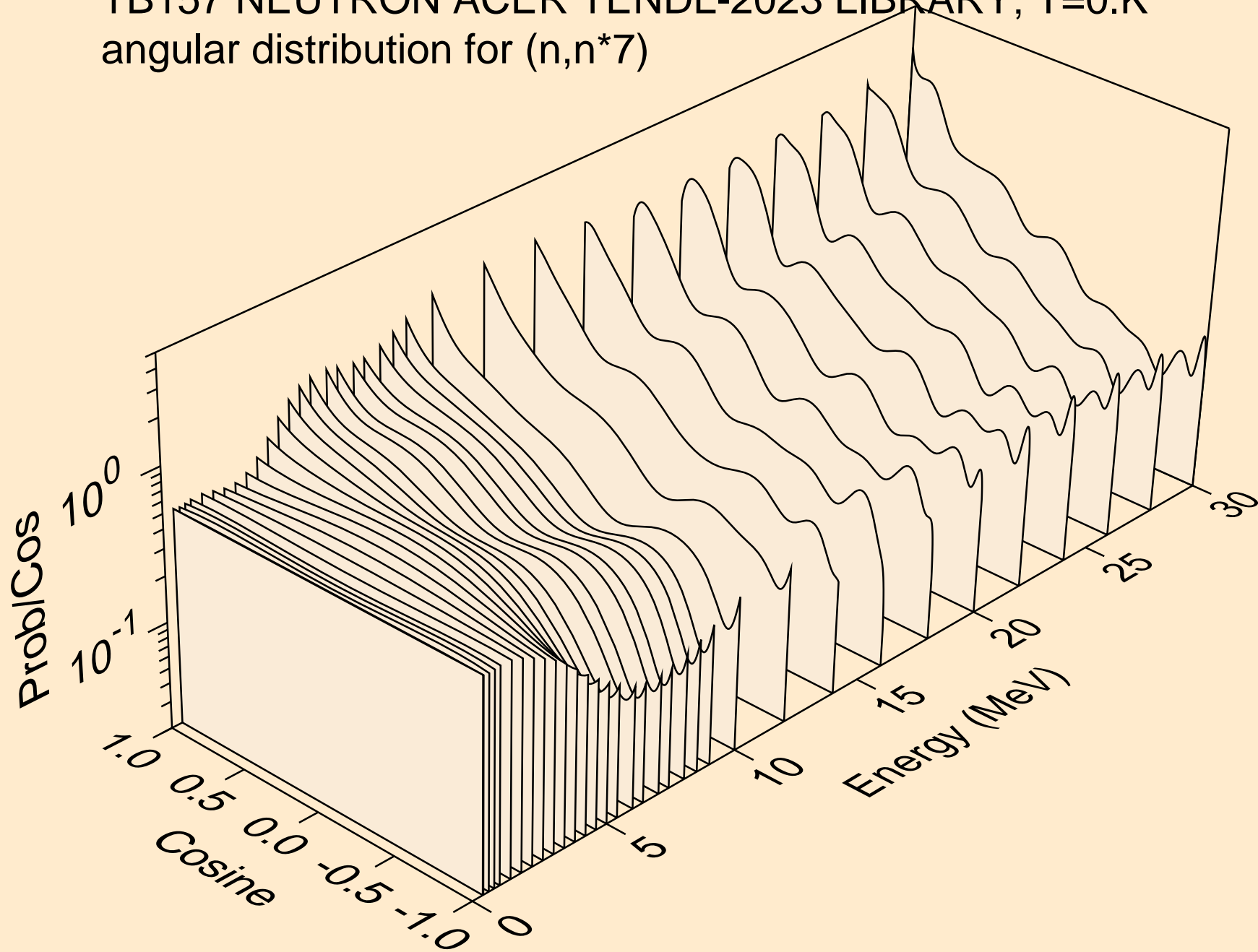

TB157 NEUTRON ACER TENDL-2023 LIBRARY; T=0.K
angular distribution for (n,n*8)

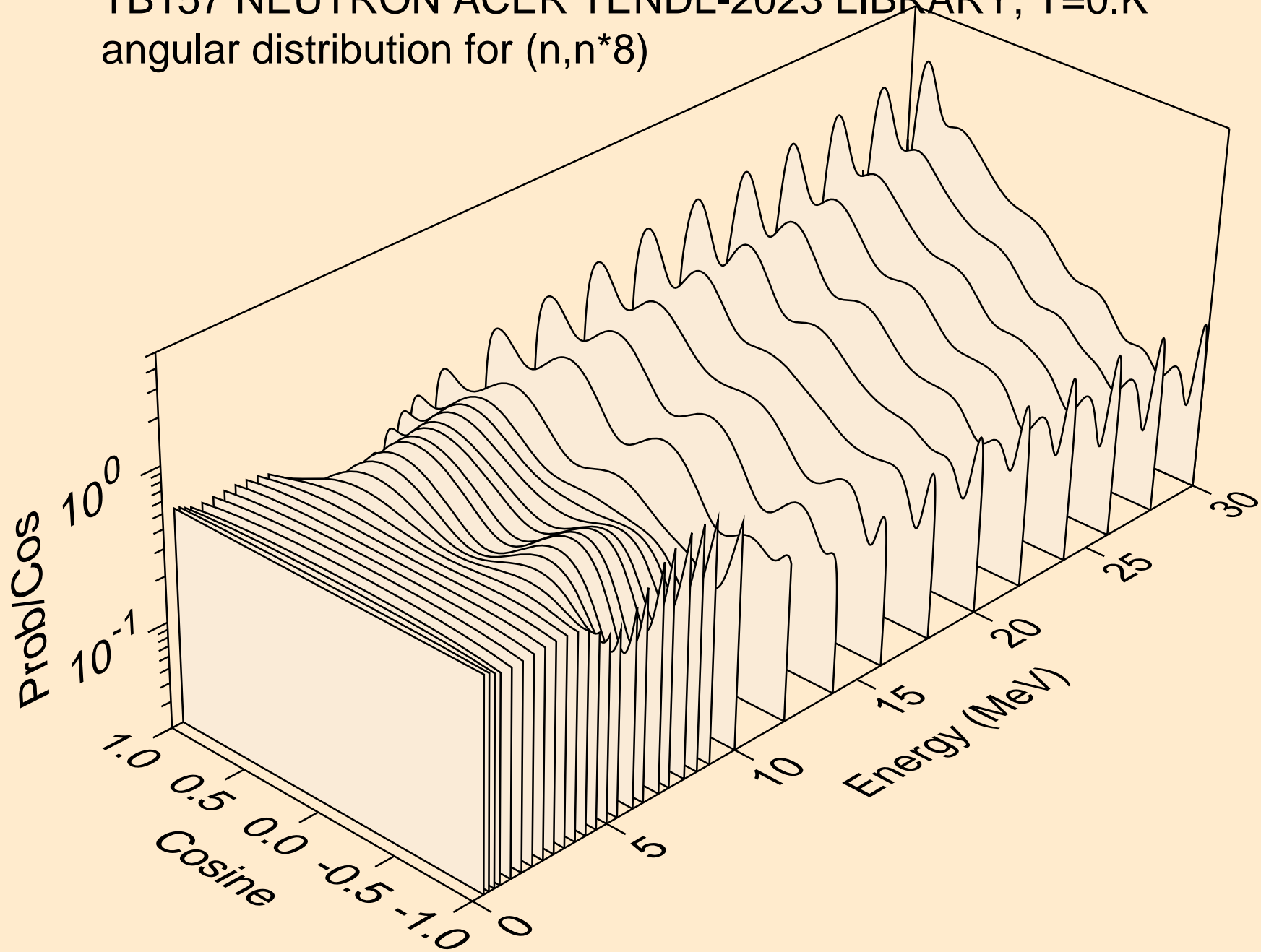

TB157 NEUTRON ACER TENDL-2023 LIBRARY; T=0.K
angular distribution for (n,n*9)

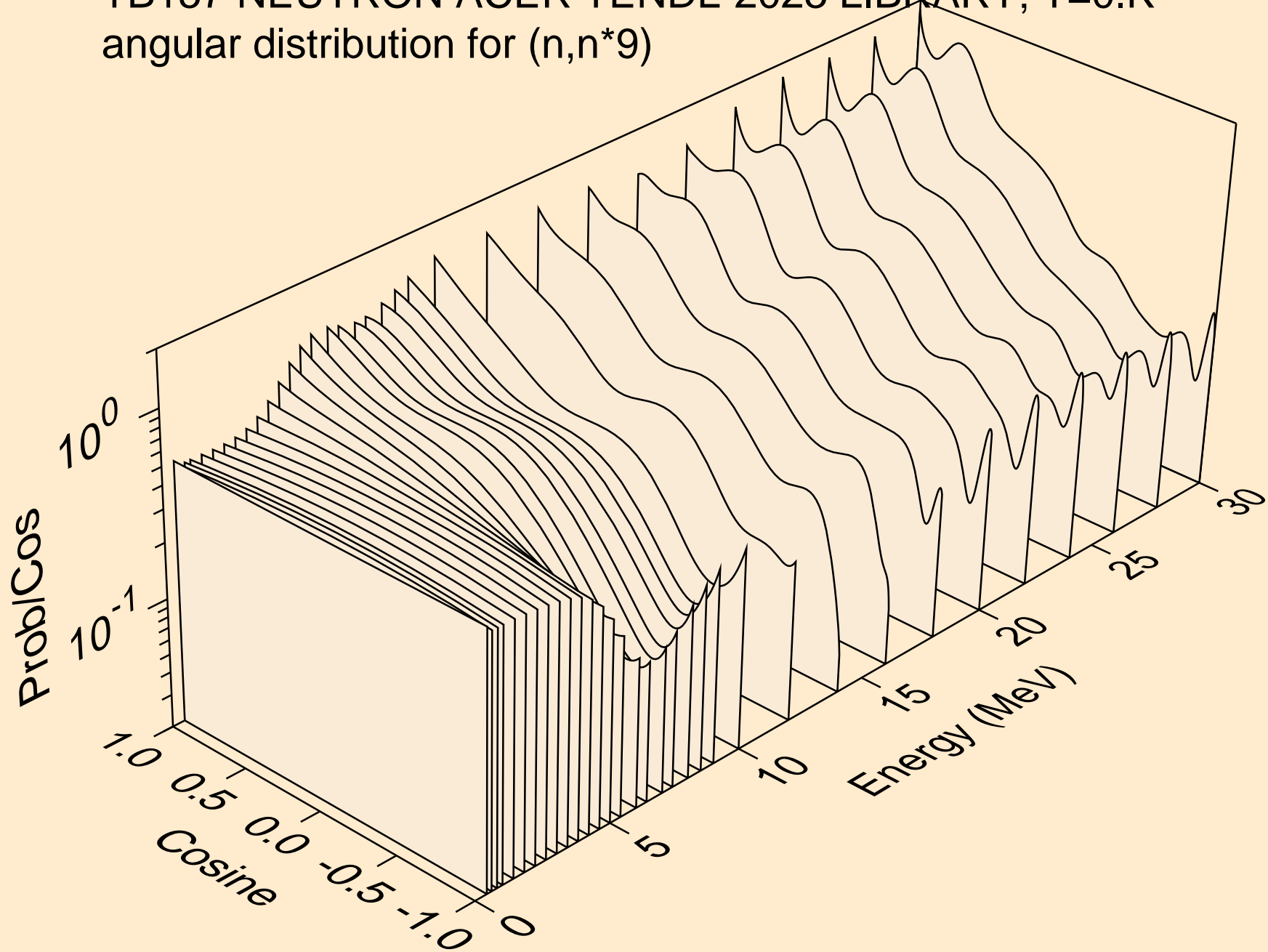

TB157 NEUTRON ACER TENDL-2023 LIBRARY; T=0.K
angular distribution for (n,n*10)

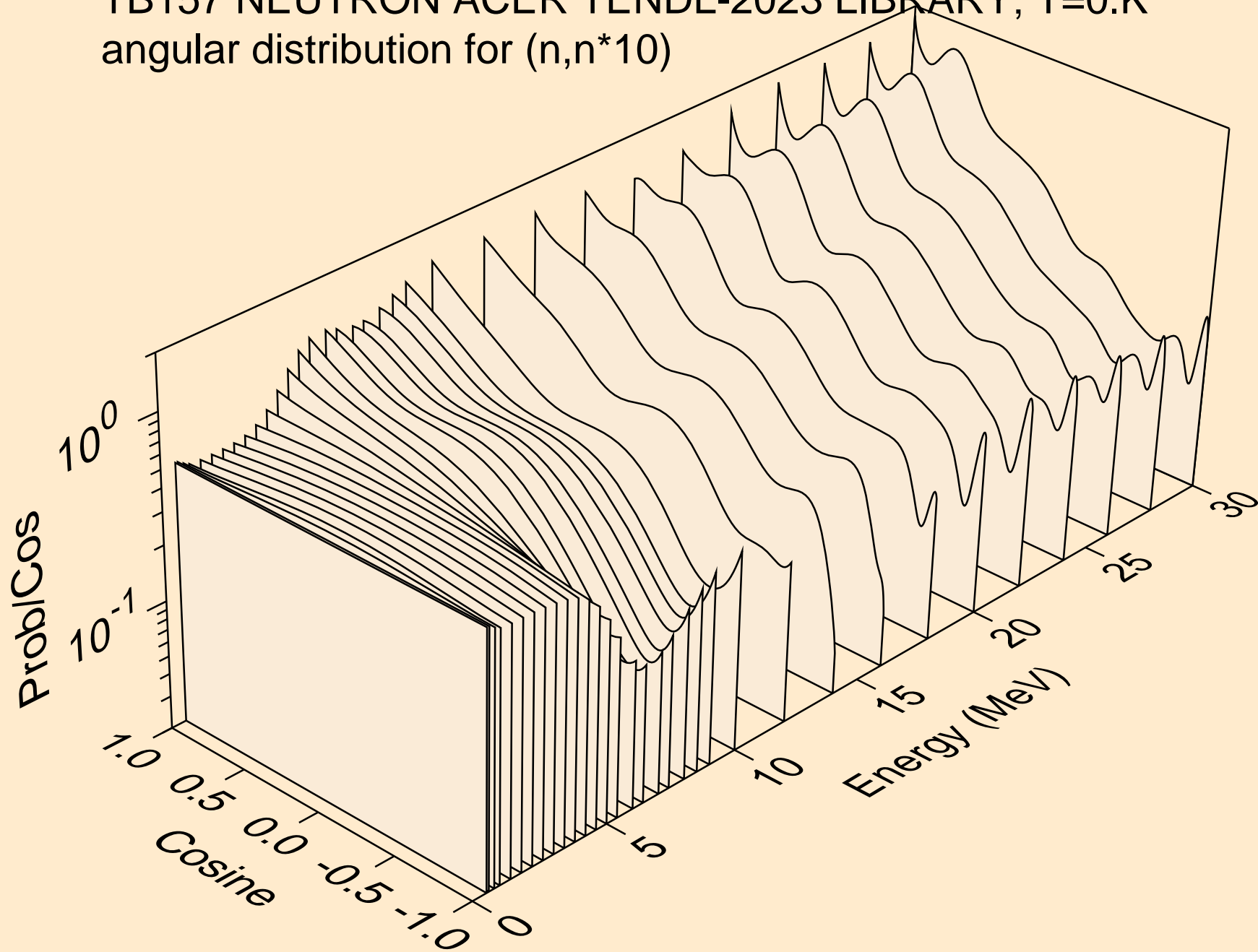

TB157 NEUTRON ACER TENDL-2023 LIBRARY; T=0.K
angular distribution for (n,n*11)

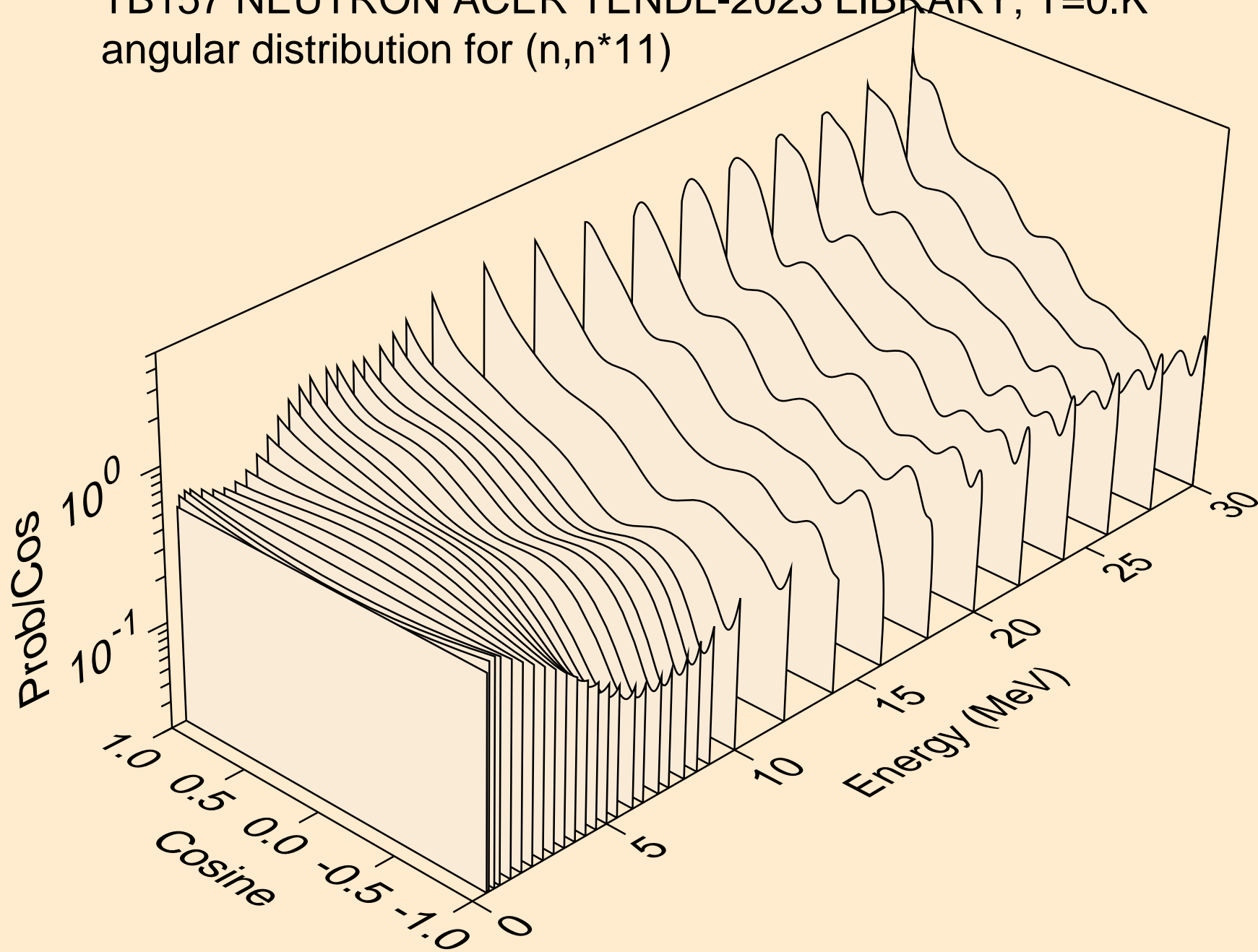

TB157 NEUTRON ACER TENDL-2023 LIBRARY; T=0.K
angular distribution for (n,n*12)

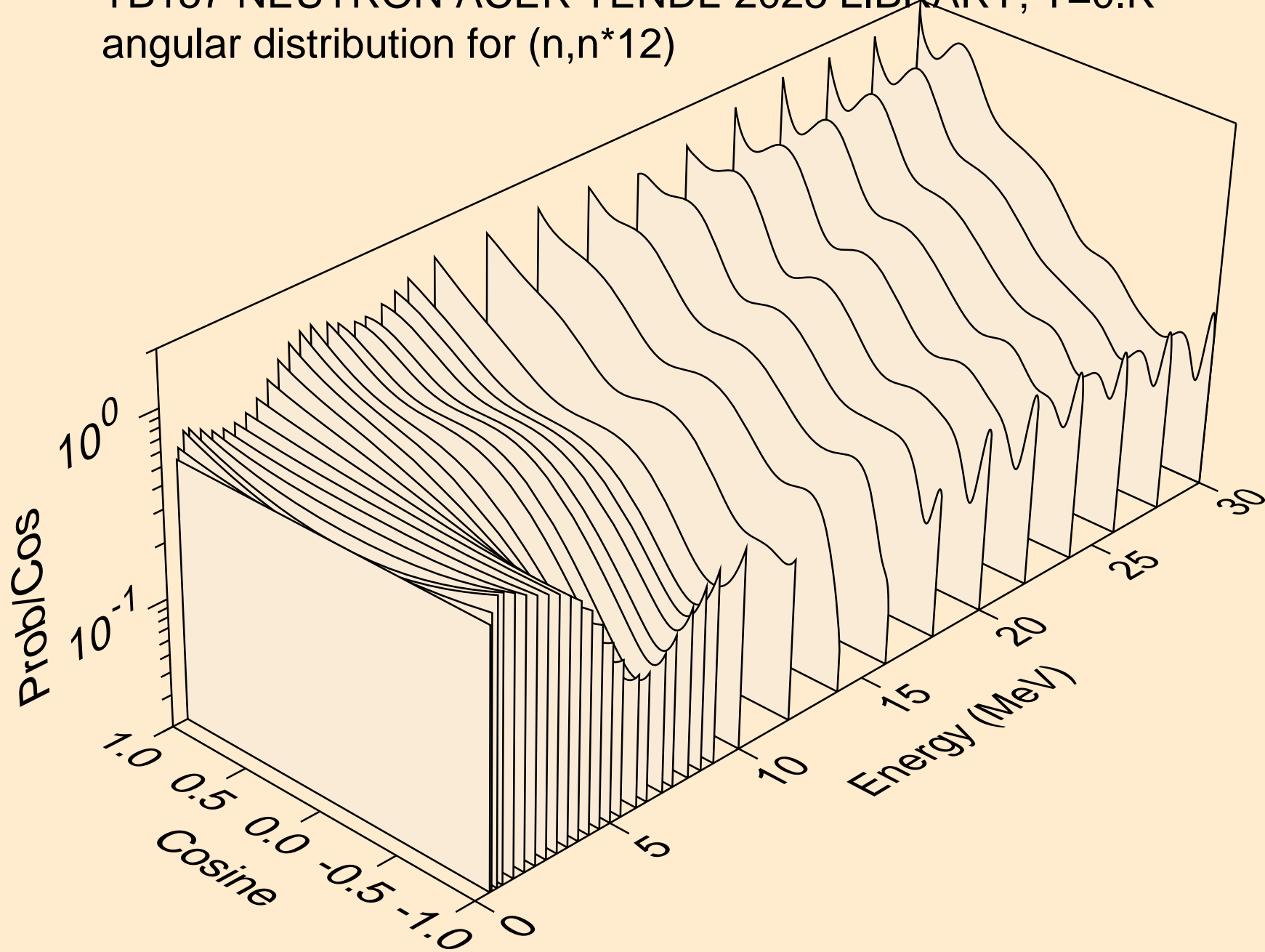

TB157 NEUTRON ACER TENDL-2023 LIBRARY; T=0.K
angular distribution for (n,n*13)

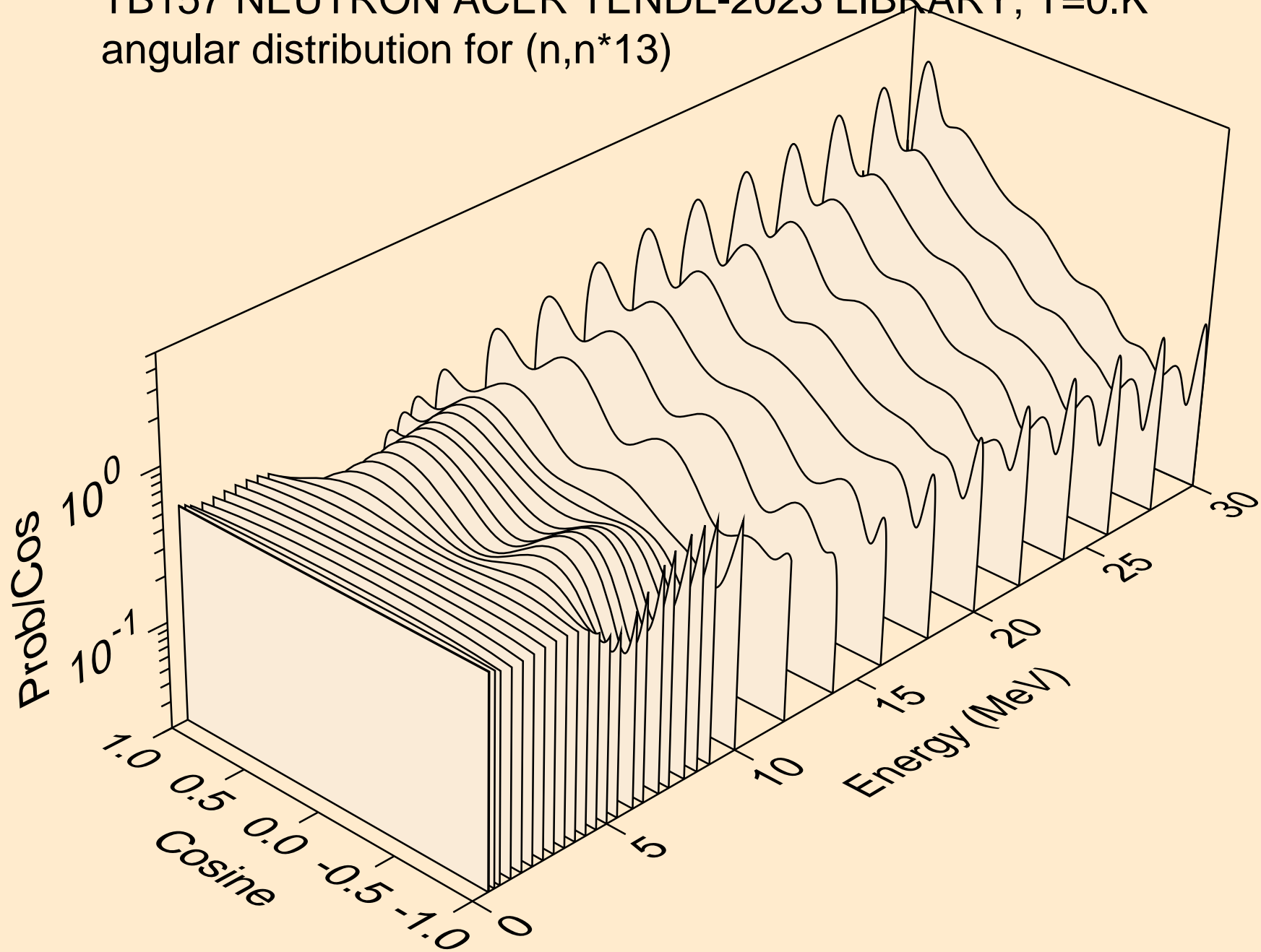

TB157 NEUTRON ACER TENDL-2023 LIBRARY; T=0.K
angular distribution for (n,n*14)

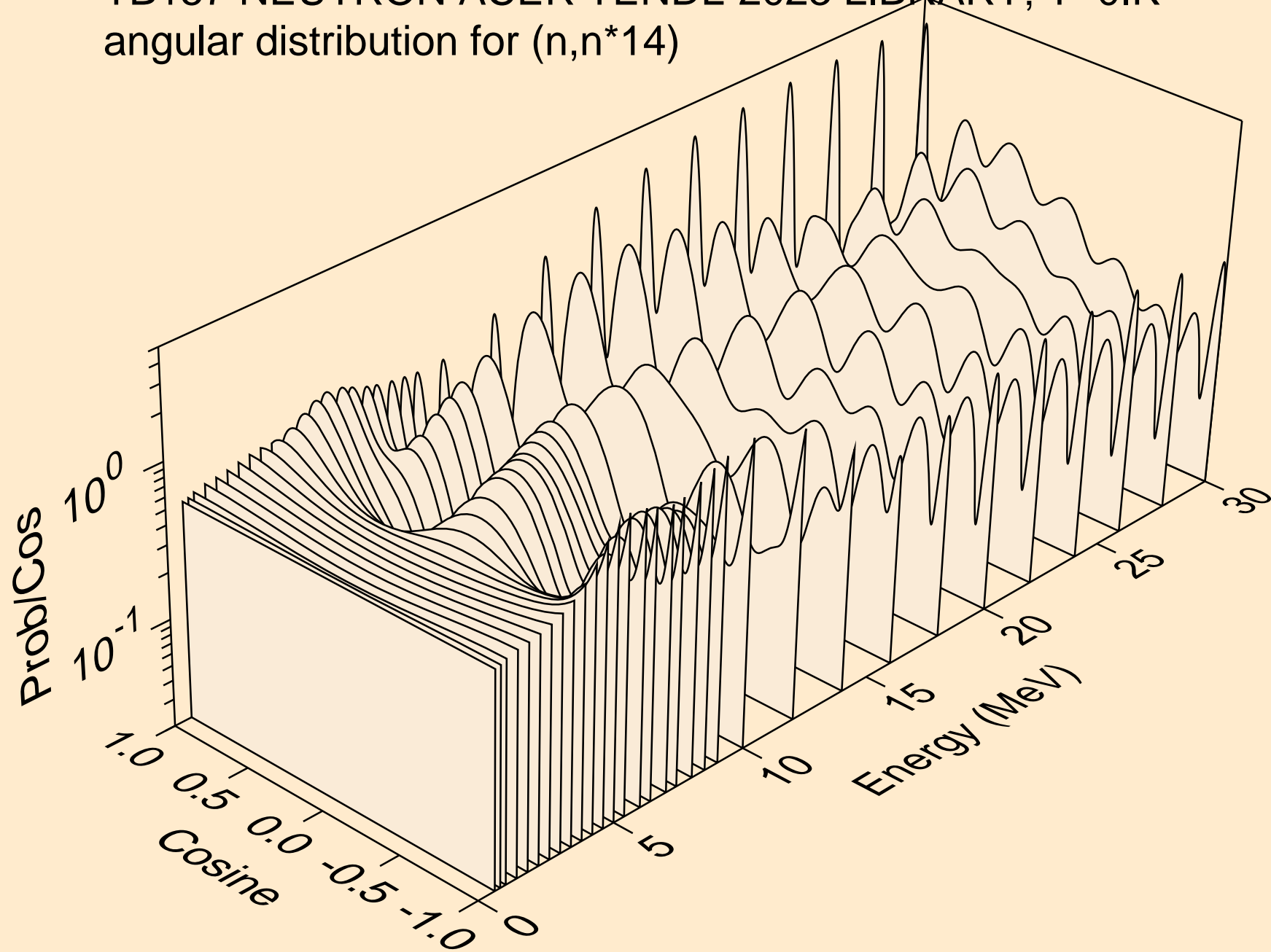

TB157 NEUTRON ACER TENDL-2023 LIBRARY; T=0.K
angular distribution for (n,n*15)

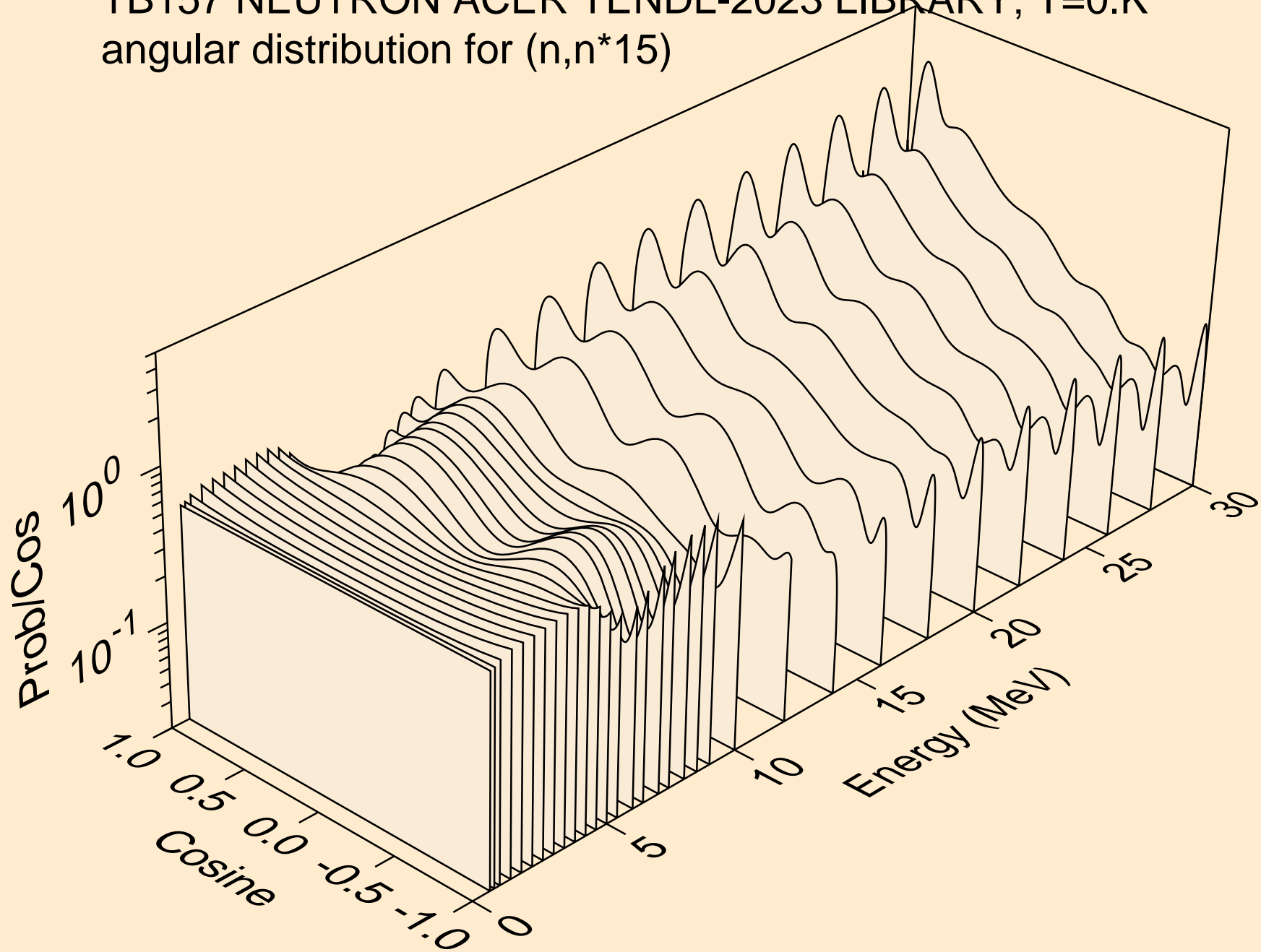

TB157 NEUTRON ACER TENDL-2023 LIBRARY; T=0.K
angular distribution for (n,n*16)

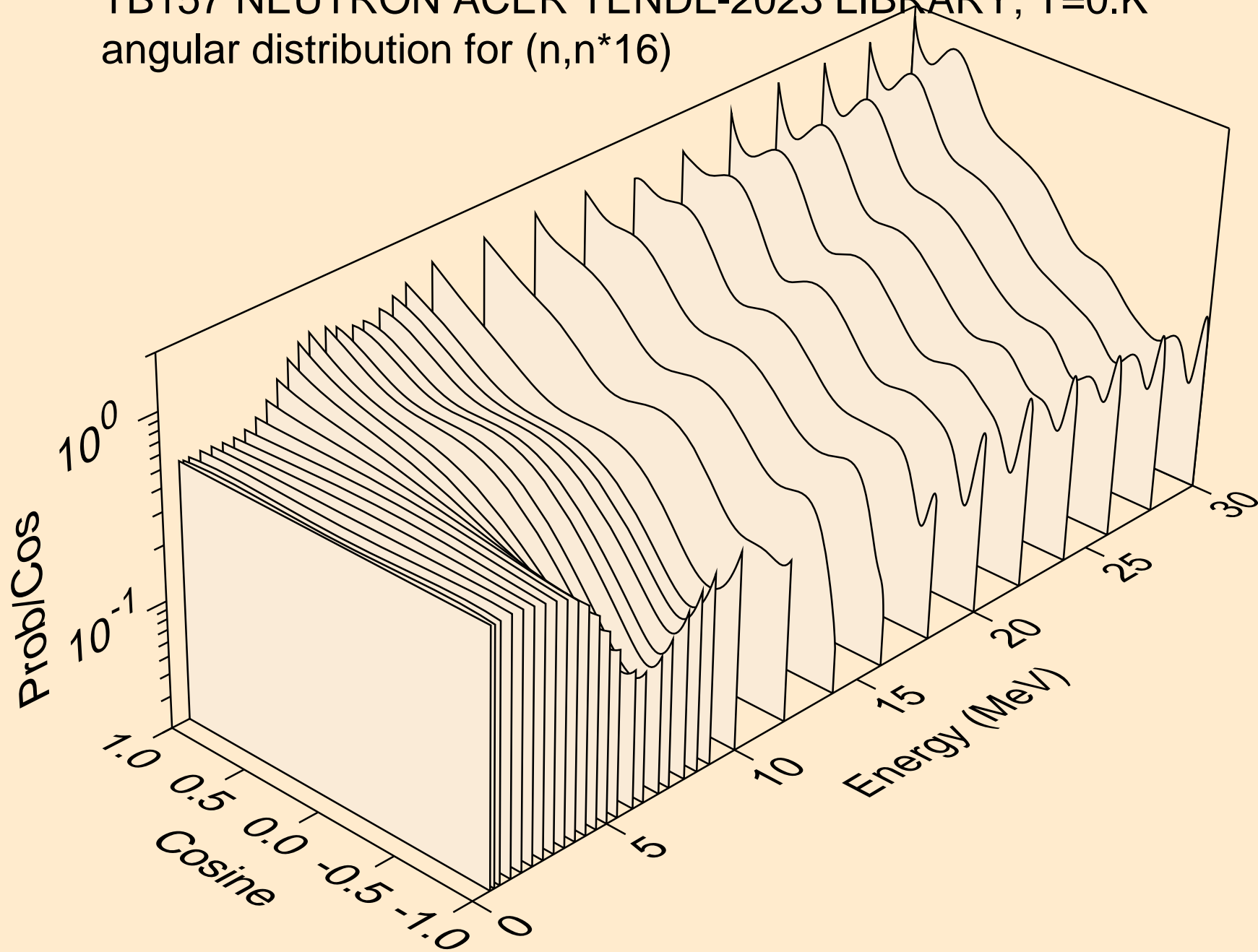

TB157 NEUTRON ACER TENDL-2023 LIBRARY; T=0.K
angular distribution for (n,n*17)

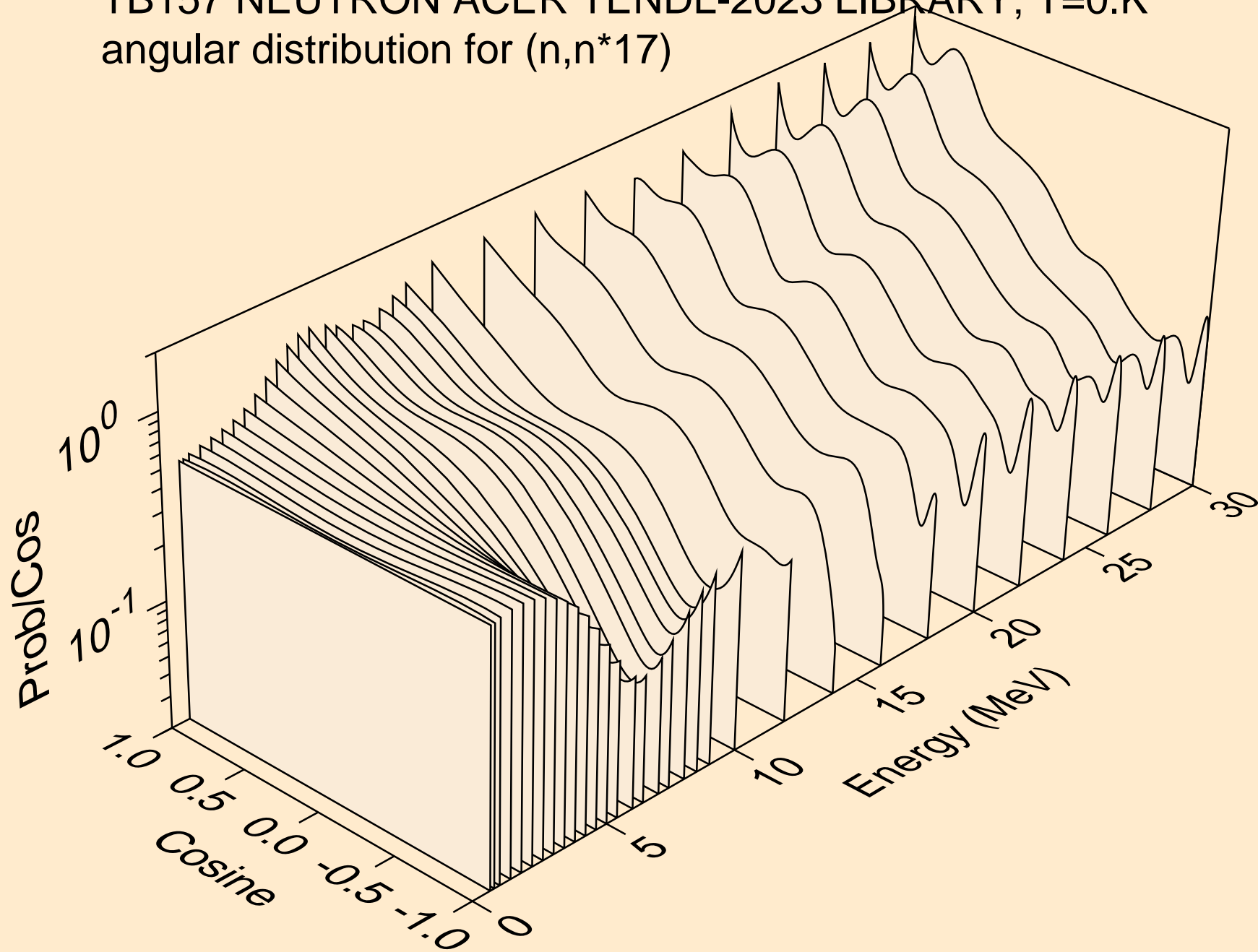

TB157 NEUTRON ACER TENDL-2023 LIBRARY; T=0.K
angular distribution for (n,n*18)

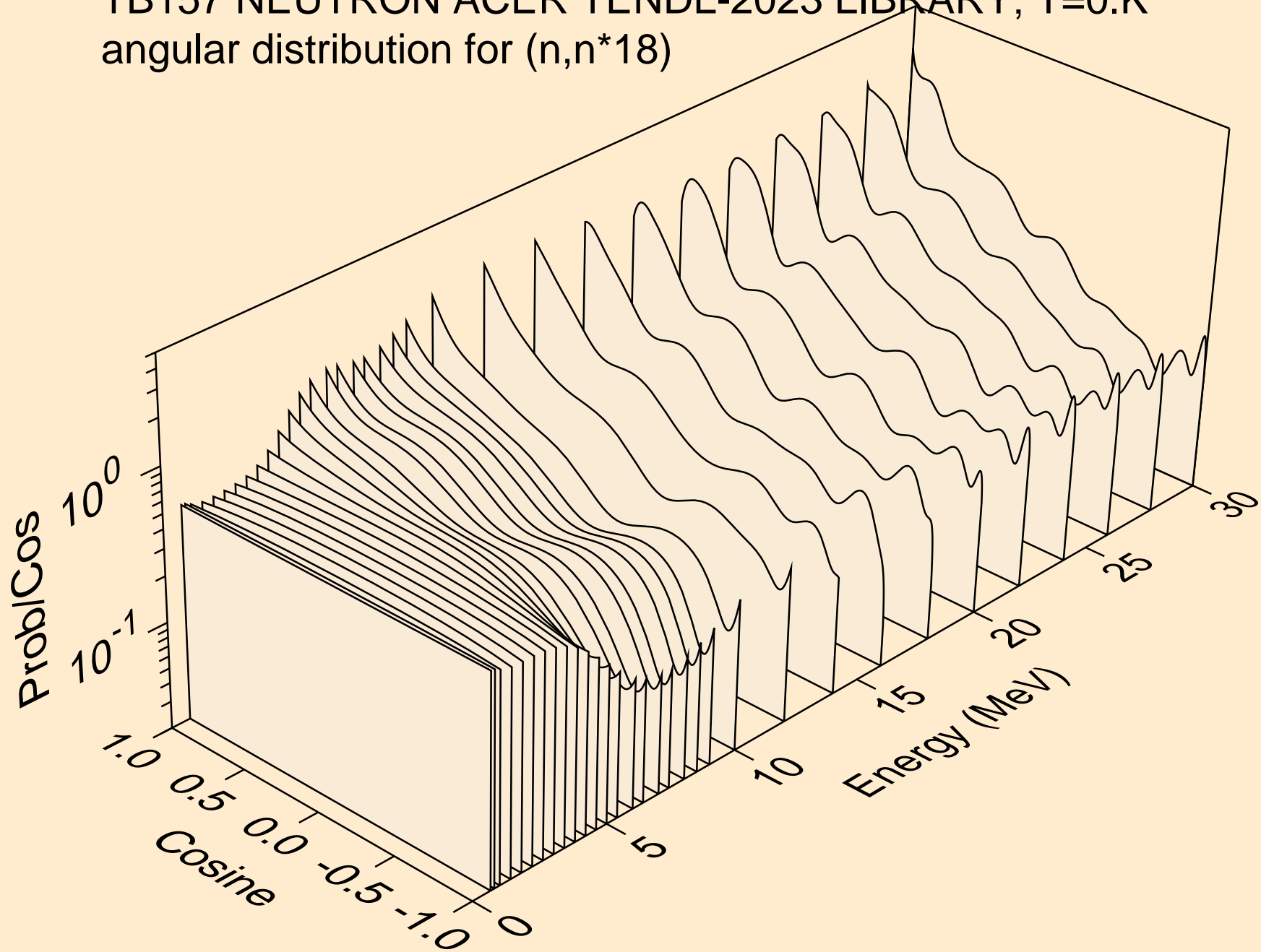

TB157 NEUTRON ACER TENDL-2023 LIBRARY; T=0.K
angular distribution for (n,n*19)

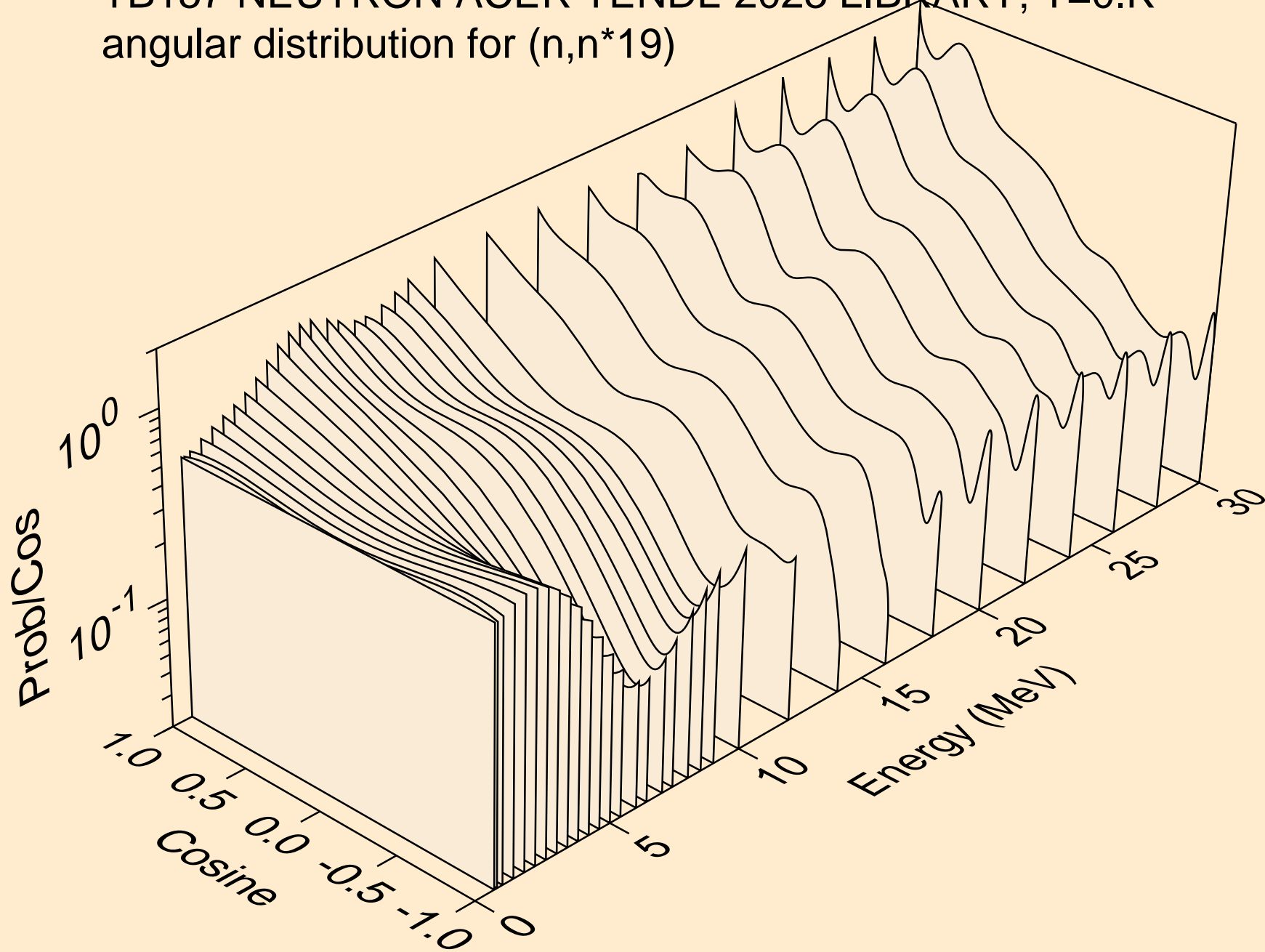

TB157 NEUTRON ACER TENDL-2023 LIBRARY; T=0.K
angular distribution for (n,n*20)

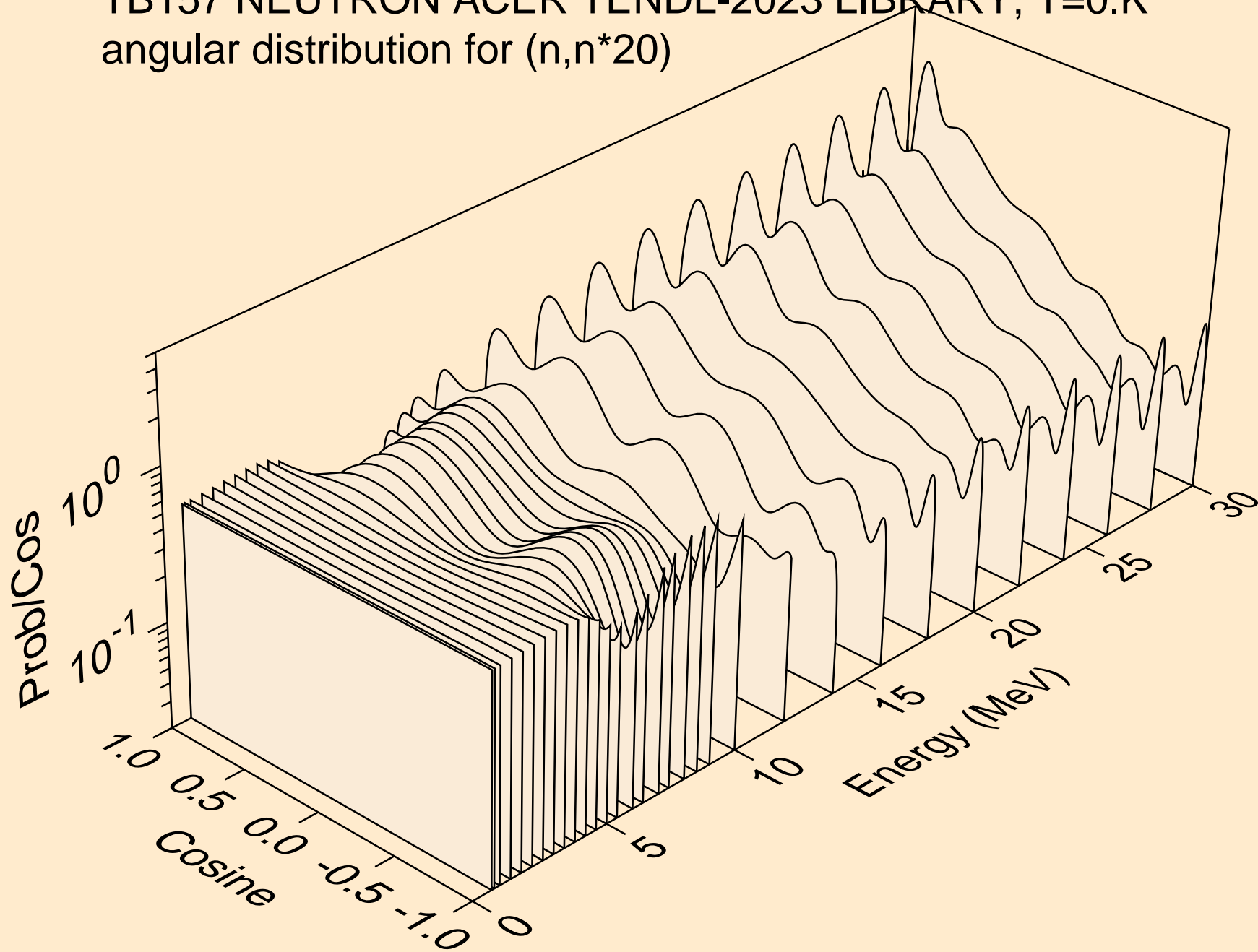

TB157 NEUTRON ACER TENDL-2023 LIBRARY; T=0.K
Neutron emission for (n,x)

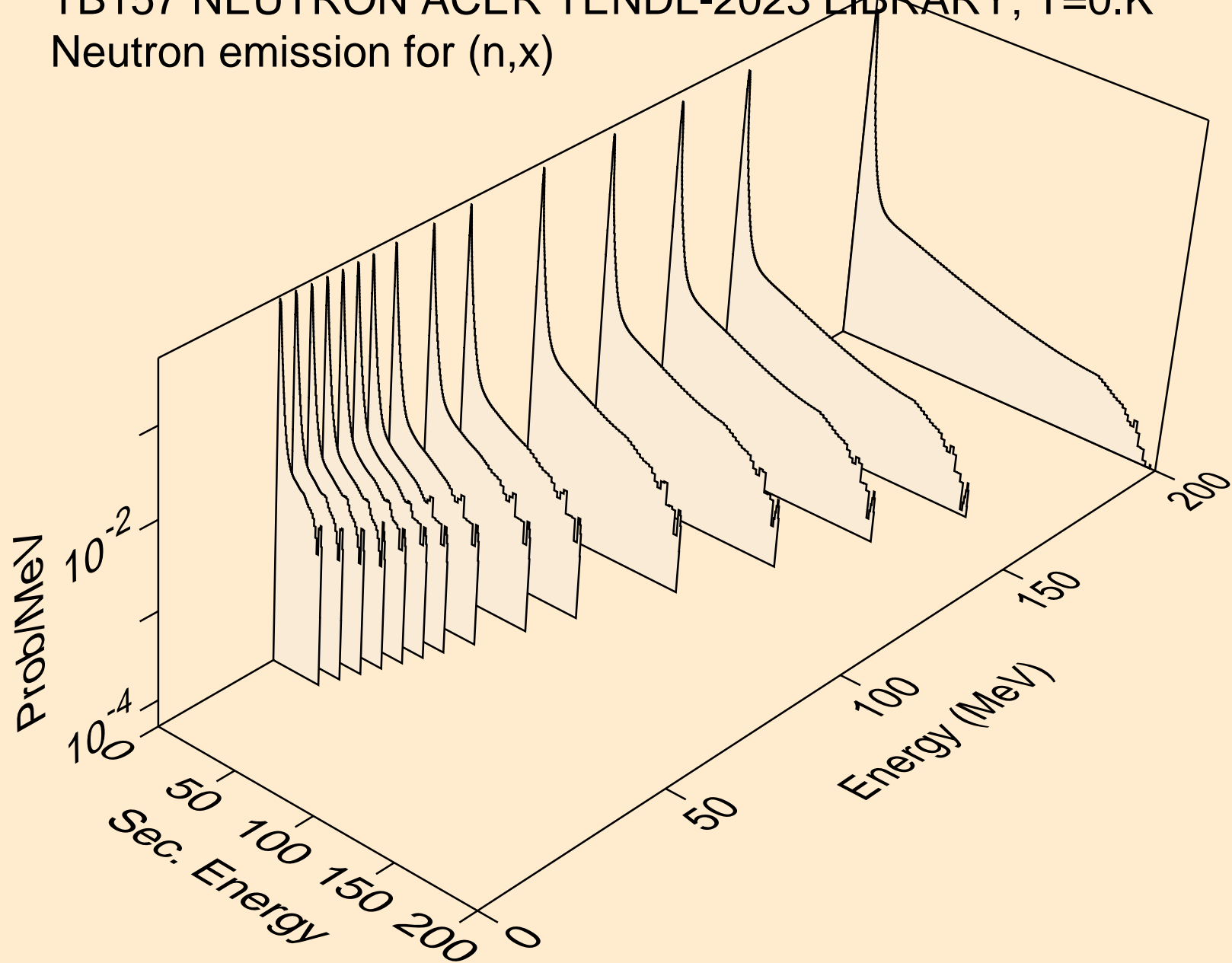

TB157 NEUTRON ACER TENDL-2023 LIBRARY; T=0.K
Neutron emission for (n,2nd)

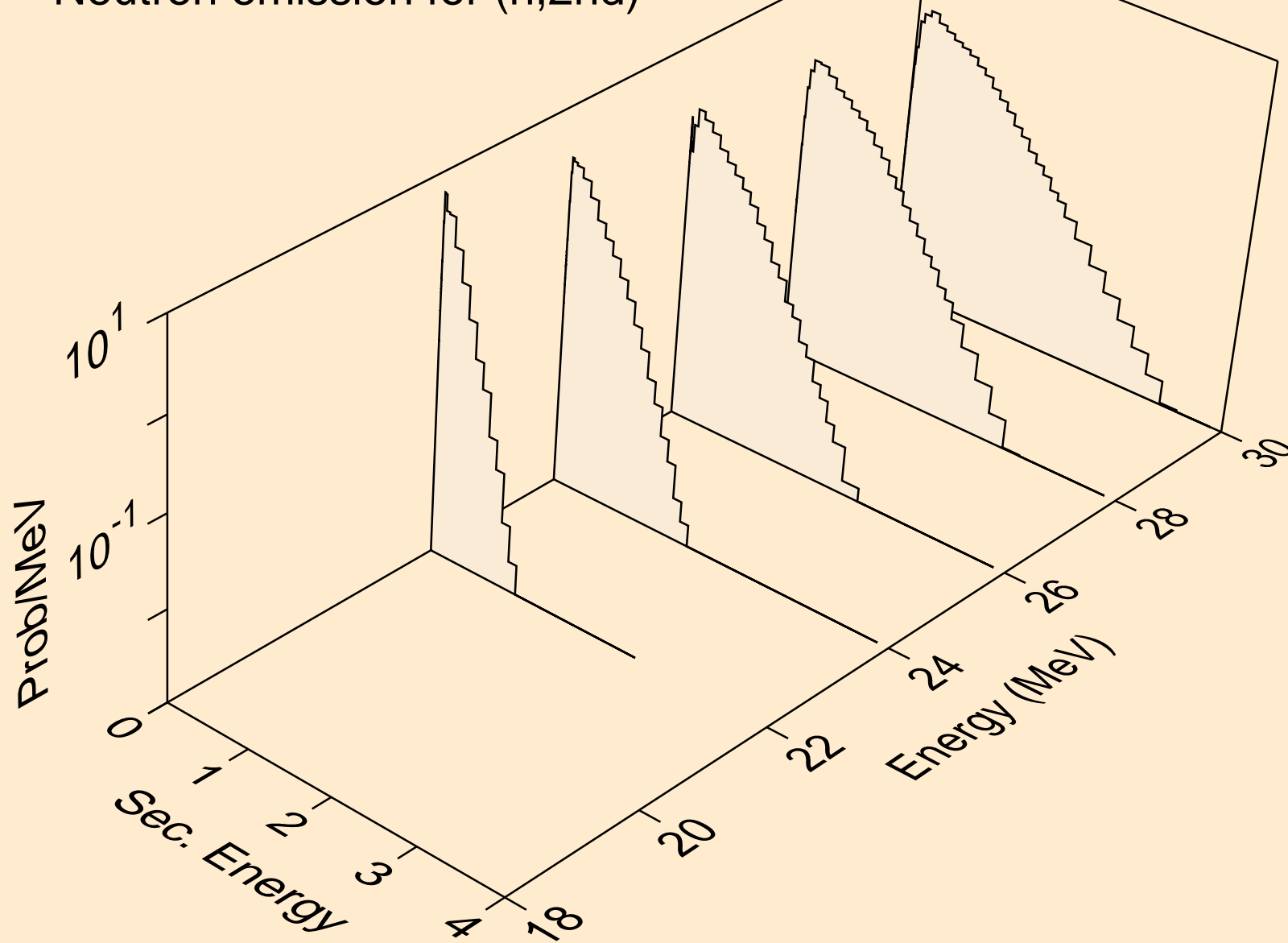

TB157 NEUTRON ACER TENDL-2023 LIBRARY; T=0.K
Neutron emission for (n,2n)

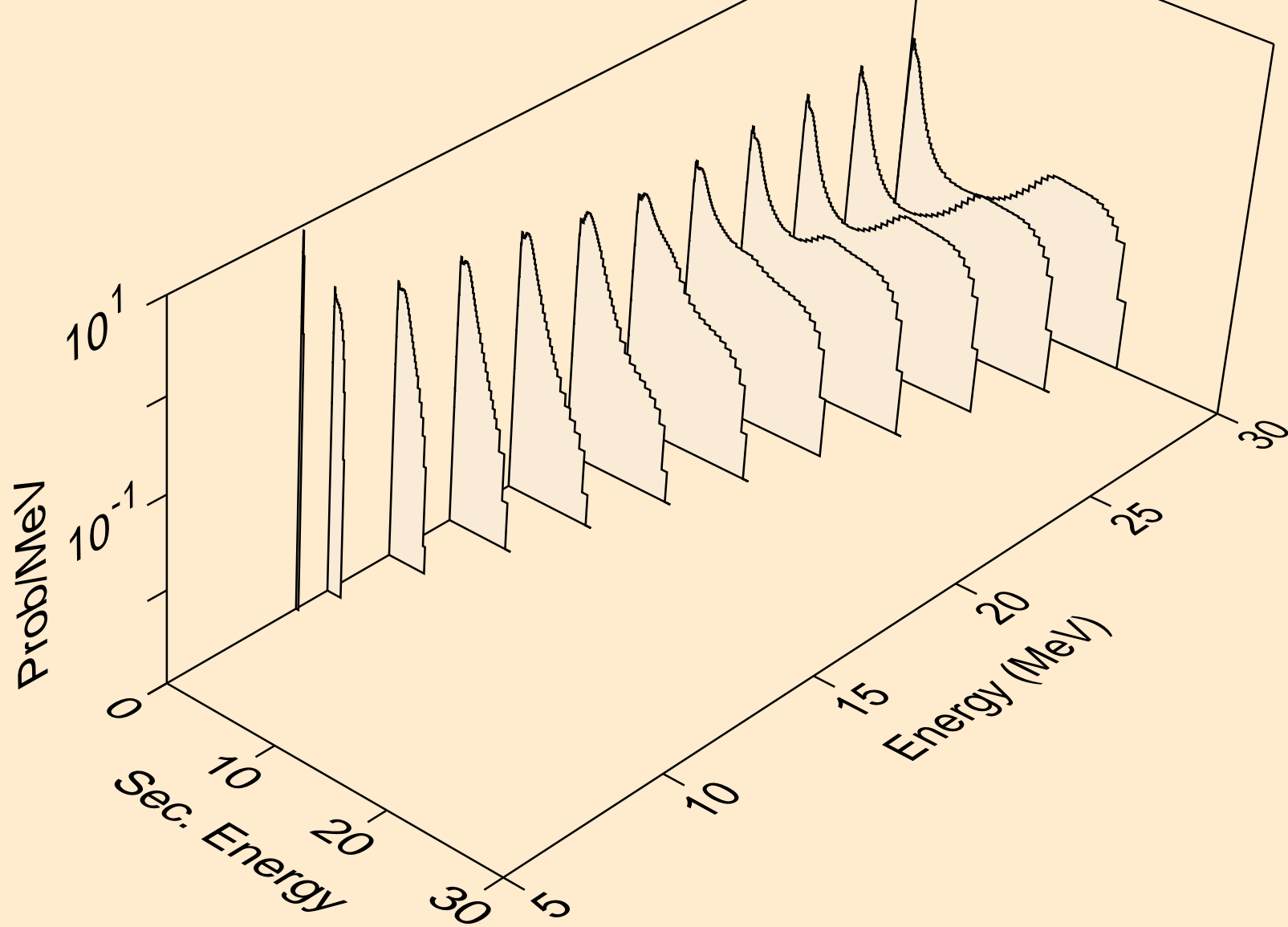

TB157 NEUTRON ACER TENDL-2023 LIBRARY; T=0.K
Neutron emission for (n,3n)

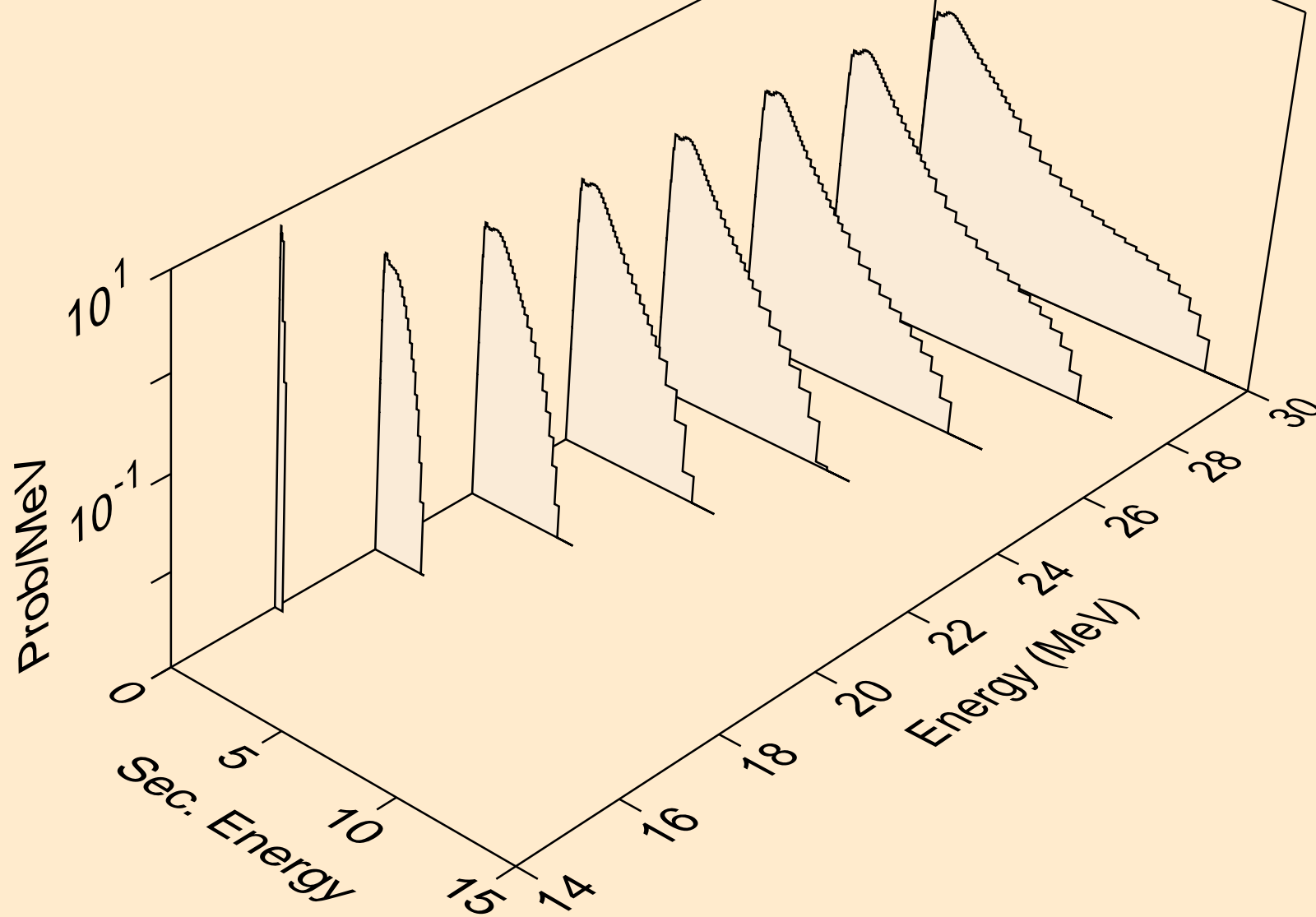

TB157 NEUTRON ACER TENDL-2023 LIBRARY; T=0.K
Neutron emission for (n,n*)a

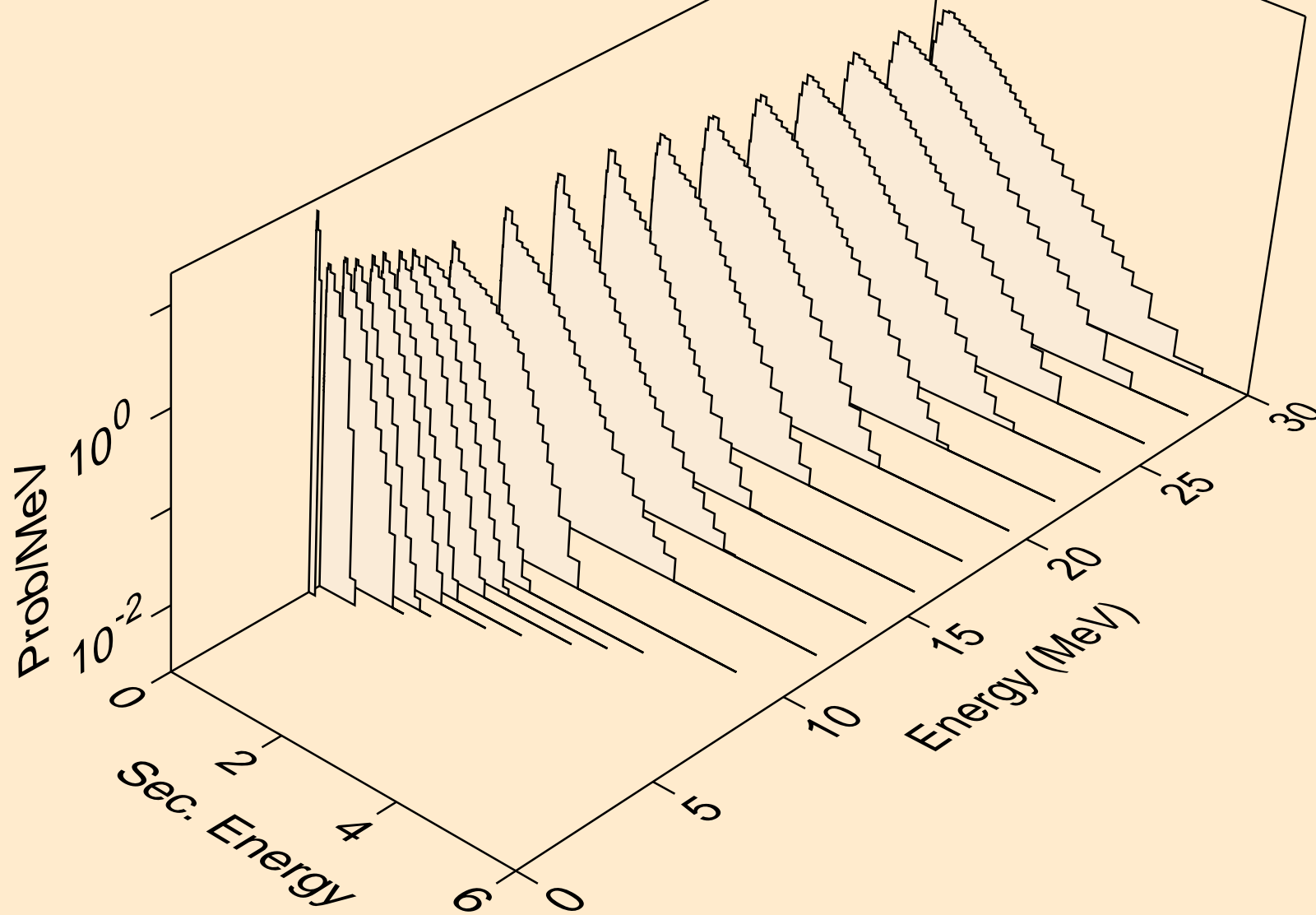

TB157 NEUTRON ACER TENDL-2023 LIBRARY; T=0.K
Neutron emission for (n,2n)a

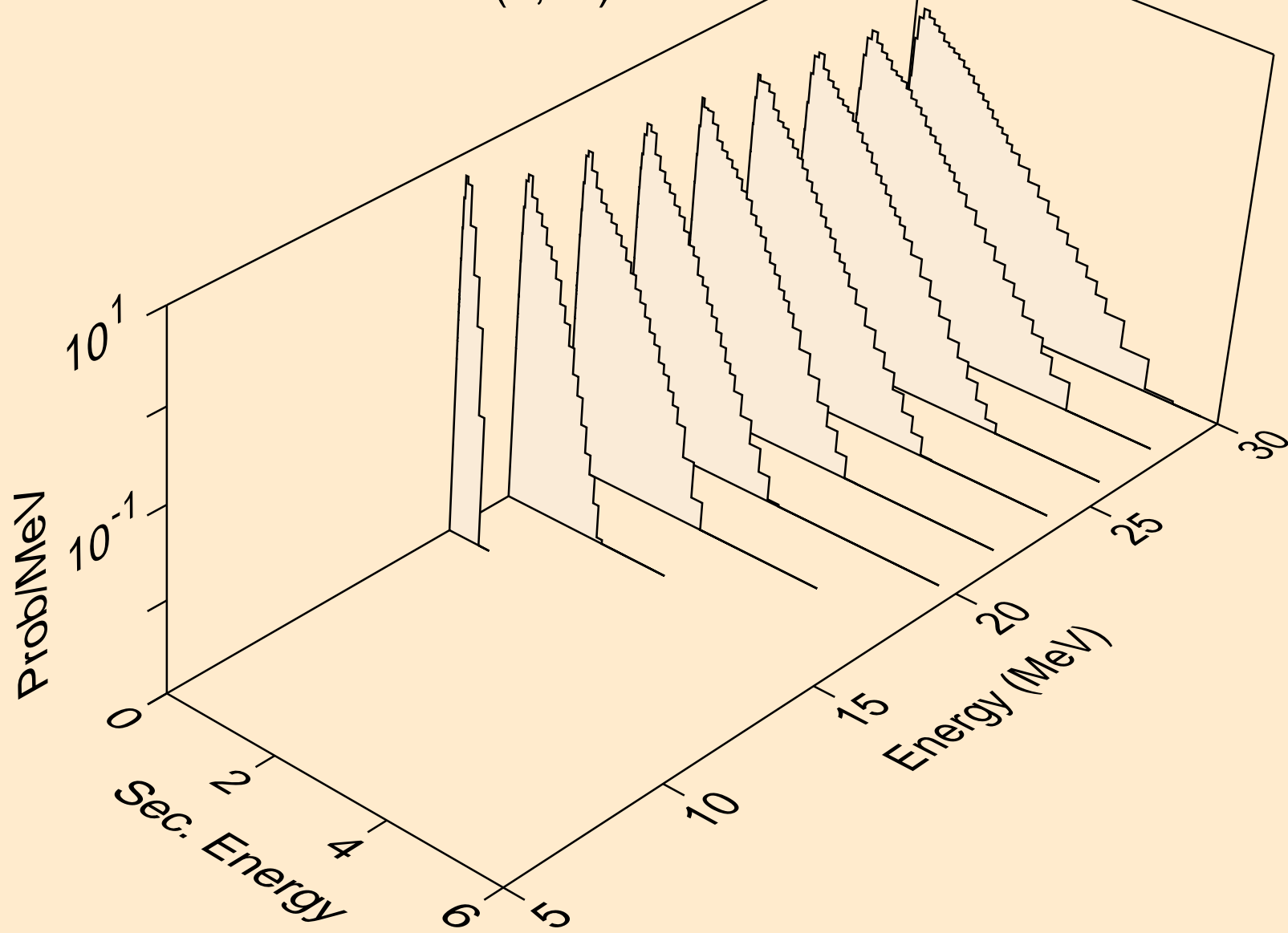

TB157 NEUTRON ACER TENDL-2023 LIBRARY; T=0.K
Neutron emission for (n,3n)a

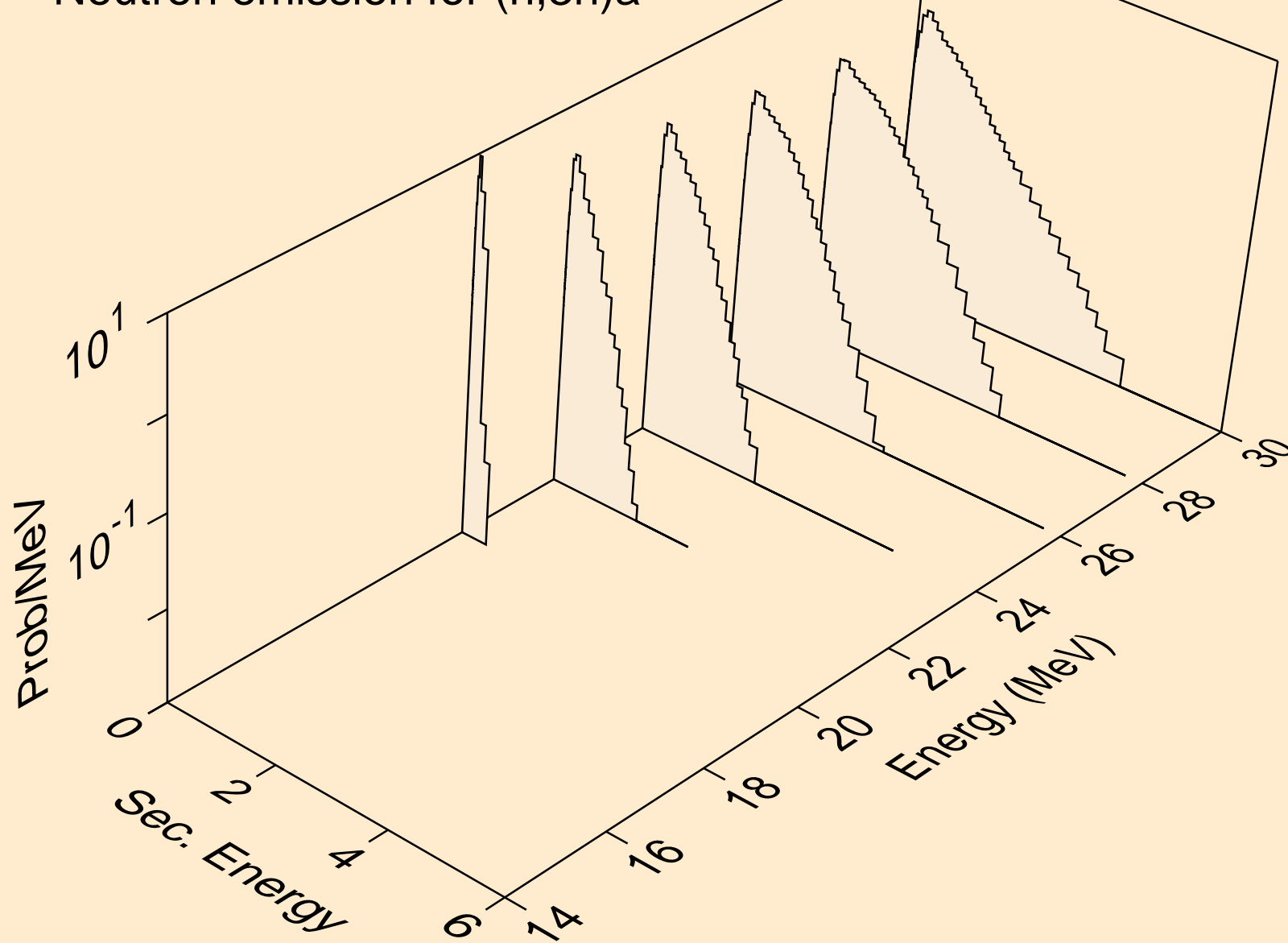

TB157 NEUTRON ACER TENDL-2023 LIBRARY; T=0.K
Neutron emission for (n,n*)p

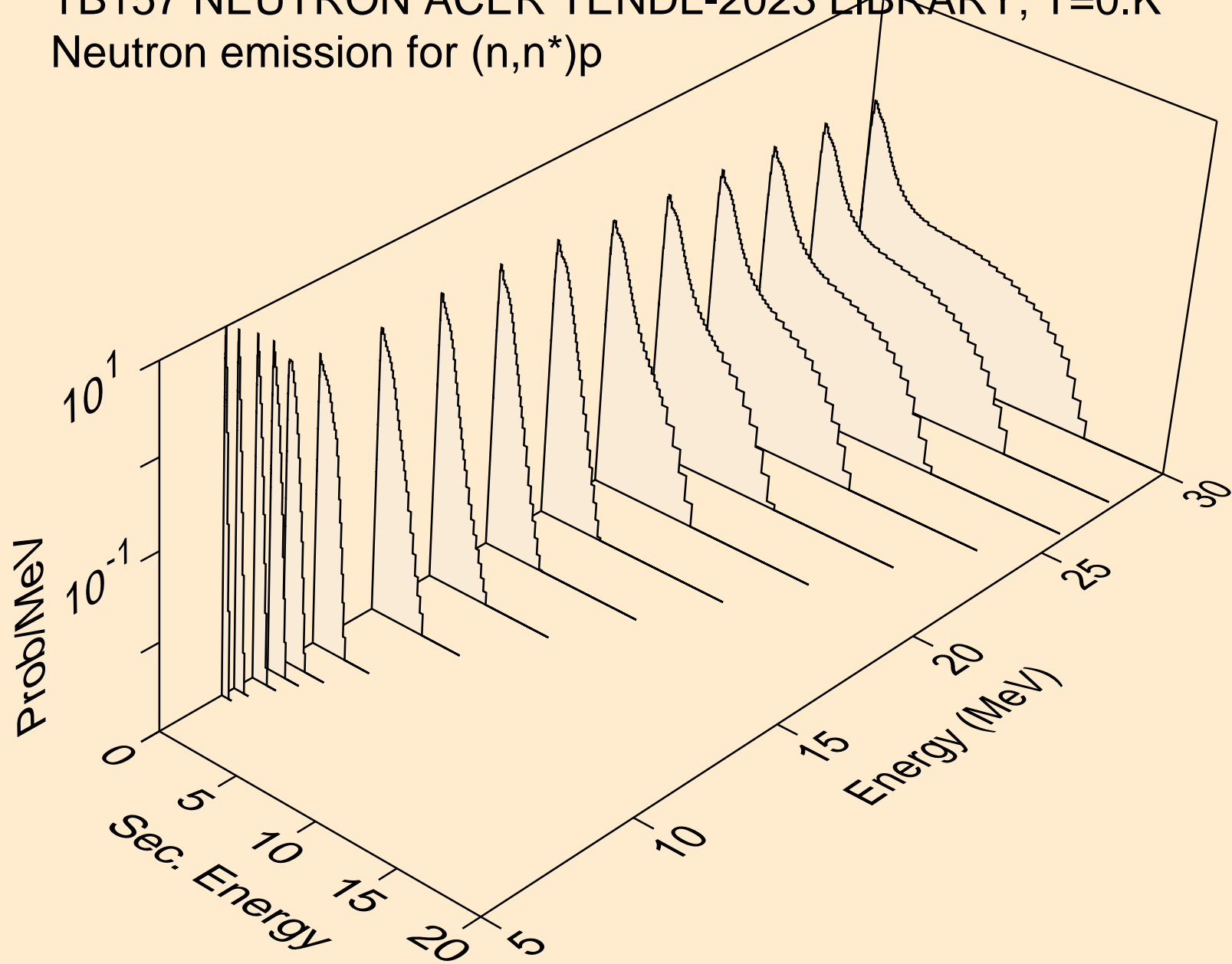

TB157 NEUTRON ACER TENDL-2023 LIBRARY; T=0.K
Neutron emission for (n,n*)2a

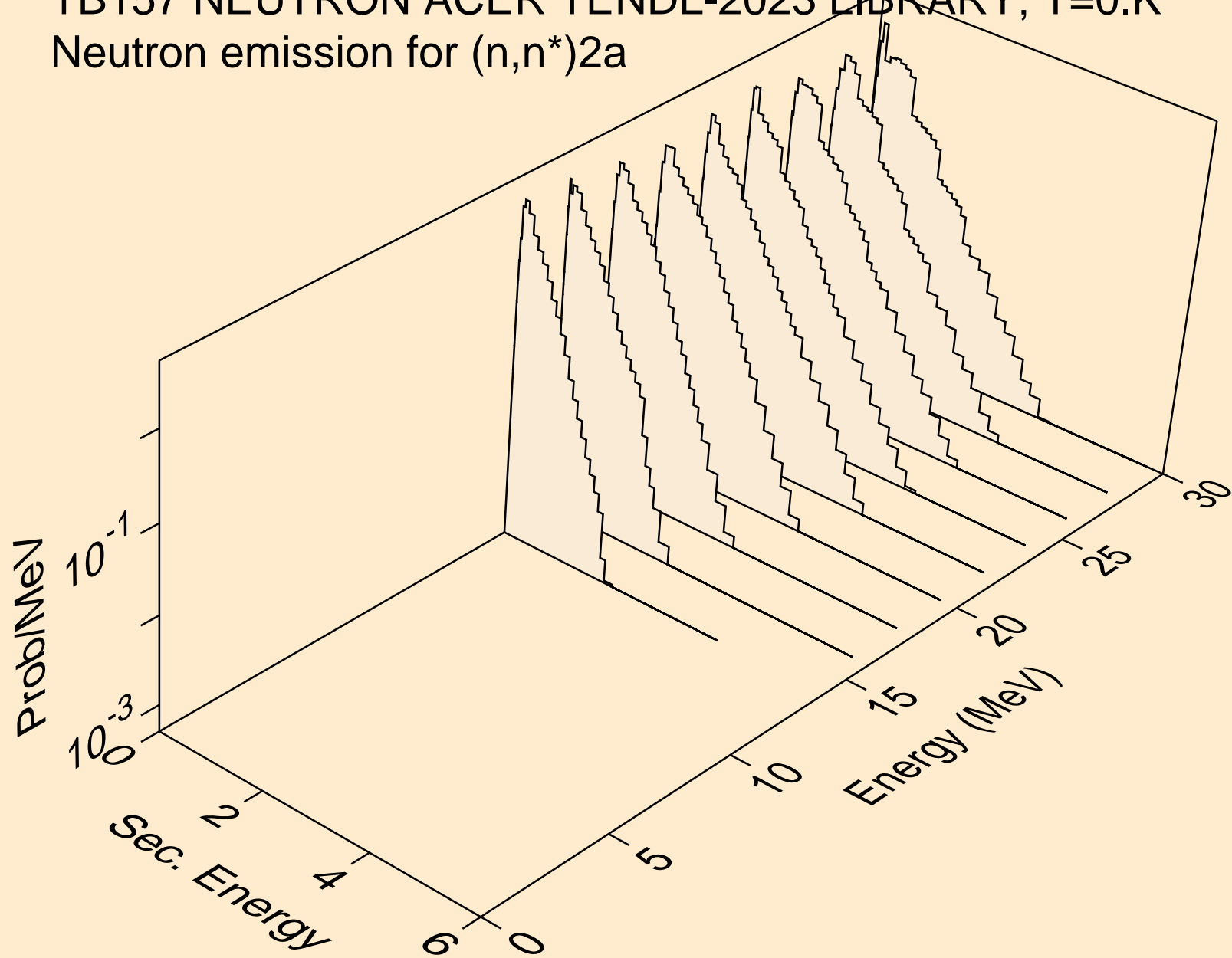

TB157 NEUTRON ACER TENDL-2023 LIBRARY; T=0.K
Neutron emission for (n,n*)d

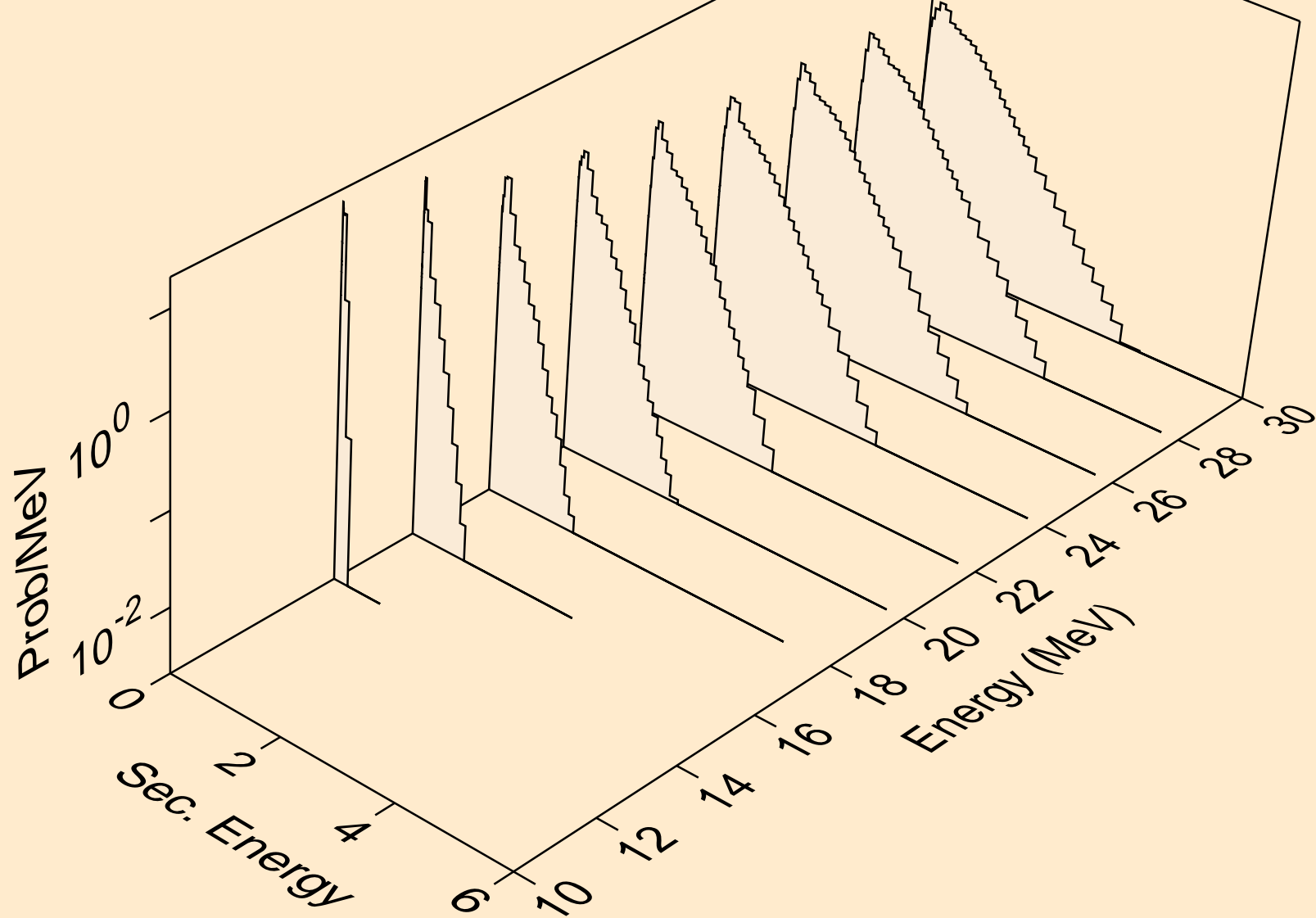

TB157 NEUTRON ACER TENDL-2023 LIBRARY; T=0.K
Neutron emission for (n,n*)t

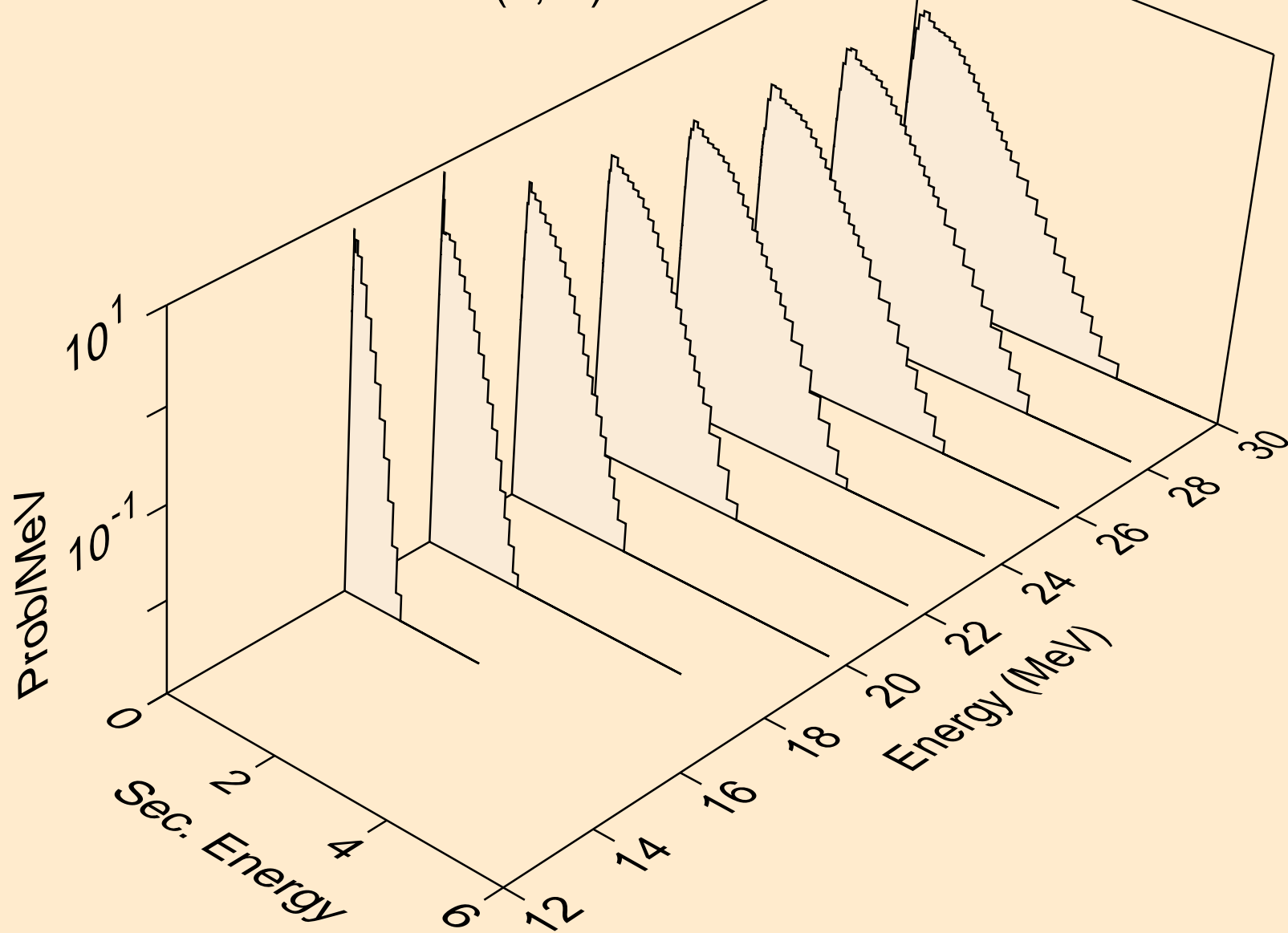

TB157 NEUTRON ACER TENDL-2023 LIBRARY; T=0.K
Neutron emission for (n,n*)he3

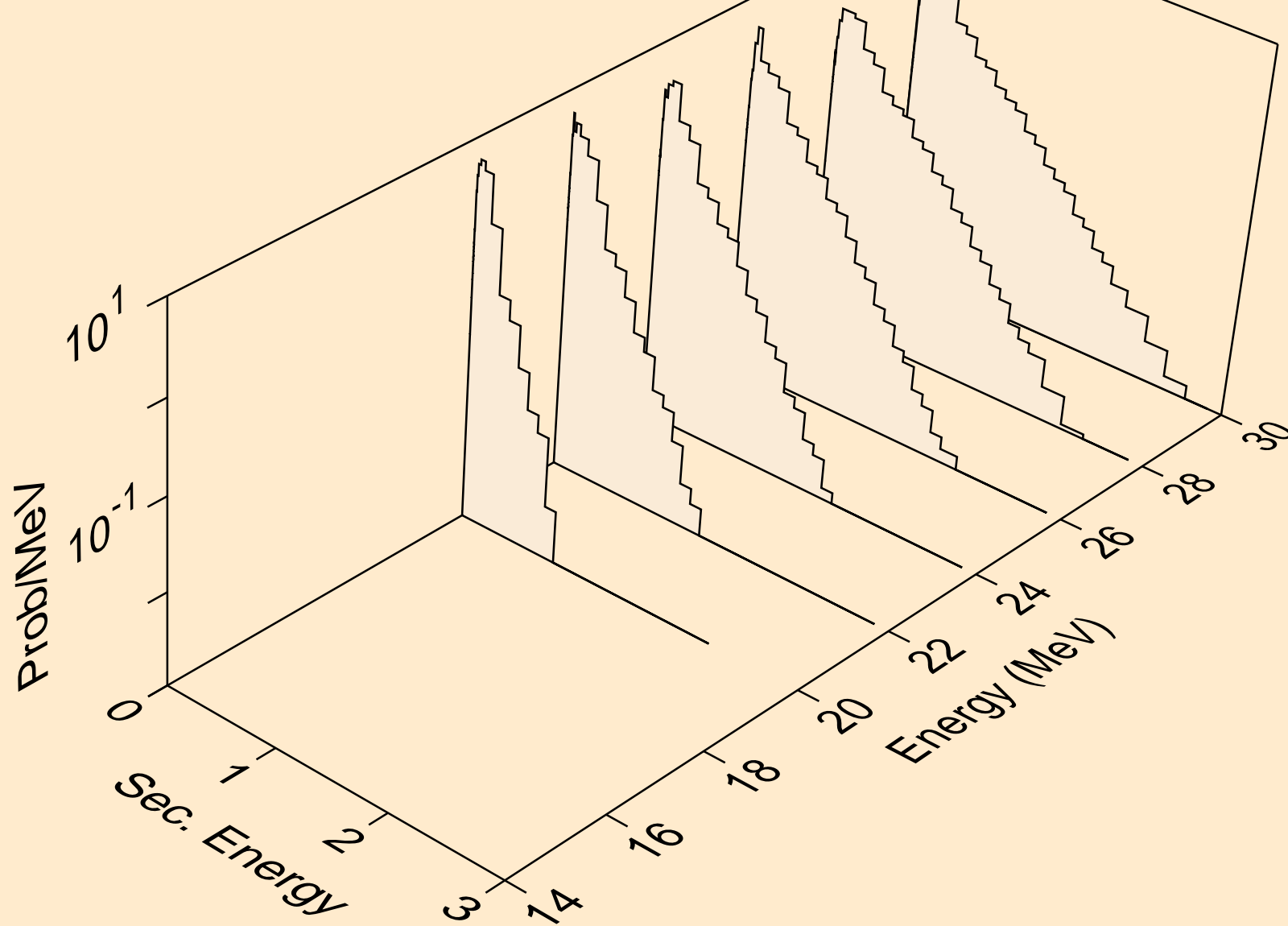

TB157 NEUTRON ACER TENDL-2023 LIBRARY; T=0.K
Neutron emission for (n,4n)

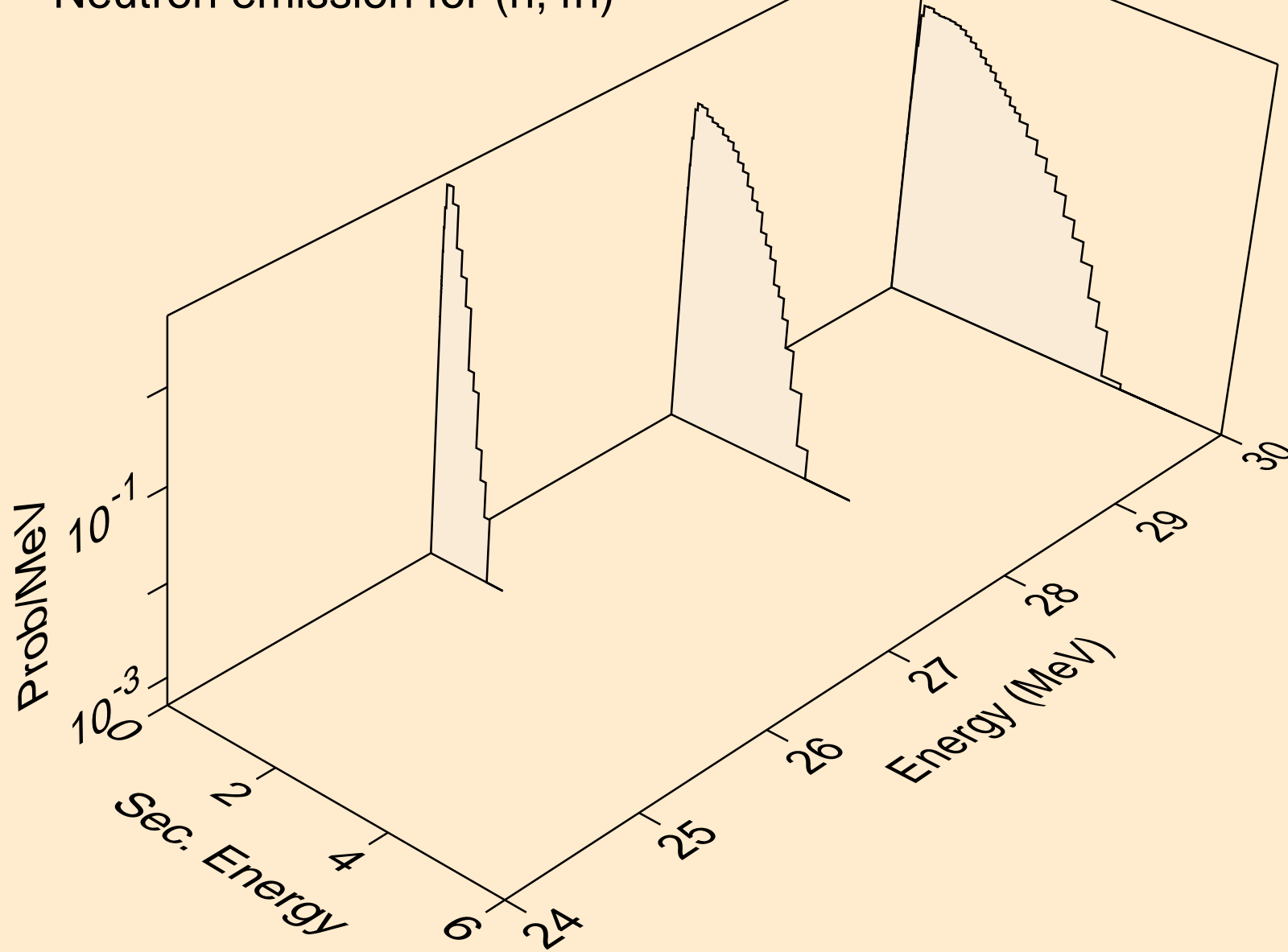

TB157 NEUTRON ACER TENDL-2023 LIBRARY; T=0.K
Neutron emission for (n,2np)

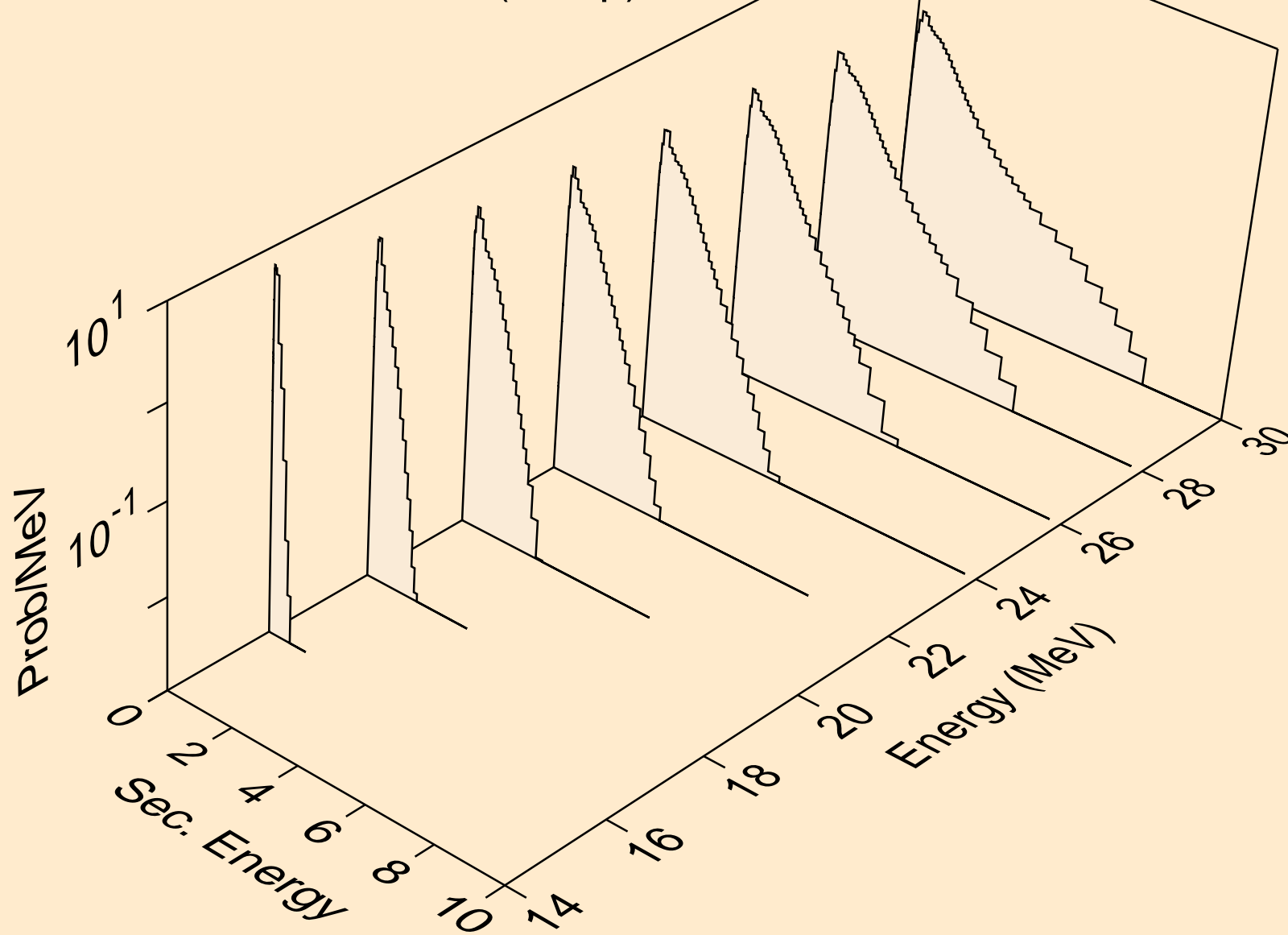

TB157 NEUTRON ACER TENDL-2023 LIBRARY; T=0.K
Neutron emission for (n,3np)

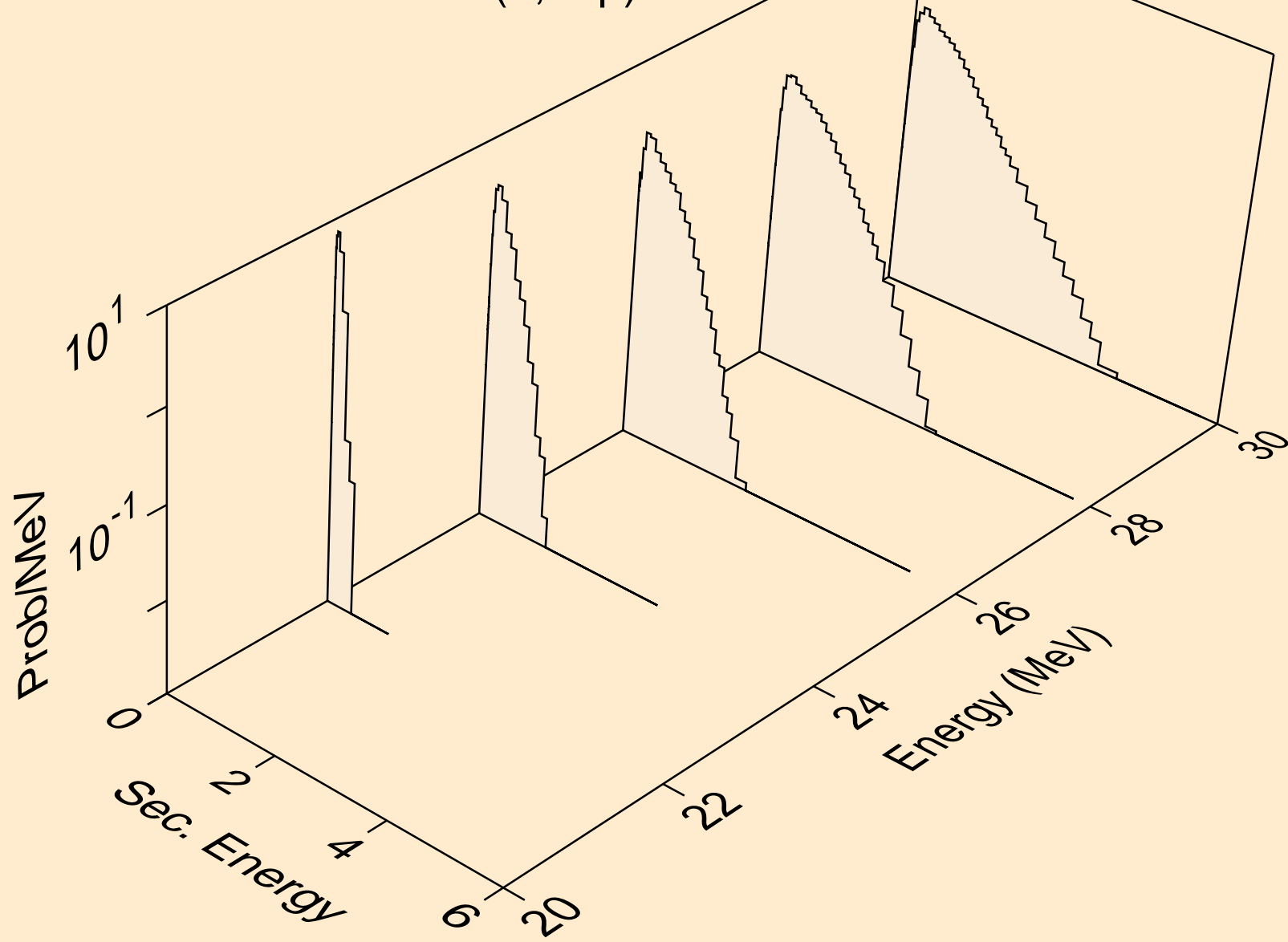

TB157 NEUTRON ACER TENDL-2023 LIBRARY; T=0.K
Neutron emission for (n,n2p)

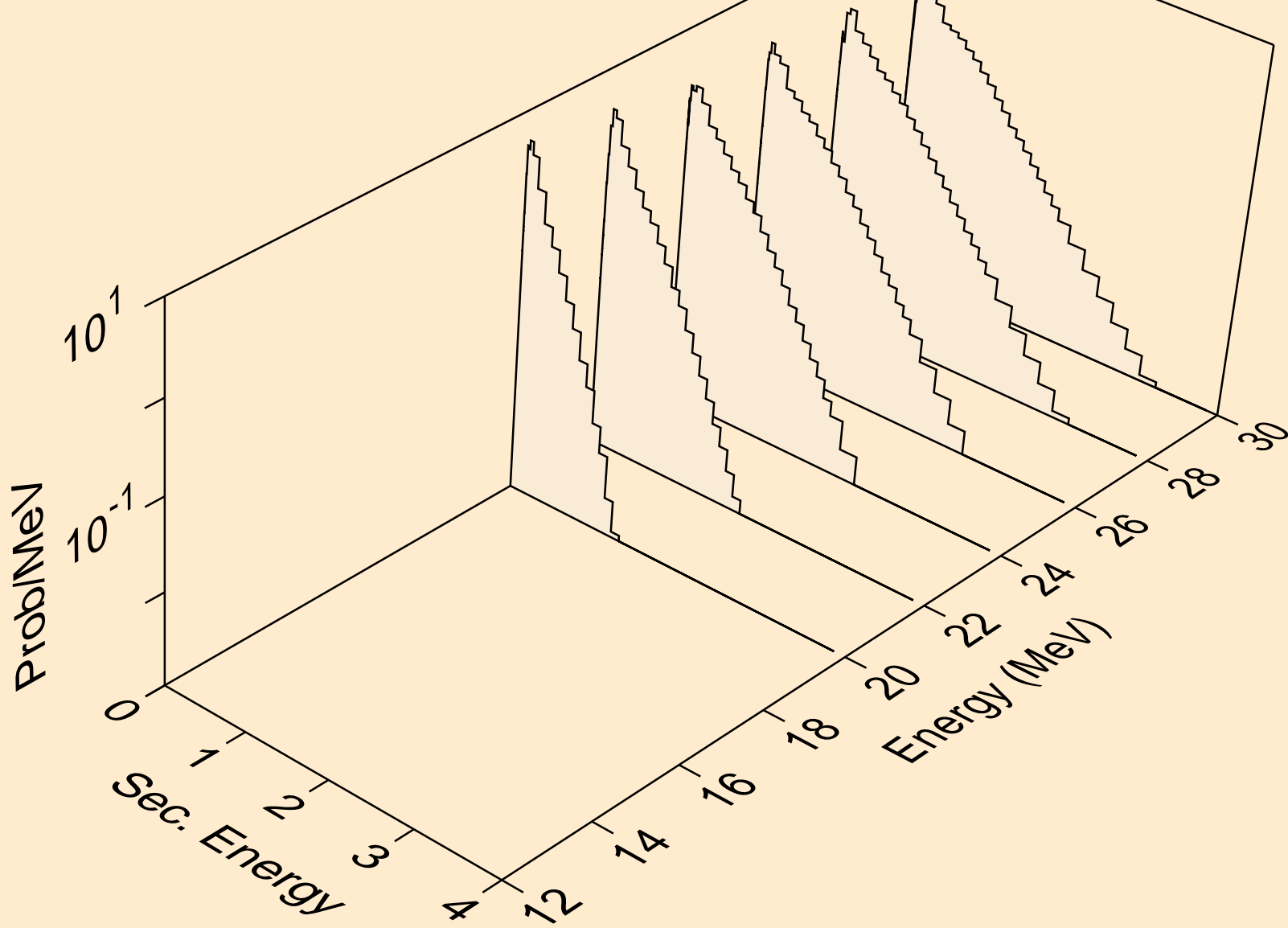

TB157 NEUTRON ACER TENDL-2023 LIBRARY; T=0.K
Neutron emission for (n,npa)

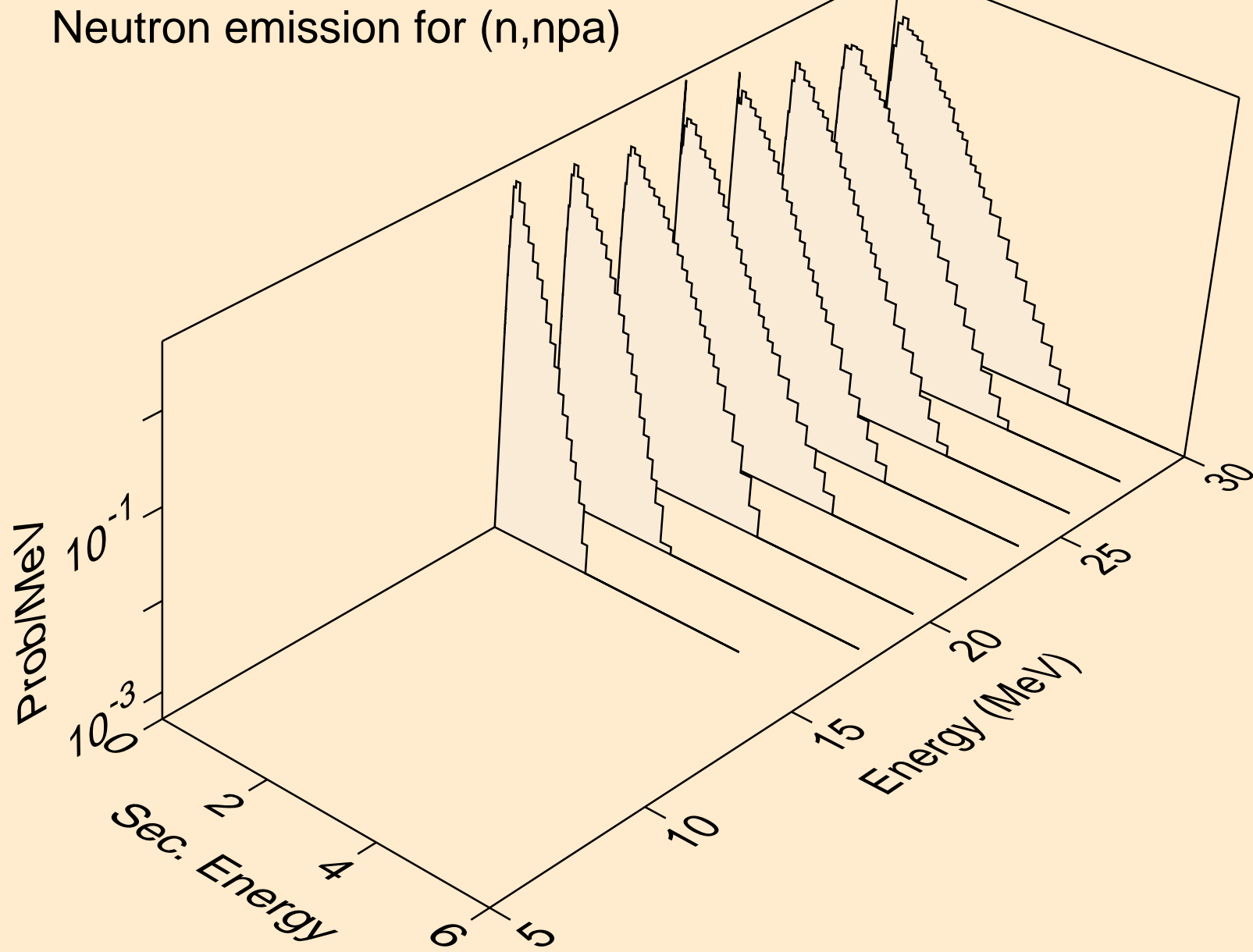

TB157 NEUTRON ACER TENDL-2023 LIBRARY; T=0.K
Neutron emission for (n,n*c)

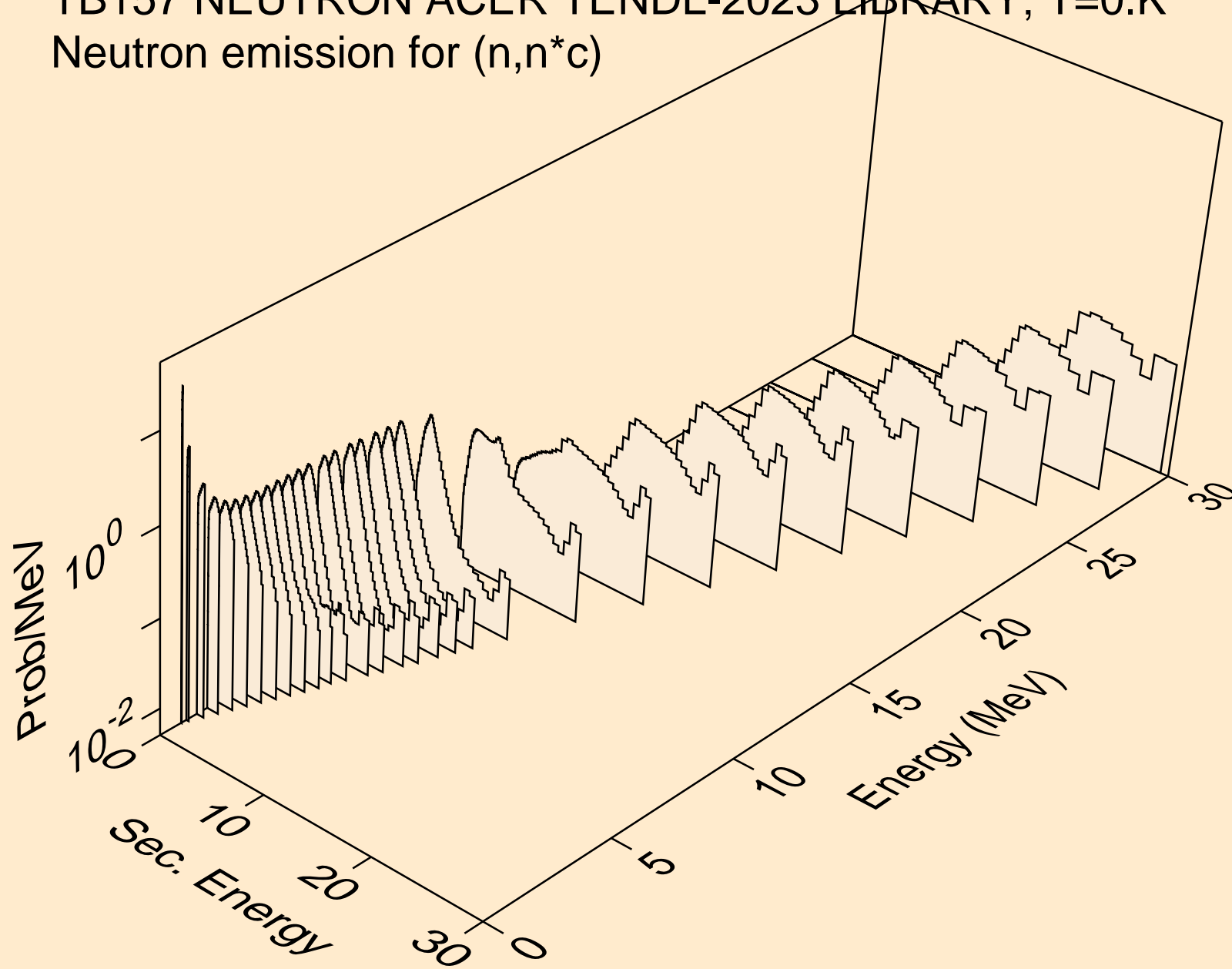

TB157 NEUTRON ACER TENDL-2023 LIBRARY; T=0.K
Photon emission for (n,x)

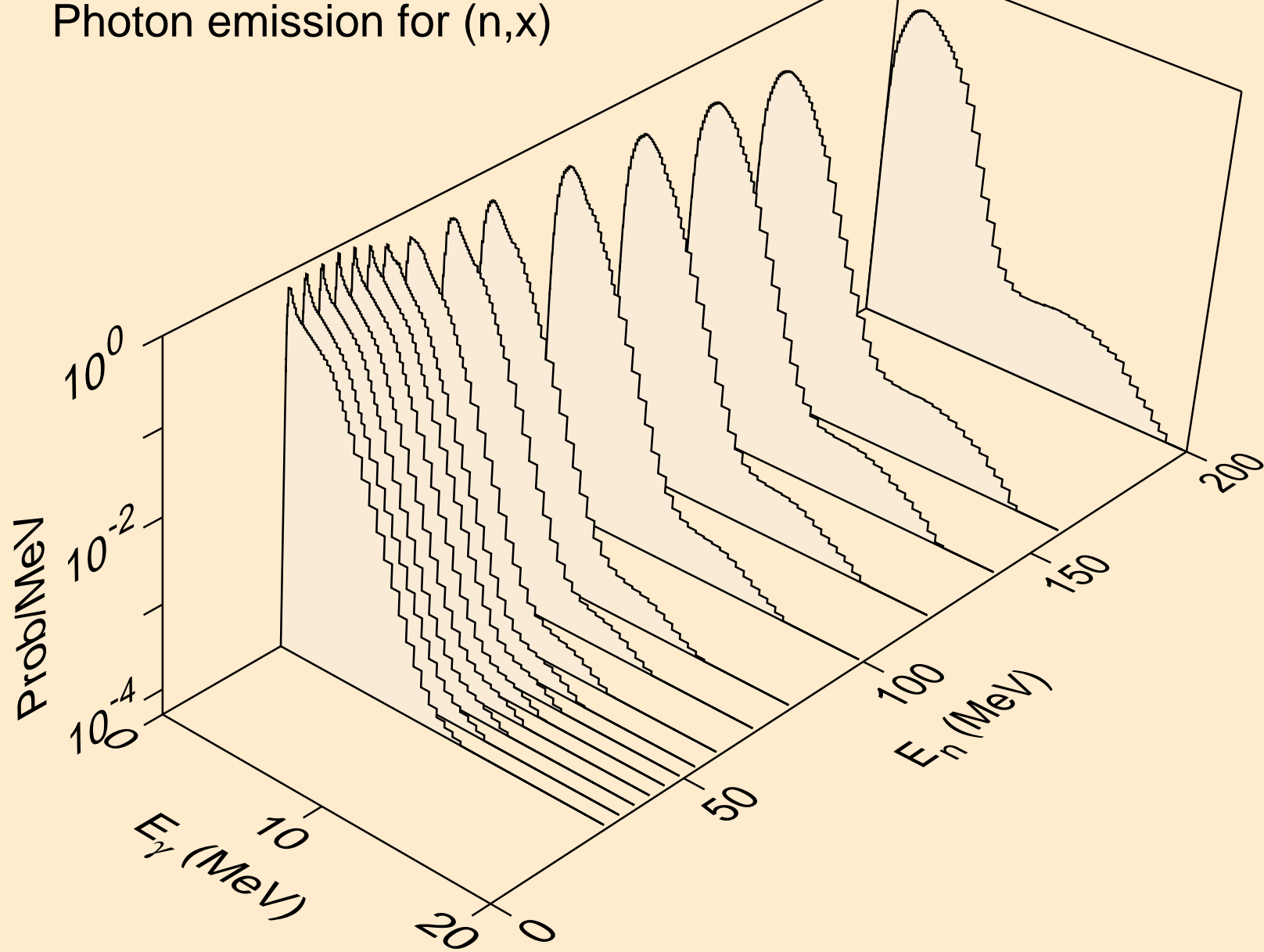

TB157 NEUTRON ACER TENDL-2023 LIBRARY; T=0.K
Photon emission for (n,2nd)

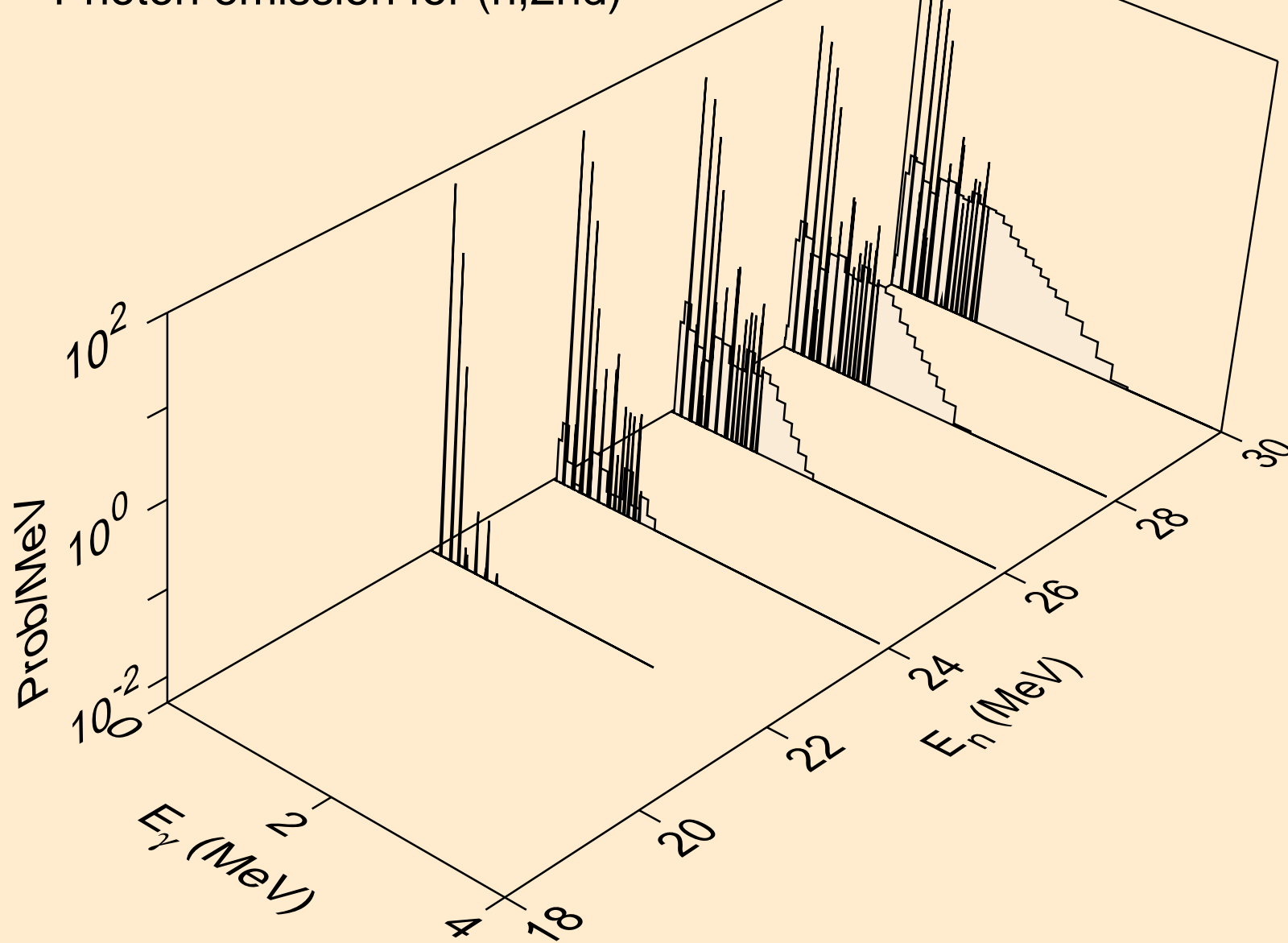

TB157 NEUTRON ACER TENDL-2023 LIBRARY; T=0.K
Photon emission for (n,2n)

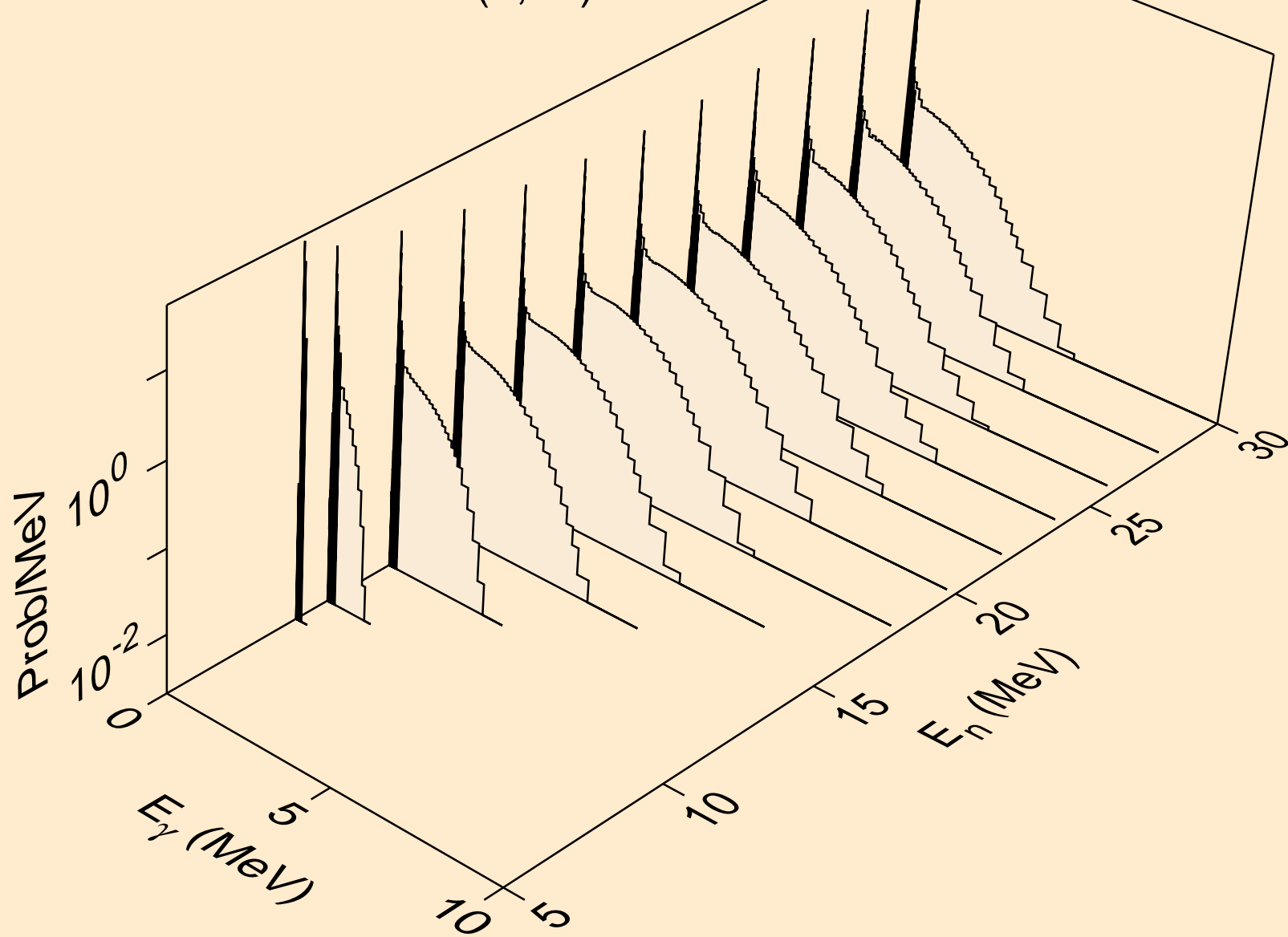

TB157 NEUTRON ACER TENDL-2023 LIBRARY; T=0.K
Photon emission for (n,3n)

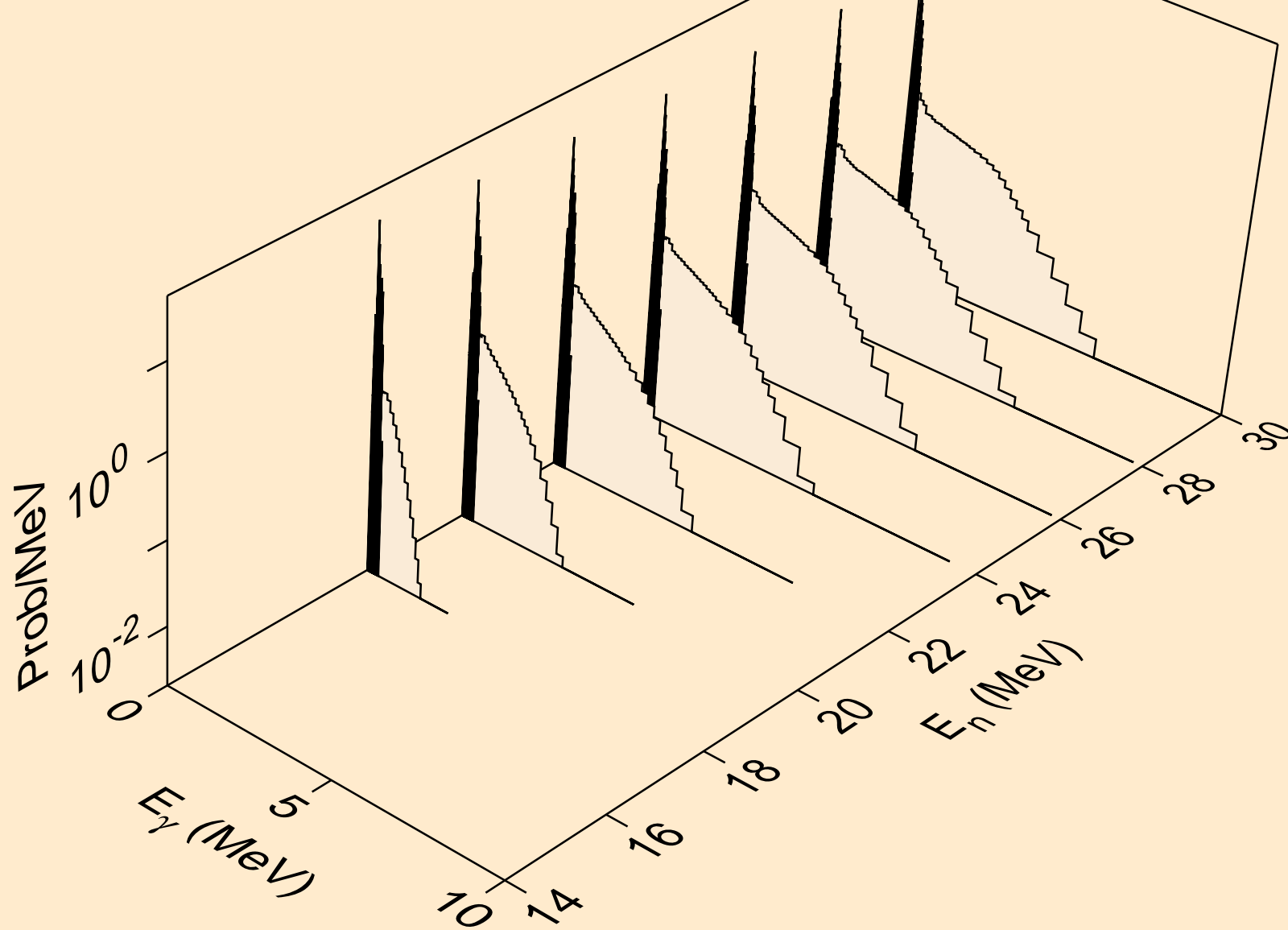

TB157 NEUTRON ACER TENDL-2023 LIBRARY; T=0.K
Photon emission for (n,n*)a

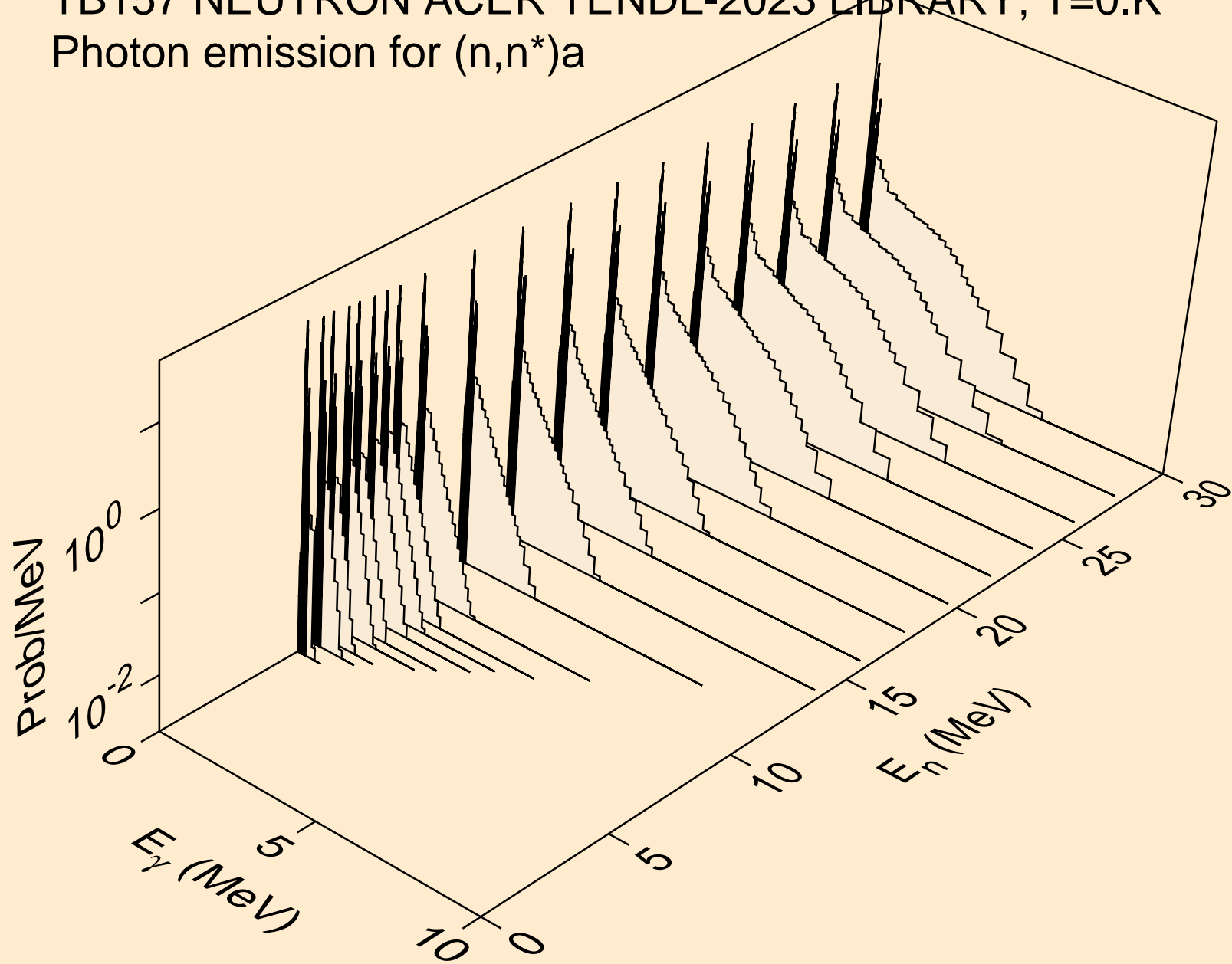

TB157 NEUTRON ACER TENDL-2023 LIBRARY; T=0.K

Photon emission for (n,2n) α

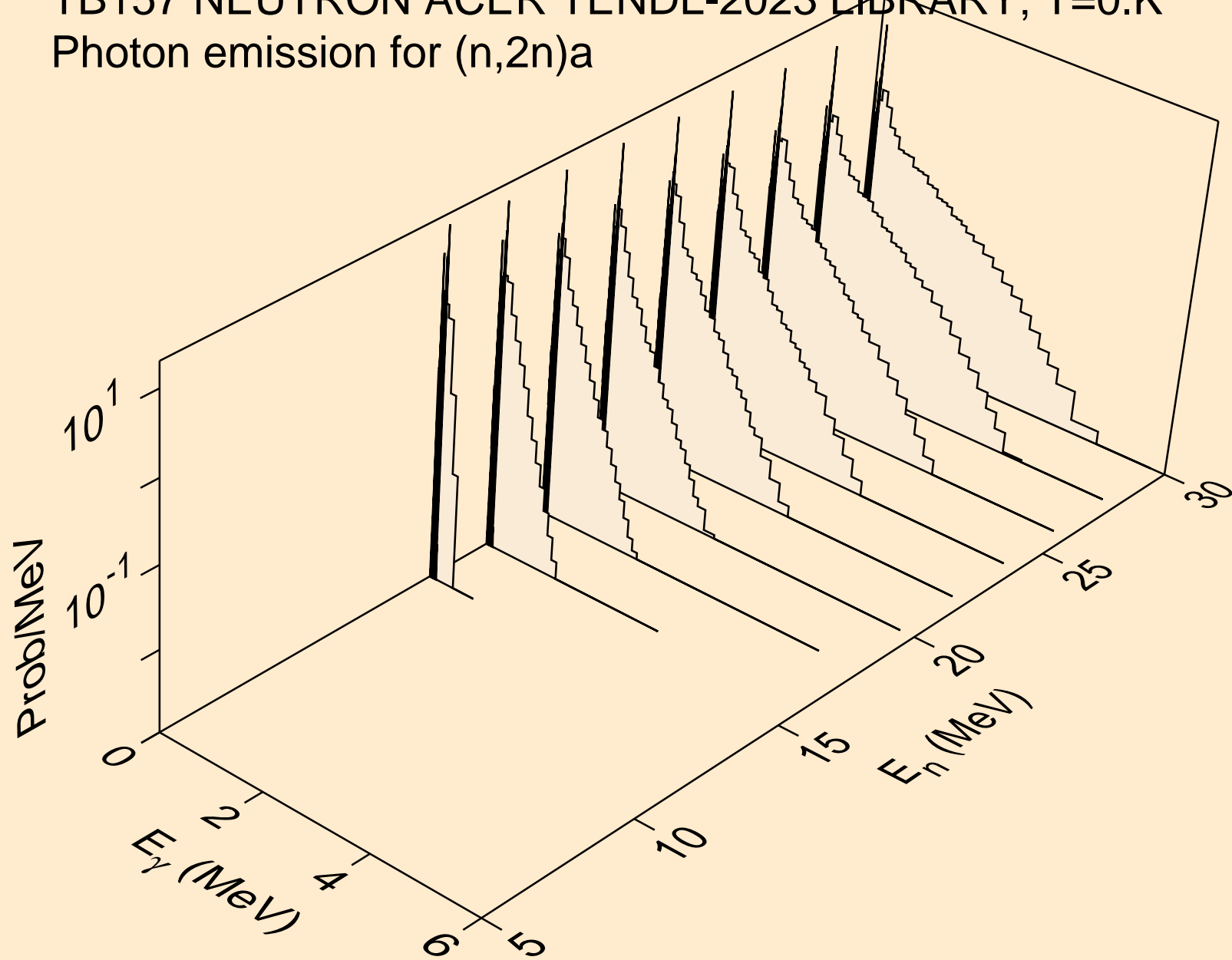

TB157 NEUTRON ACER TENDL-2023 LIBRARY; T=0.K
Photon emission for (n,3n)a

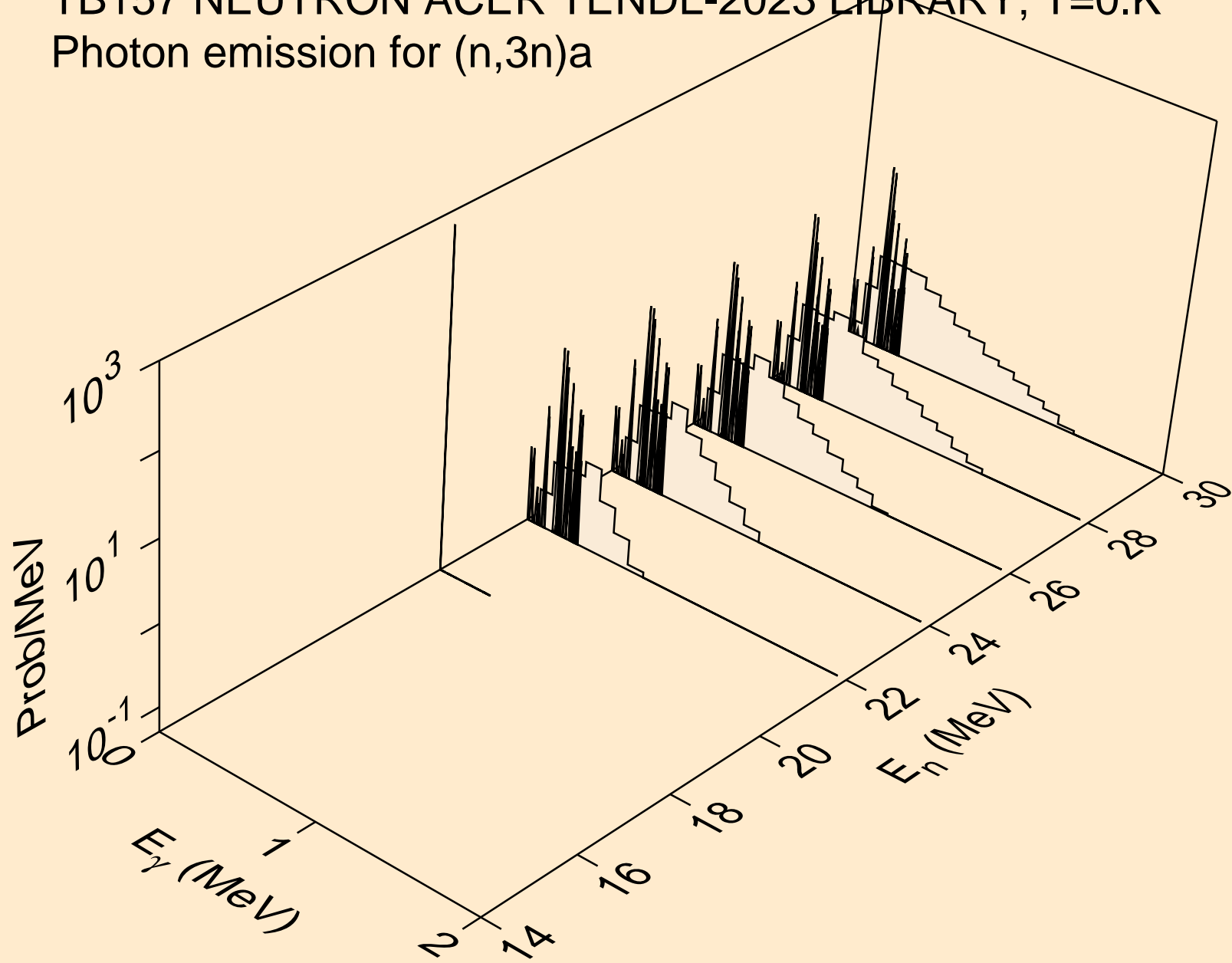

TB157 NEUTRON ACER TENDL-2023 LIBRARY; T=0.K
Photon emission for (n,n*)p

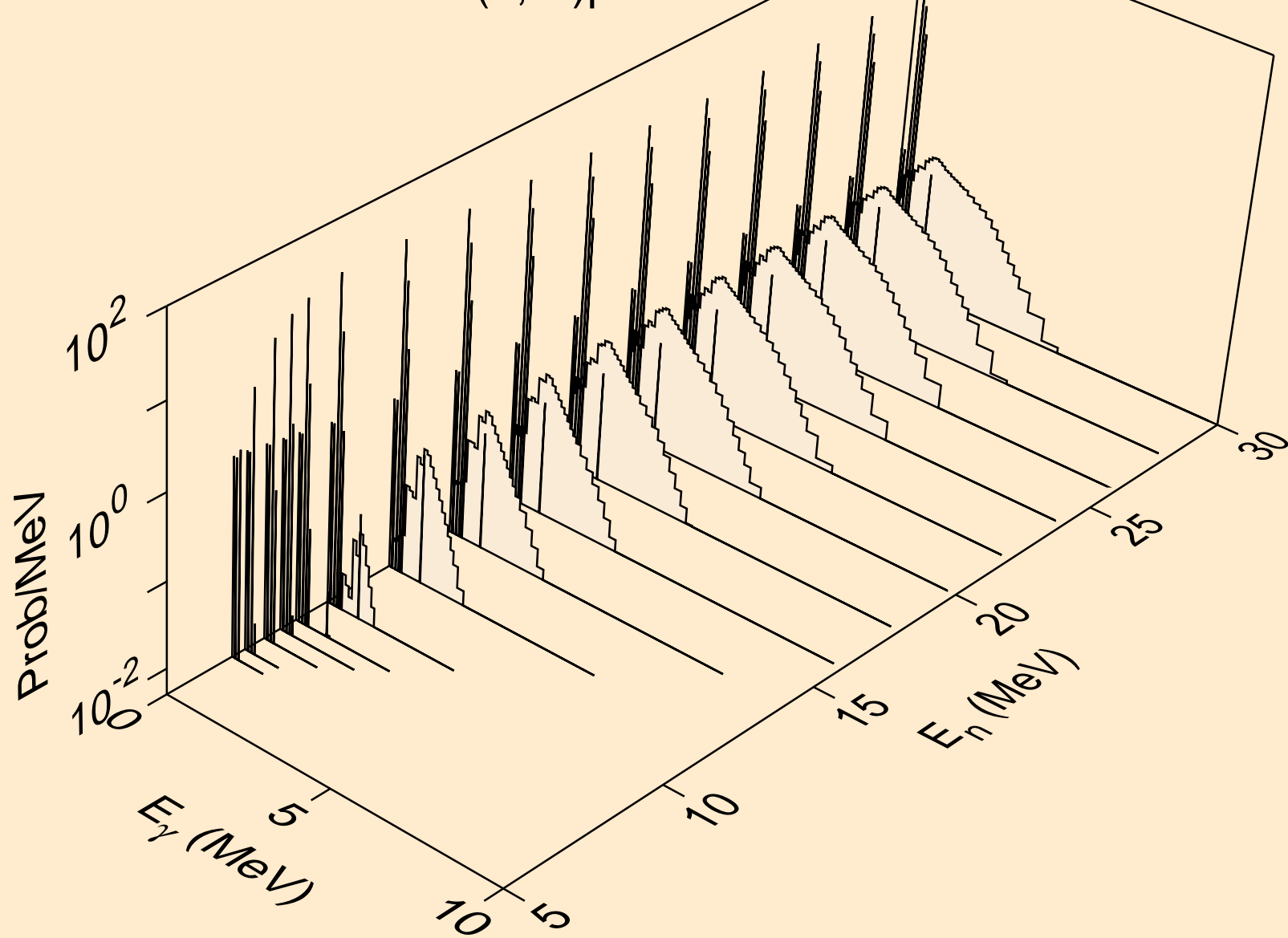

TB157 NEUTRON ACER TENDL-2023 LIBRARY; T=0.K
Photon emission for (n,n*)2a

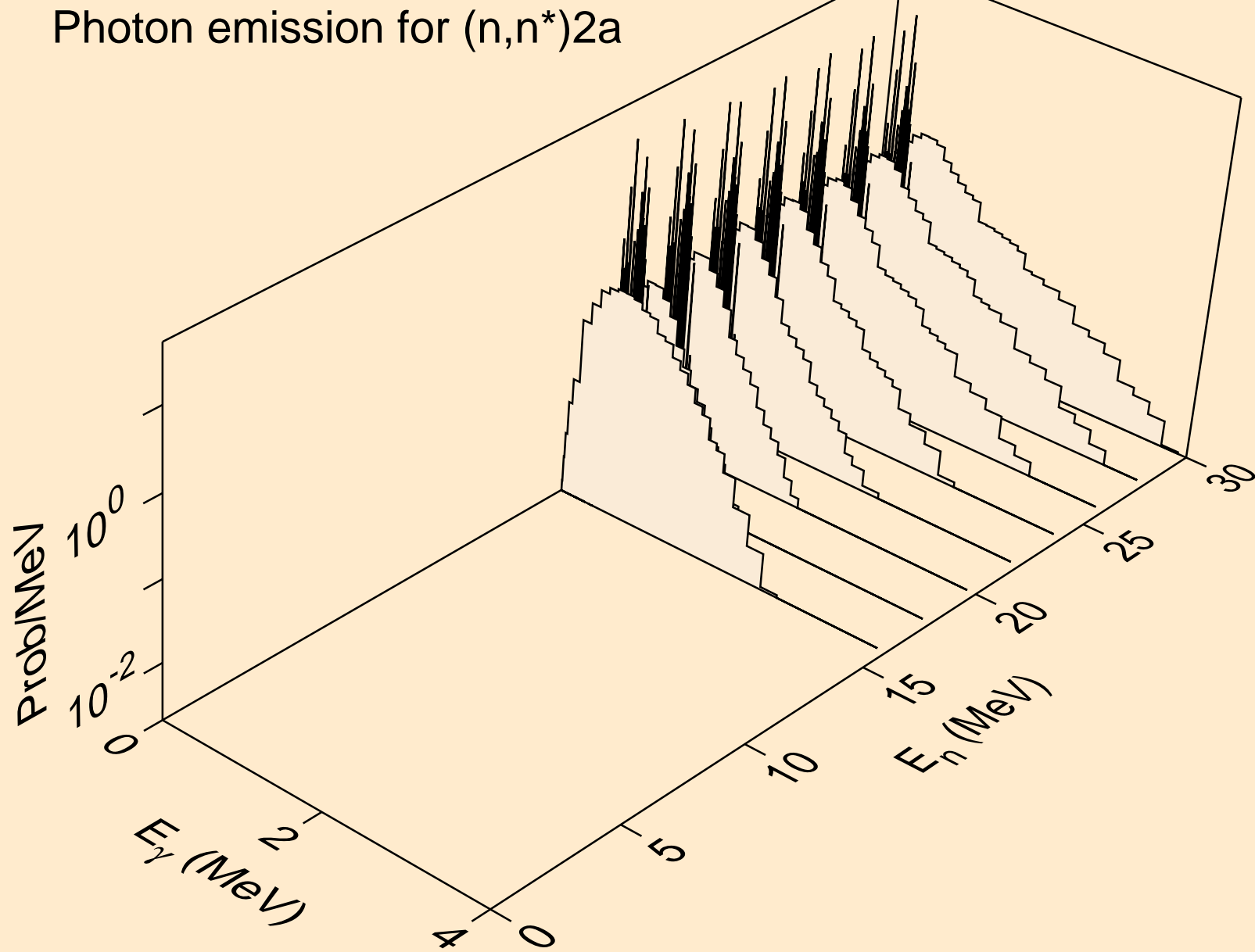

TB157 NEUTRON ACER TENDL-2023 LIBRARY; T=0.K

Photon emission for (n,n*)d

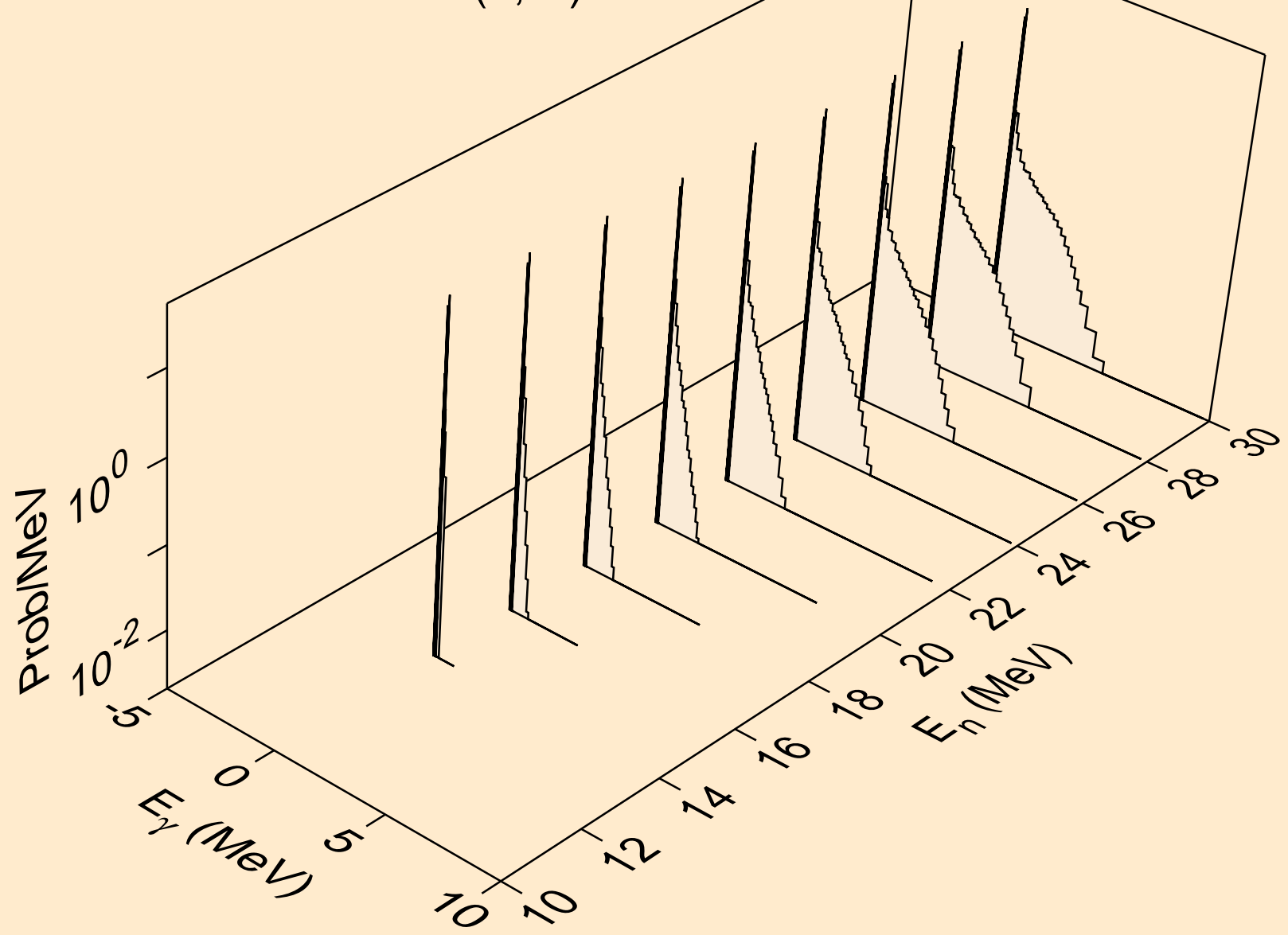

TB157 NEUTRON ACER TENDL-2023 LIBRARY; T=0.K
Photon emission for (n,n*)t

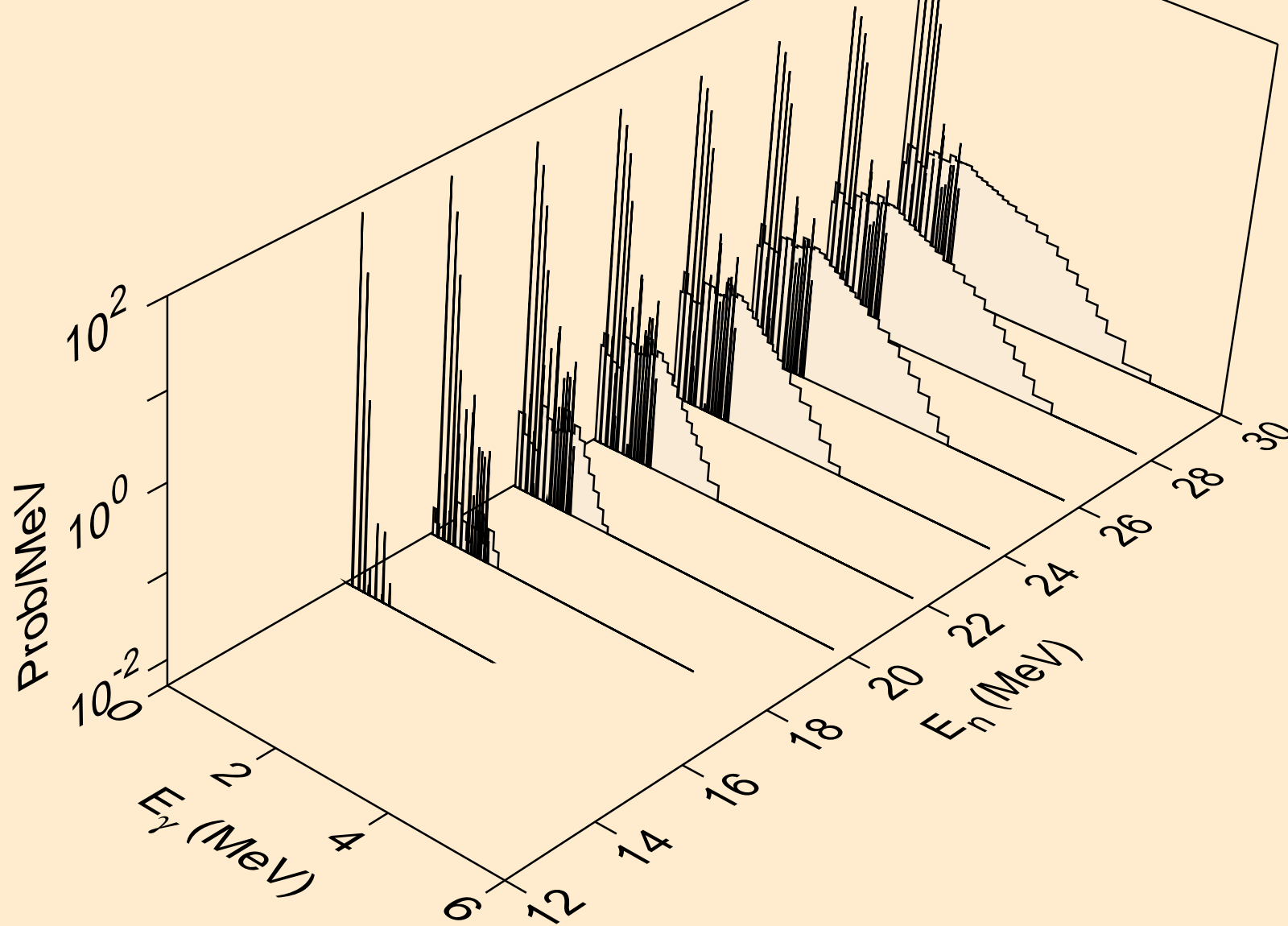

TB157 NEUTRON ACER TENDL-2023 LIBRARY; T=0.K
Photon emission for (n,n*)he3

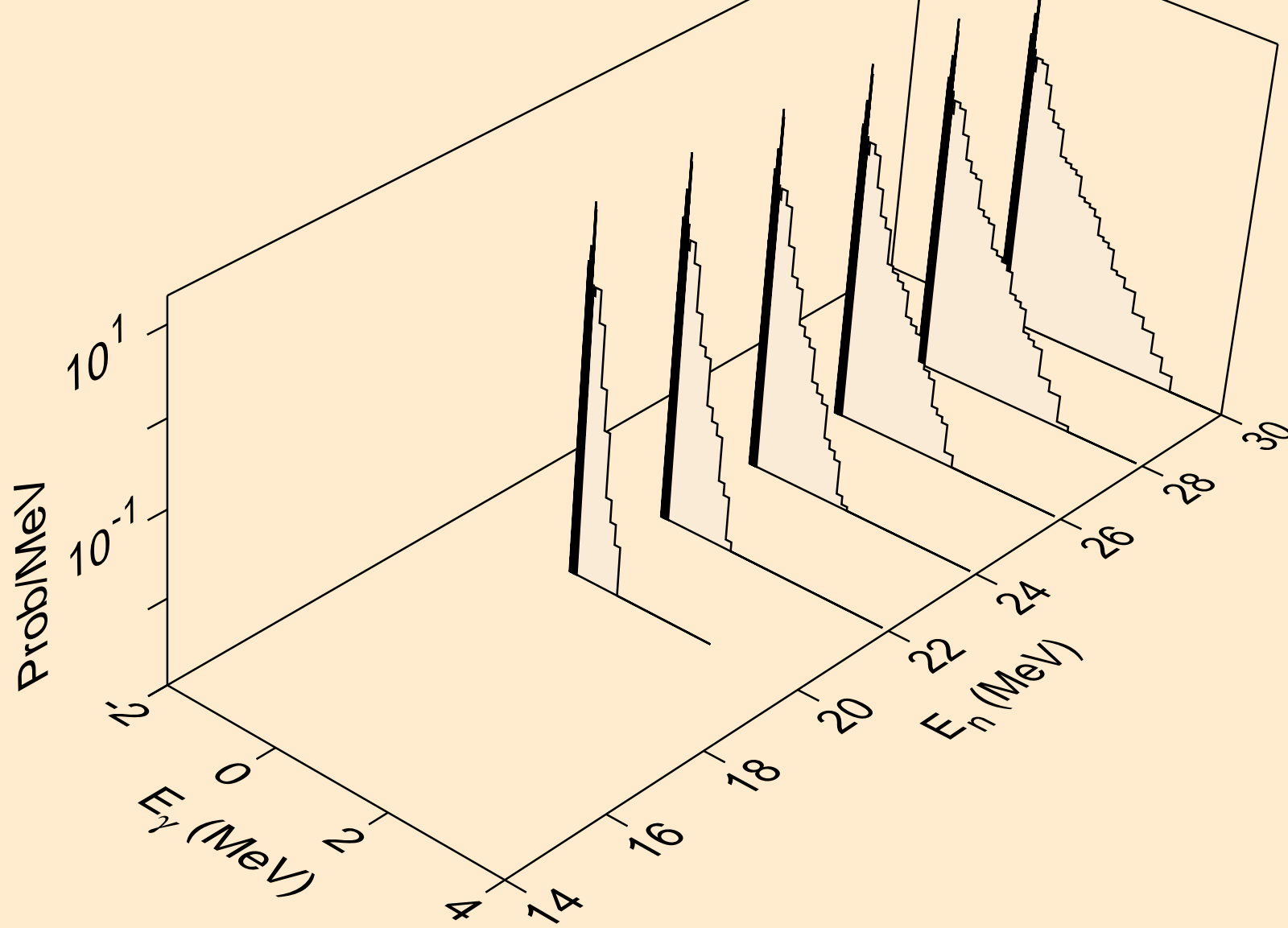

TB157 NEUTRON ACER TENDL-2023 LIBRARY; T=0.K
Photon emission for (n,4n)

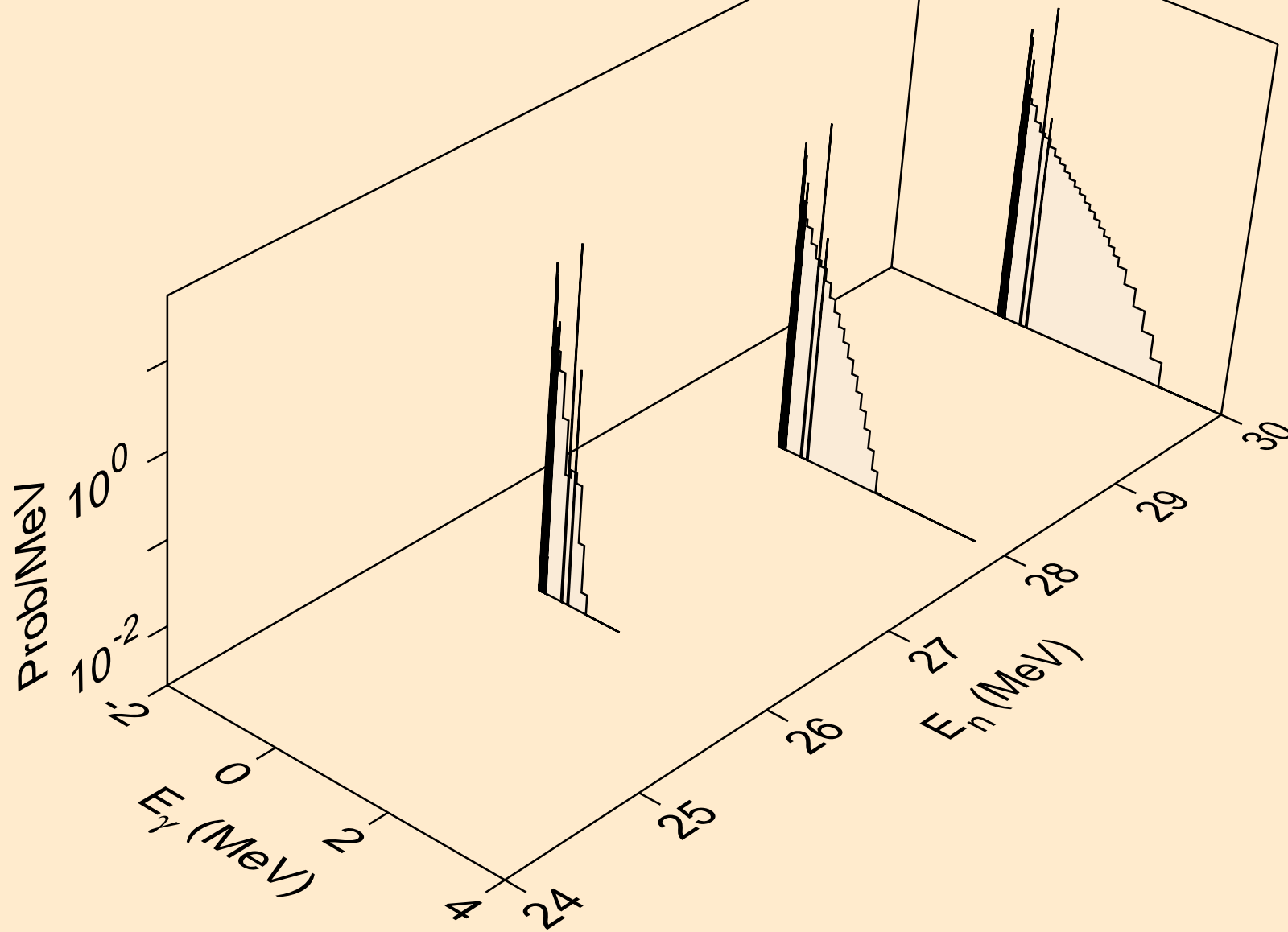

TB157 NEUTRON ACER TENDL-2023 LIBRARY; T=0.K
Photon emission for (n,2np)

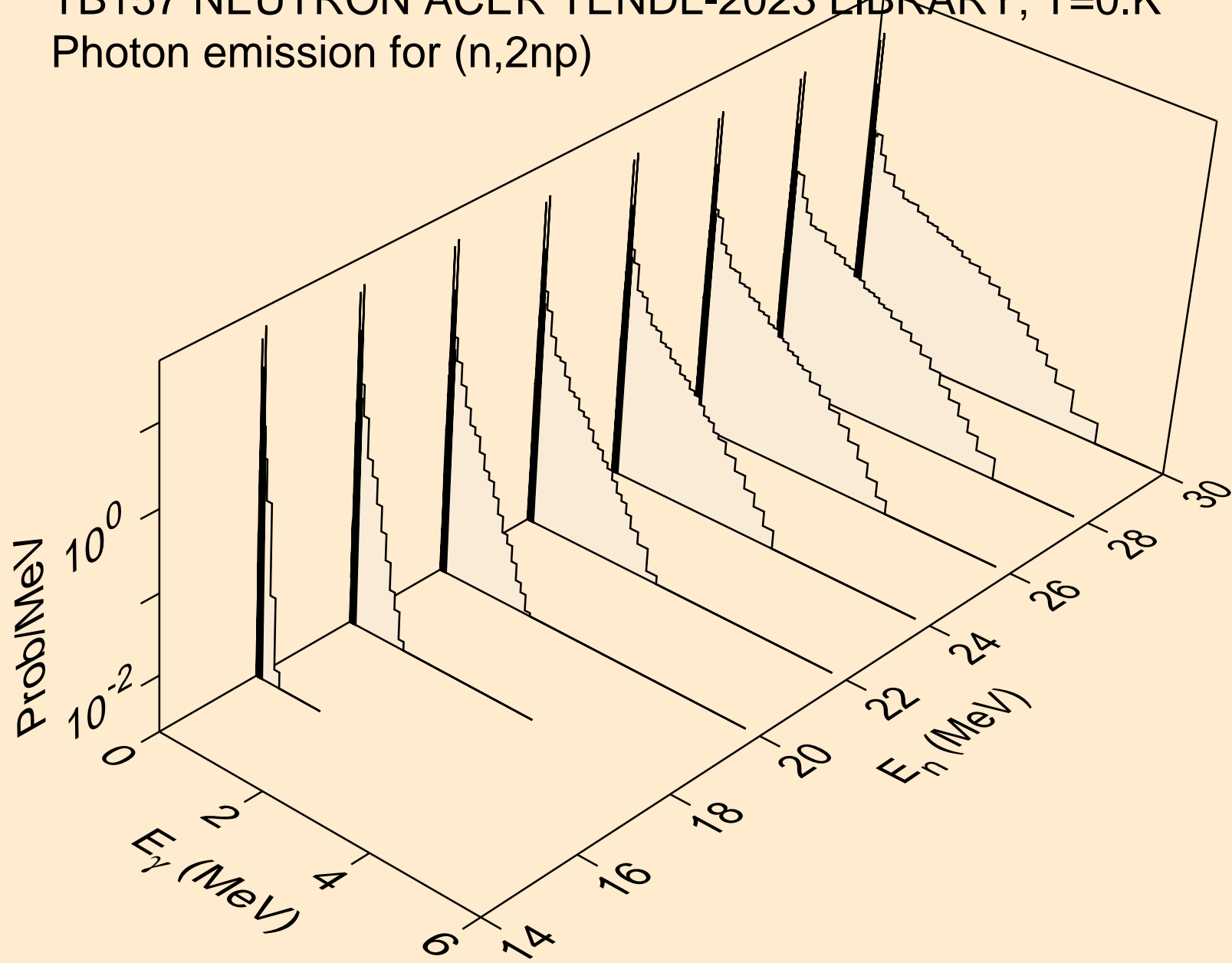

TB157 NEUTRON ACER TENDL-2023 LIBRARY; T=0.K
Photon emission for (n,3np)

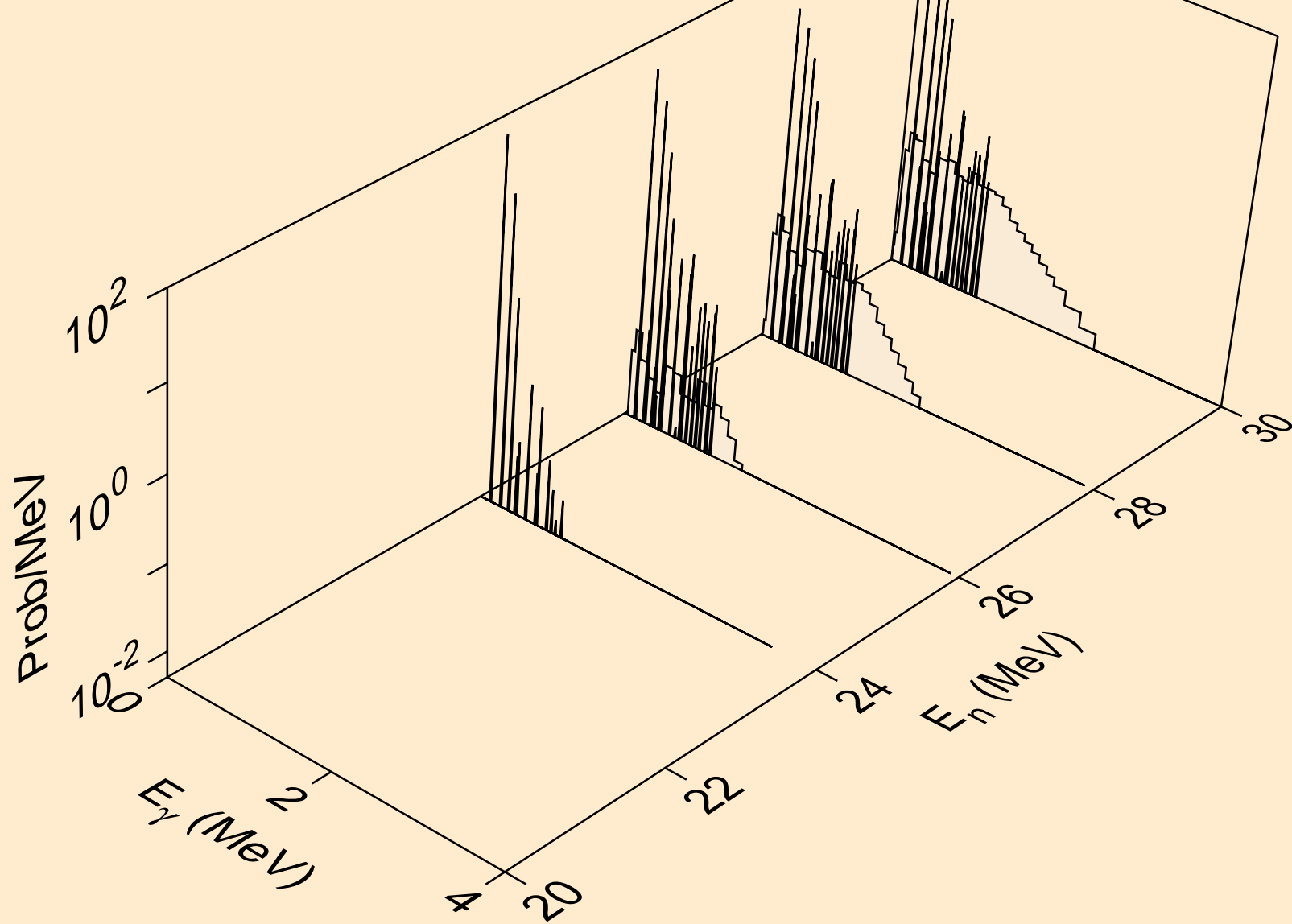

TB157 NEUTRON ACER TENDL-2023 LIBRARY; T=0.K
Photon emission for (n,n2p)

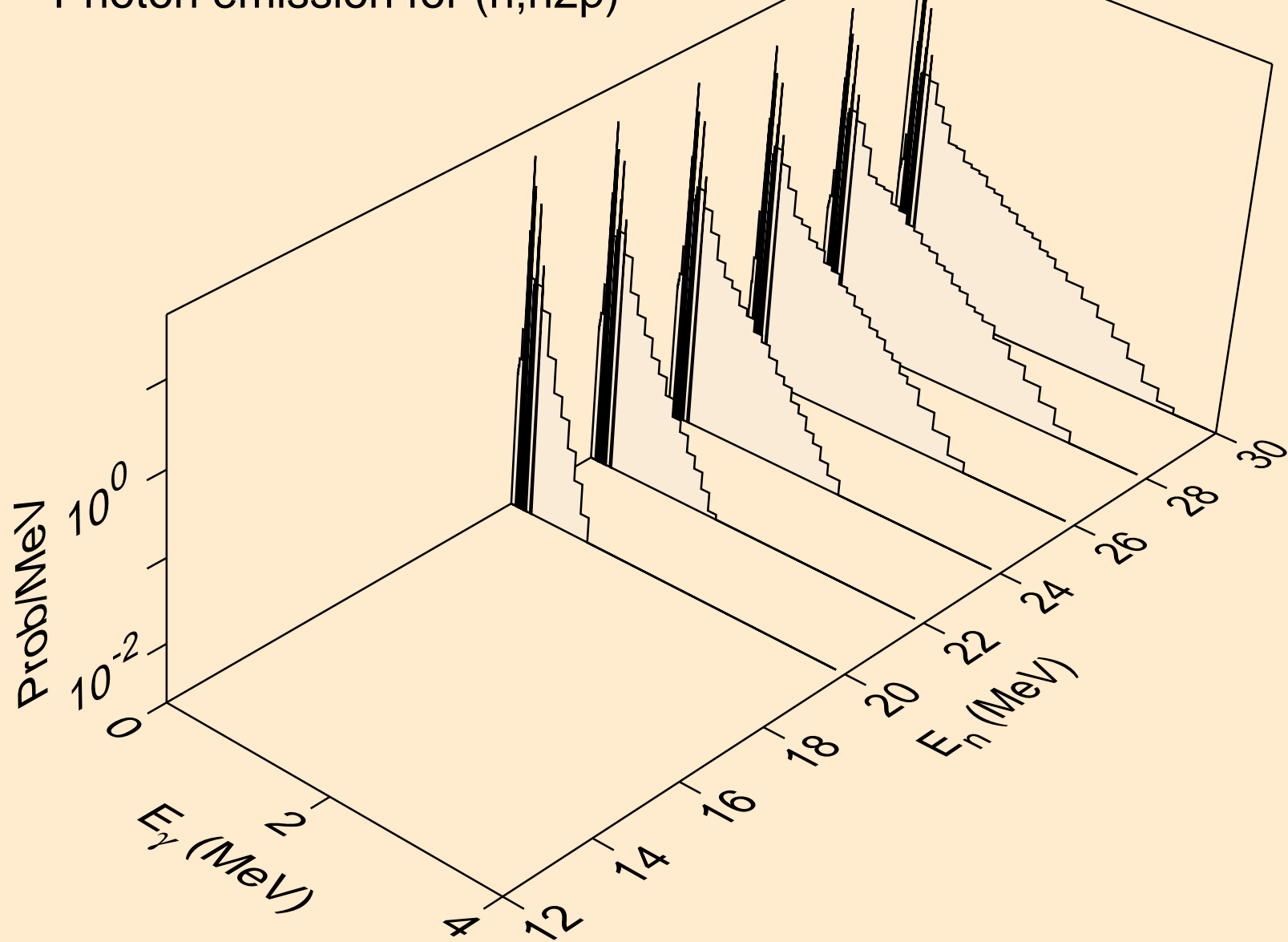

TB157 NEUTRON ACER TENDL-2023 LIBRARY; T=0.K
Photon emission for (n,npa)

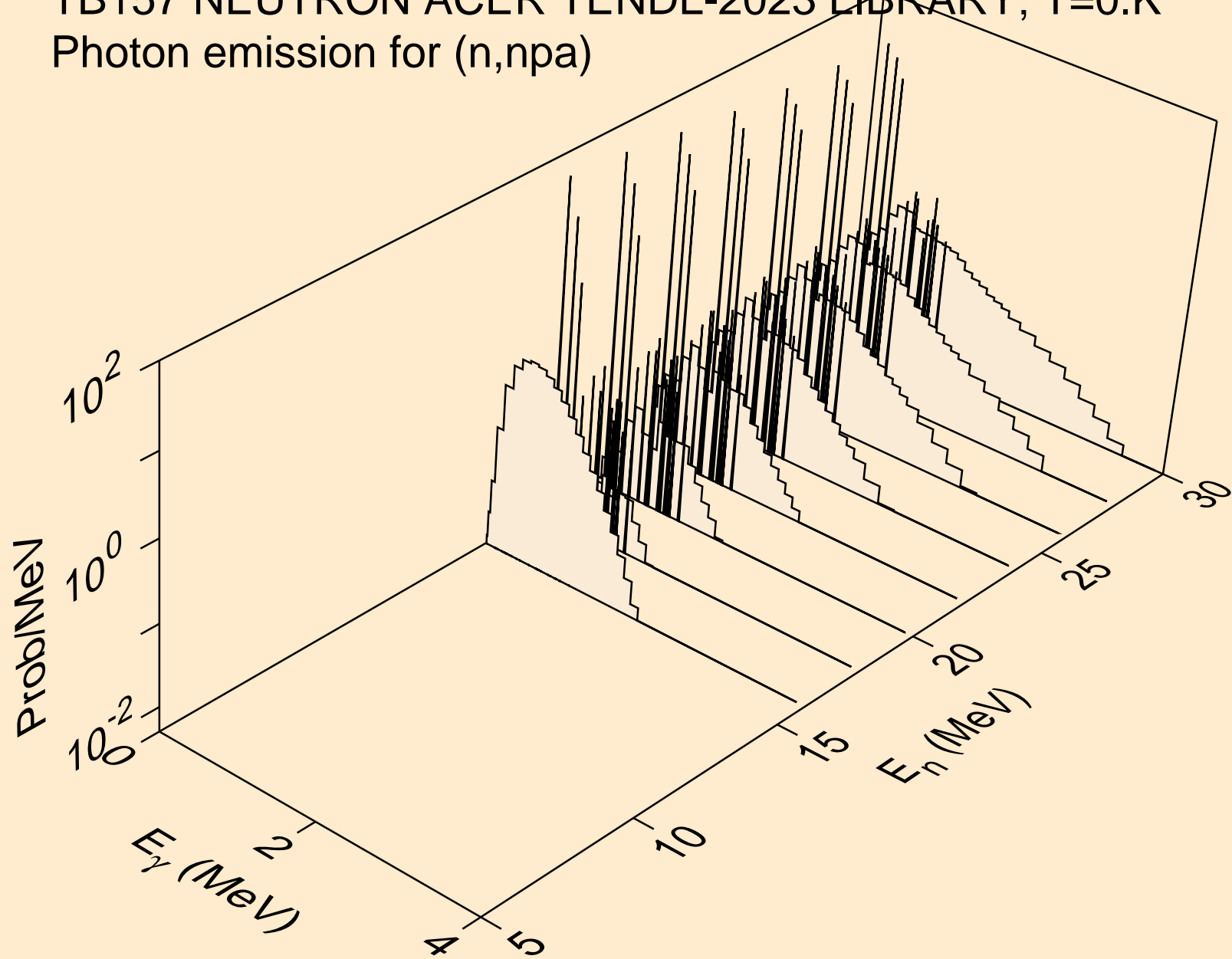

TB157 NEUTRON ACER TENDL-2023 LIBRARY; T=0.K
Photon emission for (n,n*c)

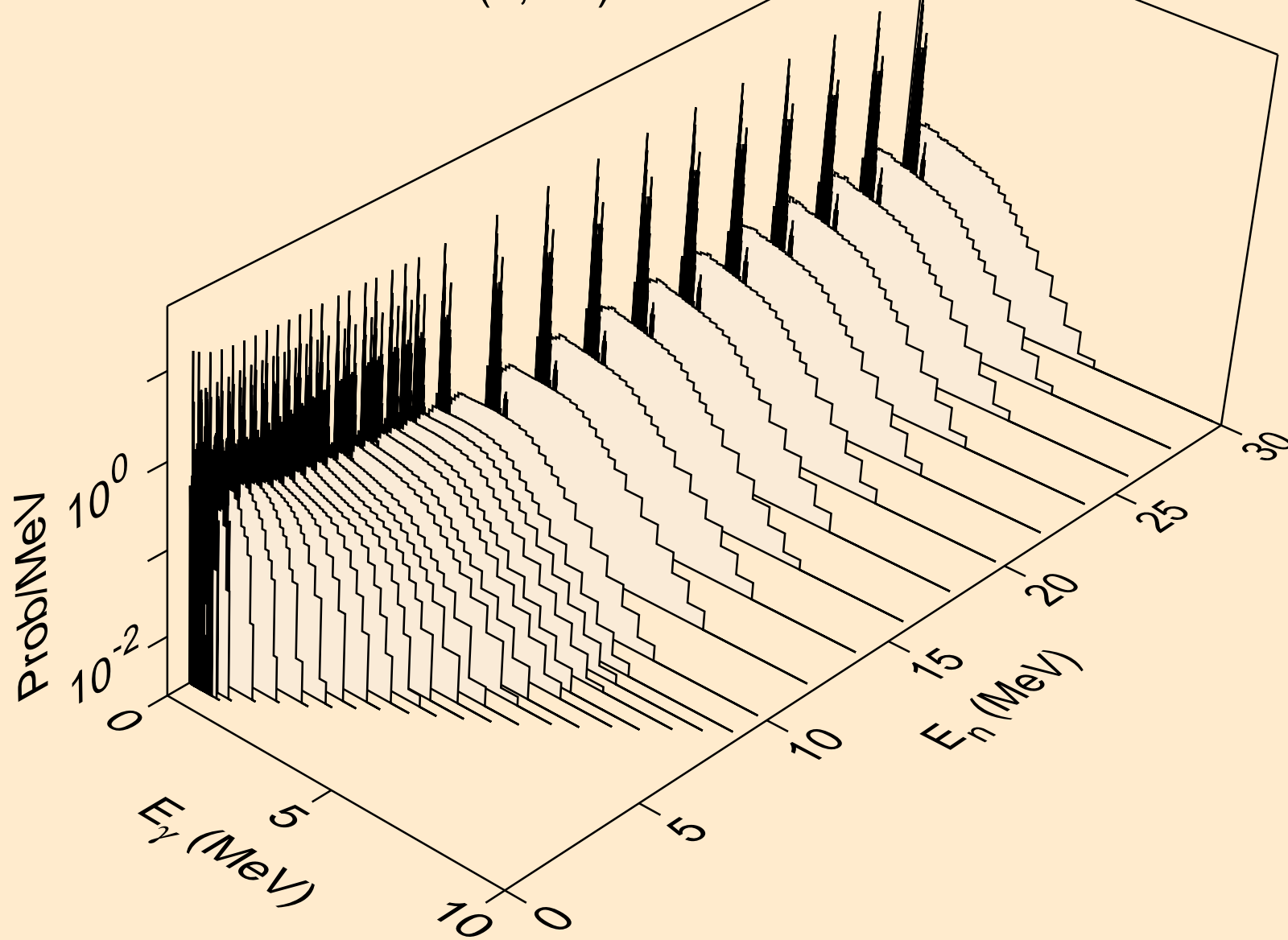

TB157 NEUTRON ACER TENDL-2023 LIBRARY; T=0.K
Photon emission for (n,gma)

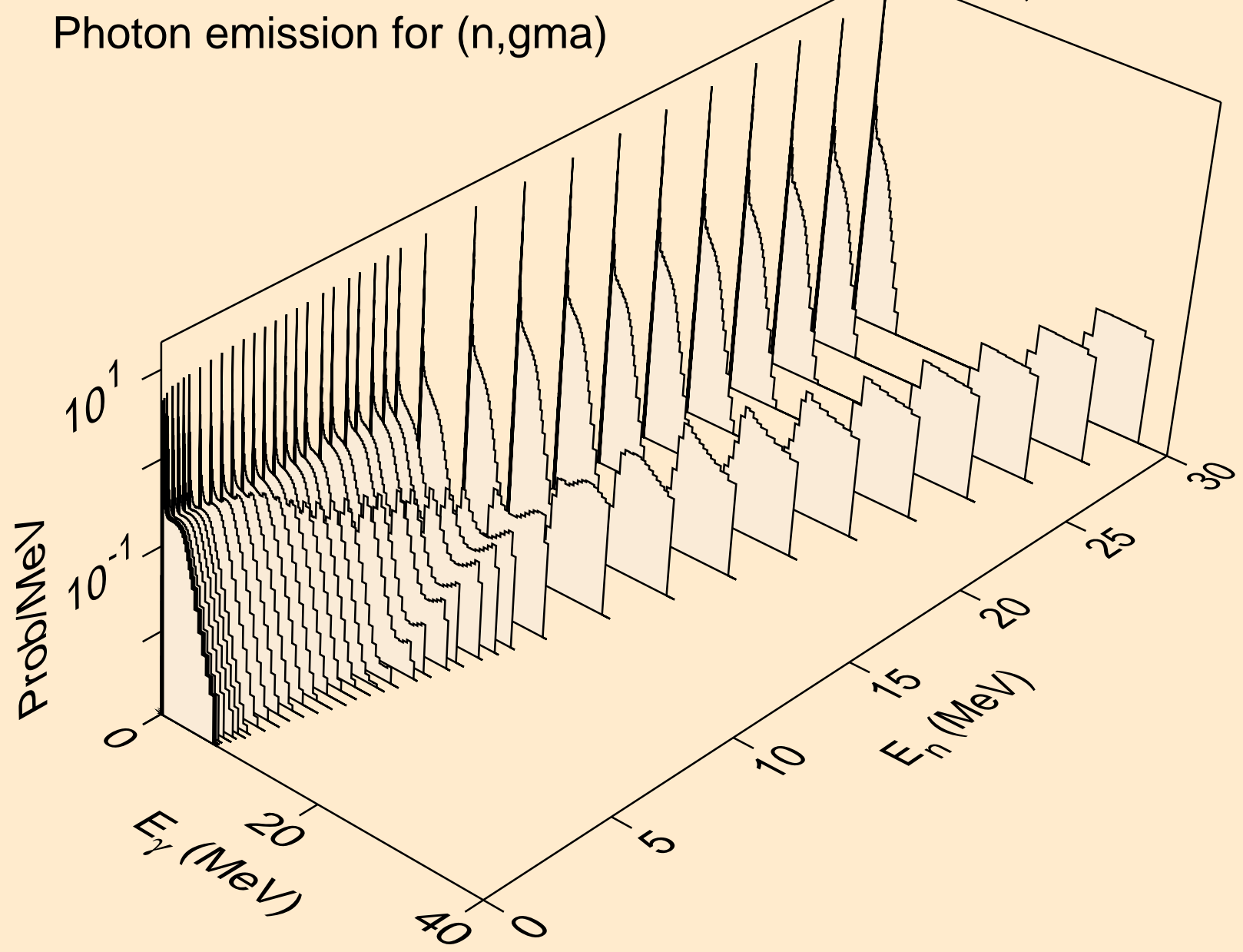

TB157 NEUTRON ACER TENDL-2023 LIBRARY; T=0.K
Photon emission for (n,p)

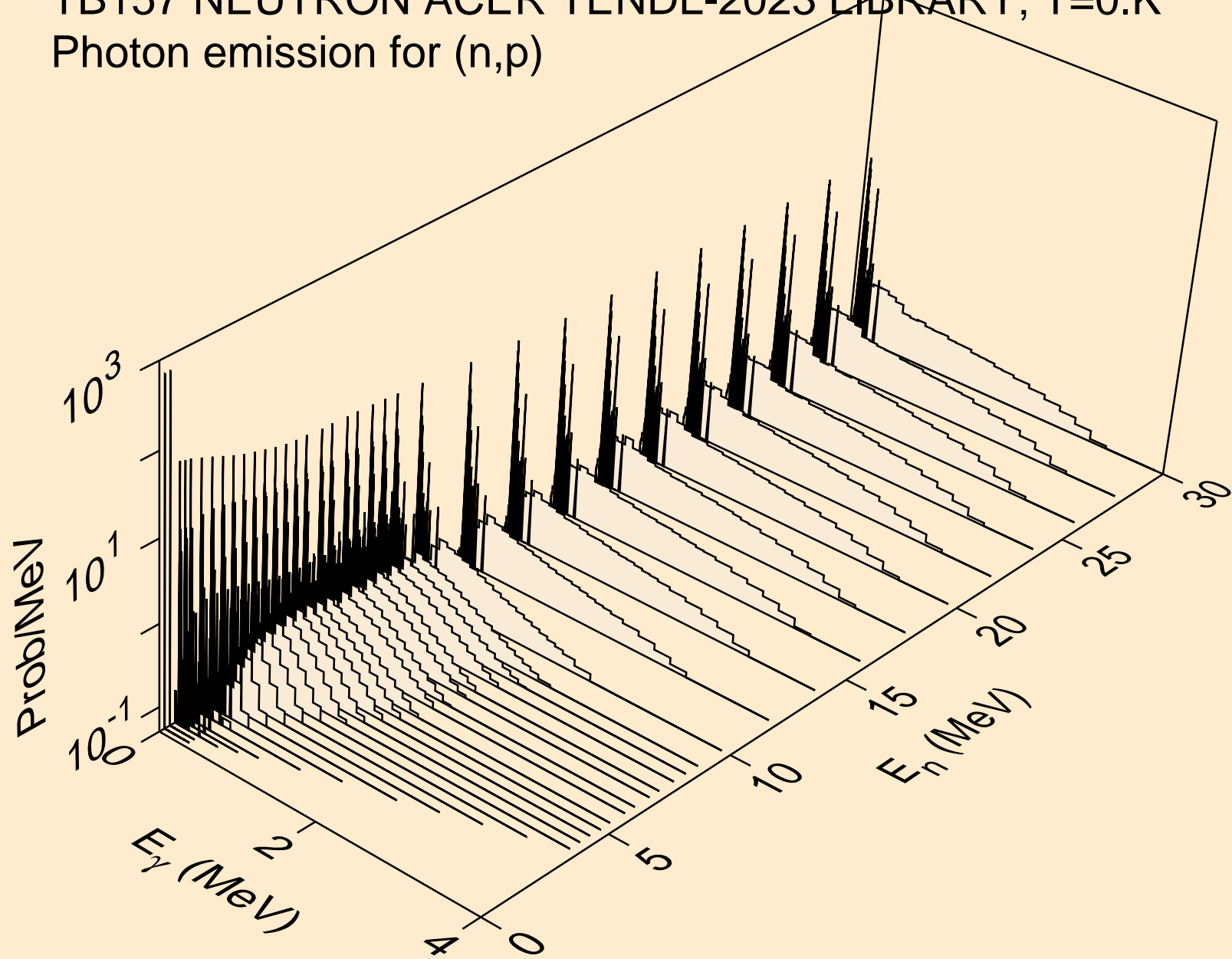

TB157 NEUTRON ACER TENDL-2023 LIBRARY; T=0.K
Photon emission for (n,d)

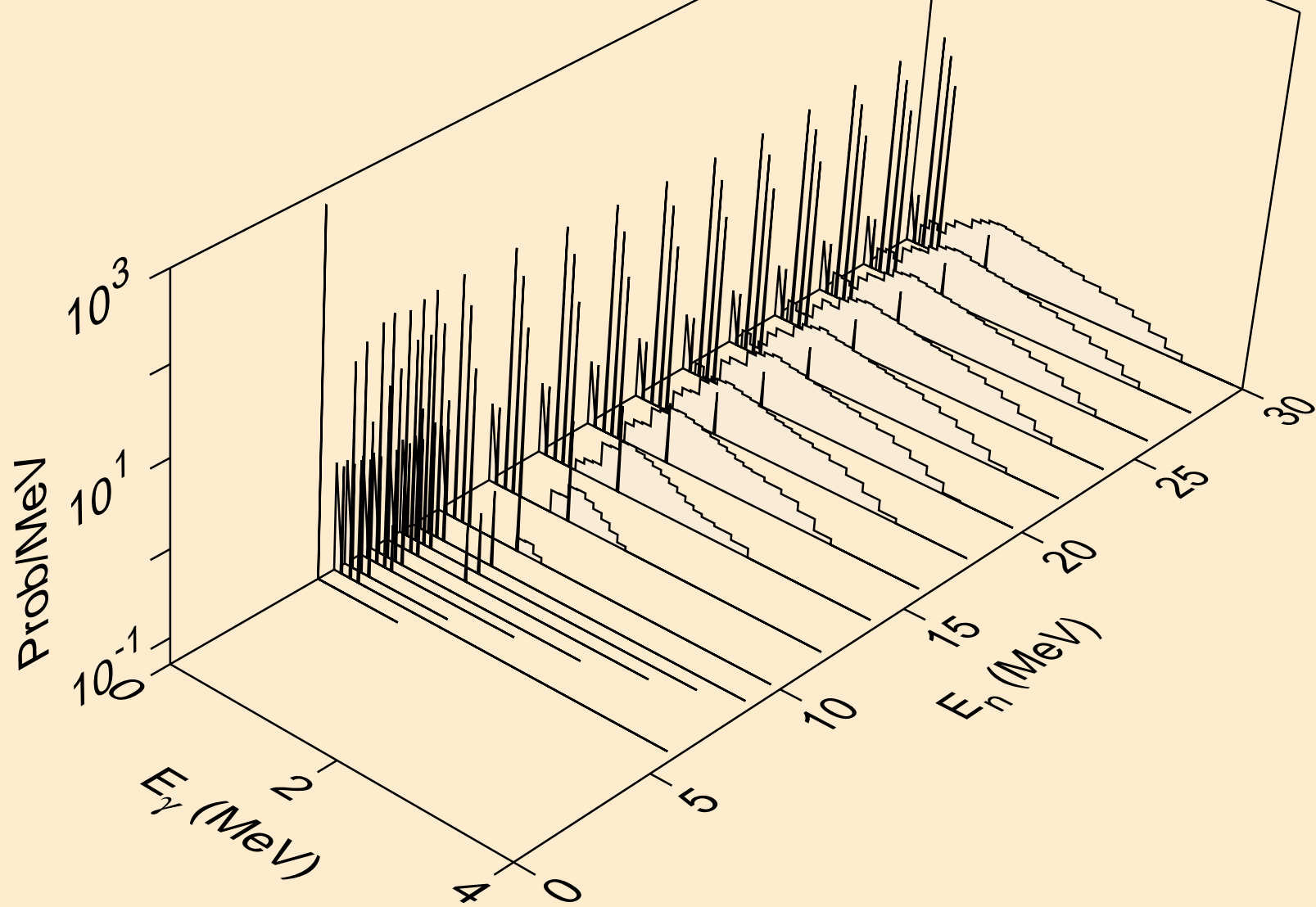

TB157 NEUTRON ACER TENDL-2023 LIBRARY; T=0.K
Photon emission for (n,t)

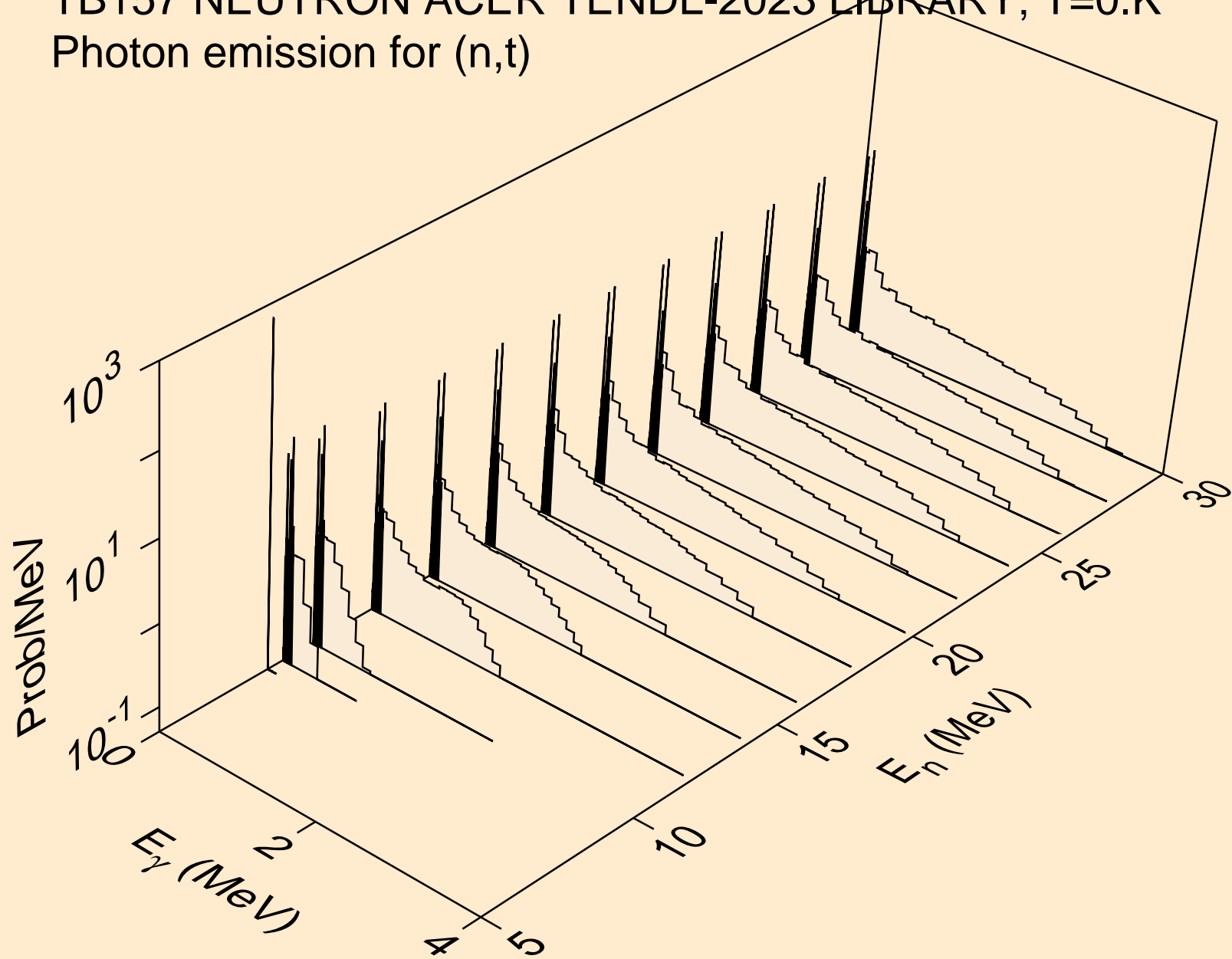

TB157 NEUTRON ACER TENDL-2023 LIBRARY; T=0.K
Photon emission for (n,he3)

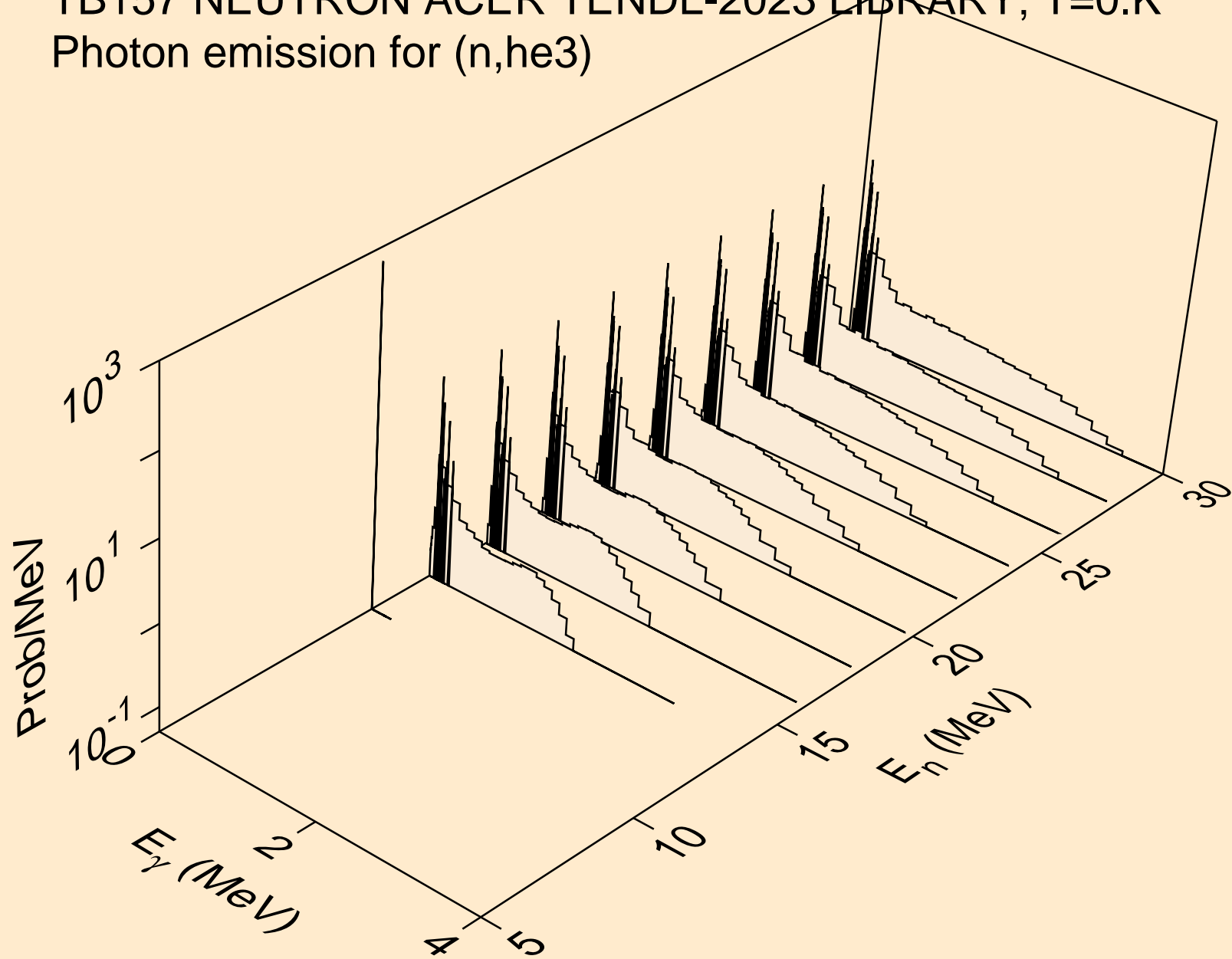

TB157 NEUTRON ACER TENDL-2023 LIBRARY; T=0.K
Photon emission for (n,a)

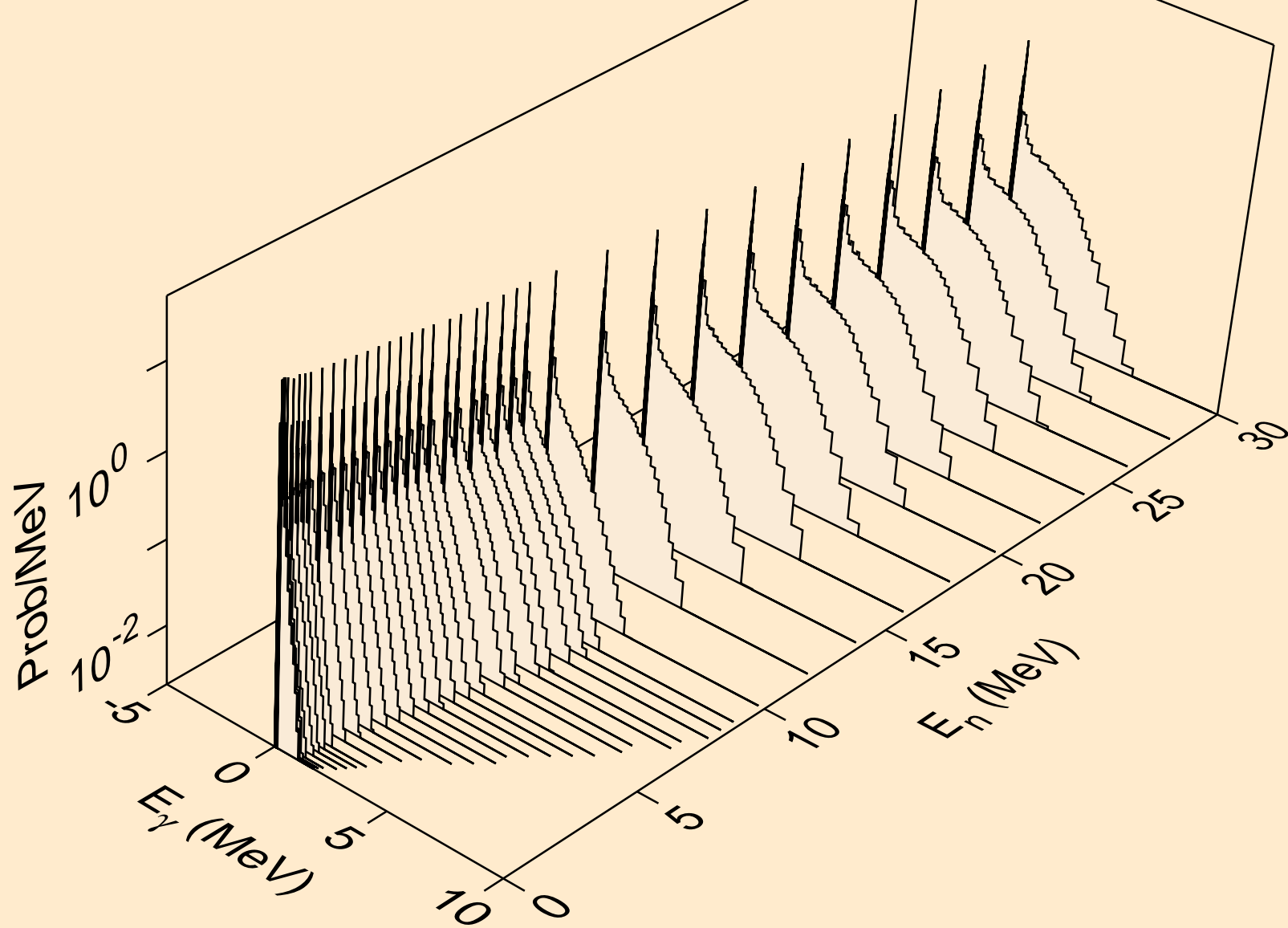

TB157 NEUTRON ACER TENDL-2023 LIBRARY; T=0.K
Photon emission for (n,2a)

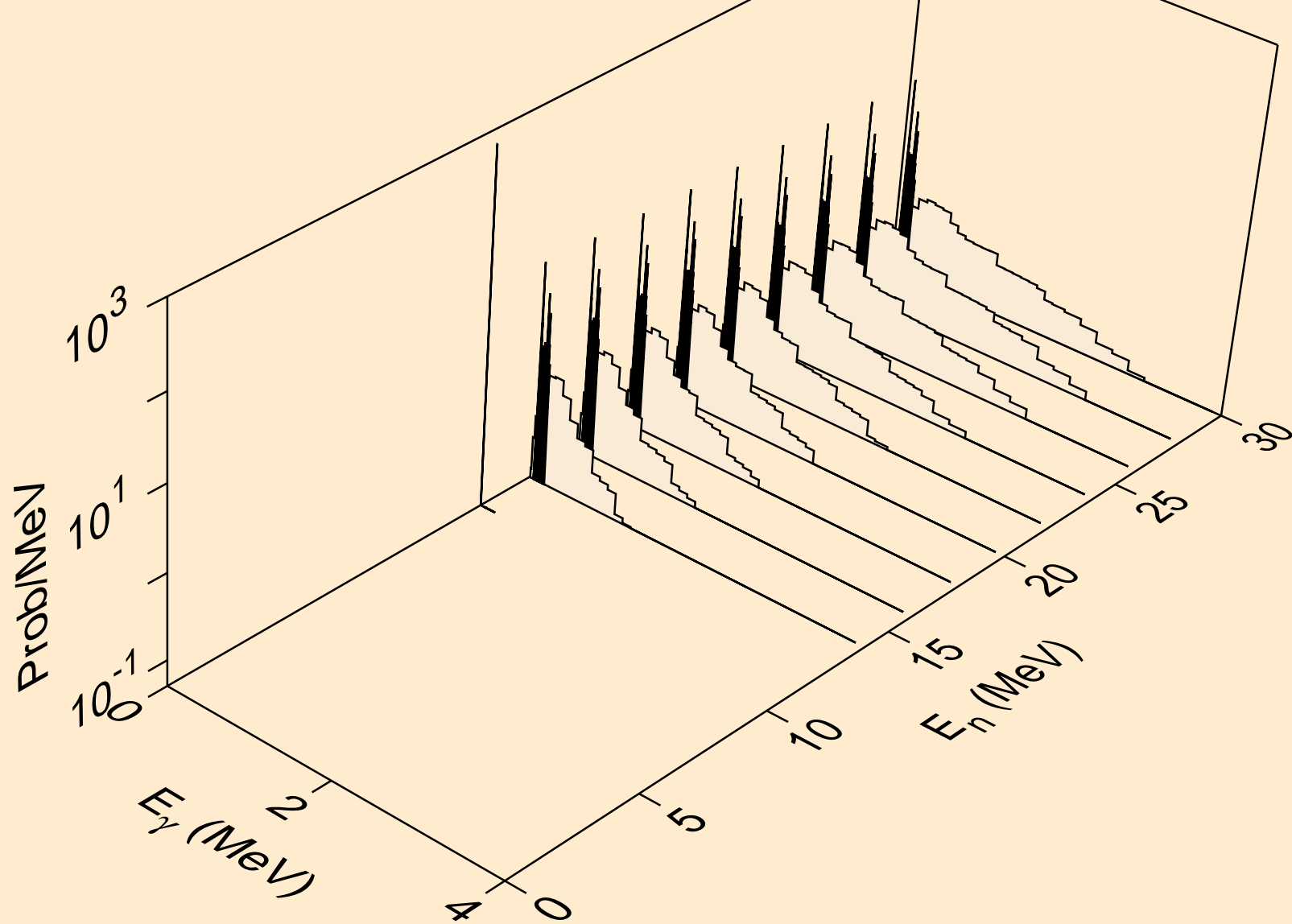

TB157 NEUTRON ACER TENDL-2023 LIBRARY; T=0.K
Photon emission for (n,2p)

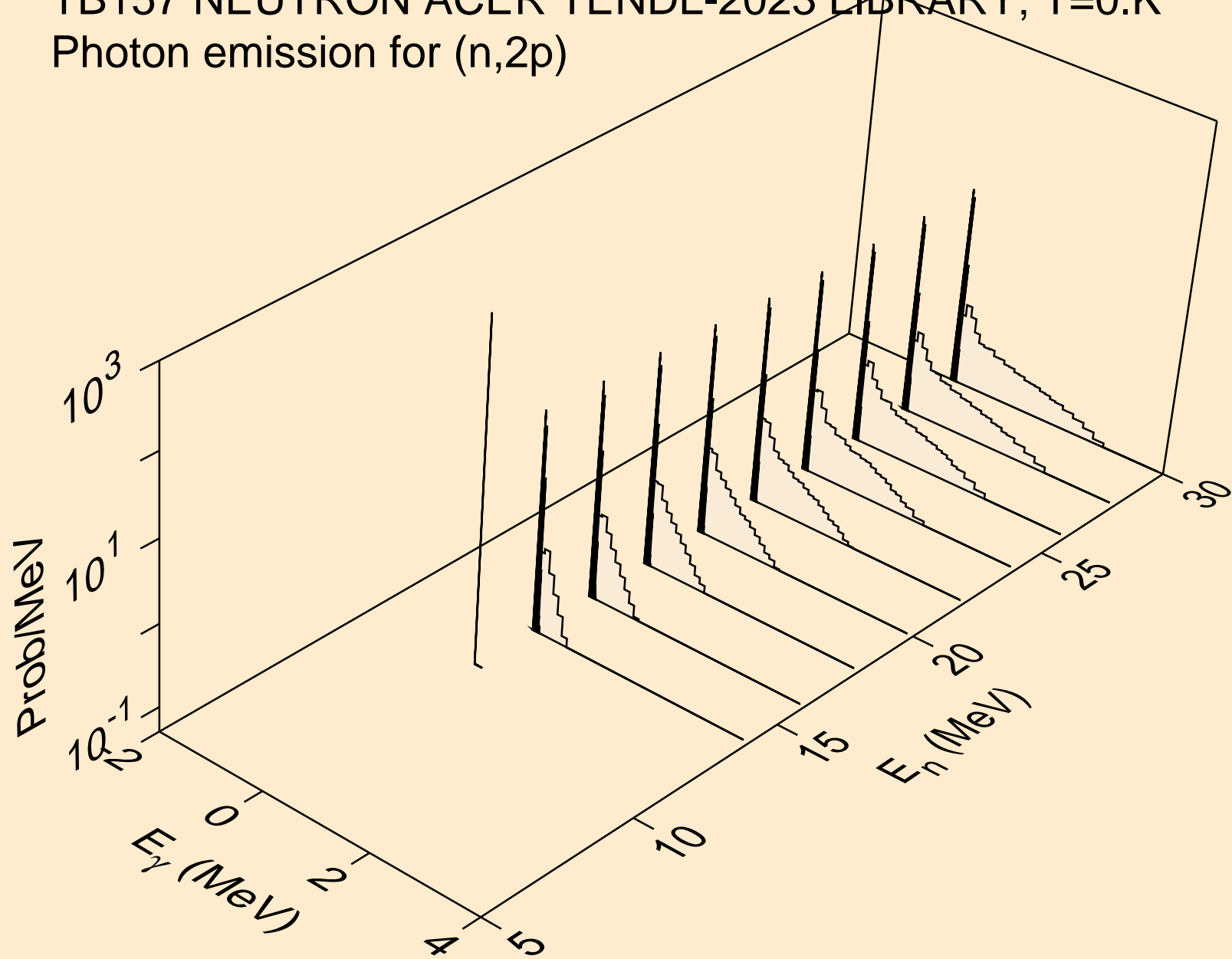

TB157 NEUTRON ACER TENDL-2023 LIBRARY; T=0.K
Photon emission for (n,p)

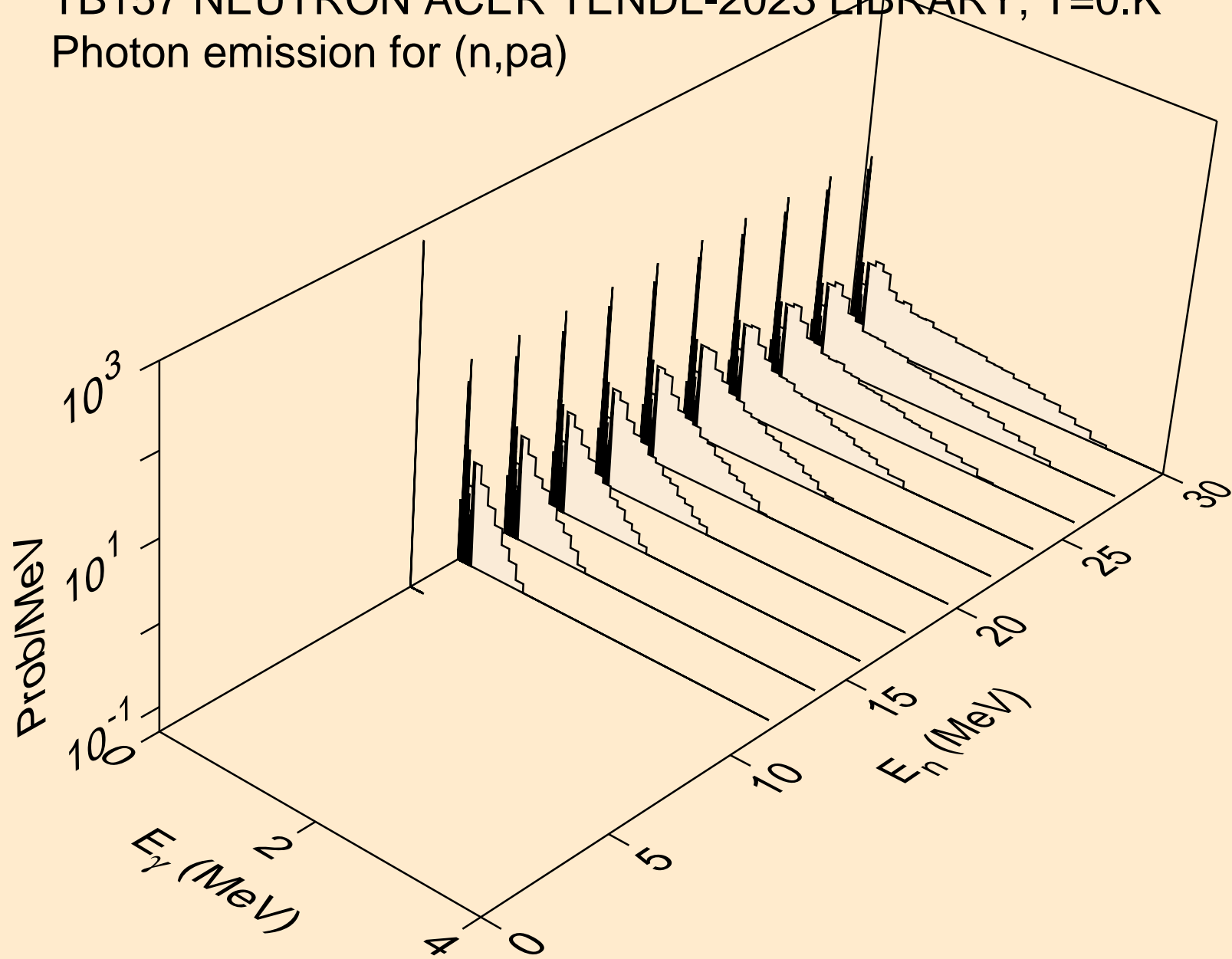

TB157 NEUTRON ACER TENDL-2023 LIBRARY; T=0.K
Photon emission for (n,pd)

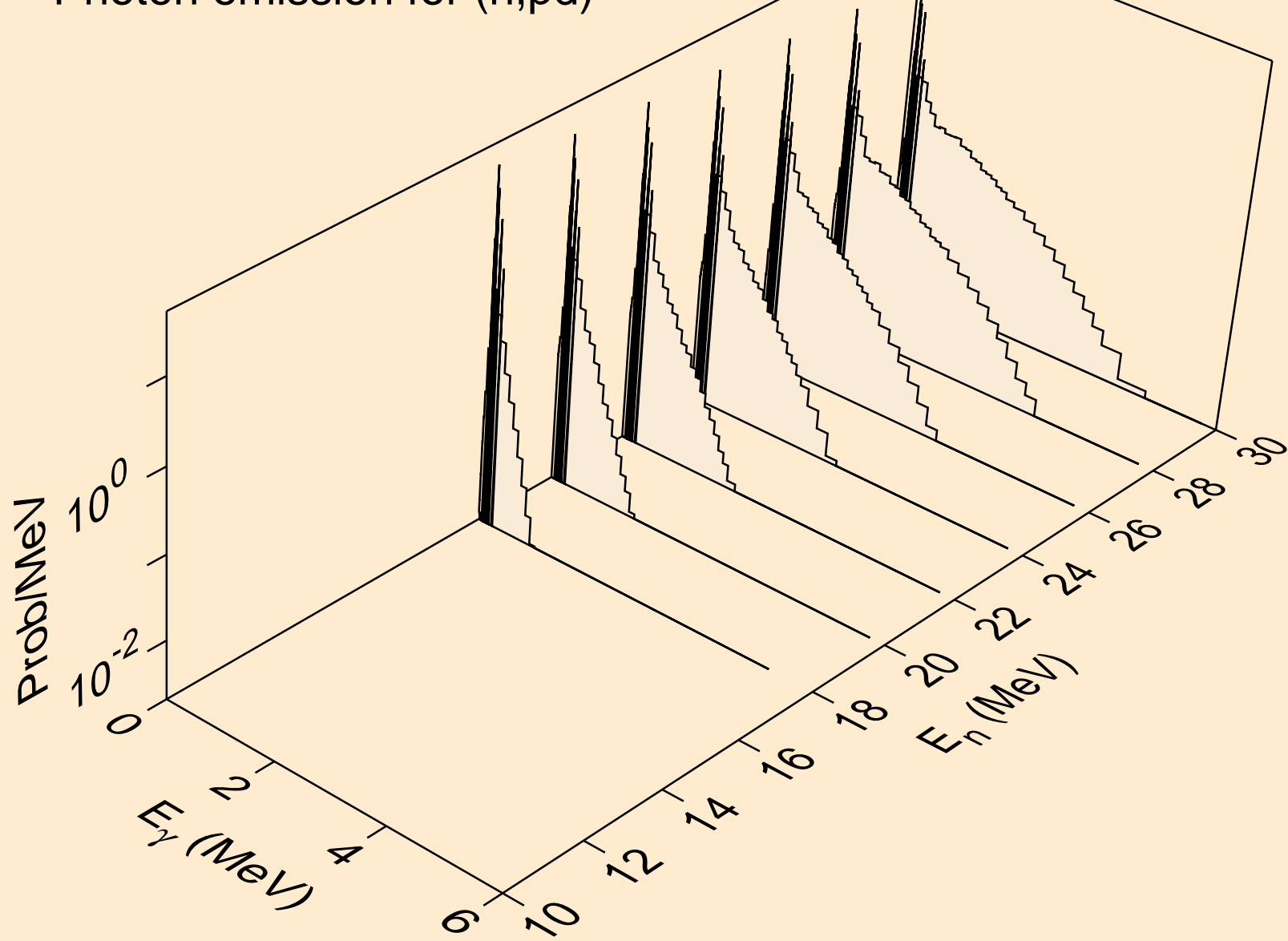

TB157 NEUTRON ACER TENDL-2023 LIBRARY; T=0.K
Photon emission for (n,pt)

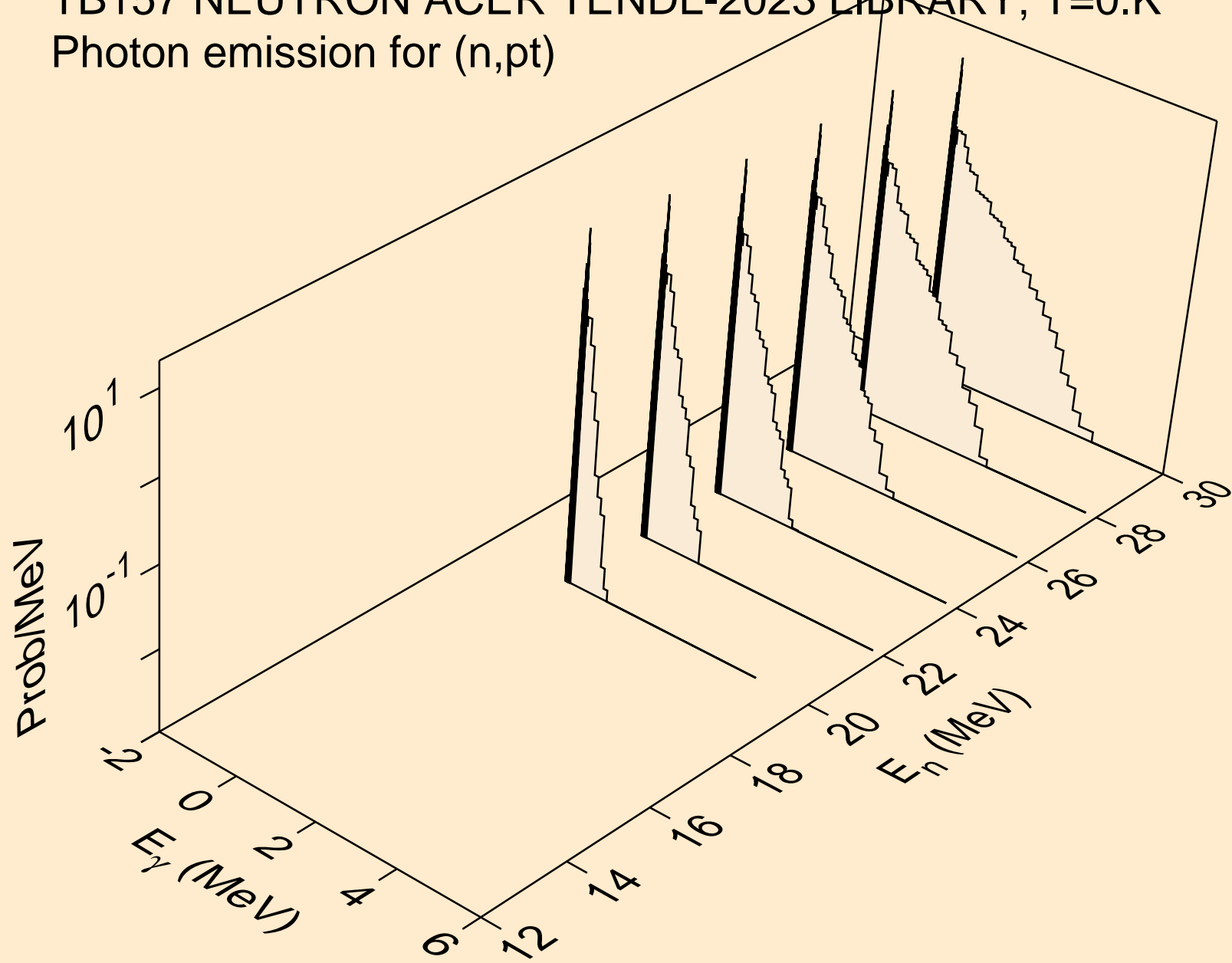

TB157 NEUTRON ACER TENDL-2023 LIBRARY; T=0.K
Photon emission for (n,da)

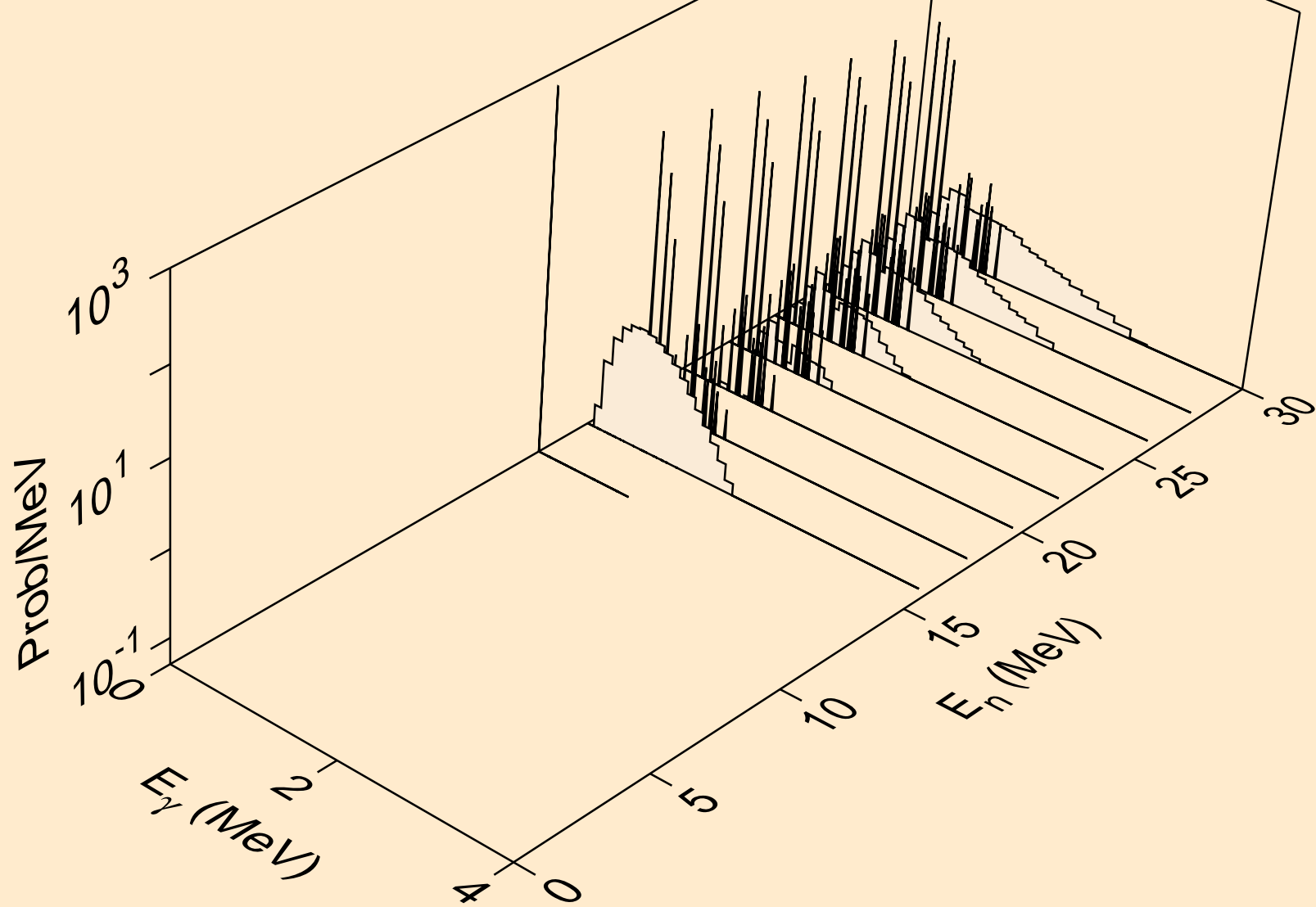

TB157 NEUTRON ACER TENDL-2023 LIBRARY; T=0.K
thermal capture photon spectrum

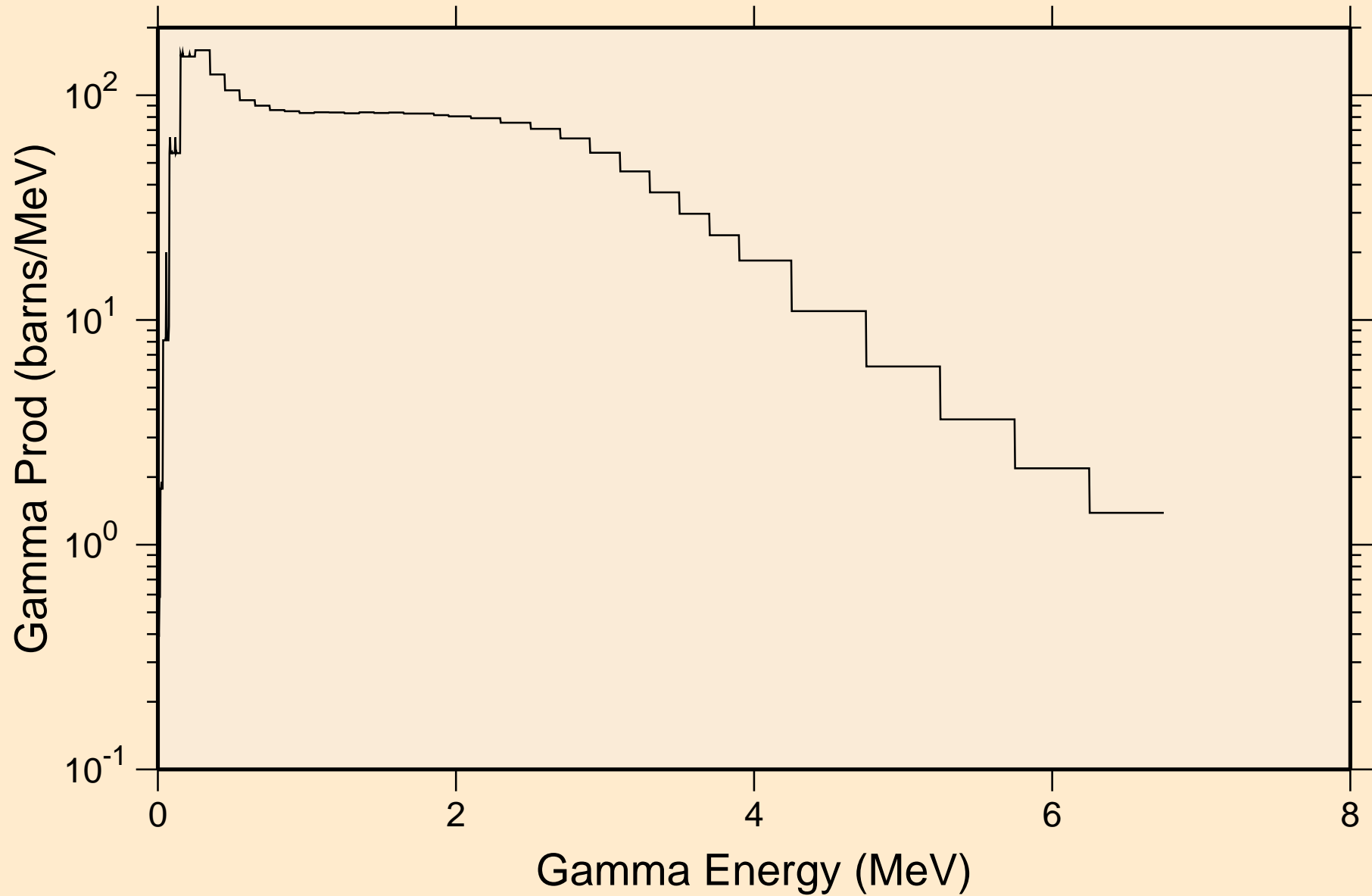

TB157 NEUTRON ACER TENDL-2023 LIBRARY; T=0.K
14 MeV photon spectrum

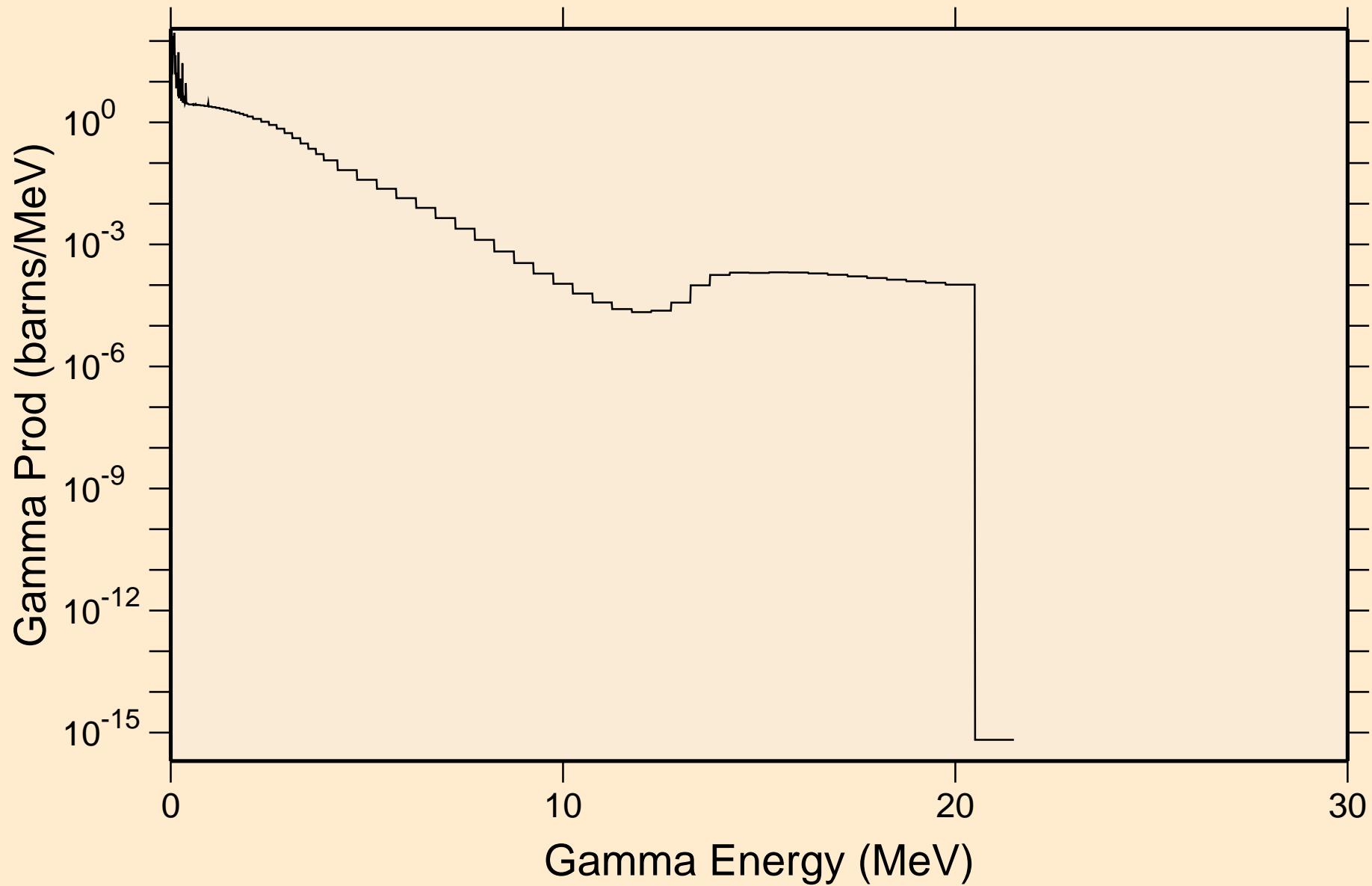

TB157 NEUTRON ACER TENDL-2023 LIBRARY; T=0.K

Particle heating contributions

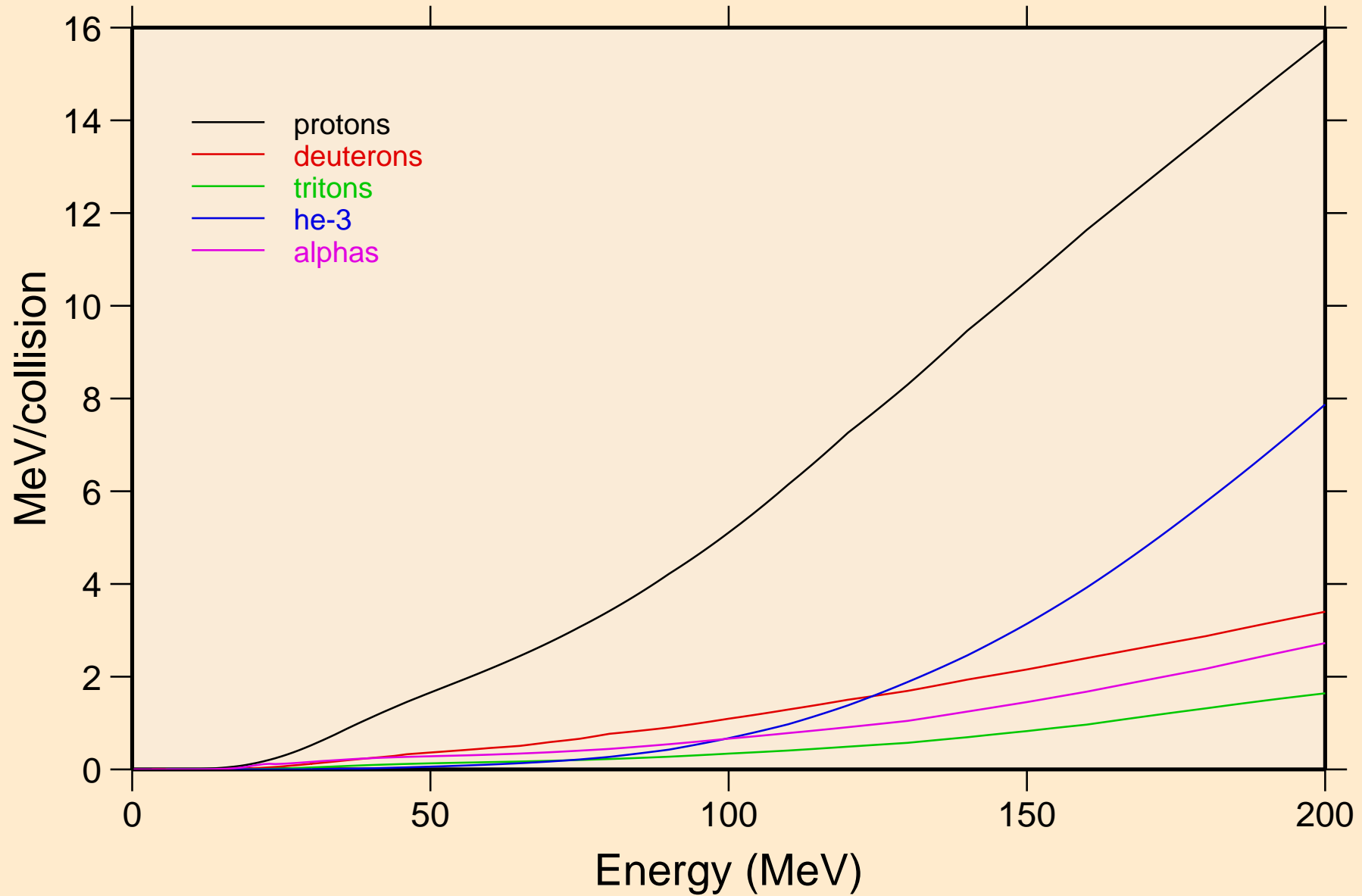

TB157 NEUTRON ACER TENDL-2023 LIBRARY; T=0.K
Recoil Heating

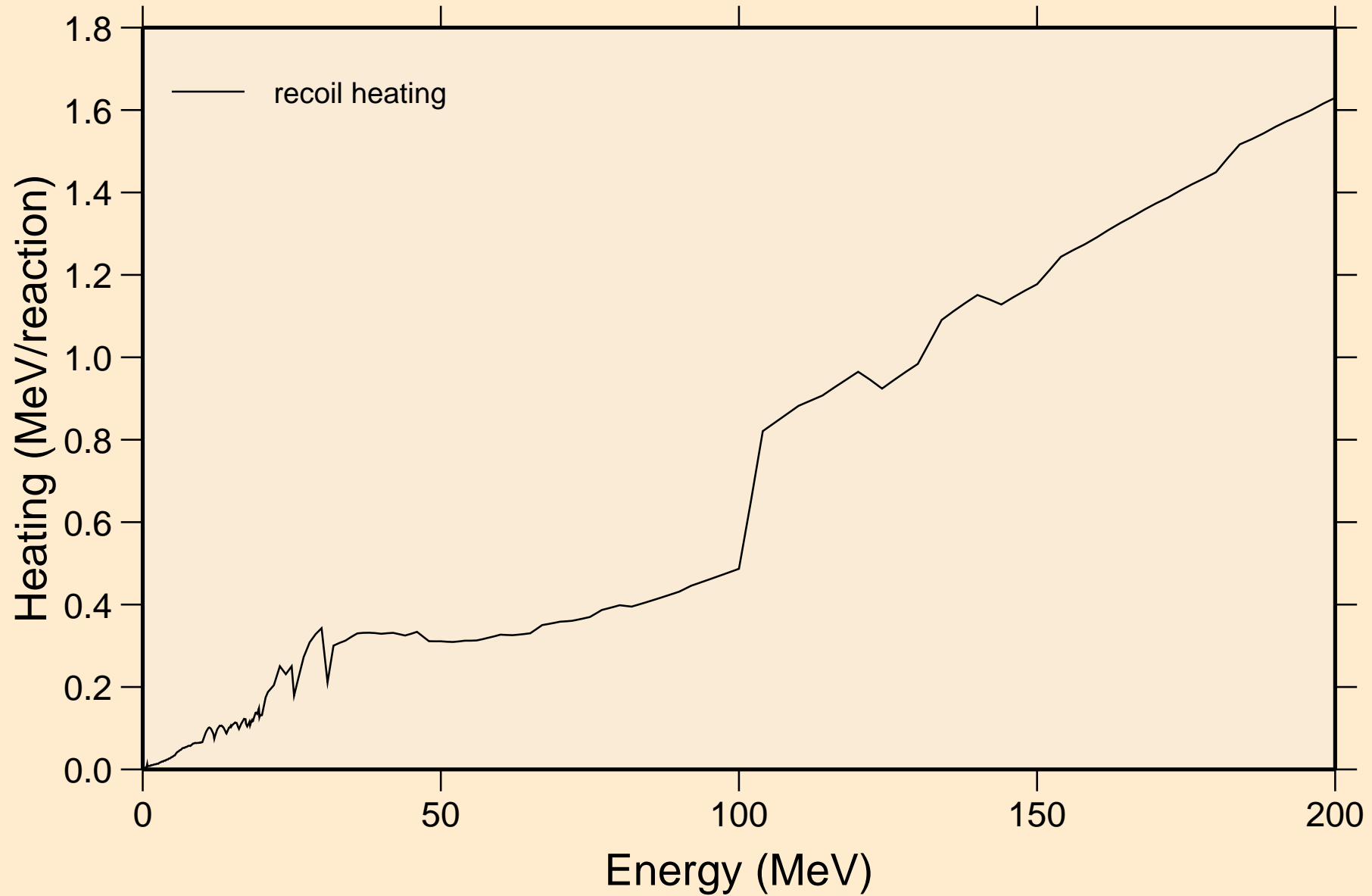

TB157 NEUTRON ACER TENDL-2023 LIBRARY; T=0.K
Particle production cross sections

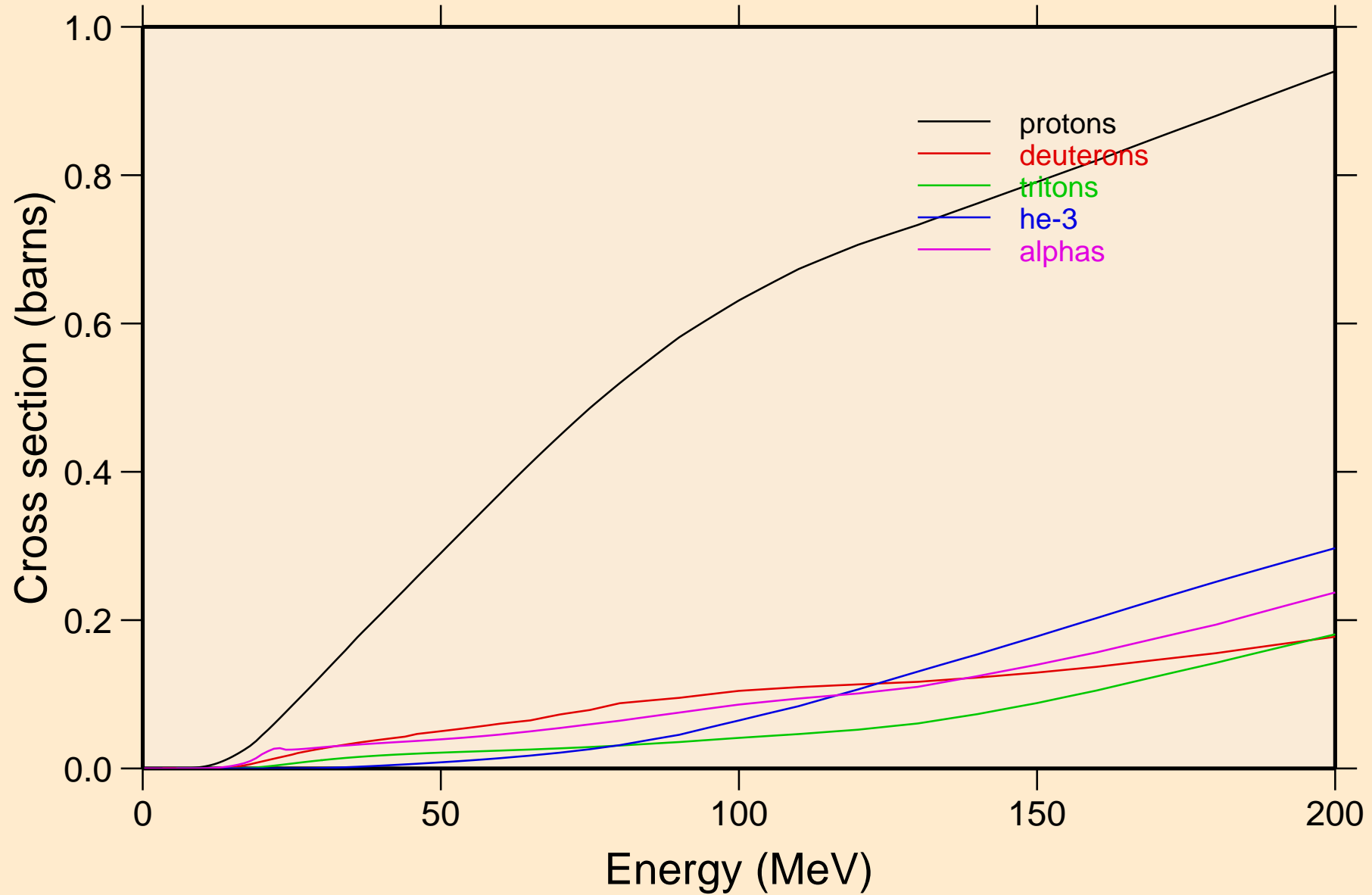

TB157 NEUTRON ACER TENDL-2023 LIBRARY; T=0.K
protons from (n,x)

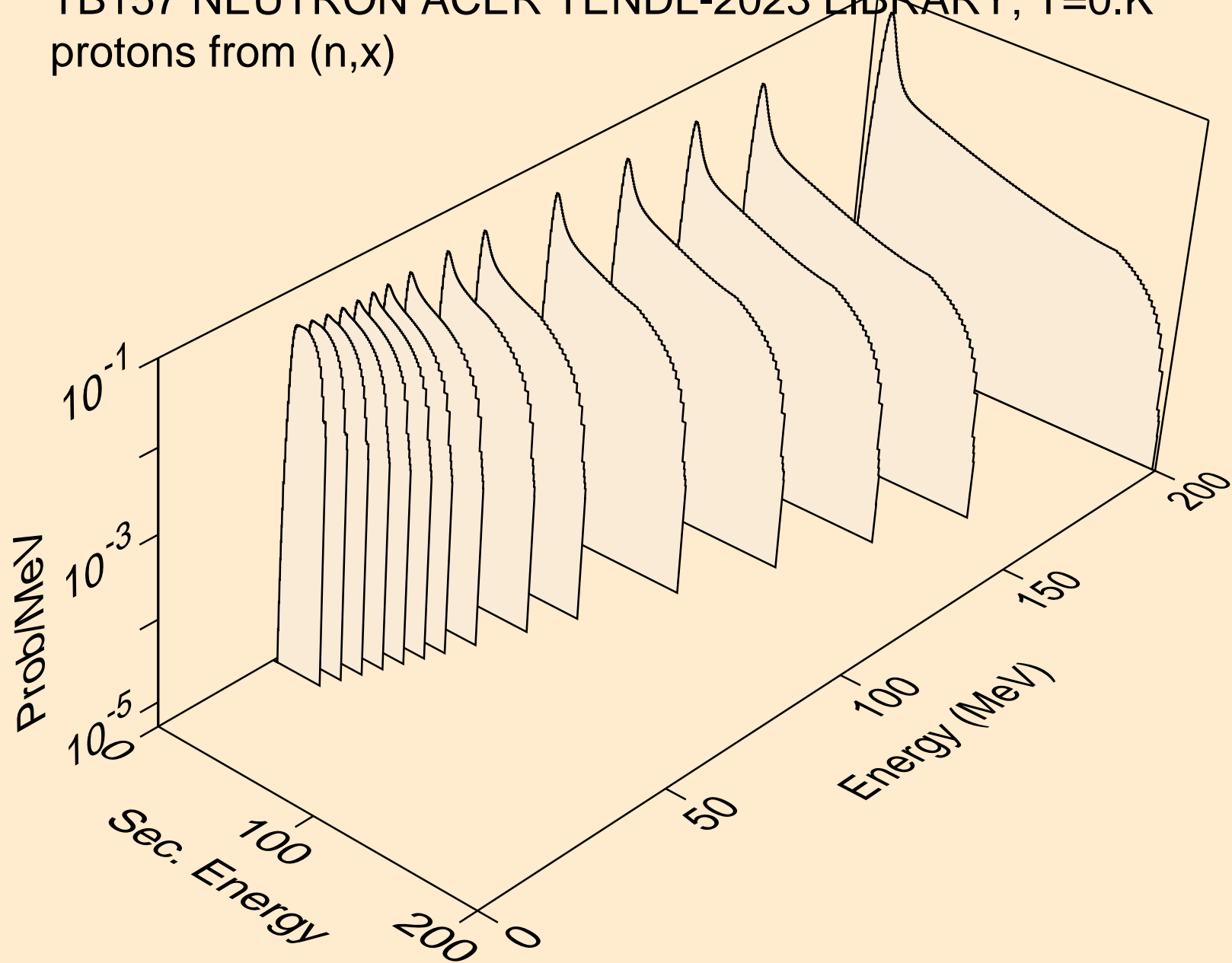

TB157 NEUTRON ACER TENDL-2023 LIBRARY; T=0.K
protons from (n,n*)p

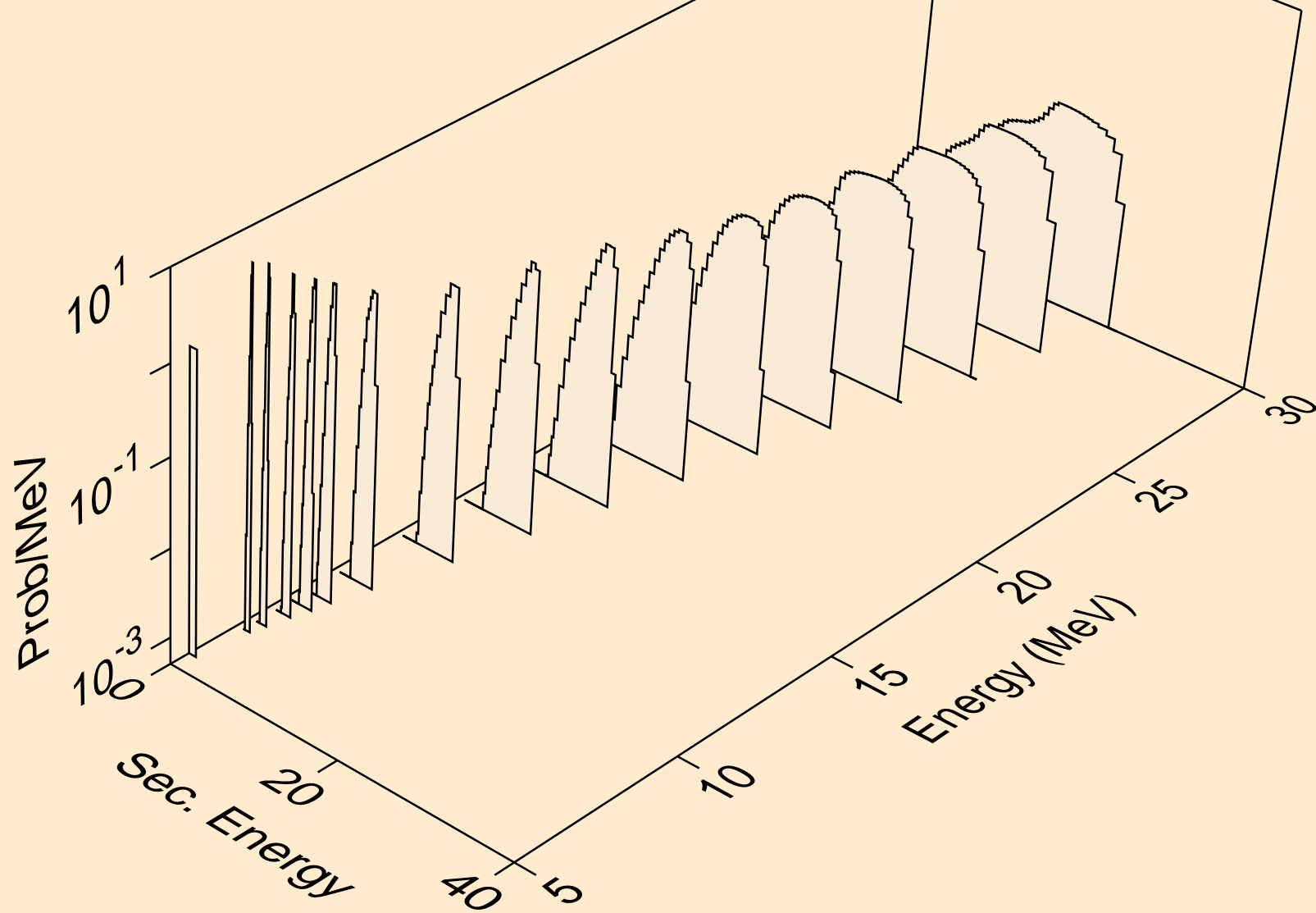

TB157 NEUTRON ACER TENDL-2023 LIBRARY; T=0.K
protons from (n,2np)

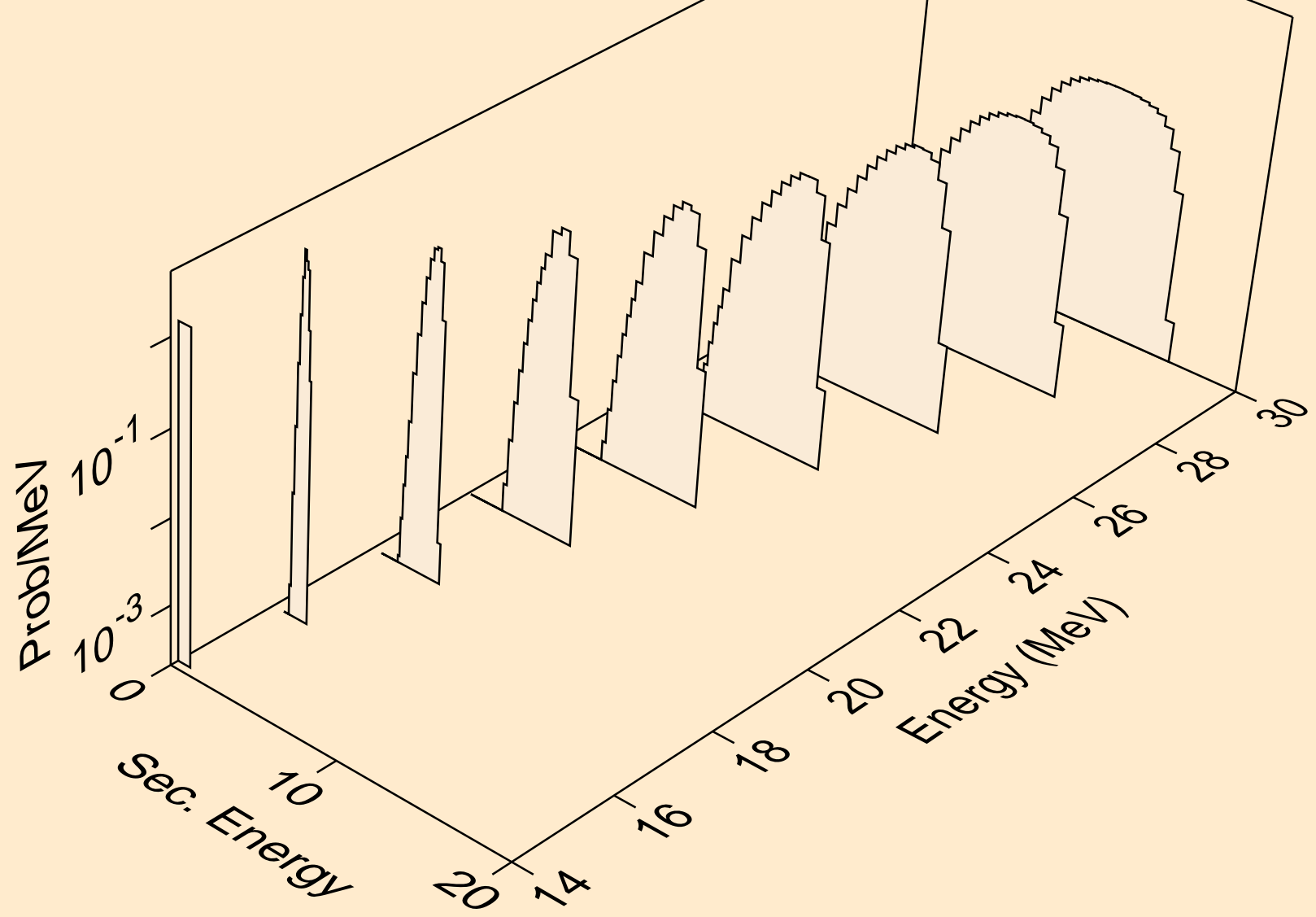

TB157 NEUTRON ACER TENDL-2023 LIBRARY; T=0.K
protons from (n,3np)

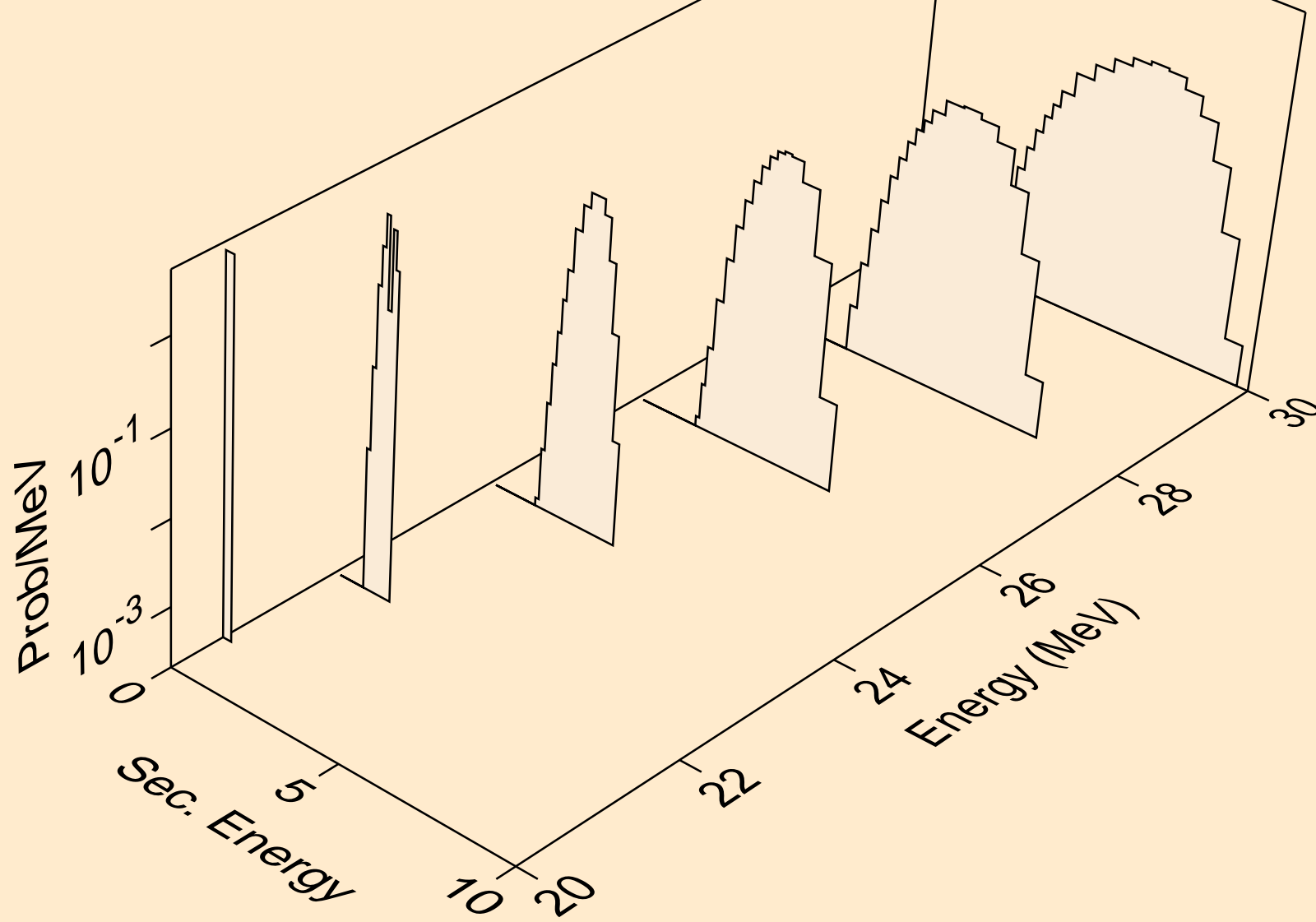

TB157 NEUTRON ACER TENDL-2023 LIBRARY; T=0.K
protons from (n,n2p)

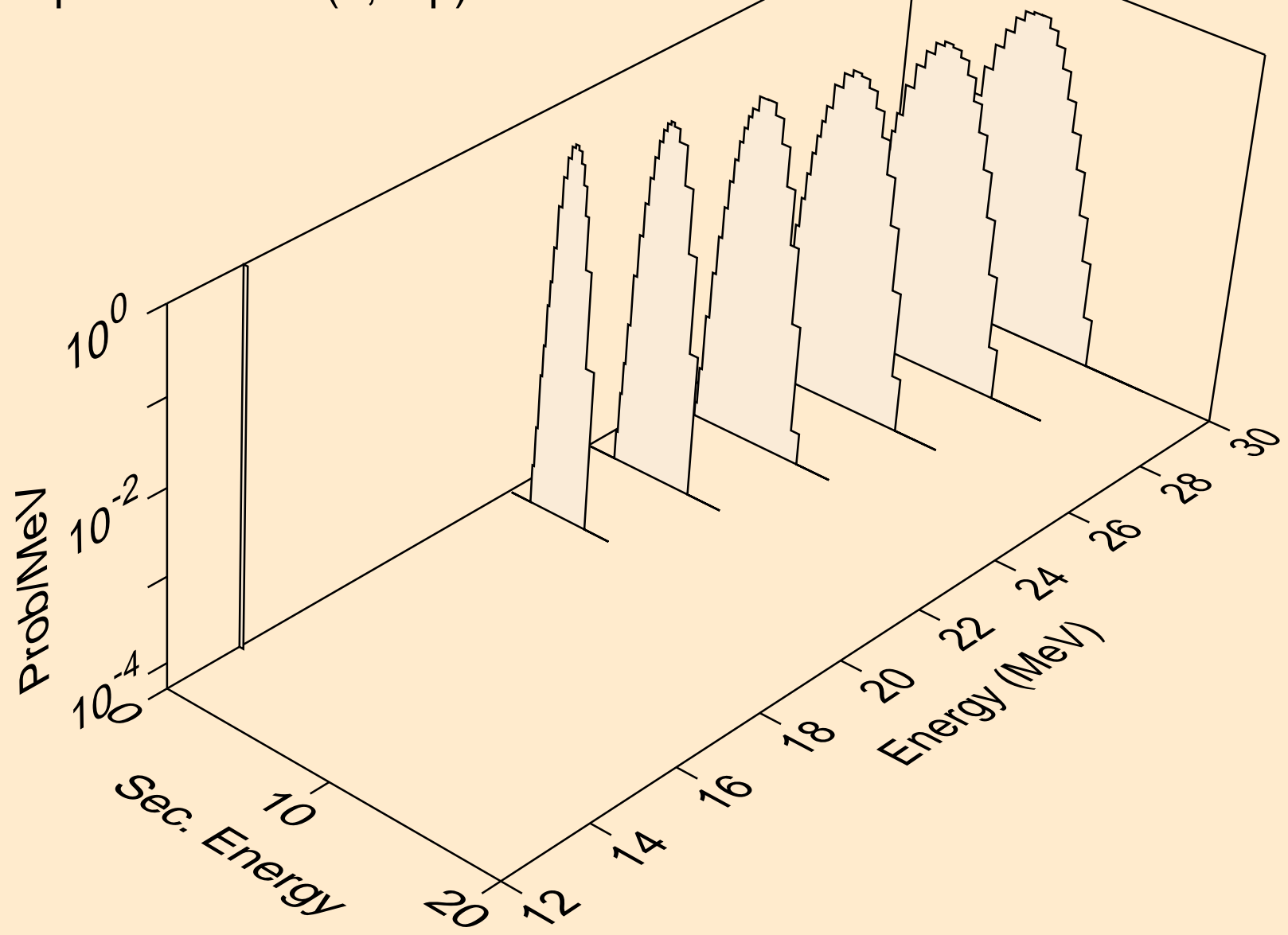

TB157 NEUTRON ACER TENDL-2023 LIBRARY; T=0.K
protons from (n,npa)

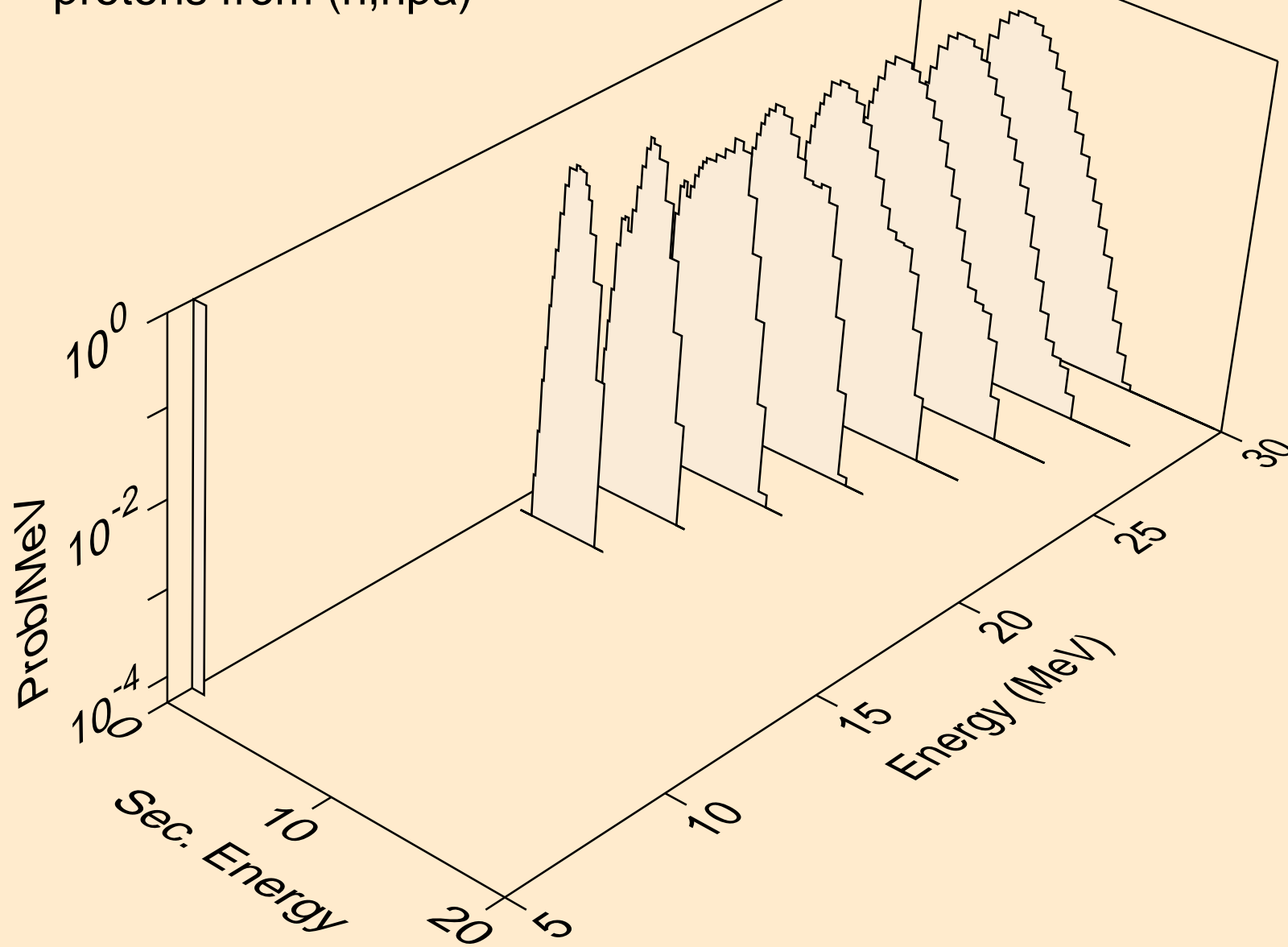

TB157 NEUTRON ACER TENDL-2023 LIBRARY; T=0.K
protons from (n,p)

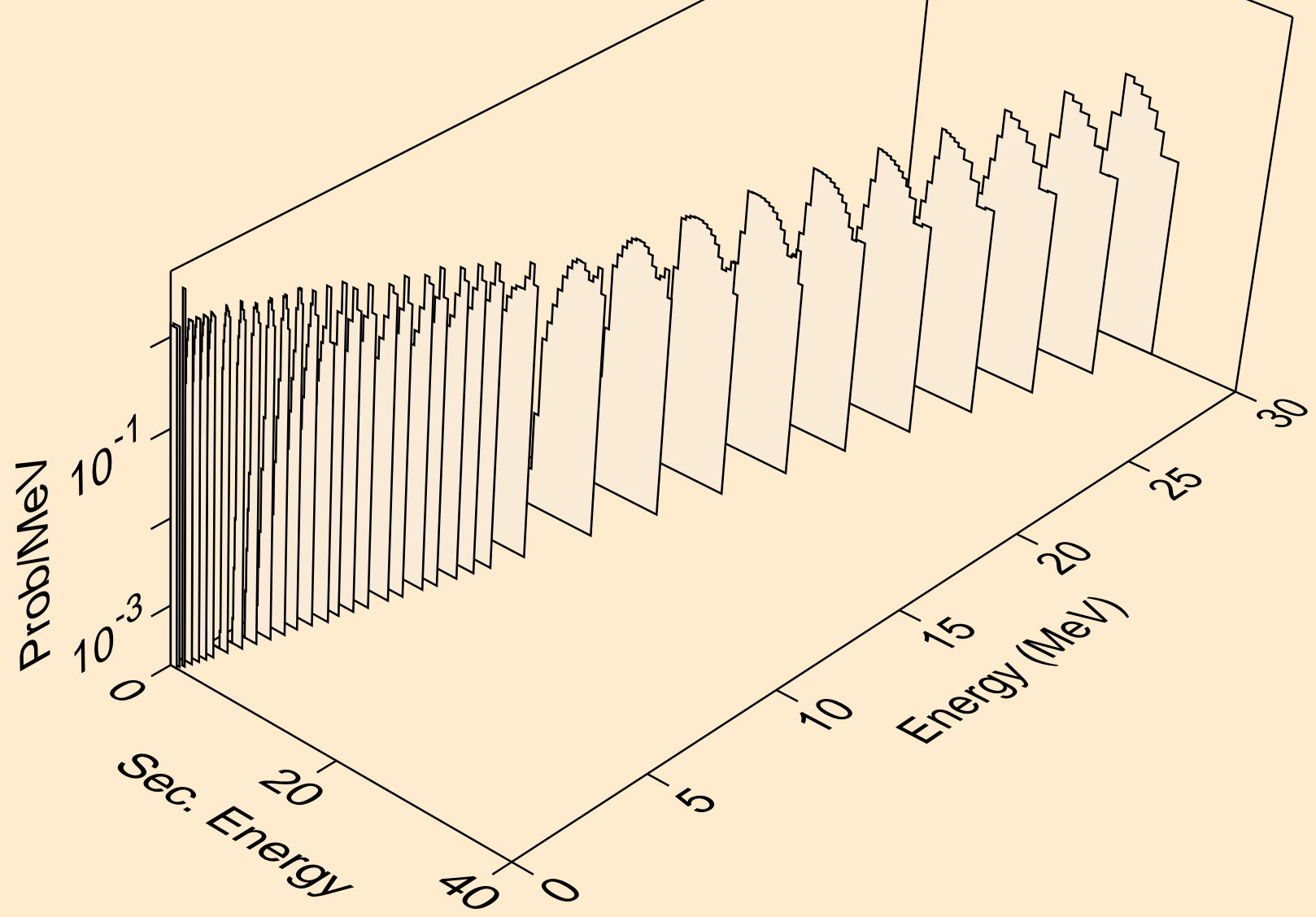

TB157 NEUTRON ACER TENDL-2023 LIBRARY; T=0.K
protons from (n,2p)

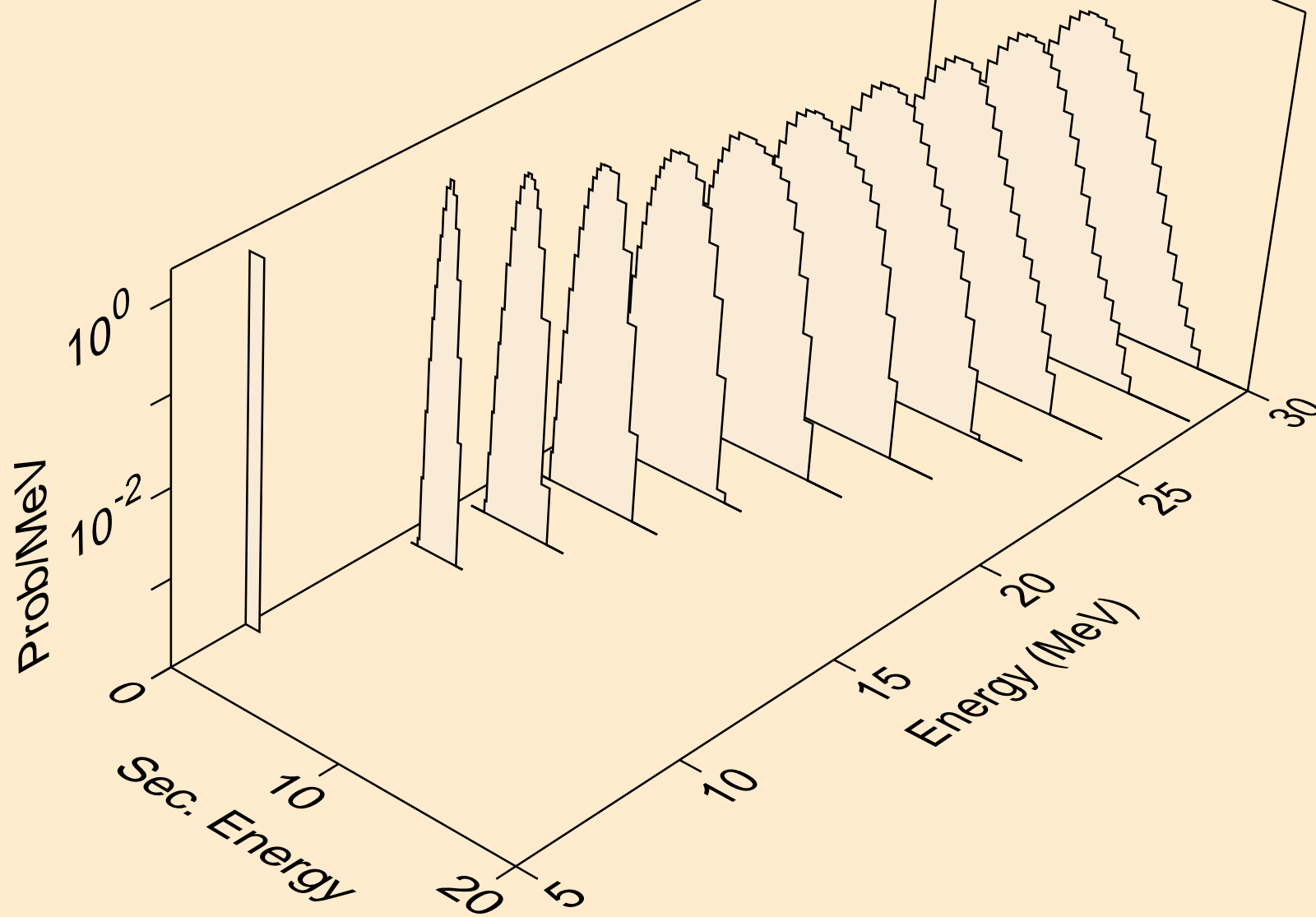

TB157 NEUTRON ACER TENDL-2023 LIBRARY; T=0.K
protons from (n,p)

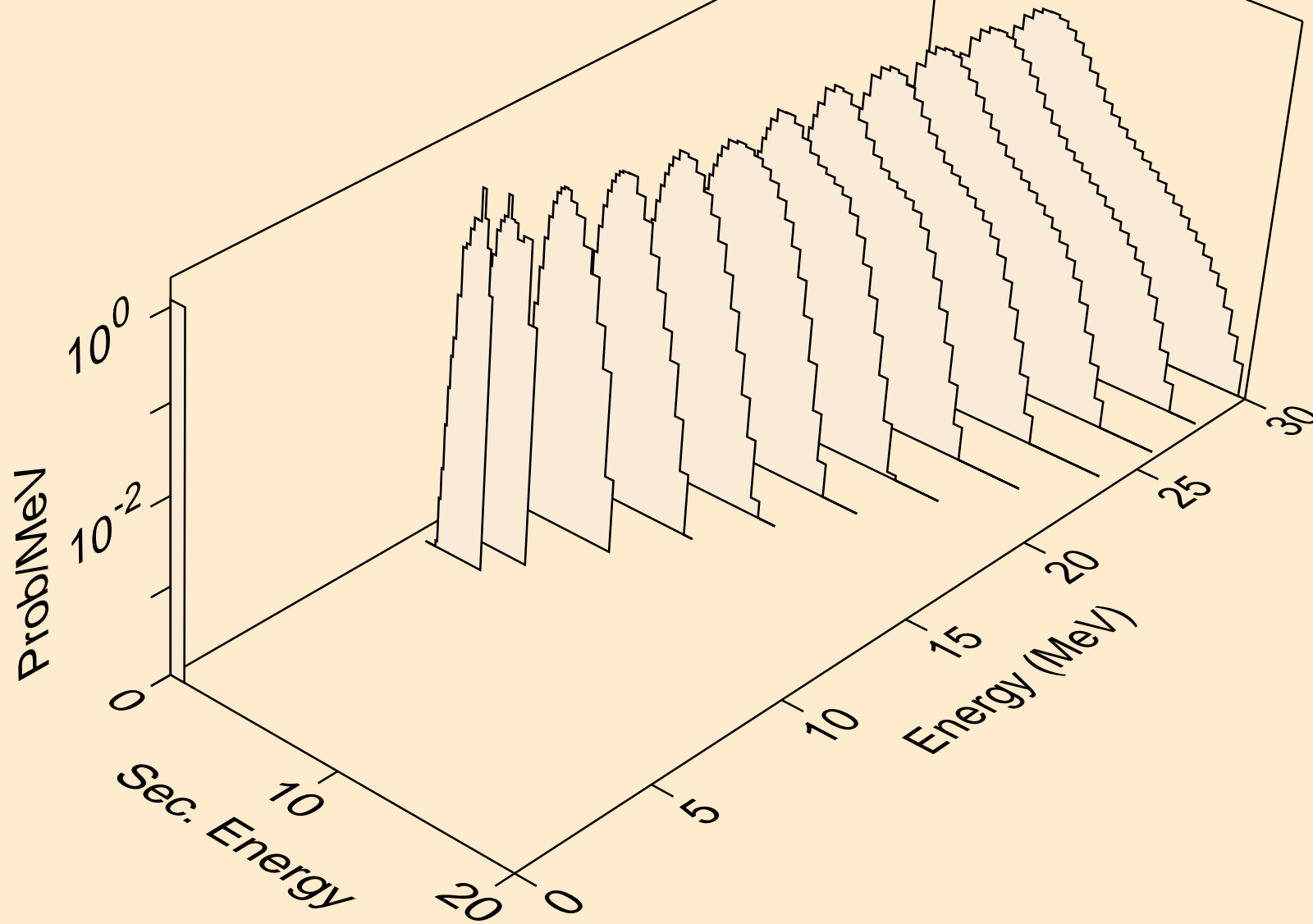

TB157 NEUTRON ACER TENDL-2023 LIBRARY; T=0.K
protons from (n,pd)

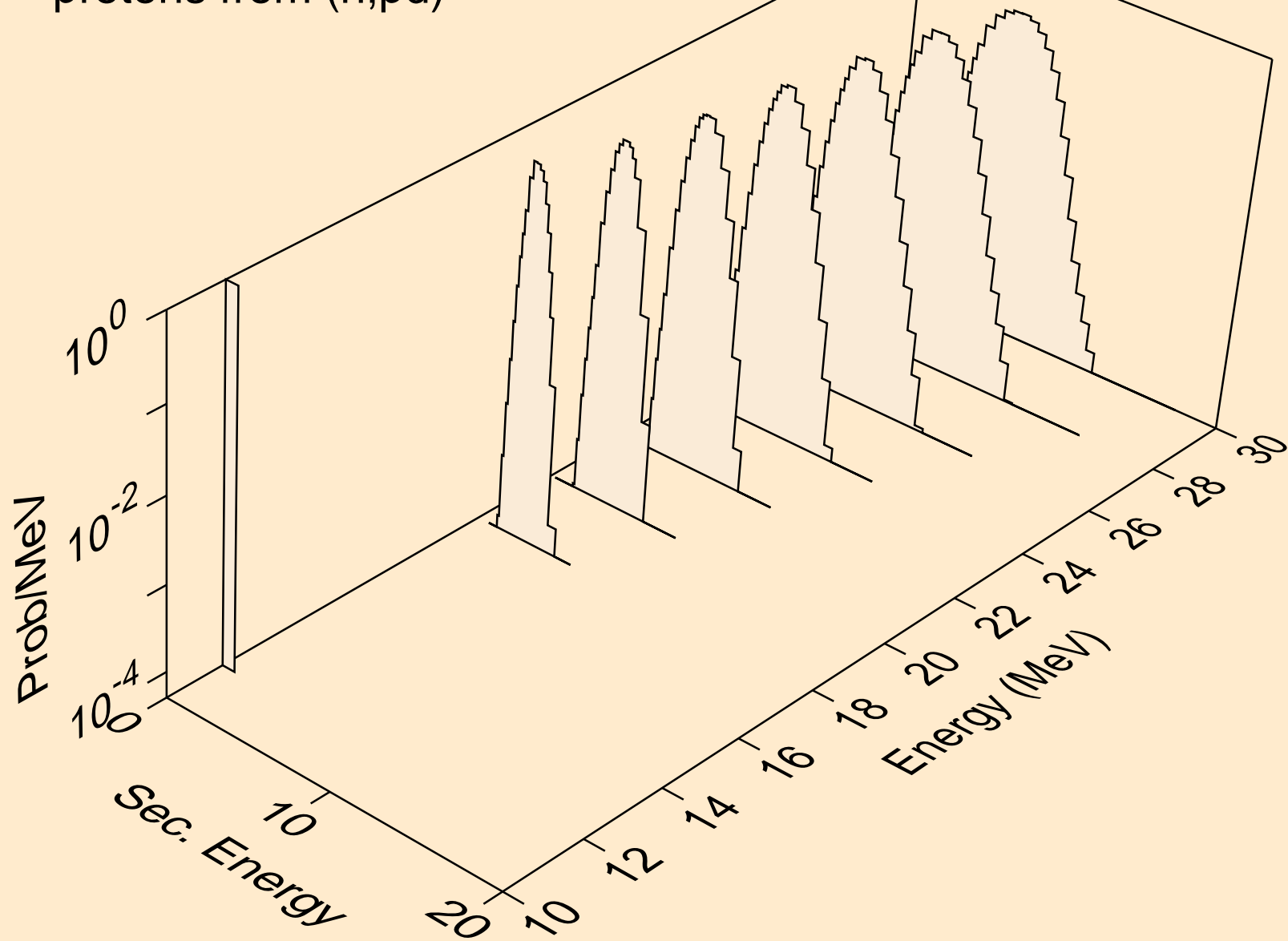

TB157 NEUTRON ACER TENDL-2023 LIBRARY; T=0.K
protons from (n,pt)

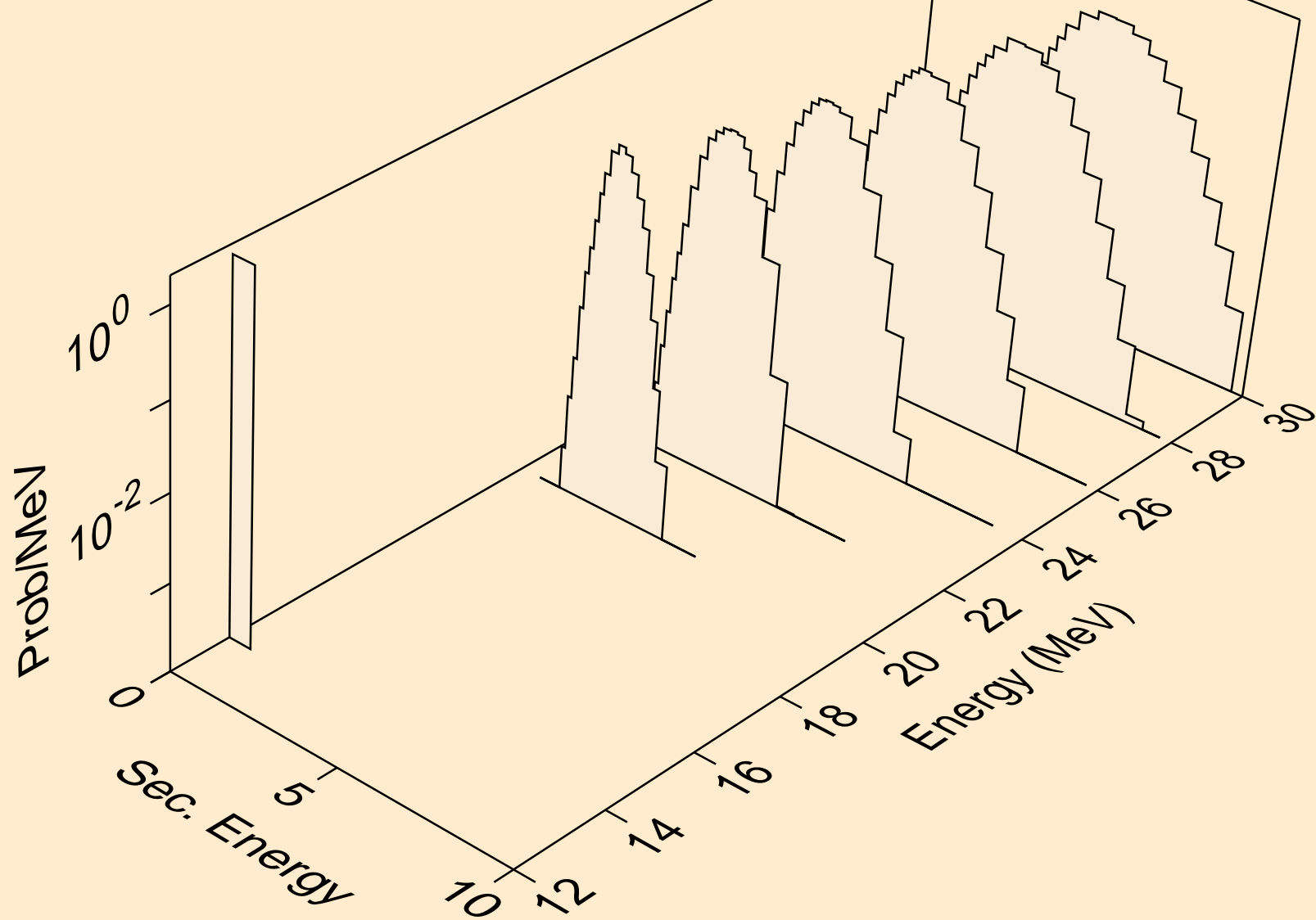

TB157 NEUTRON ACER TENDL-2023 LIBRARY; T=0.K
deuterons from (n,x)

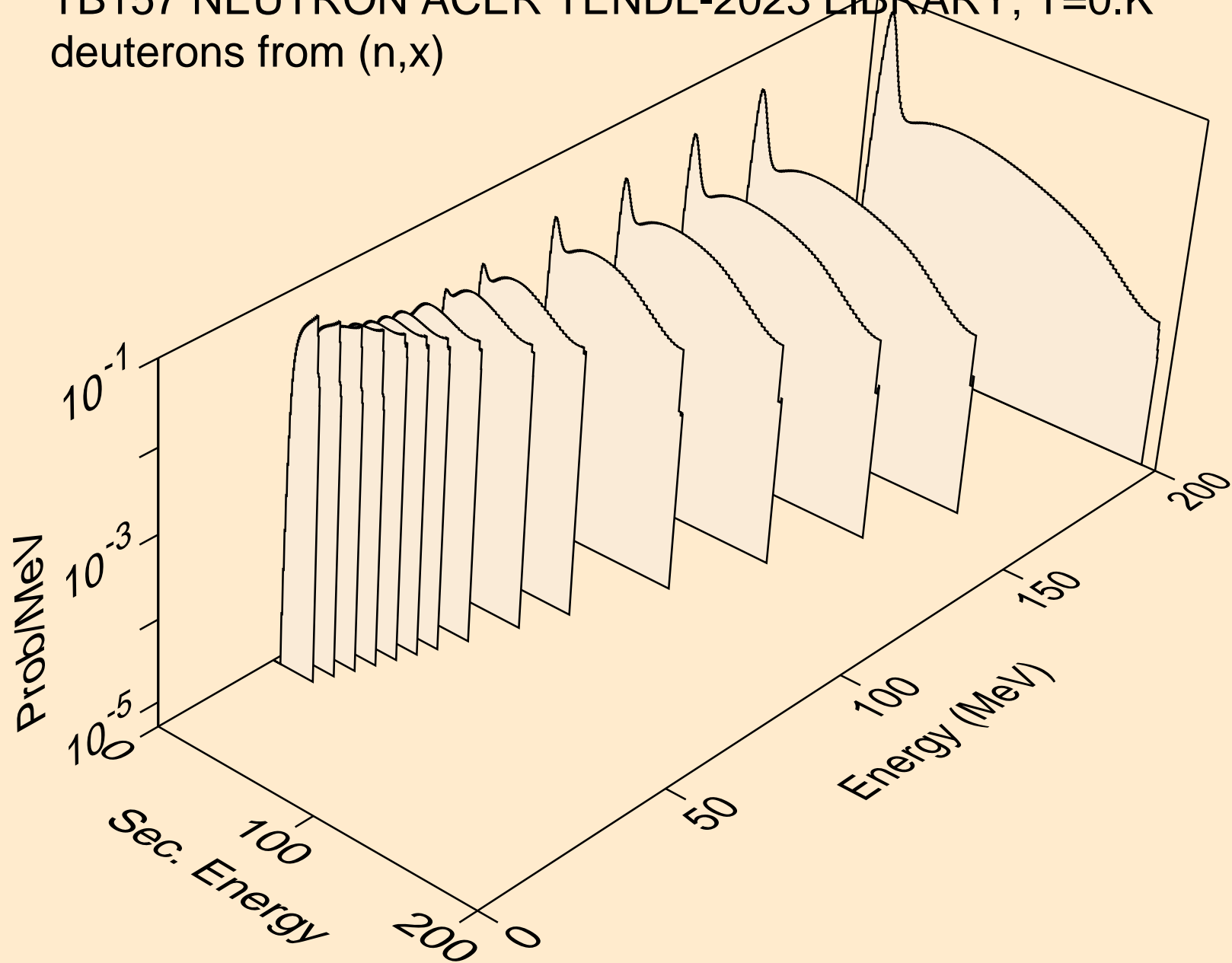

TB157 NEUTRON ACER TENDL-2023 LIBRARY; T=0.K
deuterons from (n,2nd)

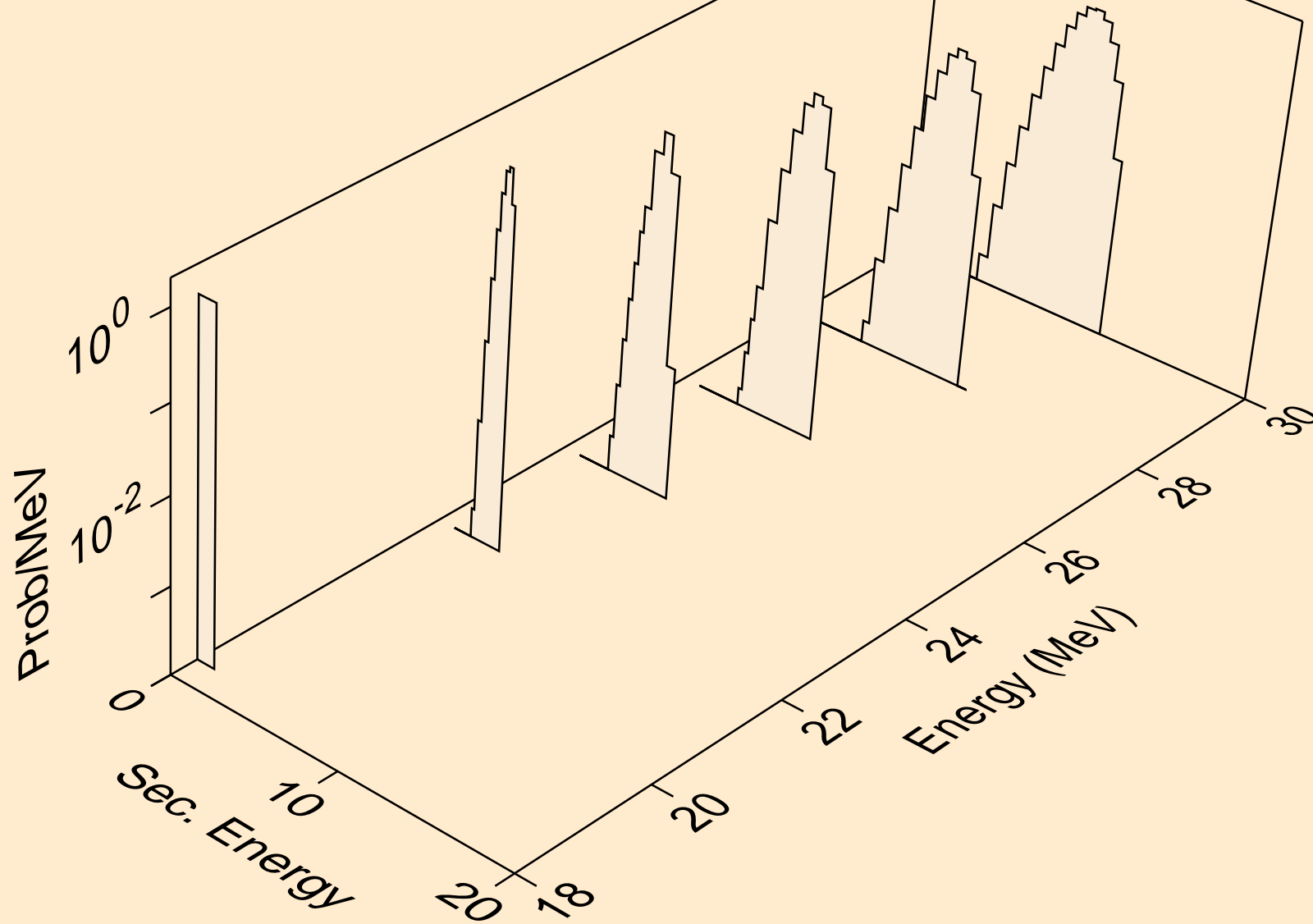

TB157 NEUTRON ACER TENDL-2023 LIBRARY; T=0.K
deuterons from (n,n*)d

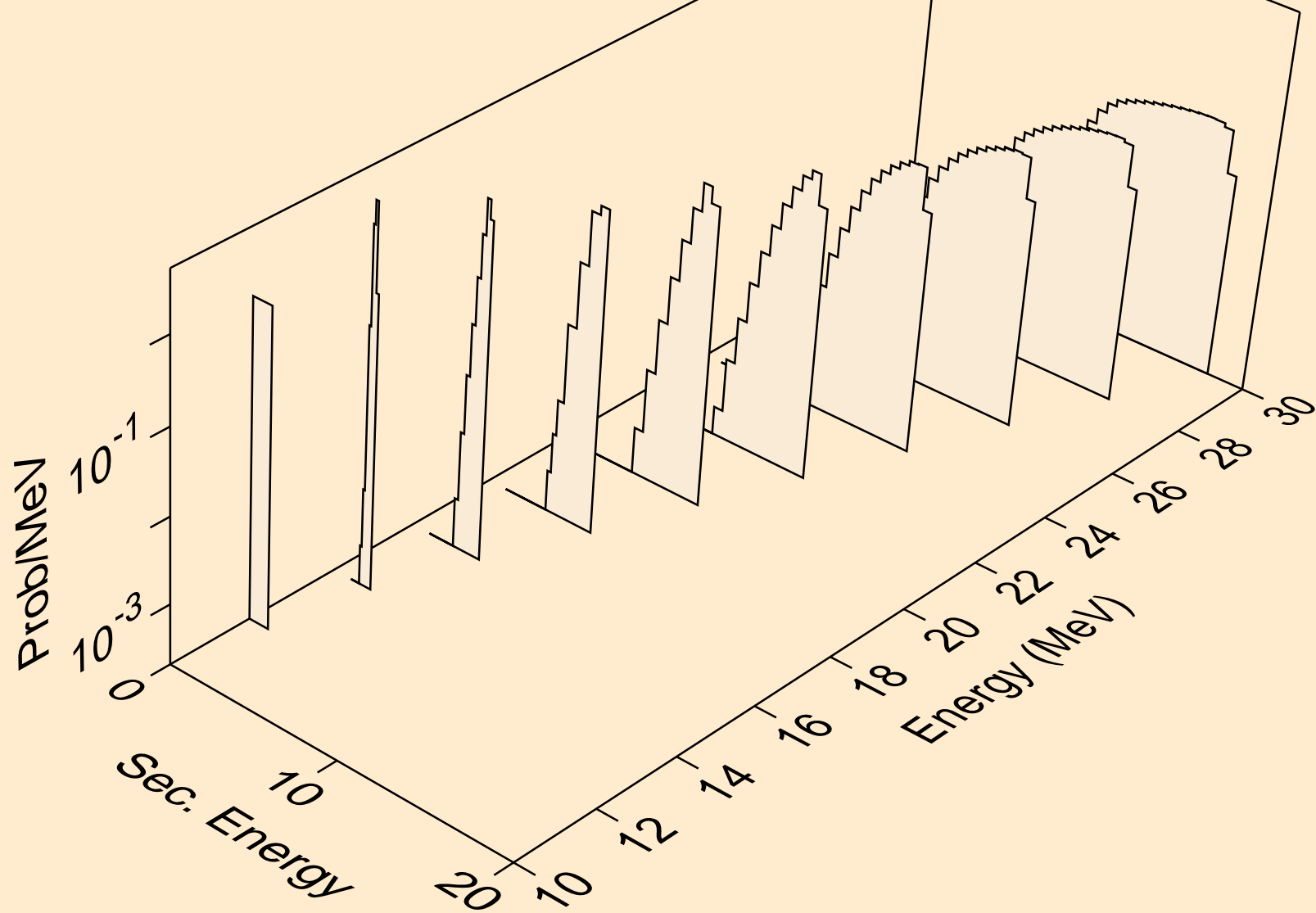

TB157 NEUTRON ACER TENDL-2023 LIBRARY; T=0.K
deuterons from (n,d)

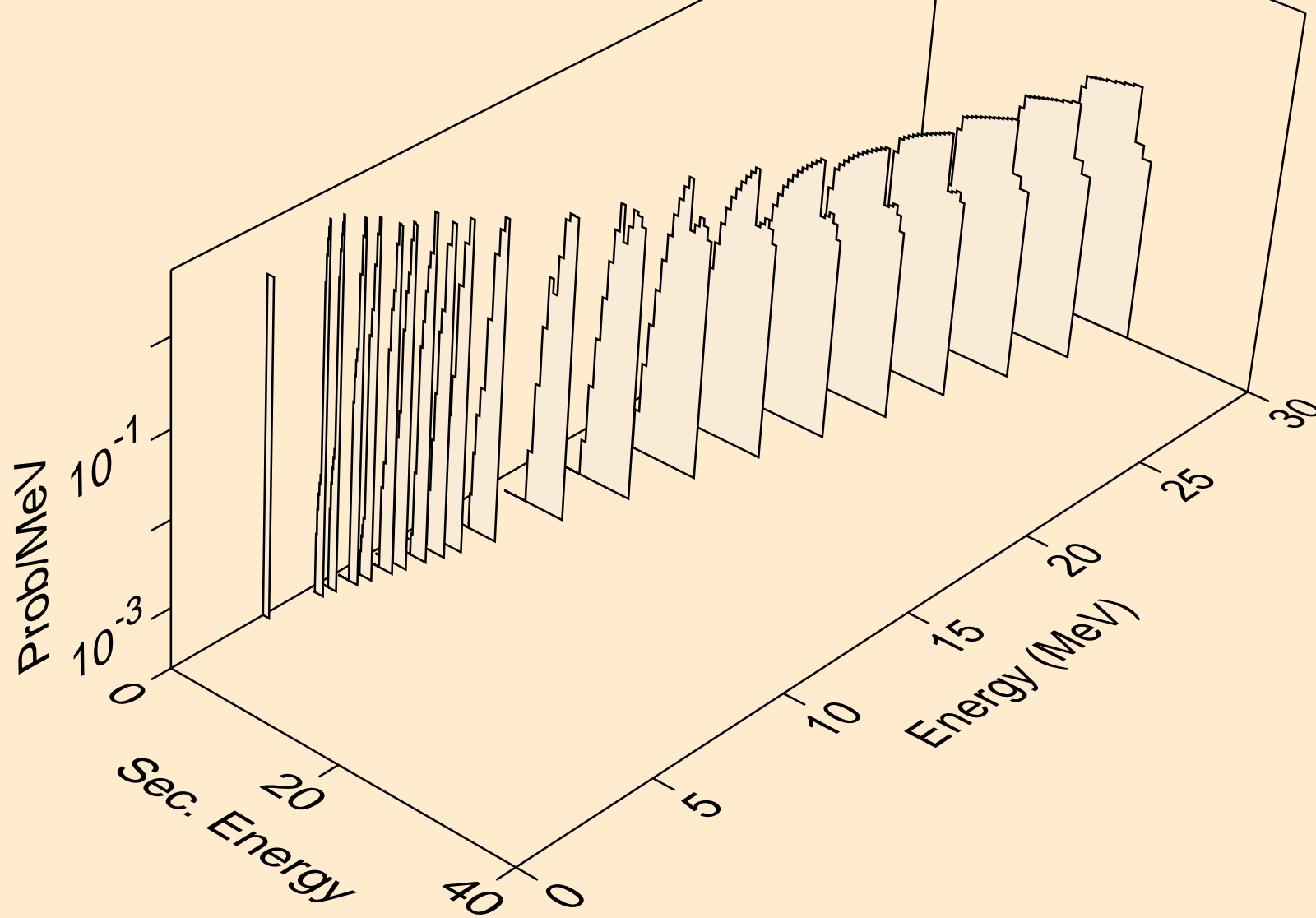

TB157 NEUTRON ACER TENDL-2023 LIBRARY; T=0.K
deuterons from (n,pd)

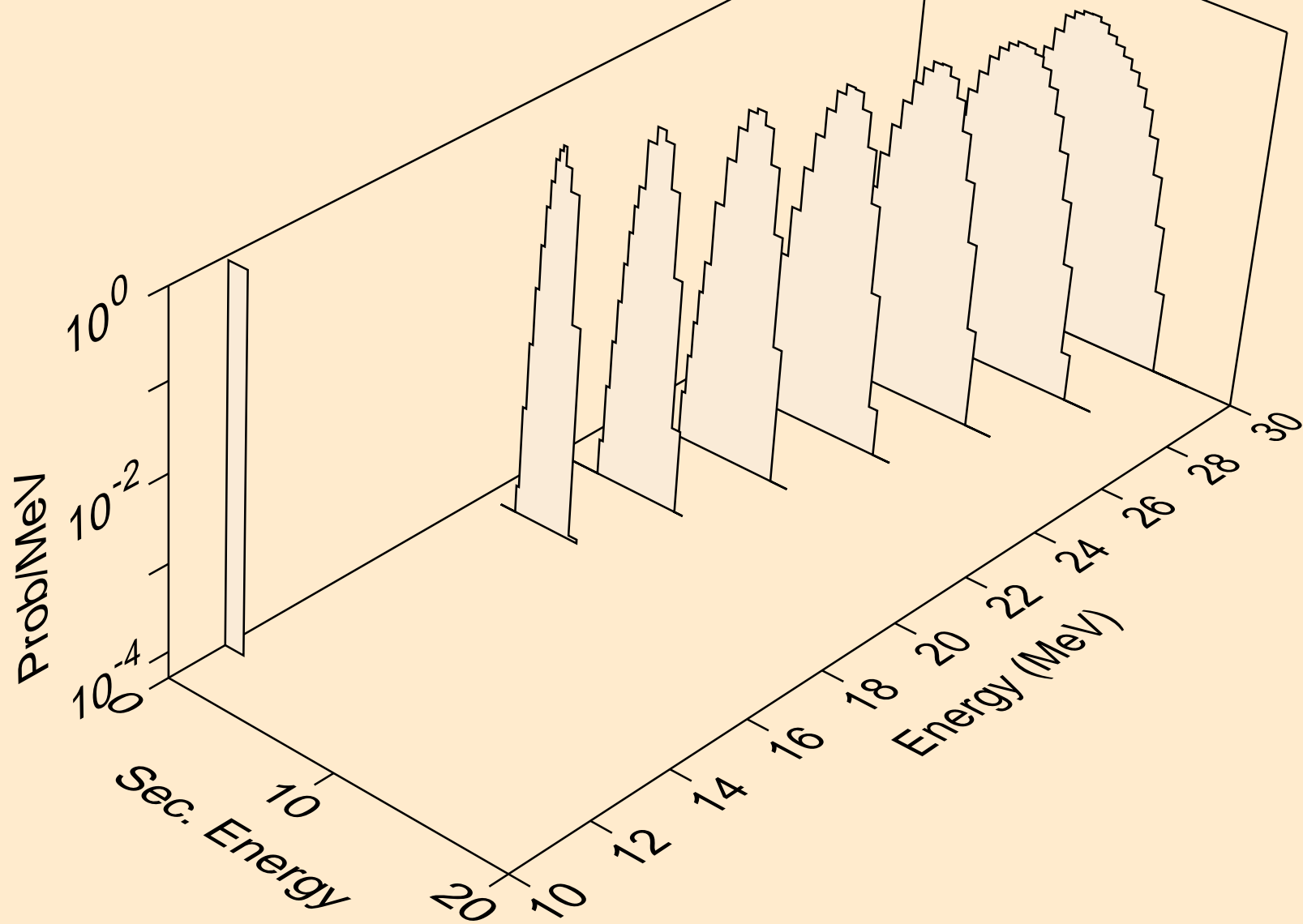

TB157 NEUTRON ACER TENDL-2023 LIBRARY; T=0.K
deuterons from (n,da)

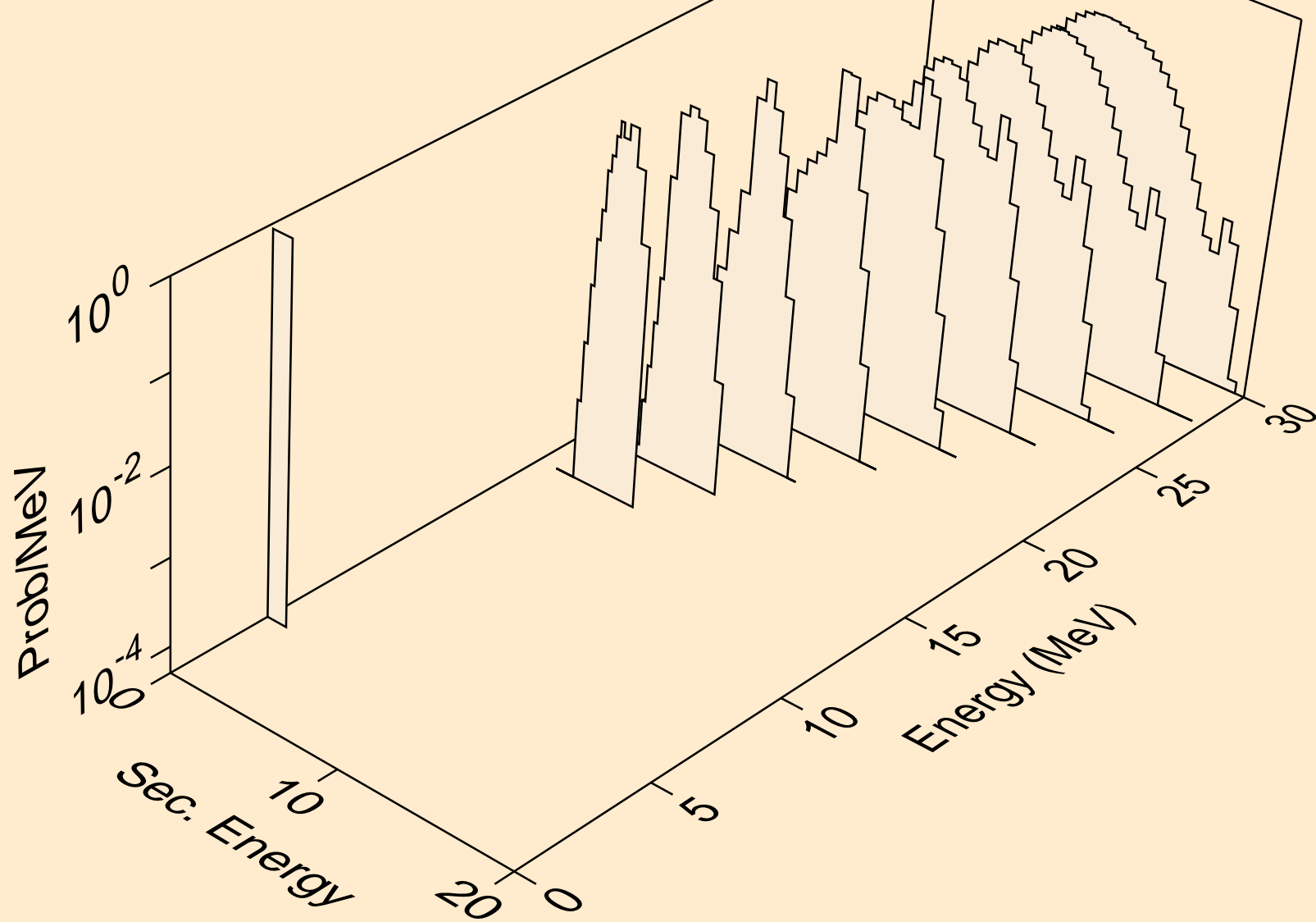

TB157 NEUTRON ACER TENDL-2023 LIBRARY; T=0.K
tritons from (n,x)

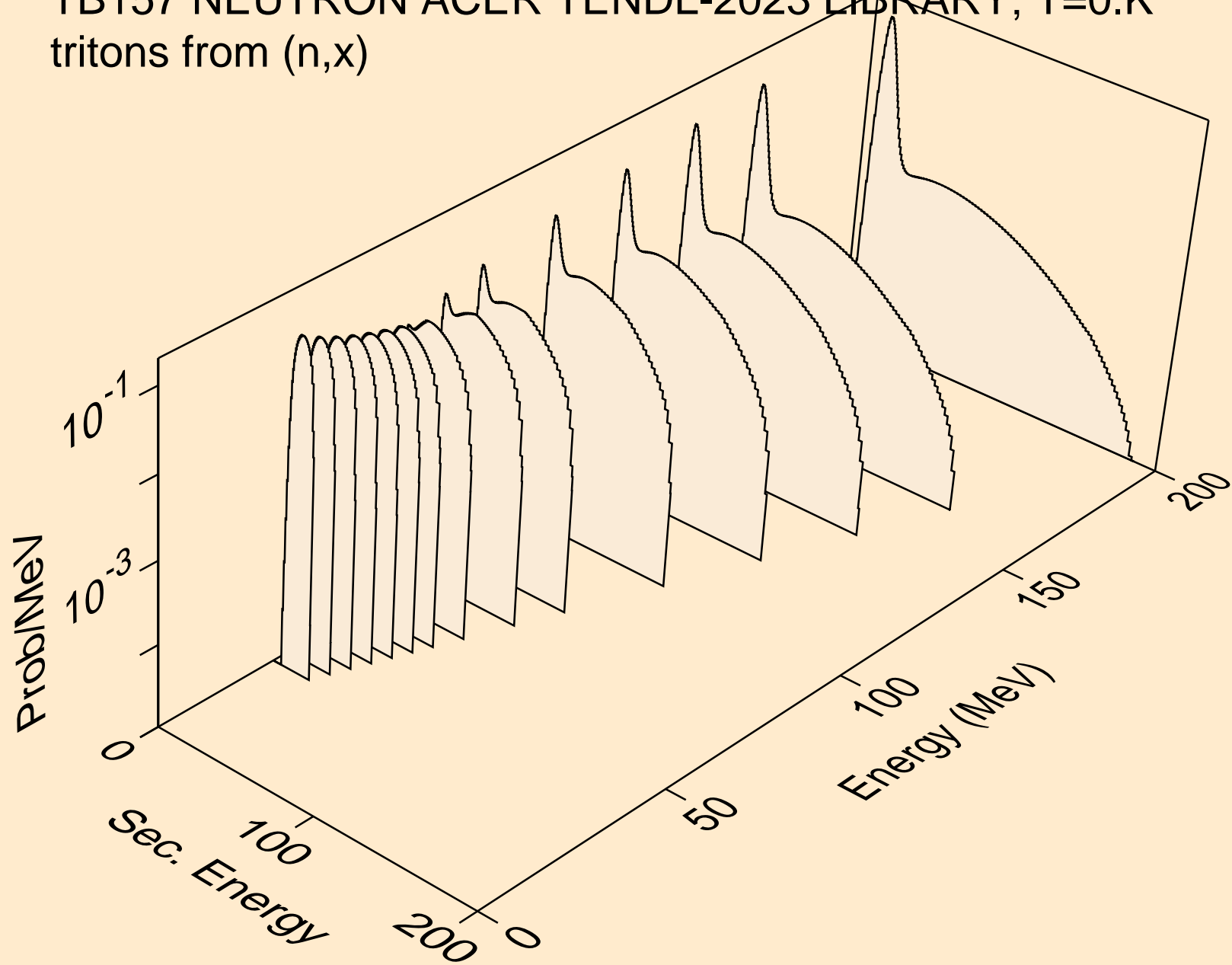

TB157 NEUTRON ACER TENDL-2023 LIBRARY; T=0.K
tritons from (n,n*)t

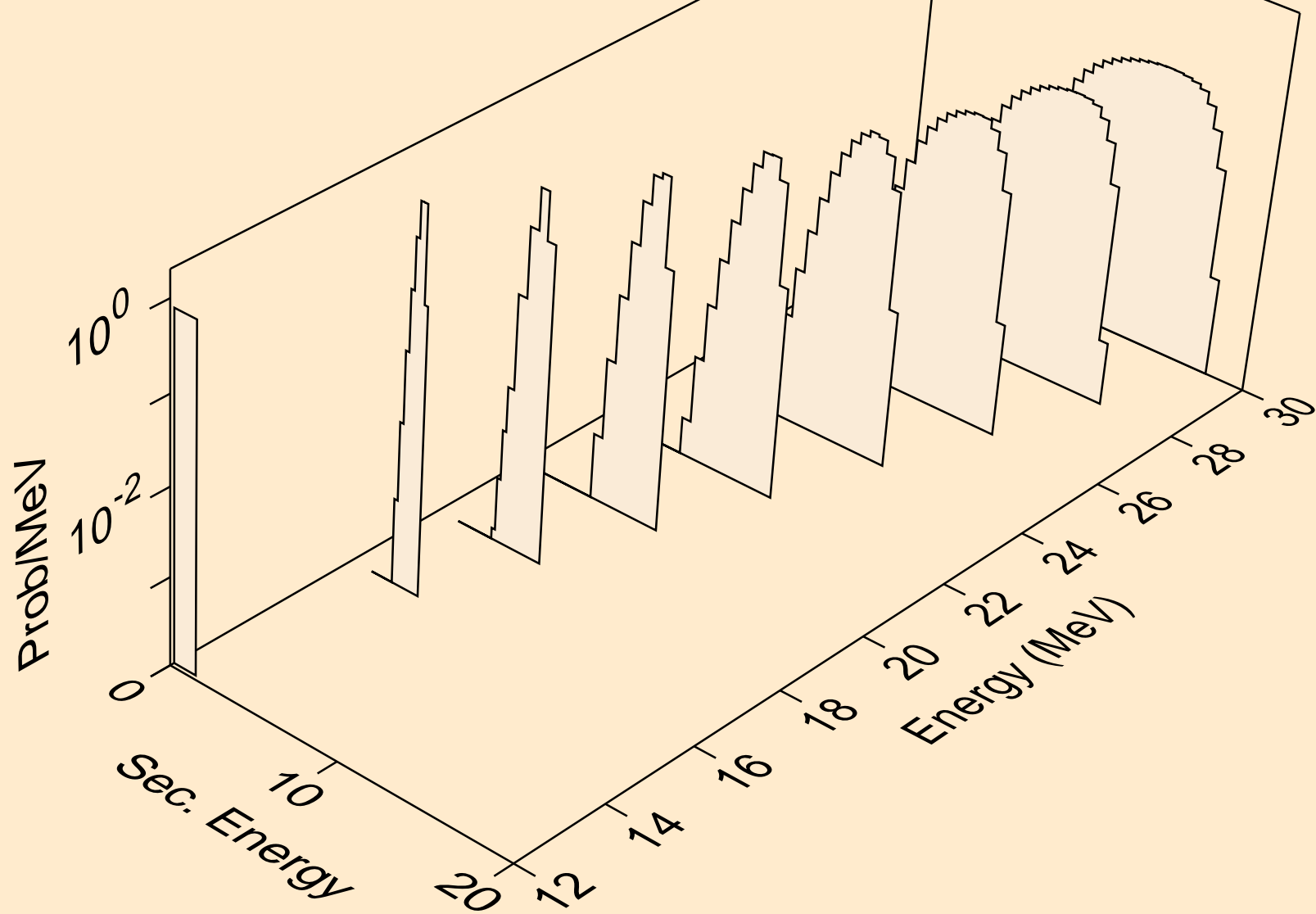

TB157 NEUTRON ACER TENDL-2023 LIBRARY; T=0.K
tritons from (n,t)

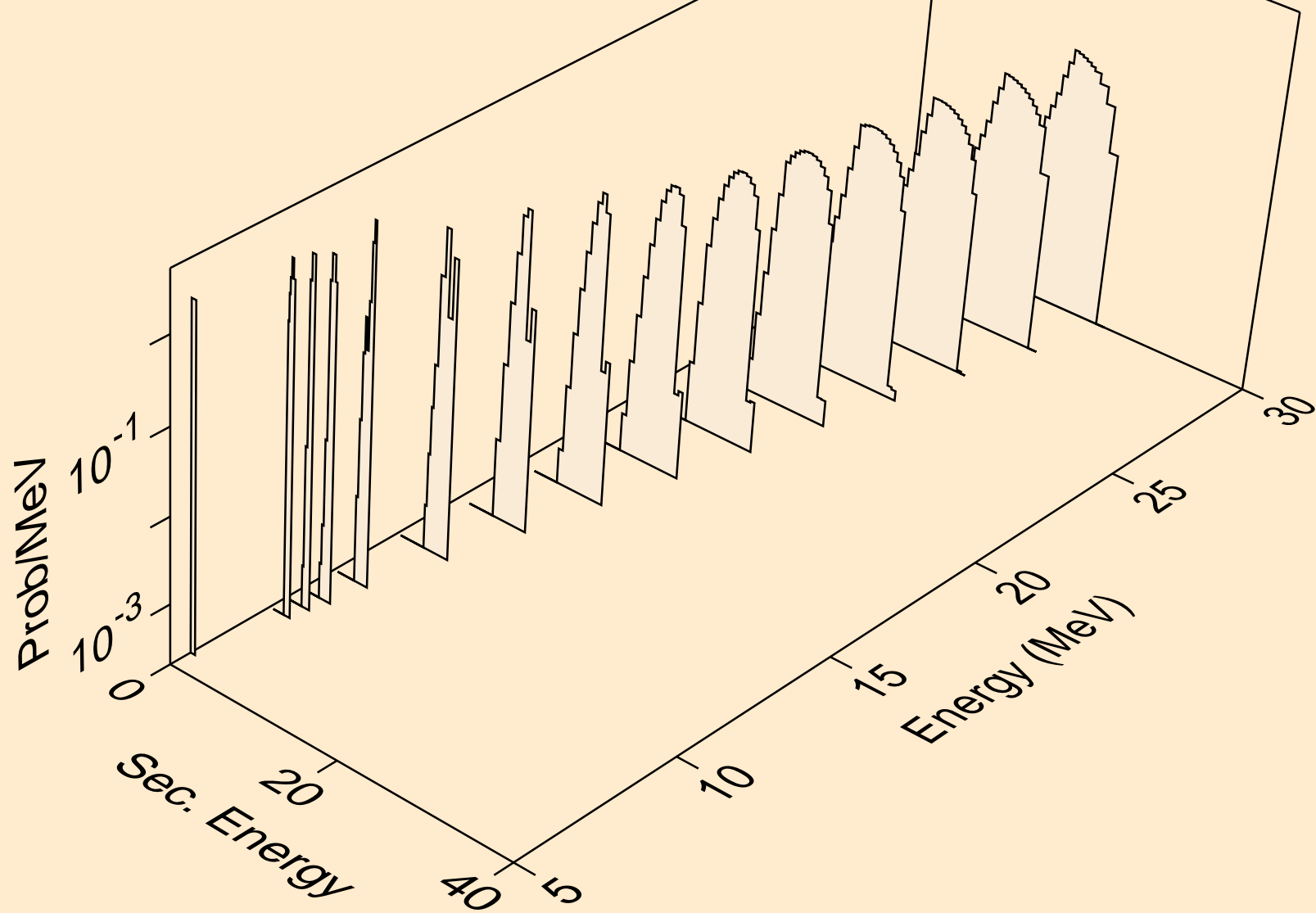

TB157 NEUTRON ACER TENDL-2023 LIBRARY; T=0.K
tritons from (n,pt)

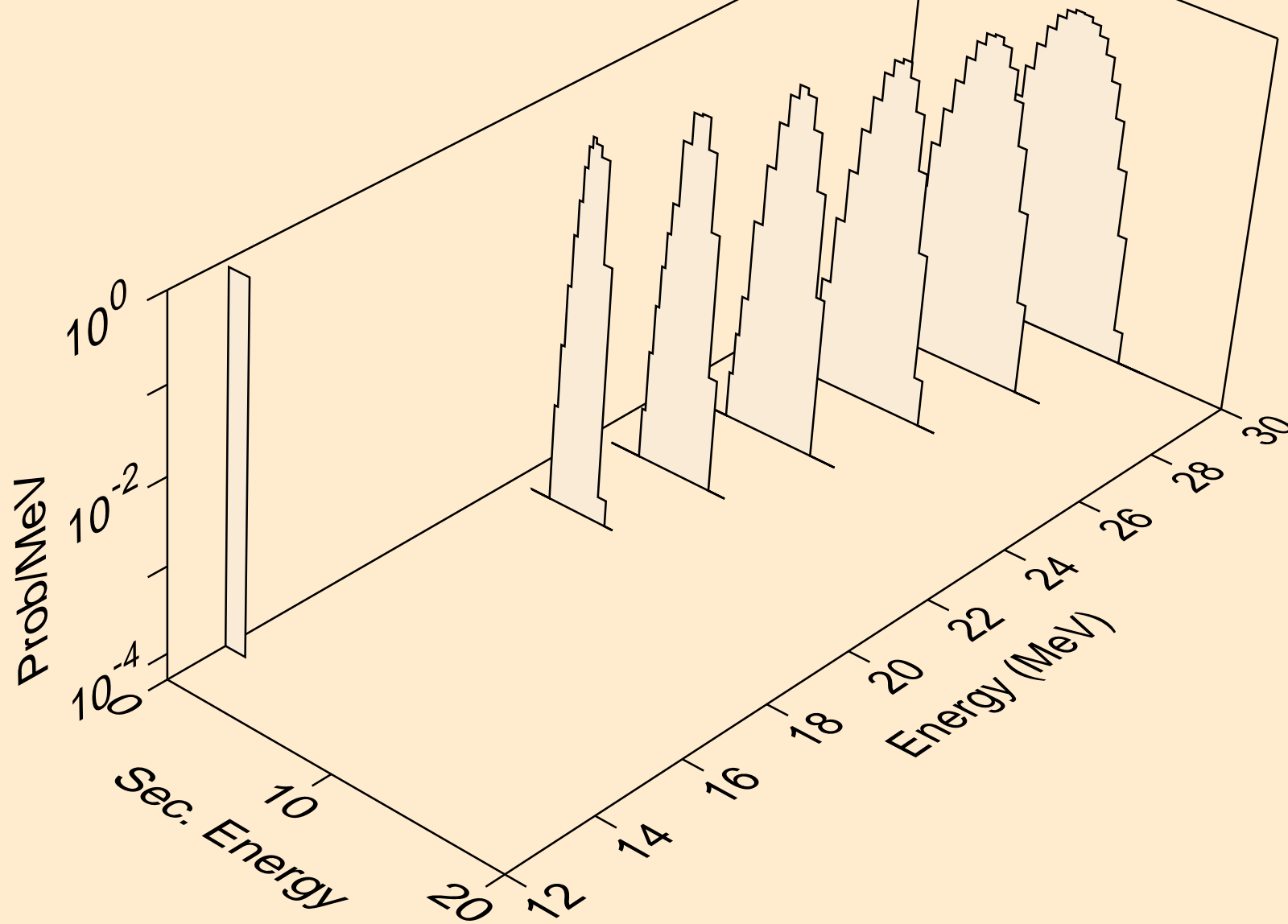

TB157 NEUTRON ACER TENDL-2023 LIBRARY; T=0.K
he3s from (n,x)

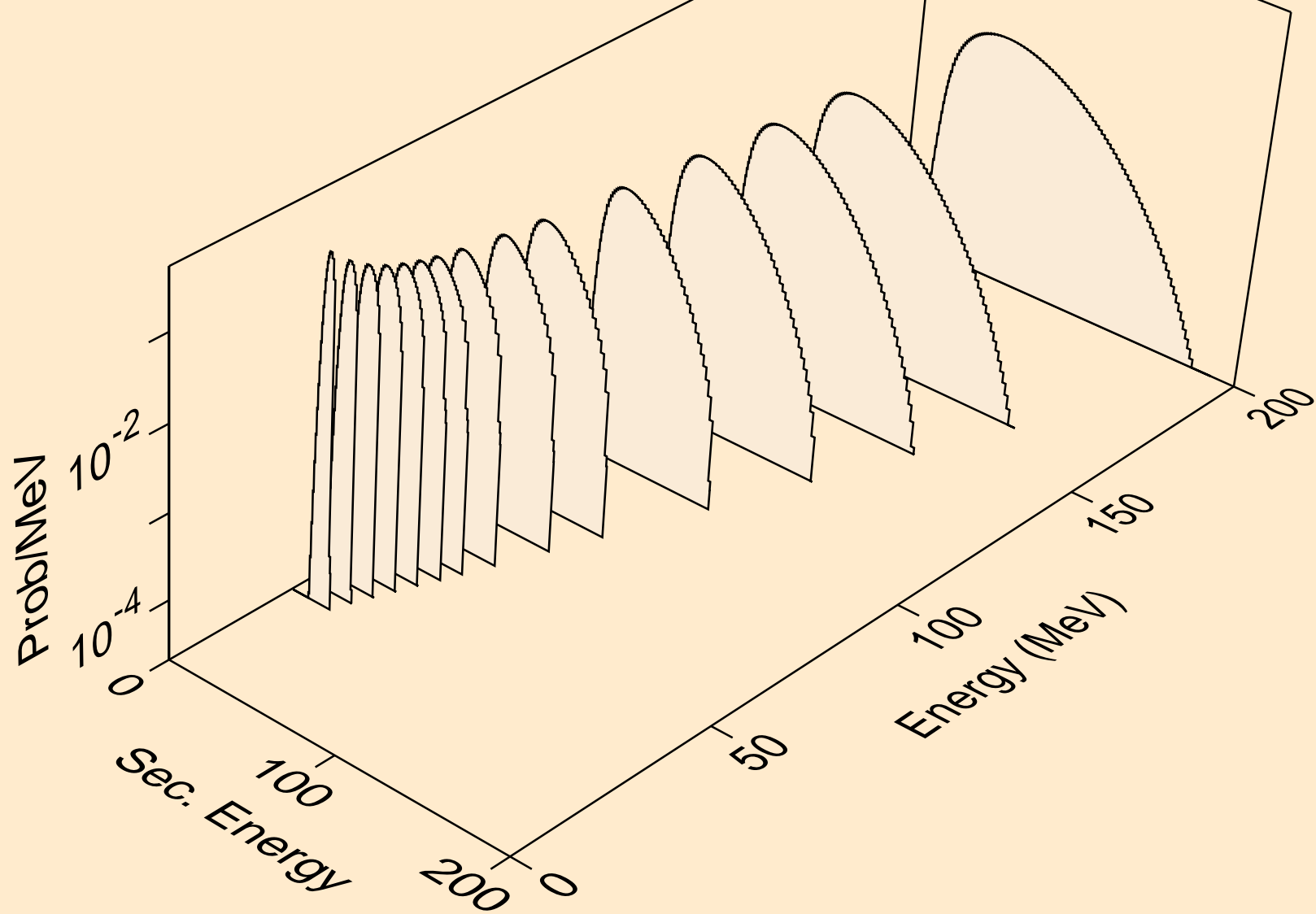

TB157 NEUTRON ACER TENDL-2023 LIBRARY; T=0.K
he3s from (n,n*)he3

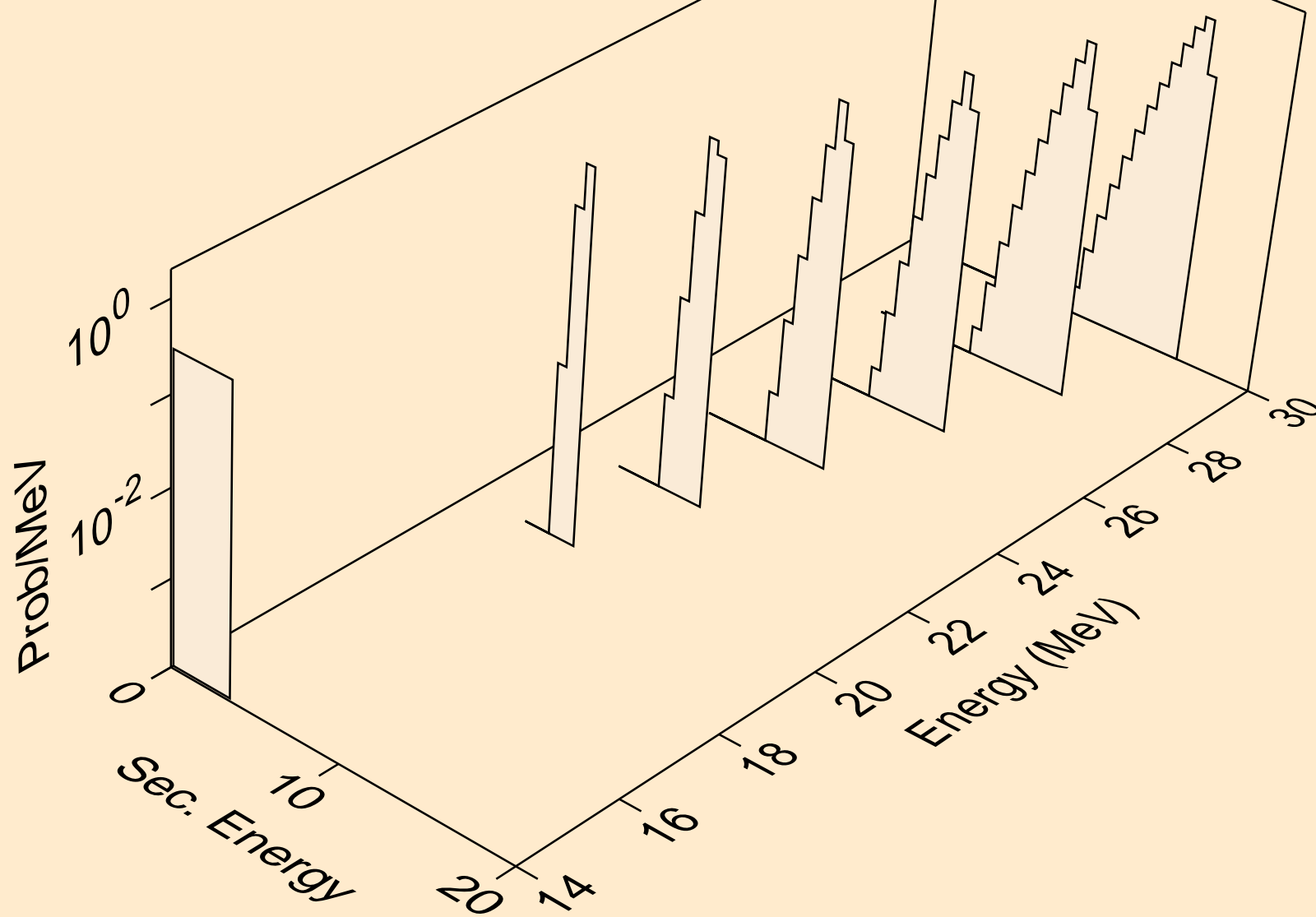

TB157 NEUTRON ACER TENDL-2023 LIBRARY; T=0.K
he3s from (n,he3)

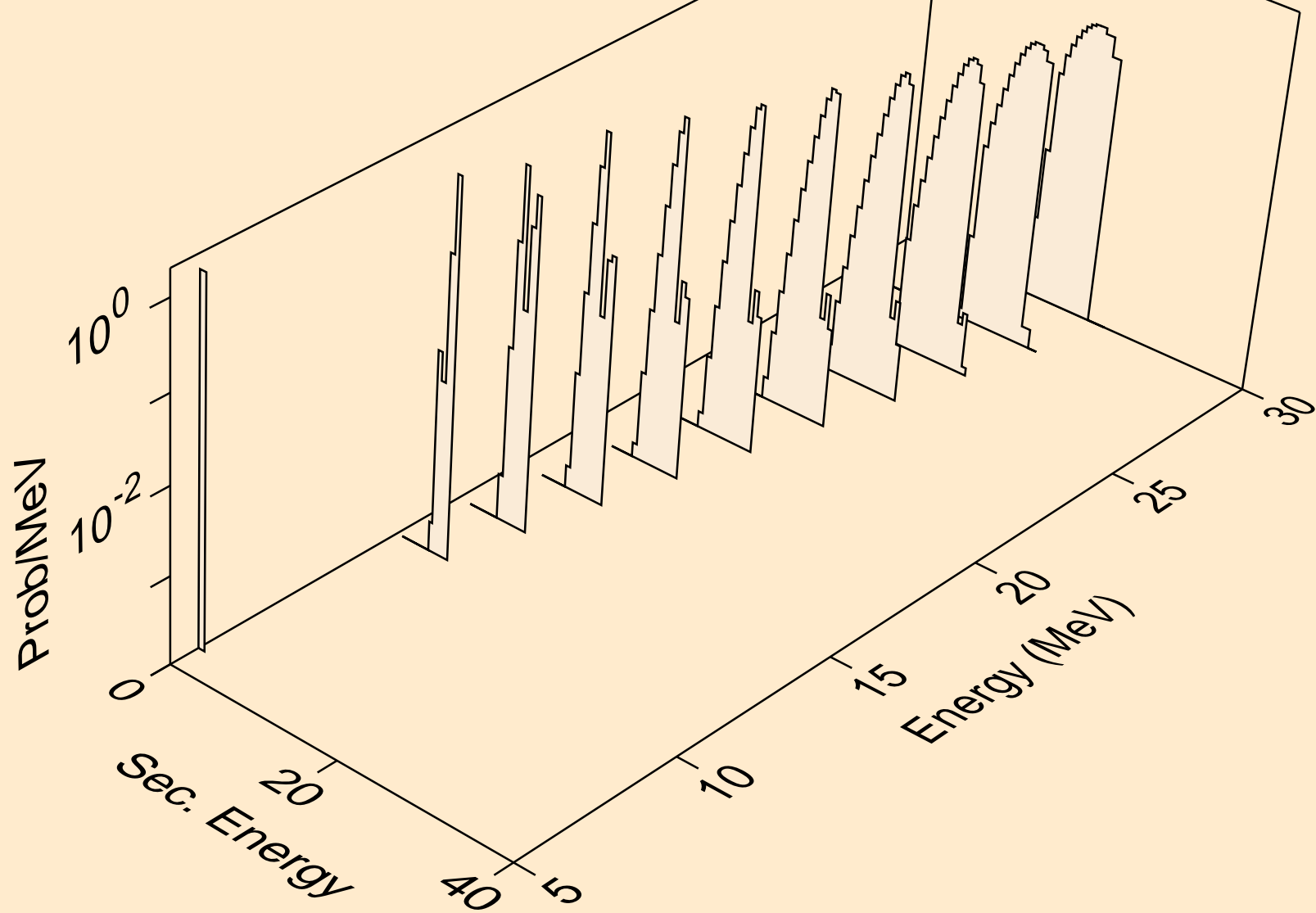

TB157 NEUTRON ACER TENDL-2023 LIBRARY; T=0.K
alphas from (n,x)

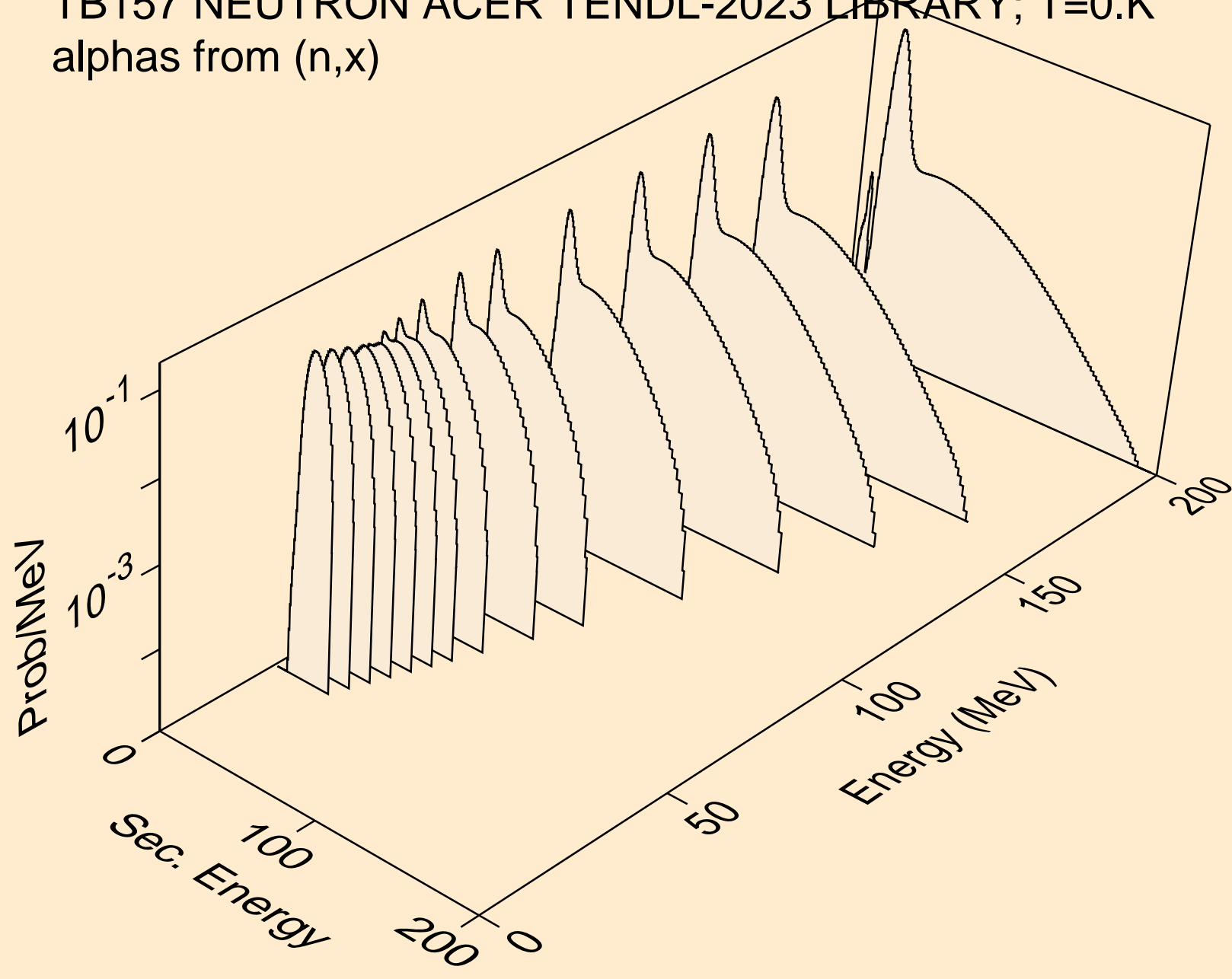

TB157 NEUTRON ACER TENDL-2023 LIBRARY; T=0.K
alphas from (n,n*)a

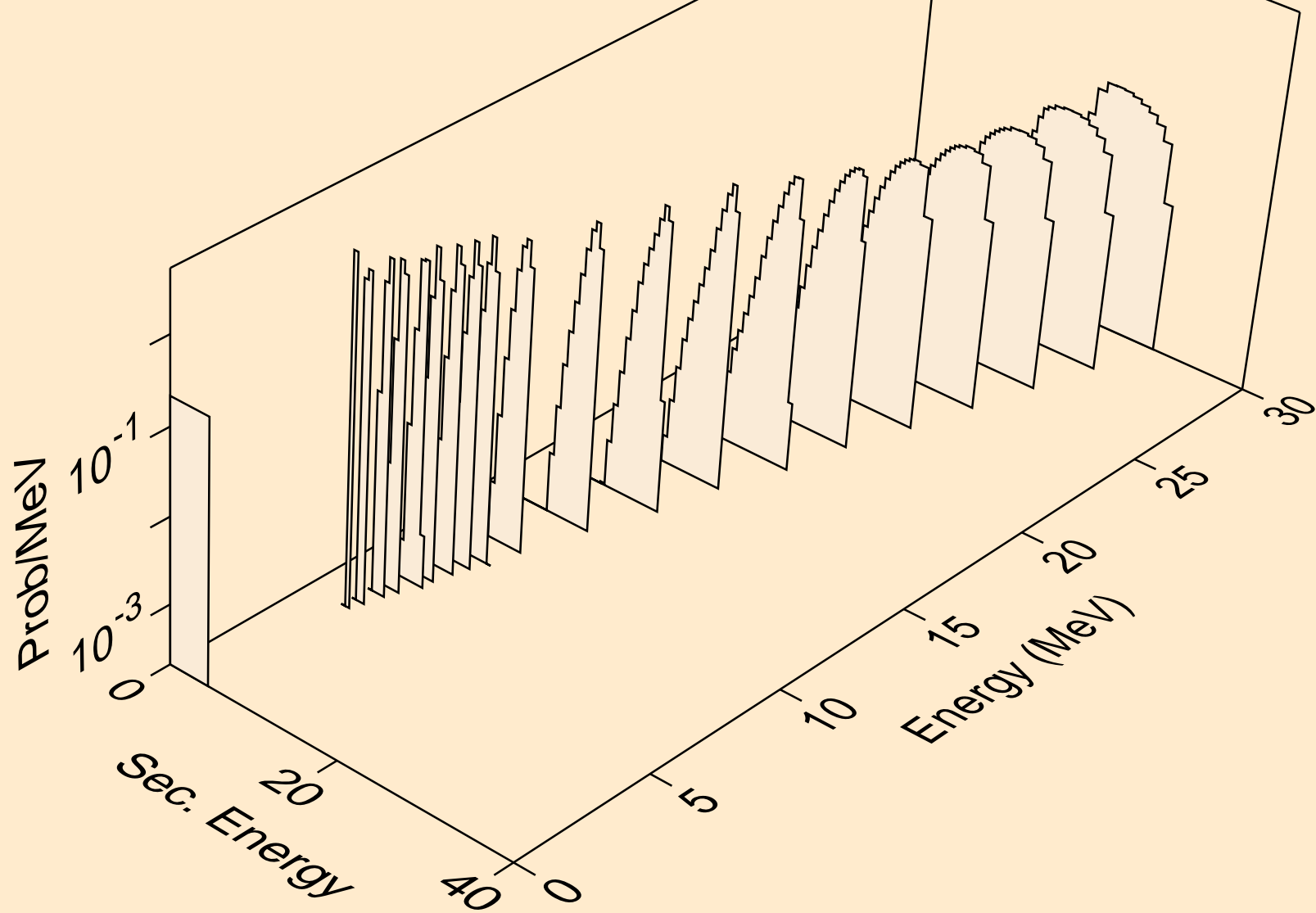

TB157 NEUTRON ACER TENDL-2023 LIBRARY; T=0.K
alphas from (n,2n)a

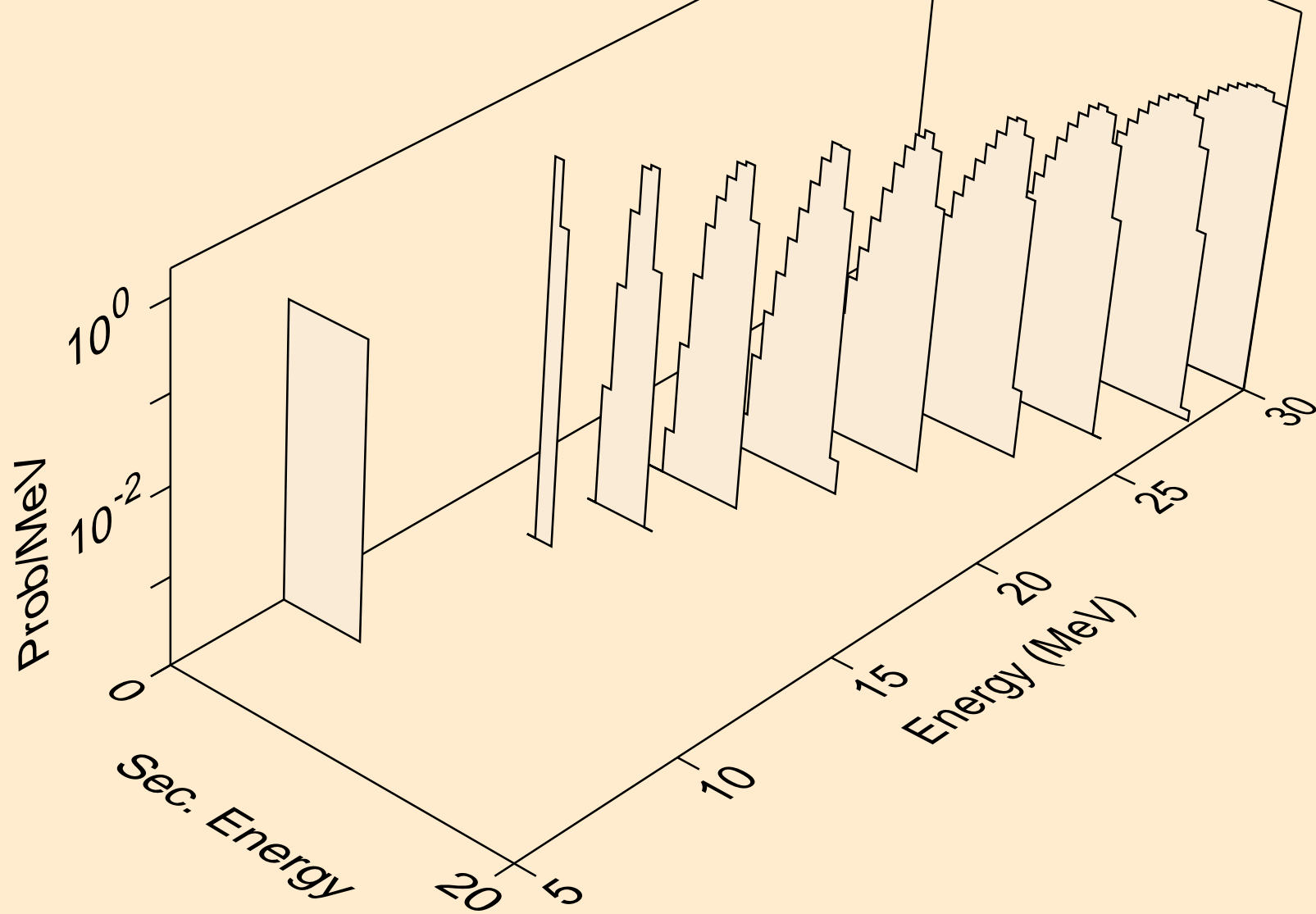

TB157 NEUTRON ACER TENDL-2023 LIBRARY; T=0.K
alphas from (n,3n)a

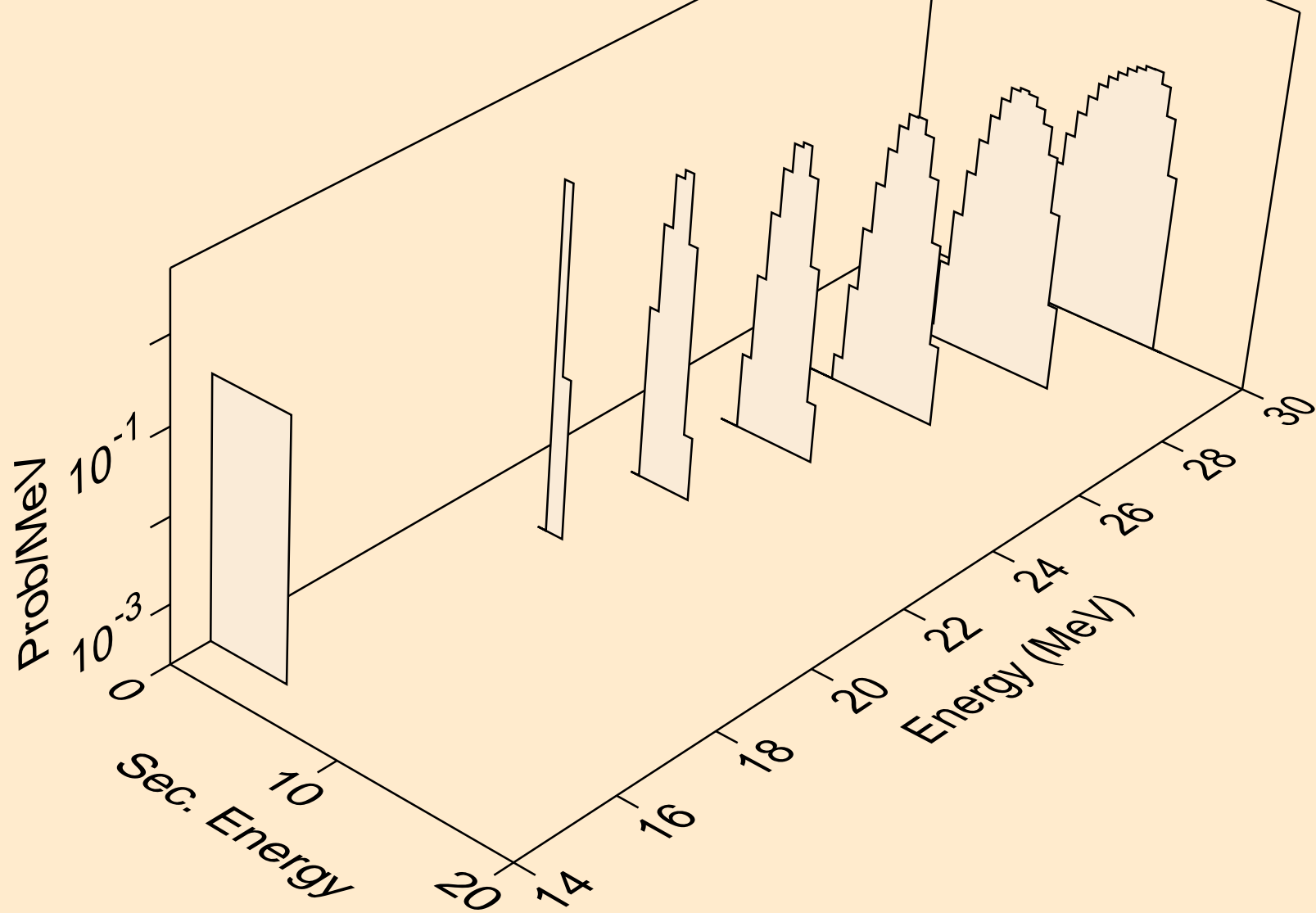

TB157 NEUTRON ACER TENDL-2023 LIBRARY; T=0.K
alphas from (n,n*)2a

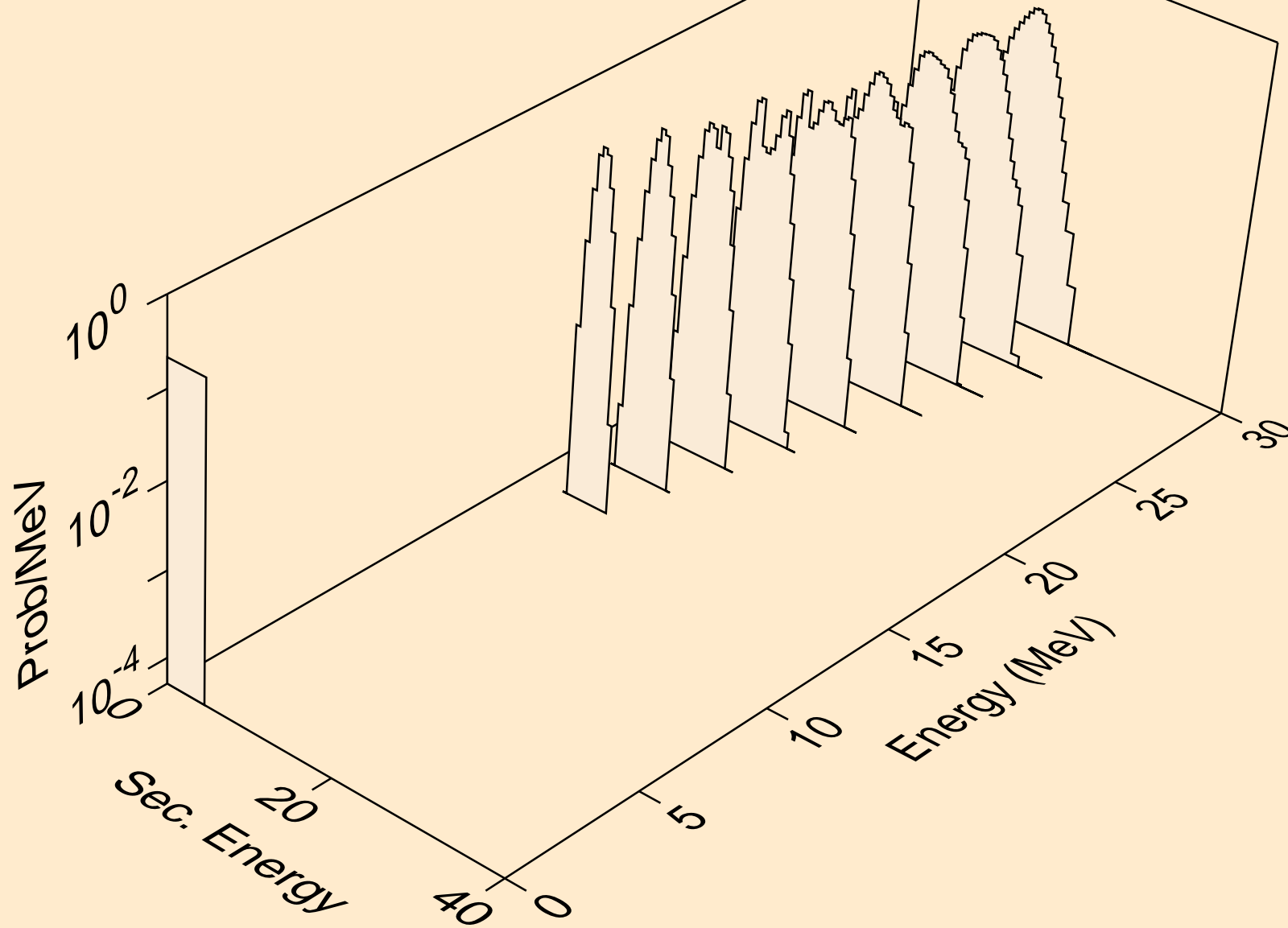

TB157 NEUTRON ACER TENDL-2023 LIBRARY; T=0.K
alphas from (n,npa)

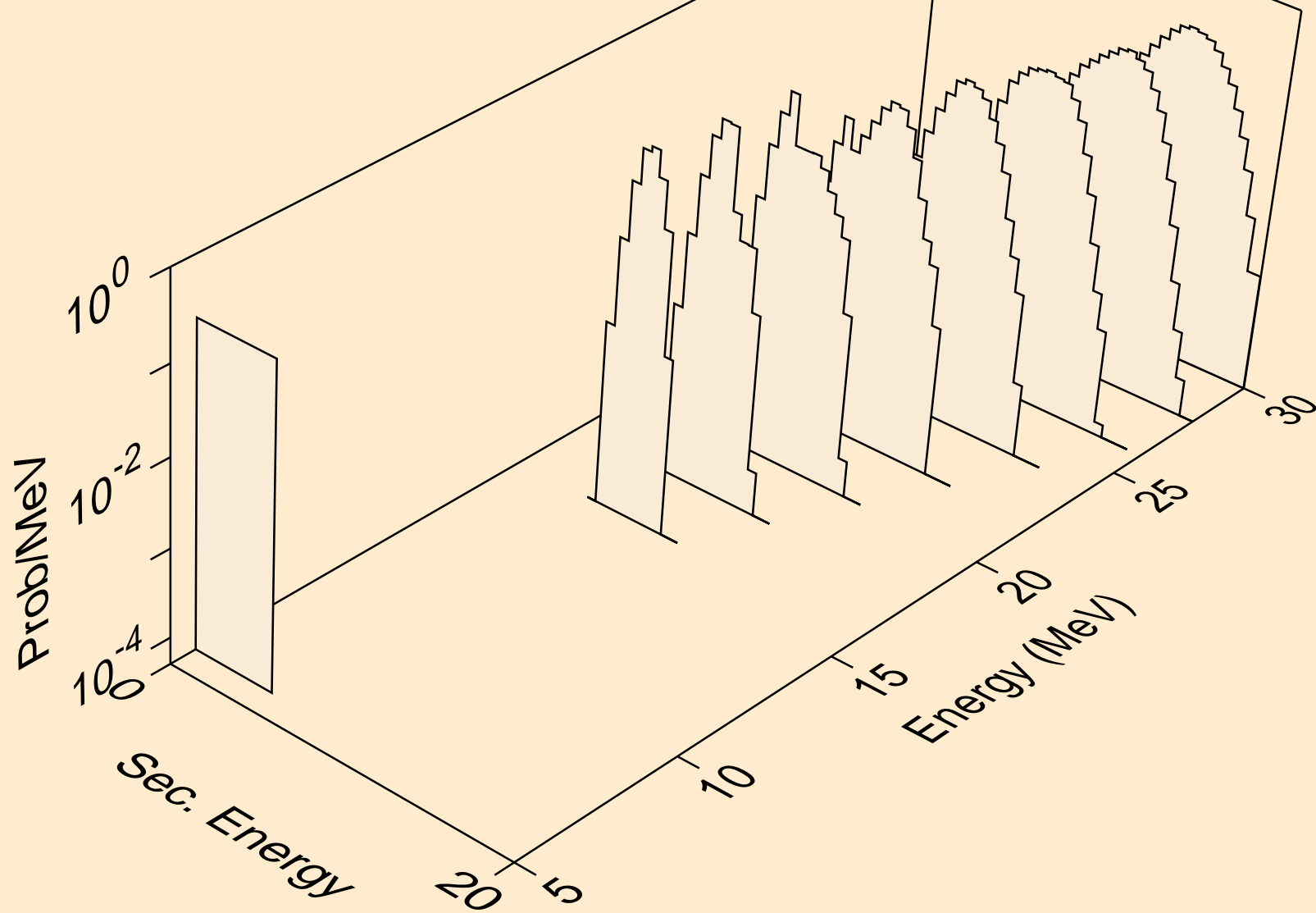

TB157 NEUTRON ACER TENDL-2023 LIBRARY; T=0.K
alphas from (n,a)

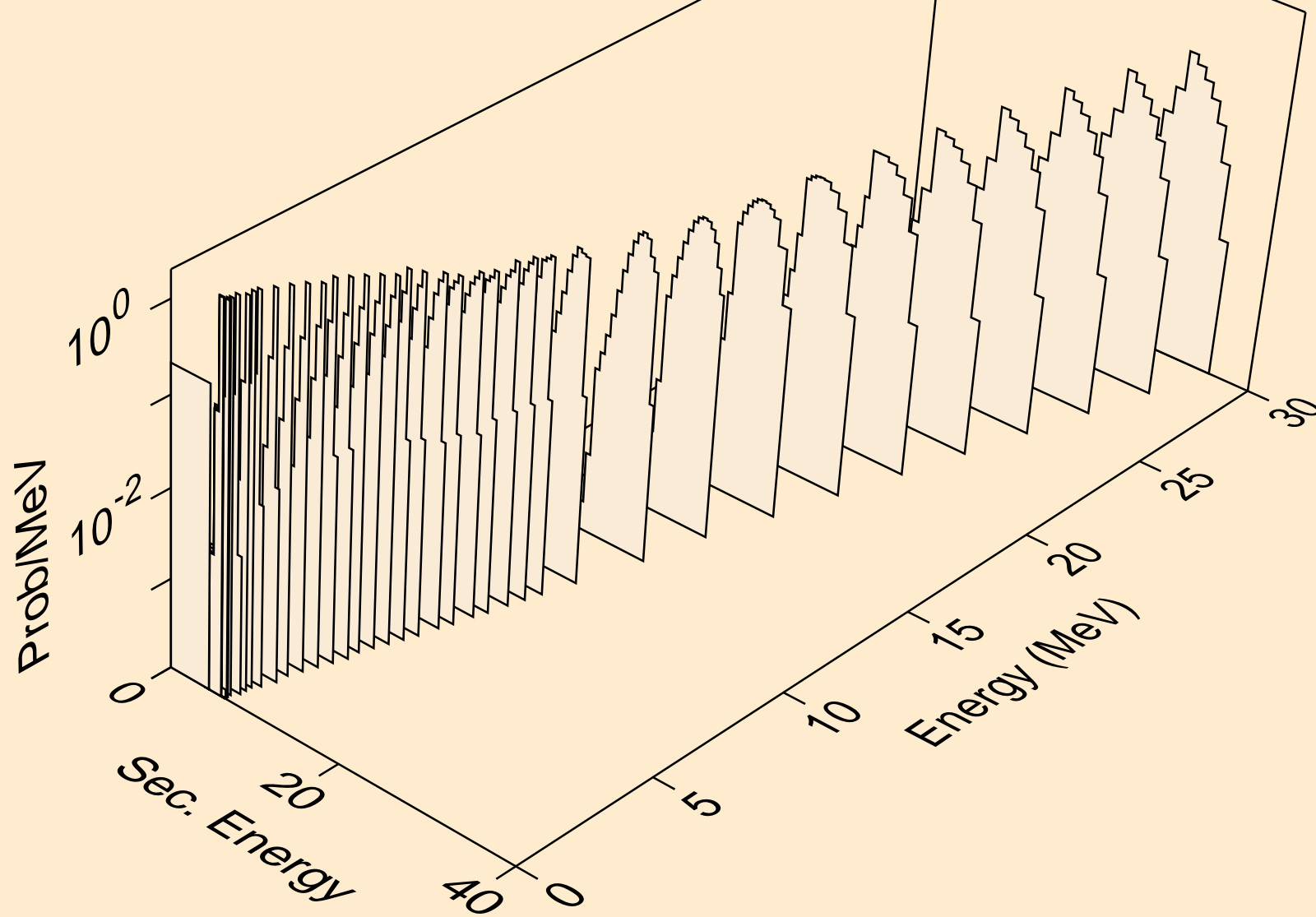

TB157 NEUTRON ACER TENDL-2023 LIBRARY; T=0.K
alphas from (n,2a)

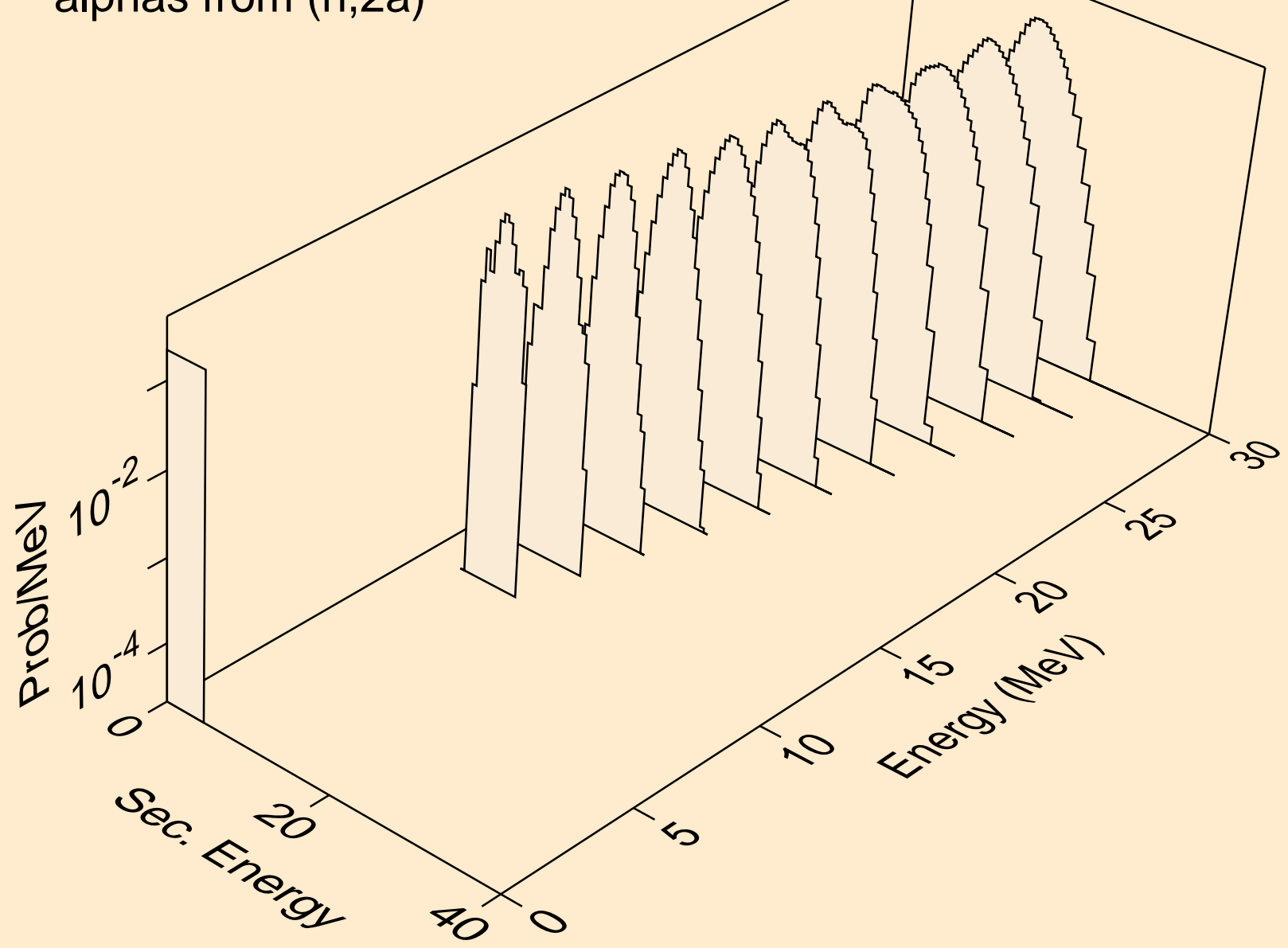

TB157 NEUTRON ACER TENDL-2023 LIBRARY; T=0.K
alphas from (n,pa)

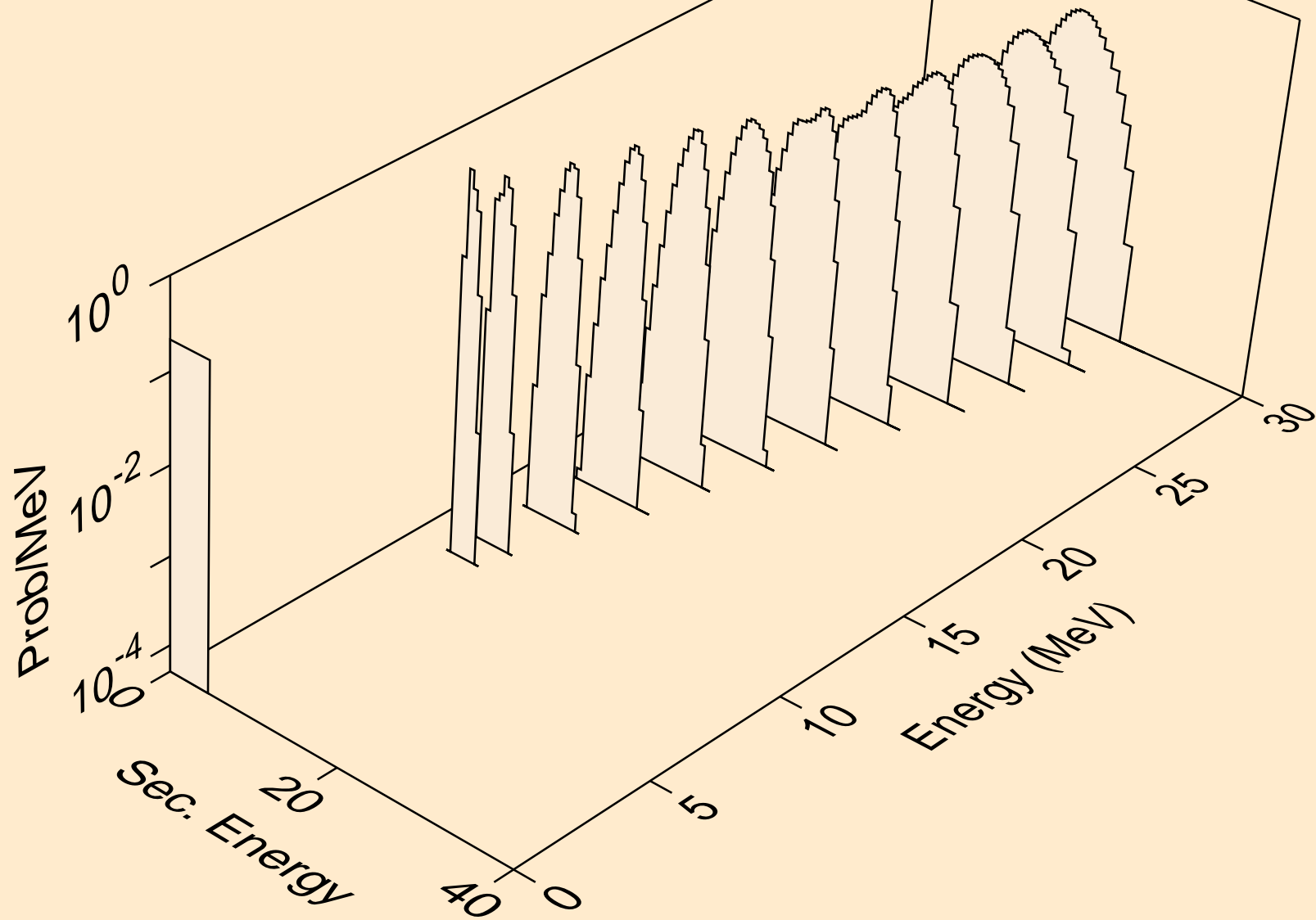

TB157 NEUTRON ACER TENDL-2023 LIBRARY; T=0.K
alphas from (n,da)

