

TC094M NEUTRON ACER TENDL-2023 LIBRARY; T=0.K
Principal cross sections

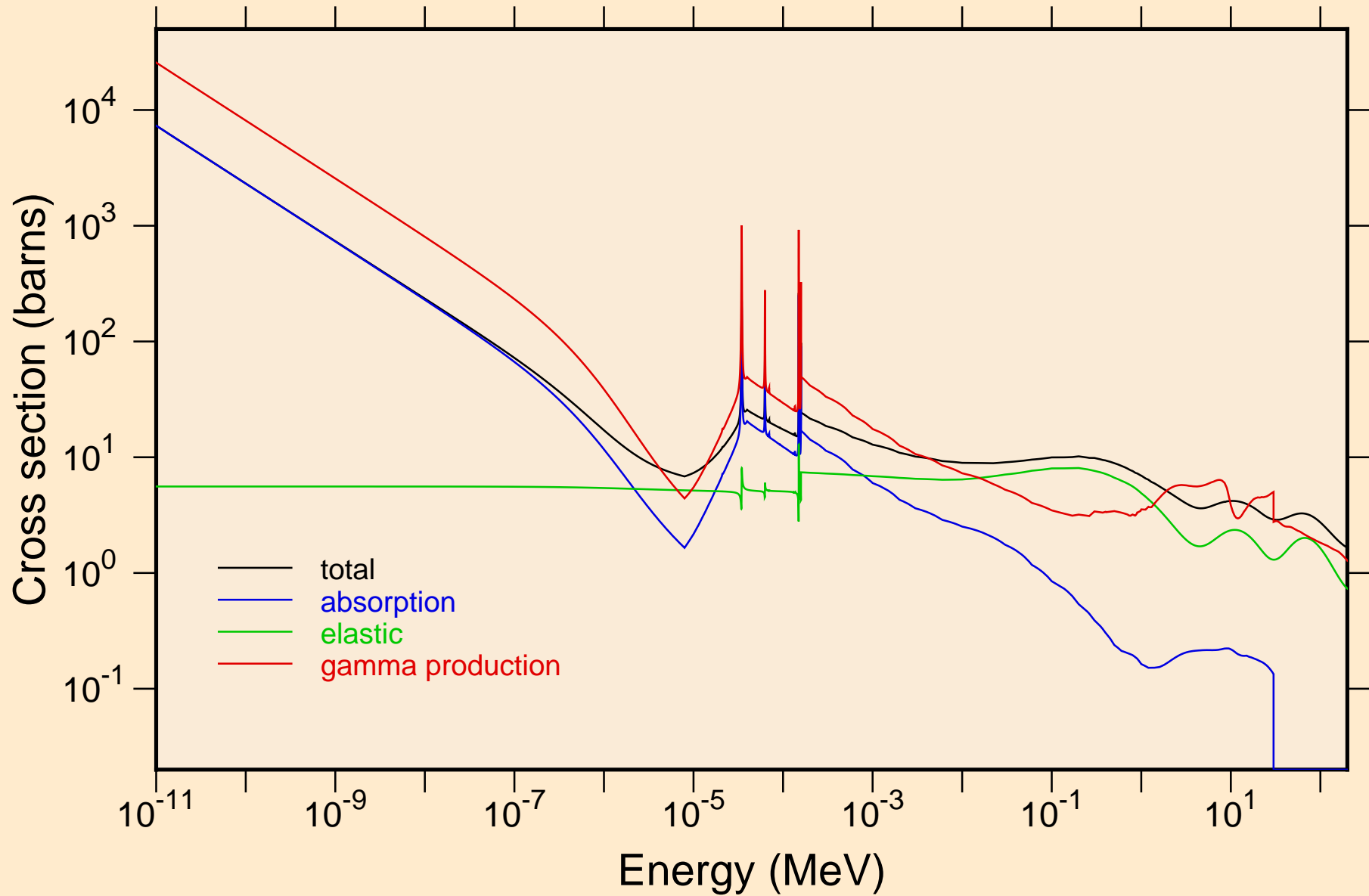

TC094M NEUTRON ACER TENDL-2023 LIBRARY; T=0.K
resonance total cross section

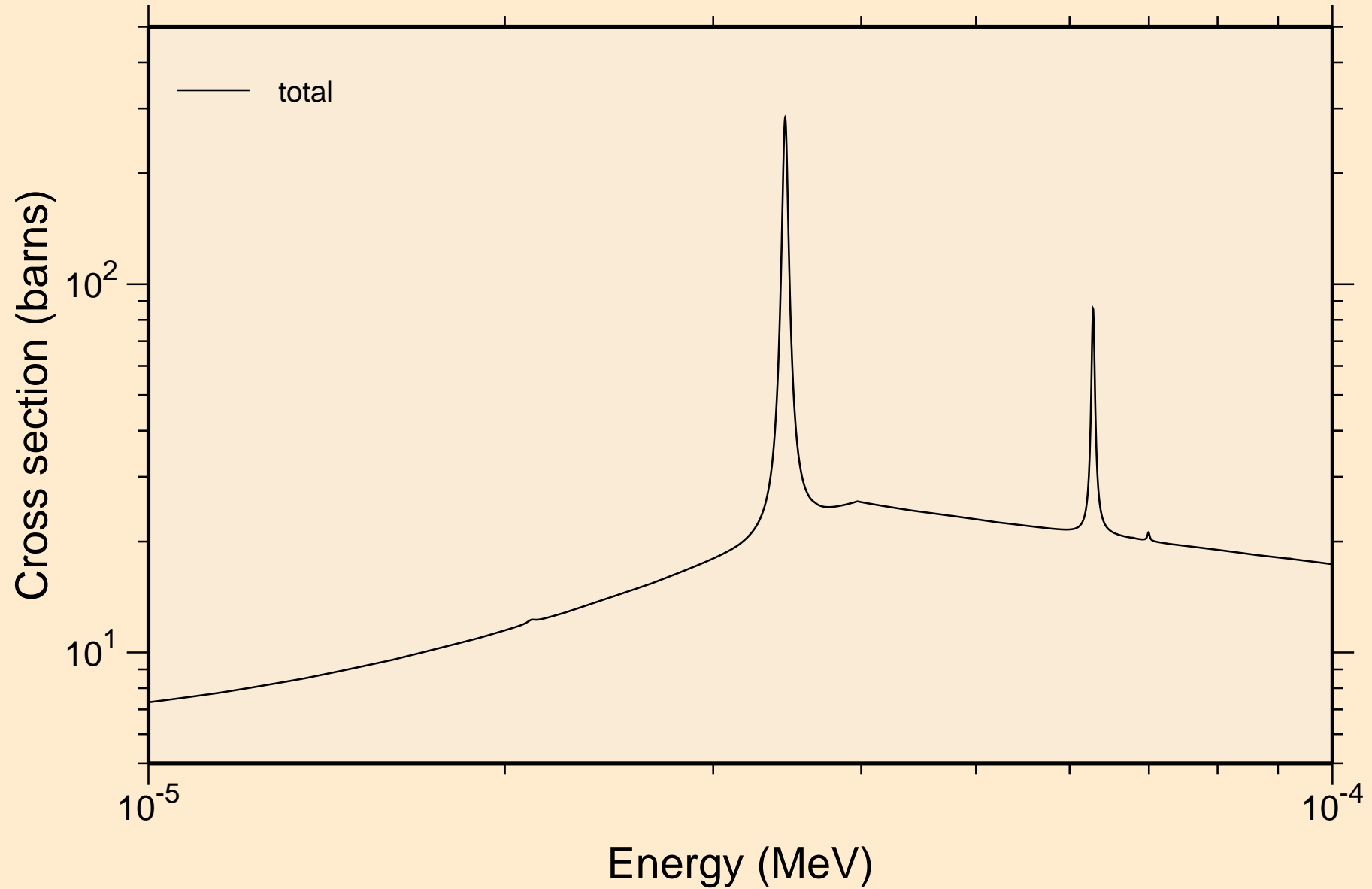

TC094M NEUTRON ACER TENDL-2023 LIBRARY; T=0.K
resonance total cross section

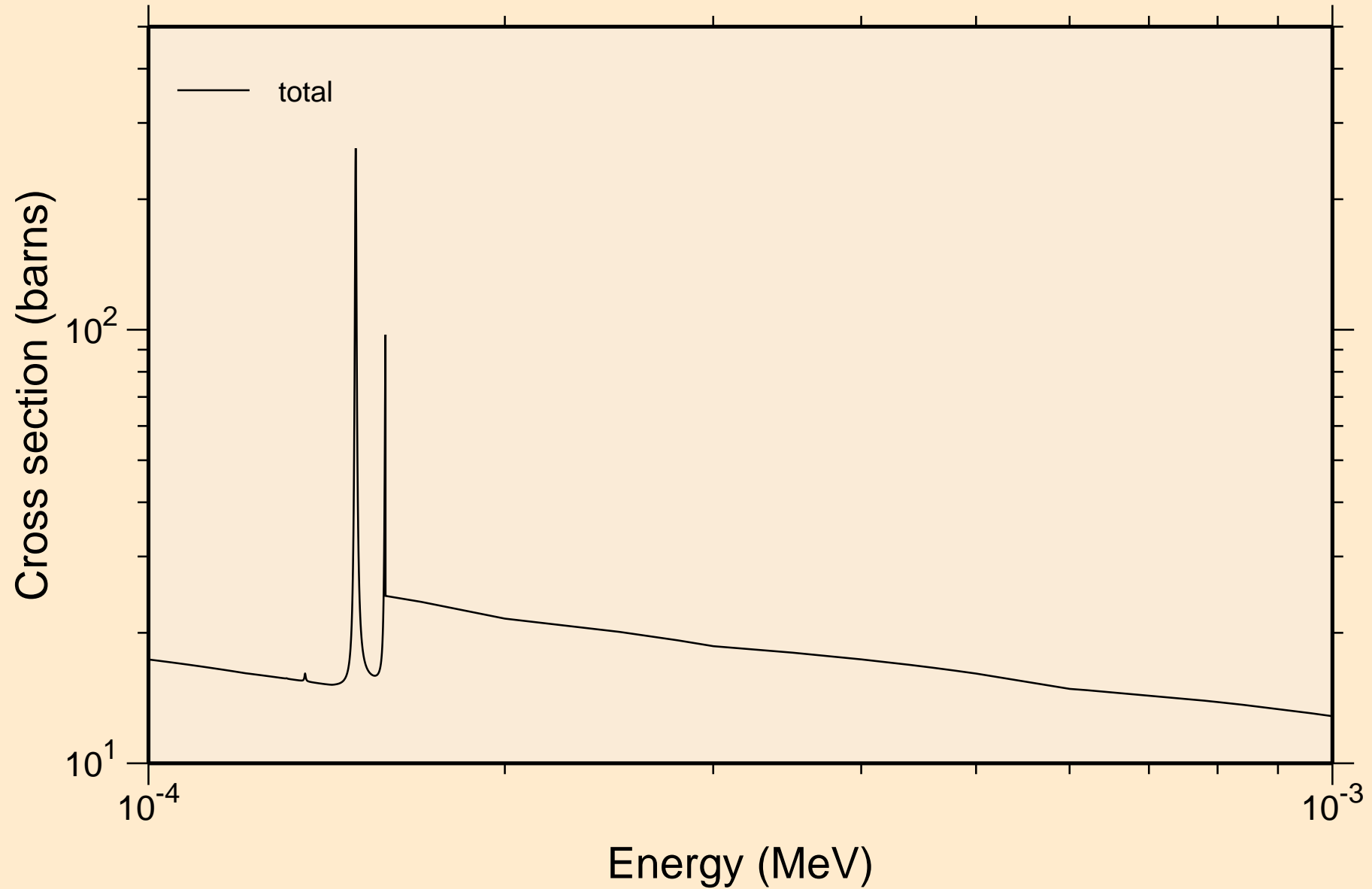

T̄C094M NEUTRON ACER TENDL-2023 LIBRARY; T=0.K
resonance total cross section

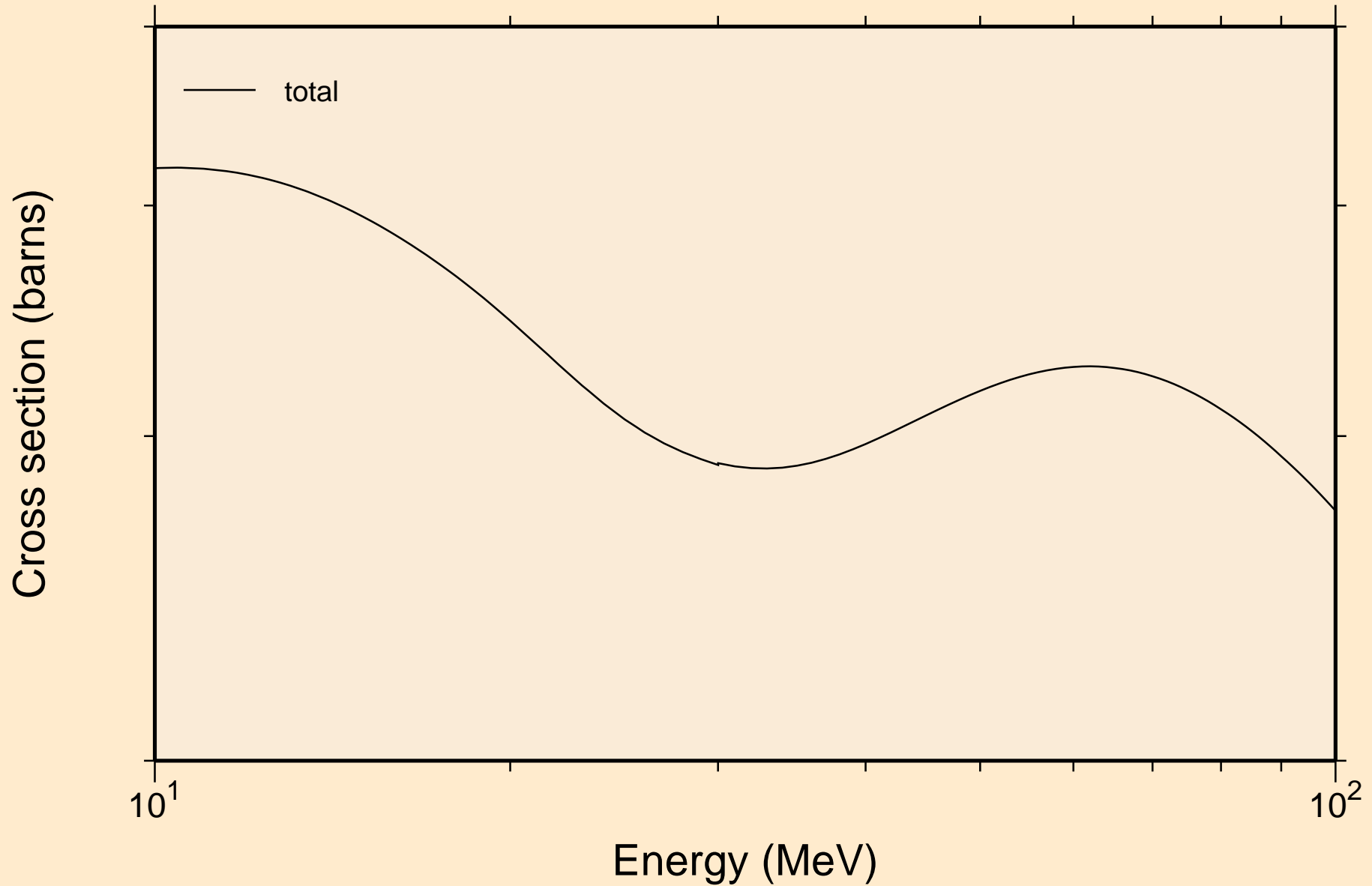

TC094M NEUTRON ACER TENDL-2023 LIBRARY; T=0.K
resonance absorption cross sections

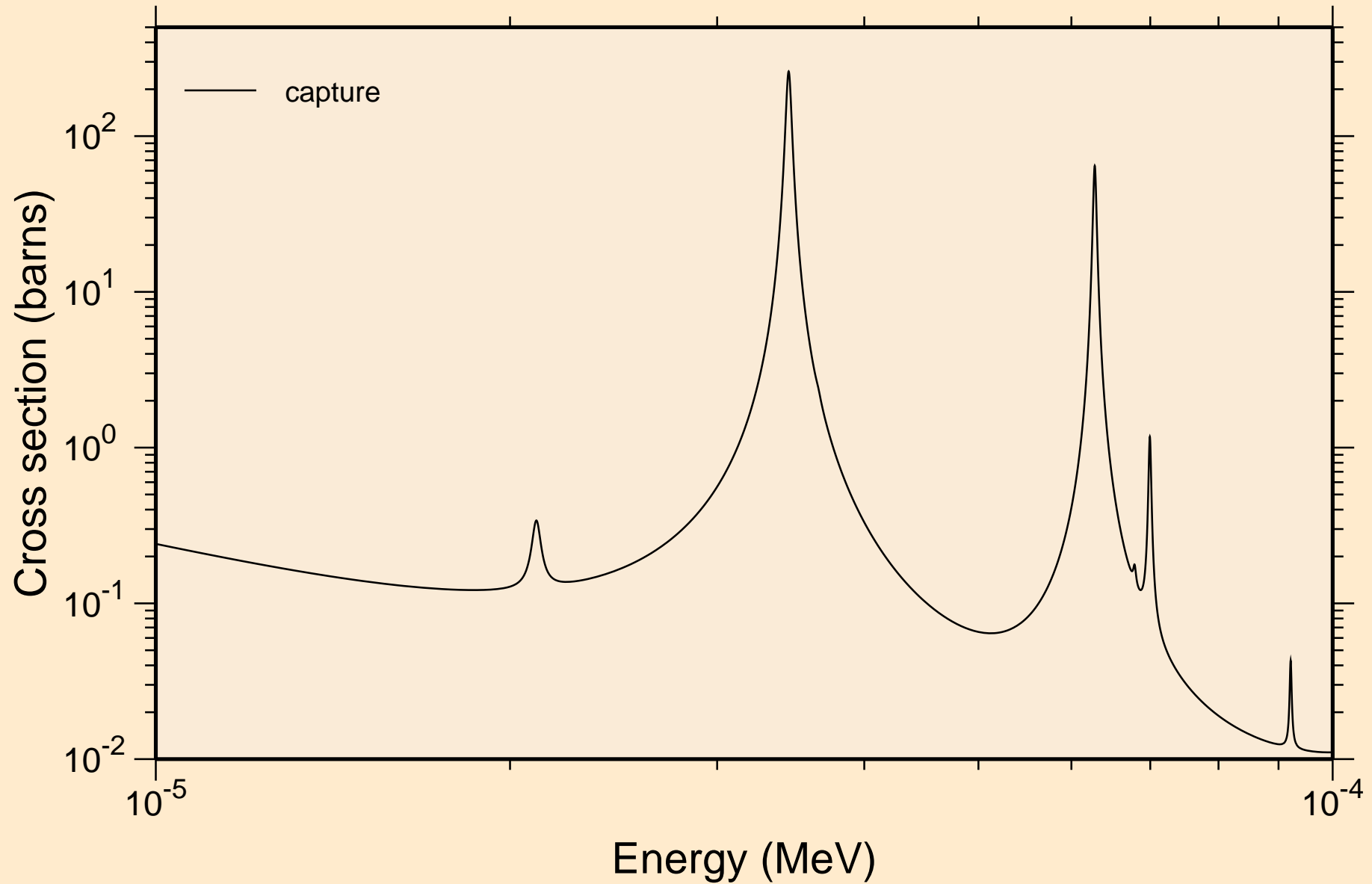

TC094M NEUTRON ACER TENDL-2023 LIBRARY; T=0.K
resonance absorption cross sections

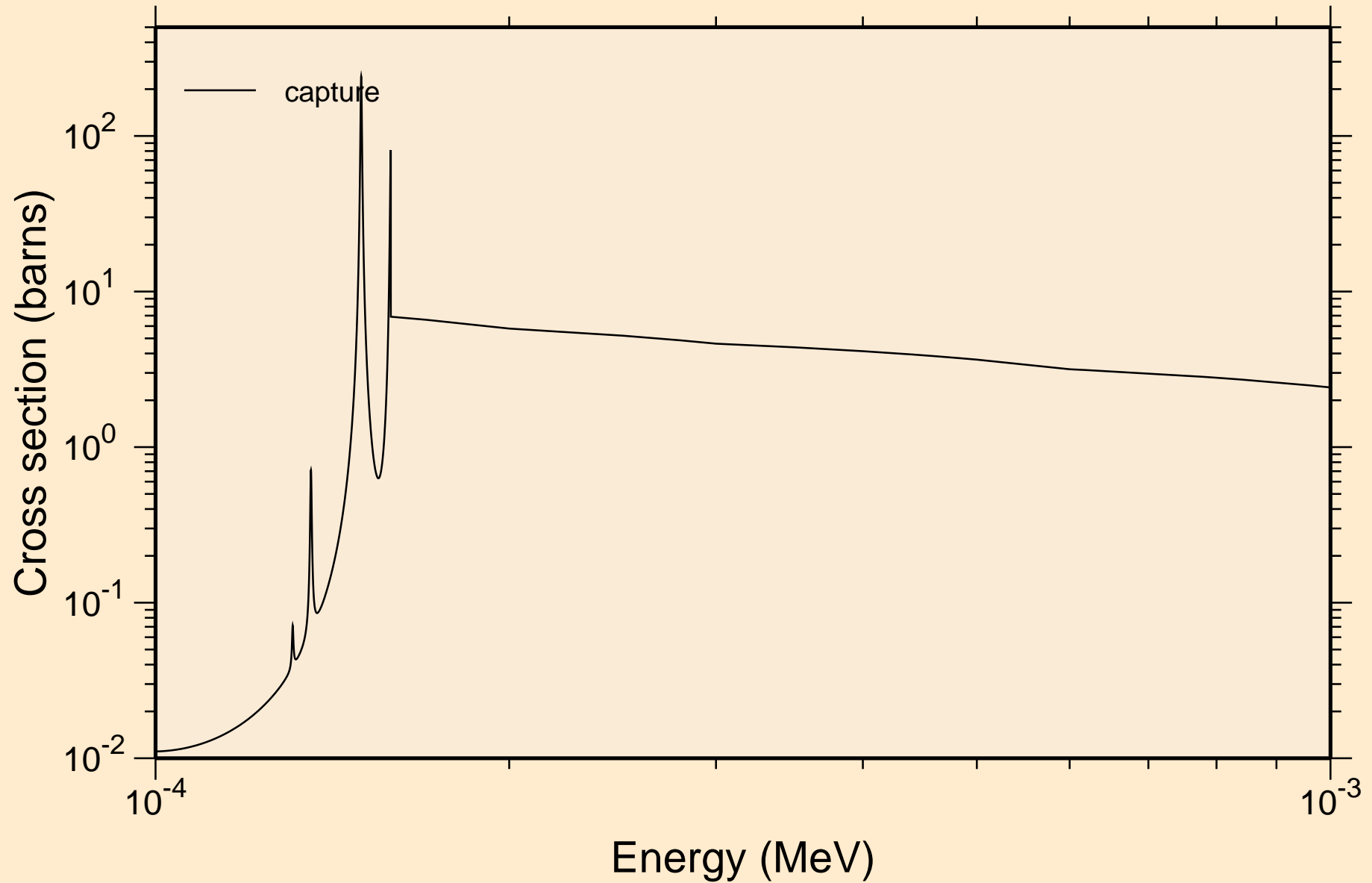

TC094M NEUTRON ACER TENDL-2023 LIBRARY; T=0.K
resonance absorption cross sections

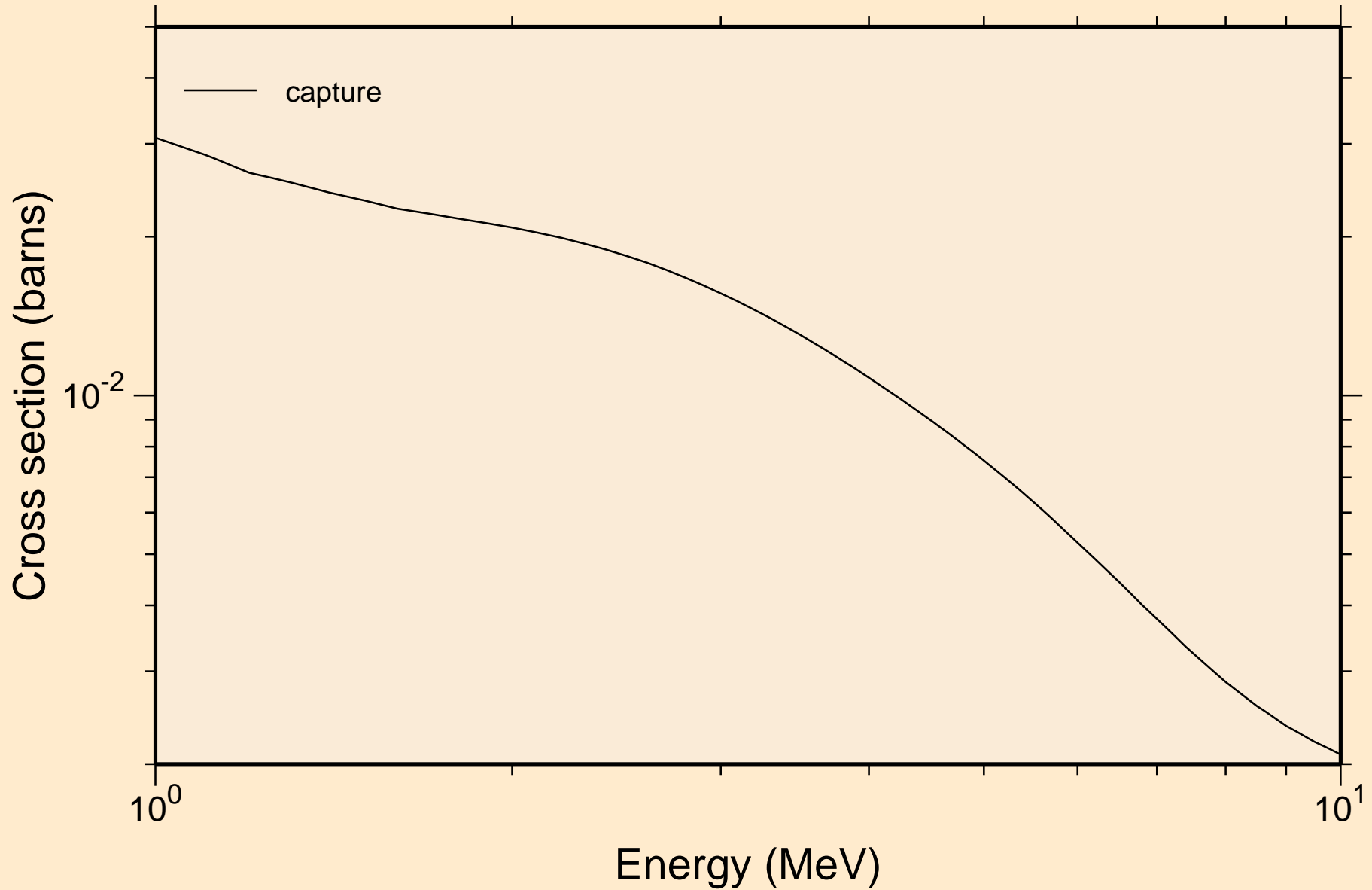

TC094M NEUTRON ACER TENDL-2023 LIBRARY; T=0.K

Heating

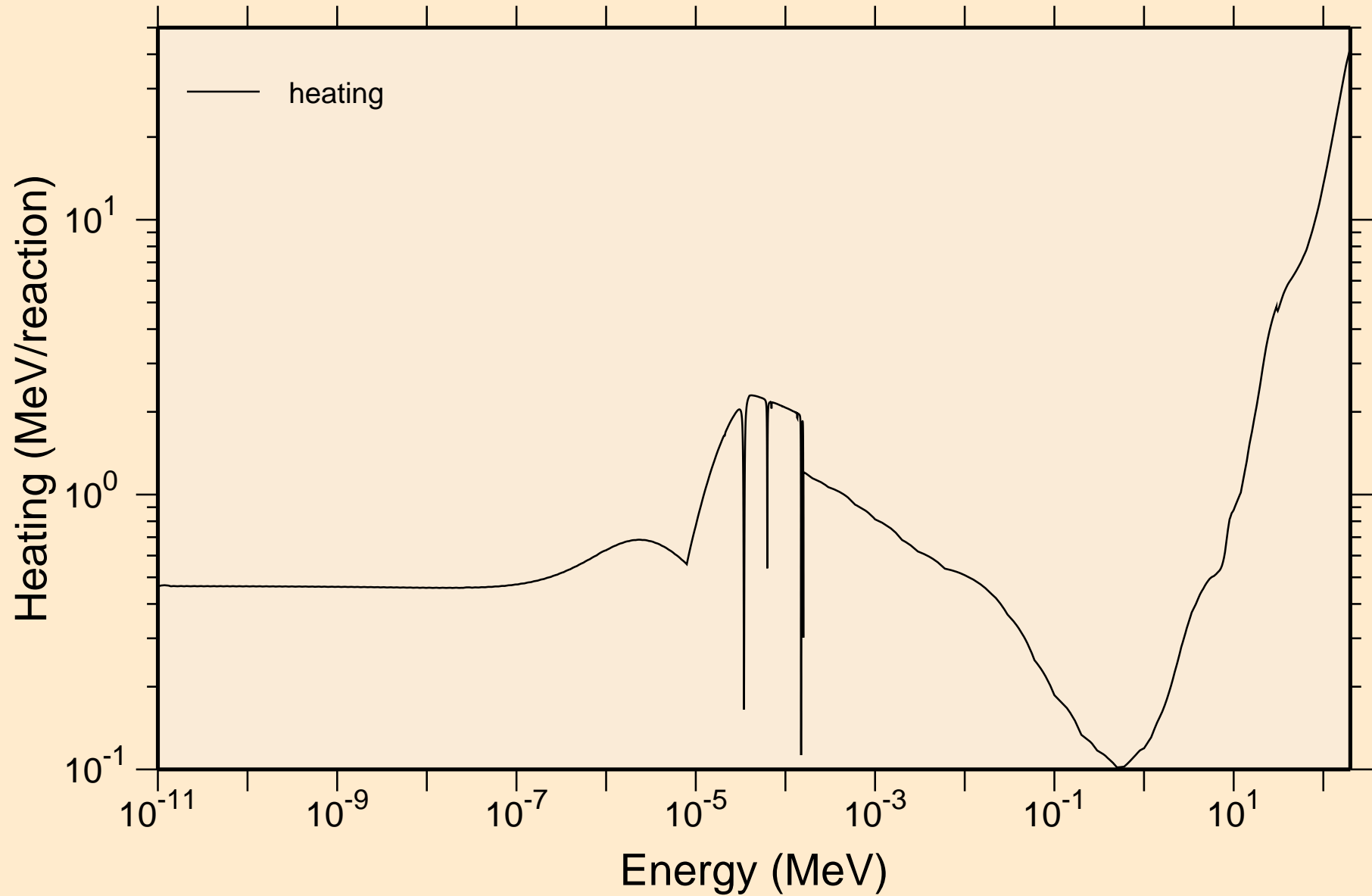

TC094M NEUTRON ACER TENDL-2023 LIBRARY; T=0.K
Damage

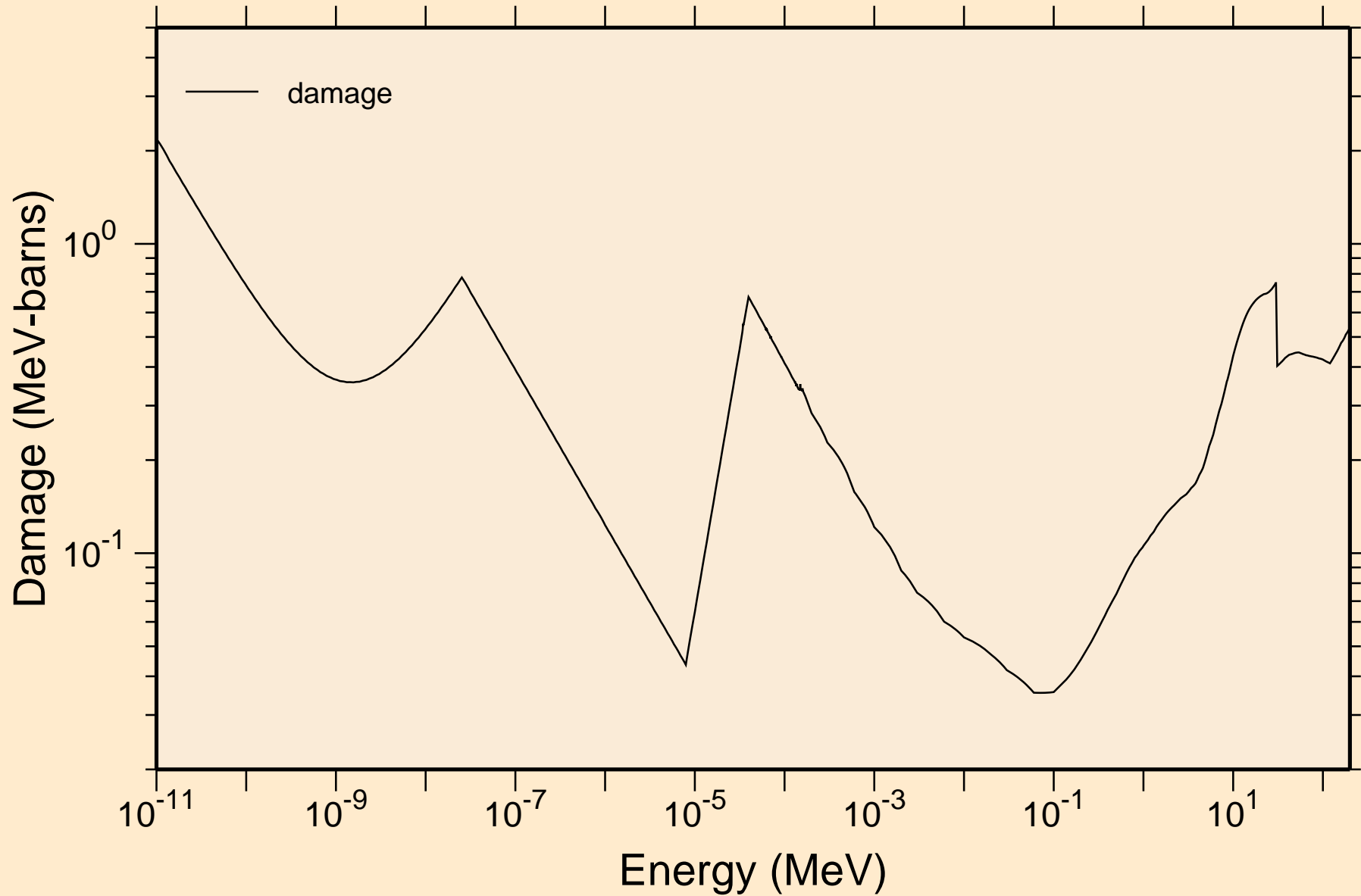

TC094M NEUTRON ACER TENDL-2023 LIBRARY; T=0.K
Non-threshold reactions

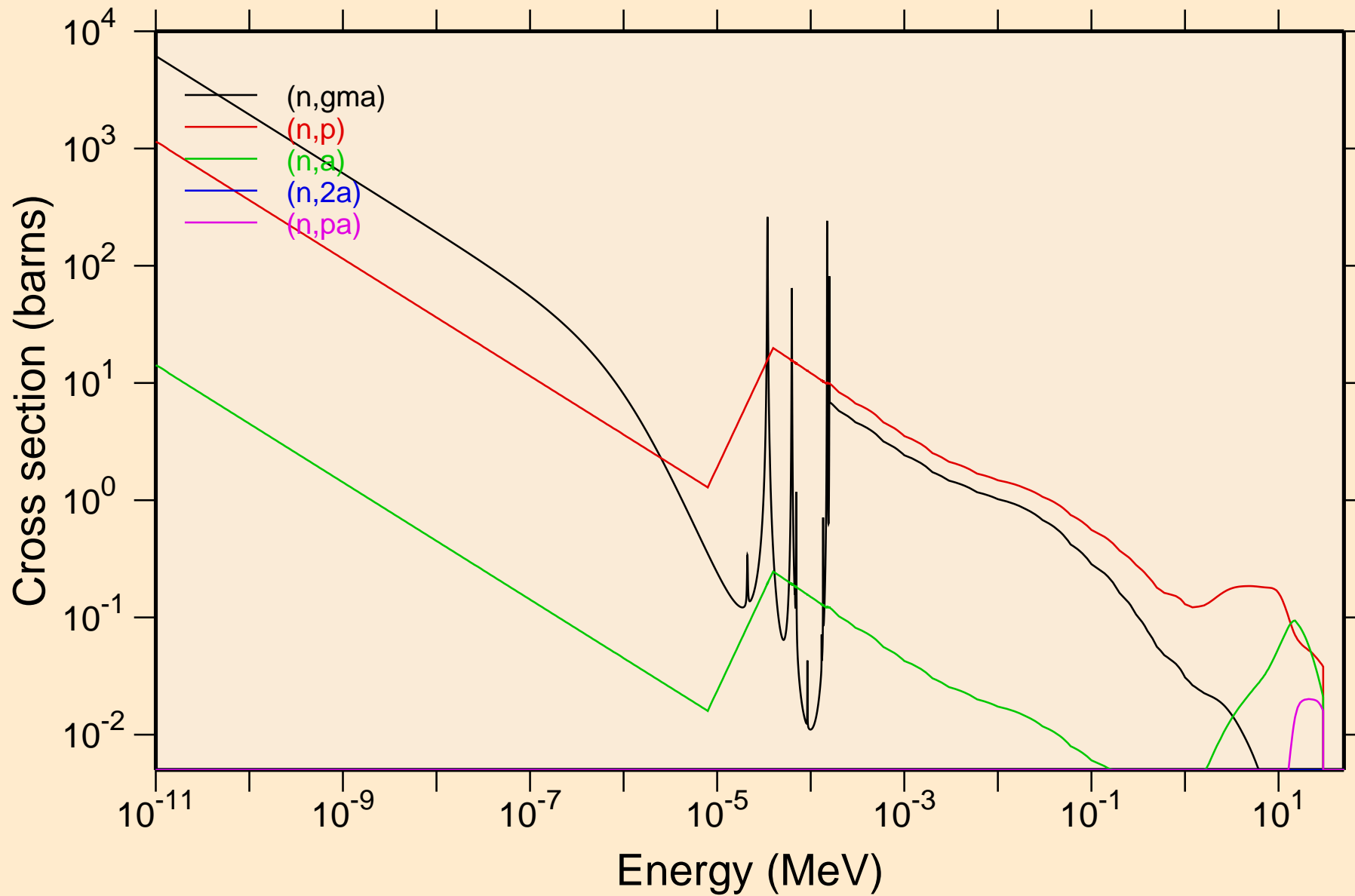

TC094M NEUTRON ACER TENDL-2023 LIBRARY; T=0.K
Non-threshold reactions

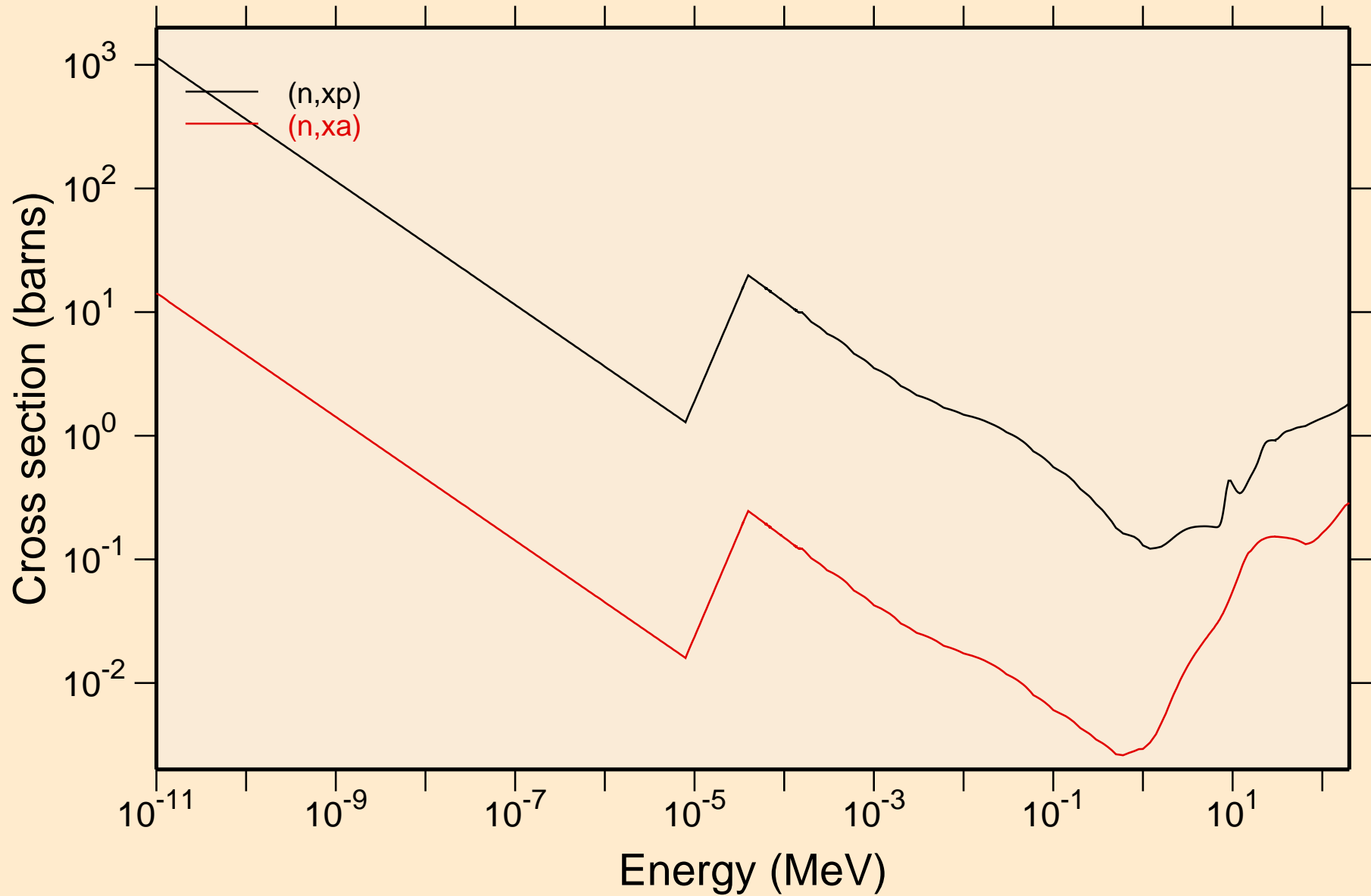

TC094M NEUTRON ACER TENDL-2023 LIBRARY; T=0.K
Principal cross sections

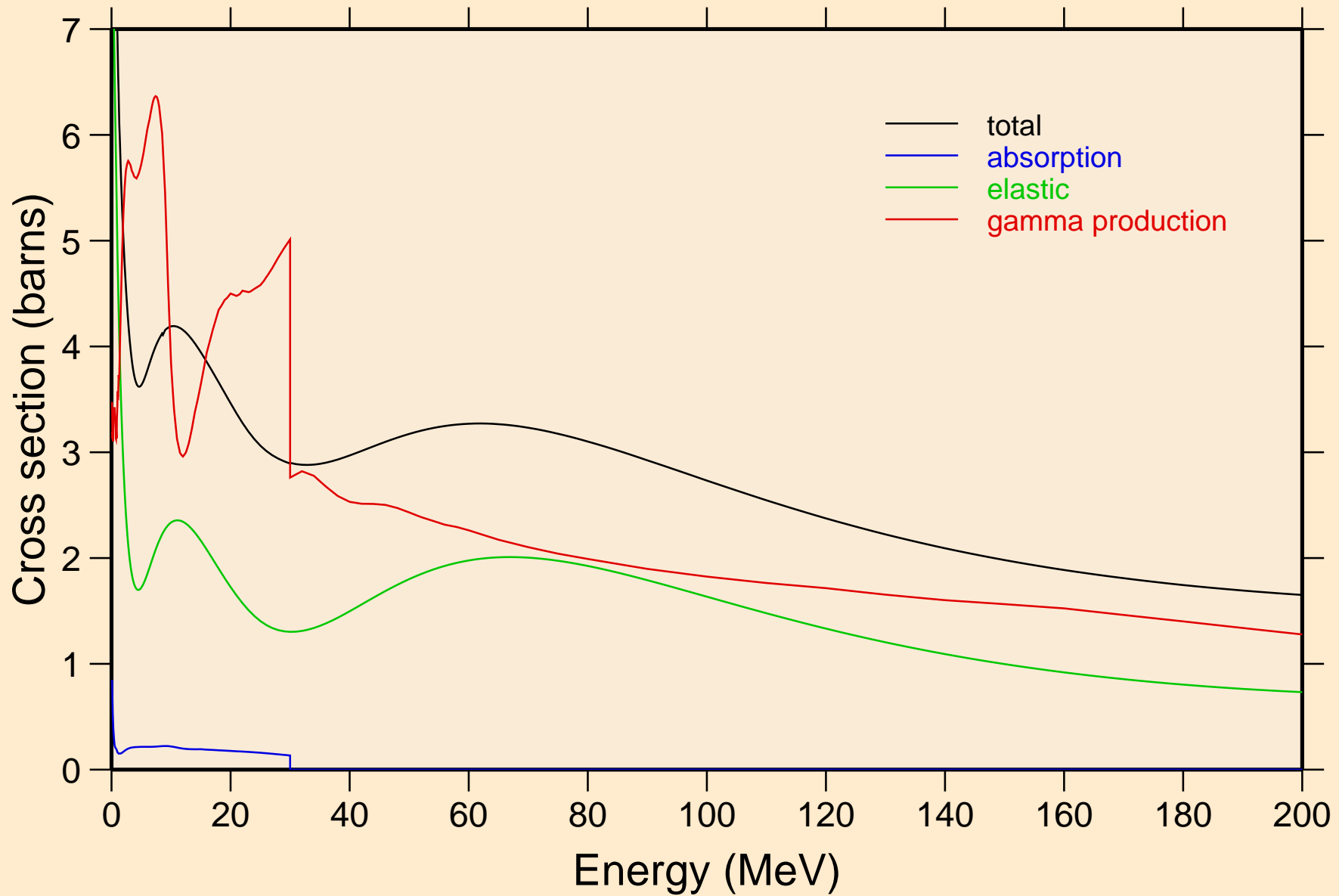

TC094M NEUTRON ACER TENDL-2023 LIBRARY; T=0.K

Heating

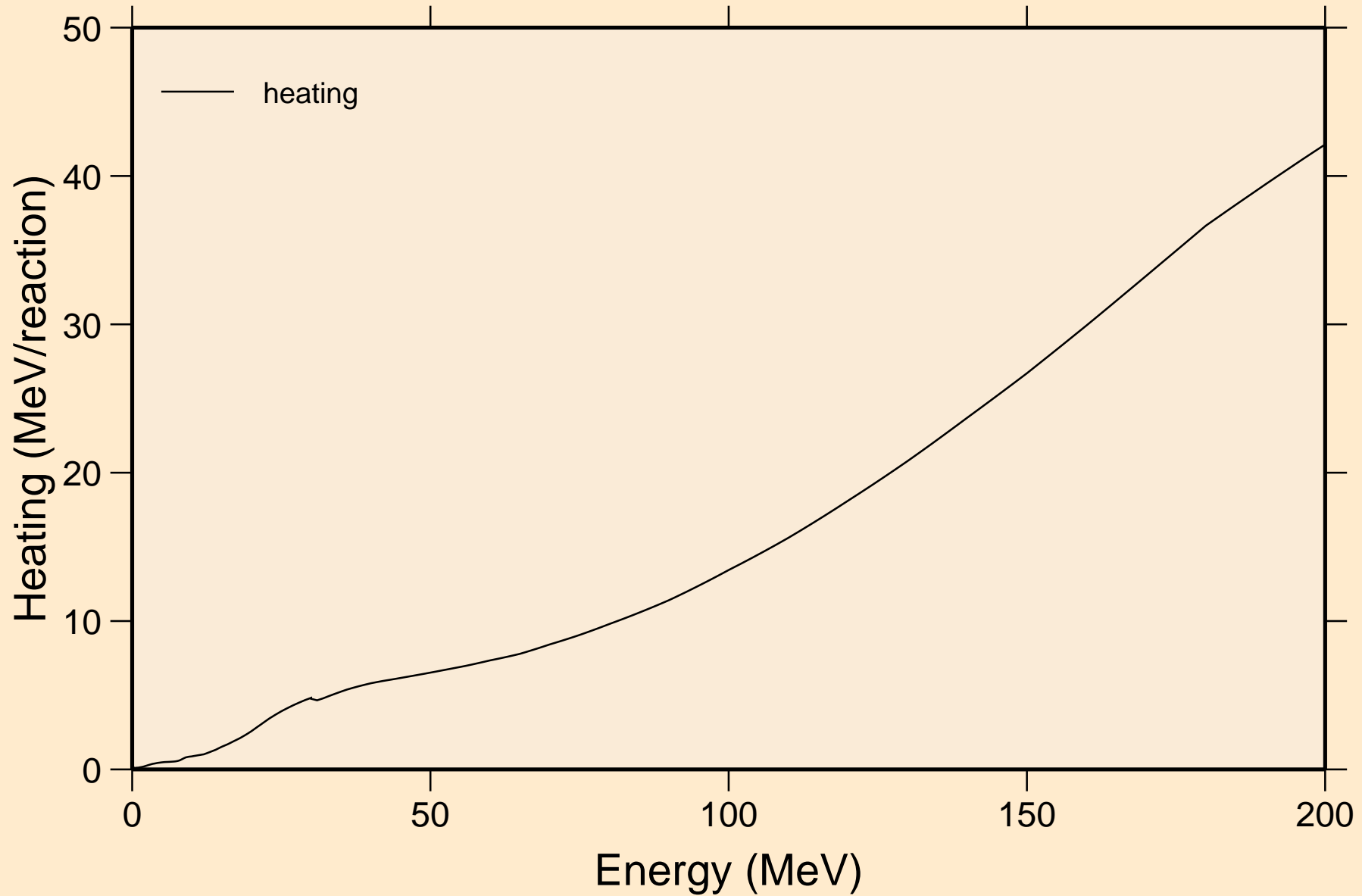

TC094M NEUTRON ACER TENDL-2023 LIBRARY; T=0.K
Damage

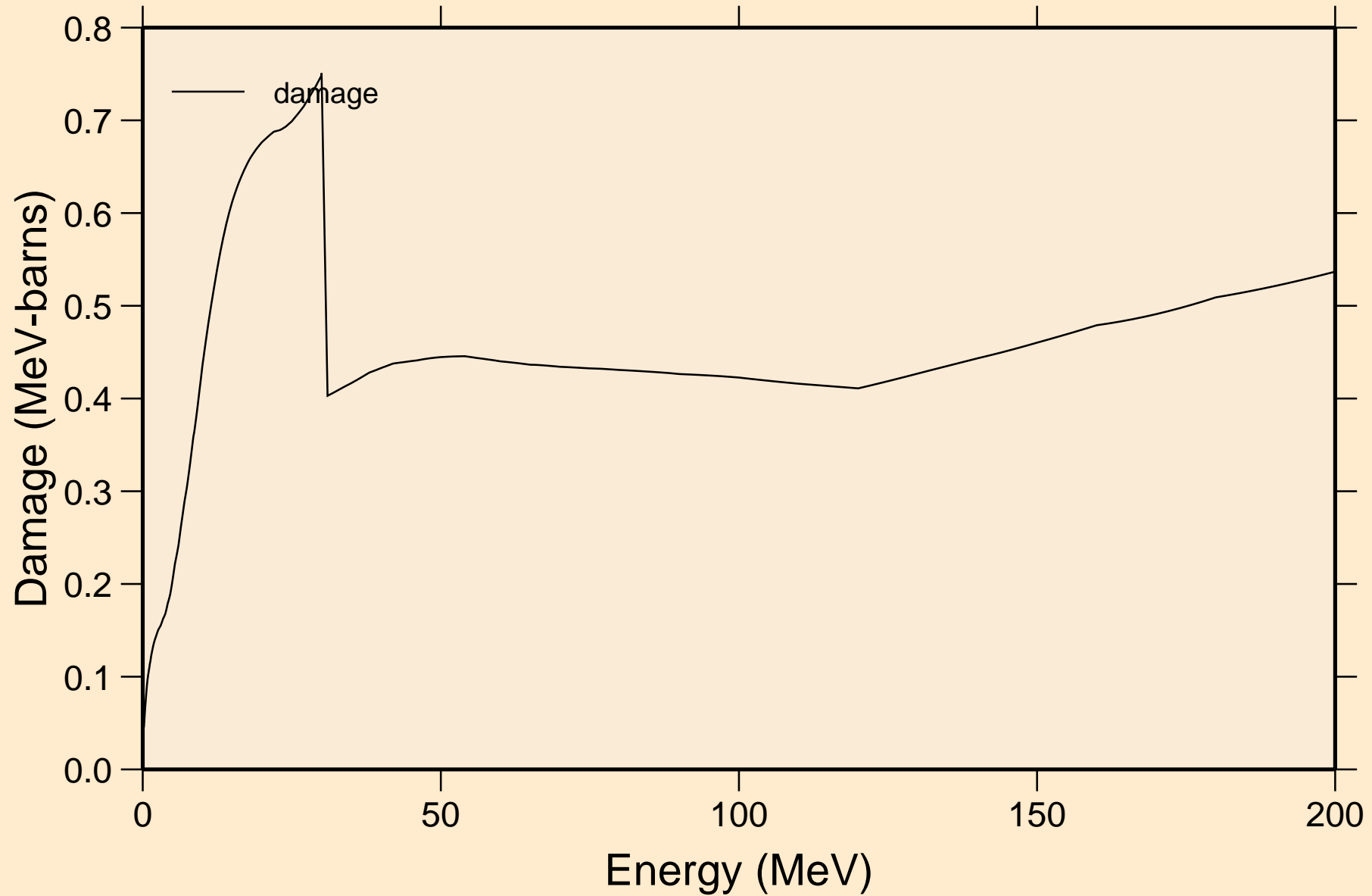

TC094M NEUTRON ACER TENDL-2023 LIBRARY; T=0.K
Non-threshold reactions

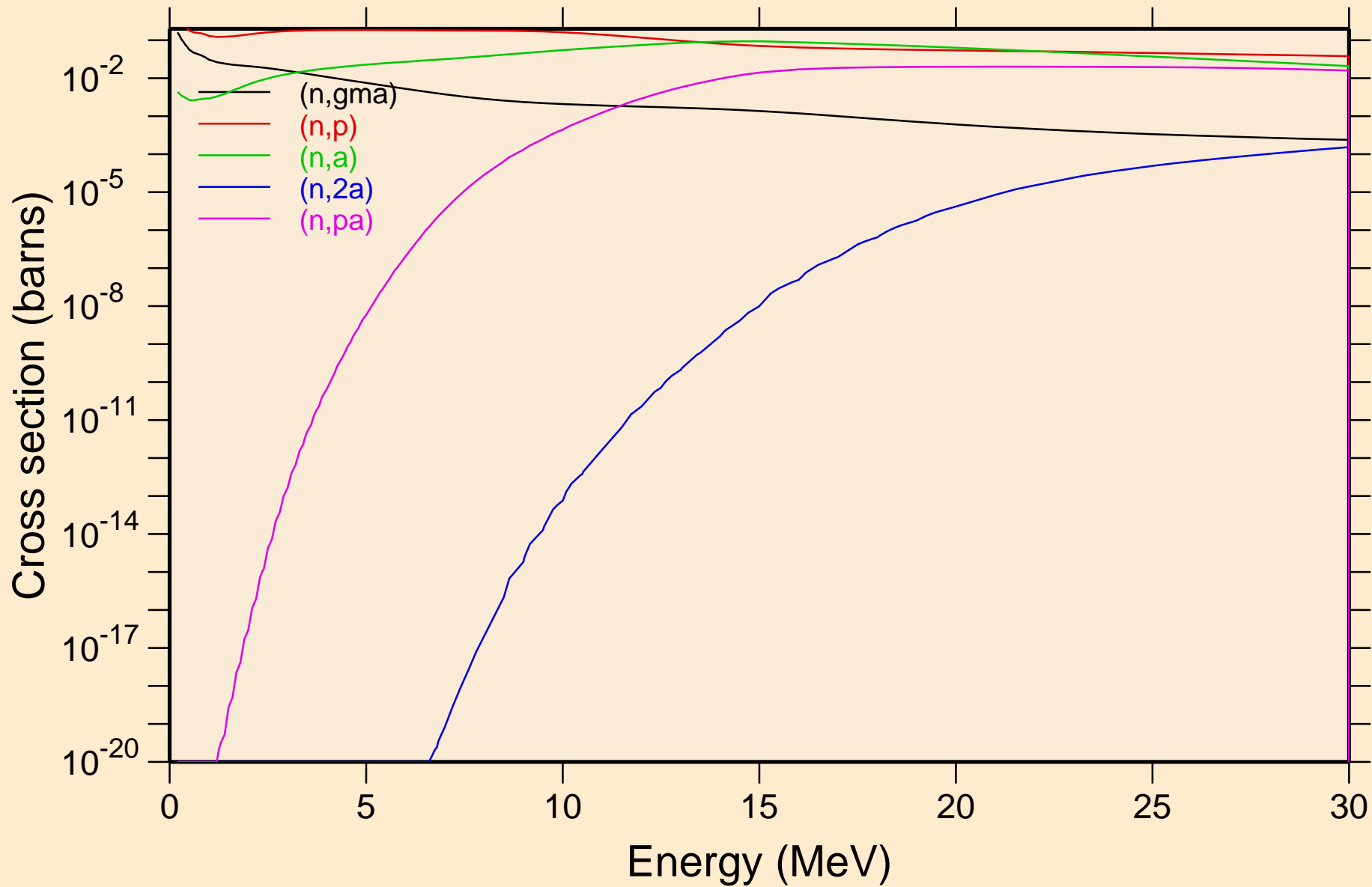

TC094M NEUTRON ACER TENDL-2023 LIBRARY; T=0.K
Non-threshold reactions

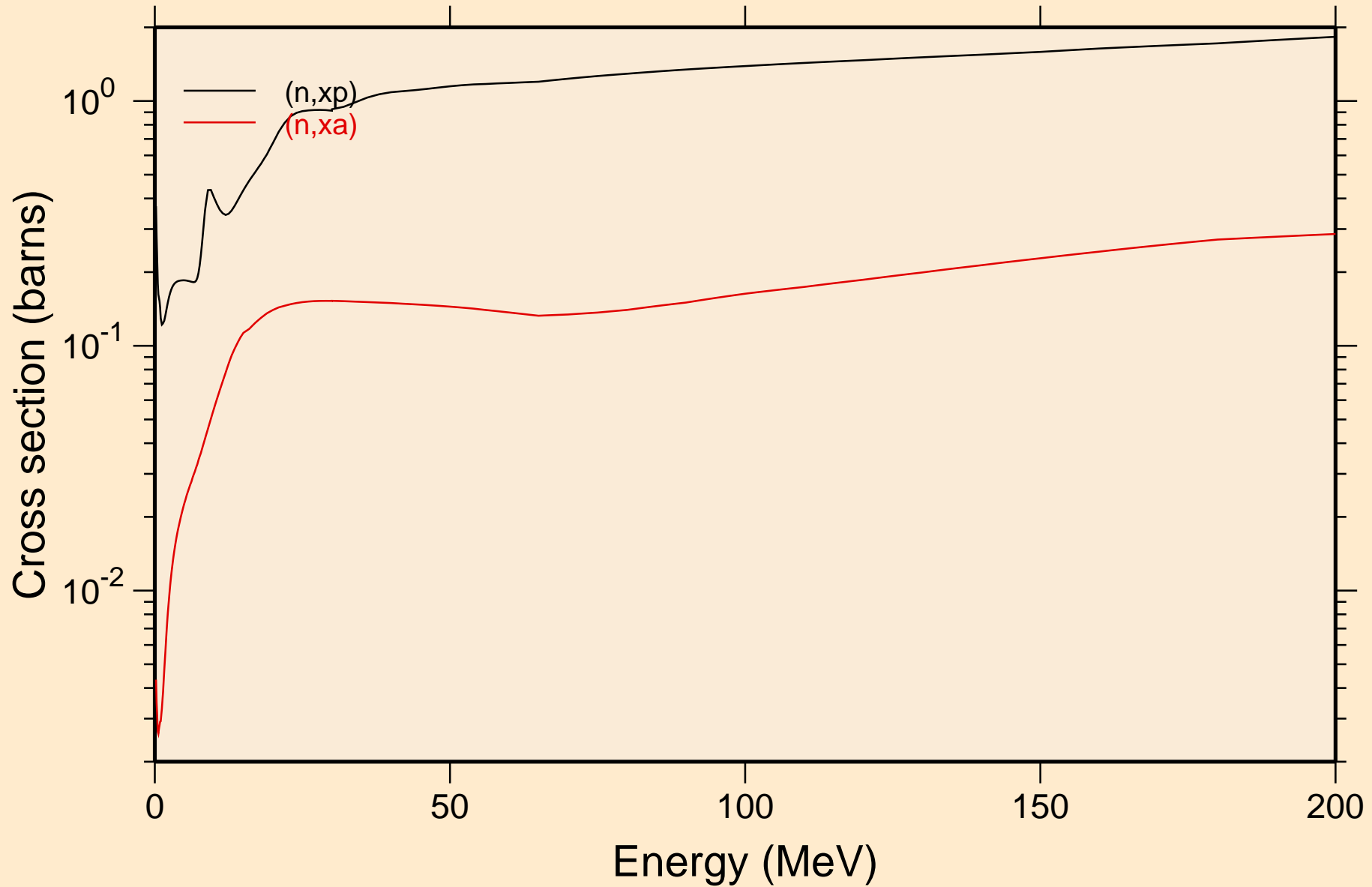

TC094M NEUTRON ACER TENDL-2023 LIBRARY; T=0.K
Inelastic levels

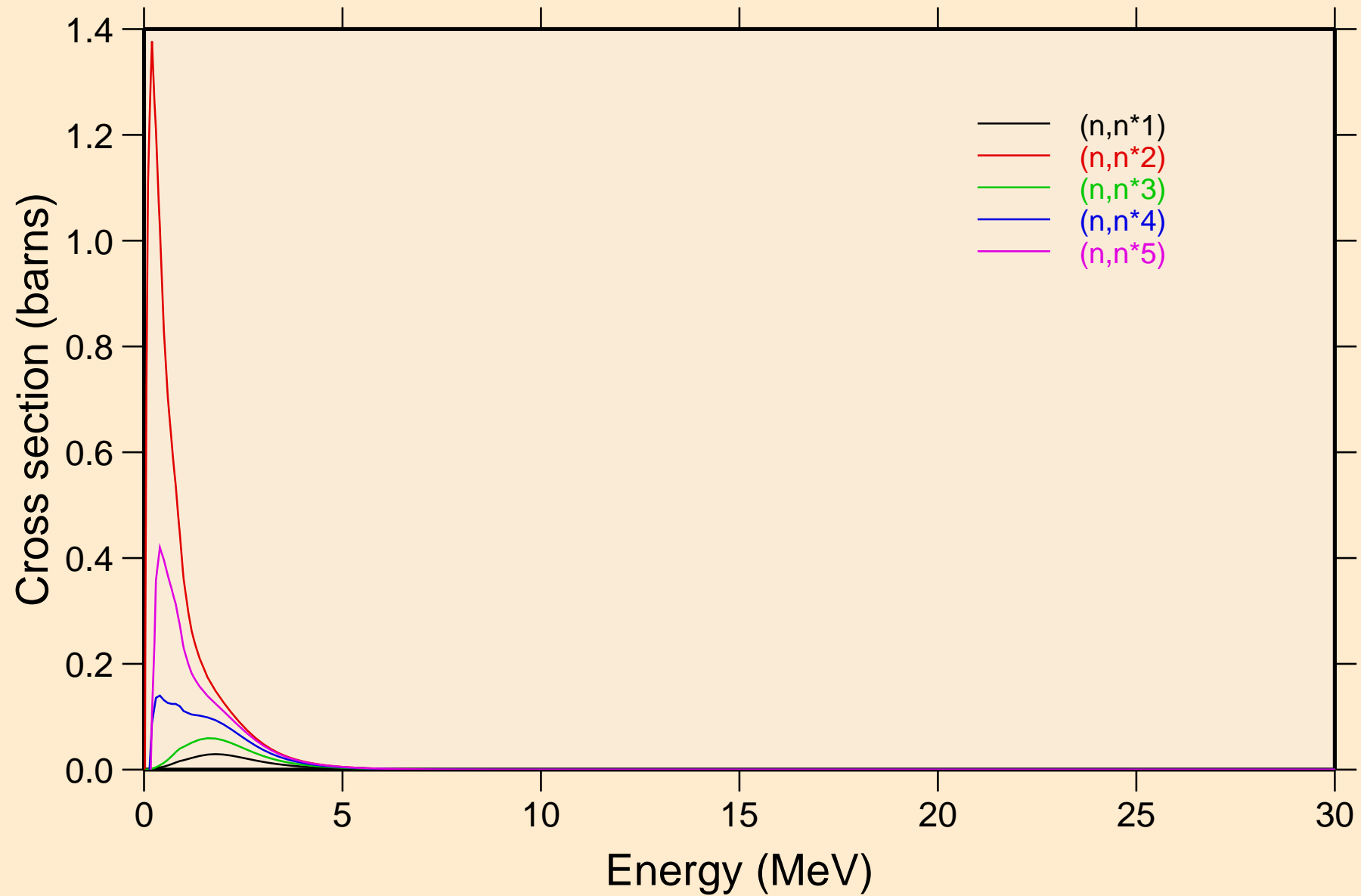

TC094M NEUTRON ACER TENDL-2023 LIBRARY; T=0.K
Inelastic levels

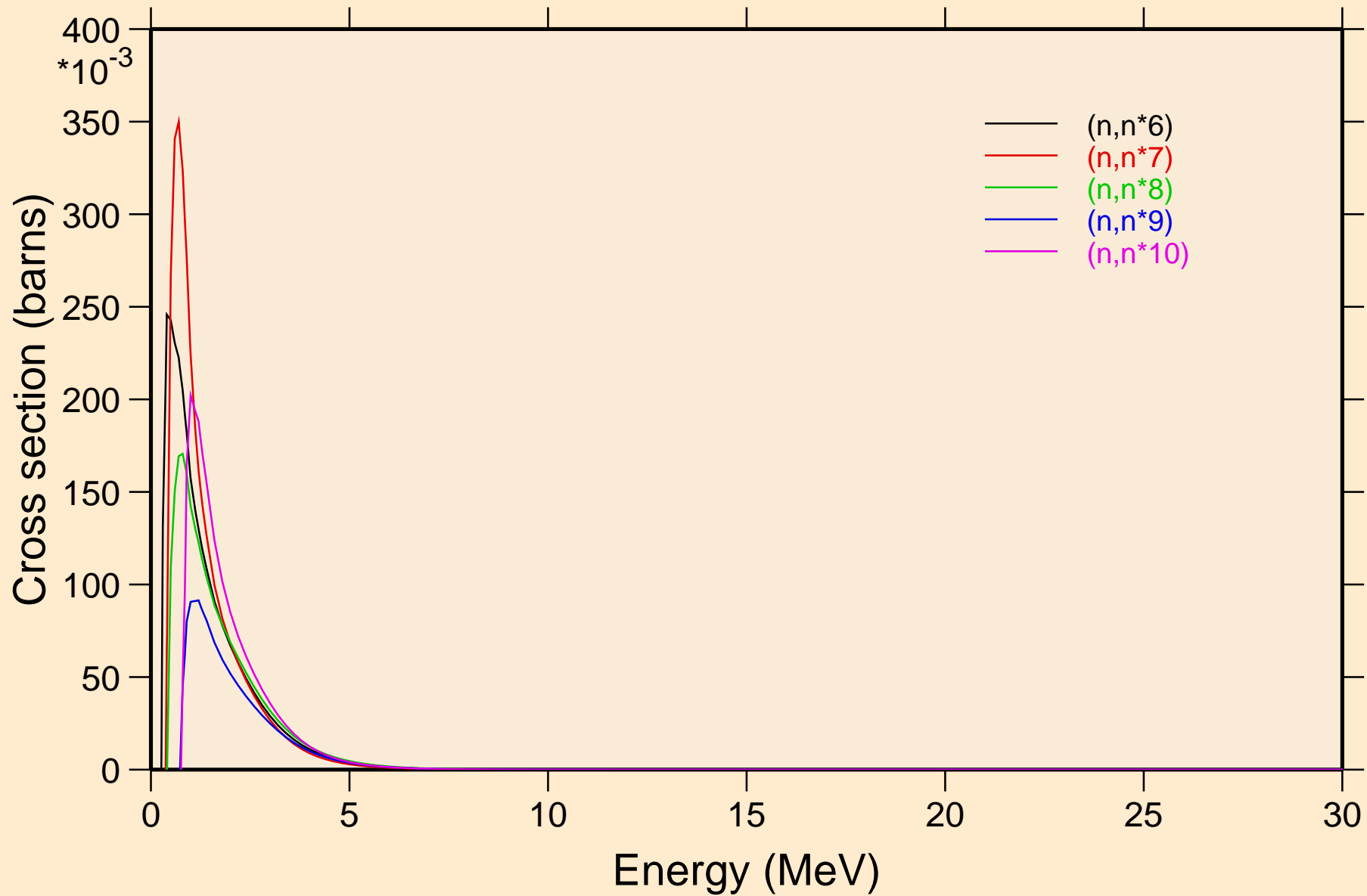

TC094M NEUTRON ACER TENDL-2023 LIBRARY; T=0.K
Inelastic levels

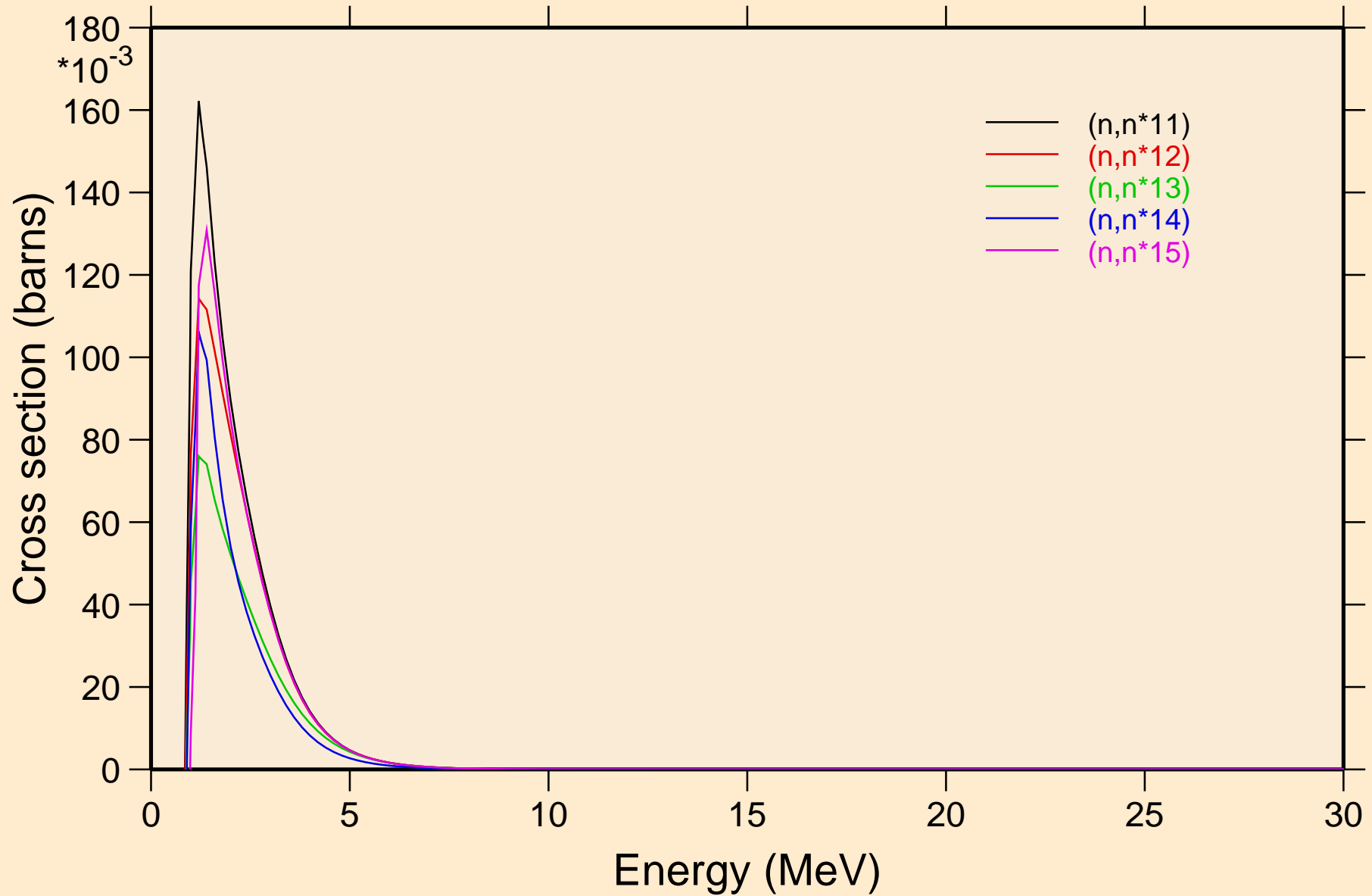

TC094M NEUTRON ACER TENDL-2023 LIBRARY; T=0.K
Inelastic levels

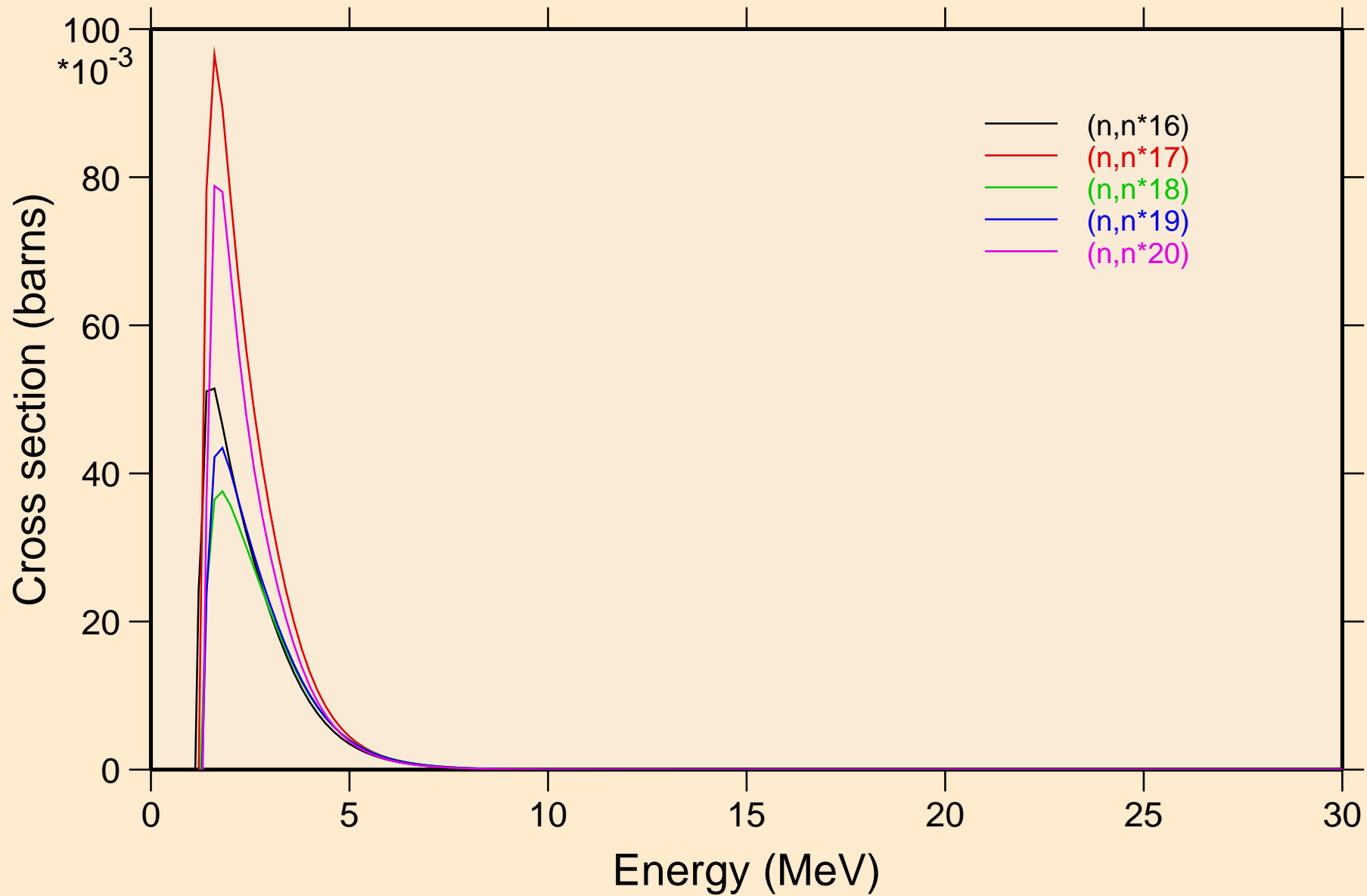

TC094M NEUTRON ACER TENDL-2023 LIBRARY; T=0.K
Threshold reactions

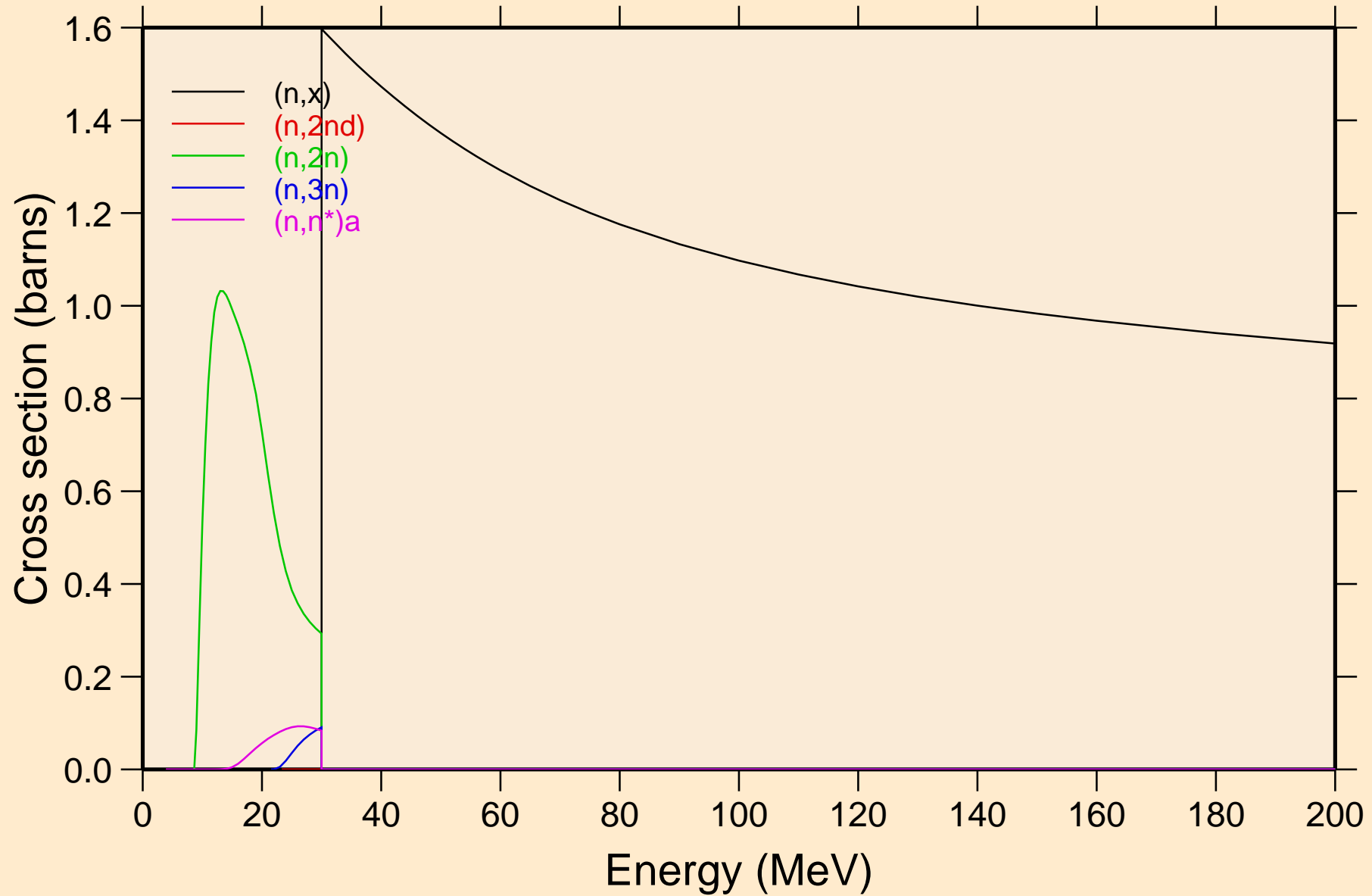

TC094M NEUTRON ACER TENDL-2023 LIBRARY; T=0.K
Threshold reactions

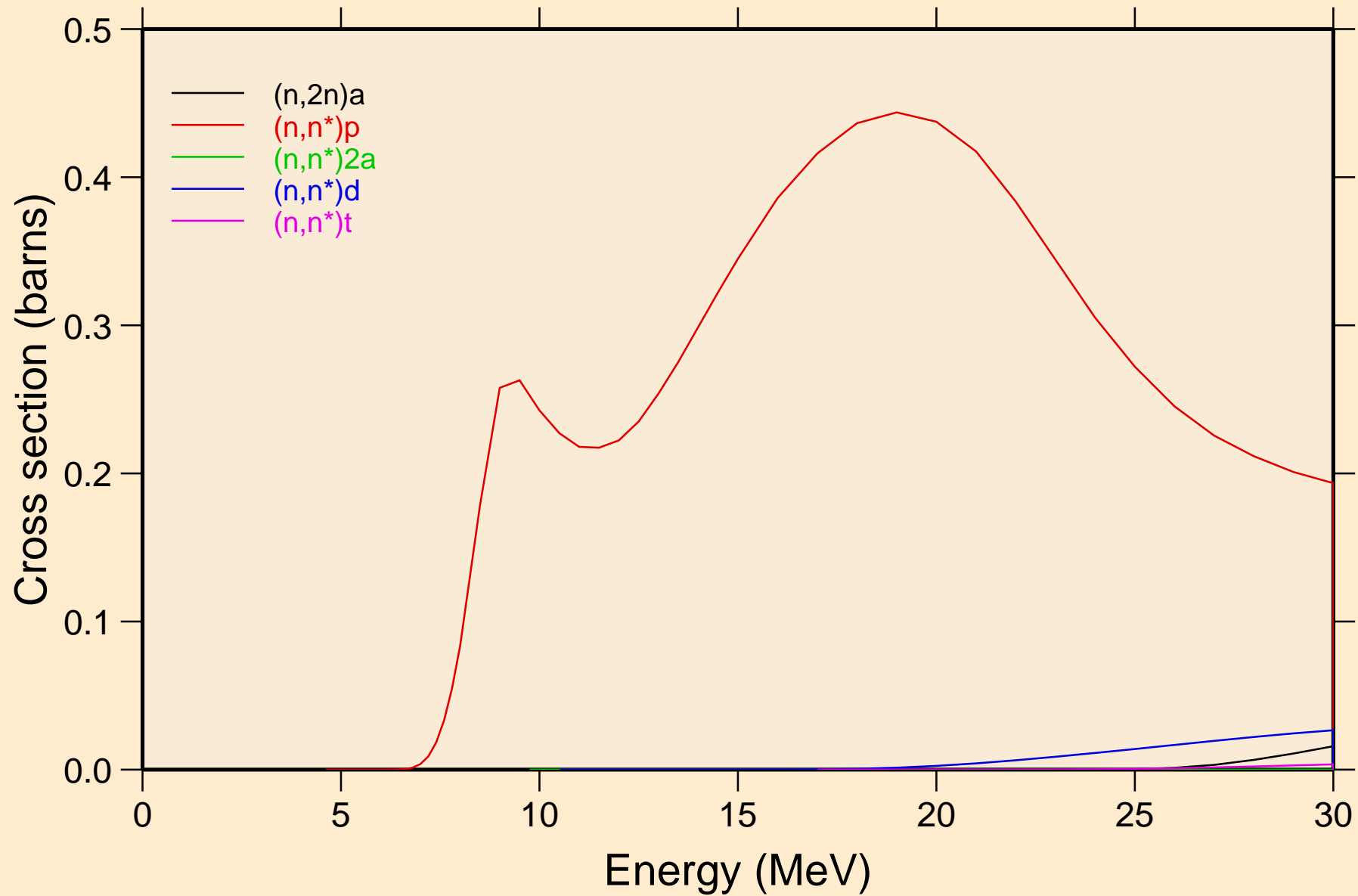

TC094M NEUTRON ACER TENDL-2023 LIBRARY; T=0.K
Threshold reactions

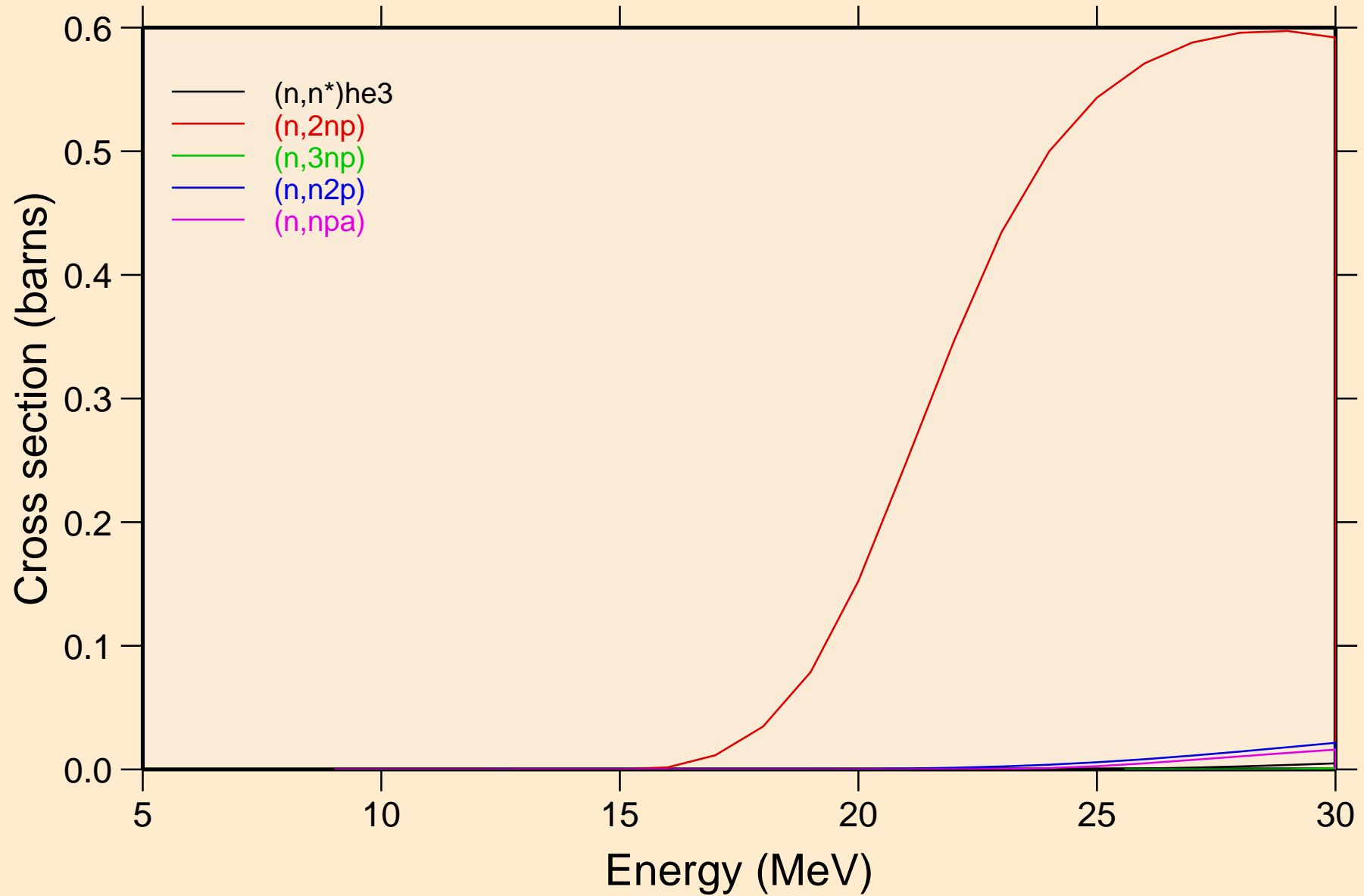

TC094M NEUTRON ACER TENDL-2023 LIBRARY; T=0.K
Threshold reactions

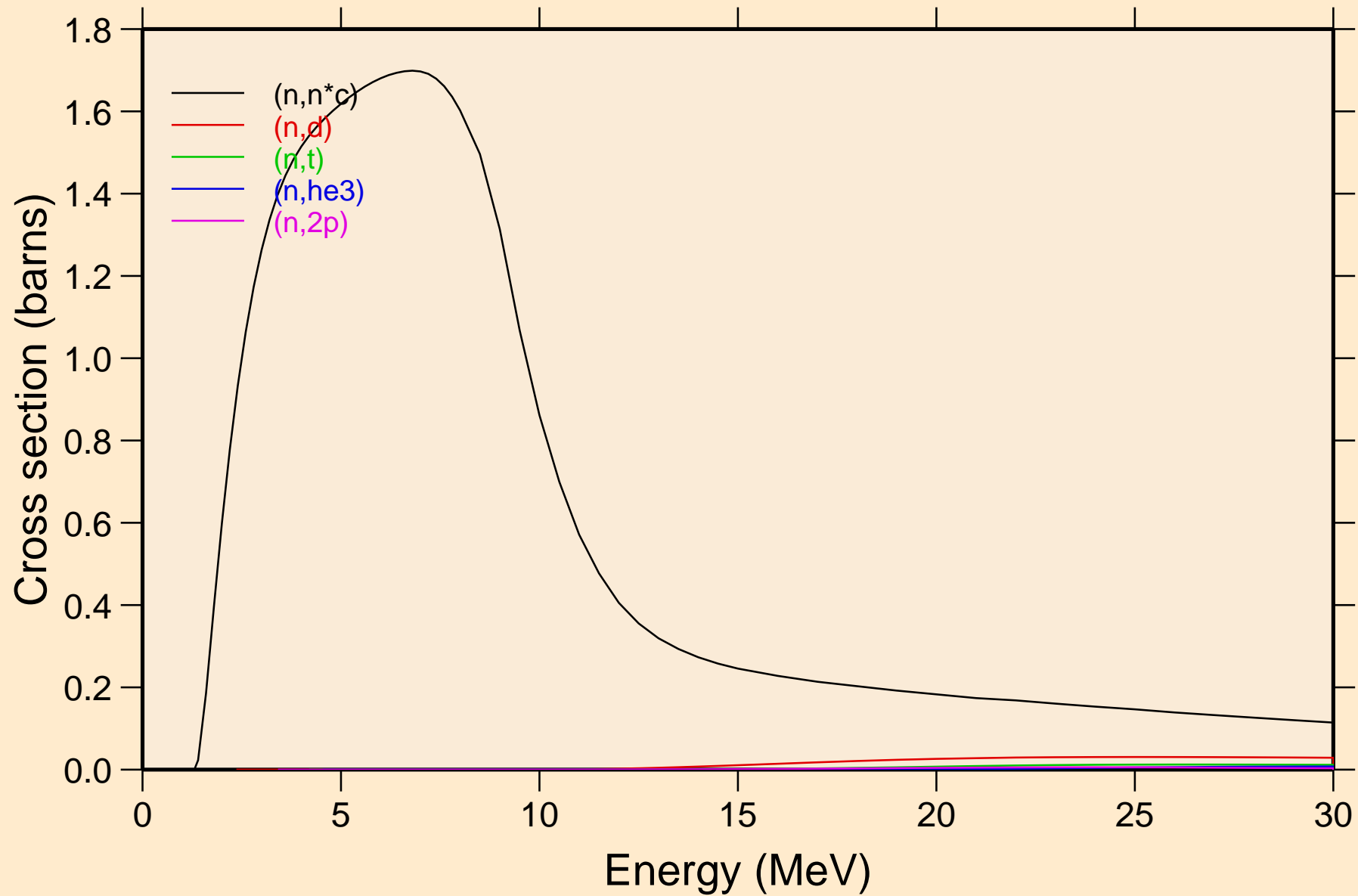

TC094M NEUTRON ACER TENDL-2023 LIBRARY; T=0.K
Threshold reactions

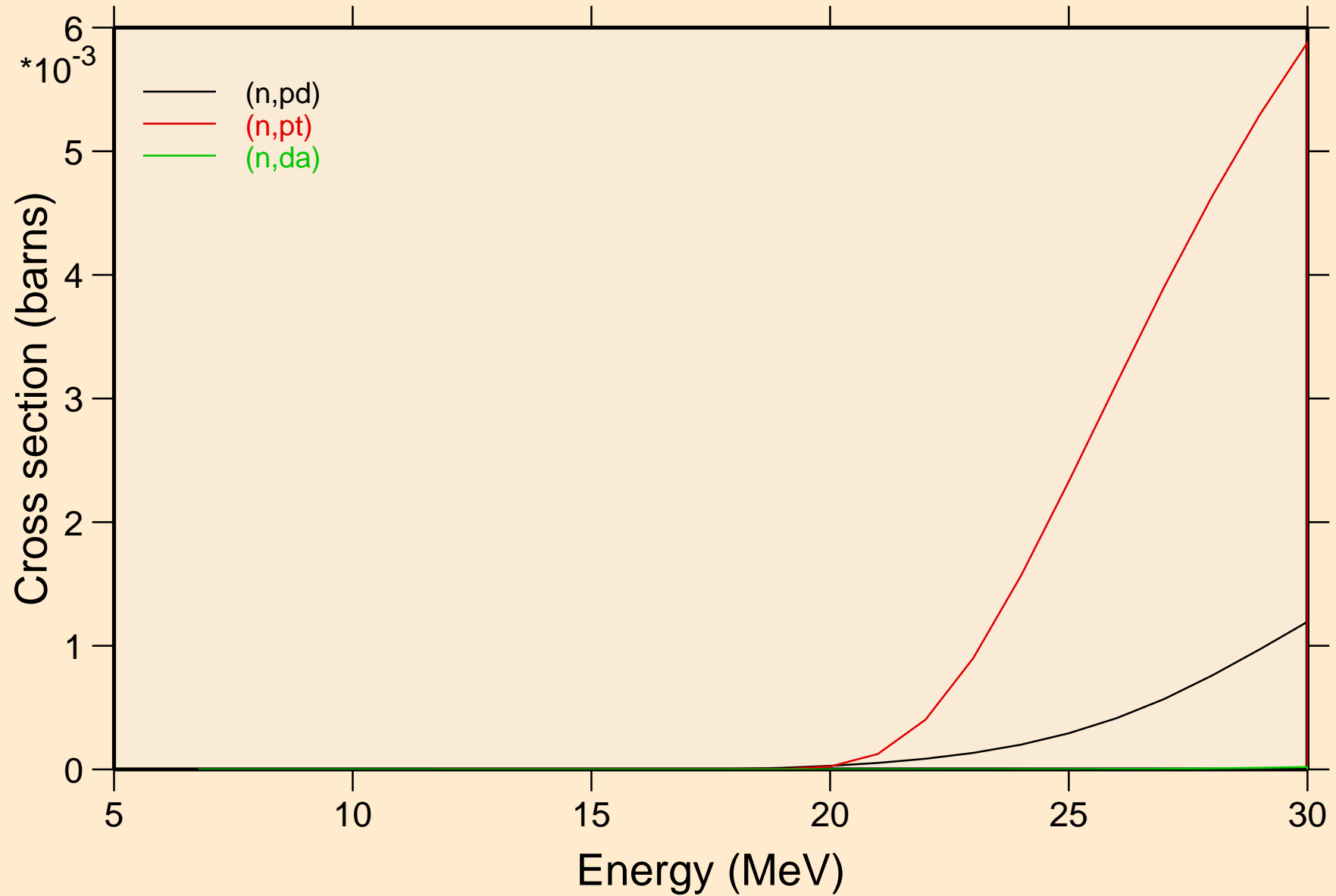

TC094M NEUTRON ACER TENDL-2023 LIBRARY; T=0.K
Threshold reactions

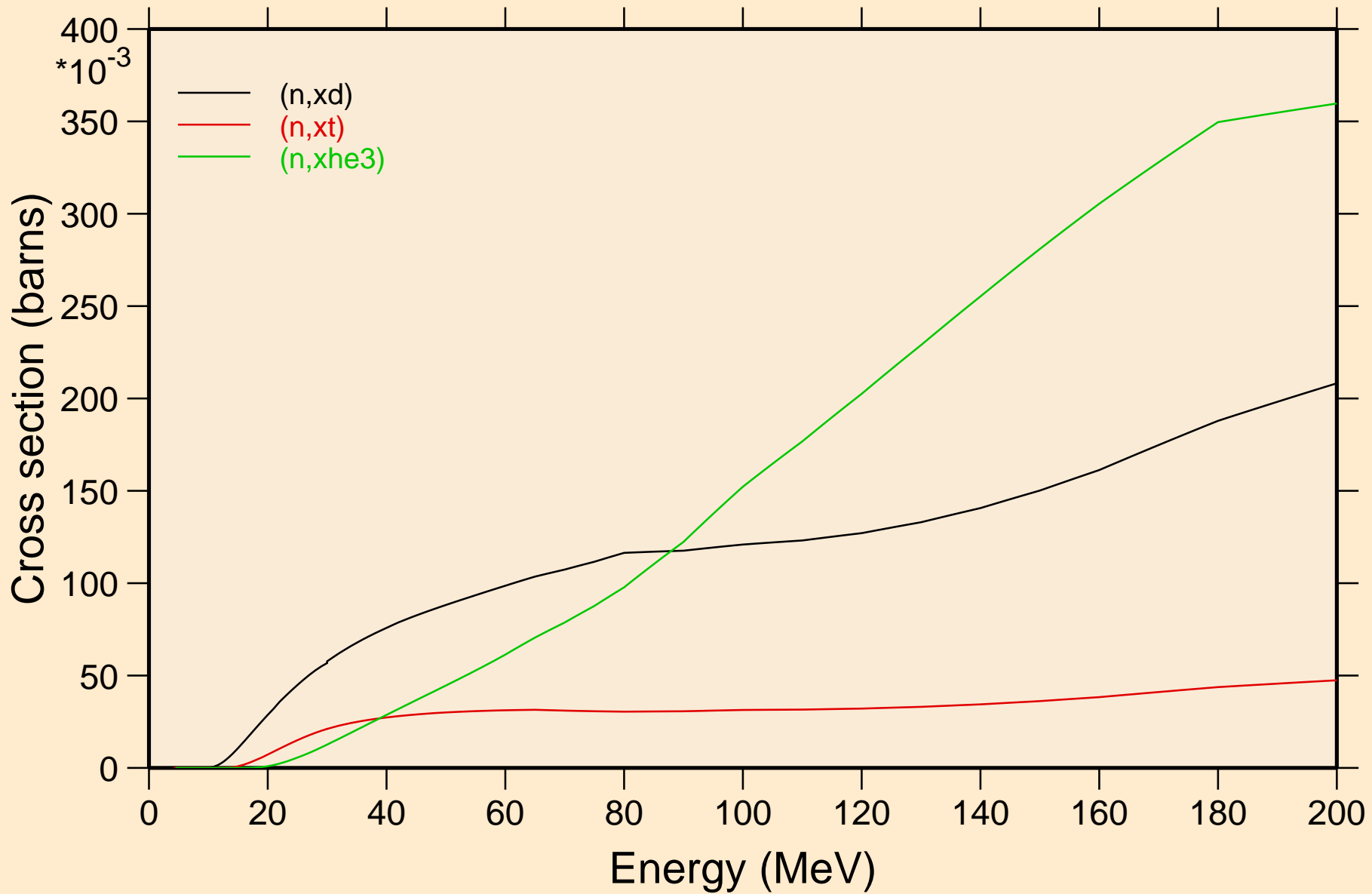

TC094M NEUTRON ACER TENDL-2023 LIBRARY; T=0.K
angular distribution for elastic

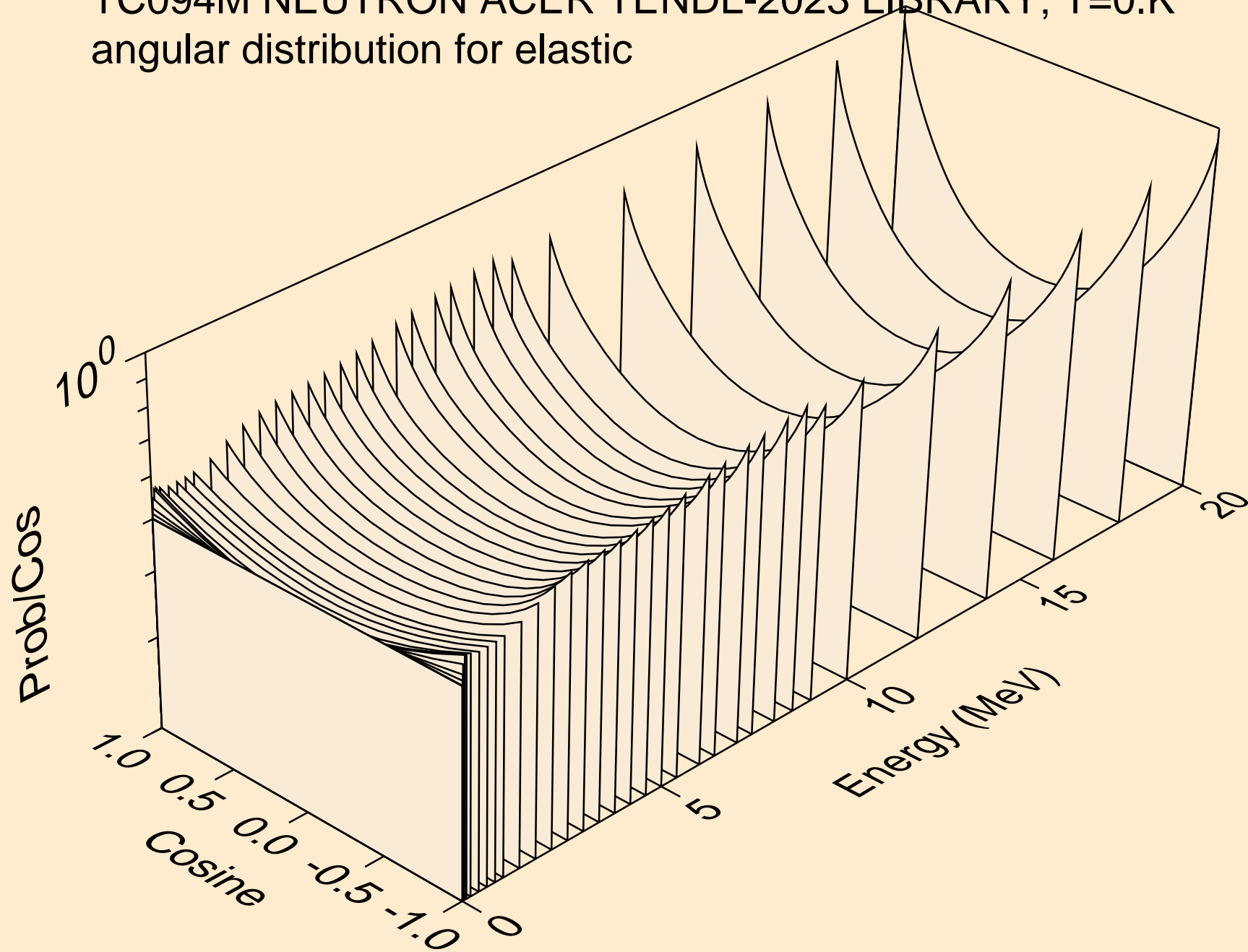

TC094M NEUTRON ACER TENDL-2023 LIBRARY; T=0.K
angular distribution for elastic

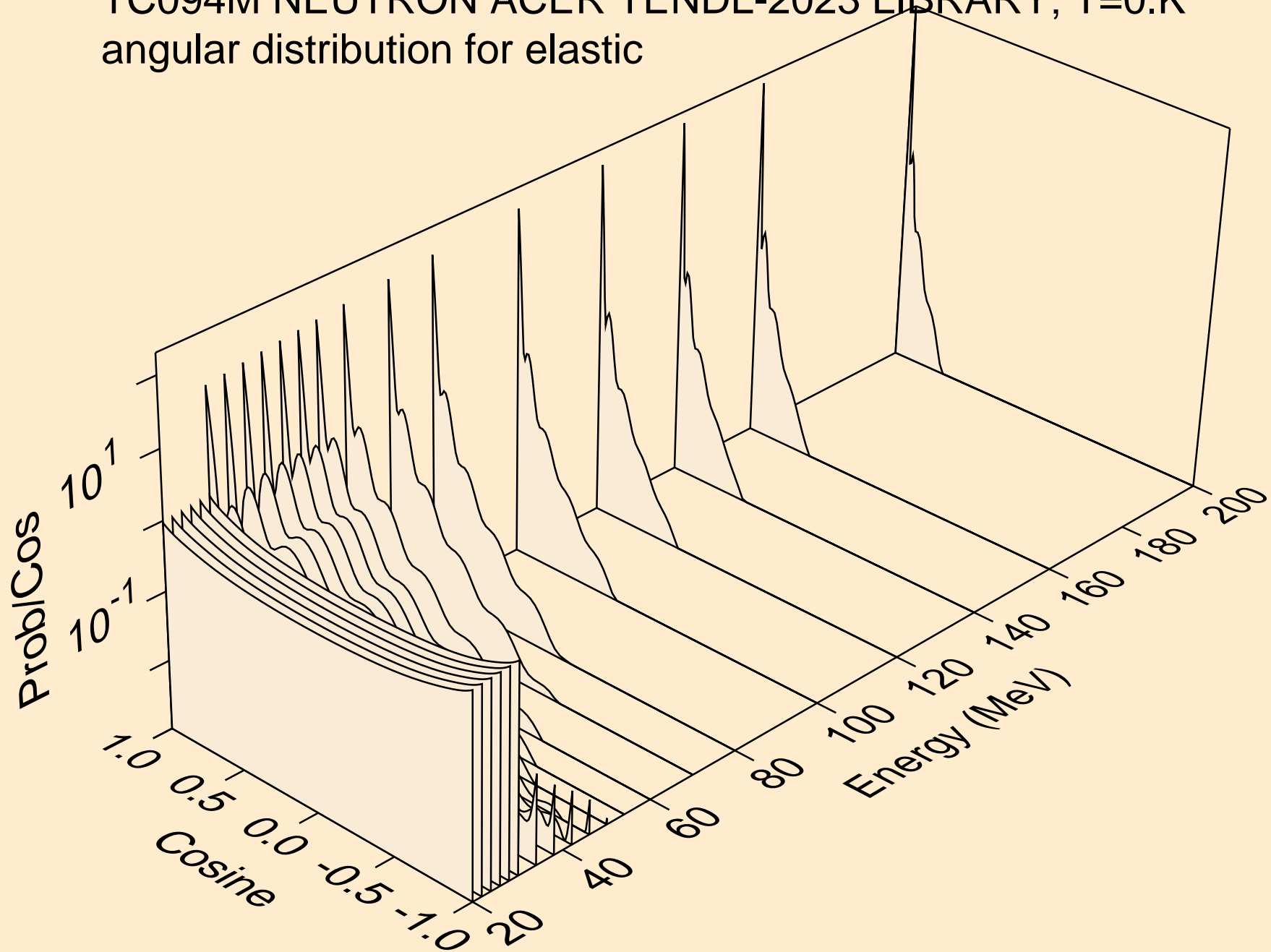

TC094M NEUTRON ACER TENDL-2023 LIBRARY; T=0.K
angular distribution for (n,n*1)

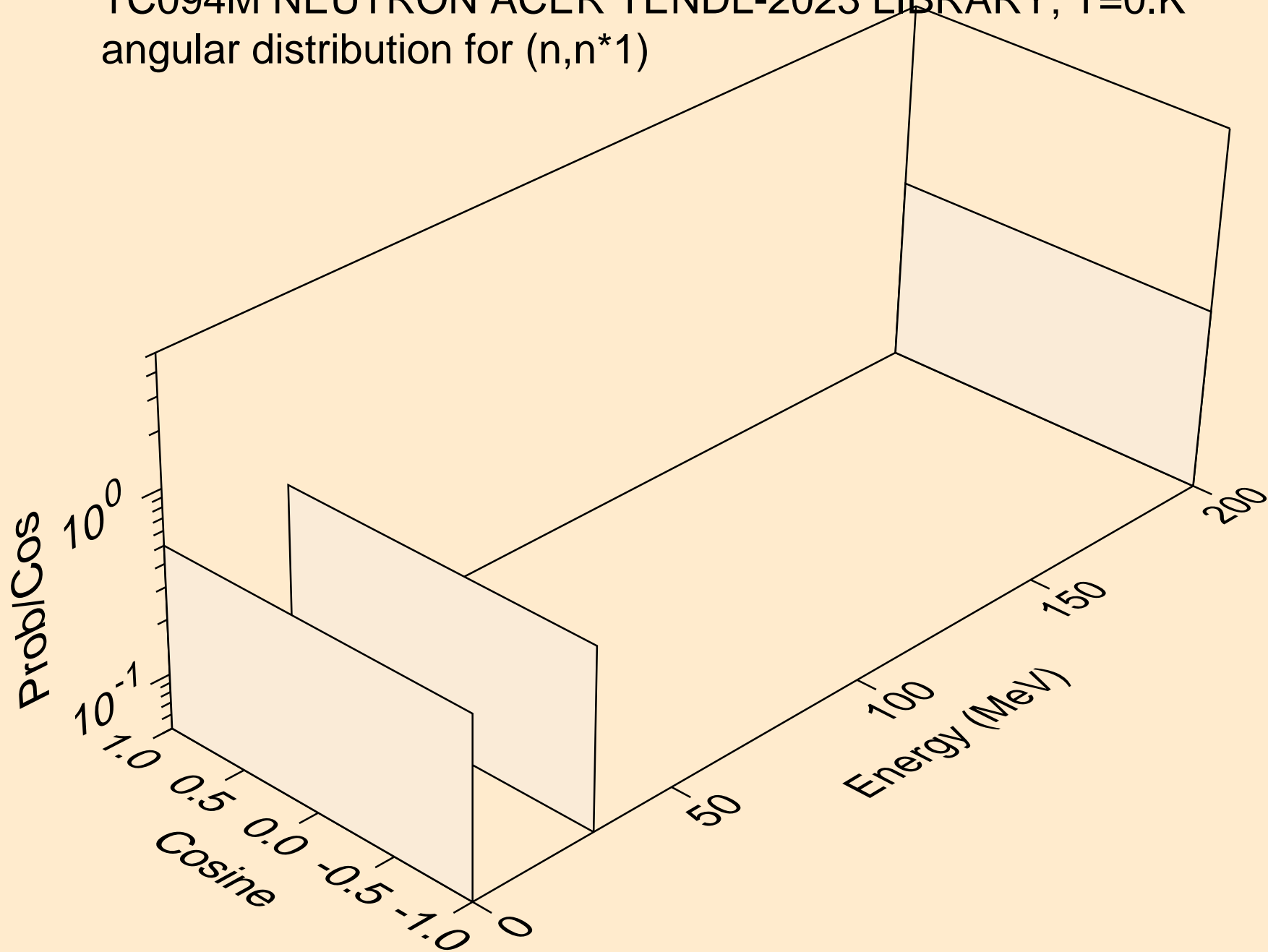

TC094M NEUTRON ACER TENDL-2023 LIBRARY; T=0.K
angular distribution for (n,n*2)

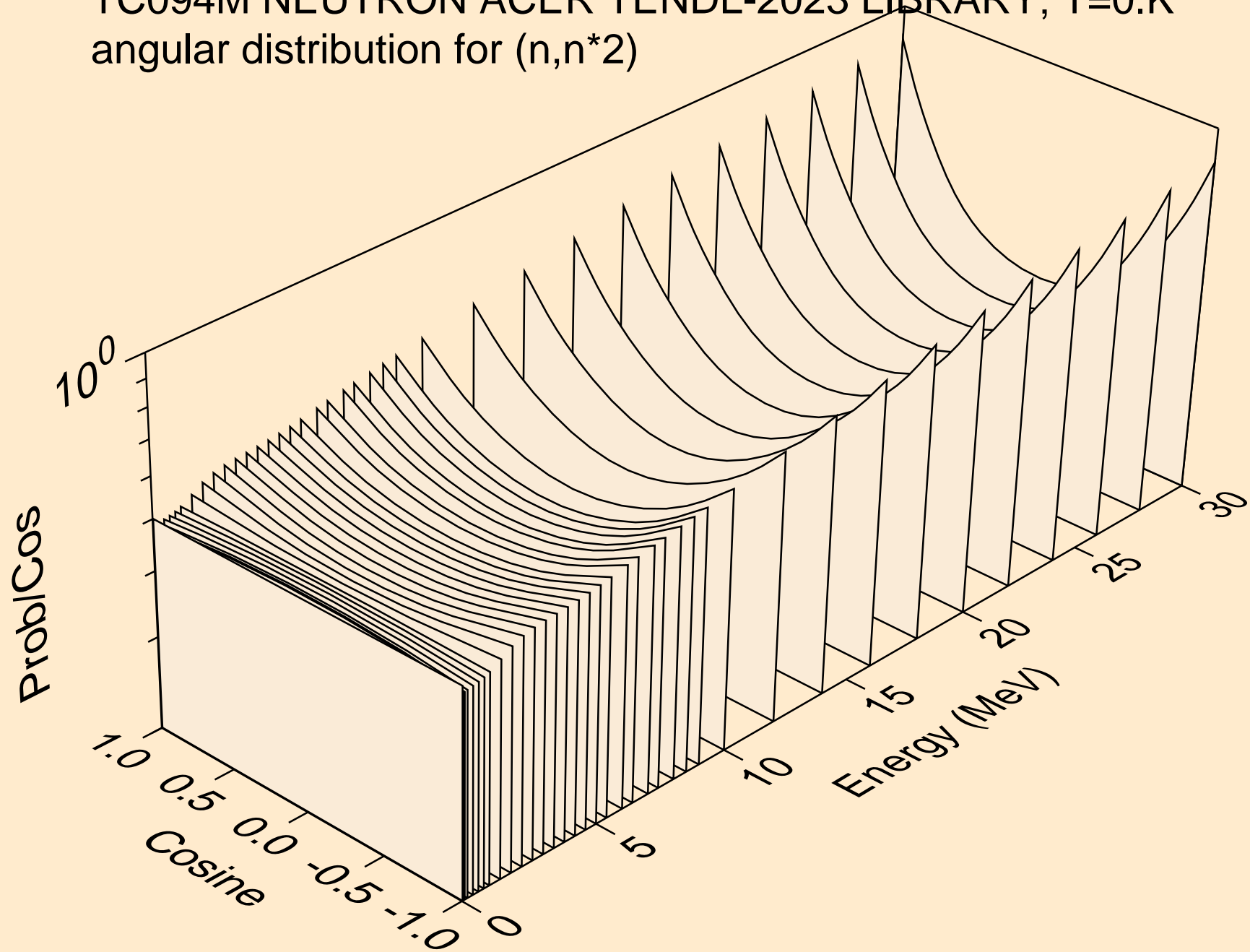

TC094M NEUTRON ACER TENDL-2023 LIBRARY; T=0.K
angular distribution for (n,n*3)

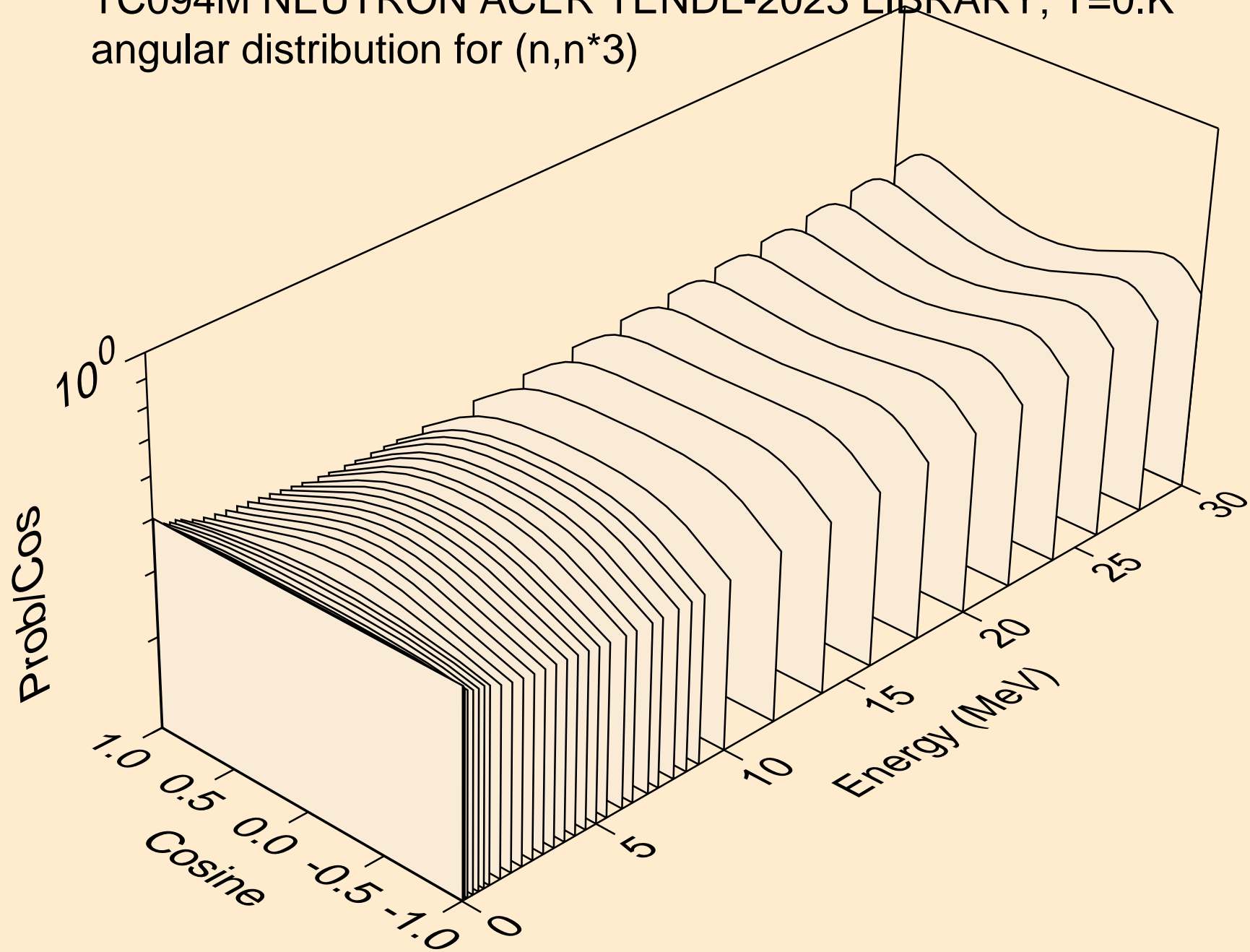

TC094M NEUTRON ACER TENDL-2023 LIBRARY; T=0.K
angular distribution for (n,n*4)

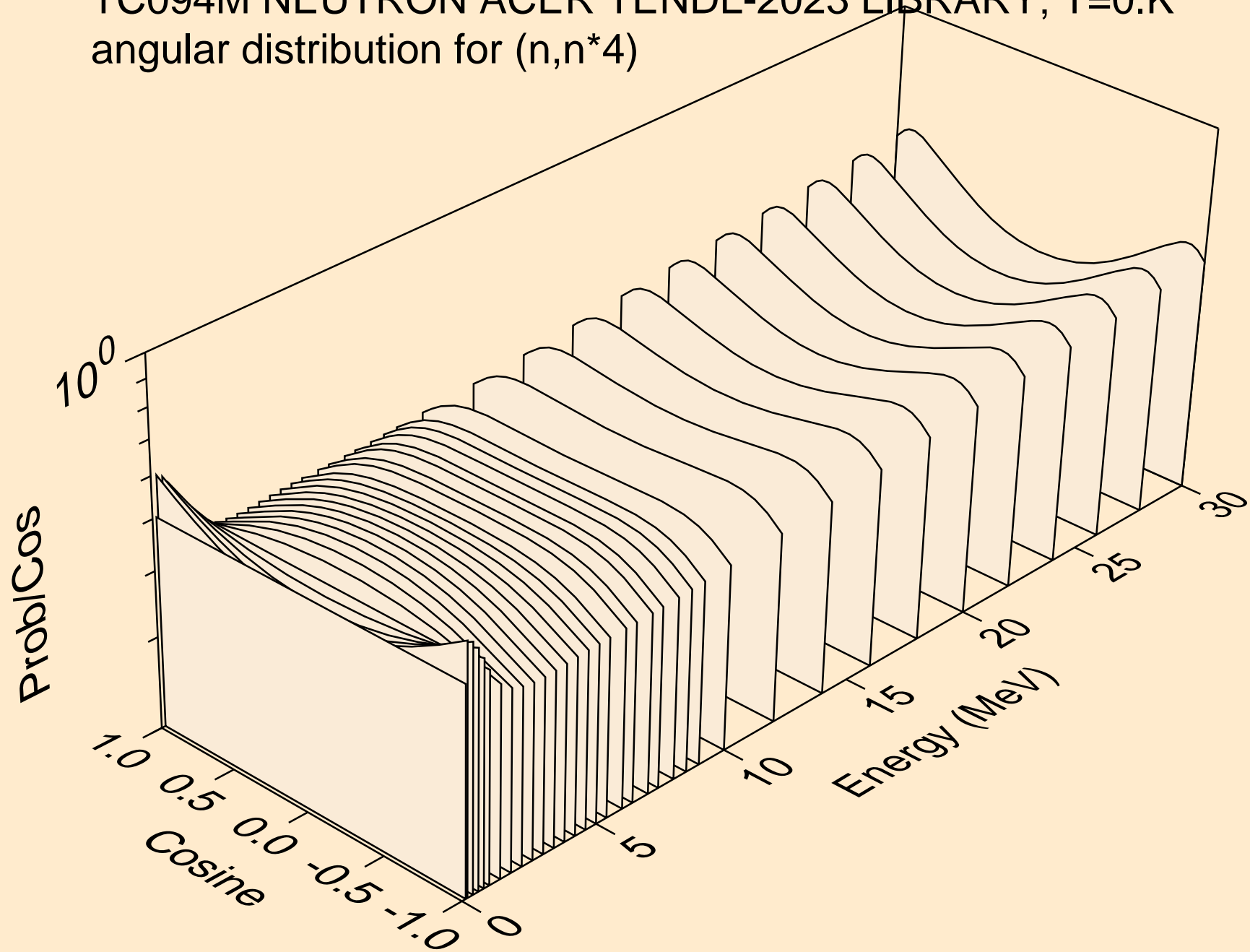

TC094M NEUTRON ACER TENDL-2023 LIBRARY; T=0.K
angular distribution for (n,n*5)

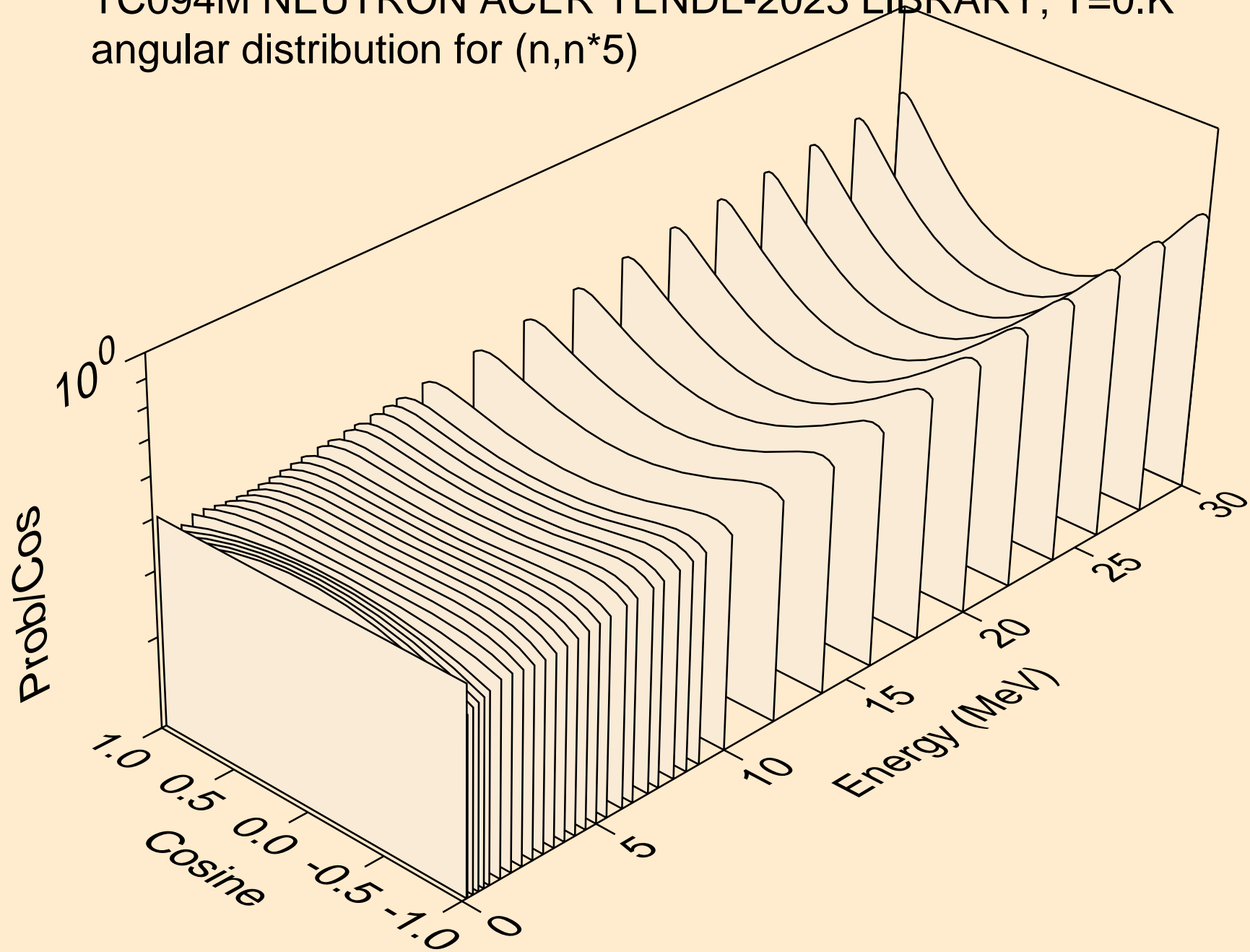

TC094M NEUTRON ACER TENDL-2023 LIBRARY; T=0.K
angular distribution for (n,n*6)

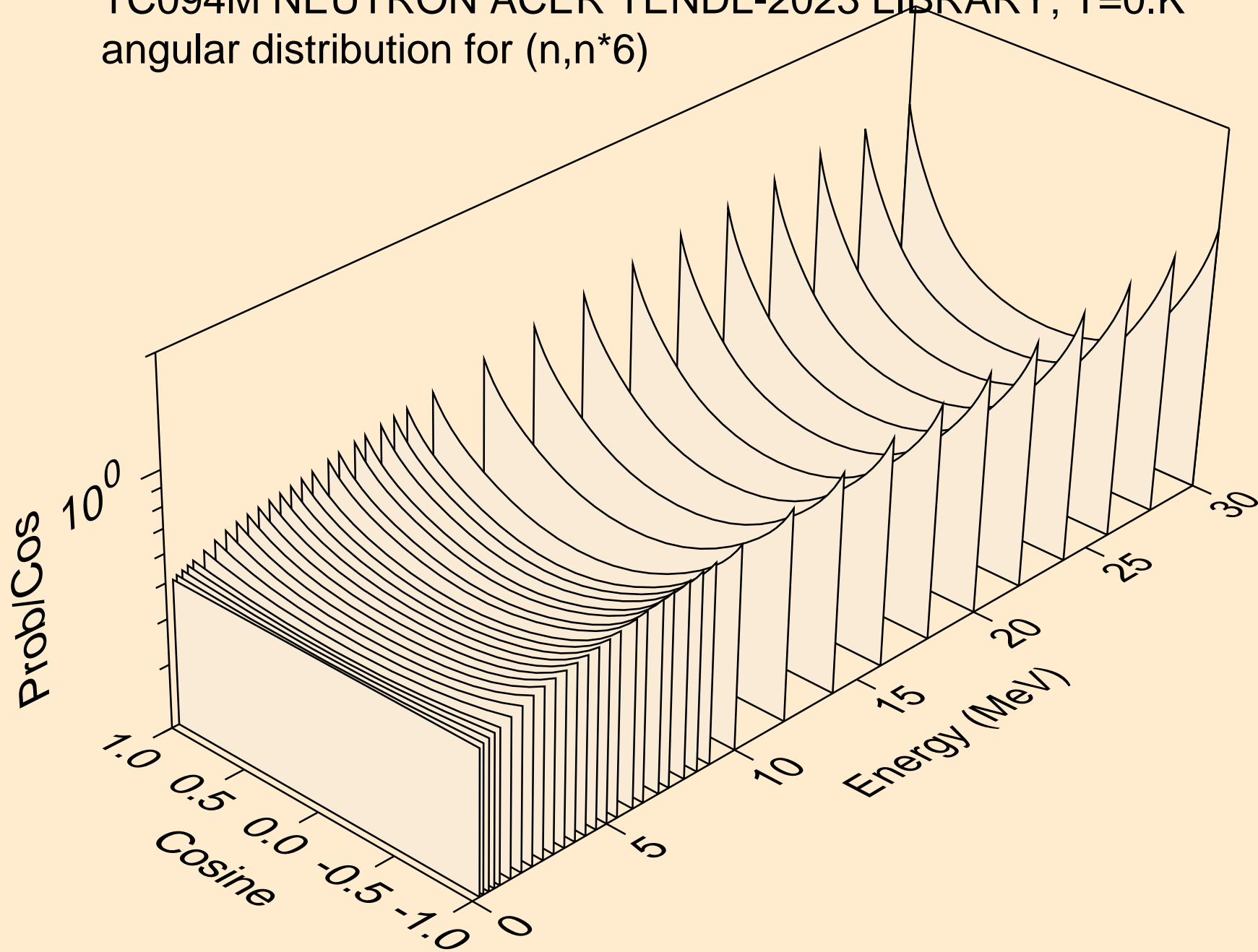

TC094M NEUTRON ACER TENDL-2023 LIBRARY; T=0.K
angular distribution for (n,n*7)

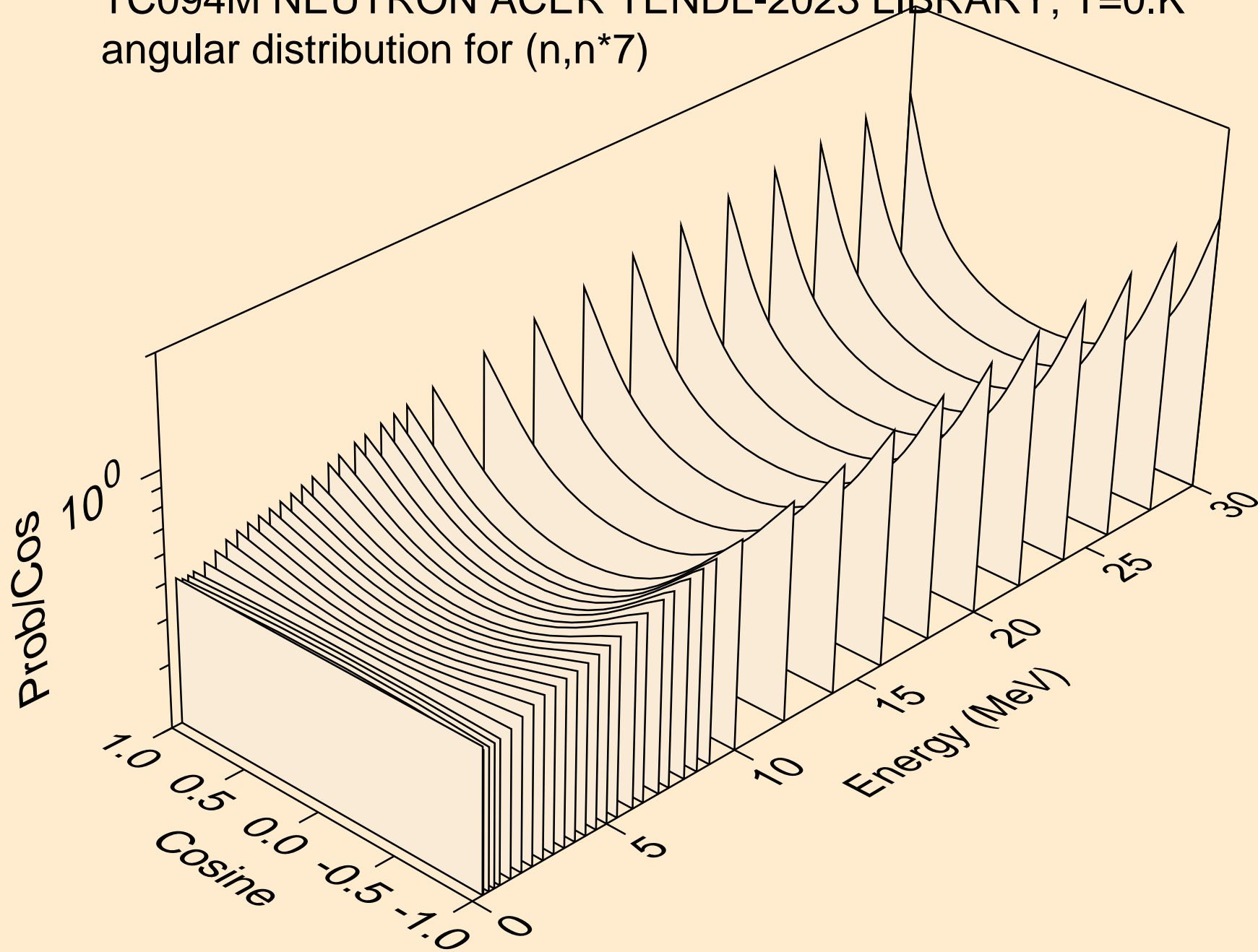

TC094M NEUTRON ACER TENDL-2023 LIBRARY; T=0.K
angular distribution for (n,n*8)

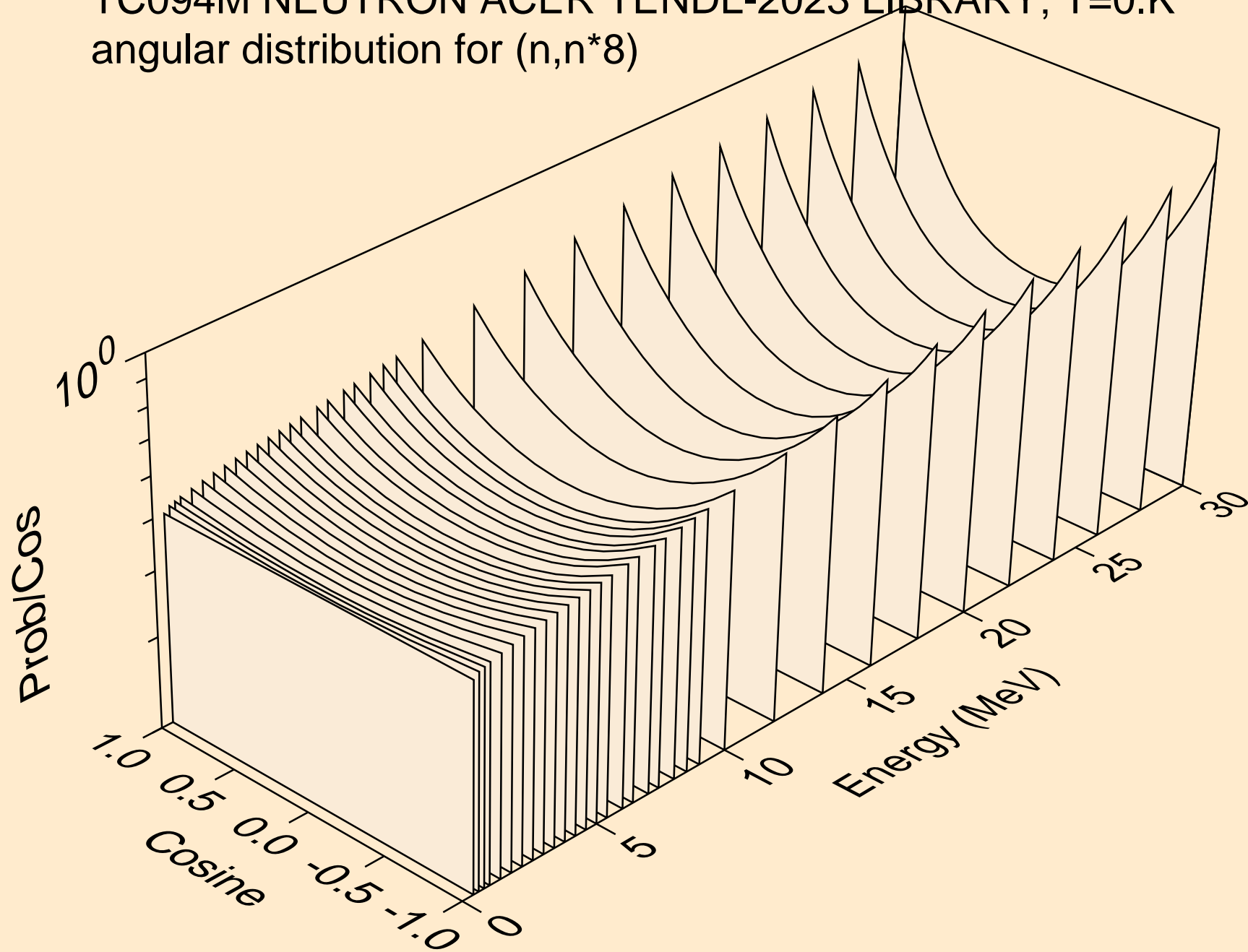

TC094M NEUTRON ACER TENDL-2023 LIBRARY; T=0.K
angular distribution for (n,n*9)

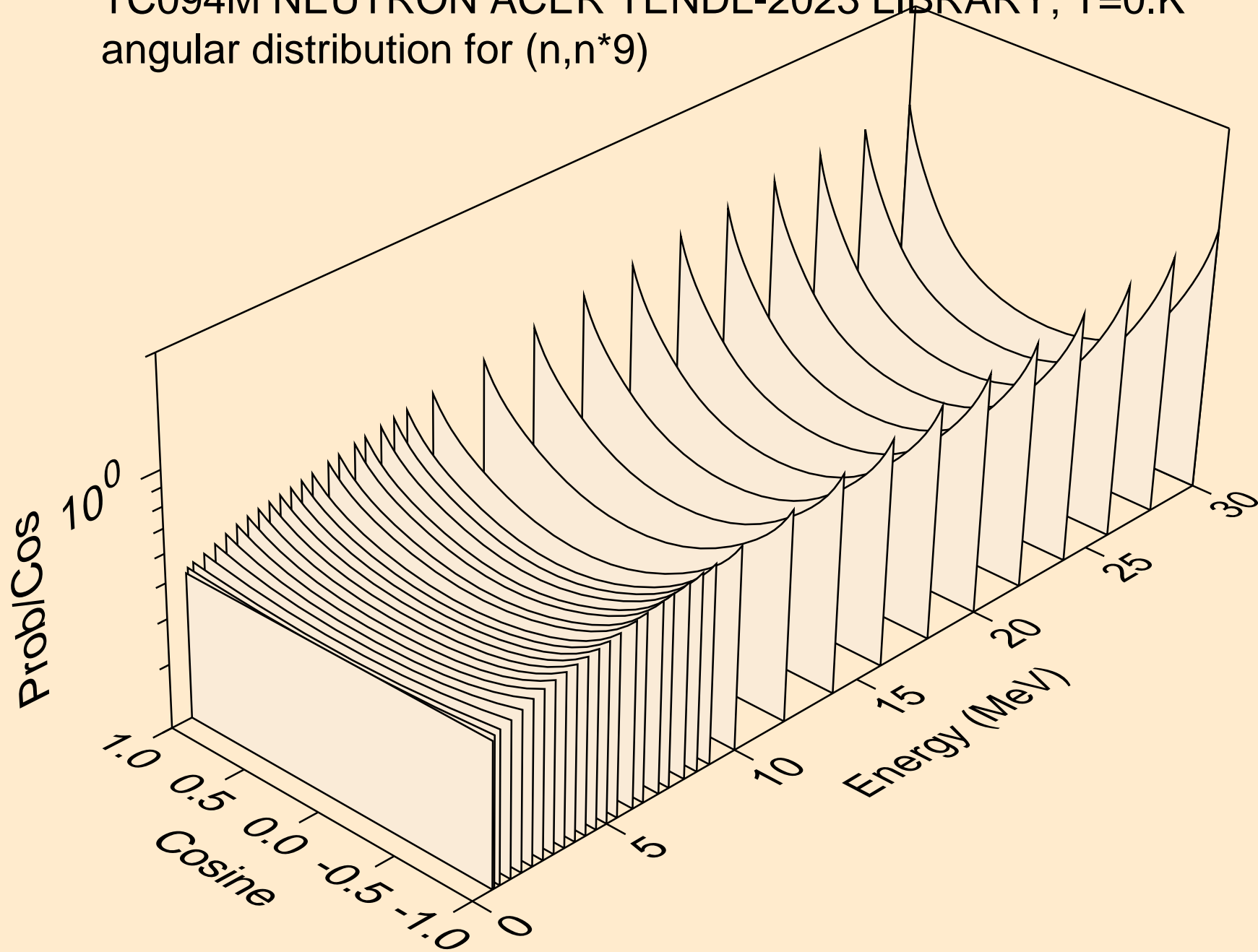

TC094M NEUTRON ACER TENDL-2023 LIBRARY; T=0.K
angular distribution for (n,n*10)

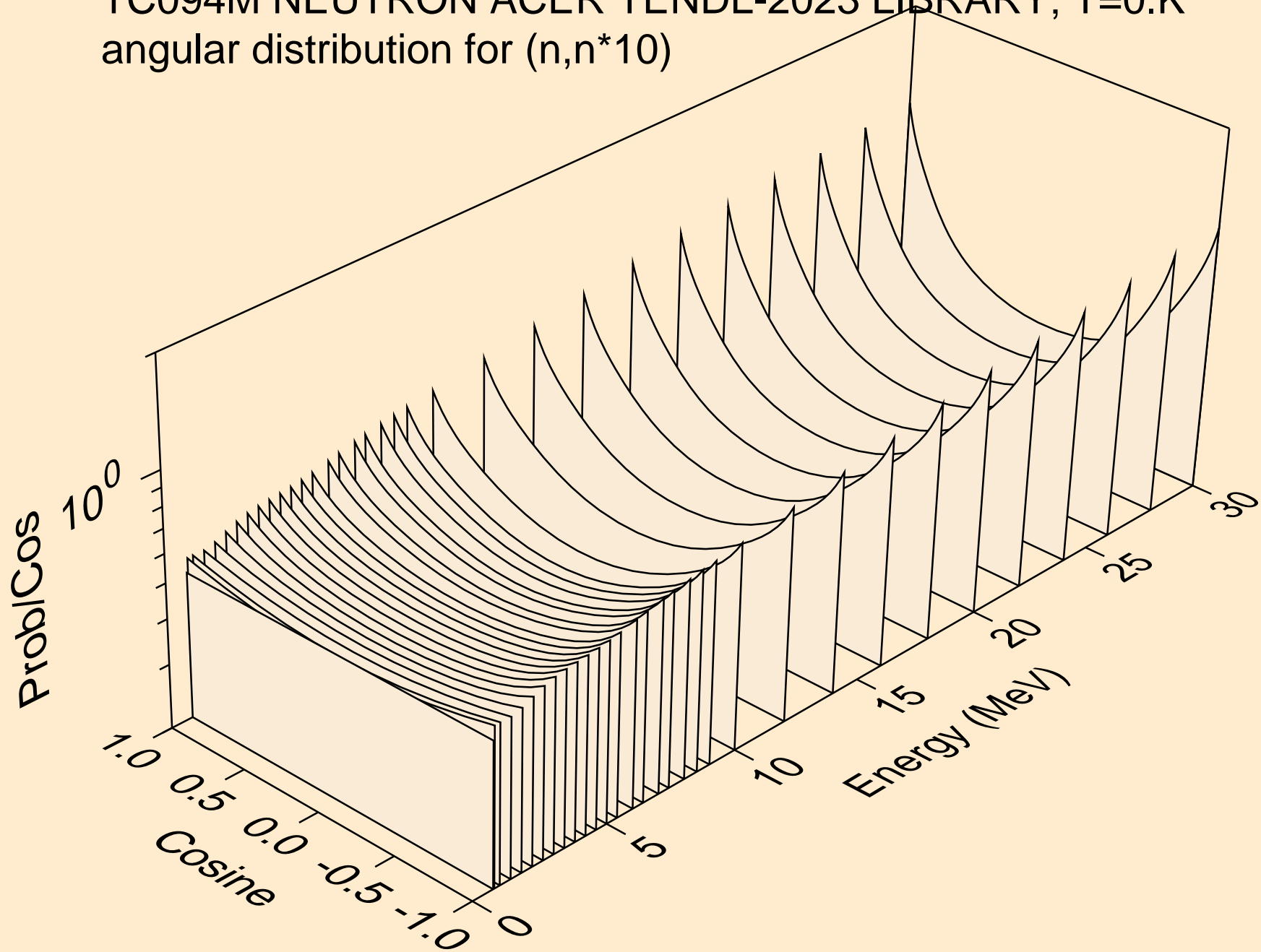

TC094M NEUTRON ACER TENDL-2023 LIBRARY; T=0.K
angular distribution for (n,n*11)

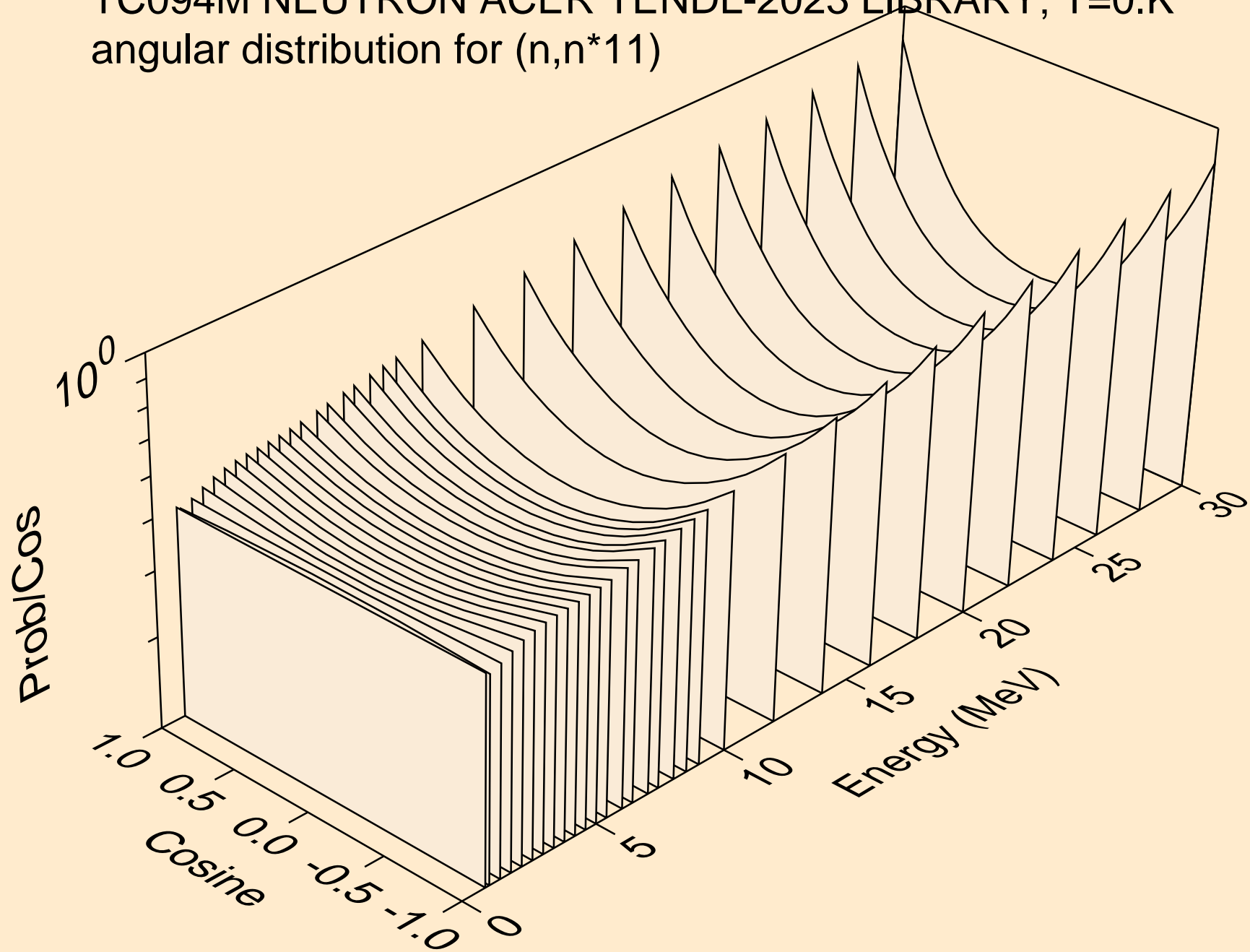

TC094M NEUTRON ACER TENDL-2023 LIBRARY; T=0.K
angular distribution for (n,n*12)

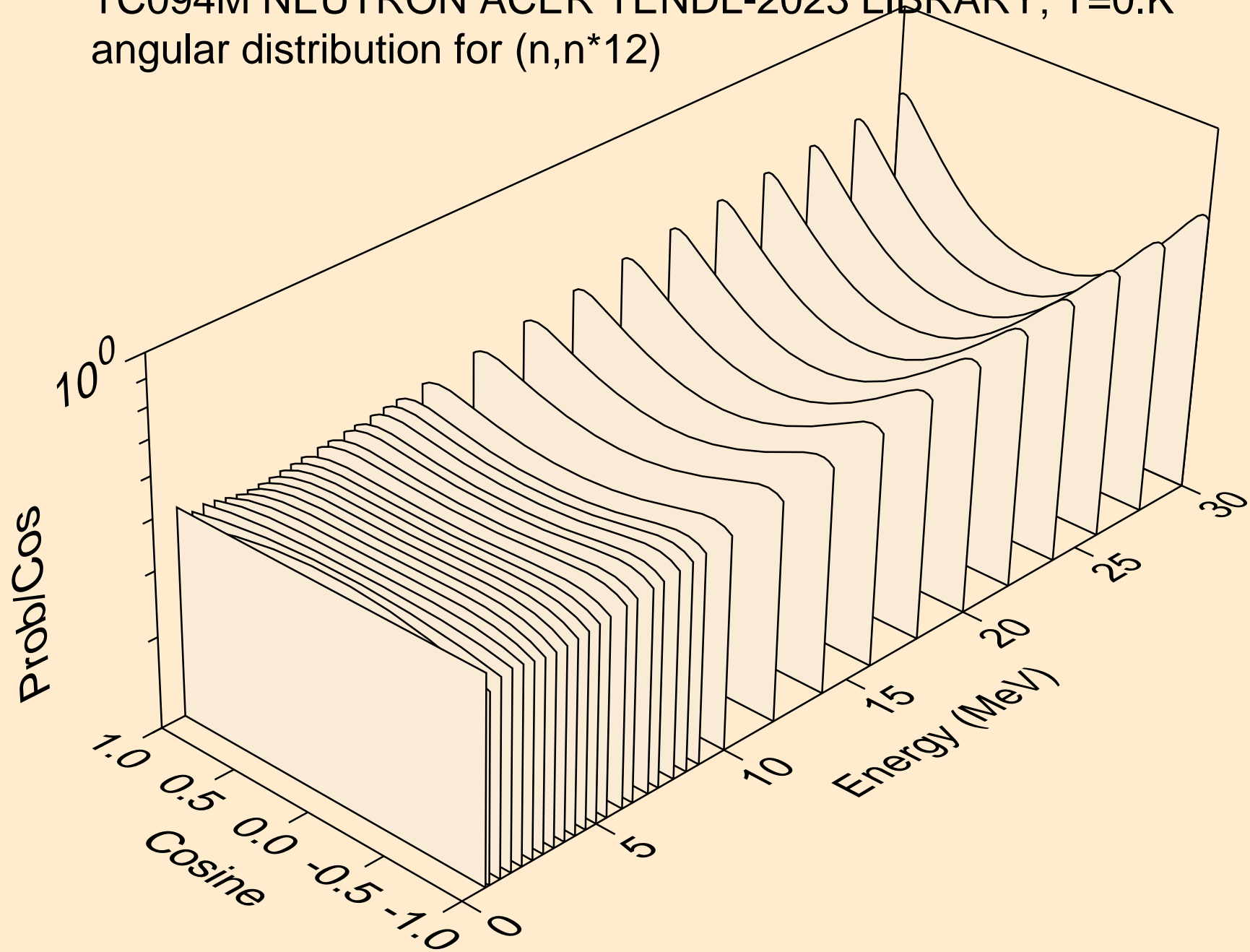

TC094M NEUTRON ACER TENDL-2023 LIBRARY; T=0.K
angular distribution for (n,n*13)

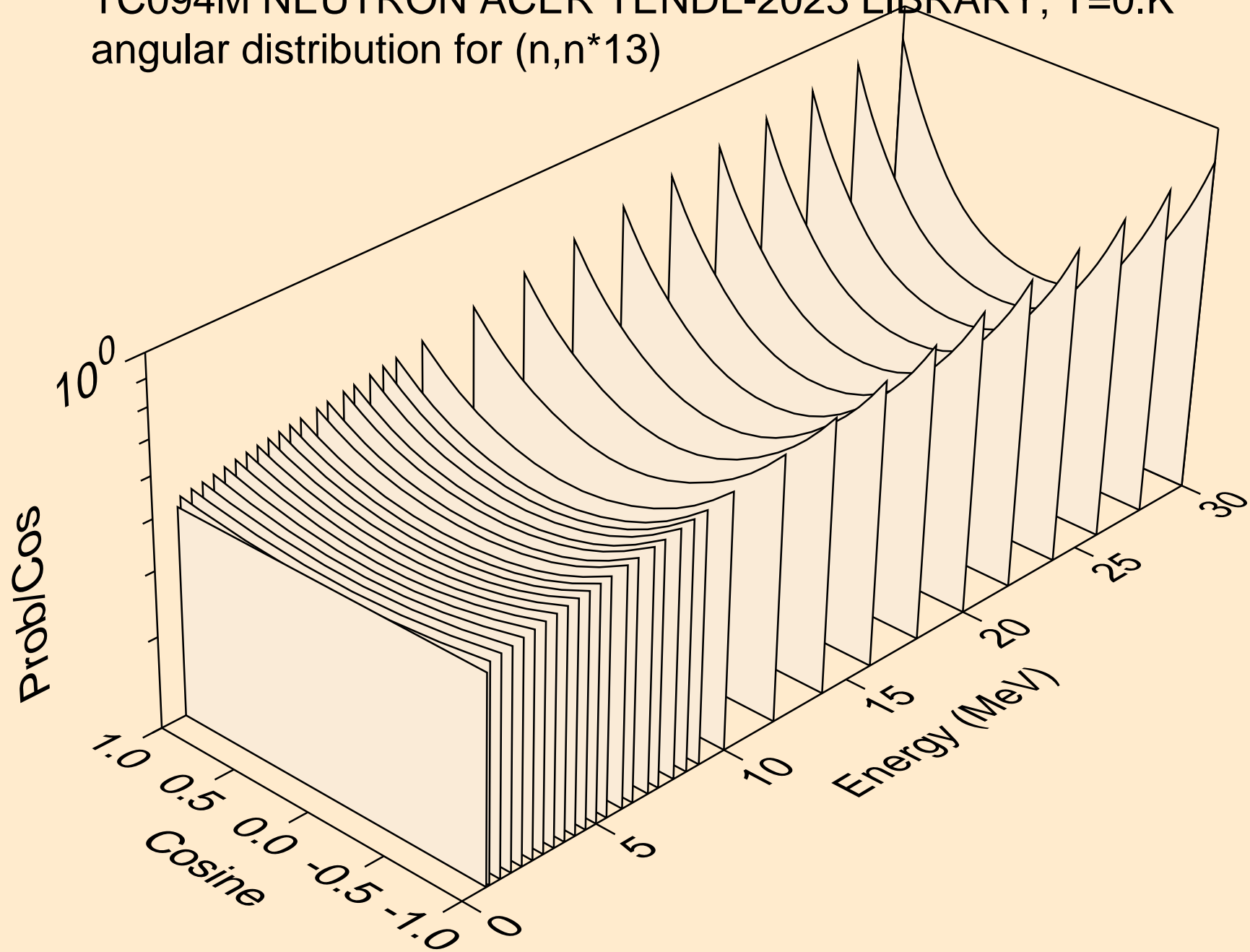

TC094M NEUTRON ACER TENDL-2023 LIBRARY; T=0.K
angular distribution for (n,n*14)

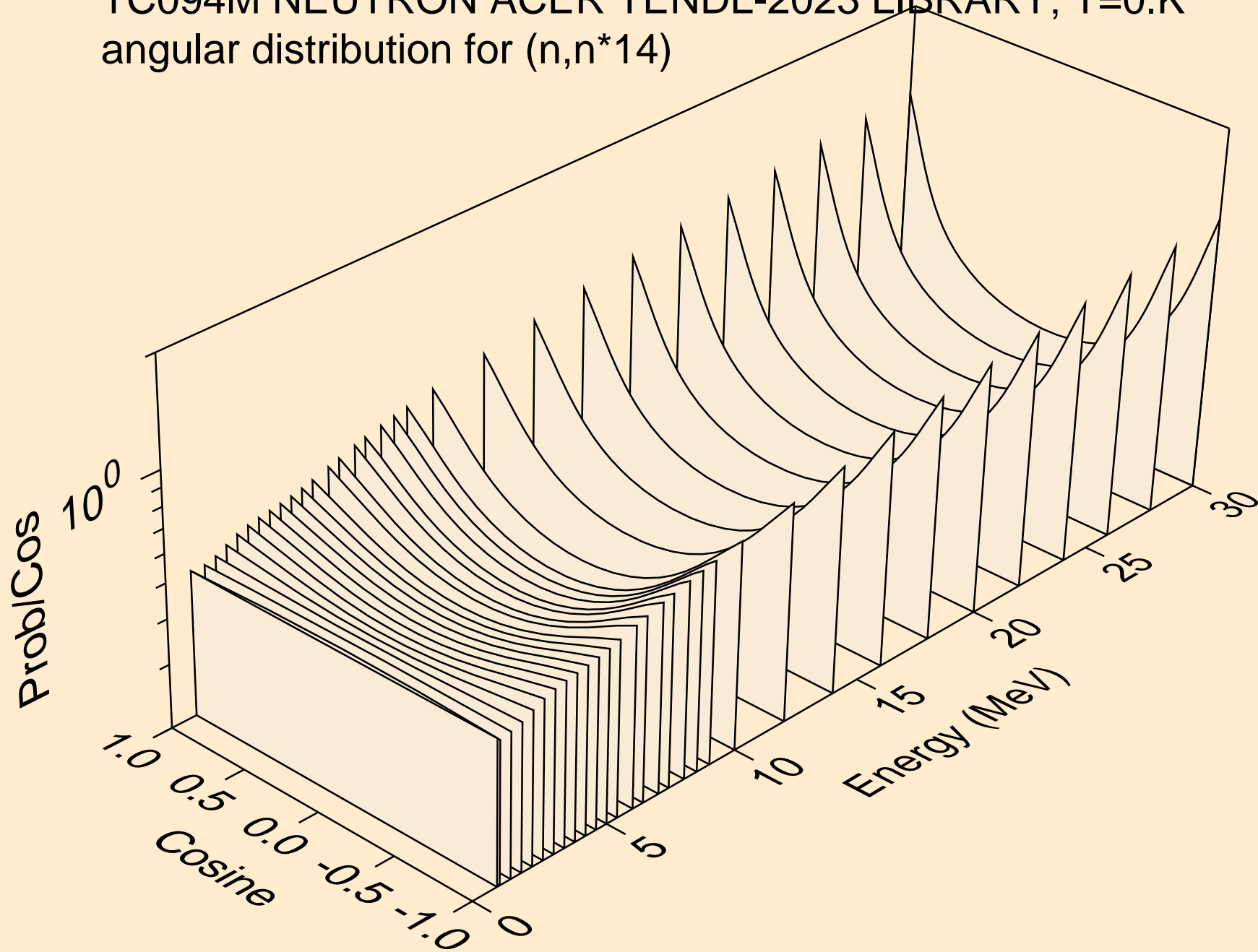

TC094M NEUTRON ACER TENDL-2023 LIBRARY; T=0.K
angular distribution for (n,n*15)

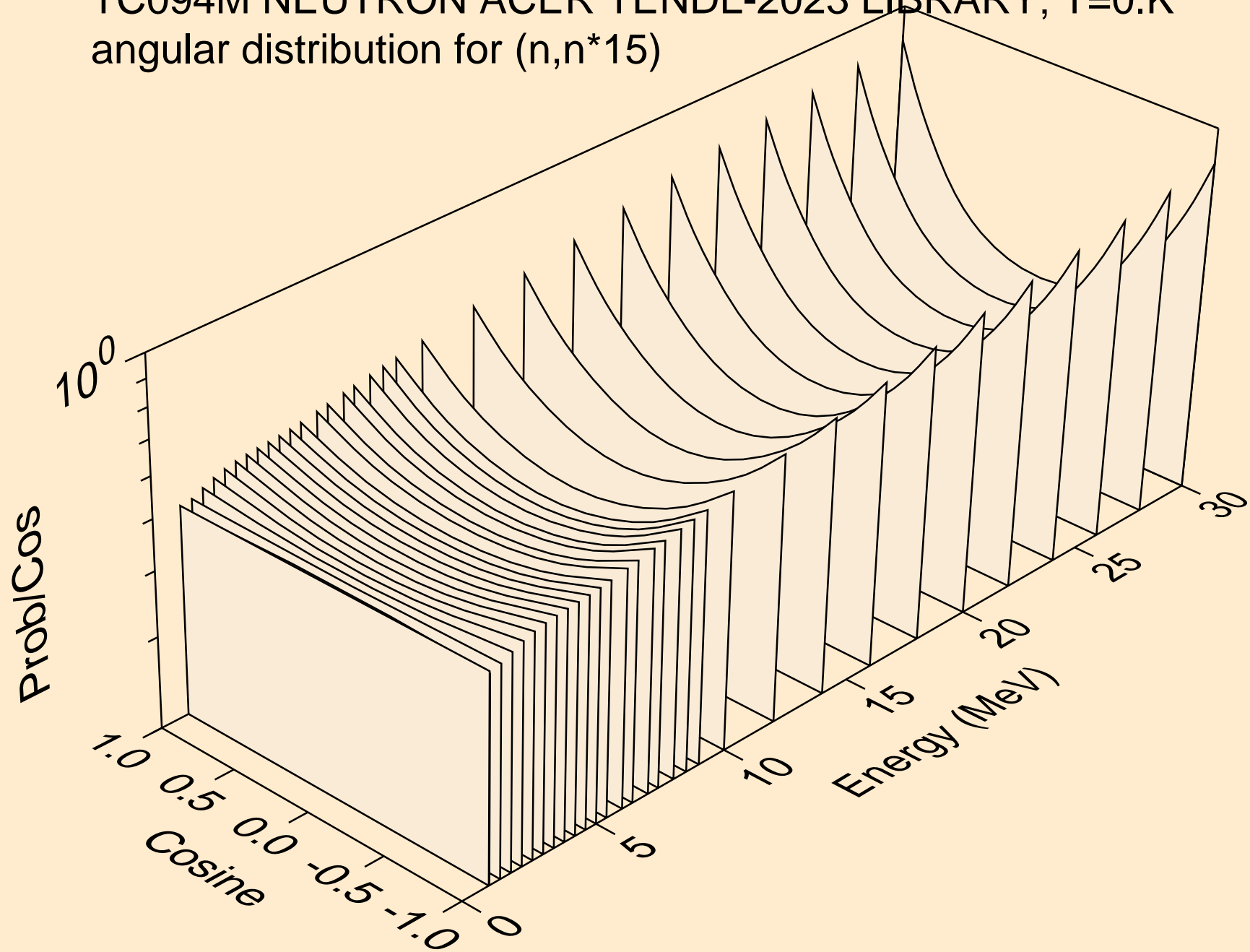

TC094M NEUTRON ACER TENDL-2023 LIBRARY; T=0.K
angular distribution for (n,n*16)

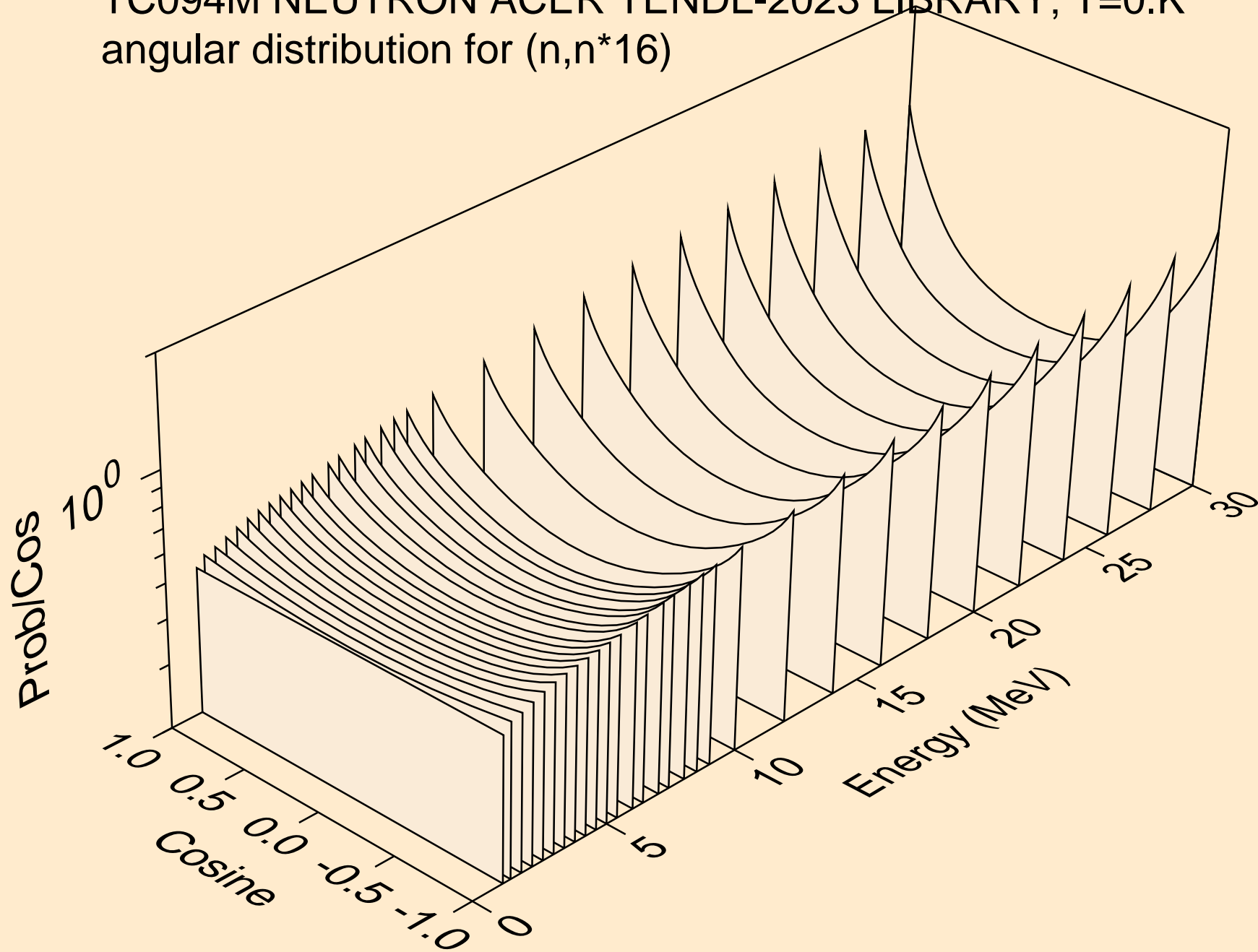

TC094M NEUTRON ACER TENDL-2023 LIBRARY; T=0.K
angular distribution for (n,n*17)

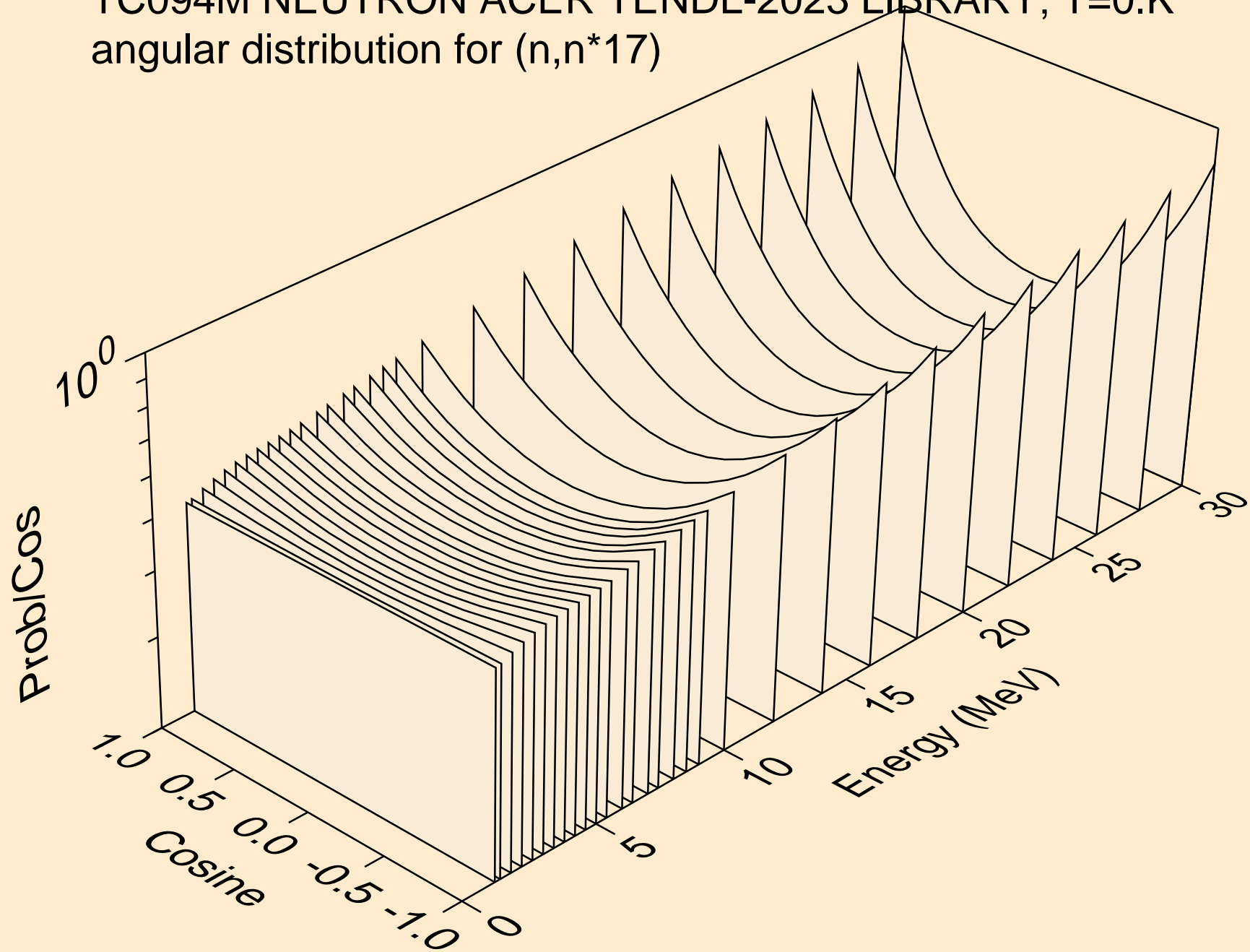

TC094M NEUTRON ACER TENDL-2023 LIBRARY; T=0.K
angular distribution for (n,n*18)

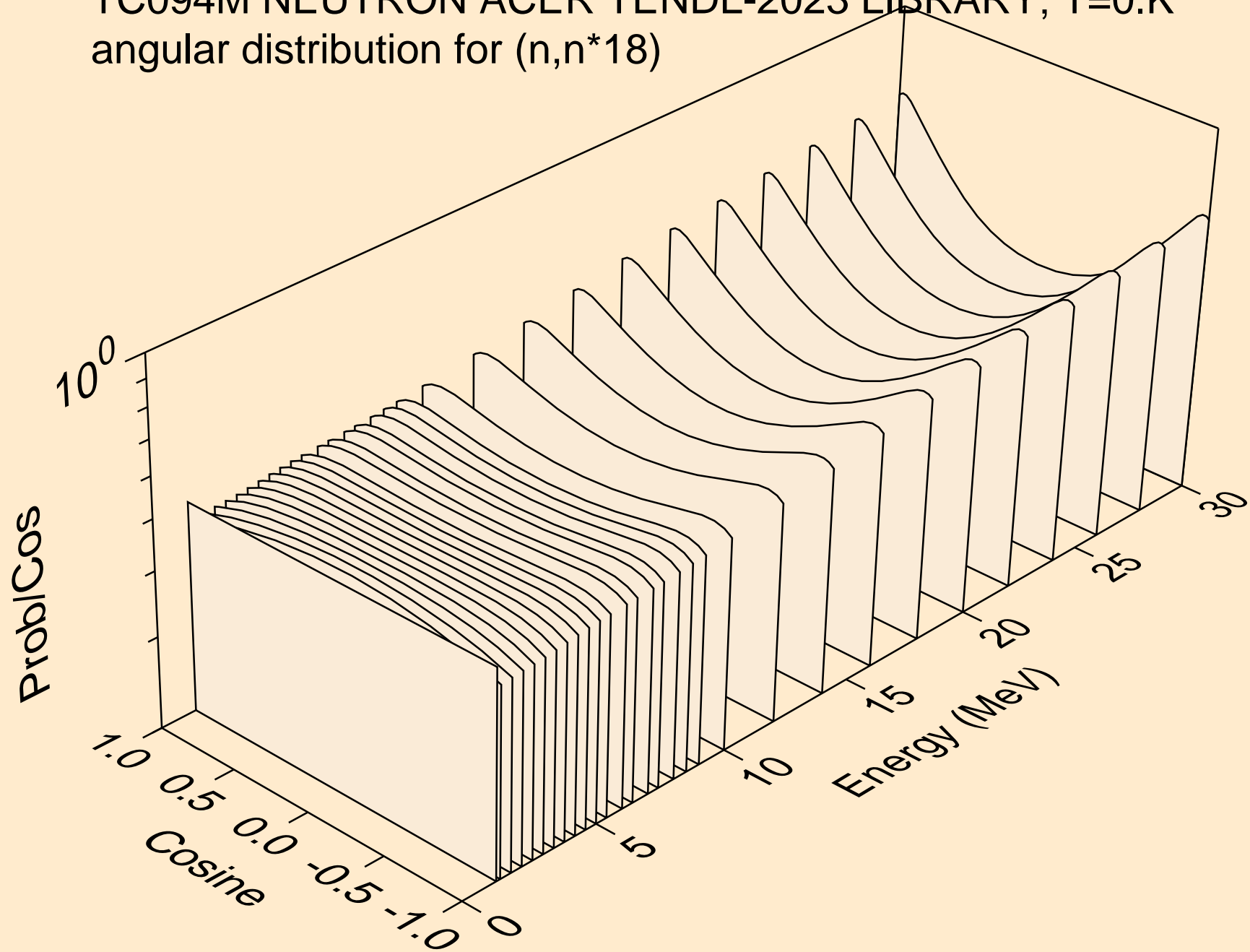

TC094M NEUTRON ACER TENDL-2023 LIBRARY; T=0.K
angular distribution for (n,n*19)

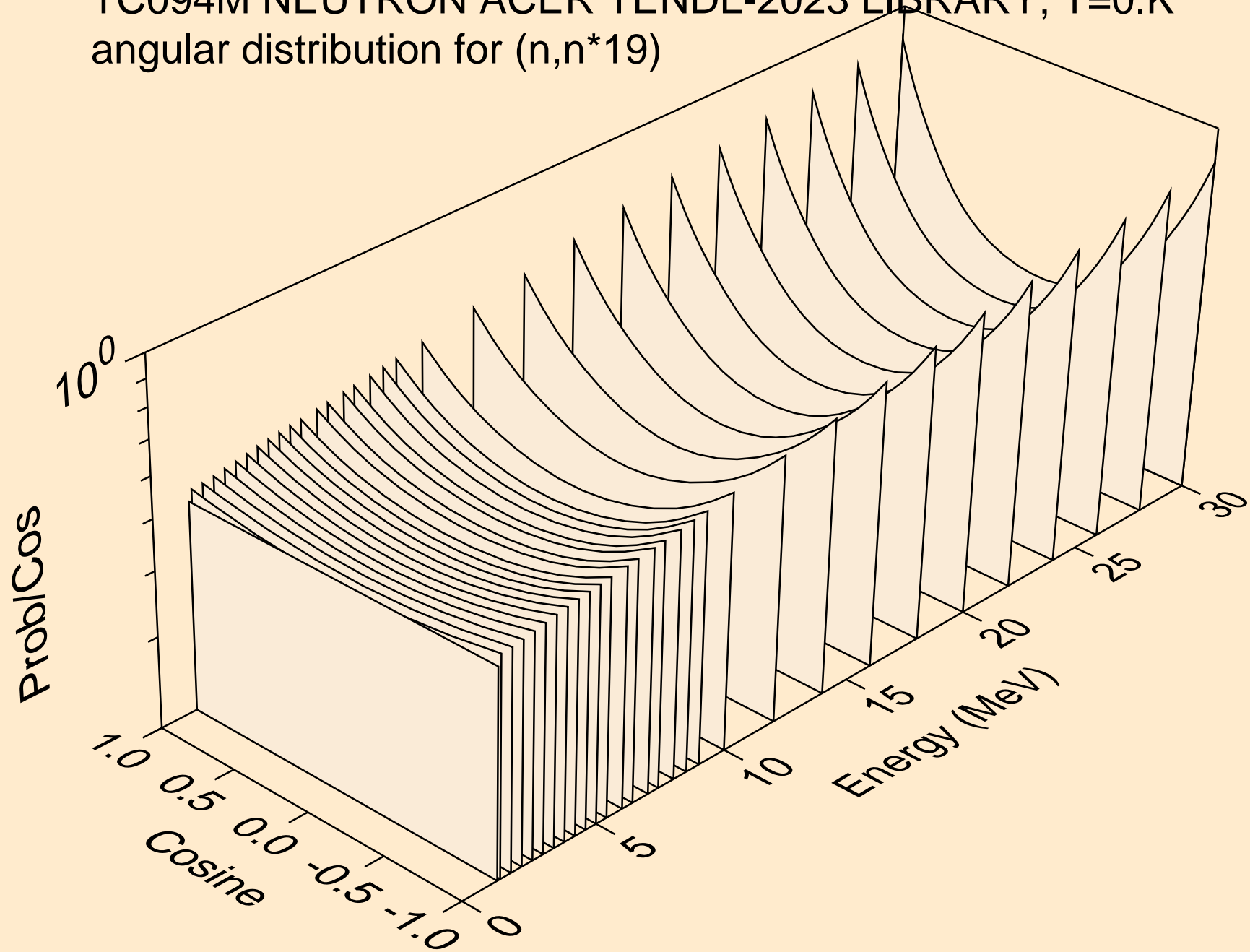

TC094M NEUTRON ACER TENDL-2023 LIBRARY; T=0.K
angular distribution for (n,n*20)

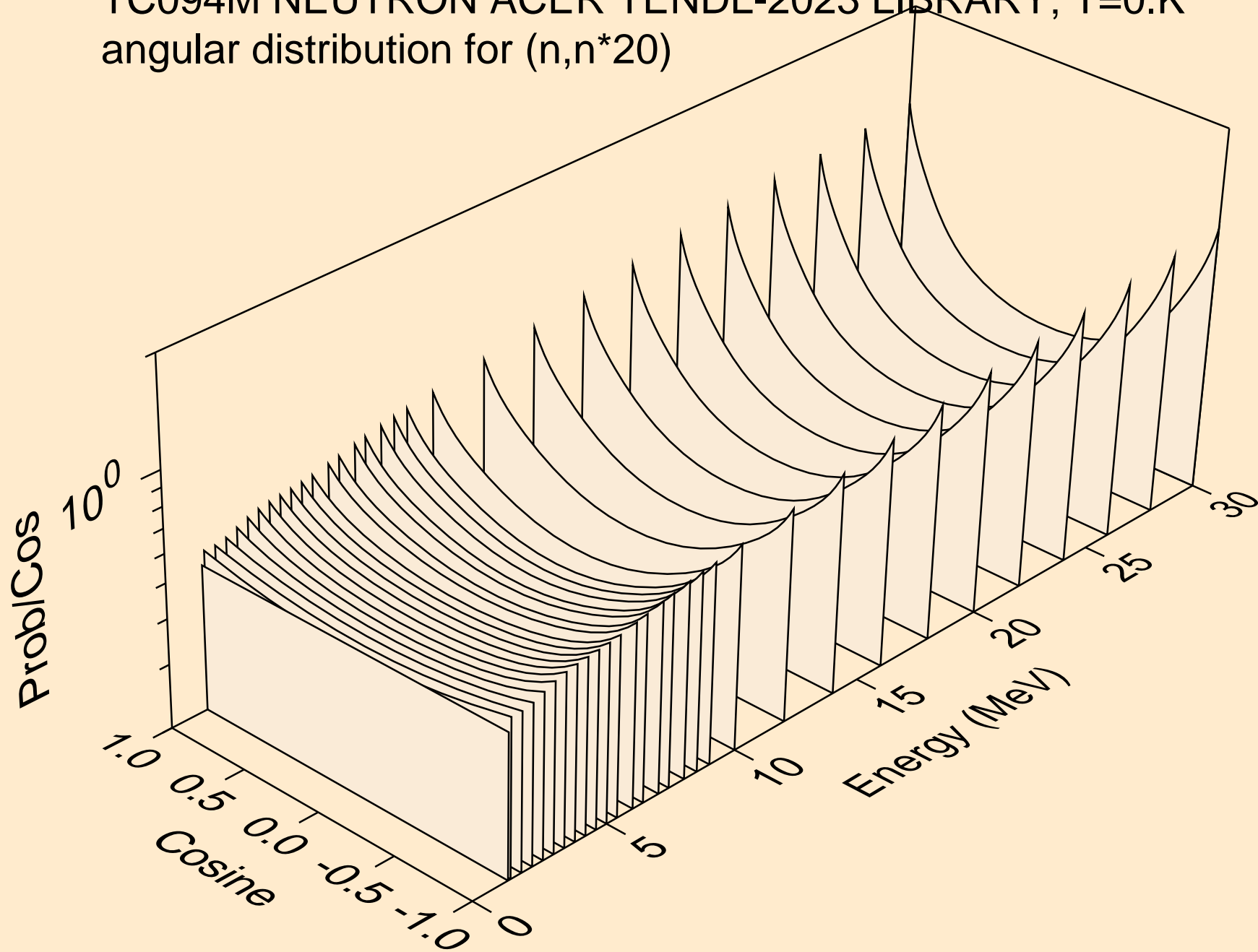

TC094M NEUTRON ACER TENDL-2023 LIBRARY; T=0.K
Neutron emission for (n,x)

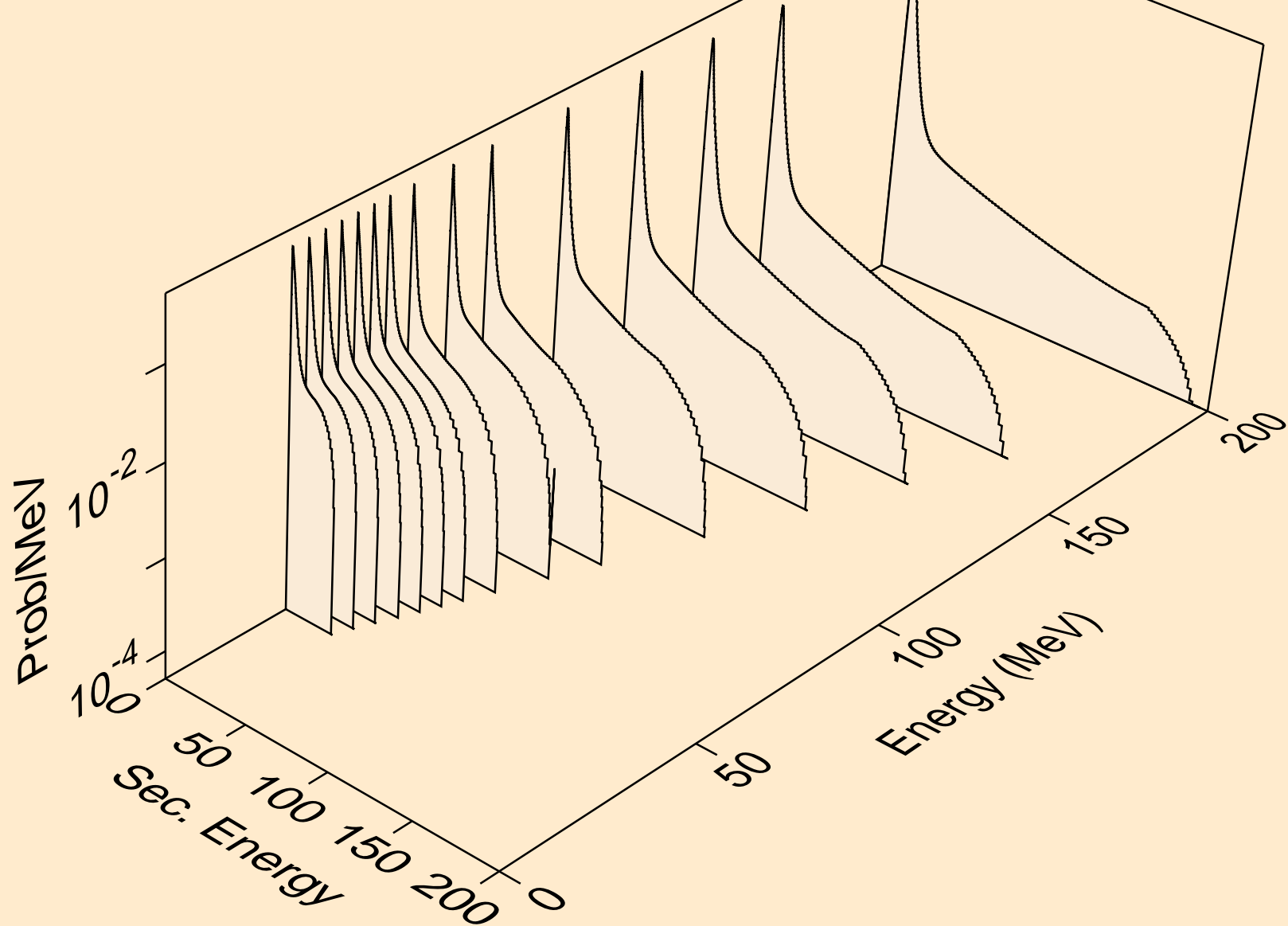

TC094M NEUTRON ACER TENDL-2023 LIBRARY; T=0.K
Neutron emission for (n,2nd)

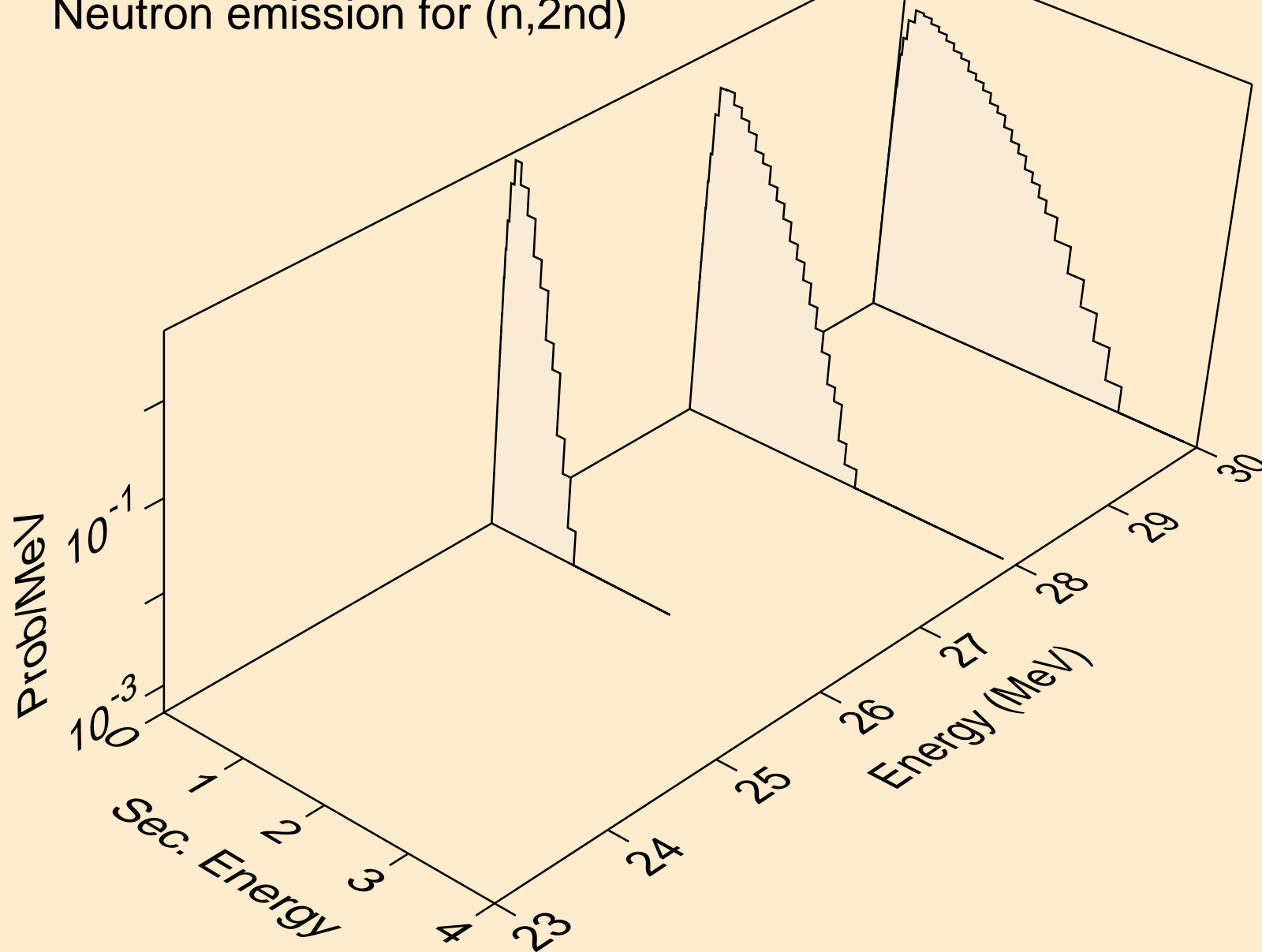

TC094M NEUTRON ACER TENDL-2023 LIBRARY; T=0.K
Neutron emission for (n,2n)

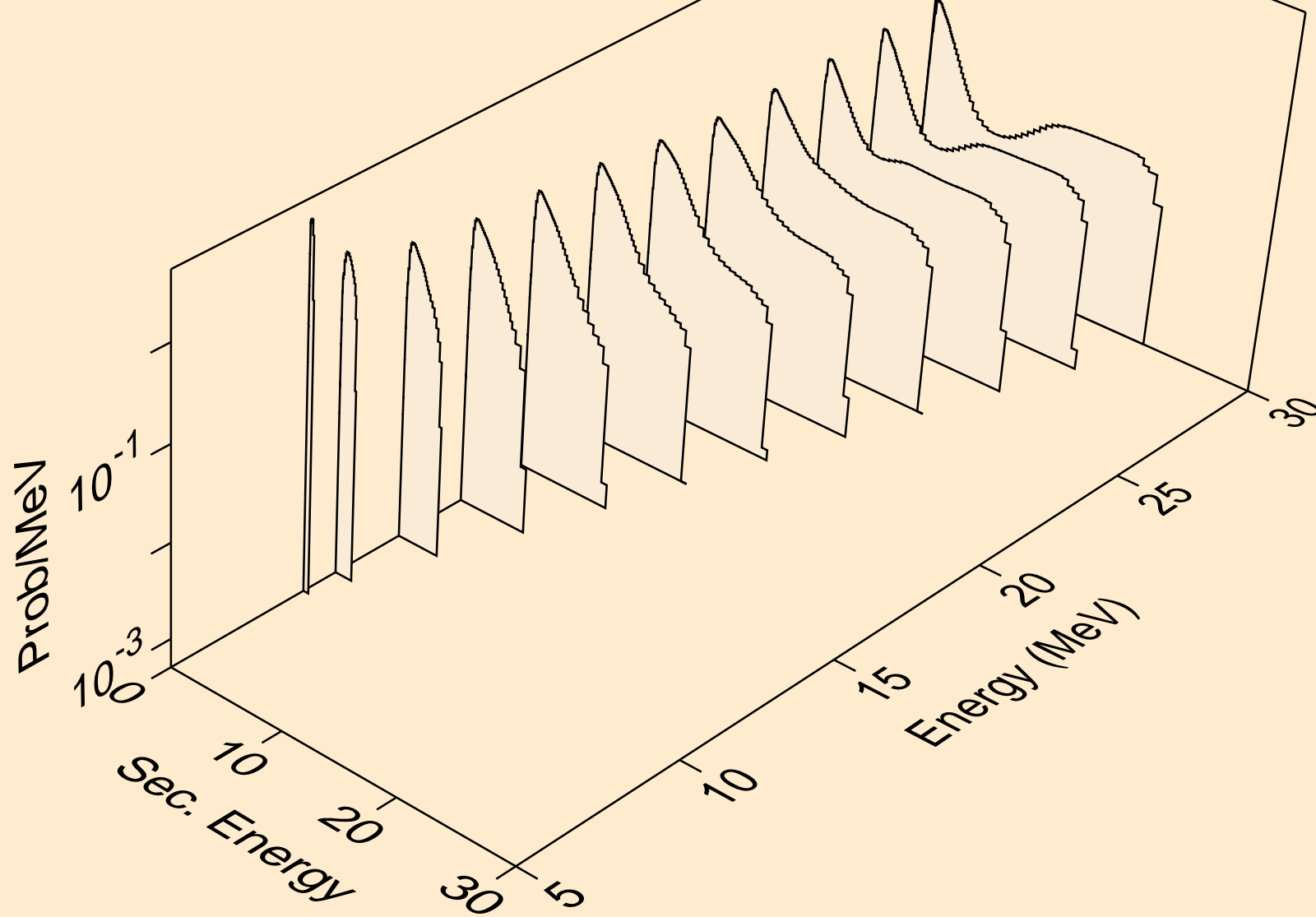

TC094M NEUTRON ACER TENDL-2023 LIBRARY; T=0.K
Neutron emission for (n,3n)

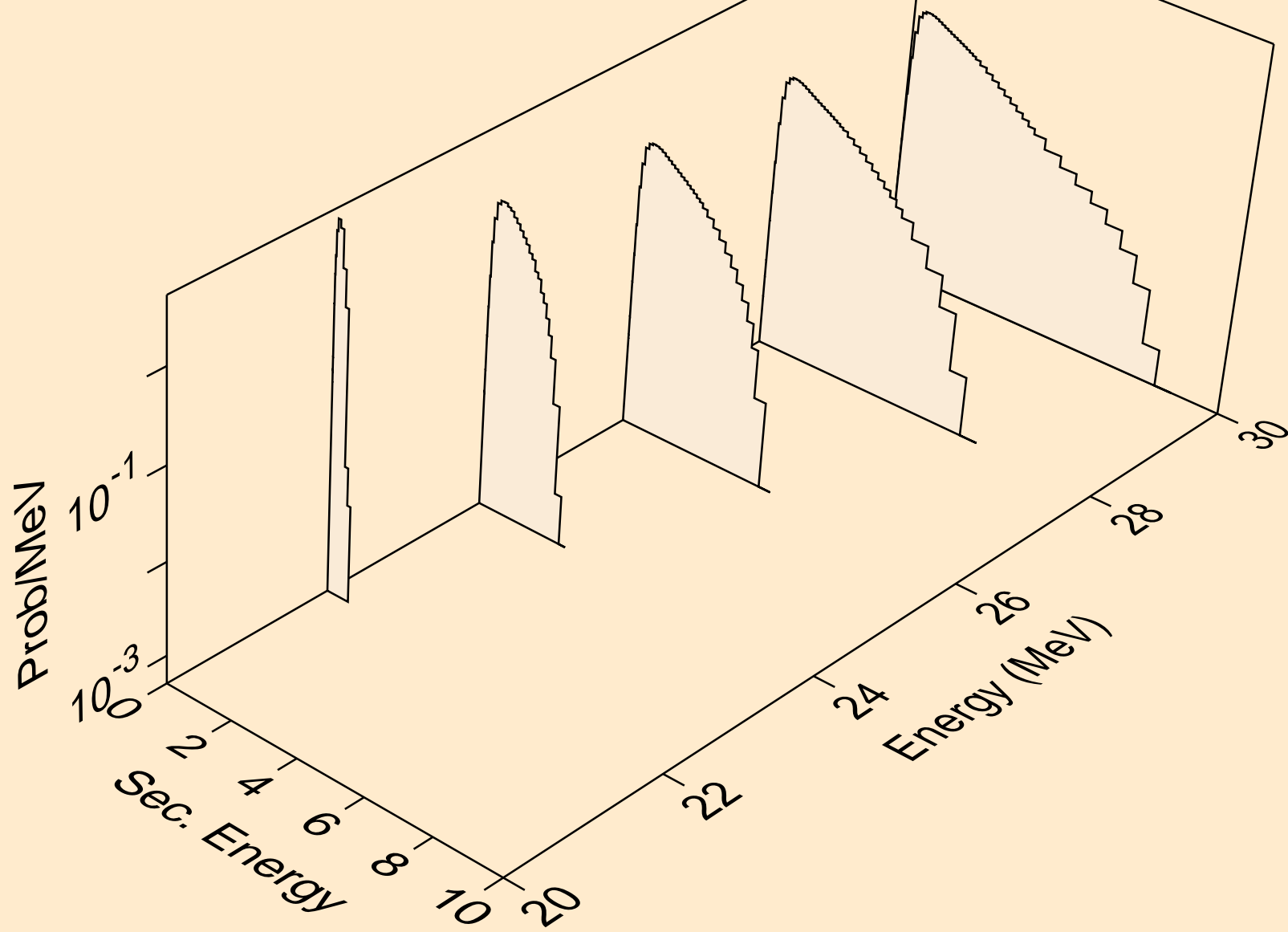

TC094M NEUTRON ACER TENDL-2023 LIBRARY; T=0.K
Neutron emission for (n,n*)a

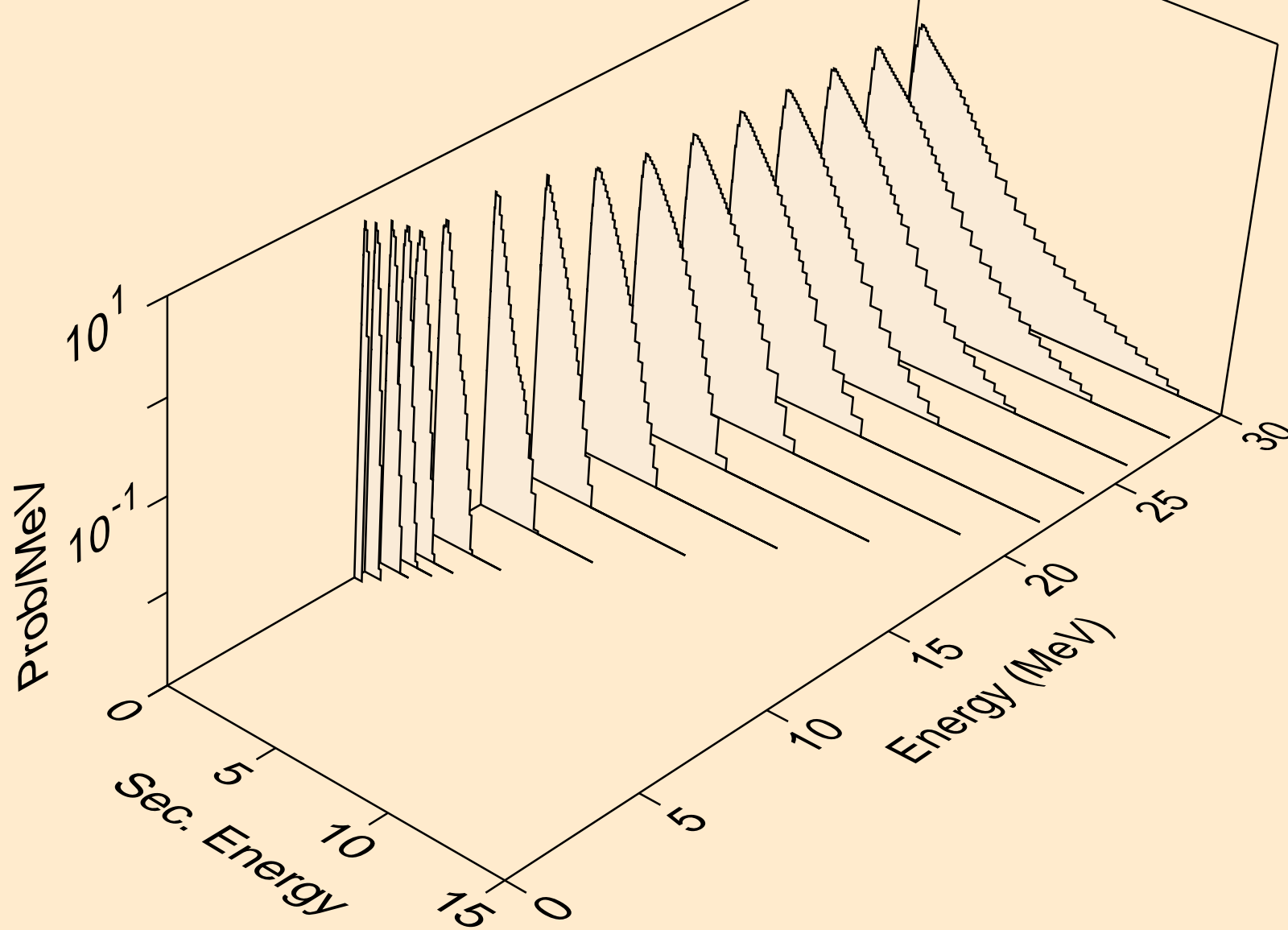

TC094M NEUTRON ACER TENDL-2023 LIBRARY; T=0.K
Neutron emission for (n,2n)a

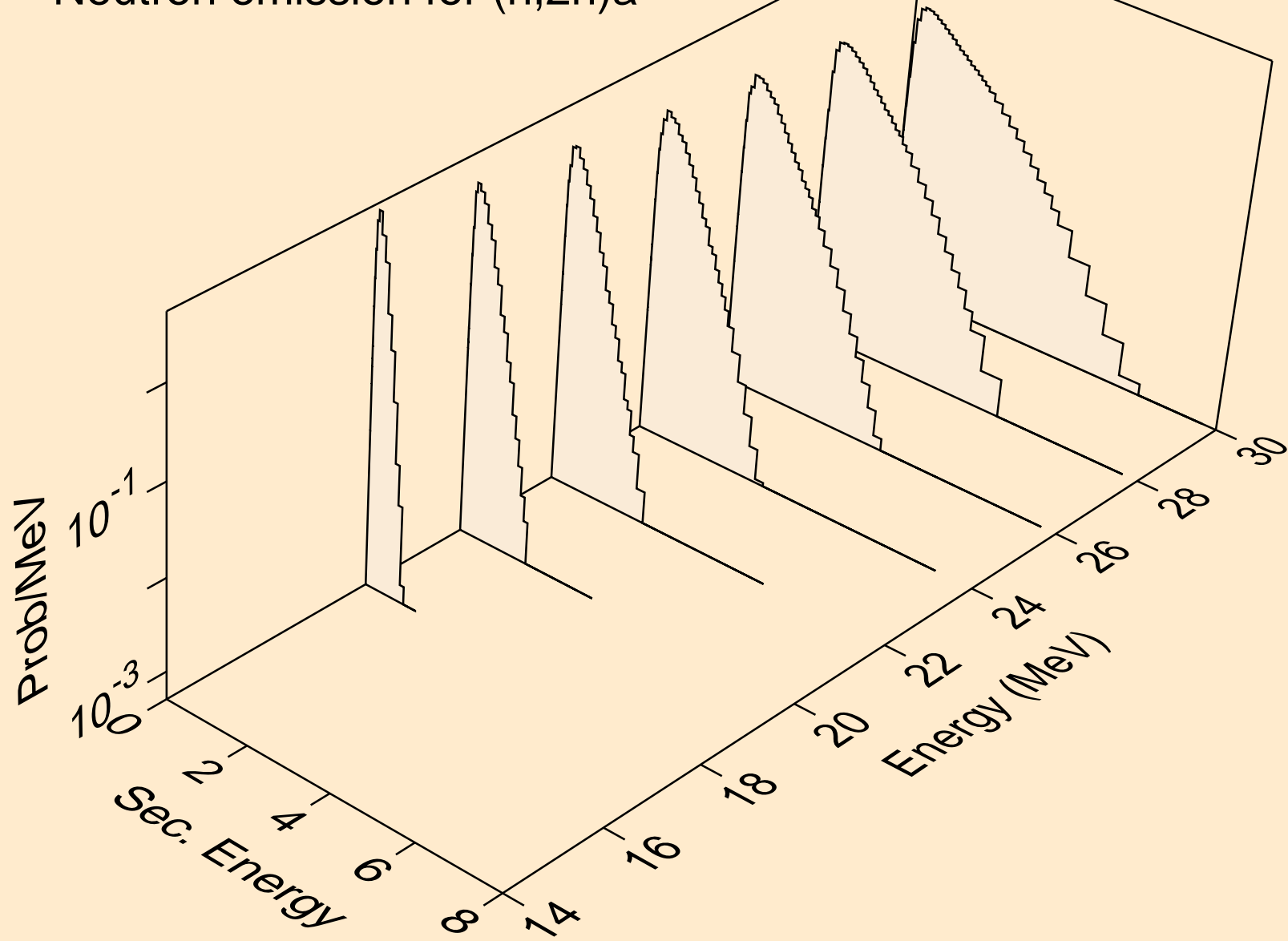

TC094M NEUTRON ACER TENDL-2023 LIBRARY; T=0.K
Neutron emission for (n,n*)p

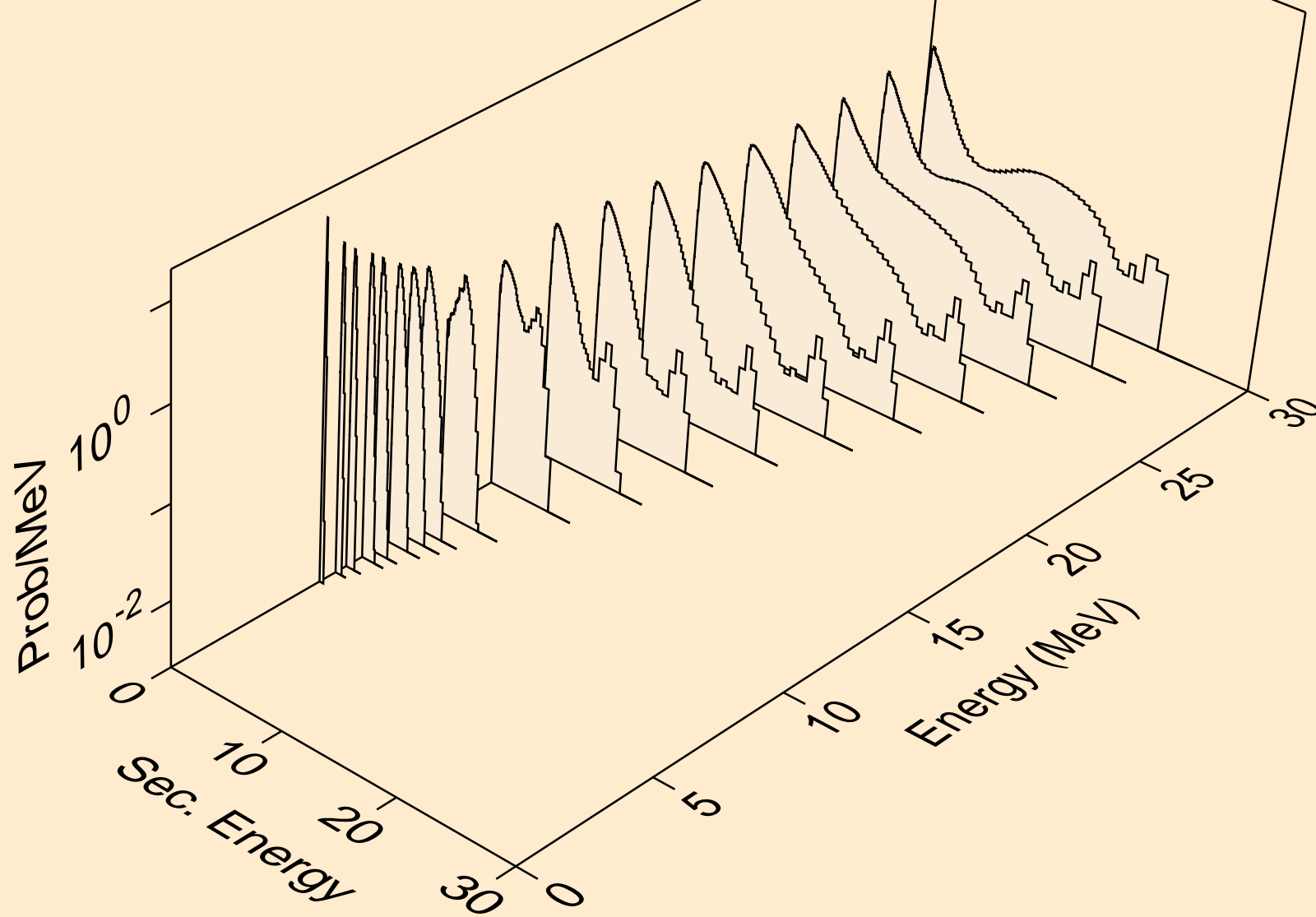

TC094M NEUTRON ACER TENDL-2023 LIBRARY; T=0.K
Neutron emission for (n,n*)2a

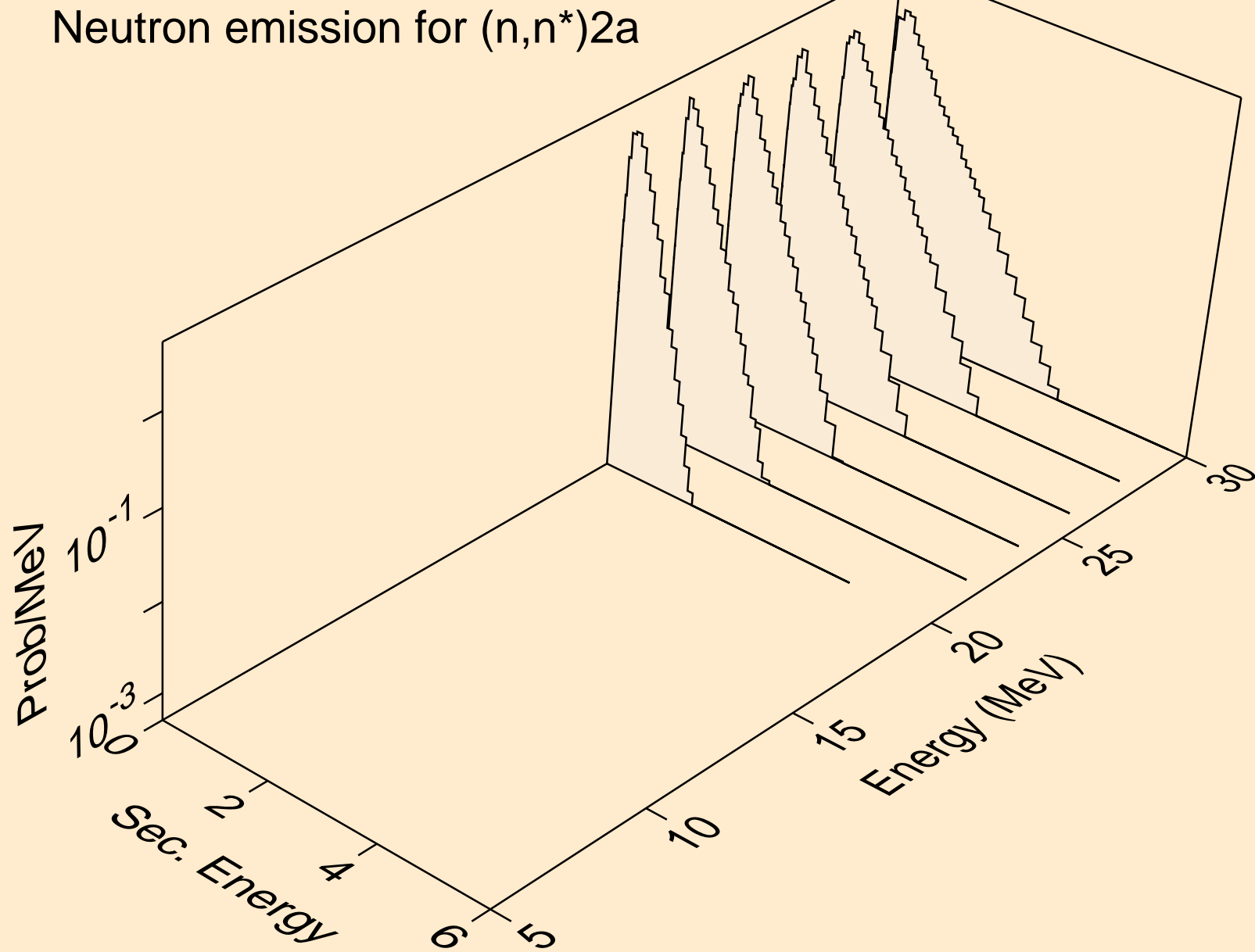

TC094M NEUTRON ACER TENDL-2023 LIBRARY; T=0.K
Neutron emission for (n,n*)d

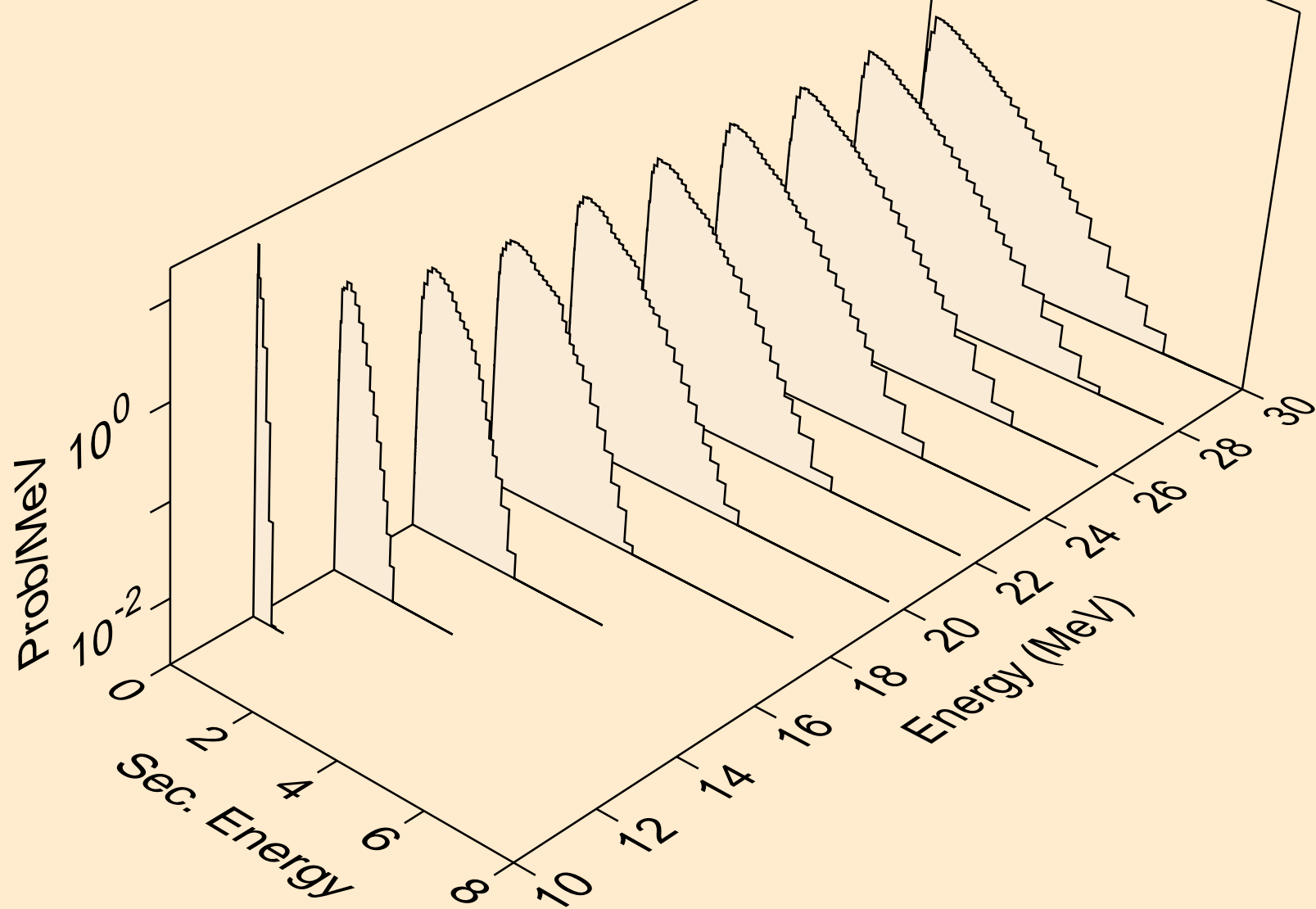

TC094M NEUTRON ACER TENDL-2023 LIBRARY; T=0.K
Neutron emission for (n,n*)t

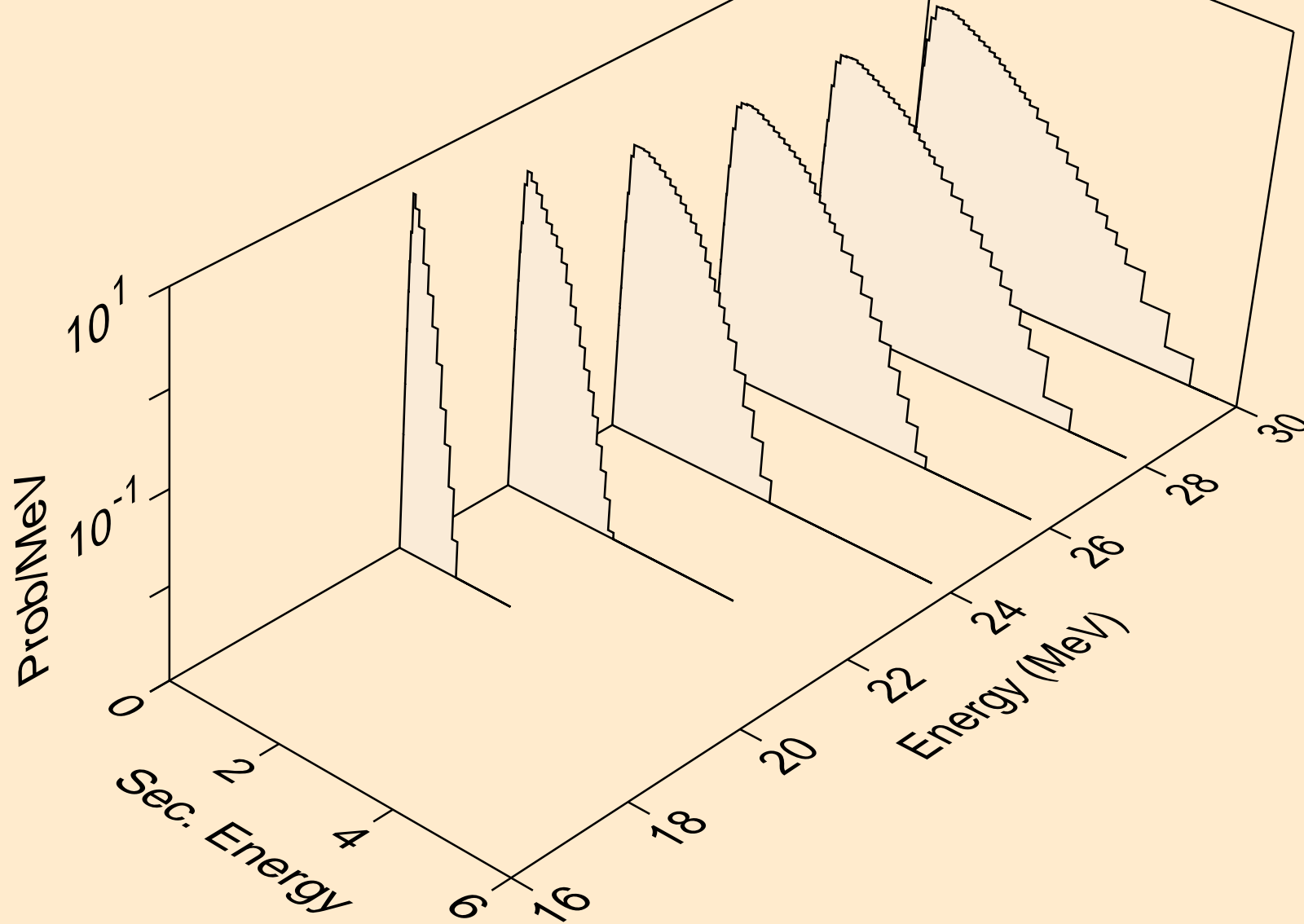

TC094M NEUTRON ACER TENDL-2023 LIBRARY; T=0.K
Neutron emission for (n,n*)he3

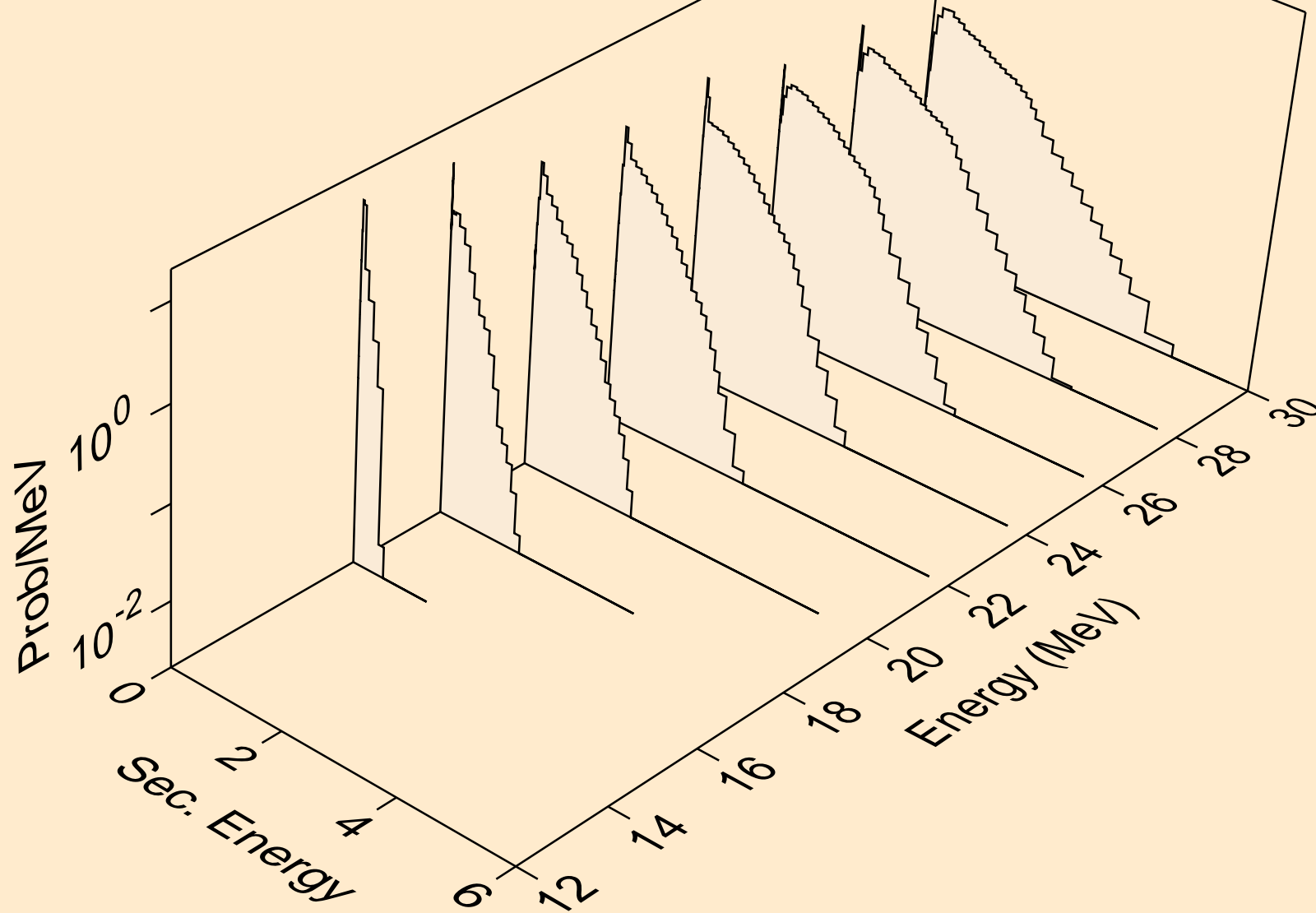

TC094M NEUTRON ACER TENDL-2023 LIBRARY; T=0.K
Neutron emission for (n,2np)

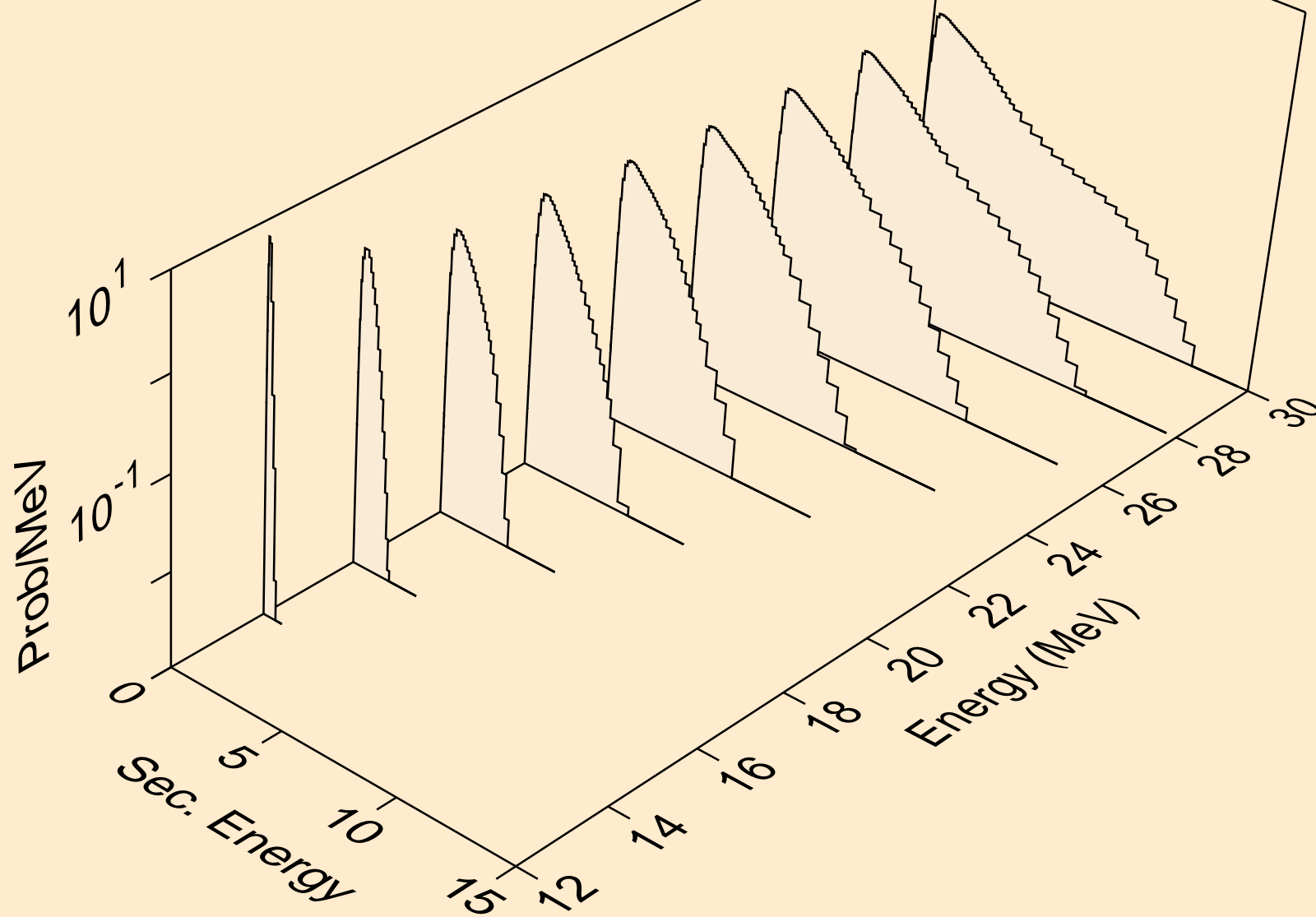

TC094M NEUTRON ACER TENDL-2023 LIBRARY; T=0.K
Neutron emission for (n,3np)

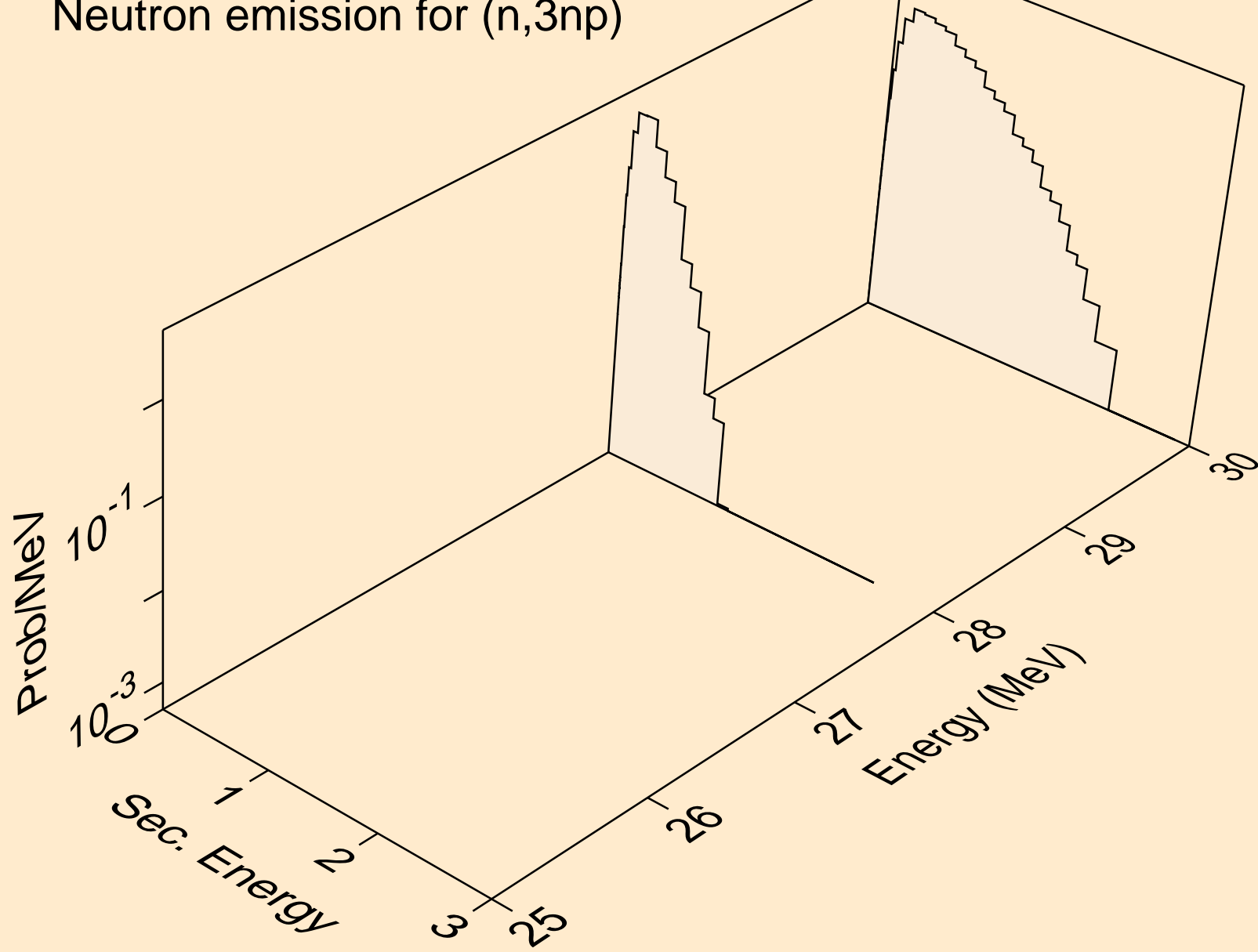

TC094M NEUTRON ACER TENDL-2023 LIBRARY; T=0.K
Neutron emission for (n,n2p)

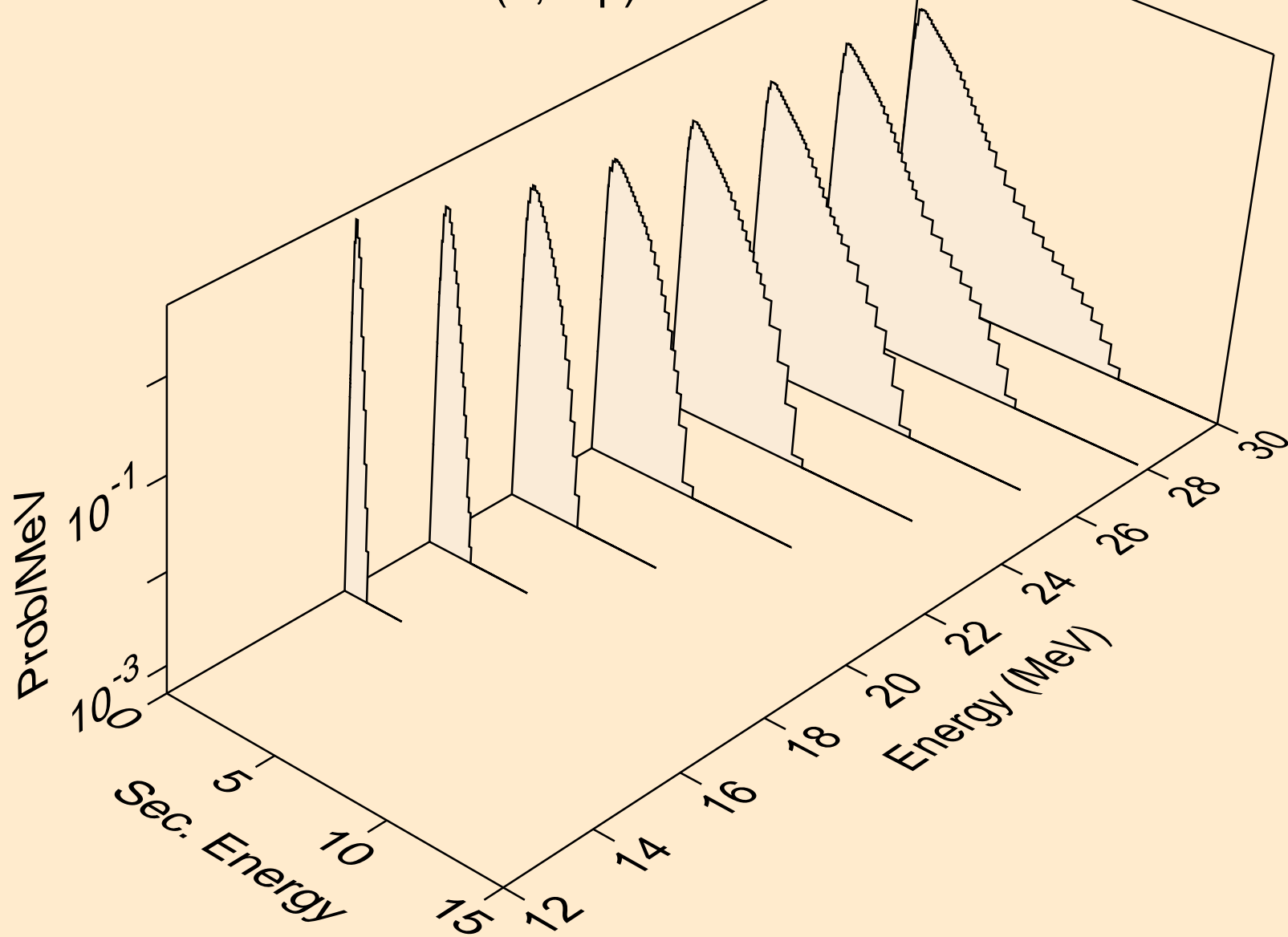

TC094M NEUTRON ACER TENDL-2023 LIBRARY; T=0.K
Neutron emission for (n,npa)

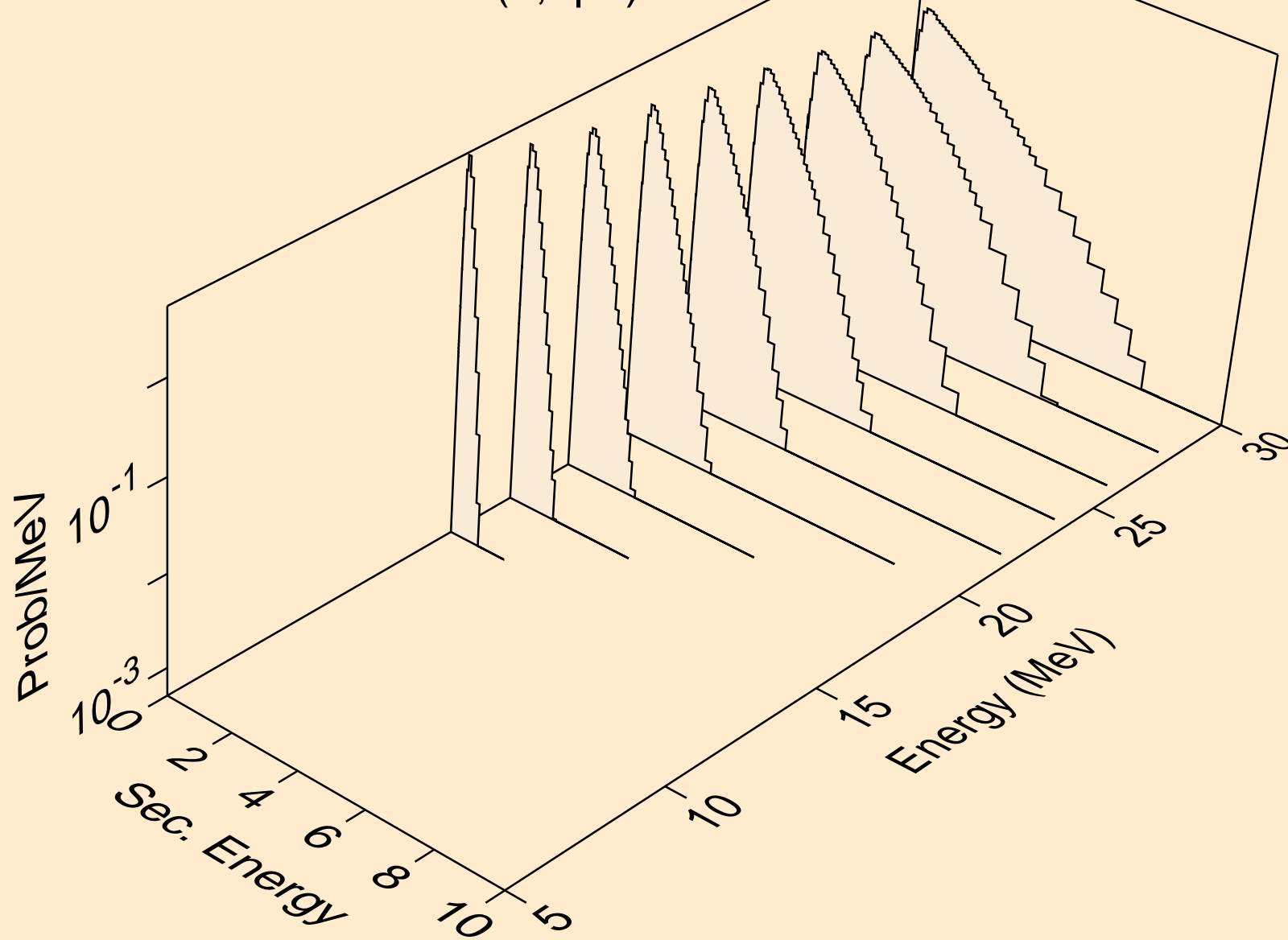

TC094M NEUTRON ACER TENDL-2023 LIBRARY; T=0.K
Neutron emission for (n,n*c)

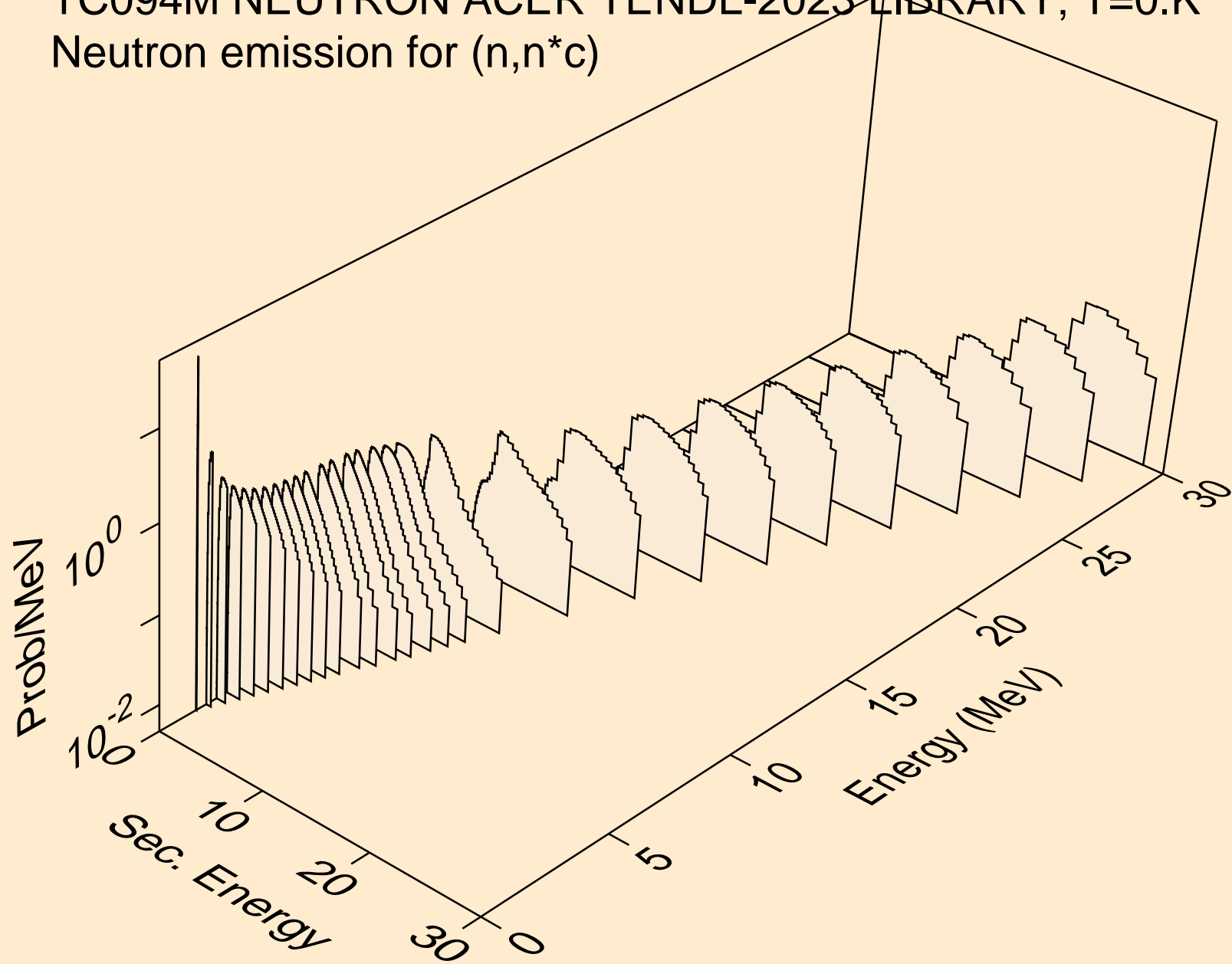

TC094M NEUTRON ACER TENDL-2023 LIBRARY; T=0.K
Photon emission for (n,x)

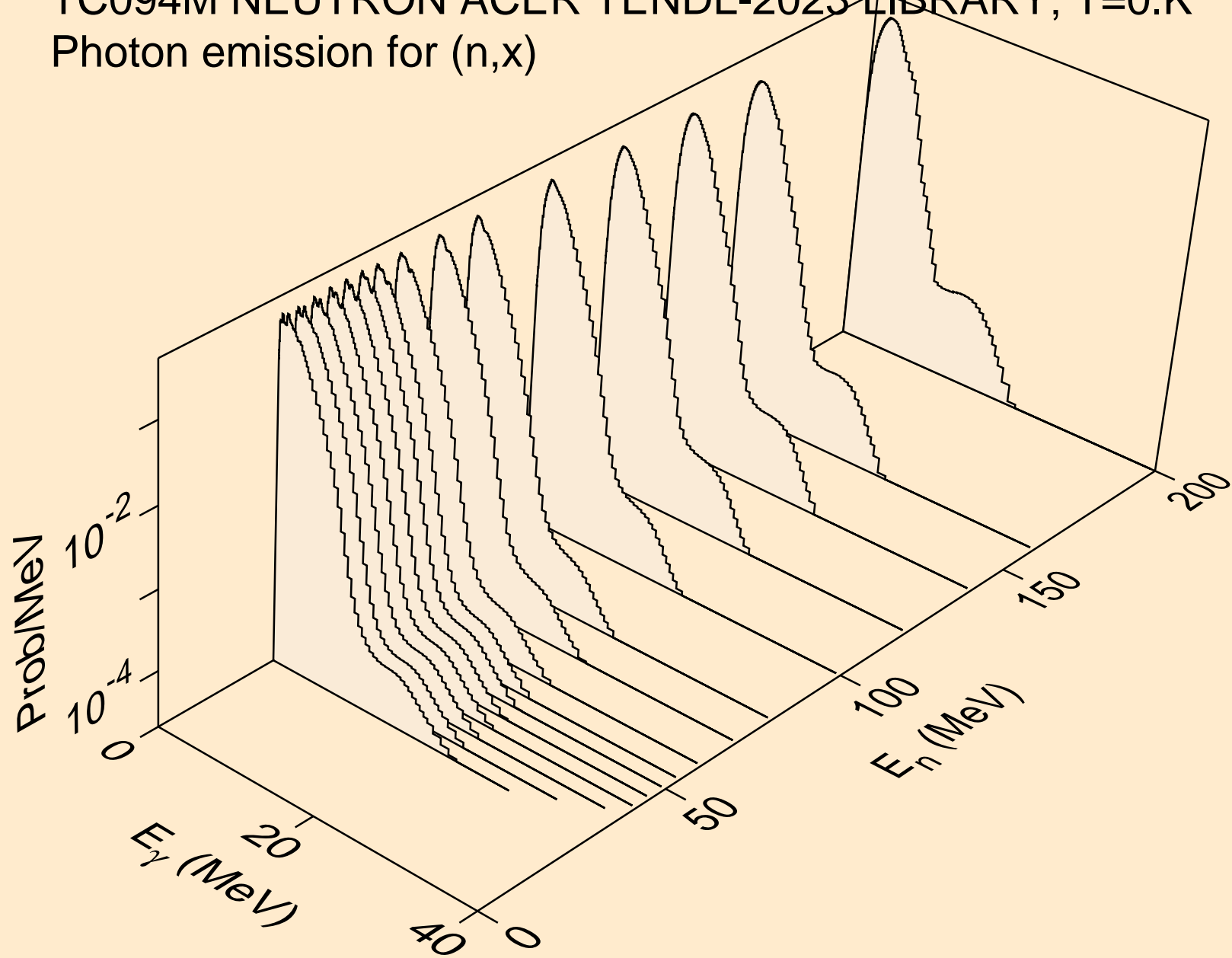

TC094M NEUTRON ACER TENDL-2023 LIBRARY; T=0.K
Photon emission for (n,2nd)

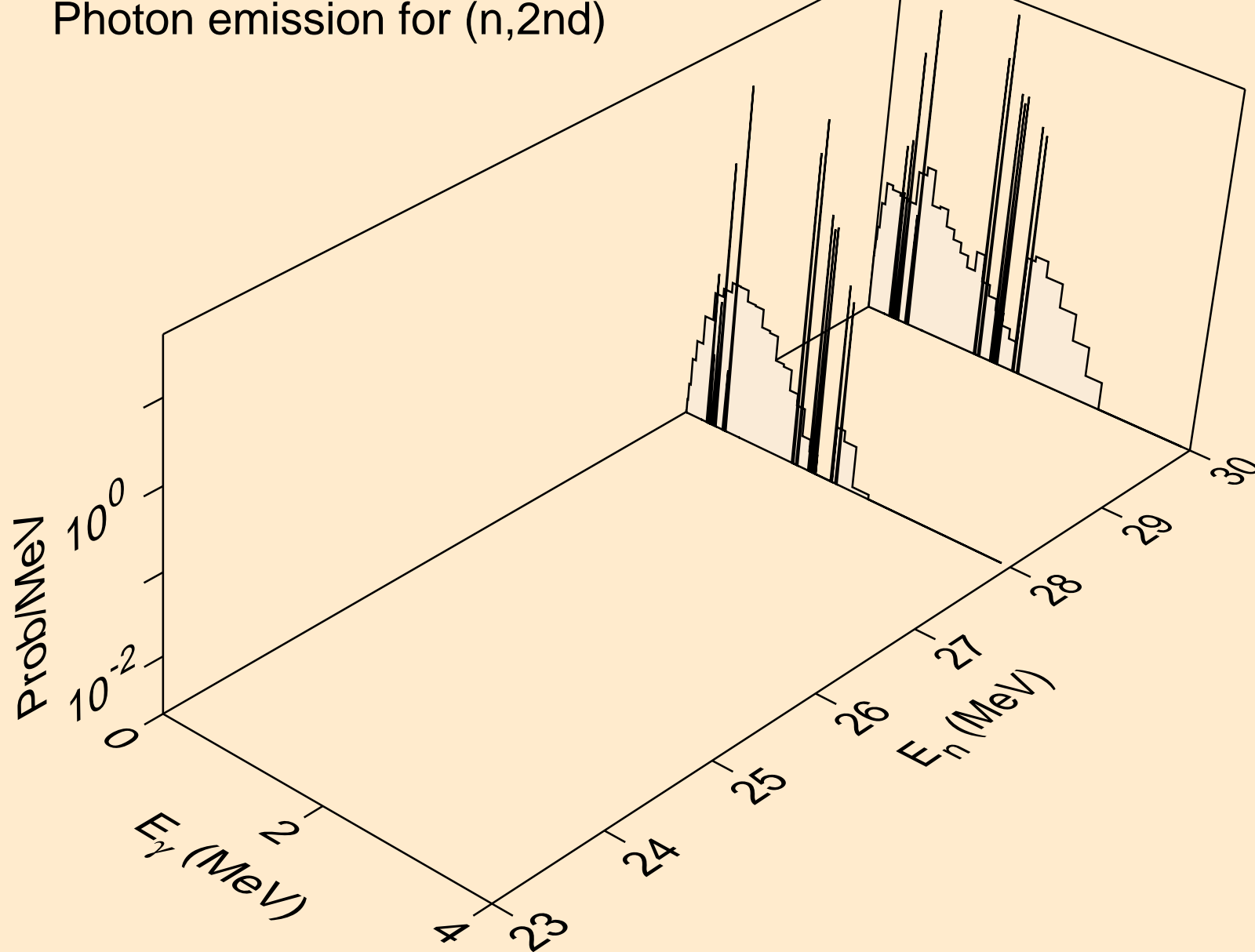

TC094M NEUTRON ACER TENDL-2023 LIBRARY; T=0.K
Photon emission for (n,2n)

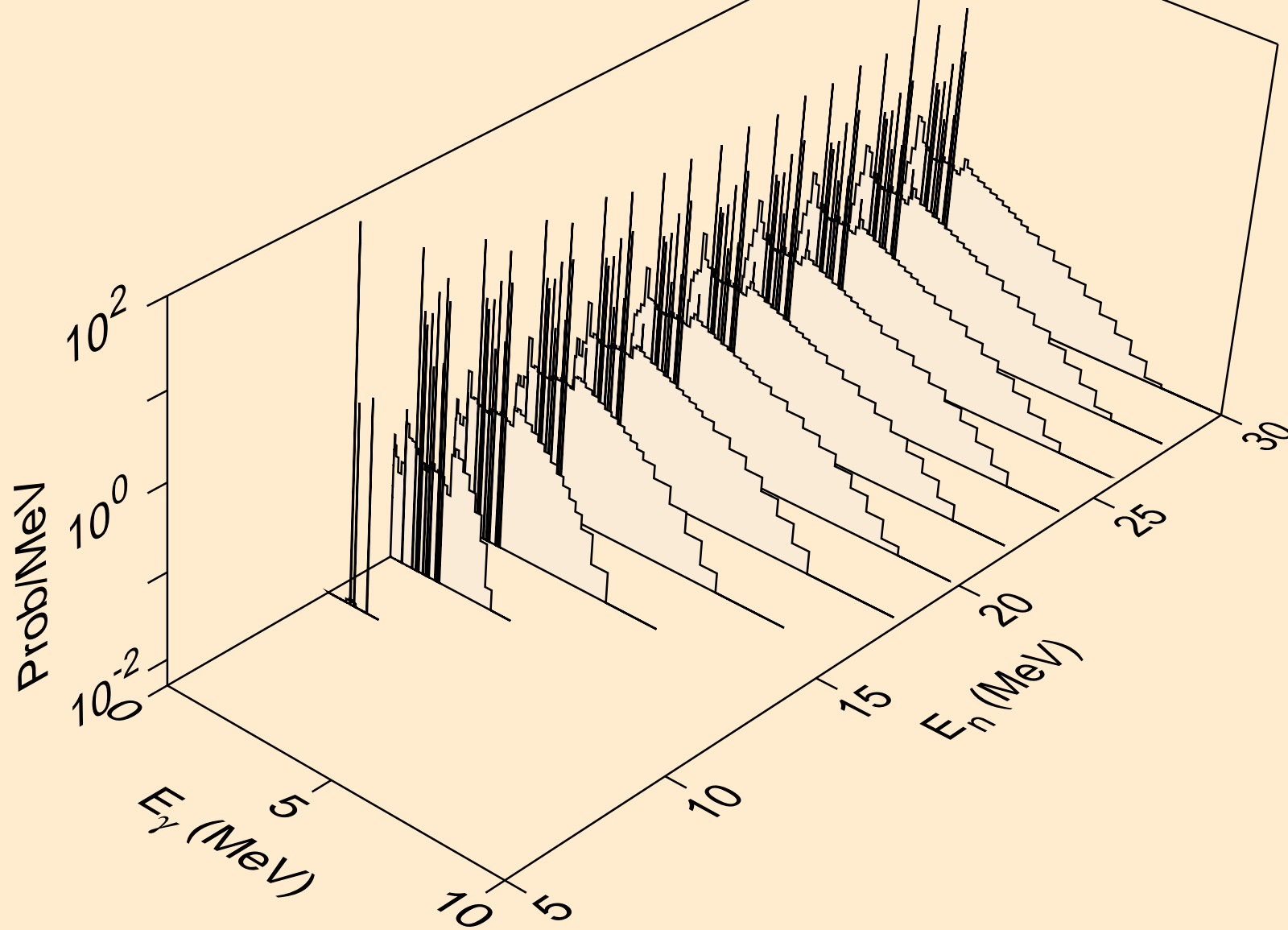

TC094M NEUTRON ACER TENDL-2023 LIBRARY; T=0.K
Photon emission for (n,3n)

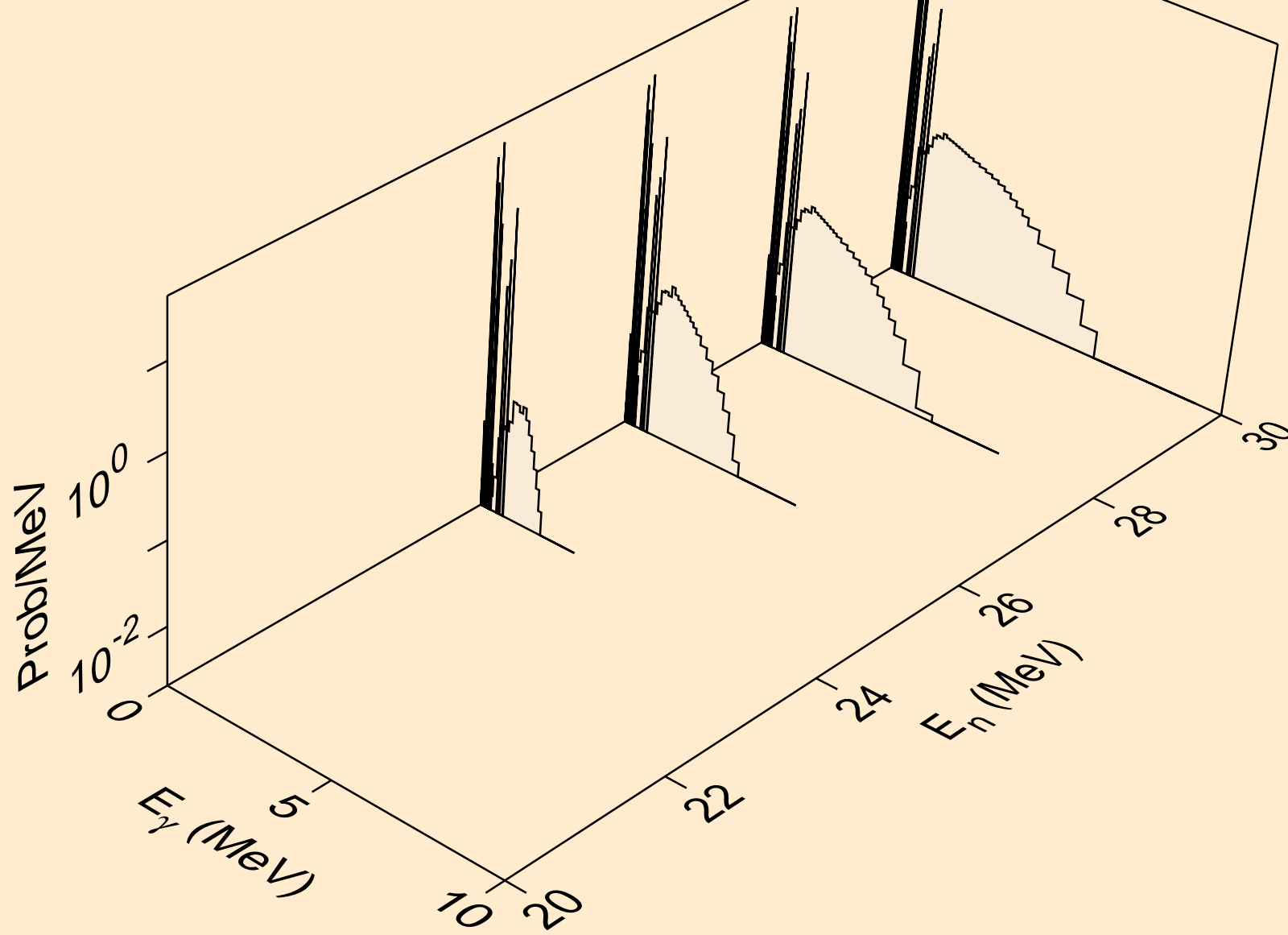

TC094M NEUTRON ACER TENDL-2023 LIBRARY; T=0.K
Photon emission for (n,n*)a

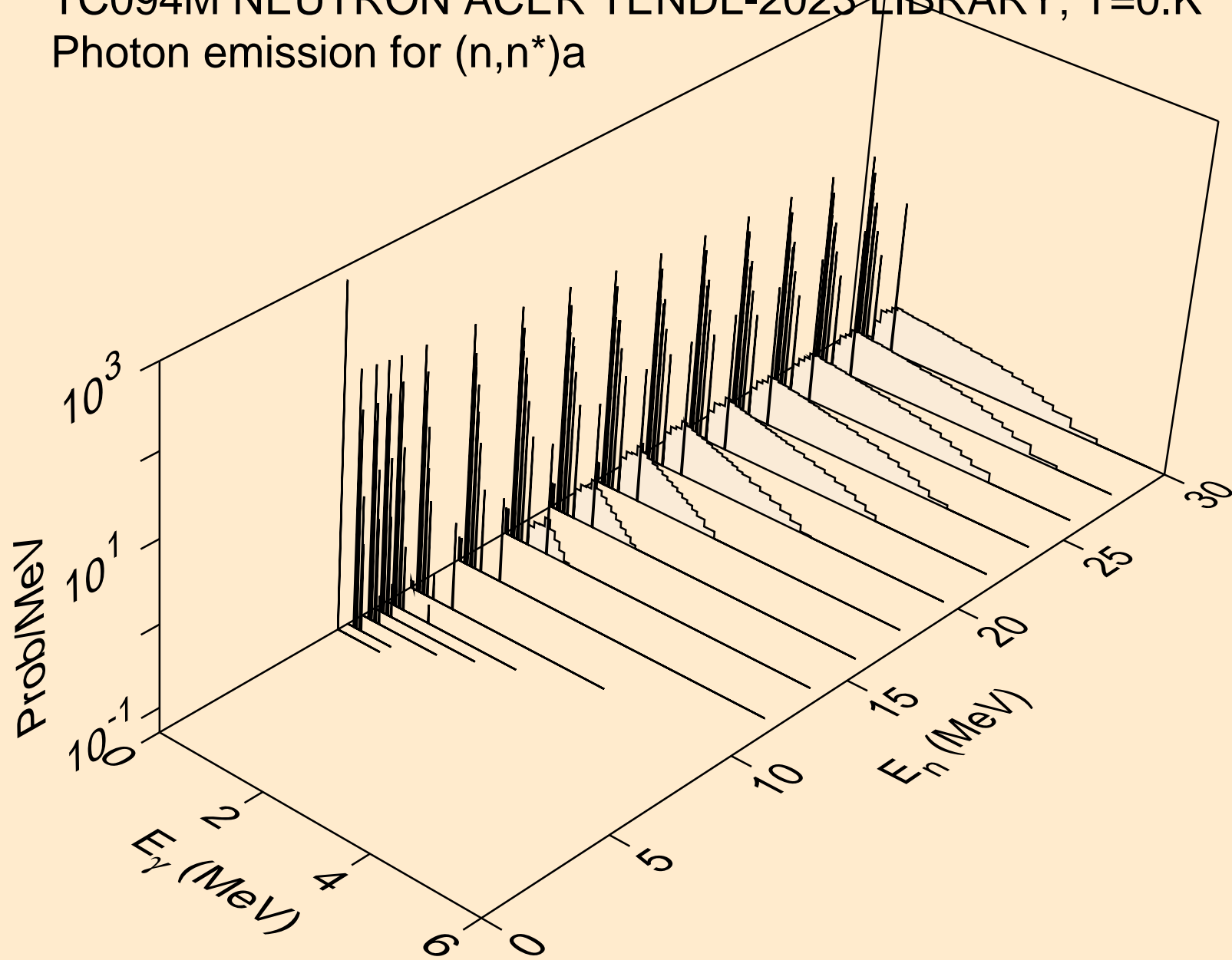

TC094M NEUTRON ACER TENDL-2023 LIBRARY; T=0.K
Photon emission for (n,2n)a

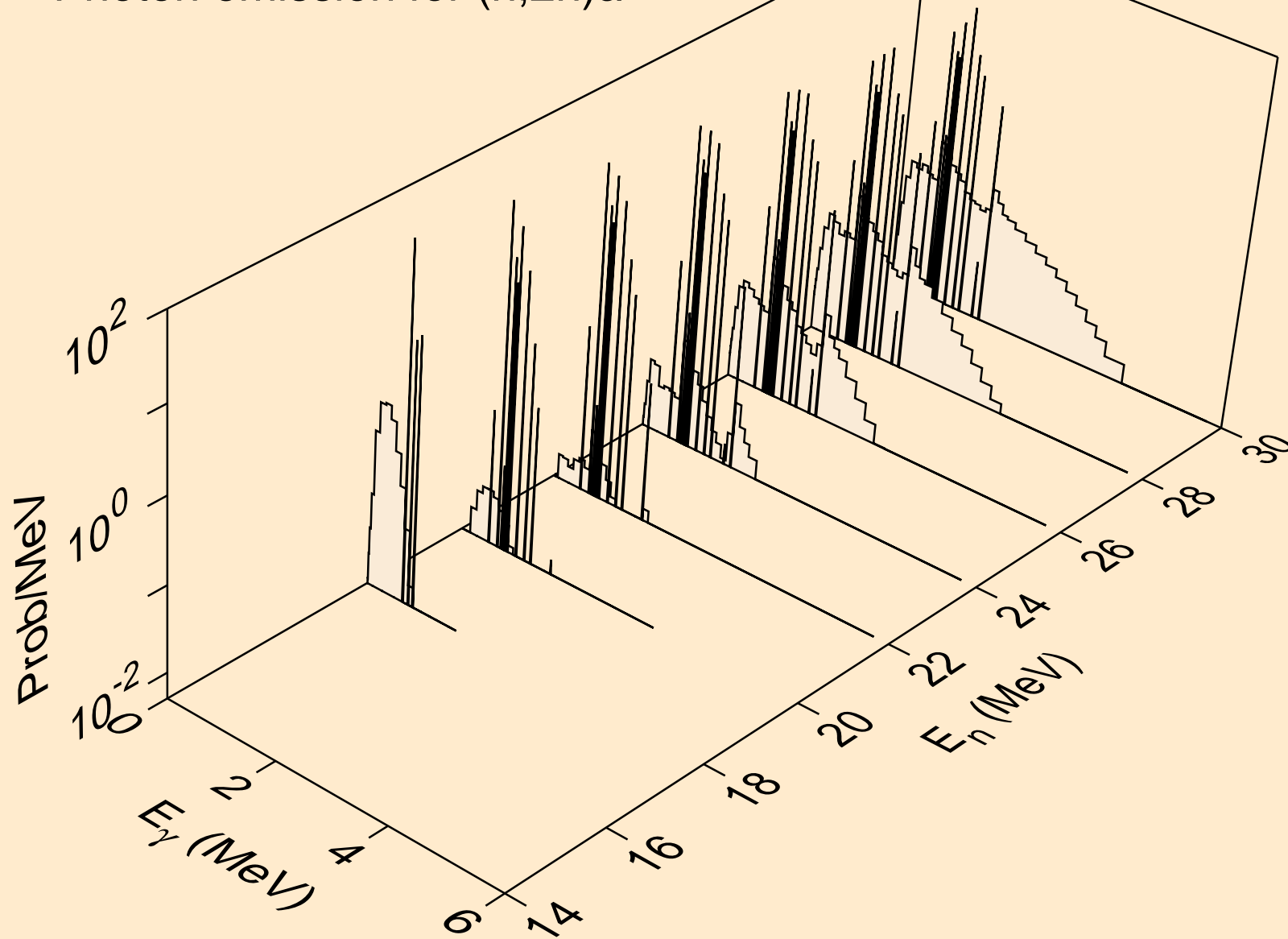

TC094M NEUTRON ACER TENDL-2023 LIBRARY; T=0.K
Photon emission for (n,n*)p

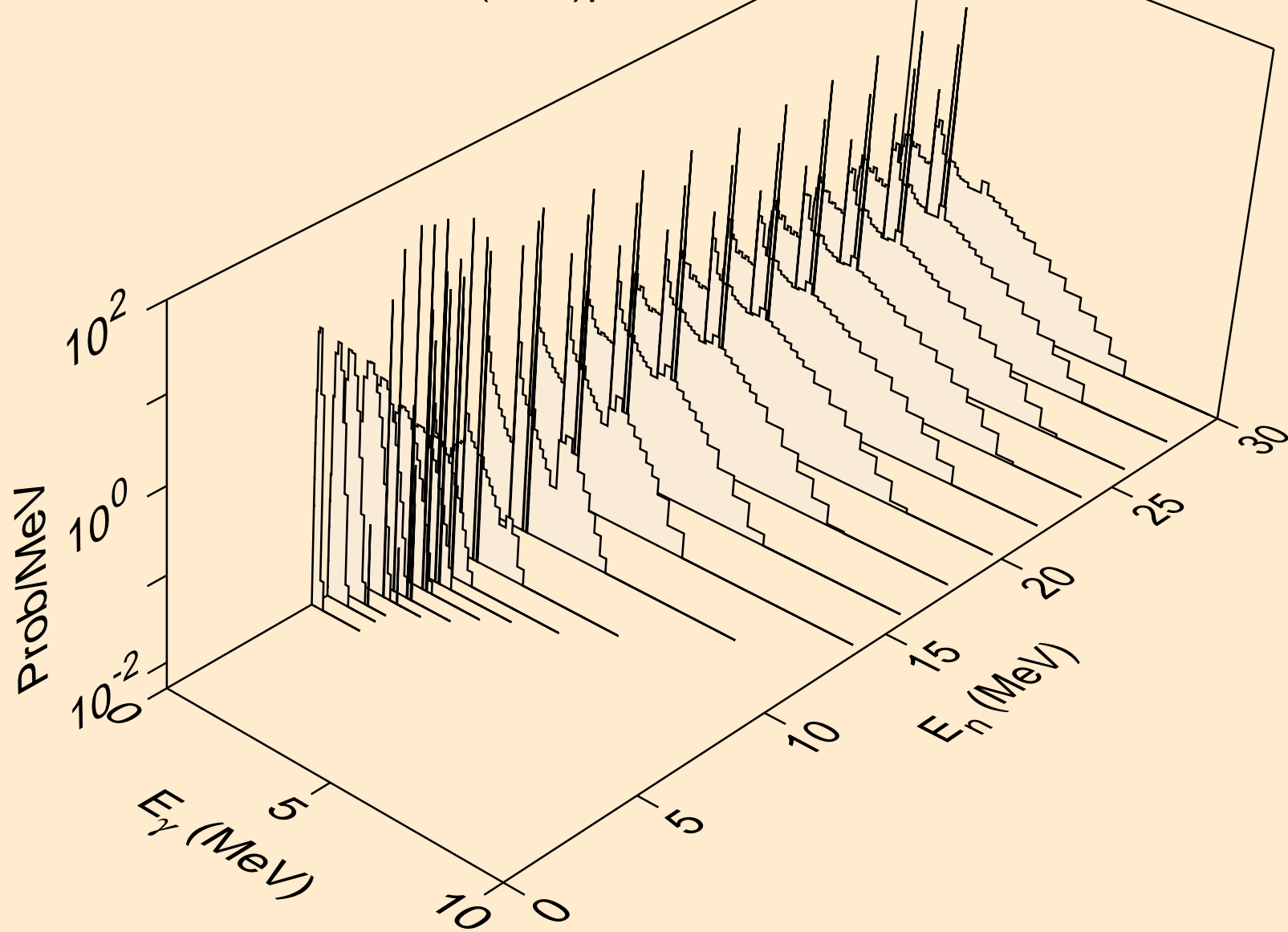

TC094M NEUTRON ACER TENDL-2023 LIBRARY; T=0.K
Photon emission for (n,n*)2a

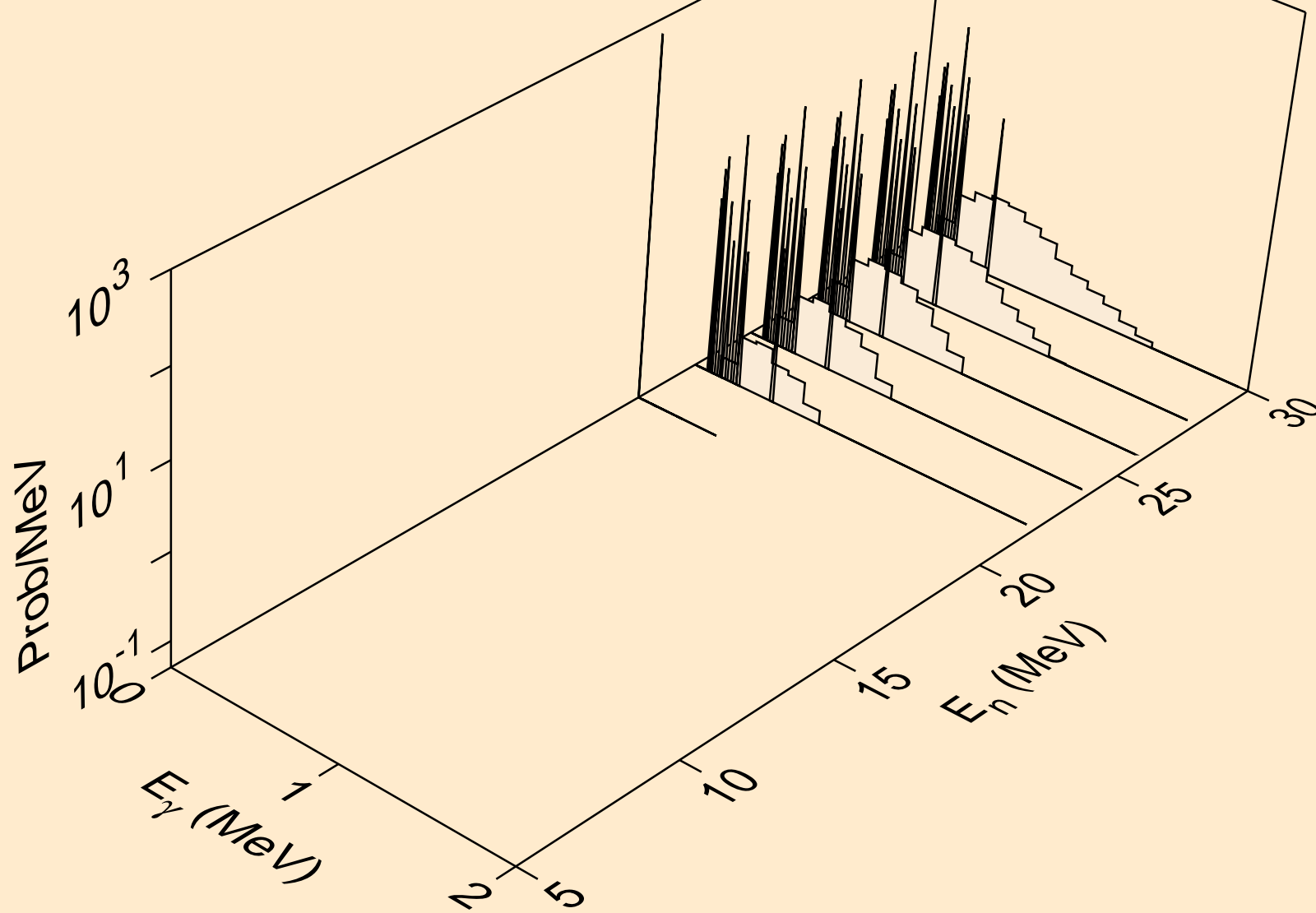

TC094M NEUTRON ACER TENDL-2023 LIBRARY; T=0.K
Photon emission for (n,n*)d

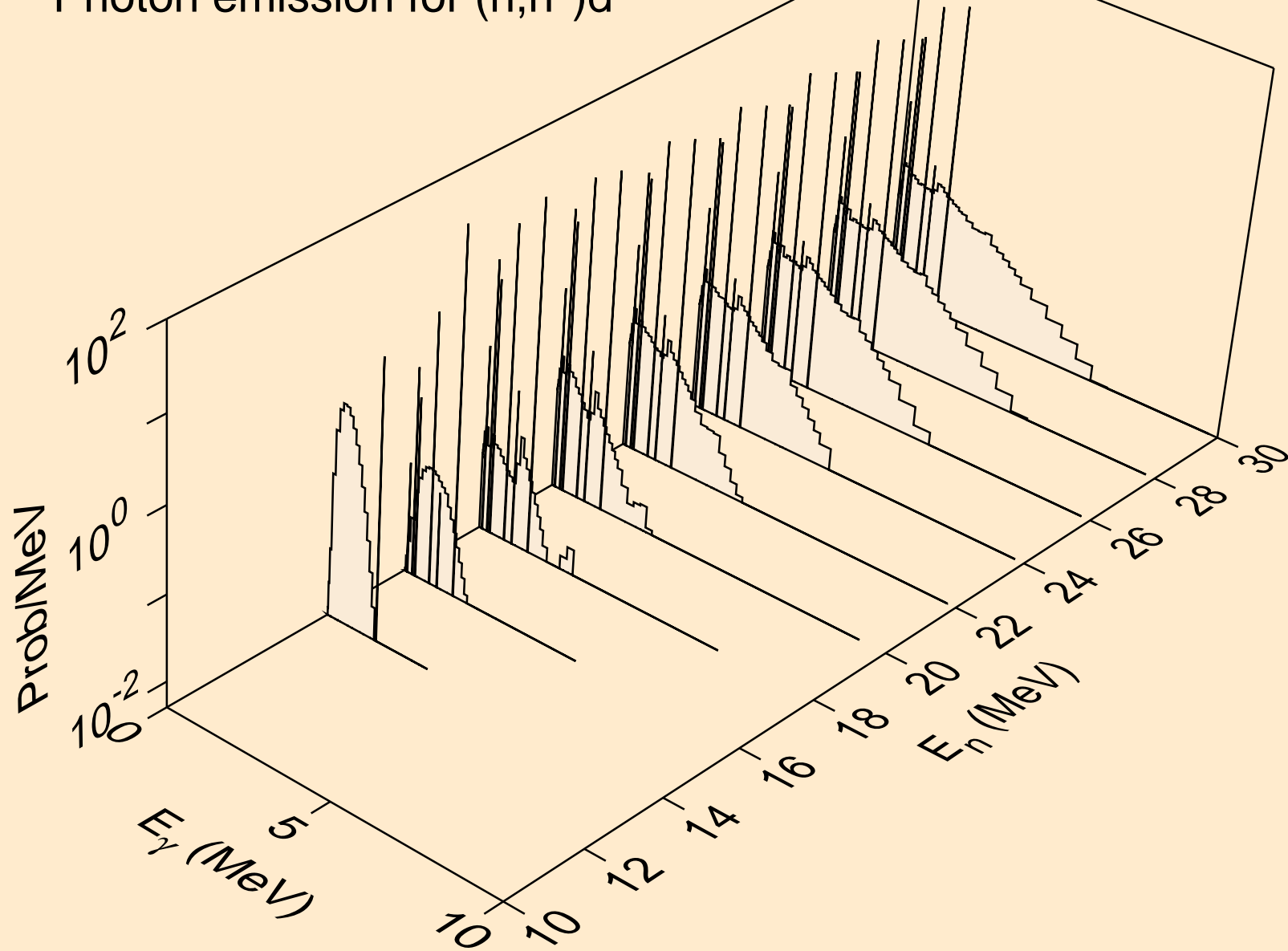

TC094M NEUTRON ACER TENDL-2023 LIBRARY; T=0.K
Photon emission for (n,n*)t

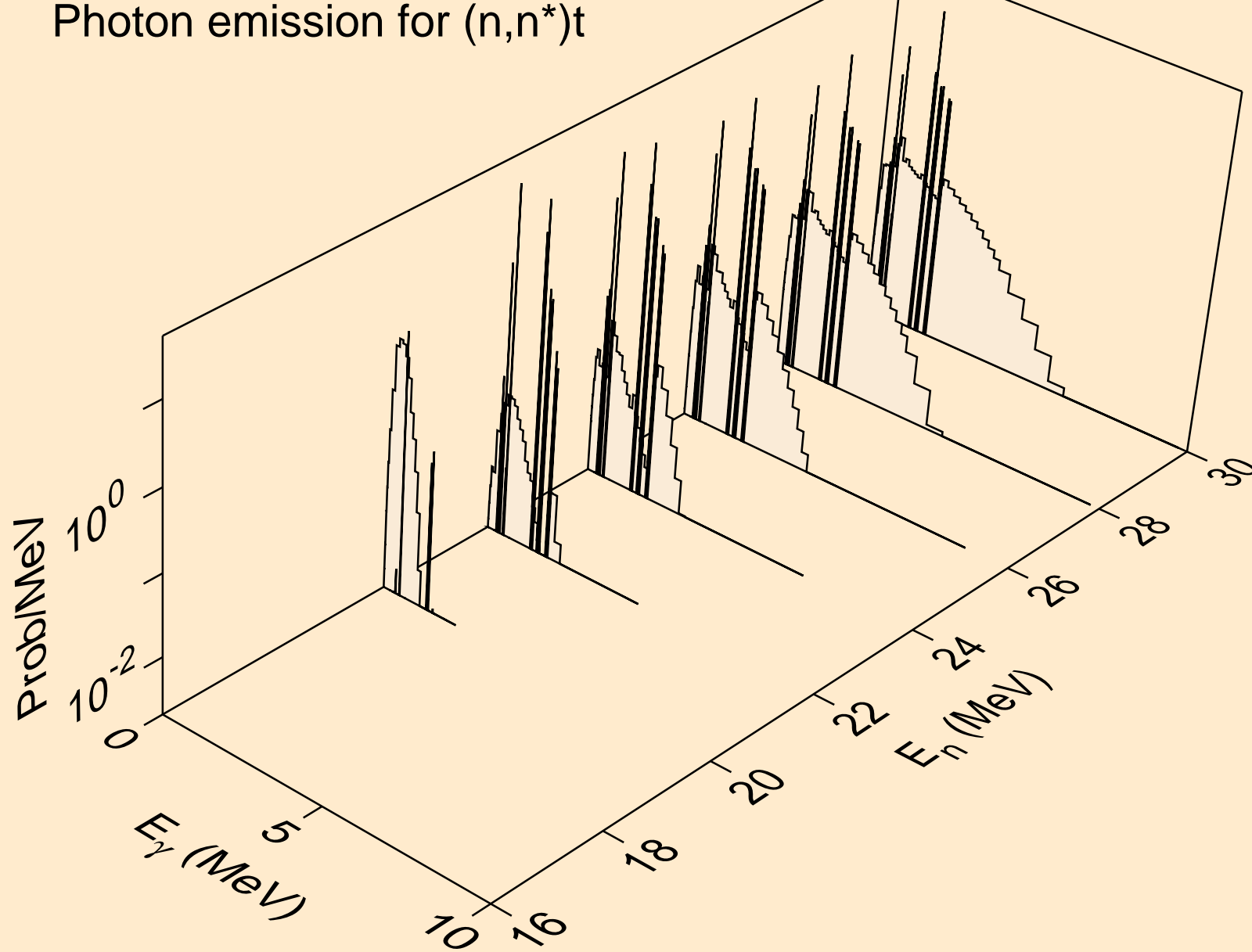

TC094M NEUTRON ACER TENDL-2023 LIBRARY; T=0.K
Photon emission for (n,n*)he3

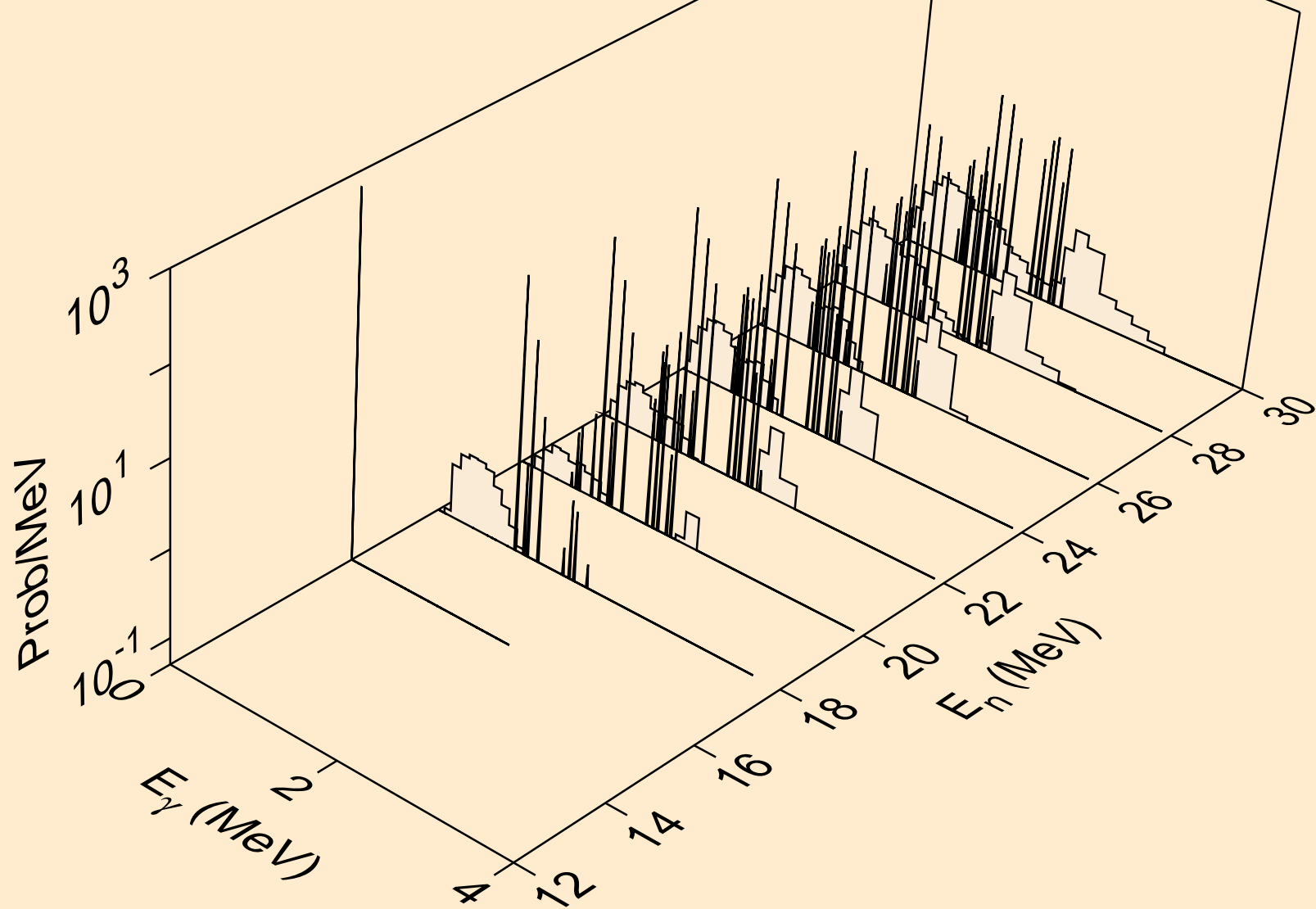

TC094M NEUTRON ACER TENDL-2023 LIBRARY; T=0.K
Photon emission for (n,2np)

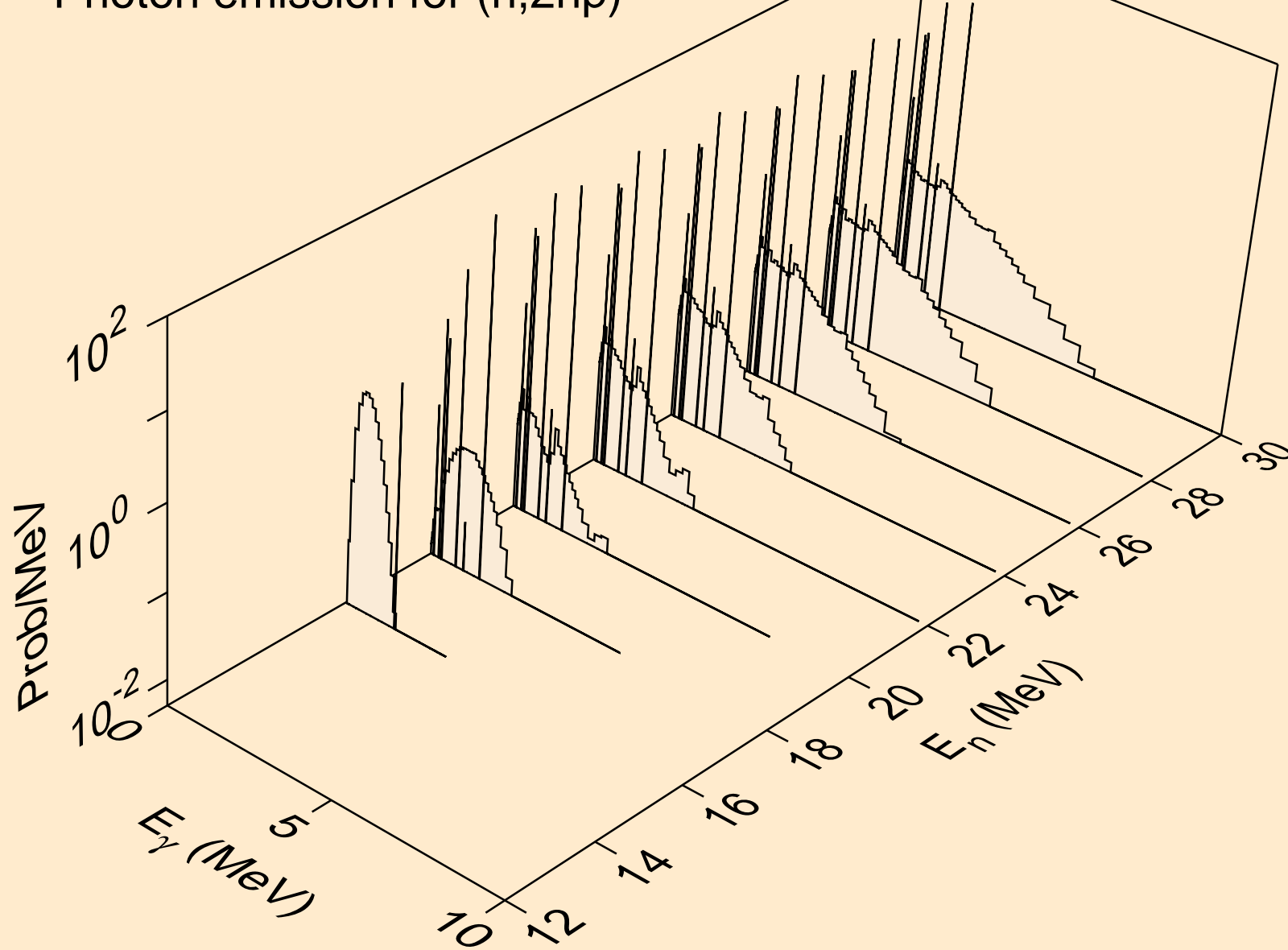

TC094M NEUTRON ACER TENDL-2023 LIBRARY; T=0.K
Photon emission for (n,3np)

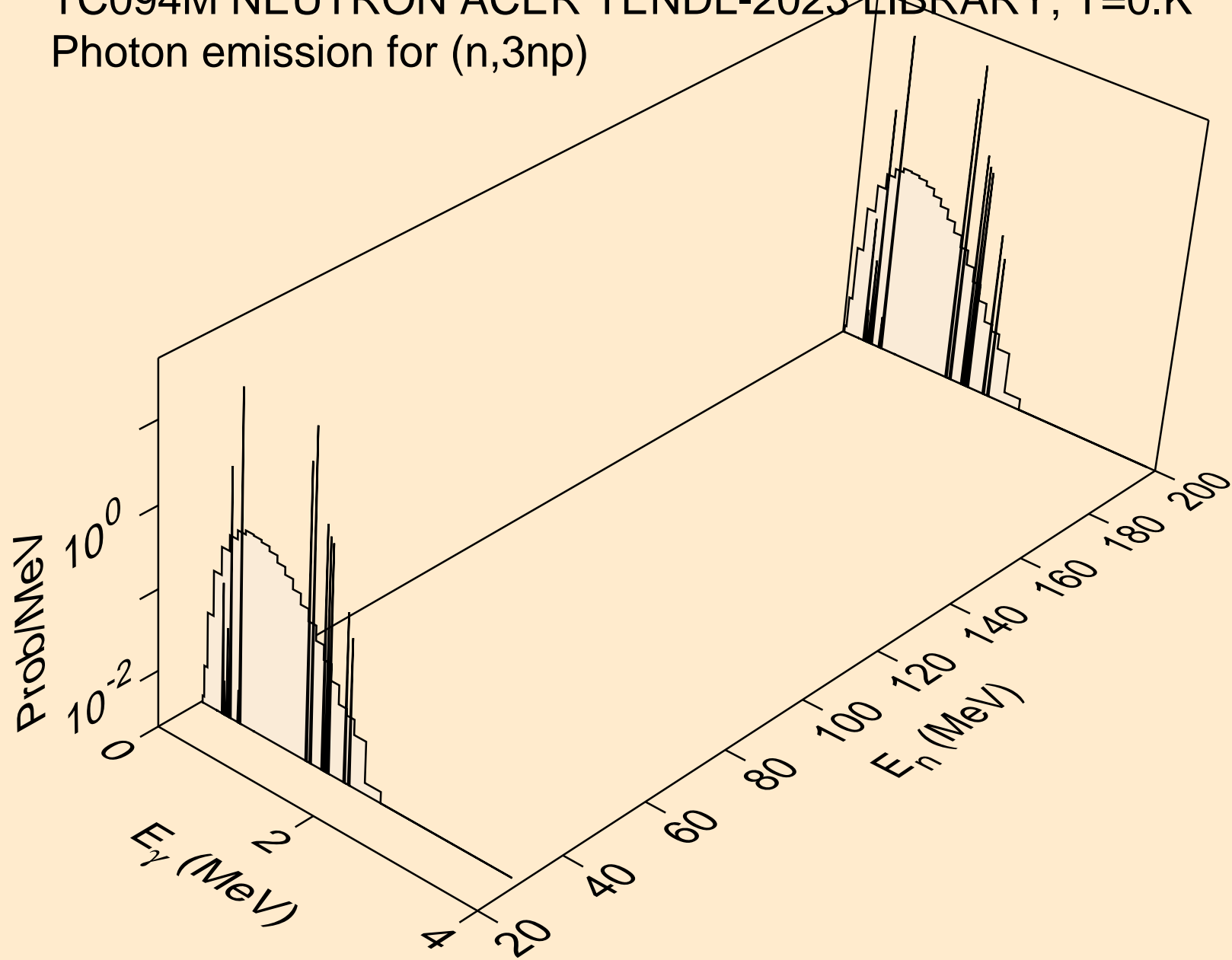

TC094M NEUTRON ACER TENDL-2023 LIBRARY; T=0.K
Photon emission for (n,n2p)

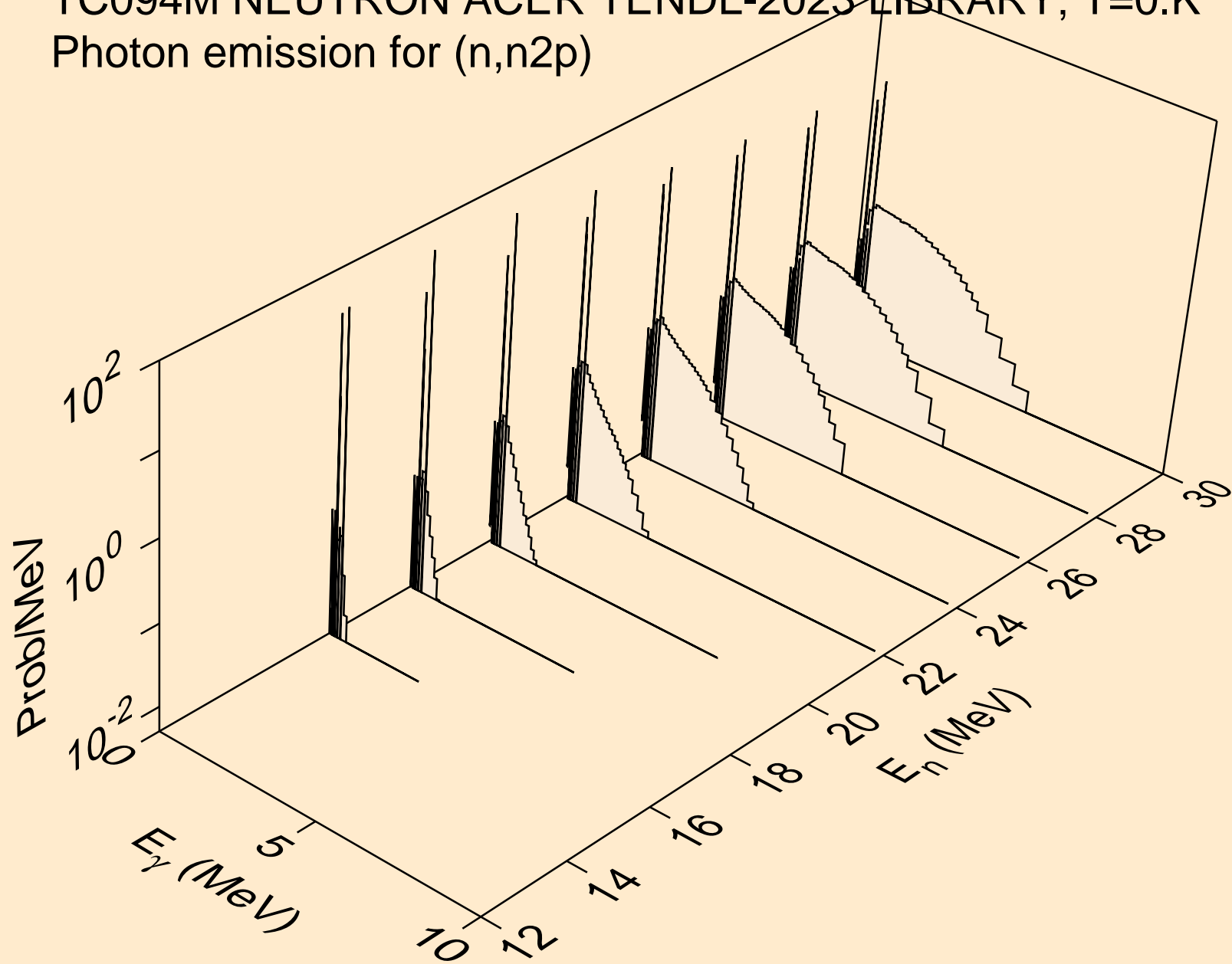

TC094M NEUTRON ACER TENDL-2023 LIBRARY; T=0.K
Photon emission for (n,npa)

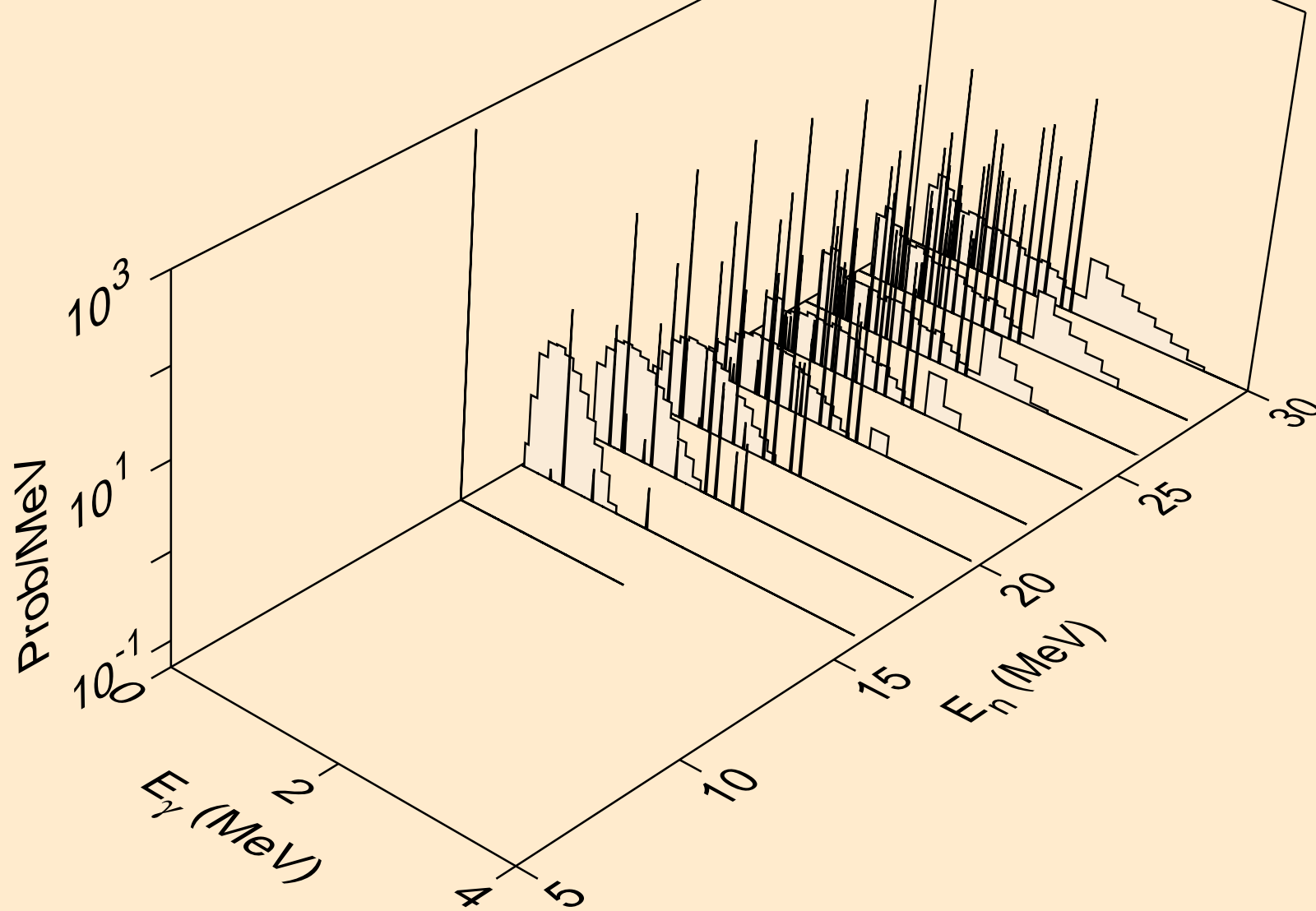

TC094M NEUTRON ACER TENDL-2023 LIBRARY; T=0.K
Photon emission for (n,n*2)

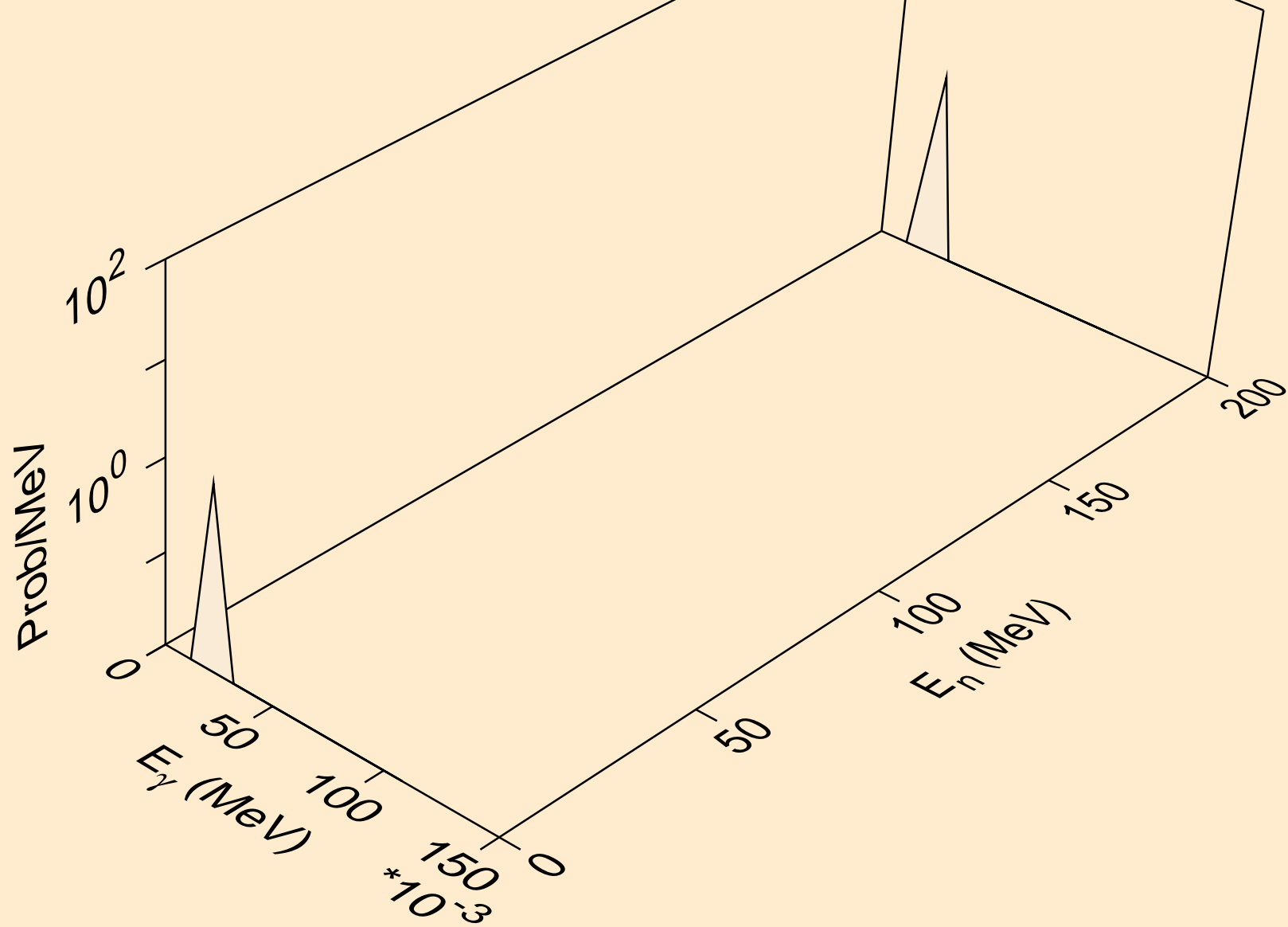

TC094M NEUTRON ACER TENDL-2023 LIBRARY; T=0.K
Photon emission for (n,n*3)

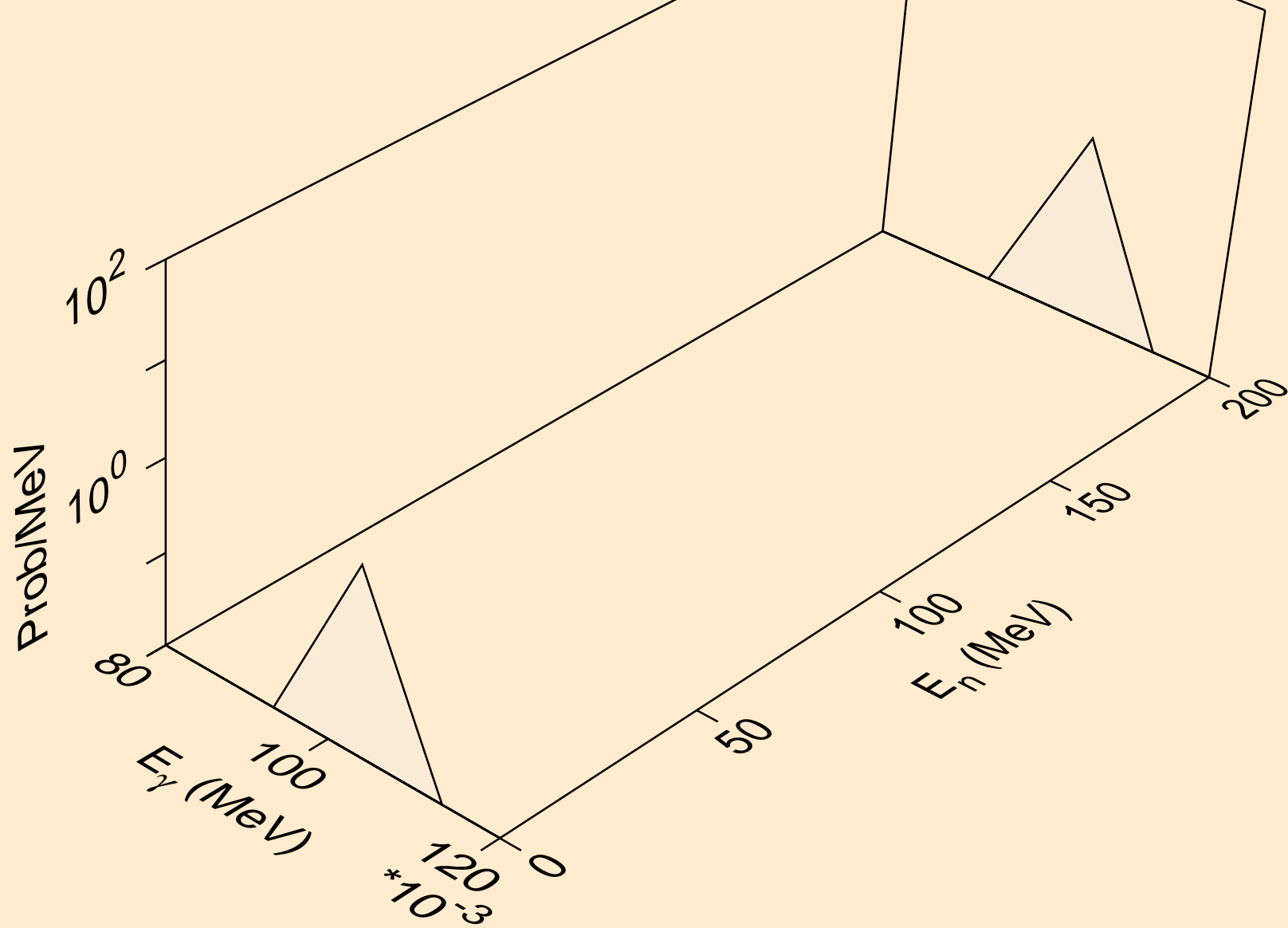

TC094M NEUTRON ACER TENDL-2023 LIBRARY; T=0.K
Photon emission for (n,n*4)

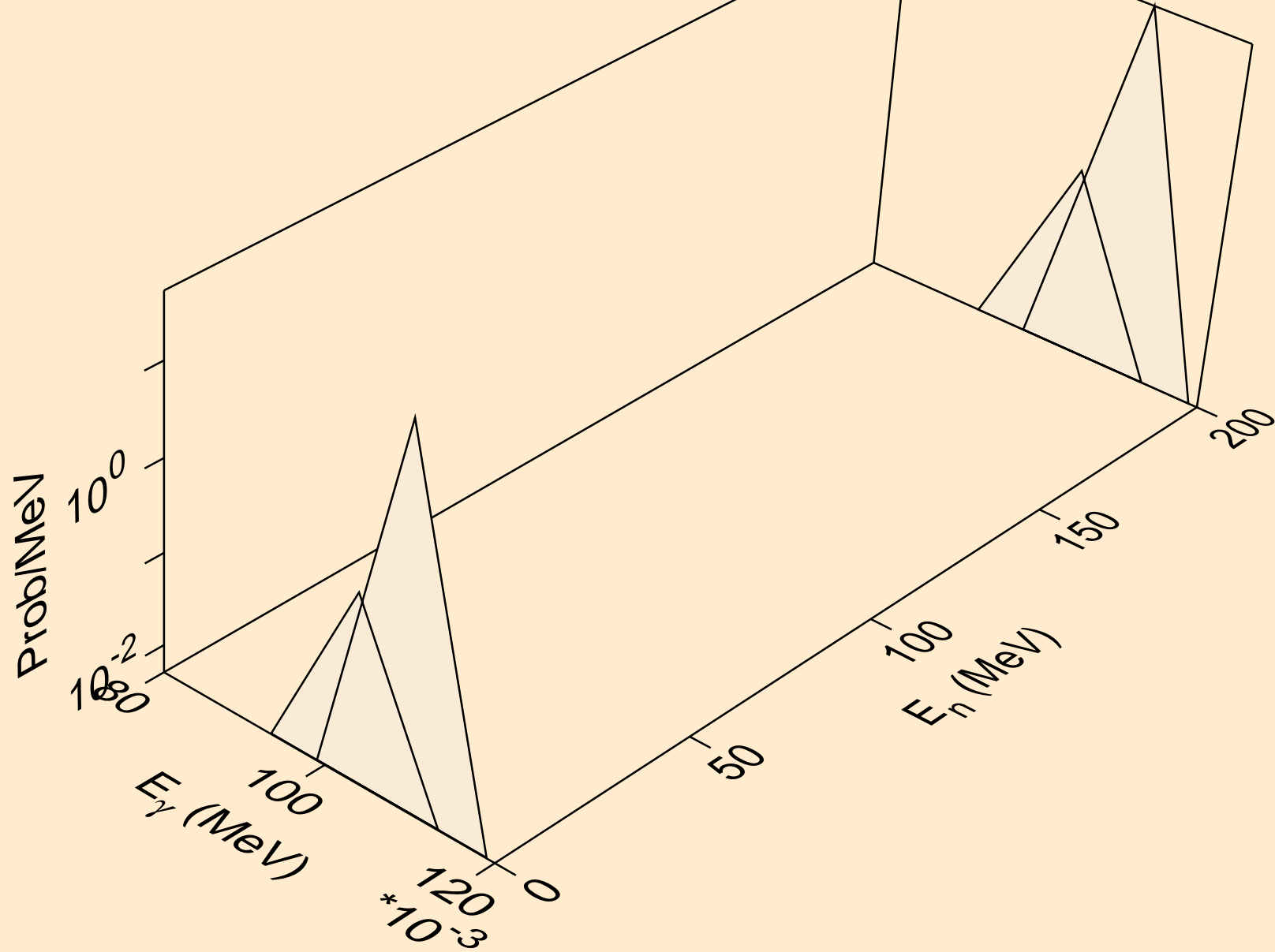

TC094M NEUTRON ACER TENDL-2023 LIBRARY; T=0.K
Photon emission for (n,n*5)

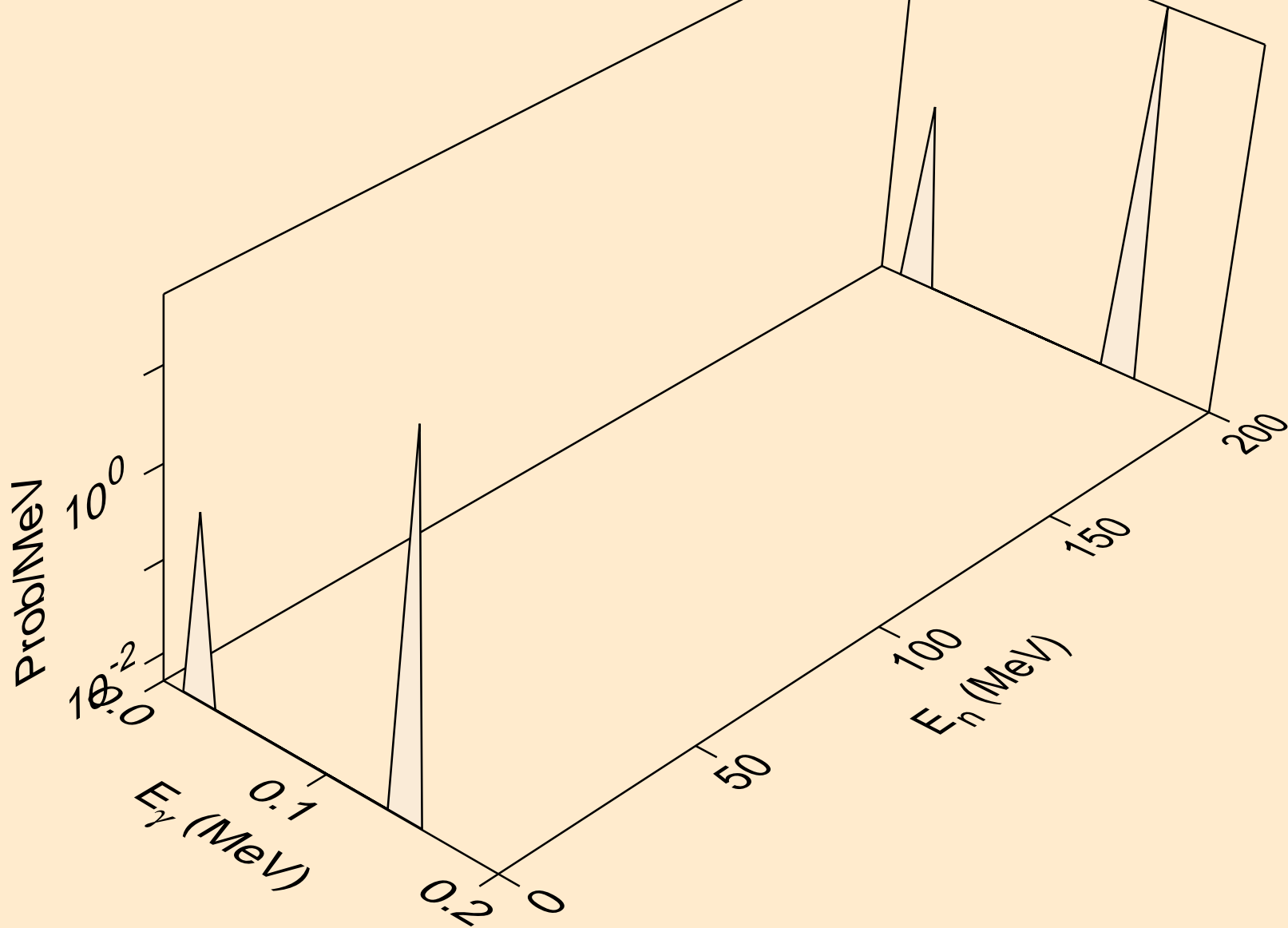

TC094M NEUTRON ACER TENDL-2023 LIBRARY; T=0.K
Photon emission for (n,n*6)

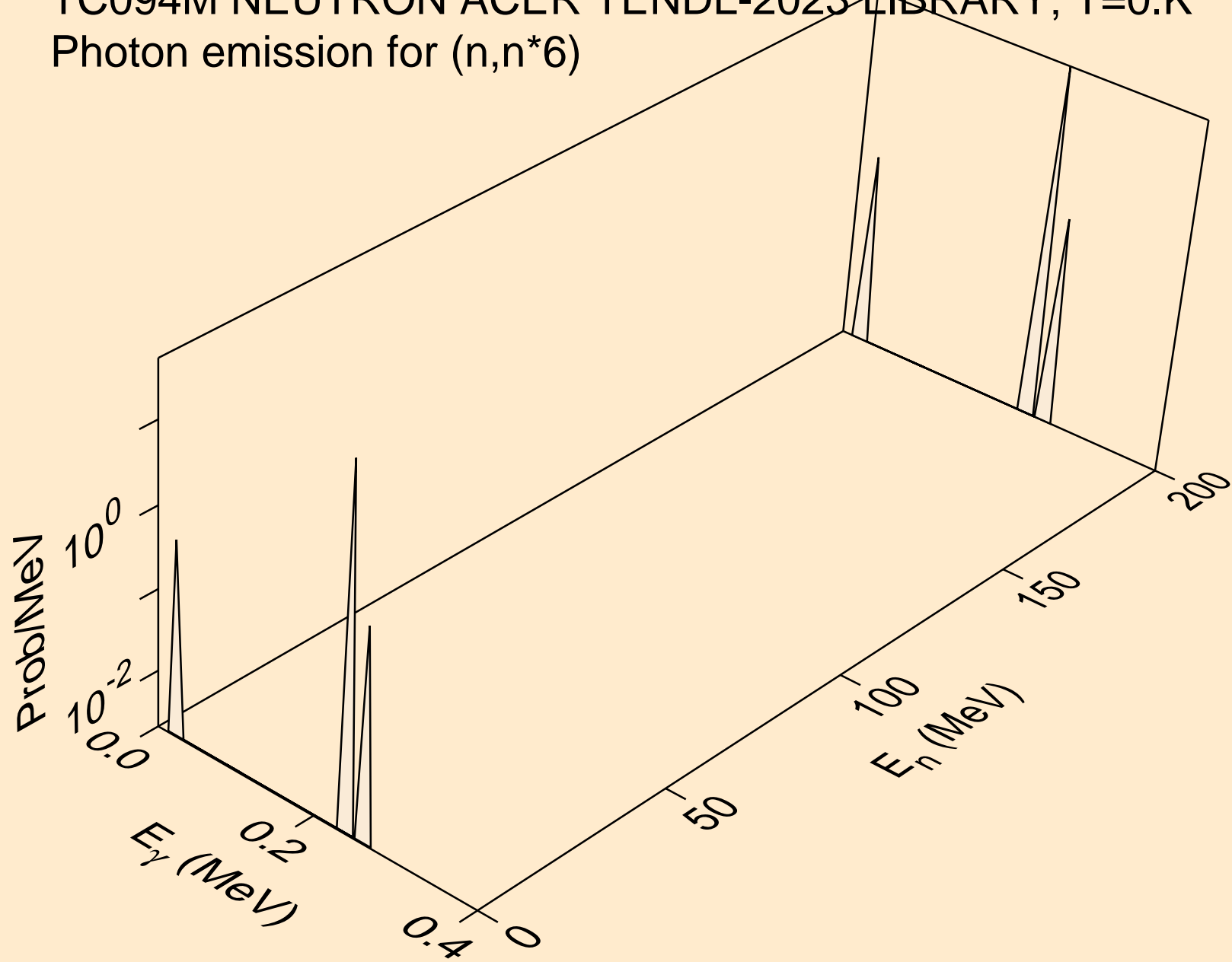

TC094M NEUTRON ACER TENDL-2023 LIBRARY; T=0.K
Photon emission for (n,n*7)

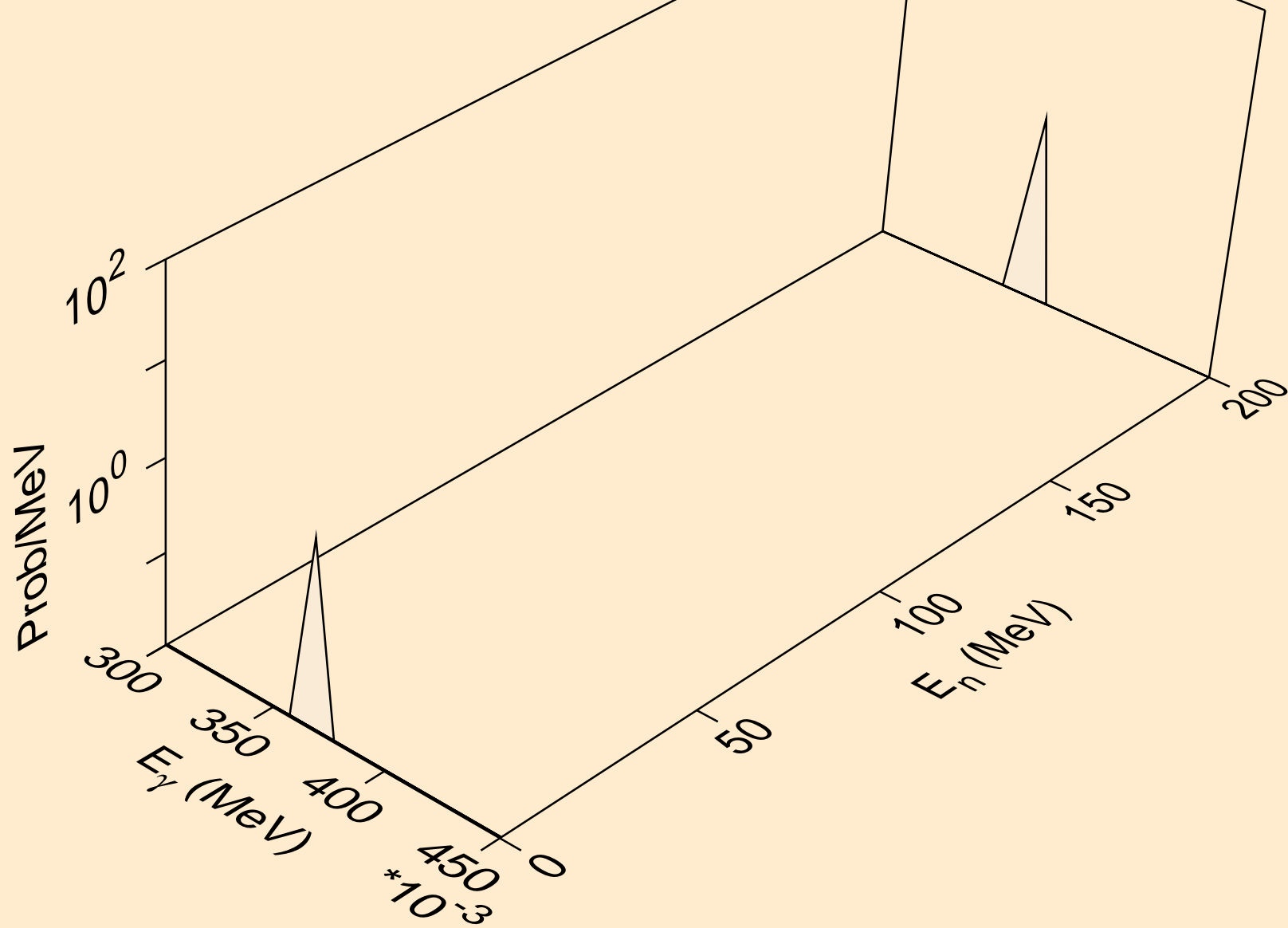

TC094M NEUTRON ACER TENDL-2023 LIBRARY; T=0.K
Photon emission for (n,n*8)

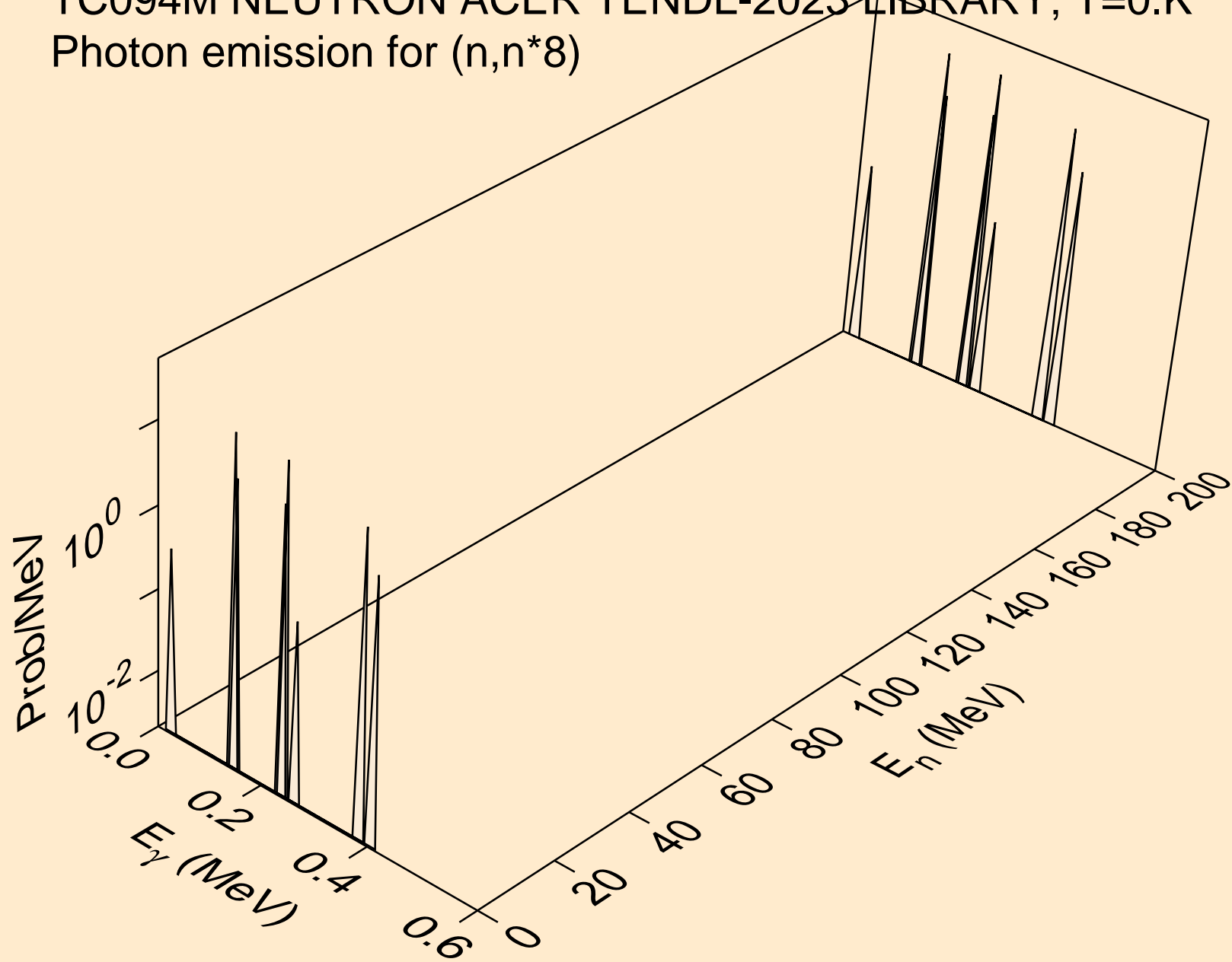

TC094M NEUTRON ACER TENDL-2023 LIBRARY; T=0.K
Photon emission for (n,n*9)

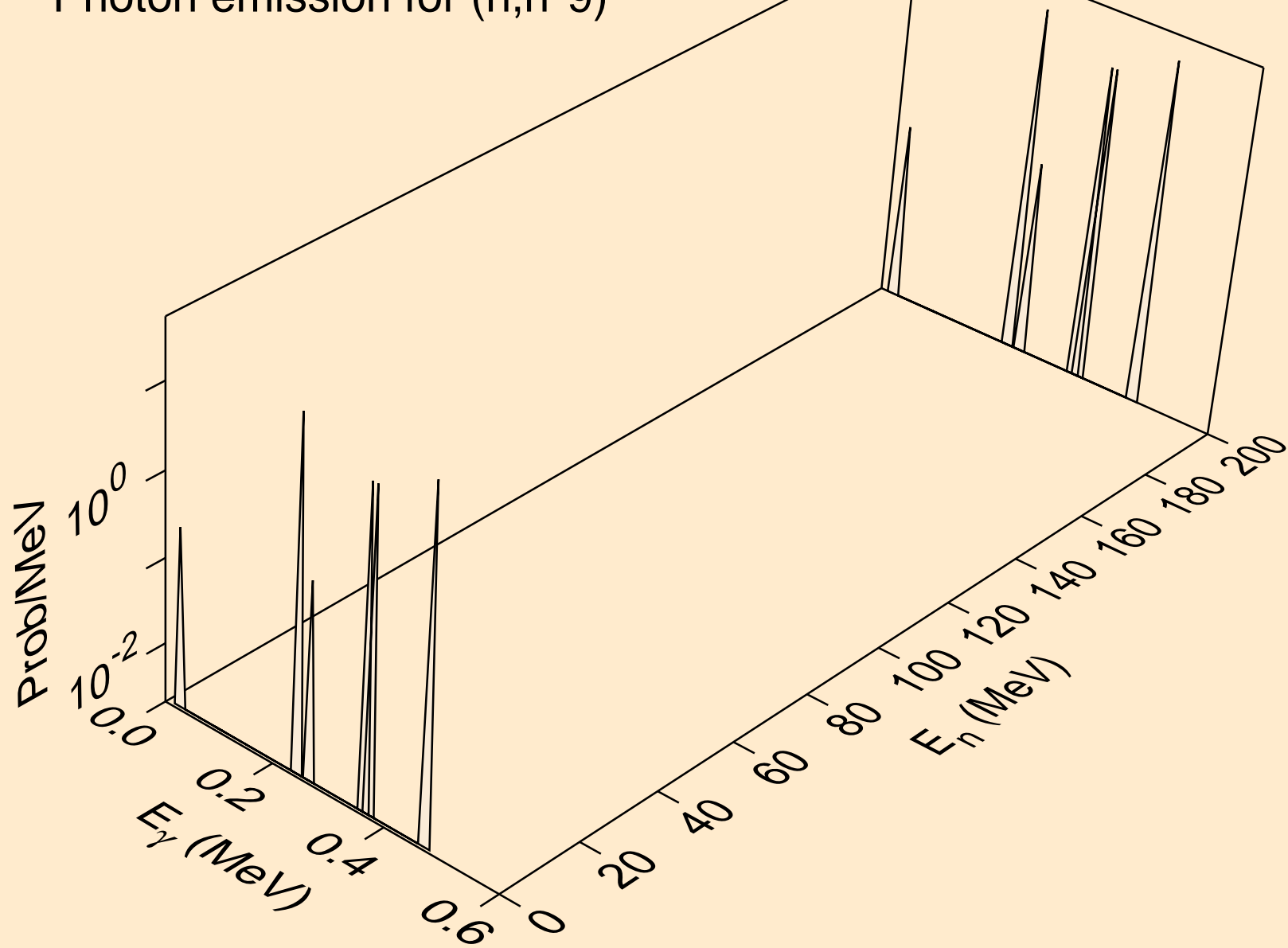

TC094M NEUTRON ACER TENDL-2023 LIBRARY; T=0.K
Photon emission for (n,n*10)

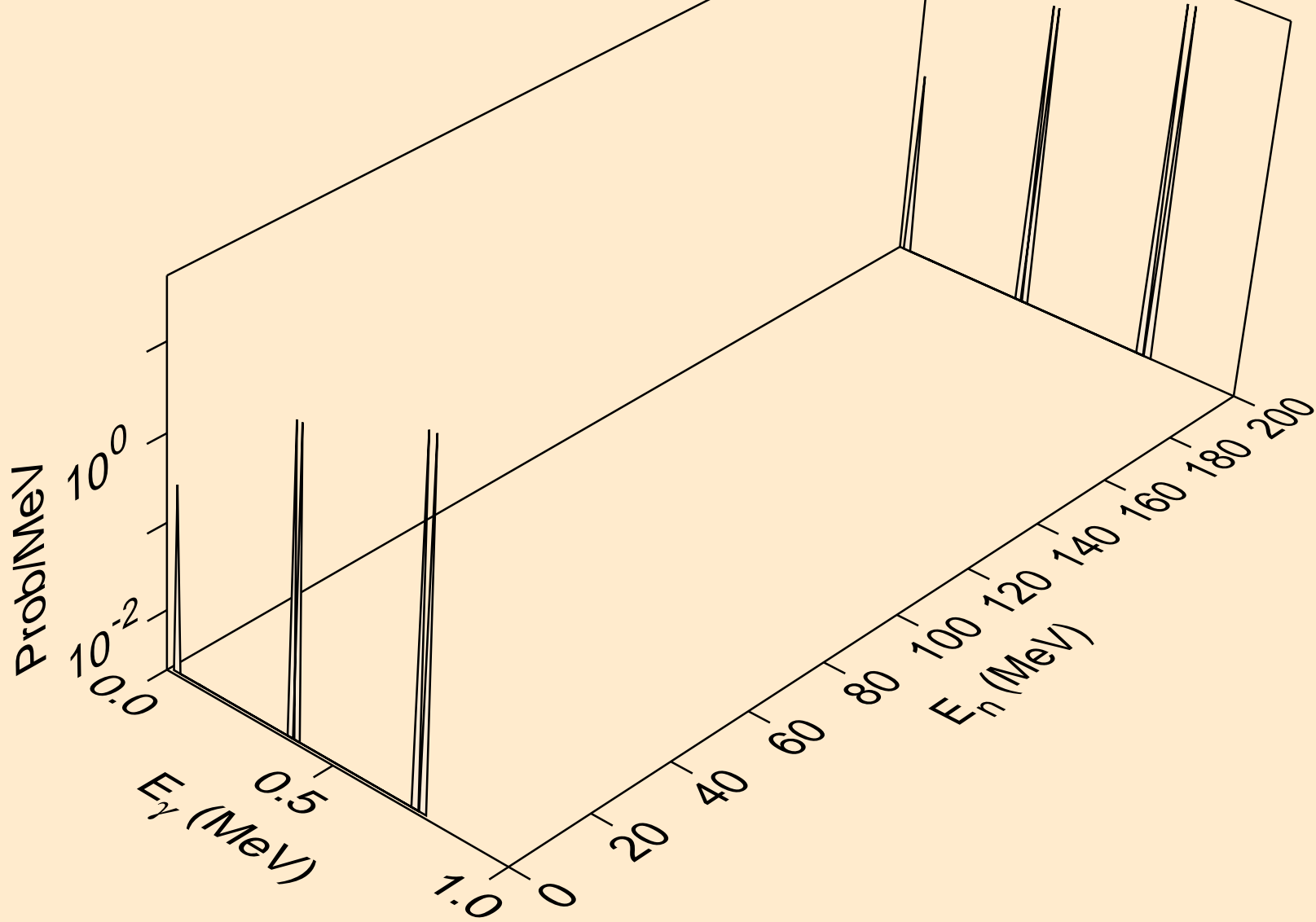

TC094M NEUTRON ACER TENDL-2023 LIBRARY; T=0.K
Photon emission for (n,n*11)

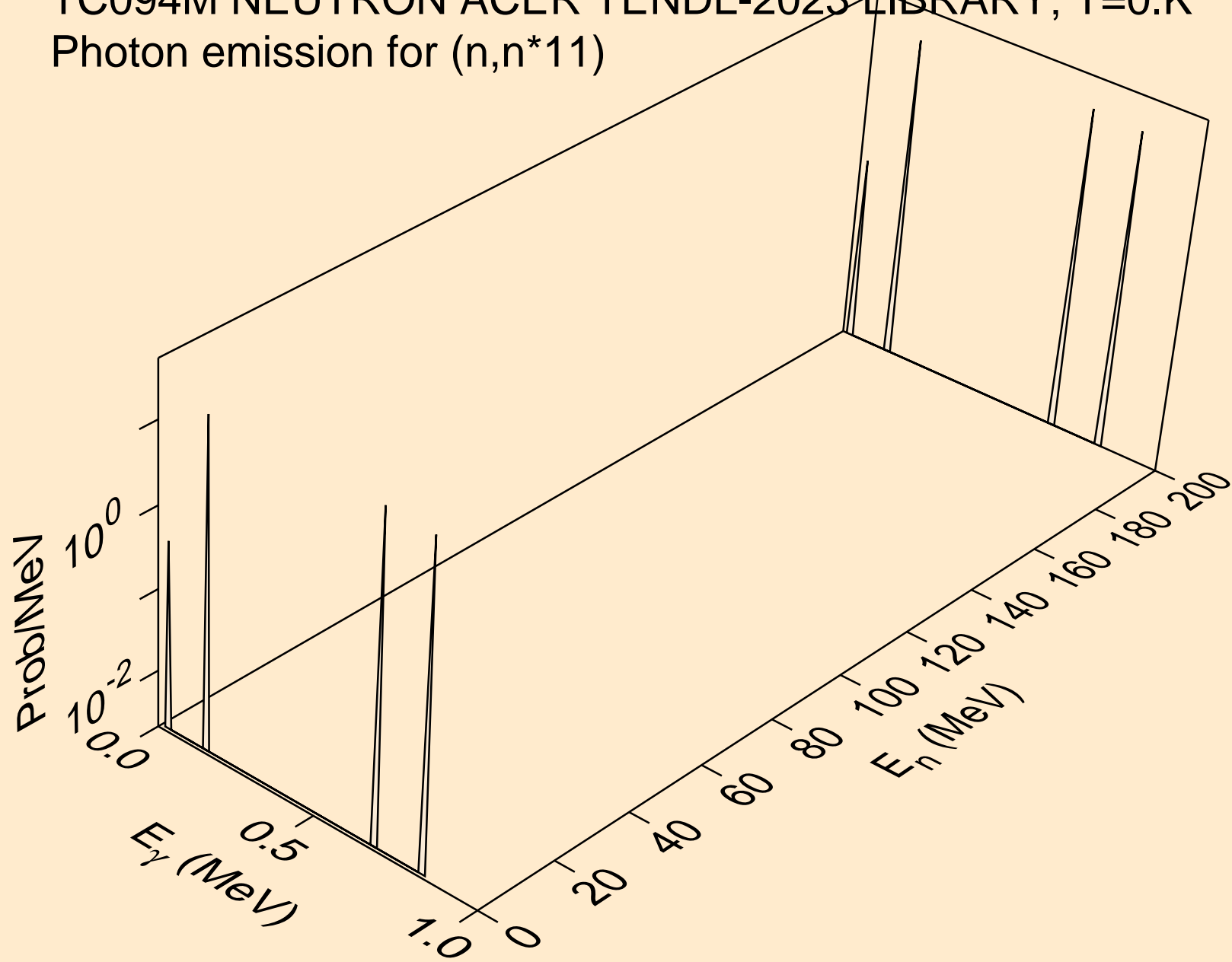

TC094M NEUTRON ACER TENDL-2023 LIBRARY; T=0.K
Photon emission for (n,n*12)

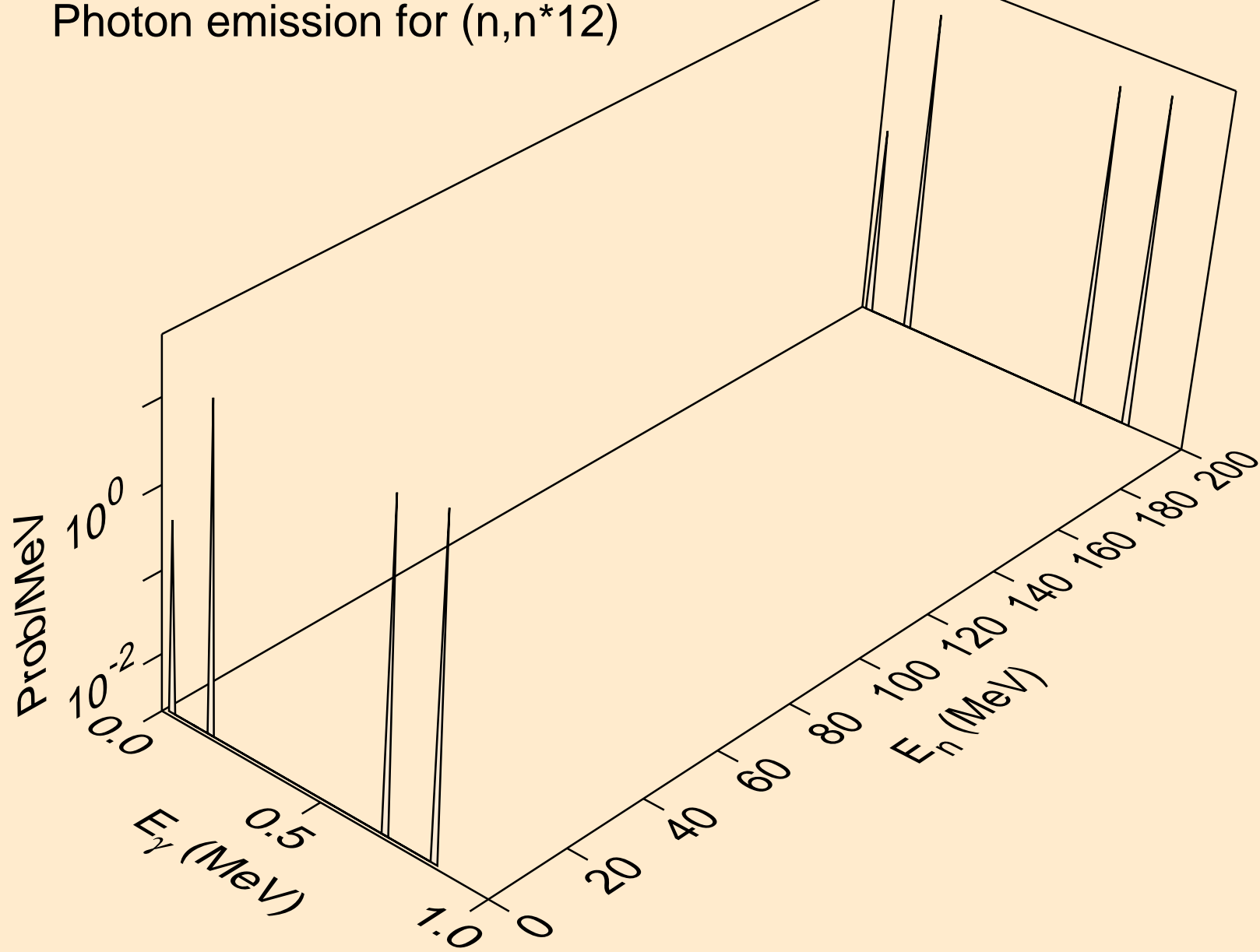

TC094M NEUTRON ACER TENDL-2023 LIBRARY; T=0.K
Photon emission for (n,n*13)

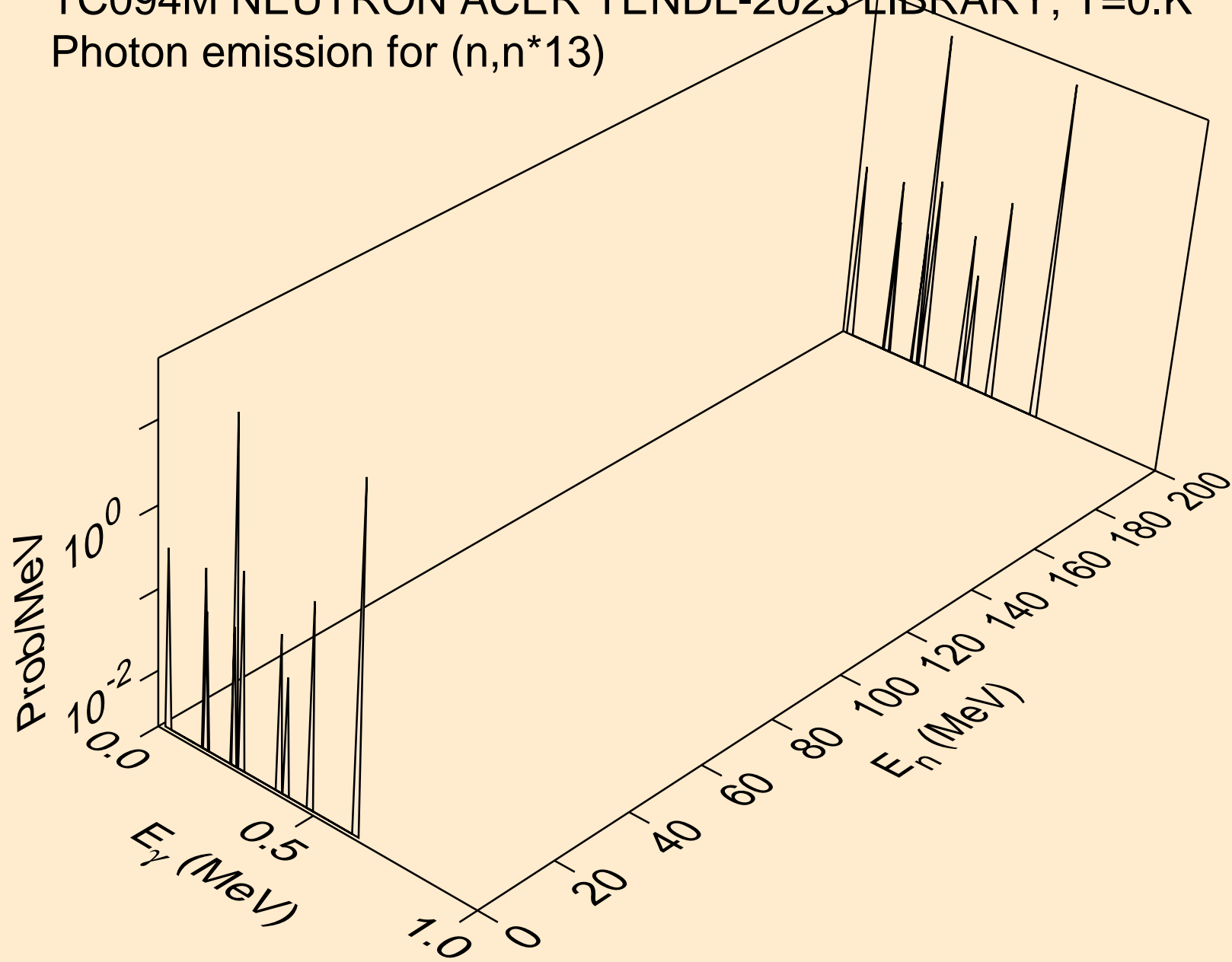

TC094M NEUTRON ACER TENDL-2023 LIBRARY; T=0.K
Photon emission for (n,n*14)

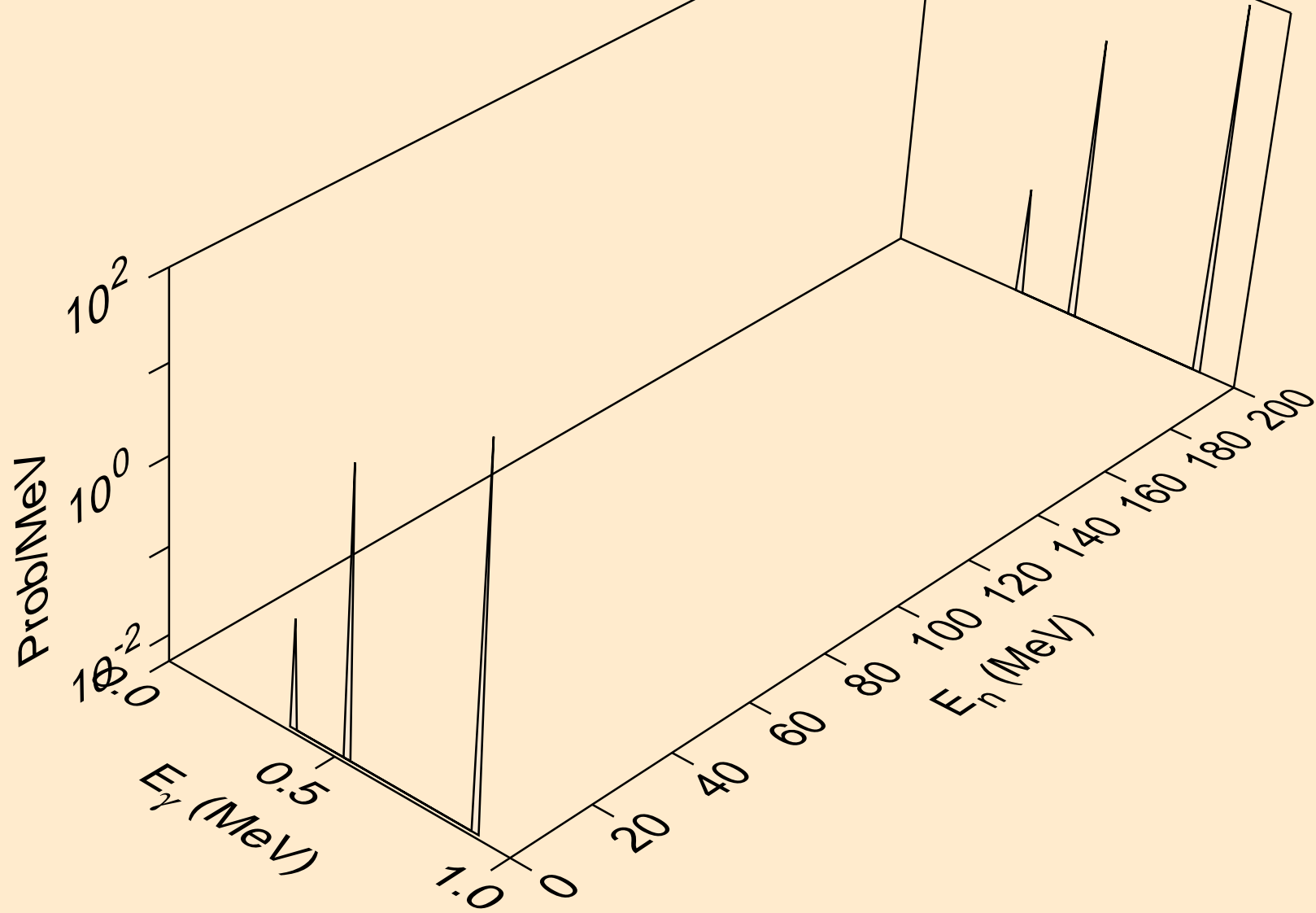

TC094M NEUTRON ACER TENDL-2023 LIBRARY; T=0.K
Photon emission for (n,n*15)

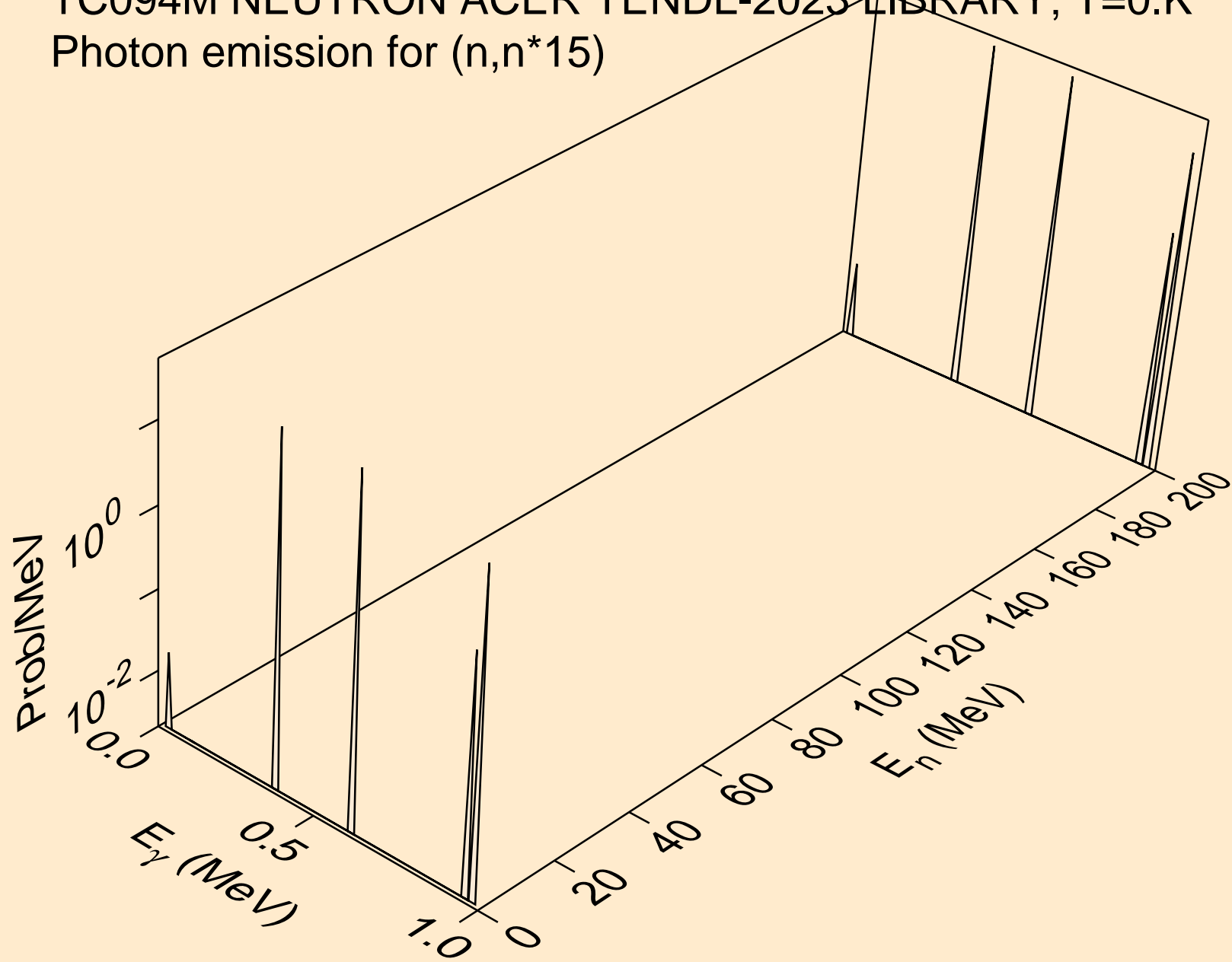

TC094M NEUTRON ACER TENDL-2023 LIBRARY; T=0.K
Photon emission for (n,n*16)

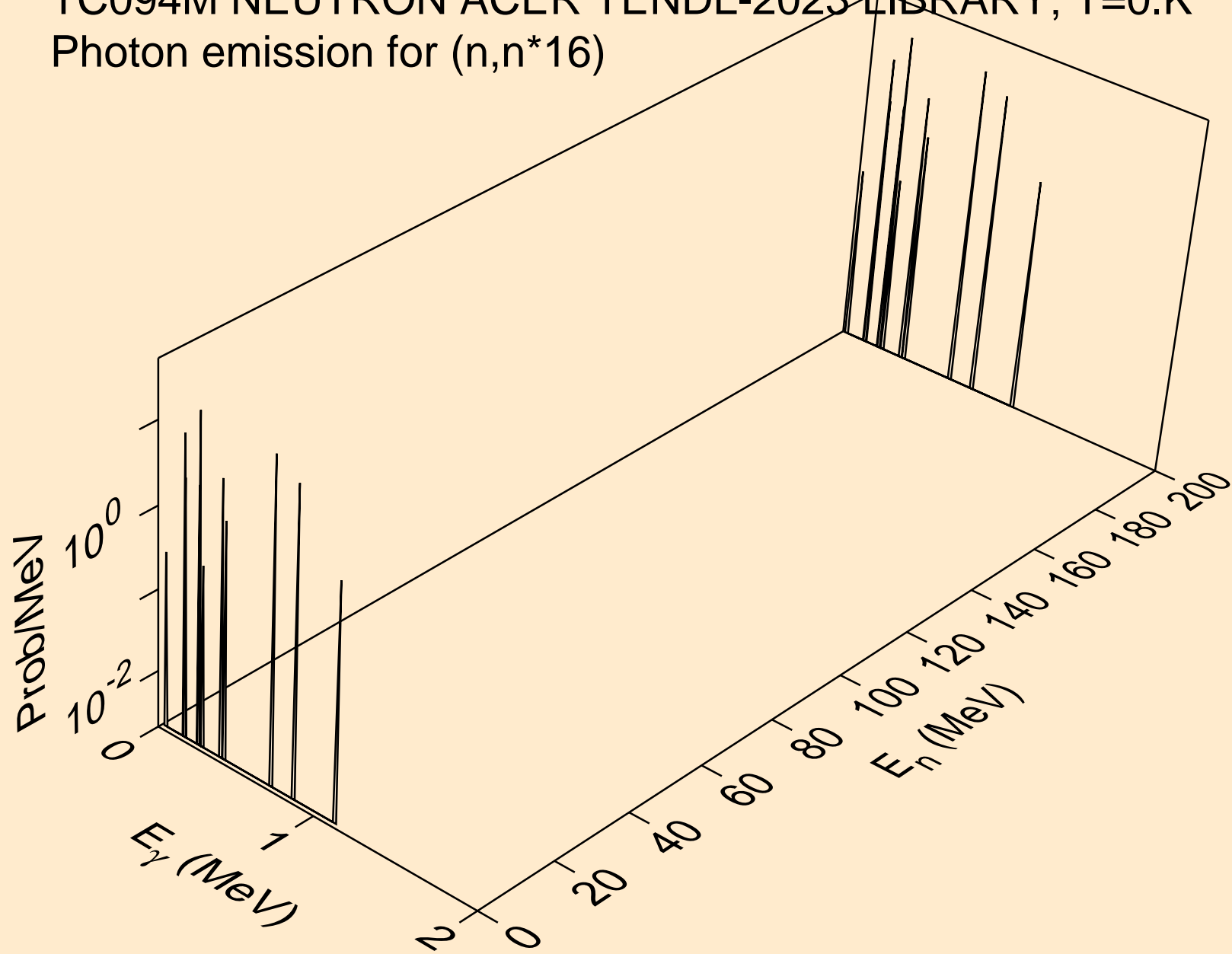

TC094M NEUTRON ACER TENDL-2023 LIBRARY; T=0.K
Photon emission for (n,n*17)

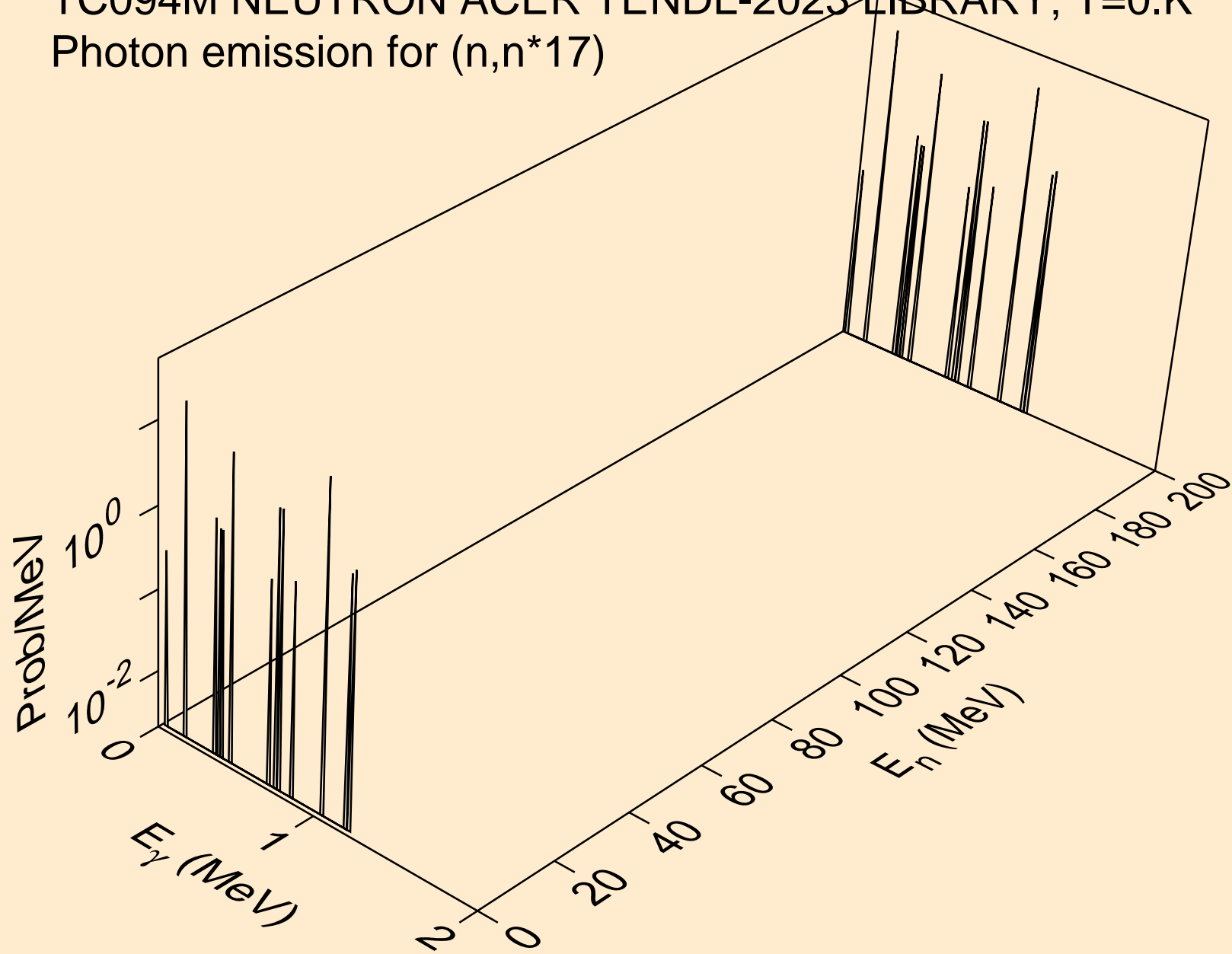

TC094M NEUTRON ACER TENDL-2023 LIBRARY; T=0.K
Photon emission for (n,n*18)

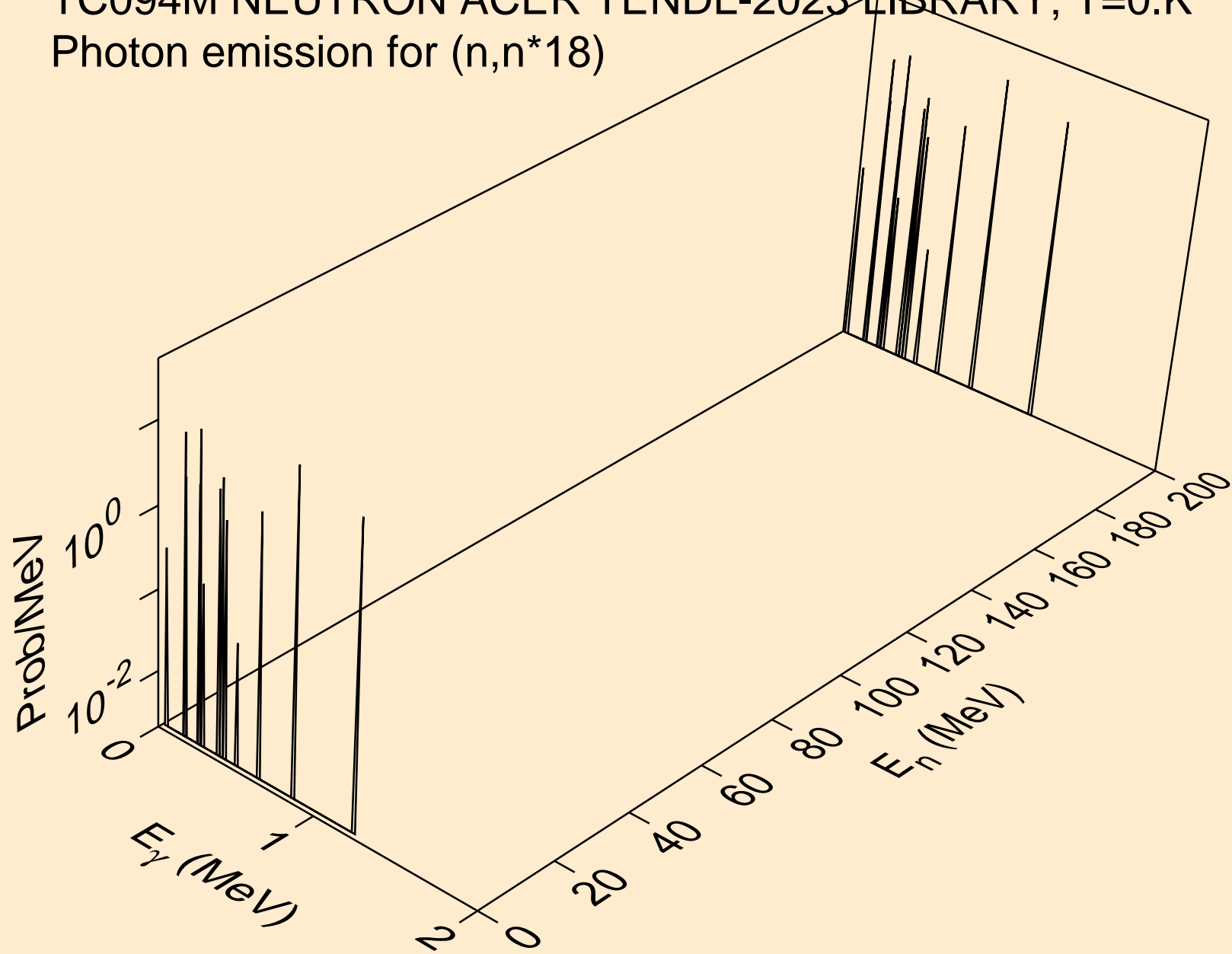

TC094M NEUTRON ACER TENDL-2023 LIBRARY; T=0.K
Photon emission for (n,n*19)

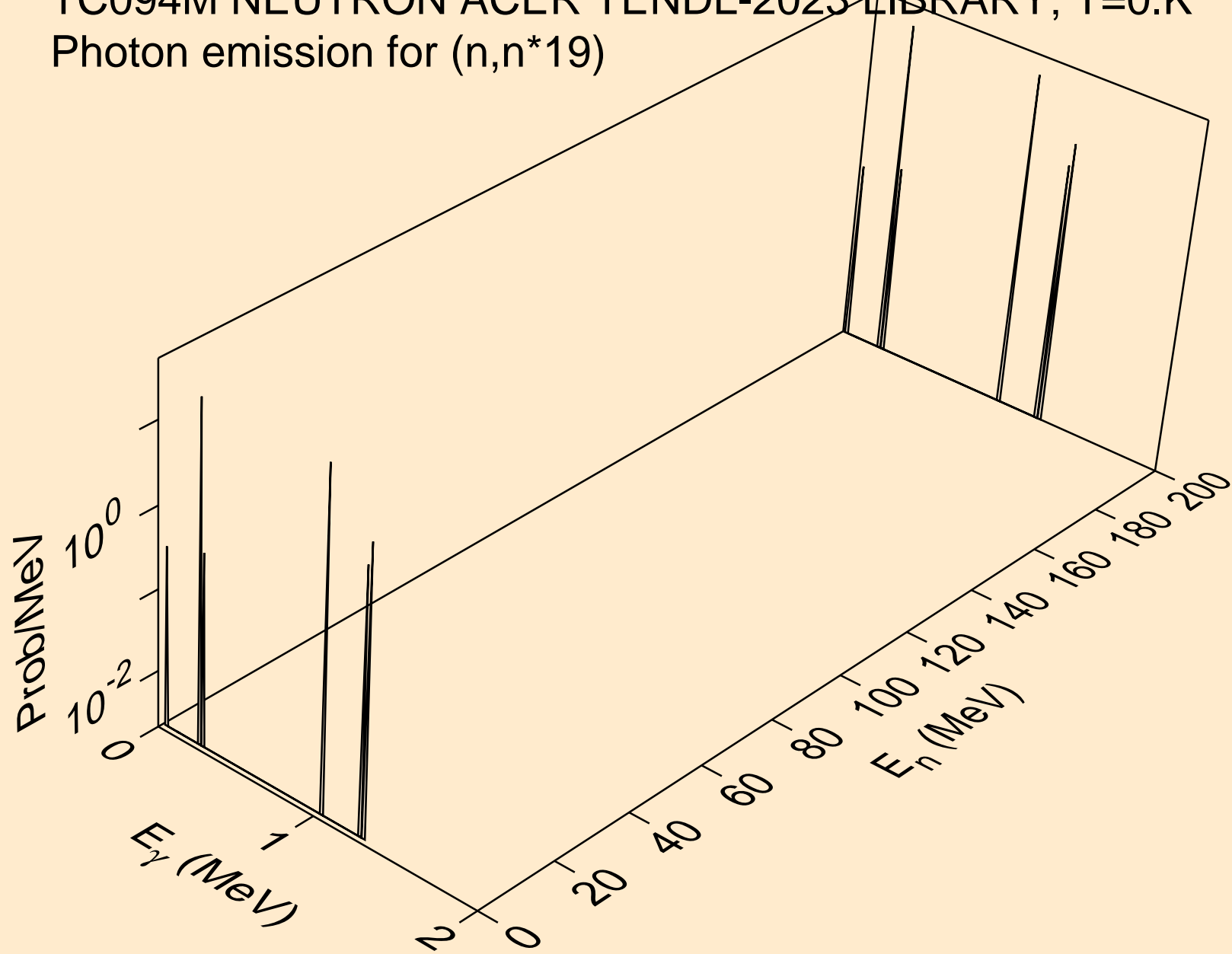

TC094M NEUTRON ACER TENDL-2023 LIBRARY; T=0.K
Photon emission for (n,n*20)

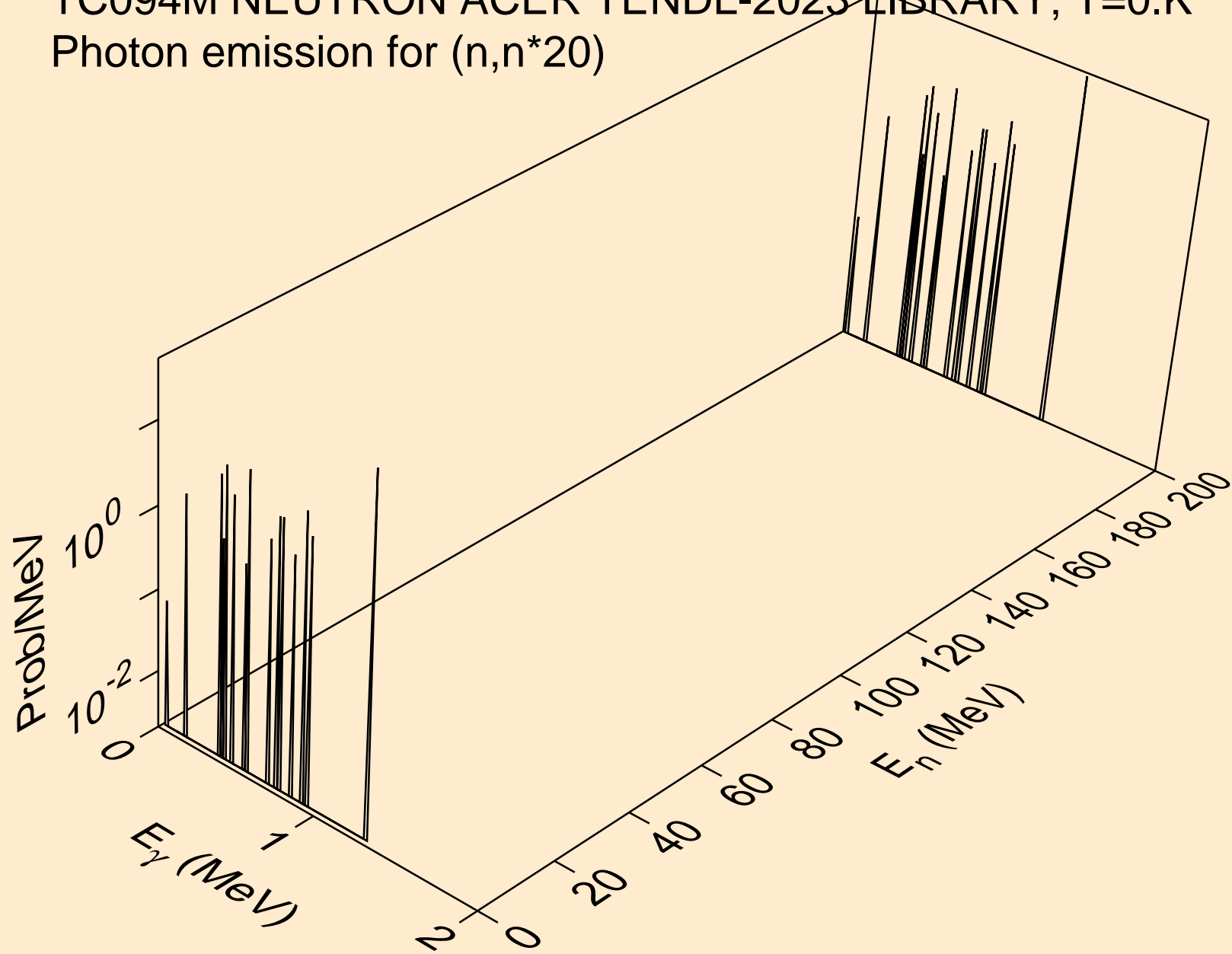

TC094M NEUTRON ACER TENDL-2023 LIBRARY; T=0.K
Photon emission for (n,n*c)

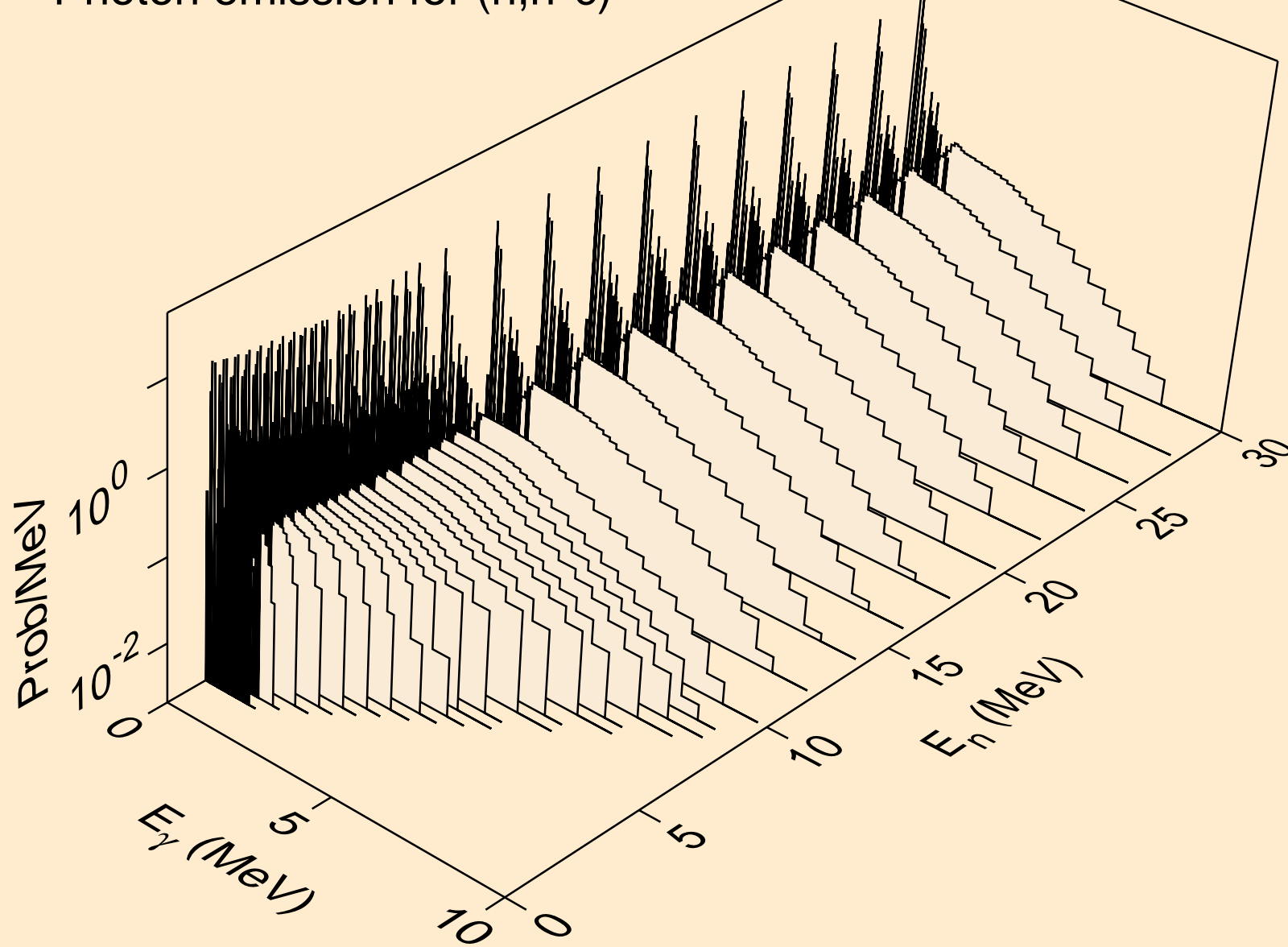

TC094M NEUTRON ACER TENDL-2023 LIBRARY; T=0.K
Photon emission for (n,gma)

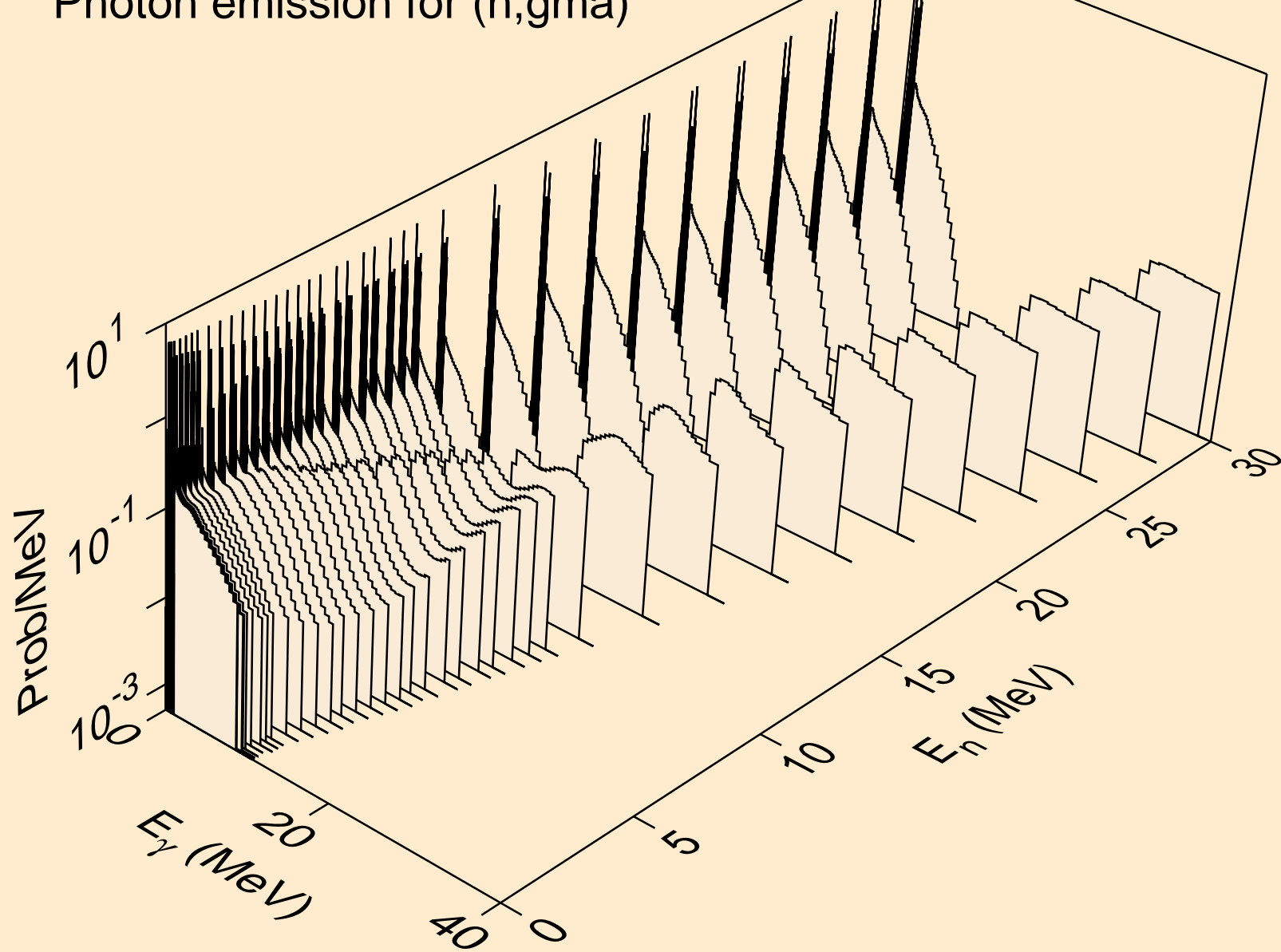

TC094M NEUTRON ACER TENDL-2023 LIBRARY; T=0.K
Photon emission for (n,p)

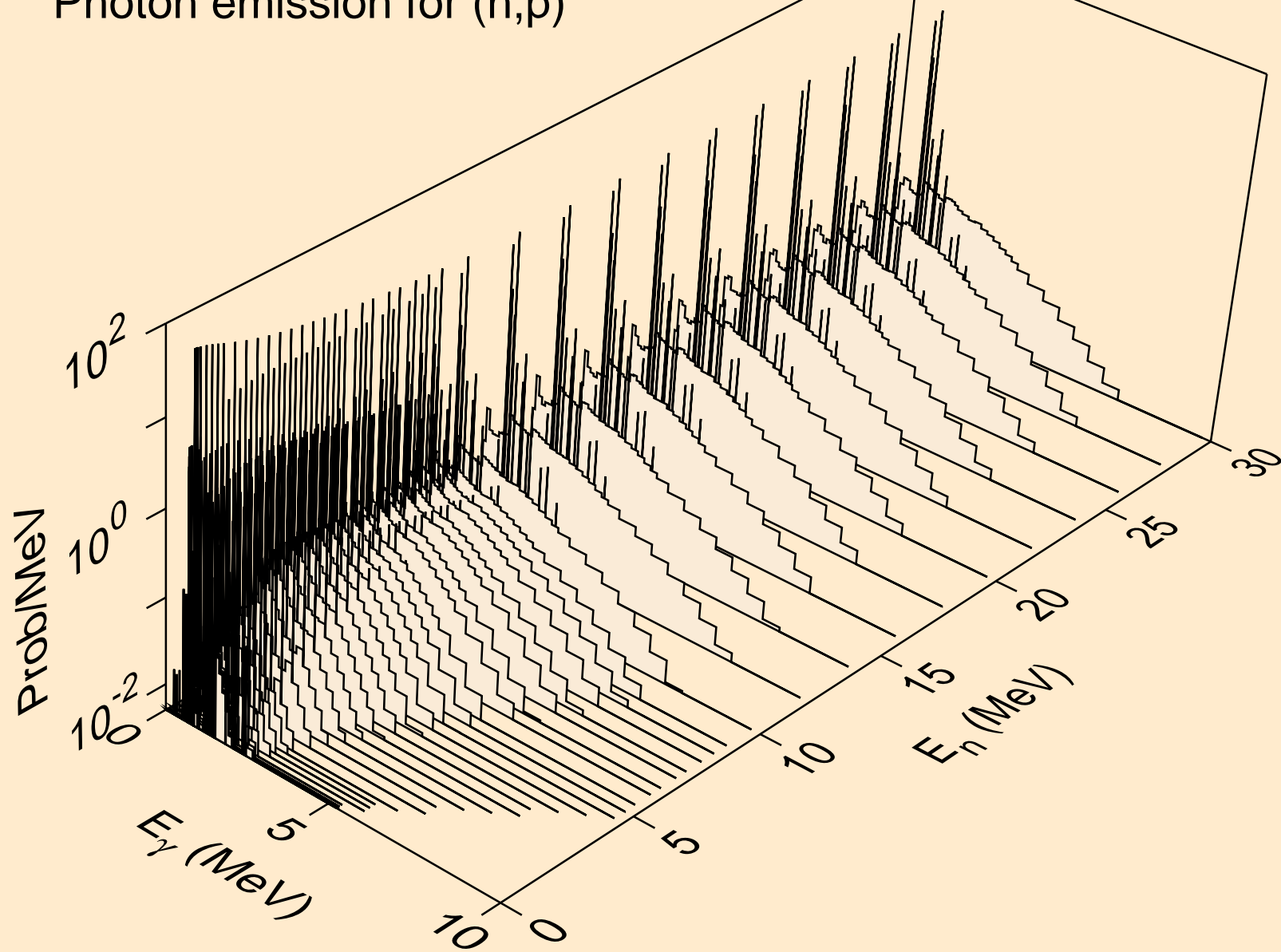

TC094M NEUTRON ACER TENDL-2023 LIBRARY; T=0.K
Photon emission for (n,d)

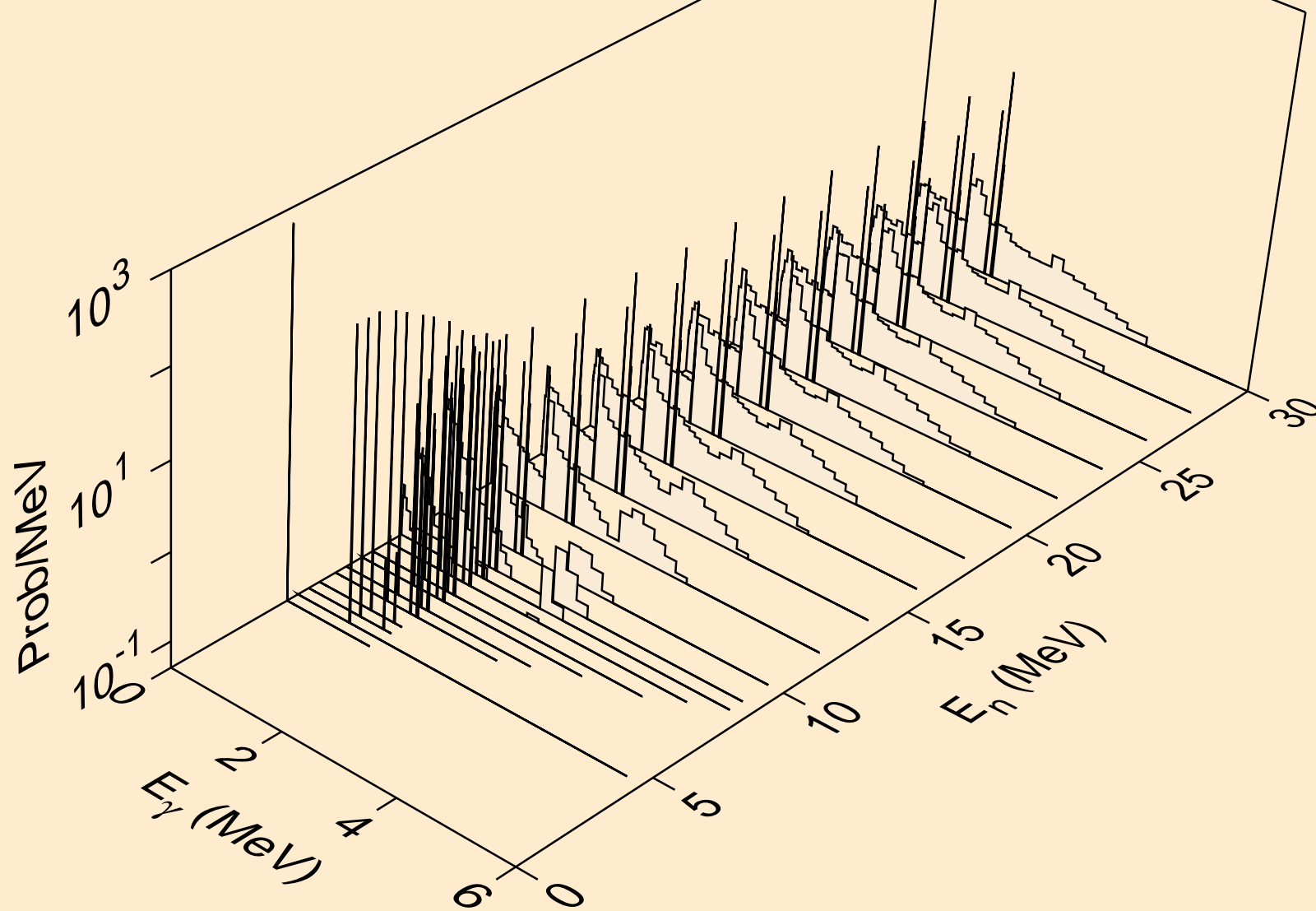

TC094M NEUTRON ACER TENDL-2023 LIBRARY; T=0.K
Photon emission for (n,t)

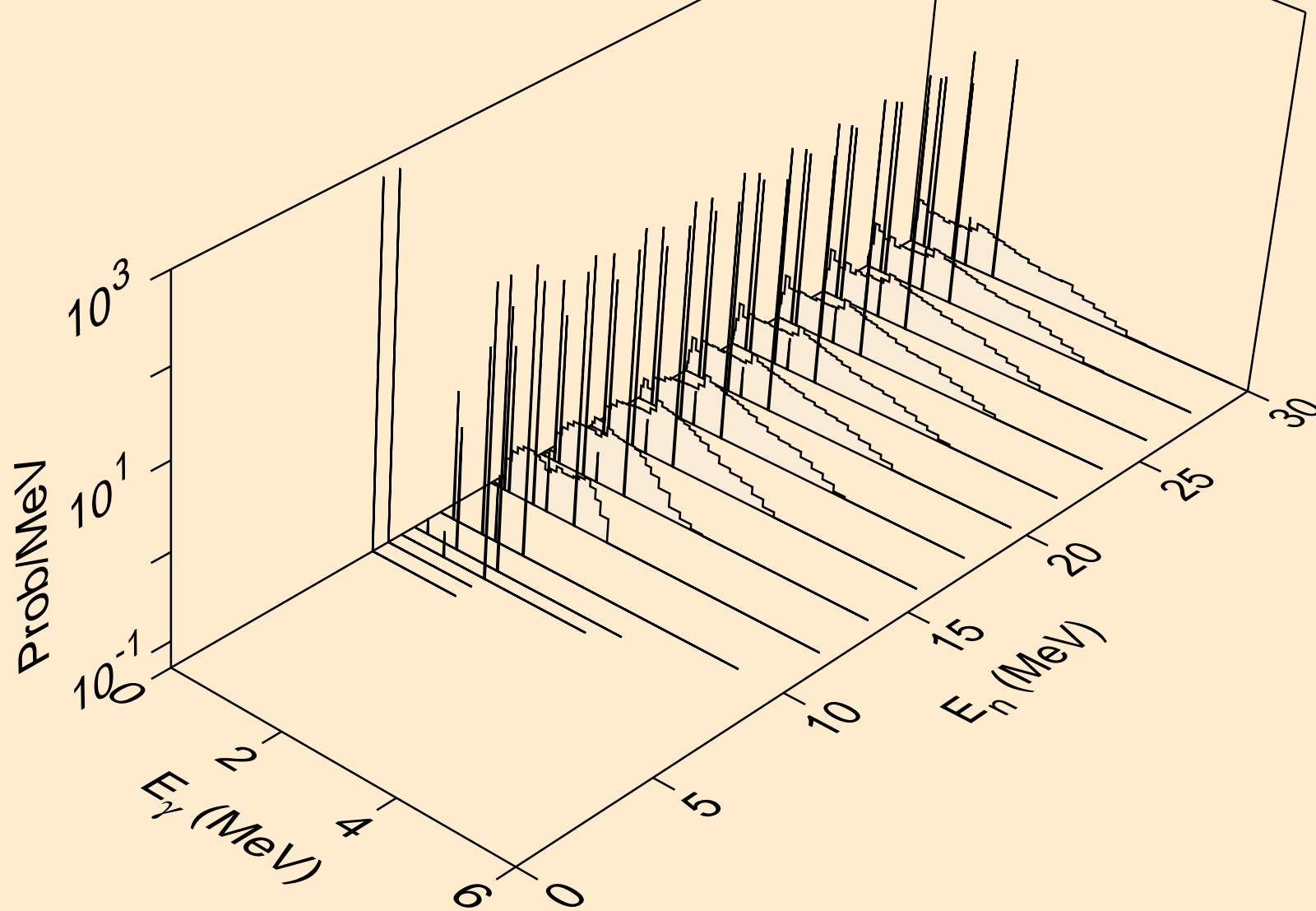

TC094M NEUTRON ACER TENDL-2023 LIBRARY; T=0.K
Photon emission for (n,he3)

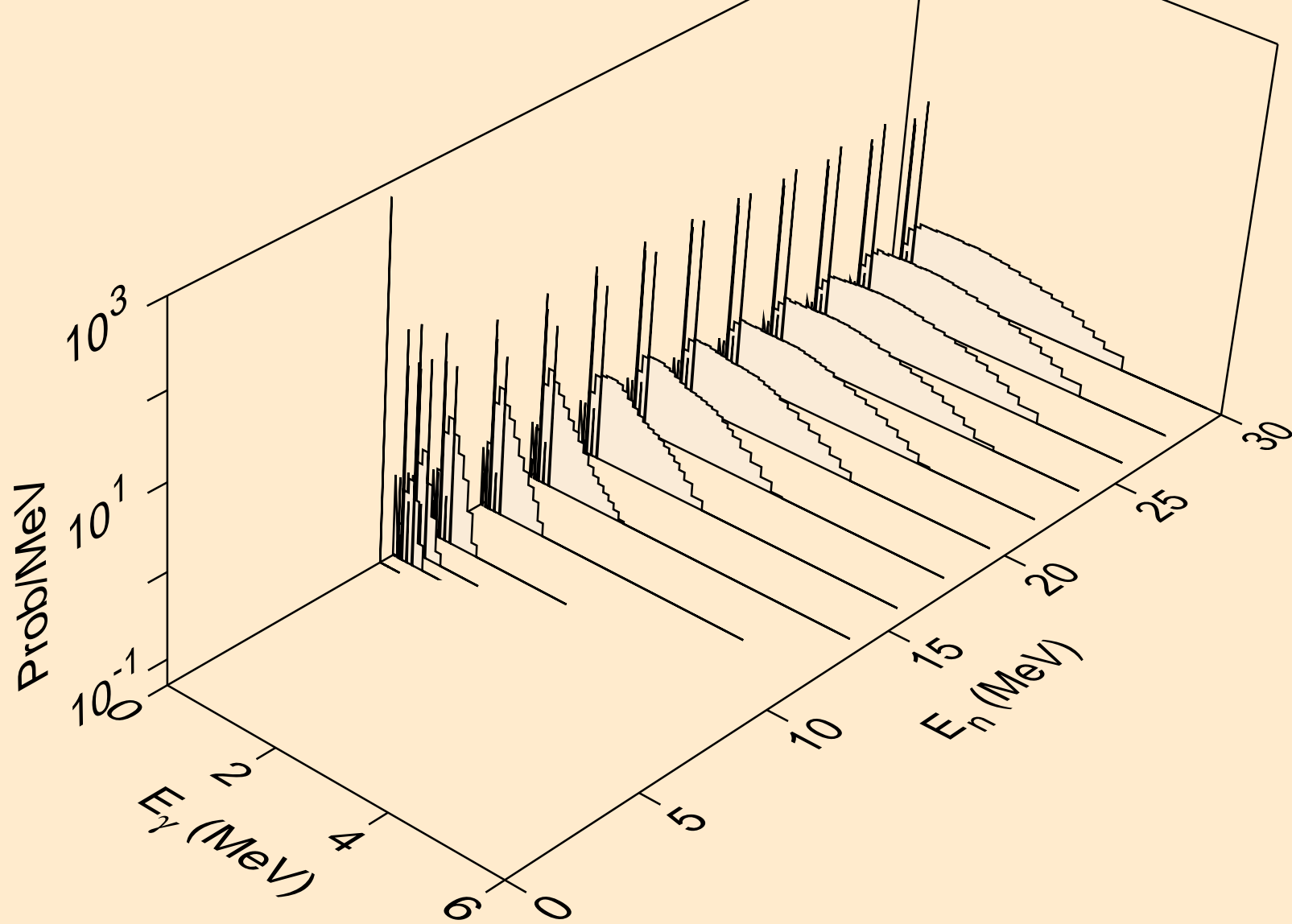

TC094M NEUTRON ACER TENDL-2023 LIBRARY; T=0.K
Photon emission for (n,a)

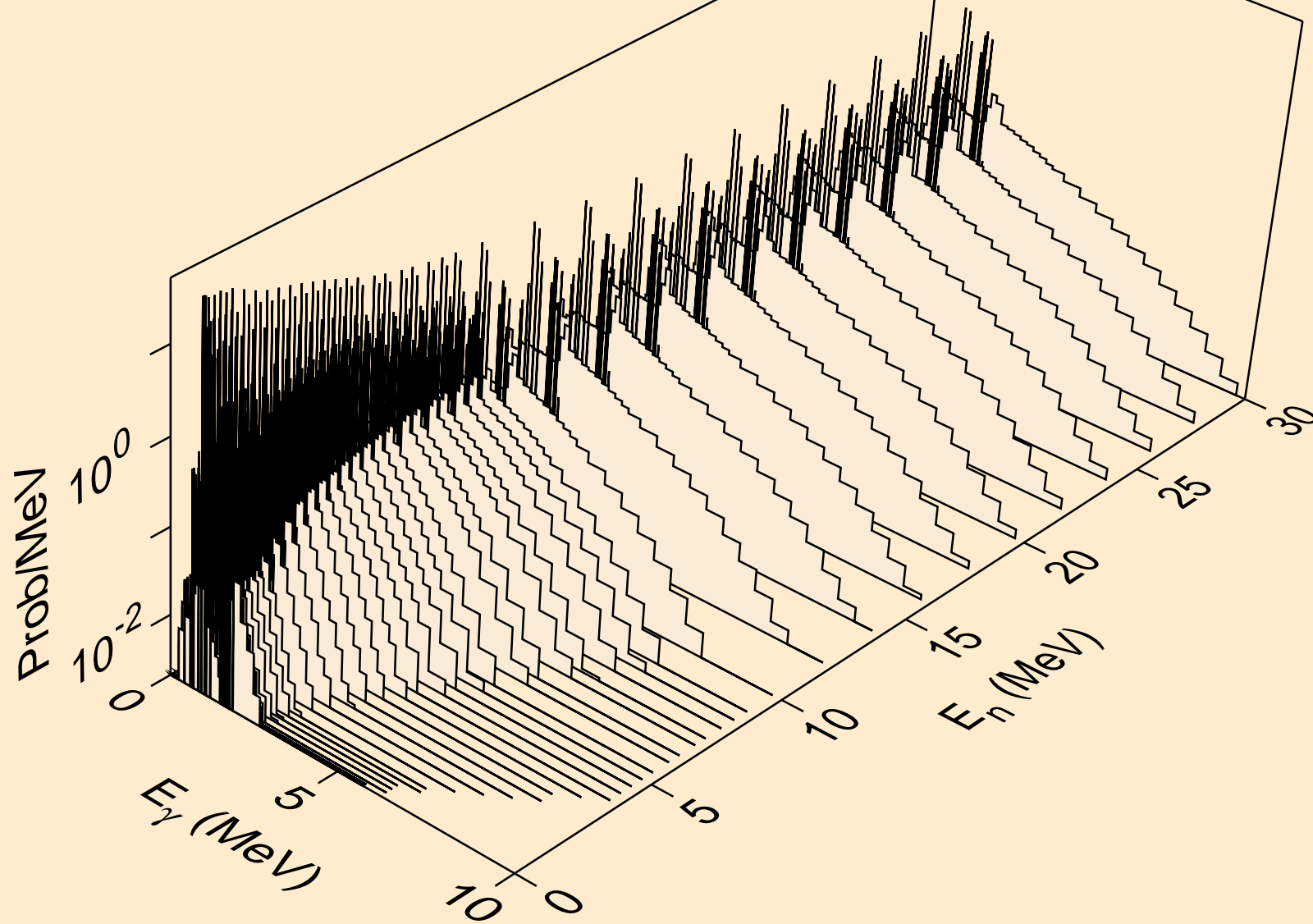

TC094M NEUTRON ACER TENDL-2023 LIBRARY; T=0.K
Photon emission for (n,2a)

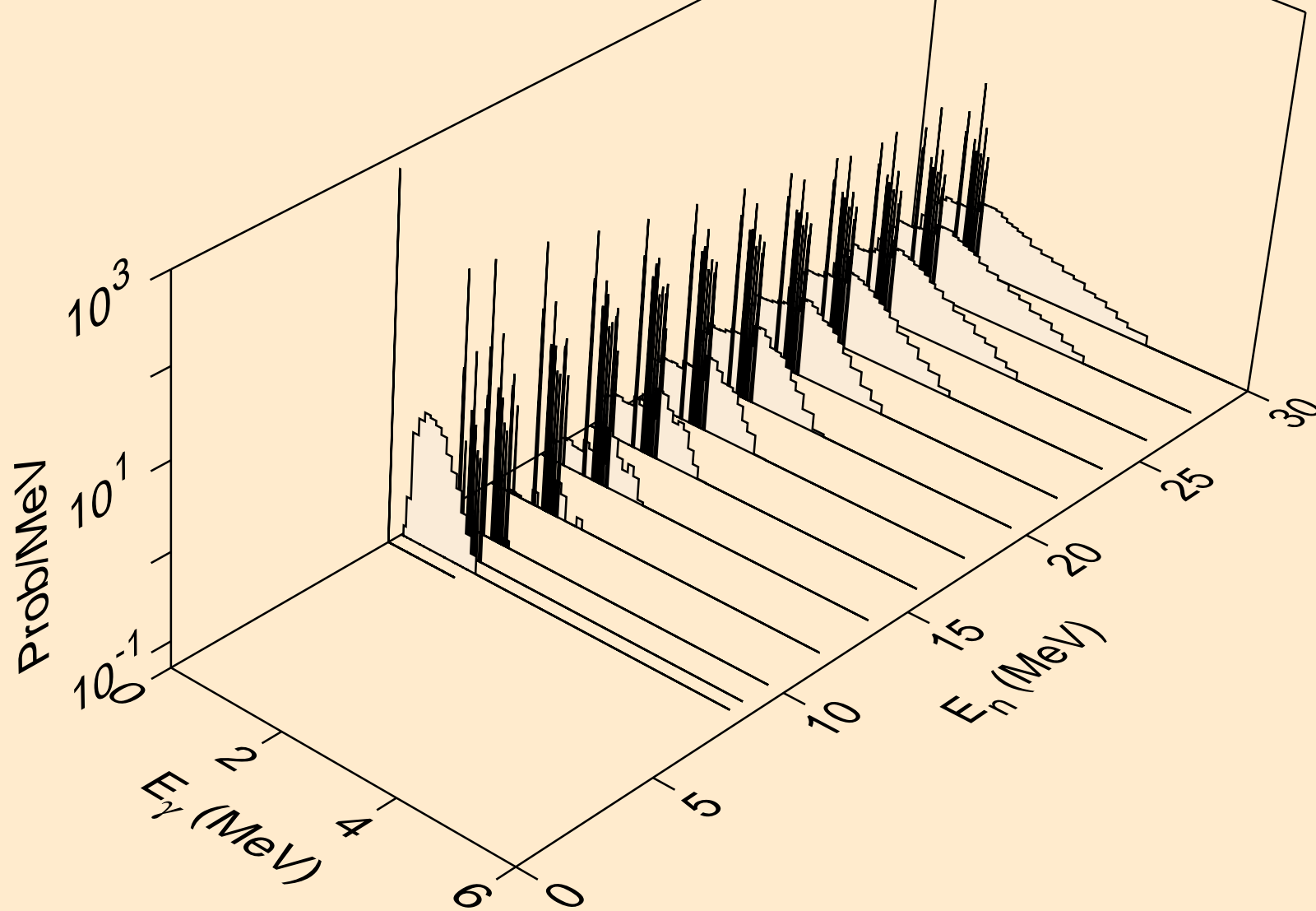

TC094M NEUTRON ACER TENDL-2023 LIBRARY; T=0.K
Photon emission for (n,2p)

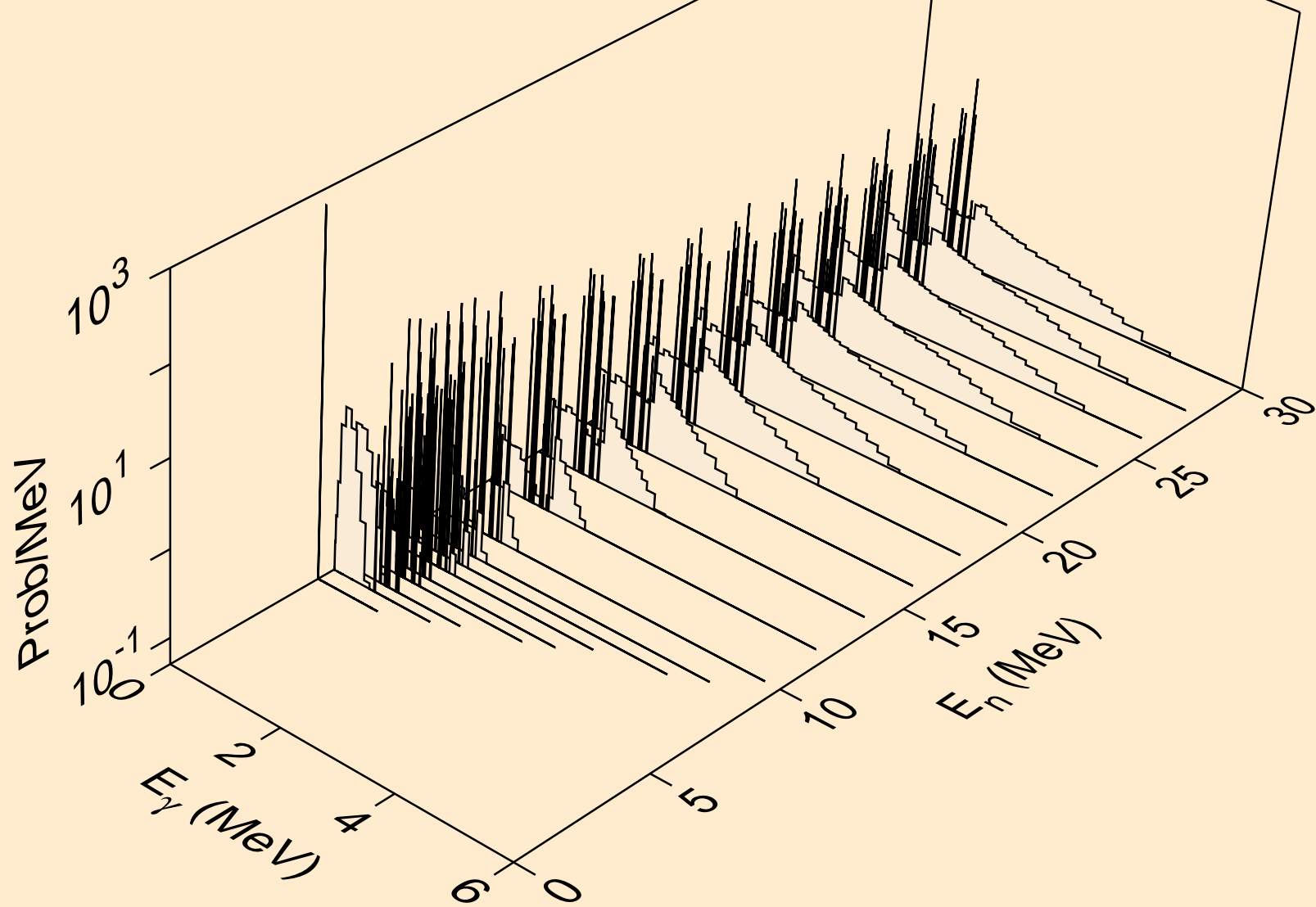

TC094M NEUTRON ACER TENDL-2023 LIBRARY; T=0.K
Photon emission for (n,p)

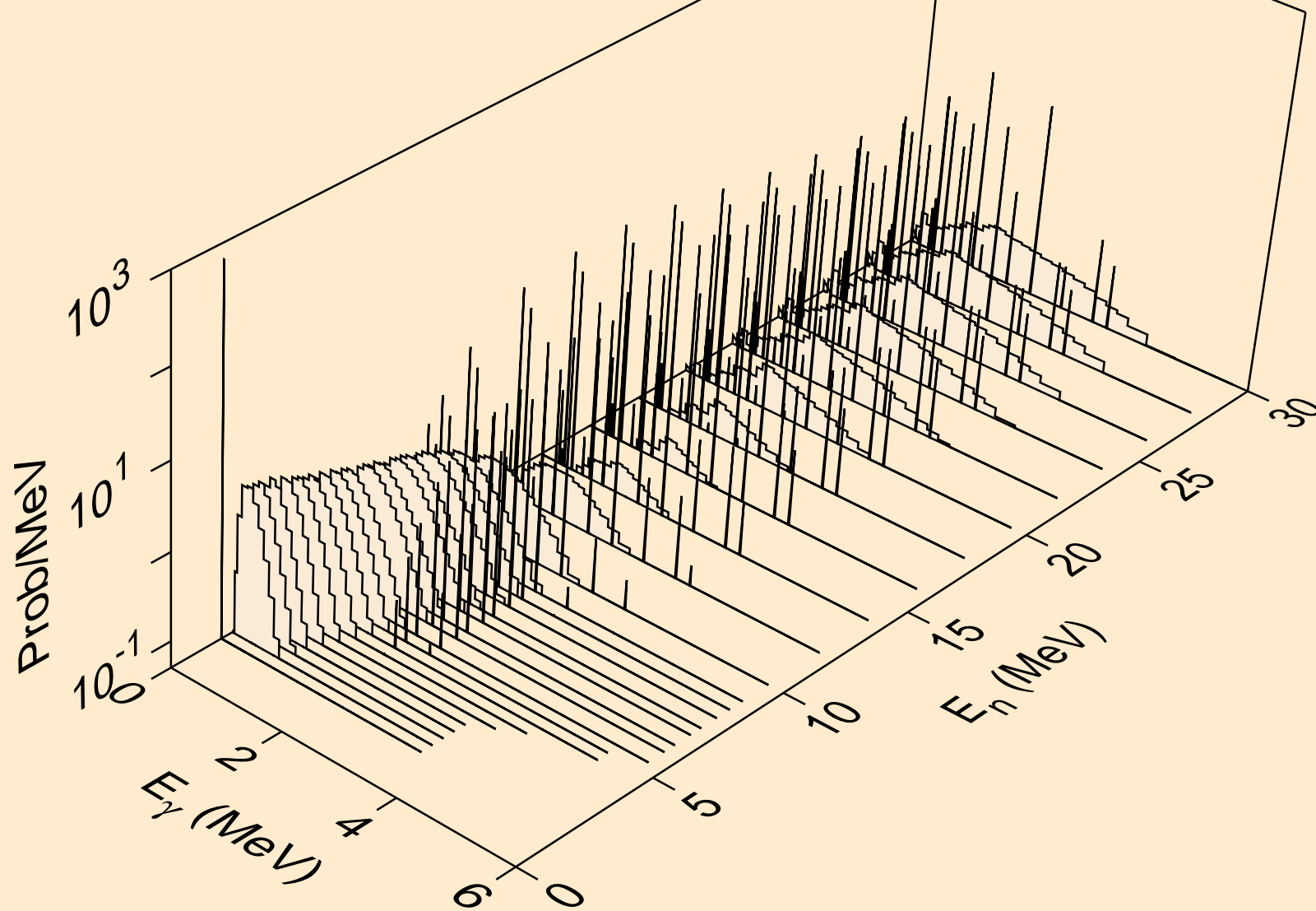

TC094M NEUTRON ACER TENDL-2023 LIBRARY; T=0.K
Photon emission for (n,pd)

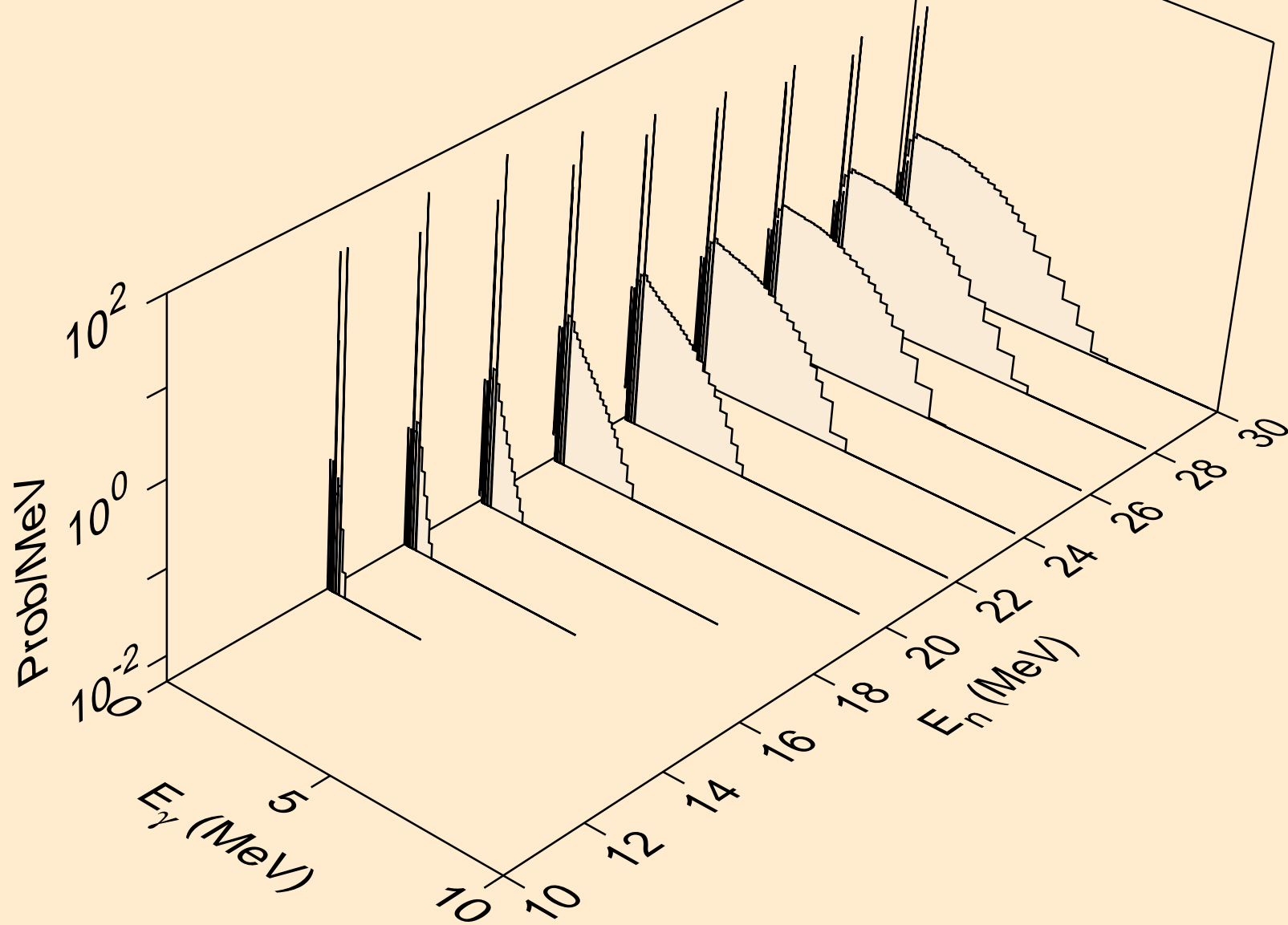

TC094M NEUTRON ACER TENDL-2023 LIBRARY; T=0.K
Photon emission for (n,pt)

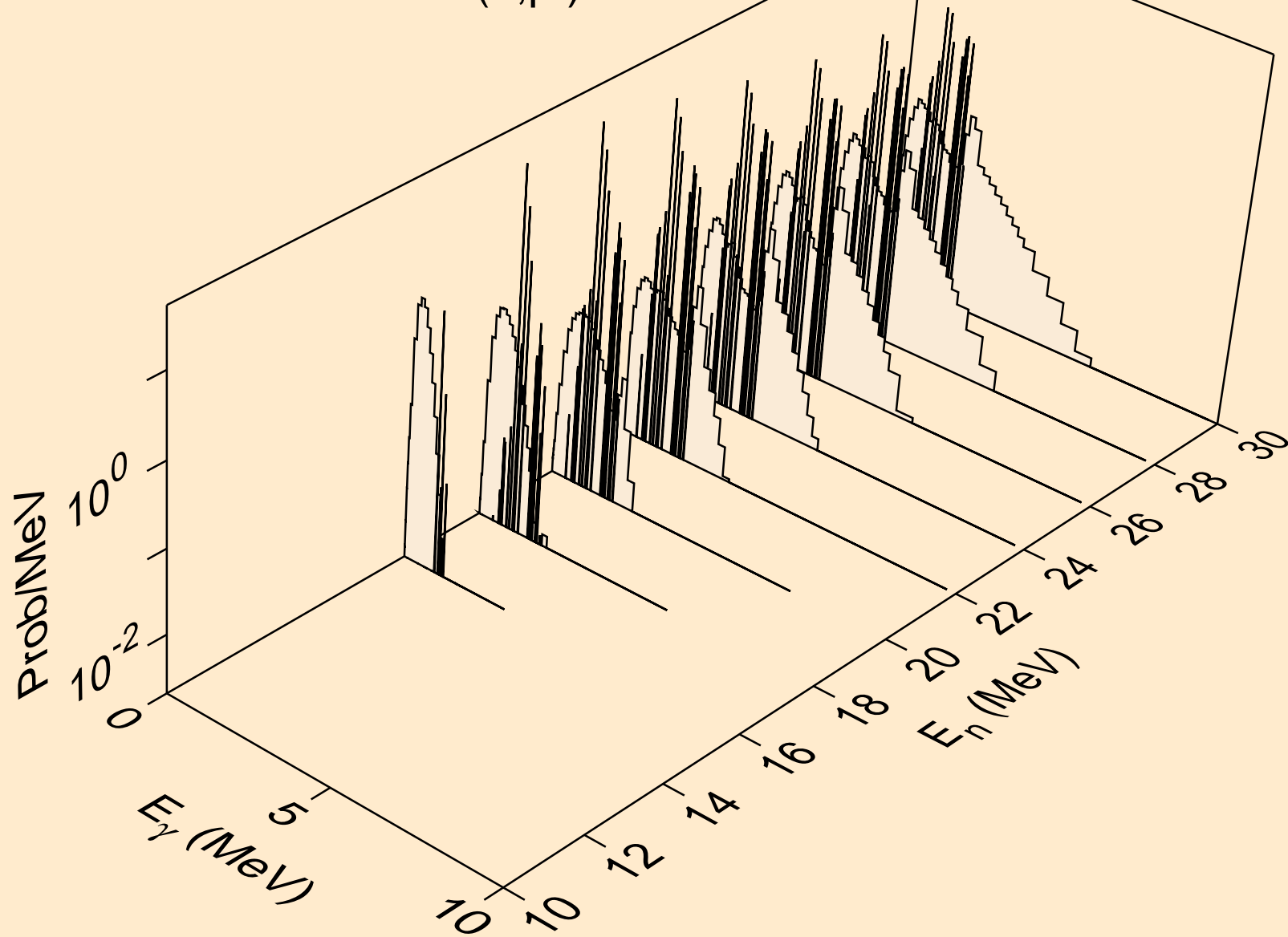

TC094M NEUTRON ACER TENDL-2023 LIBRARY; T=0.K
Photon emission for (n,da)

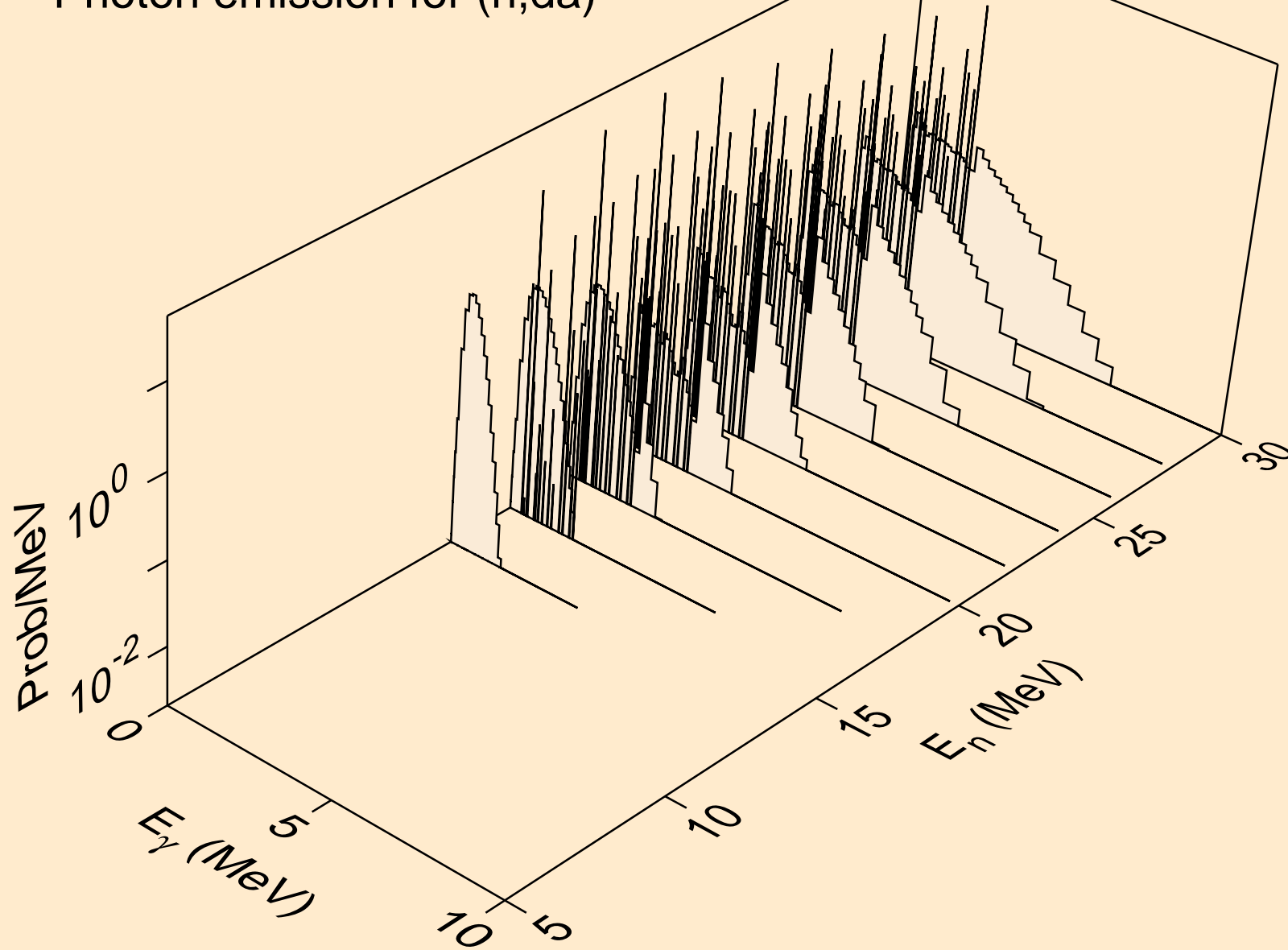

TC094M NEUTRON ACER TENDL-2023 LIBRARY; T=0.K
thermal capture photon spectrum

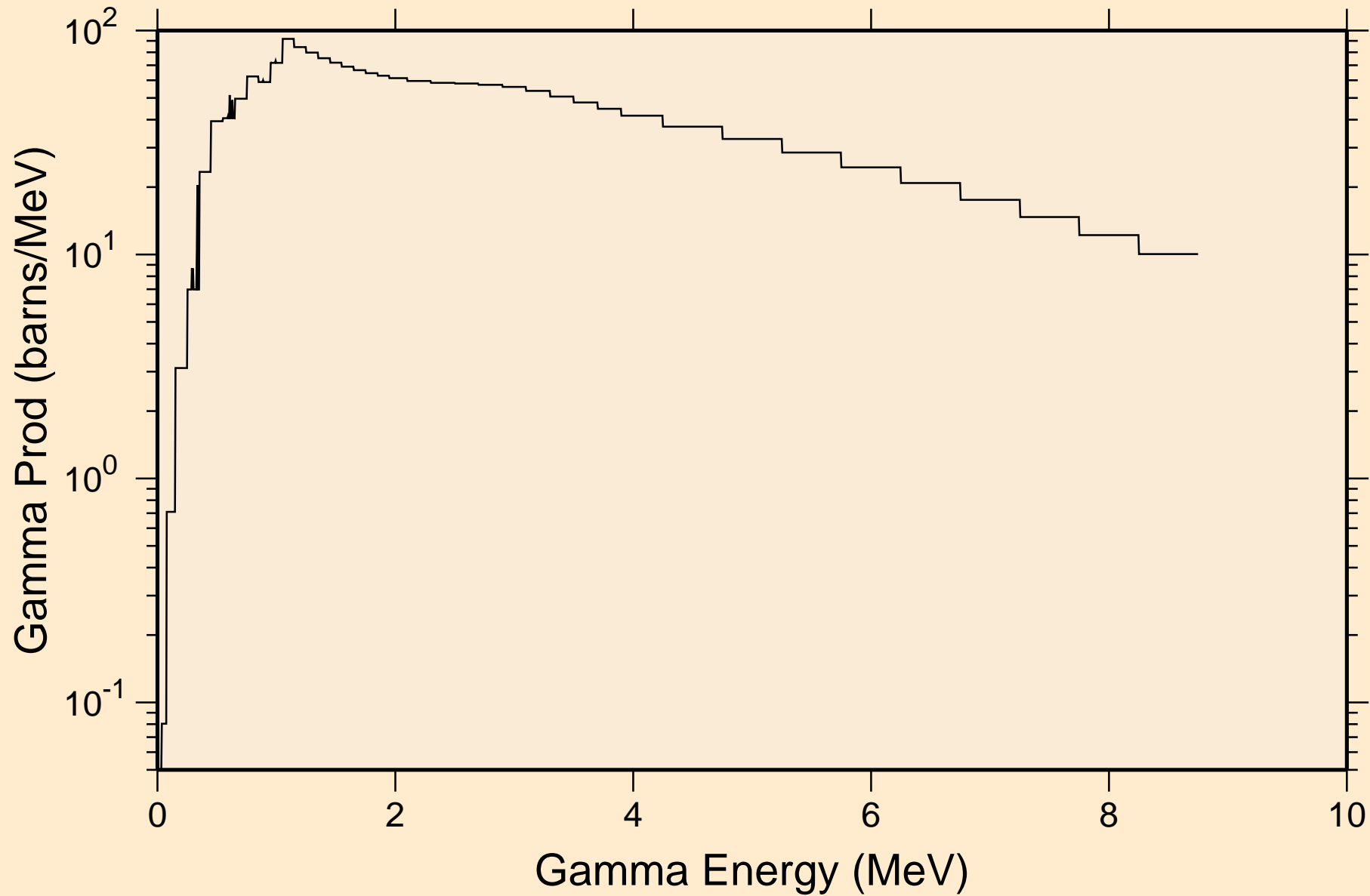

TC094M NEUTRON ACER TENDL-2023 LIBRARY; T=0.K
14 MeV photon spectrum

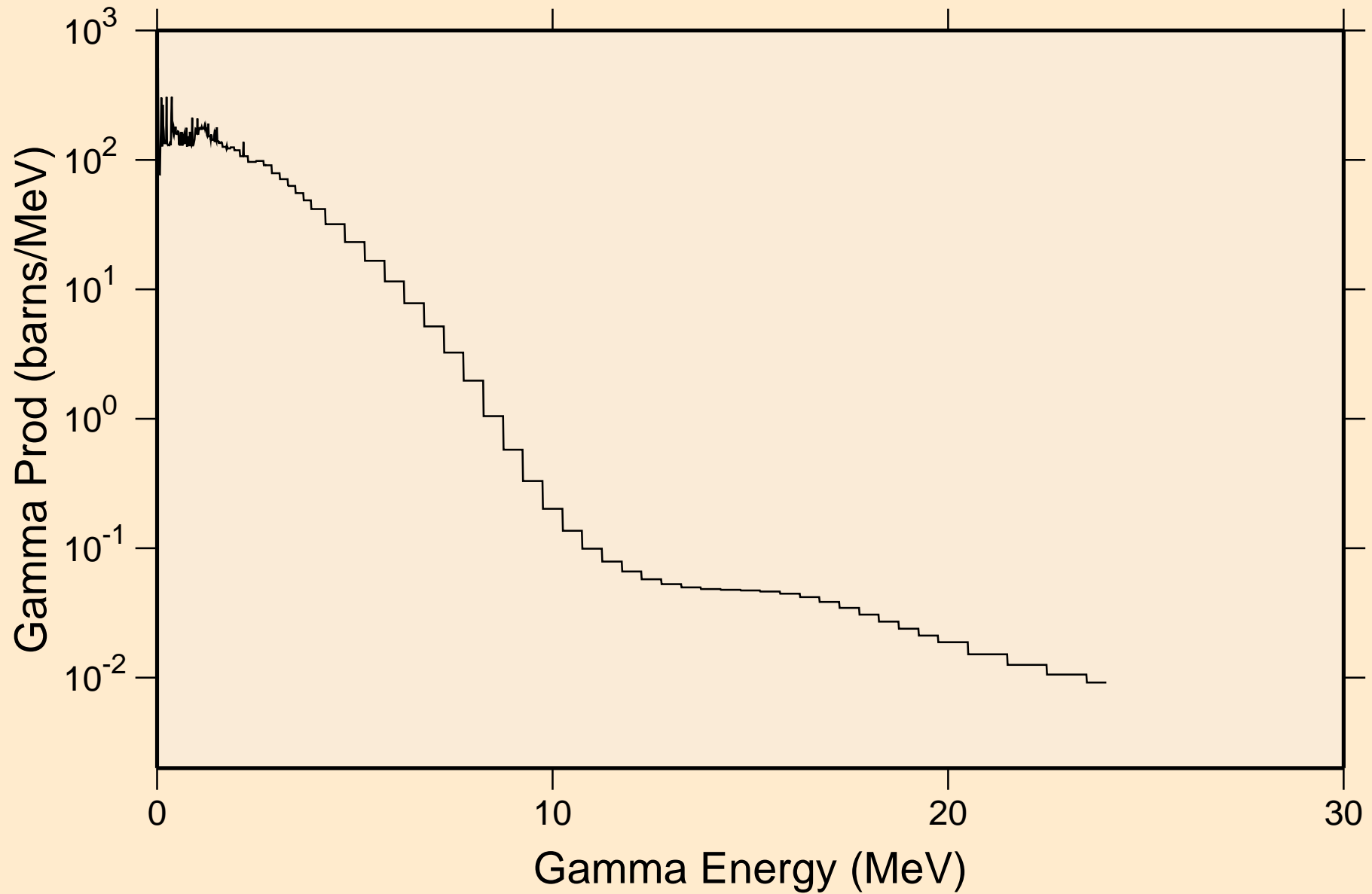

TC094M NEUTRON ACER TENDL-2023 LIBRARY; T=0.K

Particle heating contributions

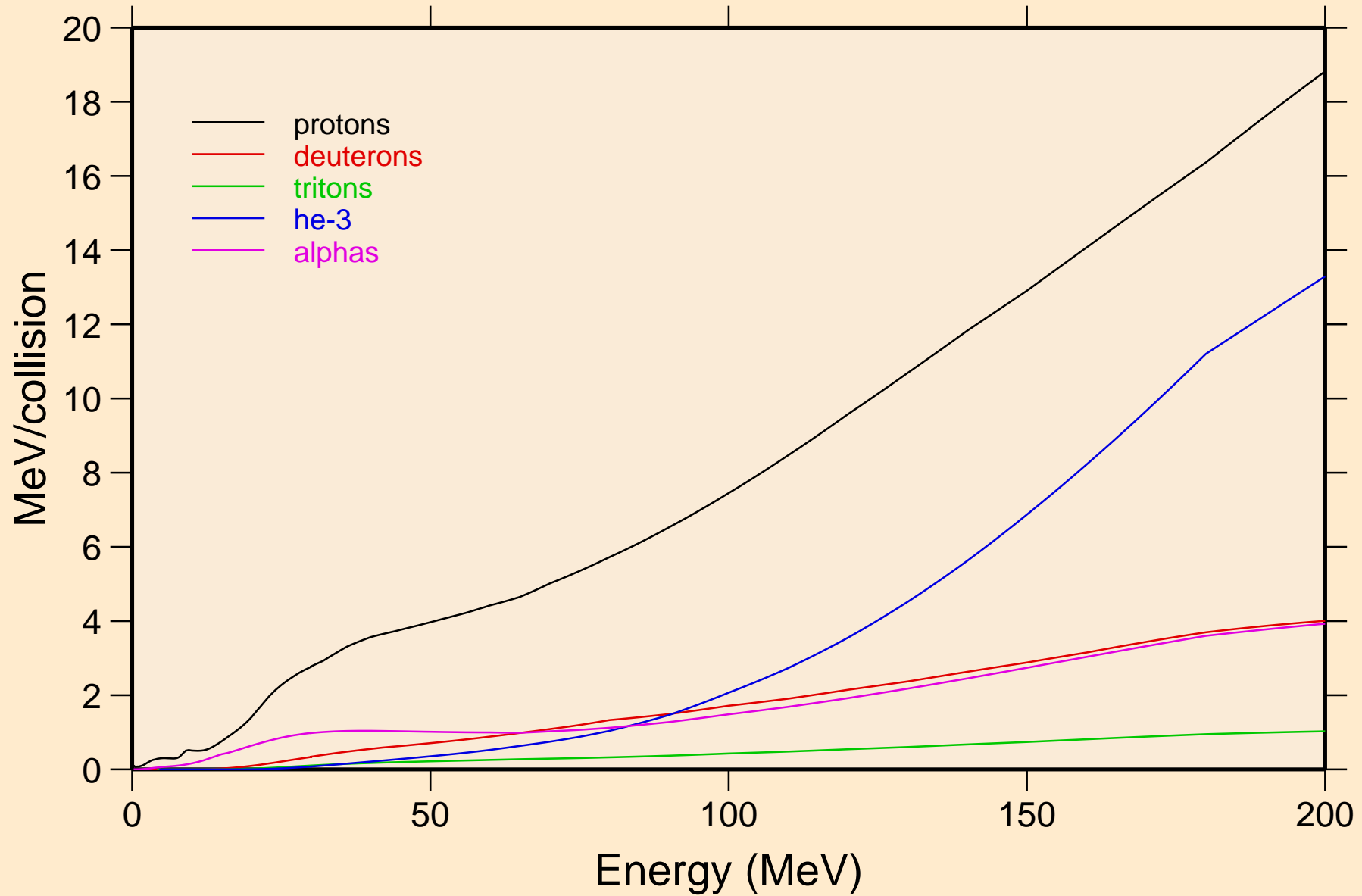

TC094M NEUTRON ACER TENDL-2023 LIBRARY; T=0.K
Recoil Heating

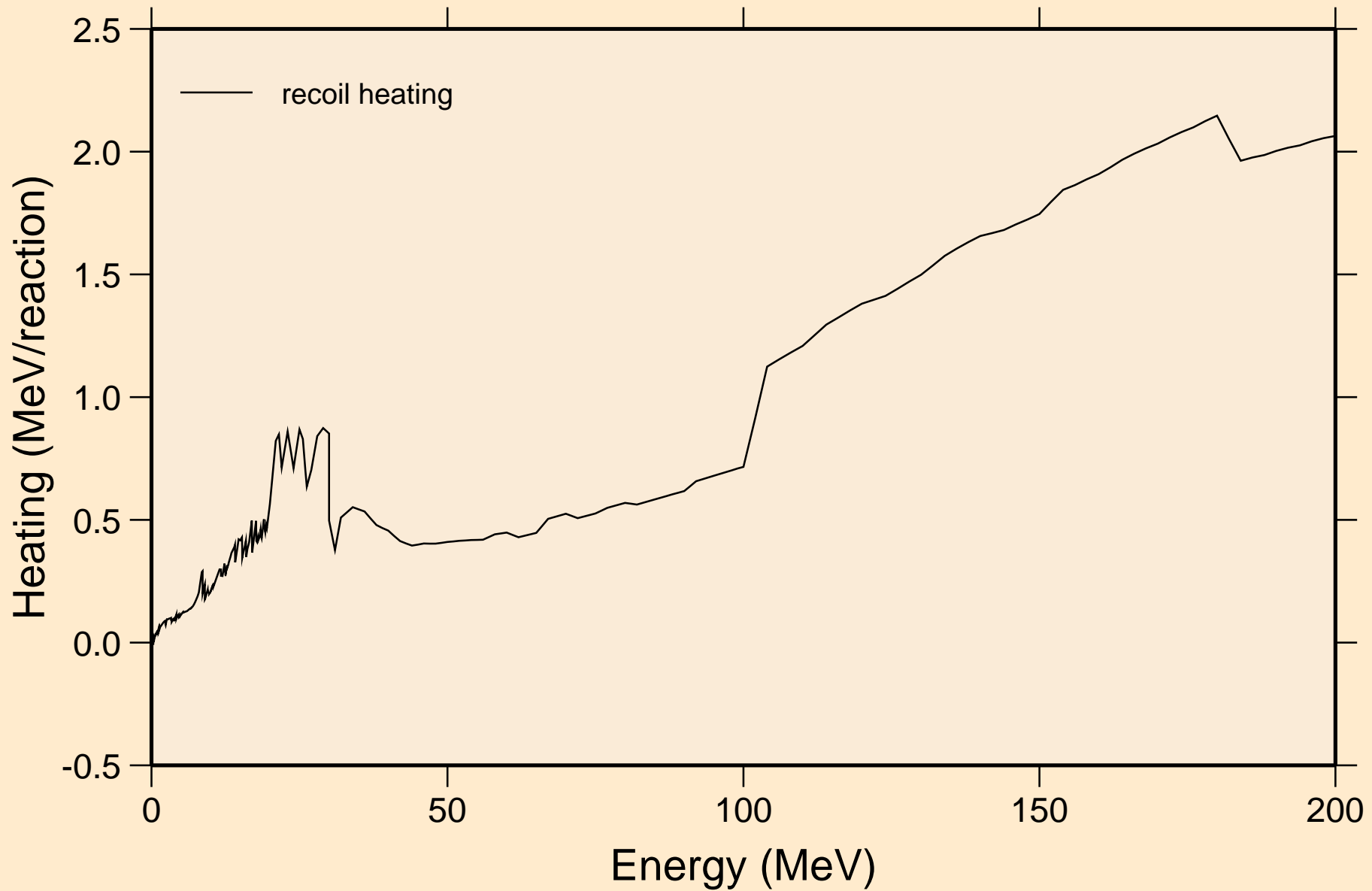

TC094M NEUTRON ACER TENDL-2023 LIBRARY; T=0.K
Particle production cross sections

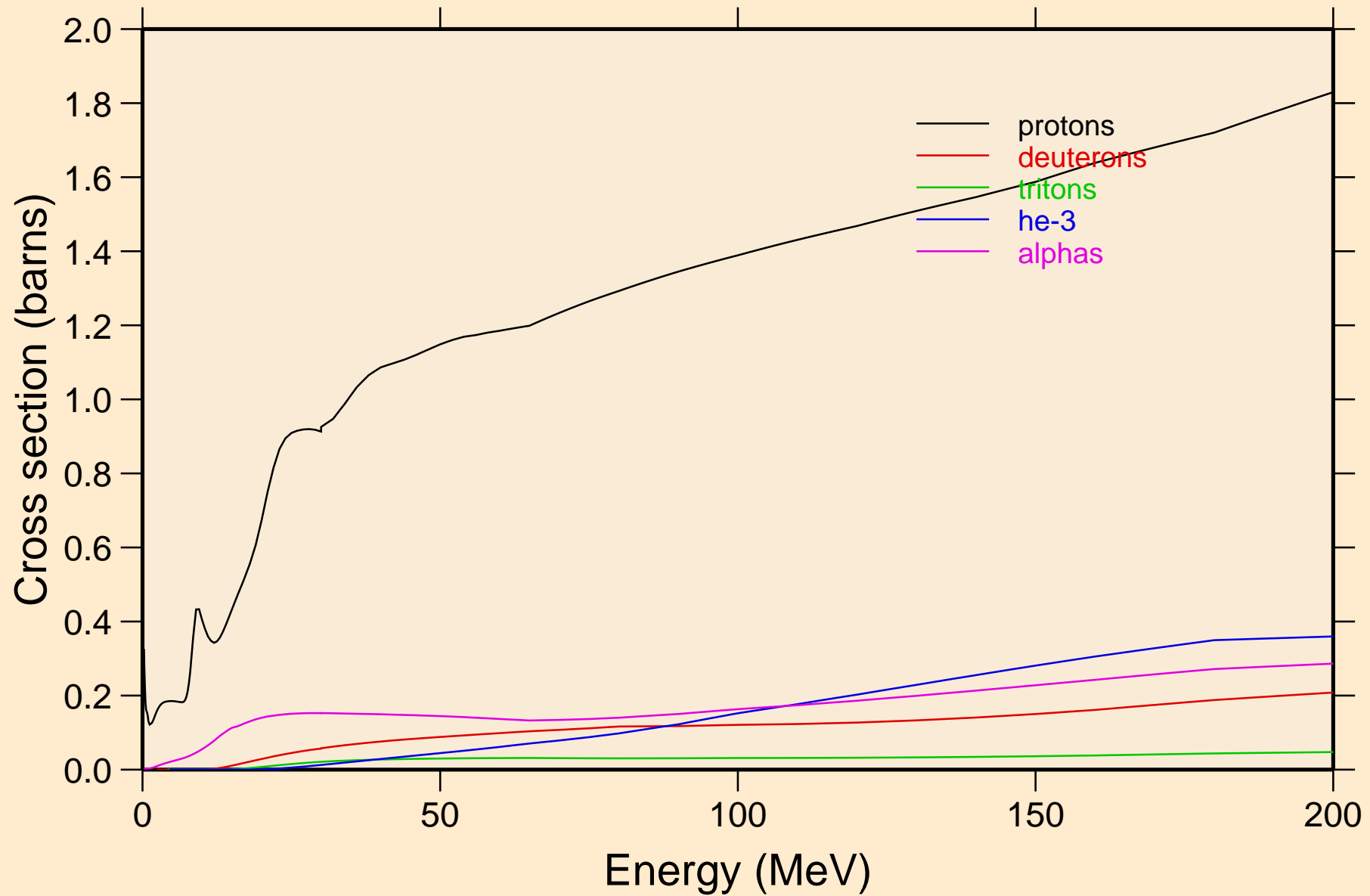

TC094M NEUTRON ACER TENDL-2023 LIBRARY; T=0.K
protons from (n,x)

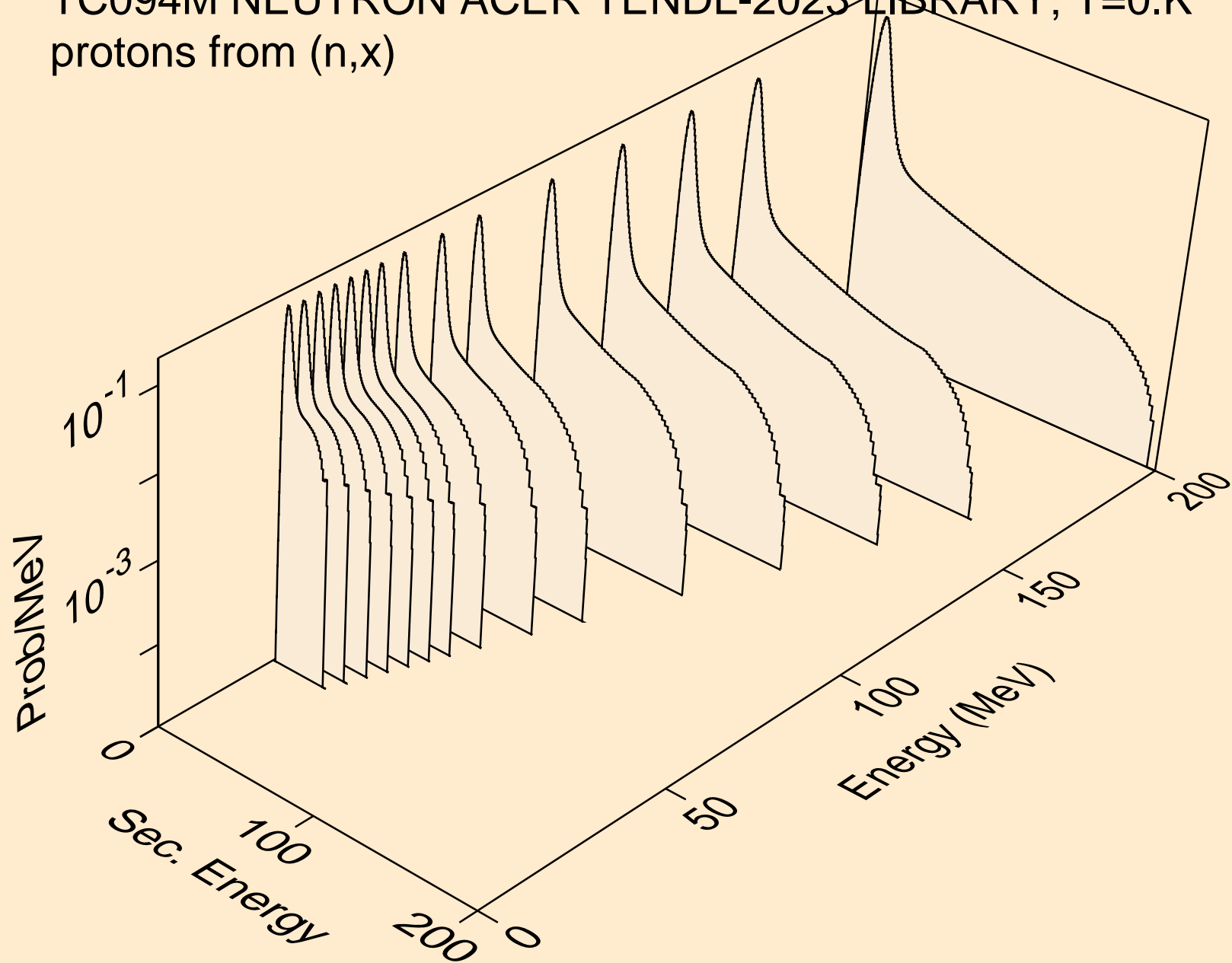

TC094M NEUTRON ACER TENDL-2023 LIBRARY; T=0.K
protons from (n,n*)p

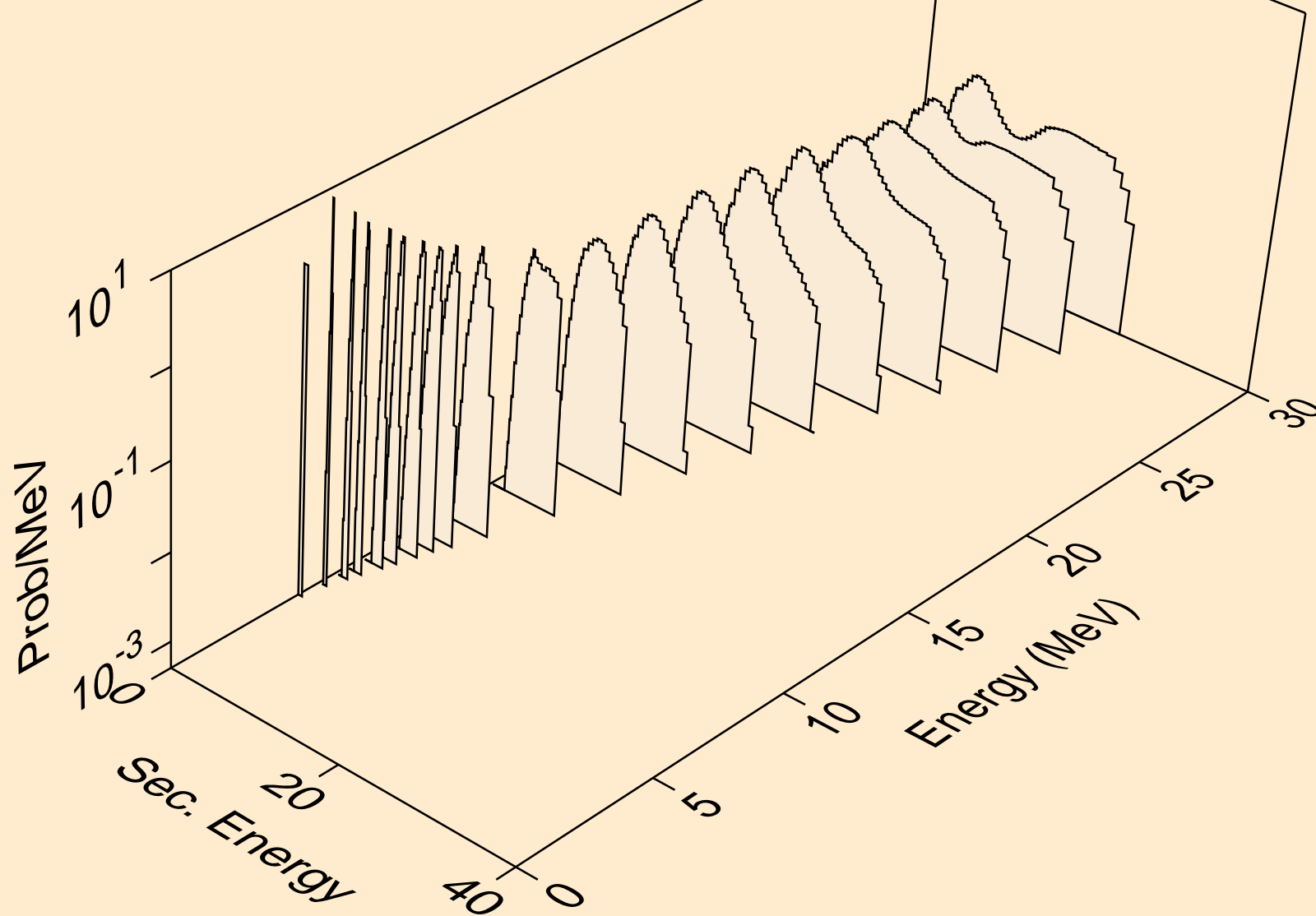

TC094M NEUTRON ACER TENDL-2023 LIBRARY; T=0.K
protons from (n,2np)

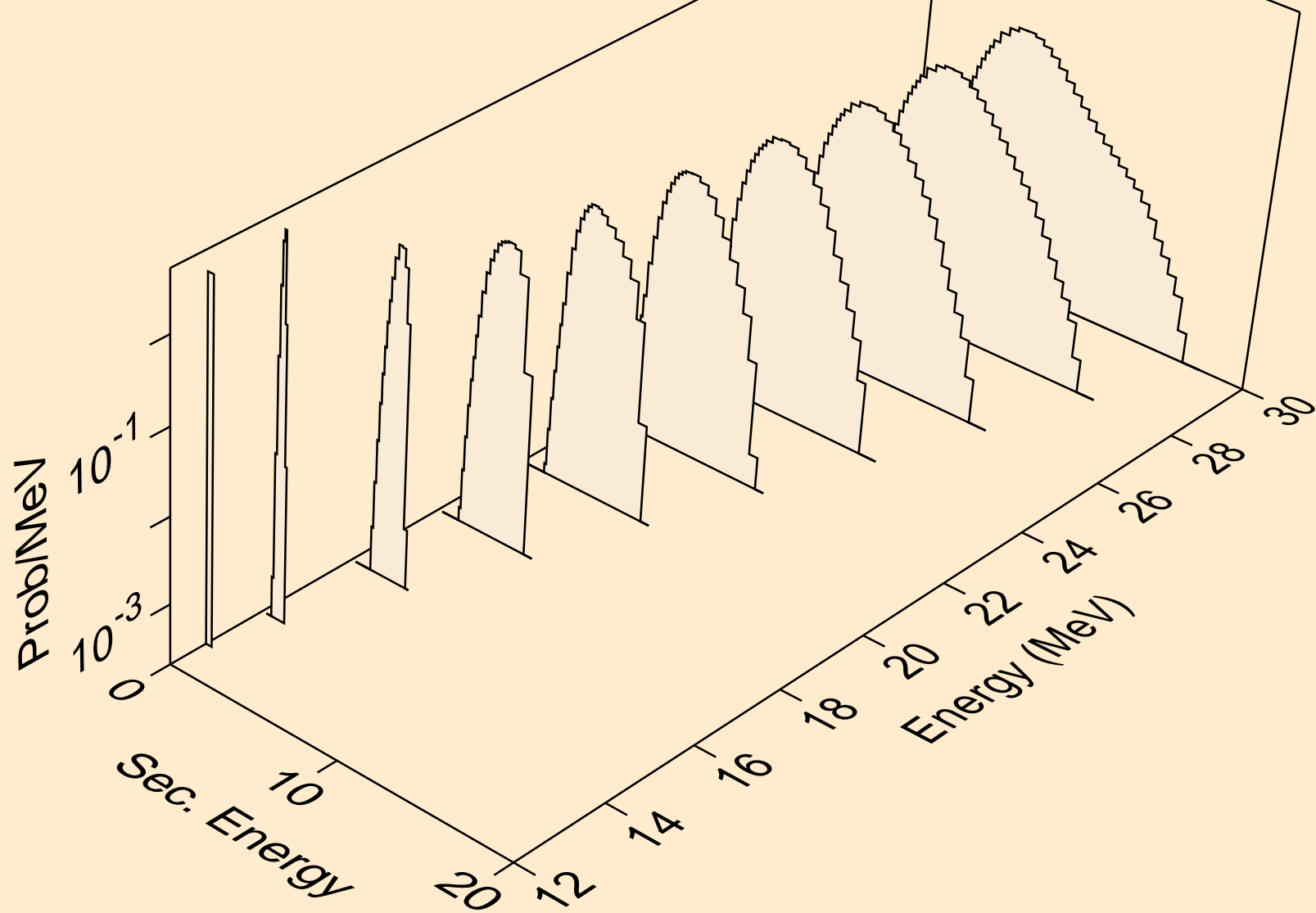

TC094M NEUTRON ACER TENDL-2023 LIBRARY; T=0.K
protons from (n,3np)

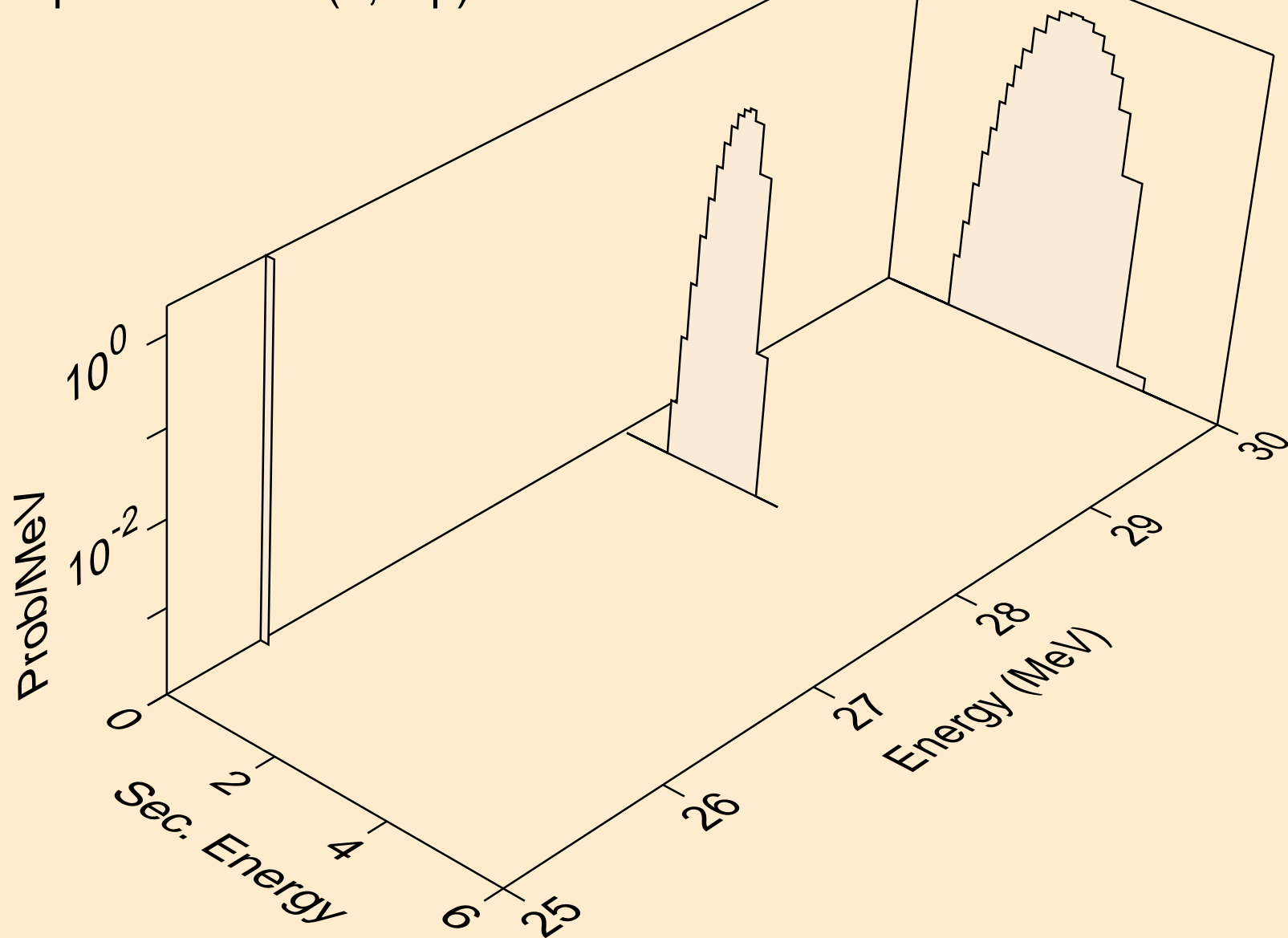

TC094M NEUTRON ACER TENDL-2023 LIBRARY; T=0.K
protons from (n,n2p)

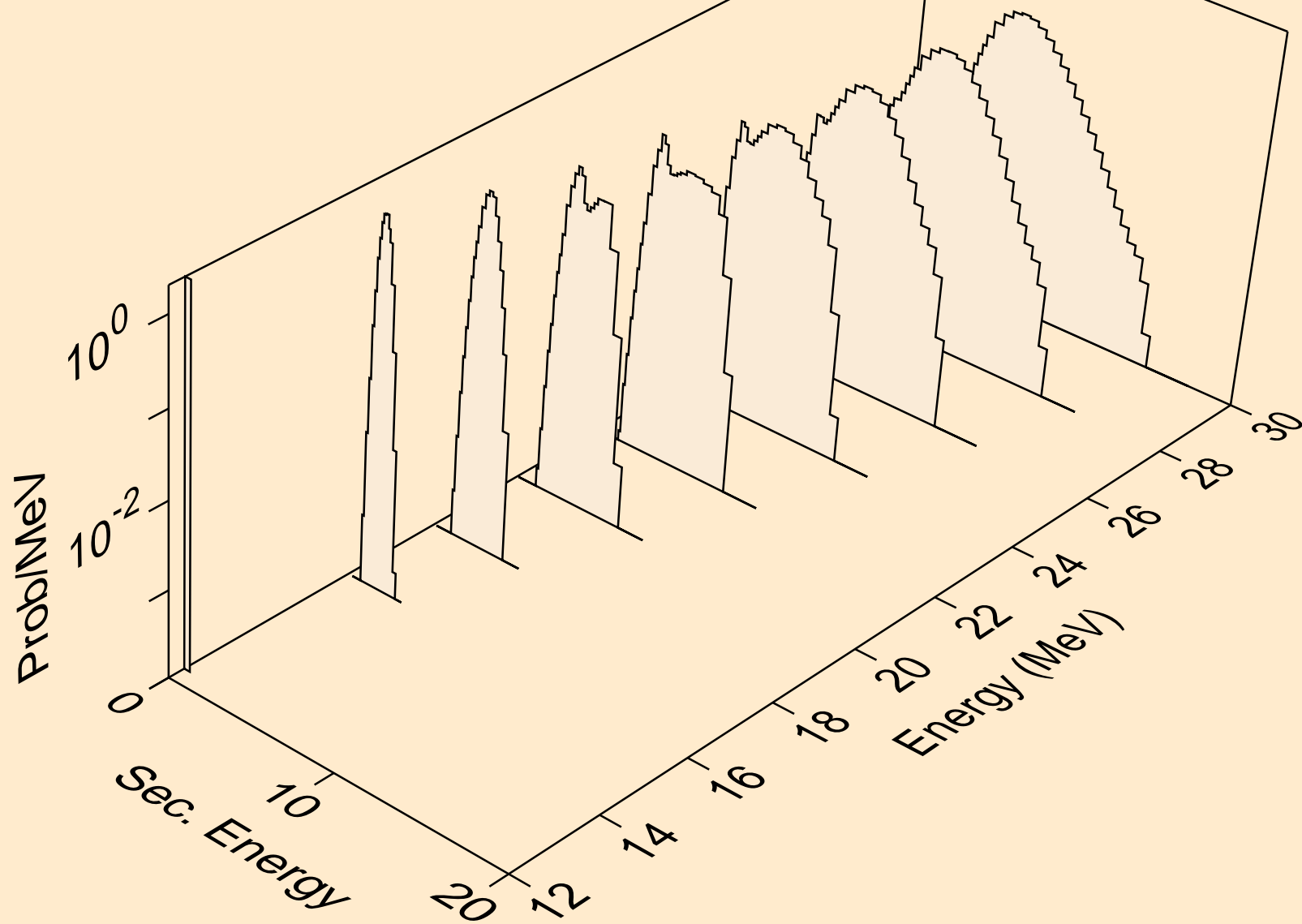

TC094M NEUTRON ACER TENDL-2023 LIBRARY; T=0.K
protons from (n,npa)

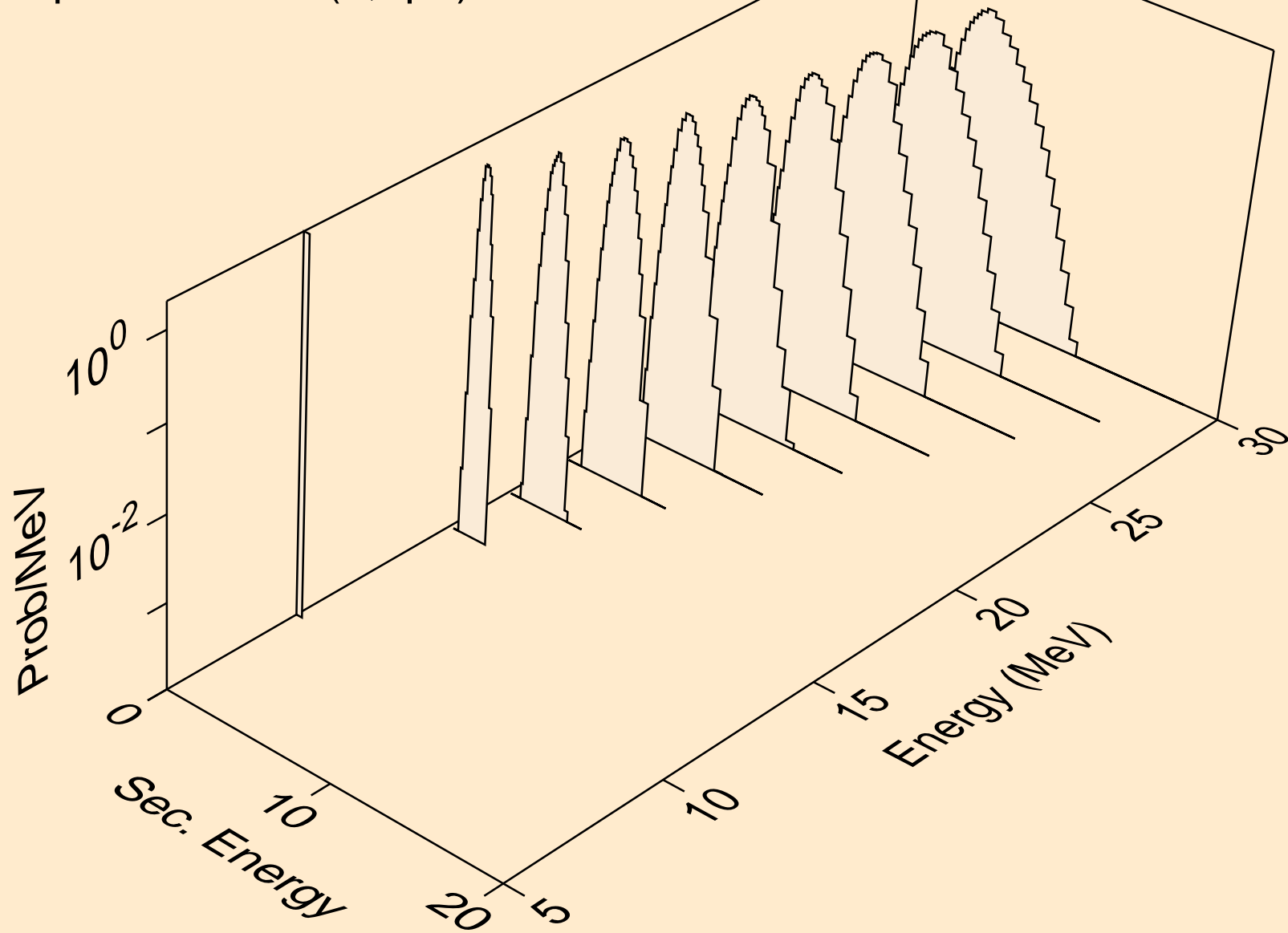

TC094M NEUTRON ACER TENDL-2023 LIBRARY; T=0.K
protons from (n,p)

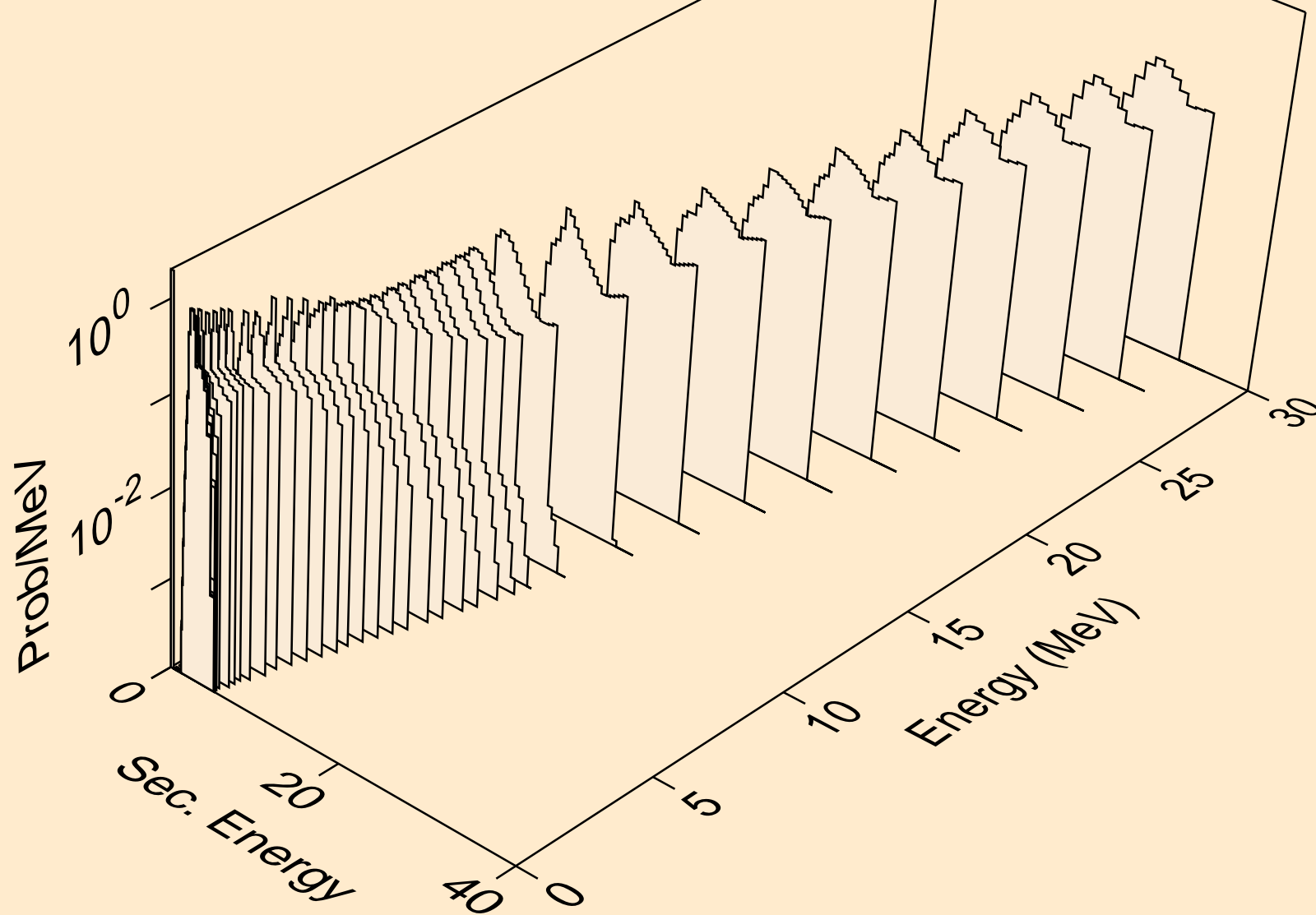

TC094M NEUTRON ACER TENDL-2023 LIBRARY; T=0.K
protons from (n,2p)

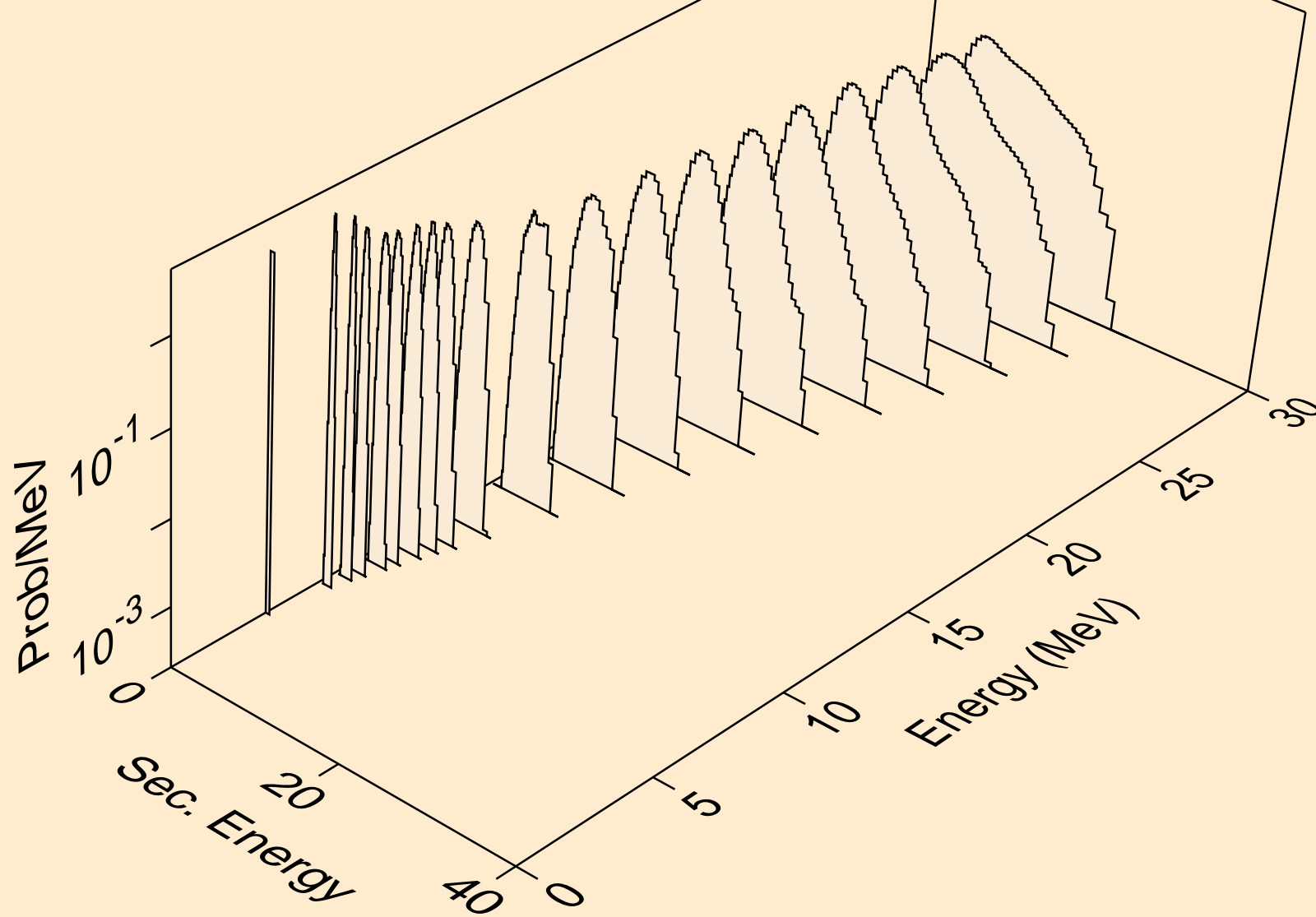

TC094M NEUTRON ACER TENDL-2023 LIBRARY; T=0.K
protons from (n,p)

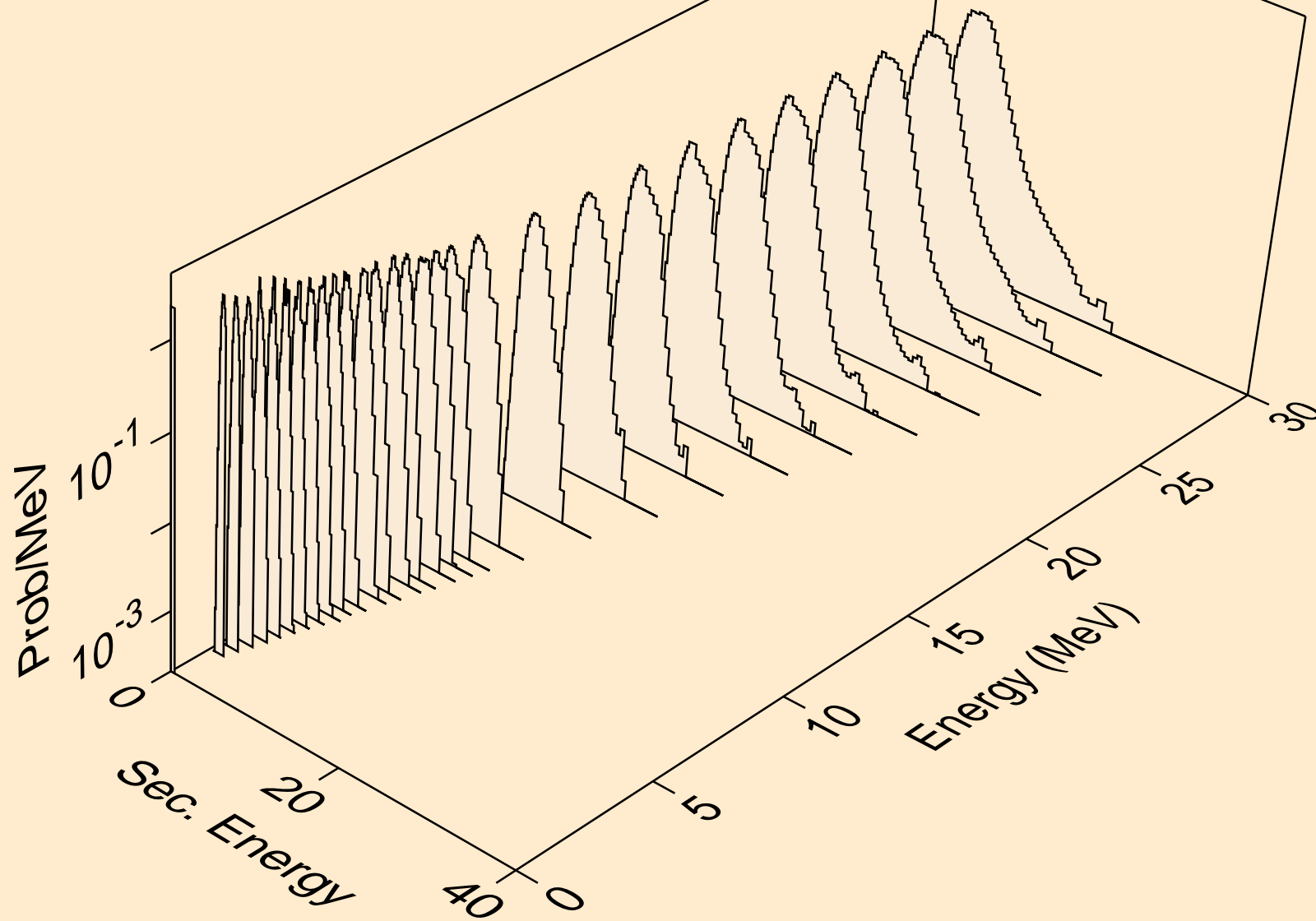

TC094M NEUTRON ACER TENDL-2023 LIBRARY; T=0.K
protons from (n,pd)

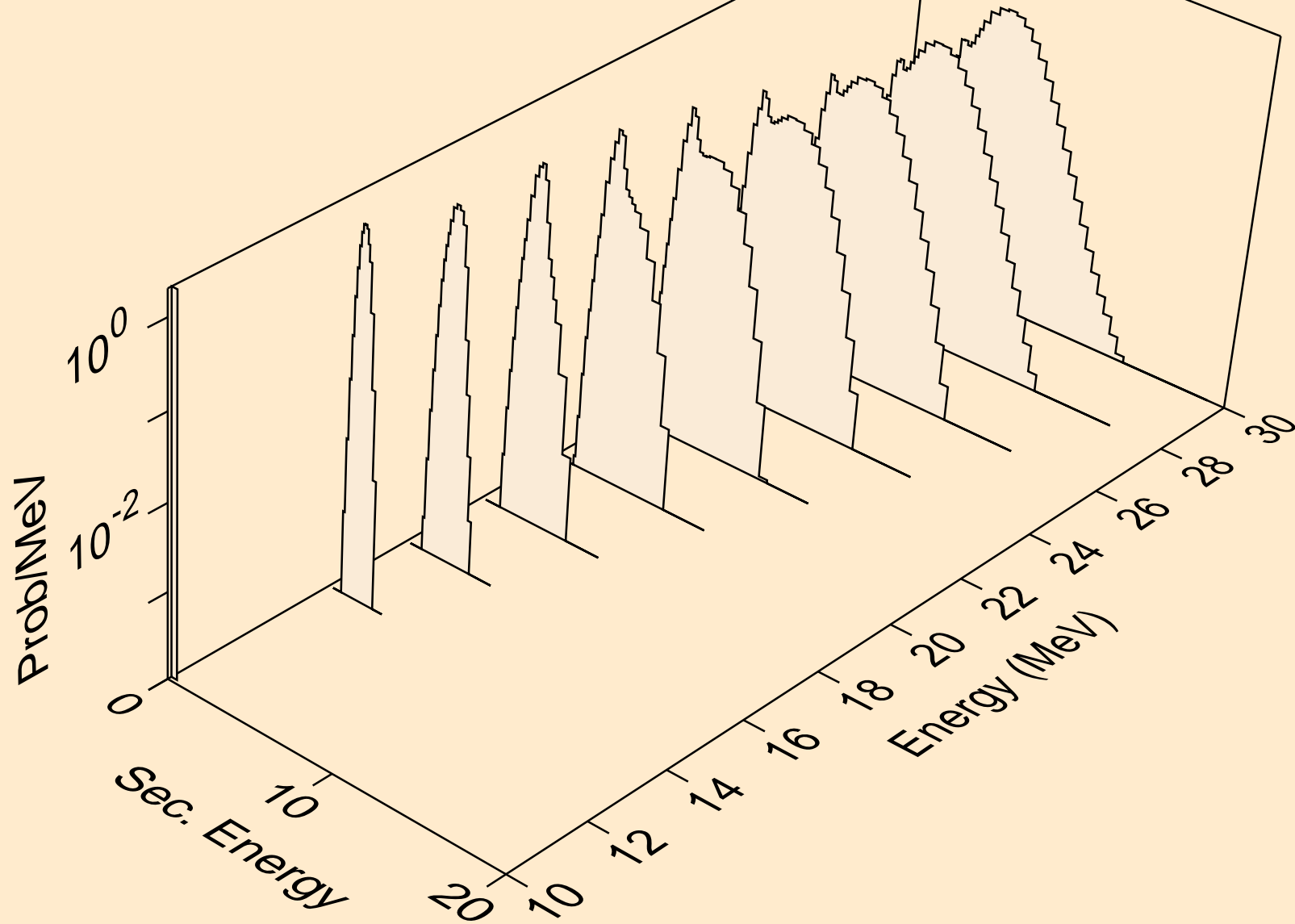

TC094M NEUTRON ACER TENDL-2023 LIBRARY; T=0.K
protons from (n,pt)

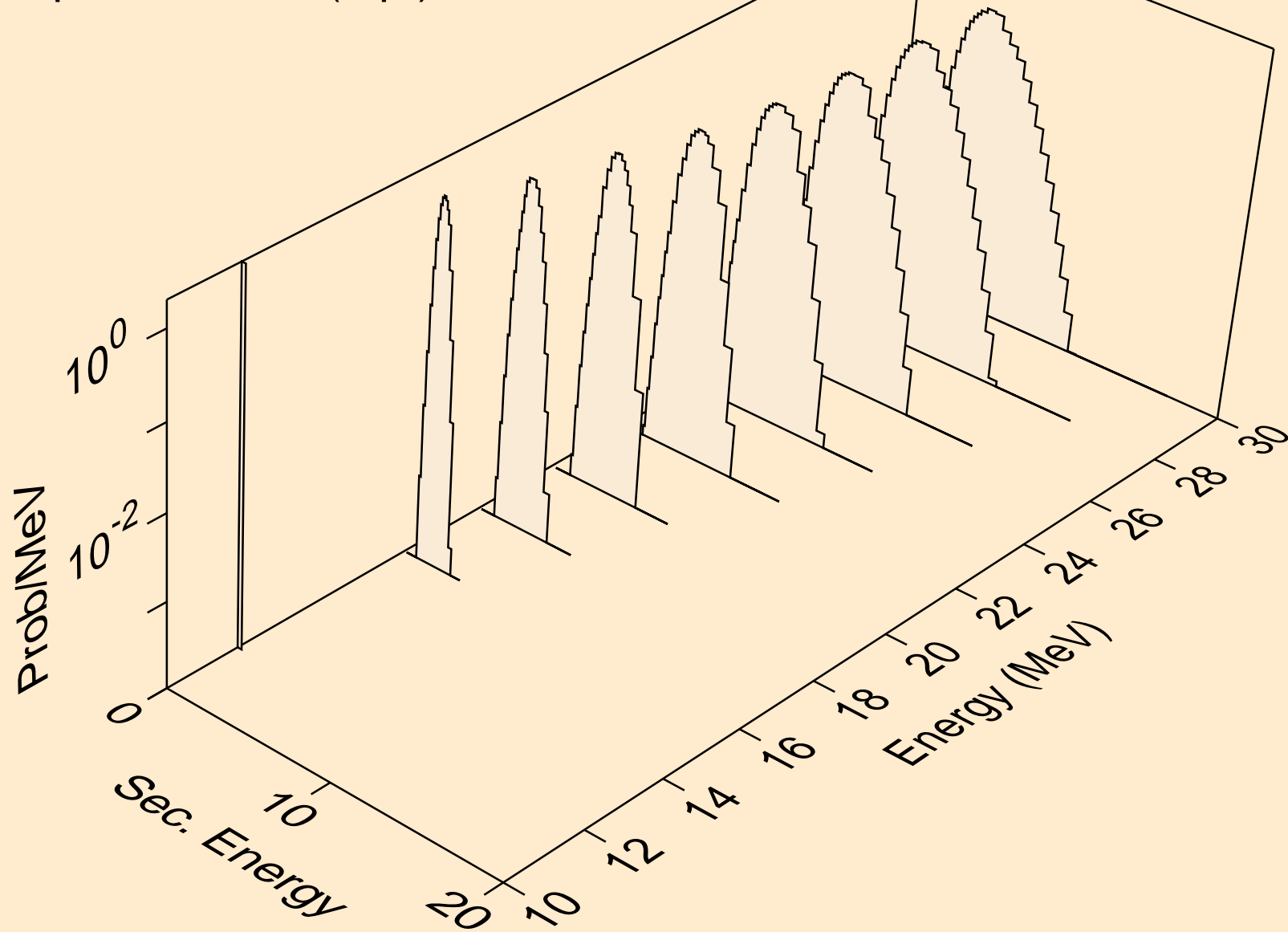

TC094M NEUTRON ACER TENDL-2023 LIBRARY; T=0.K
deuterons from (n,x)

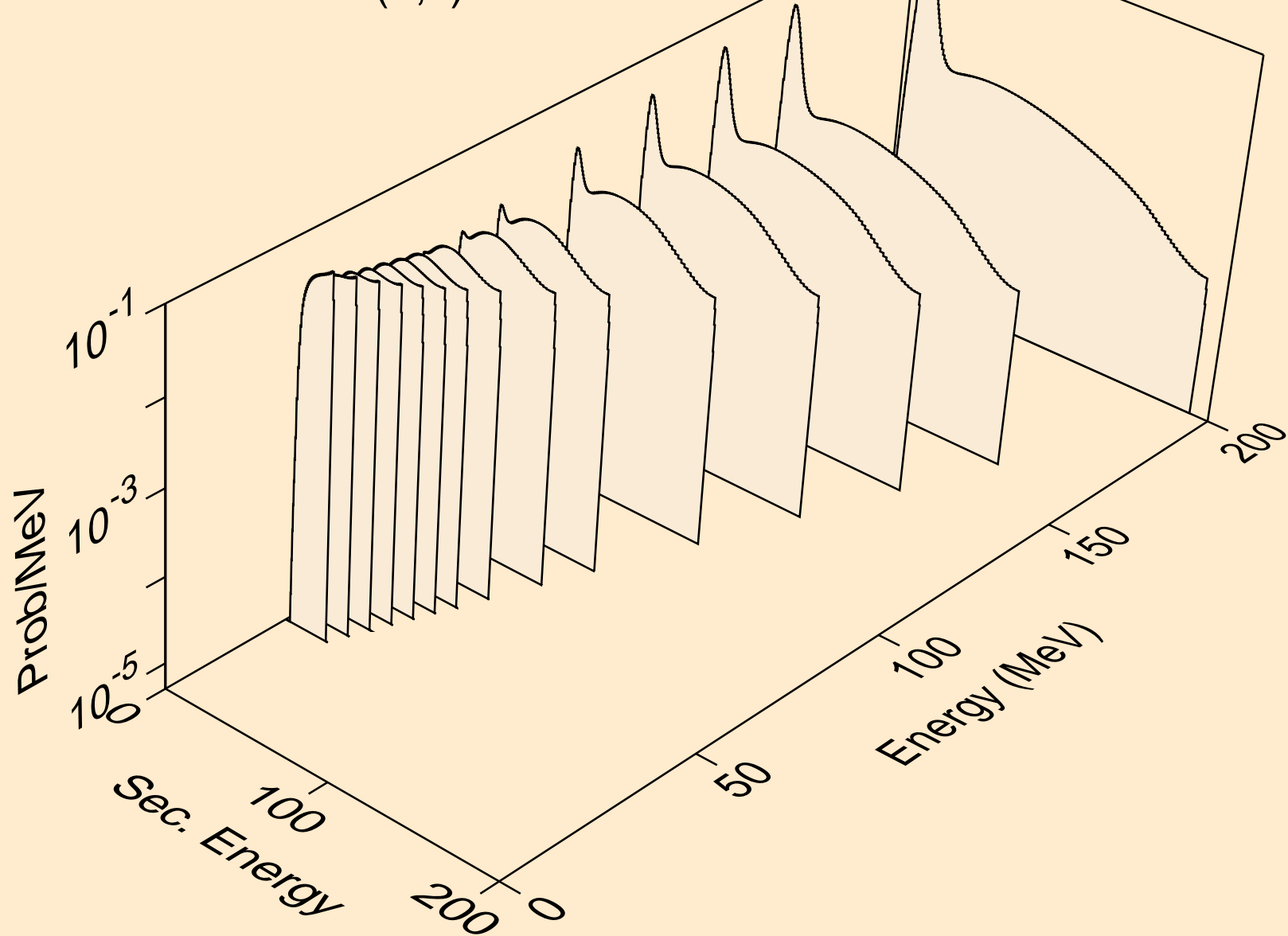

TC094M NEUTRON ACER TENDL-2023 LIBRARY; T=0.K
deuterons from (n,2nd)

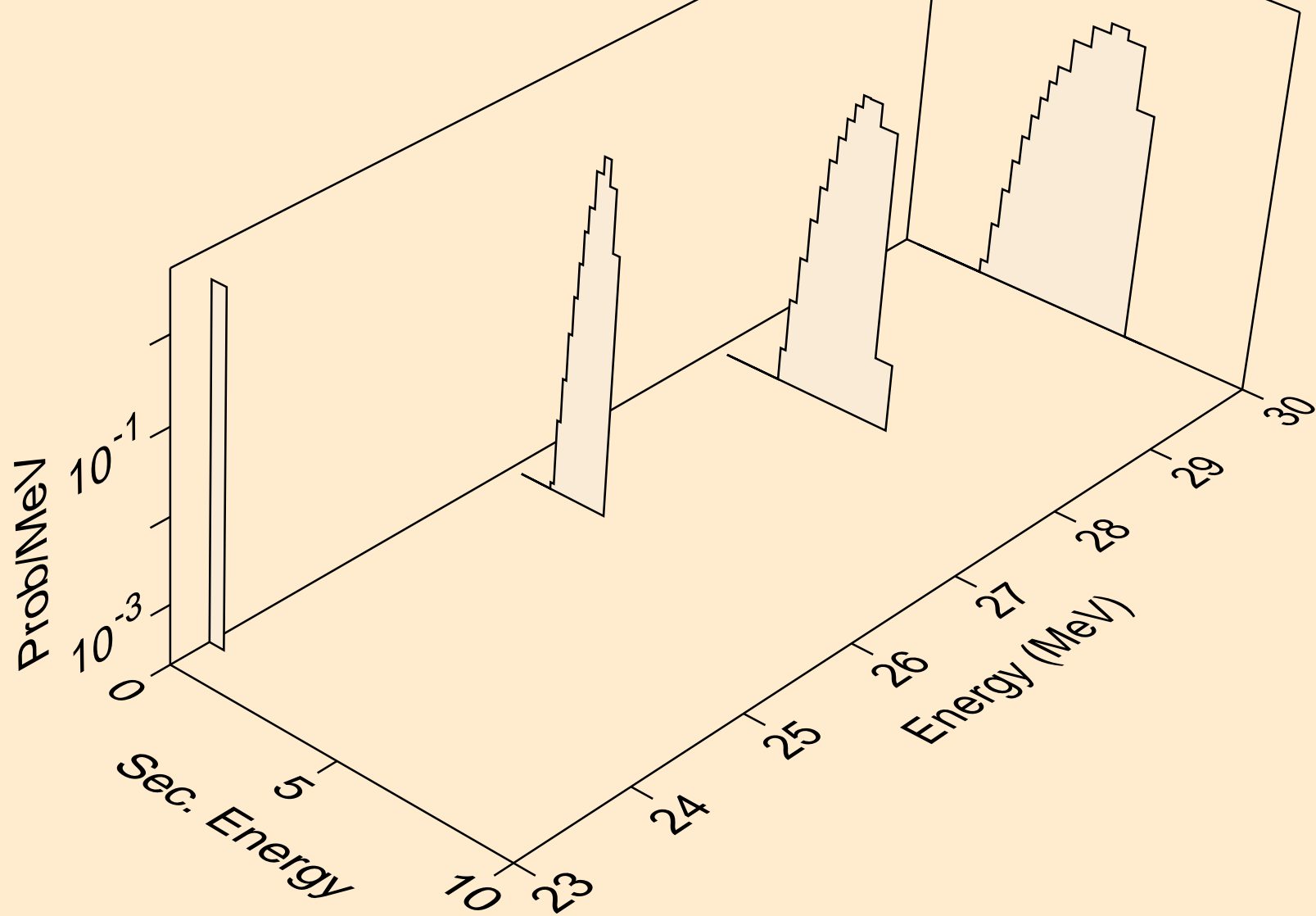

TC094M NEUTRON ACER TENDL-2023 LIBRARY; T=0.K
deuterons from (n,n*)d

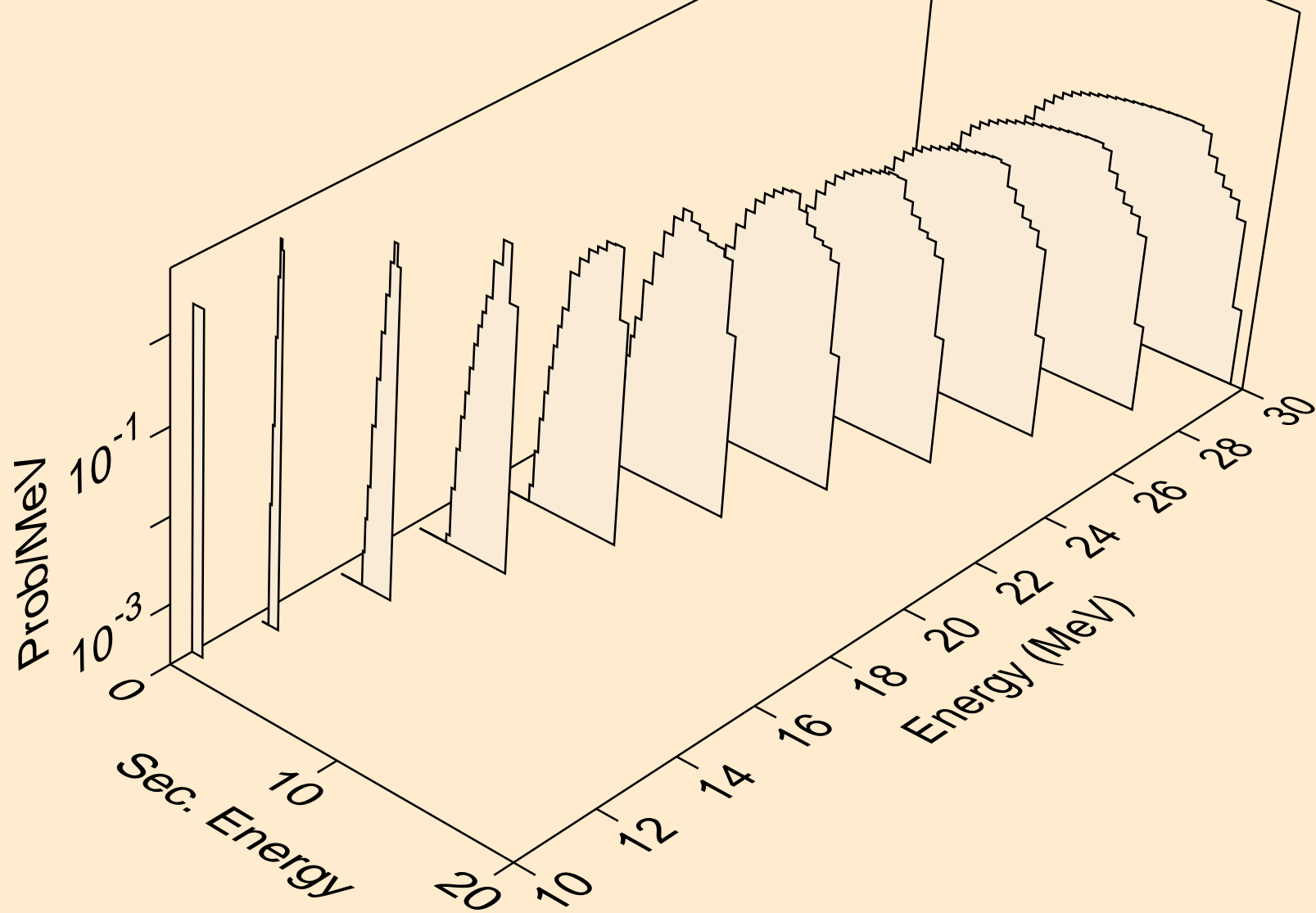

TC094M NEUTRON ACER TENDL-2023 LIBRARY; T=0.K
deuterons from (n,d)

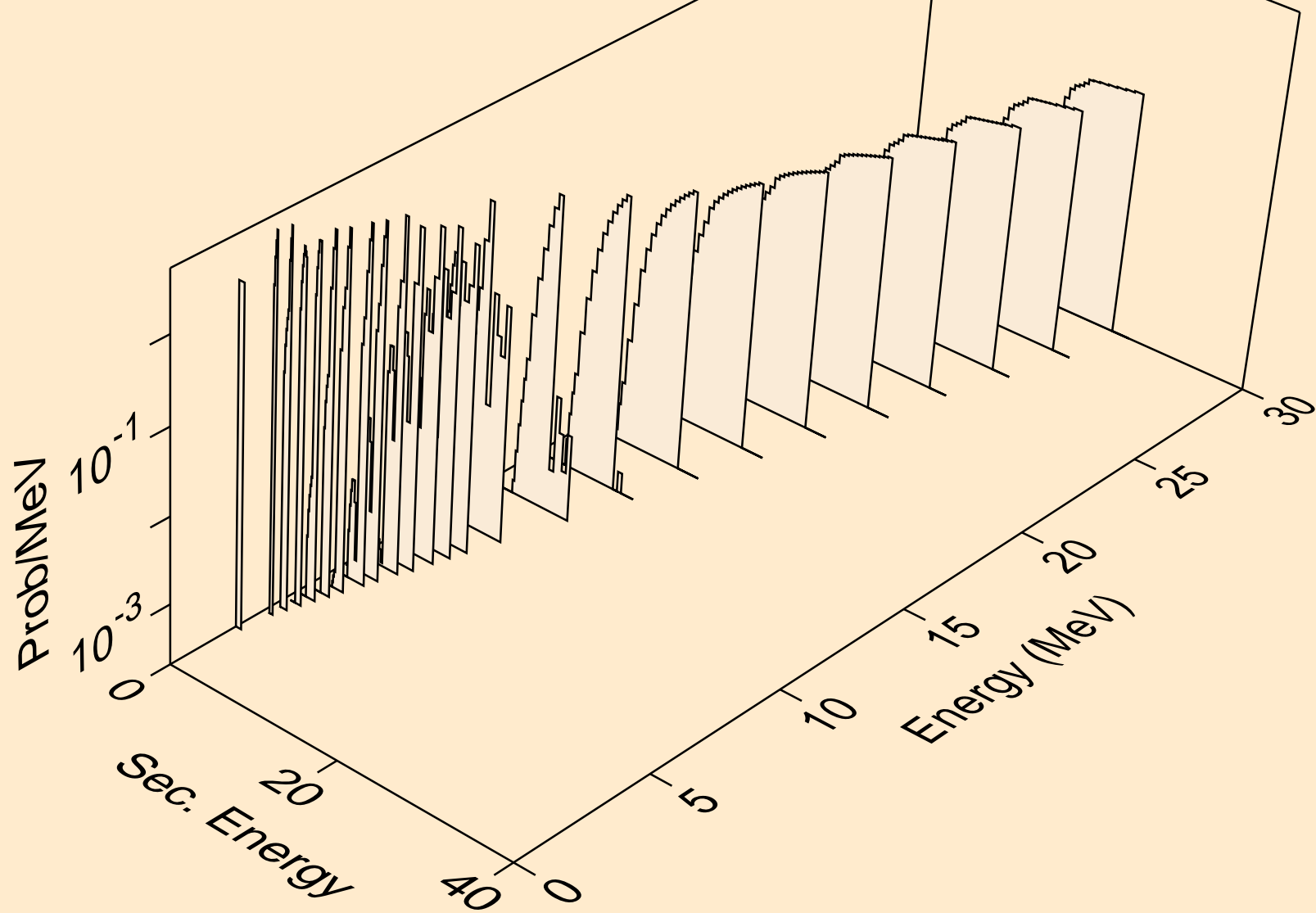

TC094M NEUTRON ACER TENDL-2023 LIBRARY; T=0.K
deuterons from (n,pd)

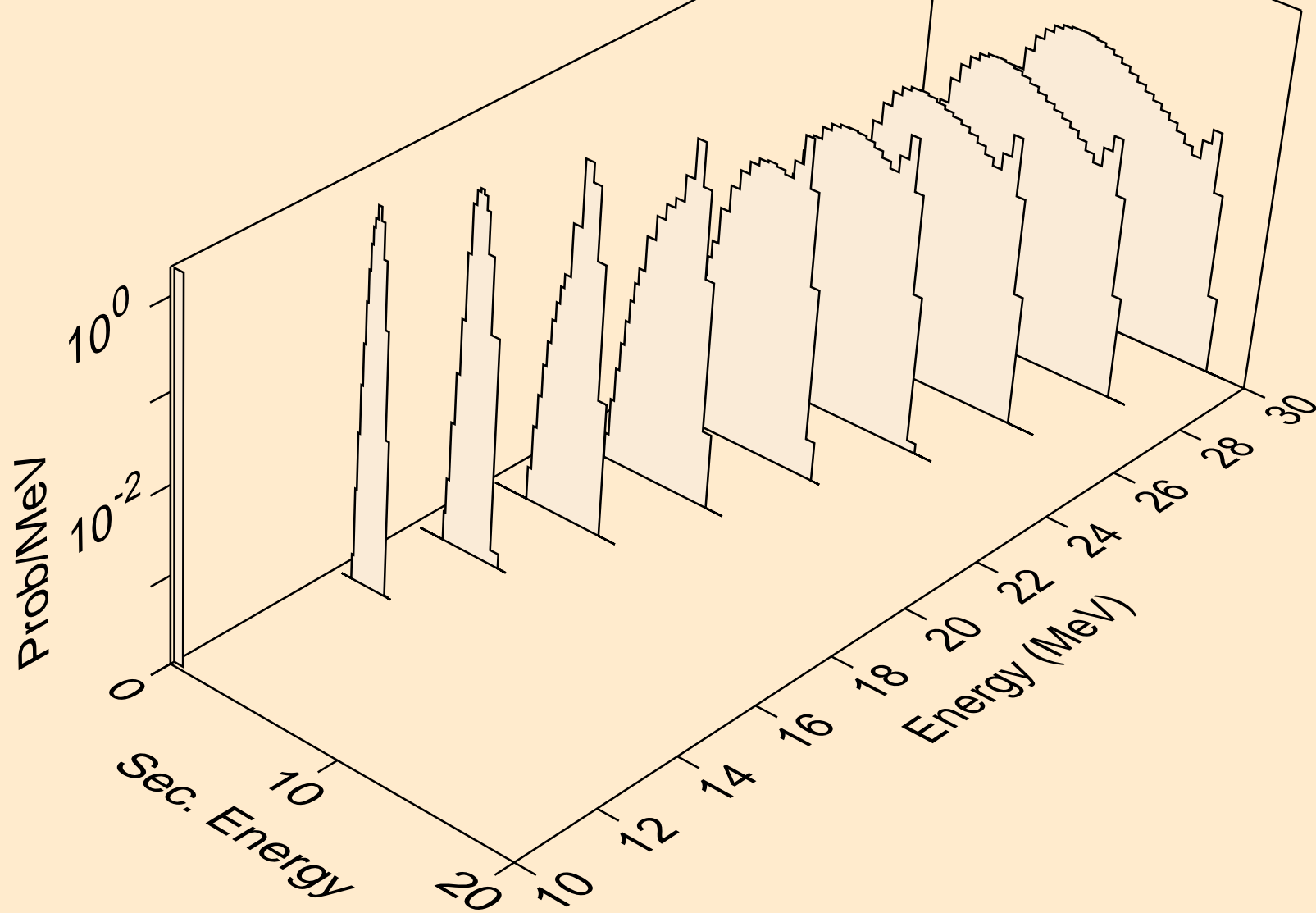

TC094M NEUTRON ACER TENDL-2023 LIBRARY; T=0.K
deuterons from (n,da)

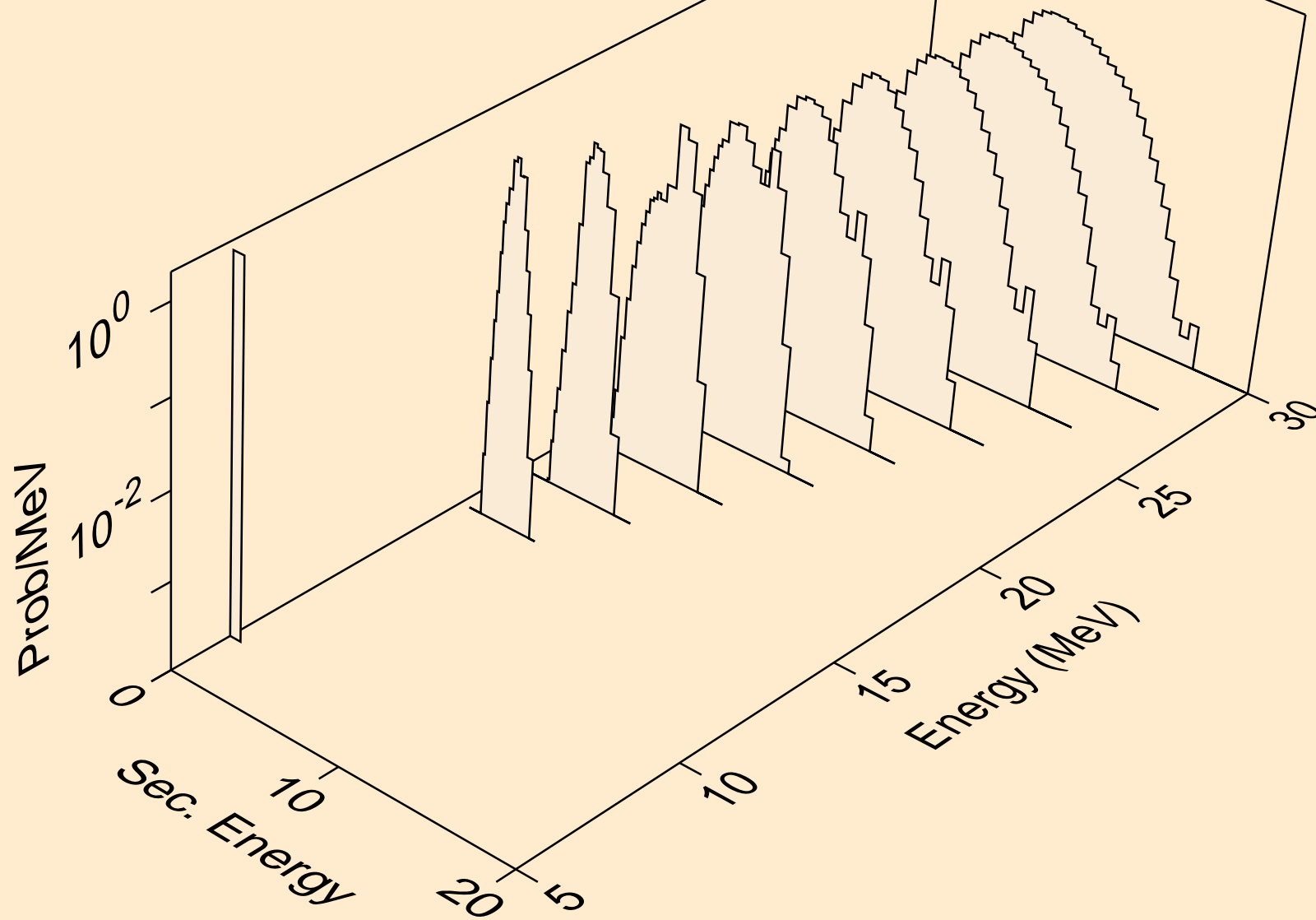

TC094M NEUTRON ACER TENDL-2023 LIBRARY; T=0.K
tritons from (n,x)

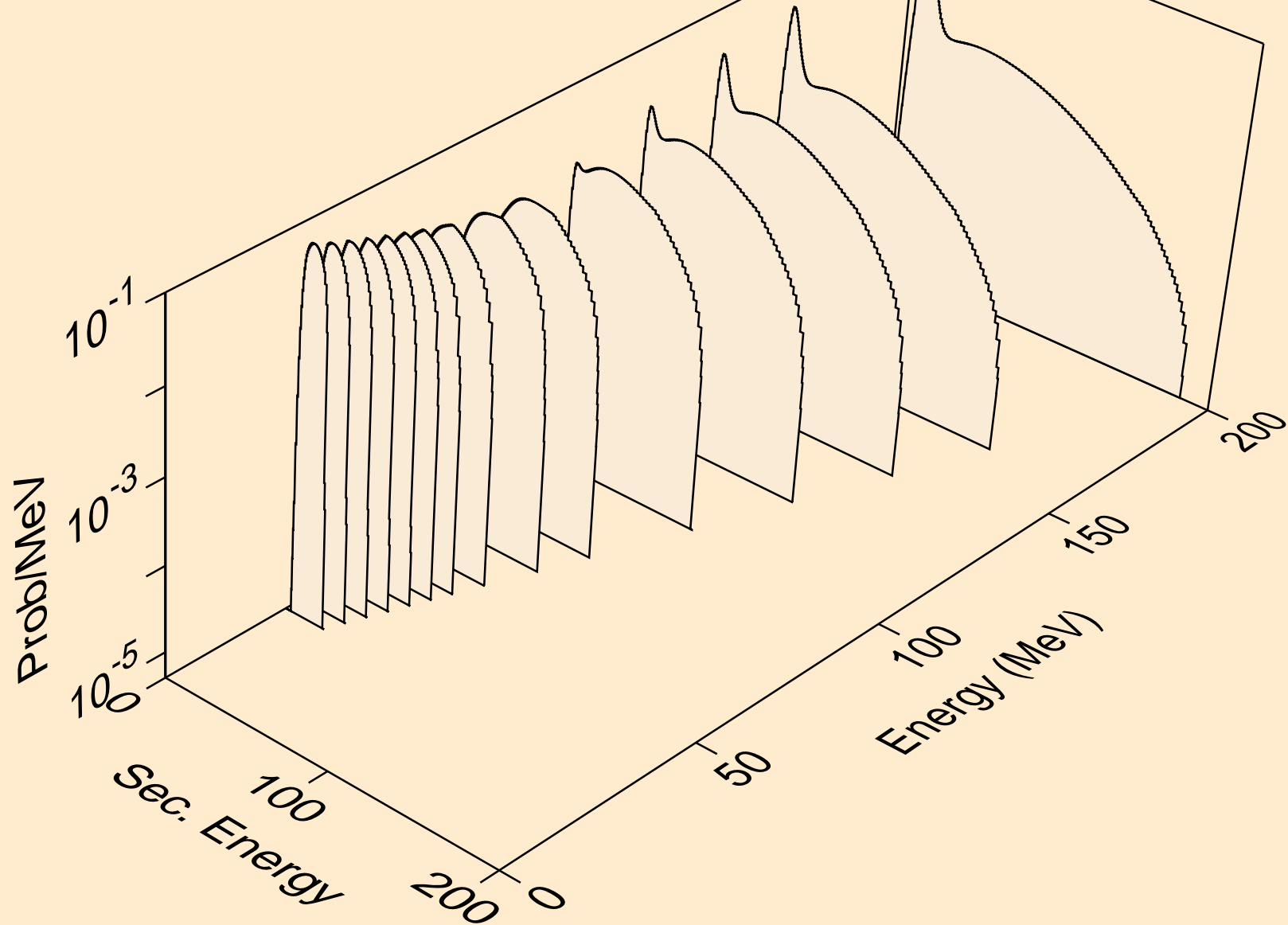

TC094M NEUTRON ACER TENDL-2023 LIBRARY; T=0.K
tritons from (n,n*)t

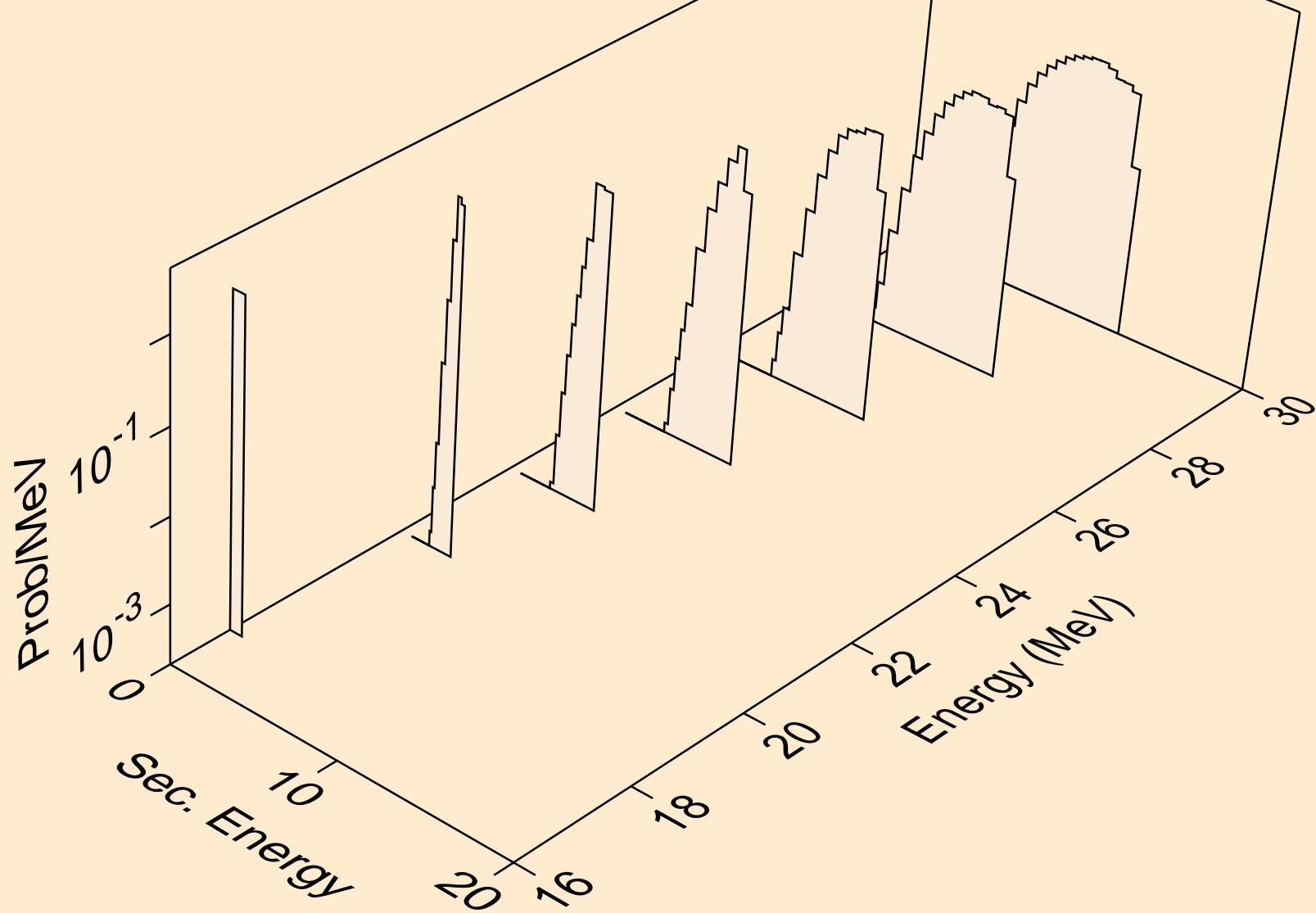

TC094M NEUTRON ACER TENDL-2023 LIBRARY; T=0.K
tritons from (n,t)

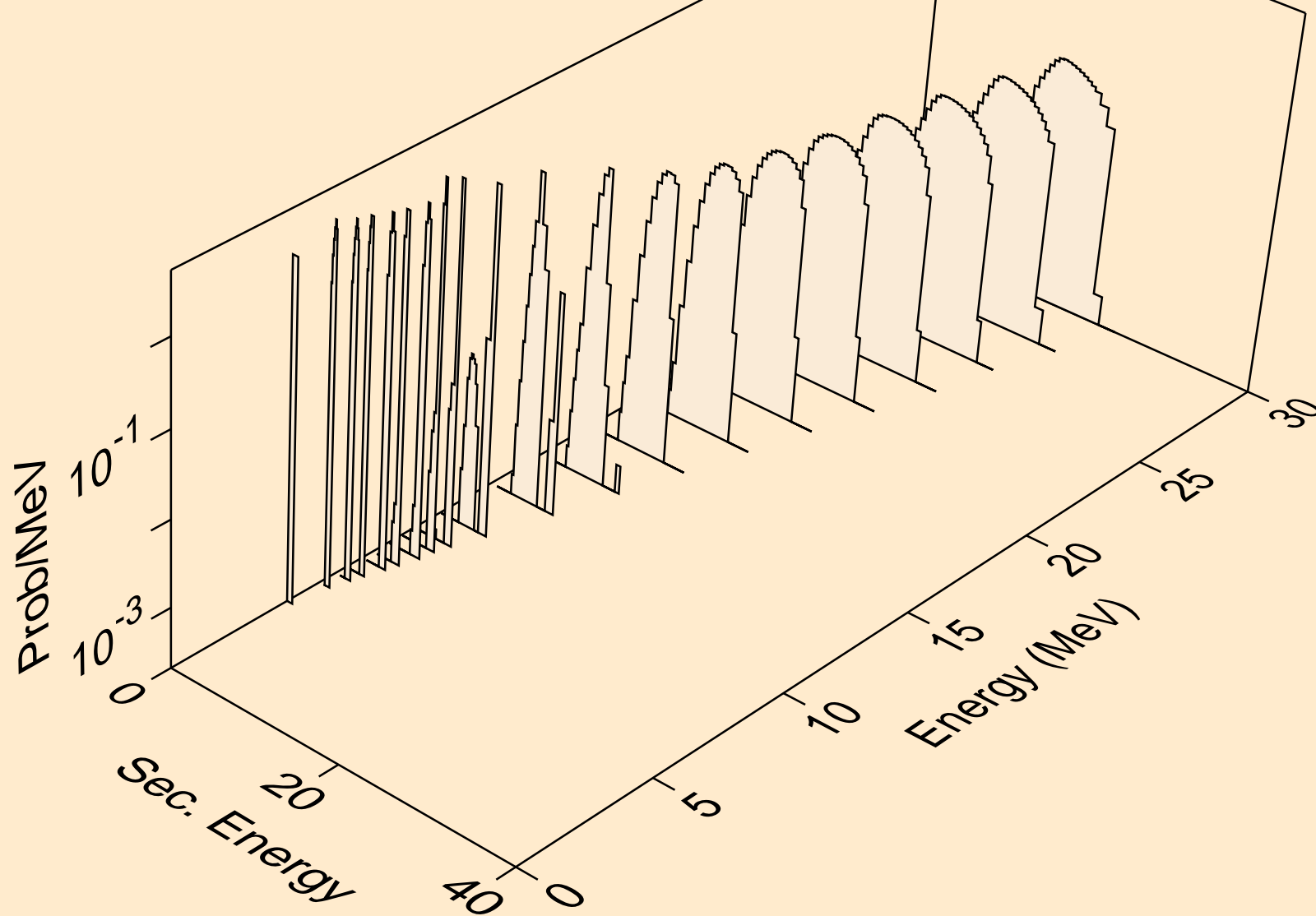

TC094M NEUTRON ACER TENDL-2023 LIBRARY; T=0.K
tritons from (n,pt)

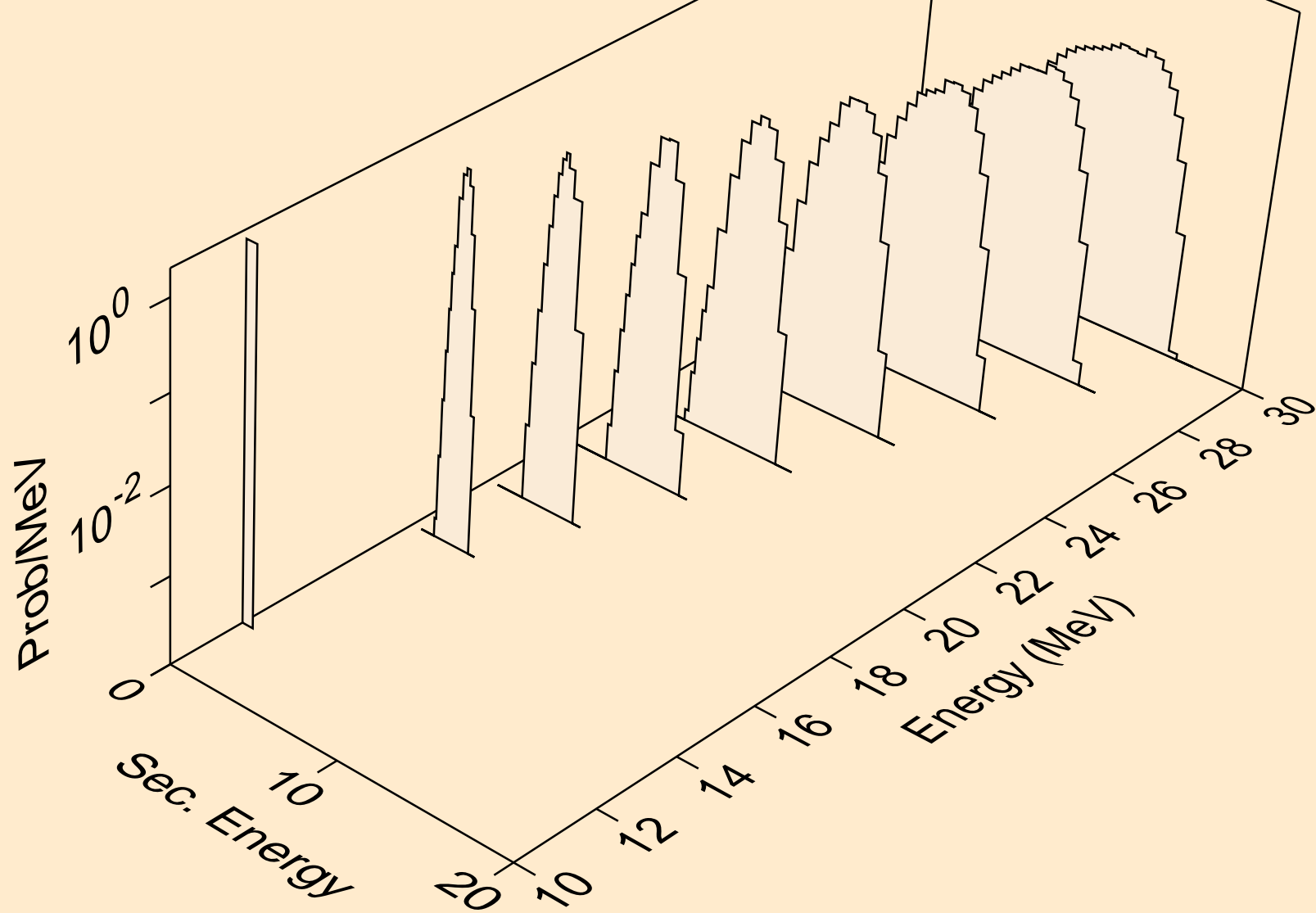

TC094M NEUTRON ACER TENDL-2023 LIBRARY; T=0.K
he3s from (n,x)

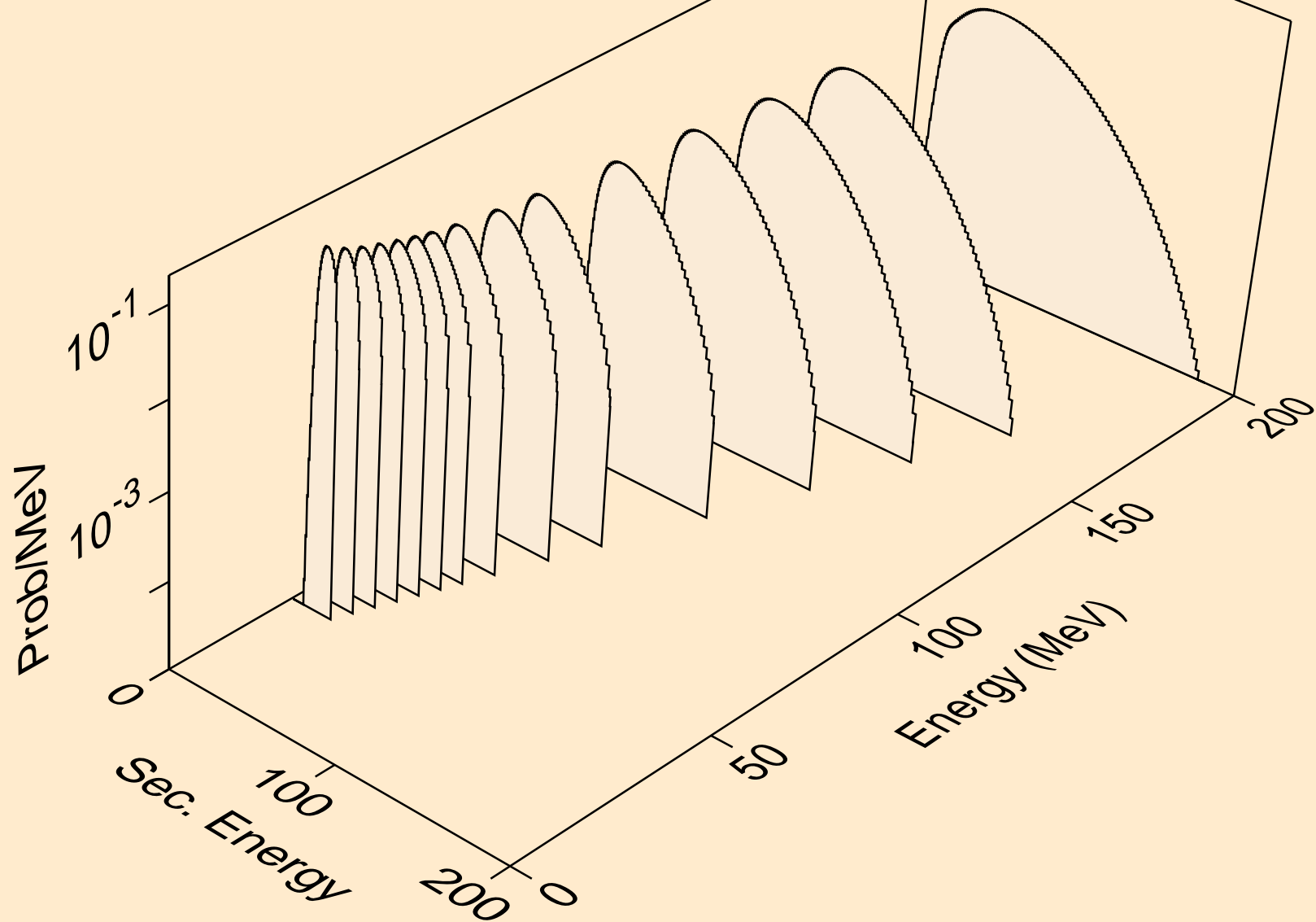

TC094M NEUTRON ACER TENDL-2023 LIBRARY; T=0.K
he3s from (n,n*)he3

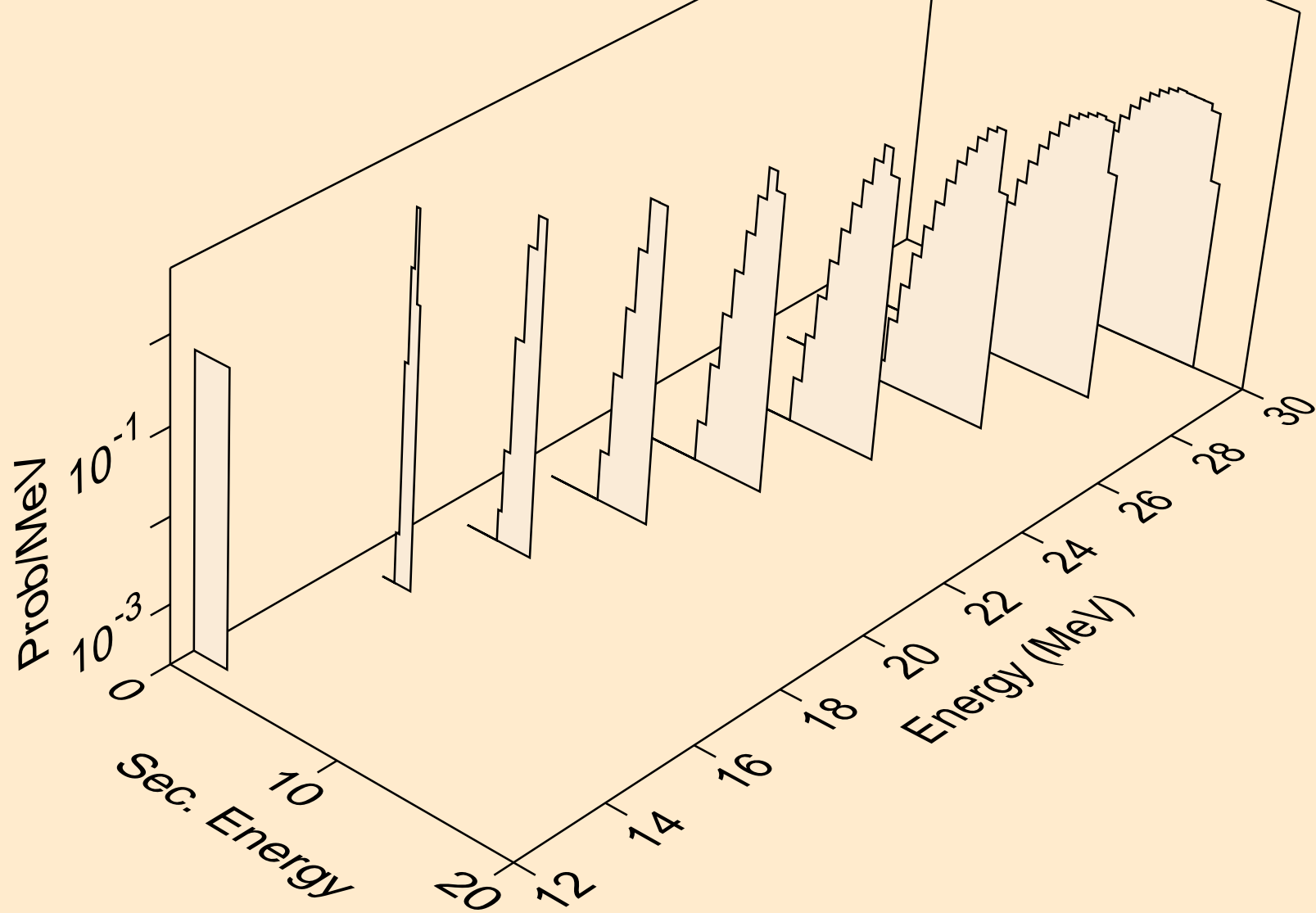

TC094M NEUTRON ACER TENDL-2023 LIBRARY; T=0.K
he3s from (n,he3)

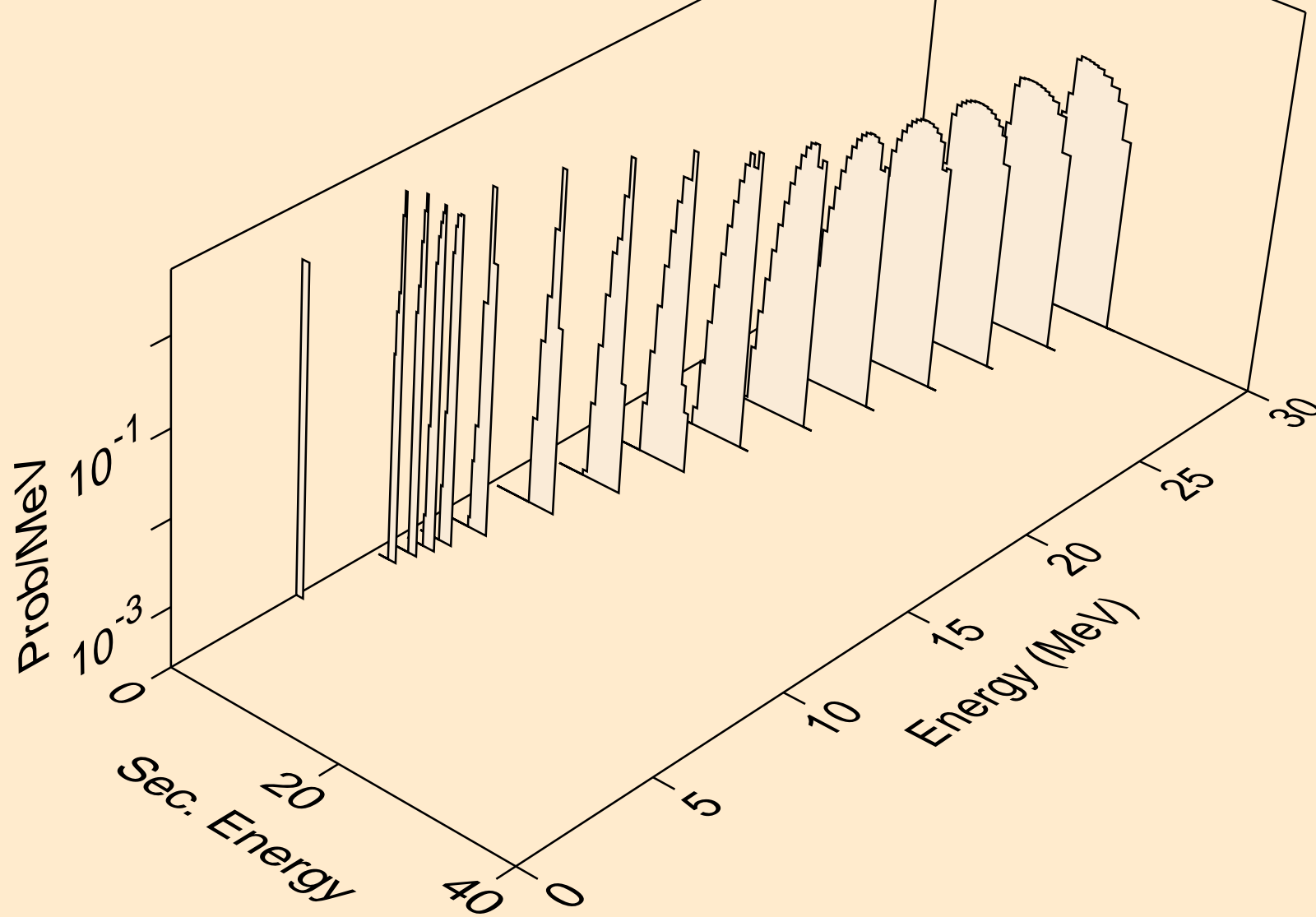

TC094M NEUTRON ACER TENDL-2023 LIBRARY; T=0.K
alphas from (n,x)

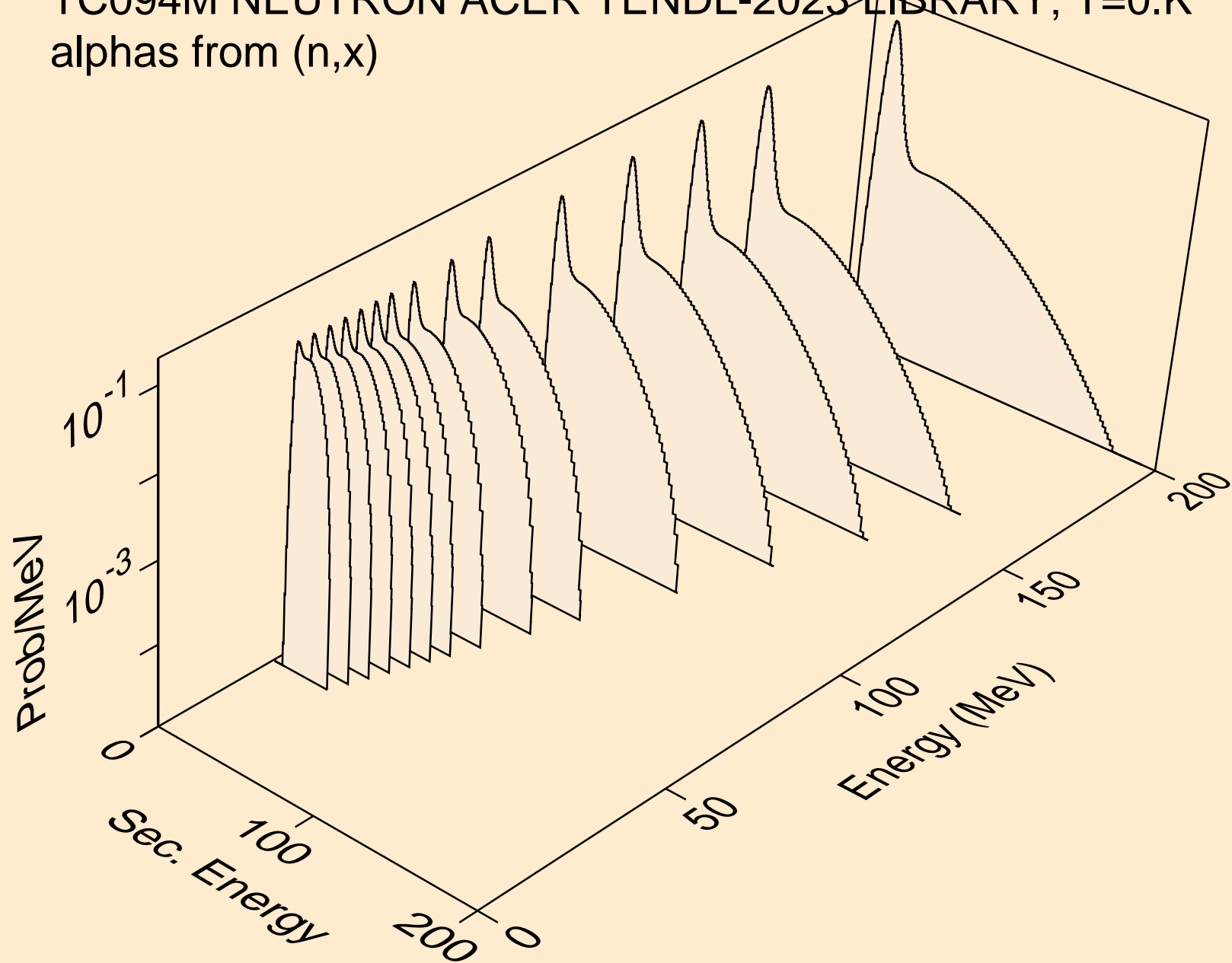

TC094M NEUTRON ACER TENDL-2023 LIBRARY; T=0.K
alphas from (n,n*)a

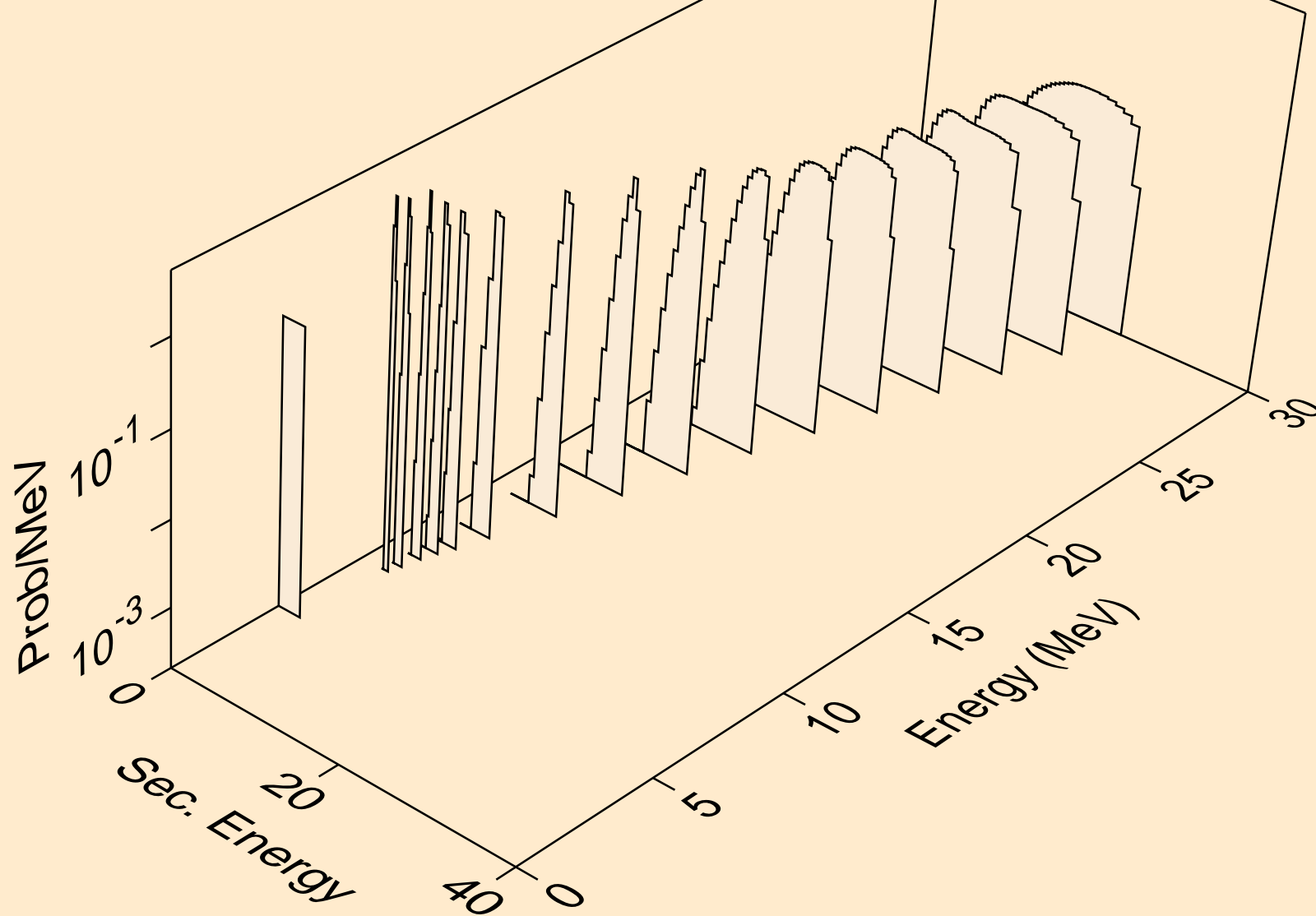

TC094M NEUTRON ACER TENDL-2023 LIBRARY; T=0.K
alphas from (n,2n)a

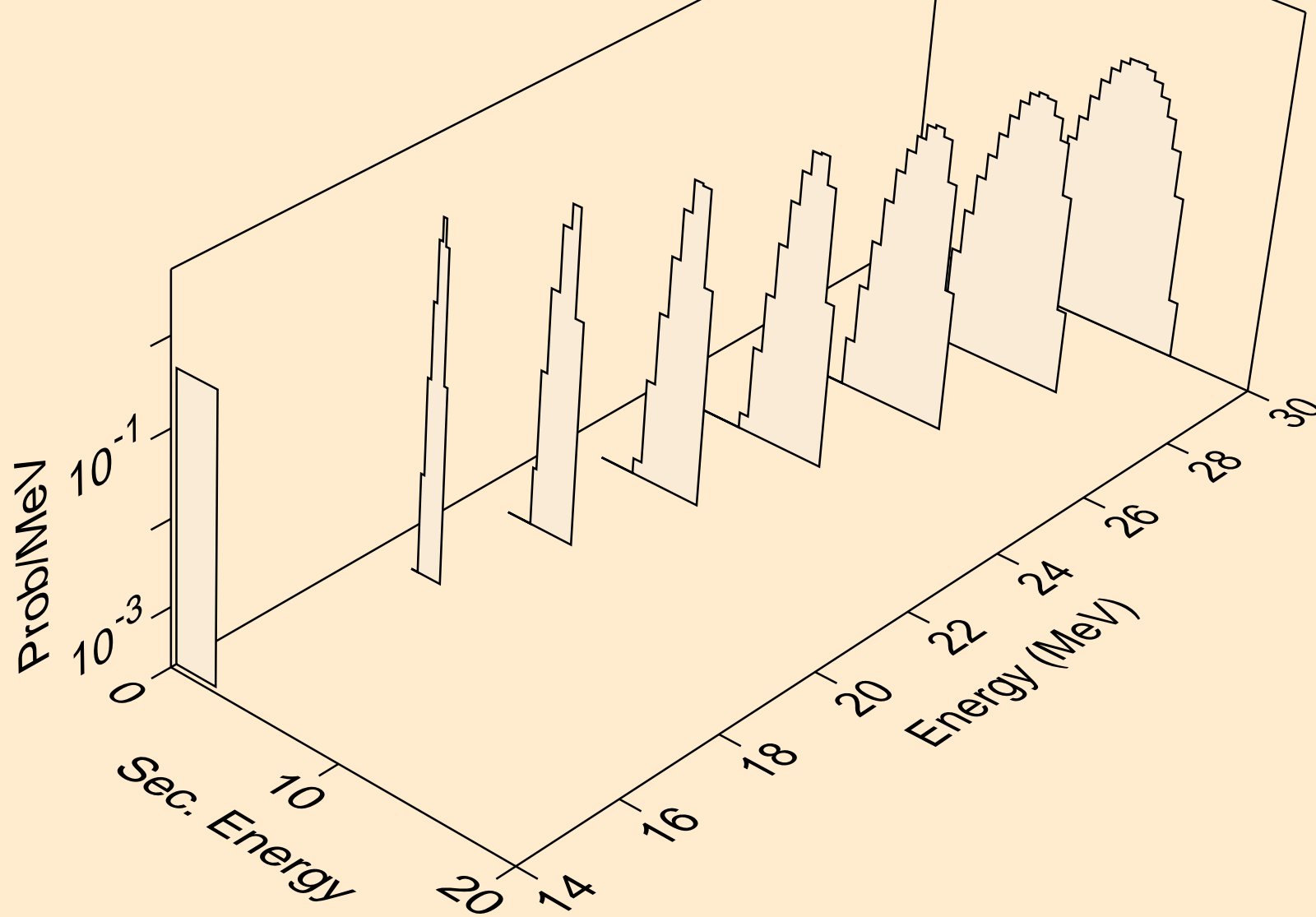

TC094M NEUTRON ACER TENDL-2023 LIBRARY; T=0.K
alphas from (n,n*)2a

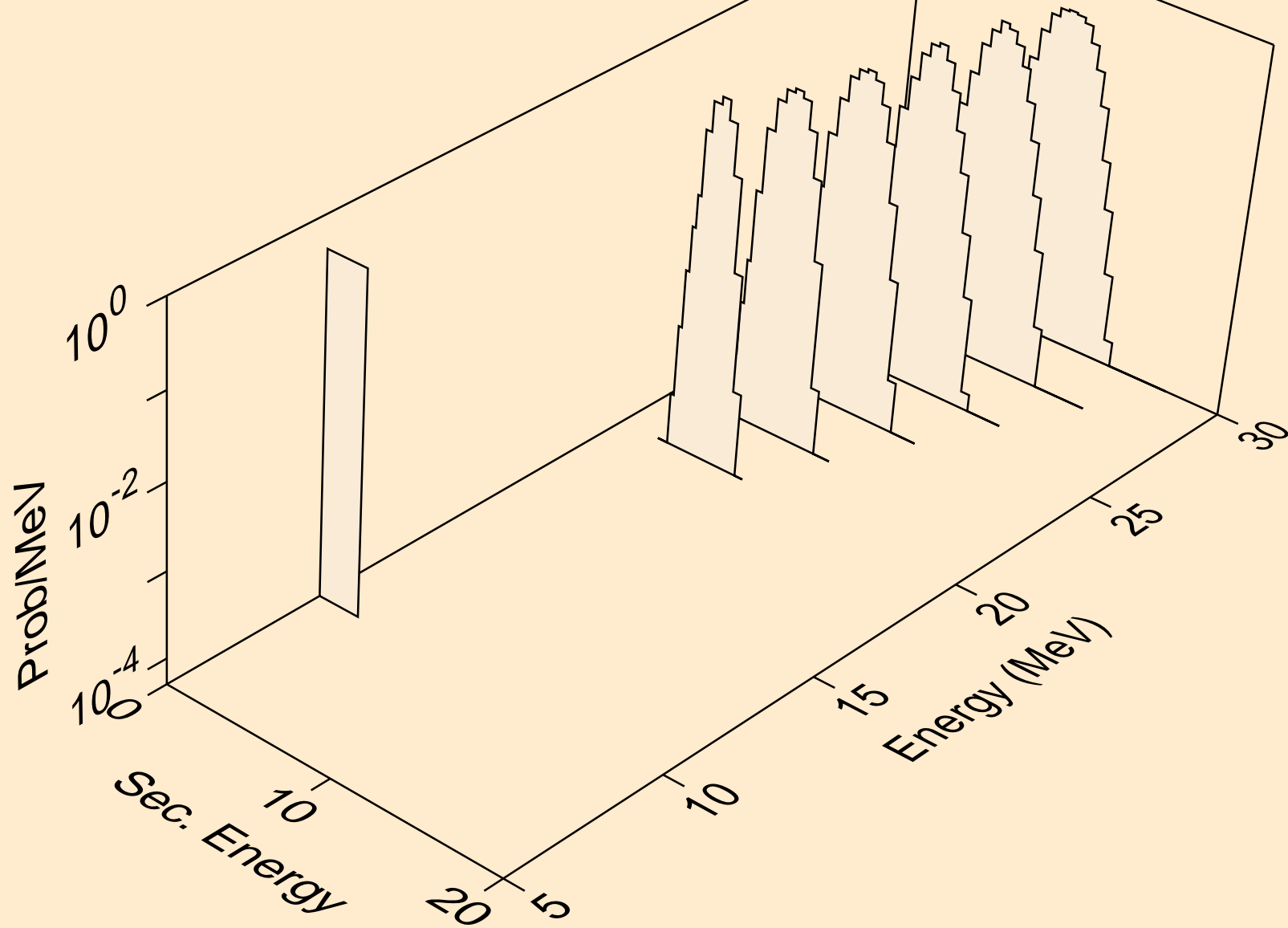

TC094M NEUTRON ACER TENDL-2023 LIBRARY; T=0.K
alphas from (n,npa)

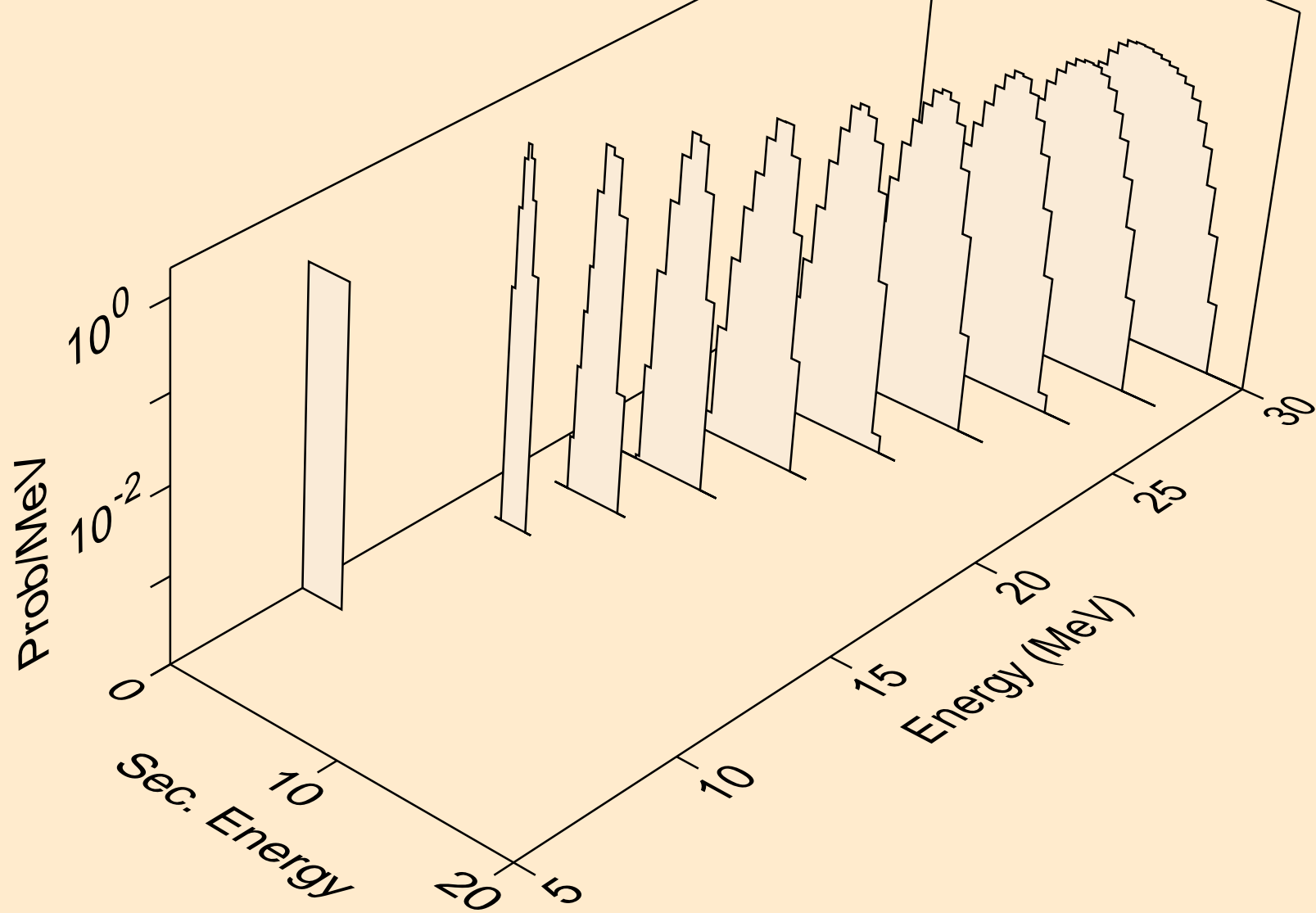

TC094M NEUTRON ACER TENDL-2023 LIBRARY; T=0.K
alphas from (n,a)

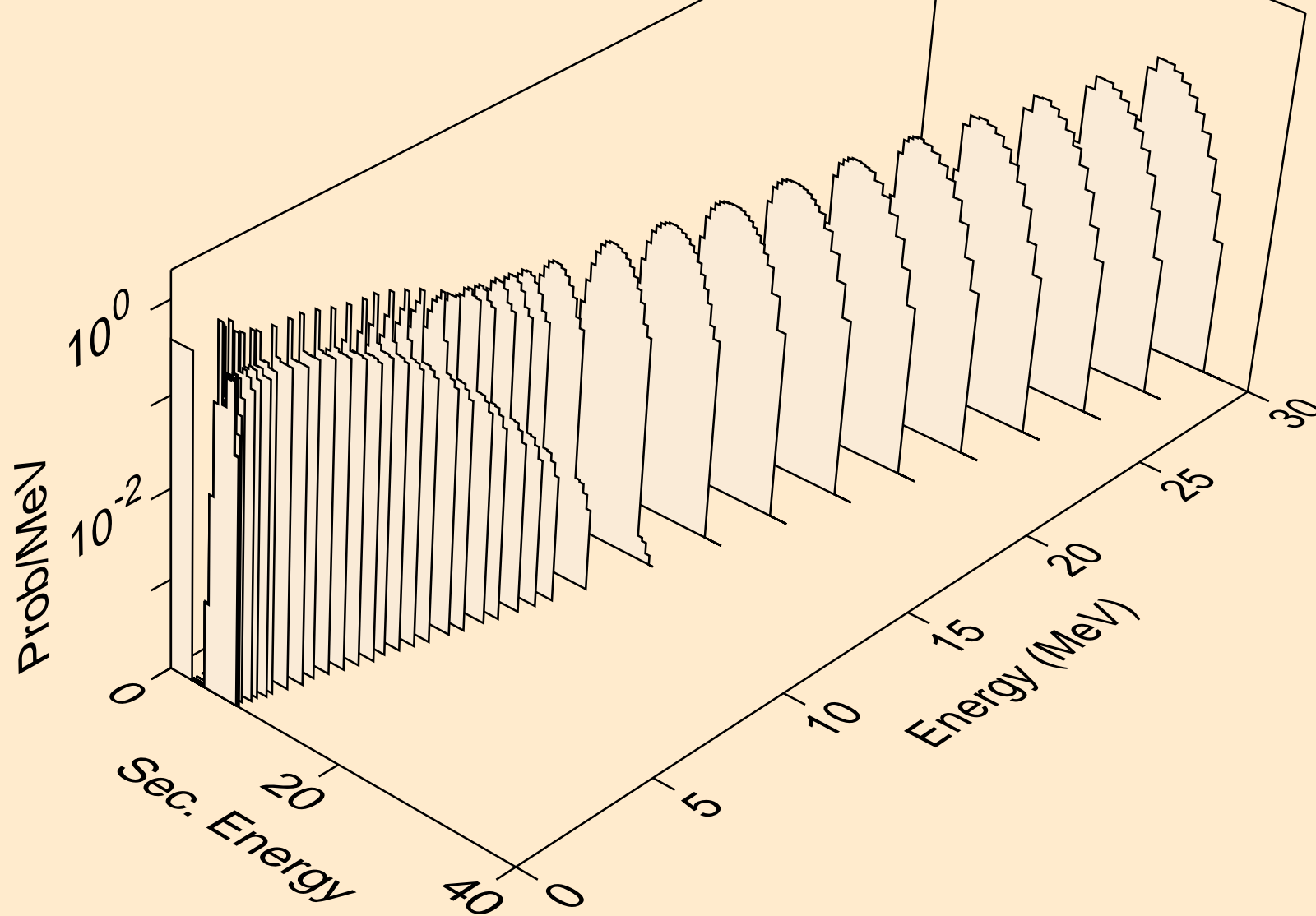

TC094M NEUTRON ACER TENDL-2023 LIBRARY; T=0.K
alphas from (n,2a)

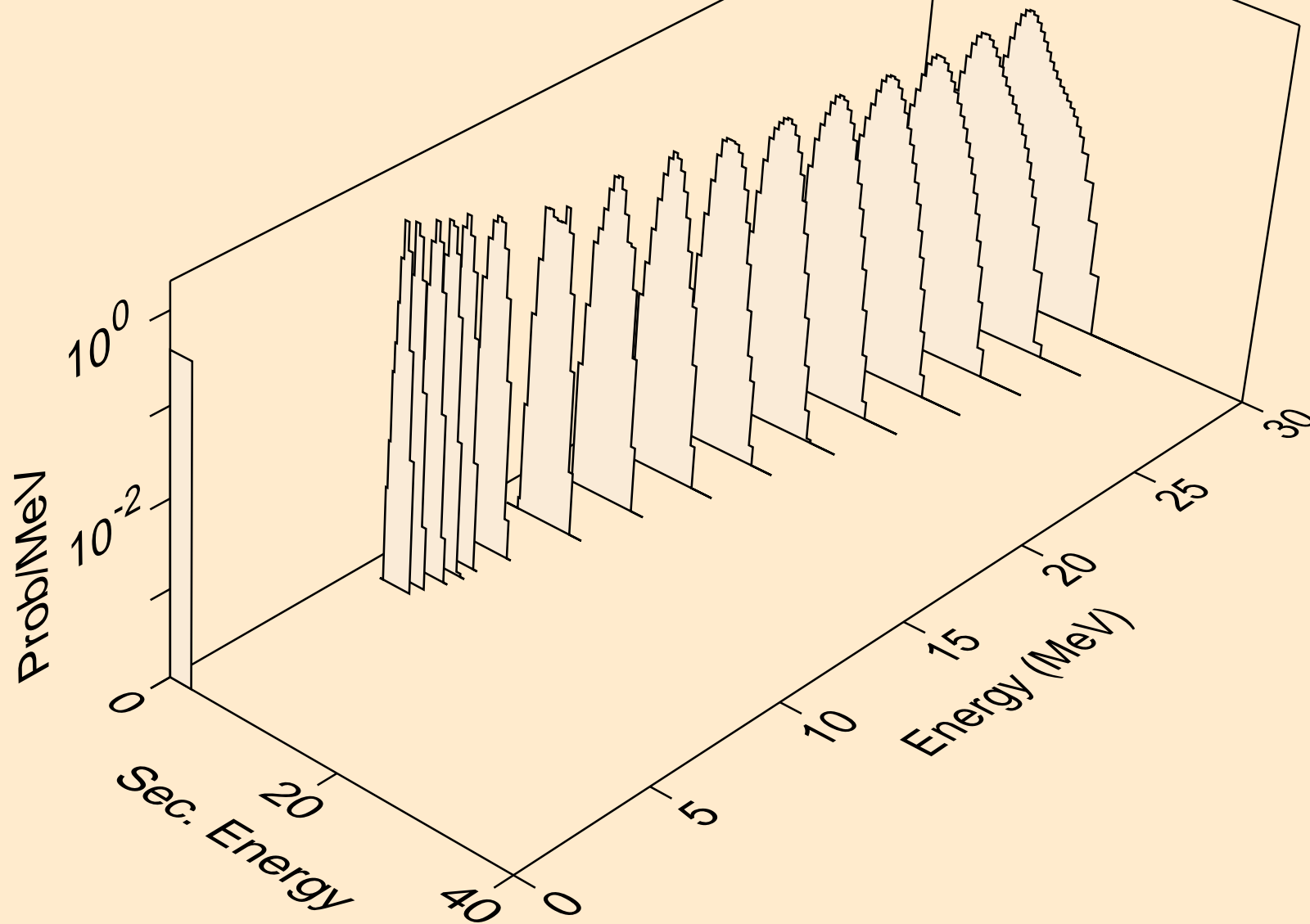

TC094M NEUTRON ACER TENDL-2023 LIBRARY; T=0.K
alphas from (n,pa)

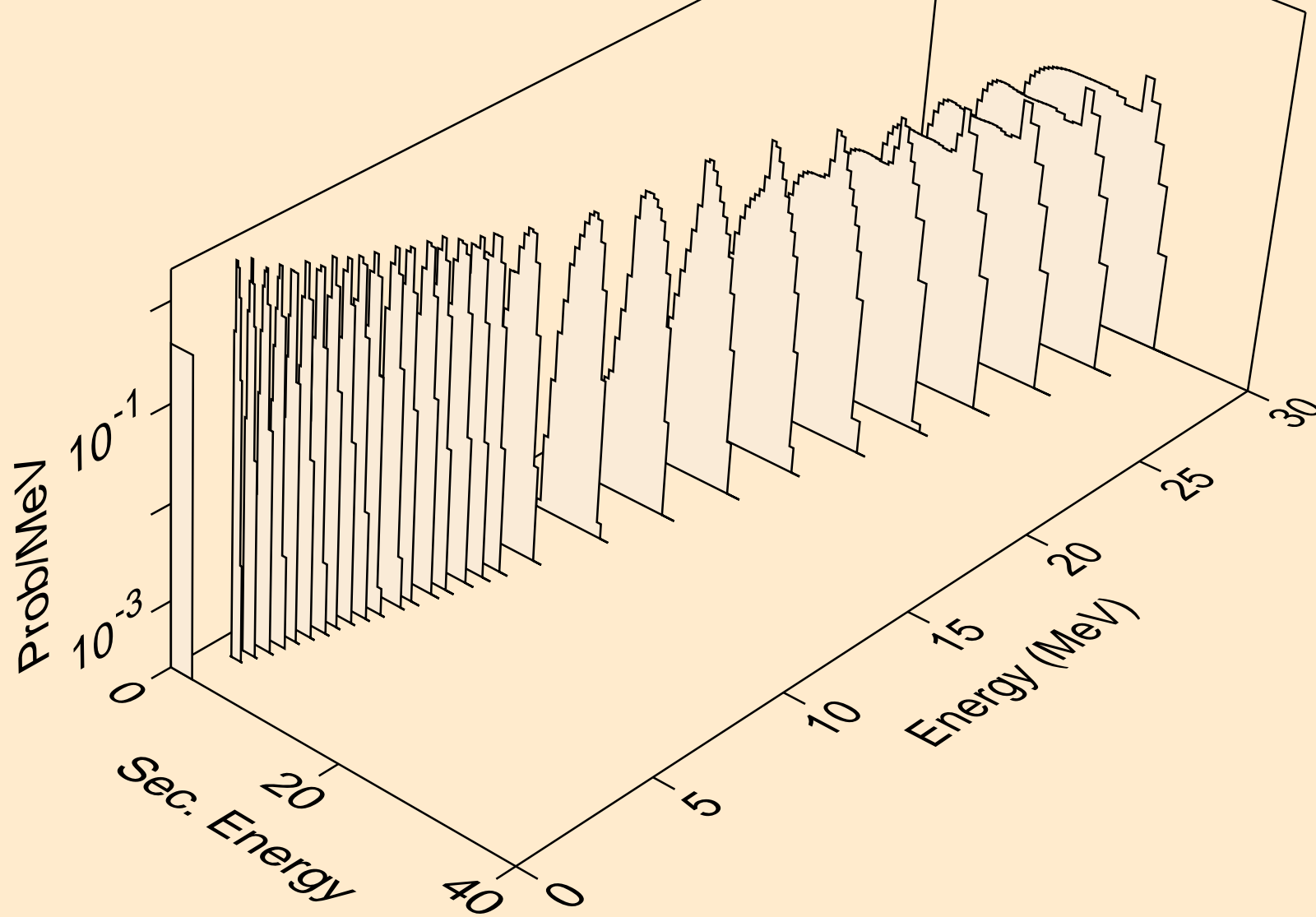

TC094M NEUTRON ACER TENDL-2023 LIBRARY; T=0.K
alphas from (n,da)

