

# TH224 NEUTRON ACER TENDL-2023 LIBRARY; T=0.K

## Principal cross sections

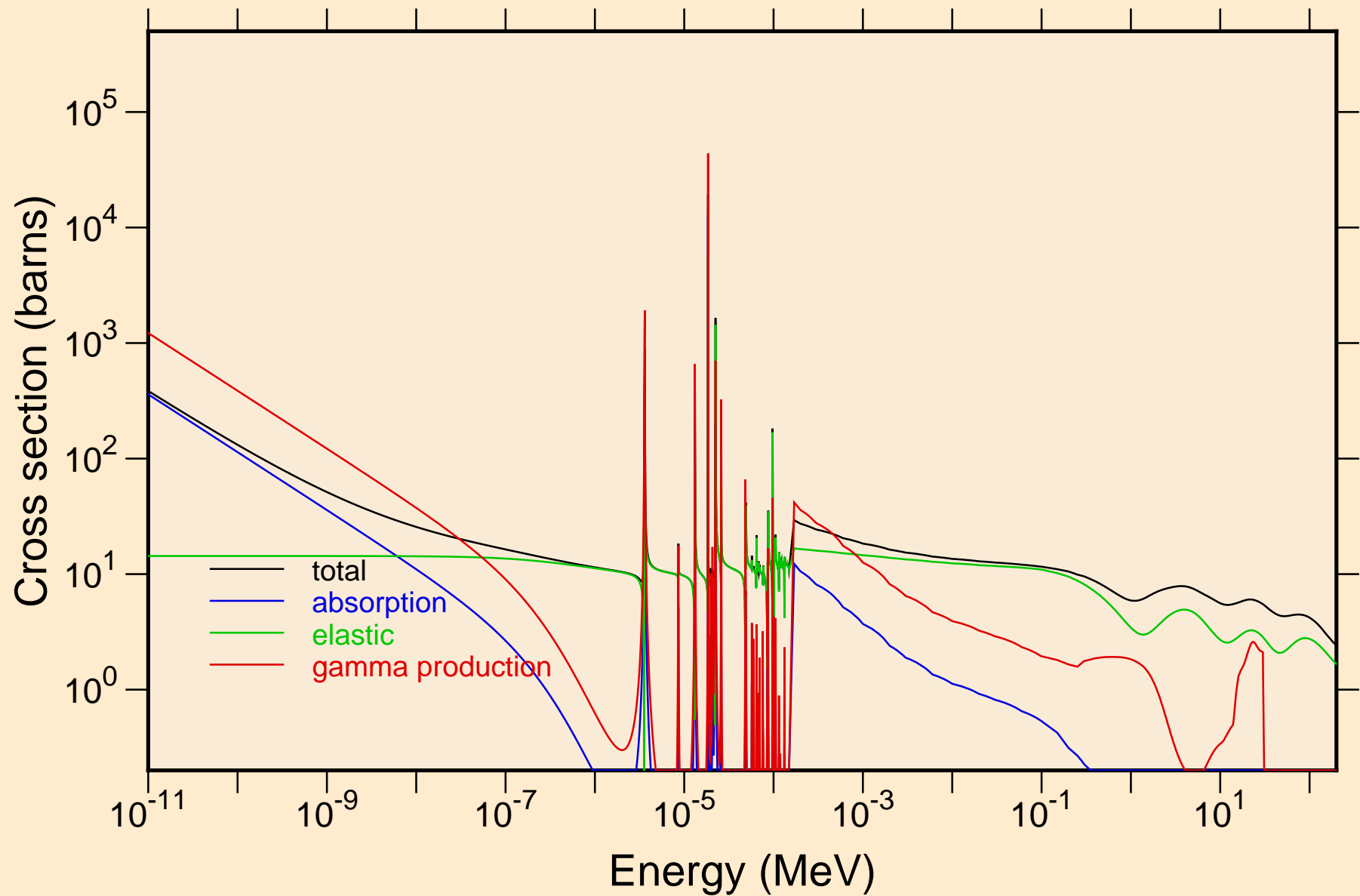

TH224 NEUTRON ACER TENDL-2023 LIBRARY; T=0.K  
resonance total cross section

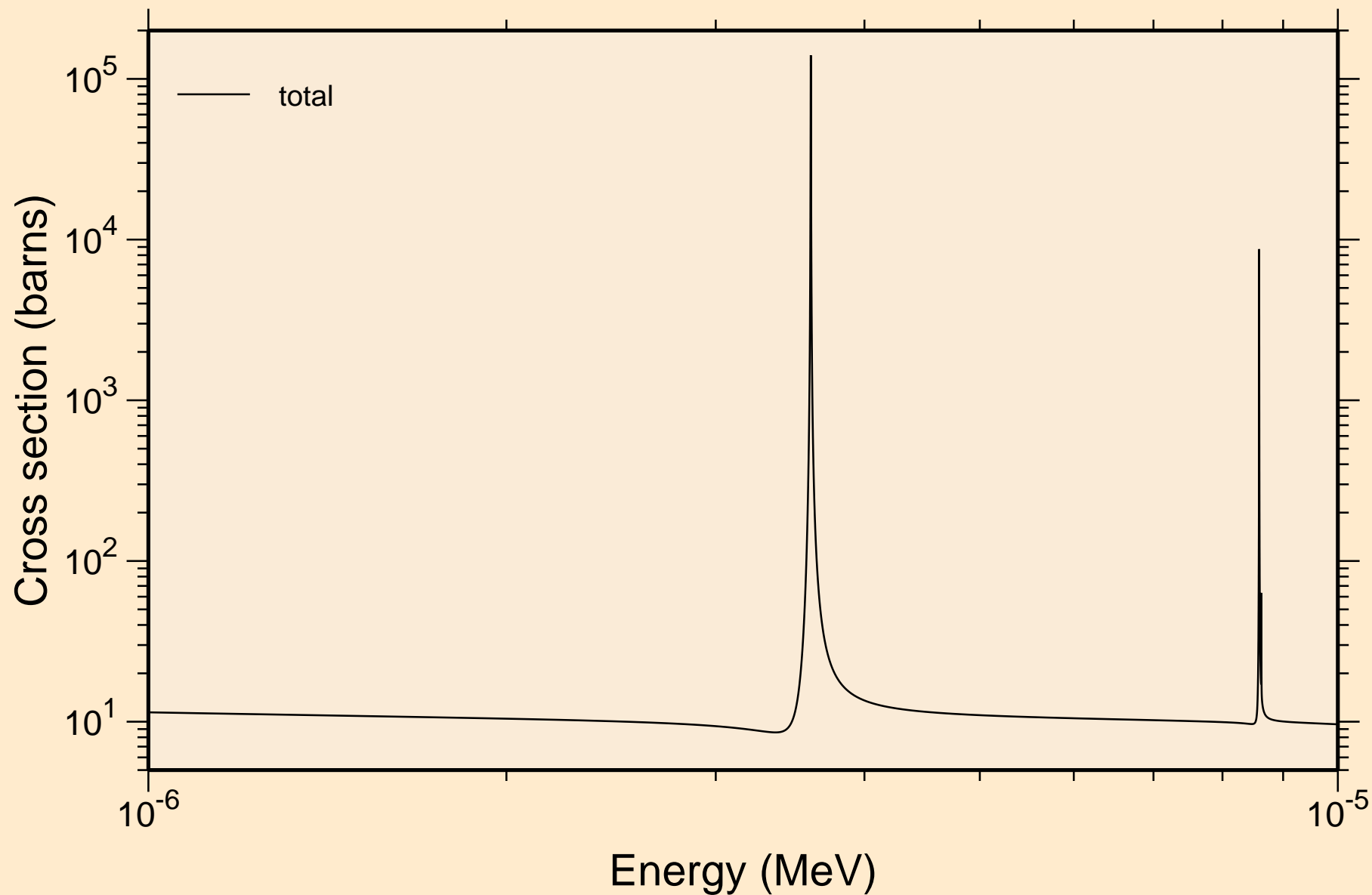

TH224 NEUTRON ACER TENDL-2023 LIBRARY; T=0.K  
resonance total cross section

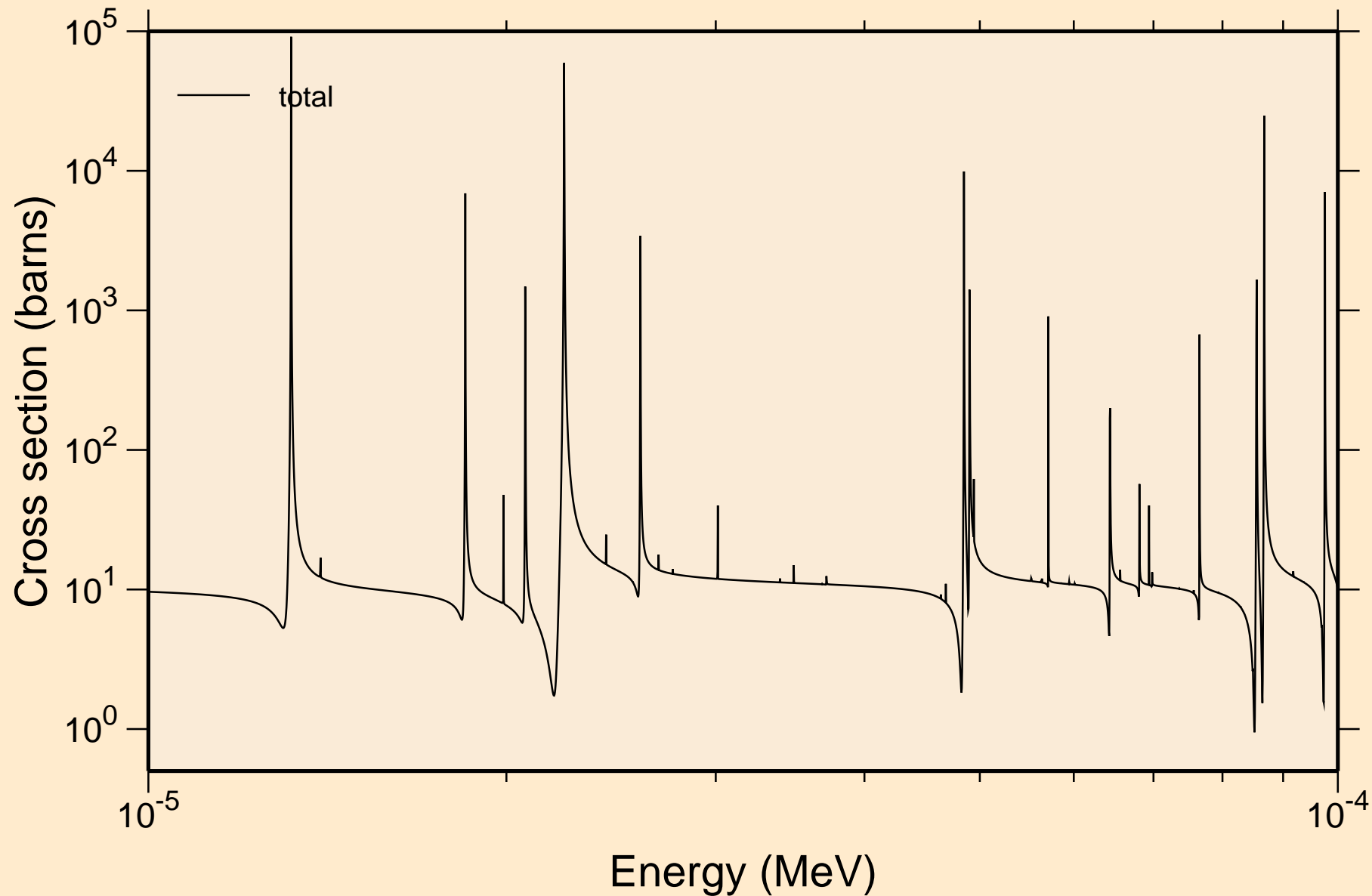

TH224 NEUTRON ACER TENDL-2023 LIBRARY; T=0.K  
resonance total cross section

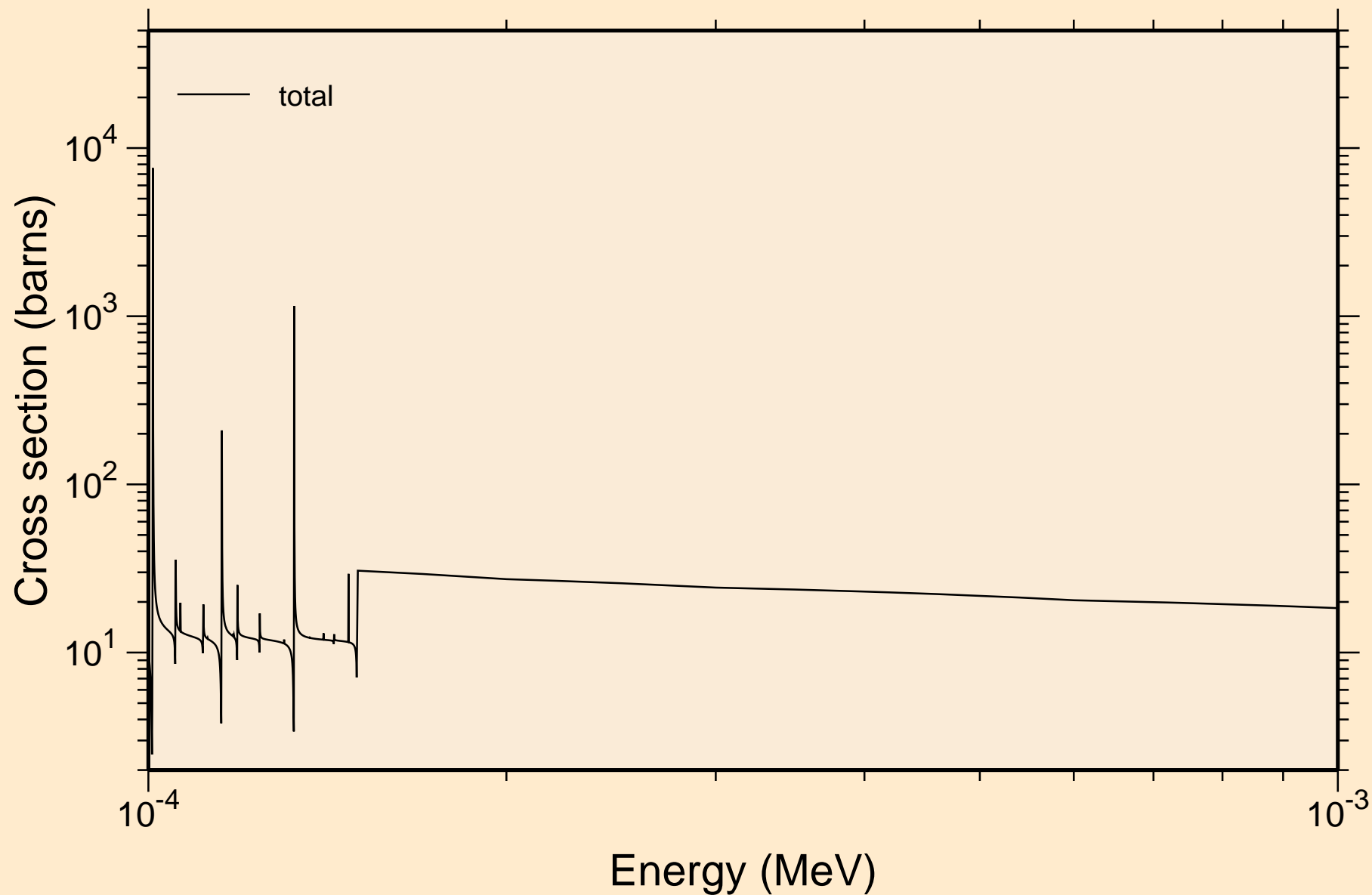

TH224 NEUTRON ACER TENDL-2023 LIBRARY; T=0.K  
resonance total cross section

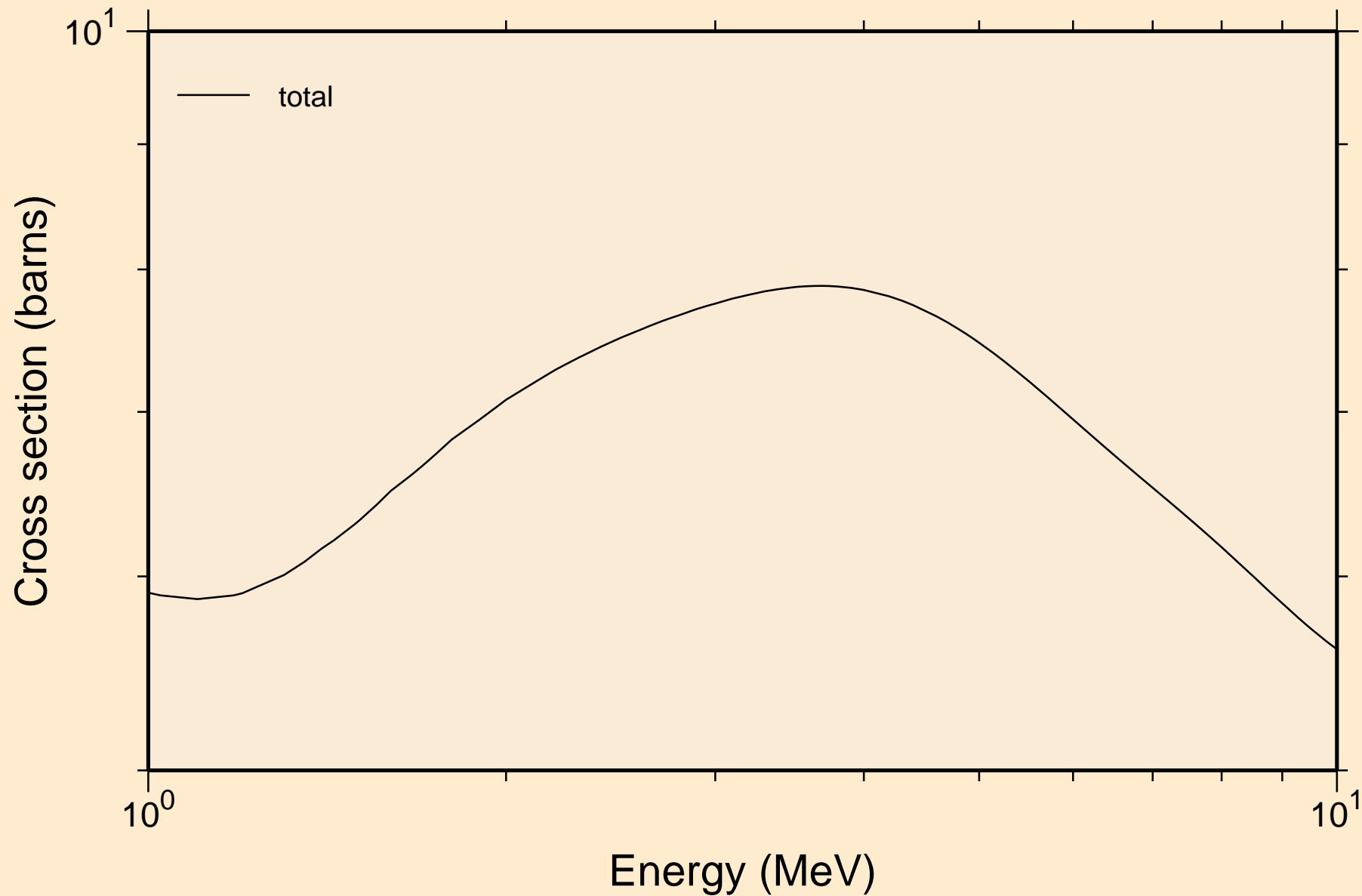

TH224 NEUTRON ACER TENDL-2023 LIBRARY; T=0.K  
resonance absorption cross sections

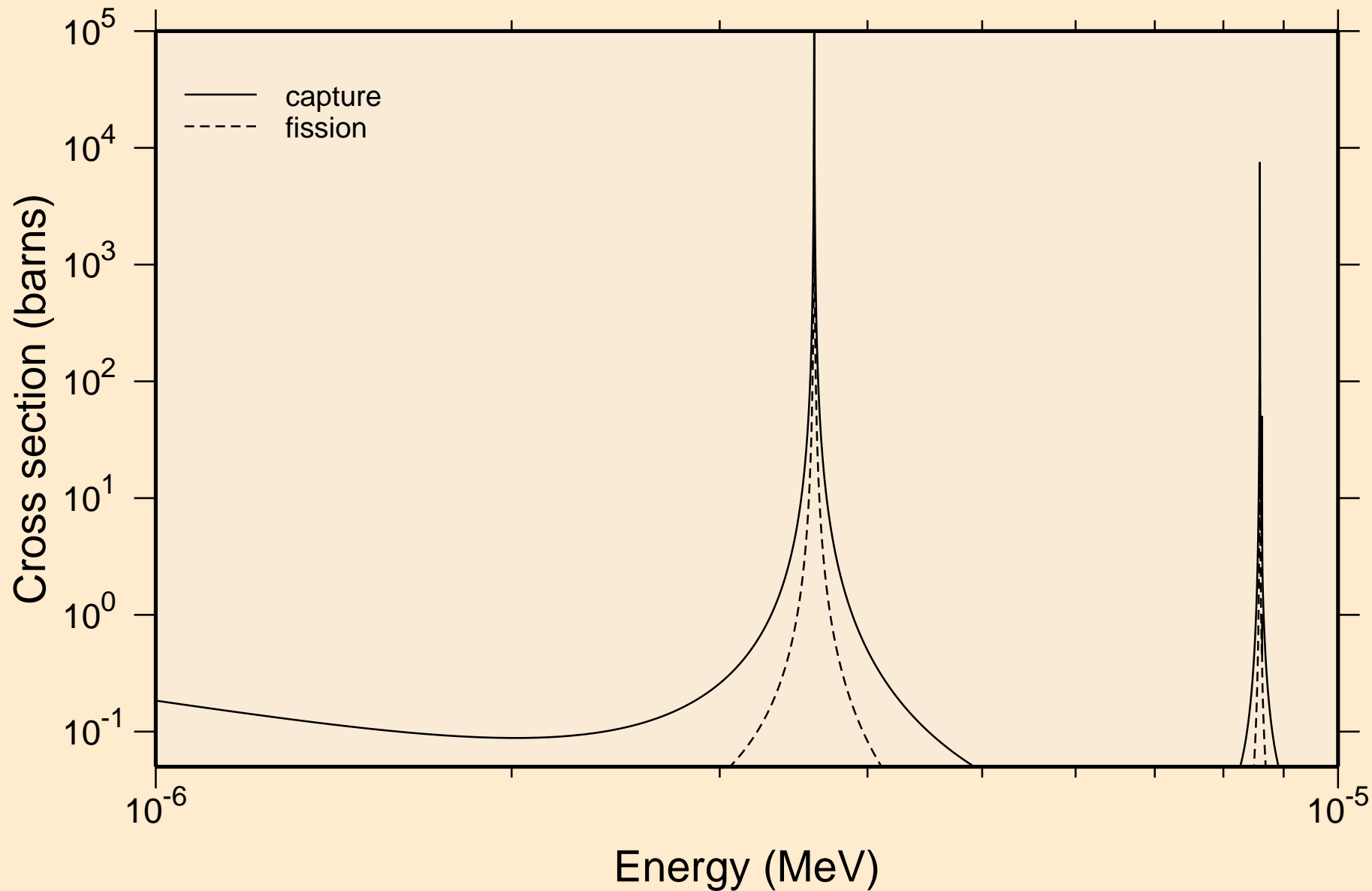

TH224 NEUTRON ACER TENDL-2023 LIBRARY; T=0.K  
resonance absorption cross sections

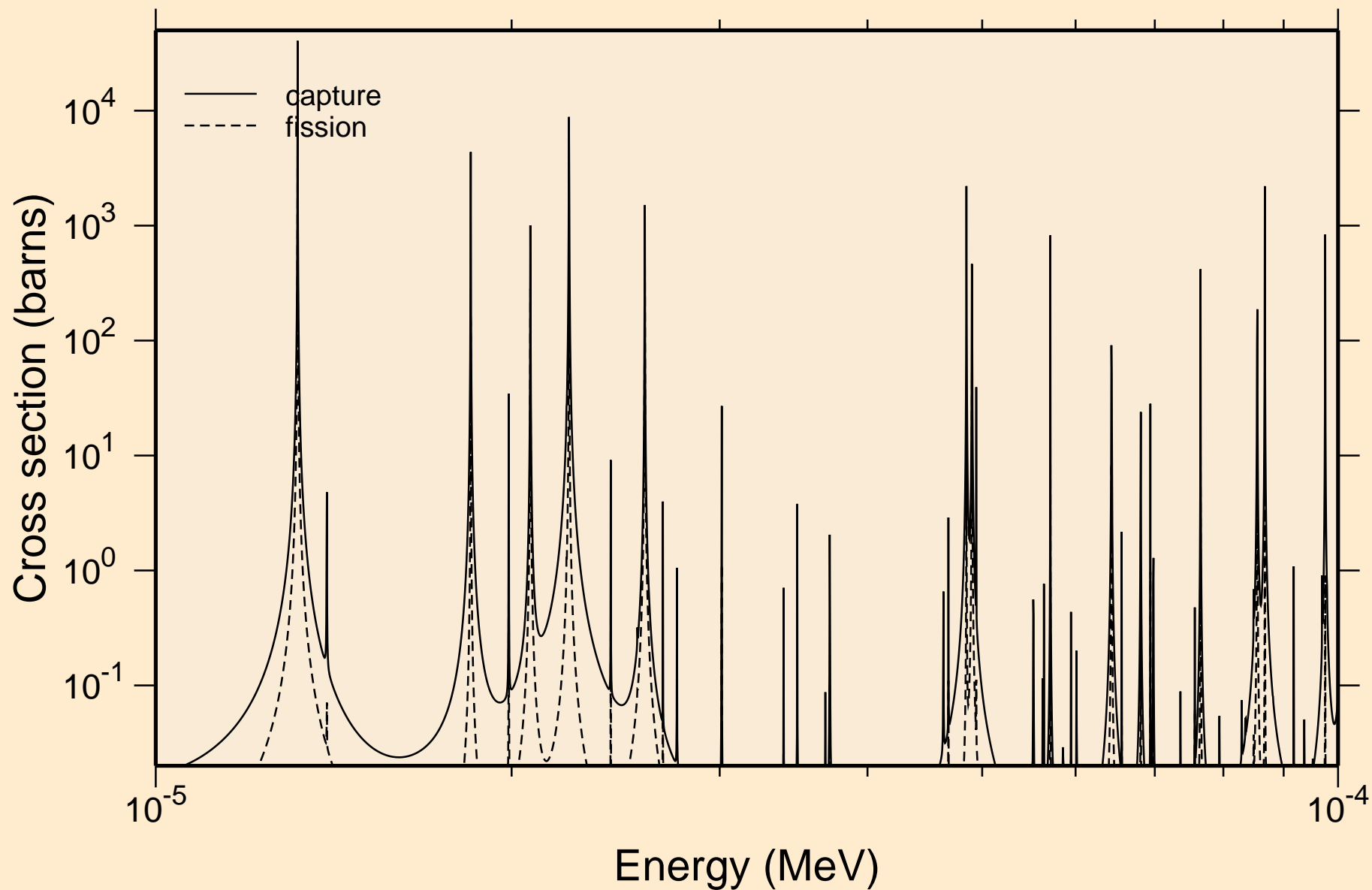

TH224 NEUTRON ACER TENDL-2023 LIBRARY; T=0.K  
resonance absorption cross sections

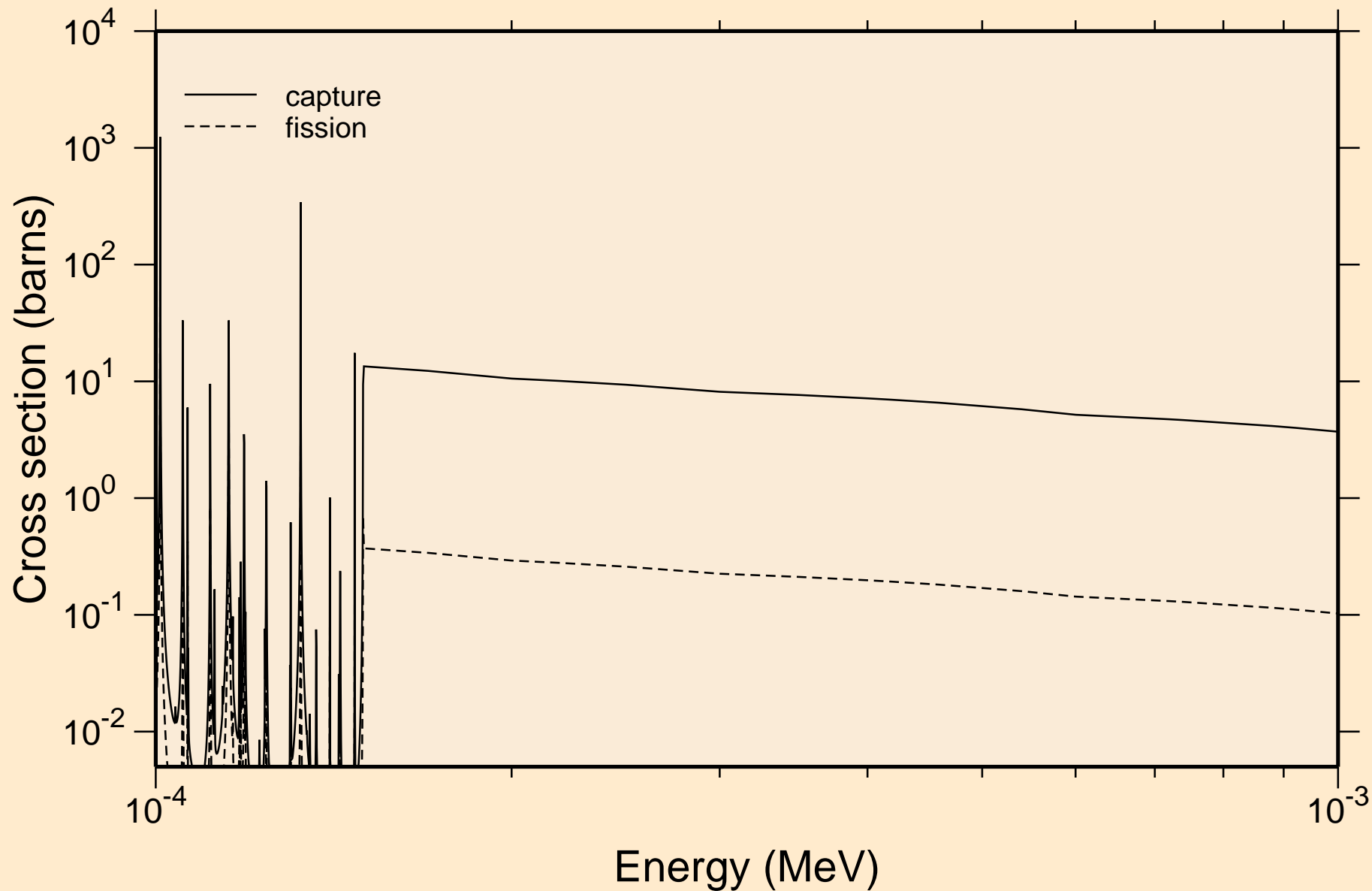

TH224 NEUTRON ACER TENDL-2023 LIBRARY; T=0.K  
resonance absorption cross sections

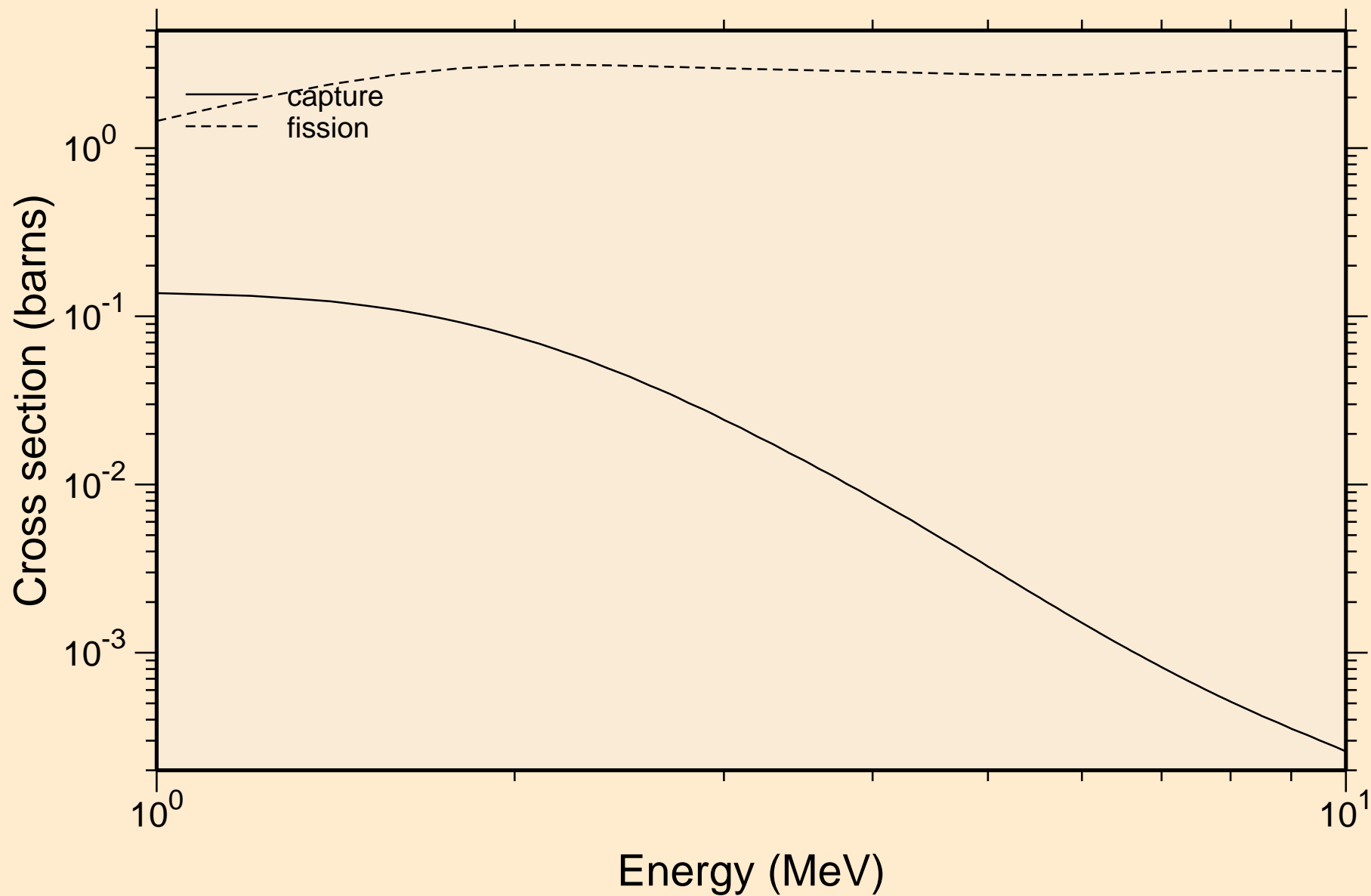

TH224 NEUTRON ACER TENDL-2023 LIBRARY; T=0.K  
Heating

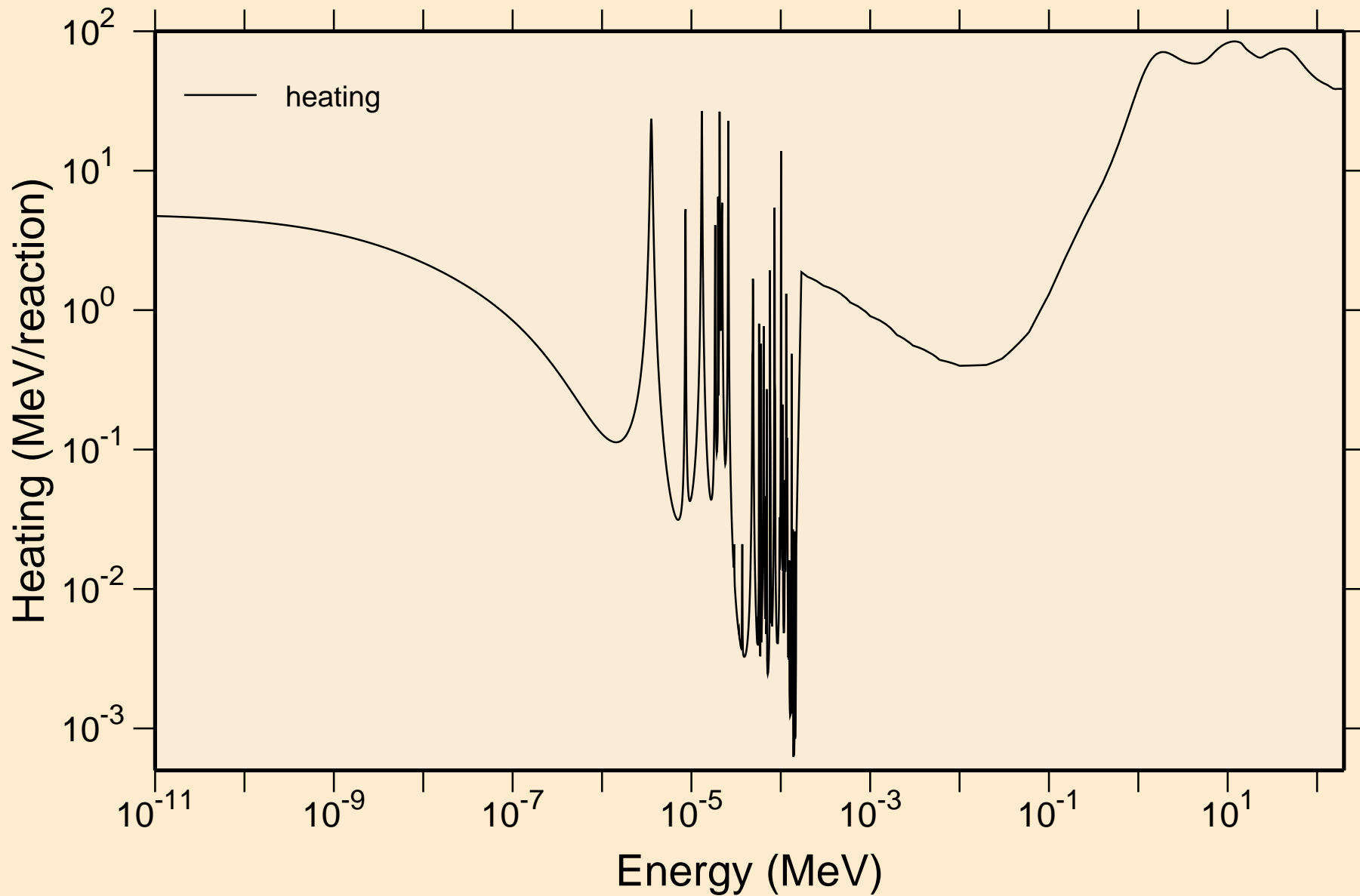

# TH224 NEUTRON ACER TENDL-2023 LIBRARY; T=0.K

## Damage

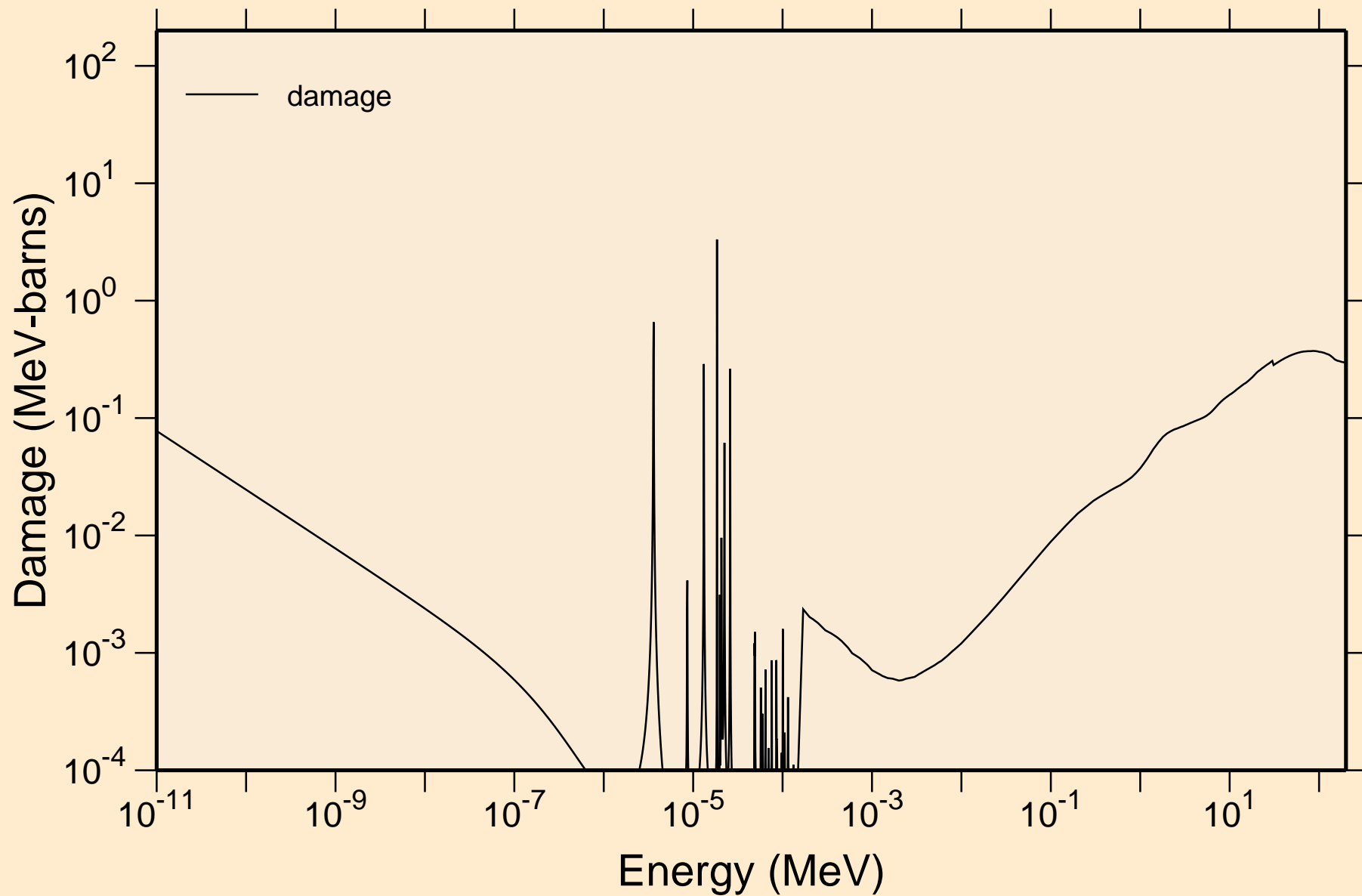

# TH224 NEUTRON ACER TENDL-2023 LIBRARY; T=0.K

## Non-threshold reactions

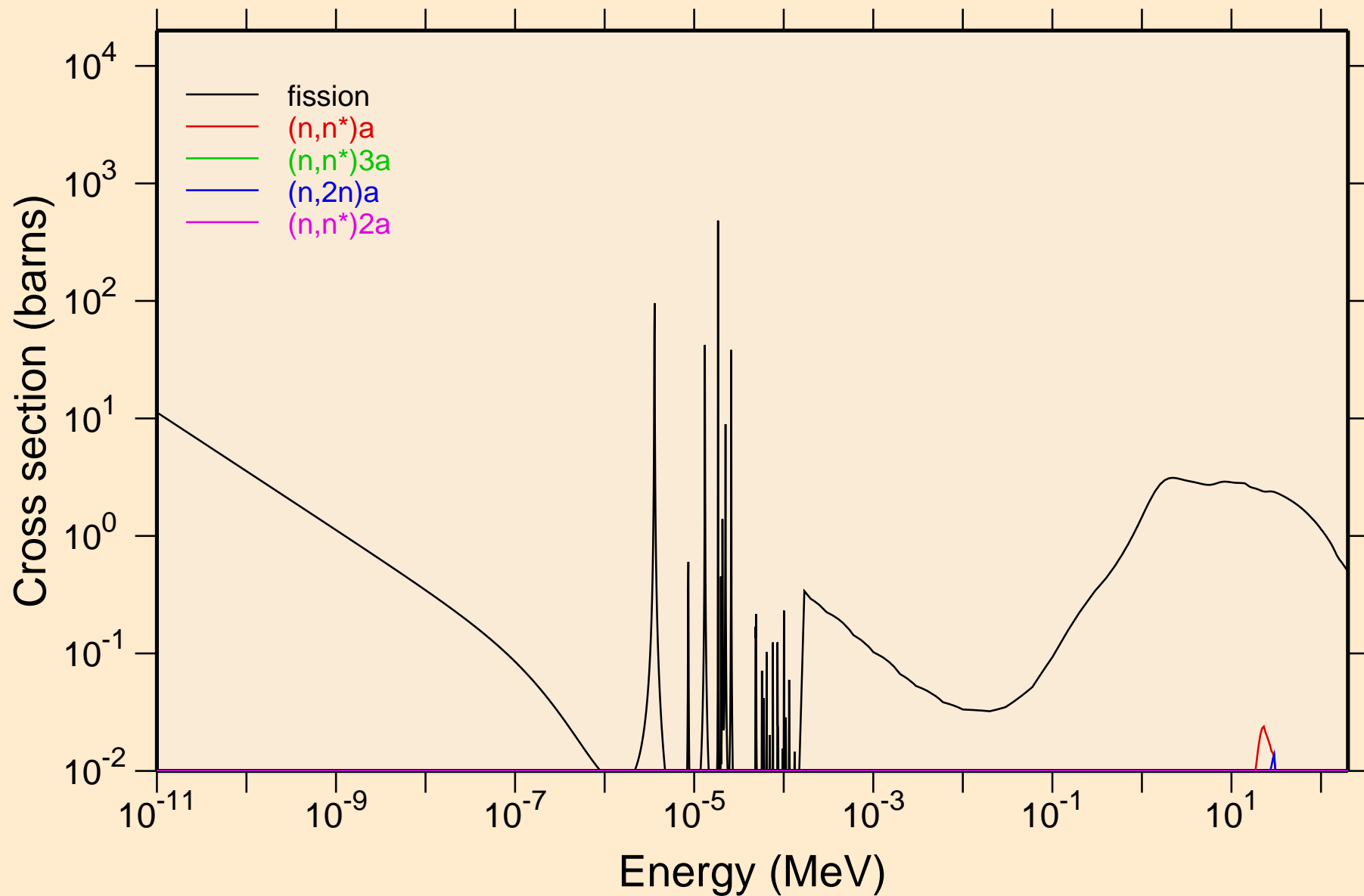

TH224 NEUTRON ACER TENDL-2023 LIBRARY; T=0.K  
Non-threshold reactions

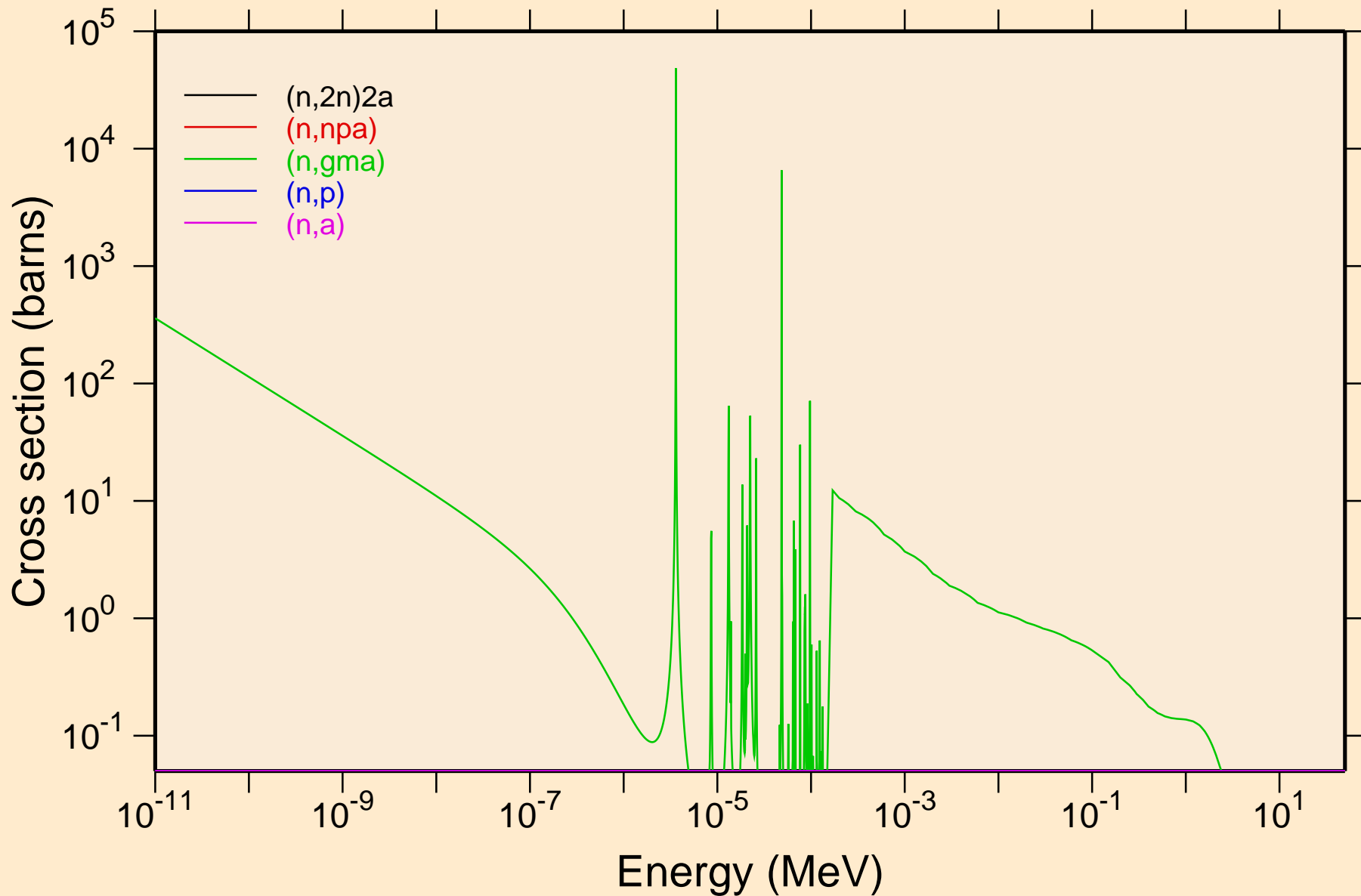

TH224 NEUTRON ACER TENDL-2023 LIBRARY; T=0.K  
Non-threshold reactions

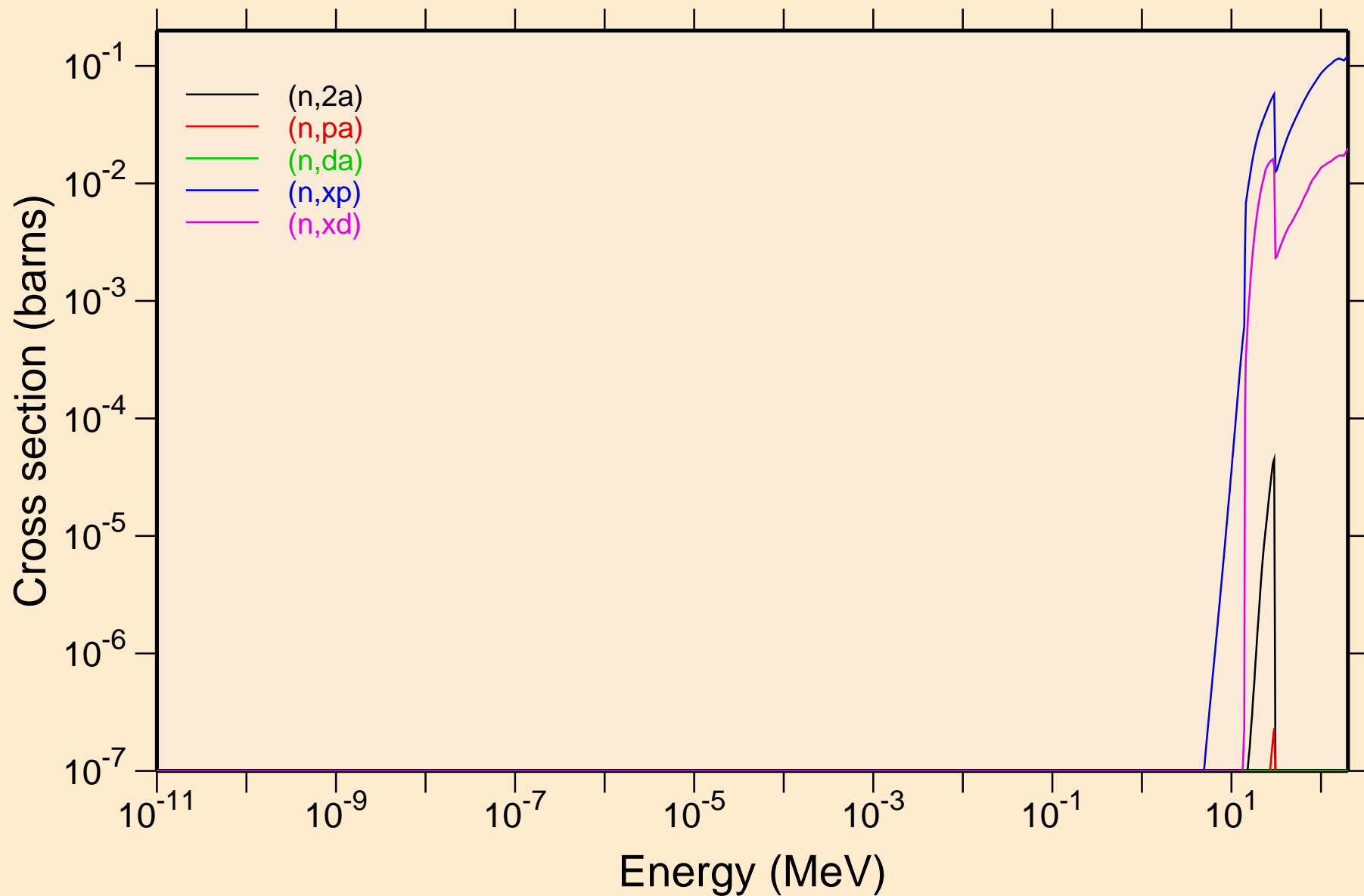

TH224 NEUTRON ACER TENDL-2023 LIBRARY; T=0.K  
Non-threshold reactions

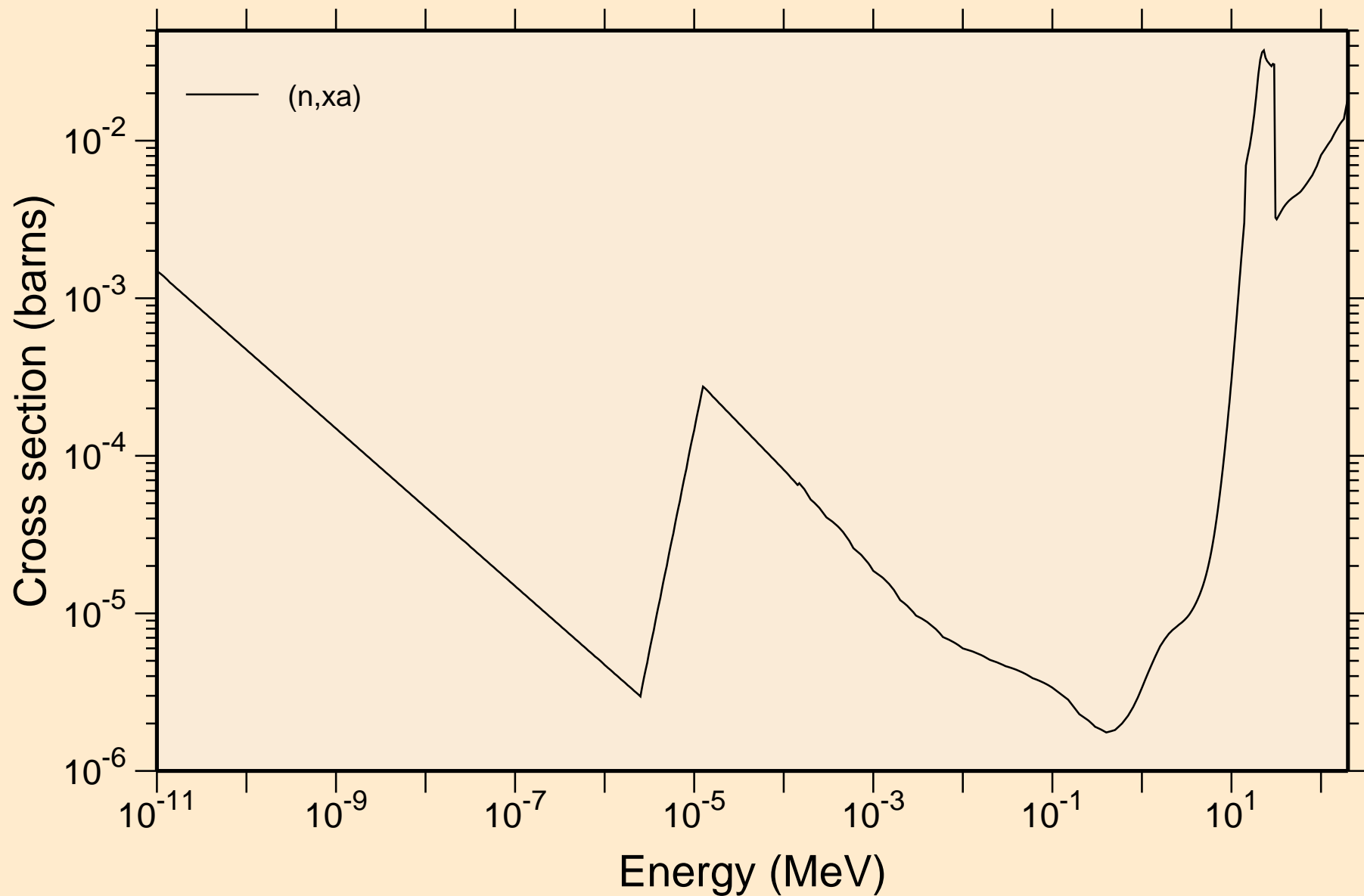

# TH224 NEUTRON ACER TENDL-2023 LIBRARY; T=0.K

## Principal cross sections

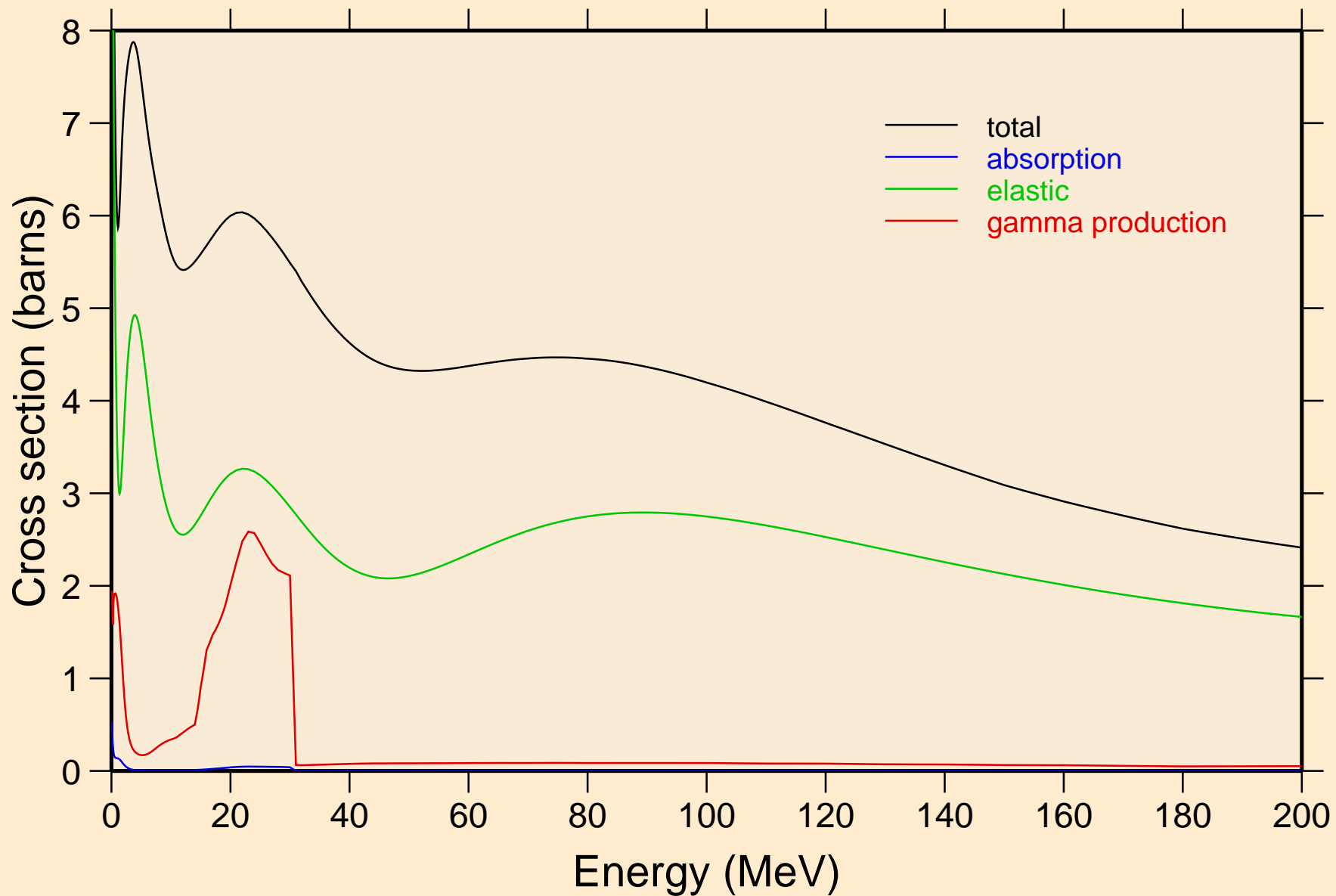

TH224 NEUTRON ACER TENDL-2023 LIBRARY; T=0.K  
Heating

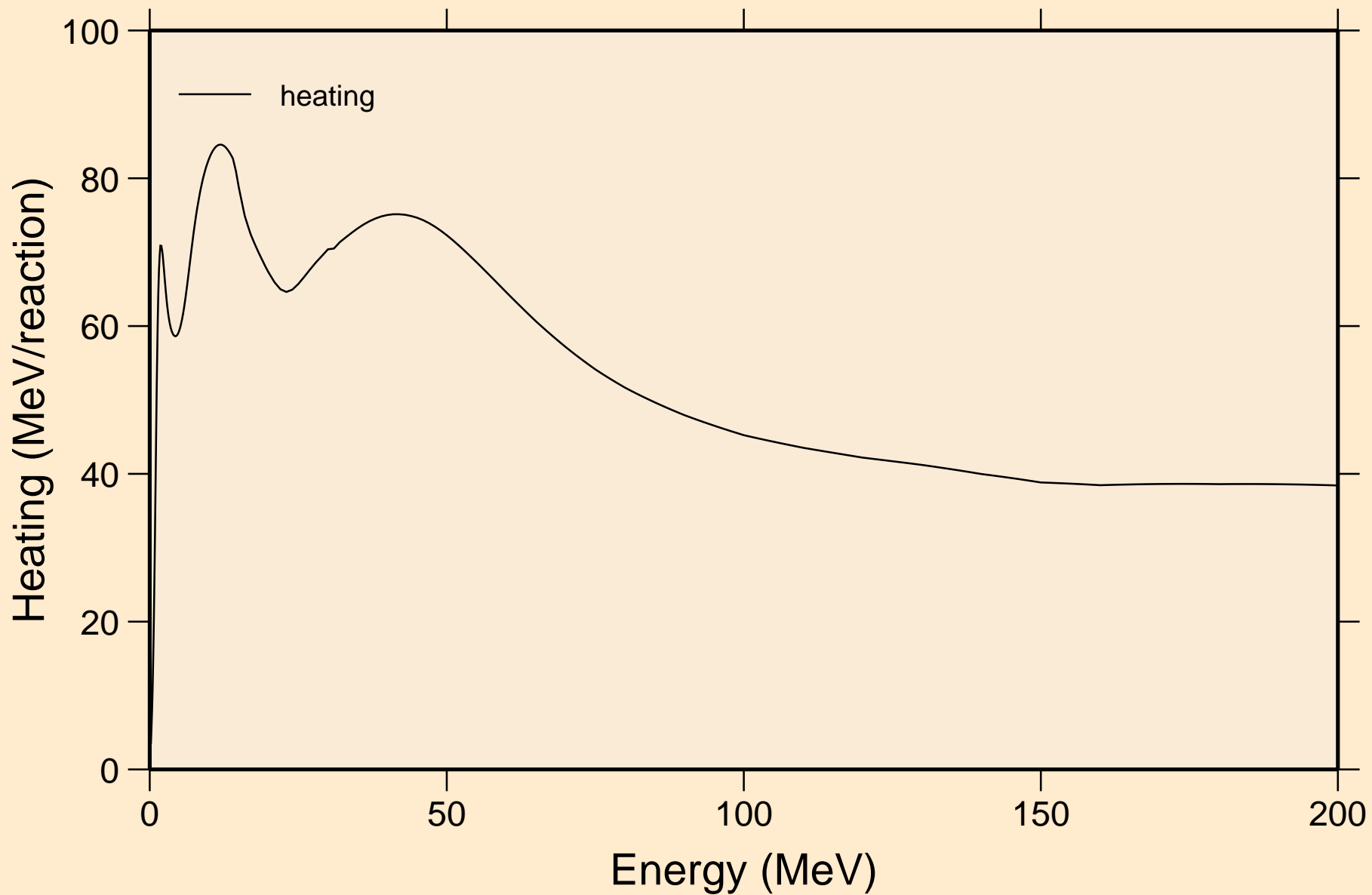

TH224 NEUTRON ACER TENDL-2023 LIBRARY; T=0.K  
Damage

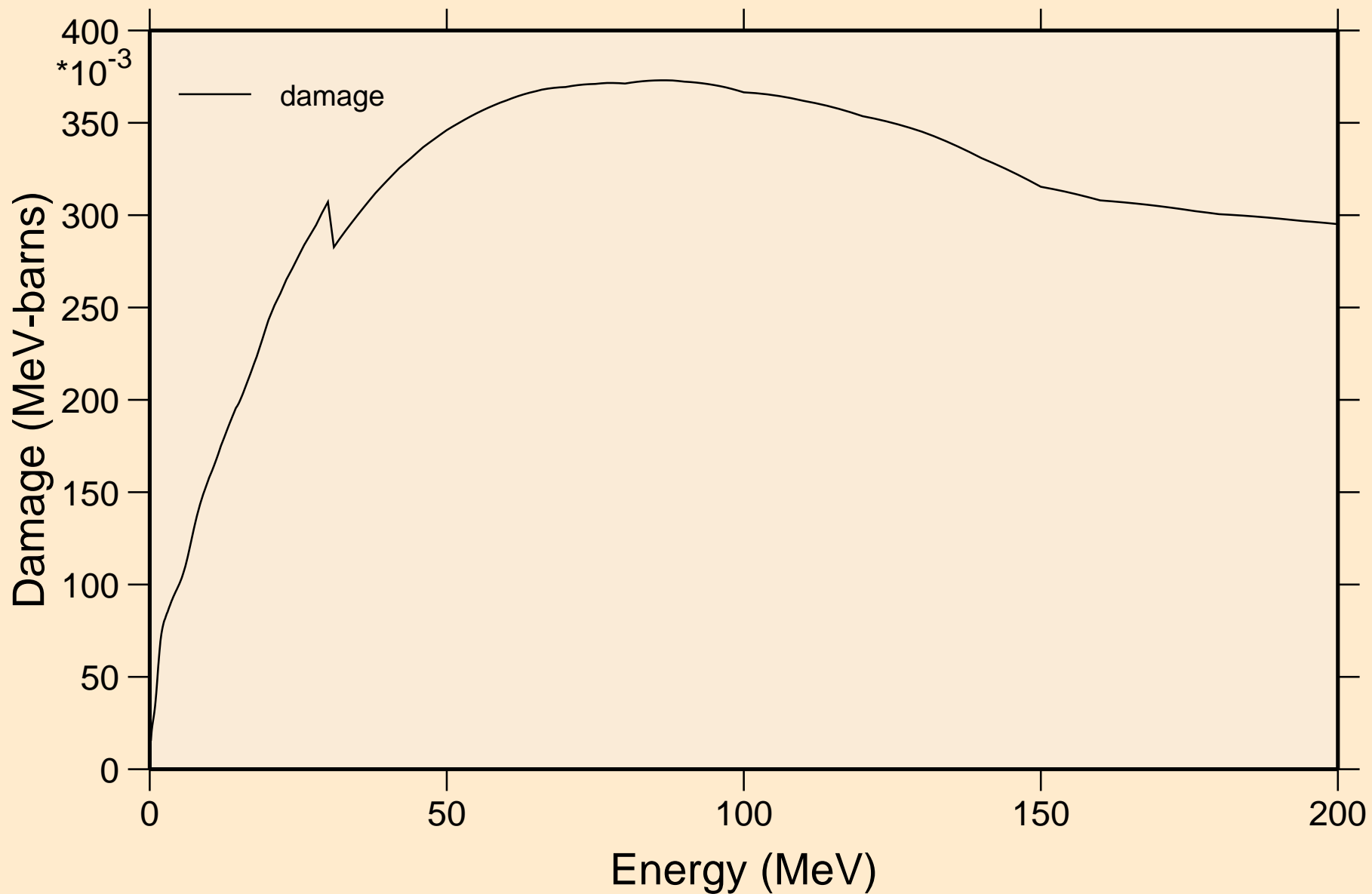

# TH224 NEUTRON ACER TENDL-2023 LIBRARY; T=0.K

## Non-threshold reactions

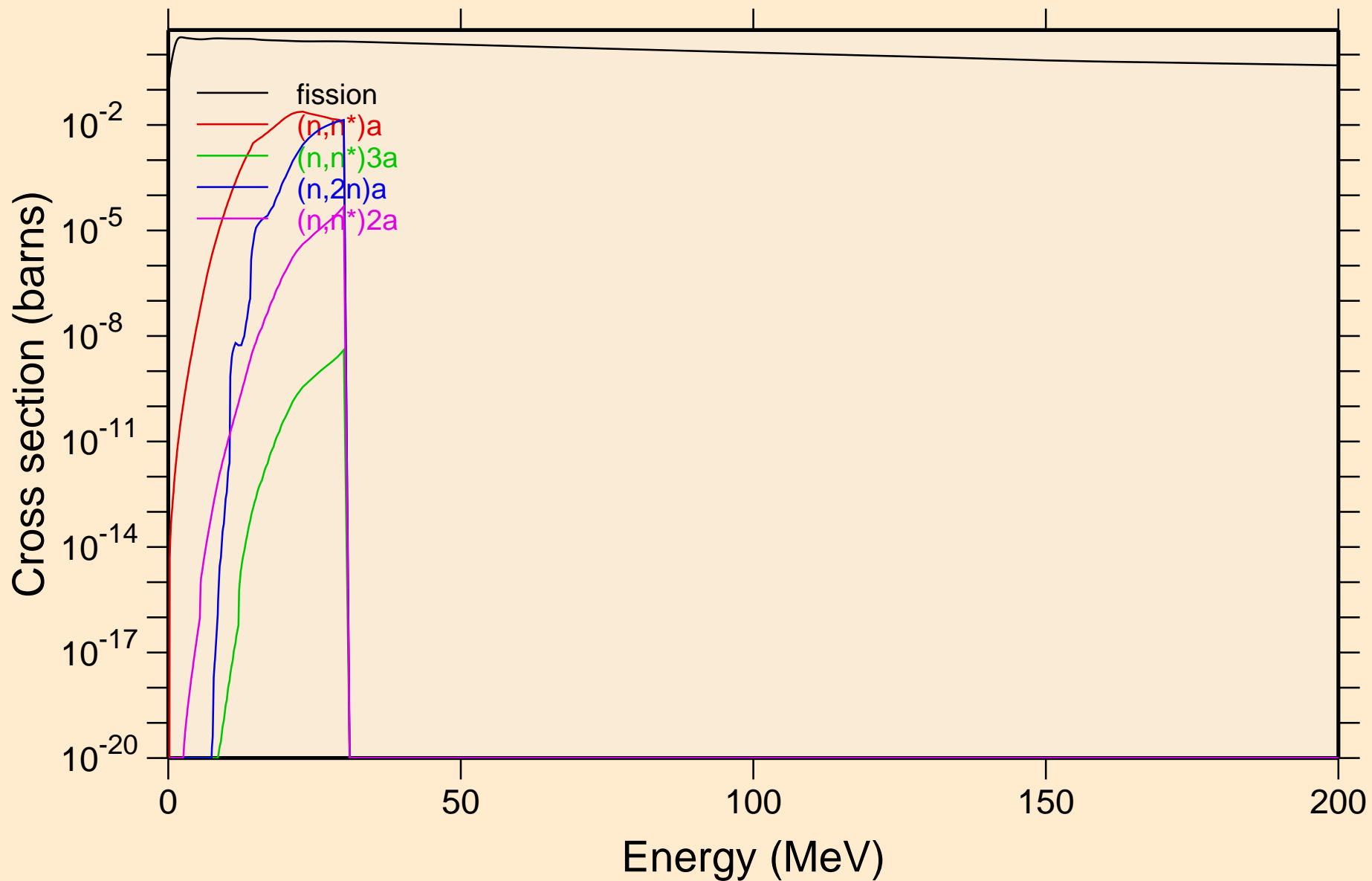

TH224 NEUTRON ACER TENDL-2023 LIBRARY; T=0.K  
Non-threshold reactions

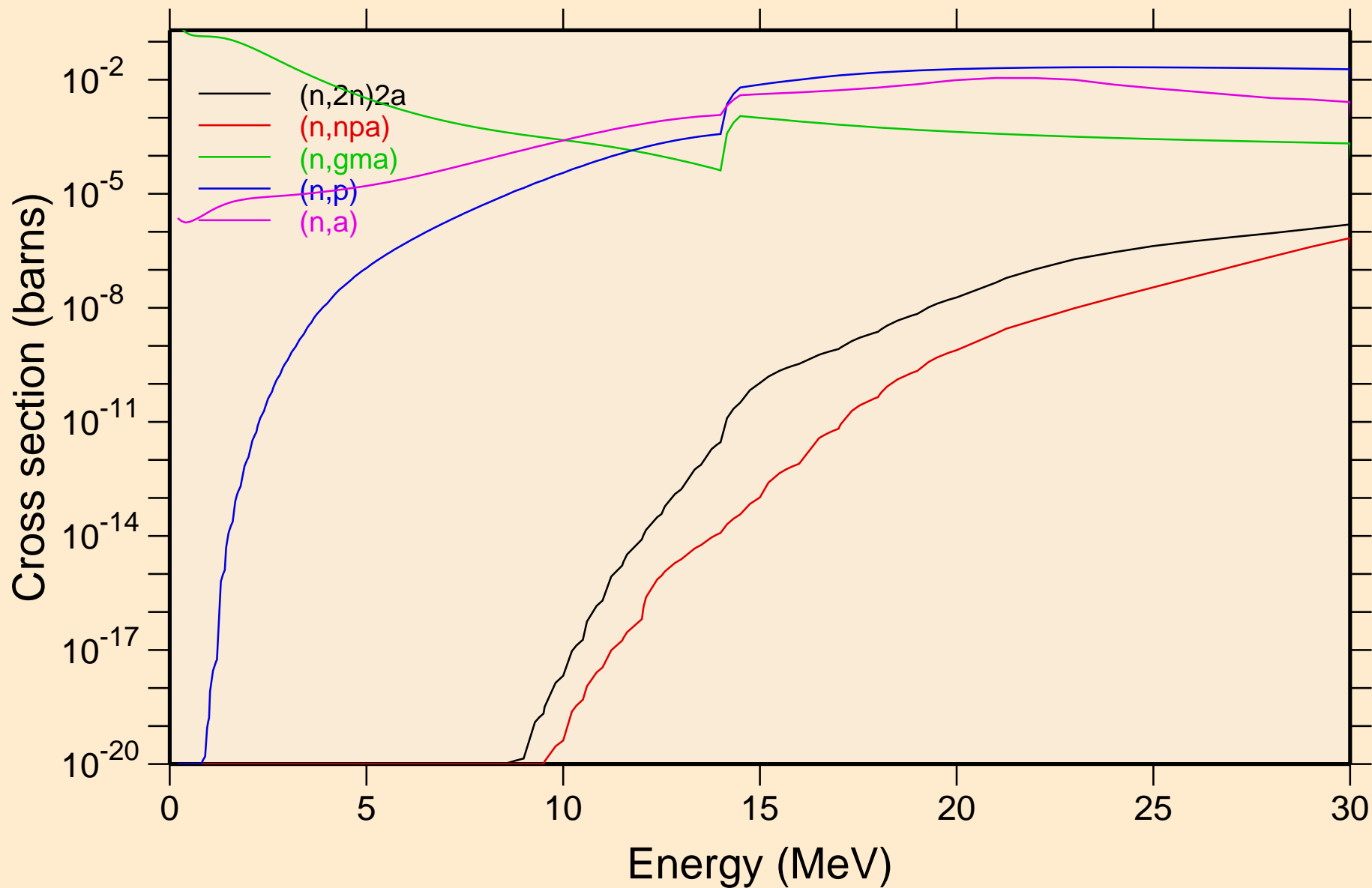

TH224 NEUTRON ACER TENDL-2023 LIBRARY; T=0.K  
Non-threshold reactions

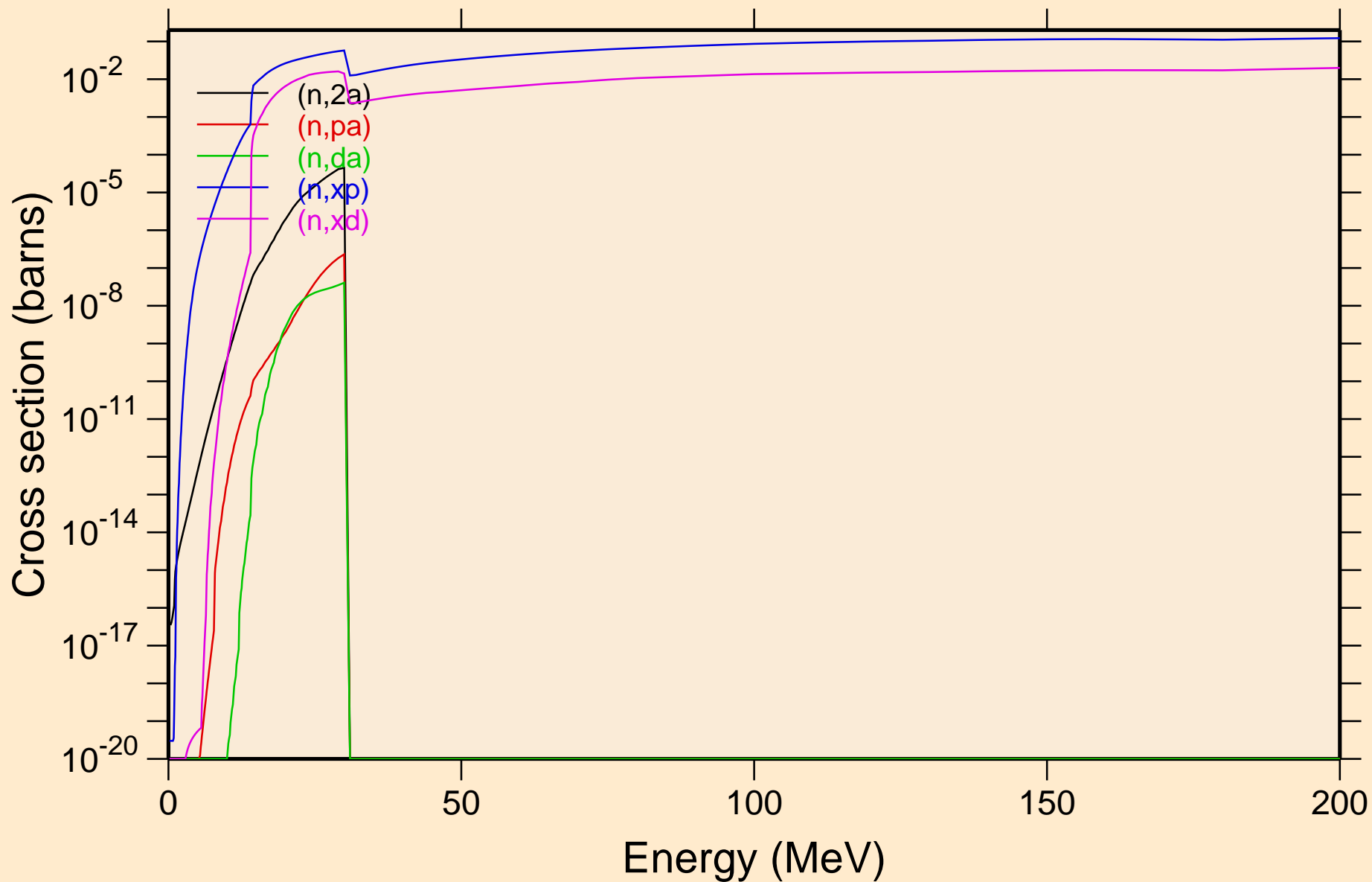

TH224 NEUTRON ACER TENDL-2023 LIBRARY; T=0.K  
Non-threshold reactions

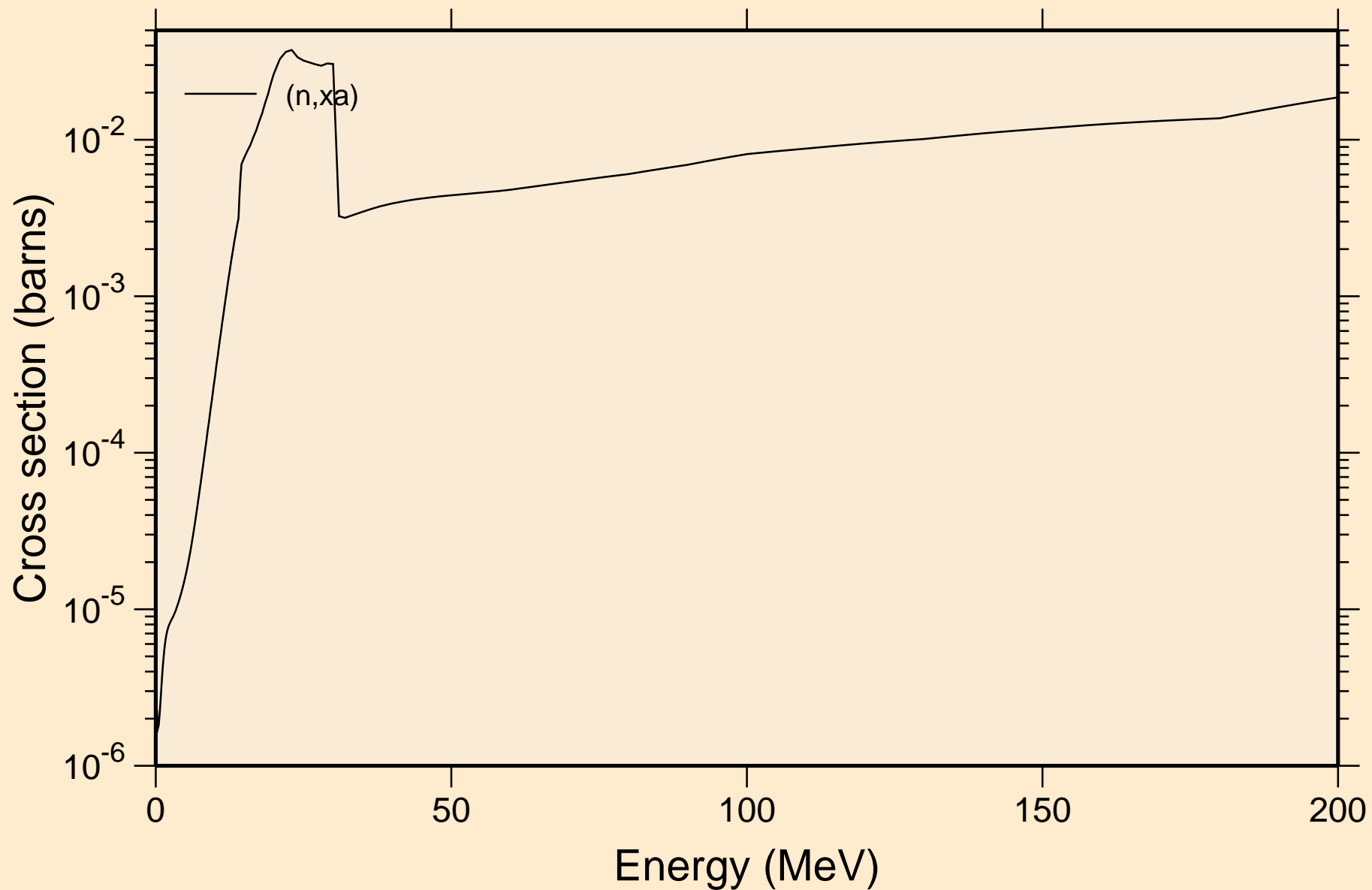

TH224 NEUTRON ACER TENDL-2023 LIBRARY; T=0.K  
Inelastic levels

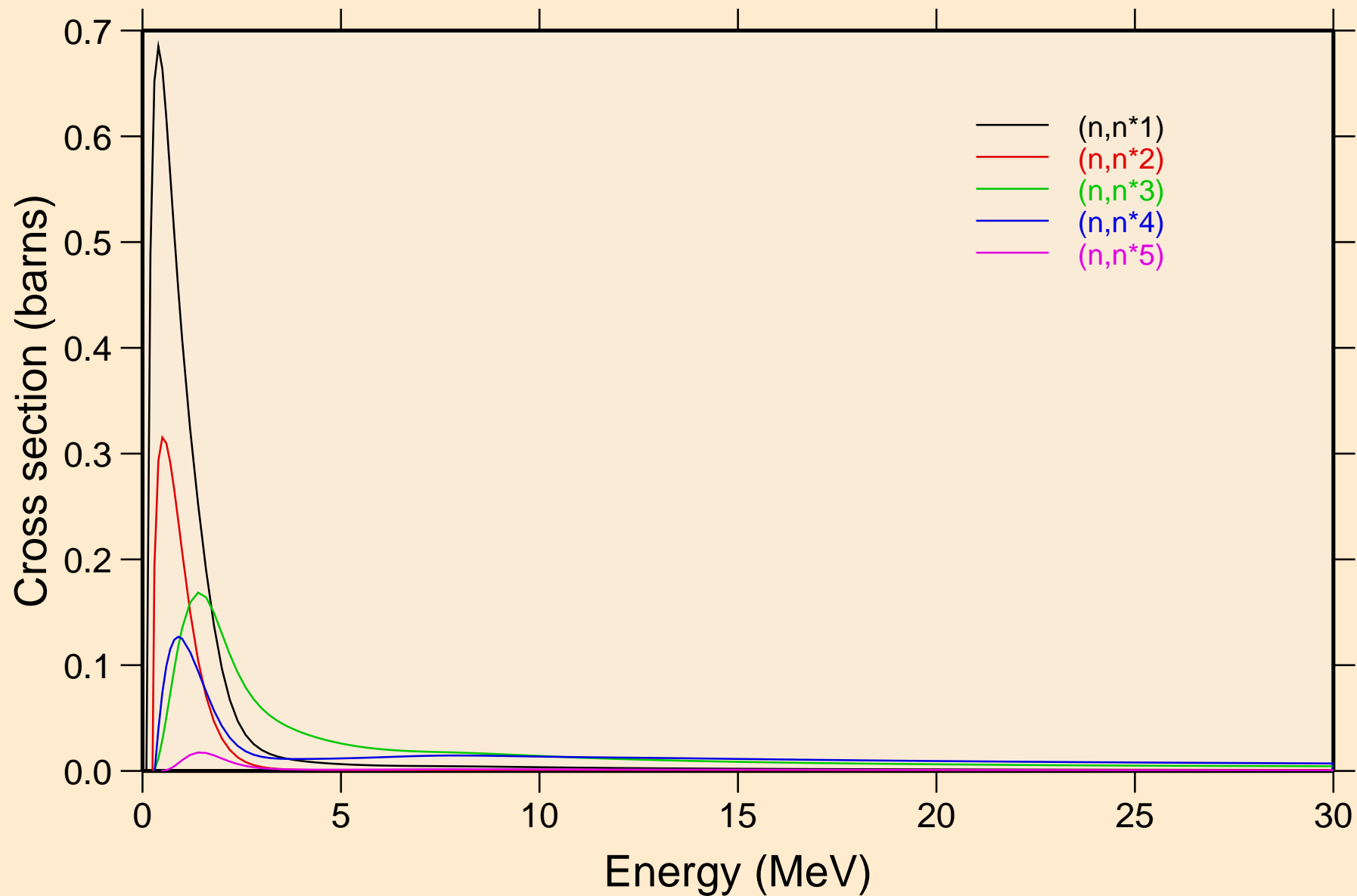

TH224 NEUTRON ACER TENDL-2023 LIBRARY; T=0.K  
Inelastic levels

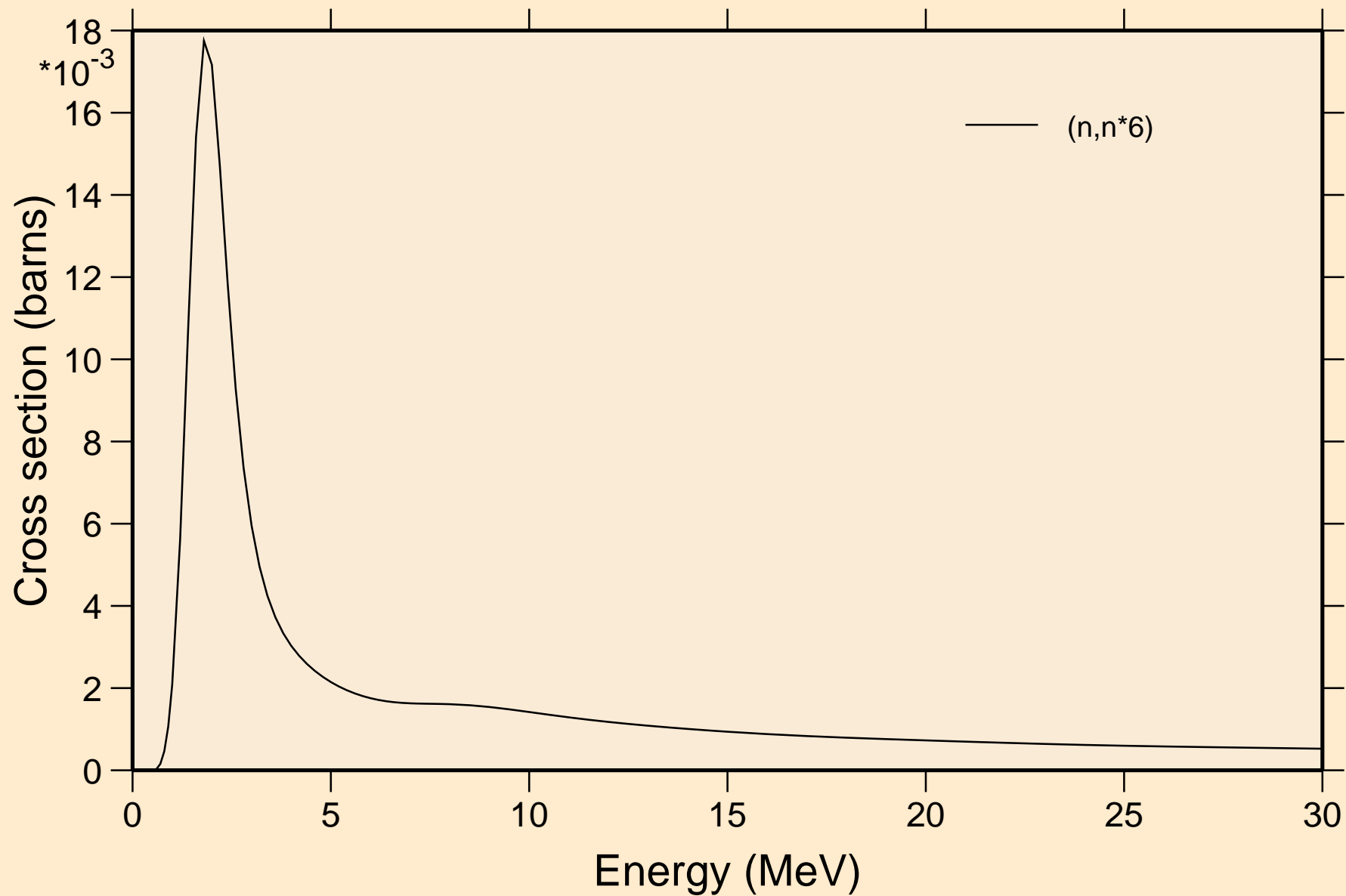

TH224 NEUTRON ACER TENDL-2023 LIBRARY; T=0.K  
Threshold reactions

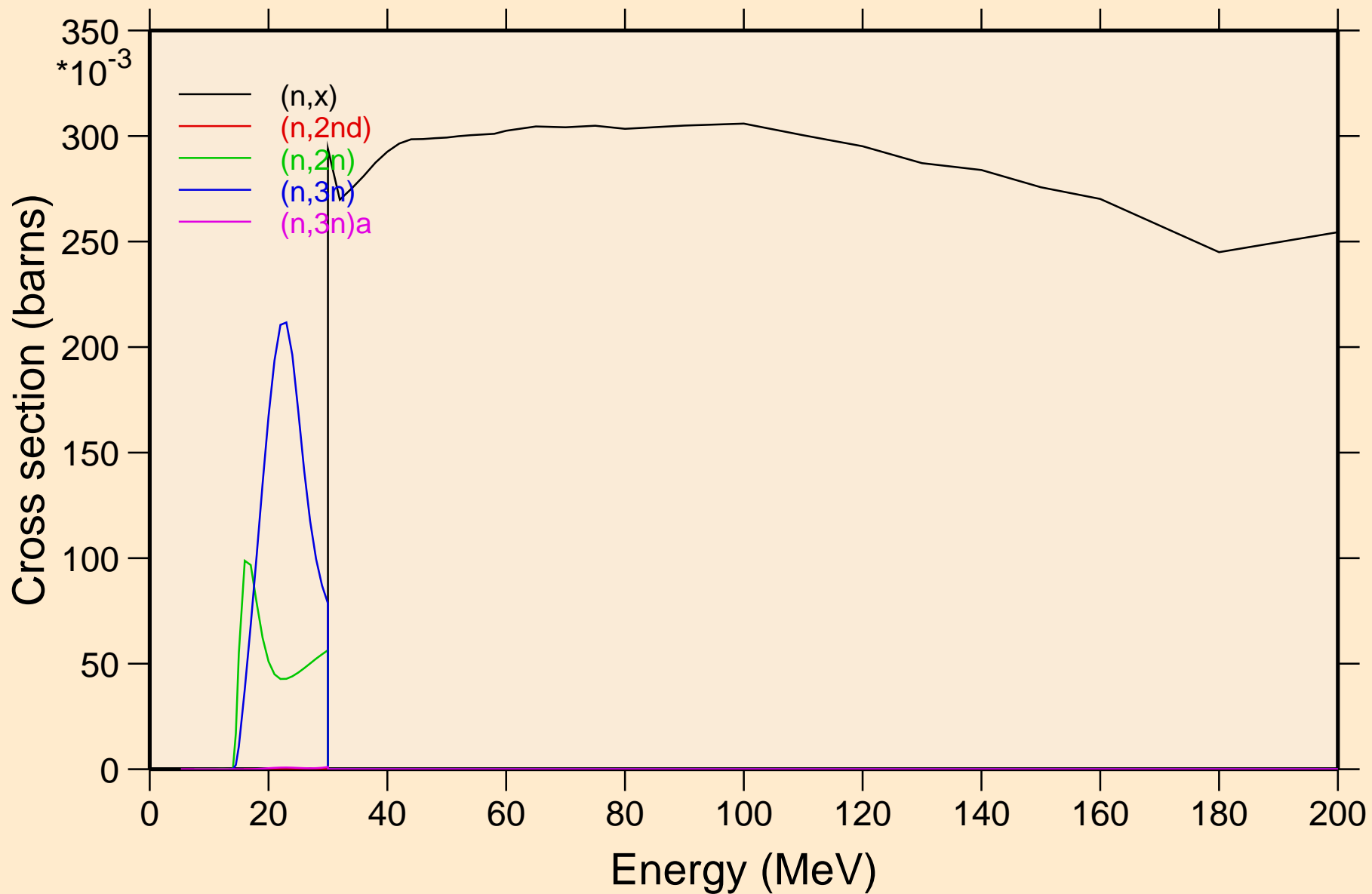

# TH224 NEUTRON ACER TENDL-2023 LIBRARY; T=0.K

## Threshold reactions

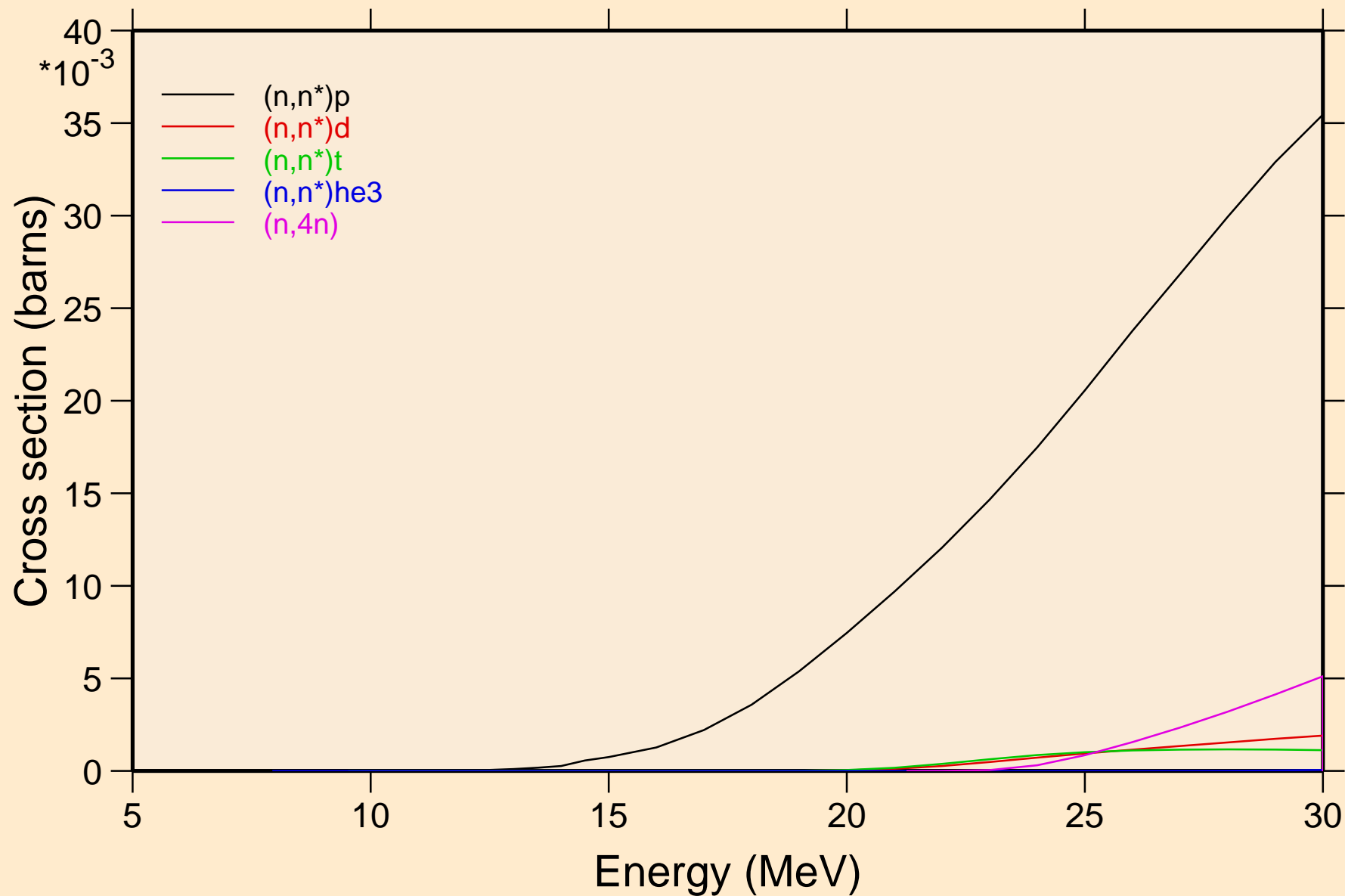

TH224 NEUTRON ACER TENDL-2023 LIBRARY; T=0.K  
Threshold reactions

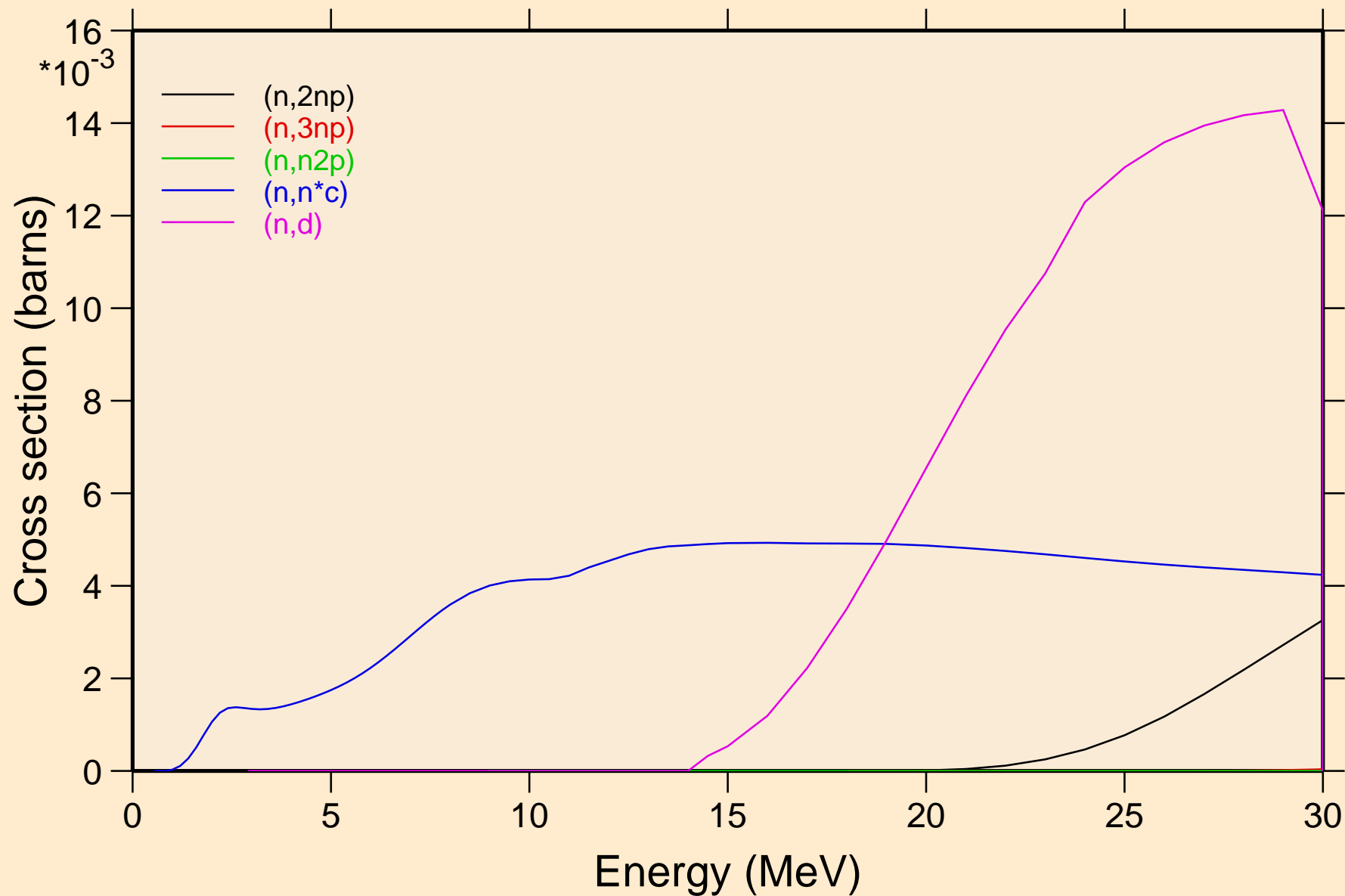

TH224 NEUTRON ACER TENDL-2023 LIBRARY; T=0.K  
Threshold reactions

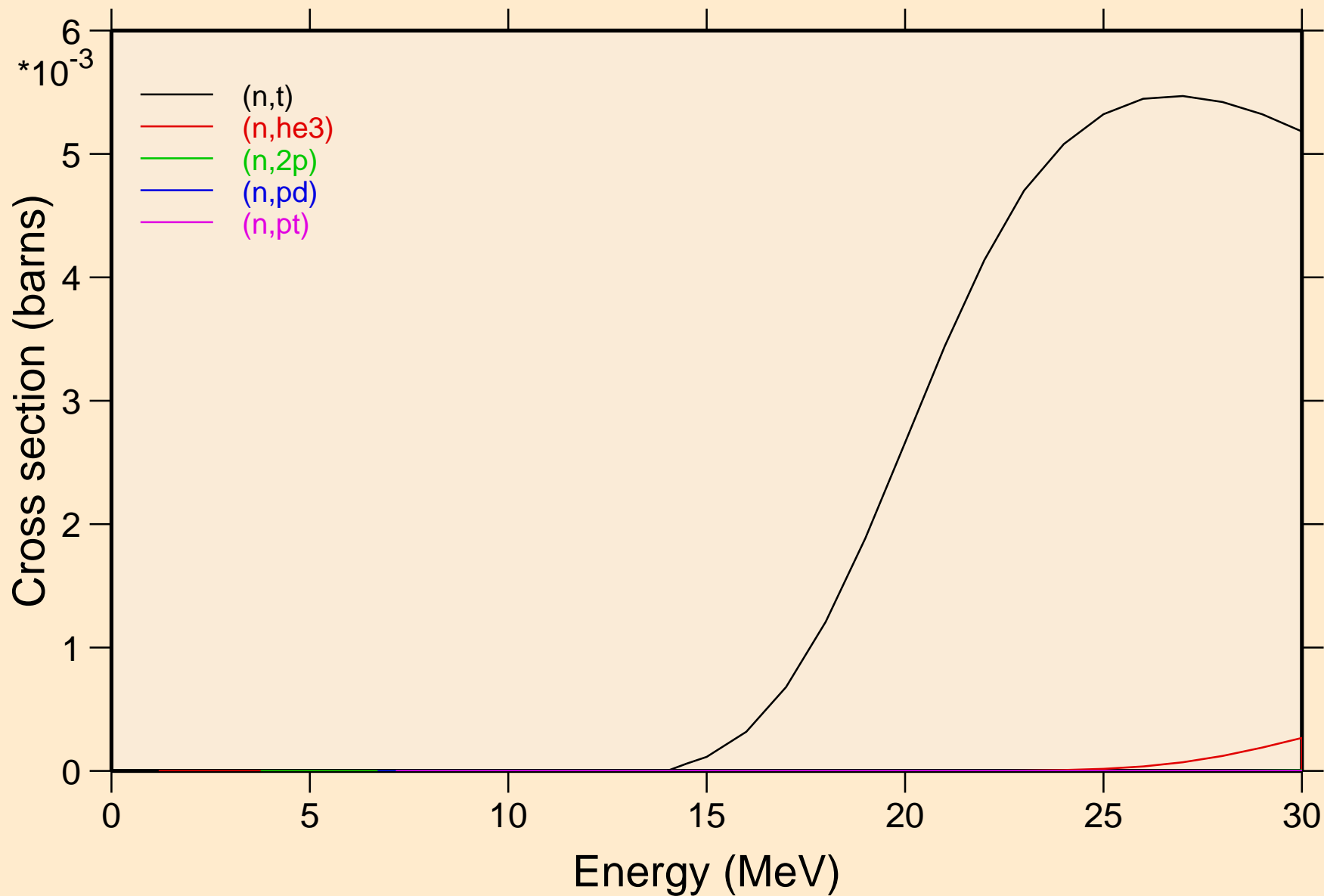

TH224 NEUTRON ACER TENDL-2023 LIBRARY; T=0.K  
Threshold reactions

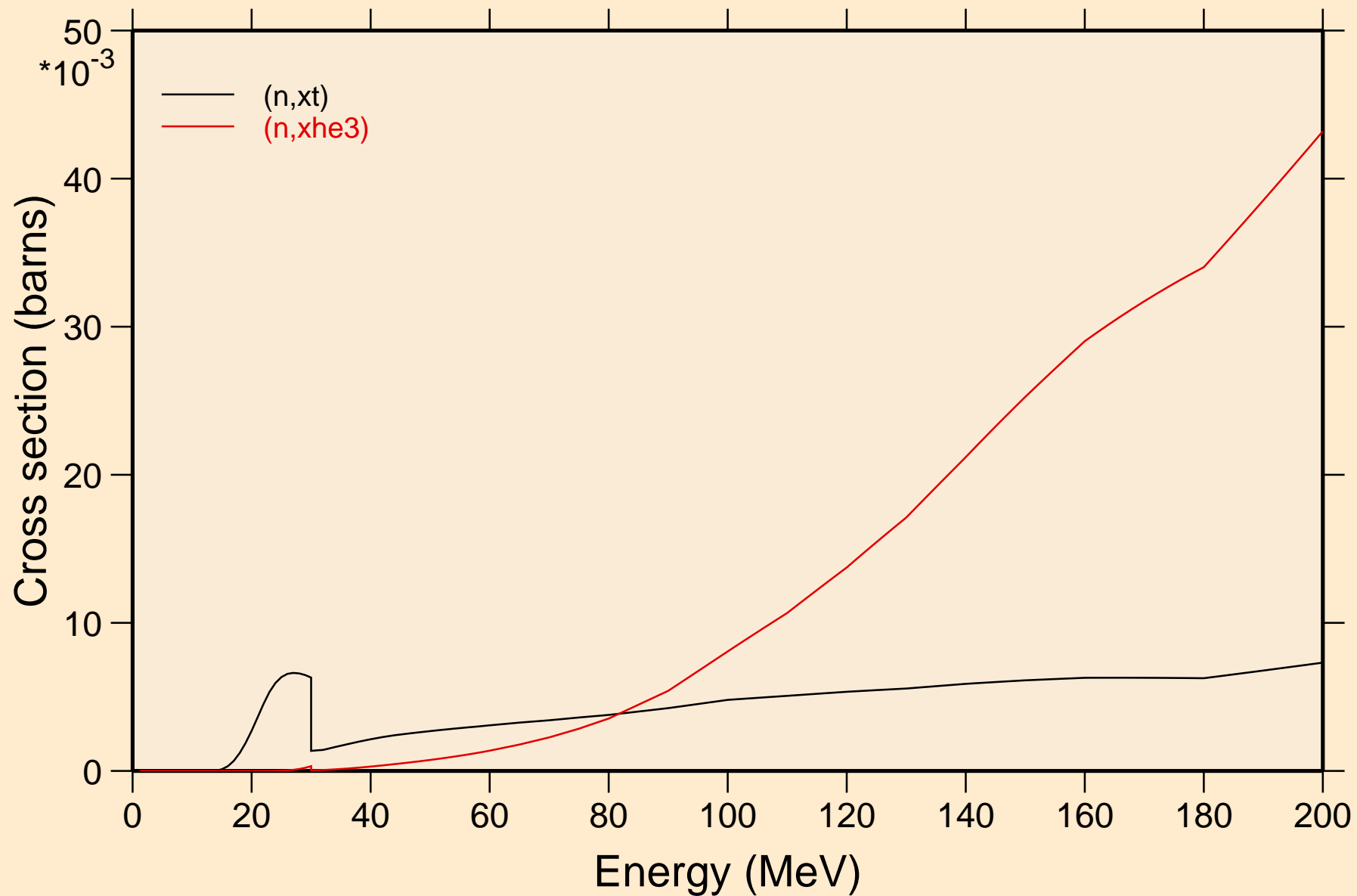

TH224 NEUTRON ACER TENDL-2023 LIBRARY; T=0.K  
angular distribution for elastic

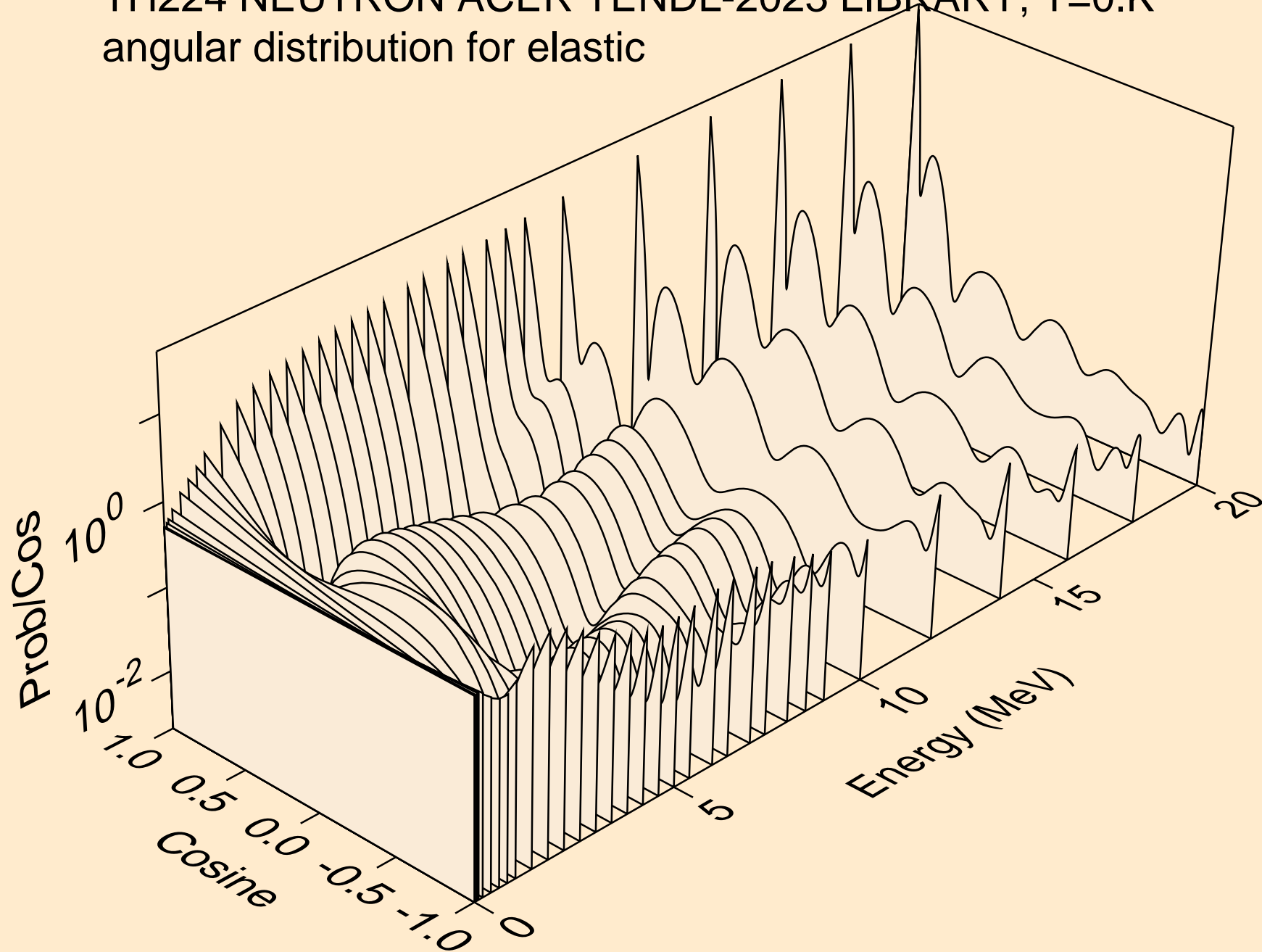

TH224 NEUTRON ACER TENDL-2023 LIBRARY; T=0.K  
angular distribution for elastic

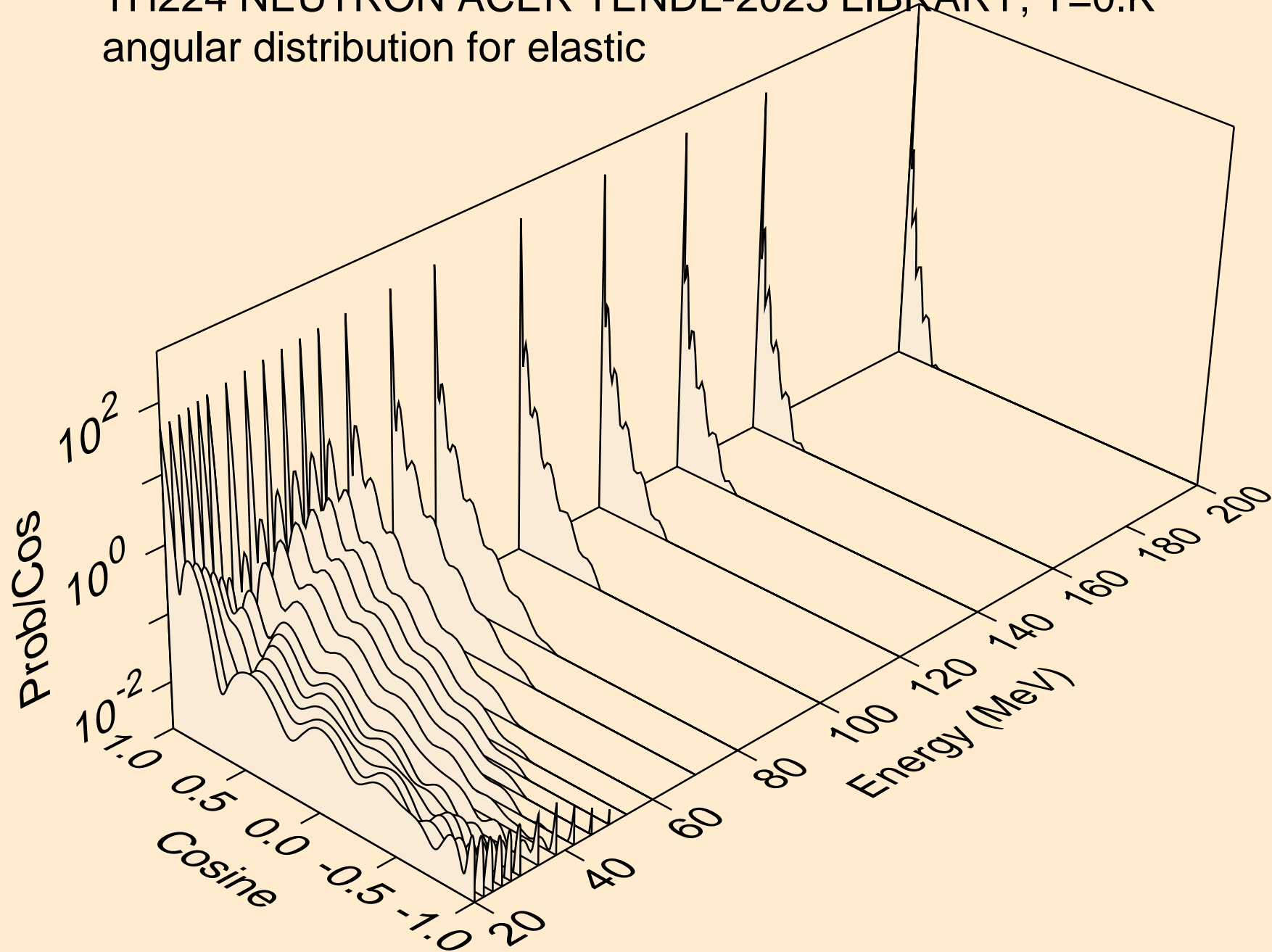

TH224 NEUTRON ACER TENDL-2023 LIBRARY; T=0.K  
angular distribution for (n,n\*1)

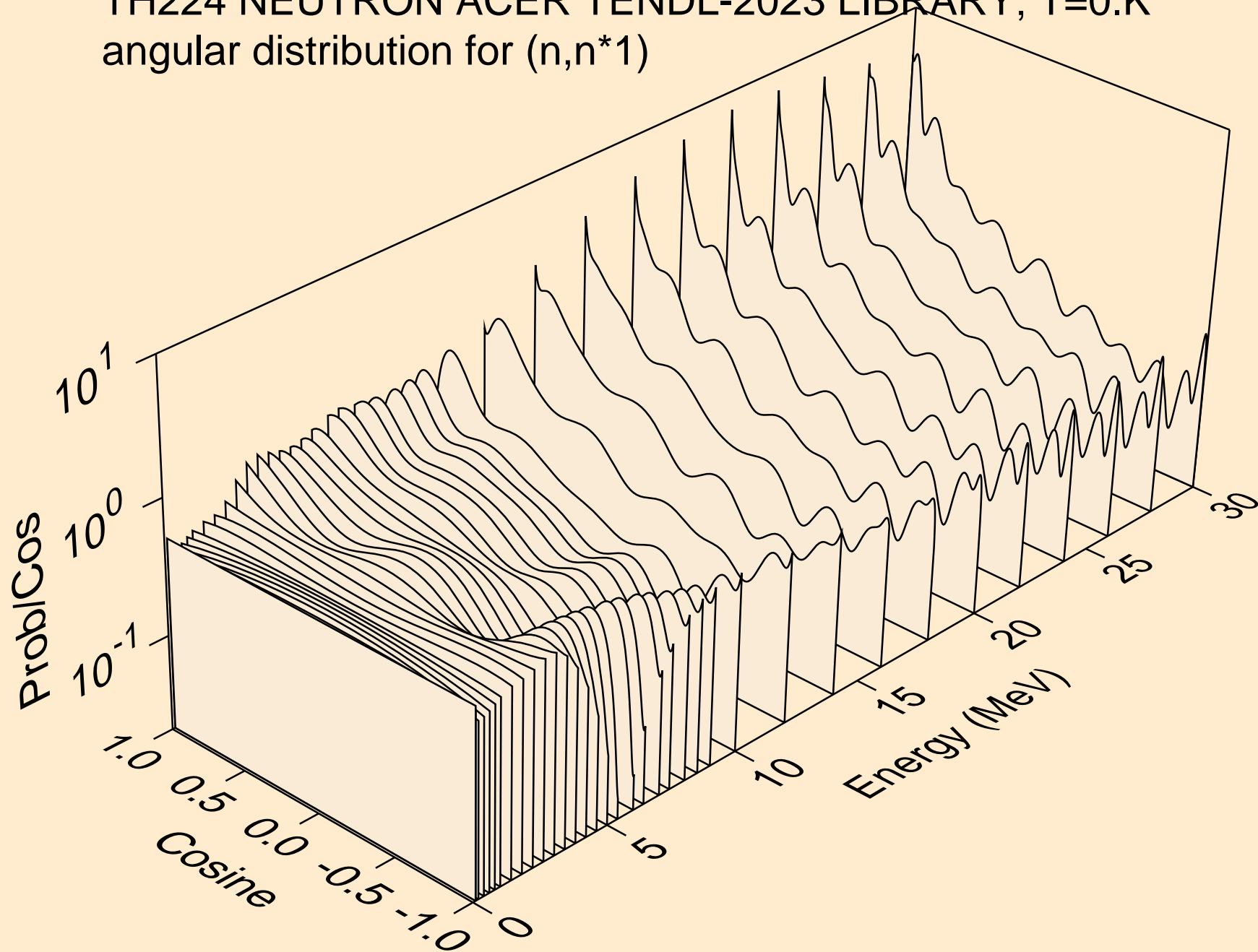

TH224 NEUTRON ACER TENDL-2023 LIBRARY; T=0.K  
angular distribution for (n,n\*2)

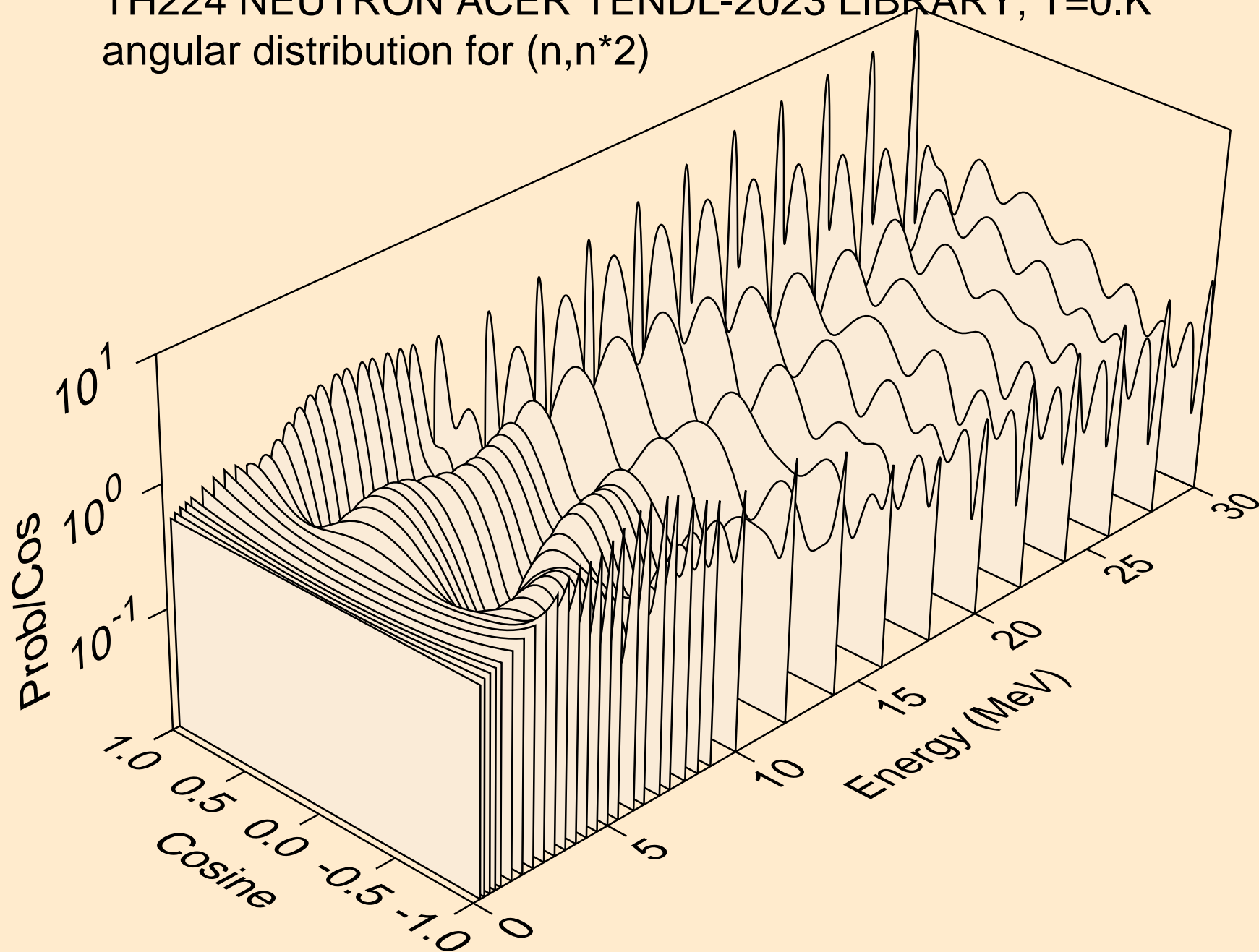

TH224 NEUTRON ACER TENDL-2023 LIBRARY; T=0.K  
angular distribution for (n,n\*3)

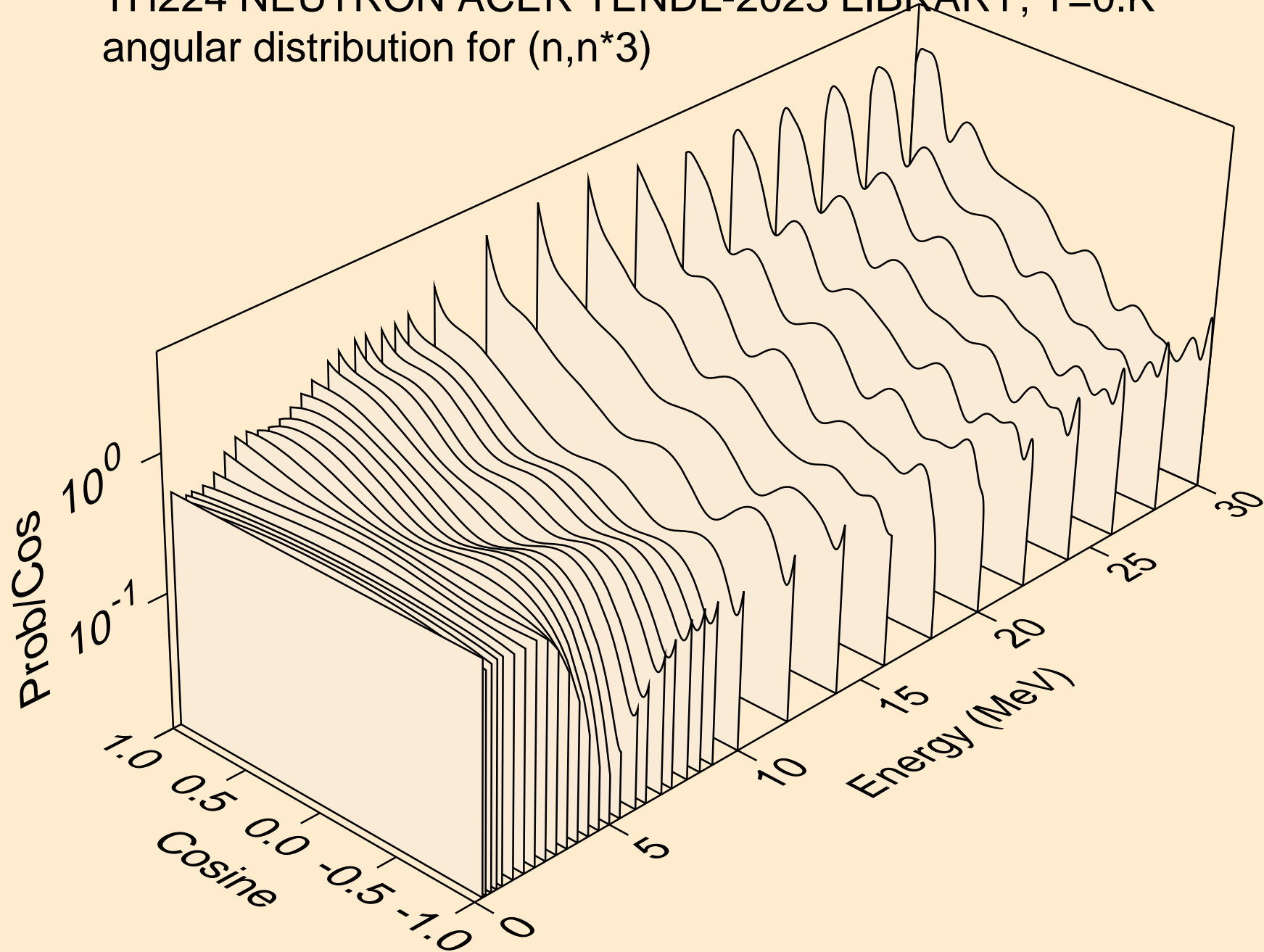

TH224 NEUTRON ACER TENDL-2023 LIBRARY; T=0.K  
angular distribution for (n,n\*4)

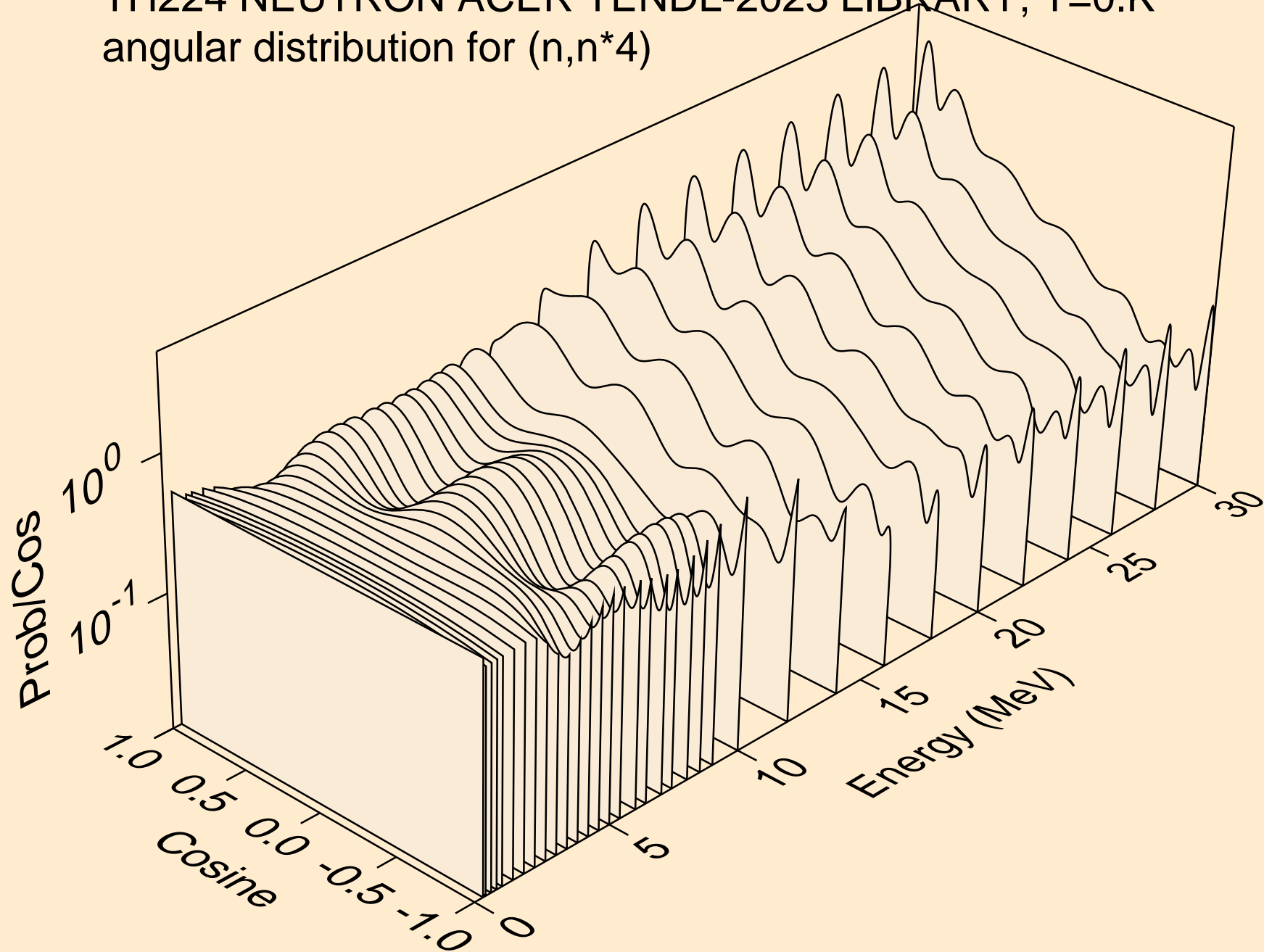

TH224 NEUTRON ACER TENDL-2023 LIBRARY; T=0.K  
angular distribution for (n,n\*5)

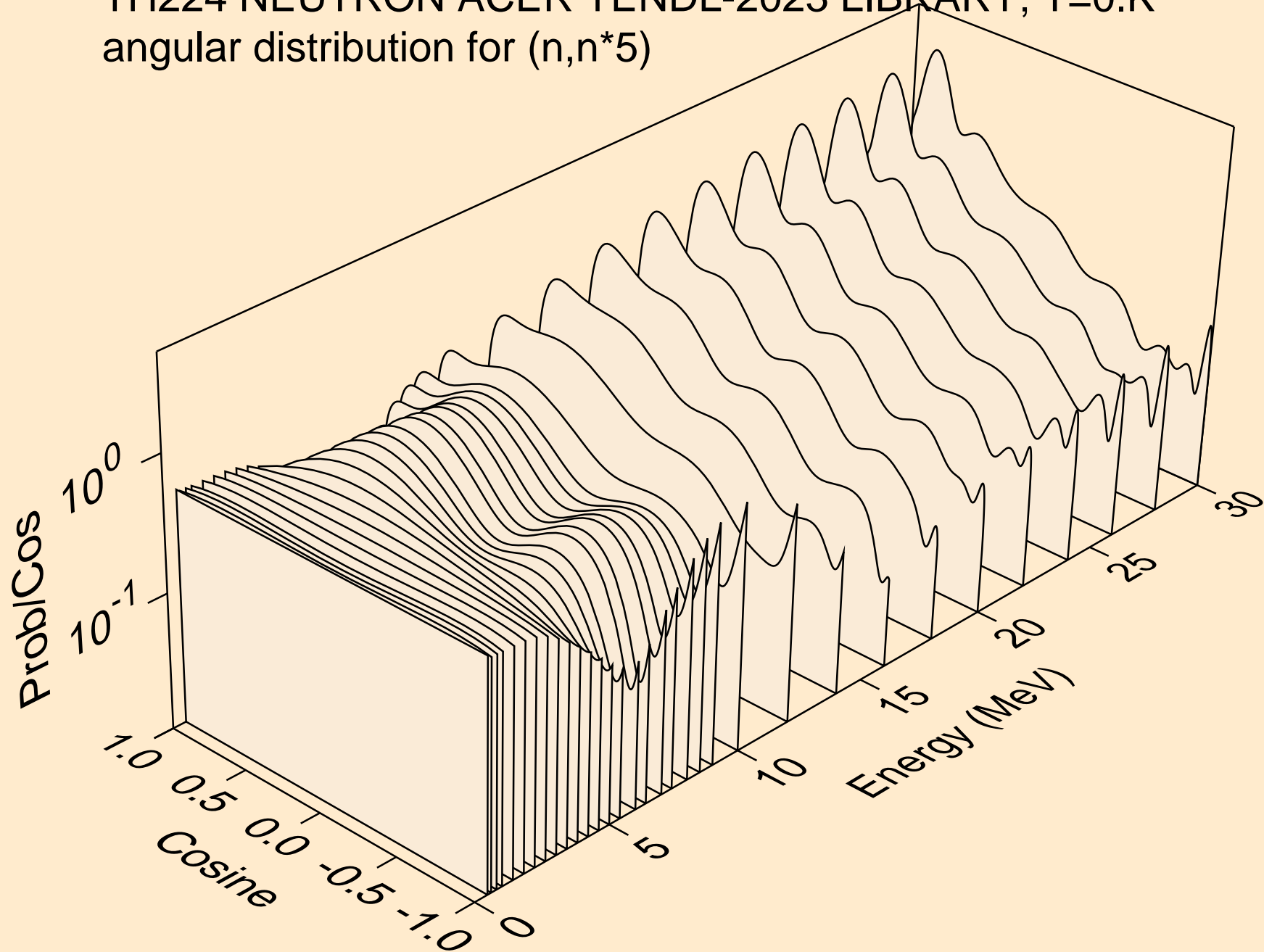

TH224 NEUTRON ACER TENDL-2023 LIBRARY; T=0.K  
angular distribution for (n,n\*6)

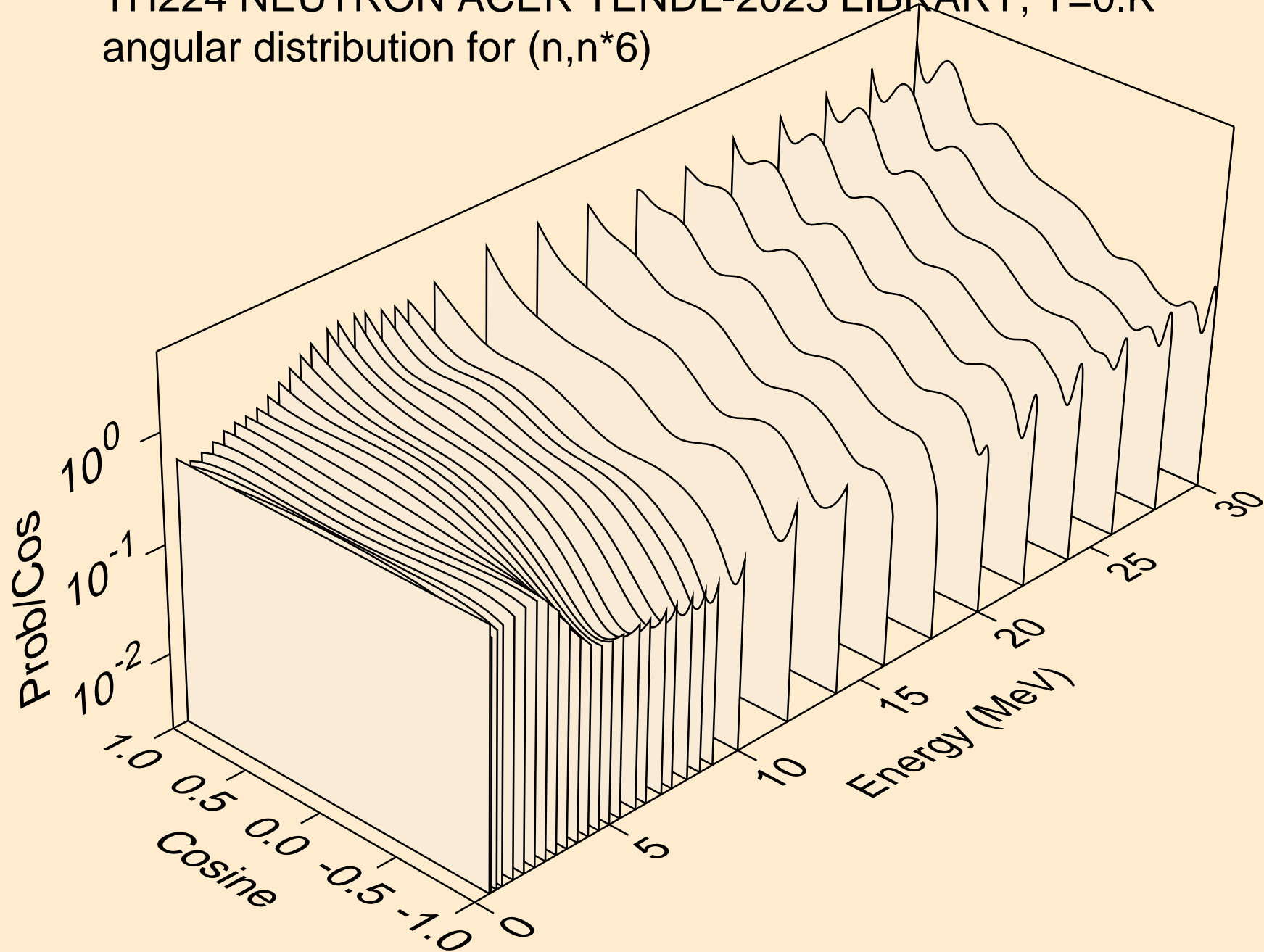

TH224 NEUTRON ACER TENDL-2023 LIBRARY; T=0.K

Total fission nubar

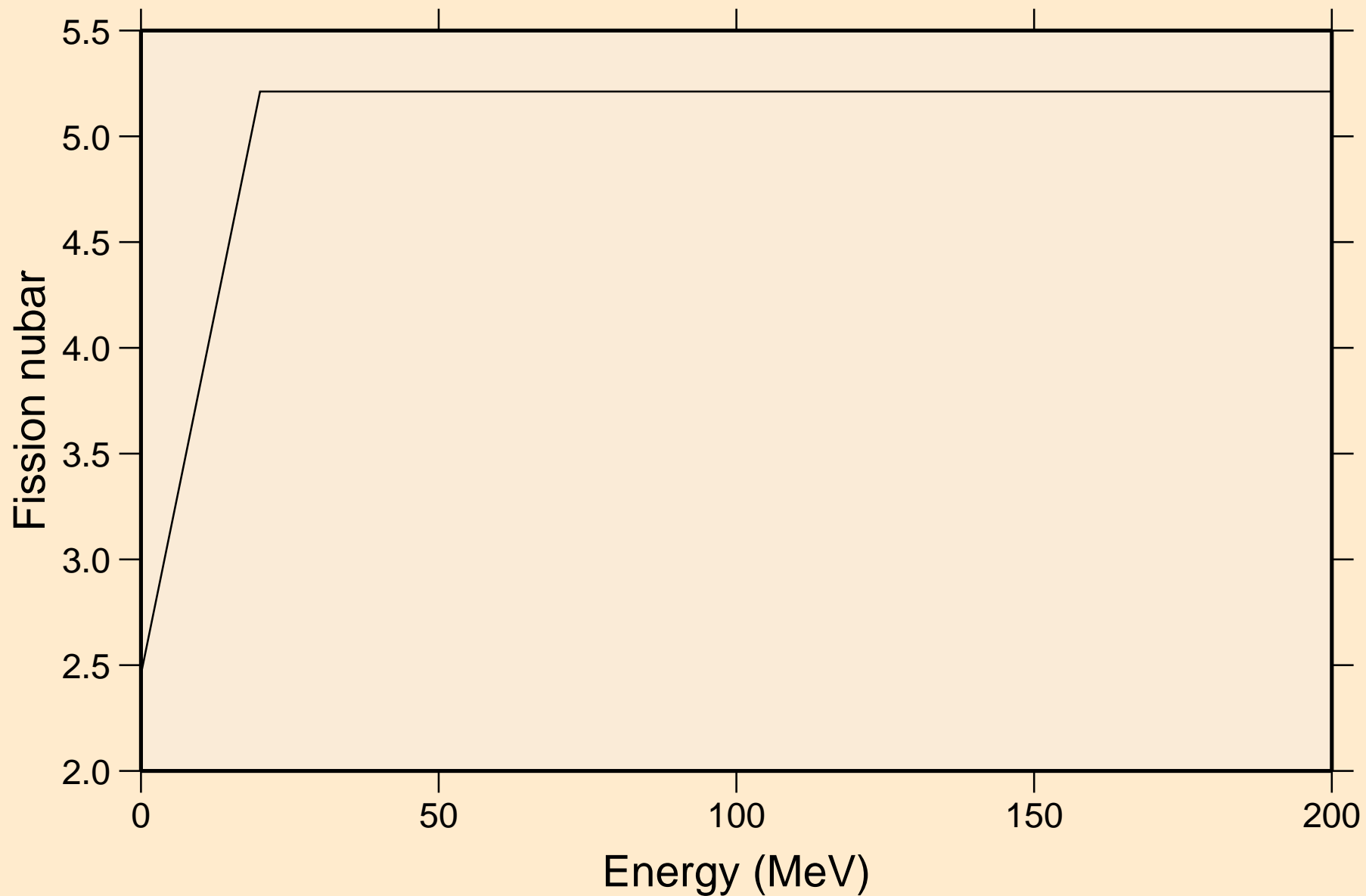

TH224 NEUTRON ACER TENDL-2023 LIBRARY; T=0.K  
Neutron emission for (n,x)

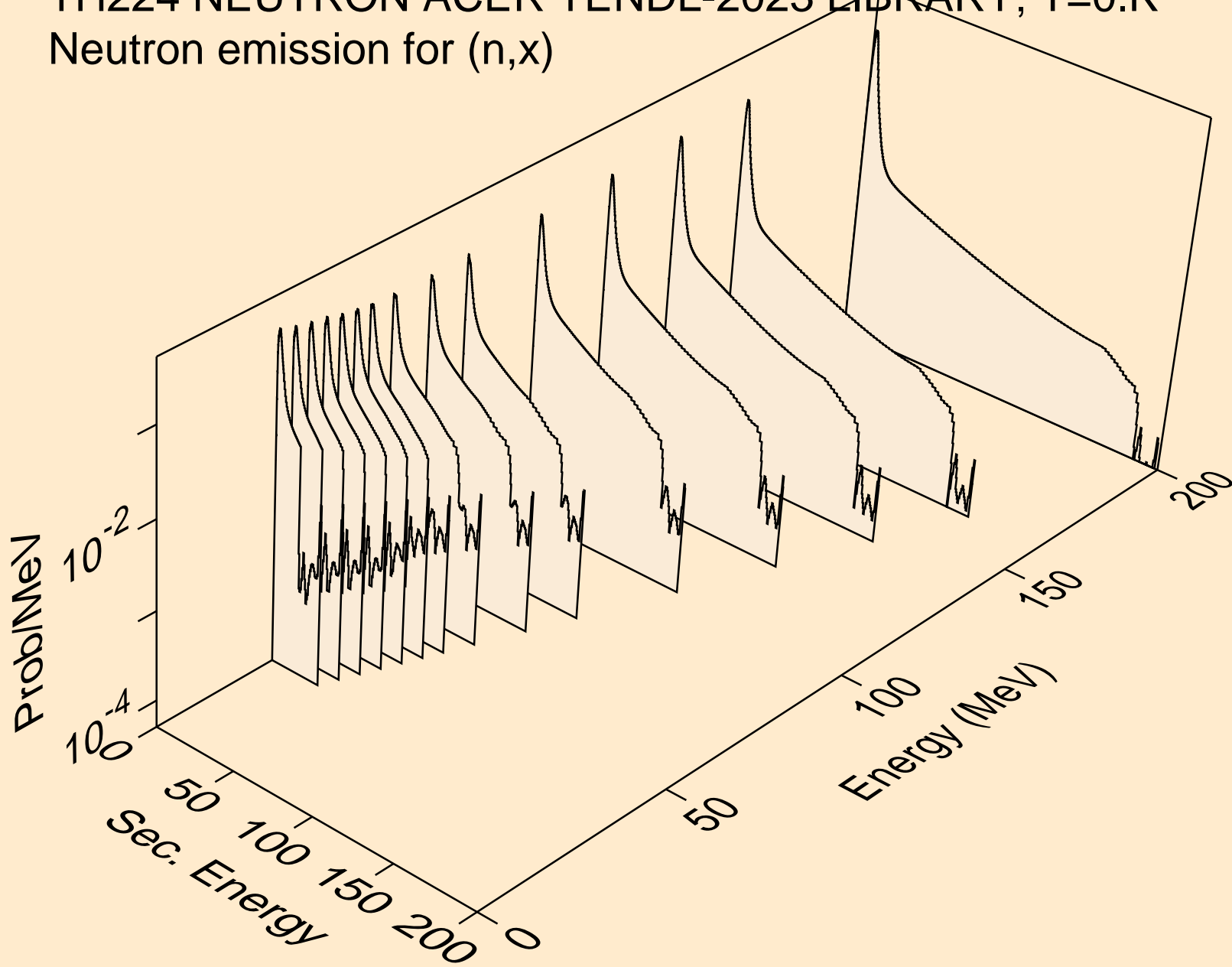

TH224 NEUTRON ACER TENDL-2023 LIBRARY; T=0.K  
Neutron emission for (n,2nd)

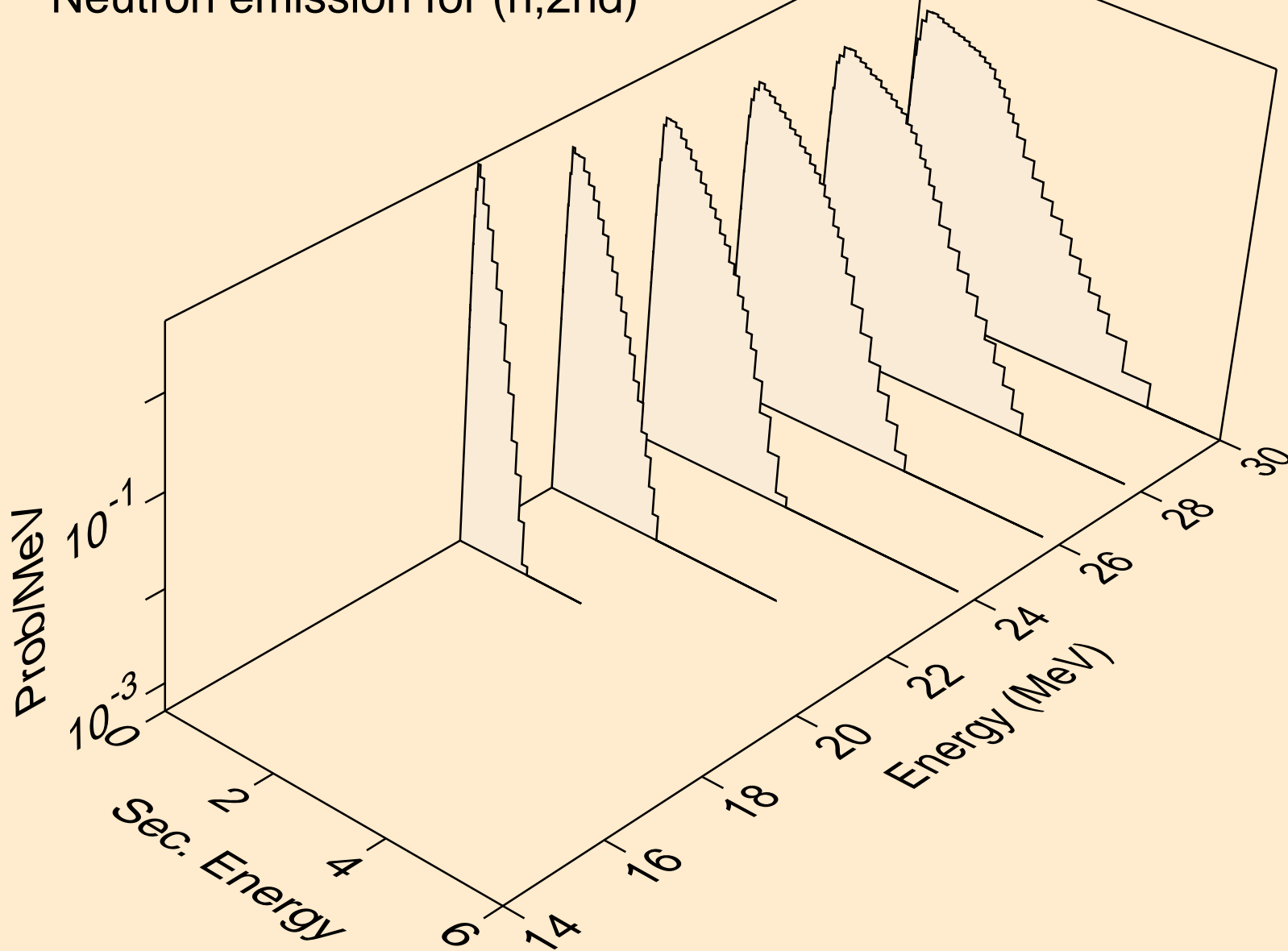

TH224 NEUTRON ACER TENDL-2023 LIBRARY; T=0.K  
Neutron emission for (n,2n)

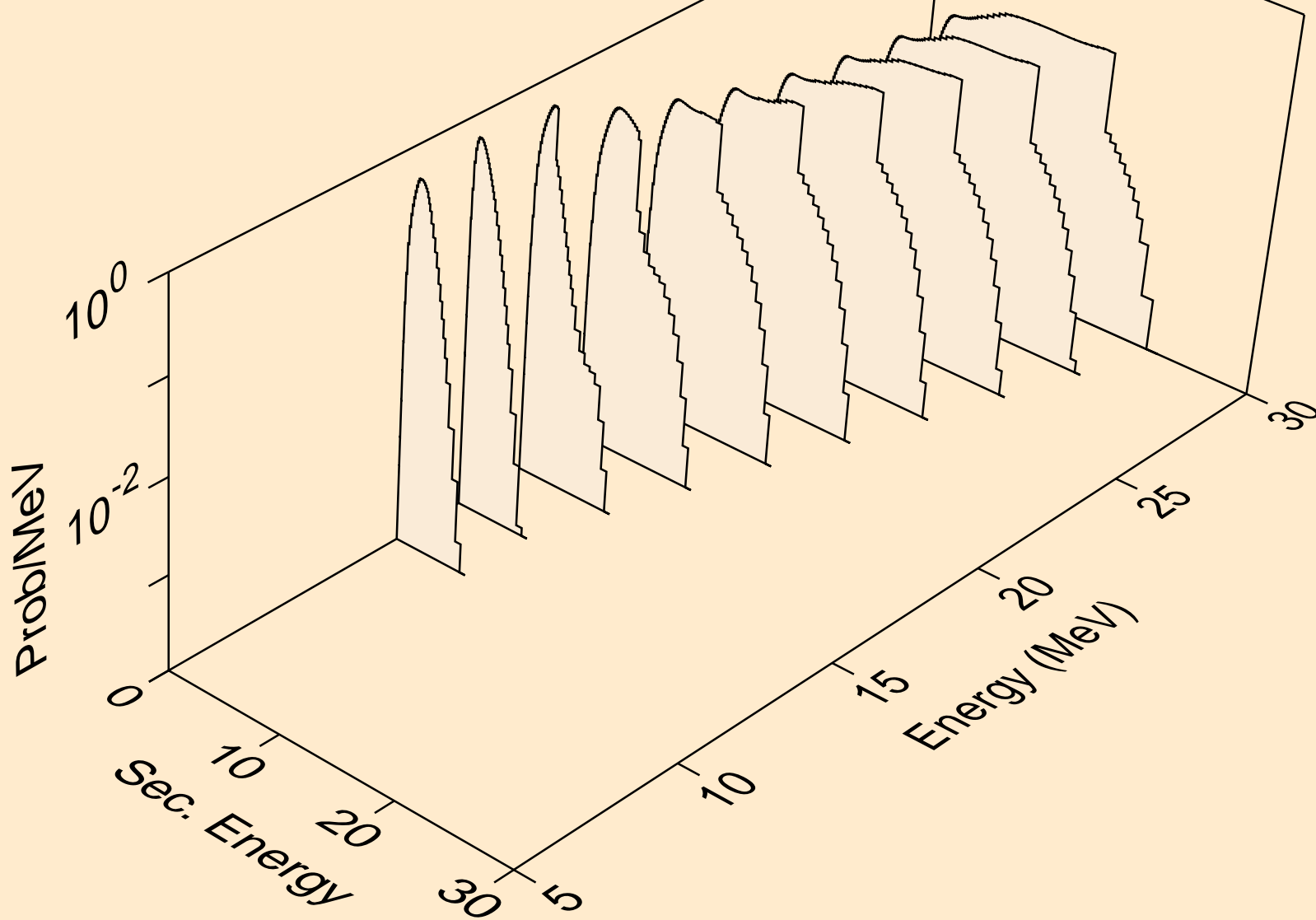

TH224 NEUTRON ACER TENDL-2023 LIBRARY; T=0.K  
Neutron emission for (n,3n)

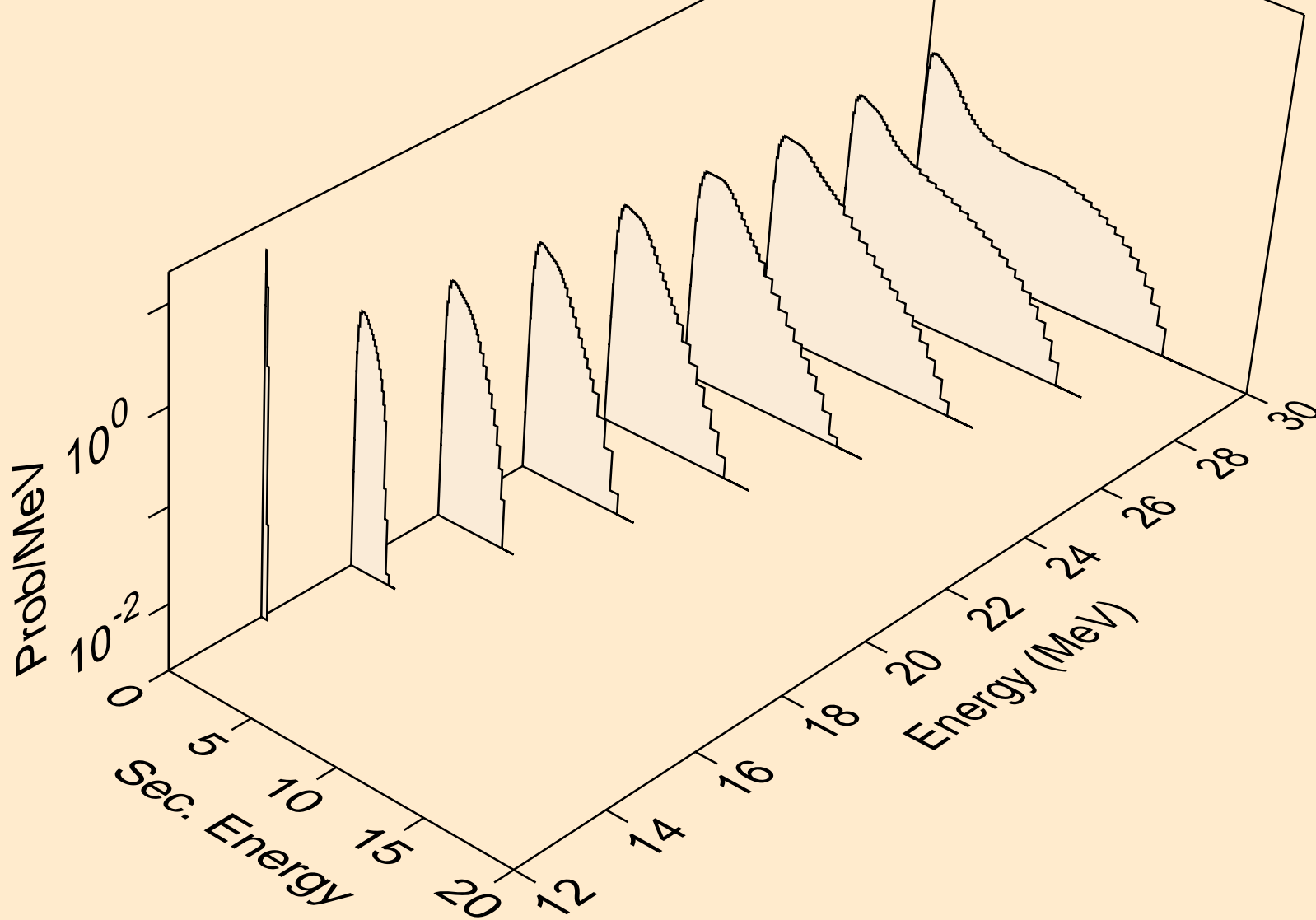

TH224 NEUTRON ACER TENDL-2023 LIBRARY; T=0.K  
Neutron emission for fission

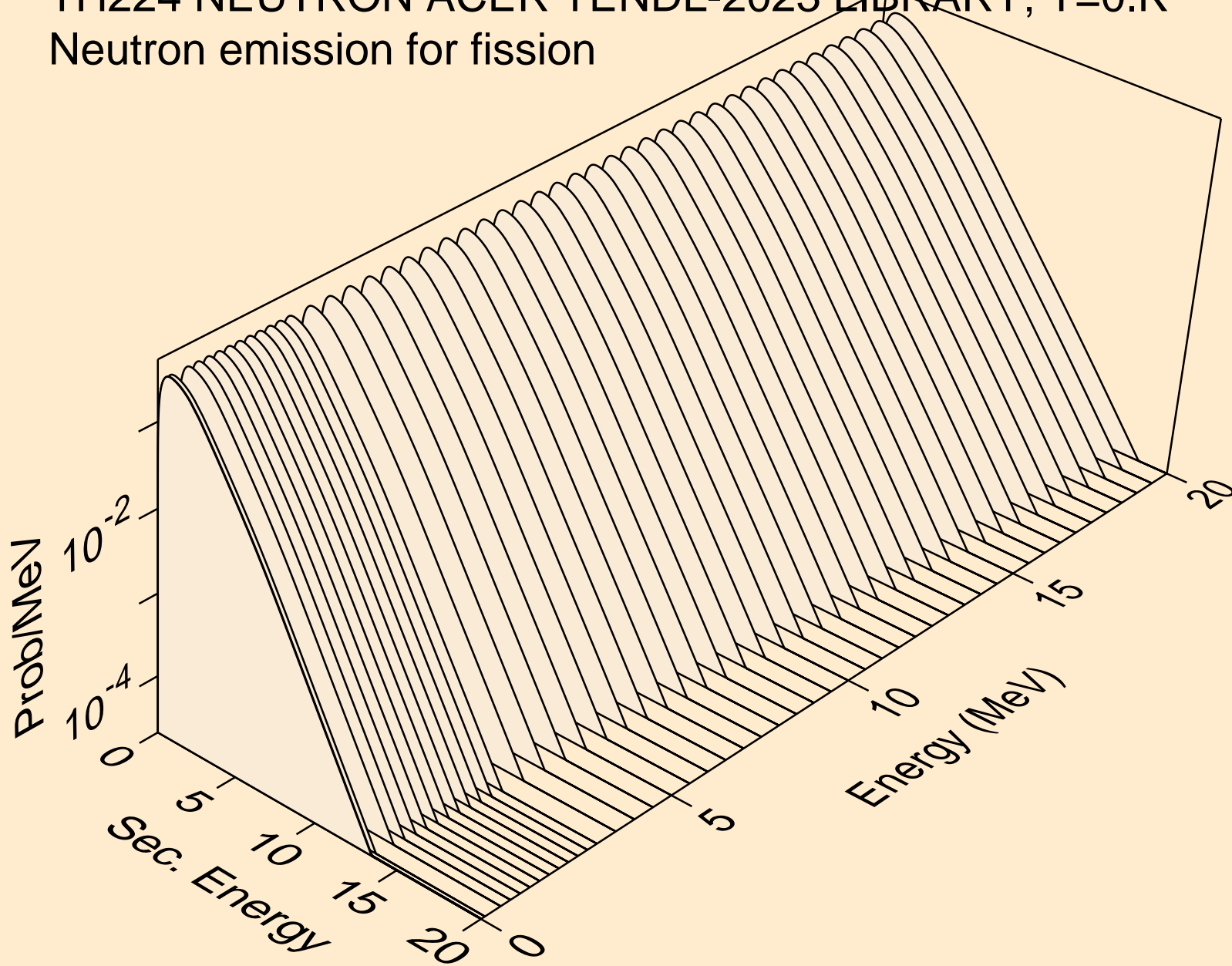

TH224 NEUTRON ACER TENDL-2023 LIBRARY; T=0.K  
Neutron emission for (n,n\*)a

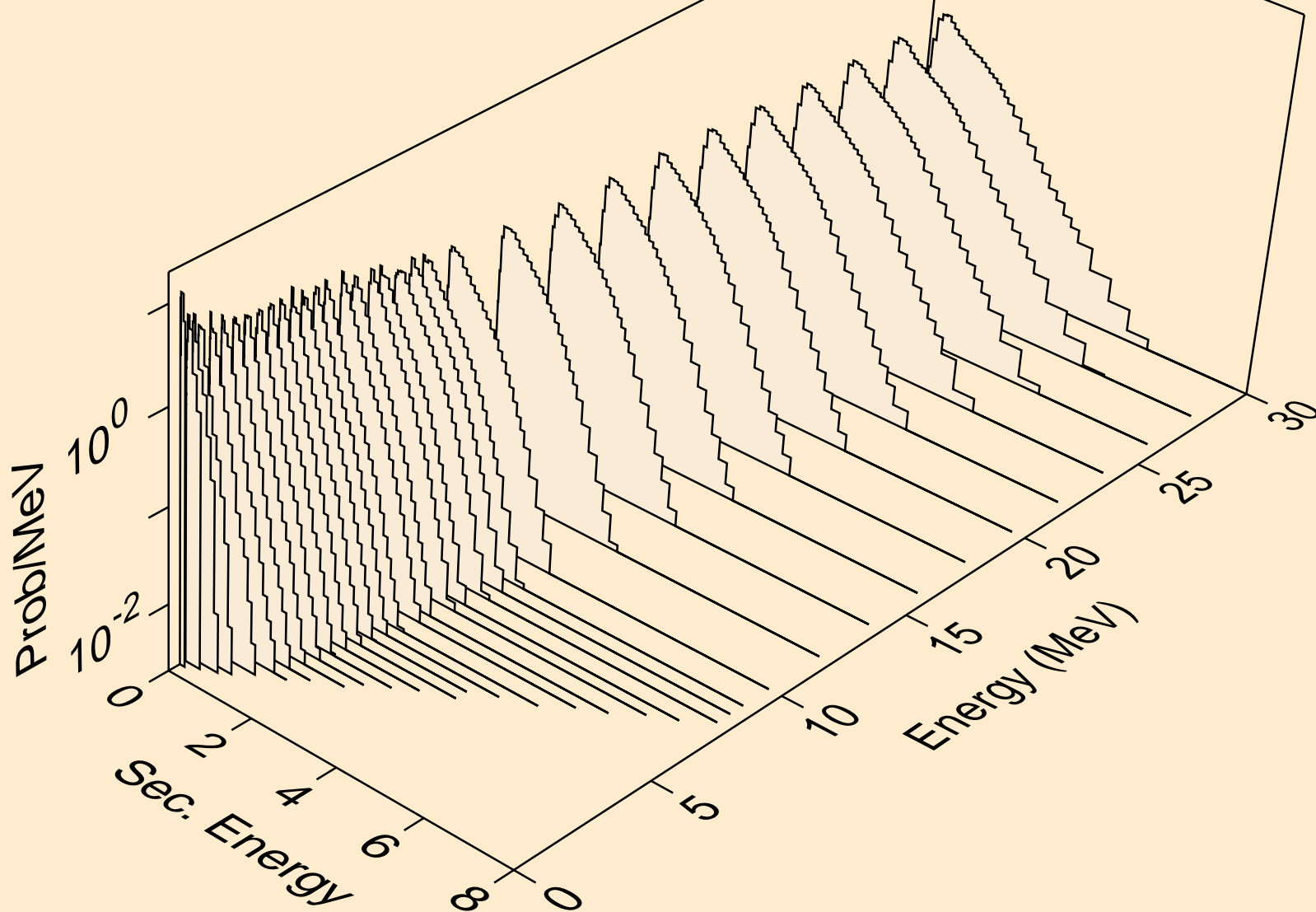

TH224 NEUTRON ACER TENDL-2023 LIBRARY; T=0.K  
Neutron emission for (n,n\*)3a

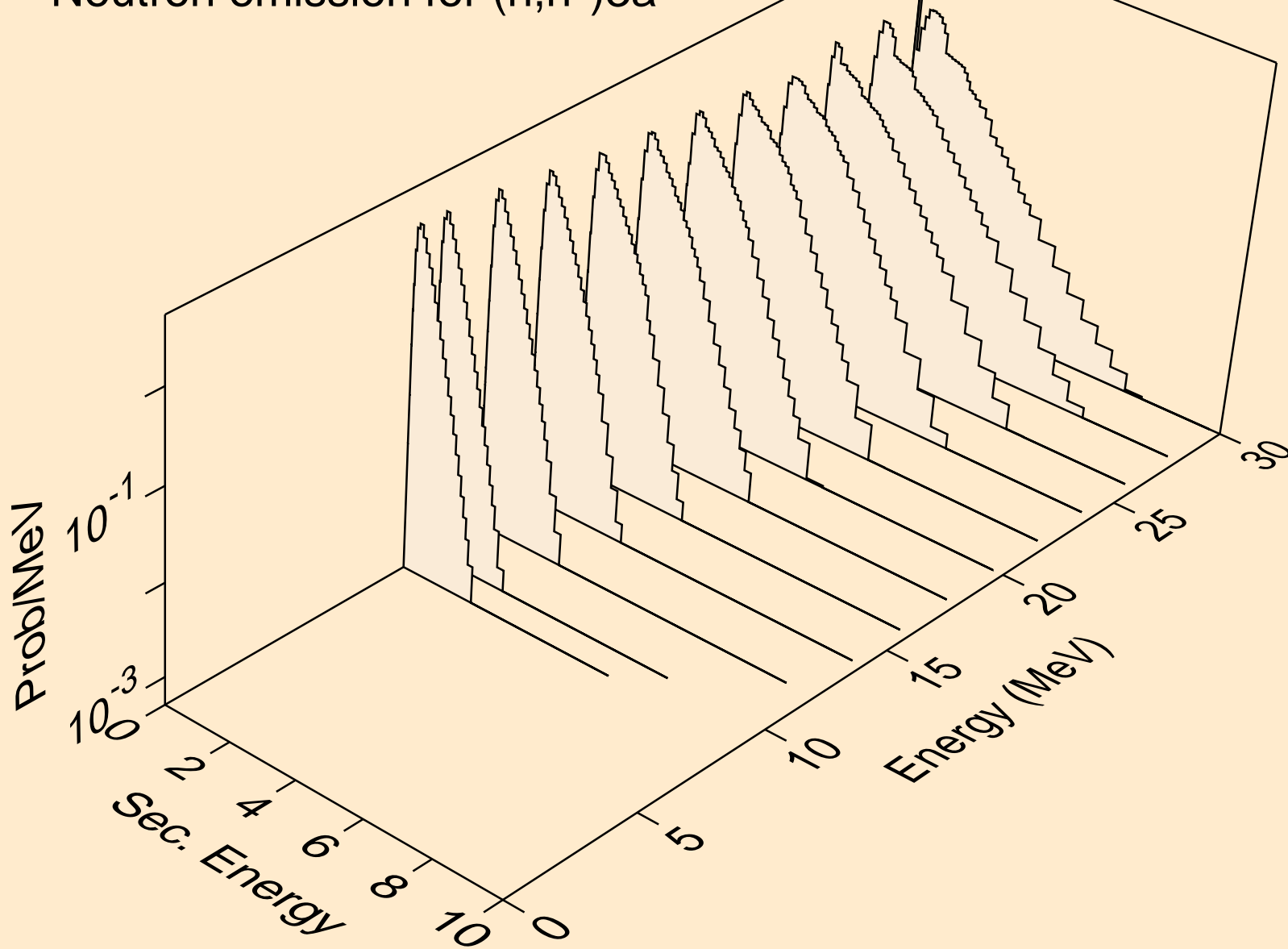

TH224 NEUTRON ACER TENDL-2023 LIBRARY; T=0.K  
Neutron emission for (n,2n)a

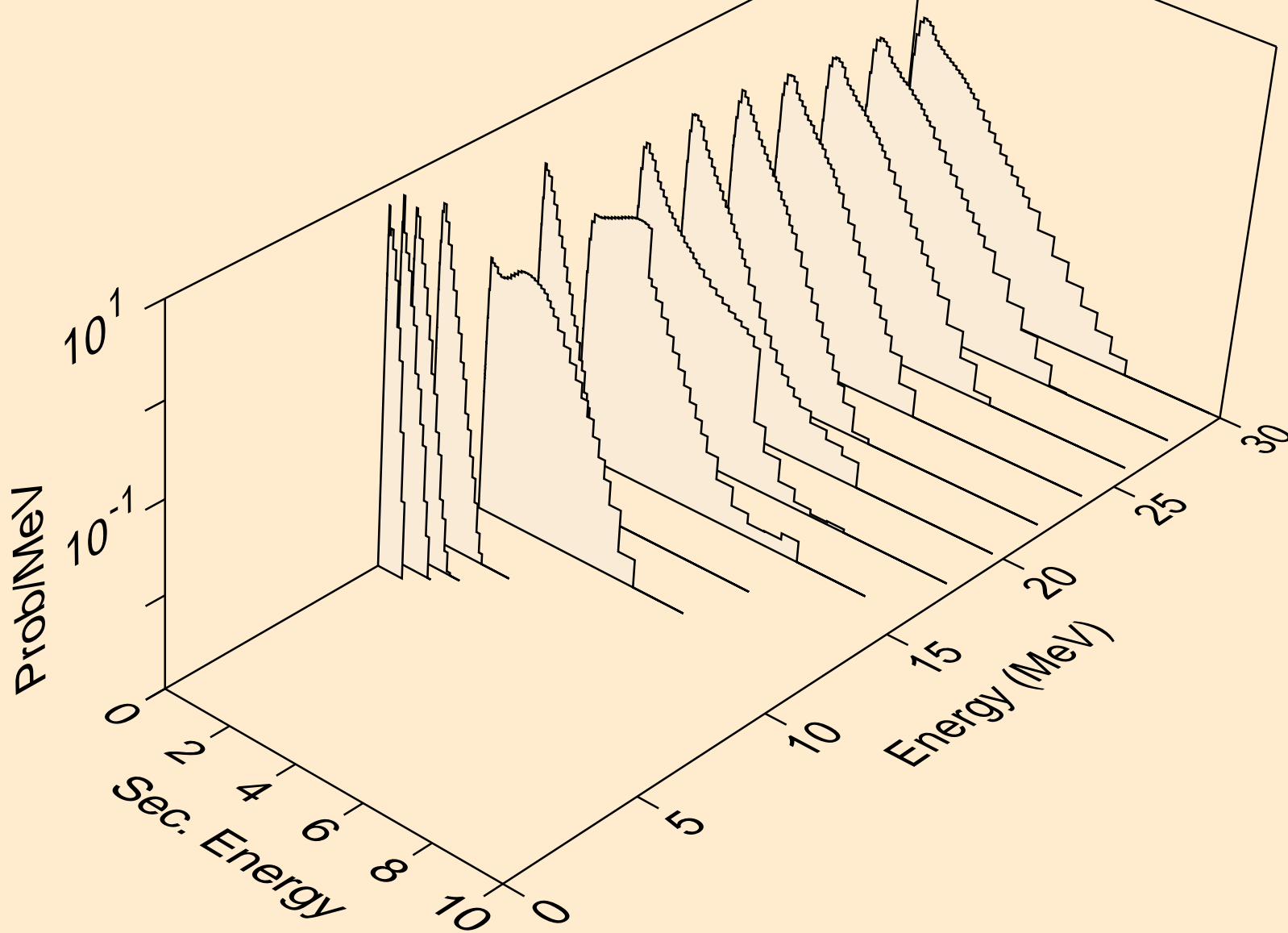

TH224 NEUTRON ACER TENDL-2023 LIBRARY; T=0.K  
Neutron emission for (n,3n)a

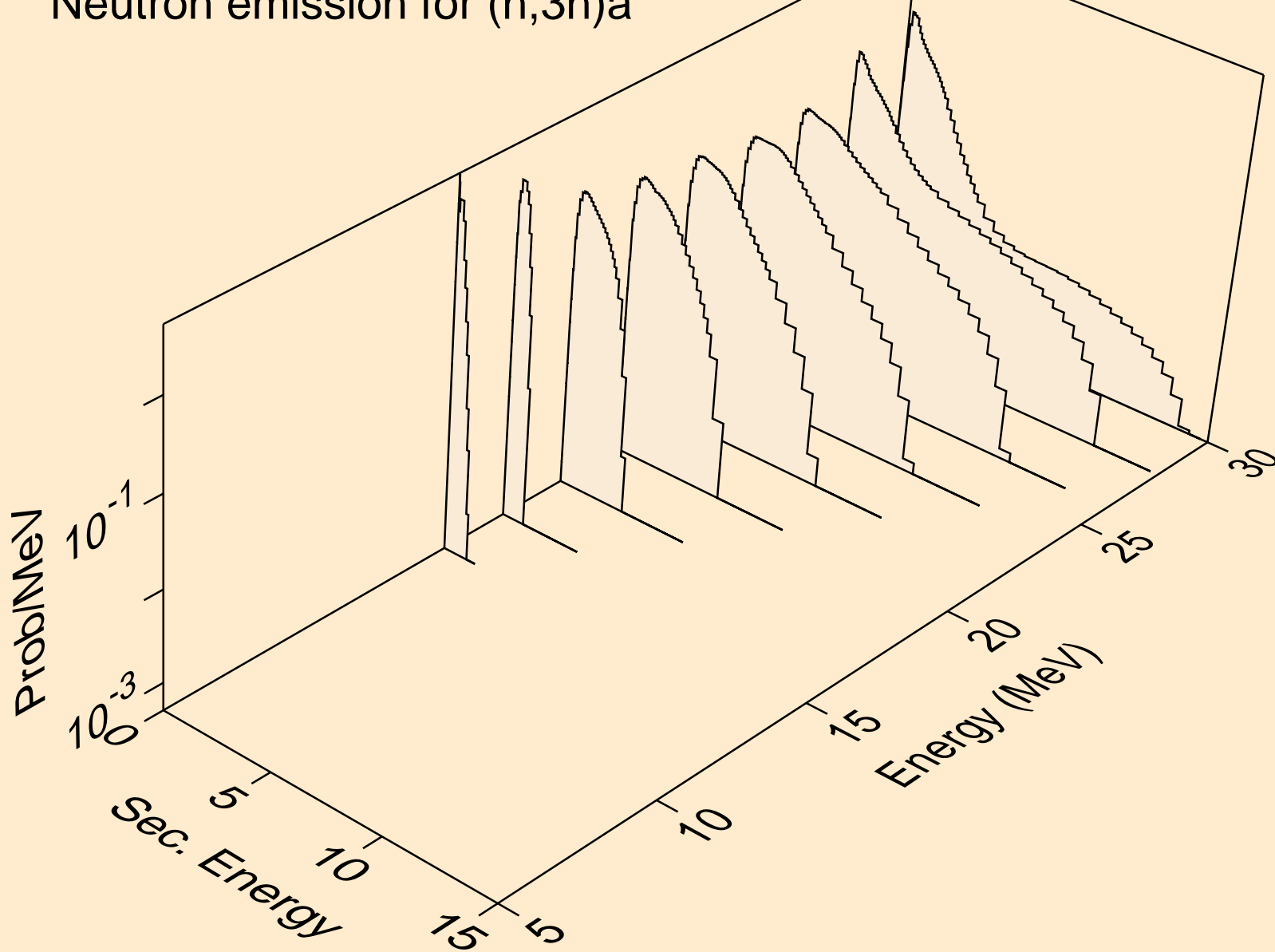

TH224 NEUTRON ACER TENDL-2023 LIBRARY; T=0.K  
Neutron emission for (n,n\*)p

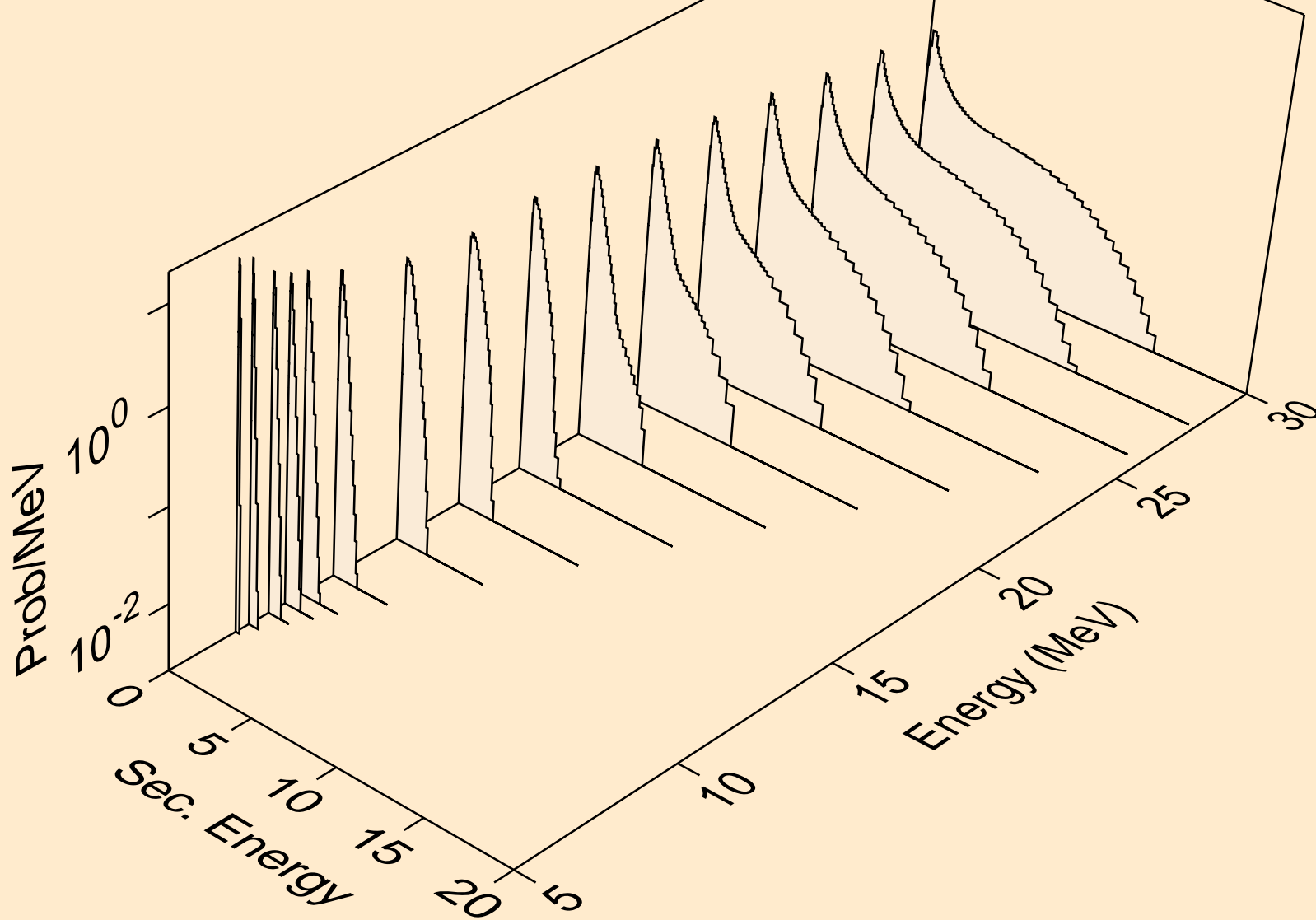

TH224 NEUTRON ACER TENDL-2023 LIBRARY; T=0.K  
Neutron emission for (n,n\*)2a

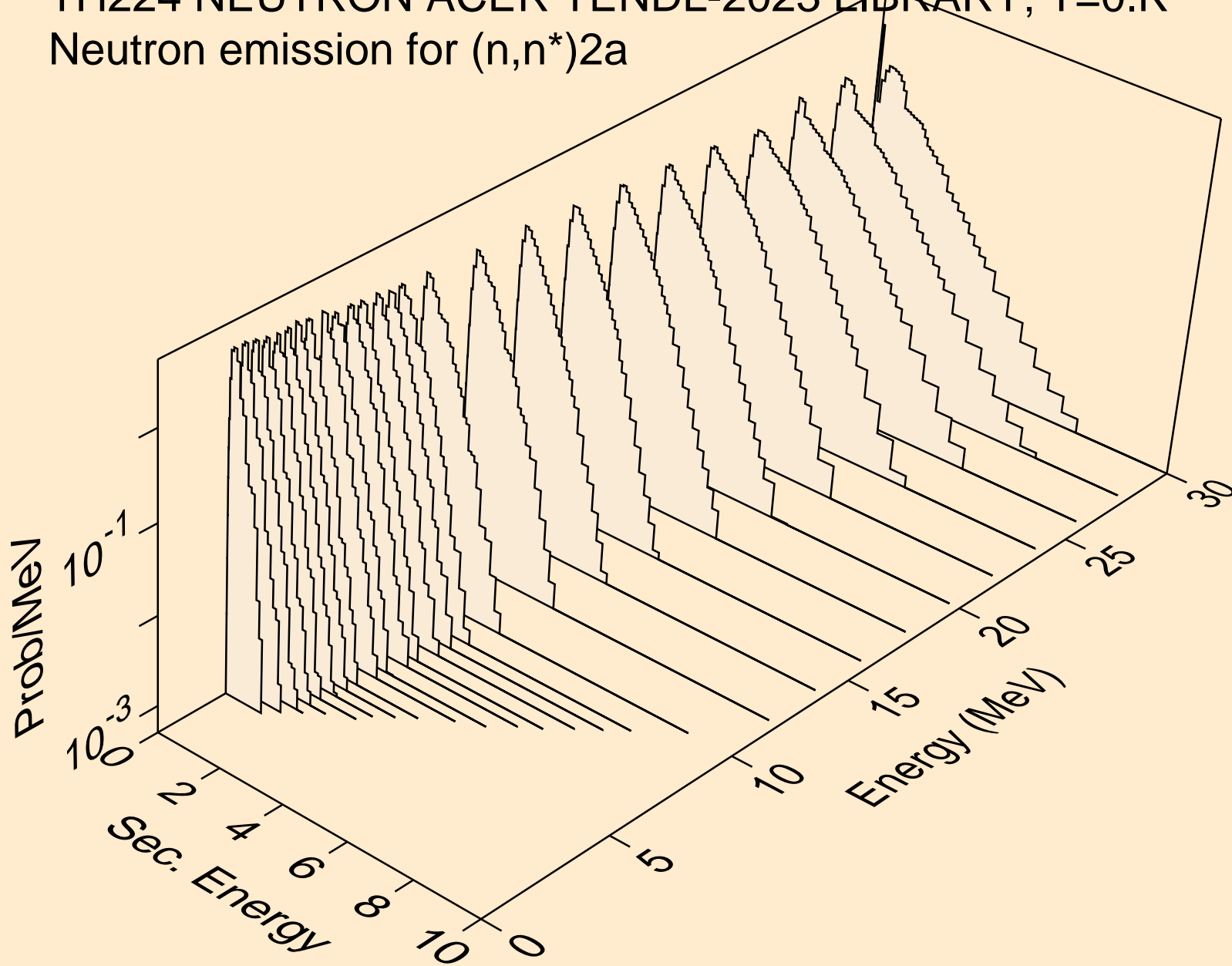

TH224 NEUTRON ACER TENDL-2023 LIBRARY; T=0.K  
Neutron emission for (n,2n)2a

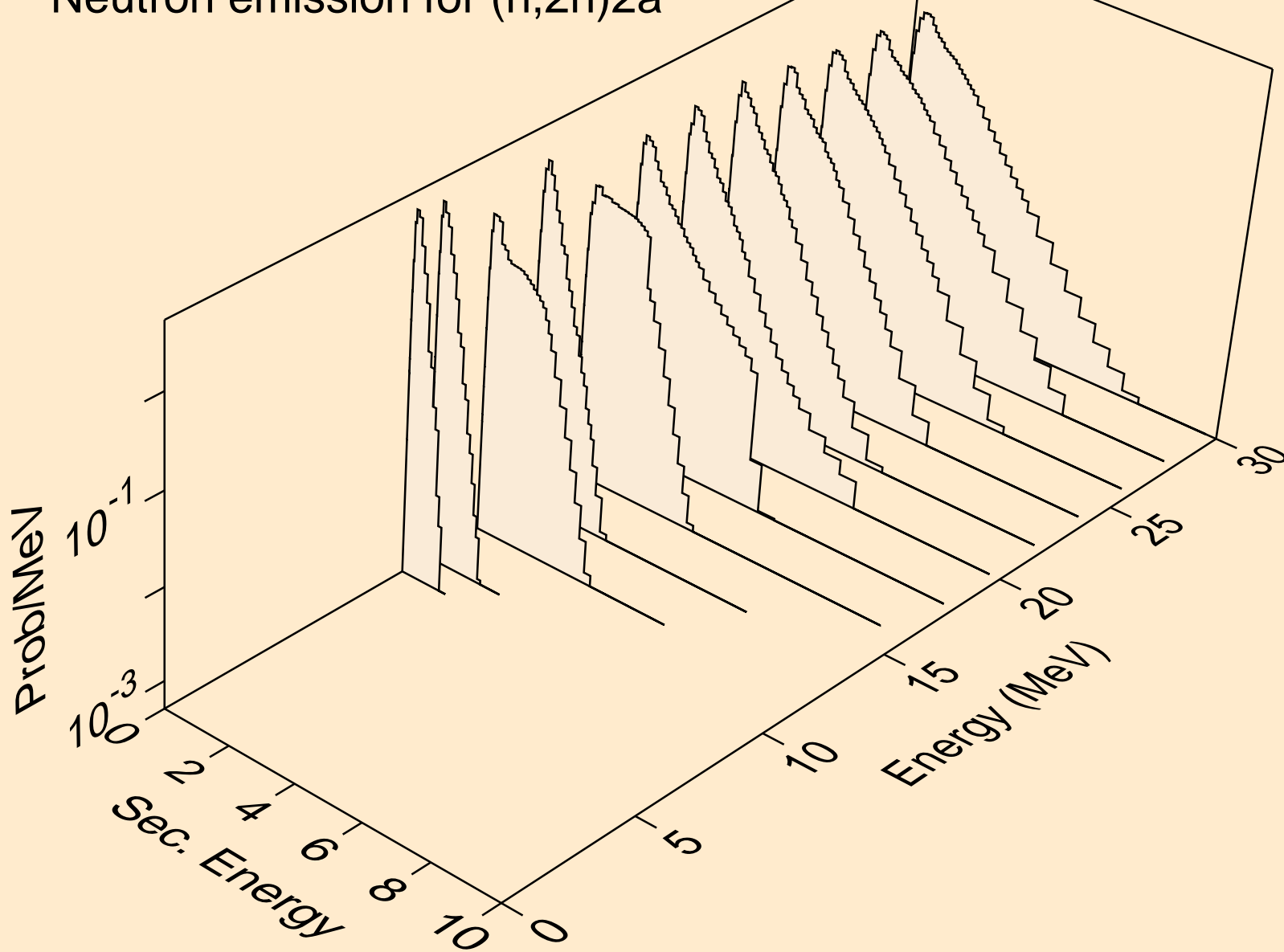

TH224 NEUTRON ACER TENDL-2023 LIBRARY; T=0.K  
Neutron emission for (n,n\*)d

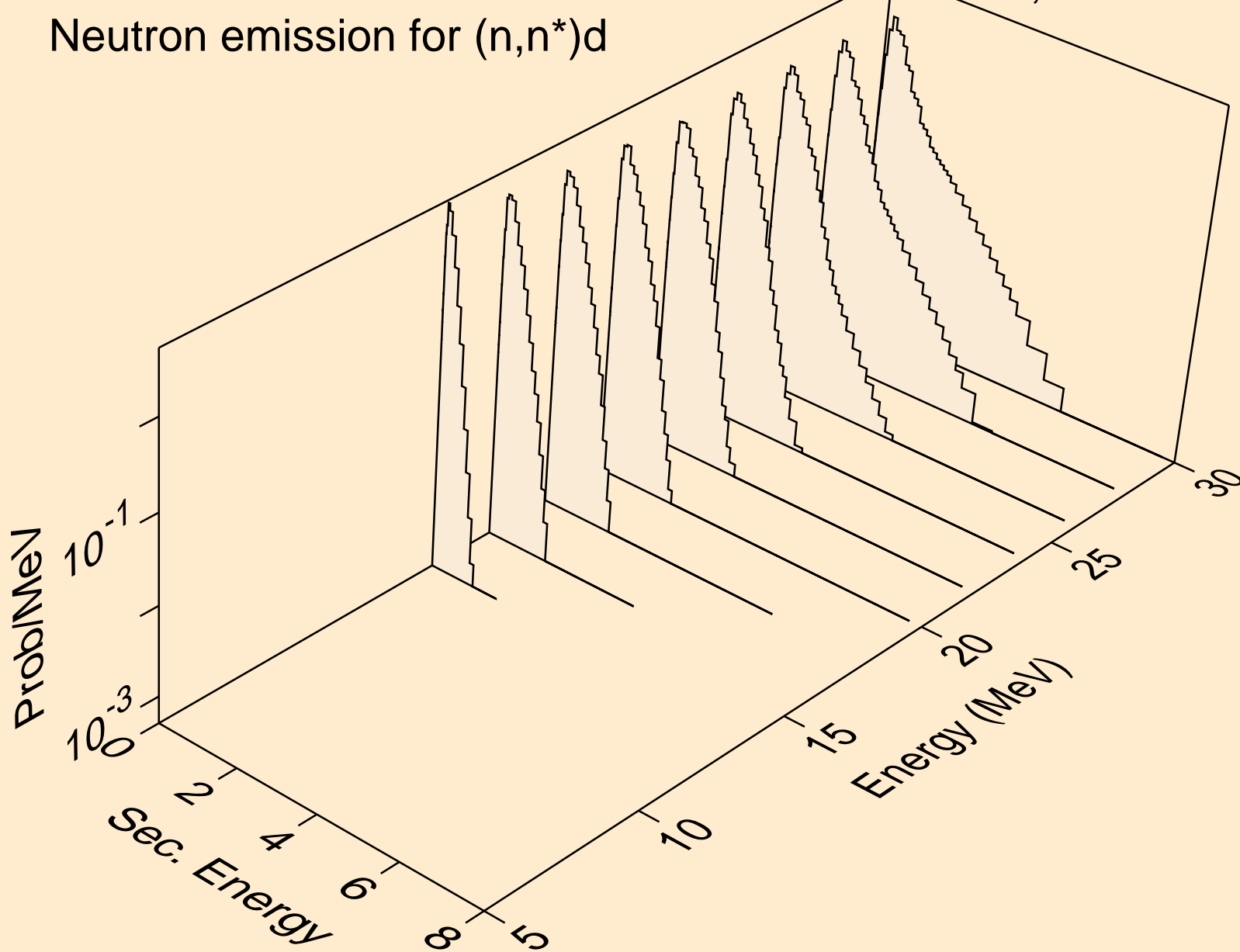

TH224 NEUTRON ACER TENDL-2023 LIBRARY; T=0.K  
Neutron emission for (n,n\*)t

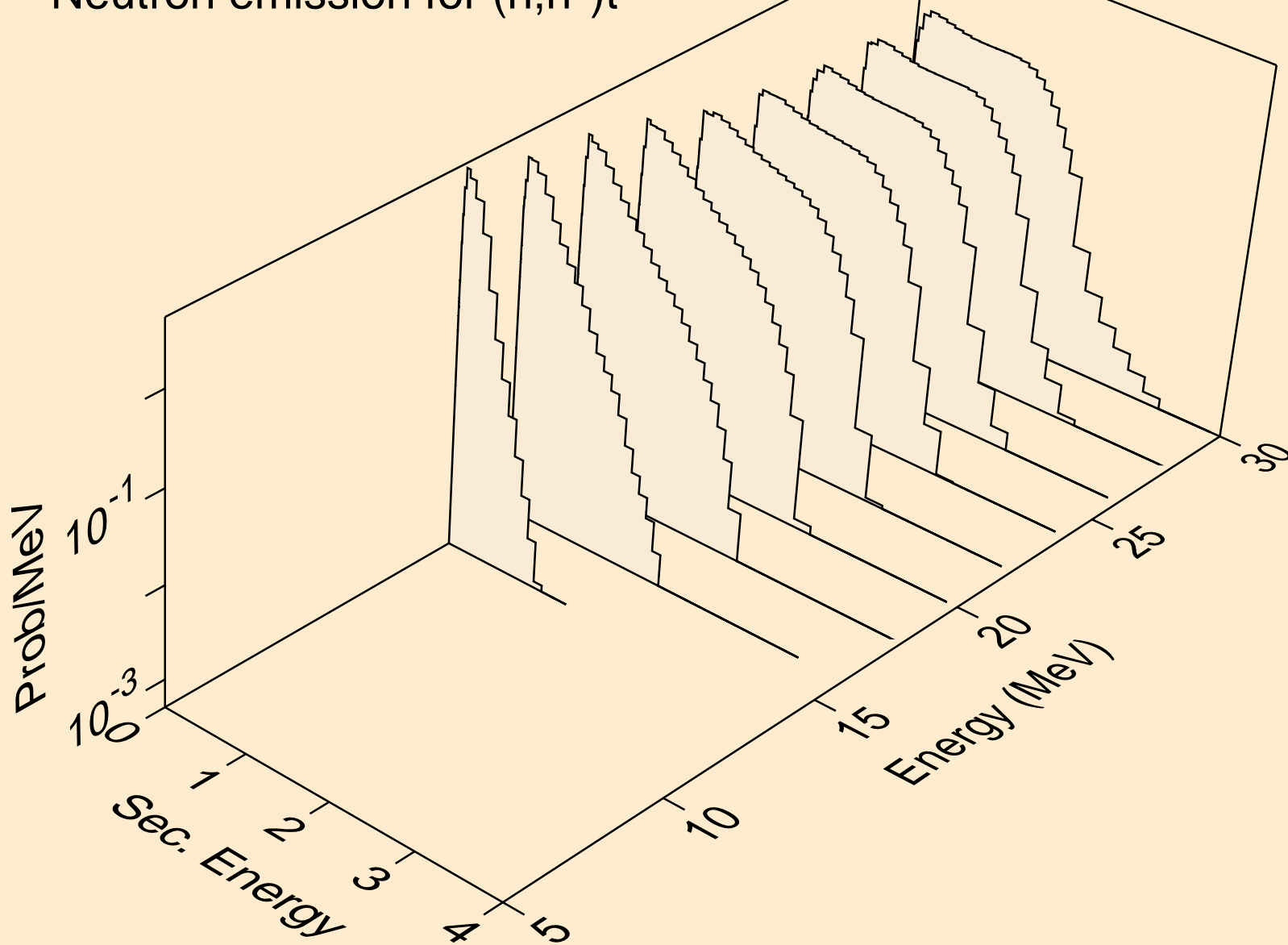

TH224 NEUTRON ACER TENDL-2023 LIBRARY; T=0.K  
Neutron emission for (n,n\*)he3

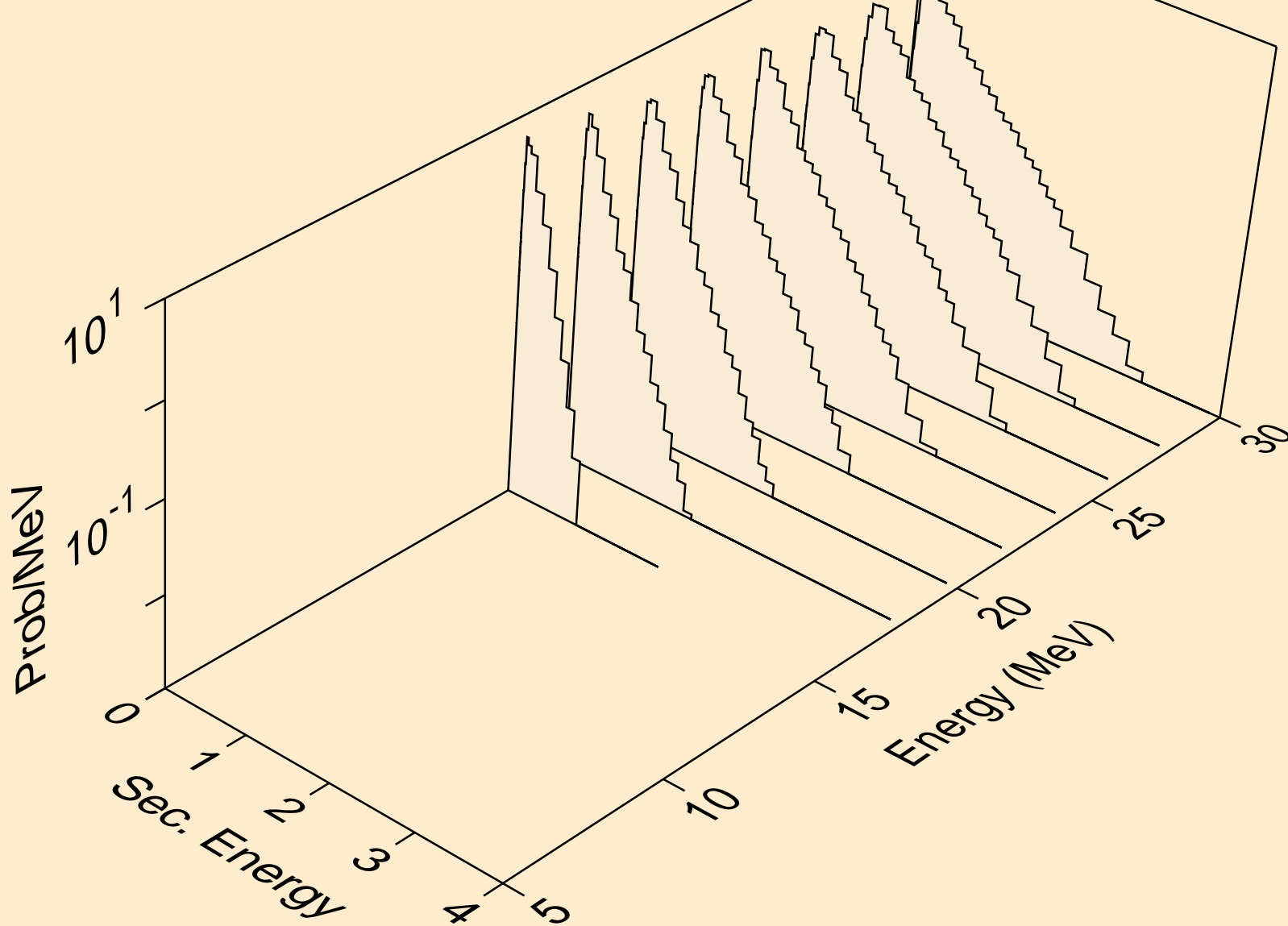

TH224 NEUTRON ACER TENDL-2023 LIBRARY; T=0.K  
Neutron emission for (n,4n)

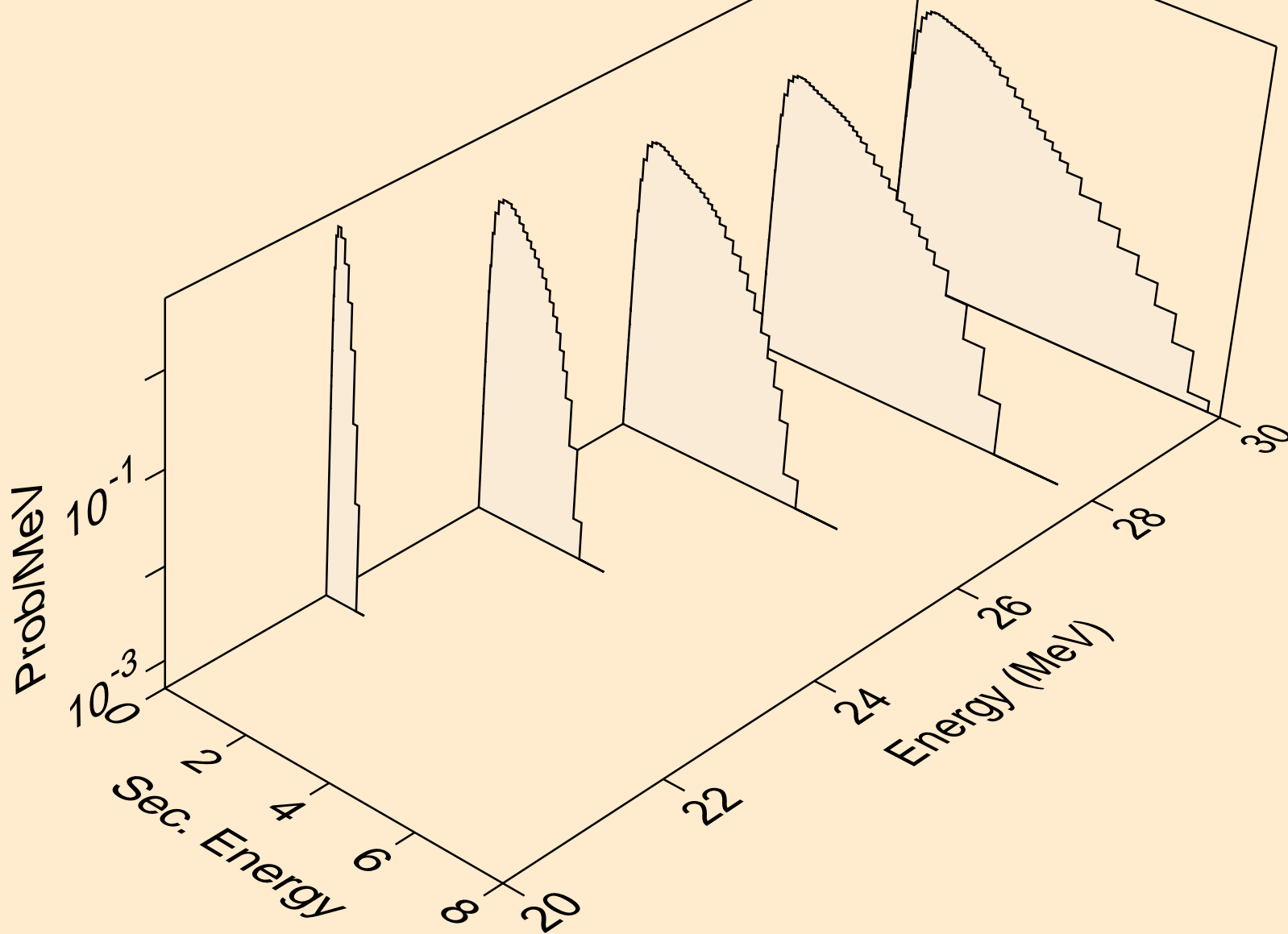

TH224 NEUTRON ACER TENDL-2023 LIBRARY; T=0.K  
Neutron emission for (n,2np)

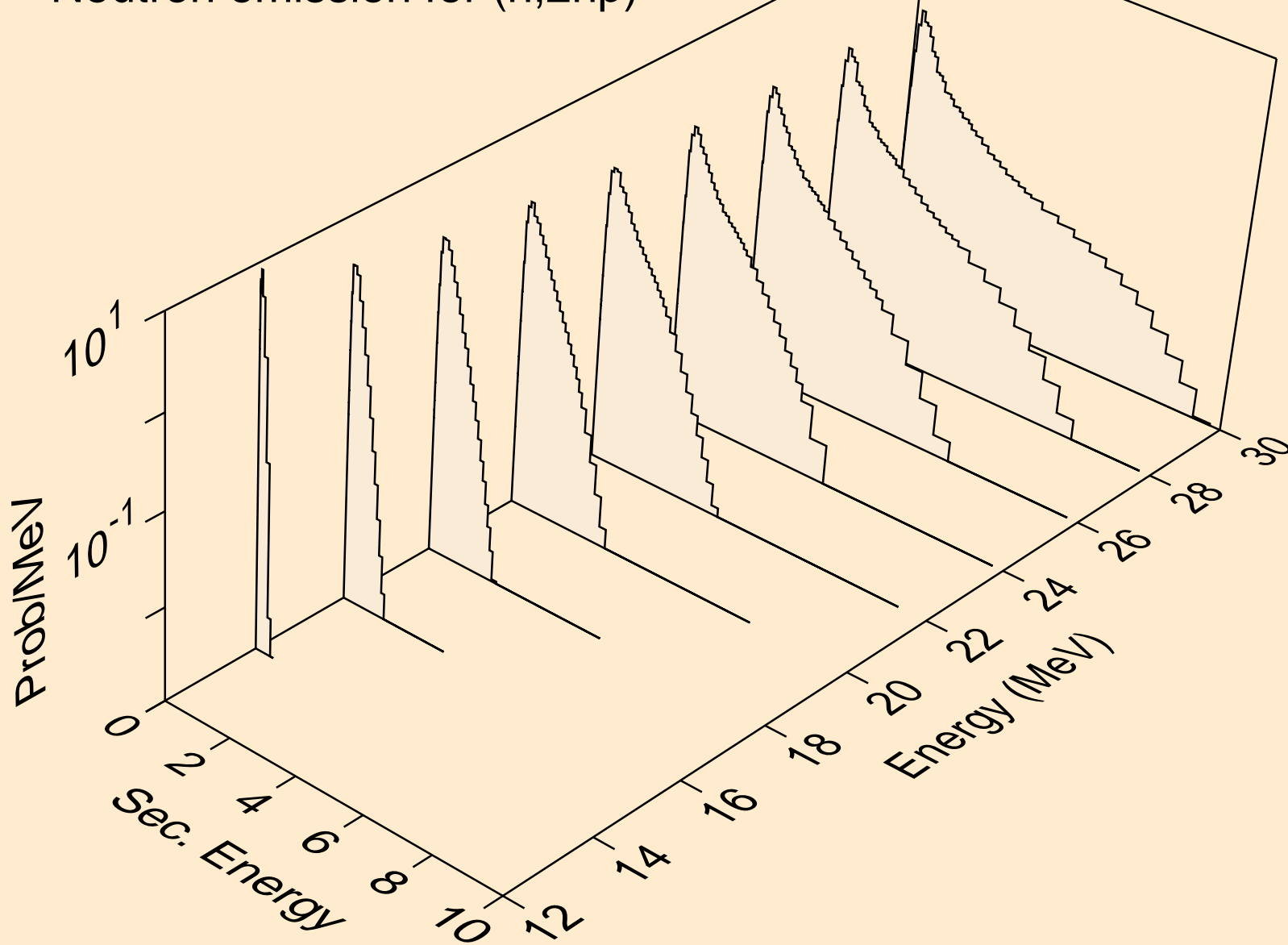

TH224 NEUTRON ACER TENDL-2023 LIBRARY; T=0.K  
Neutron emission for (n,3np)

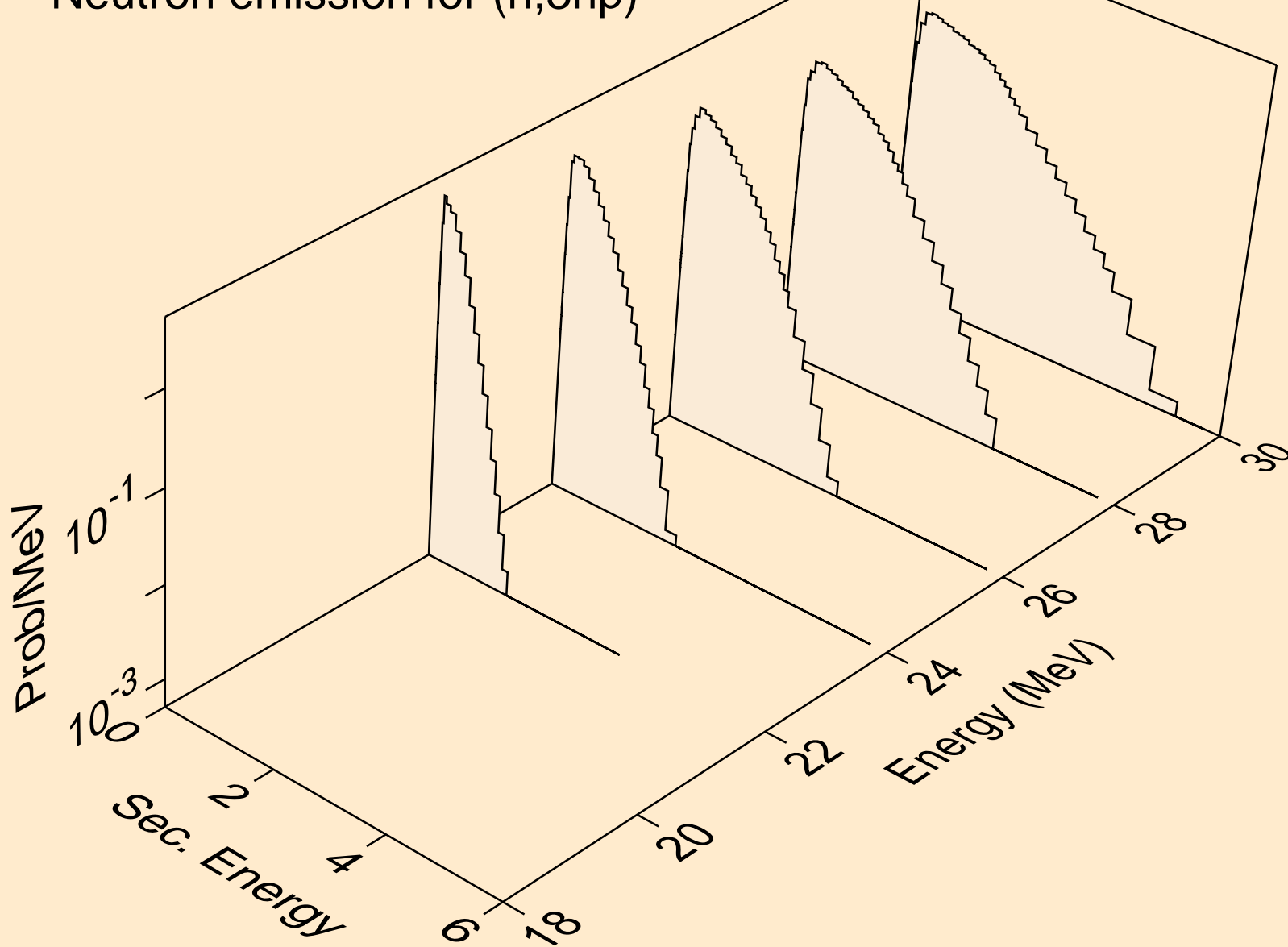

TH224 NEUTRON ACER TENDL-2023 LIBRARY; T=0.K  
Neutron emission for (n,n2p)

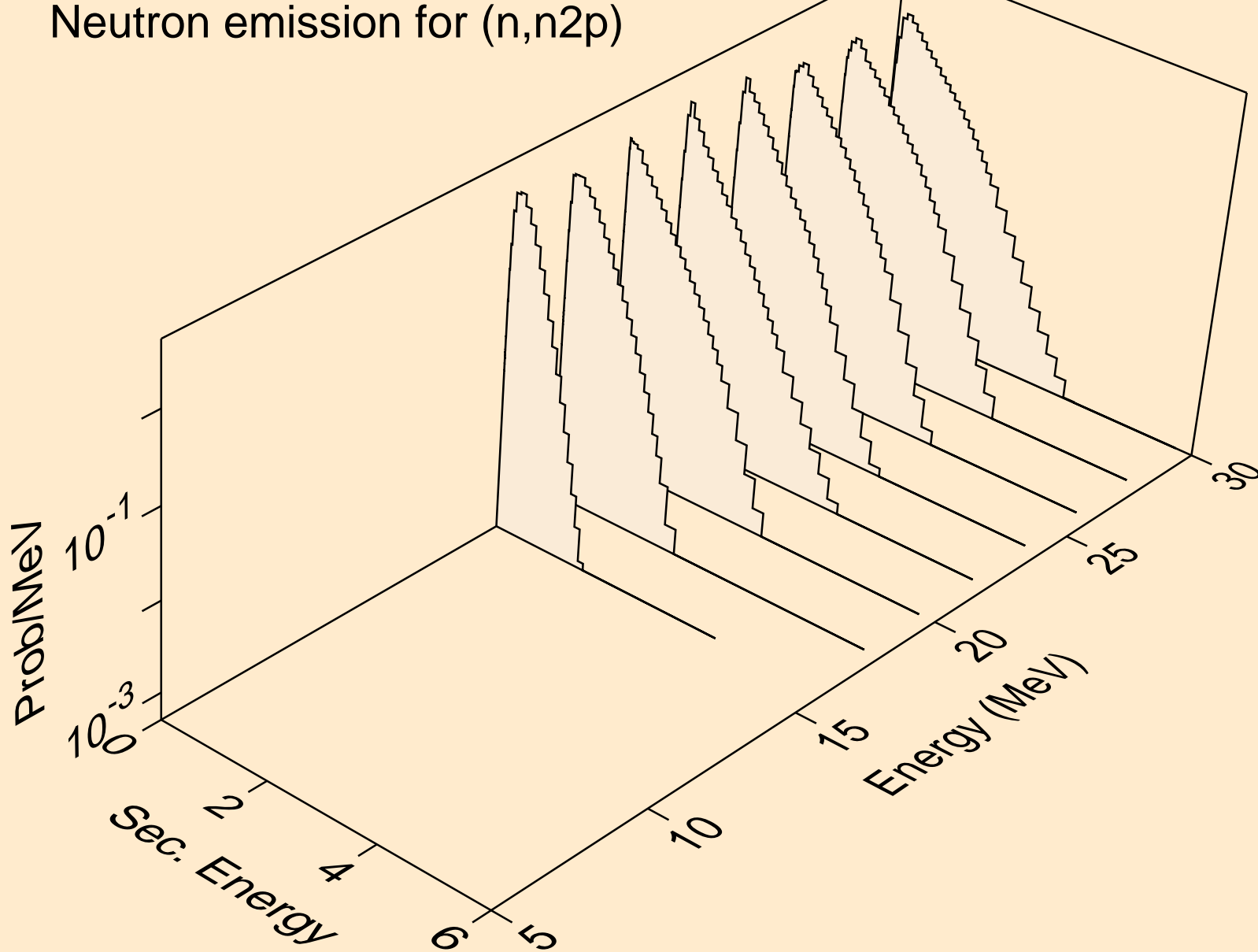

TH224 NEUTRON ACER TENDL-2023 LIBRARY; T=0.K  
Neutron emission for (n,npa)

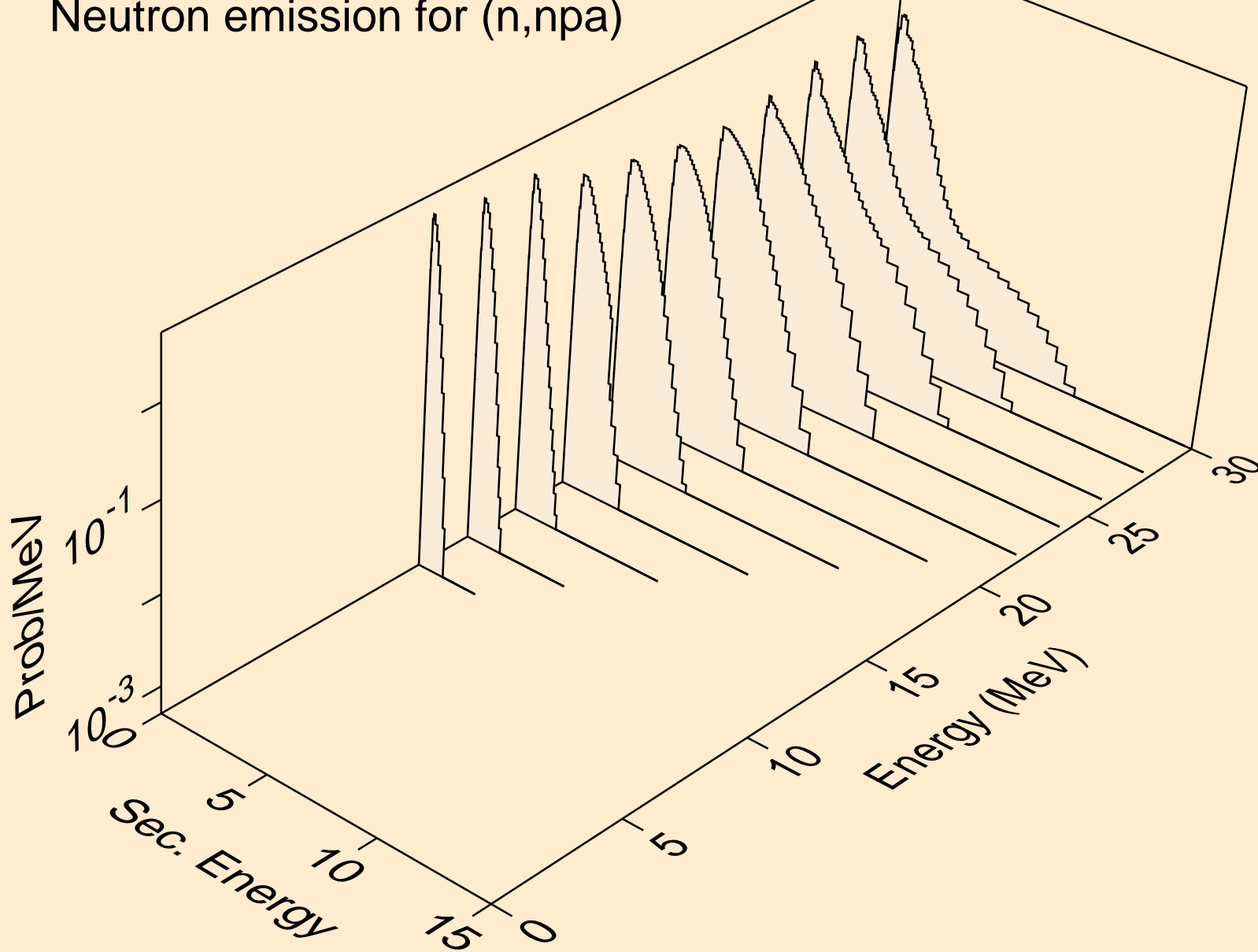

TH224 NEUTRON ACER TENDL-2023 LIBRARY; T=0.K  
Delayed nubar

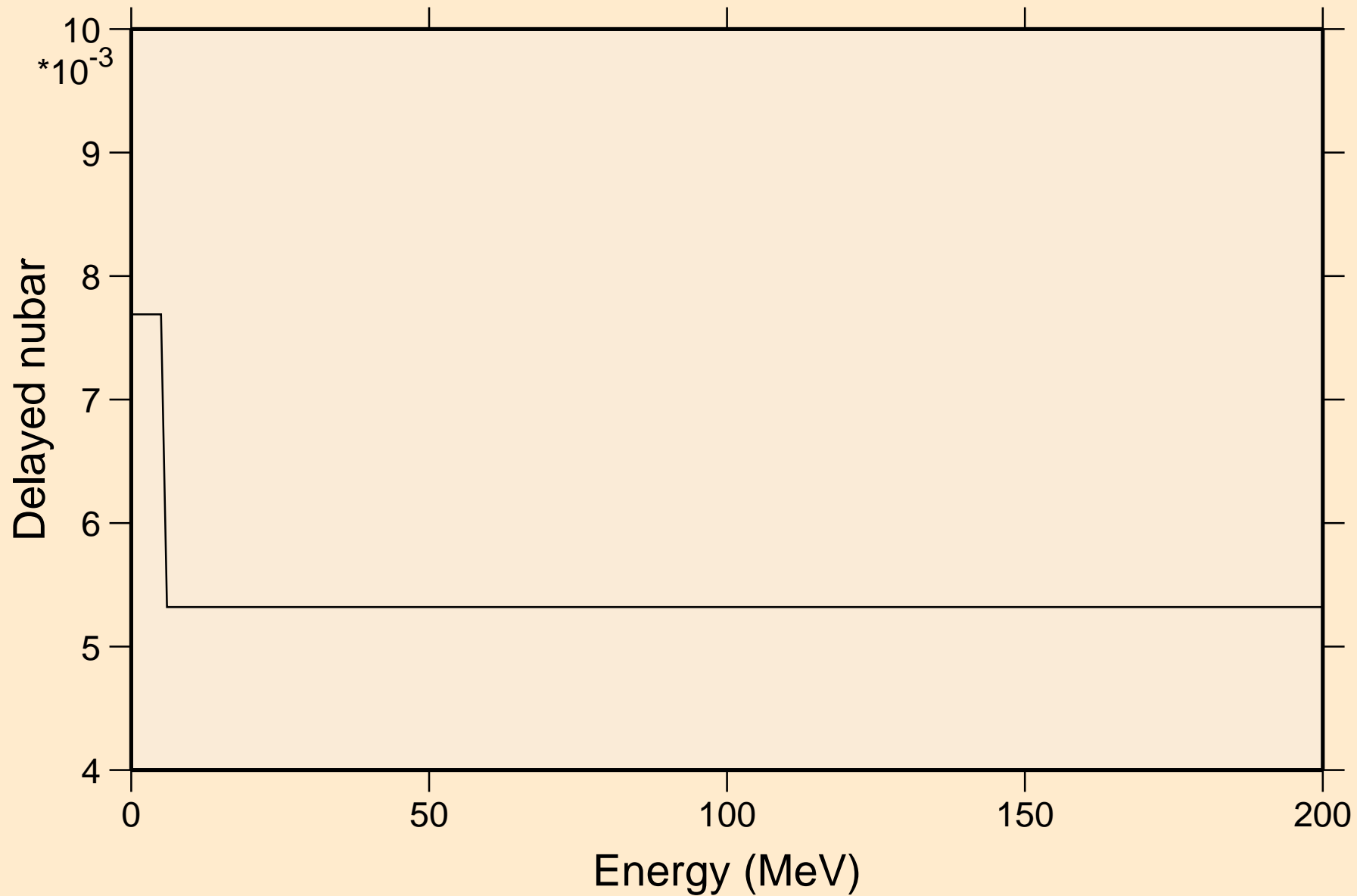

# TH224 NEUTRON ACER TENDL-2023 LIBRARY; T=0.K

## Delayed neutron spectra

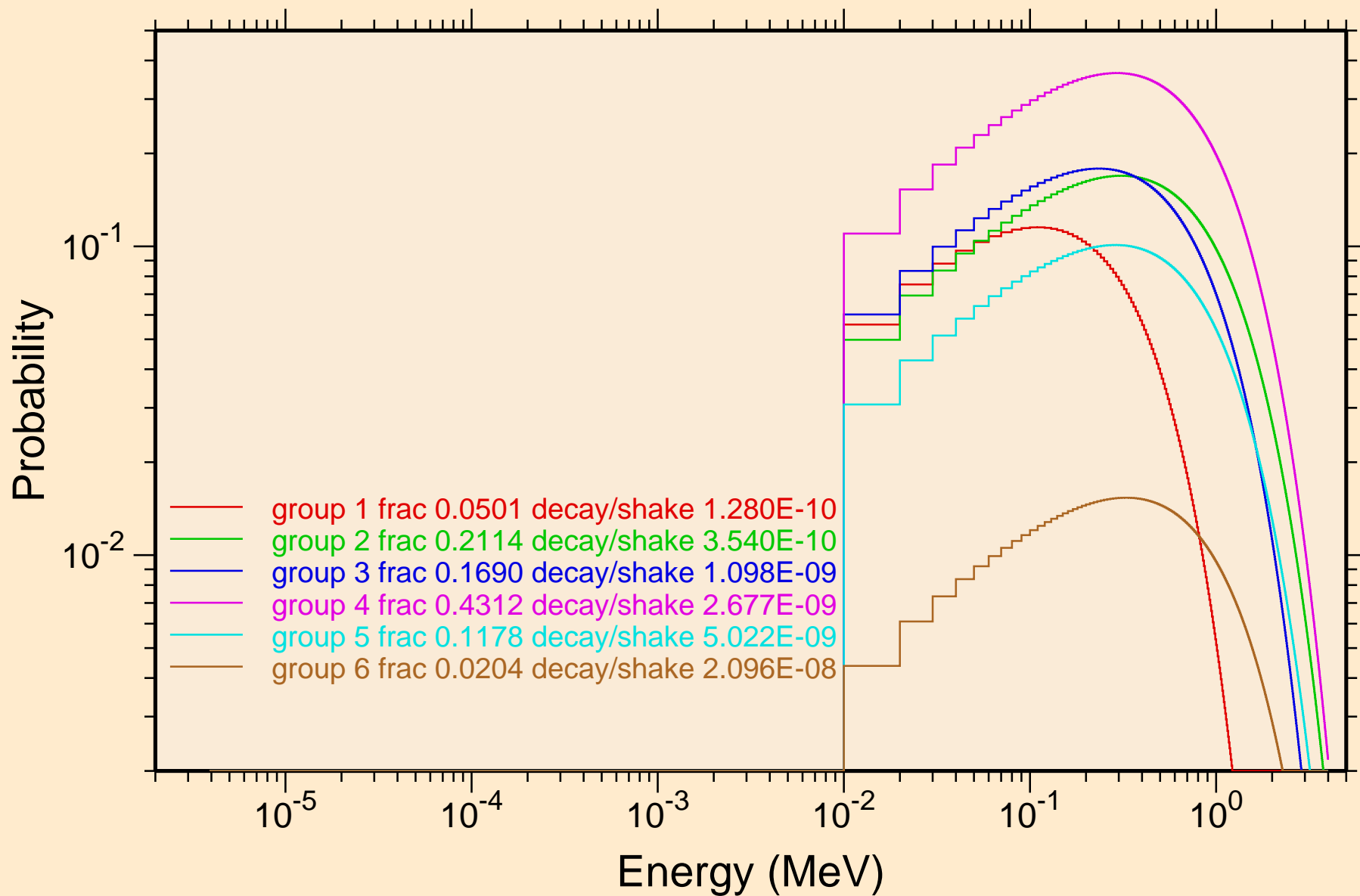

TH224 NEUTRON ACER TENDL-2023 LIBRARY; T=0.K  
Photon emission for (n,x)

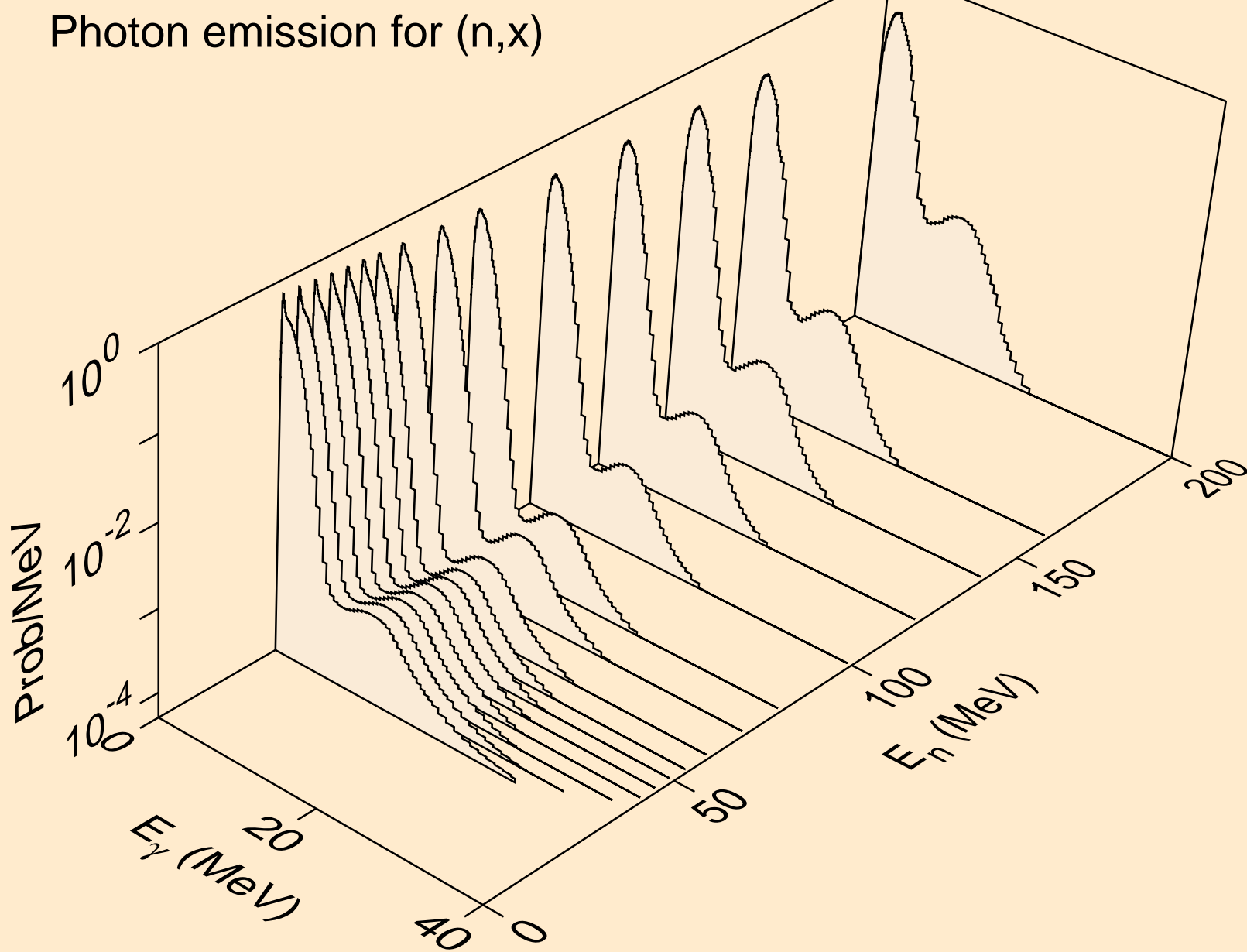

TH224 NEUTRON ACER TENDL-2023 LIBRARY; T=0.K  
Photon emission for (n,2nd)

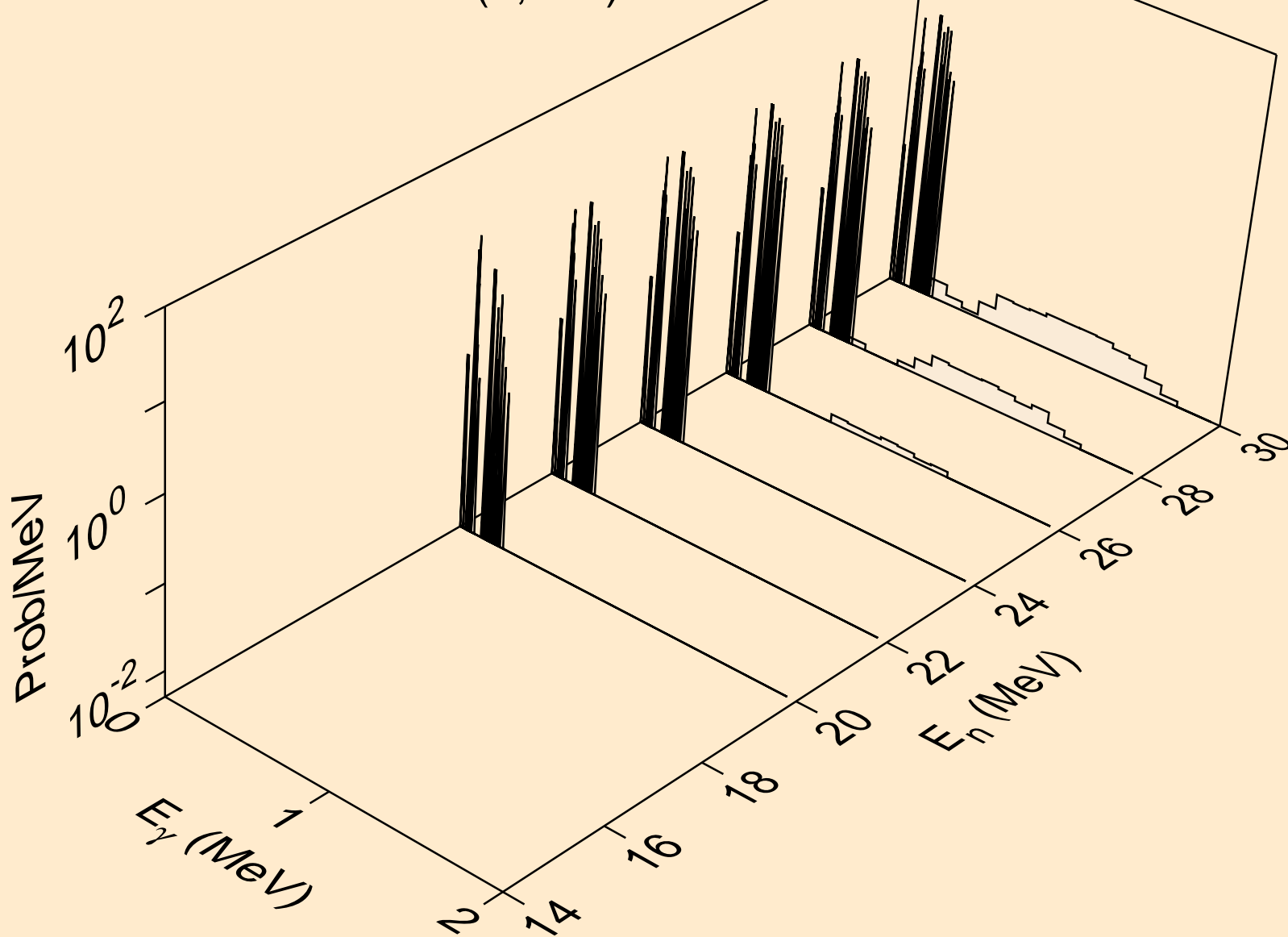

TH224 NEUTRON ACER TENDL-2023 LIBRARY; T=0.K  
Photon emission for (n,2n)

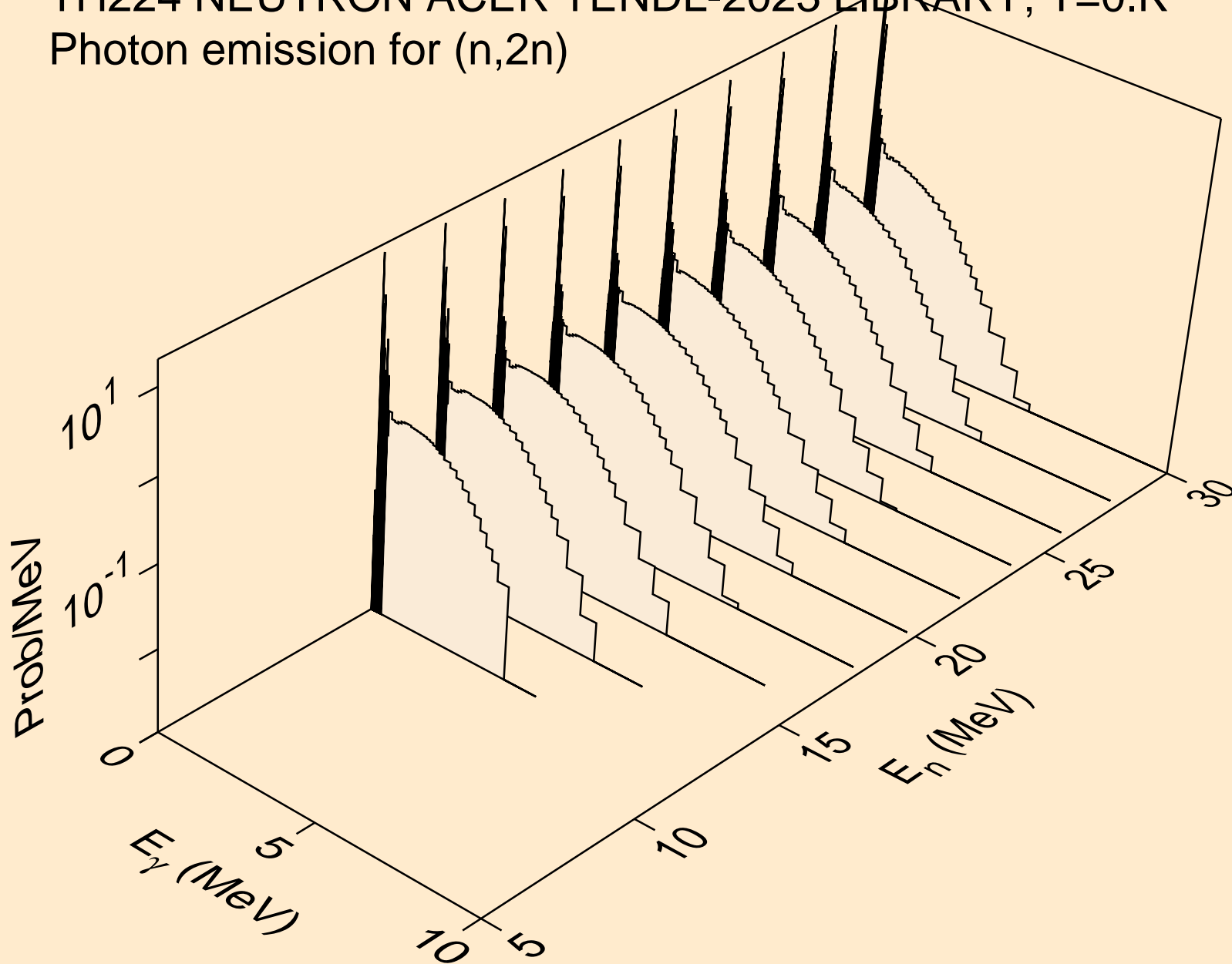

TH224 NEUTRON ACER TENDL-2023 LIBRARY; T=0.K  
Photon emission for (n,3n)

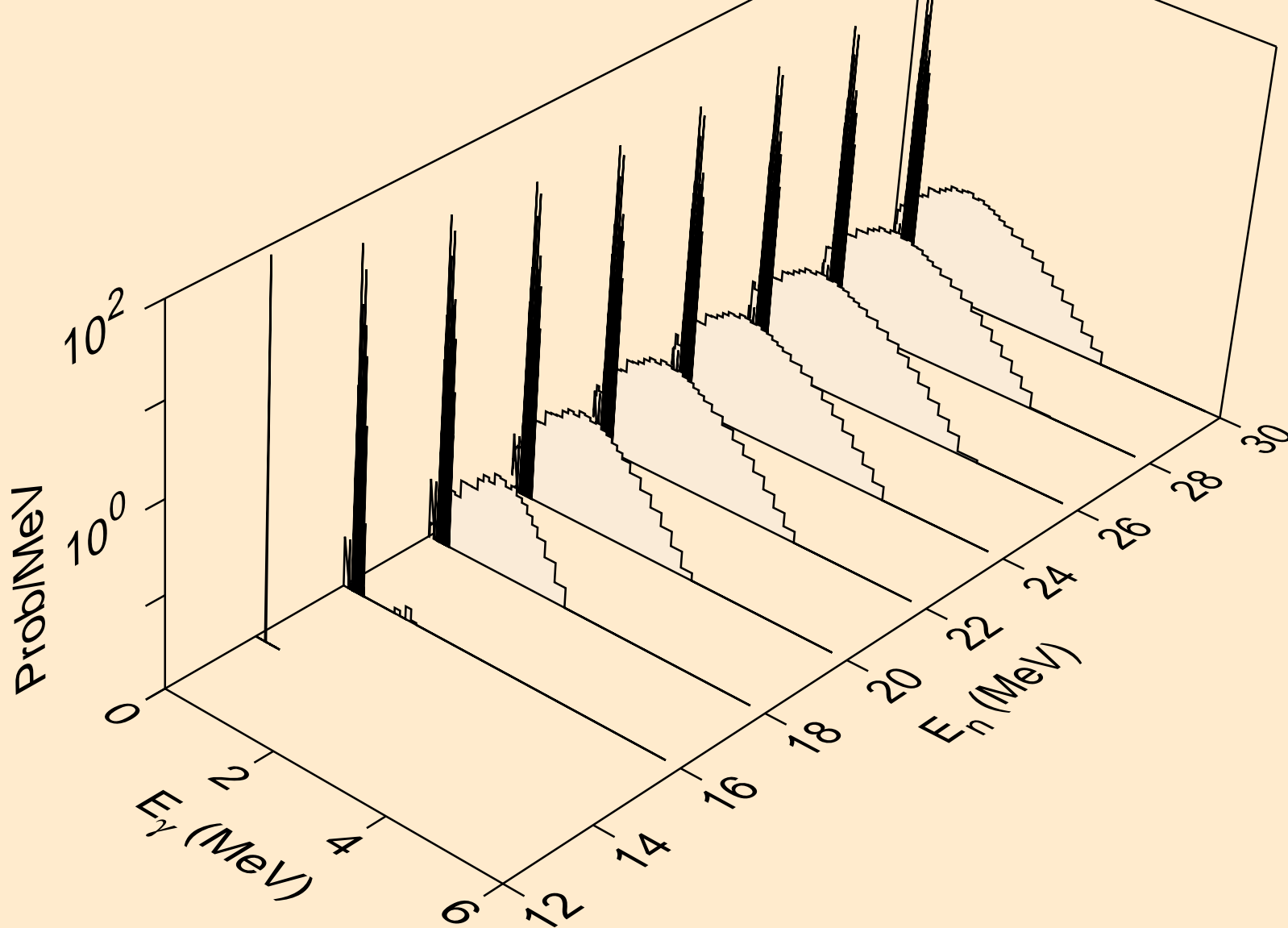

TH224 NEUTRON ACER TENDL-2023 LIBRARY; T=0.K  
Photon emission for (n,n\*)a

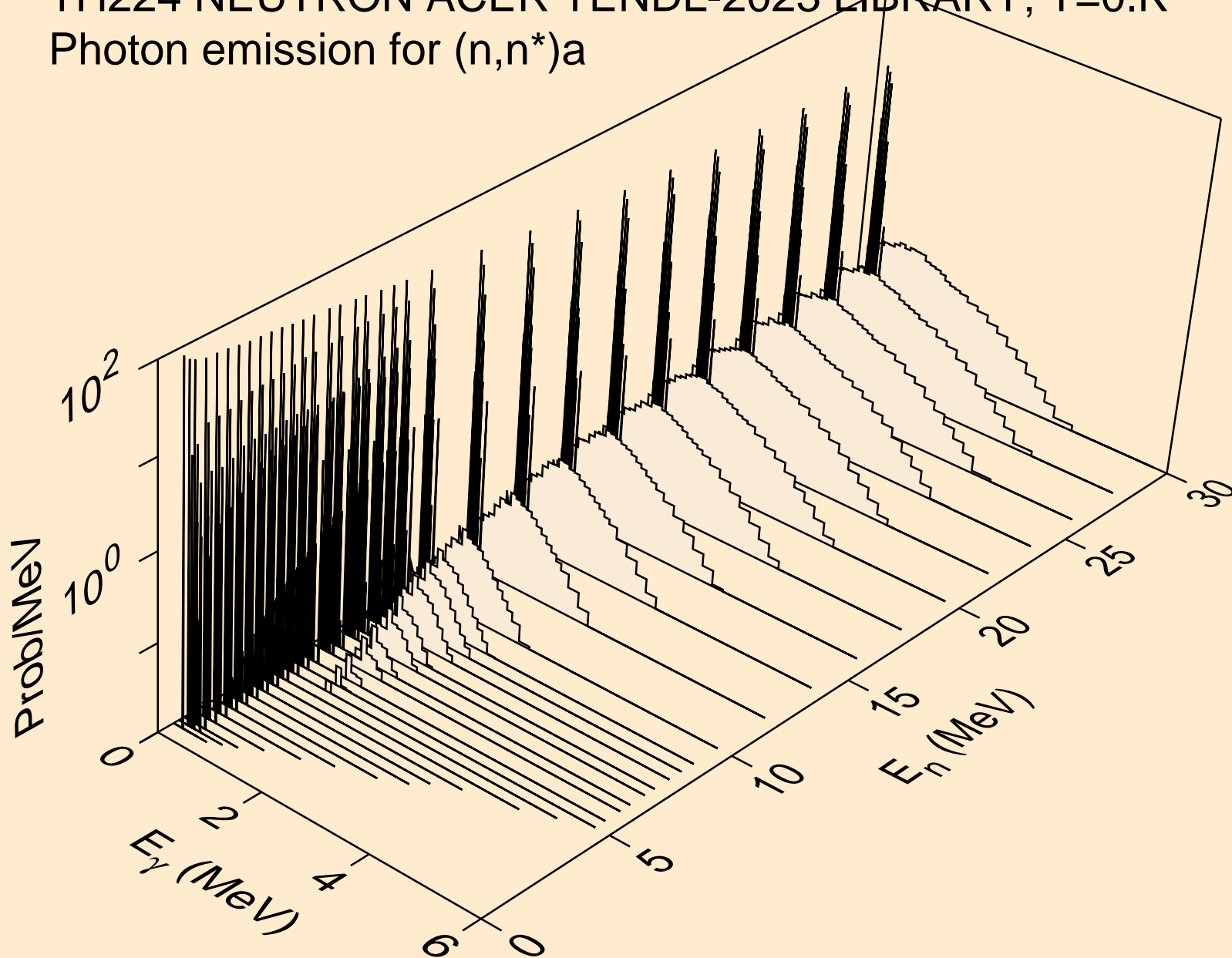

TH224 NEUTRON ACER TENDL-2023 LIBRARY; T=0.K  
Photon emission for (n,n\*)3a

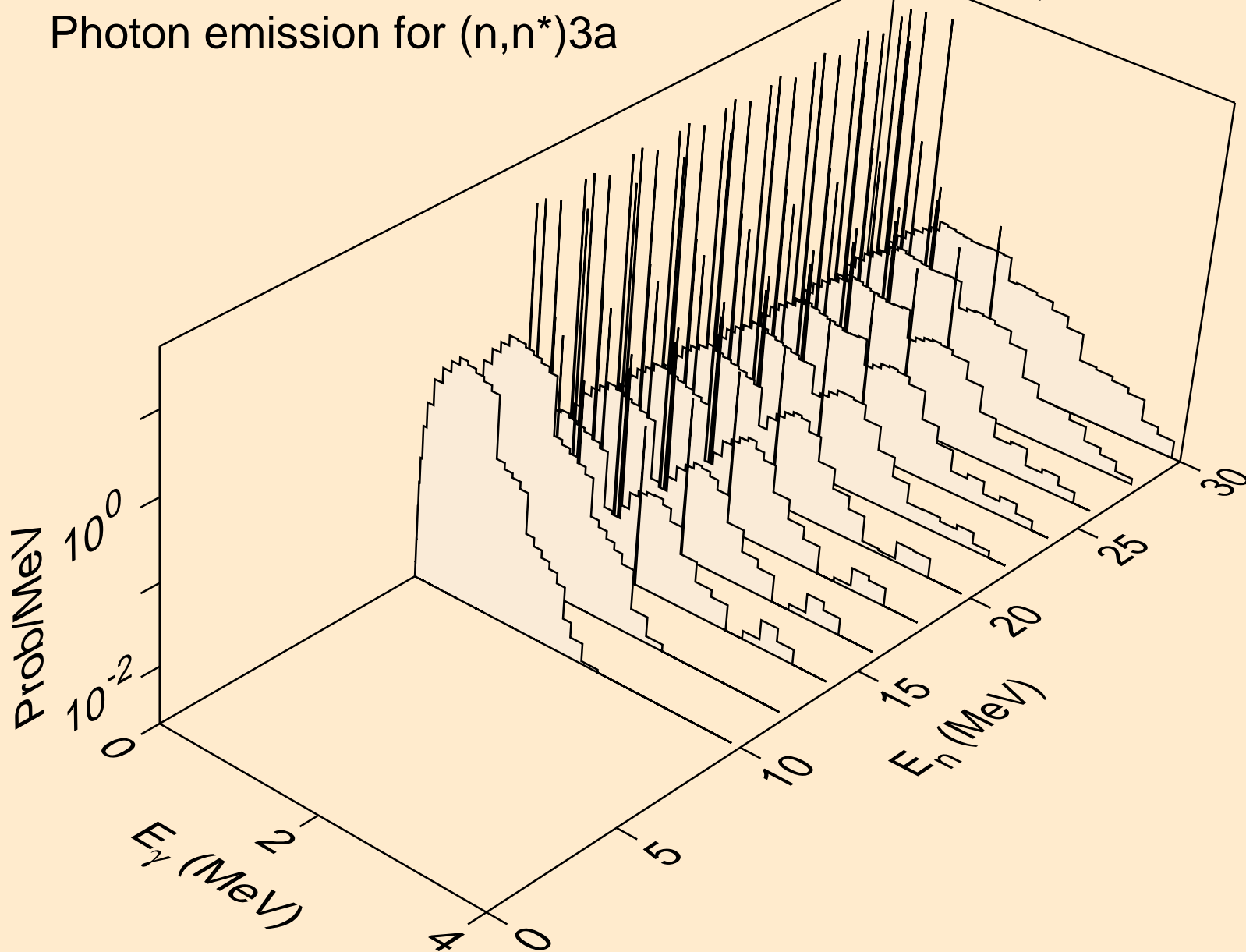

TH224 NEUTRON ACER TENDL-2023 LIBRARY; T=0.K  
Photon emission for (n,2n)a

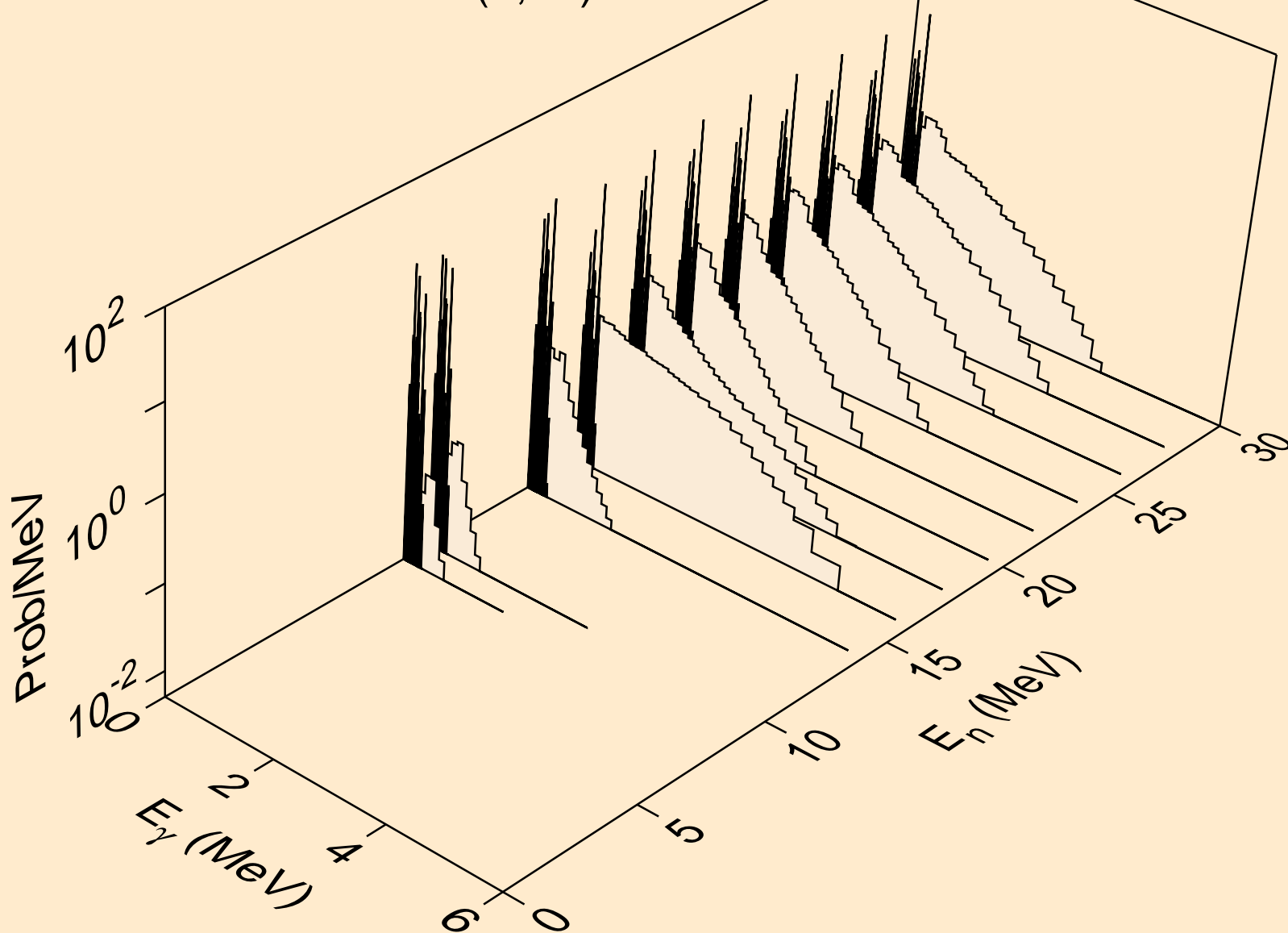

TH224 NEUTRON ACER TENDL-2023 LIBRARY; T=0.K  
Photon emission for (n,3n)a

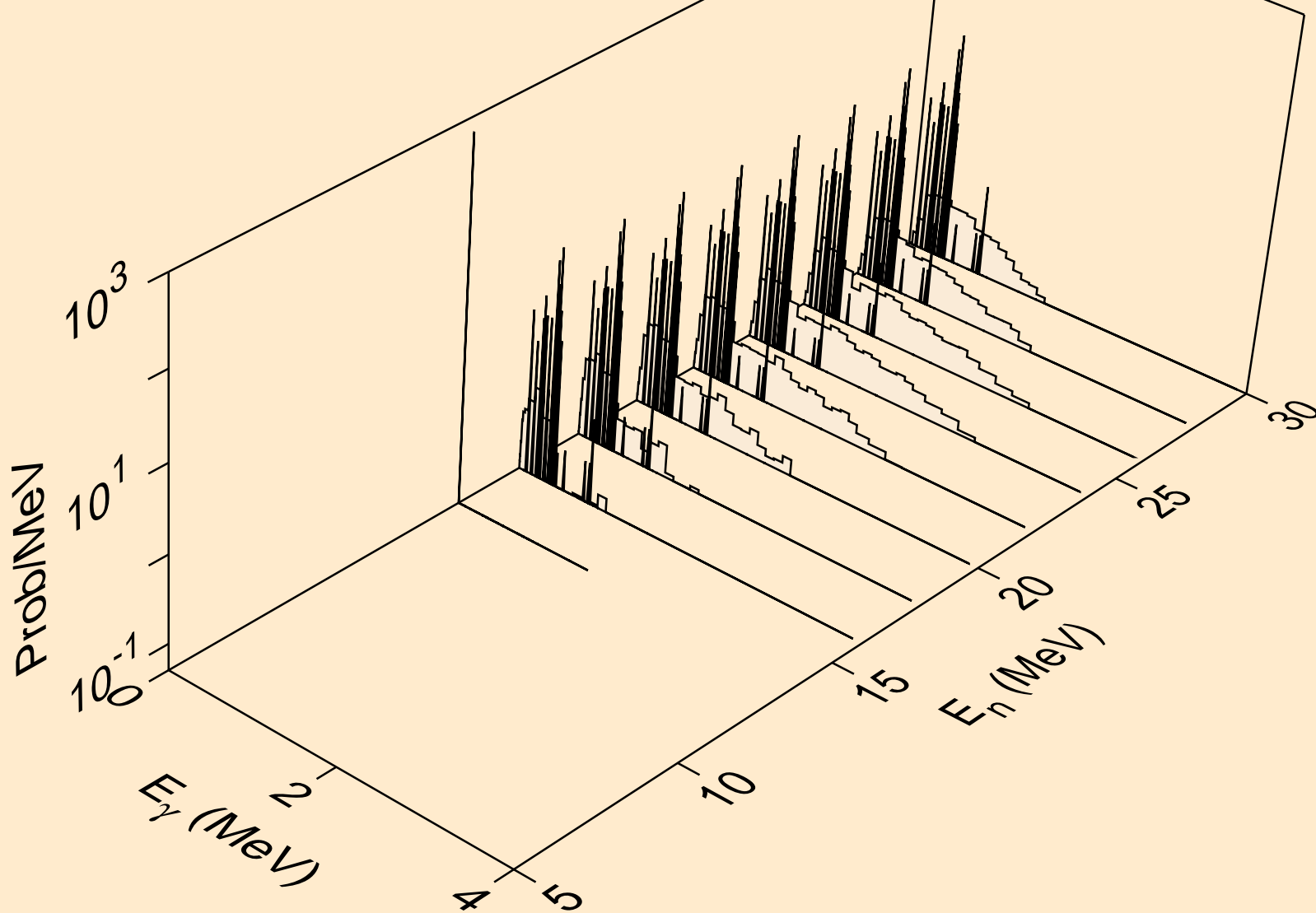

TH224 NEUTRON ACER TENDL-2023 LIBRARY; T=0.K  
Photon emission for (n,n\*)p

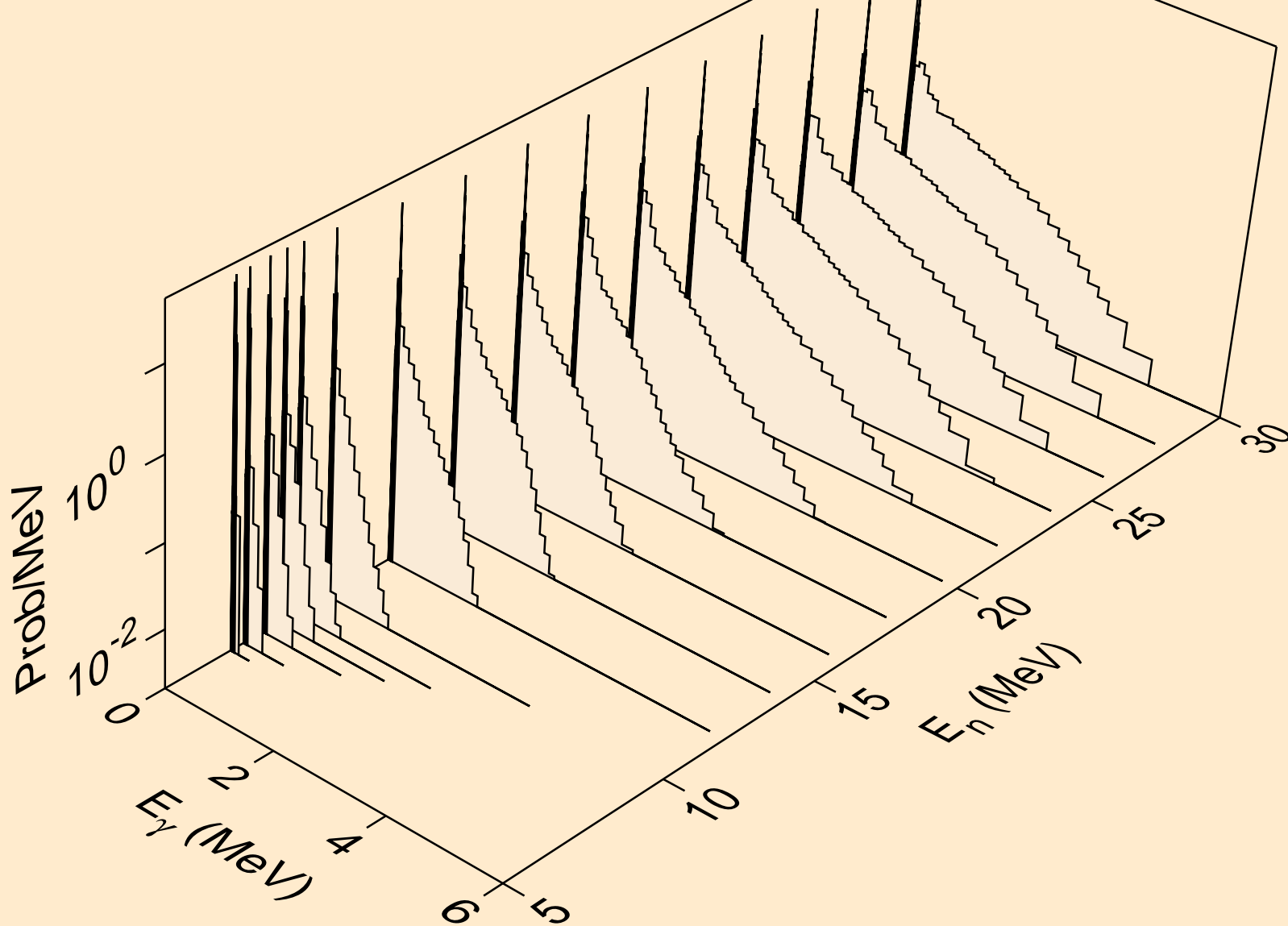

TH224 NEUTRON ACER TENDL-2023 LIBRARY; T=0.K  
Photon emission for (n,n\*)2a

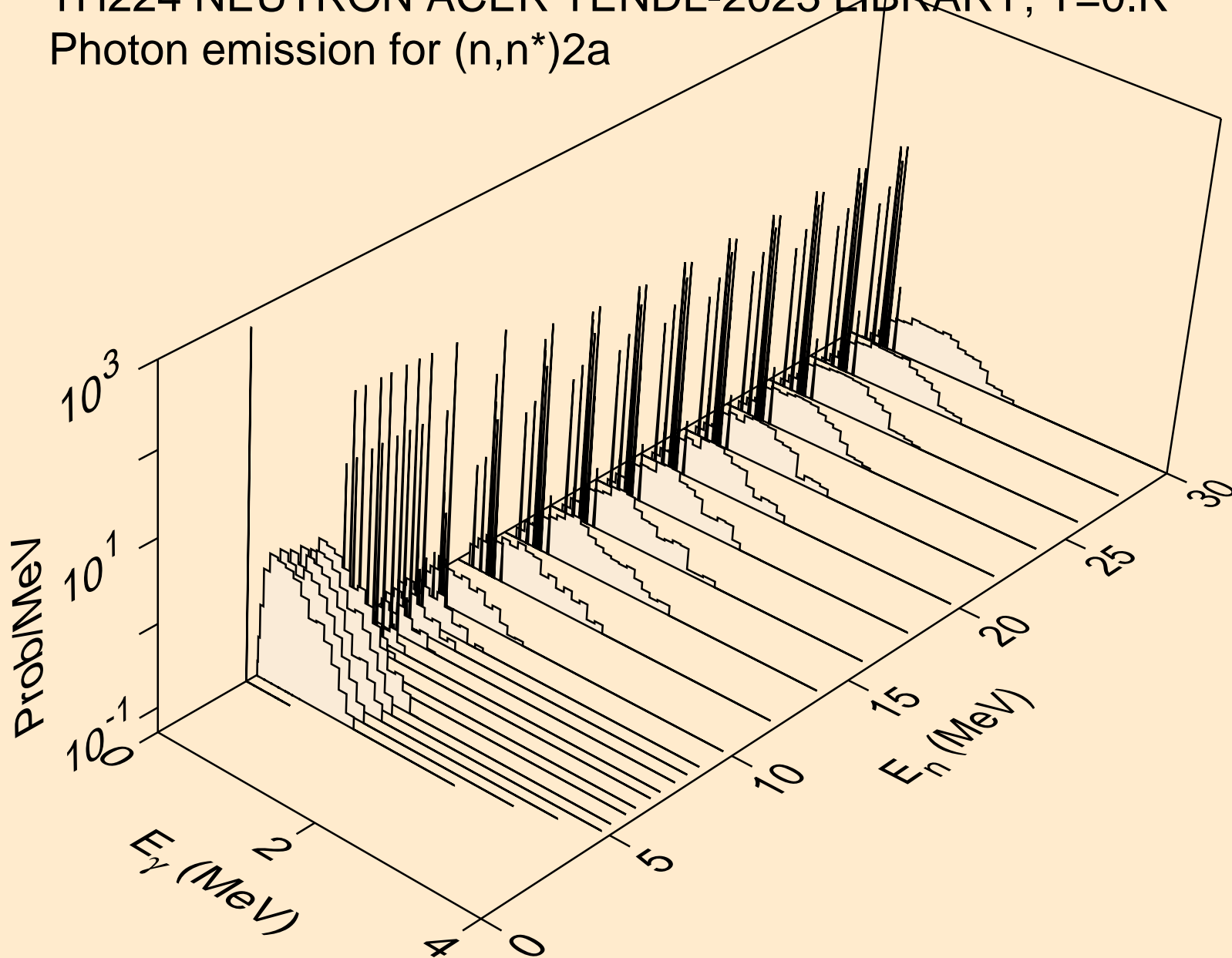

TH224 NEUTRON ACER TENDL-2023 LIBRARY; T=0.K  
Photon emission for (n,2n)2a

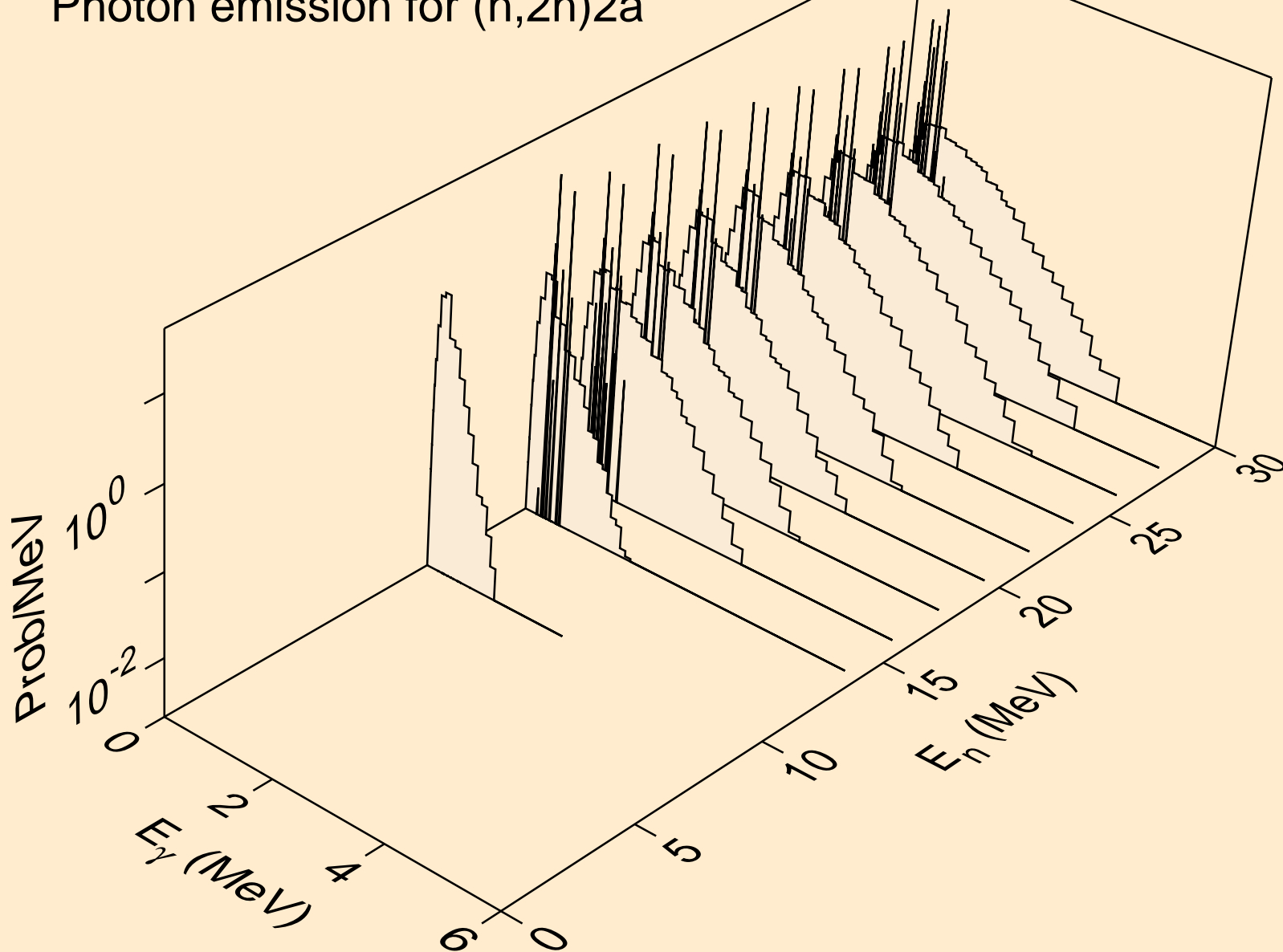

TH224 NEUTRON ACER TENDL-2023 LIBRARY; T=0.K  
Photon emission for (n,n\*)d

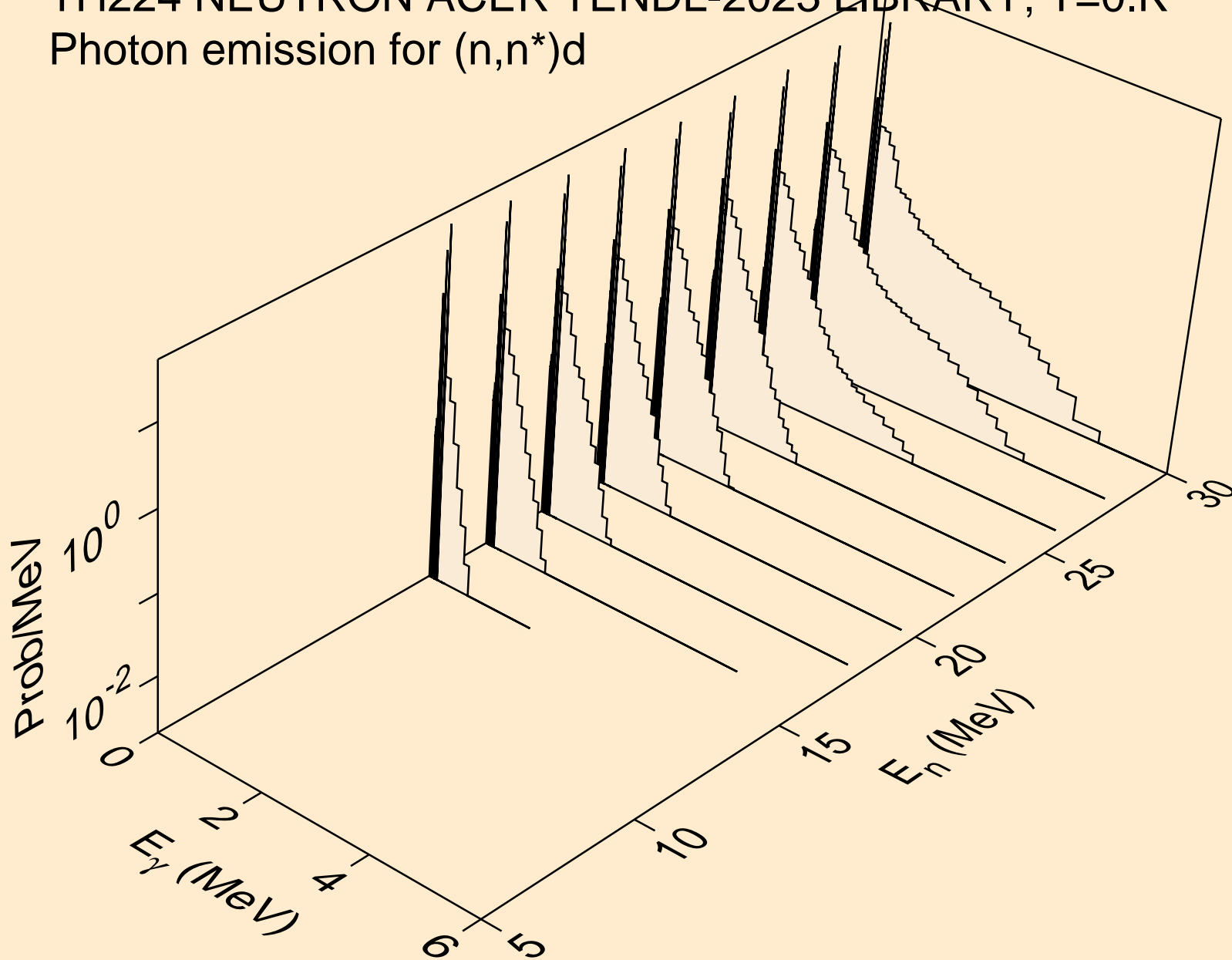

TH224 NEUTRON ACER TENDL-2023 LIBRARY; T=0.K  
Photon emission for (n,n\*)t

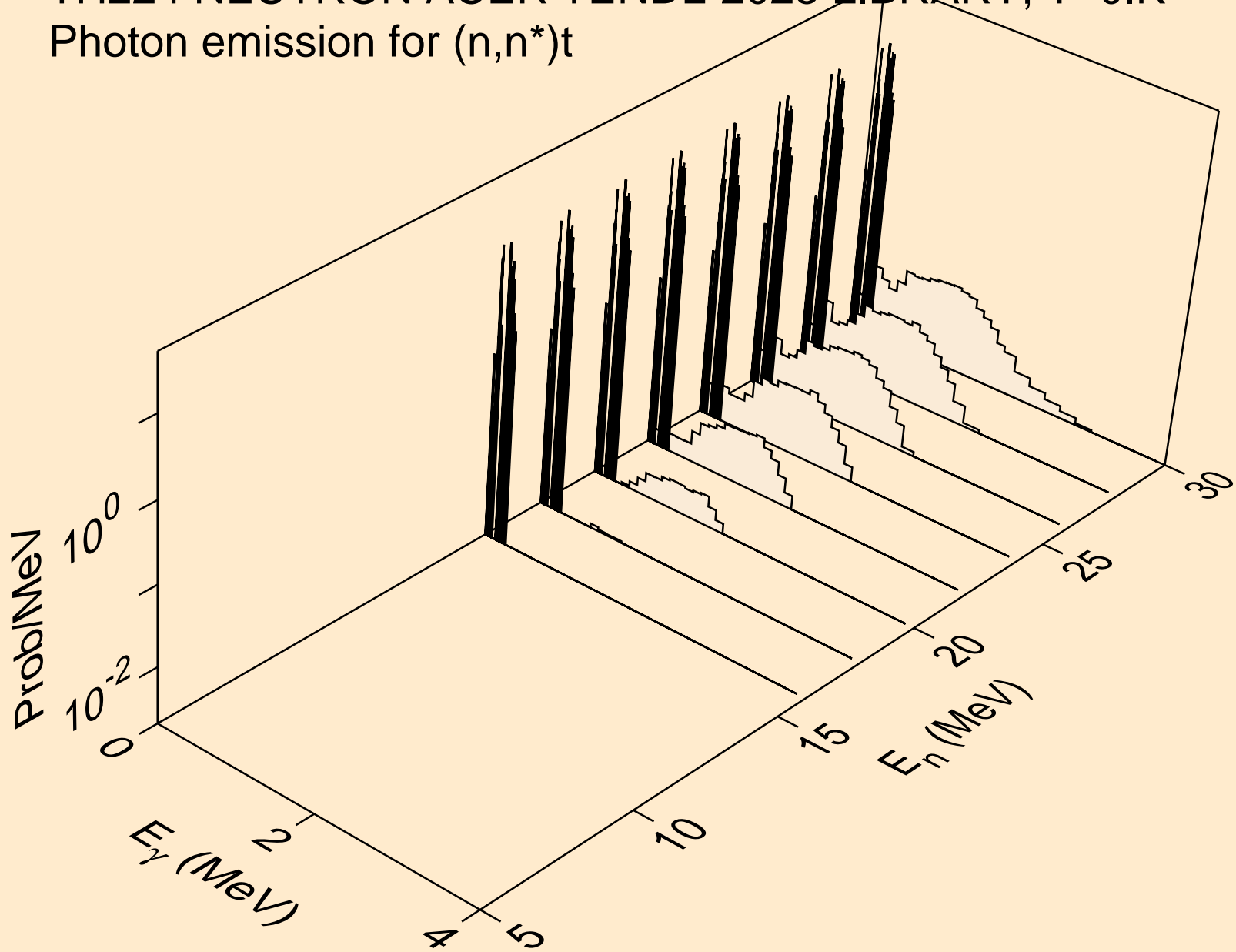

TH224 NEUTRON ACER TENDL-2023 LIBRARY; T=0.K  
Photon emission for (n,n\*)he3

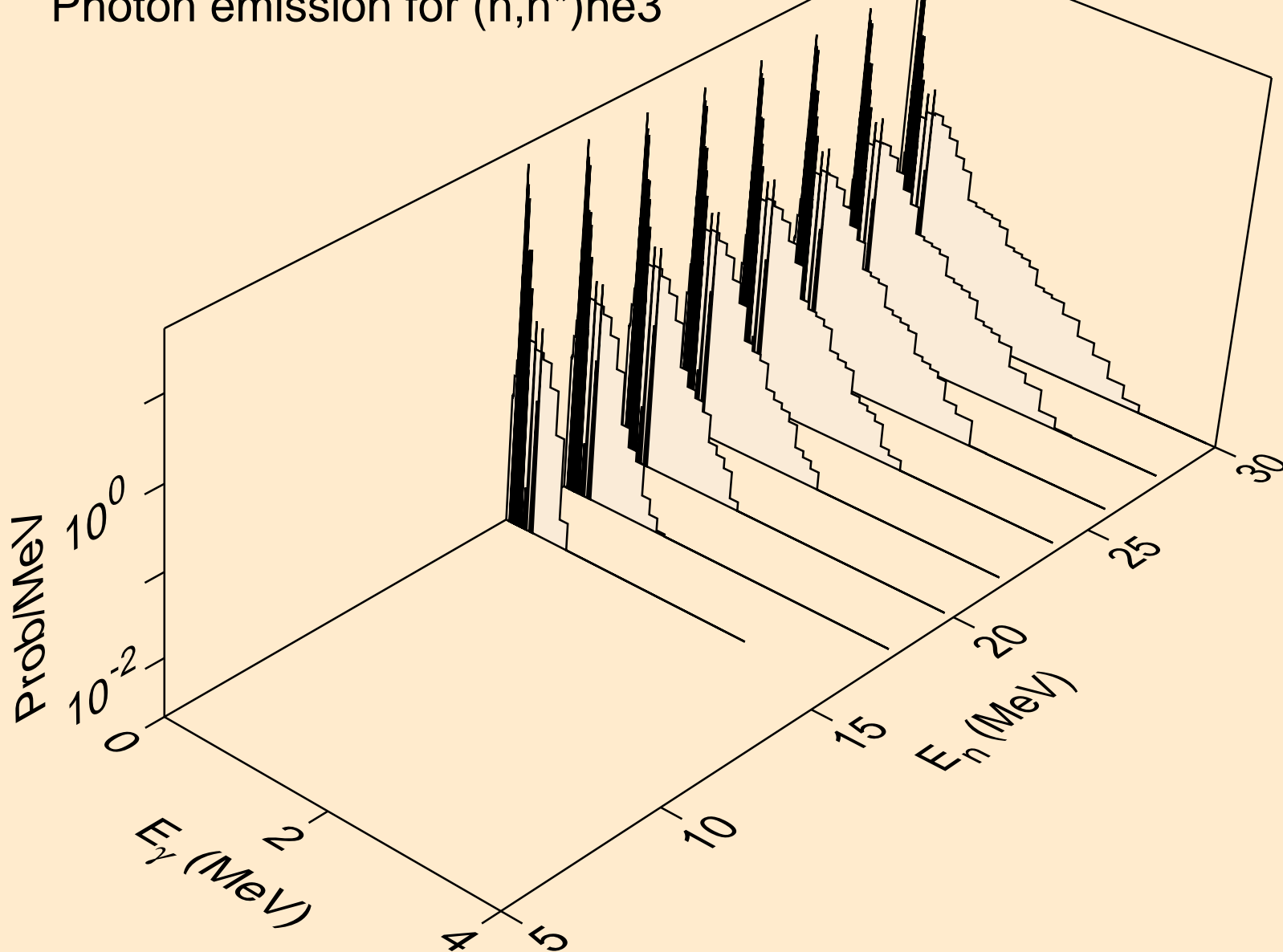

TH224 NEUTRON ACER TENDL-2023 LIBRARY; T=0.K  
Photon emission for (n,4n)

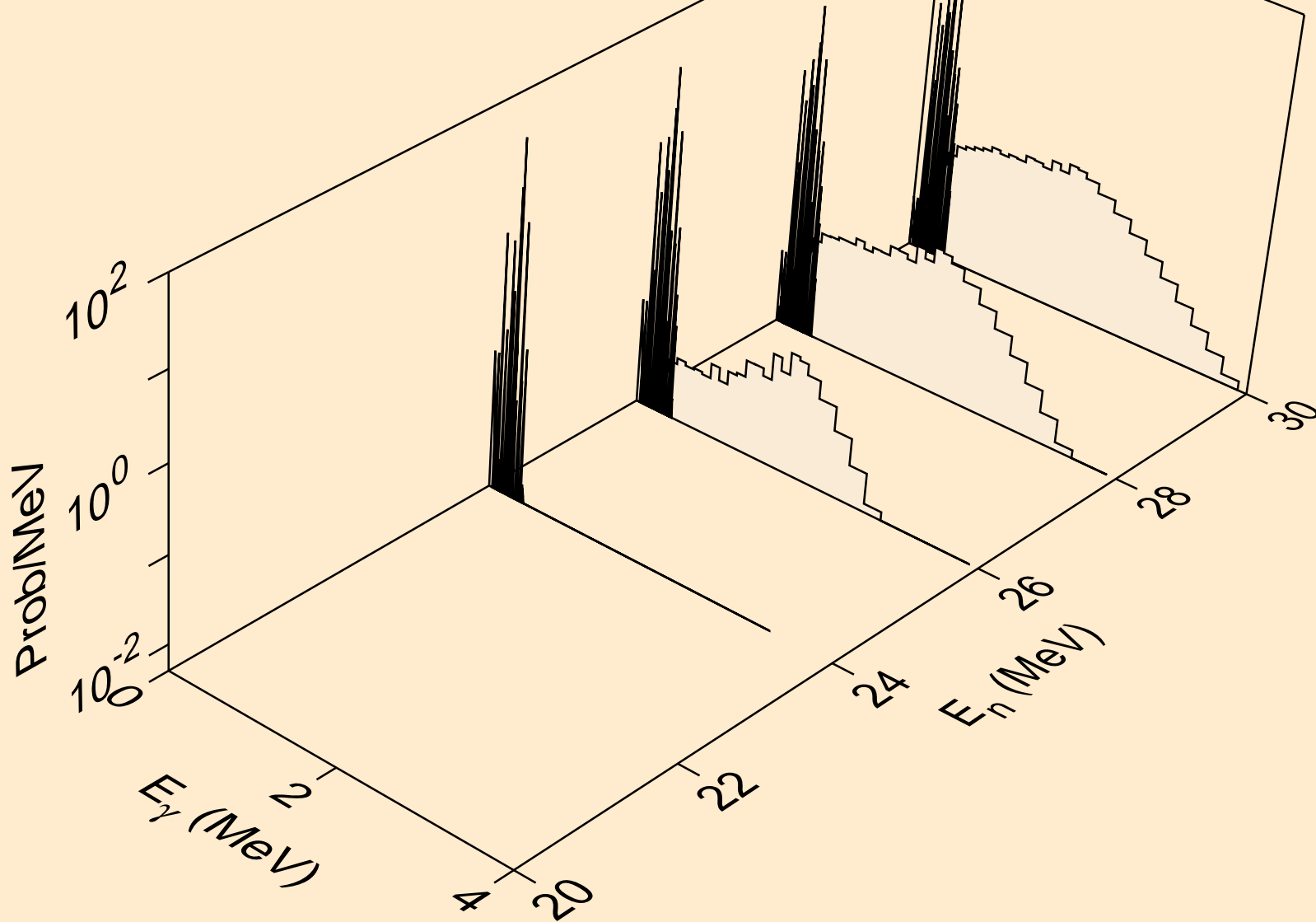

TH224 NEUTRON ACER TENDL-2023 LIBRARY; T=0.K  
Photon emission for (n,2np)

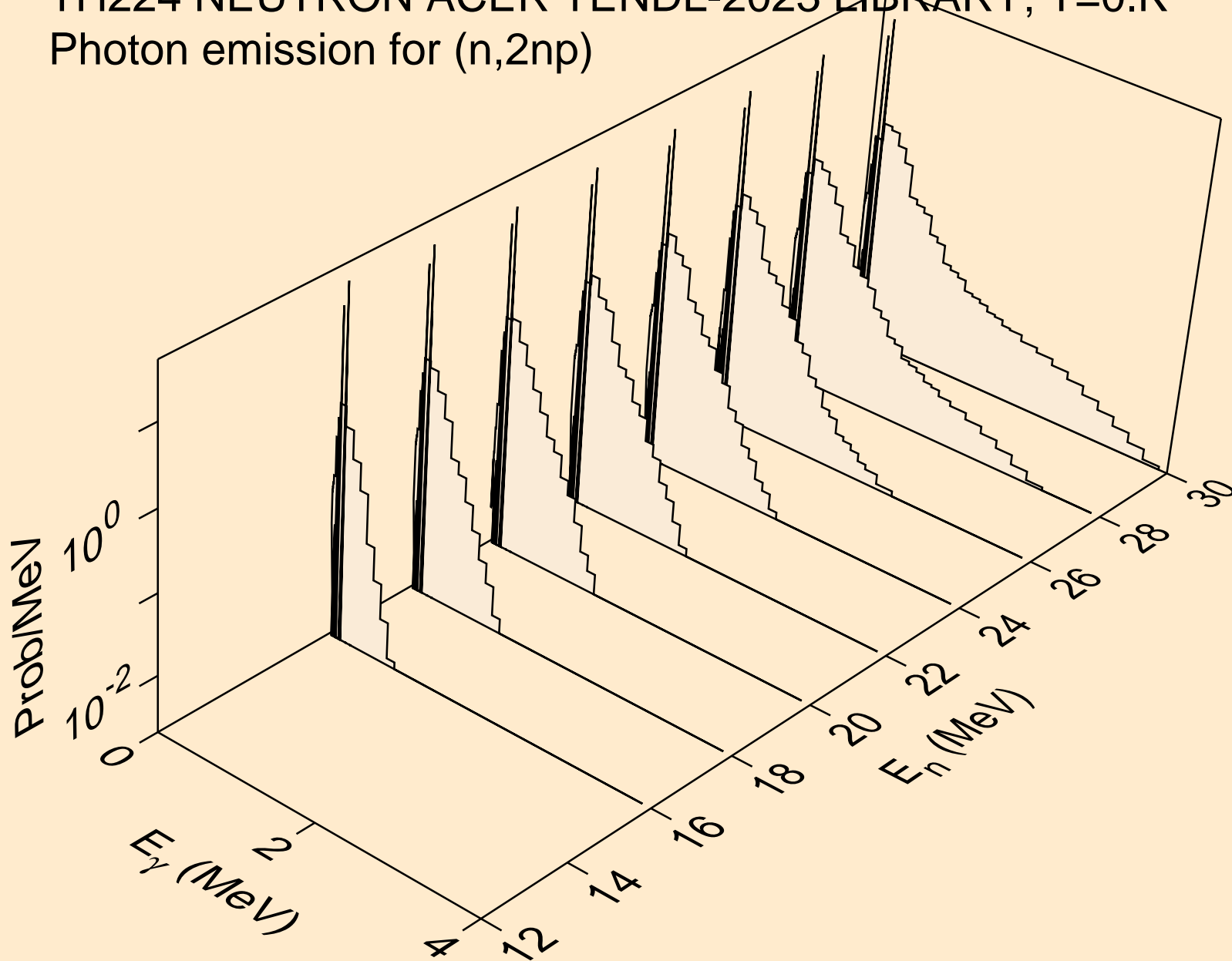

TH224 NEUTRON ACER TENDL-2023 LIBRARY; T=0.K  
Photon emission for (n,3np)

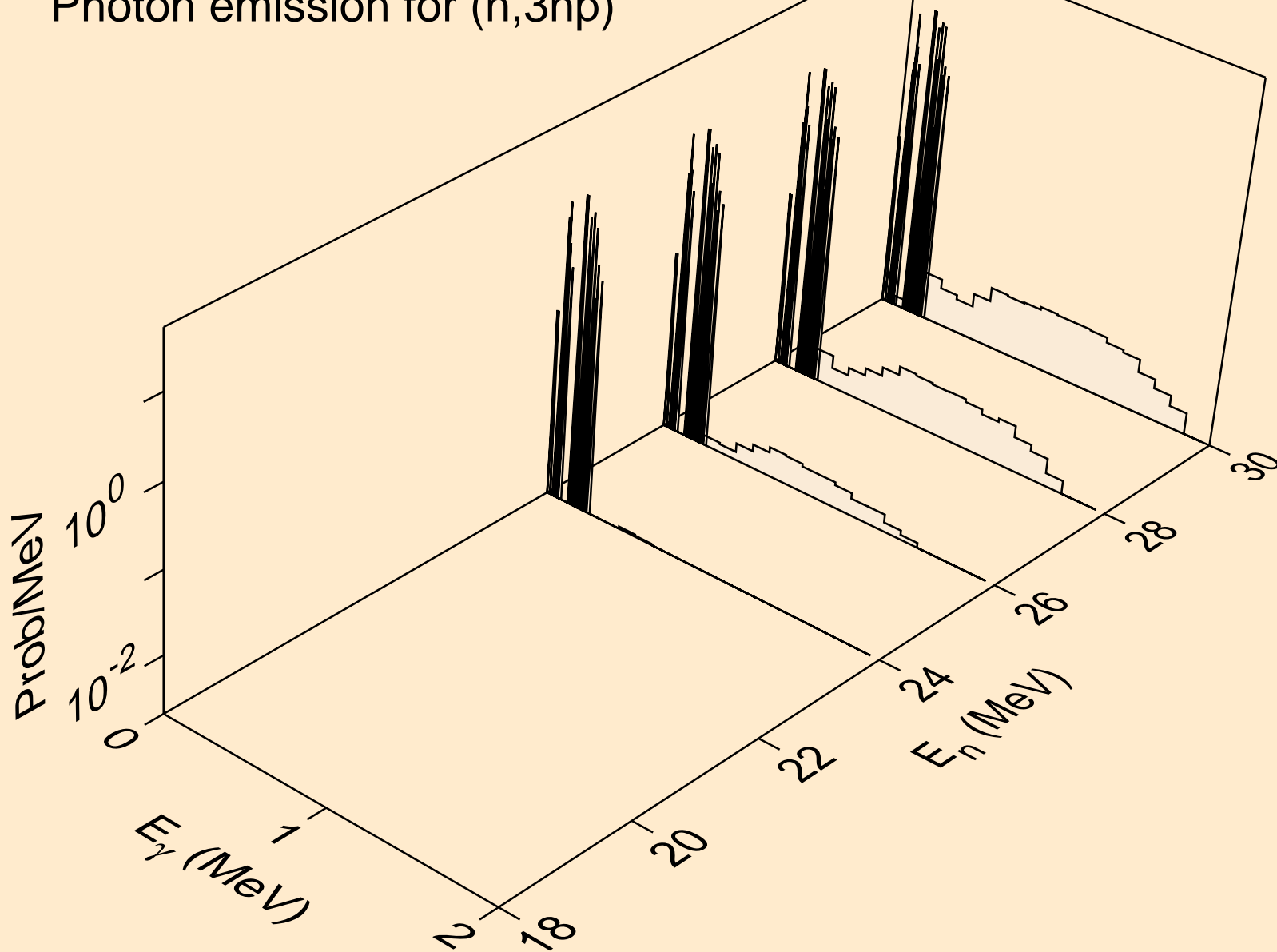

TH224 NEUTRON ACER TENDL-2023 LIBRARY; T=0.K  
Photon emission for (n,n2p)

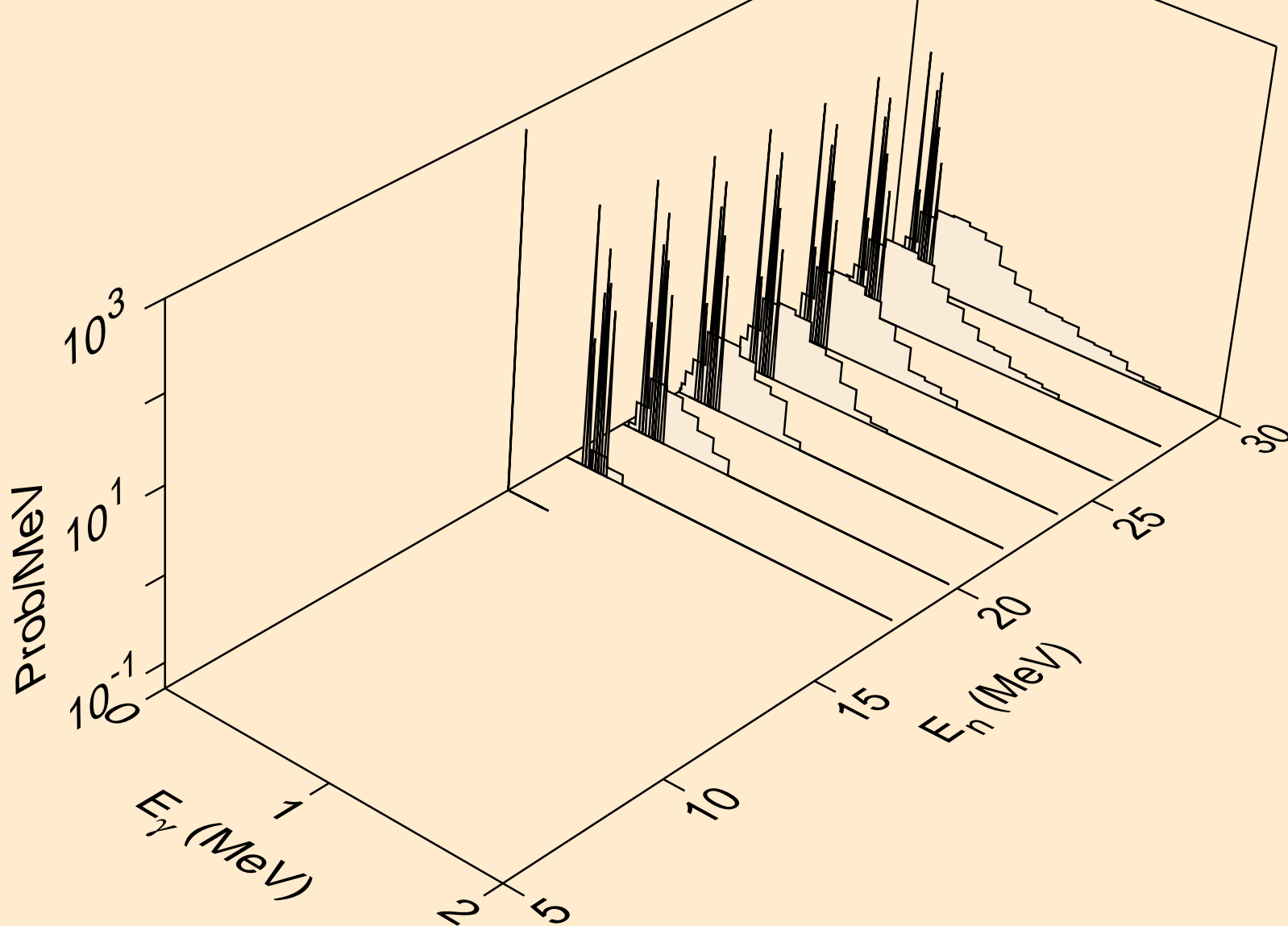

TH224 NEUTRON ACER TENDL-2023 LIBRARY; T=0.K  
Photon emission for (n,npa)

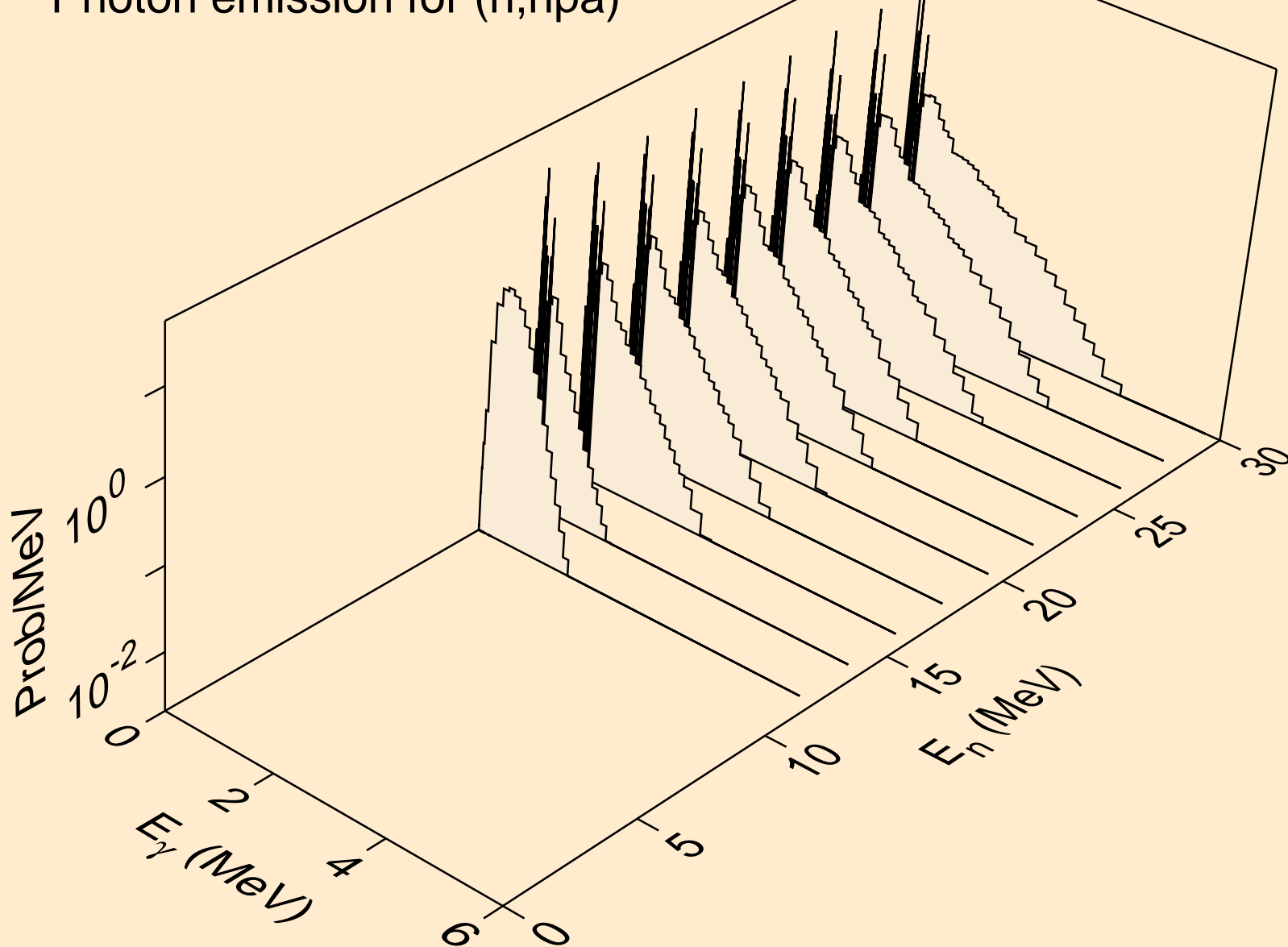

TH224 NEUTRON ACER TENDL-2023 LIBRARY; T=0.K  
Photon emission for (n,n\*c)

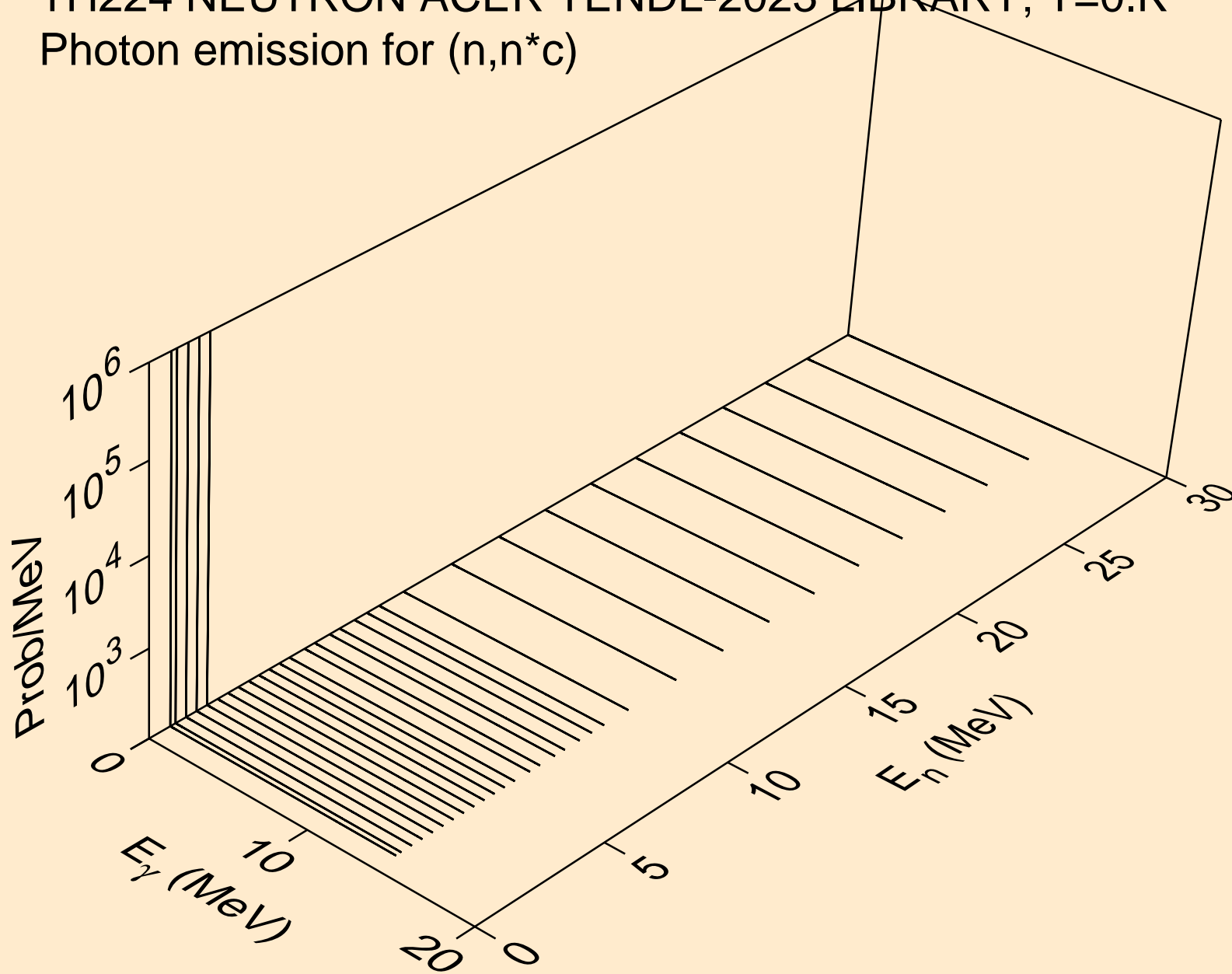

TH224 NEUTRON ACER TENDL-2023 LIBRARY; T=0.K  
Photon emission for (n,gma)

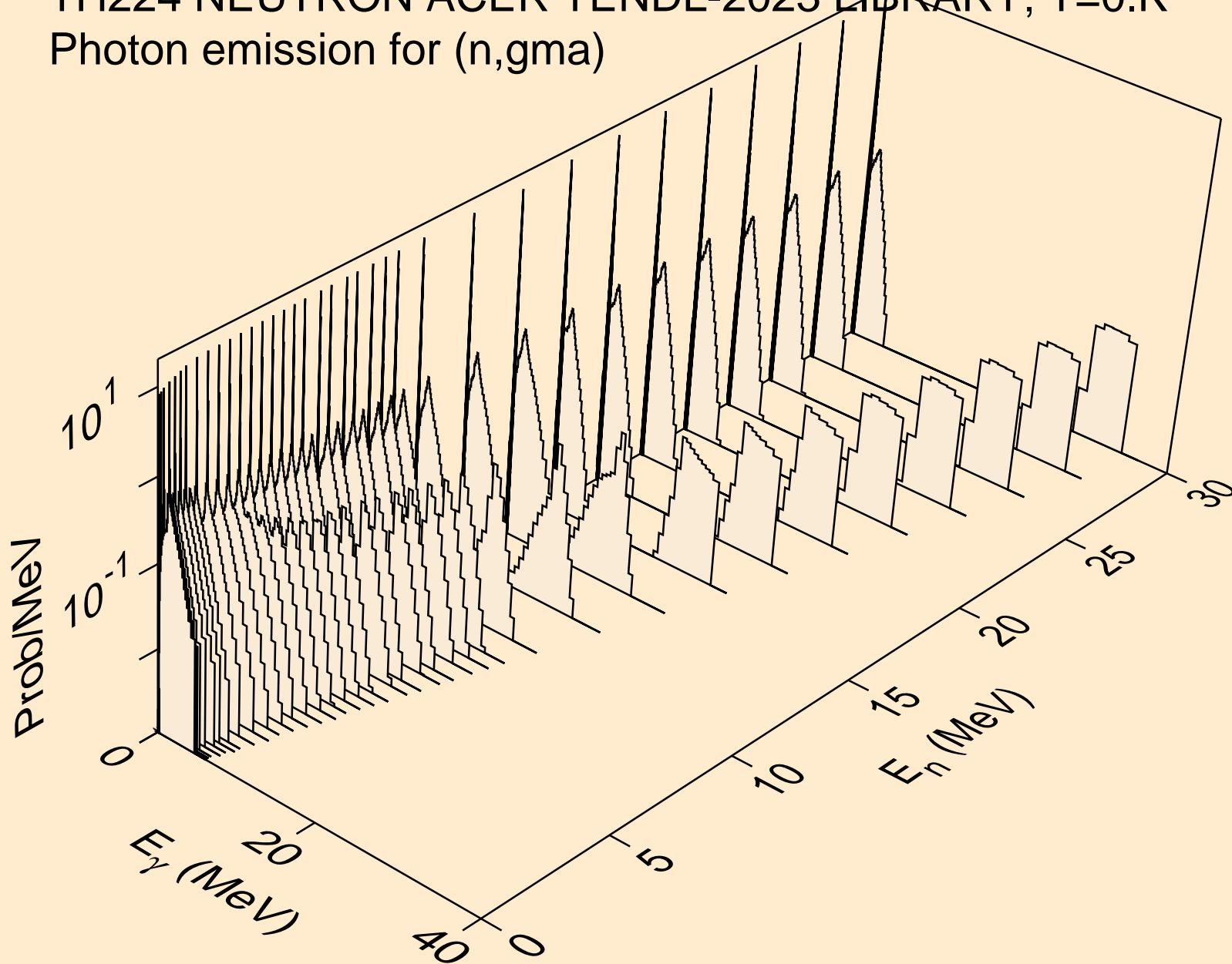

TH224 NEUTRON ACER TENDL-2023 LIBRARY; T=0.K  
Photon emission for (n,p)

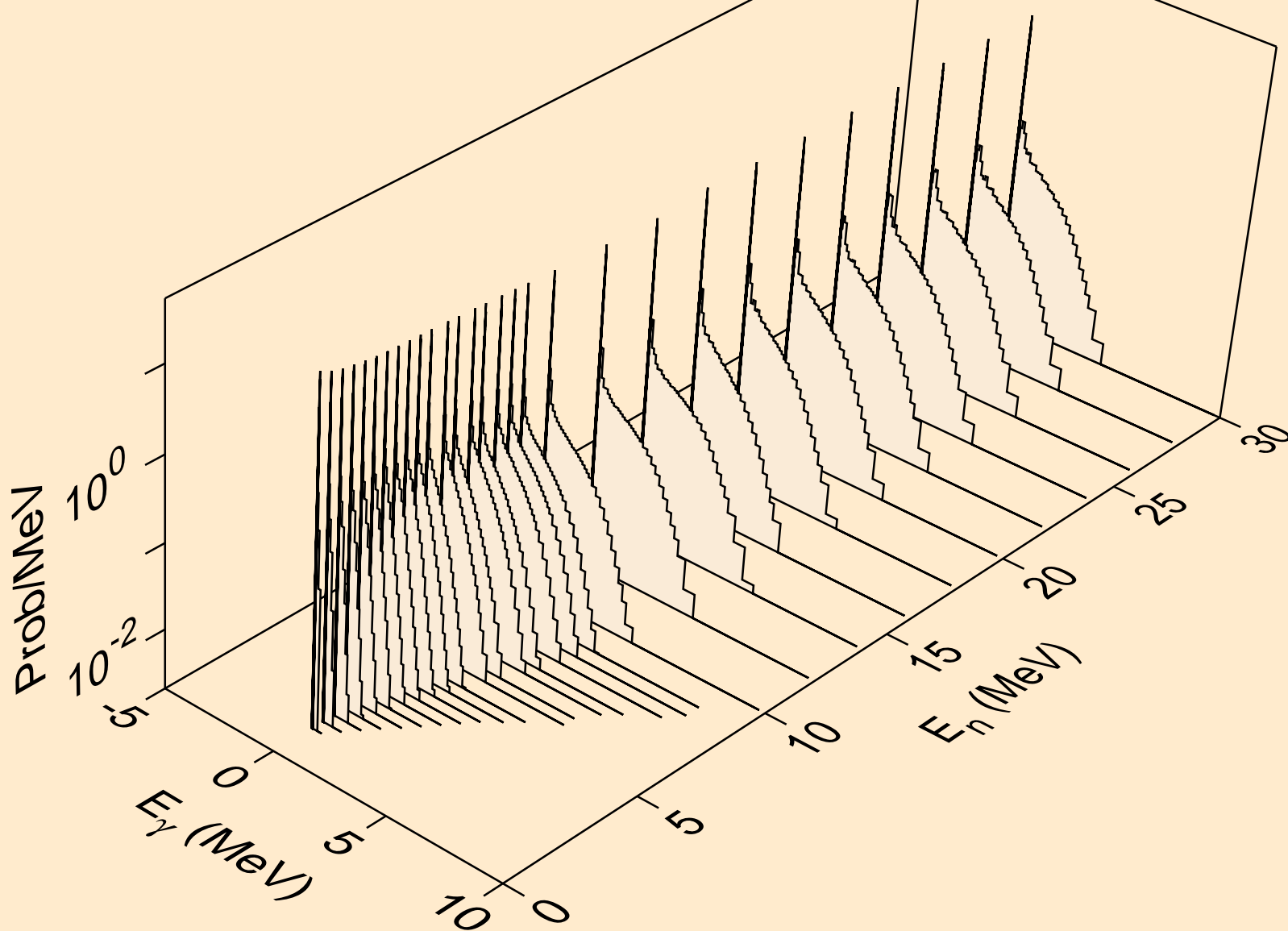

TH224 NEUTRON ACER TENDL-2023 LIBRARY; T=0.K  
Photon emission for (n,d)

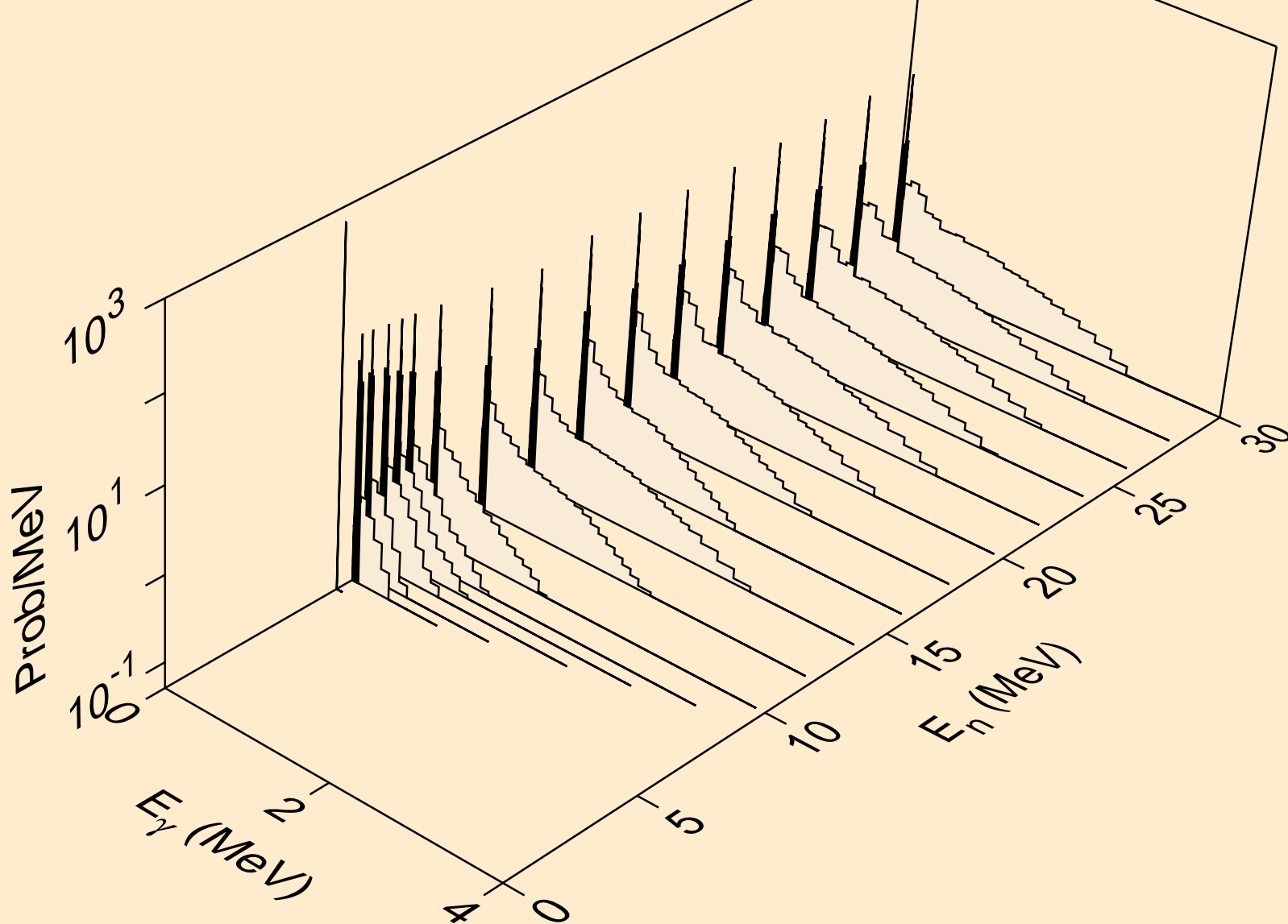

TH224 NEUTRON ACER TENDL-2023 LIBRARY; T=0.K  
Photon emission for (n,t)

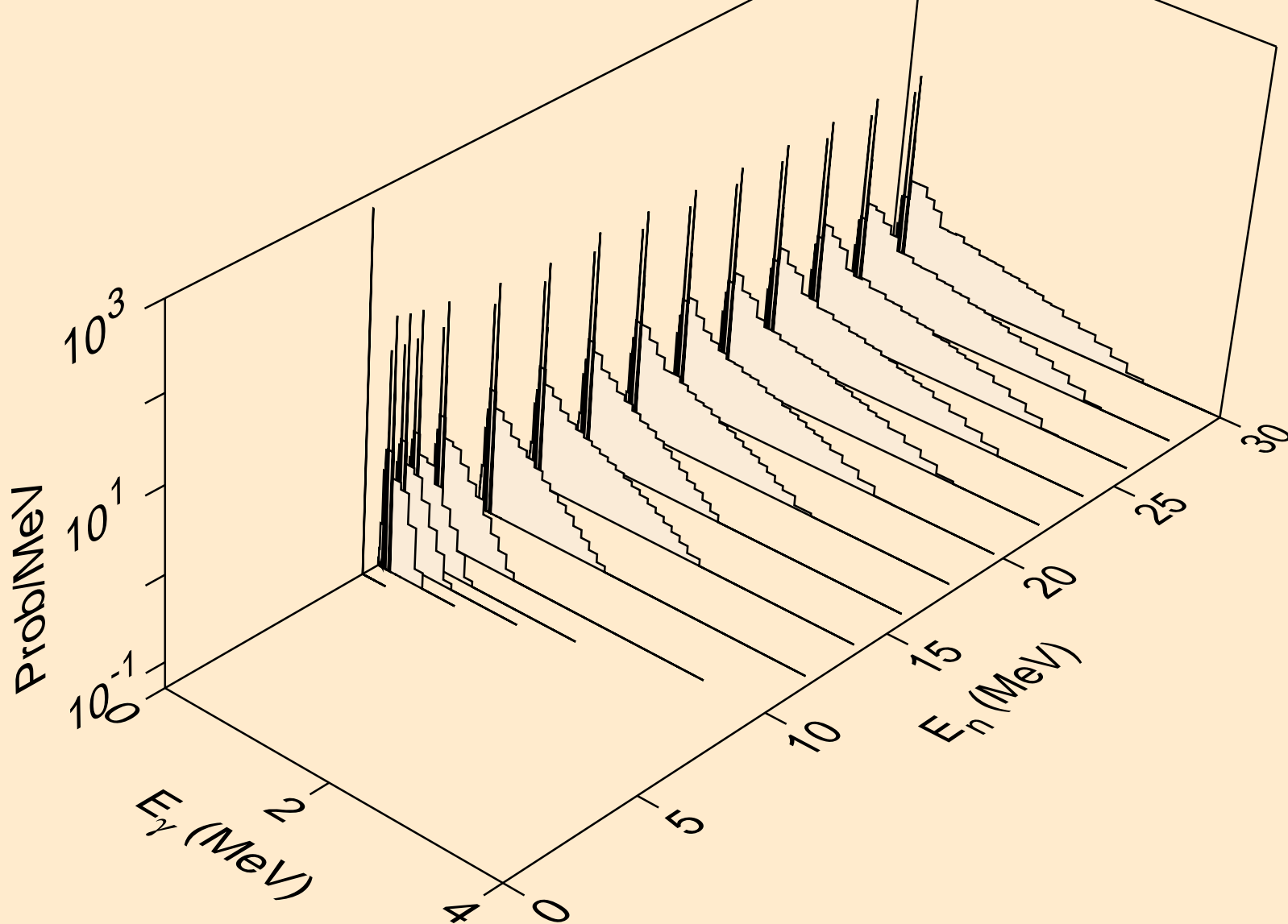

TH224 NEUTRON ACER TENDL-2023 LIBRARY; T=0.K  
Photon emission for (n,he3)

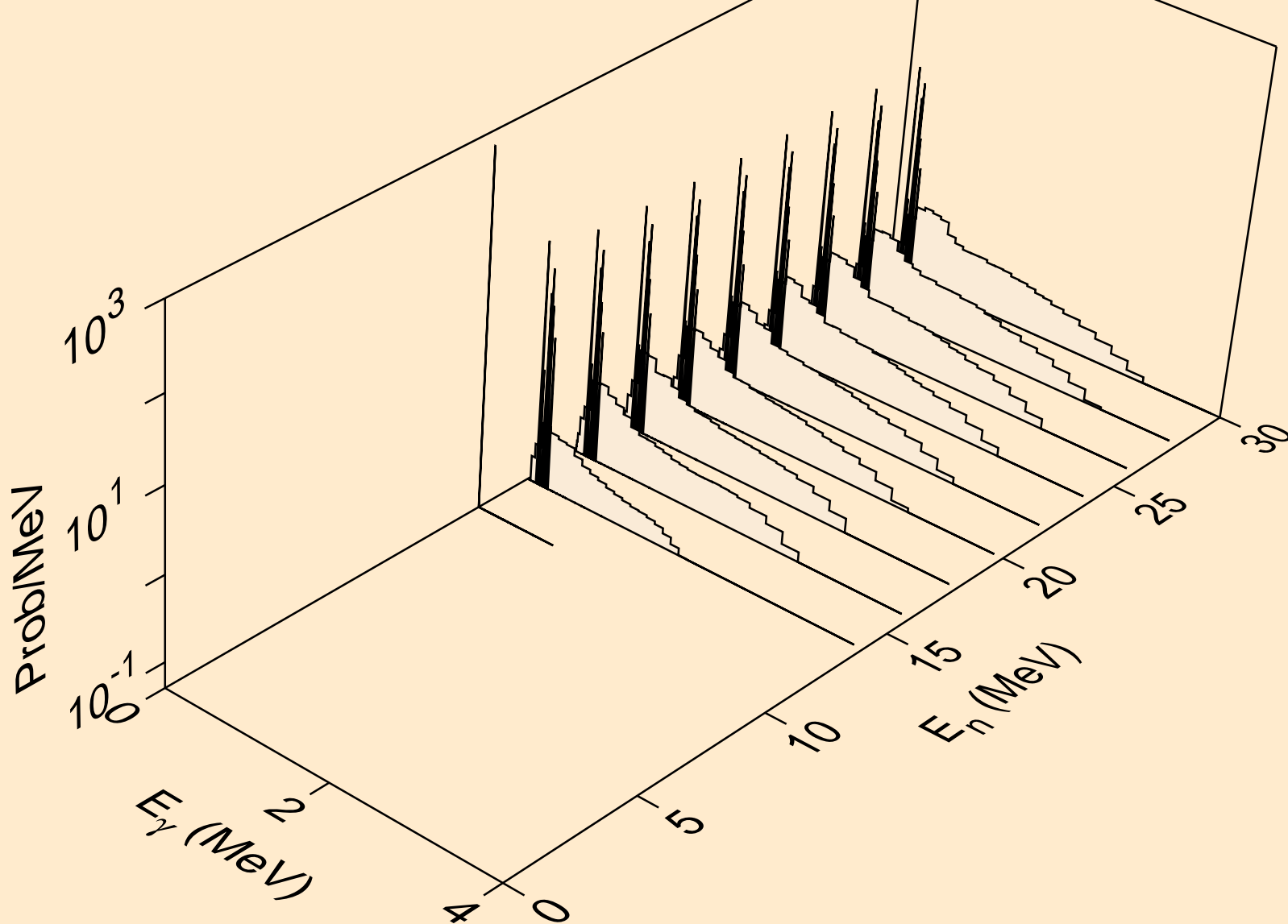

TH224 NEUTRON ACER TENDL-2023 LIBRARY; T=0.K  
Photon emission for (n,a)

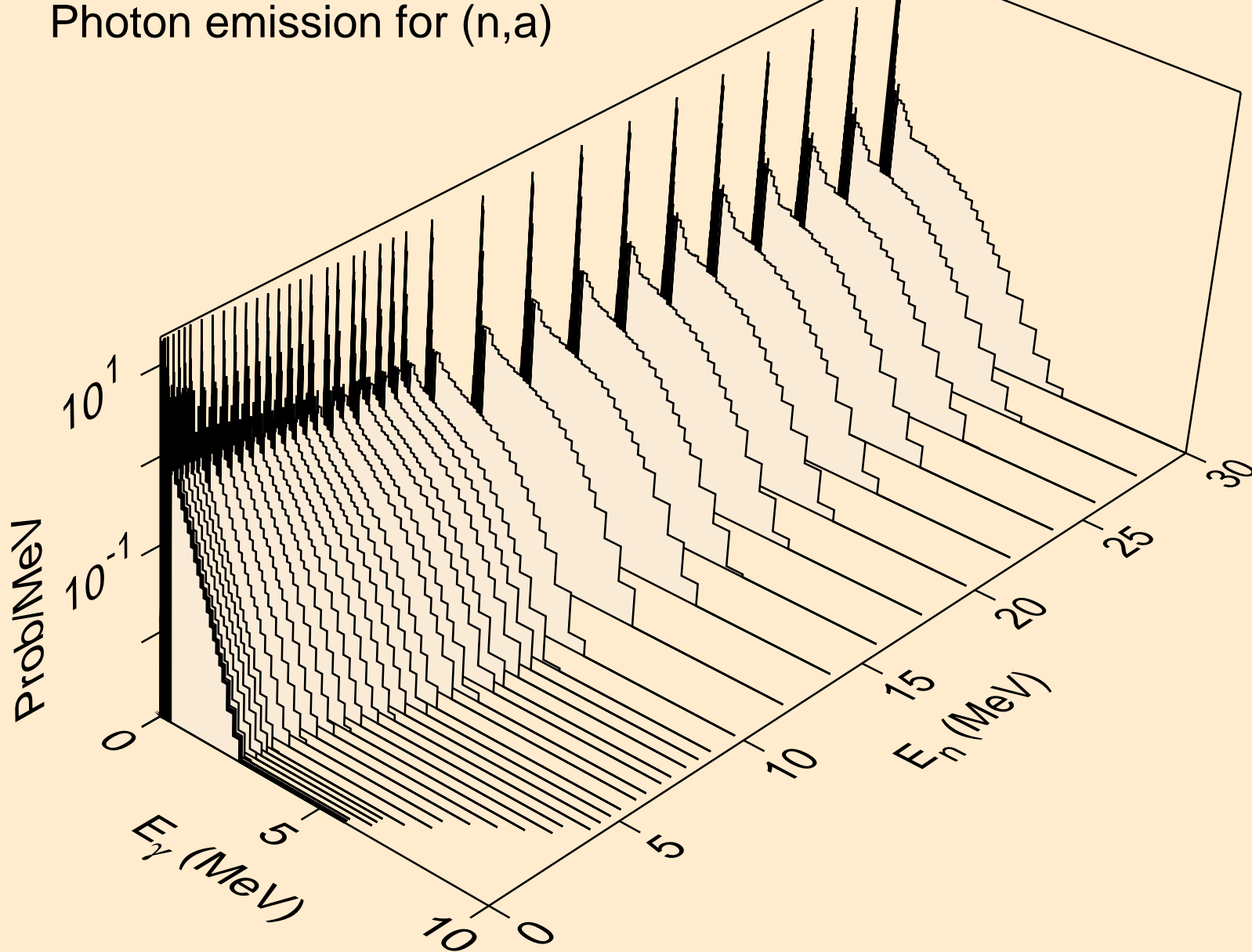

TH224 NEUTRON ACER TENDL-2023 LIBRARY; T=0.K  
Photon emission for (n,2a)

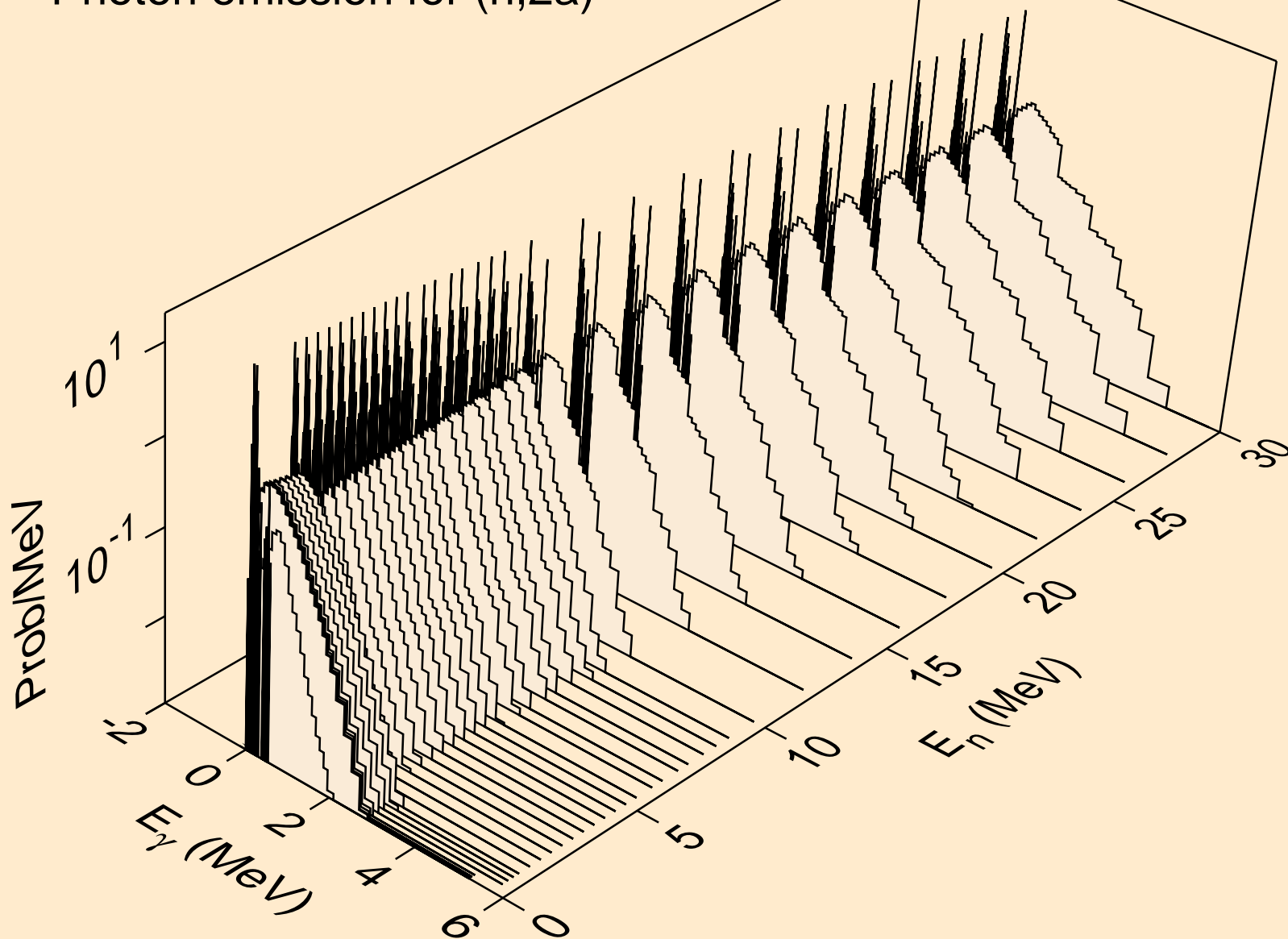

TH224 NEUTRON ACER TENDL-2023 LIBRARY; T=0.K  
Photon emission for (n,2p)

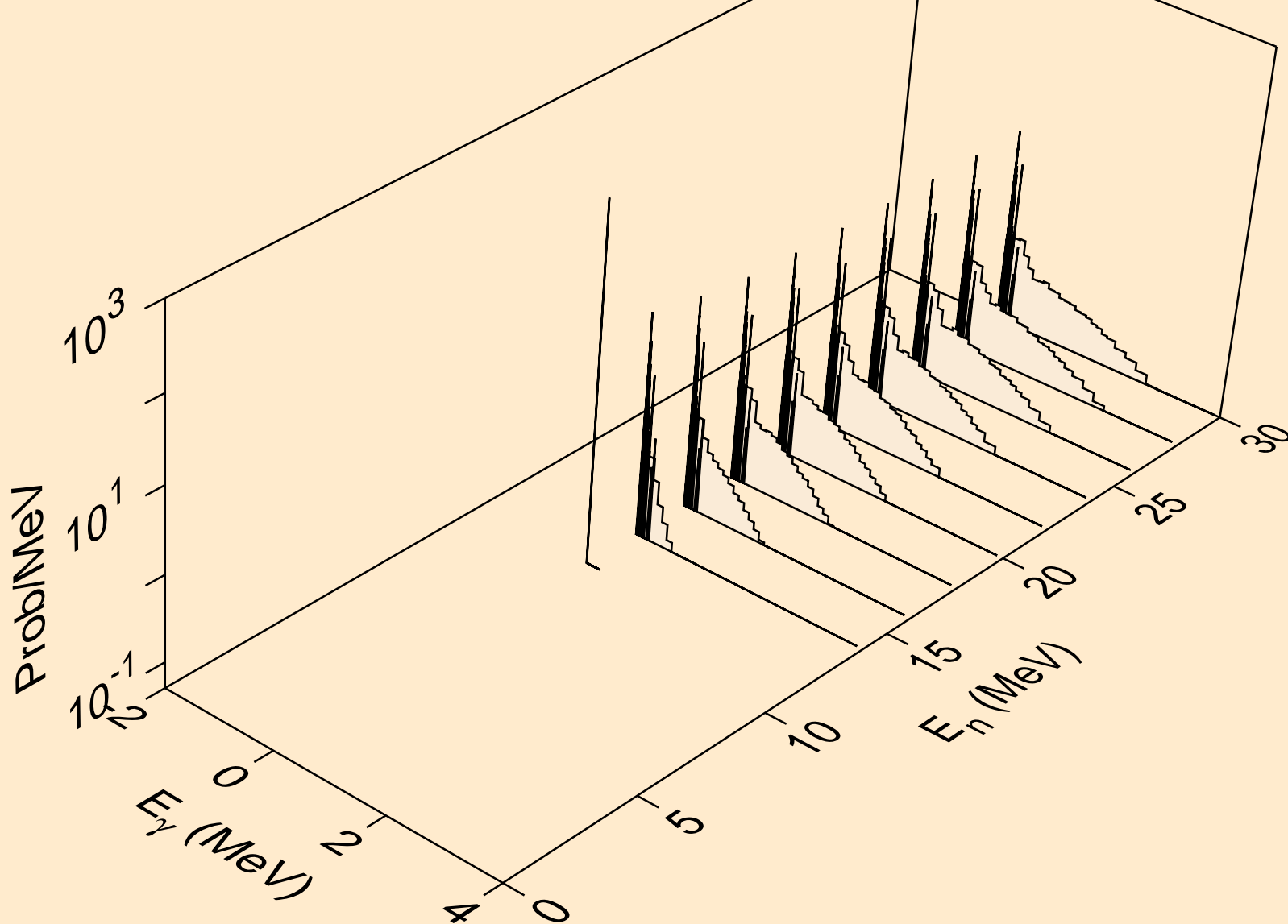

TH224 NEUTRON ACER TENDL-2023 LIBRARY; T=0.K  
Photon emission for (n,p $\alpha$ )

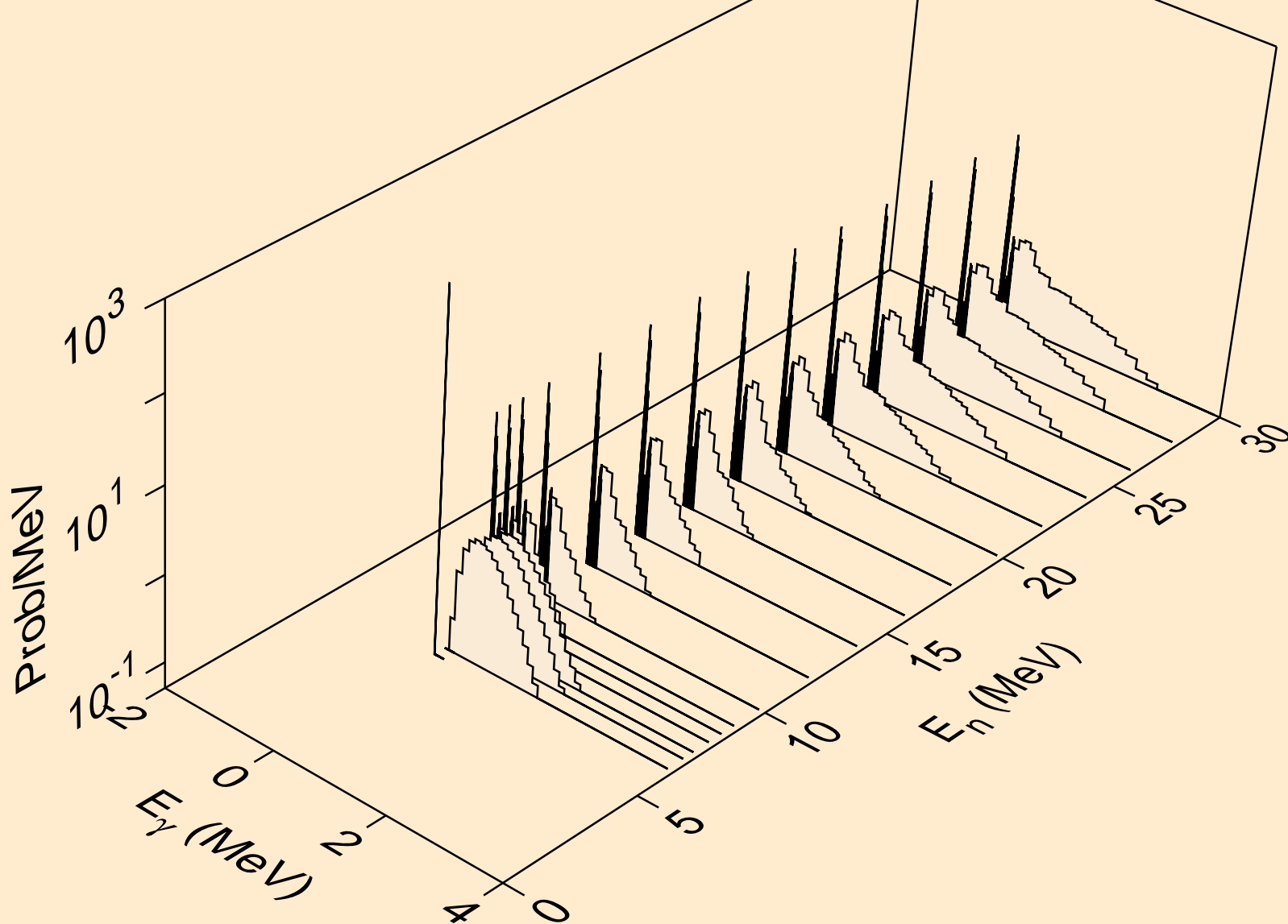

TH224 NEUTRON ACER TENDL-2023 LIBRARY; T=0.K  
Photon emission for (n,pd)

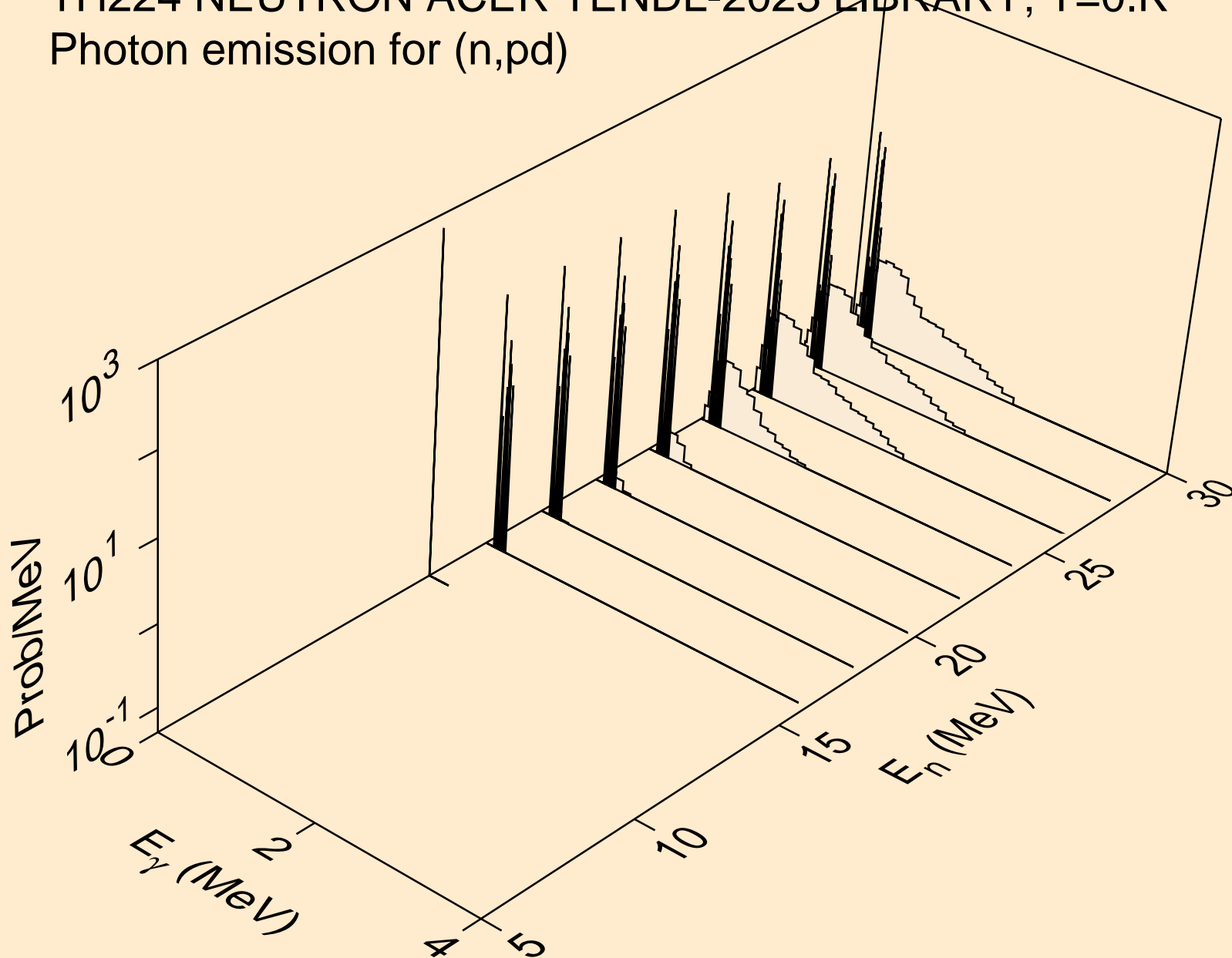

TH224 NEUTRON ACER TENDL-2023 LIBRARY; T=0.K  
Photon emission for (n,pt)

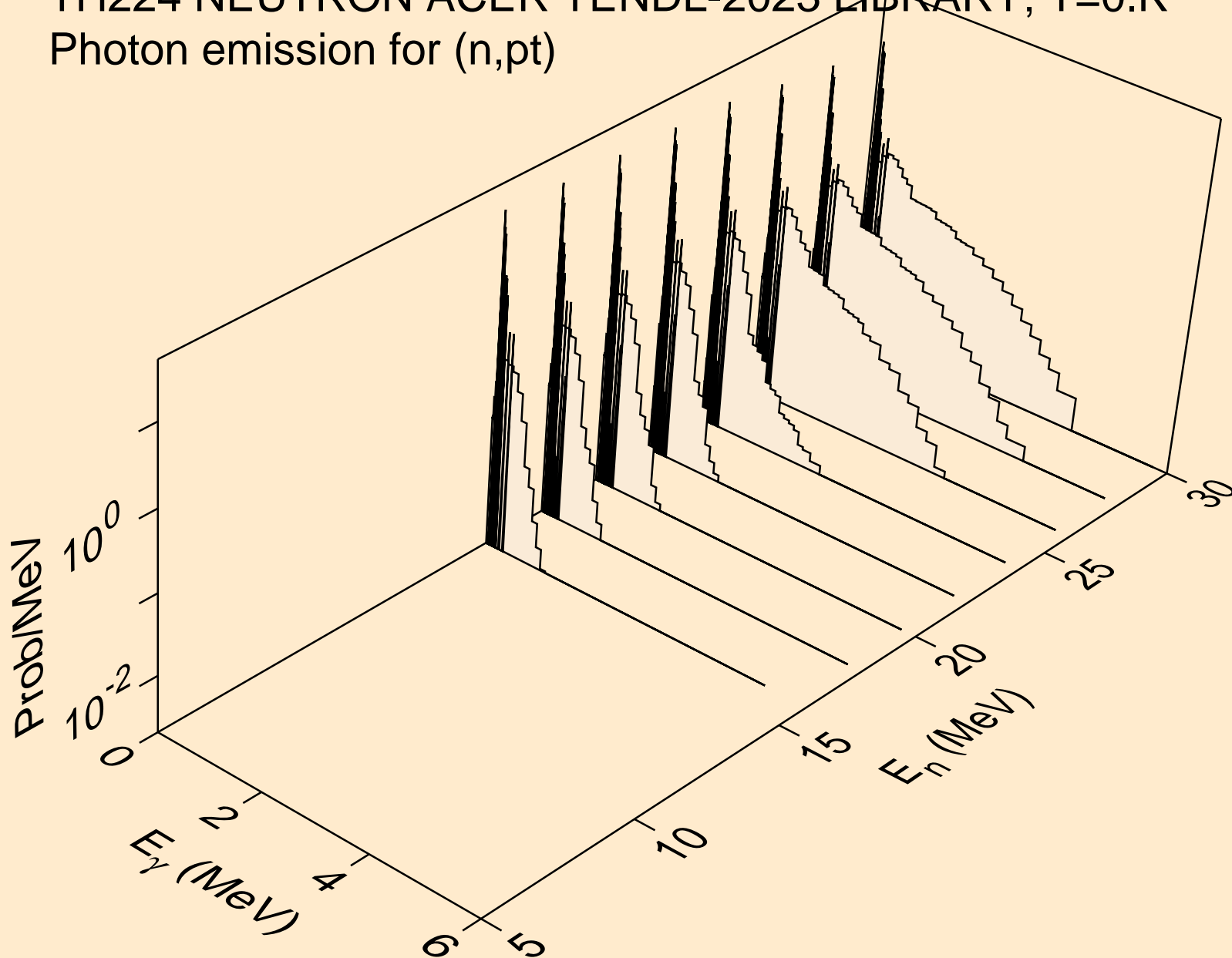

TH224 NEUTRON ACER TENDL-2023 LIBRARY; T=0.K  
Photon emission for (n,da)

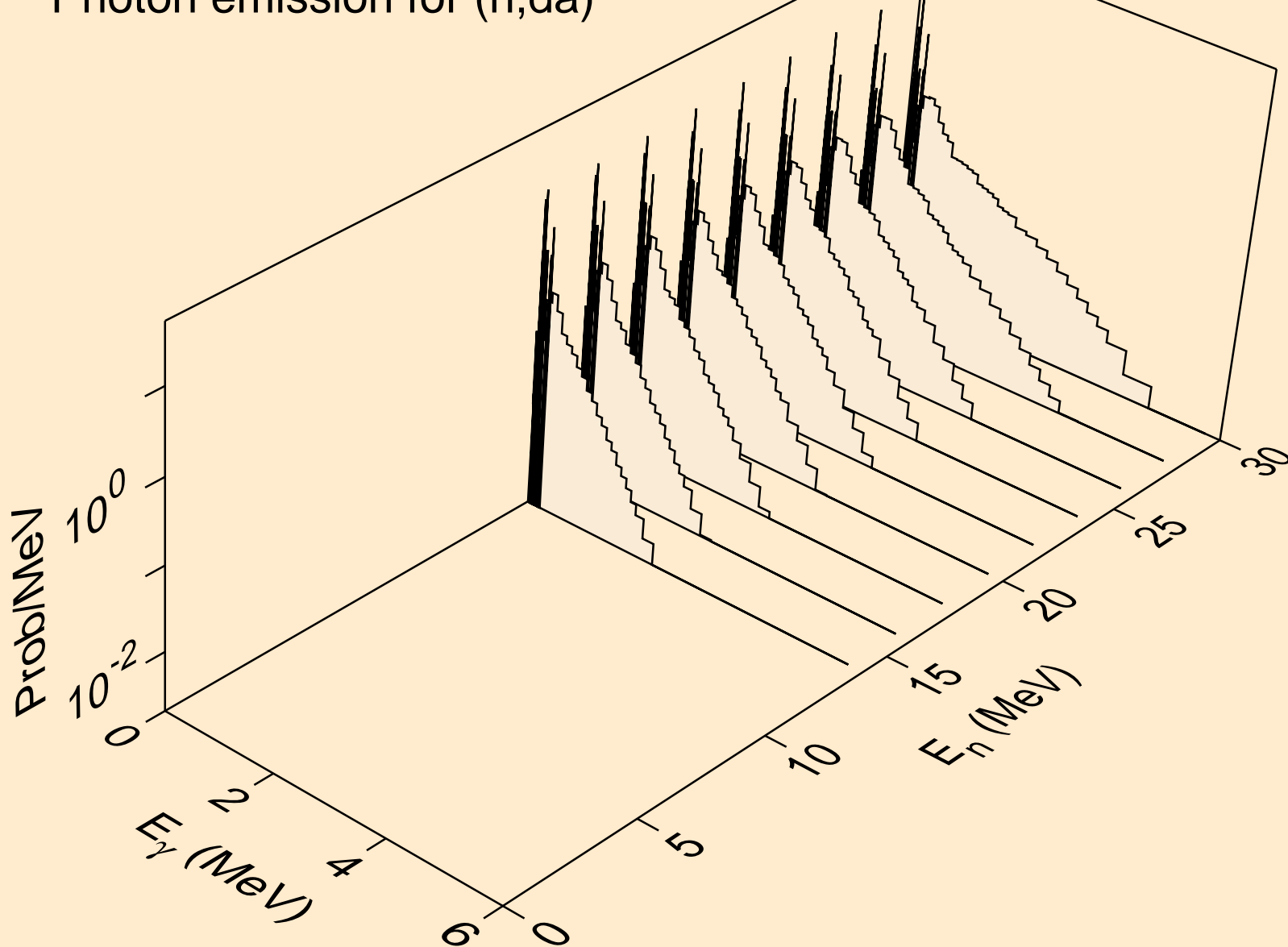

TH224 NEUTRON ACER TENDL-2023 LIBRARY; T=0.K  
thermal capture photon spectrum

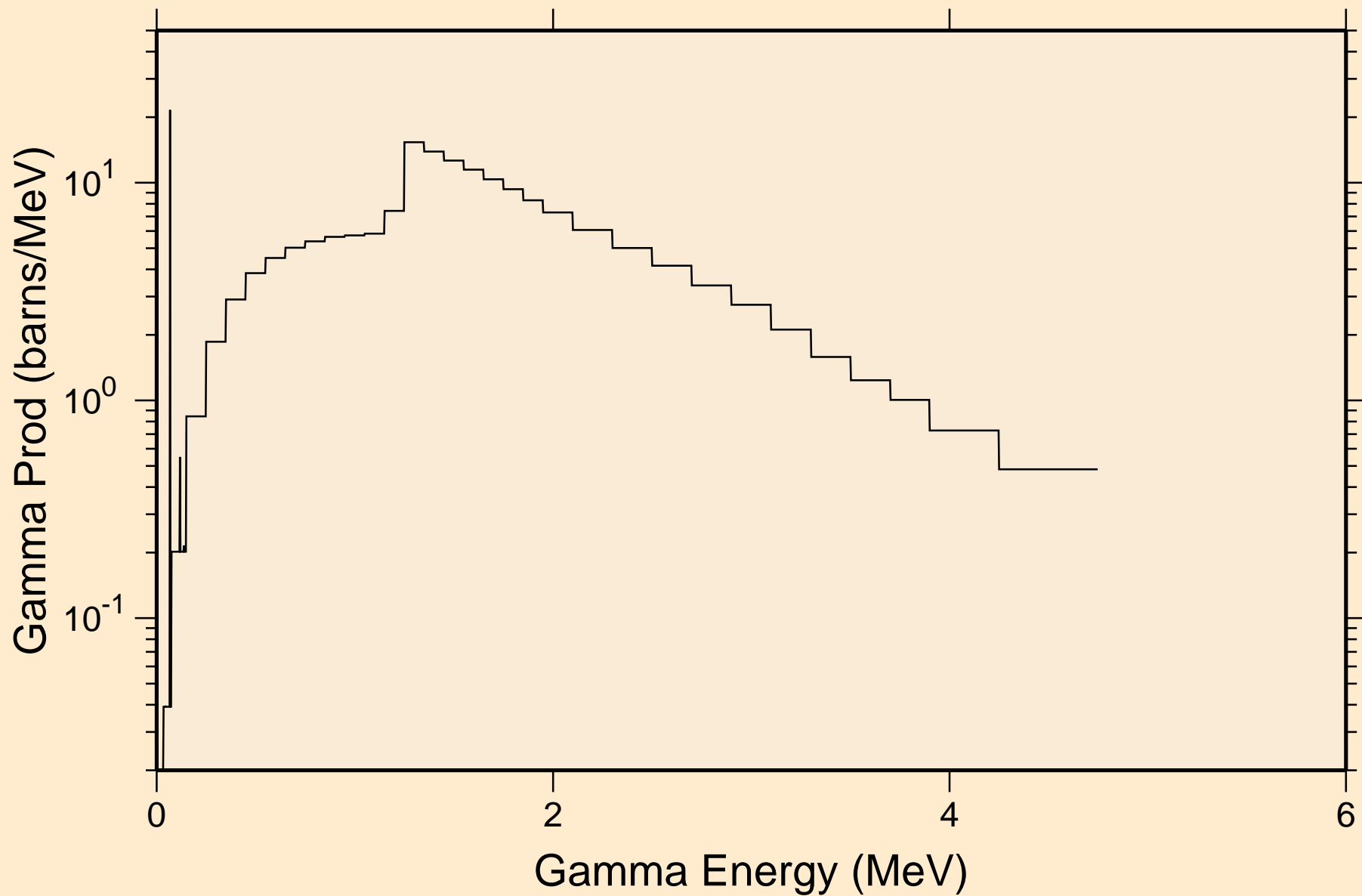

TH224 NEUTRON ACER TENDL-2023 LIBRARY; T=0.K  
14 MeV photon spectrum

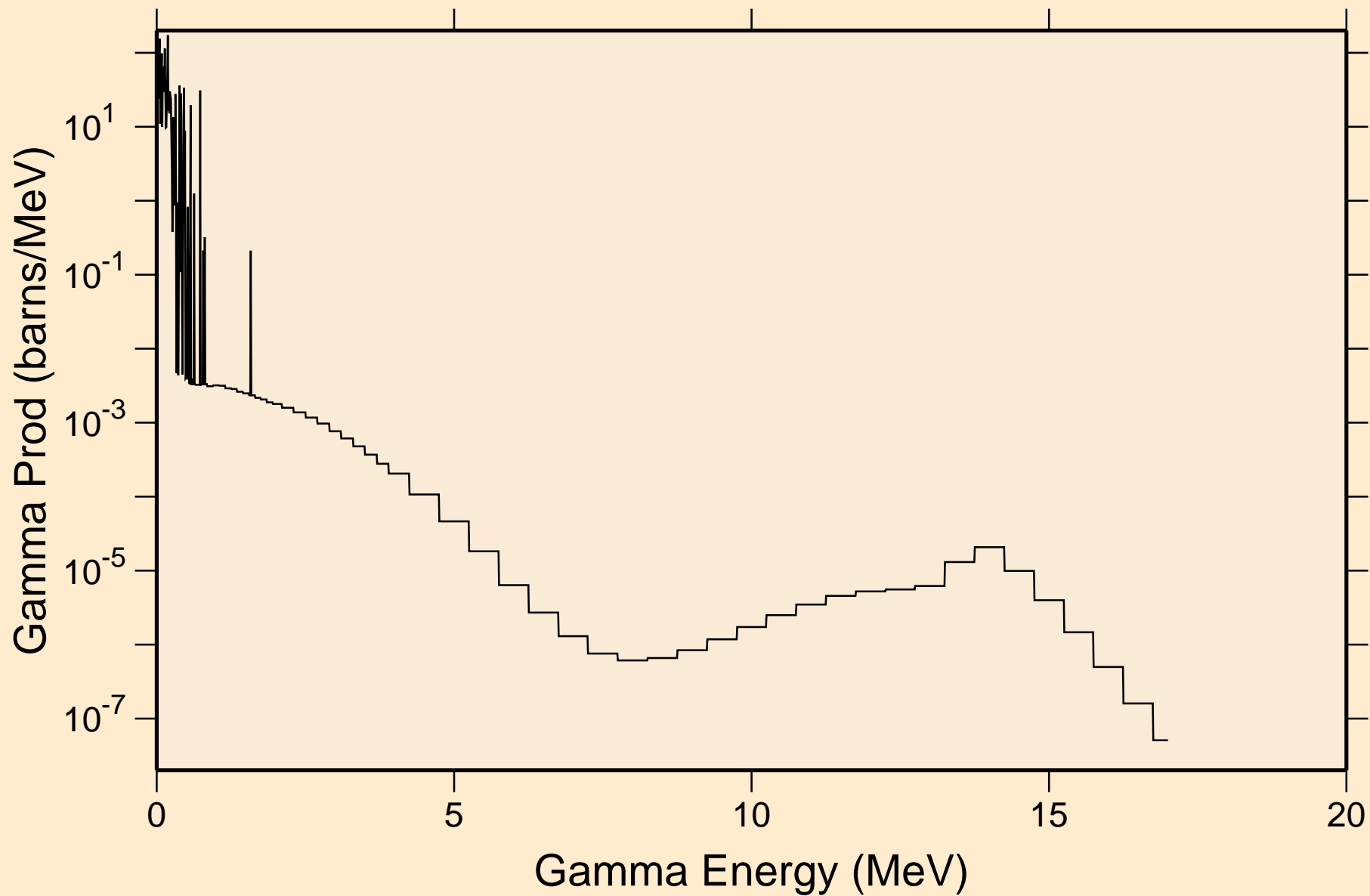

# TH224 NEUTRON ACER TENDL-2023 LIBRARY; T=0.K

## Particle heating contributions

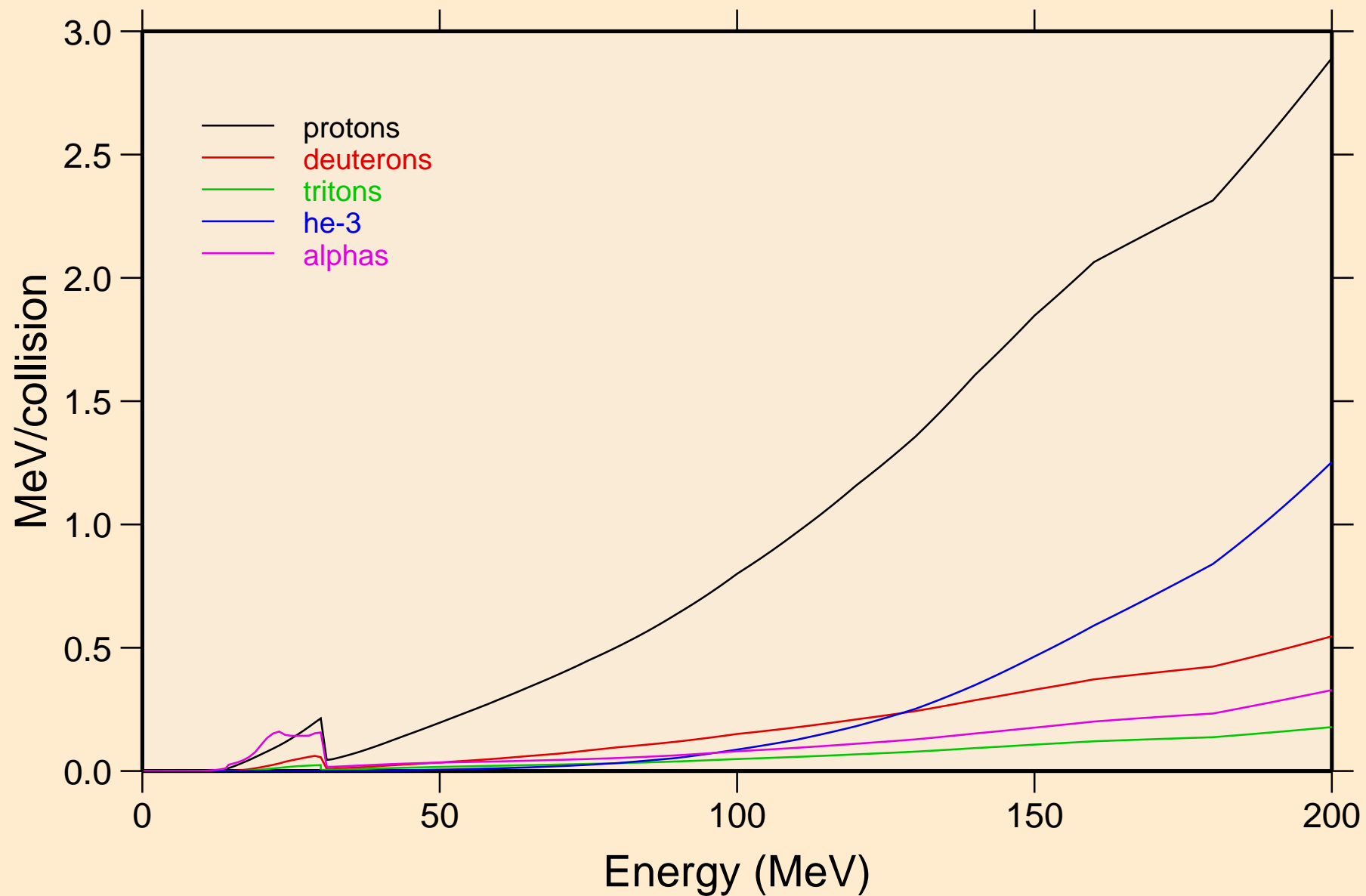

TH224 NEUTRON ACER TENDL-2023 LIBRARY; T=0.K  
Recoil Heating

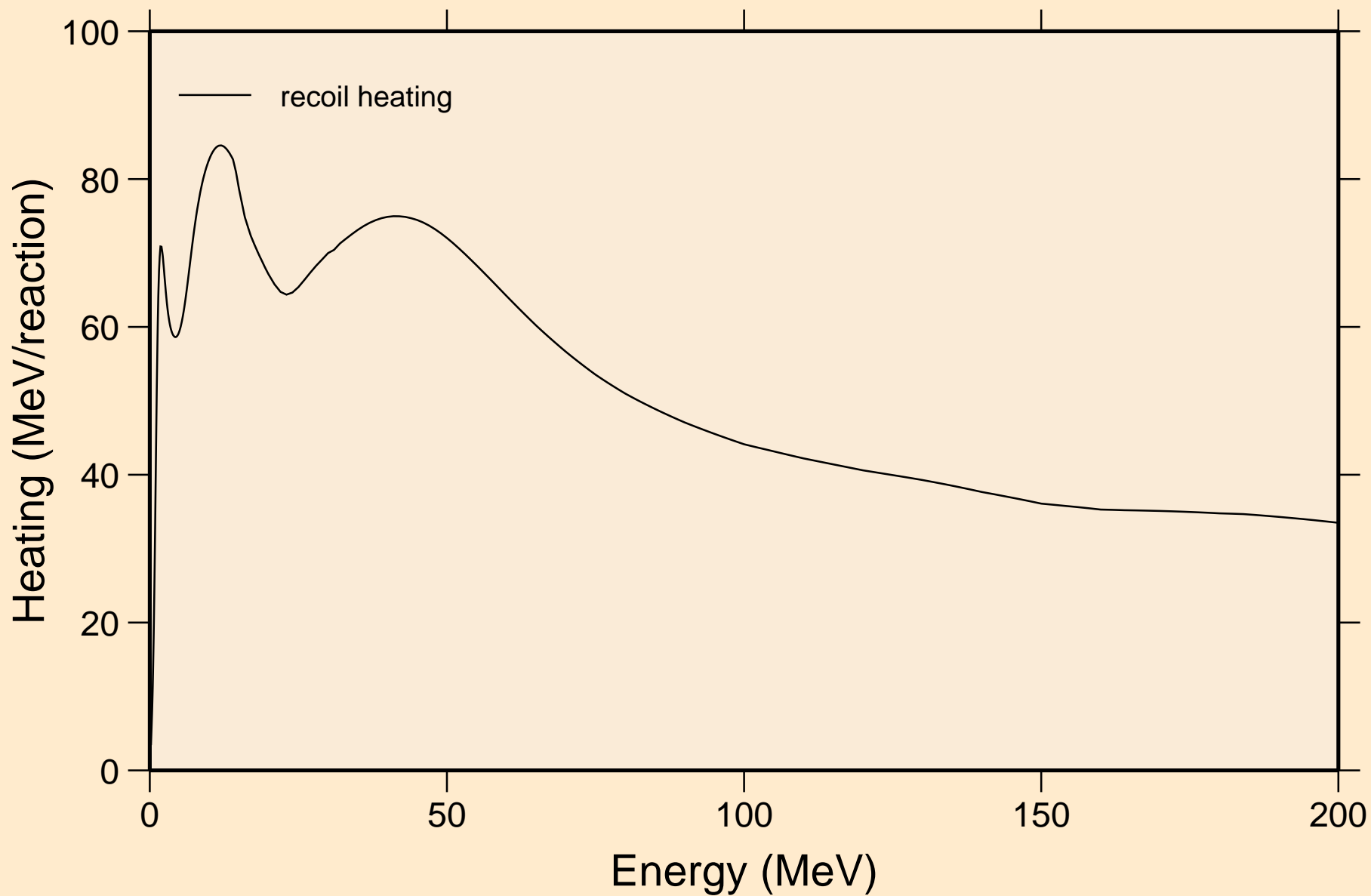

# TH224 NEUTRON ACER TENDL-2023 LIBRARY; T=0.K

## Particle production cross sections

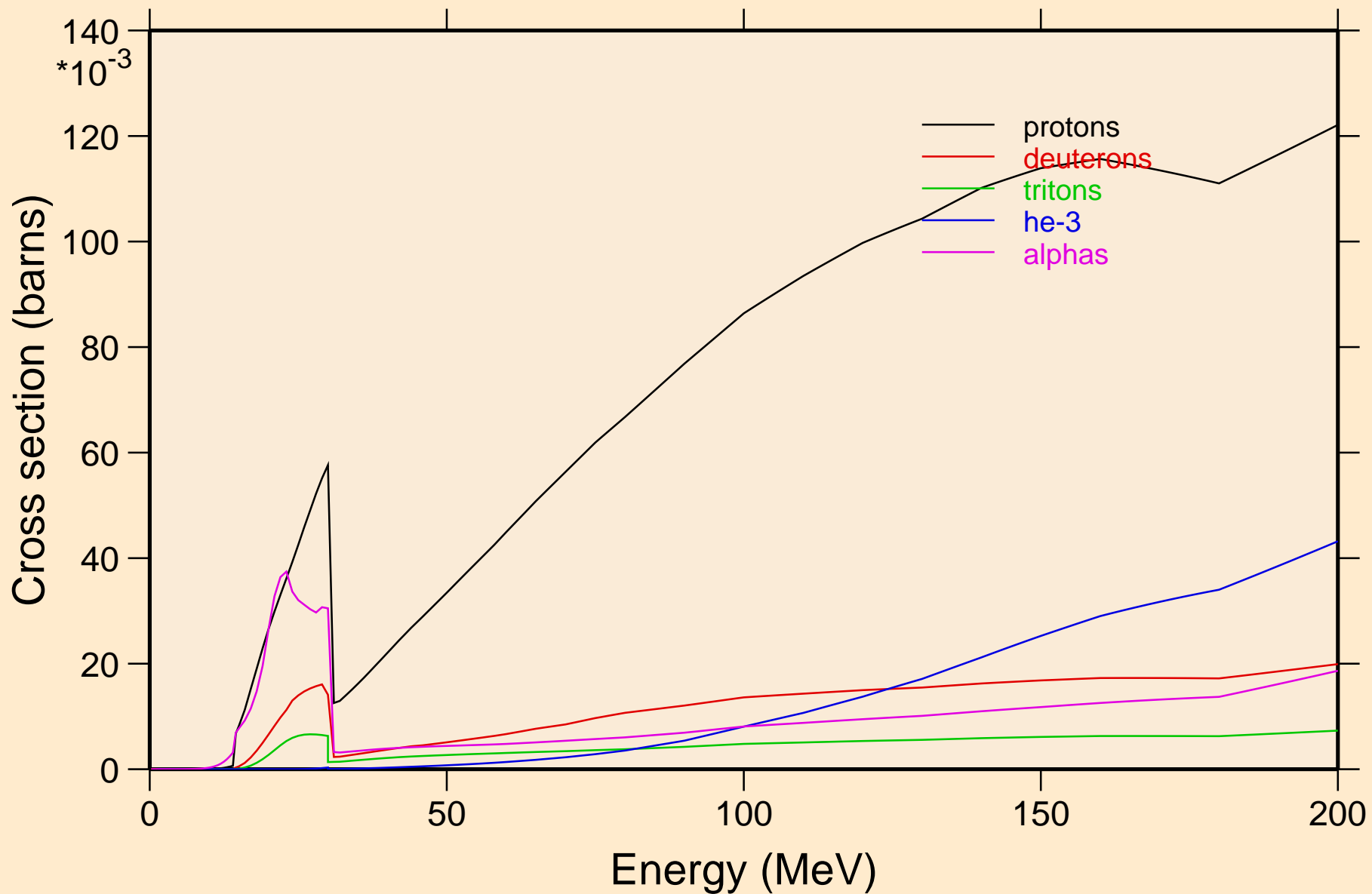

TH224 NEUTRON ACER TENDL-2023 LIBRARY; T=0.K  
protons from (n,x)

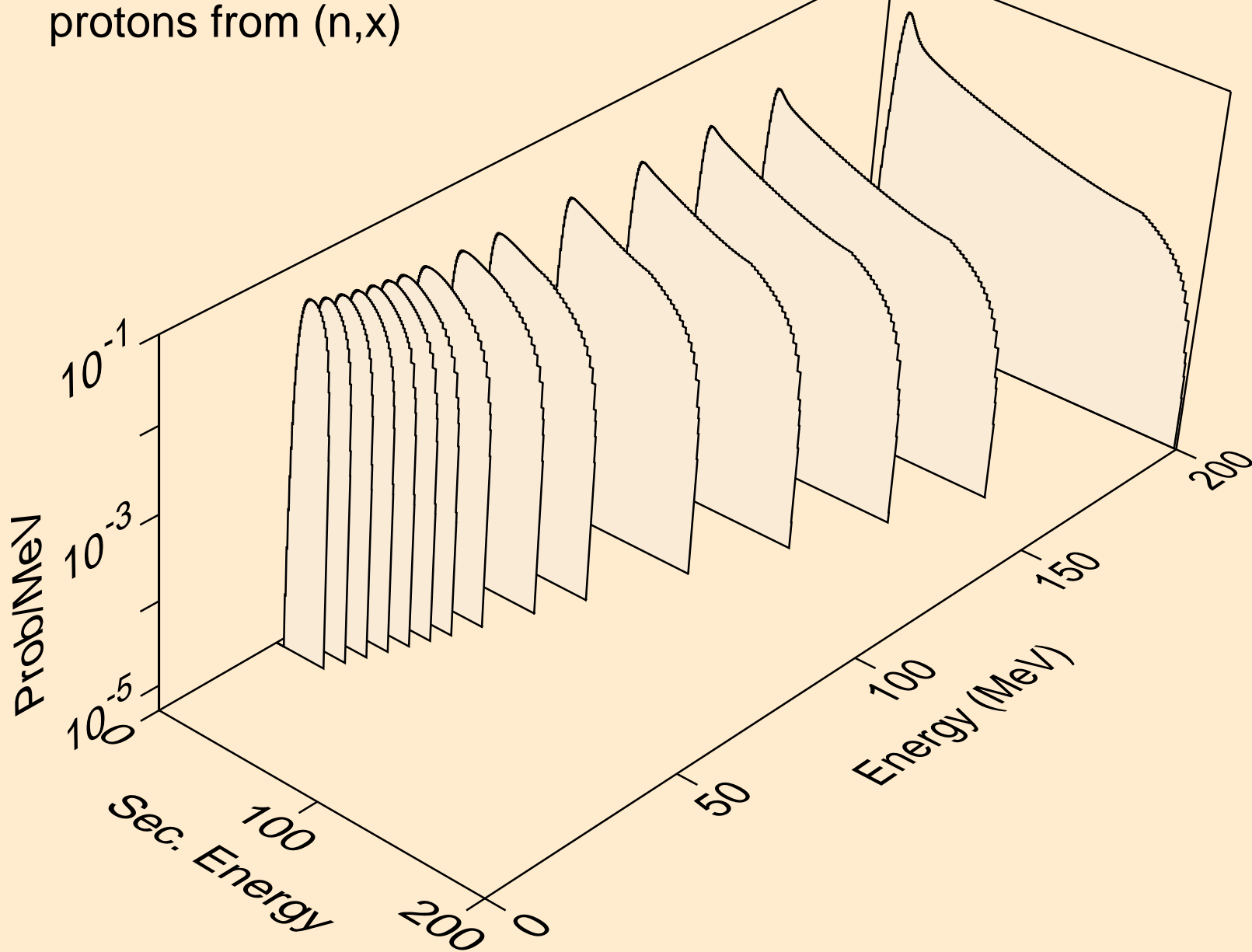

TH224 NEUTRON ACER TENDL-2023 LIBRARY; T=0.K  
protons from (n,n\*)p

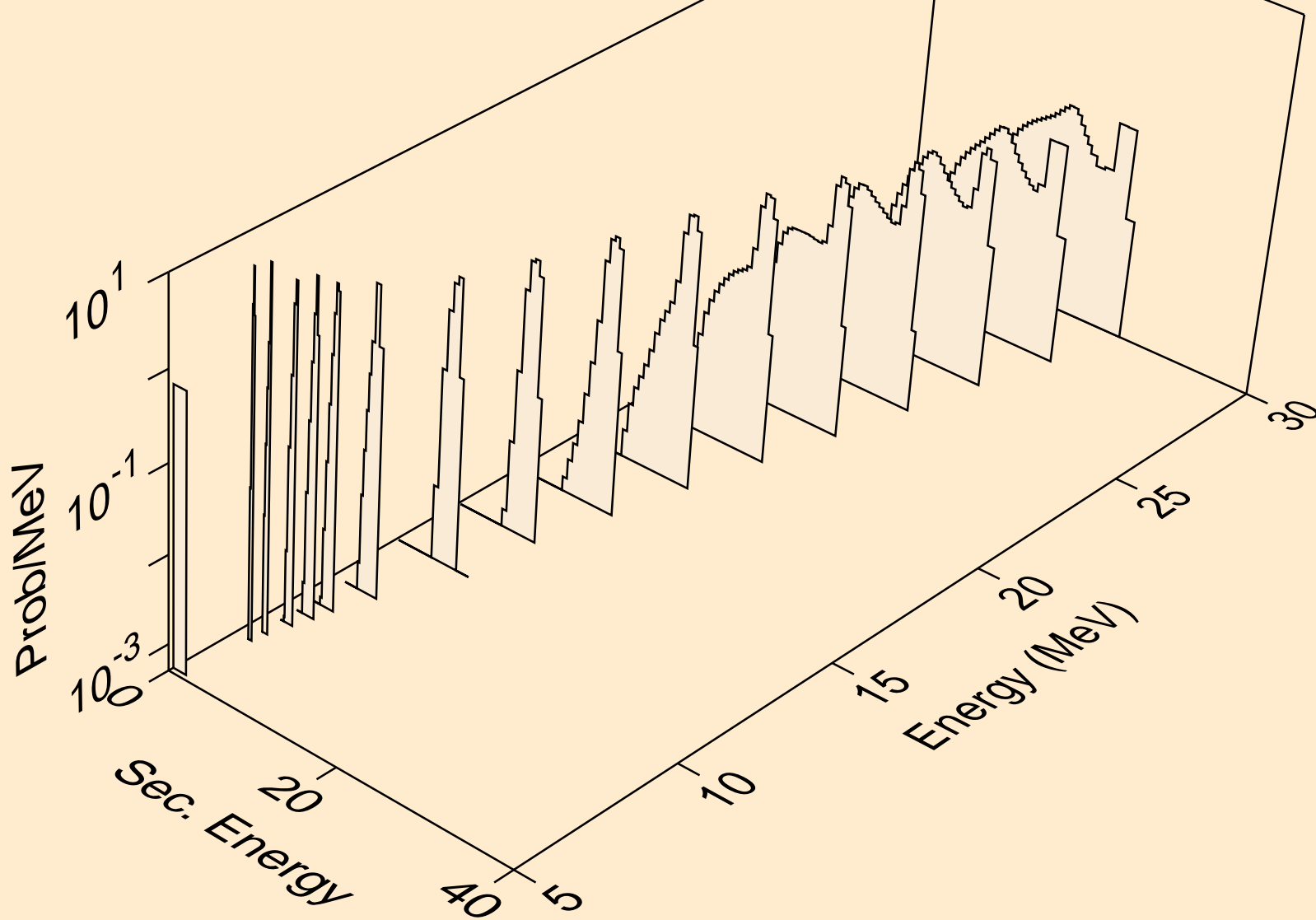

TH224 NEUTRON ACER TENDL-2023 LIBRARY; T=0.K  
protons from (n,2np)

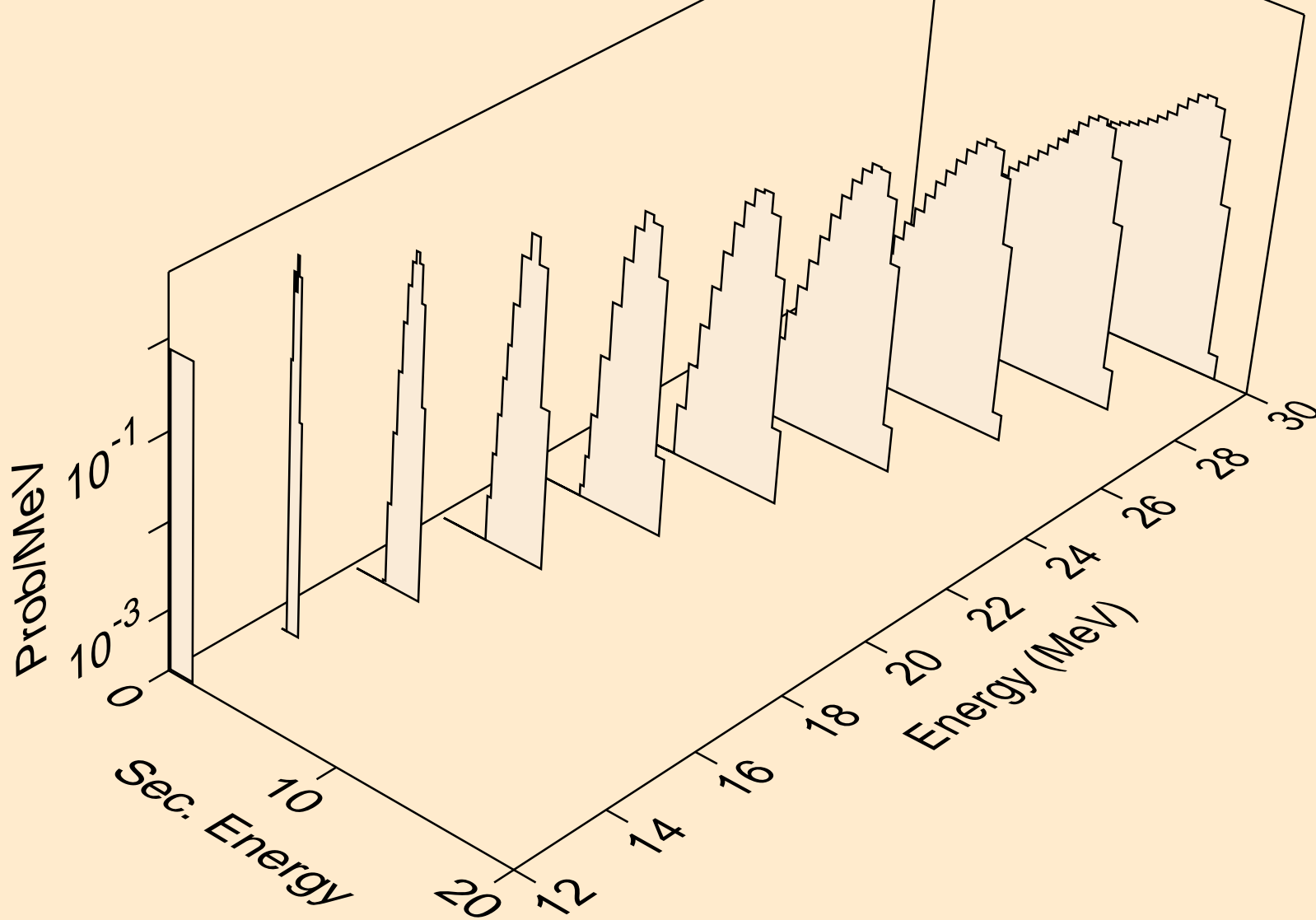

TH224 NEUTRON ACER TENDL-2023 LIBRARY; T=0.K  
protons from (n,3np)

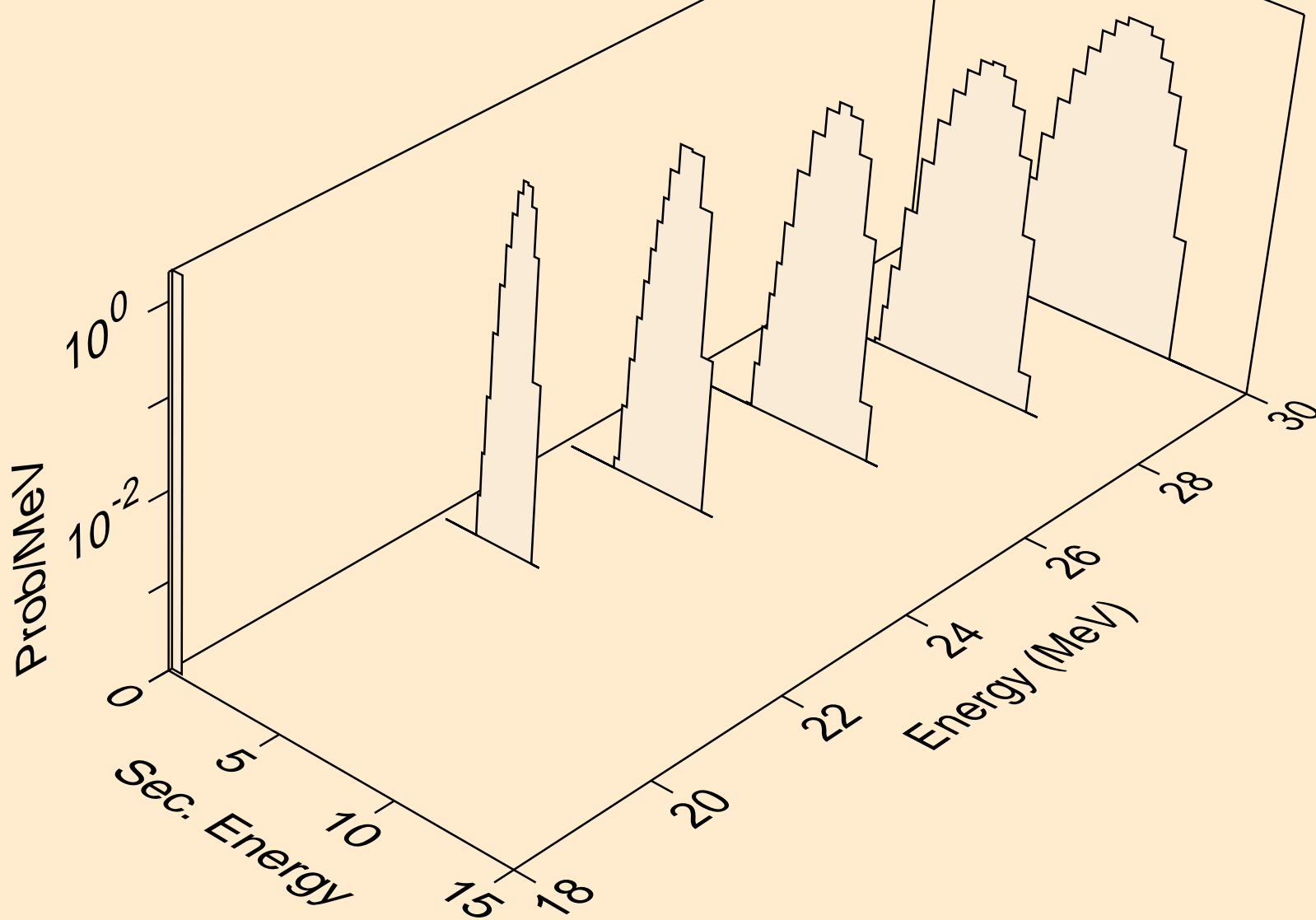

TH224 NEUTRON ACER TENDL-2023 LIBRARY; T=0.K  
protons from (n,n2p)

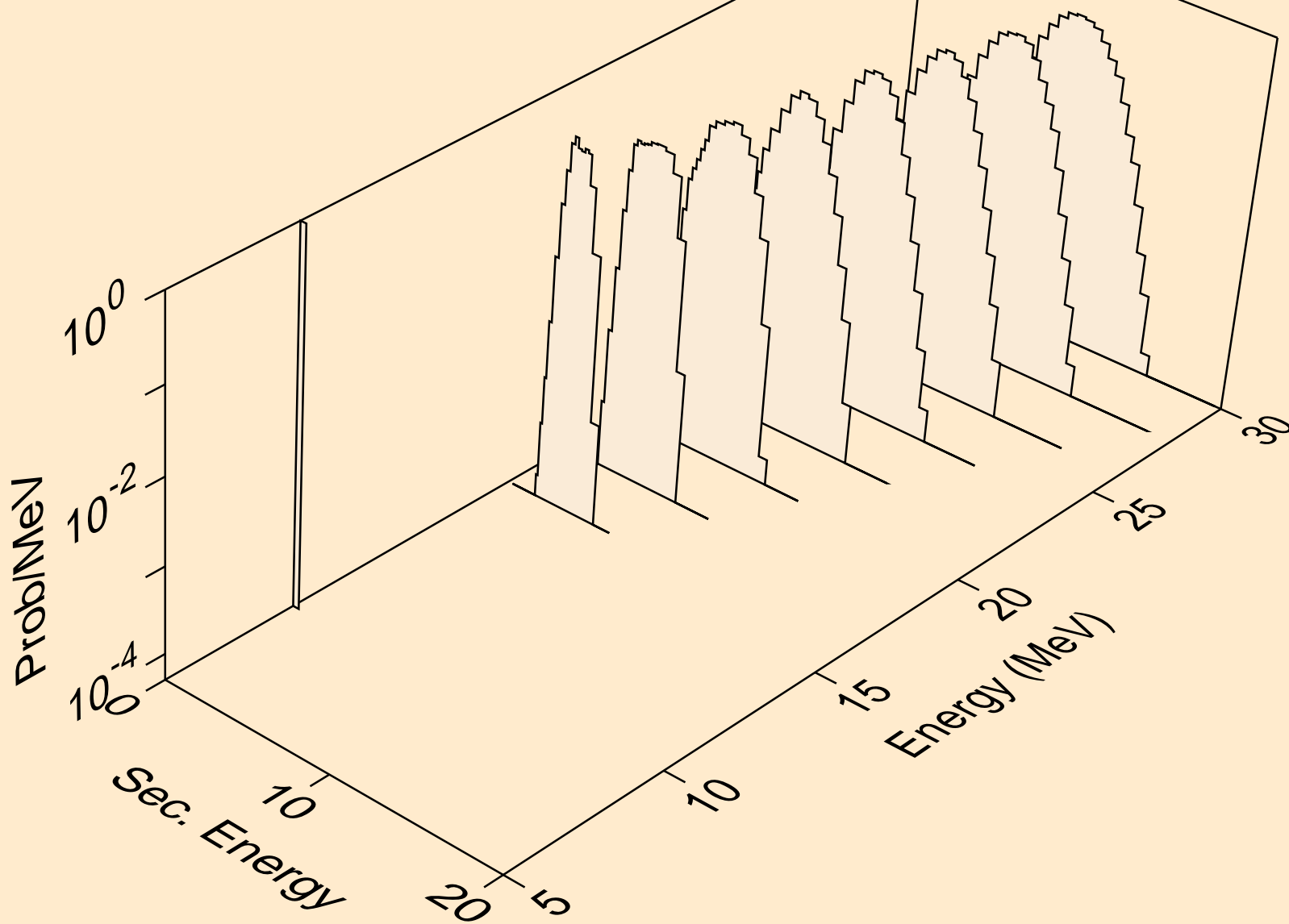

TH224 NEUTRON ACER TENDL-2023 LIBRARY; T=0.K  
protons from (n,npa)

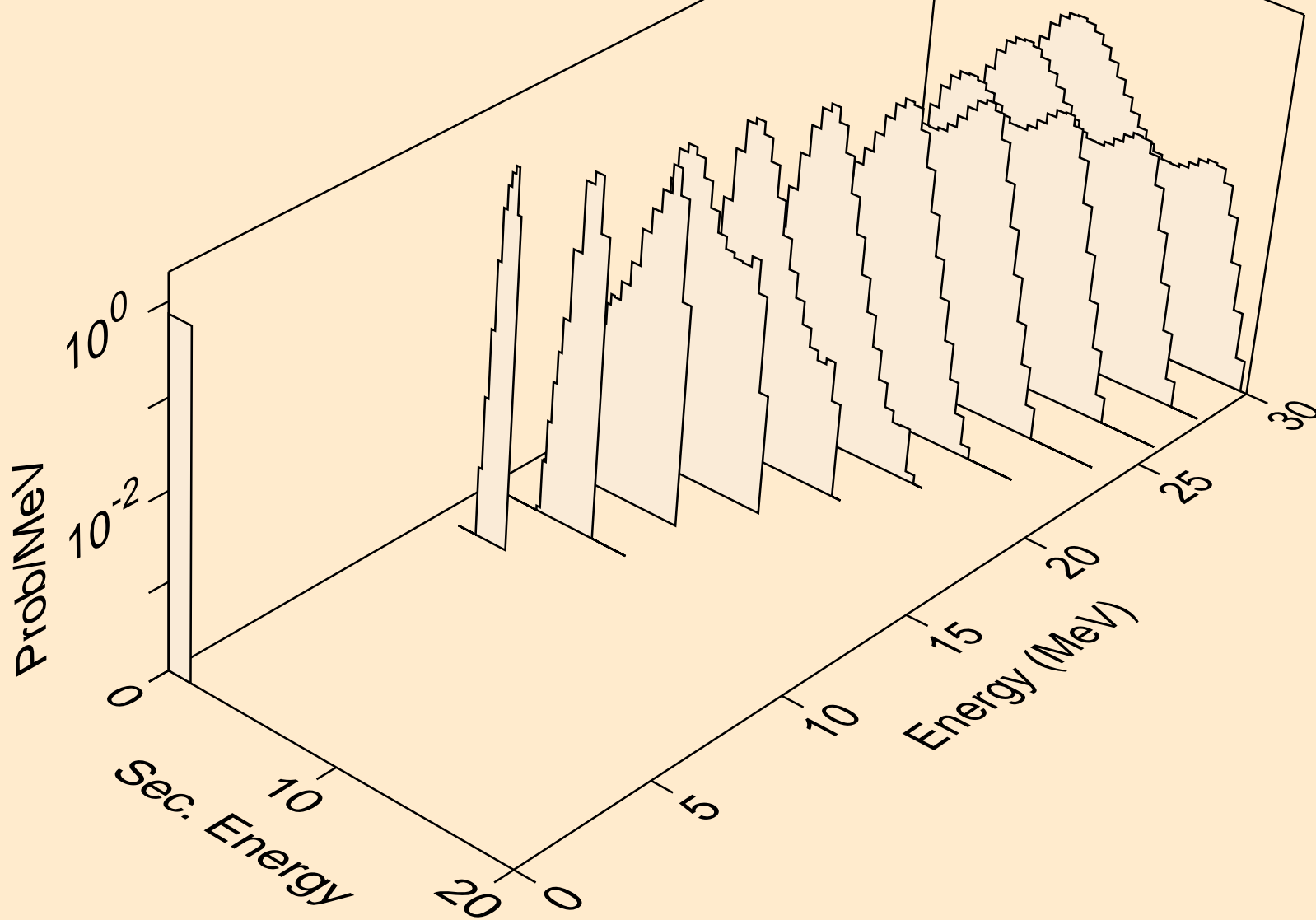

TH224 NEUTRON ACER TENDL-2023 LIBRARY; T=0.K  
protons from (n,p)

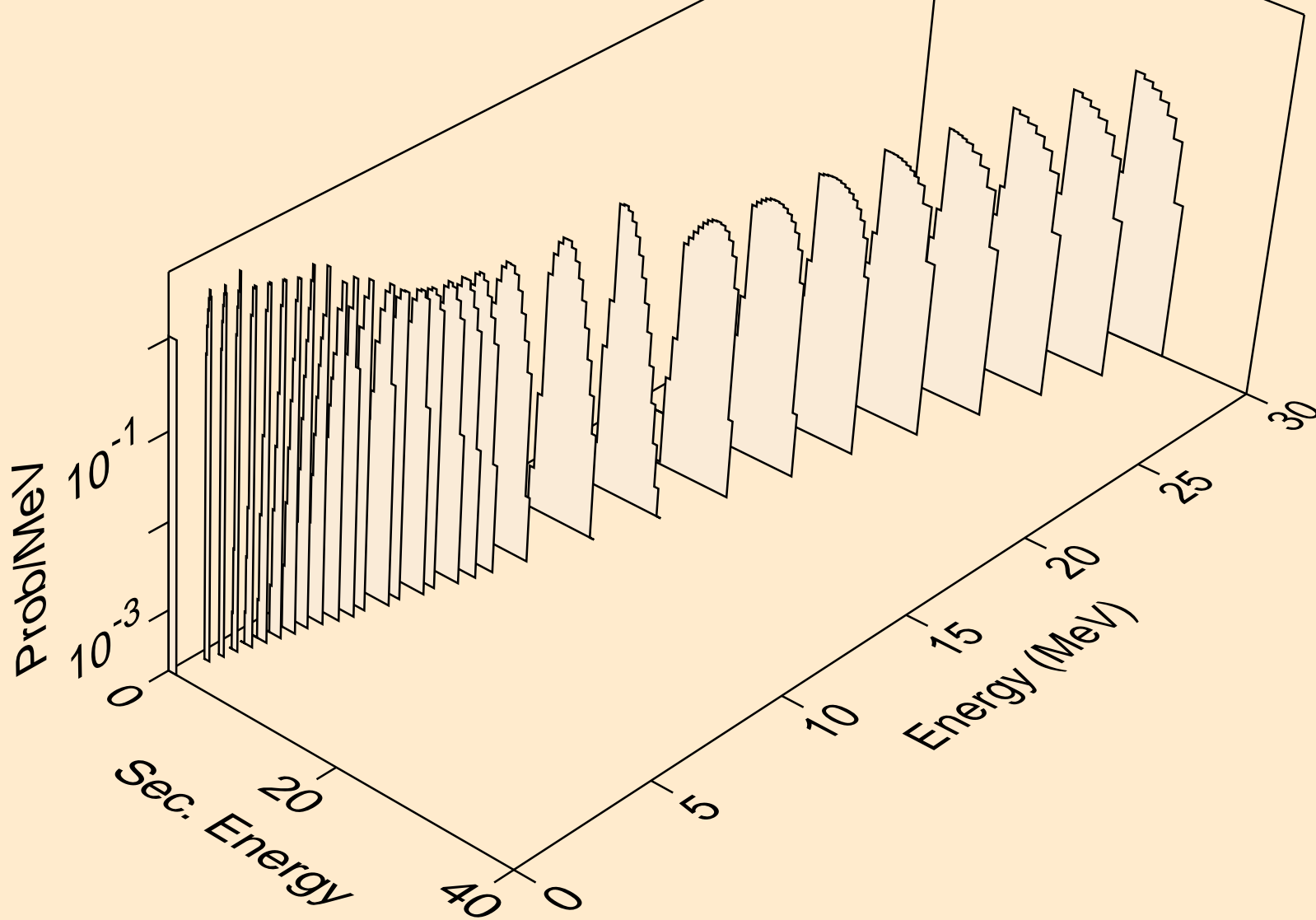

TH224 NEUTRON ACER TENDL-2023 LIBRARY; T=0.K  
protons from (n,2p)

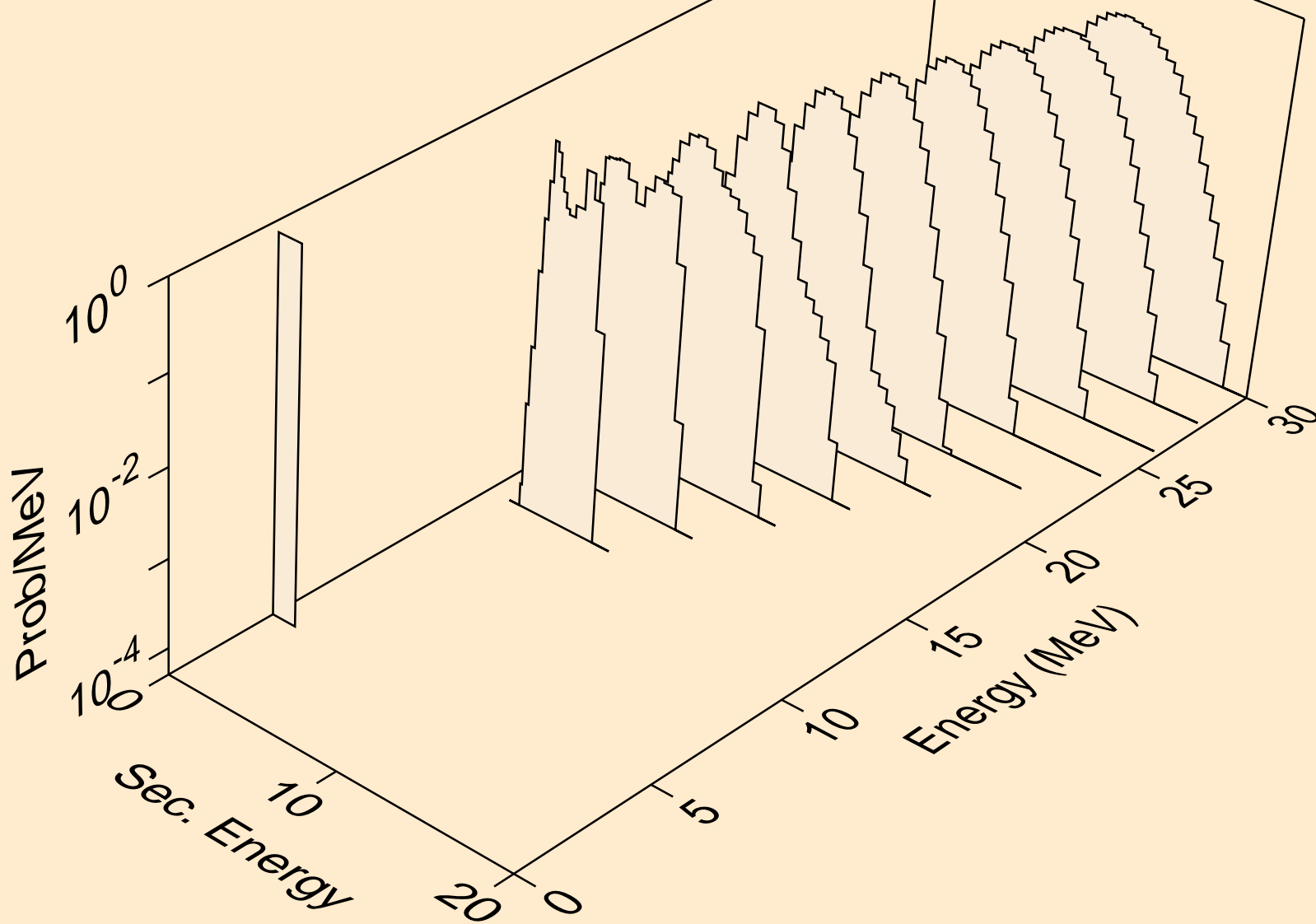

TH224 NEUTRON ACER TENDL-2023 LIBRARY; T=0.K  
protons from (n,p)

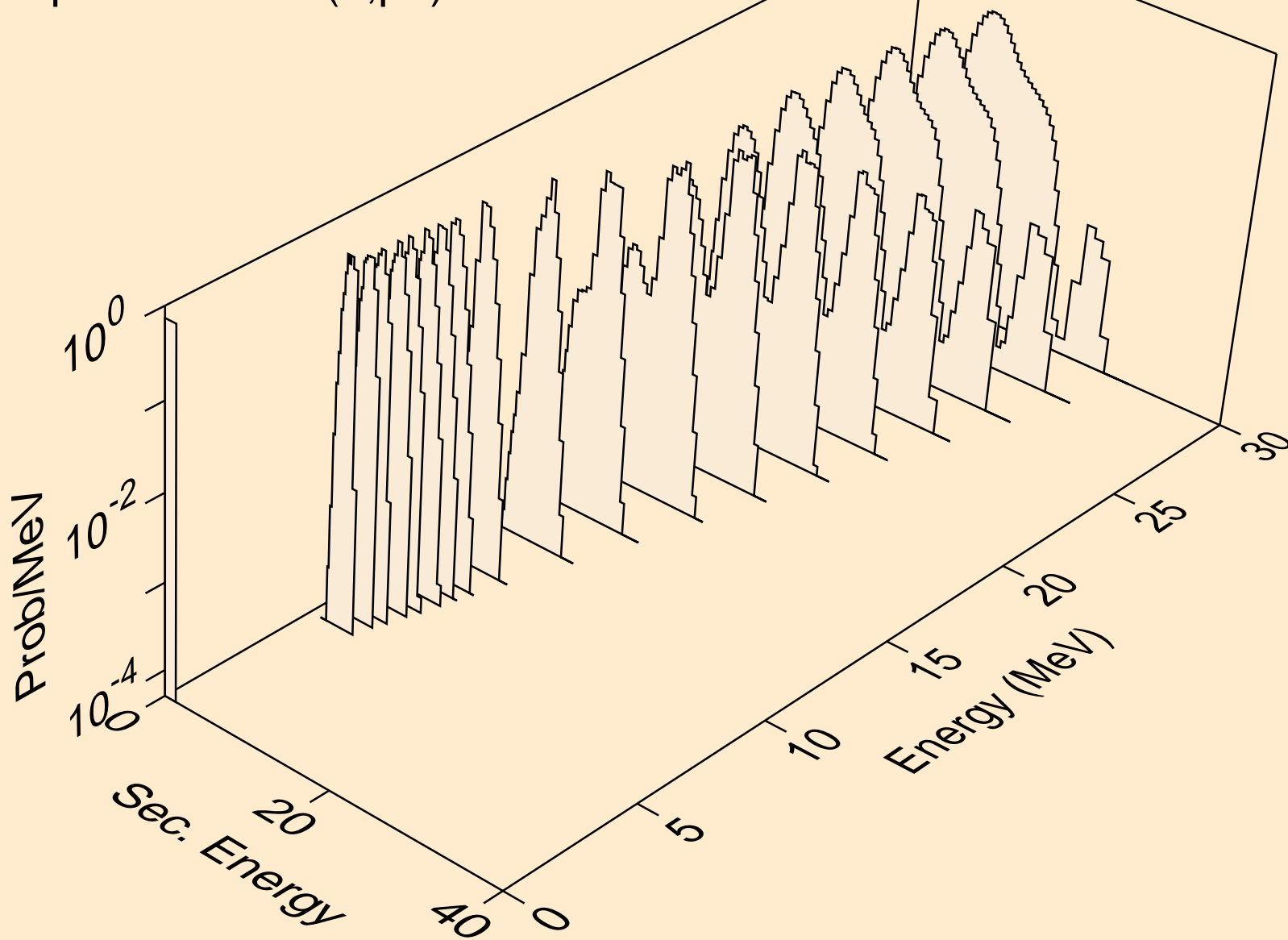

TH224 NEUTRON ACER TENDL-2023 LIBRARY; T=0.K  
protons from (n,pd)

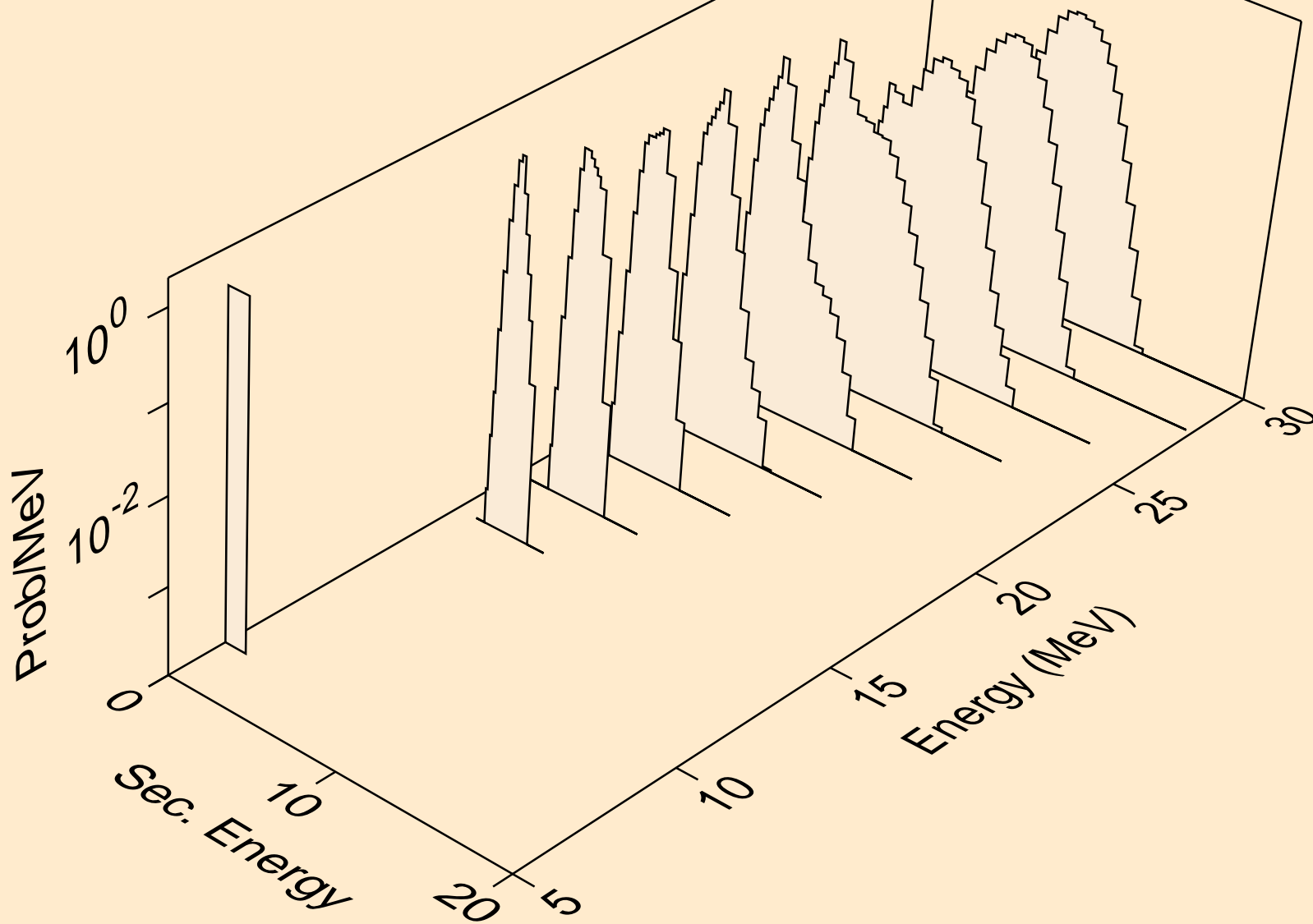

TH224 NEUTRON ACER TENDL-2023 LIBRARY; T=0.K  
protons from (n,pt)

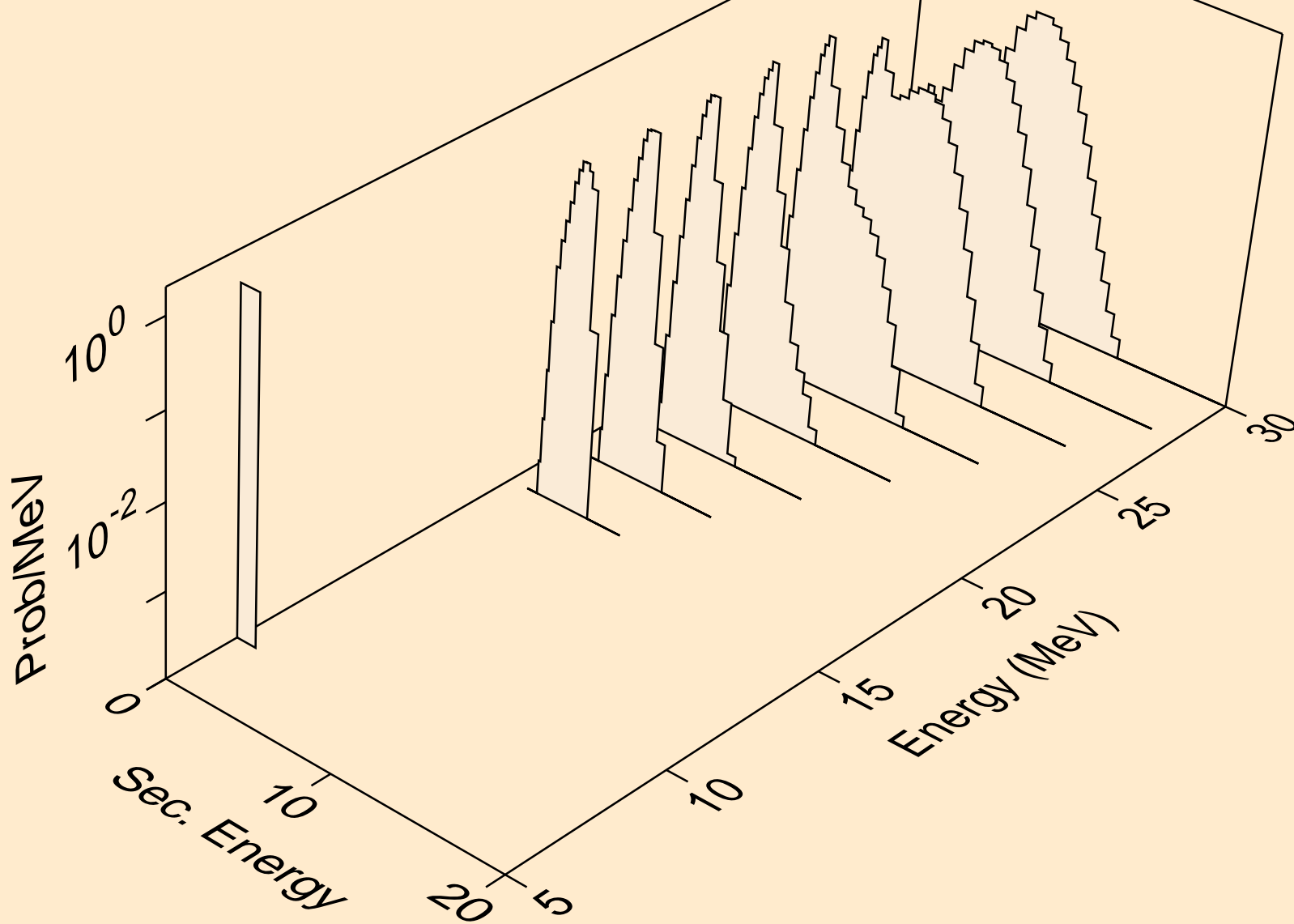

TH224 NEUTRON ACER TENDL-2023 LIBRARY; T=0.K  
deuterons from (n,x)

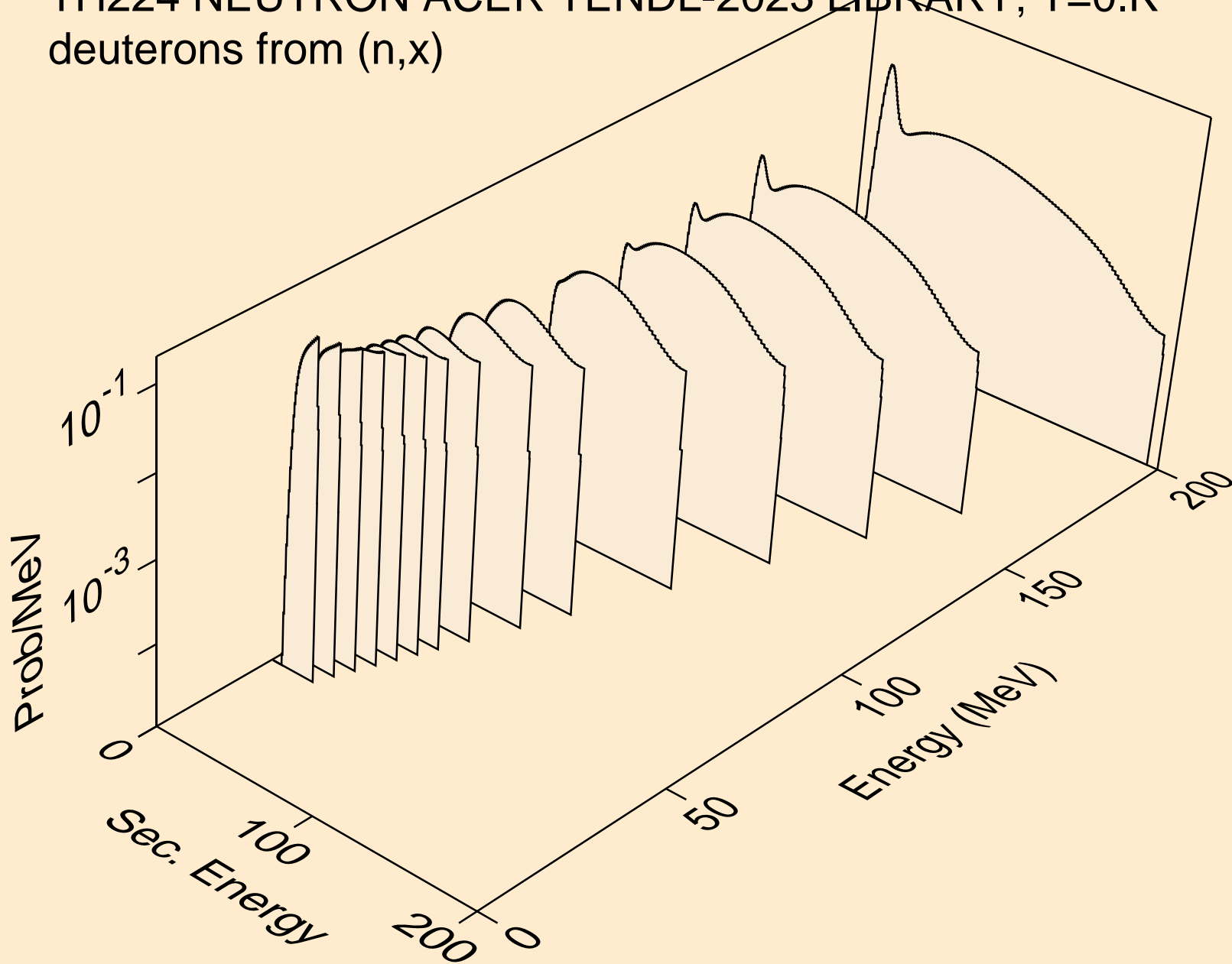

TH224 NEUTRON ACER TENDL-2023 LIBRARY; T=0.K  
deuterons from (n,2nd)

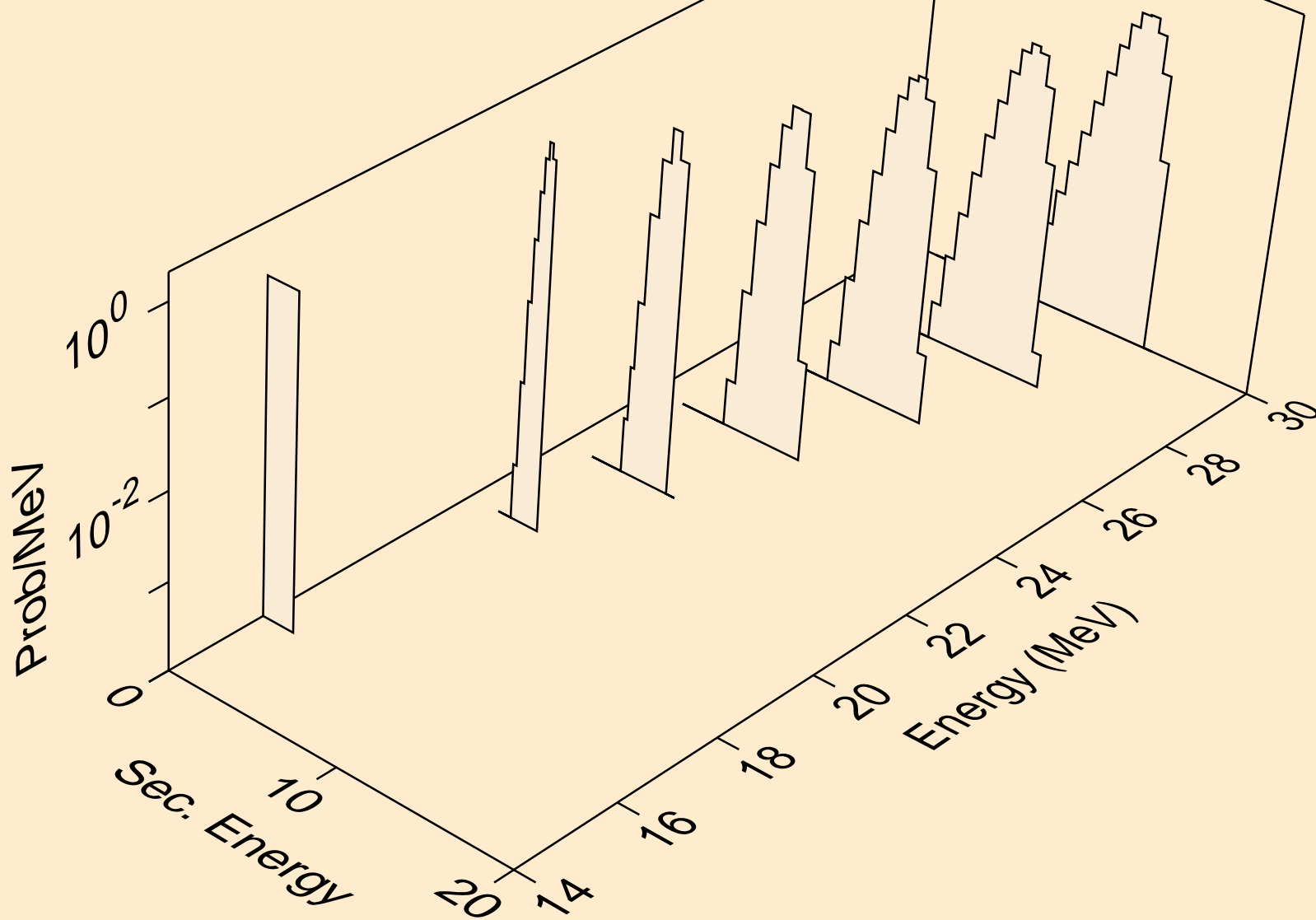

TH224 NEUTRON ACER TENDL-2023 LIBRARY; T=0.K  
deuterons from (n,n\*)d

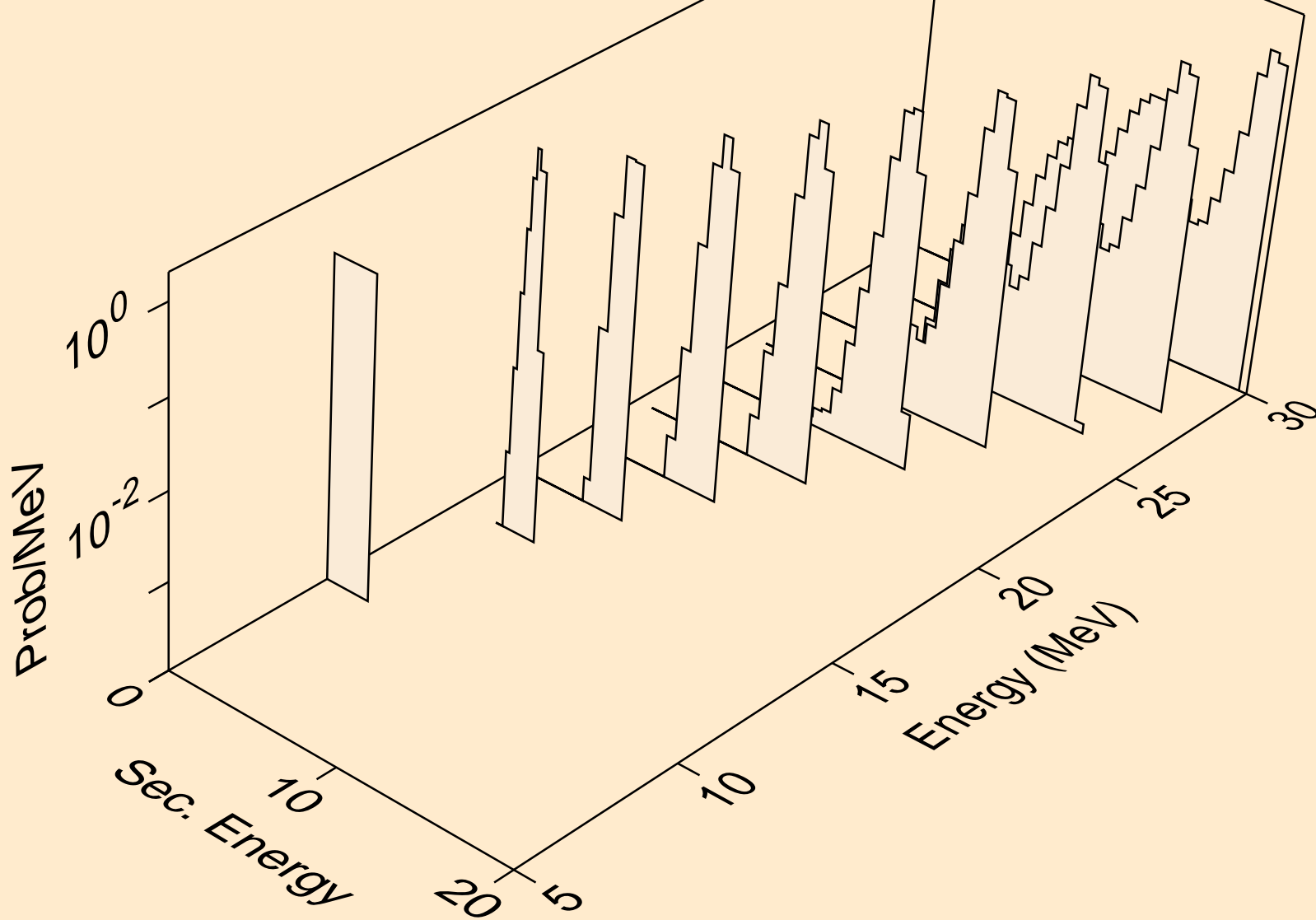

TH224 NEUTRON ACER TENDL-2023 LIBRARY; T=0.K  
deuterons from (n,d)

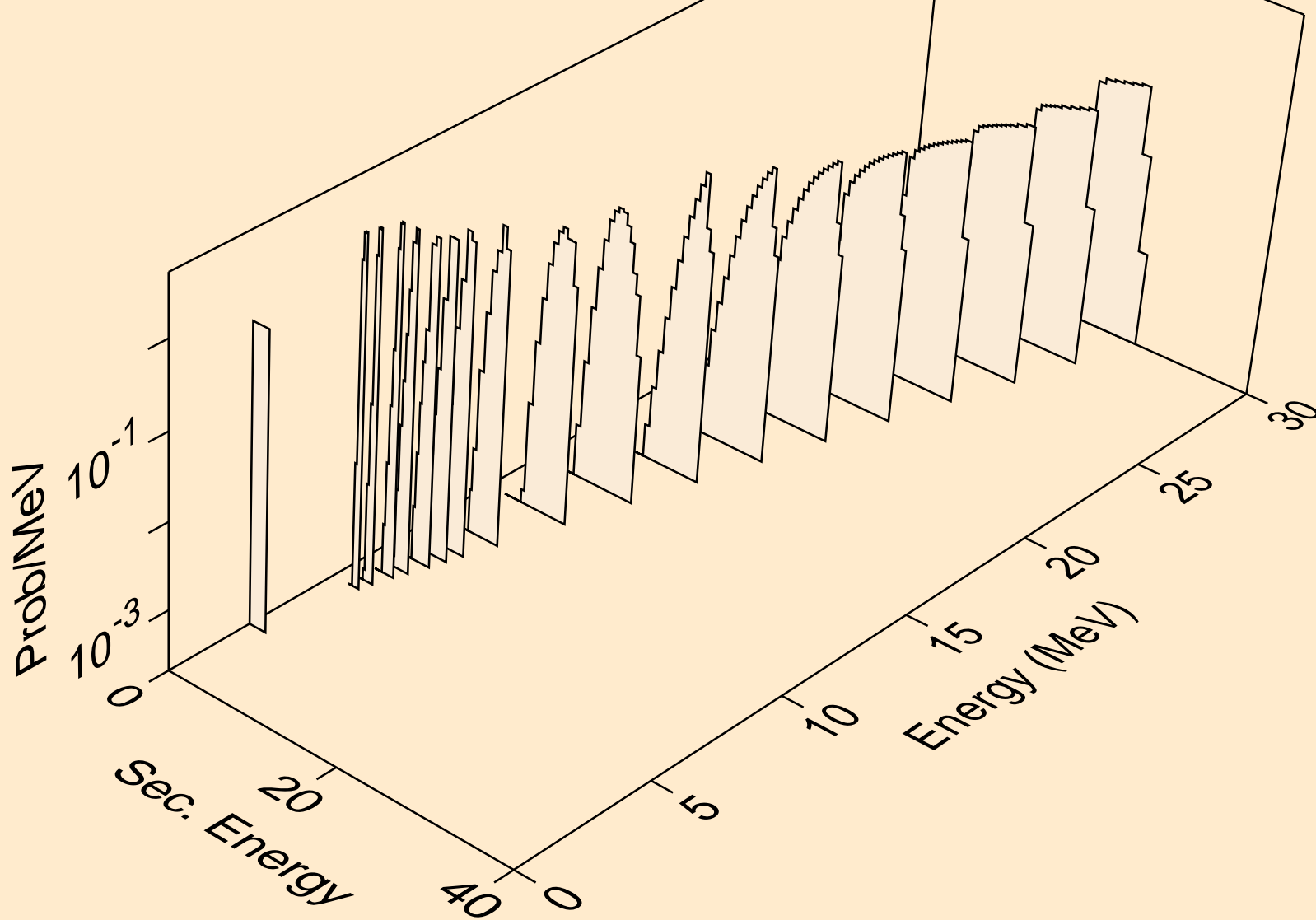

TH224 NEUTRON ACER TENDL-2023 LIBRARY; T=0.K  
deuterons from (n,pd)

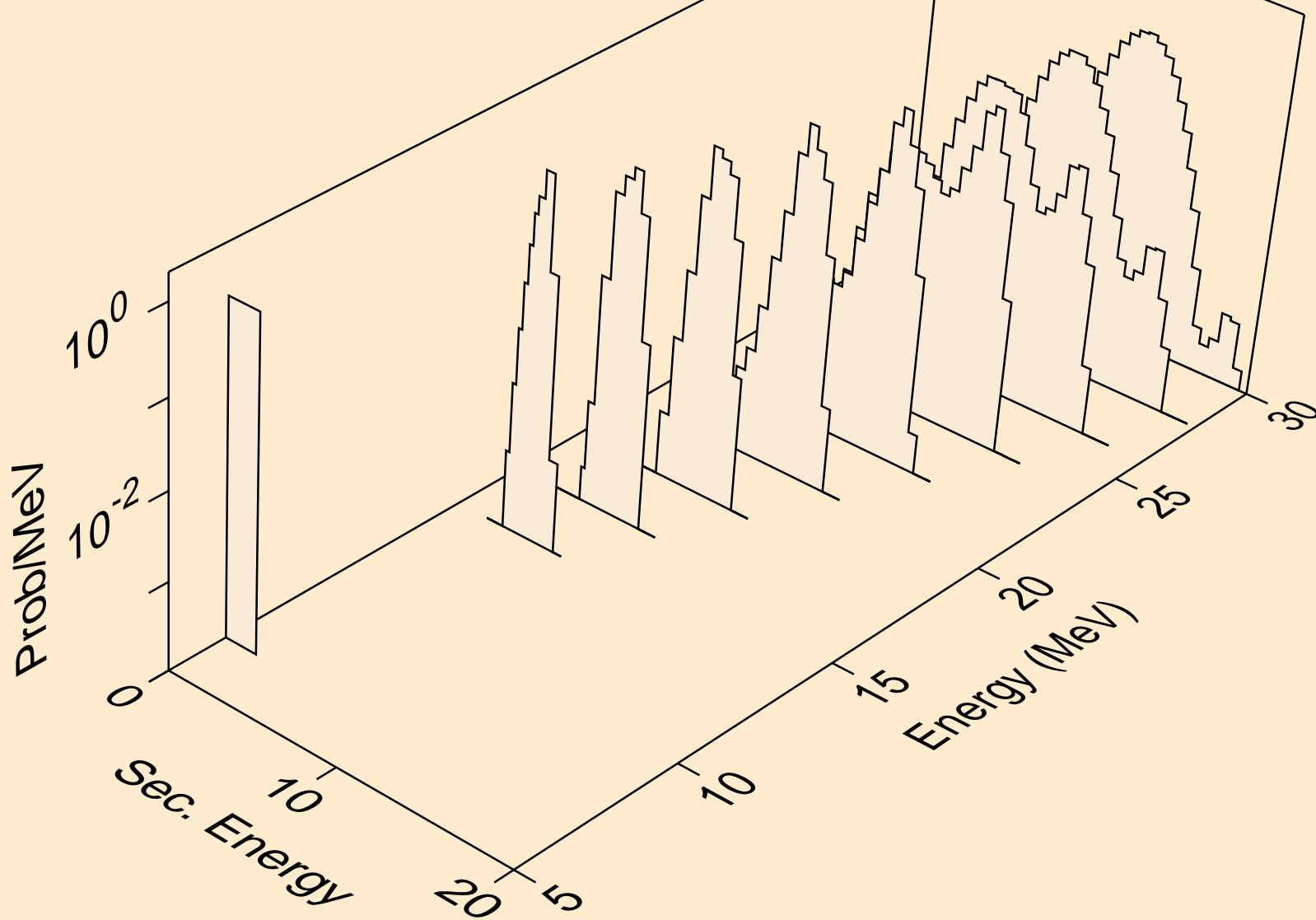

TH224 NEUTRON ACER TENDL-2023 LIBRARY; T=0.K  
deuterons from (n,da)

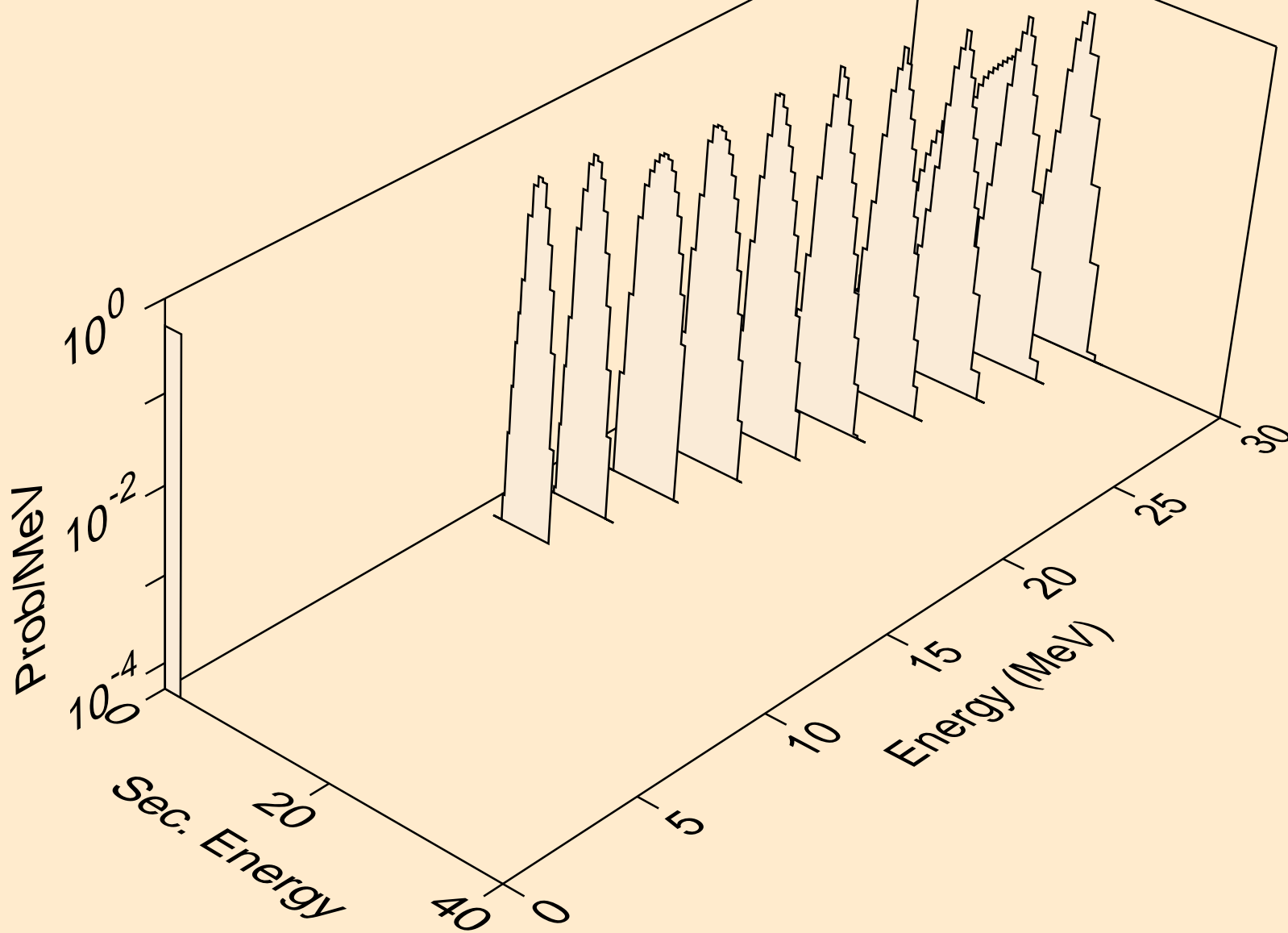

TH224 NEUTRON ACER TENDL-2023 LIBRARY; T=0.K  
tritons from (n,x)

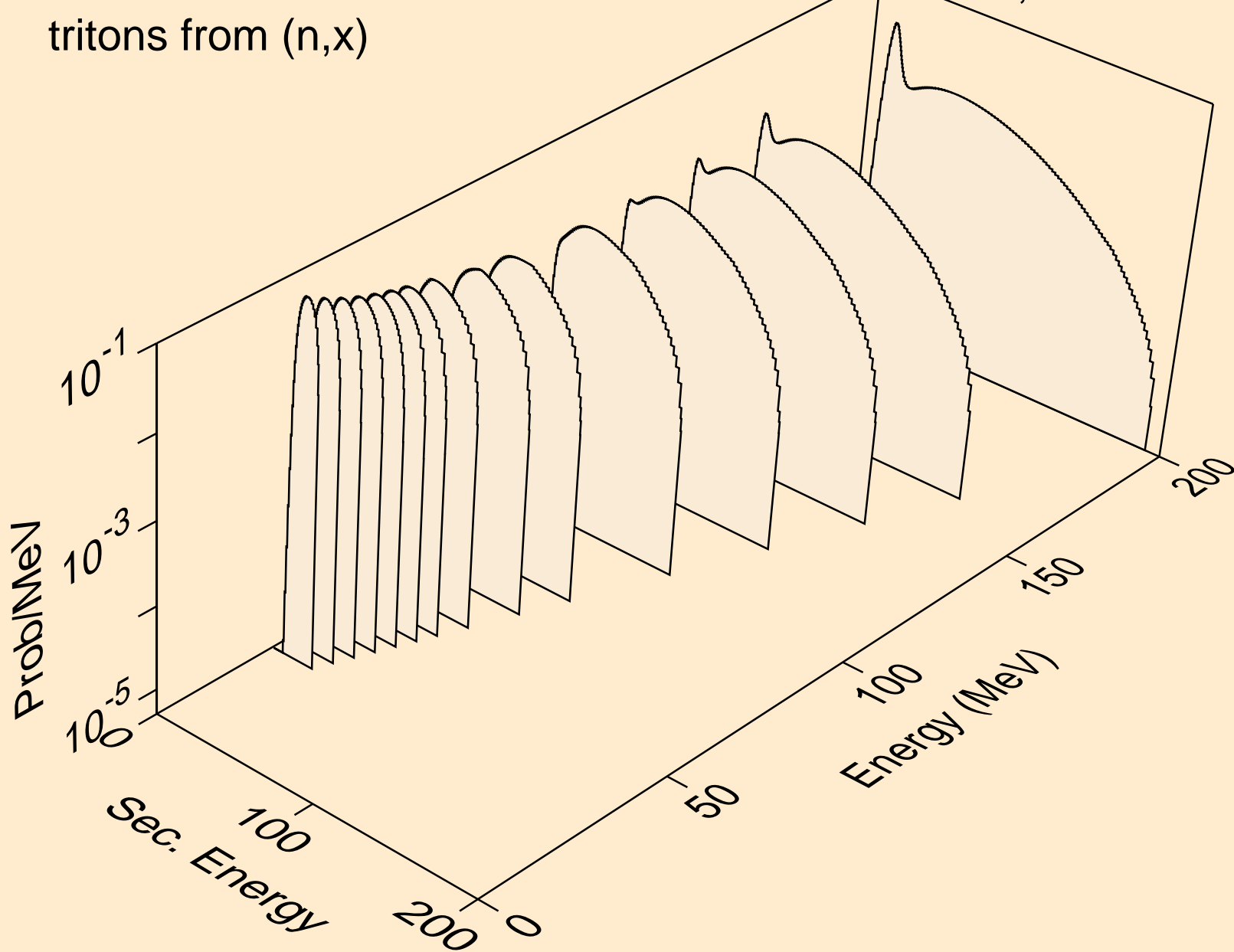

TH224 NEUTRON ACER TENDL-2023 LIBRARY; T=0.K  
tritons from (n,n\*)t

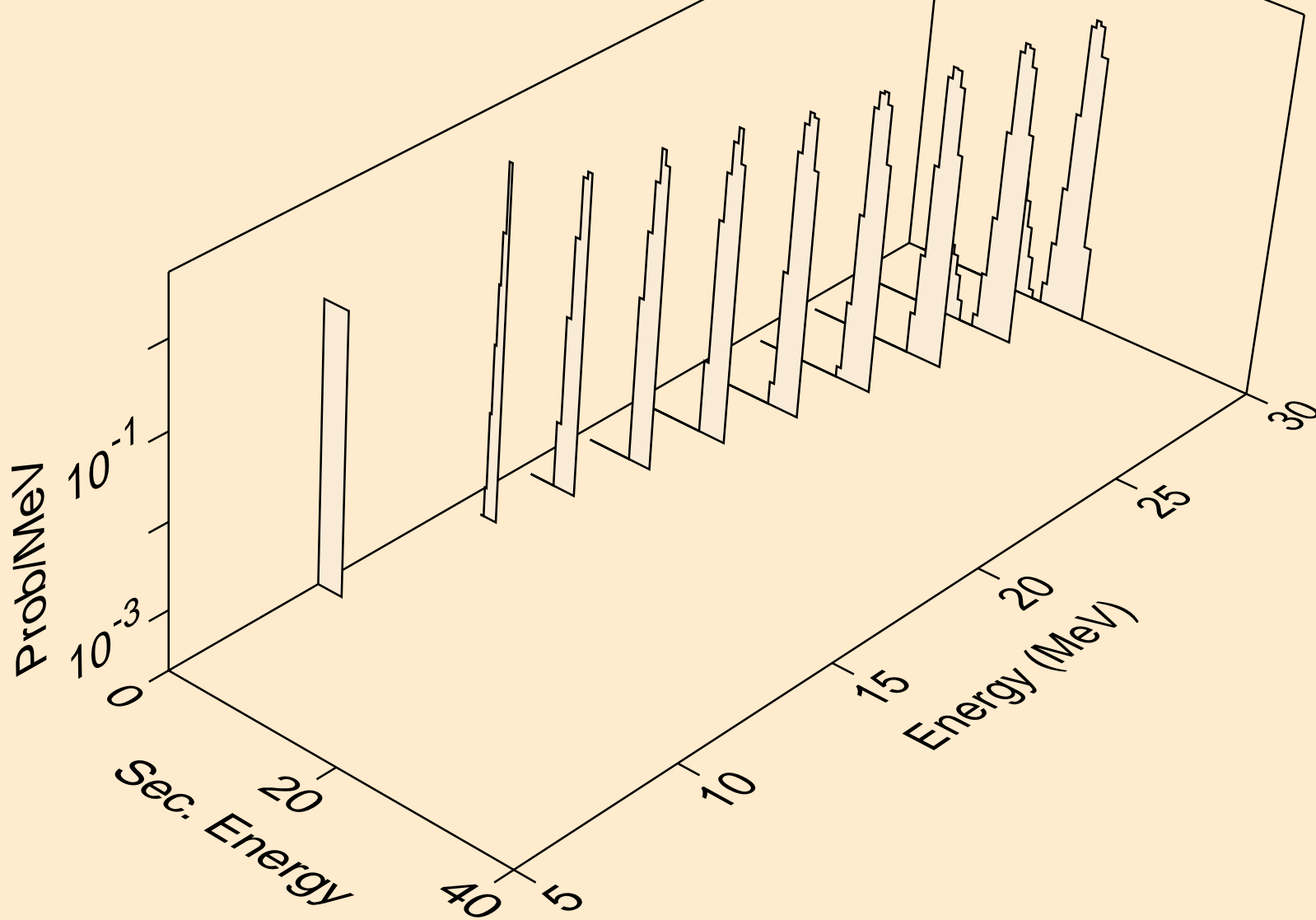

TH224 NEUTRON ACER TENDL-2023 LIBRARY; T=0.K  
tritons from (n,t)

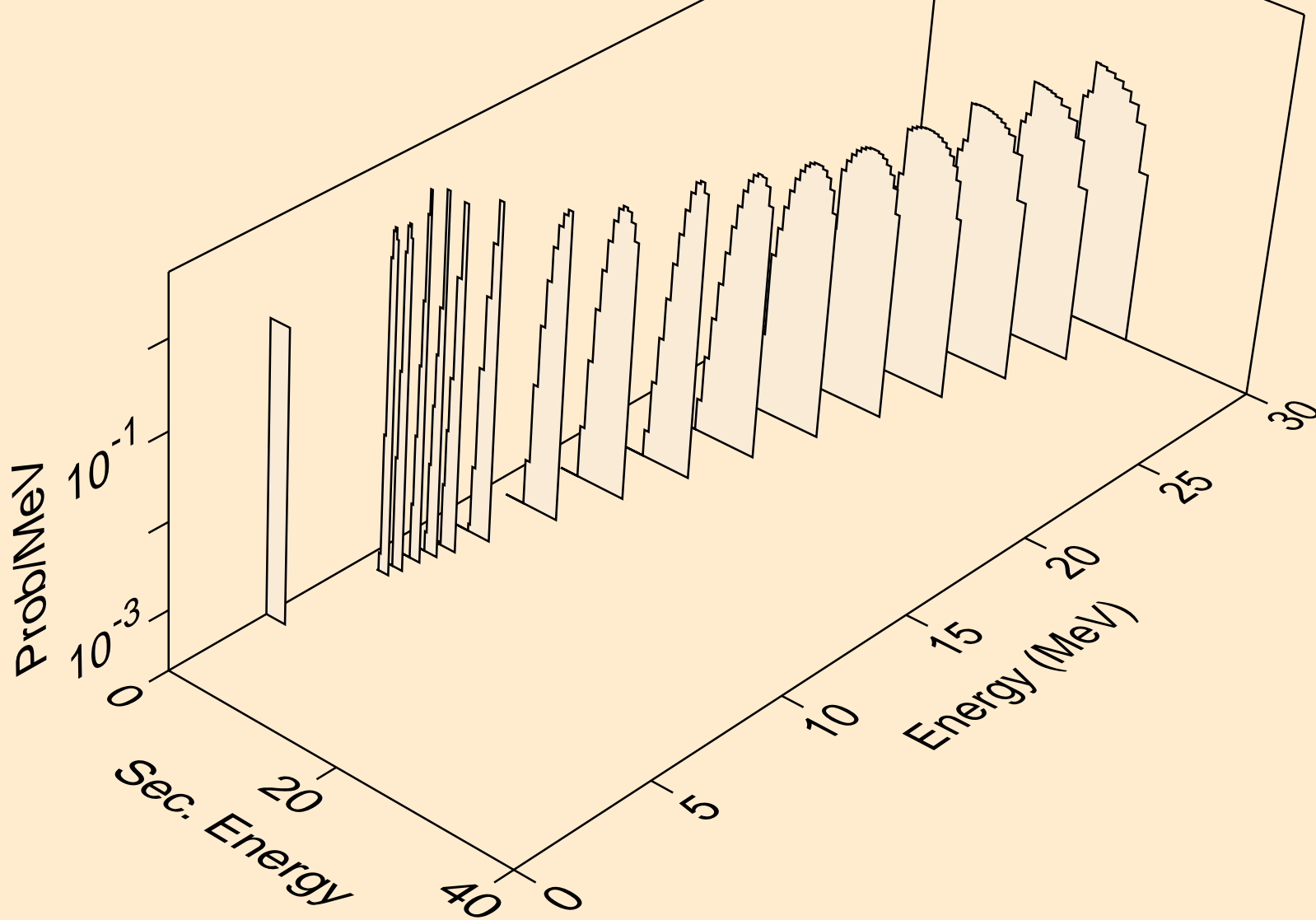

TH224 NEUTRON ACER TENDL-2023 LIBRARY; T=0.K  
tritons from (n,pt)

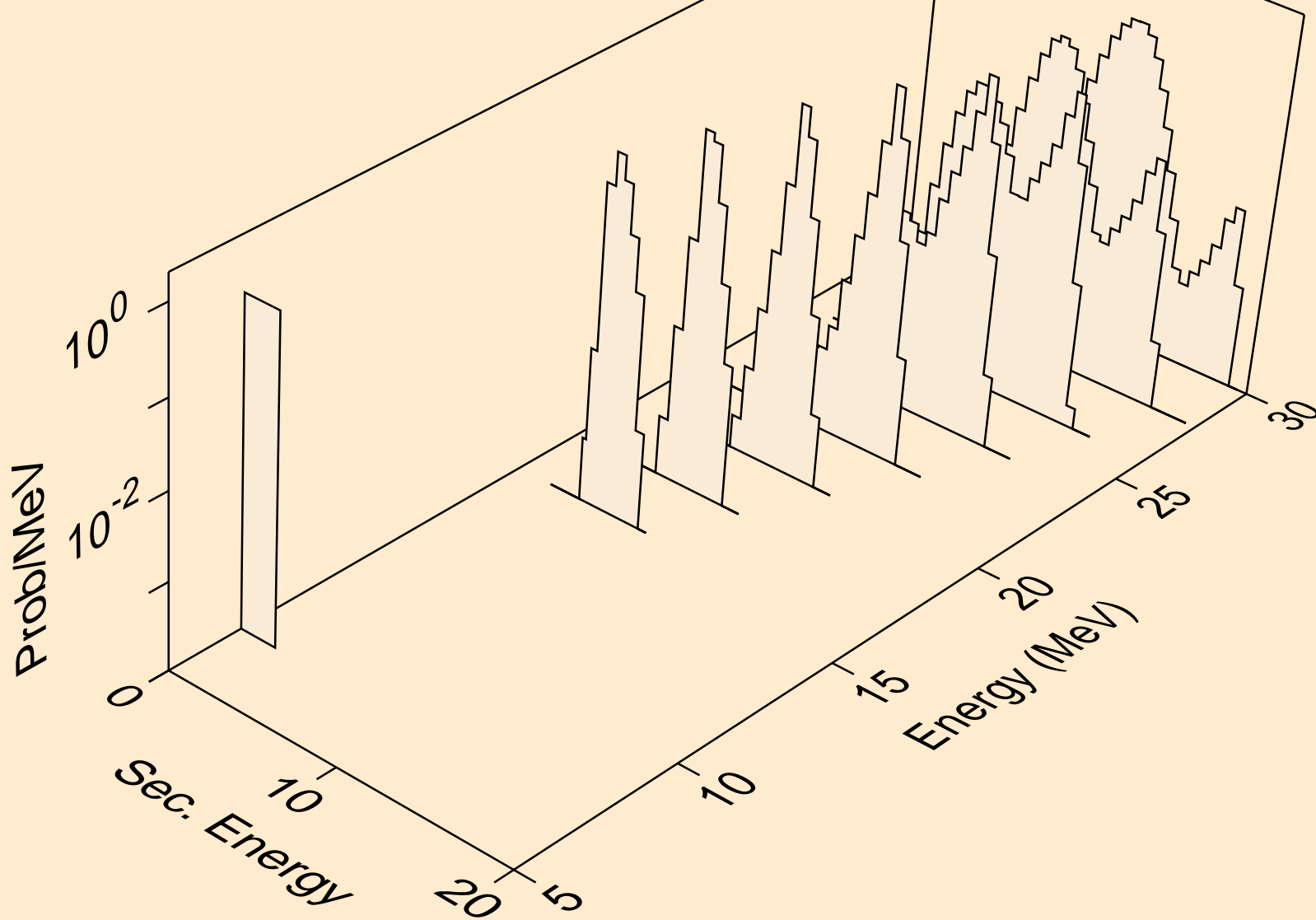

TH224 NEUTRON ACER TENDL-2023 LIBRARY; T=0.K  
he3s from (n,x)

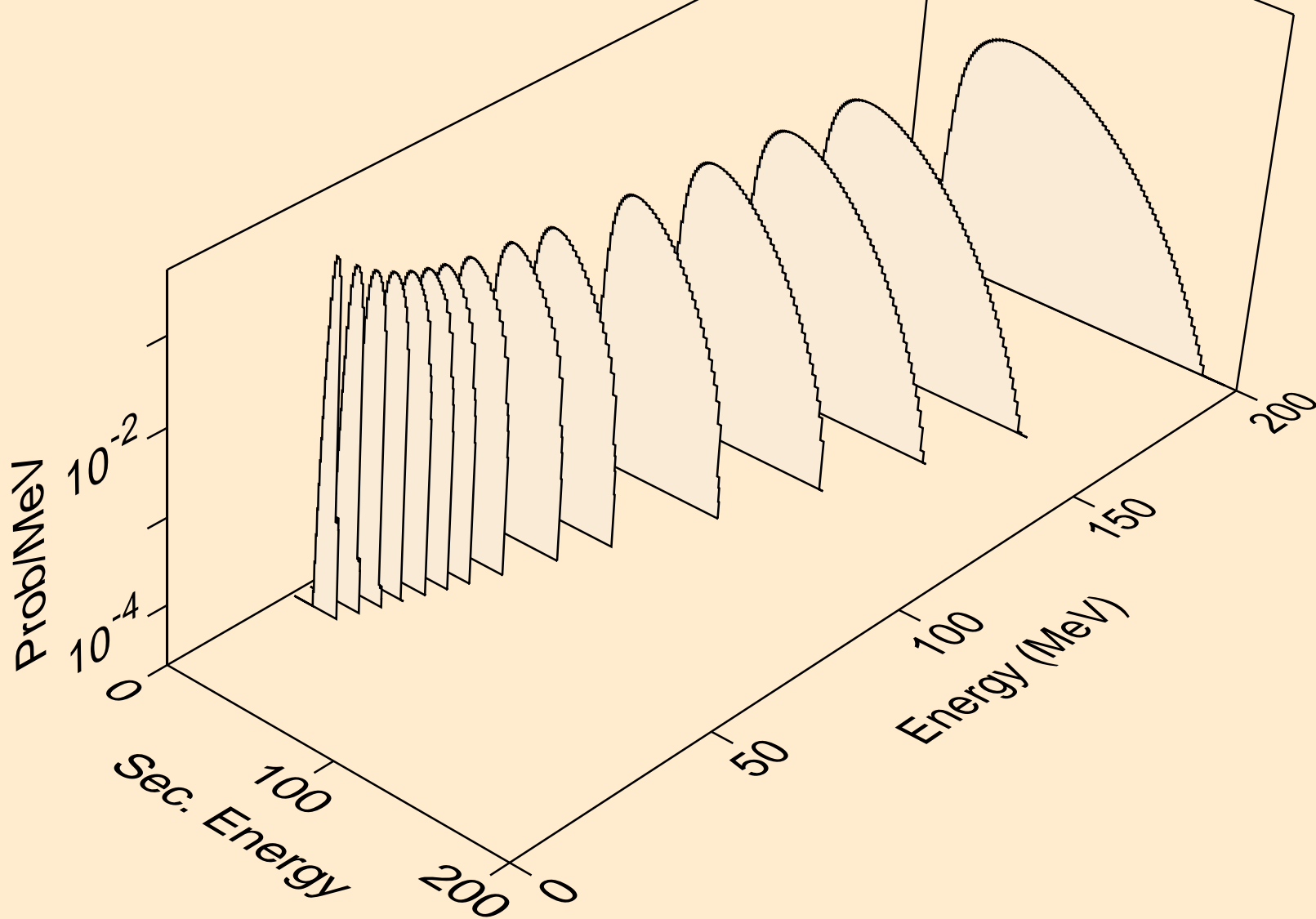

TH224 NEUTRON ACER TENDL-2023 LIBRARY; T=0.K  
he3s from (n,n\*)he3

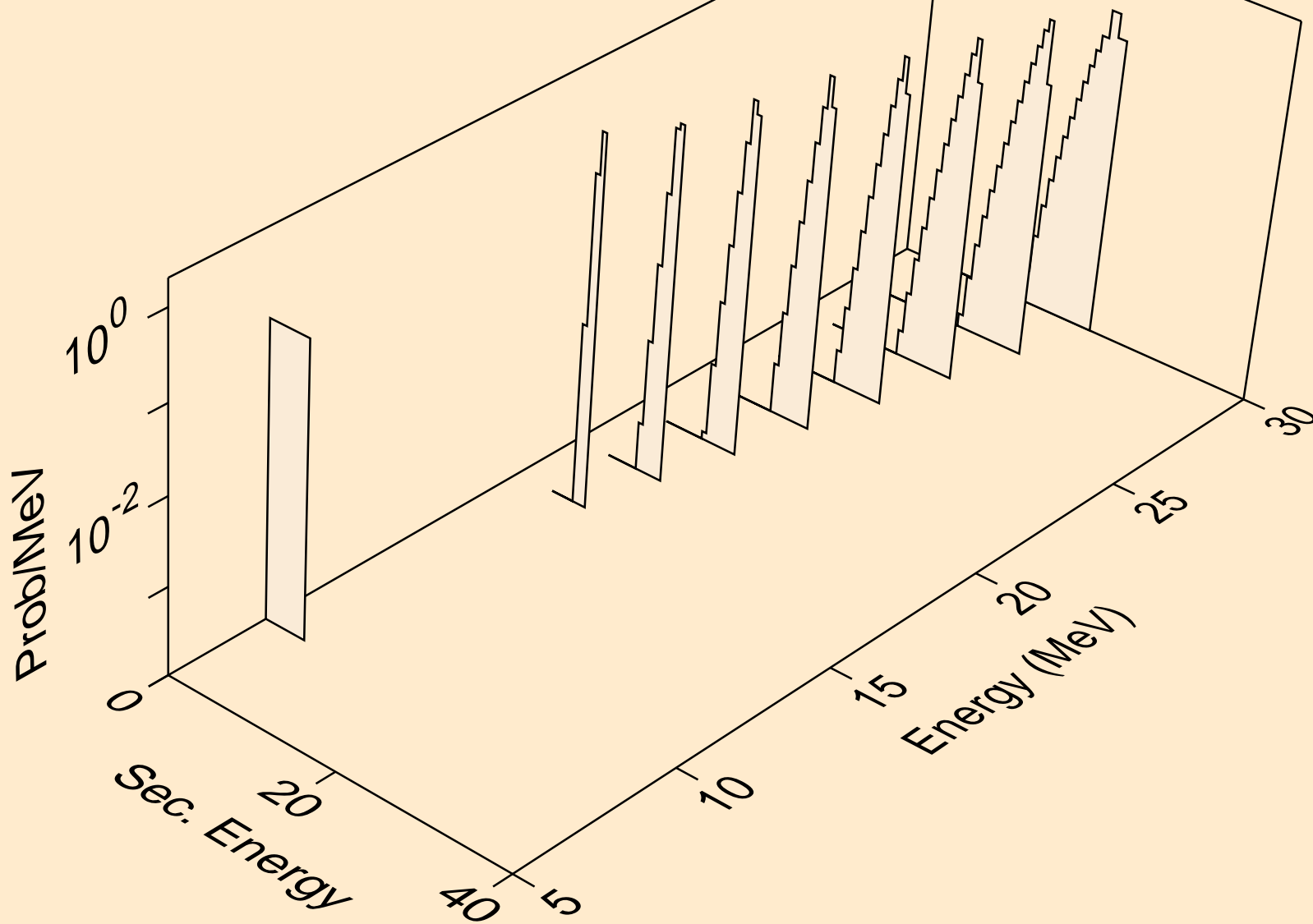

TH224 NEUTRON ACER TENDL-2023 LIBRARY; T=0.K  
he3s from (n,he3)

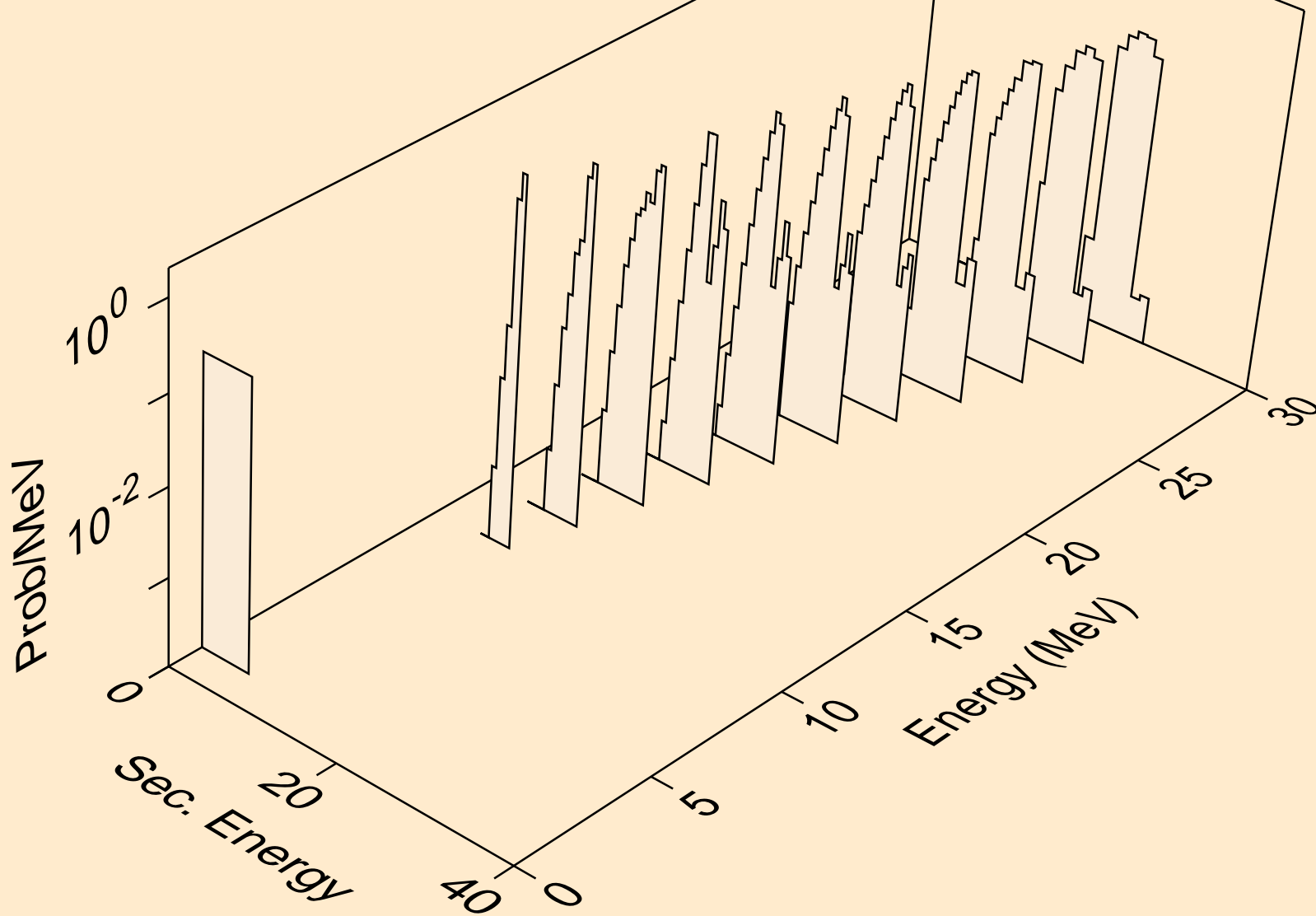

TH224 NEUTRON ACER TENDL-2023 LIBRARY; T=0.K  
alphas from (n,x)

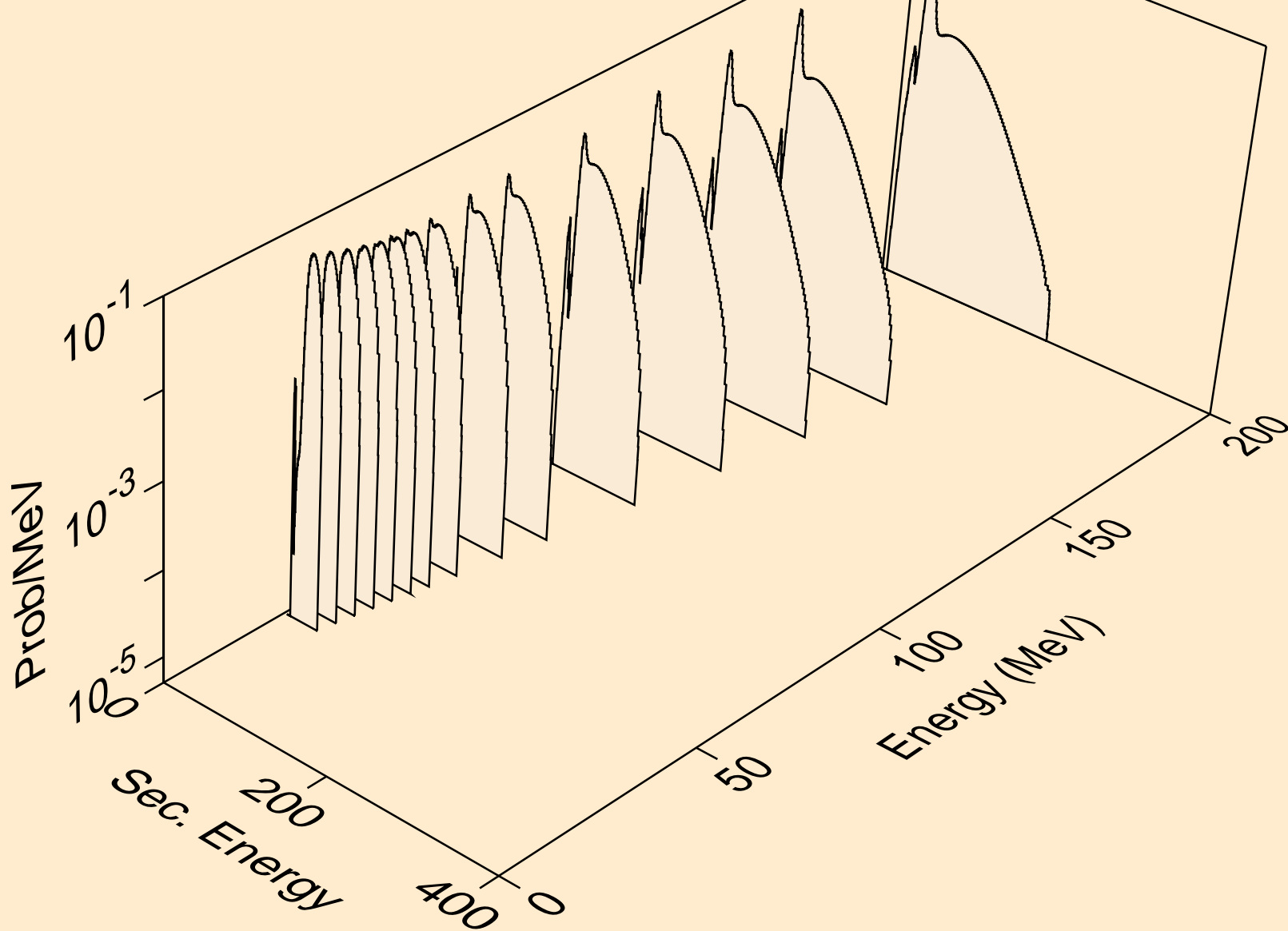

TH224 NEUTRON ACER TENDL-2023 LIBRARY; T=0.K  
alphas from (n,n\*)a

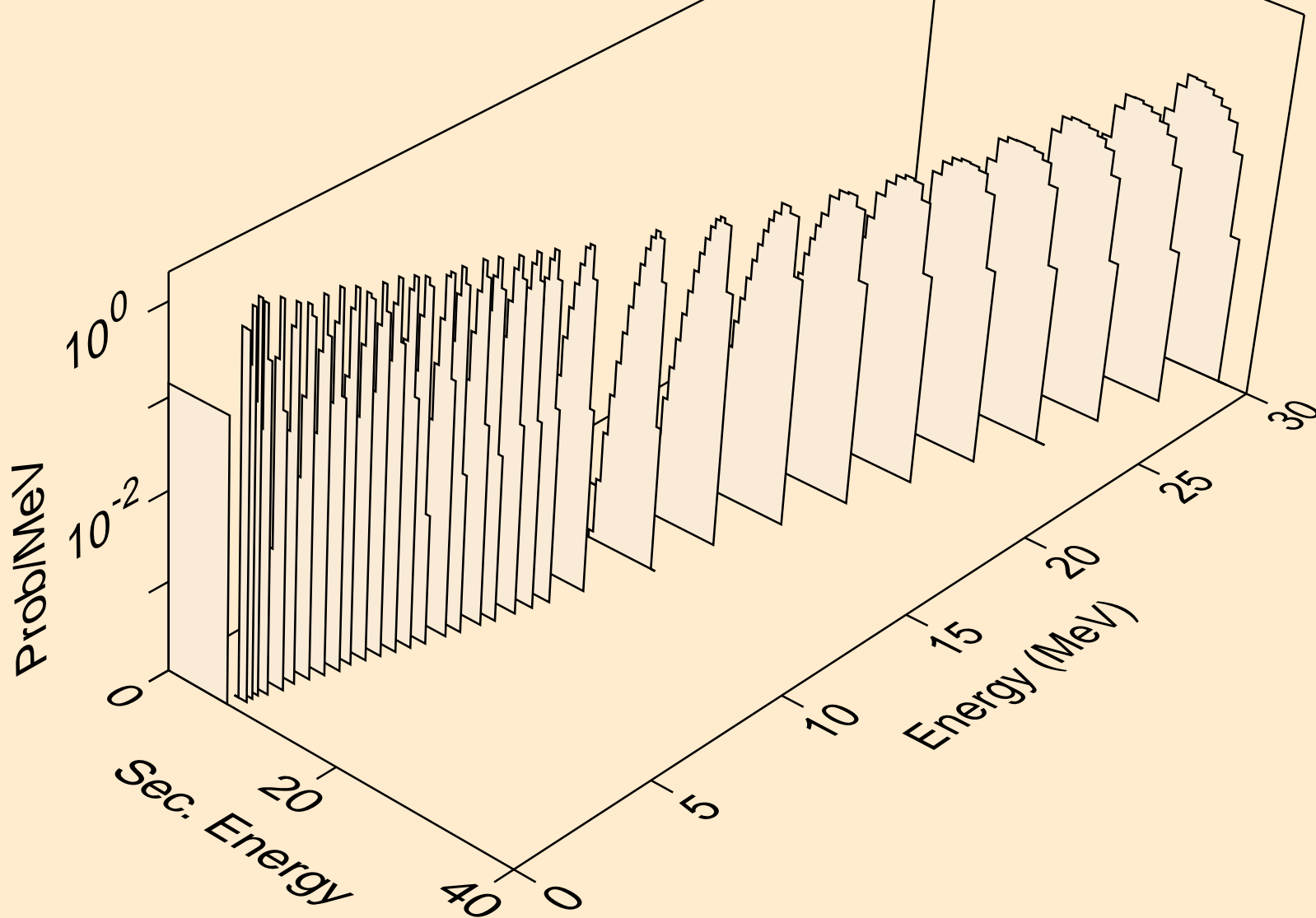

TH224 NEUTRON ACER TENDL-2023 LIBRARY; T=0.K  
alphas from (n,n\*)3a

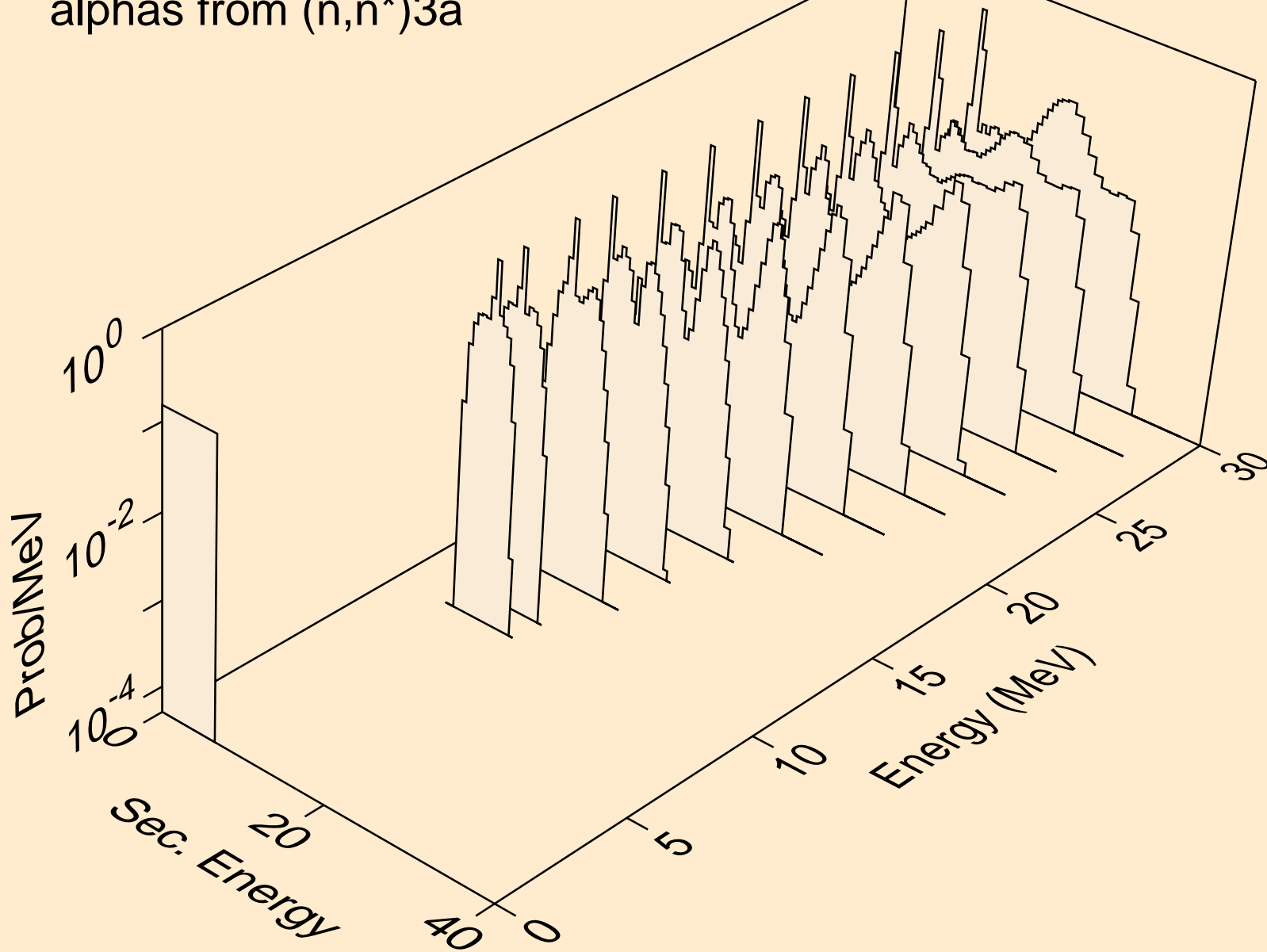

TH224 NEUTRON ACER TENDL-2023 LIBRARY; T=0.K  
alphas from (n,2n)a

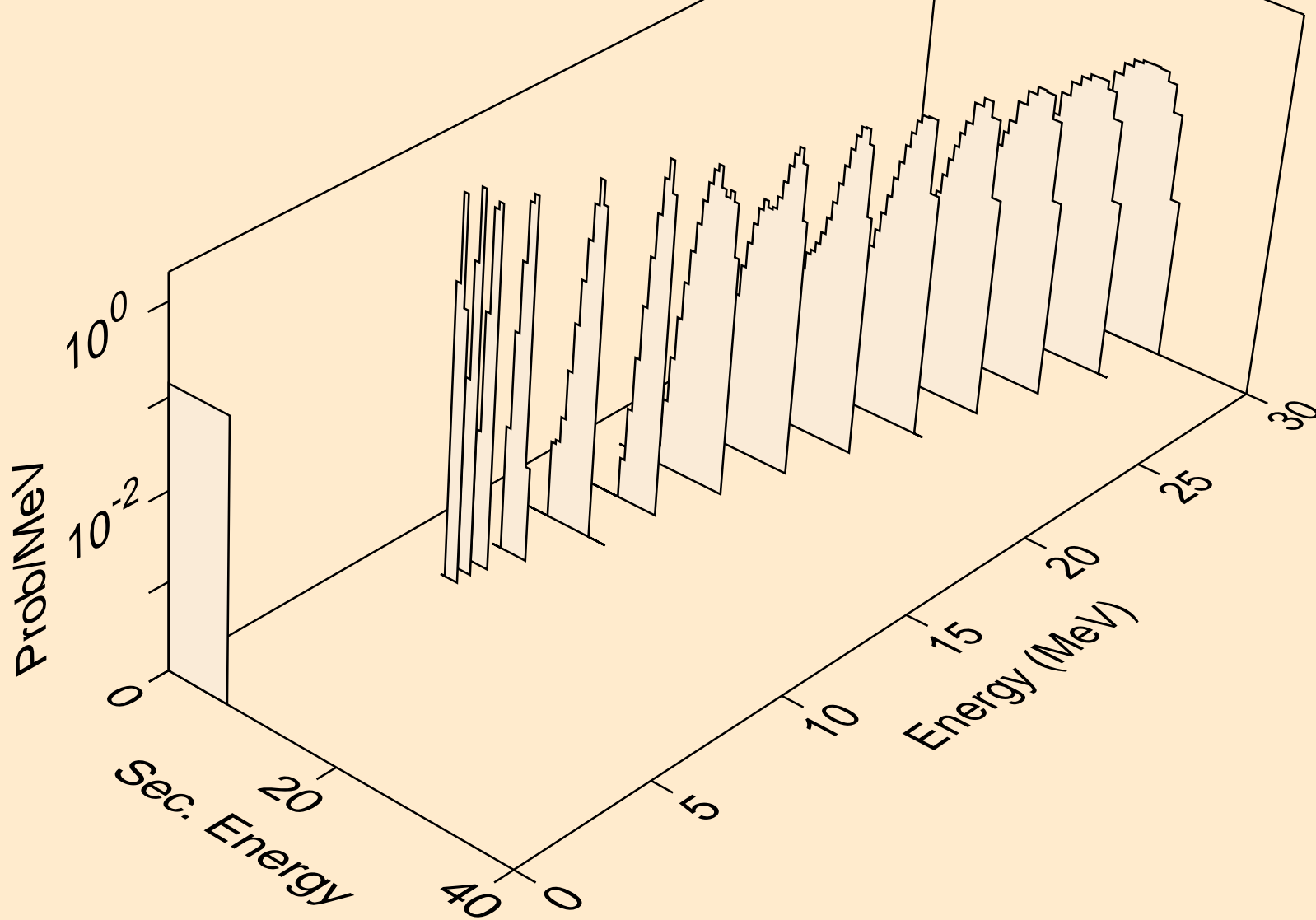

TH224 NEUTRON ACER TENDL-2023 LIBRARY; T=0.K  
alphas from (n,3n)a

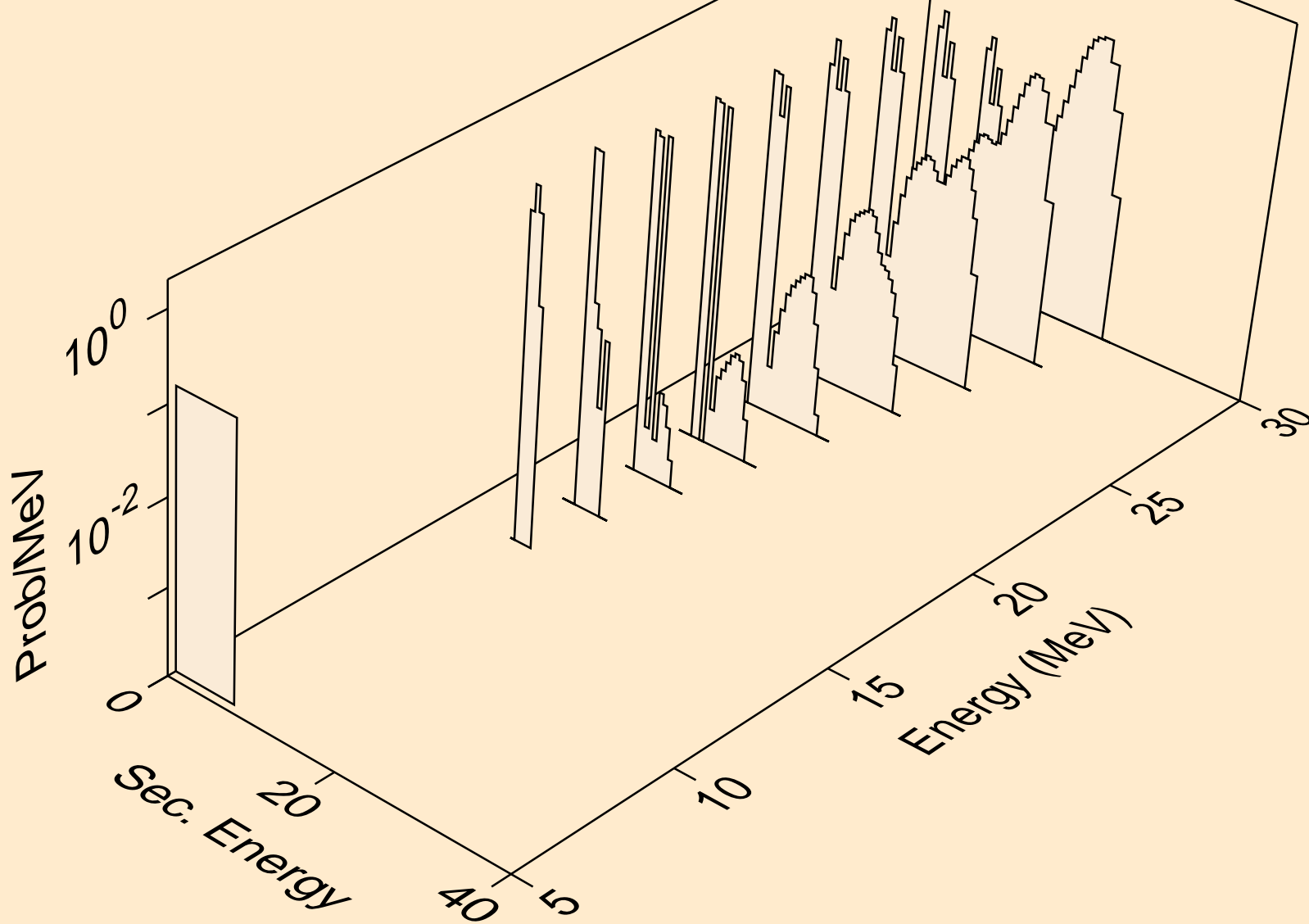

TH224 NEUTRON ACER TENDL-2023 LIBRARY; T=0.K  
alphas from (n,n\*)2a

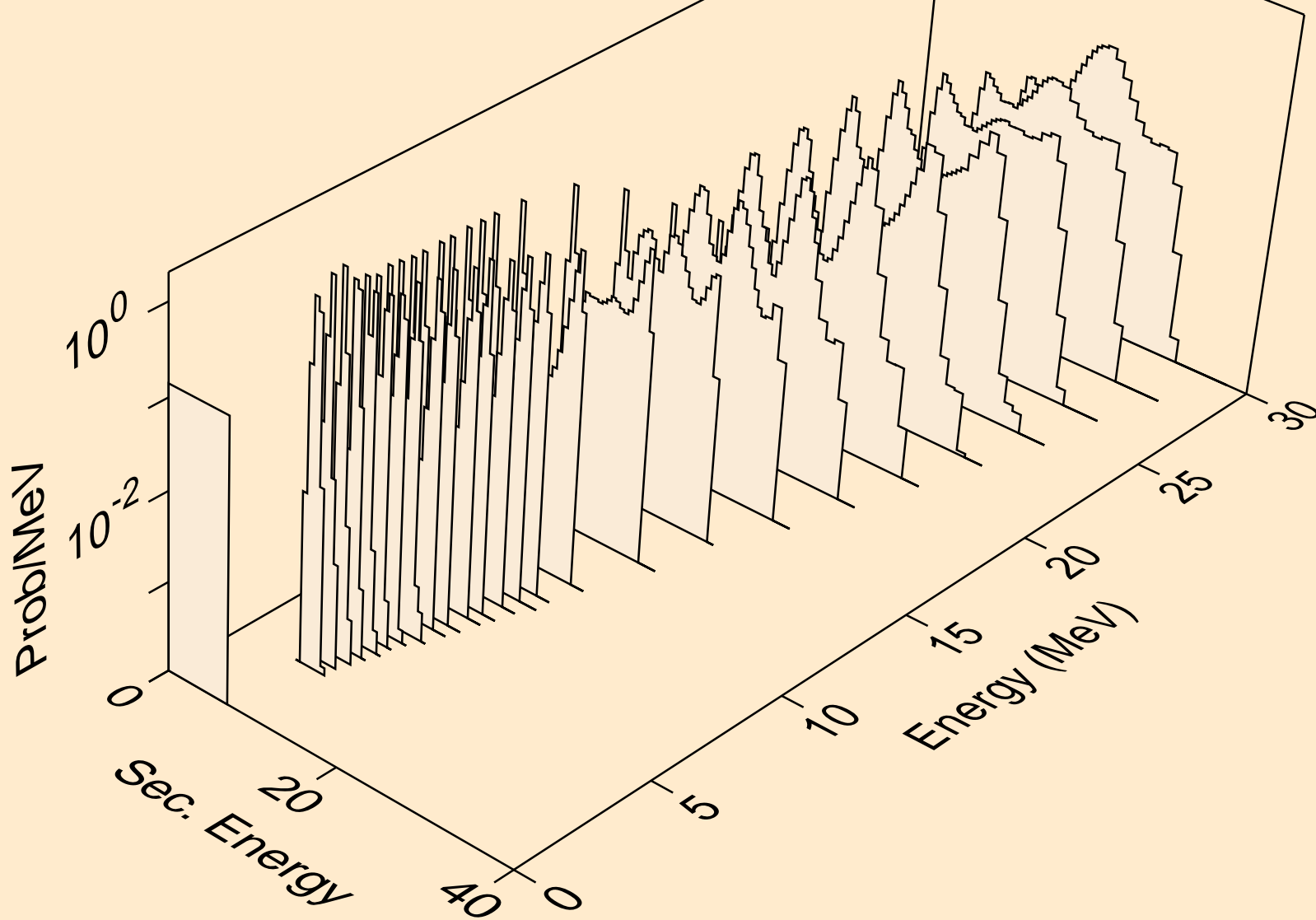

TH224 NEUTRON ACER TENDL-2023 LIBRARY; T=0.K  
alphas from (n,2n)2a

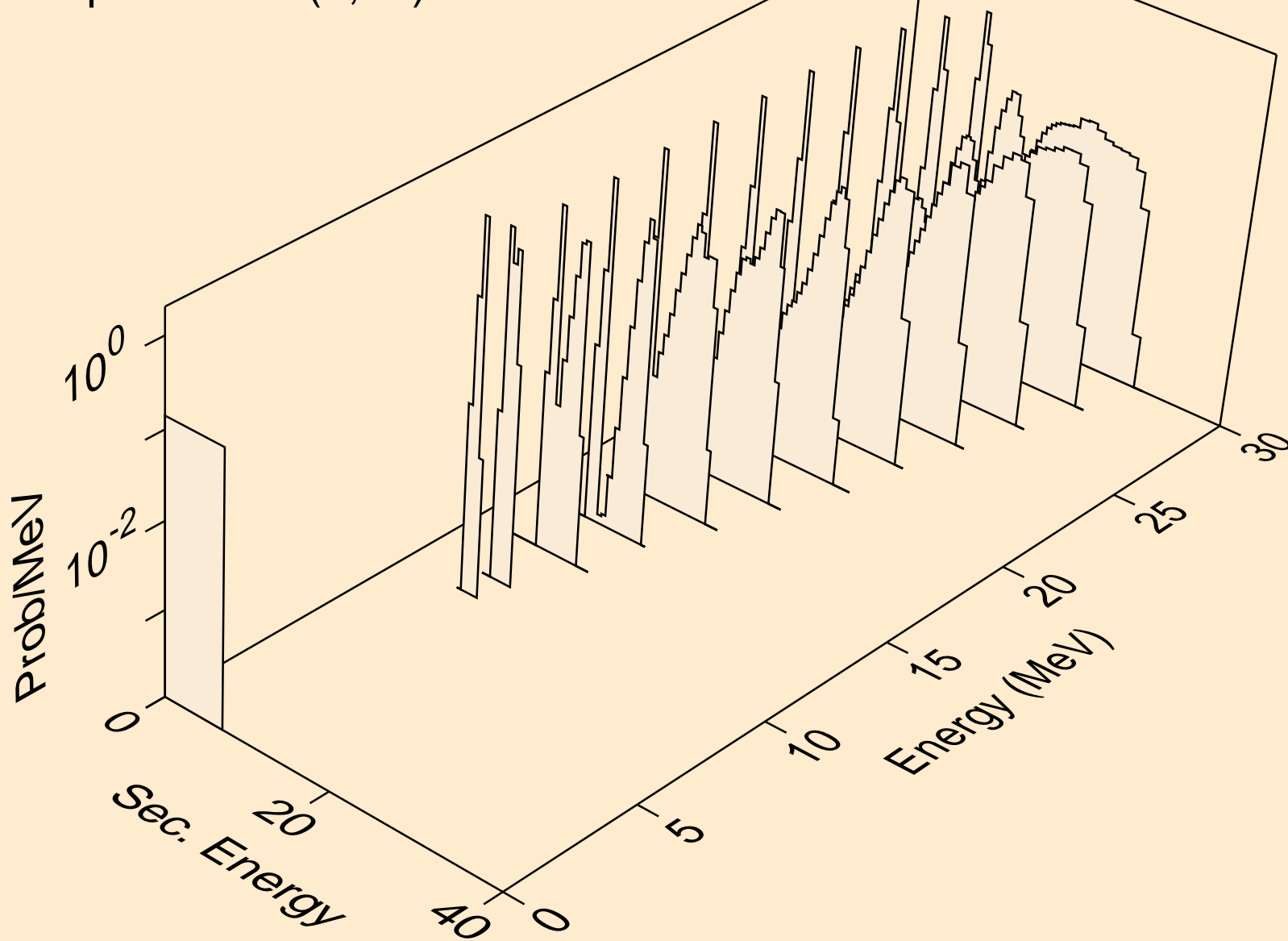

TH224 NEUTRON ACER TENDL-2023 LIBRARY; T=0.K  
alphas from (n,npa)

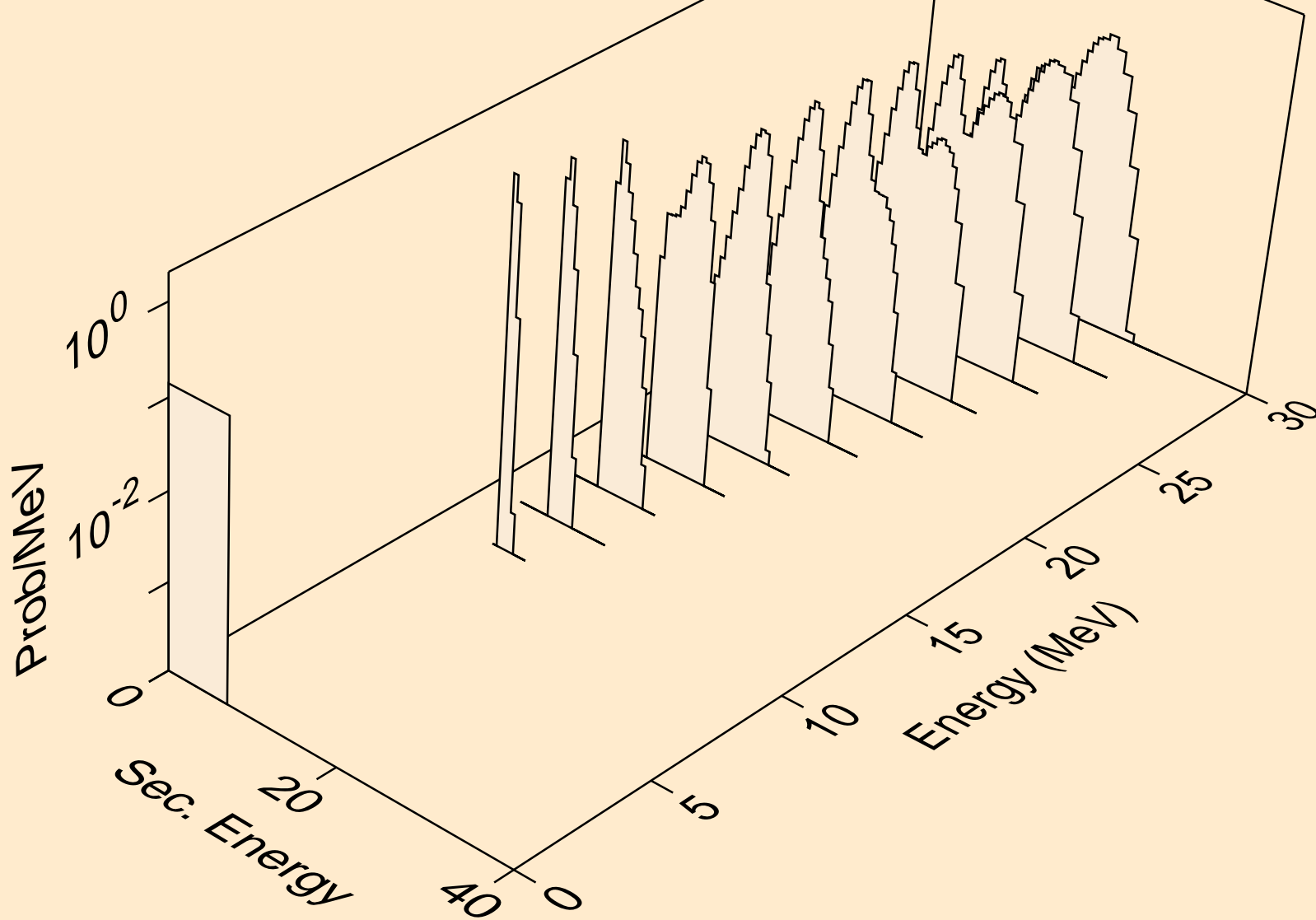

TH224 NEUTRON ACER TENDL-2023 LIBRARY; T=0.K  
alphas from (n,a)

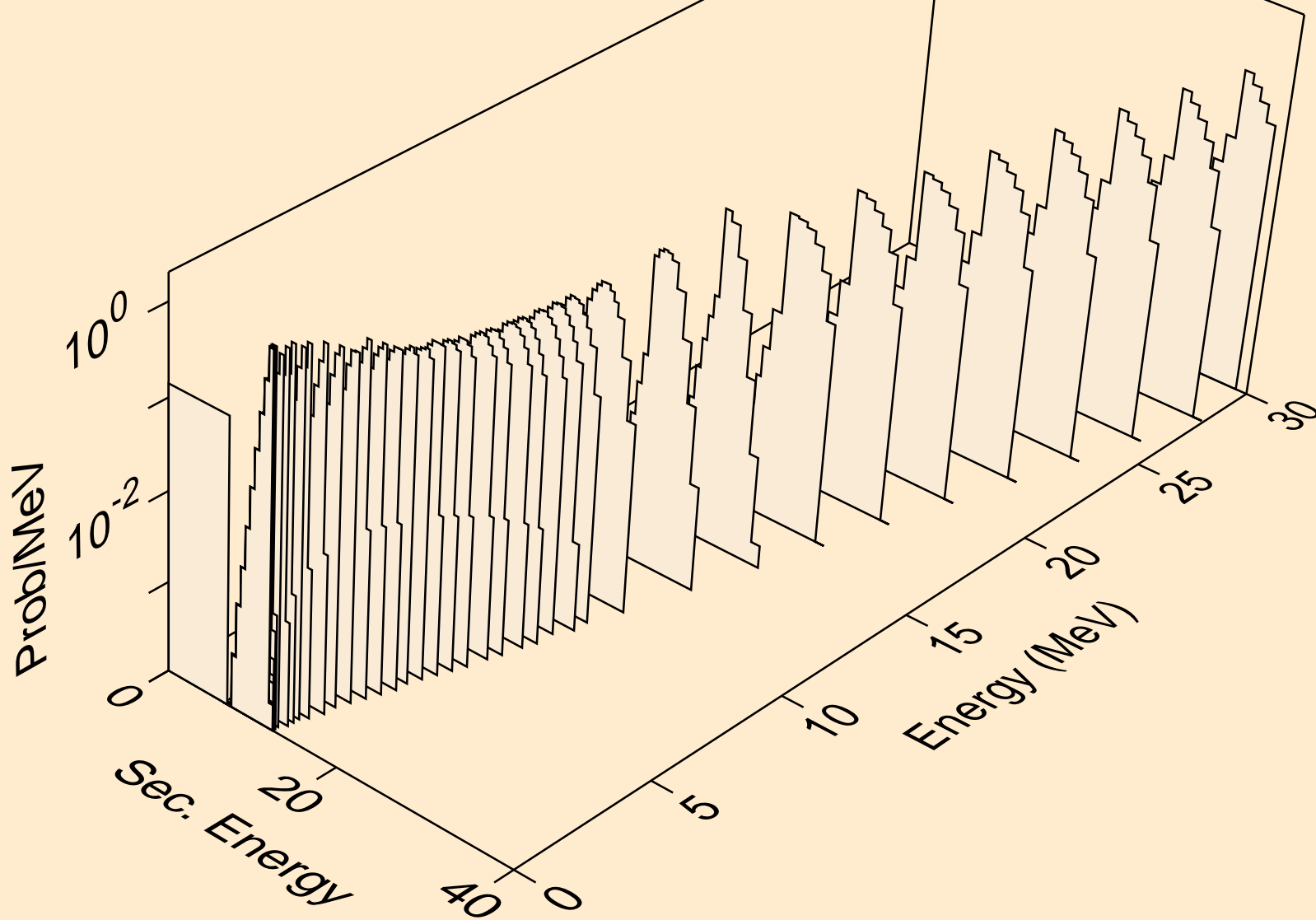

TH224 NEUTRON ACER TENDL-2023 LIBRARY; T=0.K  
alphas from (n,2a)

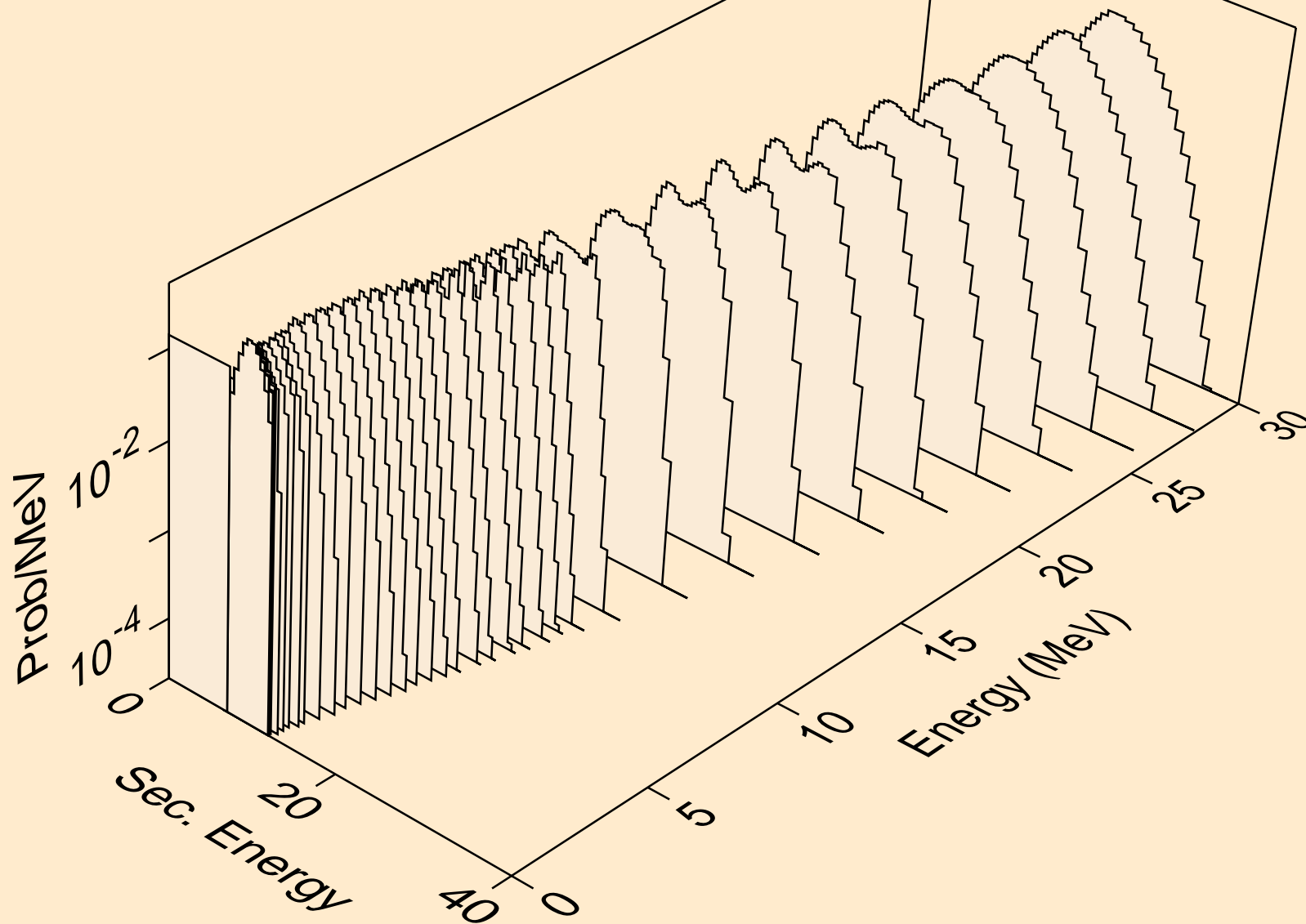

TH224 NEUTRON ACER TENDL-2023 LIBRARY; T=0.K  
alphas from (n,pa)

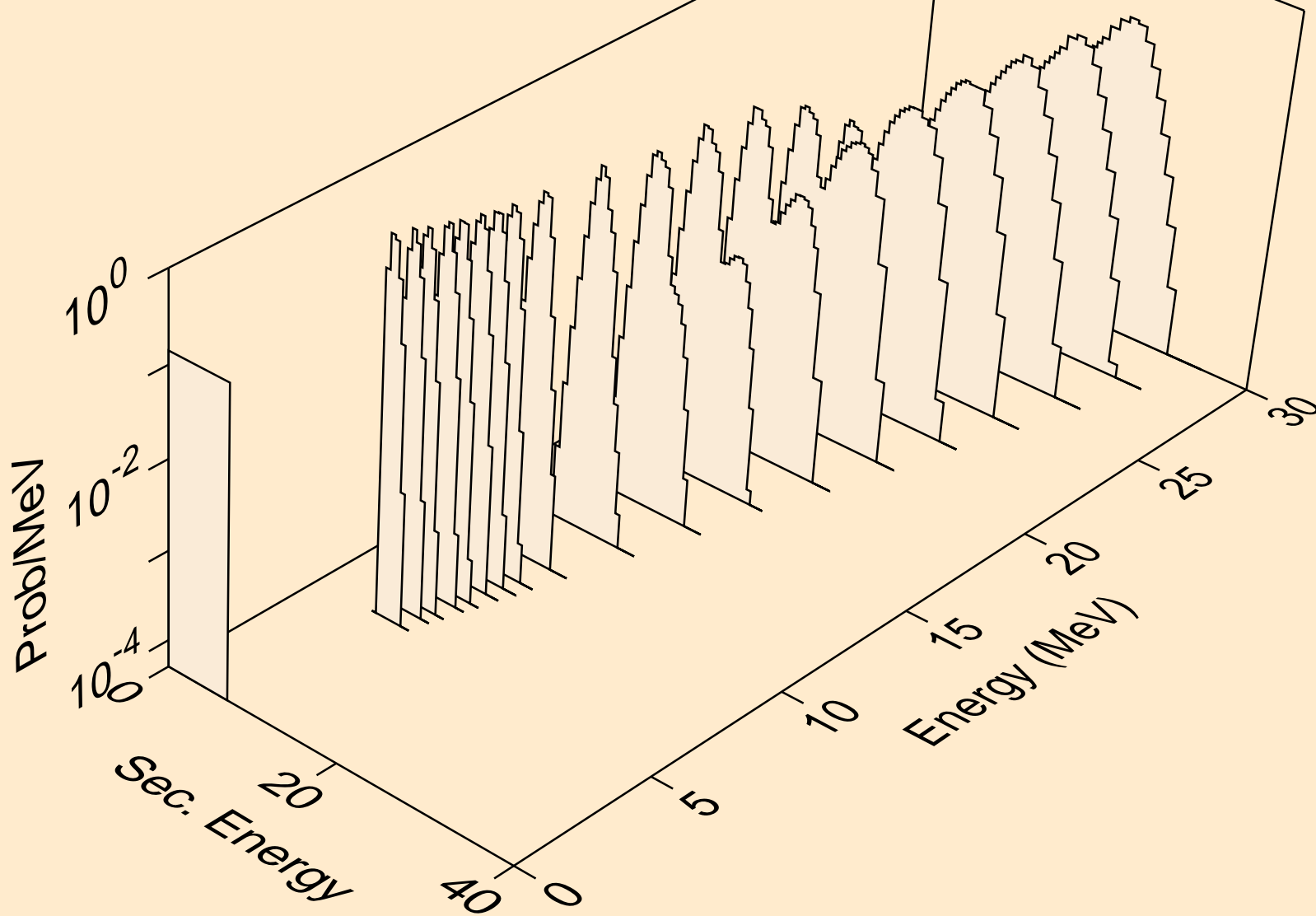

TH224 NEUTRON ACER TENDL-2023 LIBRARY; T=0.K  
alphas from (n,da)

