

TL185 NEUTRON ACER TENDL-2023 LIBRARY; T=0.K  
Principal cross sections

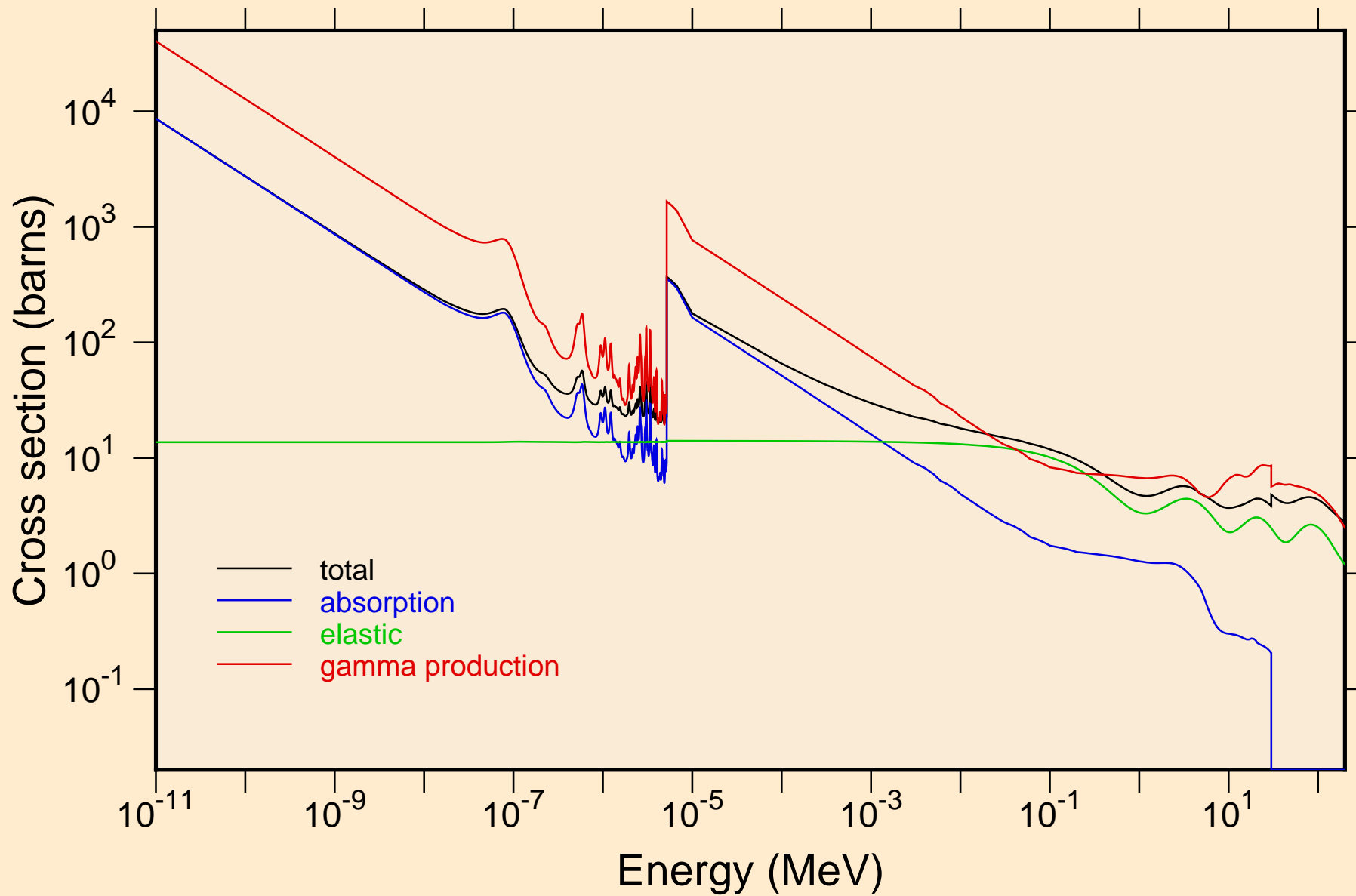

TL185 NEUTRON ACER TENDL-2023 LIBRARY; T=0.K  
resonance total cross section

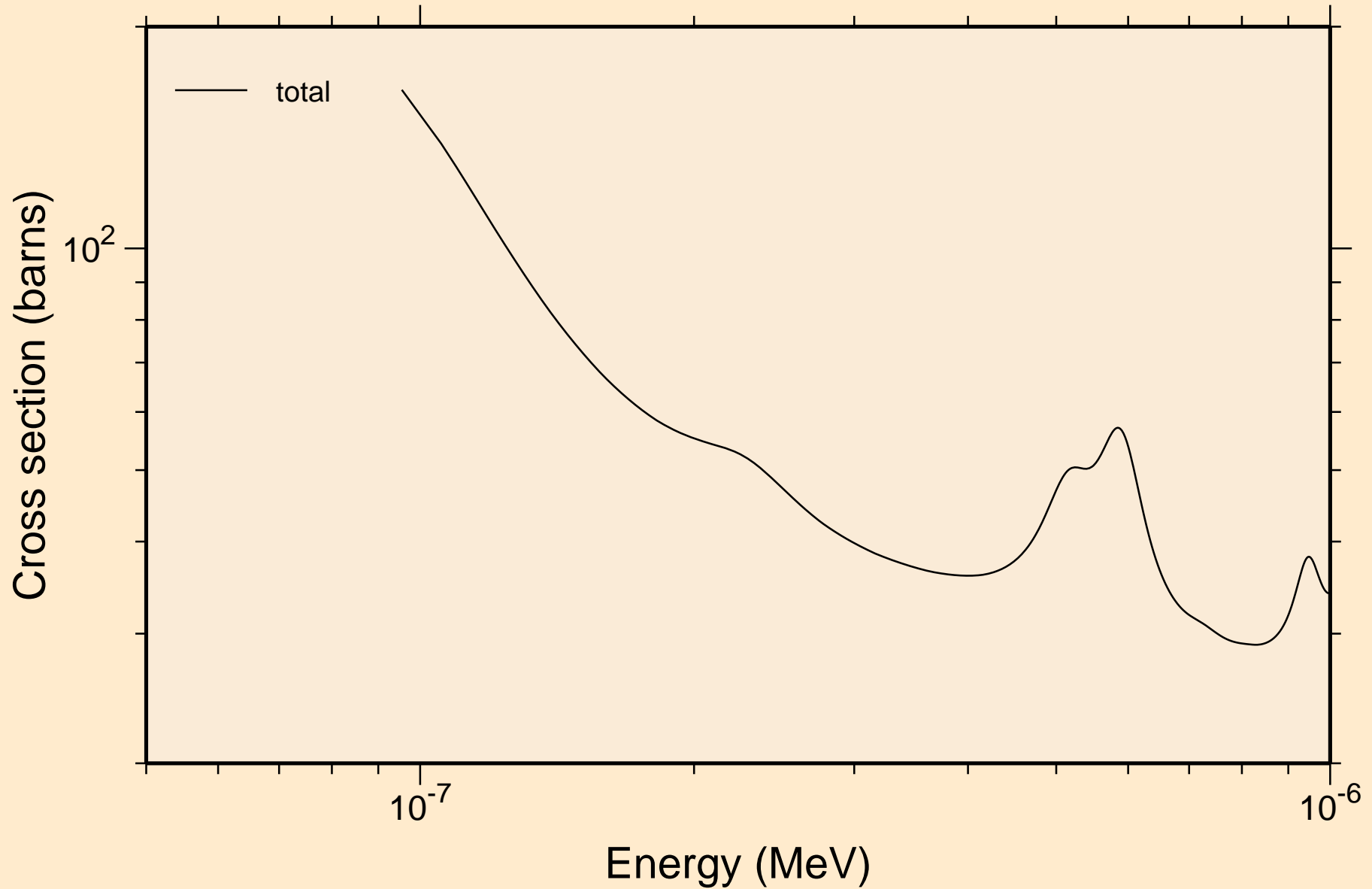

TL185 NEUTRON ACER TENDL-2023 LIBRARY; T=0.K  
resonance total cross section

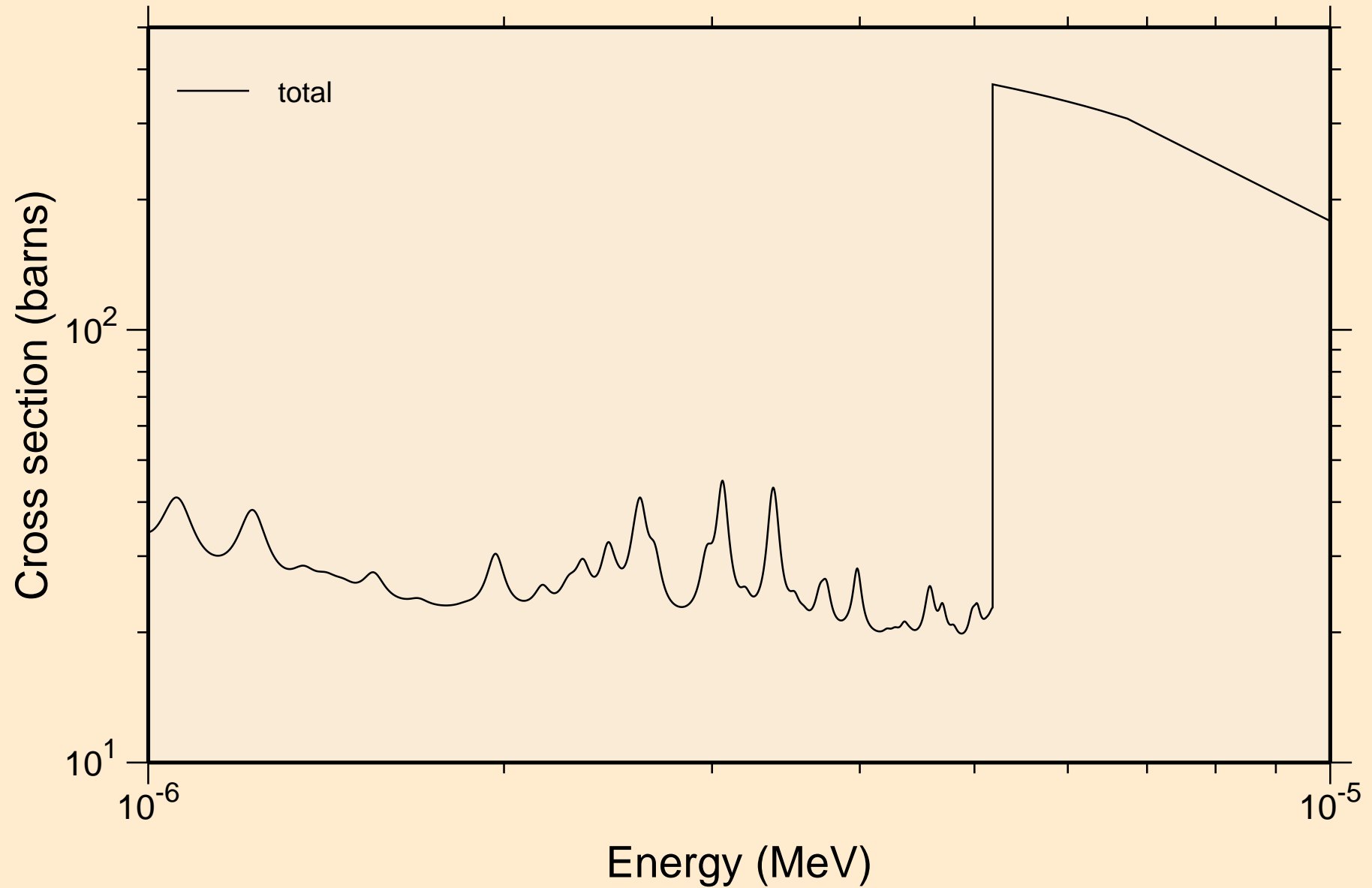

TL185 NEUTRON ACER TENDL-2023 LIBRARY; T=0.K  
resonance total cross section

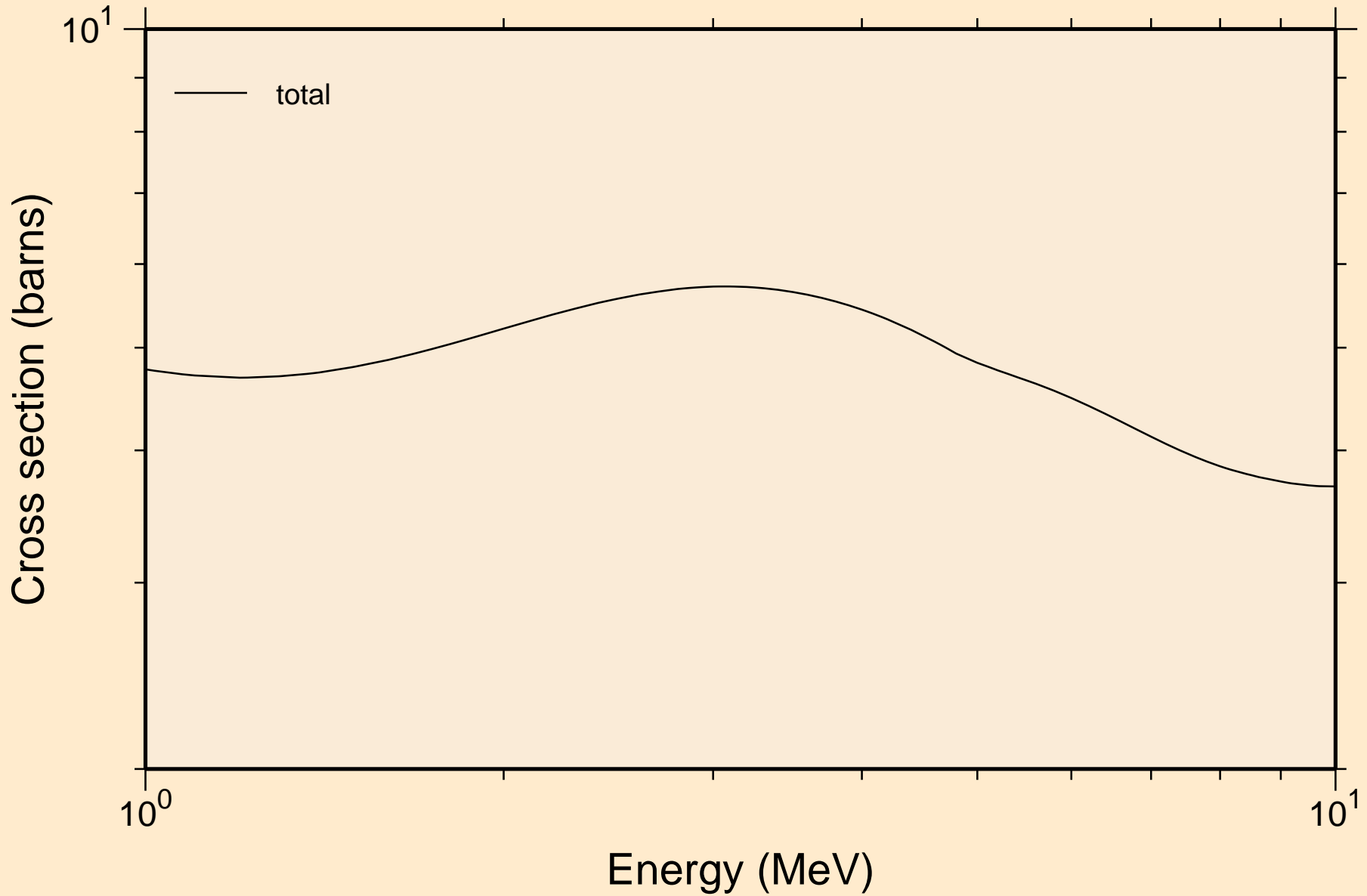

TL185 NEUTRON ACER TENDL-2023 LIBRARY; T=0.K  
resonance absorption cross sections

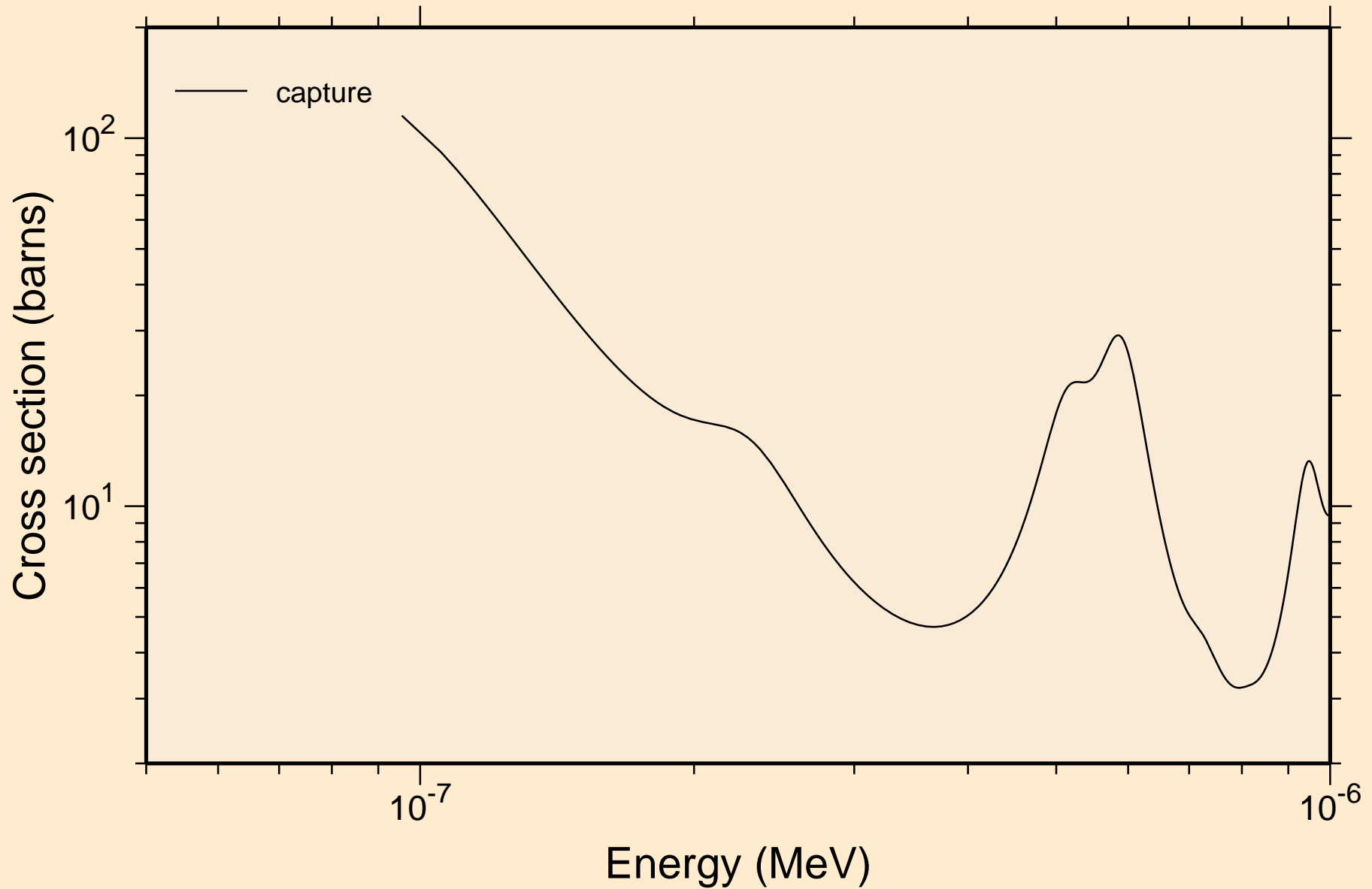

TL185 NEUTRON ACER TENDL-2023 LIBRARY; T=0.K  
resonance absorption cross sections

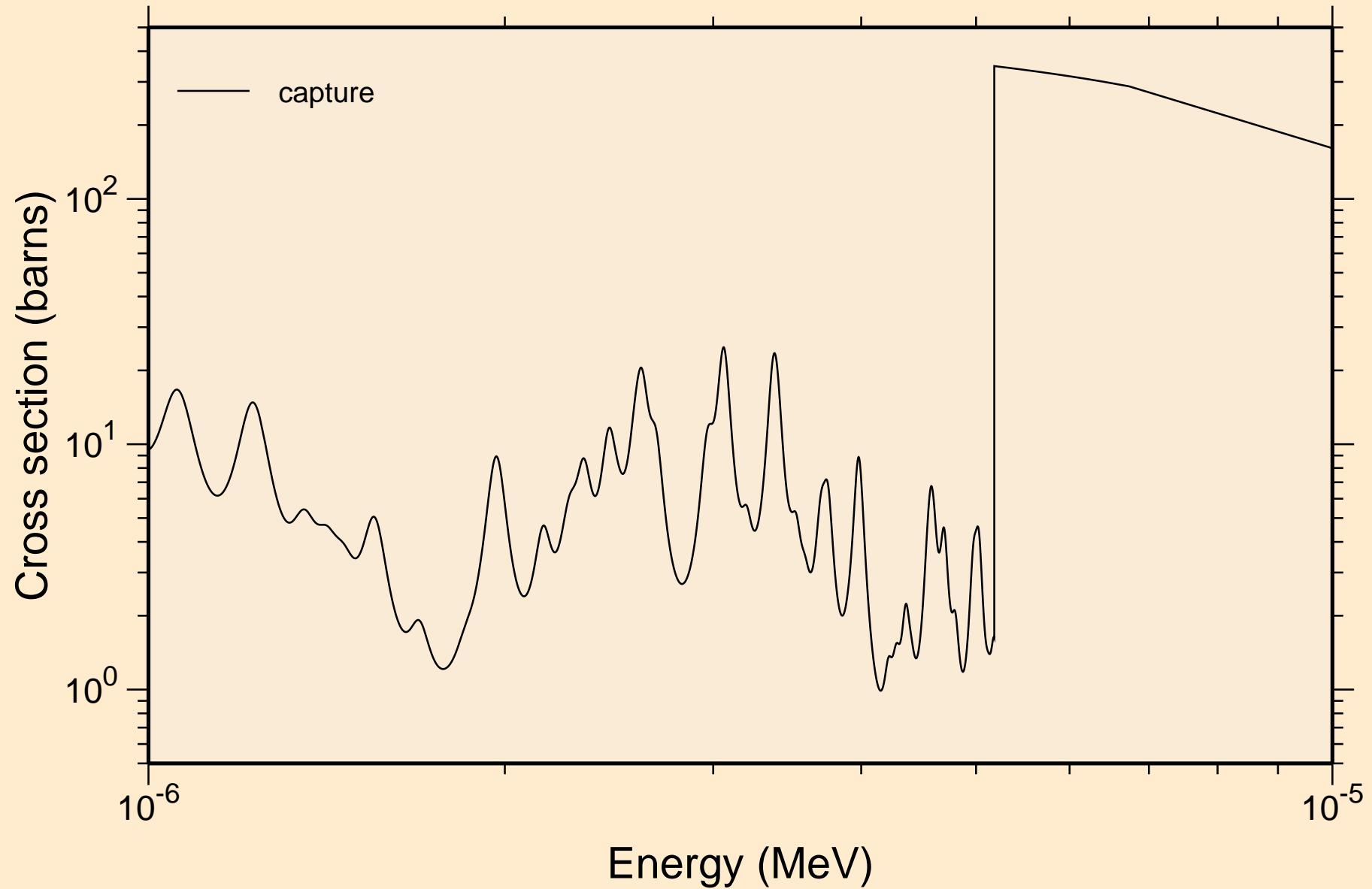

TL185 NEUTRON ACER TENDL-2023 LIBRARY; T=0.K  
resonance absorption cross sections

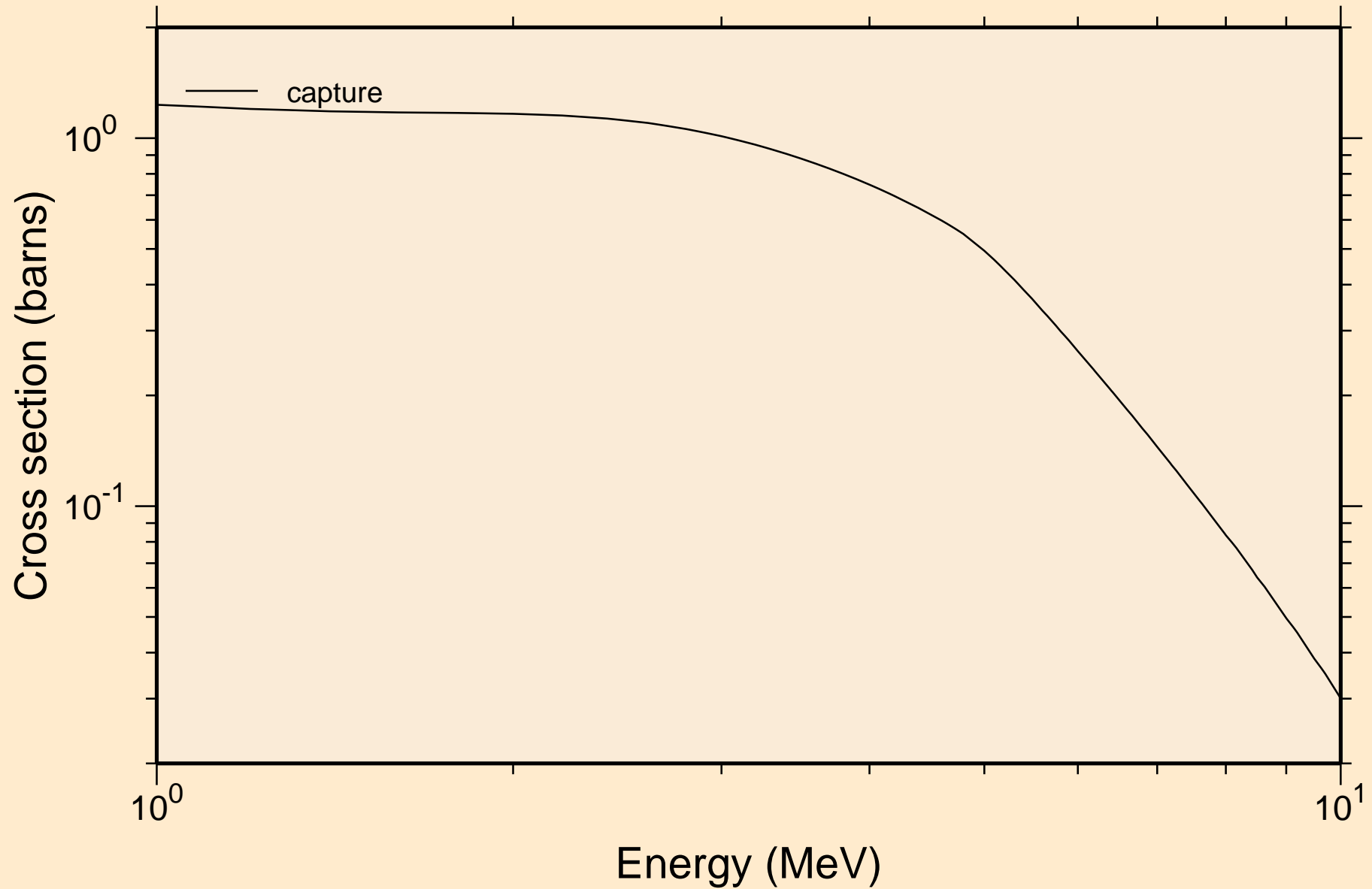

TL185 NEUTRON ACER TENDL-2023 LIBRARY; T=0.K

Heating

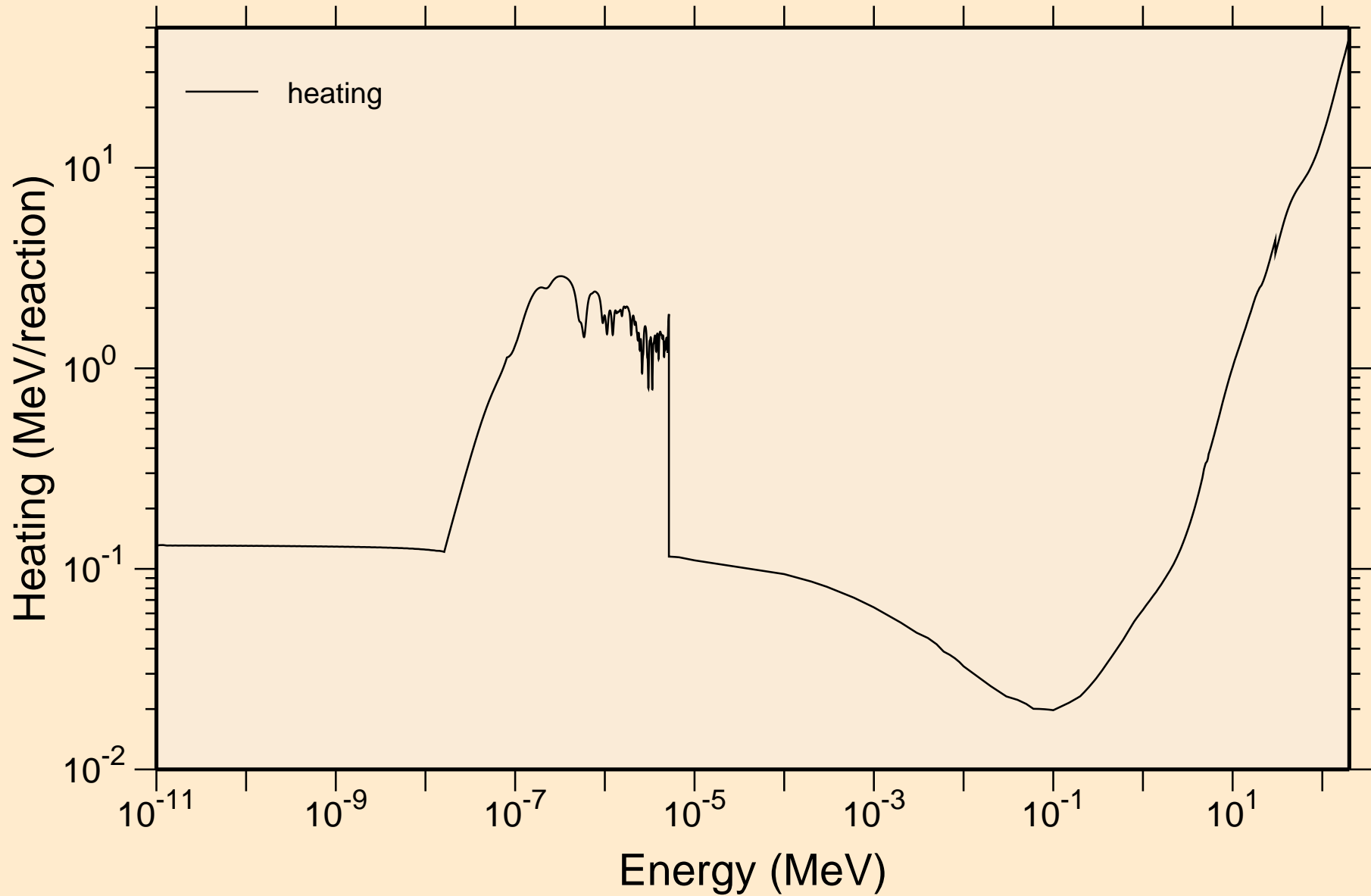

TL185 NEUTRON ACER TENDL-2023 LIBRARY; T=0.K  
Damage

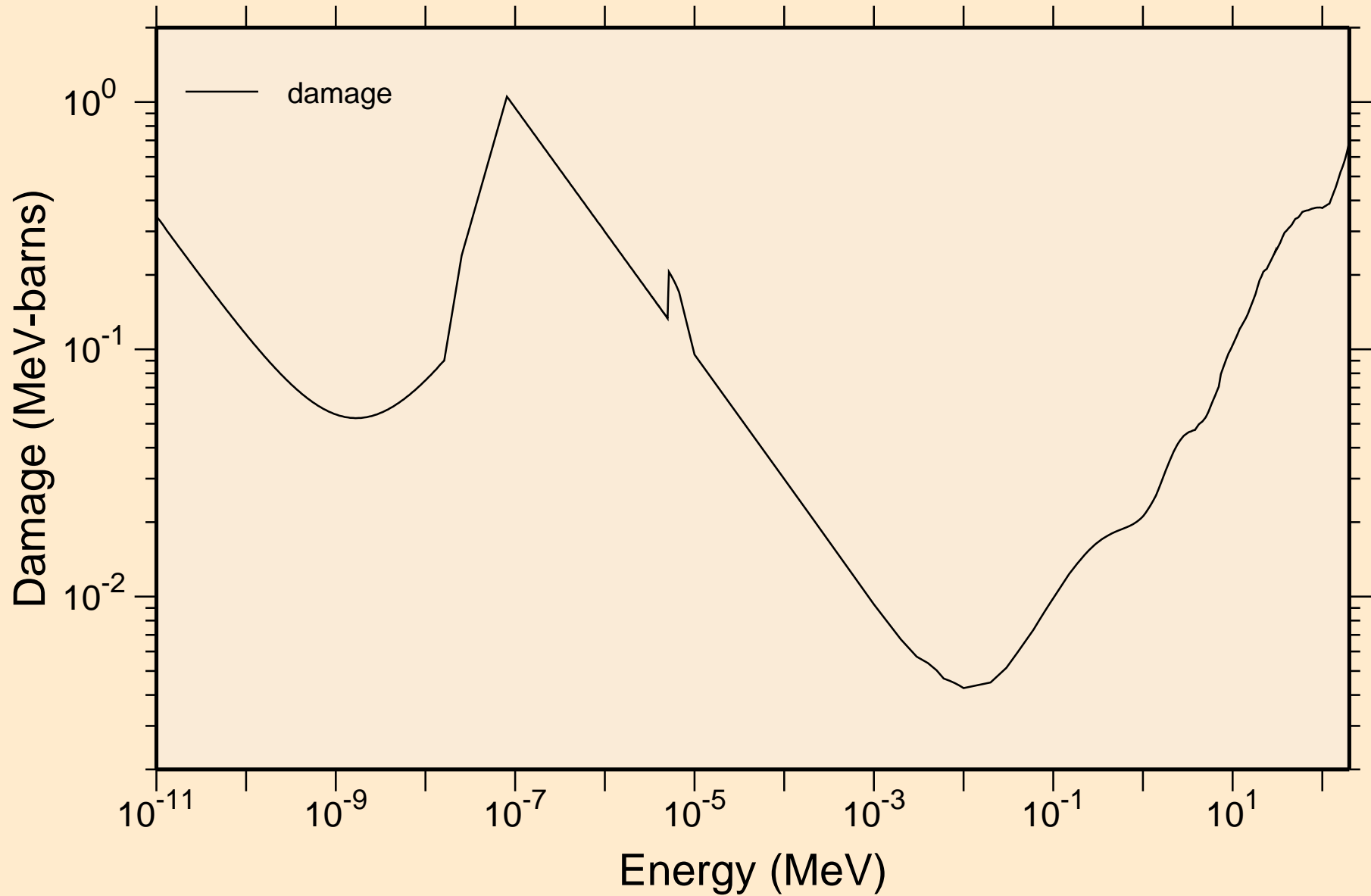

TL185 NEUTRON ACER TENDL-2023 LIBRARY; T=0.K  
Non-threshold reactions

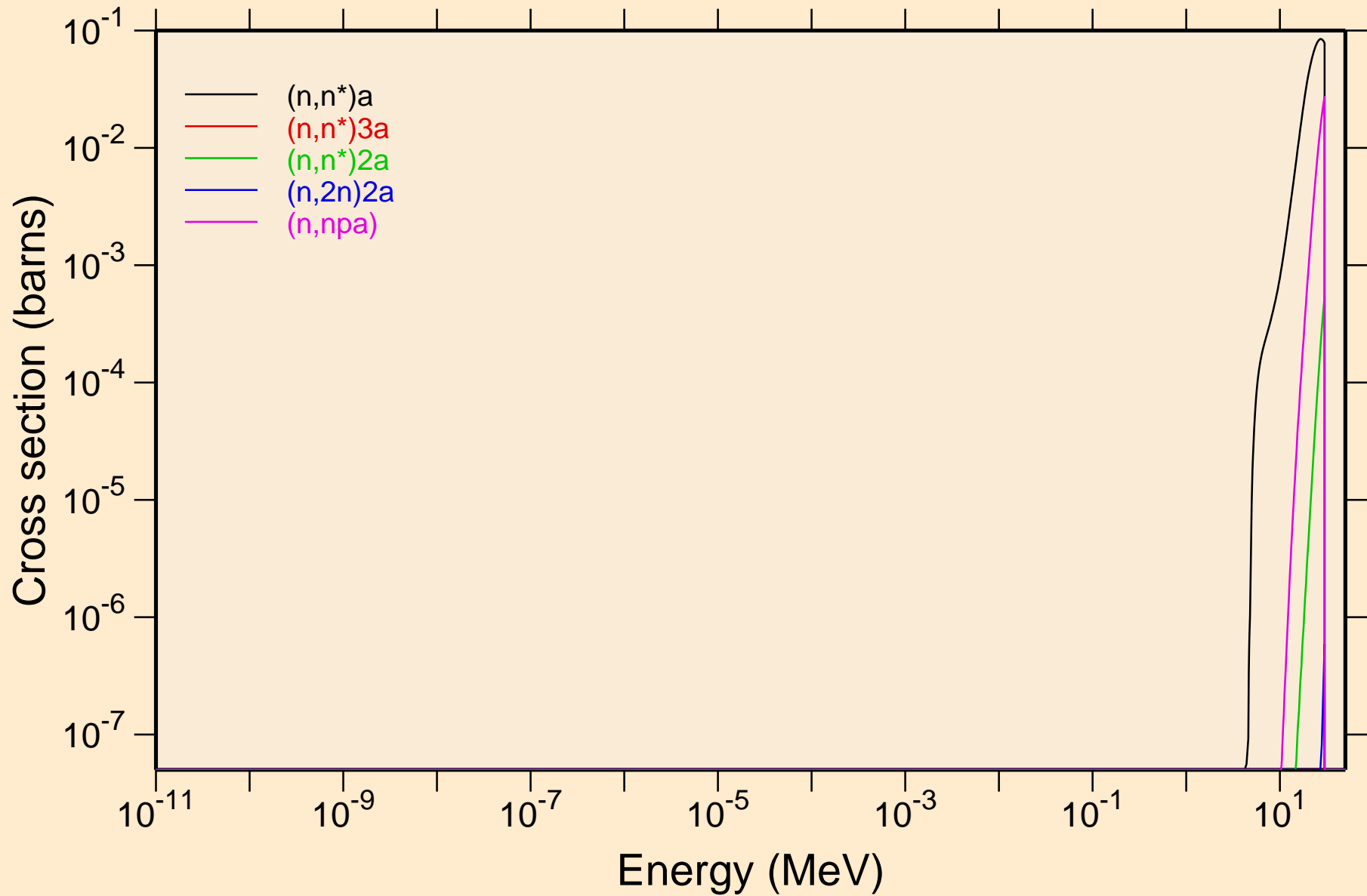

TL185 NEUTRON ACER TENDL-2023 LIBRARY; T=0.K  
Non-threshold reactions

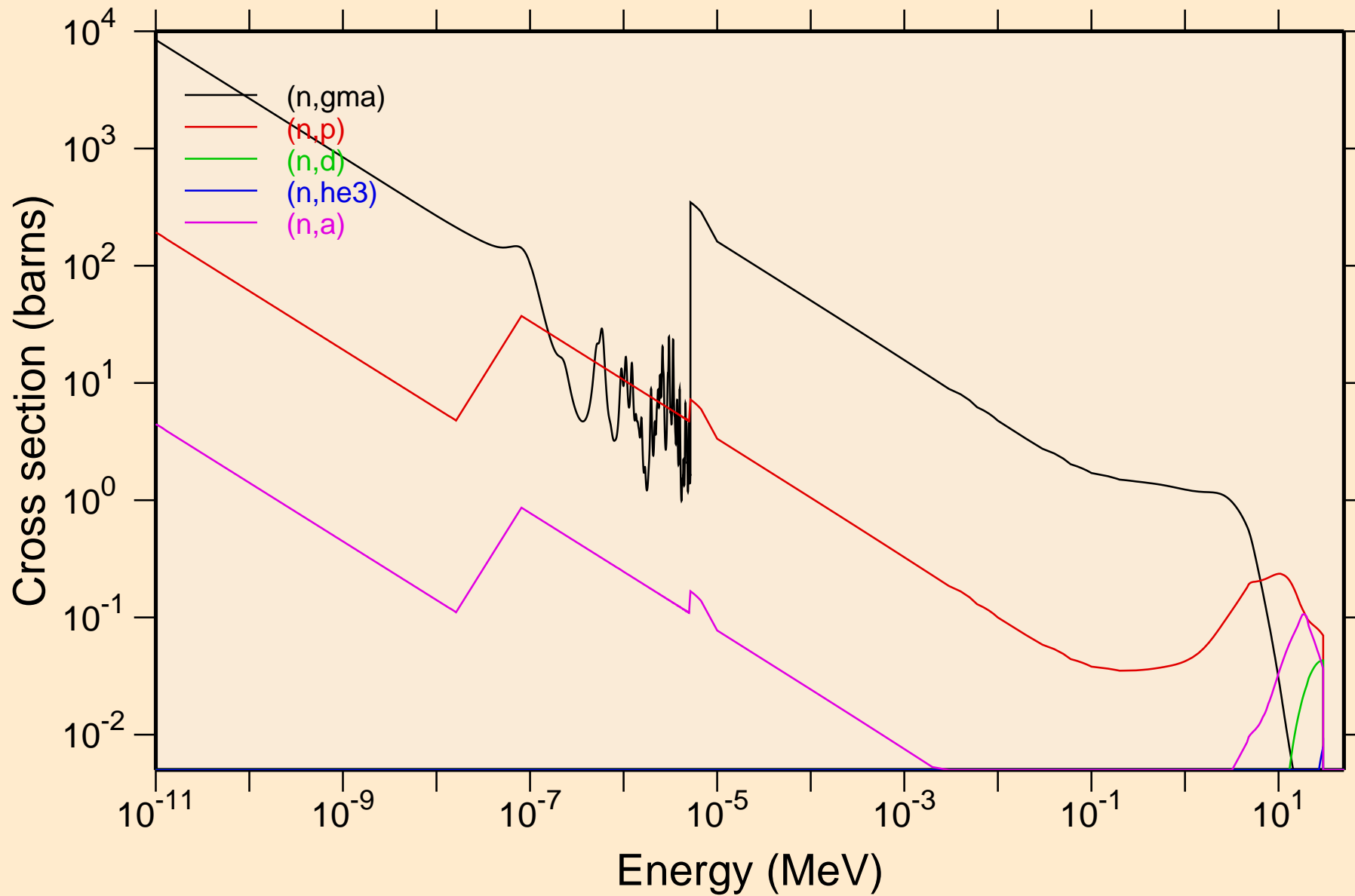

TL185 NEUTRON ACER TENDL-2023 LIBRARY; T=0.K  
Non-threshold reactions

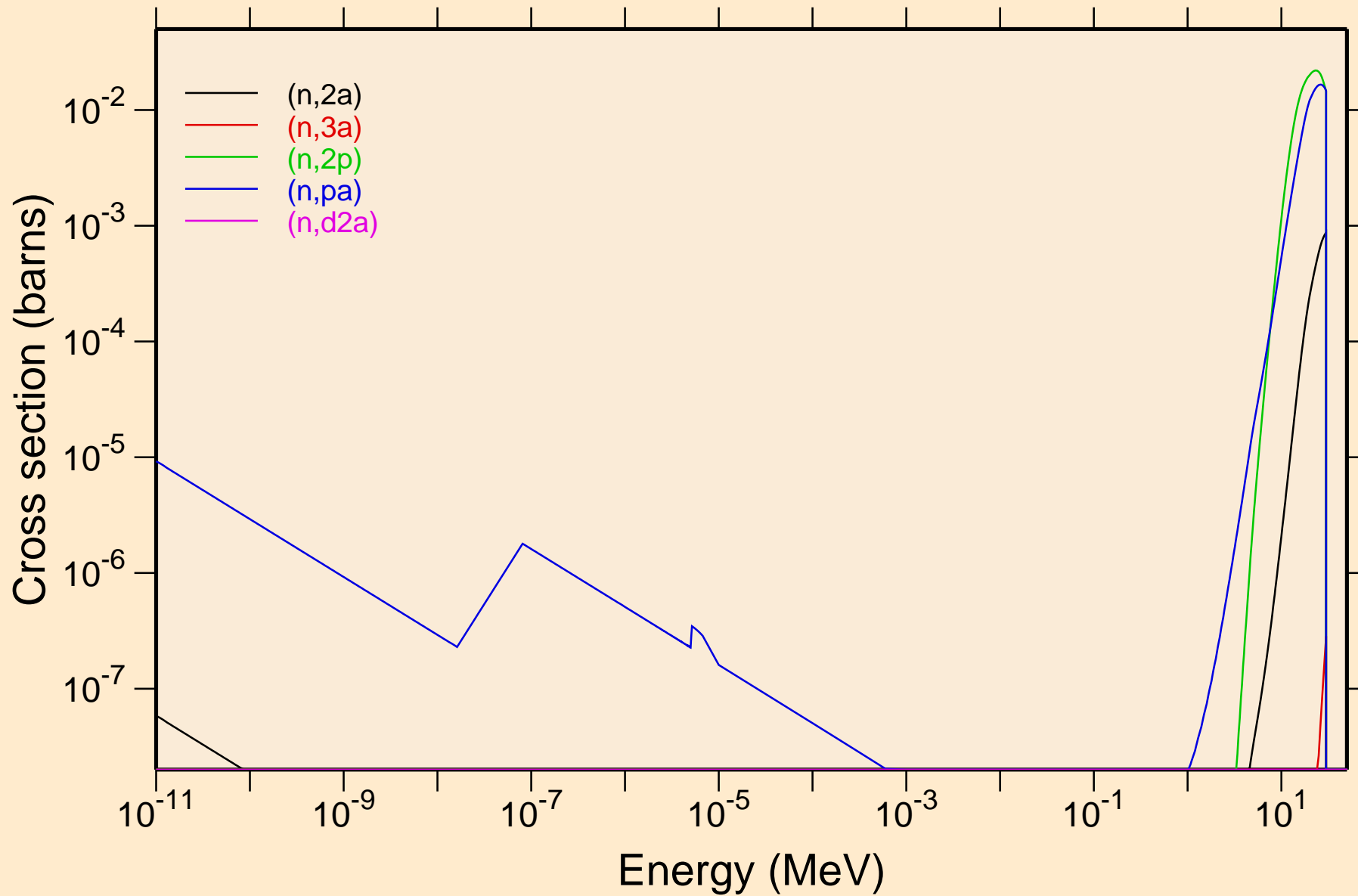

TL185 NEUTRON ACER TENDL-2023 LIBRARY; T=0.K  
Non-threshold reactions

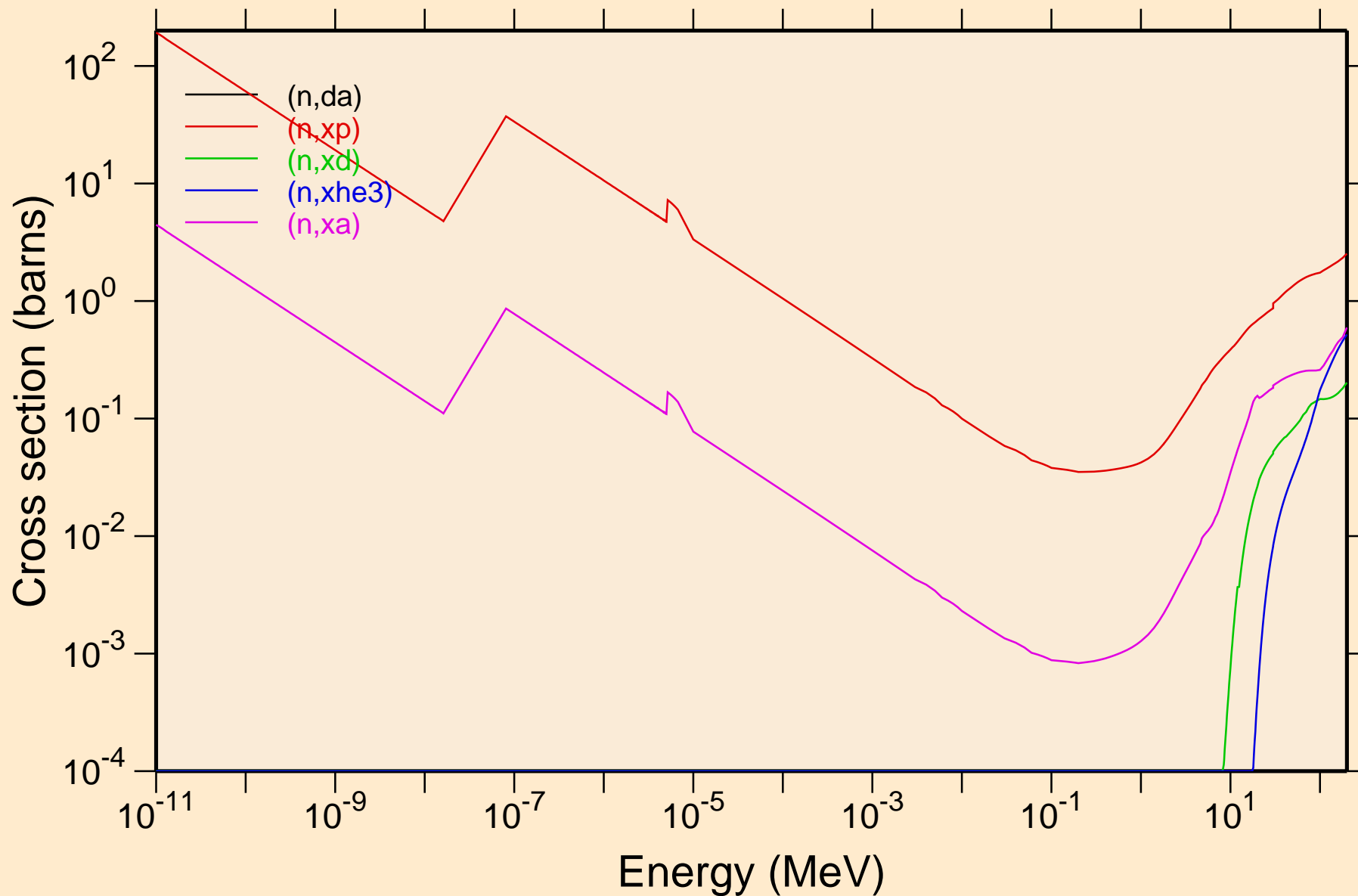

TL185 NEUTRON ACER TENDL-2023 LIBRARY; T=0.K  
Principal cross sections

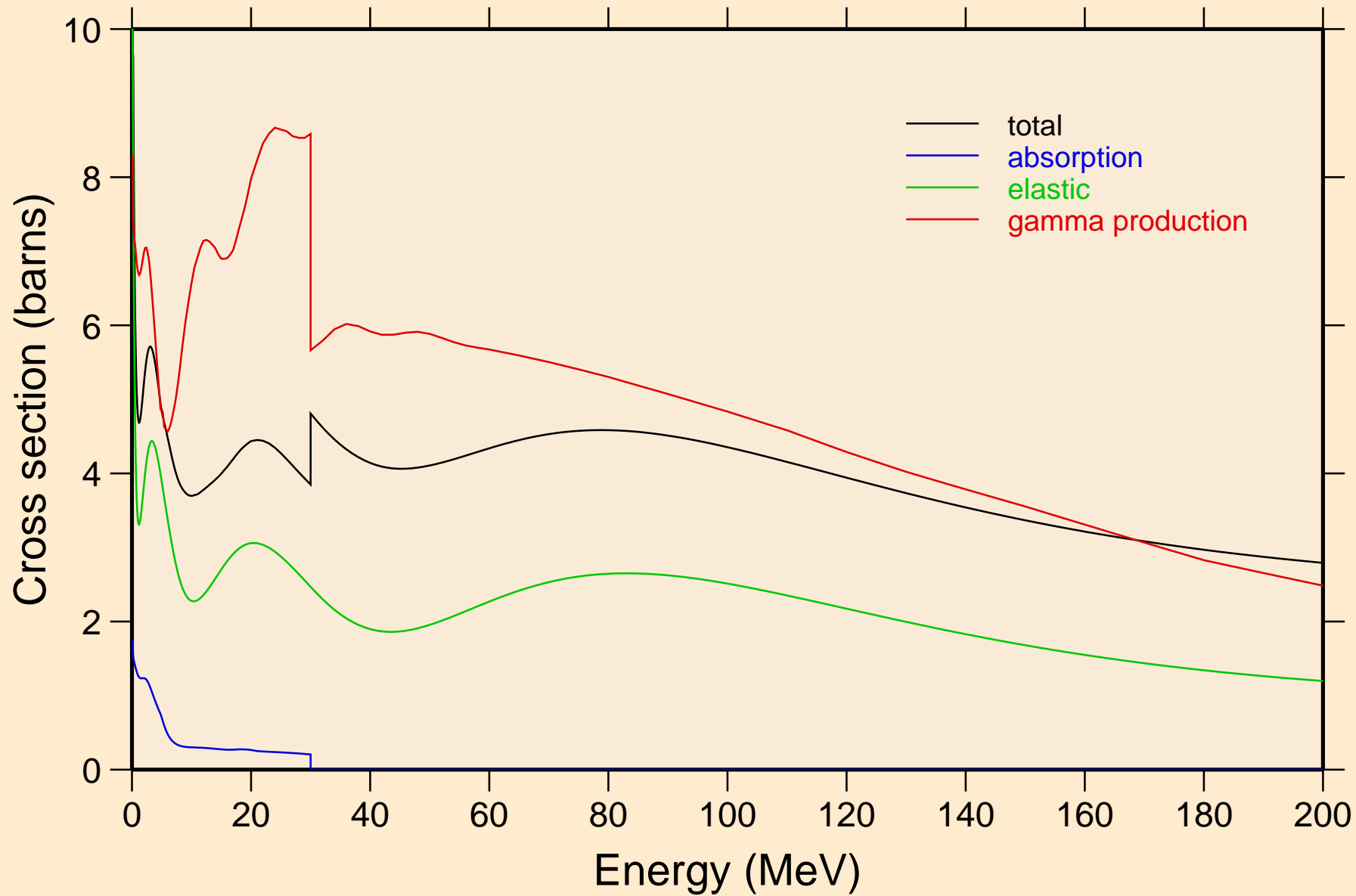

# TL185 NEUTRON ACER TENDL-2023 LIBRARY; T=0.K

## Heating

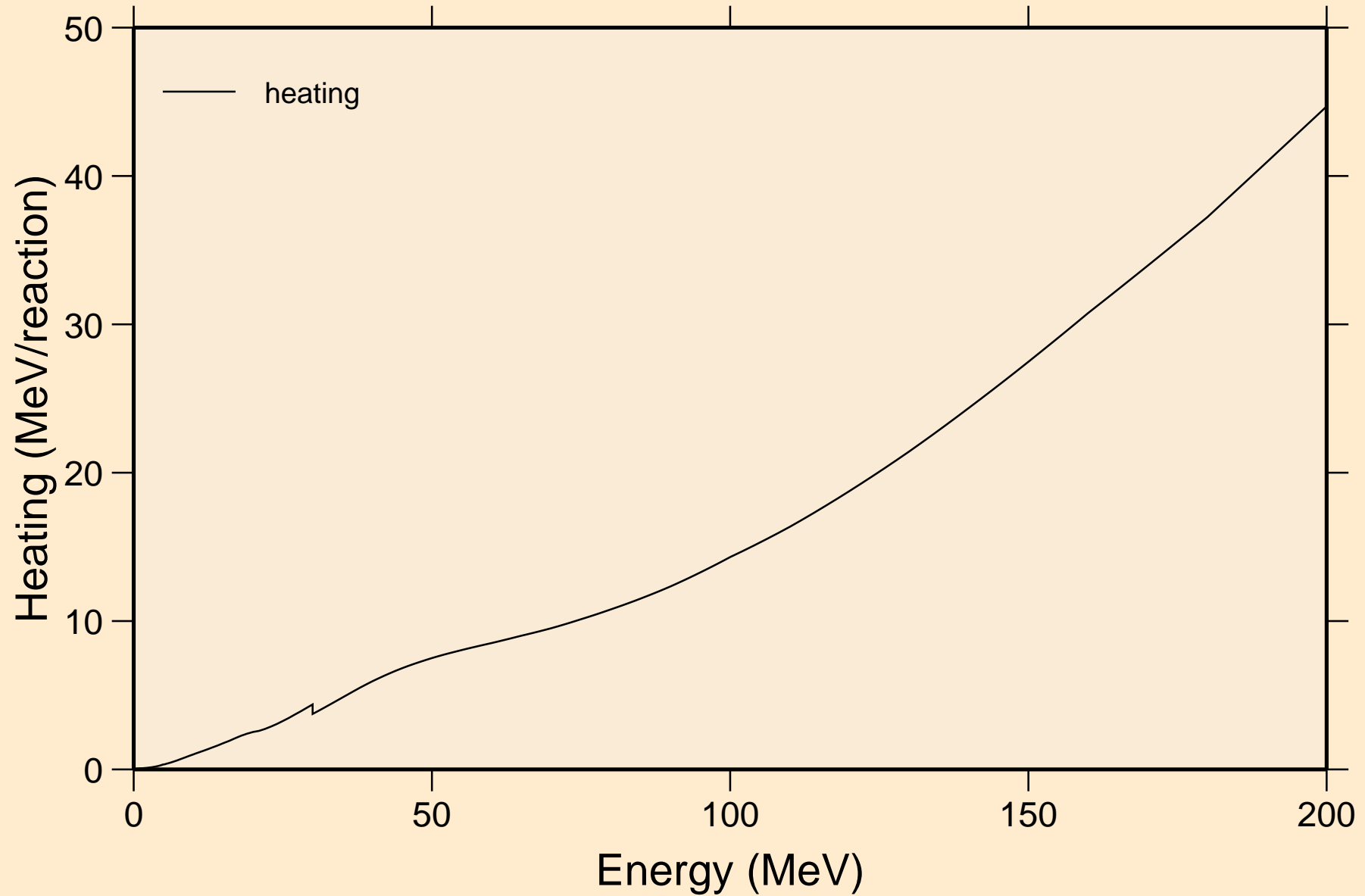

TL185 NEUTRON ACER TENDL-2023 LIBRARY; T=0.K  
Damage

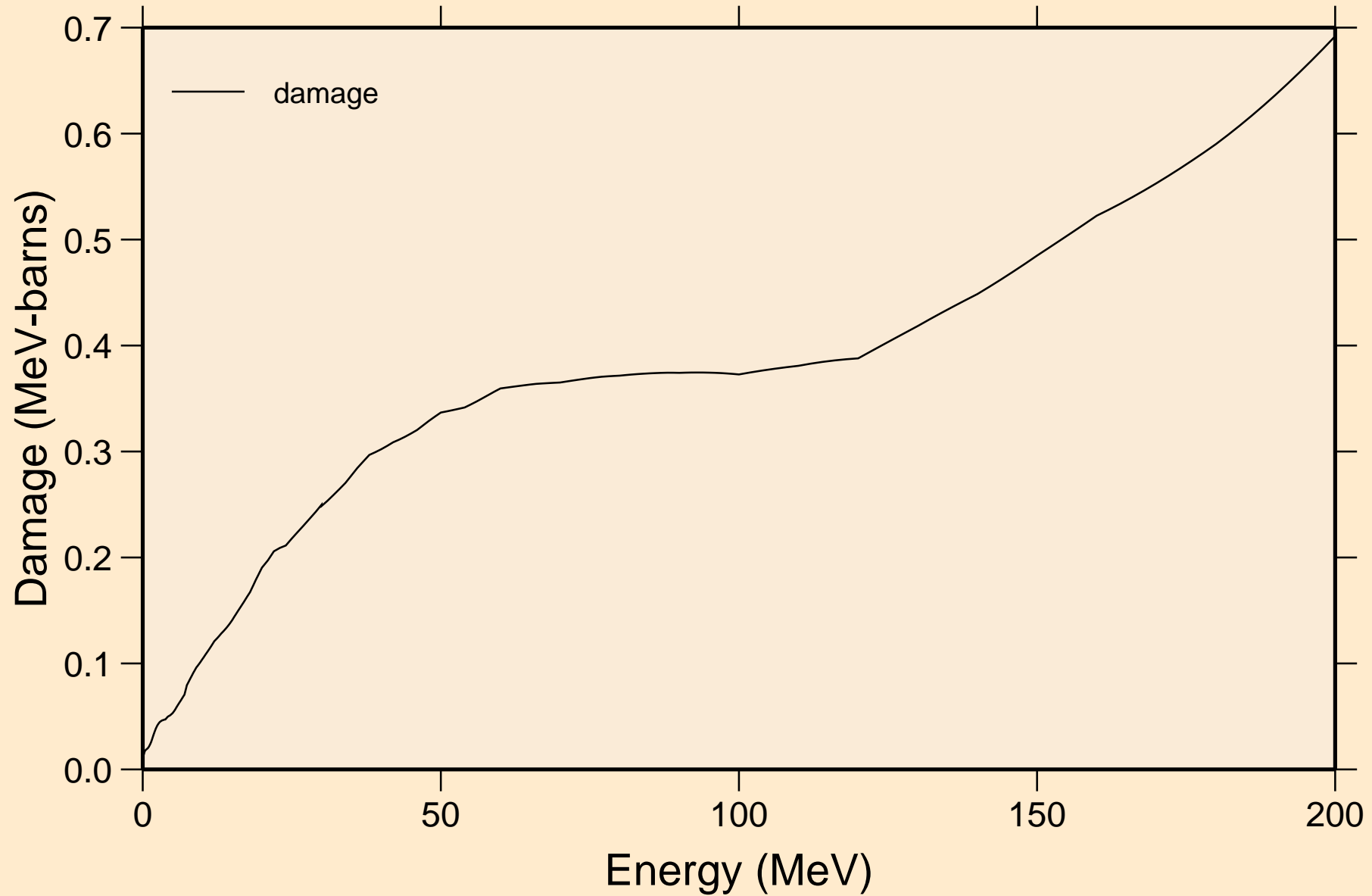

TL185 NEUTRON ACER TENDL-2023 LIBRARY; T=0.K  
Non-threshold reactions

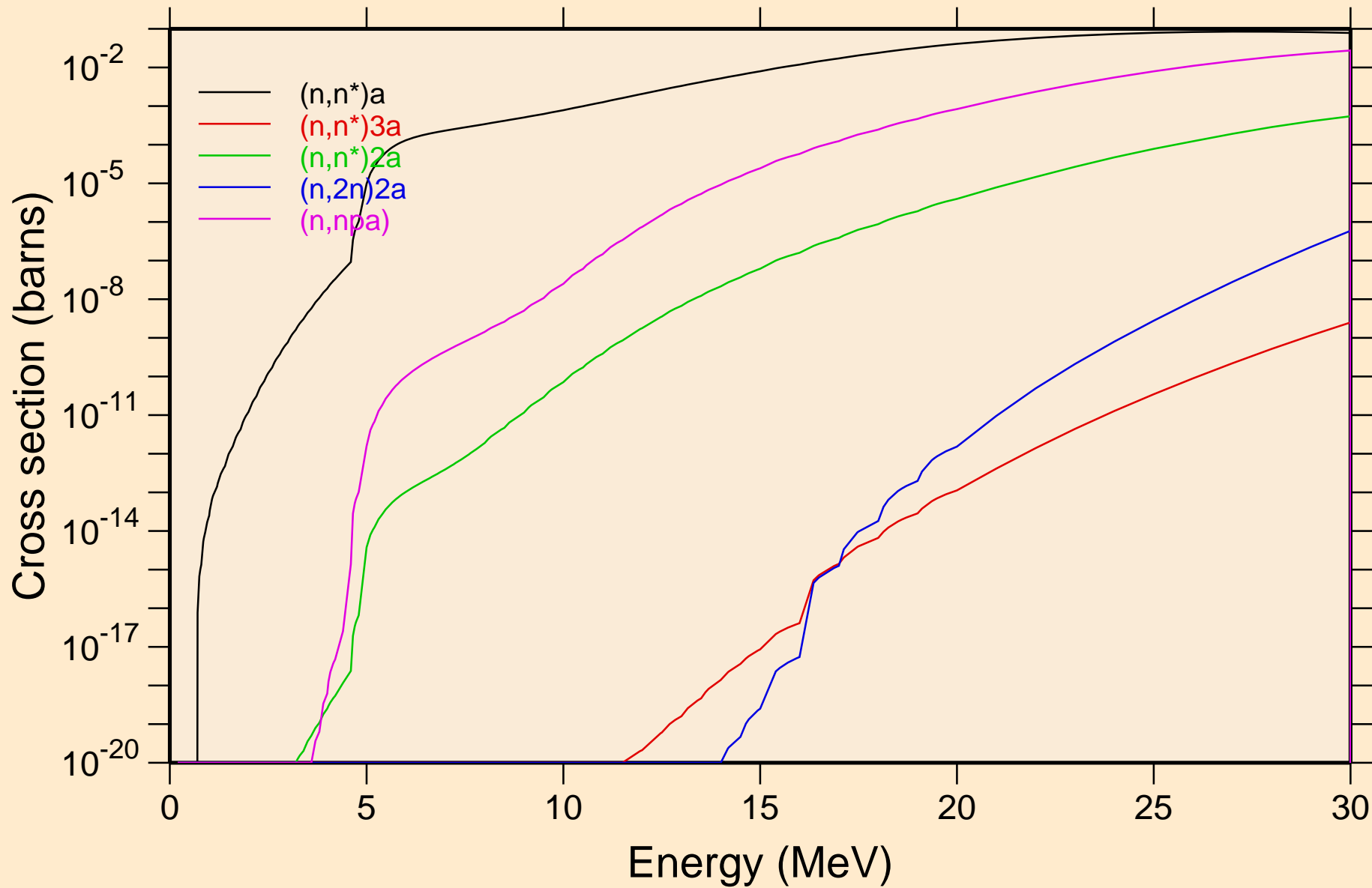

TL185 NEUTRON ACER TENDL-2023 LIBRARY; T=0.K  
Non-threshold reactions

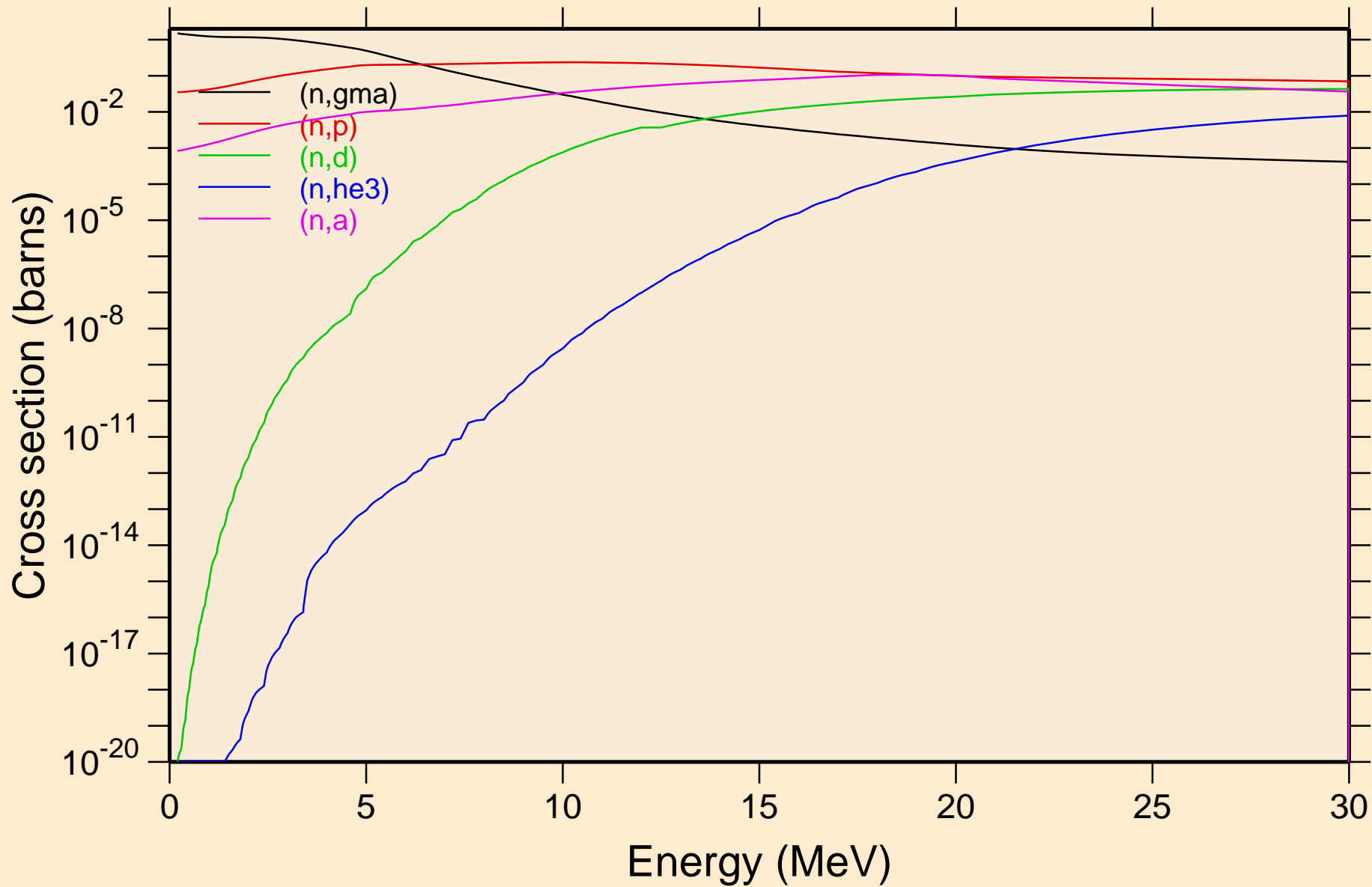

TL185 NEUTRON ACER TENDL-2023 LIBRARY; T=0.K  
Non-threshold reactions

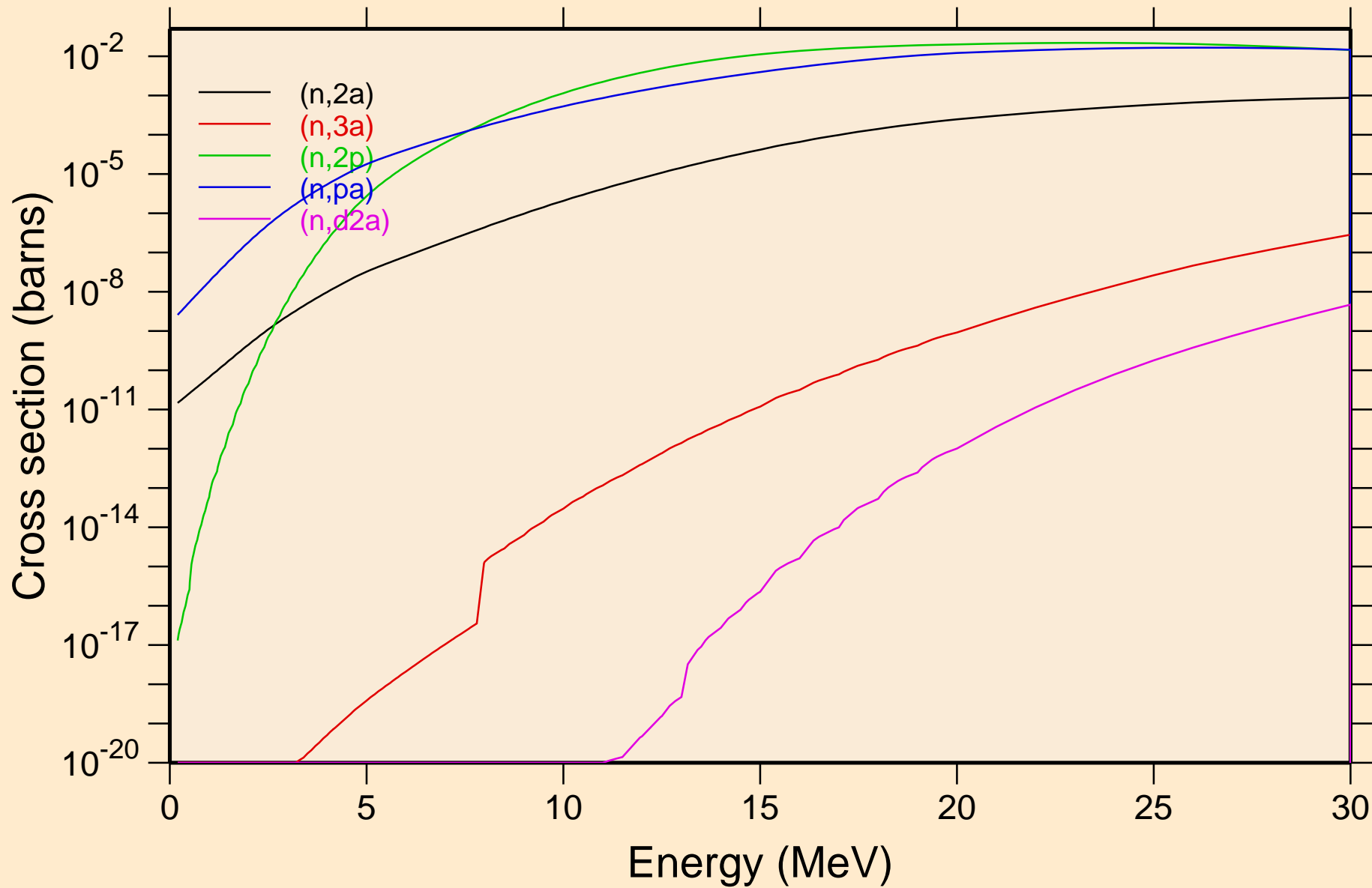

TL185 NEUTRON ACER TENDL-2023 LIBRARY; T=0.K  
Non-threshold reactions

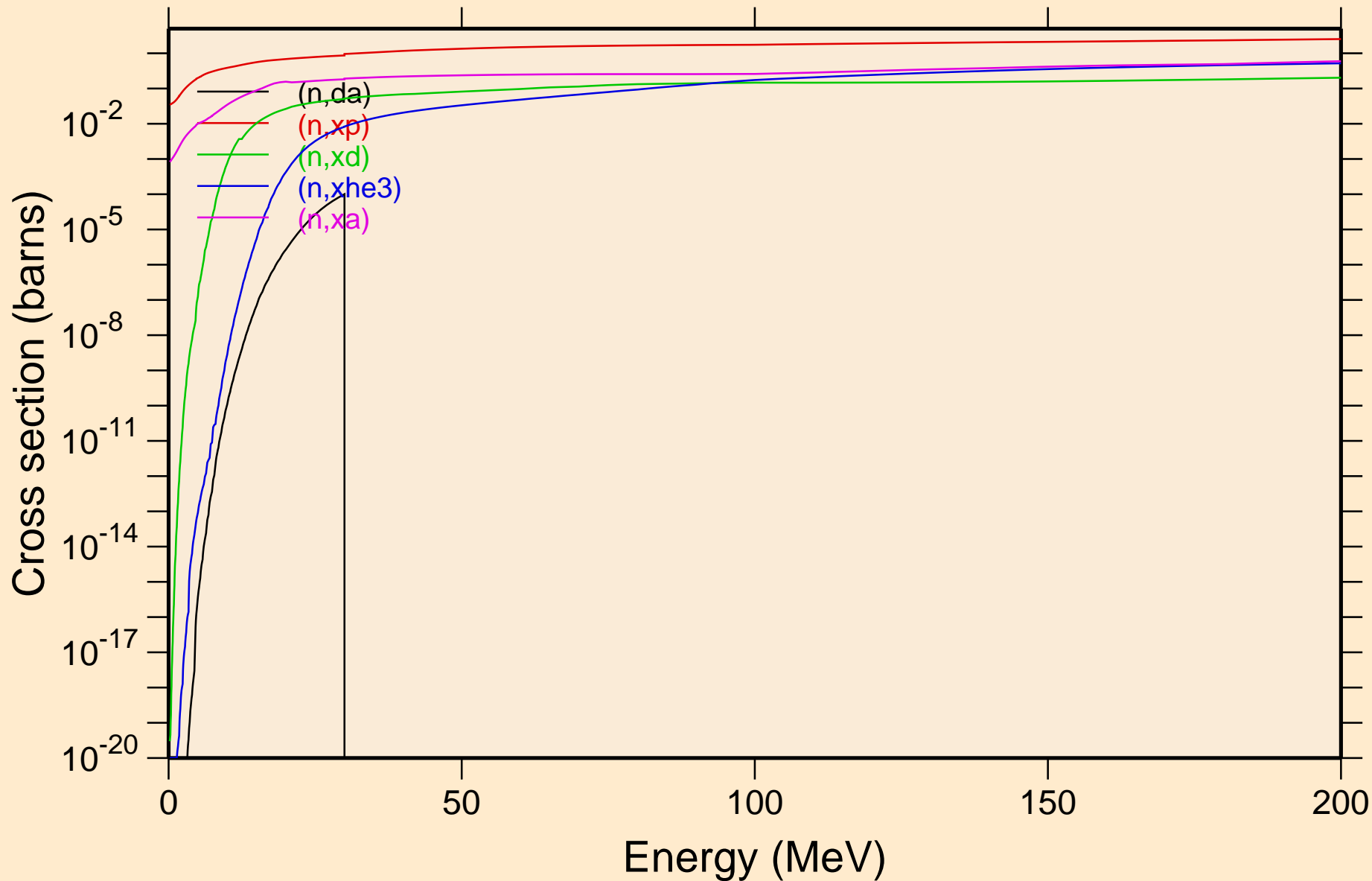

TL185 NEUTRON ACER TENDL-2023 LIBRARY; T=0.K  
Inelastic levels

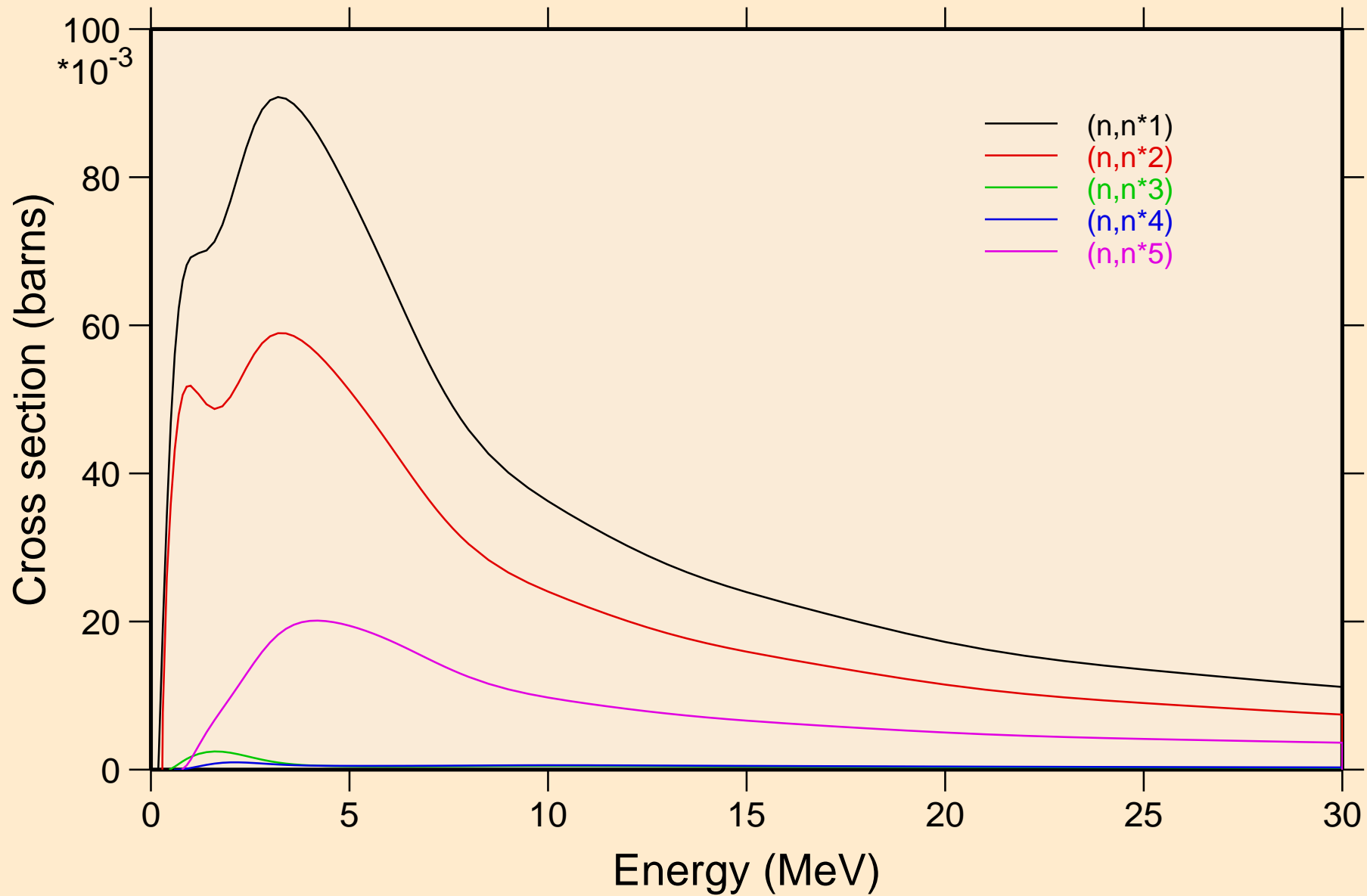

TL185 NEUTRON ACER TENDL-2023 LIBRARY; T=0.K  
Inelastic levels

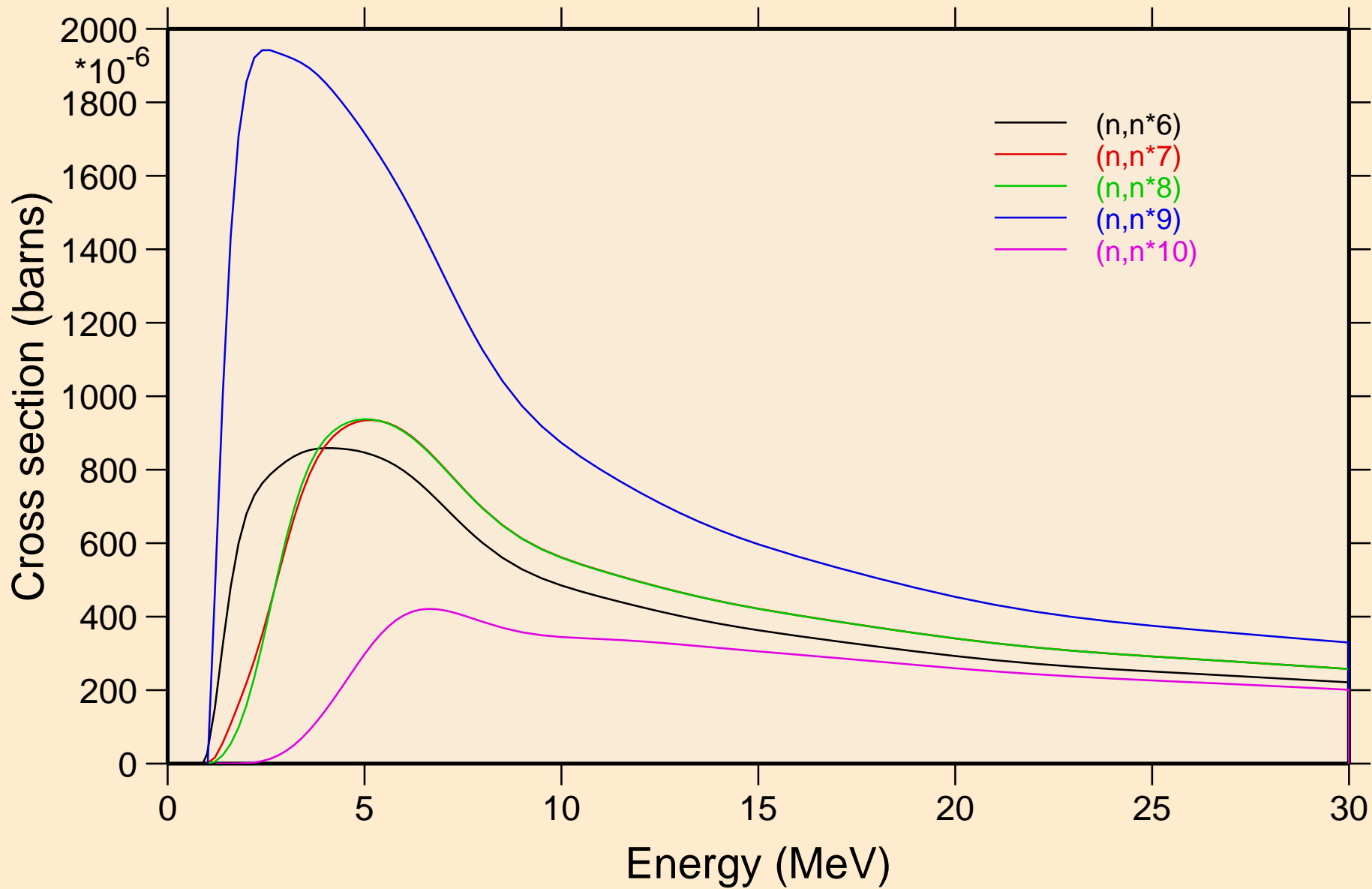

TL185 NEUTRON ACER TENDL-2023 LIBRARY; T=0.K  
Inelastic levels

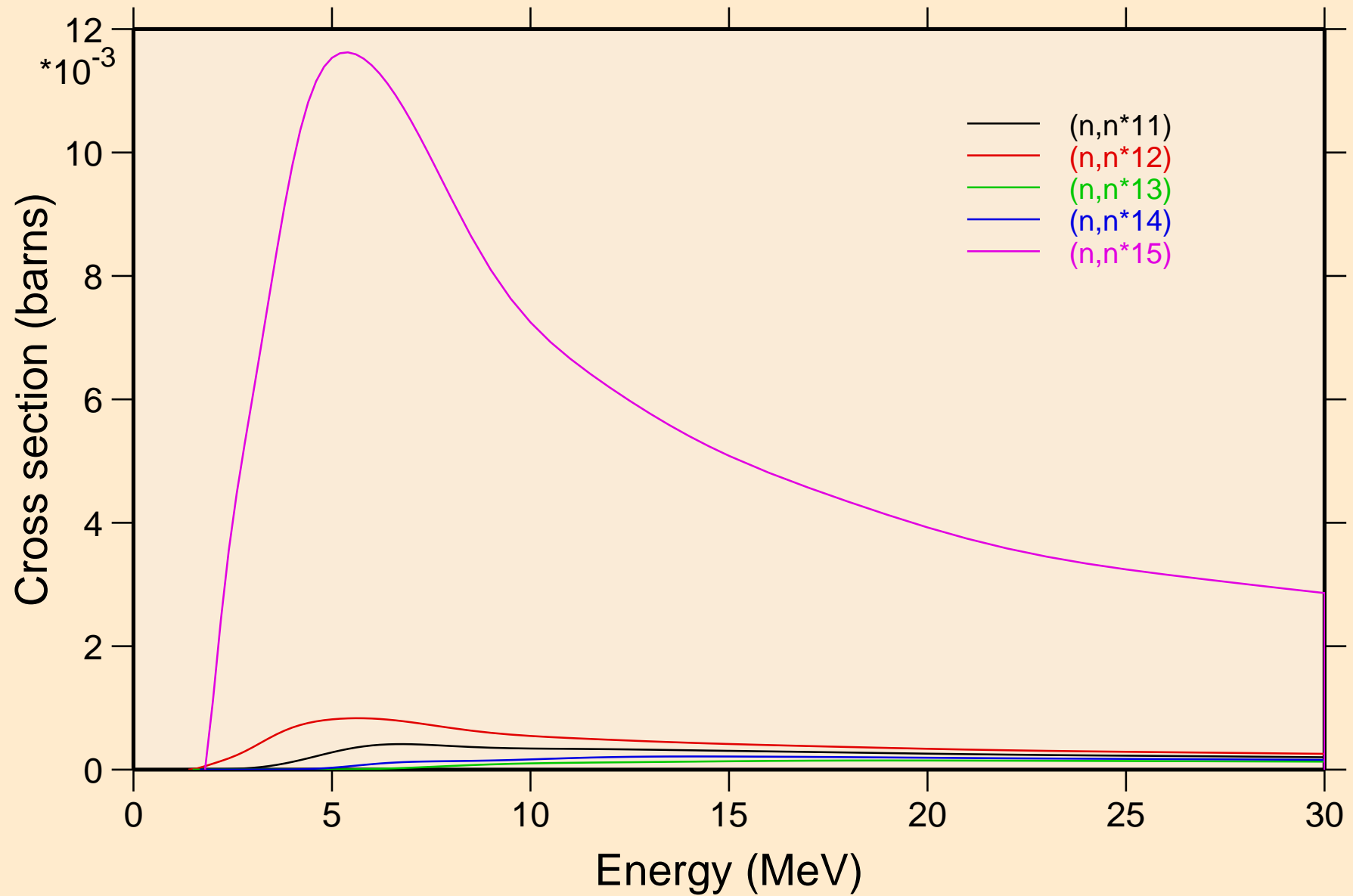

TL185 NEUTRON ACER TENDL-2023 LIBRARY; T=0.K  
Inelastic levels

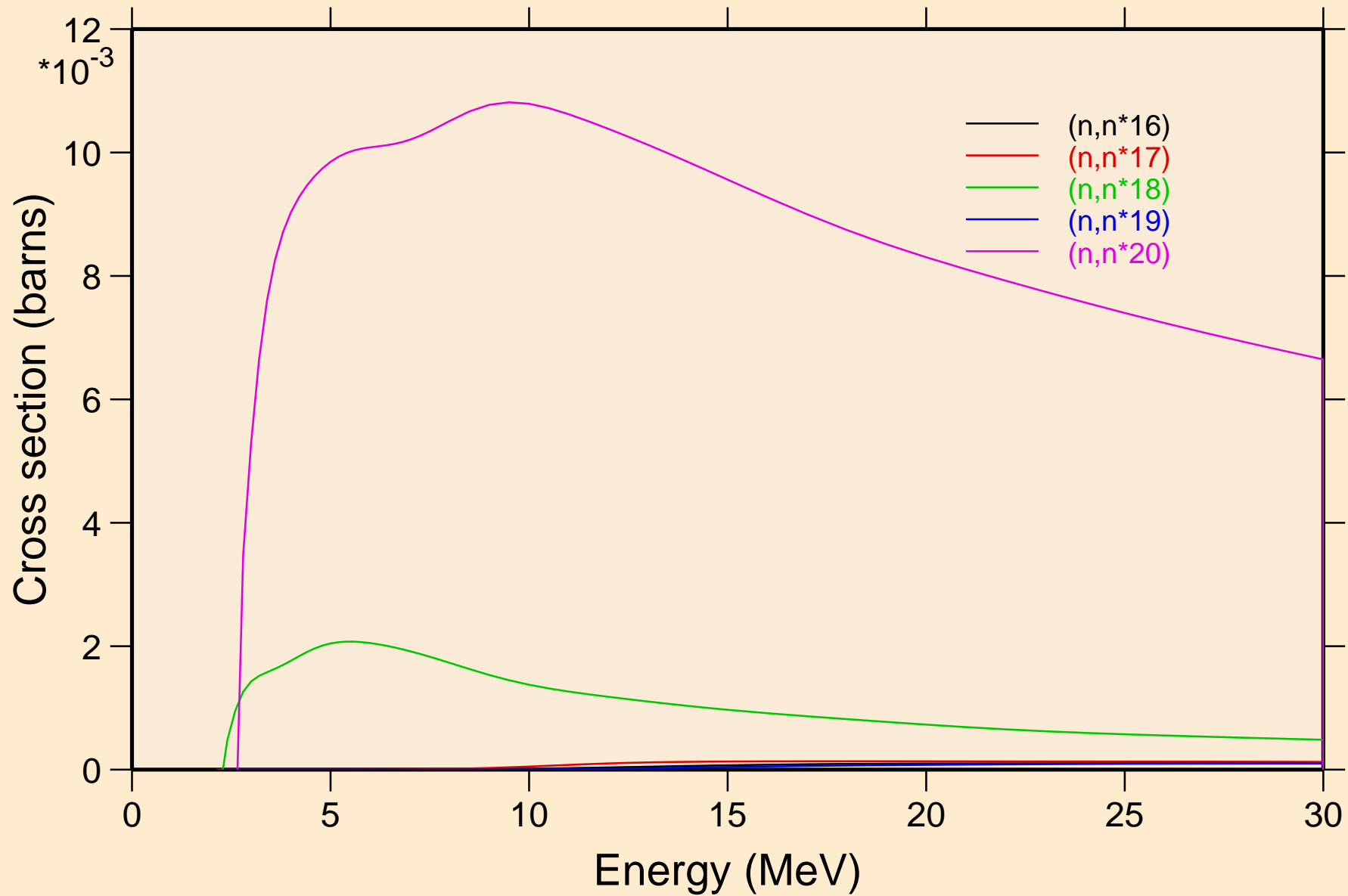

TL185 NEUTRON ACER TENDL-2023 LIBRARY; T=0.K  
Threshold reactions

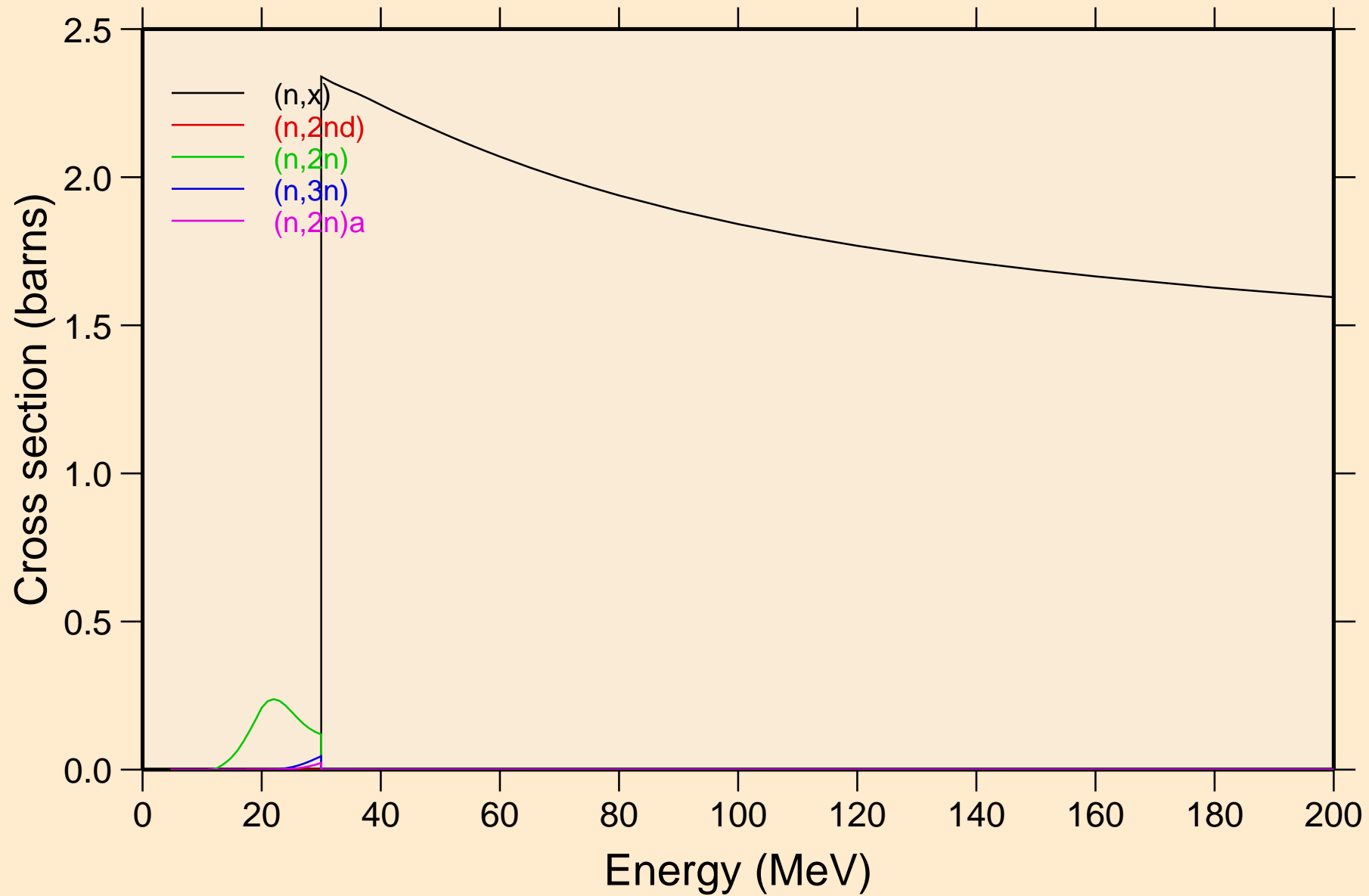

TL185 NEUTRON ACER TENDL-2023 LIBRARY; T=0.K  
Threshold reactions

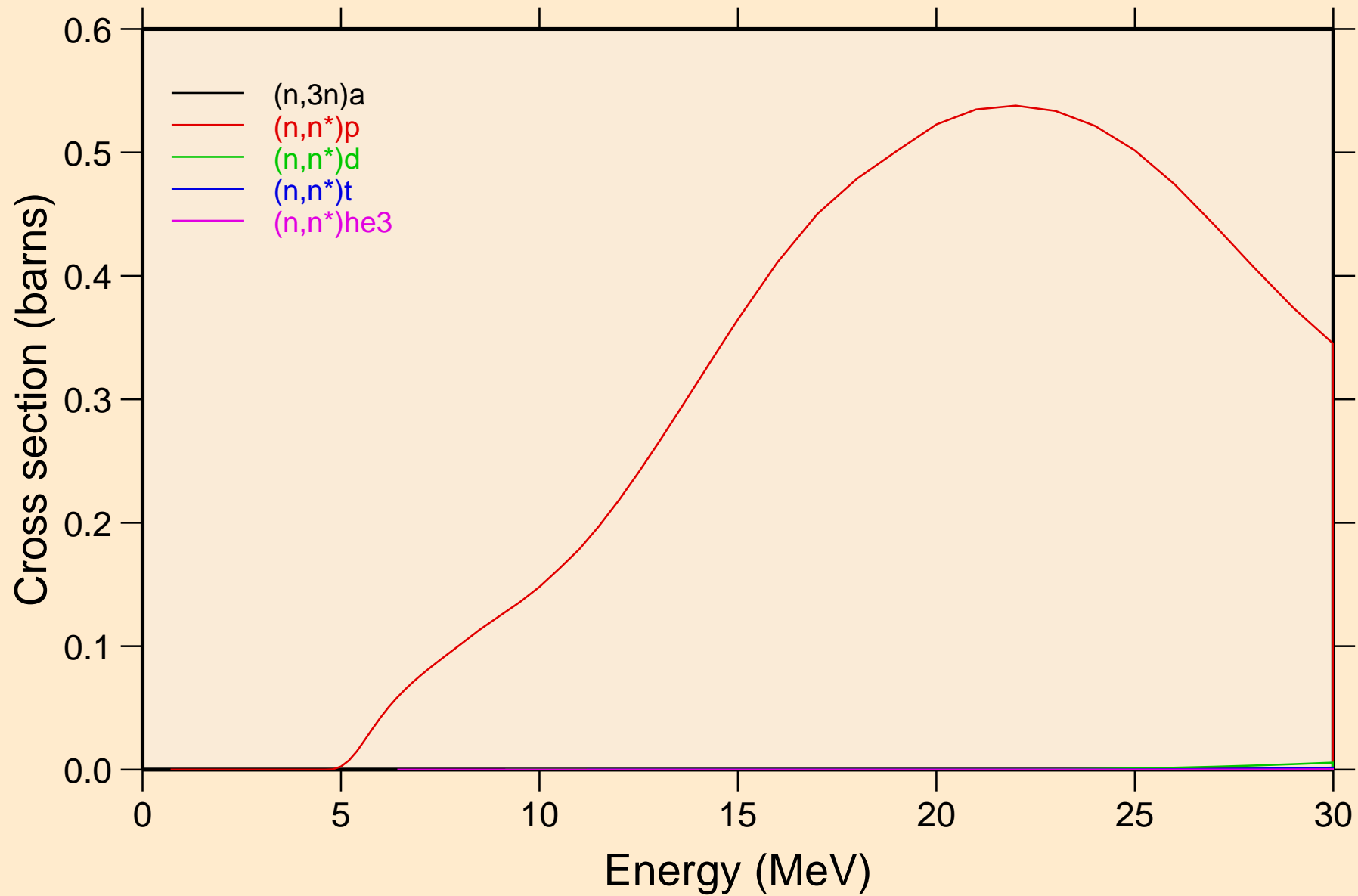

TL185 NEUTRON ACER TENDL-2023 LIBRARY; T=0.K  
Threshold reactions

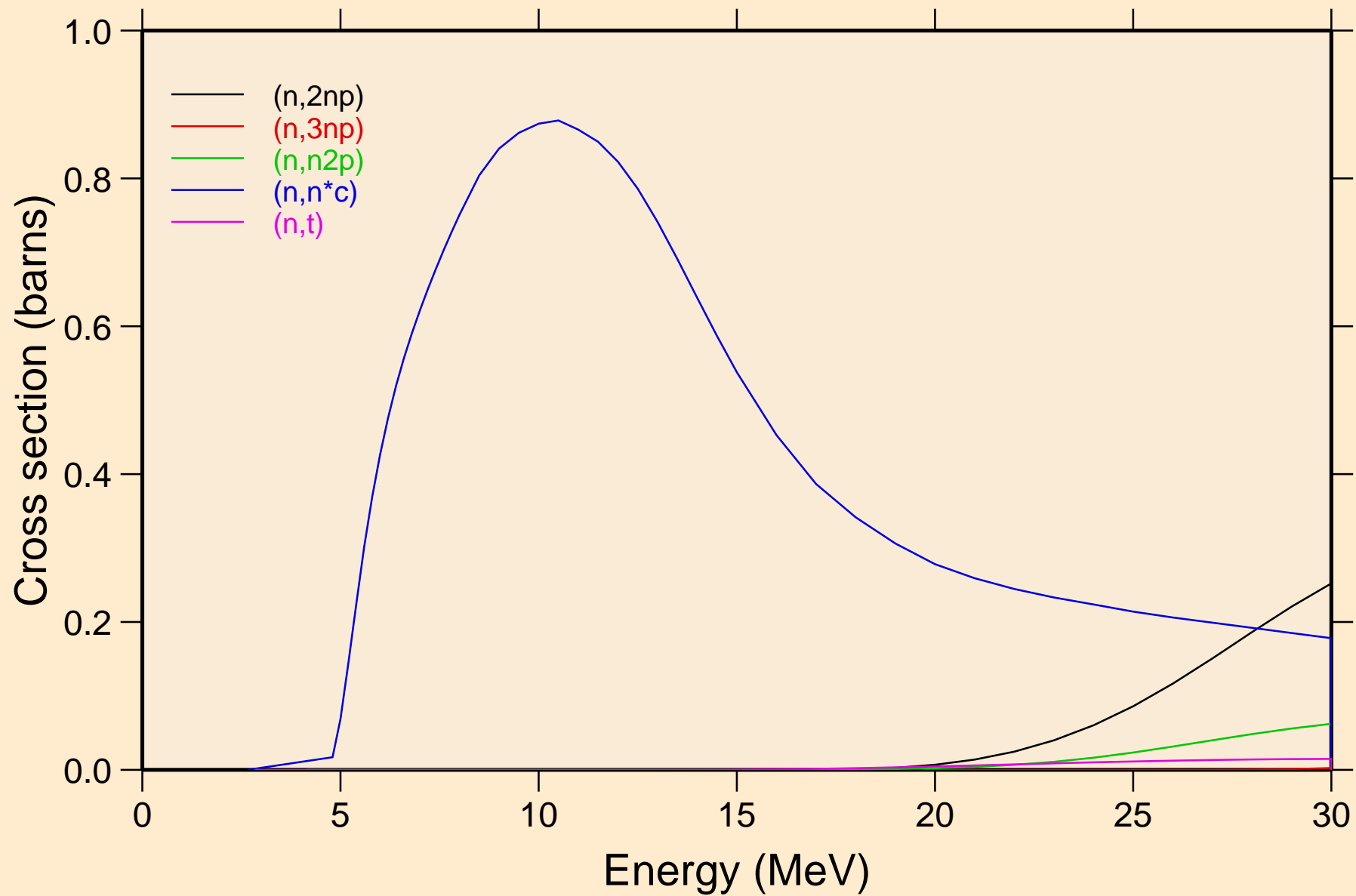

TL185 NEUTRON ACER TENDL-2023 LIBRARY; T=0.K  
Threshold reactions

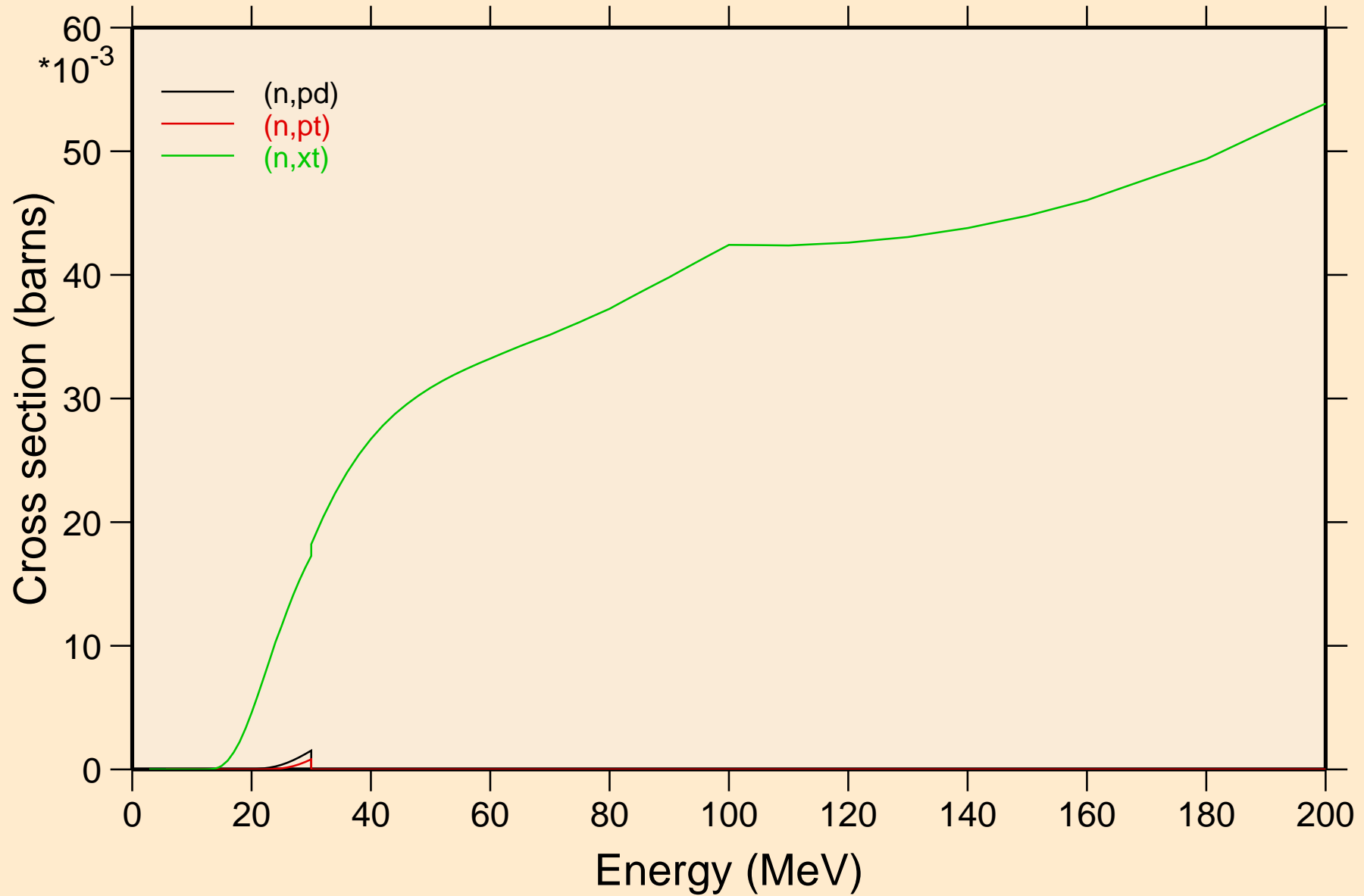

TL185 NEUTRON ACER TENDL-2023 LIBRARY; T=0.K  
angular distribution for elastic

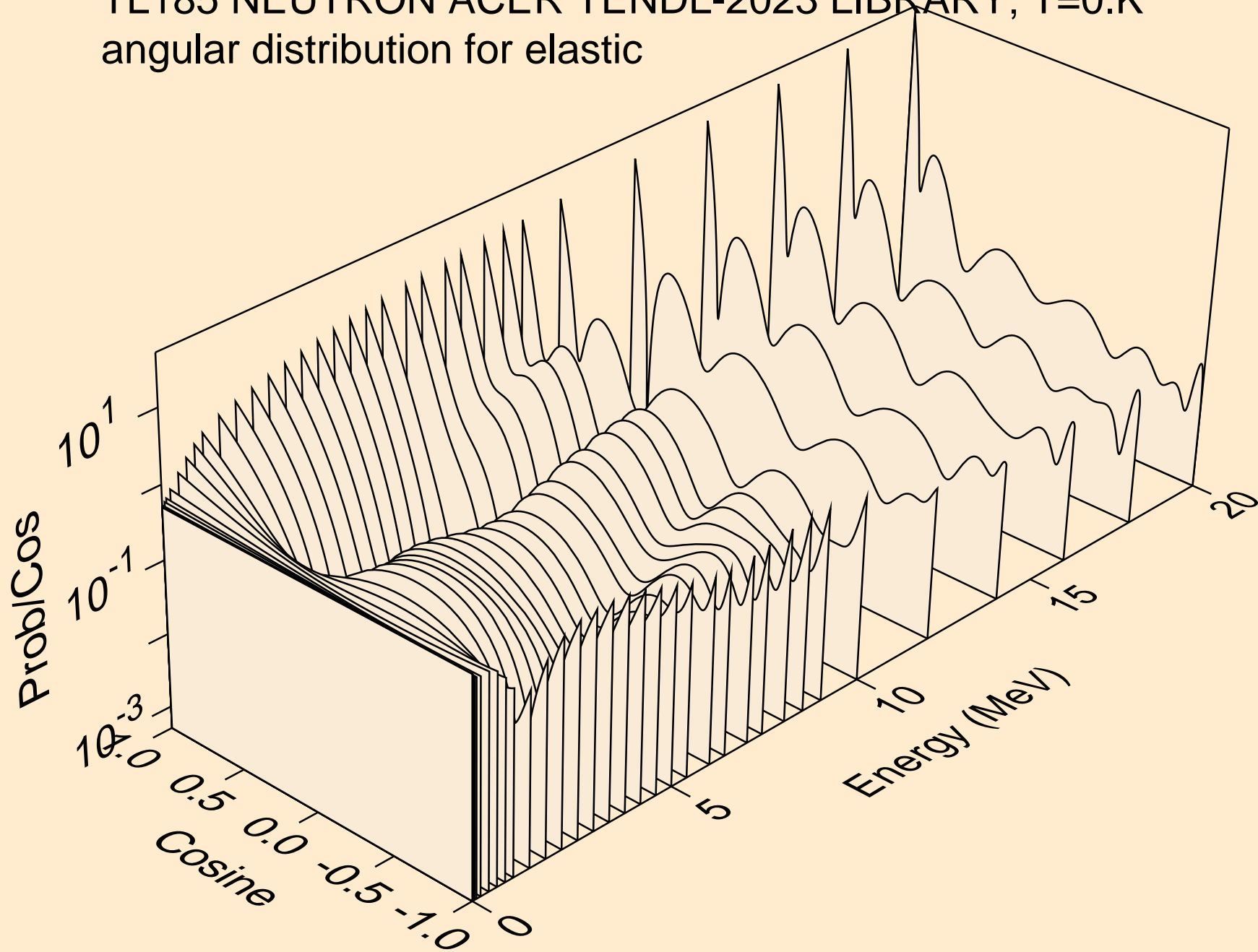

TL185 NEUTRON ACER TENDL-2023 LIBRARY; T=0.K  
angular distribution for elastic

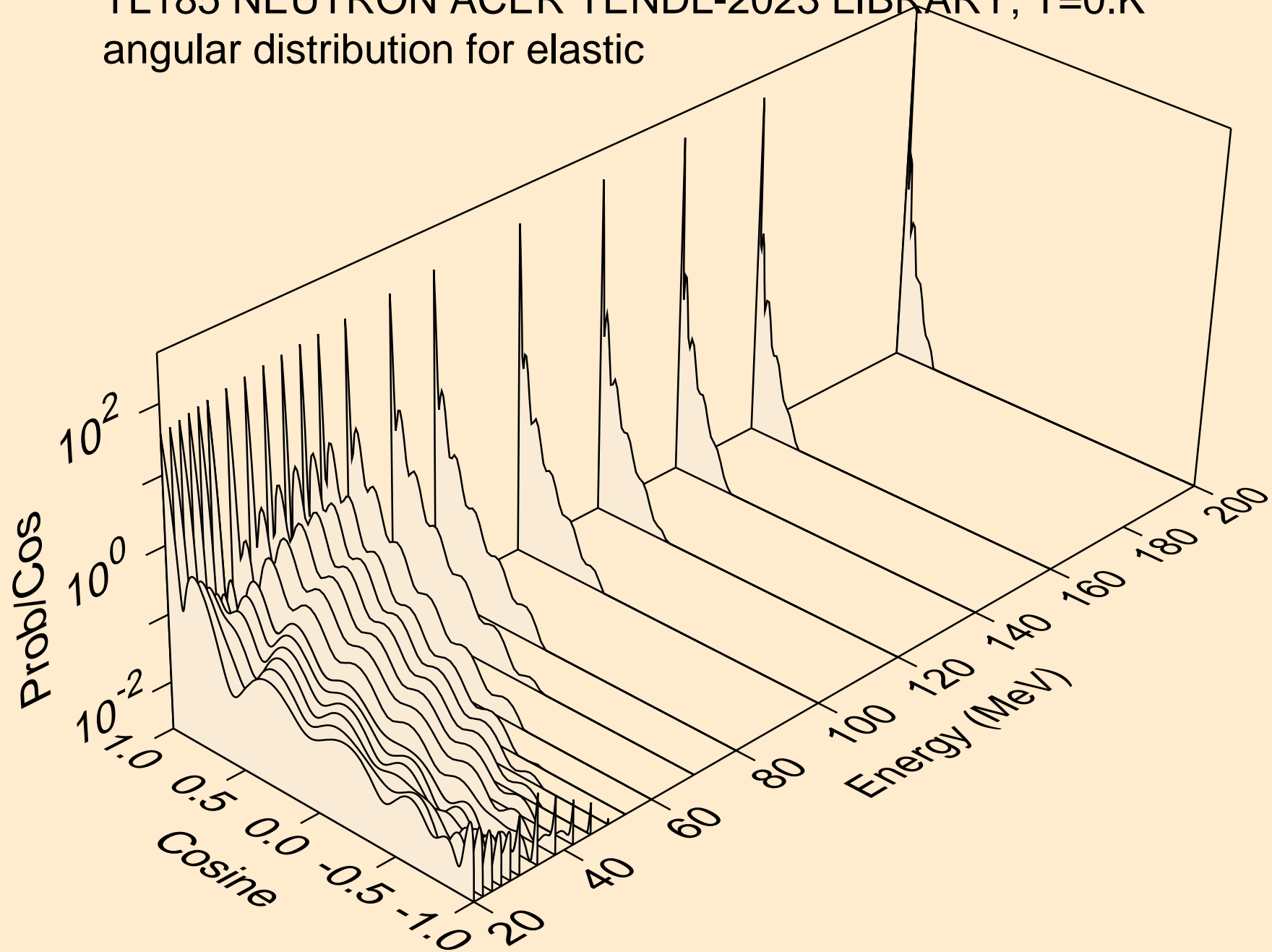

TL185 NEUTRON ACER TENDL-2023 LIBRARY; T=0.K  
angular distribution for (n,n\*1)

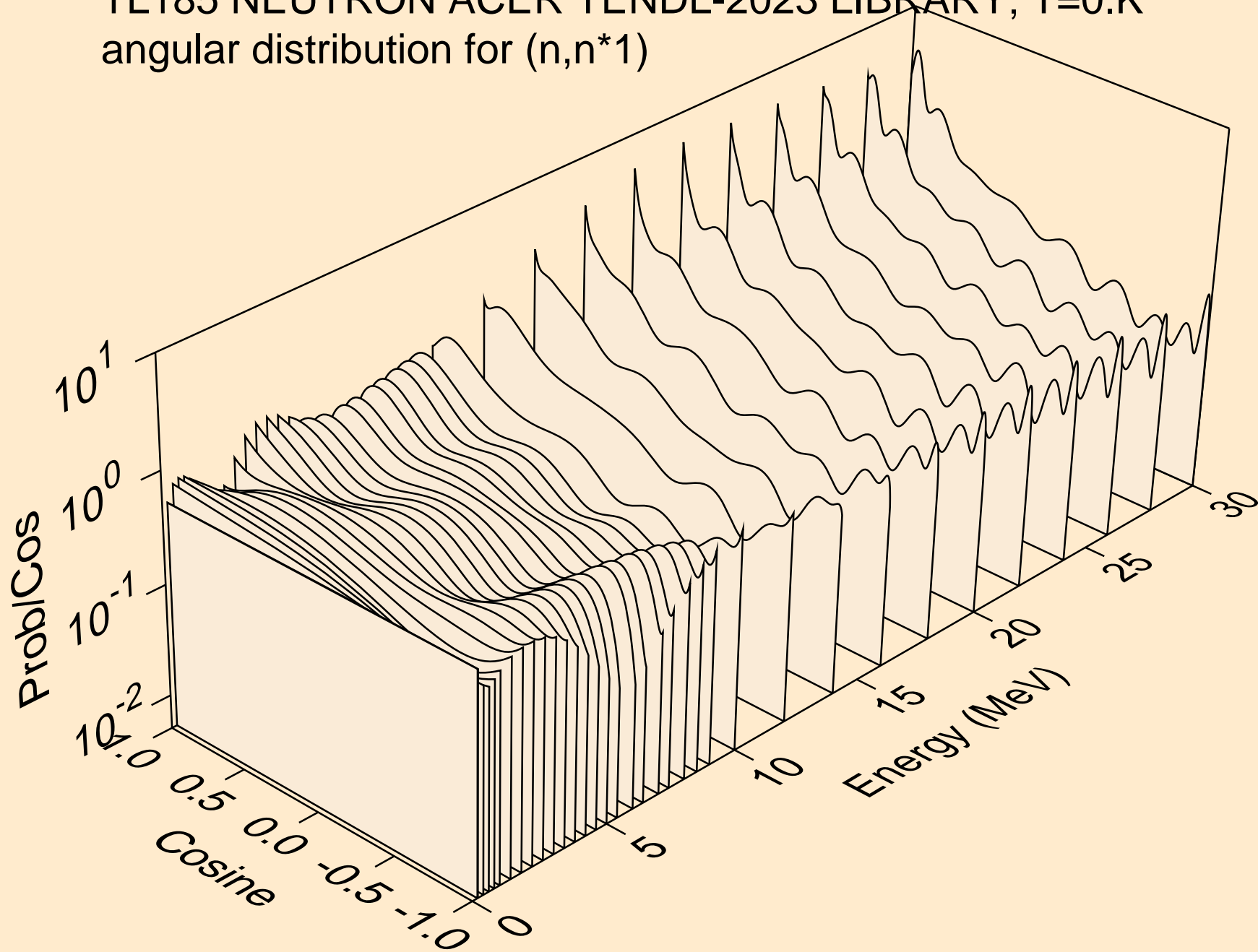

TL185 NEUTRON ACER TENDL-2023 LIBRARY; T=0.K  
angular distribution for (n,n\*2)

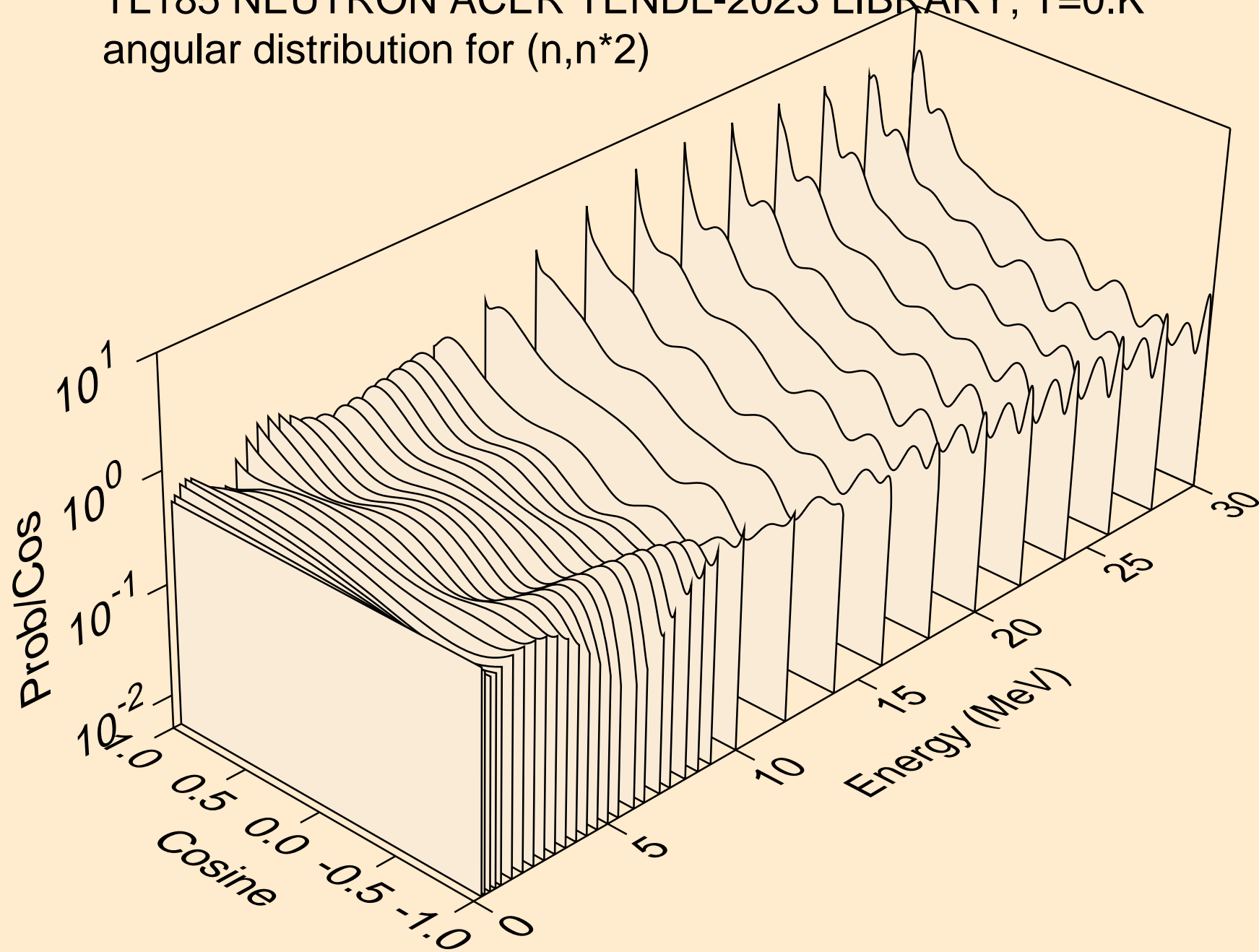

TL185 NEUTRON ACER TENDL-2023 LIBRARY; T=0.K  
angular distribution for (n,n\*3)

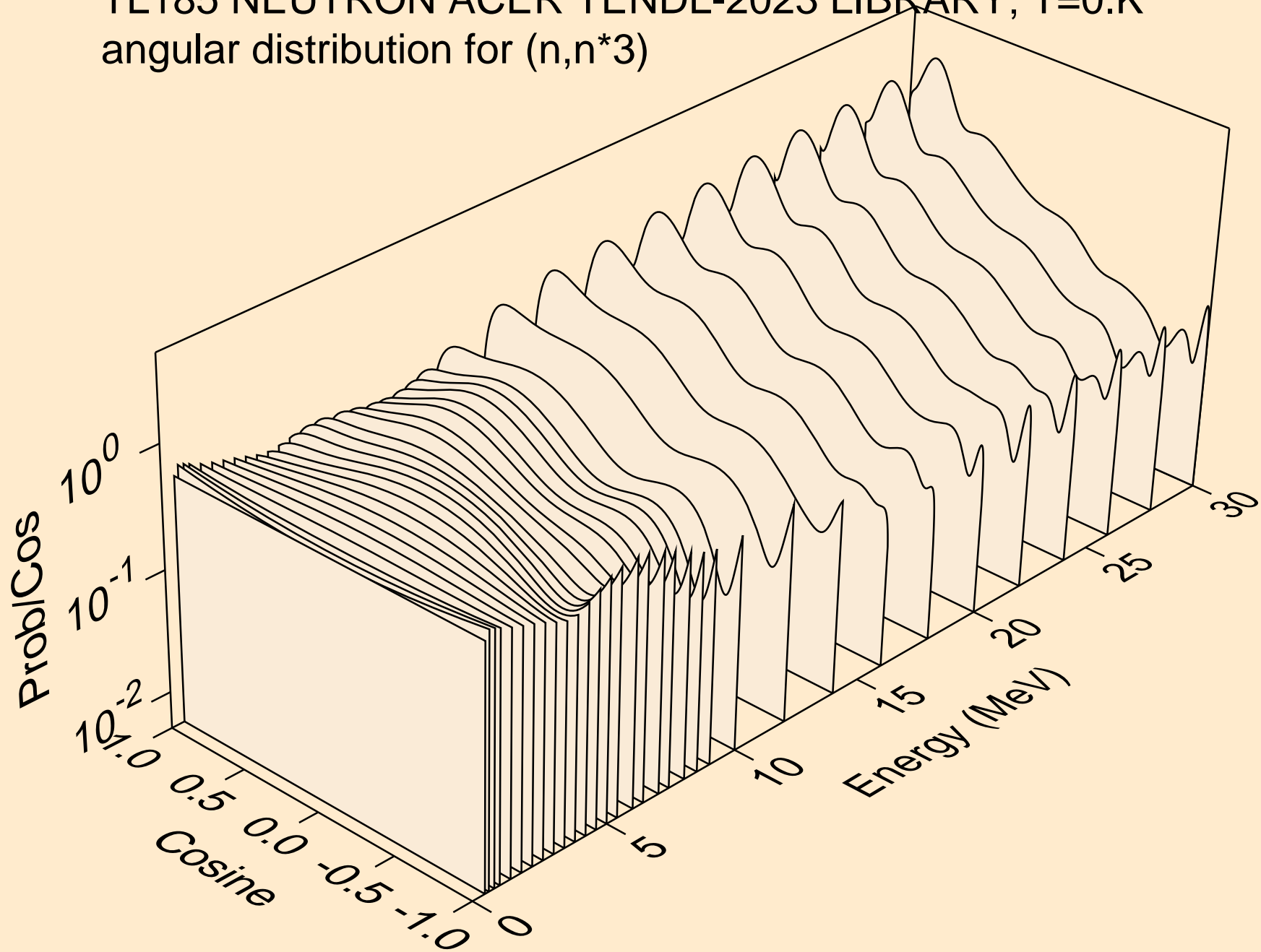

TL185 NEUTRON ACER TENDL-2023 LIBRARY; T=0.K  
angular distribution for (n,n\*4)

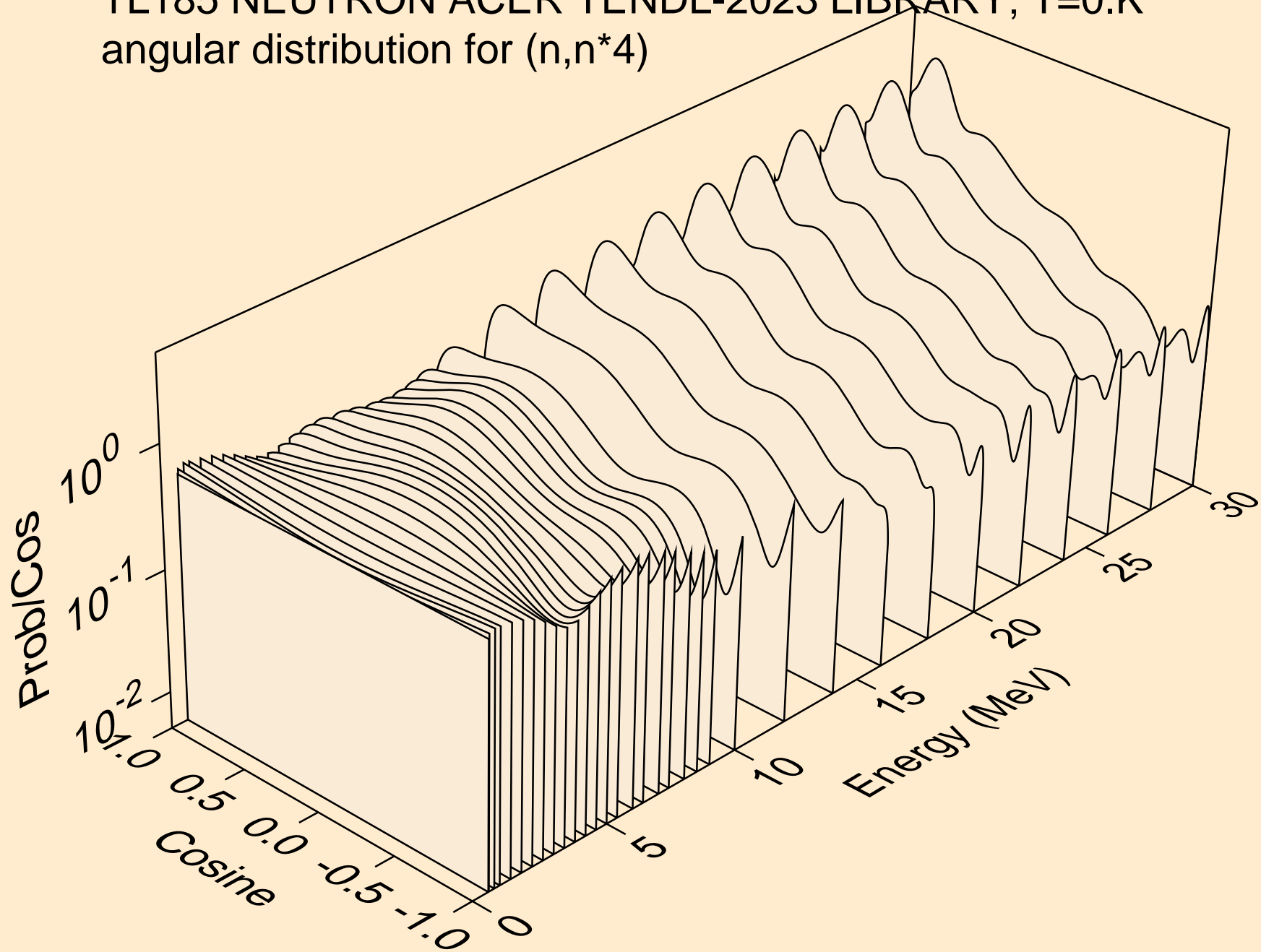

TL185 NEUTRON ACER TENDL-2023 LIBRARY; T=0.K  
angular distribution for (n,n\*5)

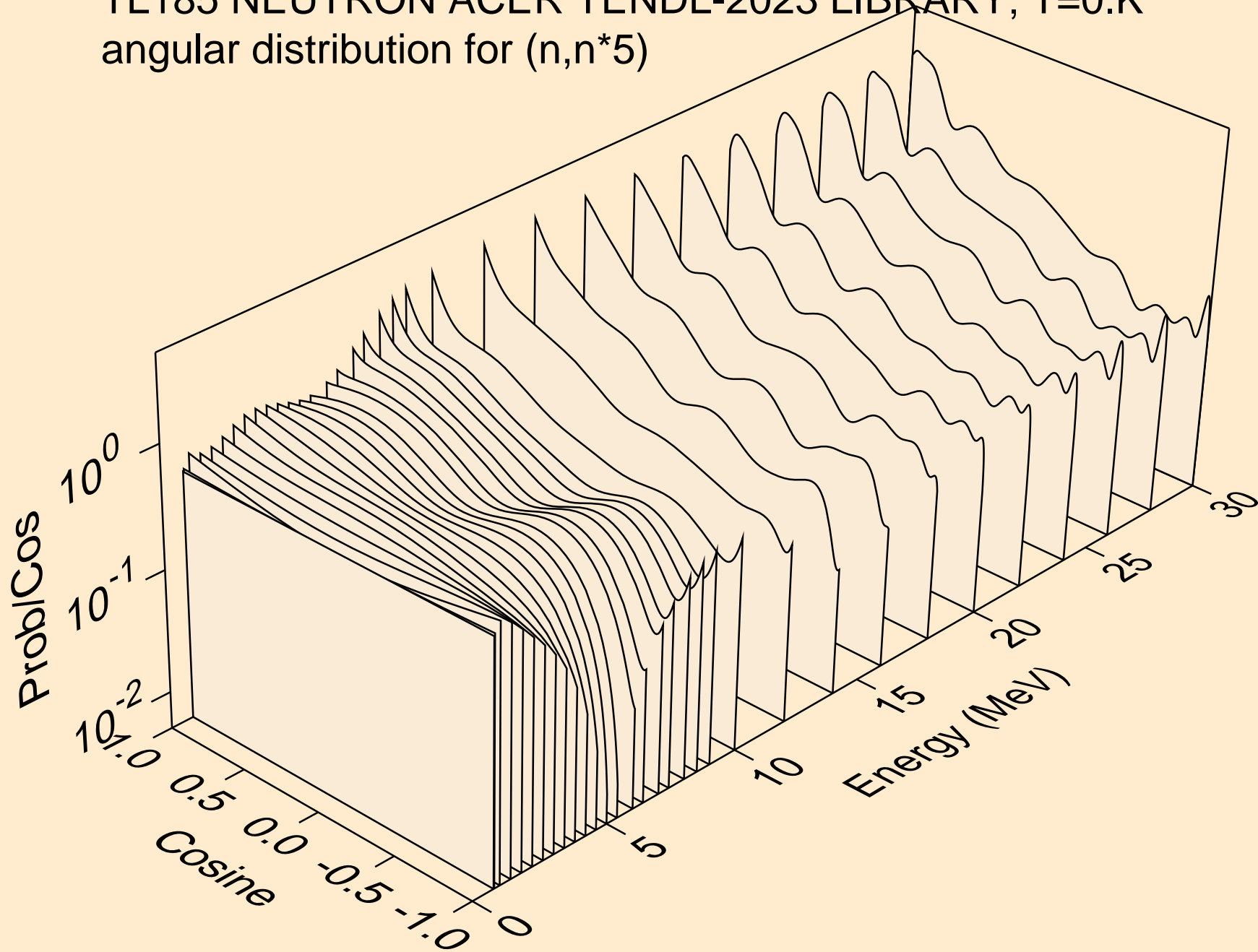

TL185 NEUTRON ACER TENDL-2023 LIBRARY; T=0.K  
angular distribution for (n,n\*6)

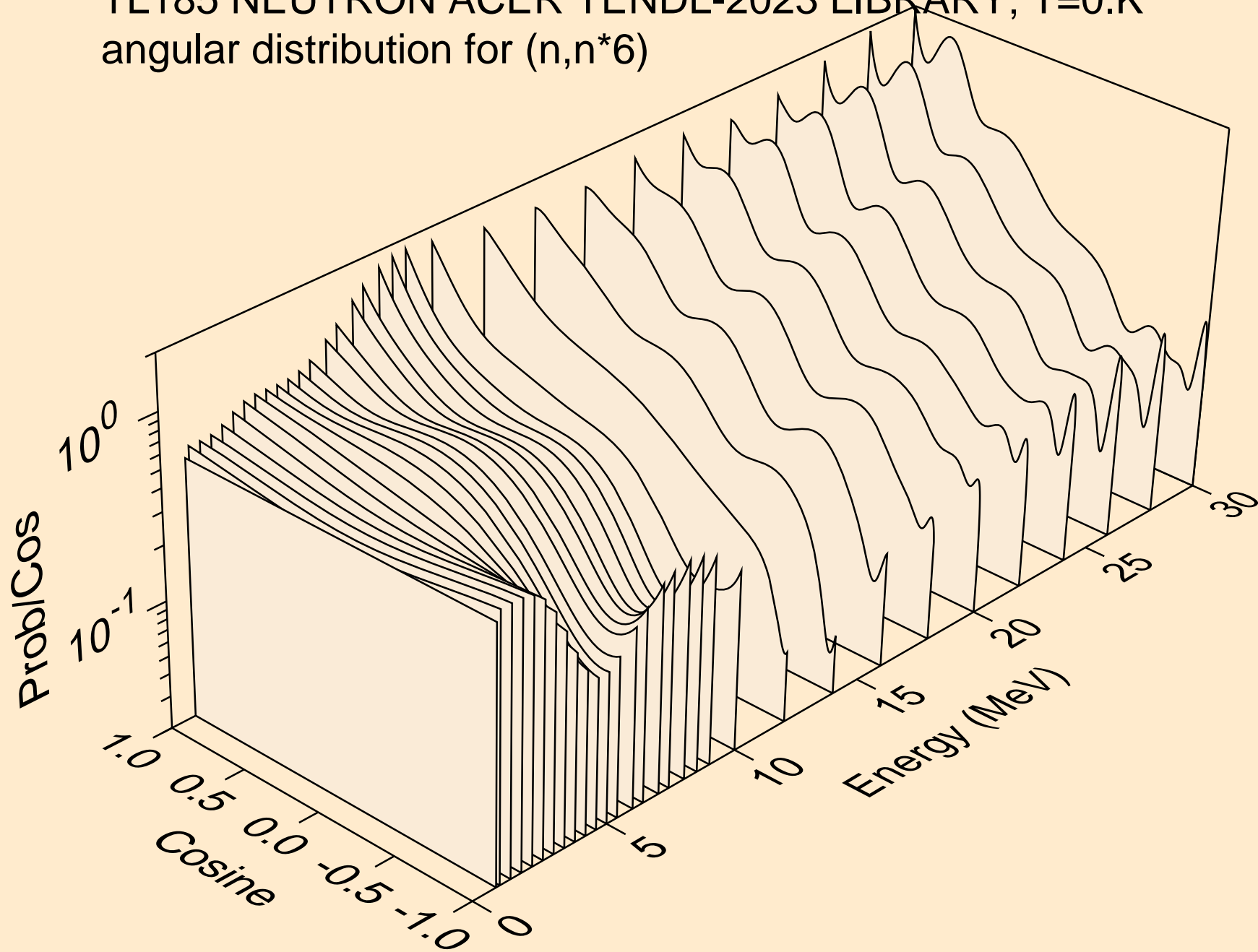

TL185 NEUTRON ACER TENDL-2023 LIBRARY; T=0.K  
angular distribution for (n,n\*7)

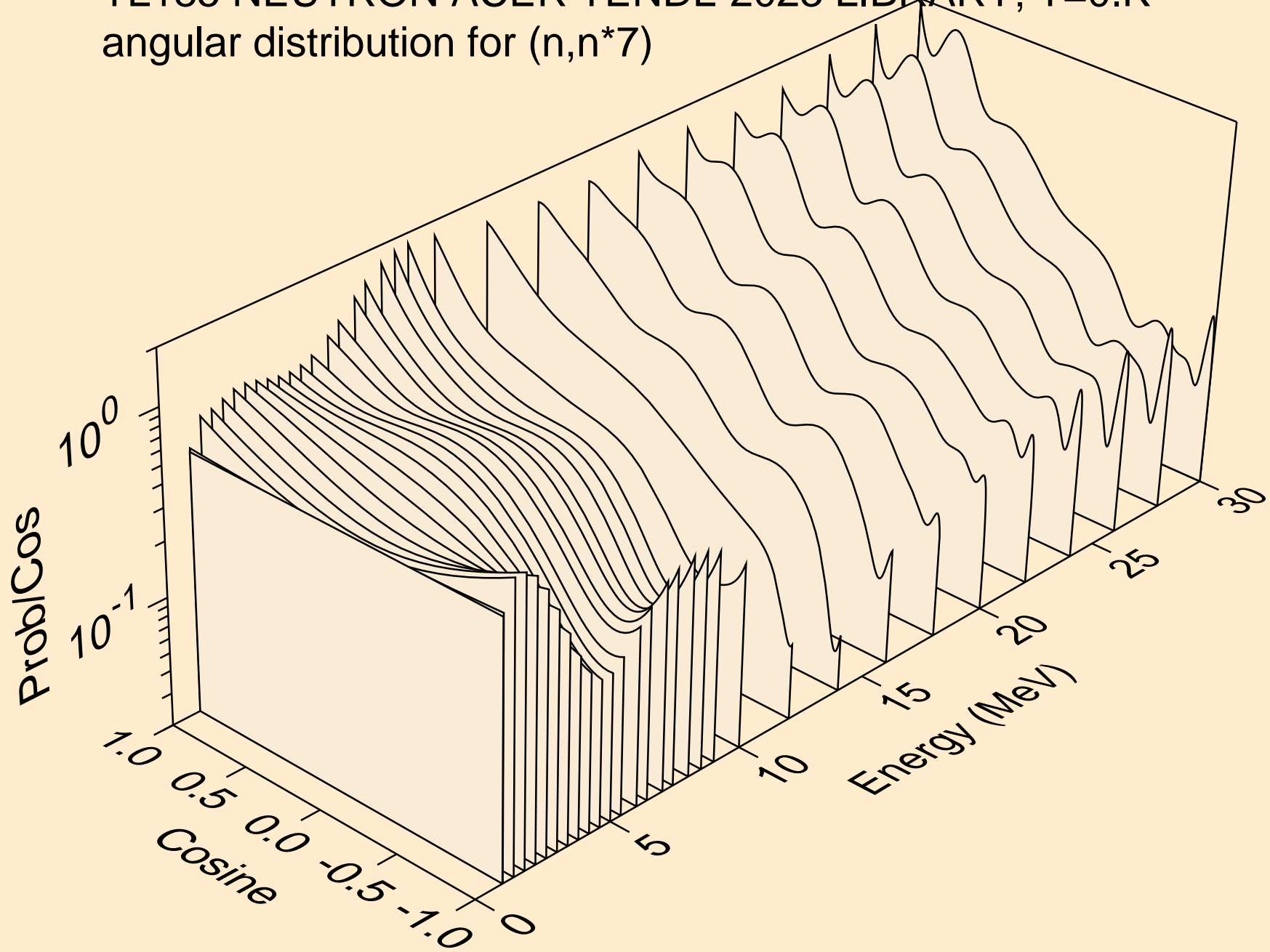

TL185 NEUTRON ACER TENDL-2023 LIBRARY; T=0.K  
angular distribution for (n,n\*8)

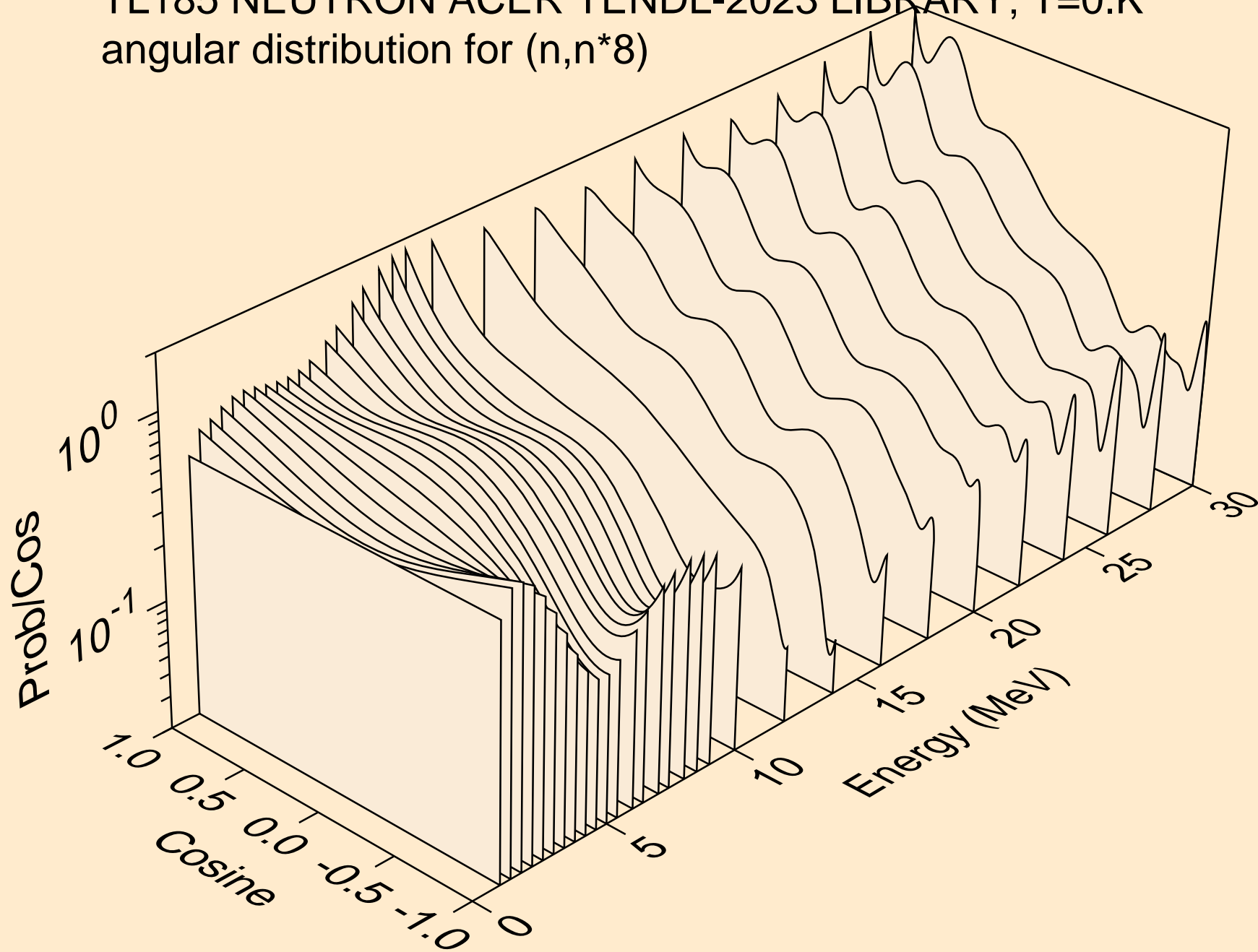

TL185 NEUTRON ACER TENDL-2023 LIBRARY; T=0.K  
angular distribution for (n,n\*9)

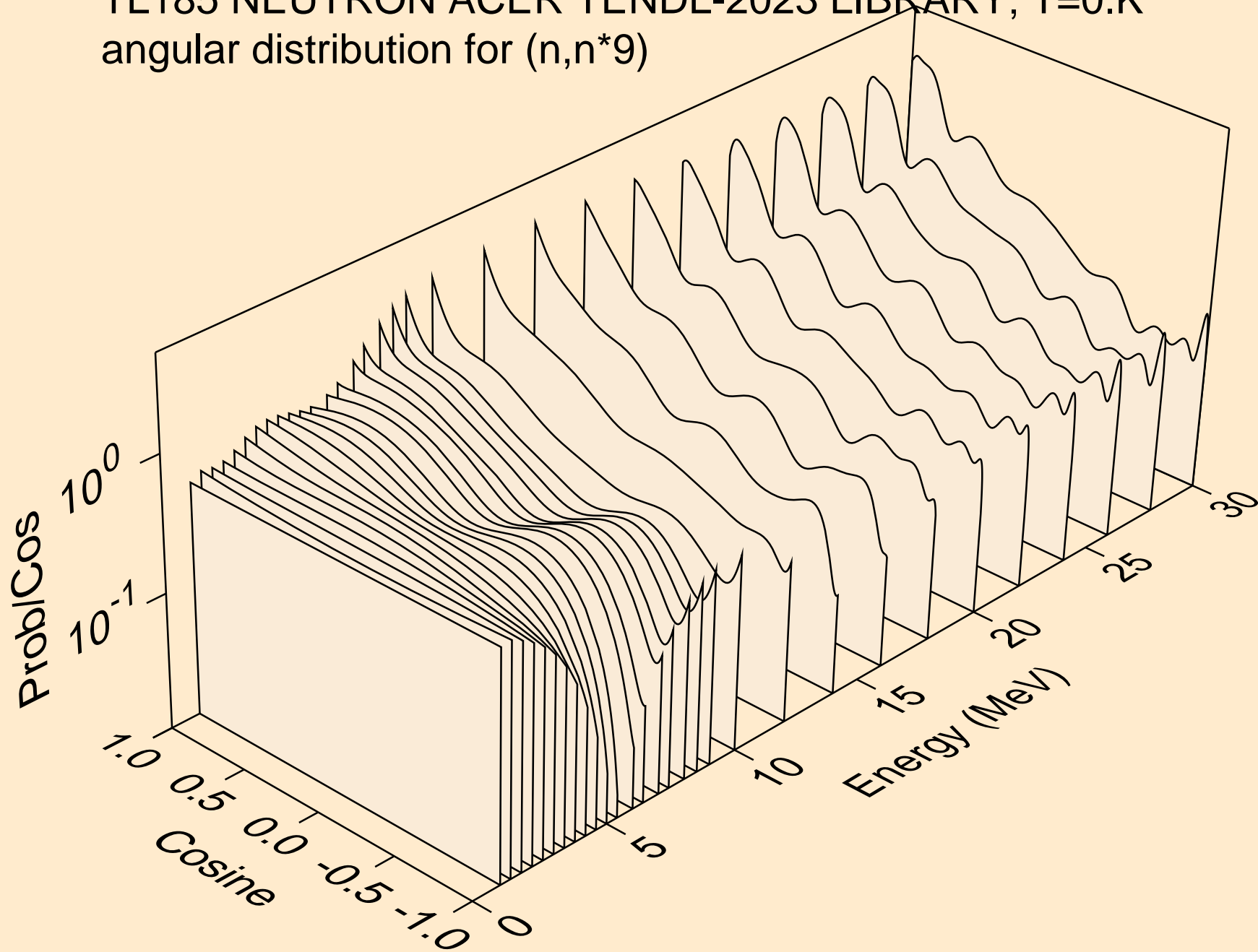

TL185 NEUTRON ACER TENDL-2023 LIBRARY; T=0.K  
angular distribution for (n,n\*10)

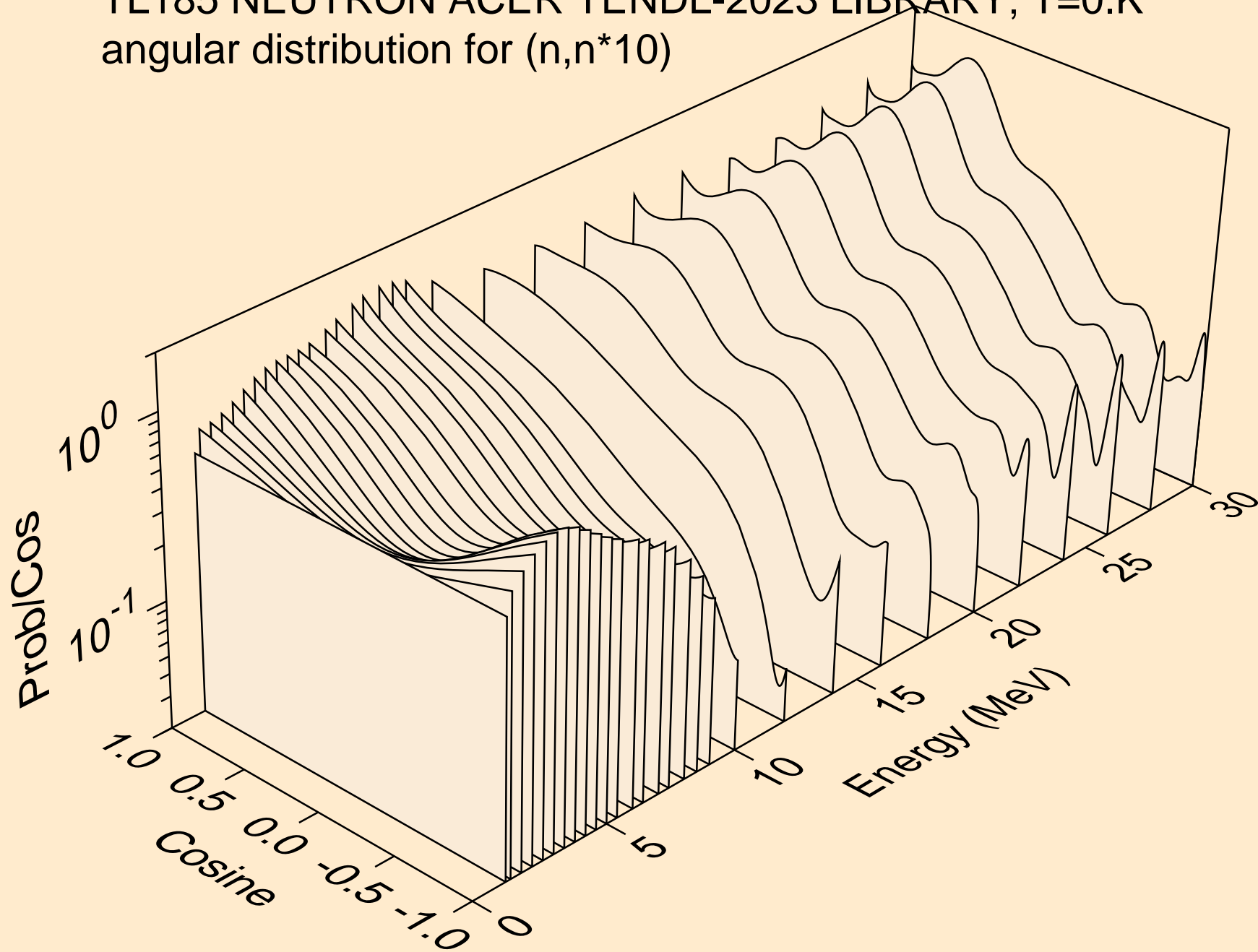

TL185 NEUTRON ACER TENDL-2023 LIBRARY; T=0.K  
angular distribution for (n,n\*11)

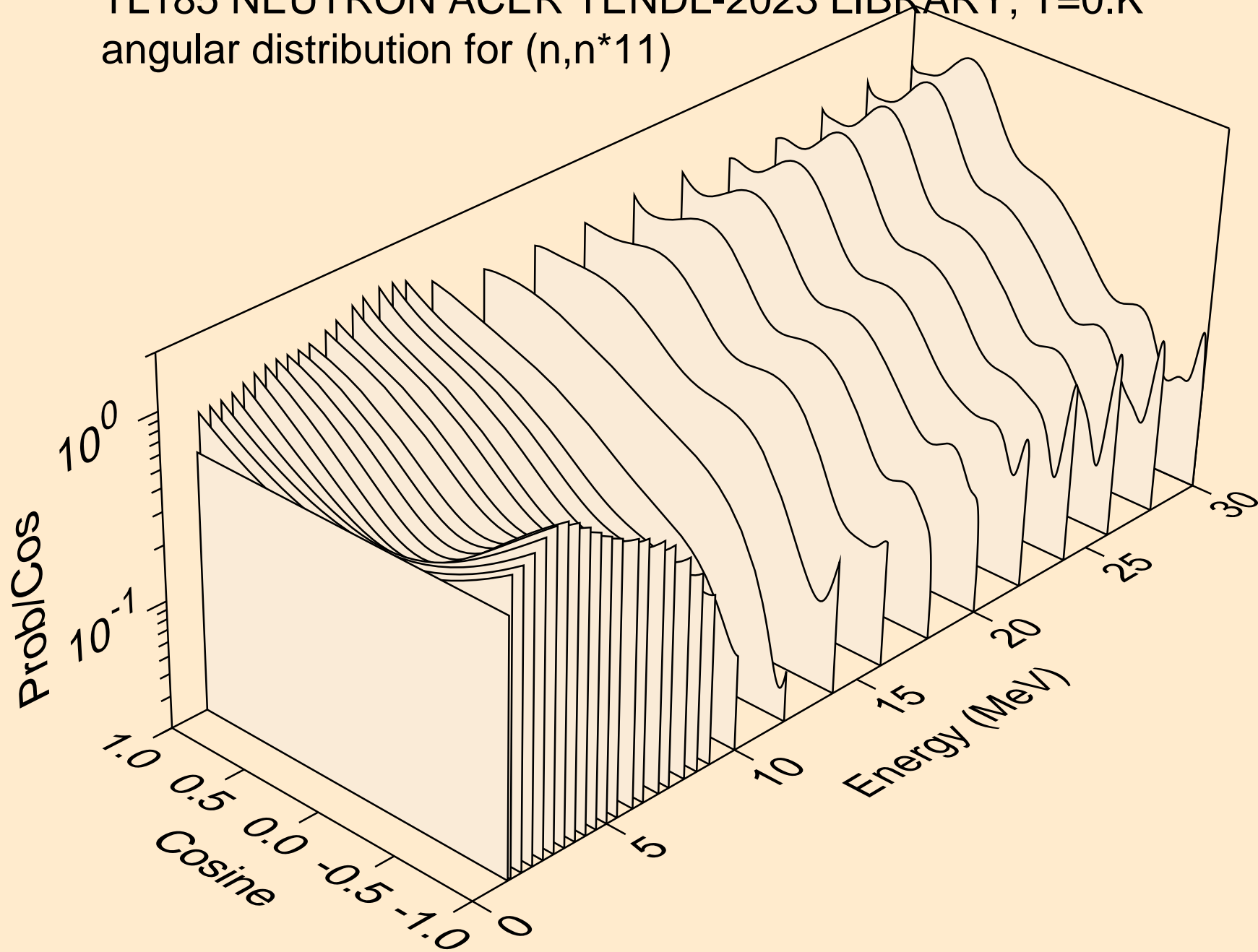

TL185 NEUTRON ACER TENDL-2023 LIBRARY; T=0.K  
angular distribution for (n,n\*12)

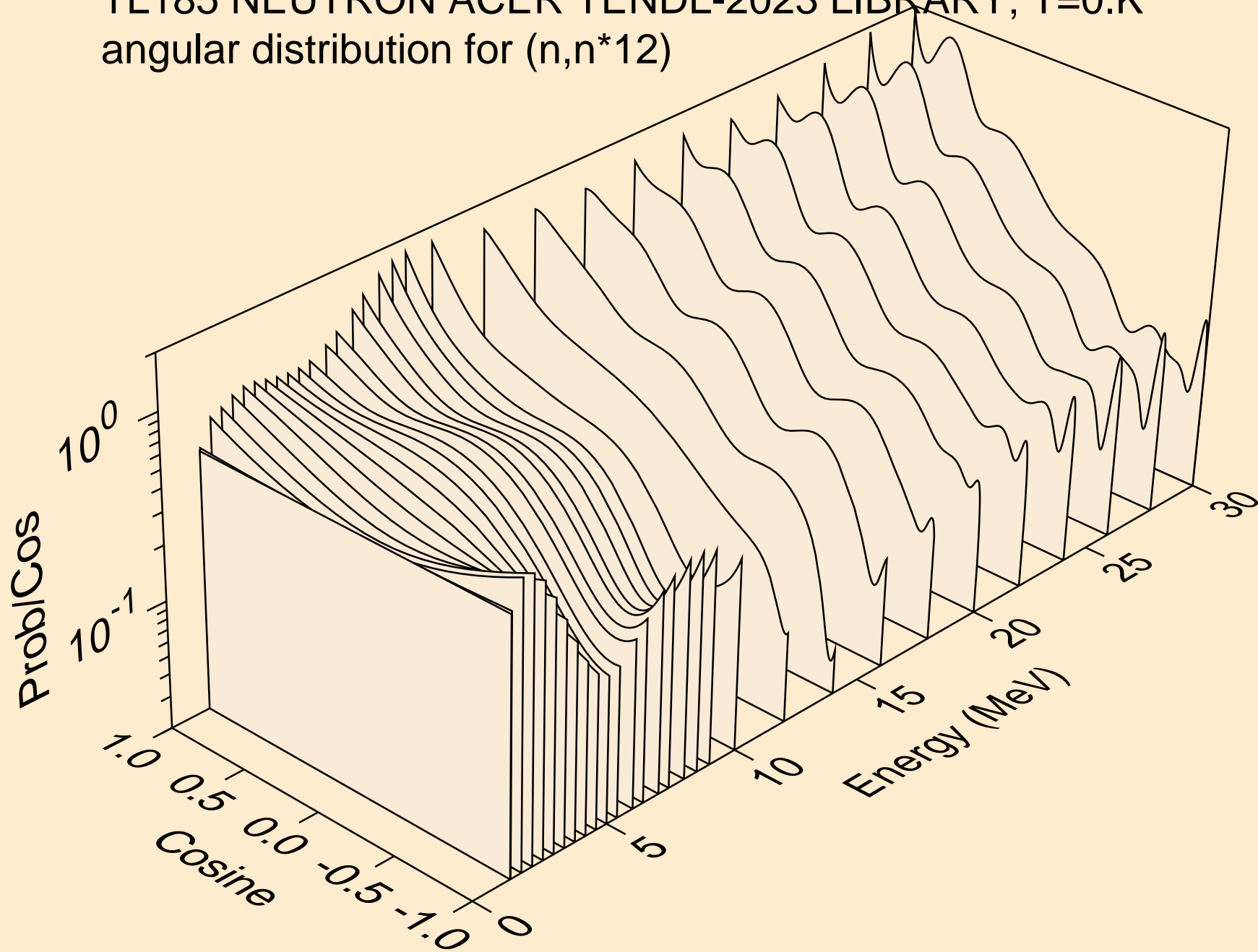

TL185 NEUTRON ACER TENDL-2023 LIBRARY; T=0.K  
angular distribution for (n,n\*13)

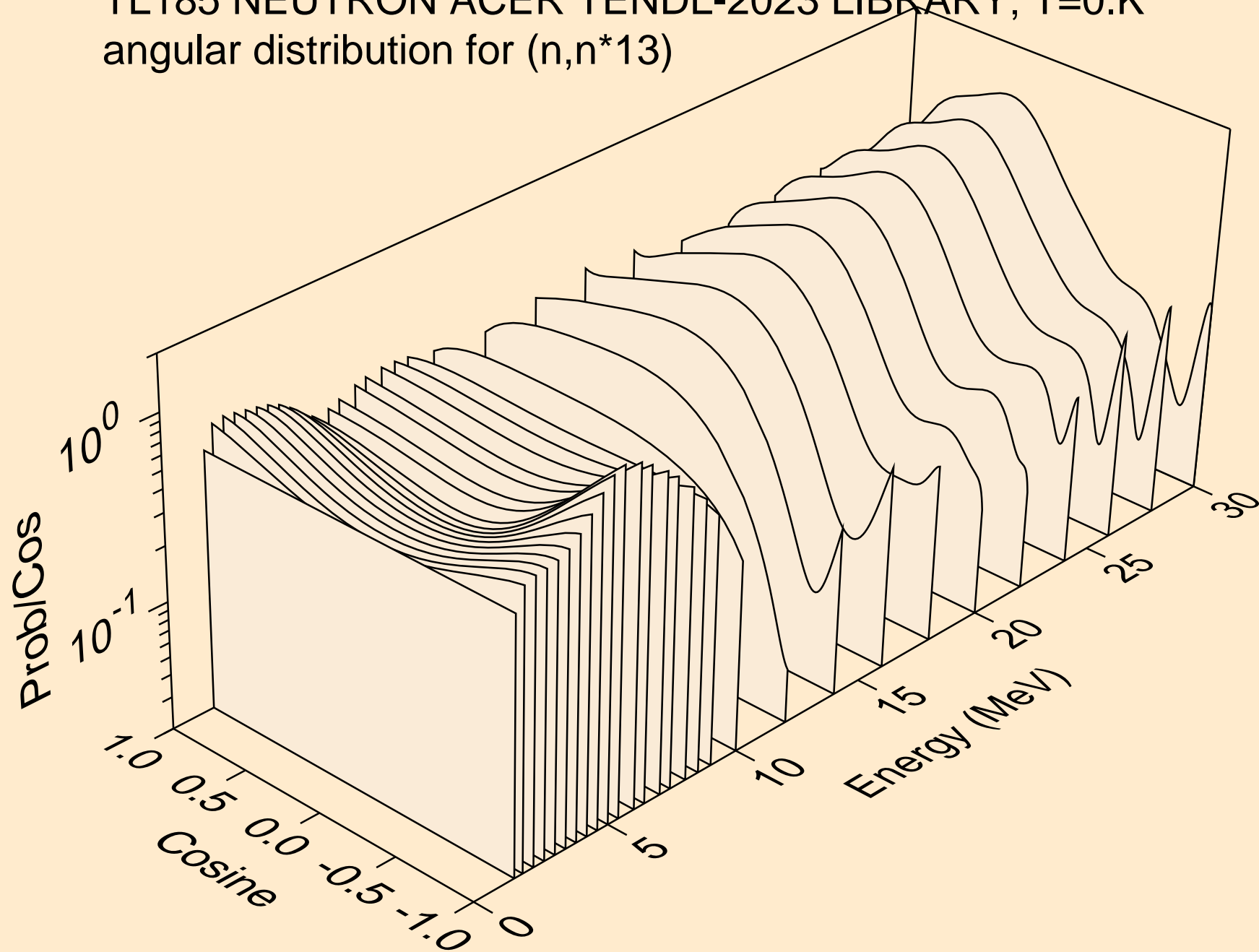

TL185 NEUTRON ACER TENDL-2023 LIBRARY; T=0.K  
angular distribution for (n,n\*14)

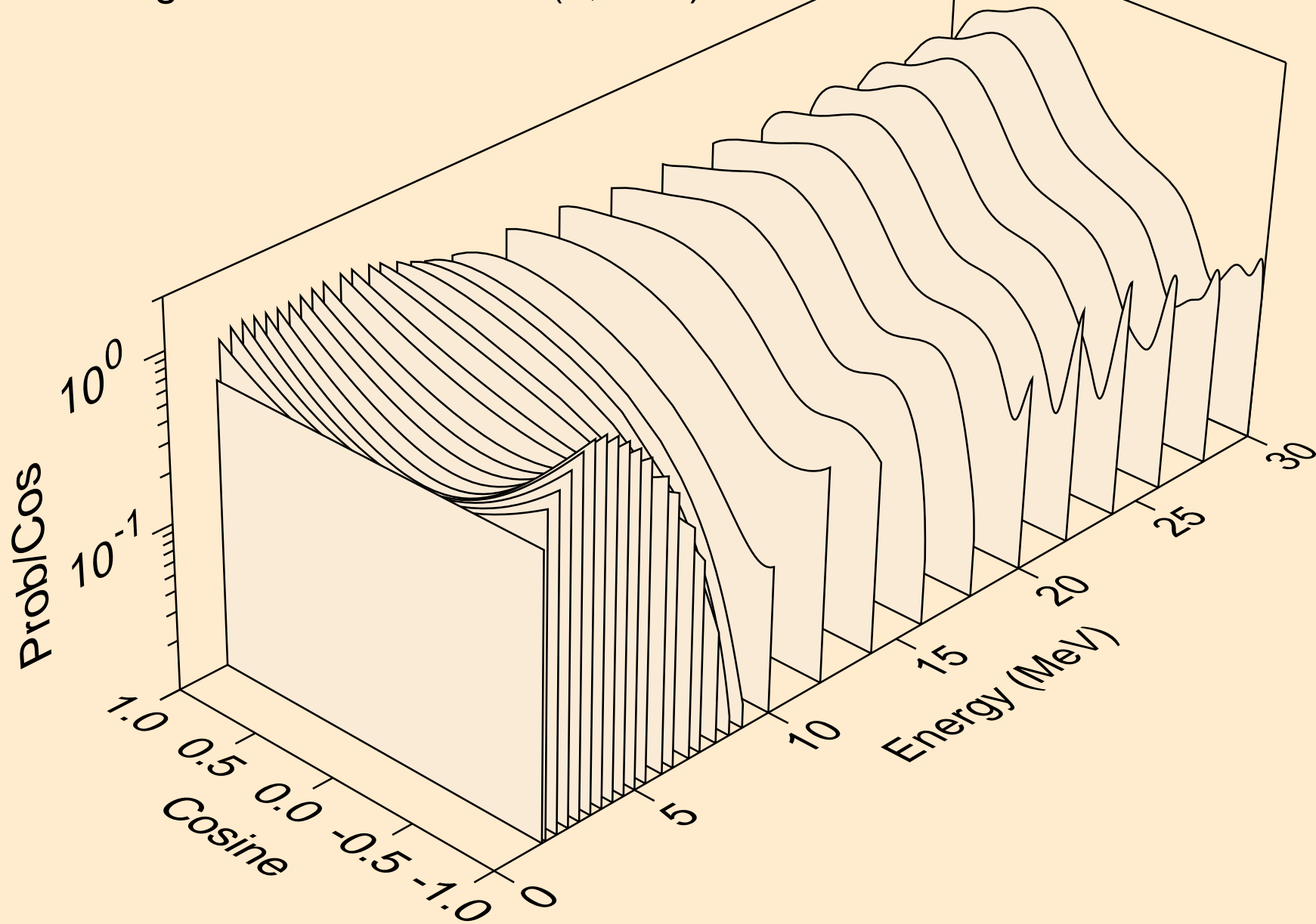

TL185 NEUTRON ACER TENDL-2023 LIBRARY; T=0.K  
angular distribution for (n,n\*15)

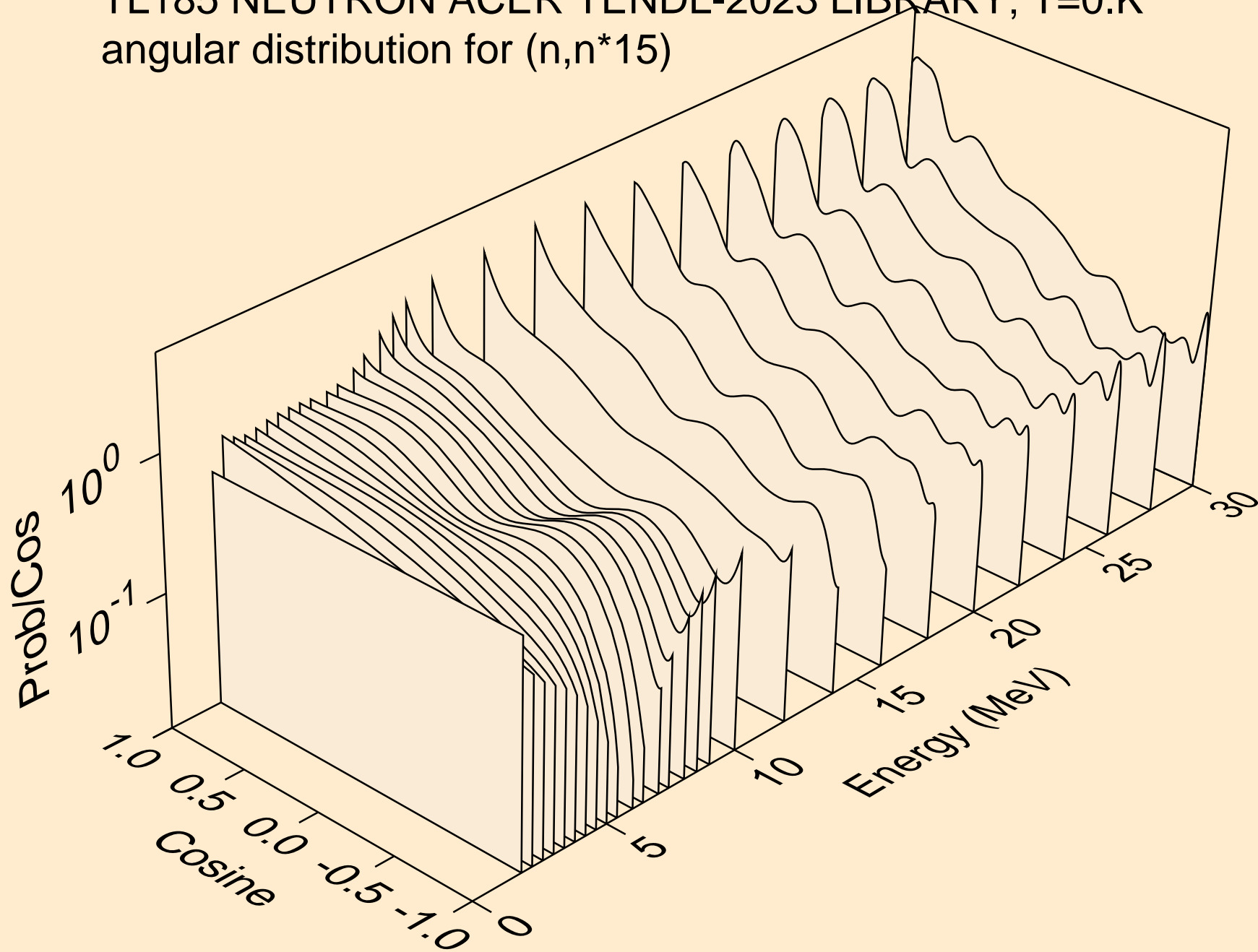

TL185 NEUTRON ACER TENDL-2023 LIBRARY; T=0.K  
angular distribution for (n,n\*16)

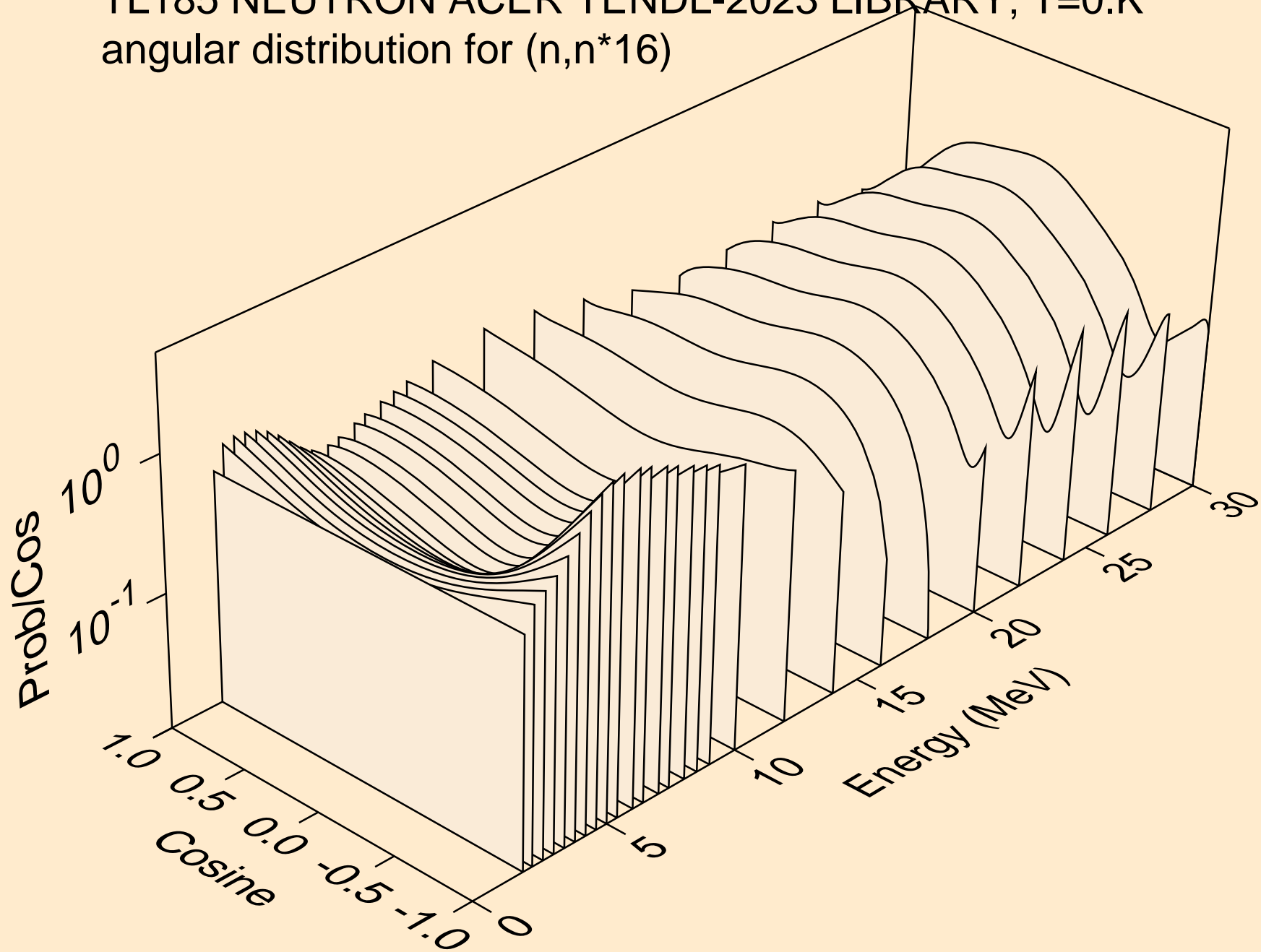

TL185 NEUTRON ACER TENDL-2023 LIBRARY; T=0.K  
angular distribution for (n,n\*17)

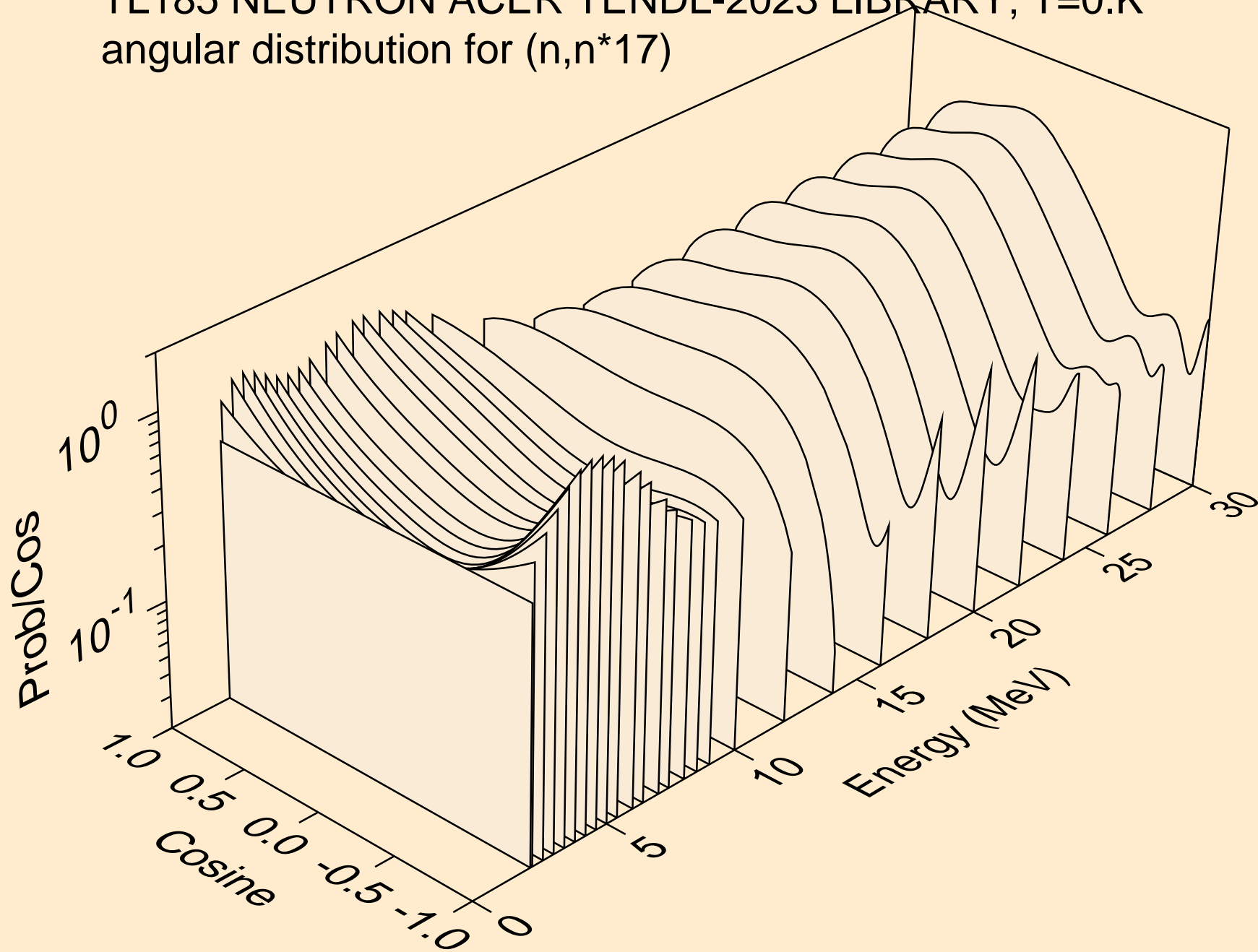

TL185 NEUTRON ACER TENDL-2023 LIBRARY; T=0.K  
angular distribution for (n,n\*18)

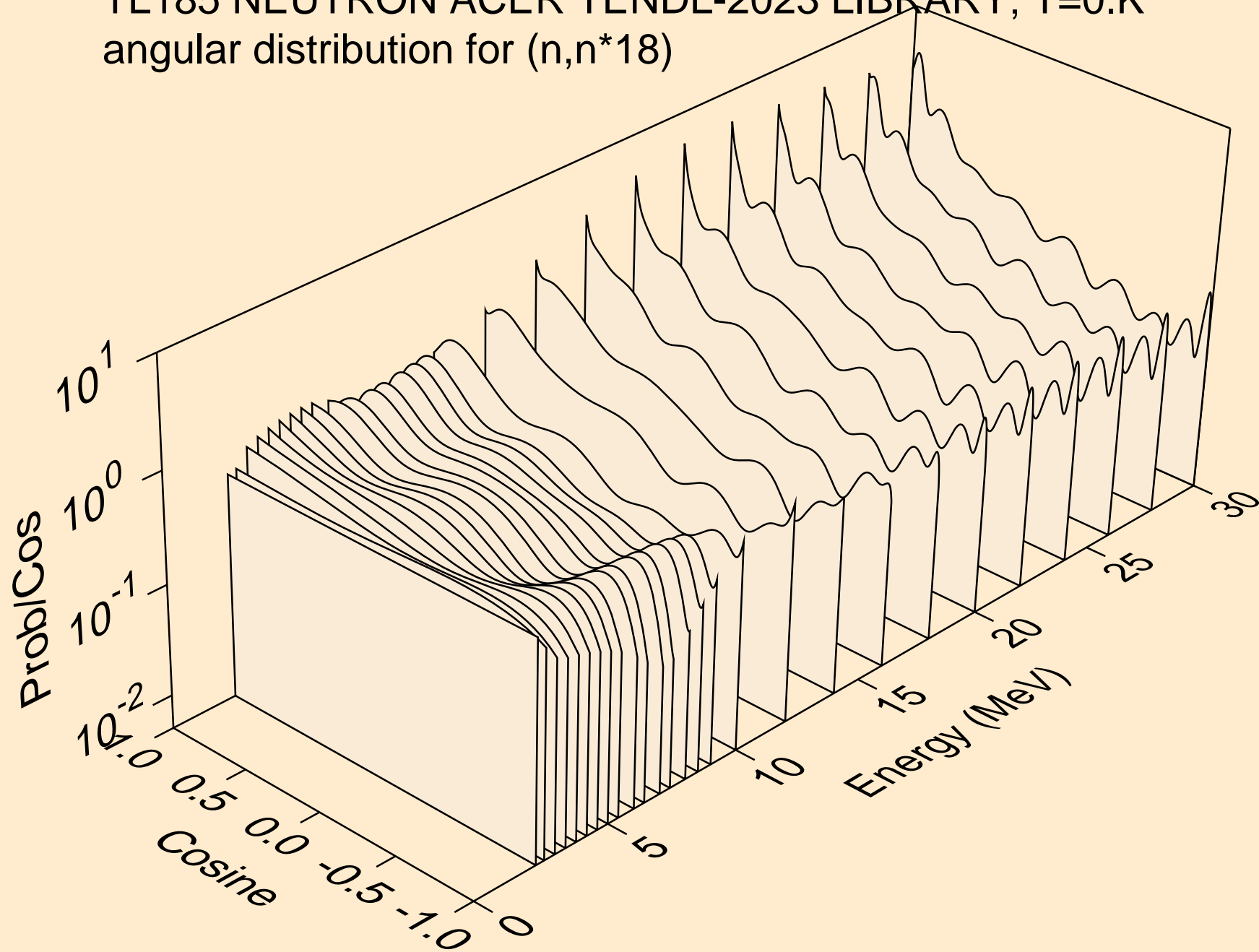

TL185 NEUTRON ACER TENDL-2023 LIBRARY; T=0.K  
angular distribution for (n,n\*19)

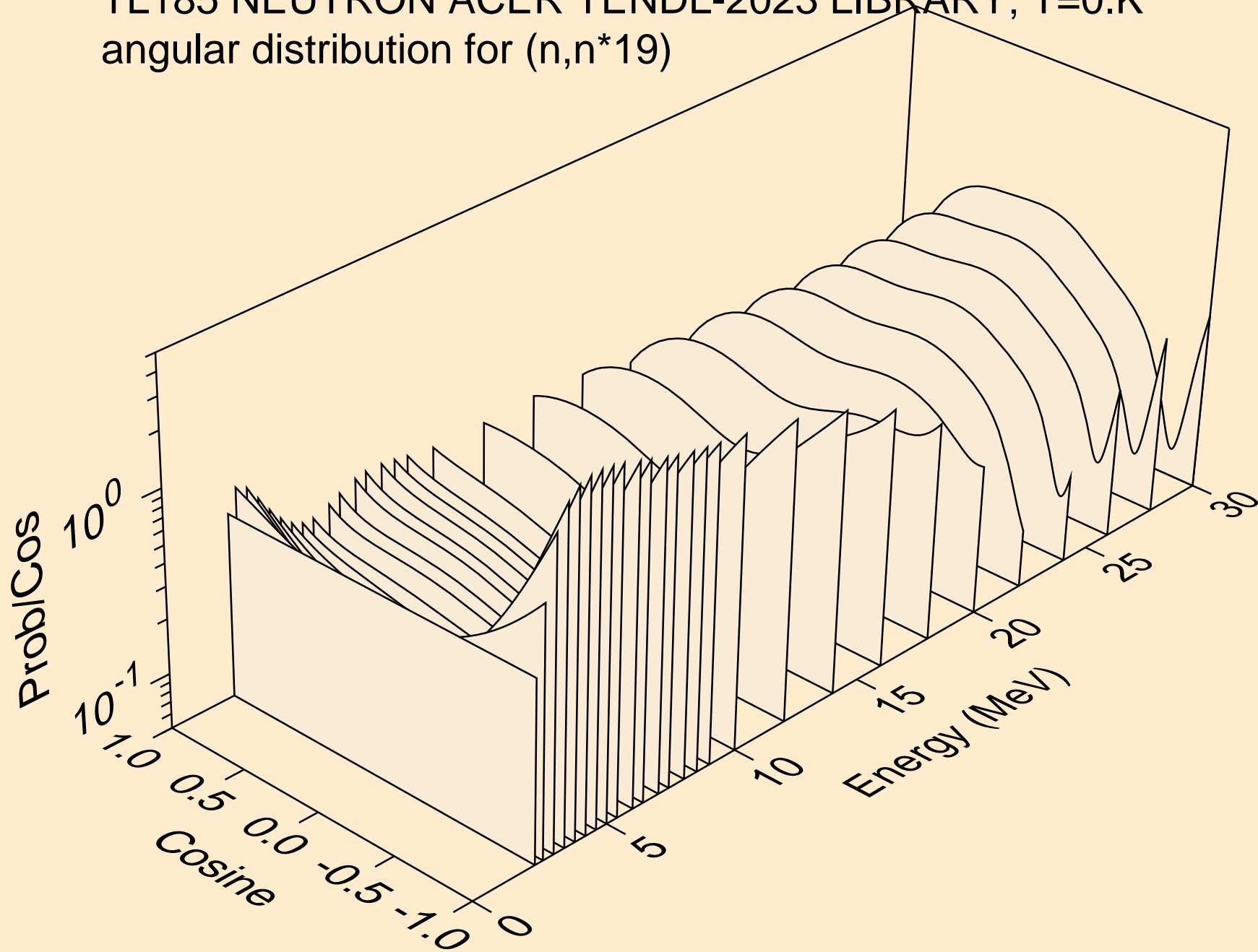

TL185 NEUTRON ACER TENDL-2023 LIBRARY; T=0.K  
angular distribution for (n,n\*20)

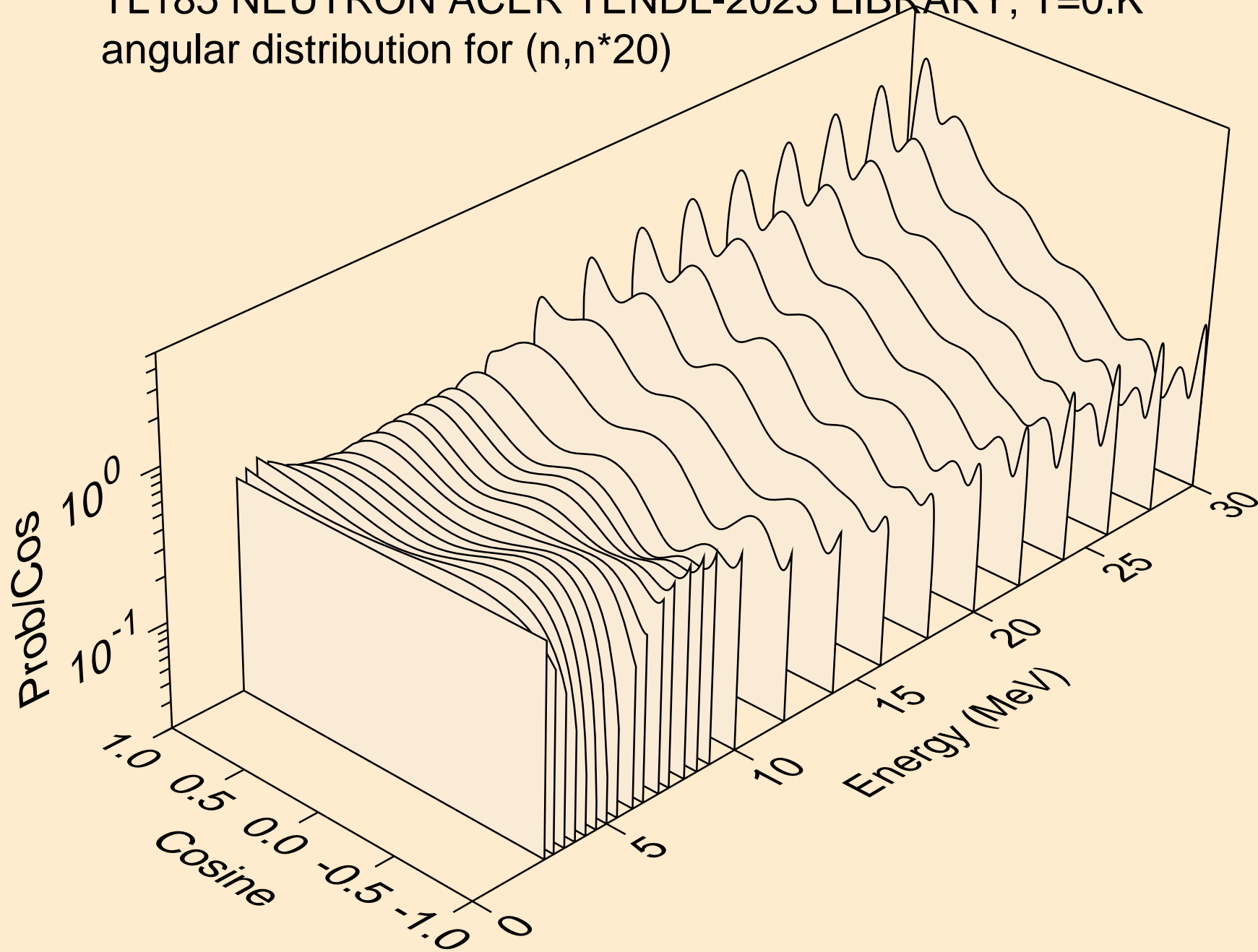

TL185 NEUTRON ACER TENDL-2023 LIBRARY; T=0.K  
Neutron emission for (n,x)

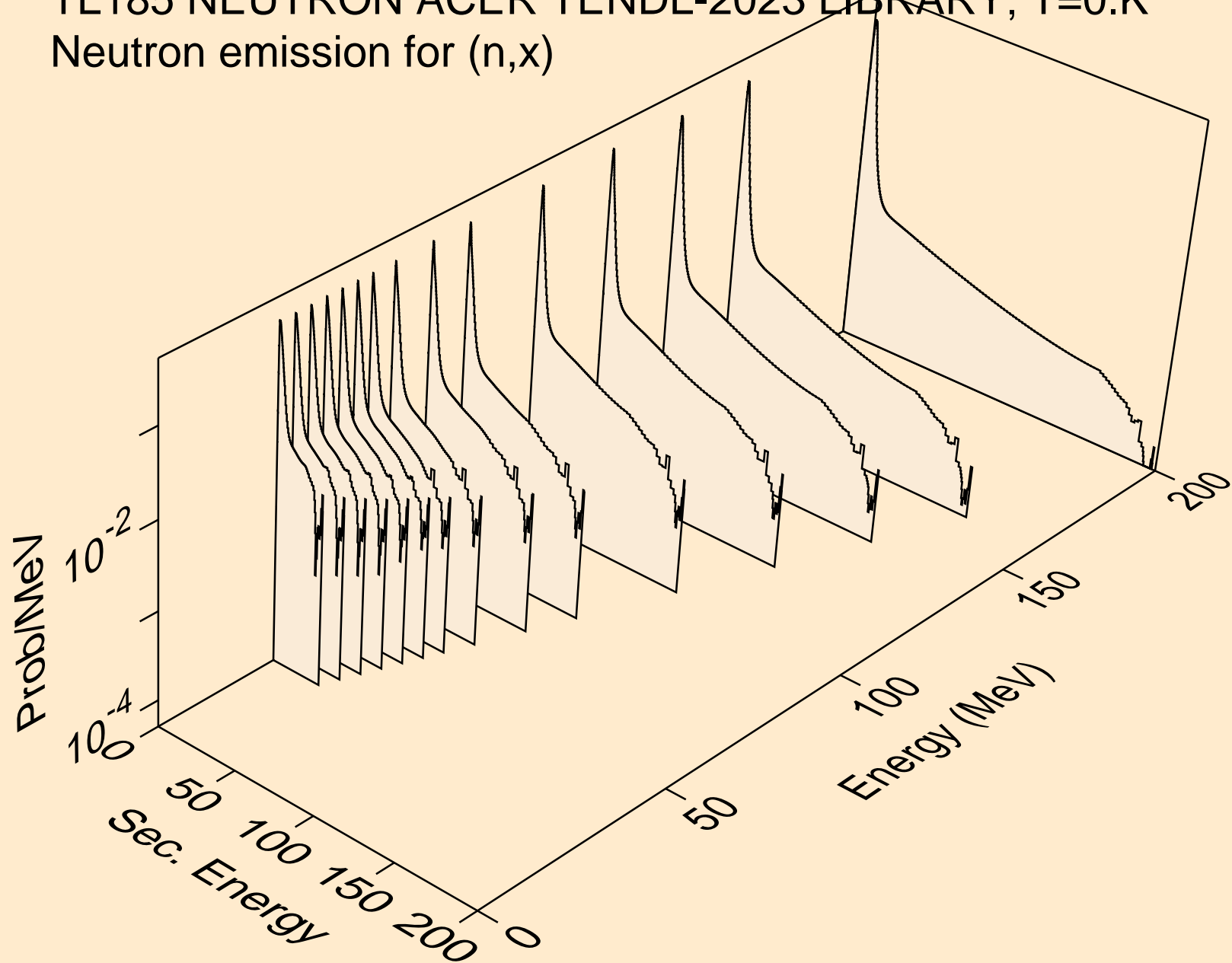

TL185 NEUTRON ACER TENDL-2023 LIBRARY; T=0.K  
Neutron emission for (n,2nd)

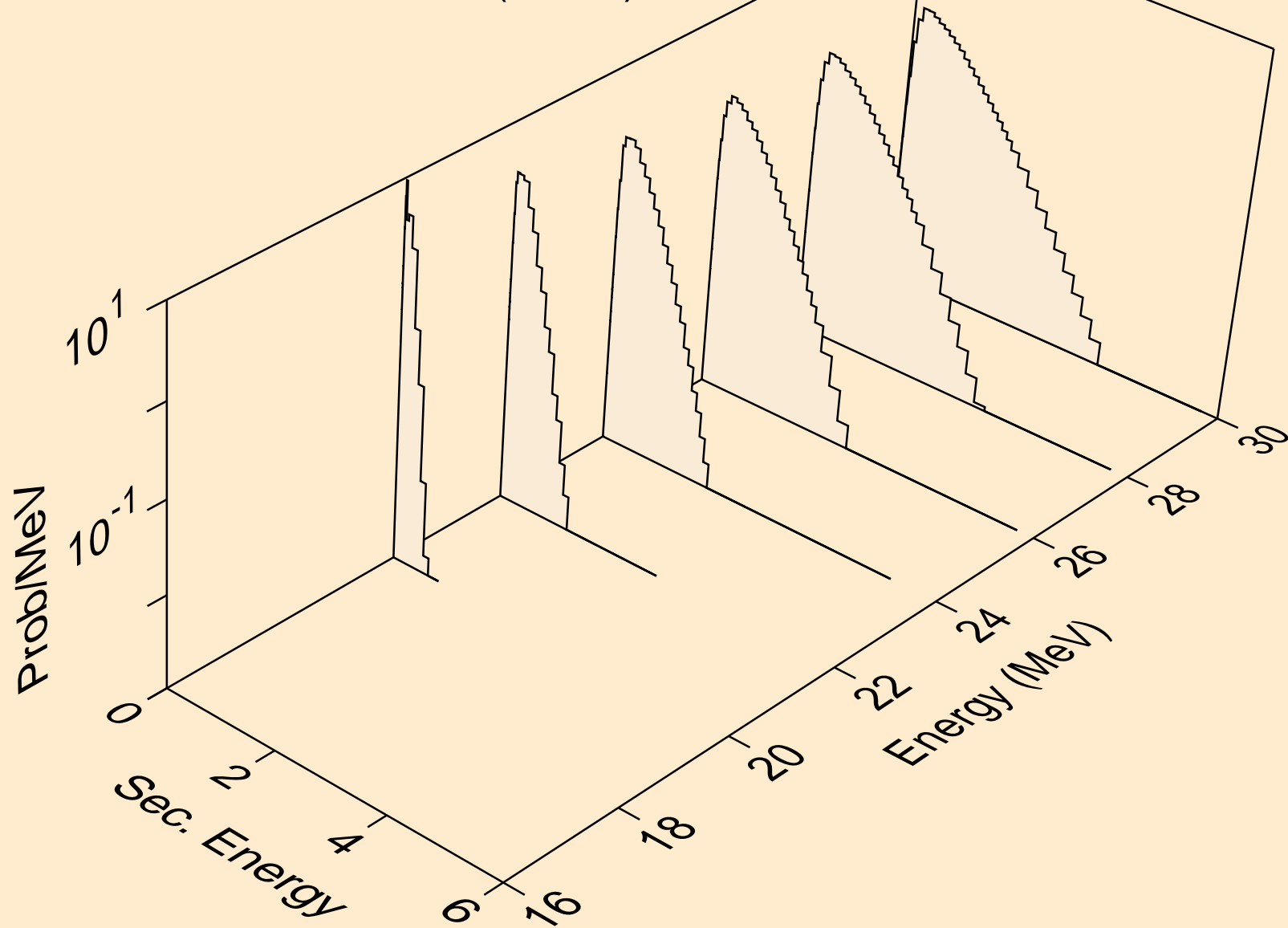

TL185 NEUTRON ACER TENDL-2023 LIBRARY; T=0.K  
Neutron emission for (n,2n)

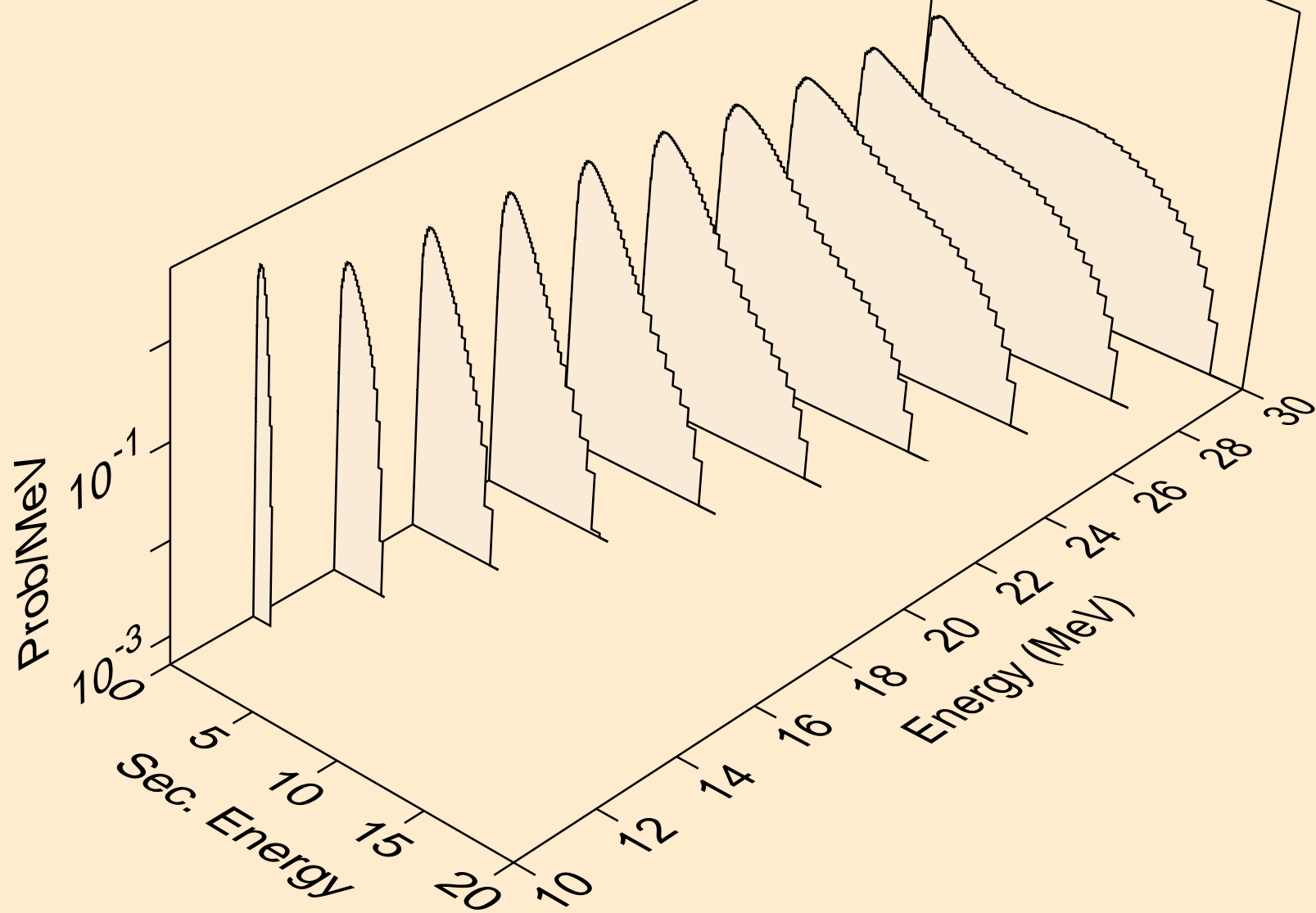

TL185 NEUTRON ACER TENDL-2023 LIBRARY; T=0.K  
Neutron emission for (n,3n)

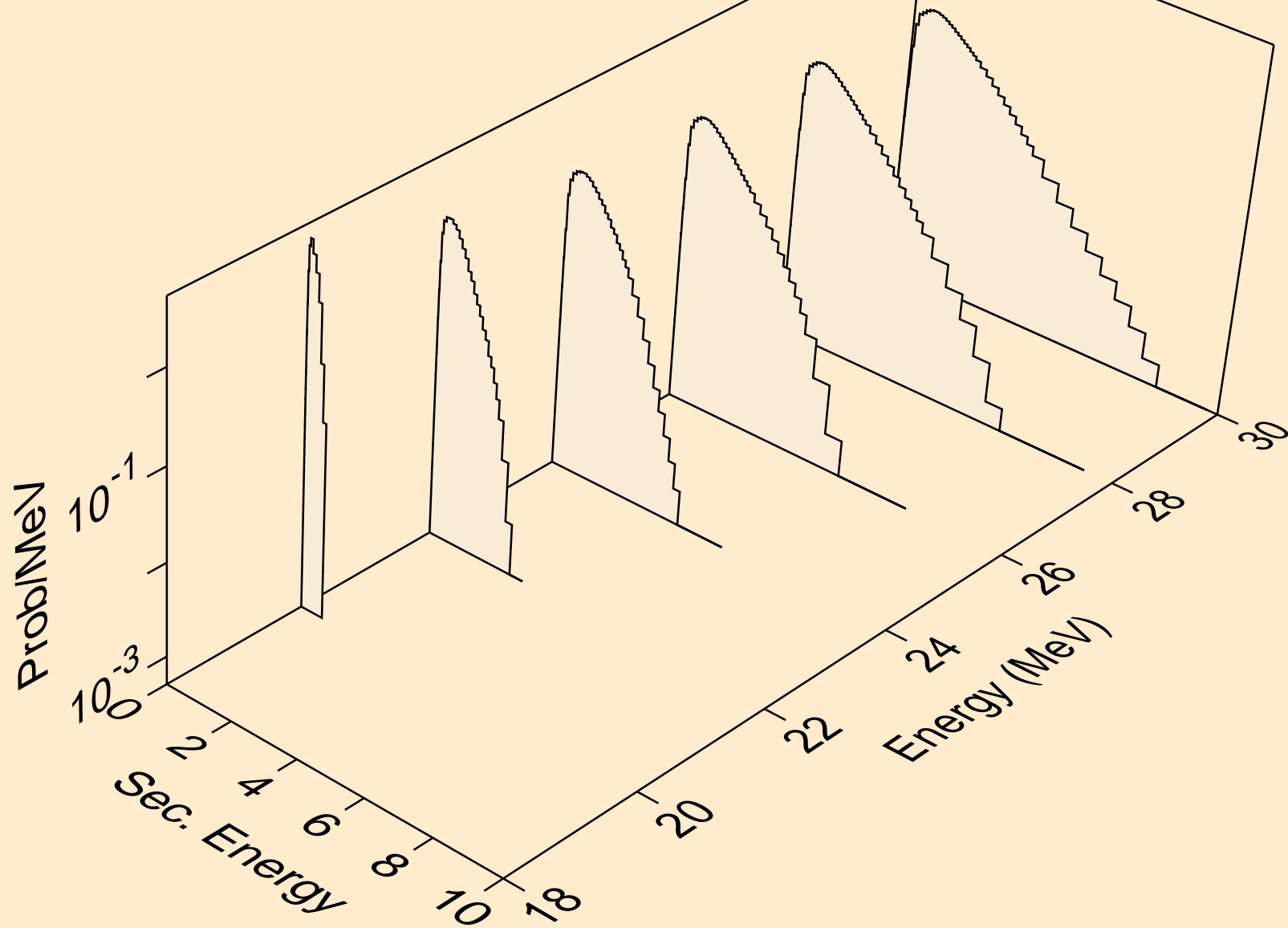

TL185 NEUTRON ACER TENDL-2023 LIBRARY; T=0.K  
Neutron emission for (n,n\*)a

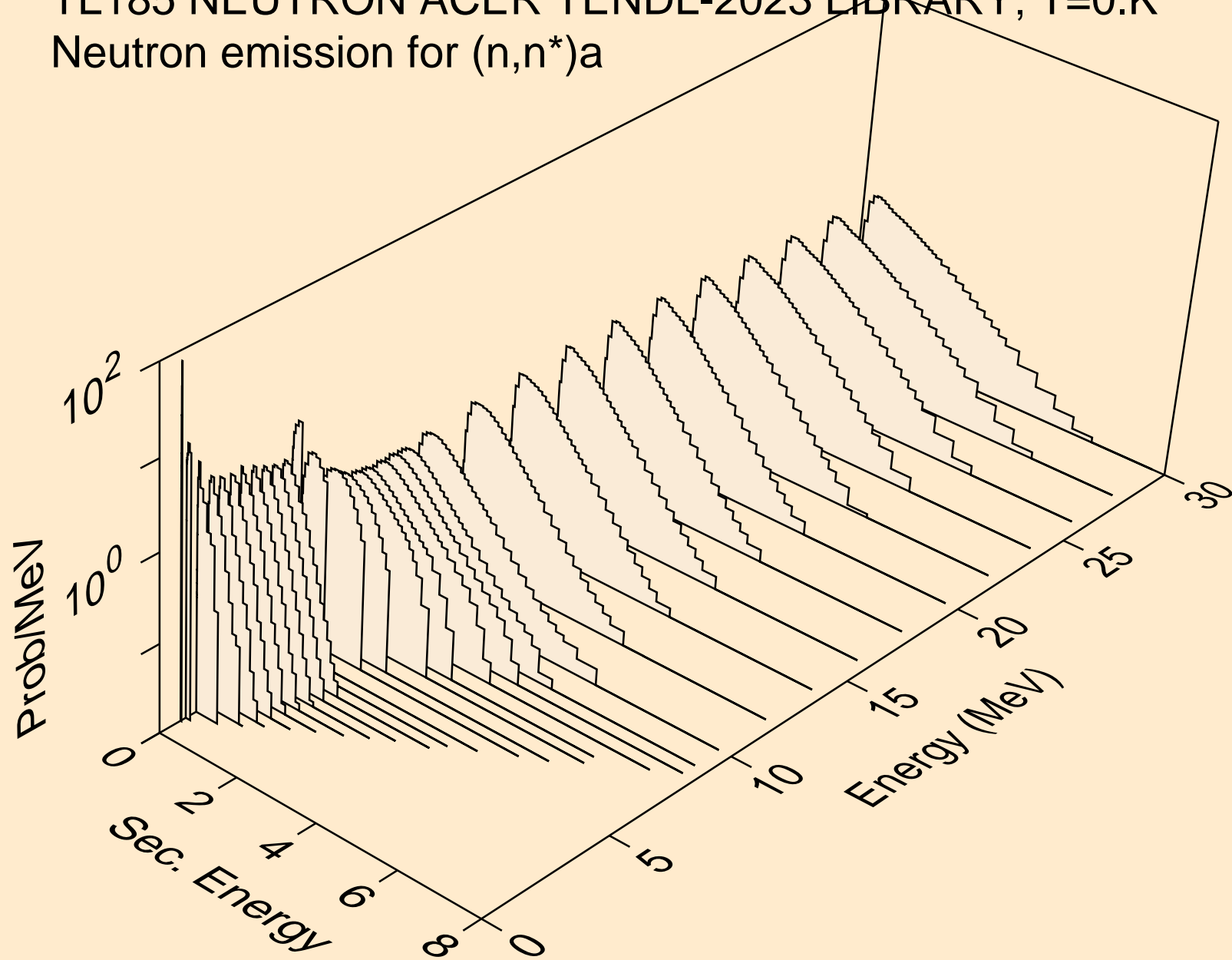

TL185 NEUTRON ACER TENDL-2023 LIBRARY; T=0.K  
Neutron emission for (n,n\*)3a

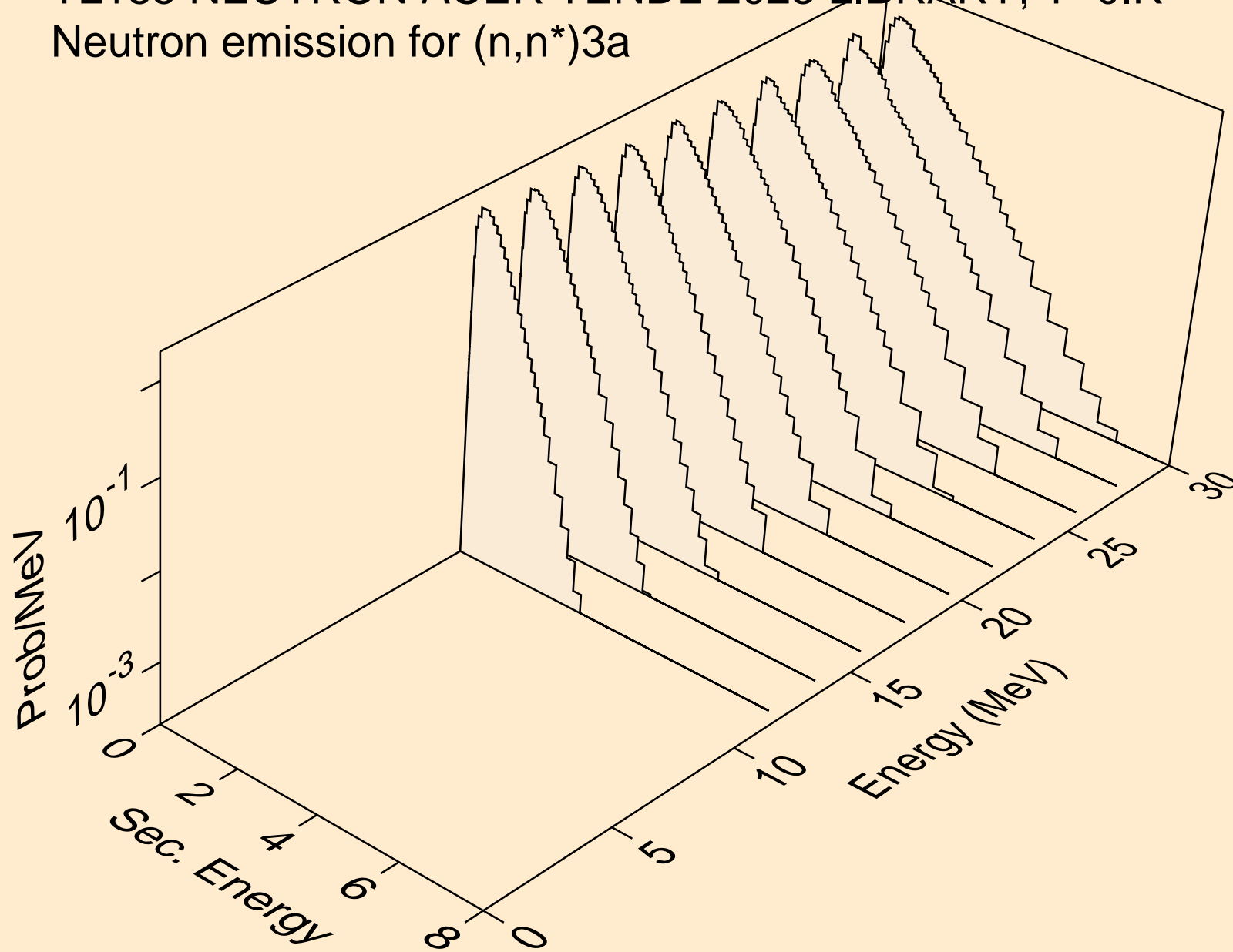

TL185 NEUTRON ACER TENDL-2023 LIBRARY; T=0.K  
Neutron emission for (n,2n)a

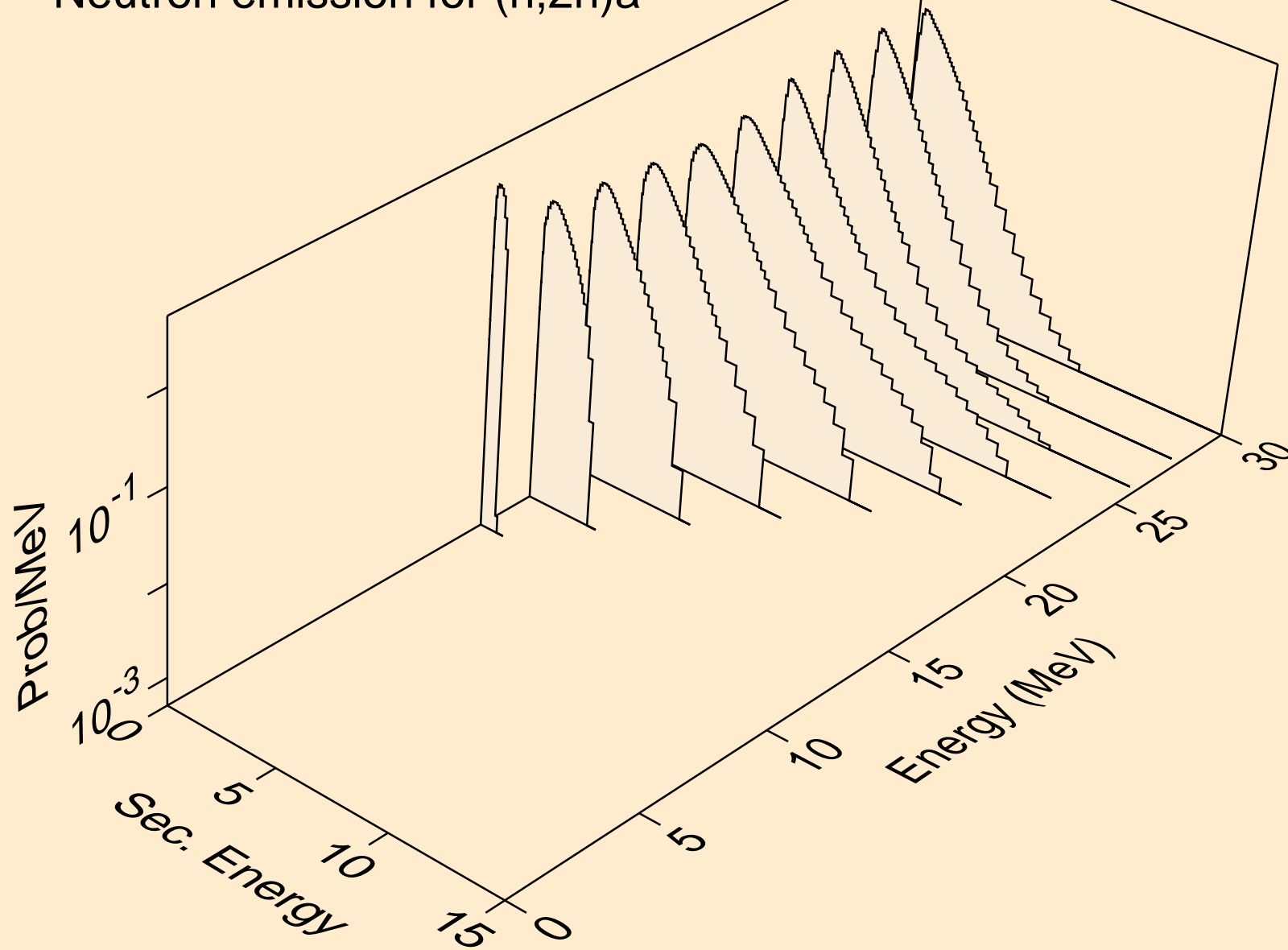

TL185 NEUTRON ACER TENDL-2023 LIBRARY; T=0.K  
Neutron emission for (n,3n)a

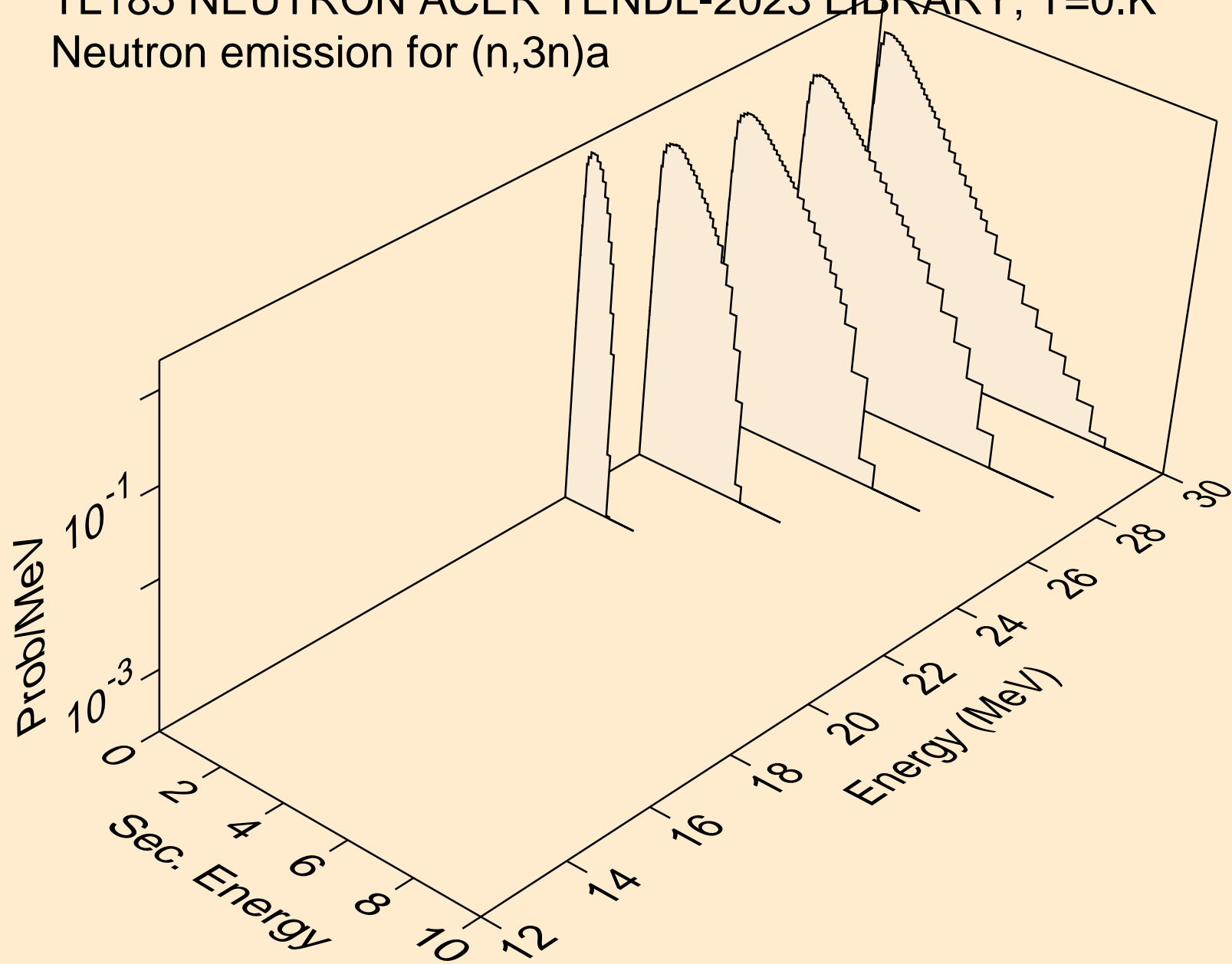

TL185 NEUTRON ACER TENDL-2023 LIBRARY; T=0.K  
Neutron emission for (n,n\*)p

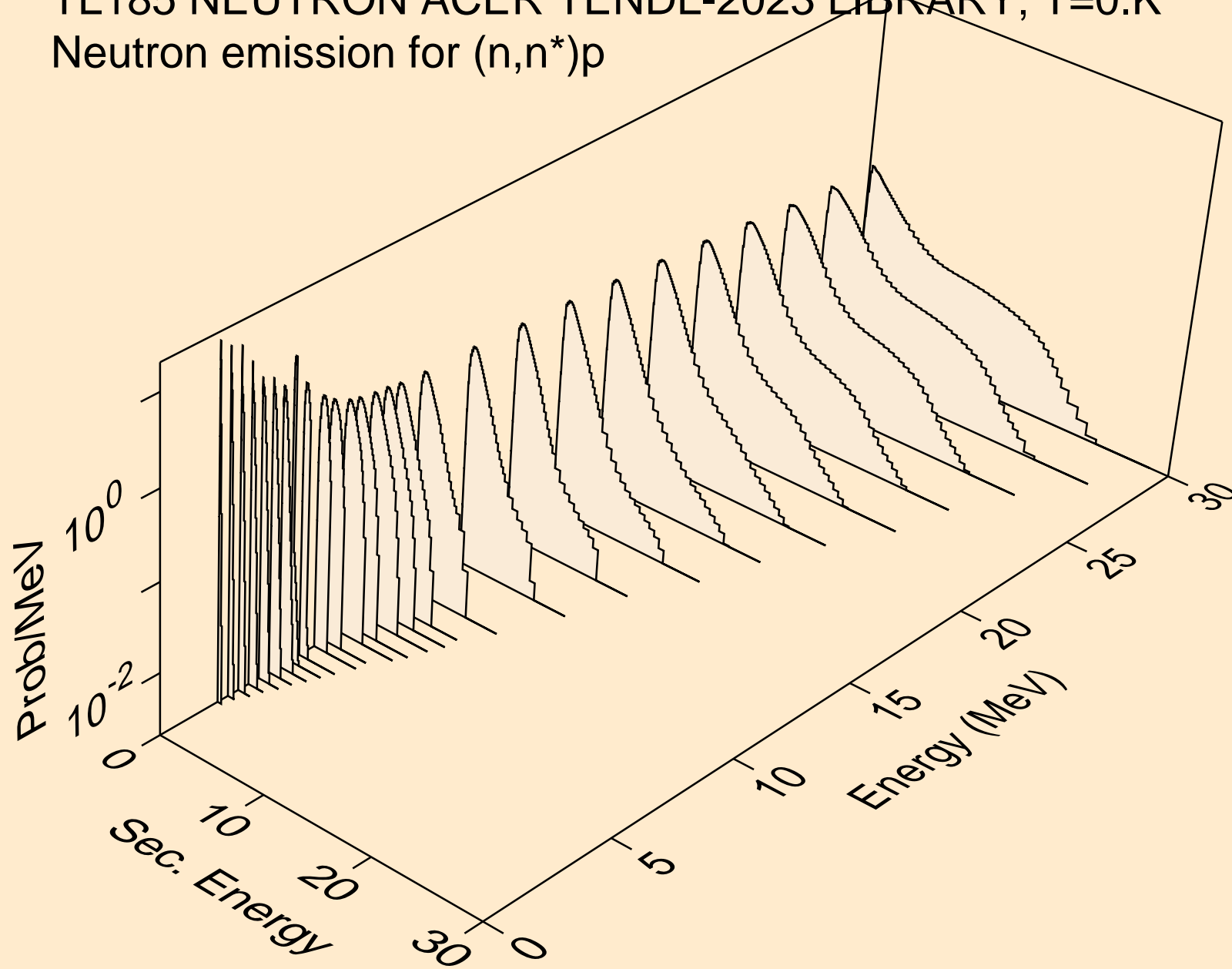

TL185 NEUTRON ACER TENDL-2023 LIBRARY; T=0.K  
Neutron emission for (n,n\*)2a

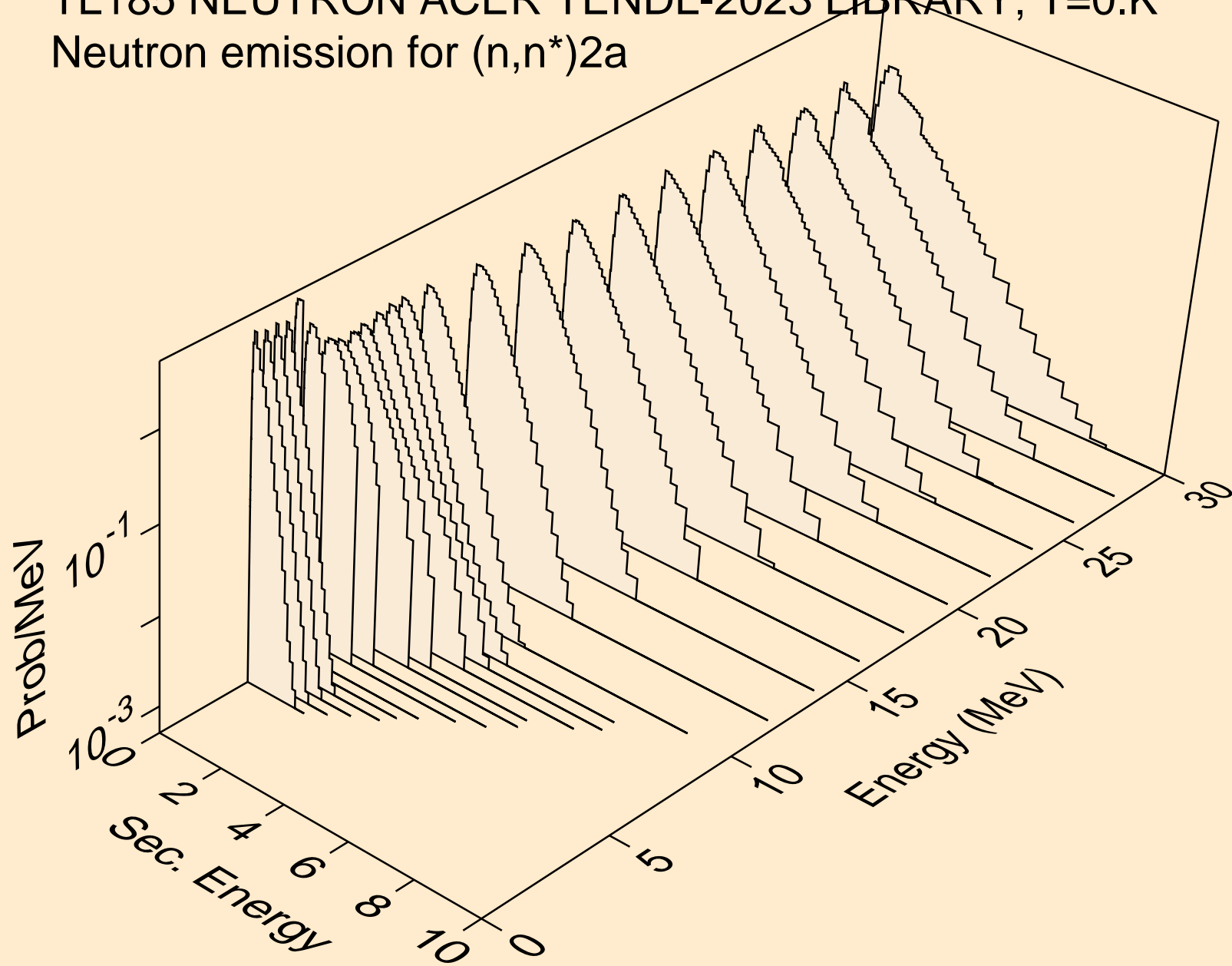

TL185 NEUTRON ACER TENDL-2023 LIBRARY; T=0.K  
Neutron emission for (n,2n)2a

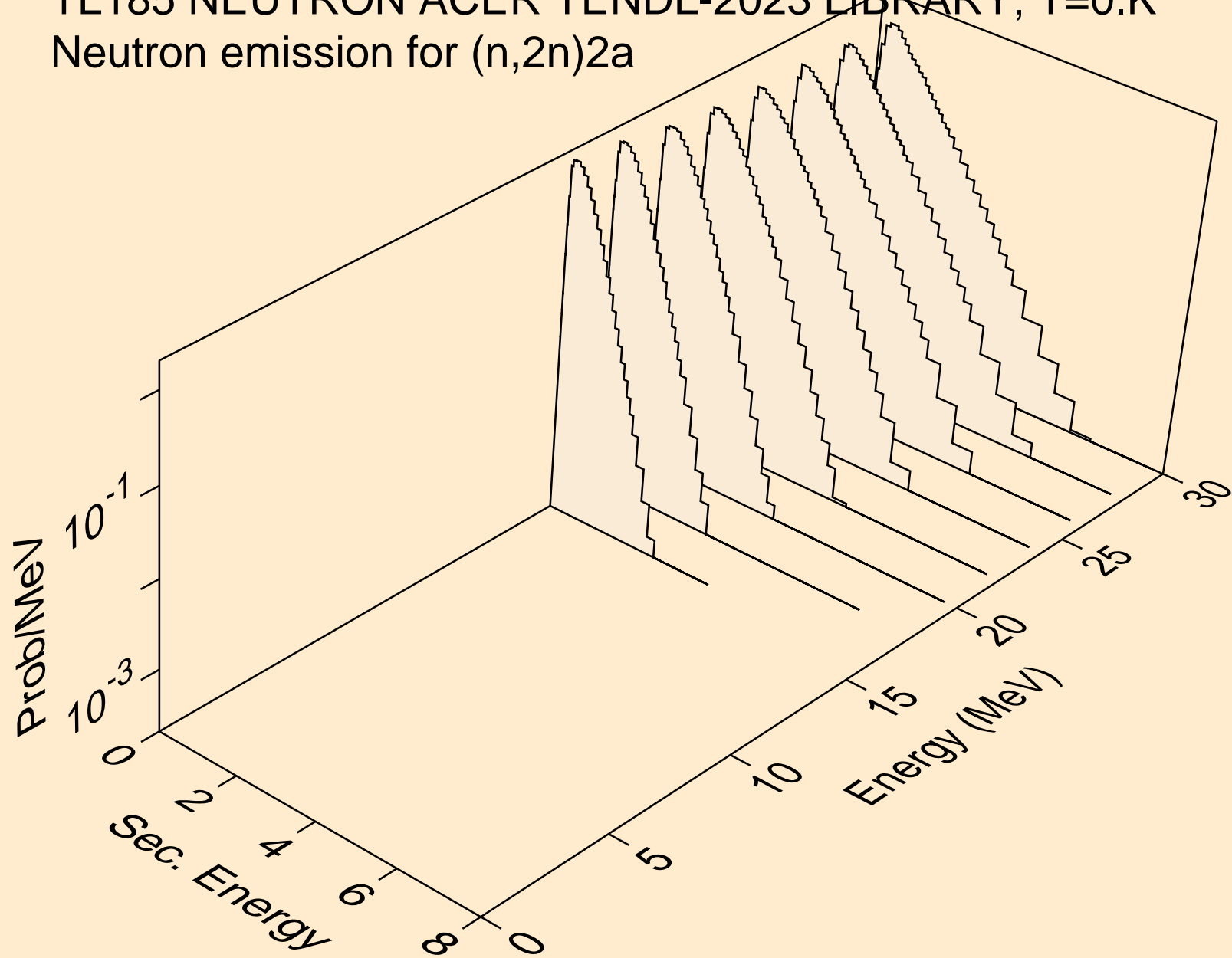

TL185 NEUTRON ACER TENDL-2023 LIBRARY; T=0.K  
Neutron emission for (n,n\*)d

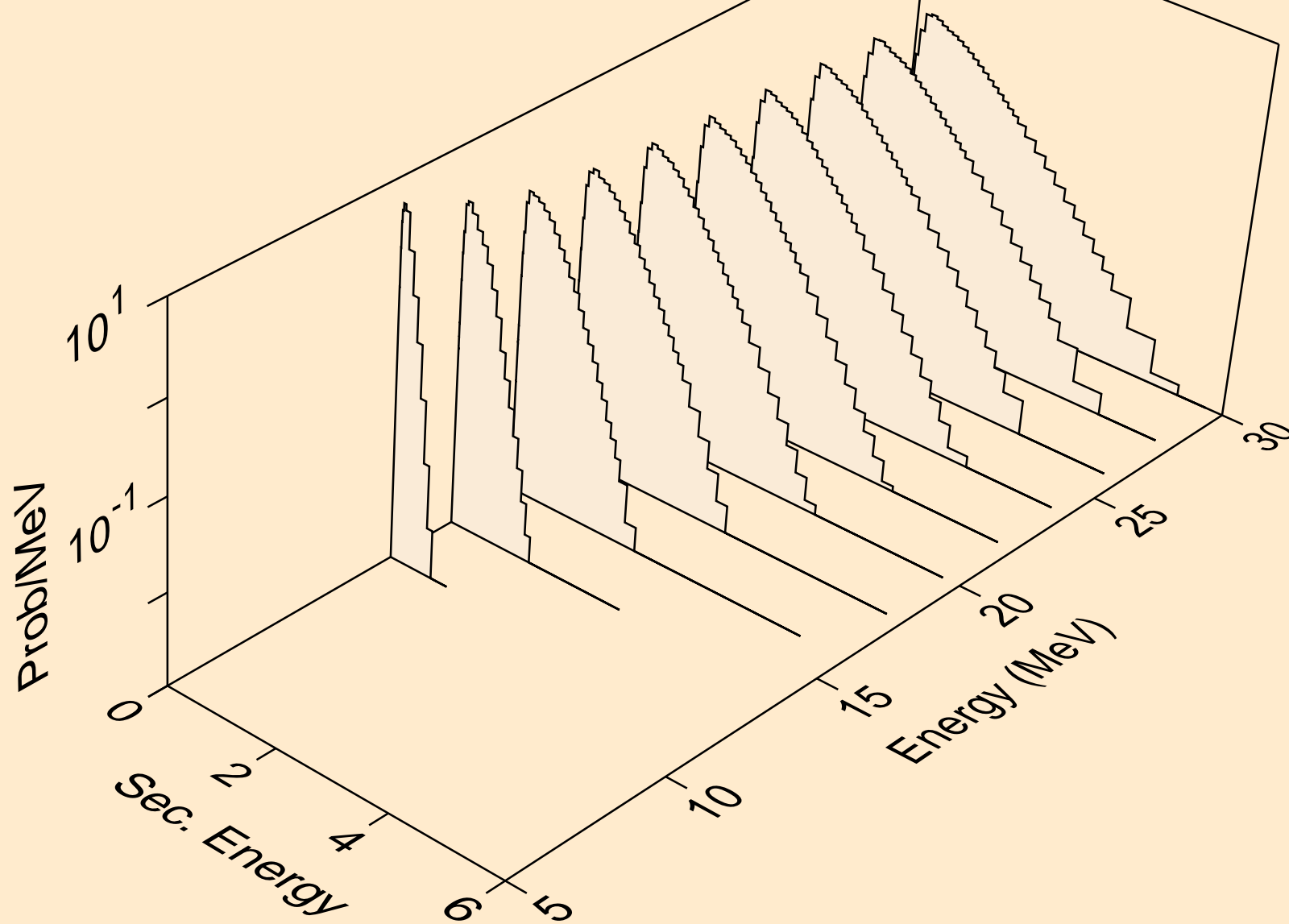

TL185 NEUTRON ACER TENDL-2023 LIBRARY; T=0.K  
Neutron emission for (n,n\*)t

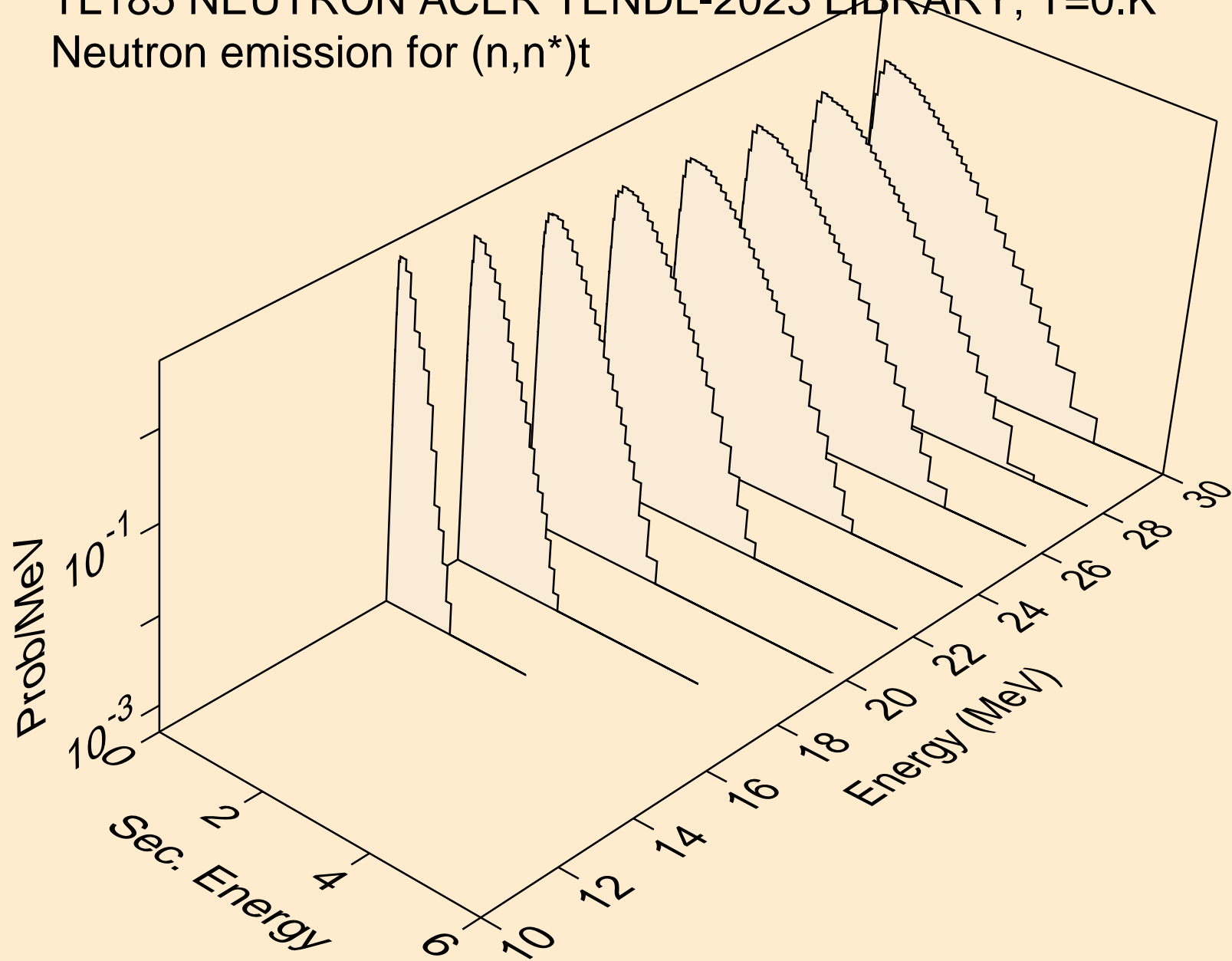

TL185 NEUTRON ACER TENDL-2023 LIBRARY; T=0.K  
Neutron emission for (n,n\*)he3

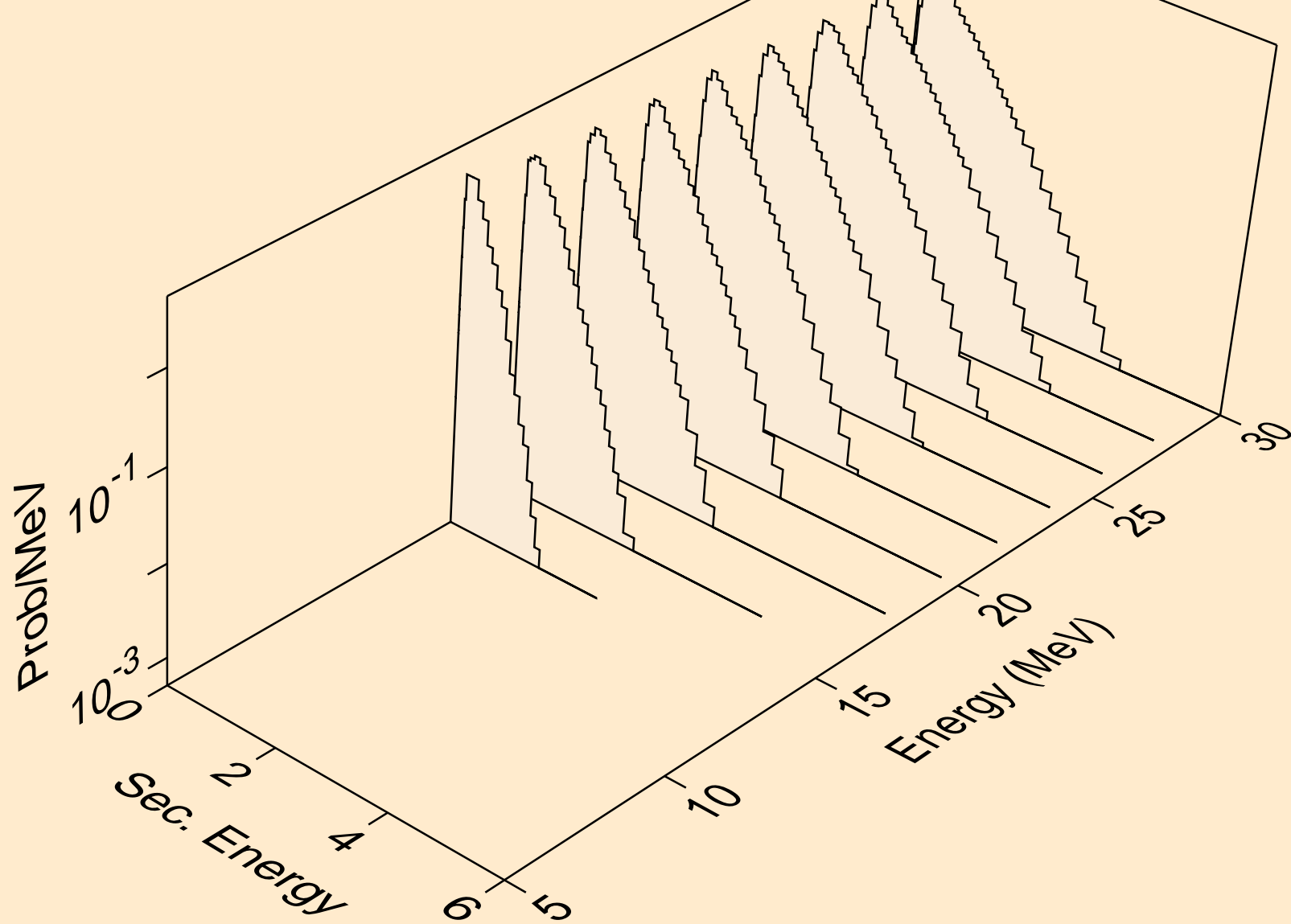

TL185 NEUTRON ACER TENDL-2023 LIBRARY; T=0.K  
Neutron emission for (n,2np)

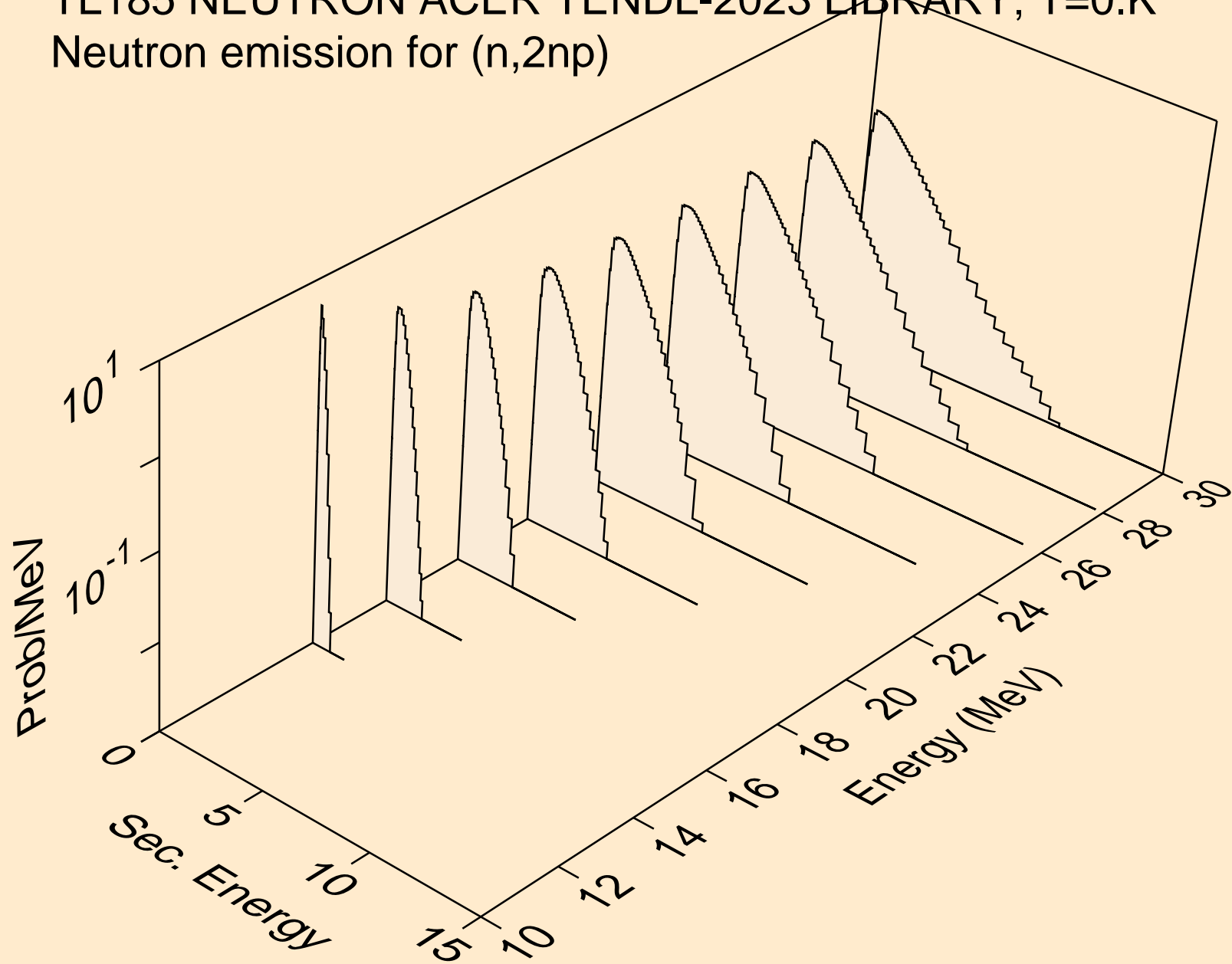

TL185 NEUTRON ACER TENDL-2023 LIBRARY; T=0.K  
Neutron emission for (n,3np)

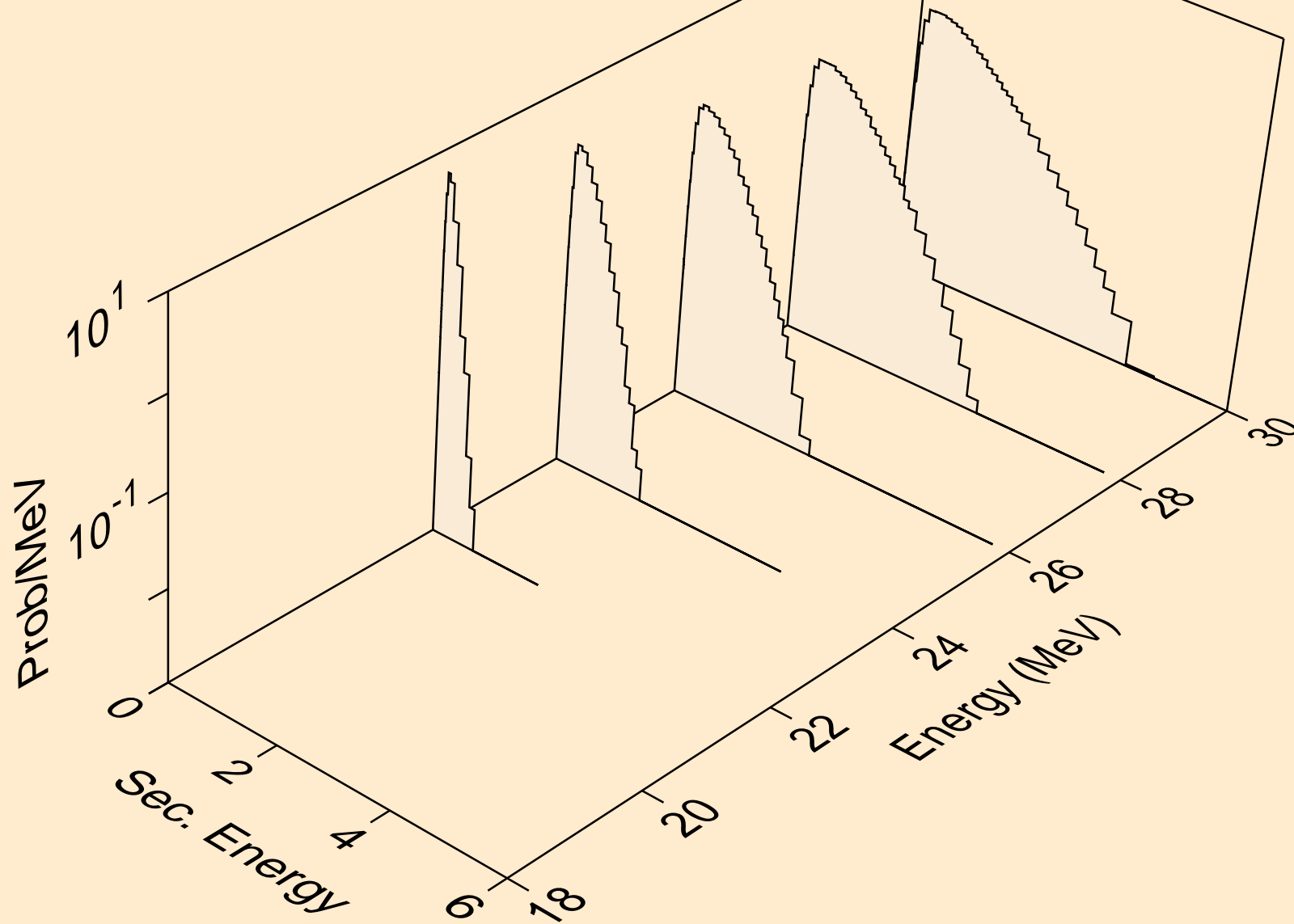

TL185 NEUTRON ACER TENDL-2023 LIBRARY; T=0.K  
Neutron emission for (n,n2p)

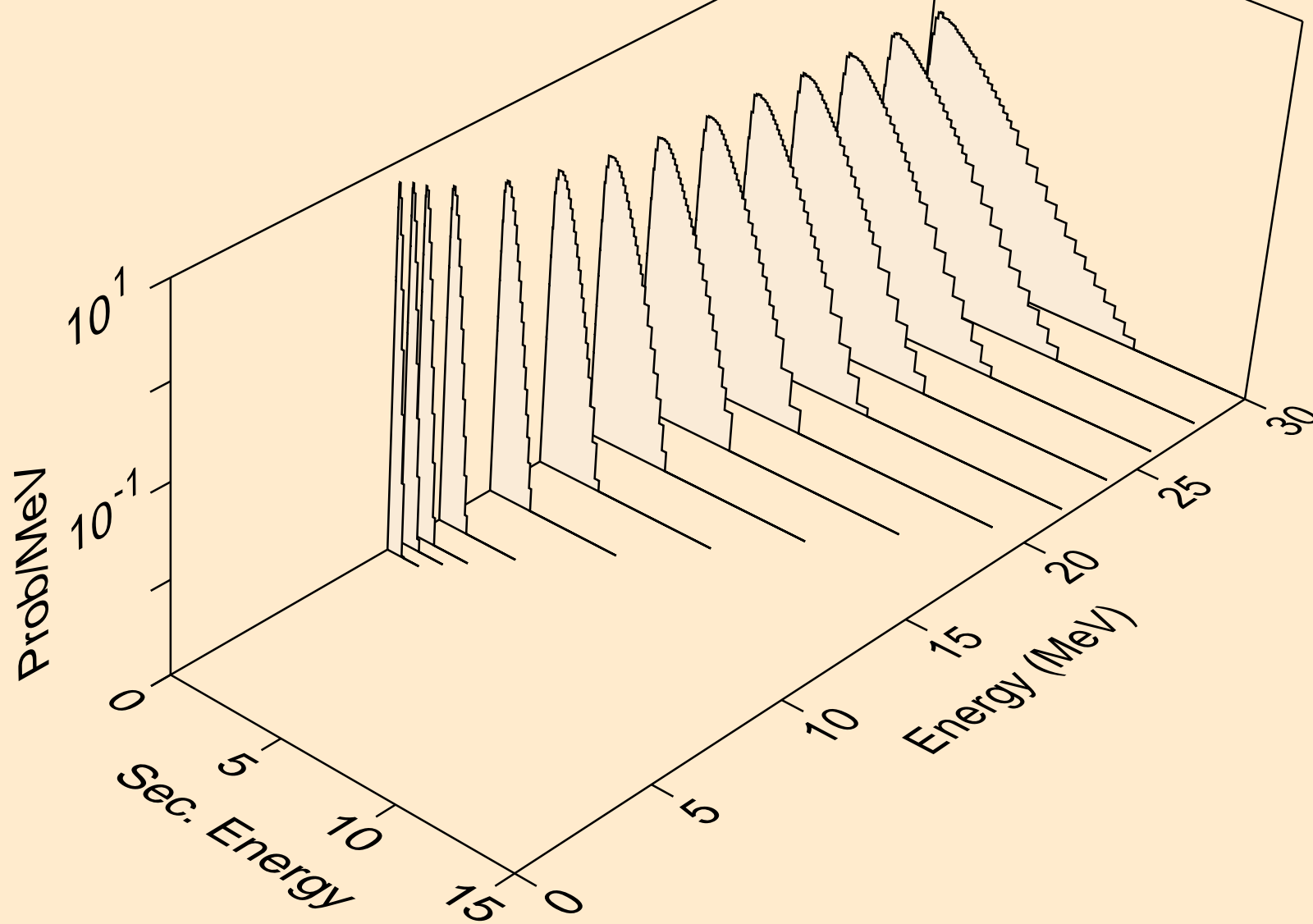

TL185 NEUTRON ACER TENDL-2023 LIBRARY; T=0.K  
Neutron emission for (n,npa)

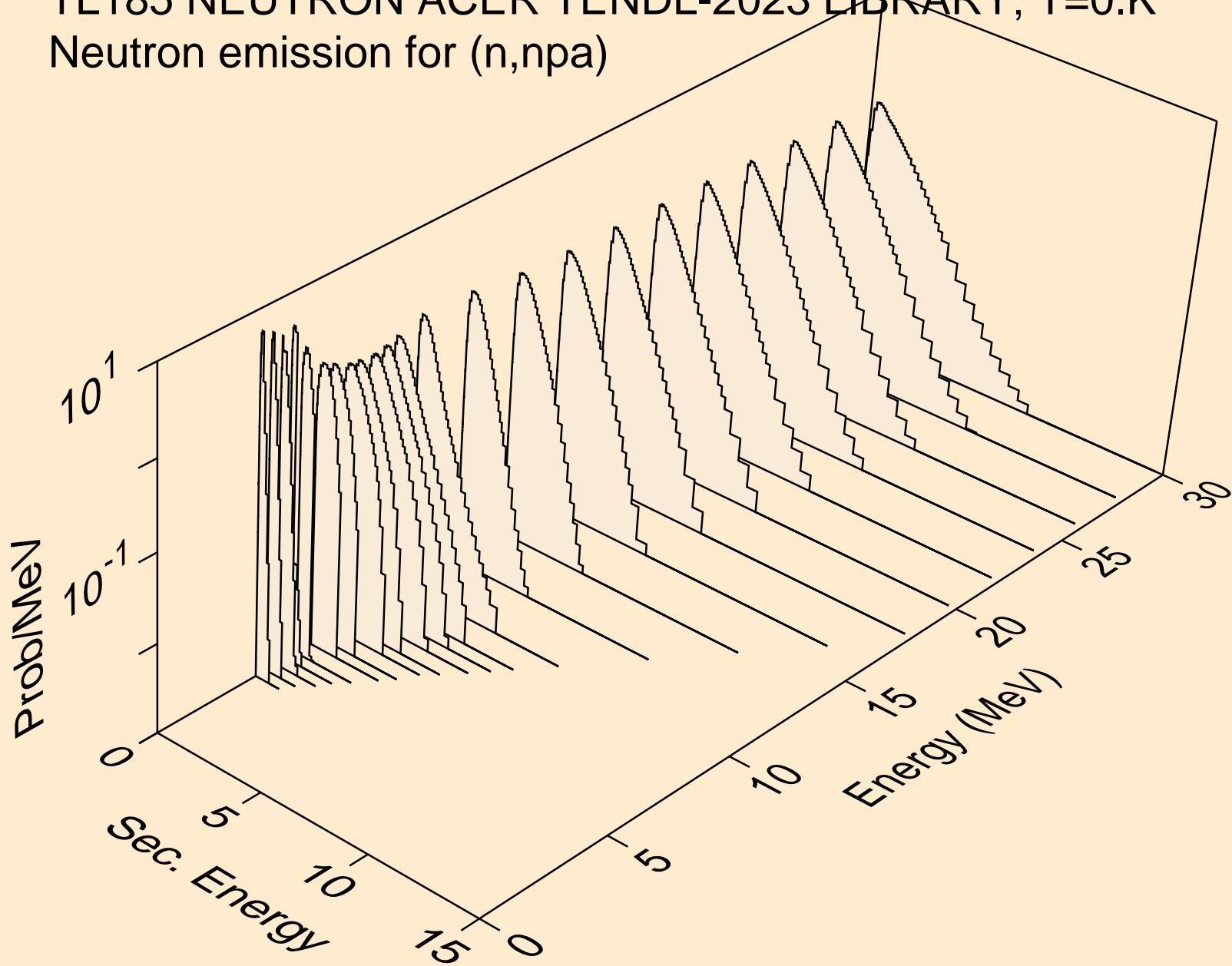

TL185 NEUTRON ACER TENDL-2023 LIBRARY; T=0.K  
Neutron emission for (n,n\*c)

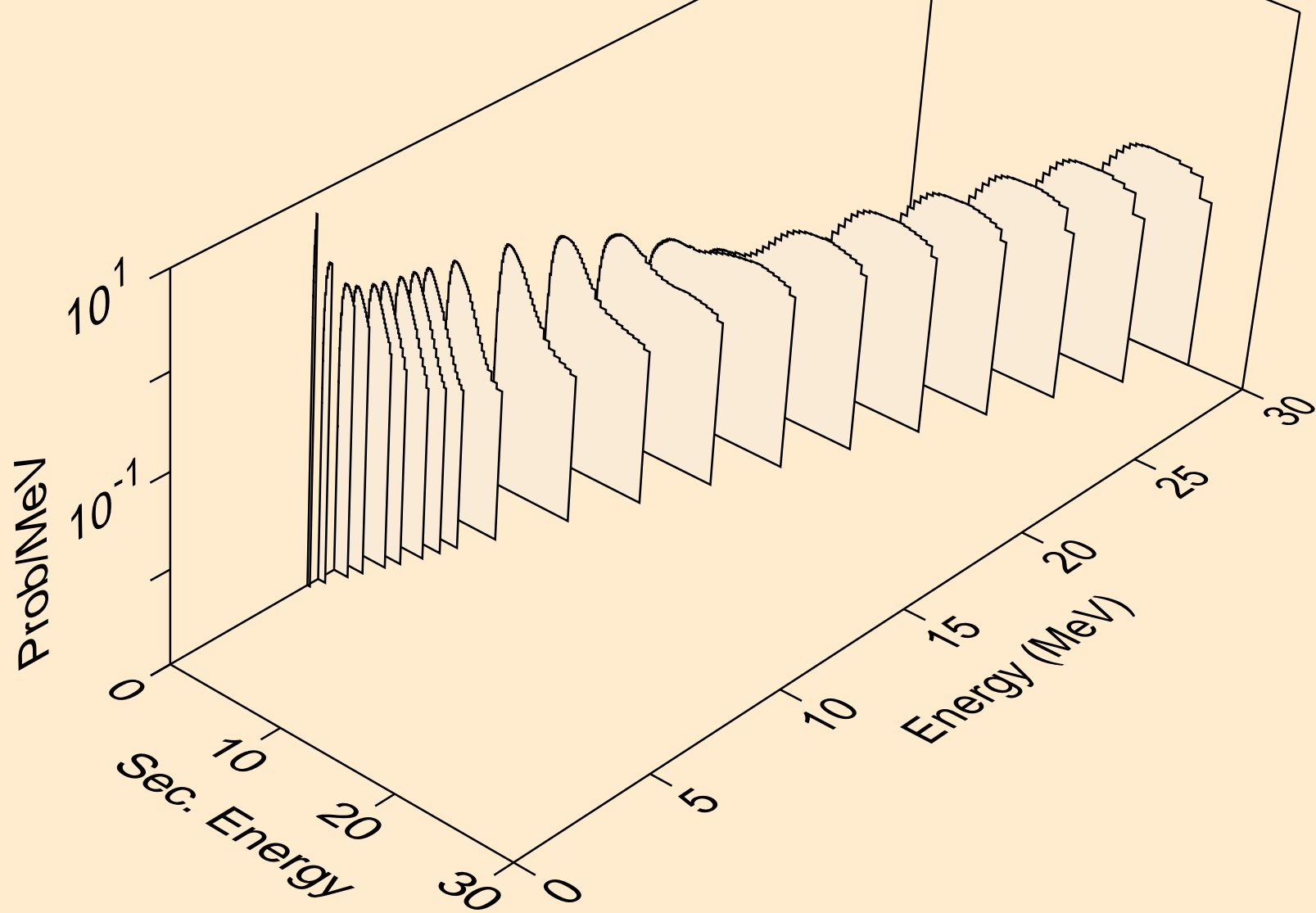

TL185 NEUTRON ACER TENDL-2023 LIBRARY; T=0.K  
Photon emission for (n,x)

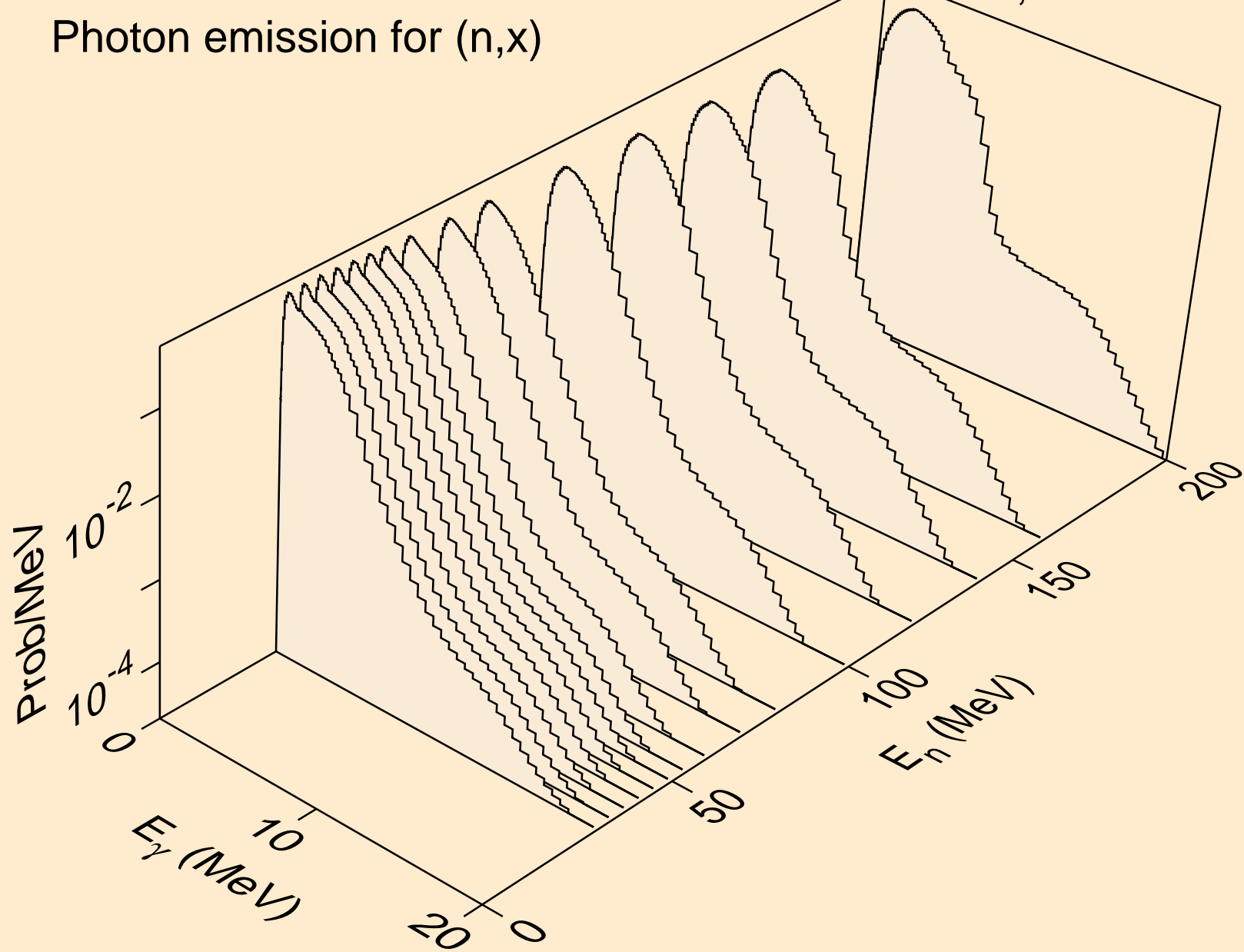

TL185 NEUTRON ACER TENDL-2023 LIBRARY; T=0.K  
Photon emission for (n,2nd)

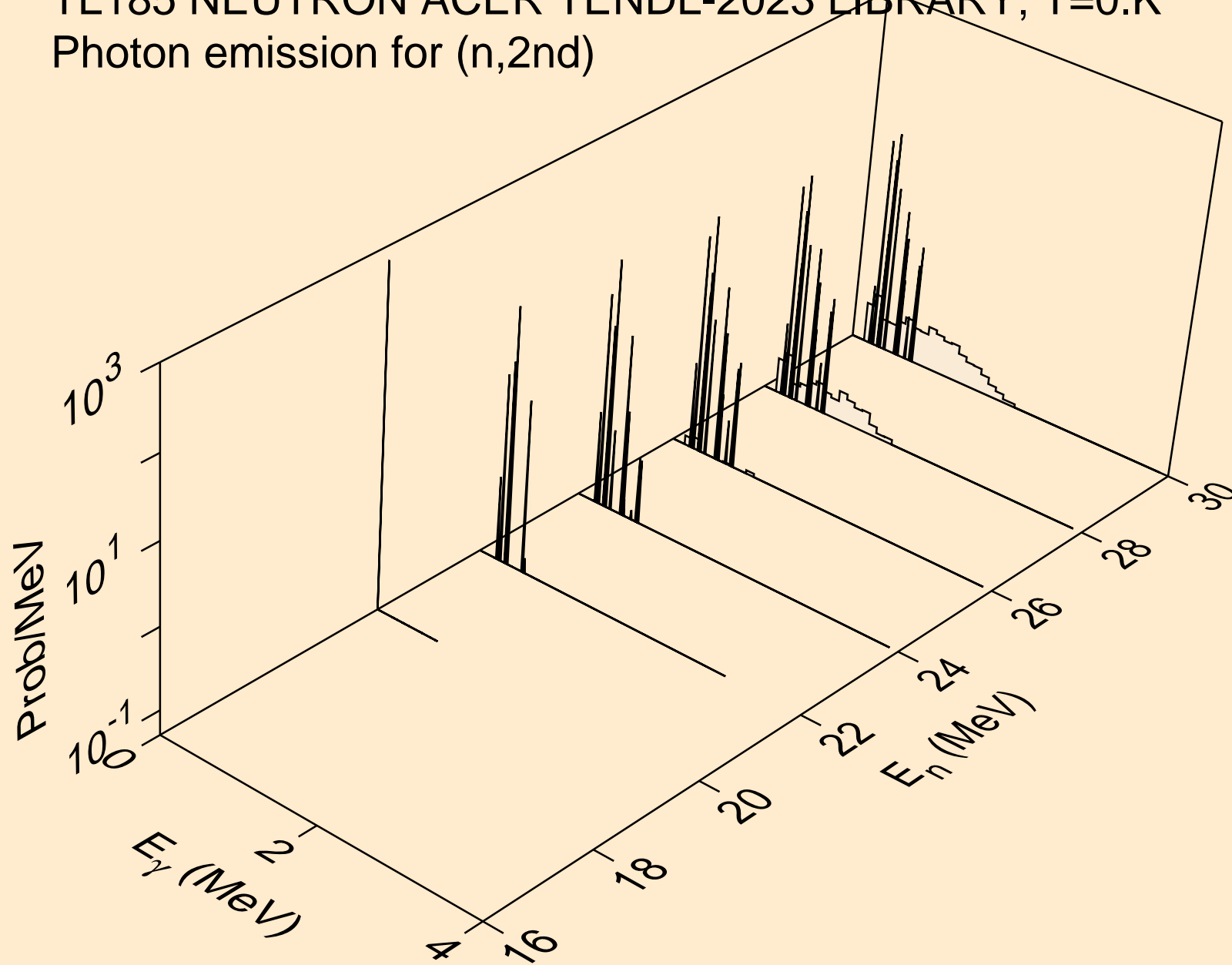

TL185 NEUTRON ACER TENDL-2023 LIBRARY; T=0.K  
Photon emission for (n,2n)

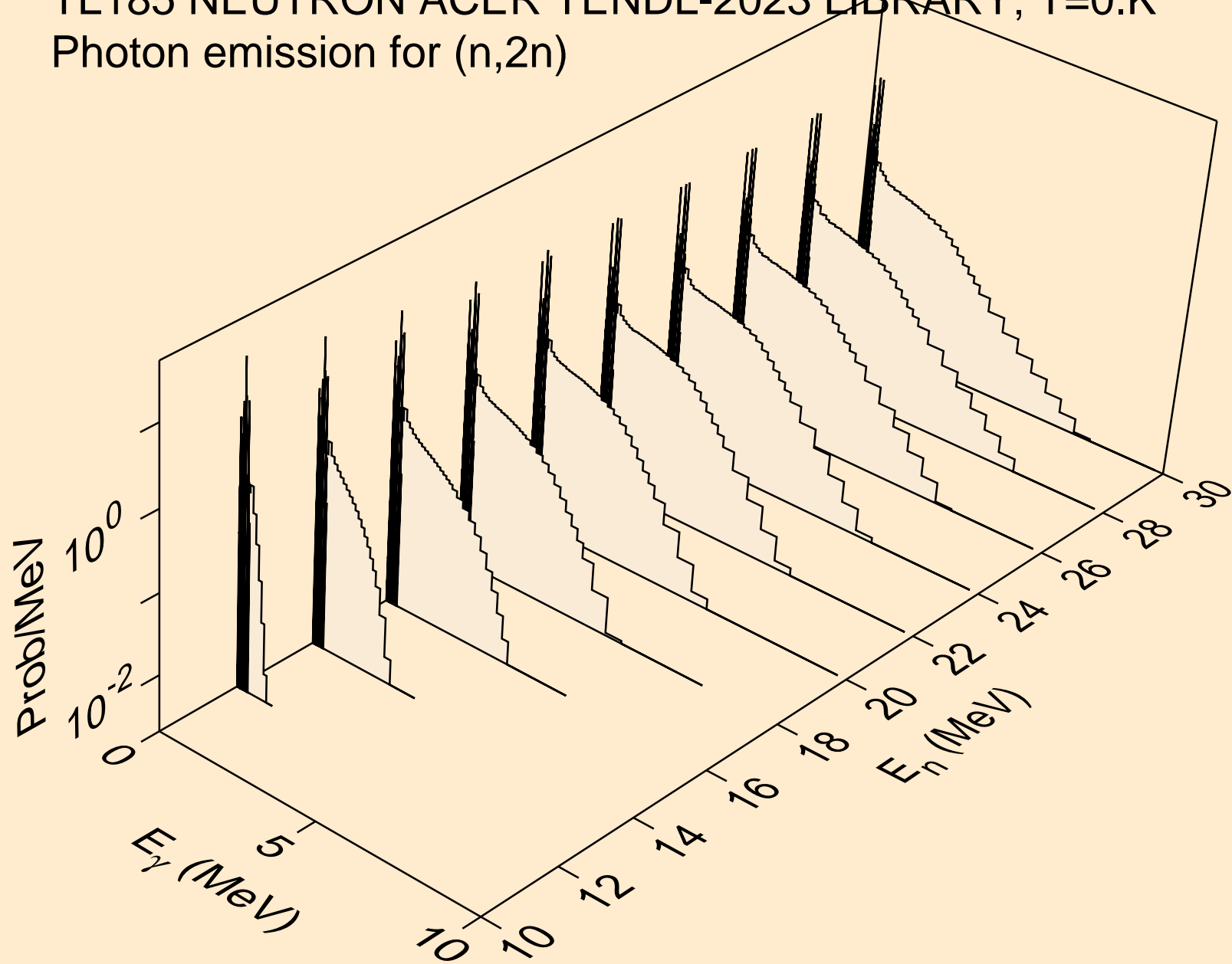

TL185 NEUTRON ACER TENDL-2023 LIBRARY; T=0.K  
Photon emission for (n,3n)

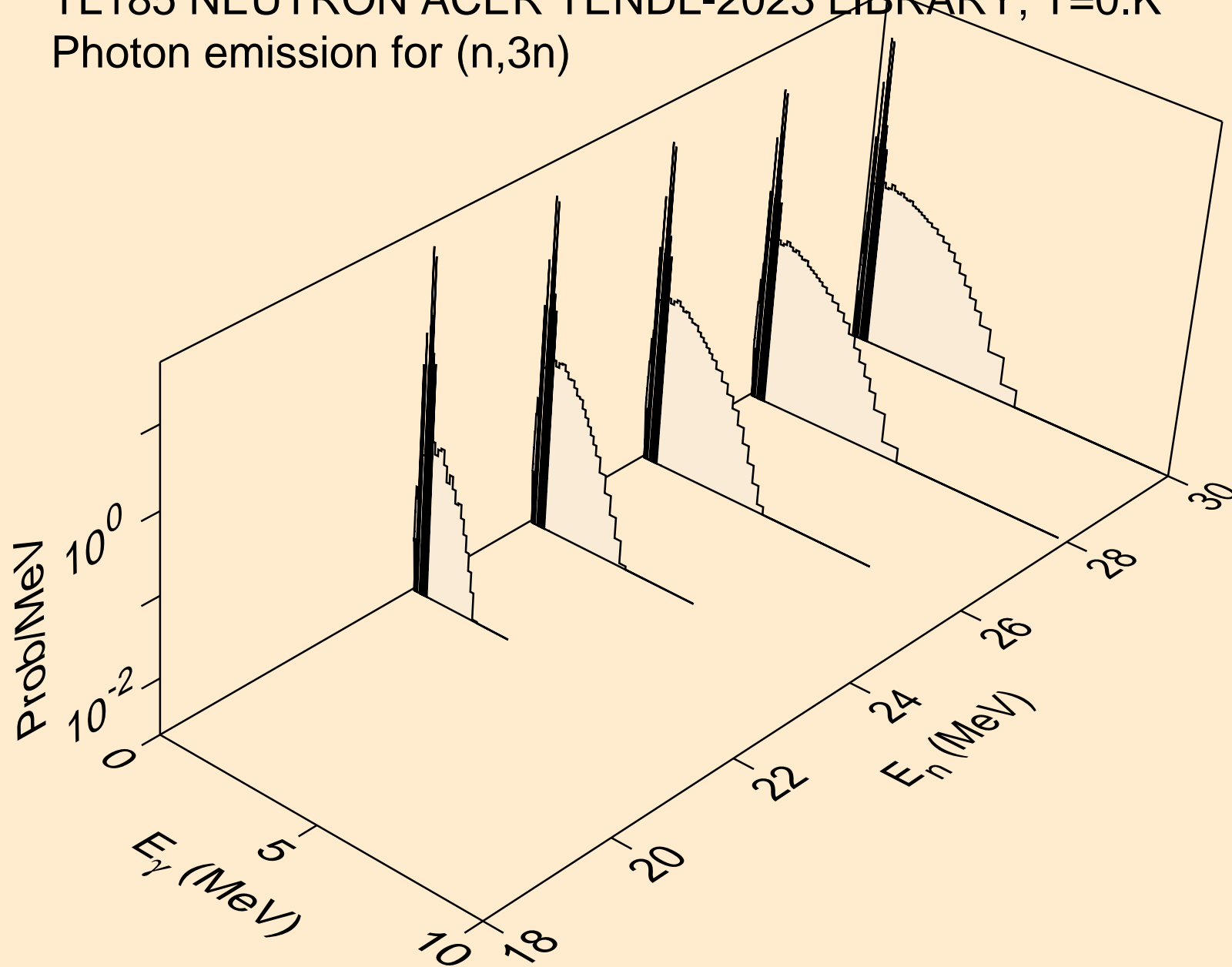

TL185 NEUTRON ACER TENDL-2023 LIBRARY; T=0.K  
Photon emission for (n,n\*)a

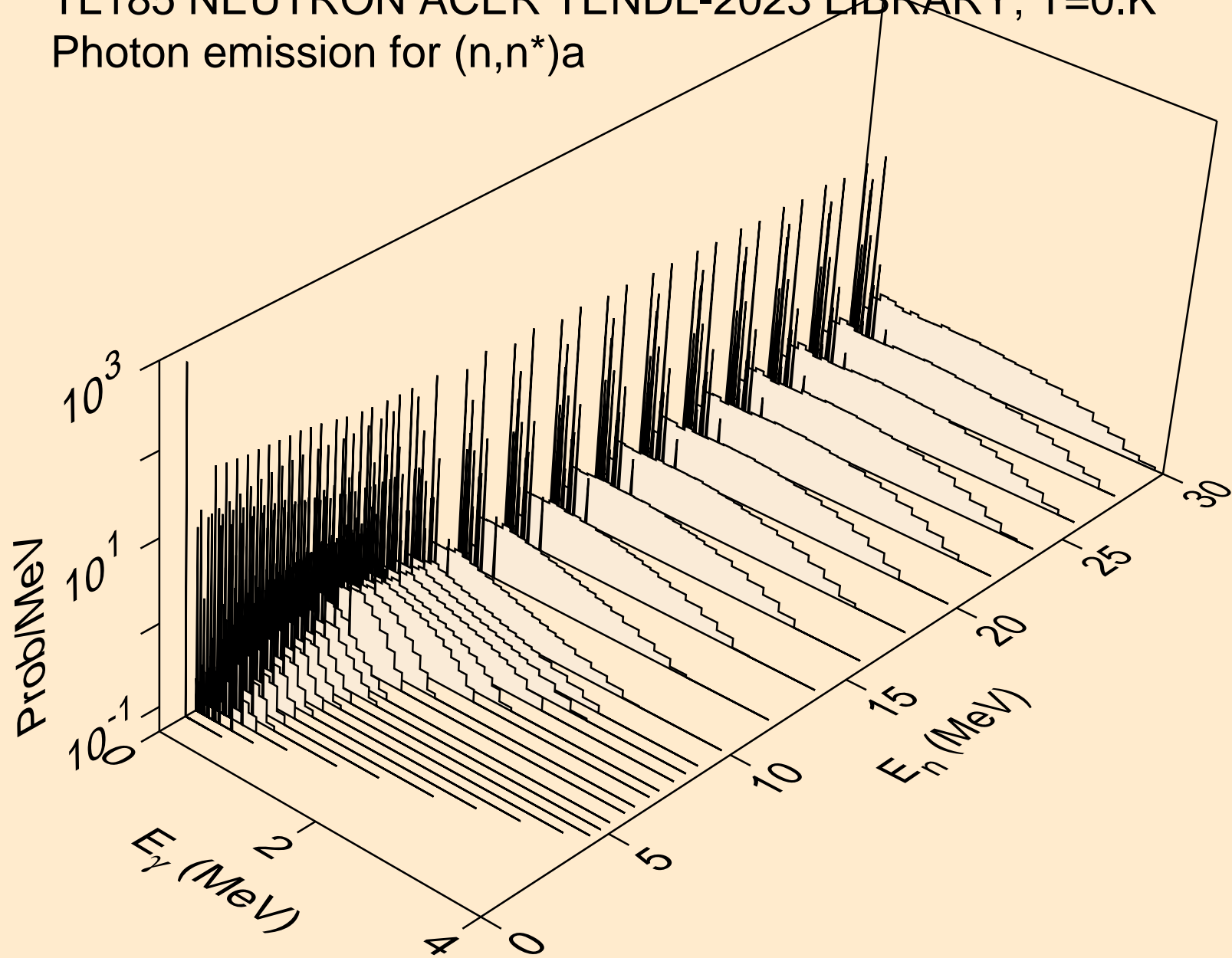

TL185 NEUTRON ACER TENDL-2023 LIBRARY; T=0.K  
Photon emission for (n,n\*)3a

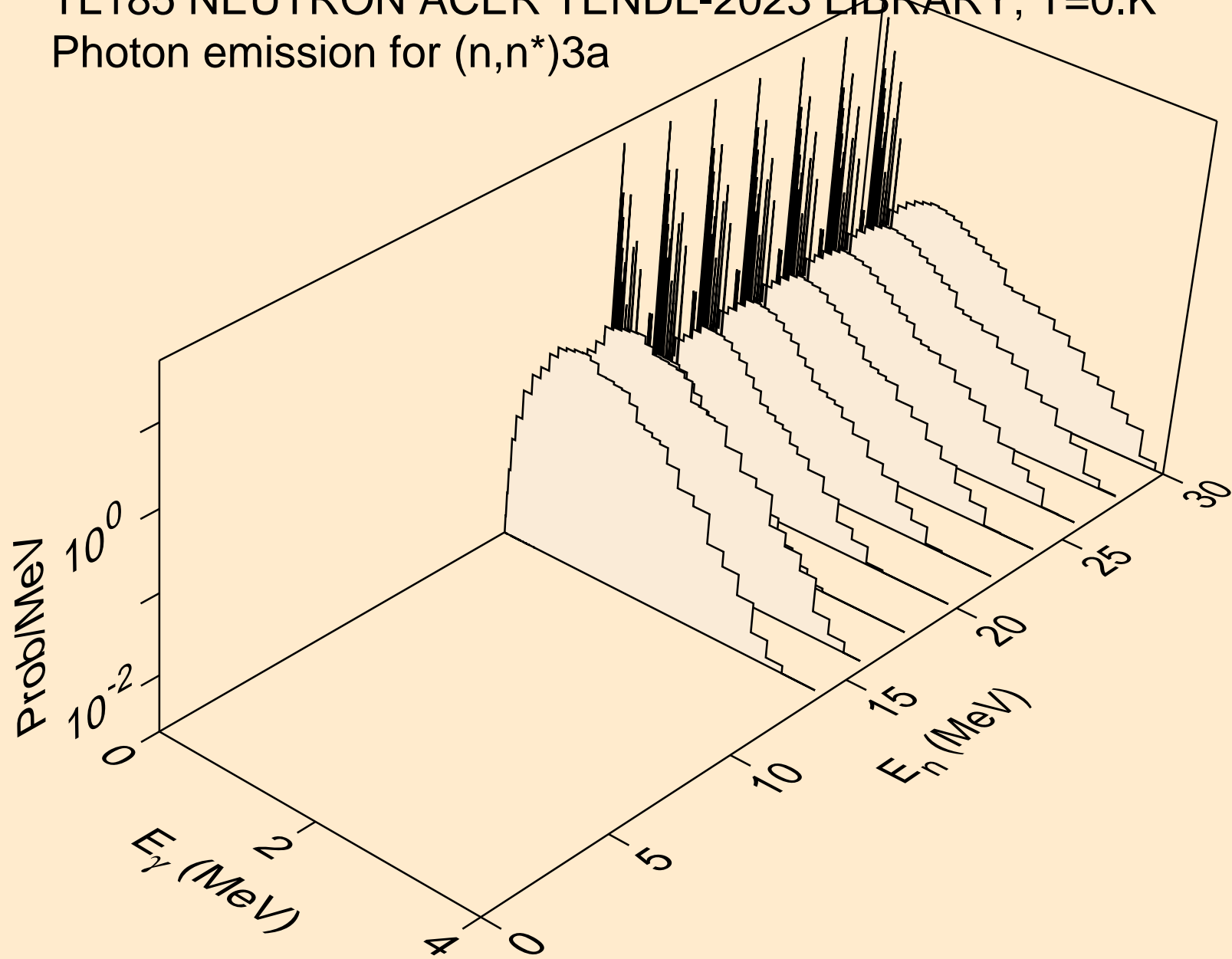

TL185 NEUTRON ACER TENDL-2023 LIBRARY; T=0.K  
Photon emission for (n,2n)a

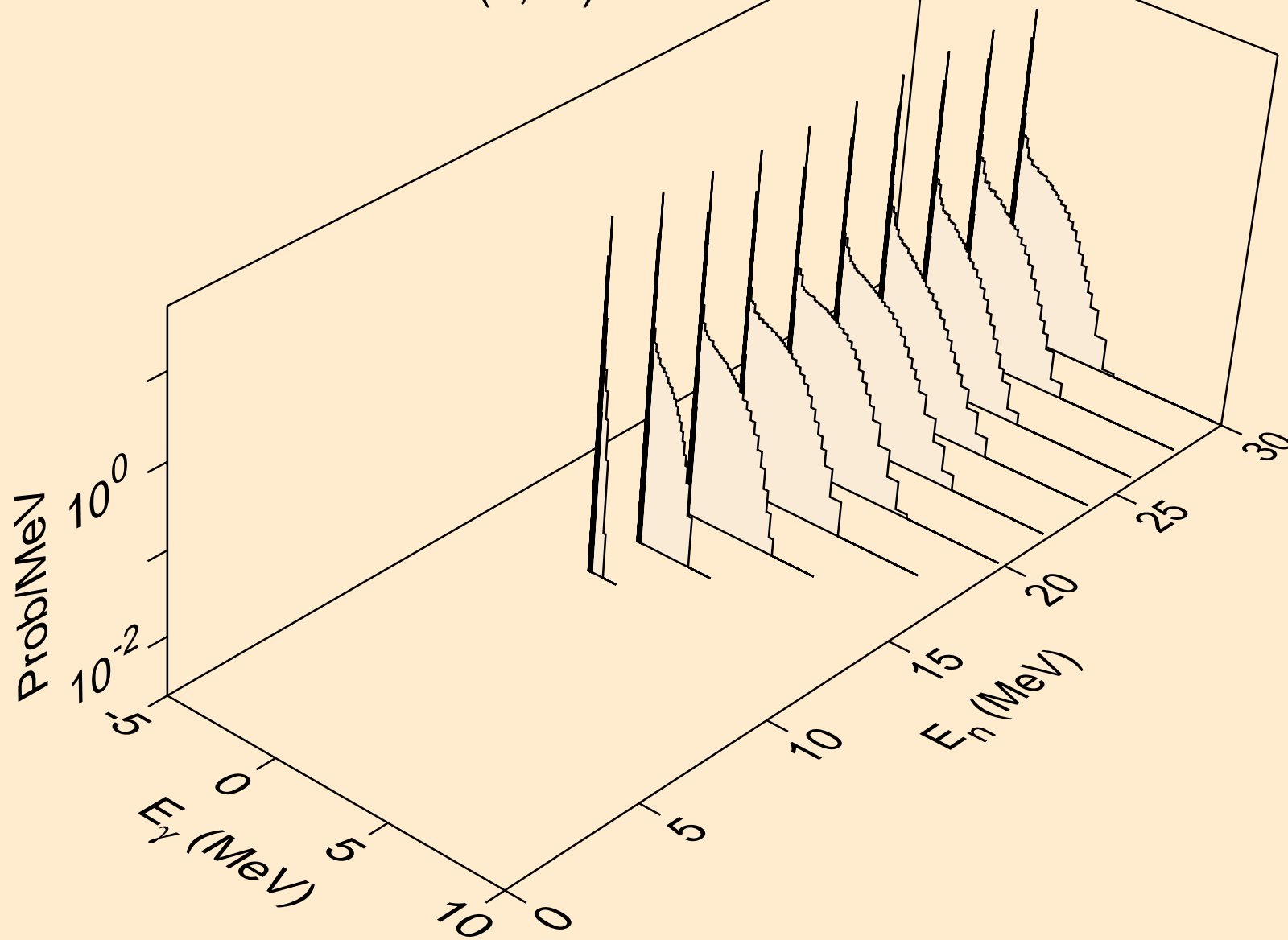

TL185 NEUTRON ACER TENDL-2023 LIBRARY; T=0.K  
Photon emission for (n,3n)a

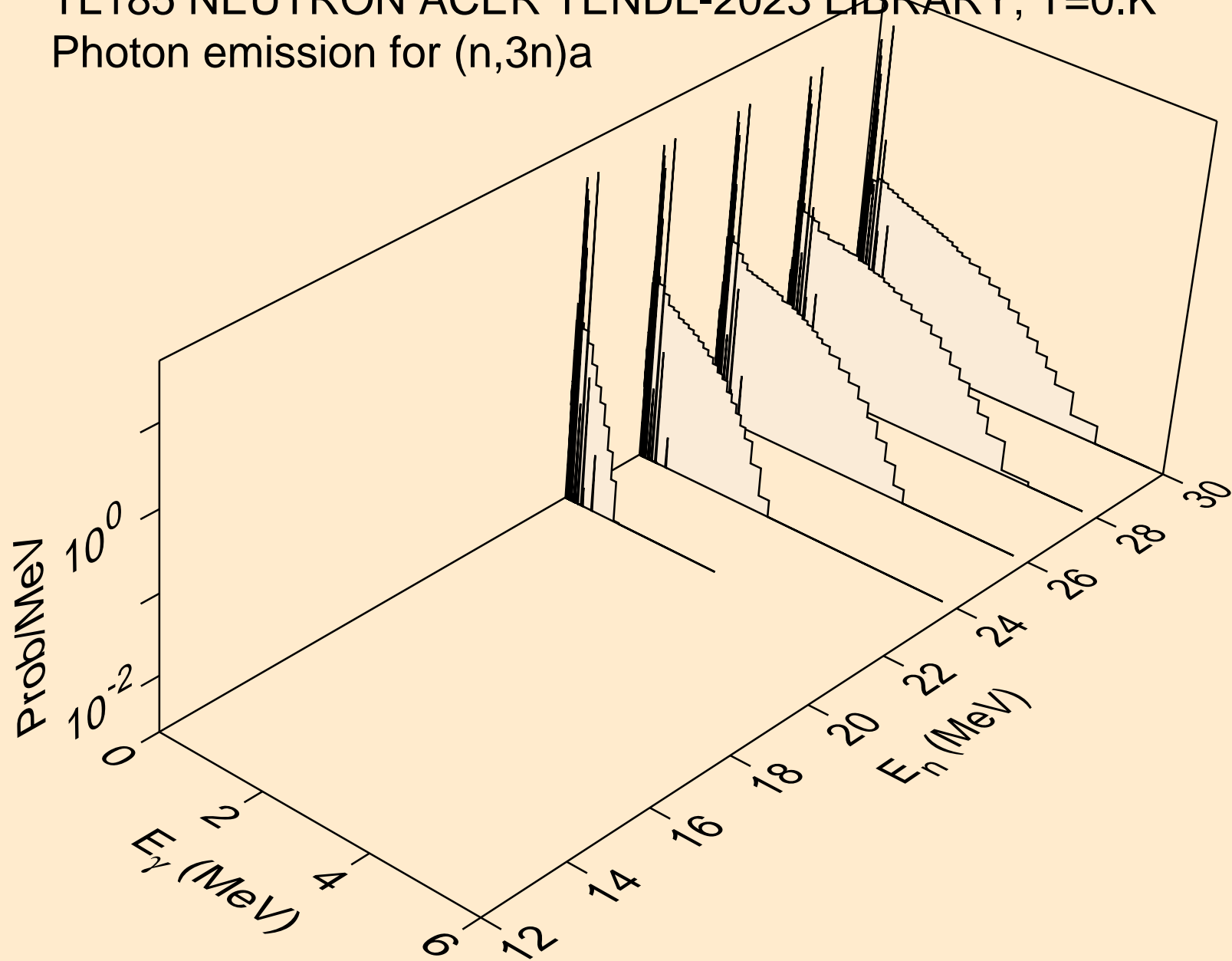

TL185 NEUTRON ACER TENDL-2023 LIBRARY; T=0.K  
Photon emission for (n,n\*)p

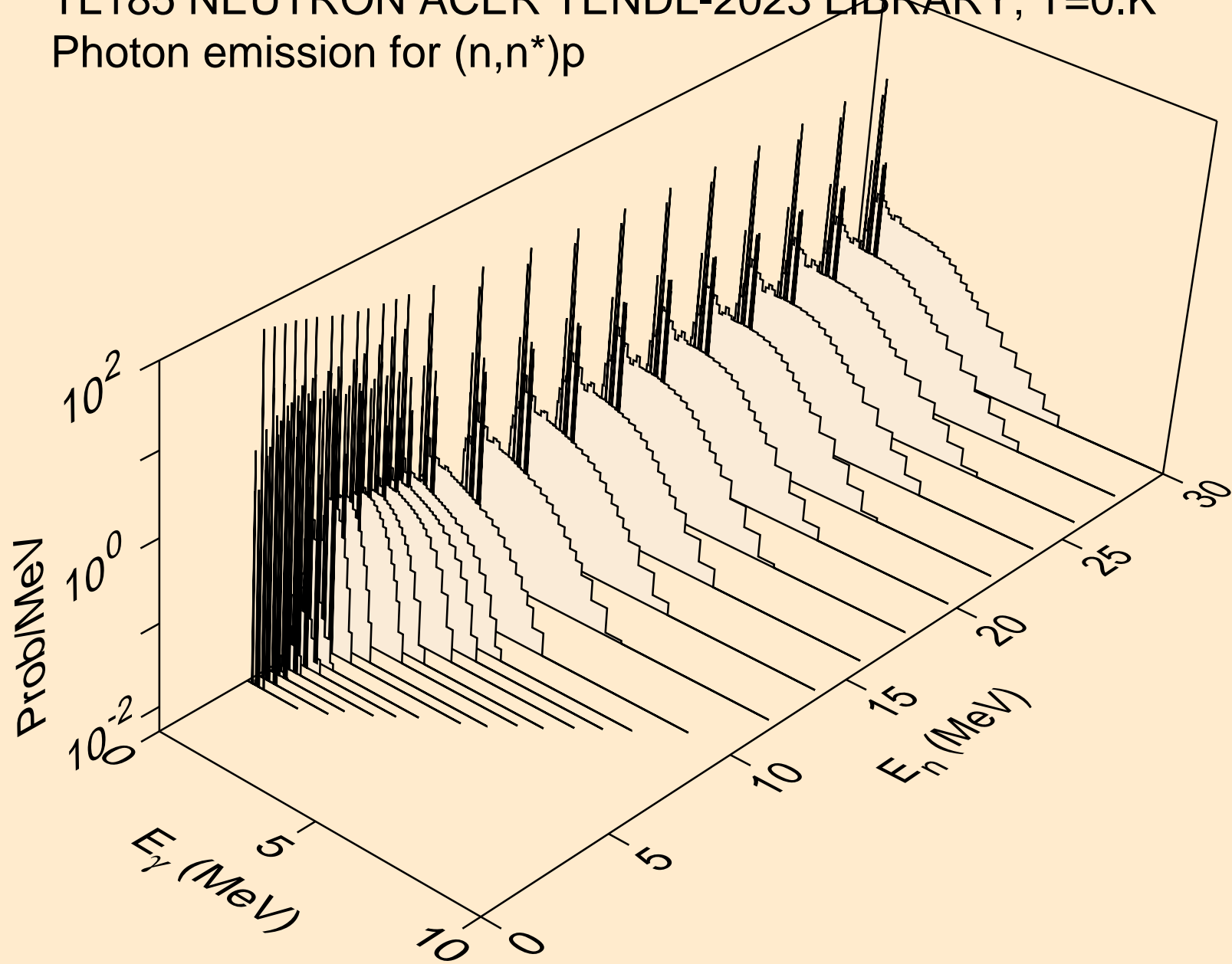

TL185 NEUTRON ACER TENDL-2023 LIBRARY; T=0.K  
Photon emission for (n,n\*)2a

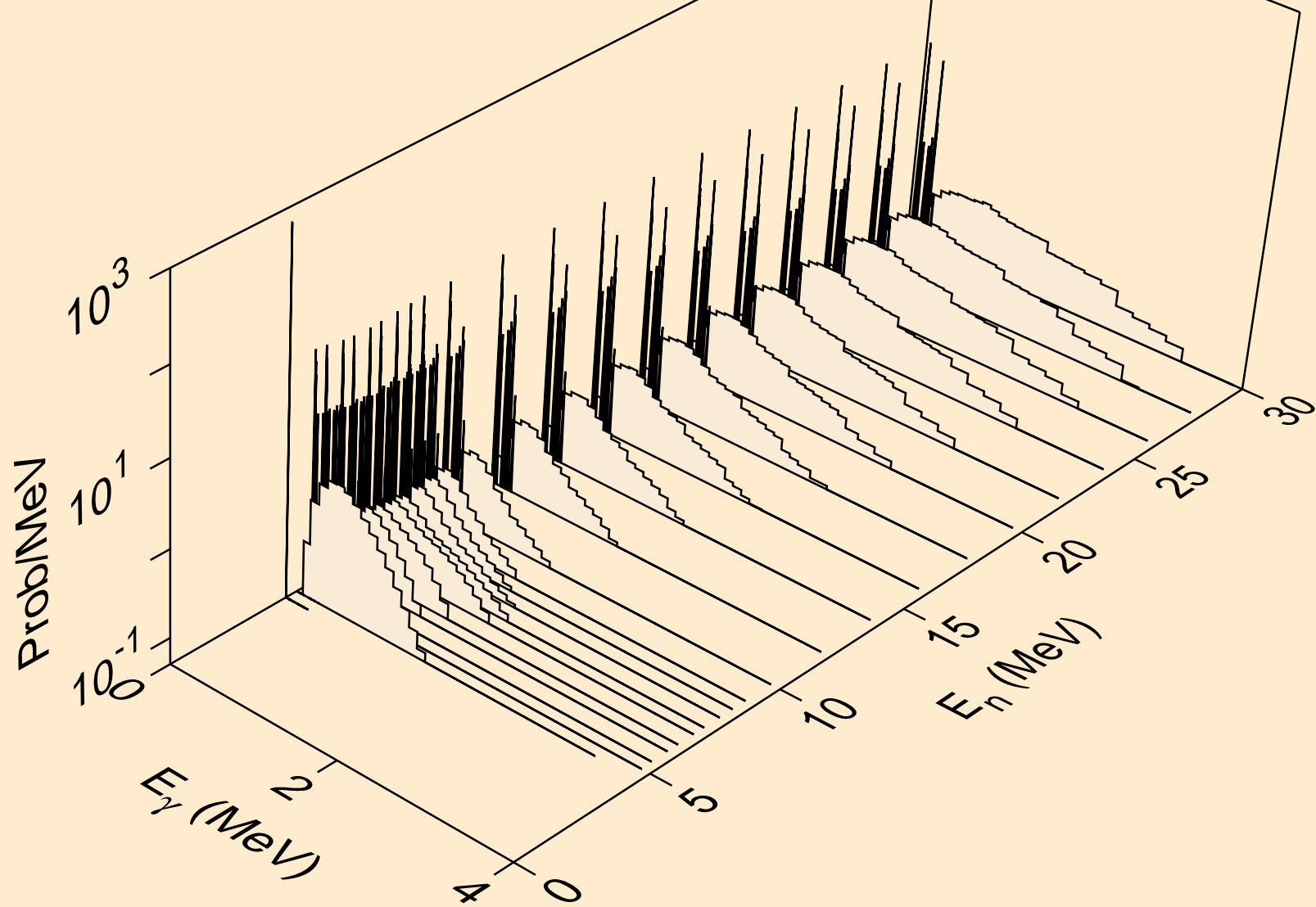

TL185 NEUTRON ACER TENDL-2023 LIBRARY; T=0.K  
Photon emission for (n,2n)2a

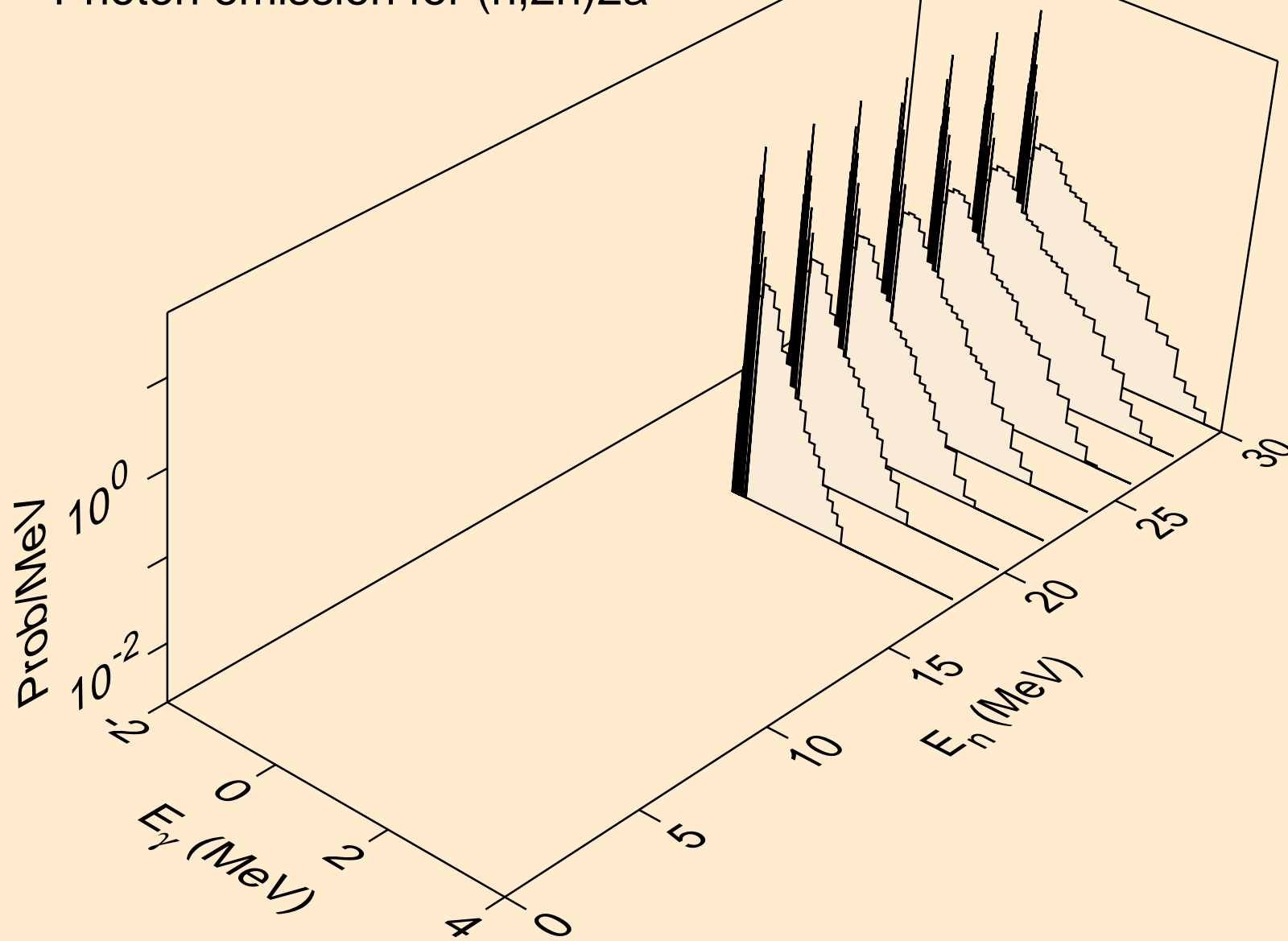

TL185 NEUTRON ACER TENDL-2023 LIBRARY; T=0.K  
Photon emission for (n,n\*)d

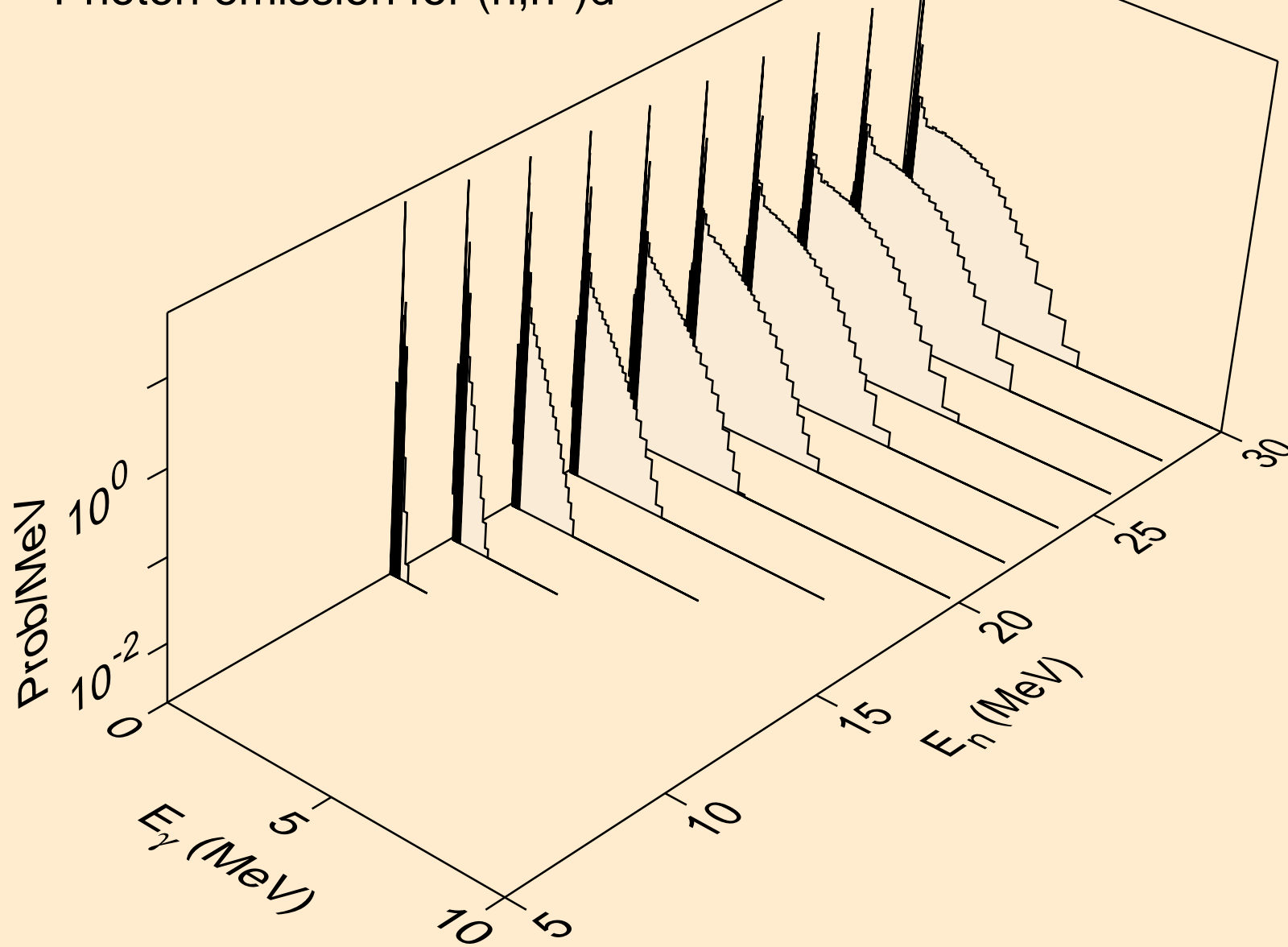

TL185 NEUTRON ACER TENDL-2023 LIBRARY; T=0.K  
Photon emission for (n,n\*)t

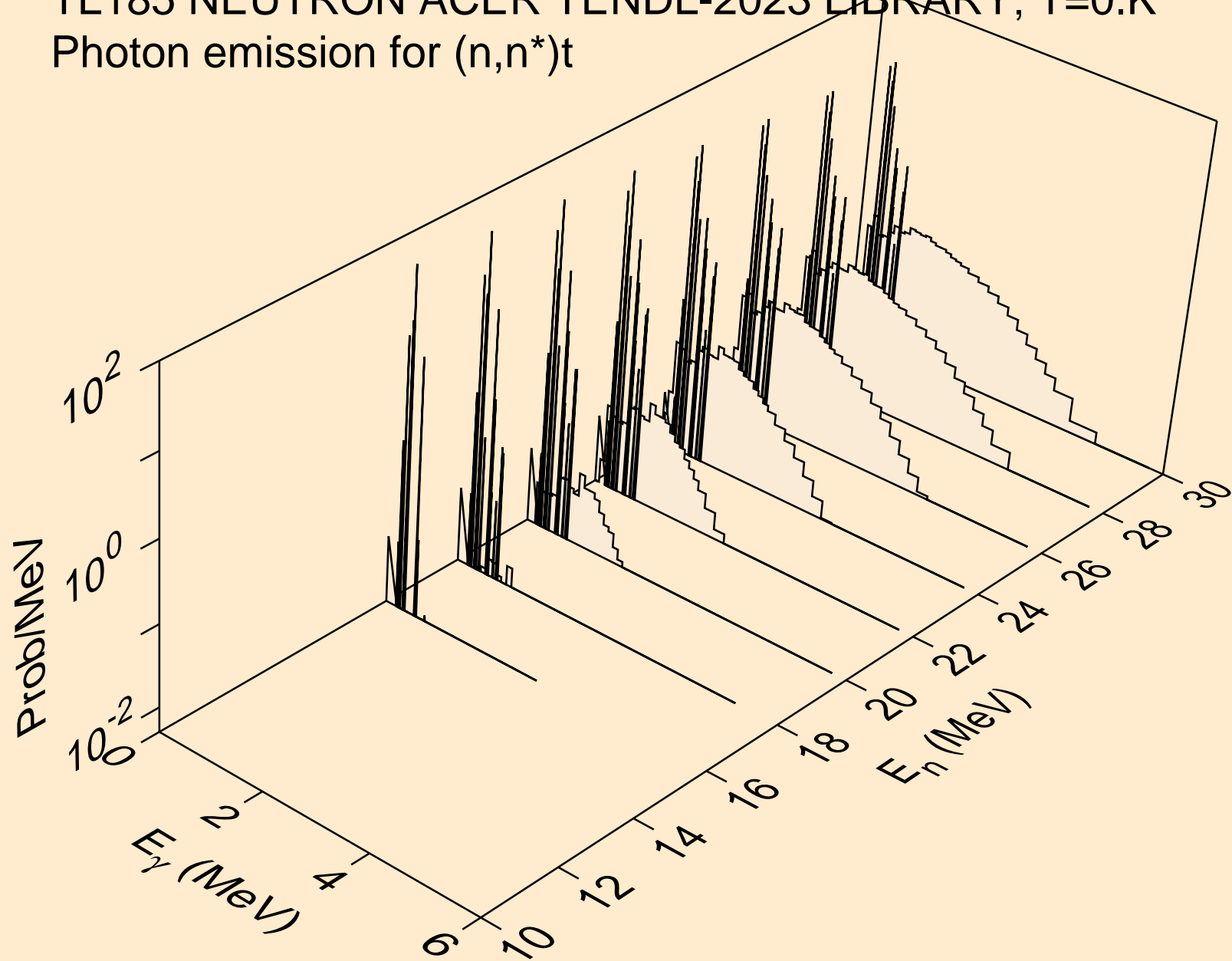

TL185 NEUTRON ACER TENDL-2023 LIBRARY; T=0.K  
Photon emission for (n,n\*)he3

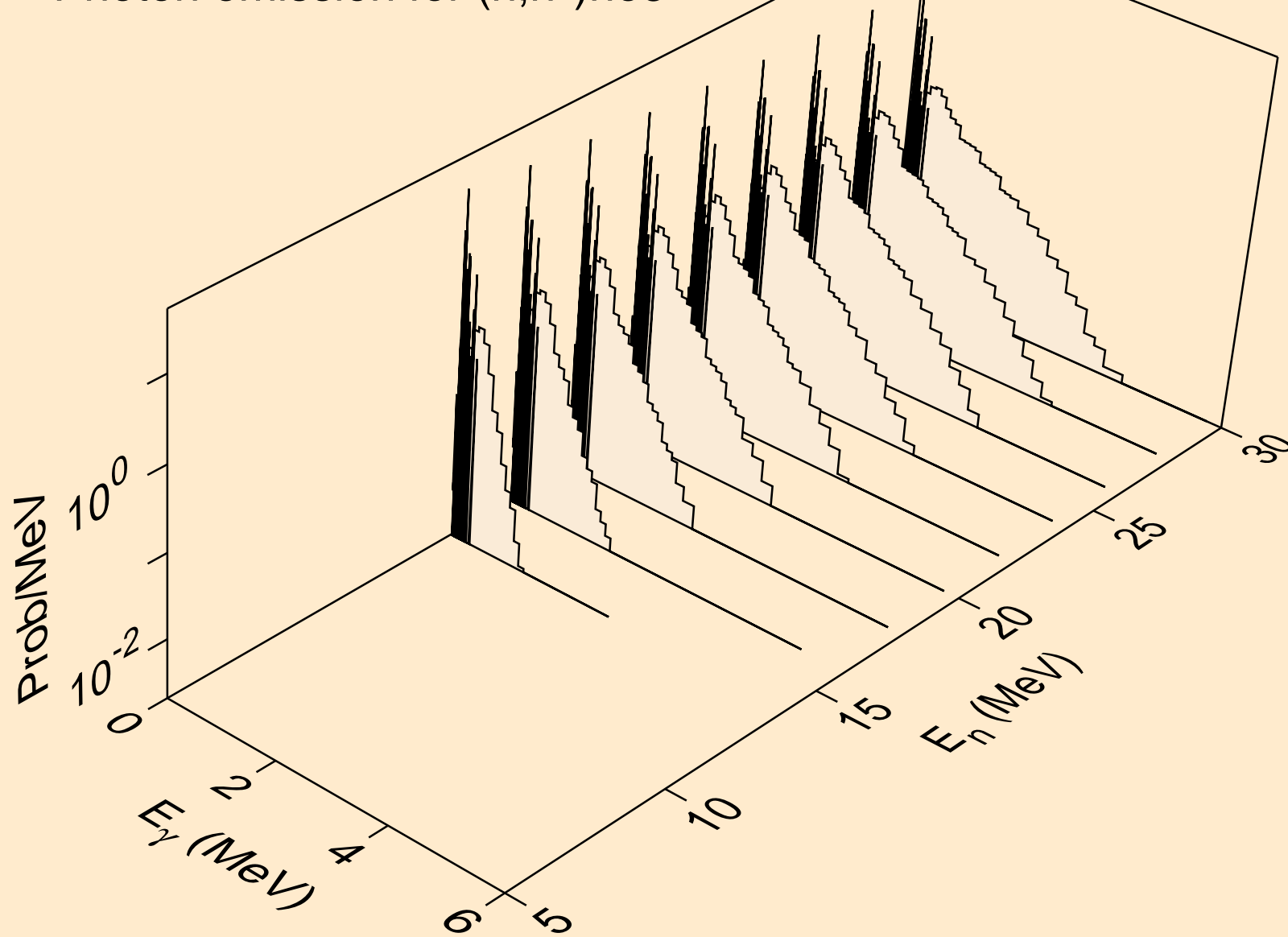

TL185 NEUTRON ACER TENDL-2023 LIBRARY; T=0.K  
Photon emission for (n,2np)

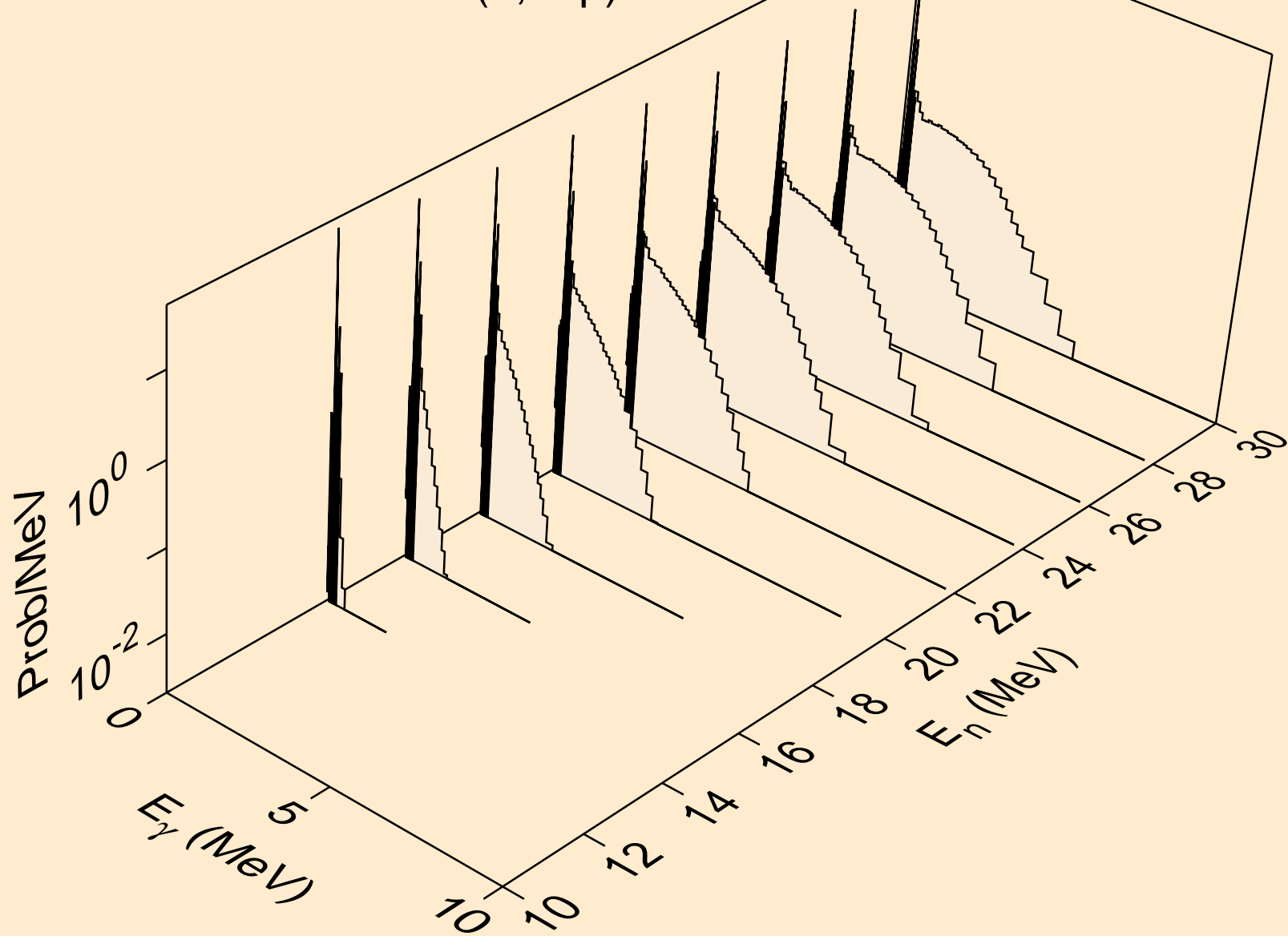

TL185 NEUTRON ACER TENDL-2023 LIBRARY; T=0.K  
Photon emission for (n,3np)

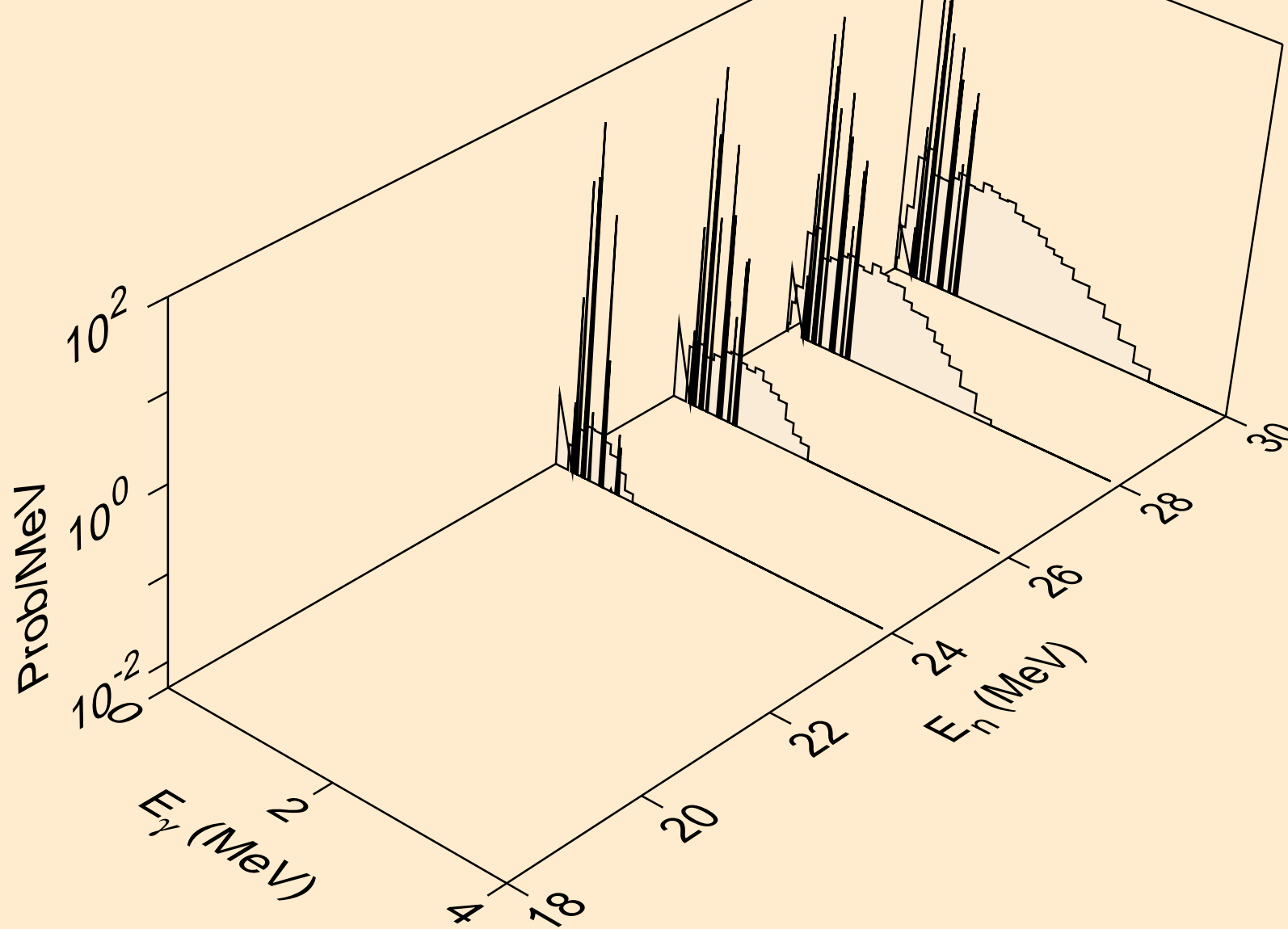

TL185 NEUTRON ACER TENDL-2023 LIBRARY; T=0.K  
Photon emission for (n,n2p)

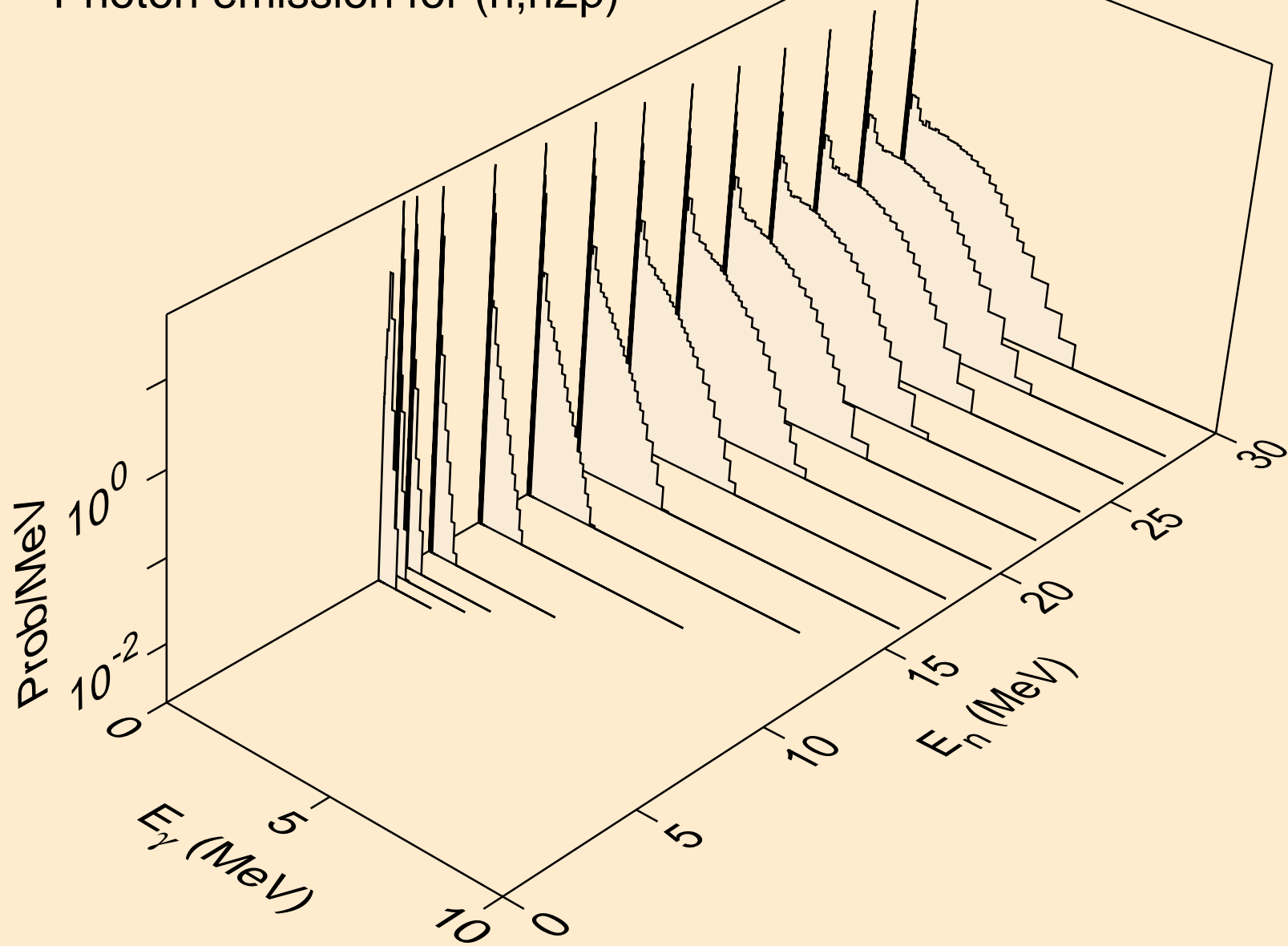

TL185 NEUTRON ACER TENDL-2023 LIBRARY; T=0.K  
Photon emission for (n,npa)

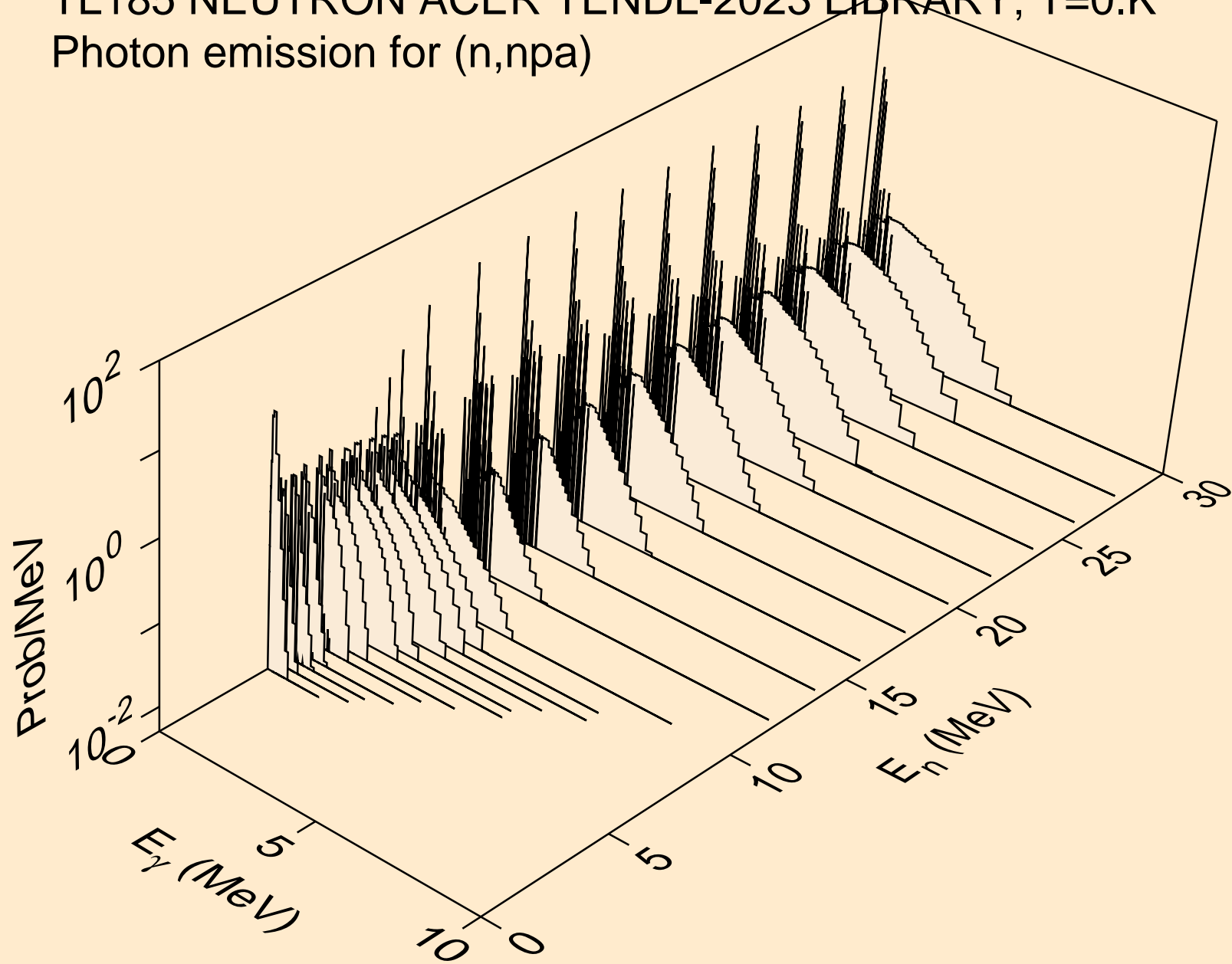

TL185 NEUTRON ACER TENDL-2023 LIBRARY; T=0.K  
Photon emission for (n,n\*c)

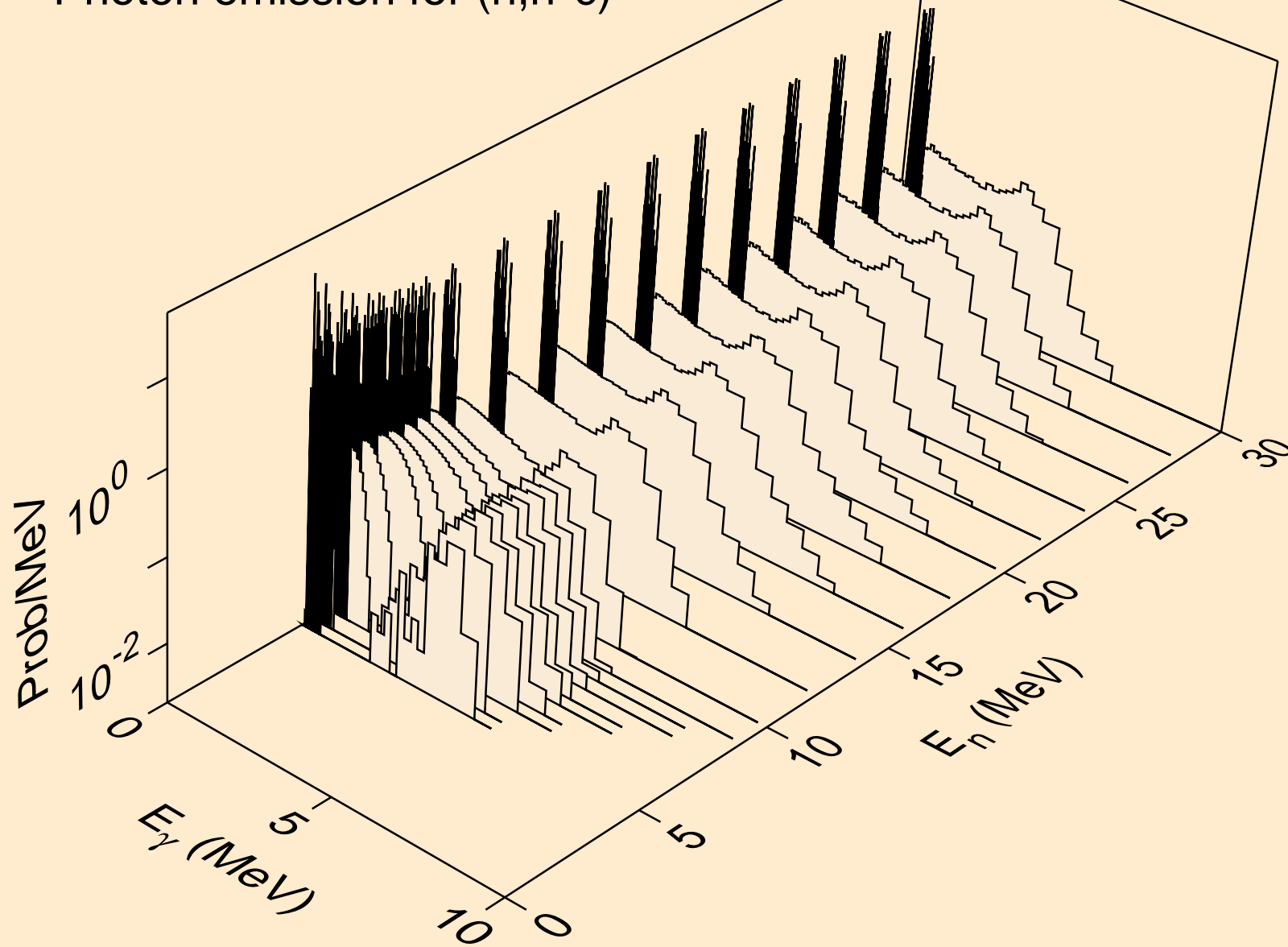

TL185 NEUTRON ACER TENDL-2023 LIBRARY; T=0.K  
Photon emission for (n,gma)

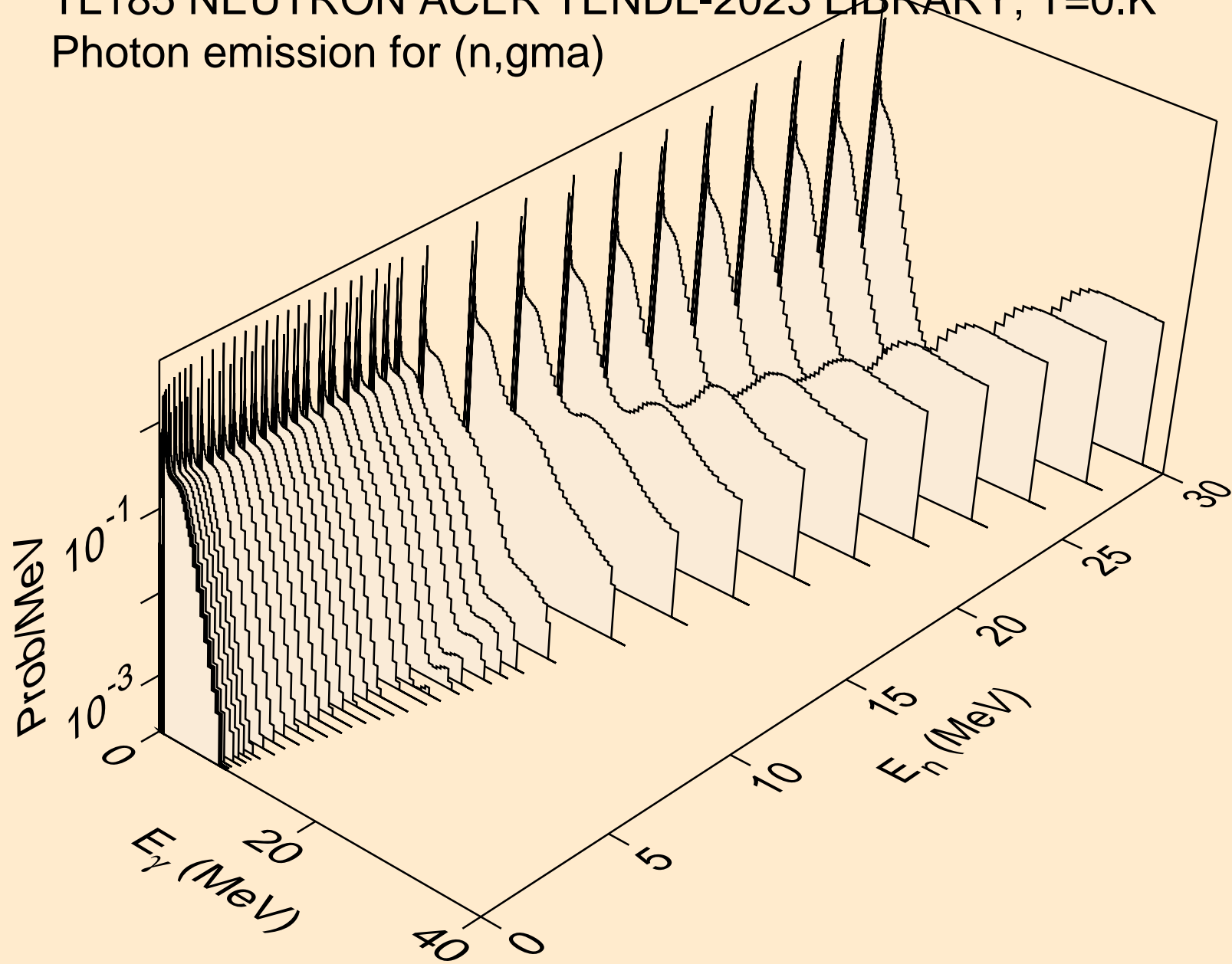

TL185 NEUTRON ACER TENDL-2023 LIBRARY; T=0.K  
Photon emission for (n,p)

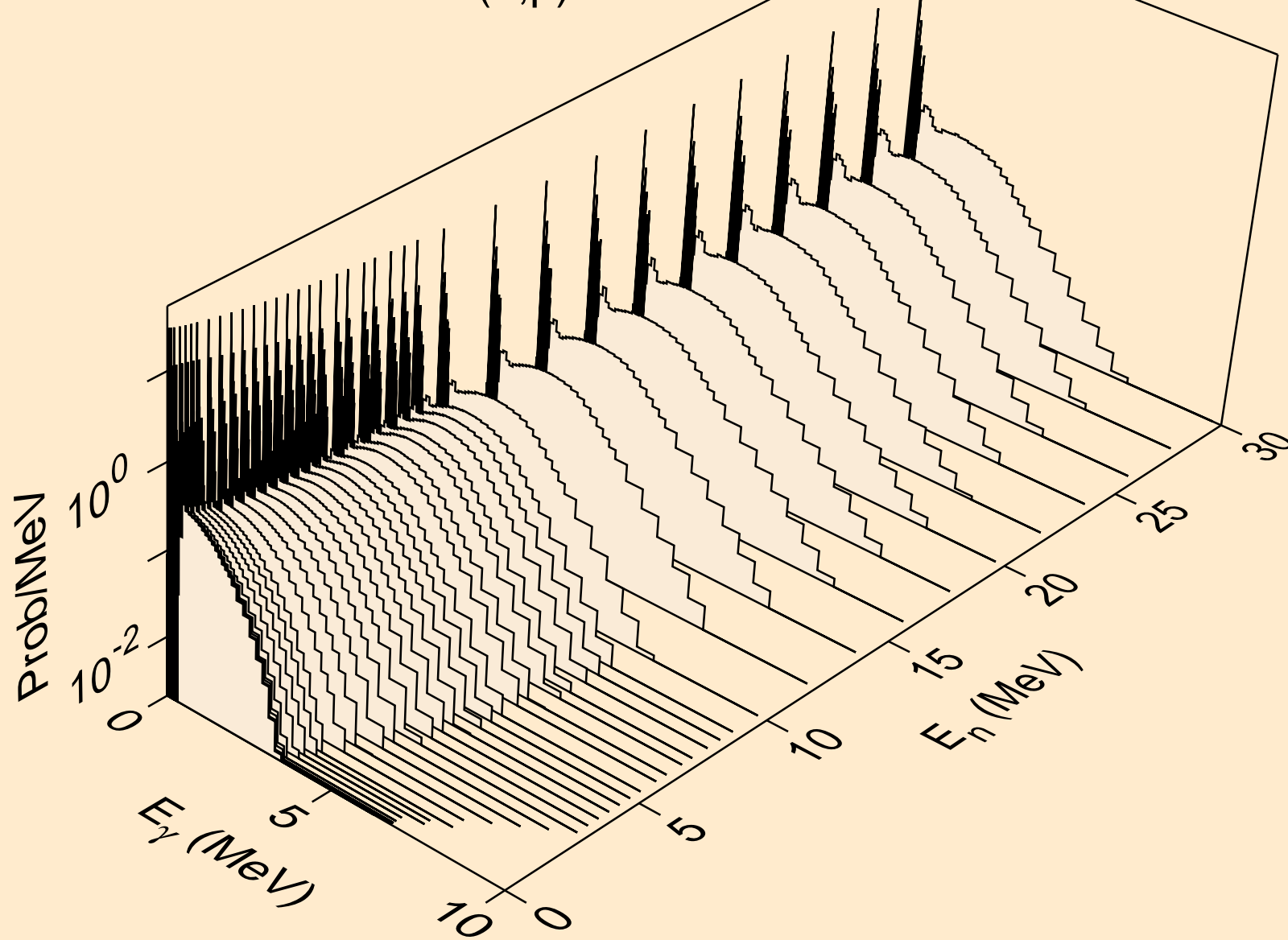

TL185 NEUTRON ACER TENDL-2023 LIBRARY; T=0.K  
Photon emission for (n,d)



TL185 NEUTRON ACER TENDL-2023 LIBRARY; T=0.K  
Photon emission for (n,t)

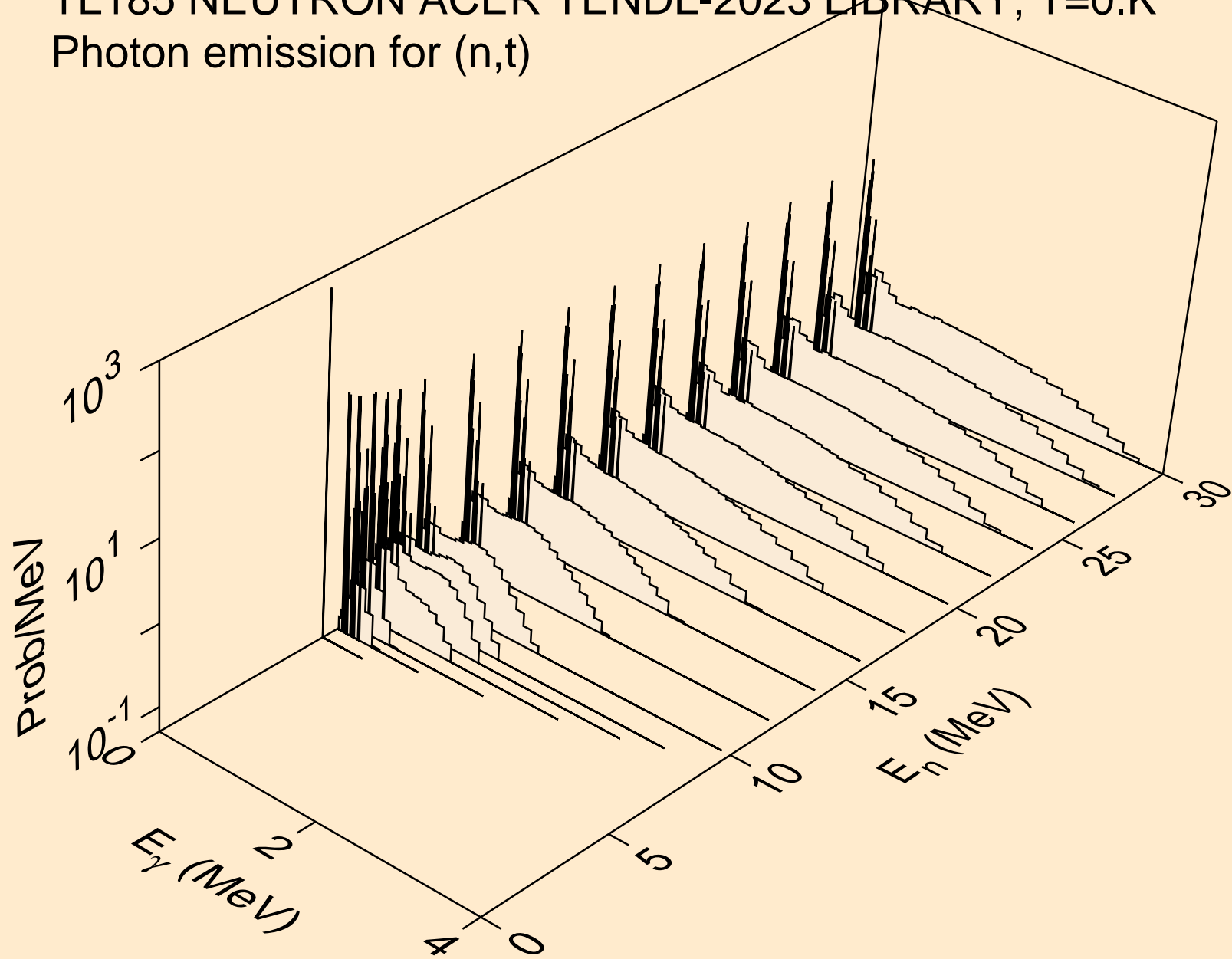

TL185 NEUTRON ACER TENDL-2023 LIBRARY; T=0.K  
Photon emission for (n,he3)

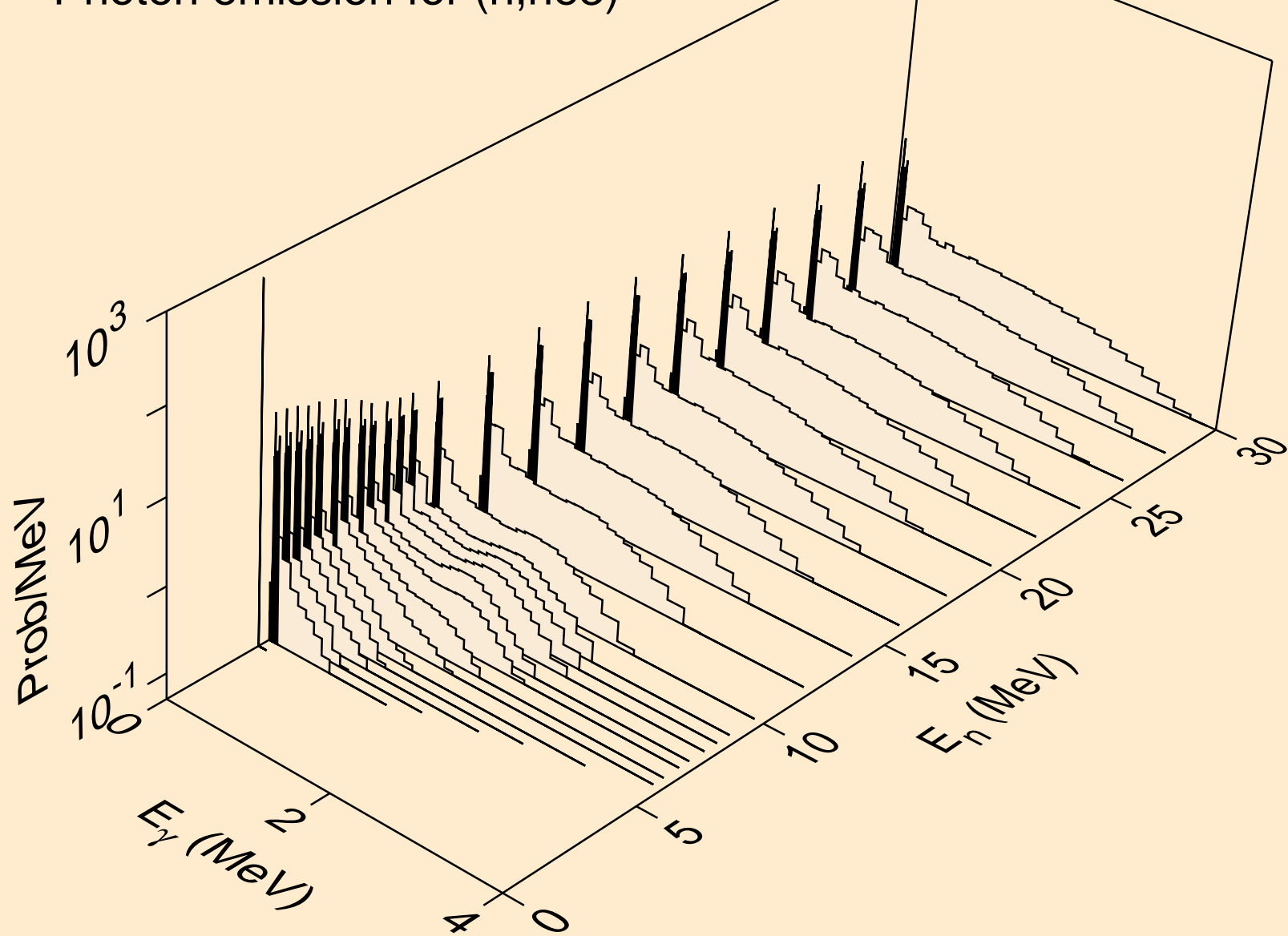

TL185 NEUTRON ACER TENDL-2023 LIBRARY; T=0.K  
Photon emission for (n,a)

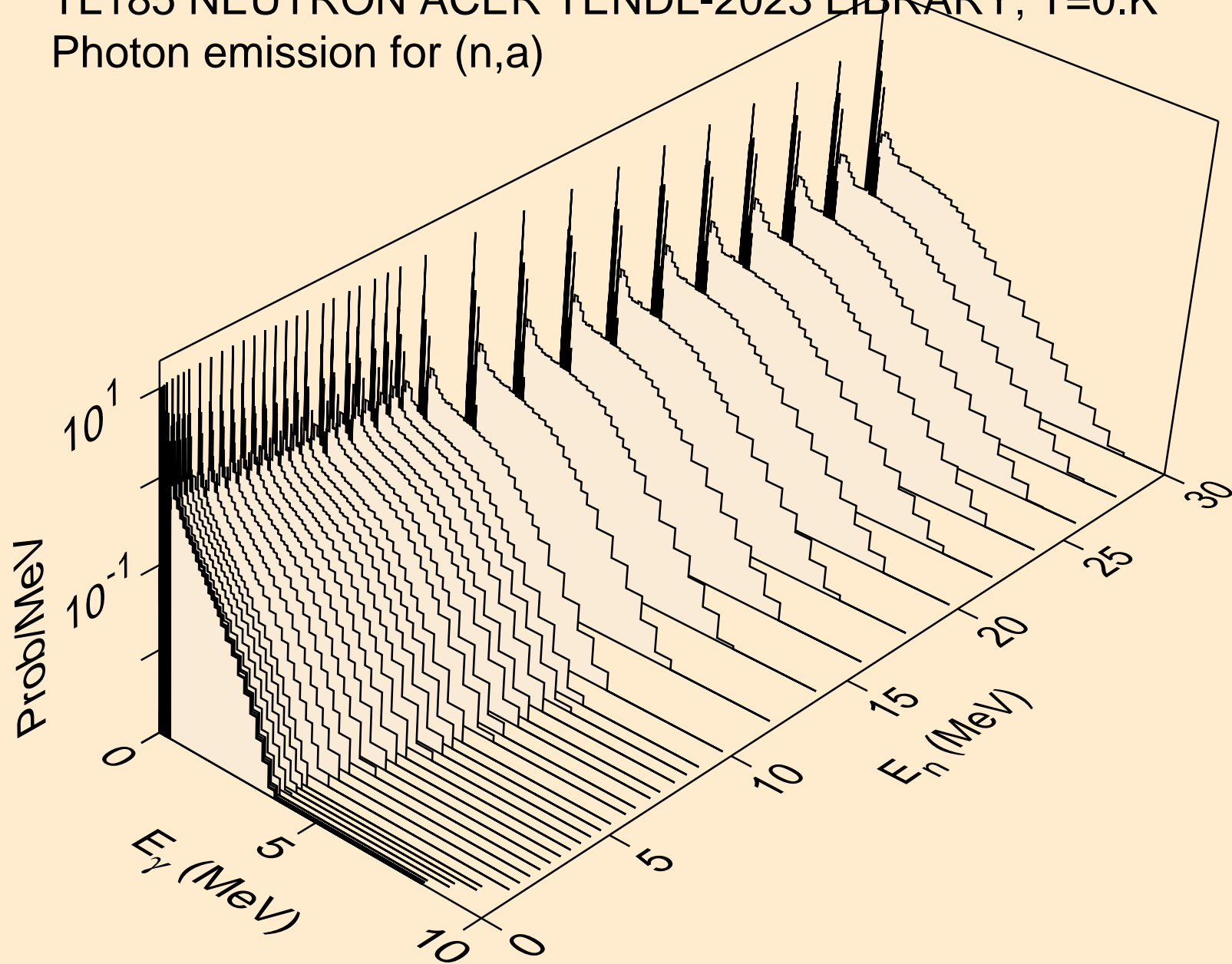

TL185 NEUTRON ACER TENDL-2023 LIBRARY; T=0.K  
Photon emission for (n,2a)

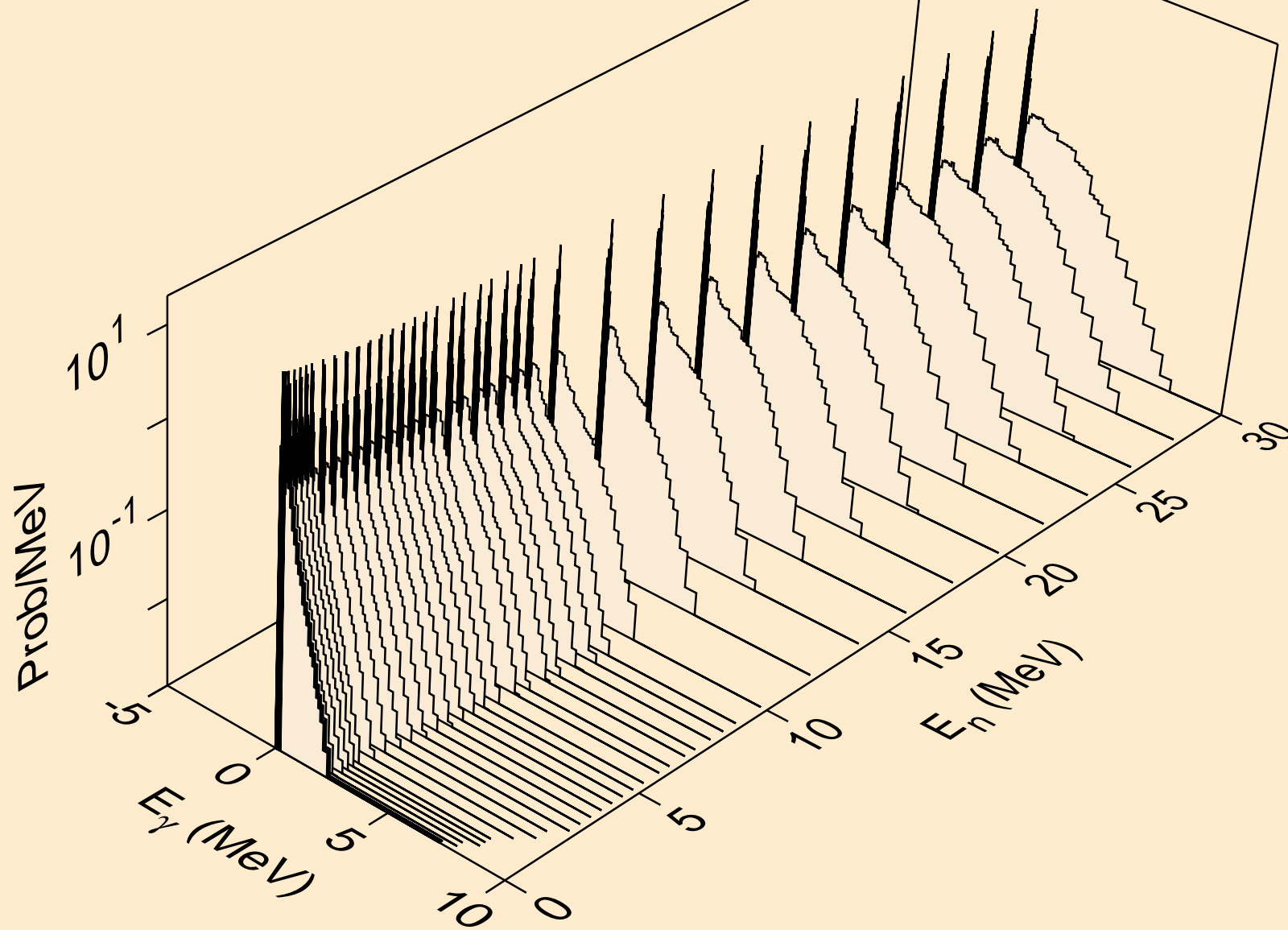

TL185 NEUTRON ACER TENDL-2023 LIBRARY; T=0.K  
Photon emission for (n,3a)

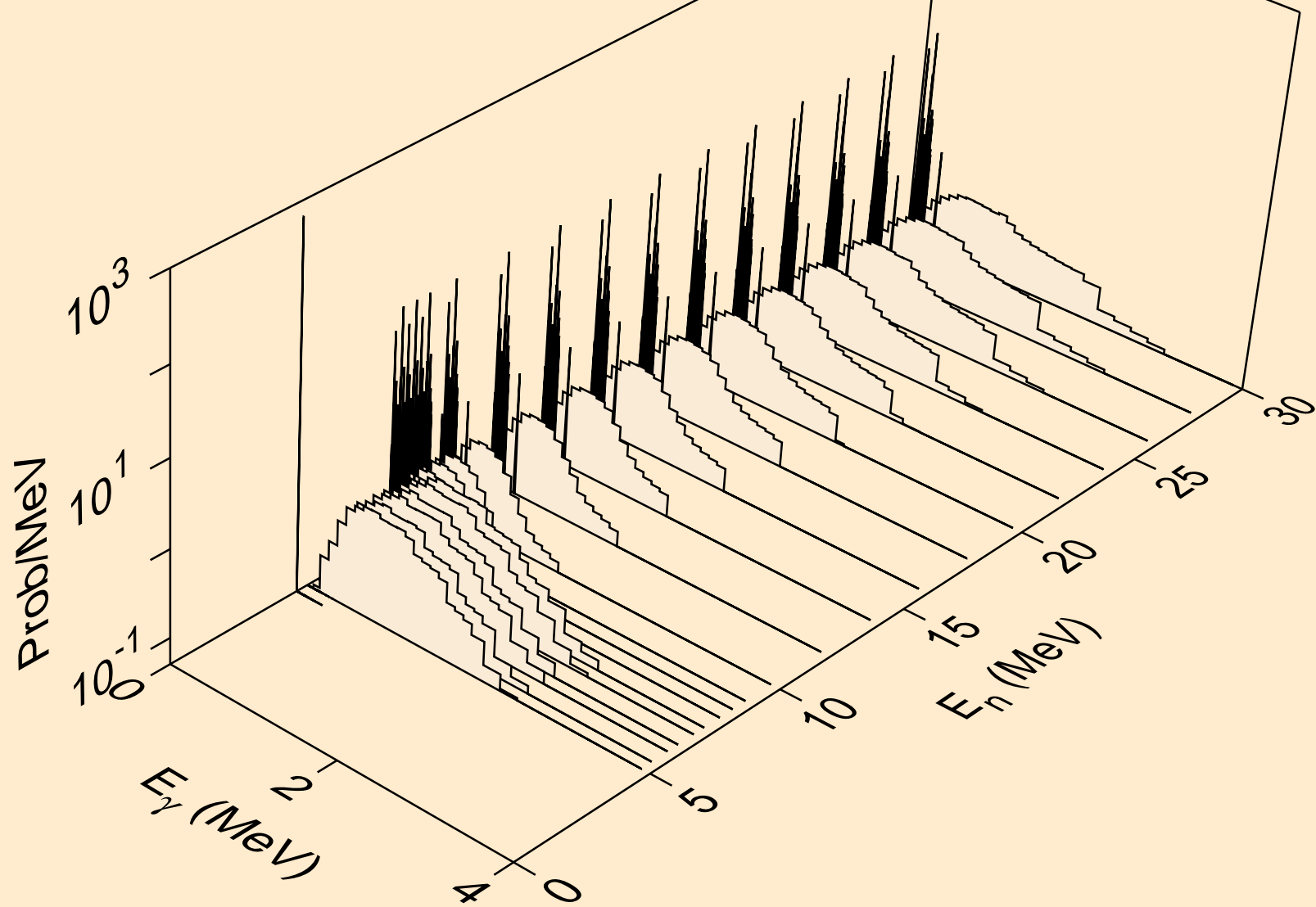

TL185 NEUTRON ACER TENDL-2023 LIBRARY; T=0.K  
Photon emission for (n,2p)

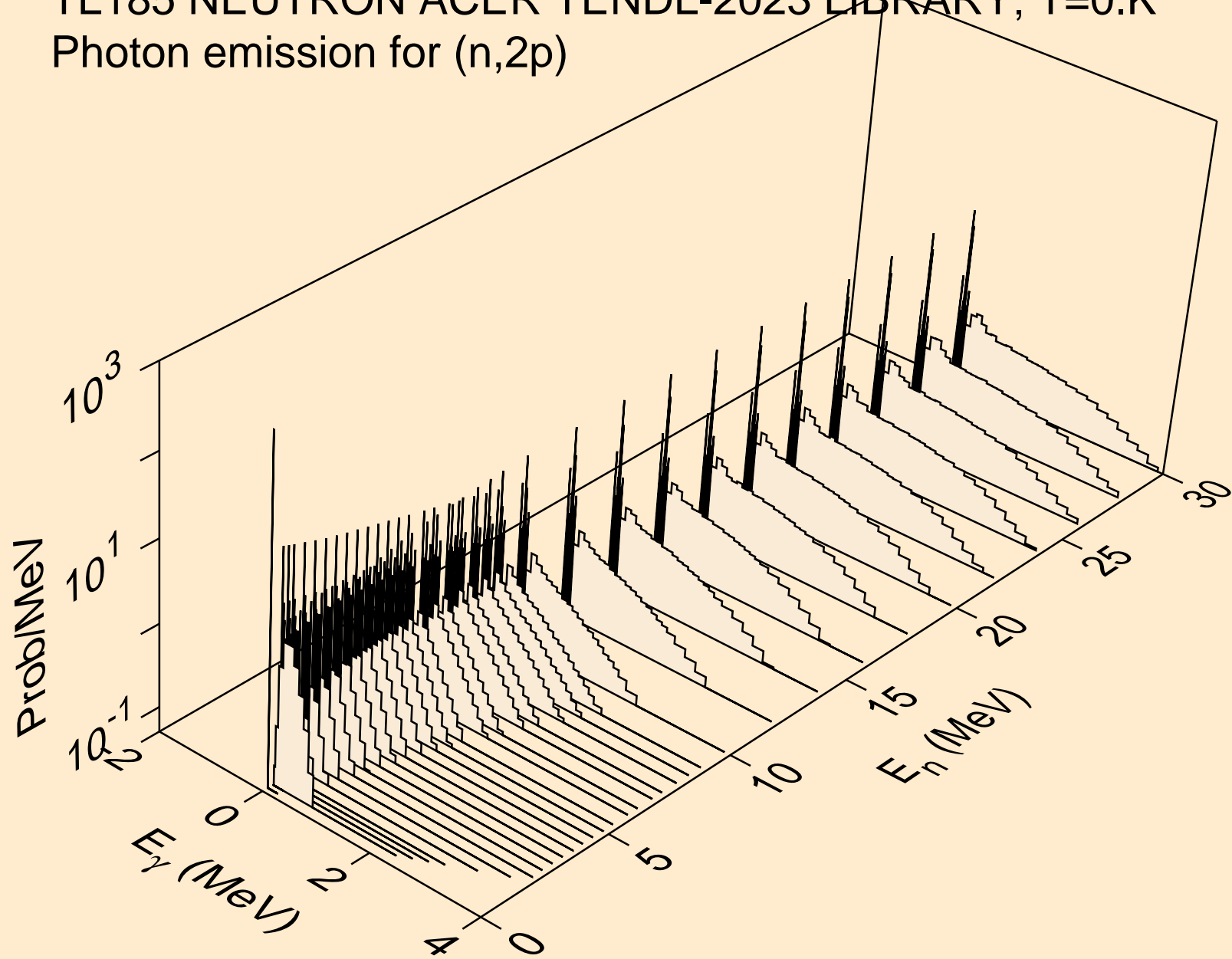

TL185 NEUTRON ACER TENDL-2023 LIBRARY; T=0.K  
Photon emission for (n,p $\alpha$ )

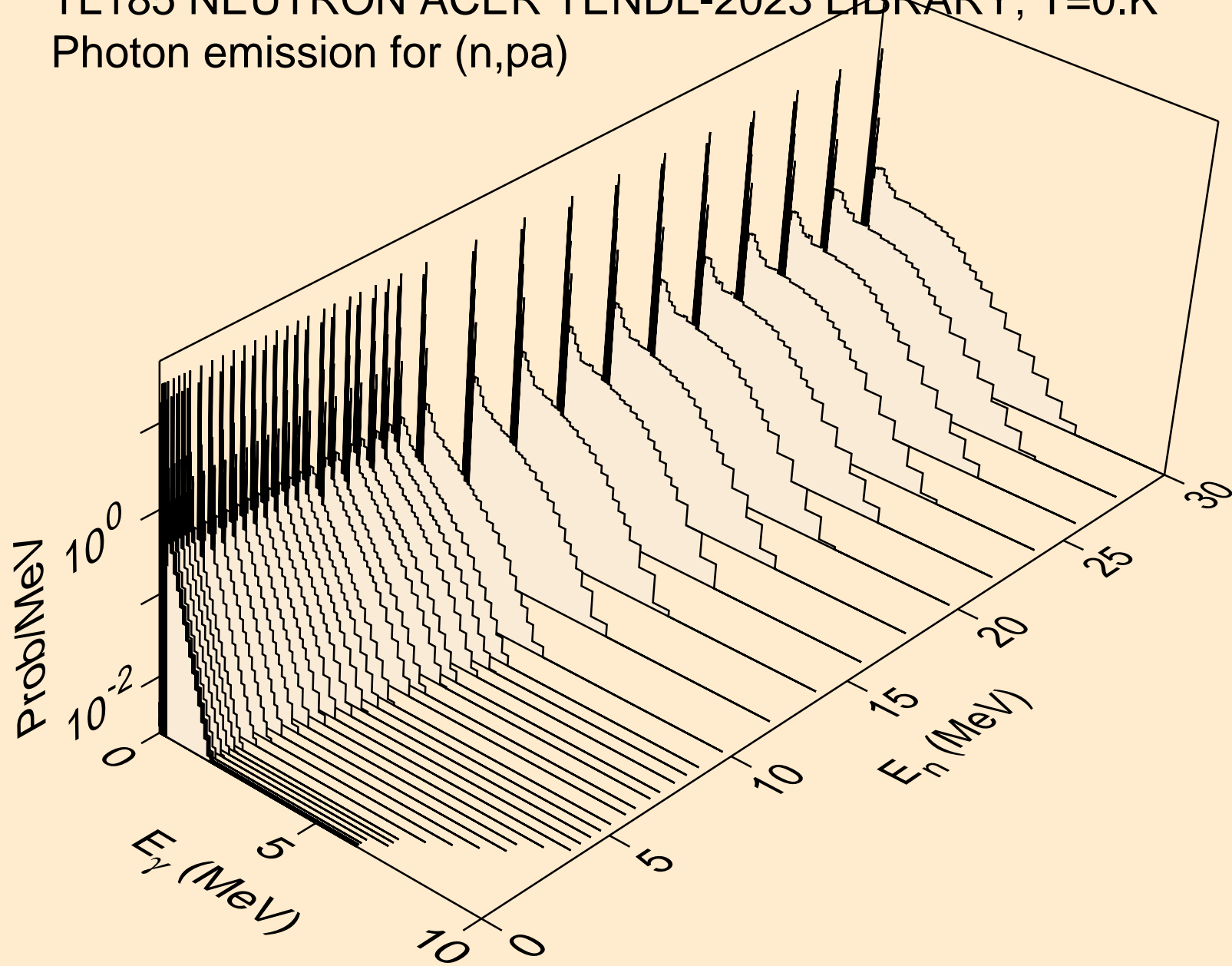

TL185 NEUTRON ACER TENDL-2023 LIBRARY; T=0.K  
Photon emission for (n,d2a)

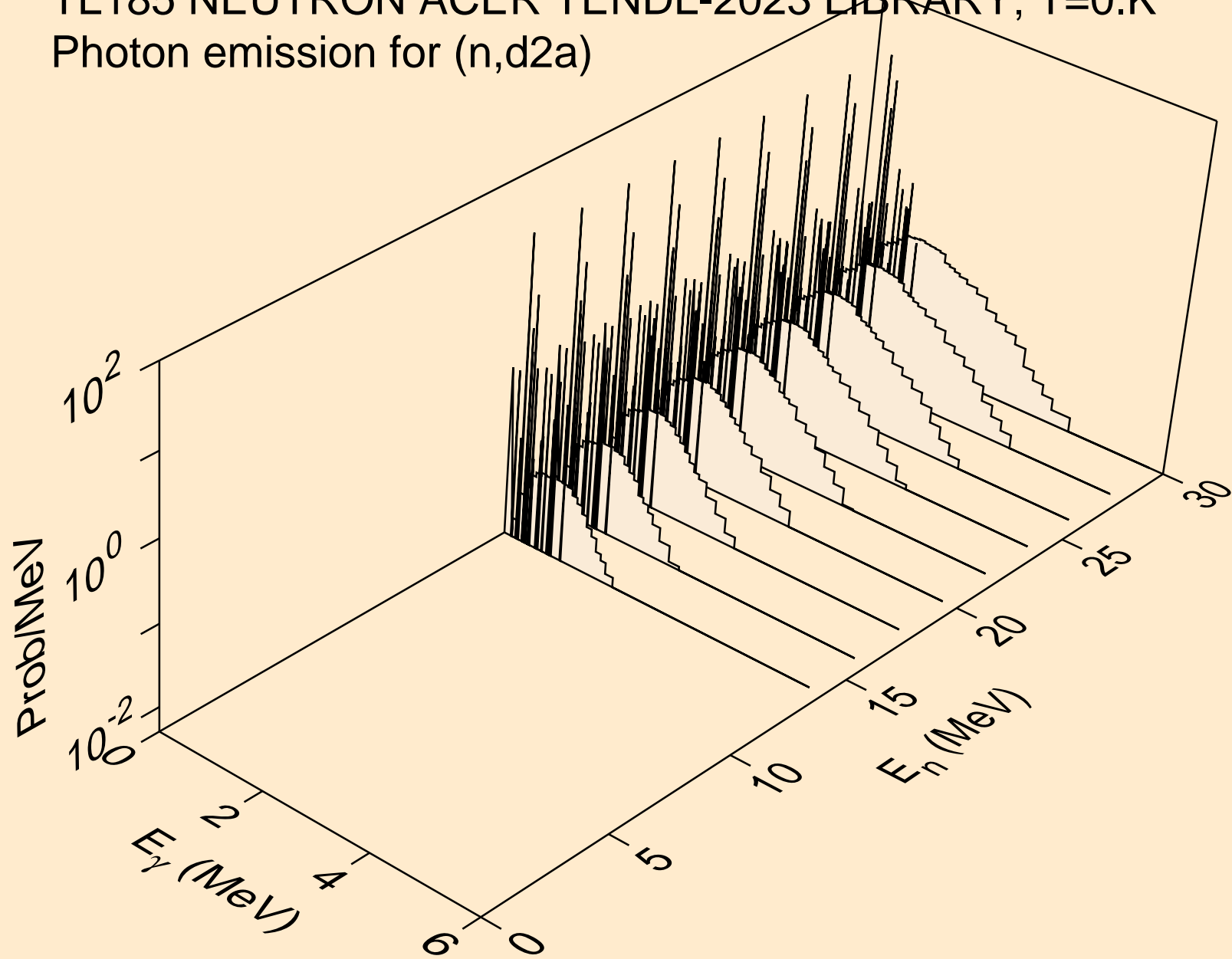

TL185 NEUTRON ACER TENDL-2023 LIBRARY; T=0.K  
Photon emission for (n,pd)

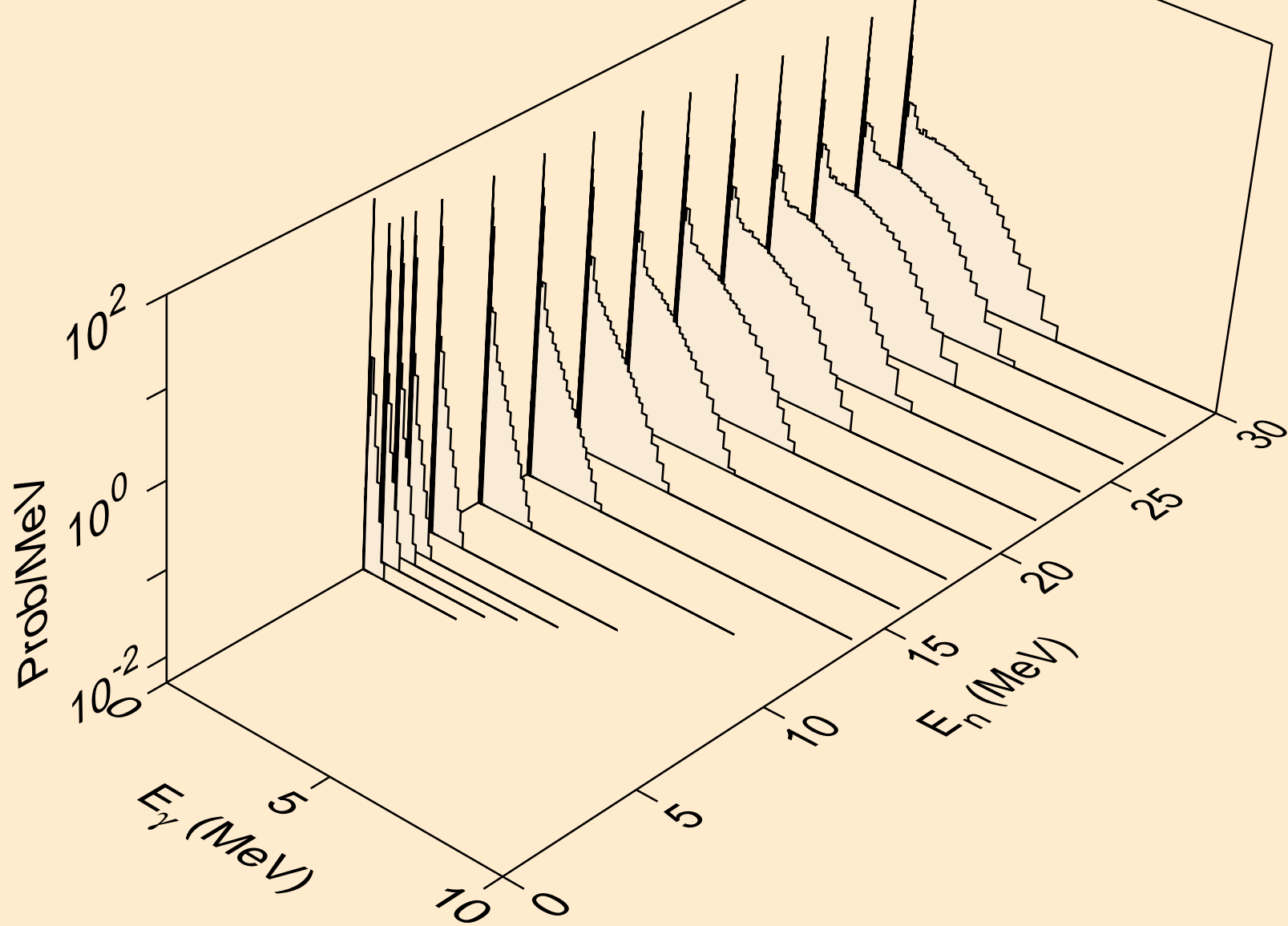

TL185 NEUTRON ACER TENDL-2023 LIBRARY; T=0.K  
Photon emission for (n,pt)

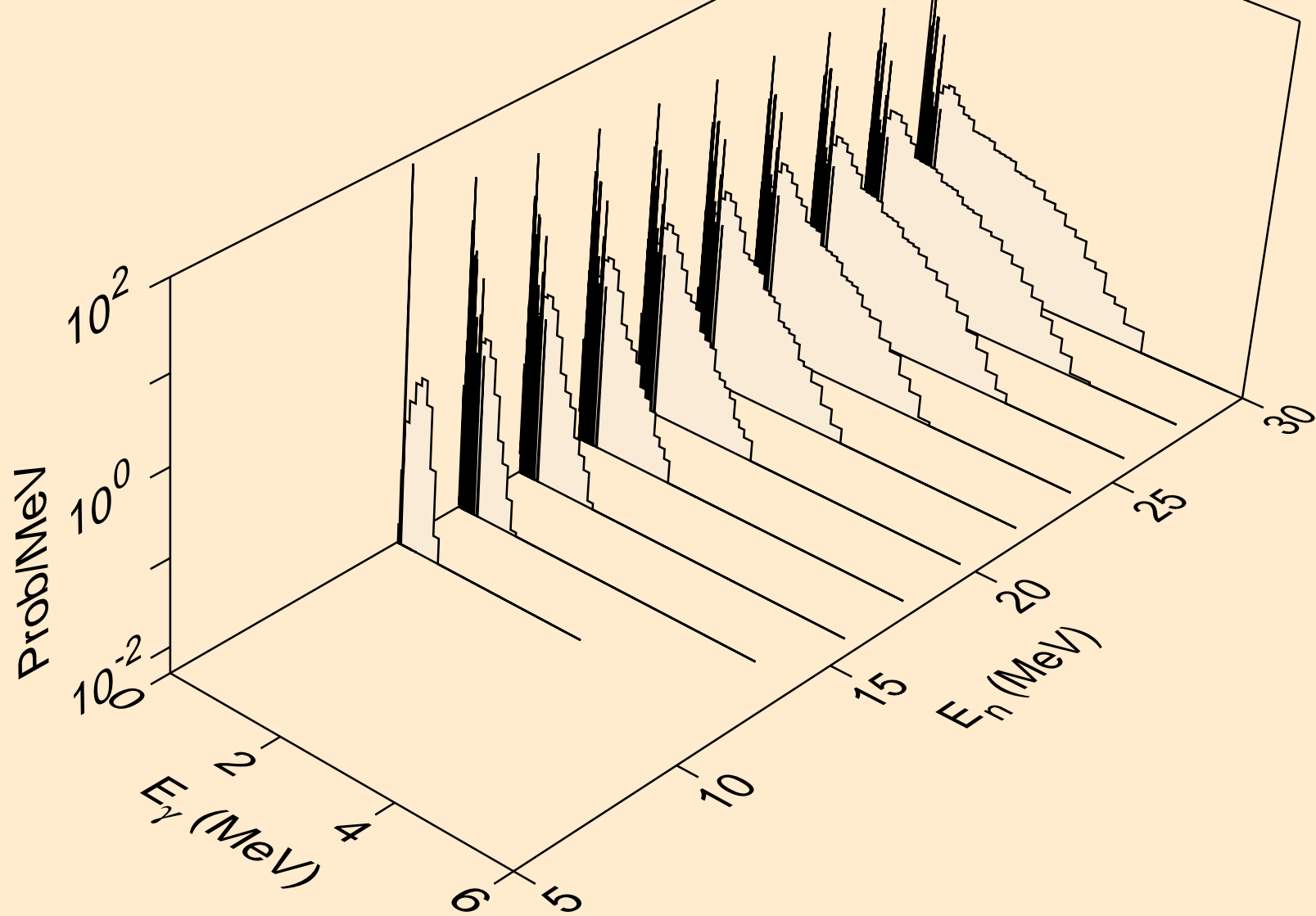

TL185 NEUTRON ACER TENDL-2023 LIBRARY; T=0.K  
Photon emission for (n,da)

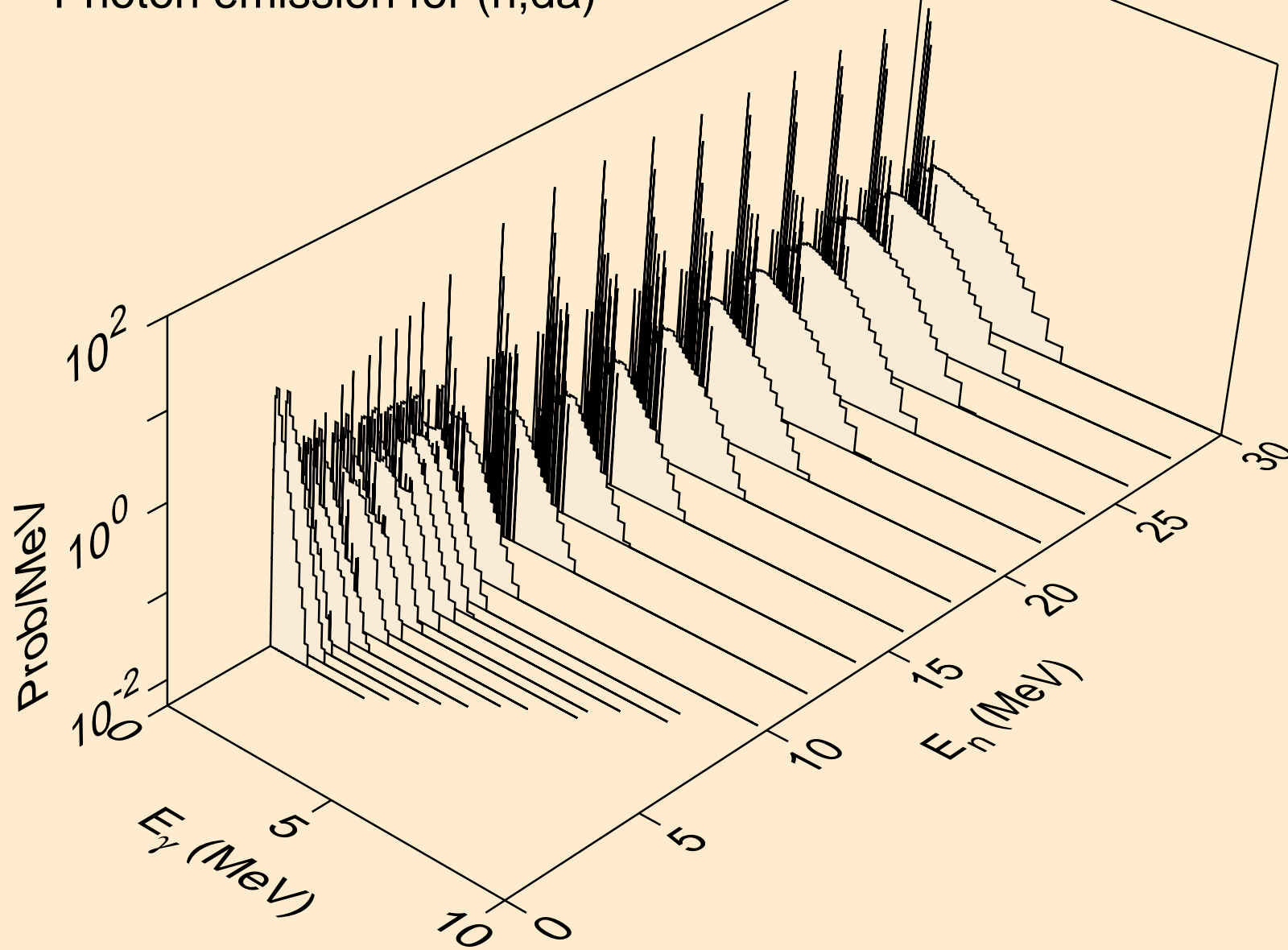

TL185 NEUTRON ACER TENDL-2023 LIBRARY; T=0.K  
thermal capture photon spectrum

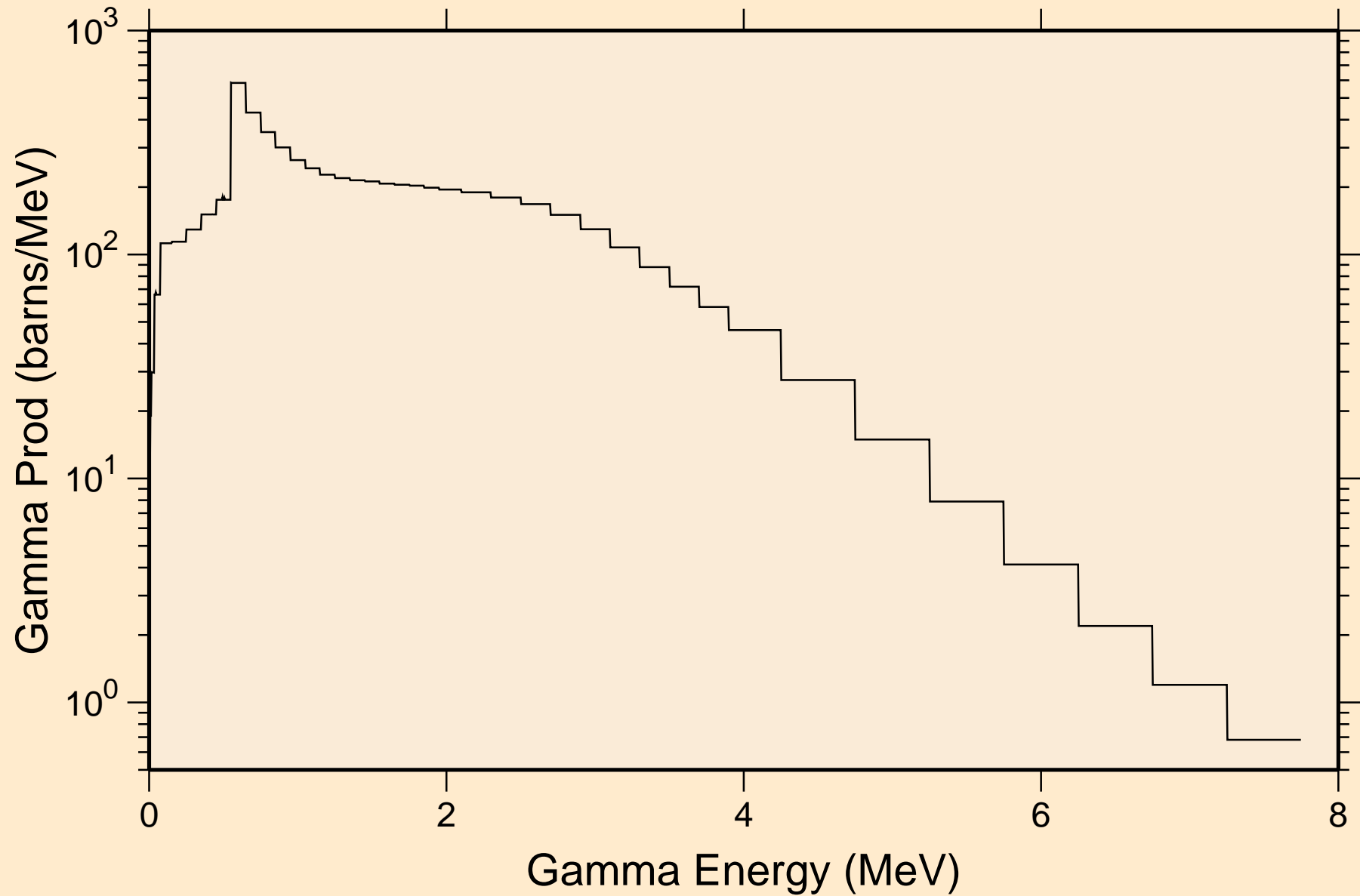

TL185 NEUTRON ACER TENDL-2023 LIBRARY; T=0.K  
14 MeV photon spectrum

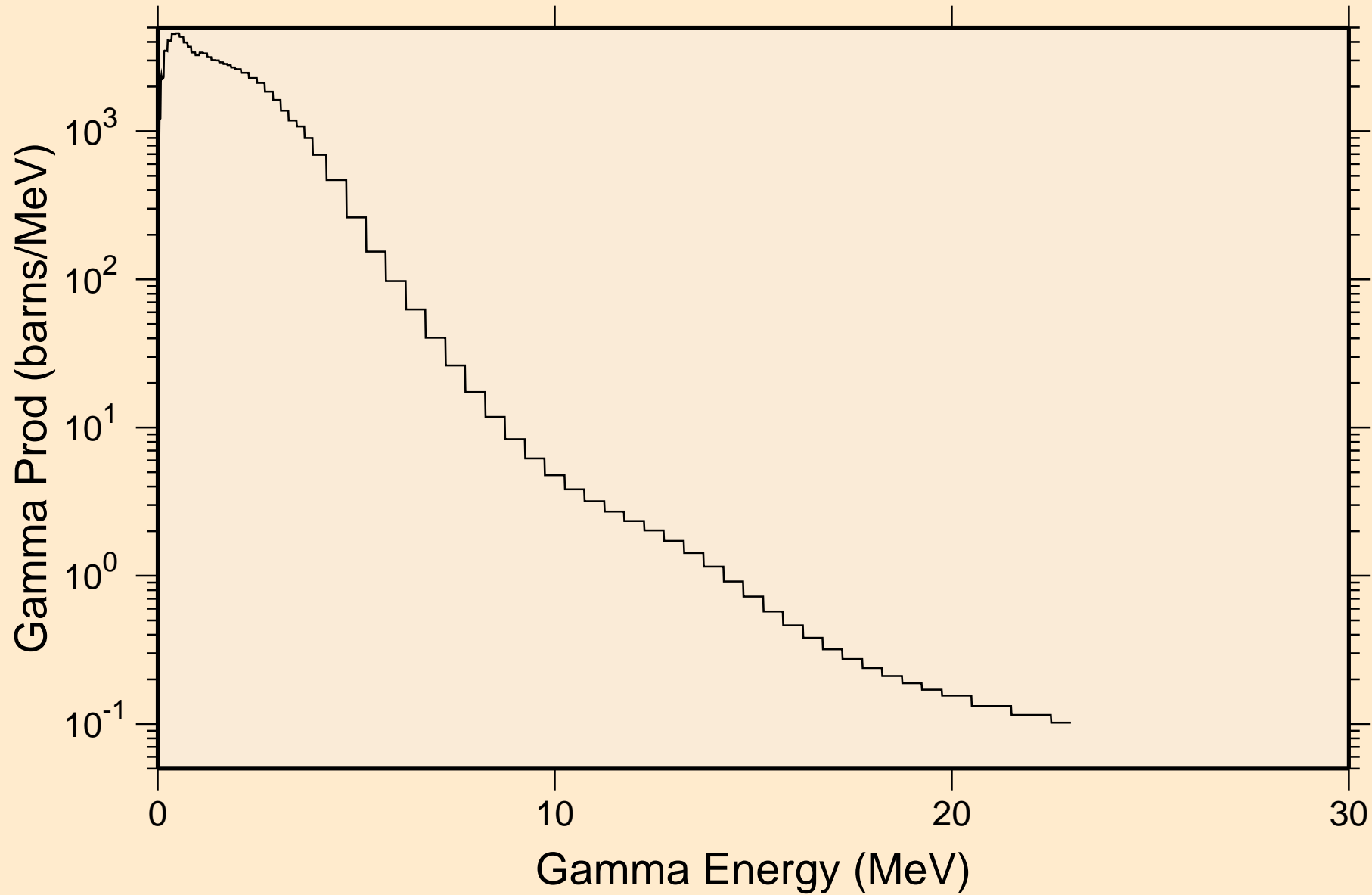

# TL185 NEUTRON ACER TENDL-2023 LIBRARY; T=0.K

## Particle heating contributions

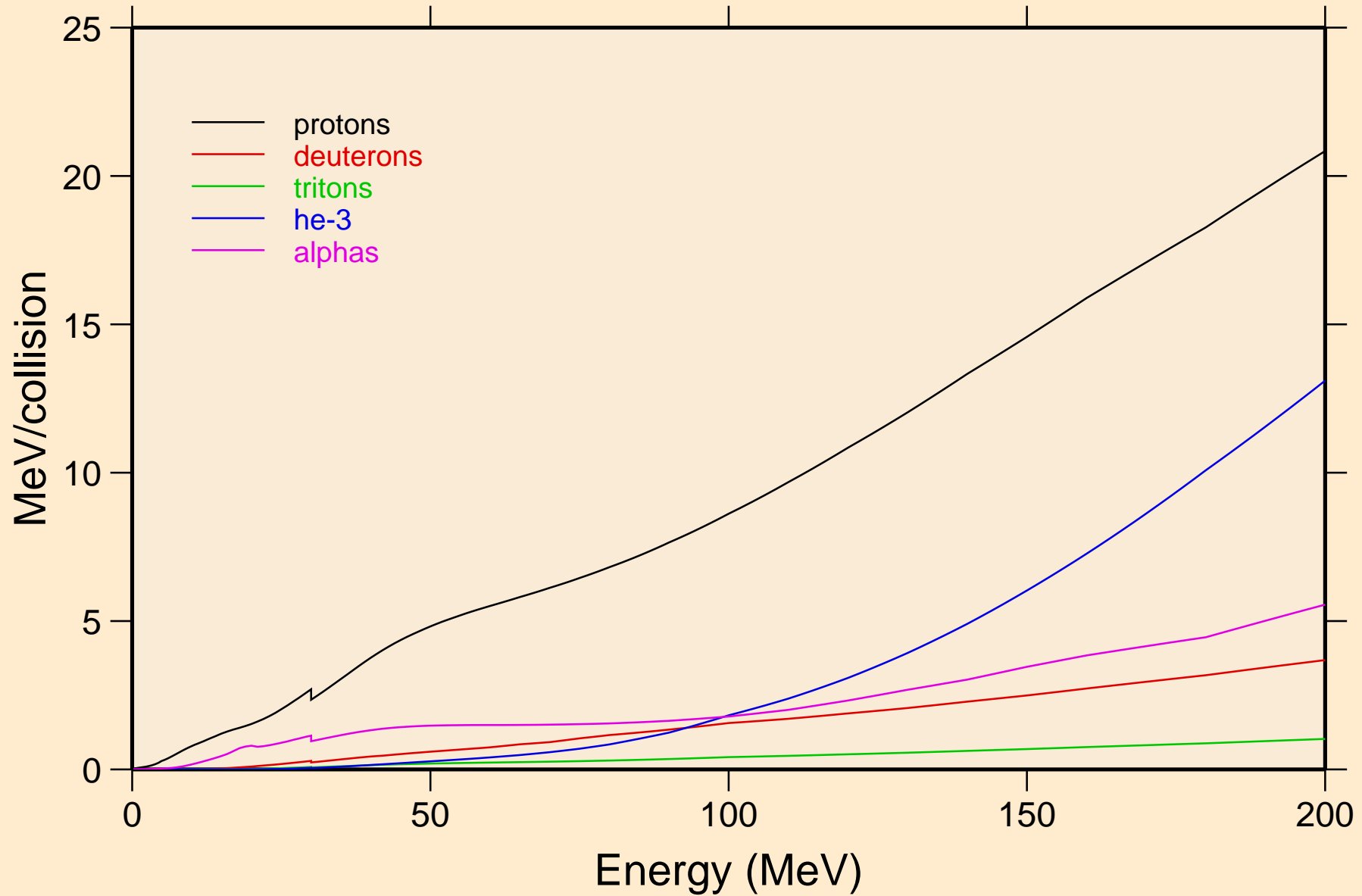

TL185 NEUTRON ACER TENDL-2023 LIBRARY; T=0.K  
Recoil Heating

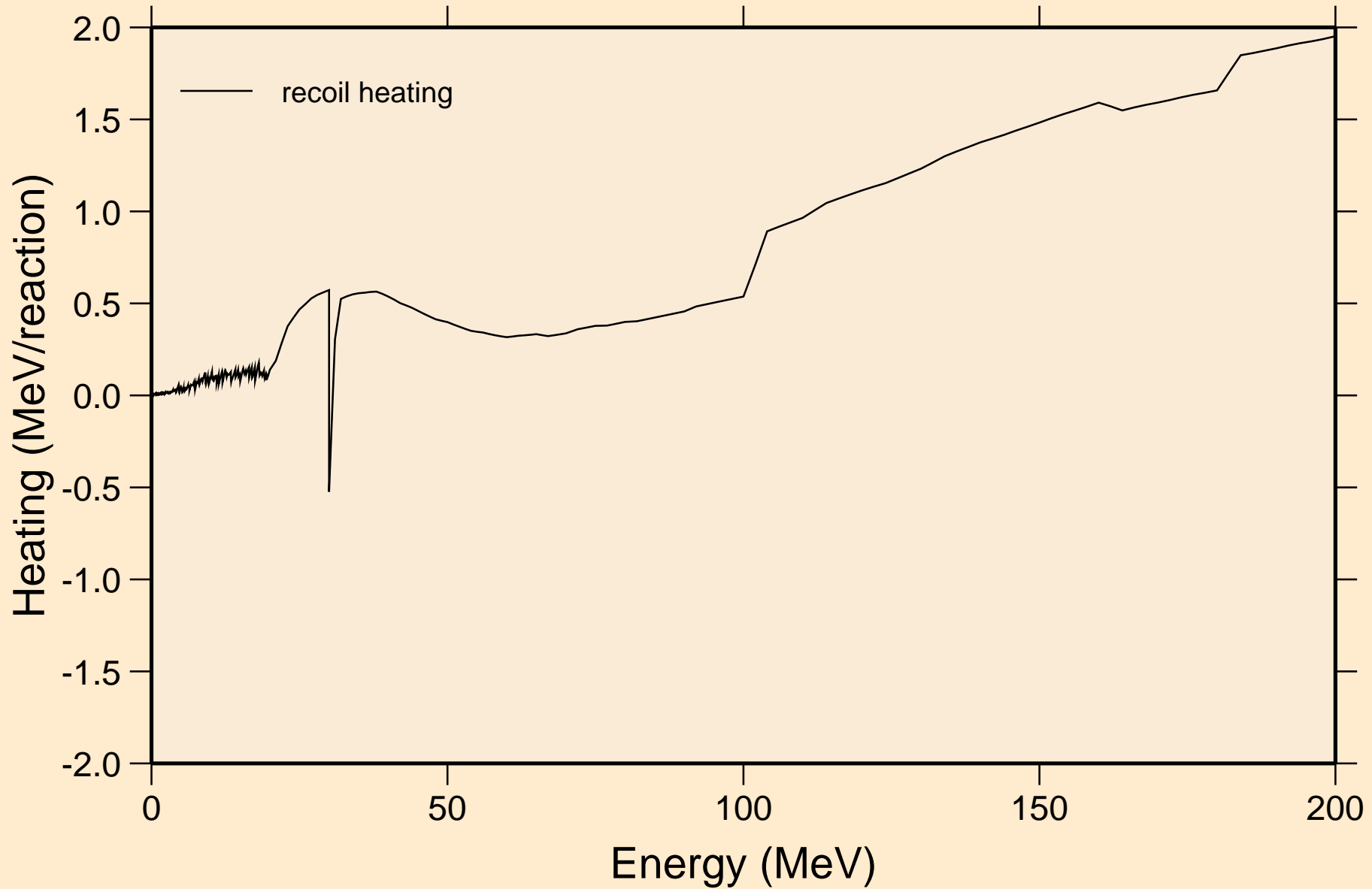

TL185 NEUTRON ACER TENDL-2023 LIBRARY; T=0.K  
Particle production cross sections

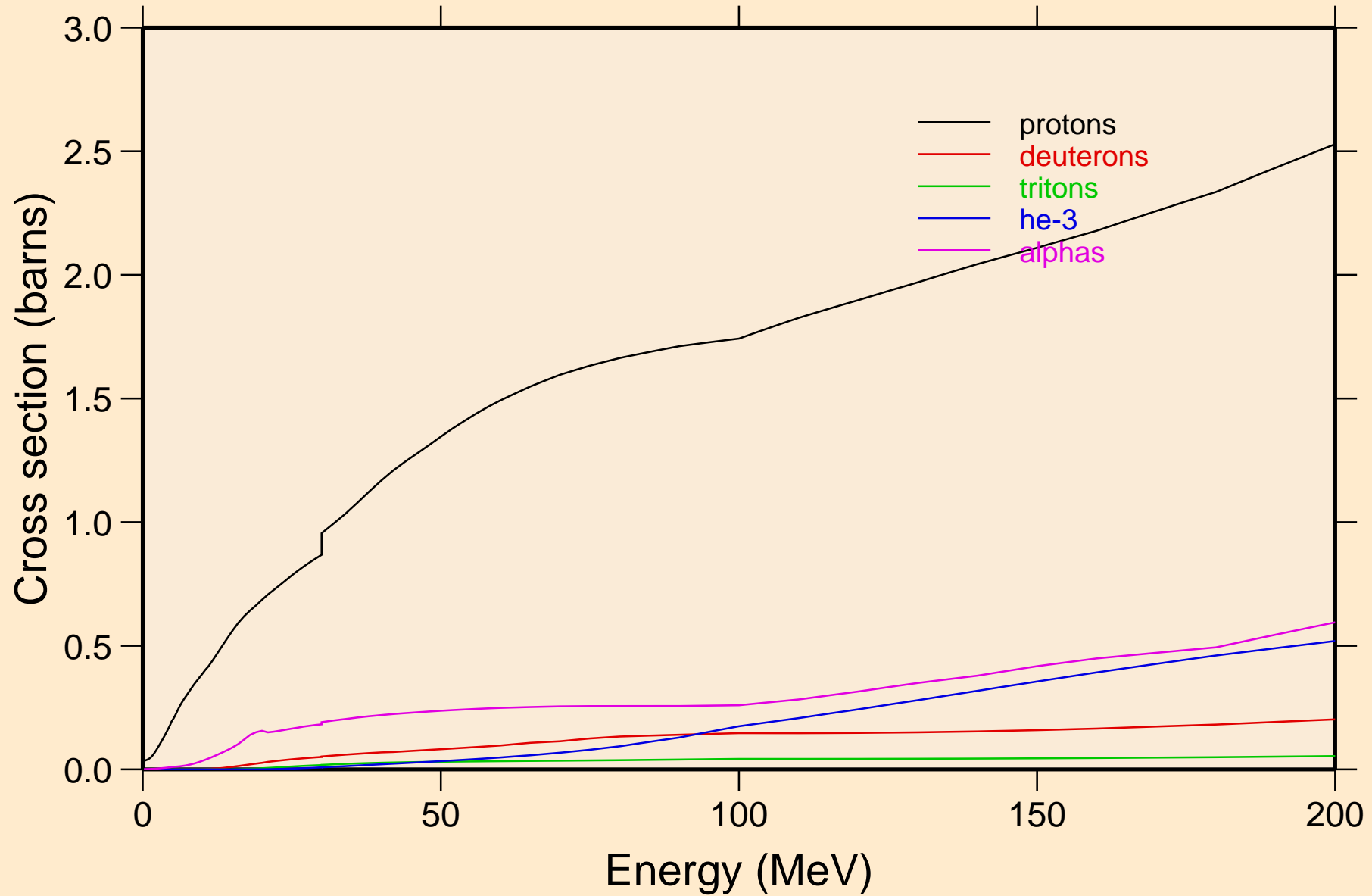

TL185 NEUTRON ACER TENDL-2023 LIBRARY; T=0.K  
protons from (n,x)

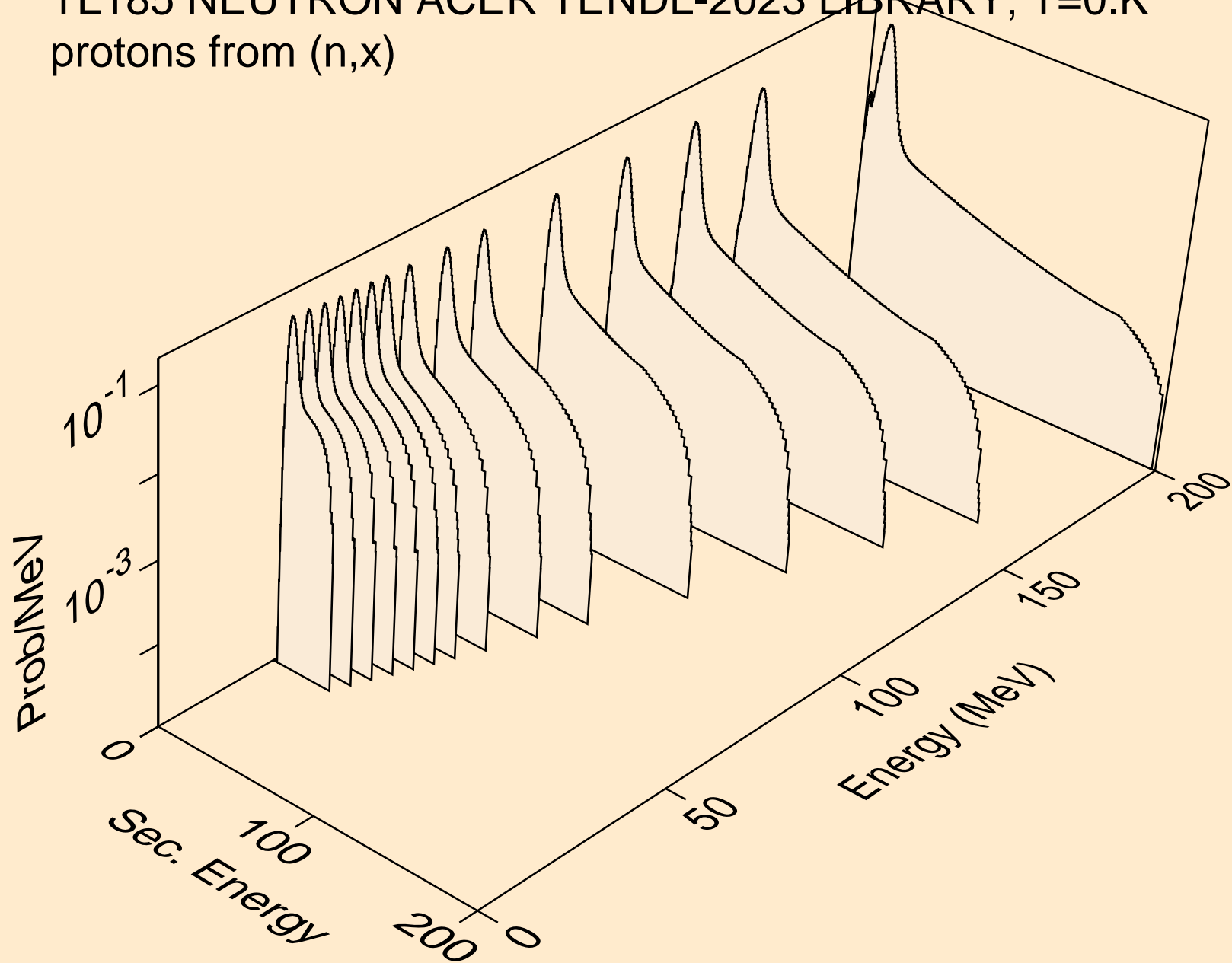

TL185 NEUTRON ACER TENDL-2023 LIBRARY; T=0.K  
protons from (n,n\*)p

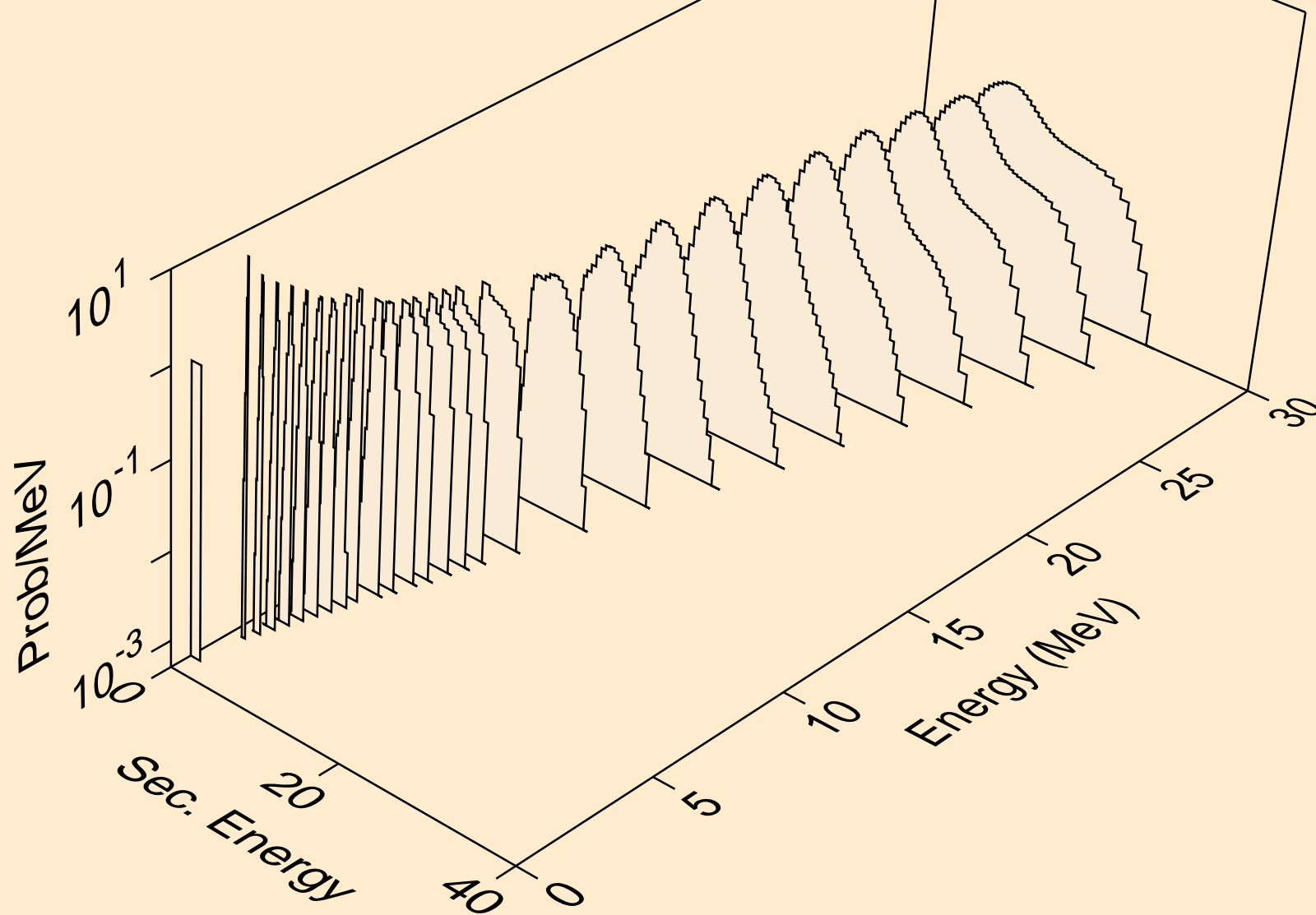

TL185 NEUTRON ACER TENDL-2023 LIBRARY; T=0.K  
protons from (n,2np)

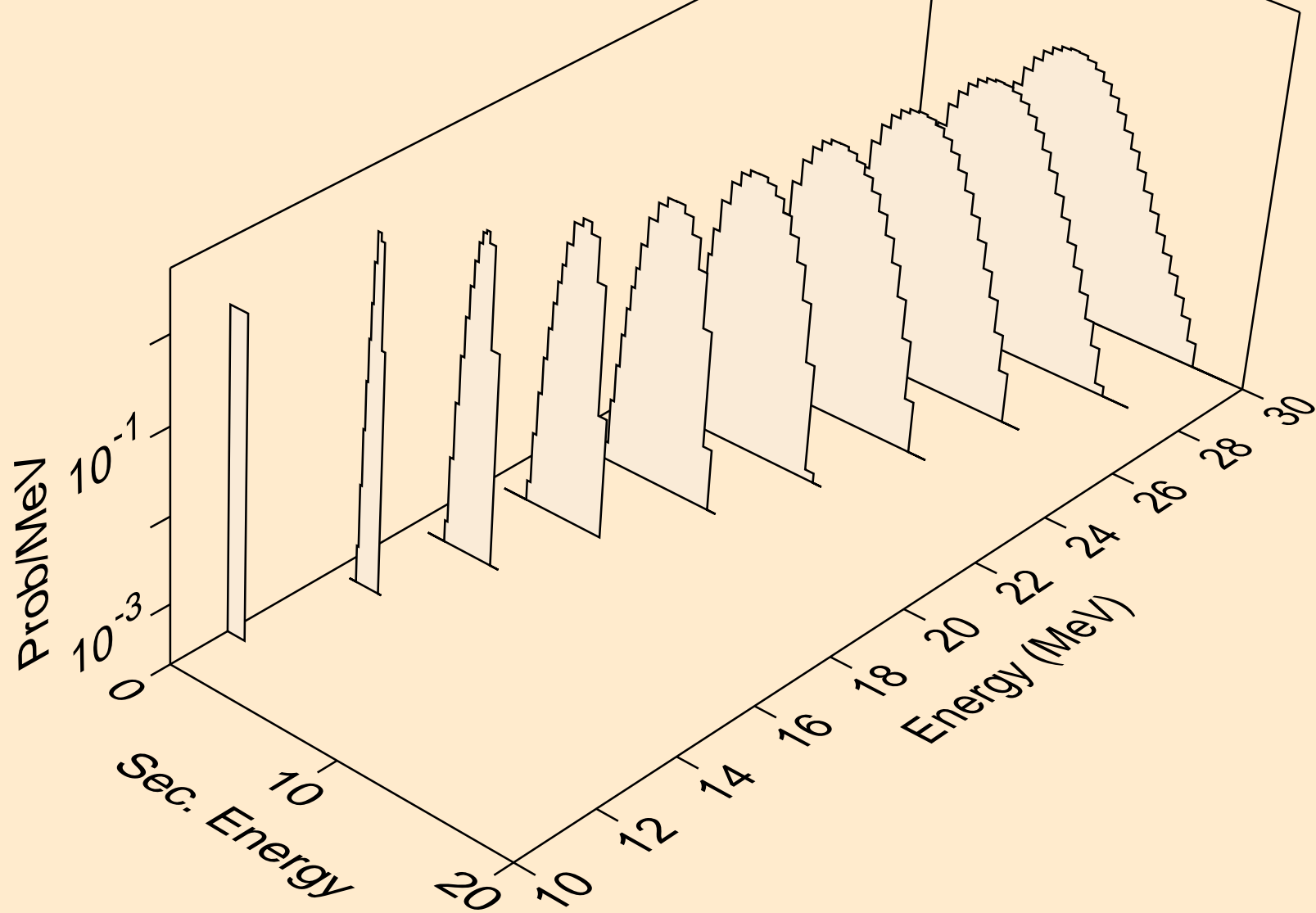

TL185 NEUTRON ACER TENDL-2023 LIBRARY; T=0.K  
protons from (n,3np)

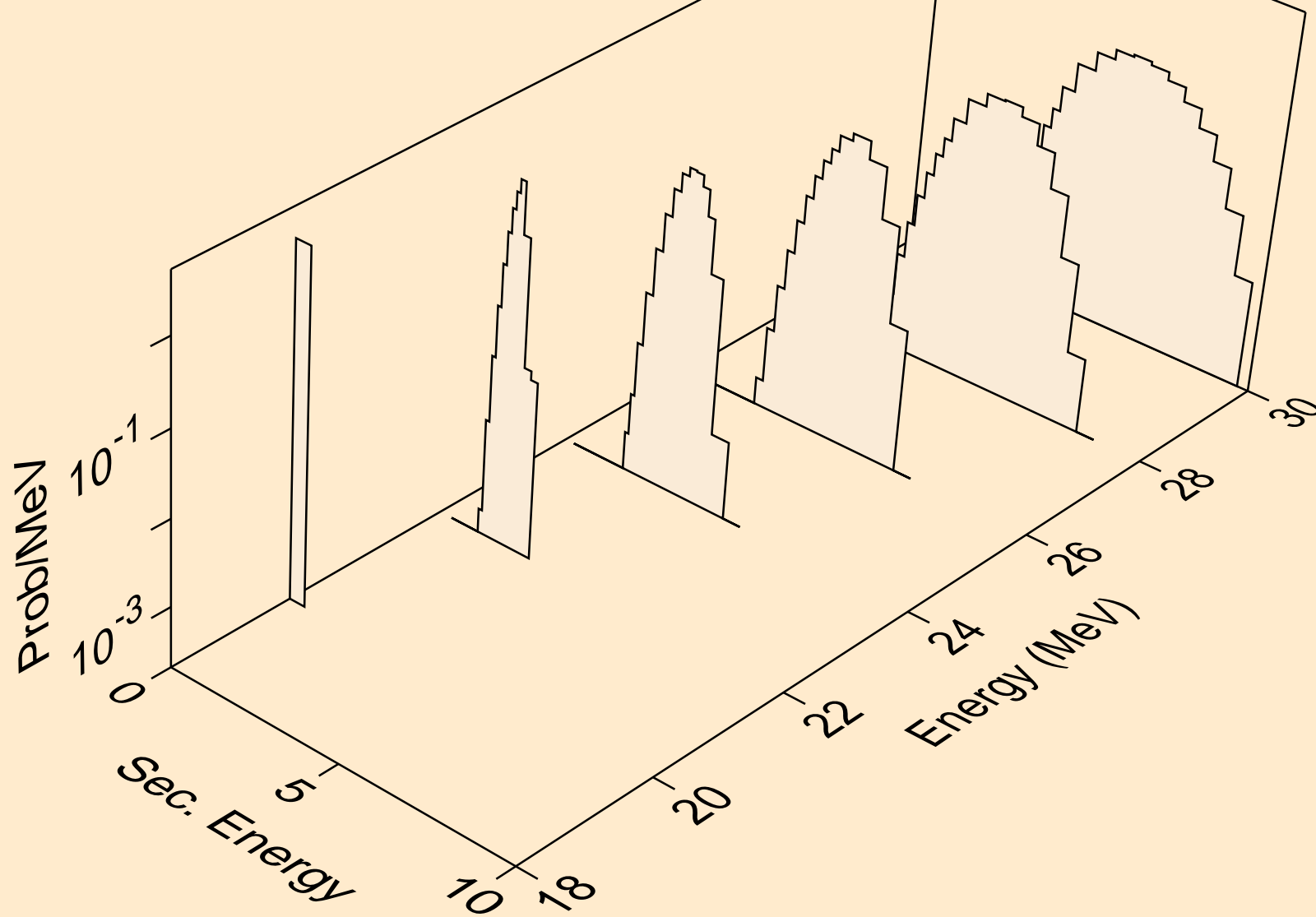

TL185 NEUTRON ACER TENDL-2023 LIBRARY; T=0.K  
protons from (n,n2p)

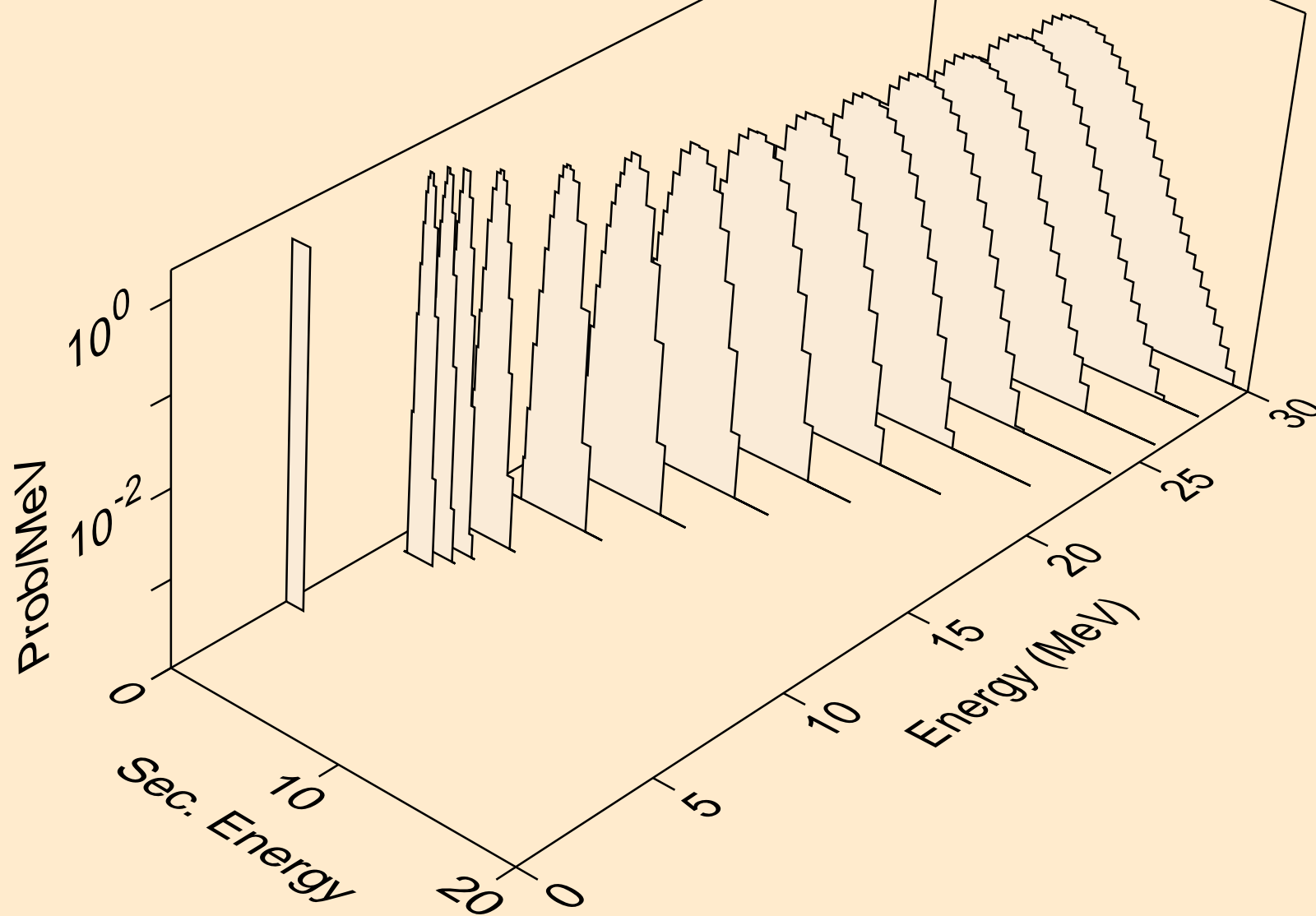

TL185 NEUTRON ACER TENDL-2023 LIBRARY; T=0.K  
protons from (n,npa)

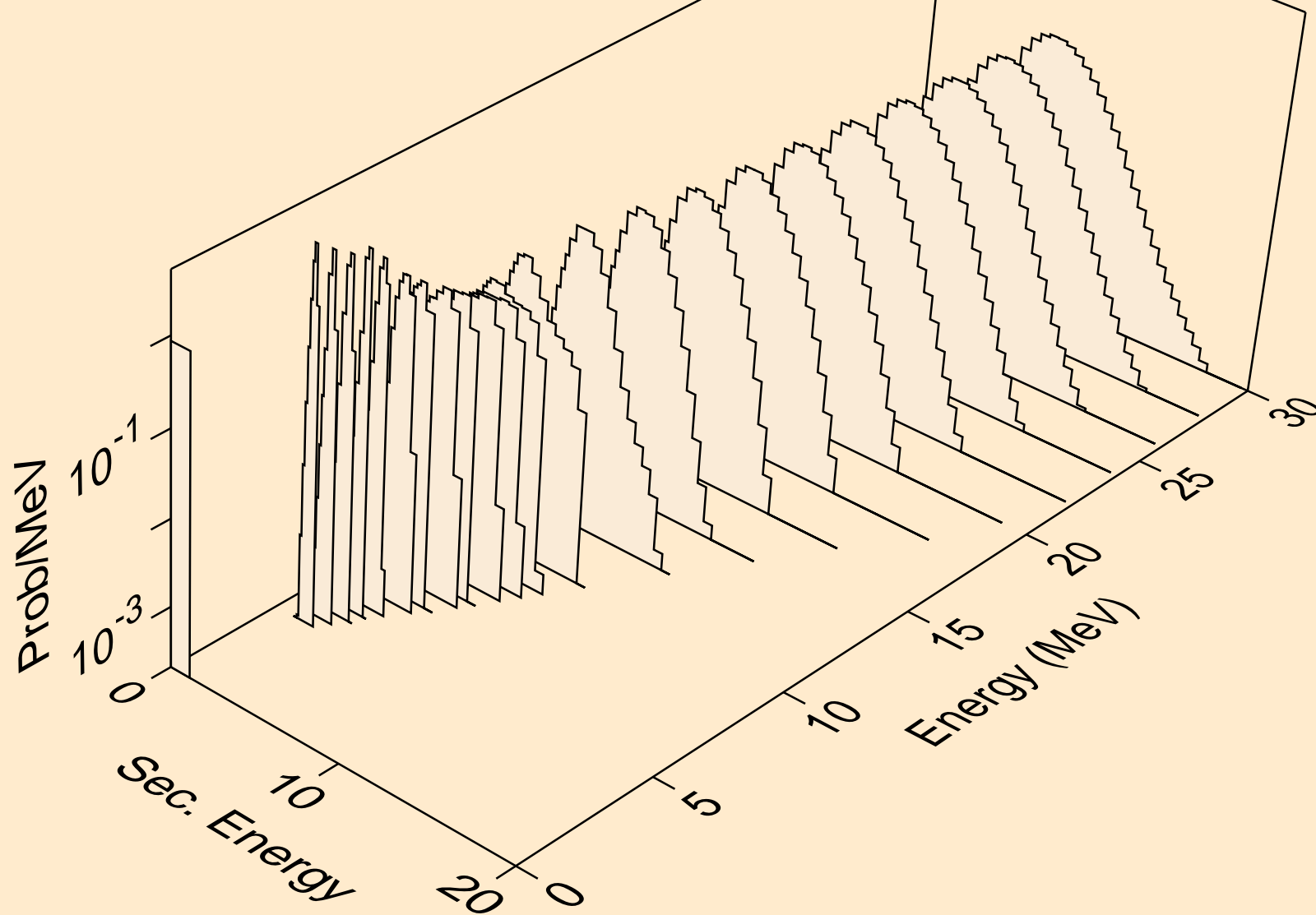

TL185 NEUTRON ACER TENDL-2023 LIBRARY; T=0.K  
protons from (n,p)

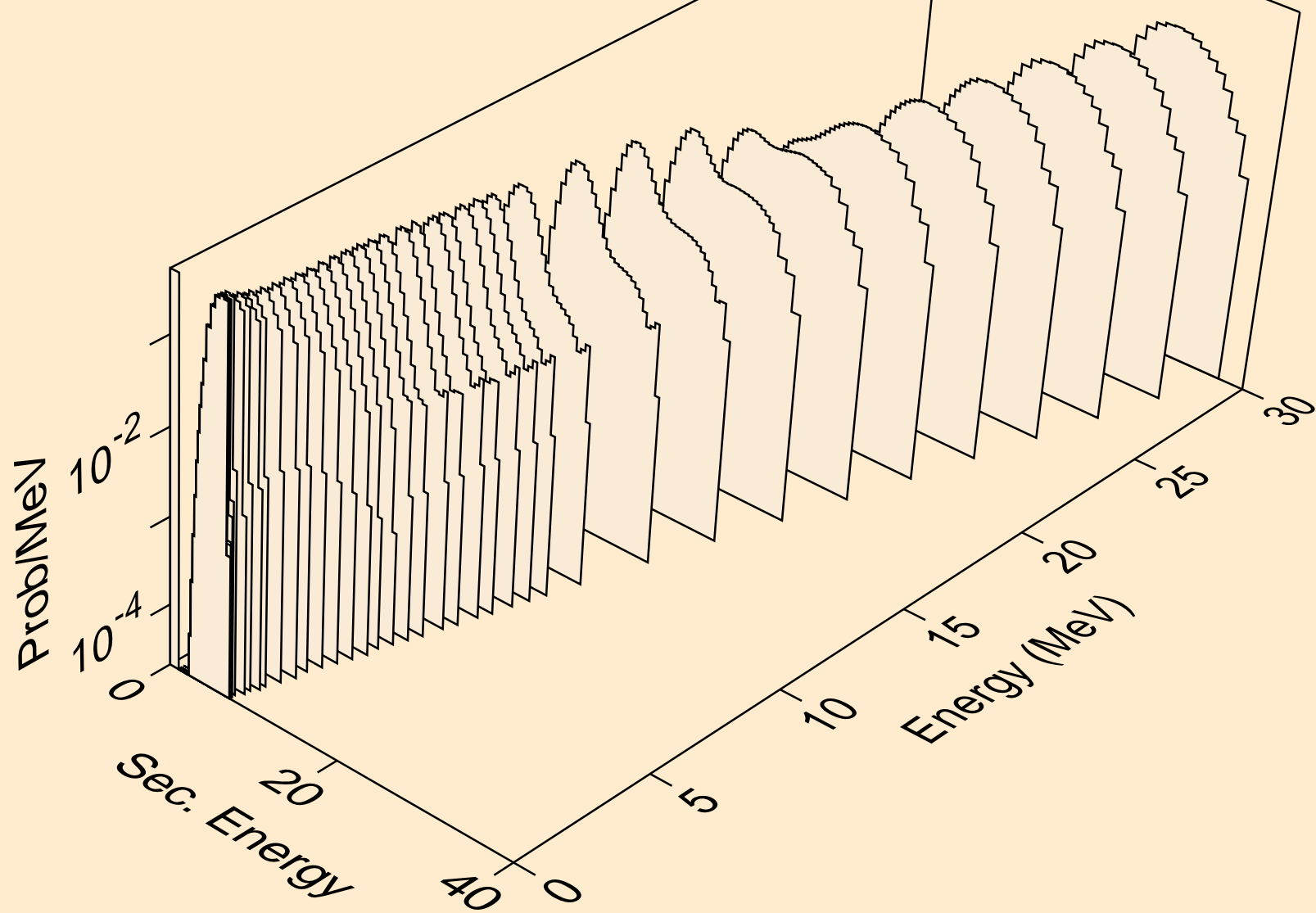

TL185 NEUTRON ACER TENDL-2023 LIBRARY; T=0.K  
protons from (n,2p)

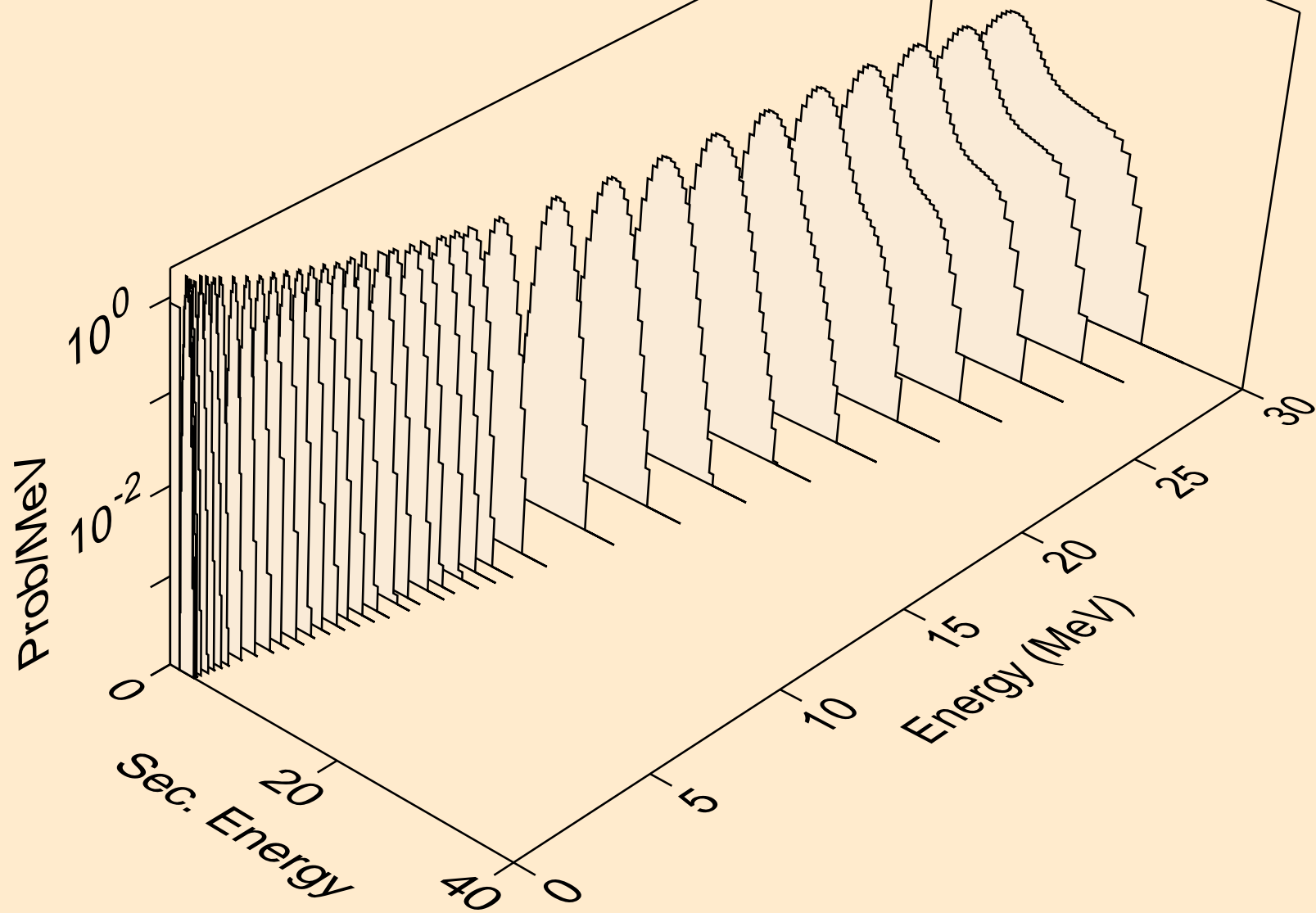

TL185 NEUTRON ACER TENDL-2023 LIBRARY; T=0.K  
protons from (n,p)

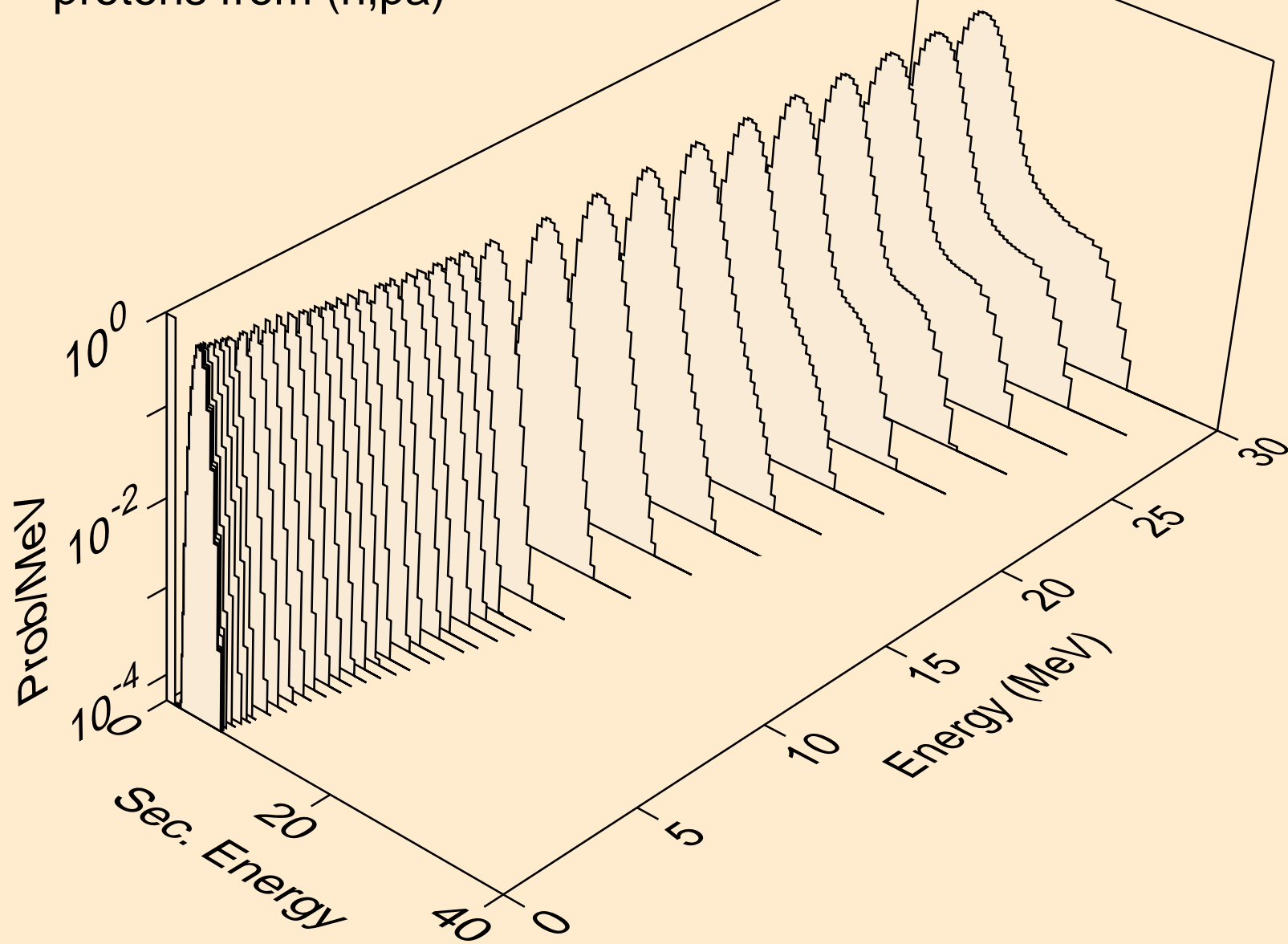

TL185 NEUTRON ACER TENDL-2023 LIBRARY; T=0.K  
protons from (n,pd)

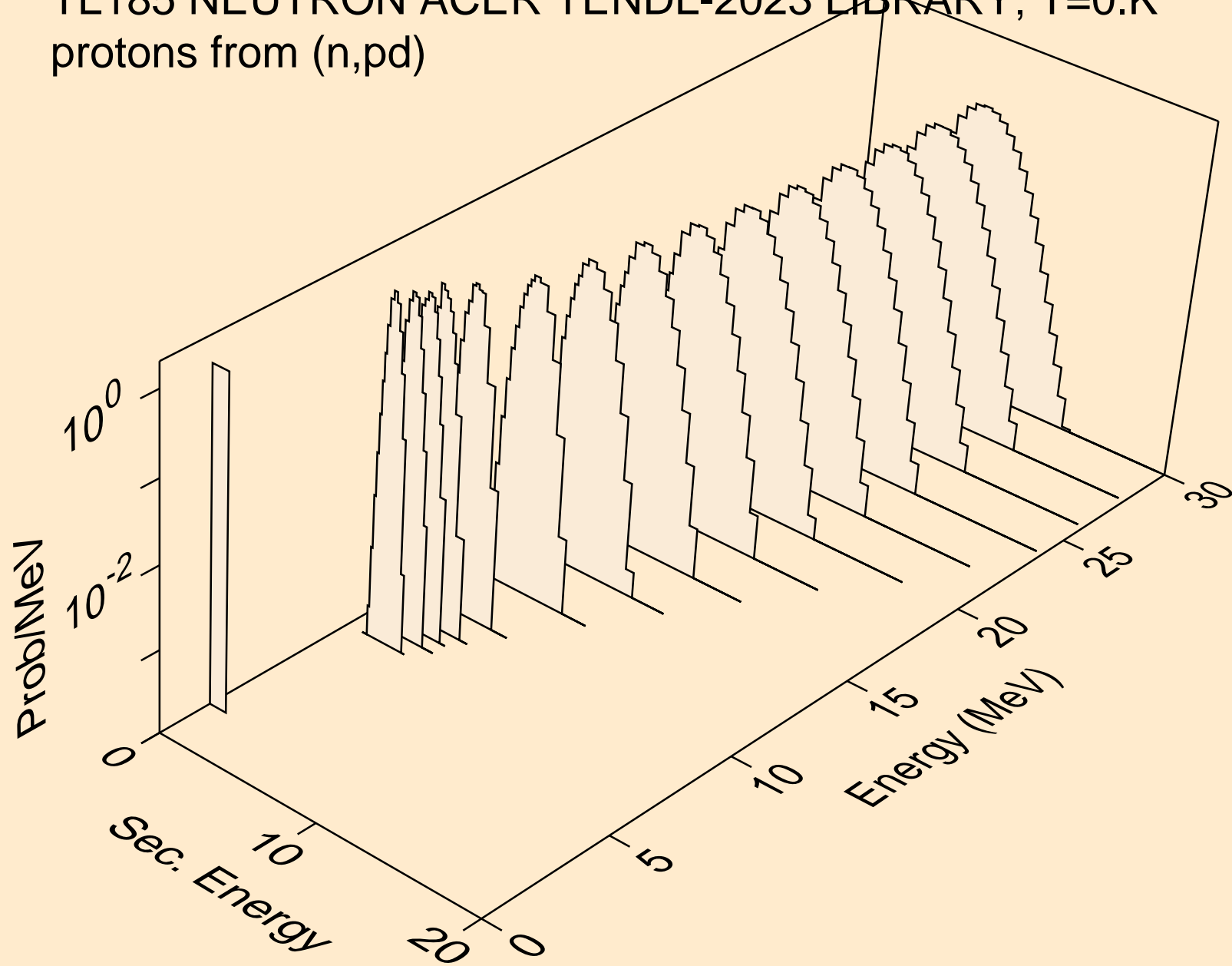

TL185 NEUTRON ACER TENDL-2023 LIBRARY; T=0.K  
protons from (n,pt)

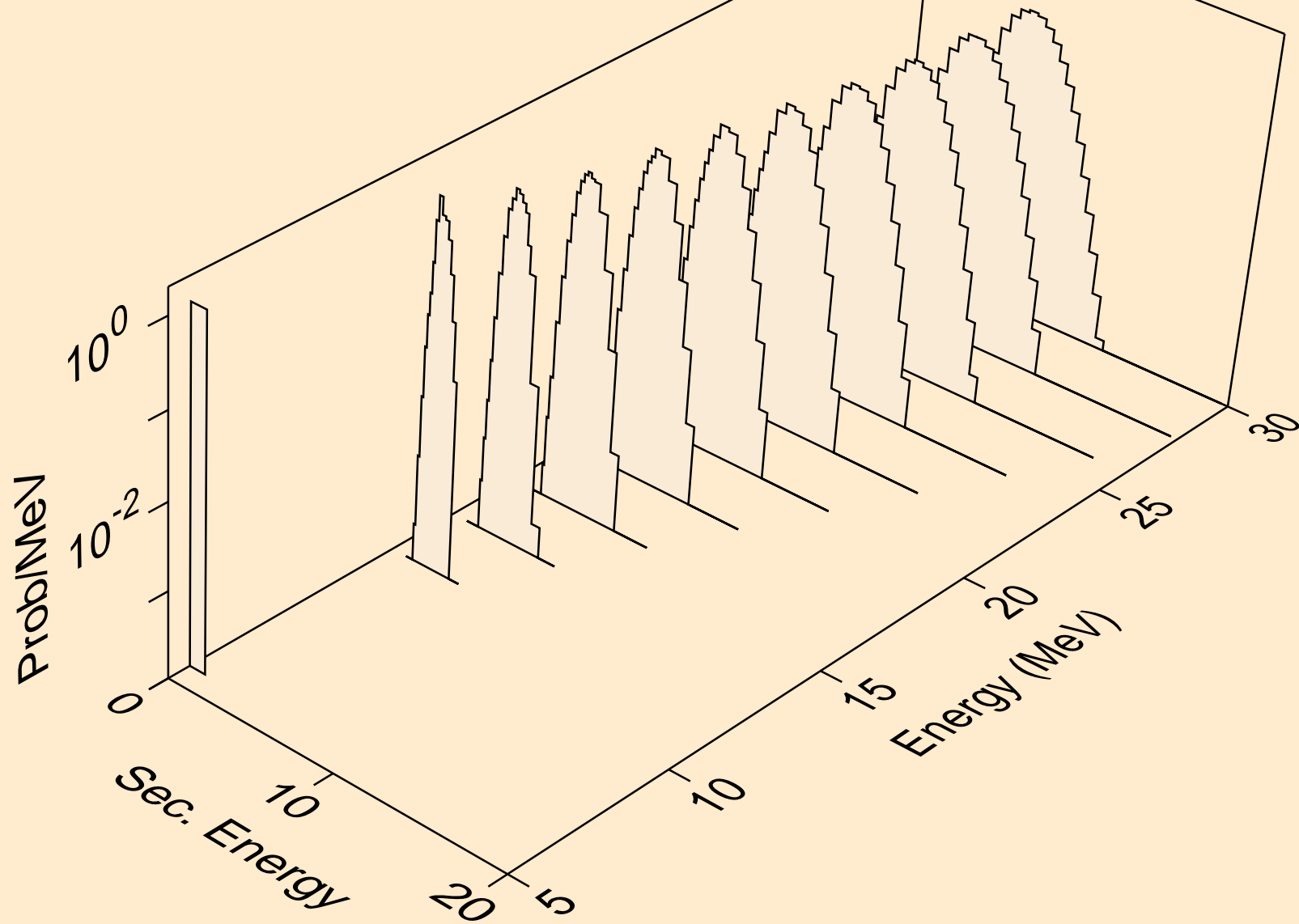

TL185 NEUTRON ACER TENDL-2023 LIBRARY; T=0.K  
deuterons from (n,x)

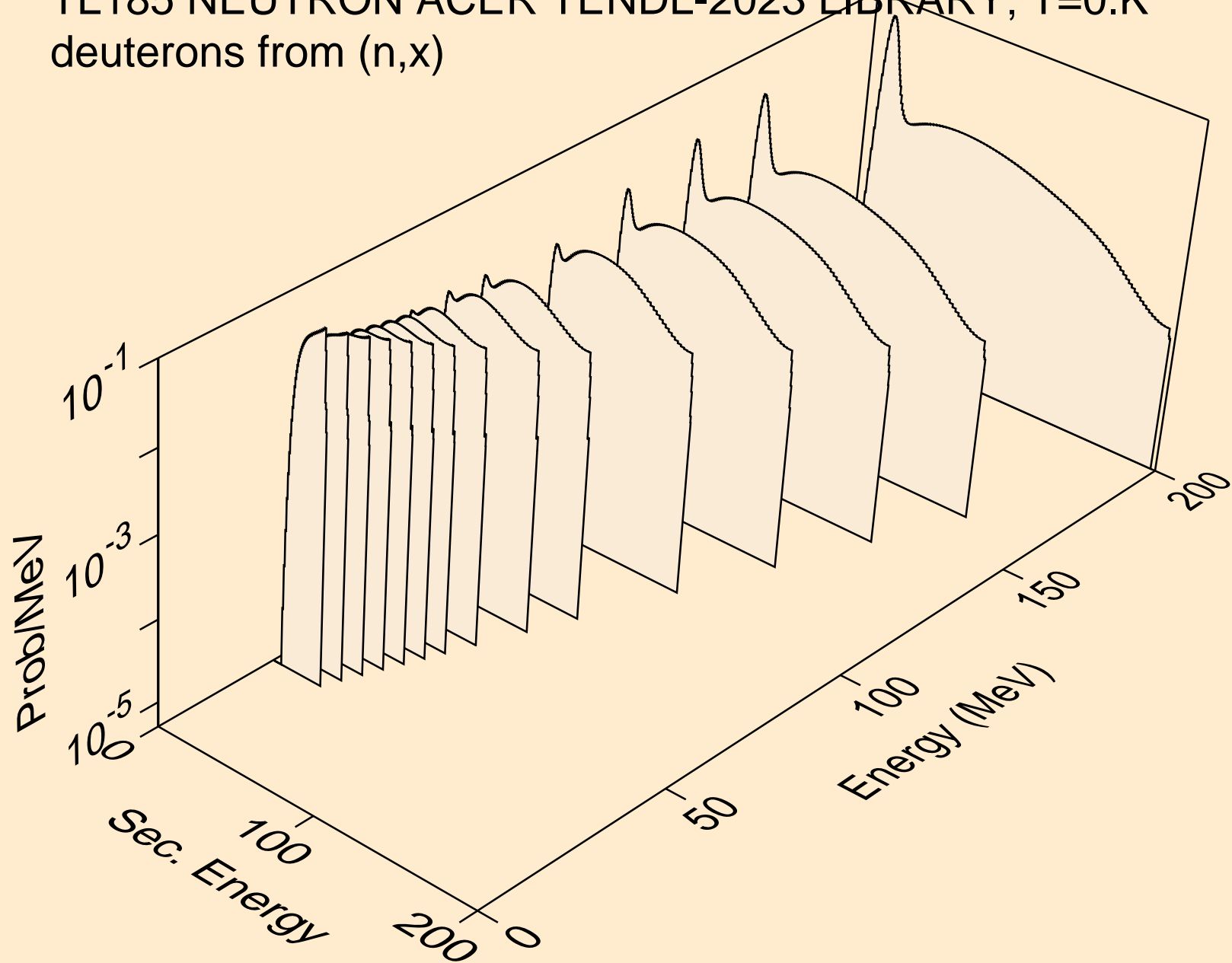

TL185 NEUTRON ACER TENDL-2023 LIBRARY; T=0.K  
deuterons from (n,2nd)

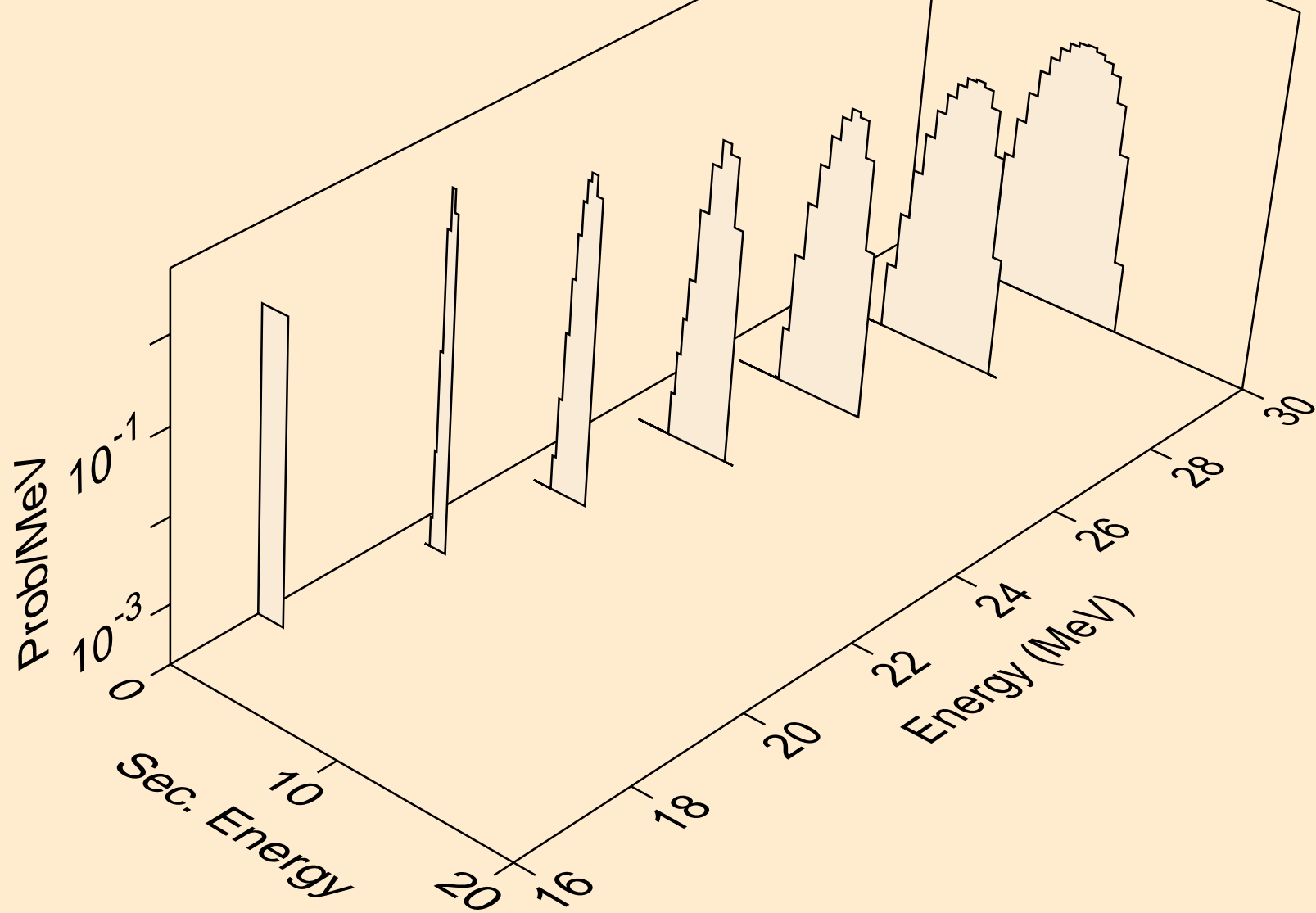

TL185 NEUTRON ACER TENDL-2023 LIBRARY; T=0.K  
deuterons from (n,n\*)d

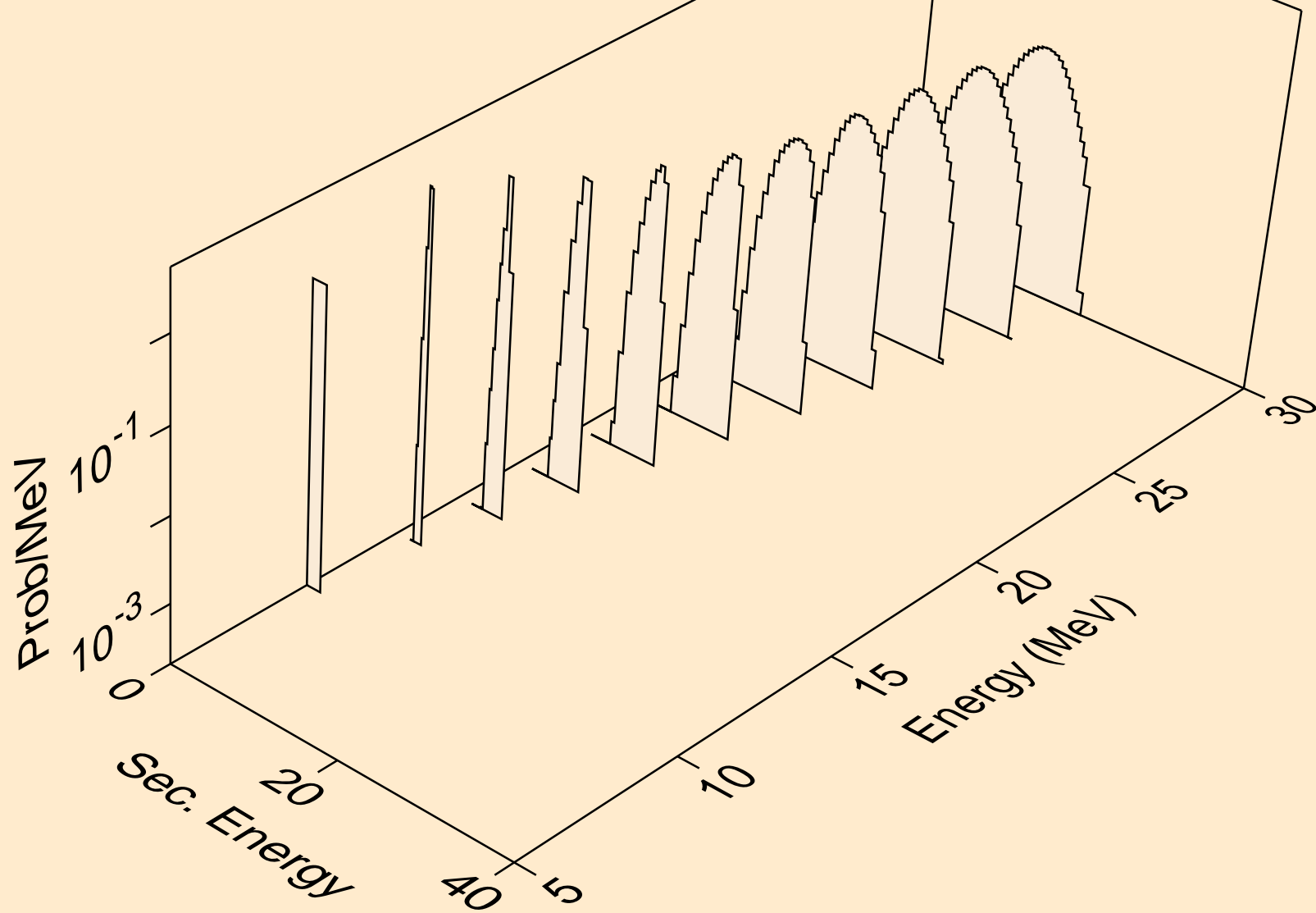

TL185 NEUTRON ACER TENDL-2023 LIBRARY; T=0.K  
deuterons from (n,d)

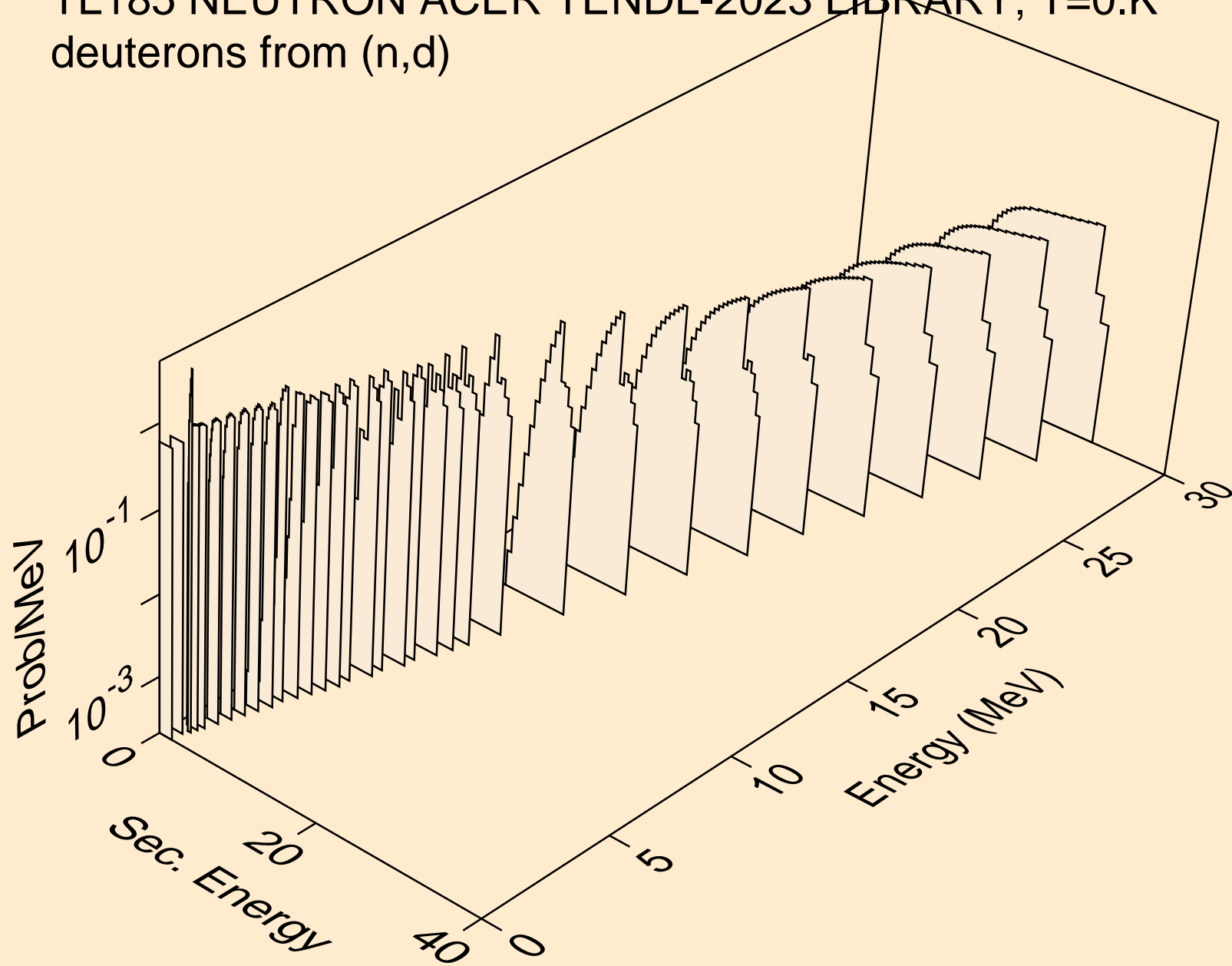

TL185 NEUTRON ACER TENDL-2023 LIBRARY; T=0.K  
deuterons from (n,d2a)

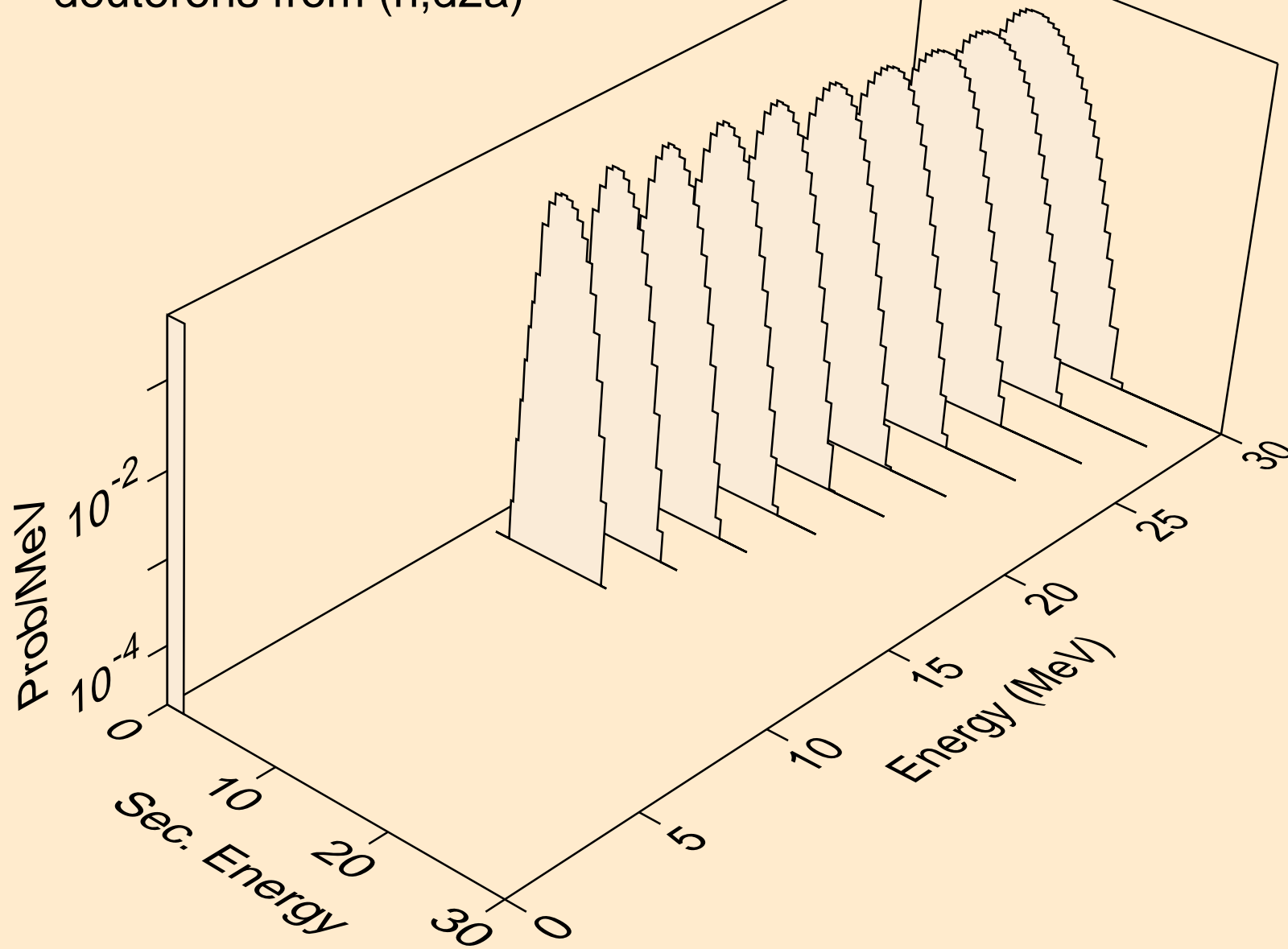

TL185 NEUTRON ACER TENDL-2023 LIBRARY; T=0.K  
deuterons from (n,pd)

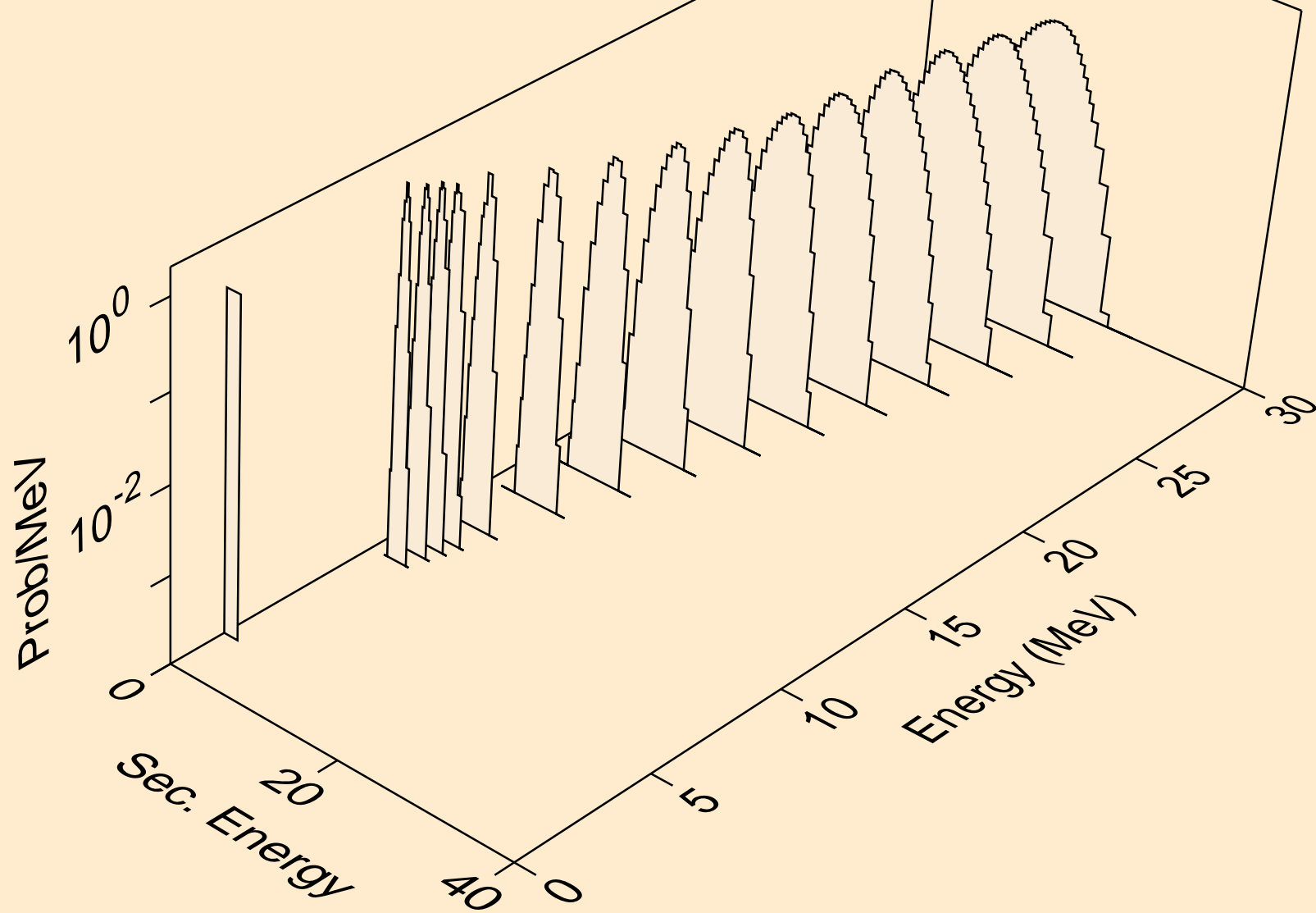

TL185 NEUTRON ACER TENDL-2023 LIBRARY; T=0.K  
deuterons from (n,da)

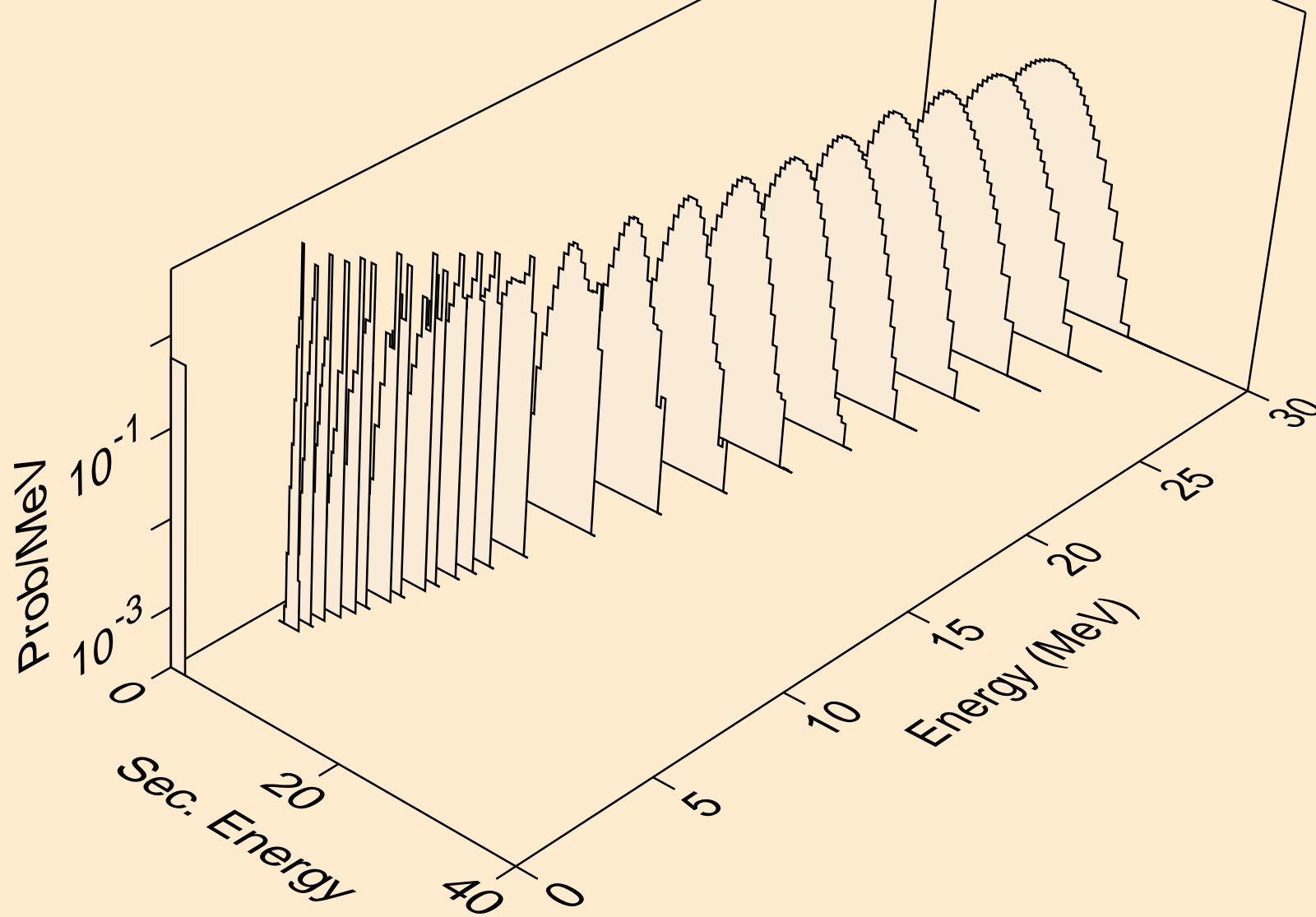

TL185 NEUTRON ACER TENDL-2023 LIBRARY; T=0.K  
tritons from (n,x)

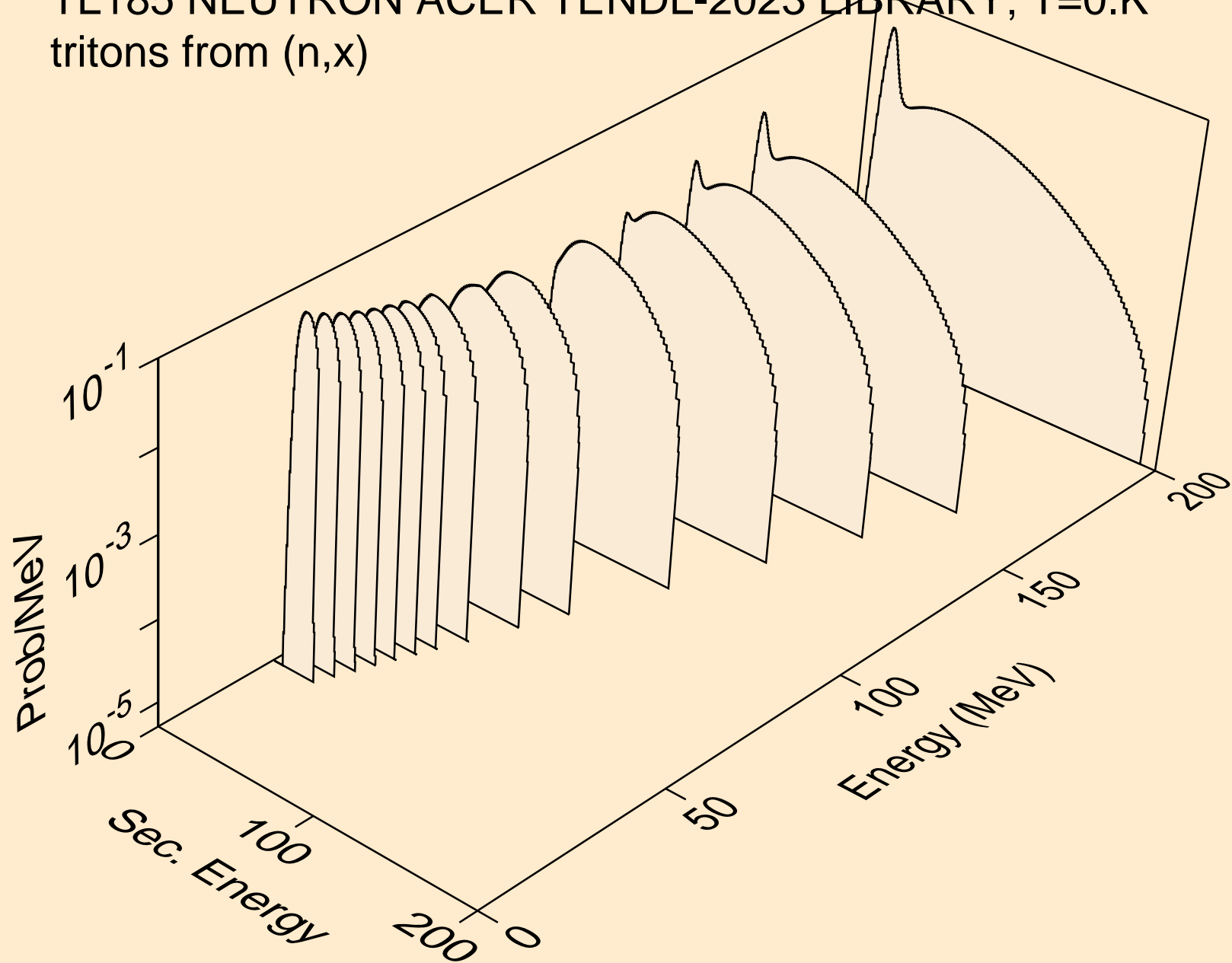

TL185 NEUTRON ACER TENDL-2023 LIBRARY; T=0.K  
tritons from (n,n\*)t

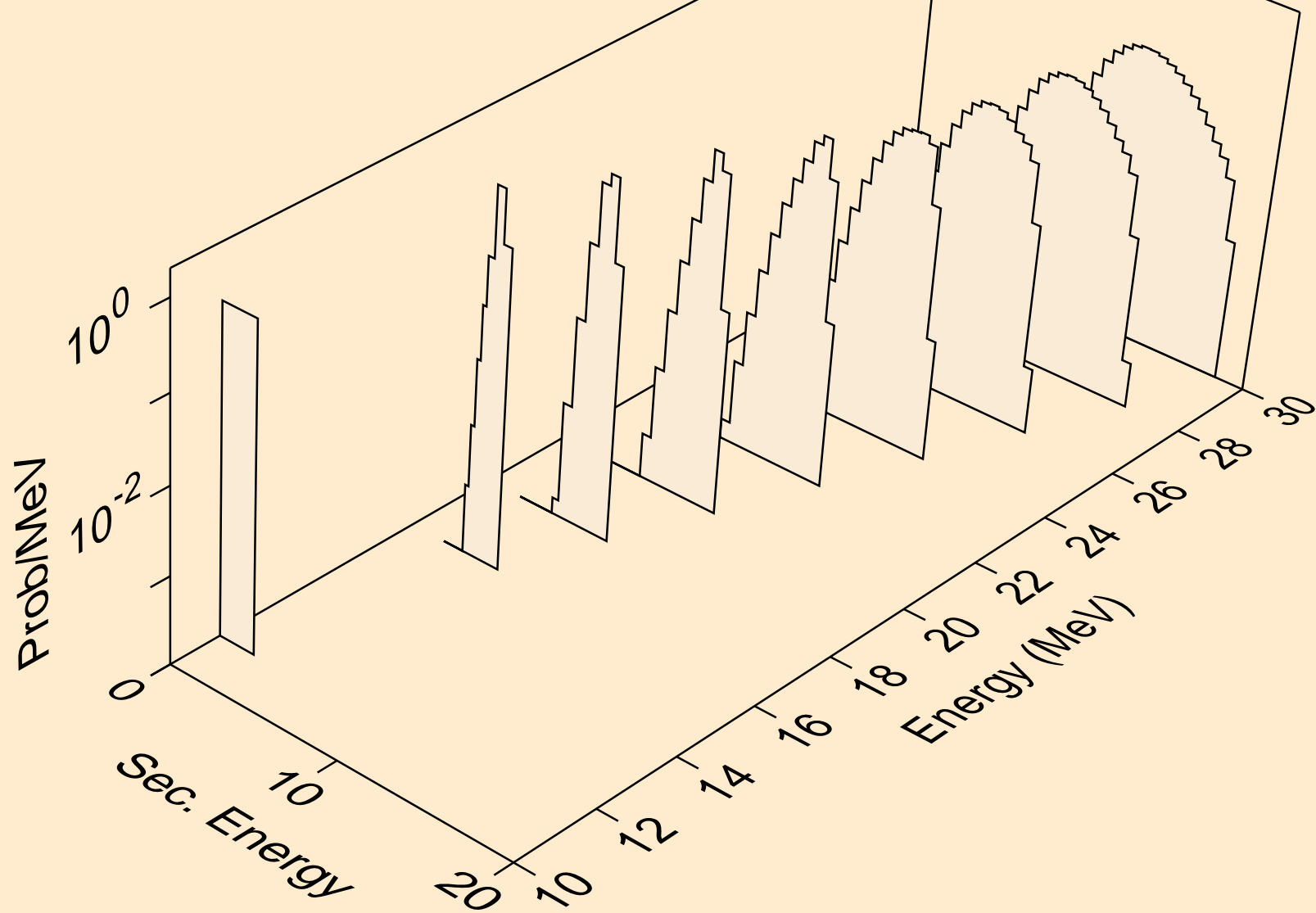

TL185 NEUTRON ACER TENDL-2023 LIBRARY; T=0.K  
tritons from (n,t)

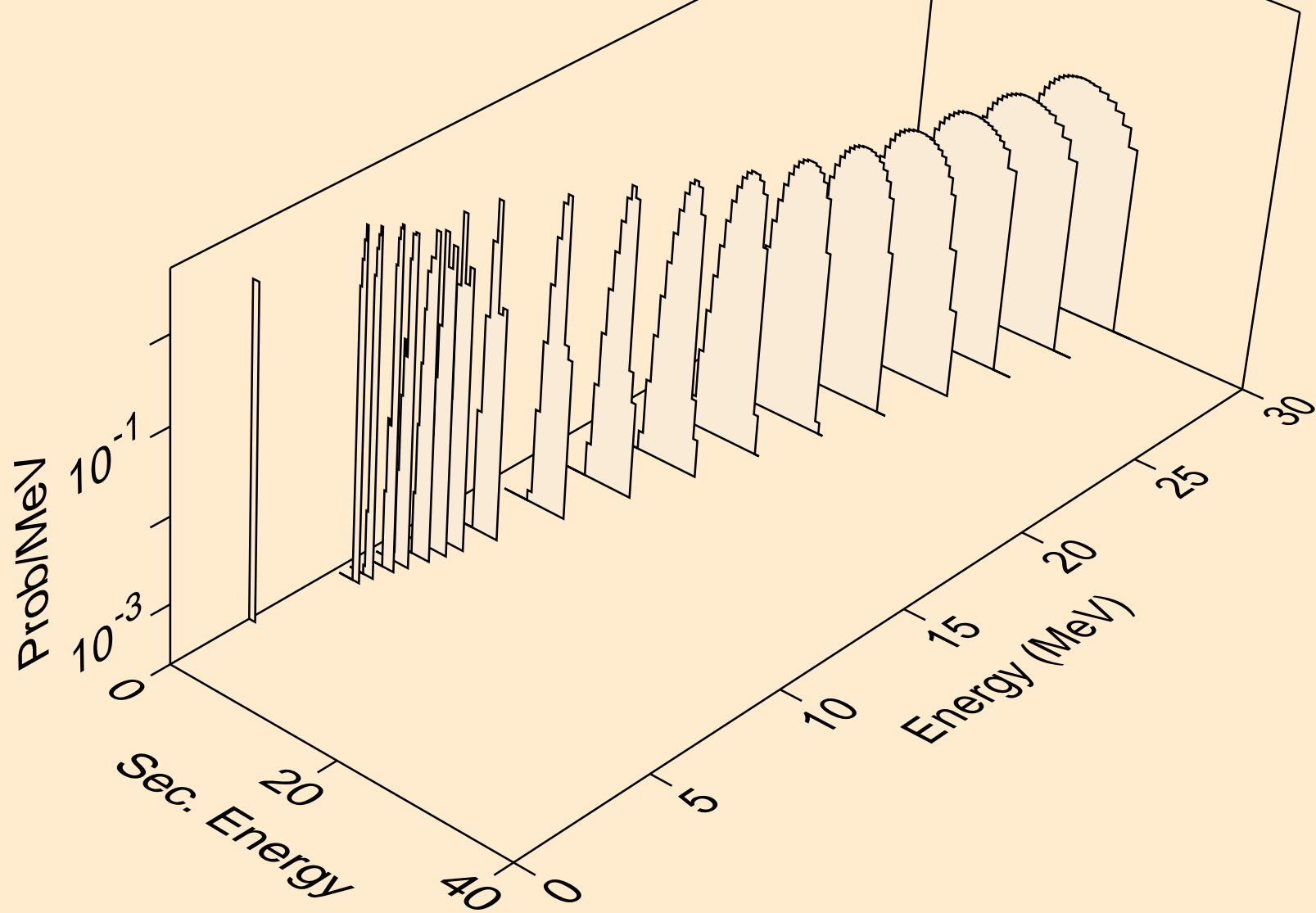

TL185 NEUTRON ACER TENDL-2023 LIBRARY; T=0.K  
tritons from (n,pt)

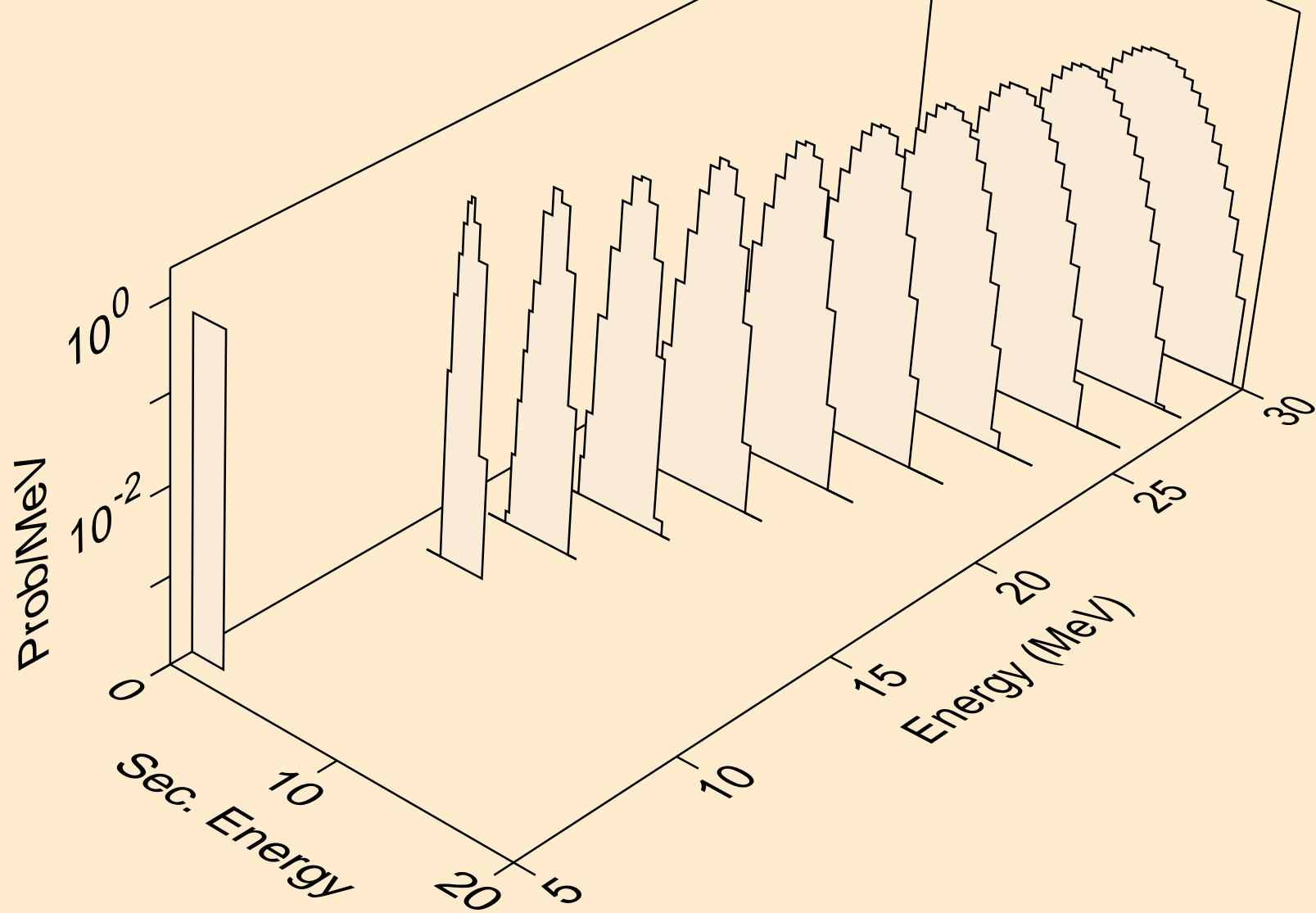

TL185 NEUTRON ACER TENDL-2023 LIBRARY; T=0.K  
he3s from (n,x)

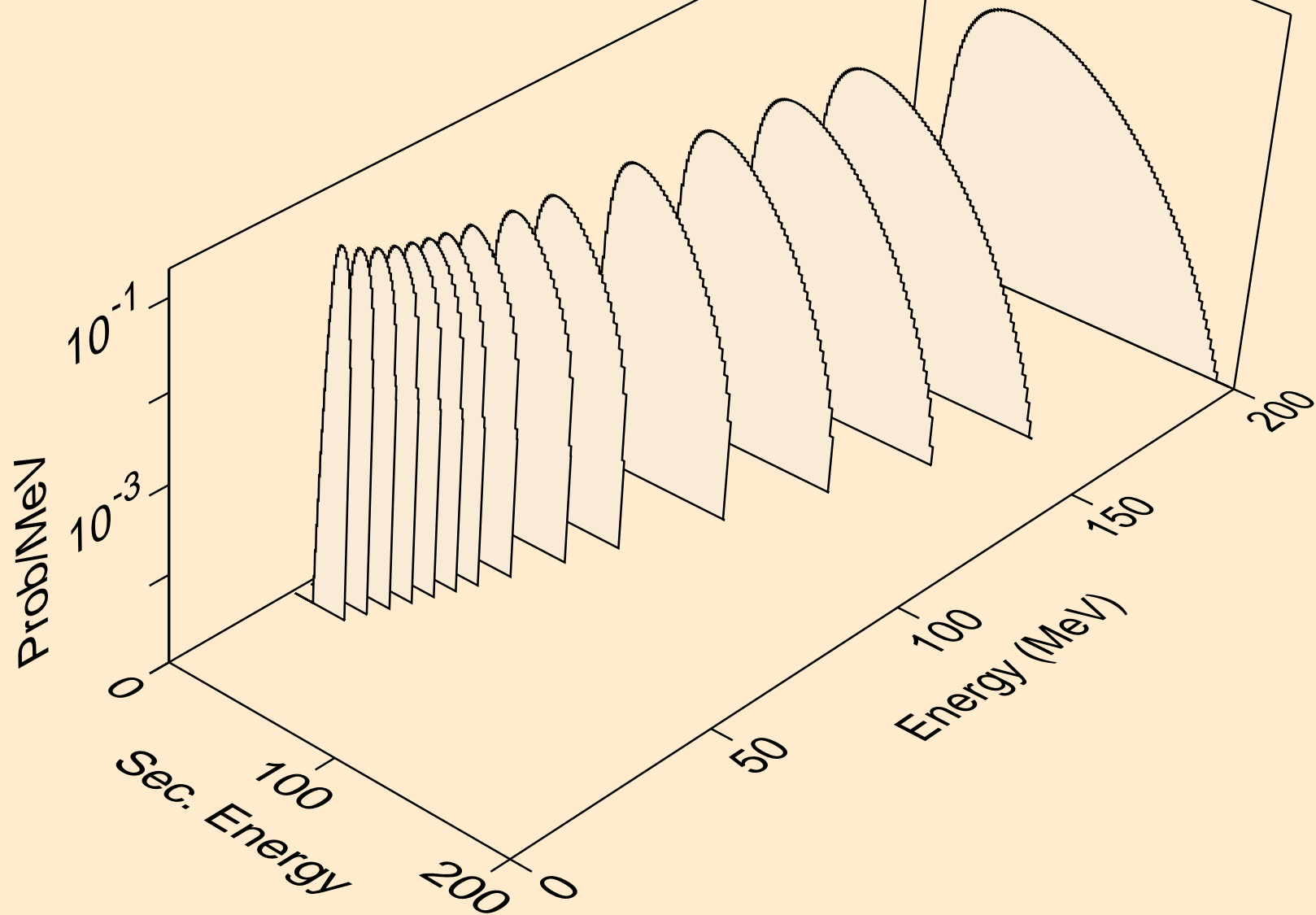

TL185 NEUTRON ACER TENDL-2023 LIBRARY; T=0.K  
he3s from (n,n\*)he3

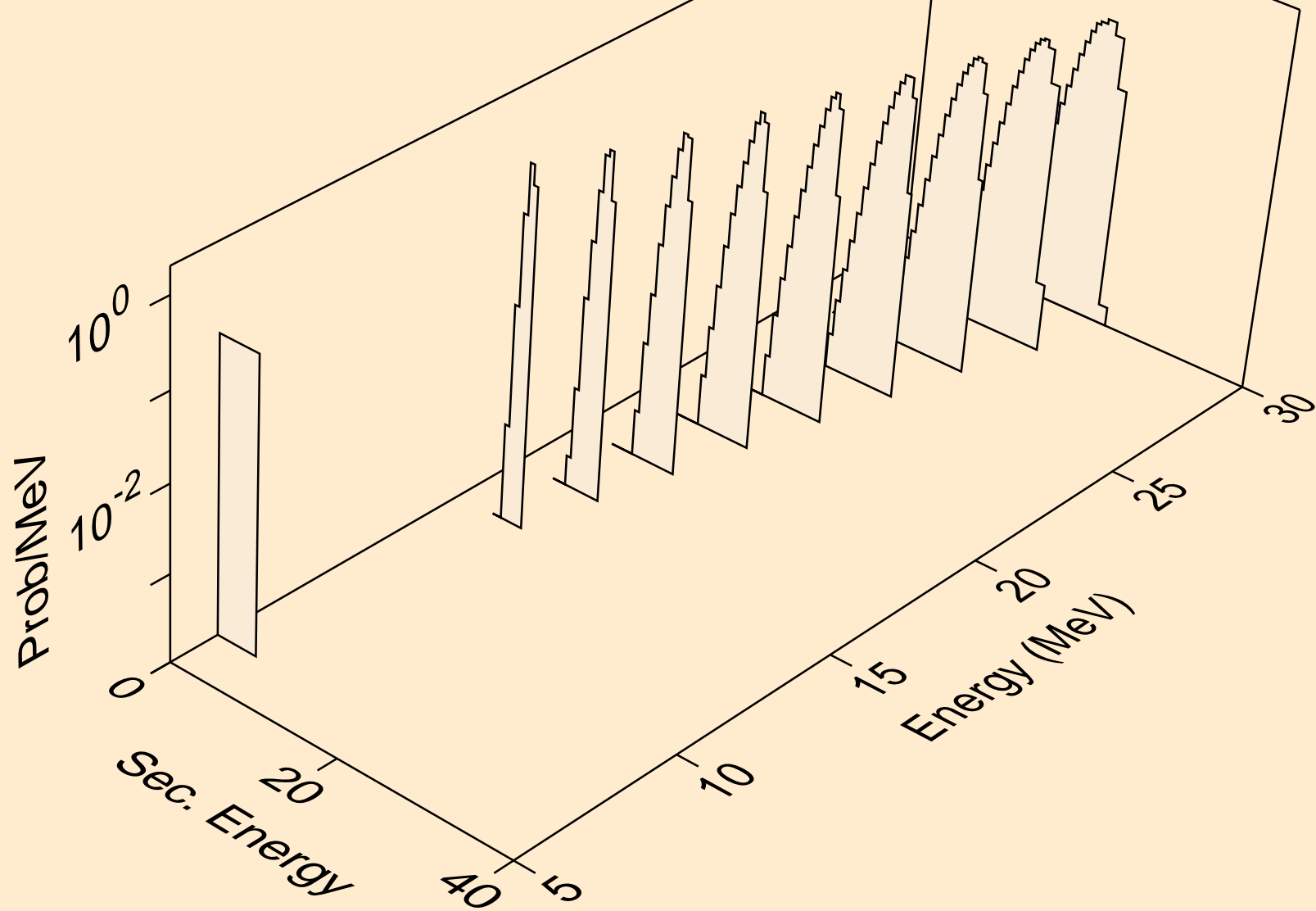

TL185 NEUTRON ACER TENDL-2023 LIBRARY; T=0.K  
he3s from (n,he3)

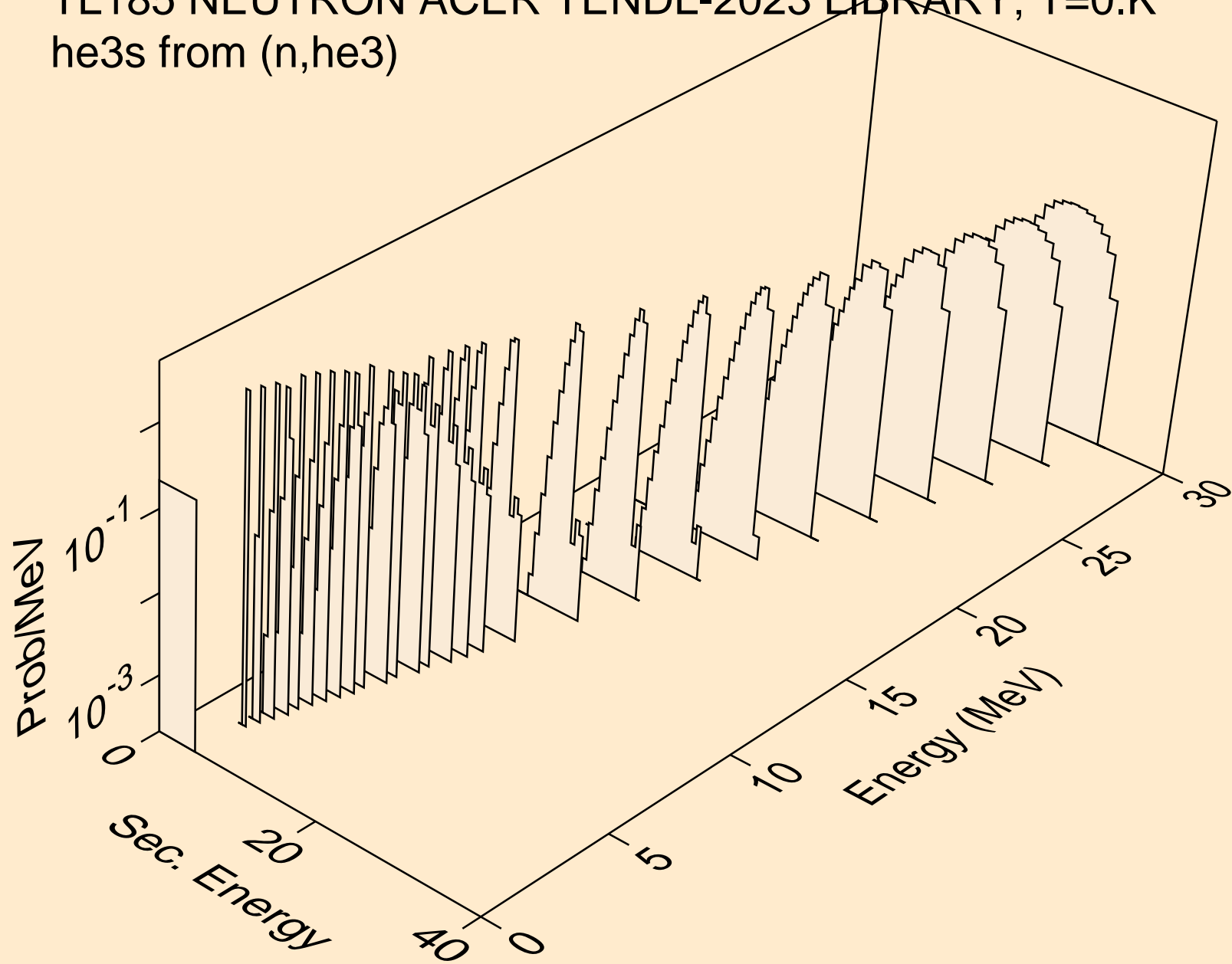

TL185 NEUTRON ACER TENDL-2023 LIBRARY; T=0.K  
alphas from (n,x)

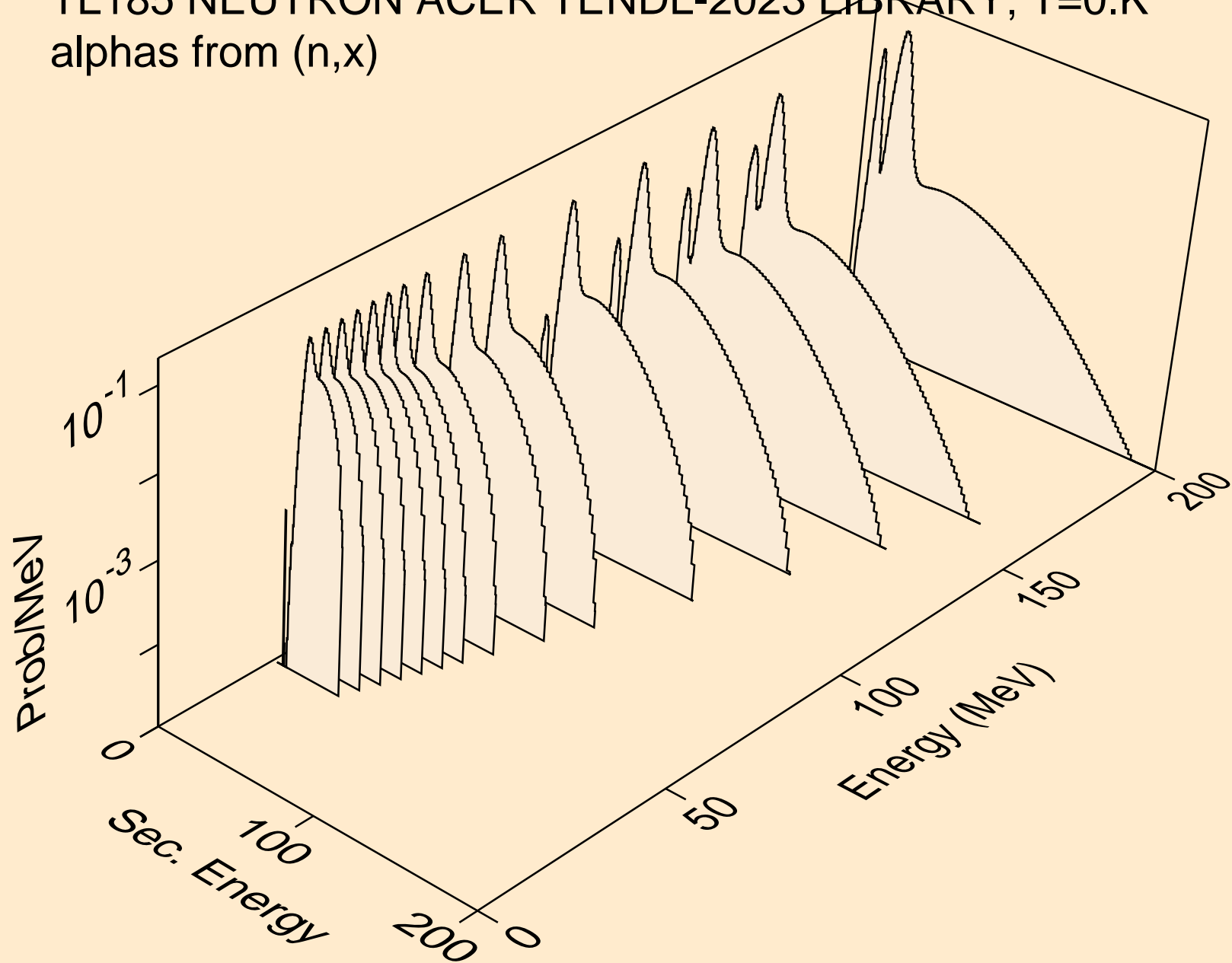

TL185 NEUTRON ACER TENDL-2023 LIBRARY; T=0.K  
alphas from (n,n\*)a

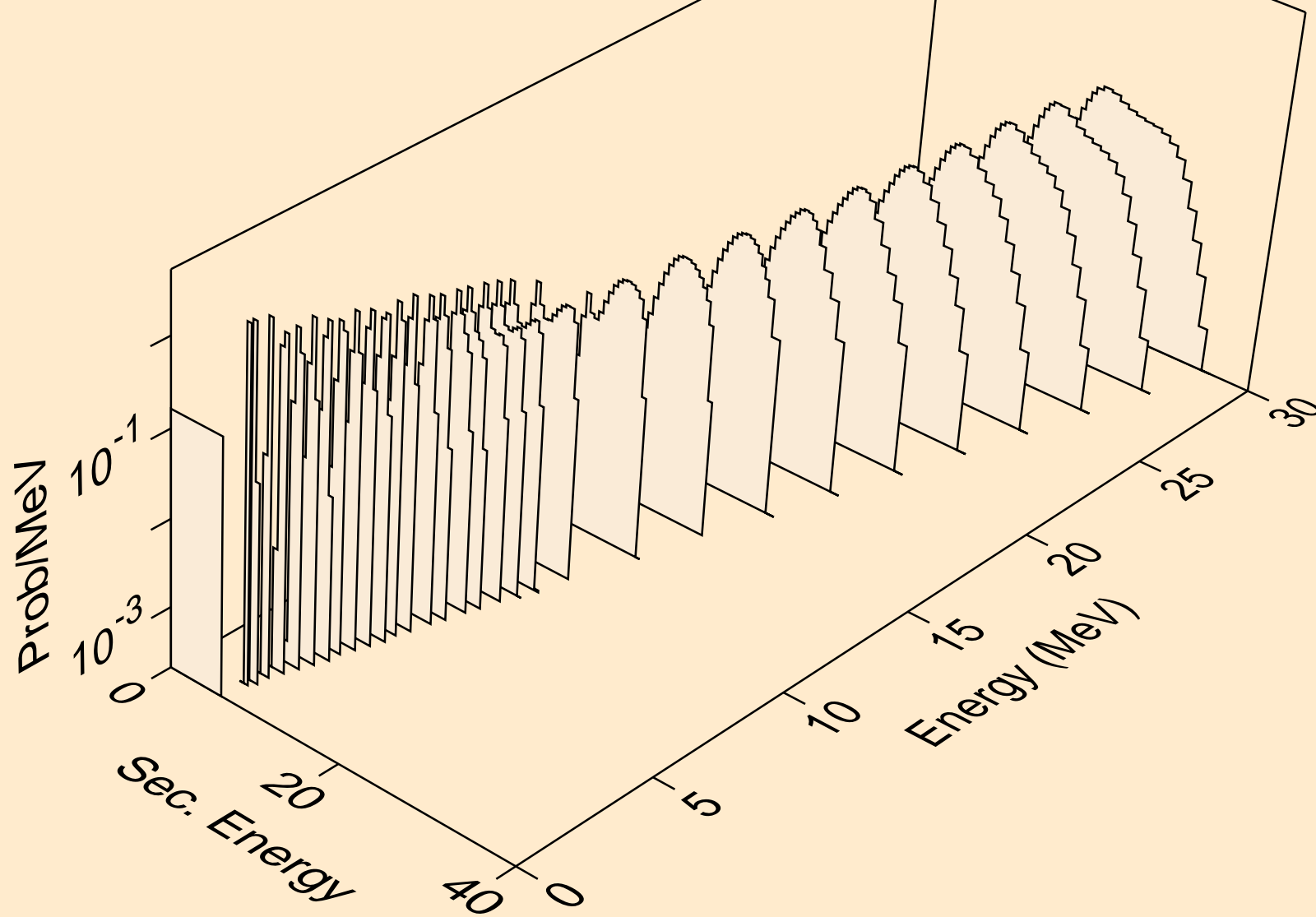

TL185 NEUTRON ACER TENDL-2023 LIBRARY; T=0.K  
alphas from (n,n\*)3a

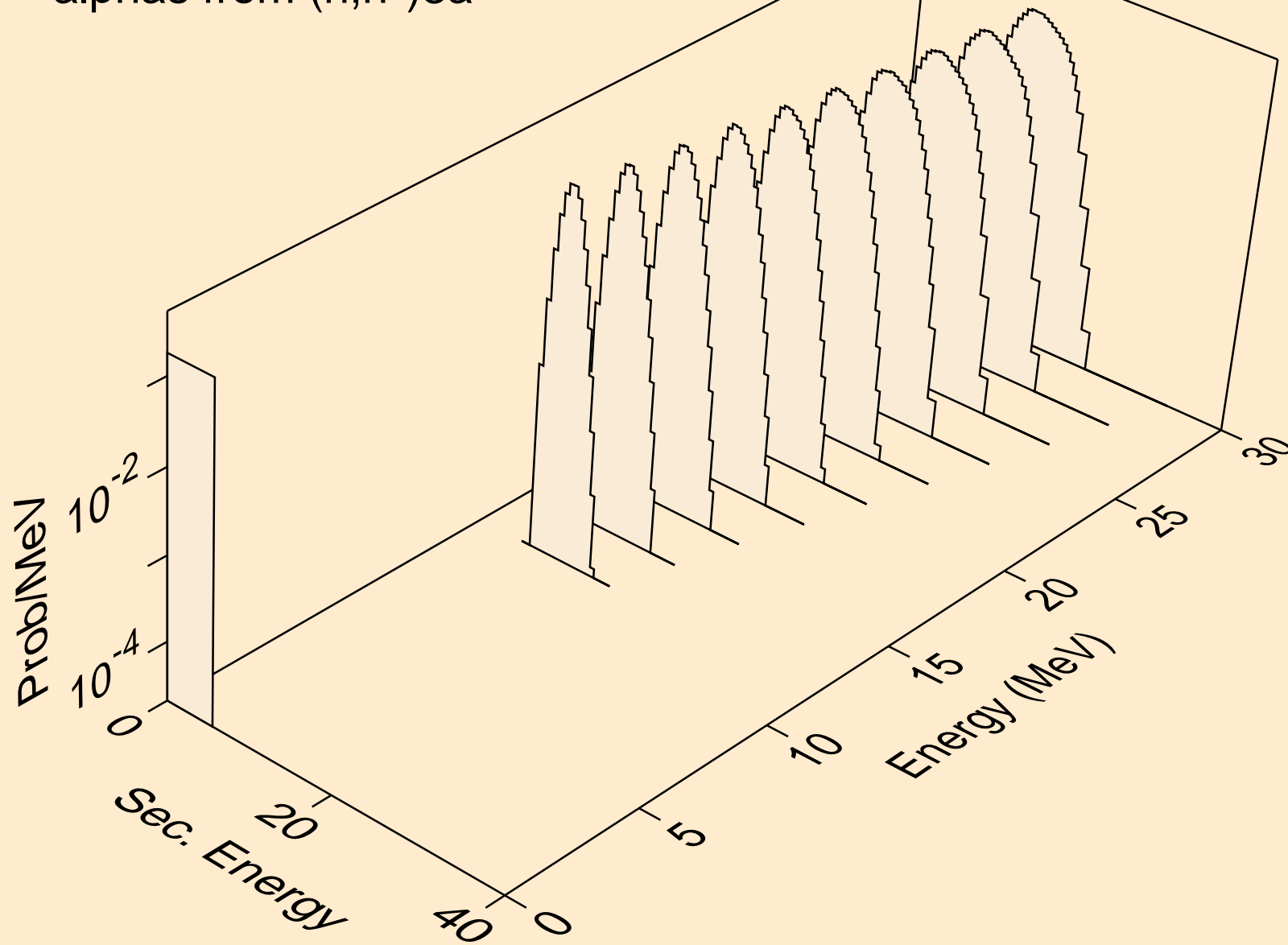

TL185 NEUTRON ACER TENDL-2023 LIBRARY; T=0.K  
alphas from (n,2n)a

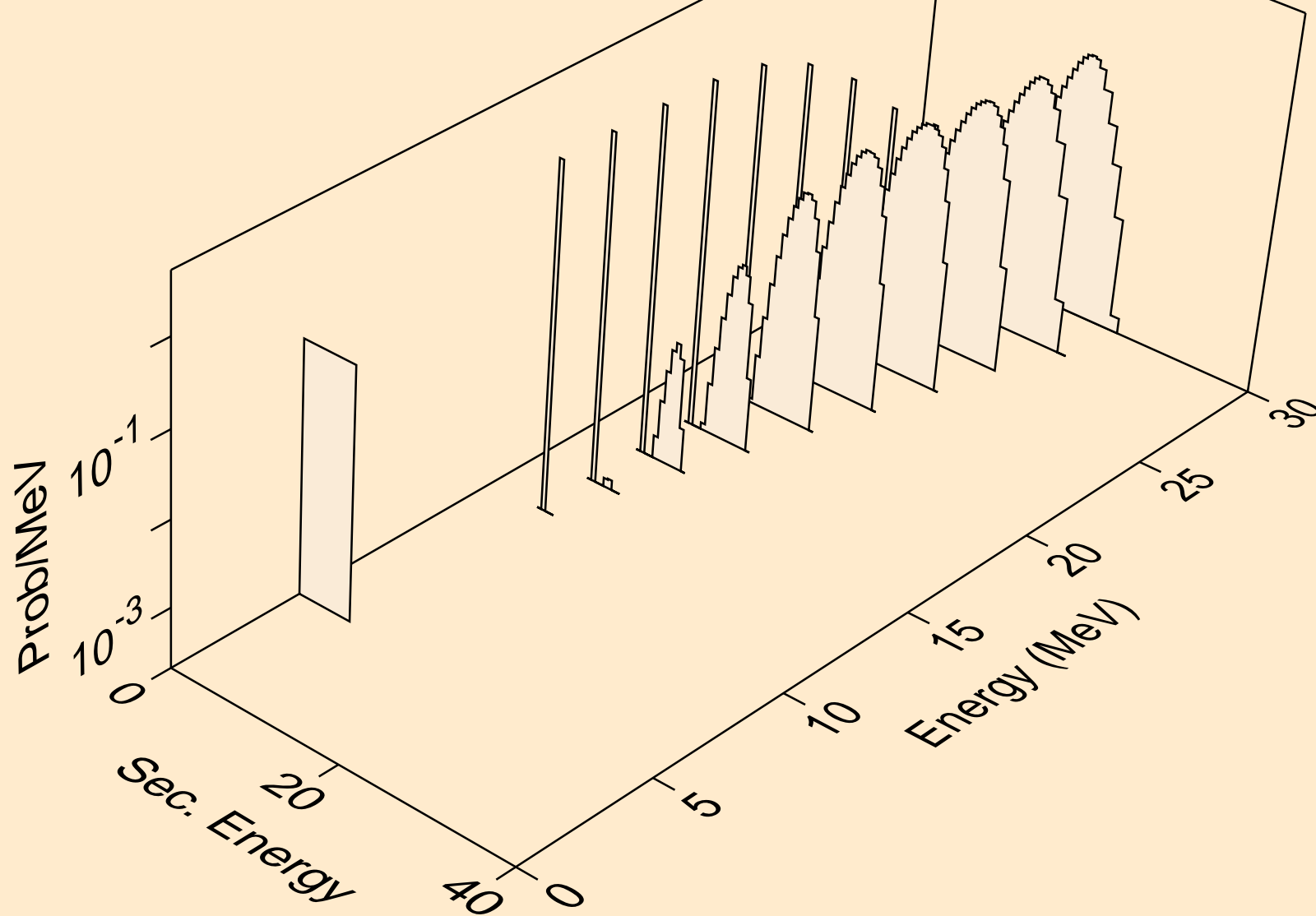

TL185 NEUTRON ACER TENDL-2023 LIBRARY; T=0.K  
alphas from (n,3n)a

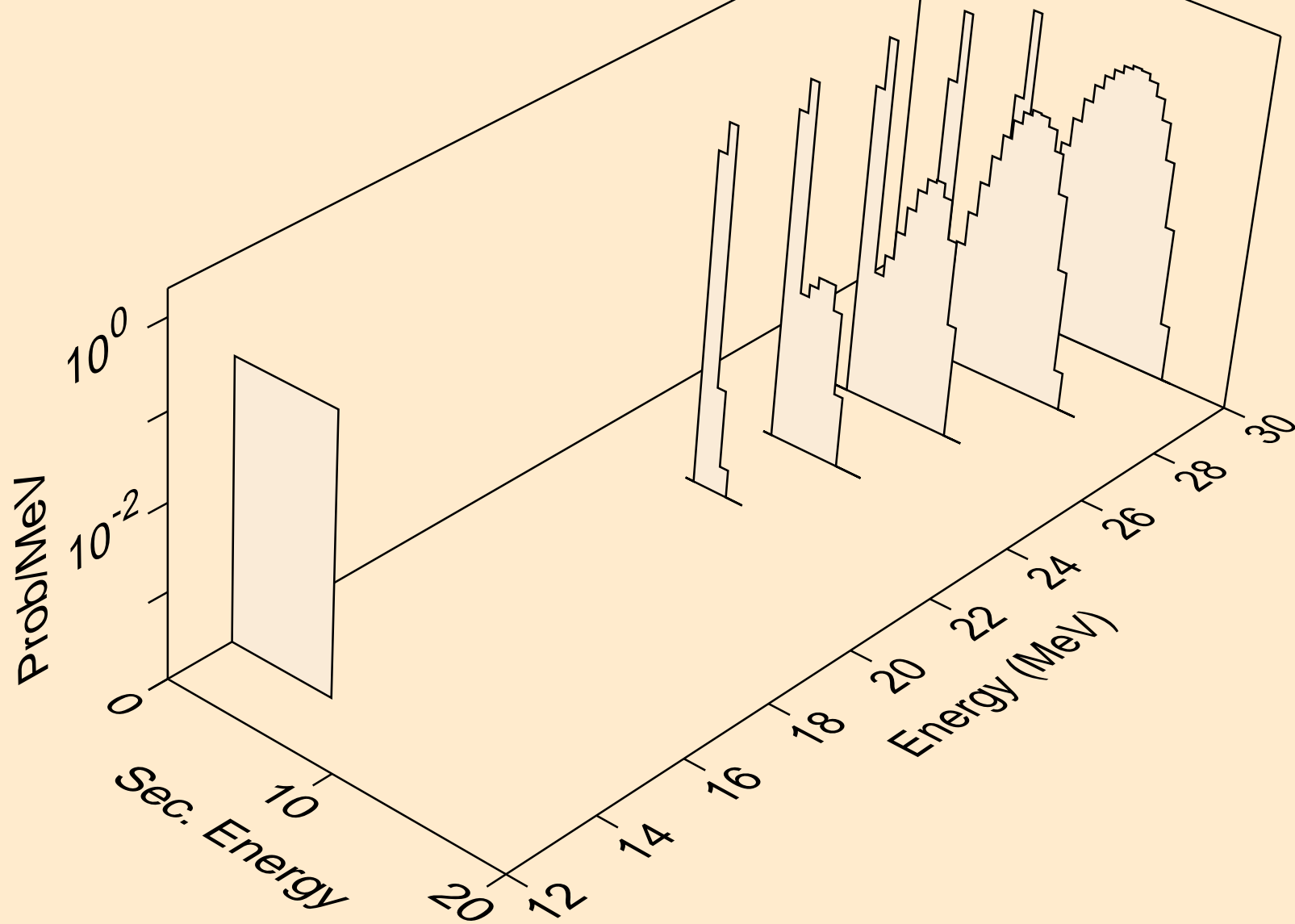

TL185 NEUTRON ACER TENDL-2023 LIBRARY; T=0.K  
alphas from (n,n\*)2a

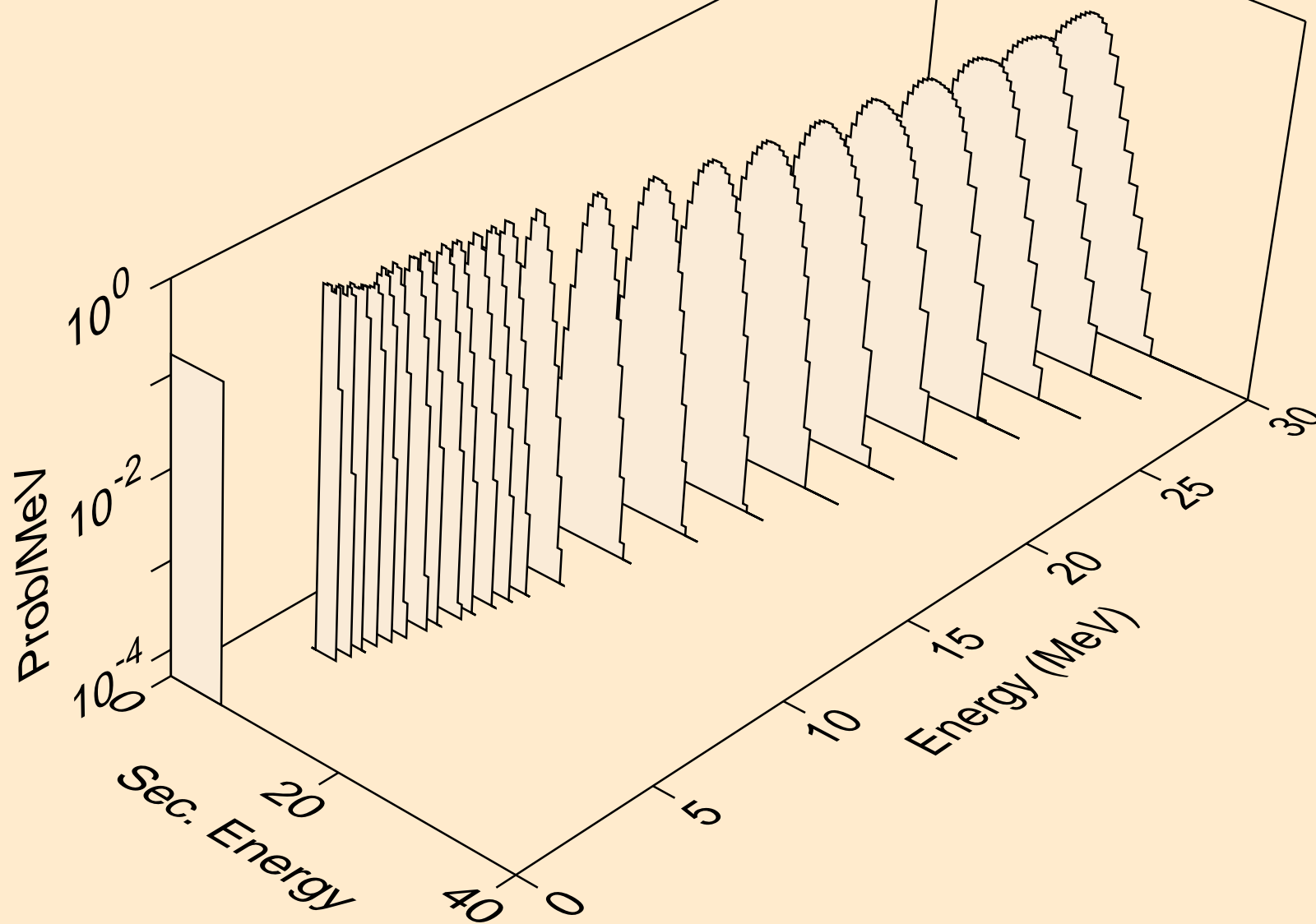

TL185 NEUTRON ACER TENDL-2023 LIBRARY; T=0.K  
alphas from (n,2n)2a

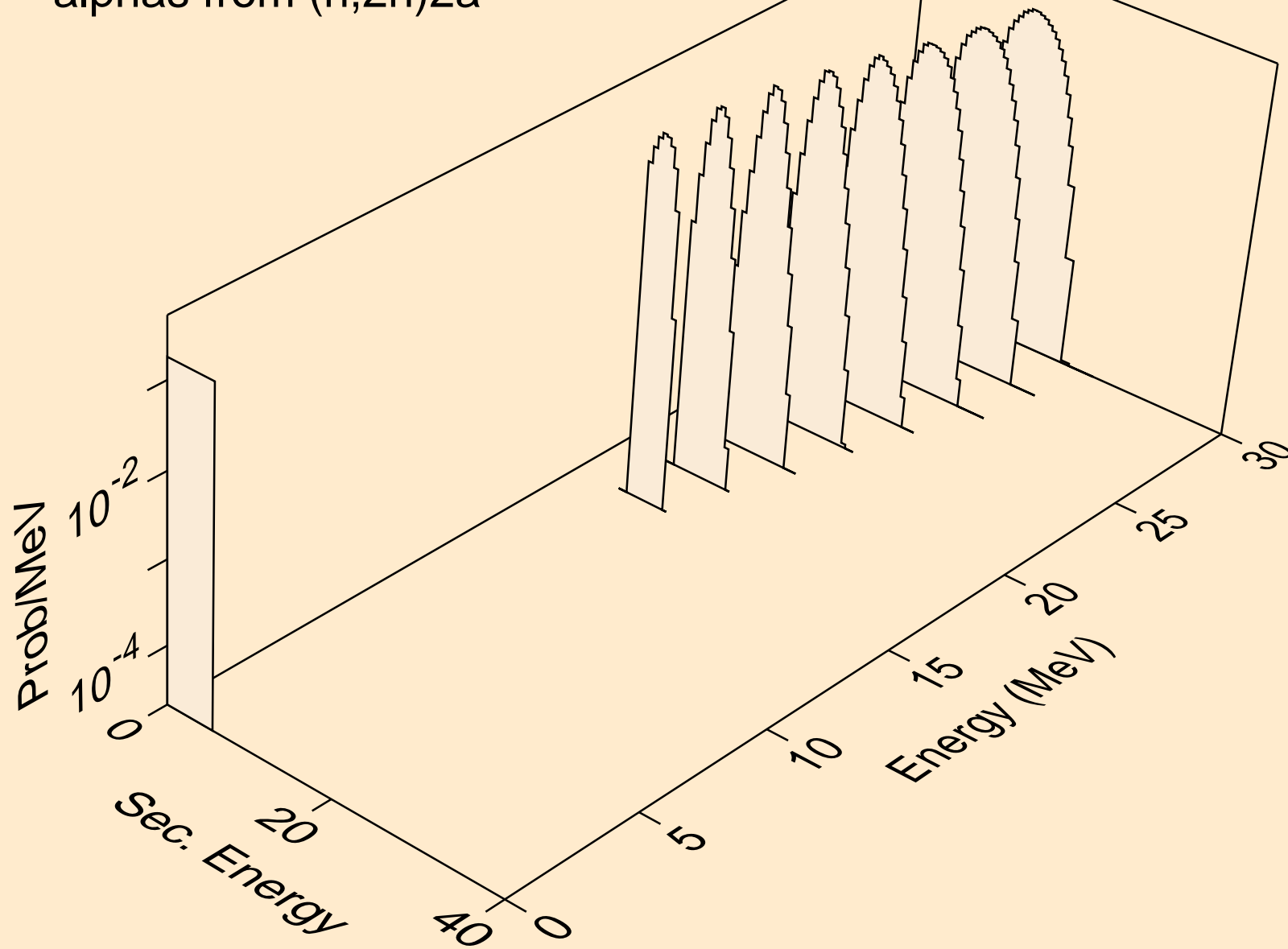

TL185 NEUTRON ACER TENDL-2023 LIBRARY; T=0.K  
alphas from (n,npa)

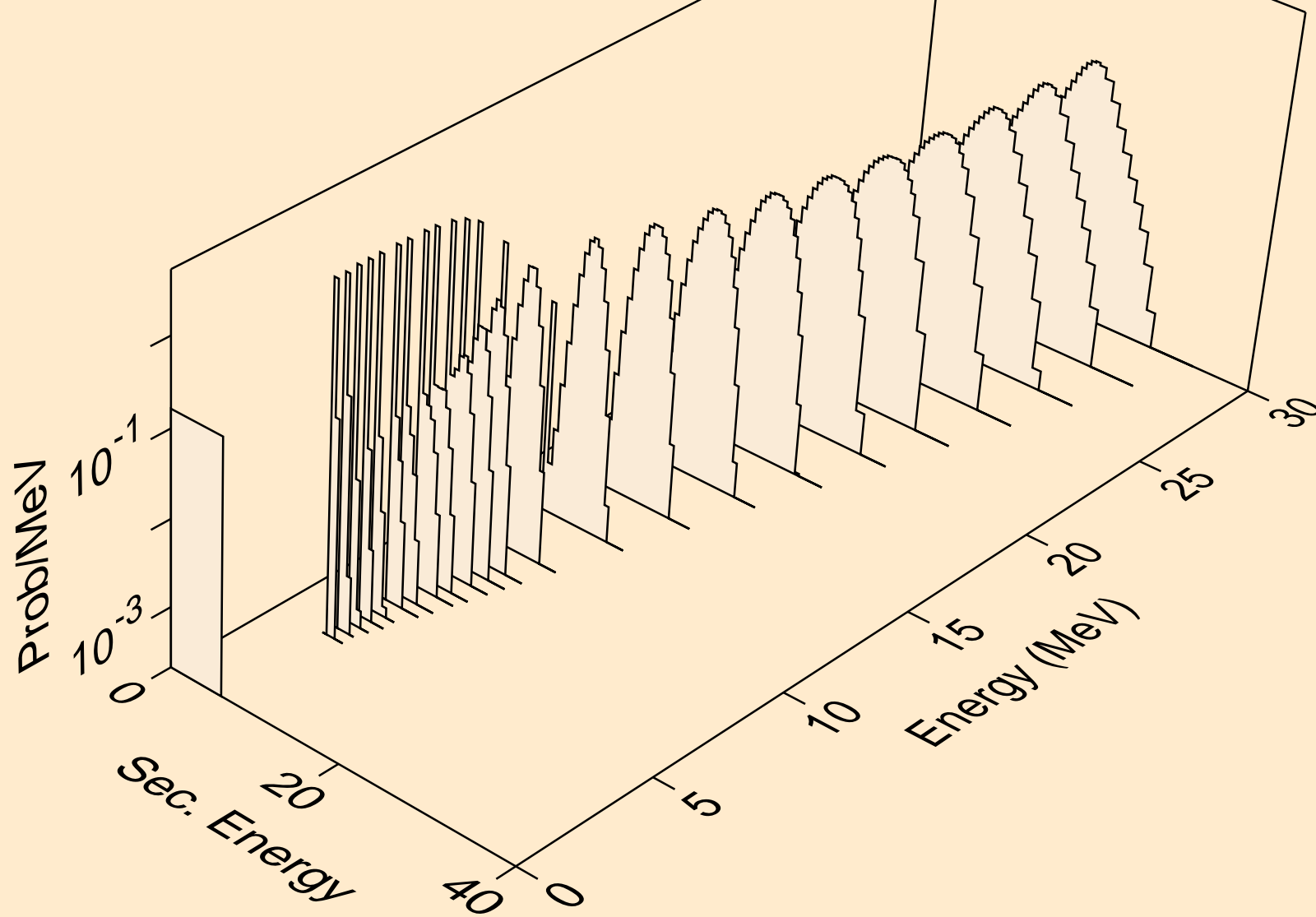

TL185 NEUTRON ACER TENDL-2023 LIBRARY; T=0.K  
alphas from (n,a)

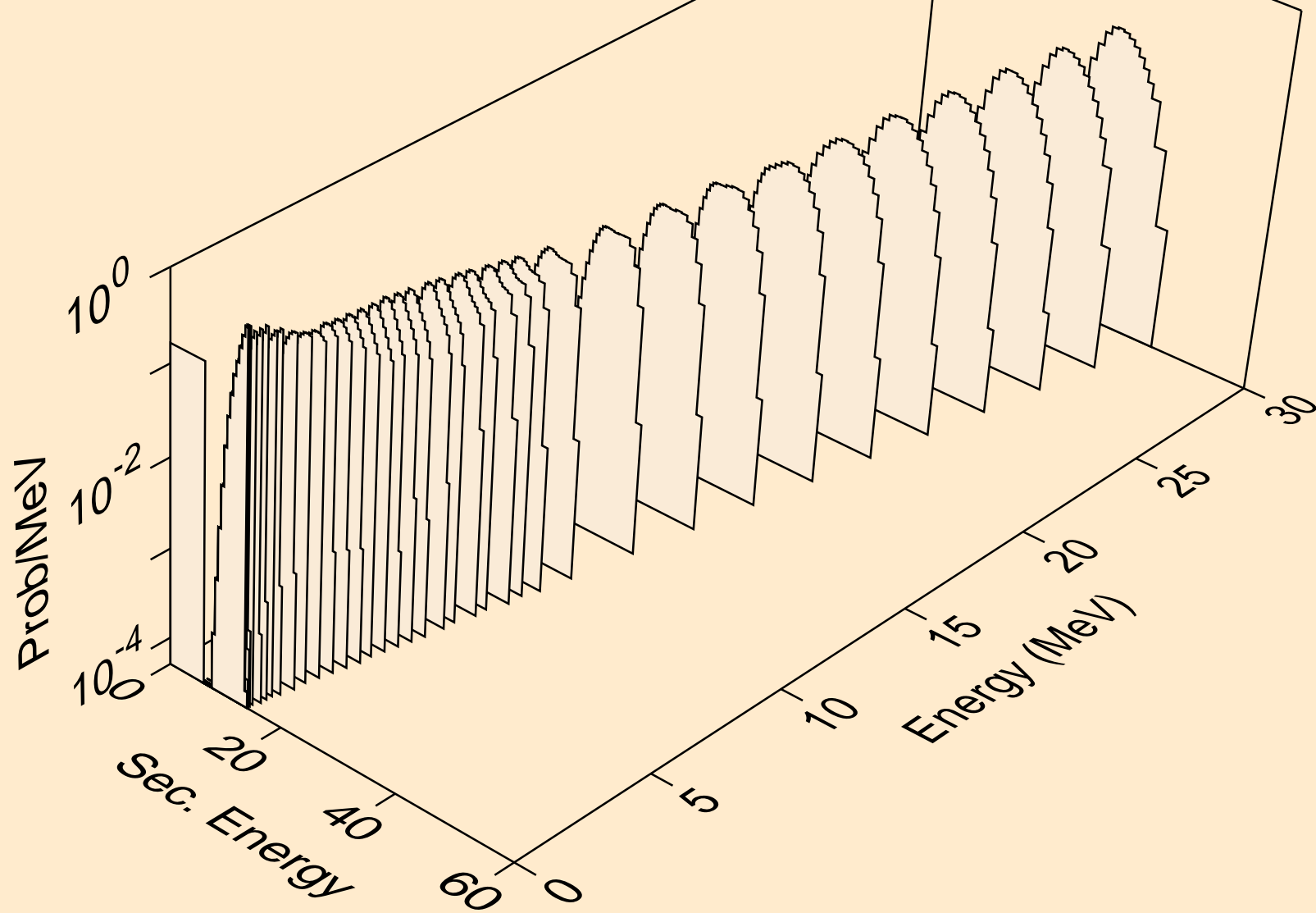

TL185 NEUTRON ACER TENDL-2023 LIBRARY; T=0.K  
alphas from (n,2a)

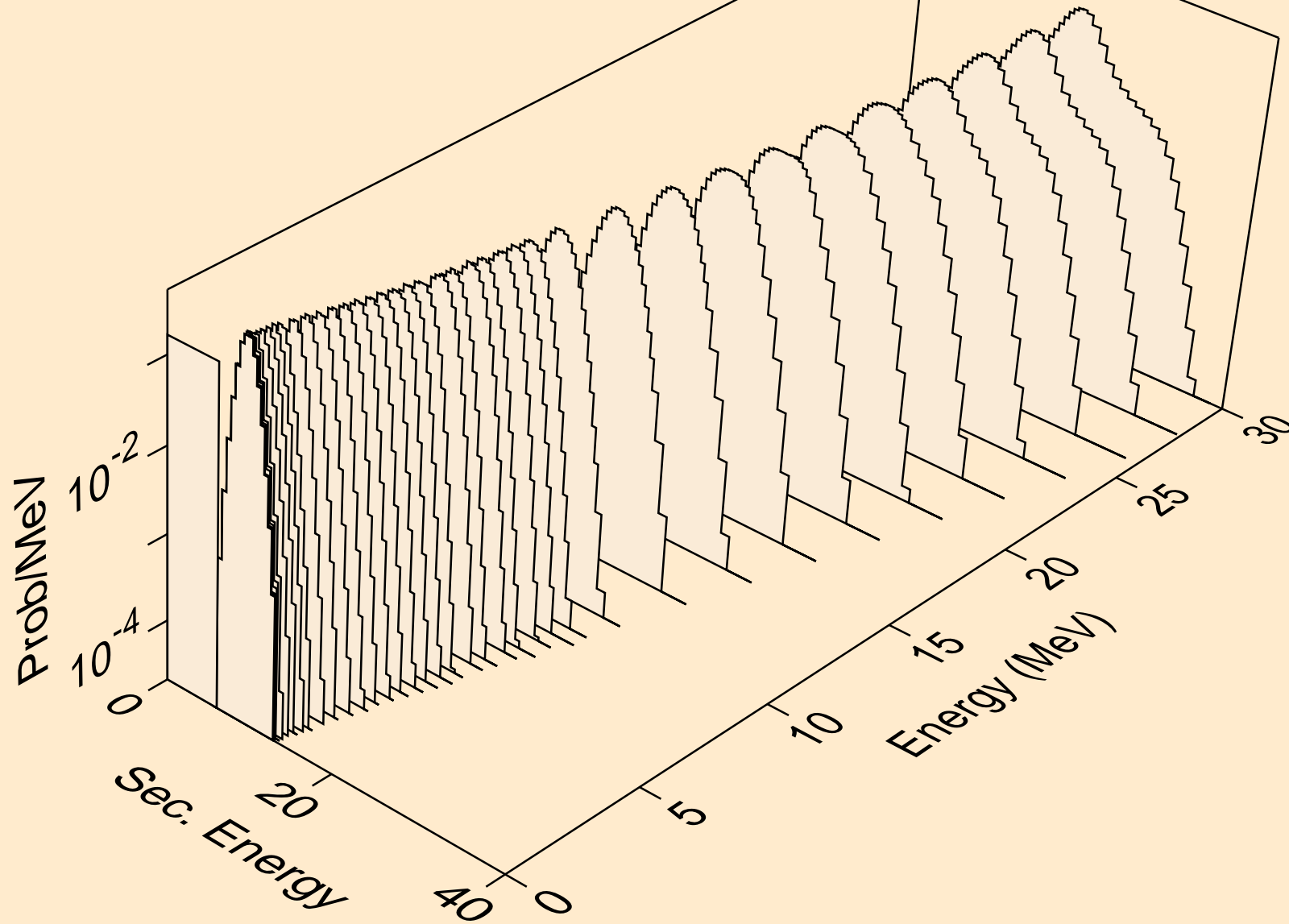

TL185 NEUTRON ACER TENDL-2023 LIBRARY; T=0.K  
alphas from (n,3a)

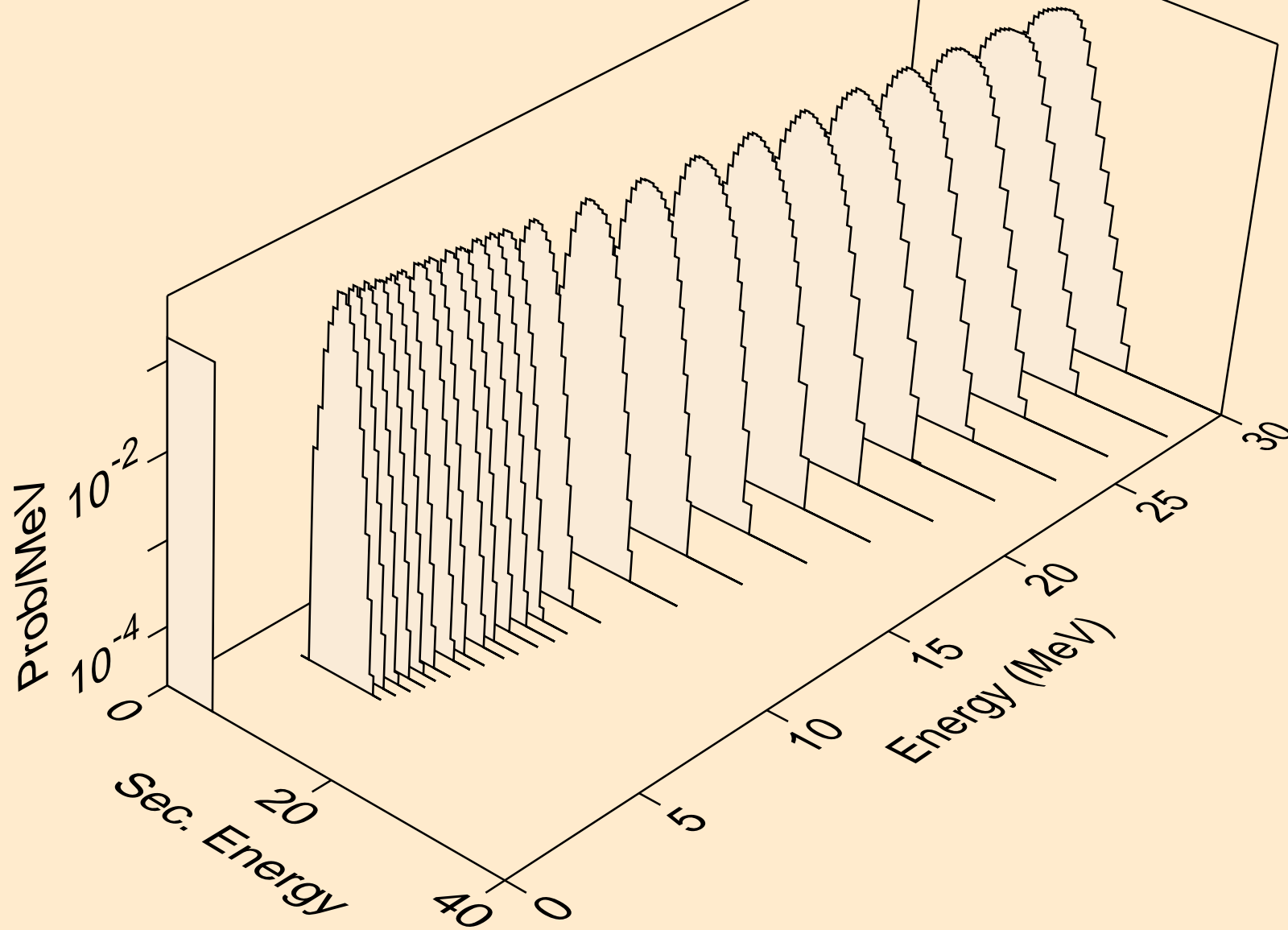

TL185 NEUTRON ACER TENDL-2023 LIBRARY; T=0.K  
alphas from (n,pa)

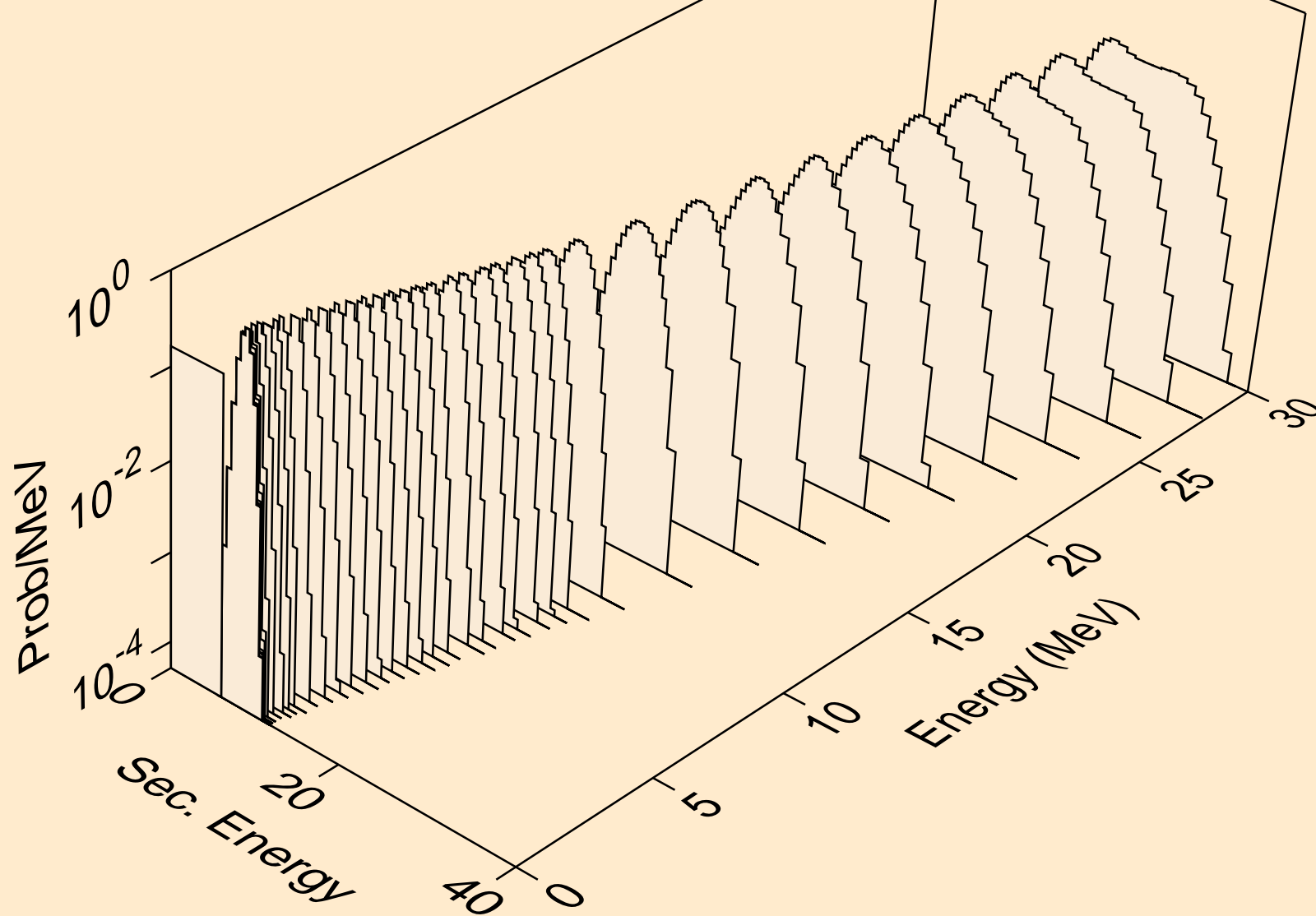

TL185 NEUTRON ACER TENDL-2023 LIBRARY; T=0.K  
alphas from (n,d2a)

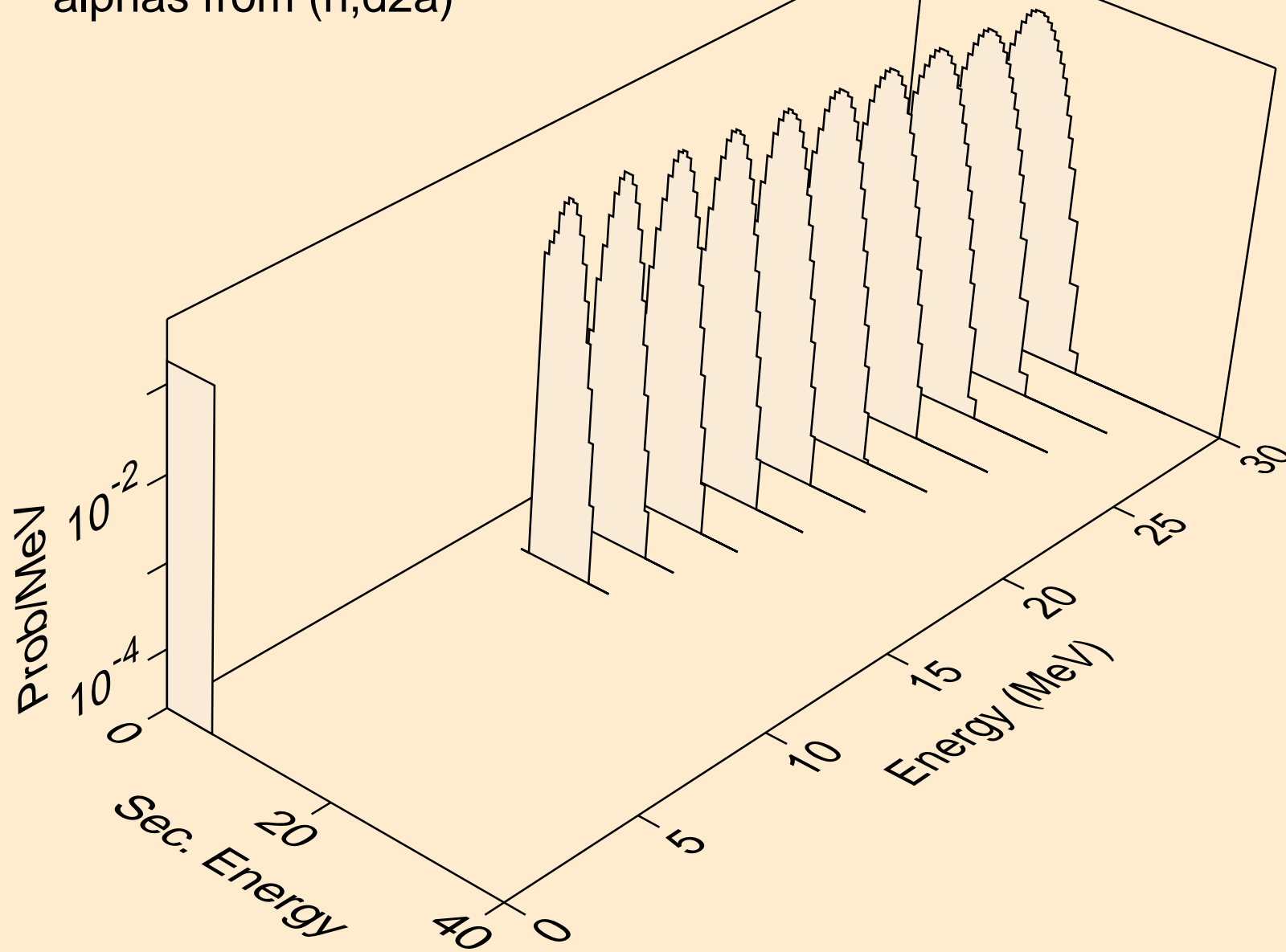

TL185 NEUTRON ACER TENDL-2023 LIBRARY; T=0.K  
alphas from (n,da)

