

TL210 NEUTRON ACER TENDL-2023 LIBRARY; T=0.K  
Principal cross sections

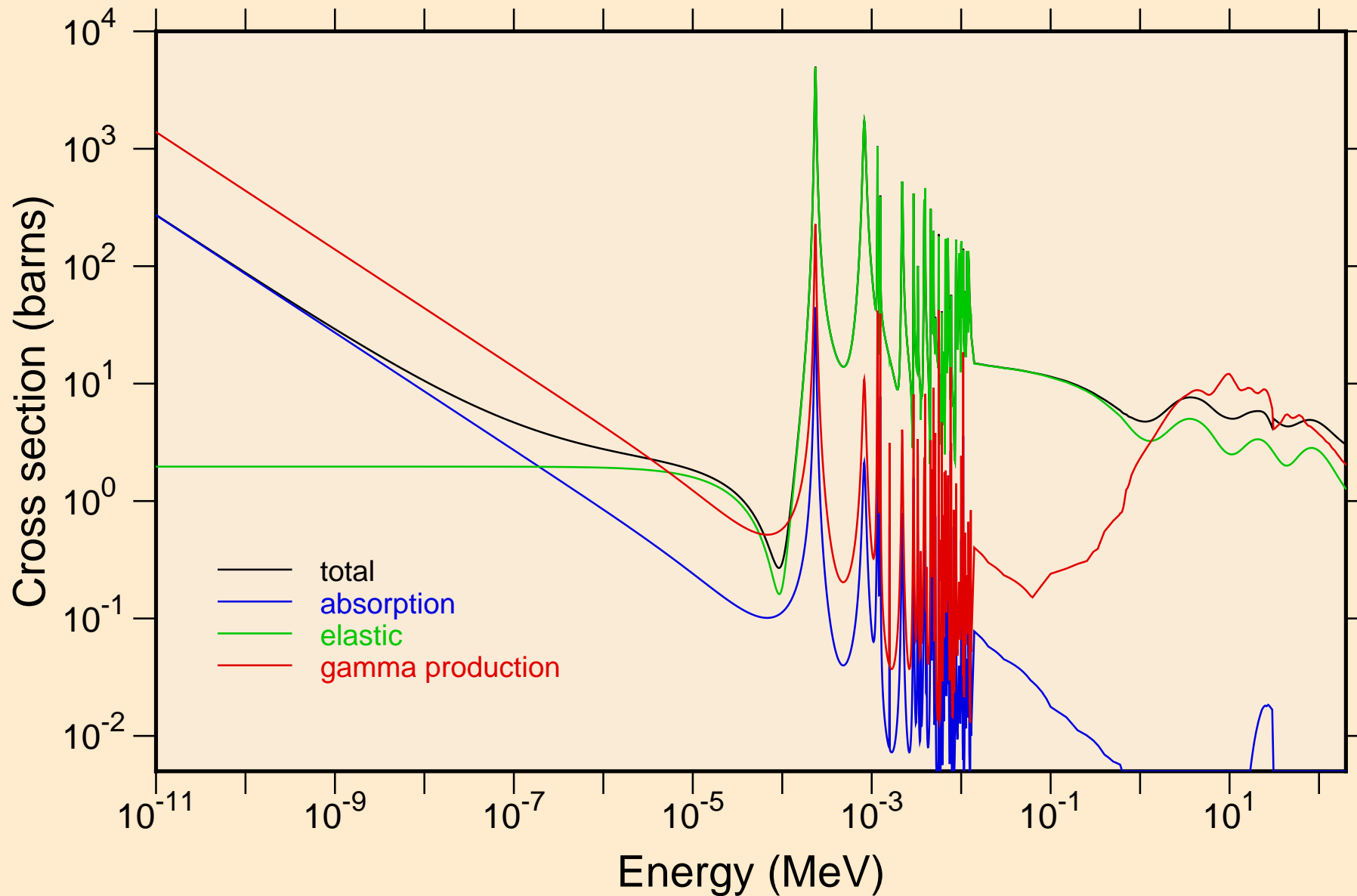

TL210 NEUTRON ACER TENDL-2023 LIBRARY; T=0.K  
resonance total cross section

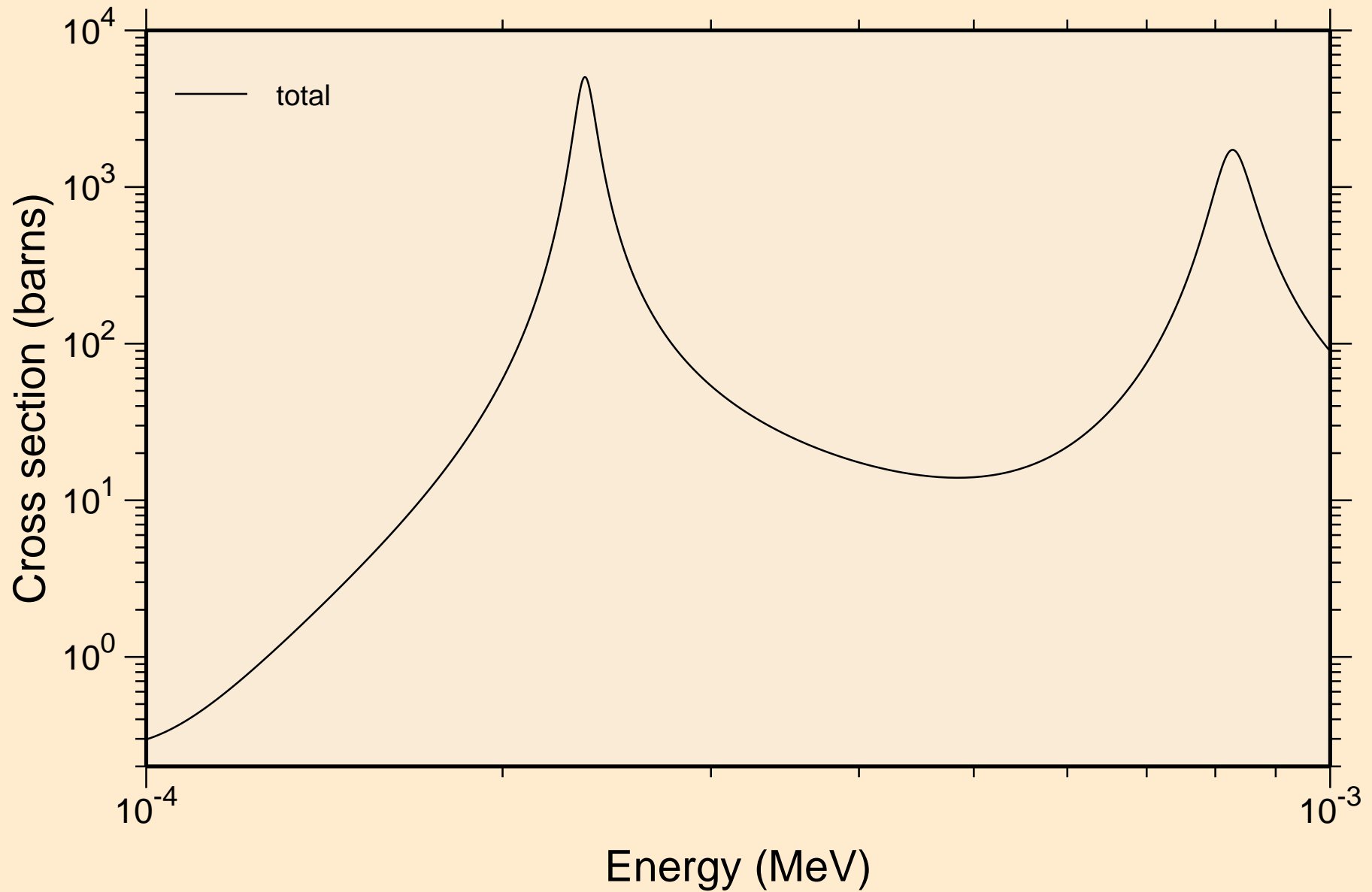

TL210 NEUTRON ACER TENDL-2023 LIBRARY; T=0.K  
resonance total cross section

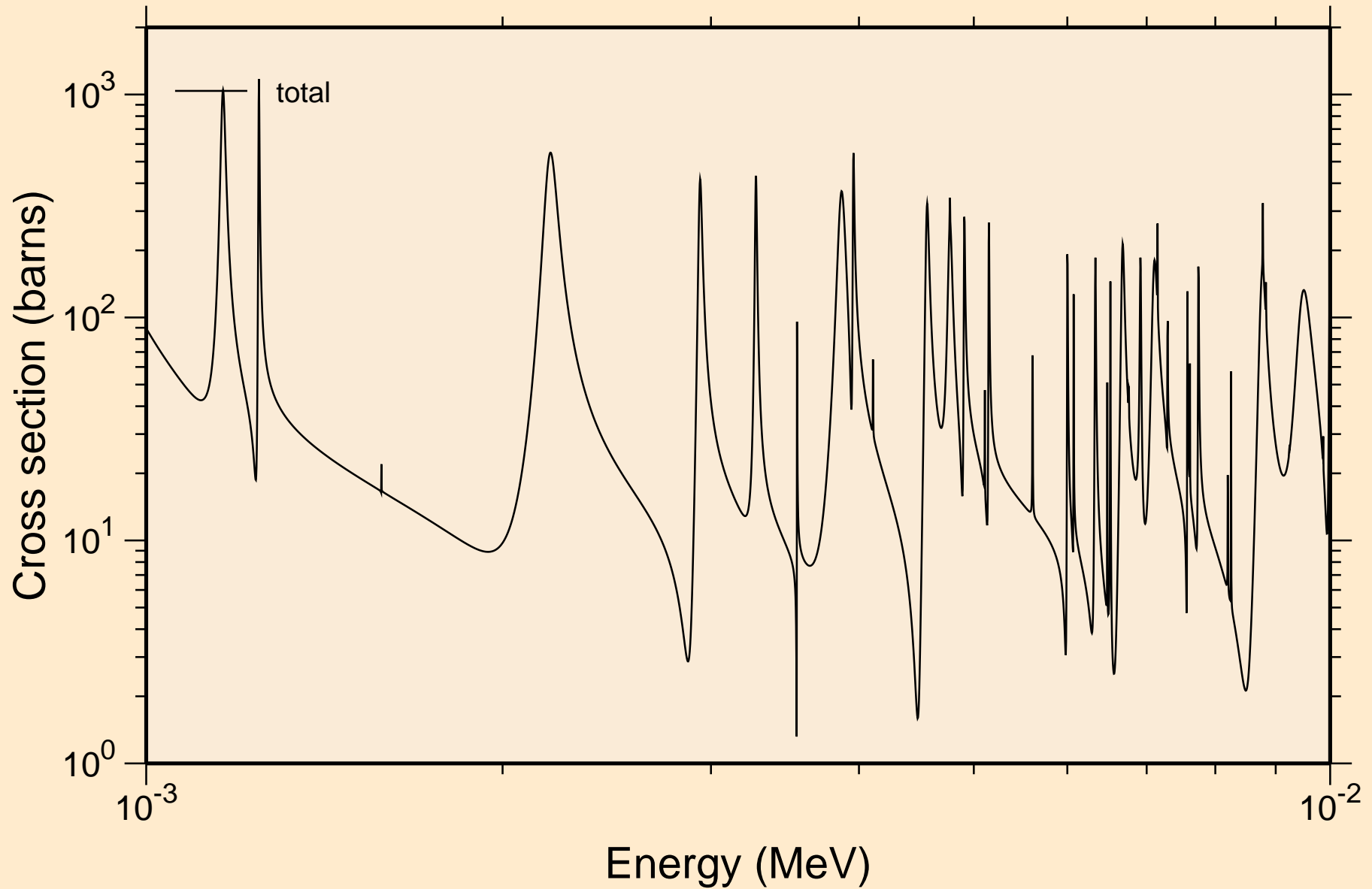

TL210 NEUTRON ACER TENDL-2023 LIBRARY; T=0.K  
resonance total cross section

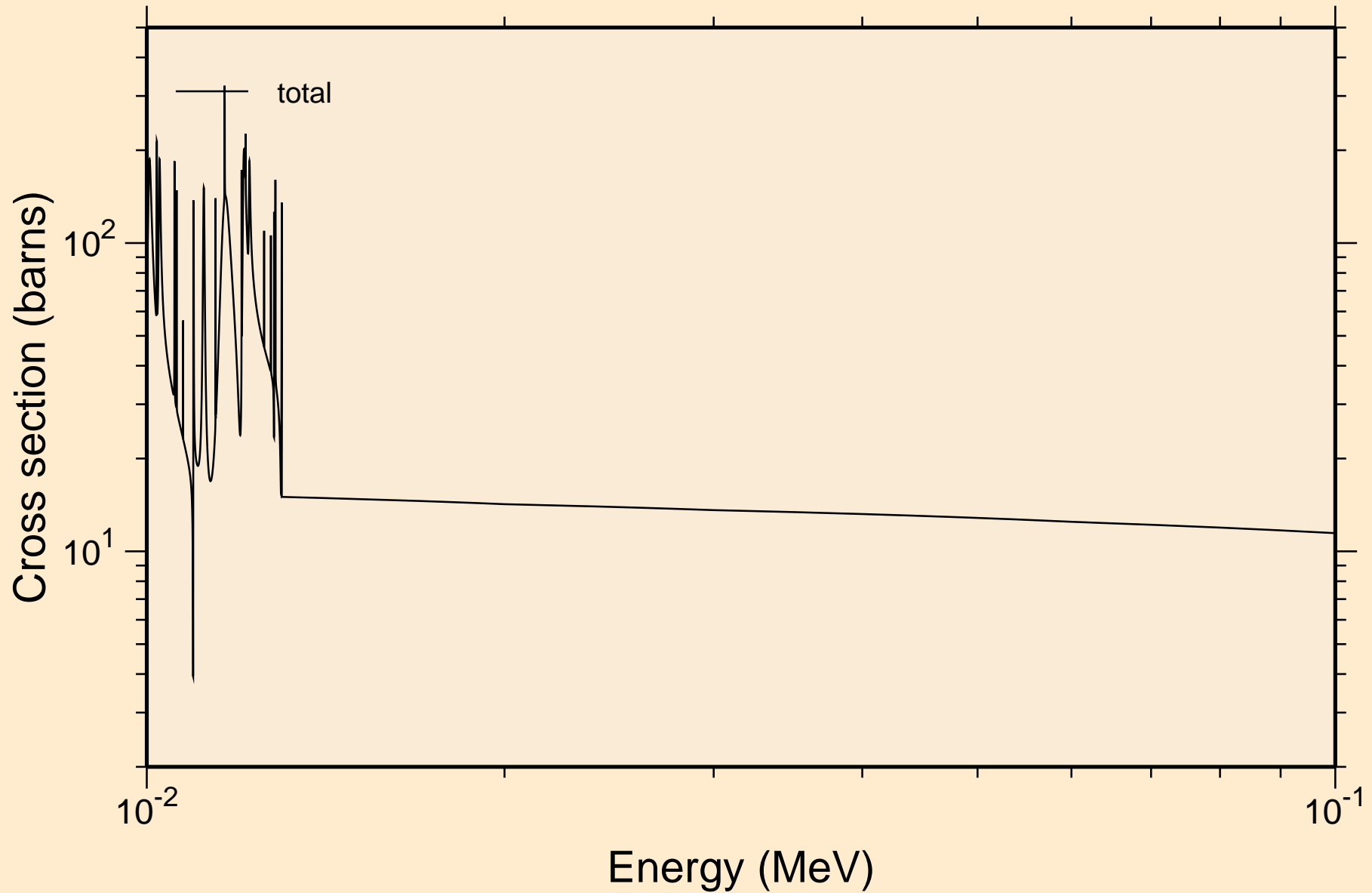

TL210 NEUTRON ACER TENDL-2023 LIBRARY; T=0.K  
resonance total cross section

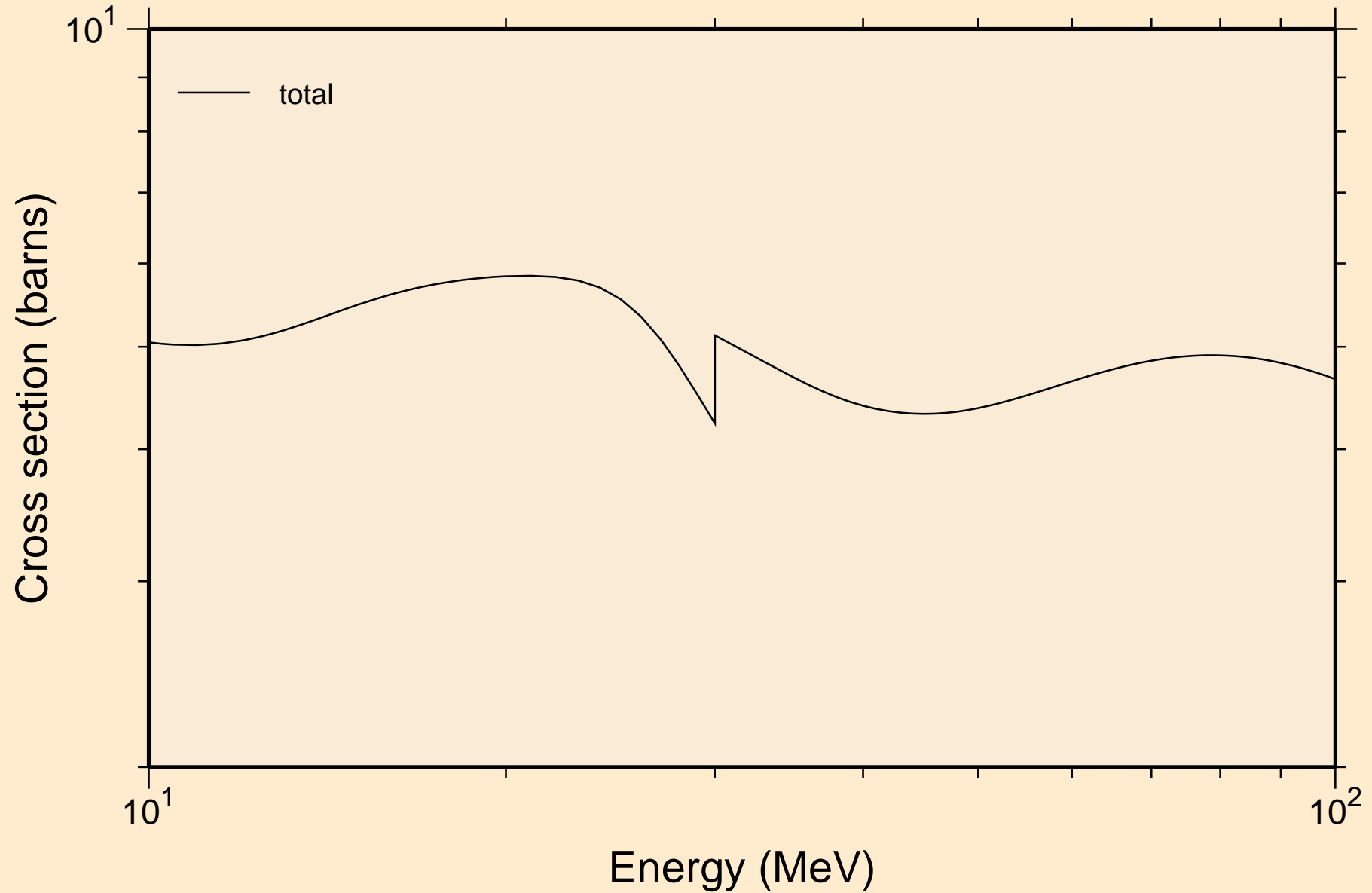

TL210 NEUTRON ACER TENDL-2023 LIBRARY; T=0.K  
resonance absorption cross sections

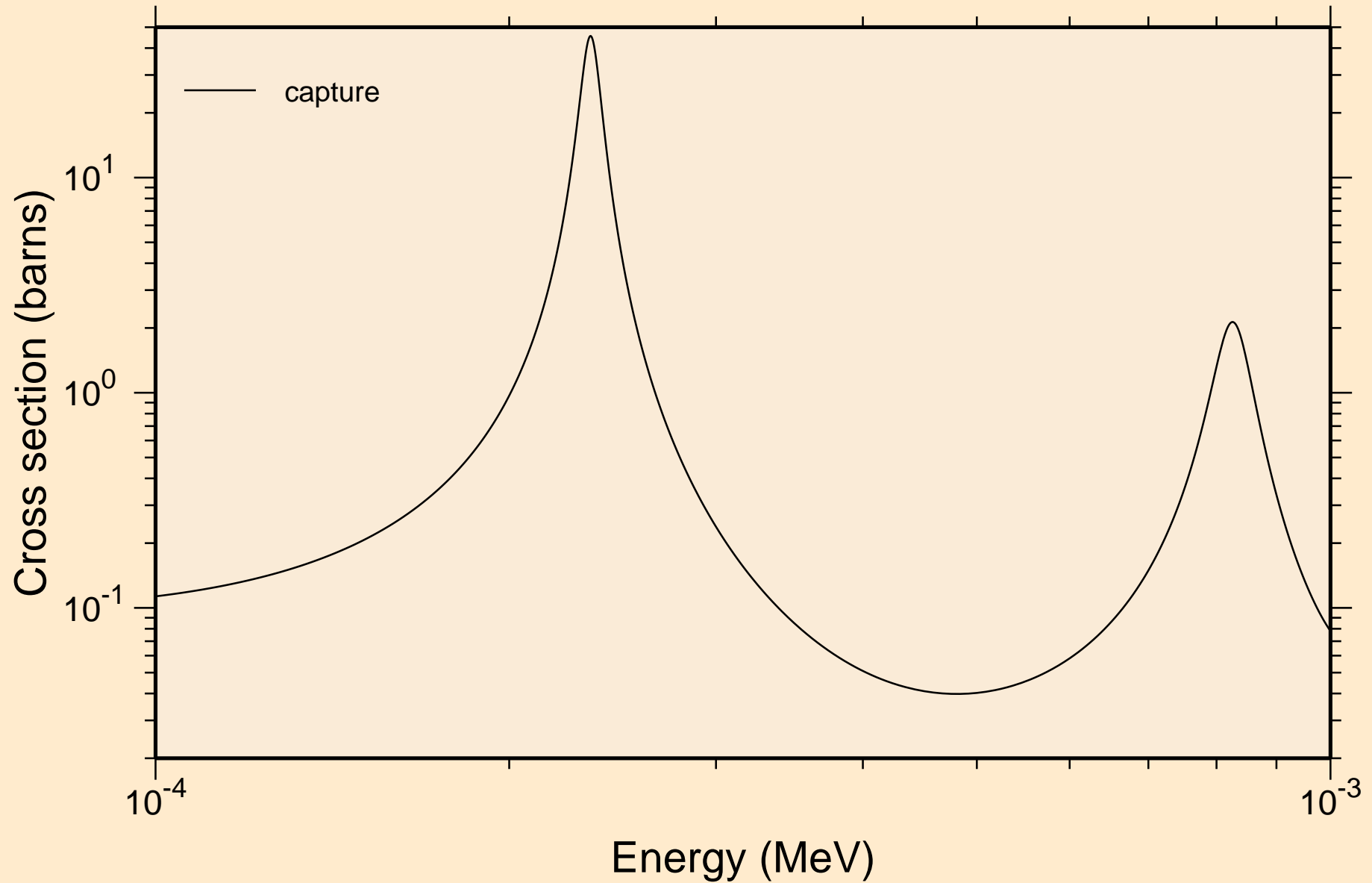

TL210 NEUTRON ACER TENDL-2023 LIBRARY; T=0.K  
resonance absorption cross sections

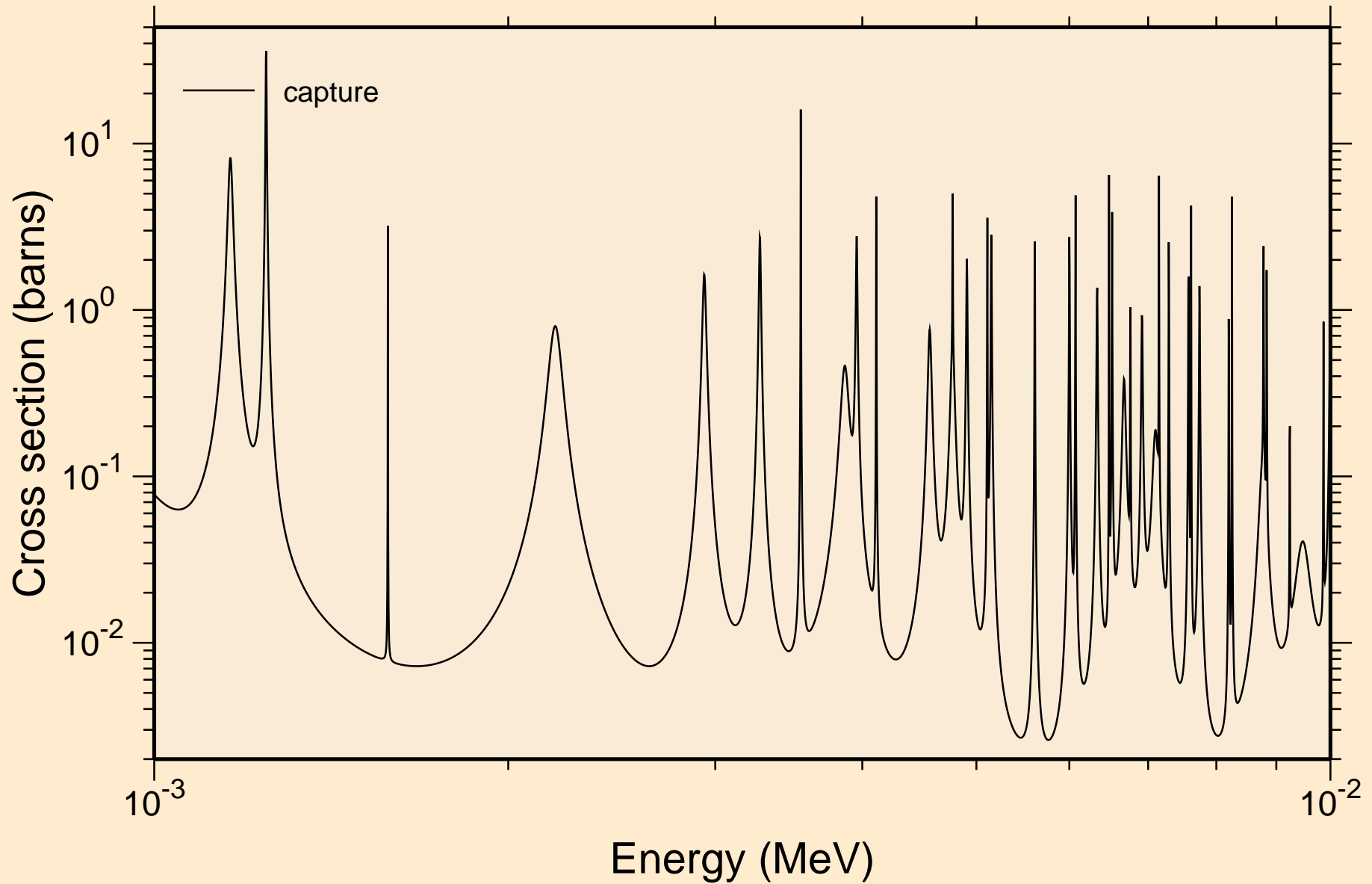

TL210 NEUTRON ACER TENDL-2023 LIBRARY; T=0.K  
resonance absorption cross sections

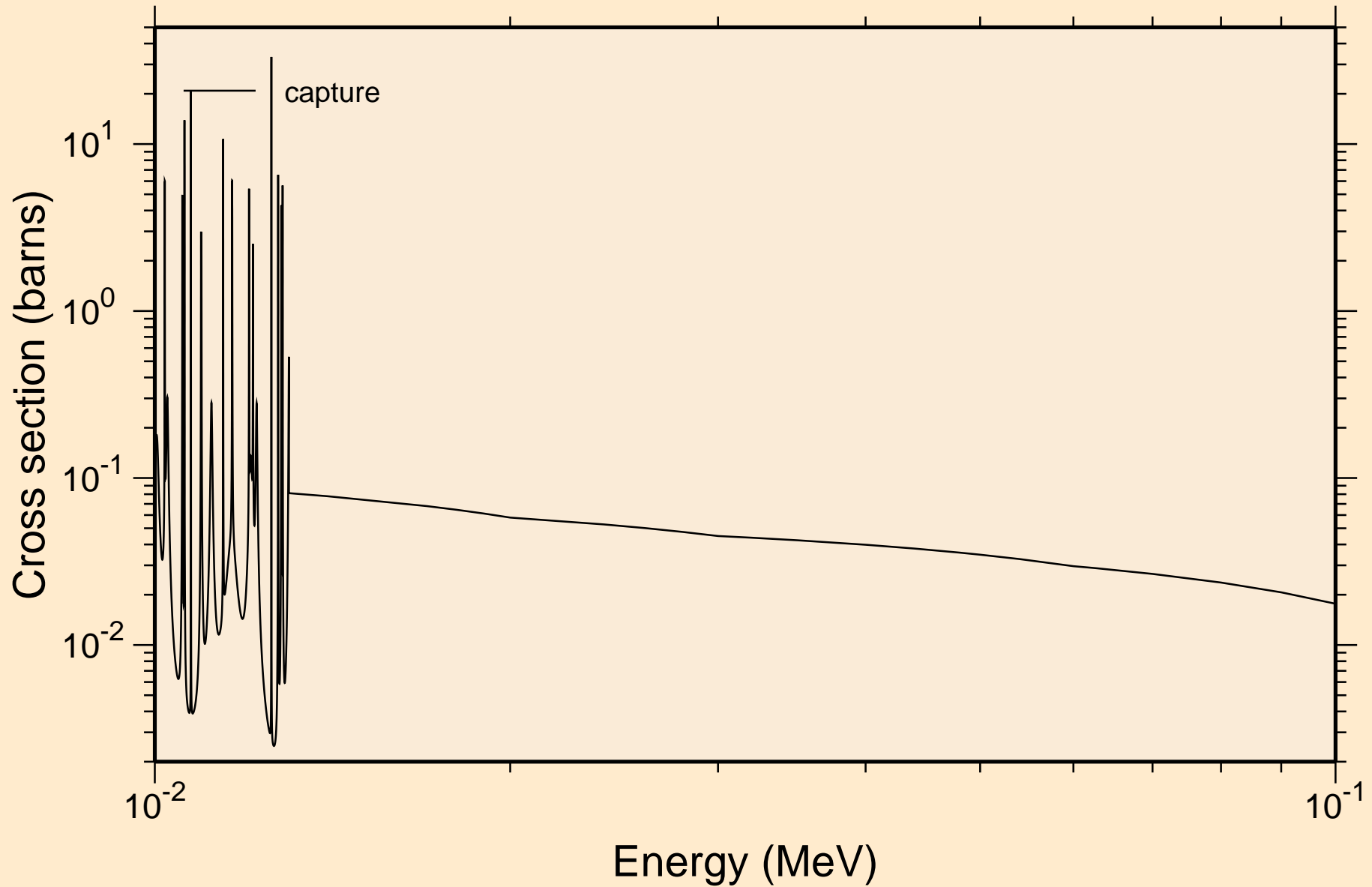

TL210 NEUTRON ACER TENDL-2023 LIBRARY; T=0.K  
resonance absorption cross sections

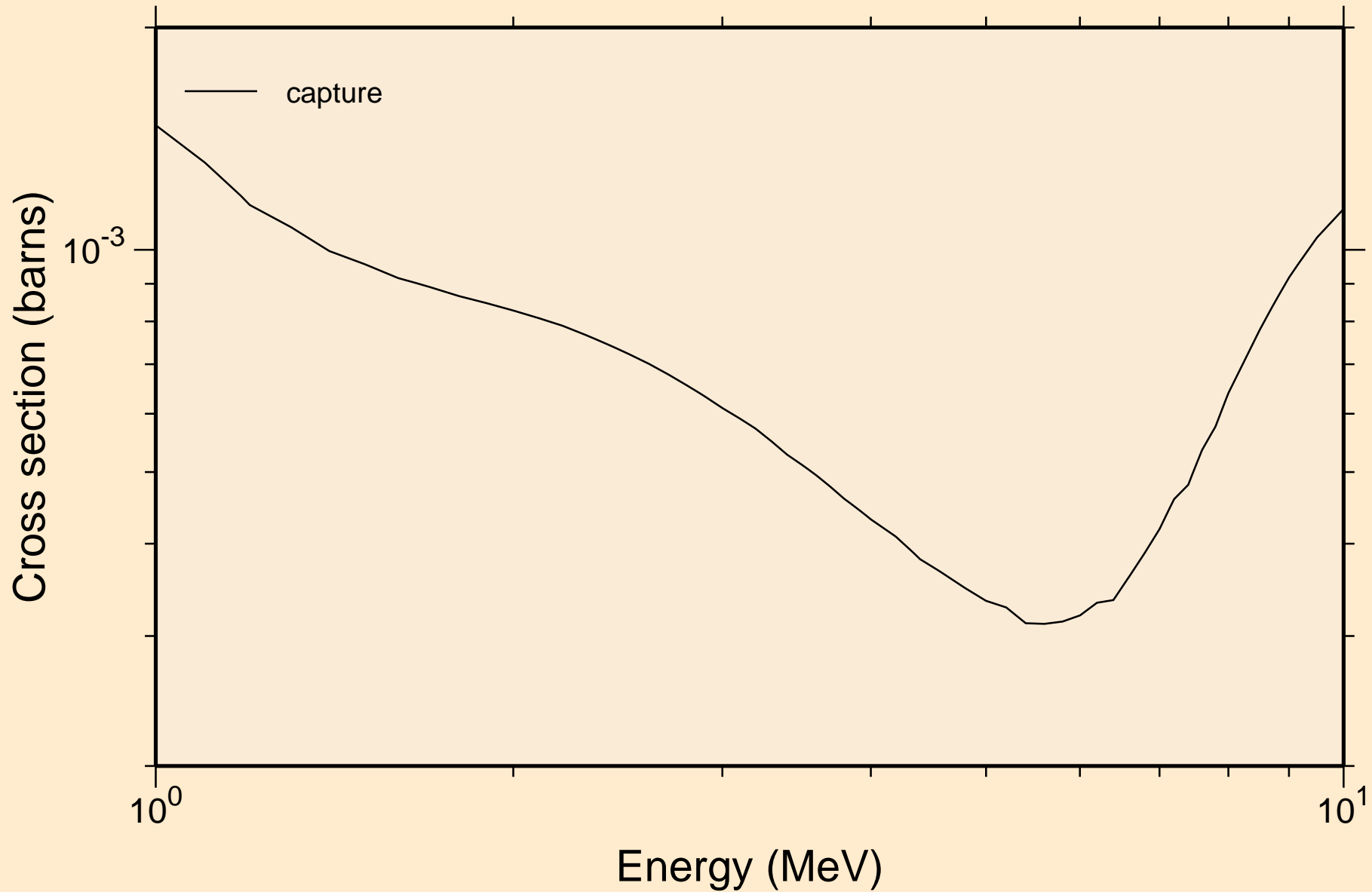

TL210 NEUTRON ACER TENDL-2023 LIBRARY; T=0.K  
Heating

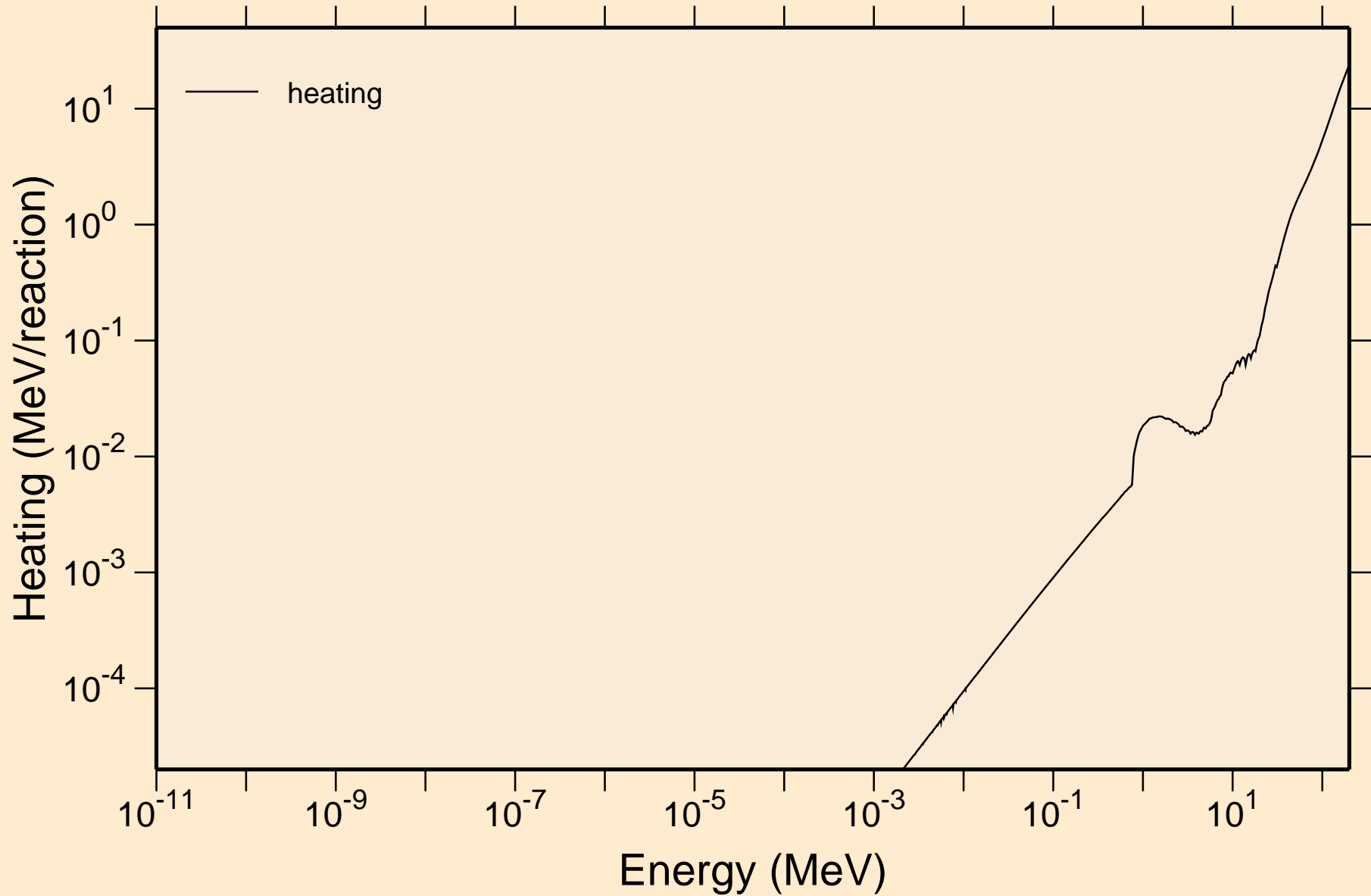

TL210 NEUTRON ACER TENDL-2023 LIBRARY; T=0.K  
Damage

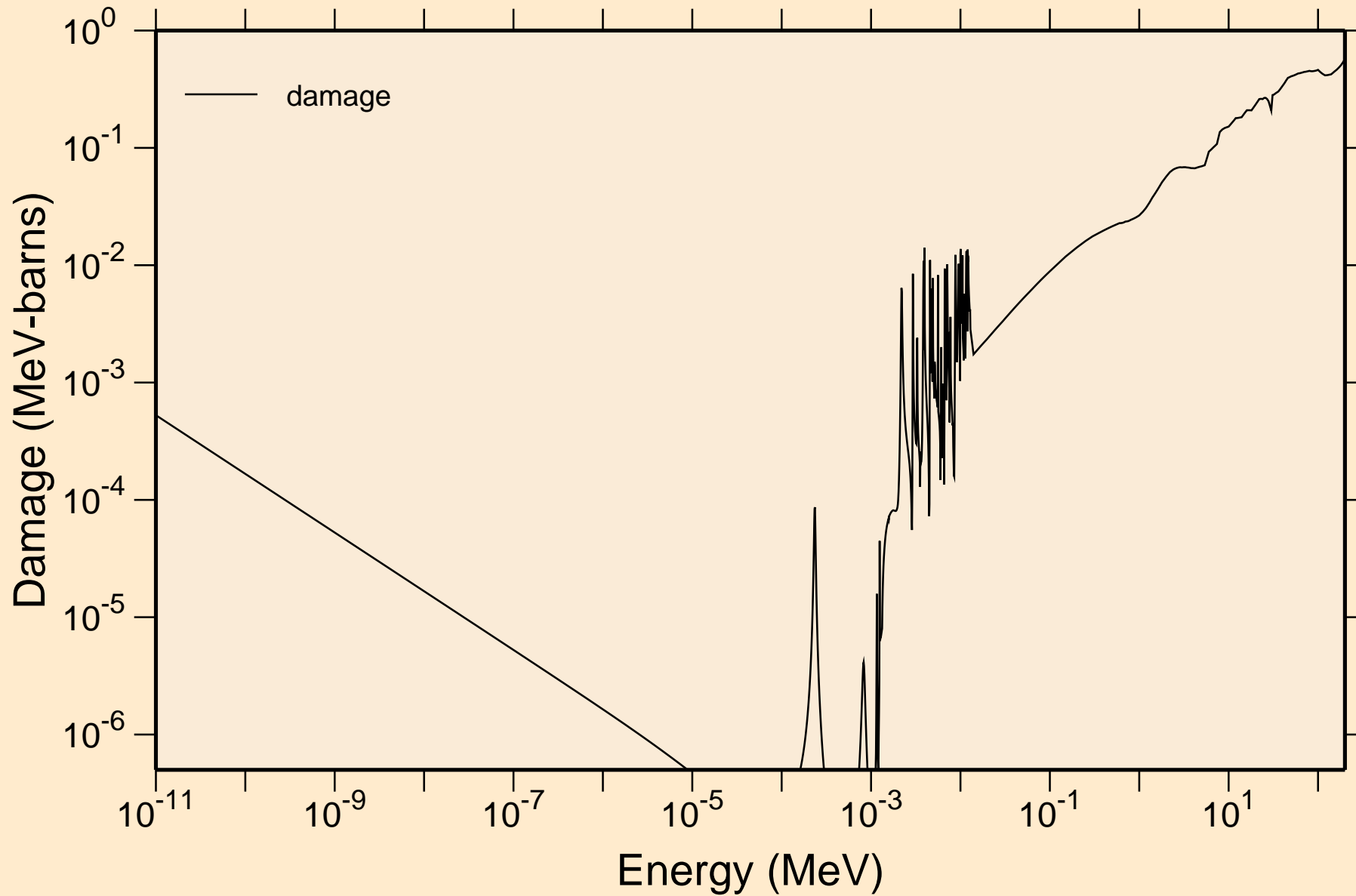

TL210 NEUTRON ACER TENDL-2023 LIBRARY; T=0.K  
Non-threshold reactions

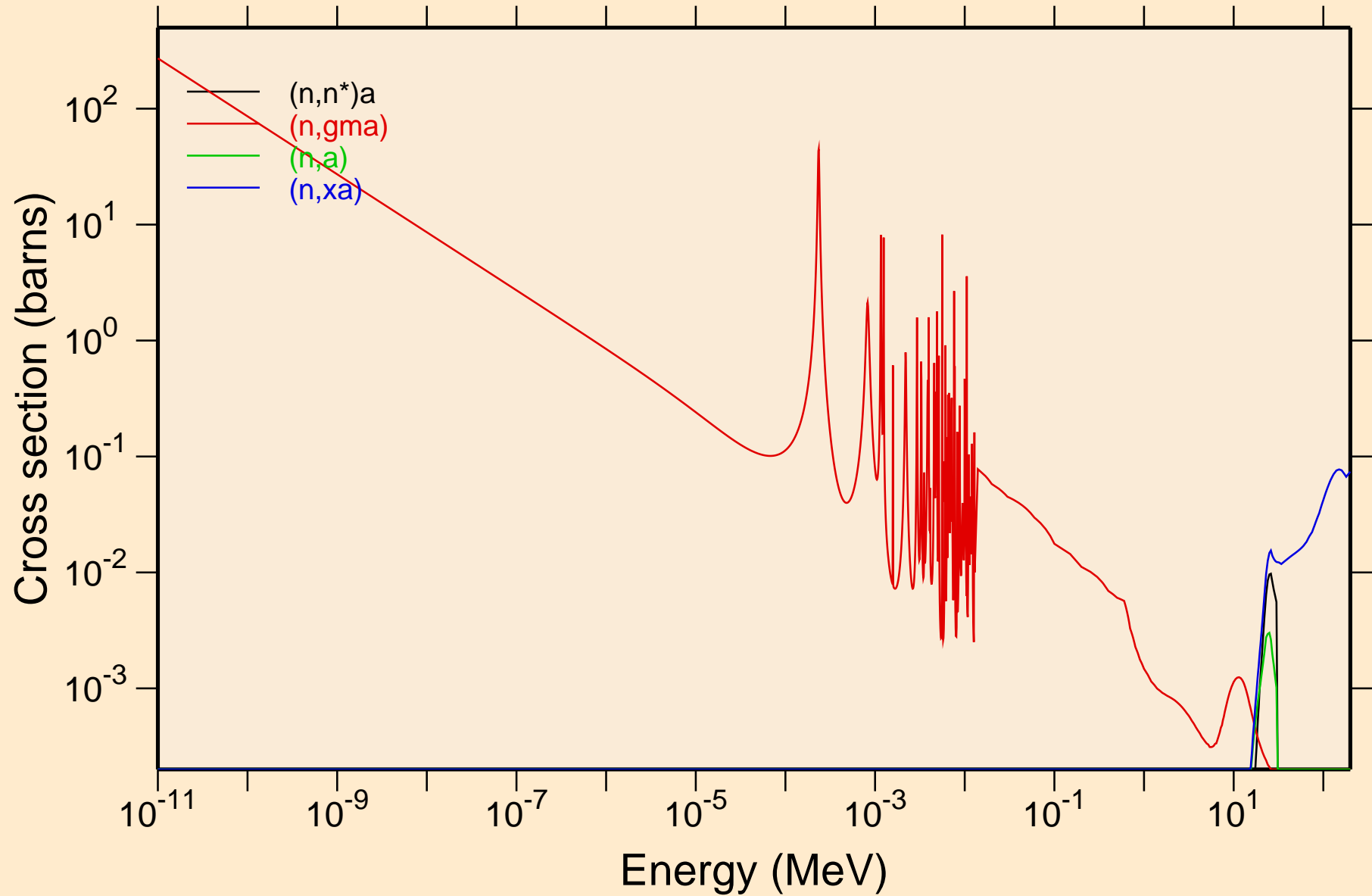

# TL210 NEUTRON ACER TENDL-2023 LIBRARY; T=0.K

## Principal cross sections

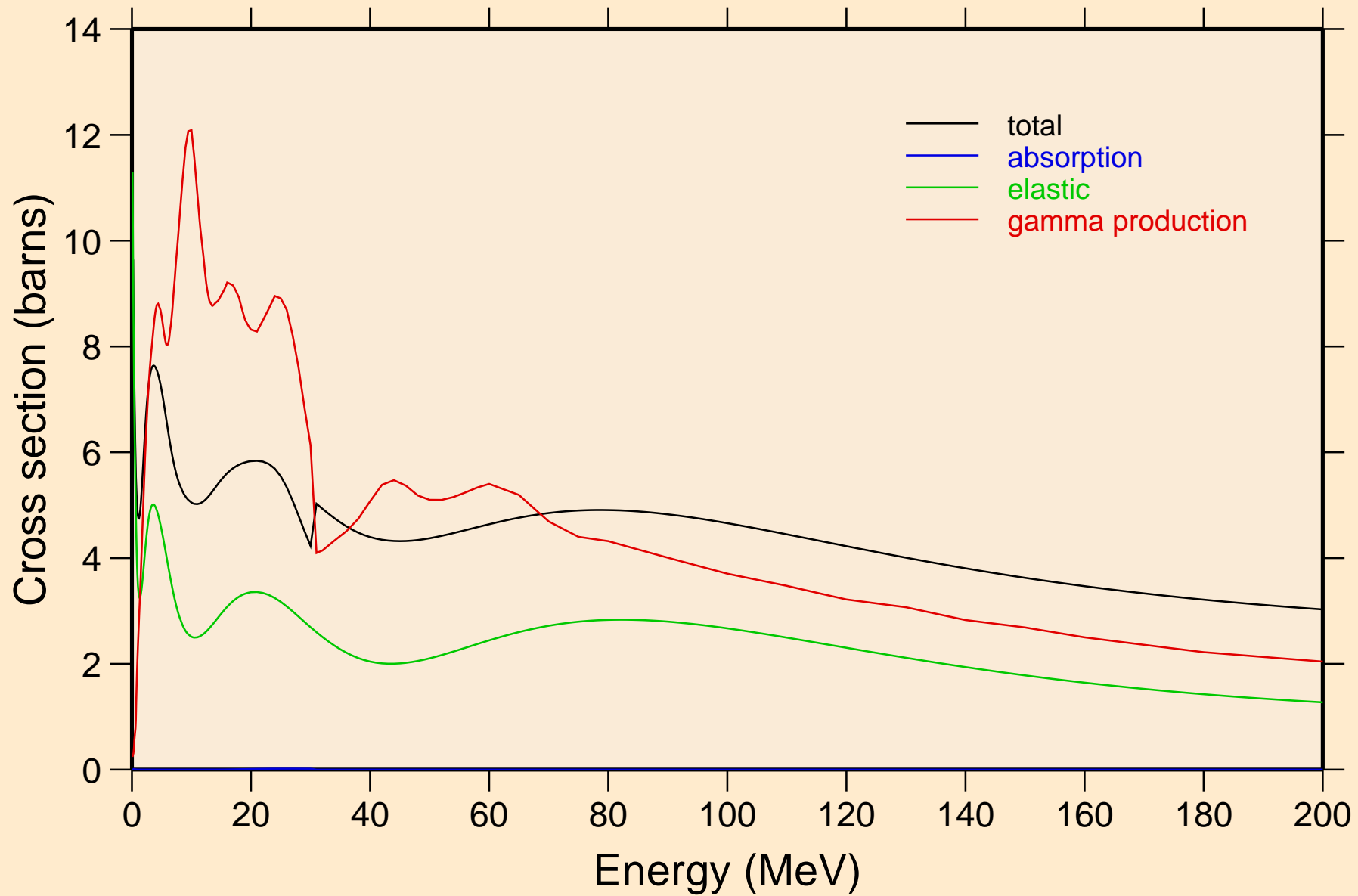

# TL210 NEUTRON ACER TENDL-2023 LIBRARY; T=0.K

## Heating

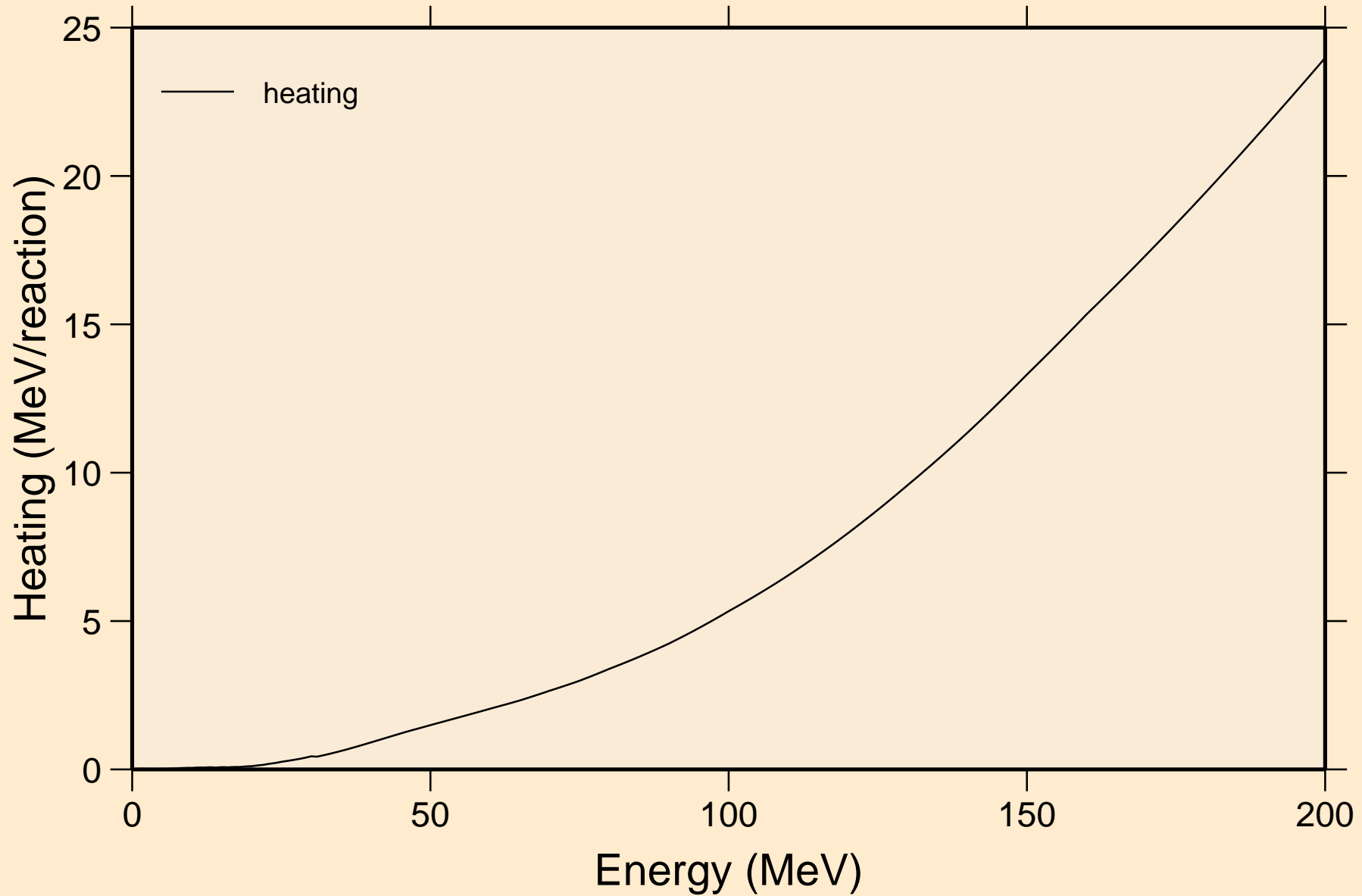

TL210 NEUTRON ACER TENDL-2023 LIBRARY; T=0.K  
Damage

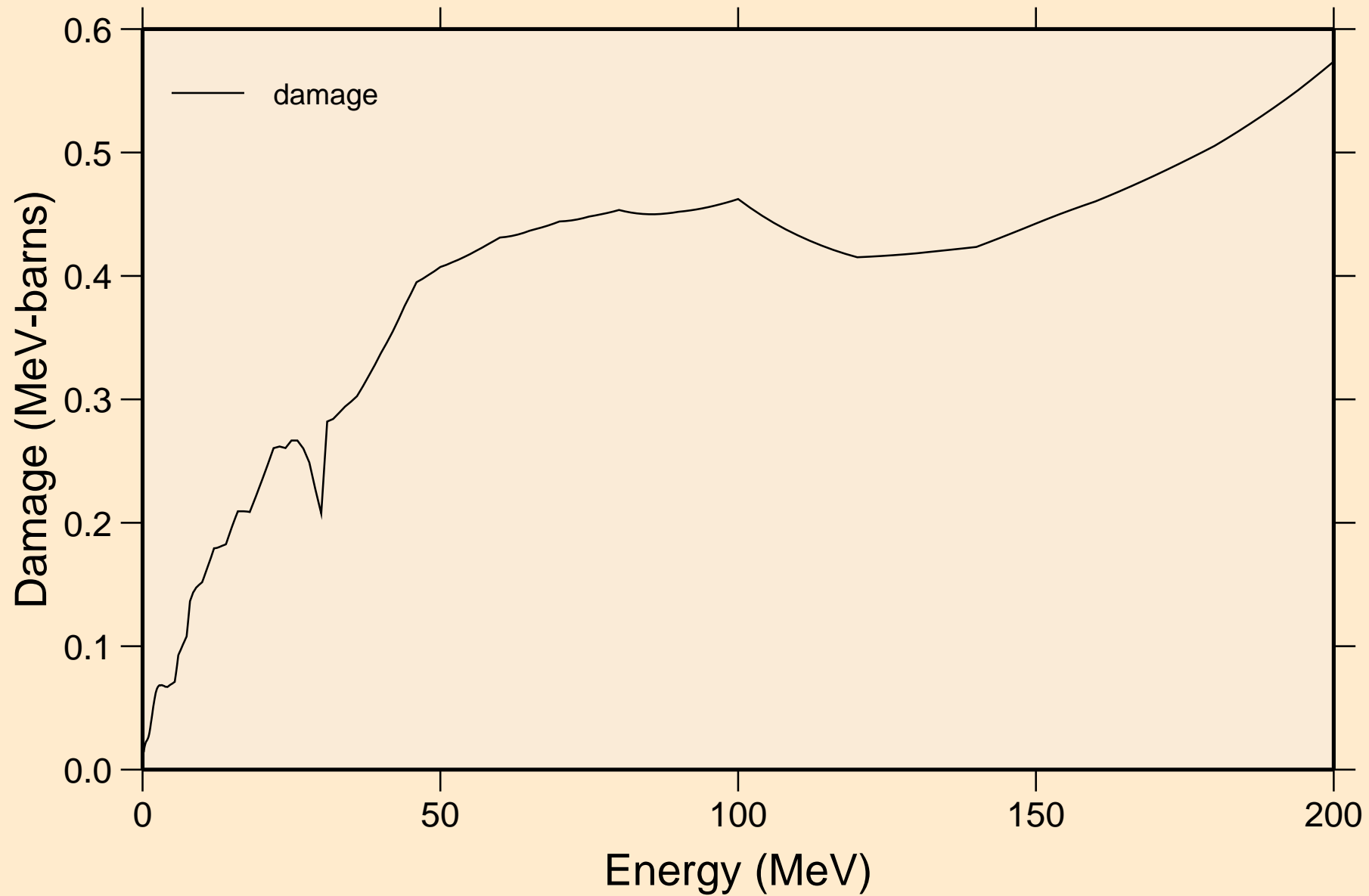

TL210 NEUTRON ACER TENDL-2023 LIBRARY; T=0.K  
Non-threshold reactions

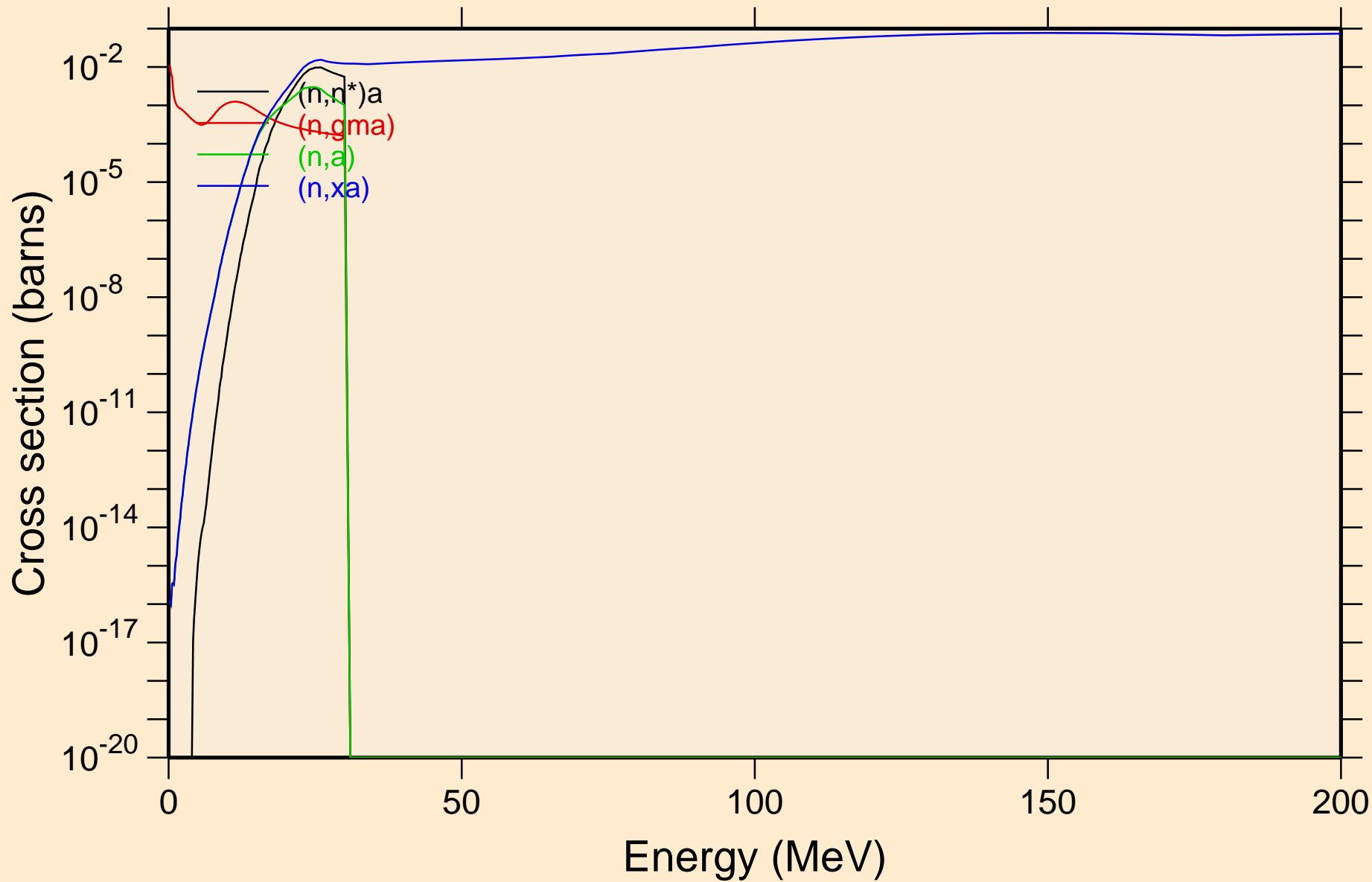

TL210 NEUTRON ACER TENDL-2023 LIBRARY; T=0.K  
Inelastic levels

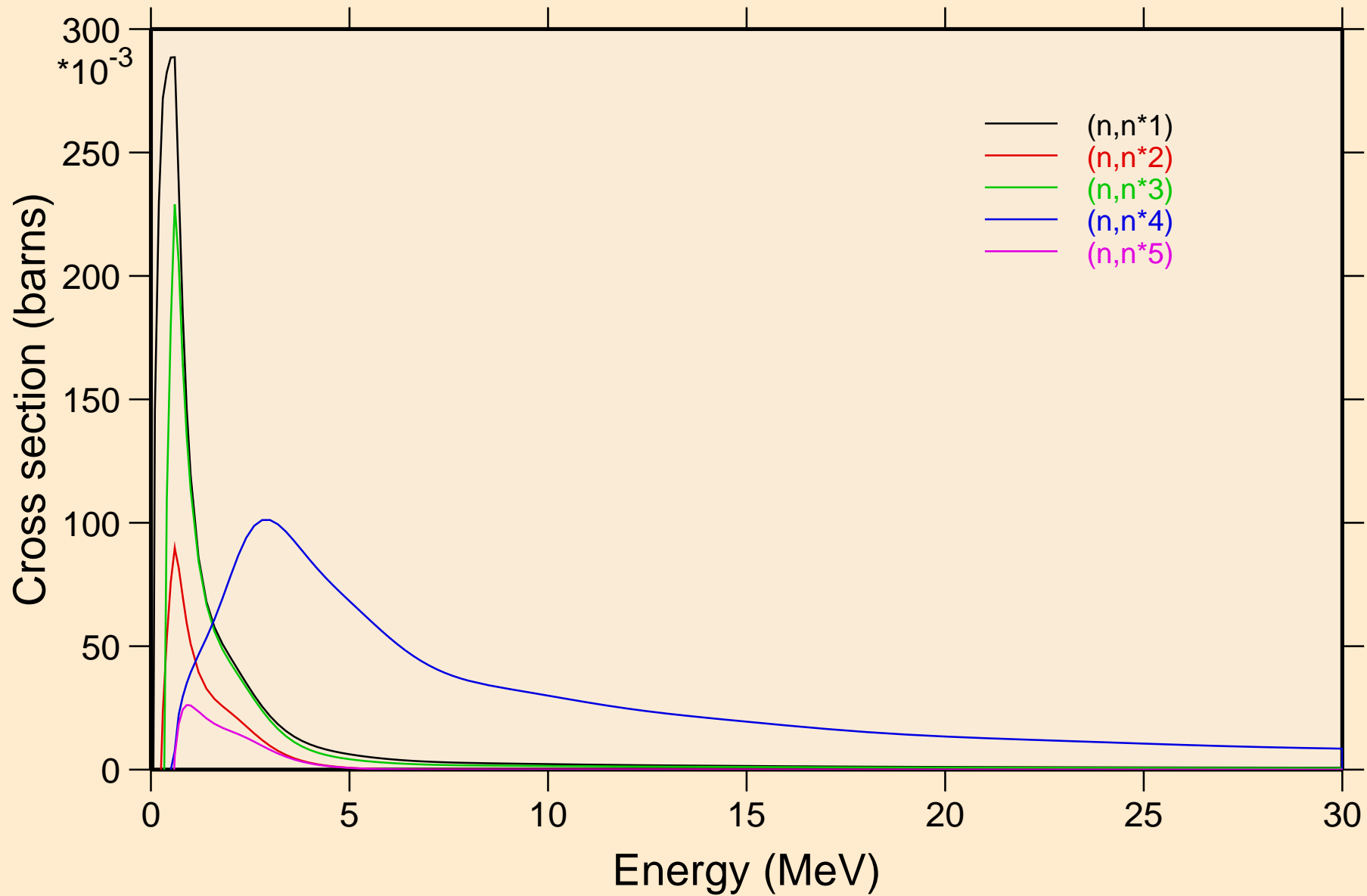

TL210 NEUTRON ACER TENDL-2023 LIBRARY; T=0.K  
Inelastic levels

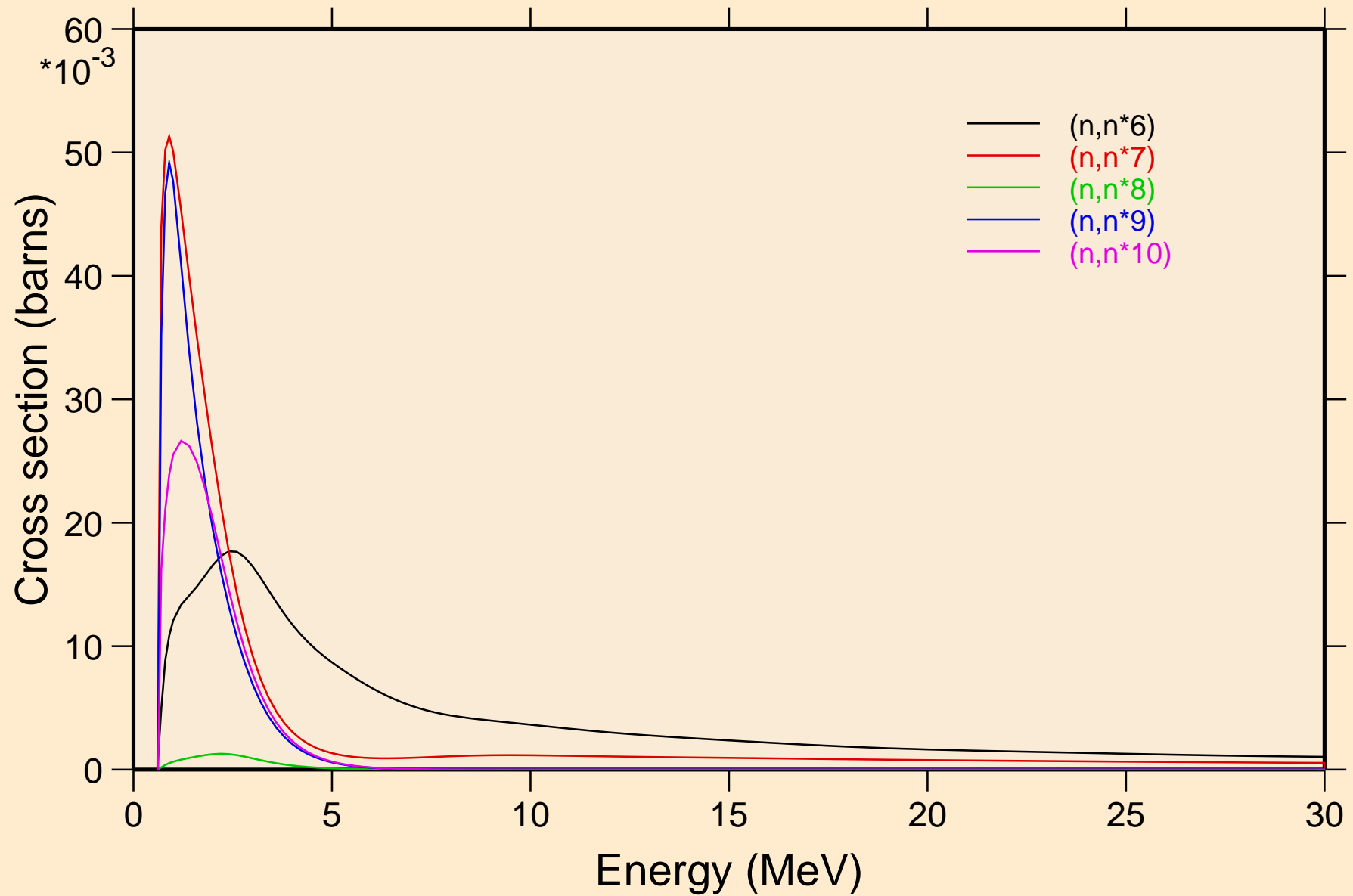

TL210 NEUTRON ACER TENDL-2023 LIBRARY; T=0.K  
Inelastic levels

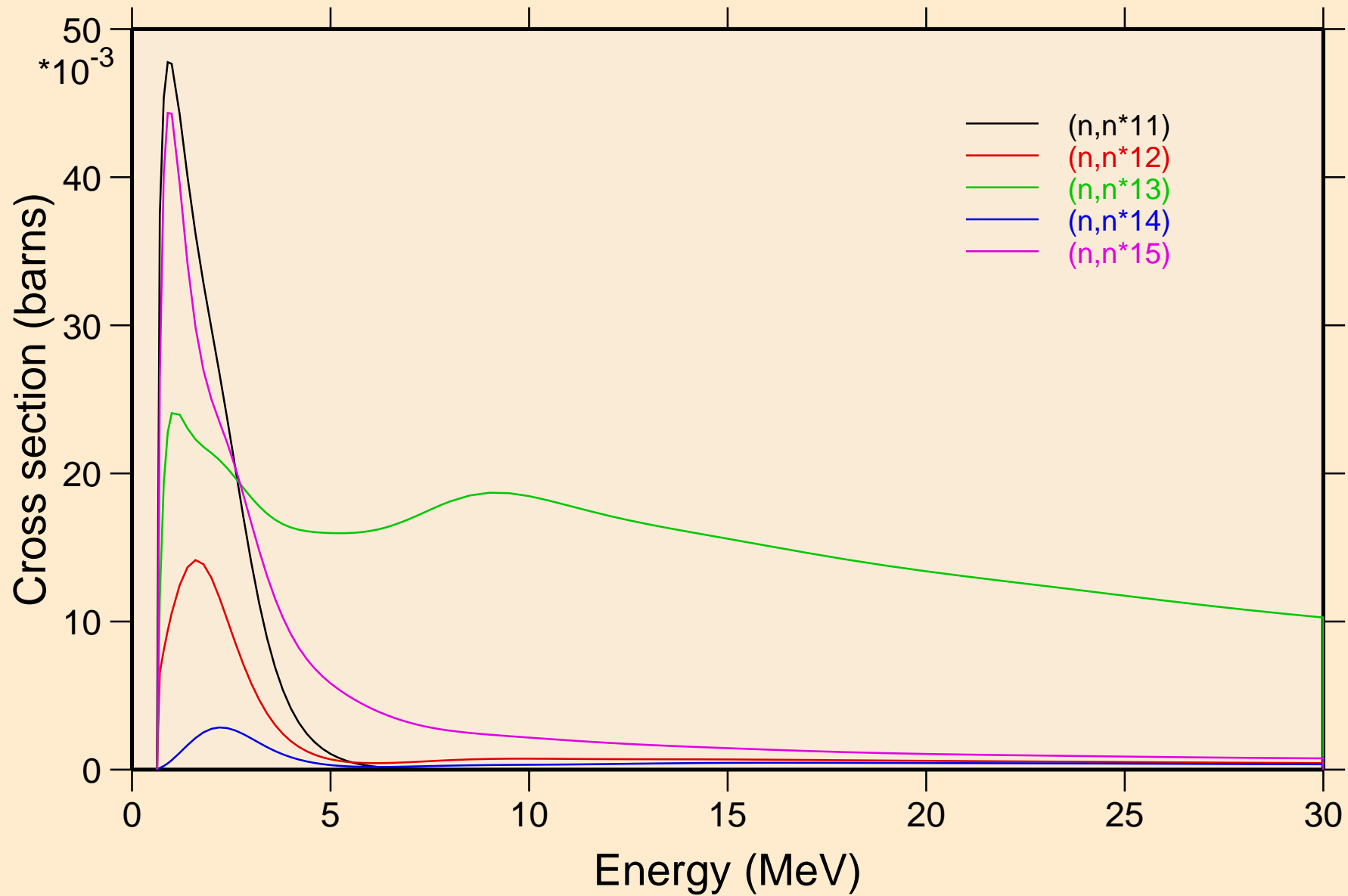

TL210 NEUTRON ACER TENDL-2023 LIBRARY; T=0.K  
Inelastic levels

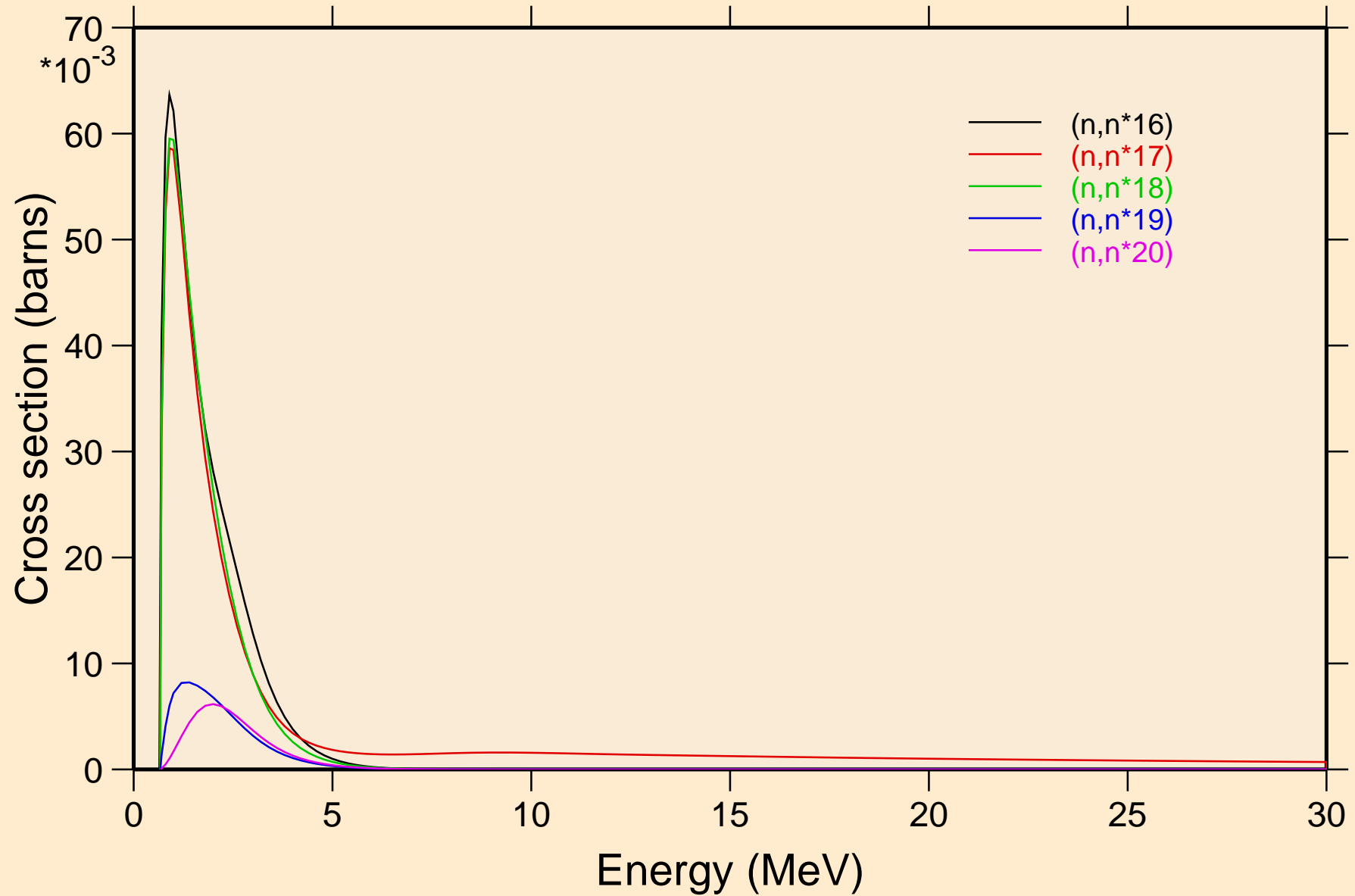

TL210 NEUTRON ACER TENDL-2023 LIBRARY; T=0.K  
Inelastic levels

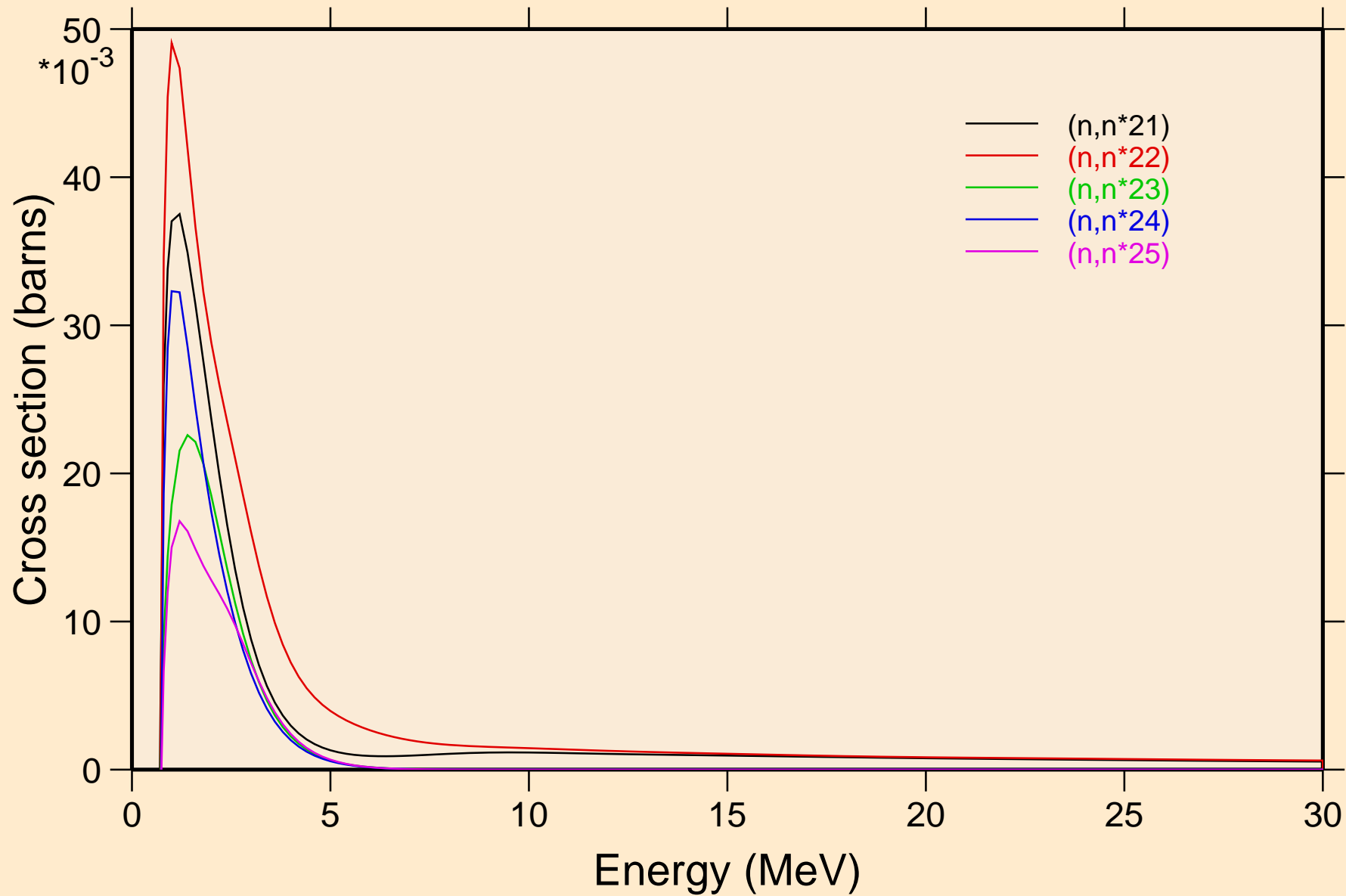

TL210 NEUTRON ACER TENDL-2023 LIBRARY; T=0.K  
Inelastic levels

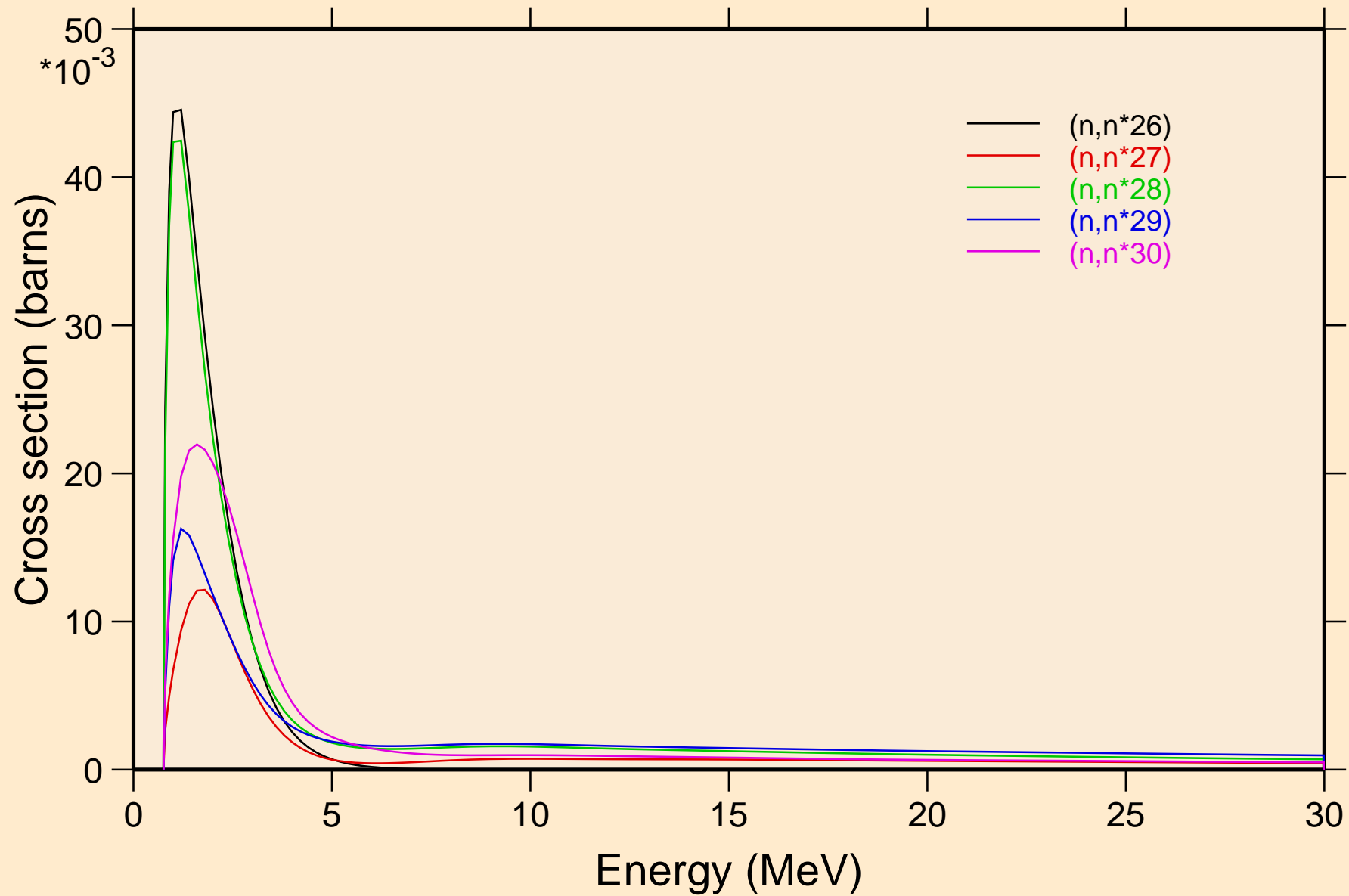

TL210 NEUTRON ACER TENDL-2023 LIBRARY; T=0.K  
Threshold reactions

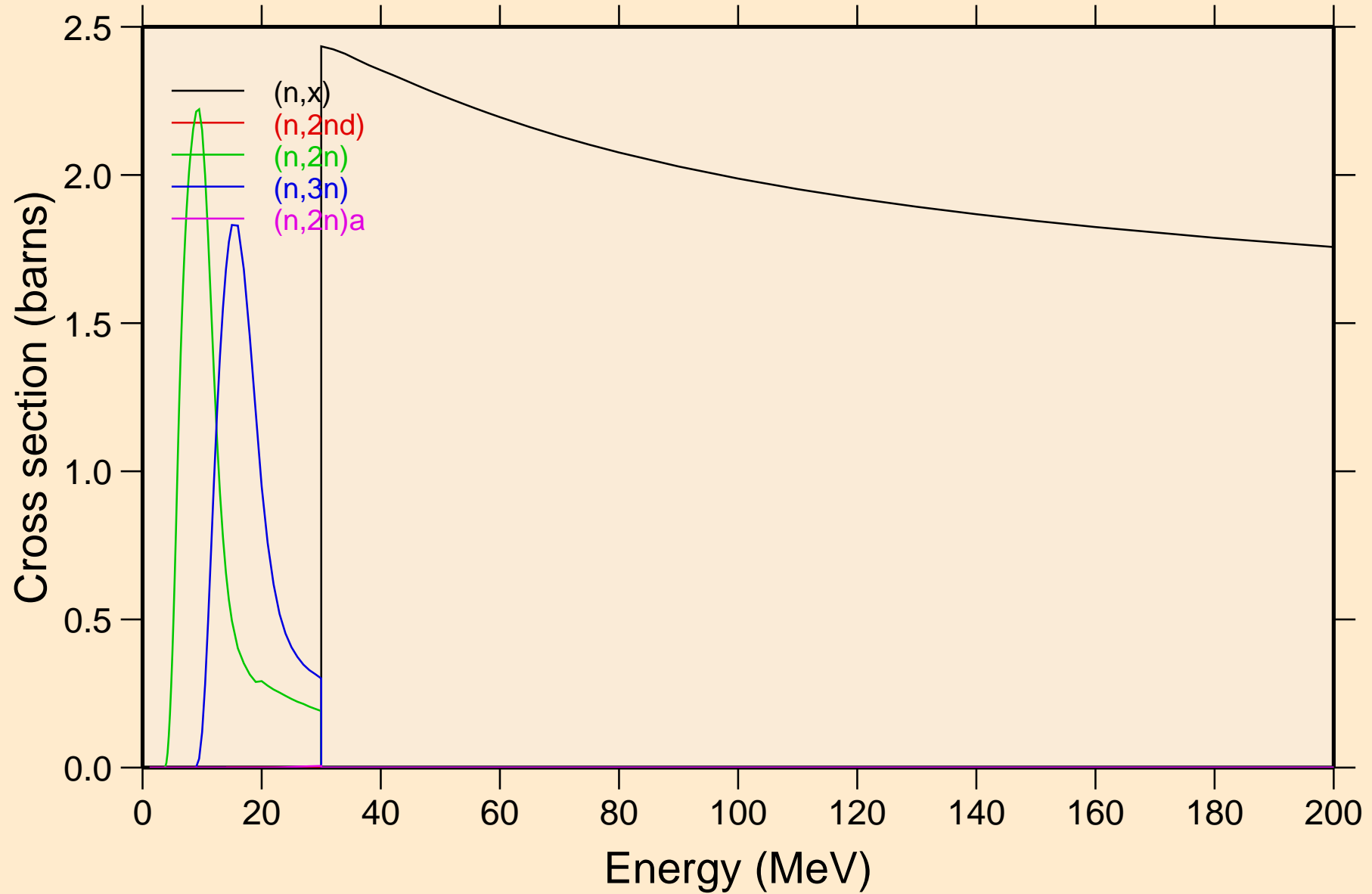

TL210 NEUTRON ACER TENDL-2023 LIBRARY; T=0.K  
Threshold reactions

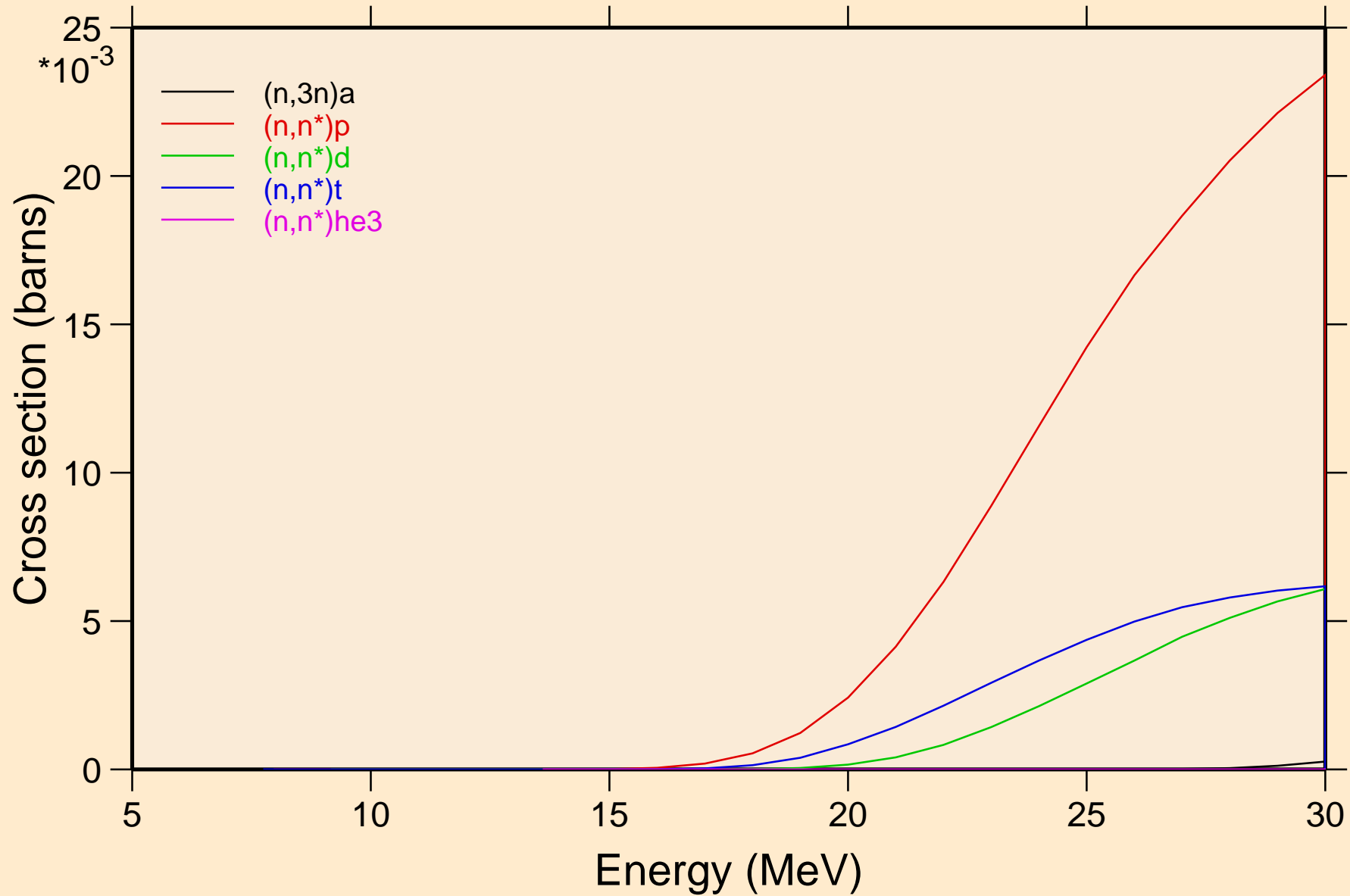

TL210 NEUTRON ACER TENDL-2023 LIBRARY; T=0.K  
Threshold reactions

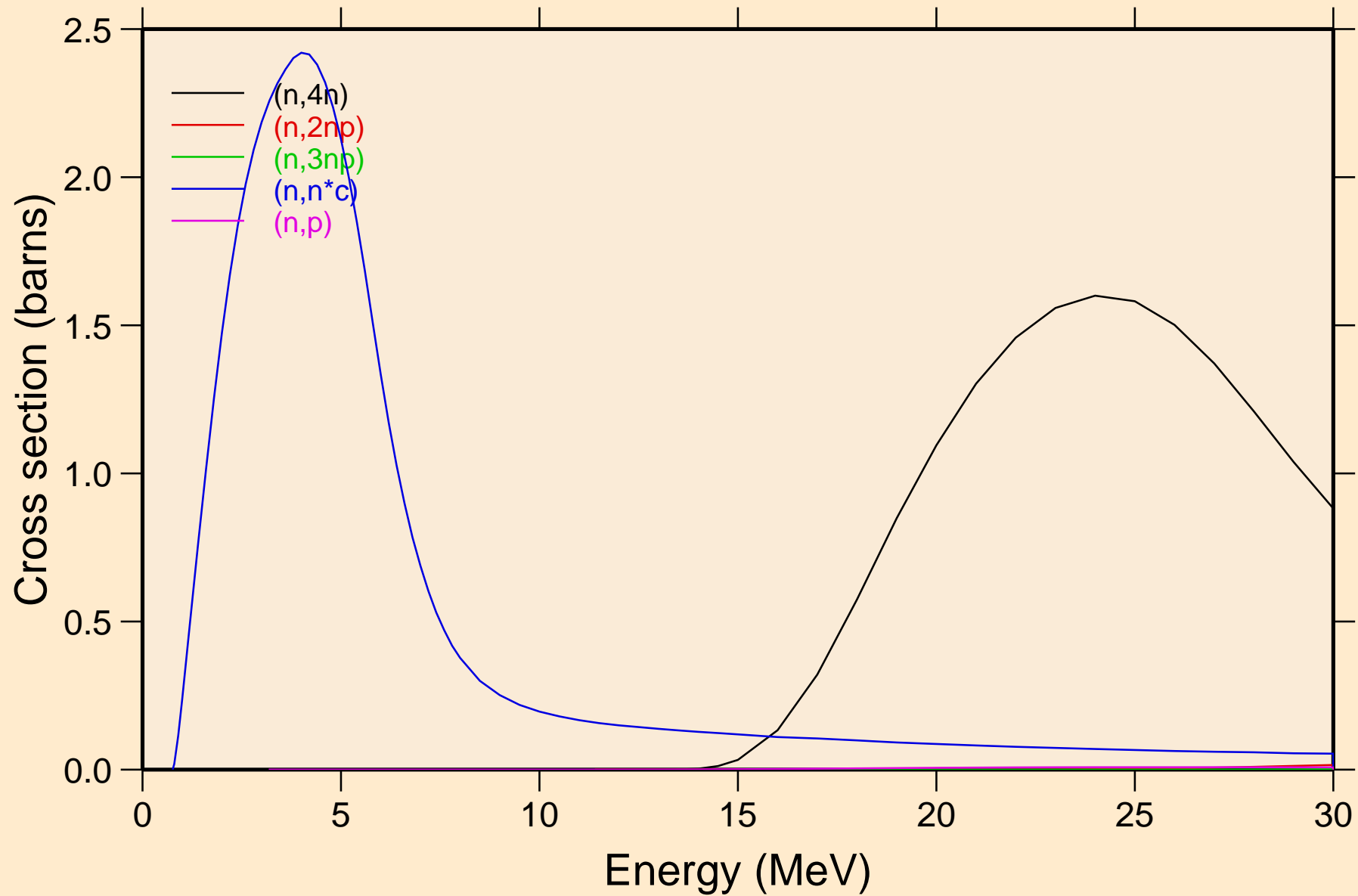

TL210 NEUTRON ACER TENDL-2023 LIBRARY; T=0.K  
Threshold reactions

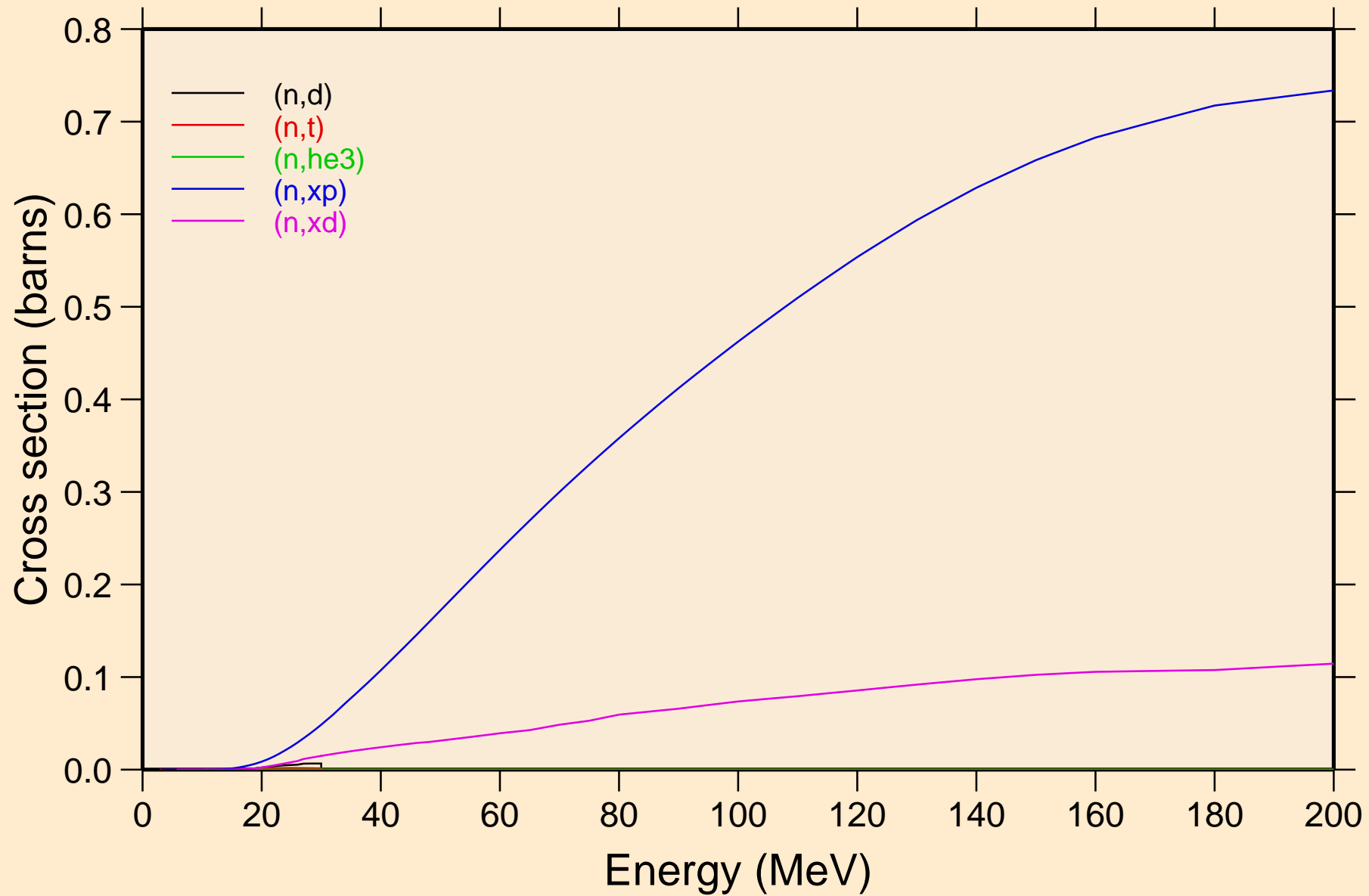

TL210 NEUTRON ACER TENDL-2023 LIBRARY; T=0.K  
Threshold reactions

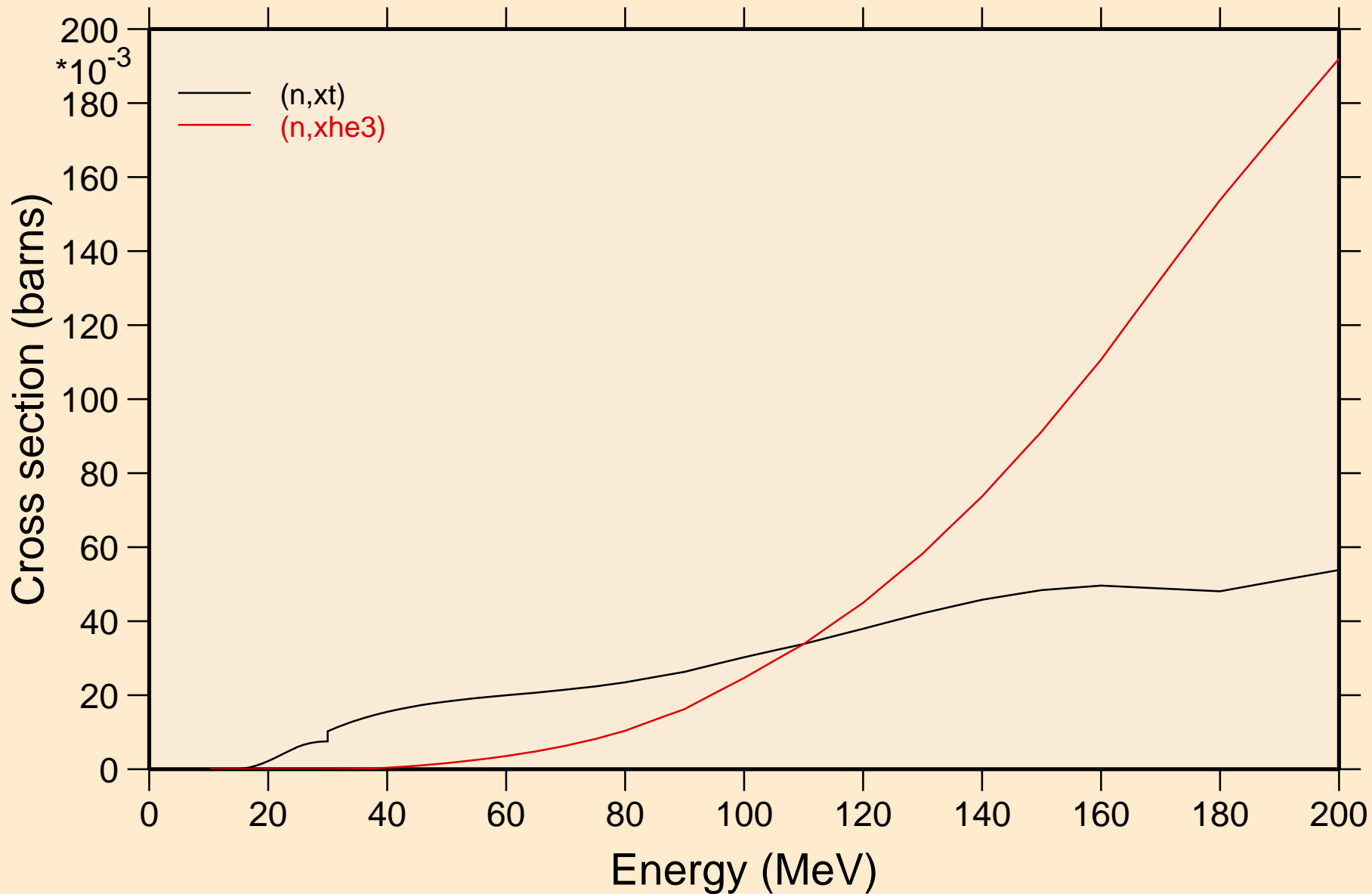

TL210 NEUTRON ACER TENDL-2023 LIBRARY; T=0.K  
angular distribution for elastic

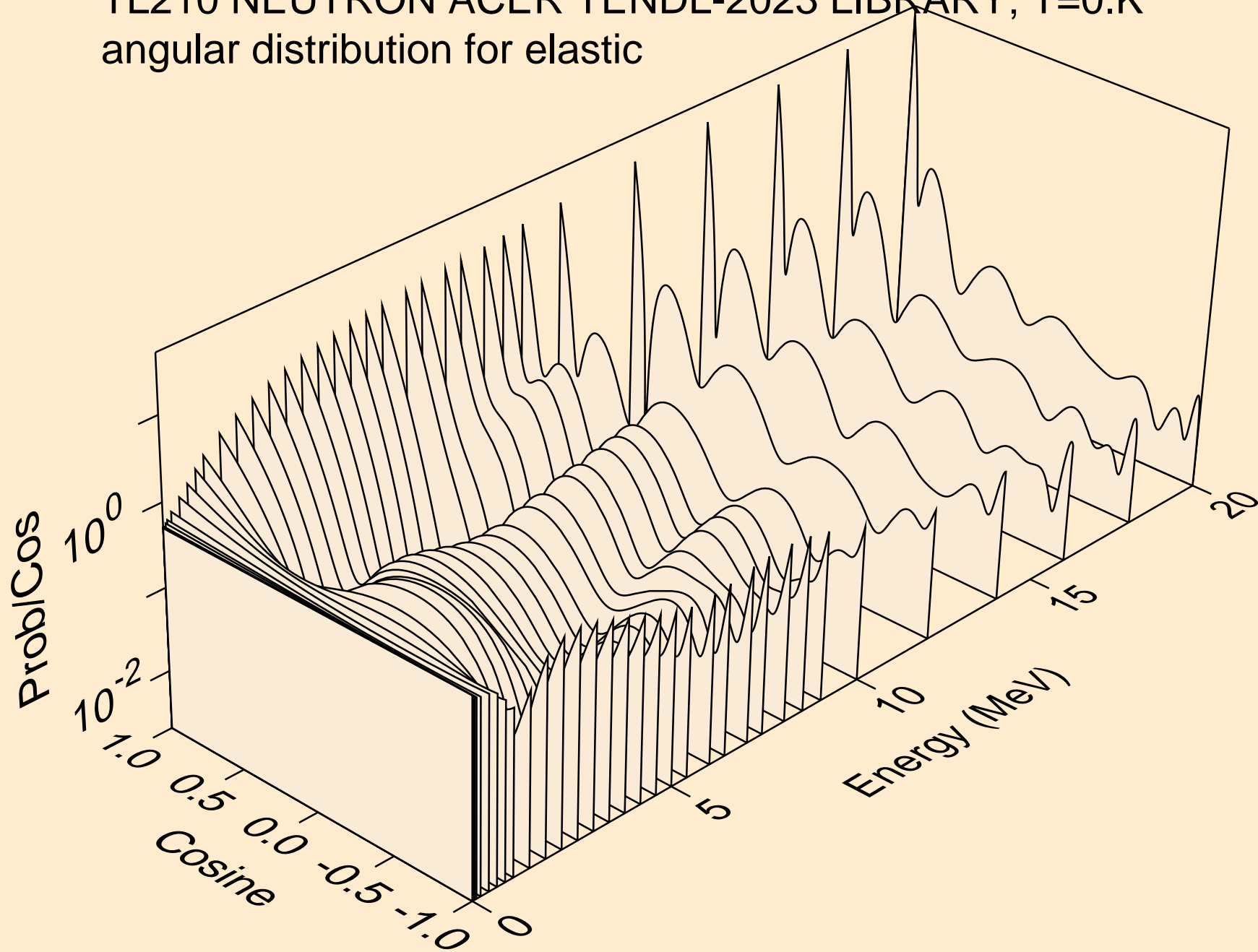

TL210 NEUTRON ACER TENDL-2023 LIBRARY; T=0.K  
angular distribution for elastic

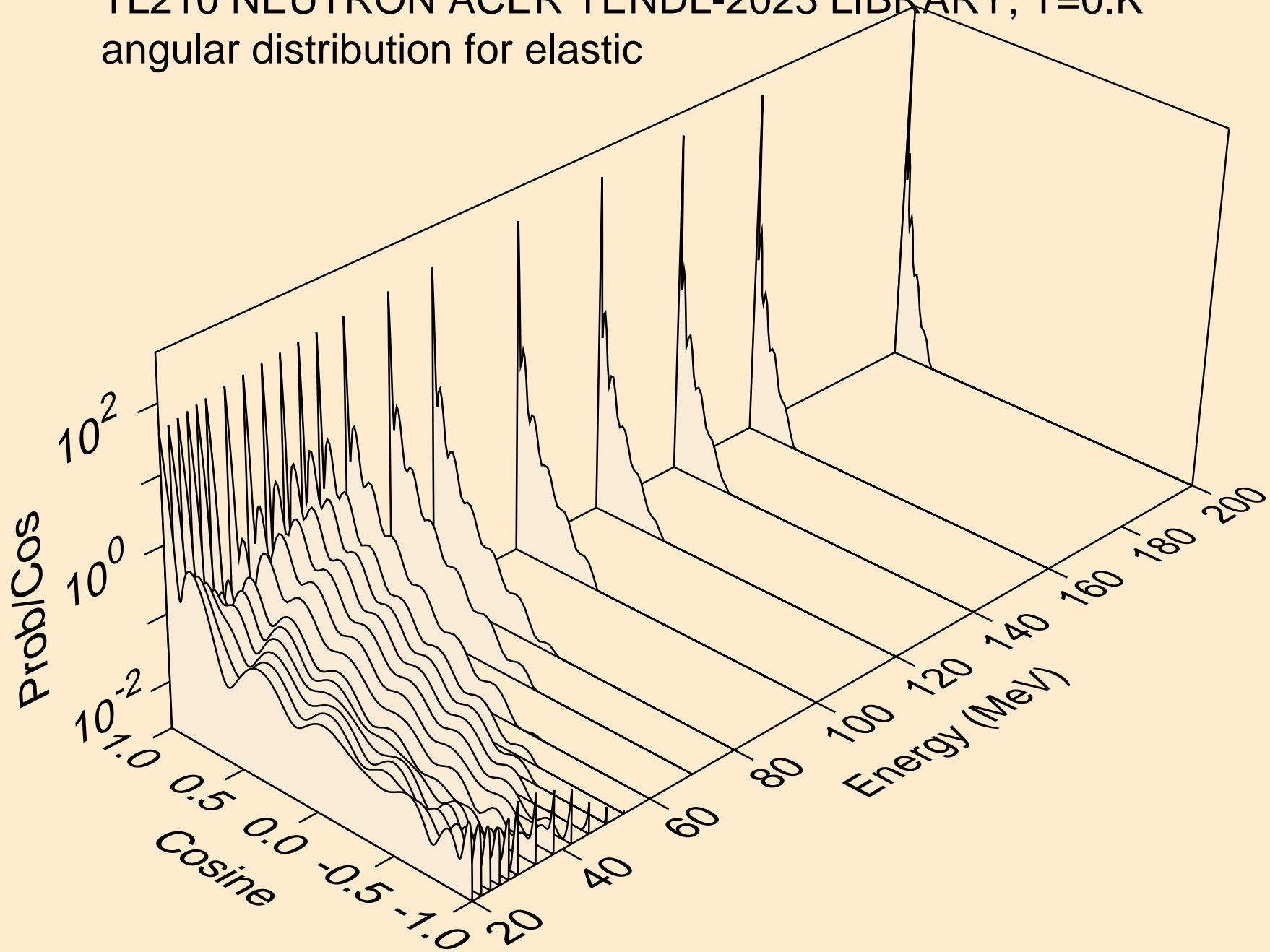

TL210 NEUTRON ACER TENDL-2023 LIBRARY; T=0.K  
angular distribution for (n,n\*1)

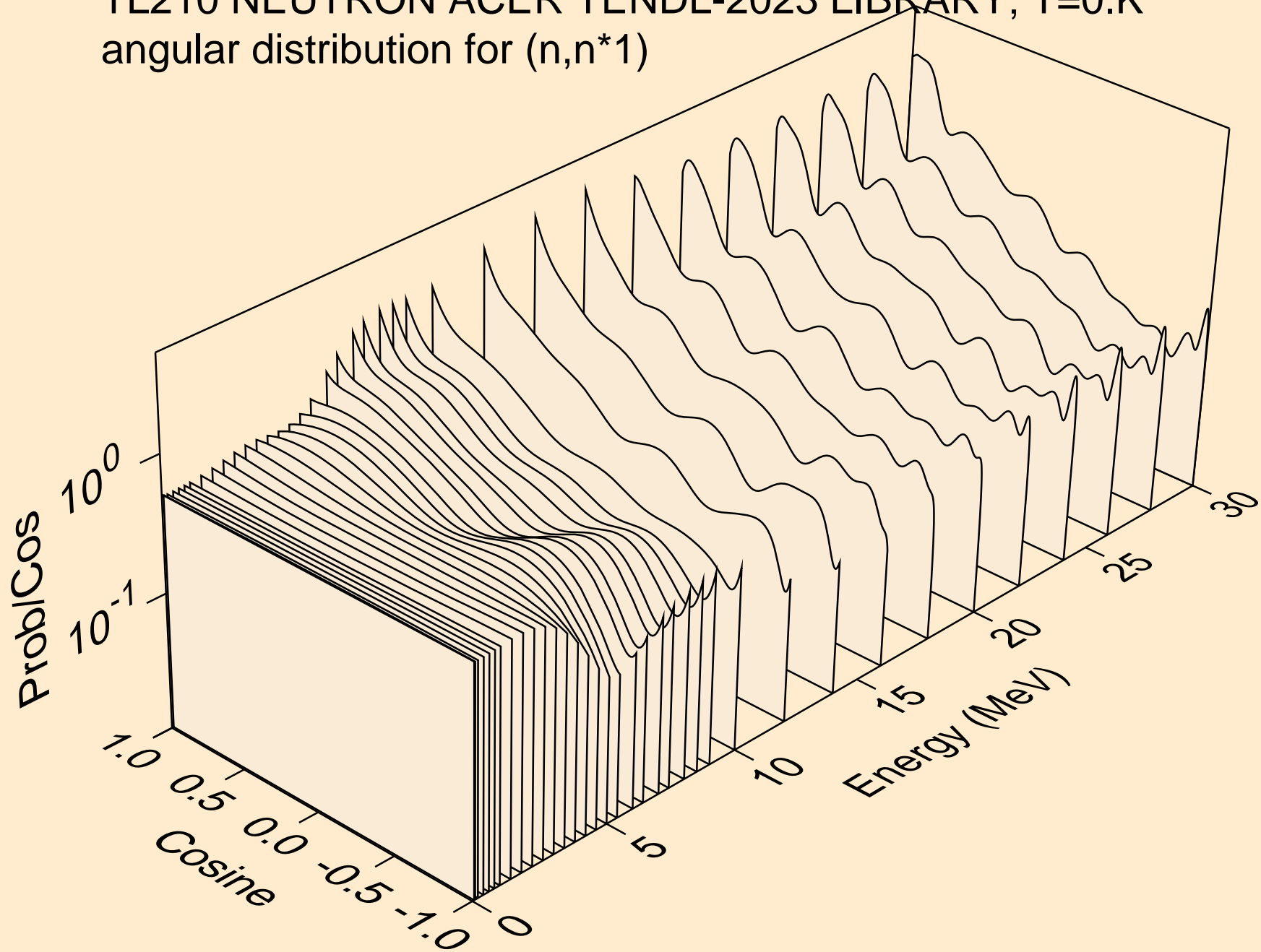

TL210 NEUTRON ACER TENDL-2023 LIBRARY; T=0.K  
angular distribution for (n,n\*2)

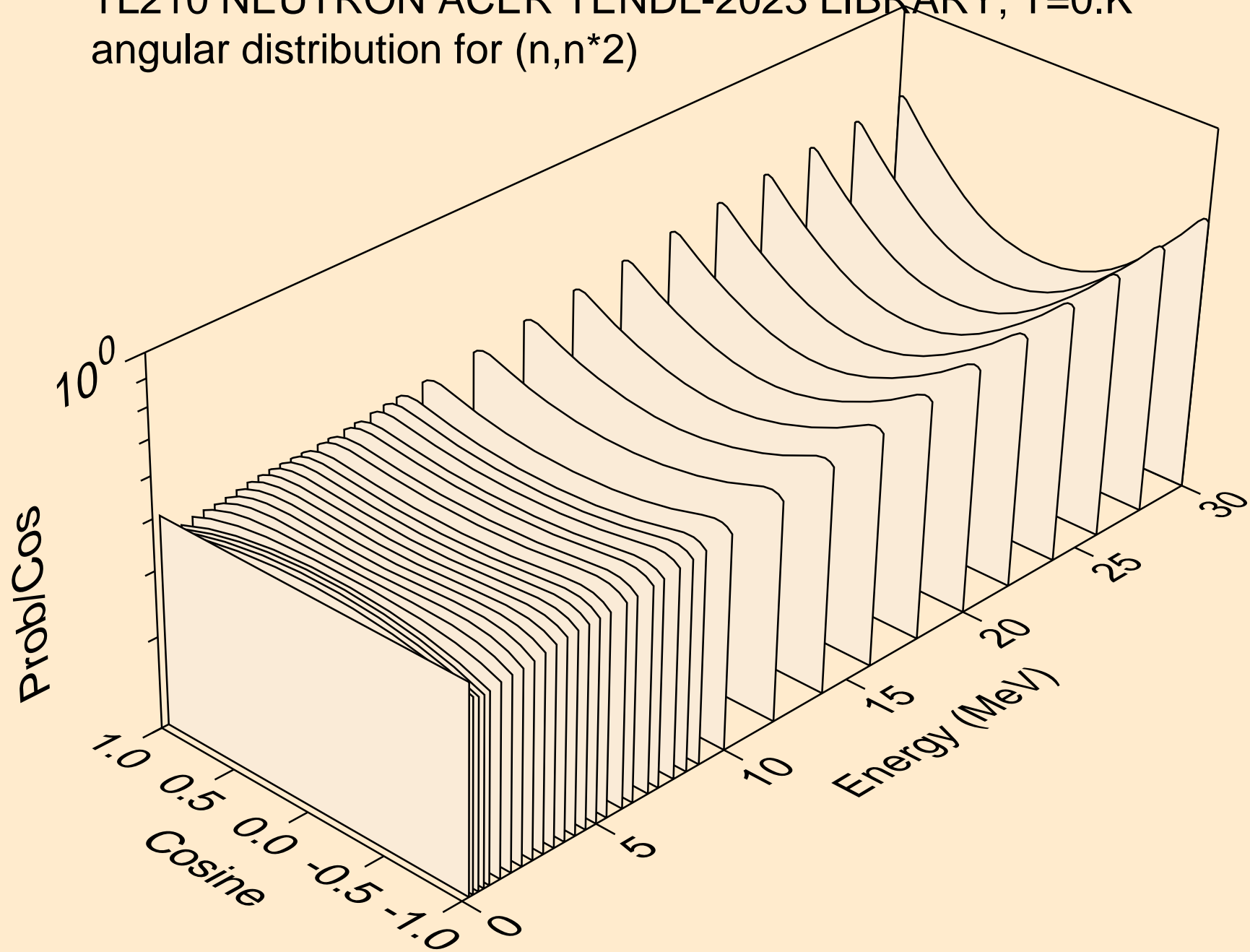

TL210 NEUTRON ACER TENDL-2023 LIBRARY; T=0.K  
angular distribution for (n,n\*3)

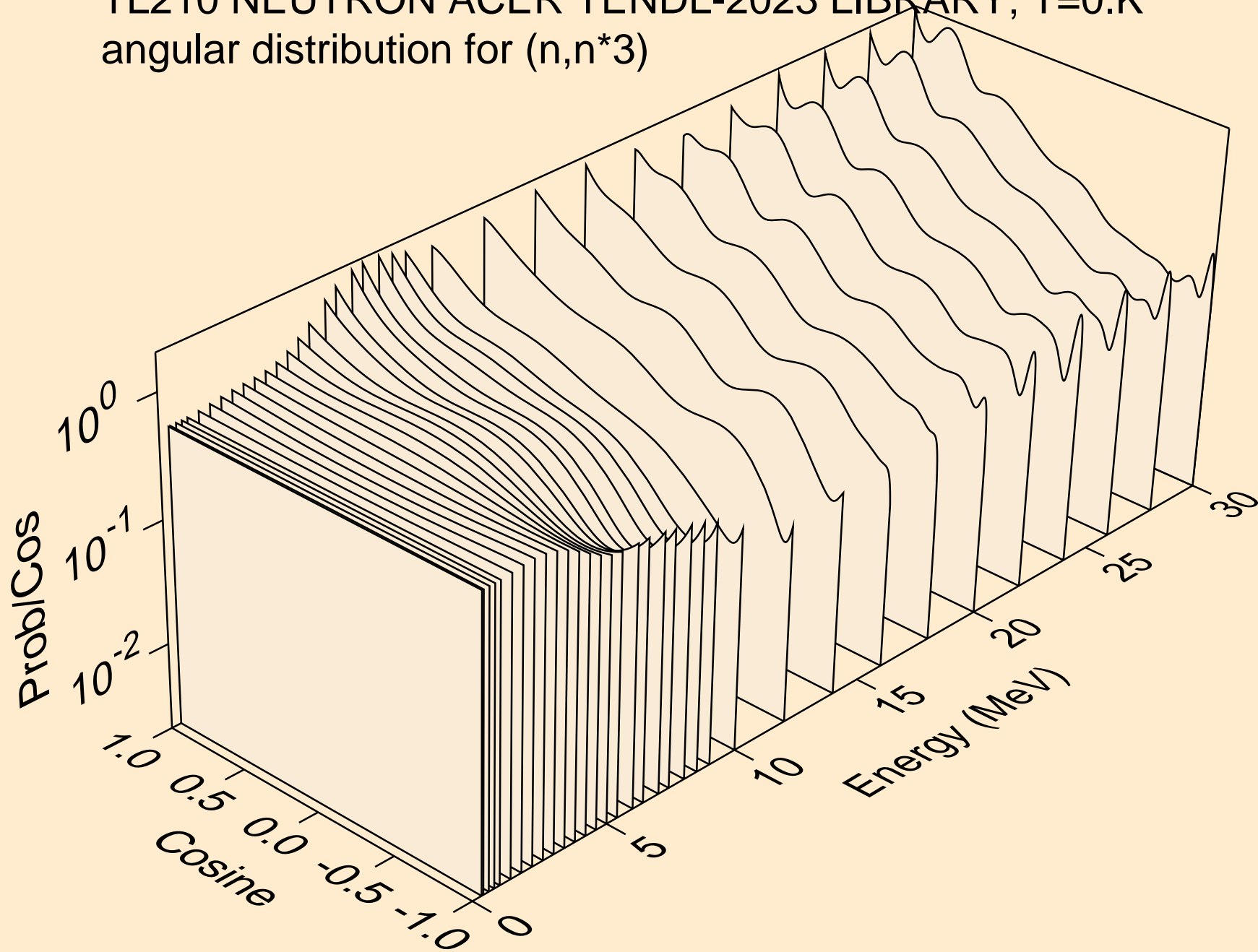

TL210 NEUTRON ACER TENDL-2023 LIBRARY; T=0.K  
angular distribution for (n,n\*4)

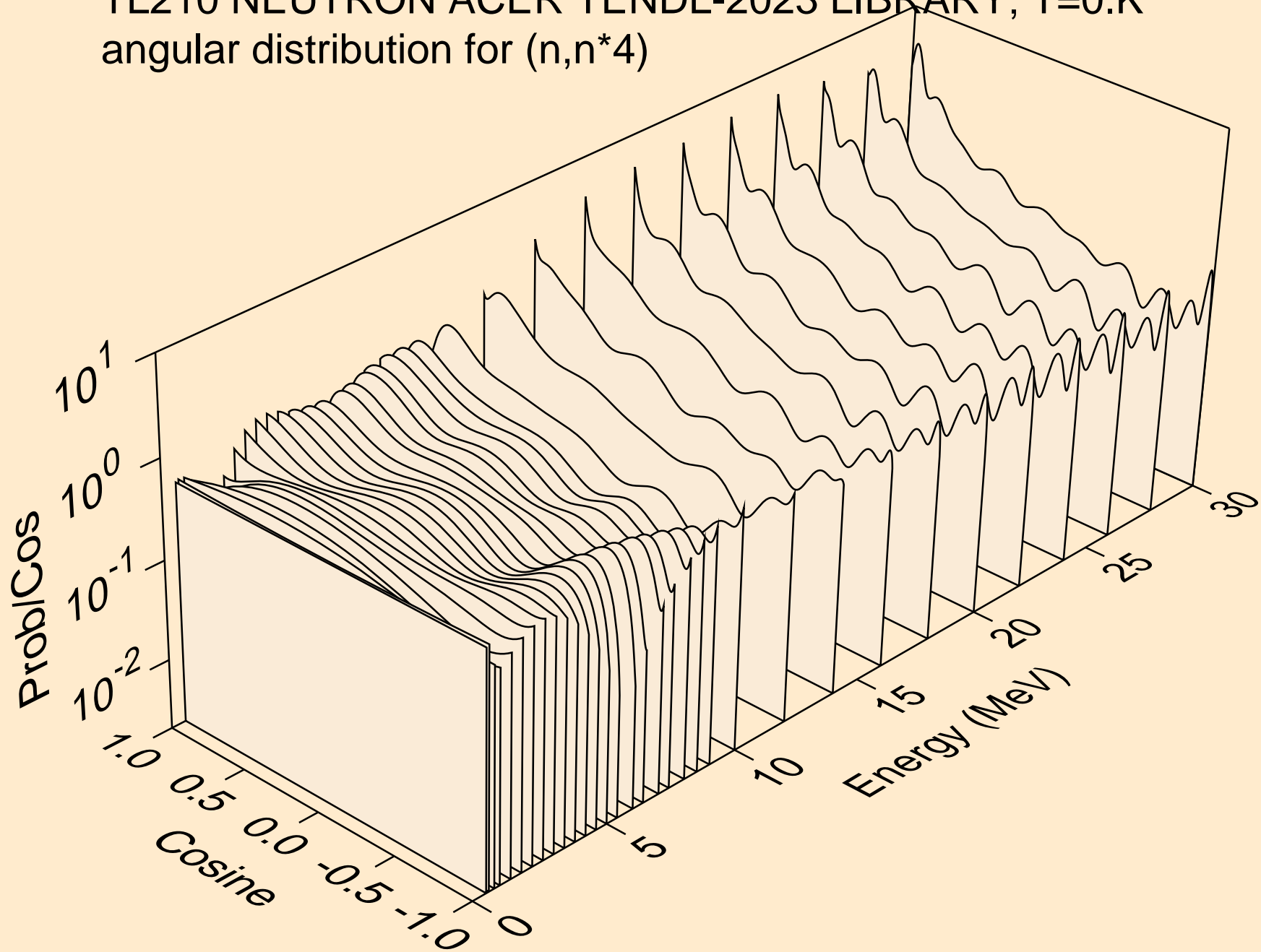

TL210 NEUTRON ACER TENDL-2023 LIBRARY; T=0.K  
angular distribution for (n,n\*5)

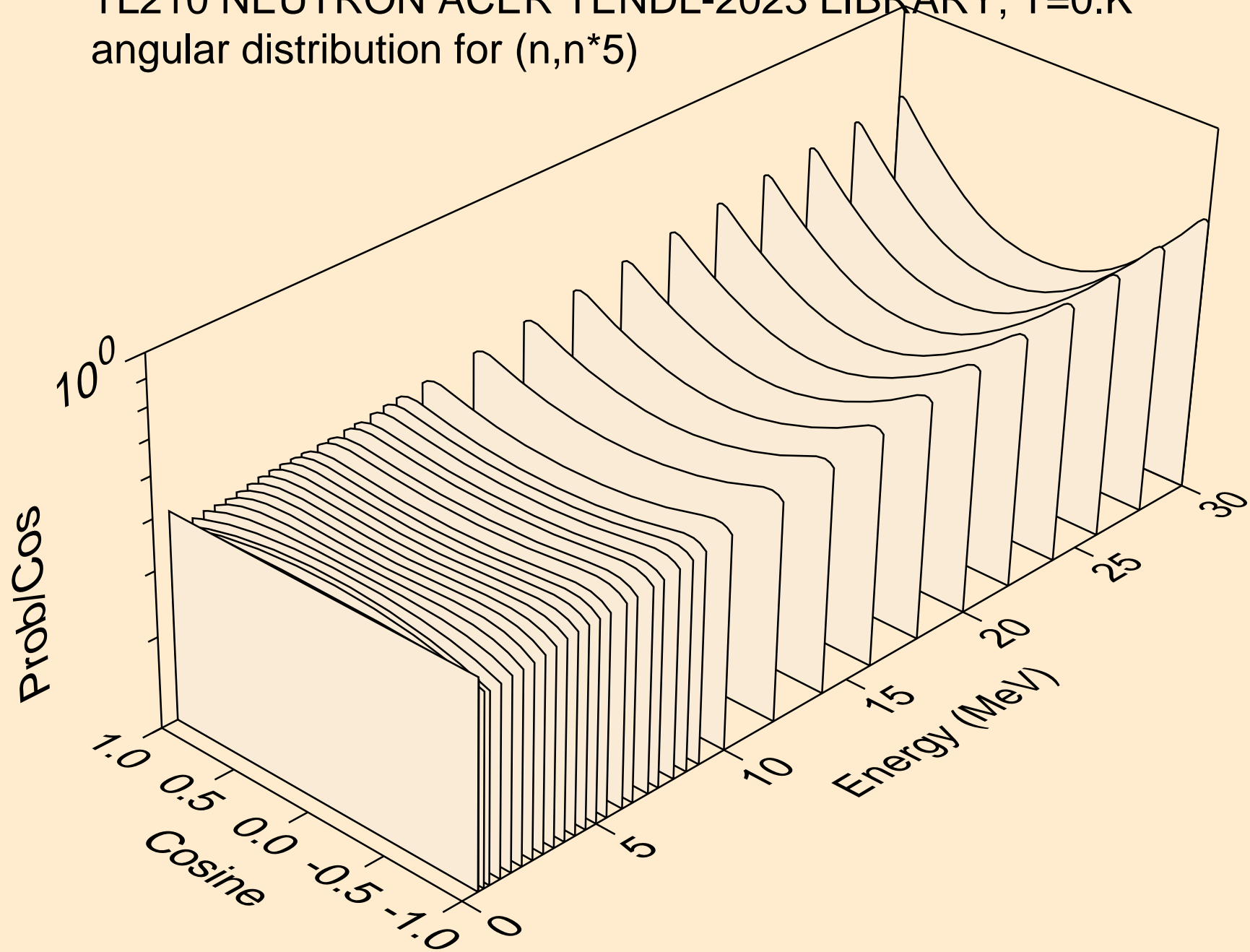

TL210 NEUTRON ACER TENDL-2023 LIBRARY; T=0.K  
angular distribution for (n,n\*6)

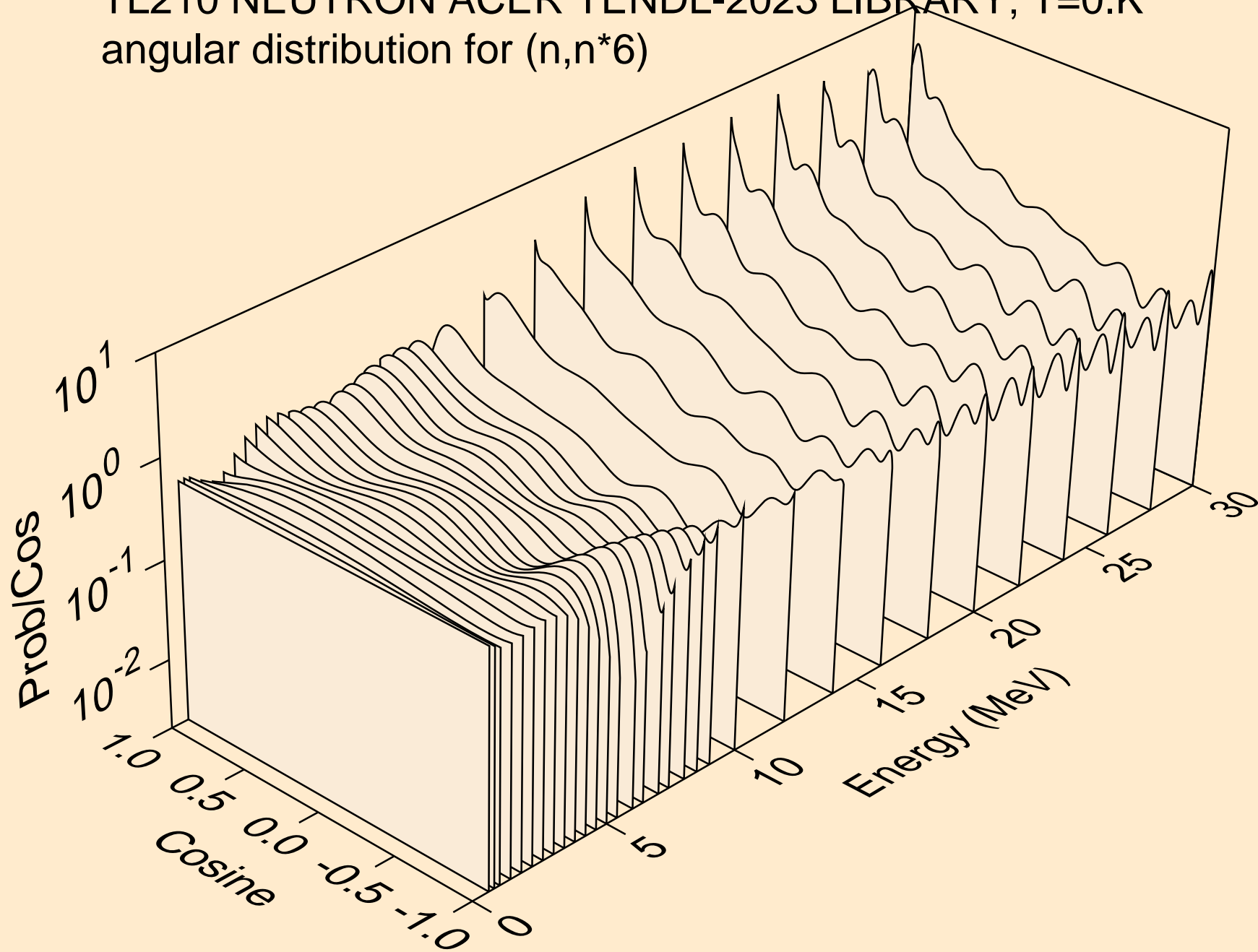

TL210 NEUTRON ACER TENDL-2023 LIBRARY; T=0.K  
angular distribution for (n,n\*7)

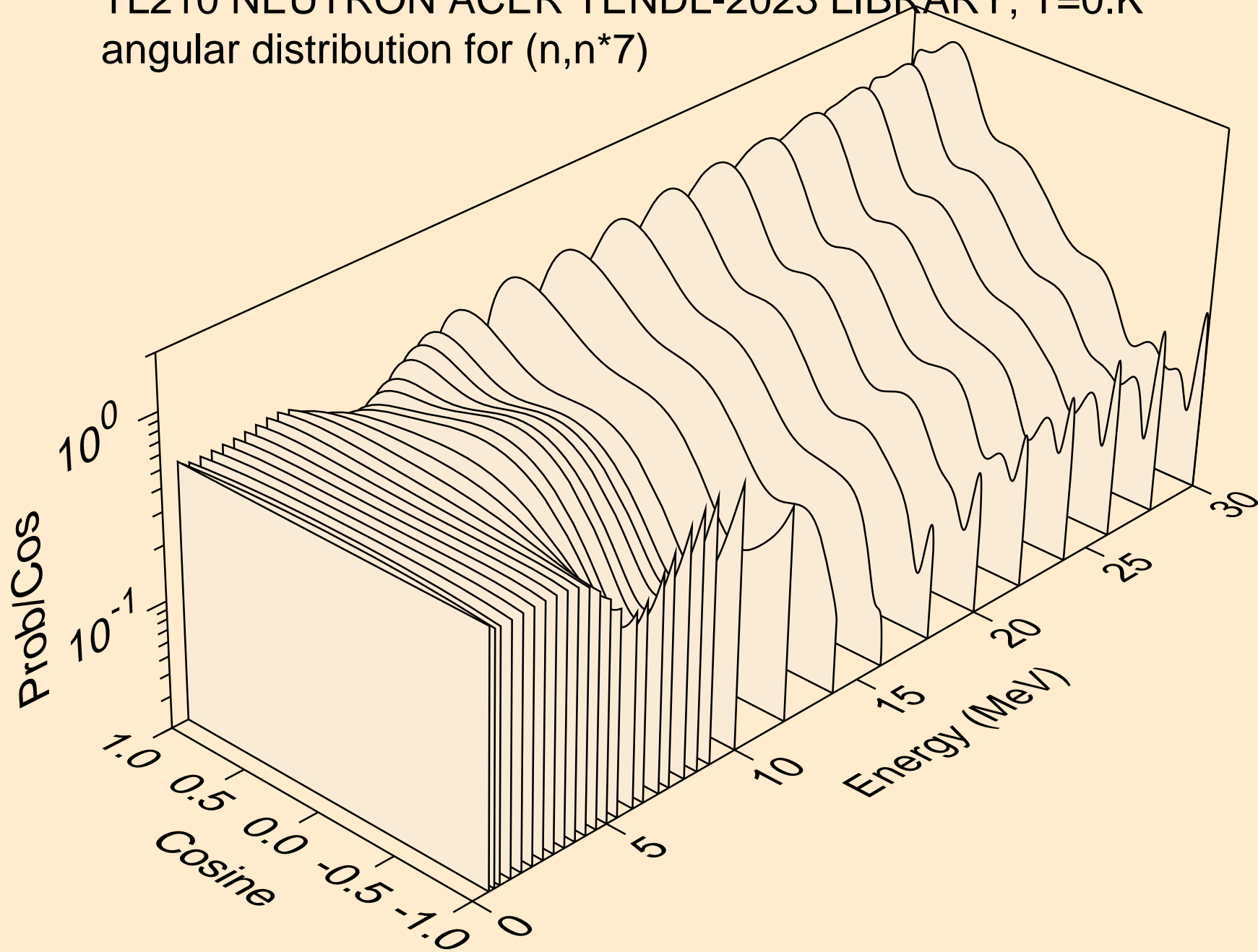

TL210 NEUTRON ACER TENDL-2023 LIBRARY; T=0.K  
angular distribution for (n,n\*8)

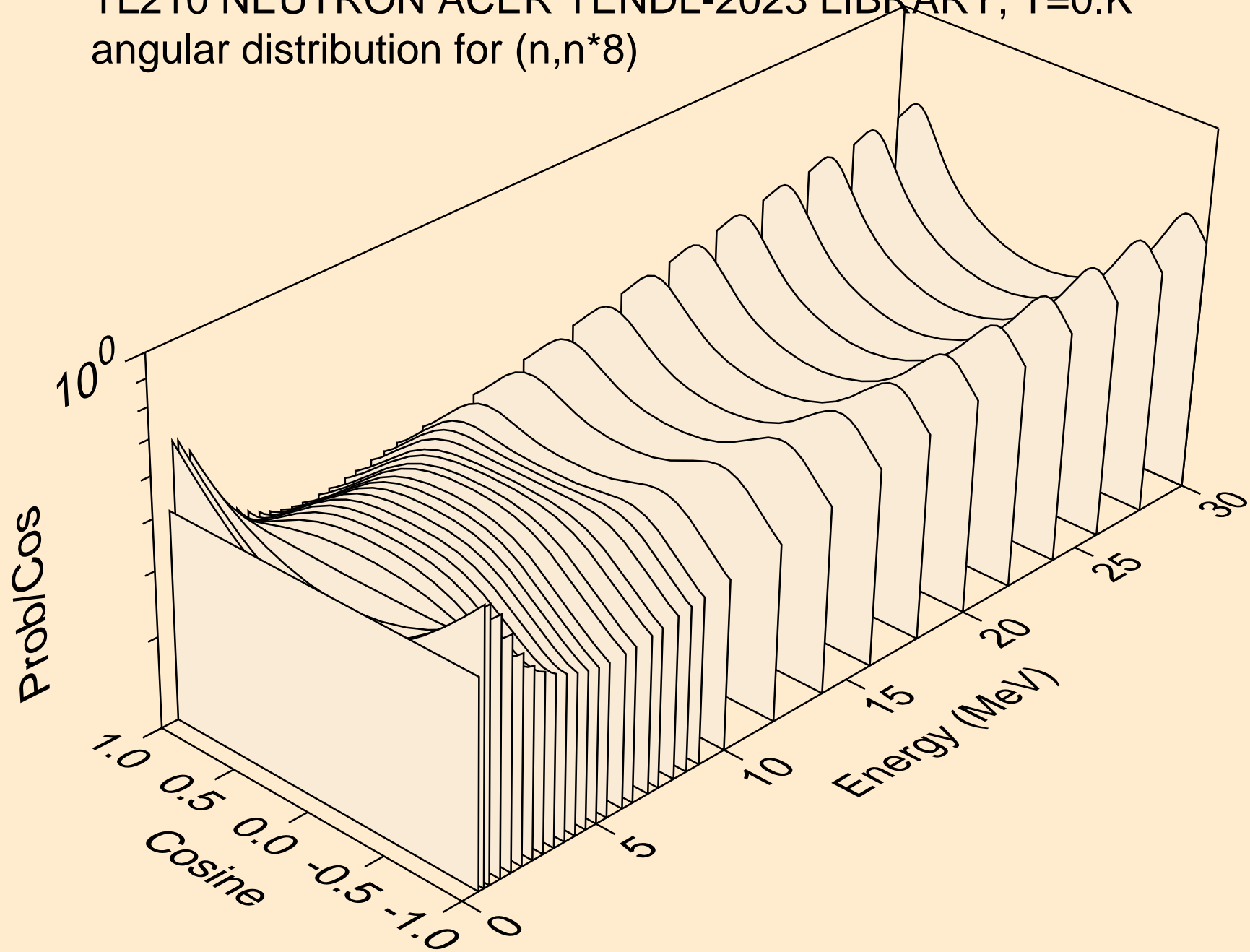

TL210 NEUTRON ACER TENDL-2023 LIBRARY; T=0.K  
angular distribution for (n,n\*9)

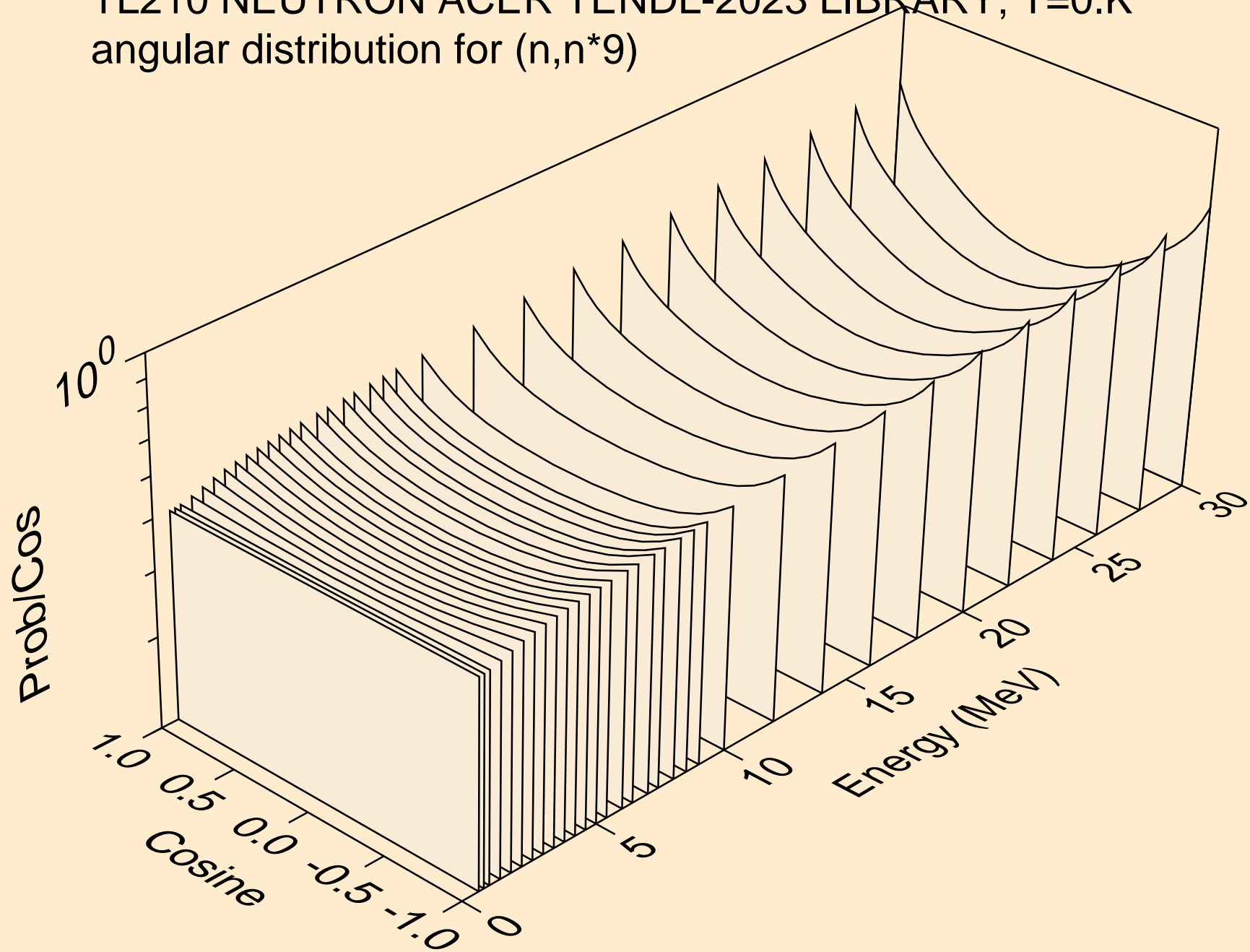

TL210 NEUTRON ACER TENDL-2023 LIBRARY; T=0.K  
angular distribution for (n,n\*10)

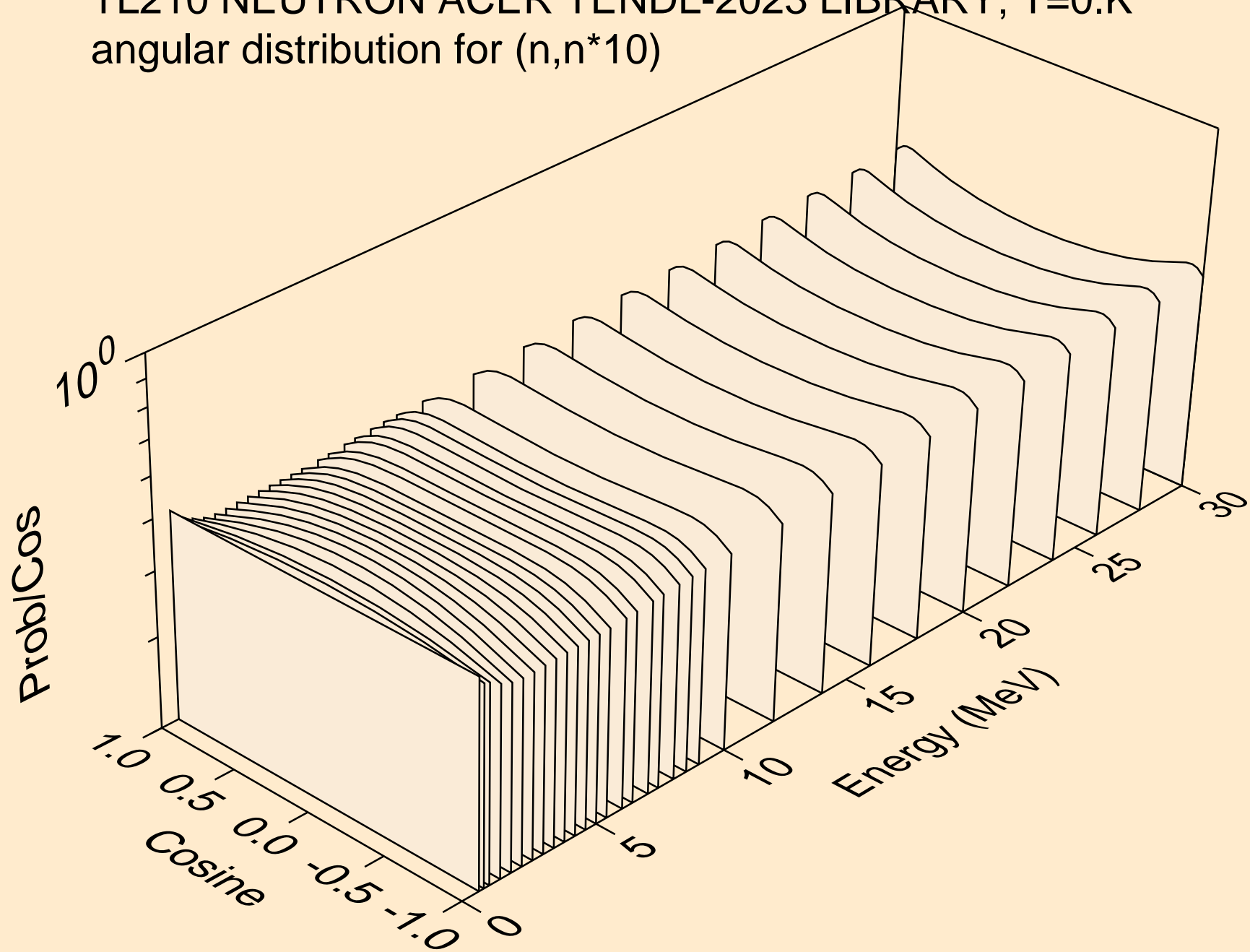

TL210 NEUTRON ACER TENDL-2023 LIBRARY; T=0.K  
angular distribution for (n,n\*11)

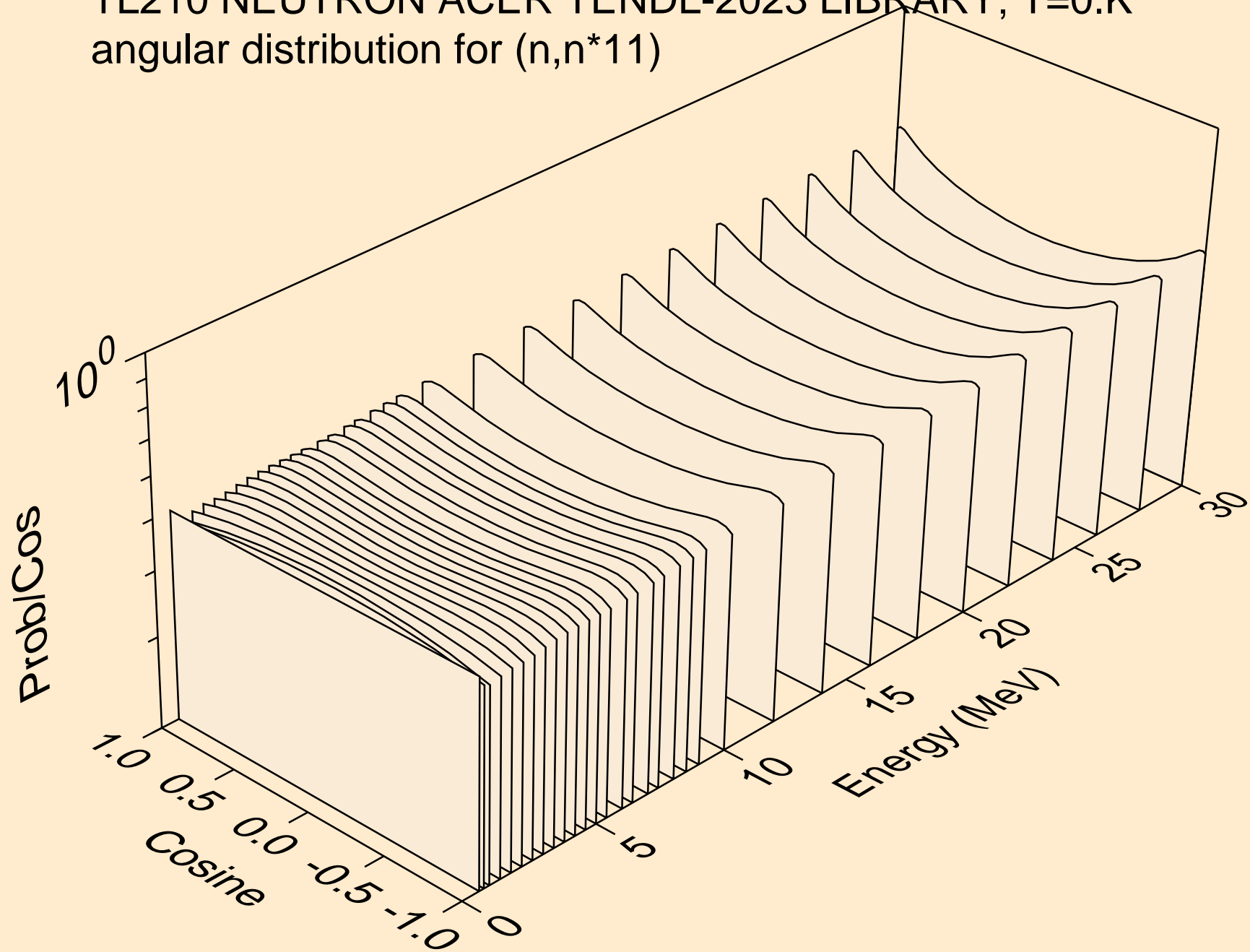

TL210 NEUTRON ACER TENDL-2023 LIBRARY; T=0.K  
angular distribution for (n,n\*12)

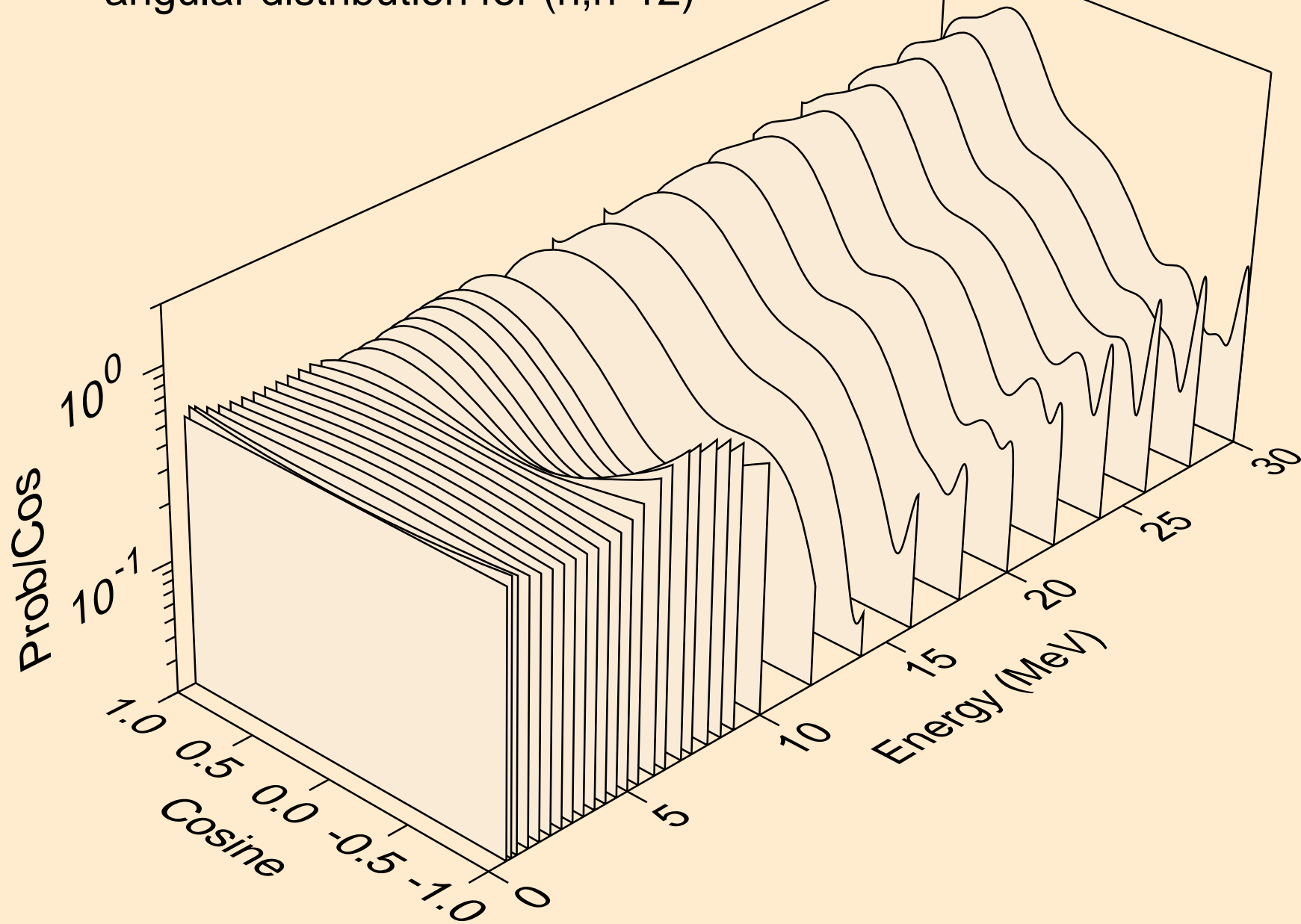

TL210 NEUTRON ACER TENDL-2023 LIBRARY; T=0.K  
angular distribution for (n,n\*13)

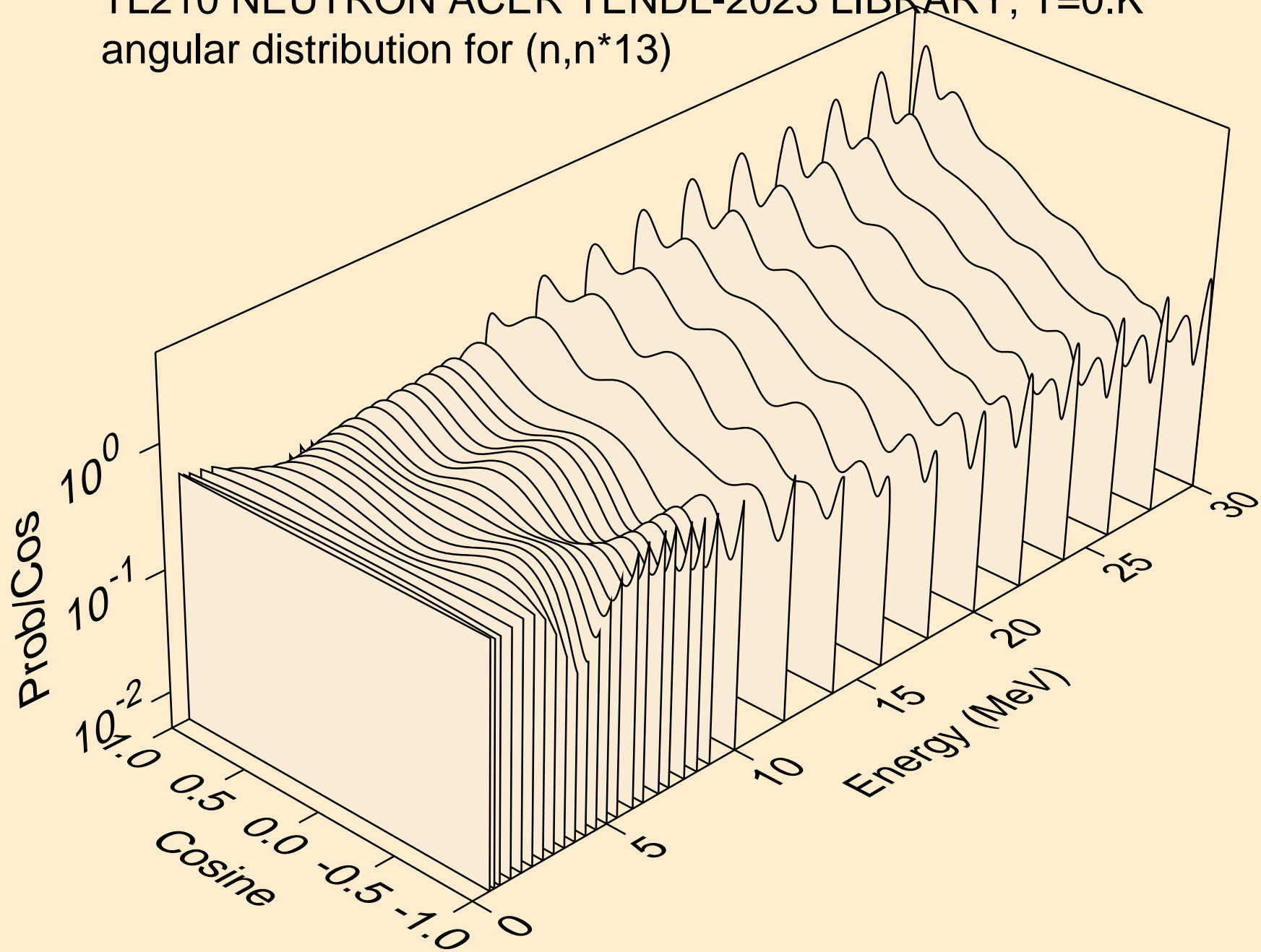

TL210 NEUTRON ACER TENDL-2023 LIBRARY; T=0.K  
angular distribution for (n,n\*14)

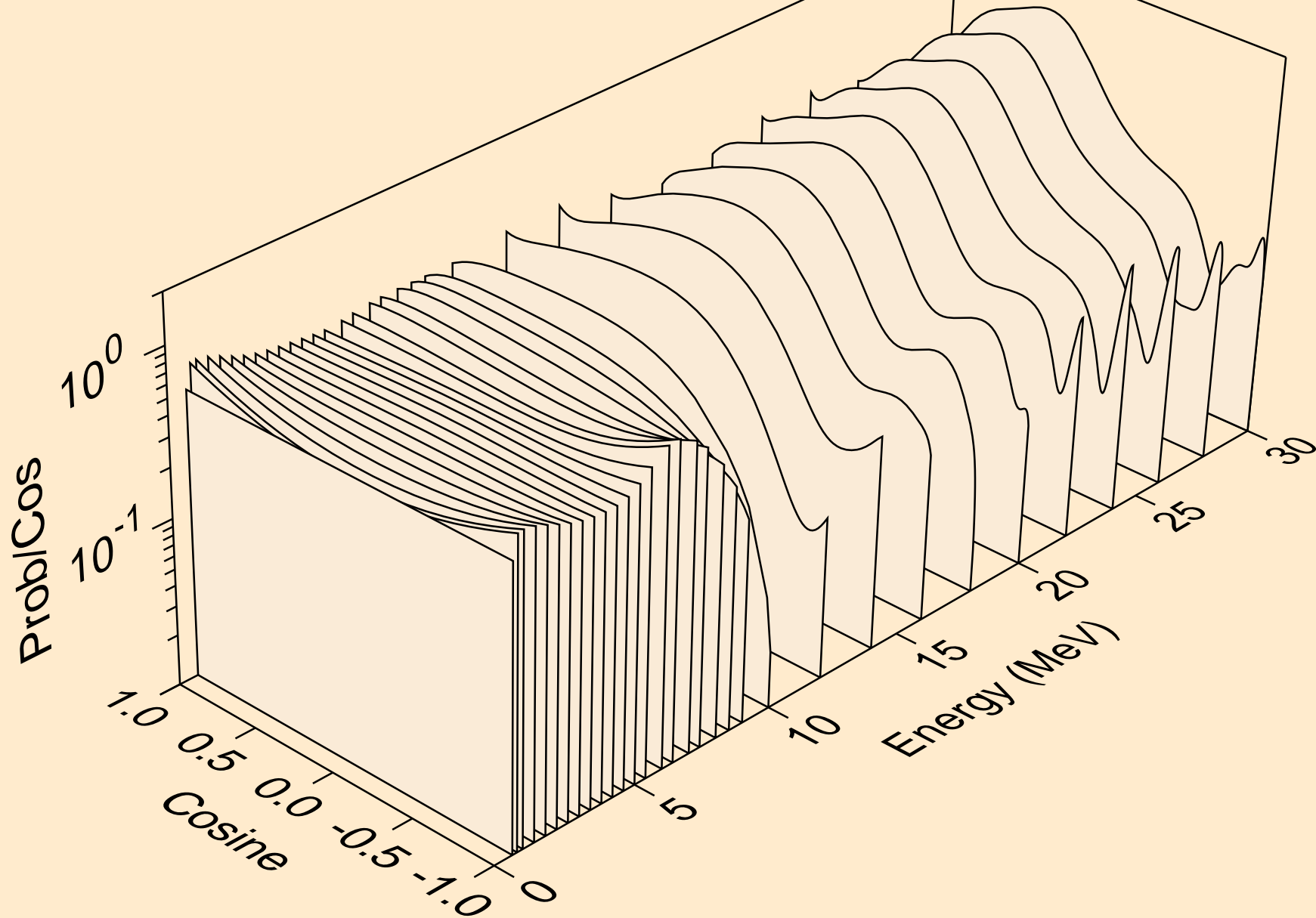

TL210 NEUTRON ACER TENDL-2023 LIBRARY; T=0.K  
angular distribution for (n,n\*15)

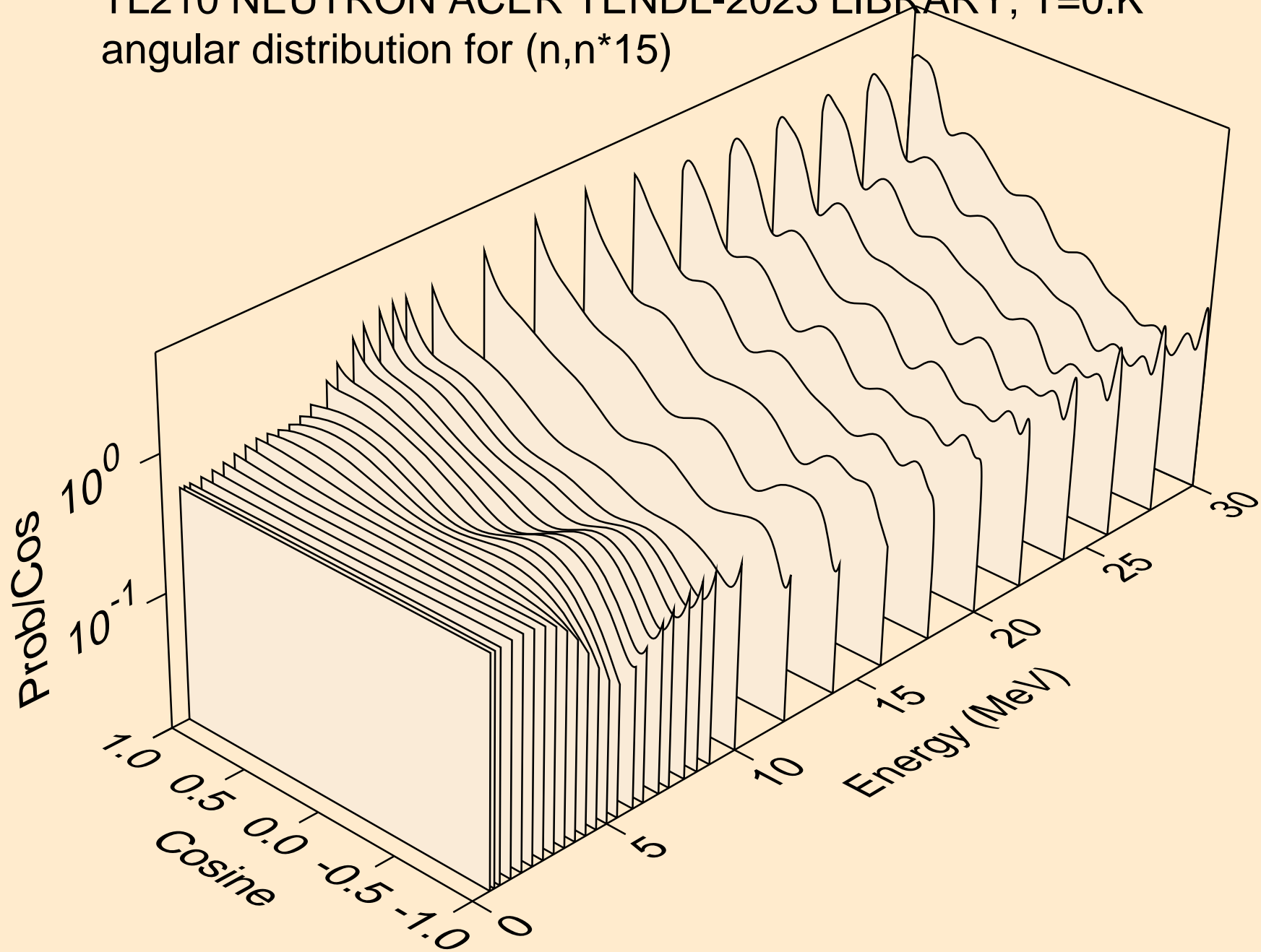

TL210 NEUTRON ACER TENDL-2023 LIBRARY; T=0.K  
angular distribution for (n,n\*16)

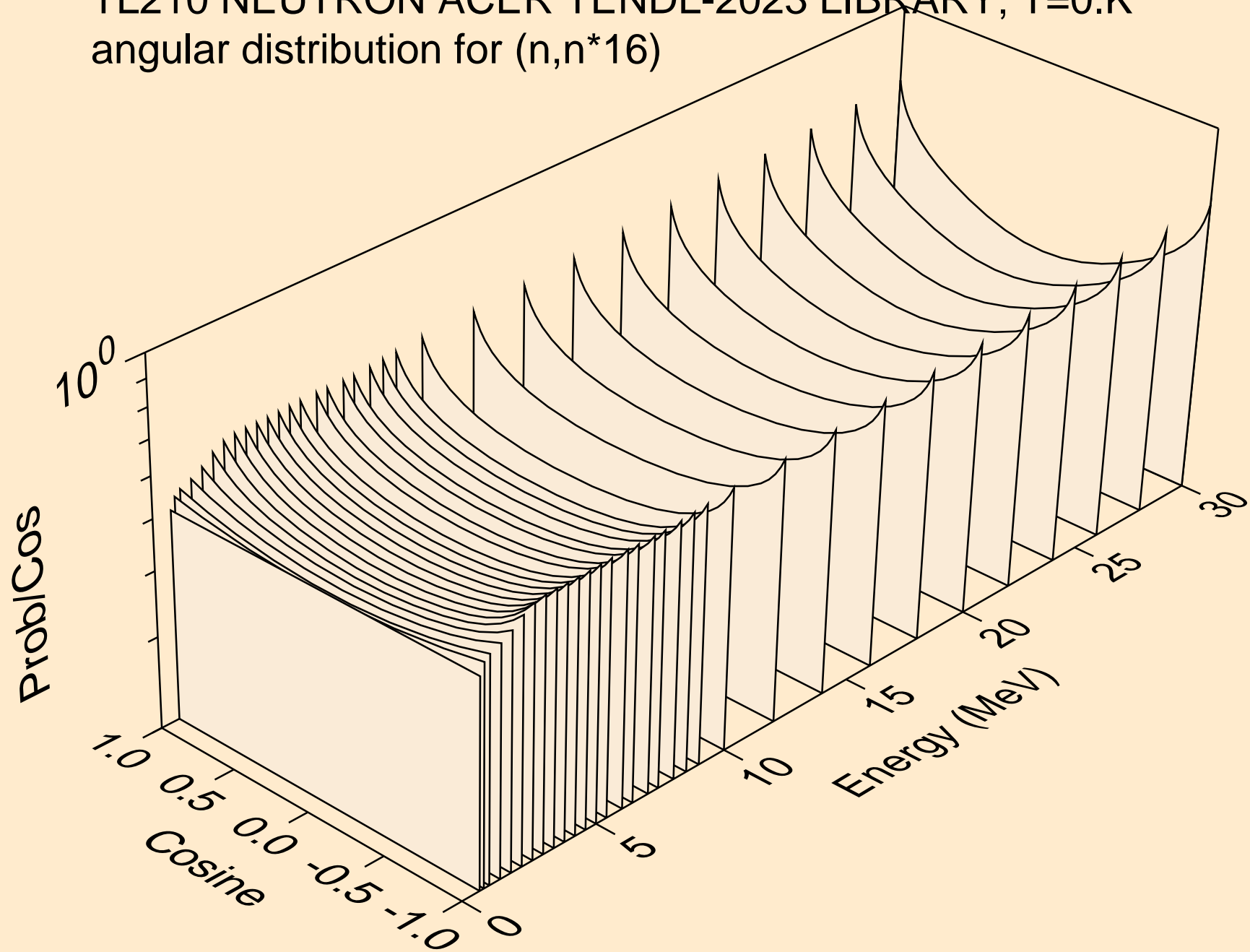

TL210 NEUTRON ACER TENDL-2023 LIBRARY; T=0.K  
angular distribution for (n,n\*17)

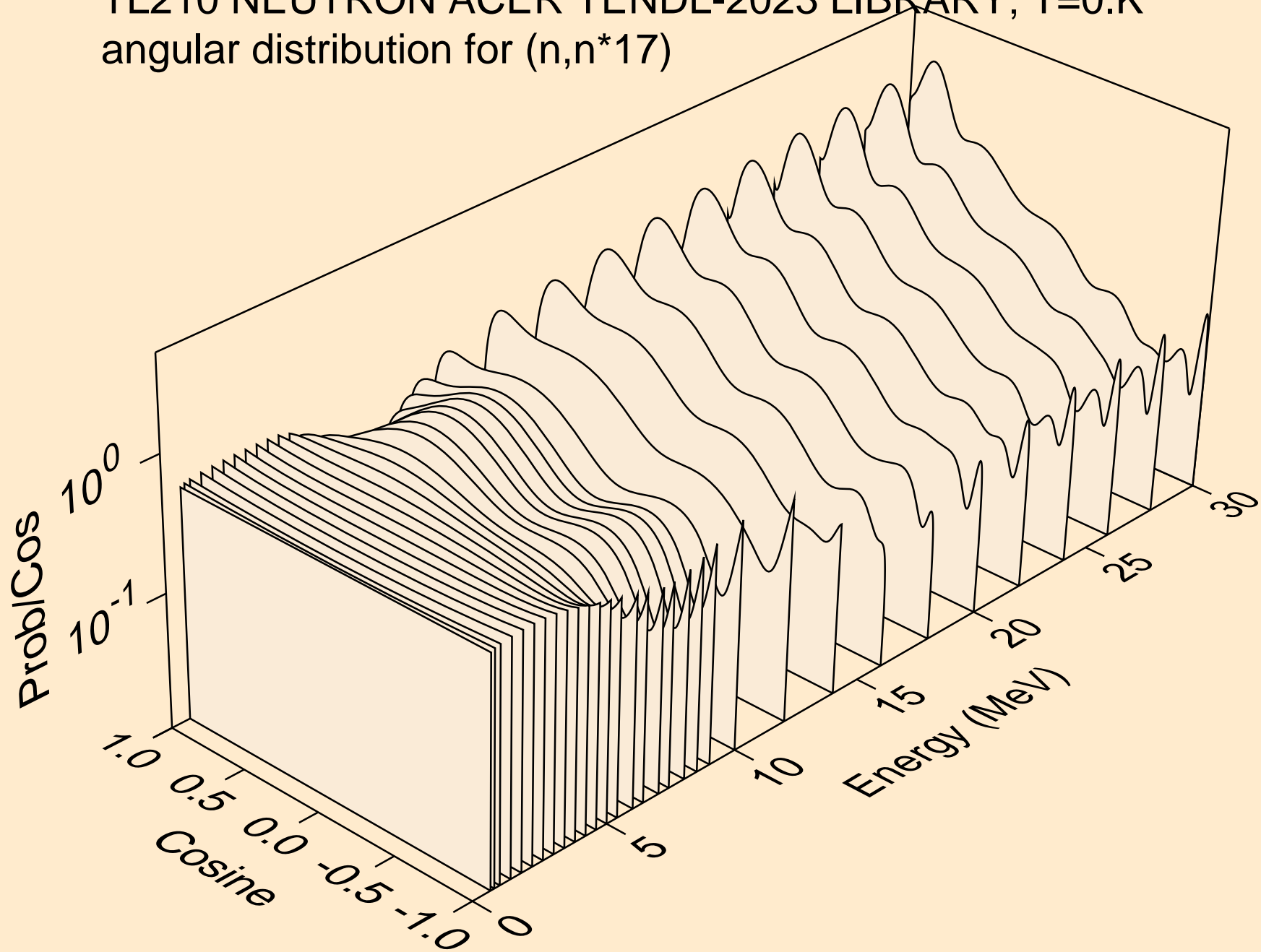

TL210 NEUTRON ACER TENDL-2023 LIBRARY; T=0.K  
angular distribution for (n,n\*18)

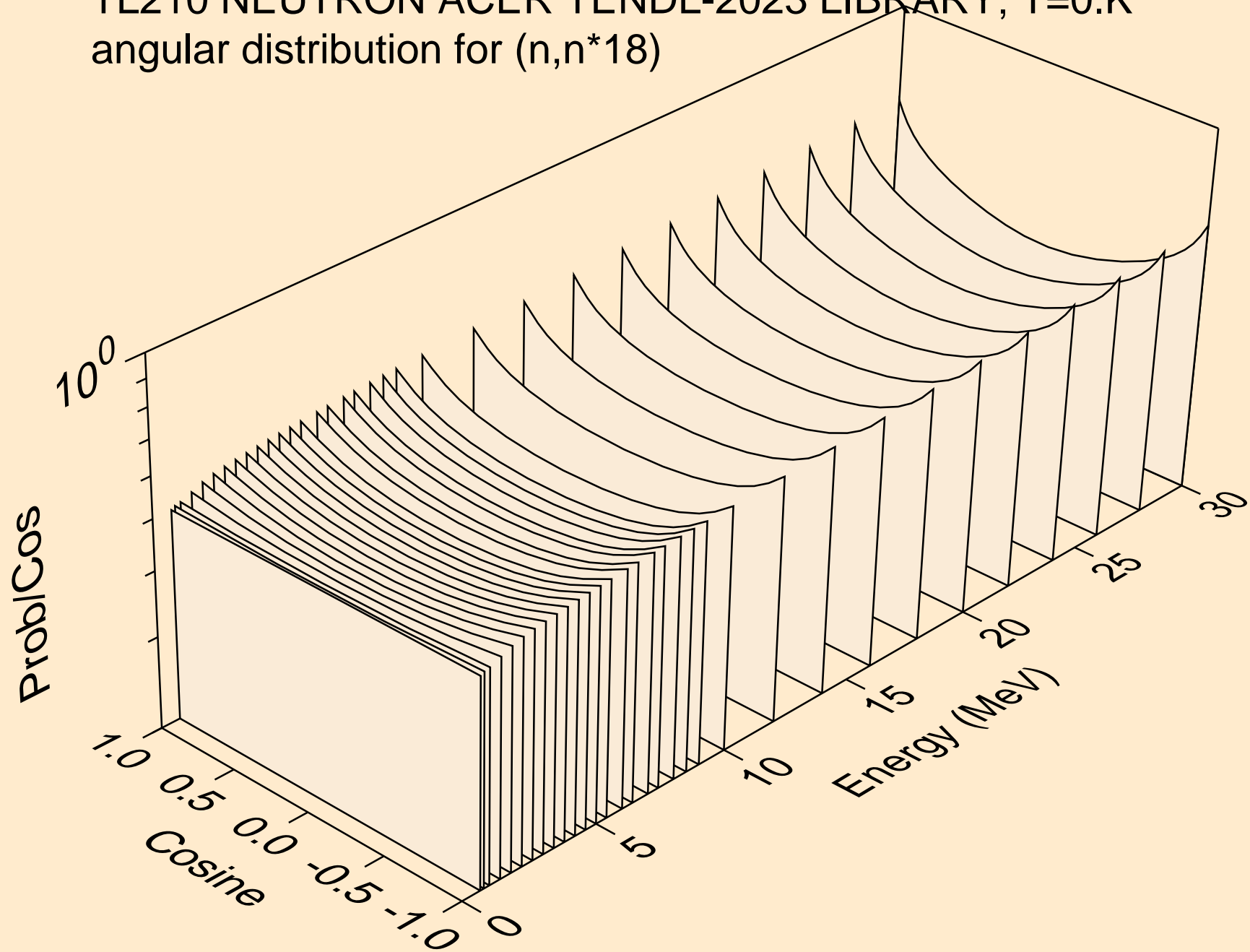

TL210 NEUTRON ACER TENDL-2023 LIBRARY; T=0.K  
angular distribution for (n,n\*19)

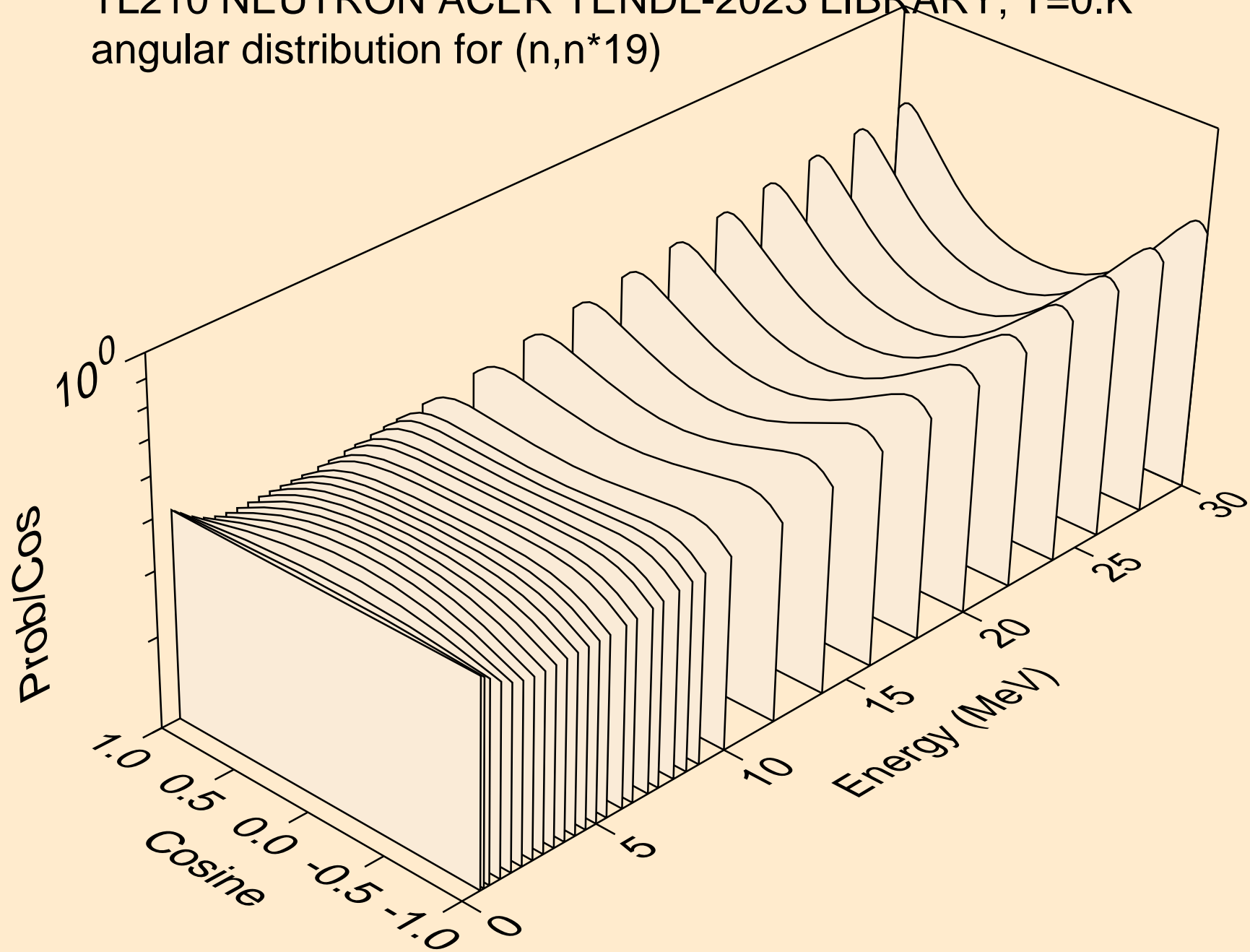

TL210 NEUTRON ACER TENDL-2023 LIBRARY; T=0.K  
angular distribution for (n,n\*20)

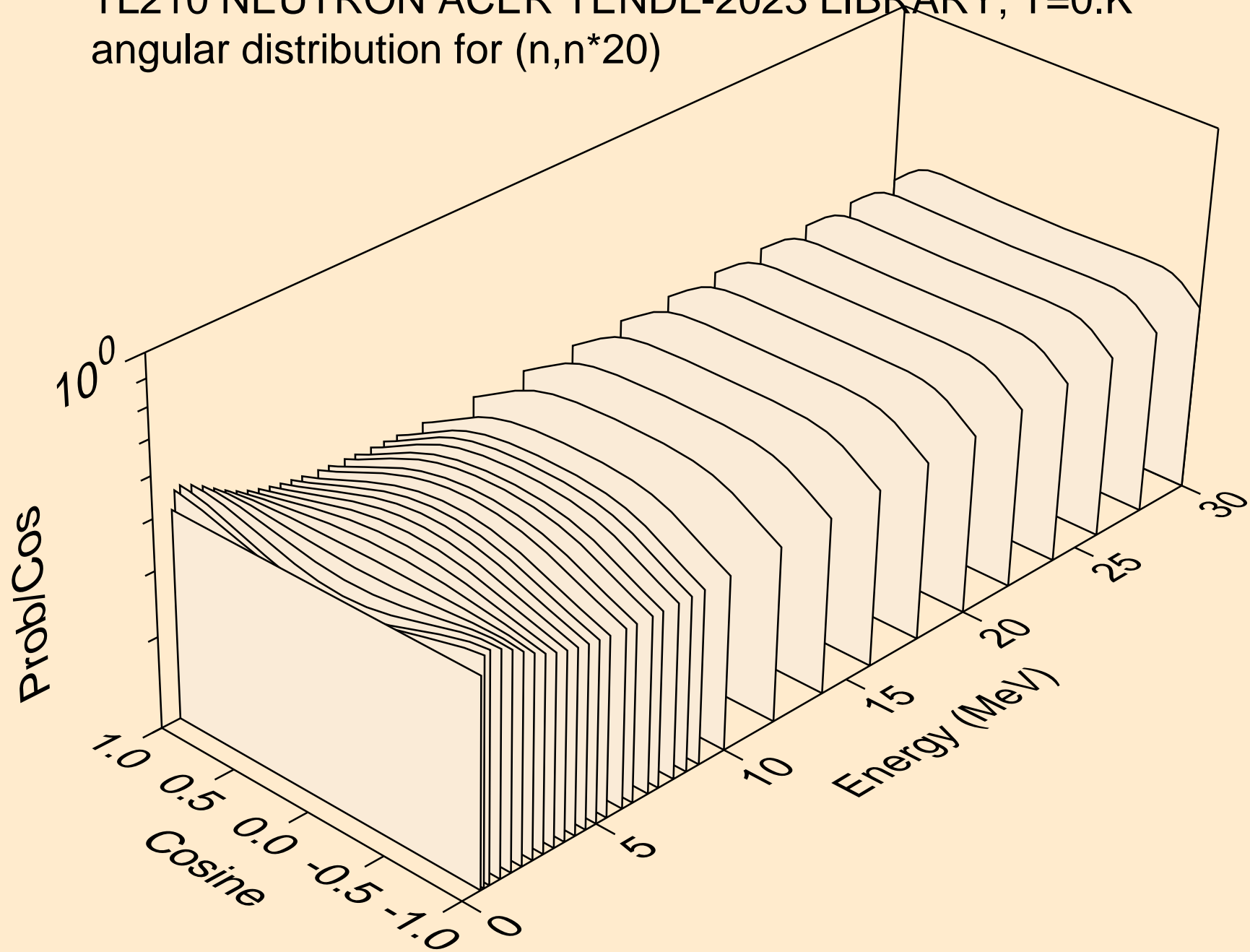

TL210 NEUTRON ACER TENDL-2023 LIBRARY; T=0.K  
angular distribution for (n,n\*21)

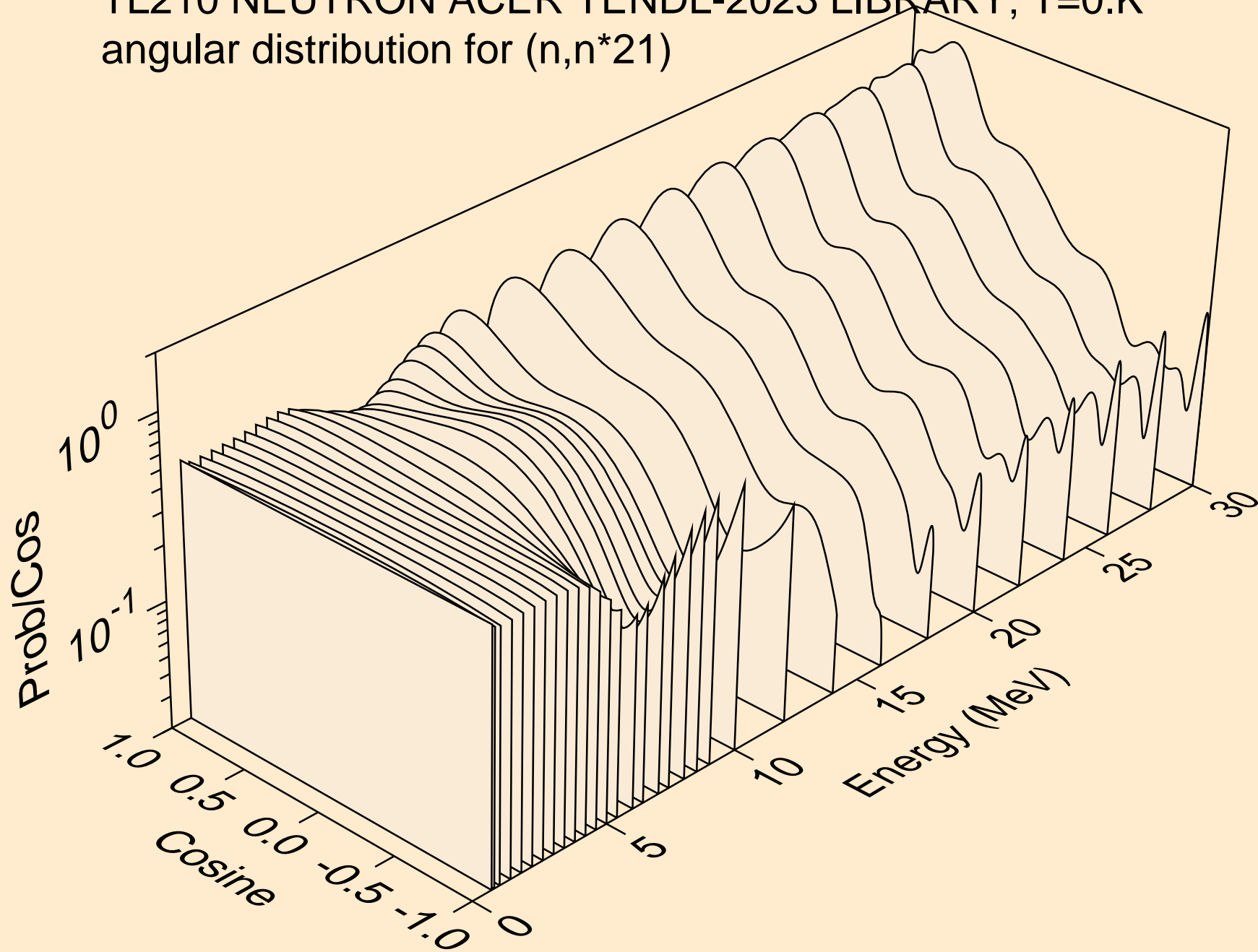

TL210 NEUTRON ACER TENDL-2023 LIBRARY; T=0.K  
angular distribution for (n,n\*22)

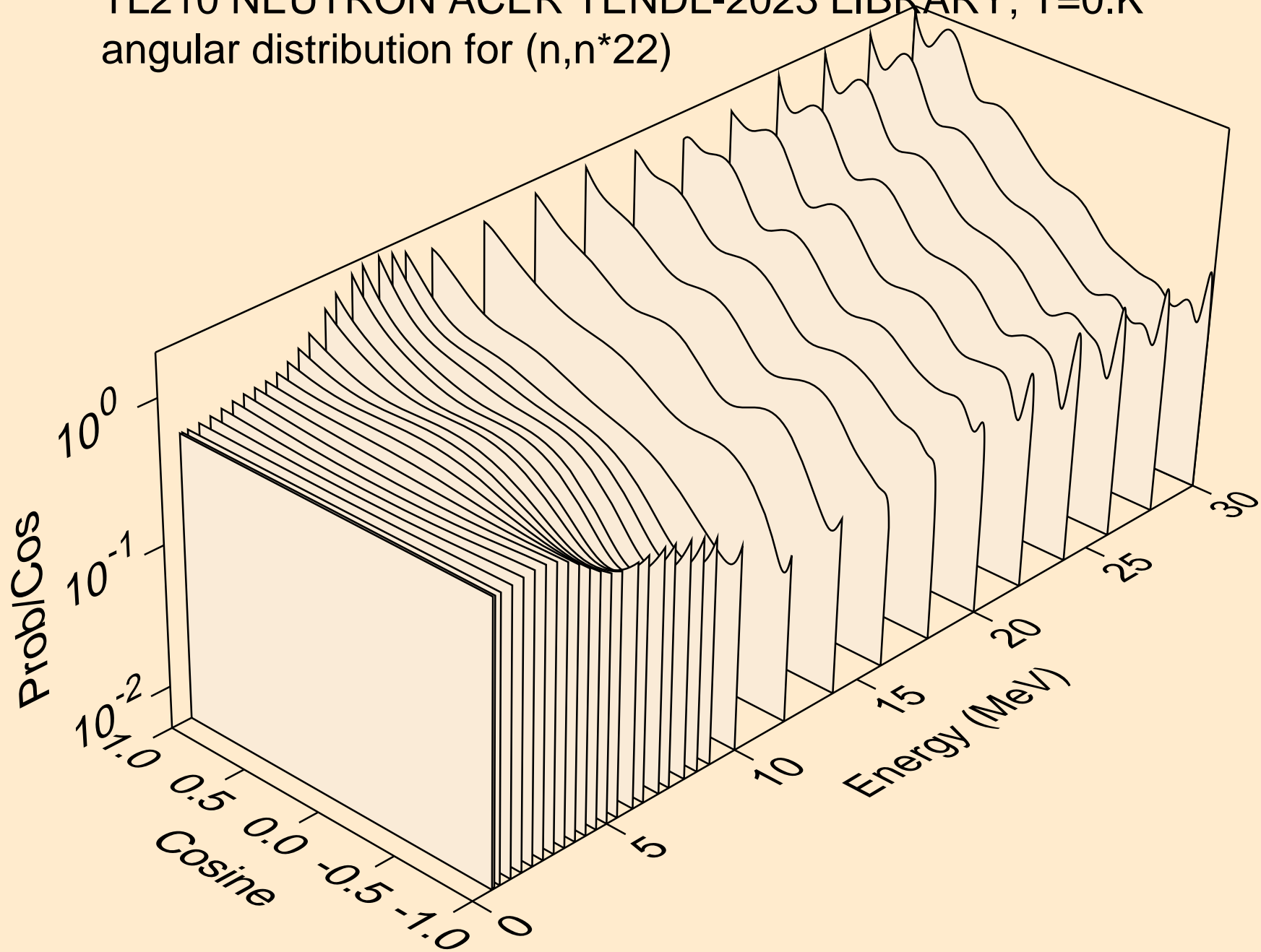

TL210 NEUTRON ACER TENDL-2023 LIBRARY; T=0.K  
angular distribution for (n,n\*23)

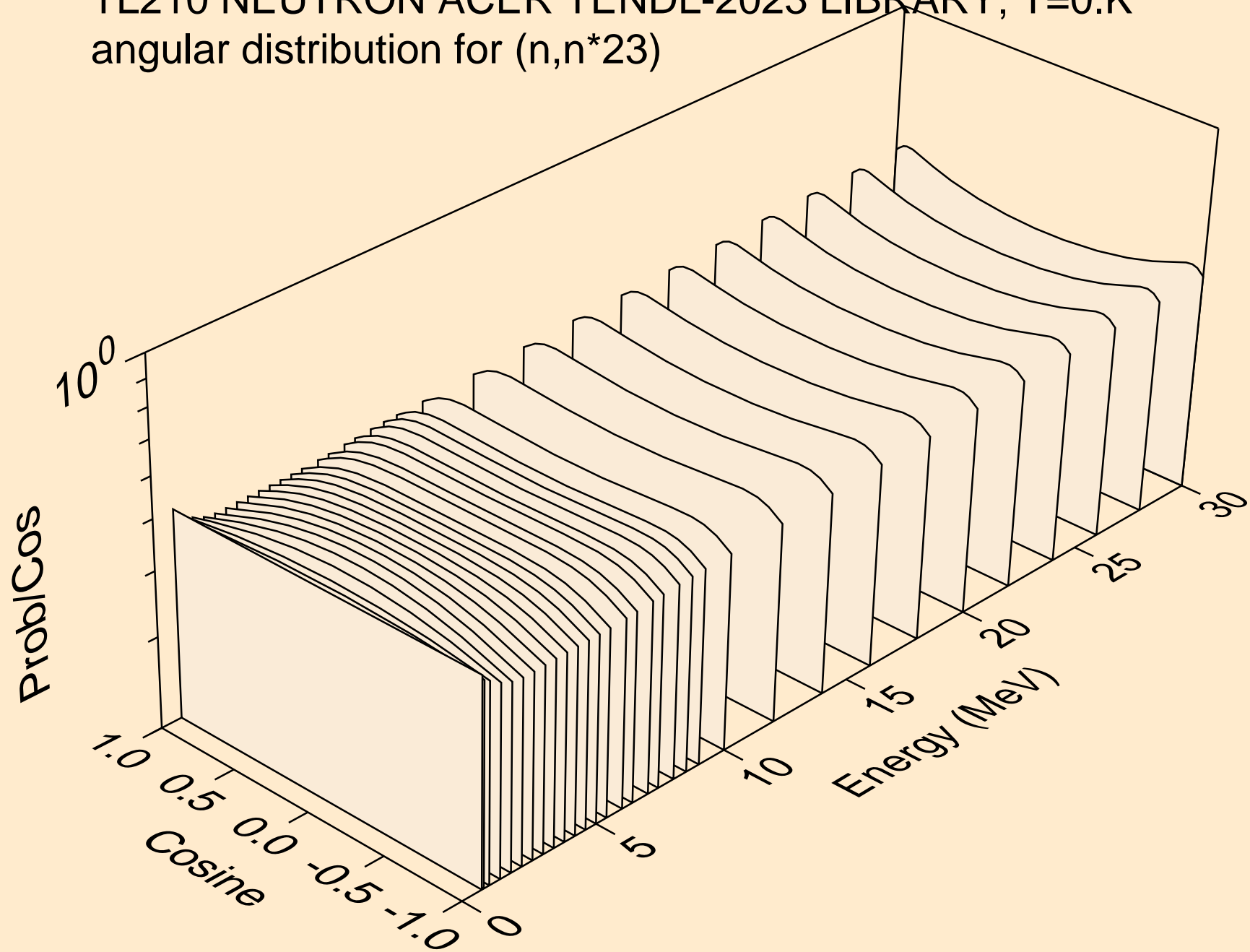

TL210 NEUTRON ACER TENDL-2023 LIBRARY; T=0.K  
angular distribution for (n,n\*24)

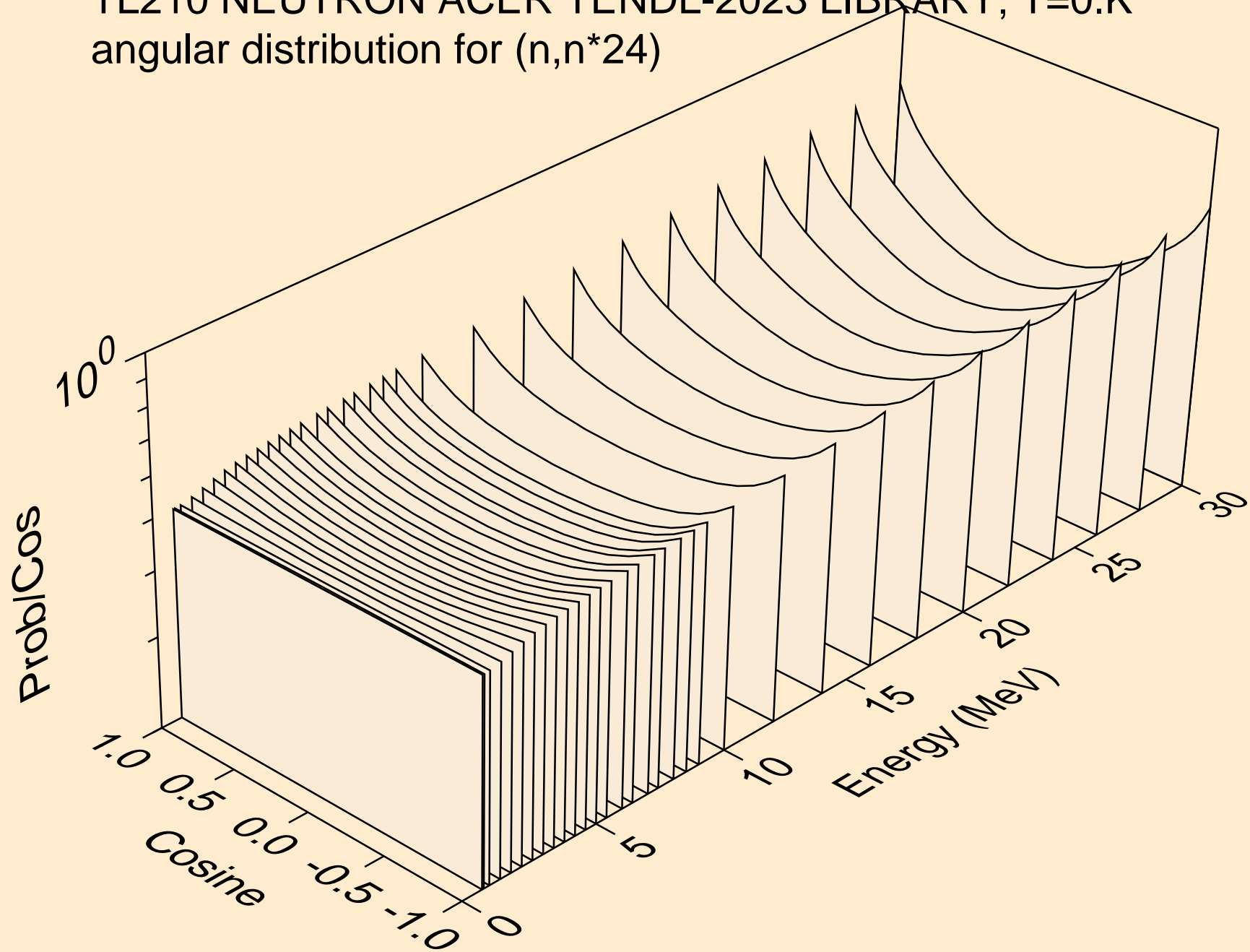

TL210 NEUTRON ACER TENDL-2023 LIBRARY; T=0.K  
angular distribution for (n,n\*25)

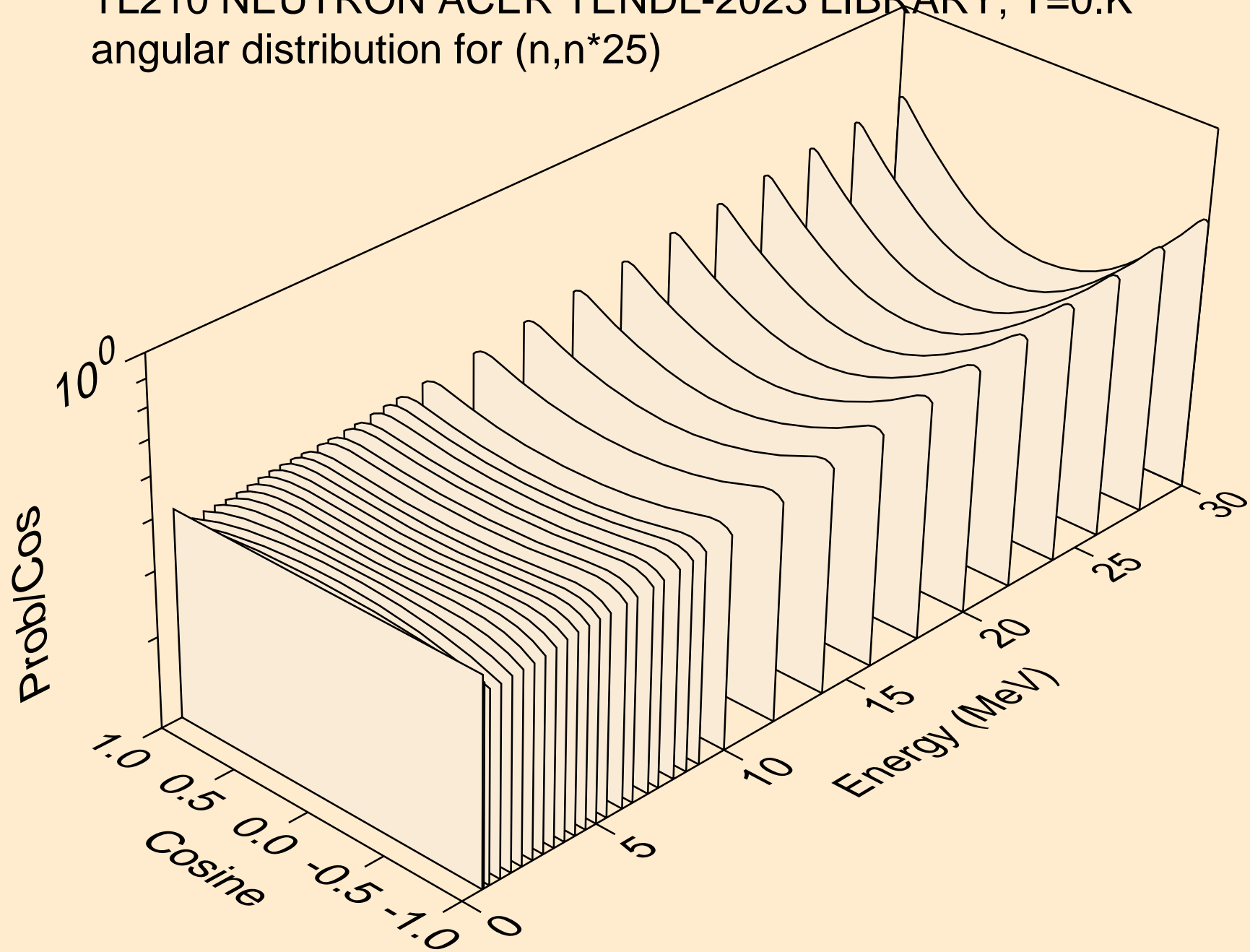

TL210 NEUTRON ACER TENDL-2023 LIBRARY; T=0.K  
angular distribution for (n,n\*26)

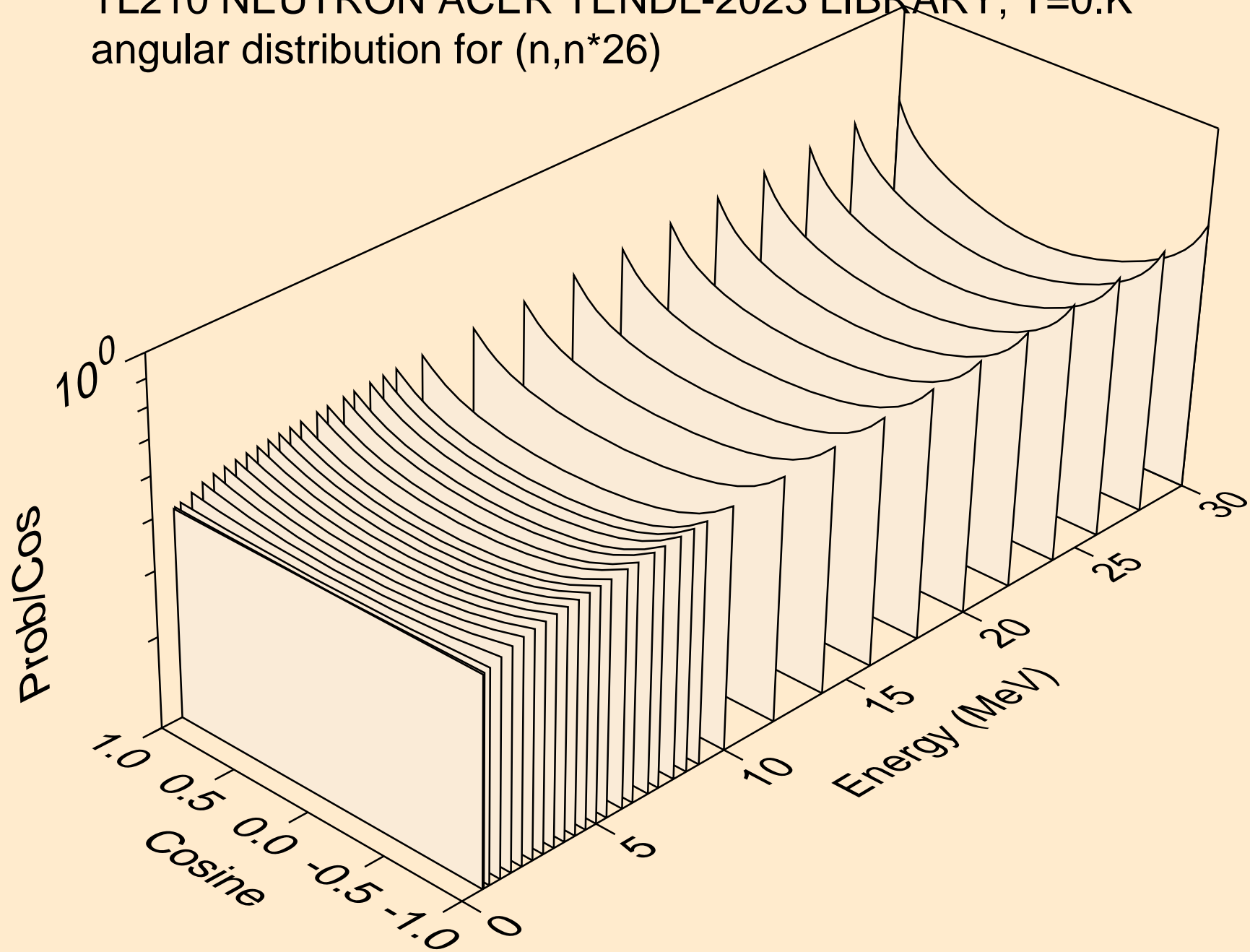

TL210 NEUTRON ACER TENDL-2023 LIBRARY; T=0.K  
angular distribution for (n,n\*27)

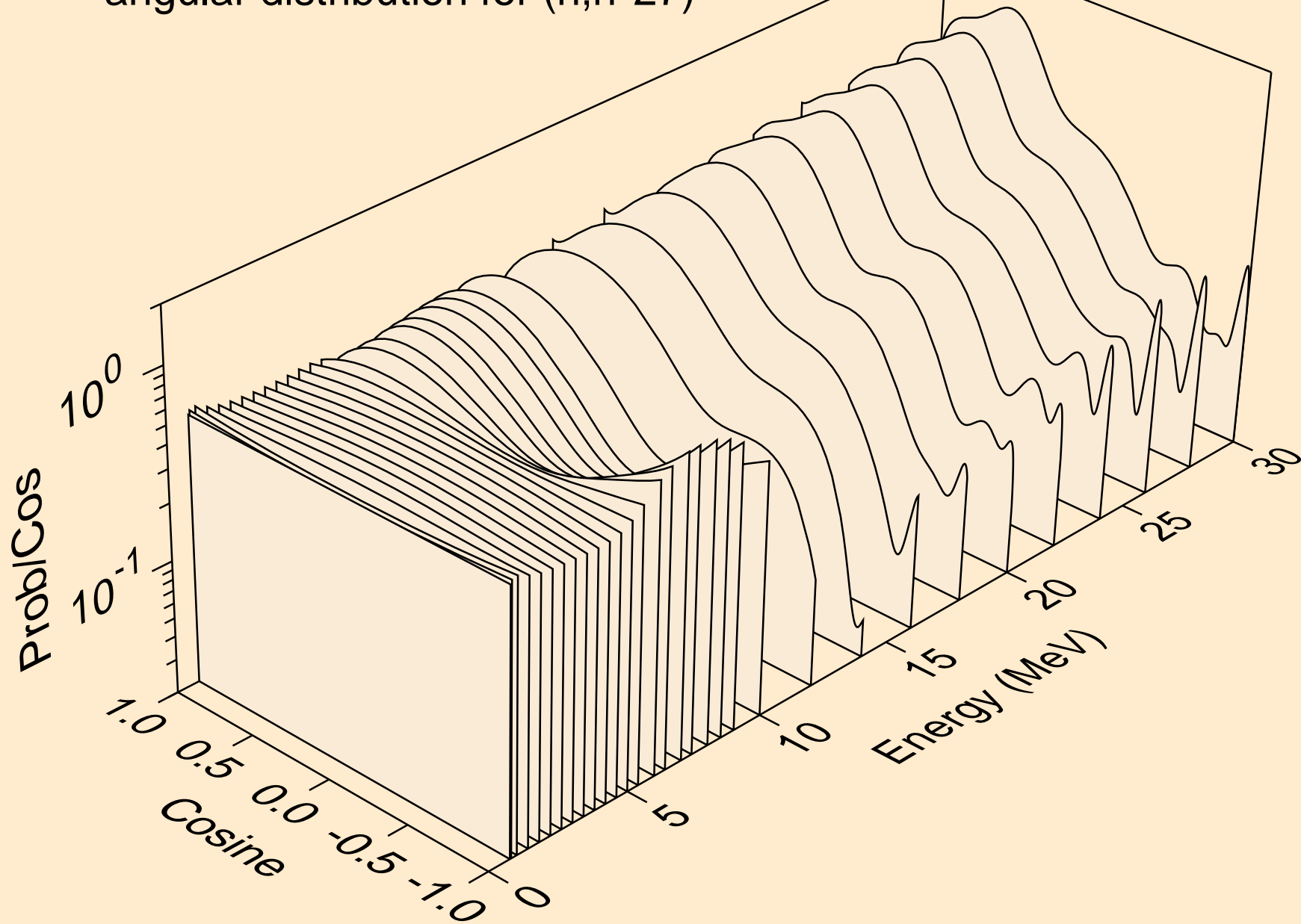

TL210 NEUTRON ACER TENDL-2023 LIBRARY; T=0.K  
angular distribution for (n,n\*28)

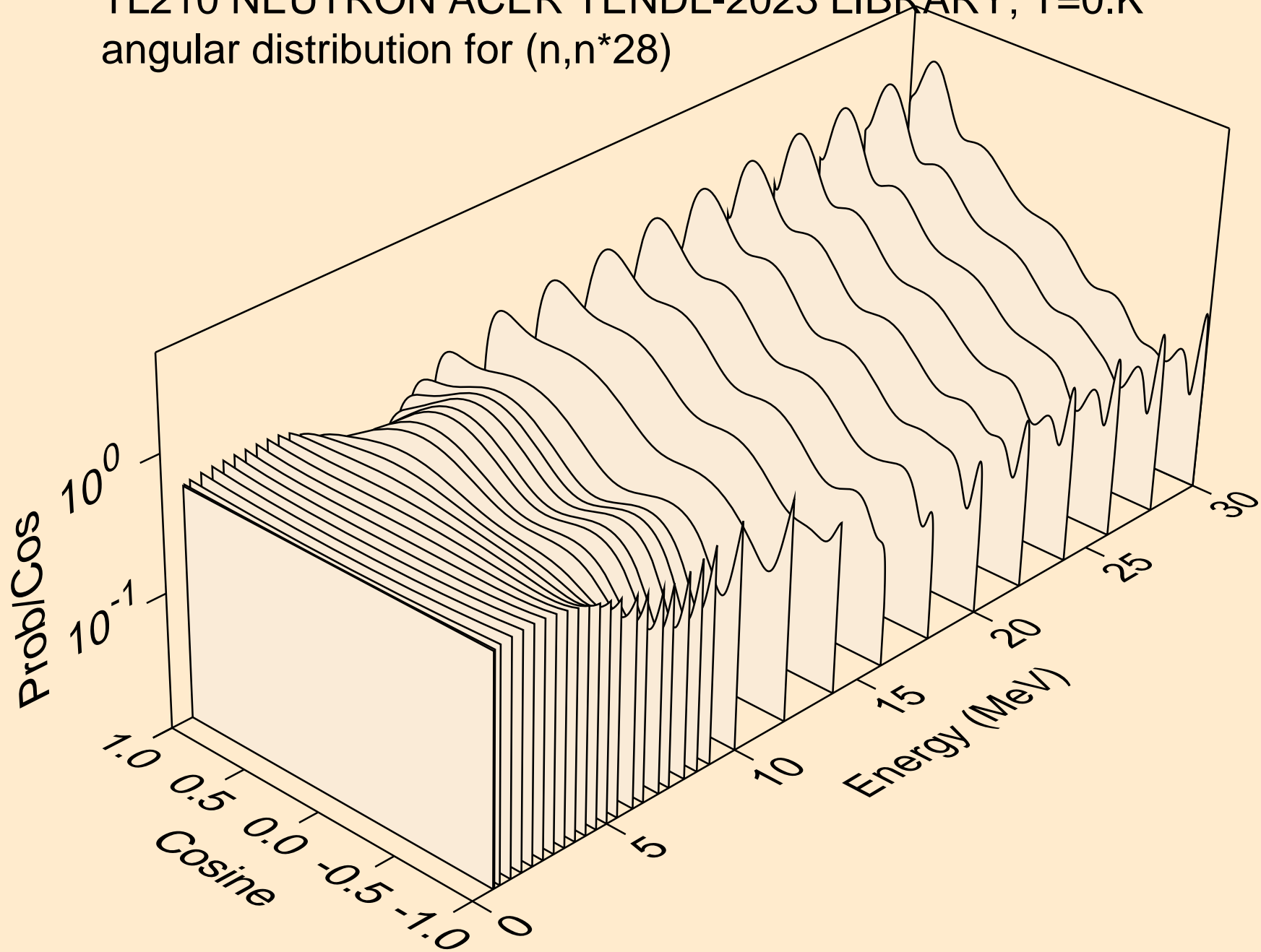

TL210 NEUTRON ACER TENDL-2023 LIBRARY; T=0.K  
angular distribution for (n,n\*29)

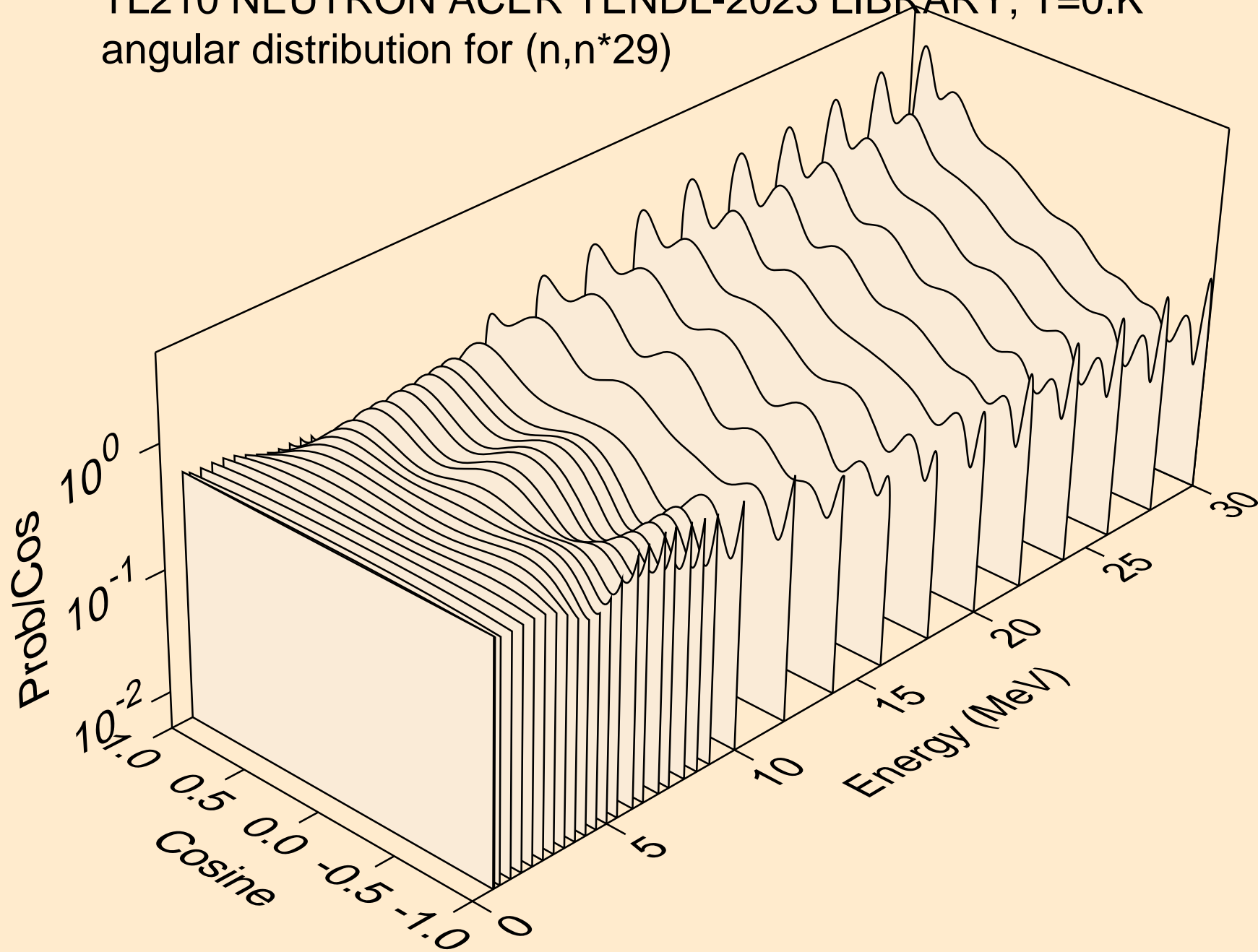

TL210 NEUTRON ACER TENDL-2023 LIBRARY; T=0.K  
angular distribution for (n,n\*30)

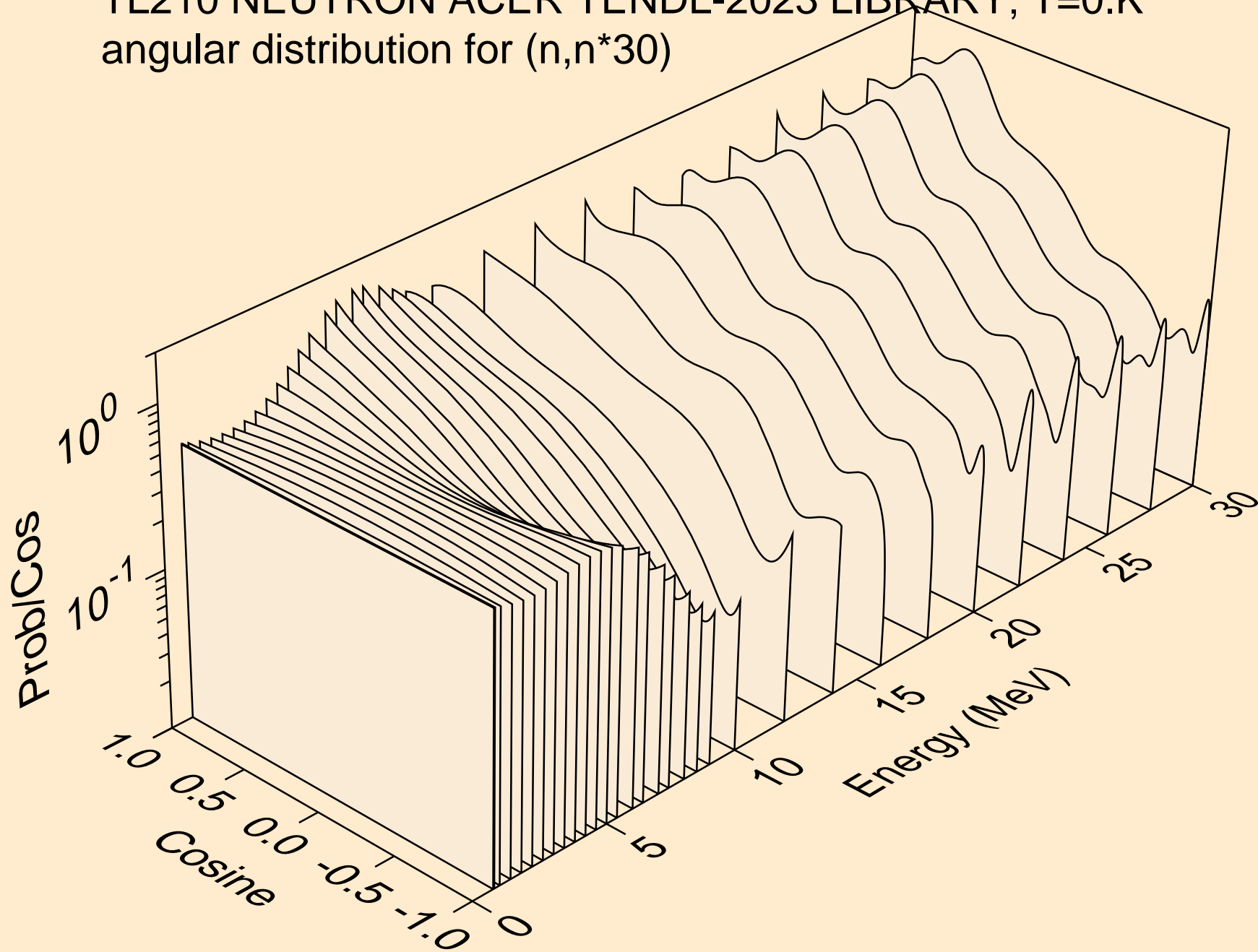

TL210 NEUTRON ACER TENDL-2023 LIBRARY; T=0.K  
Neutron emission for (n,x)

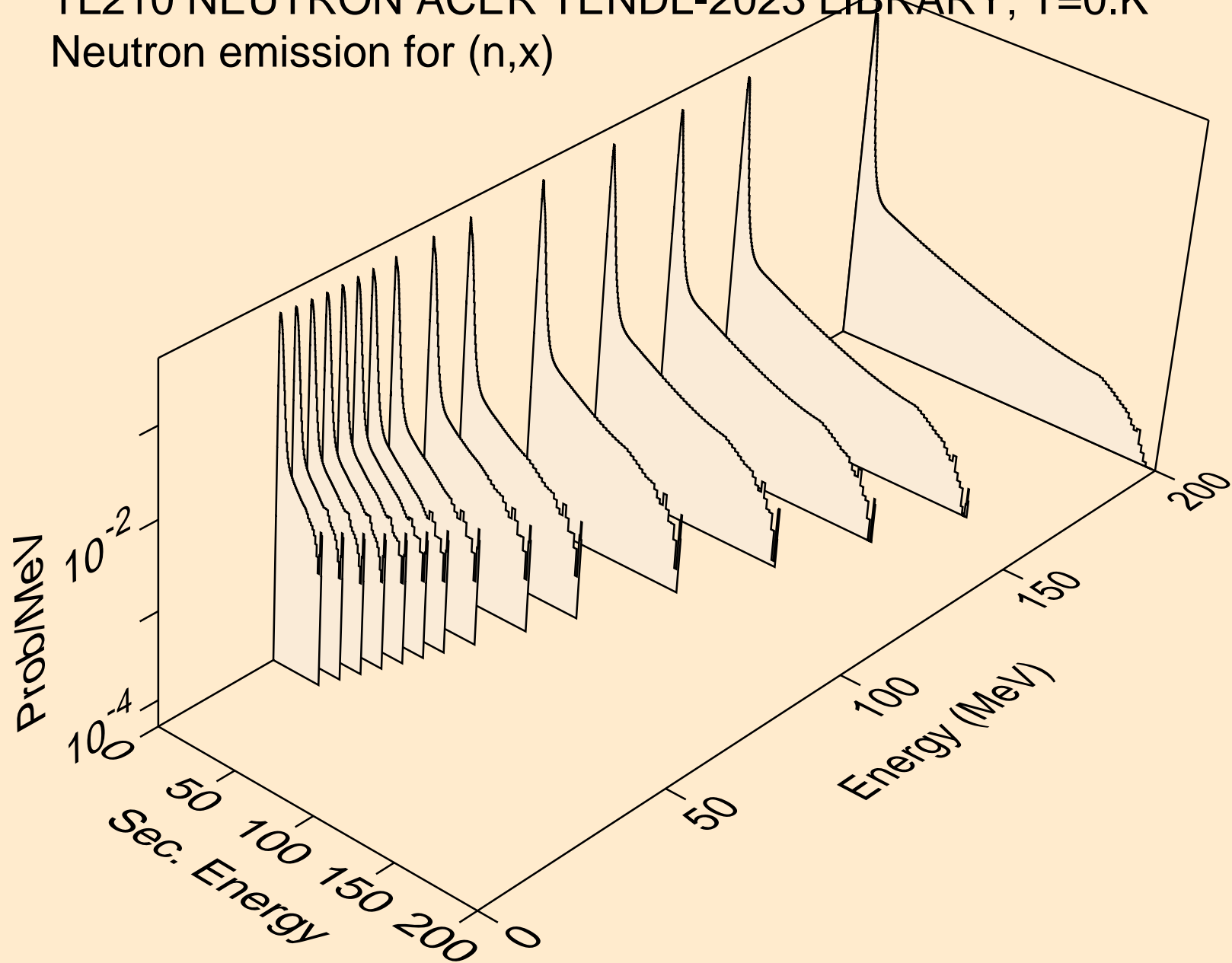

TL210 NEUTRON ACER TENDL-2023 LIBRARY; T=0.K  
Neutron emission for (n,2nd)

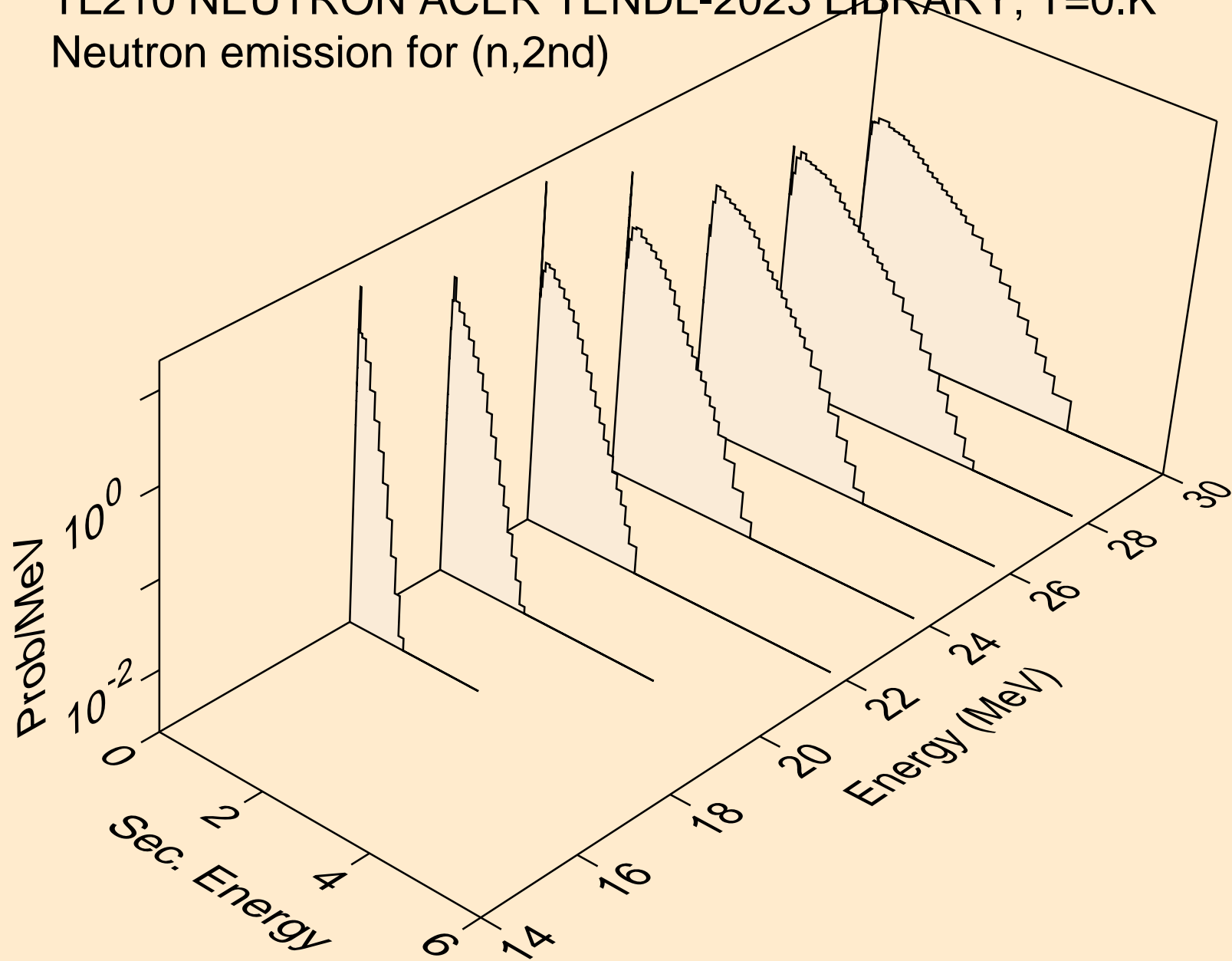

TL210 NEUTRON ACER TENDL-2023 LIBRARY; T=0.K  
Neutron emission for (n,2n)

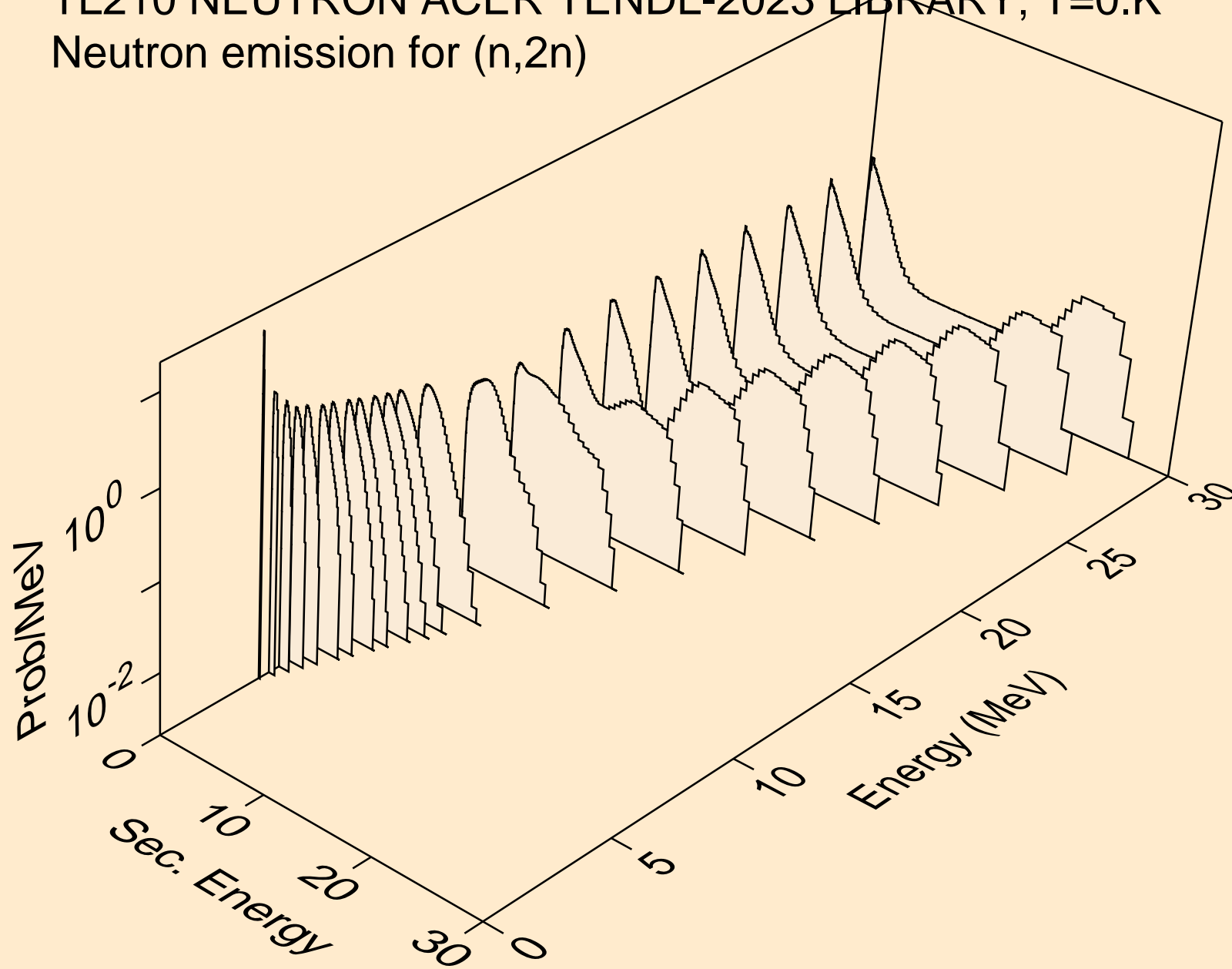

TL210 NEUTRON ACER TENDL-2023 LIBRARY; T=0.K  
Neutron emission for (n,3n)

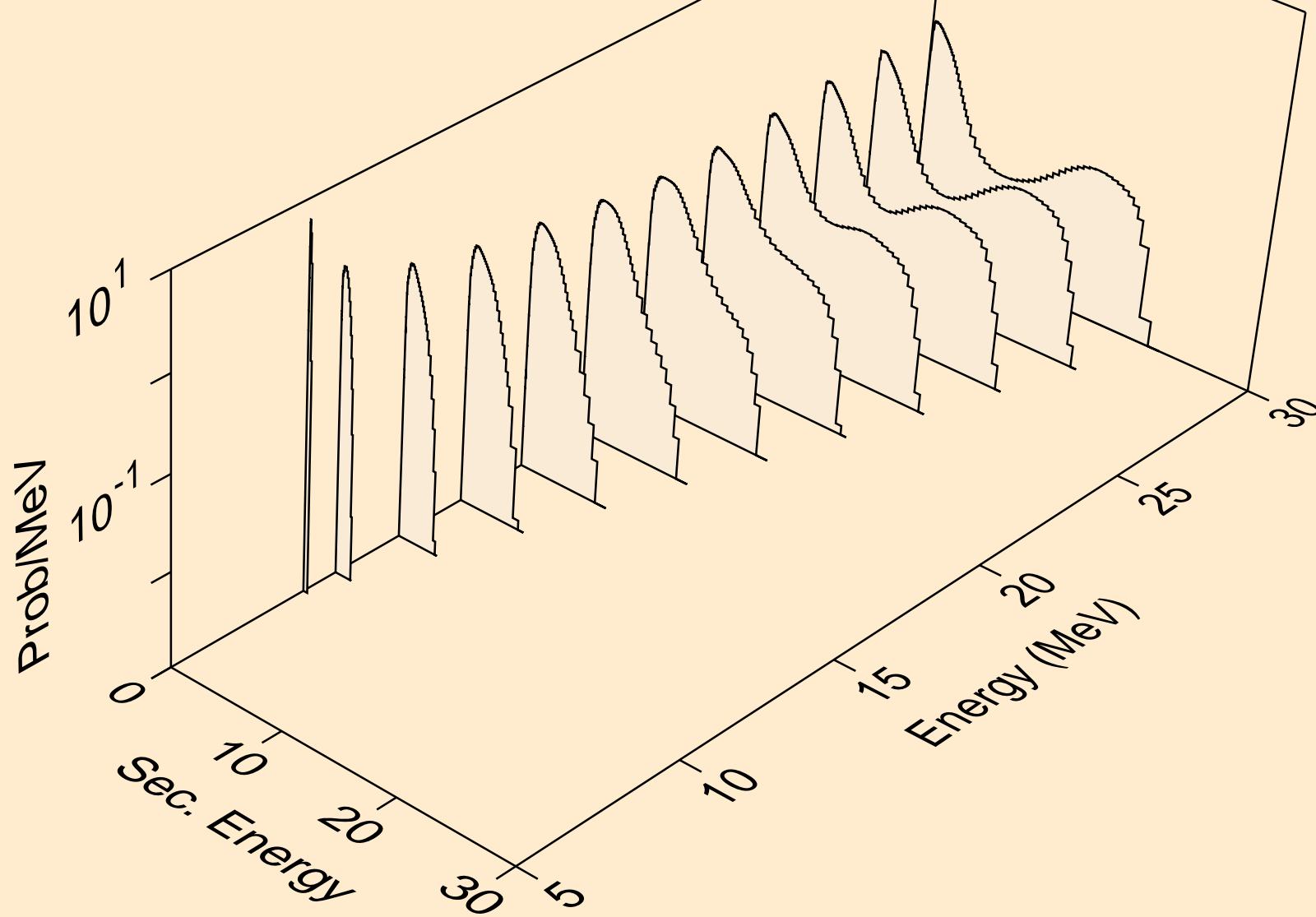

TL210 NEUTRON ACER TENDL-2023 LIBRARY; T=0.K  
Neutron emission for (n,n\*)a

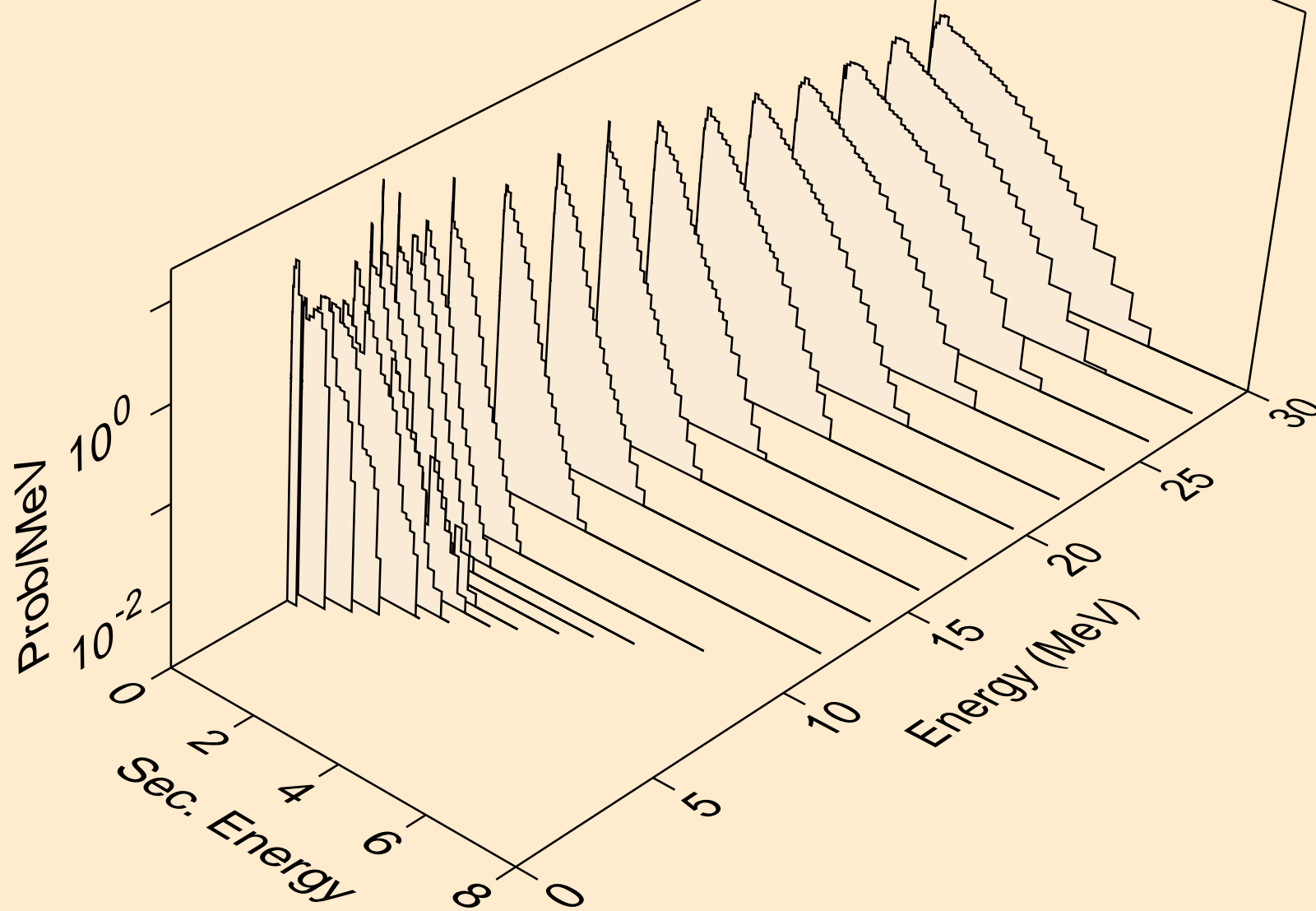

TL210 NEUTRON ACER TENDL-2023 LIBRARY; T=0.K  
Neutron emission for (n,2n)a

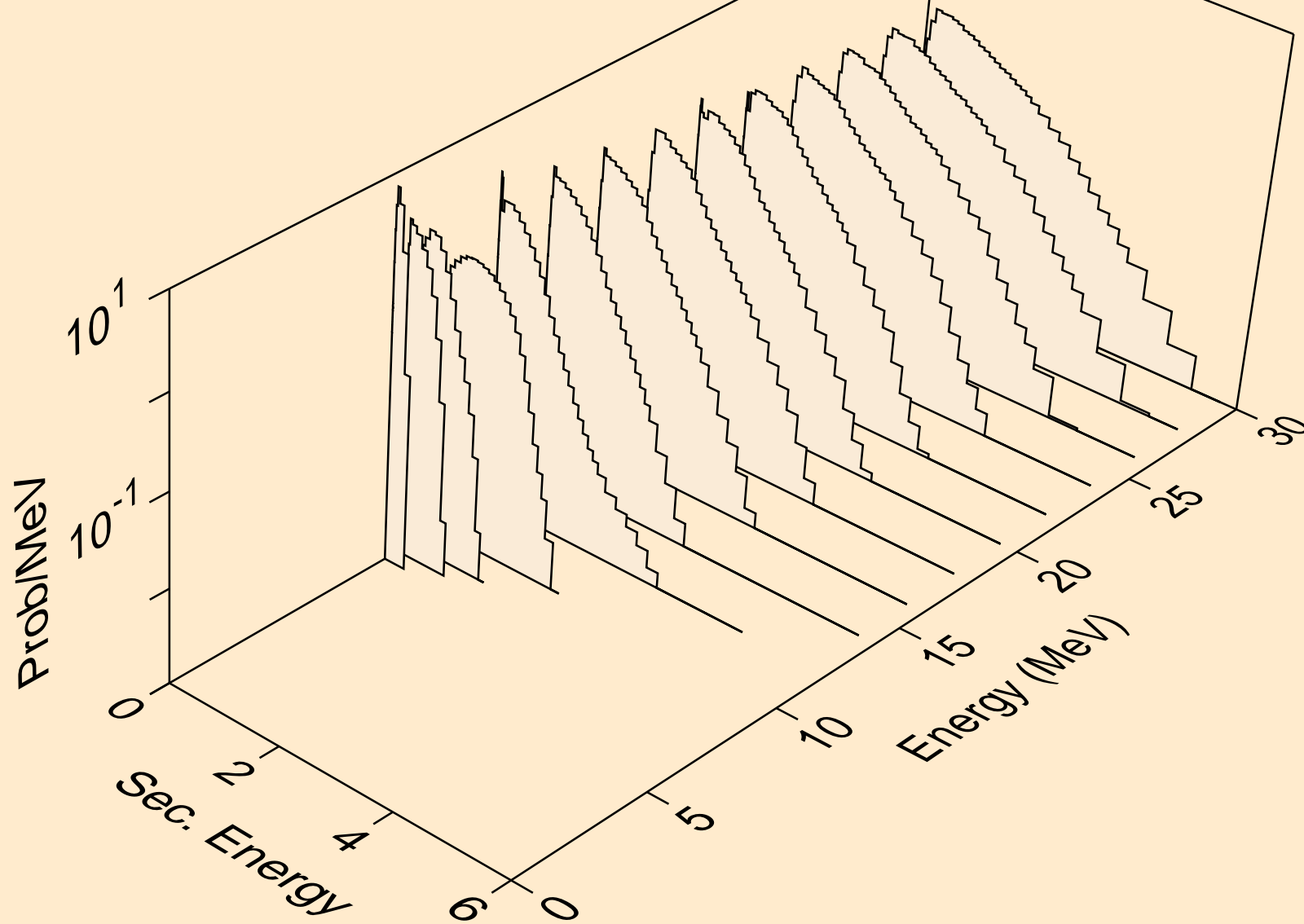

TL210 NEUTRON ACER TENDL-2023 LIBRARY; T=0.K  
Neutron emission for (n,3n)a

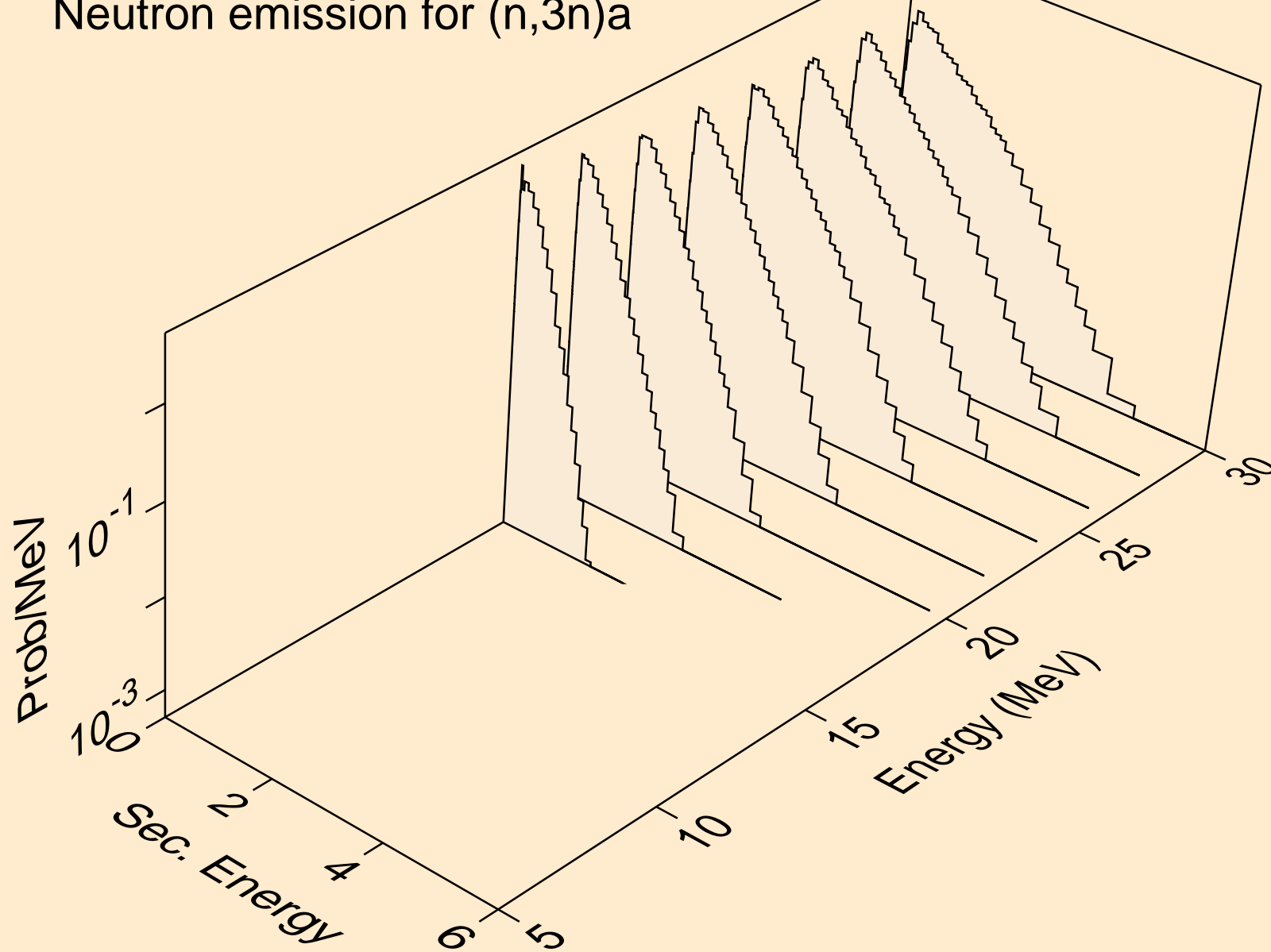

TL210 NEUTRON ACER TENDL-2023 LIBRARY; T=0.K  
Neutron emission for (n,n\*)p

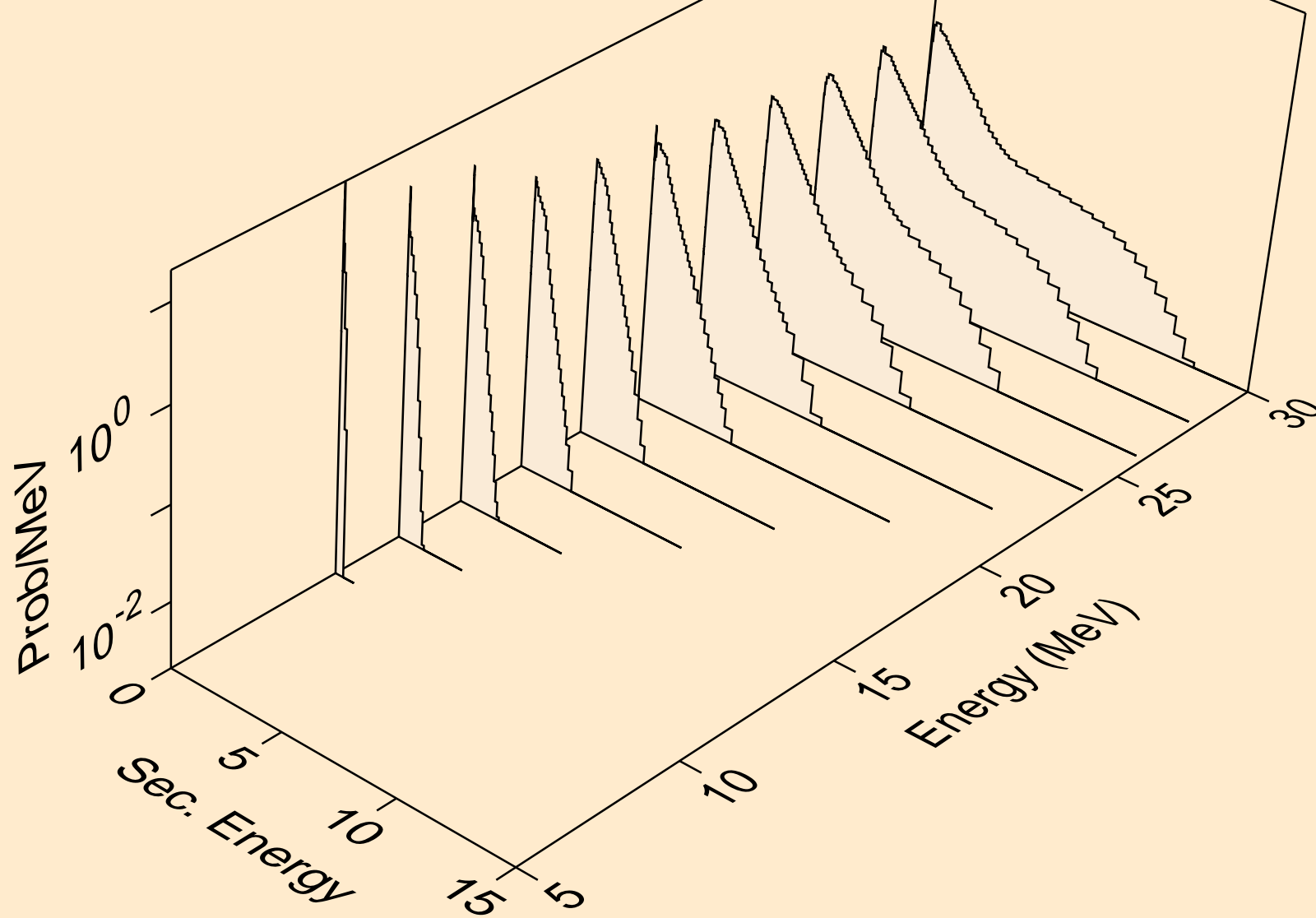

TL210 NEUTRON ACER TENDL-2023 LIBRARY; T=0.K  
Neutron emission for (n,n\*)d

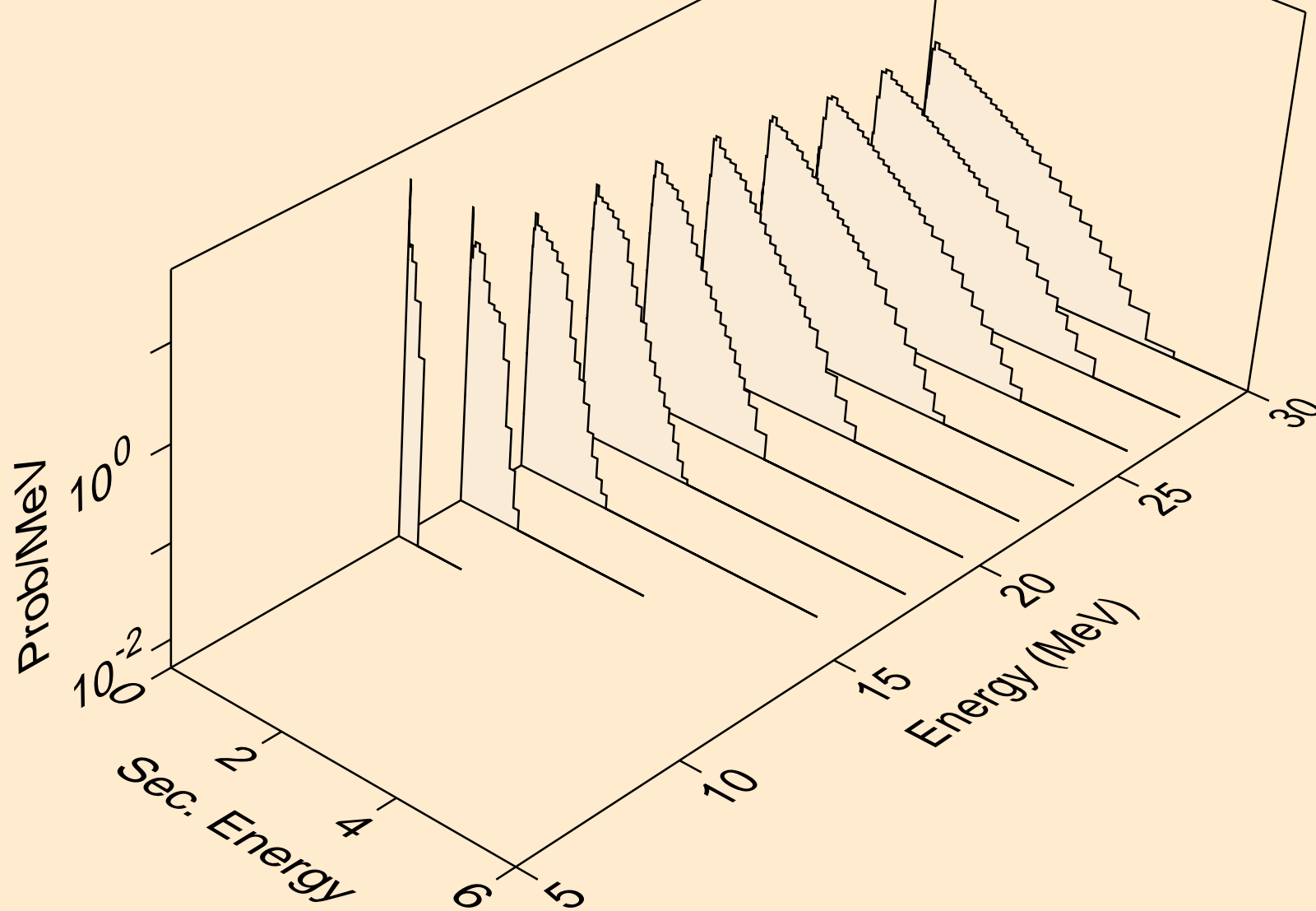

TL210 NEUTRON ACER TENDL-2023 LIBRARY; T=0.K  
Neutron emission for (n,n\*)t

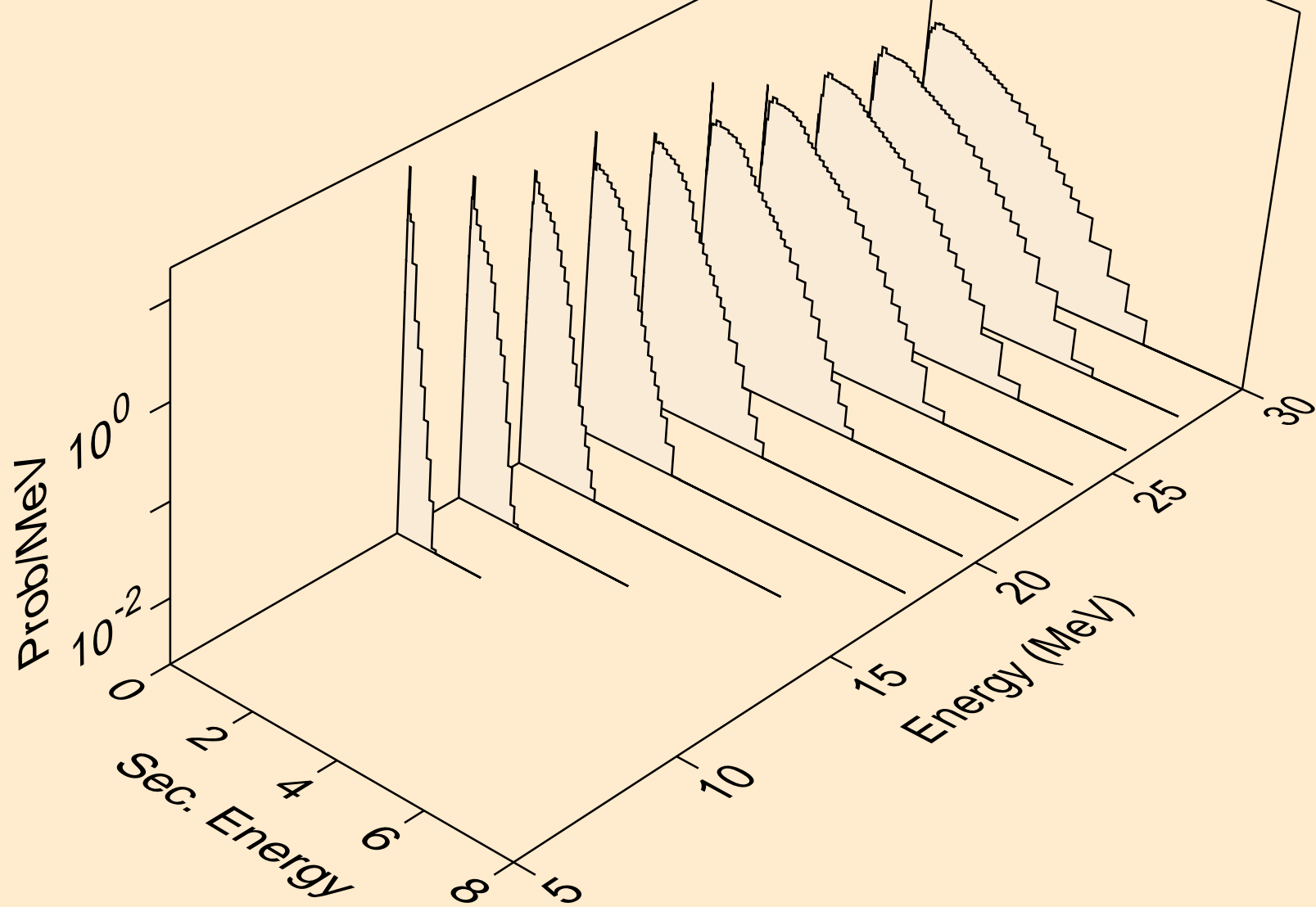

TL210 NEUTRON ACER TENDL-2023 LIBRARY; T=0.K  
Neutron emission for (n,n\*)he3

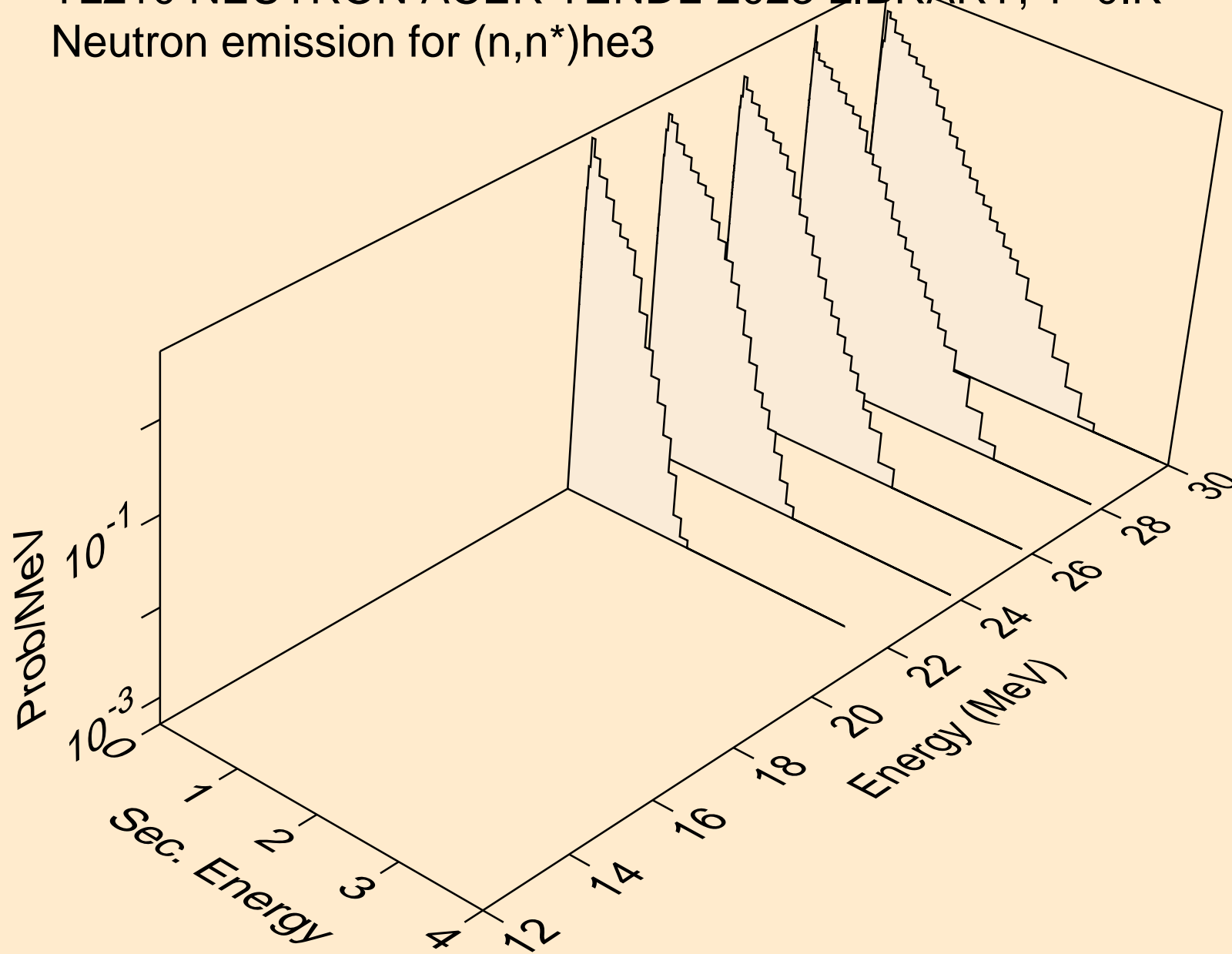

TL210 NEUTRON ACER TENDL-2023 LIBRARY; T=0.K  
Neutron emission for (n,4n)

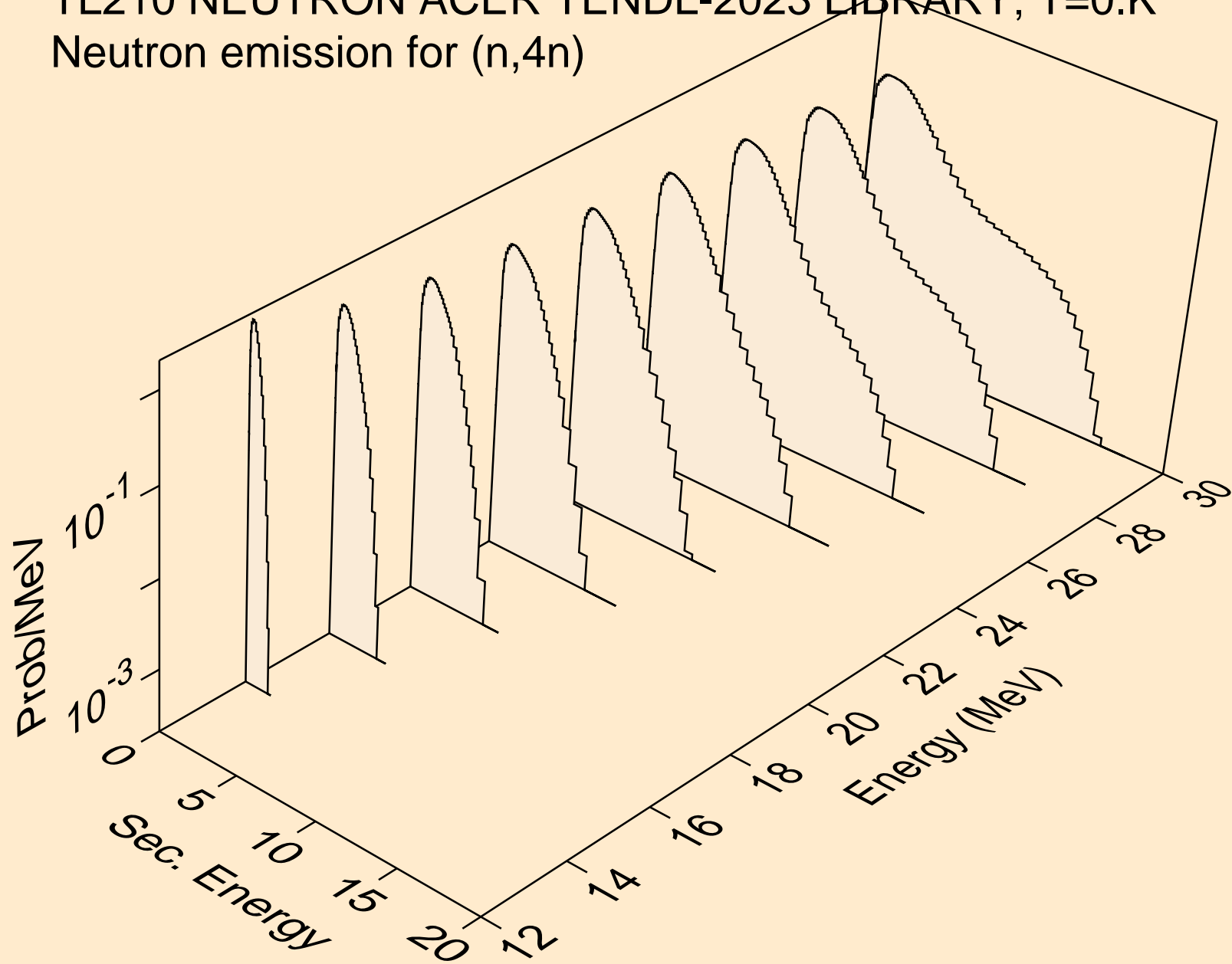

TL210 NEUTRON ACER TENDL-2023 LIBRARY; T=0.K  
Neutron emission for (n,2np)

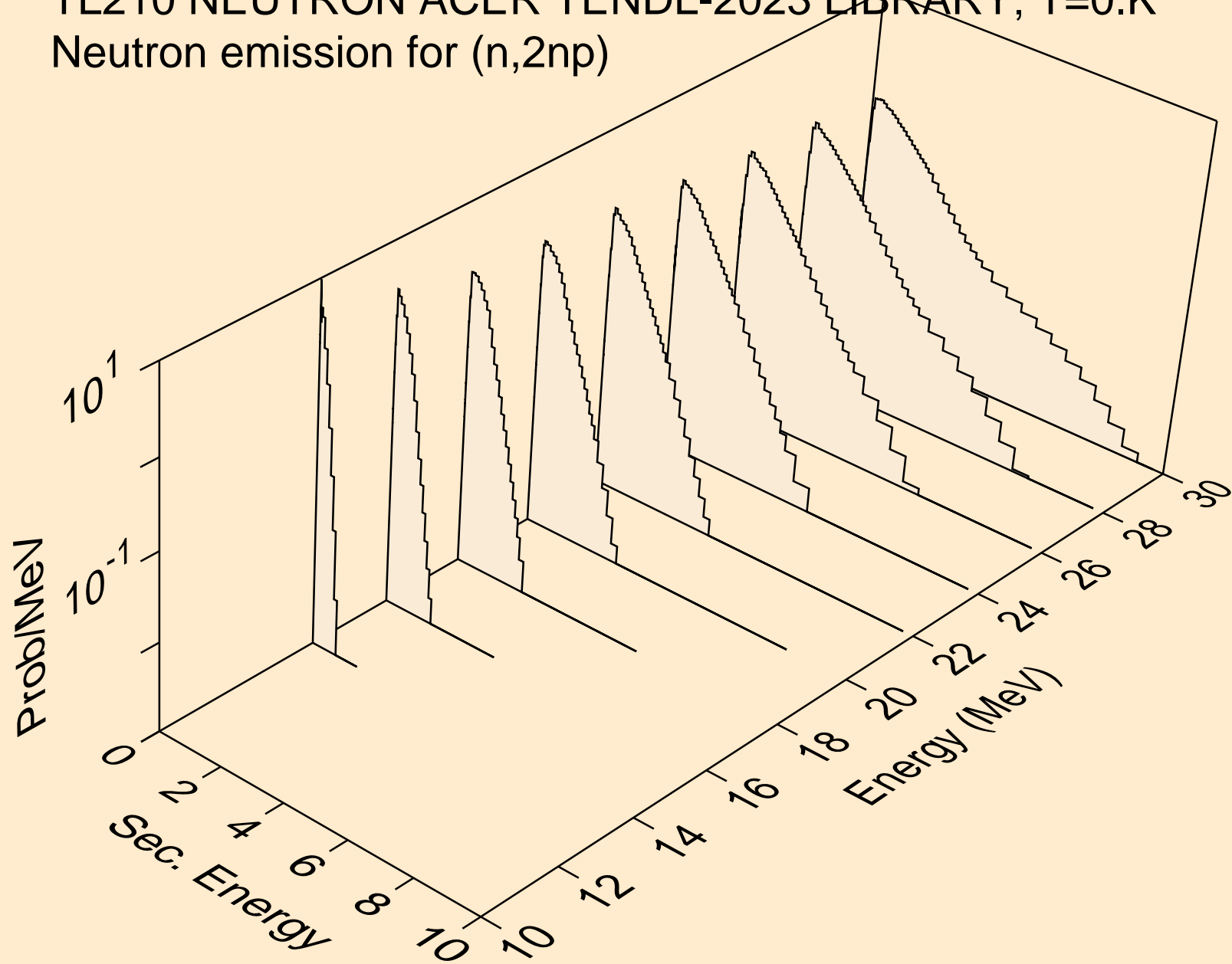

TL210 NEUTRON ACER TENDL-2023 LIBRARY; T=0.K  
Neutron emission for (n,3np)

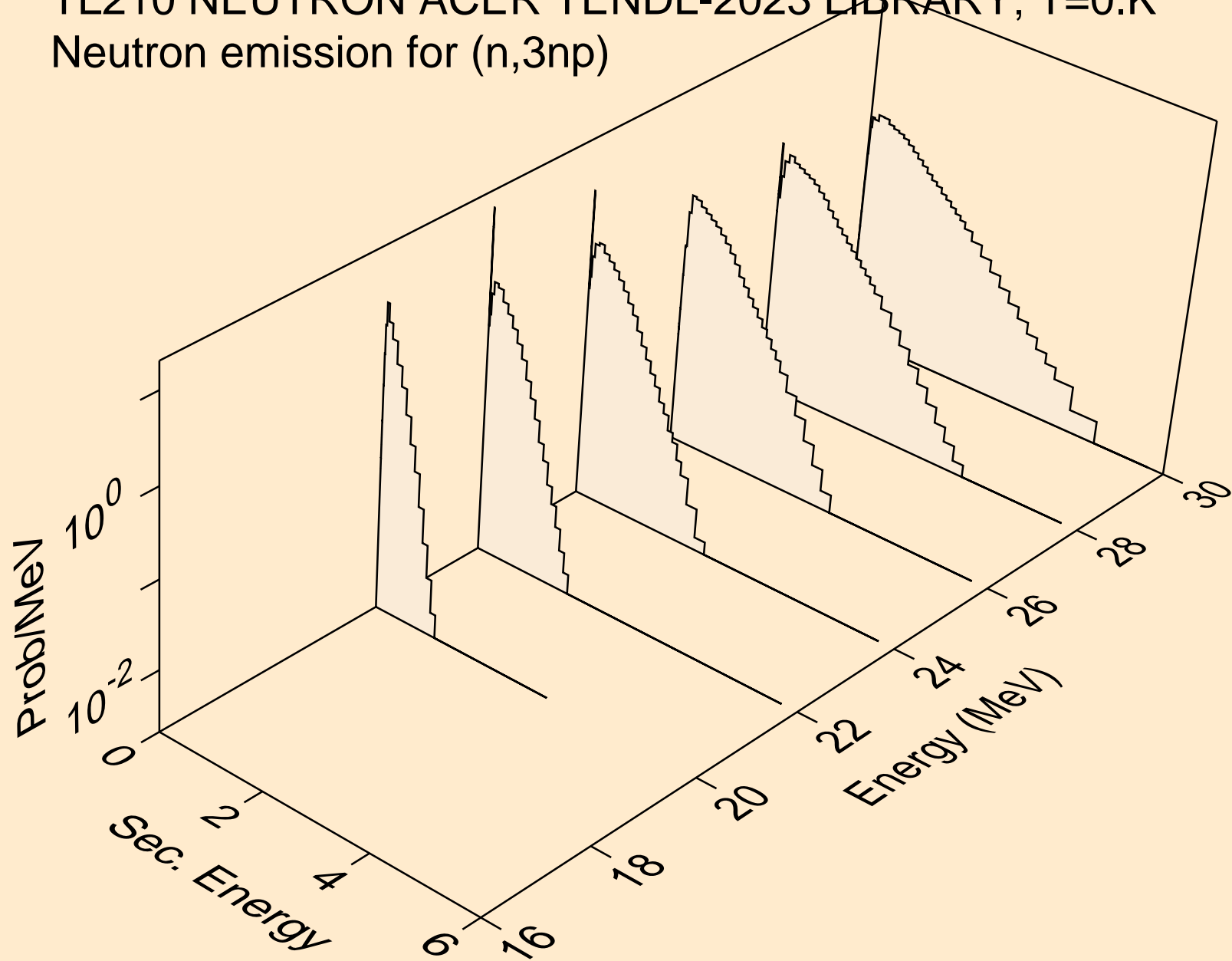

TL210 NEUTRON ACER TENDL-2023 LIBRARY; T=0.K  
Neutron emission for (n,n\*c)

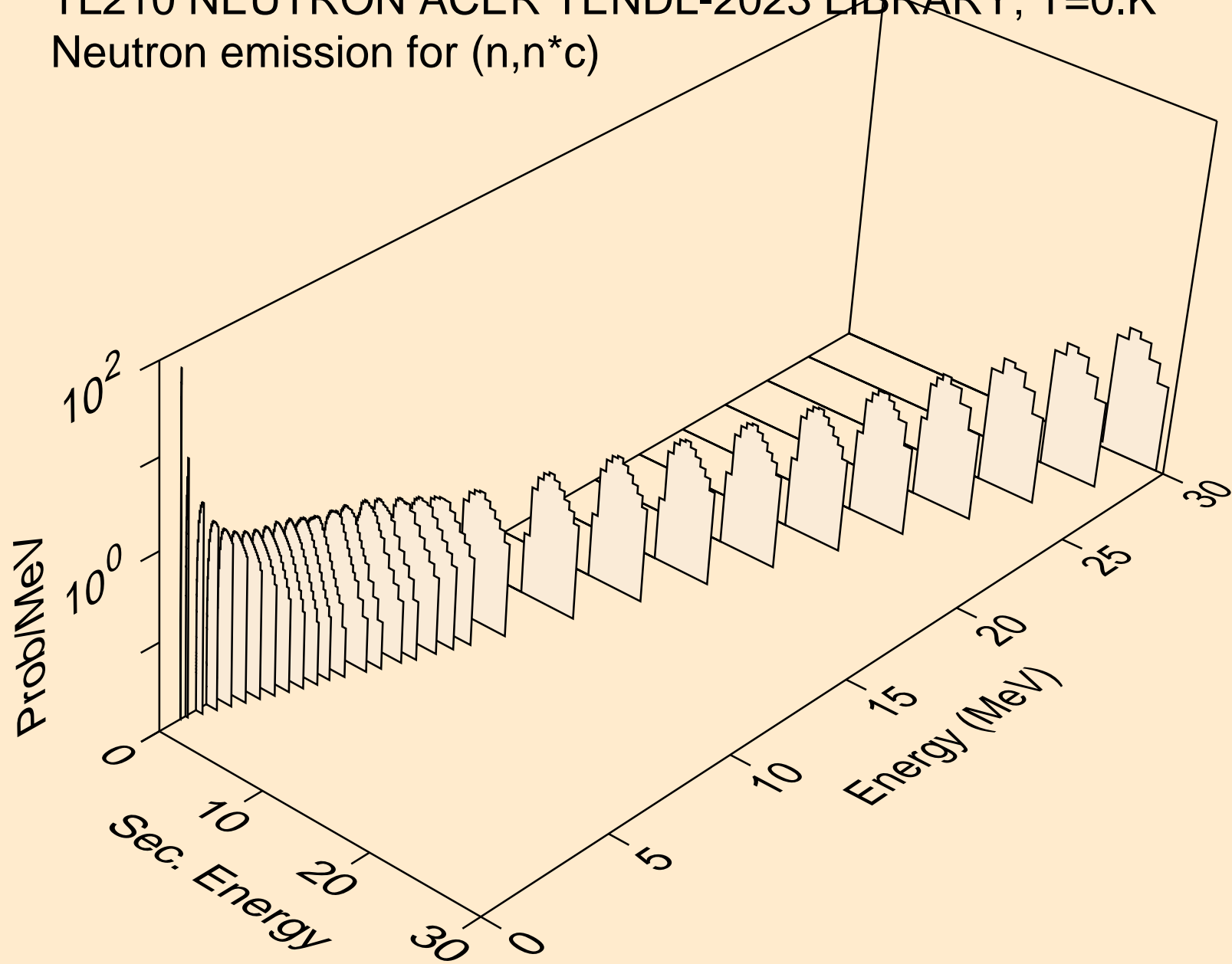

TL210 NEUTRON ACER TENDL-2023 LIBRARY; T=0.K  
Photon emission for (n,x)

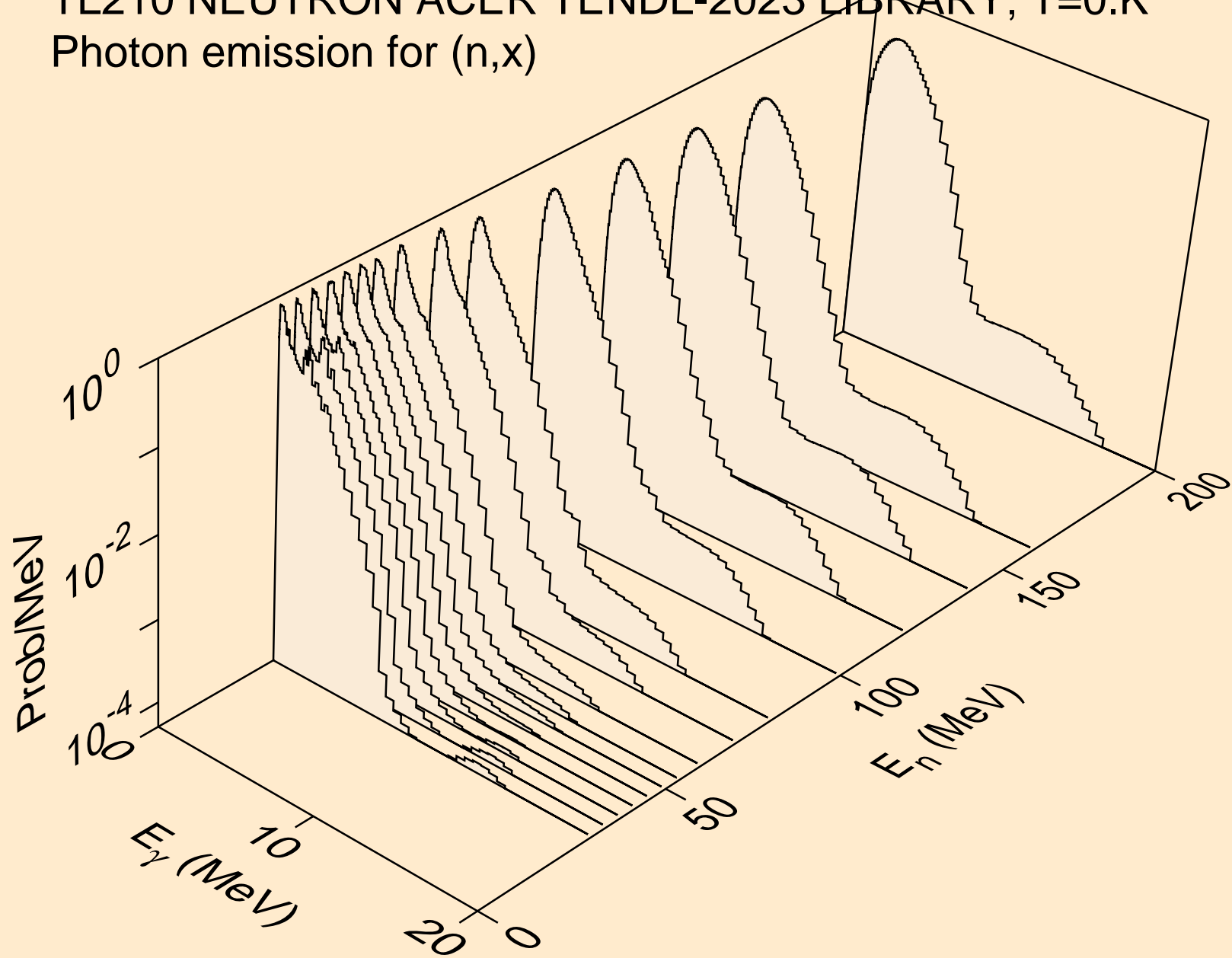

TL210 NEUTRON ACER TENDL-2023 LIBRARY; T=0.K  
Photon emission for (n,2nd)

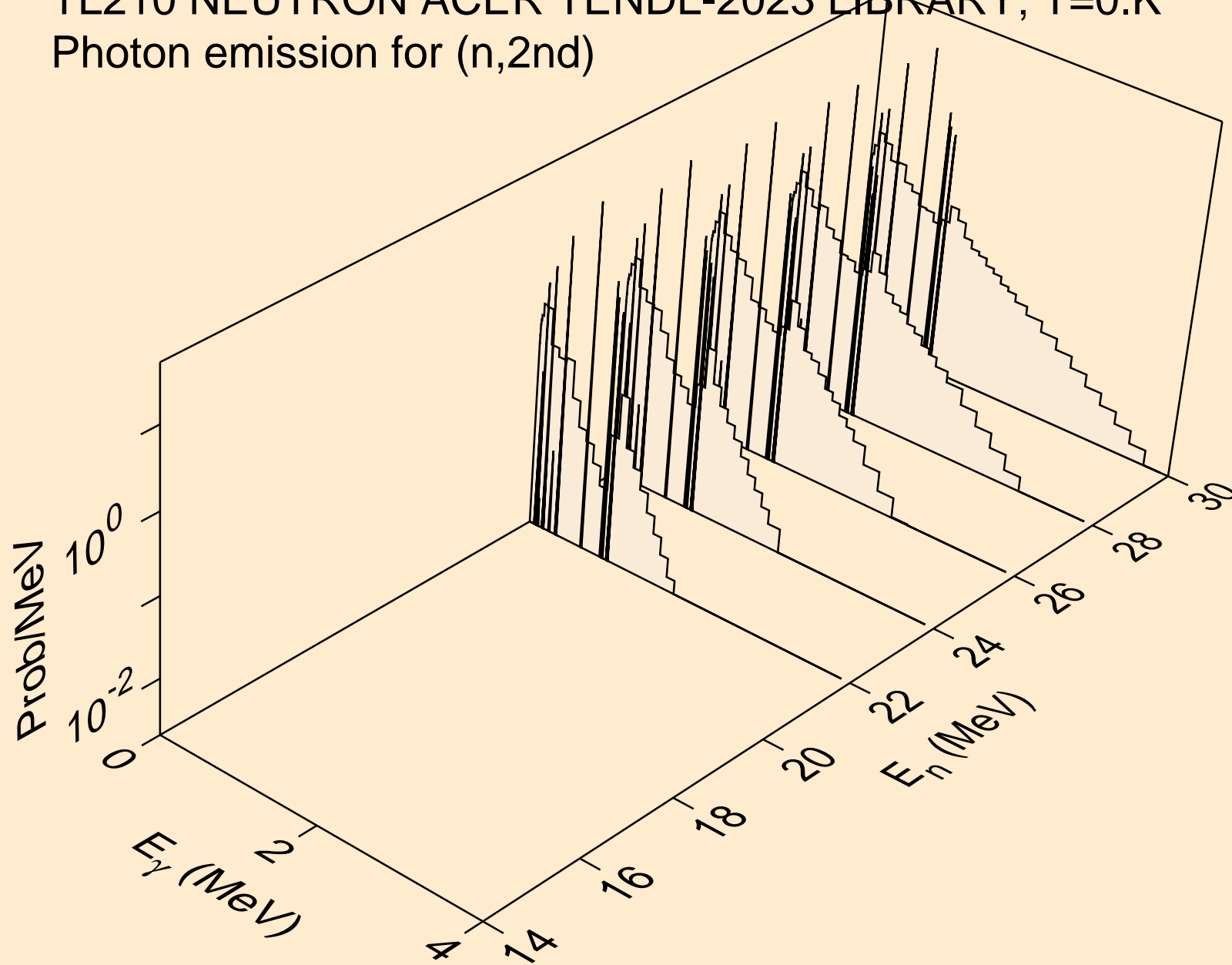

TL210 NEUTRON ACER TENDL-2023 LIBRARY; T=0.K  
Photon emission for (n,2n)

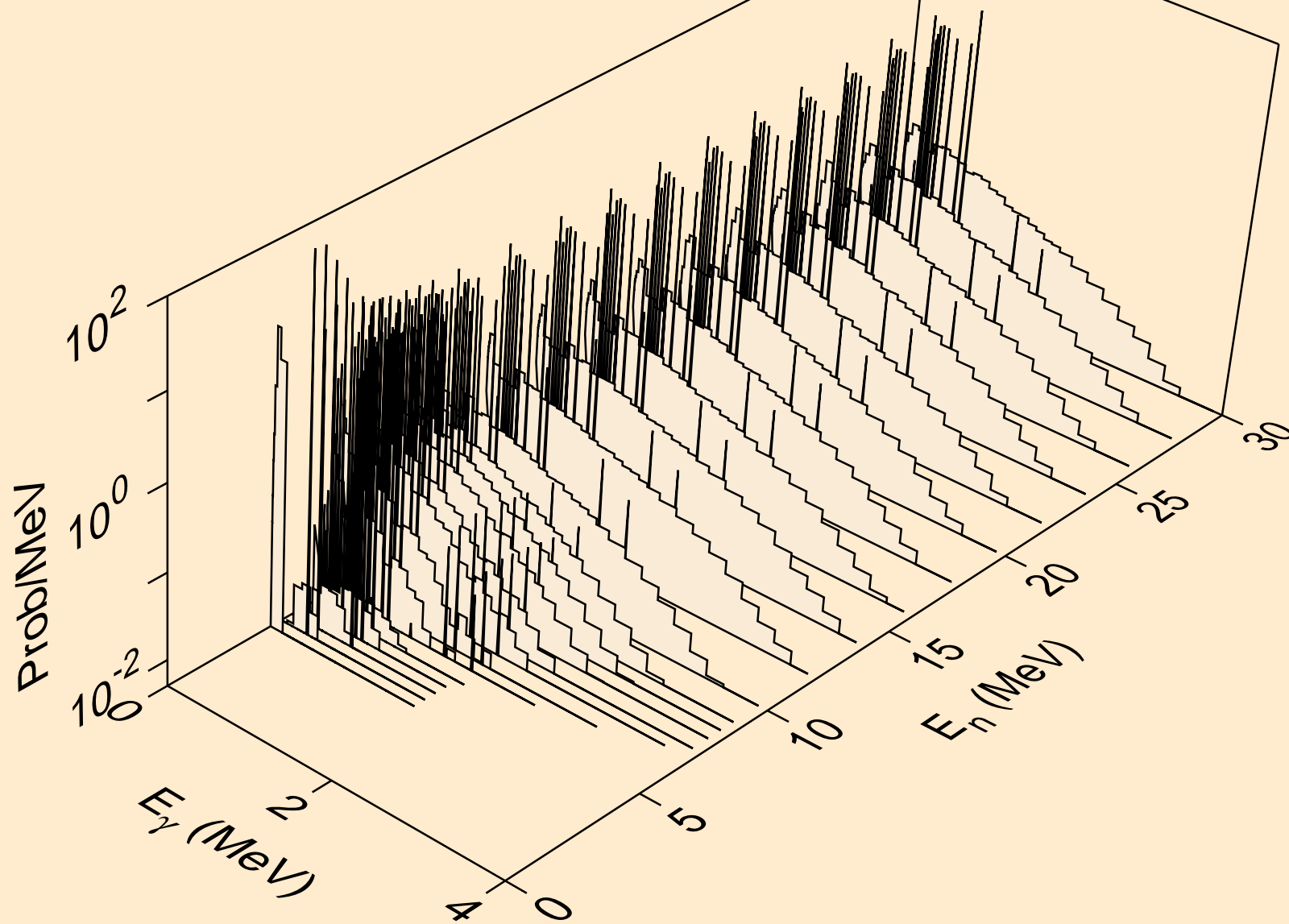

TL210 NEUTRON ACER TENDL-2023 LIBRARY; T=0.K  
Photon emission for (n,3n)

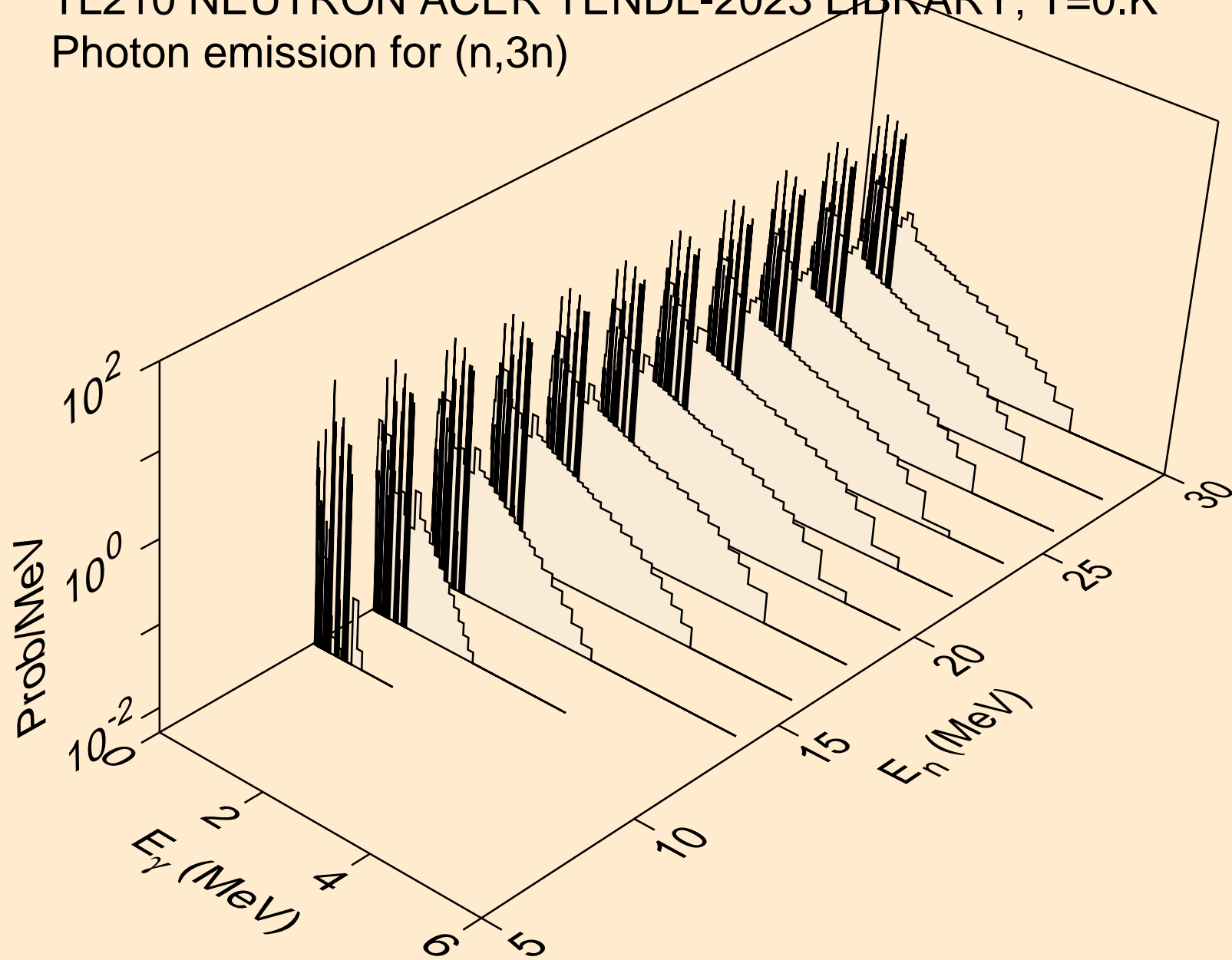

TL210 NEUTRON ACER TENDL-2023 LIBRARY; T=0.K  
Photon emission for (n,n\*)a

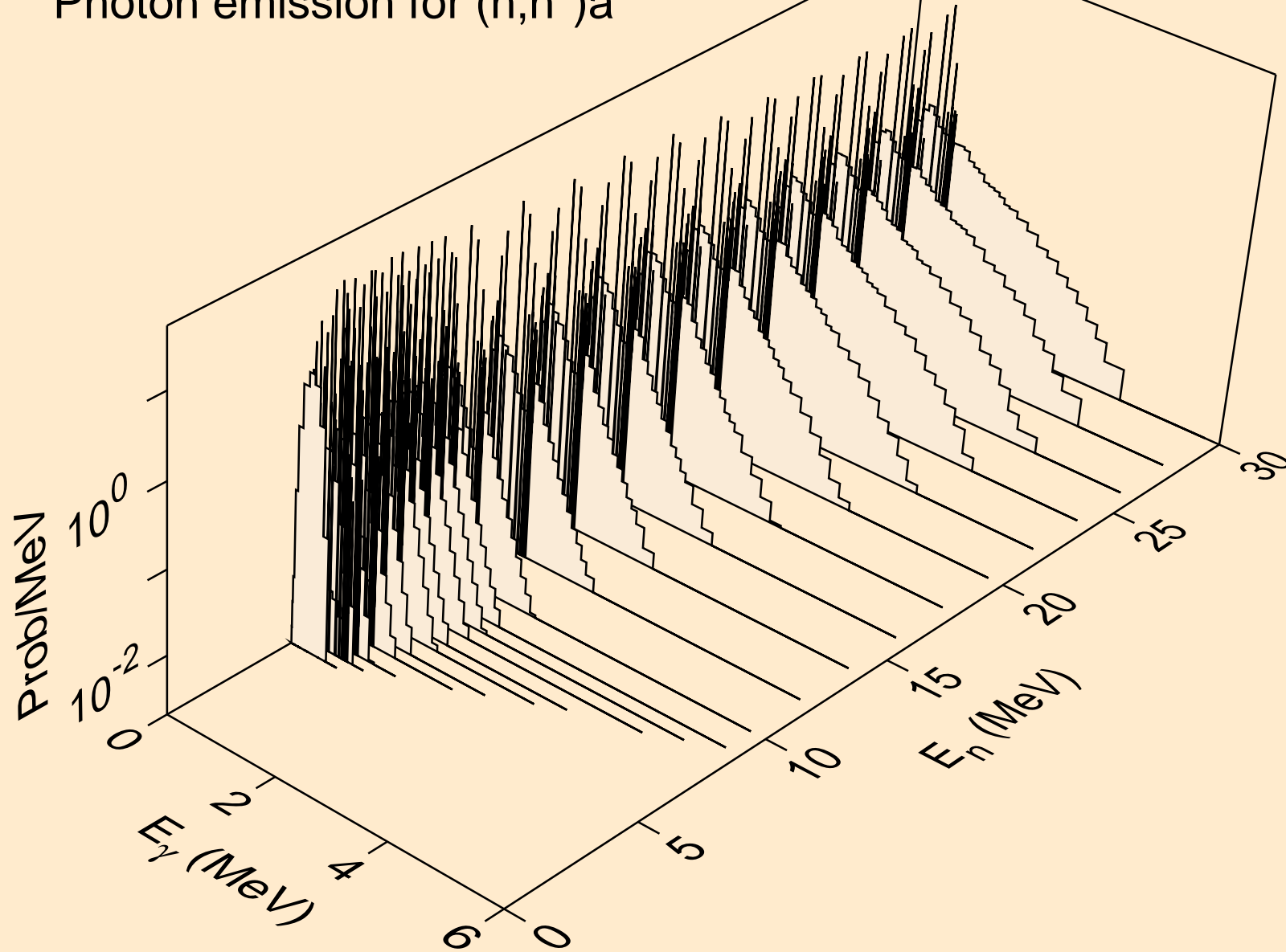

TL210 NEUTRON ACER TENDL-2023 LIBRARY; T=0.K  
Photon emission for (n,2n)a

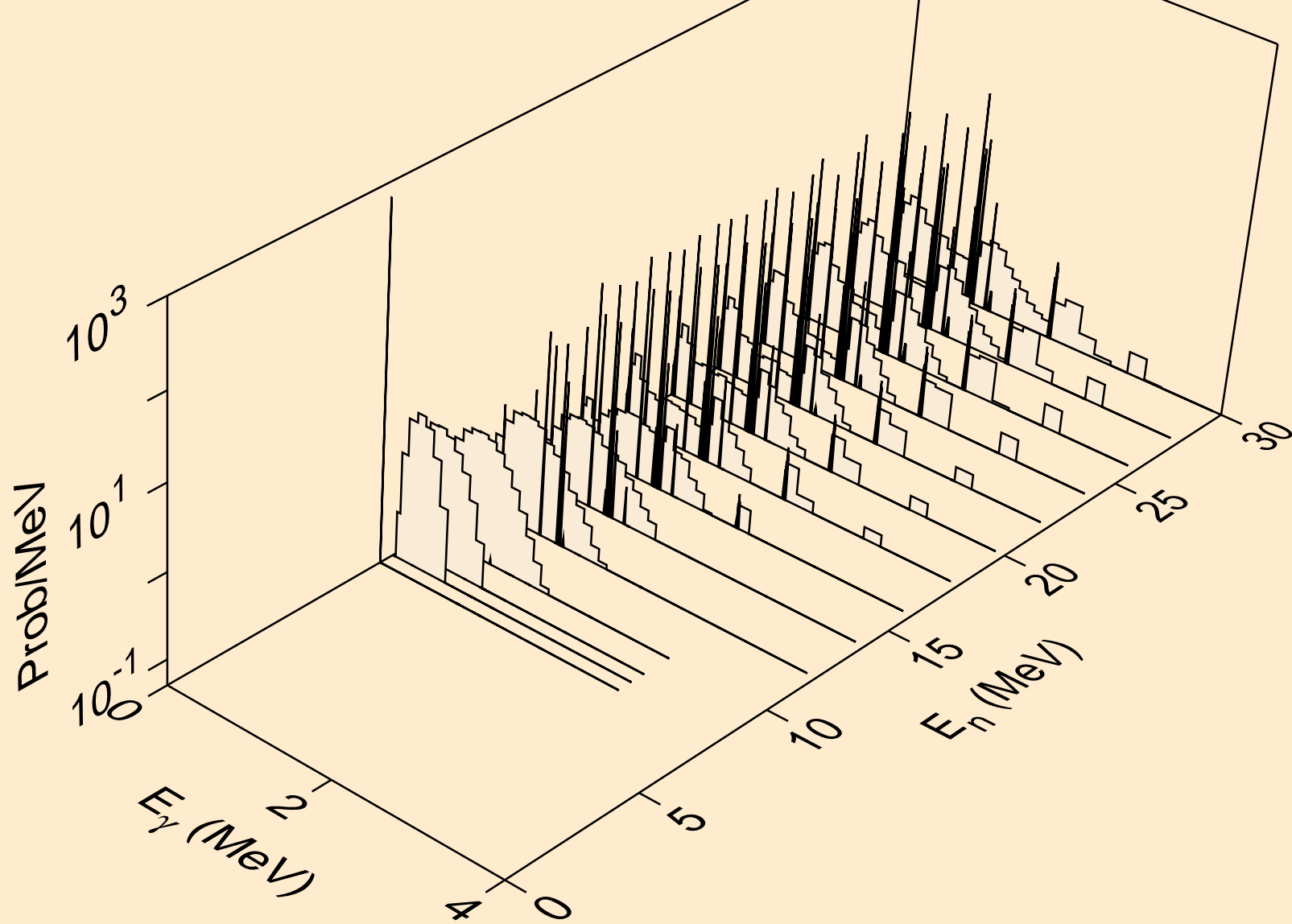

TL210 NEUTRON ACER TENDL-2023 LIBRARY; T=0.K  
Photon emission for (n,3n)a

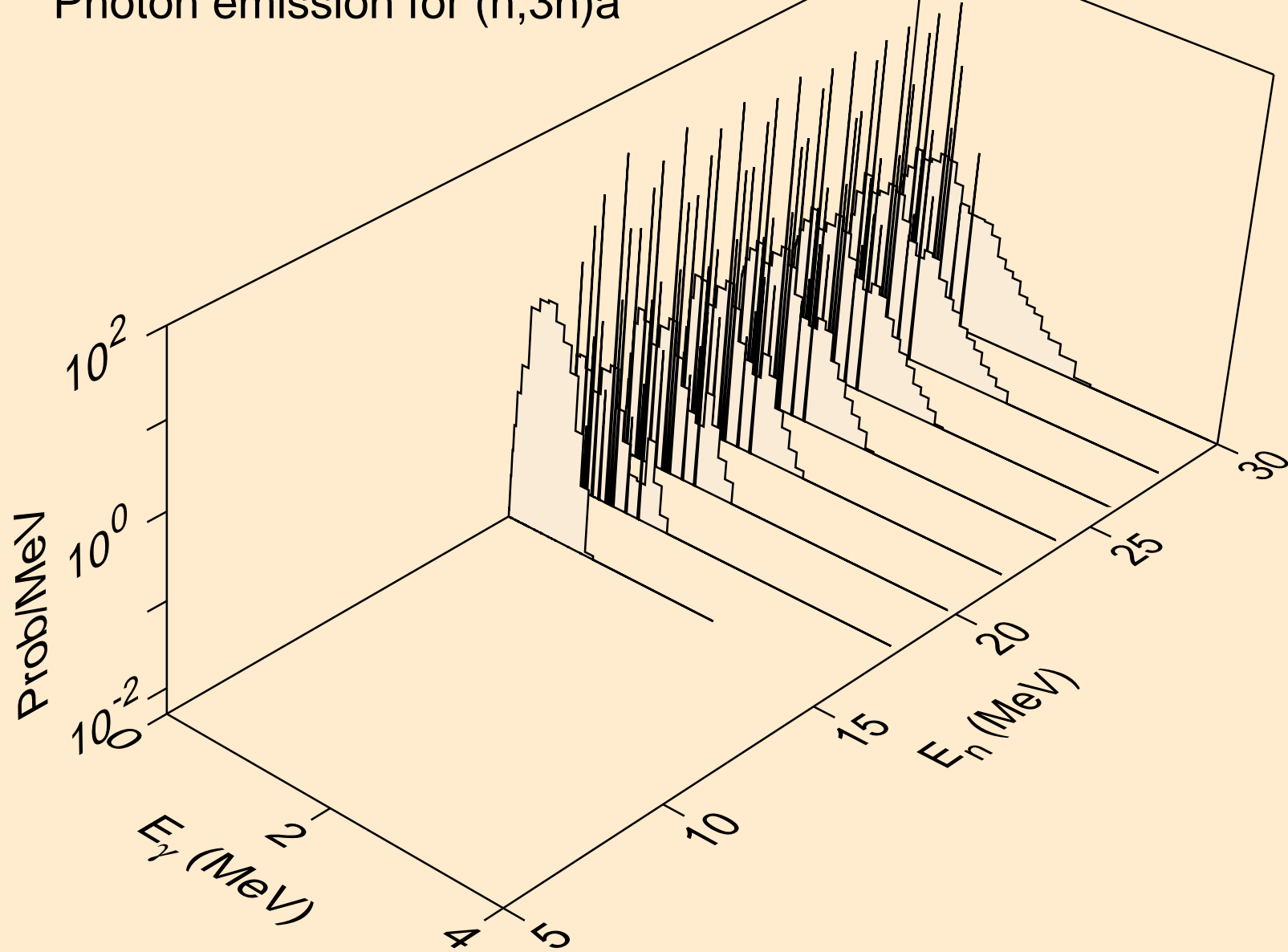

TL210 NEUTRON ACER TENDL-2023 LIBRARY; T=0.K  
Photon emission for (n,n\*)p

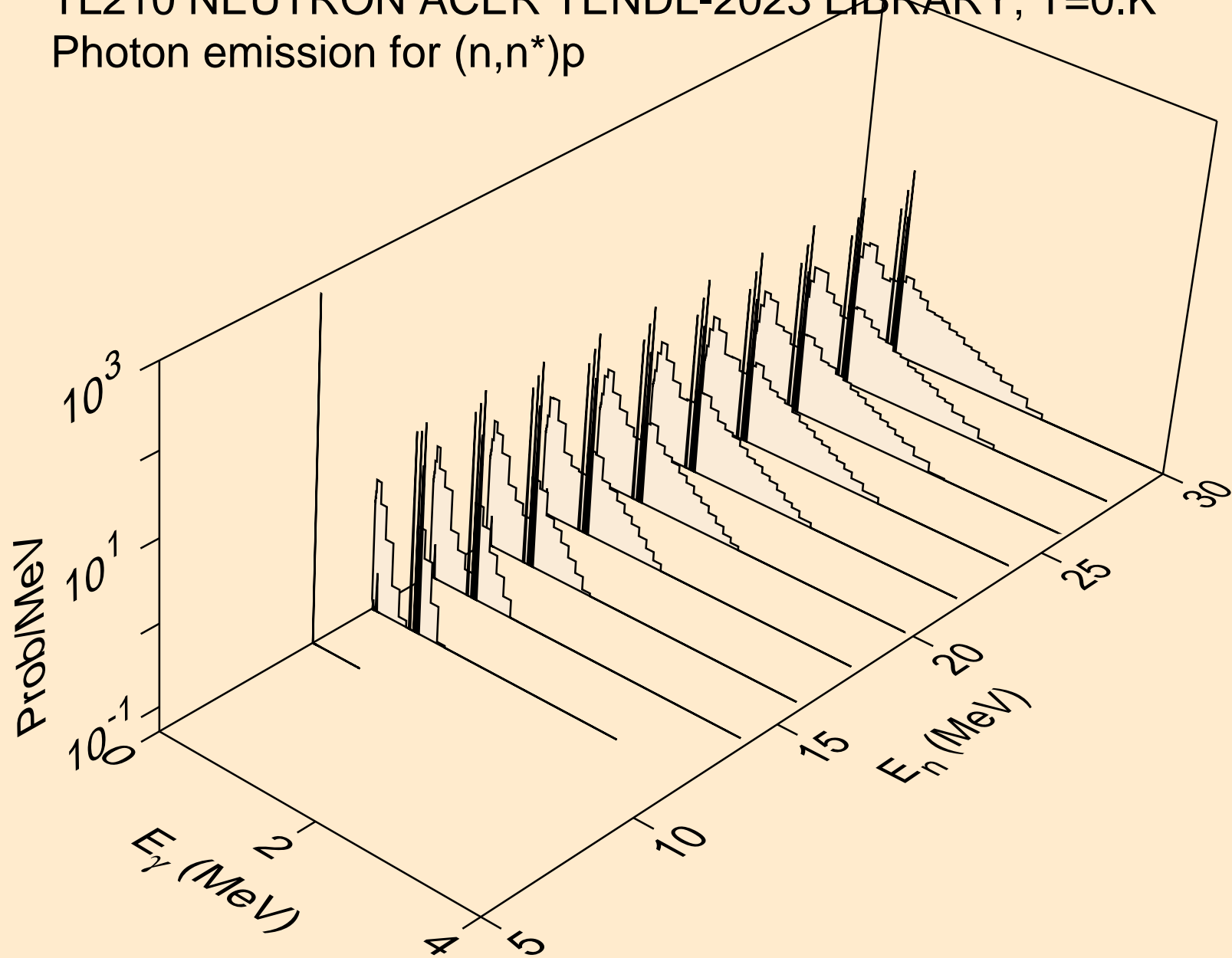

TL210 NEUTRON ACER TENDL-2023 LIBRARY; T=0.K  
Photon emission for (n,n\*)d

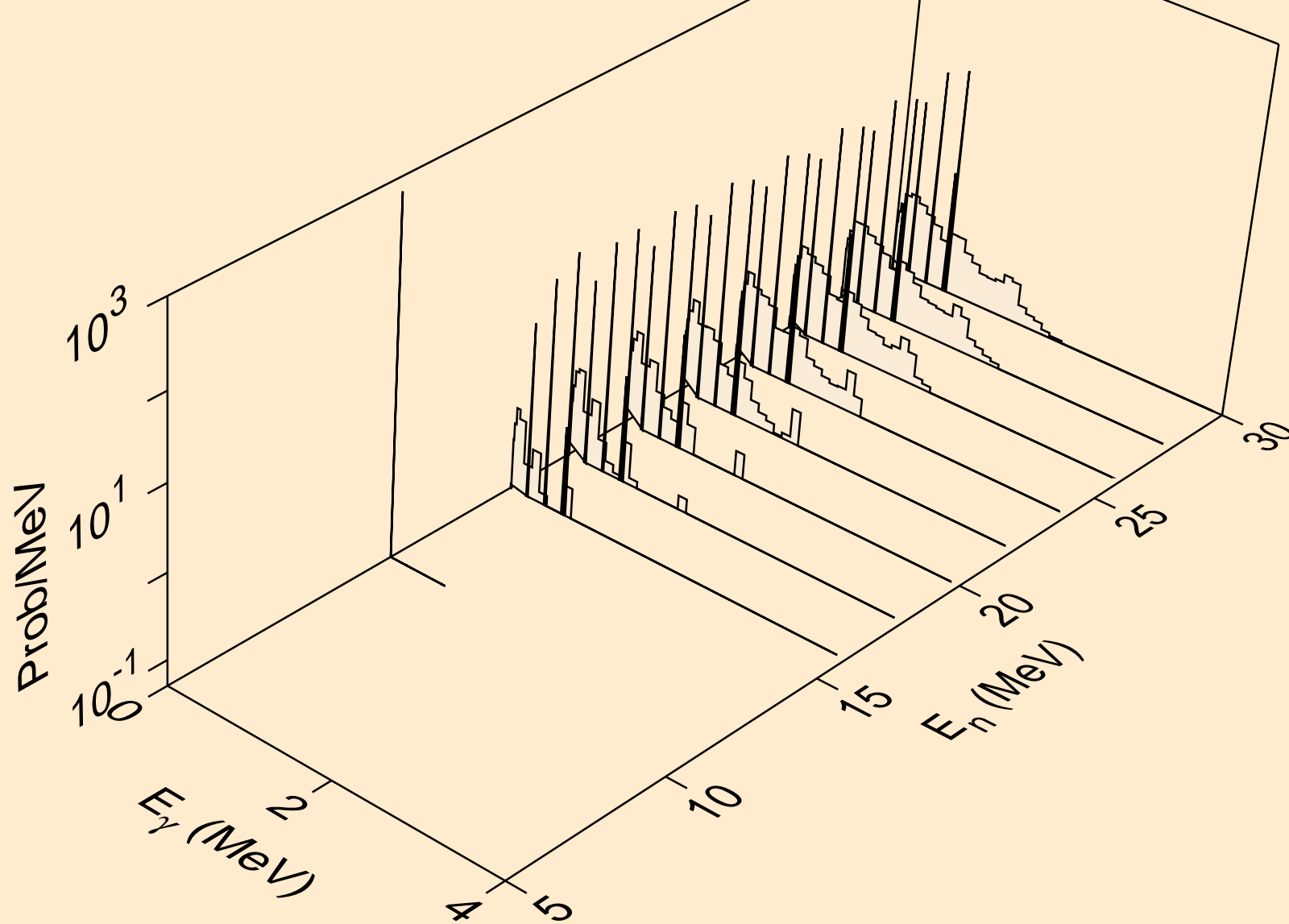

TL210 NEUTRON ACER TENDL-2023 LIBRARY; T=0.K  
Photon emission for (n,n\*)t

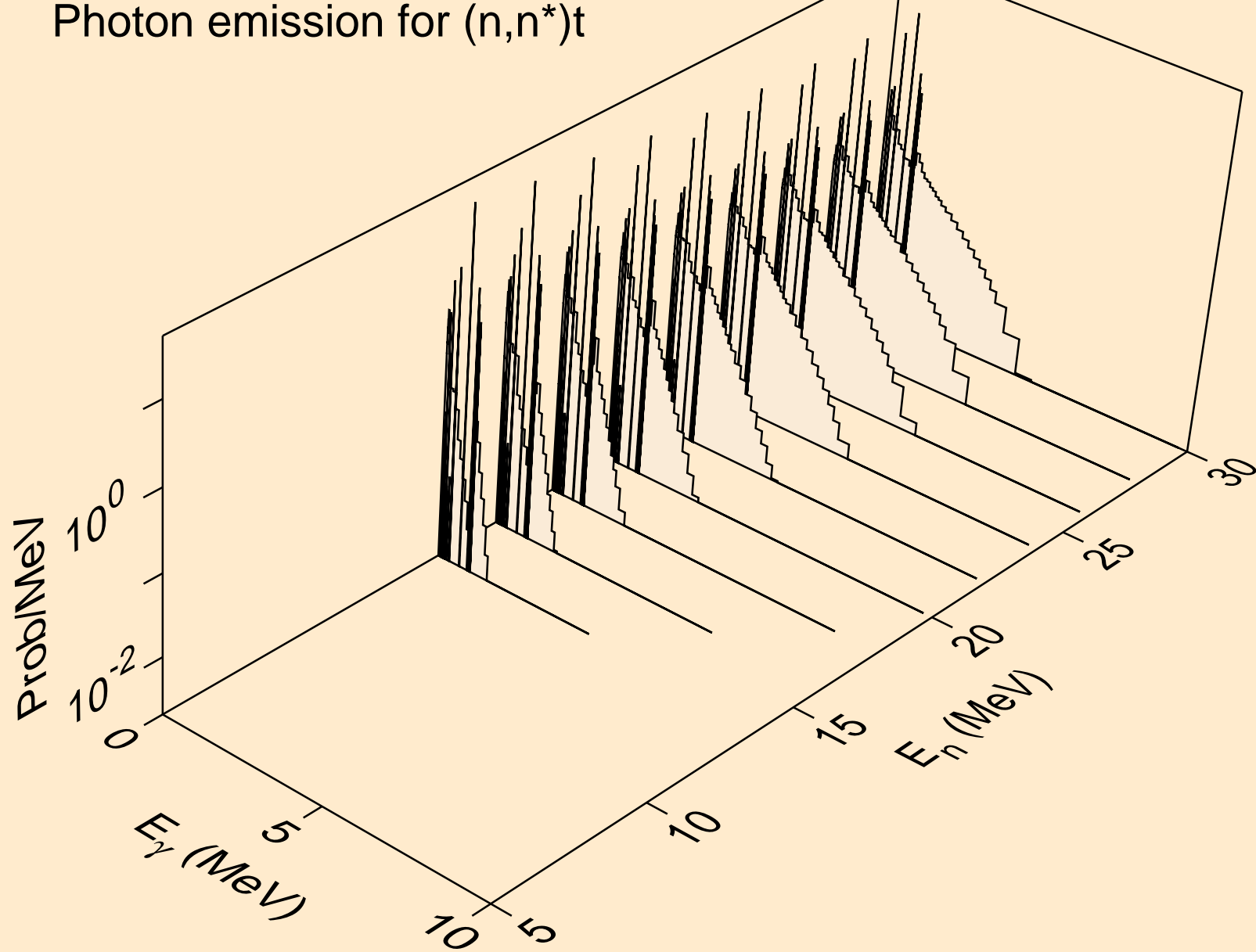

TL210 NEUTRON ACER TENDL-2023 LIBRARY; T=0.K  
Photon emission for (n,n\*)he3

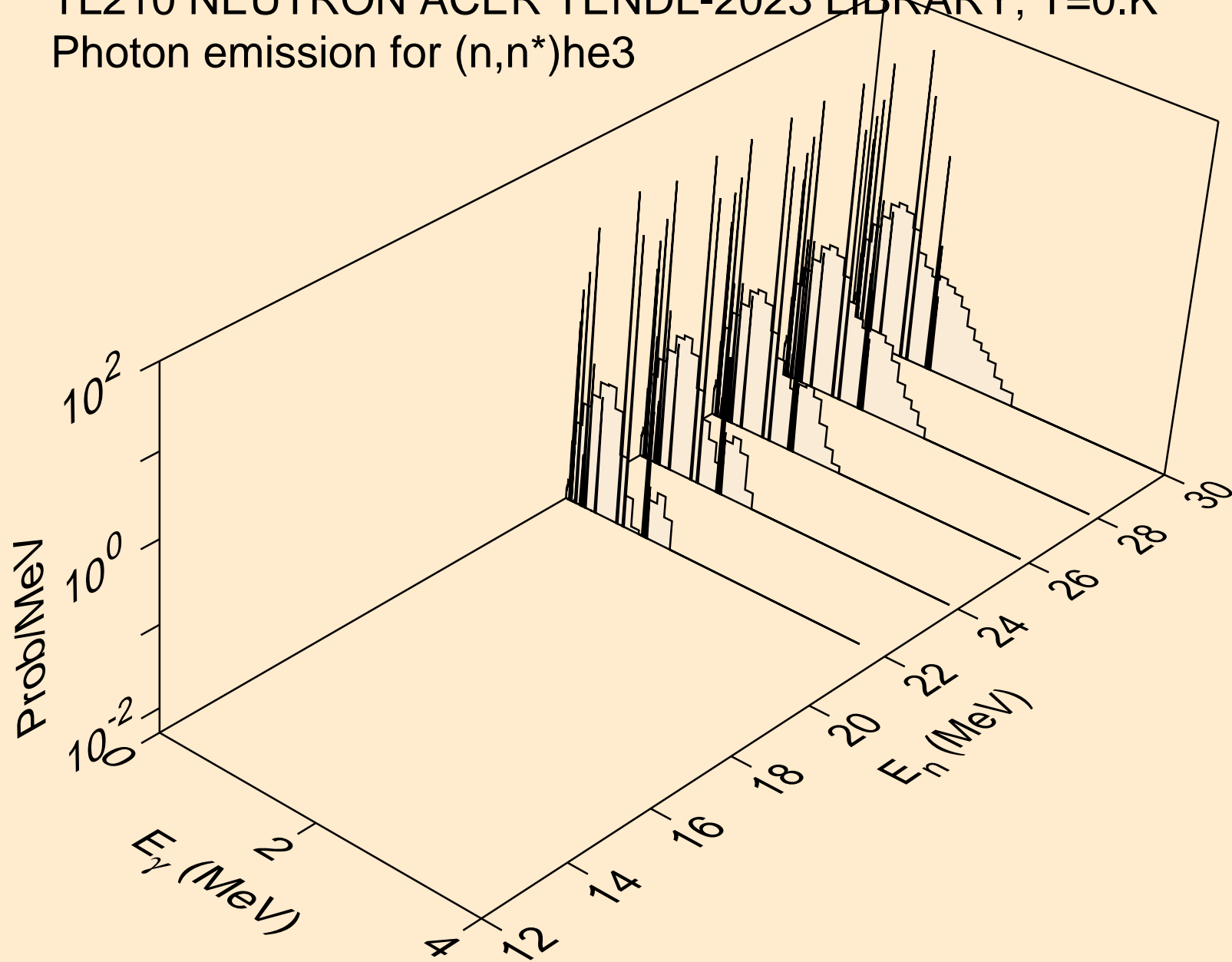

TL210 NEUTRON ACER TENDL-2023 LIBRARY; T=0.K  
Photon emission for (n,4n)

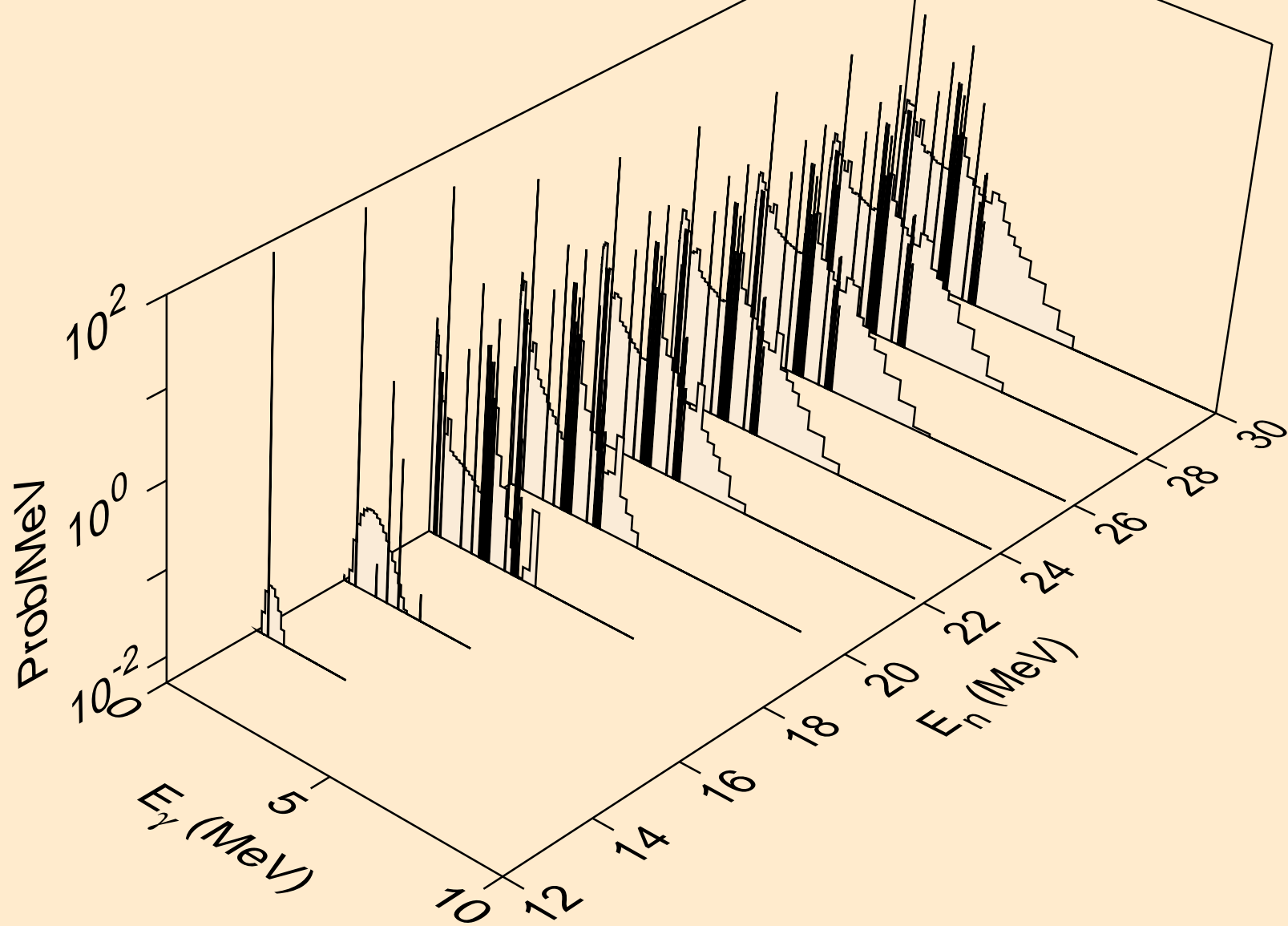

TL210 NEUTRON ACER TENDL-2023 LIBRARY; T=0.K  
Photon emission for (n,2np)

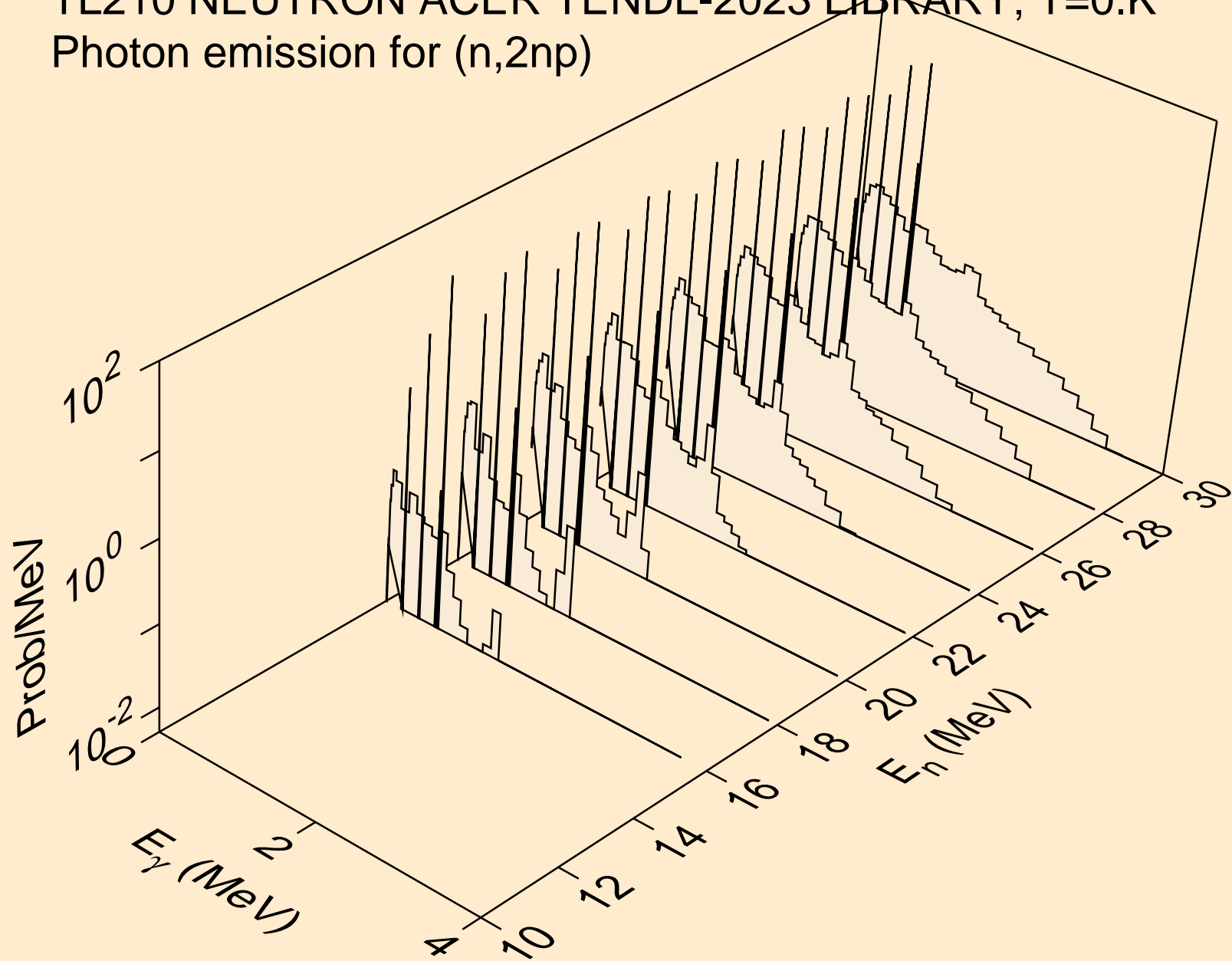

TL210 NEUTRON ACER TENDL-2023 LIBRARY; T=0.K  
Photon emission for (n,3np)

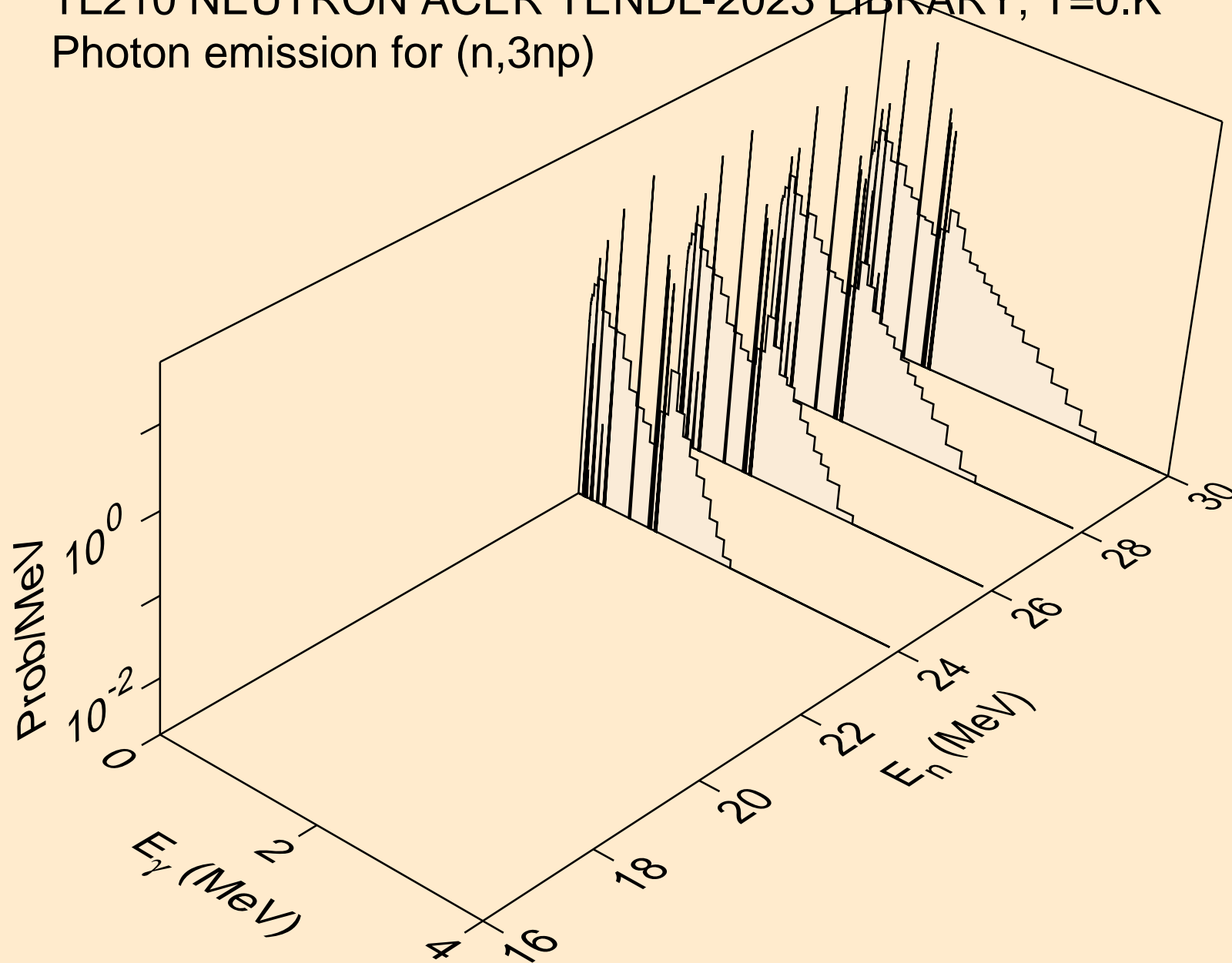

TL210 NEUTRON ACER TENDL-2023 LIBRARY; T=0.K  
Photon emission for (n,n\*c)

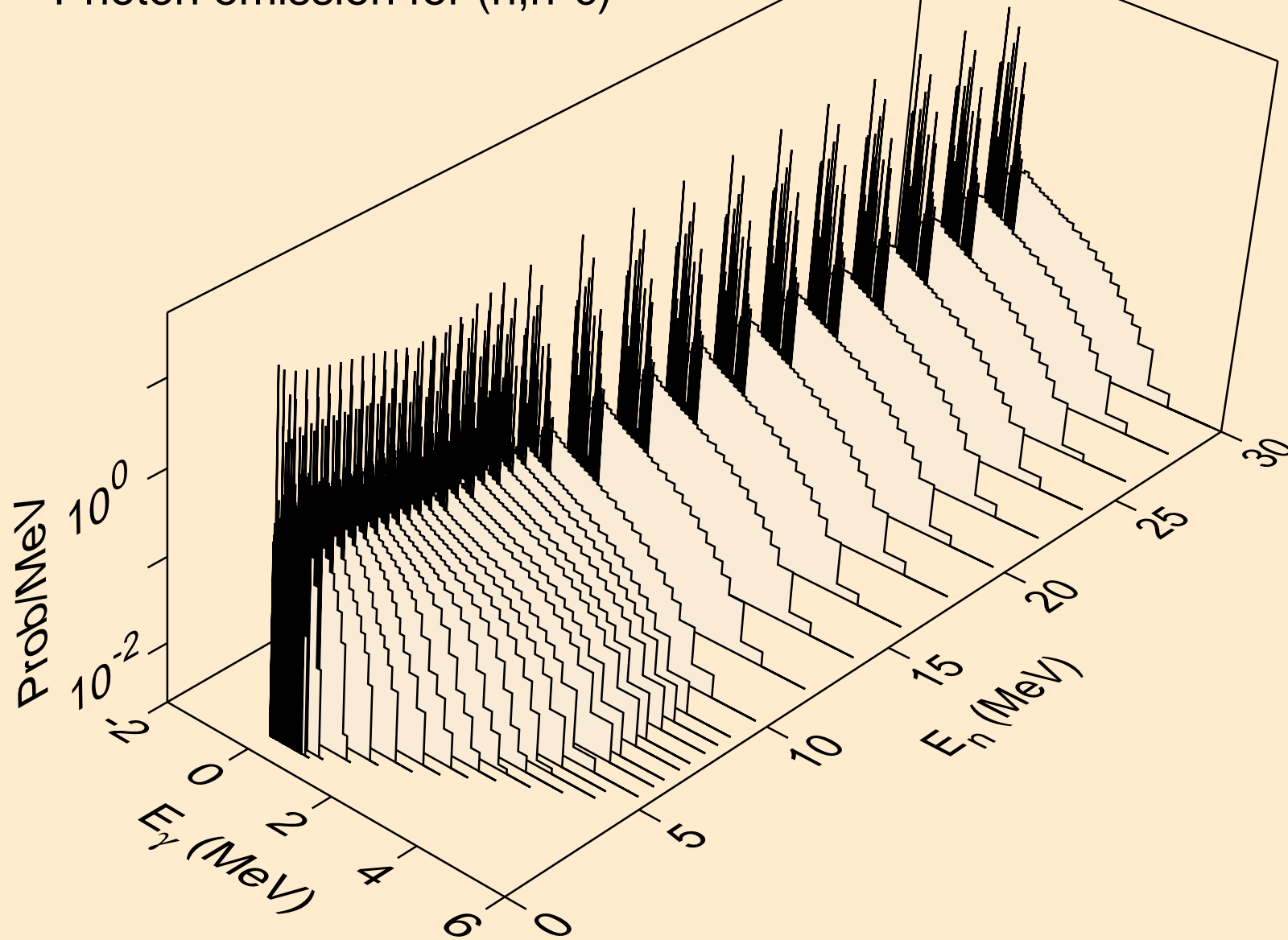

TL210 NEUTRON ACER TENDL-2023 LIBRARY; T=0.K  
Photon emission for (n,gma)

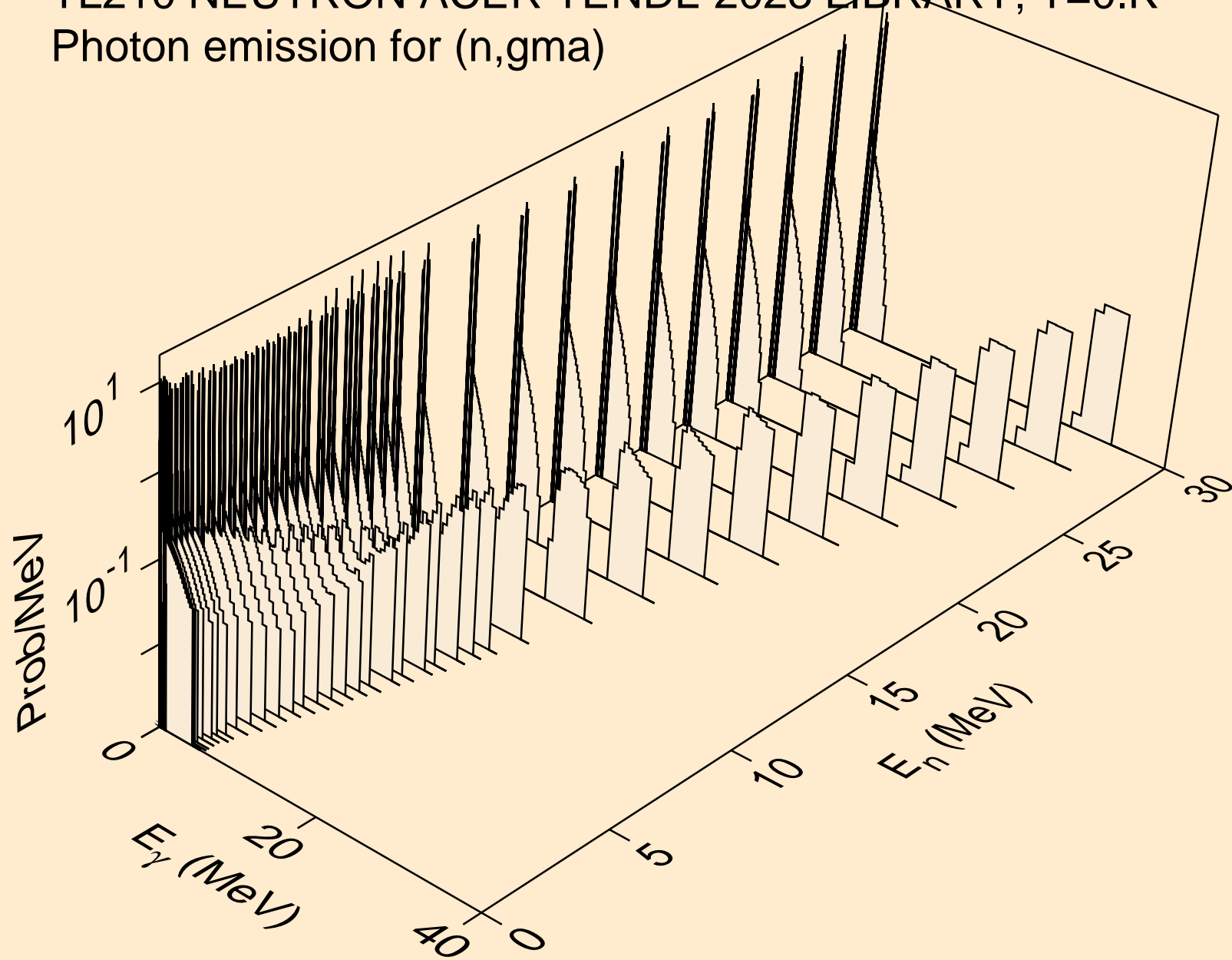

TL210 NEUTRON ACER TENDL-2023 LIBRARY; T=0.K  
Photon emission for (n,p)

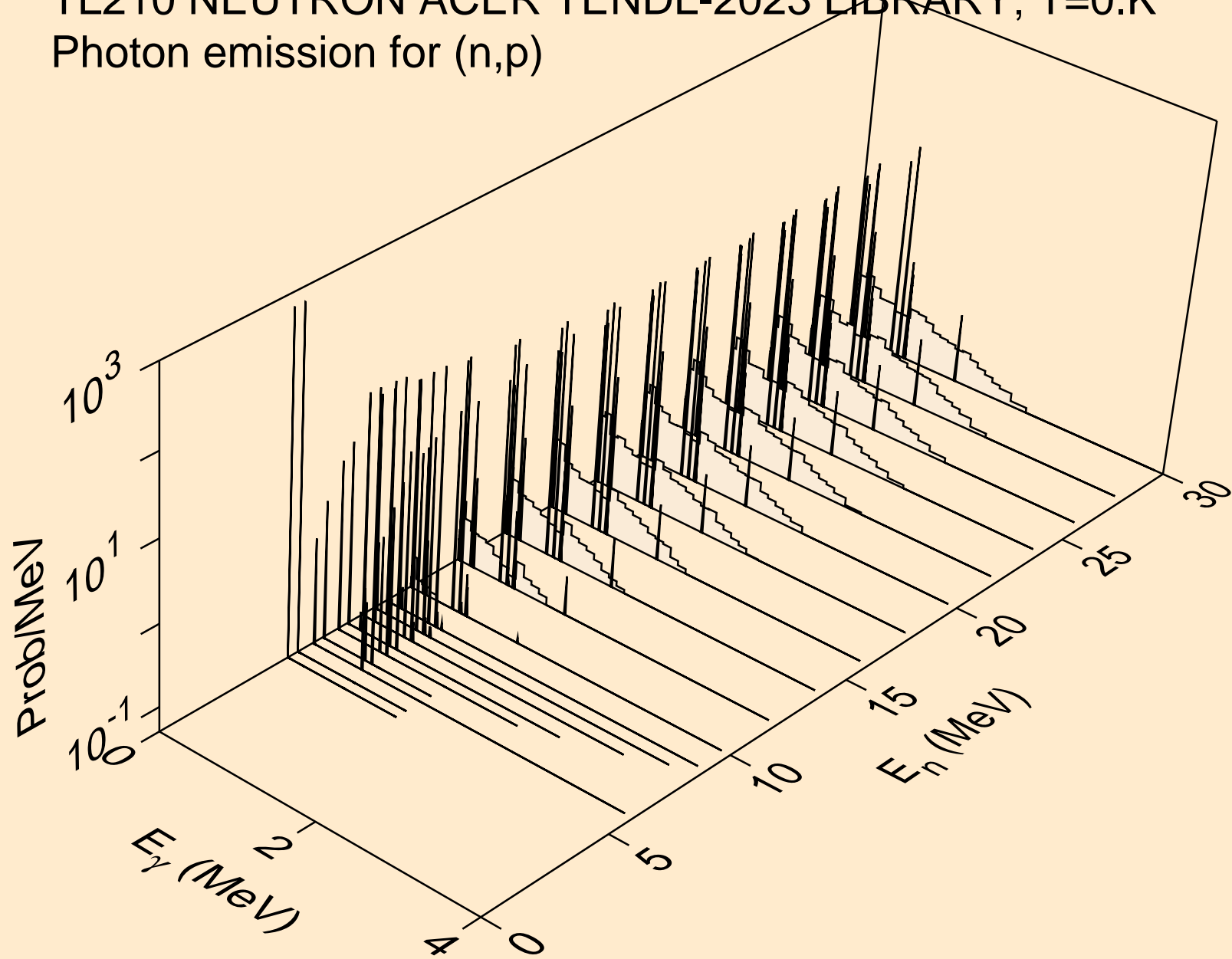

TL210 NEUTRON ACER TENDL-2023 LIBRARY; T=0.K  
Photon emission for (n,d)

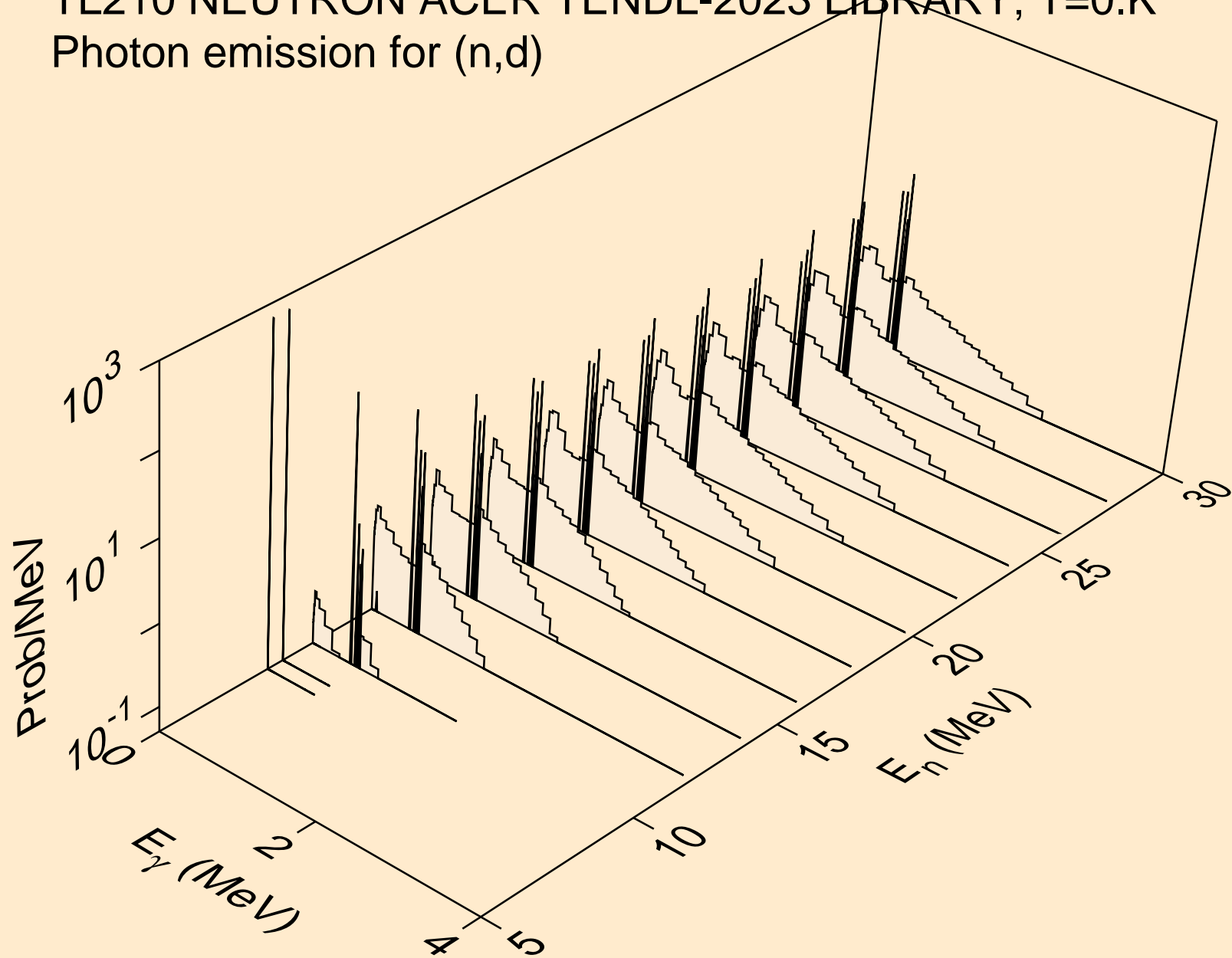

TL210 NEUTRON ACER TENDL-2023 LIBRARY; T=0.K  
Photon emission for (n,t)

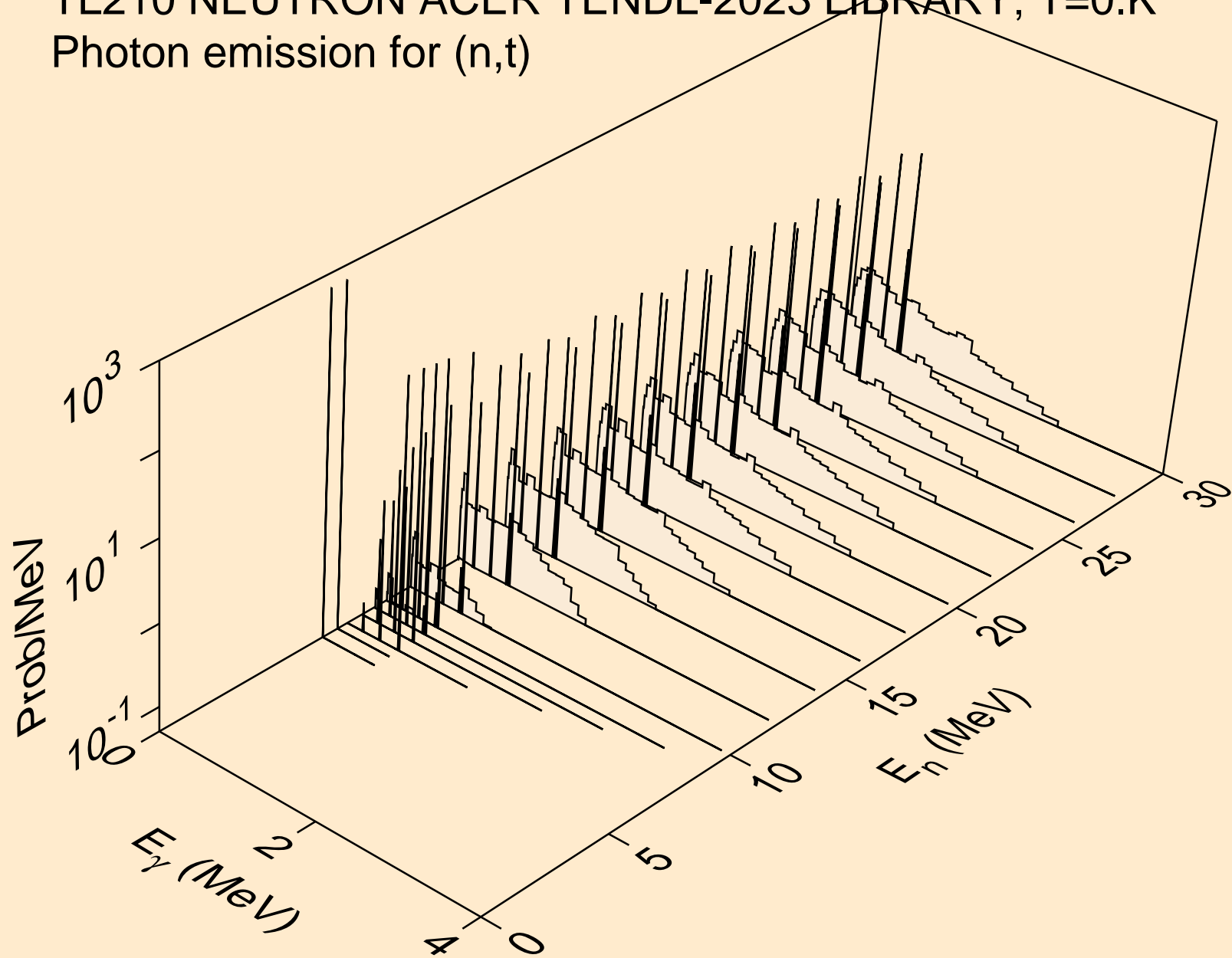

TL210 NEUTRON ACER TENDL-2023 LIBRARY; T=0.K  
Photon emission for (n,he3)

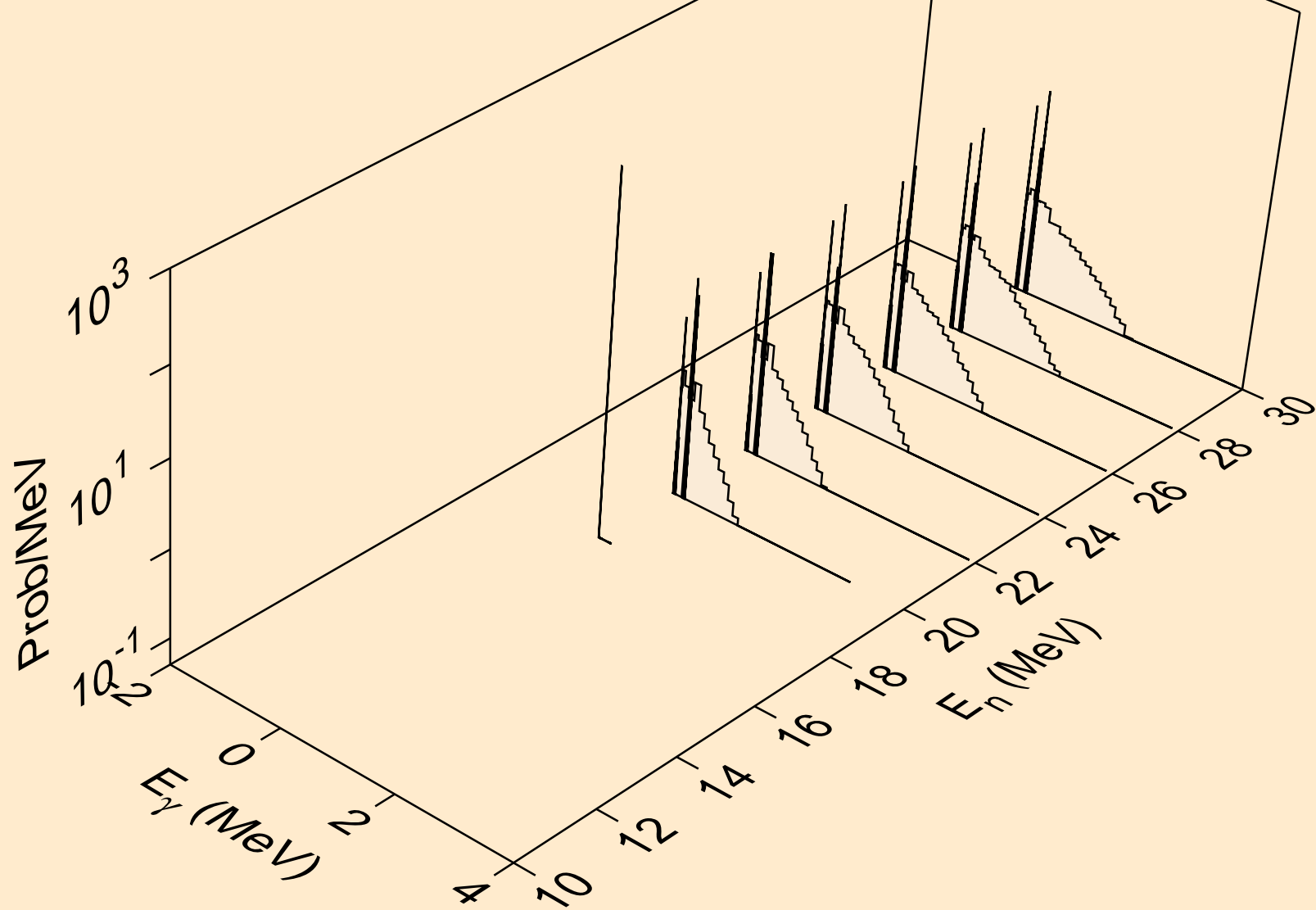

TL210 NEUTRON ACER TENDL-2023 LIBRARY; T=0.K  
Photon emission for (n,a)

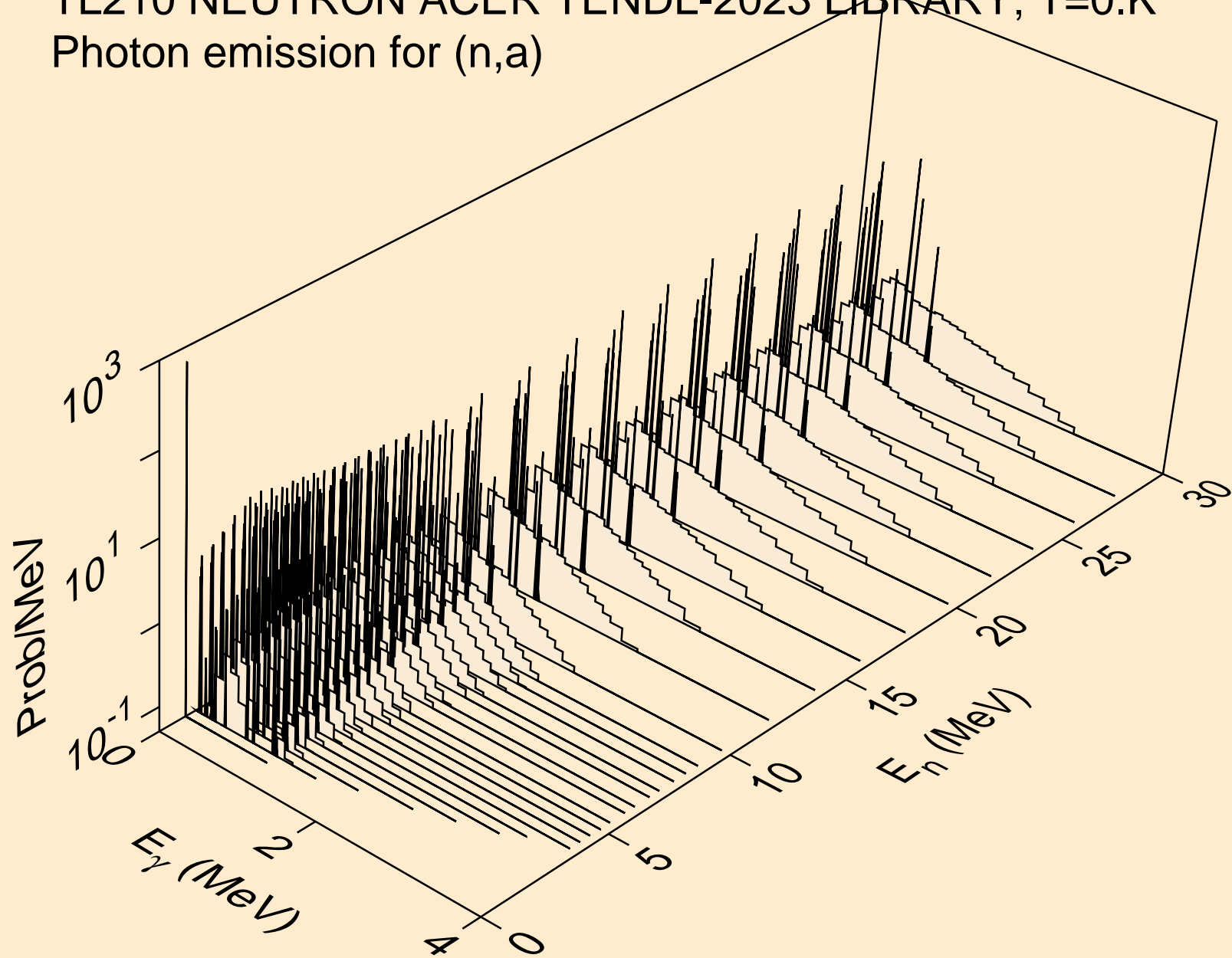

TL210 NEUTRON ACER TENDL-2023 LIBRARY; T=0.K  
thermal capture photon spectrum

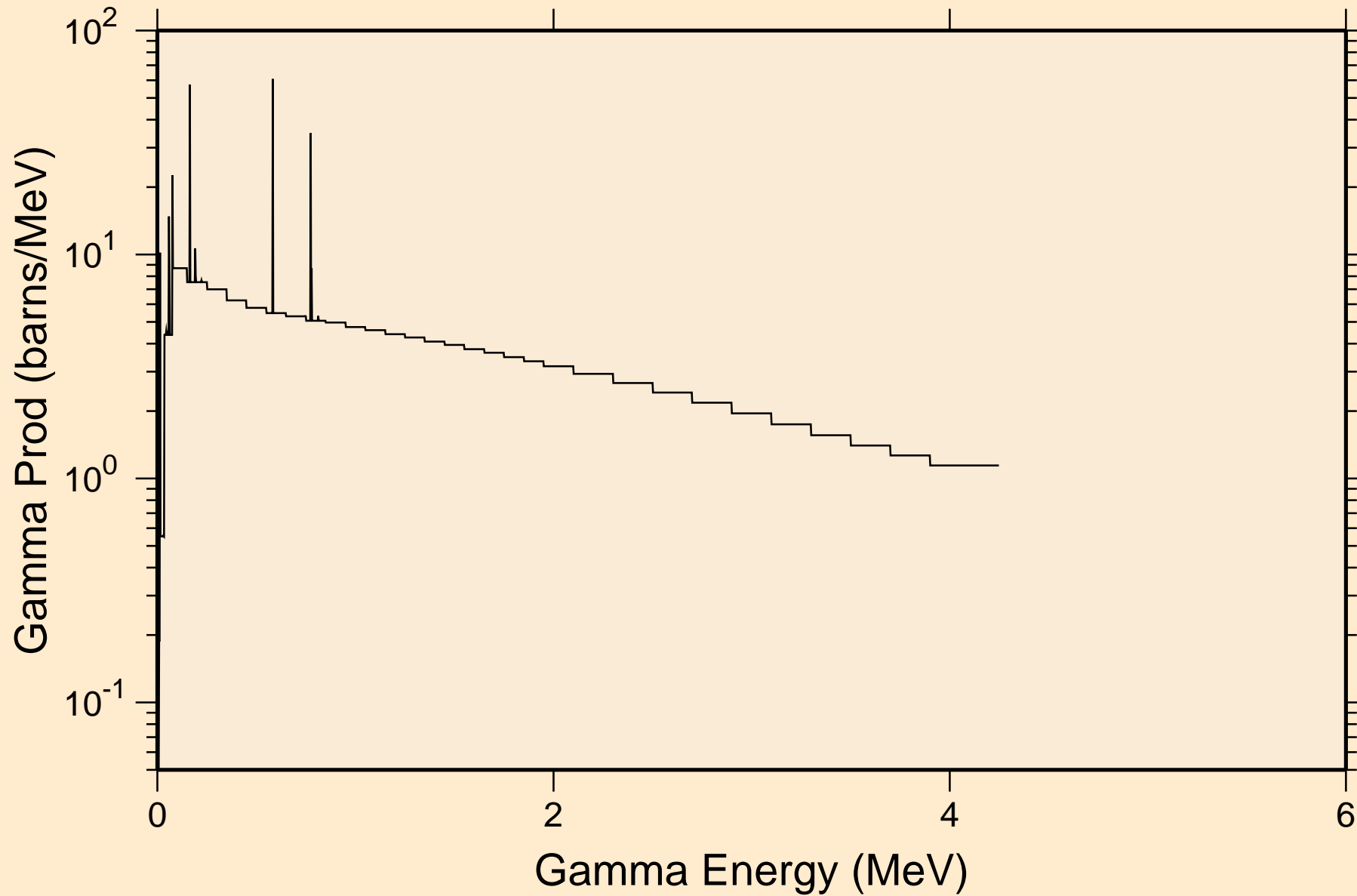

TL210 NEUTRON ACER TENDL-2023 LIBRARY; T=0.K  
14 MeV photon spectrum

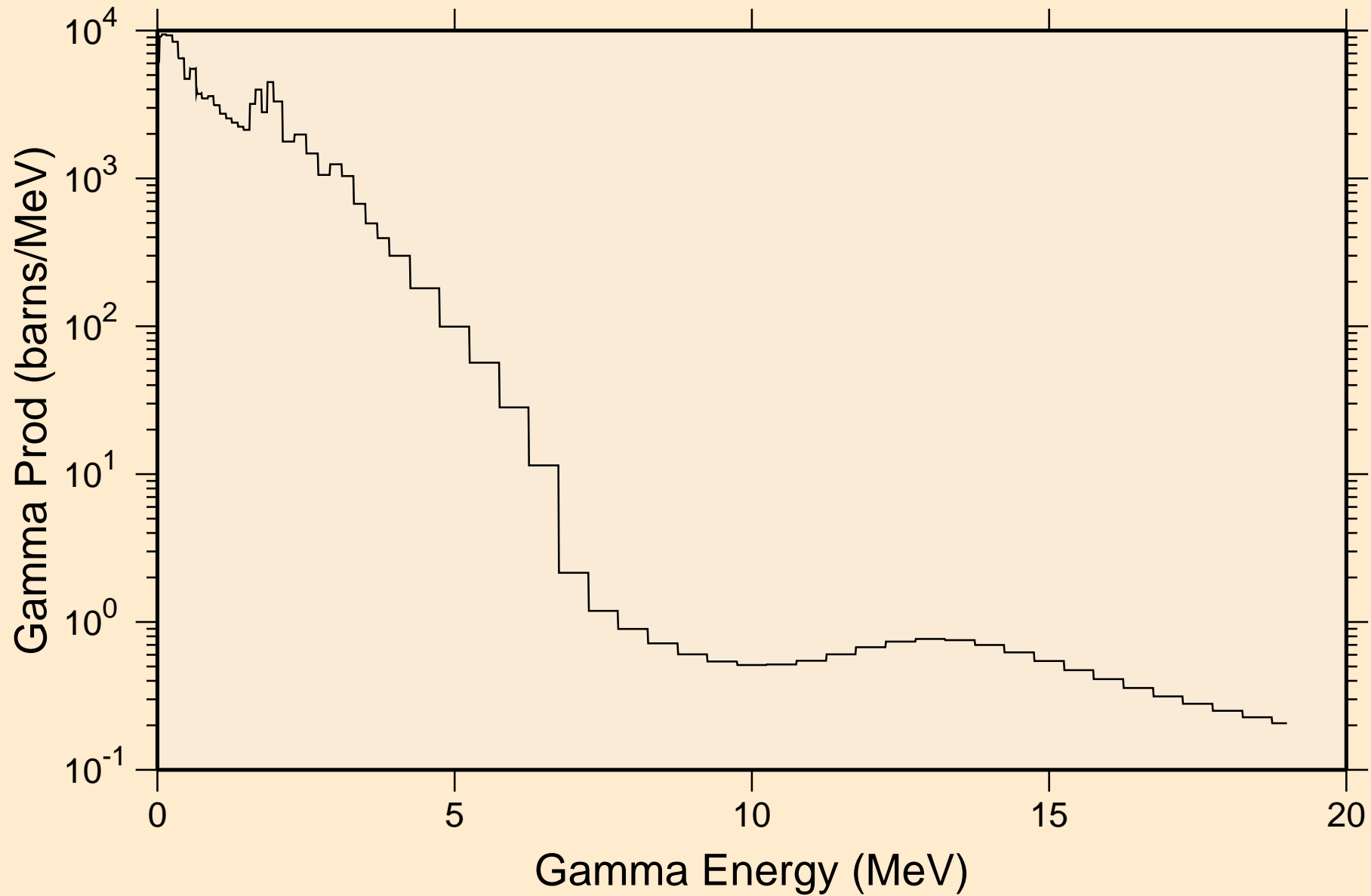

TL210 NEUTRON ACER TENDL-2023 LIBRARY; T=0.K  
Particle heating contributions

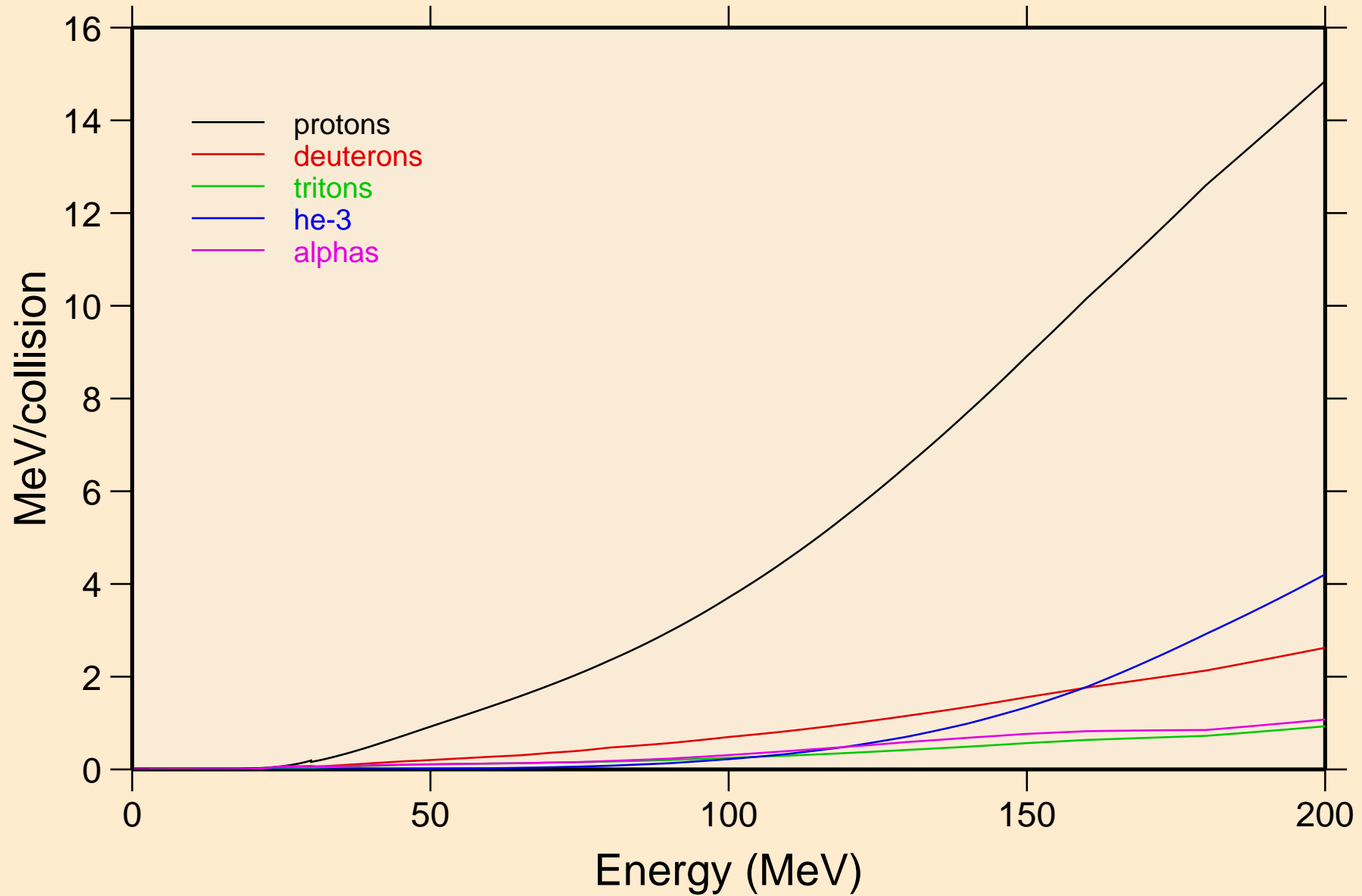

TL210 NEUTRON ACER TENDL-2023 LIBRARY; T=0.K  
Recoil Heating

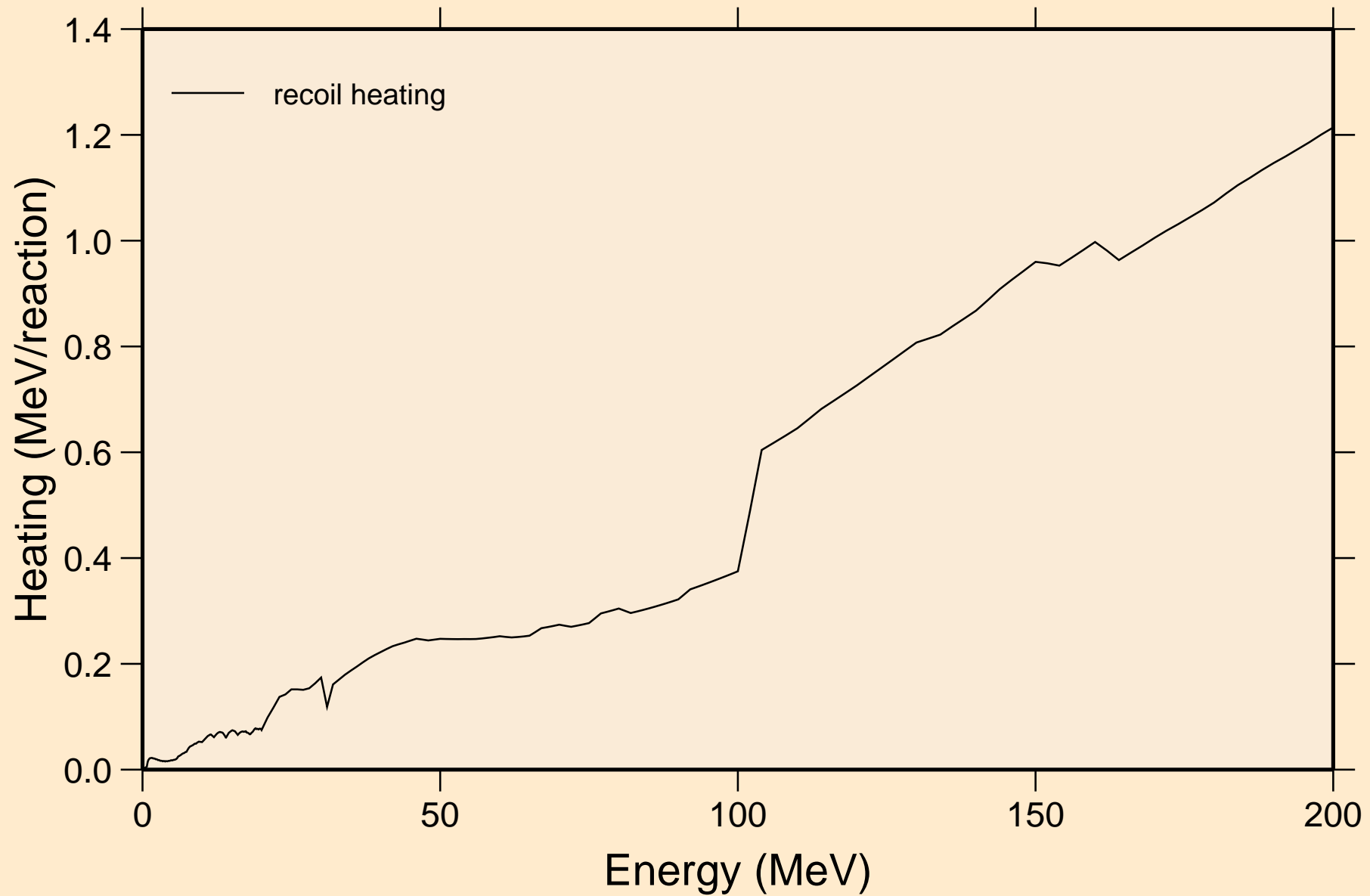

# TL210 NEUTRON ACER TENDL-2023 LIBRARY; T=0.K

## Particle production cross sections

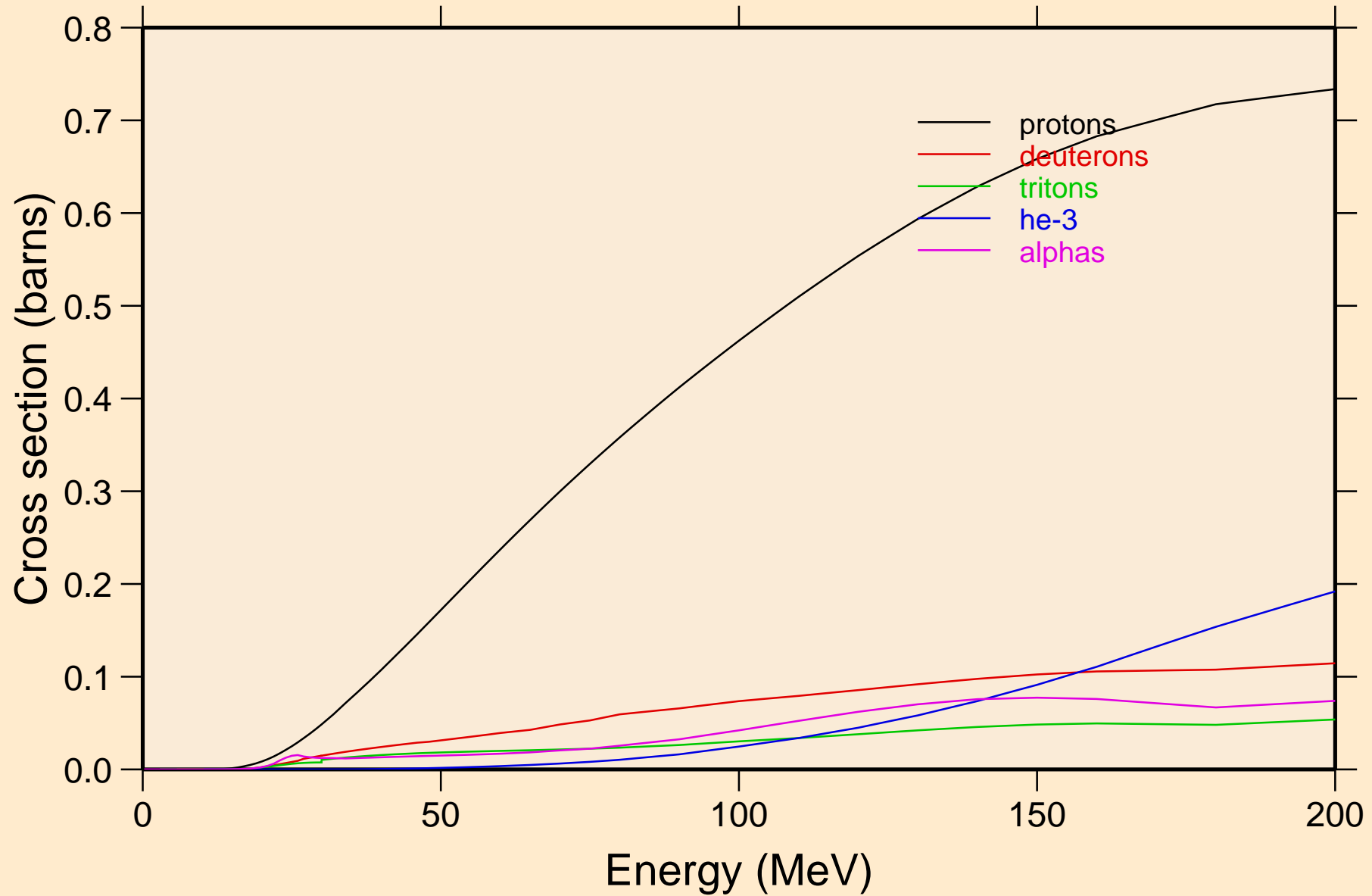

TL210 NEUTRON ACER TENDL-2023 LIBRARY; T=0.K  
protons from (n,x)

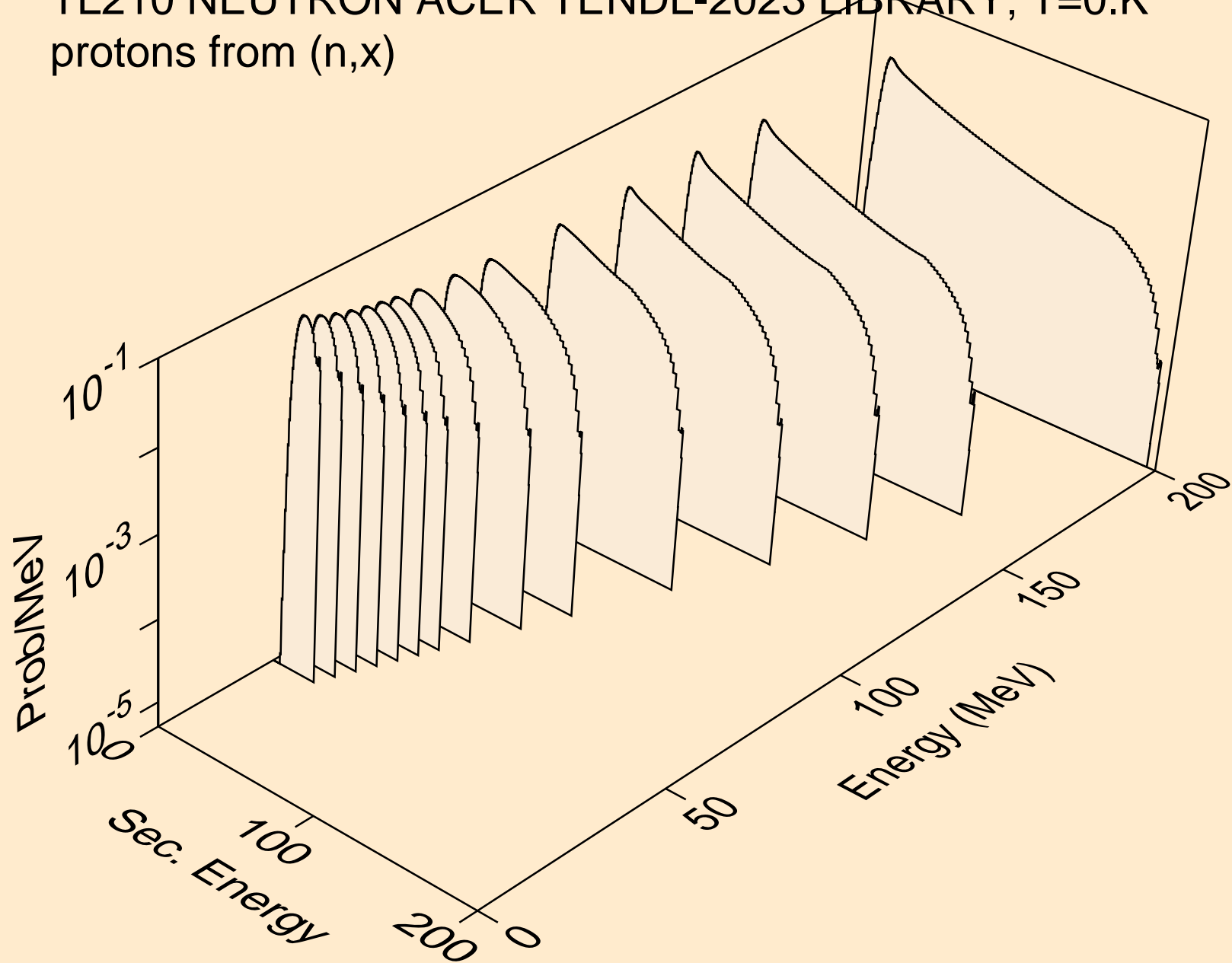

TL210 NEUTRON ACER TENDL-2023 LIBRARY; T=0.K  
protons from (n,n\*)p

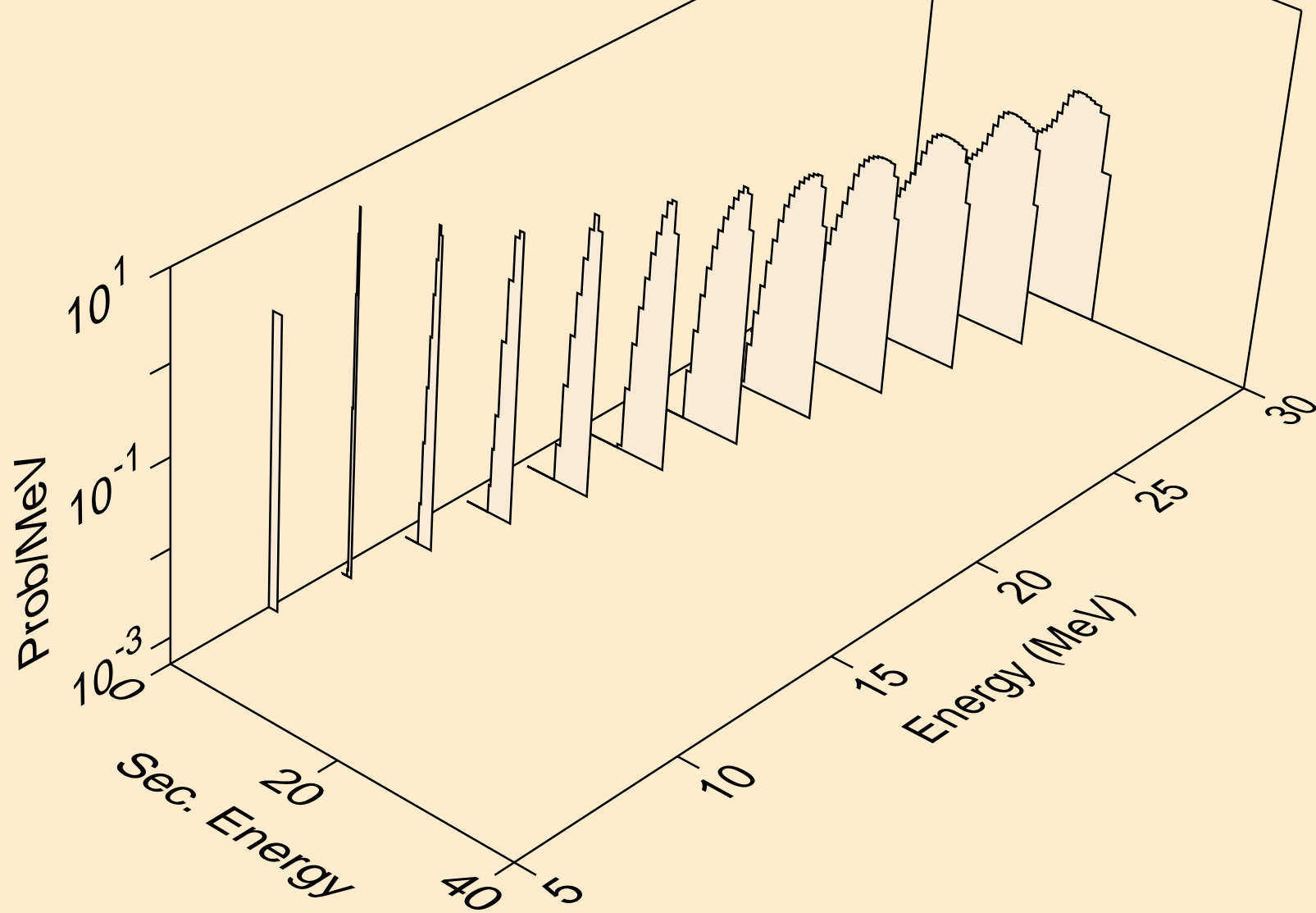

TL210 NEUTRON ACER TENDL-2023 LIBRARY; T=0.K  
protons from (n,2np)

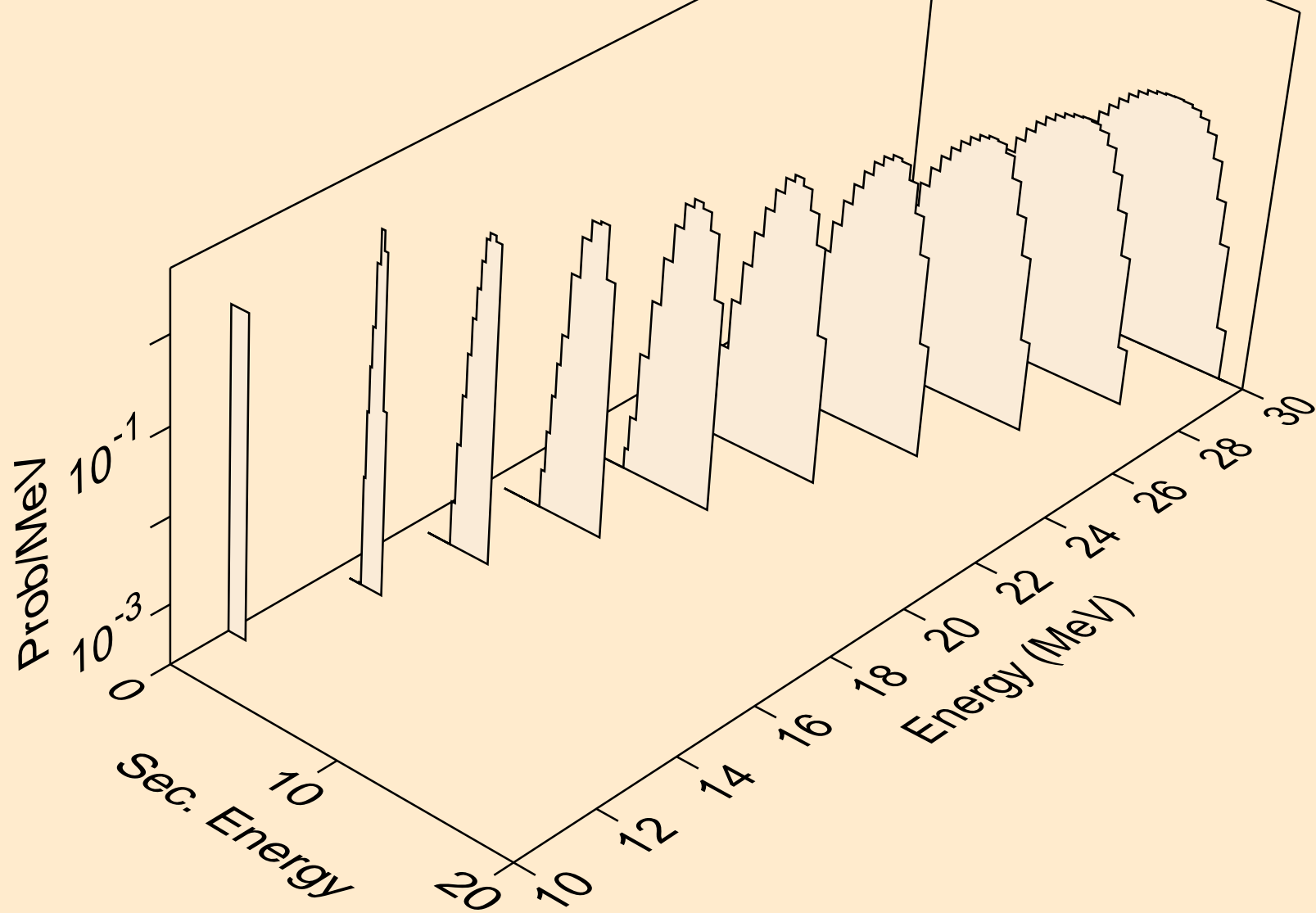

TL210 NEUTRON ACER TENDL-2023 LIBRARY; T=0.K  
protons from (n,3np)

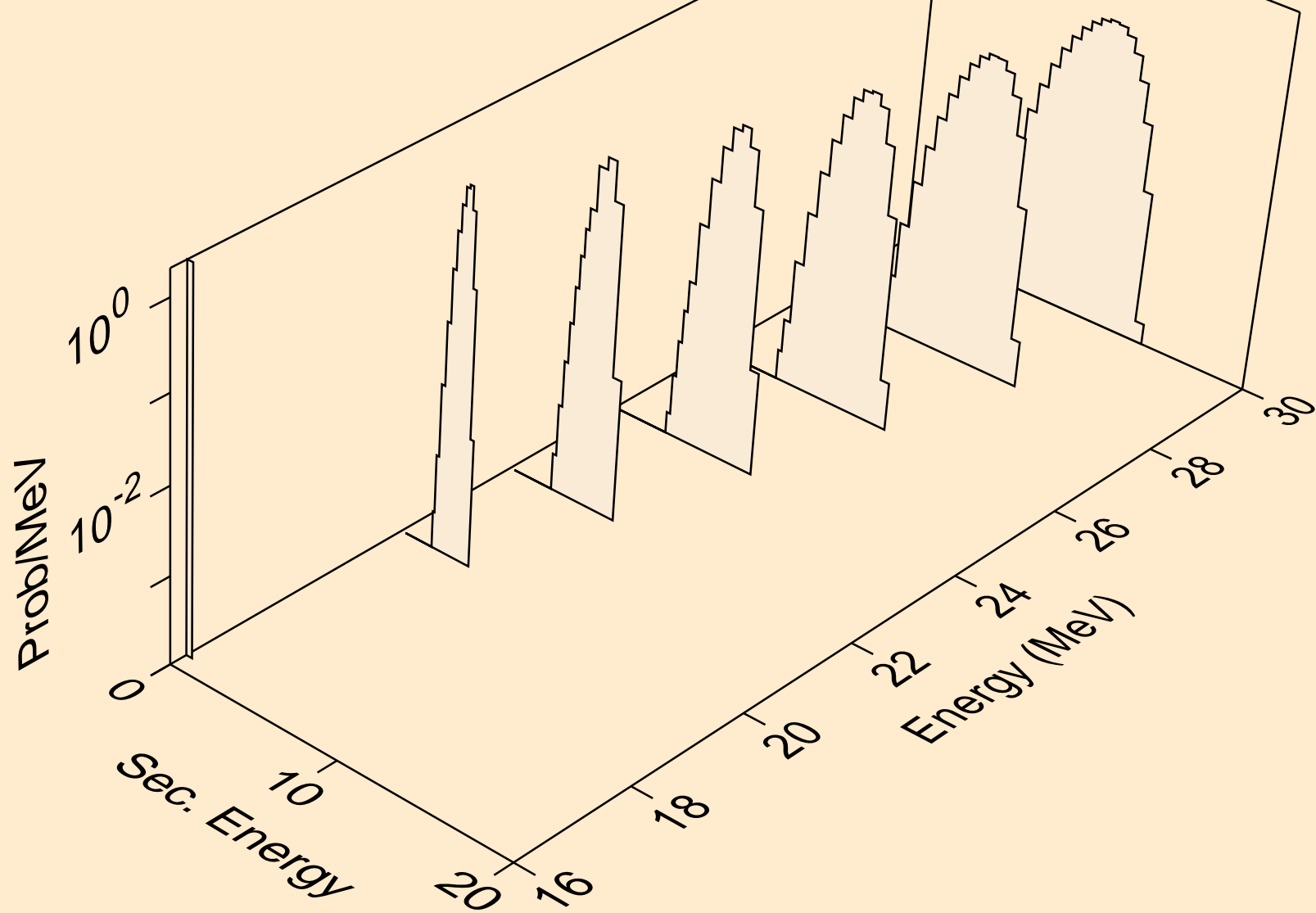

TL210 NEUTRON ACER TENDL-2023 LIBRARY; T=0.K  
protons from (n,p)

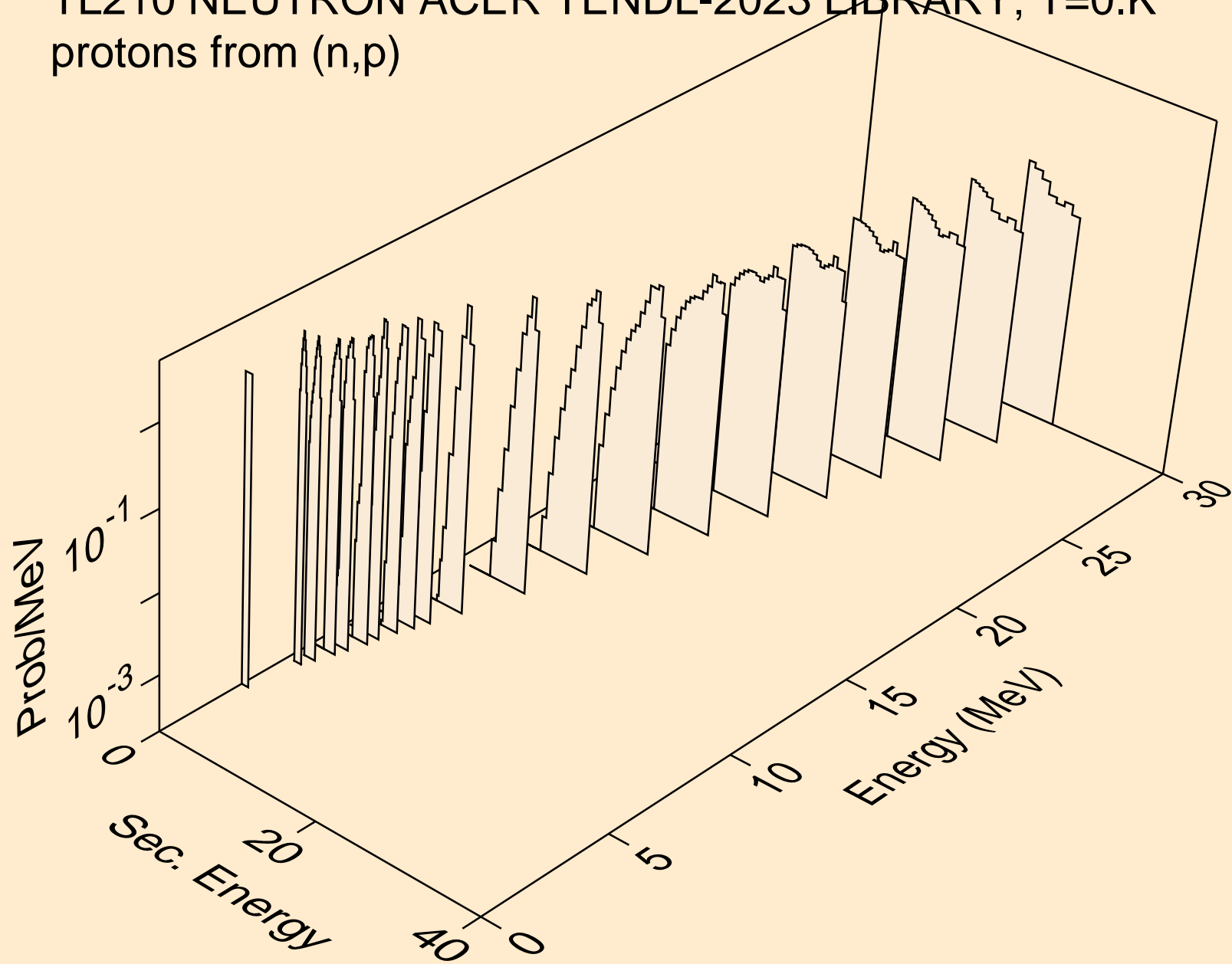

TL210 NEUTRON ACER TENDL-2023 LIBRARY; T=0.K  
deuterons from (n,x)

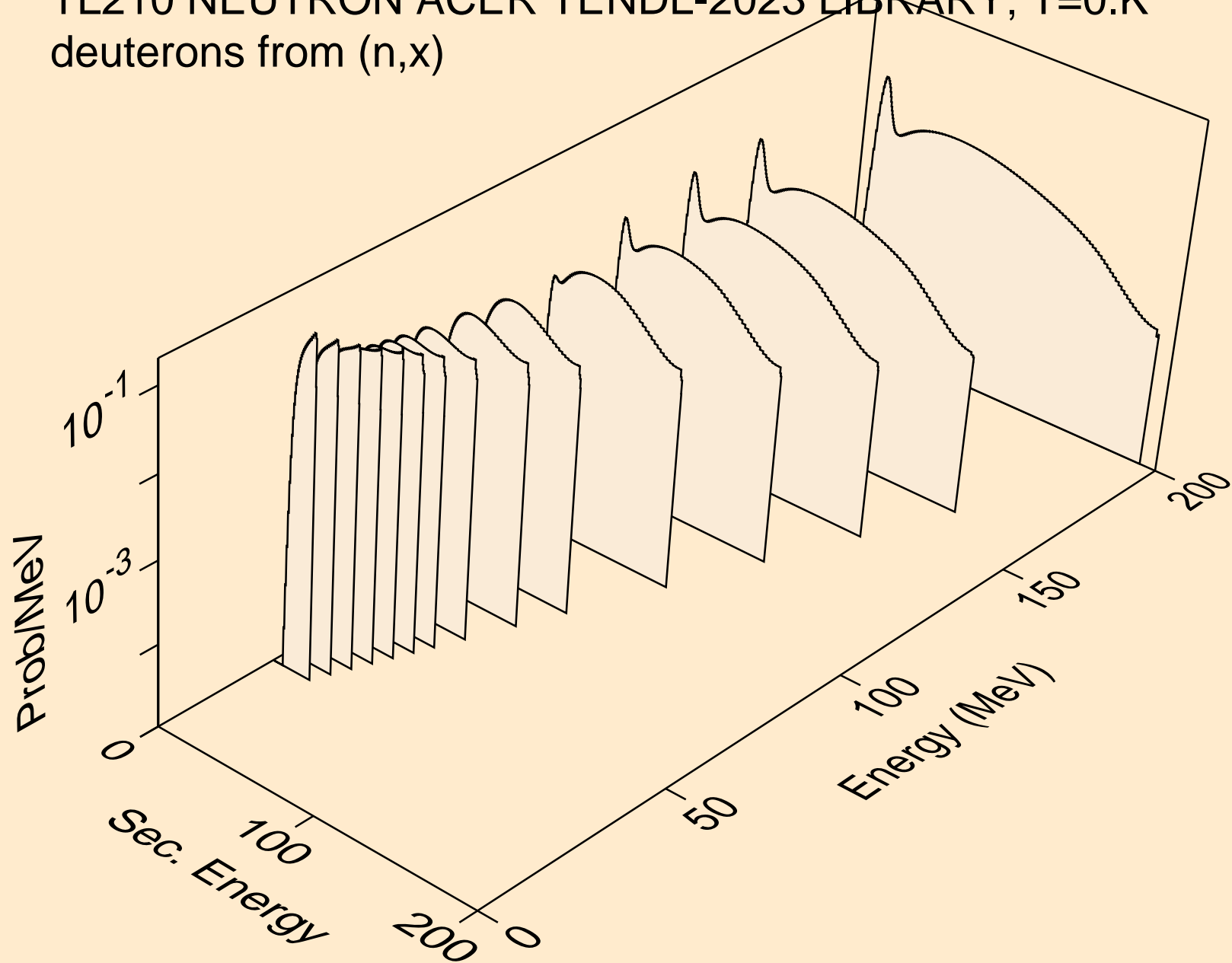

TL210 NEUTRON ACER TENDL-2023 LIBRARY; T=0.K  
deuterons from (n,2nd)

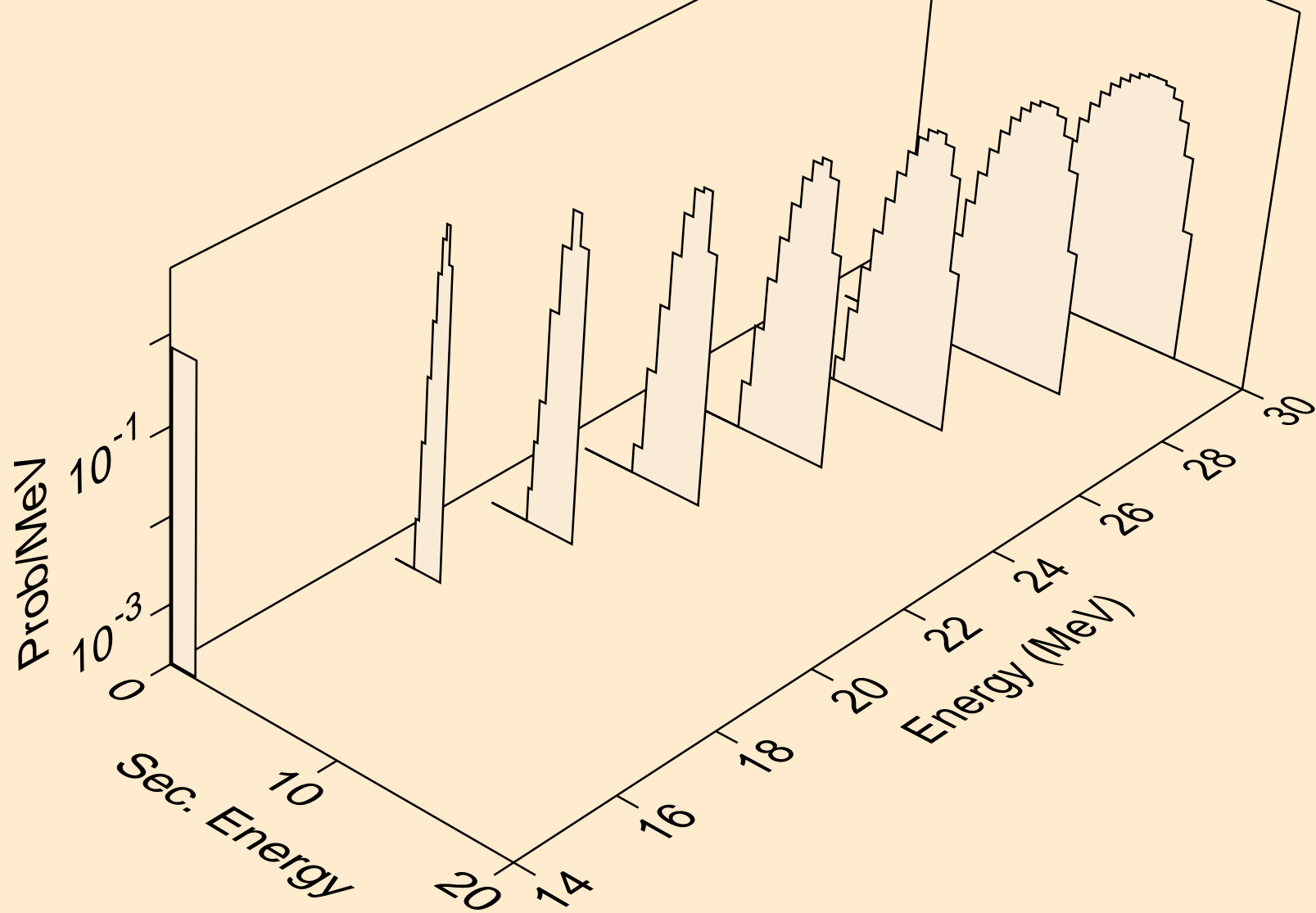

TL210 NEUTRON ACER TENDL-2023 LIBRARY; T=0.K  
deuterons from (n,n\*)d

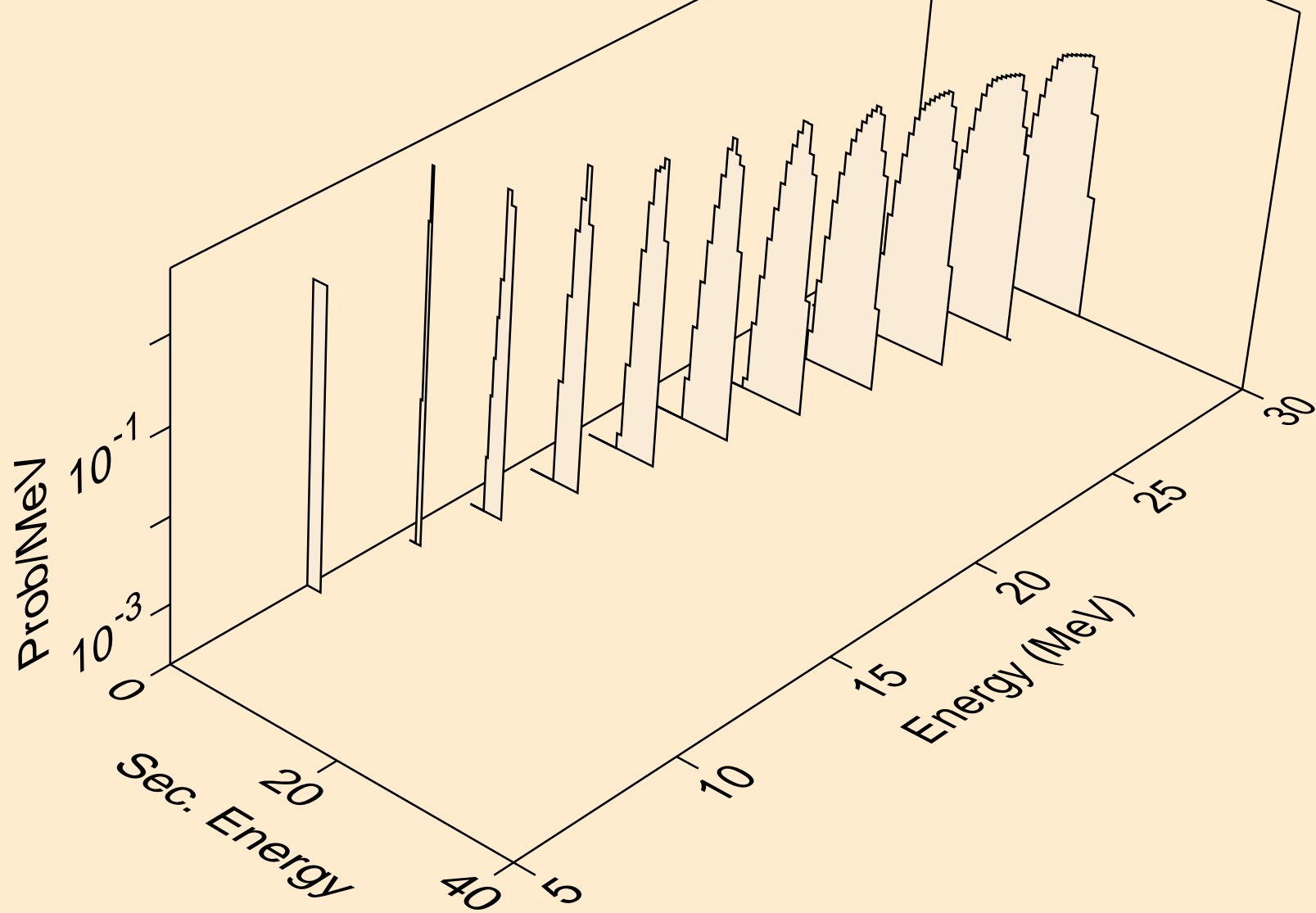

TL210 NEUTRON ACER TENDL-2023 LIBRARY; T=0.K  
deuterons from (n,d)

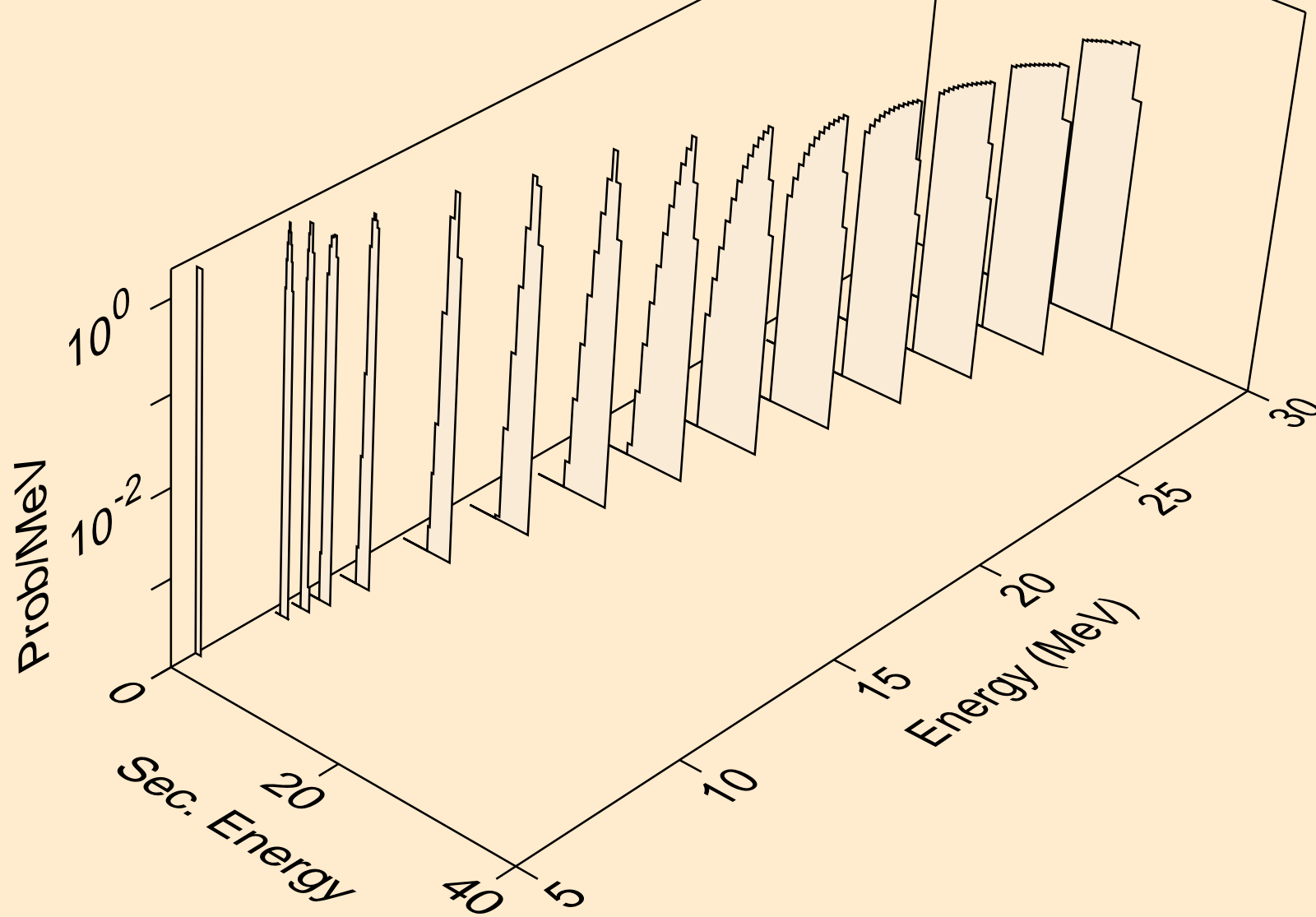

TL210 NEUTRON ACER TENDL-2023 LIBRARY; T=0.K  
tritons from (n,x)

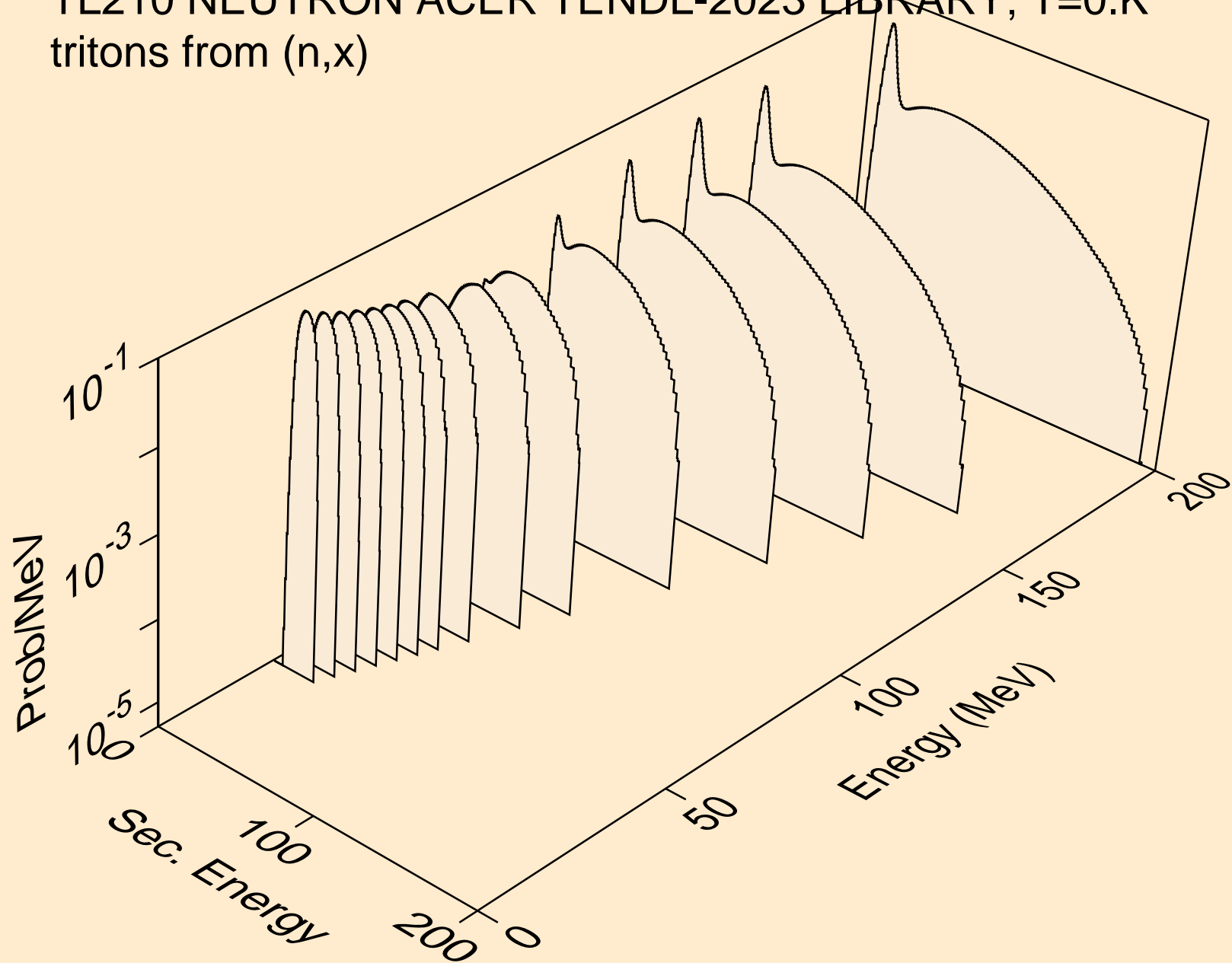

TL210 NEUTRON ACER TENDL-2023 LIBRARY; T=0.K  
tritons from (n,n\*)t

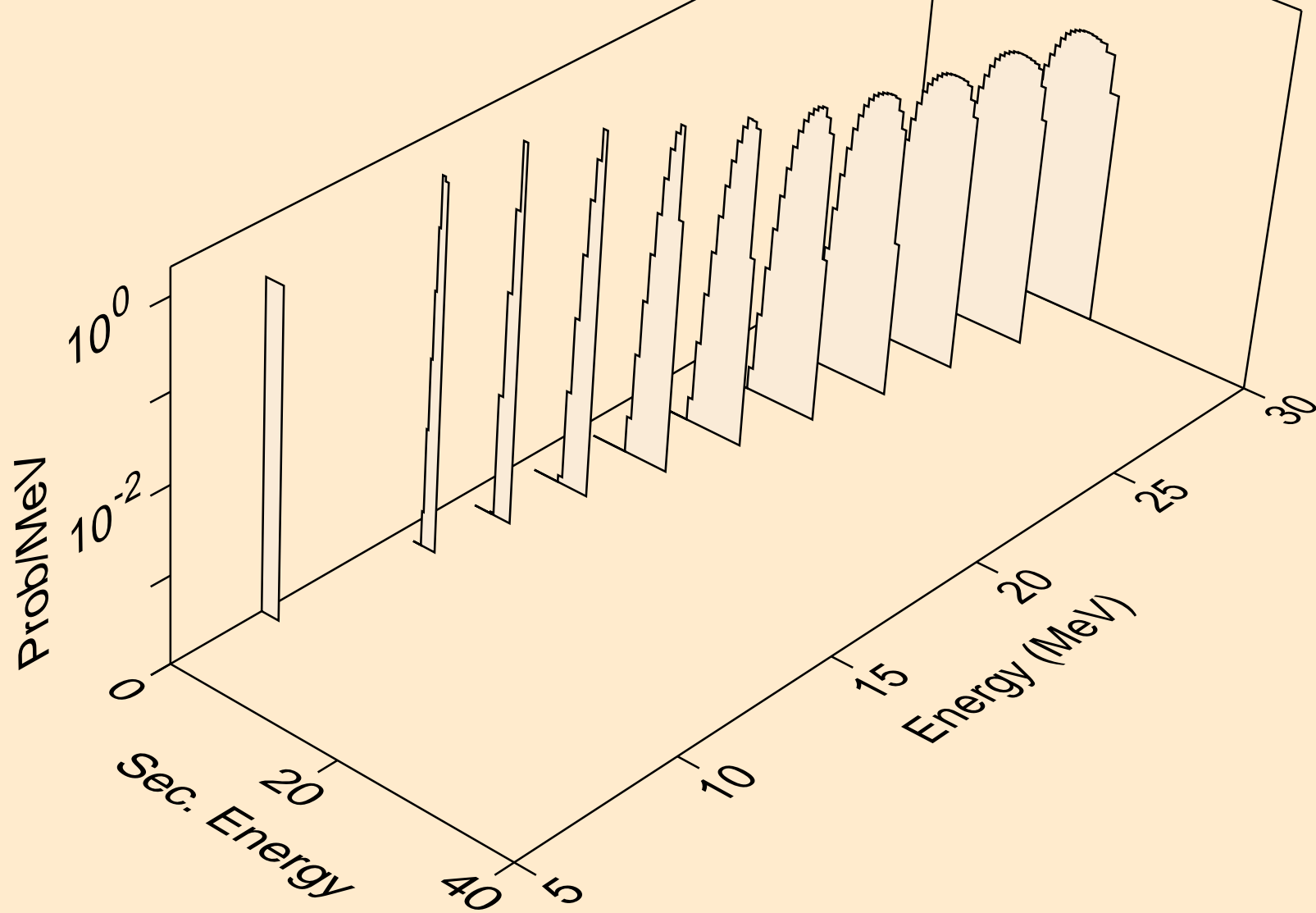

TL210 NEUTRON ACER TENDL-2023 LIBRARY; T=0.K  
tritons from (n,t)

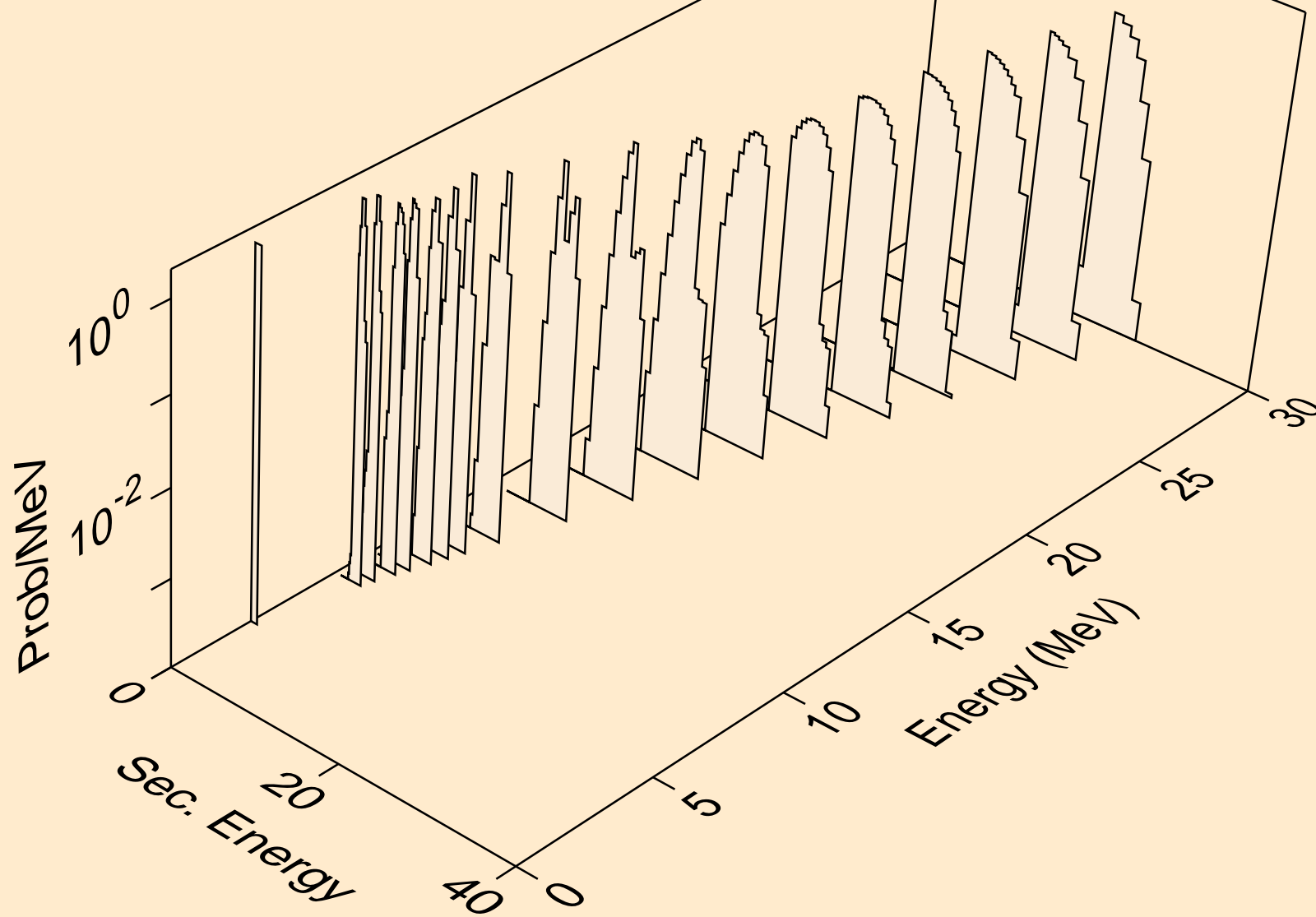

TL210 NEUTRON ACER TENDL-2023 LIBRARY; T=0.K  
he3s from (n,x)

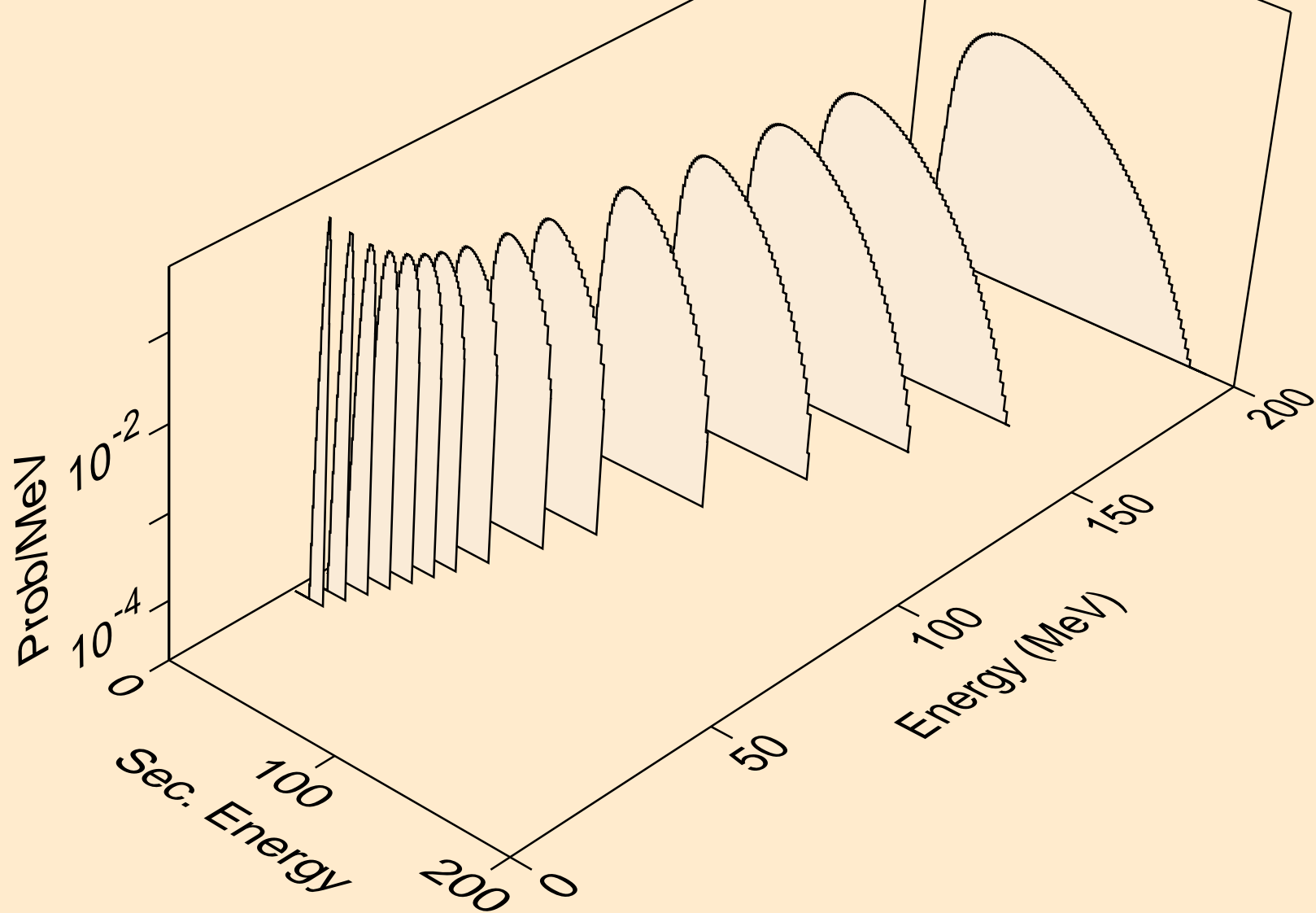

TL210 NEUTRON ACER TENDL-2023 LIBRARY; T=0.K  
he3s from (n,n\*)he3

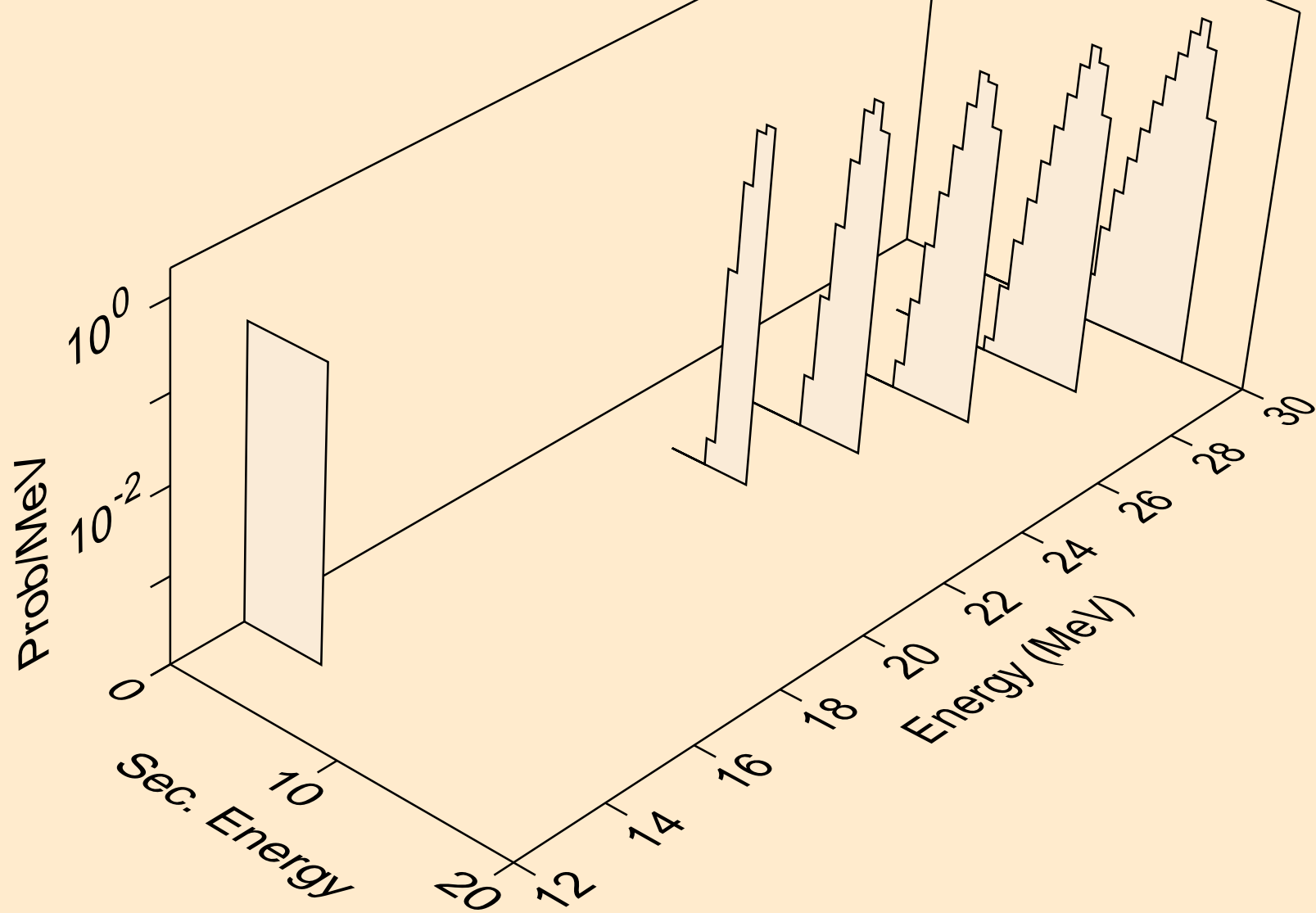

TL210 NEUTRON ACER TENDL-2023 LIBRARY; T=0.K  
he3s from (n,he3)

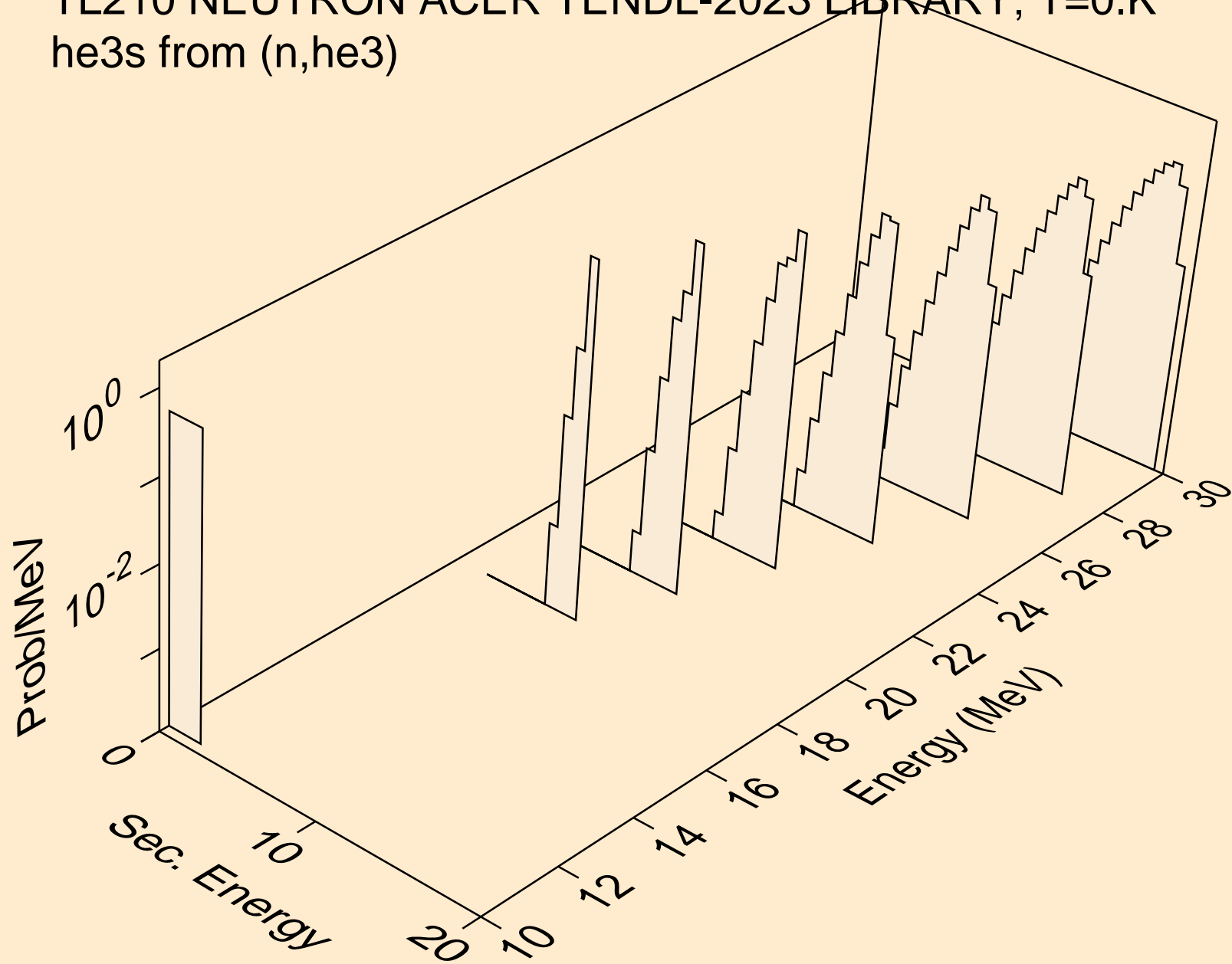

TL210 NEUTRON ACER TENDL-2023 LIBRARY; T=0.K  
alphas from (n,x)

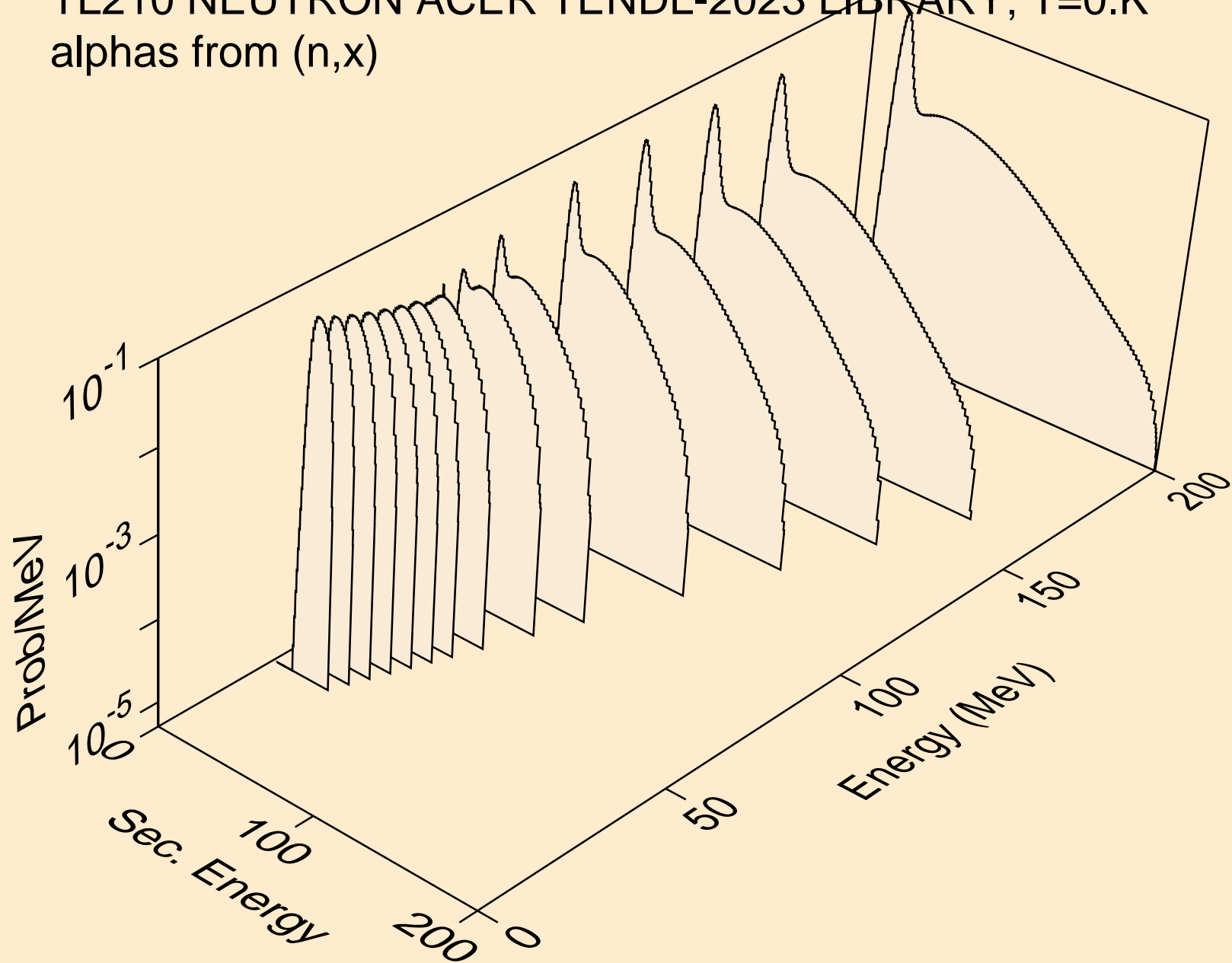

TL210 NEUTRON ACER TENDL-2023 LIBRARY; T=0.K  
alphas from (n,n\*)a

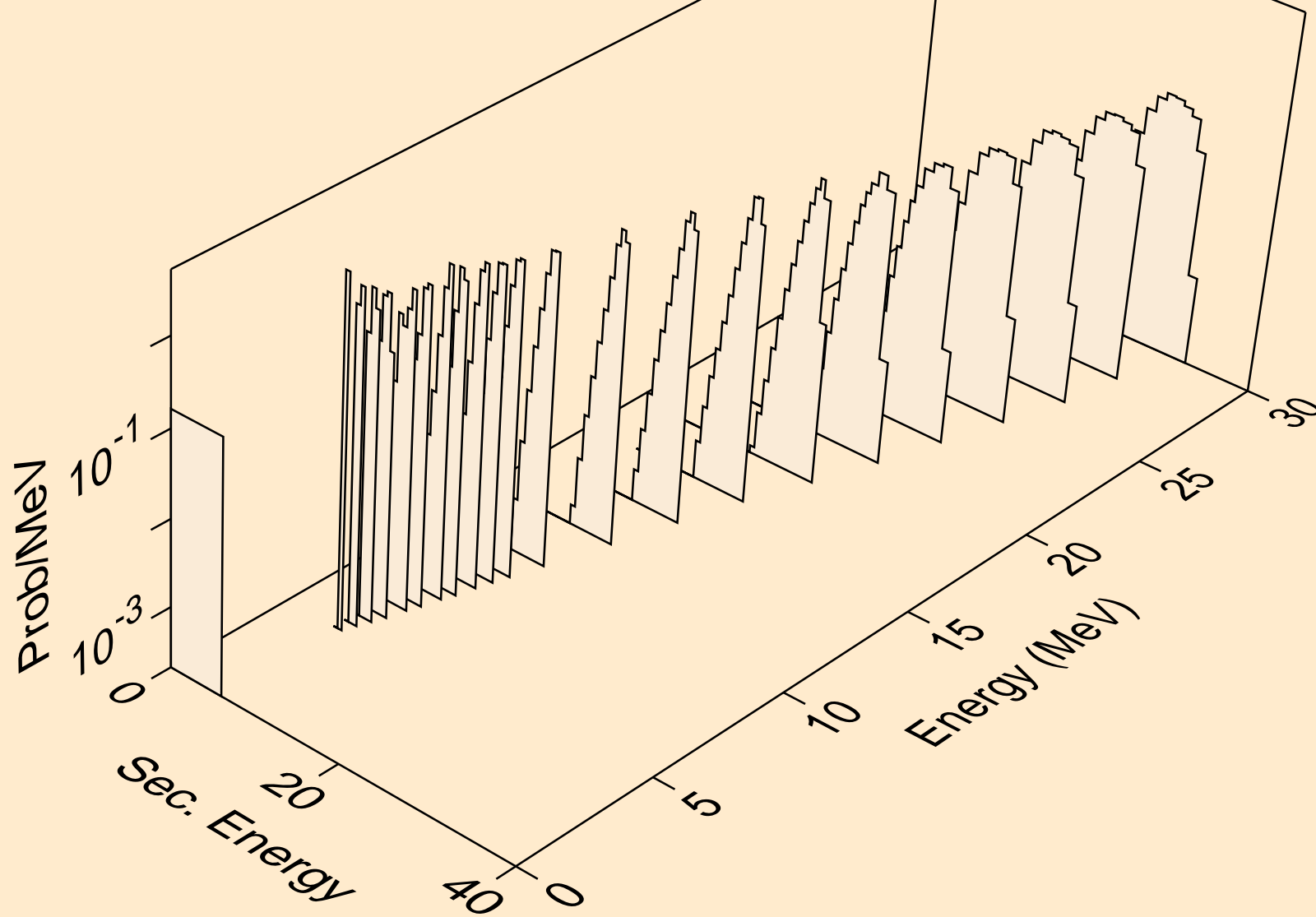

TL210 NEUTRON ACER TENDL-2023 LIBRARY; T=0.K  
alphas from (n,2n)a

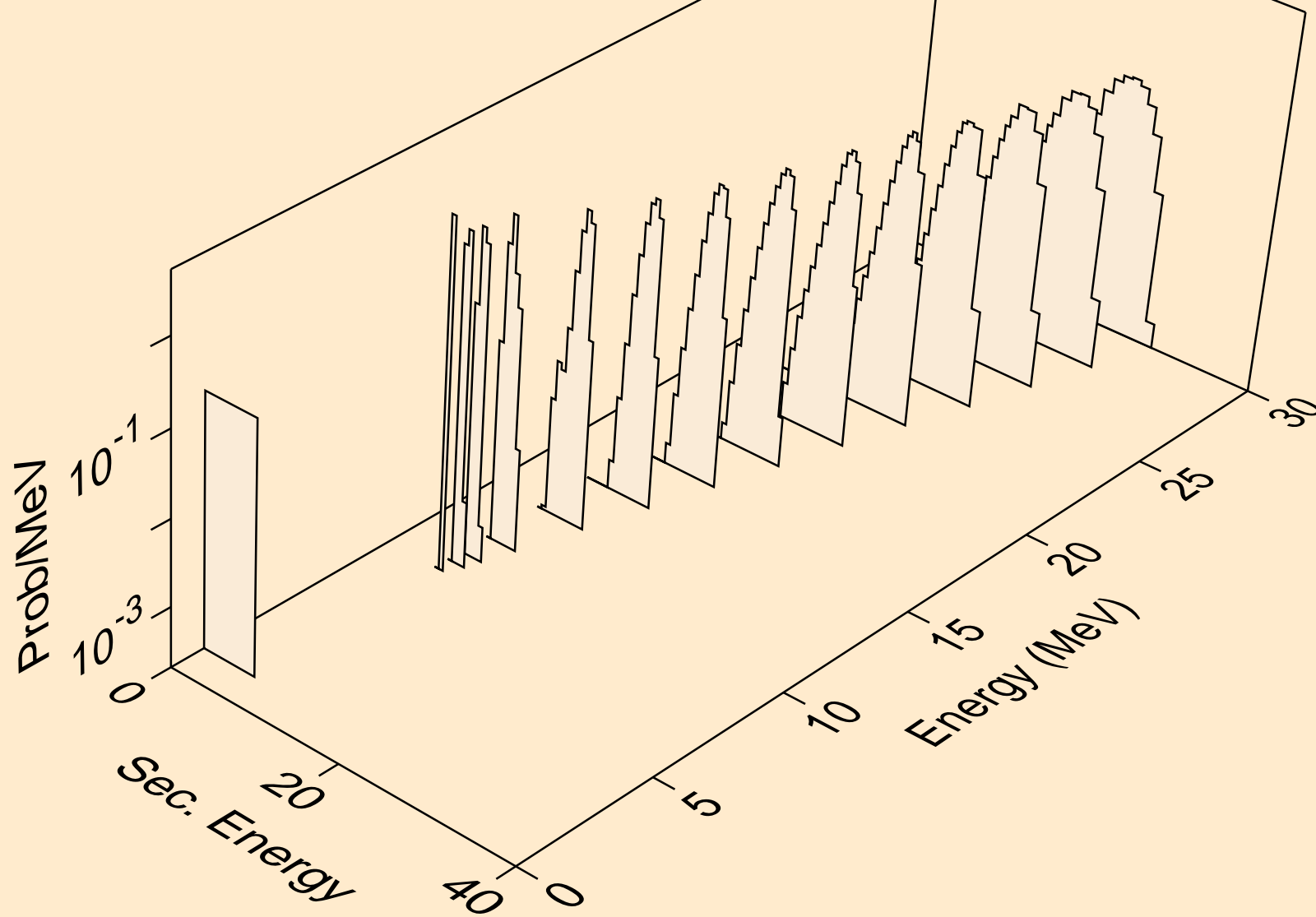

TL210 NEUTRON ACER TENDL-2023 LIBRARY; T=0.K  
alphas from (n,3n)a

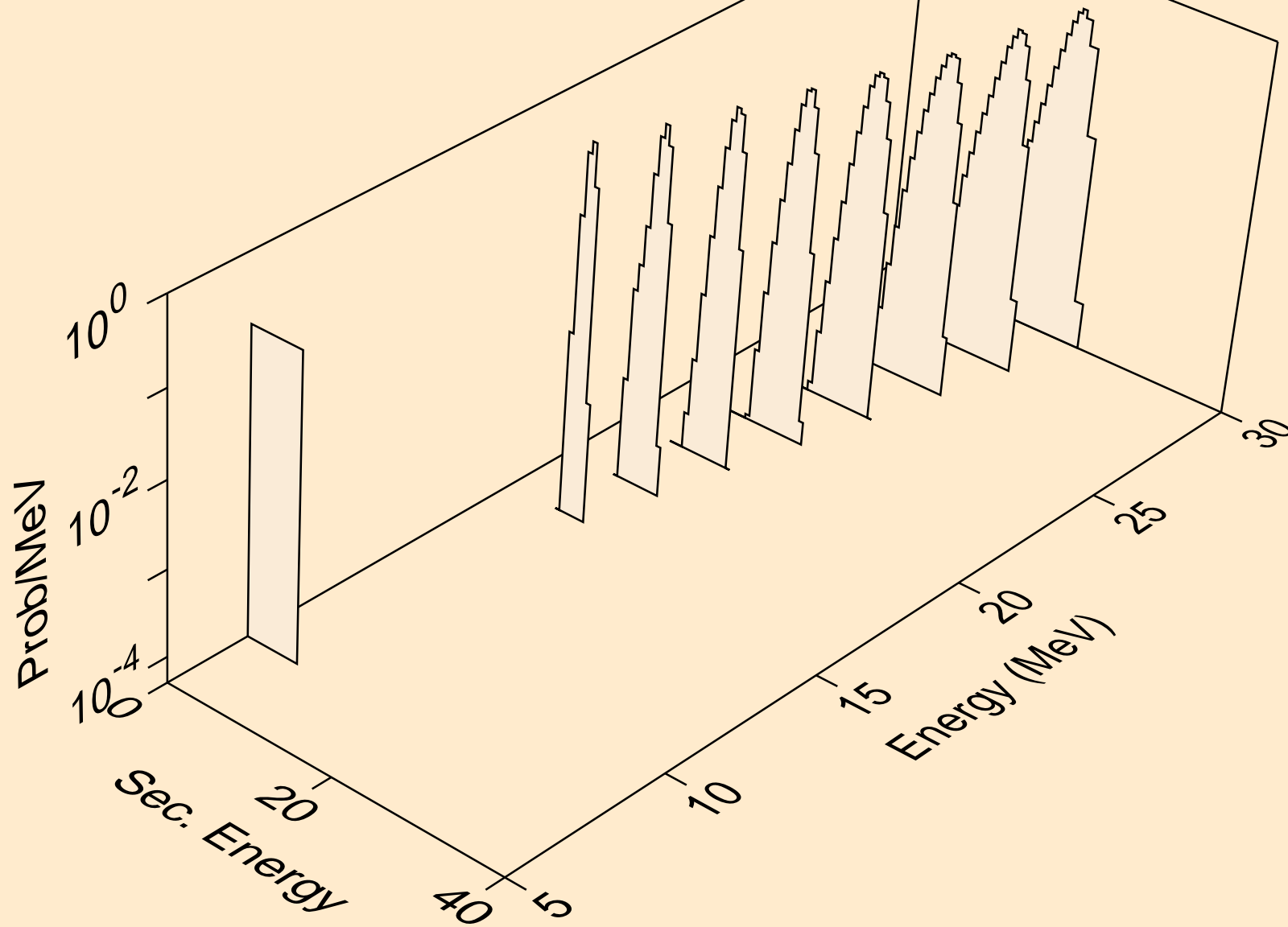

TL210 NEUTRON ACER TENDL-2023 LIBRARY; T=0.K  
alphas from (n,a)

