

TL217 NEUTRON ACER TENDL-2023 LIBRARY; T=0.K

Principal cross sections

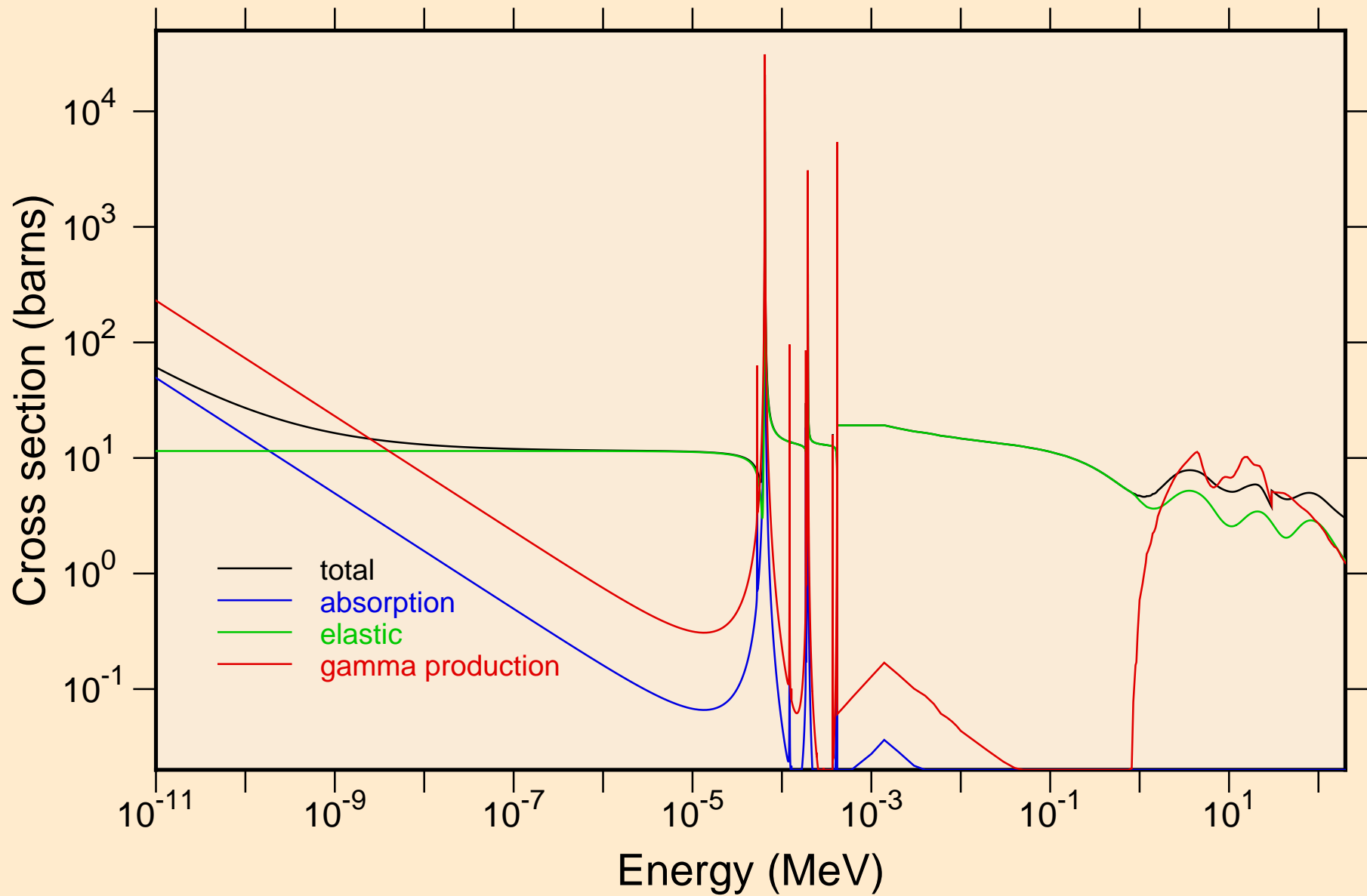

TL217 NEUTRON ACER TENDL-2023 LIBRARY; T=0.K
resonance total cross section

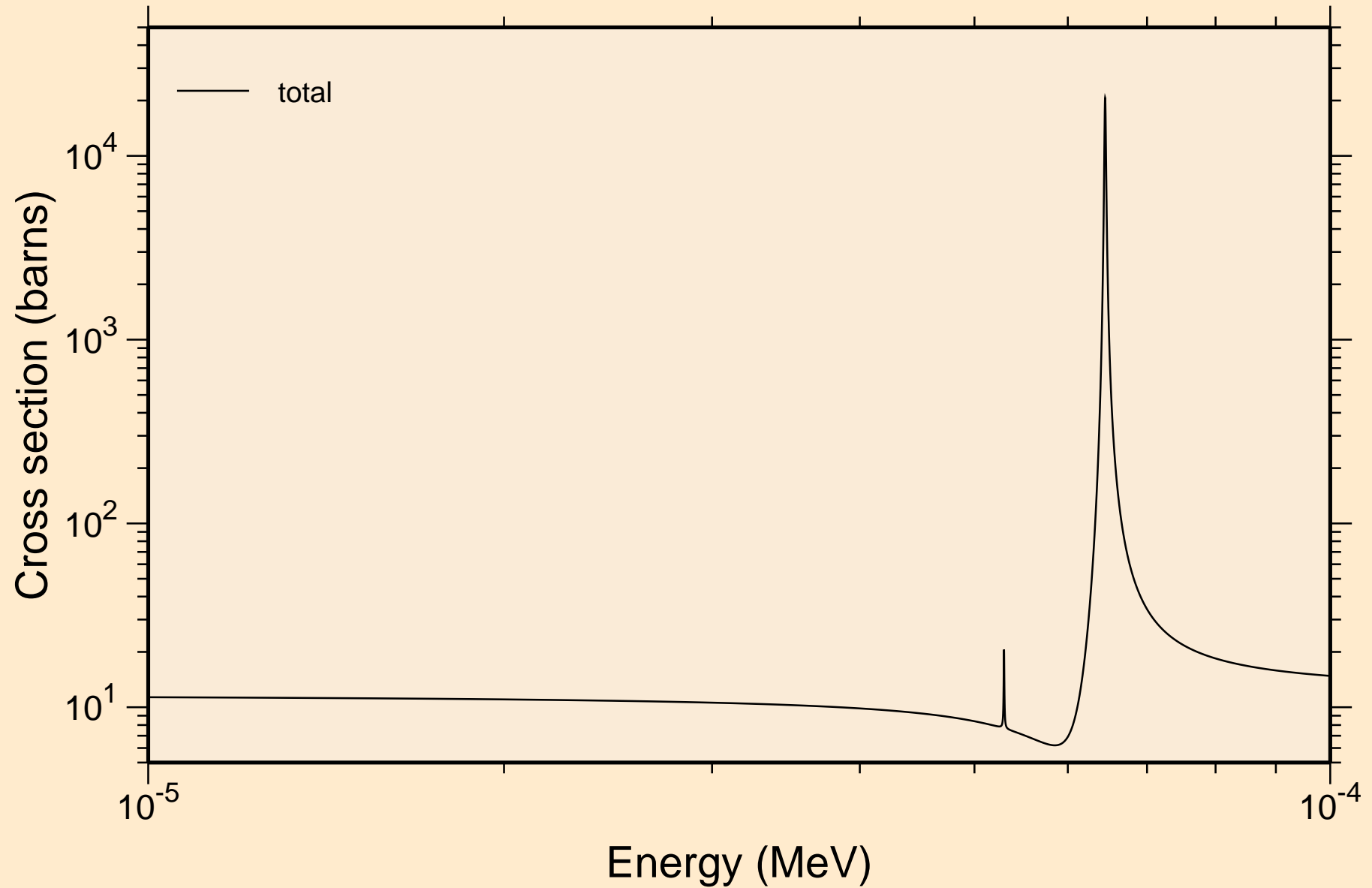

TL217 NEUTRON ACER TENDL-2023 LIBRARY; T=0.K
resonance total cross section

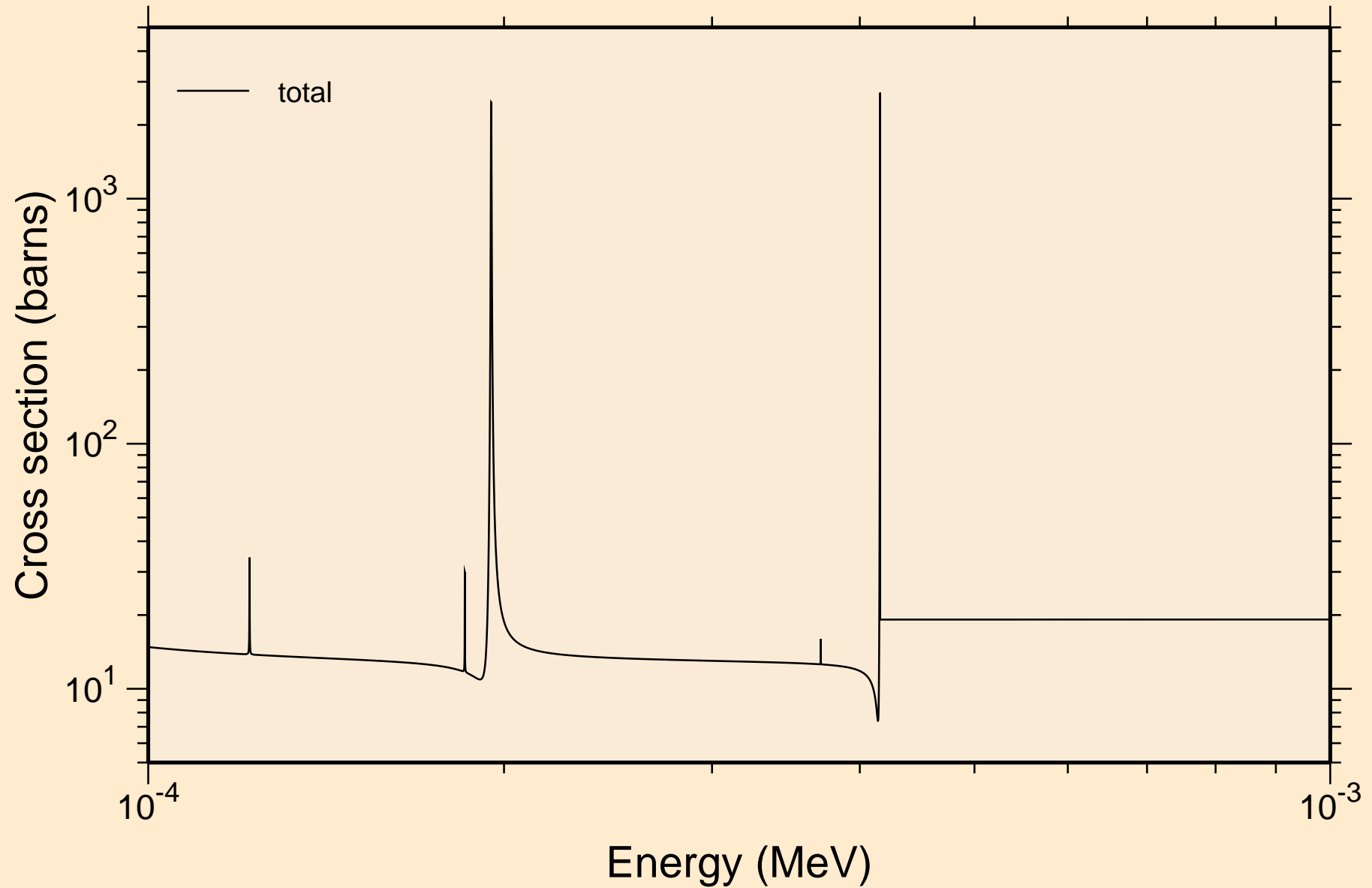

TL217 NEUTRON ACER TENDL-2023 LIBRARY; T=0.K
resonance total cross section

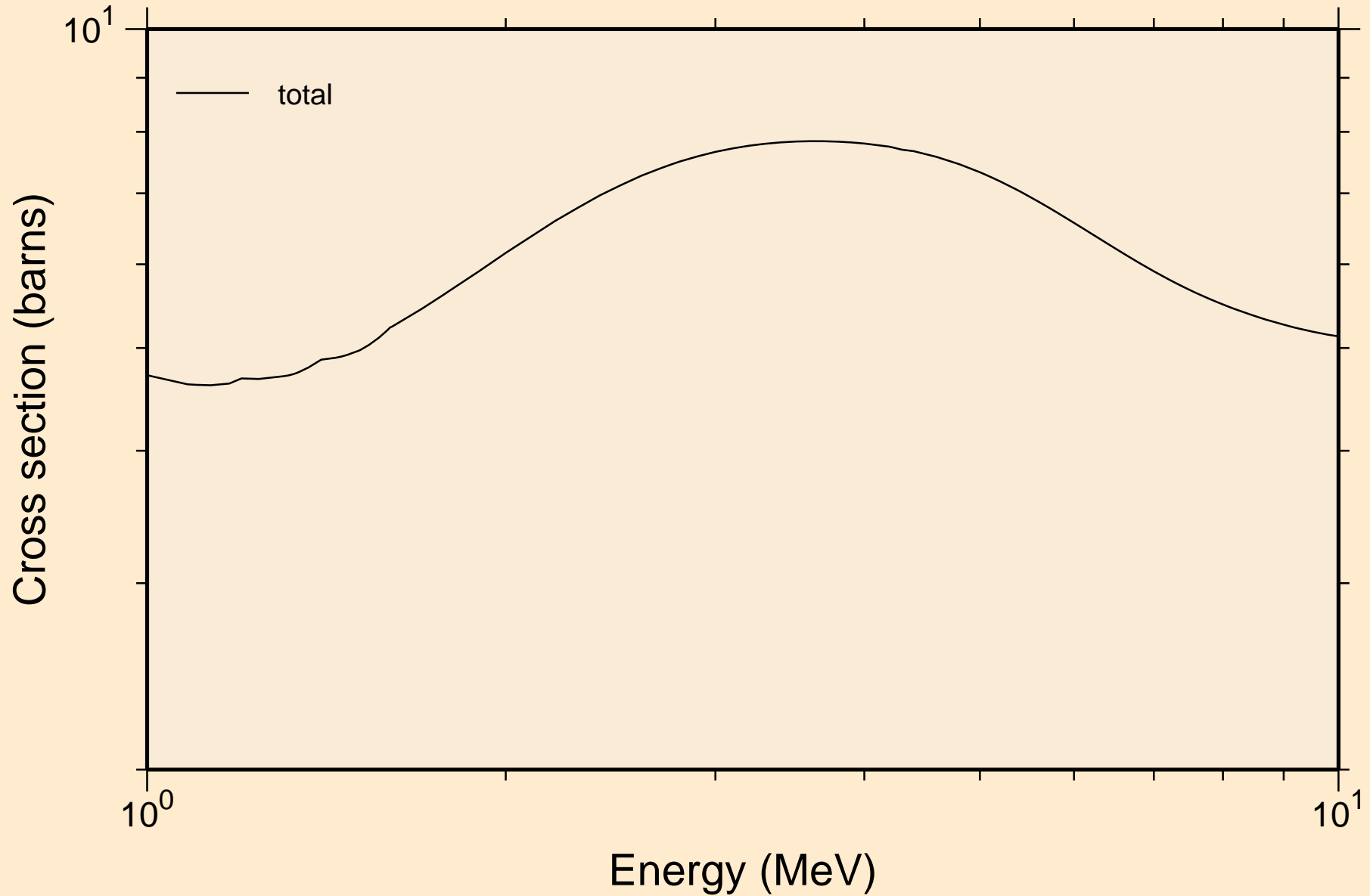

TL217 NEUTRON ACER TENDL-2023 LIBRARY; T=0.K
resonance absorption cross sections

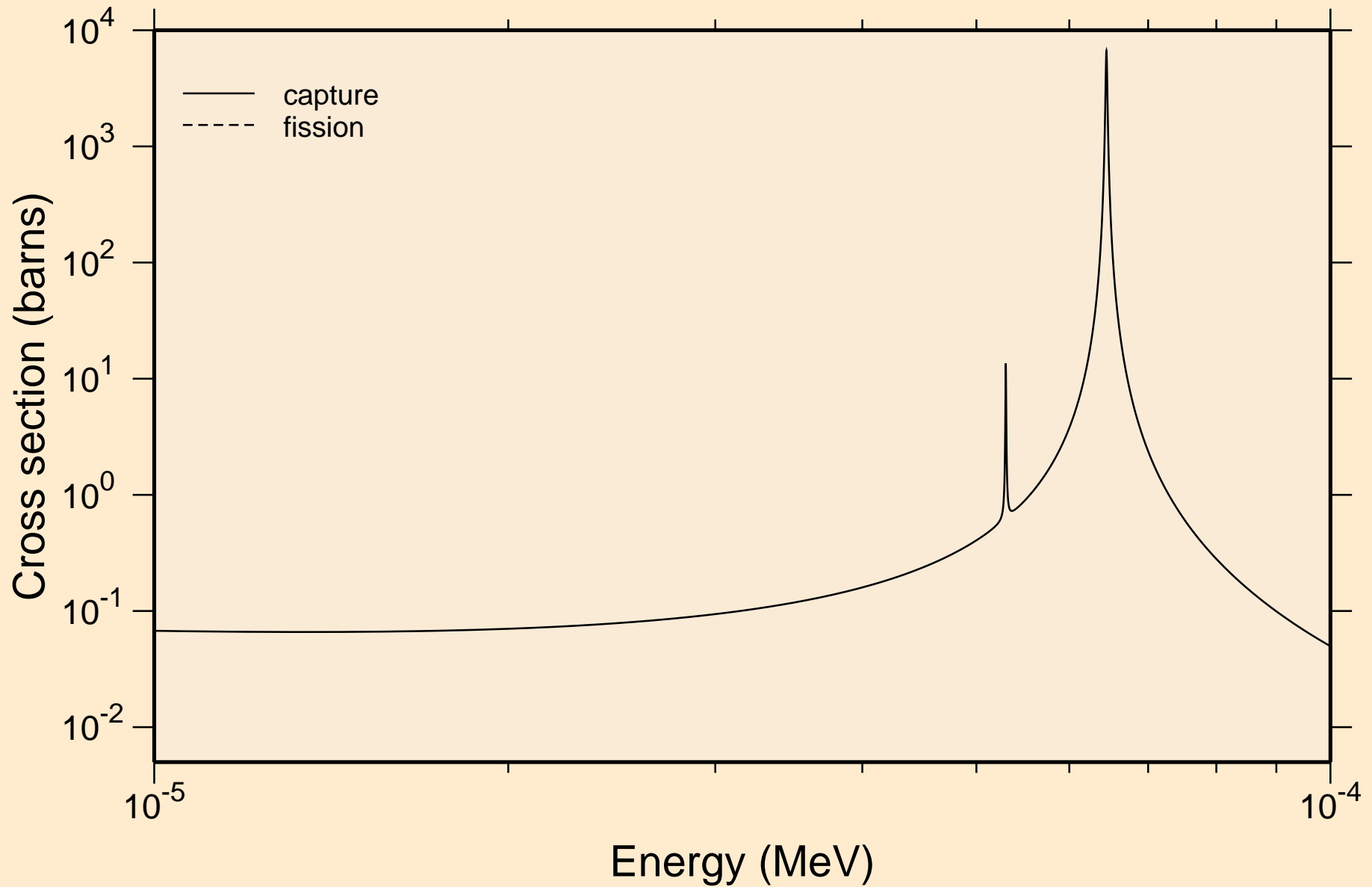

TL217 NEUTRON ACER TENDL-2023 LIBRARY; T=0.K
resonance absorption cross sections

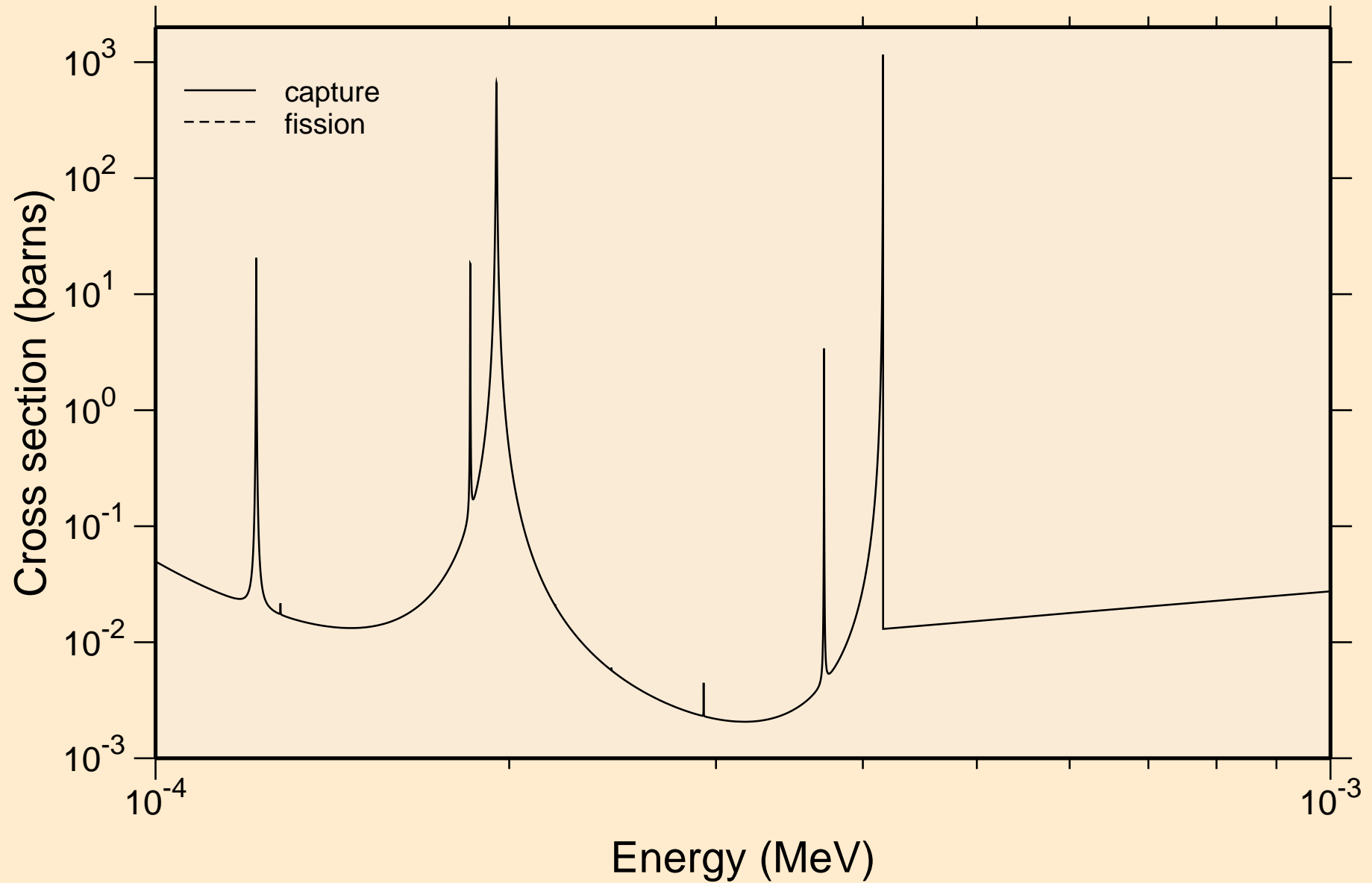

TL217 NEUTRON ACER TENDL-2023 LIBRARY; T=0.K
resonance absorption cross sections

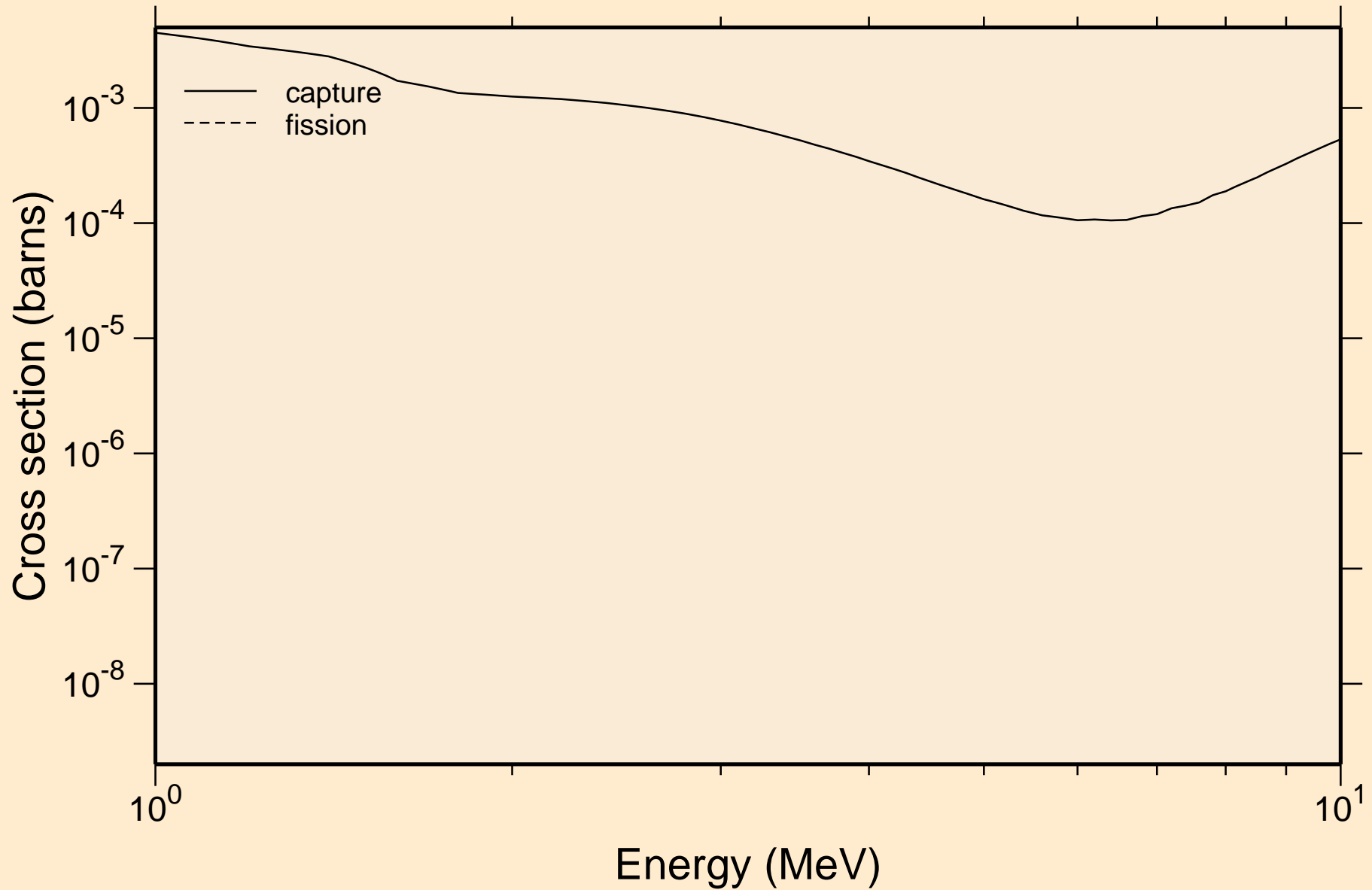

TL217 NEUTRON ACER TENDL-2023 LIBRARY; T=0.K
Heating

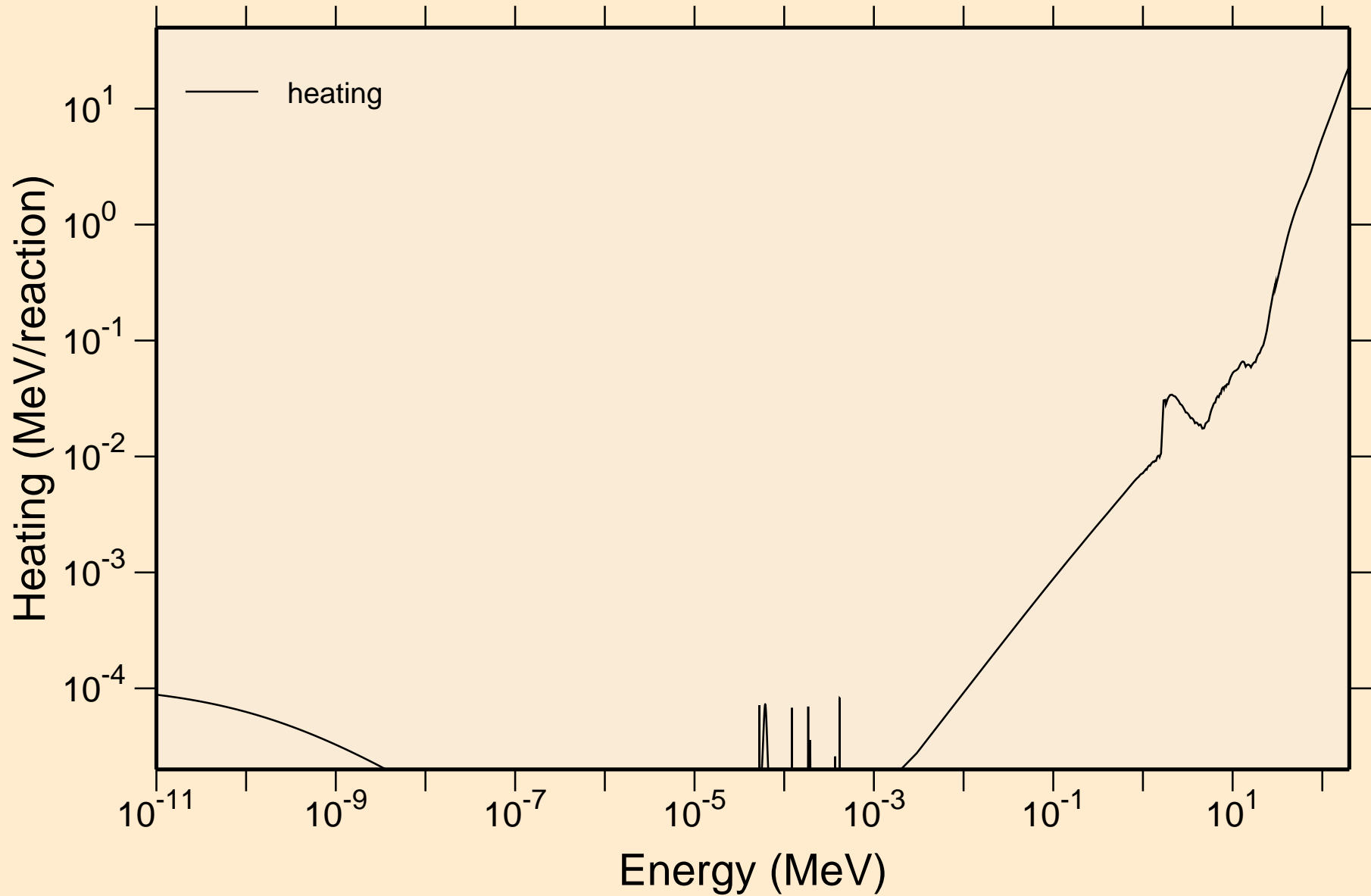

TL217 NEUTRON ACER TENDL-2023 LIBRARY; T=0.K

Damage

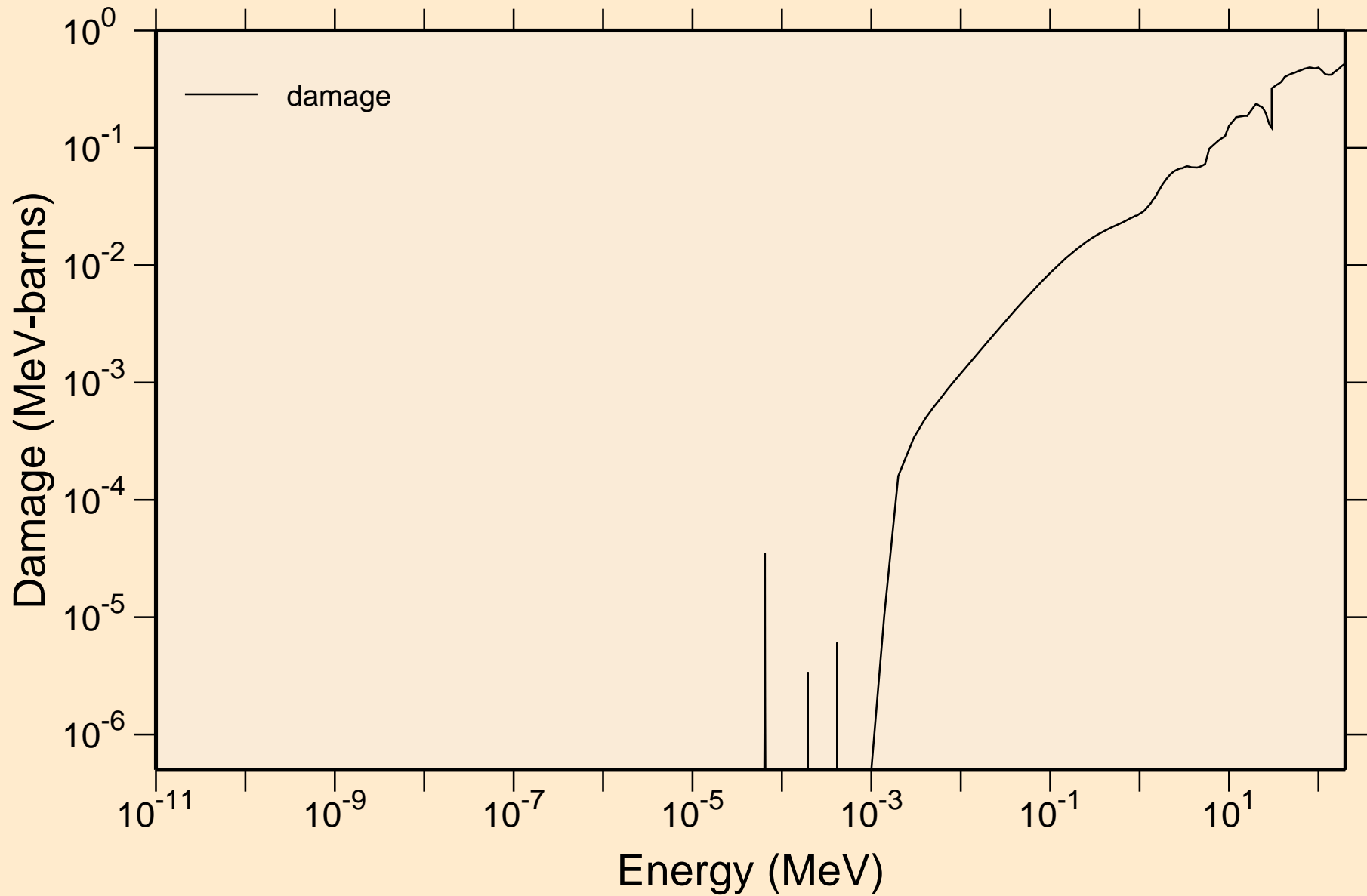

TL217 NEUTRON ACER TENDL-2023 LIBRARY; T=0.K
Non-threshold reactions

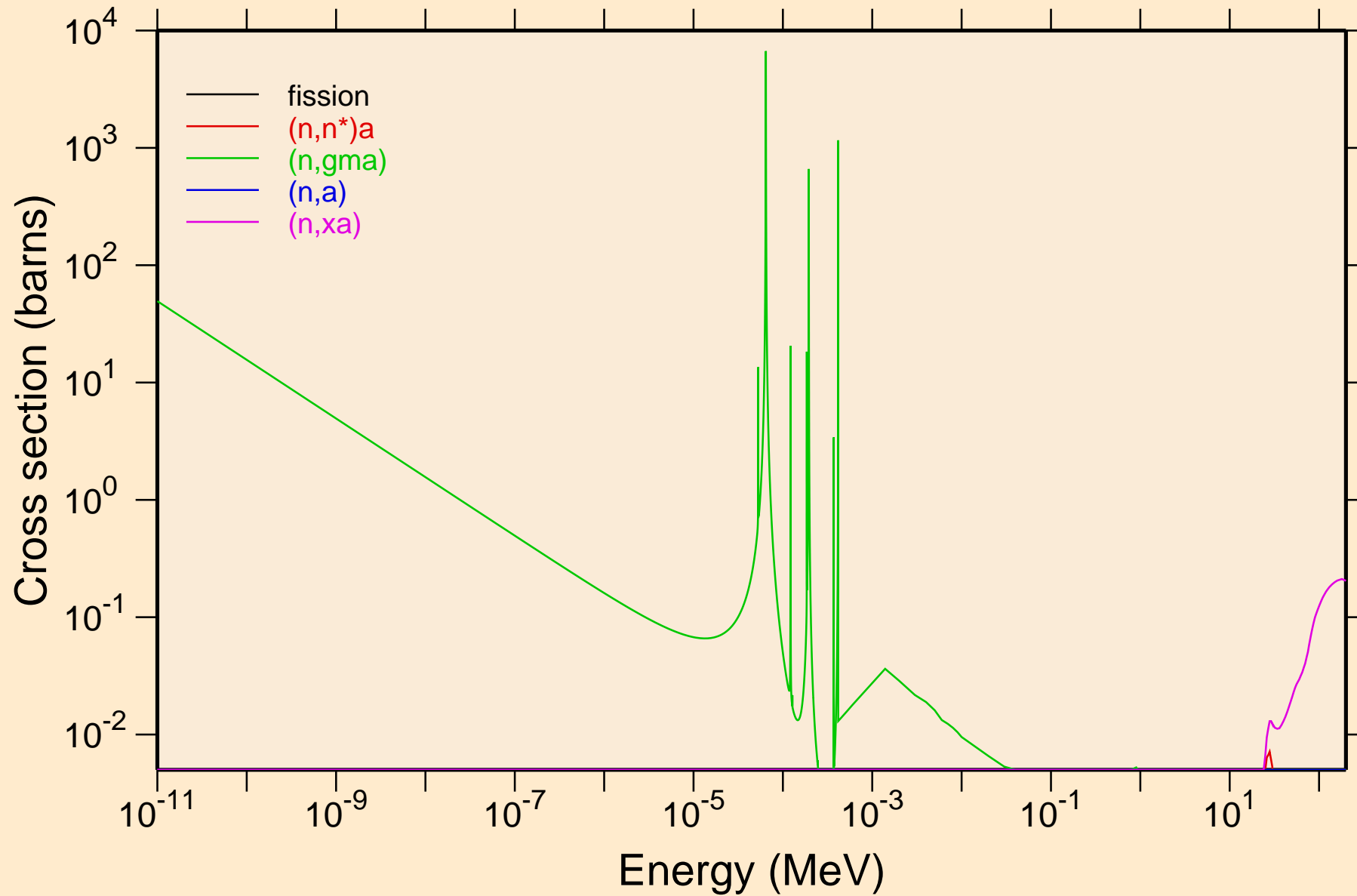

TL217 NEUTRON ACER TENDL-2023 LIBRARY; T=0.K
Principal cross sections

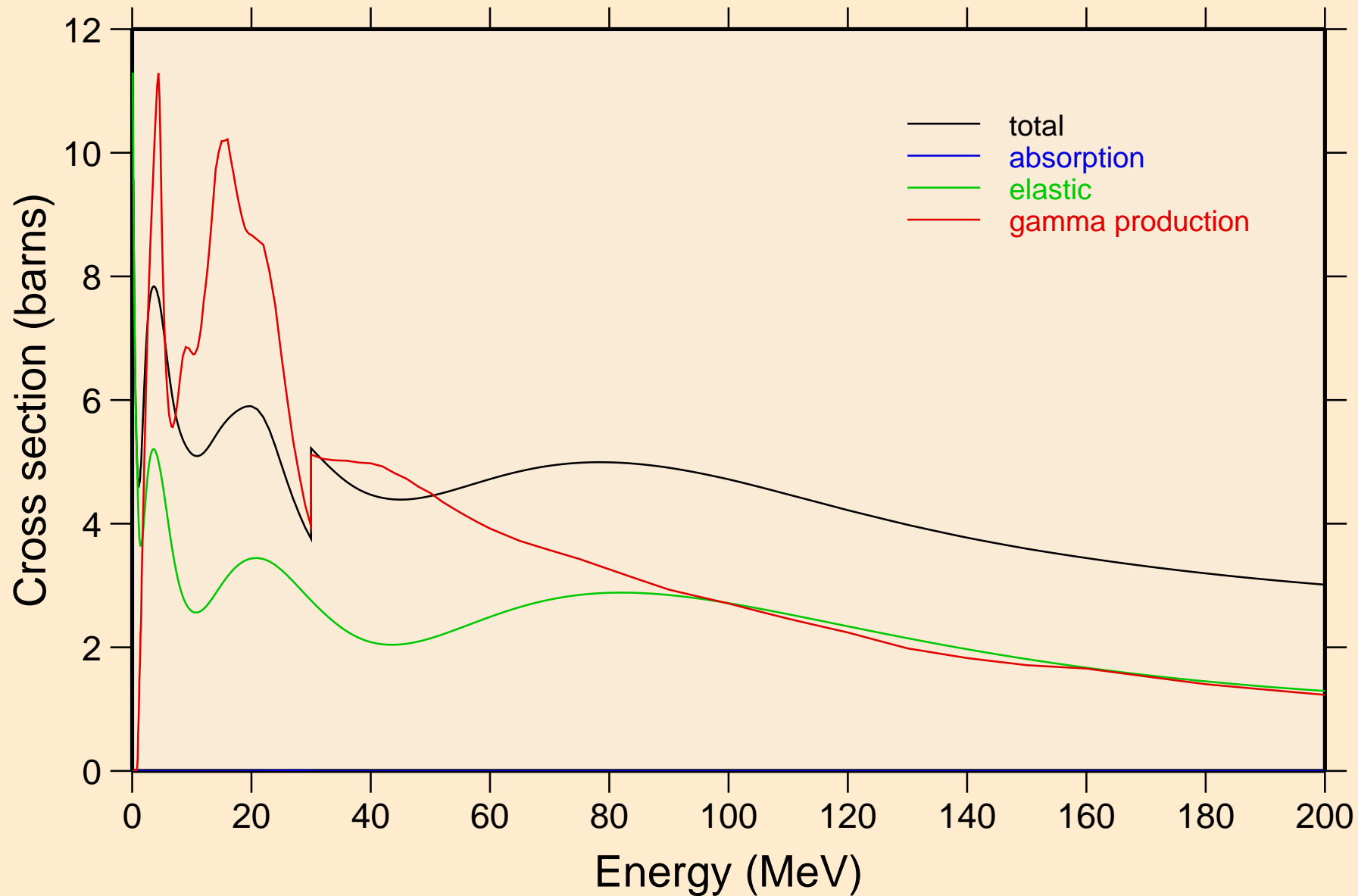

TL217 NEUTRON ACER TENDL-2023 LIBRARY; T=0.K

Heating

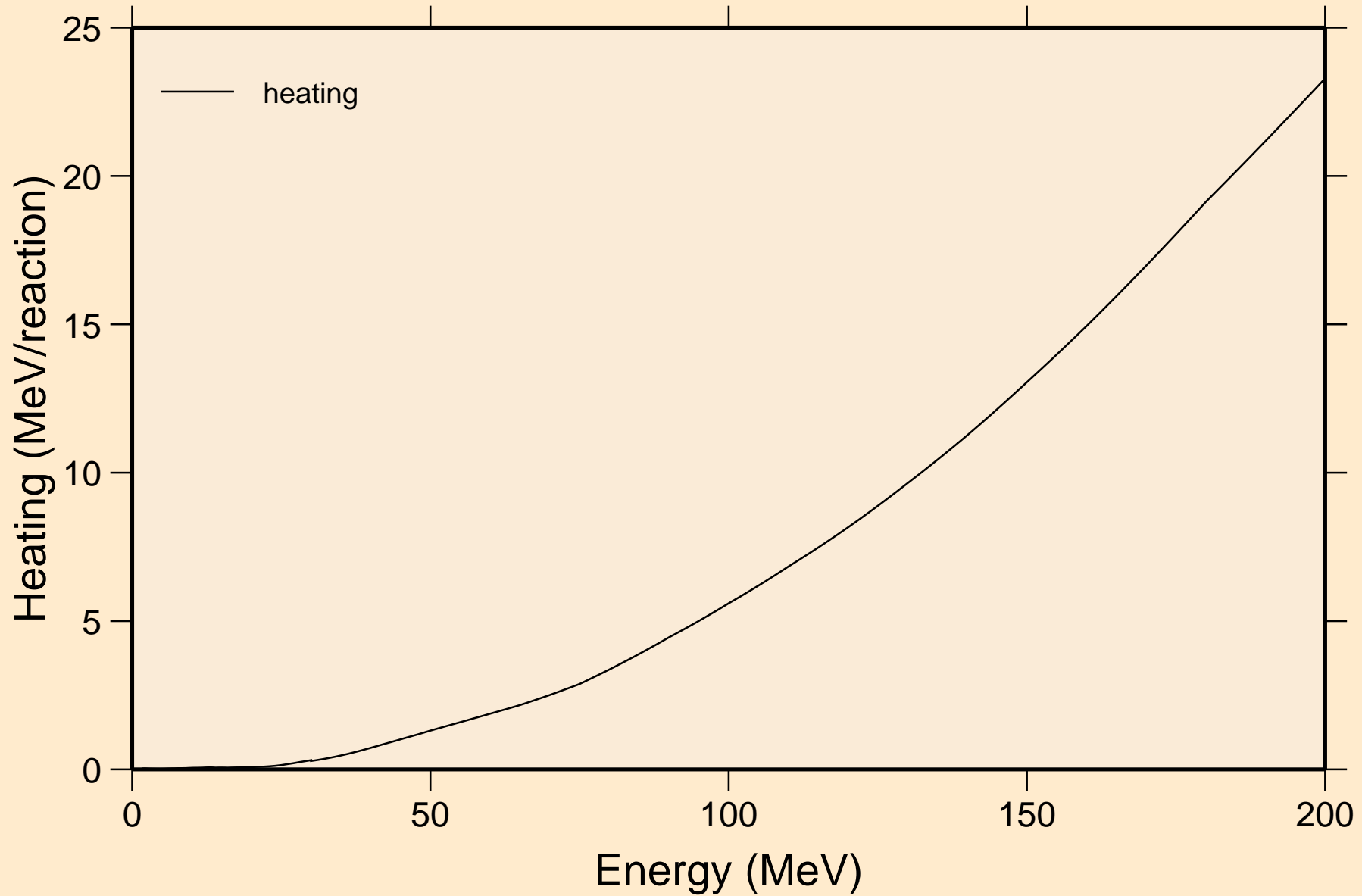

TL217 NEUTRON ACER TENDL-2023 LIBRARY; T=0.K
Damage

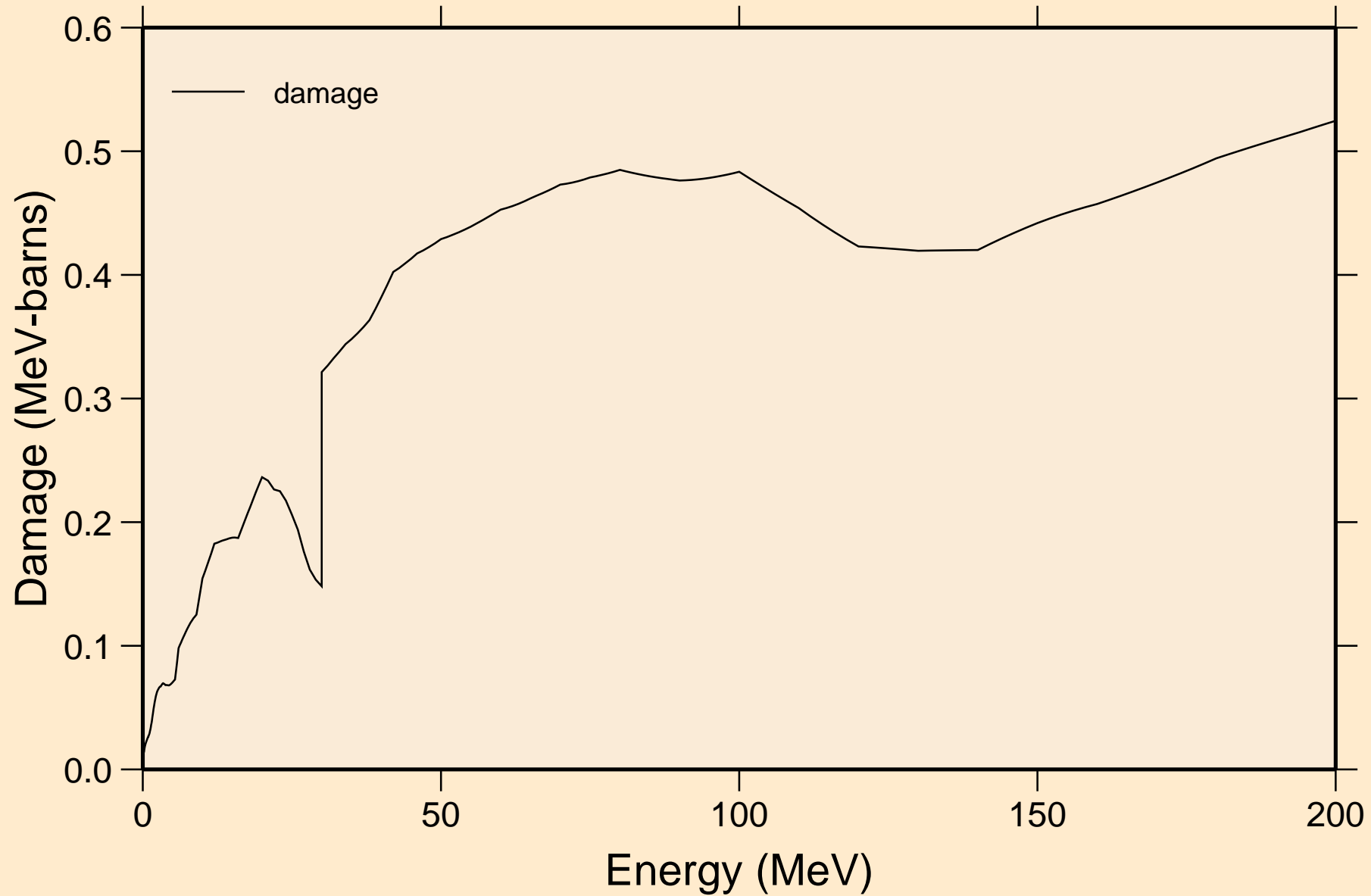

TL217 NEUTRON ACER TENDL-2023 LIBRARY; T=0.K

Non-threshold reactions

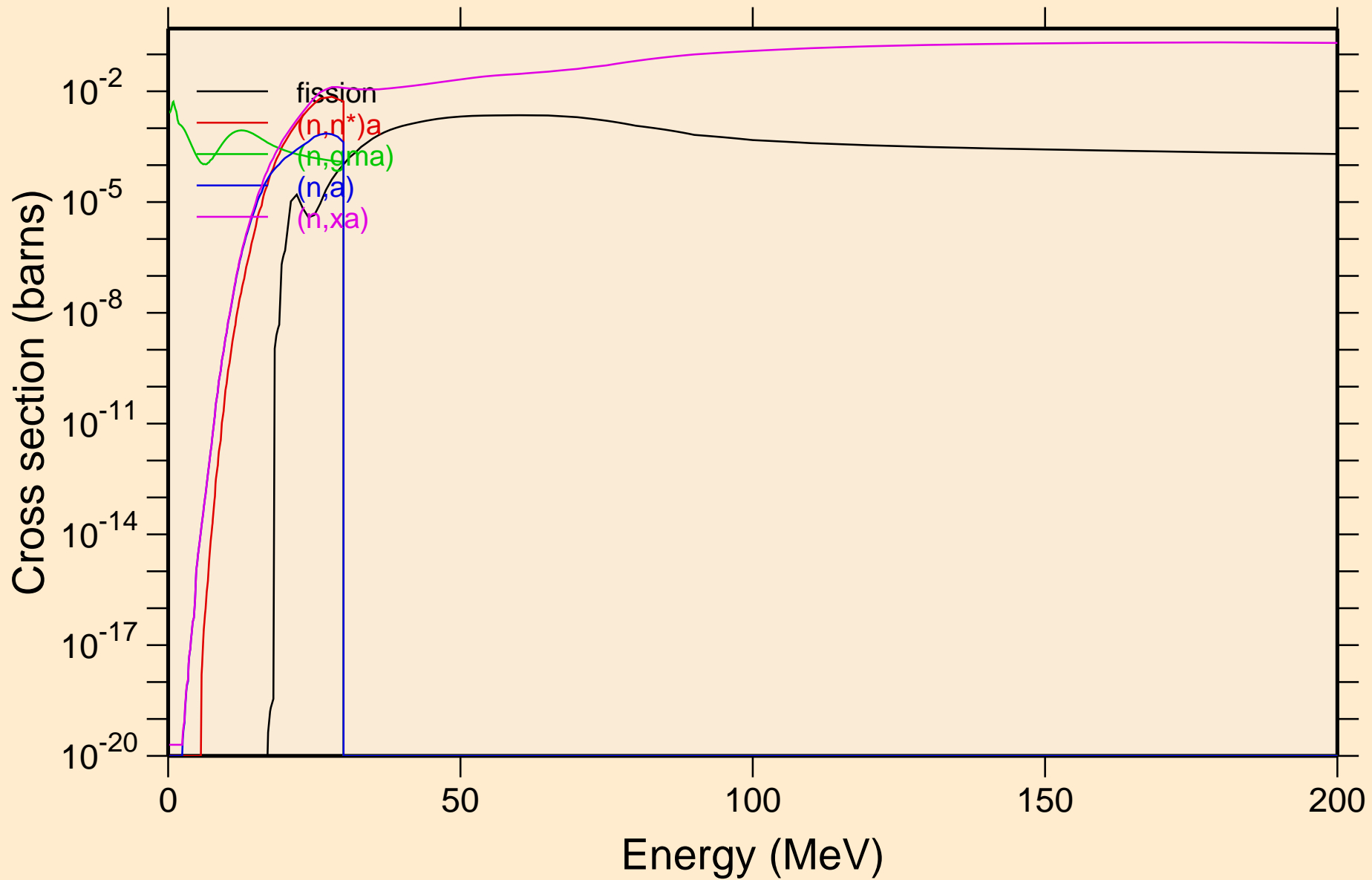

TL217 NEUTRON ACER TENDL-2023 LIBRARY; T=0.K
Inelastic levels

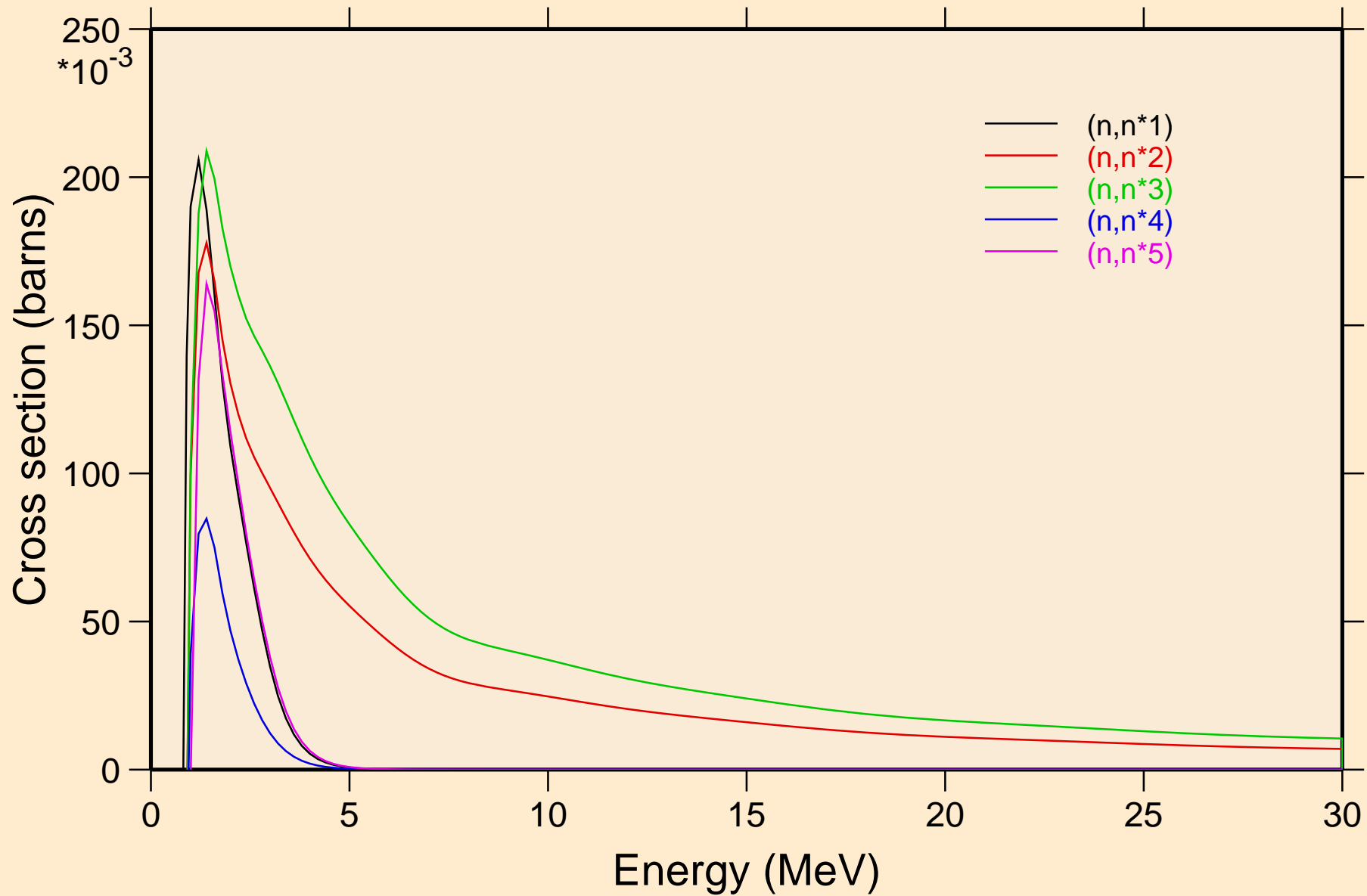

TL217 NEUTRON ACER TENDL-2023 LIBRARY; T=0.K
Inelastic levels

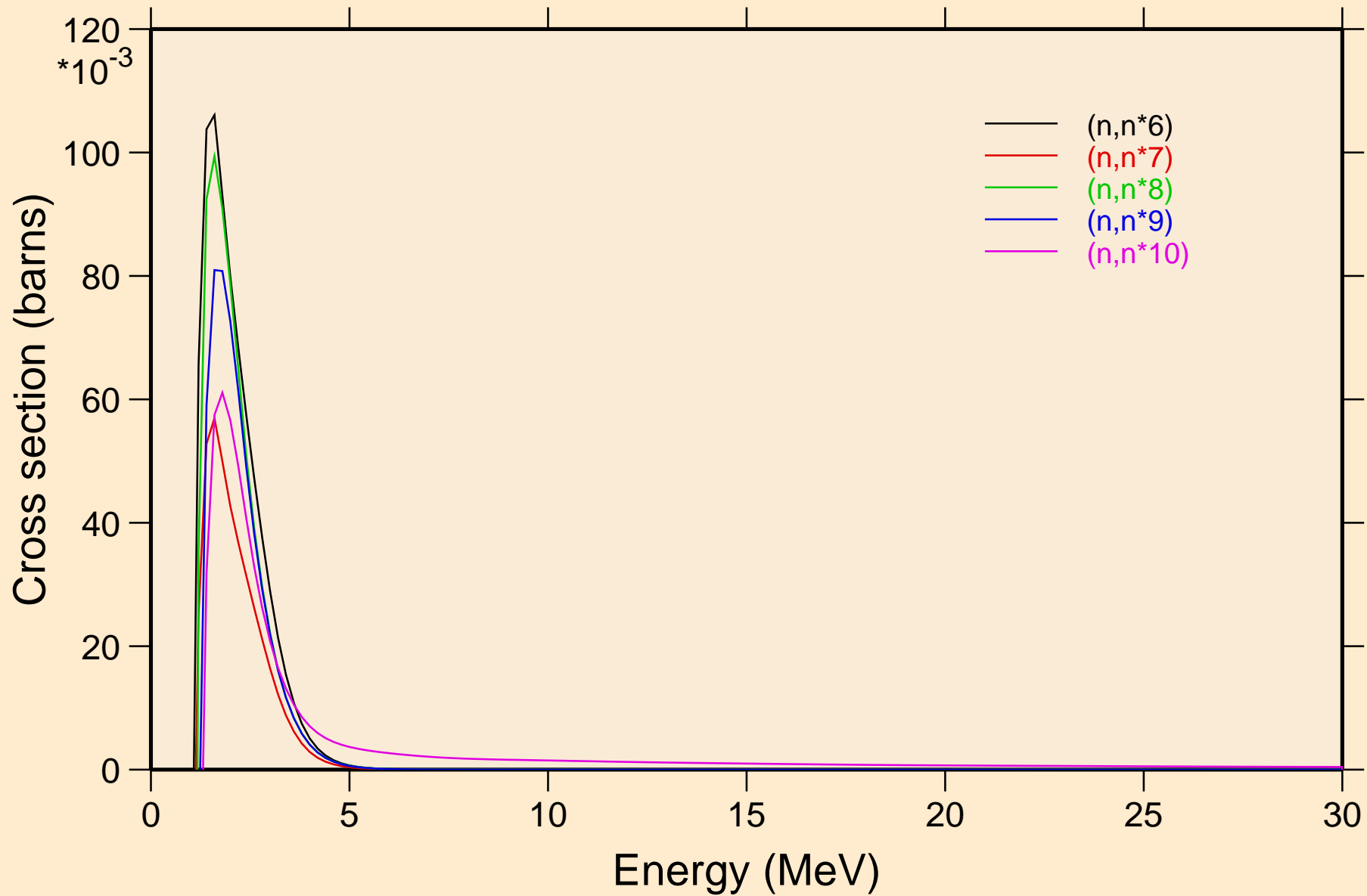

TL217 NEUTRON ACER TENDL-2023 LIBRARY; T=0.K
Inelastic levels

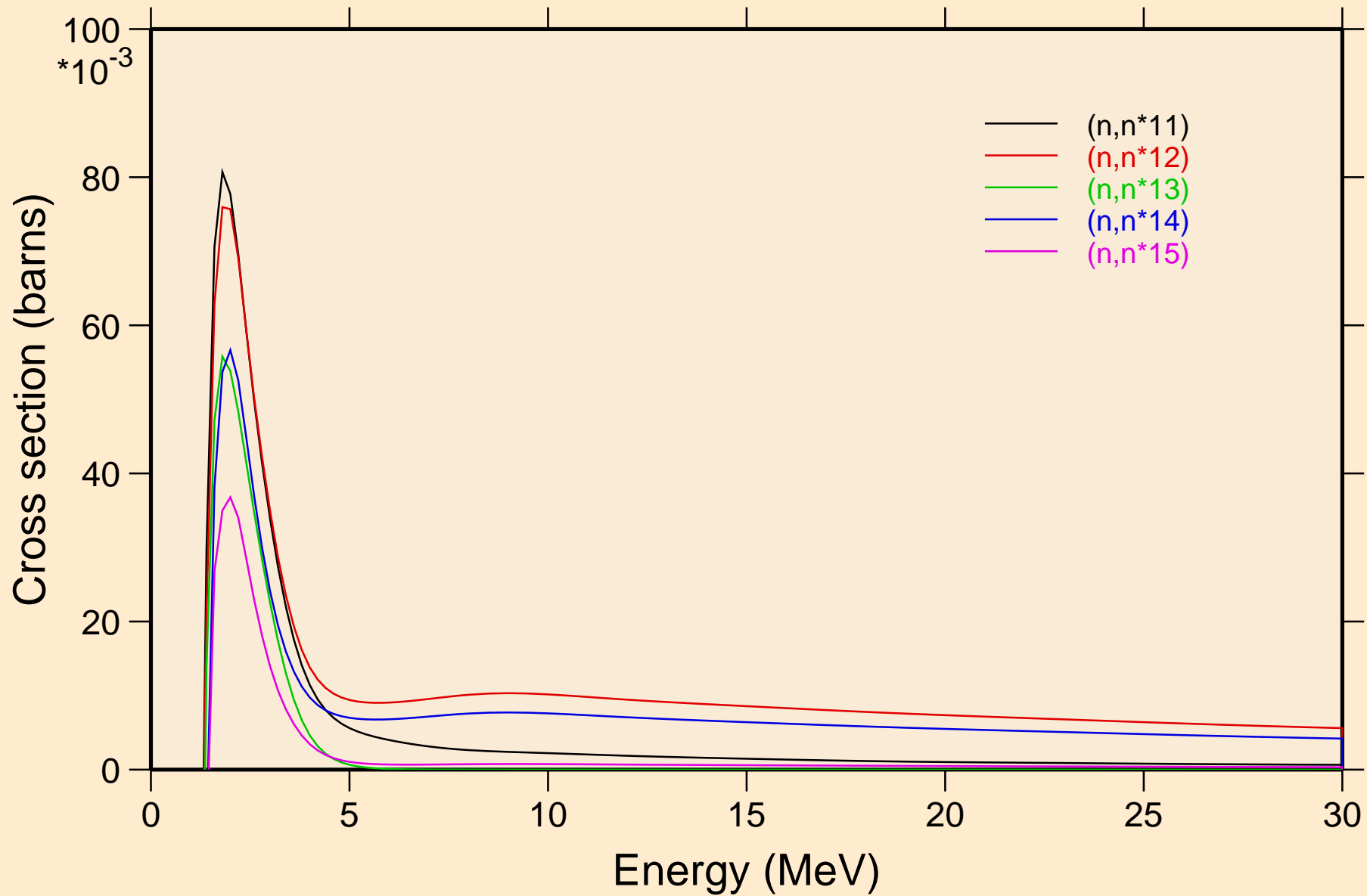

TL217 NEUTRON ACER TENDL-2023 LIBRARY; T=0.K
Inelastic levels

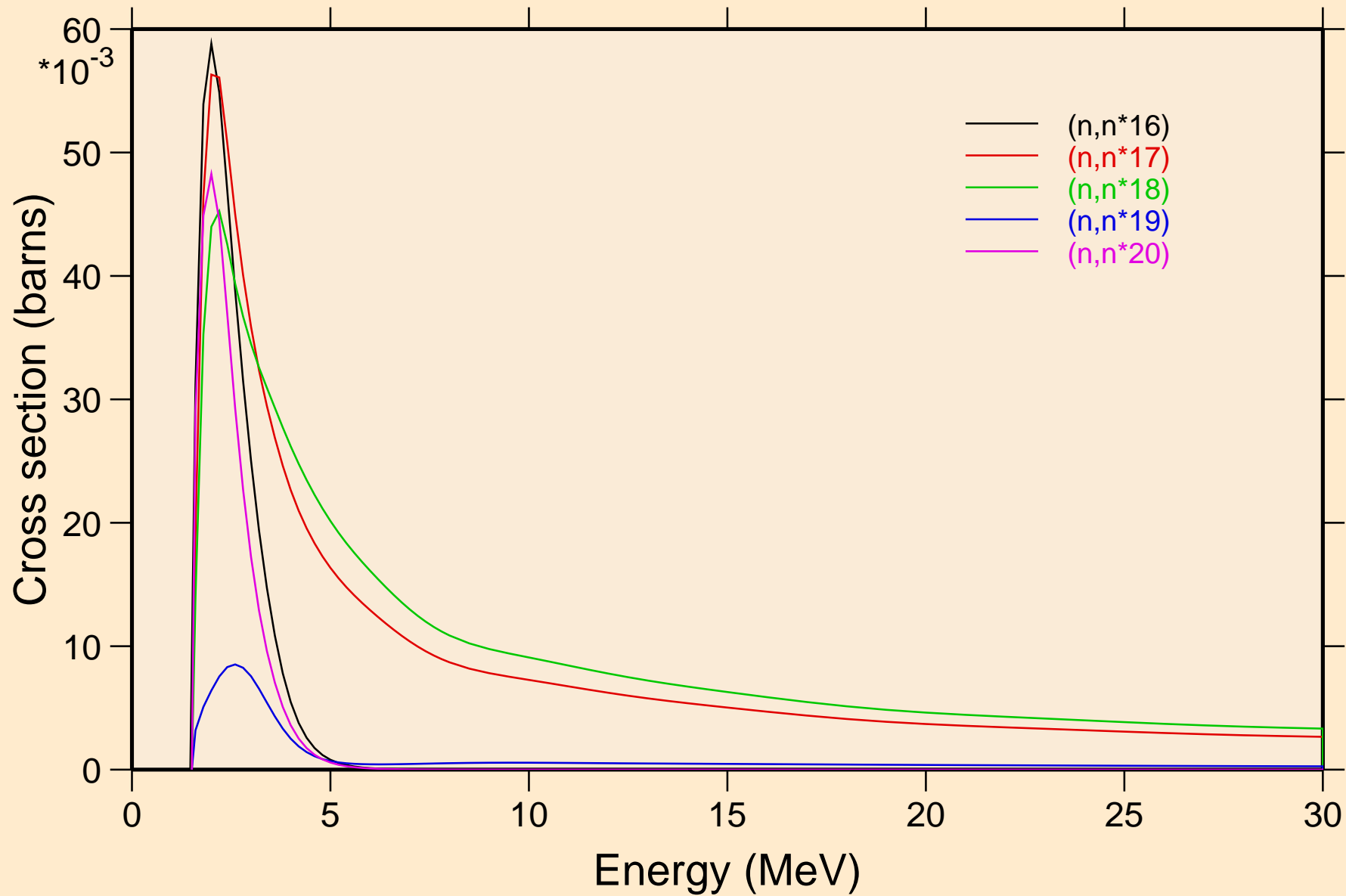

TL217 NEUTRON ACER TENDL-2023 LIBRARY; T=0.K
Inelastic levels

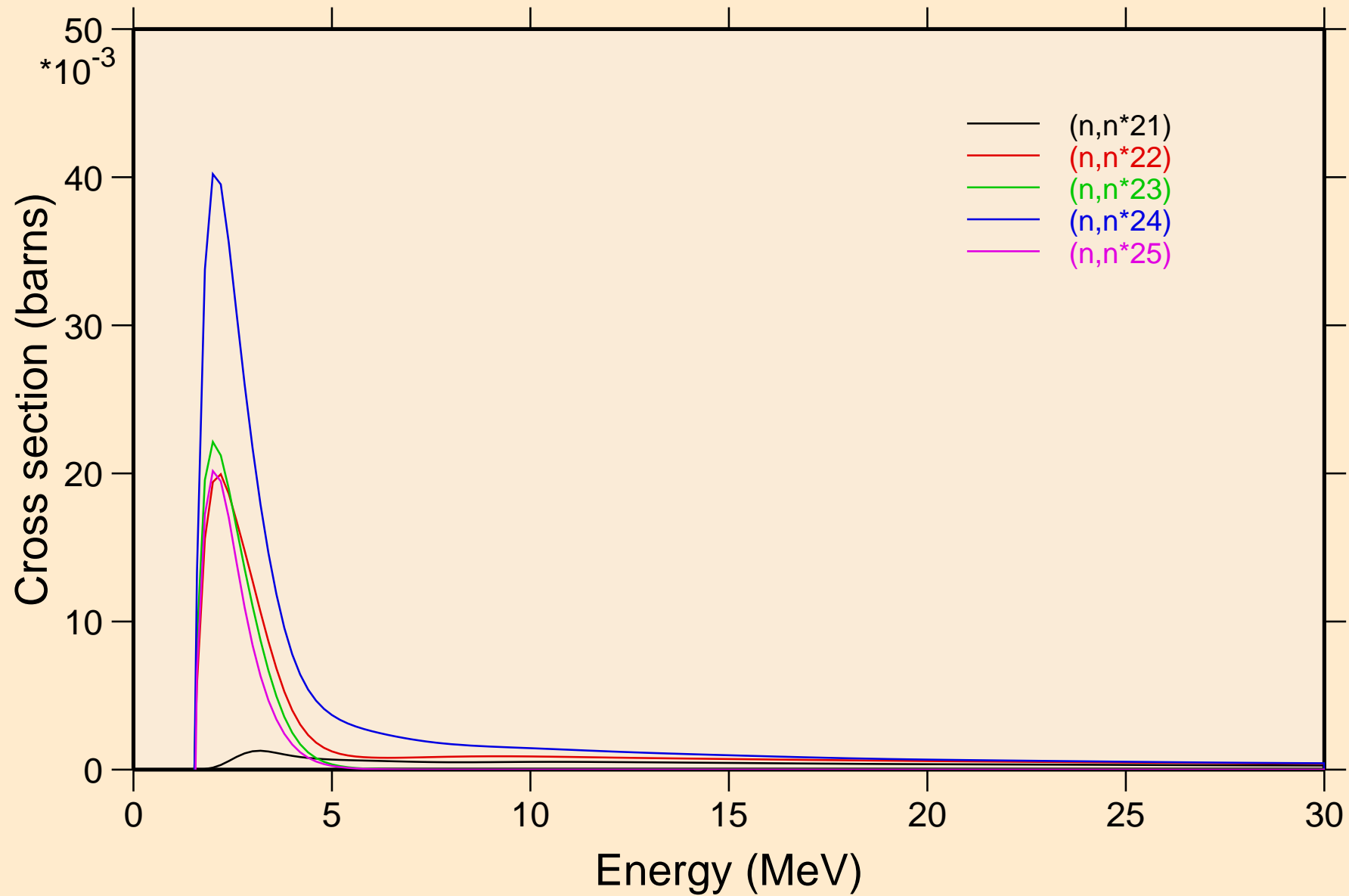

TL217 NEUTRON ACER TENDL-2023 LIBRARY; T=0.K
Inelastic levels

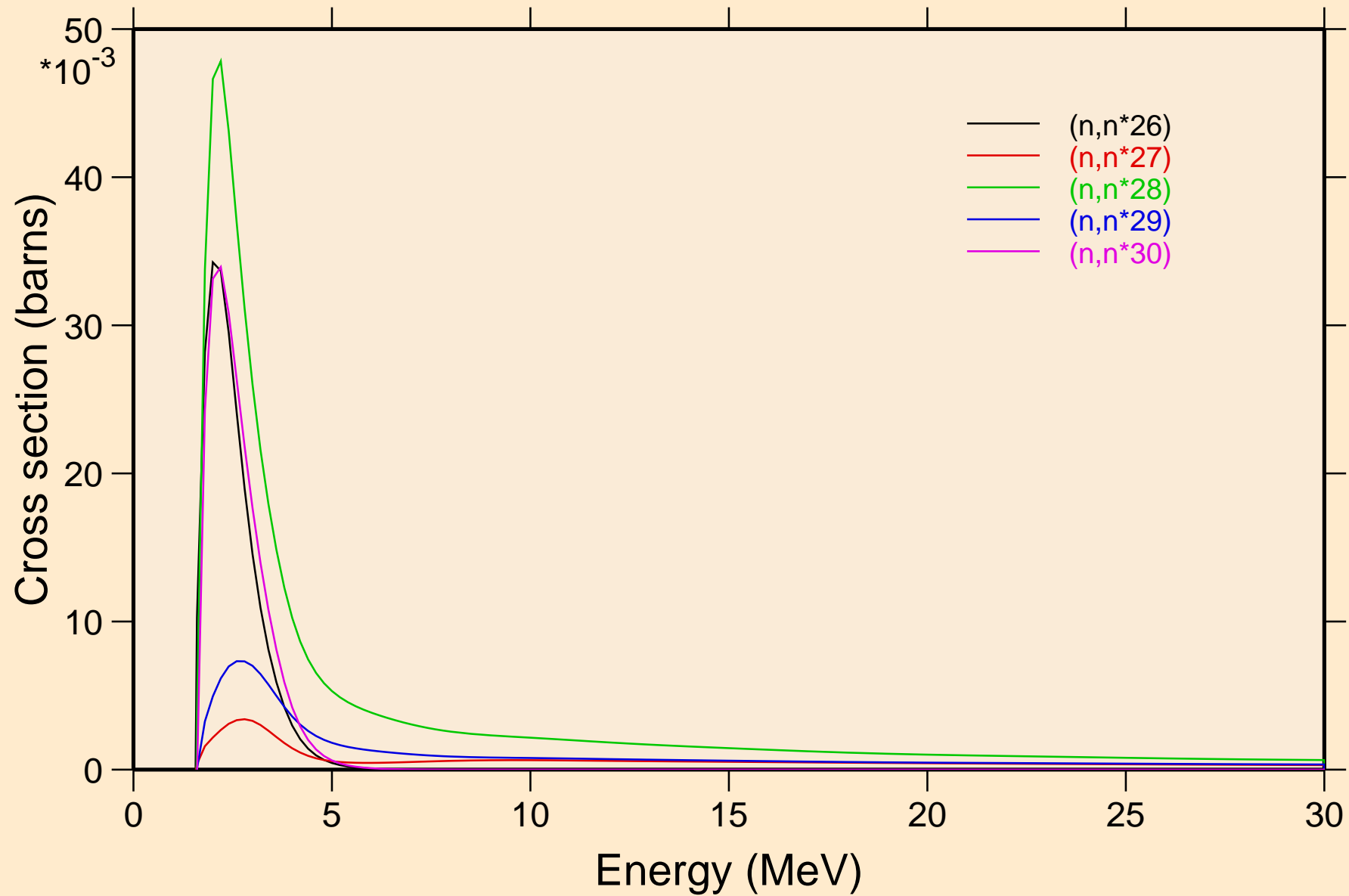

TL217 NEUTRON ACER TENDL-2023 LIBRARY; T=0.K
Threshold reactions

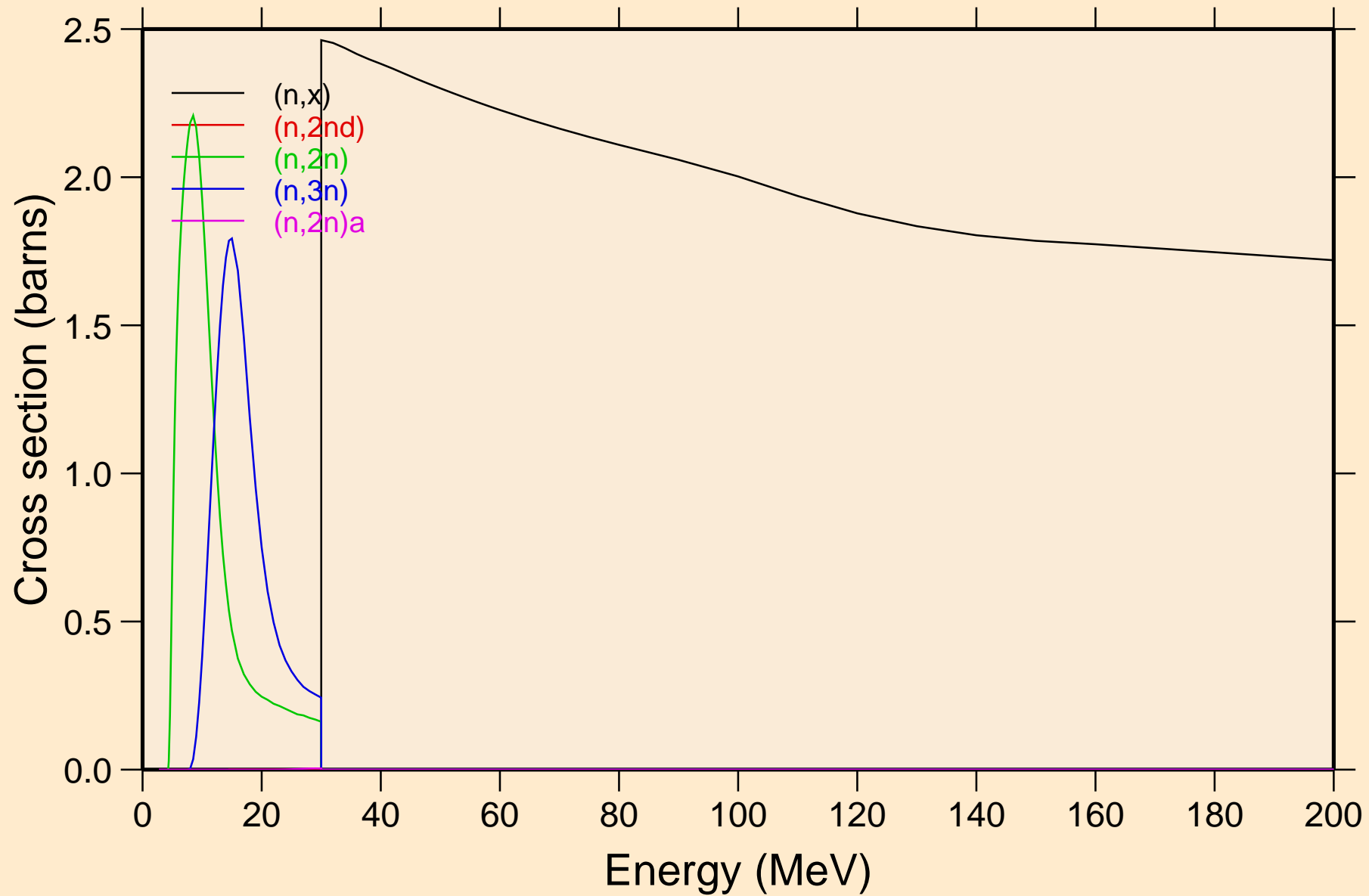

TL217 NEUTRON ACER TENDL-2023 LIBRARY; T=0.K
Threshold reactions

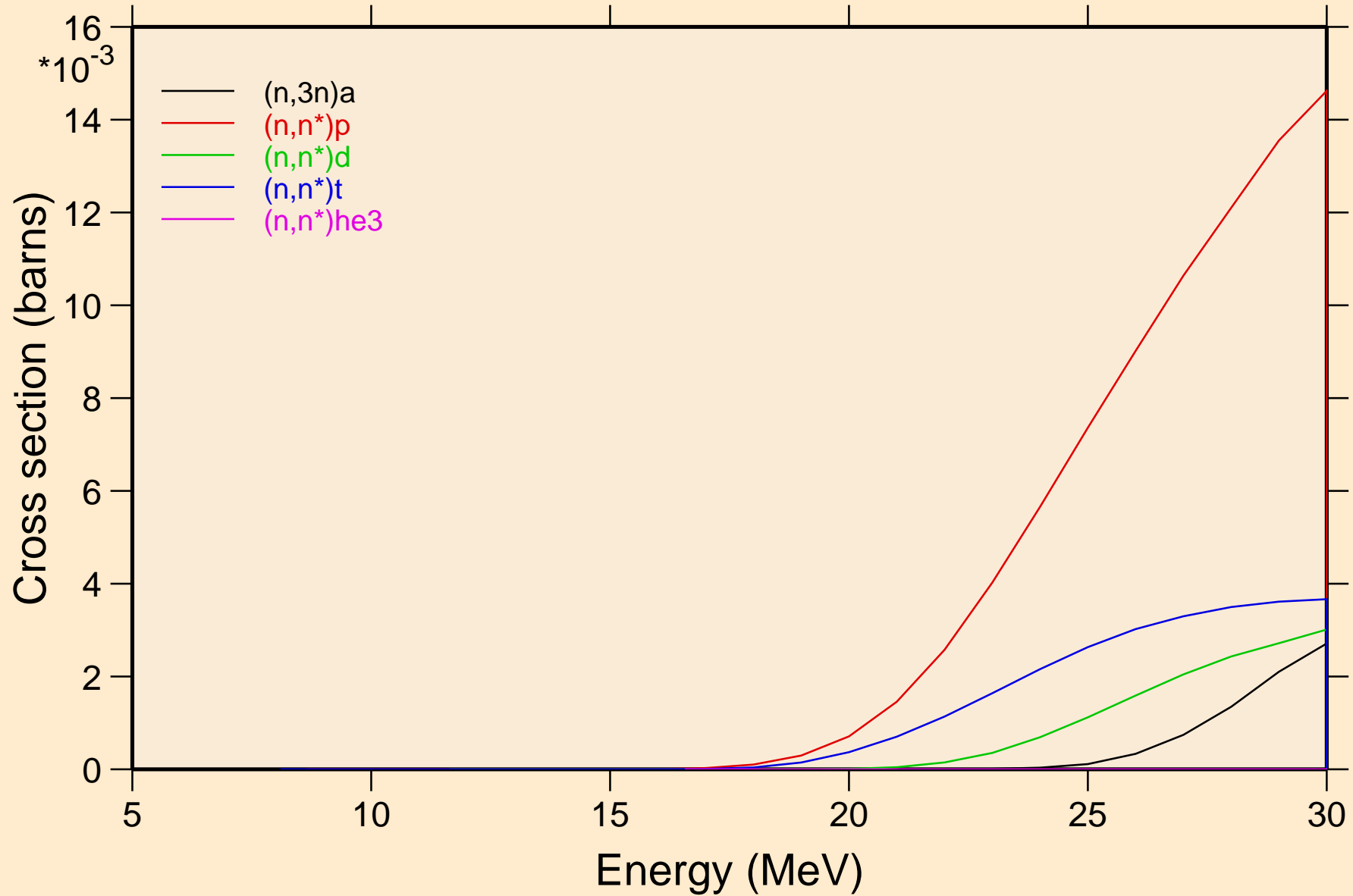

TL217 NEUTRON ACER TENDL-2023 LIBRARY; T=0.K
Threshold reactions

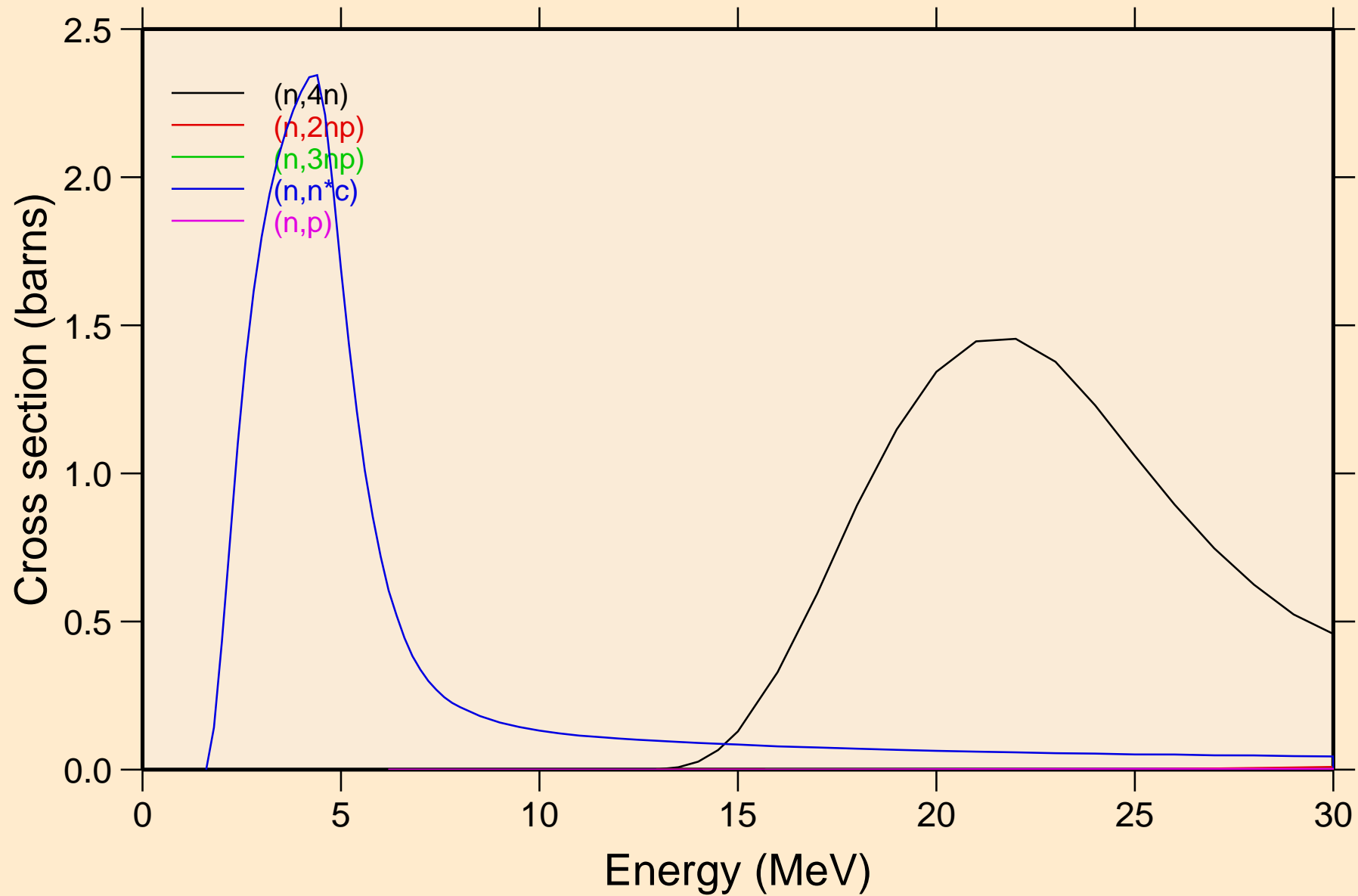

TL217 NEUTRON ACER TENDL-2023 LIBRARY; T=0.K
Threshold reactions

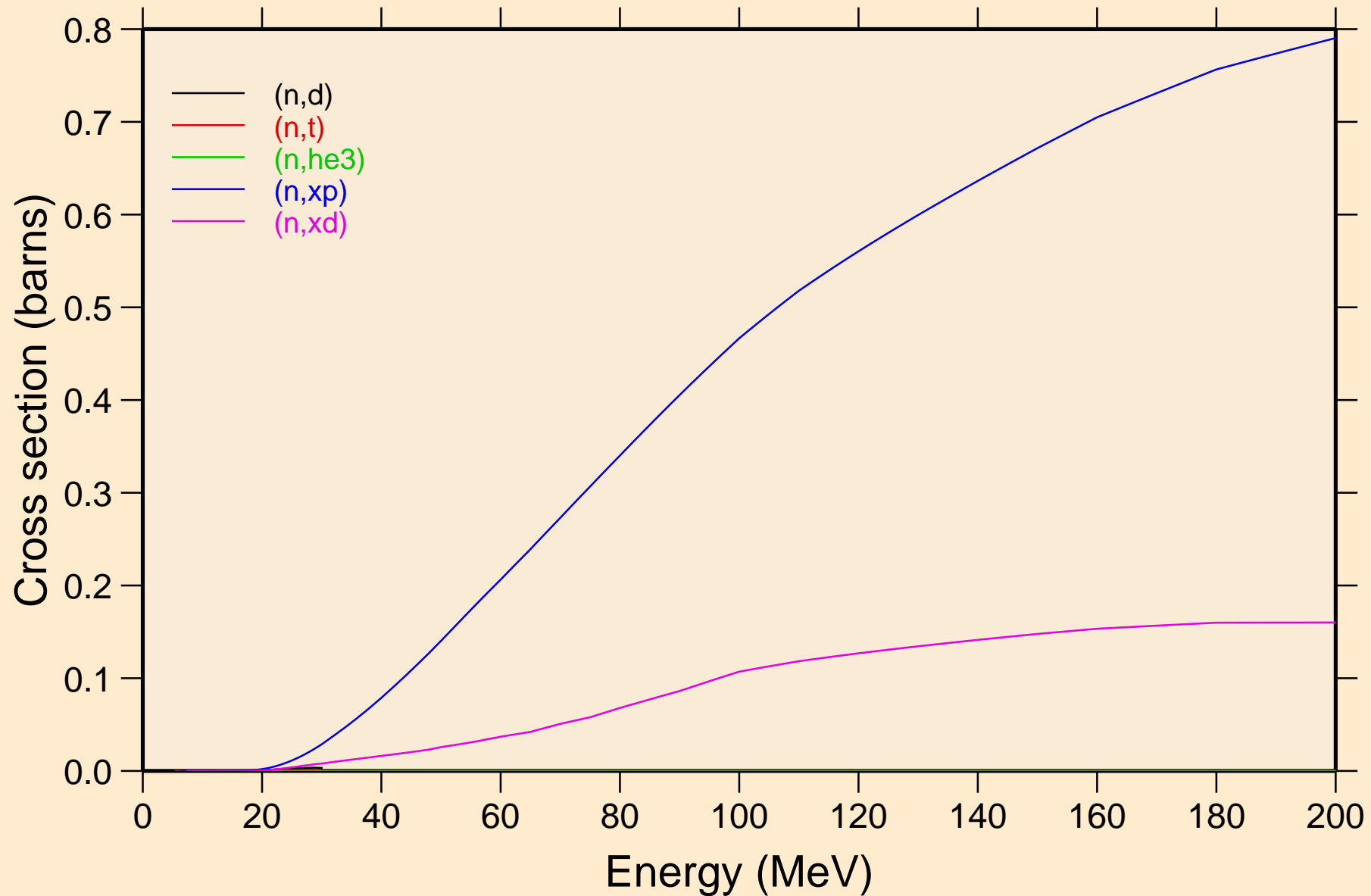

TL217 NEUTRON ACER TENDL-2023 LIBRARY; T=0.K
Threshold reactions

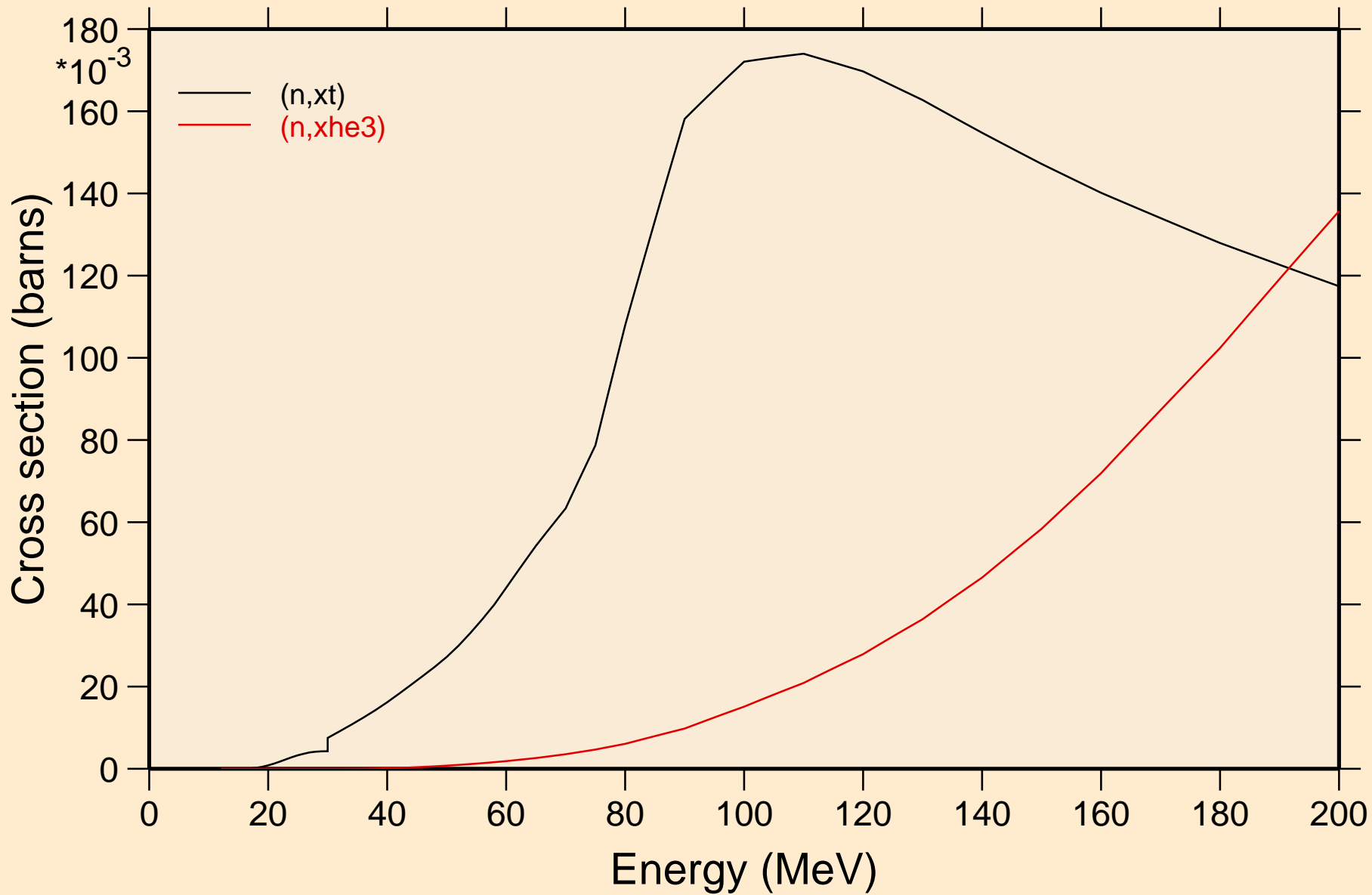

TL217 NEUTRON ACER TENDL-2023 LIBRARY; T=0.K
angular distribution for elastic

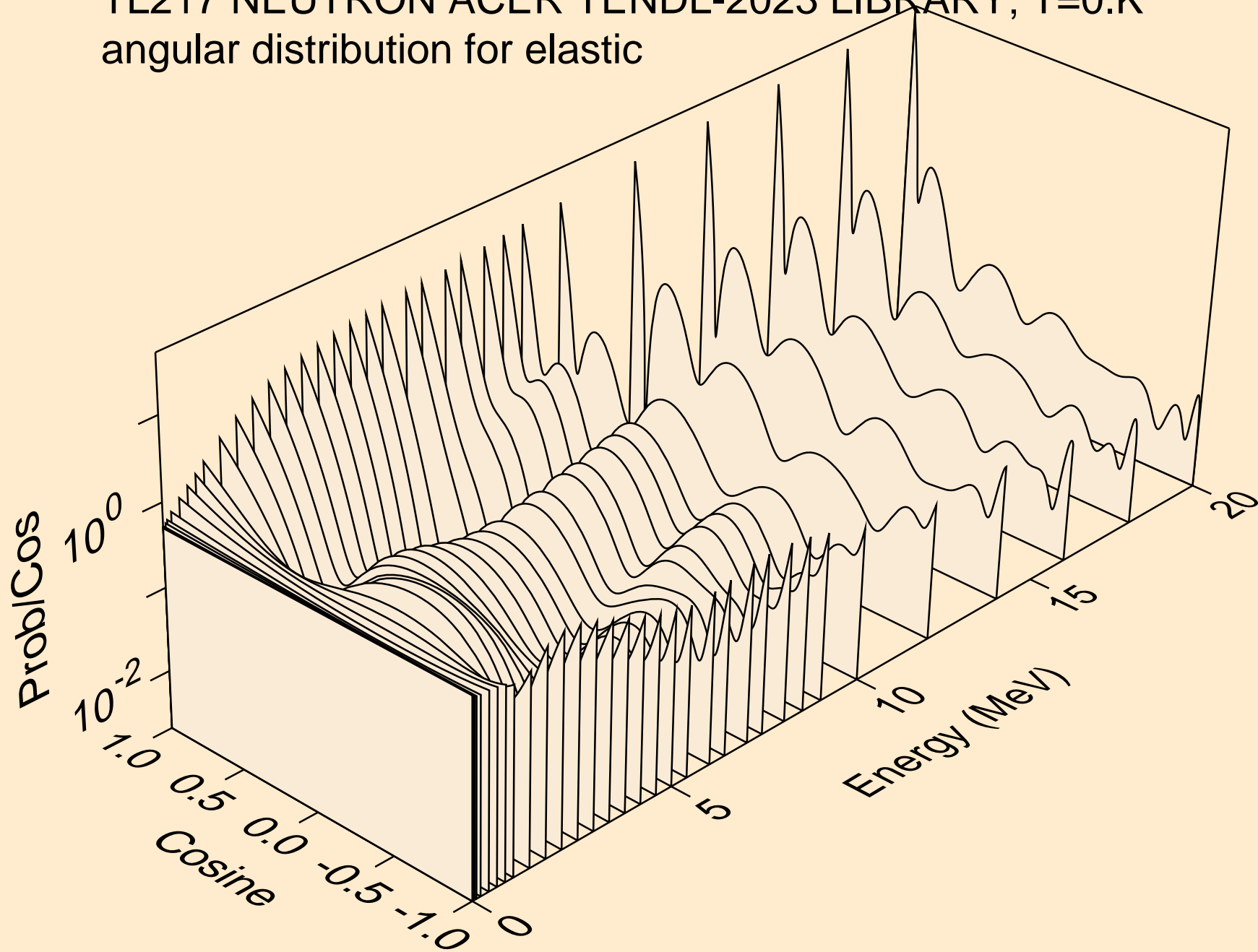

TL217 NEUTRON ACER TENDL-2023 LIBRARY; T=0.K
angular distribution for elastic

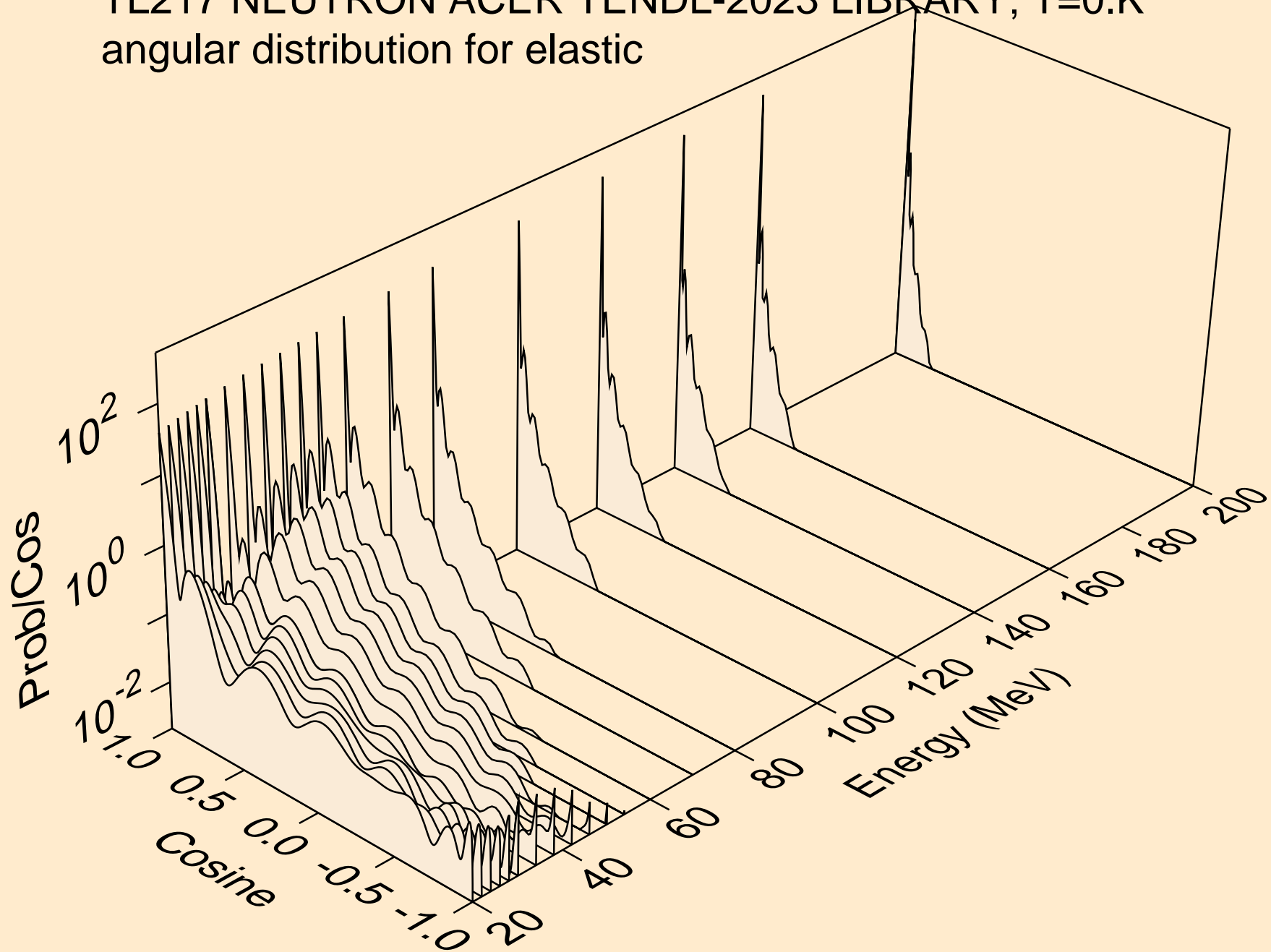

TL217 NEUTRON ACER TENDL-2023 LIBRARY; T=0.K
angular distribution for (n,n*1)

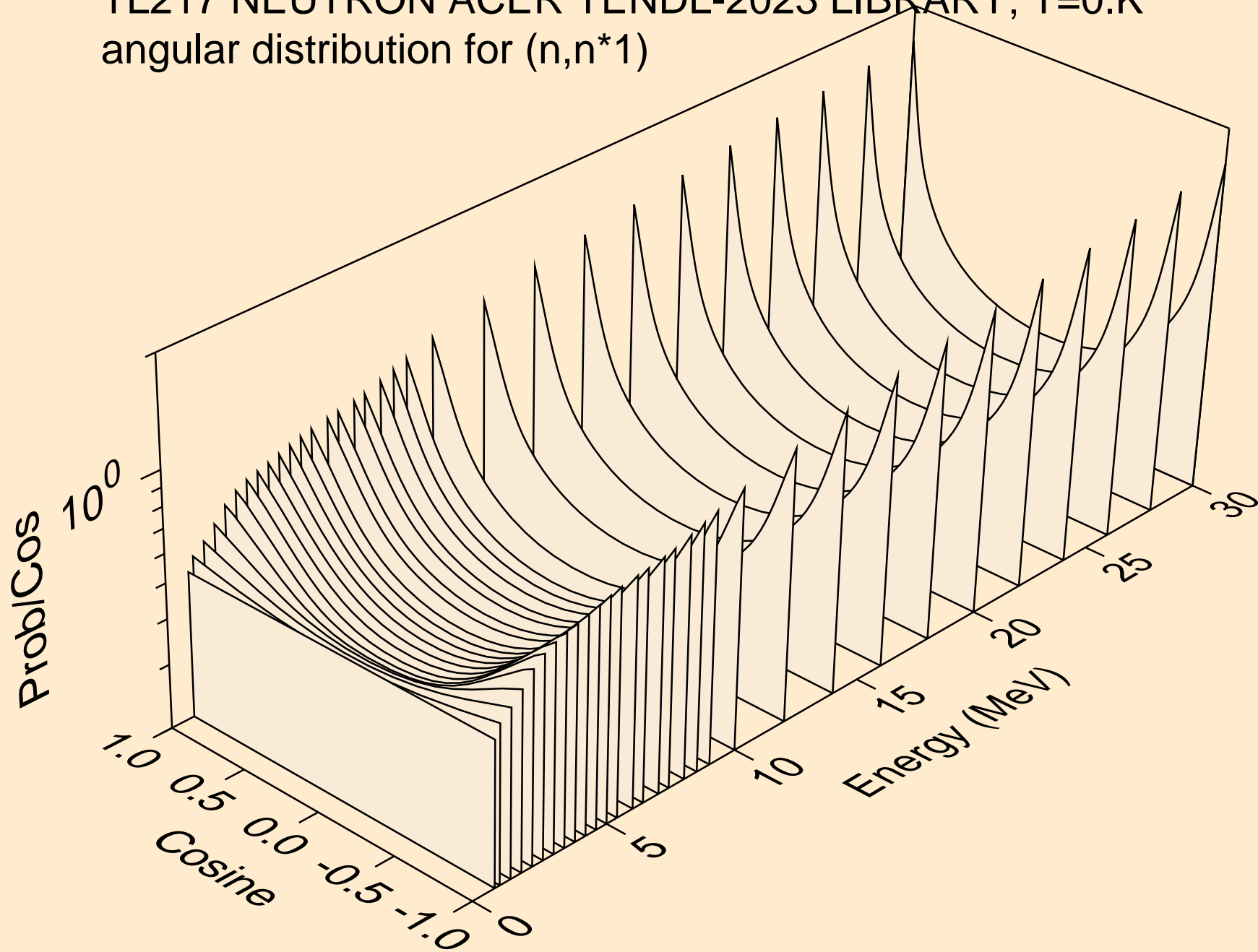

TL217 NEUTRON ACER TENDL-2023 LIBRARY; T=0.K
angular distribution for (n,n*2)

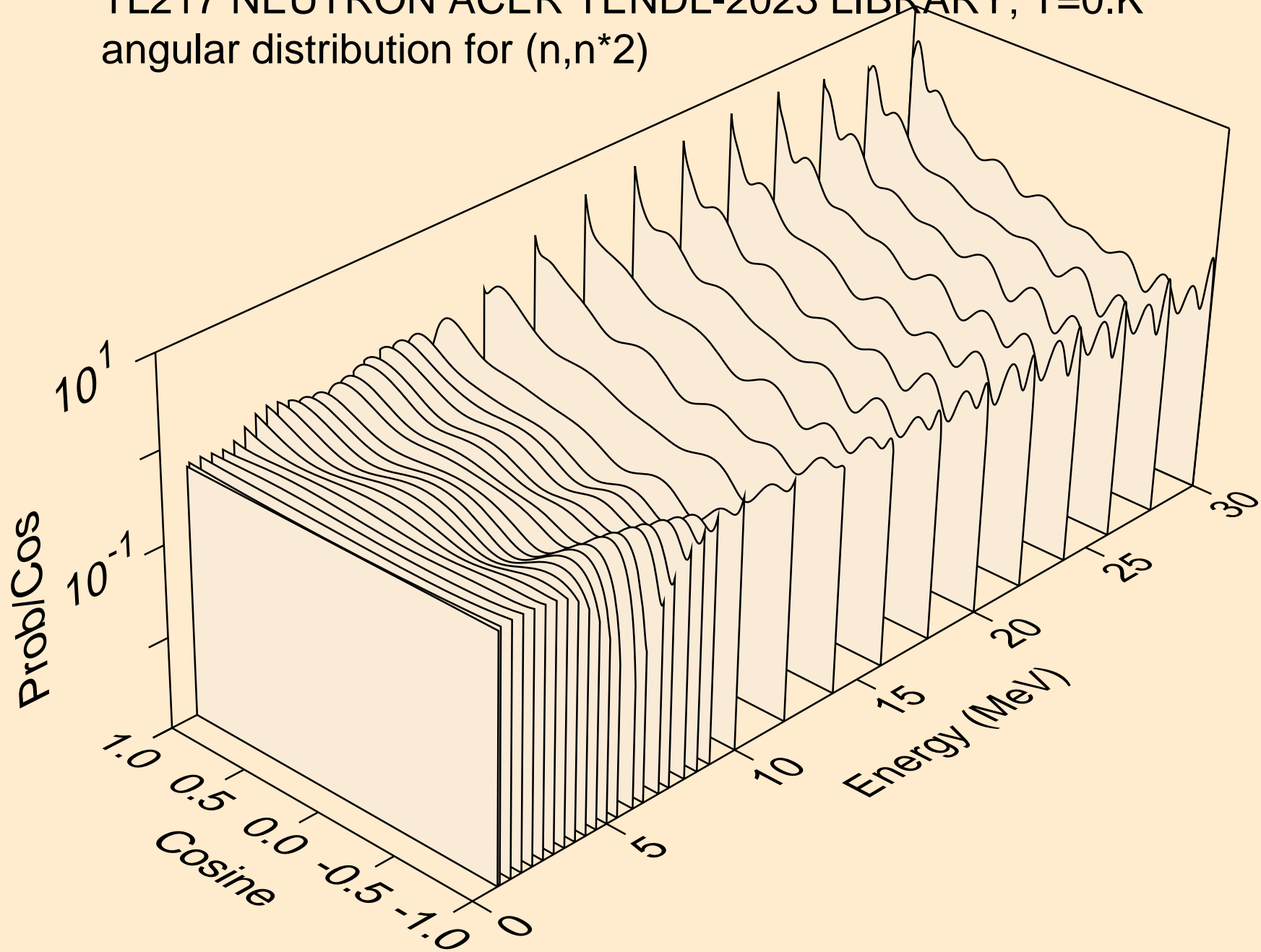

TL217 NEUTRON ACER TENDL-2023 LIBRARY; T=0.K
angular distribution for (n,n*3)

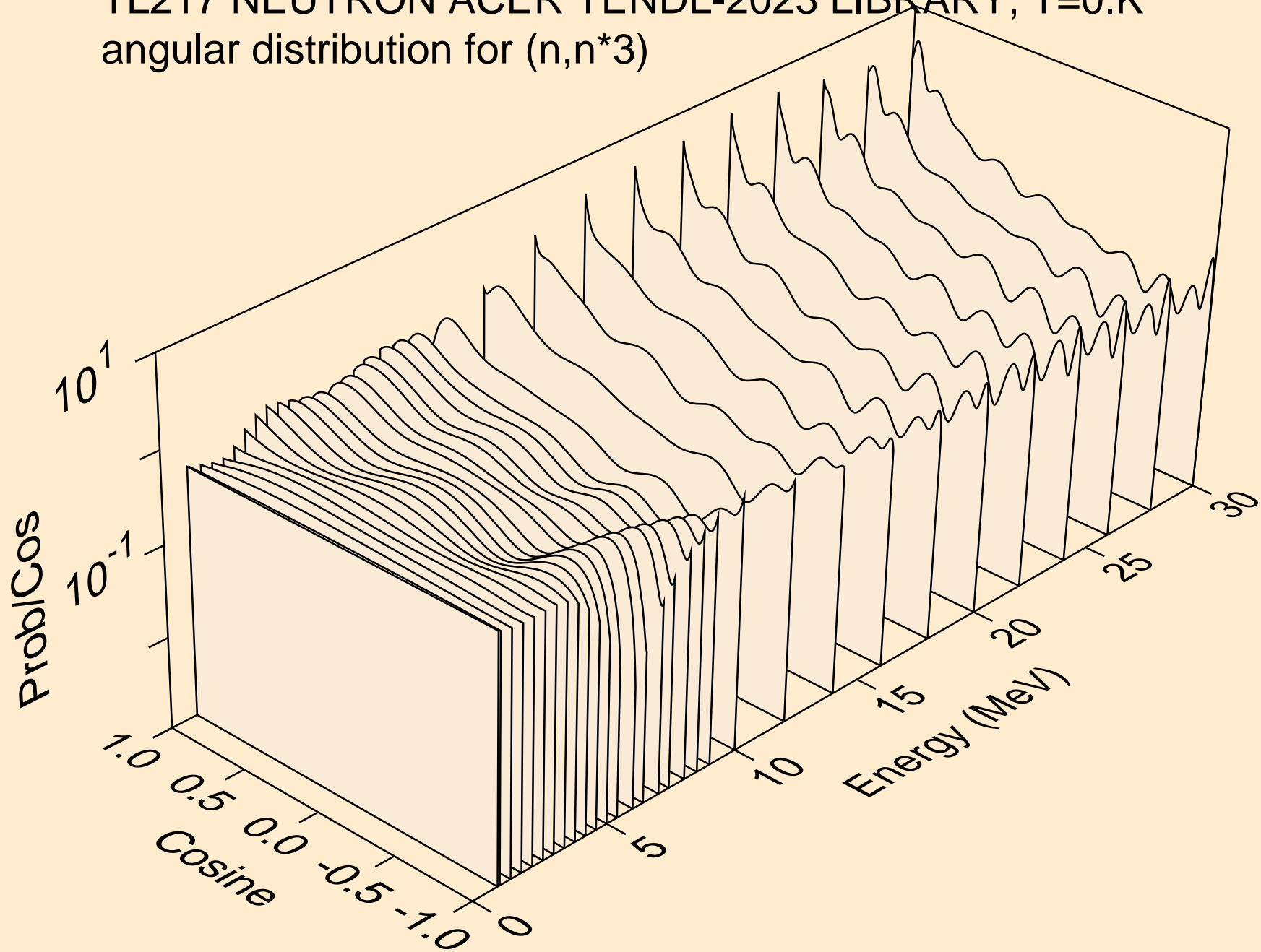

TL217 NEUTRON ACER TENDL-2023 LIBRARY; T=0.K
angular distribution for (n,n*4)

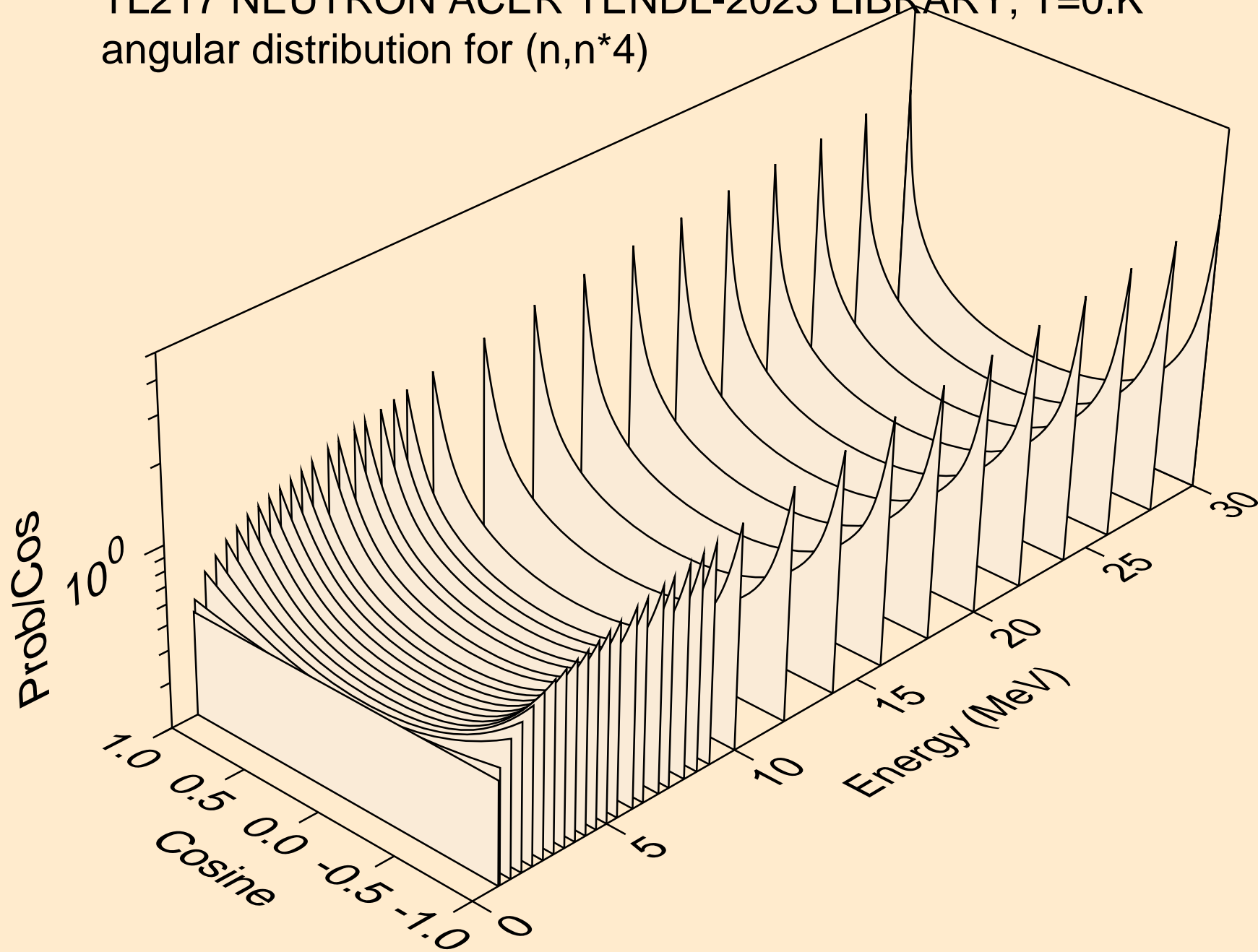

TL217 NEUTRON ACER TENDL-2023 LIBRARY; T=0.K
angular distribution for (n,n*5)

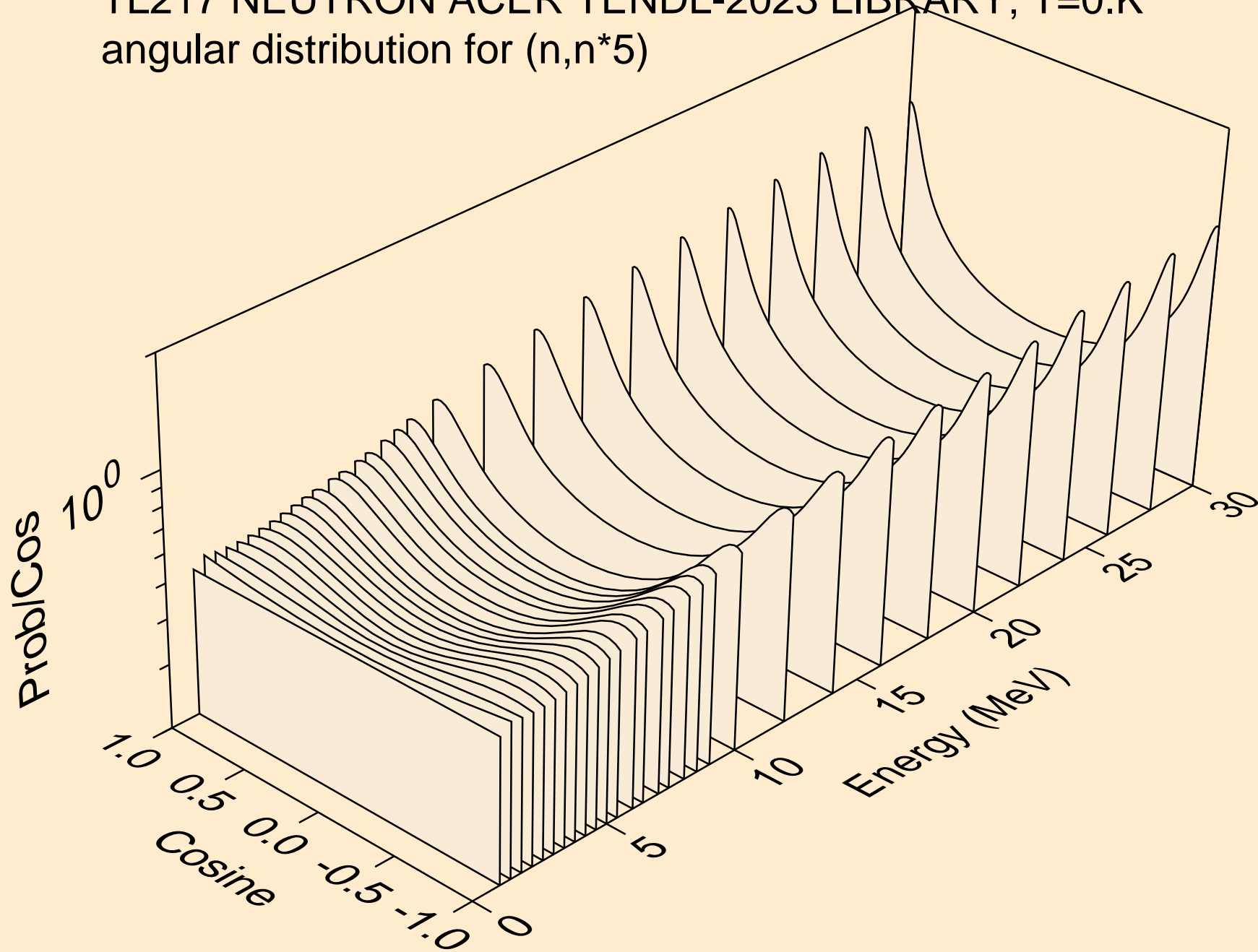

TL217 NEUTRON ACER TENDL-2023 LIBRARY; T=0.K
angular distribution for (n,n*6)

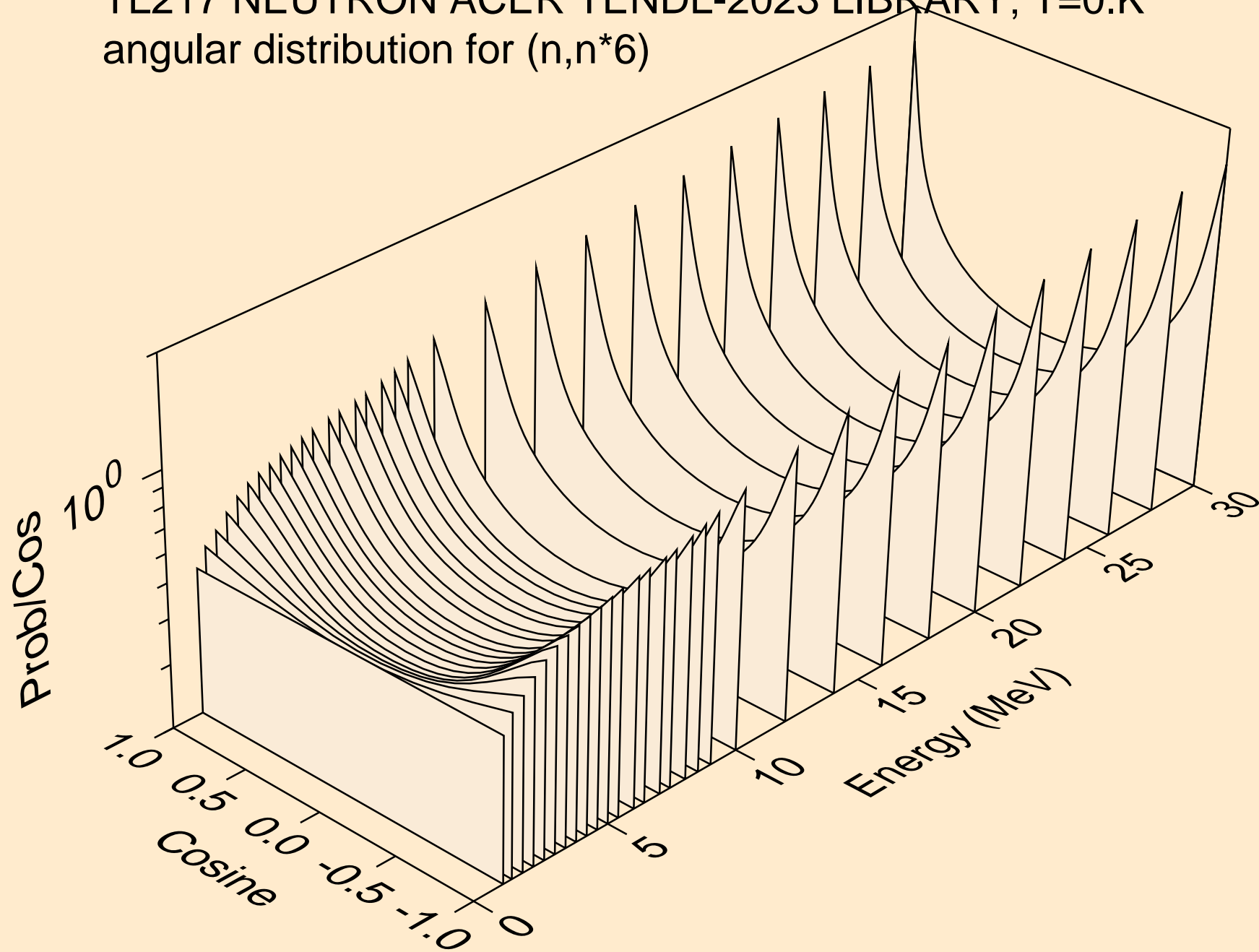

TL217 NEUTRON ACER TENDL-2023 LIBRARY; T=0.K
angular distribution for (n,n*7)

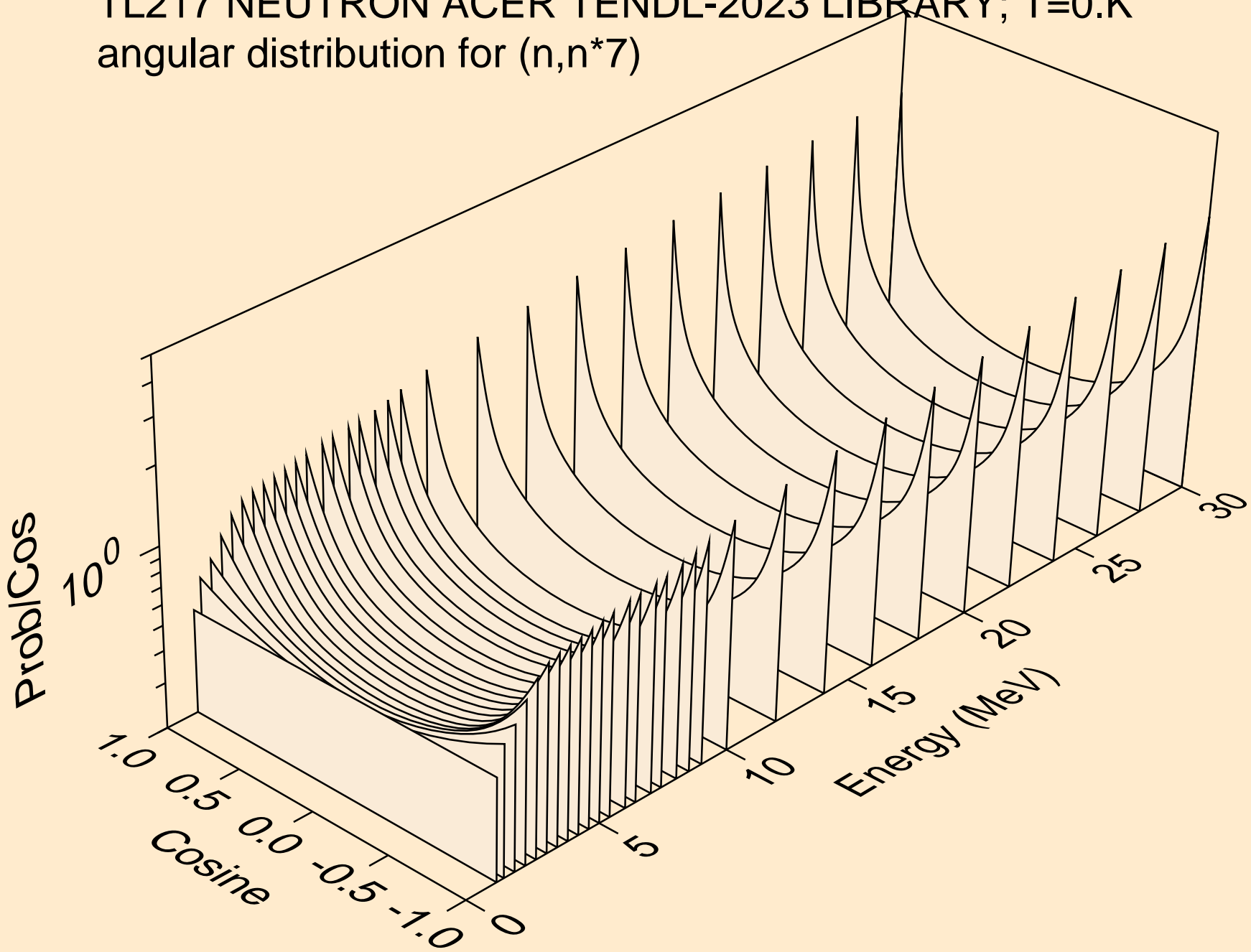

TL217 NEUTRON ACER TENDL-2023 LIBRARY; T=0.K
angular distribution for (n,n*8)

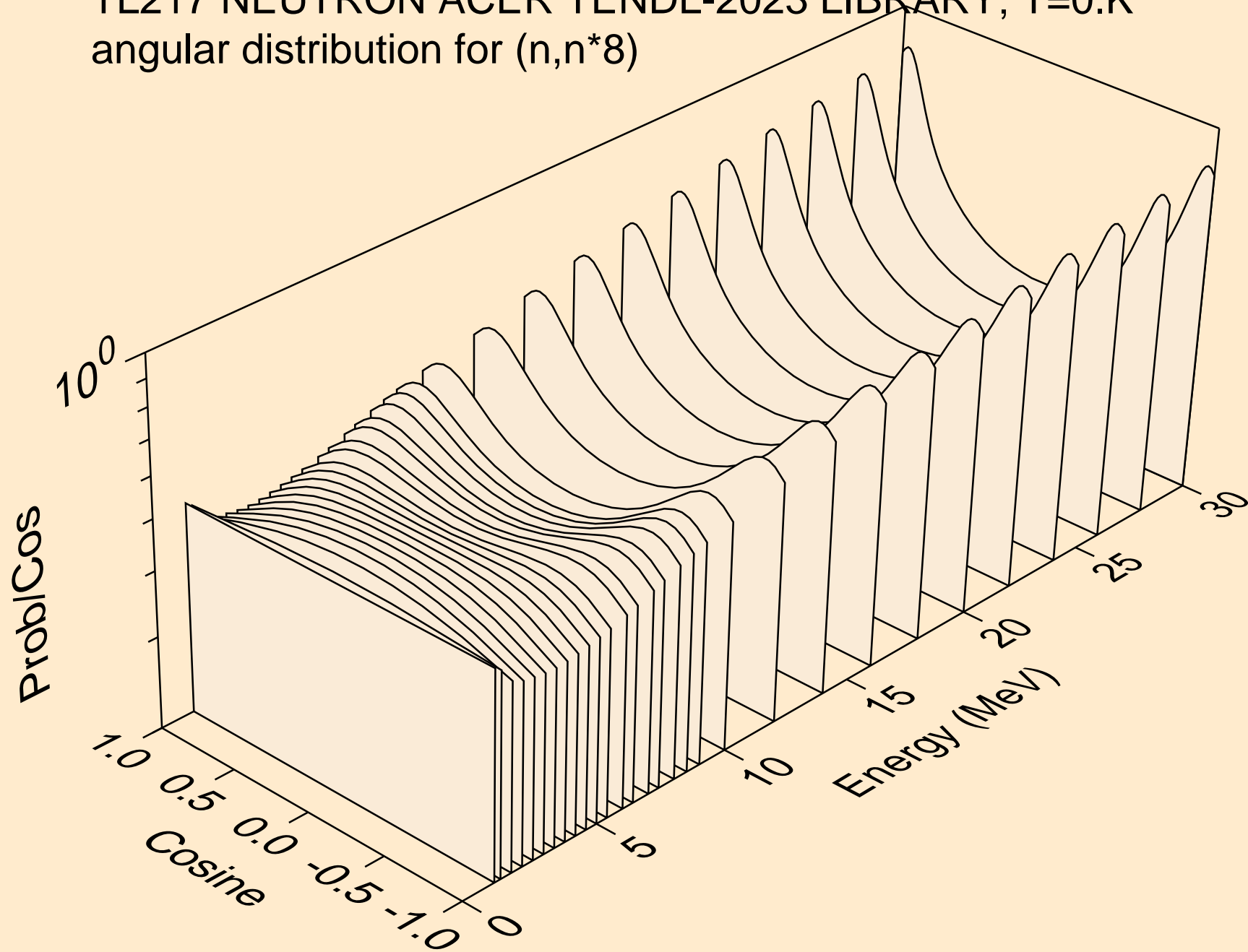

TL217 NEUTRON ACER TENDL-2023 LIBRARY; T=0.K
angular distribution for (n,n*9)

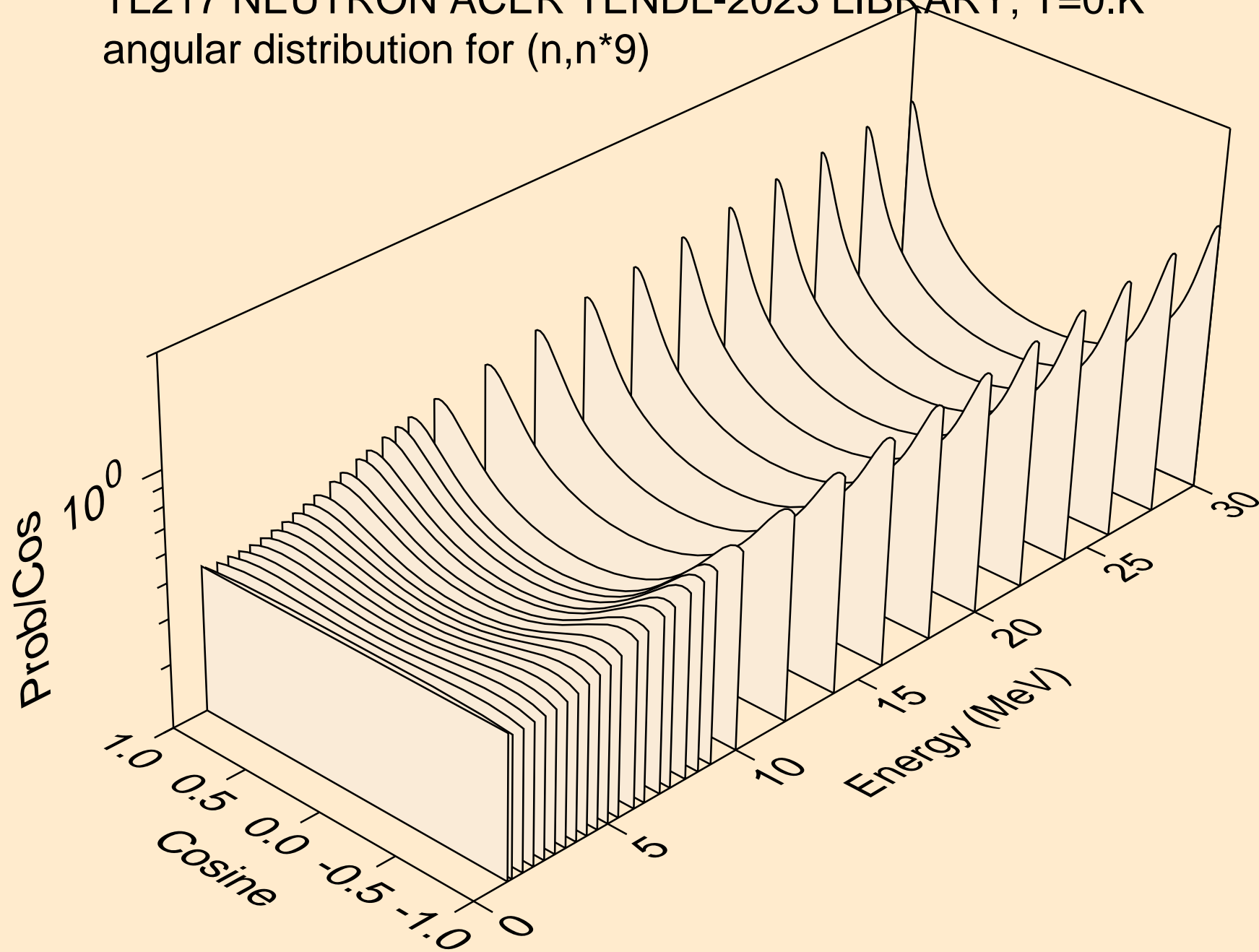

TL217 NEUTRON ACER TENDL-2023 LIBRARY; T=0.K
angular distribution for (n,n*10)

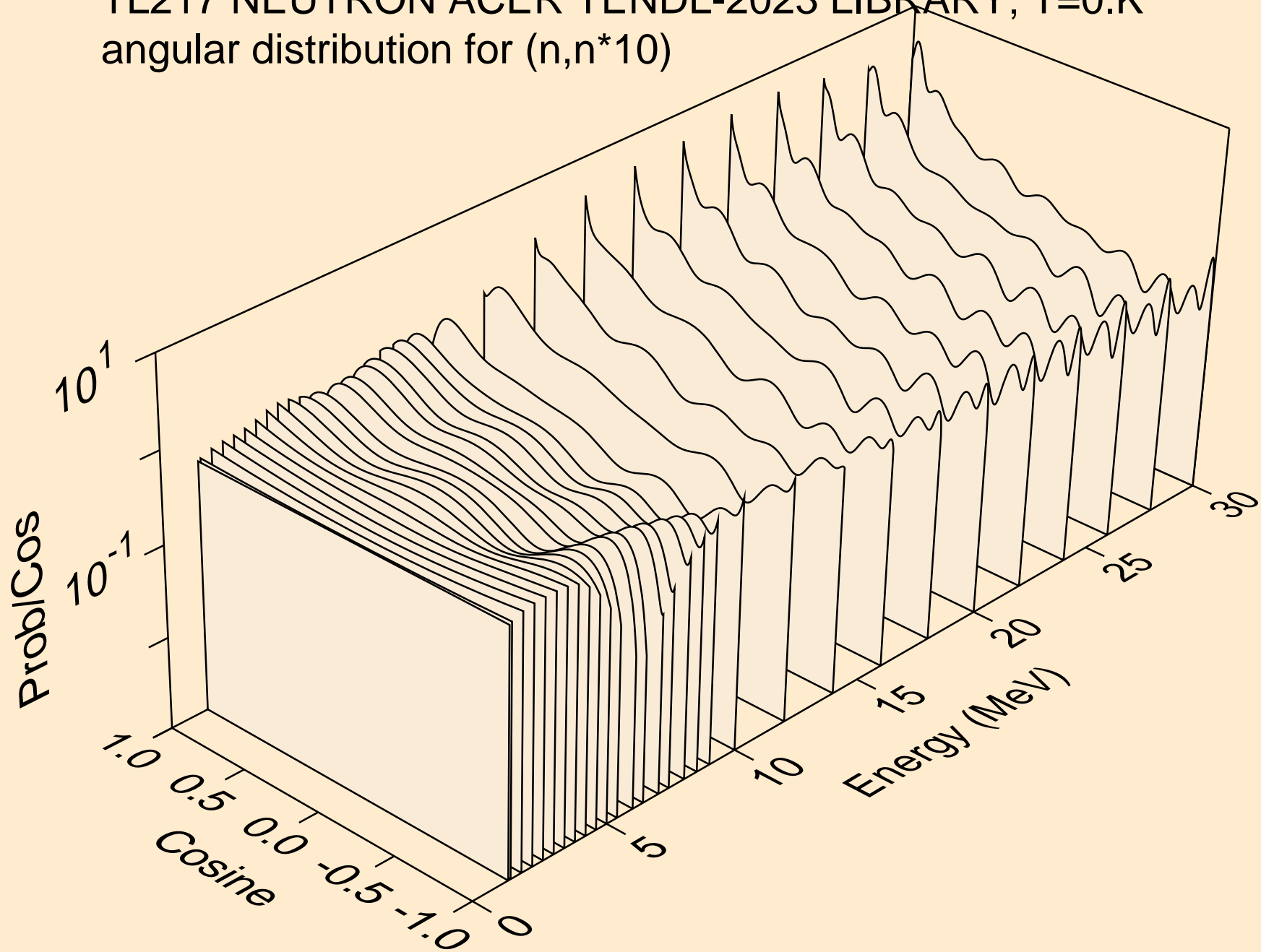

TL217 NEUTRON ACER TENDL-2023 LIBRARY; T=0.K
angular distribution for (n,n*11)

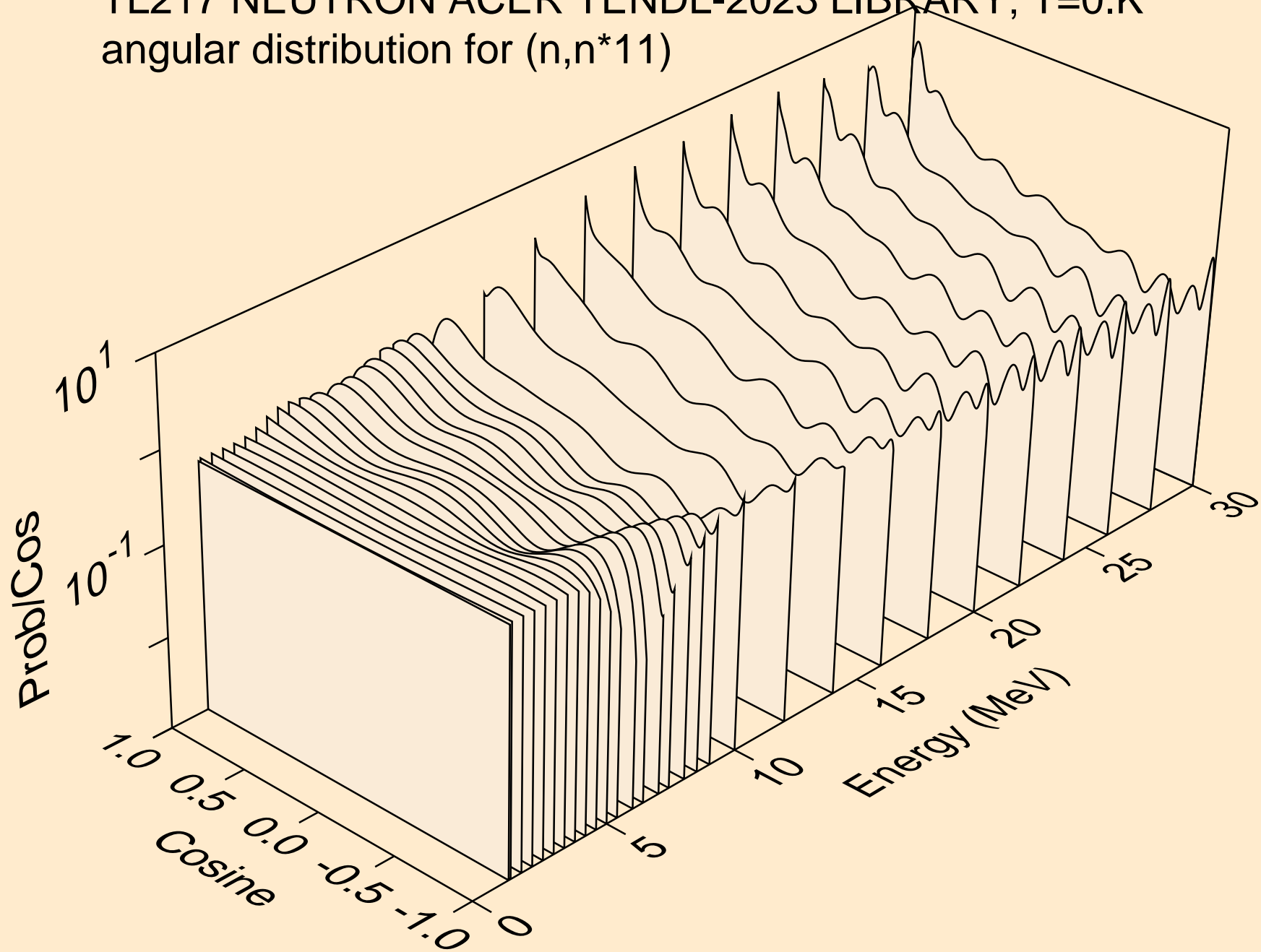

TL217 NEUTRON ACER TENDL-2023 LIBRARY; T=0.K
angular distribution for (n,n*12)

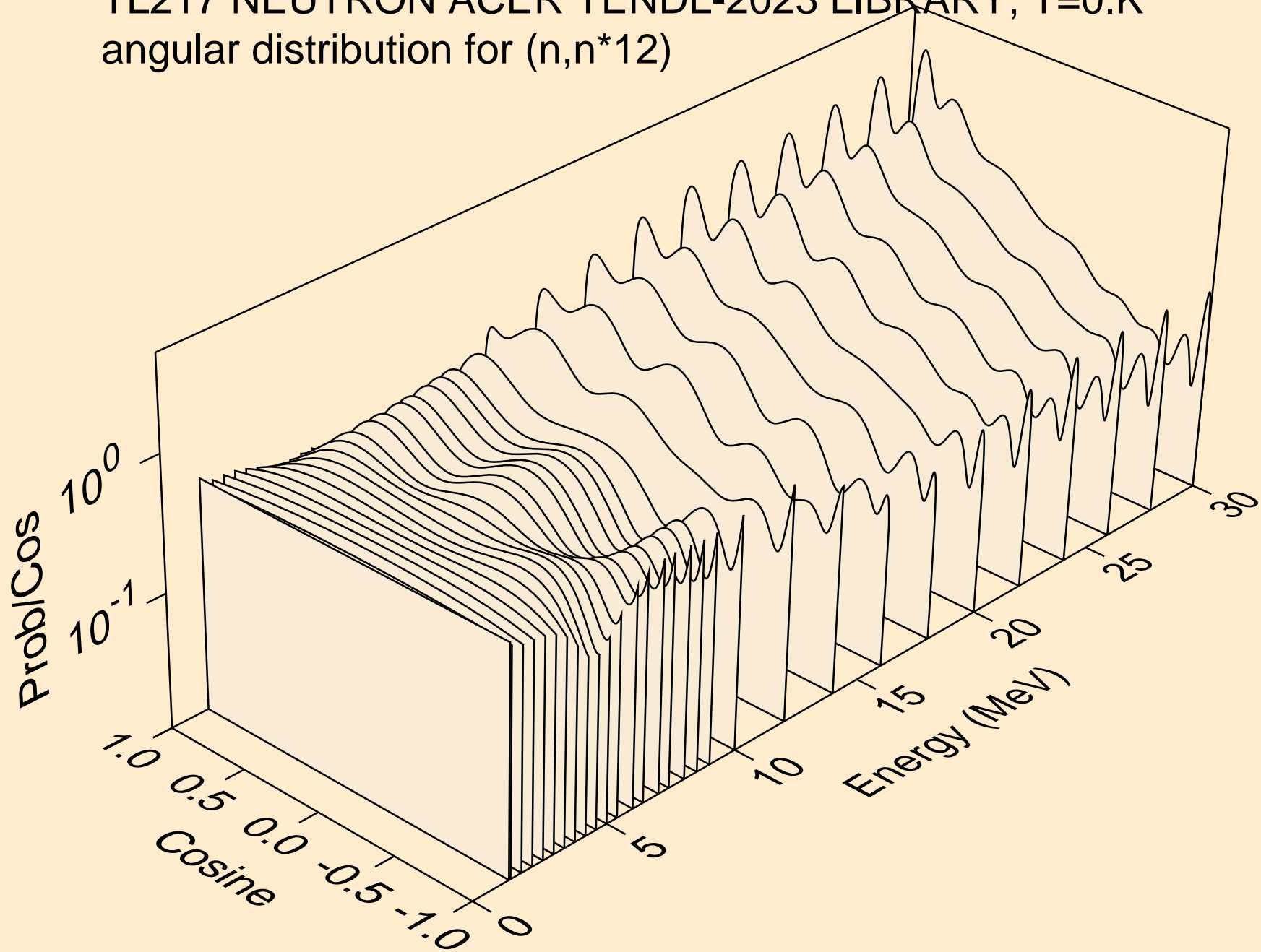

TL217 NEUTRON ACER TENDL-2023 LIBRARY; T=0.K
angular distribution for (n,n*13)

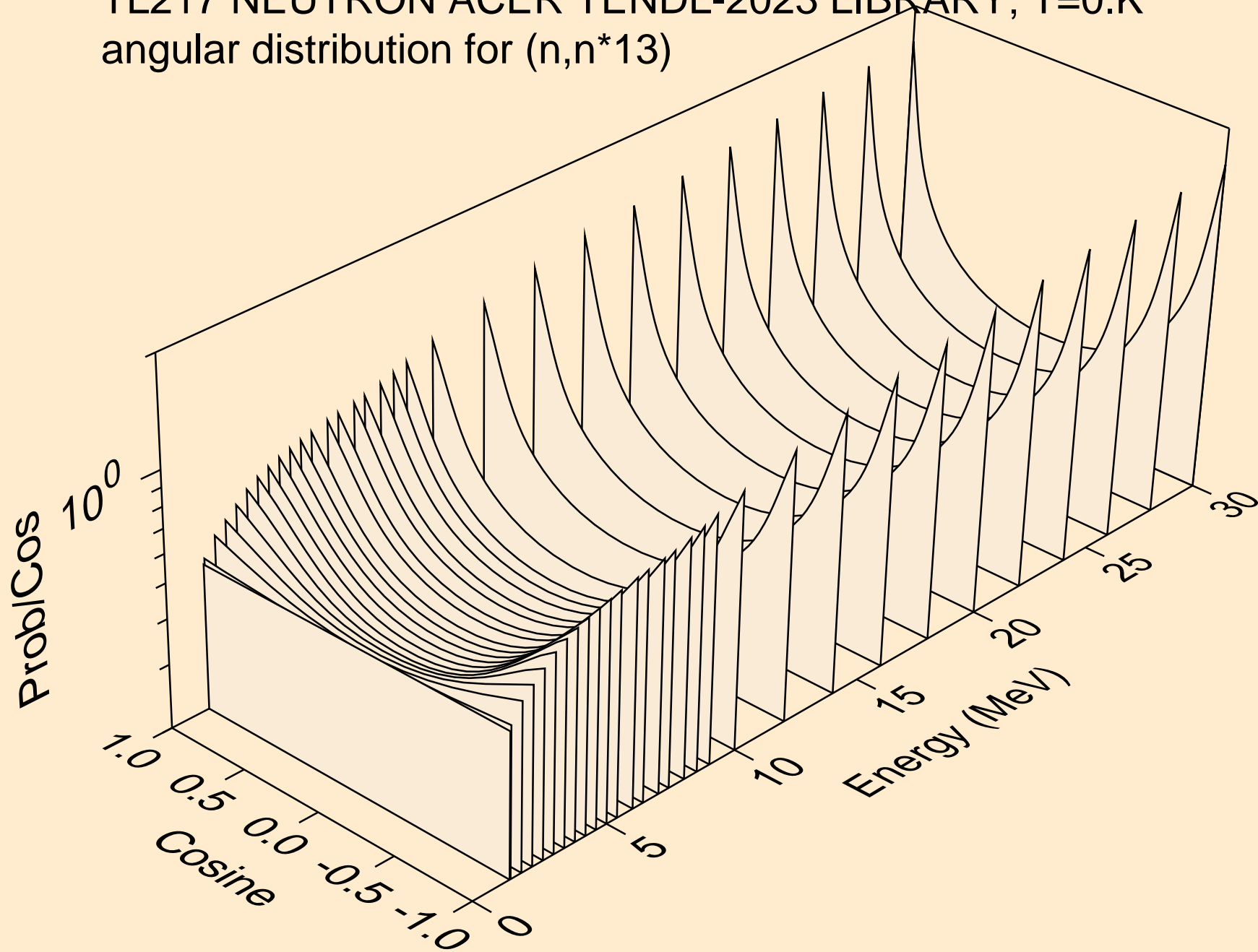

TL217 NEUTRON ACER TENDL-2023 LIBRARY; T=0.K
angular distribution for (n,n*14)

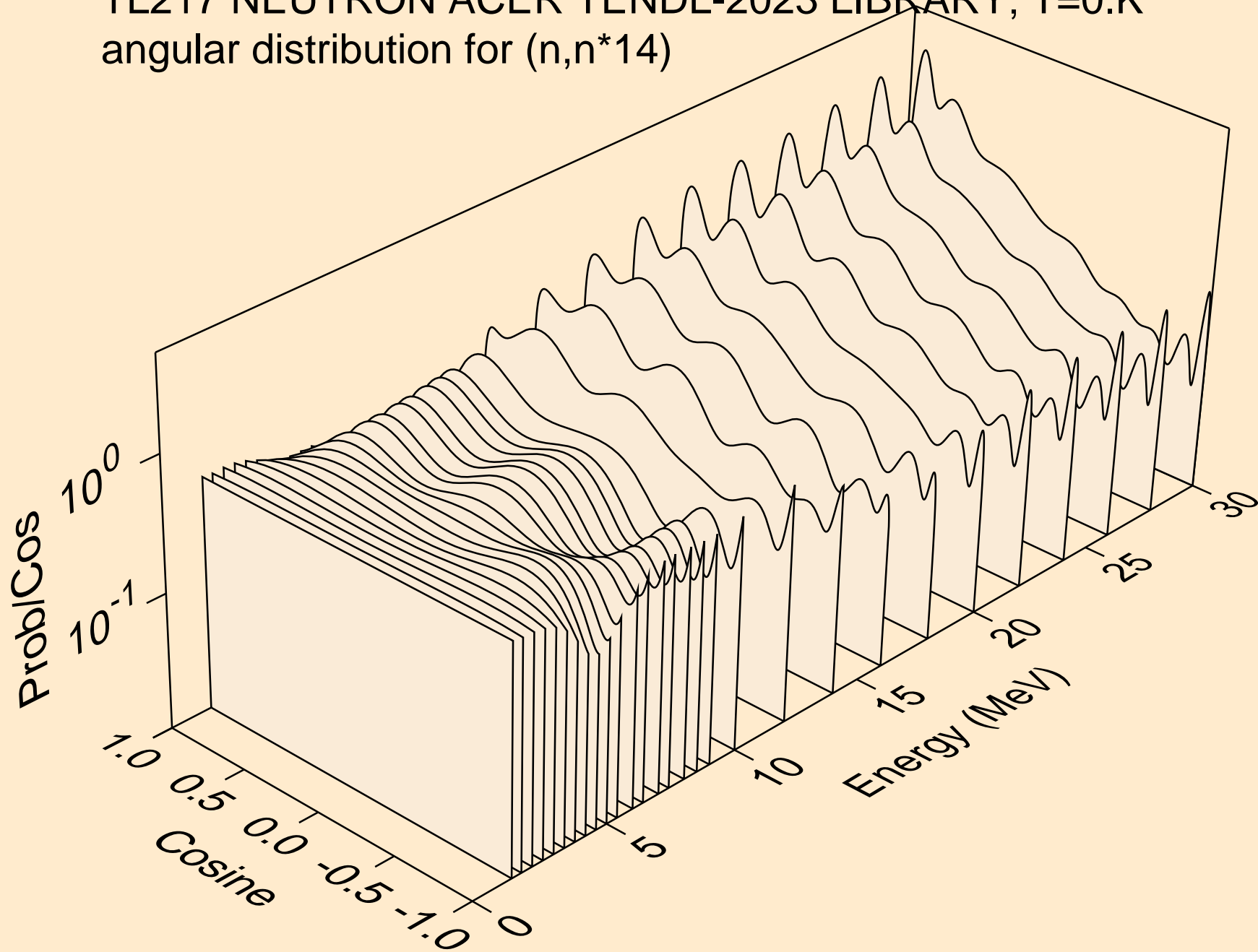

TL217 NEUTRON ACER TENDL-2023 LIBRARY; T=0.K
angular distribution for (n,n*15)

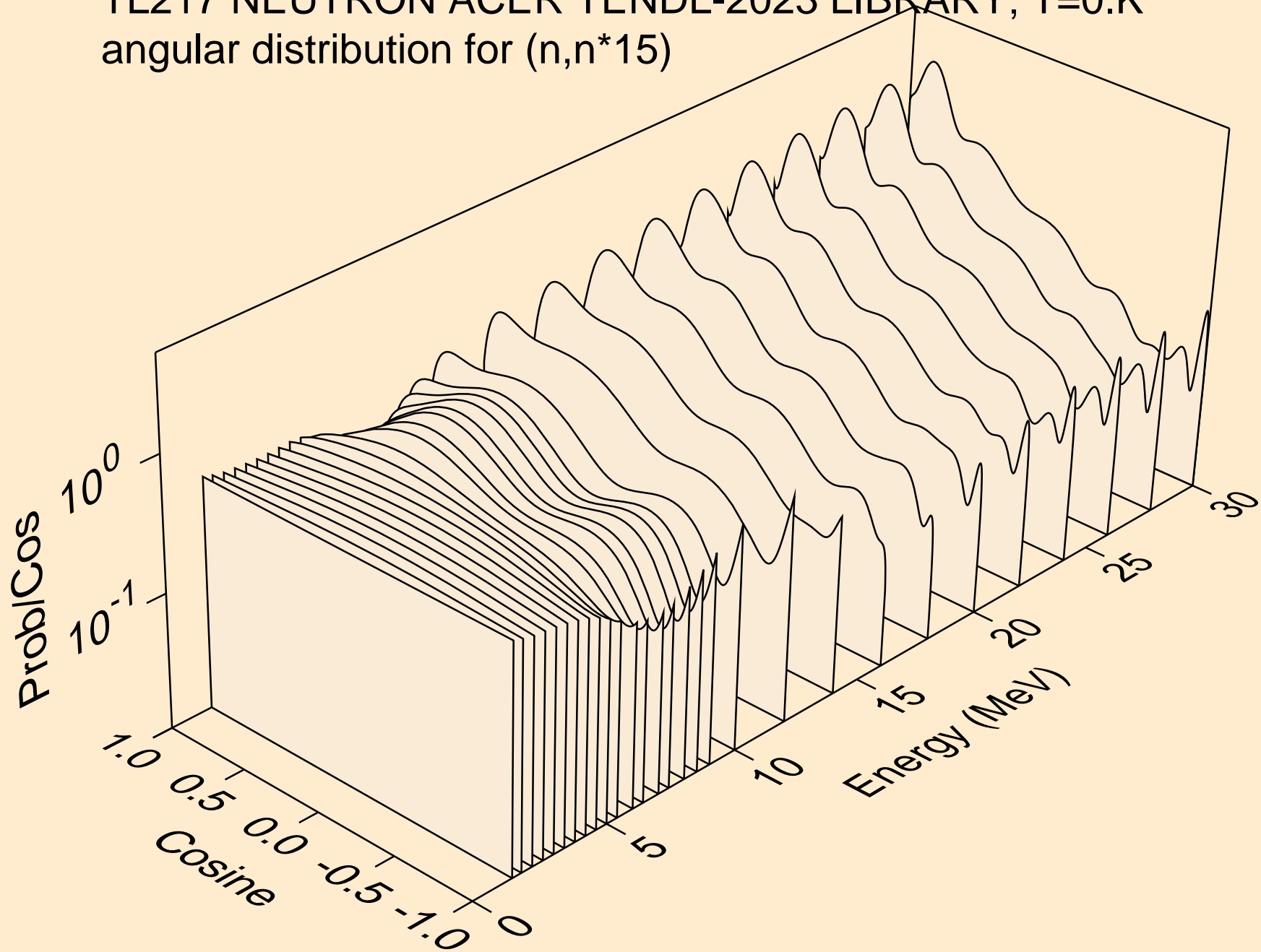

TL217 NEUTRON ACER TENDL-2023 LIBRARY; T=0.K
angular distribution for (n,n*16)

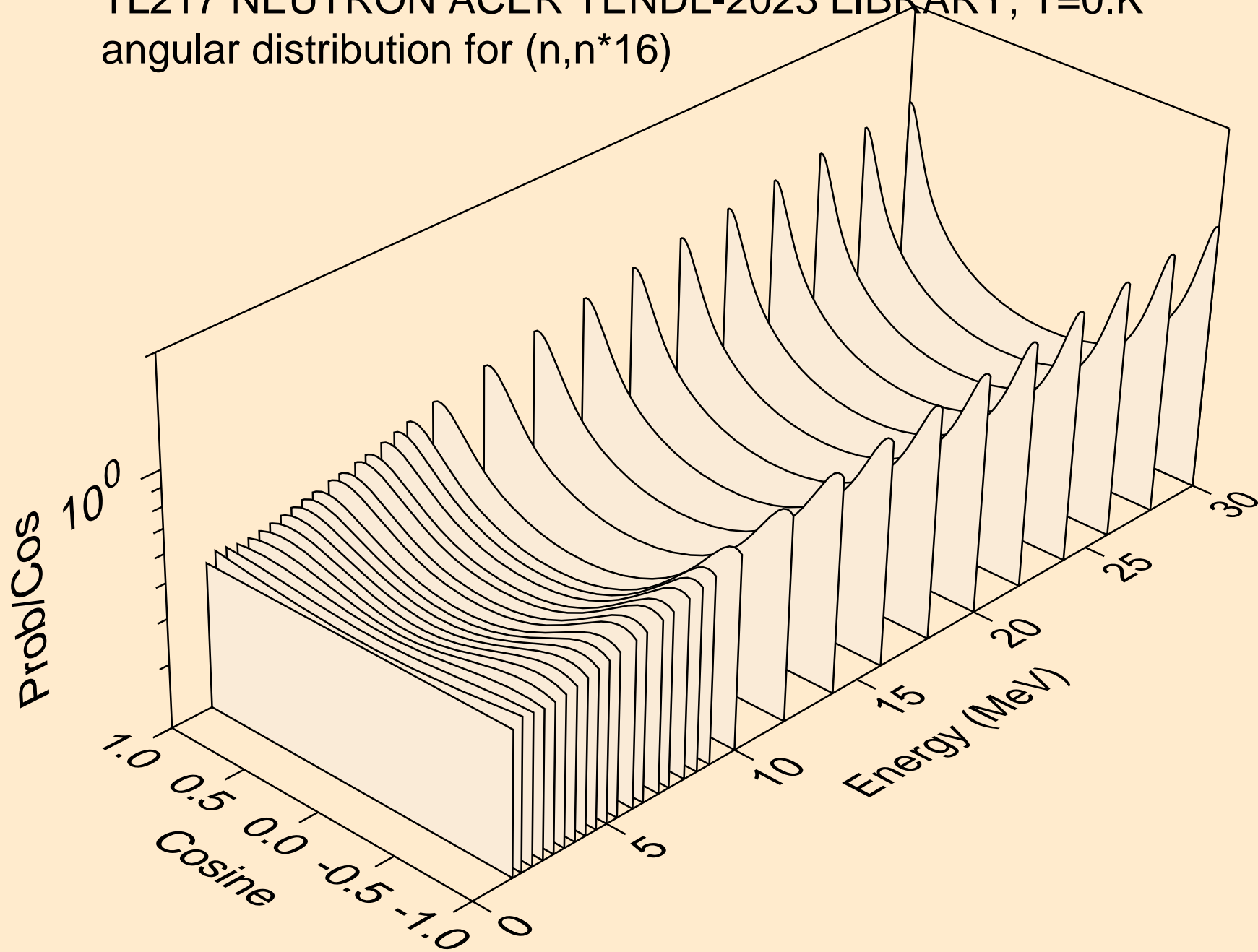

TL217 NEUTRON ACER TENDL-2023 LIBRARY; T=0.K
angular distribution for (n,n*17)

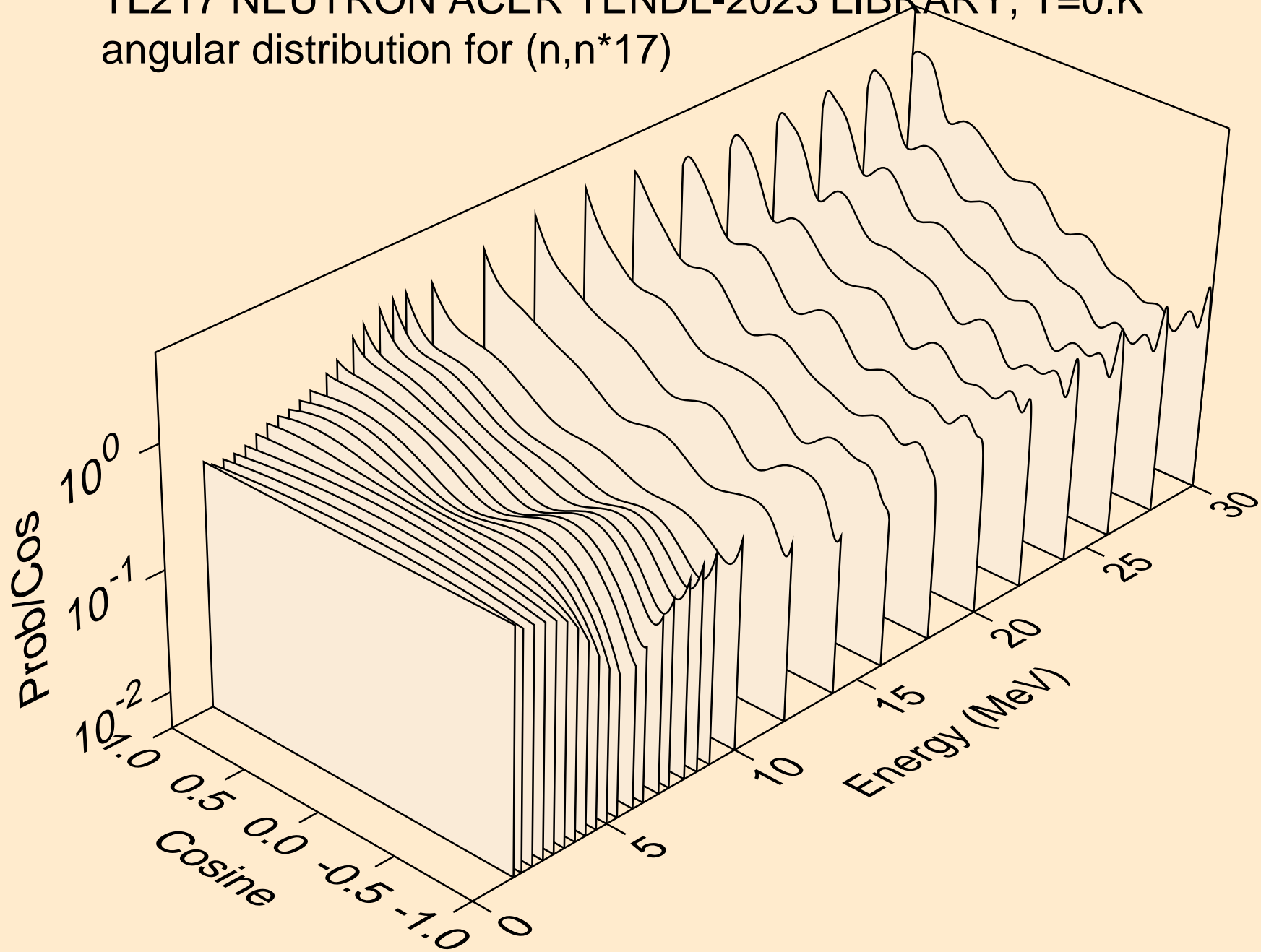

TL217 NEUTRON ACER TENDL-2023 LIBRARY; T=0.K
angular distribution for (n,n*18)

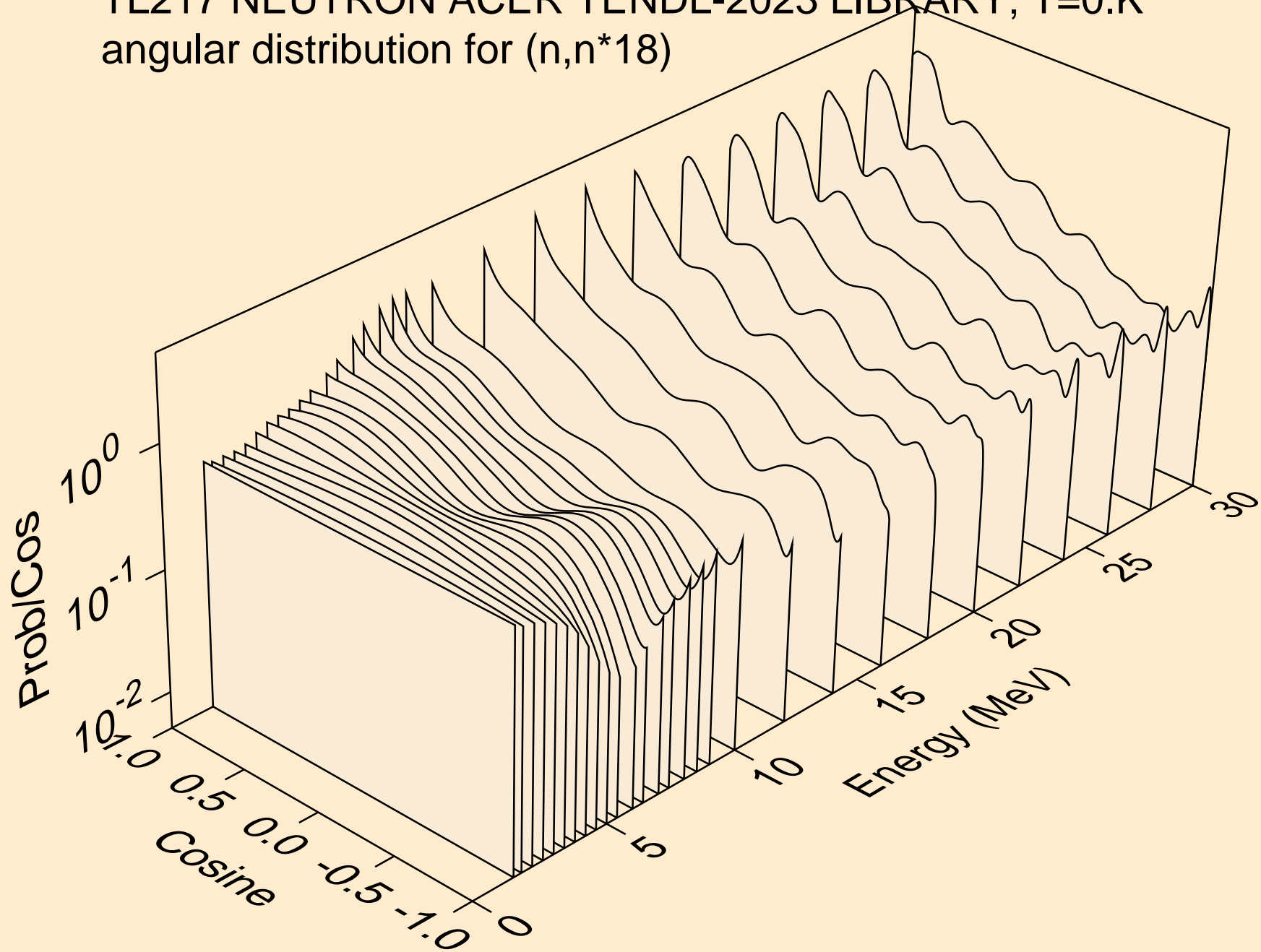

TL217 NEUTRON ACER TENDL-2023 LIBRARY; T=0.K
angular distribution for (n,n*19)

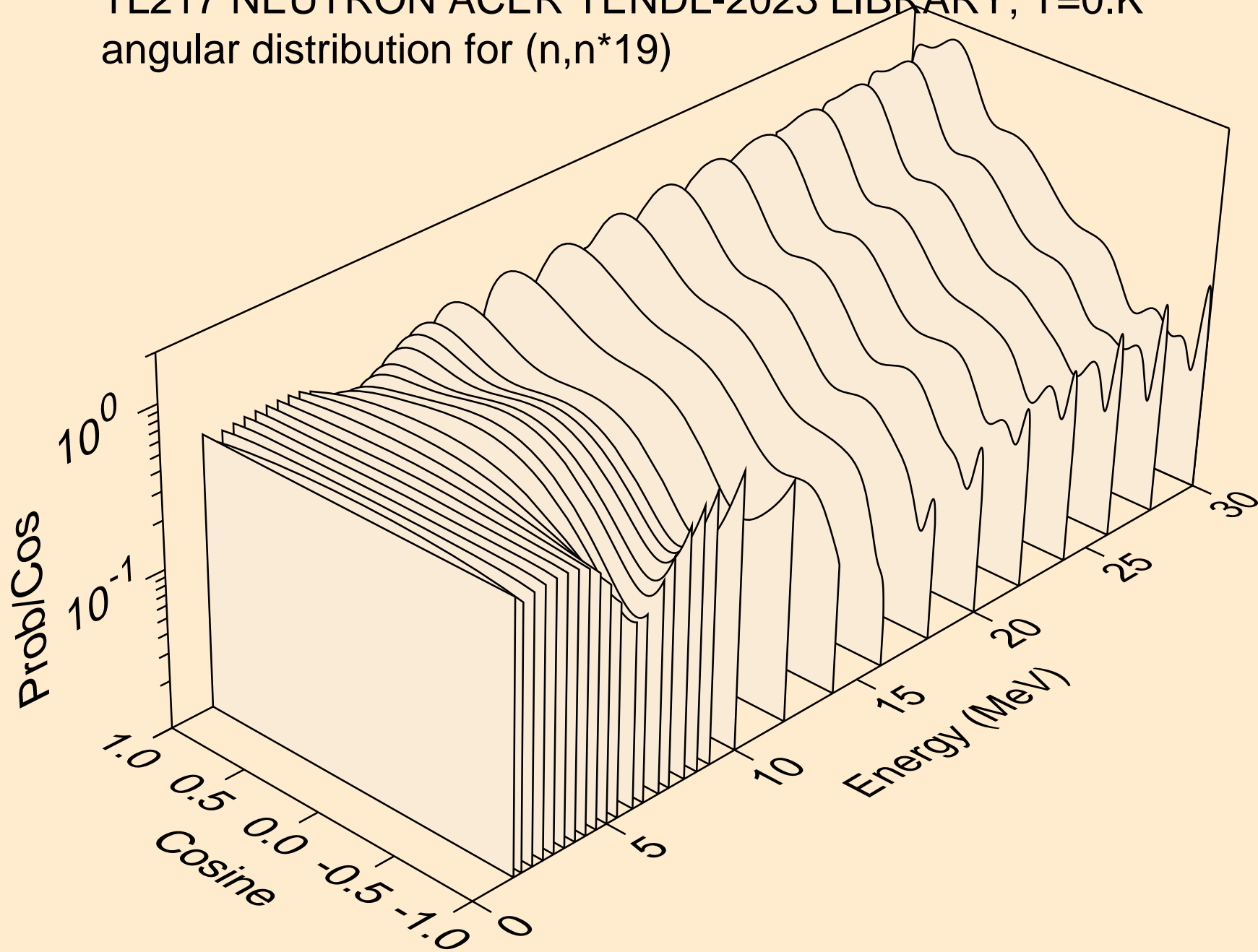

TL217 NEUTRON ACER TENDL-2023 LIBRARY; T=0.K
angular distribution for (n,n*20)

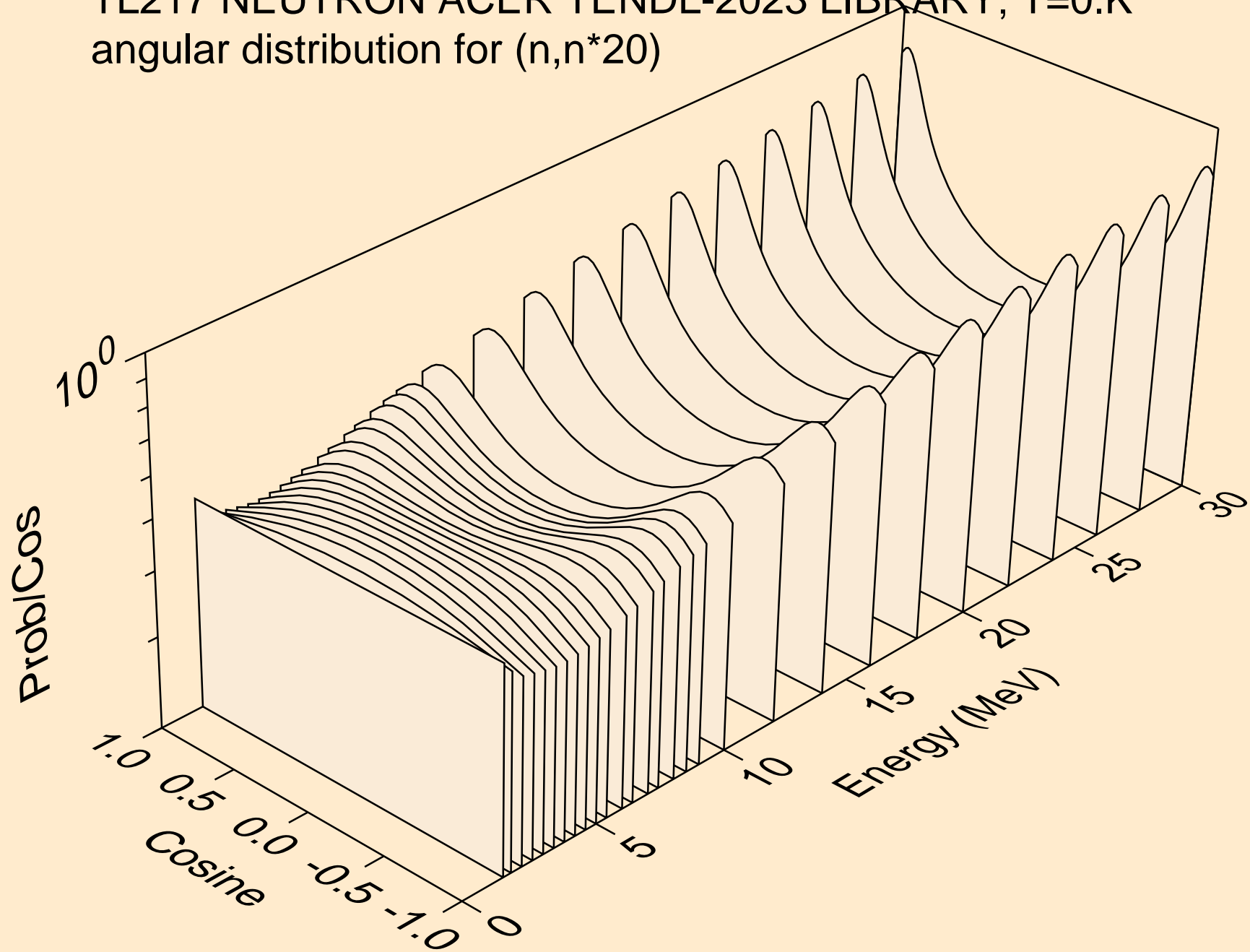

TL217 NEUTRON ACER TENDL-2023 LIBRARY; T=0.K
angular distribution for (n,n*21)

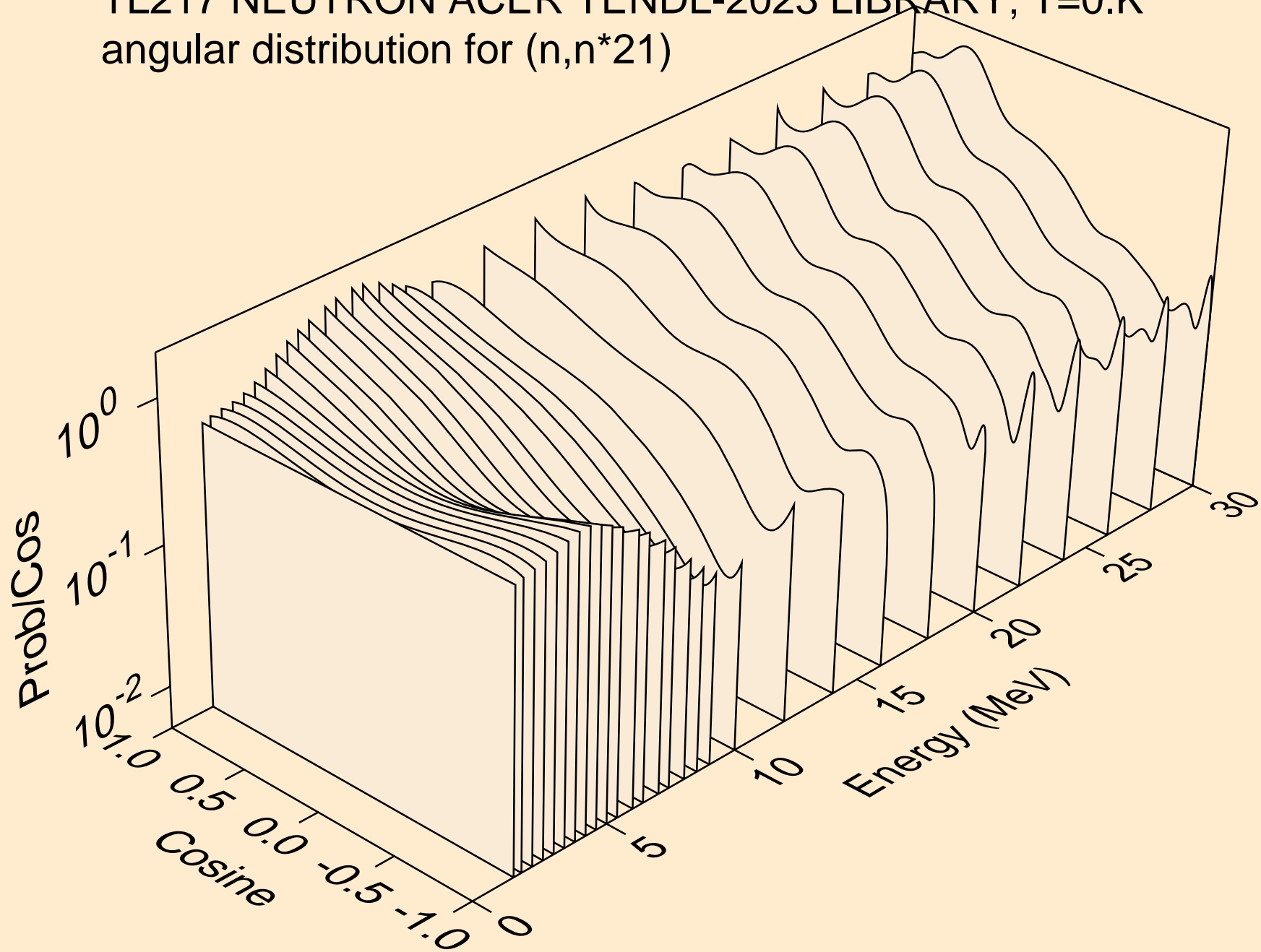

TL217 NEUTRON ACER TENDL-2023 LIBRARY; T=0.K
angular distribution for (n,n*22)

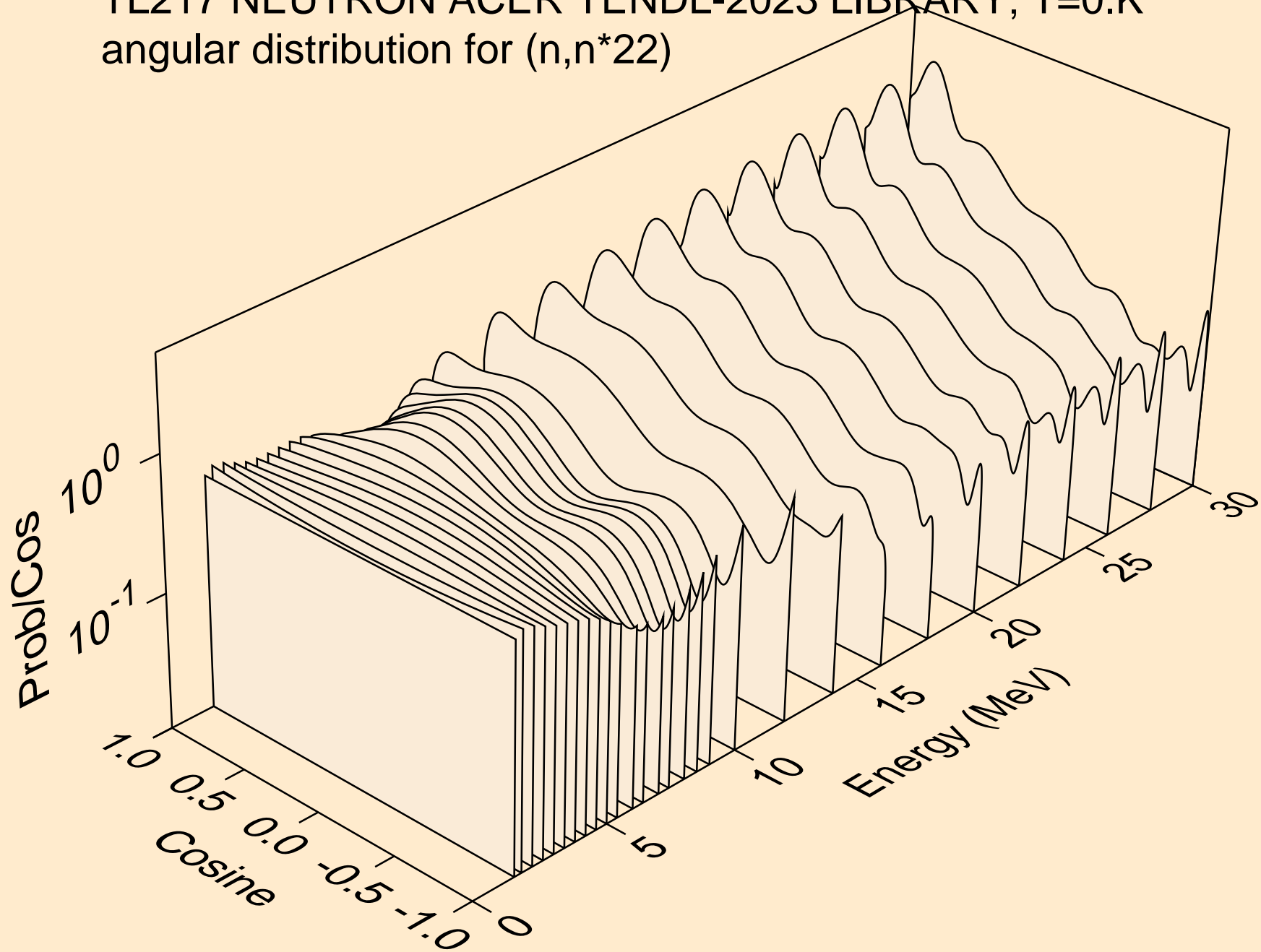

TL217 NEUTRON ACER TENDL-2023 LIBRARY; T=0.K
angular distribution for (n,n*23)

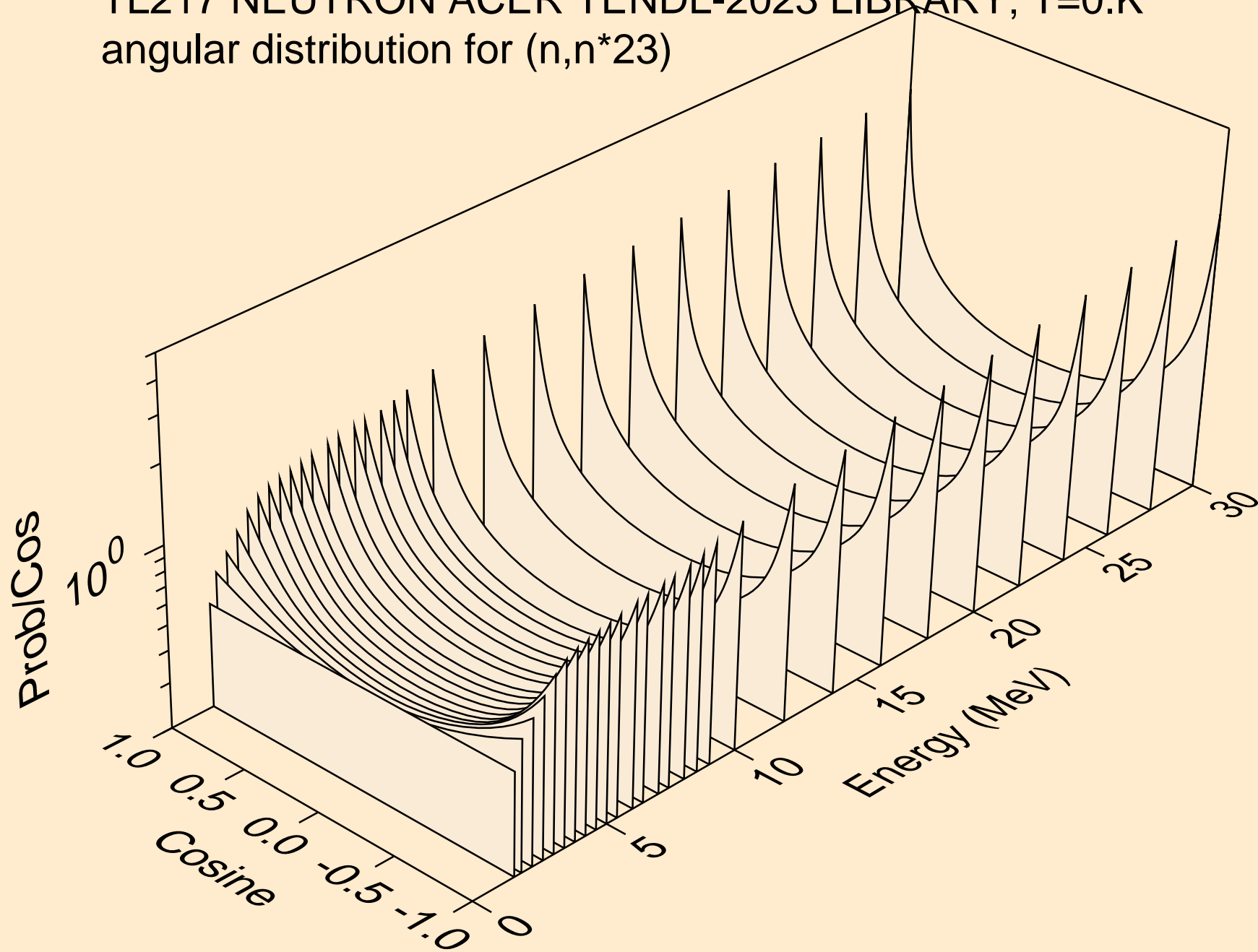

TL217 NEUTRON ACER TENDL-2023 LIBRARY; T=0.K
angular distribution for (n,n*24)

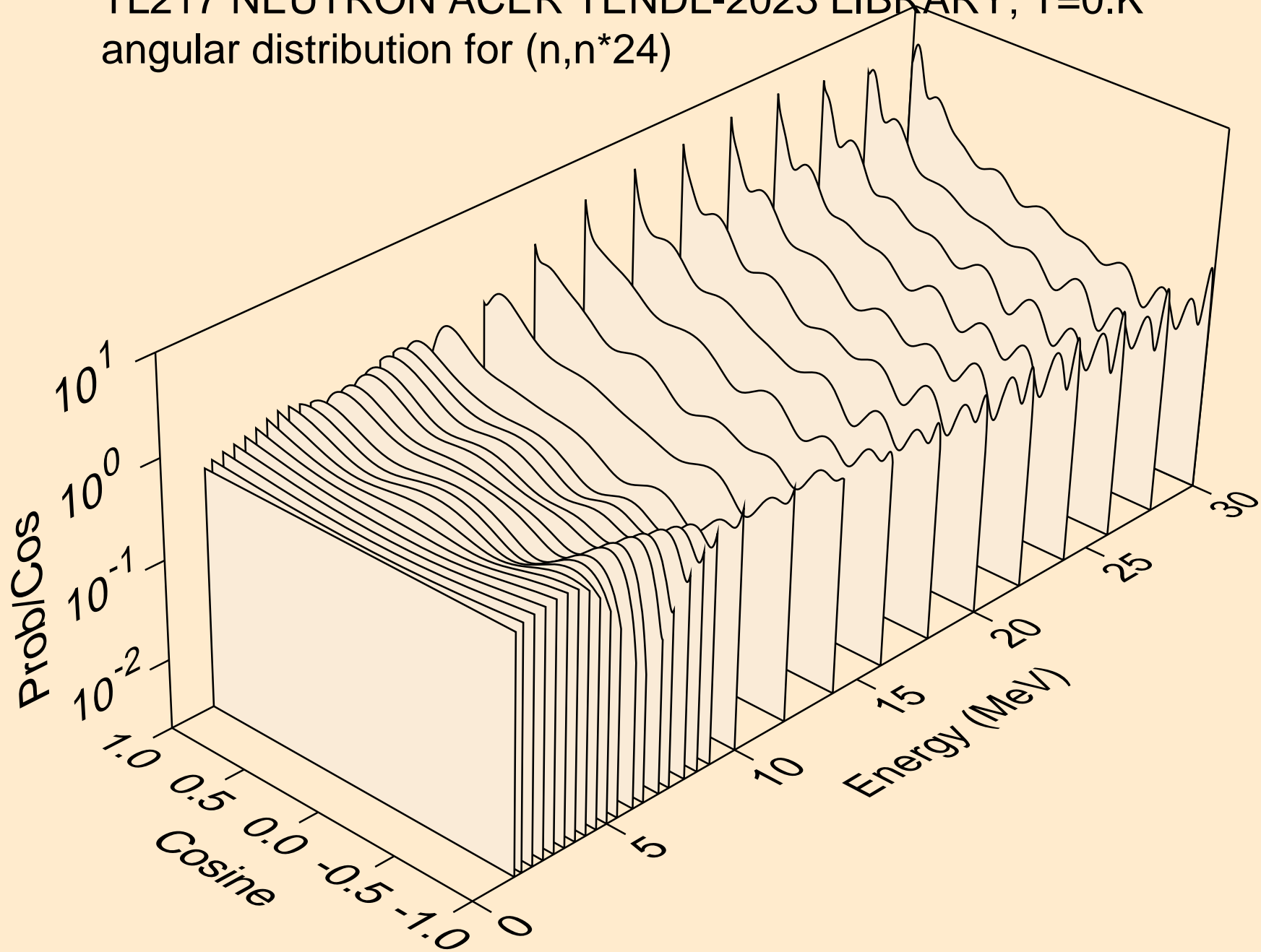

TL217 NEUTRON ACER TENDL-2023 LIBRARY; T=0.K
angular distribution for (n,n*25)

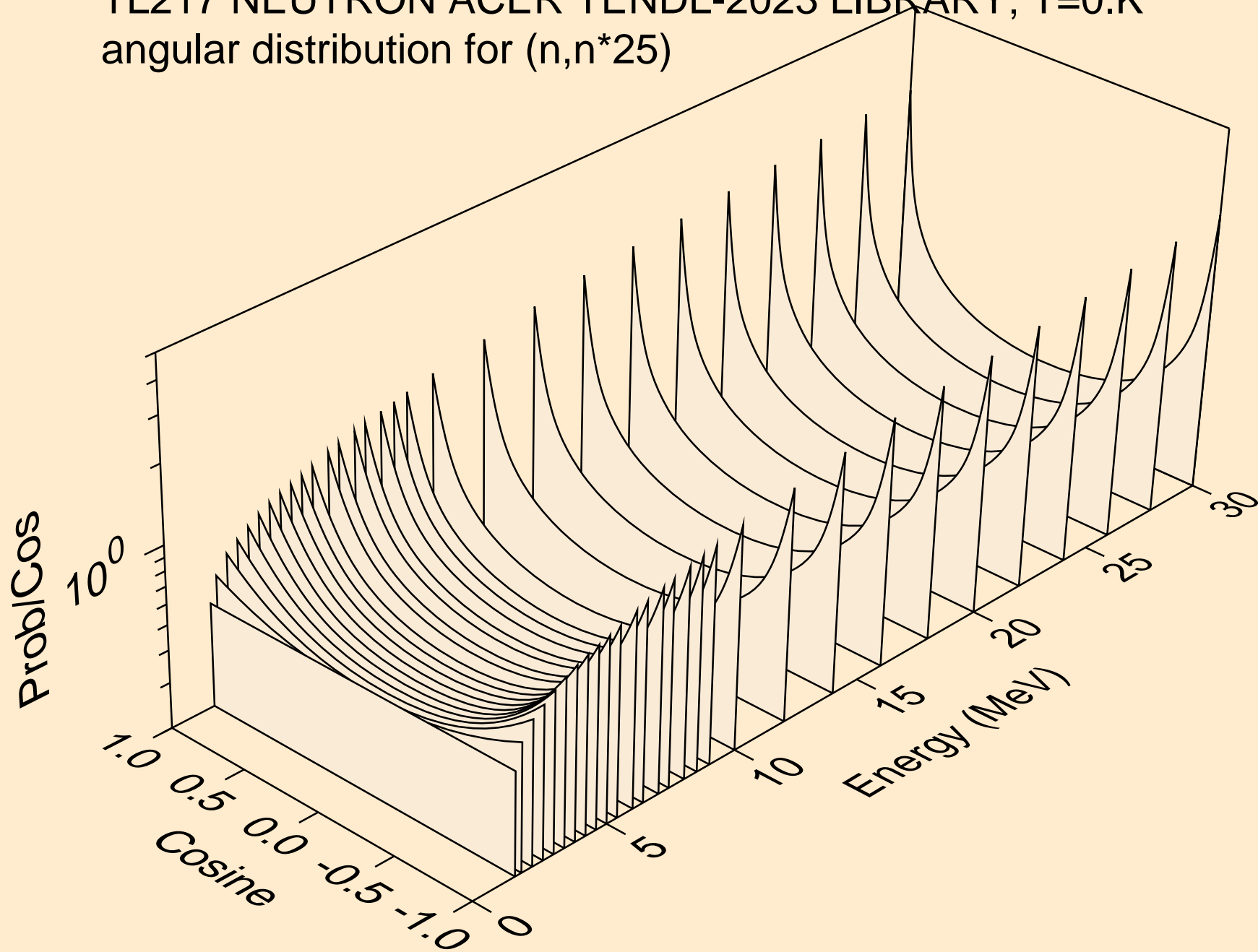

TL217 NEUTRON ACER TENDL-2023 LIBRARY; T=0.K
angular distribution for (n,n*26)

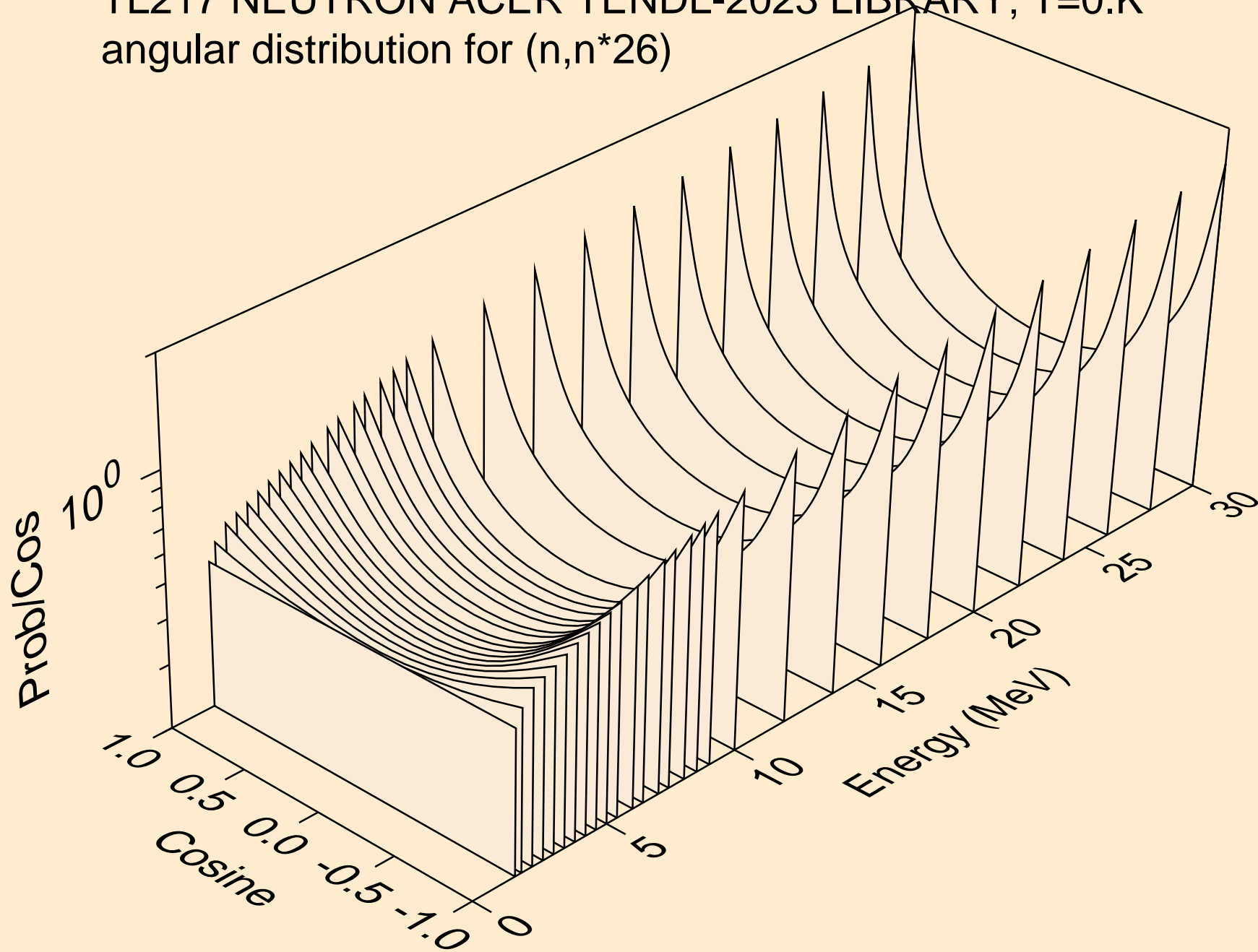

TL217 NEUTRON ACER TENDL-2023 LIBRARY; T=0.K
angular distribution for (n,n*27)

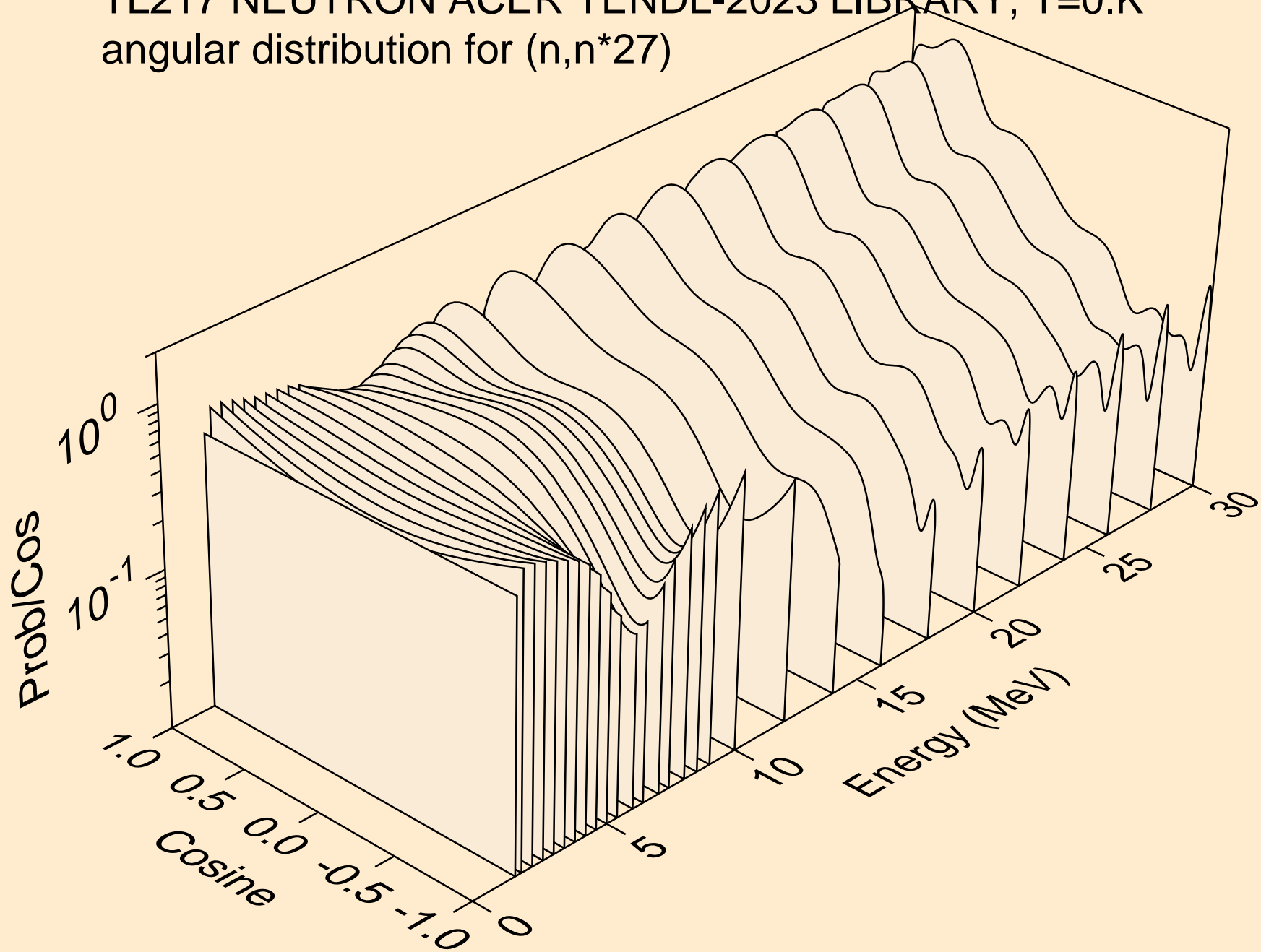

TL217 NEUTRON ACER TENDL-2023 LIBRARY; T=0.K
angular distribution for (n,n*28)

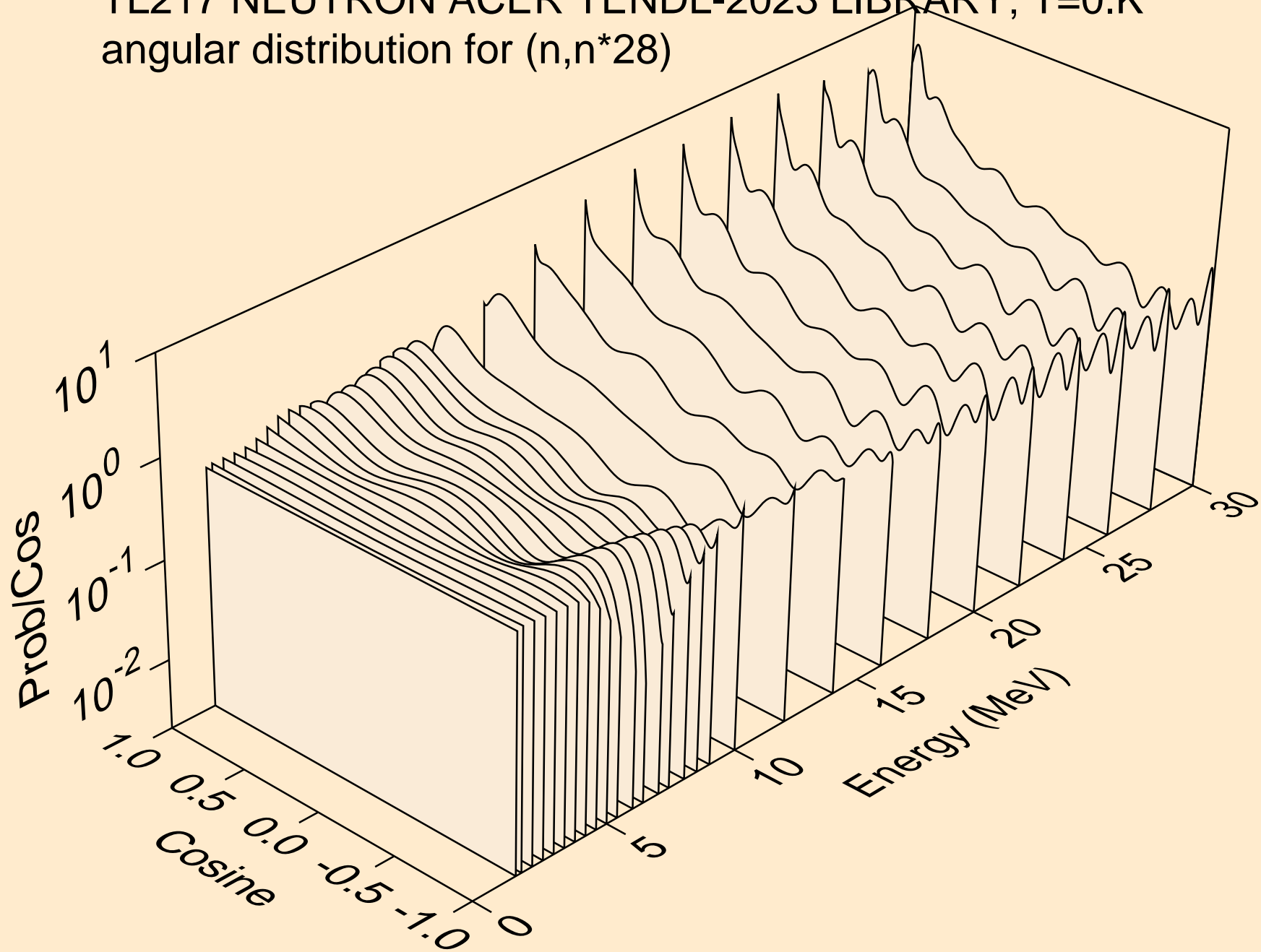

TL217 NEUTRON ACER TENDL-2023 LIBRARY; T=0.K
angular distribution for (n,n*29)

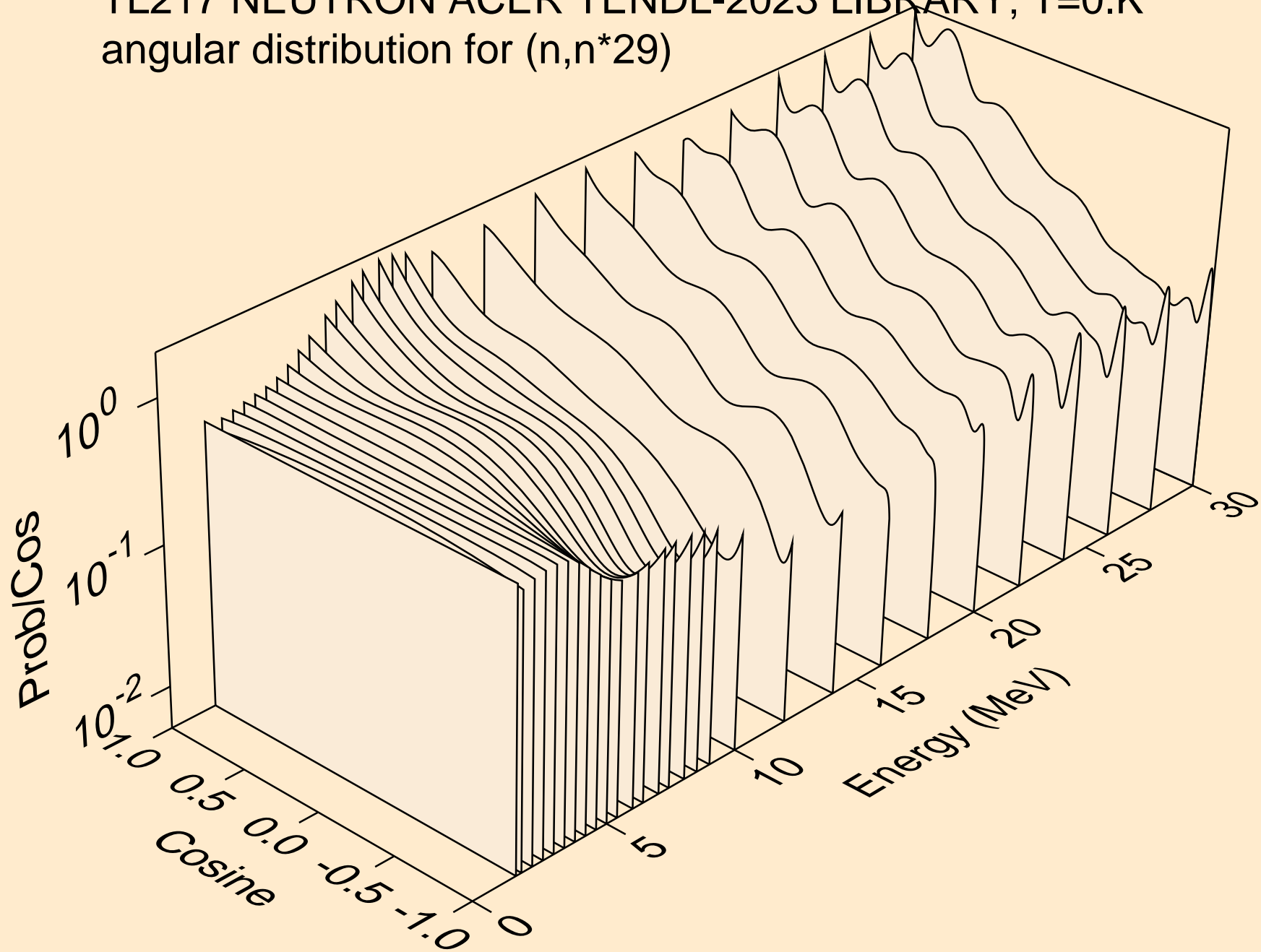

TL217 NEUTRON ACER TENDL-2023 LIBRARY; T=0.K
angular distribution for (n,n*30)

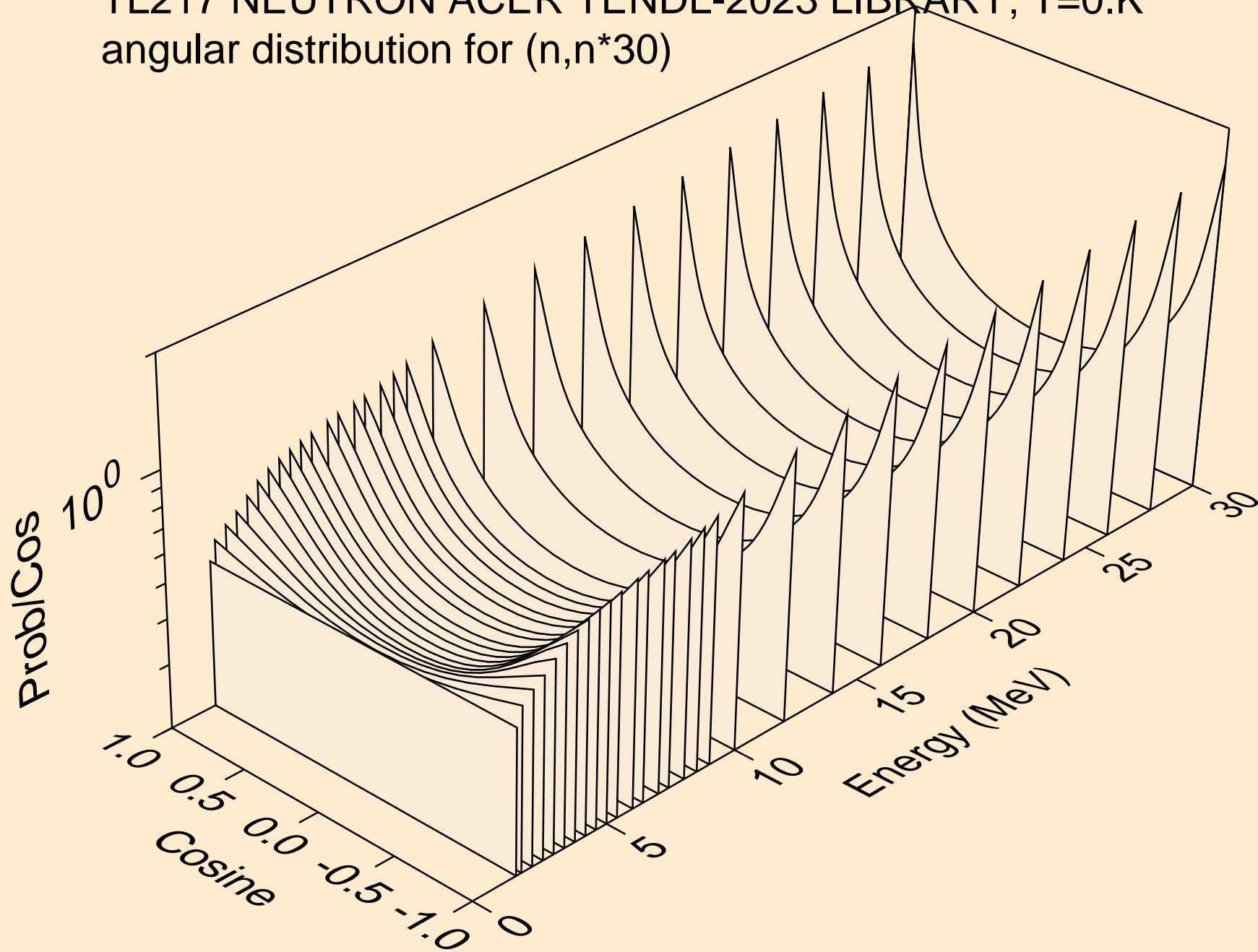

TL217 NEUTRON ACER TENDL-2023 LIBRARY; T=0.K
Total fission nubar

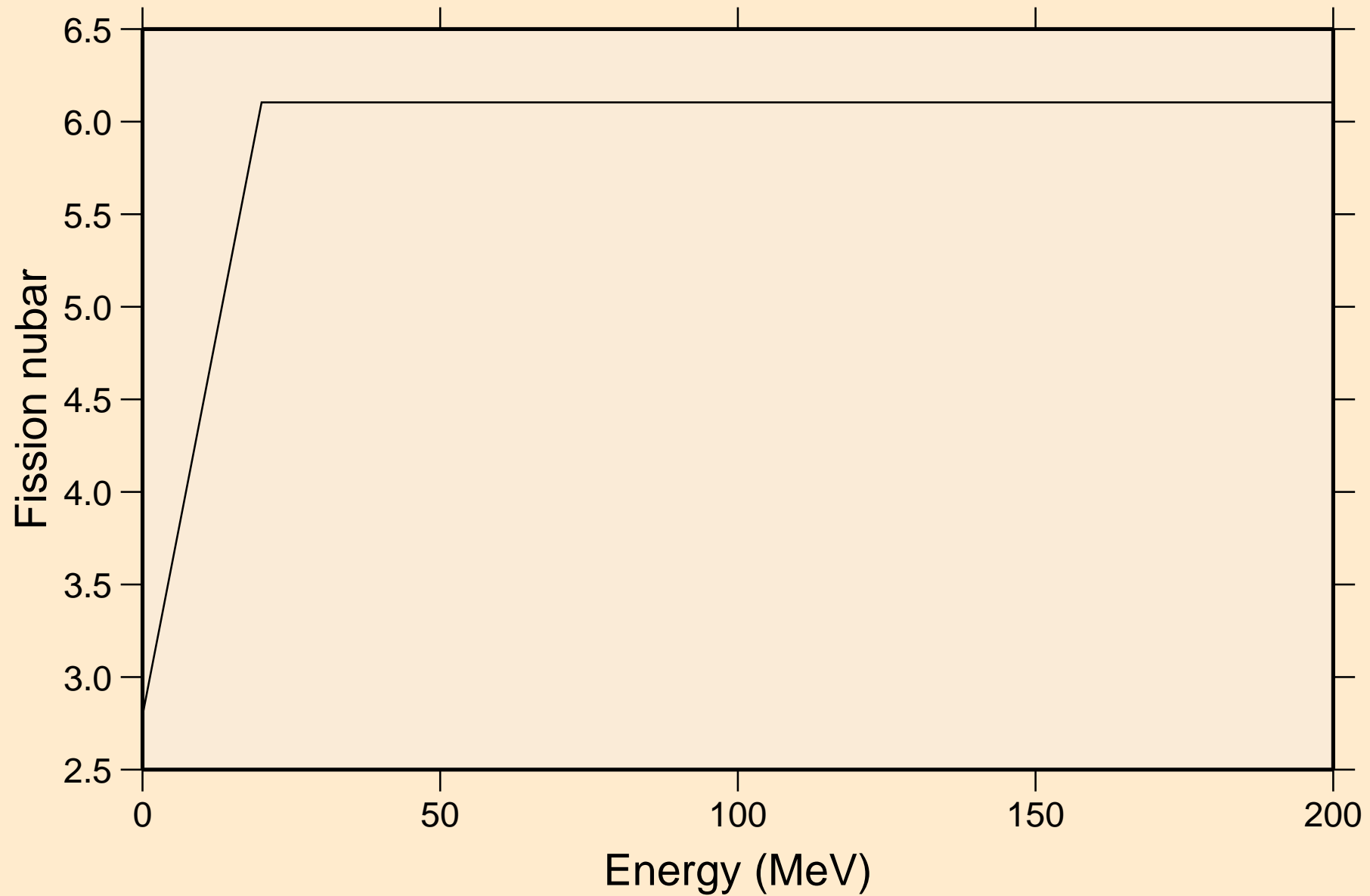

TL217 NEUTRON ACER TENDL-2023 LIBRARY; T=0.K
Neutron emission for (n,x)

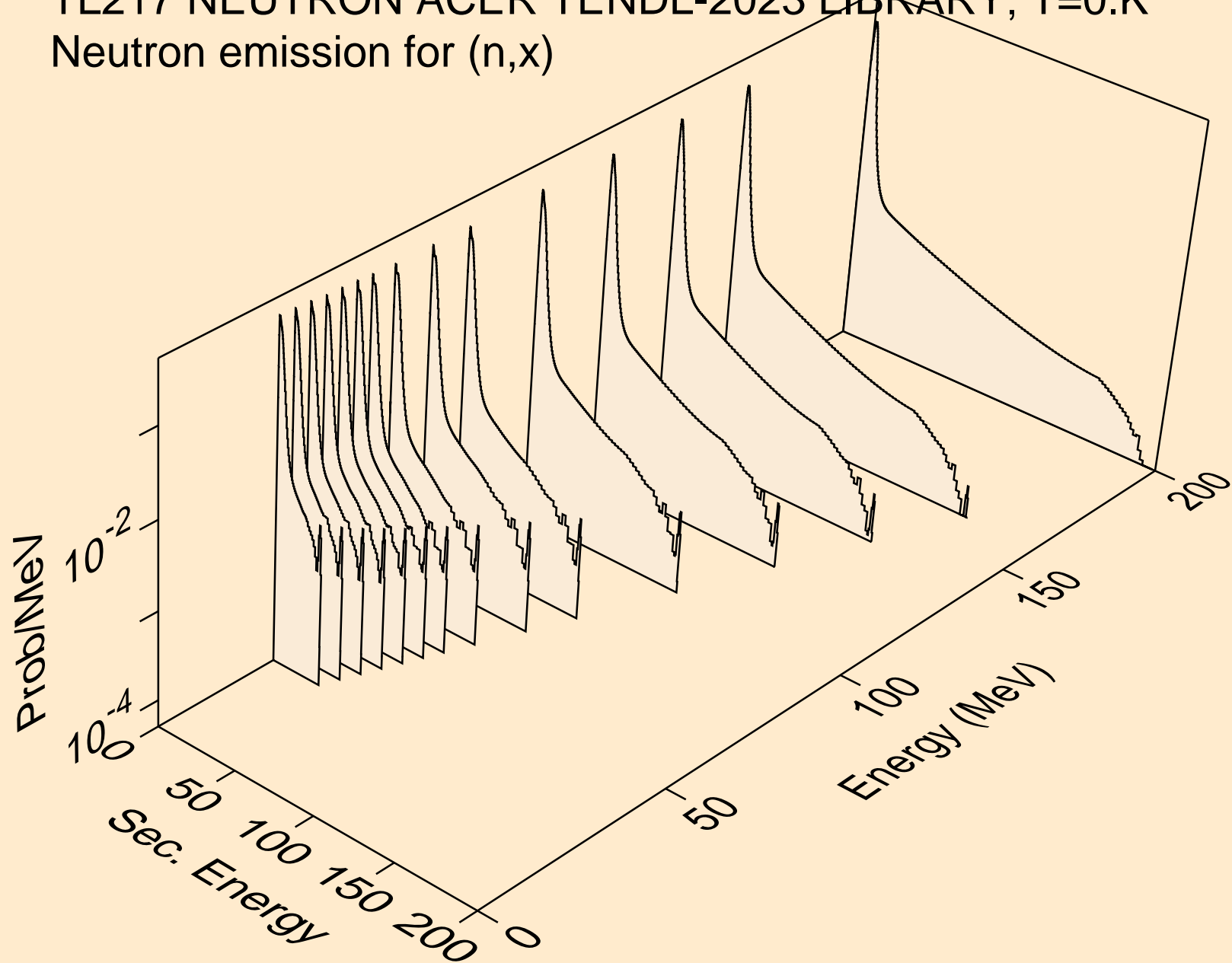

TL217 NEUTRON ACER TENDL-2023 LIBRARY; T=0.K
Neutron emission for (n,2nd)

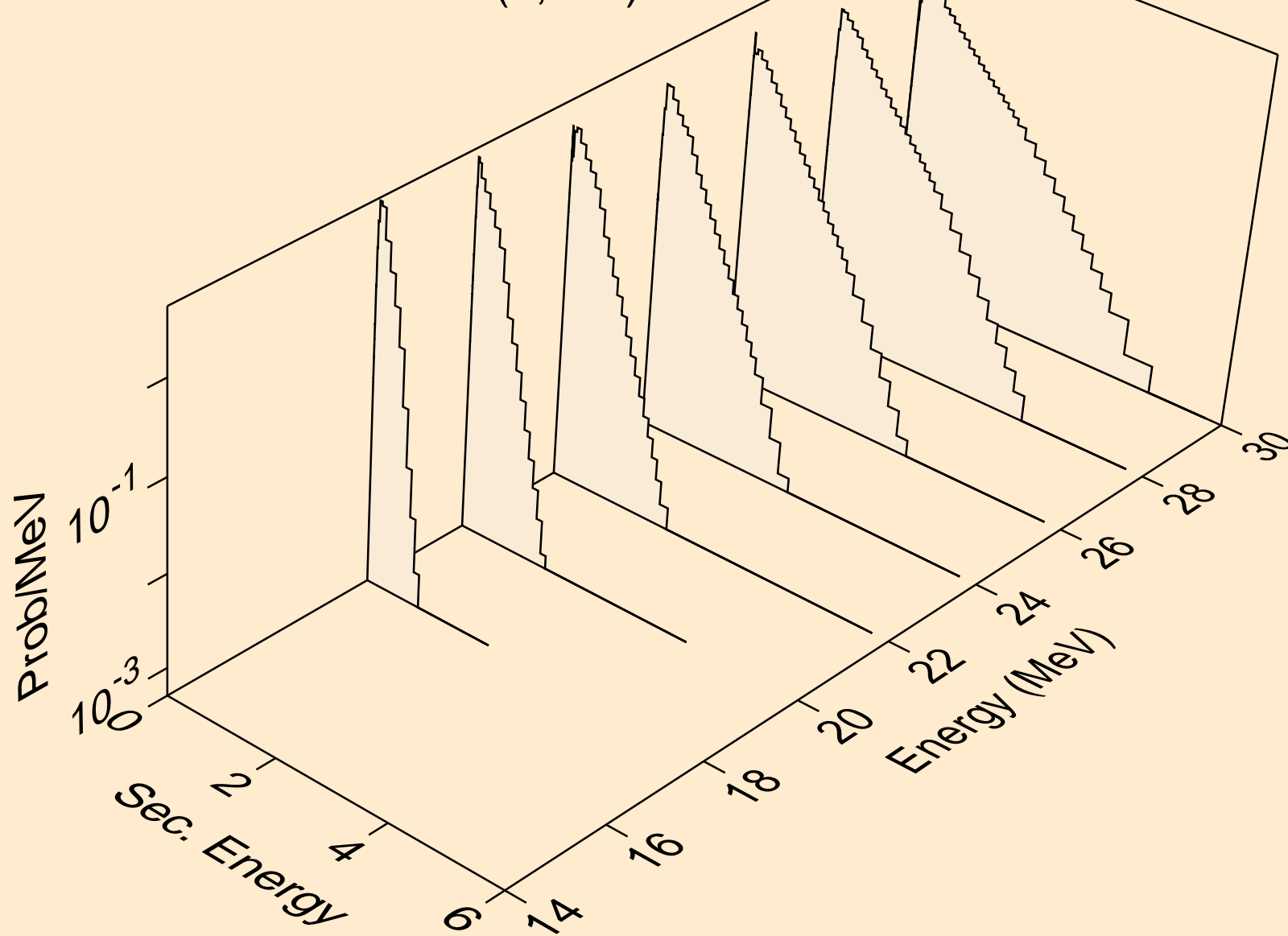

TL217 NEUTRON ACER TENDL-2023 LIBRARY; T=0.K
Neutron emission for (n,2n)

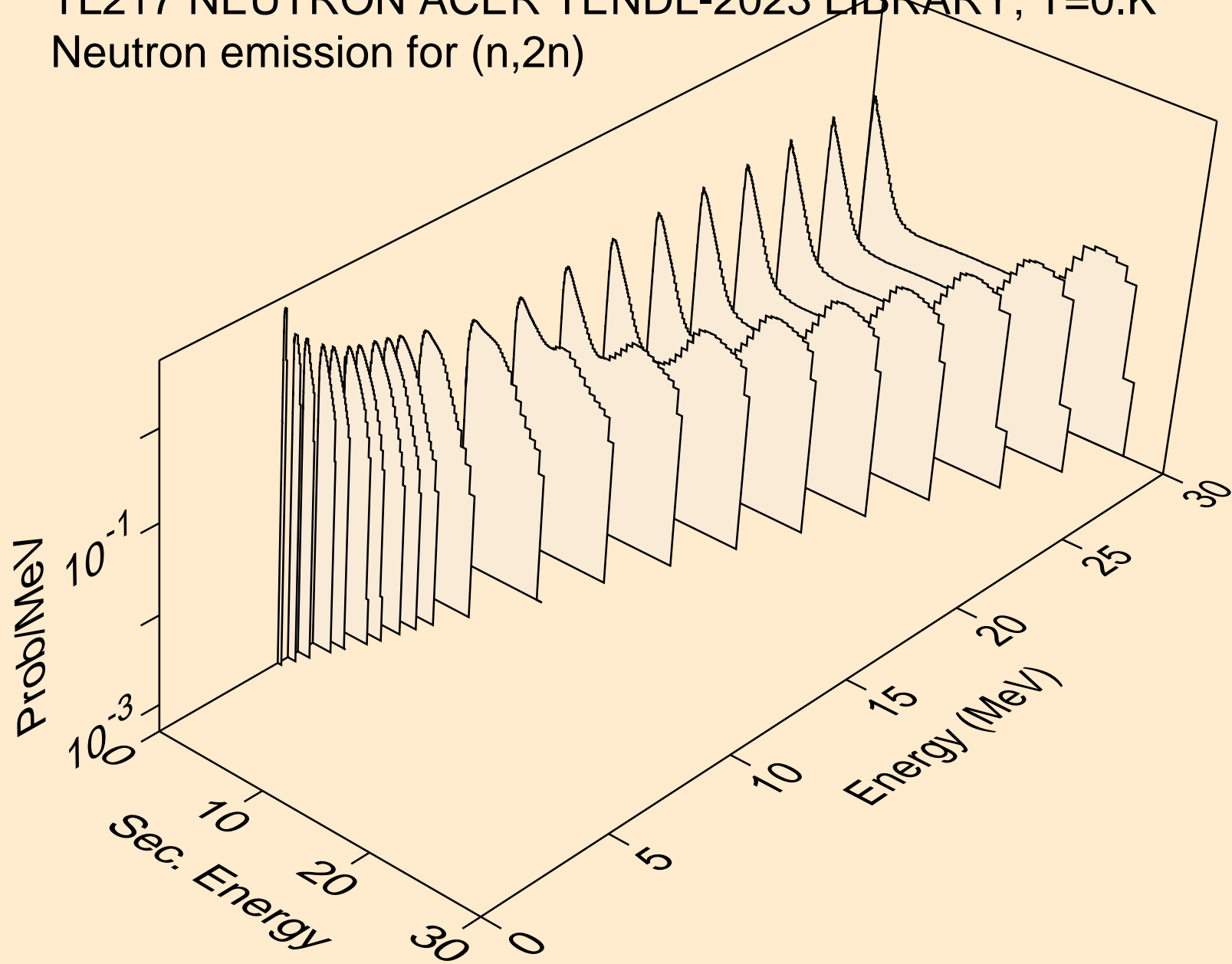

TL217 NEUTRON ACER TENDL-2023 LIBRARY; T=0.K
Neutron emission for (n,3n)

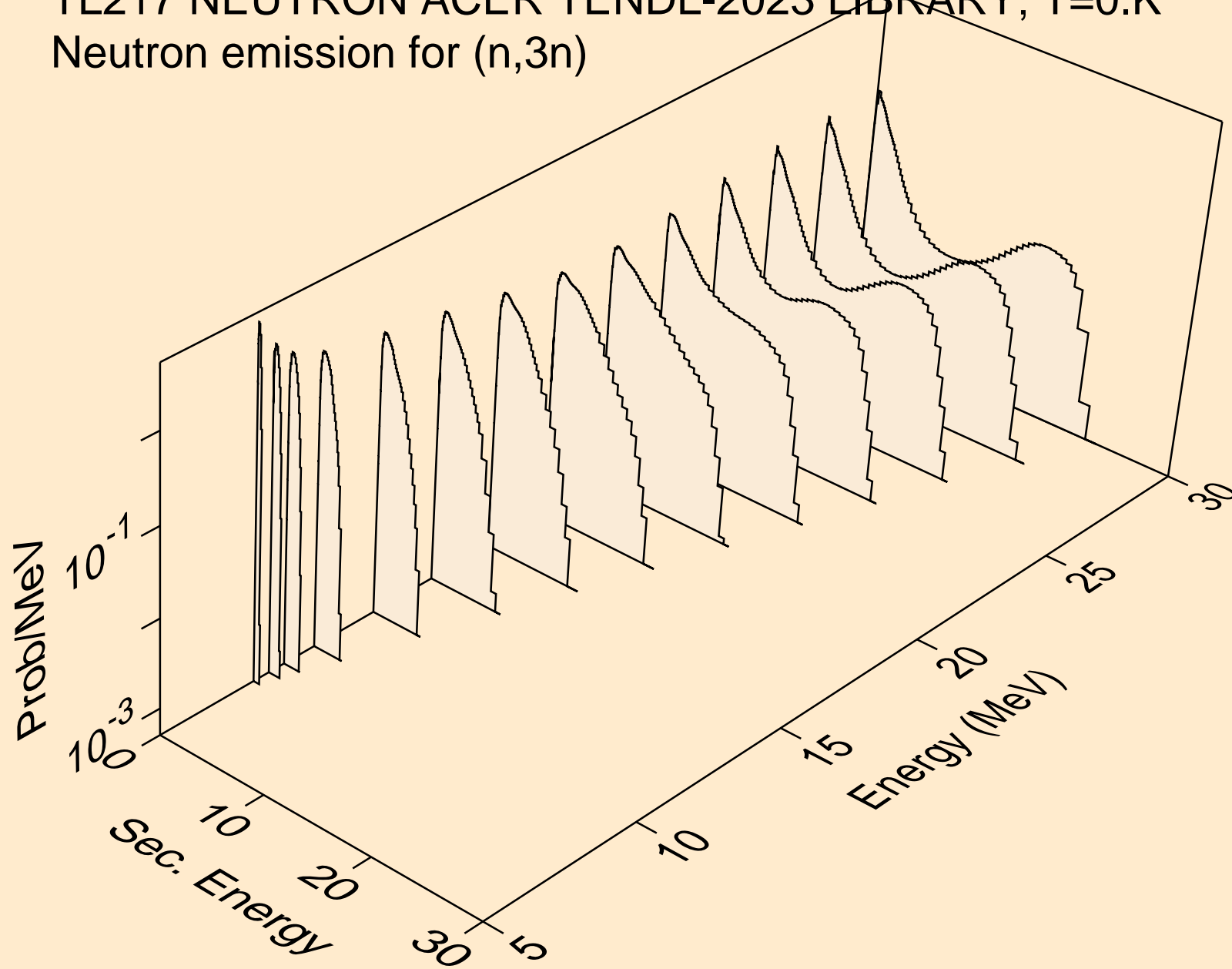

TL217 NEUTRON ACER TENDL-2023 LIBRARY; T=0.K
Neutron emission for fission

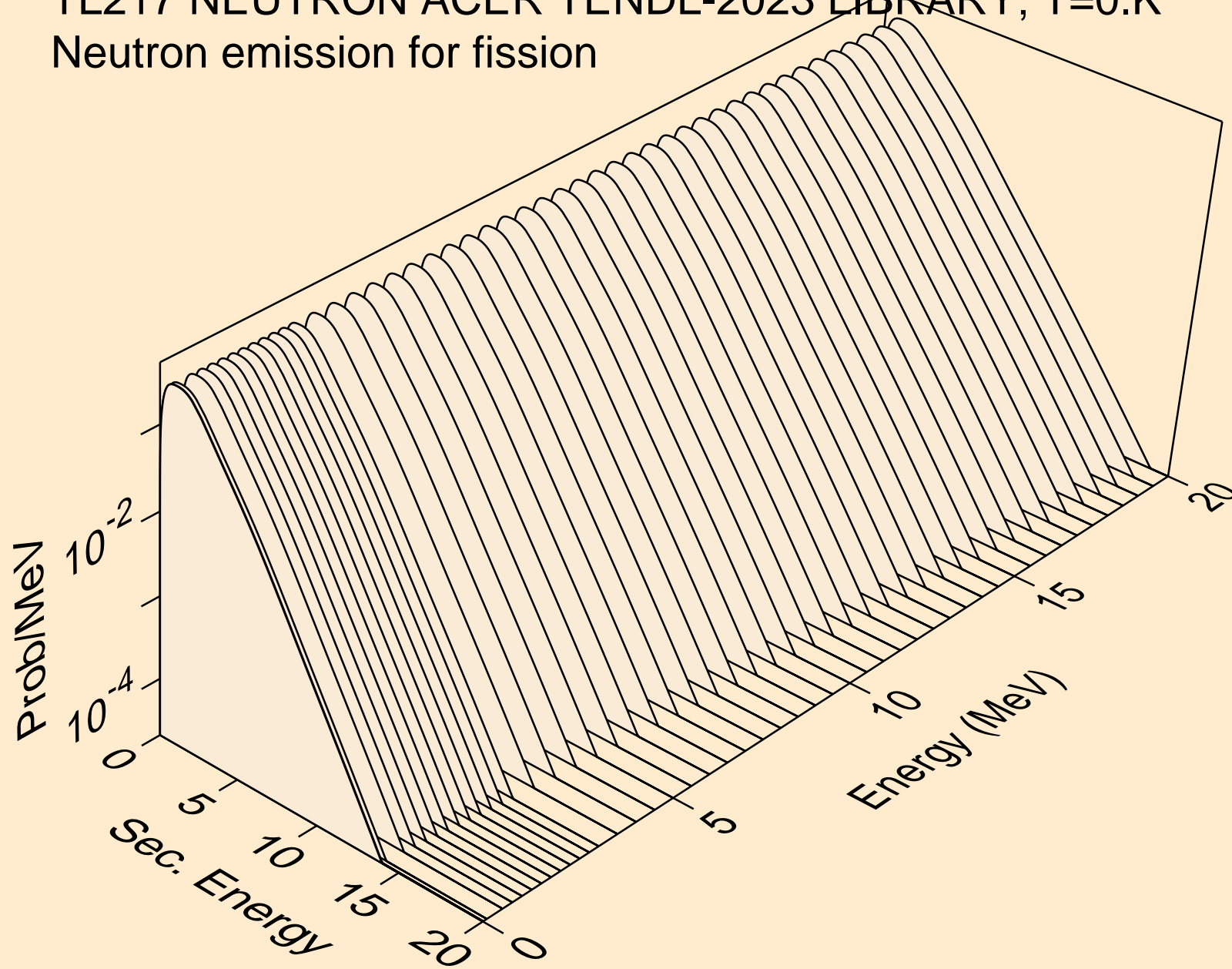

TL217 NEUTRON ACER TENDL-2023 LIBRARY; T=0.K
Neutron emission for (n,n*)a

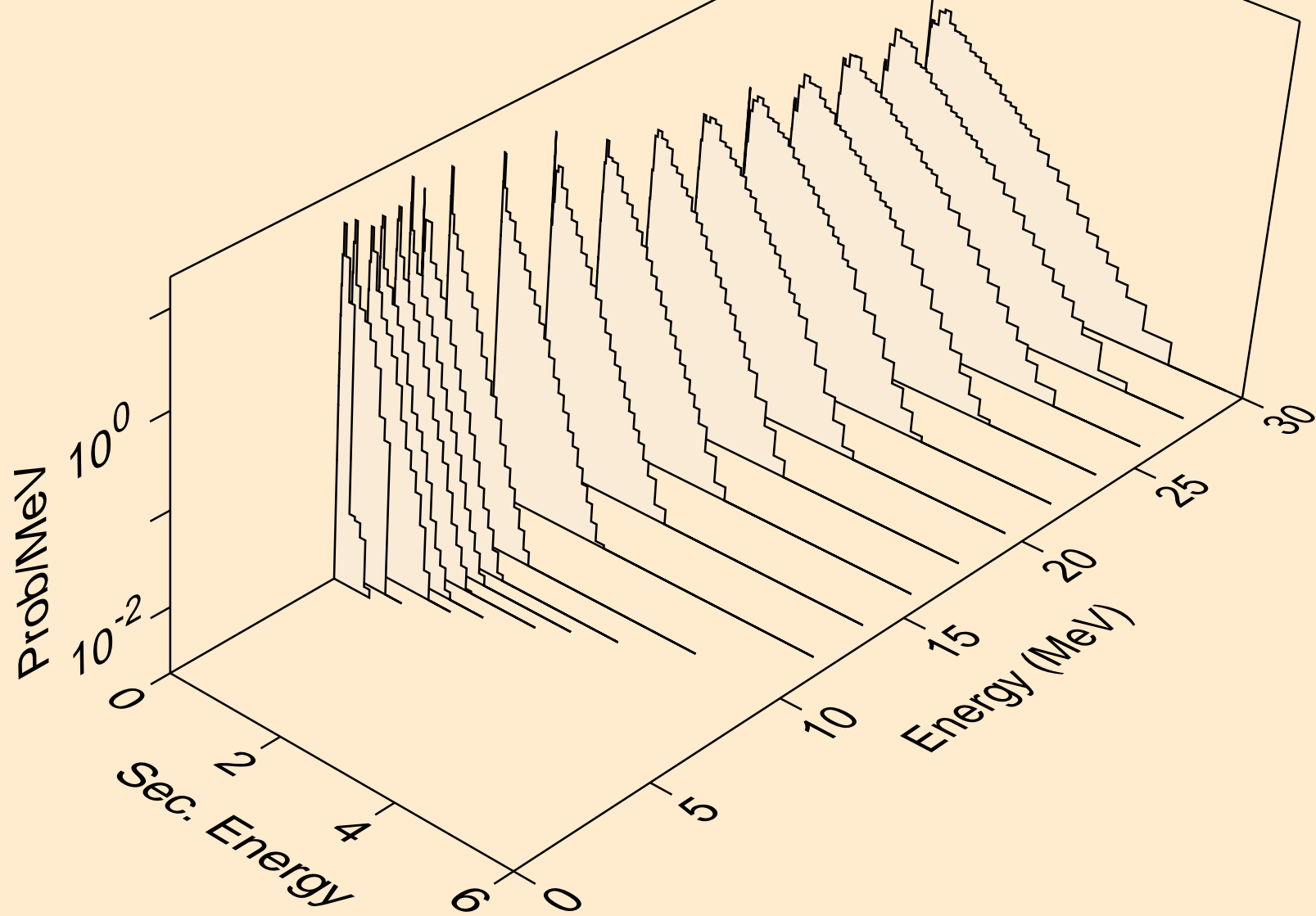

TL217 NEUTRON ACER TENDL-2023 LIBRARY; T=0.K
Neutron emission for (n,2n)a

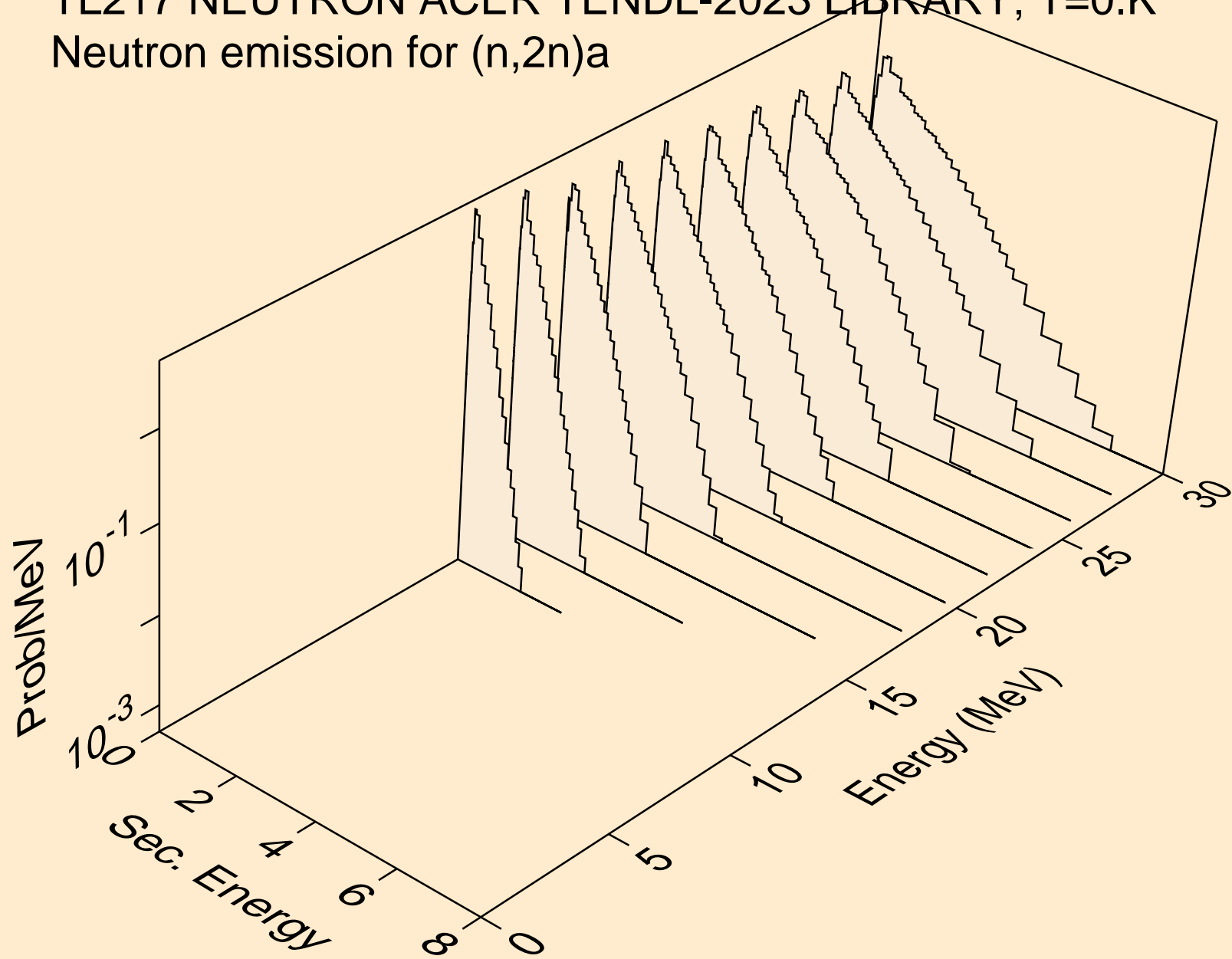

TL217 NEUTRON ACER TENDL-2023 LIBRARY; T=0.K
Neutron emission for (n,3n)a

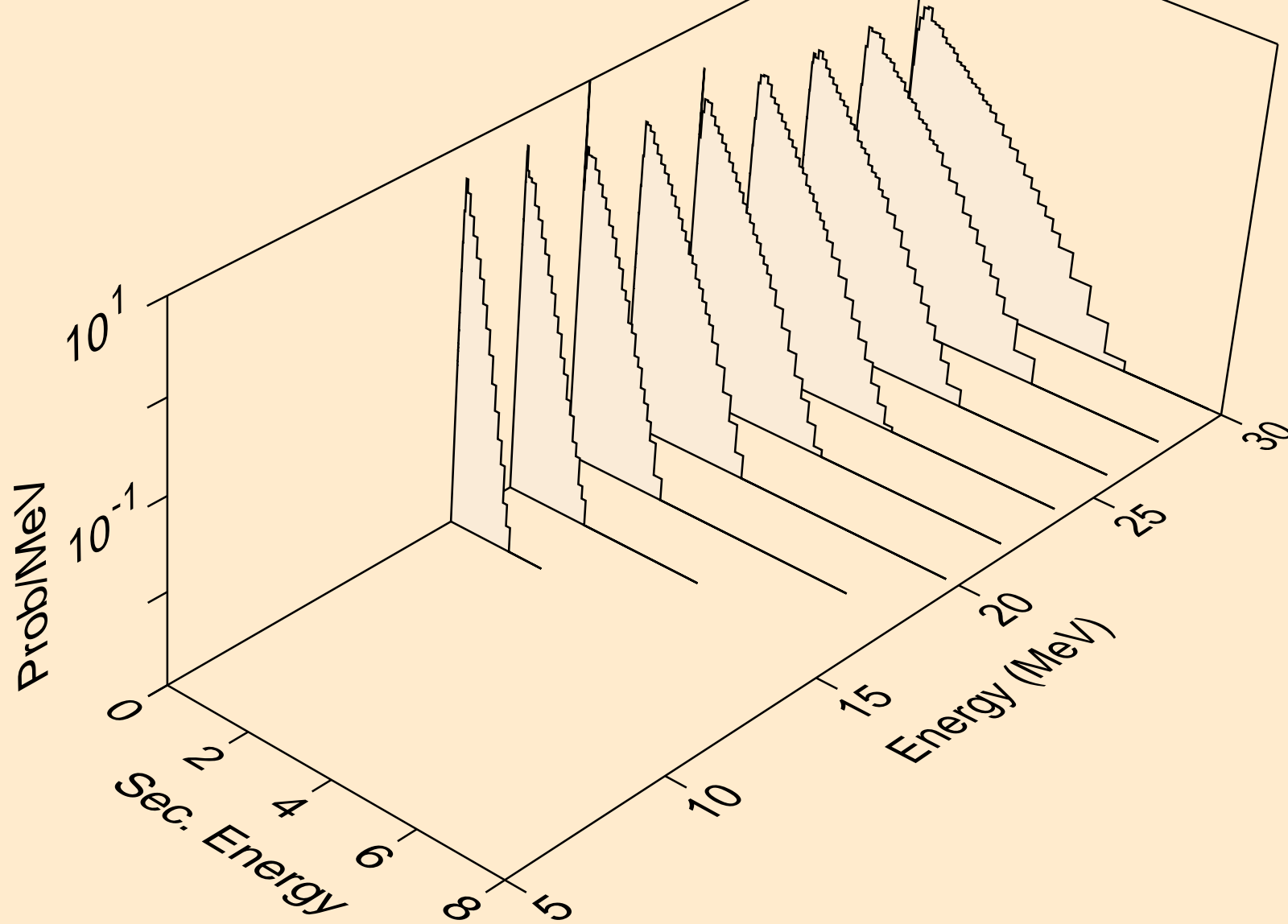

TL217 NEUTRON ACER TENDL-2023 LIBRARY; T=0.K
Neutron emission for (n,n*)p

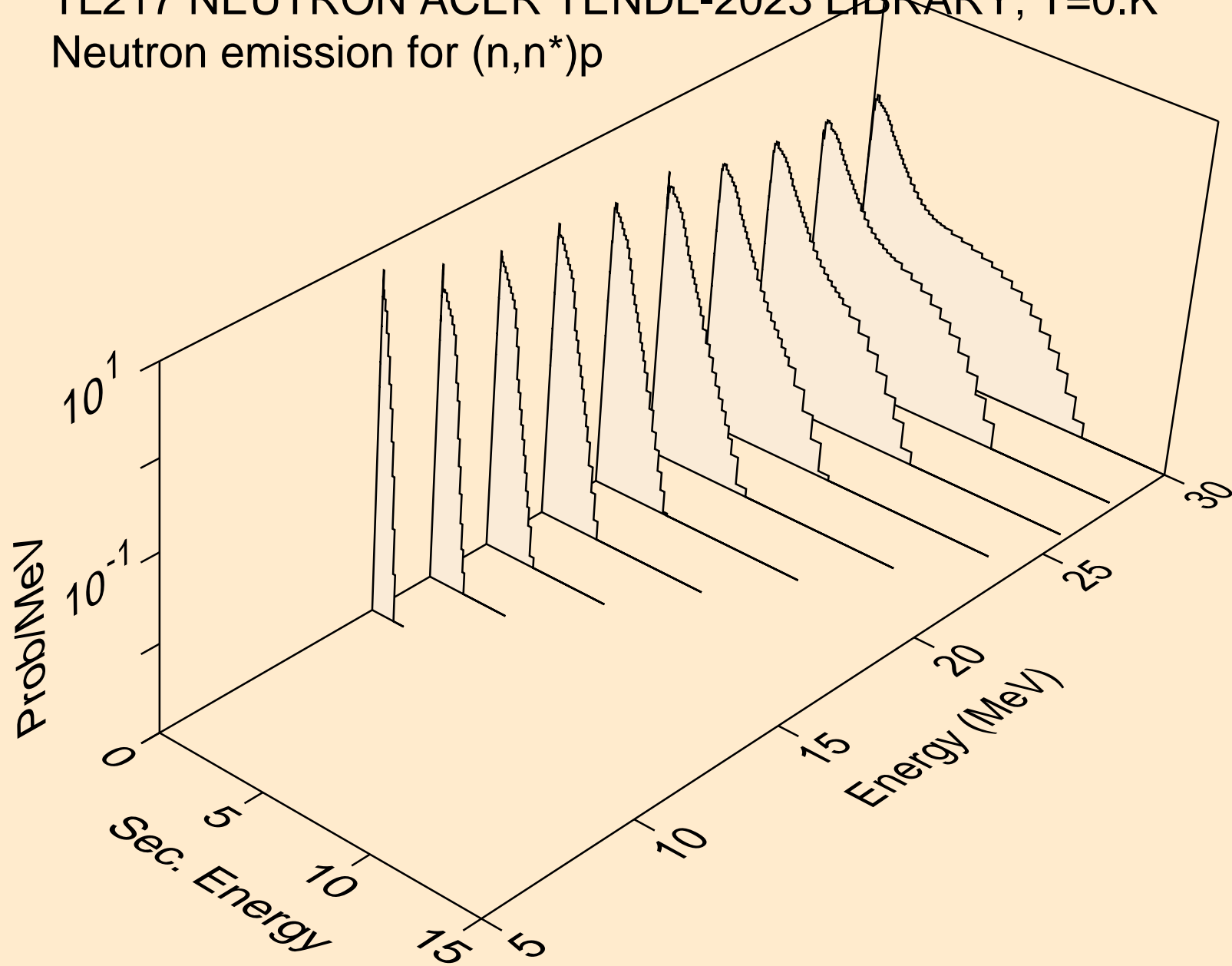

TL217 NEUTRON ACER TENDL-2023 LIBRARY; T=0.K
Neutron emission for (n,n*)d

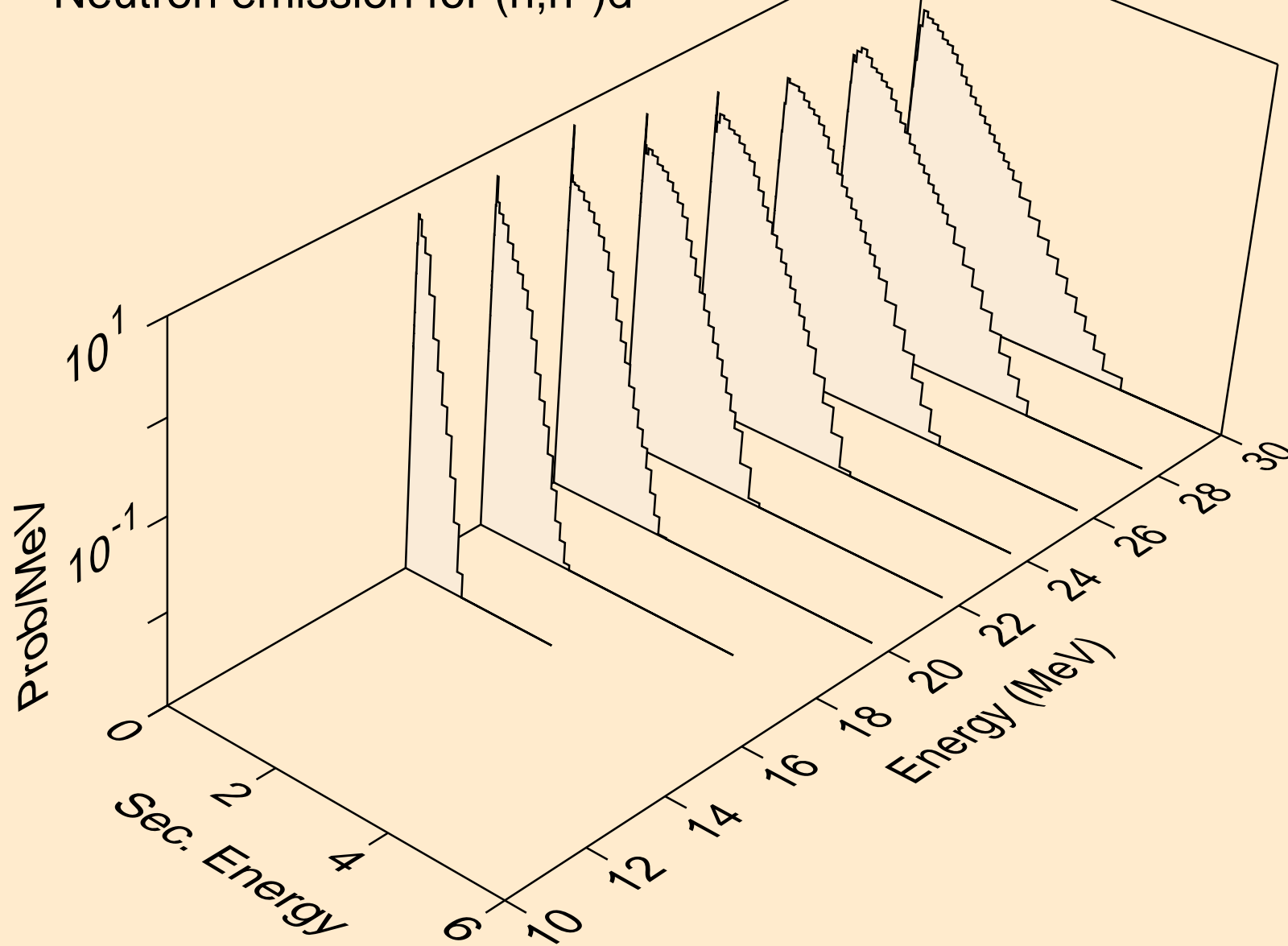

TL217 NEUTRON ACER TENDL-2023 LIBRARY; T=0.K
Neutron emission for (n,n*)t

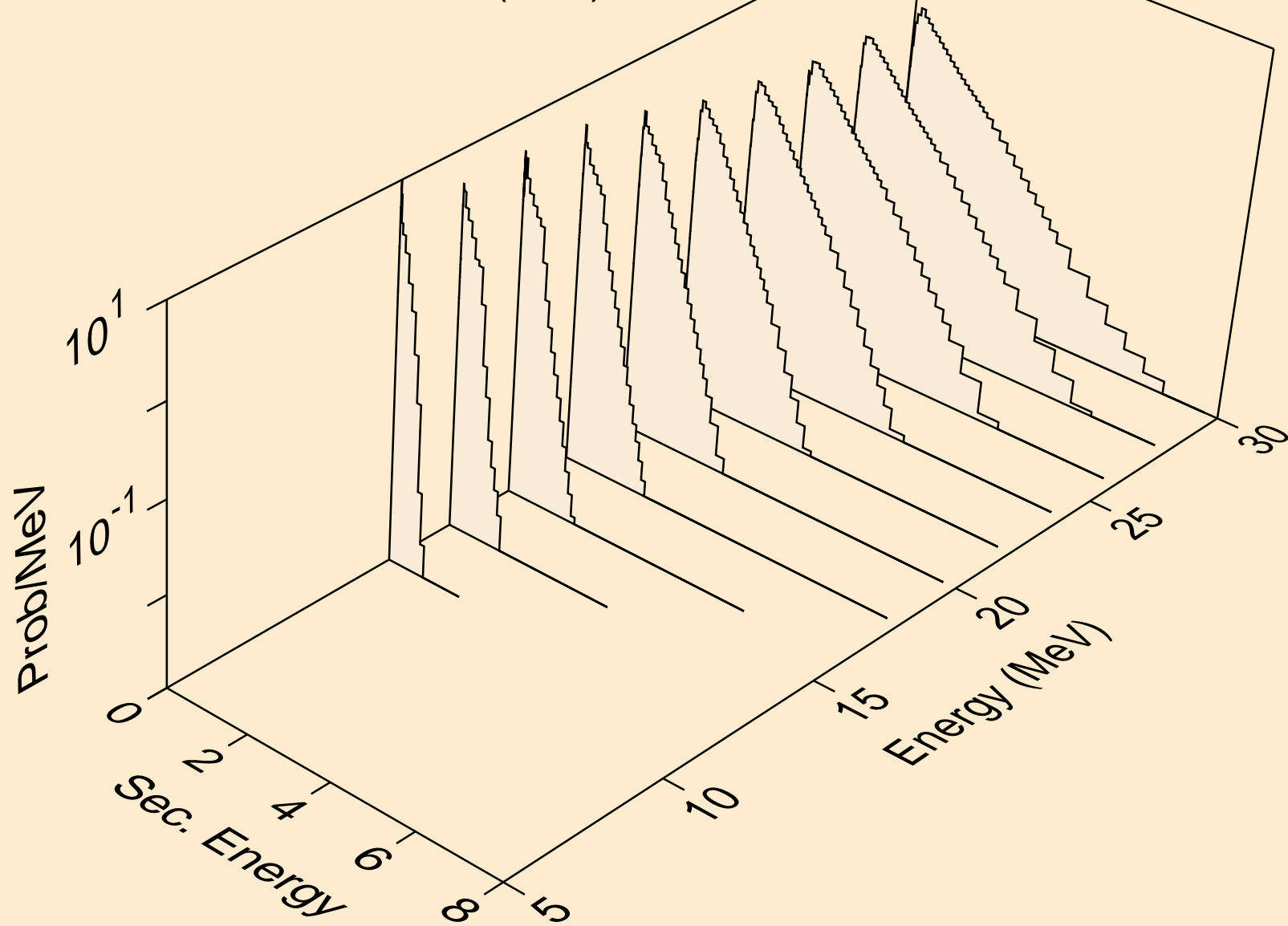

TL217 NEUTRON ACER TENDL-2023 LIBRARY; T=0.K
Neutron emission for (n,n*)he3

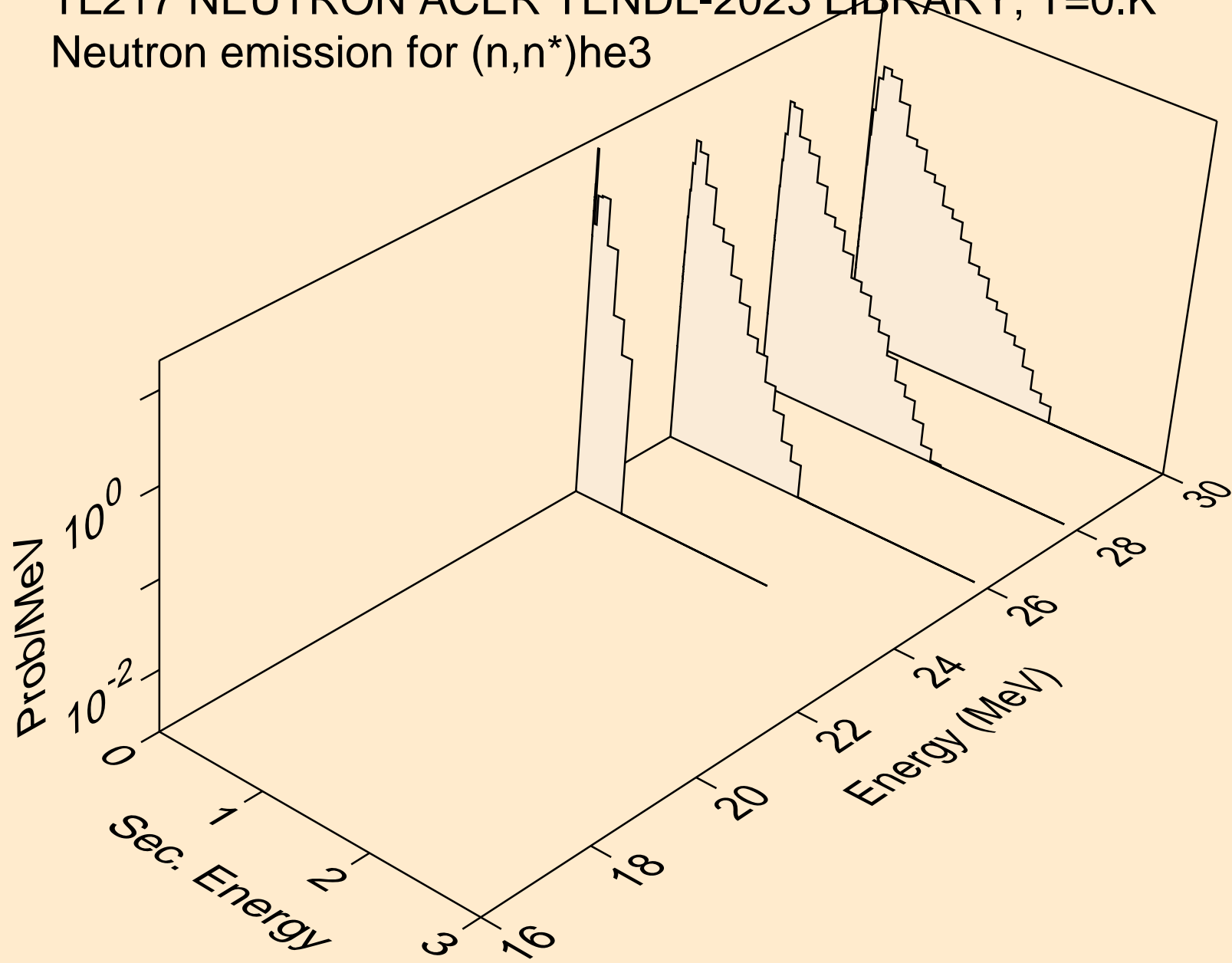

TL217 NEUTRON ACER TENDL-2023 LIBRARY; T=0.K
Neutron emission for (n,4n)

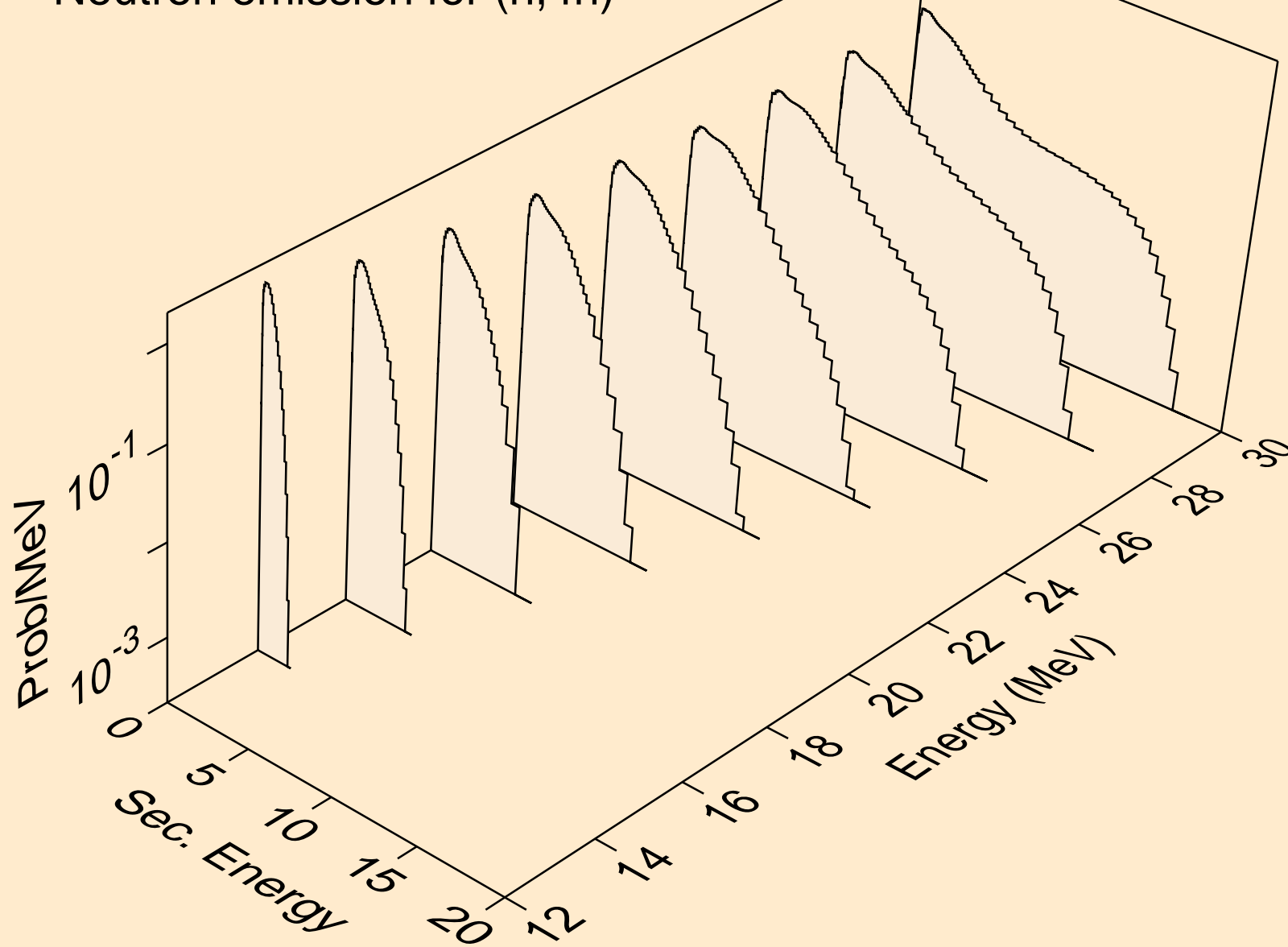

TL217 NEUTRON ACER TENDL-2023 LIBRARY; T=0.K
Neutron emission for (n,2np)

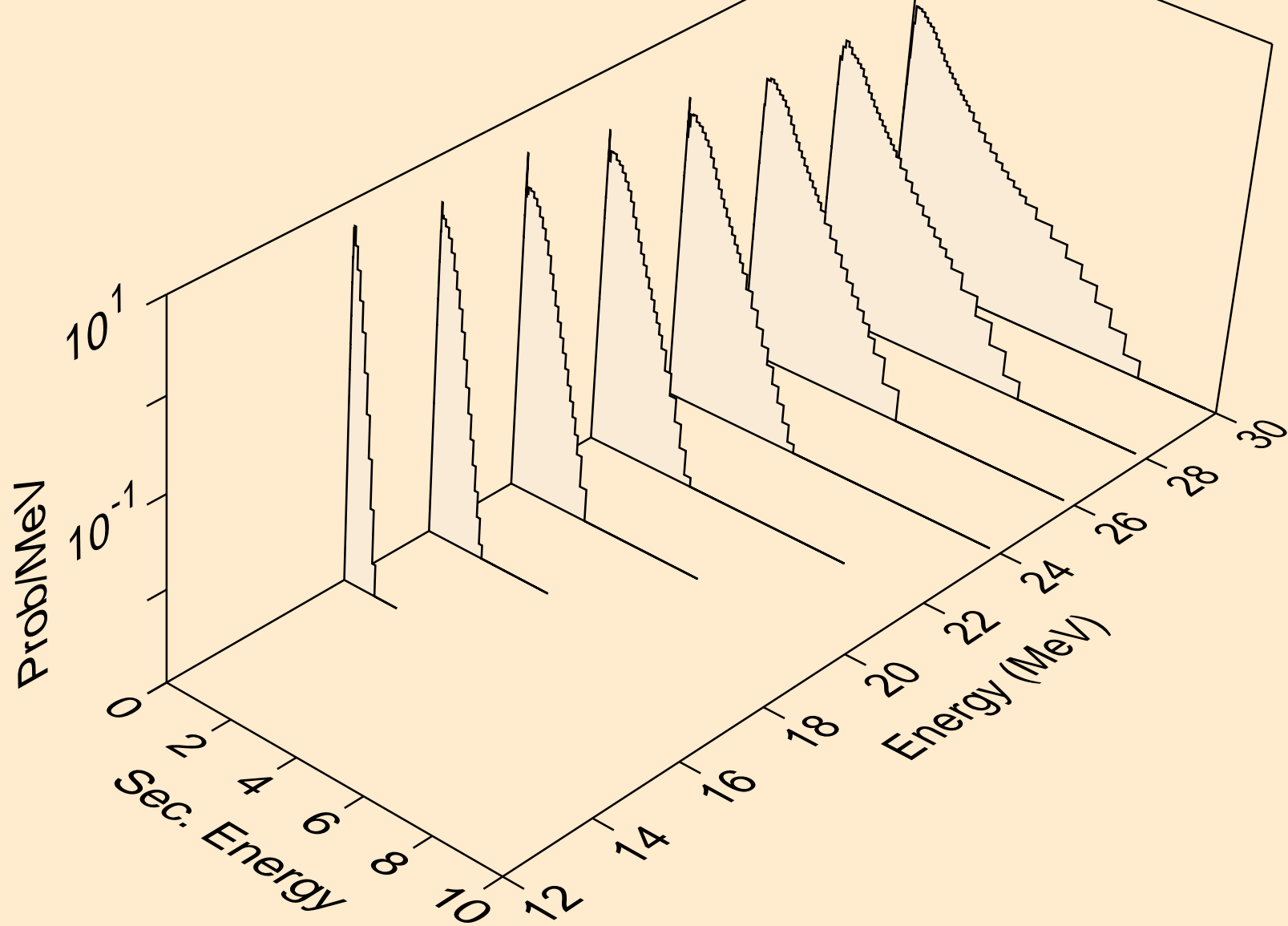

TL217 NEUTRON ACER TENDL-2023 LIBRARY; T=0.K
Neutron emission for (n,3np)

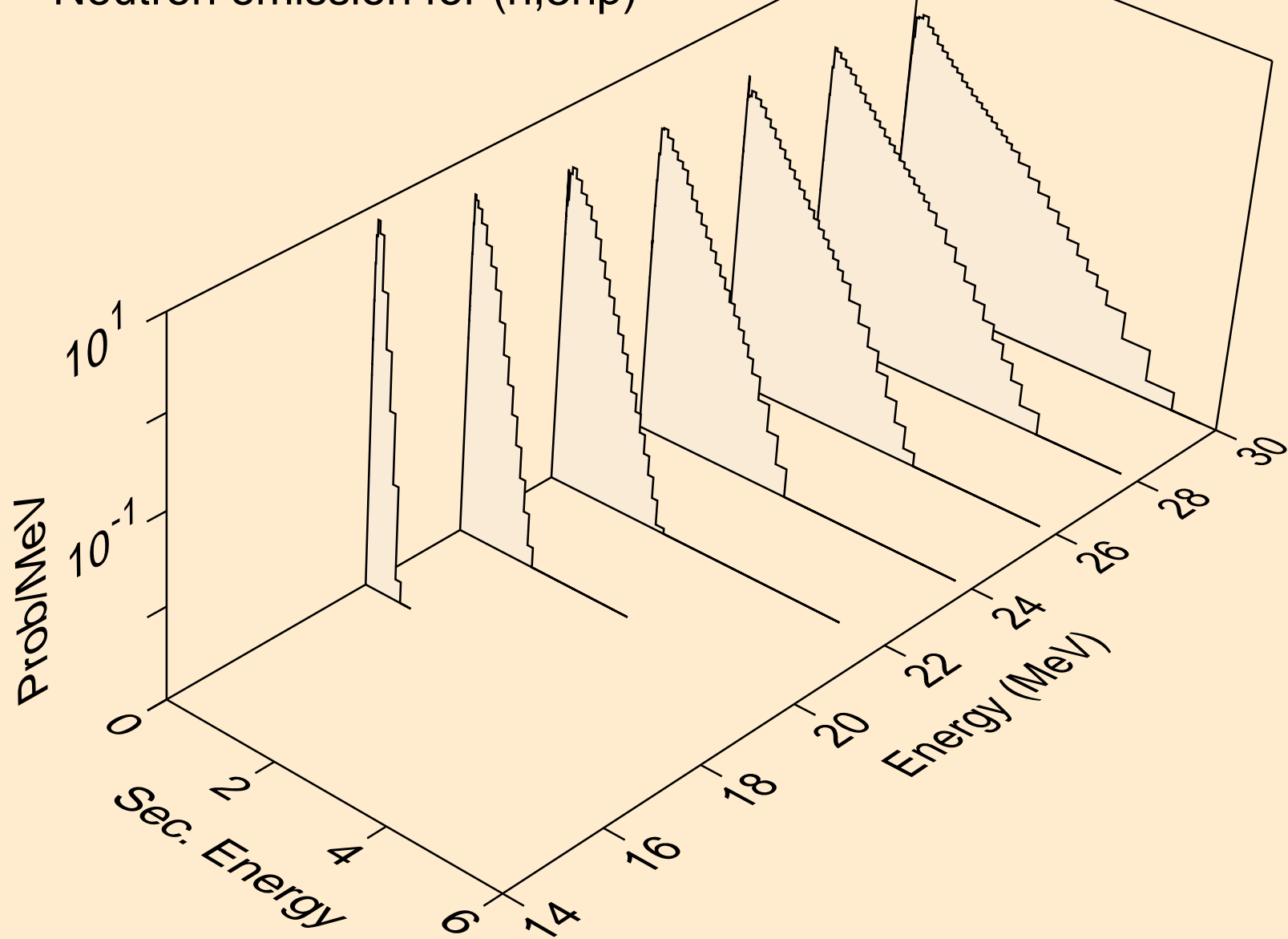

TL217 NEUTRON ACER TENDL-2023 LIBRARY; T=0.K
Neutron emission for (n,n*c)

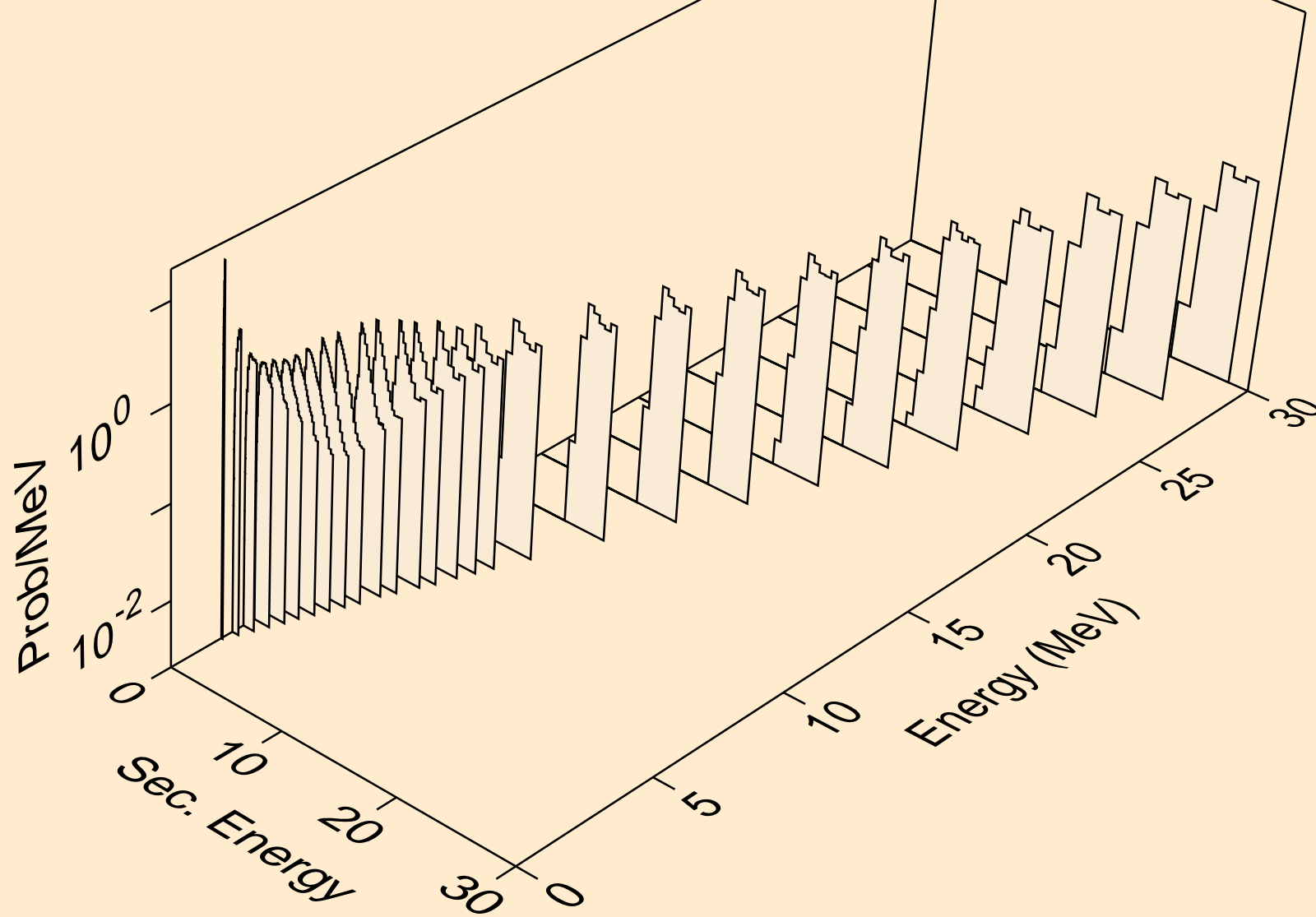

TL217 NEUTRON ACER TENDL-2023 LIBRARY; T=0.K

Delayed nubar

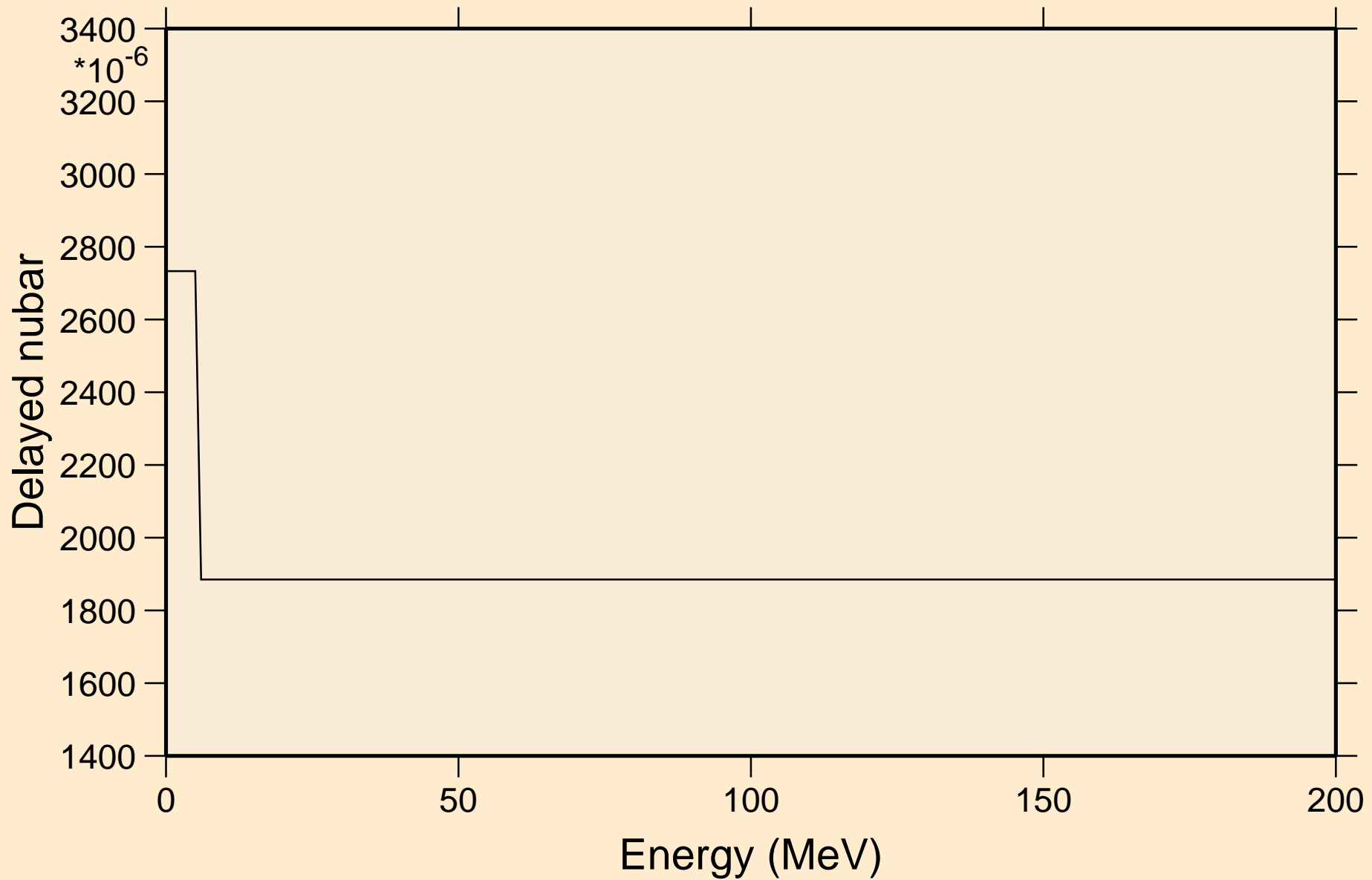

TL217 NEUTRON ACER TENDL-2023 LIBRARY; T=0.K

Delayed neutron spectra

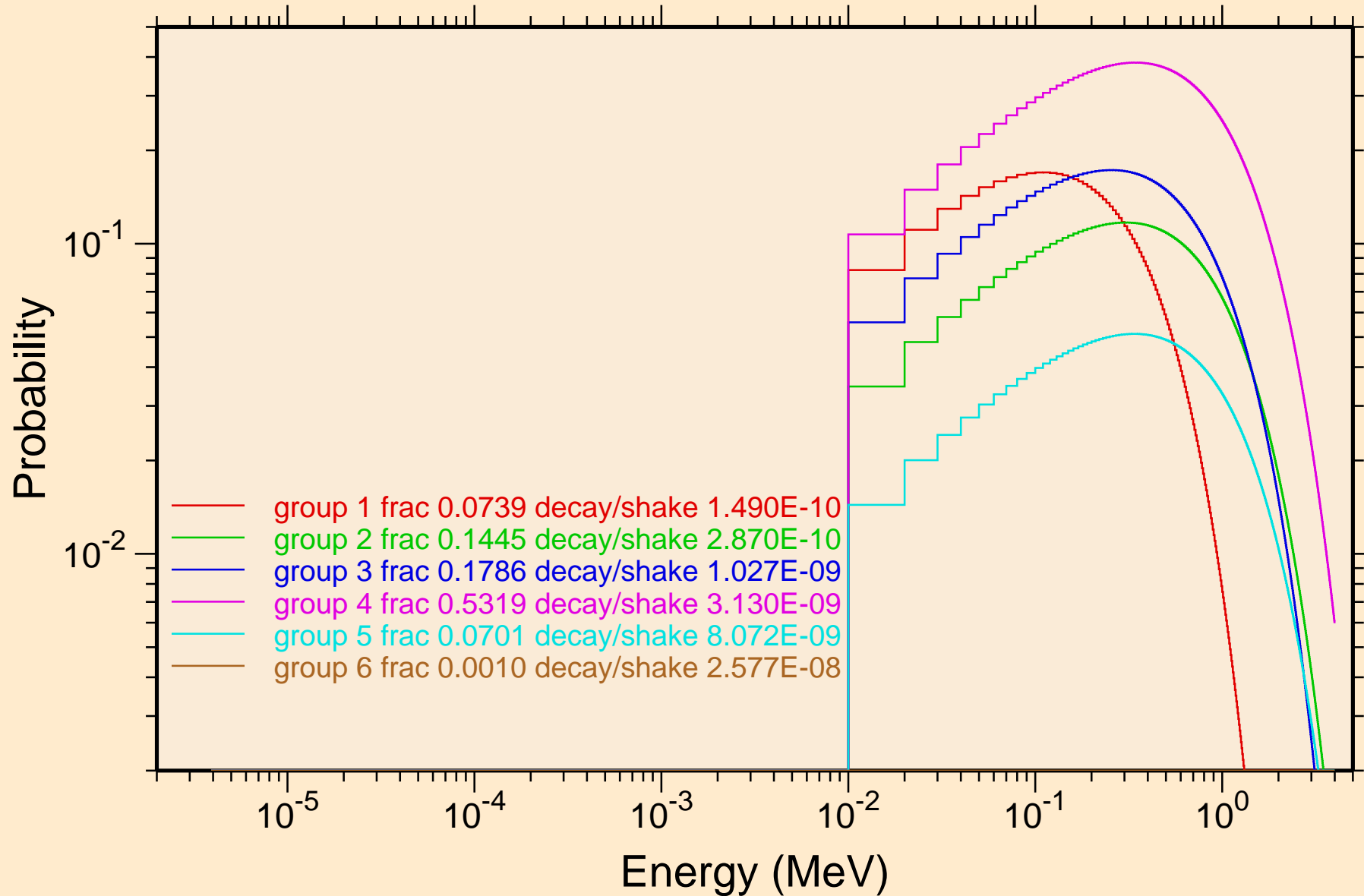

TL217 NEUTRON ACER TENDL-2023 LIBRARY; T=0.K
Photon emission for (n,x)

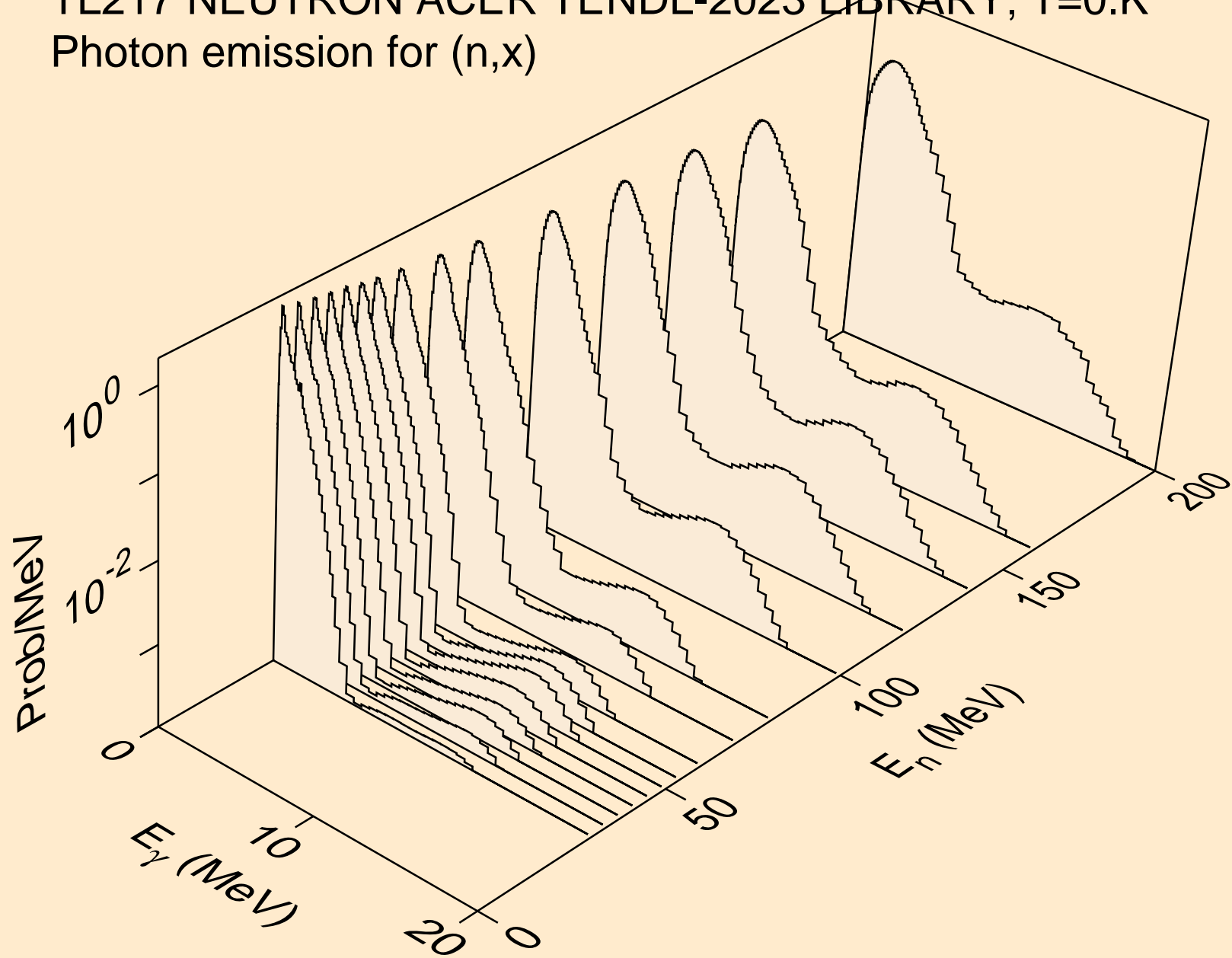

TL217 NEUTRON ACER TENDL-2023 LIBRARY; T=0.K
Photon emission for (n,2nd)

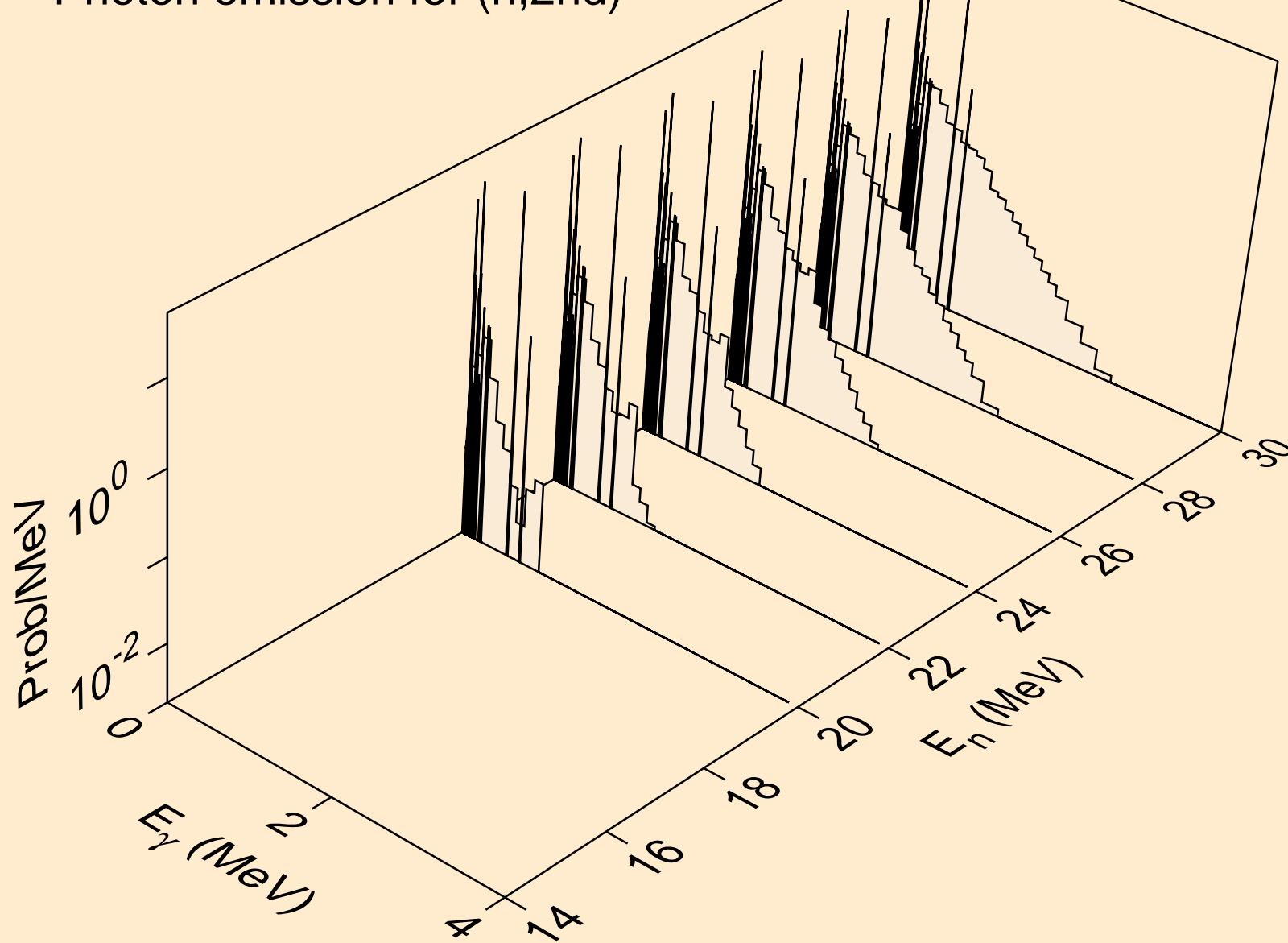

TL217 NEUTRON ACER TENDL-2023 LIBRARY; T=0.K
Photon emission for (n,2n)

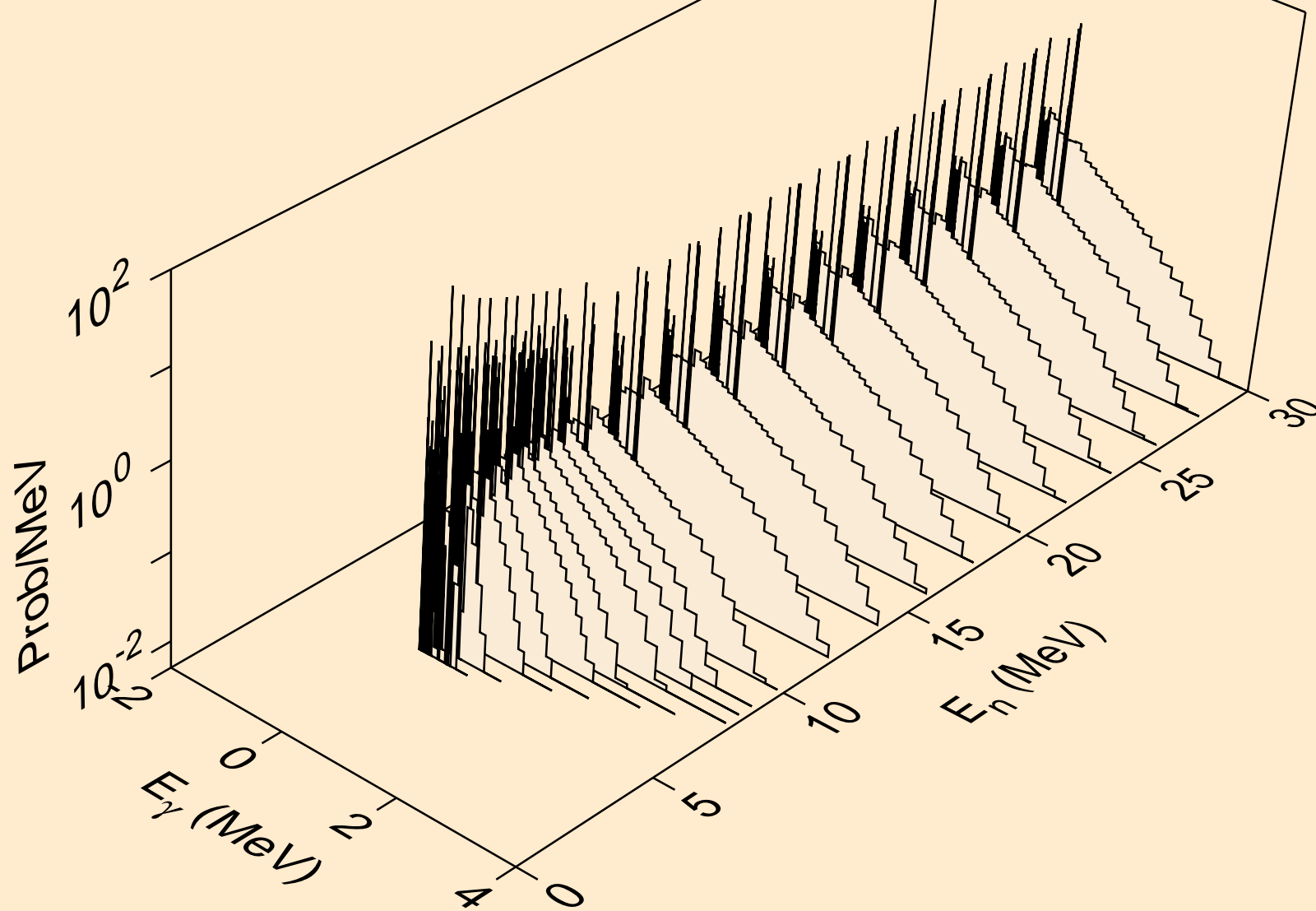

TL217 NEUTRON ACER TENDL-2023 LIBRARY; T=0.K
Photon emission for (n,3n)

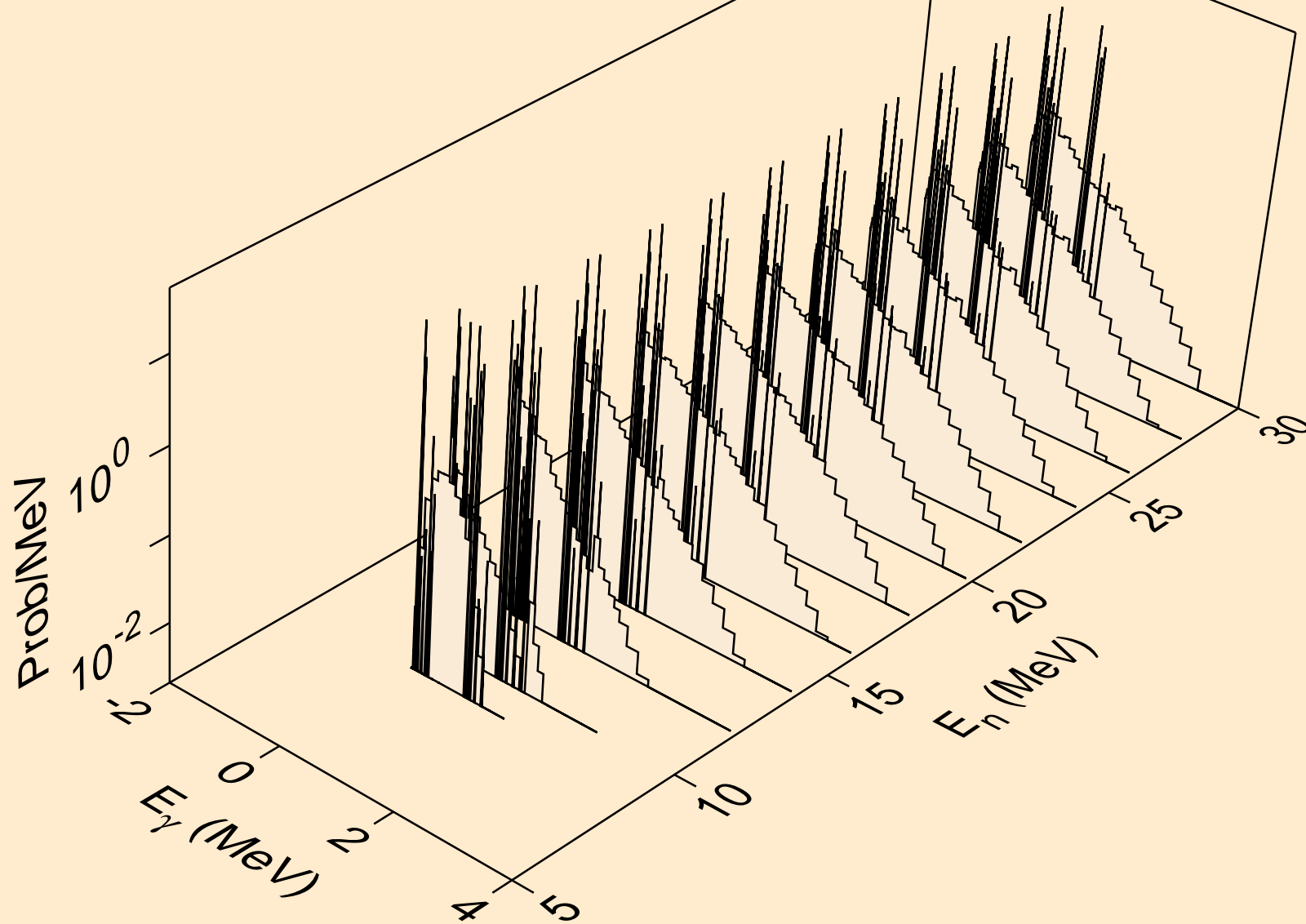

TL217 NEUTRON ACER TENDL-2023 LIBRARY; T=0.K
Photon emission for (n,n*)a

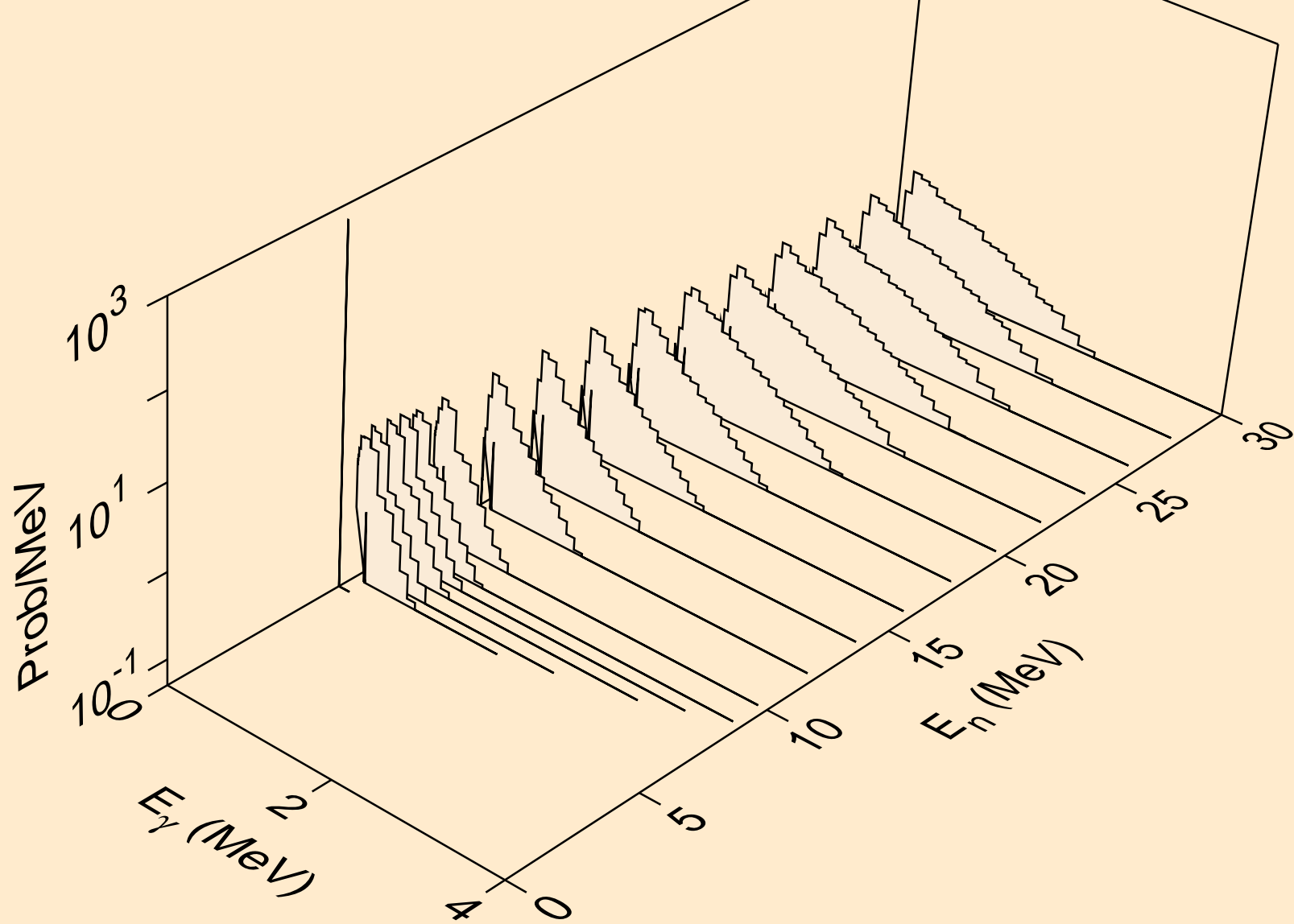

TL217 NEUTRON ACER TENDL-2023 LIBRARY; T=0.K
Photon emission for (n,2n)a

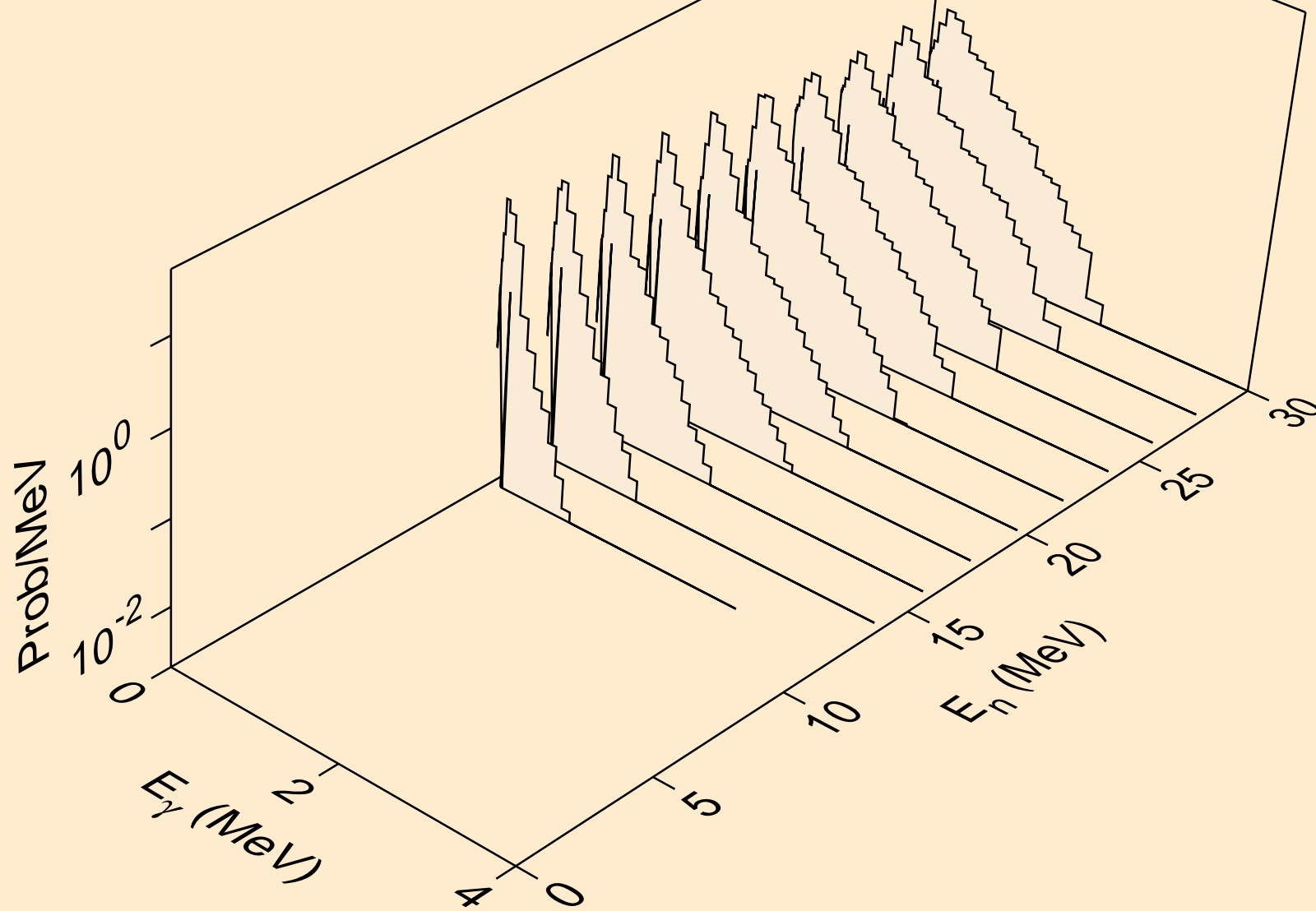

TL217 NEUTRON ACER TENDL-2023 LIBRARY; T=0.K
Photon emission for (n,3n)a

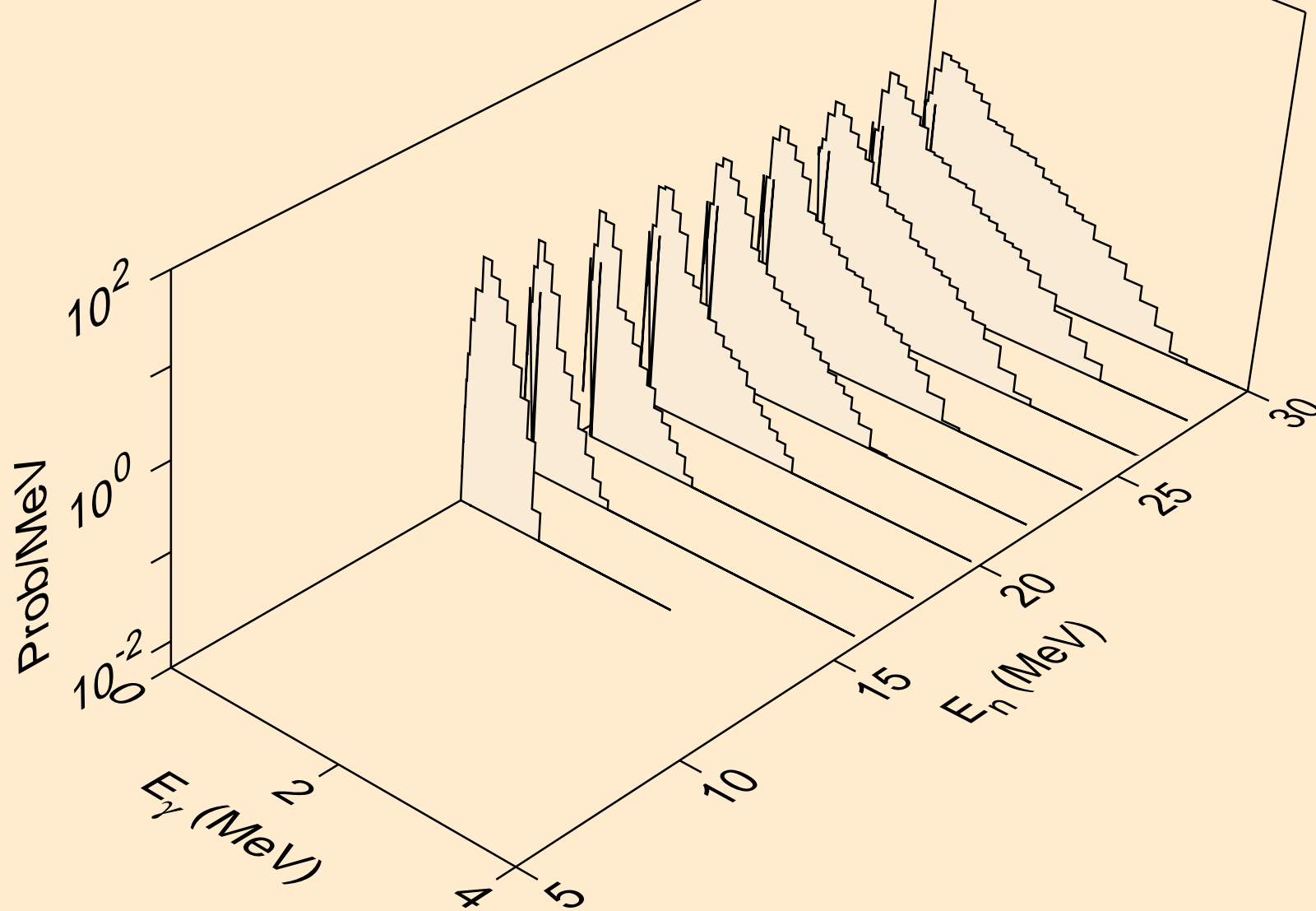

TL217 NEUTRON ACER TENDL-2023 LIBRARY; T=0.K
Photon emission for (n,n*)p

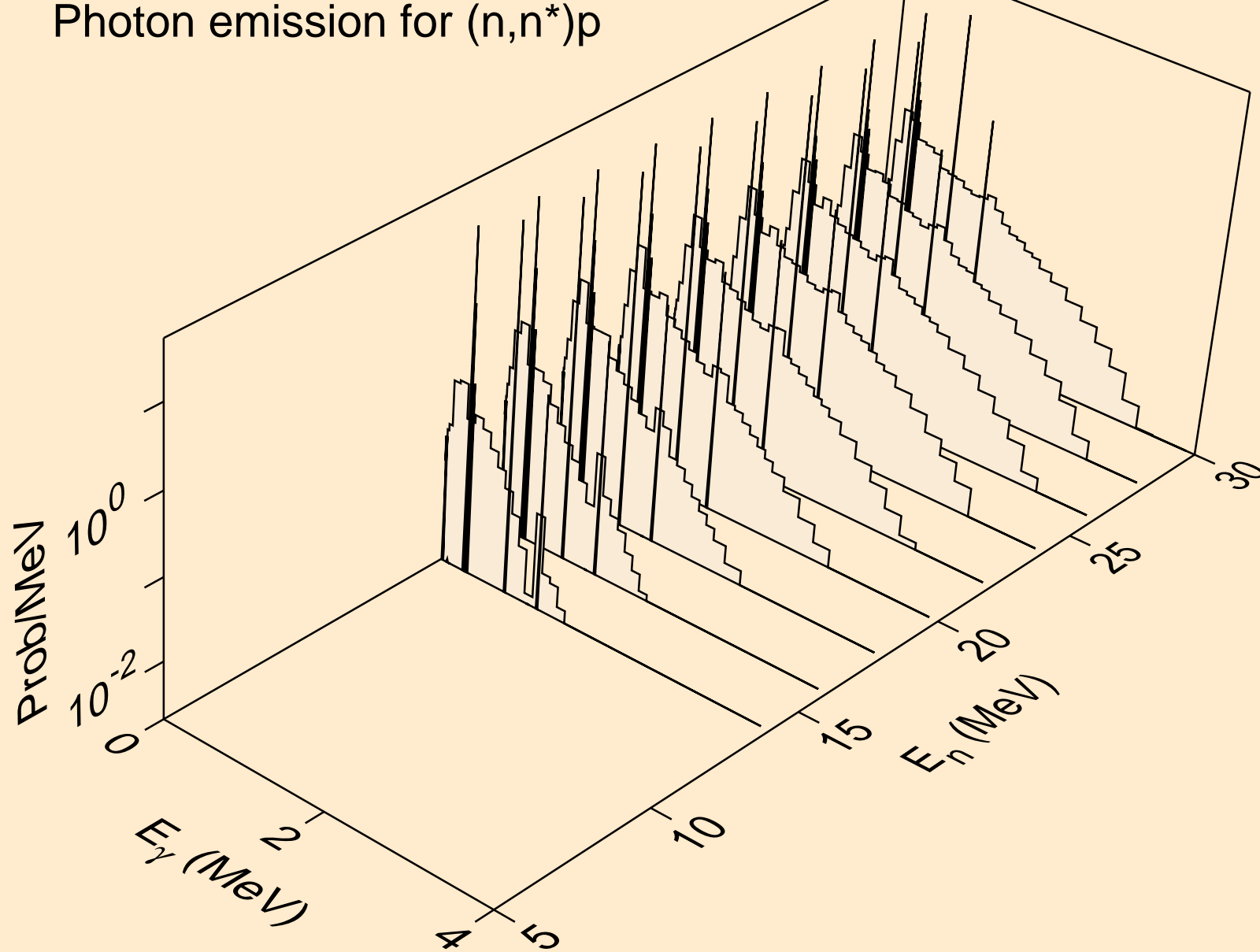

TL217 NEUTRON ACER TENDL-2023 LIBRARY; T=0.K
Photon emission for (n,n*)d

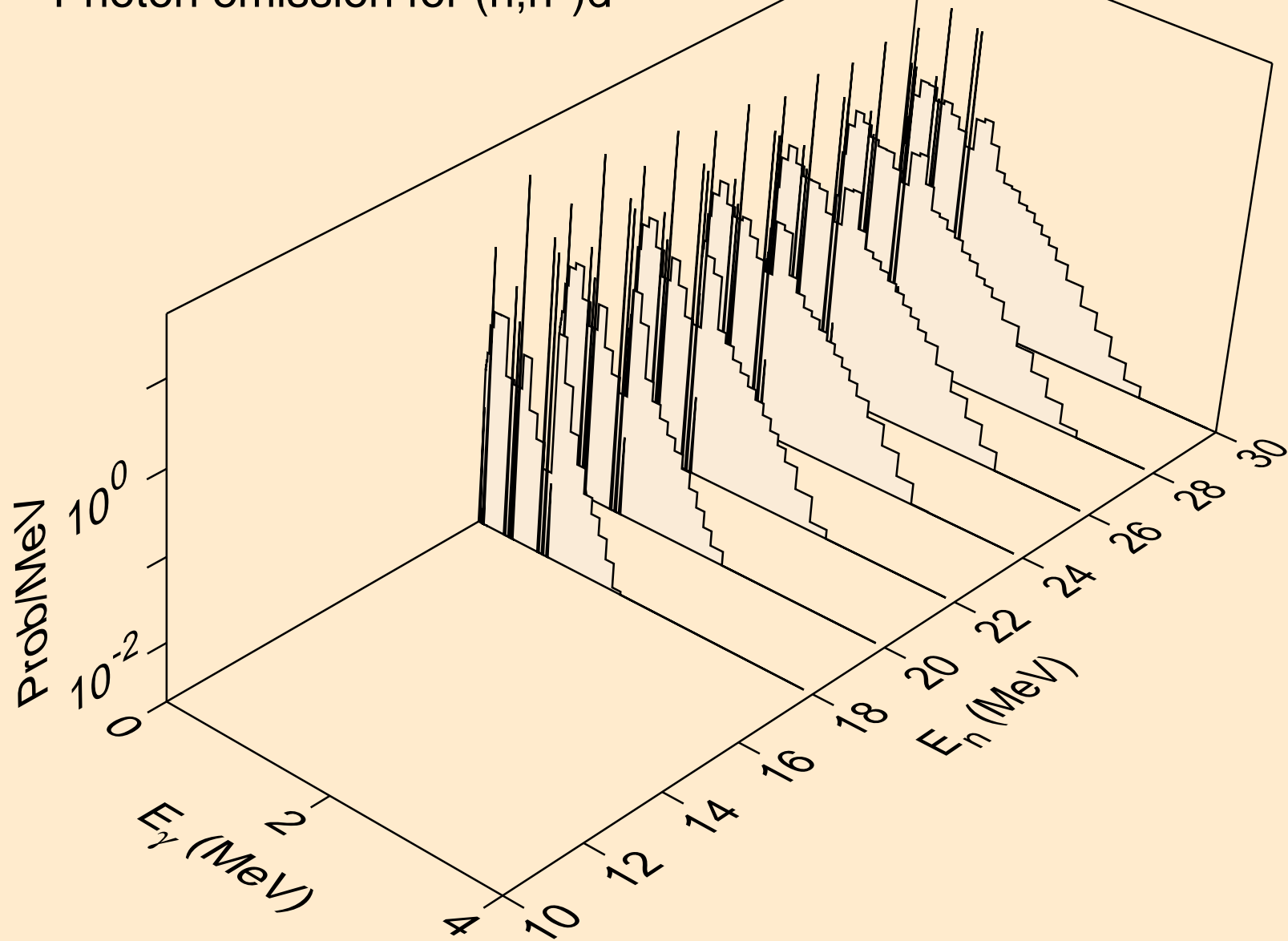

TL217 NEUTRON ACER TENDL-2023 LIBRARY; T=0.K
Photon emission for (n,n*)t

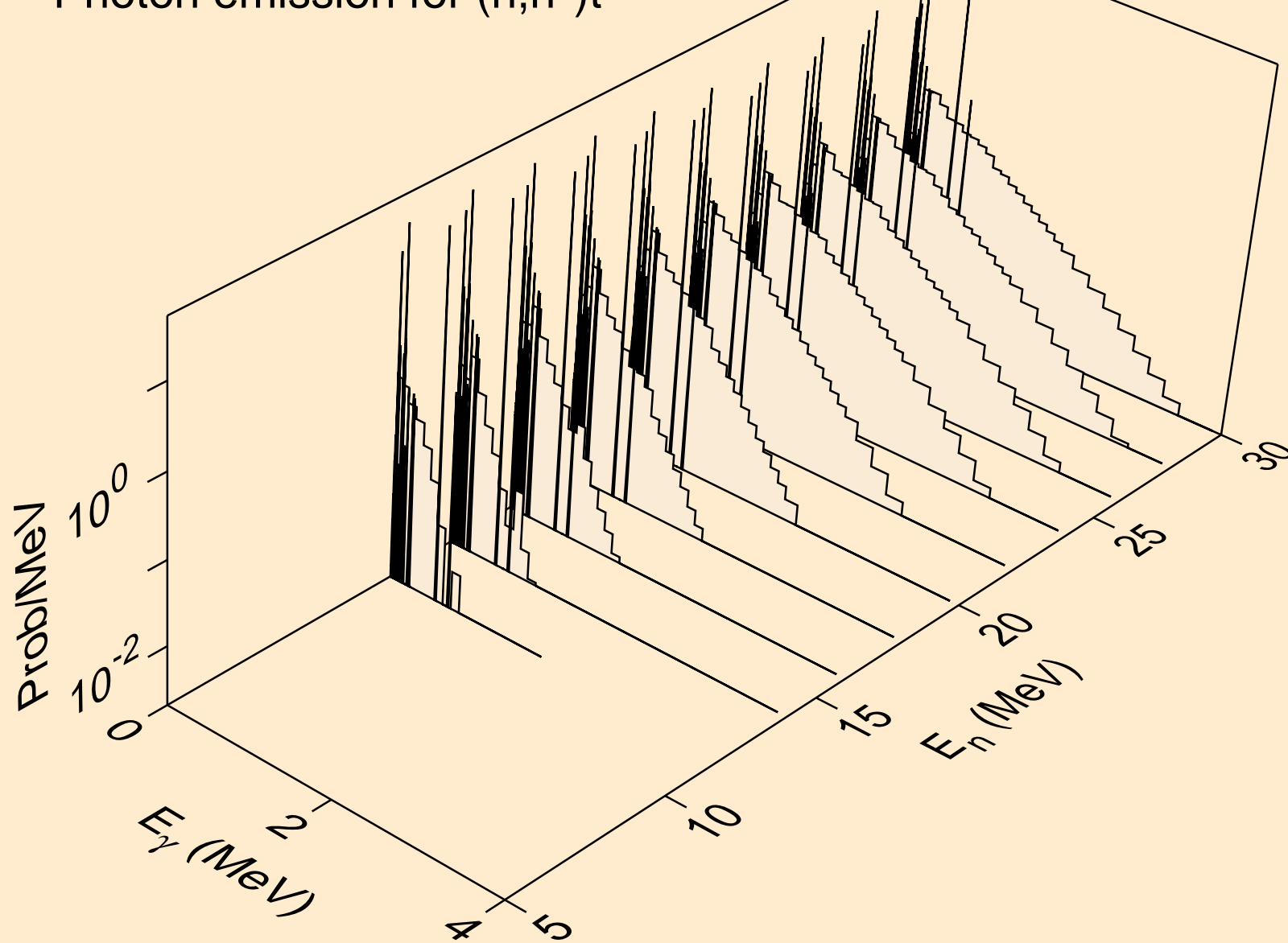

TL217 NEUTRON ACER TENDL-2023 LIBRARY; T=0.K
Photon emission for (n,n*)he3

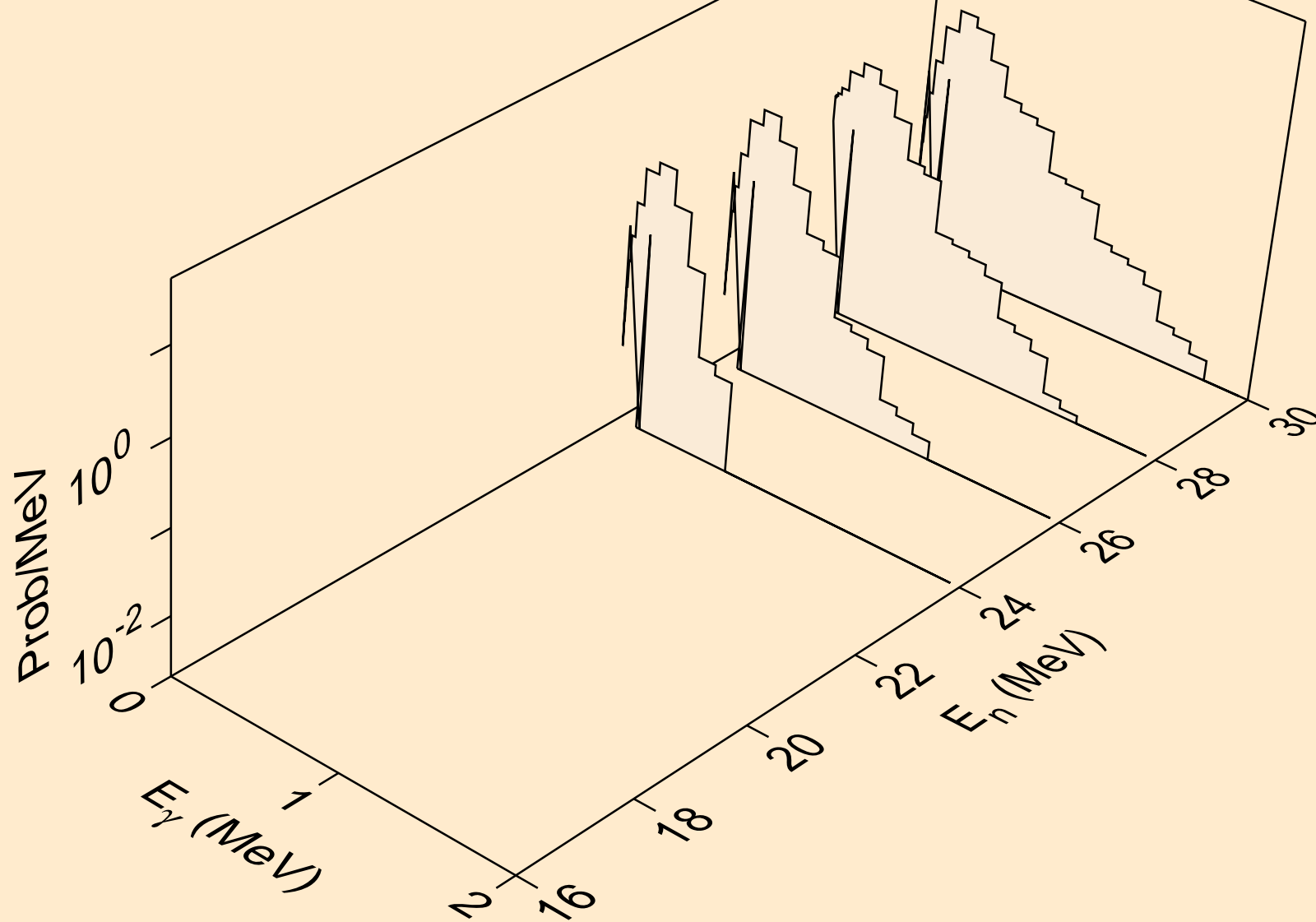

TL217 NEUTRON ACER TENDL-2023 LIBRARY; T=0.K
Photon emission for (n,4n)

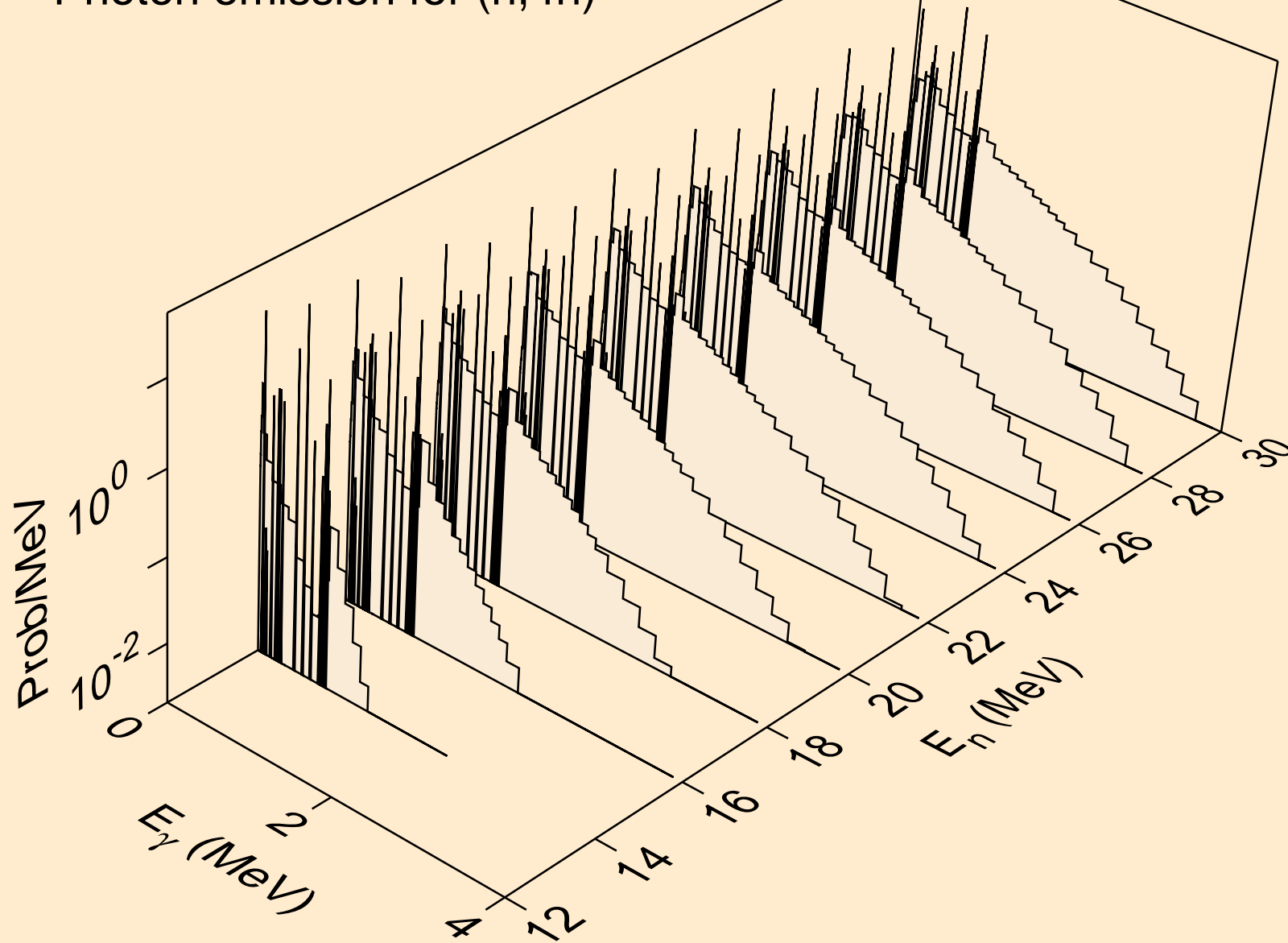

TL217 NEUTRON ACER TENDL-2023 LIBRARY; T=0.K
Photon emission for (n,2np)

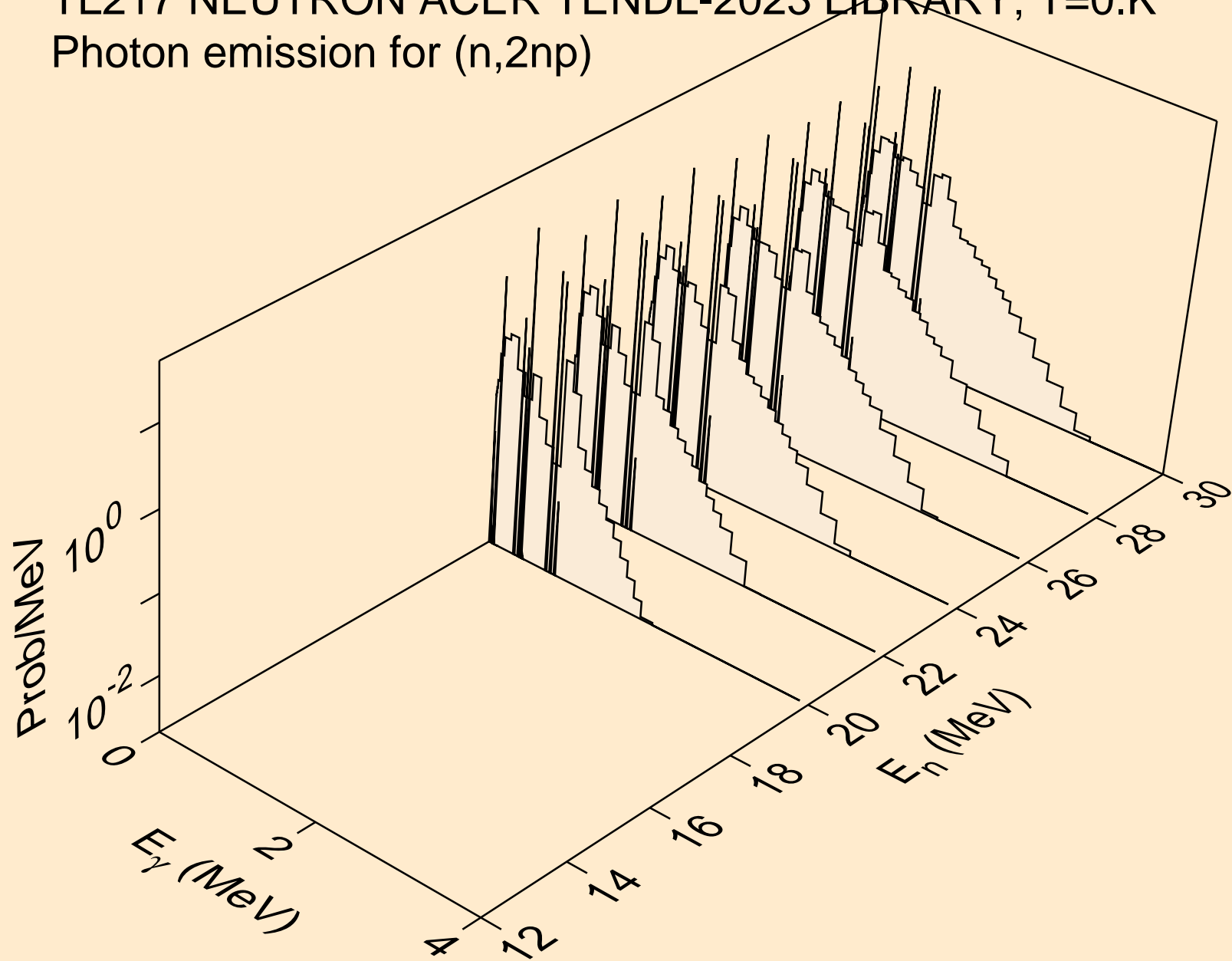

TL217 NEUTRON ACER TENDL-2023 LIBRARY; T=0.K
Photon emission for (n,3np)

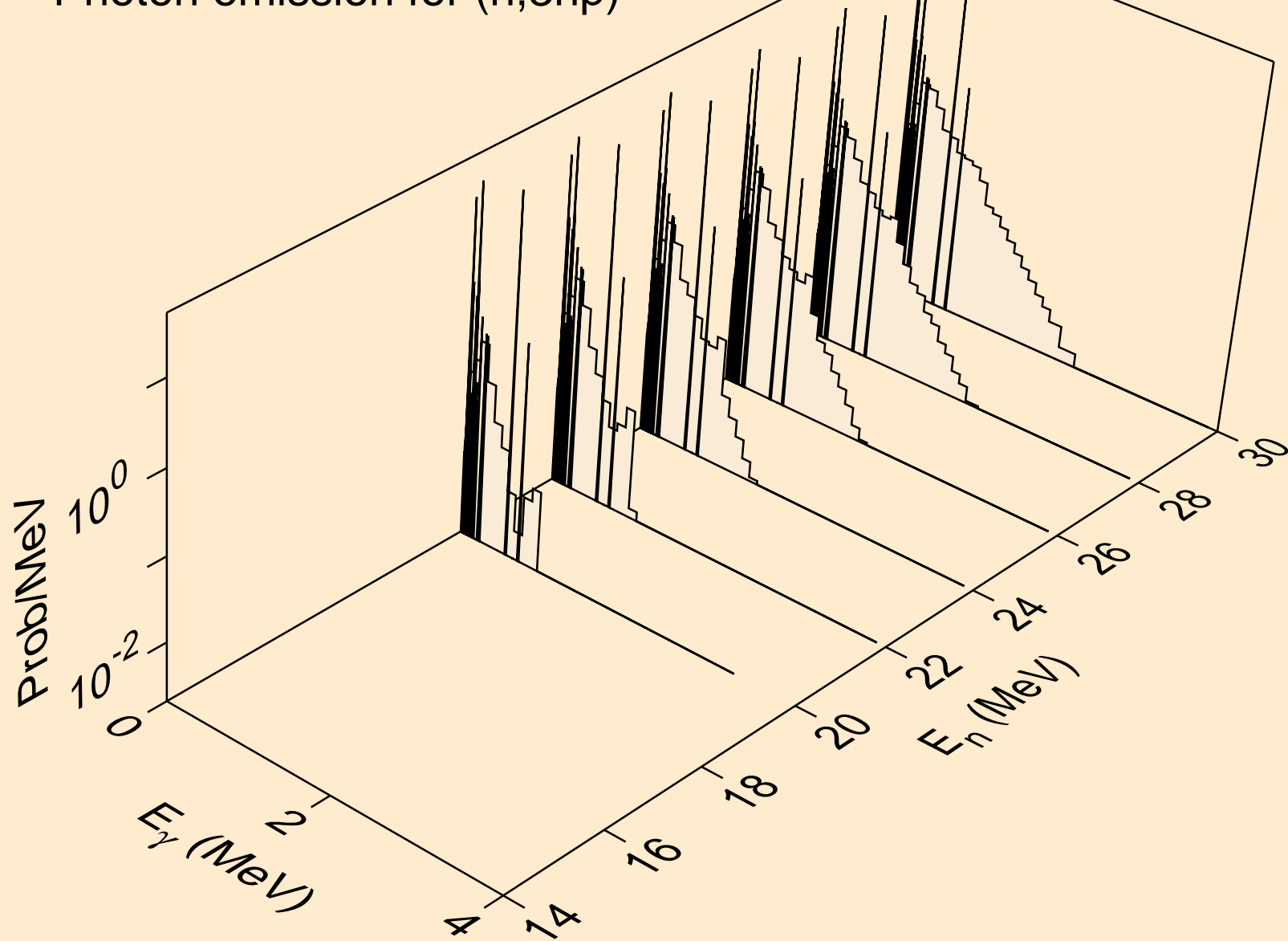

TL217 NEUTRON ACER TENDL-2023 LIBRARY; T=0.K
Photon emission for (n,n*c)

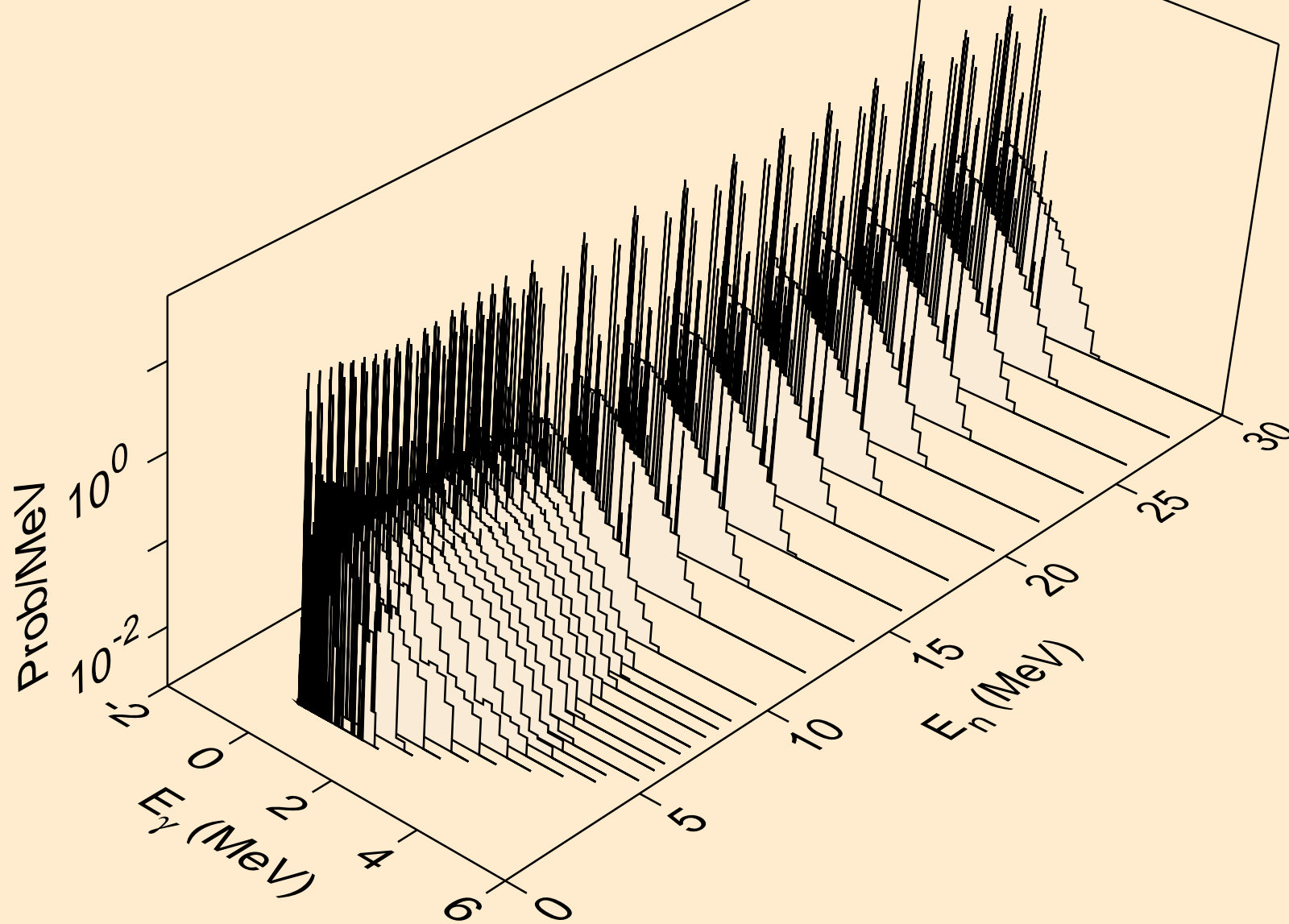

TL217 NEUTRON ACER TENDL-2023 LIBRARY; T=0.K
Photon emission for (n,gma)

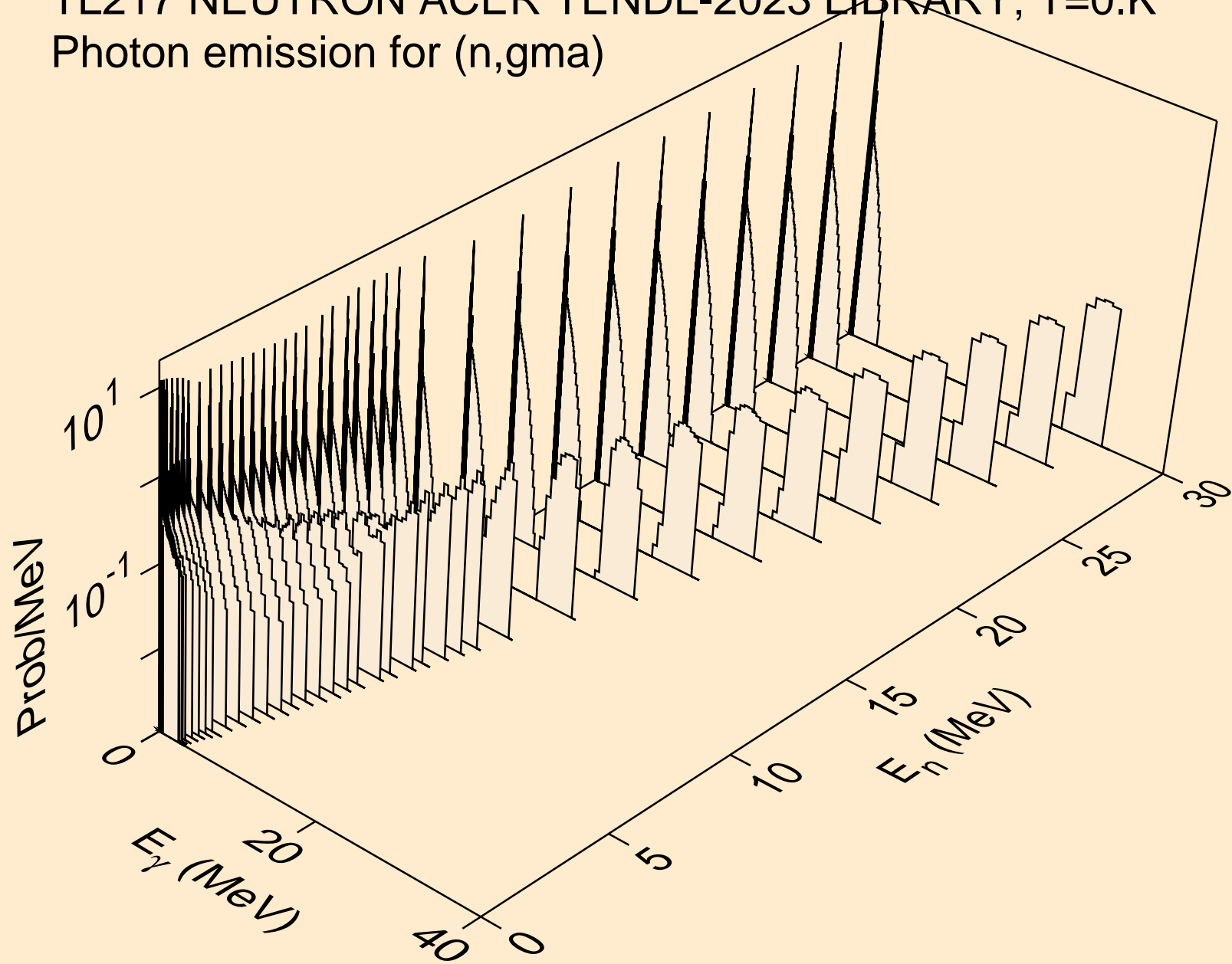

TL217 NEUTRON ACER TENDL-2023 LIBRARY; T=0.K
Photon emission for (n,p)

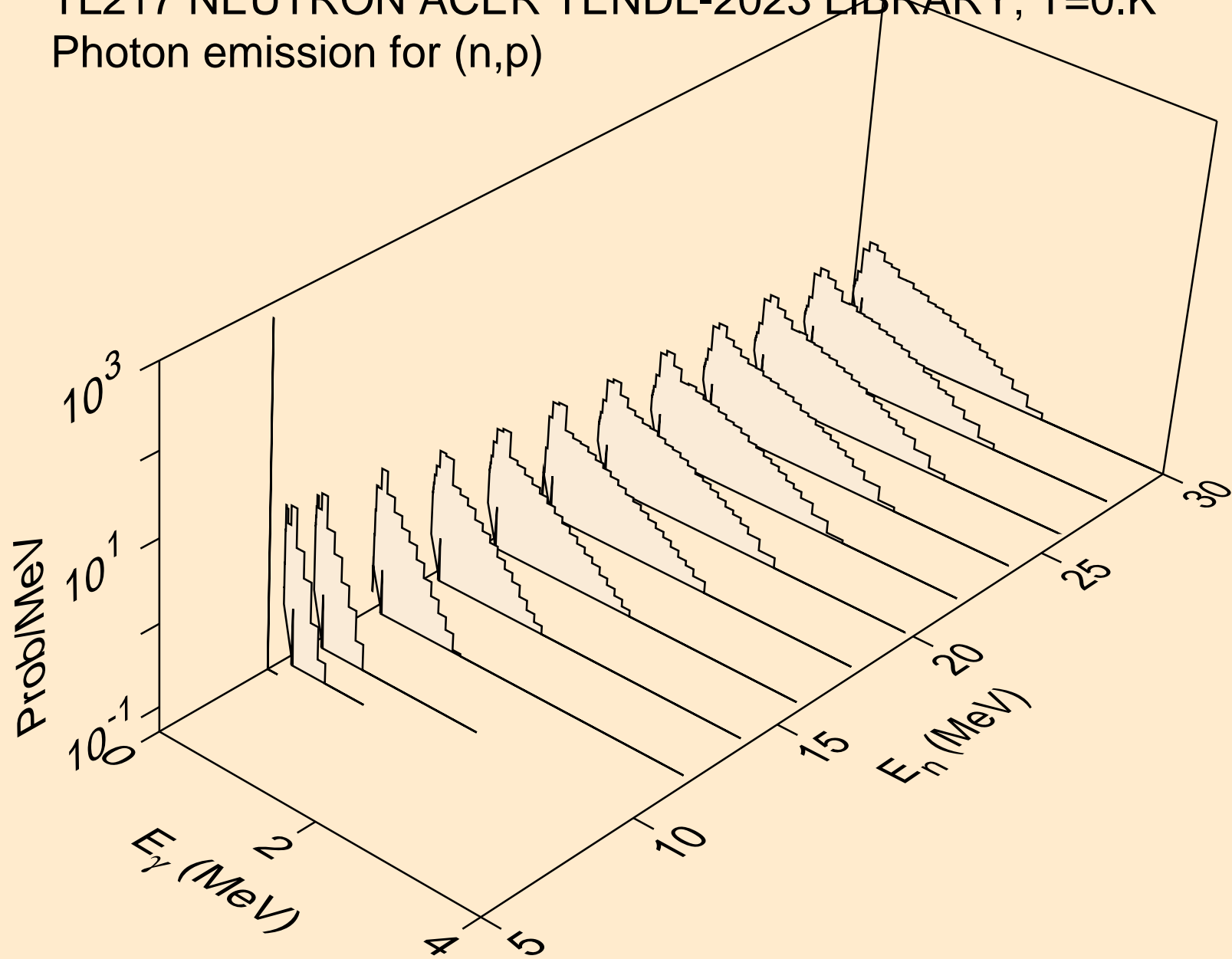

TL217 NEUTRON ACER TENDL-2023 LIBRARY; T=0.K
Photon emission for (n,d)

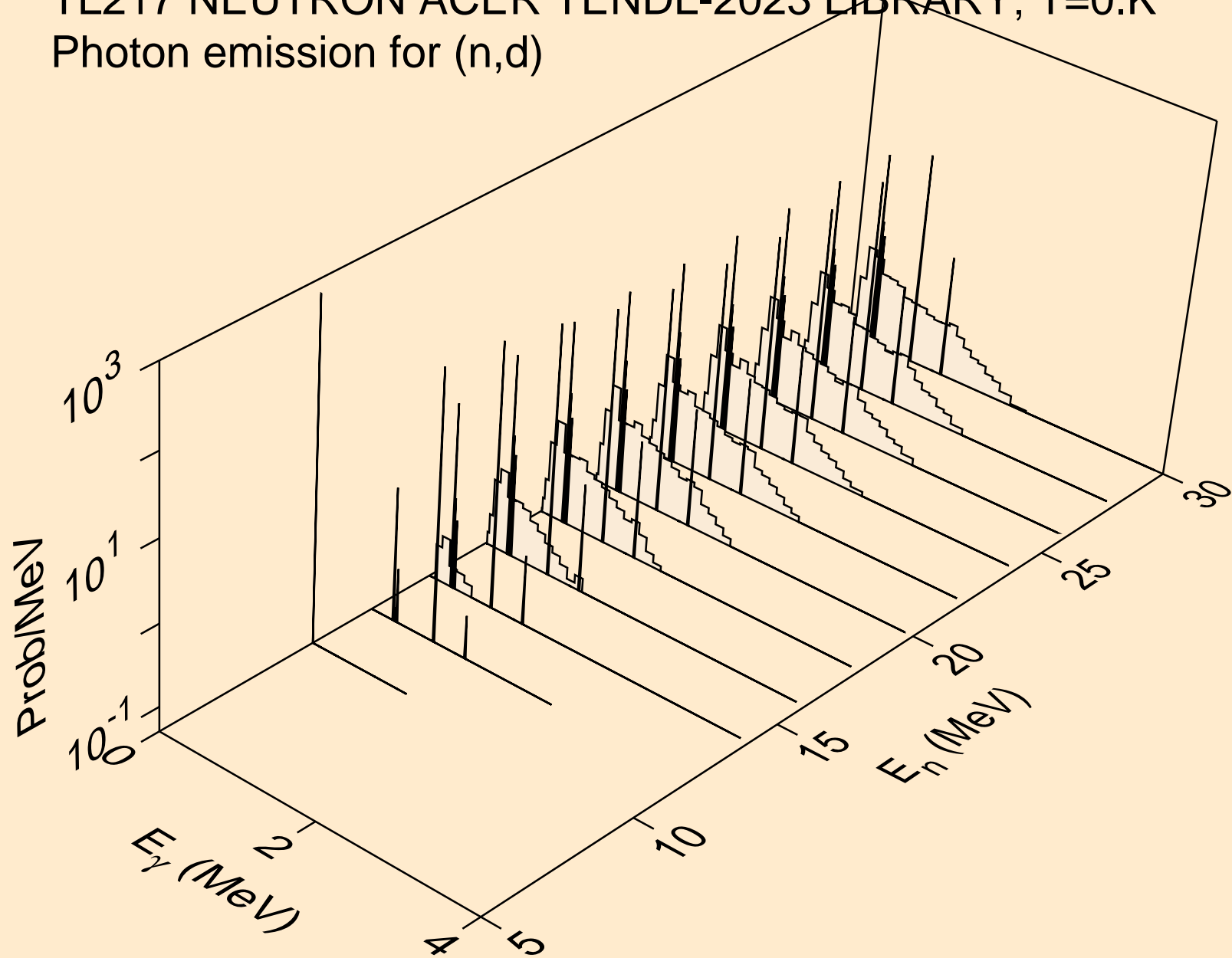

TL217 NEUTRON ACER TENDL-2023 LIBRARY; T=0.K
Photon emission for (n,t)

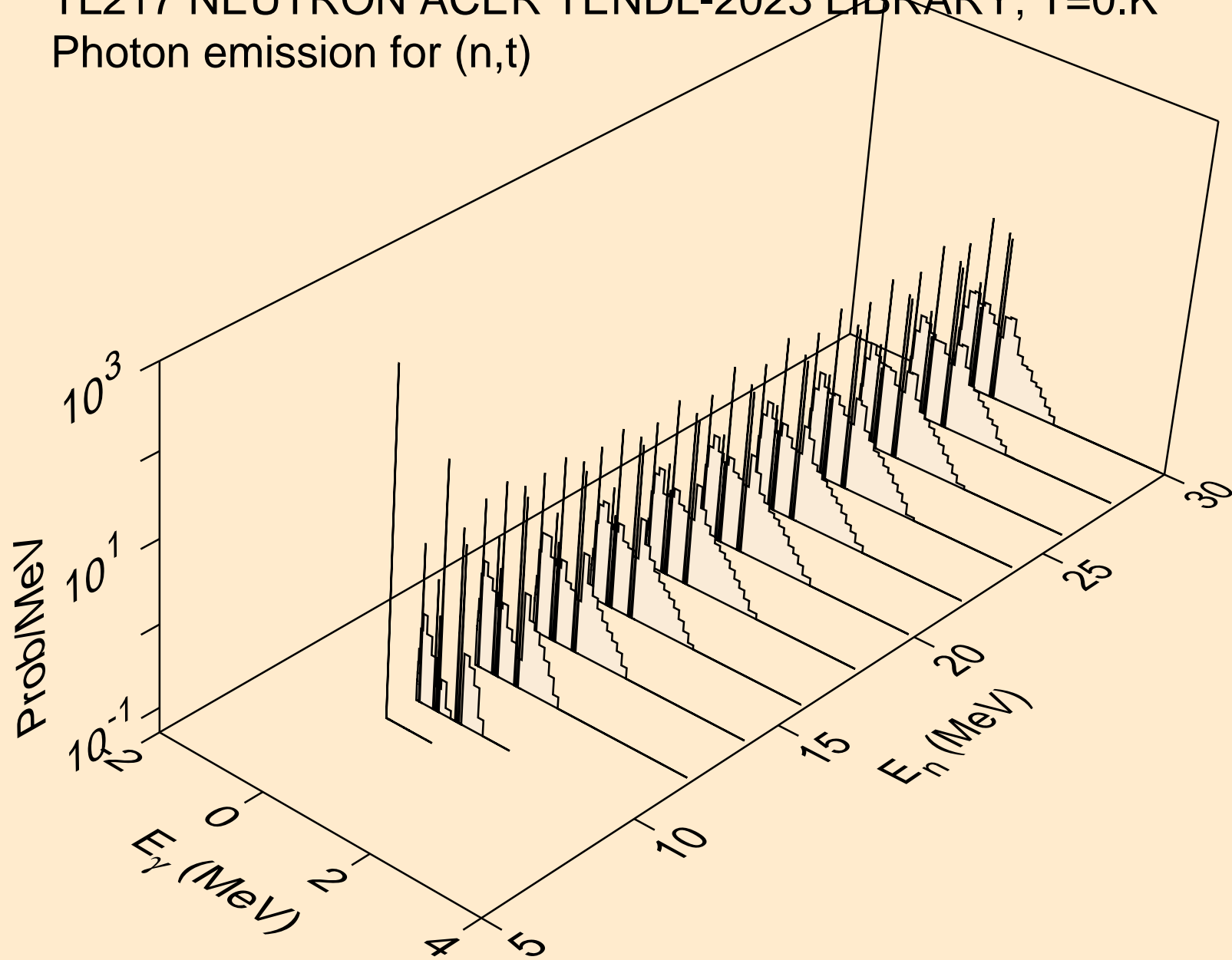

TL217 NEUTRON ACER TENDL-2023 LIBRARY; T=0.K
Photon emission for (n,he3)

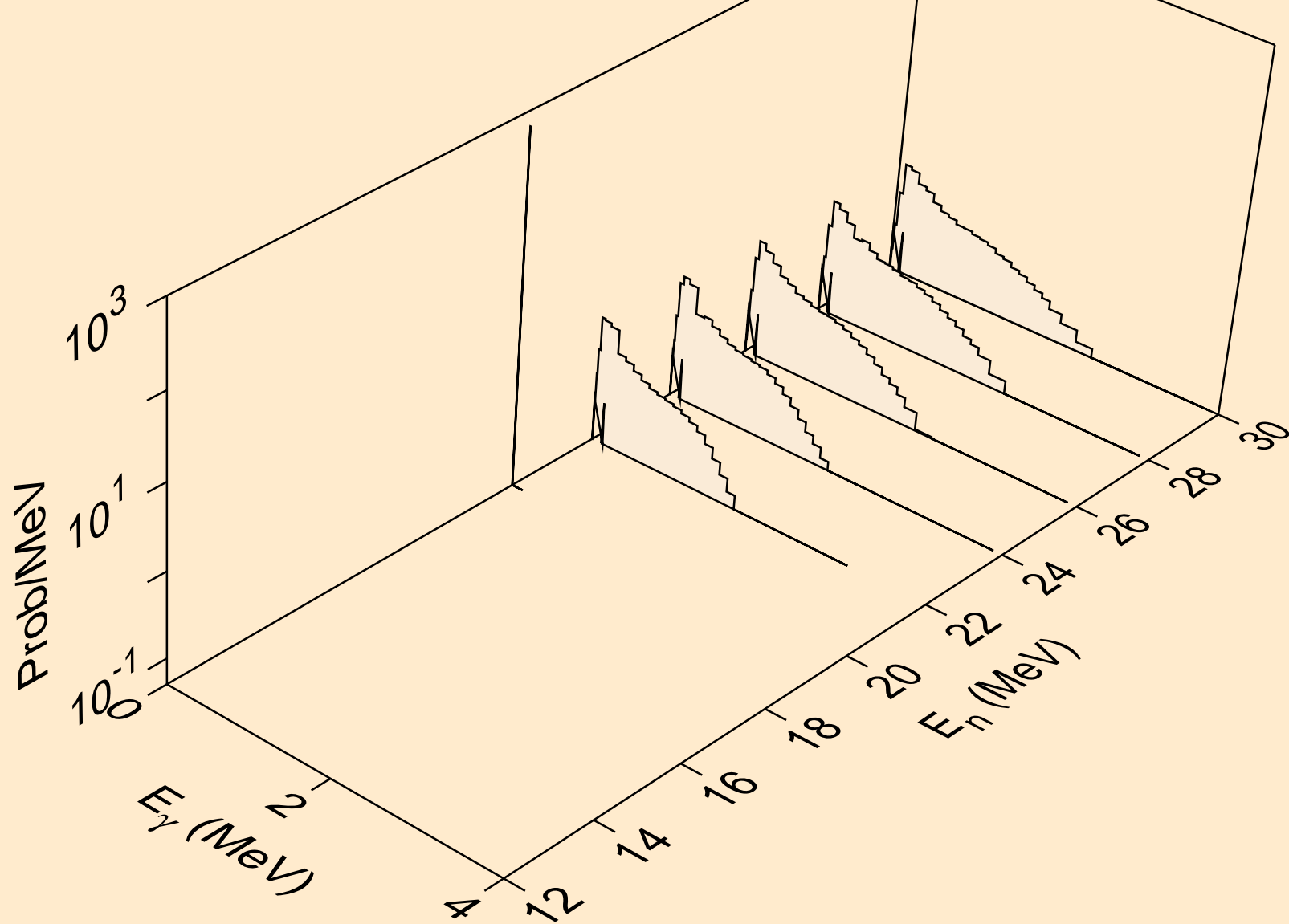

TL217 NEUTRON ACER TENDL-2023 LIBRARY; T=0.K
Photon emission for (n,a)

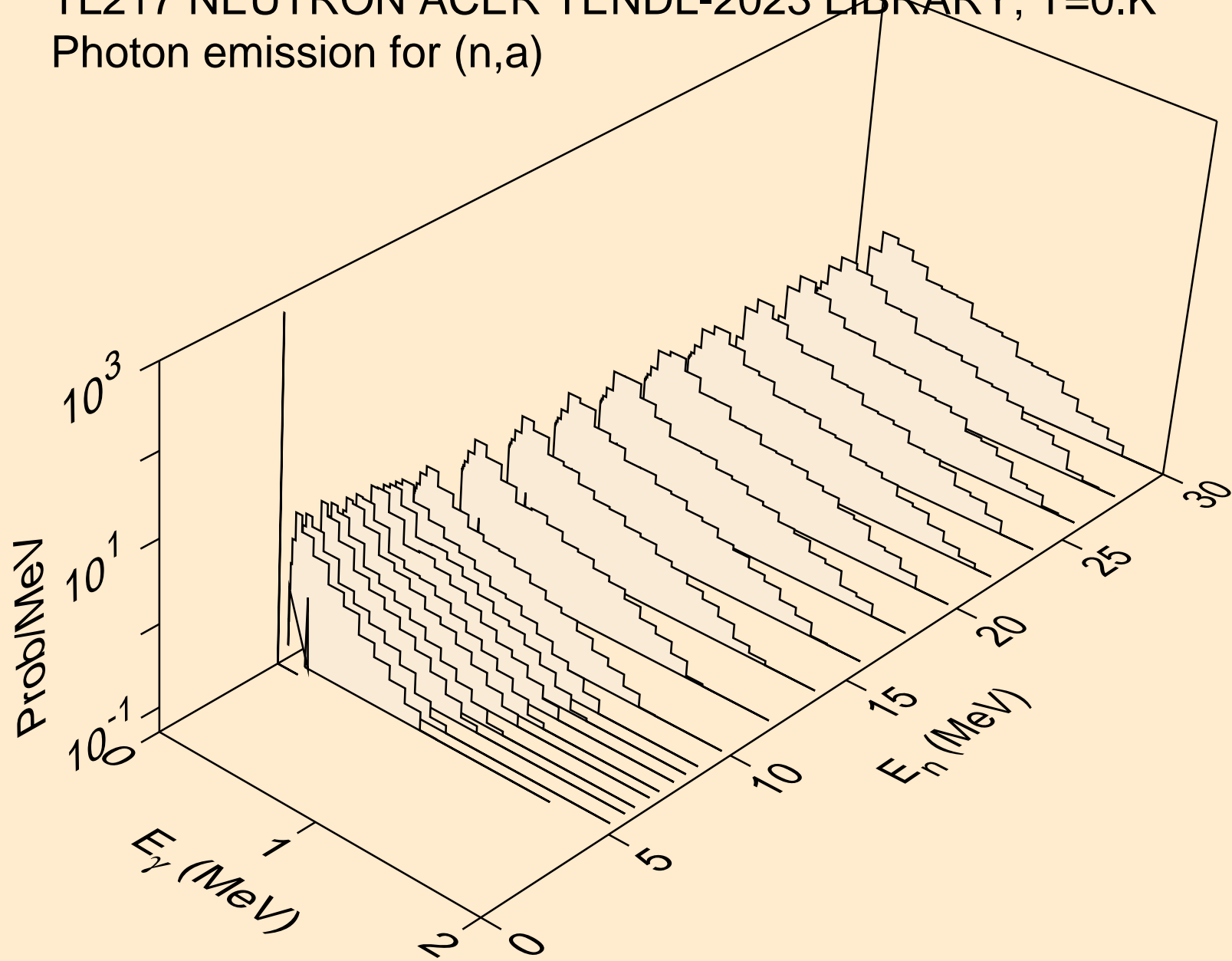

TL217 NEUTRON ACER TENDL-2023 LIBRARY; T=0.K
thermal capture photon spectrum

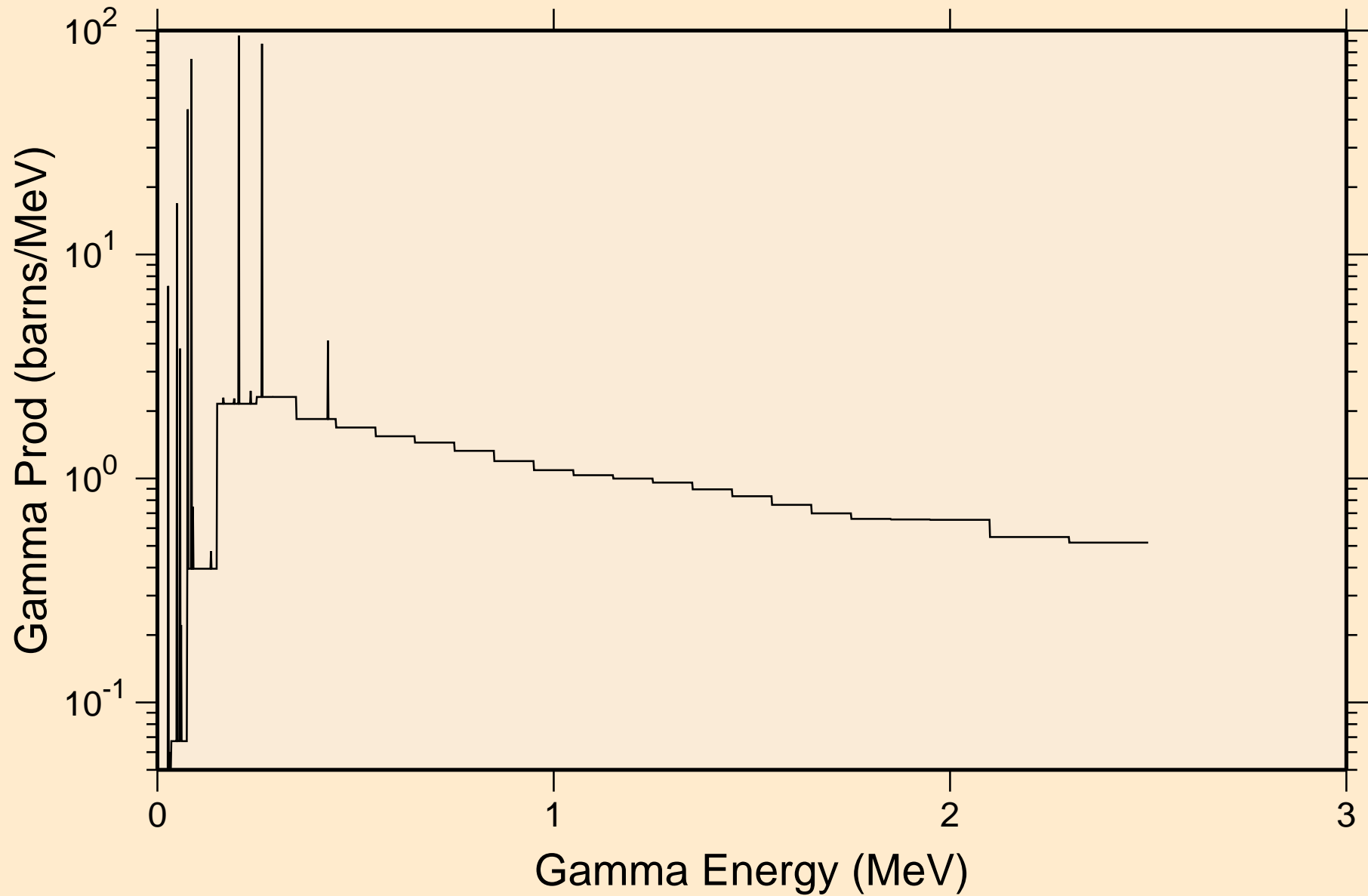

TL217 NEUTRON ACER TENDL-2023 LIBRARY; T=0.K
14 MeV photon spectrum

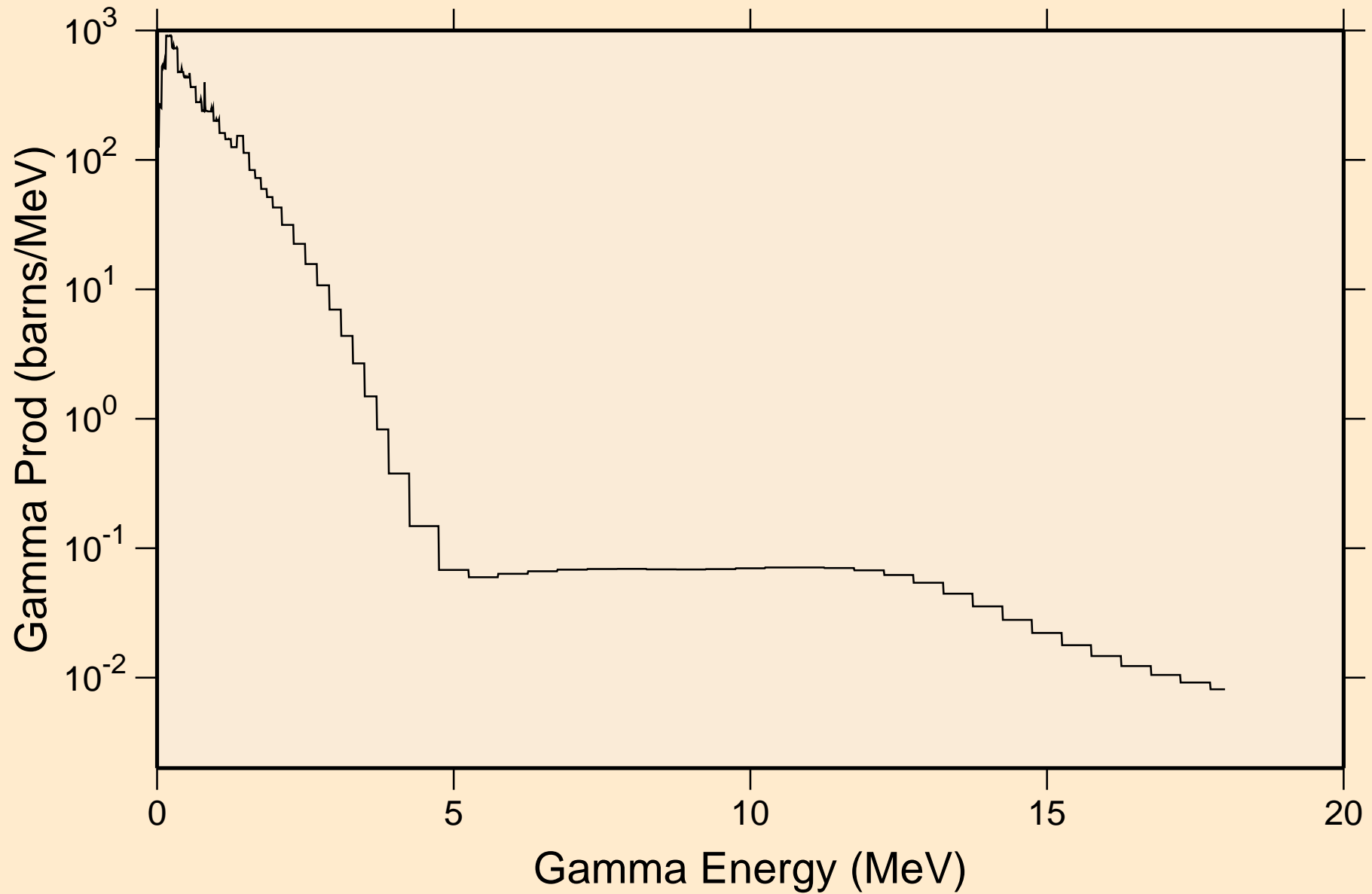

TL217 NEUTRON ACER TENDL-2023 LIBRARY; T=0.K

Particle heating contributions

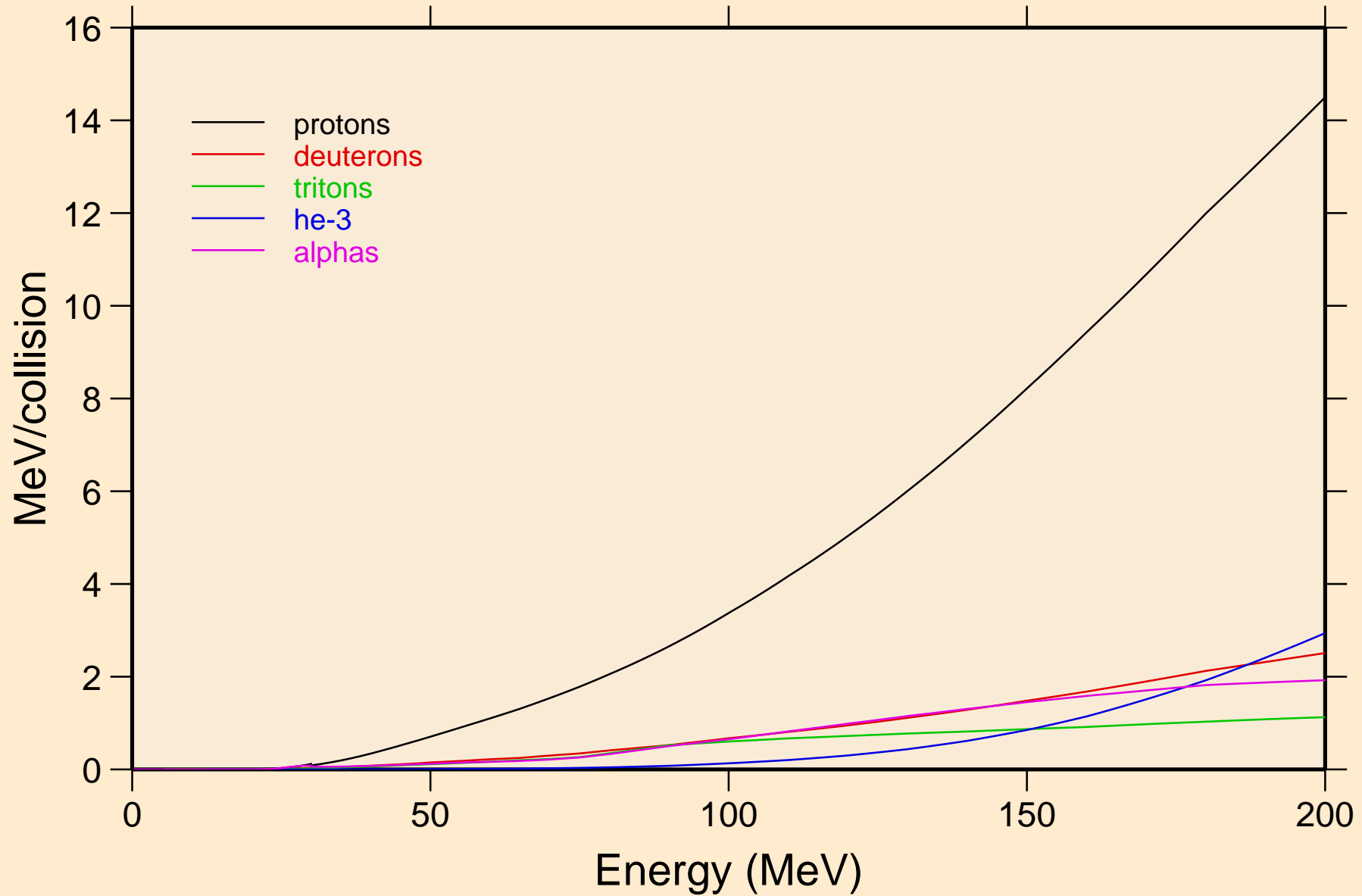

TL217 NEUTRON ACER TENDL-2023 LIBRARY; T=0.K
Recoil Heating

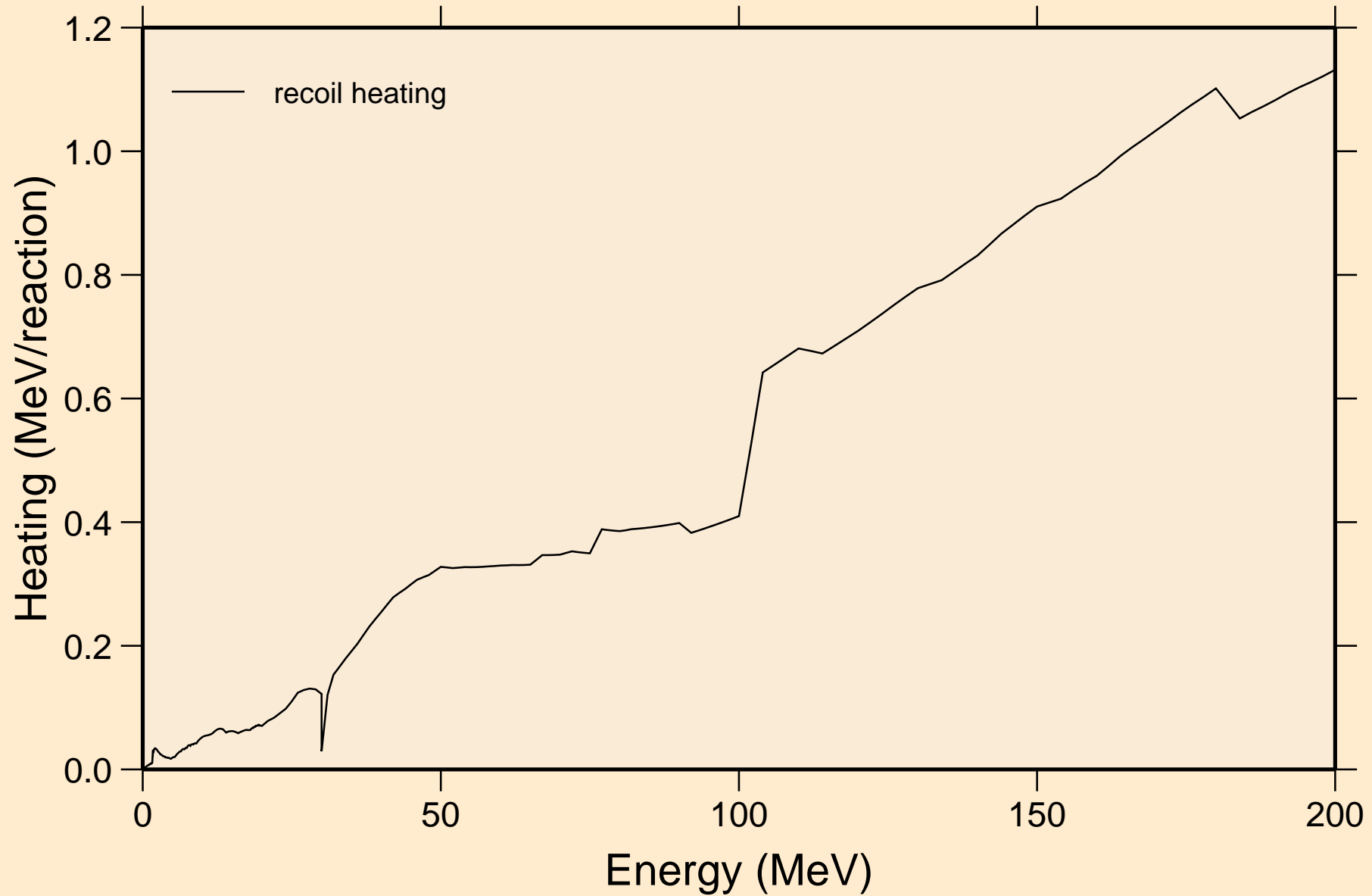

TL217 NEUTRON ACER TENDL-2023 LIBRARY; T=0.K
Particle production cross sections

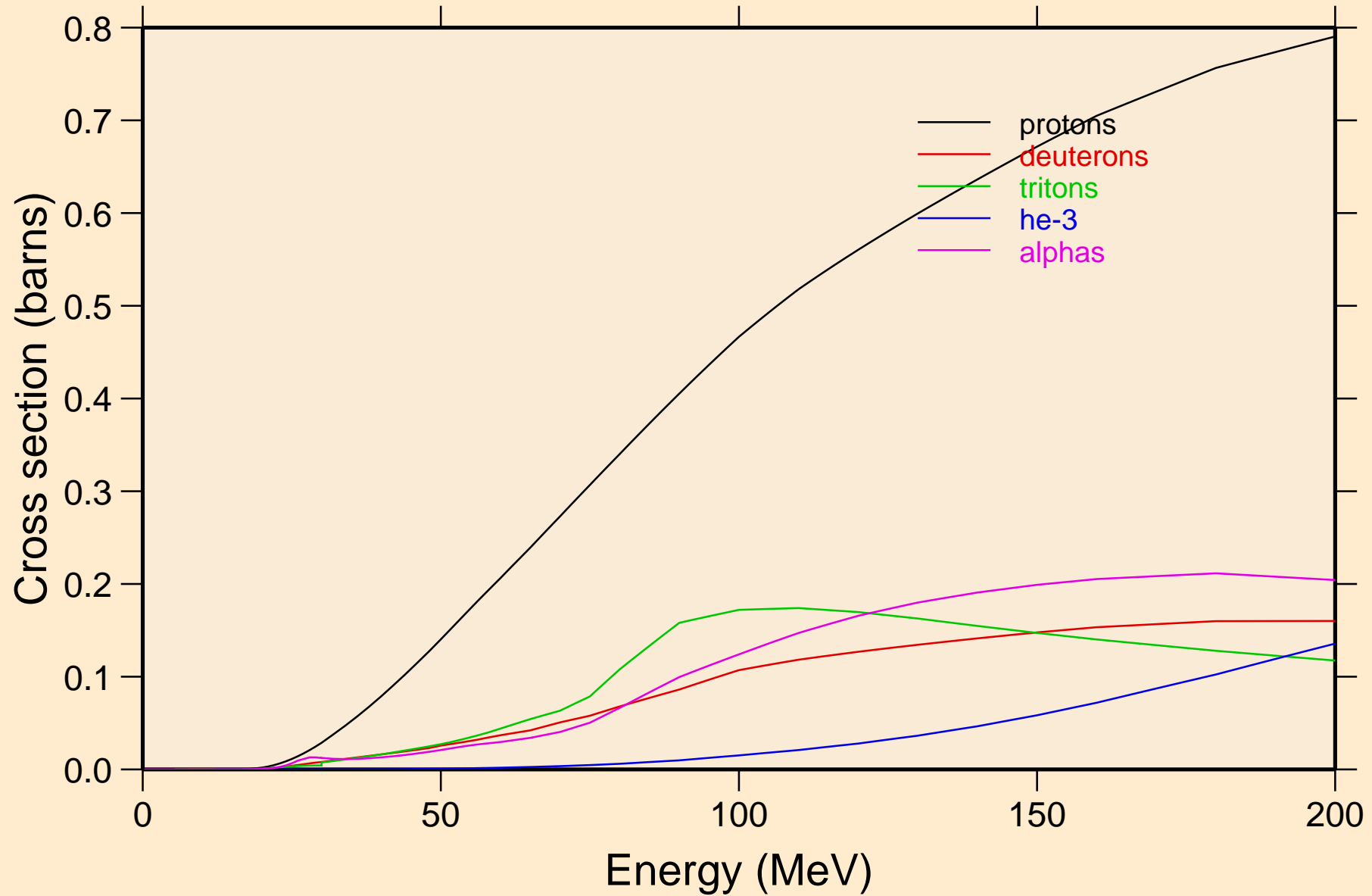

TL217 NEUTRON ACER TENDL-2023 LIBRARY; T=0.K
protons from (n,x)

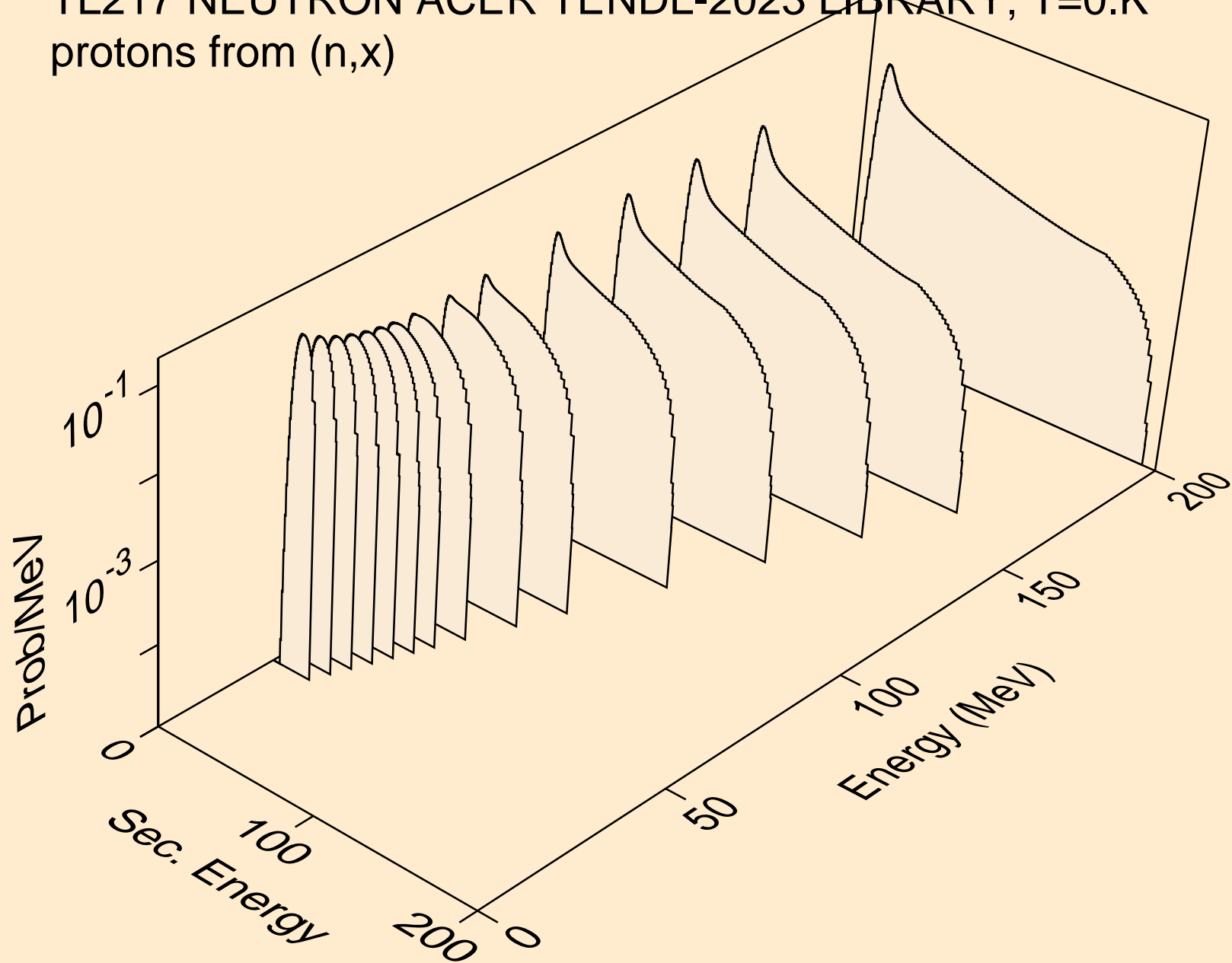

TL217 NEUTRON ACER TENDL-2023 LIBRARY; T=0.K
protons from (n,n*)p

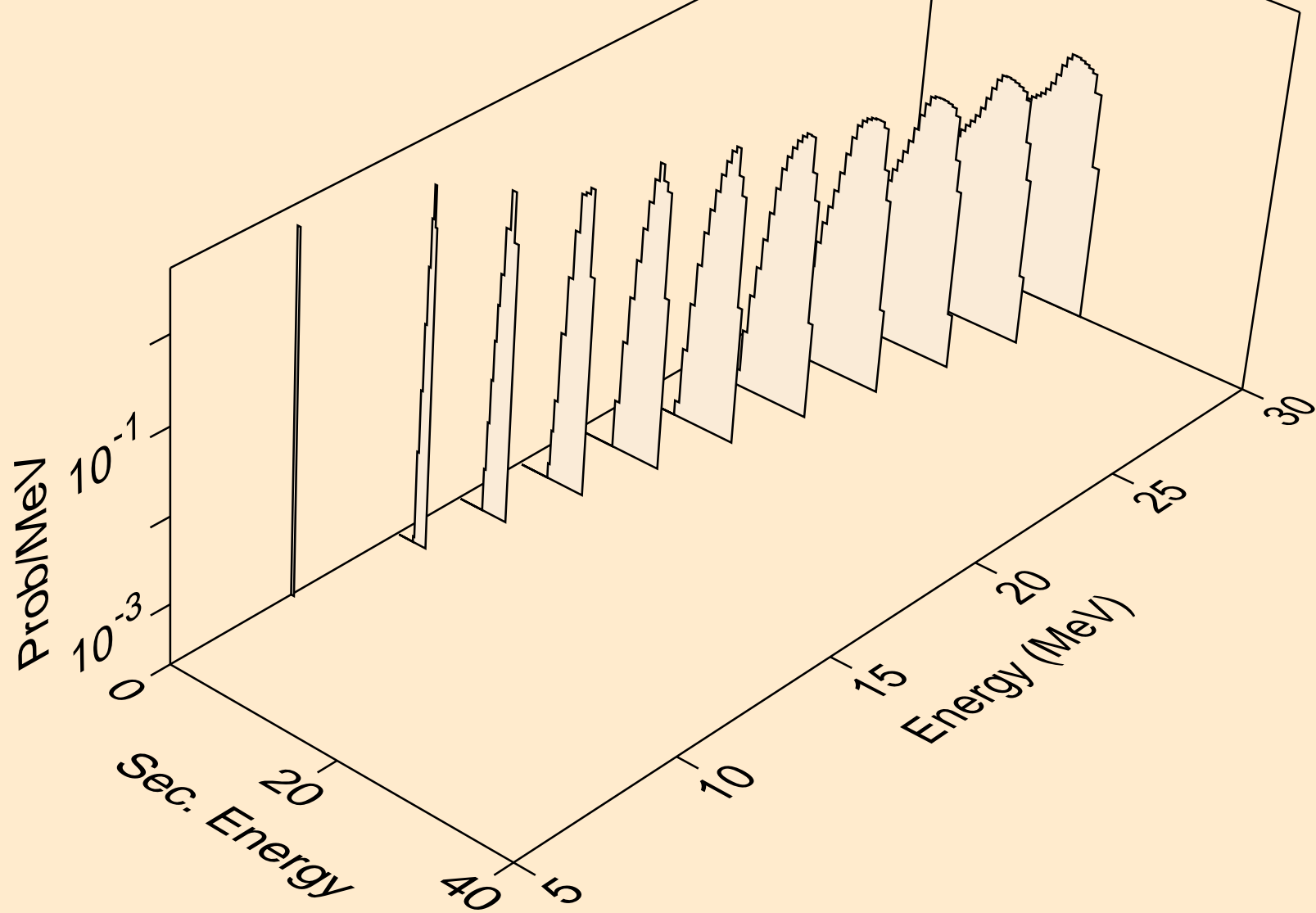

TL217 NEUTRON ACER TENDL-2023 LIBRARY; T=0.K
protons from (n,2np)

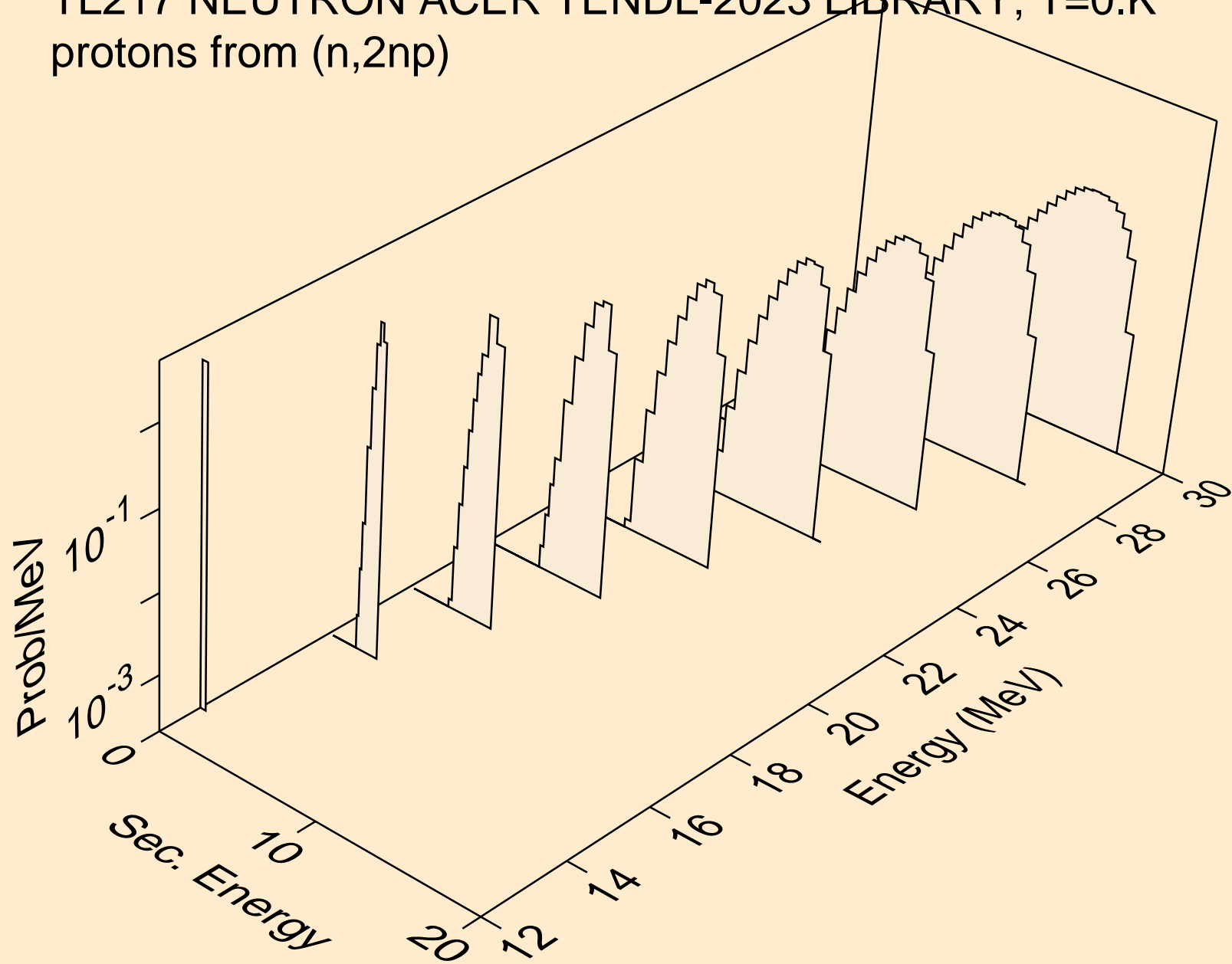

TL217 NEUTRON ACER TENDL-2023 LIBRARY; T=0.K
protons from (n,3np)

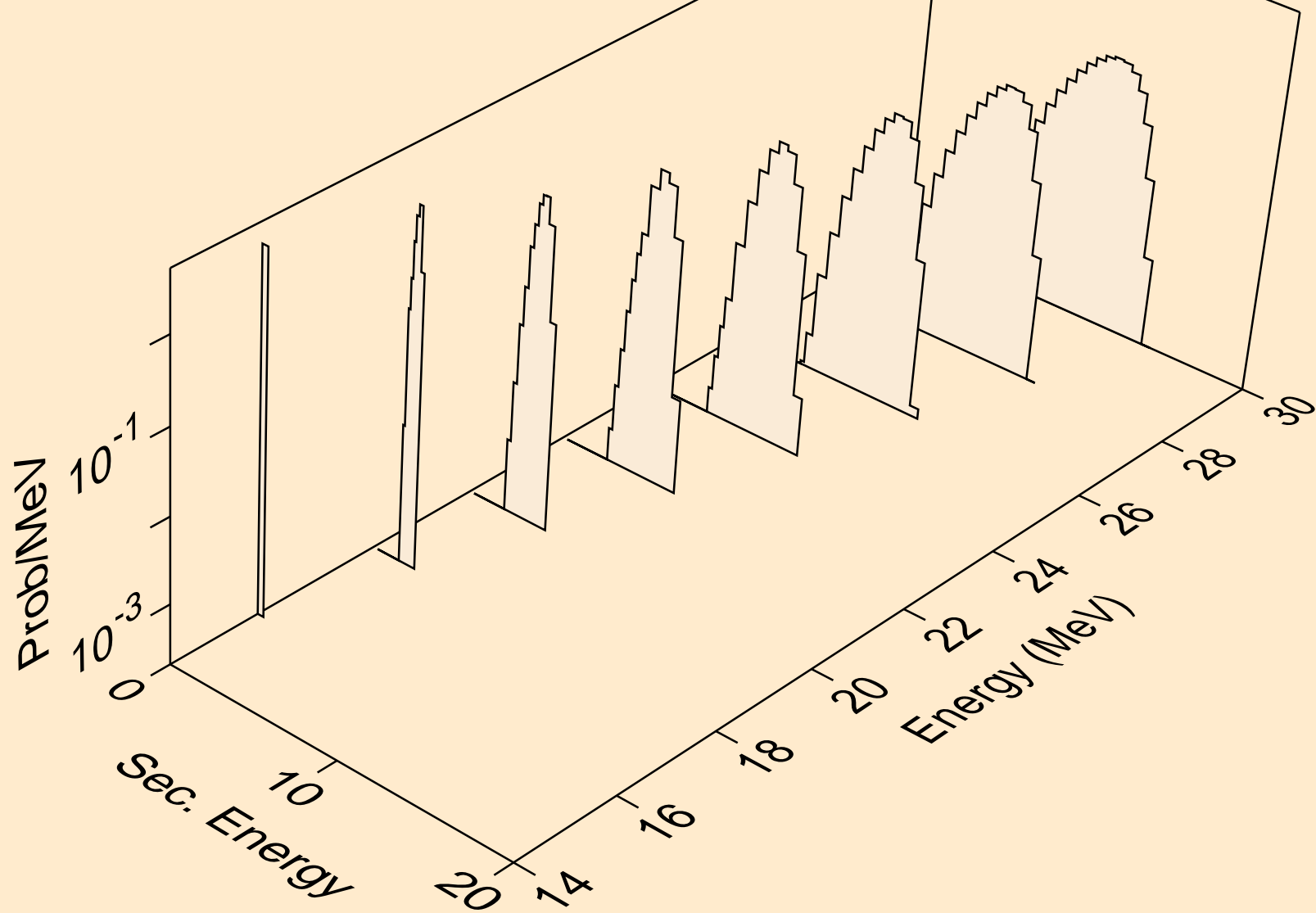

TL217 NEUTRON ACER TENDL-2023 LIBRARY; T=0.K
protons from (n,p)

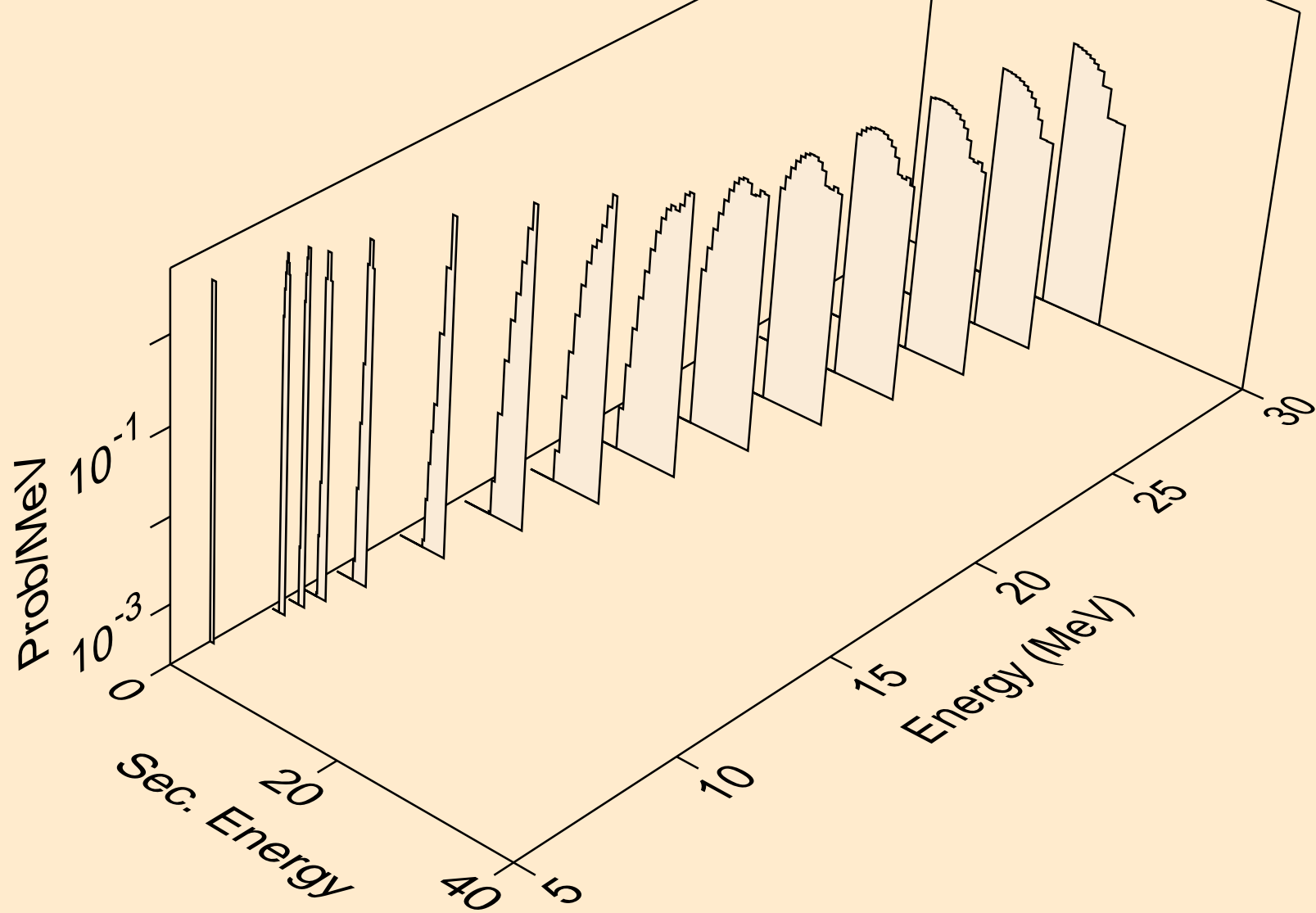

TL217 NEUTRON ACER TENDL-2023 LIBRARY; T=0.K
deuterons from (n,x)

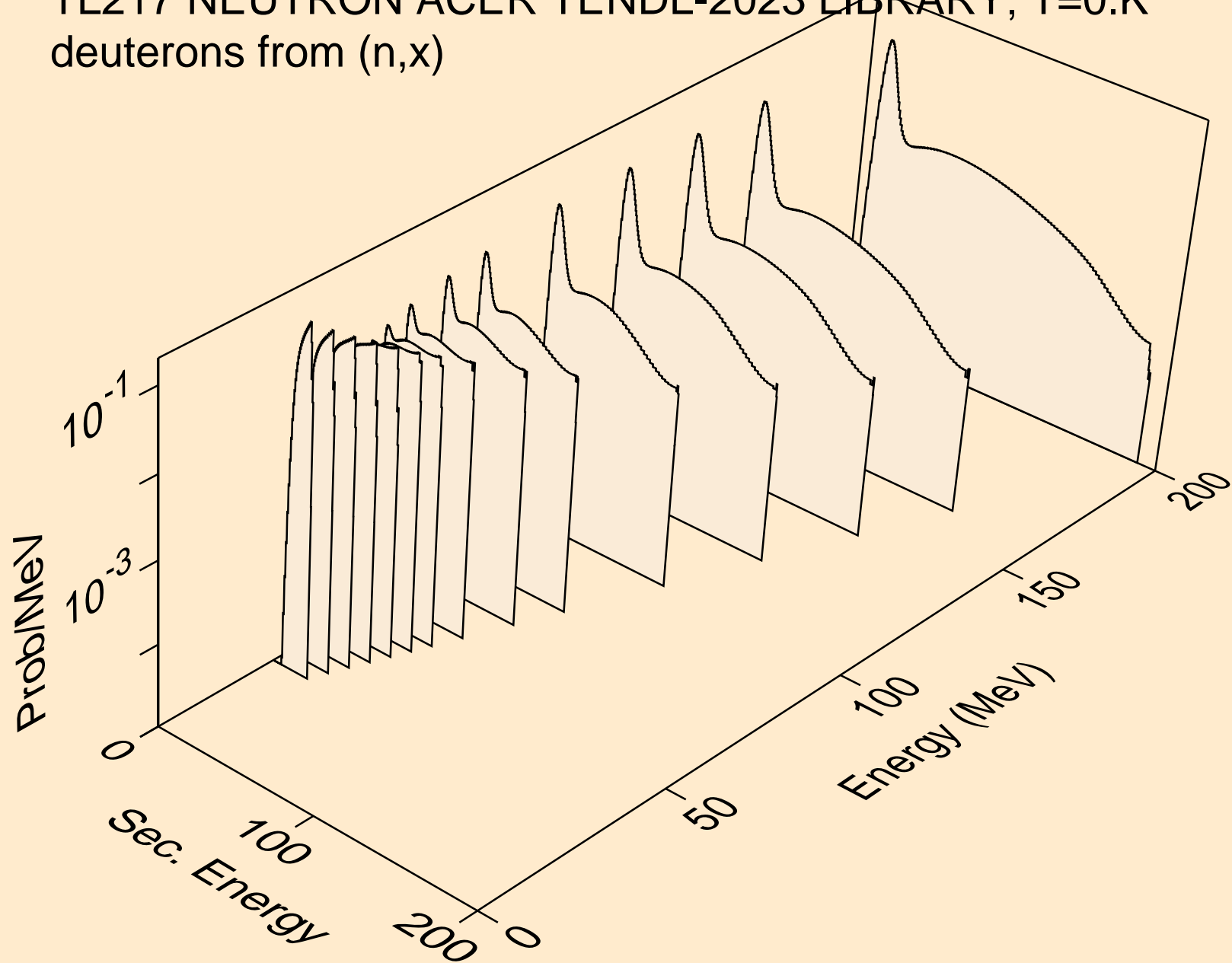

TL217 NEUTRON ACER TENDL-2023 LIBRARY; T=0.K
deuterons from (n,2nd)

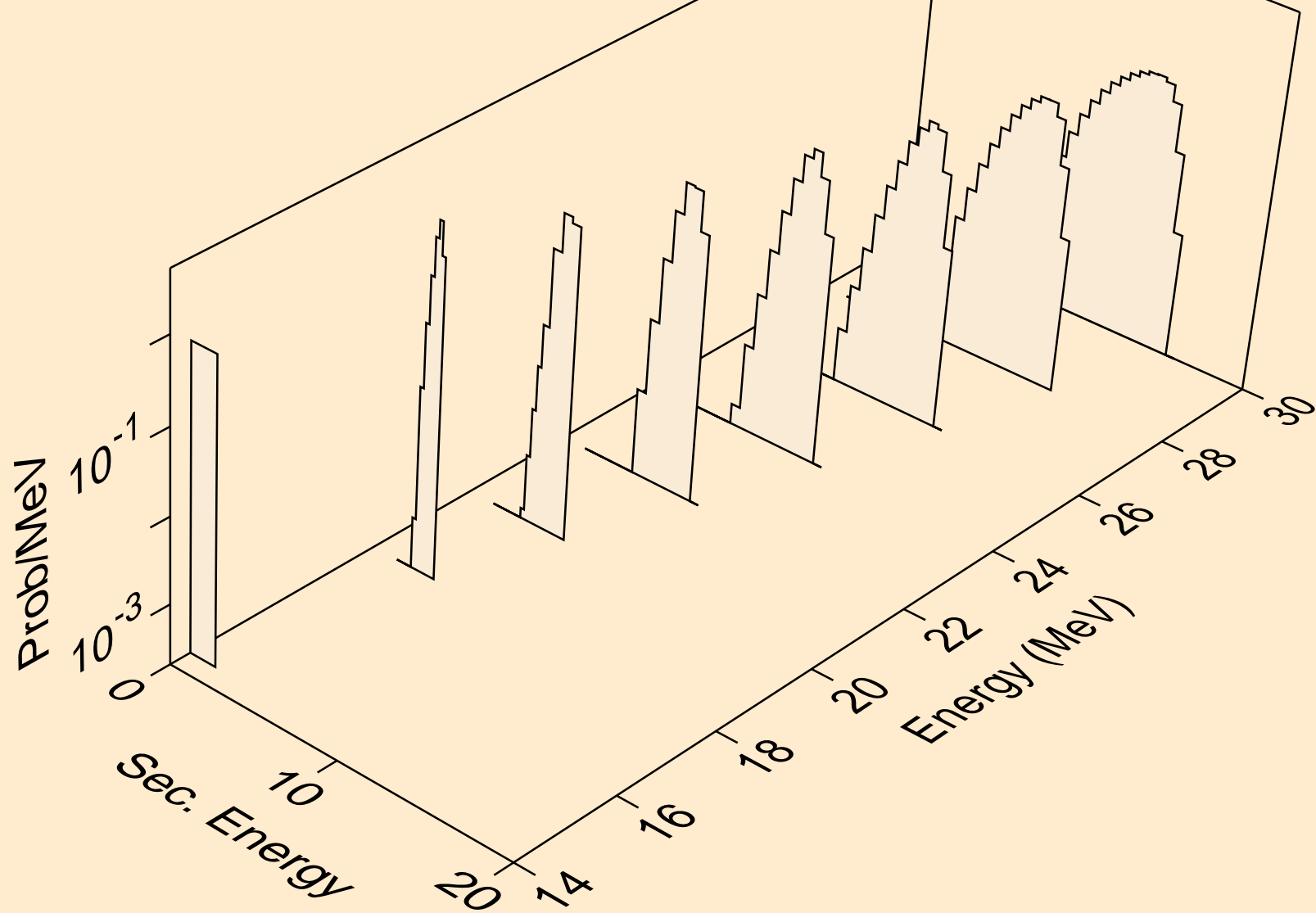

TL217 NEUTRON ACER TENDL-2023 LIBRARY; T=0.K
deuterons from (n,n*)d

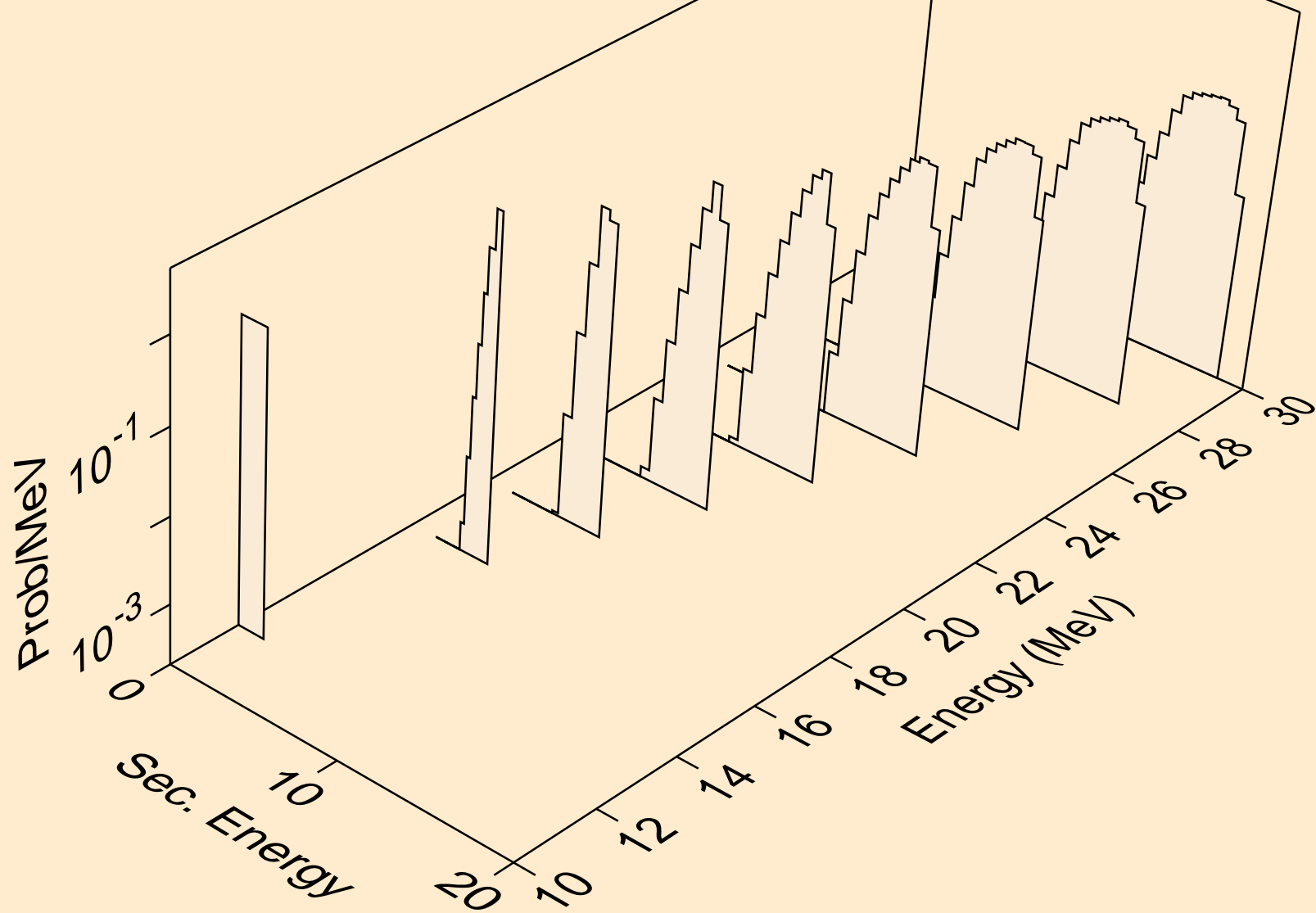

TL217 NEUTRON ACER TENDL-2023 LIBRARY; T=0.K
deuterons from (n,d)

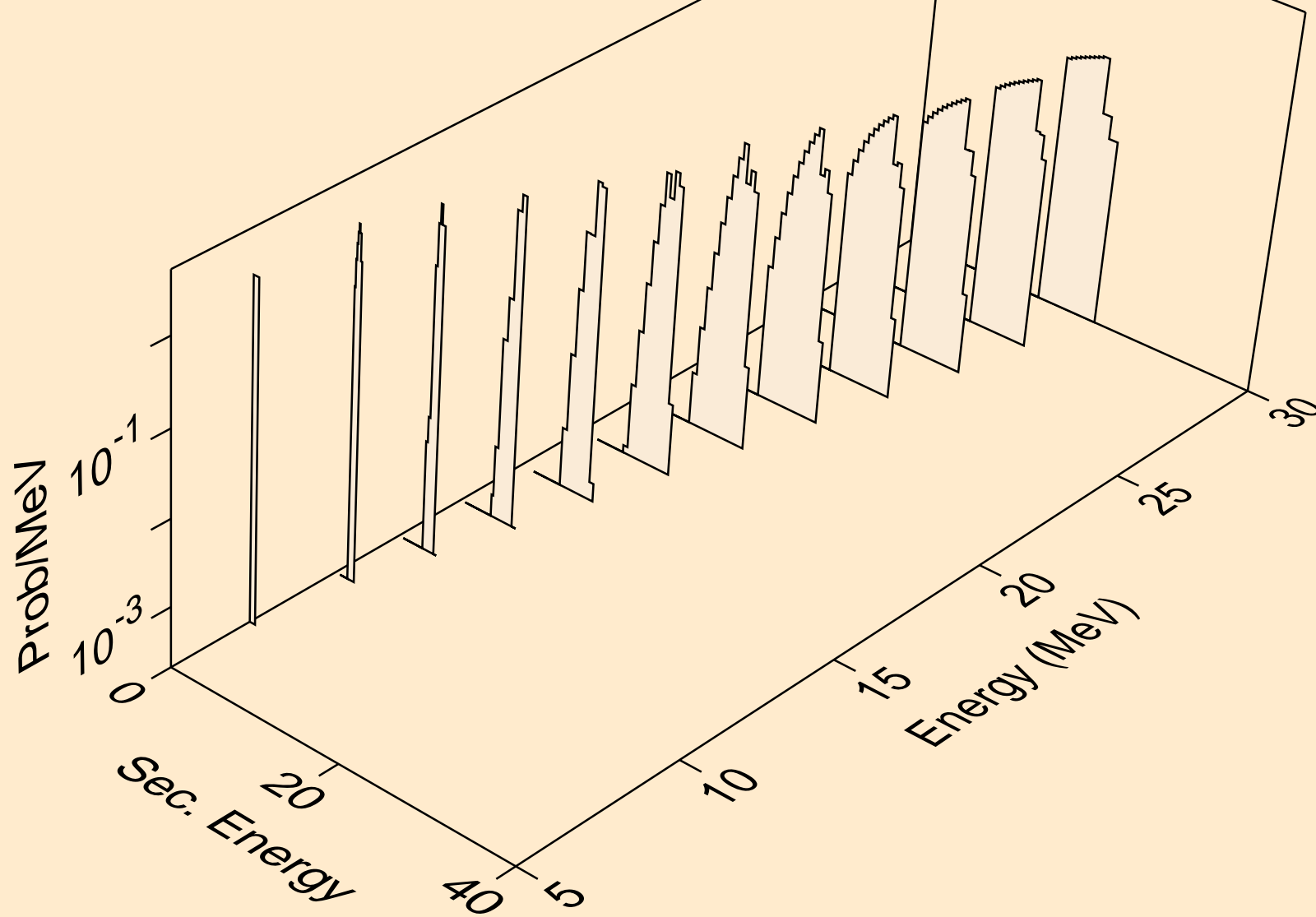

TL217 NEUTRON ACER TENDL-2023 LIBRARY; T=0.K
tritons from (n,x)

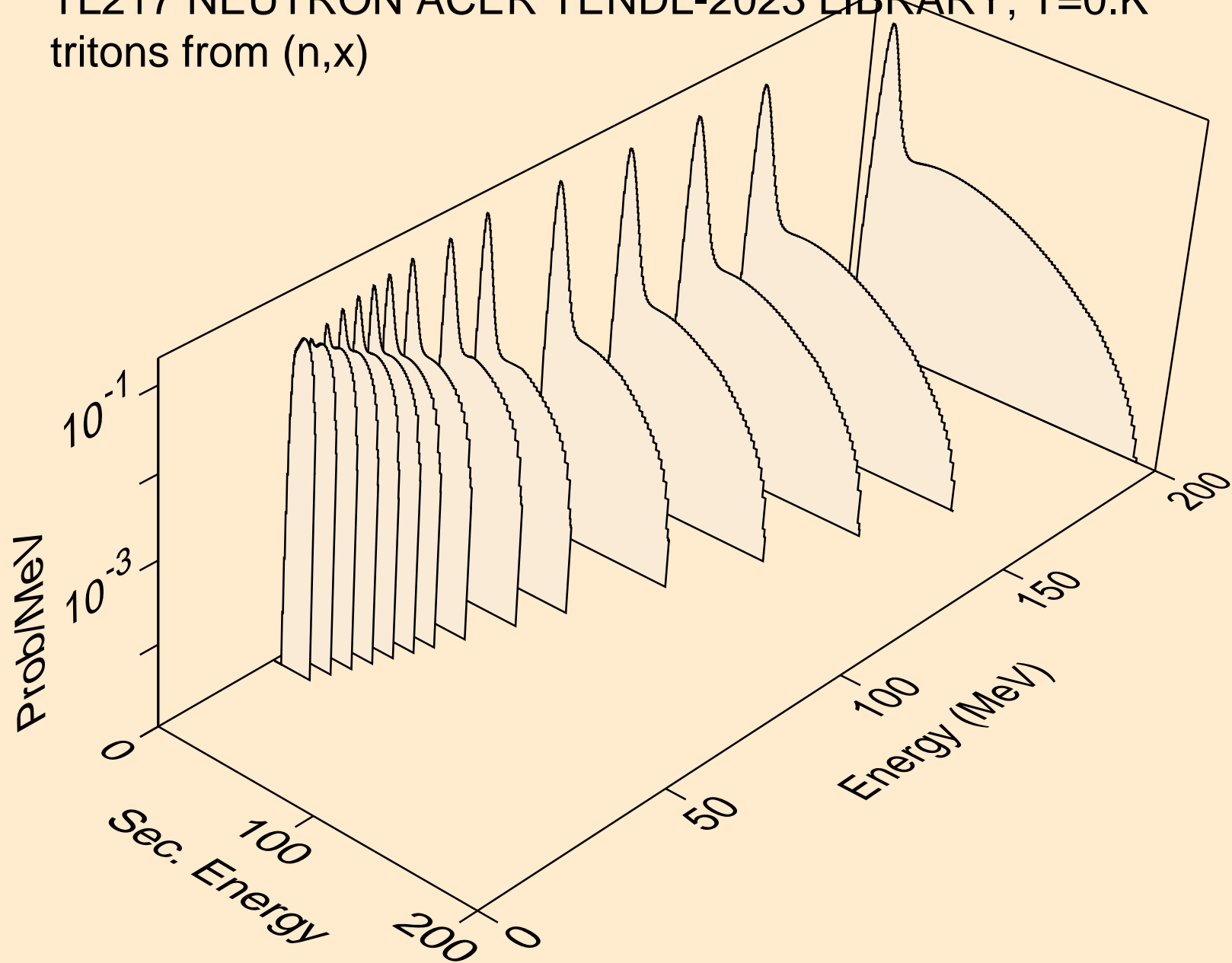

TL217 NEUTRON ACER TENDL-2023 LIBRARY; T=0.K
tritons from (n,n*)t

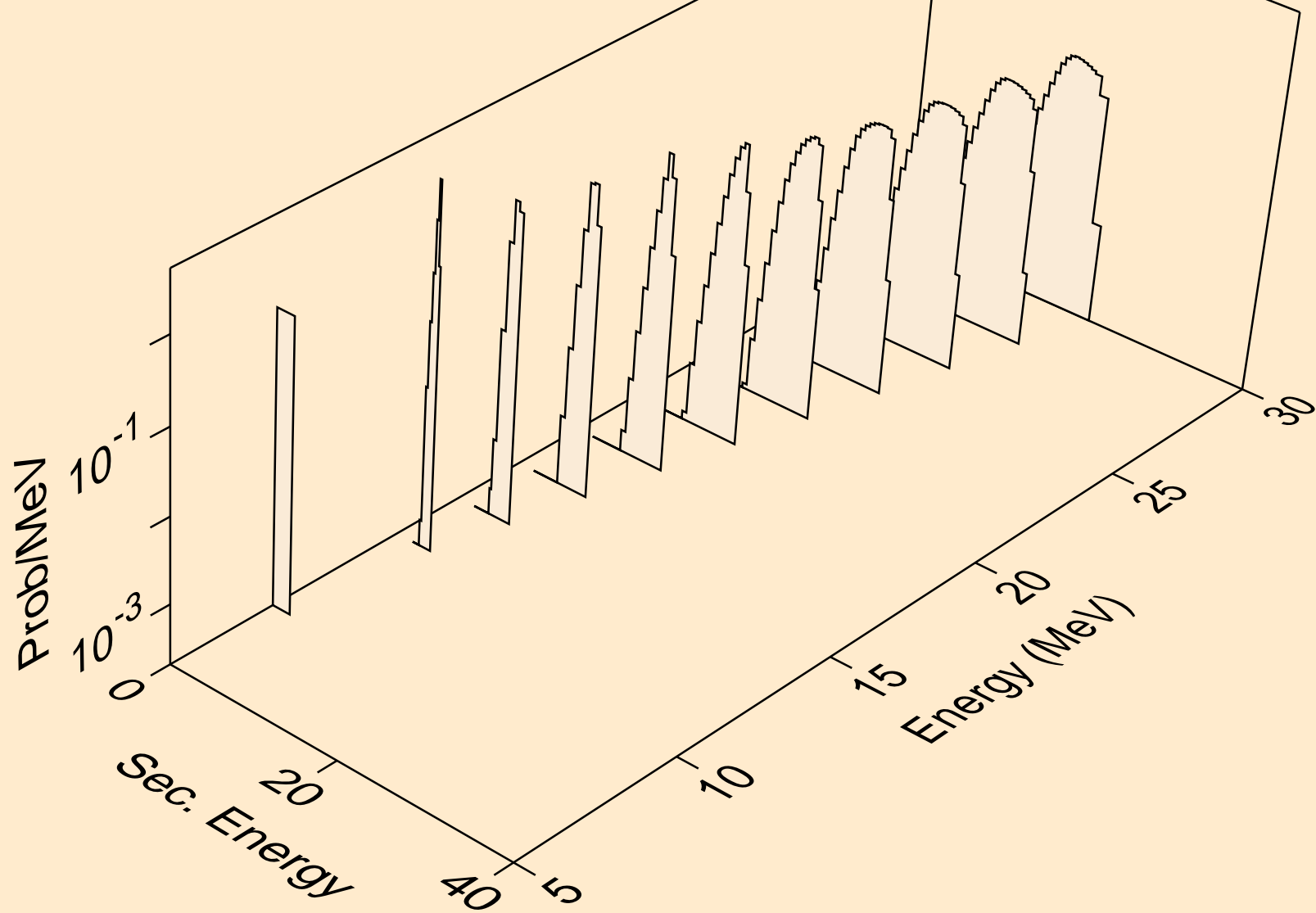

TL217 NEUTRON ACER TENDL-2023 LIBRARY; T=0.K
tritons from (n,t)

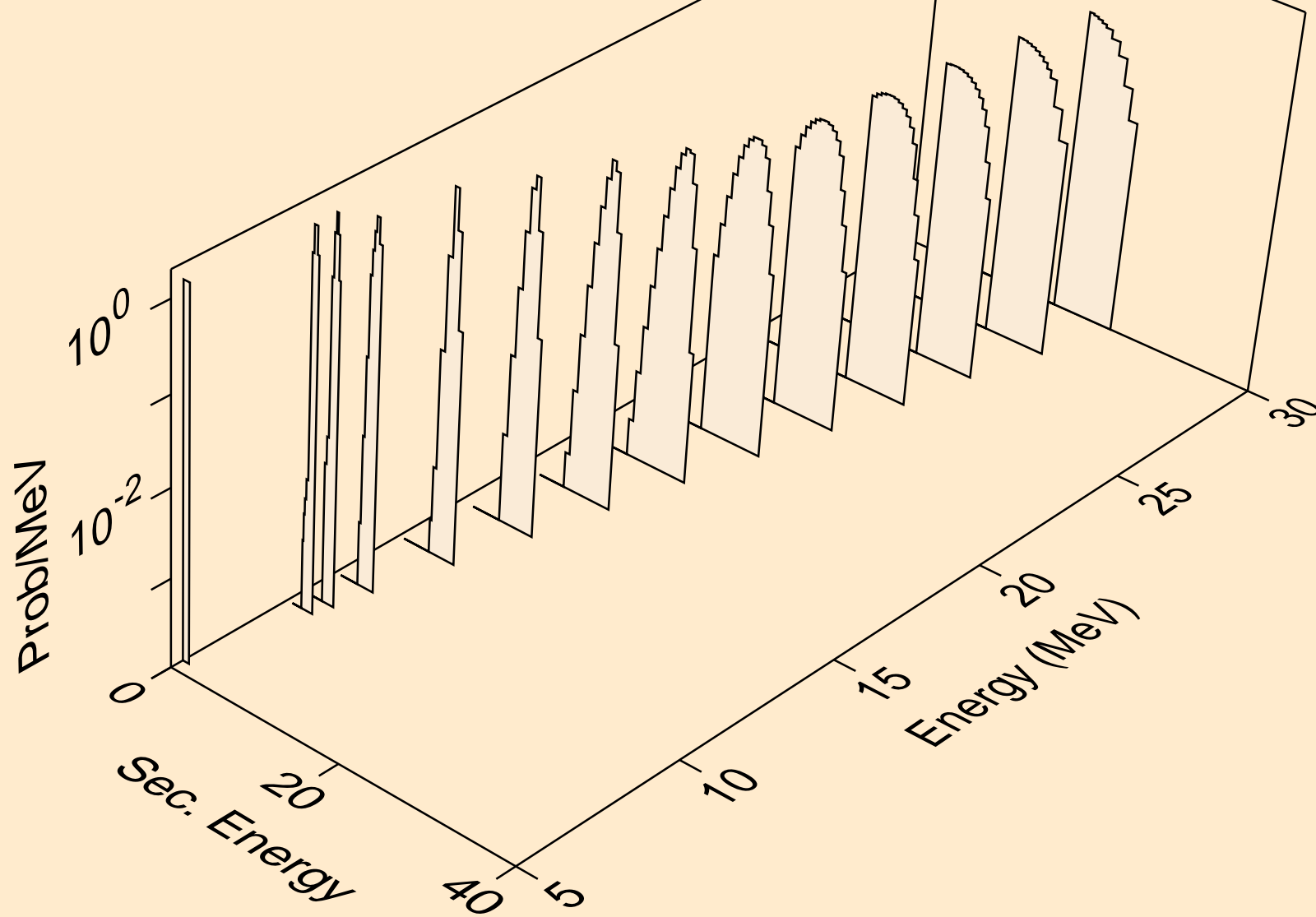

TL217 NEUTRON ACER TENDL-2023 LIBRARY; T=0.K
he3s from (n,x)

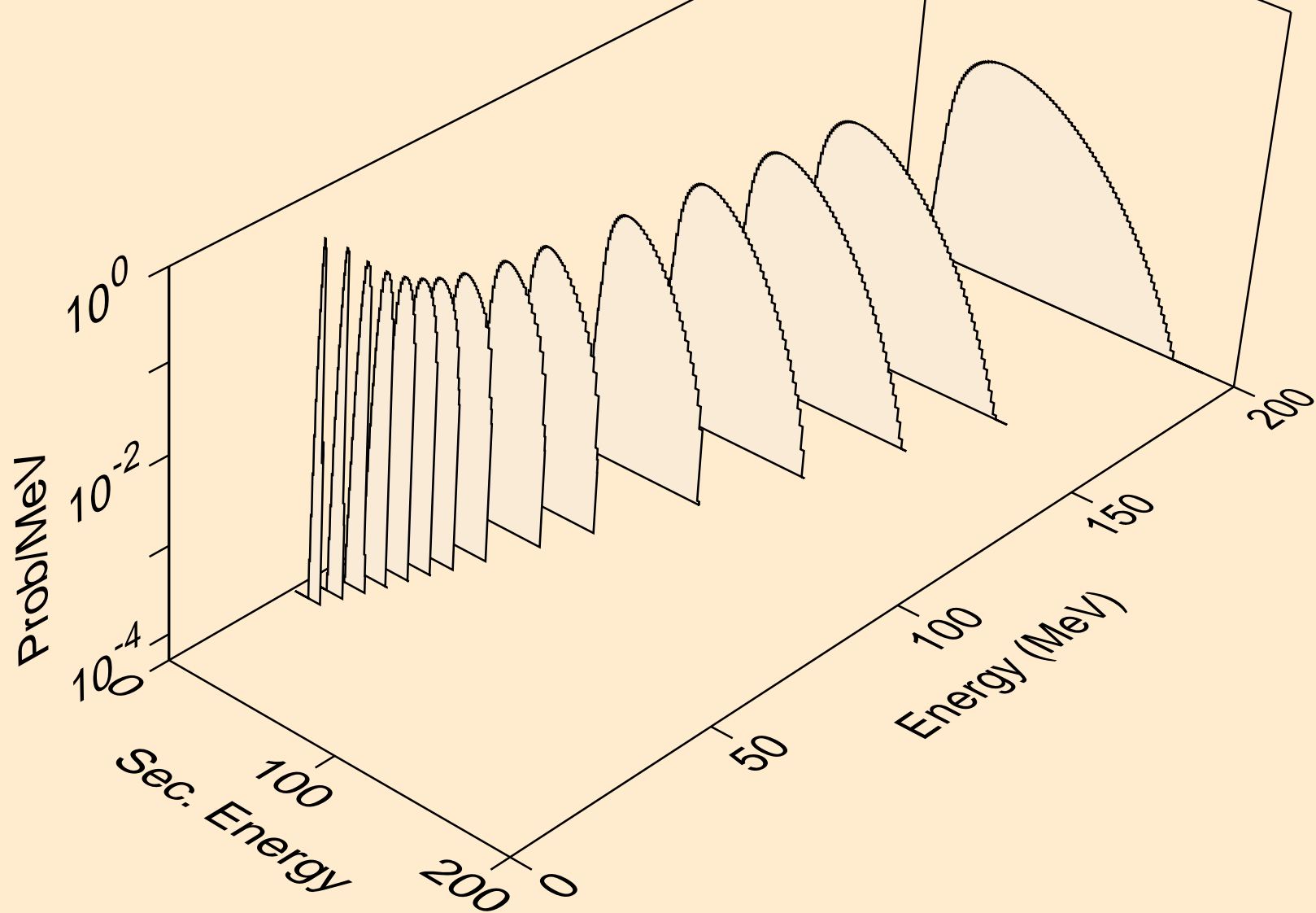

TL217 NEUTRON ACER TENDL-2023 LIBRARY; T=0.K
he3s from (n,n*)he3

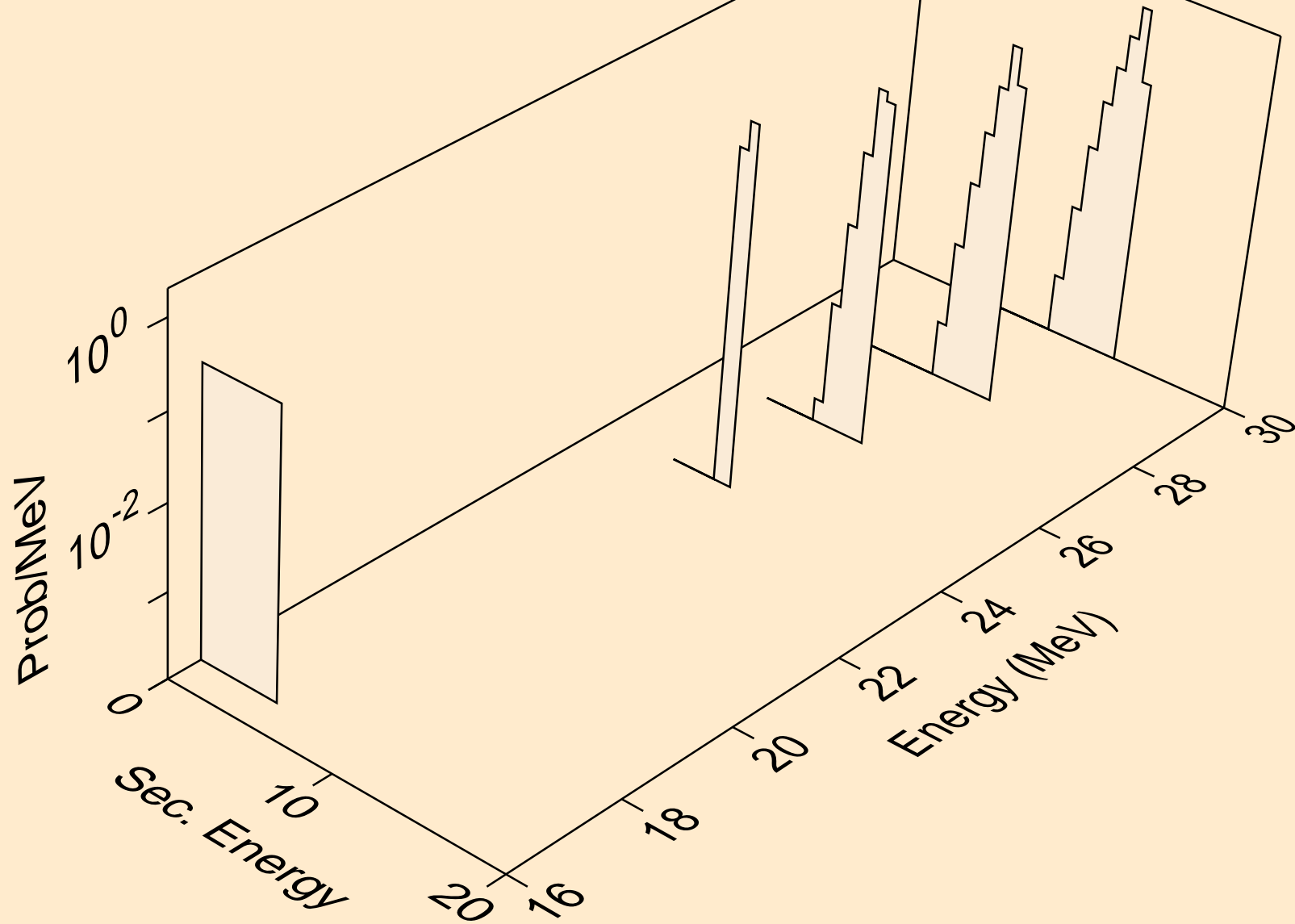

TL217 NEUTRON ACER TENDL-2023 LIBRARY; T=0.K
he3s from (n,he3)

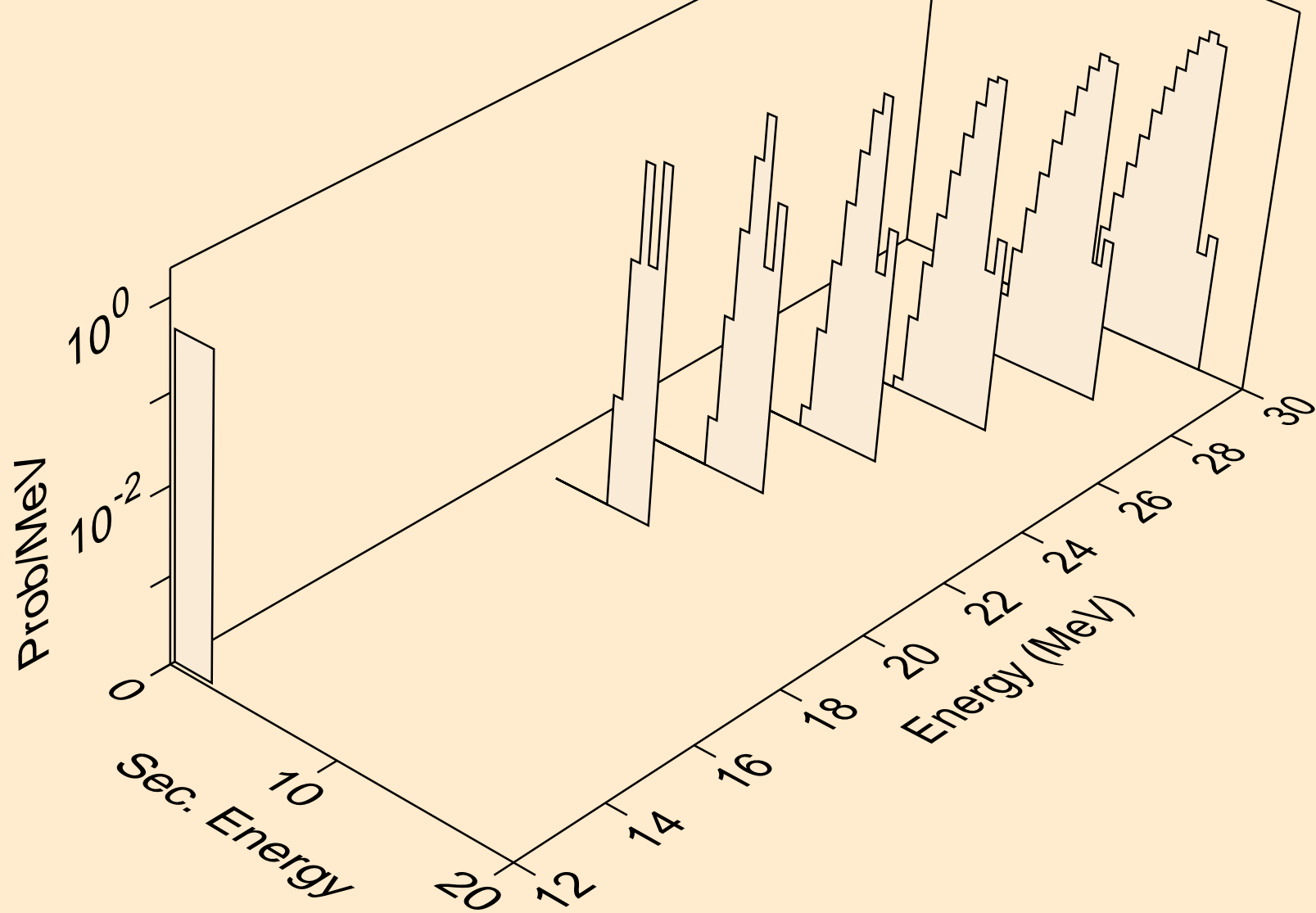

TL217 NEUTRON ACER TENDL-2023 LIBRARY; T=0.K
alphas from (n,x)

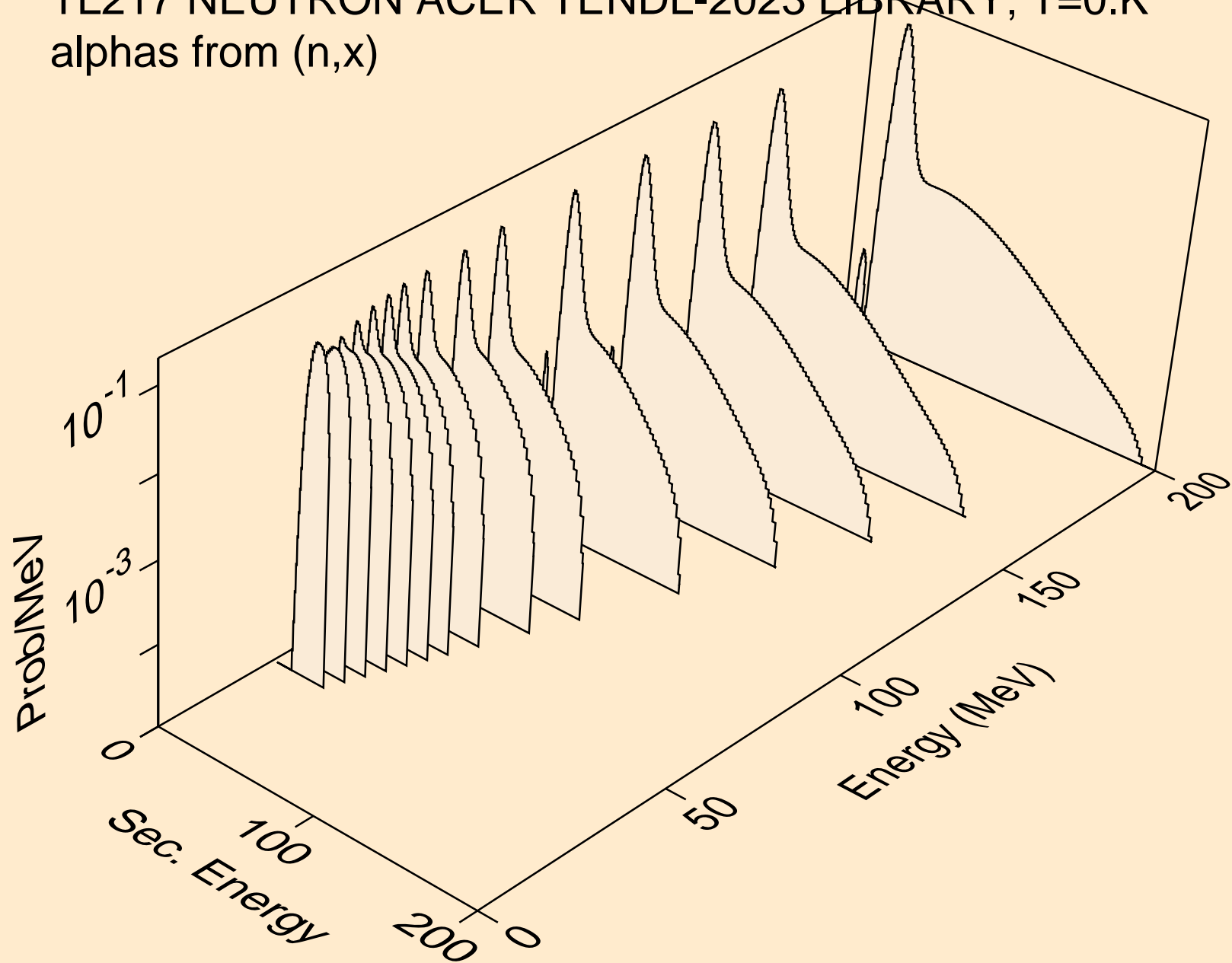

TL217 NEUTRON ACER TENDL-2023 LIBRARY; T=0.K
alphas from (n,n*)a

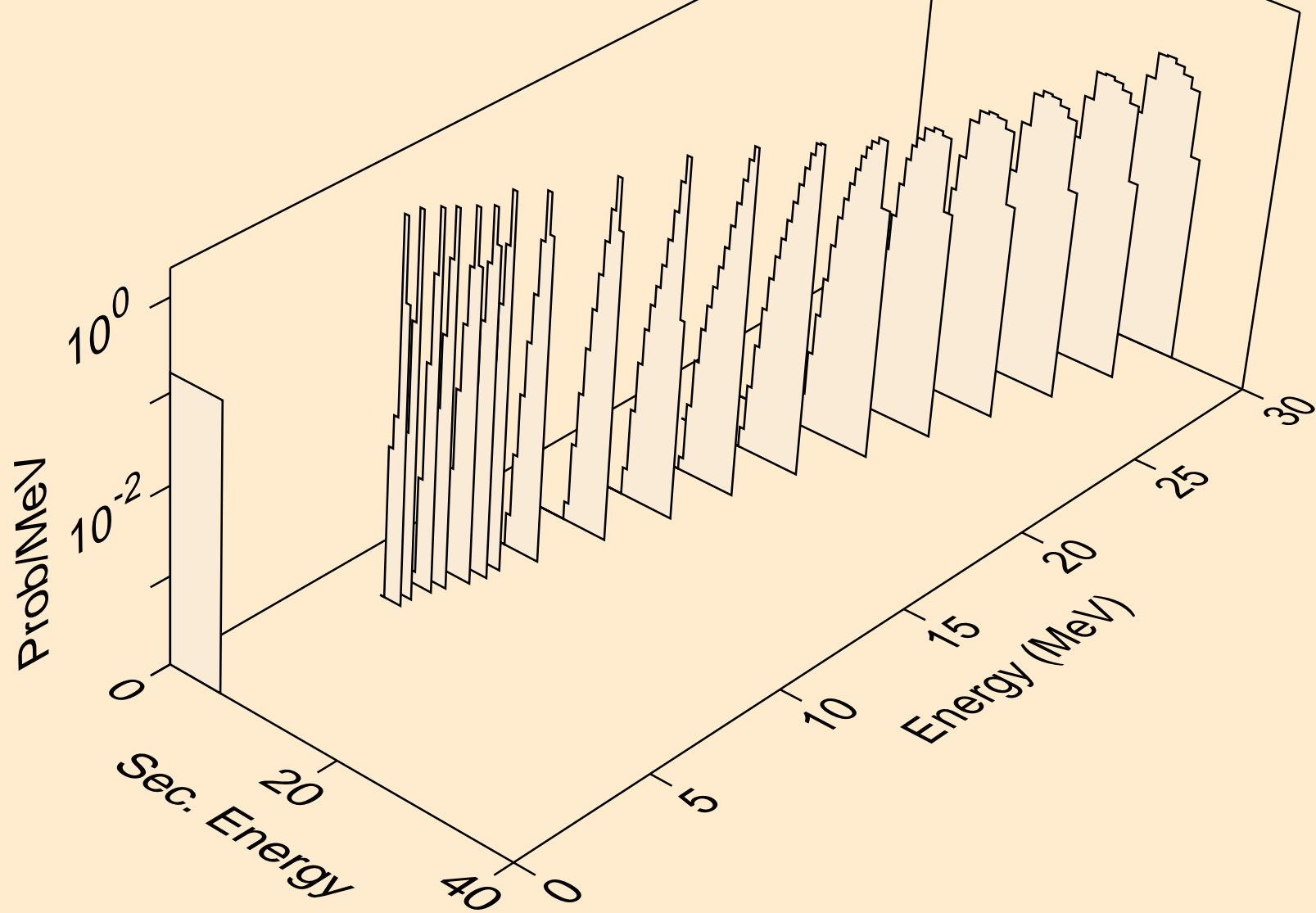

TL217 NEUTRON ACER TENDL-2023 LIBRARY; T=0.K
alphas from (n,2n)a

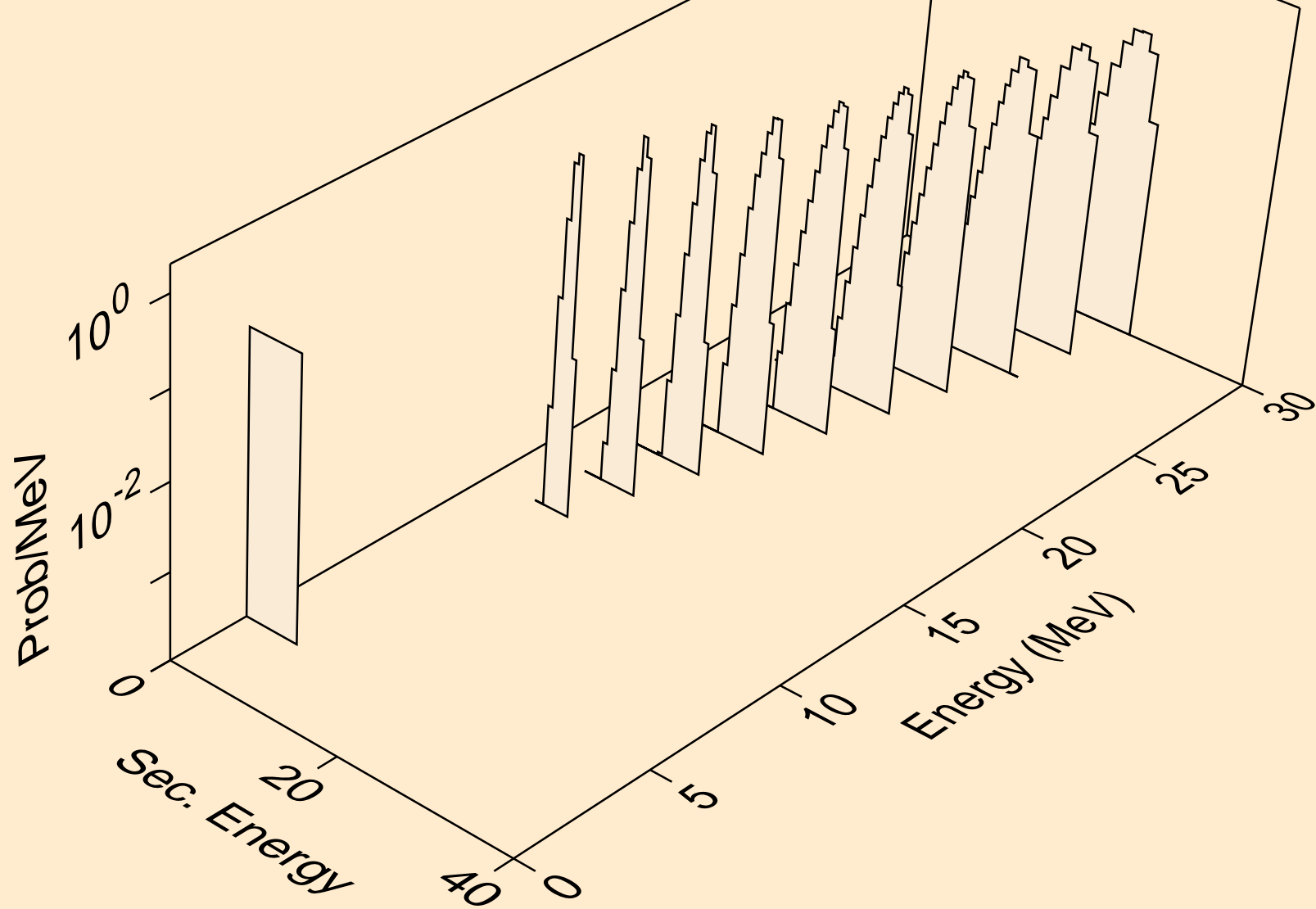

TL217 NEUTRON ACER TENDL-2023 LIBRARY; T=0.K
alphas from (n,3n)a

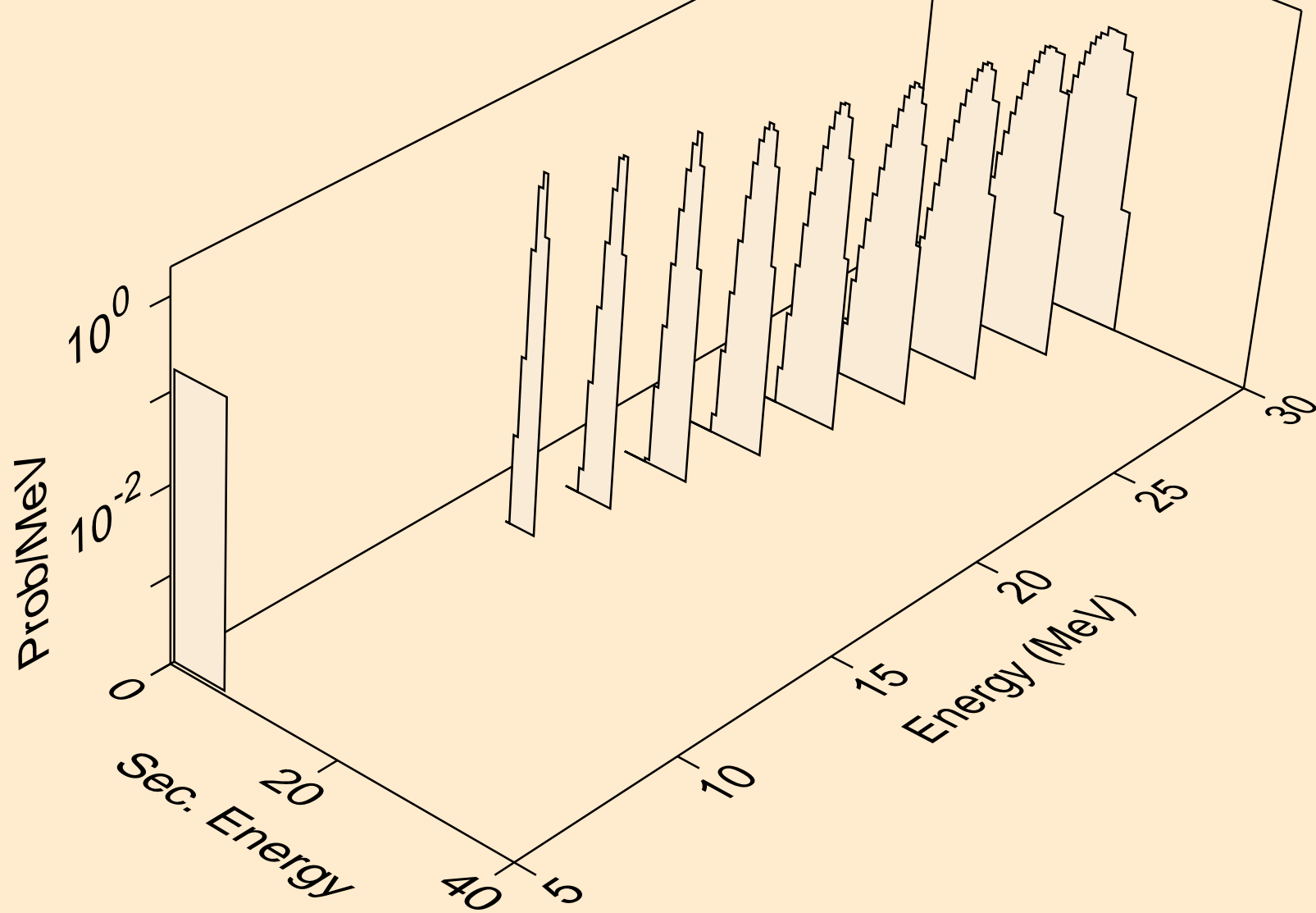

TL217 NEUTRON ACER TENDL-2023 LIBRARY; T=0.K
alphas from (n,a)

