

U243 NEUTRON ACER TENDL-2023 LIBRARY; T=0.K

Principal cross sections

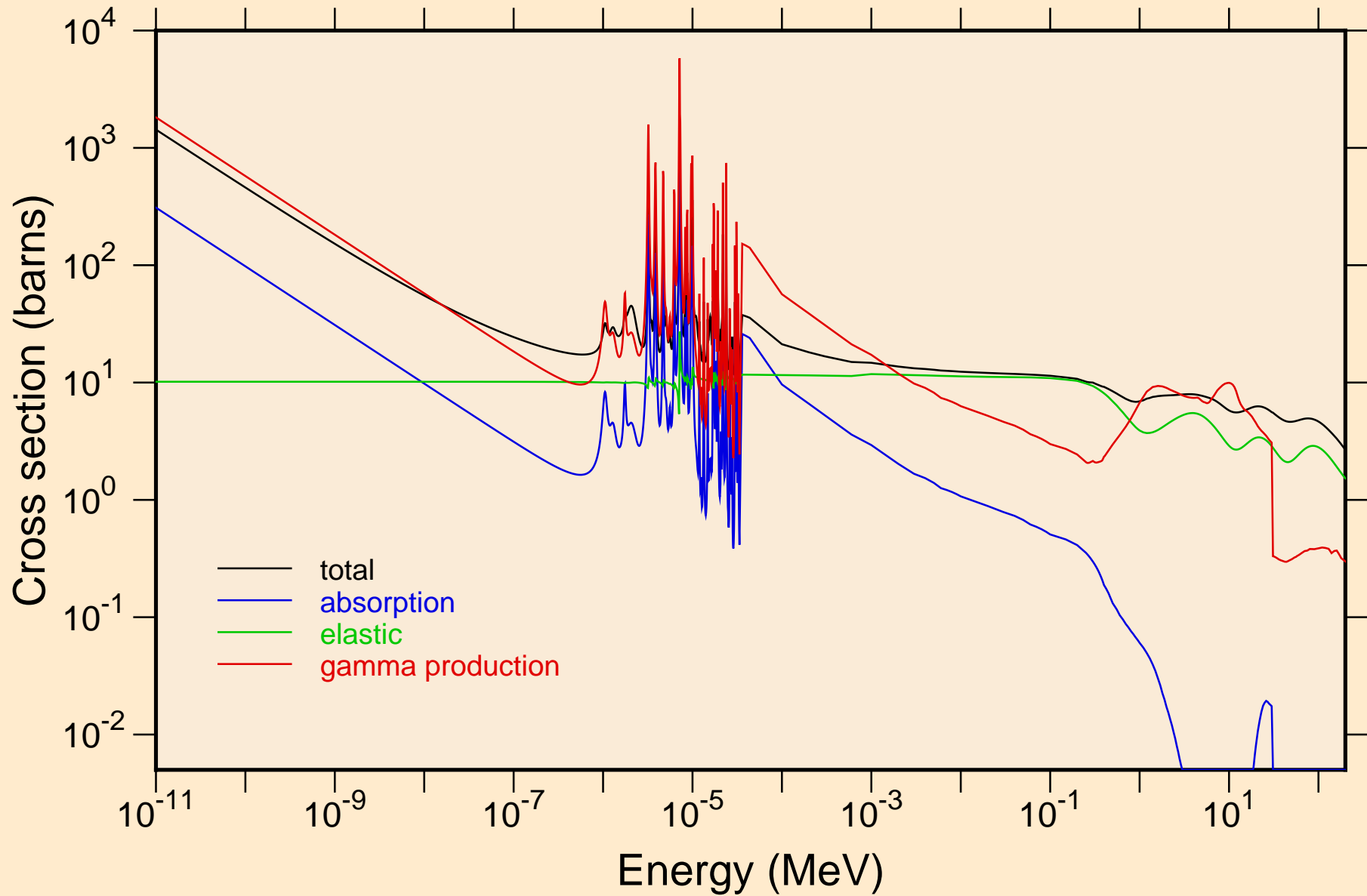

U243 NEUTRON ACER TENDL-2023 LIBRARY; T=0.K
resonance total cross section

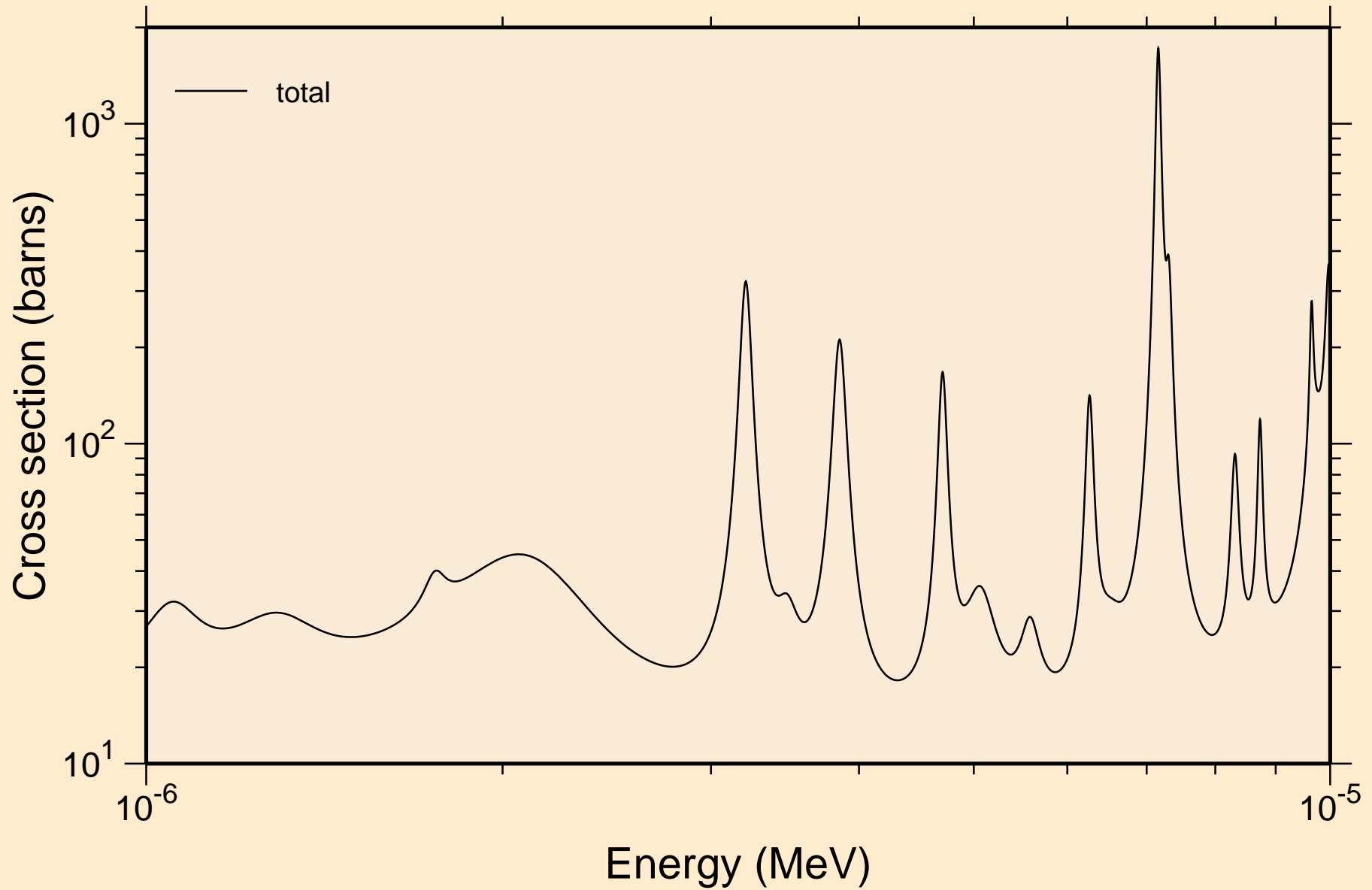

U243 NEUTRON ACER TENDL-2023 LIBRARY; T=0.K
resonance total cross section

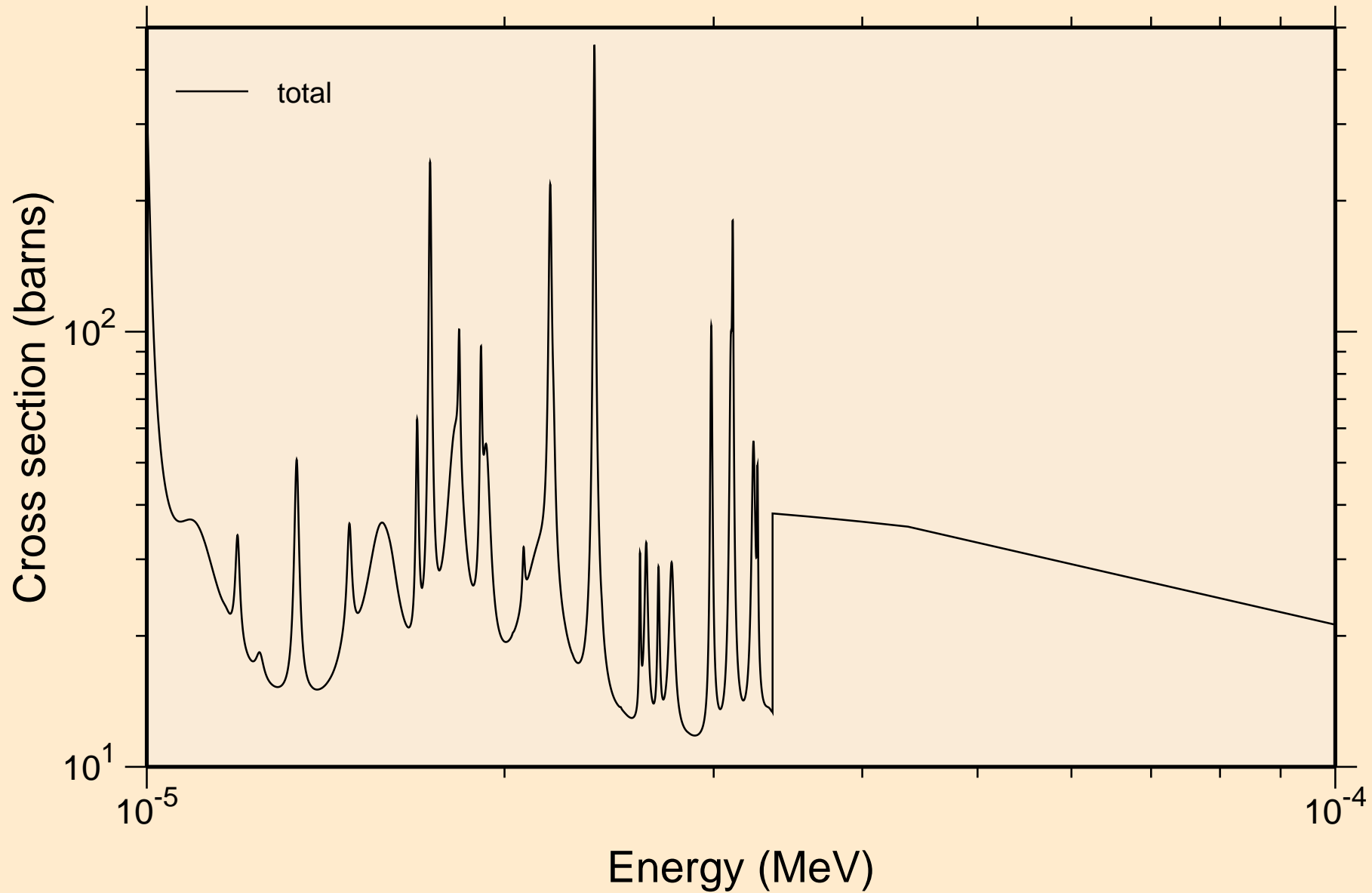

U243 NEUTRON ACER TENDL-2023 LIBRARY; T=0.K
resonance total cross section

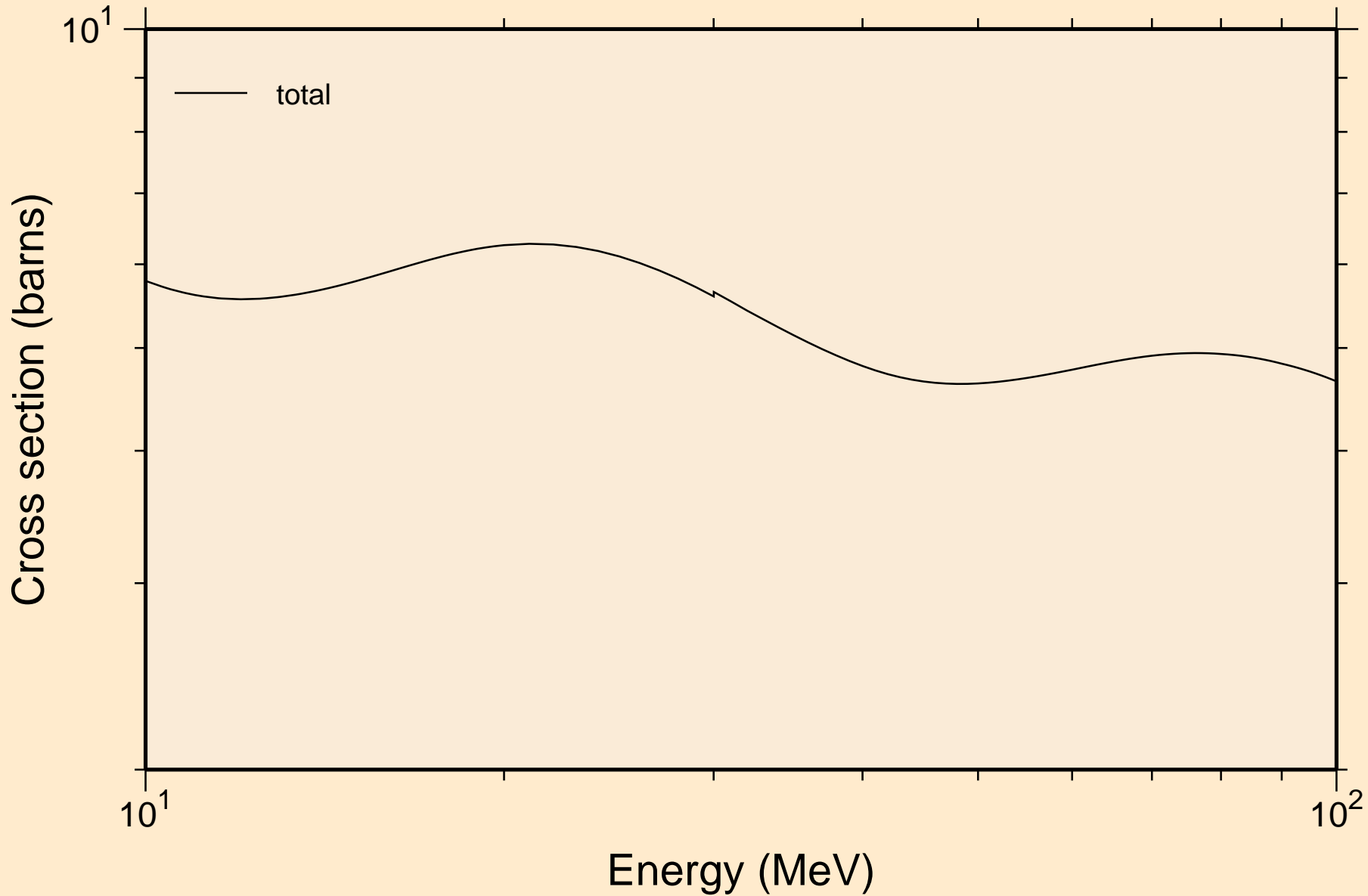

U243 NEUTRON ACER TENDL-2023 LIBRARY; T=0.K
resonance absorption cross sections

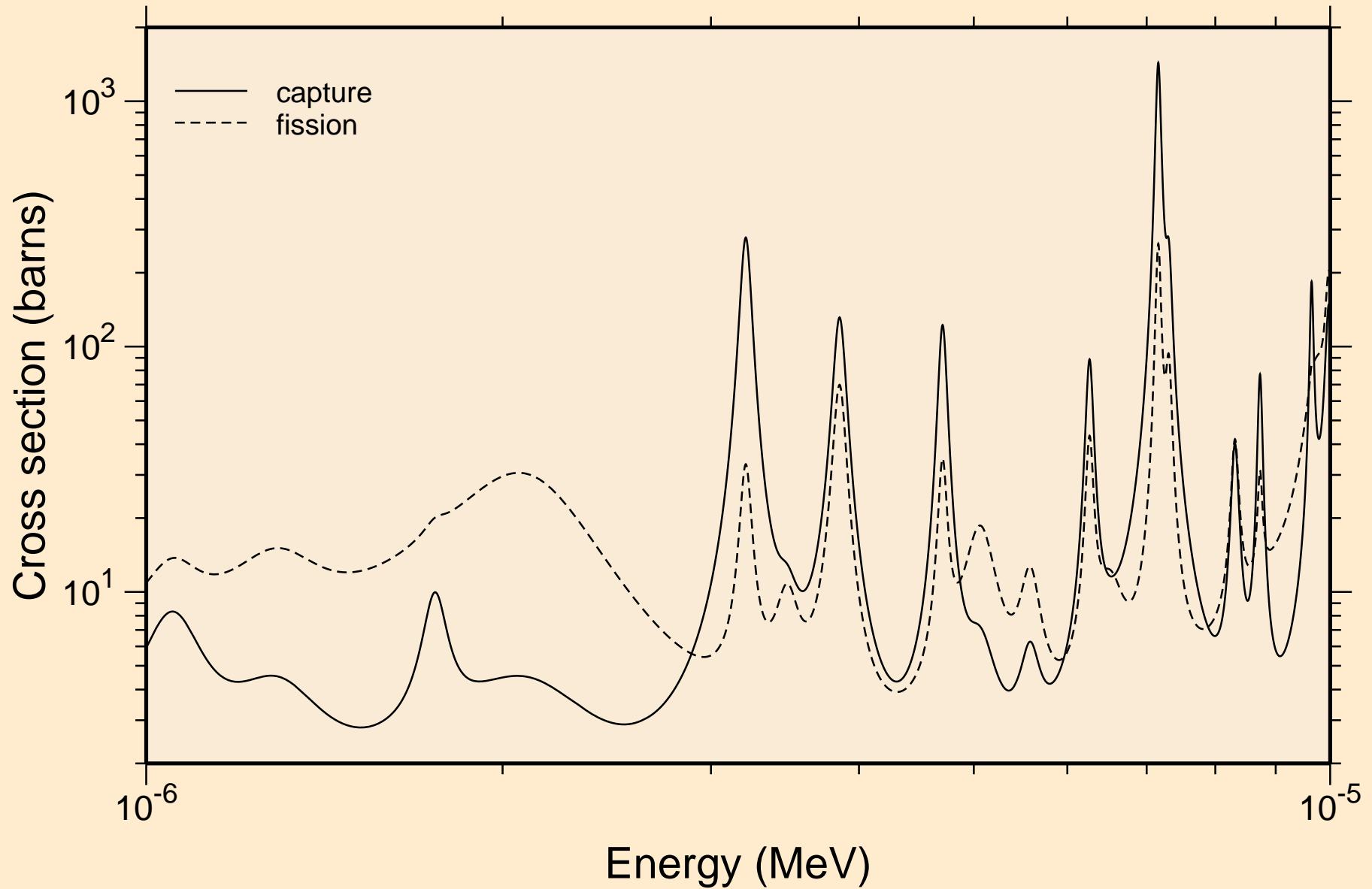

U243 NEUTRON ACER TENDL-2023 LIBRARY; T=0.K
resonance absorption cross sections

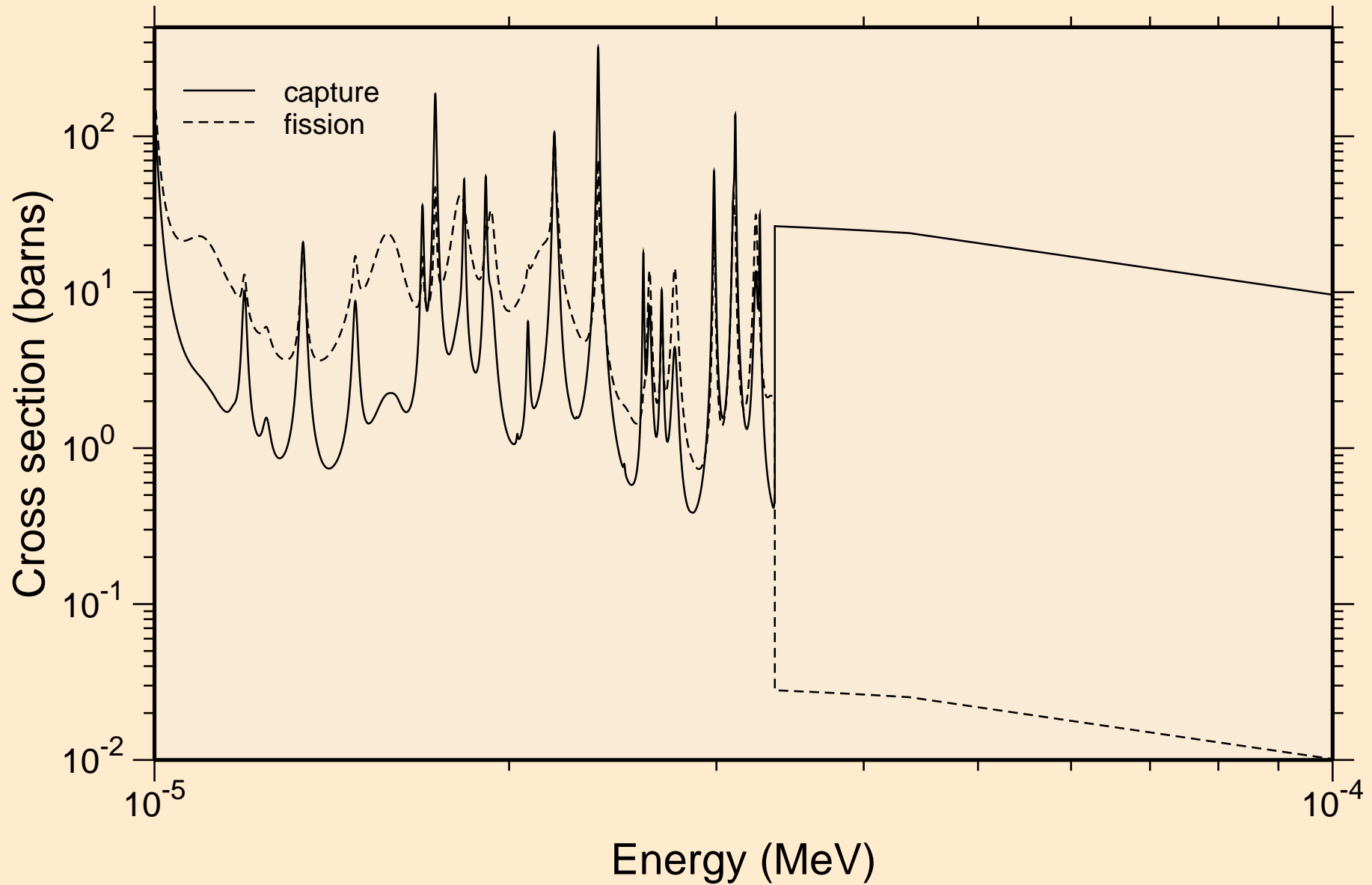

U243 NEUTRON ACER TENDL-2023 LIBRARY; T=0.K

resonance absorption cross sections

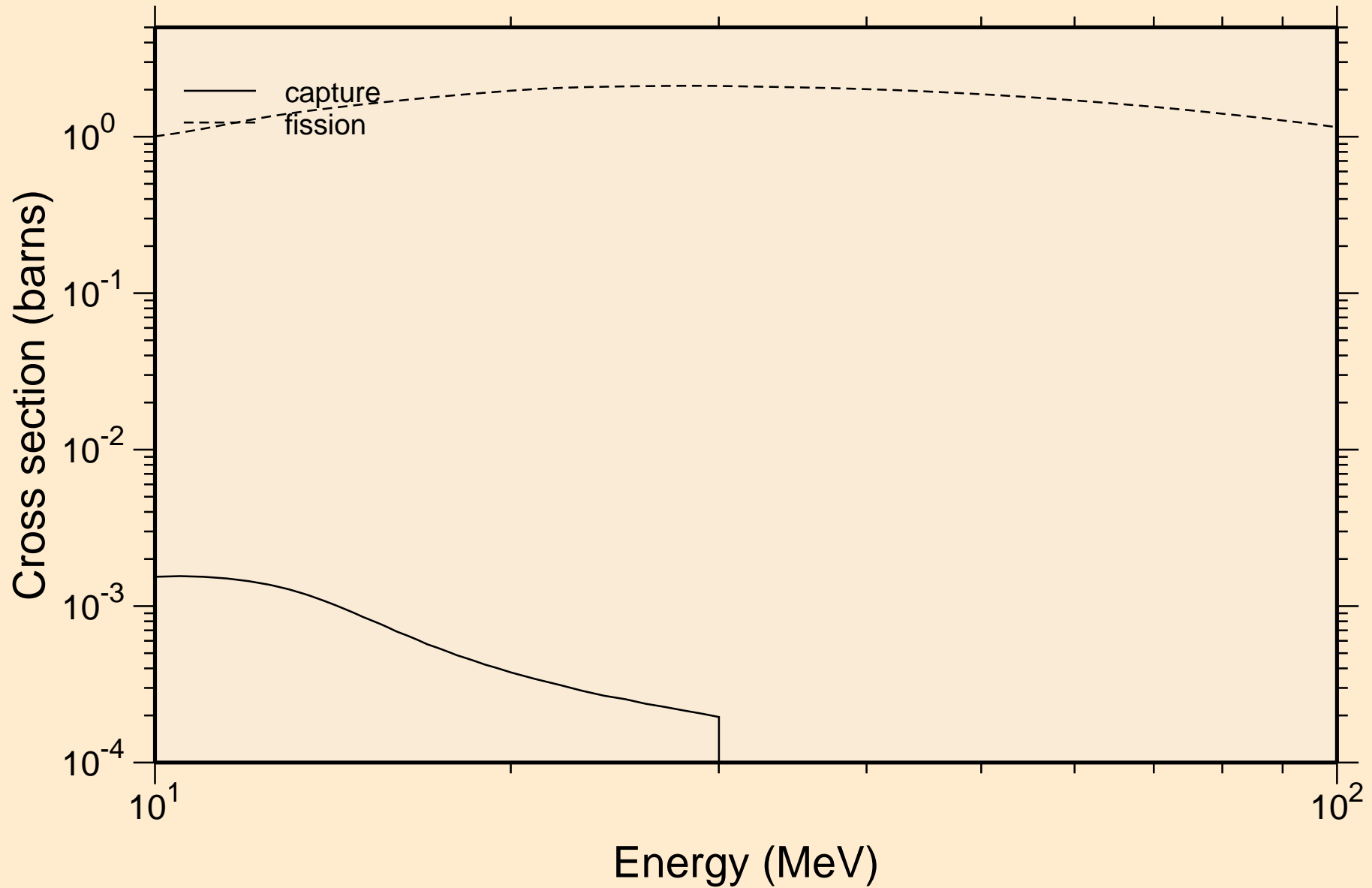

U243 NEUTRON ACER TENDL-2023 LIBRARY; T=0.K

Heating

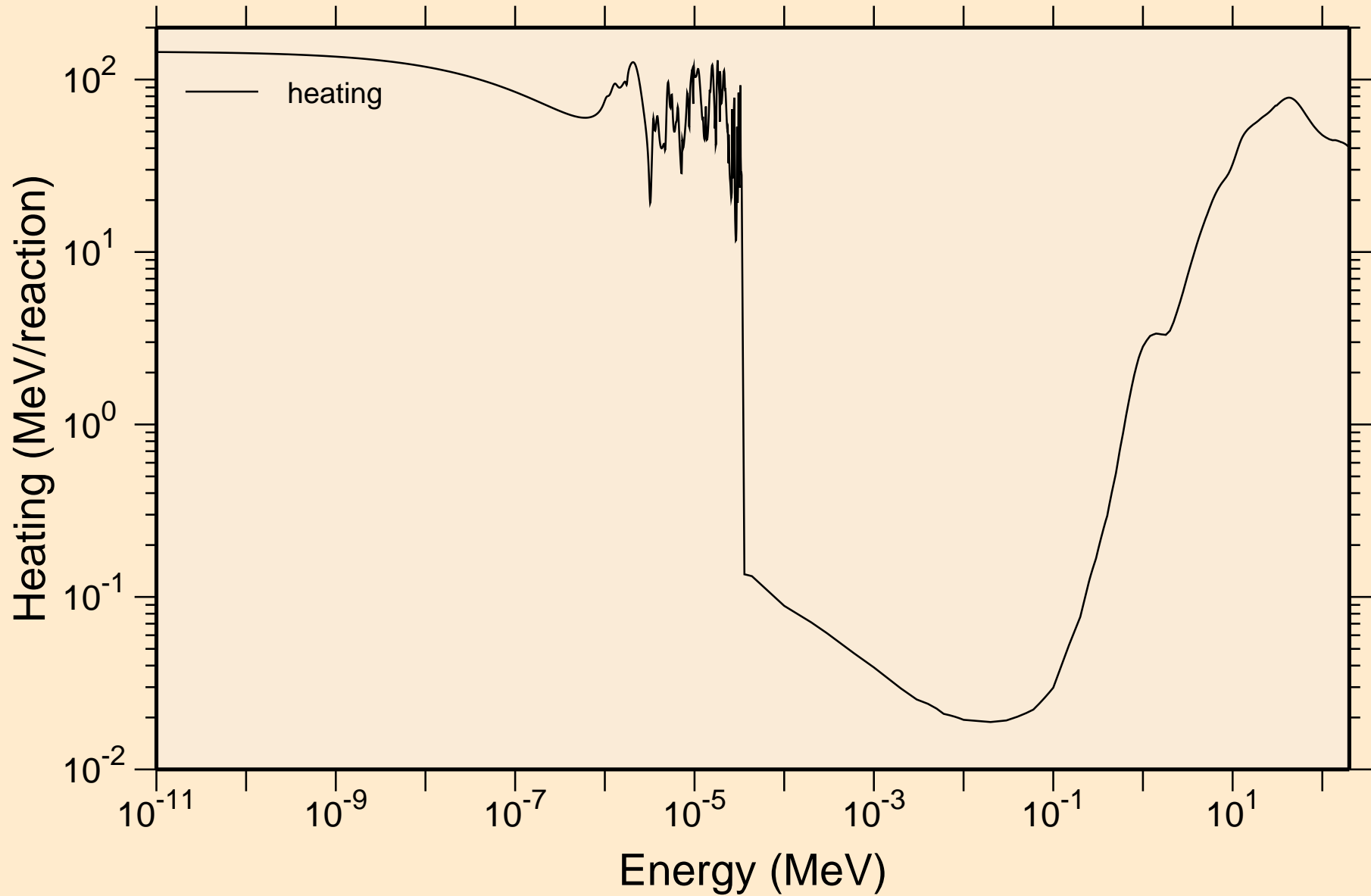

U243 NEUTRON ACER TENDL-2023 LIBRARY; T=0.K
Damage

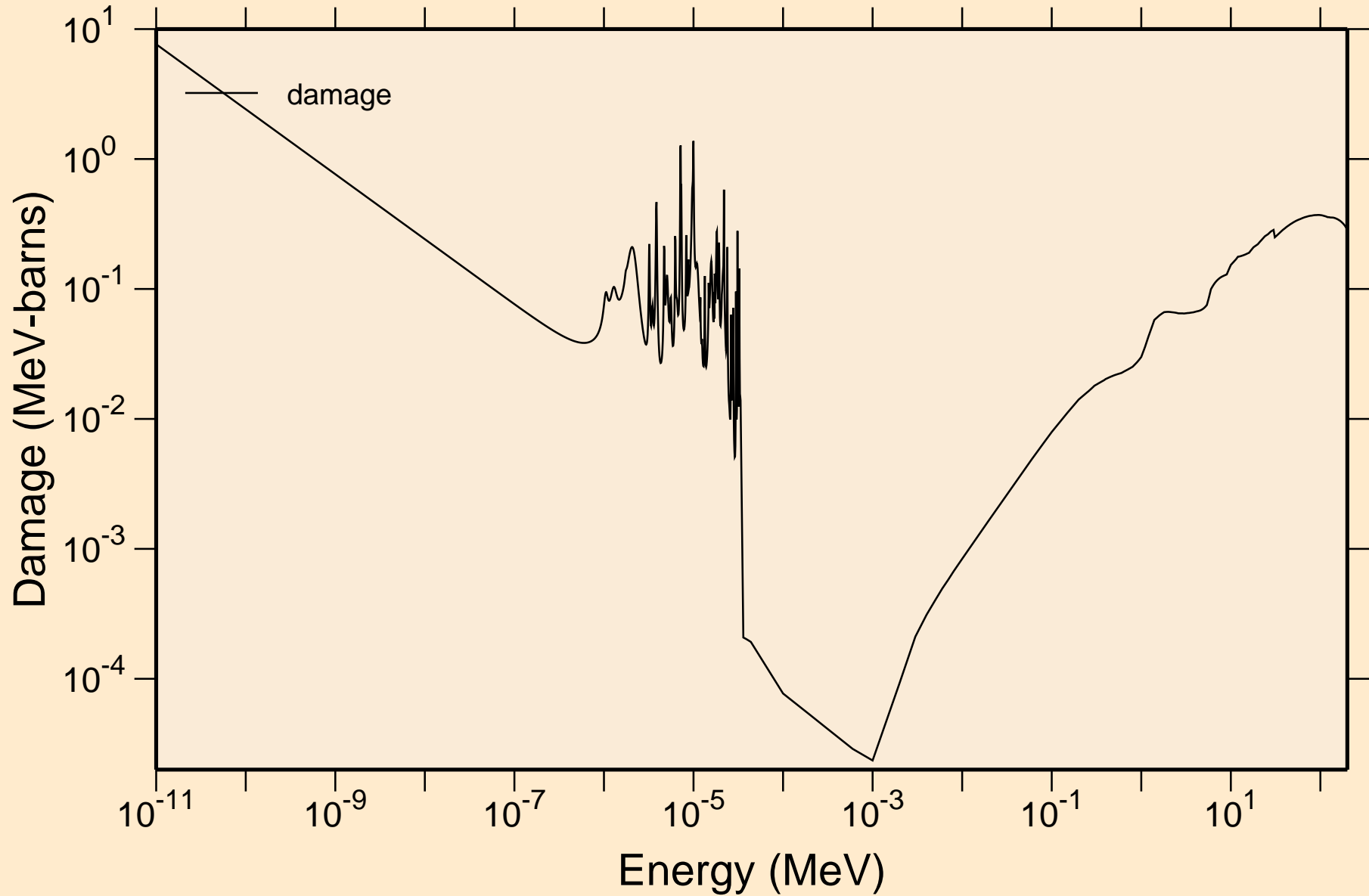

U243 NEUTRON ACER TENDL-2023 LIBRARY; T=0.K

Non-threshold reactions

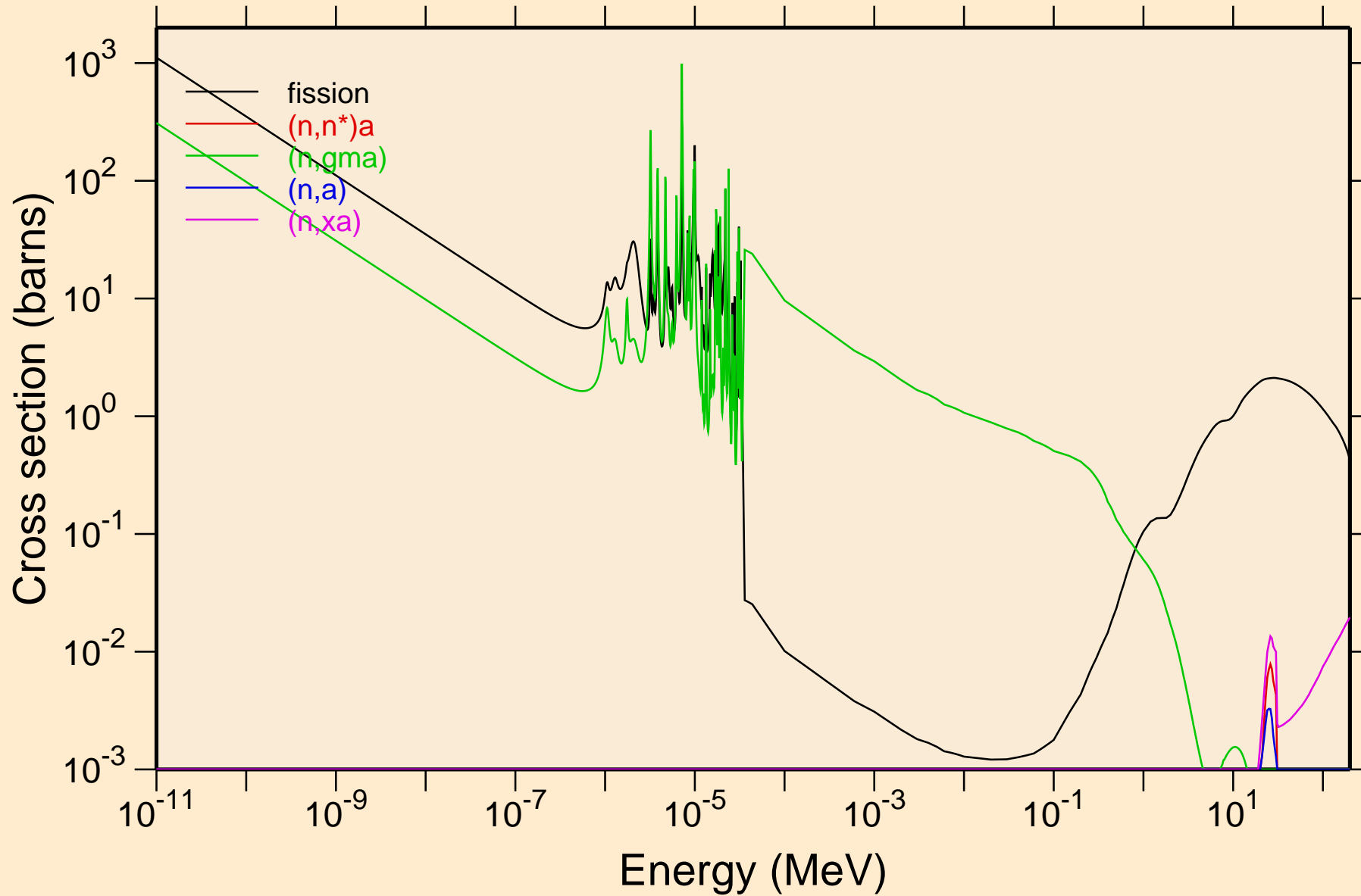

U243 NEUTRON ACER TENDL-2023 LIBRARY; T=0.K
Principal cross sections

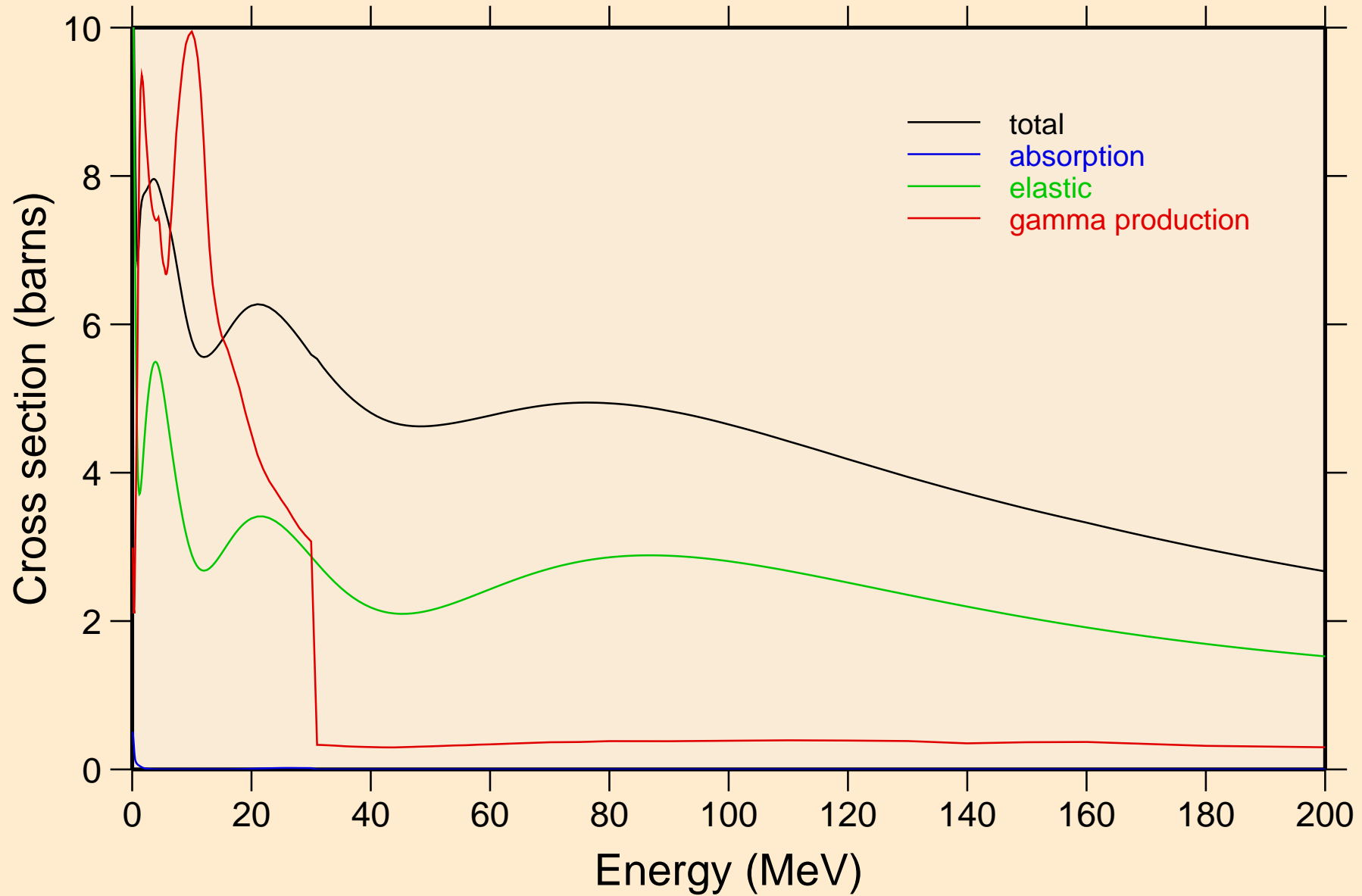

U243 NEUTRON ACER TENDL-2023 LIBRARY; T=0.K

Heating

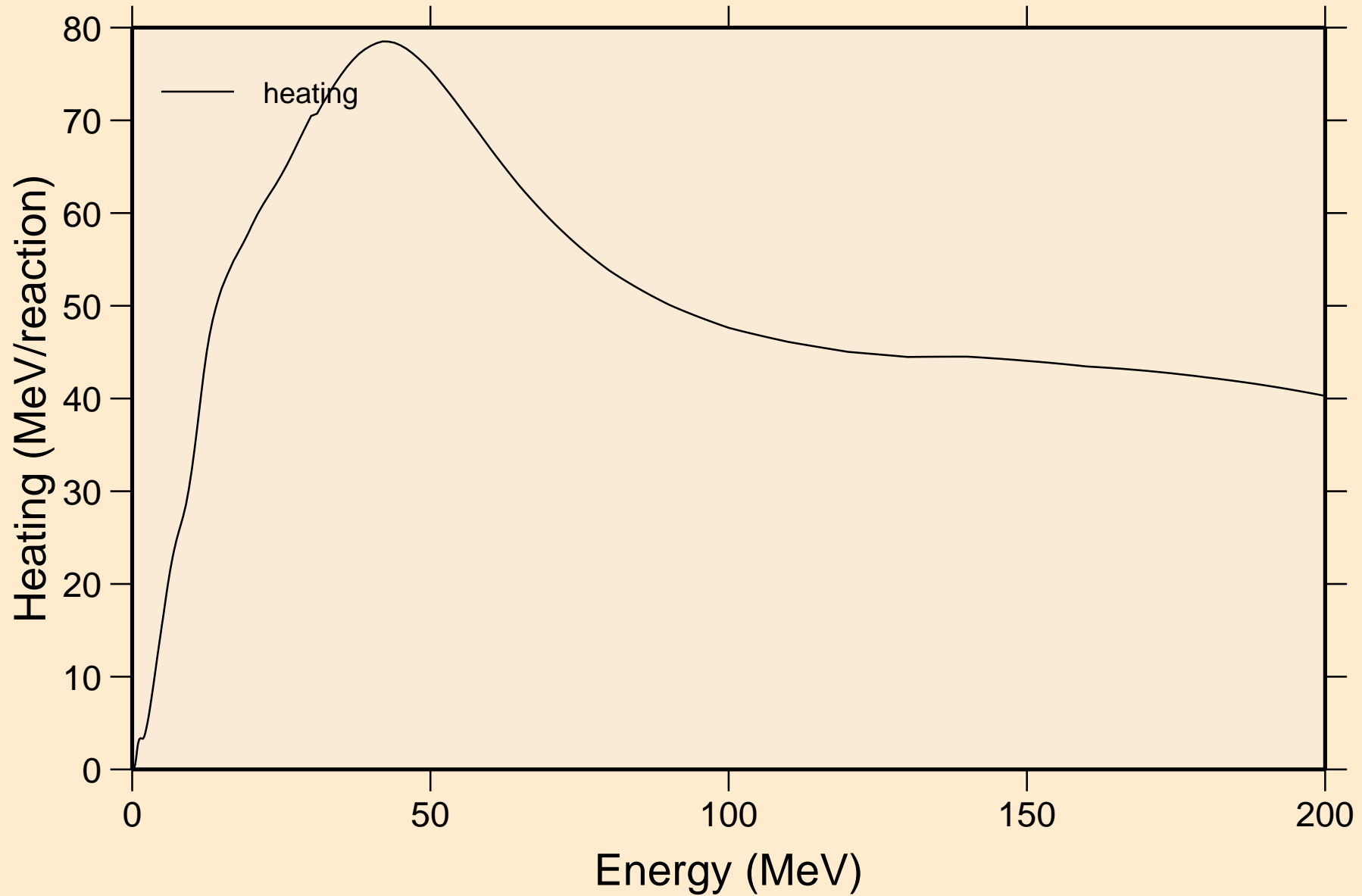

U243 NEUTRON ACER TENDL-2023 LIBRARY; T=0.K

Damage

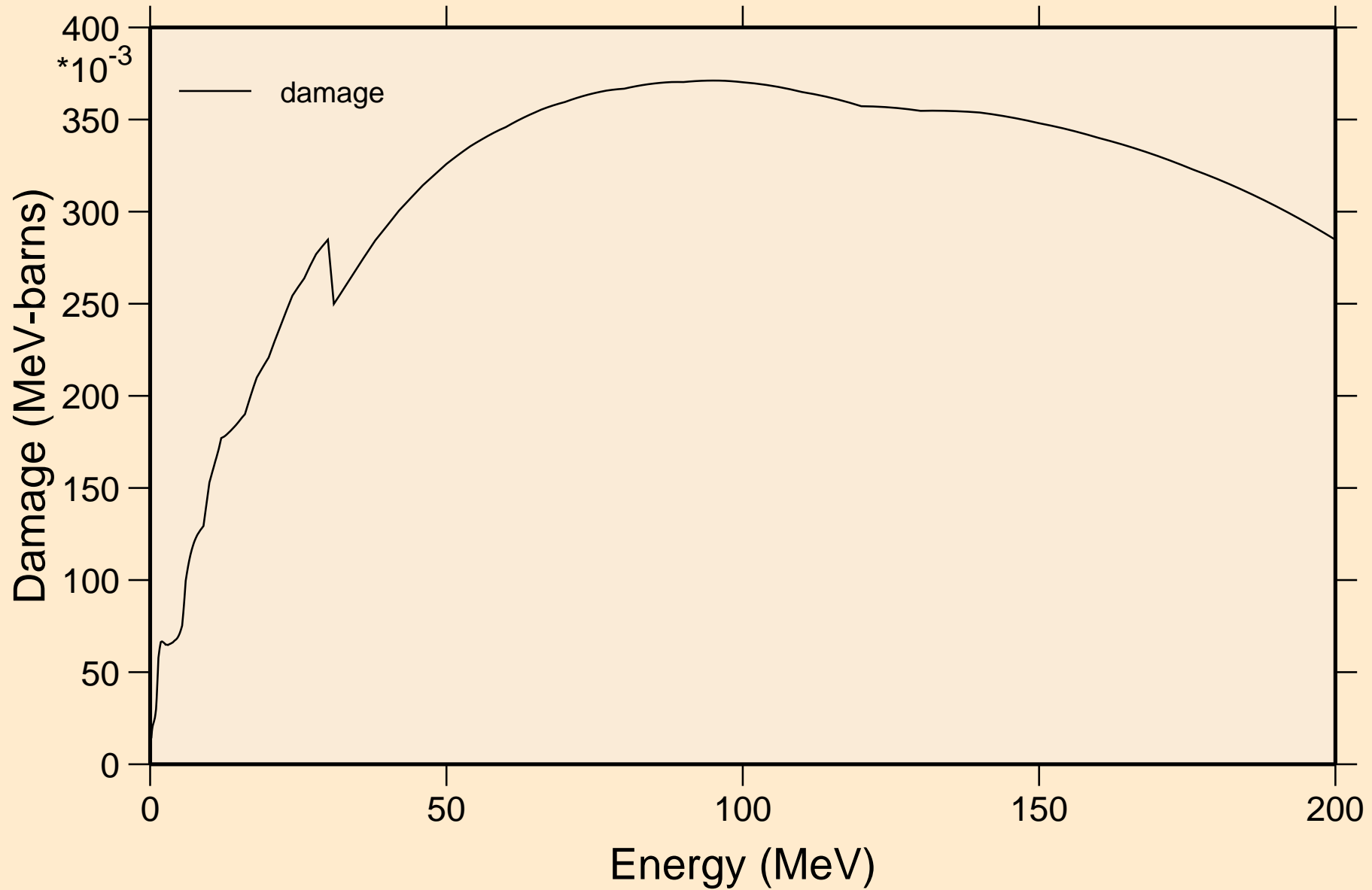

U243 NEUTRON ACER TENDL-2023 LIBRARY; T=0.K

Non-threshold reactions

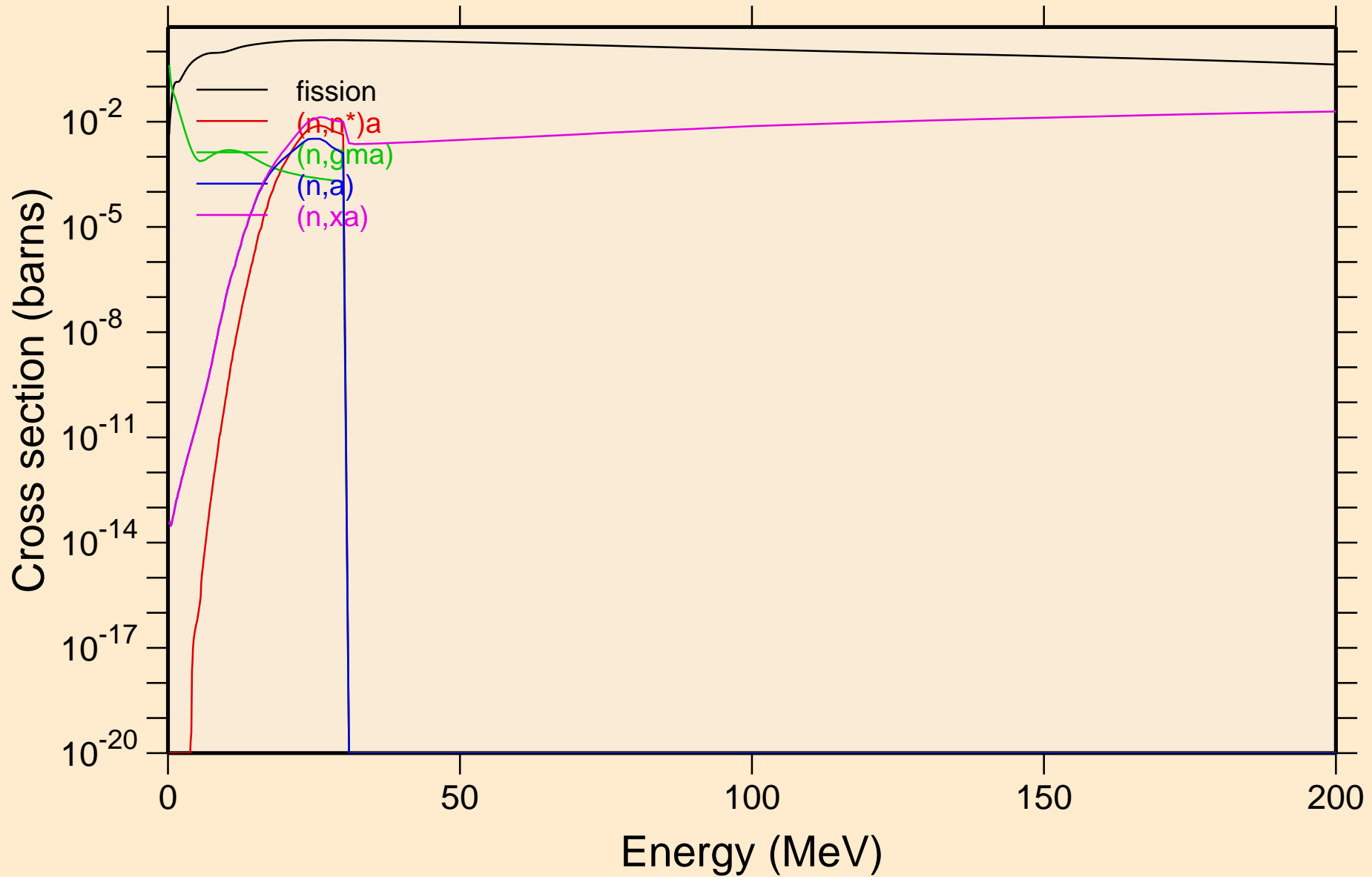

U243 NEUTRON ACER TENDL-2023 LIBRARY; T=0.K
Inelastic levels

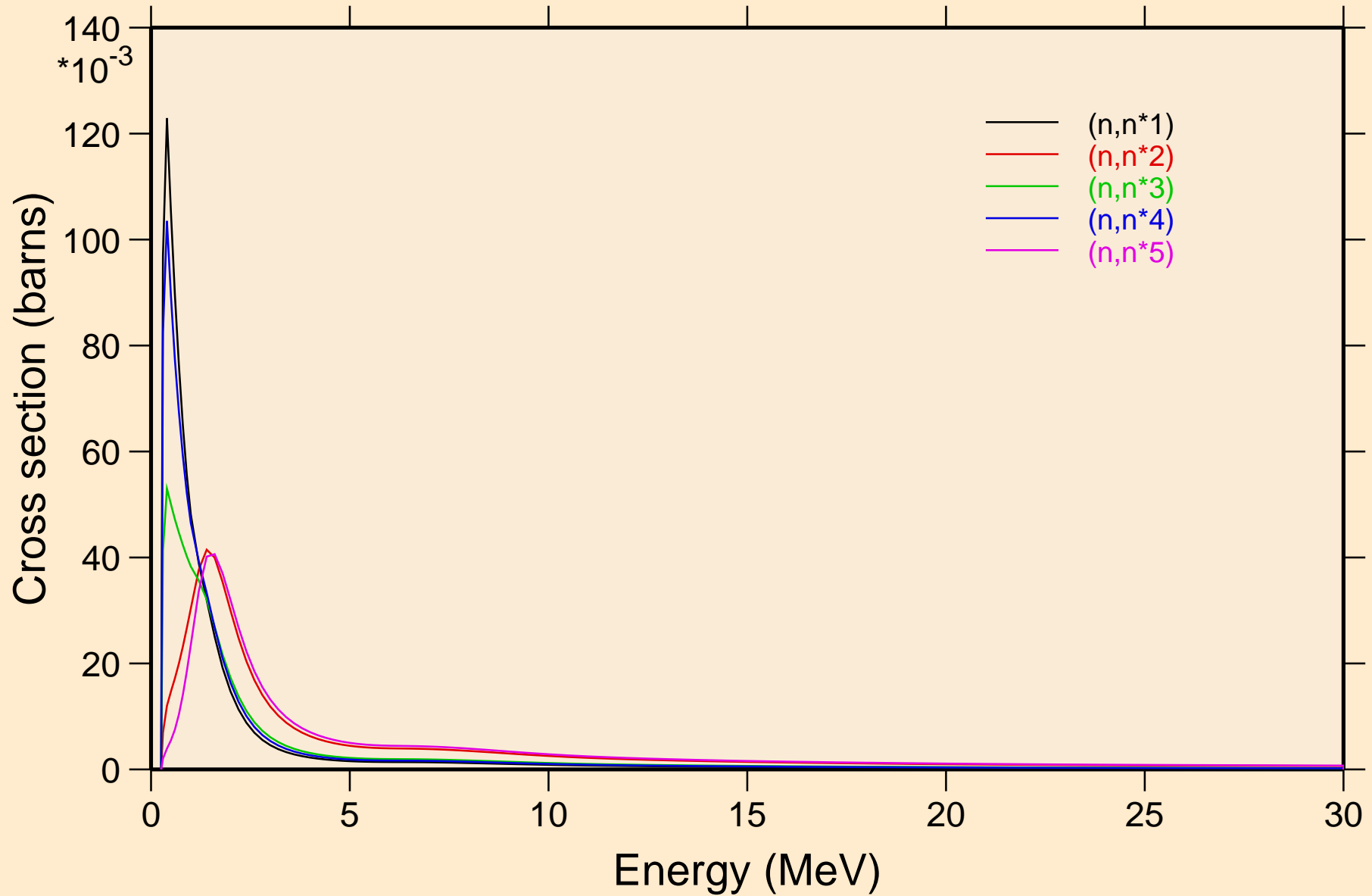

U243 NEUTRON ACER TENDL-2023 LIBRARY; T=0.K
Inelastic levels

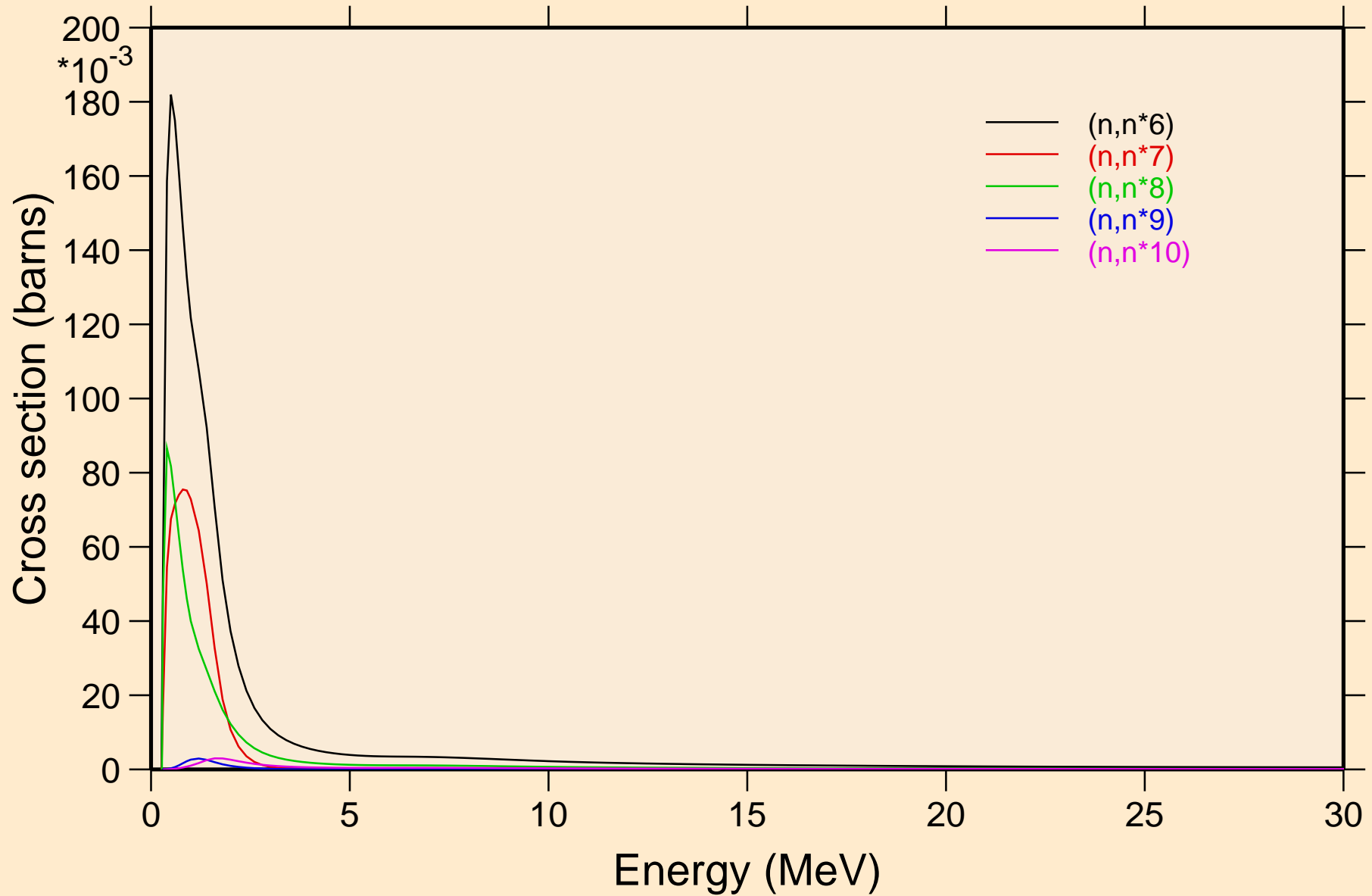

U243 NEUTRON ACER TENDL-2023 LIBRARY; T=0.K
Inelastic levels

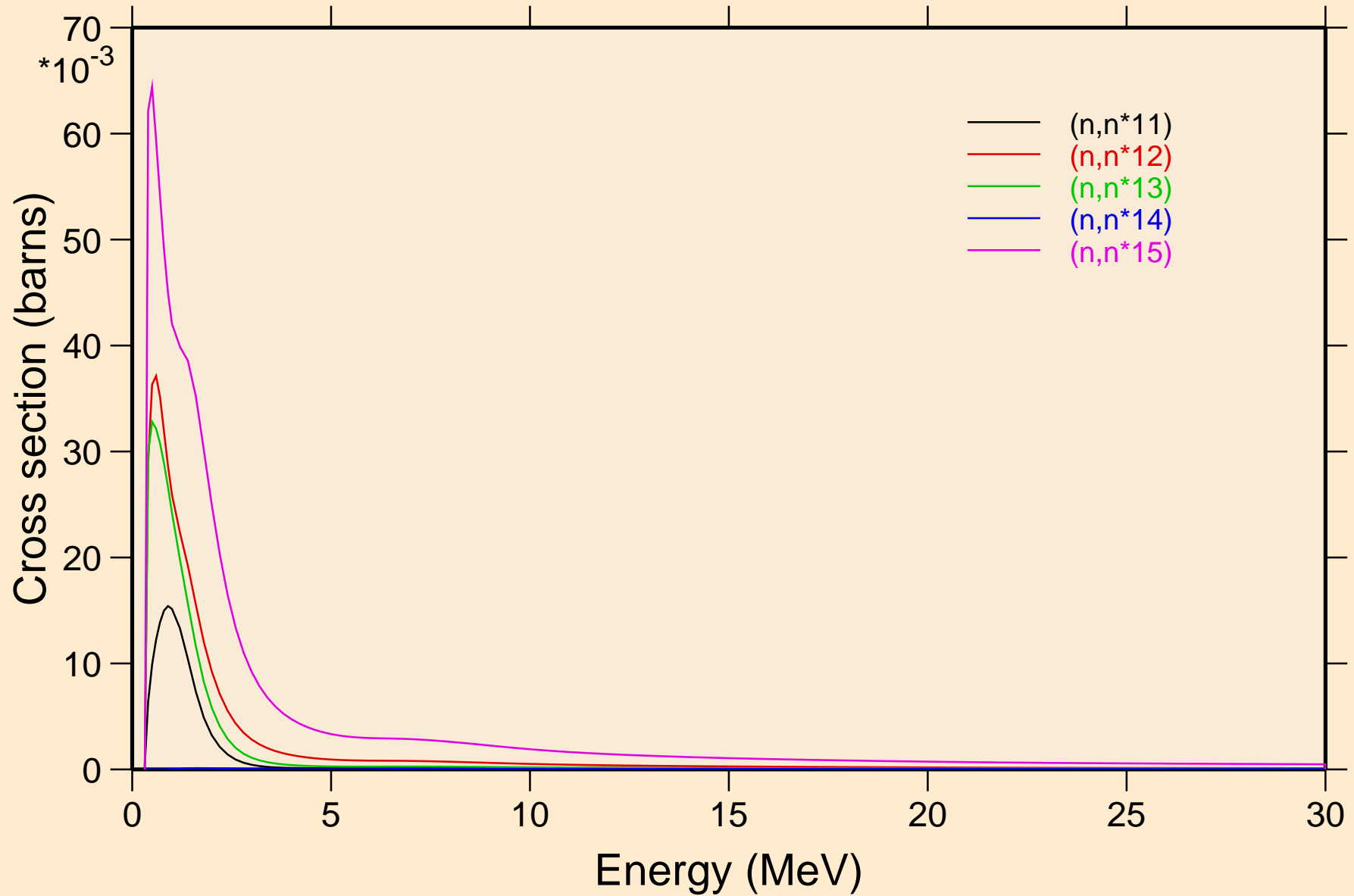

U243 NEUTRON ACER TENDL-2023 LIBRARY; T=0.K
Inelastic levels

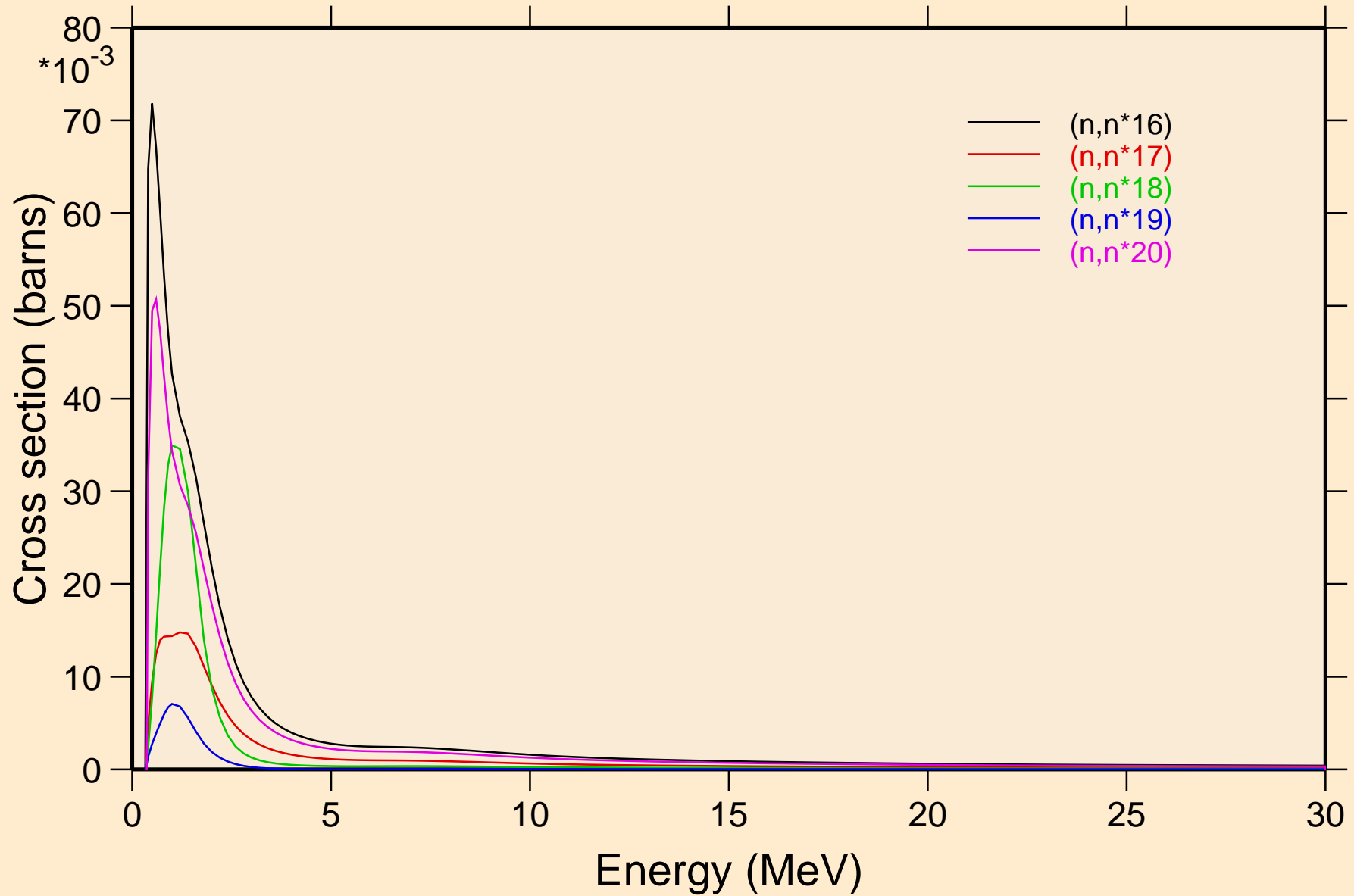

U243 NEUTRON ACER TENDL-2023 LIBRARY; T=0.K
Inelastic levels

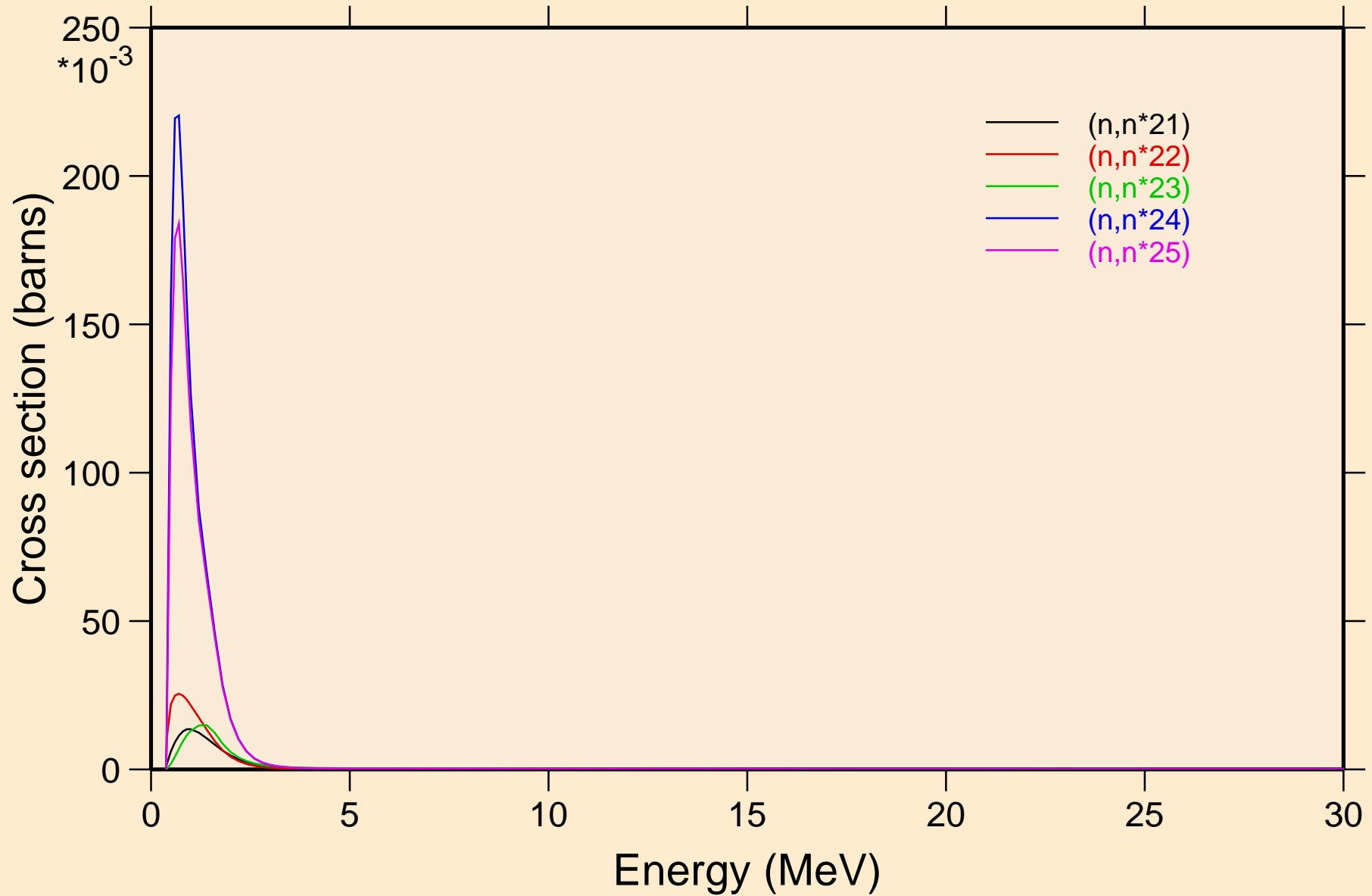

U243 NEUTRON ACER TENDL-2023 LIBRARY; T=0.K
Inelastic levels

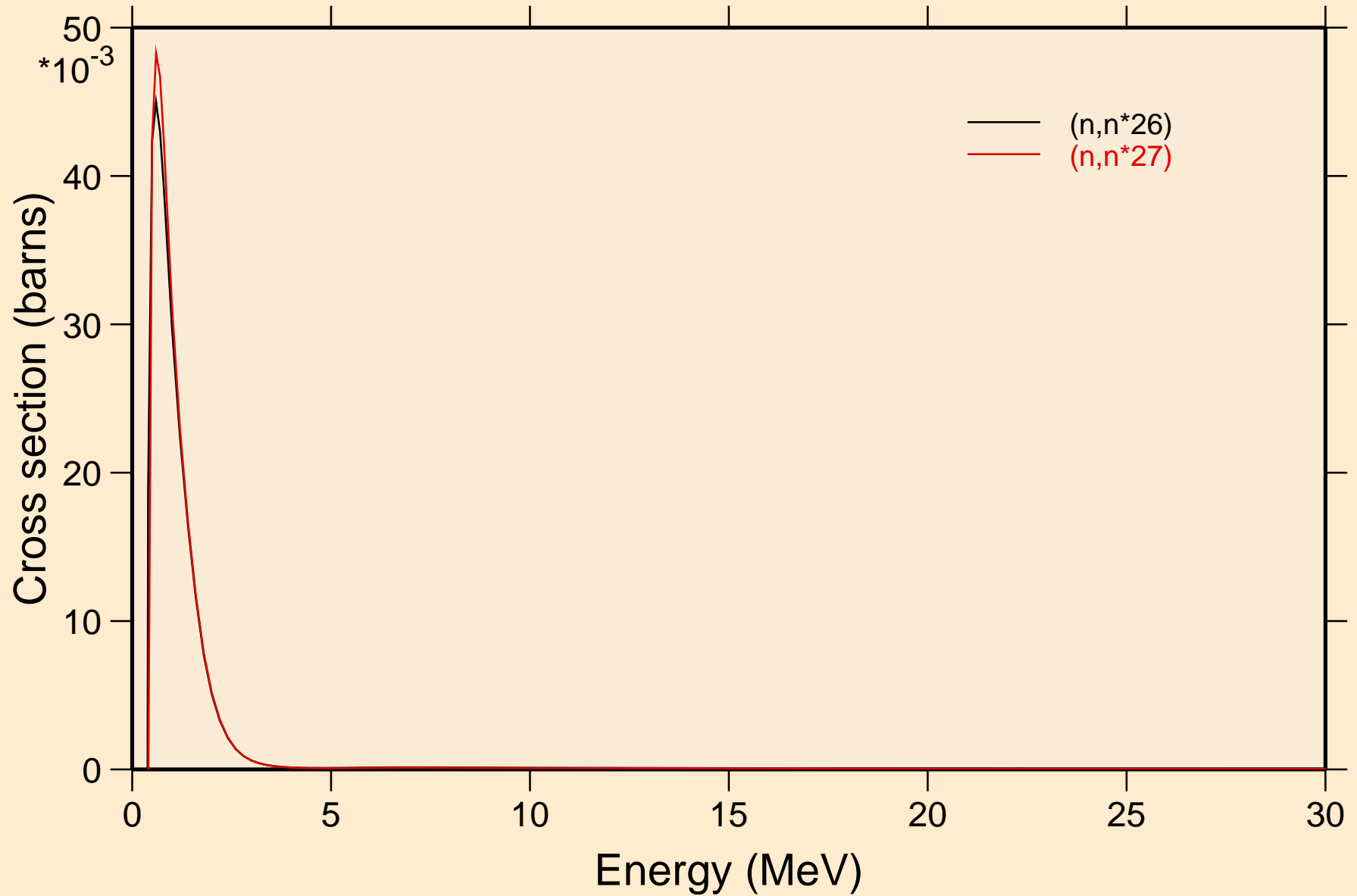

U243 NEUTRON ACER TENDL-2023 LIBRARY; T=0.K

Threshold reactions

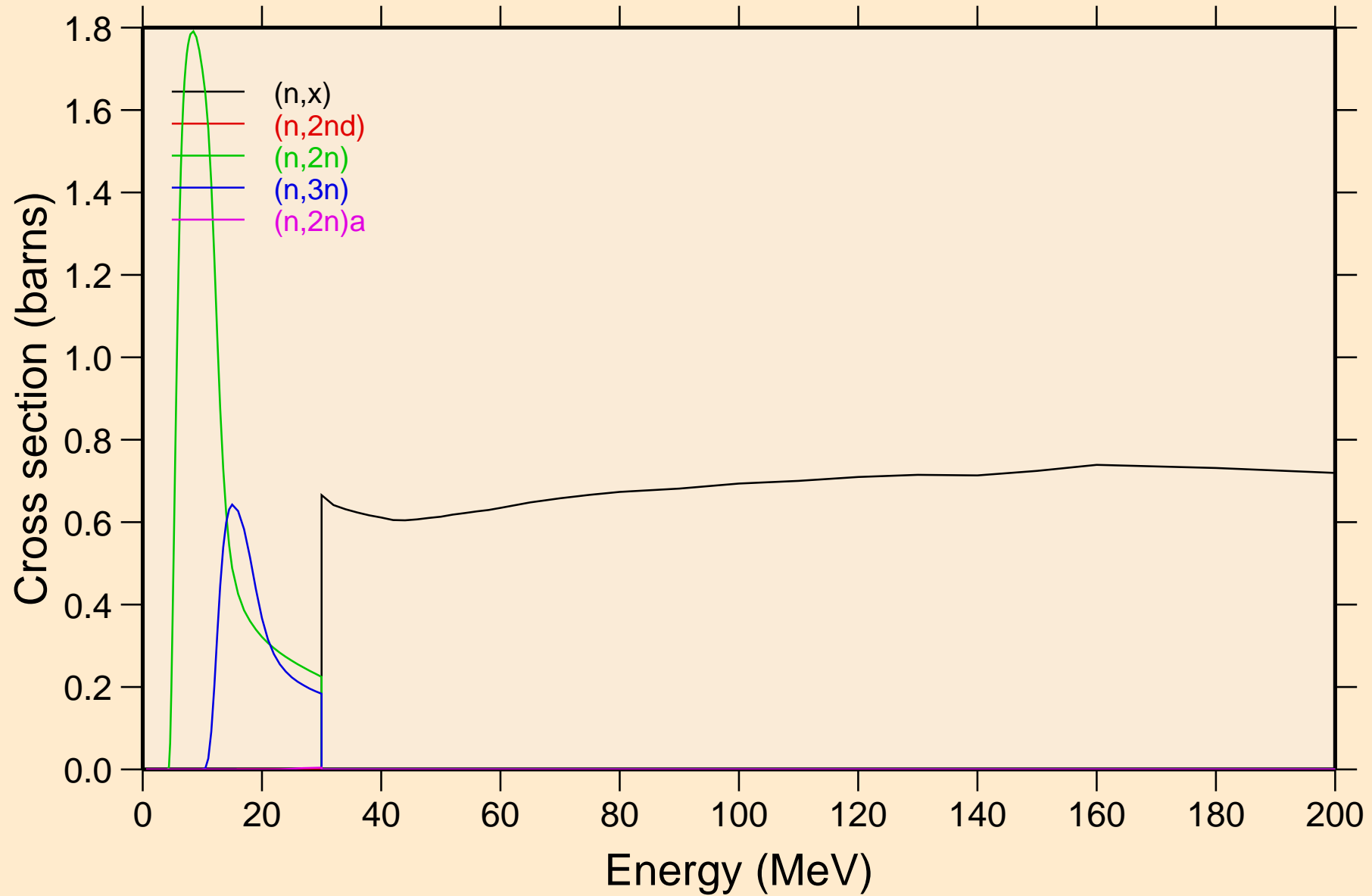

U243 NEUTRON ACER TENDL-2023 LIBRARY; T=0.K

Threshold reactions

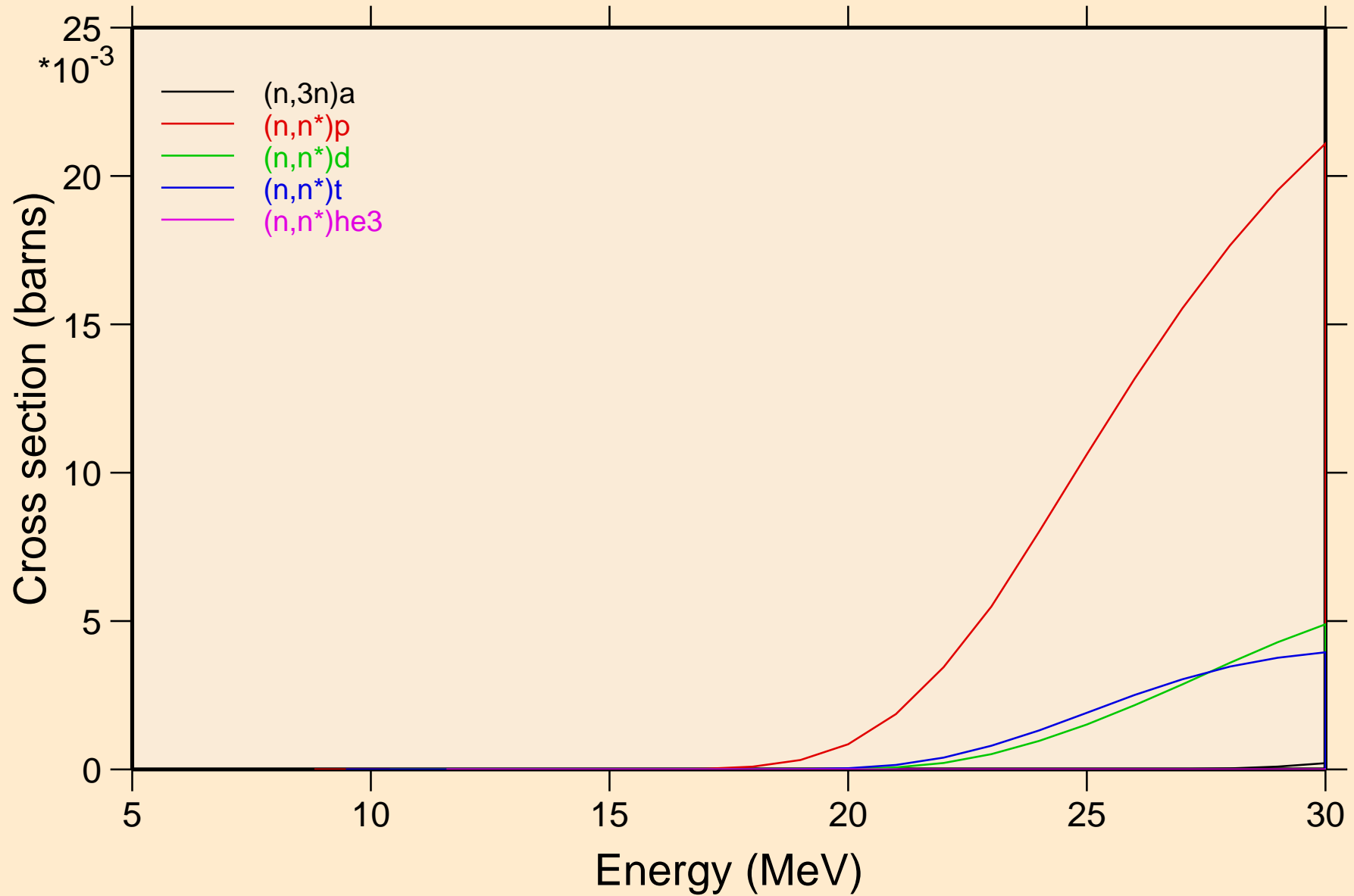

U243 NEUTRON ACER TENDL-2023 LIBRARY; T=0.K

Threshold reactions

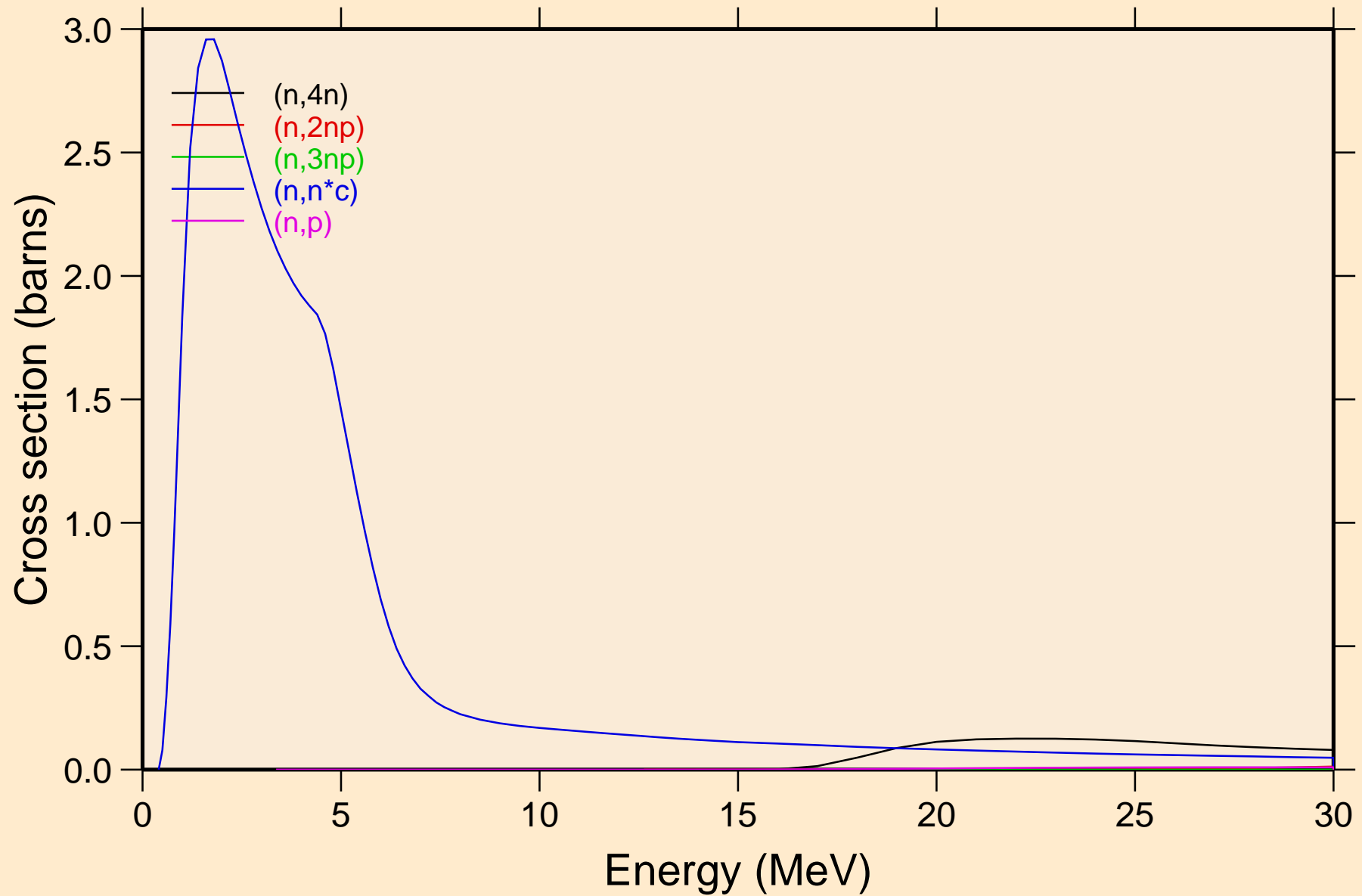

U243 NEUTRON ACER TENDL-2023 LIBRARY; T=0.K
Threshold reactions

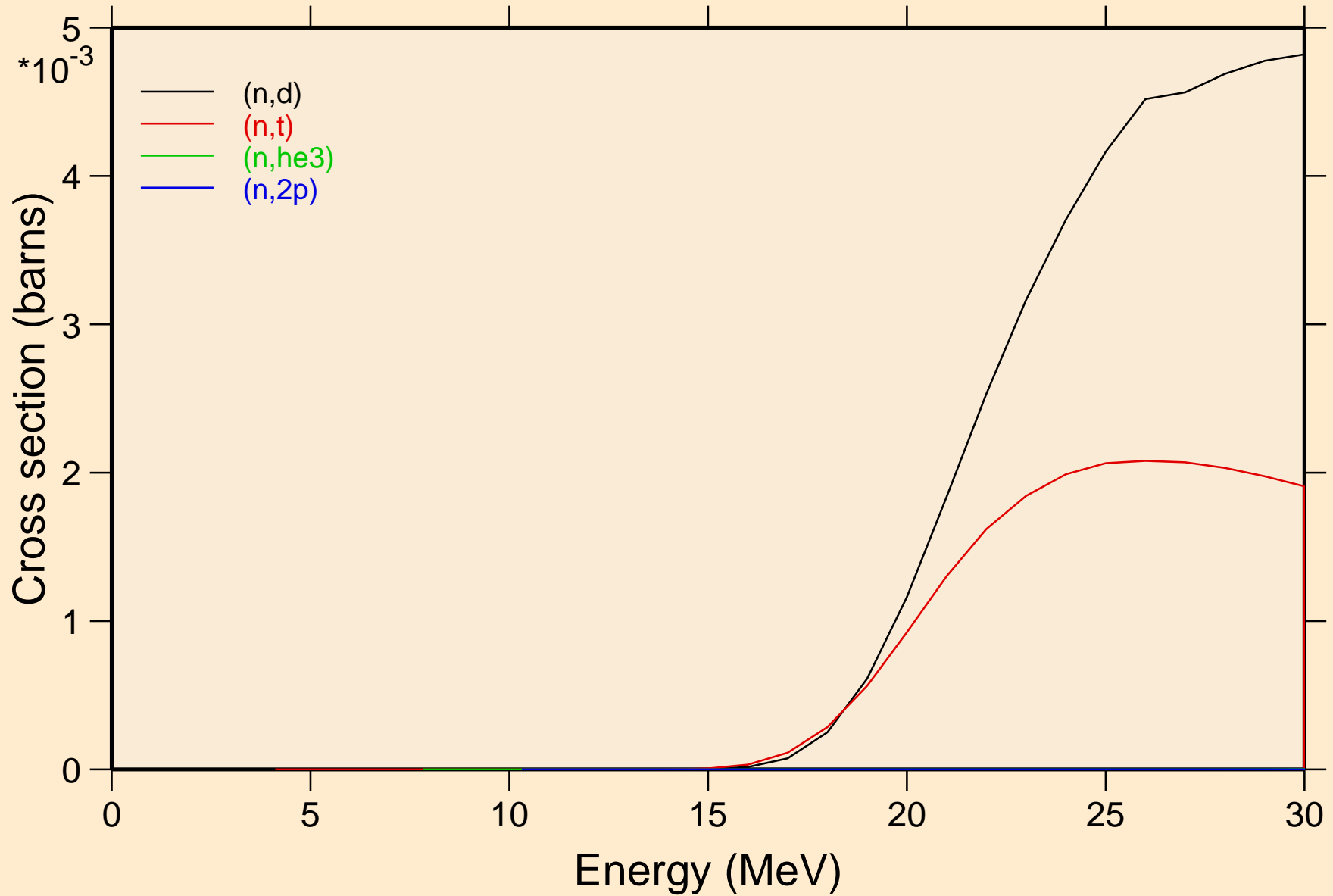

U243 NEUTRON ACER TENDL-2023 LIBRARY; T=0.K

Threshold reactions

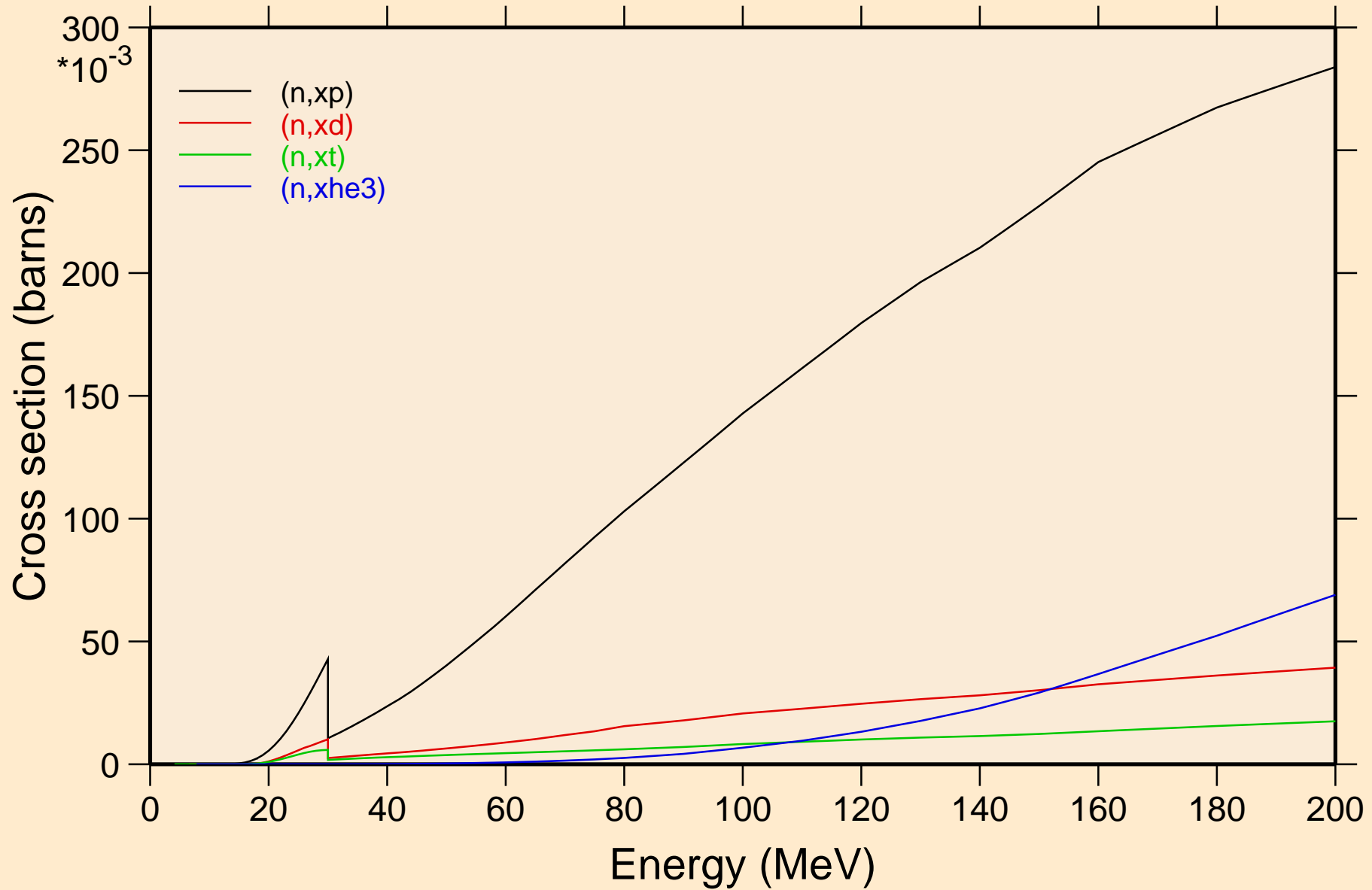

U243 NEUTRON ACER TENDL-2023 LIBRARY; T=0.K
angular distribution for elastic

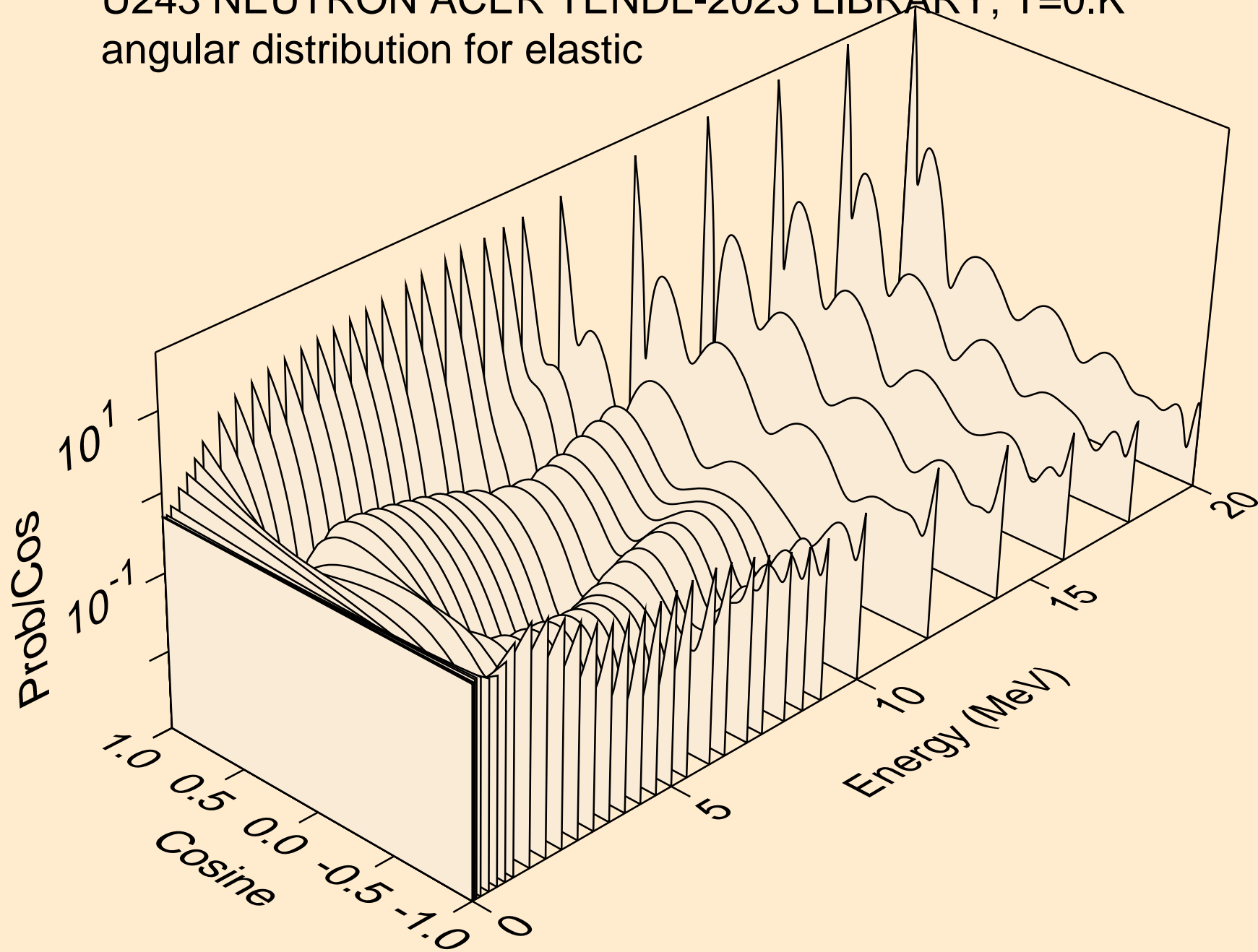

U243 NEUTRON ACER TENDL-2023 LIBRARY; T=0.K
angular distribution for elastic

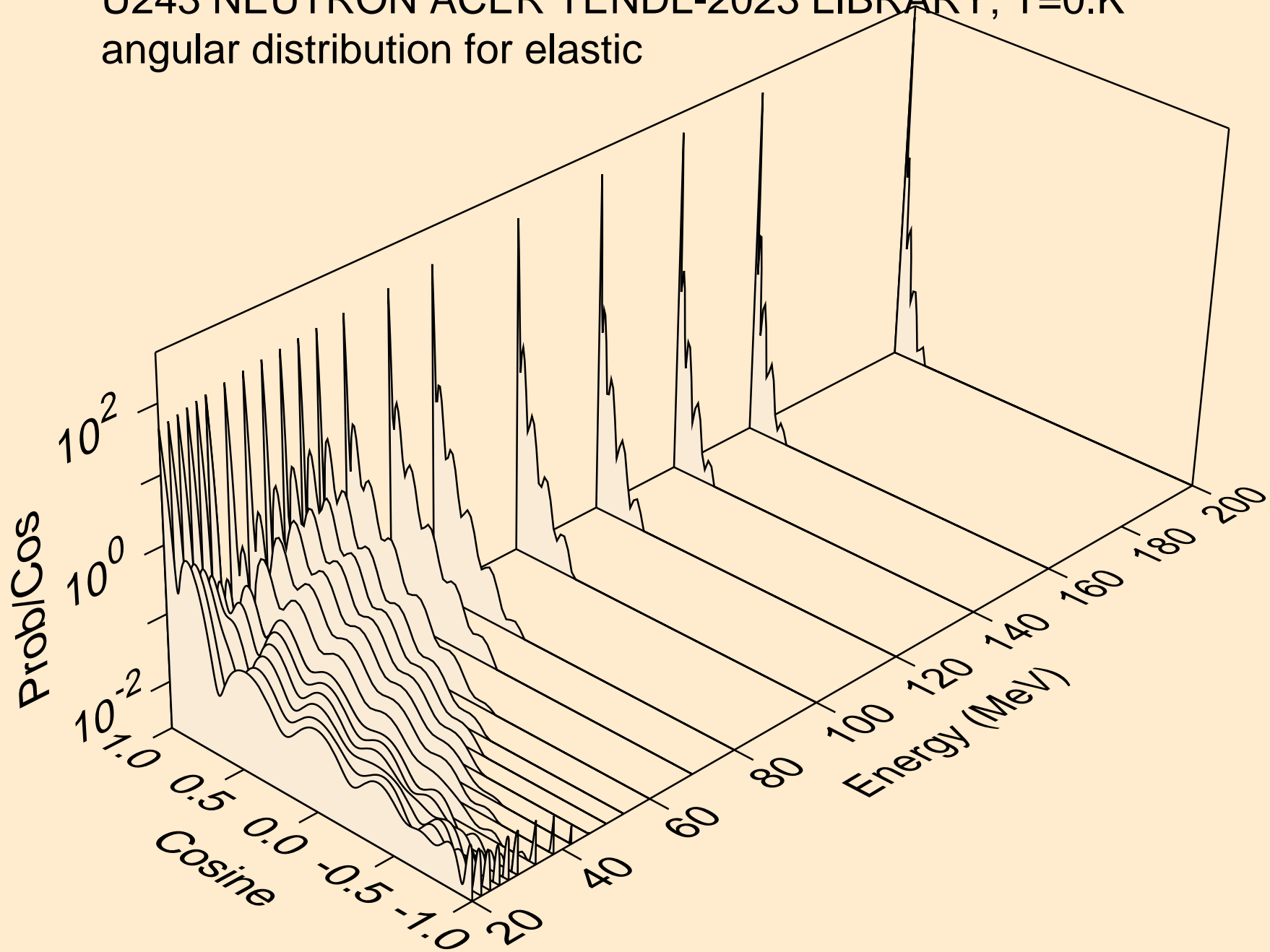

U243 NEUTRON ACER TENDL-2023 LIBRARY; T=0.K
angular distribution for (n,n*1)

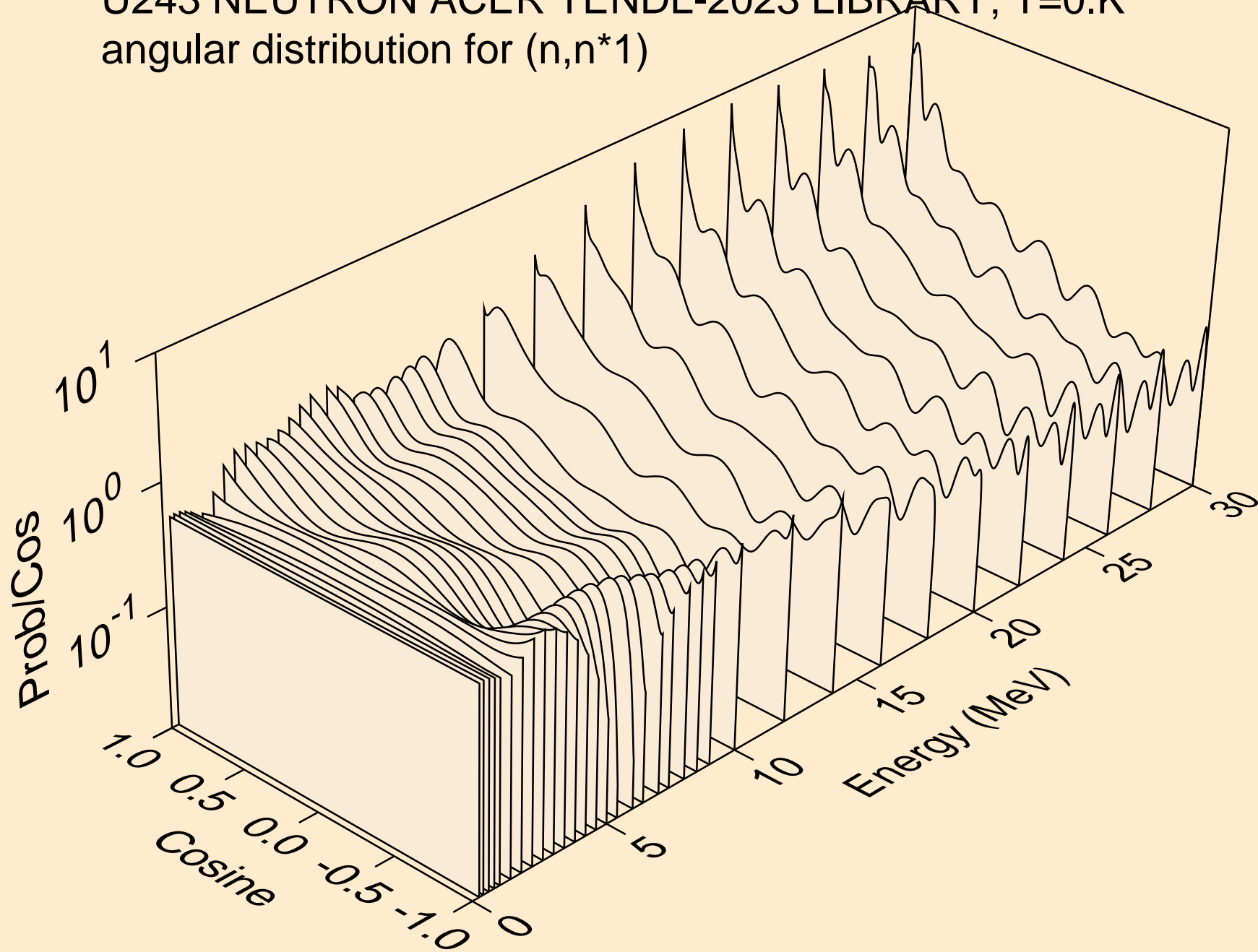

U243 NEUTRON ACER TENDL-2023 LIBRARY; T=0.K
angular distribution for (n,n*2)

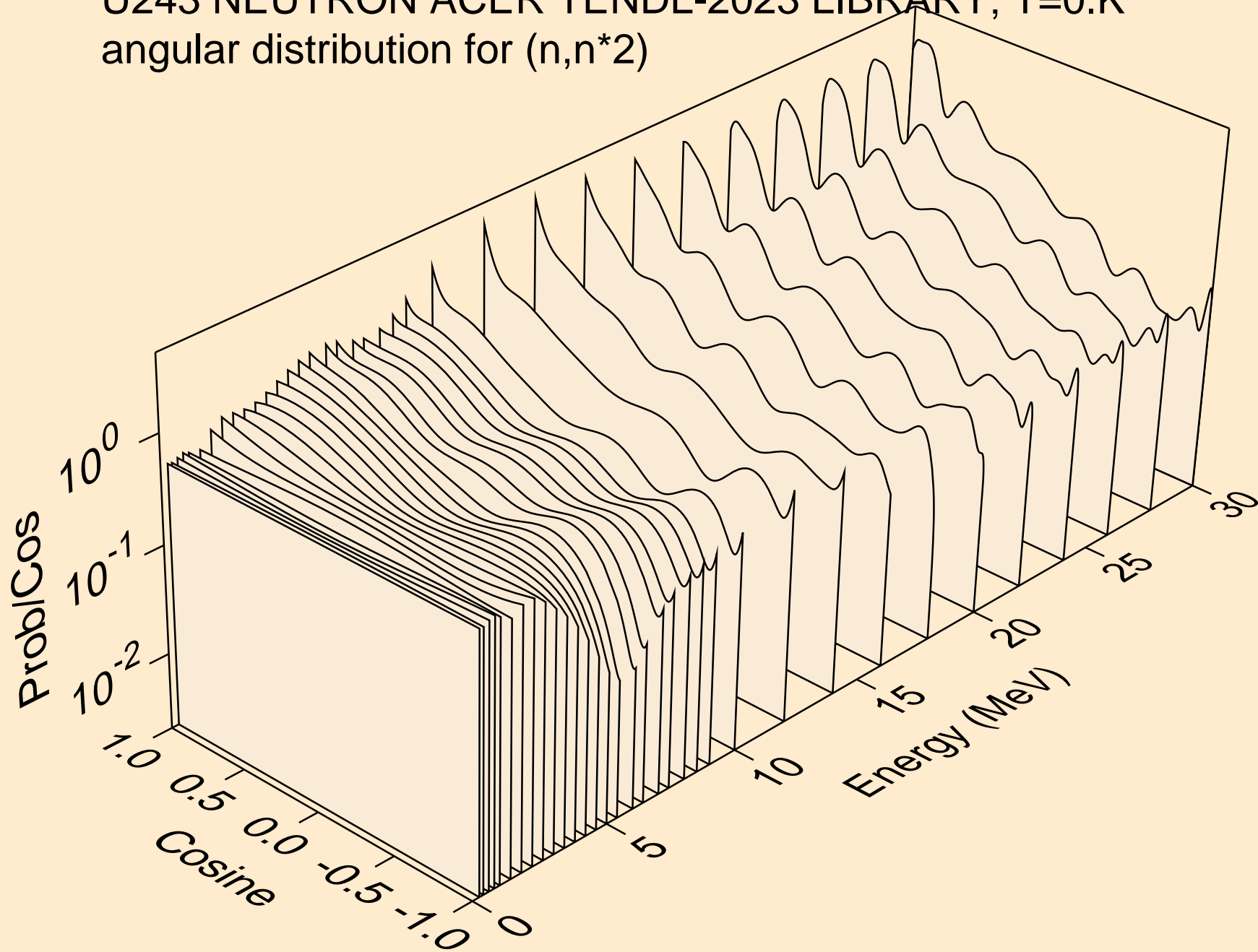

U243 NEUTRON ACER TENDL-2023 LIBRARY; T=0.K
angular distribution for (n,n*3)

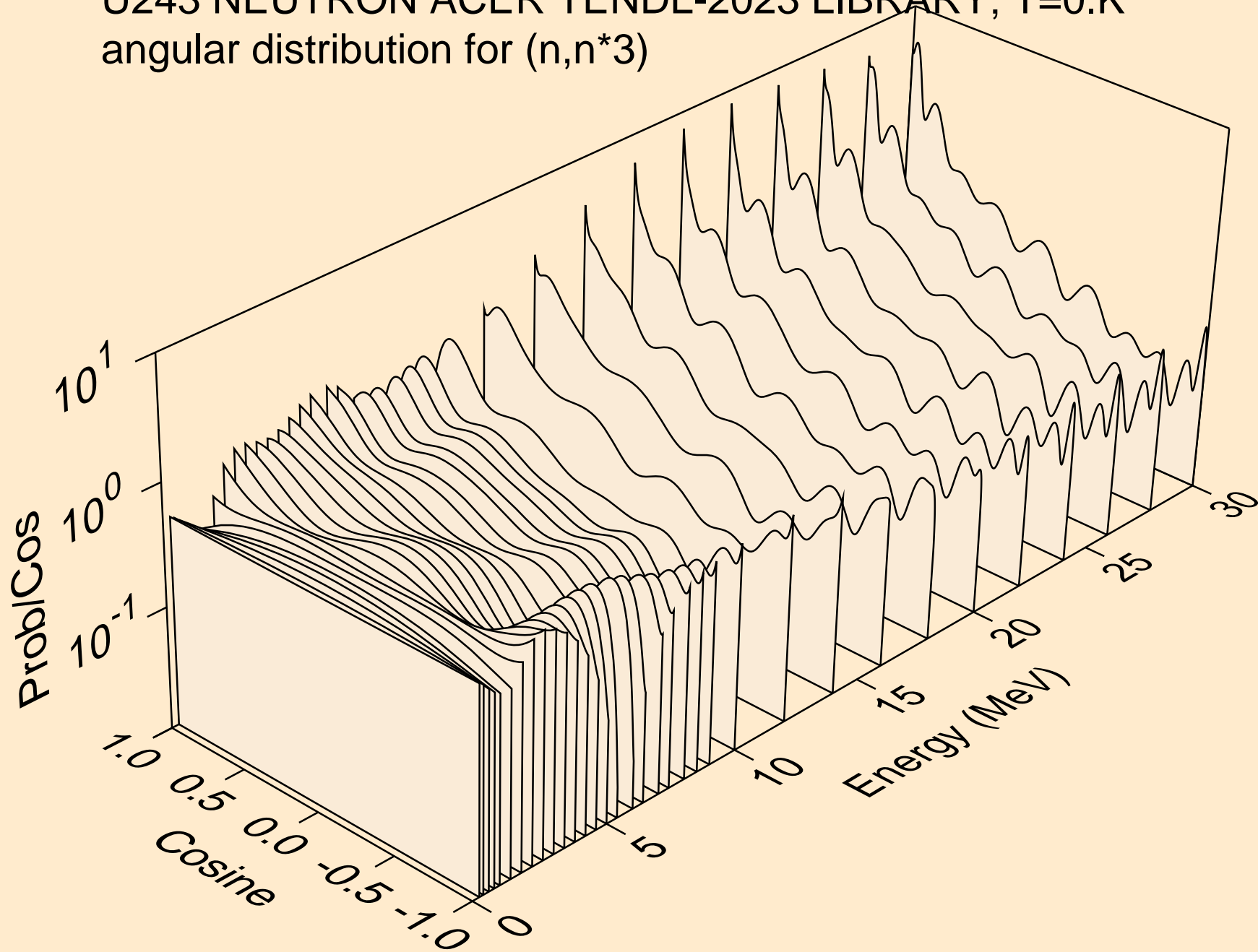

U243 NEUTRON ACER TENDL-2023 LIBRARY; T=0.K
angular distribution for (n,n*4)

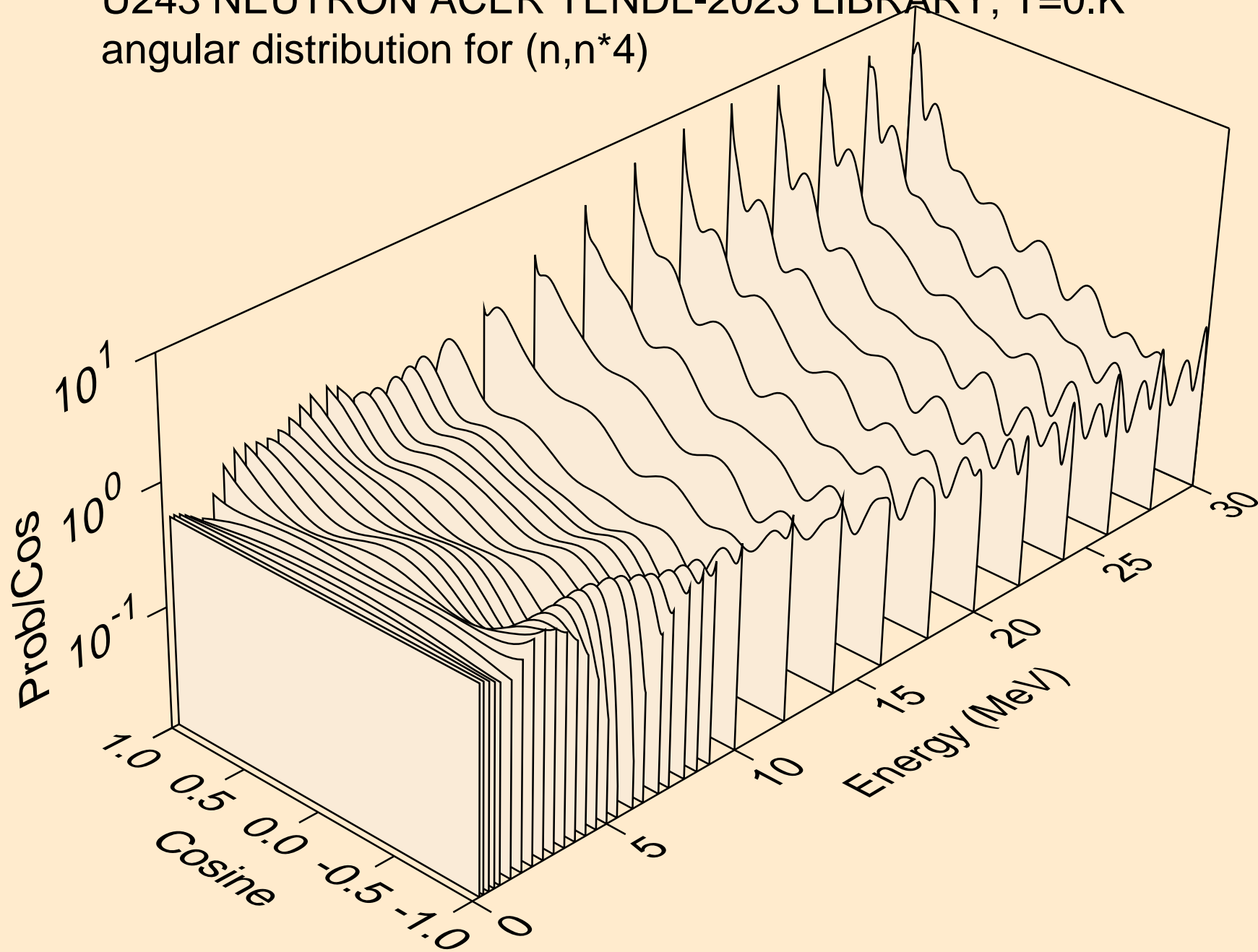

U243 NEUTRON ACER TENDL-2023 LIBRARY; T=0.K
angular distribution for (n,n*5)

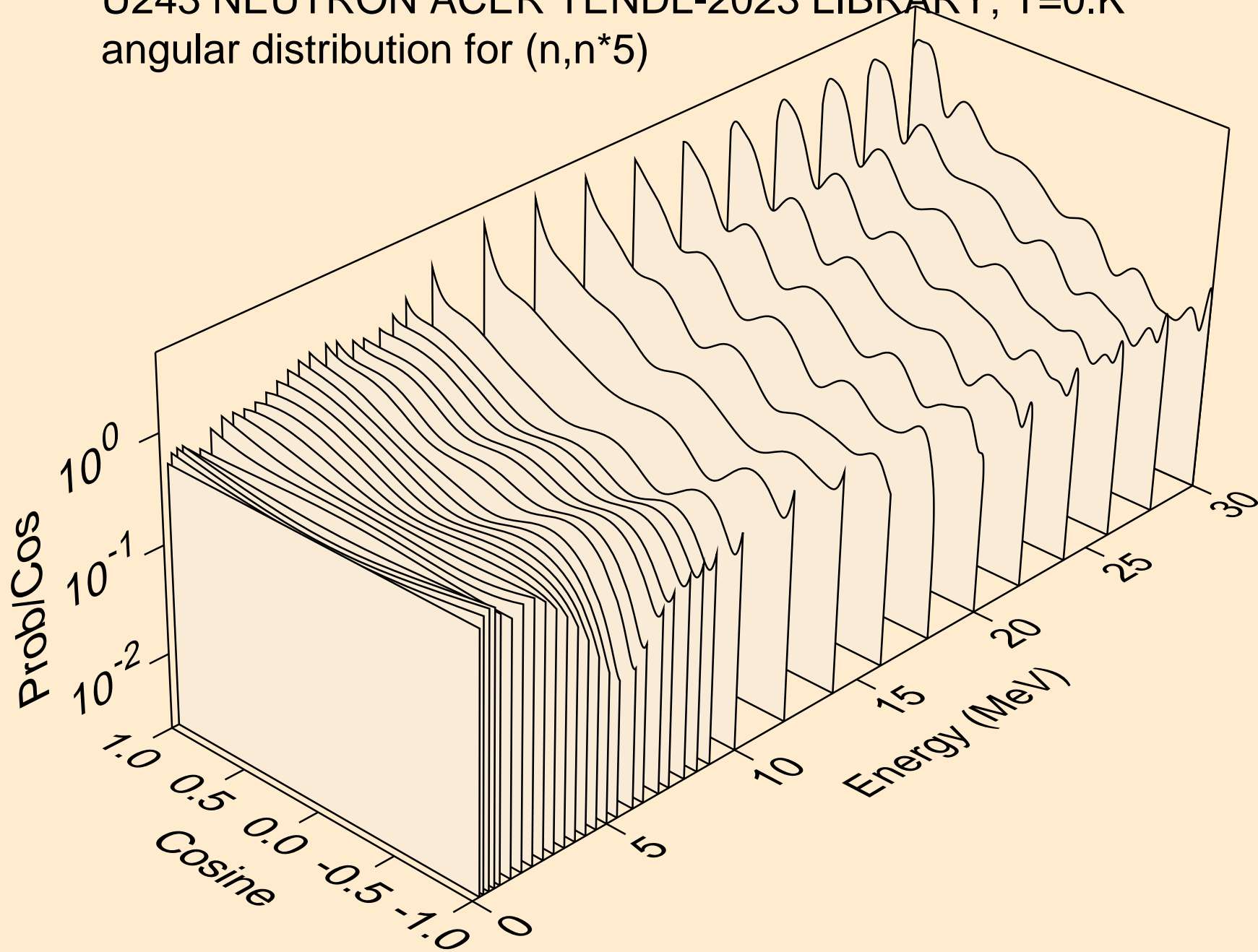

U243 NEUTRON ACER TENDL-2023 LIBRARY; T=0.K
angular distribution for (n,n*6)

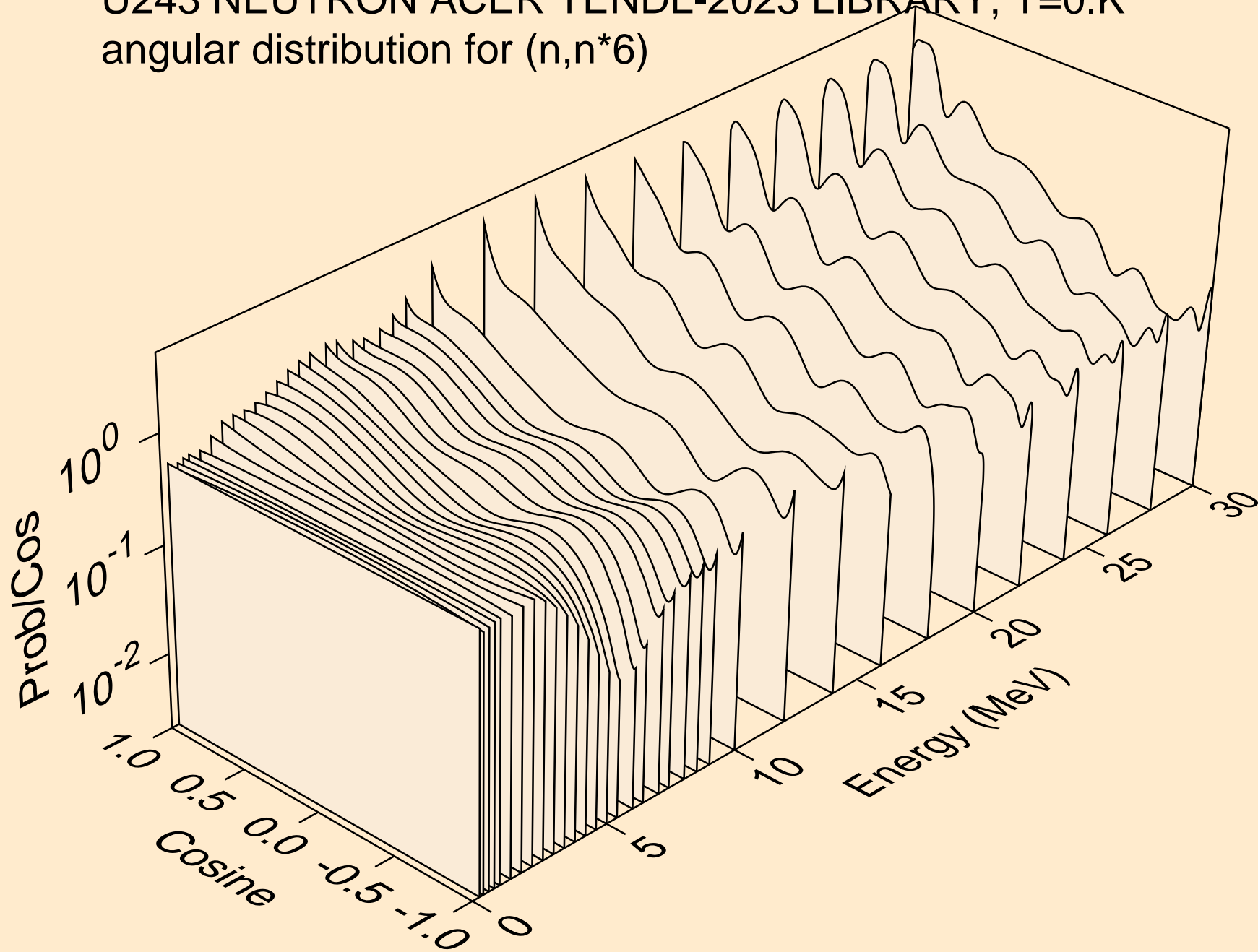

U243 NEUTRON ACER TENDL-2023 LIBRARY; T=0.K
angular distribution for (n,n*7)

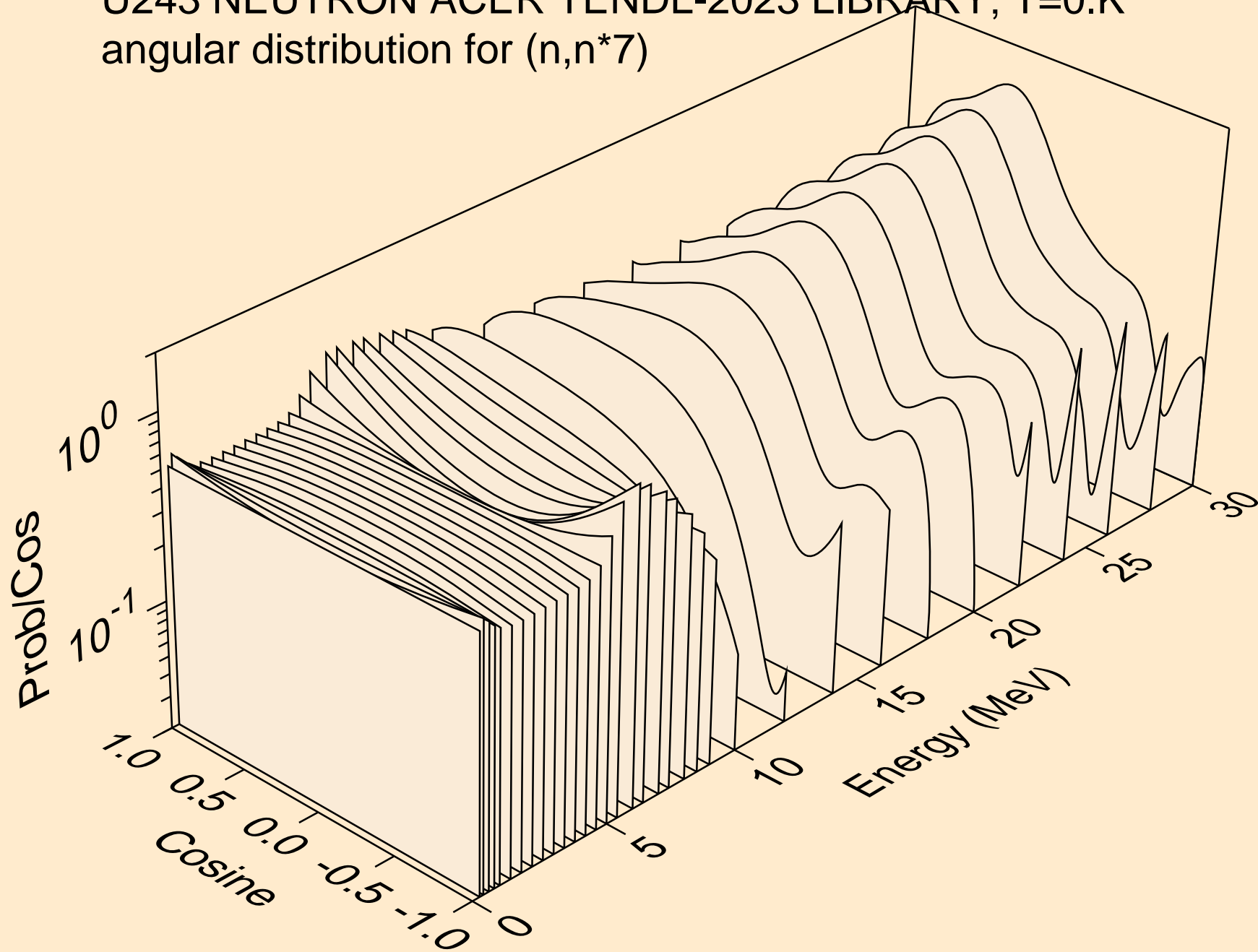

U243 NEUTRON ACER TENDL-2023 LIBRARY; T=0.K
angular distribution for (n,n*8)

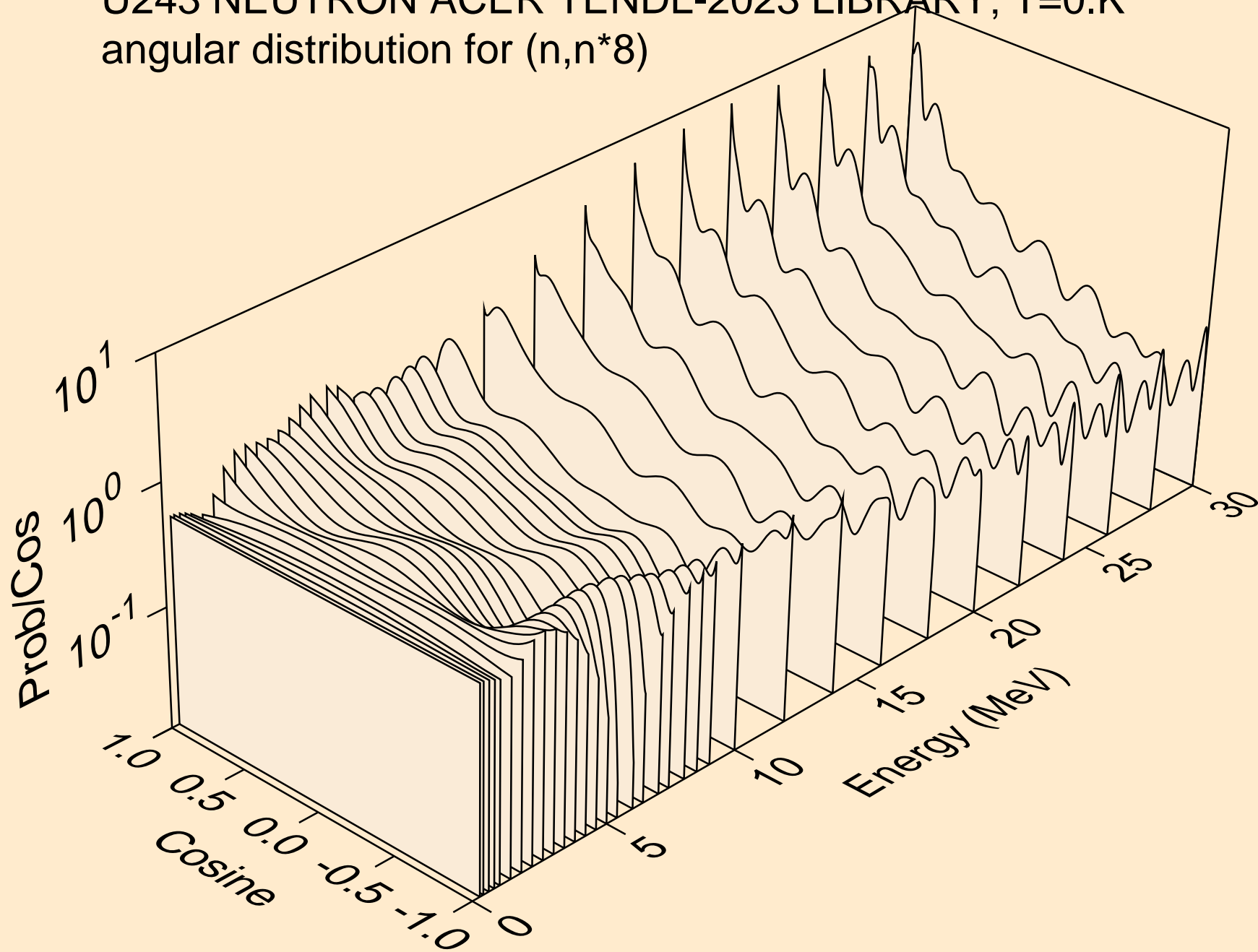

U243 NEUTRON ACER TENDL-2023 LIBRARY; T=0.K
angular distribution for (n,n*9)

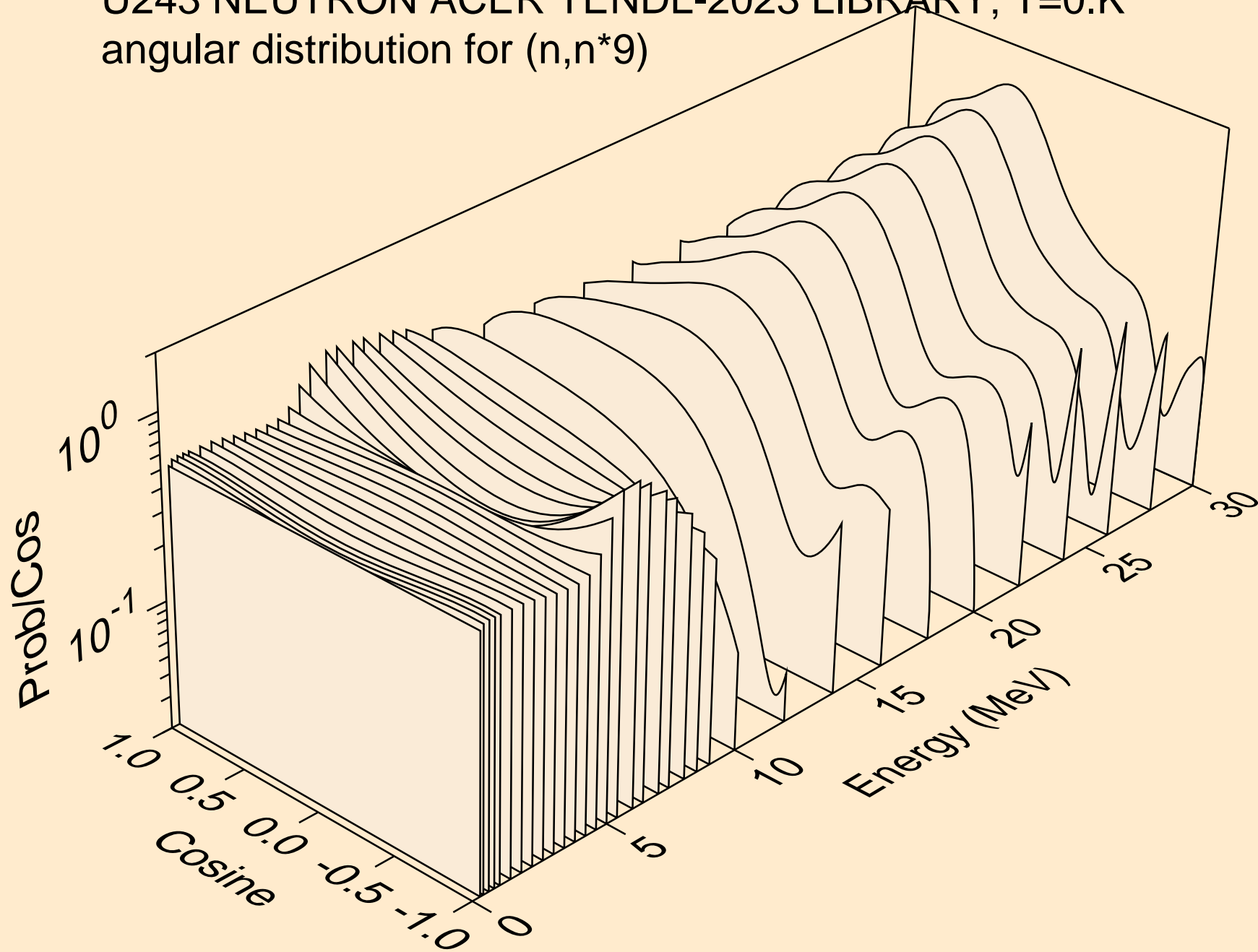

U243 NEUTRON ACER TENDL-2023 LIBRARY; T=0.K
angular distribution for (n,n*10)

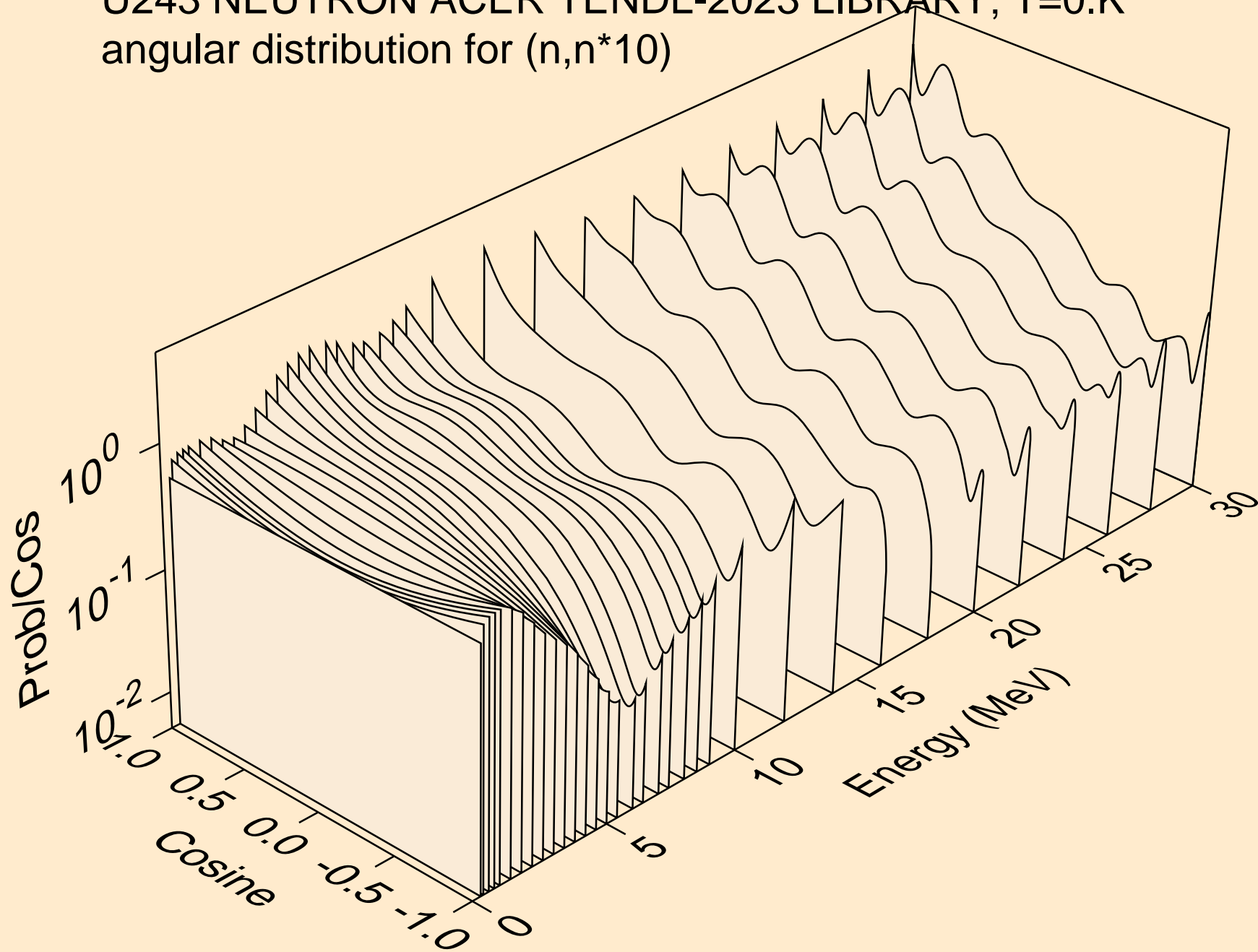

U243 NEUTRON ACER TENDL-2023 LIBRARY; T=0.K
angular distribution for (n,n*11)

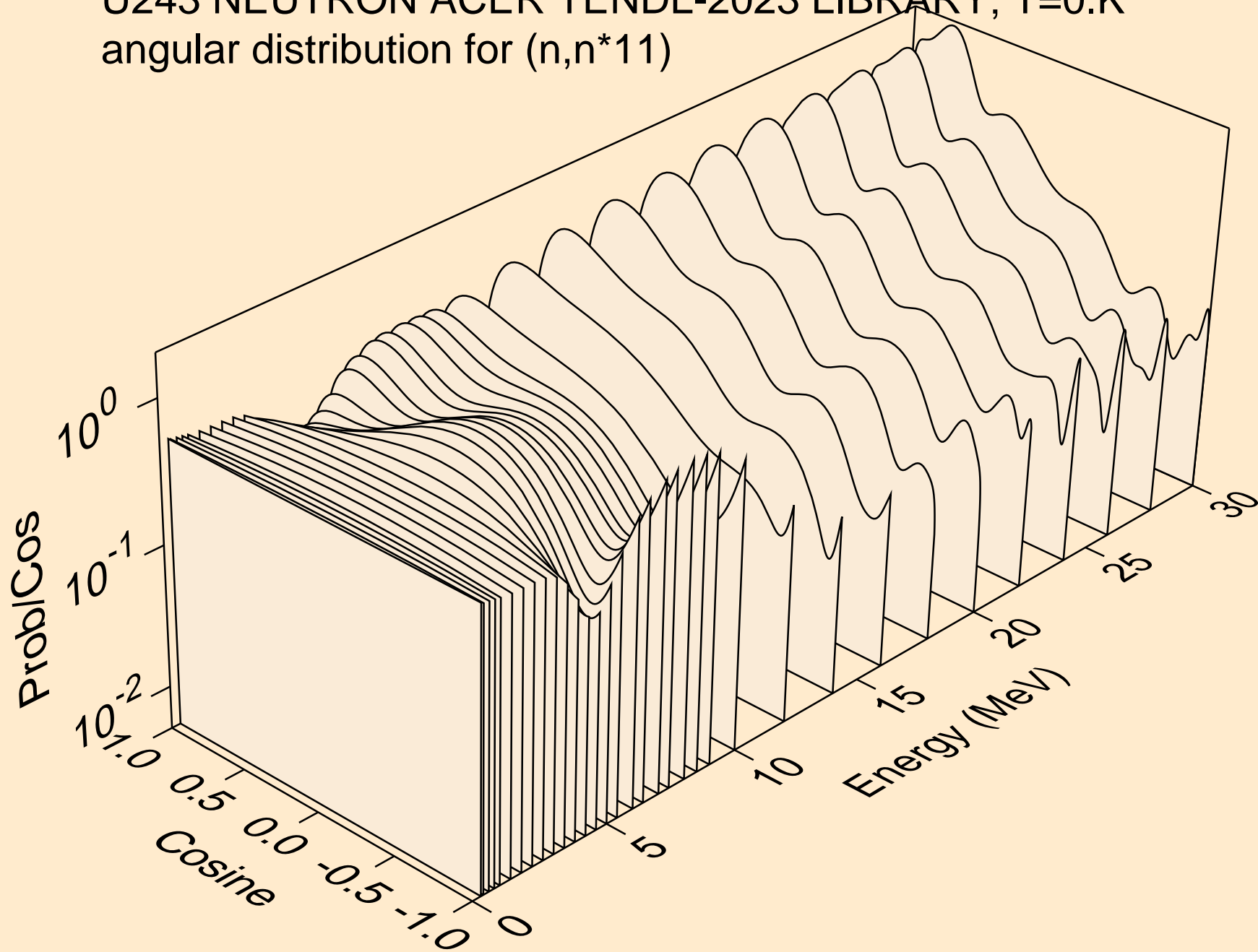

U243 NEUTRON ACER TENDL-2023 LIBRARY; T=0.K
angular distribution for (n,n*12)

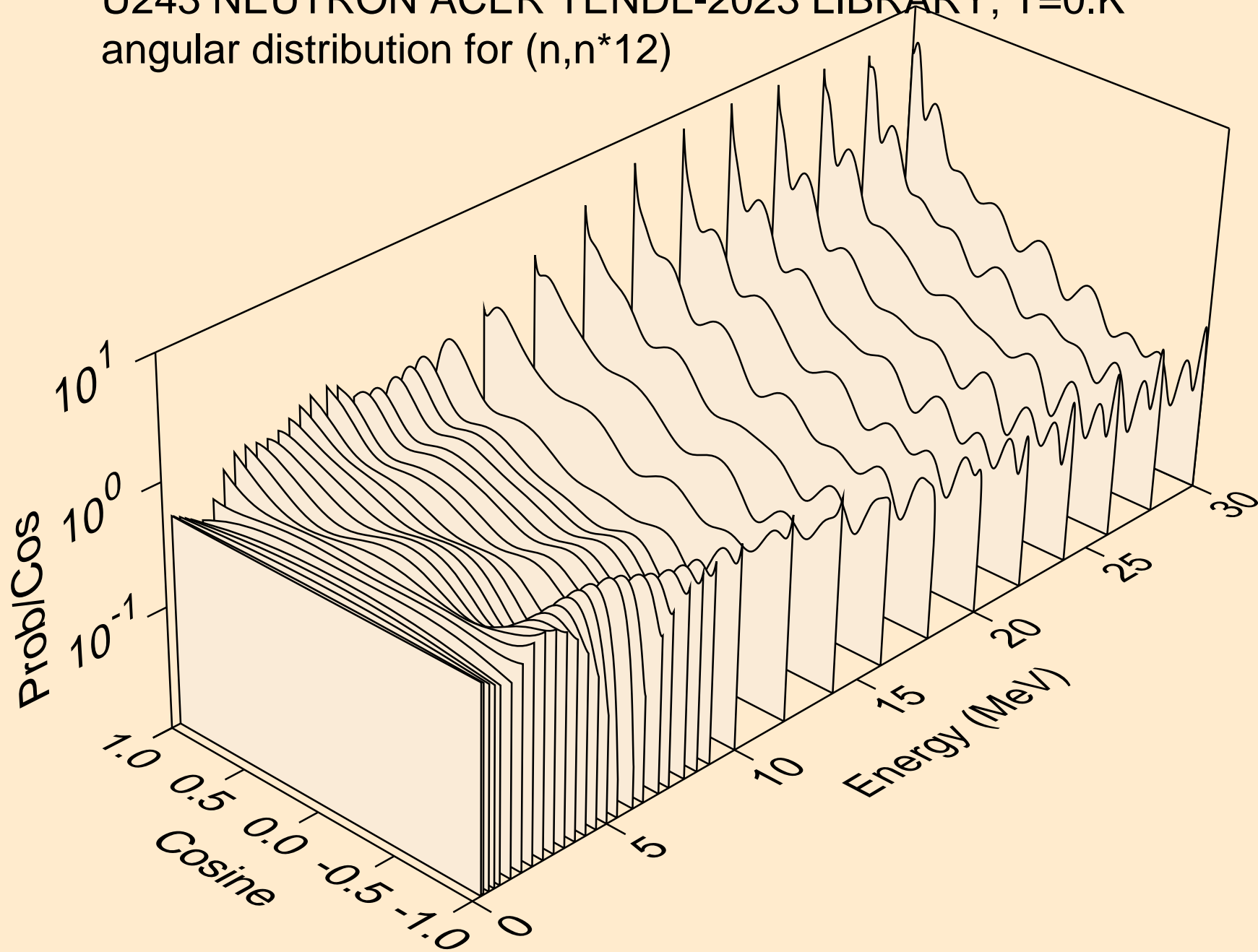

U243 NEUTRON ACER TENDL-2023 LIBRARY; T=0.K
angular distribution for (n,n*13)

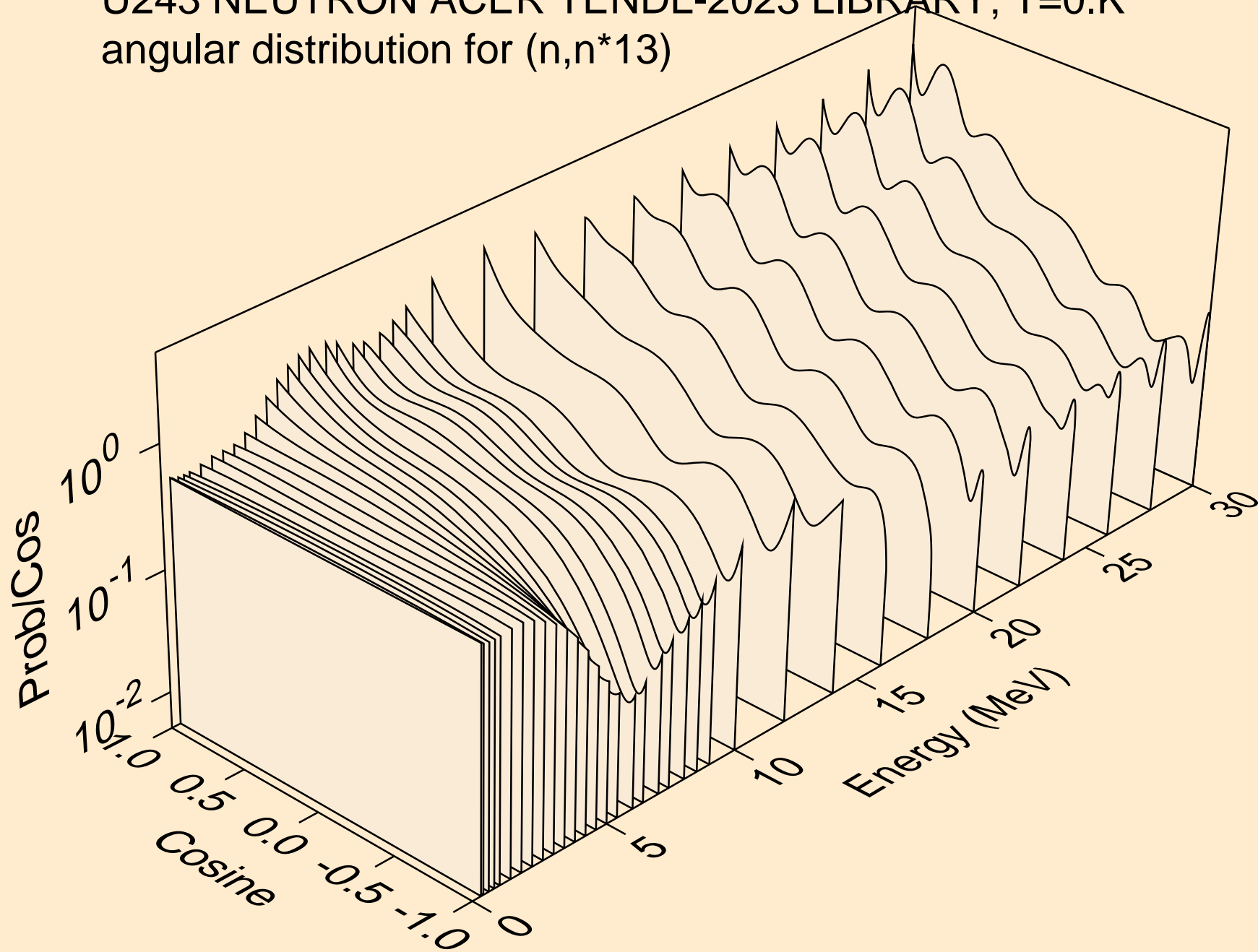

U243 NEUTRON ACER TENDL-2023 LIBRARY; T=0.K
angular distribution for (n,n*14)

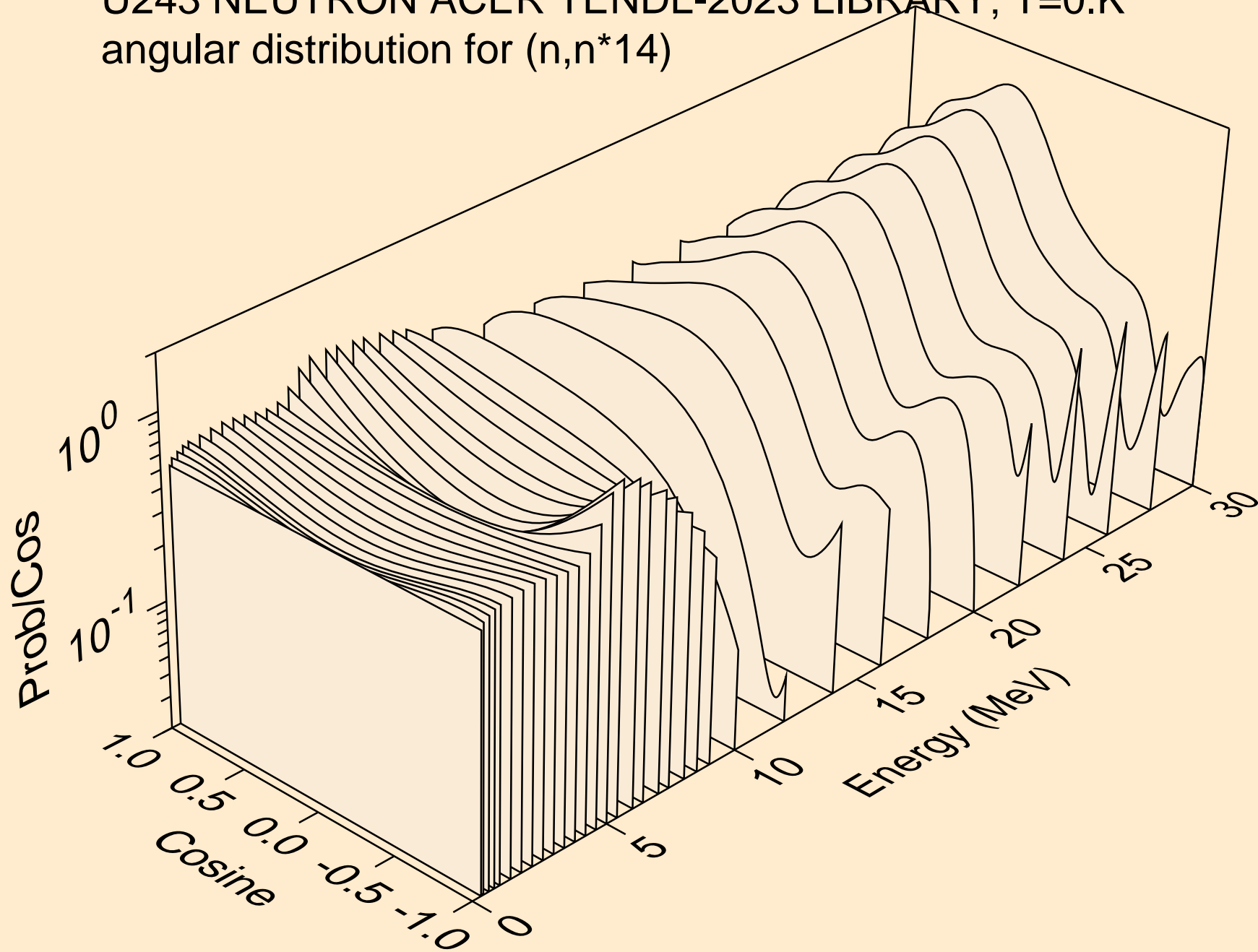

U243 NEUTRON ACER TENDL-2023 LIBRARY; T=0.K
angular distribution for (n,n*15)

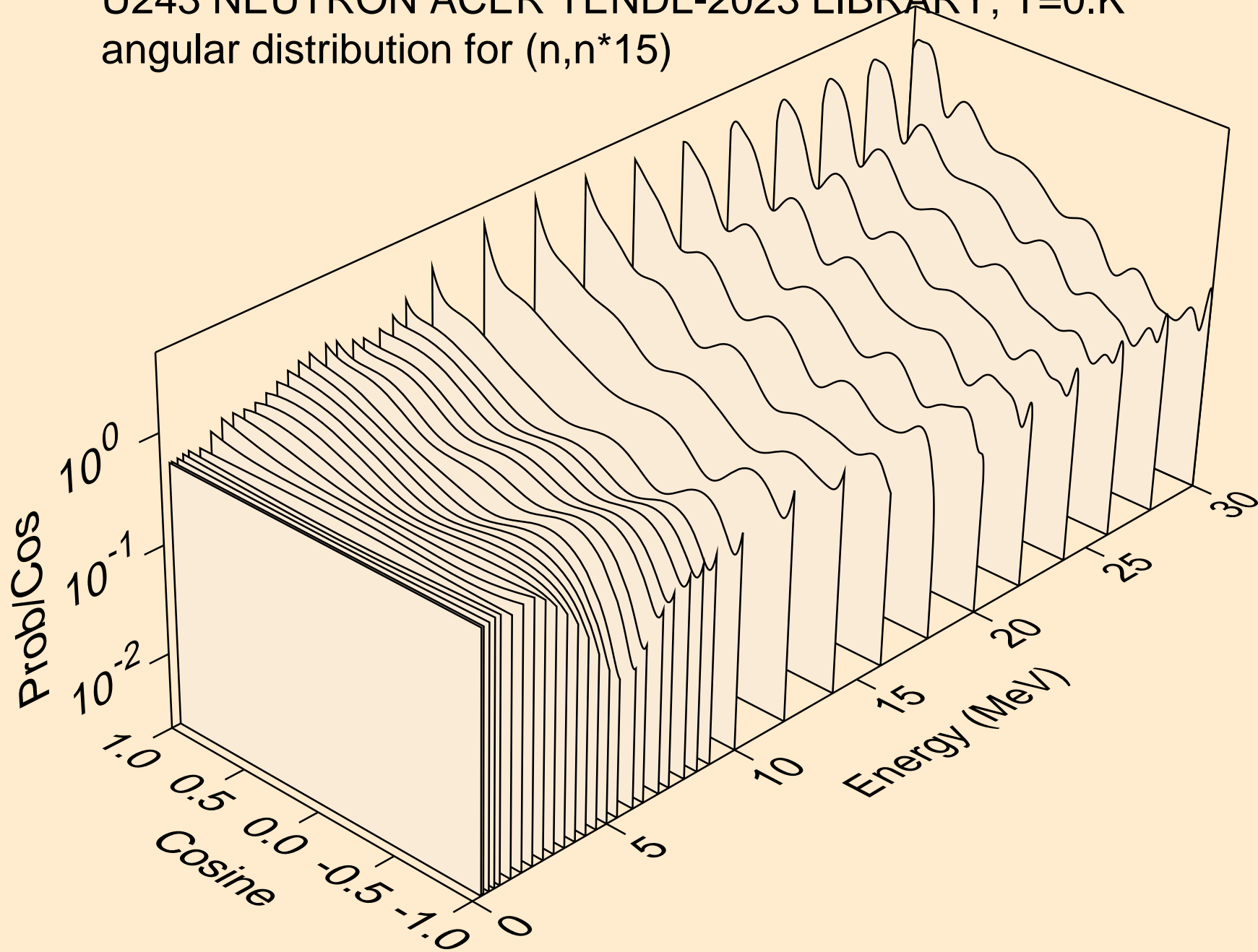

U243 NEUTRON ACER TENDL-2023 LIBRARY; T=0.K
angular distribution for (n,n*16)

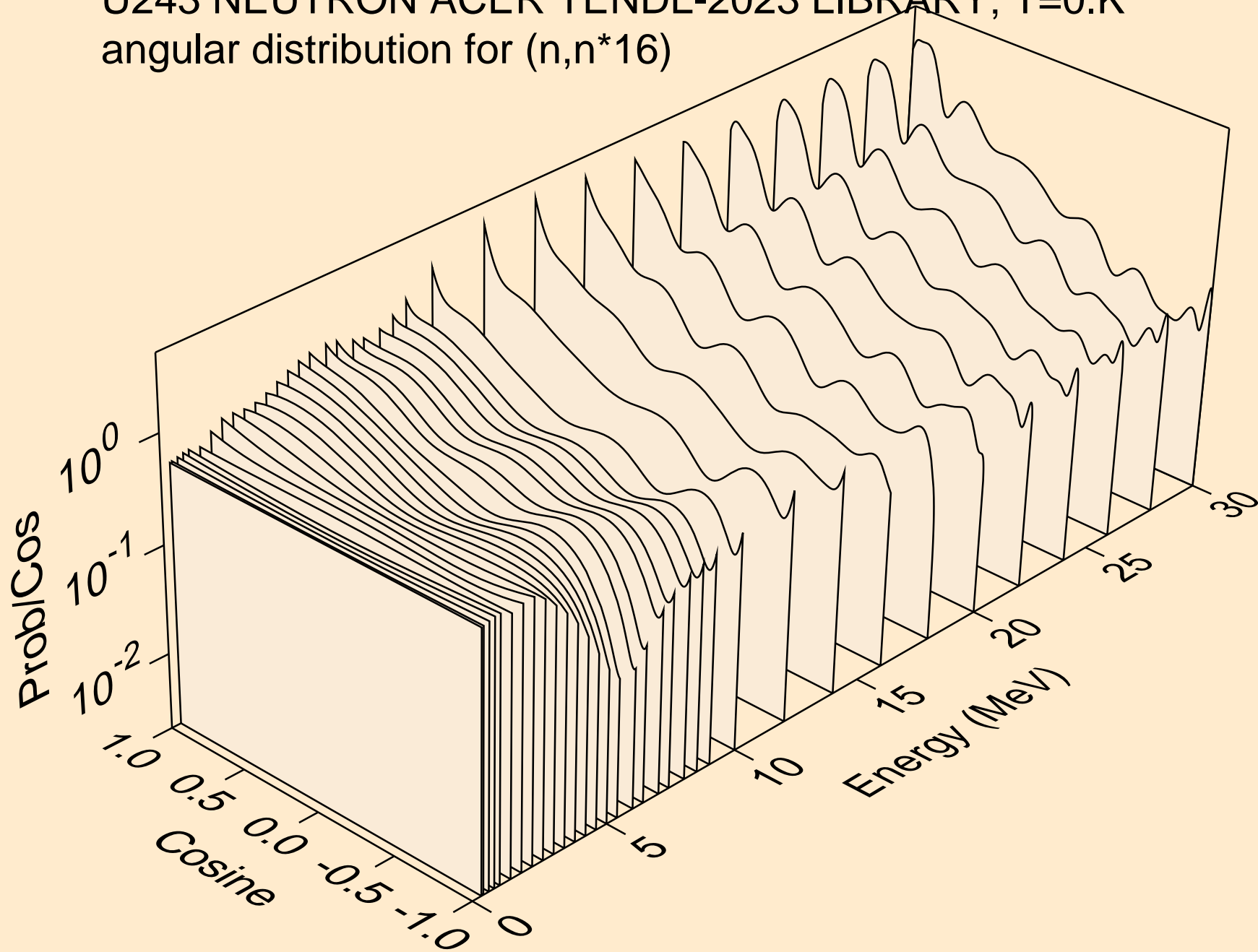

U243 NEUTRON ACER TENDL-2023 LIBRARY; T=0.K
angular distribution for (n,n*17)

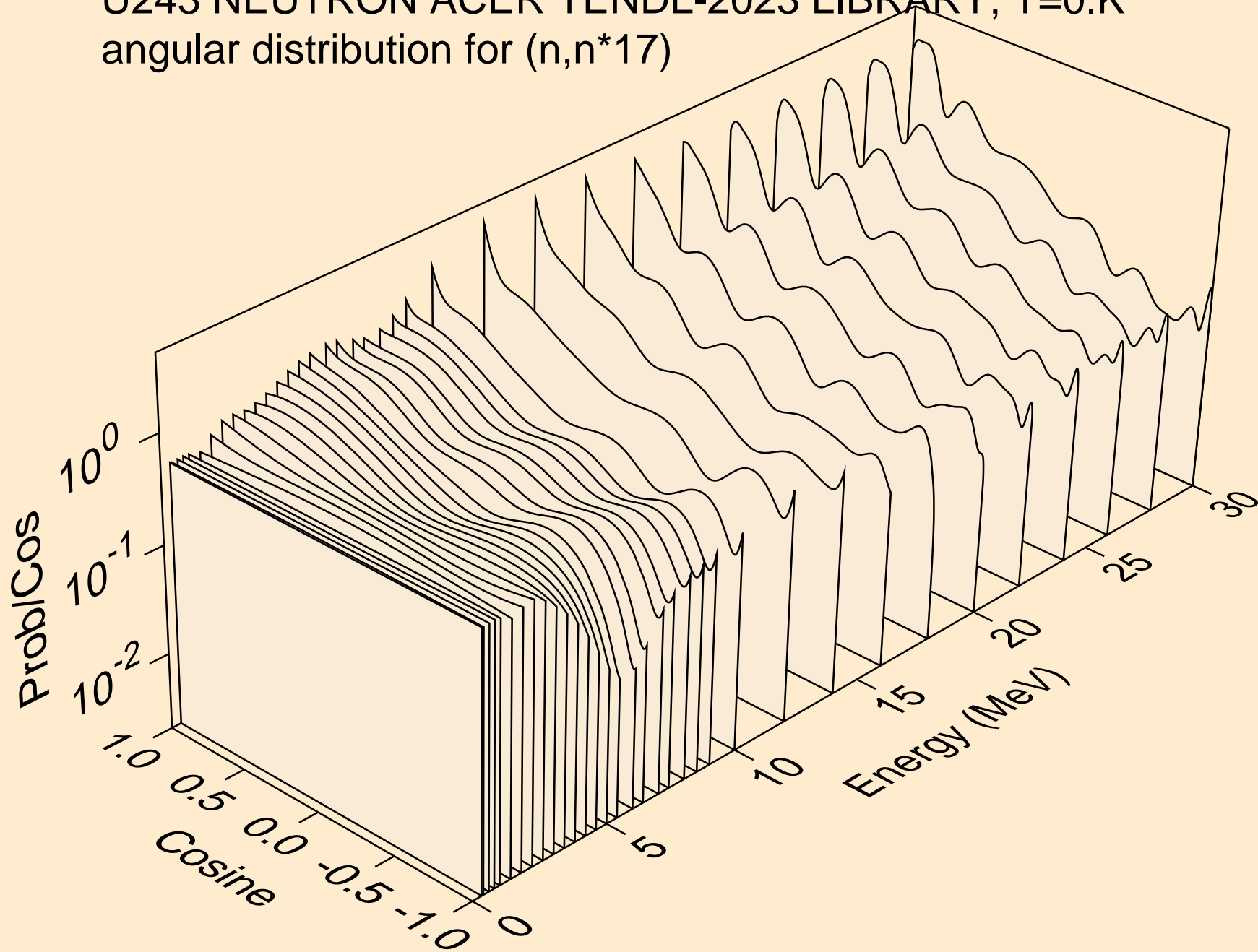

U243 NEUTRON ACER TENDL-2023 LIBRARY; T=0.K
angular distribution for (n,n*18)

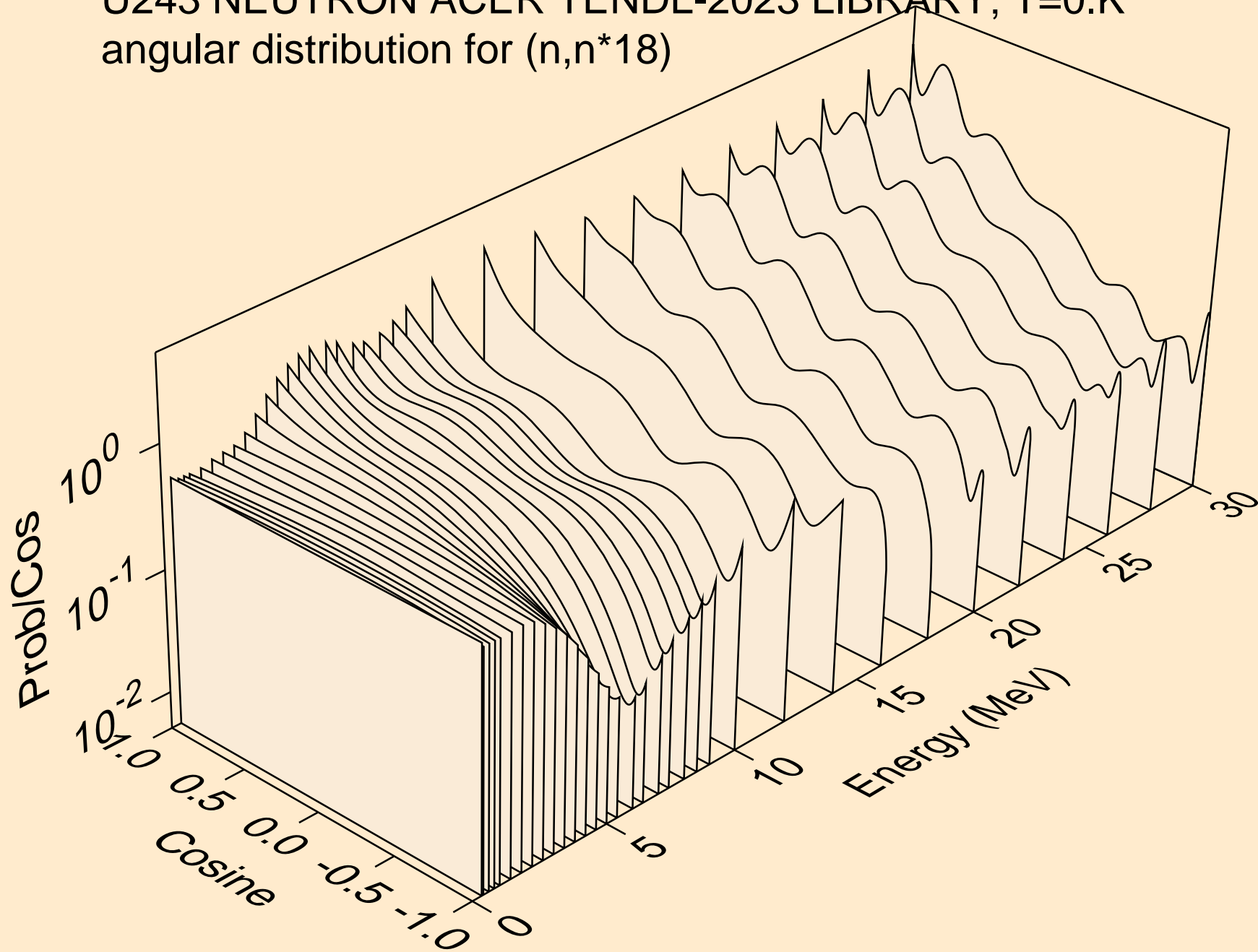

U243 NEUTRON ACER TENDL-2023 LIBRARY; T=0.K
angular distribution for (n,n*19)

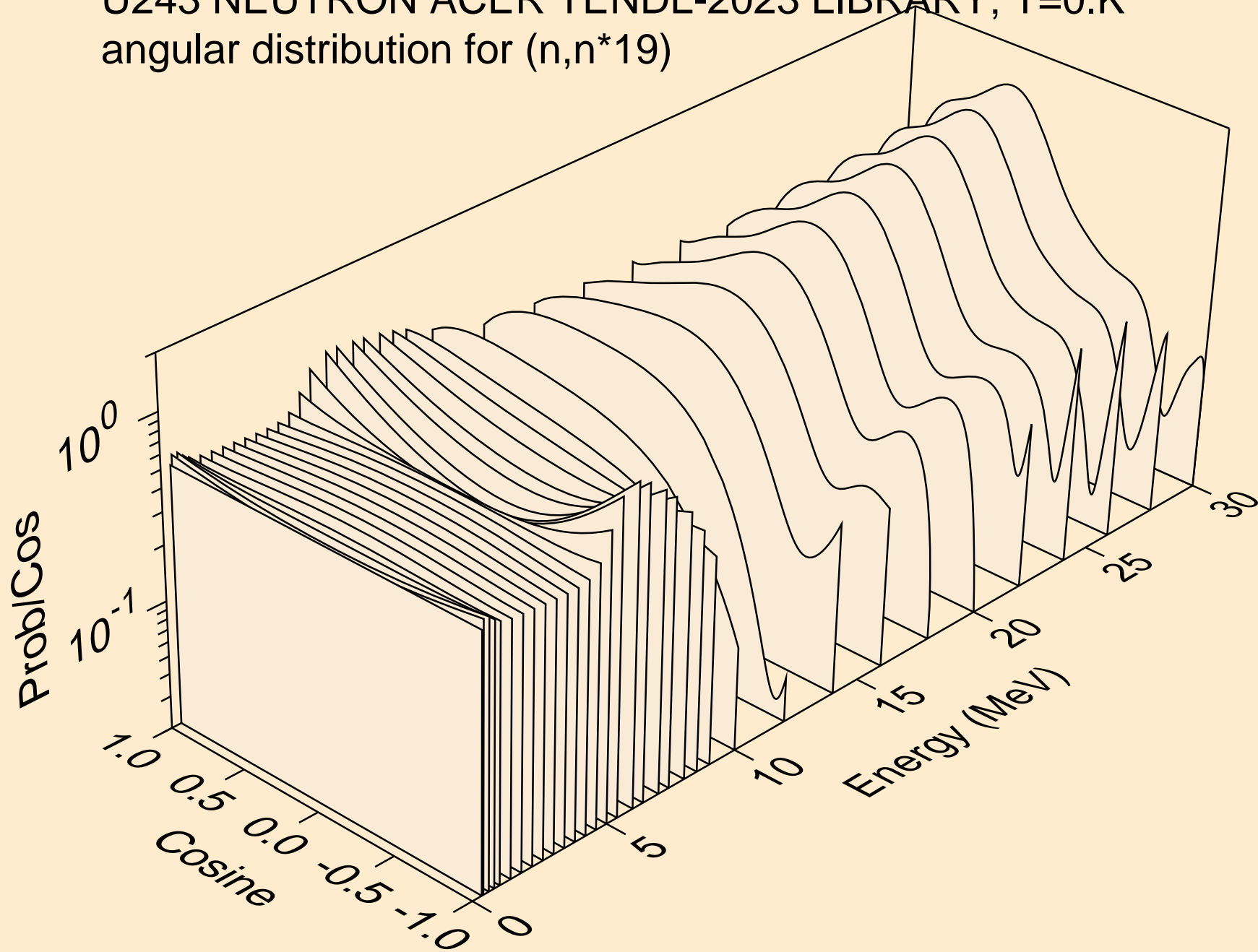

U243 NEUTRON ACER TENDL-2023 LIBRARY; T=0.K
angular distribution for (n,n*20)

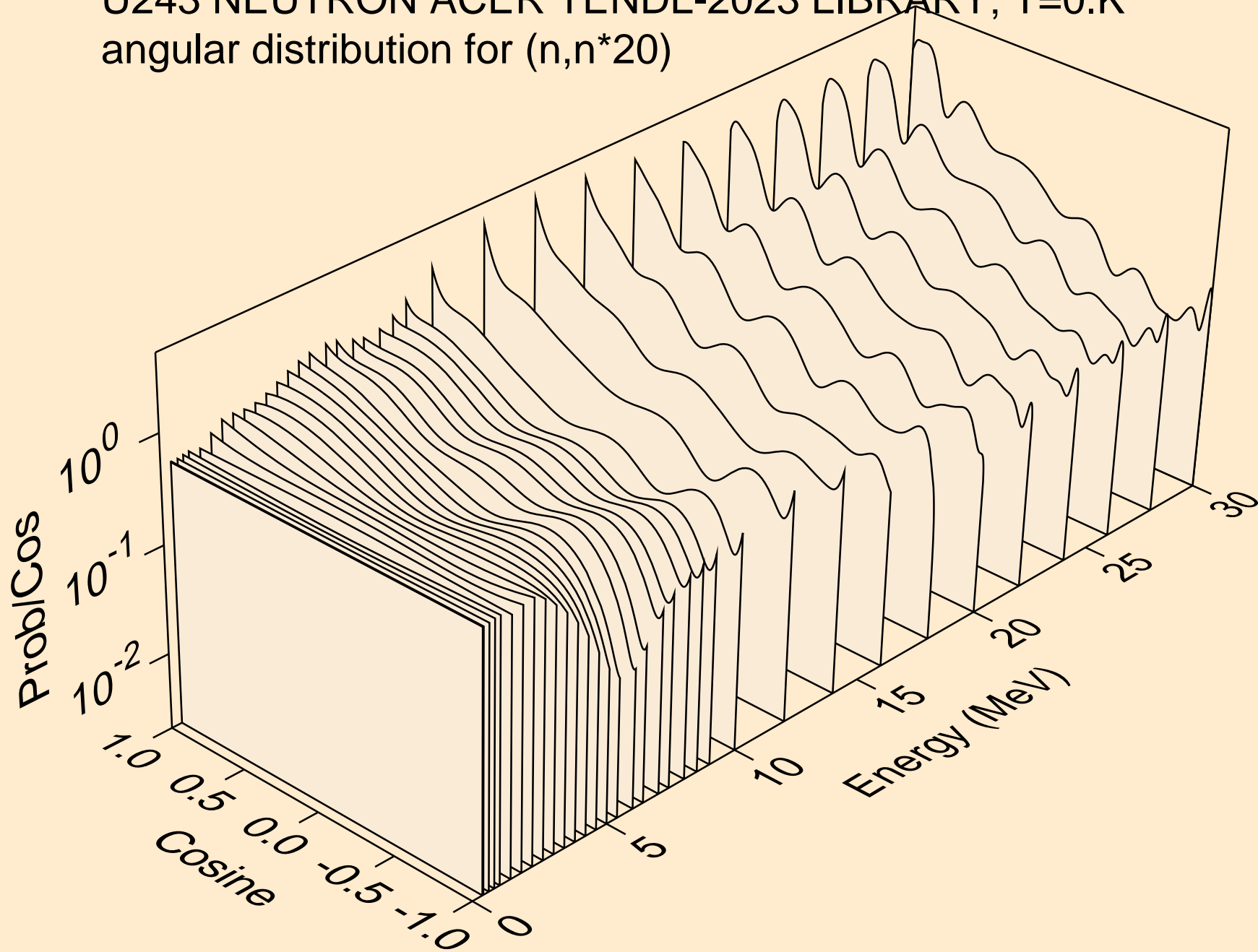

U243 NEUTRON ACER TENDL-2023 LIBRARY; T=0.K
angular distribution for (n,n*21)

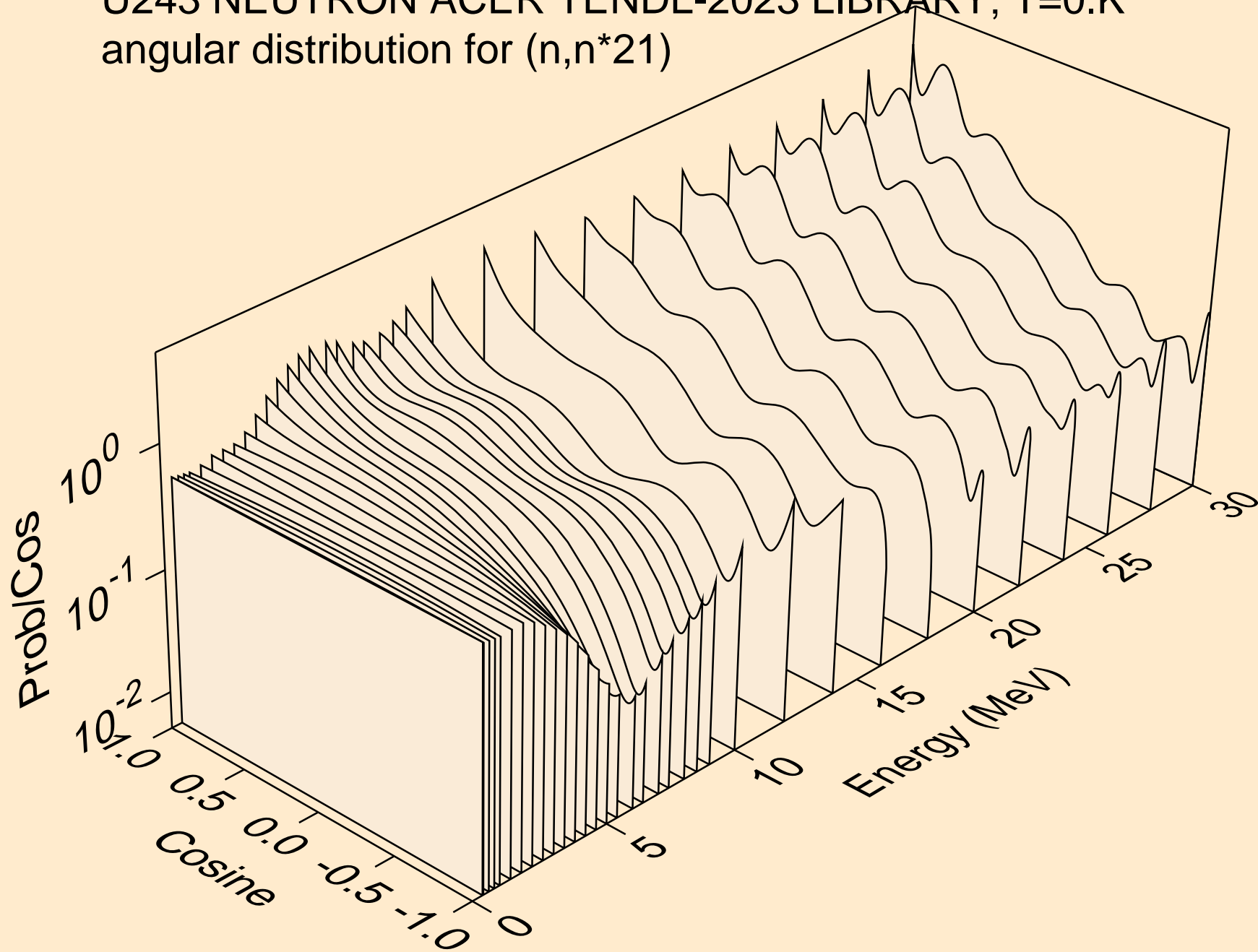

U243 NEUTRON ACER TENDL-2023 LIBRARY; T=0.K
angular distribution for (n,n*22)

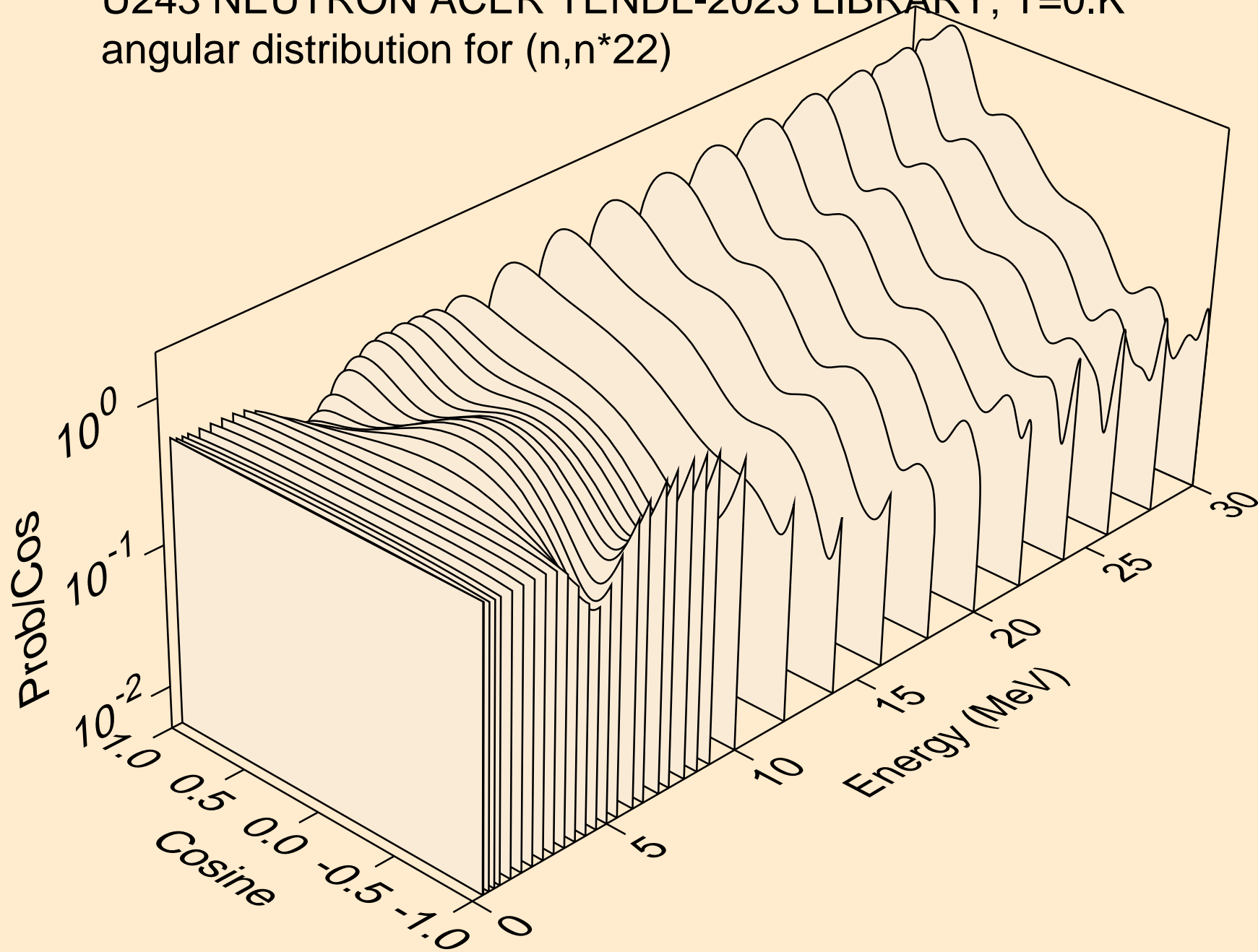

U243 NEUTRON ACER TENDL-2023 LIBRARY; T=0.K
angular distribution for (n,n*23)

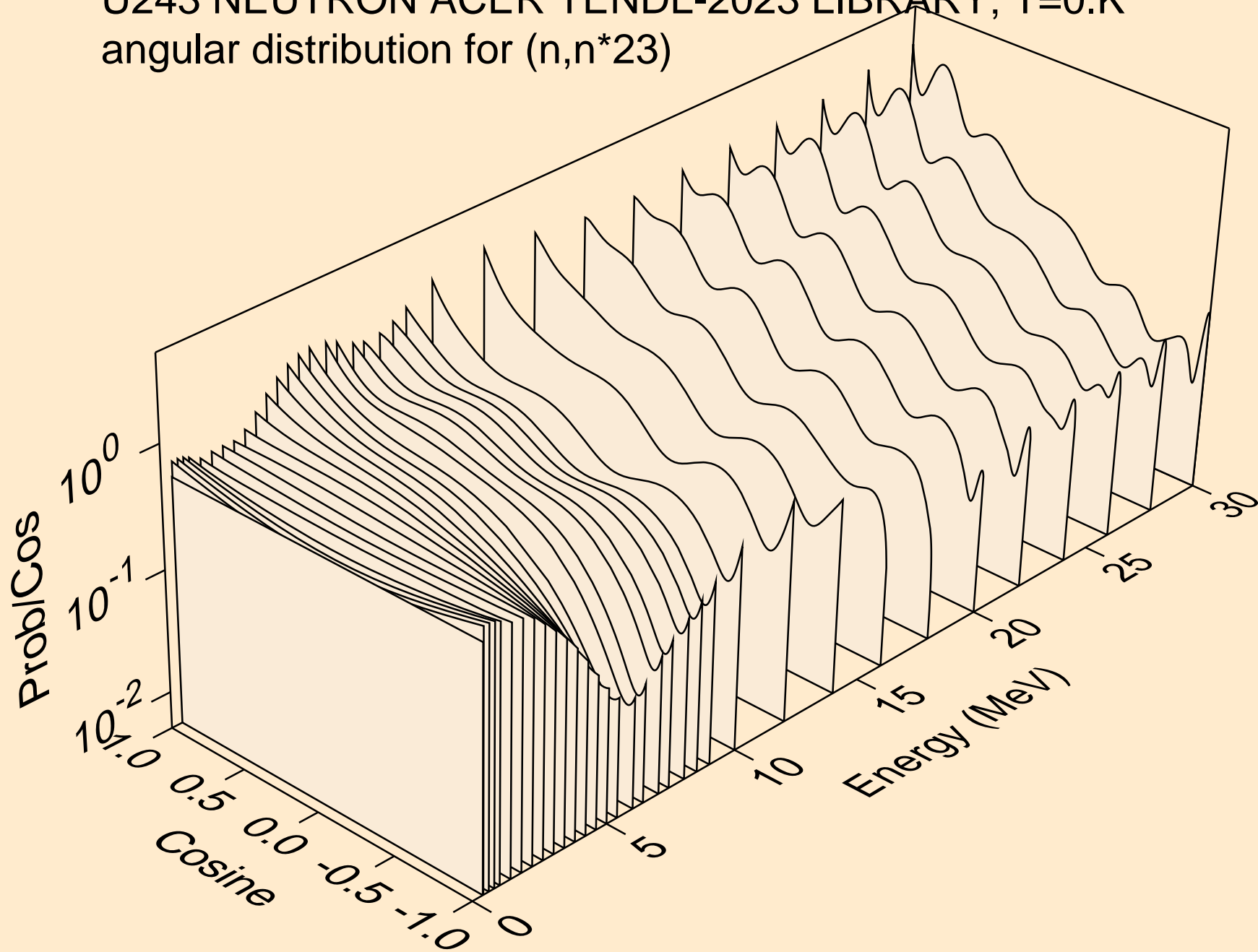

U243 NEUTRON ACER TENDL-2023 LIBRARY; T=0.K
angular distribution for (n,n*24)

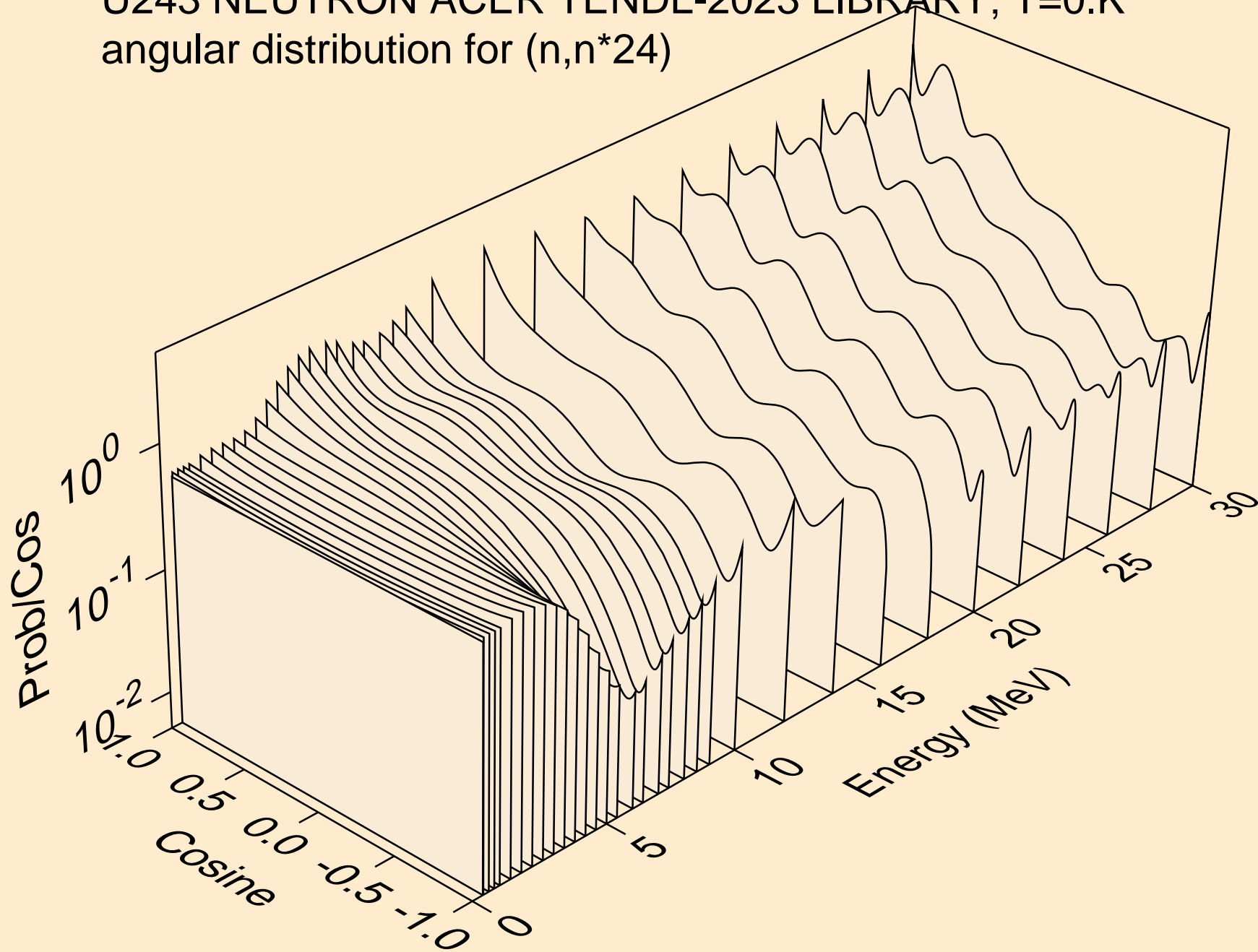

U243 NEUTRON ACER TENDL-2023 LIBRARY; T=0.K
angular distribution for (n,n*25)

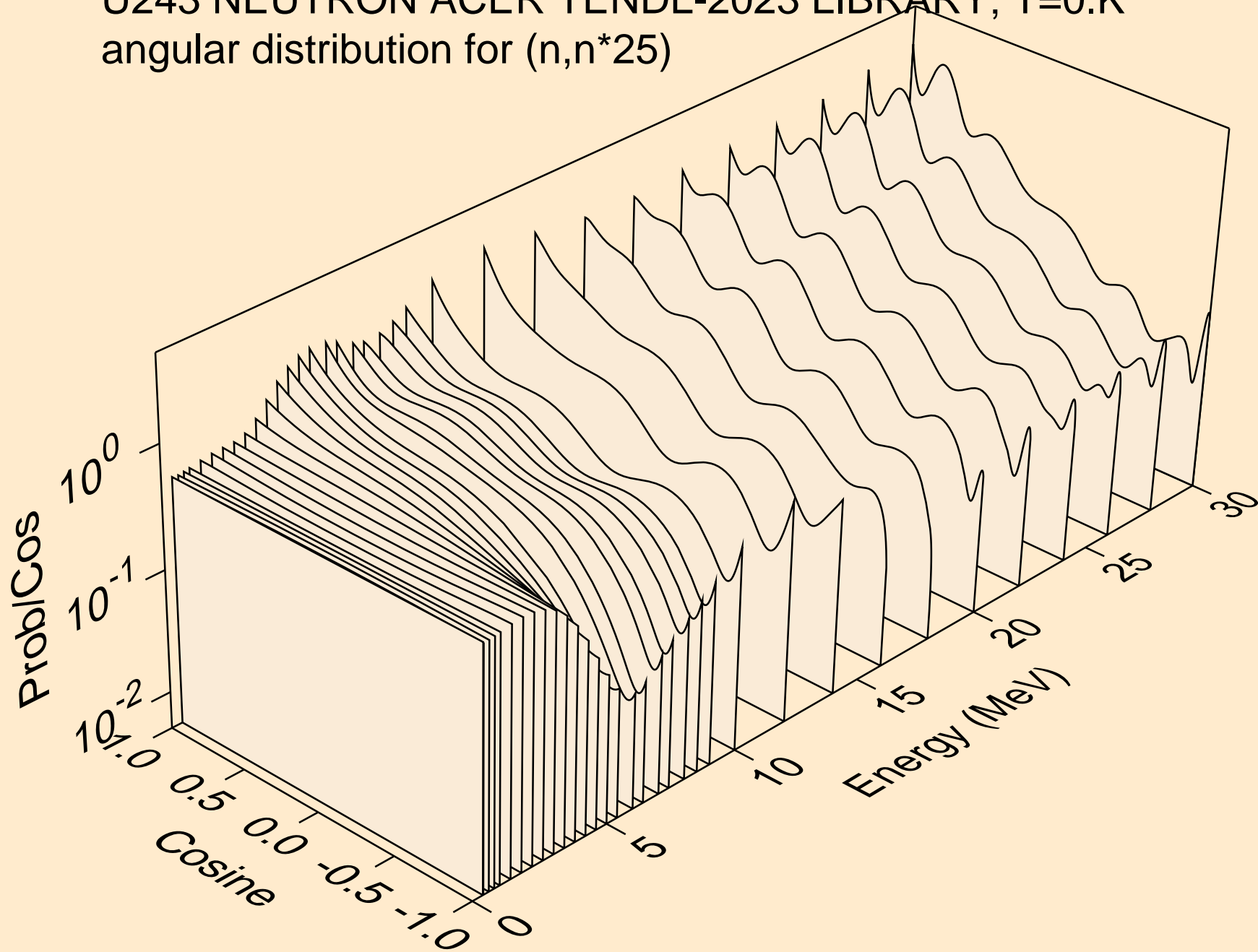

U243 NEUTRON ACER TENDL-2023 LIBRARY; T=0.K
angular distribution for (n,n*26)

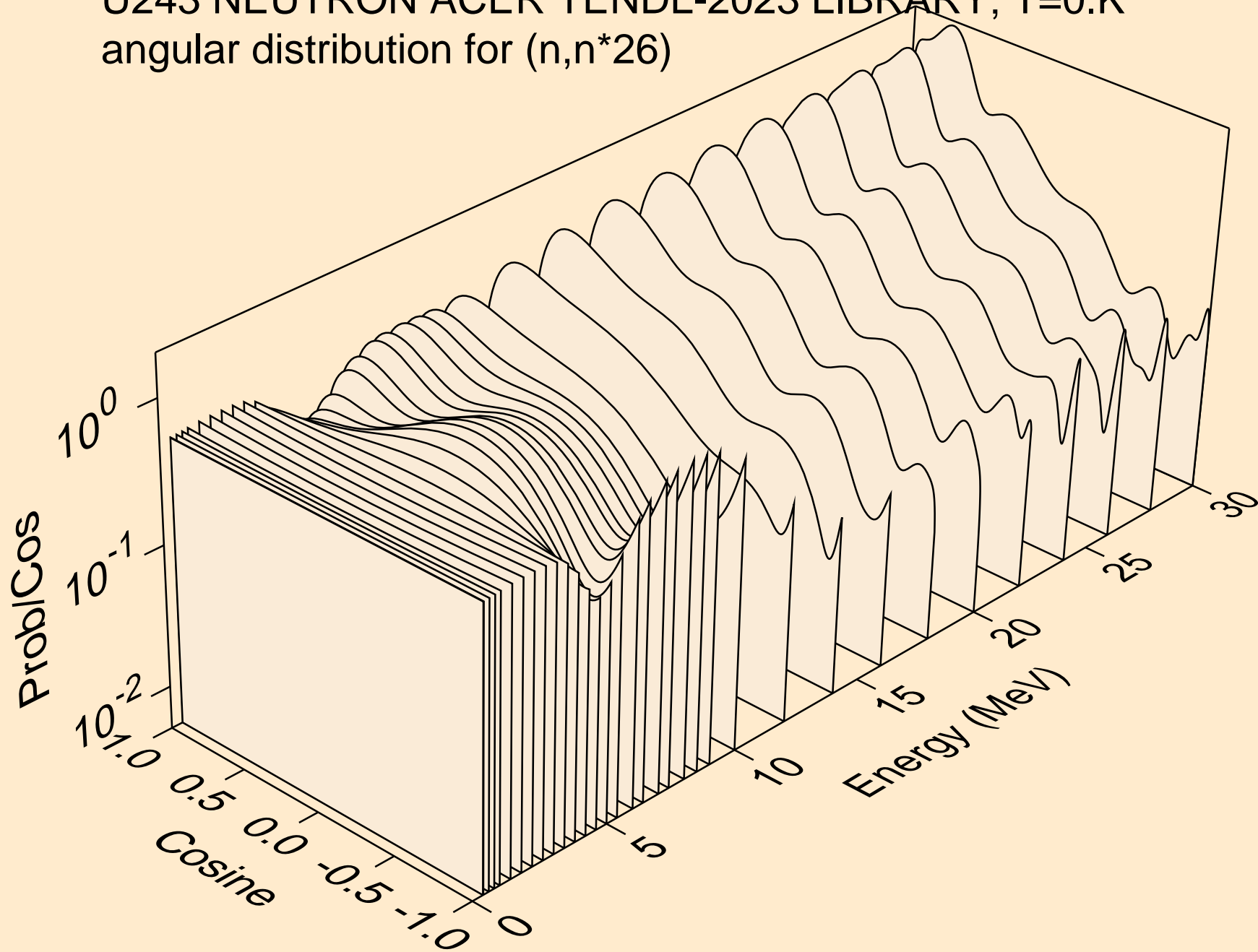

U243 NEUTRON ACER TENDL-2023 LIBRARY; T=0.K
angular distribution for (n,n*27)

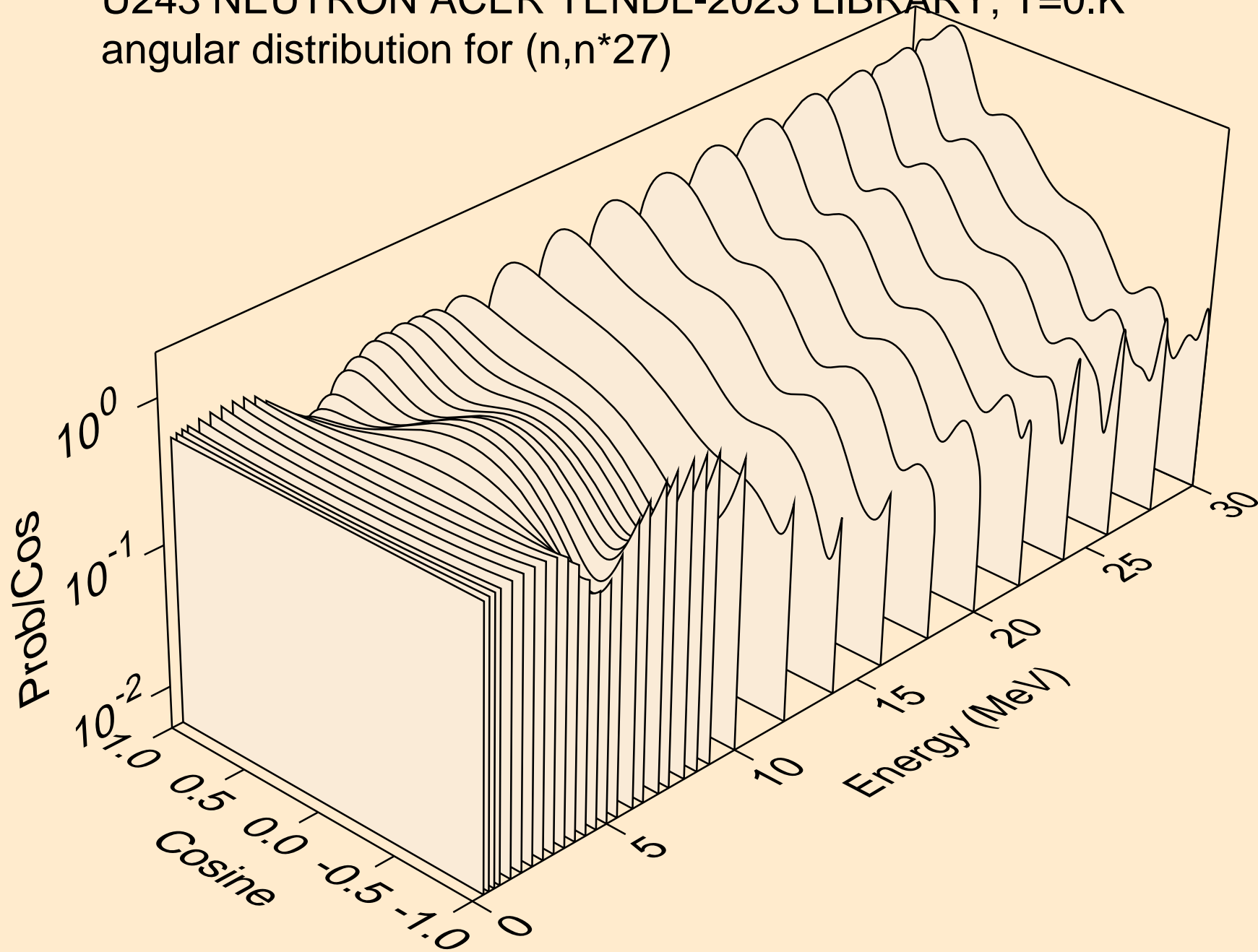

U243 NEUTRON ACER TENDL-2023 LIBRARY; T=0.K

Total fission nubar

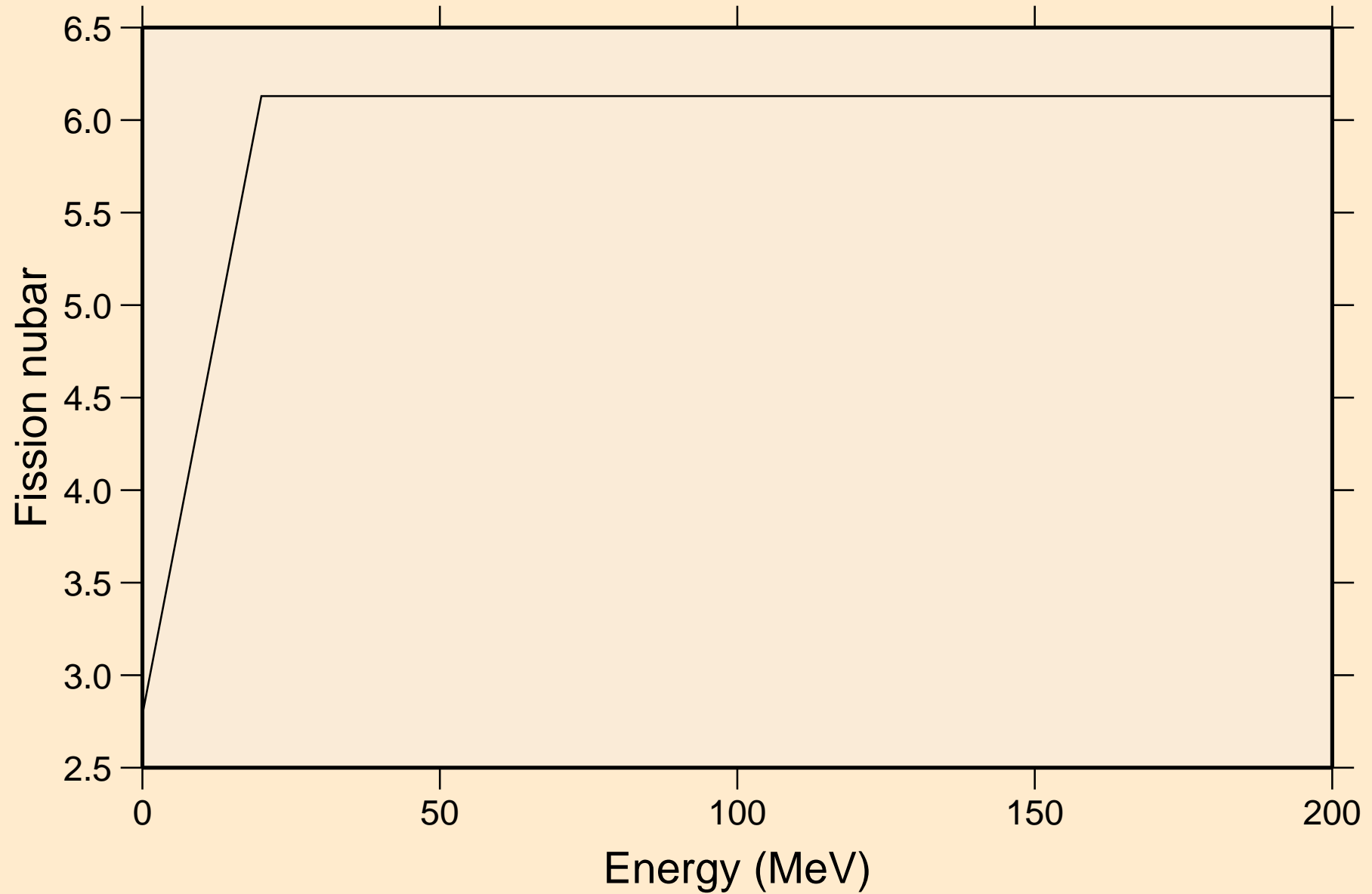

U243 NEUTRON ACER TENDL-2023 LIBRARY; T=0.K
Neutron emission for (n,x)

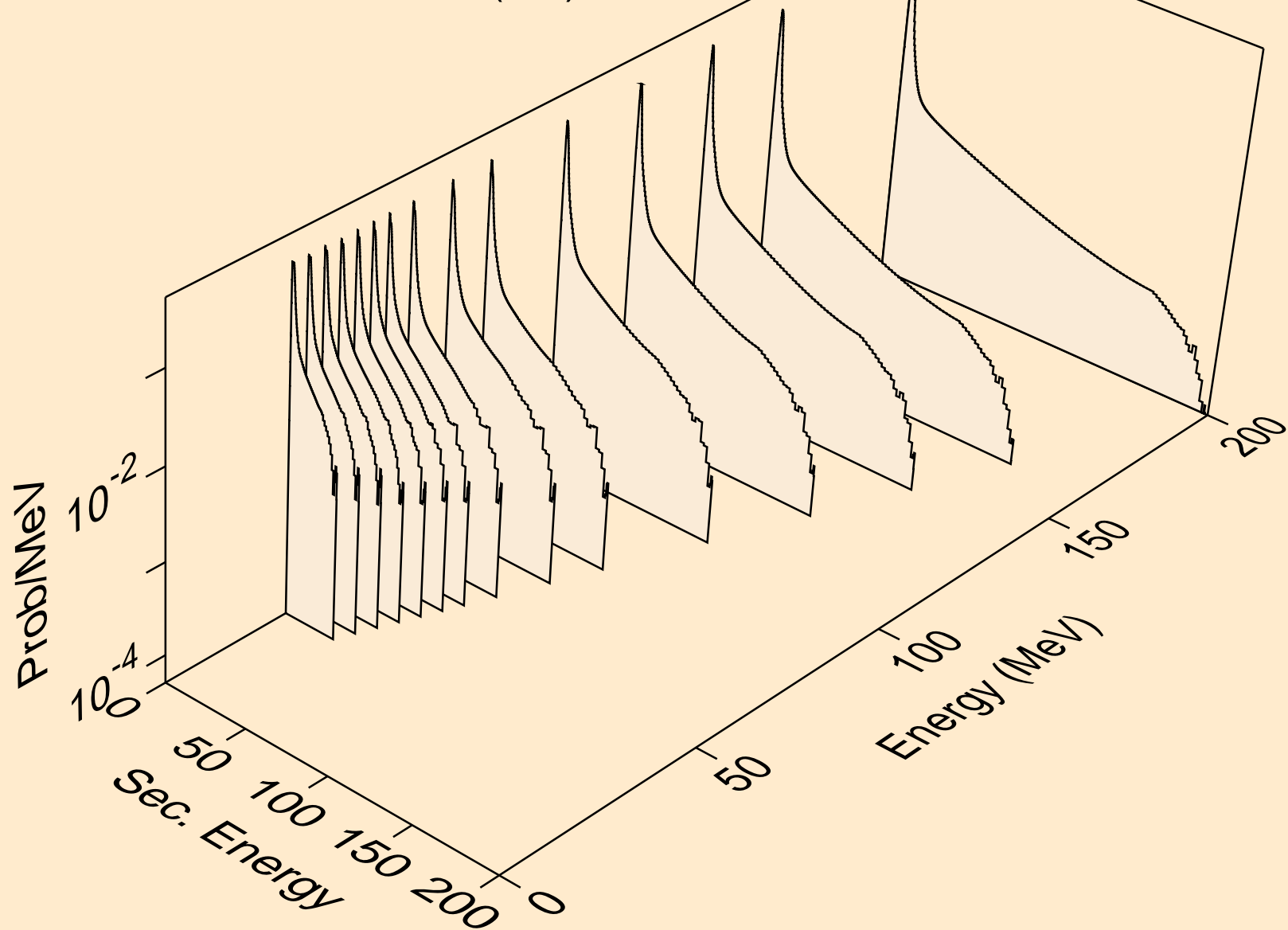

U243 NEUTRON ACER TENDL-2023 LIBRARY; T=0.K
Neutron emission for (n,2nd)

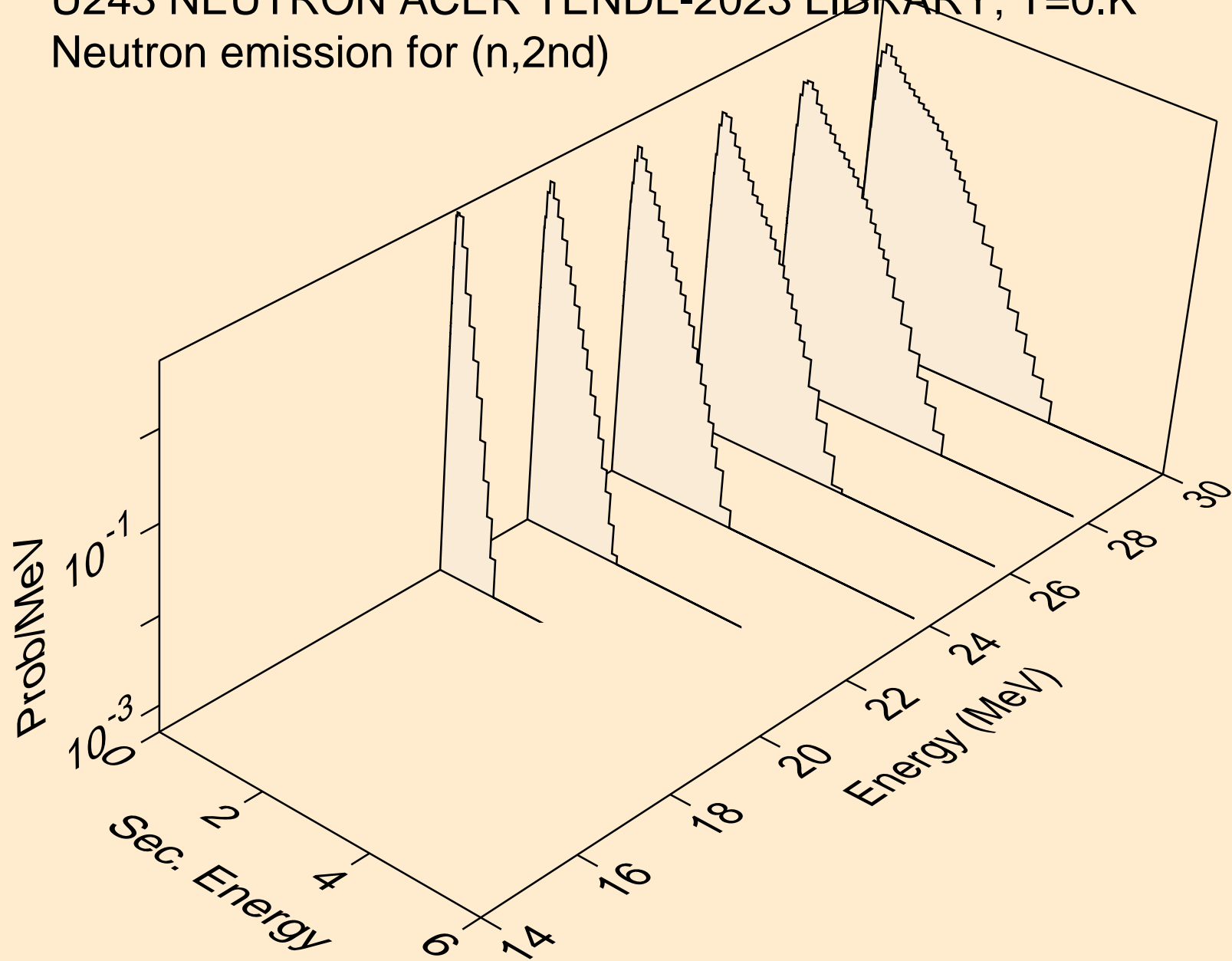

U243 NEUTRON ACER TENDL-2023 LIBRARY; T=0.K
Neutron emission for (n,2n)

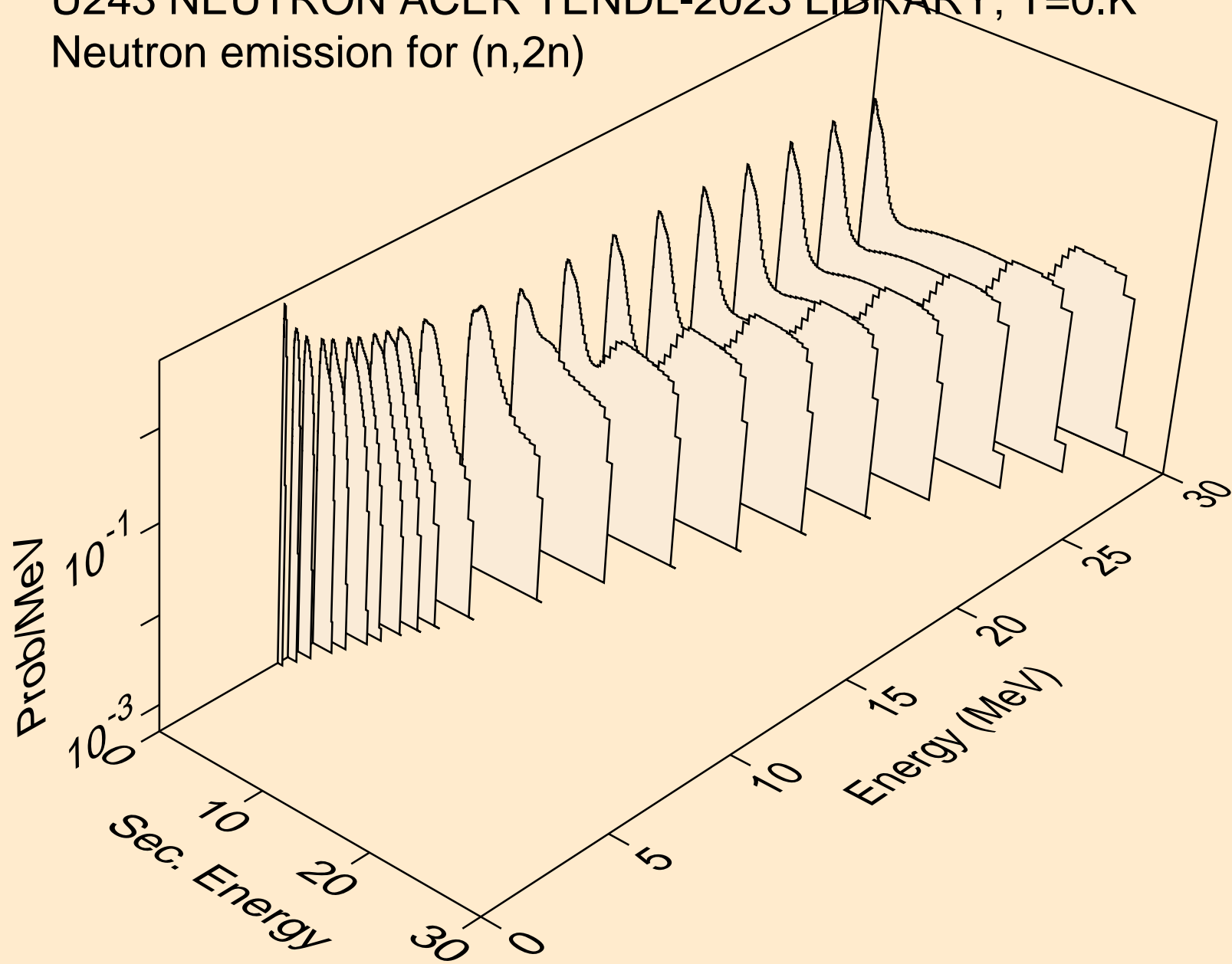

U243 NEUTRON ACER TENDL-2023 LIBRARY; T=0.K
Neutron emission for (n,3n)

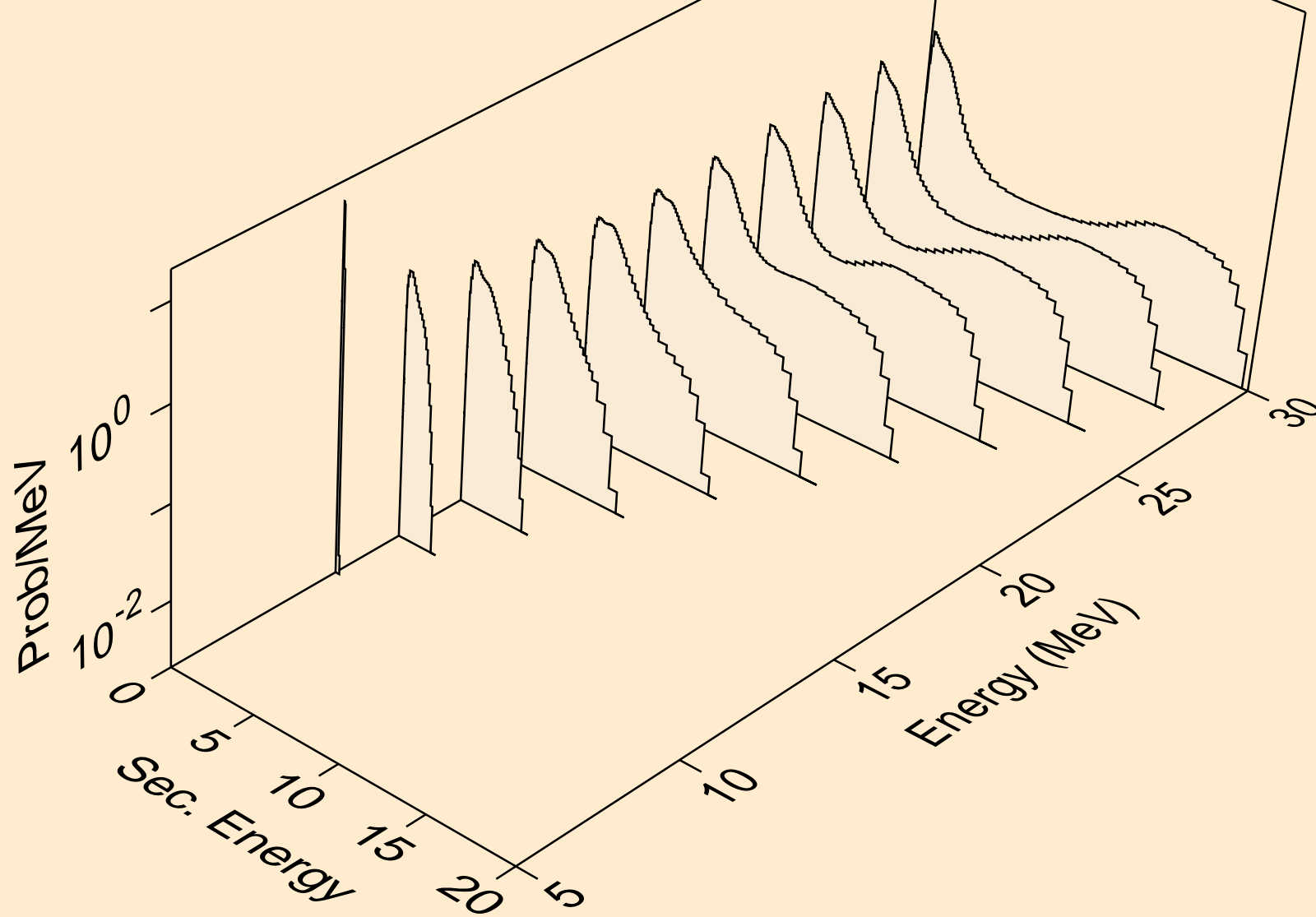

U243 NEUTRON ACER TENDL-2023 LIBRARY; T=0.K
Neutron emission for fission

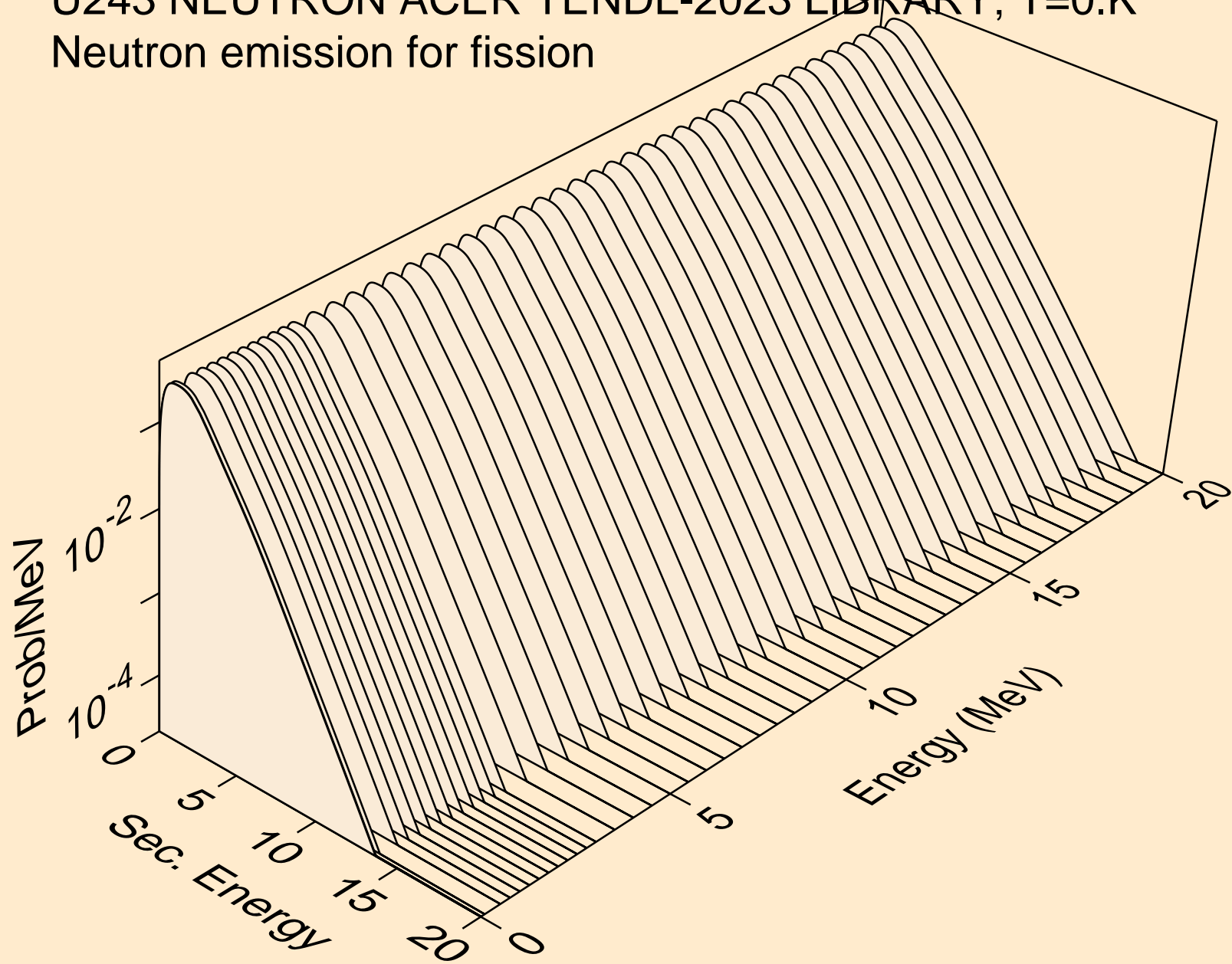

U243 NEUTRON ACER TENDL-2023 LIBRARY; T=0.K
Neutron emission for (n,n*)a

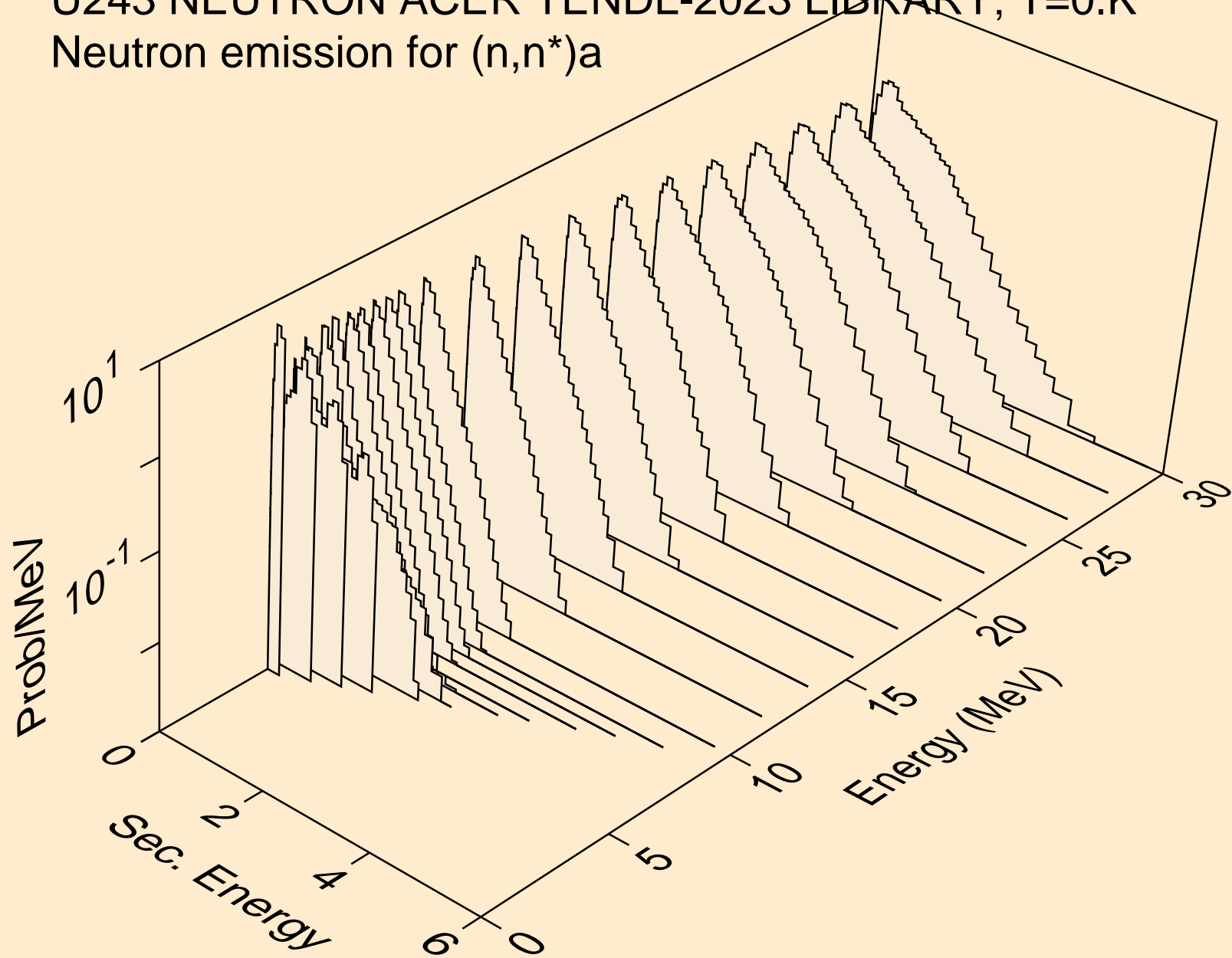

U243 NEUTRON ACER TENDL-2023 LIBRARY; T=0.K
Neutron emission for (n,2n)a

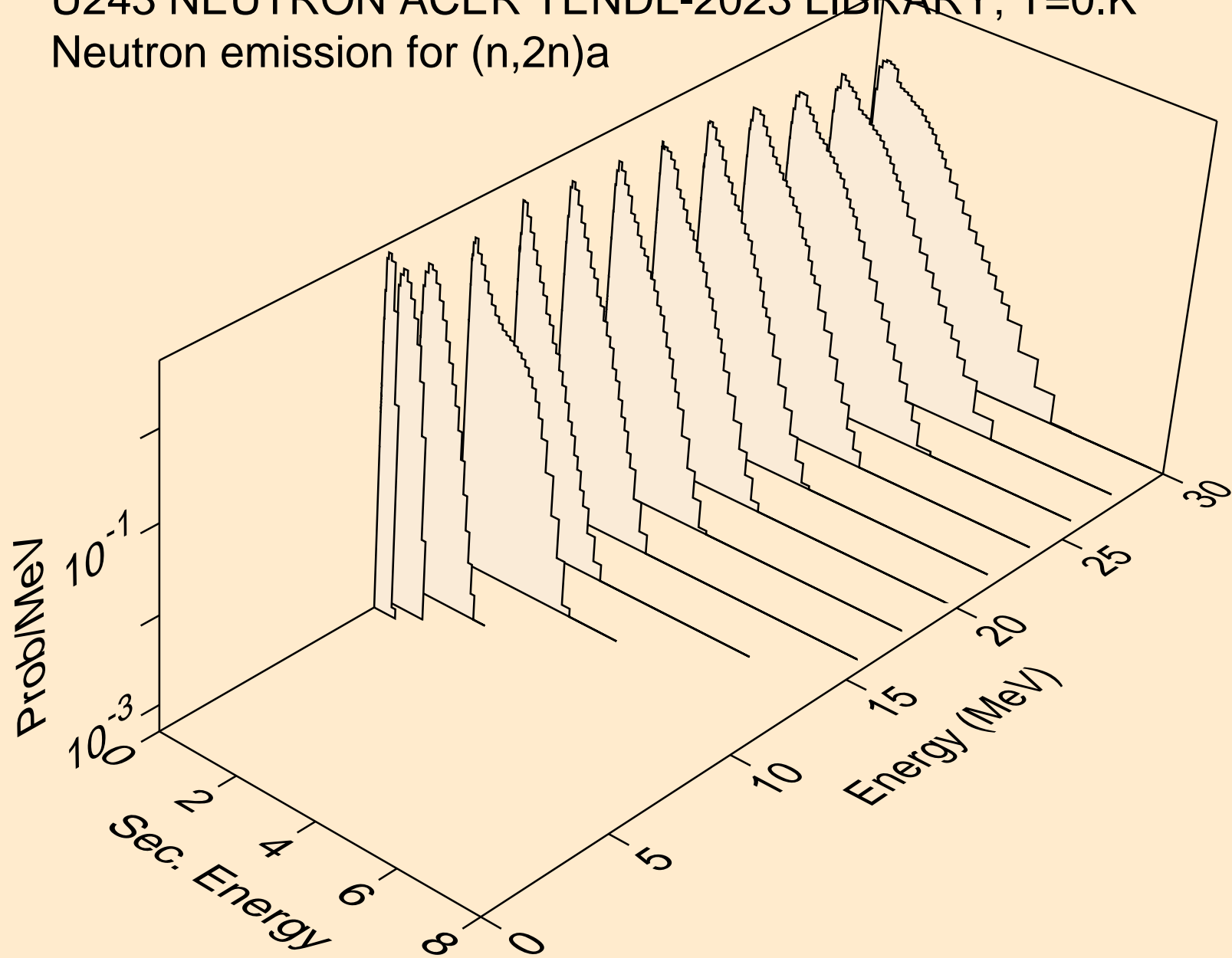

U243 NEUTRON ACER TENDL-2023 LIBRARY; T=0.K
Neutron emission for (n,3n)a

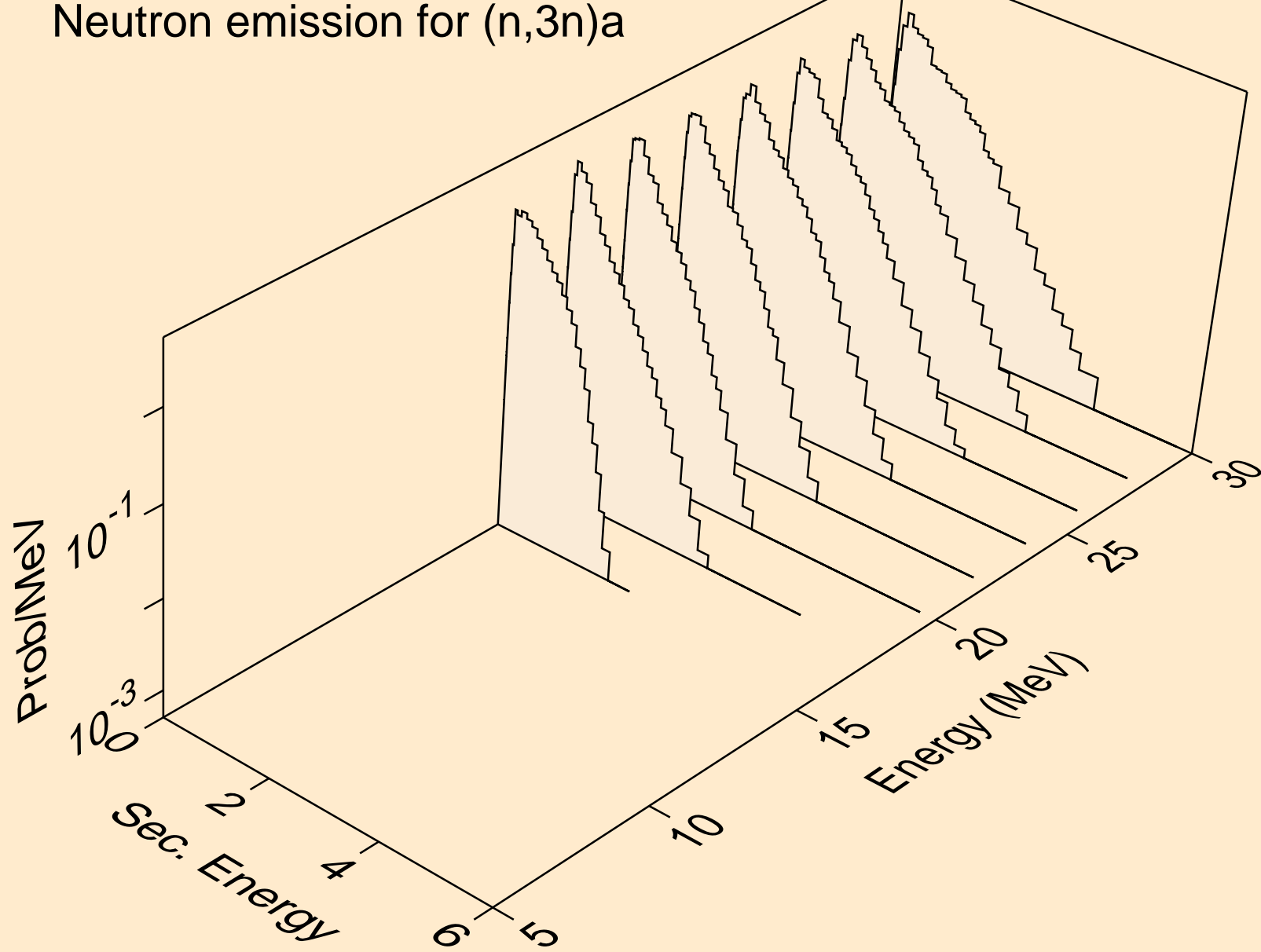

U243 NEUTRON ACER TENDL-2023 LIBRARY; T=0.K
Neutron emission for (n,n*)p

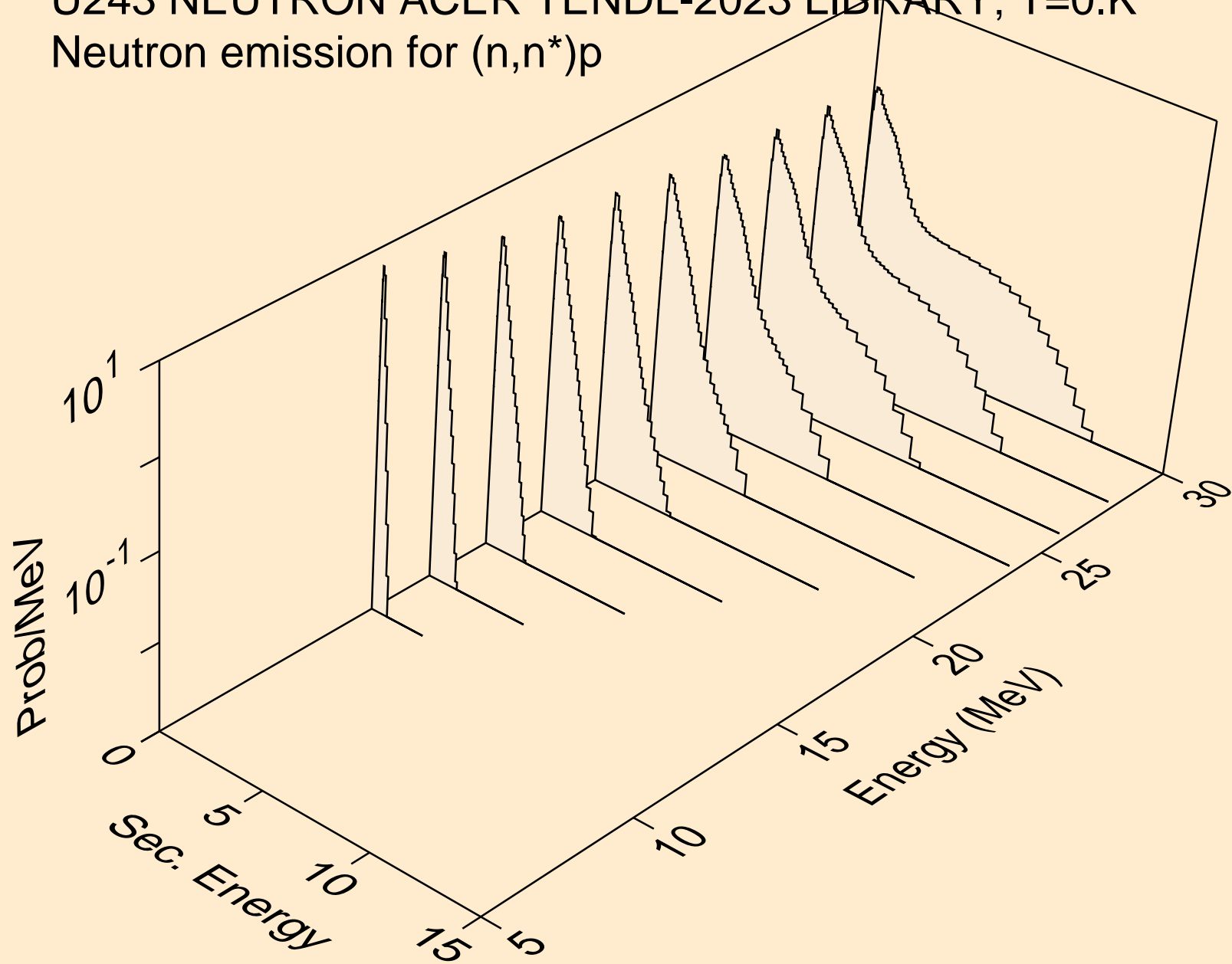

U243 NEUTRON ACER TENDL-2023 LIBRARY; T=0.K
Neutron emission for (n,n*)d

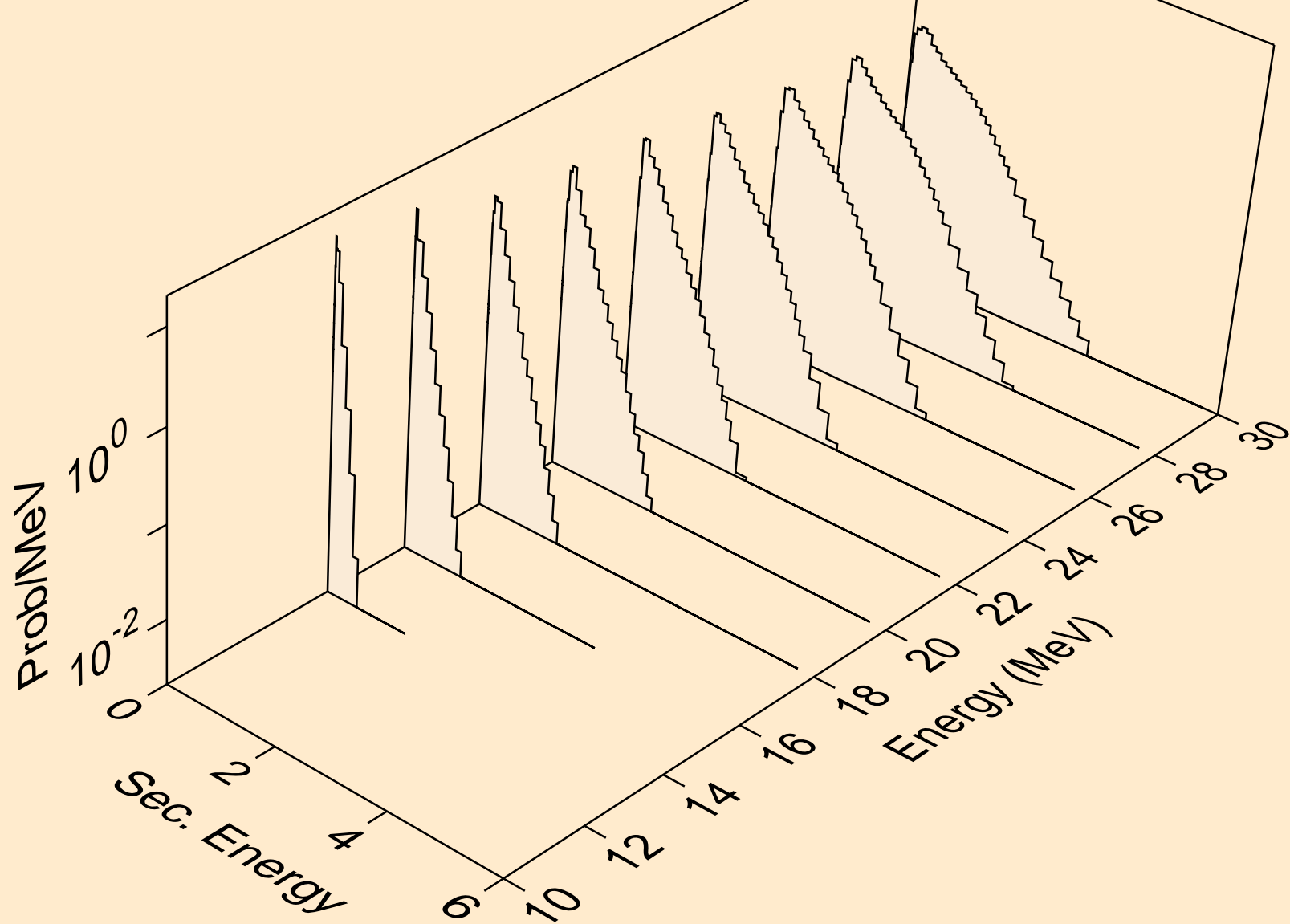

U243 NEUTRON ACER TENDL-2023 LIBRARY; T=0.K
Neutron emission for (n,n*)t

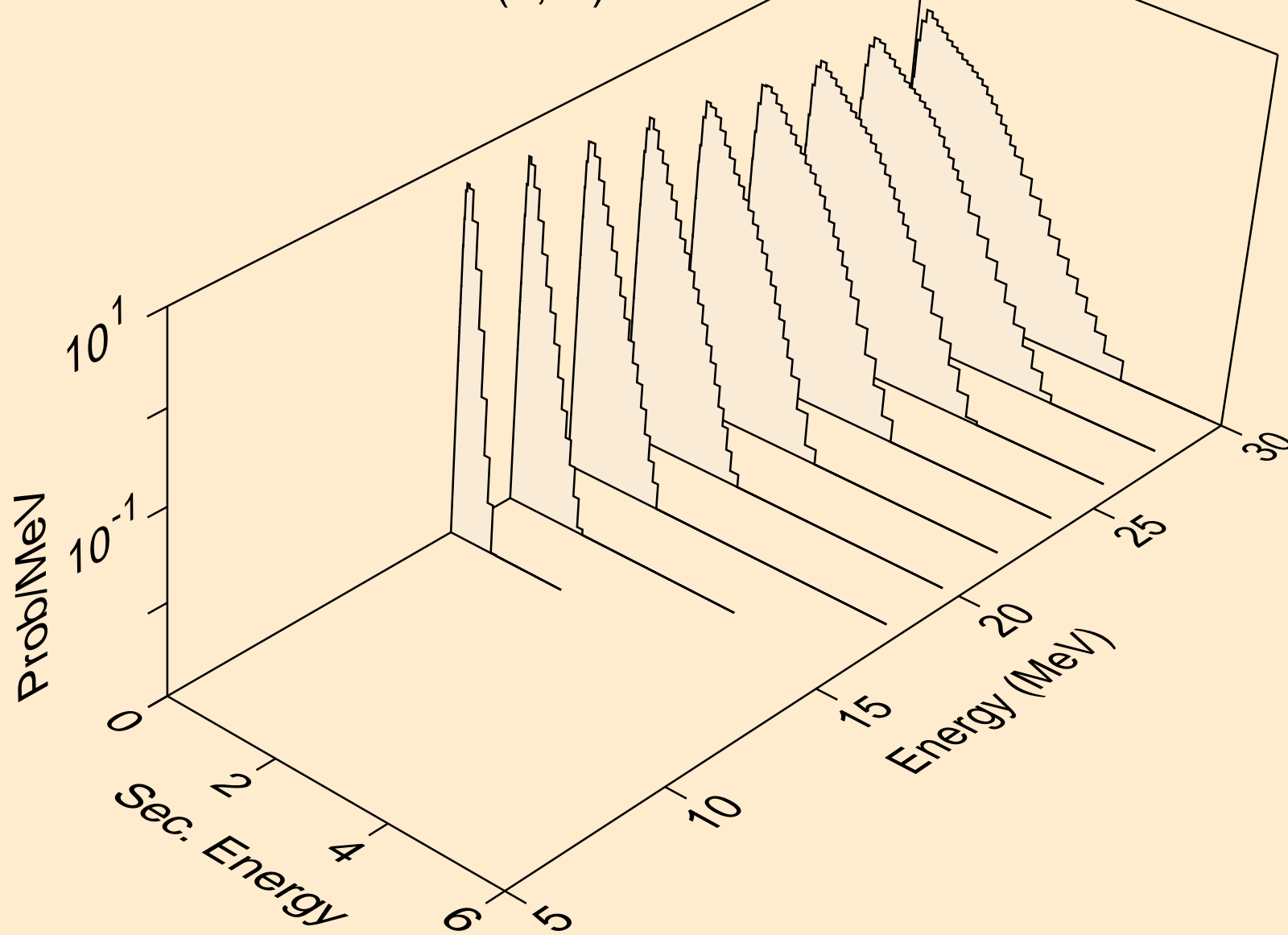

U243 NEUTRON ACER TENDL-2023 LIBRARY; T=0.K
Neutron emission for (n,n*)he3

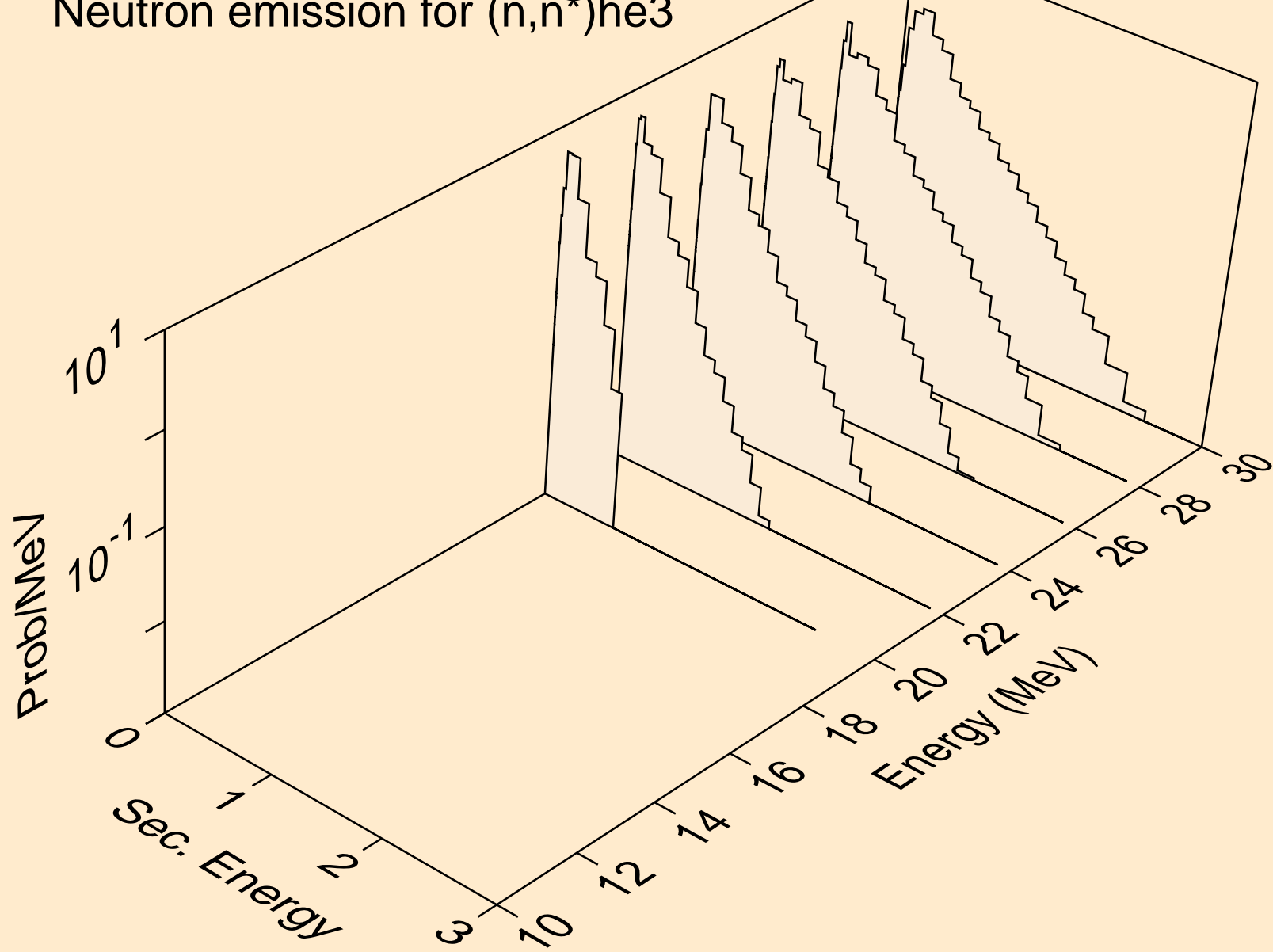

U243 NEUTRON ACER TENDL-2023 LIBRARY; T=0.K
Neutron emission for (n,4n)

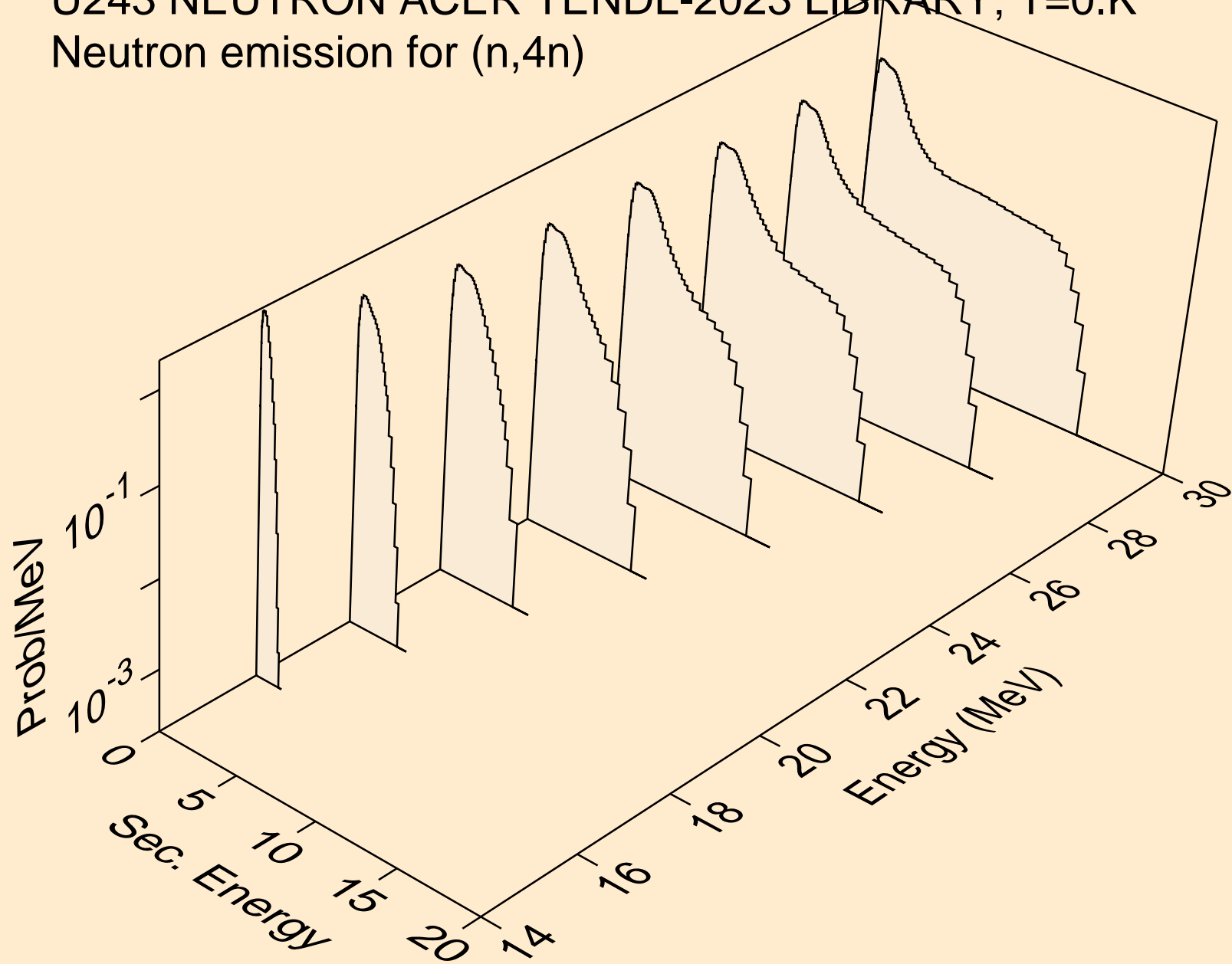

U243 NEUTRON ACER TENDL-2023 LIBRARY; T=0.K
Neutron emission for (n,2np)

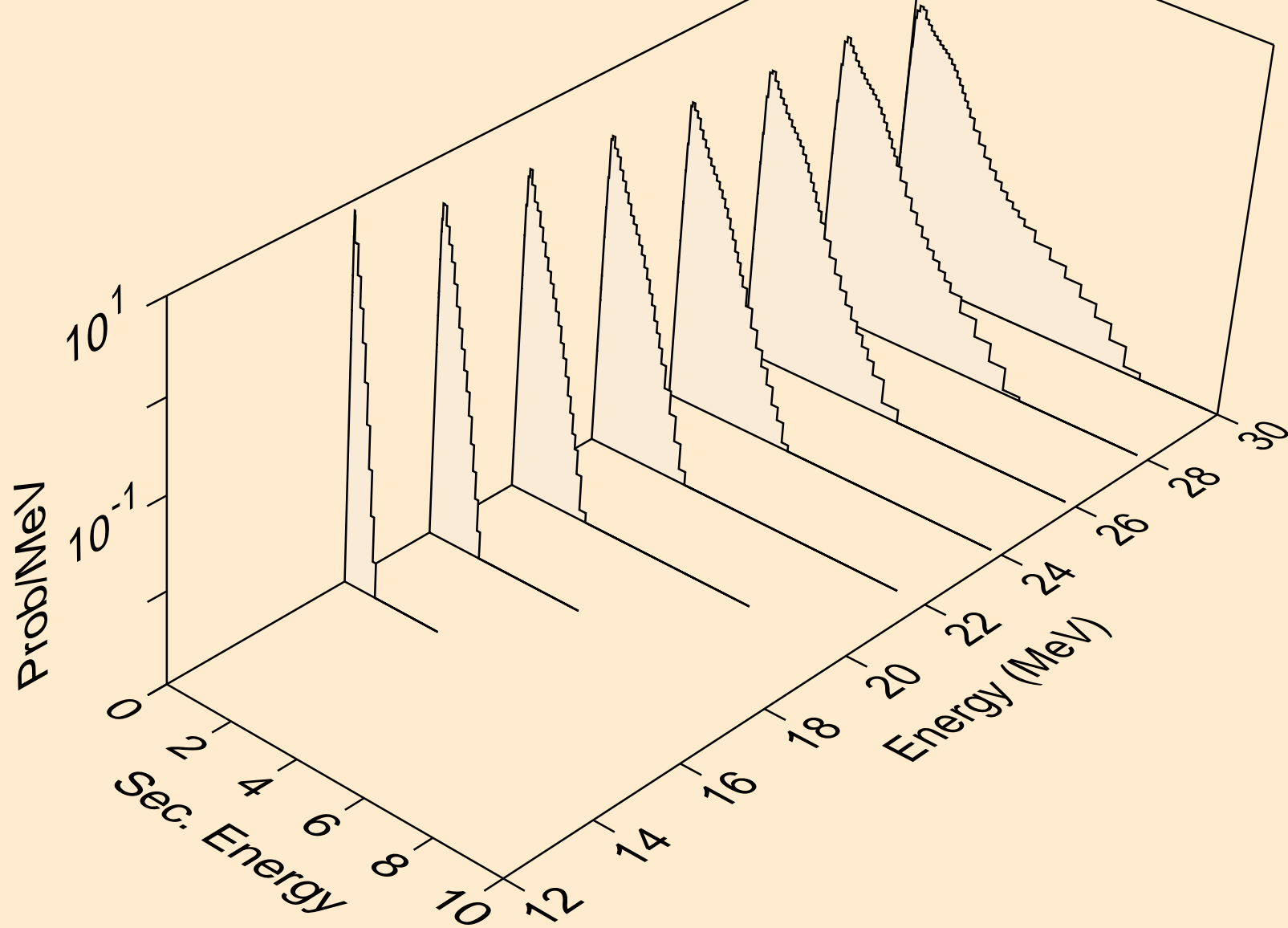

U243 NEUTRON ACER TENDL-2023 LIBRARY; T=0.K
Neutron emission for (n,3np)

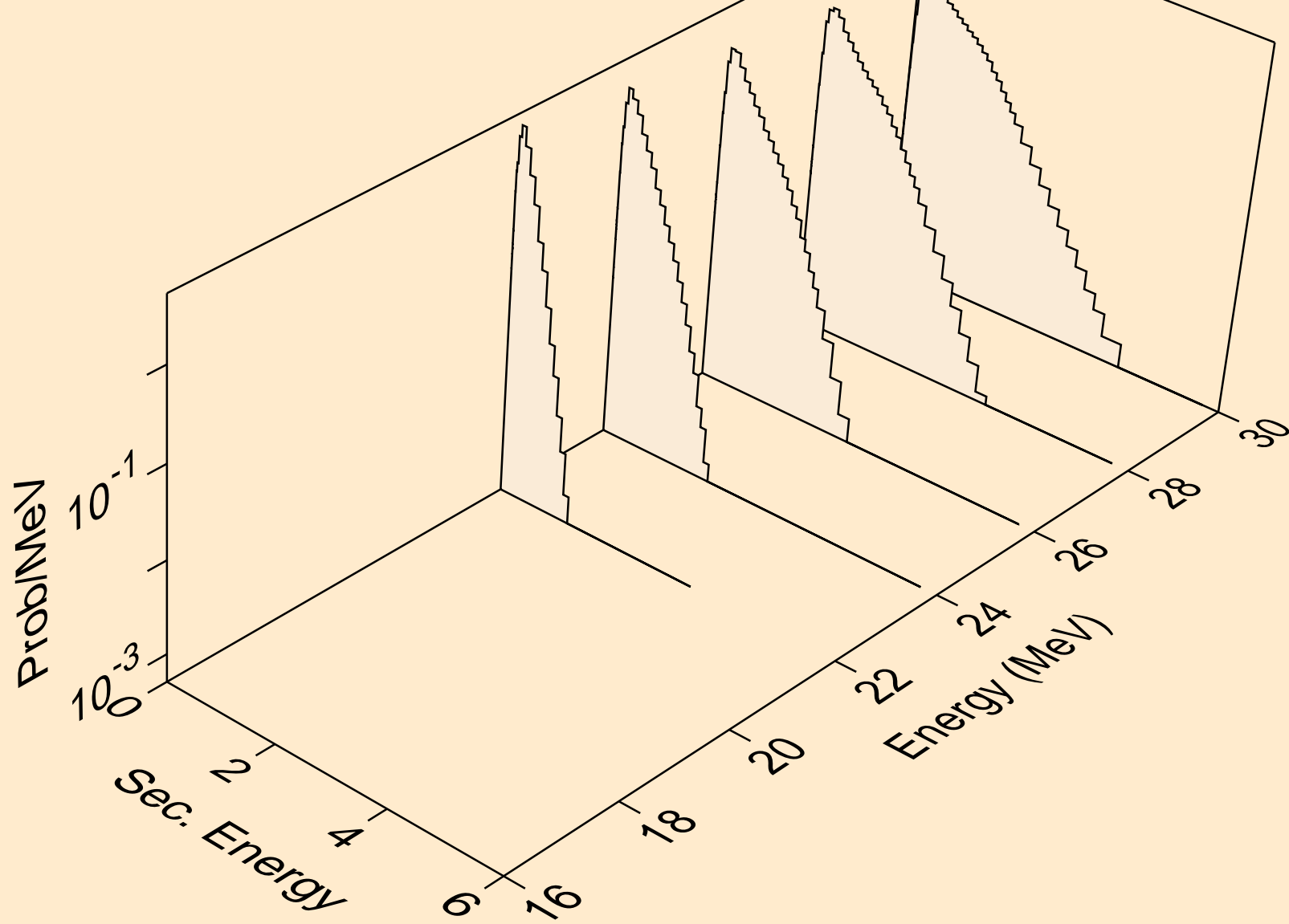

U243 NEUTRON ACER TENDL-2023 LIBRARY; T=0.K
Neutron emission for (n,n*c)

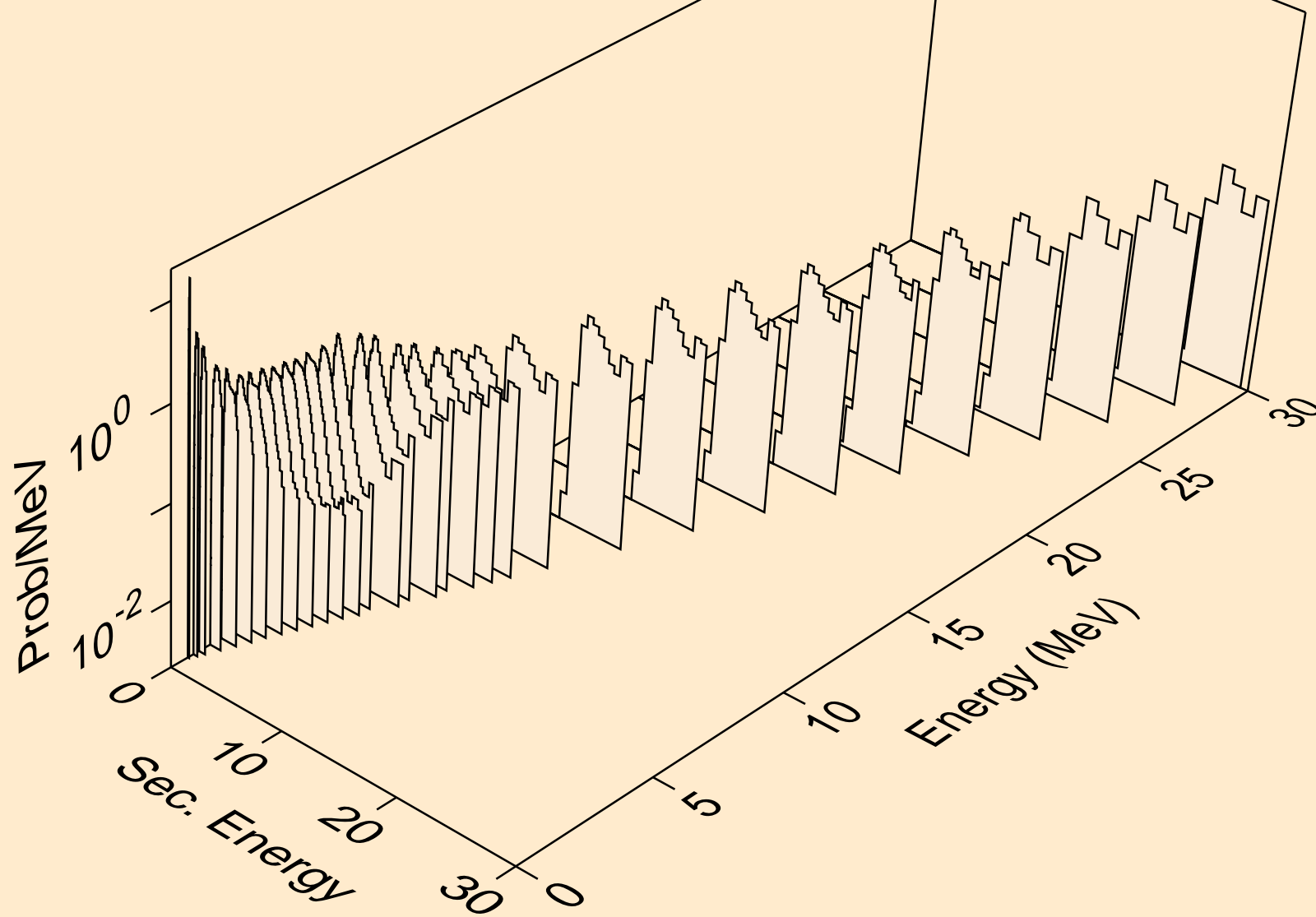

U243 NEUTRON ACER TENDL-2023 LIBRARY; T=0.K

Delayed nubar

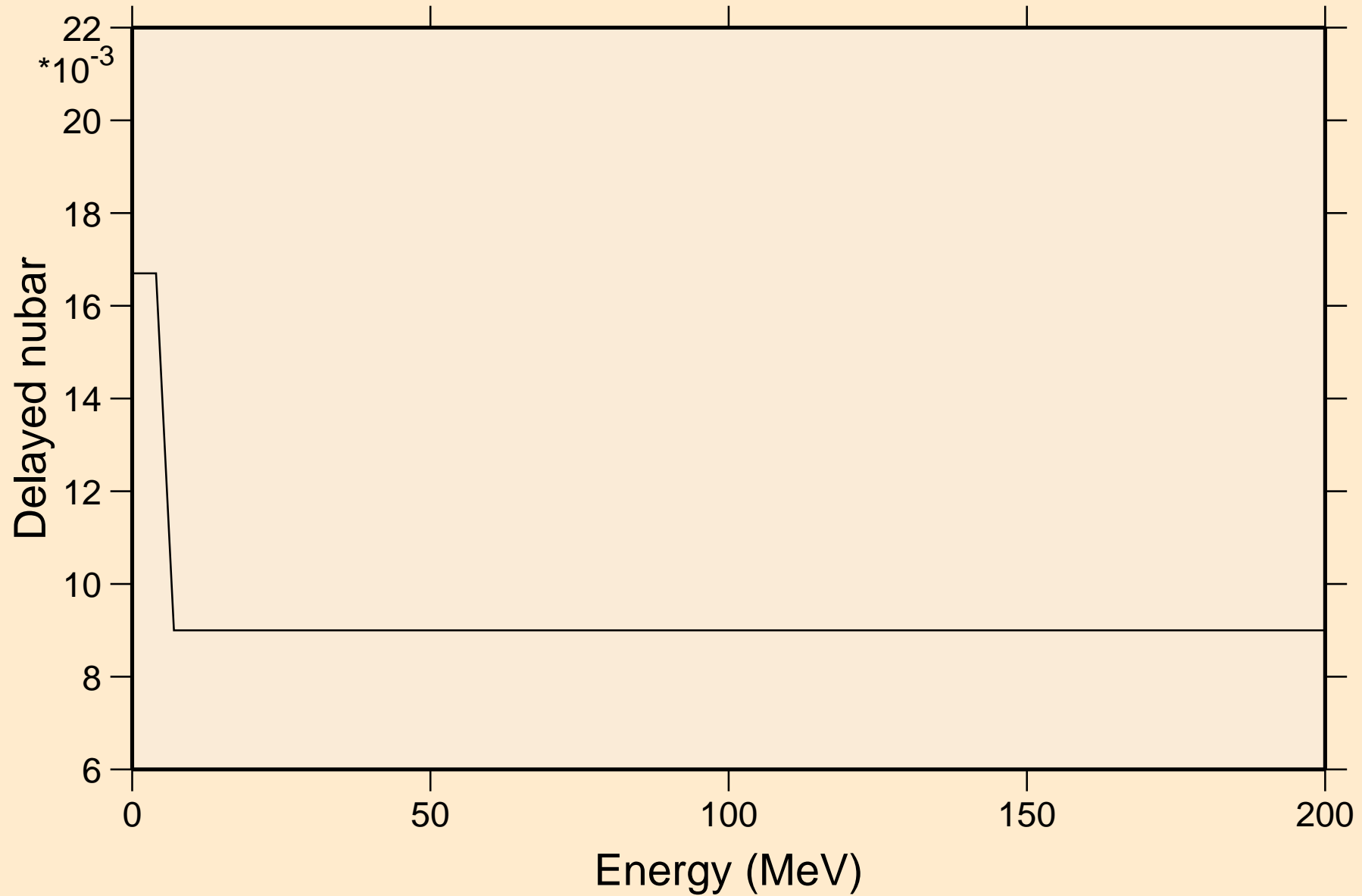

U243 NEUTRON ACER TENDL-2023 LIBRARY; T=0.K

Delayed neutron spectra

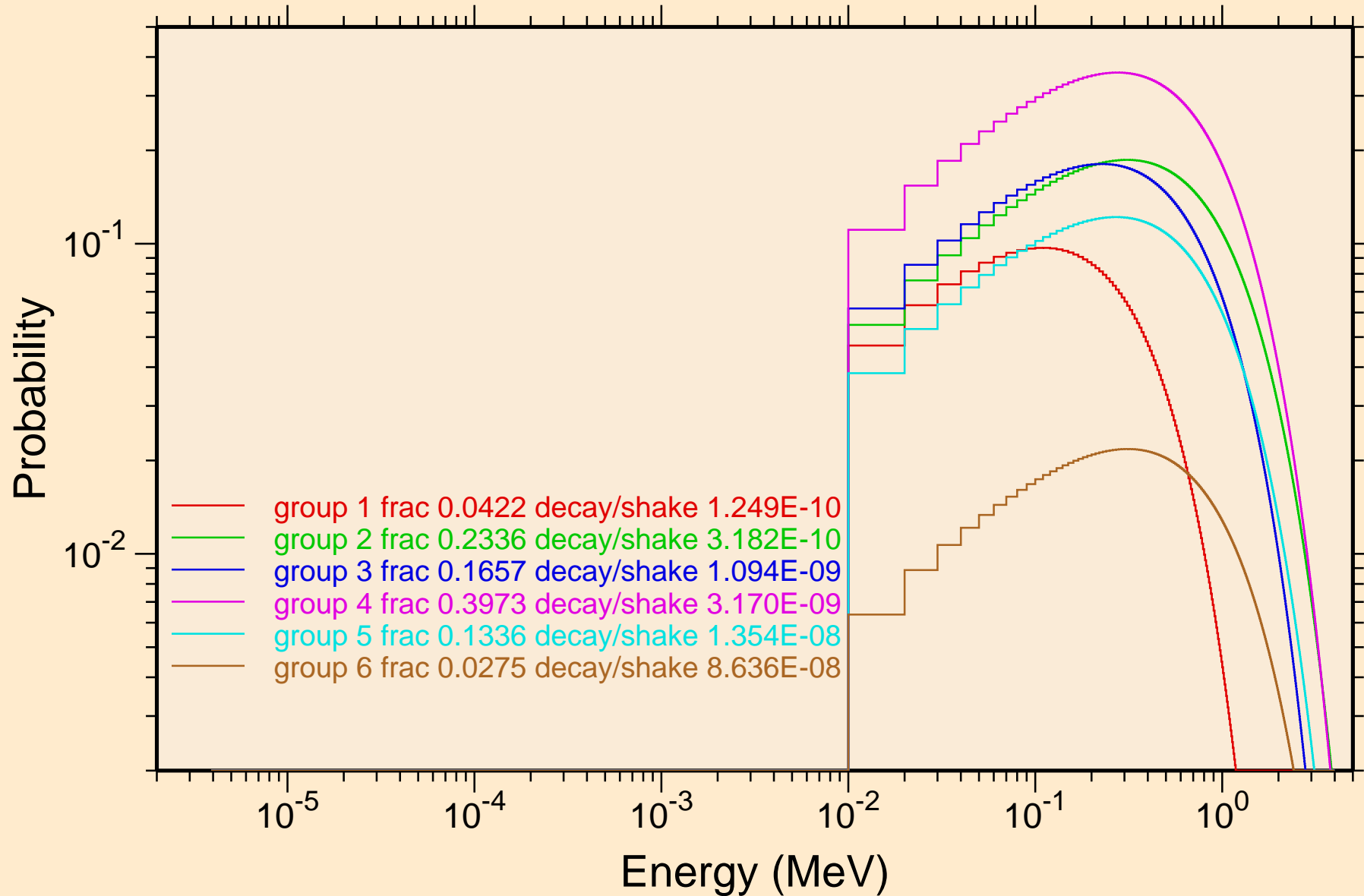

U243 NEUTRON ACER TENDL-2023 LIBRARY; T=0.K
Photon emission for (n,x)

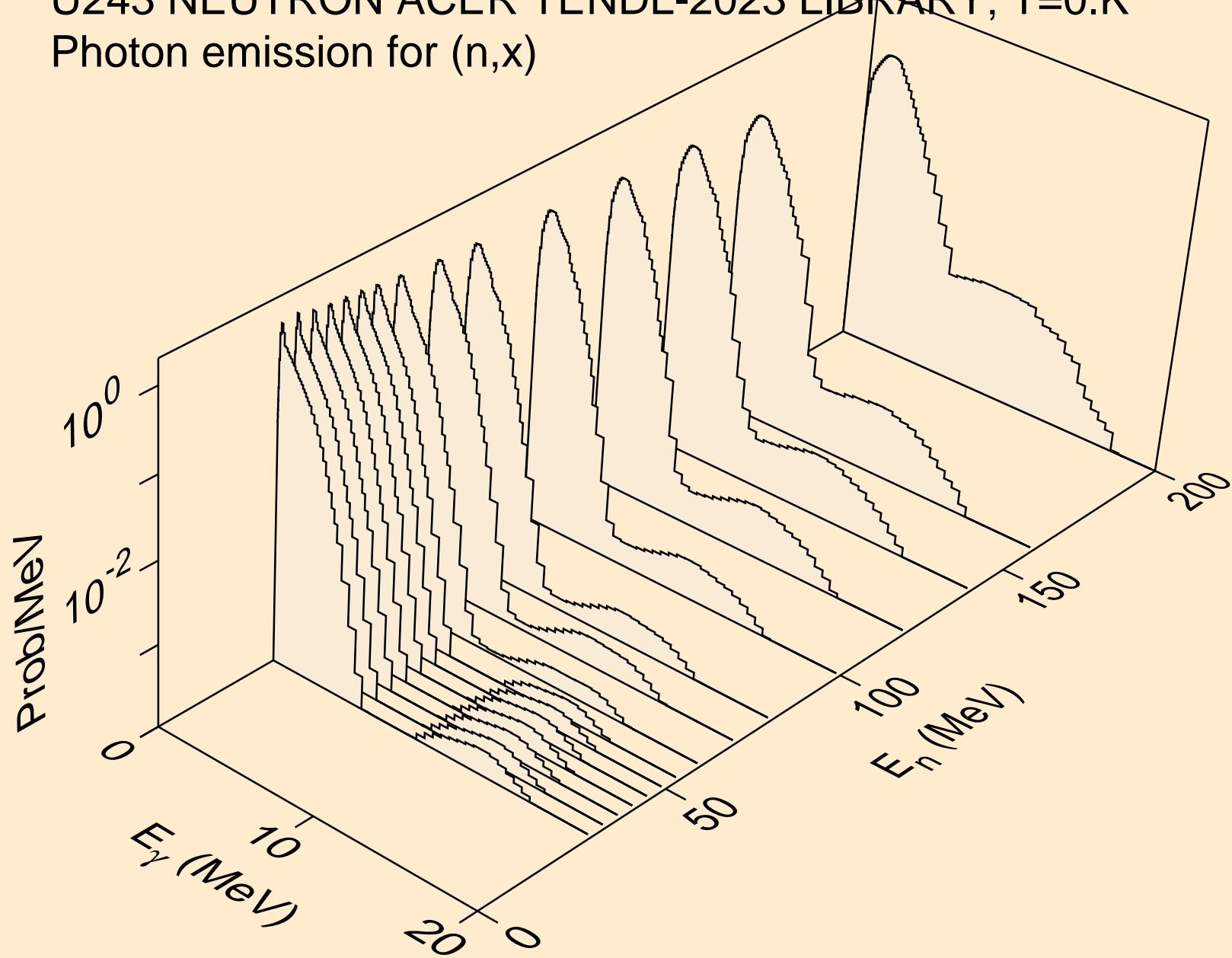

U243 NEUTRON ACER TENDL-2023 LIBRARY; T=0.K
Photon emission for (n,2nd)

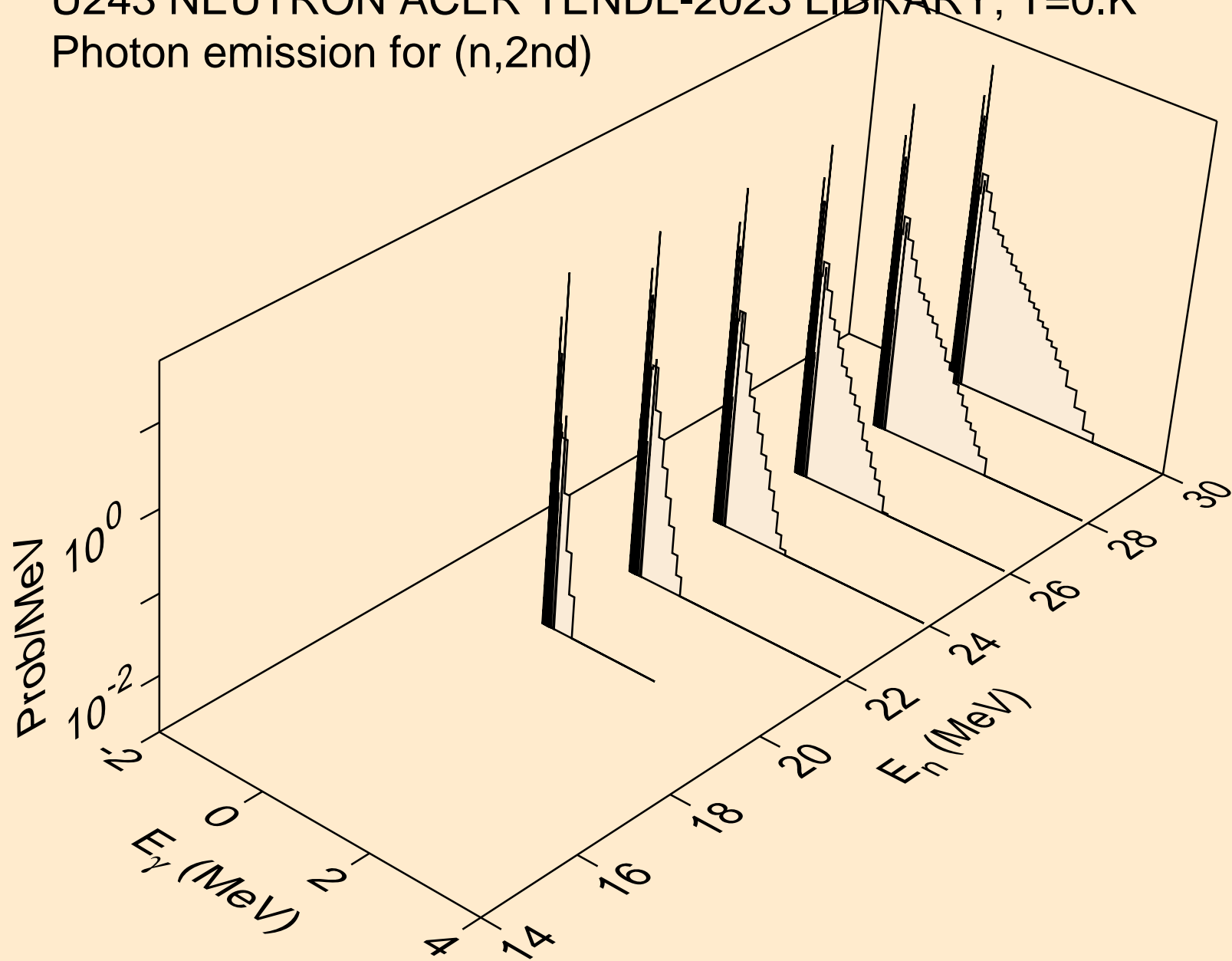

U243 NEUTRON ACER TENDL-2023 LIBRARY; T=0.K
Photon emission for (n,2n)

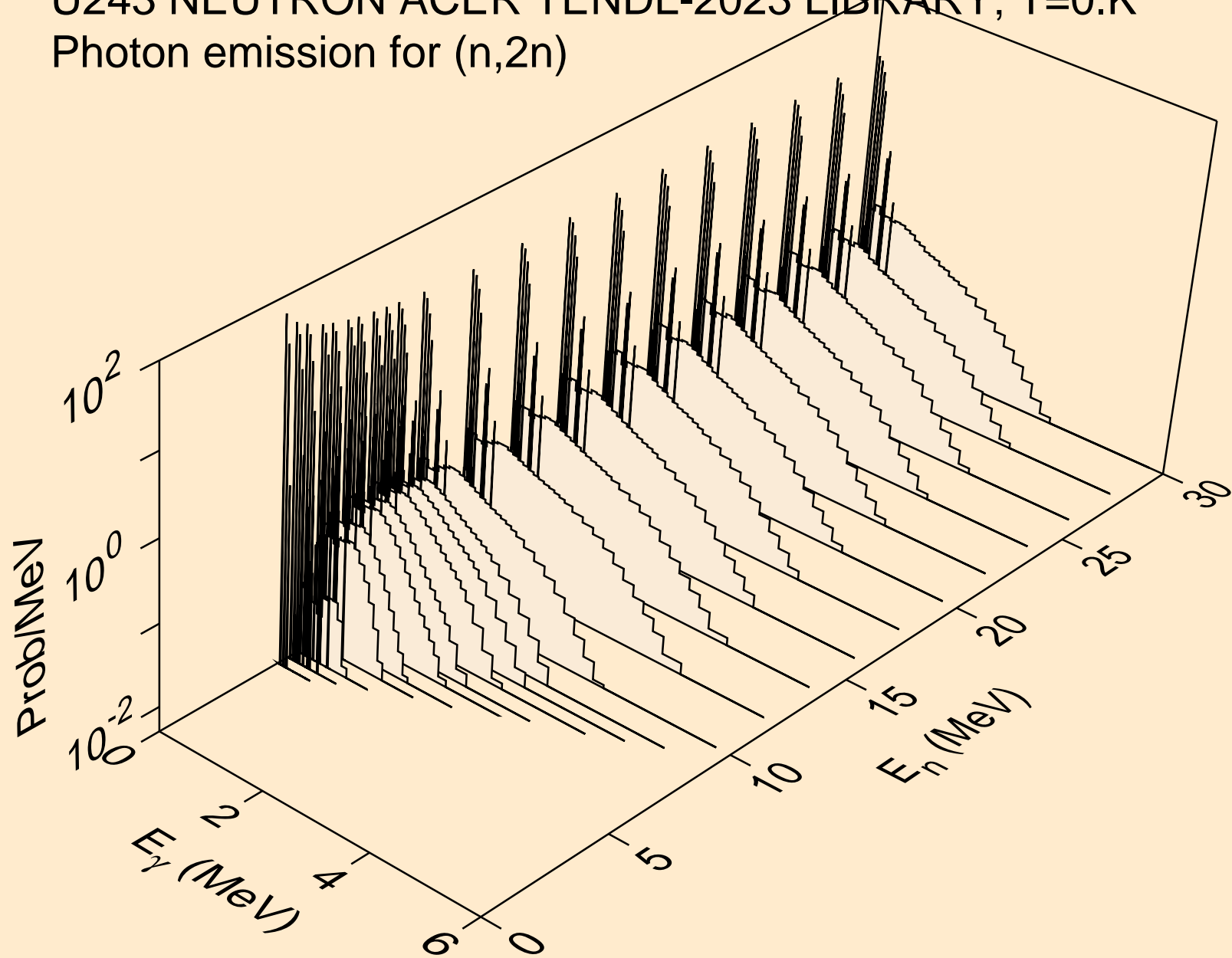

U243 NEUTRON ACER TENDL-2023 LIBRARY; T=0.K
Photon emission for (n,3n)

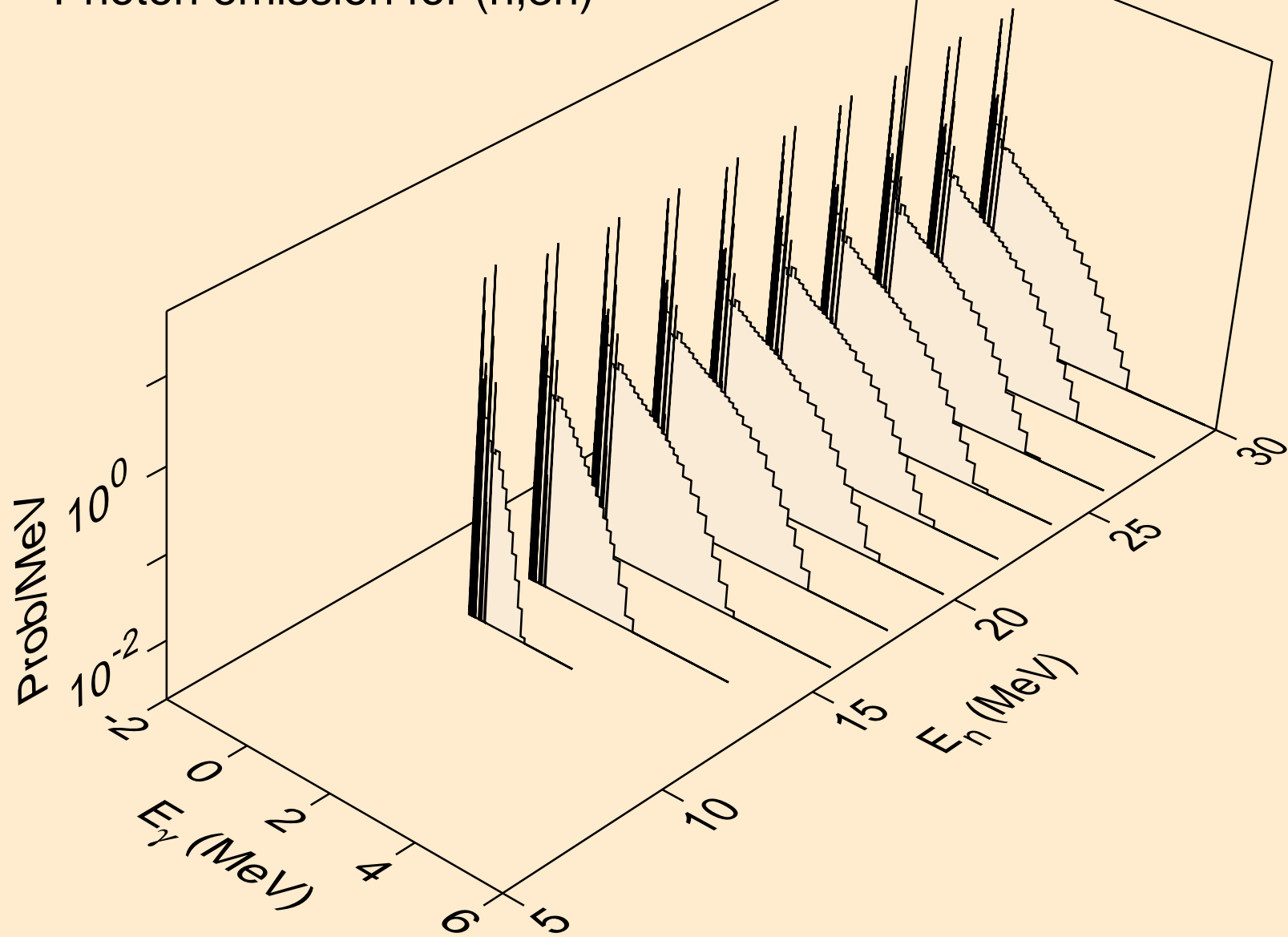

U243 NEUTRON ACER TENDL-2023 LIBRARY; T=0.K
Photon emission for (n,n*)a

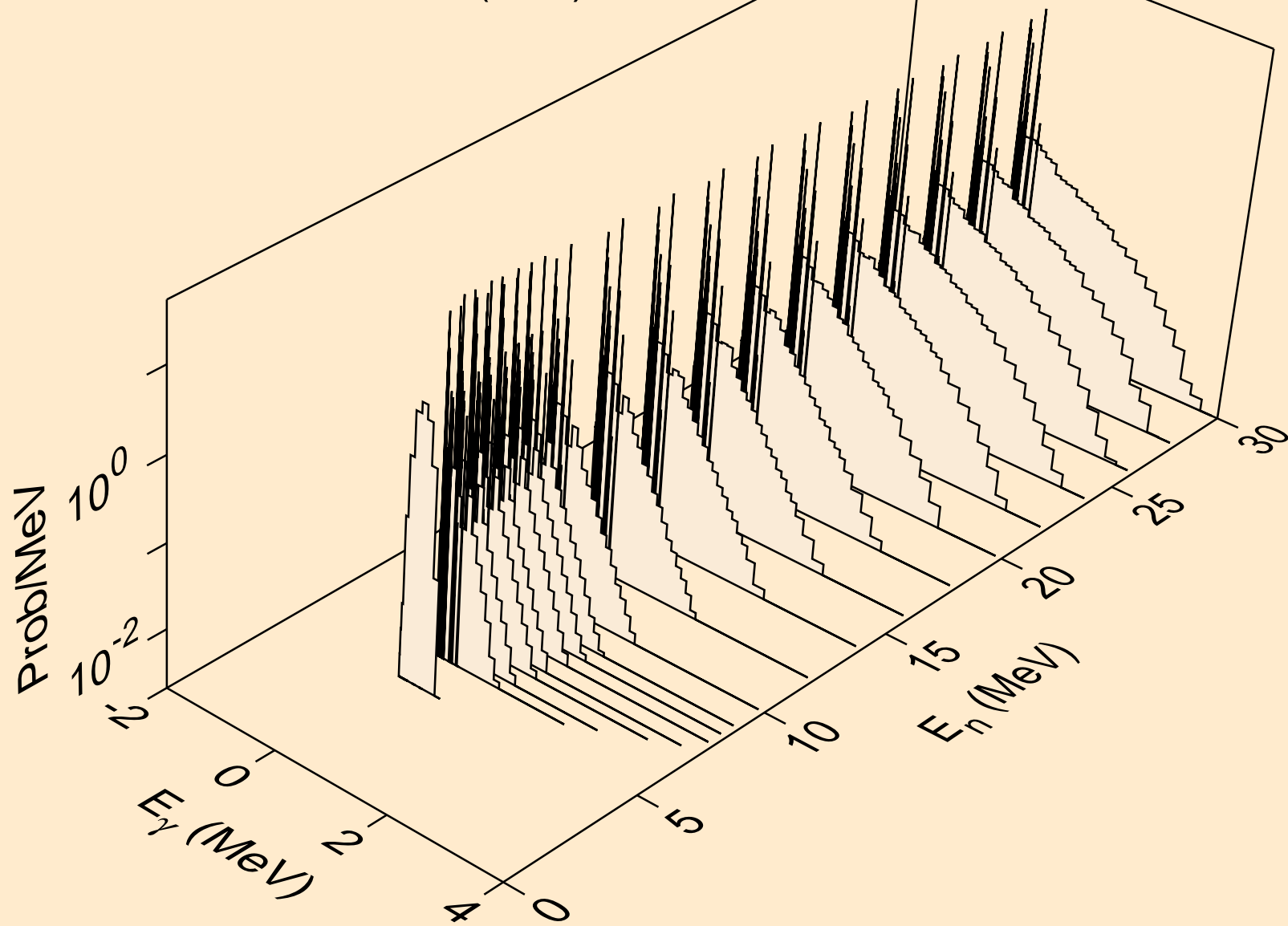

U243 NEUTRON ACER TENDL-2023 LIBRARY; T=0.K
Photon emission for (n,2n)a

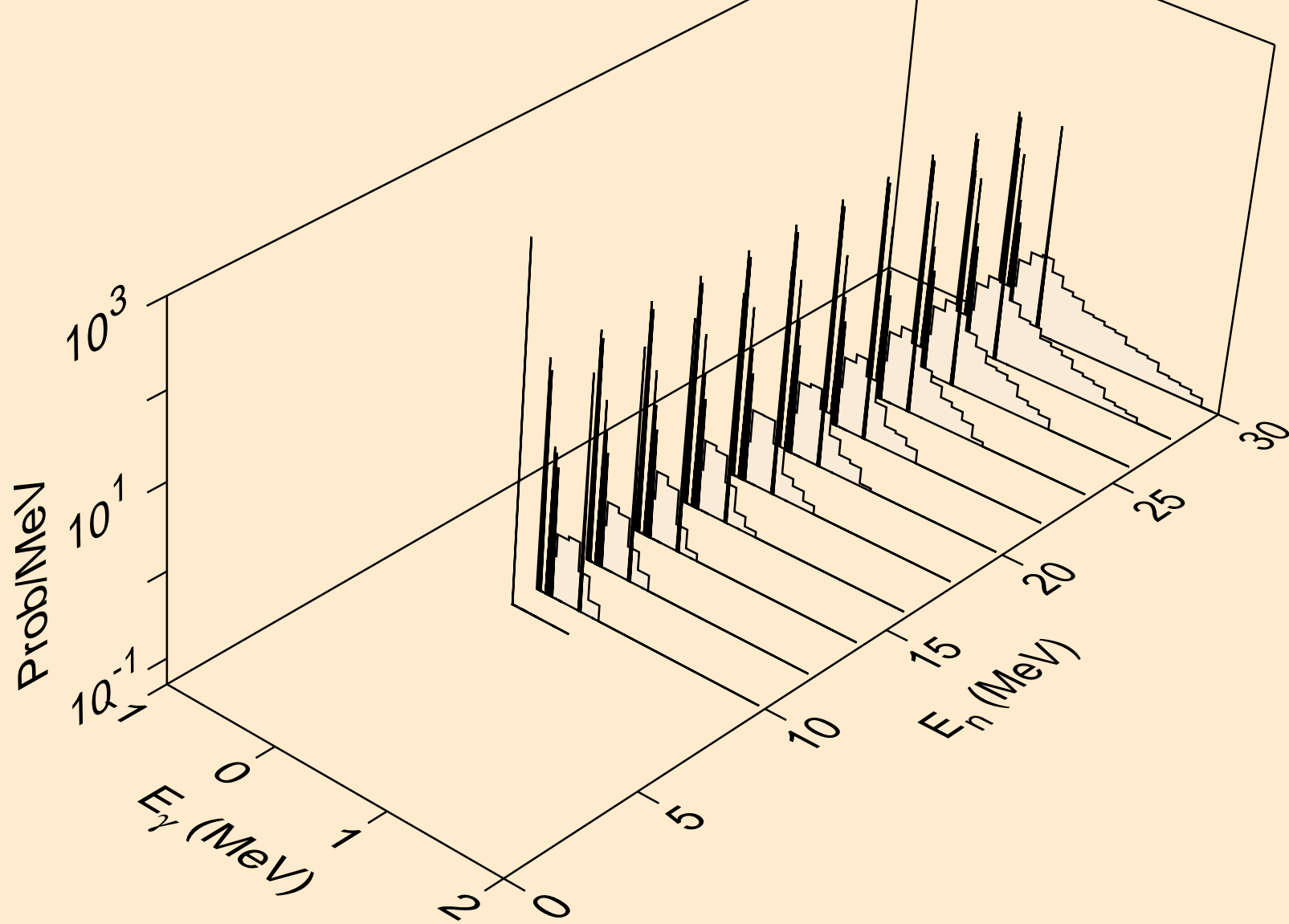

U243 NEUTRON ACER TENDL-2023 LIBRARY; T=0.K
Photon emission for (n,3n)a

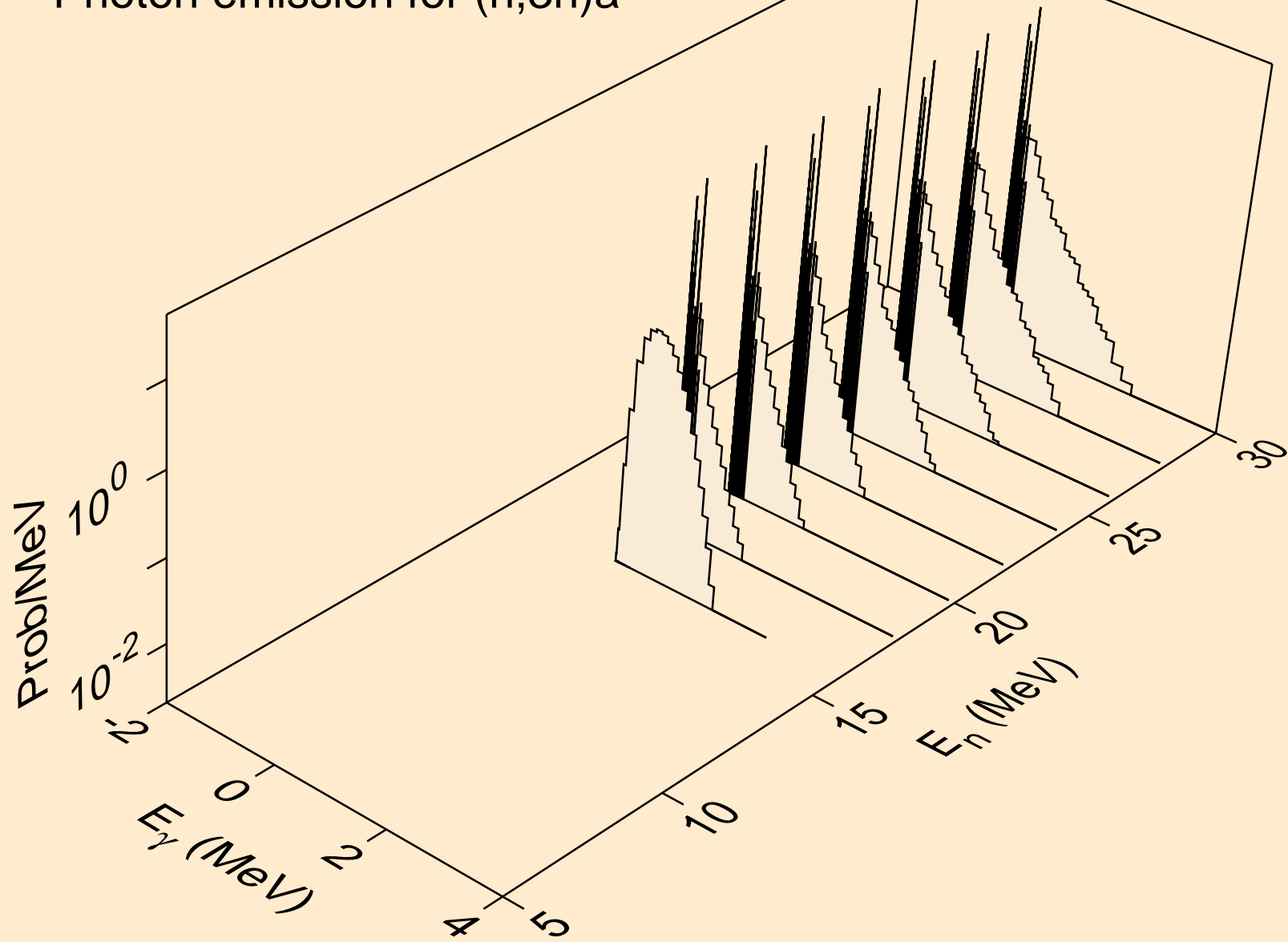

U243 NEUTRON ACER TENDL-2023 LIBRARY; T=0.K
Photon emission for (n,n*)p

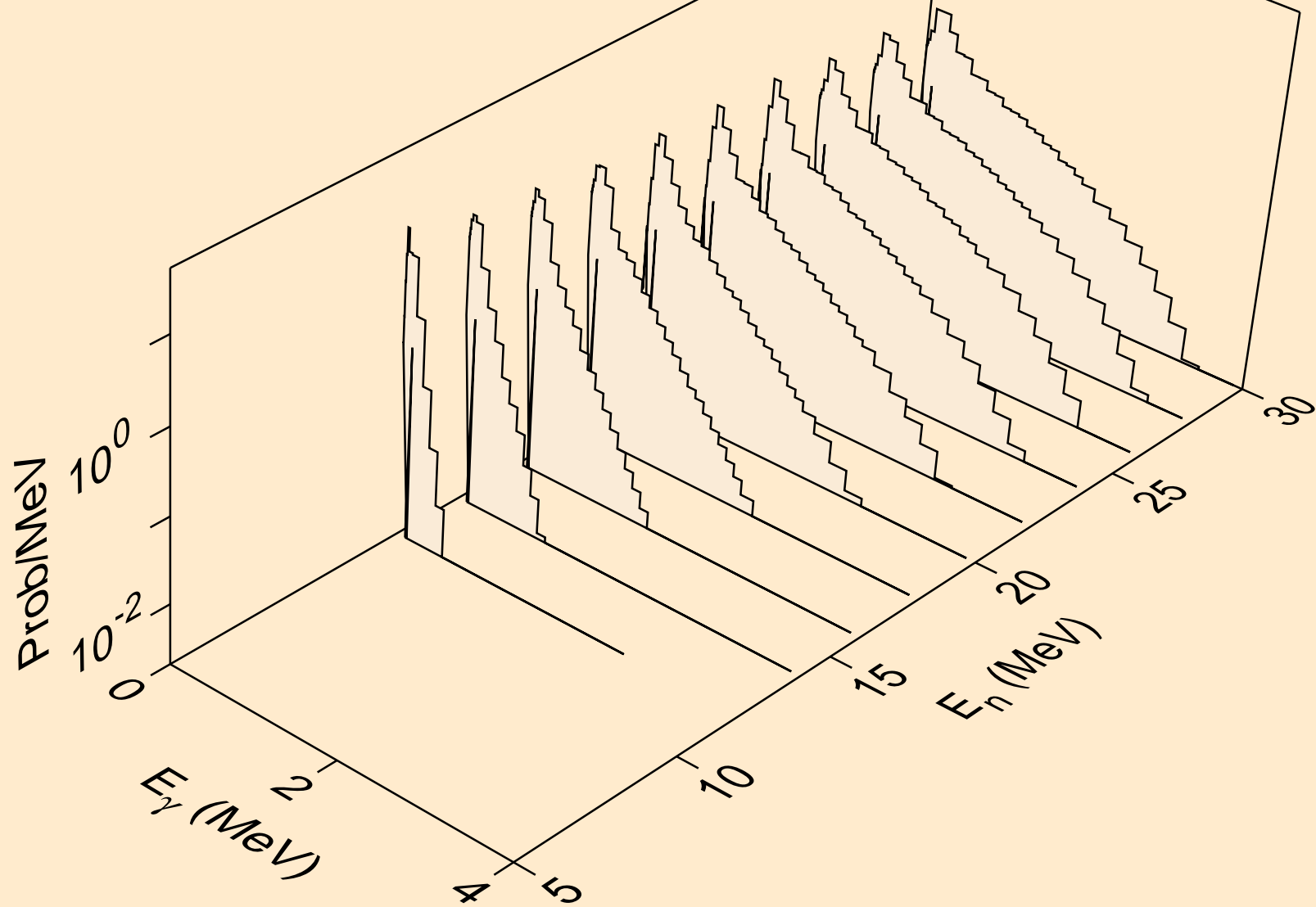

U243 NEUTRON ACER TENDL-2023 LIBRARY; T=0.K
Photon emission for (n,n*)d

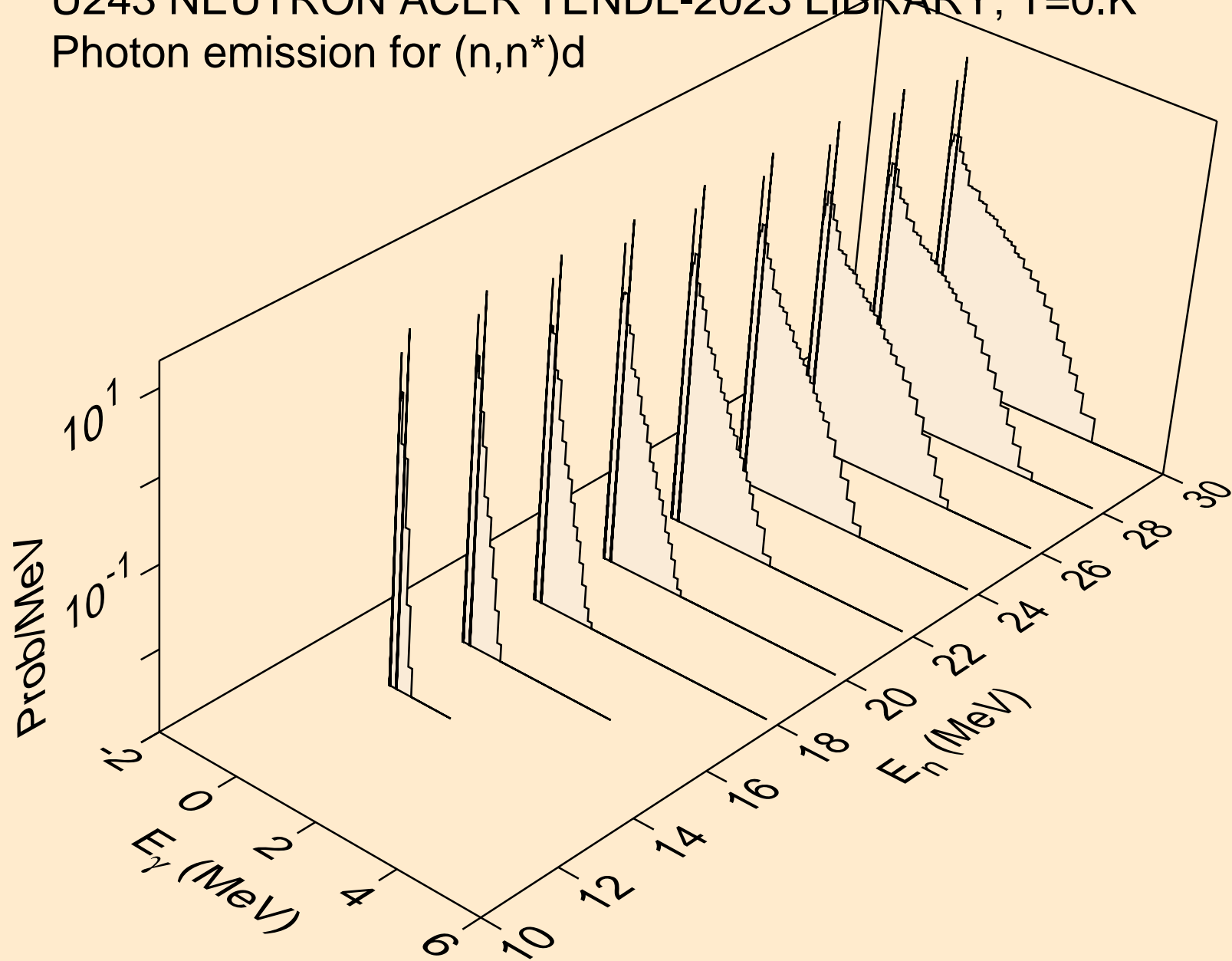

U243 NEUTRON ACER TENDL-2023 LIBRARY; T=0.K
Photon emission for (n,n*)t

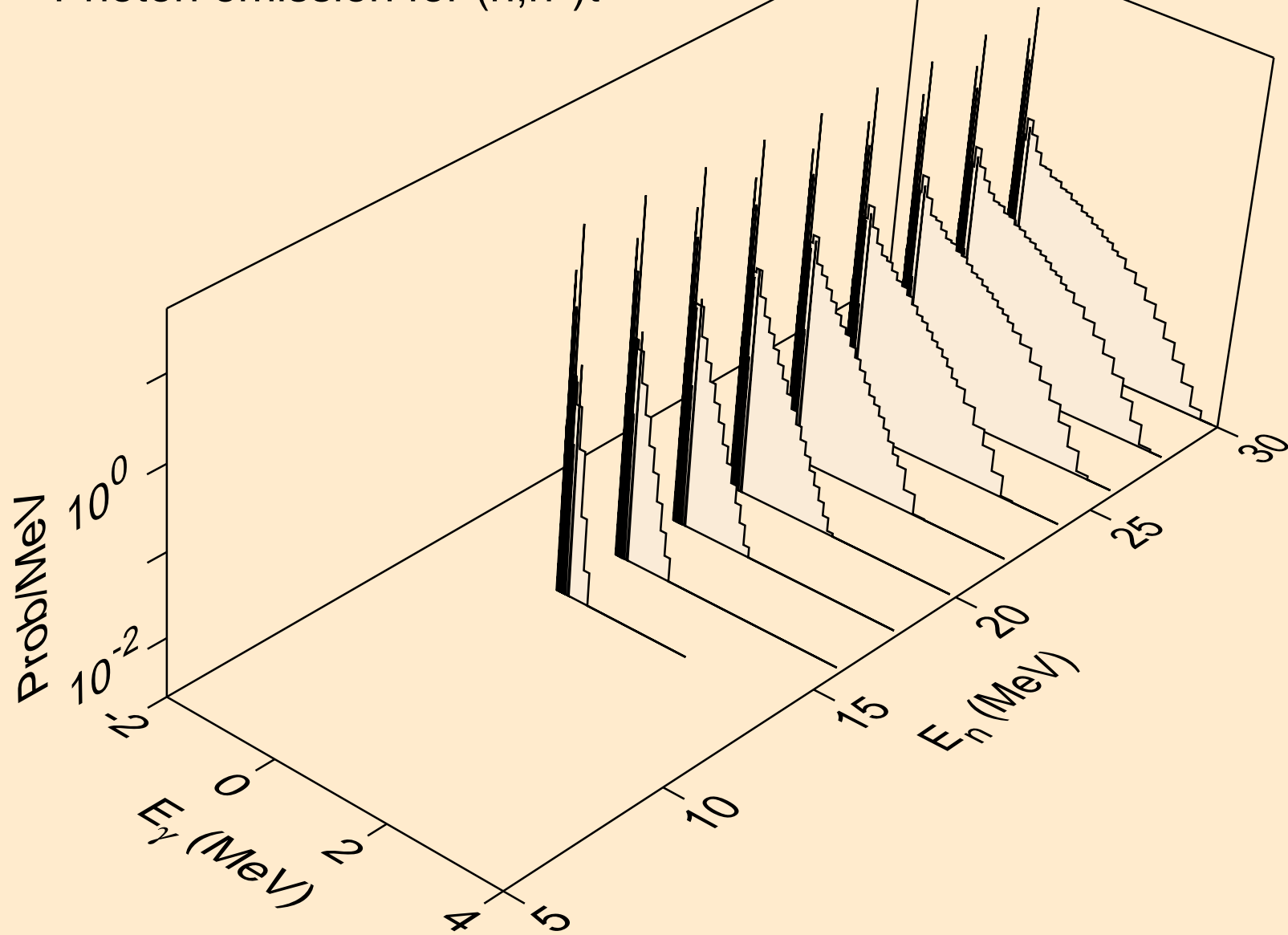

U243 NEUTRON ACER TENDL-2023 LIBRARY; T=0.K
Photon emission for (n,n*)he3

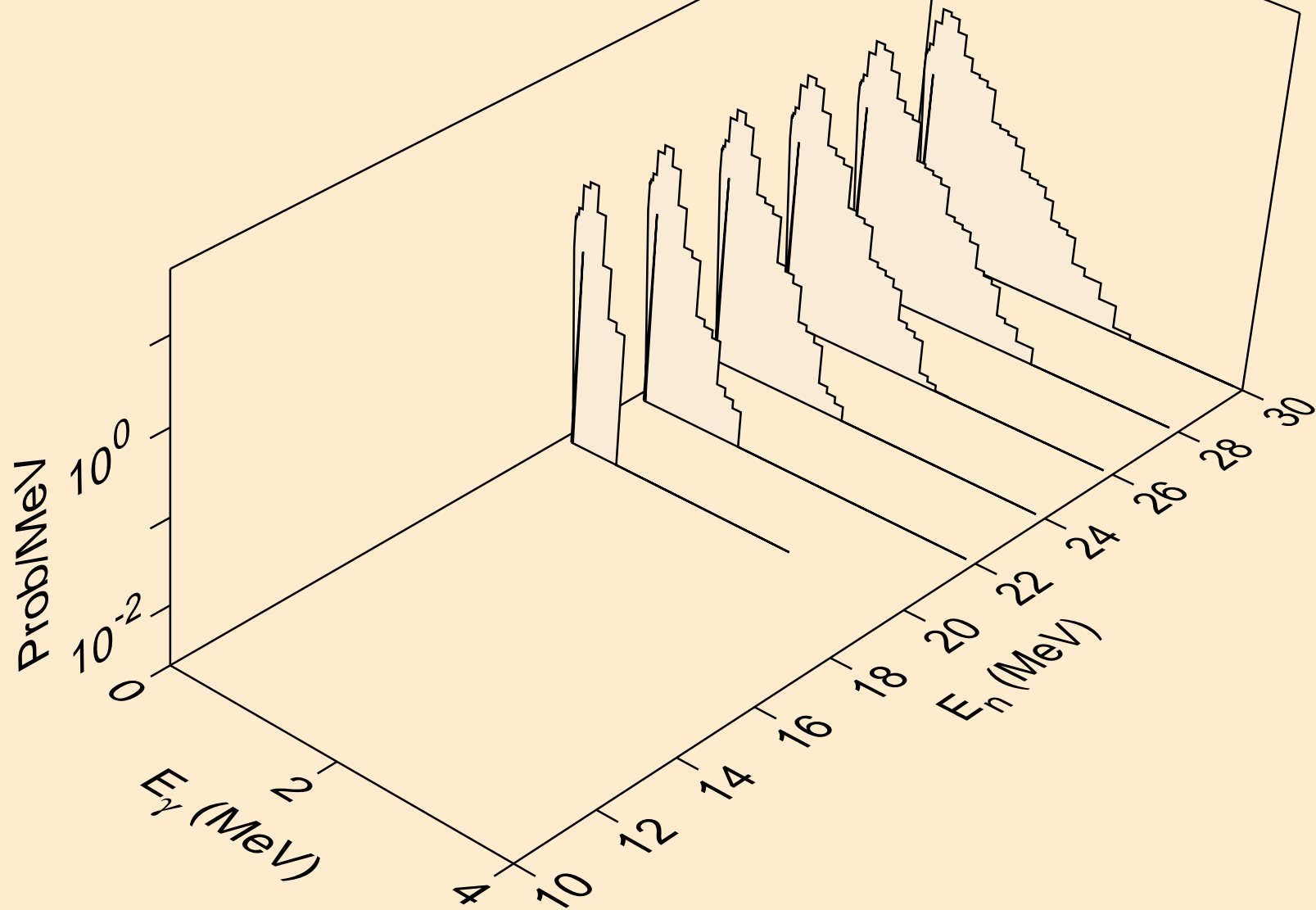

U243 NEUTRON ACER TENDL-2023 LIBRARY; T=0.K
Photon emission for (n,4n)

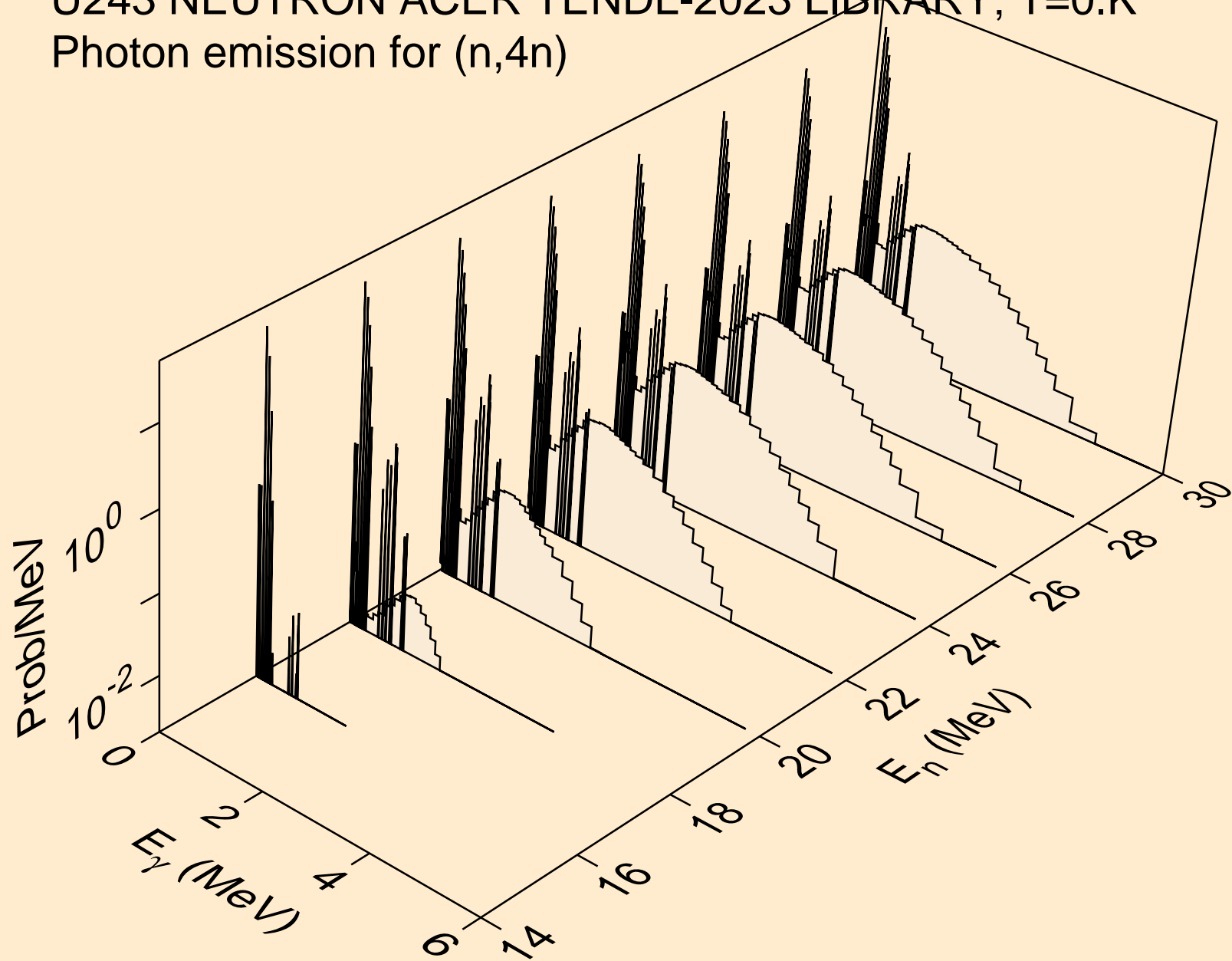

U243 NEUTRON ACER TENDL-2023 LIBRARY; T=0.K
Photon emission for (n,2np)

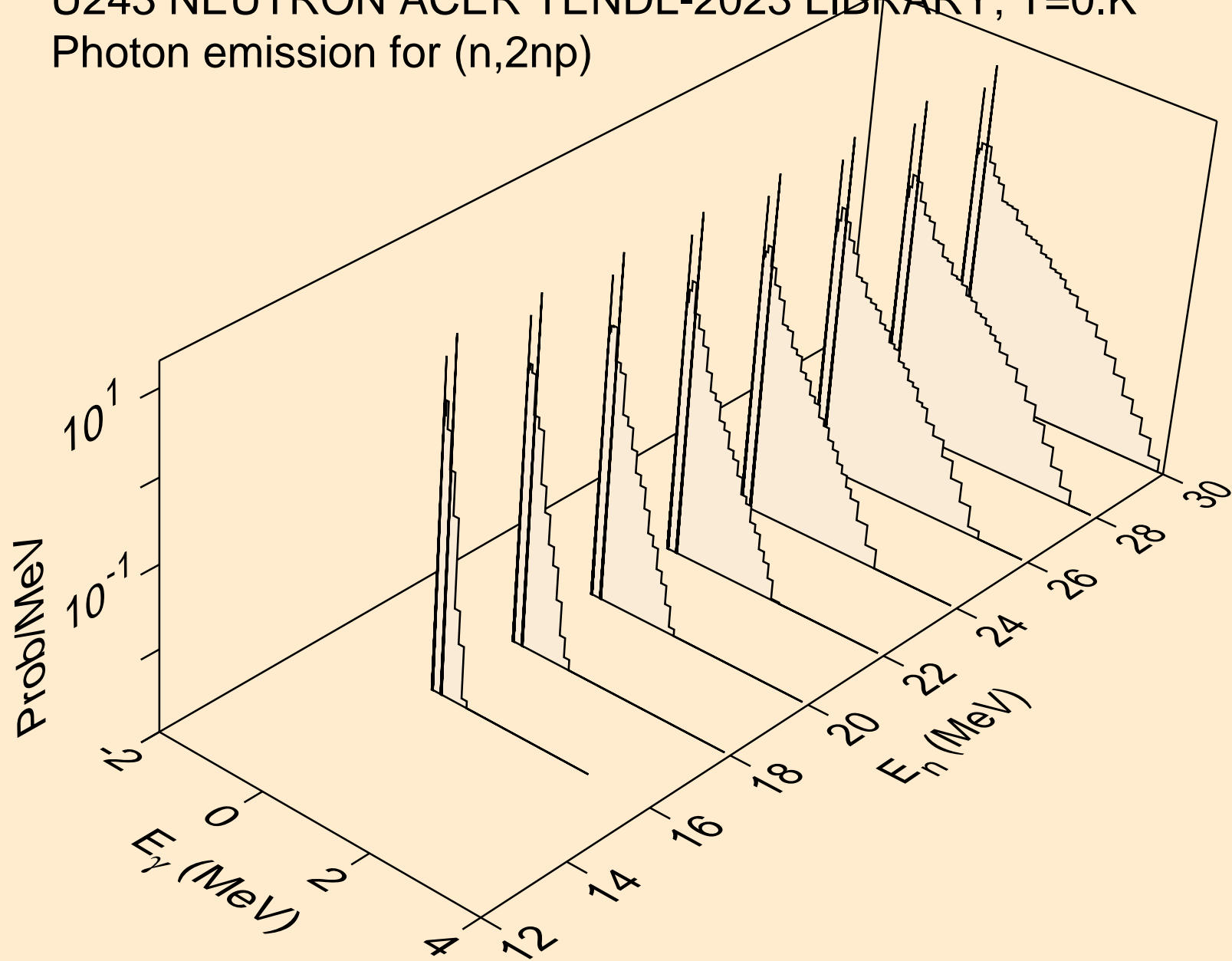

U243 NEUTRON ACER TENDL-2023 LIBRARY; T=0.K
Photon emission for (n,3np)

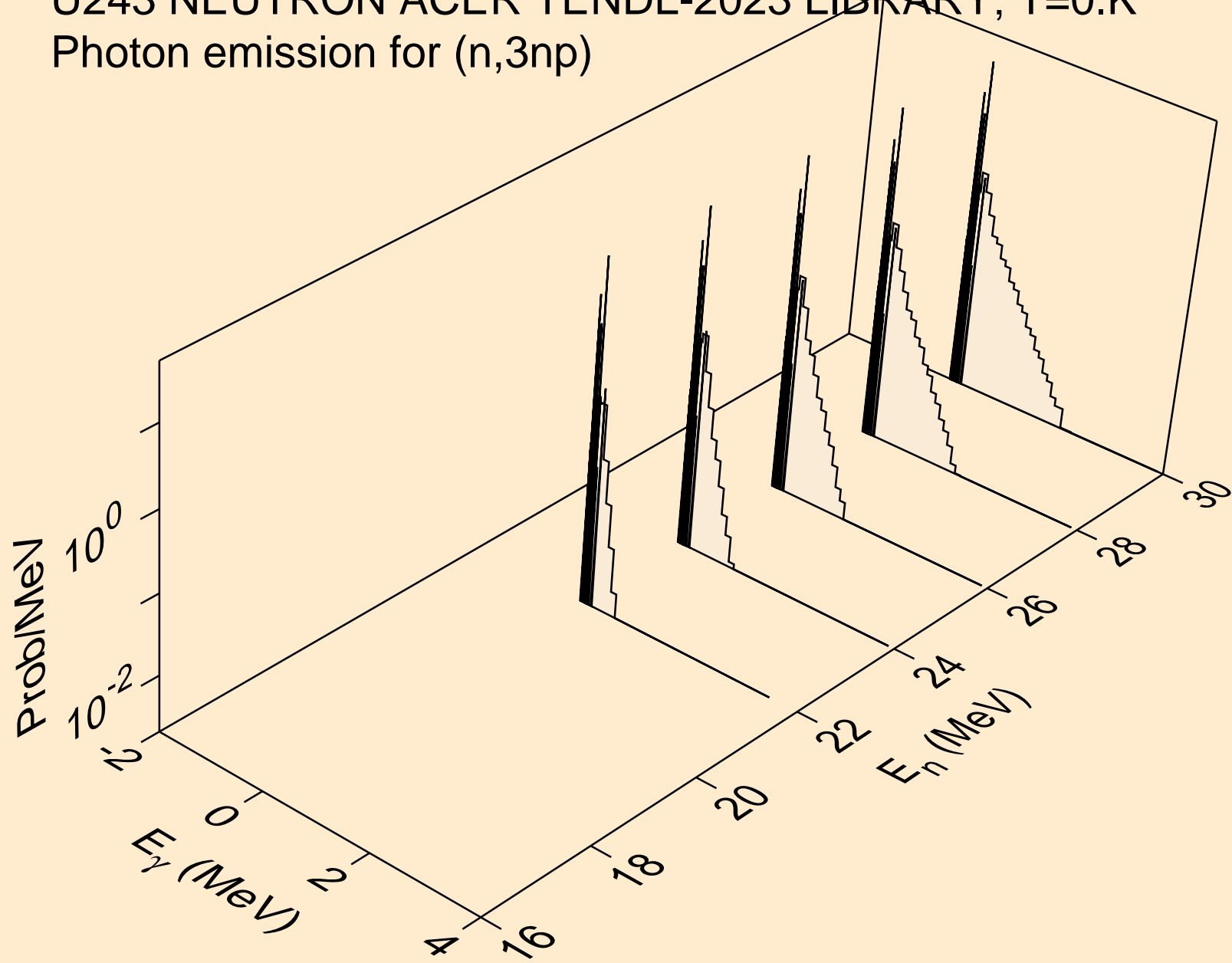

U243 NEUTRON ACER TENDL-2023 LIBRARY; T=0.K
Photon emission for (n,n*c)

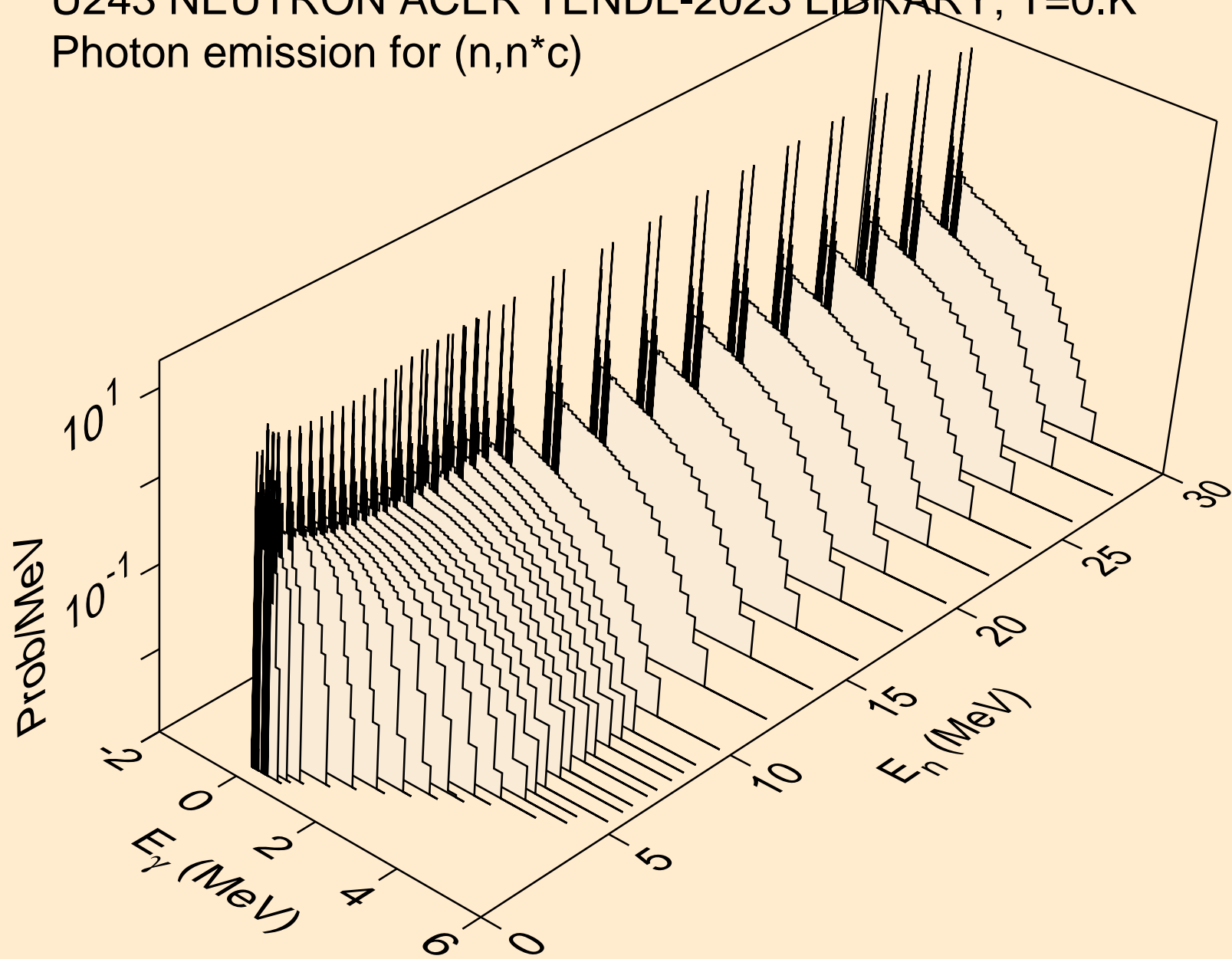

U243 NEUTRON ACER TENDL-2023 LIBRARY; T=0.K
Photon emission for (n,gma)

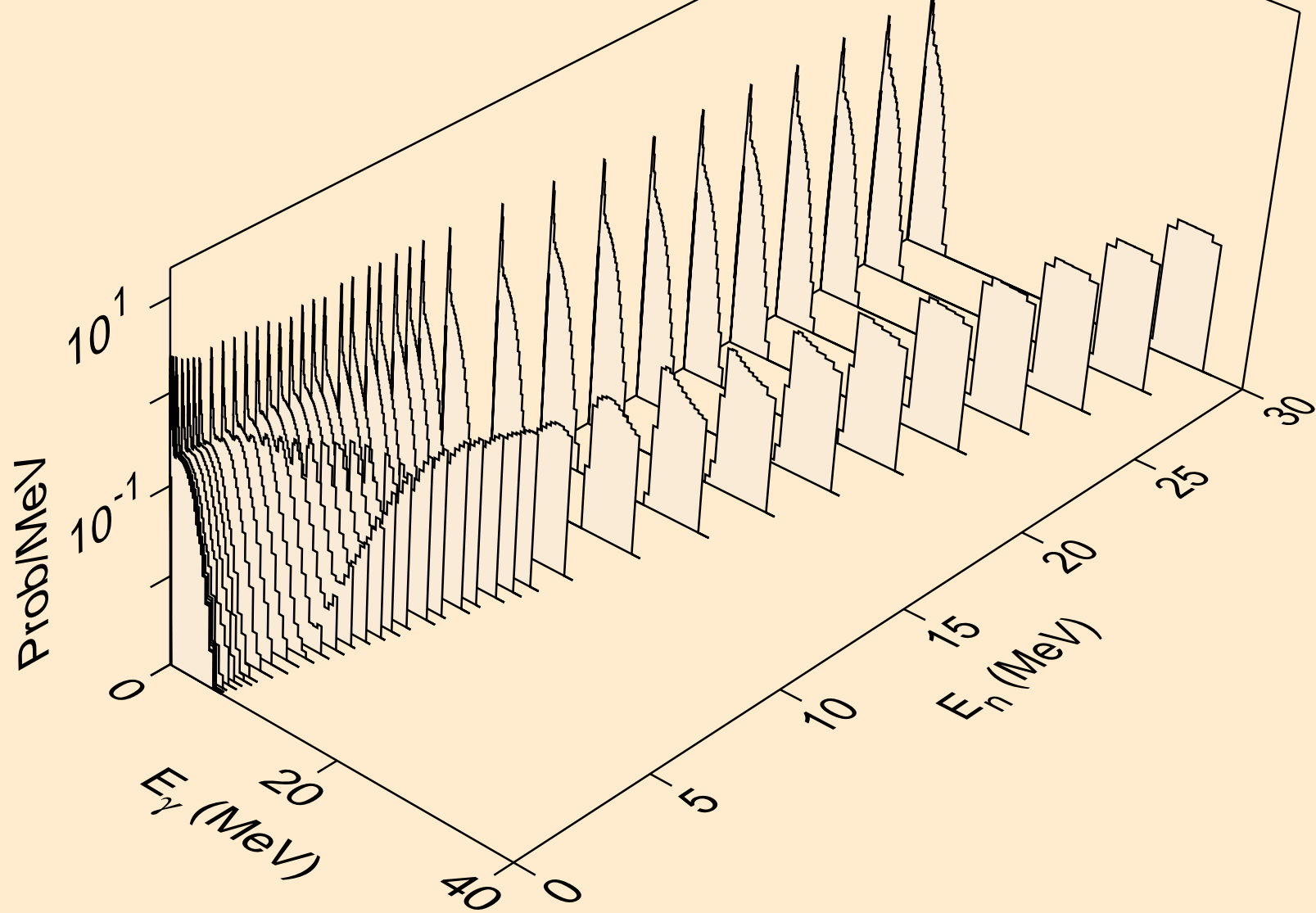

U243 NEUTRON ACER TENDL-2023 LIBRARY; T=0.K
Photon emission for (n,p)

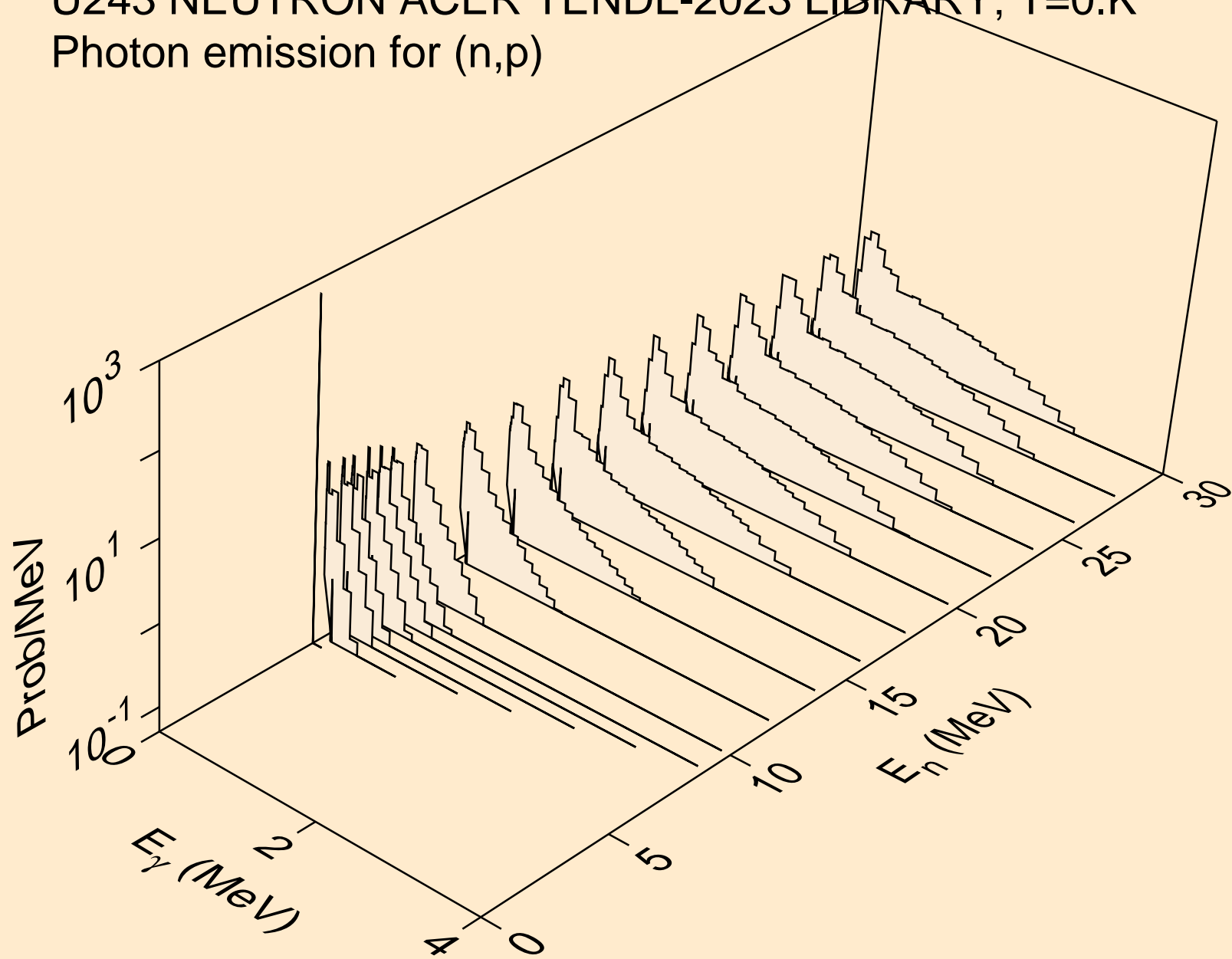

U243 NEUTRON ACER TENDL-2023 LIBRARY; T=0.K
Photon emission for (n,d)

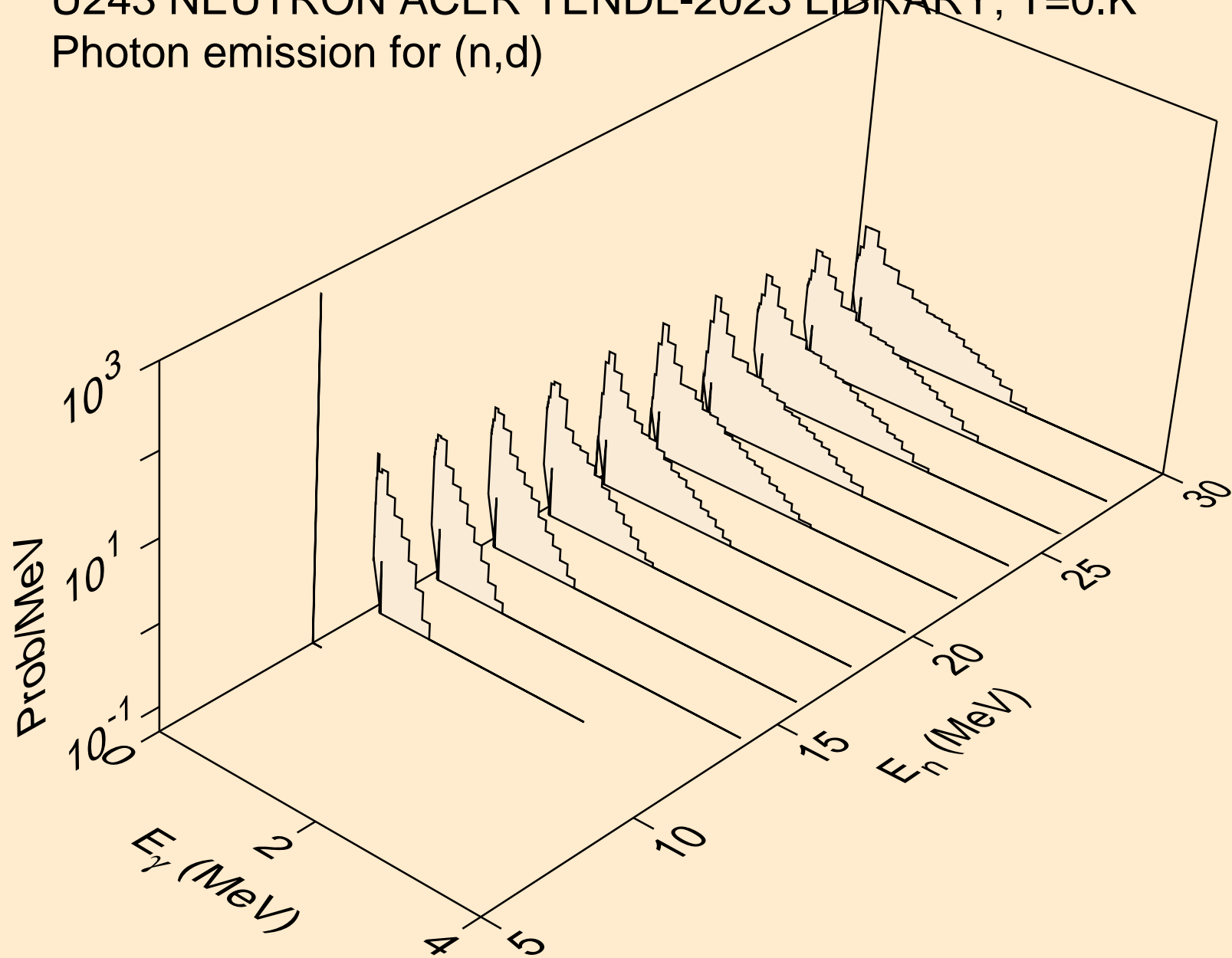

U243 NEUTRON ACER TENDL-2023 LIBRARY; T=0.K
Photon emission for (n,t)

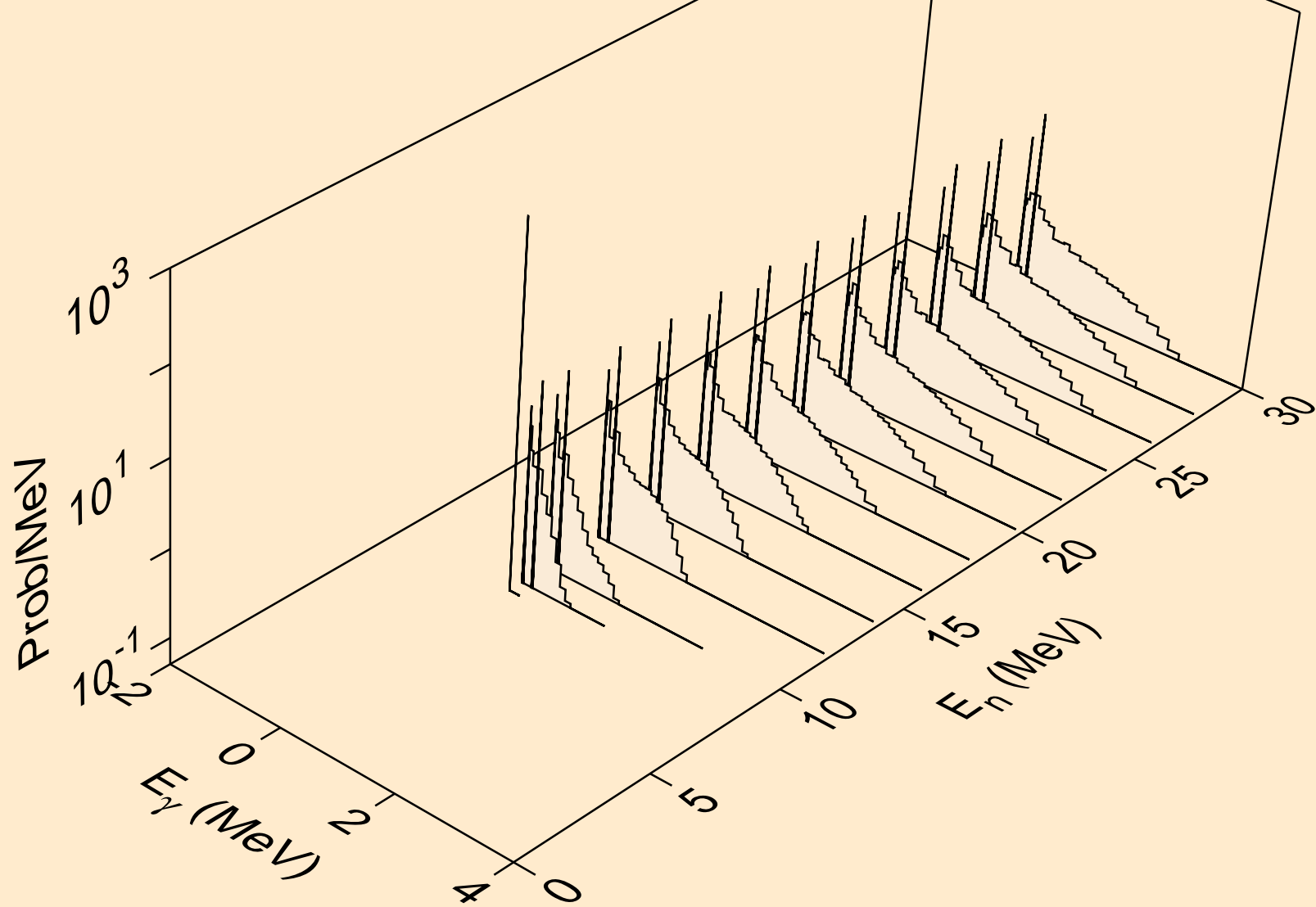

U243 NEUTRON ACER TENDL-2023 LIBRARY; T=0.K
Photon emission for (n,he3)

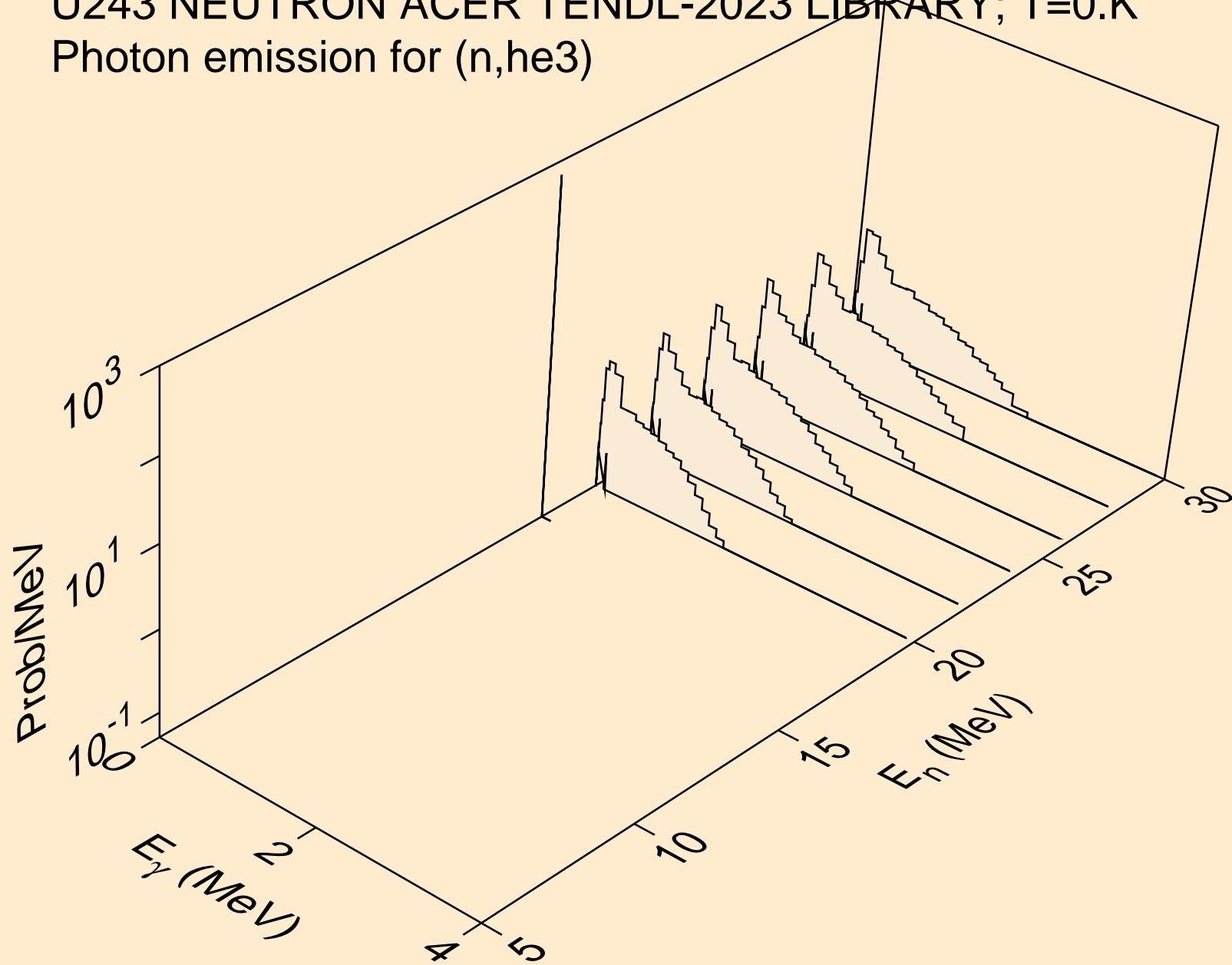

U243 NEUTRON ACER TENDL-2023 LIBRARY; T=0.K
Photon emission for (n,a)

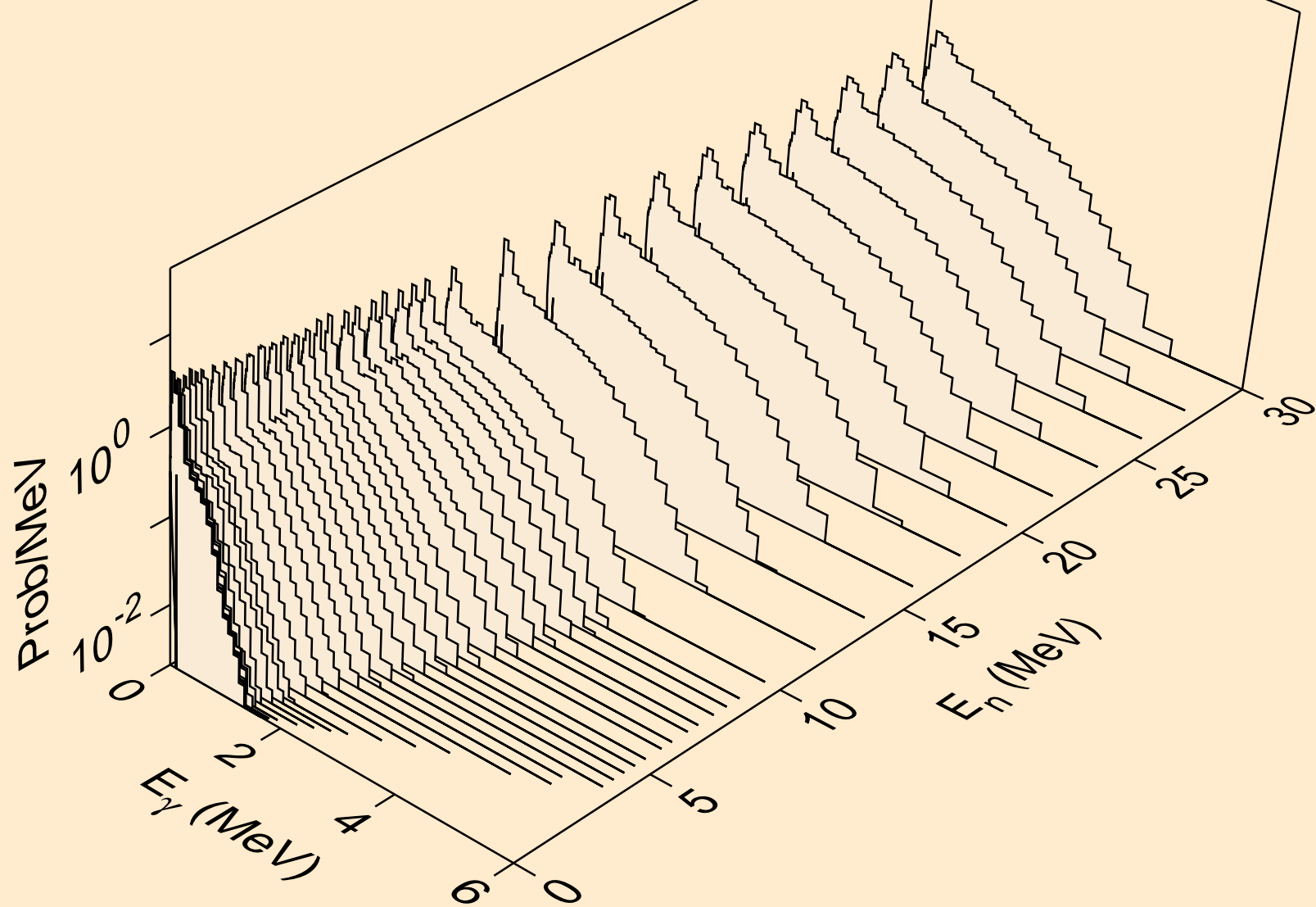

U243 NEUTRON ACER TENDL-2023 LIBRARY; T=0.K
Photon emission for (n,2p)

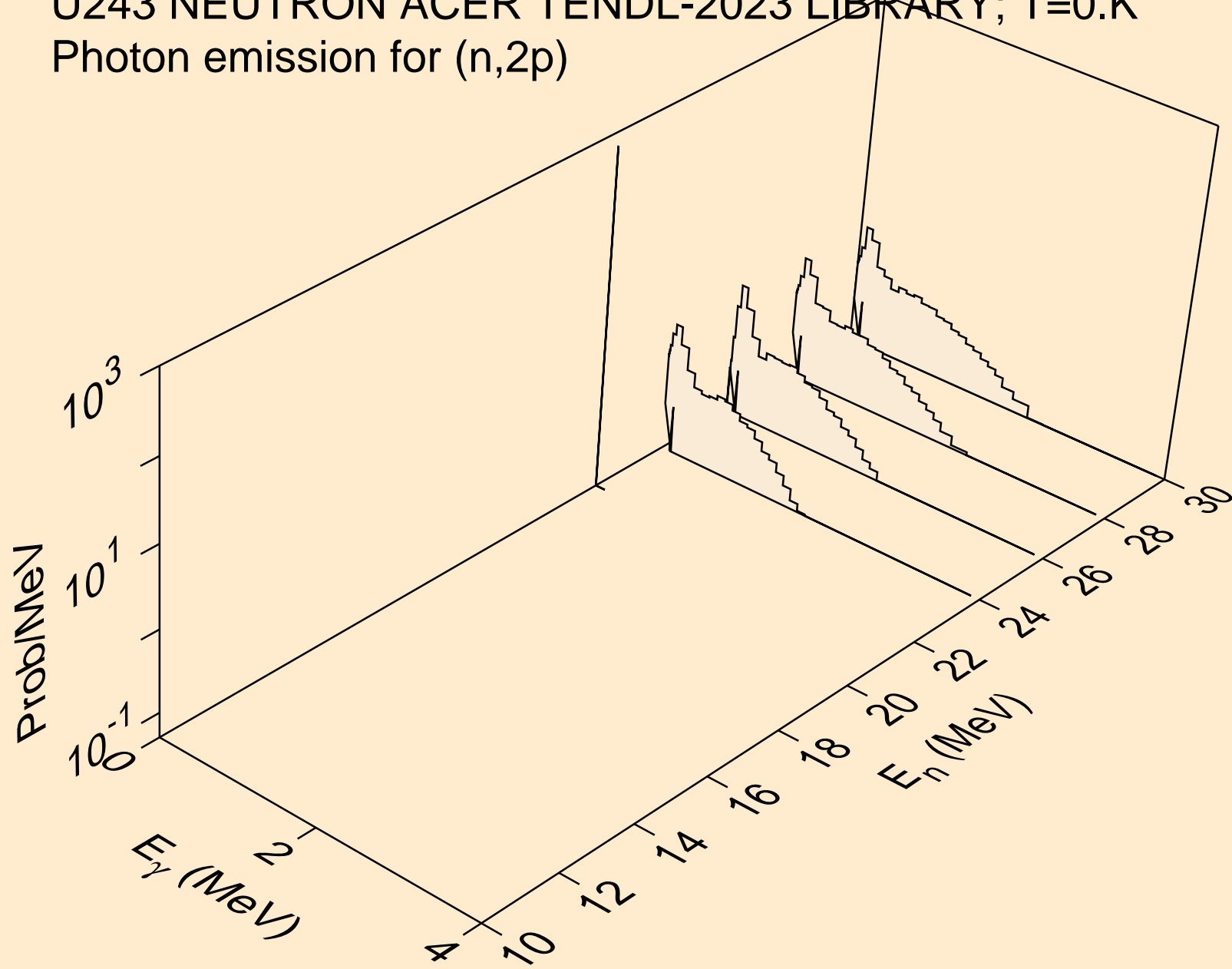

U243 NEUTRON ACER TENDL-2023 LIBRARY; T=0.K
thermal capture photon spectrum

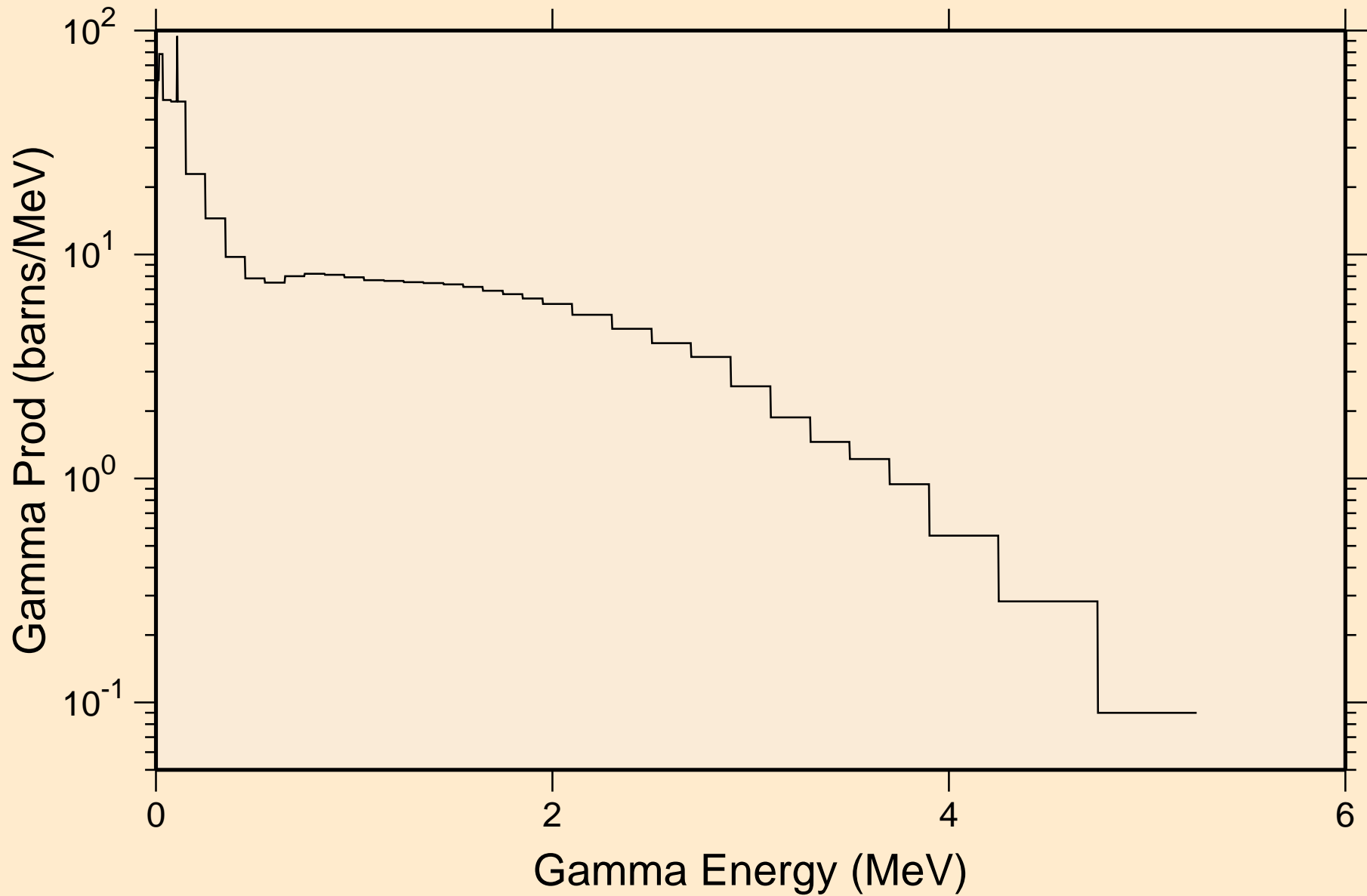

U243 NEUTRON ACER TENDL-2023 LIBRARY; T=0.K
14 MeV photon spectrum

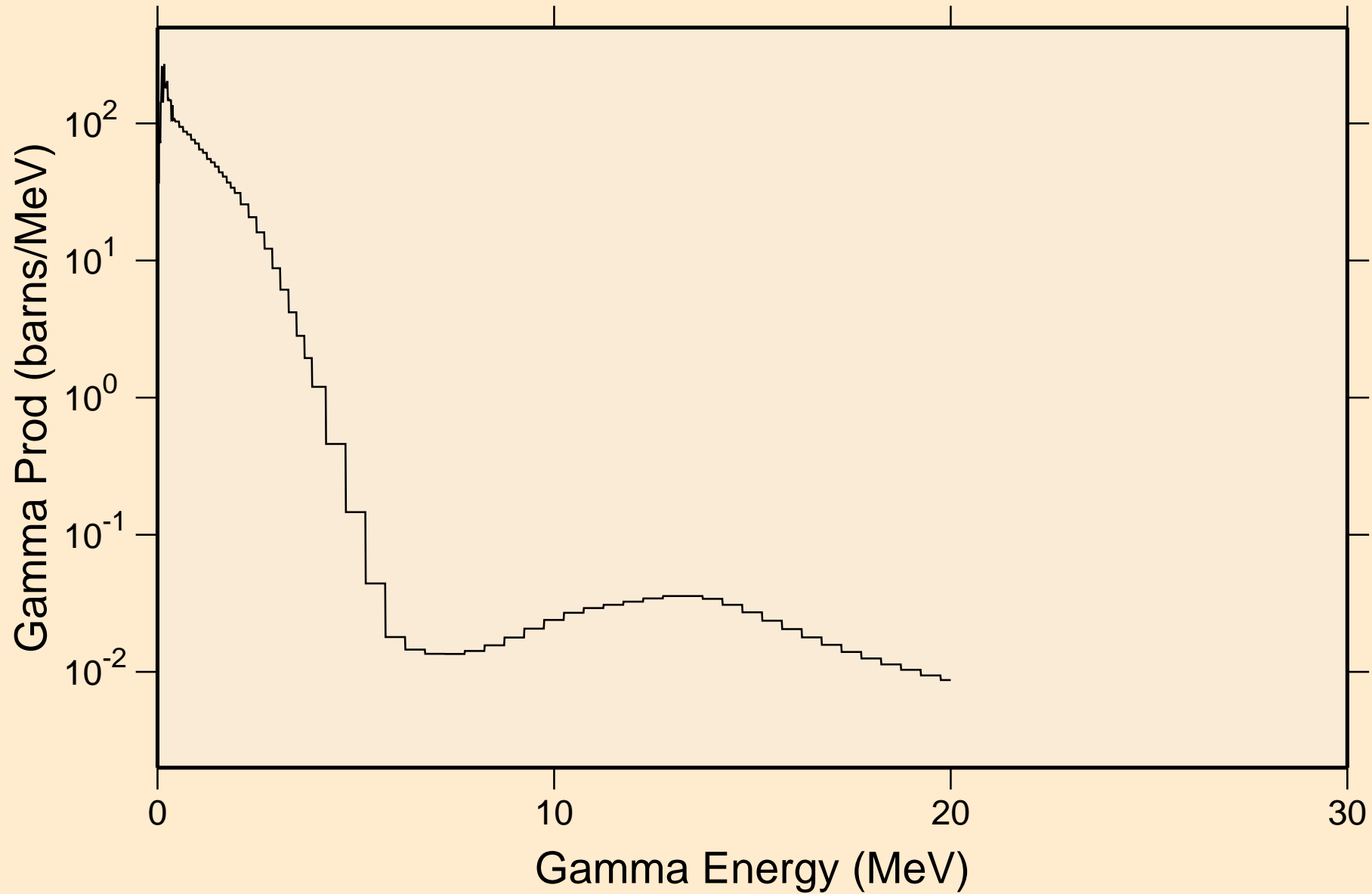

U243 NEUTRON ACER TENDL-2023 LIBRARY; T=0.K

Particle heating contributions

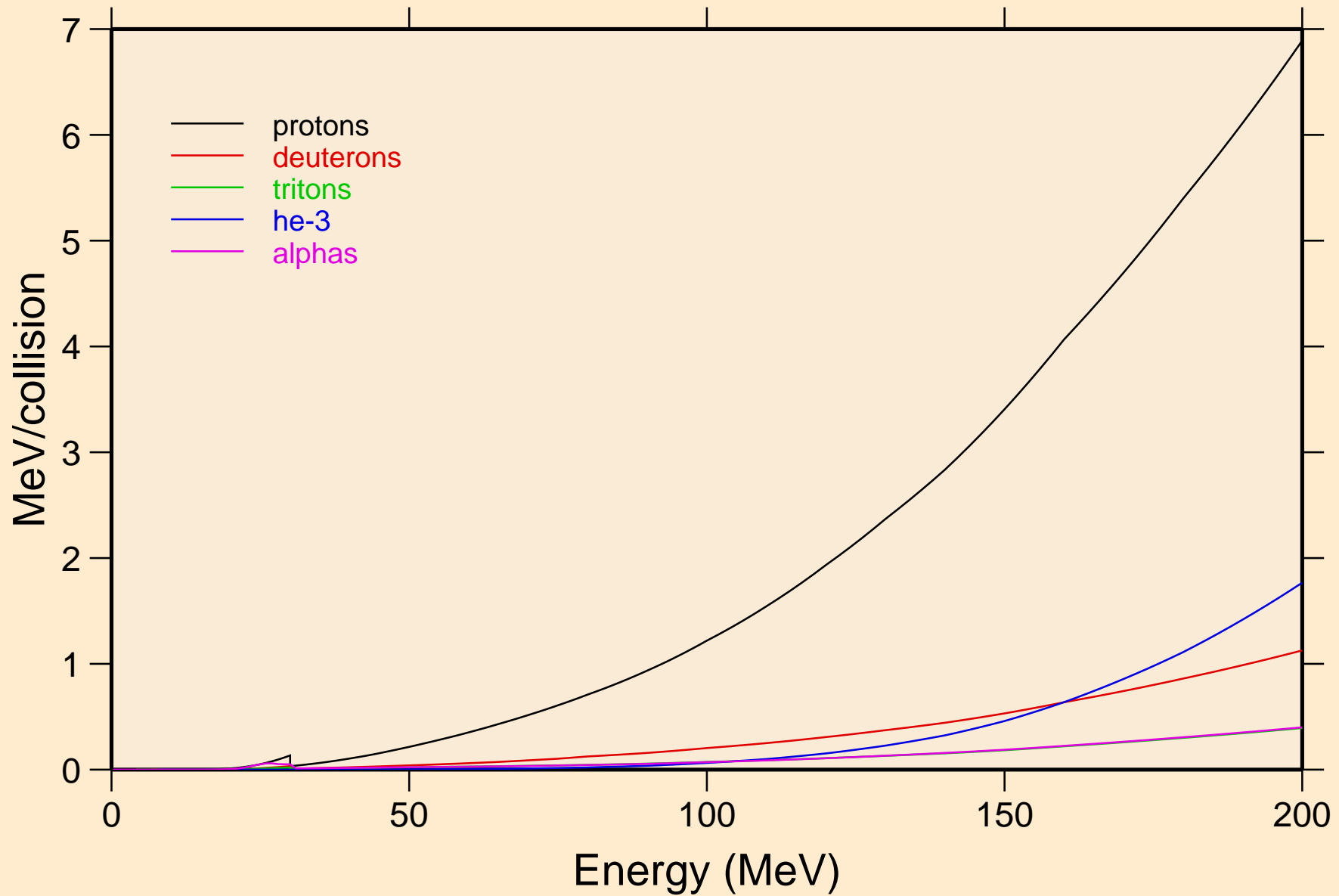

U243 NEUTRON ACER TENDL-2023 LIBRARY; T=0.K
Recoil Heating

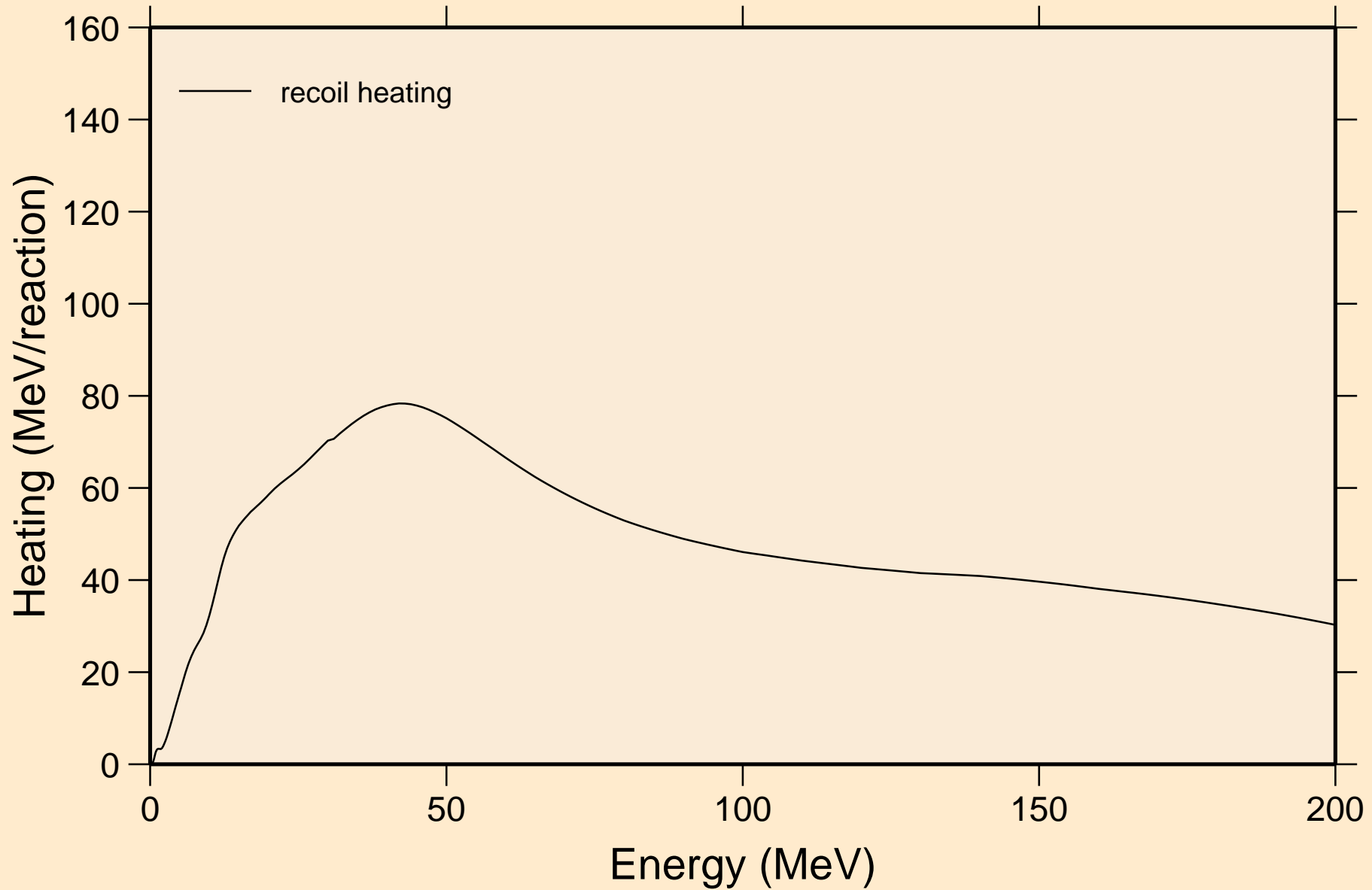

U243 NEUTRON ACER TENDL-2023 LIBRARY; T=0.K

Particle production cross sections

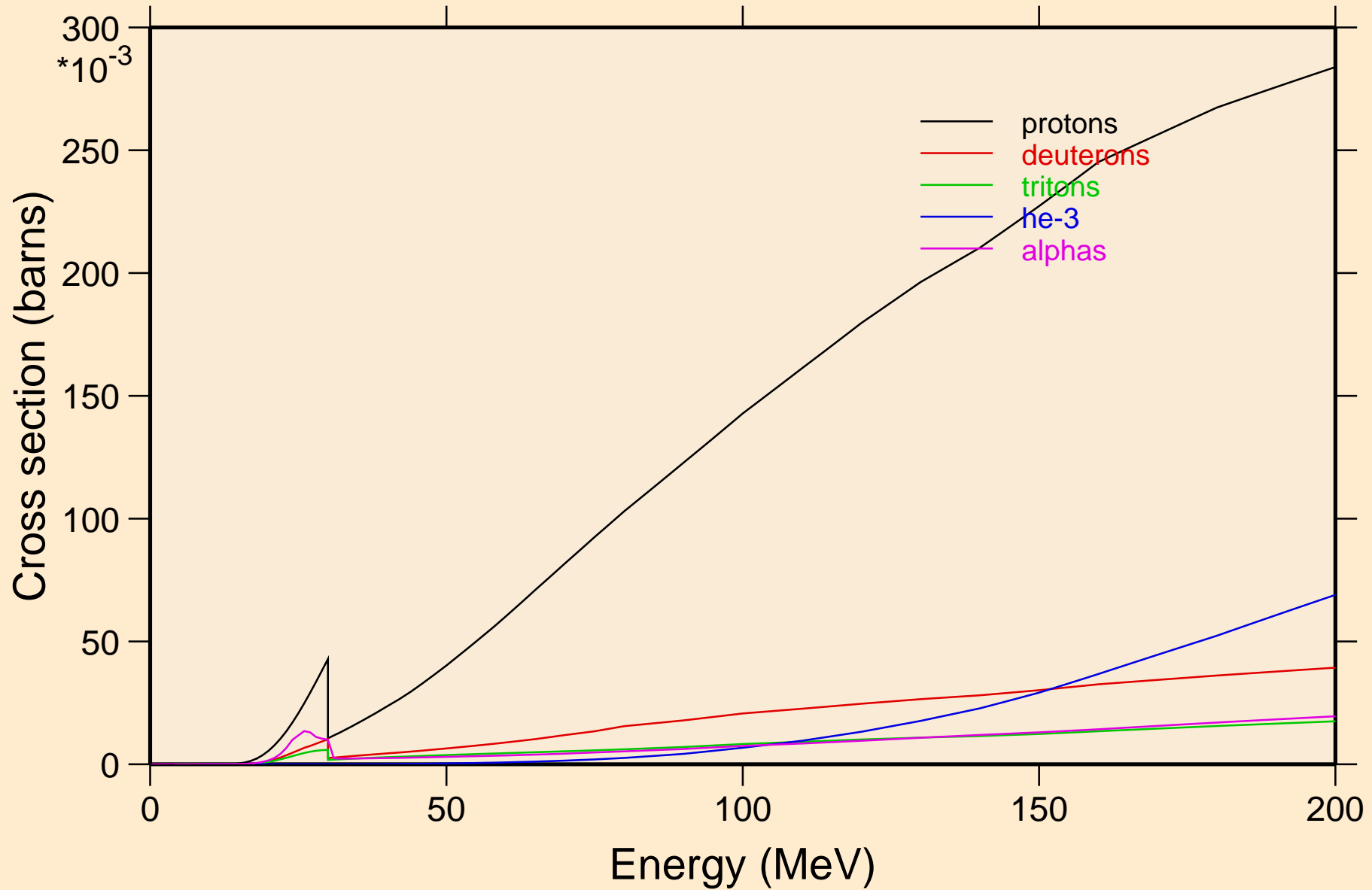

U243 NEUTRON ACER TENDL-2023 LIBRARY; T=0.K
protons from (n,x)

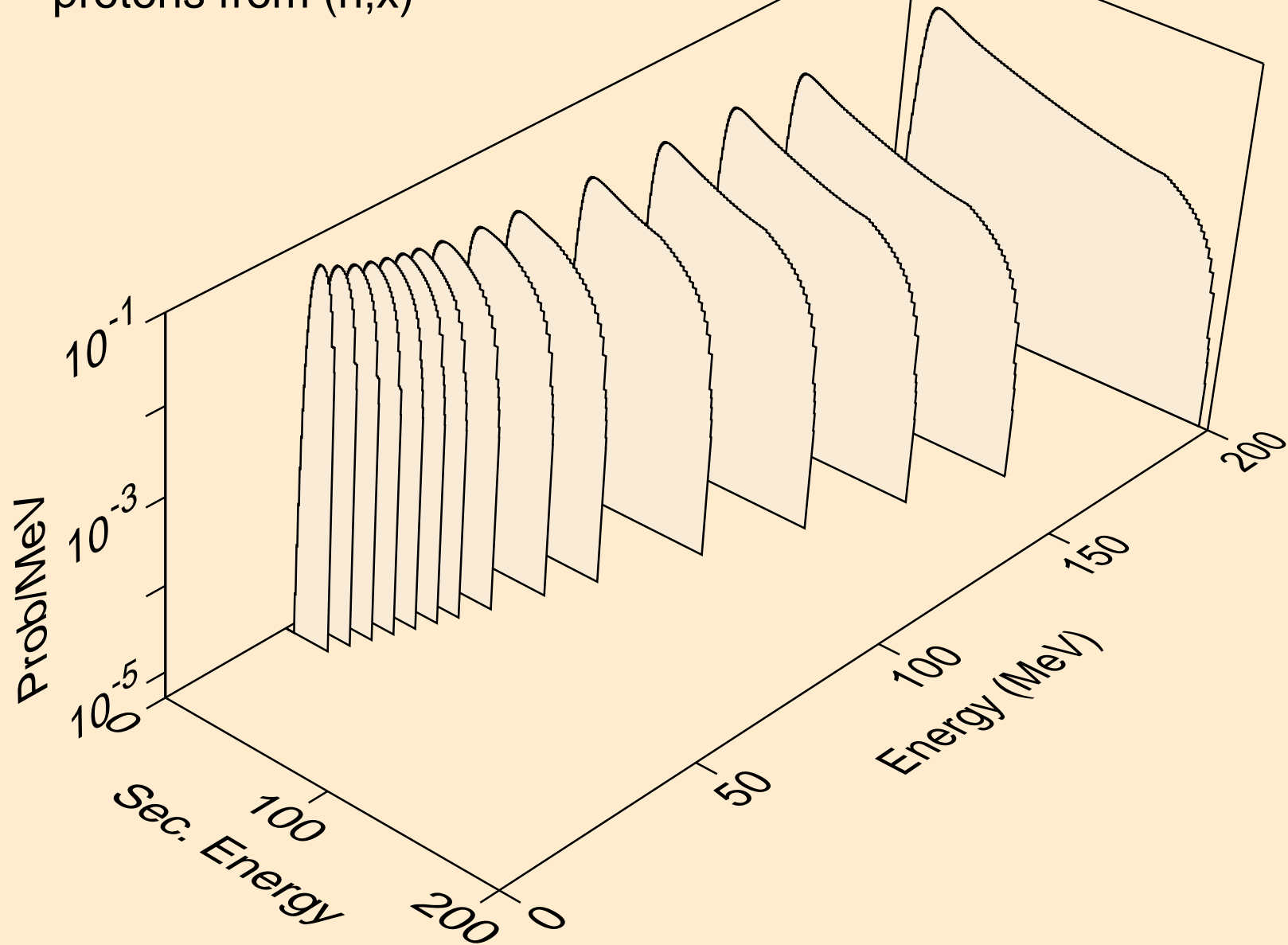

U243 NEUTRON ACER TENDL-2023 LIBRARY; T=0.K
protons from (n,n*)p

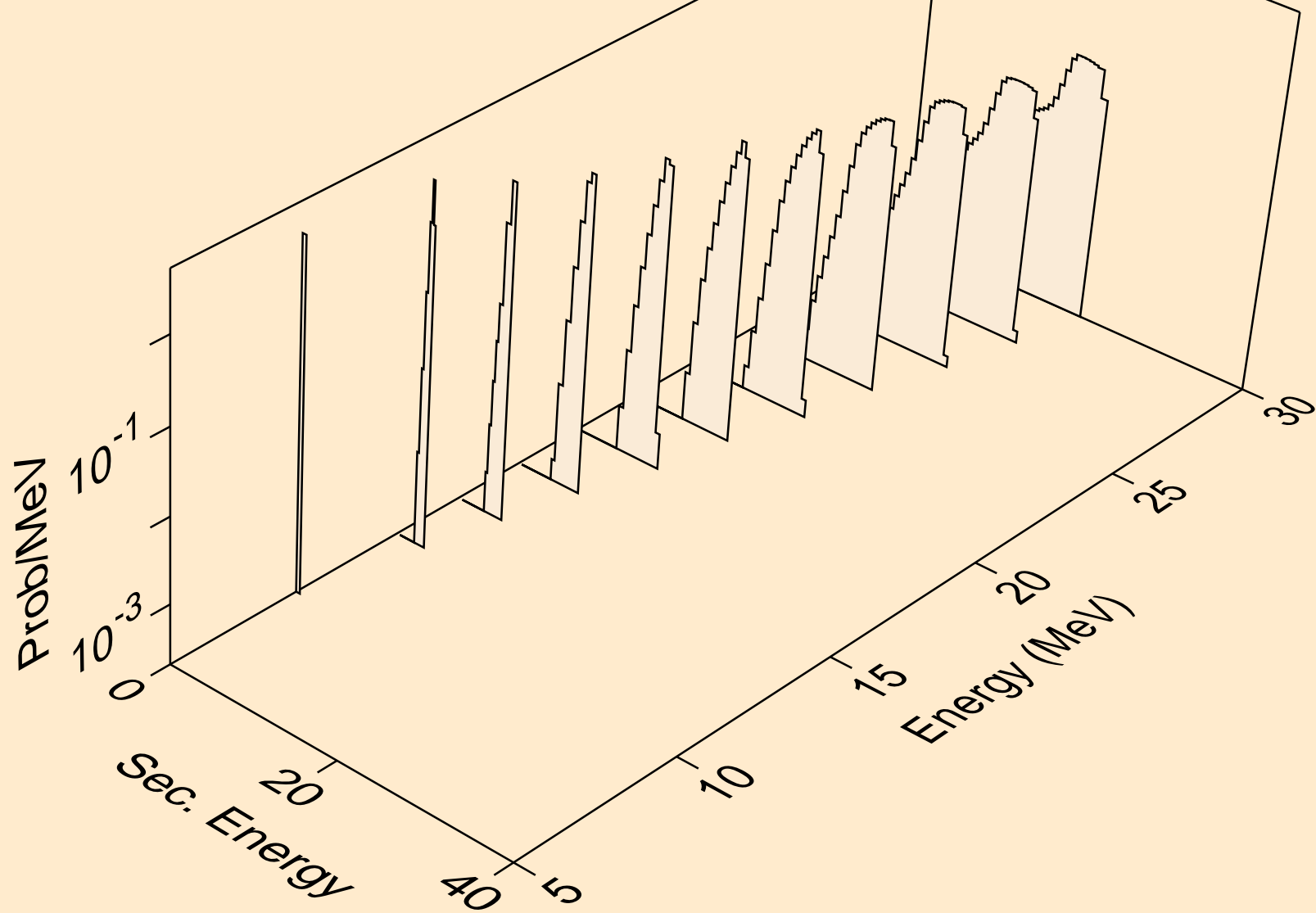

U243 NEUTRON ACER TENDL-2023 LIBRARY; T=0.K
protons from (n,2np)

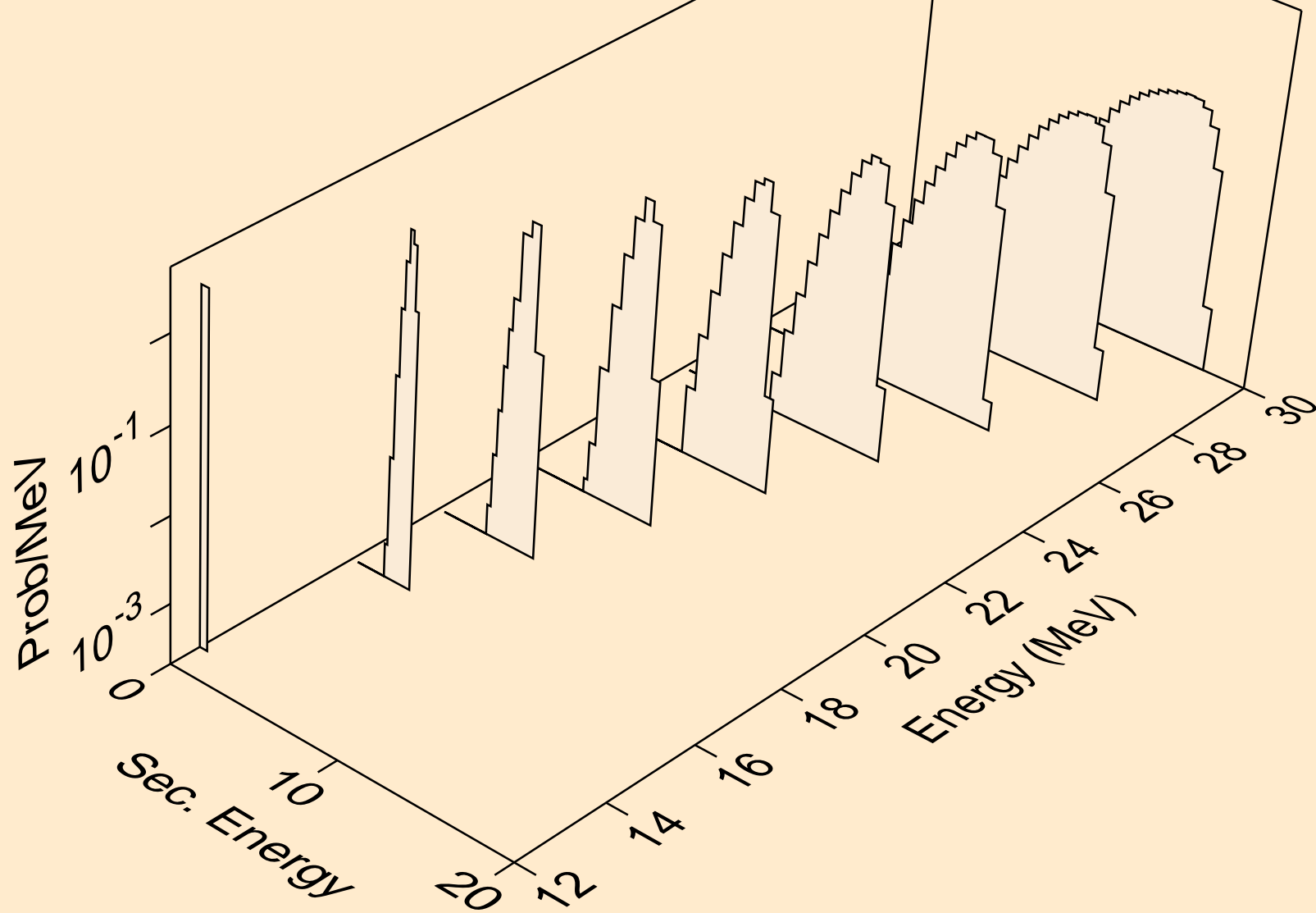

U243 NEUTRON ACER TENDL-2023 LIBRARY; T=0.K
protons from (n,3np)

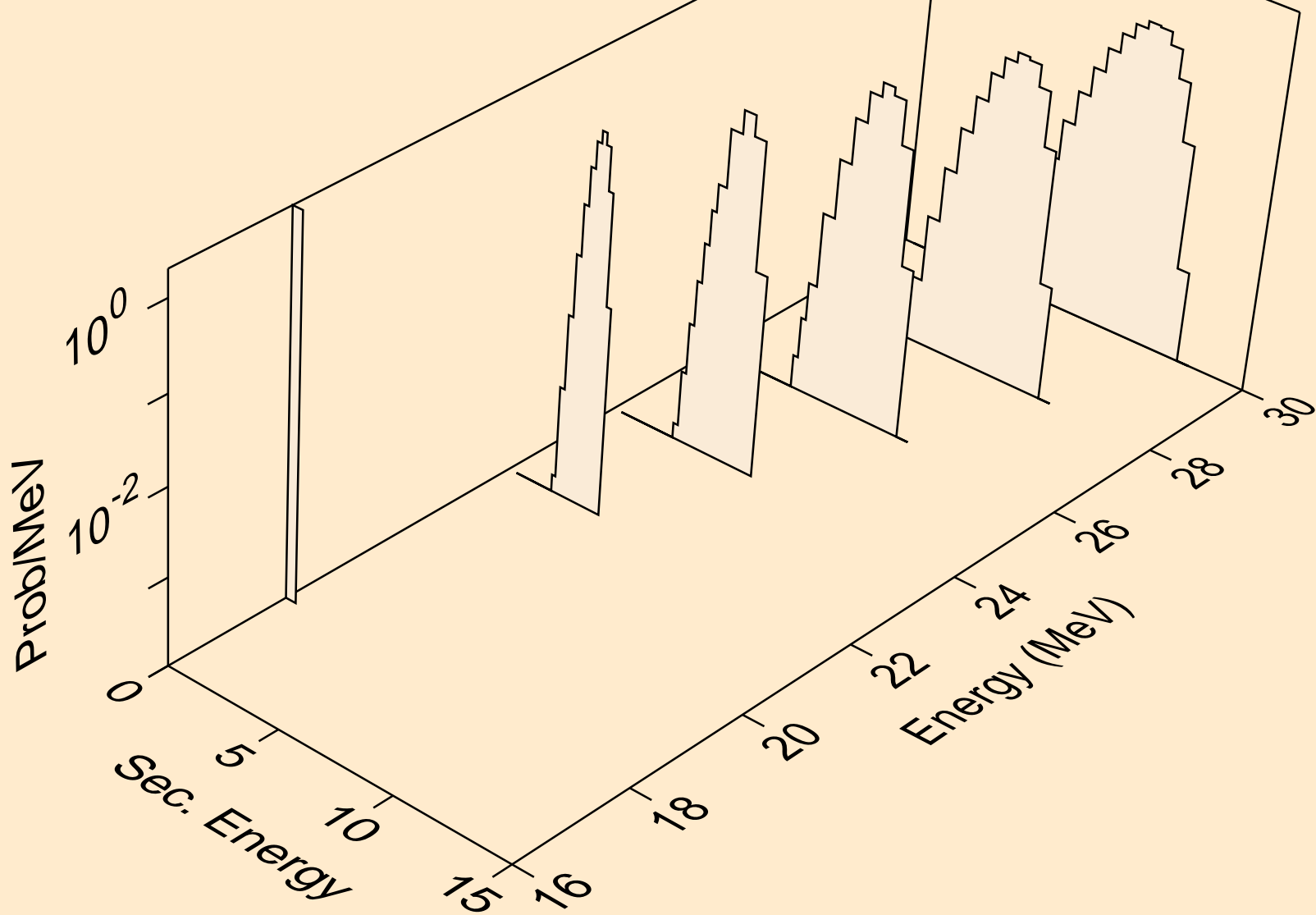

U243 NEUTRON ACER TENDL-2023 LIBRARY; T=0.K
protons from (n,p)

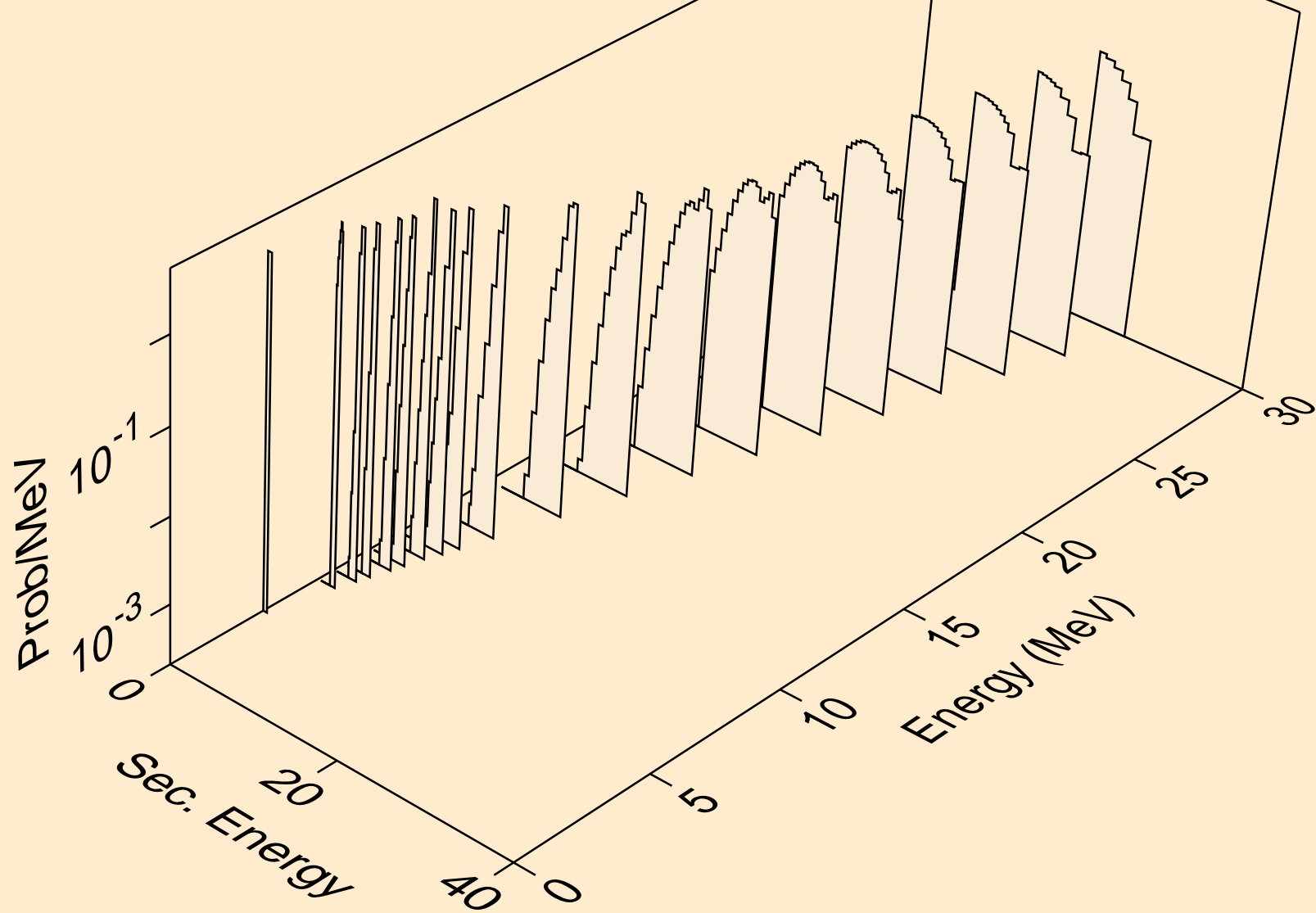

U243 NEUTRON ACER TENDL-2023 LIBRARY; T=0.K
protons from (n,2p)

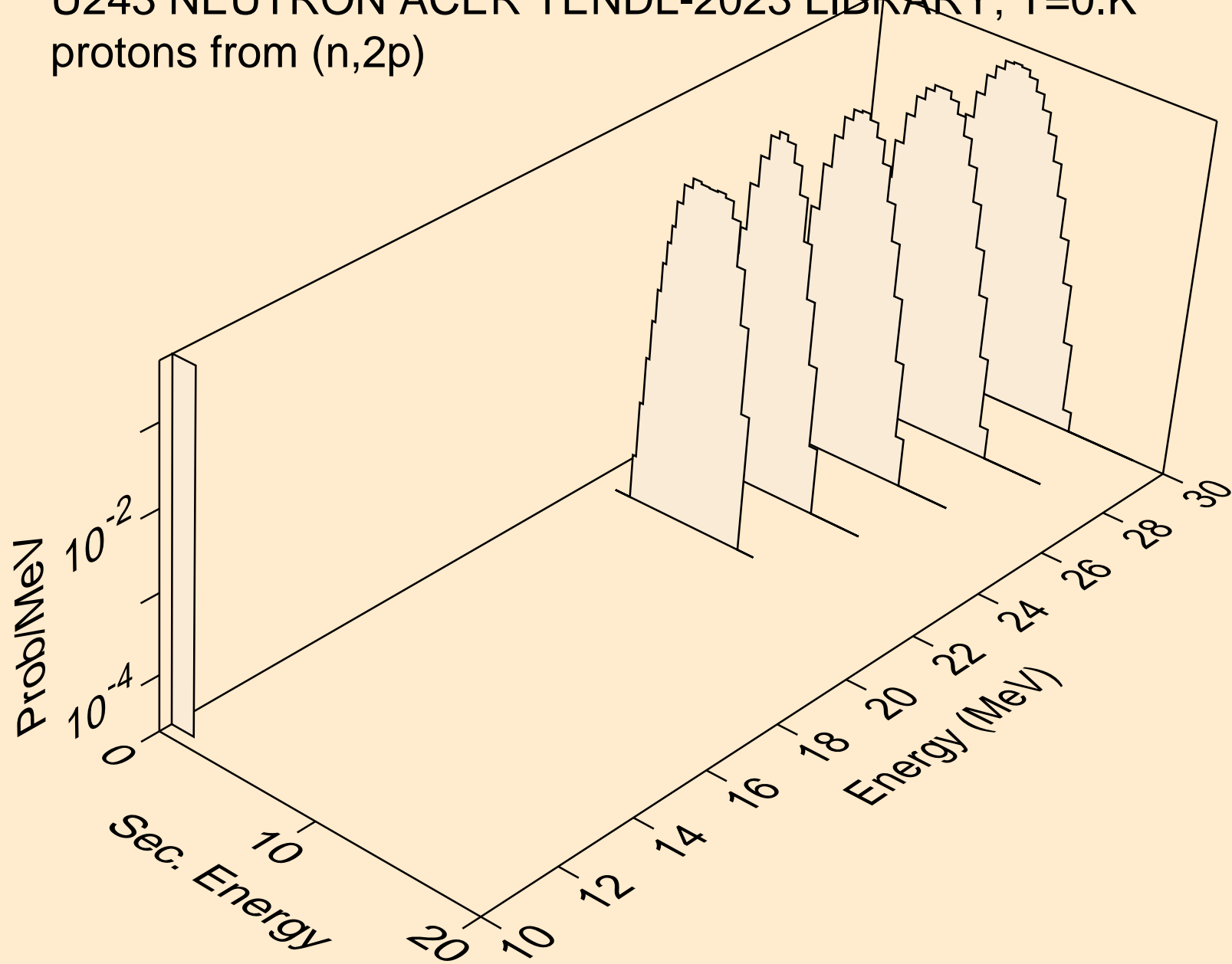

U243 NEUTRON ACER TENDL-2023 LIBRARY; T=0.K
deuterons from (n,x)

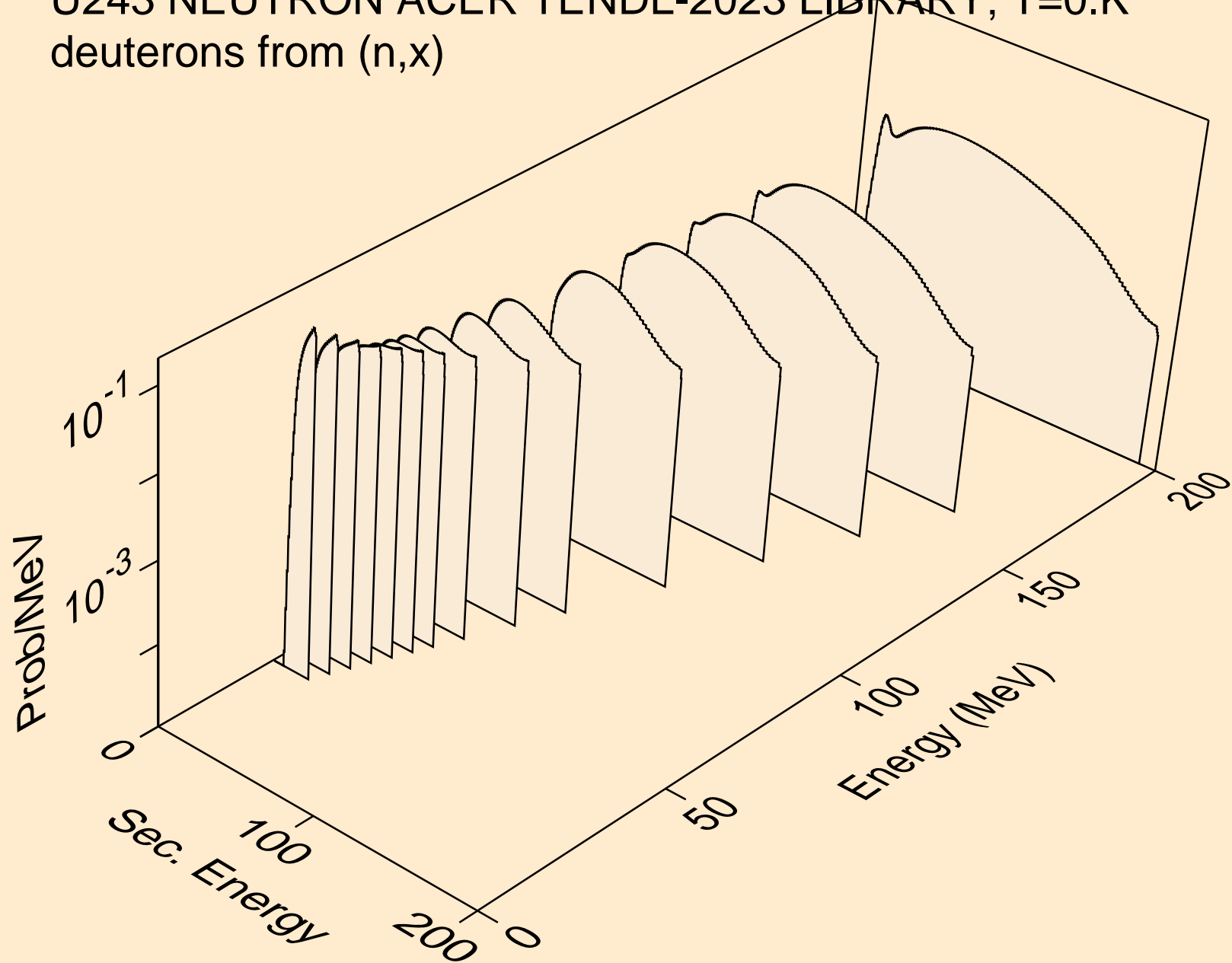

U243 NEUTRON ACER TENDL-2023 LIBRARY; T=0.K
deuterons from (n,2nd)

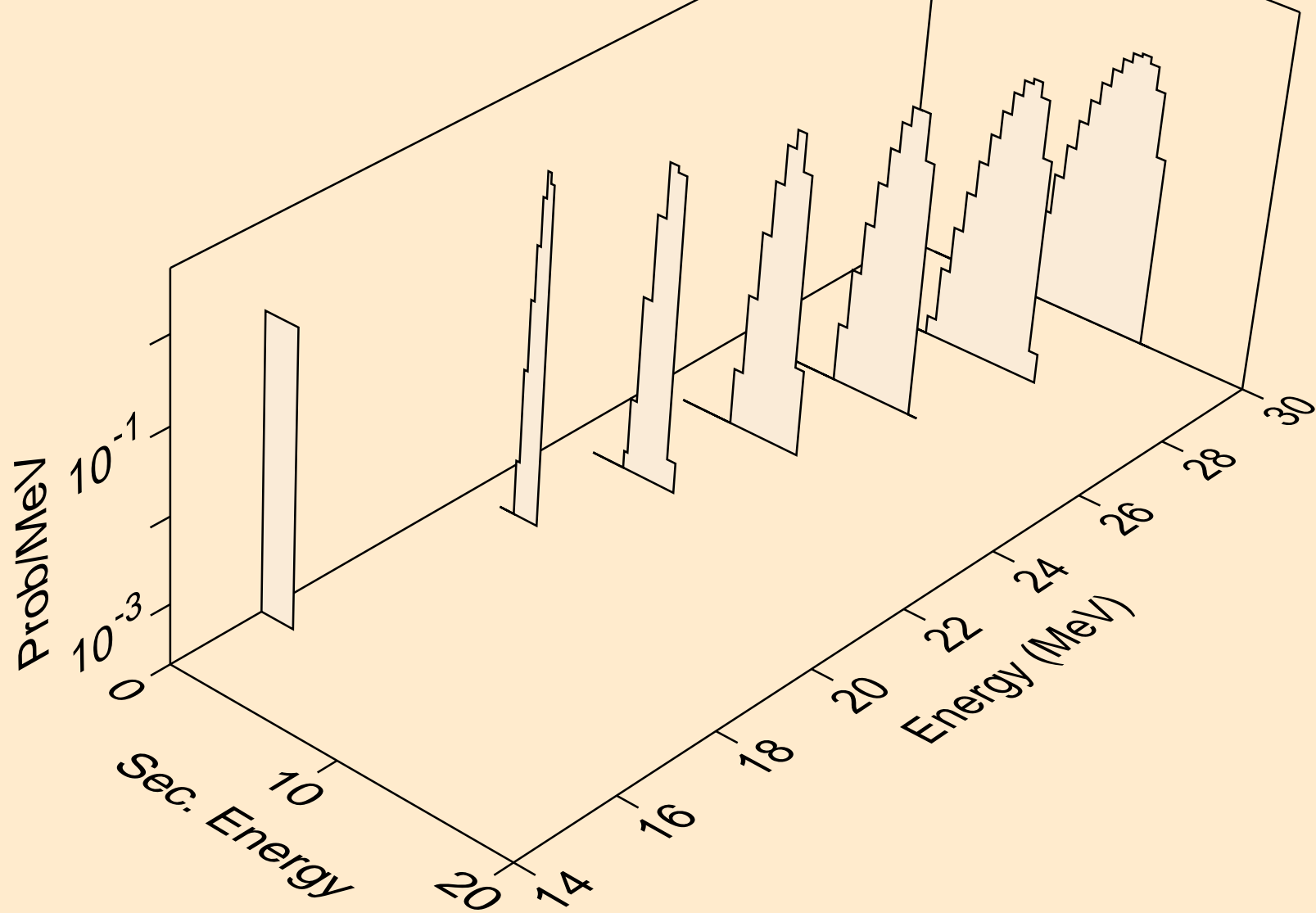

U243 NEUTRON ACER TENDL-2023 LIBRARY; T=0.K
deuterons from (n,n*)d

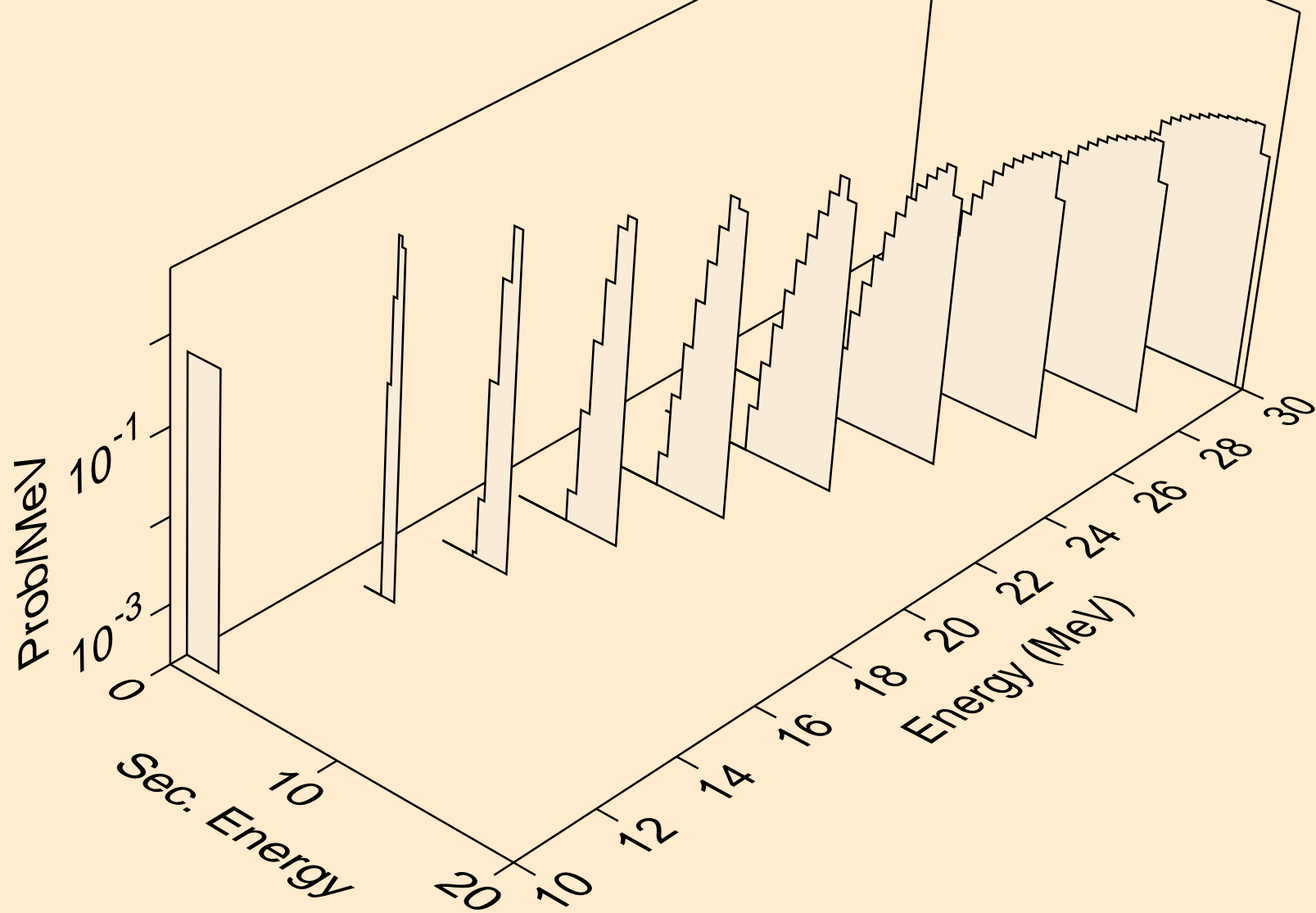

U243 NEUTRON ACER TENDL-2023 LIBRARY; T=0.K
deuterons from (n,d)

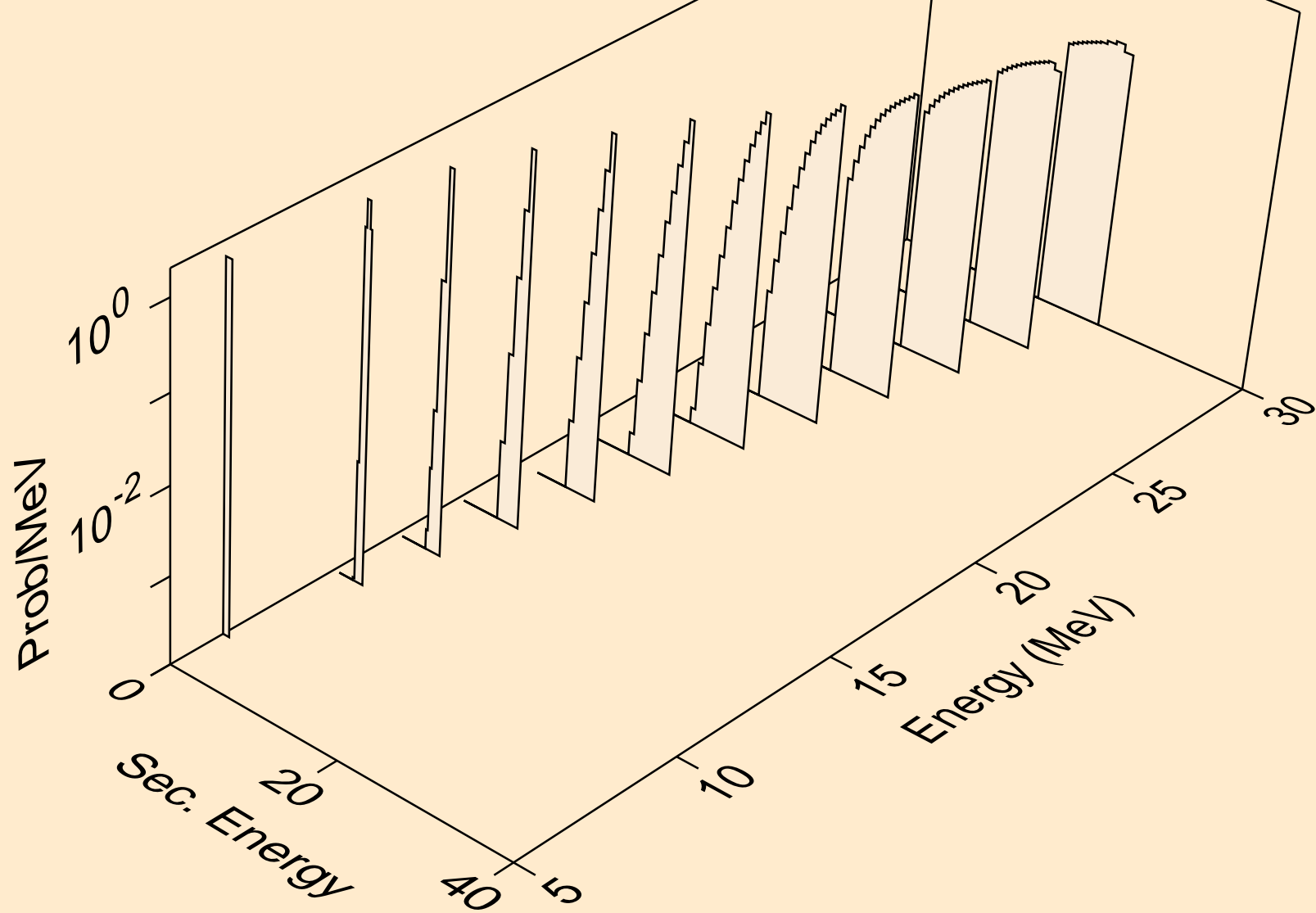

U243 NEUTRON ACER TENDL-2023 LIBRARY; T=0.K
tritons from (n,x)

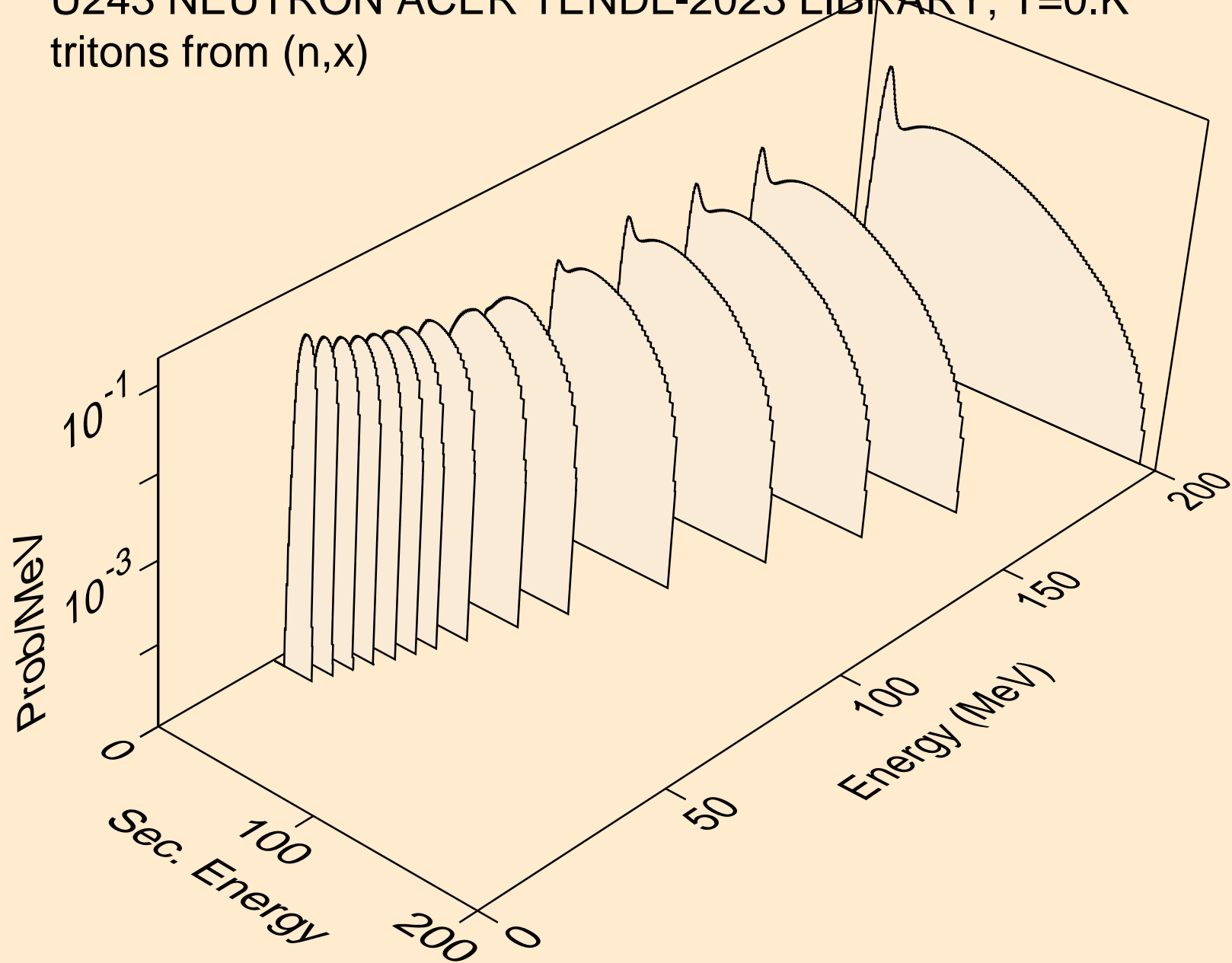

U243 NEUTRON ACER TENDL-2023 LIBRARY; T=0.K
tritons from (n,n*)t

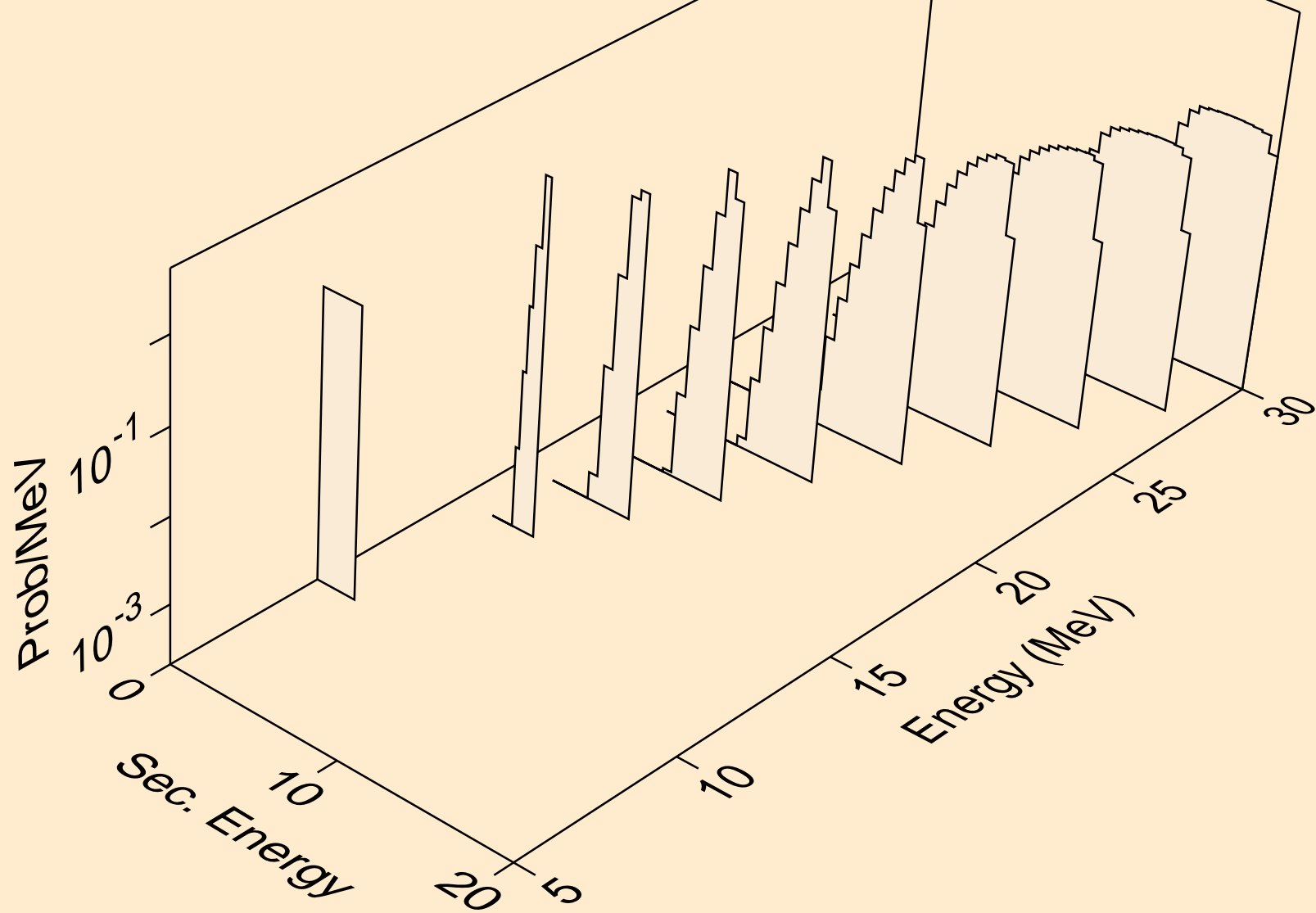

U243 NEUTRON ACER TENDL-2023 LIBRARY; T=0.K
tritons from (n,t)

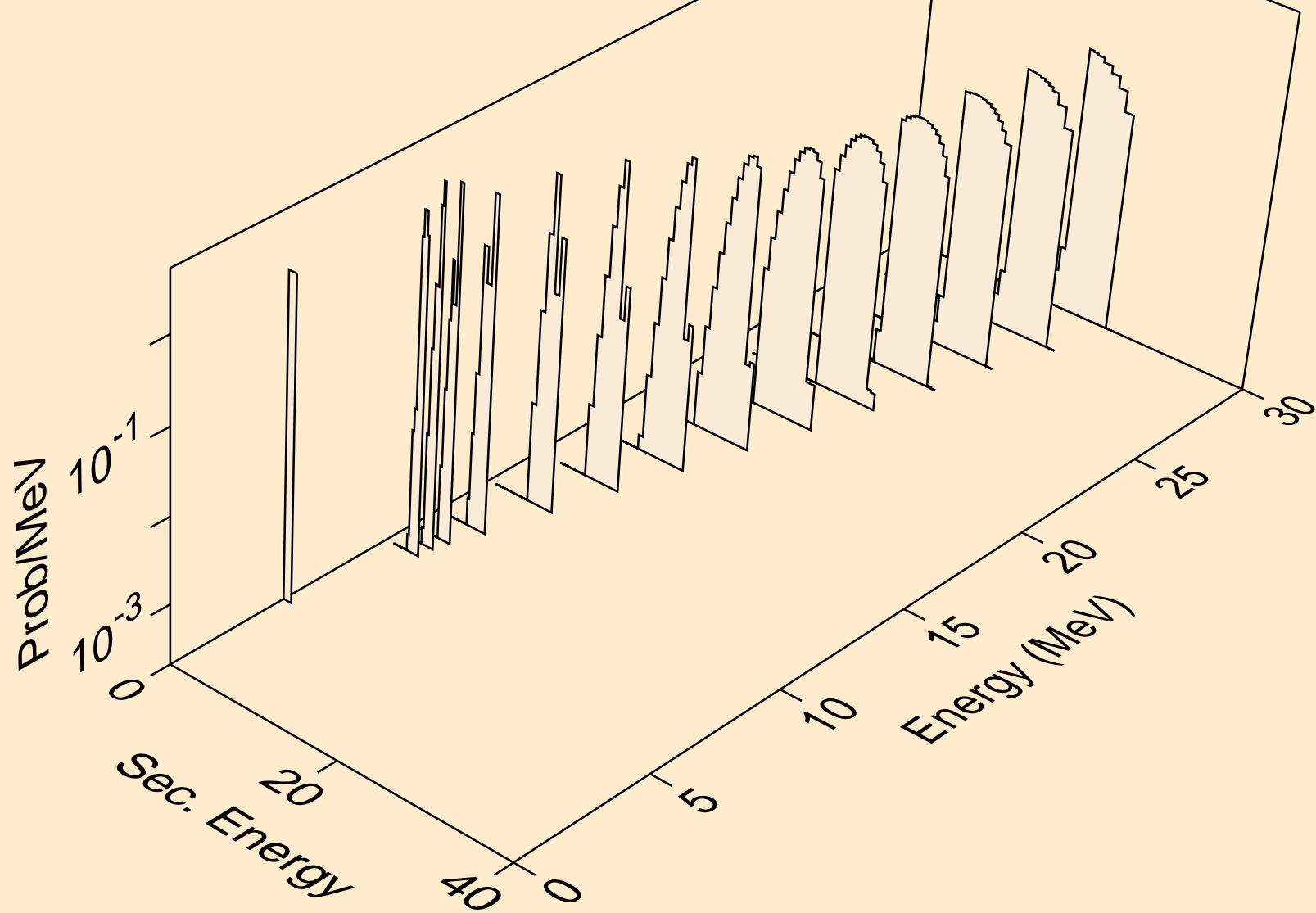

U243 NEUTRON ACER TENDL-2023 LIBRARY; T=0.K
he3s from (n,x)

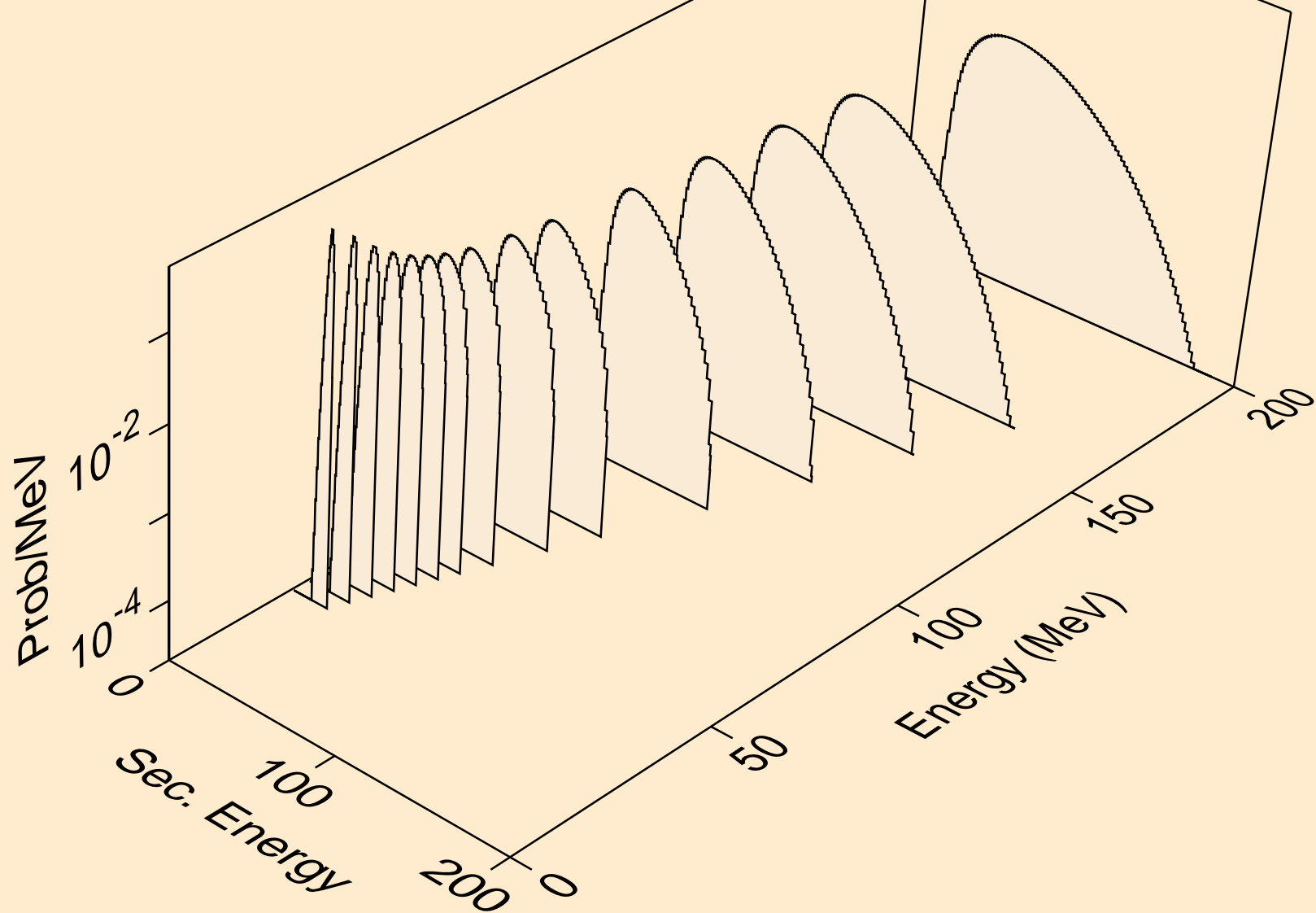

U243 NEUTRON ACER TENDL-2023 LIBRARY; T=0.K
he3s from (n,n*)he3

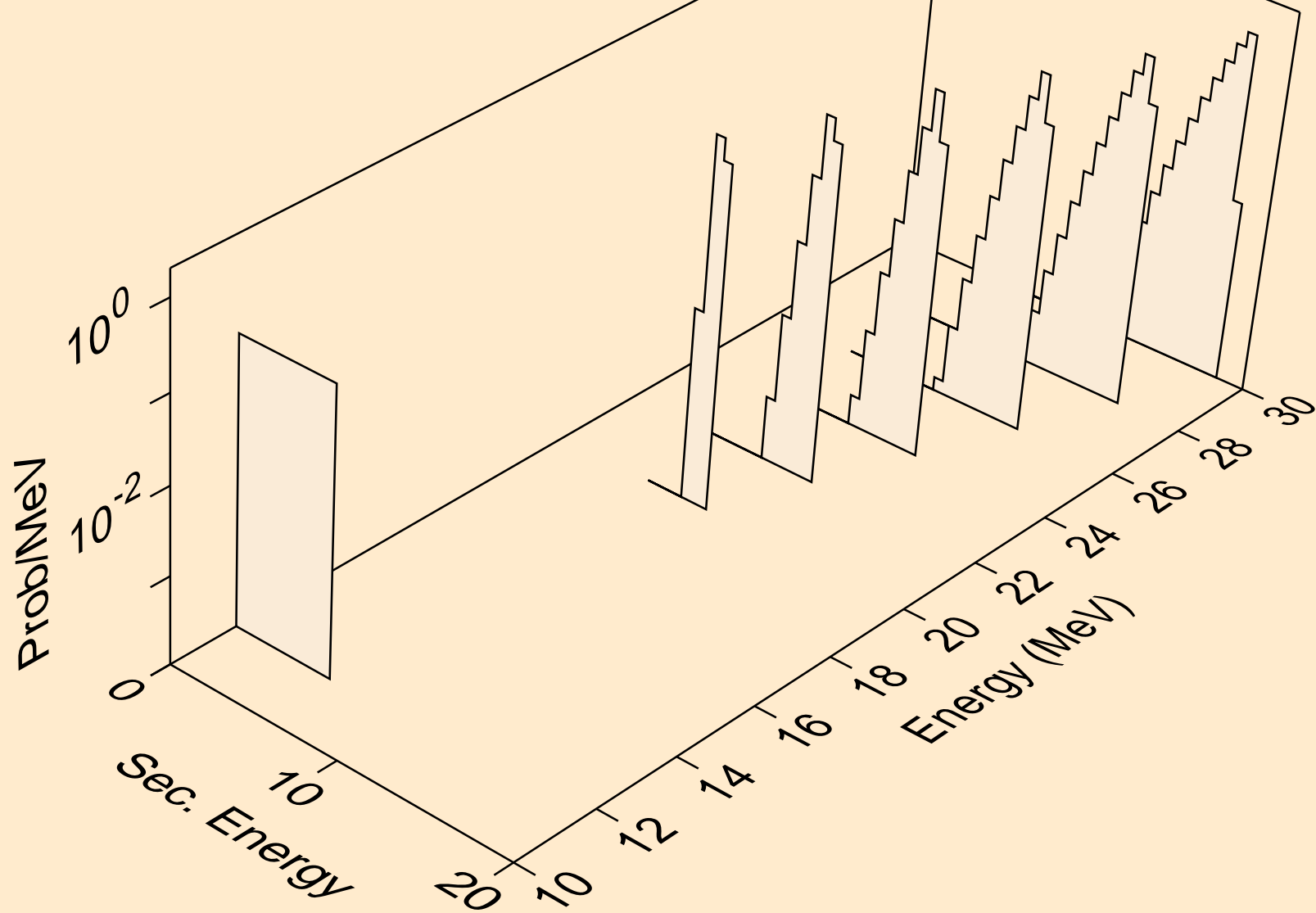

U243 NEUTRON ACER TENDL-2023 LIBRARY; T=0.K
he3s from (n,he3)

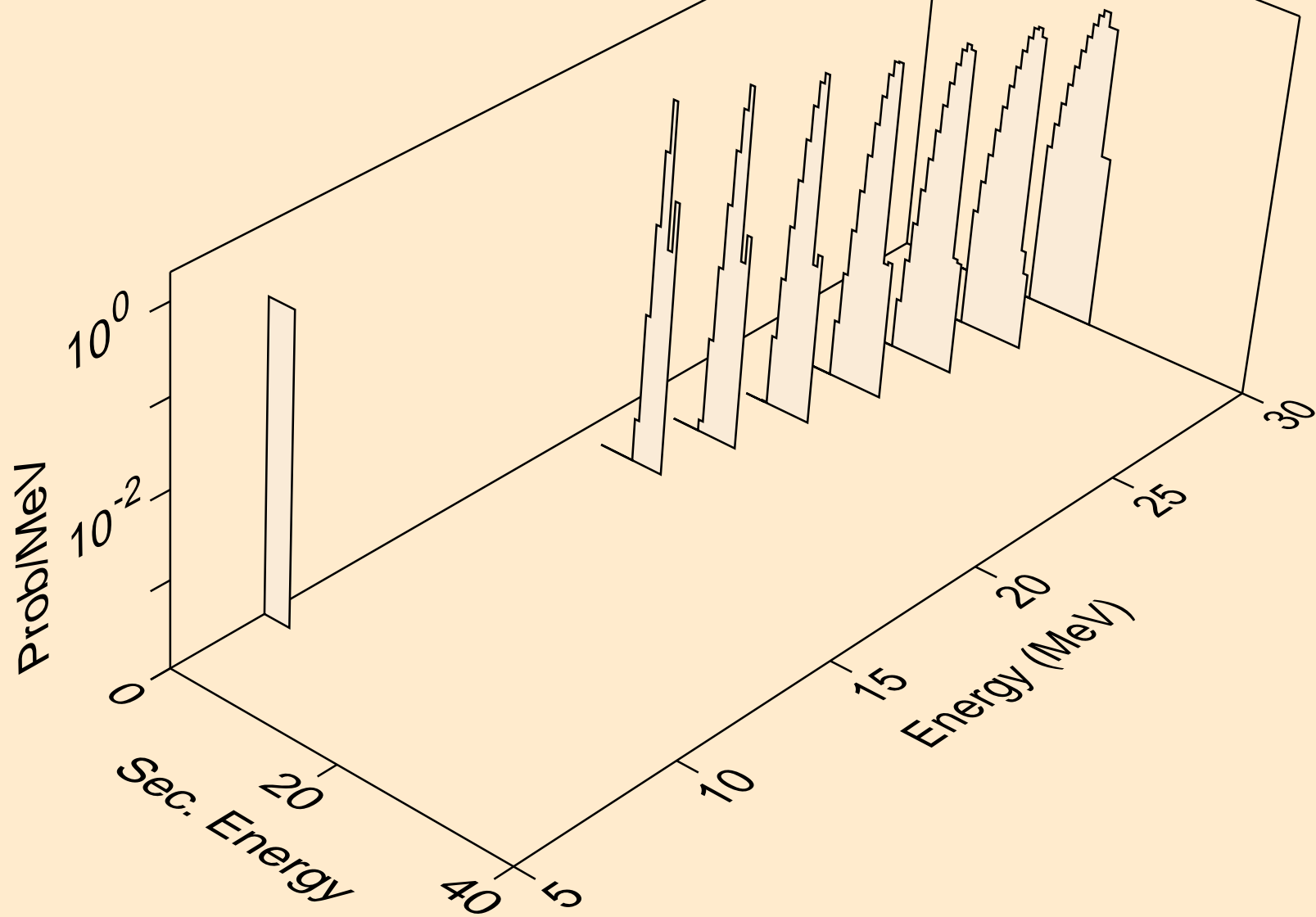

U243 NEUTRON ACER TENDL-2023 LIBRARY; T=0.K
alphas from (n,x)

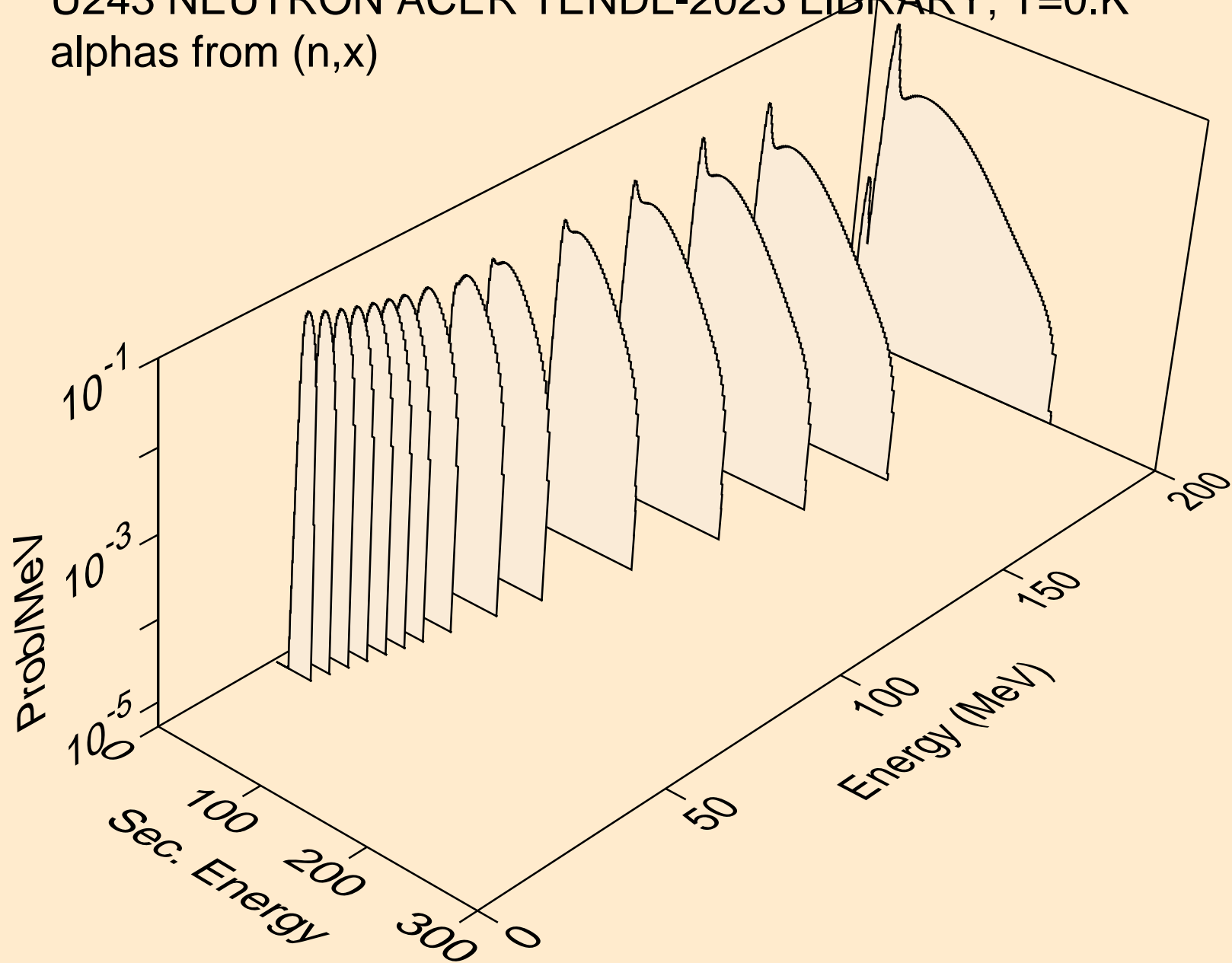

U243 NEUTRON ACER TENDL-2023 LIBRARY; T=0.K
alphas from (n,n*)a

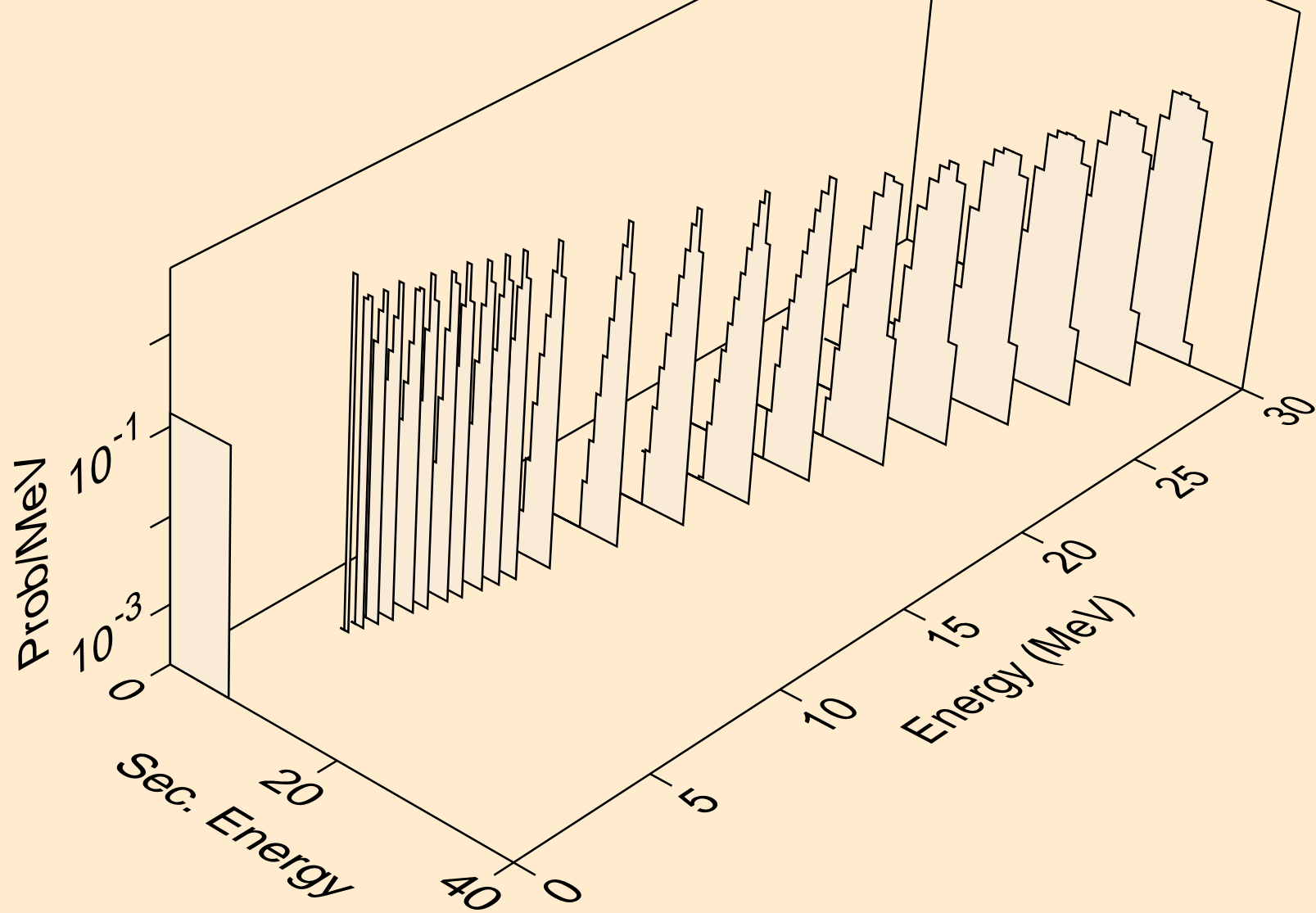

U243 NEUTRON ACER TENDL-2023 LIBRARY; T=0.K
alphas from (n,2n)a

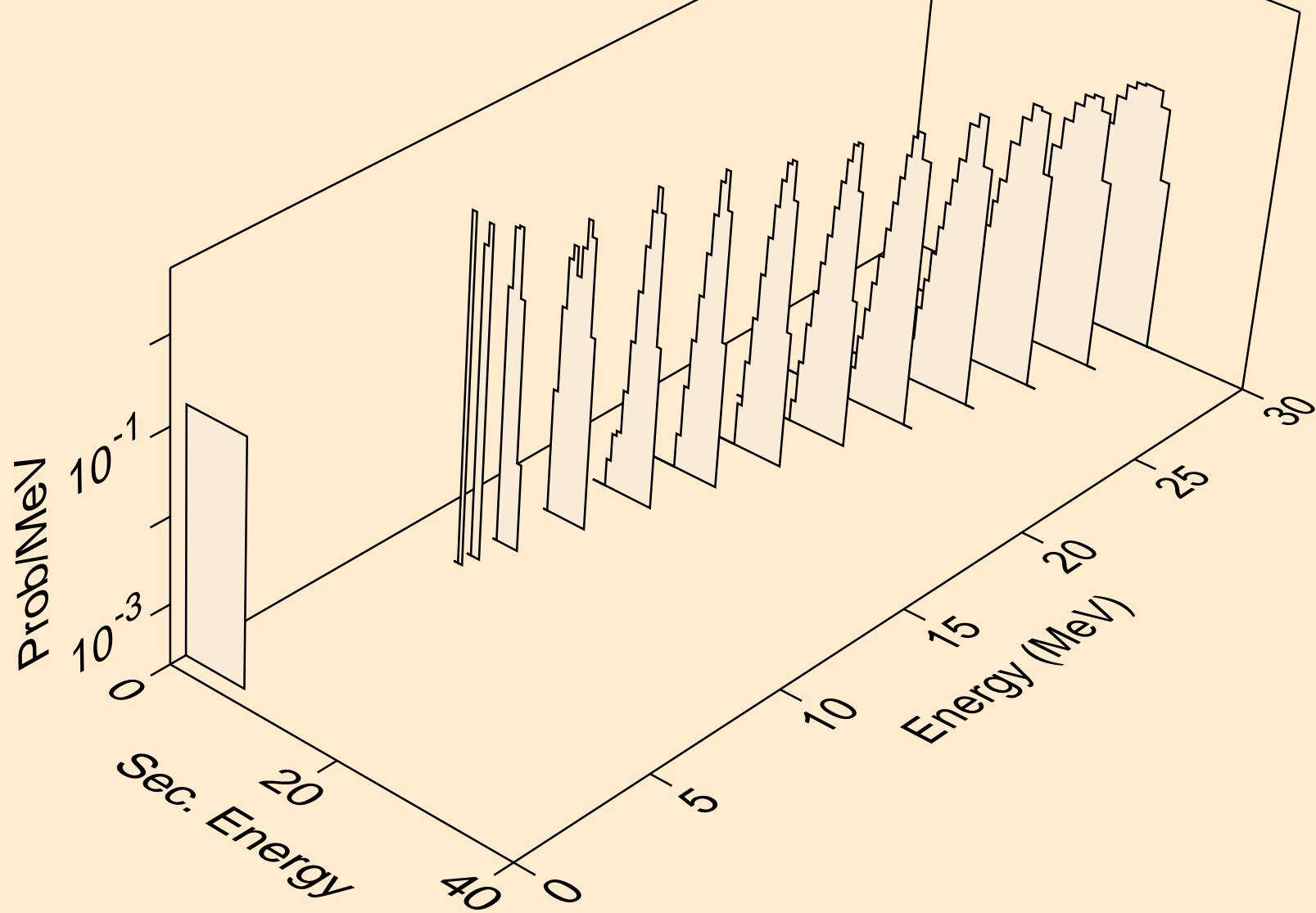

U243 NEUTRON ACER TENDL-2023 LIBRARY; T=0.K
alphas from (n,3n)a

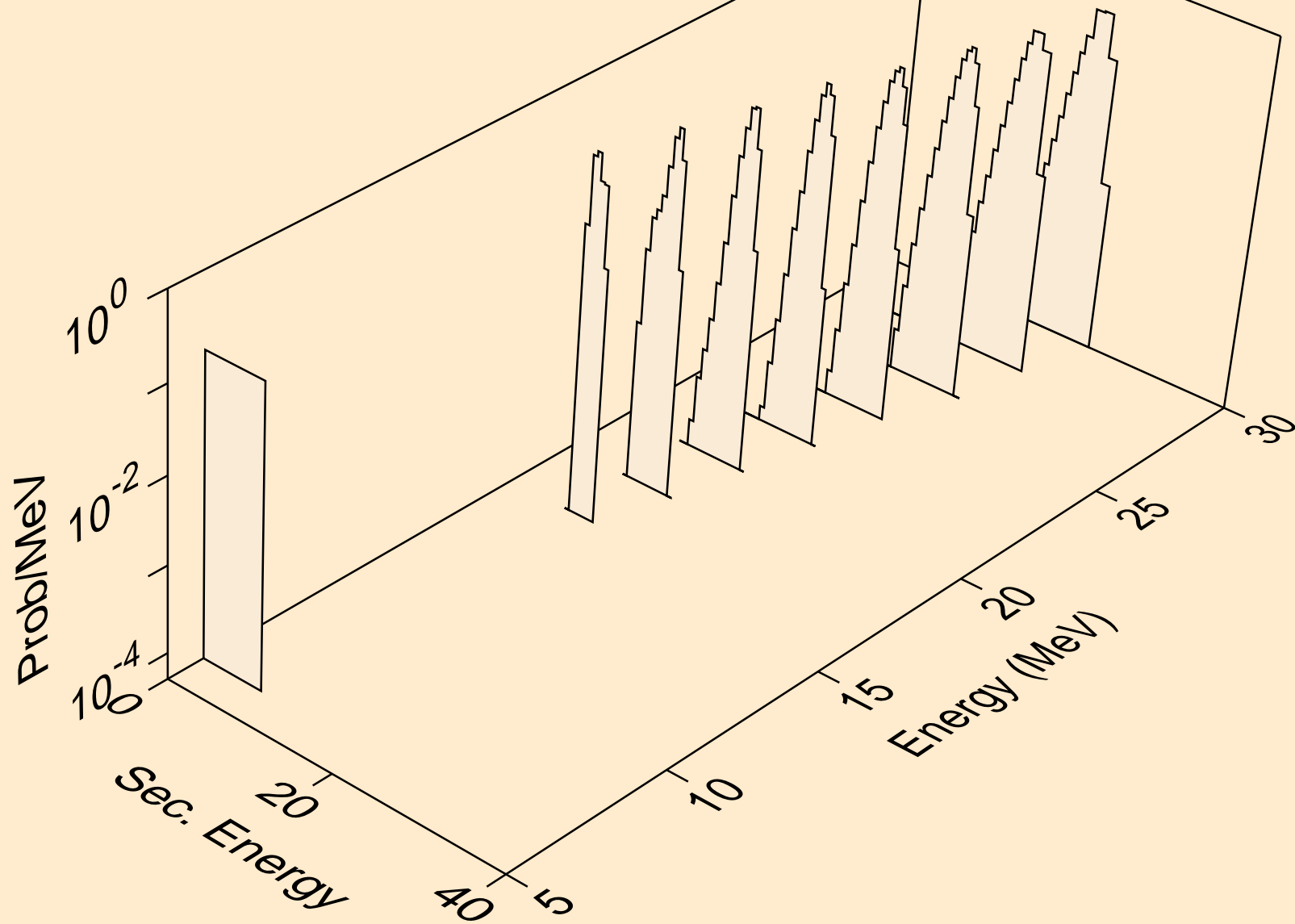

U243 NEUTRON ACER TENDL-2023 LIBRARY; T=0.K
alphas from (n,a)

