

W196 NEUTRON ACER TENDL-2023 LIBRARY; T=0.K

Principal cross sections

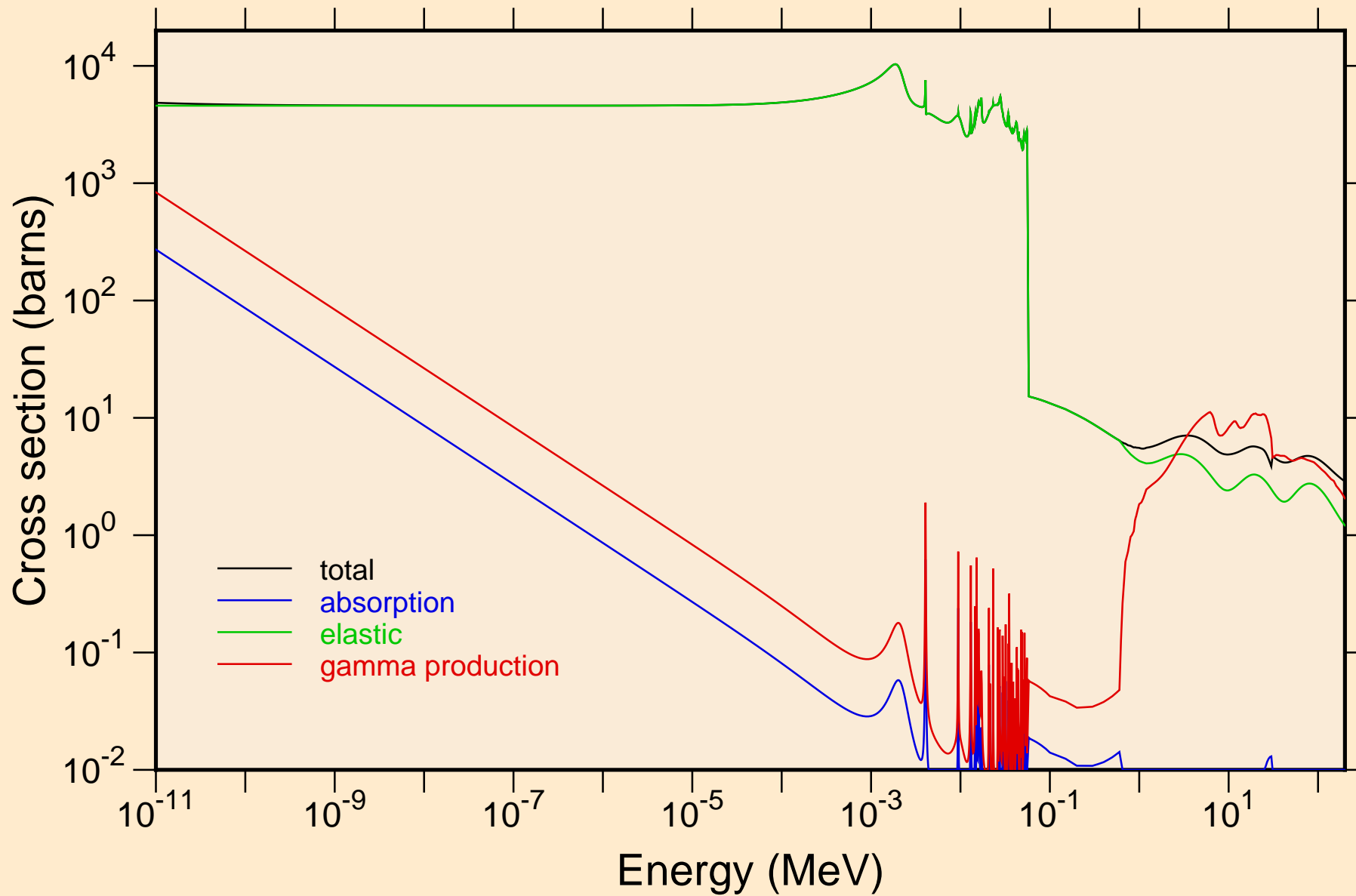

W196 NEUTRON ACER TENDL-2023 LIBRARY; T=0.K
resonance total cross section

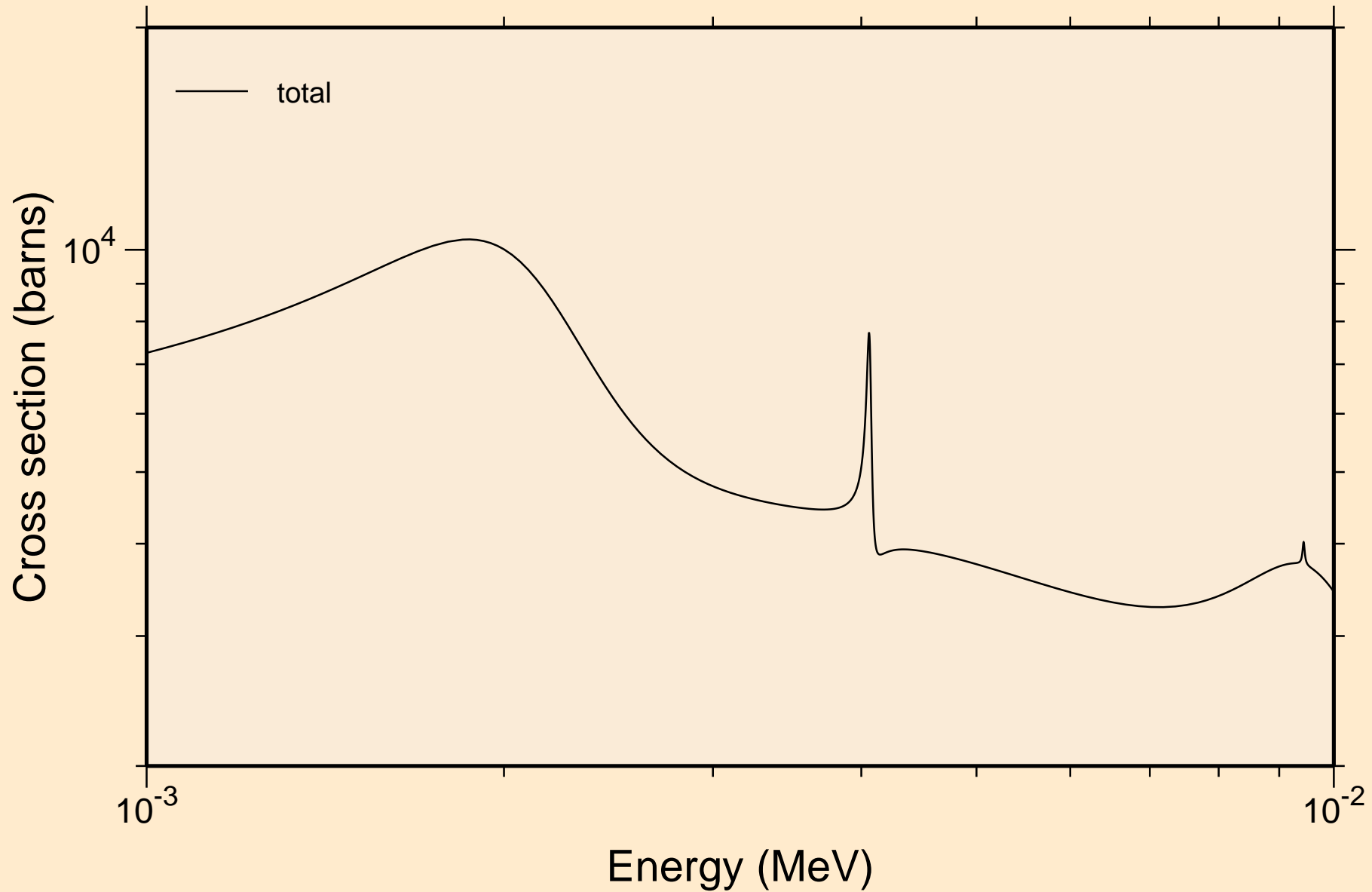

W196 NEUTRON ACER TENDL-2023 LIBRARY; T=0.K
resonance total cross section

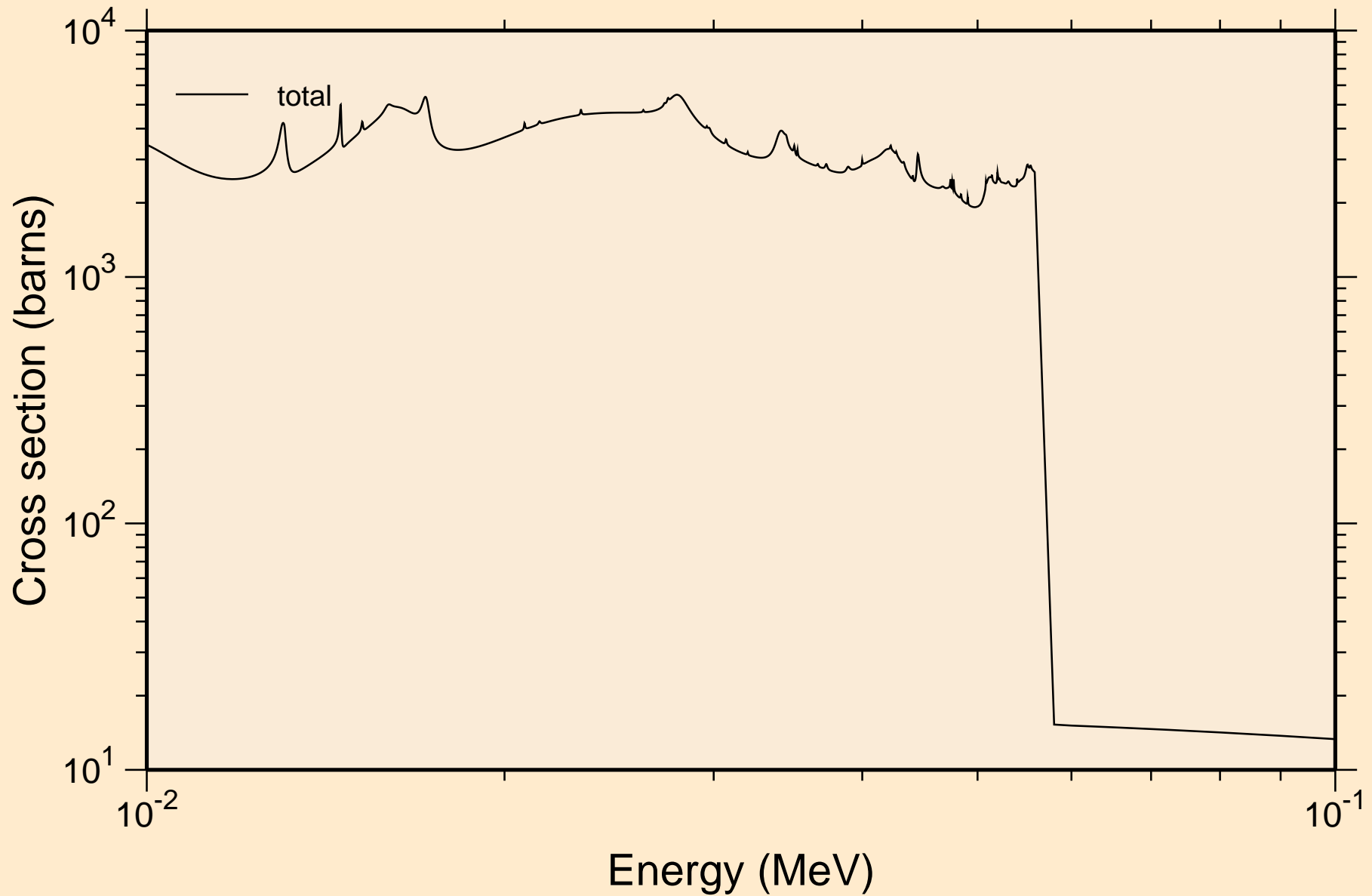

W196 NEUTRON ACER TENDL-2023 LIBRARY; T=0.K
resonance total cross section

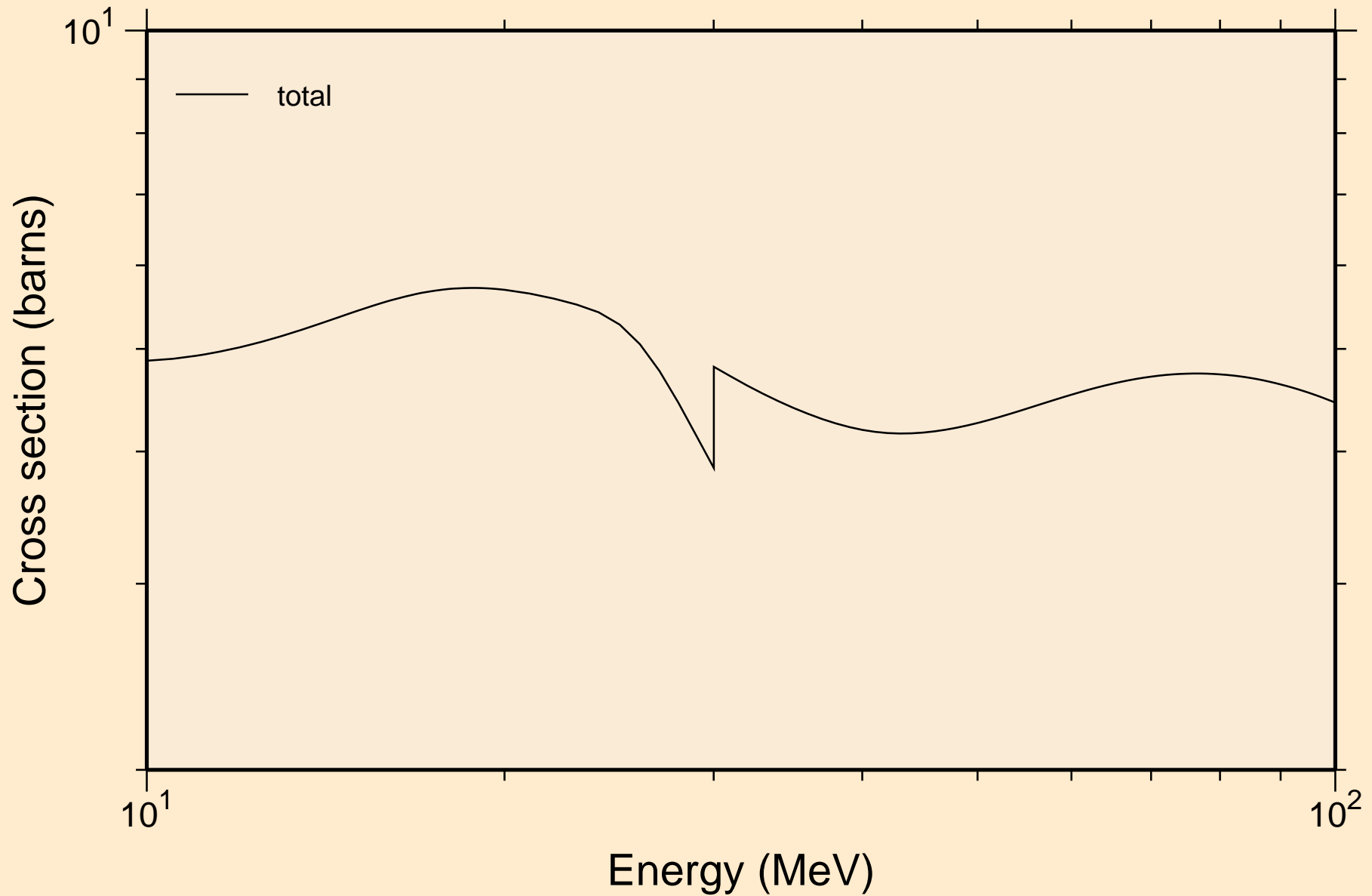

W196 NEUTRON ACER TENDL-2023 LIBRARY; T=0.K
resonance absorption cross sections

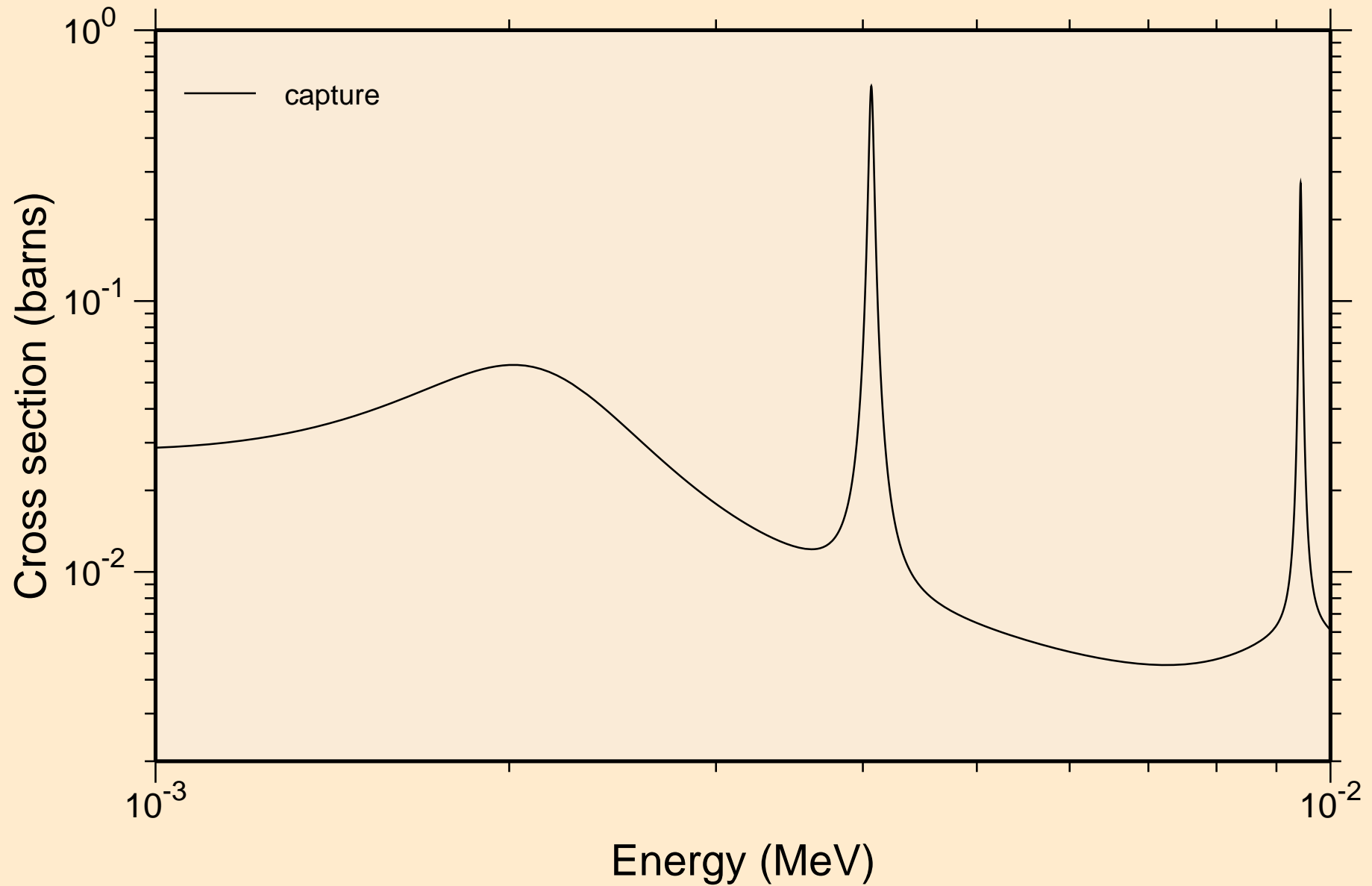

W196 NEUTRON ACER TENDL-2023 LIBRARY; T=0.K
resonance absorption cross sections

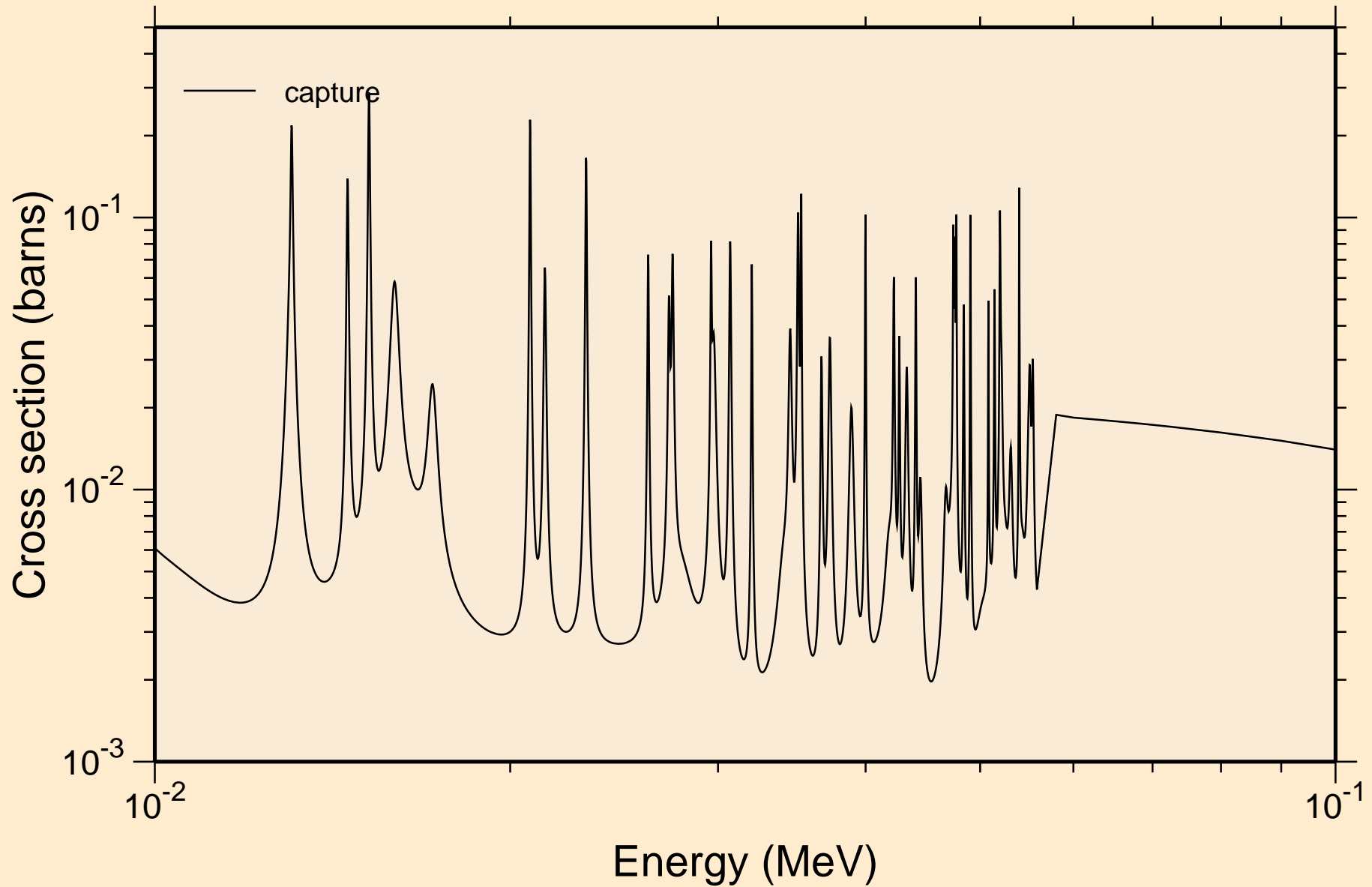

W196 NEUTRON ACER TENDL-2023 LIBRARY; T=0.K
resonance absorption cross sections

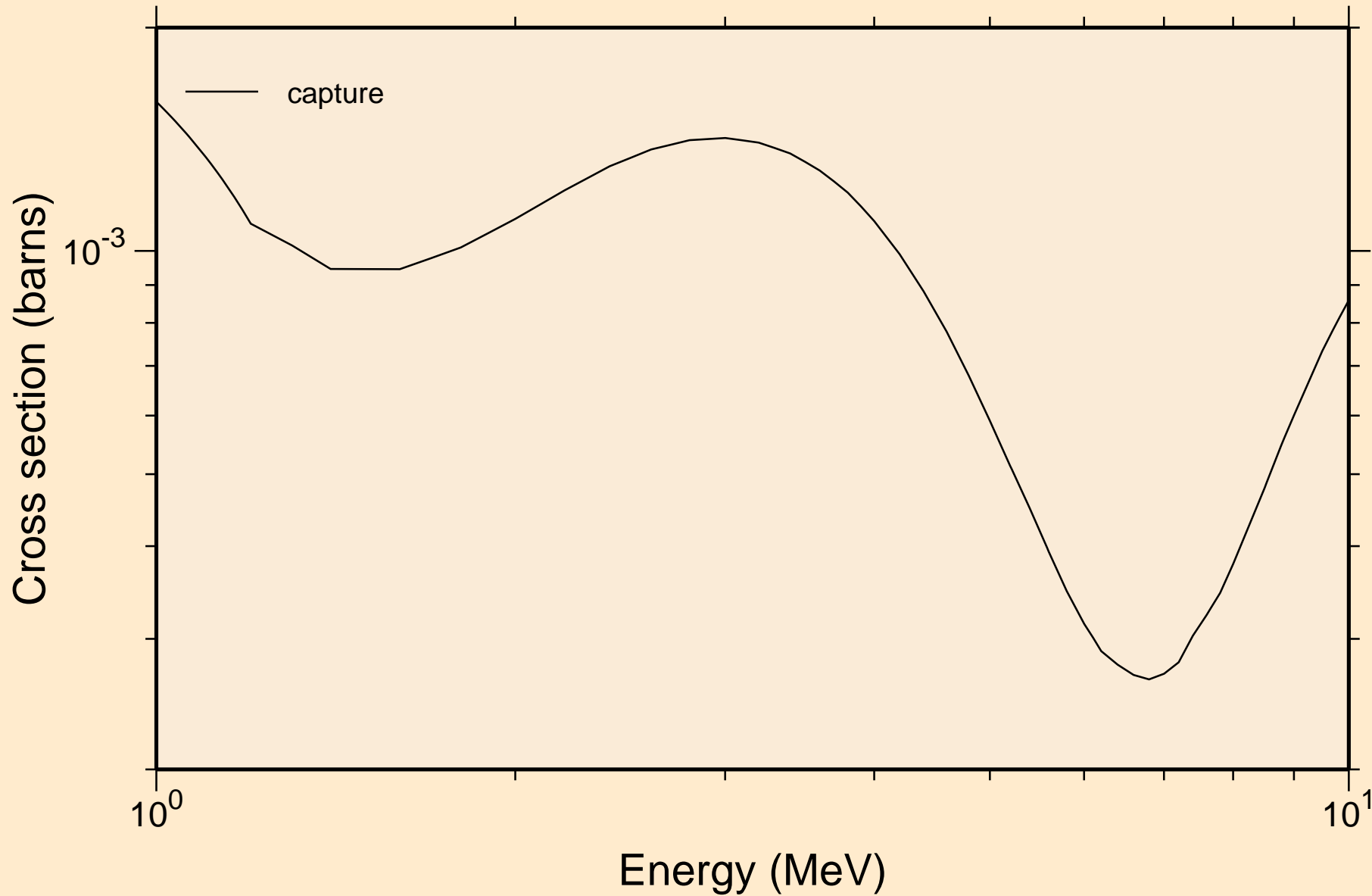

W196 NEUTRON ACER TENDL-2023 LIBRARY; T=0.K

Heating

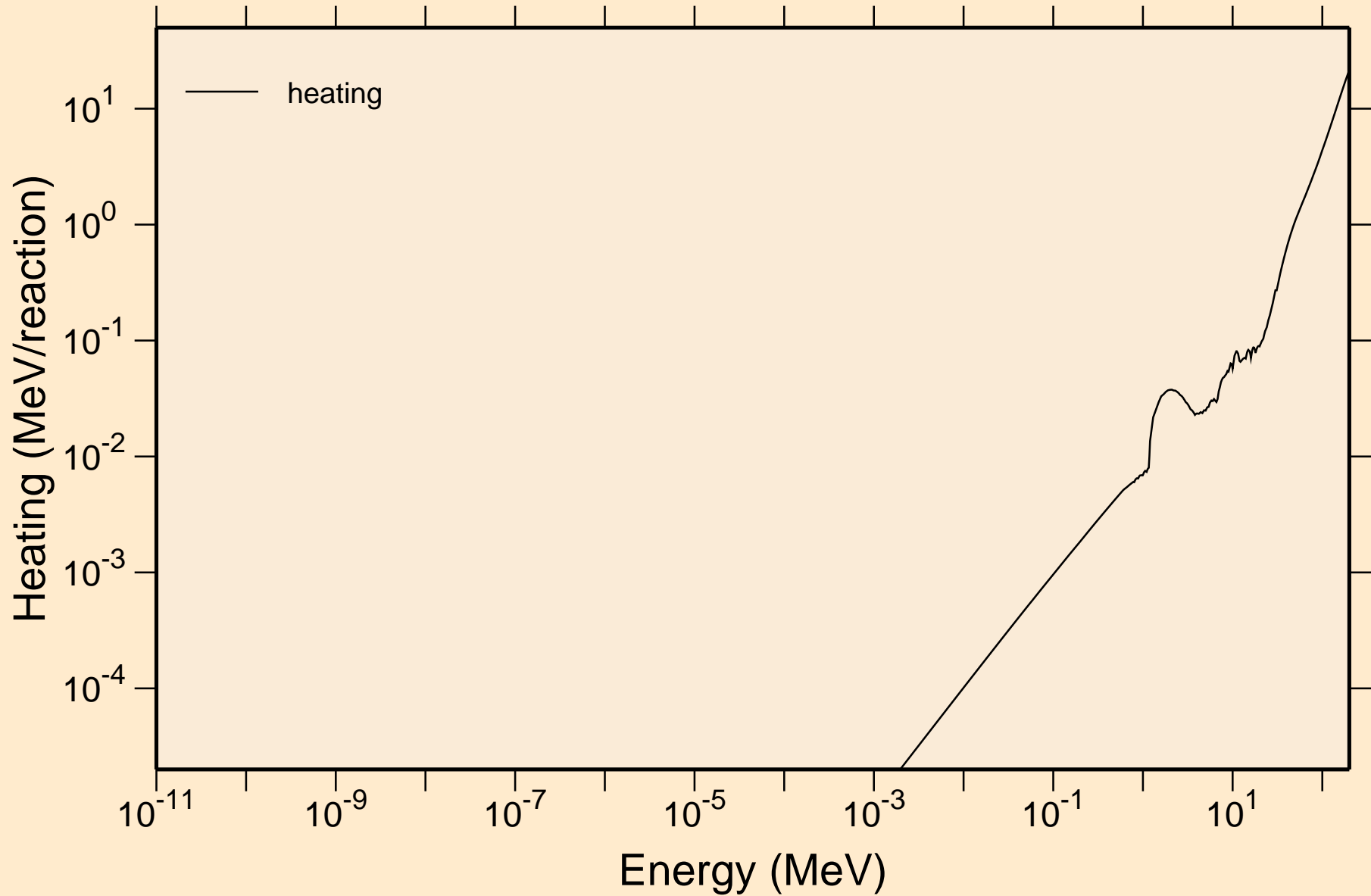

W196 NEUTRON ACER TENDL-2023 LIBRARY; T=0.K
Damage

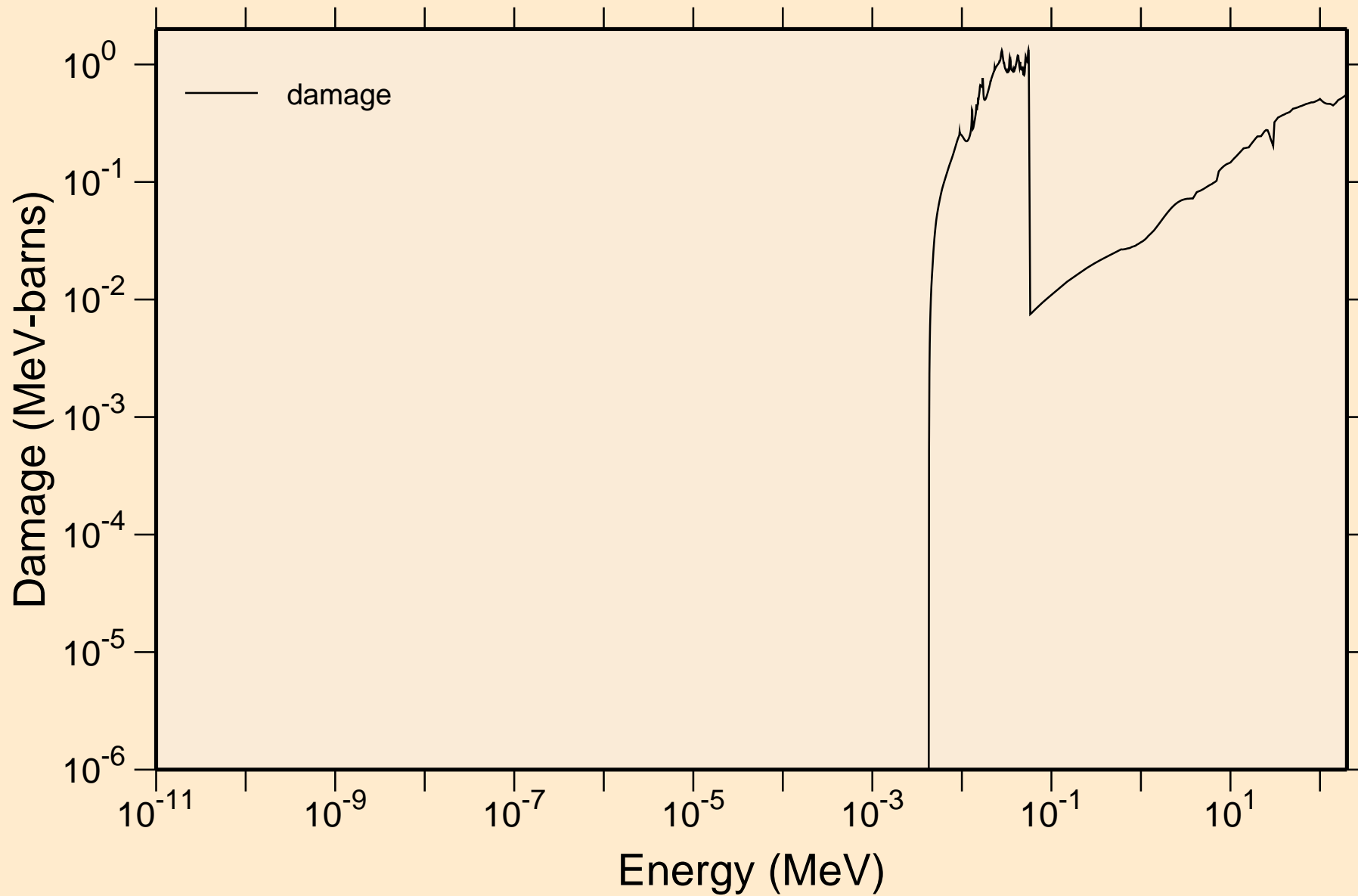

W196 NEUTRON ACER TENDL-2023 LIBRARY; T=0.K
Non-threshold reactions

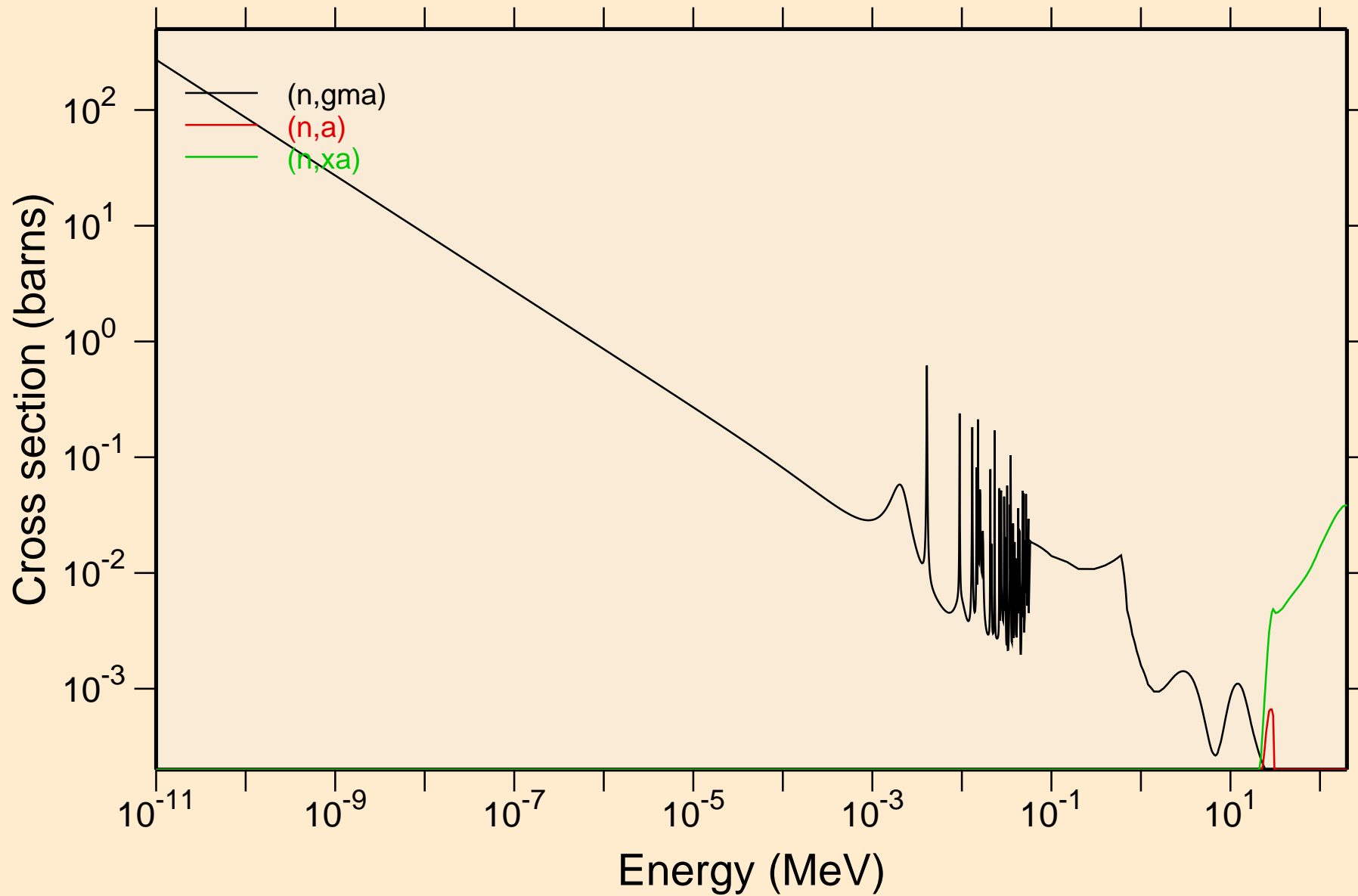

W196 NEUTRON ACER TENDL-2023 LIBRARY; T=0.K
Principal cross sections

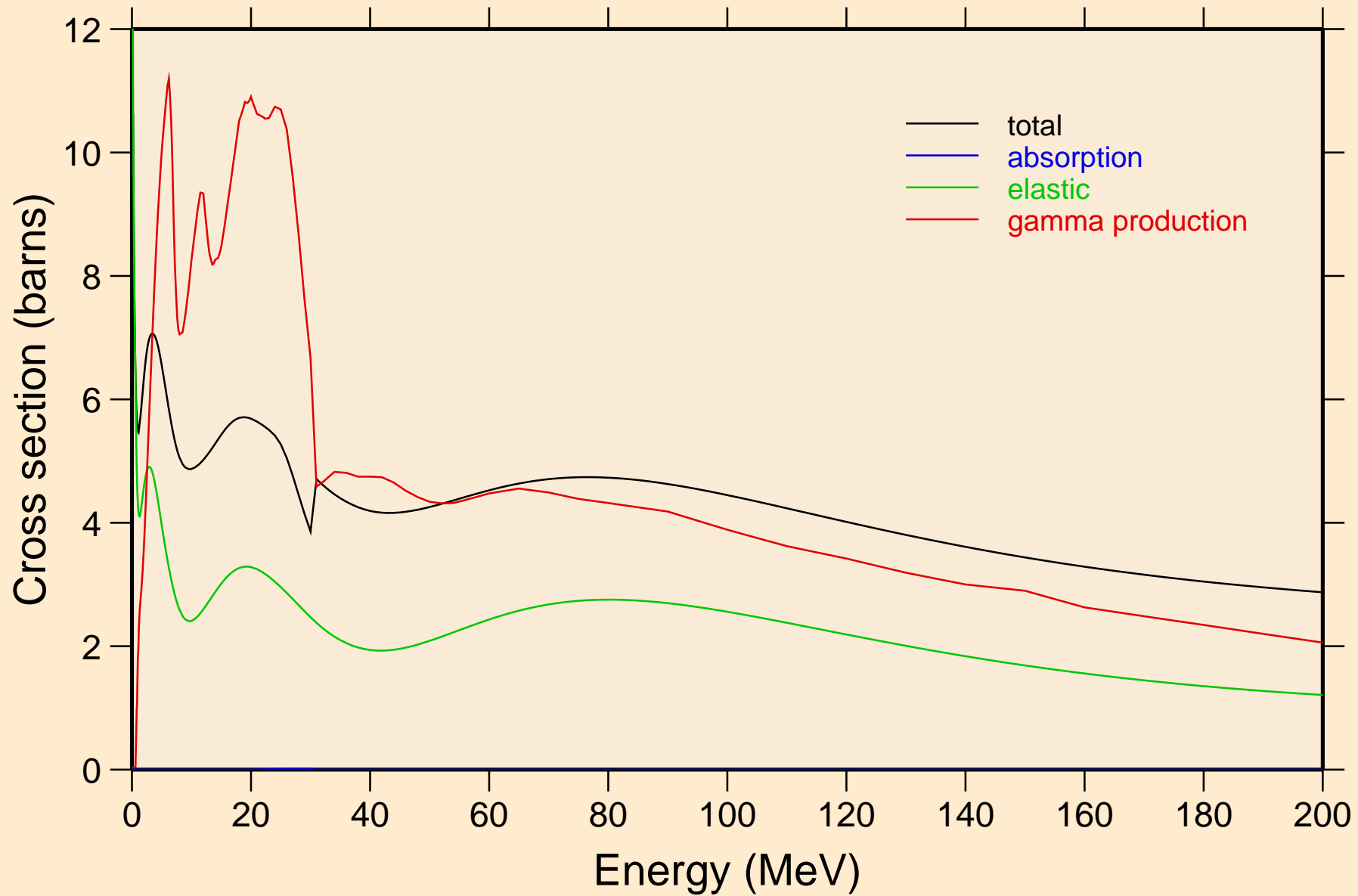

W196 NEUTRON ACER TENDL-2023 LIBRARY; T=0.K

Heating

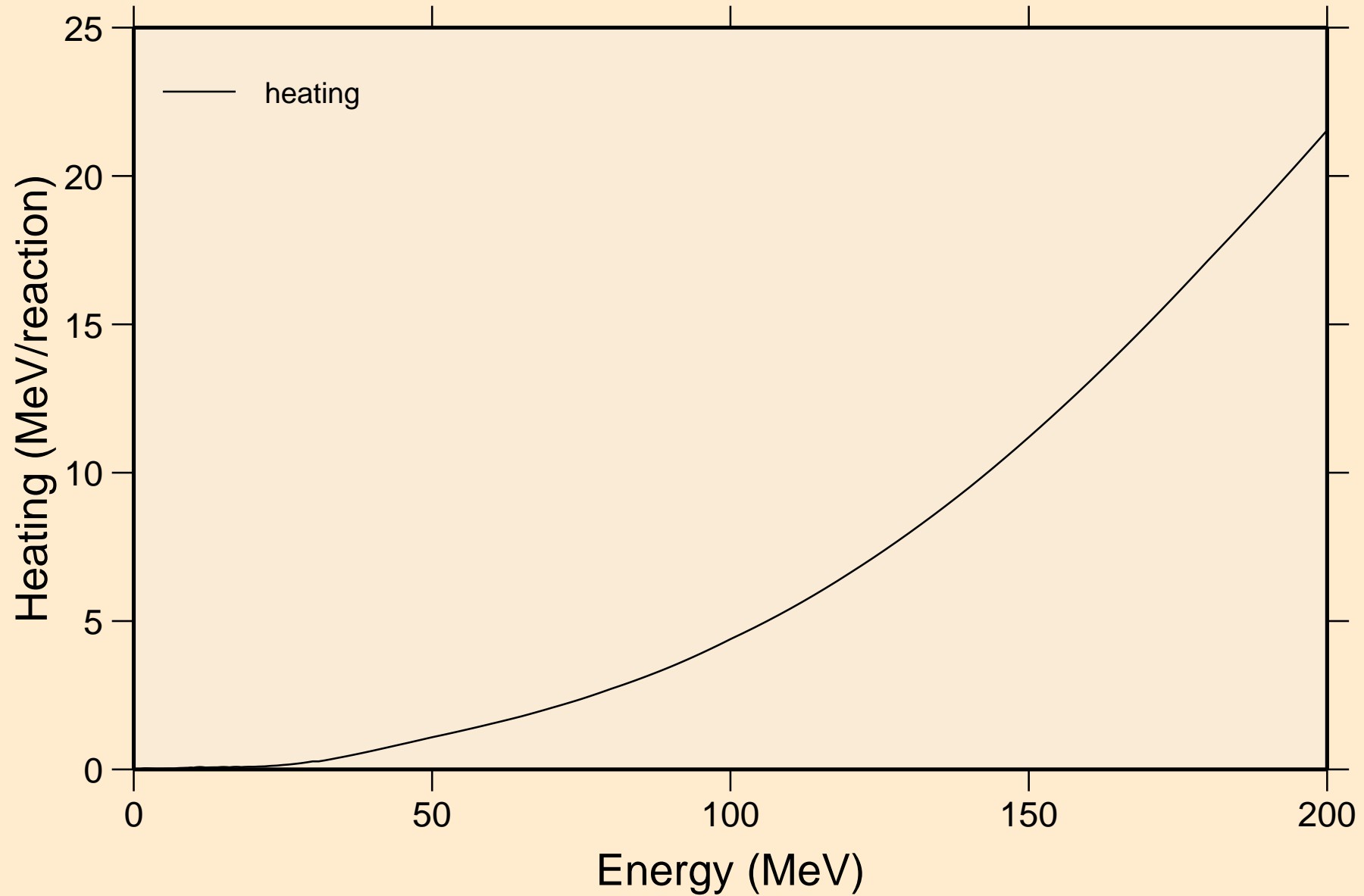

W196 NEUTRON ACER TENDL-2023 LIBRARY; T=0.K
Damage

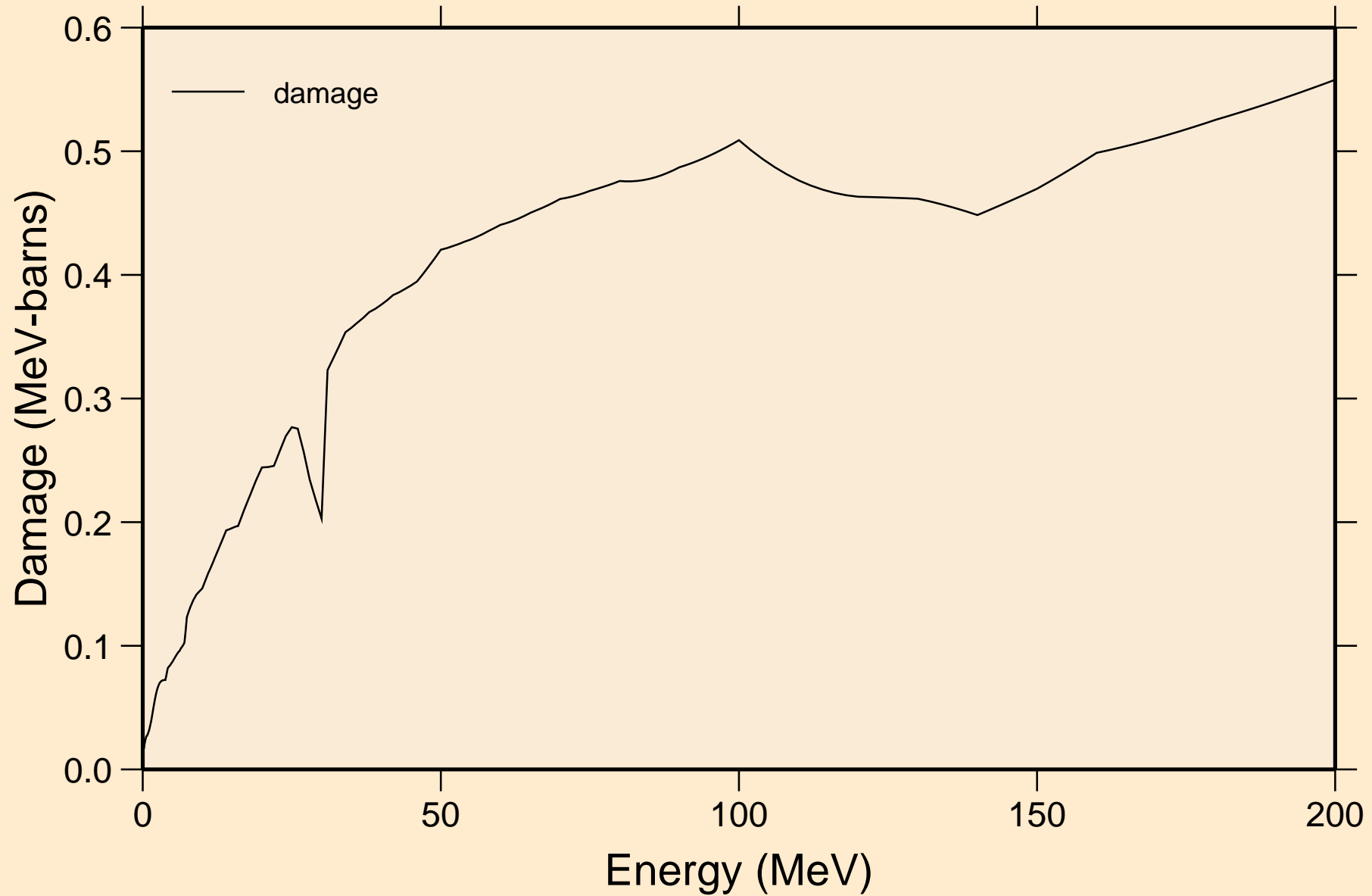

W196 NEUTRON ACER TENDL-2023 LIBRARY; T=0.K
Non-threshold reactions

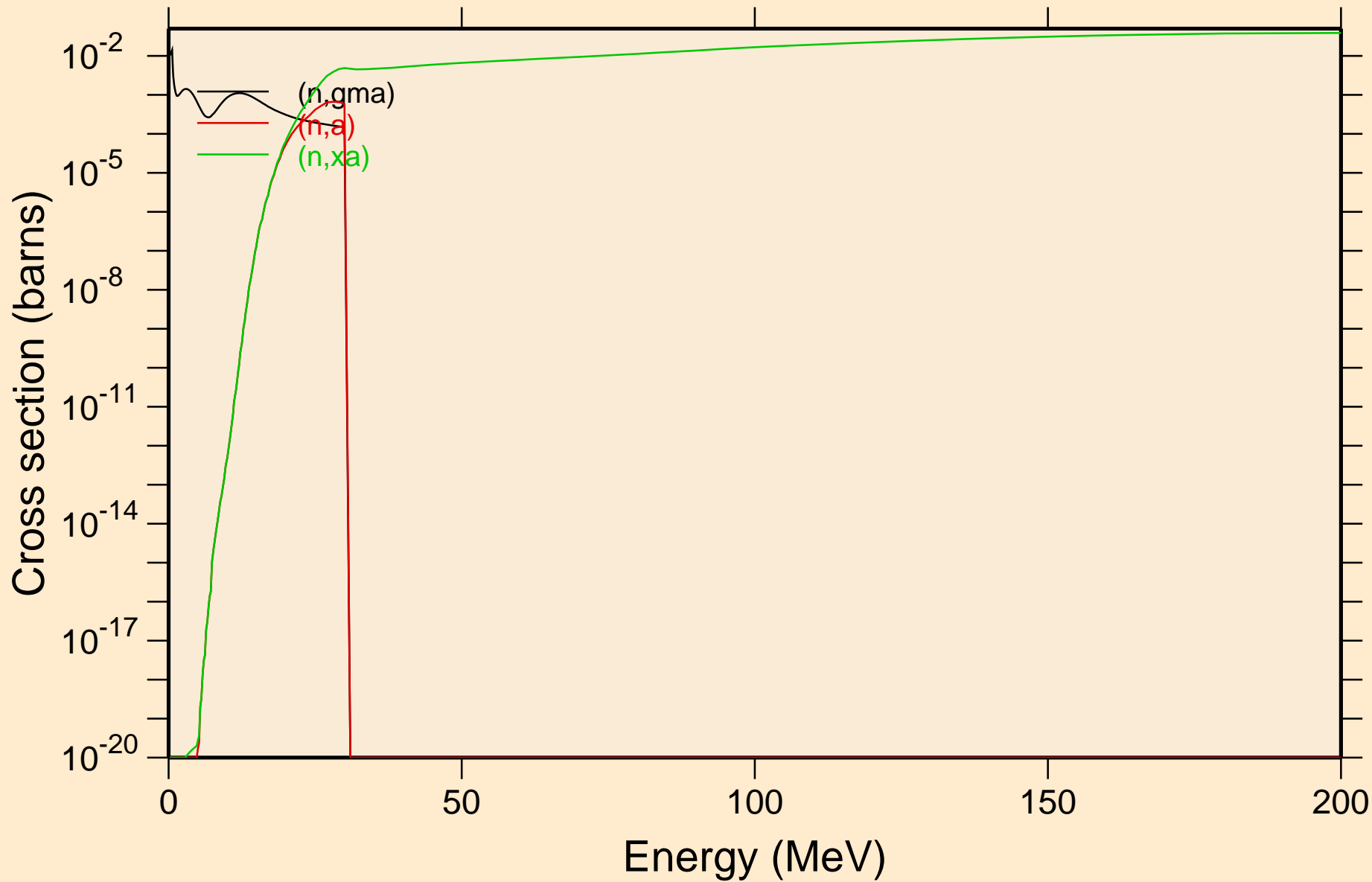

W196 NEUTRON ACER TENDL-2023 LIBRARY; T=0.K
Inelastic levels

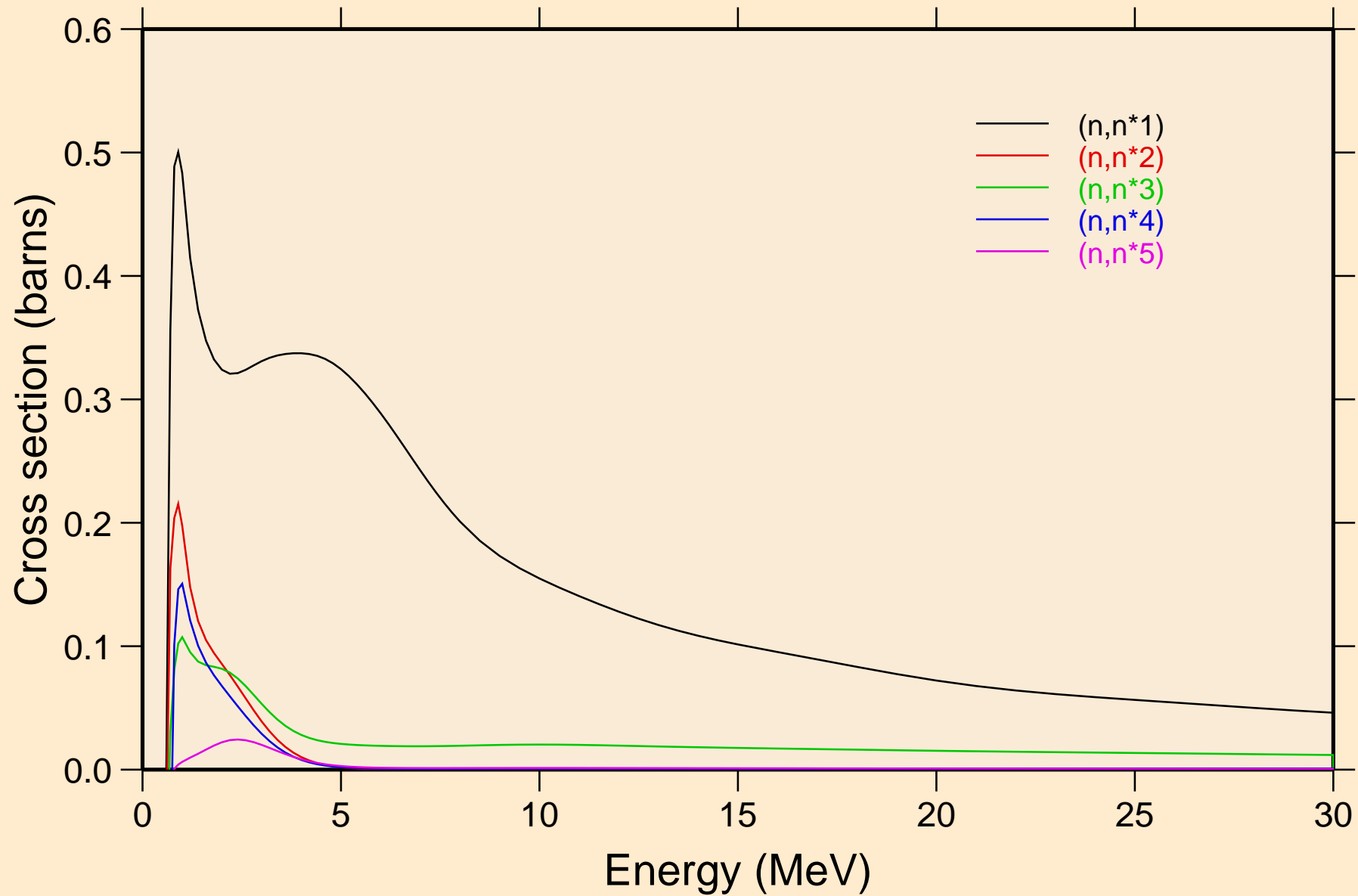

W196 NEUTRON ACER TENDL-2023 LIBRARY; T=0.K
Inelastic levels

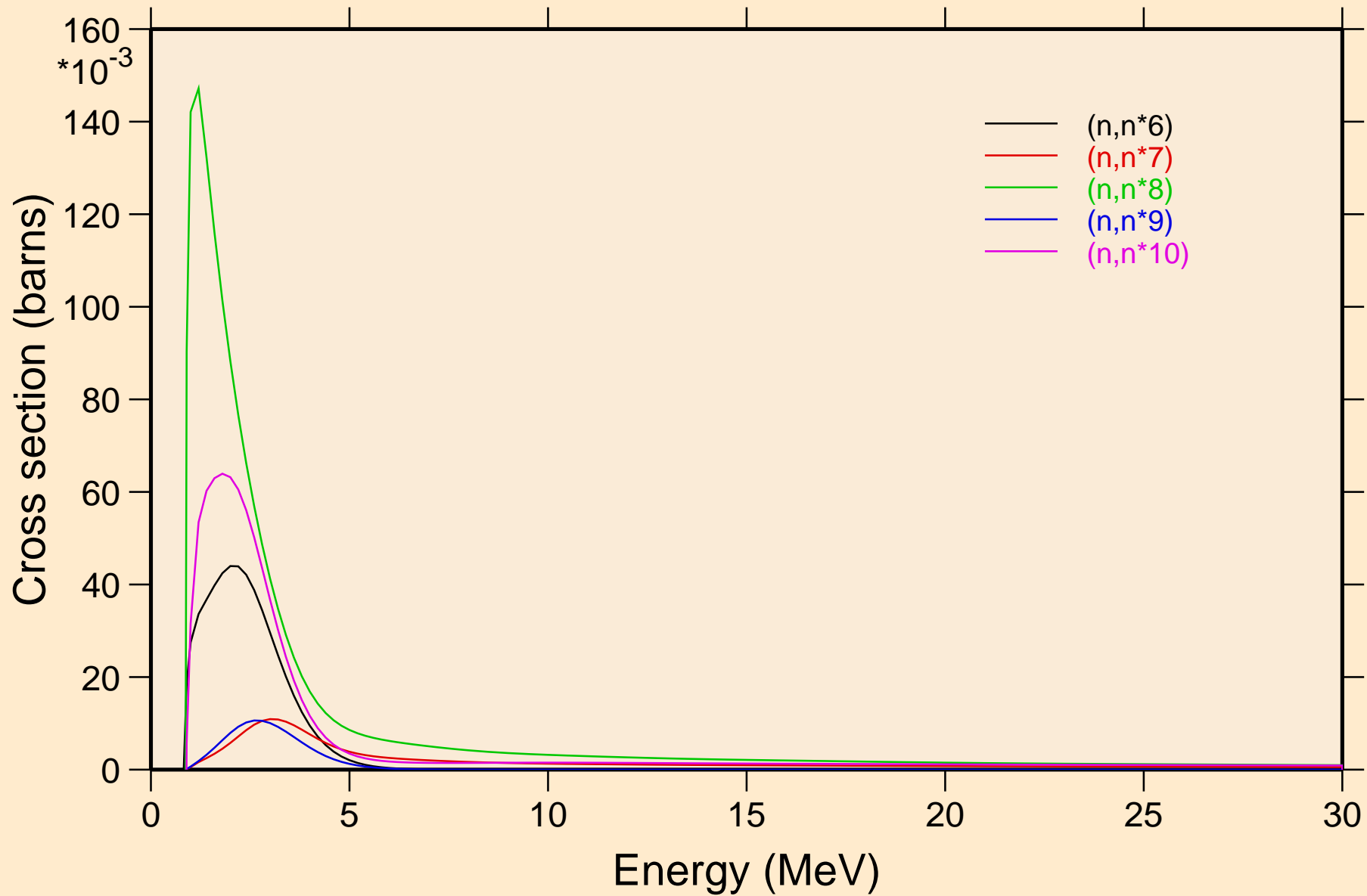

W196 NEUTRON ACER TENDL-2023 LIBRARY; T=0.K
Inelastic levels

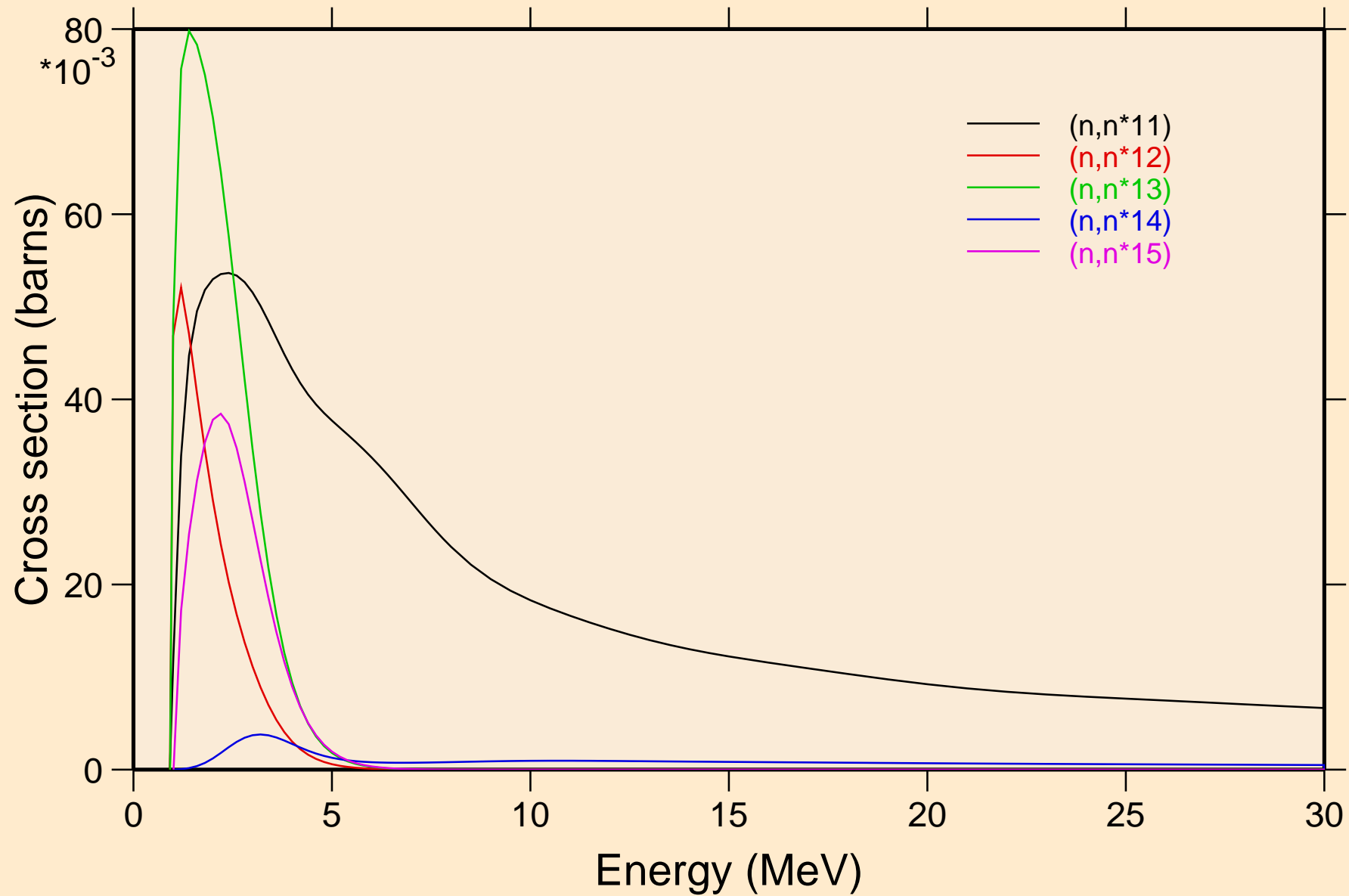

W196 NEUTRON ACER TENDL-2023 LIBRARY; T=0.K
Inelastic levels

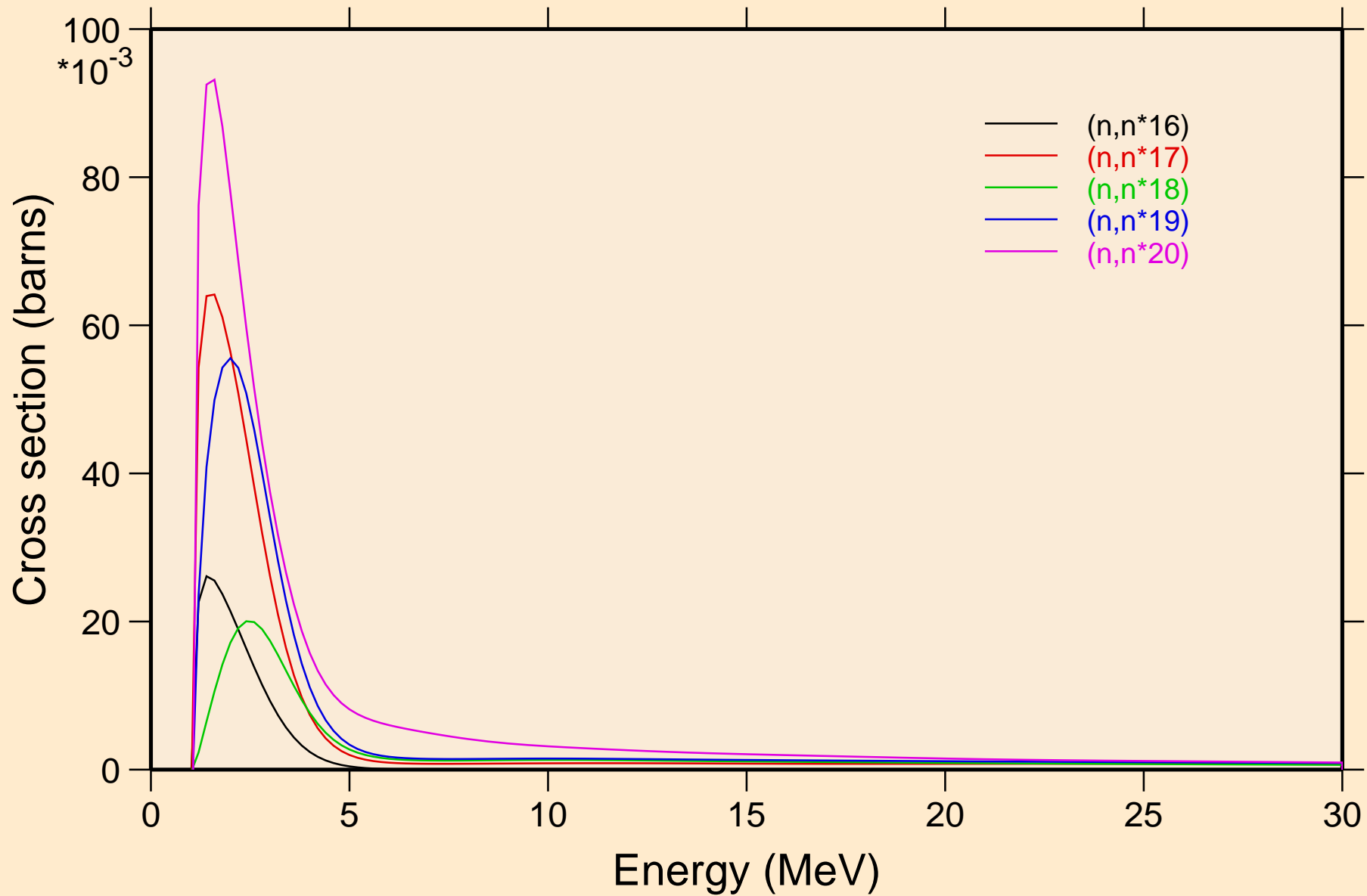

W196 NEUTRON ACER TENDL-2023 LIBRARY; T=0.K
Inelastic levels

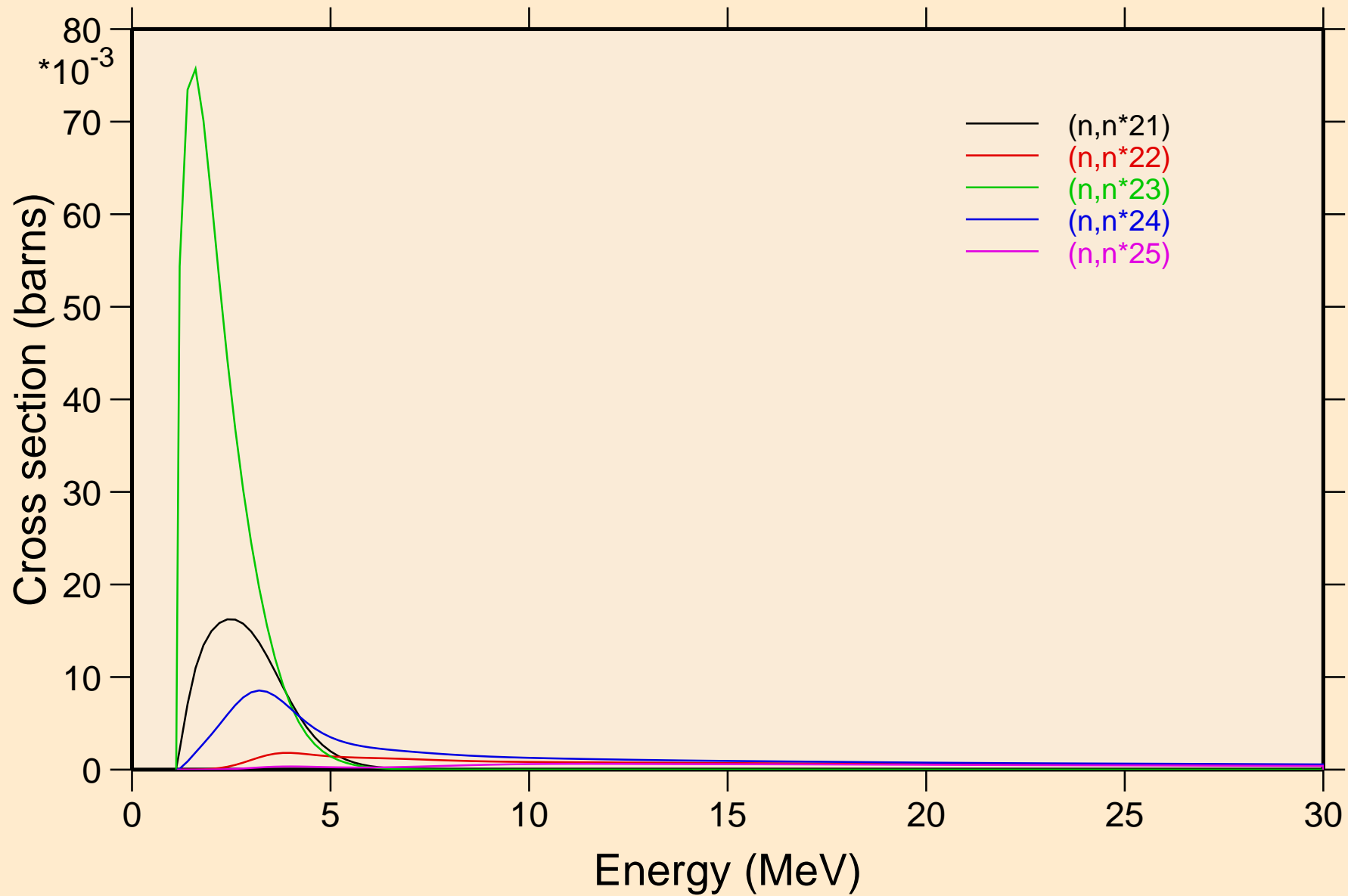

W196 NEUTRON ACER TENDL-2023 LIBRARY; T=0.K
Inelastic levels

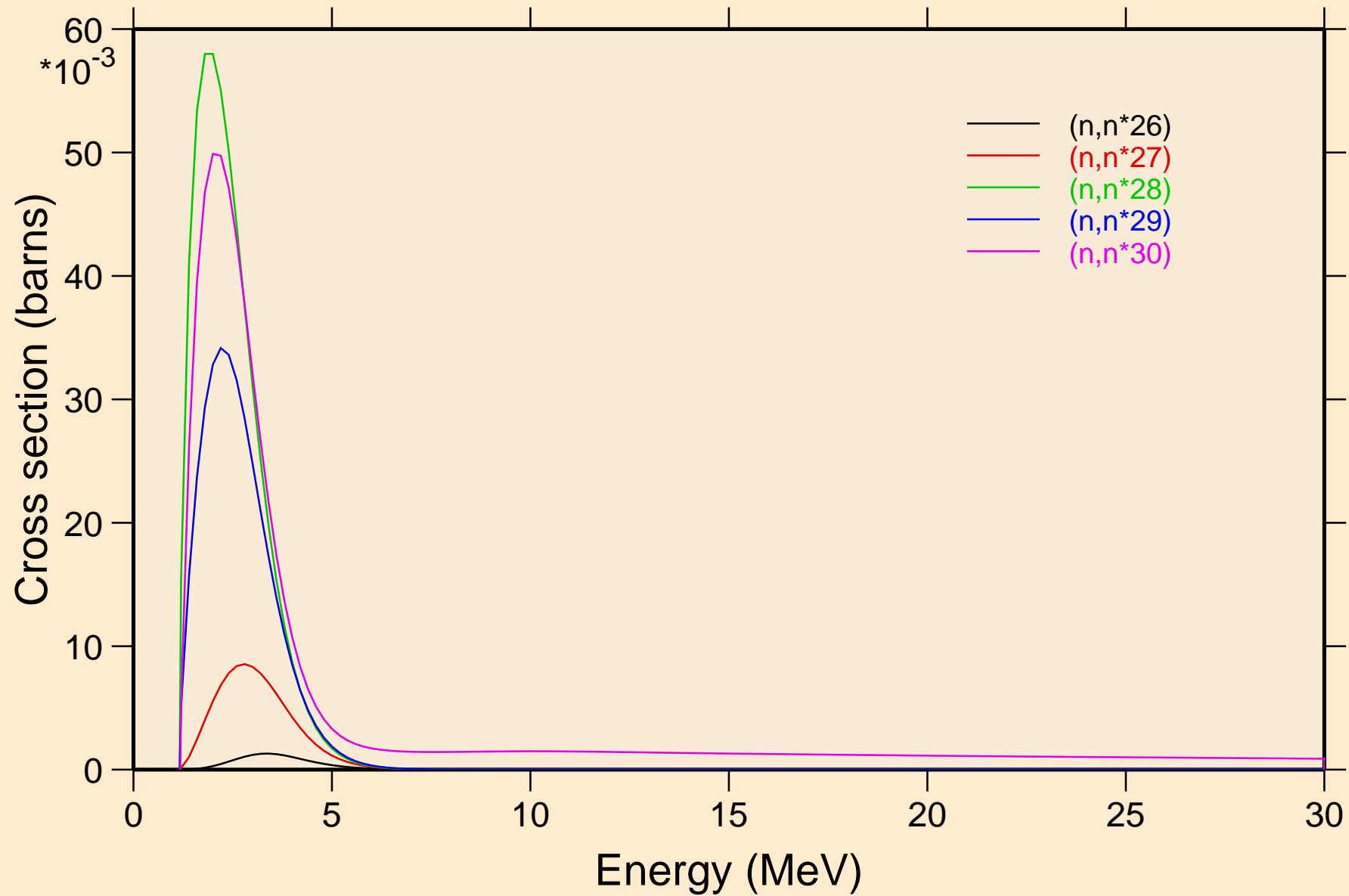

W196 NEUTRON ACER TENDL-2023 LIBRARY; T=0.K
Threshold reactions

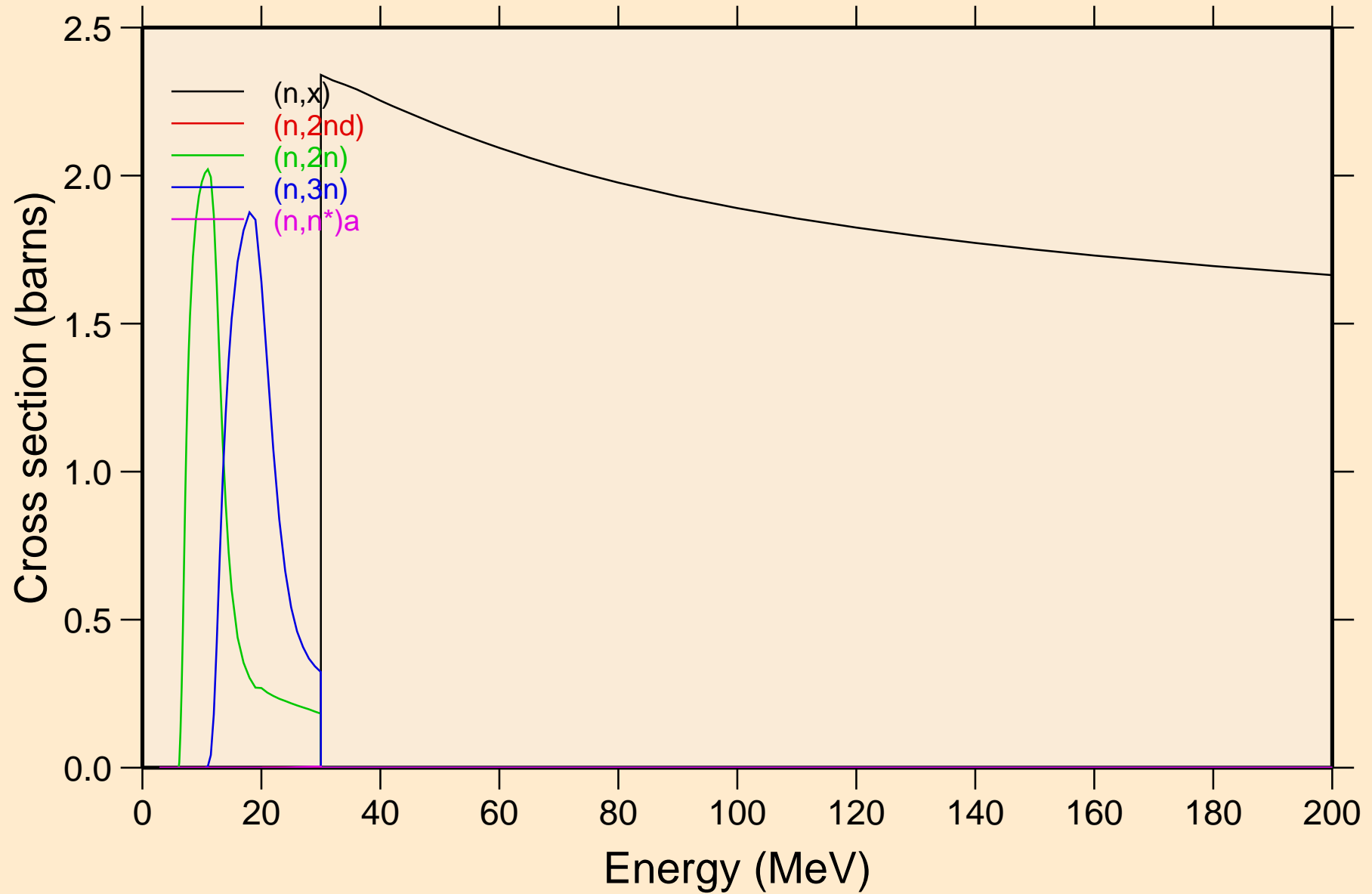

W196 NEUTRON ACER TENDL-2023 LIBRARY; T=0.K
Threshold reactions

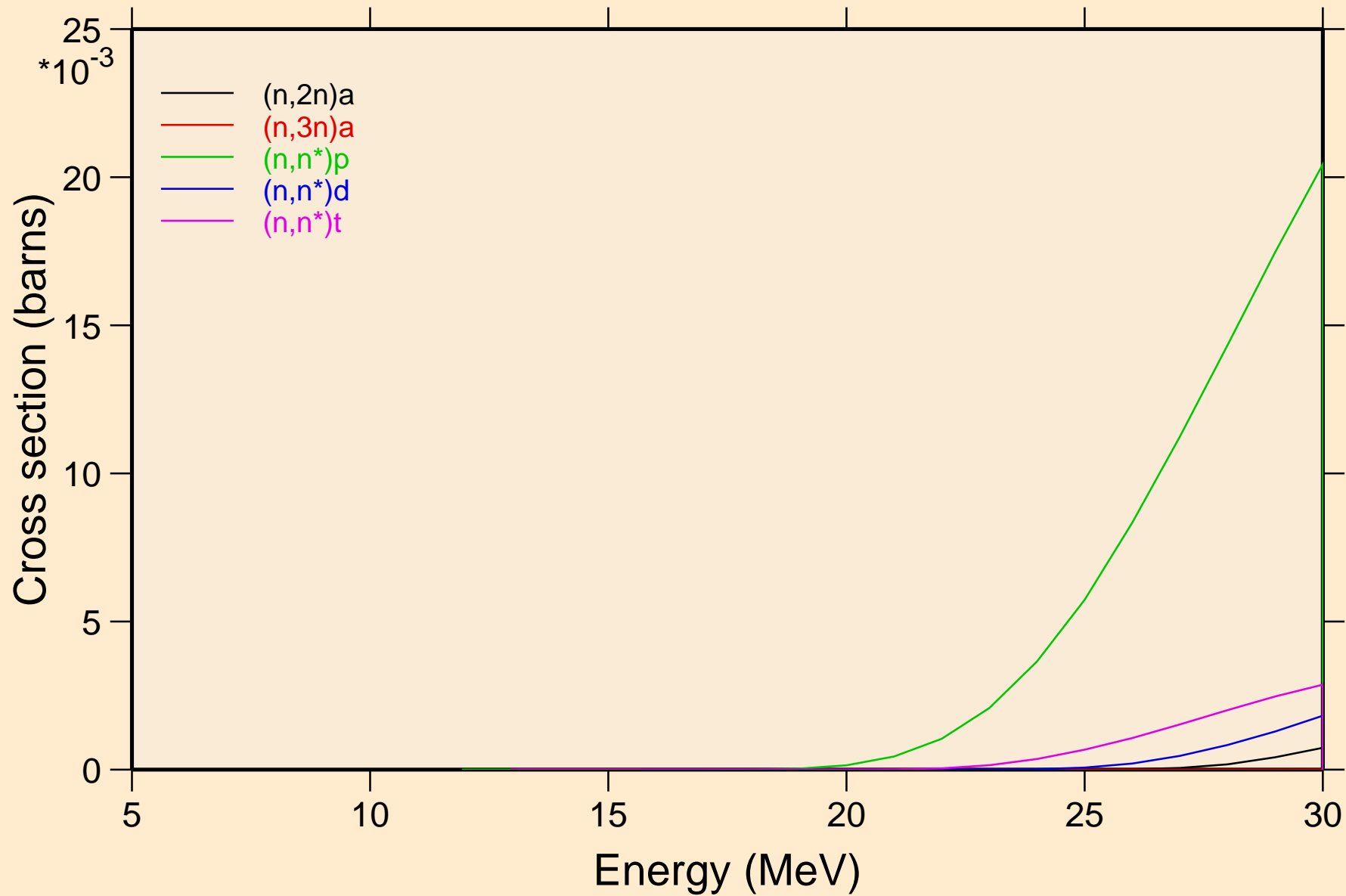

W196 NEUTRON ACER TENDL-2023 LIBRARY; T=0.K
Threshold reactions

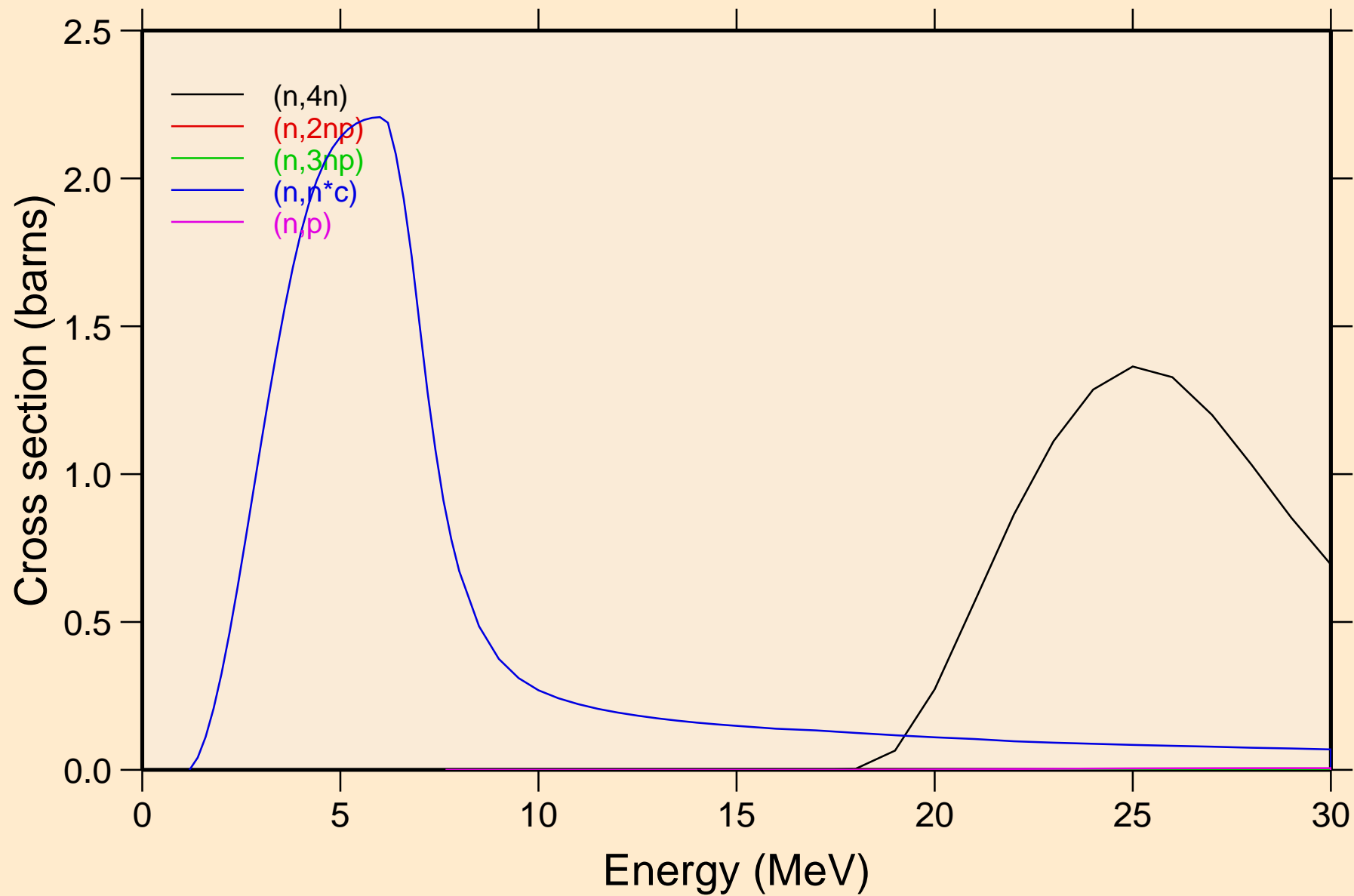

W196 NEUTRON ACER TENDL-2023 LIBRARY; T=0.K
Threshold reactions

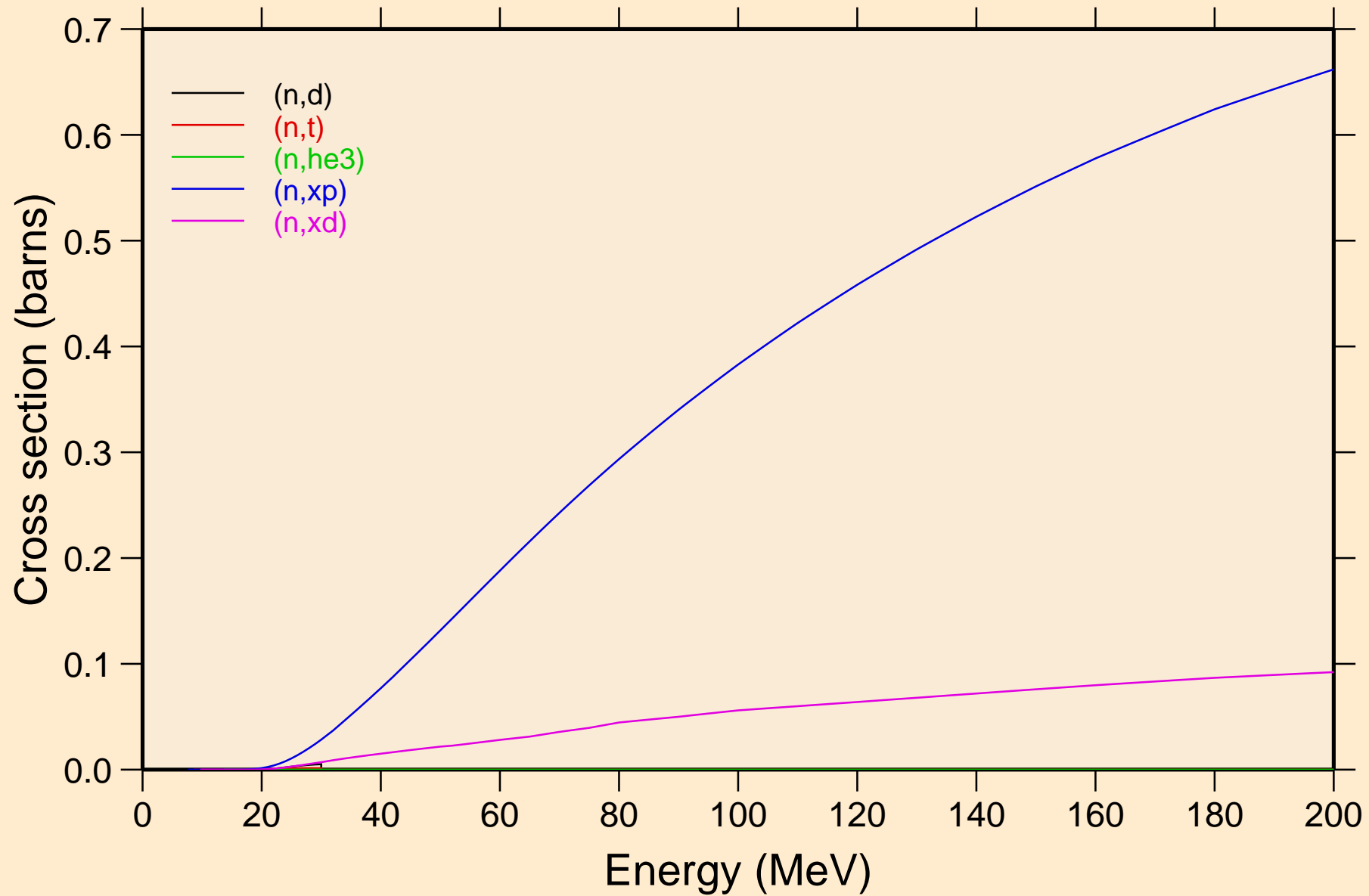

W196 NEUTRON ACER TENDL-2023 LIBRARY; T=0.K
Threshold reactions

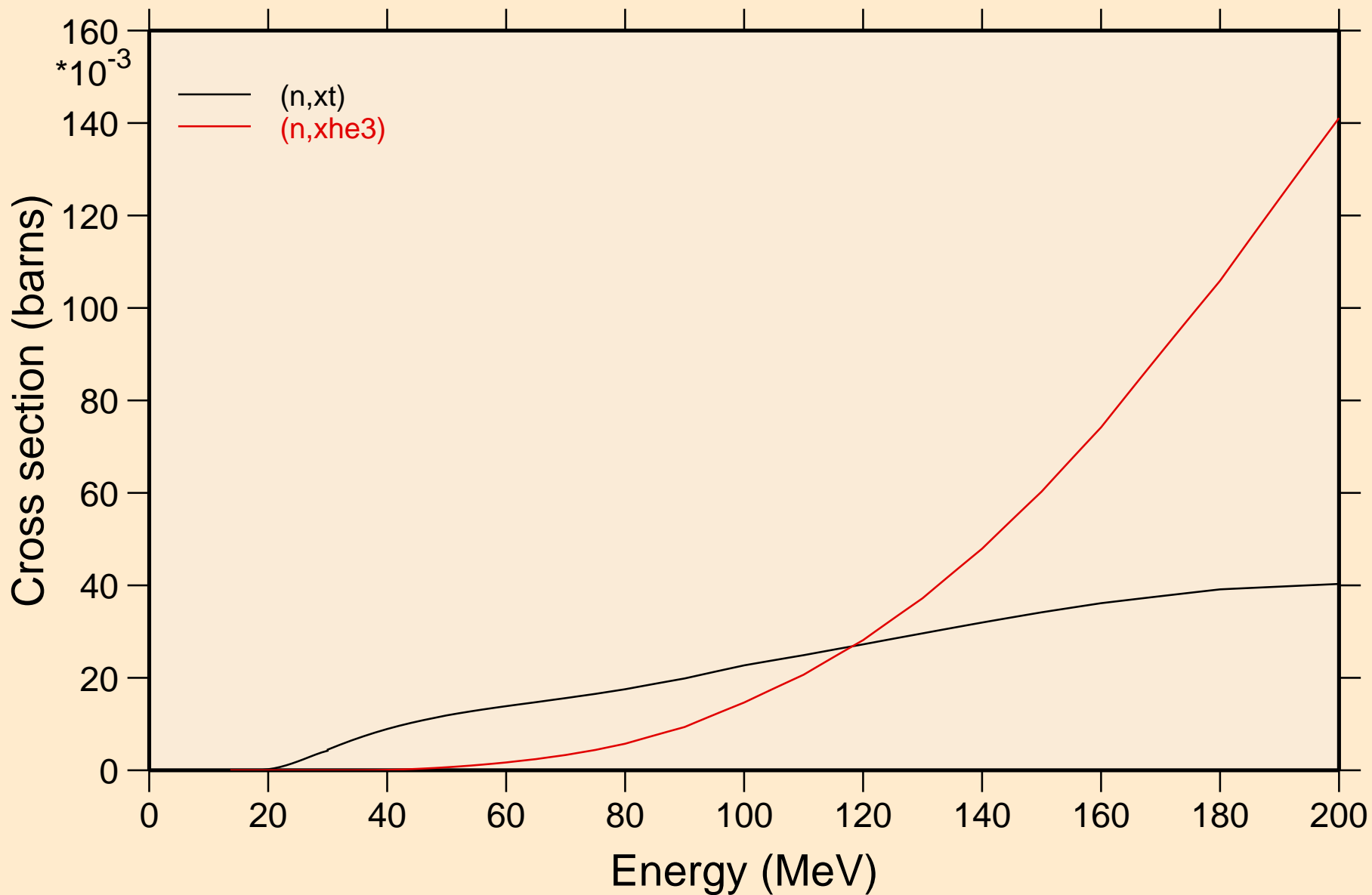

W196 NEUTRON ACER TENDL-2023 LIBRARY; T=0.K
angular distribution for elastic

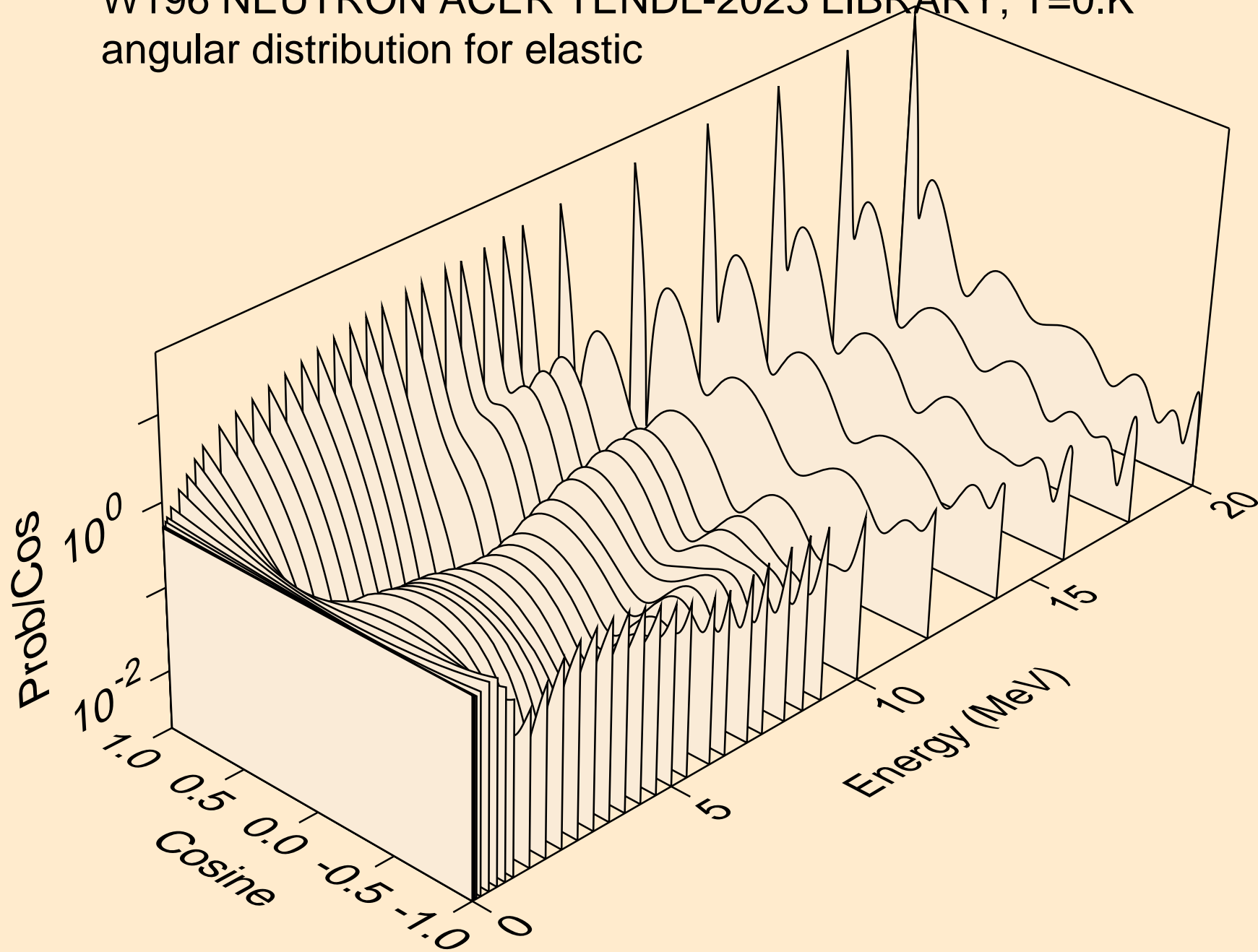

W196 NEUTRON ACER TENDL-2023 LIBRARY; T=0.K
angular distribution for elastic

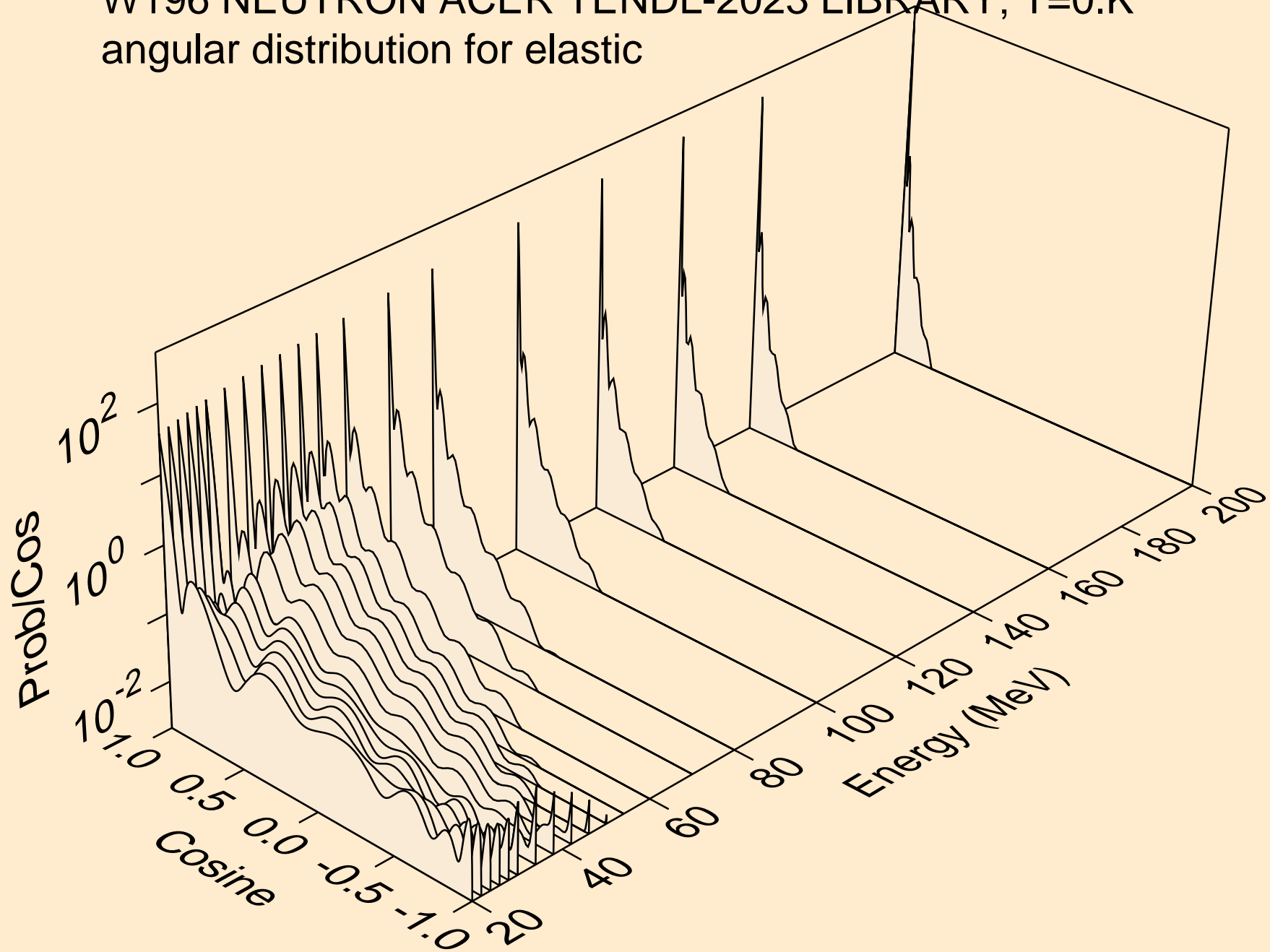

W196 NEUTRON ACER TENDL-2023 LIBRARY; T=0.K
angular distribution for (n,n*1)

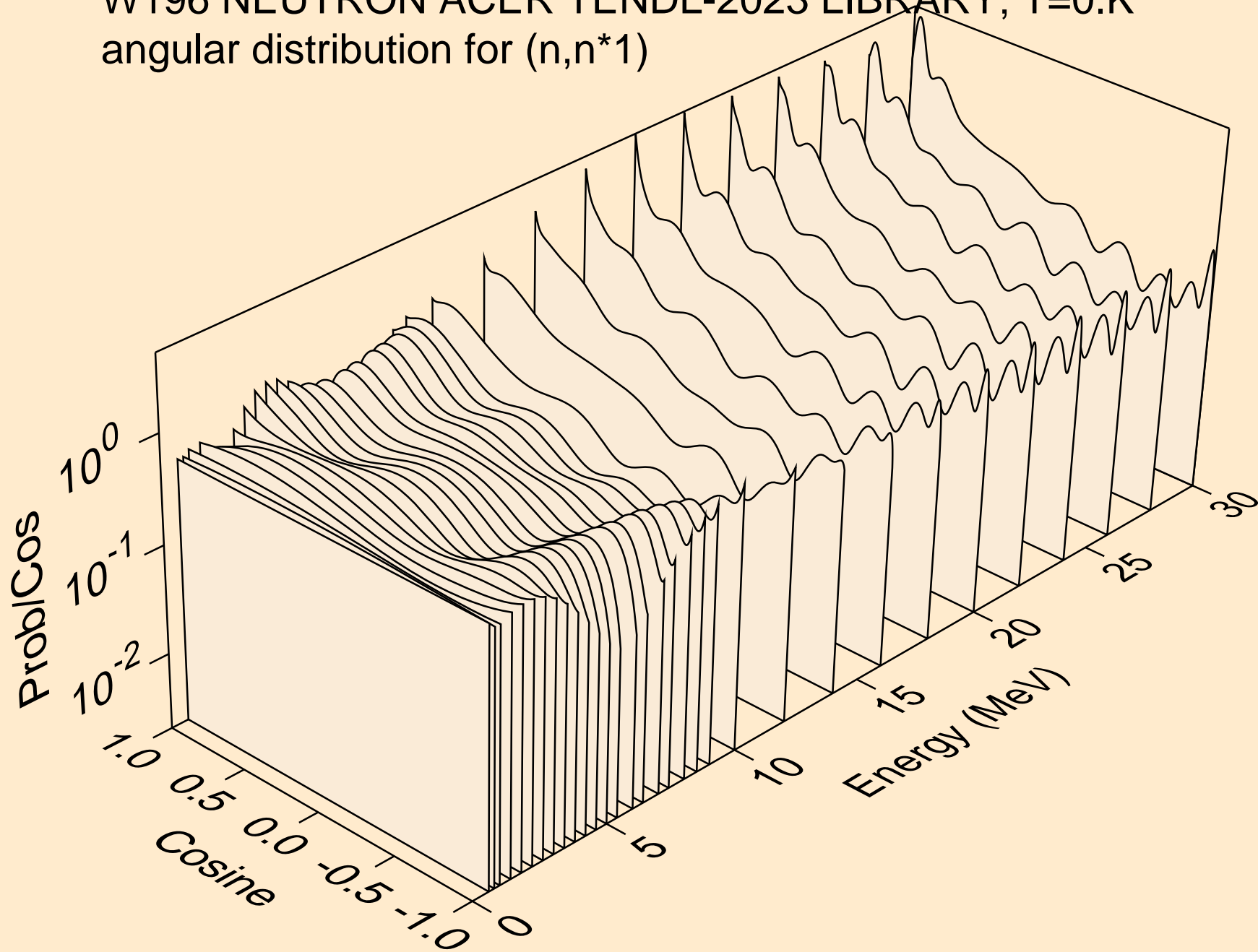

W196 NEUTRON ACER TENDL-2023 LIBRARY; T=0.K
angular distribution for (n,n*2)

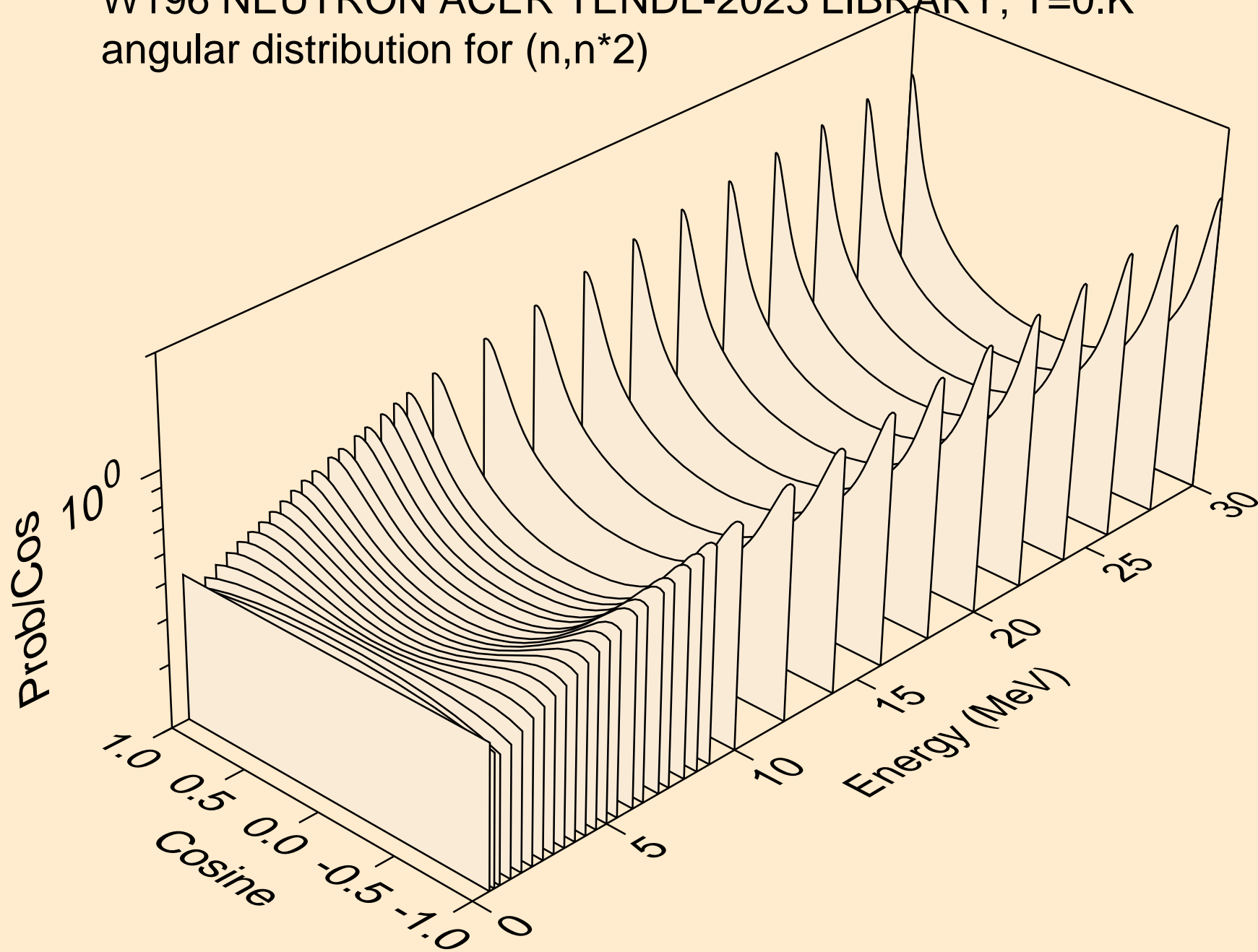

W196 NEUTRON ACER TENDL-2023 LIBRARY; T=0.K
angular distribution for (n,n*3)

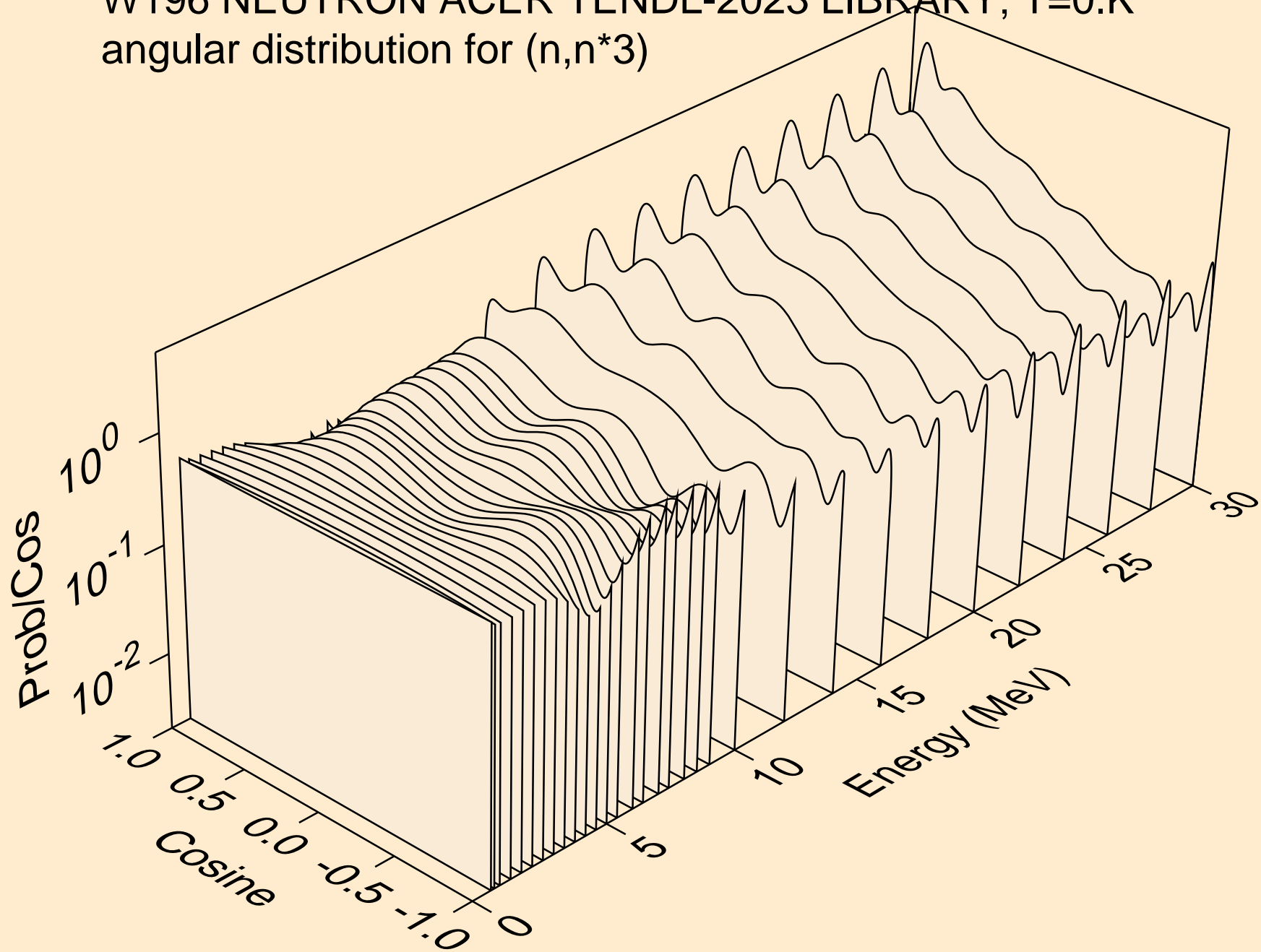

W196 NEUTRON ACER TENDL-2023 LIBRARY; T=0.K
angular distribution for (n,n*4)

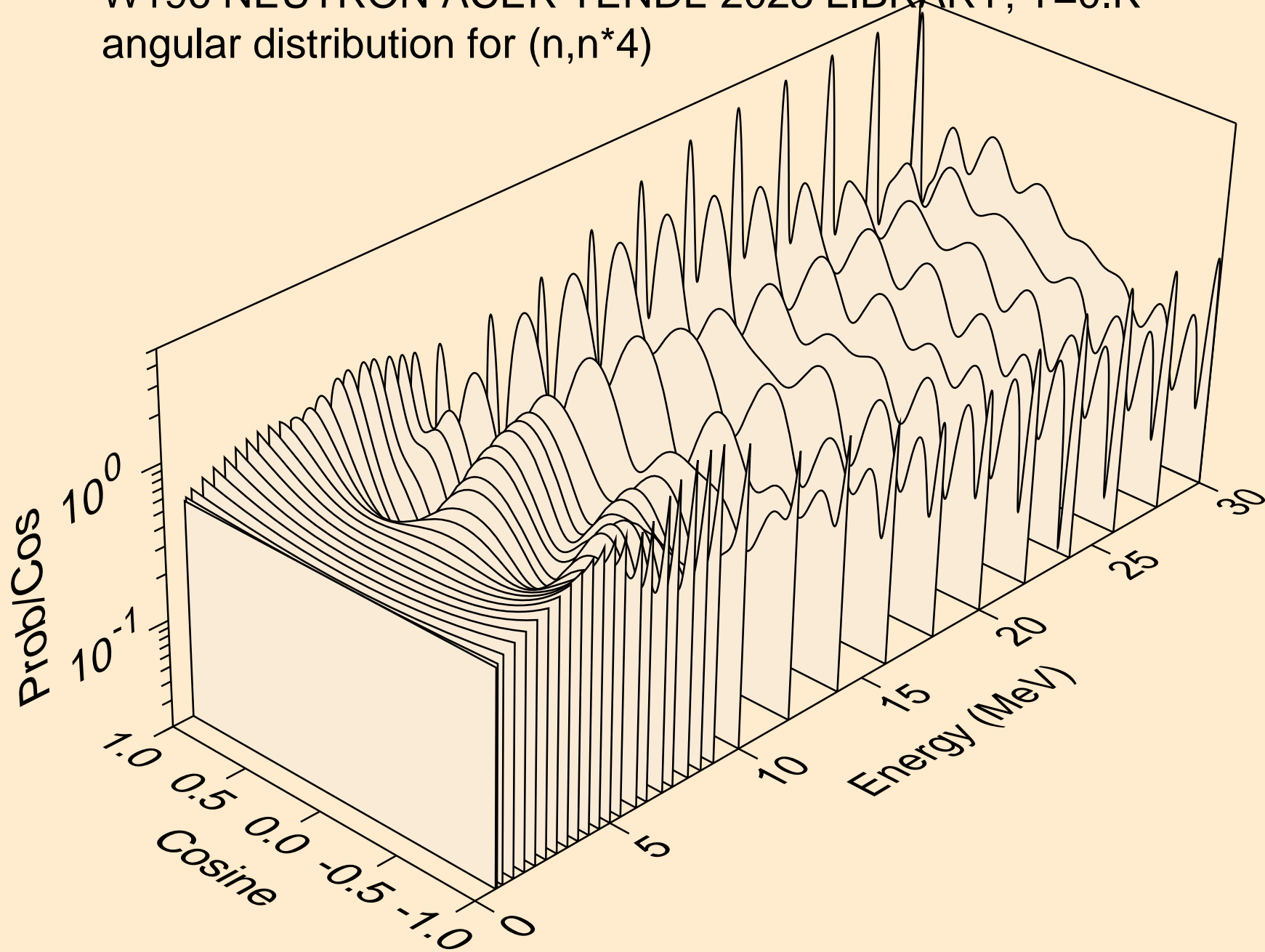

W196 NEUTRON ACER TENDL-2023 LIBRARY; T=0.K
angular distribution for (n,n*5)

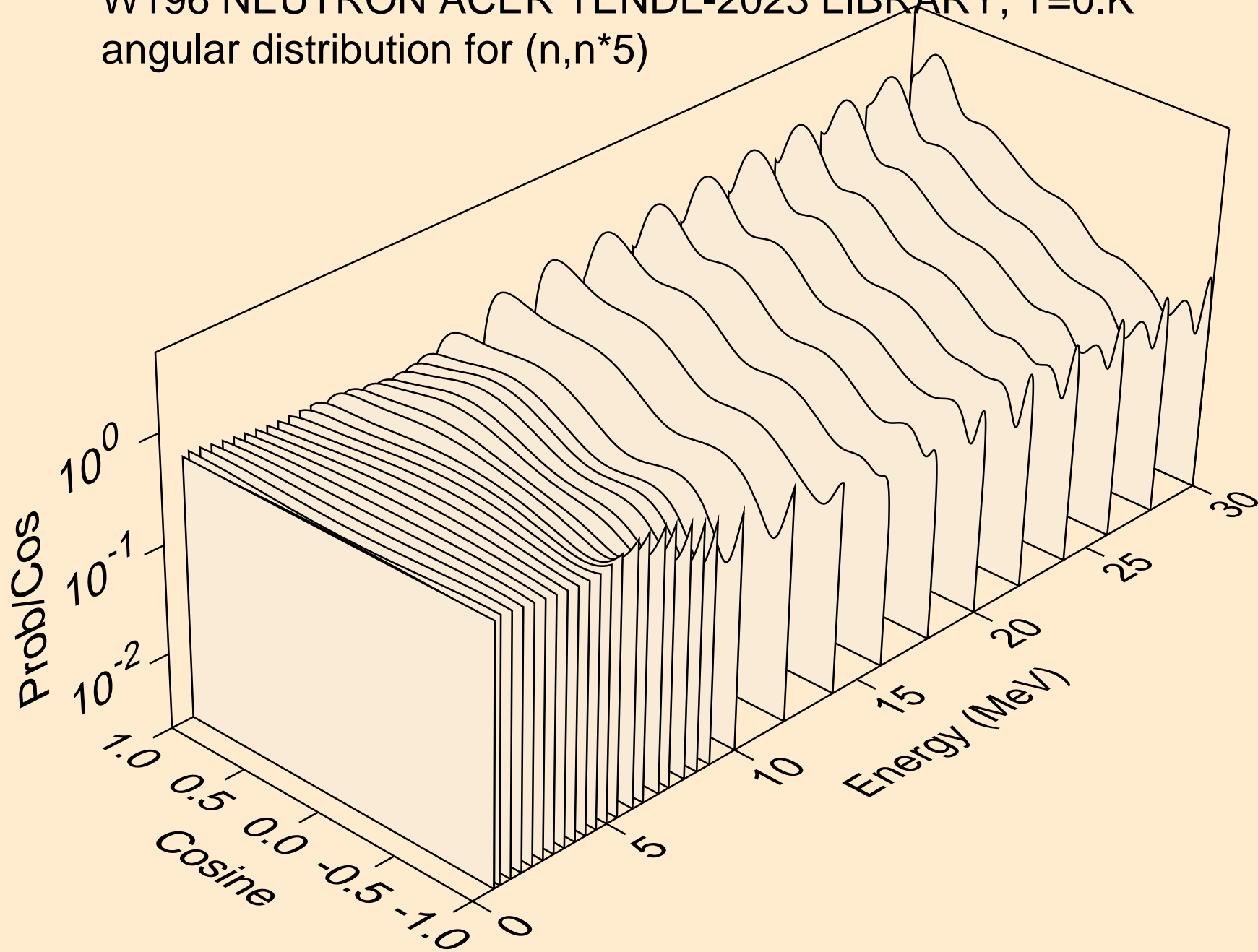

W196 NEUTRON ACER TENDL-2023 LIBRARY; T=0.K
angular distribution for (n,n*6)

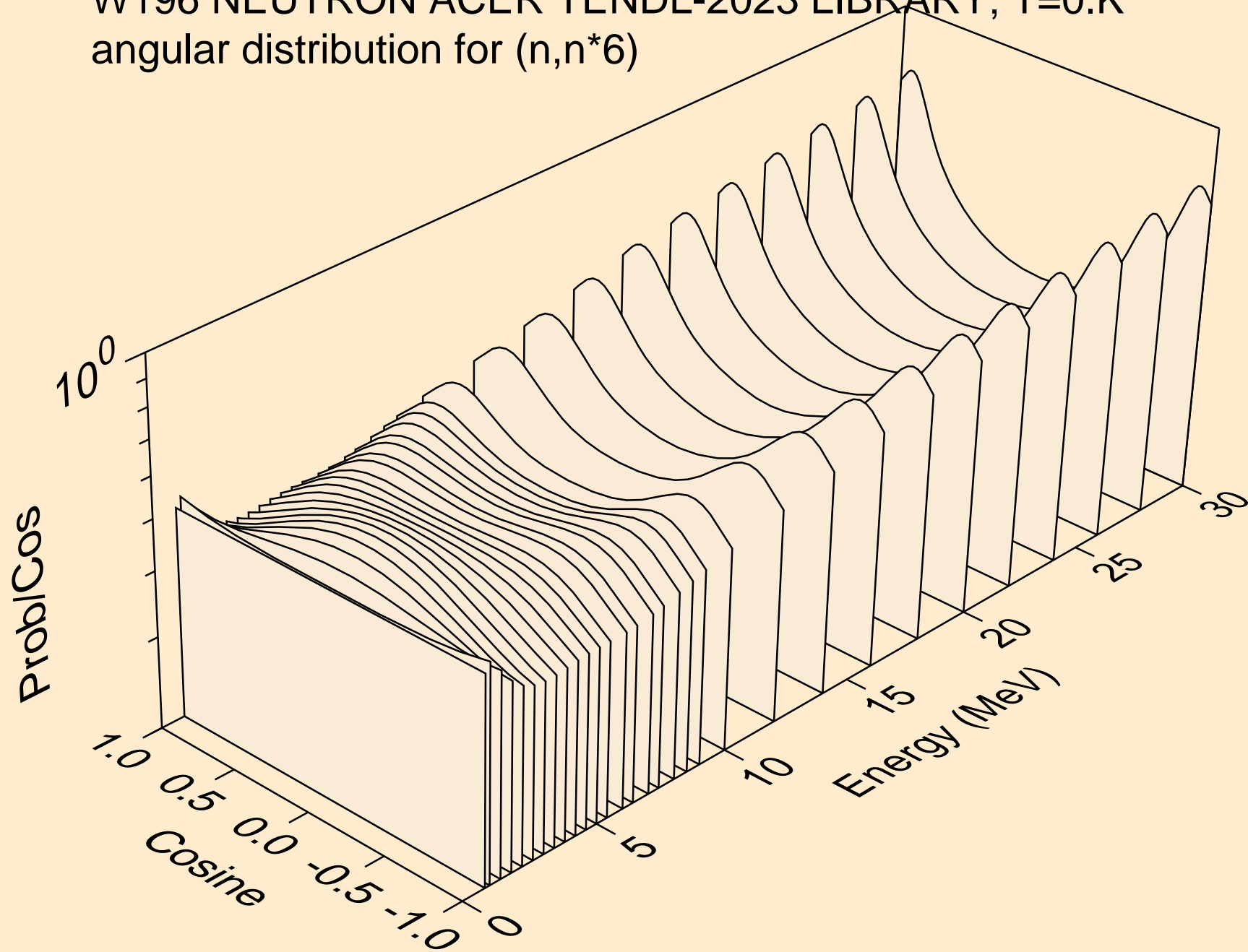

W196 NEUTRON ACER TENDL-2023 LIBRARY; T=0.K
angular distribution for (n,n*7)

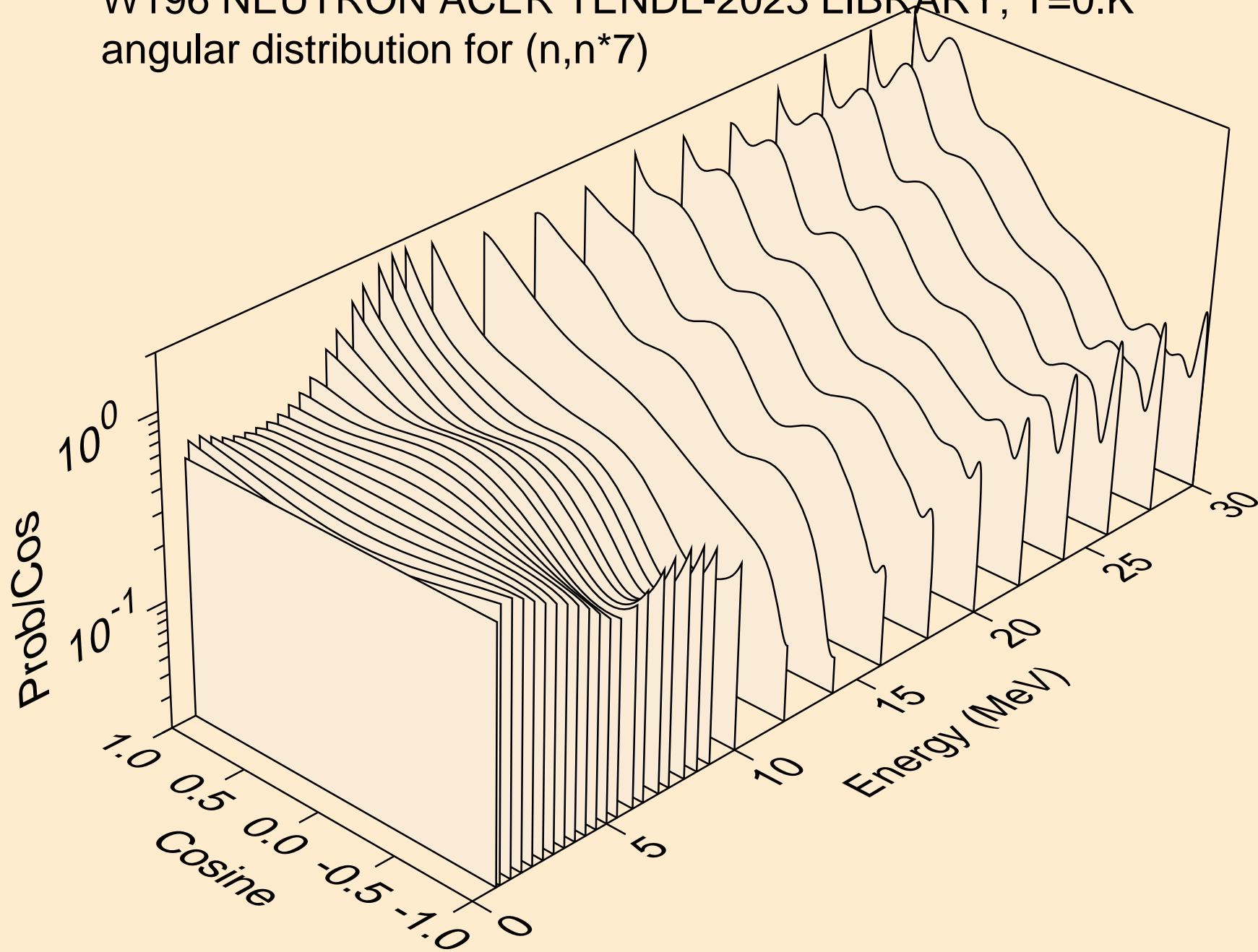

W196 NEUTRON ACER TENDL-2023 LIBRARY; T=0.K
angular distribution for (n,n*8)

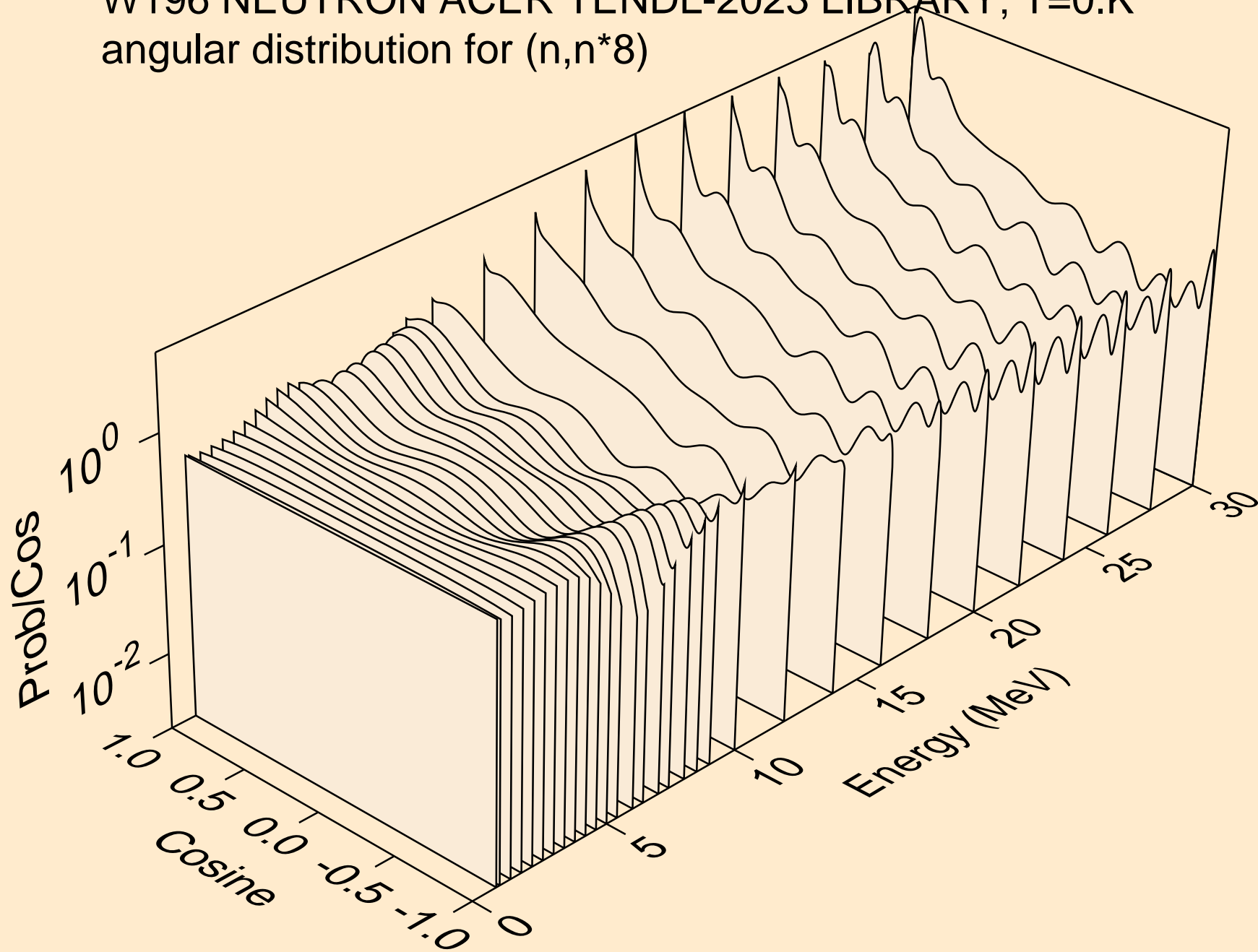

W196 NEUTRON ACER TENDL-2023 LIBRARY; T=0.K
angular distribution for (n,n*9)

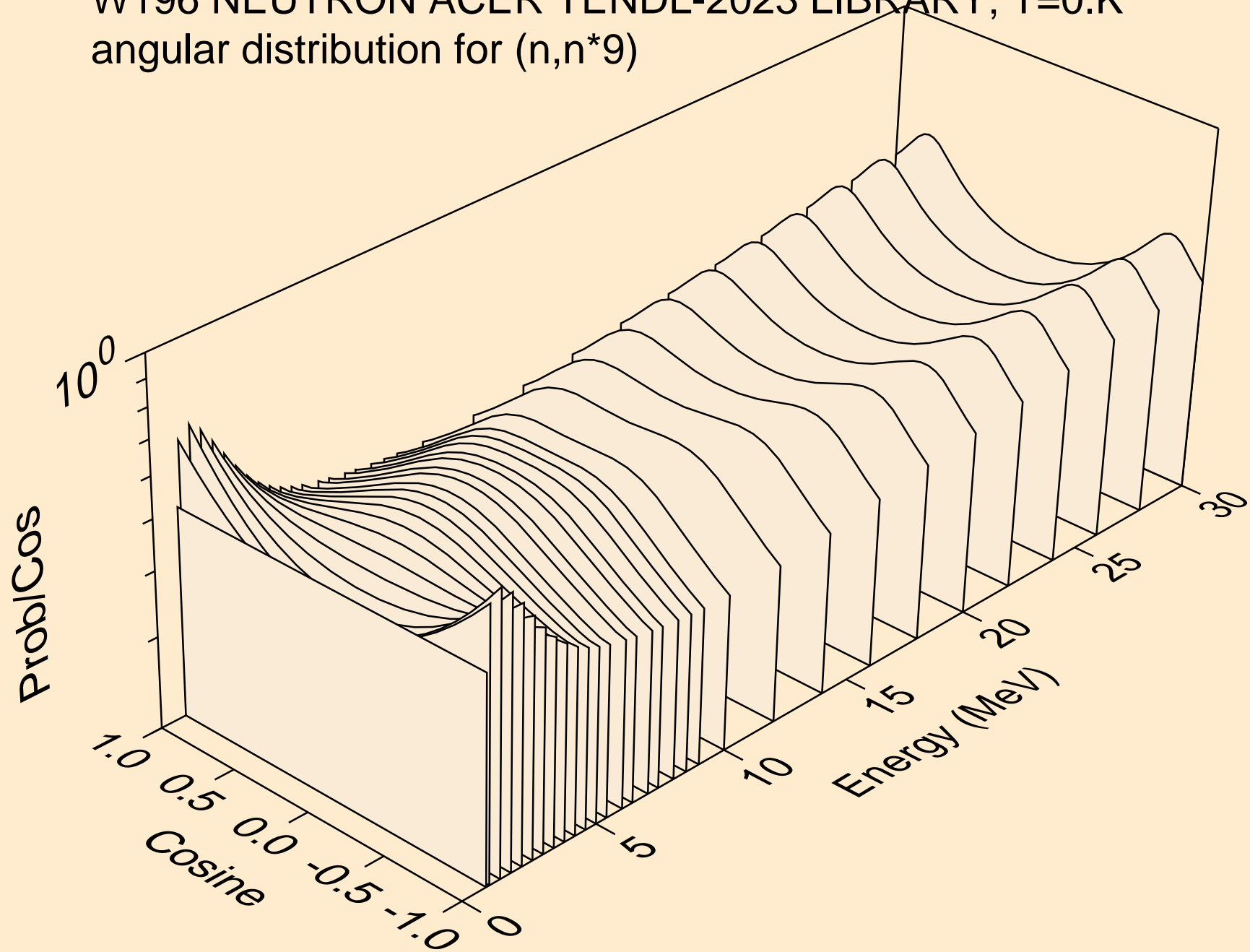

W196 NEUTRON ACER TENDL-2023 LIBRARY; T=0.K
angular distribution for (n,n*10)

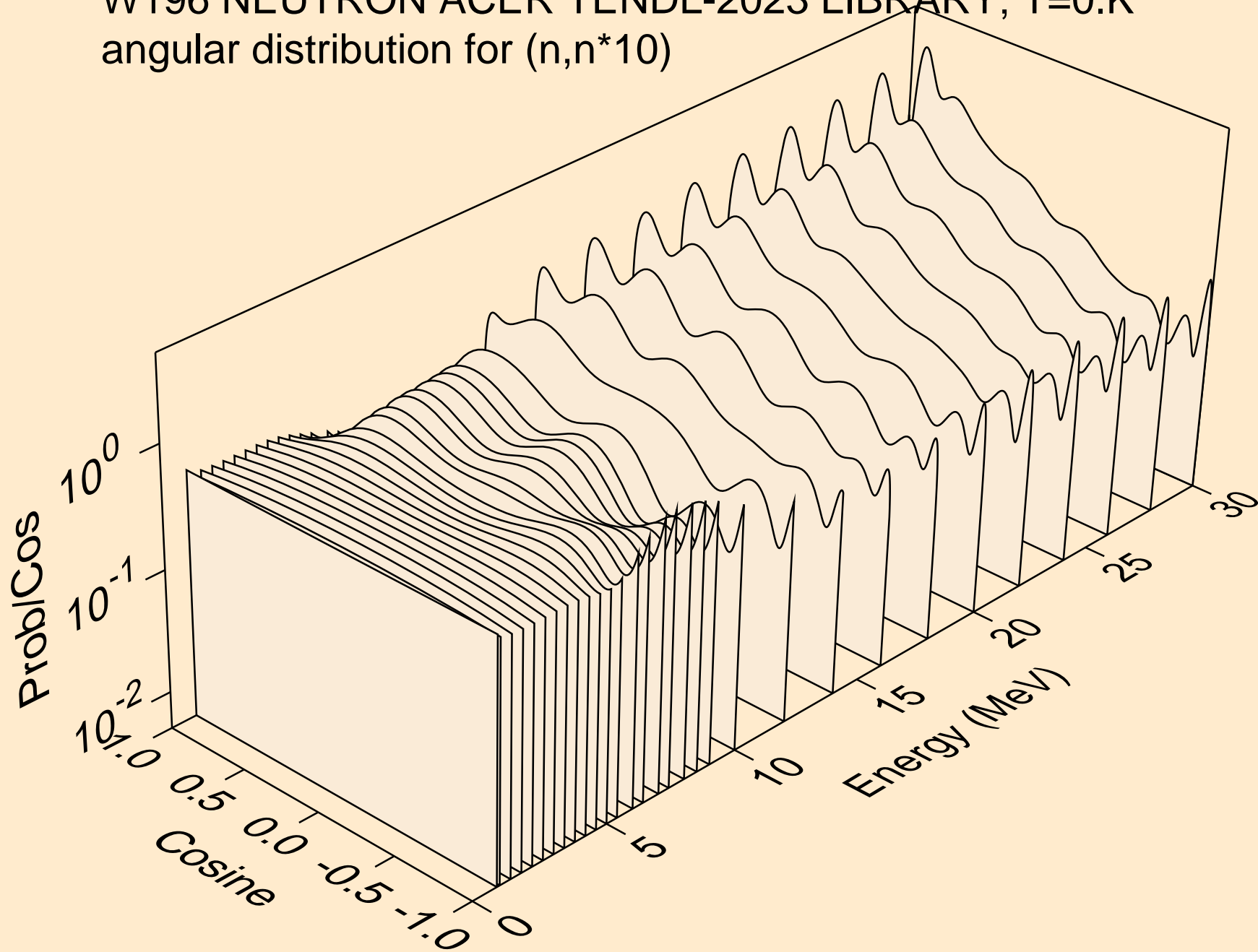

W196 NEUTRON ACER TENDL-2023 LIBRARY; T=0.K
angular distribution for (n,n*11)

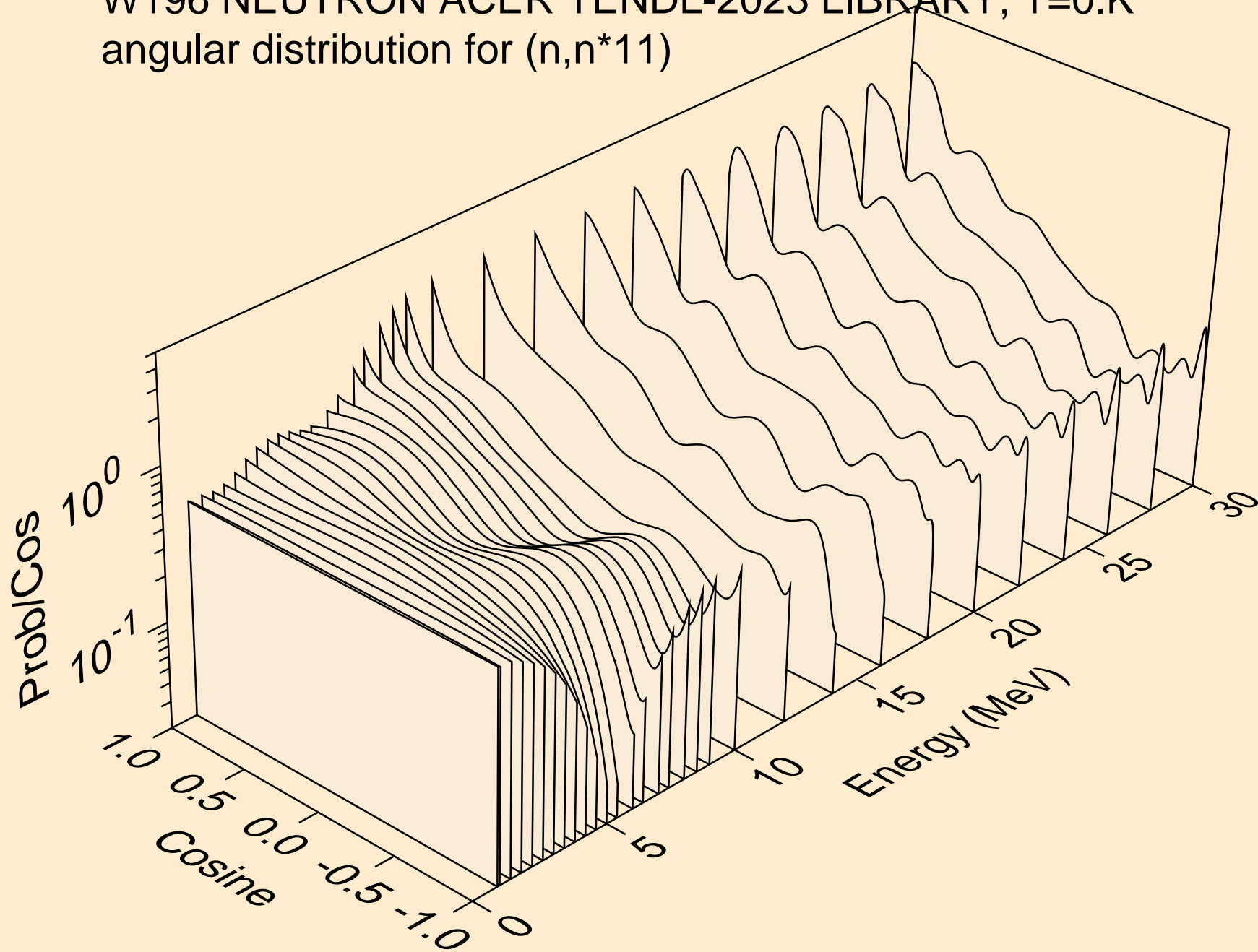

W196 NEUTRON ACER TENDL-2023 LIBRARY; T=0.K
angular distribution for (n,n*12)

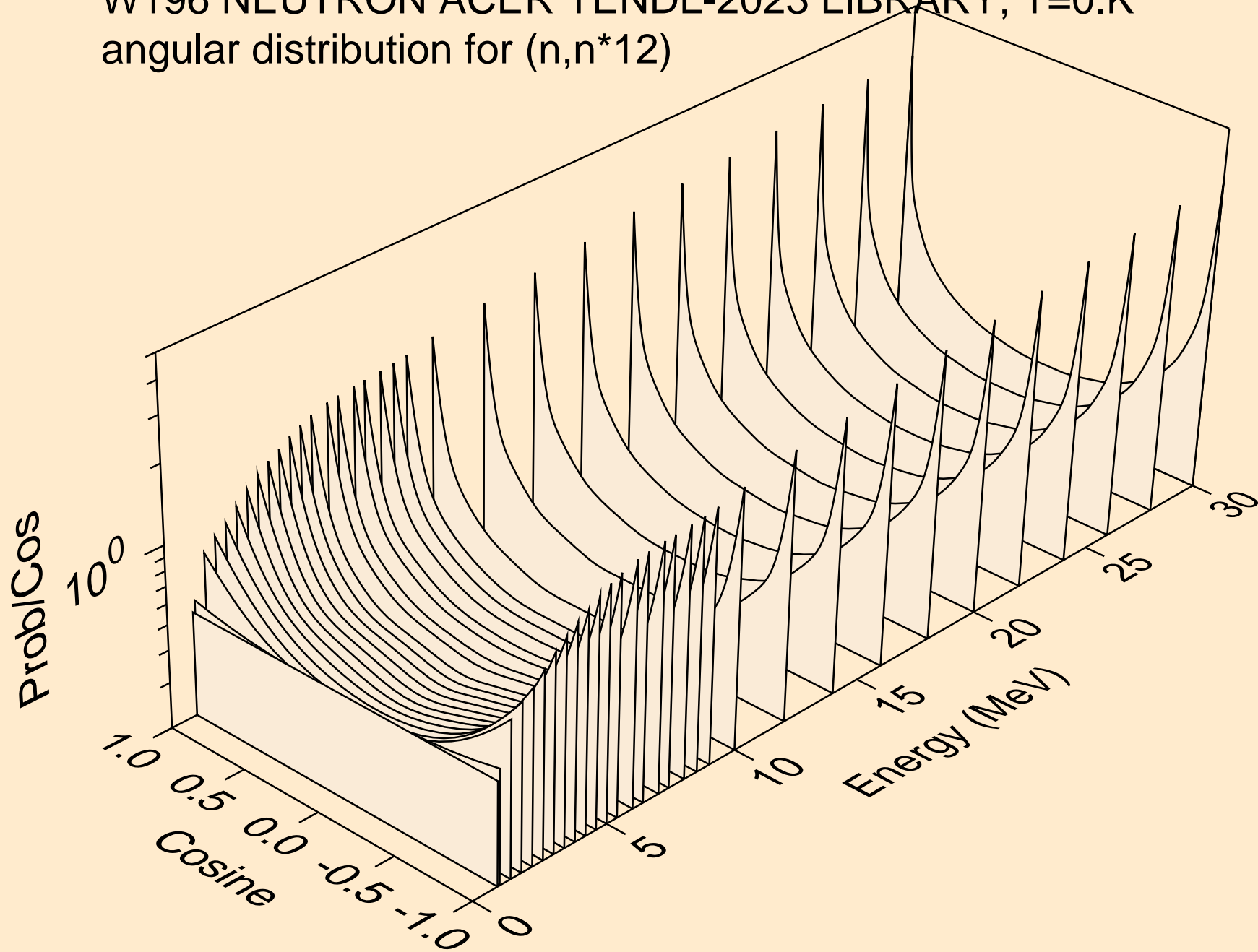

W196 NEUTRON ACER TENDL-2023 LIBRARY; T=0.K
angular distribution for (n,n*13)

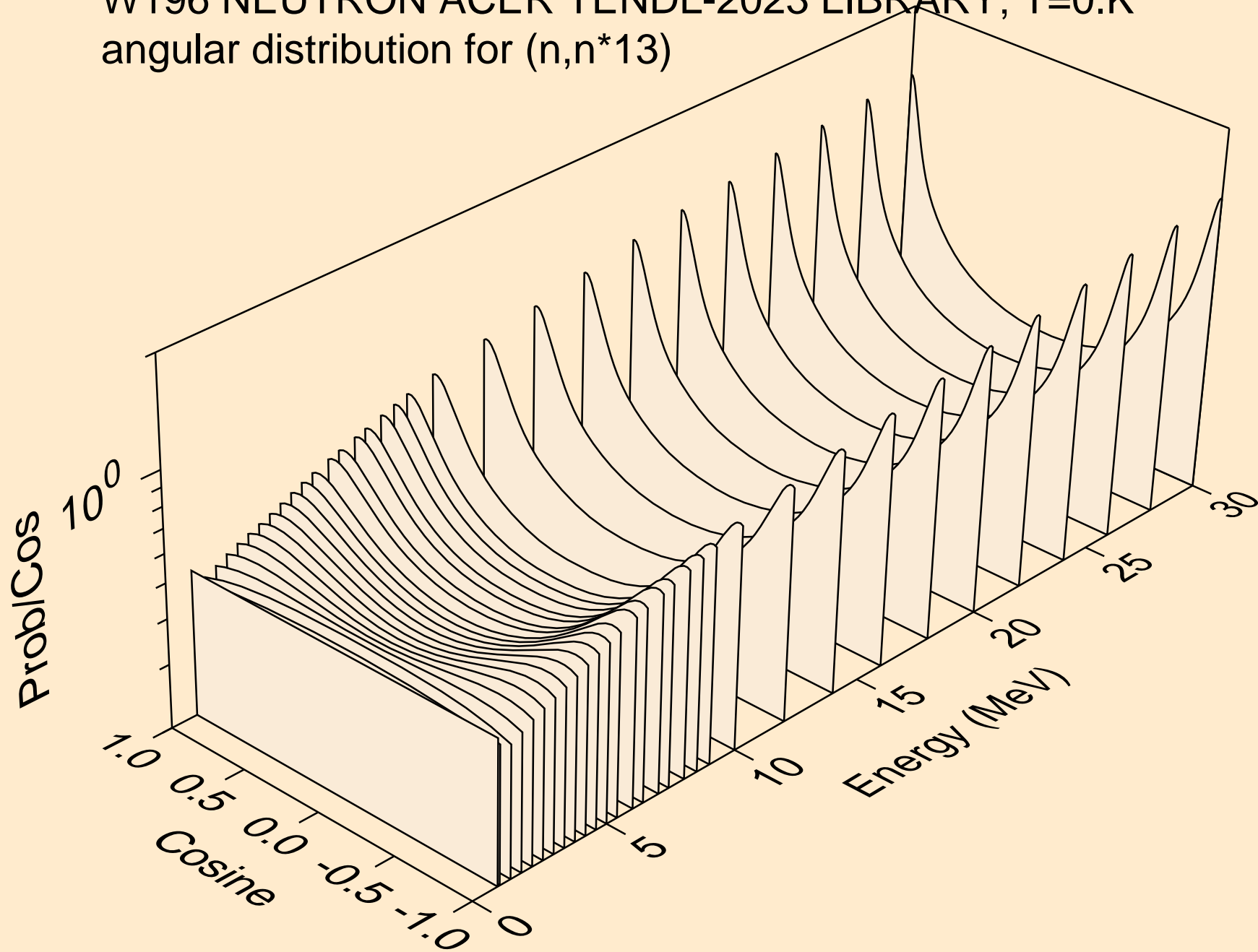

W196 NEUTRON ACER TENDL-2023 LIBRARY; T=0.K
angular distribution for (n,n*14)

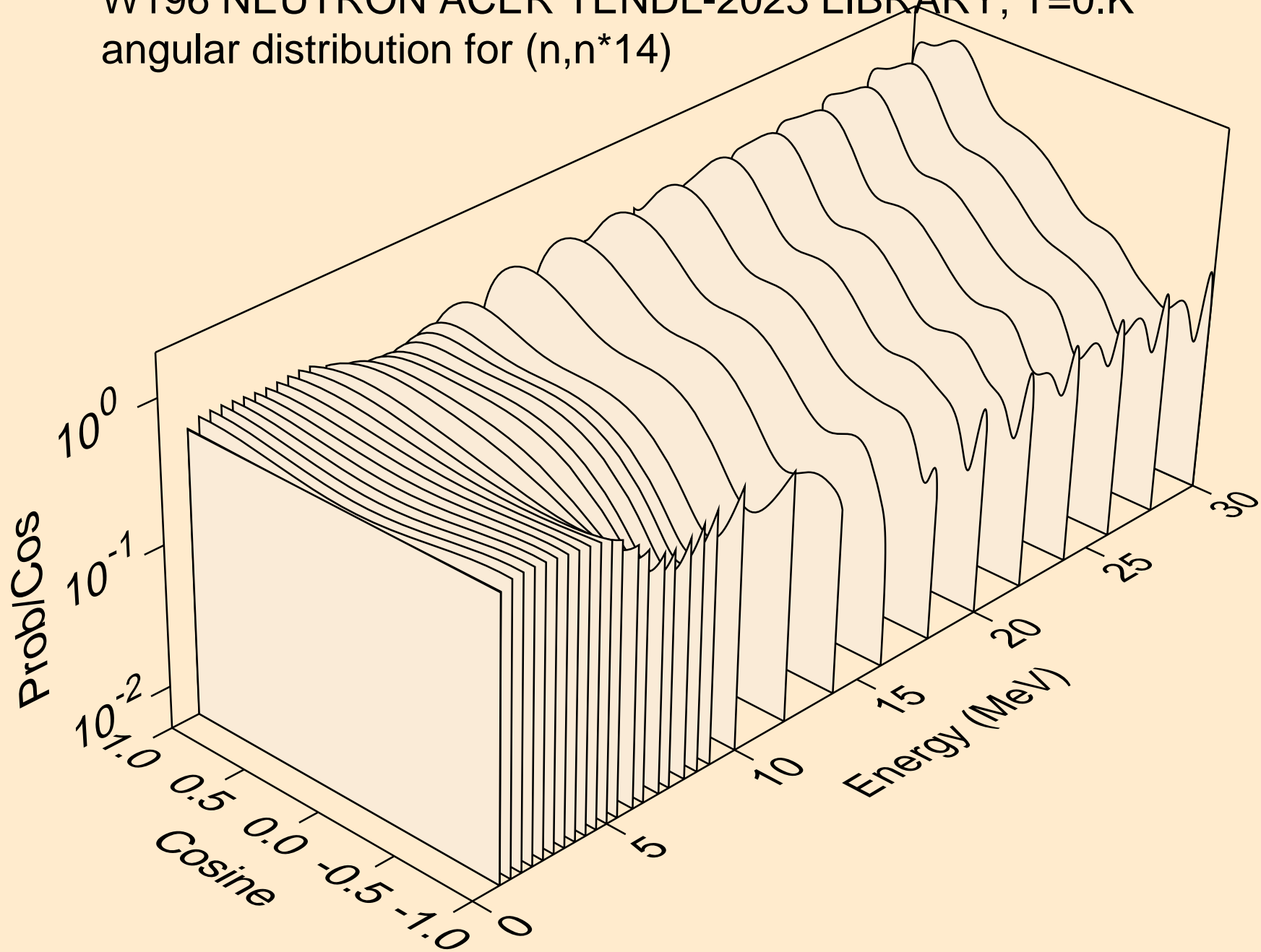

W196 NEUTRON ACER TENDL-2023 LIBRARY; T=0.K
angular distribution for (n,n*15)

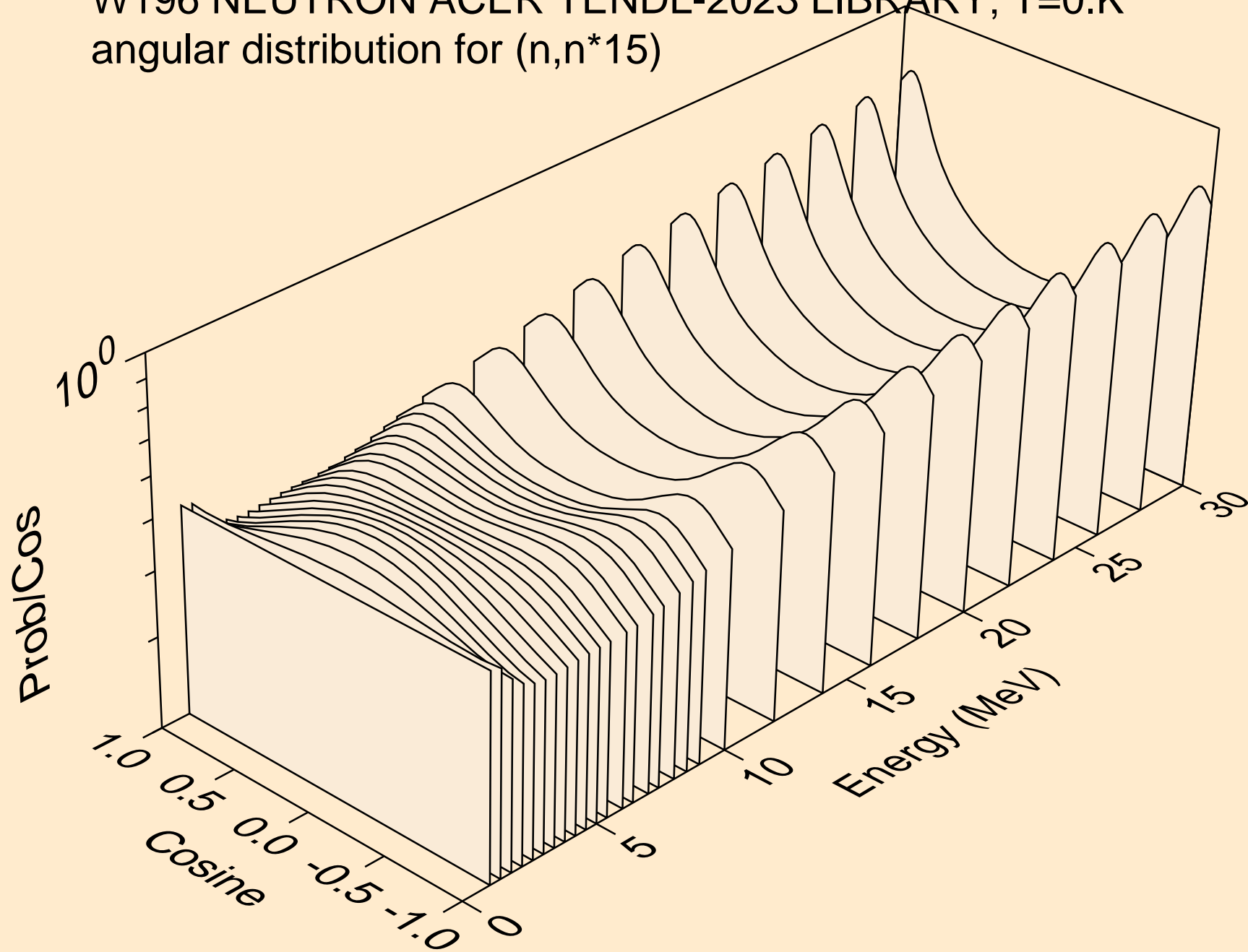

W196 NEUTRON ACER TENDL-2023 LIBRARY; T=0.K
angular distribution for (n,n*16)

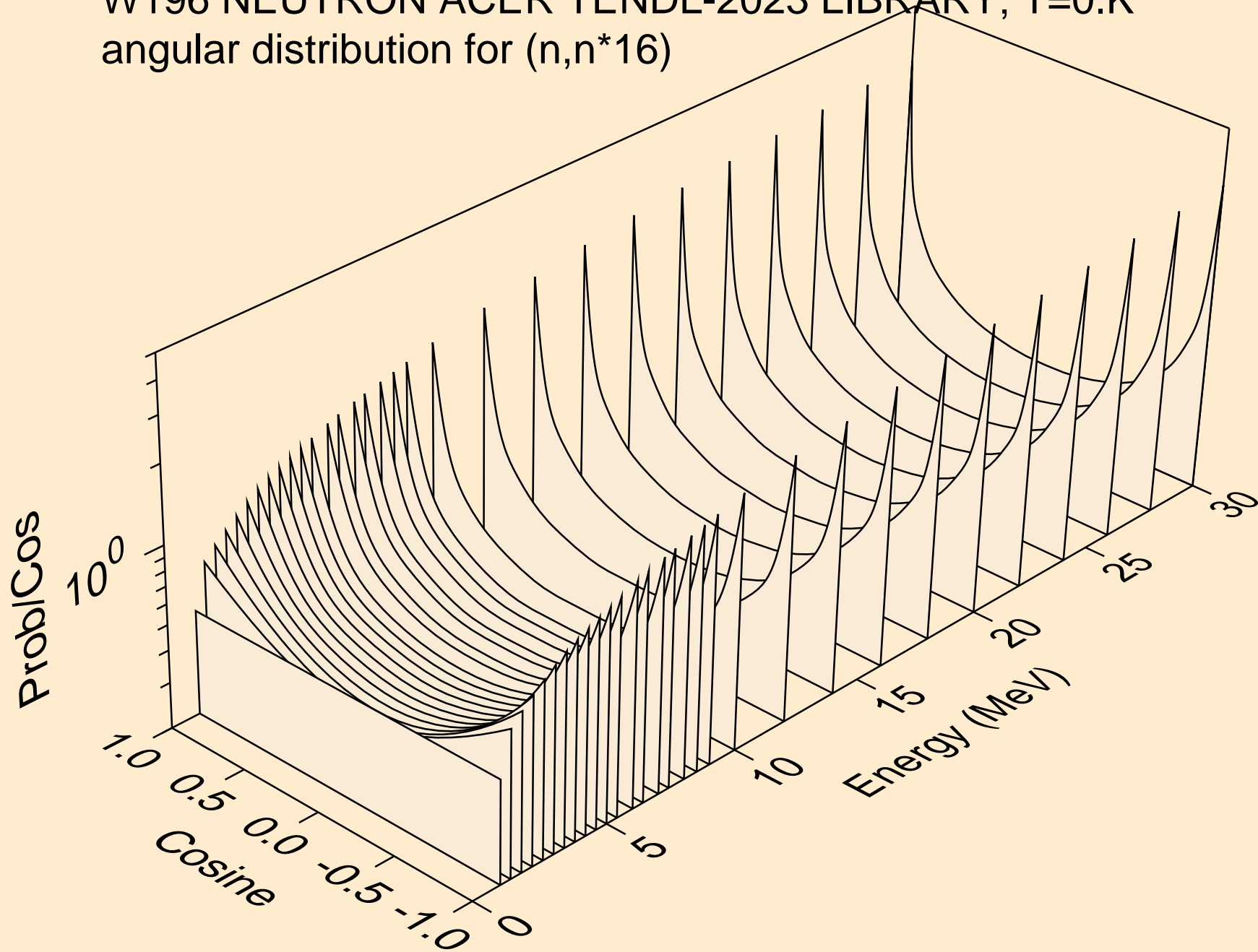

W196 NEUTRON ACER TENDL-2023 LIBRARY; T=0.K
angular distribution for (n,n*17)

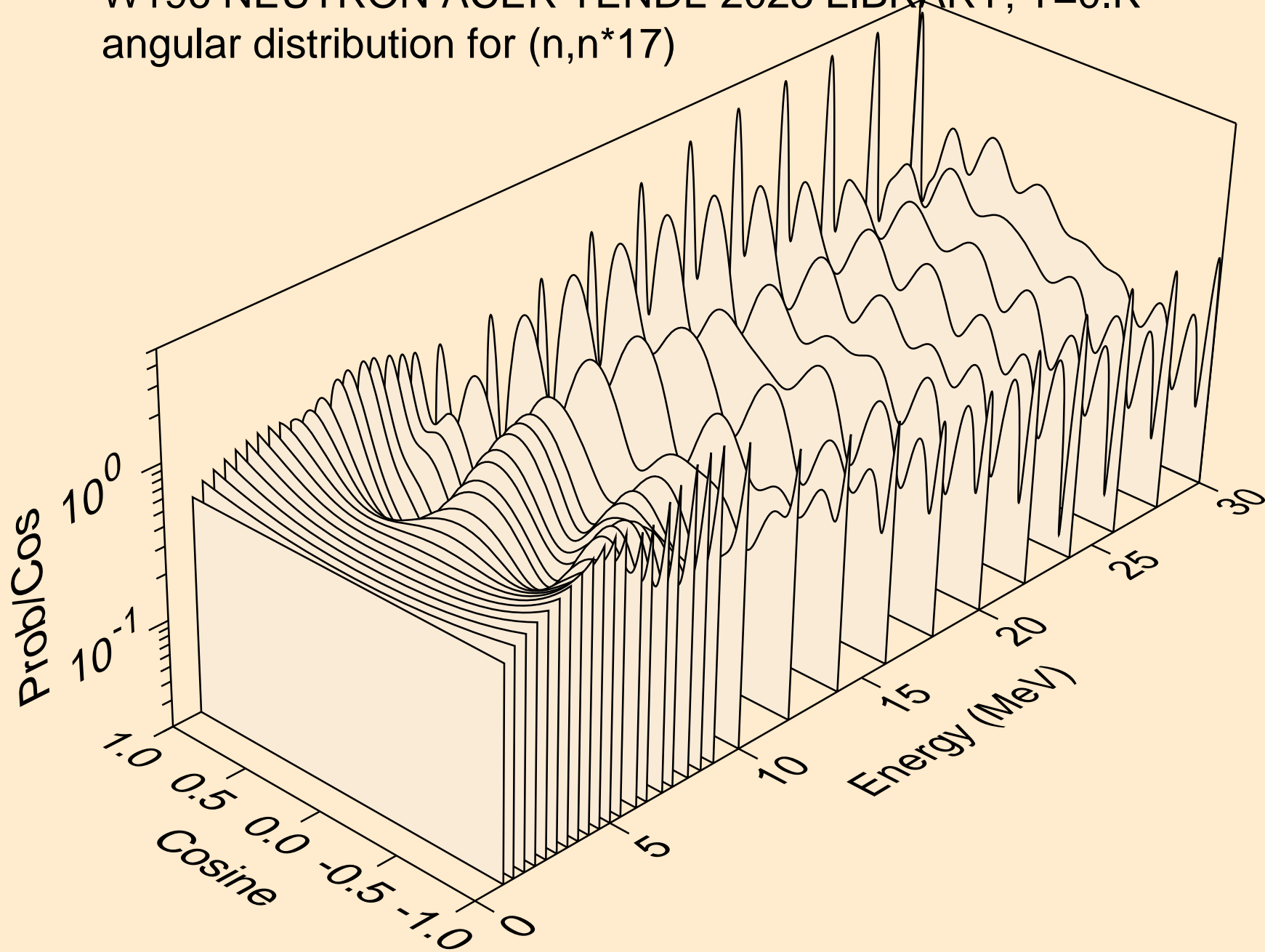

W196 NEUTRON ACER TENDL-2023 LIBRARY; T=0.K
angular distribution for (n,n*18)

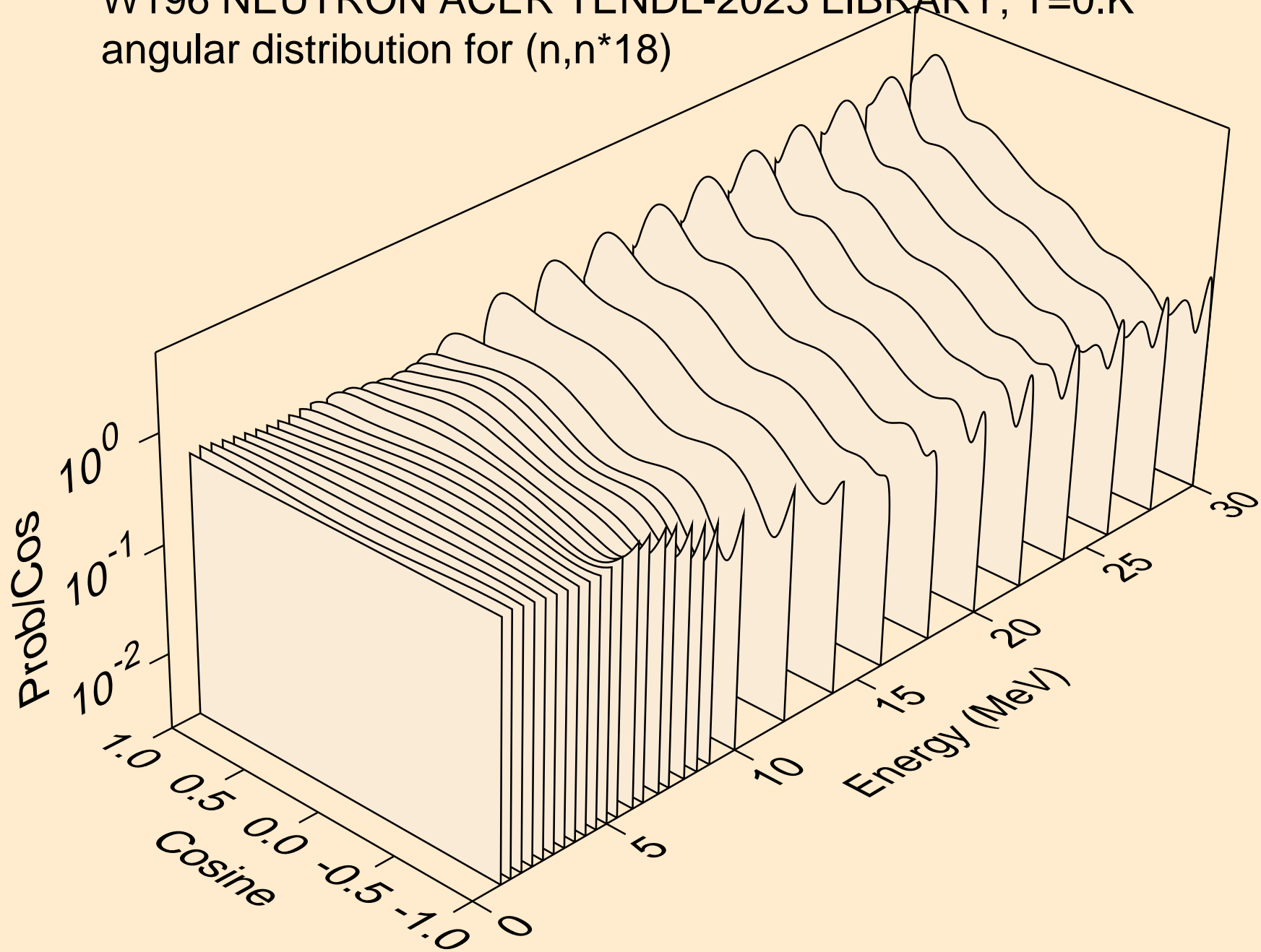

W196 NEUTRON ACER TENDL-2023 LIBRARY; T=0.K
angular distribution for (n,n*19)

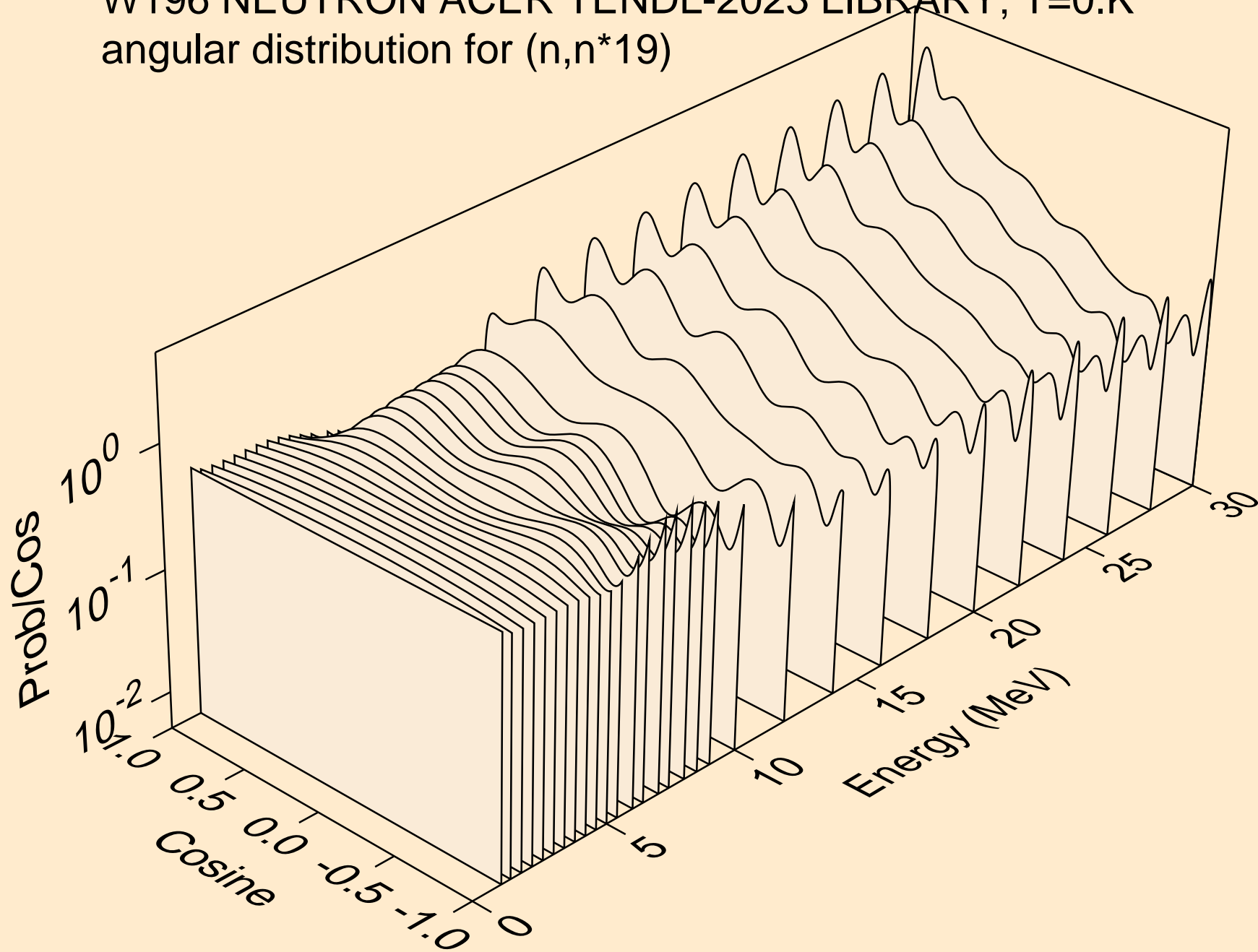

W196 NEUTRON ACER TENDL-2023 LIBRARY; T=0.K
angular distribution for (n,n*20)

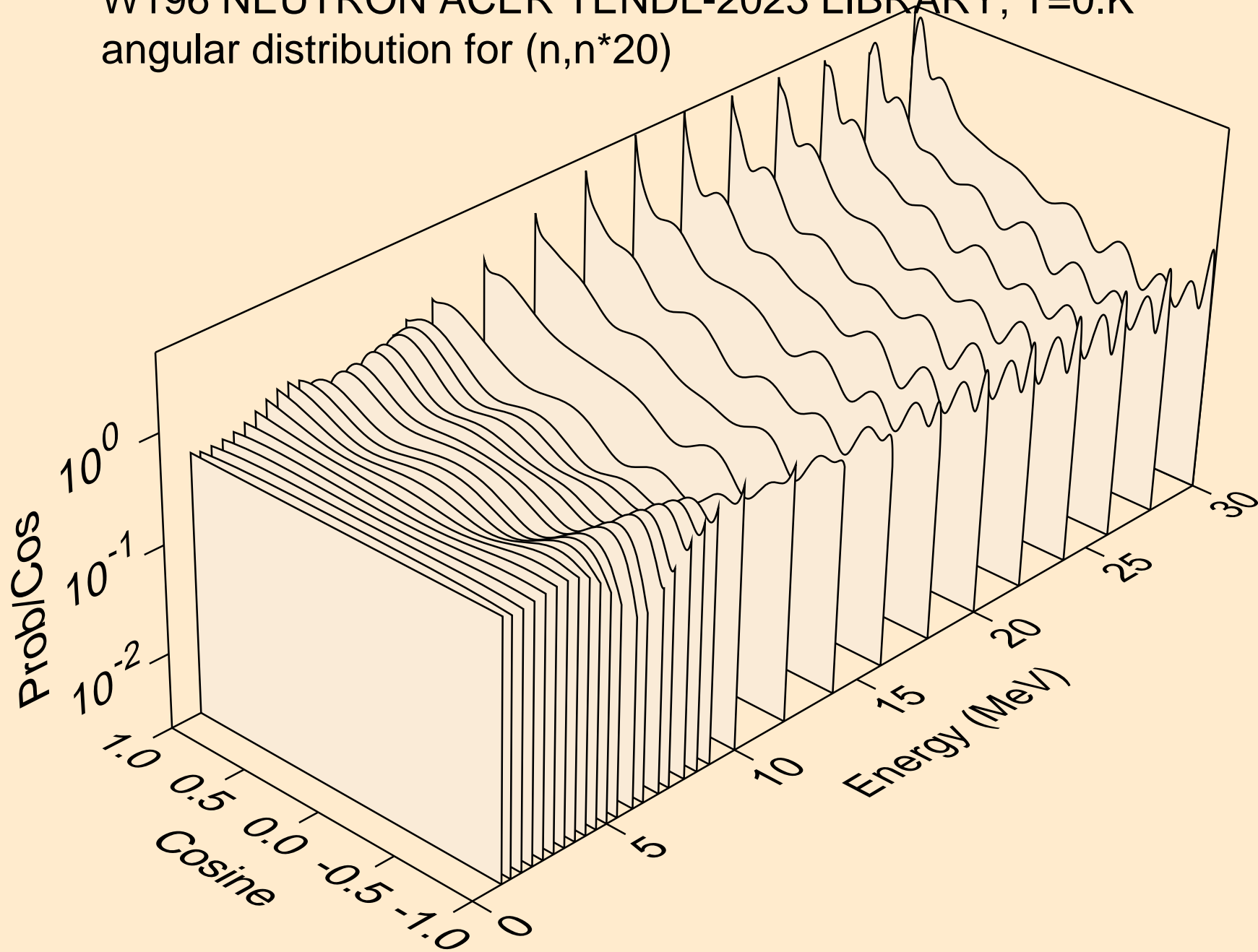

W196 NEUTRON ACER TENDL-2023 LIBRARY; T=0.K
angular distribution for (n,n*21)

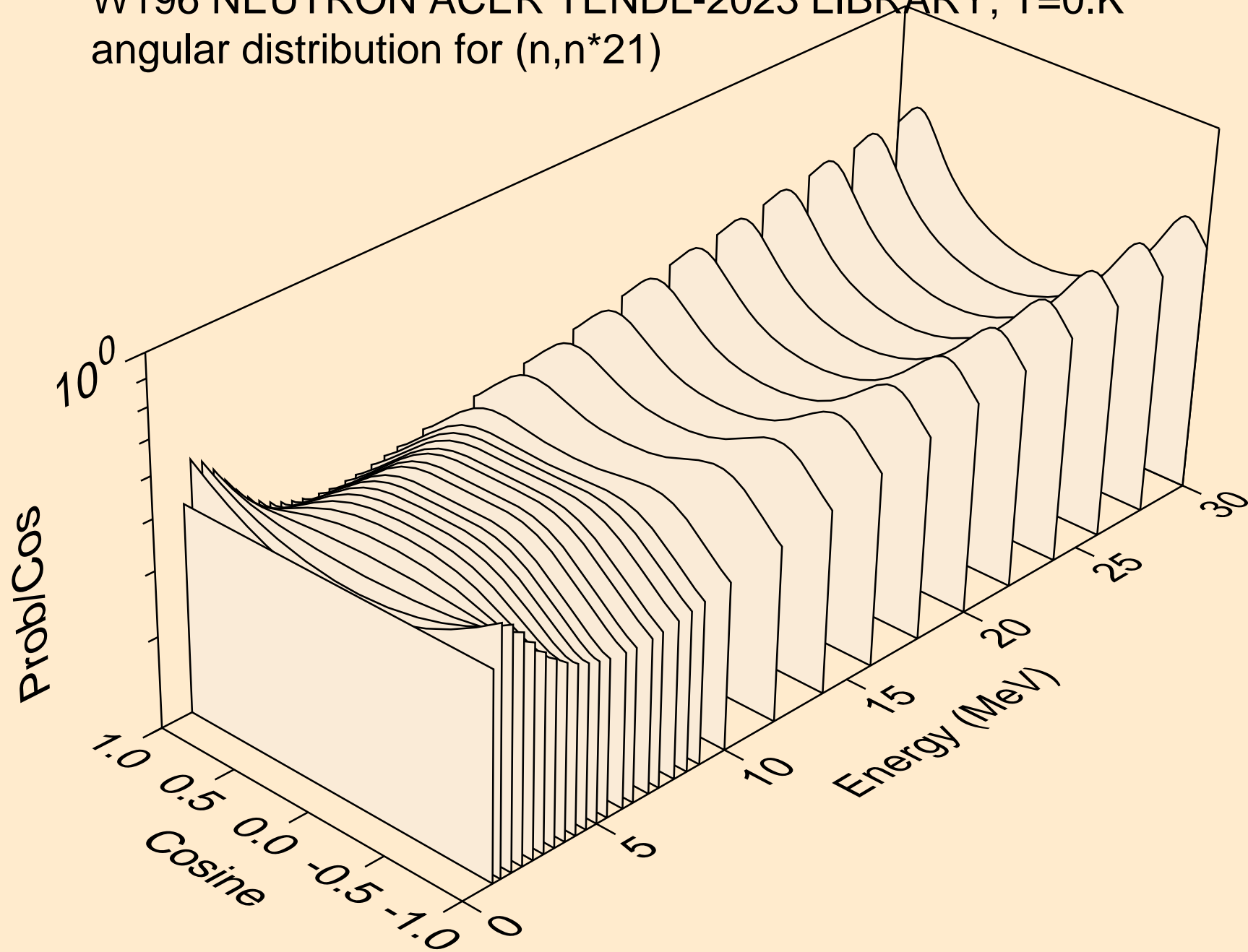

W196 NEUTRON ACER TENDL-2023 LIBRARY; T=0.K
angular distribution for (n,n*22)

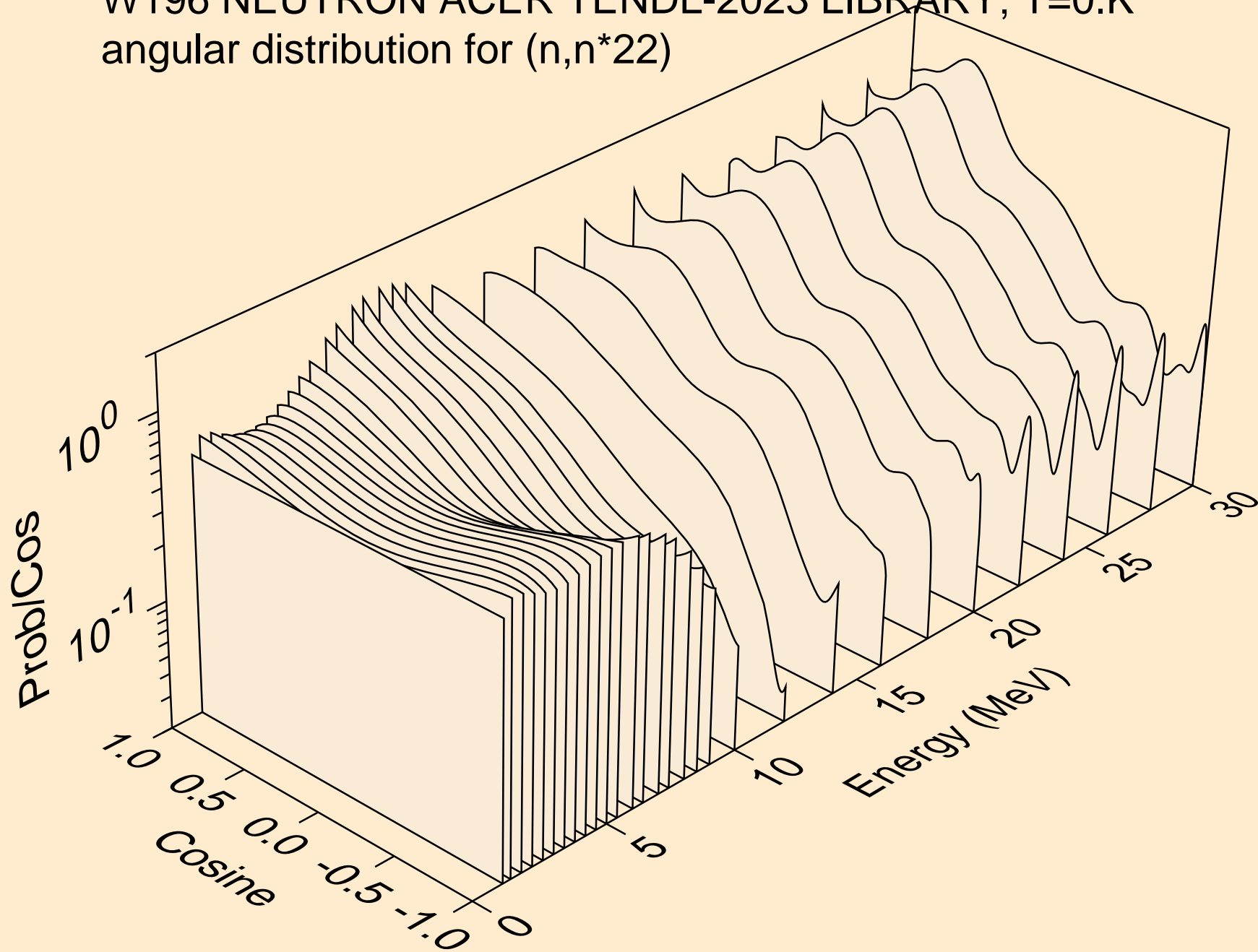

W196 NEUTRON ACER TENDL-2023 LIBRARY; T=0.K
angular distribution for (n,n*23)

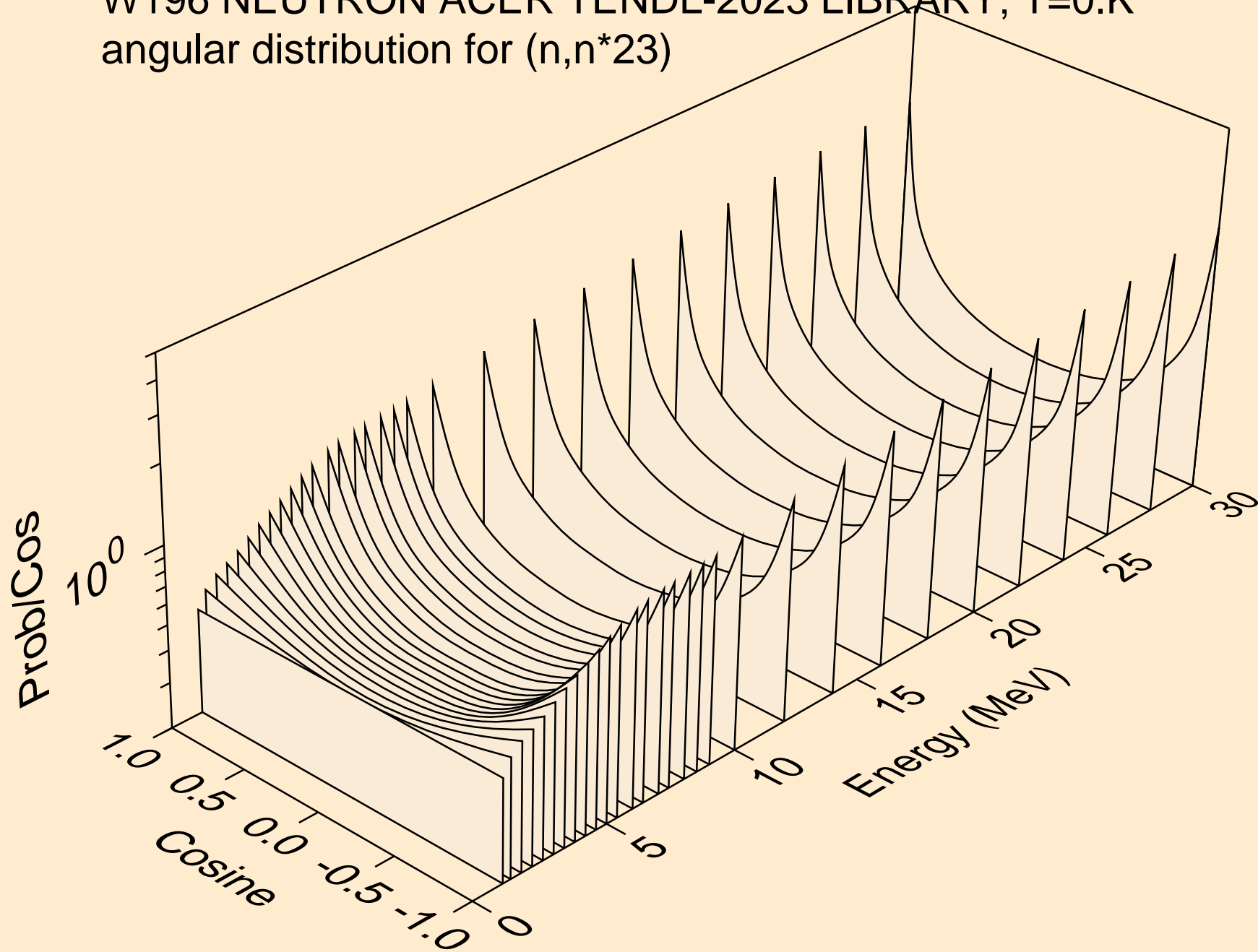

W196 NEUTRON ACER TENDL-2023 LIBRARY; T=0.K
angular distribution for (n,n*24)

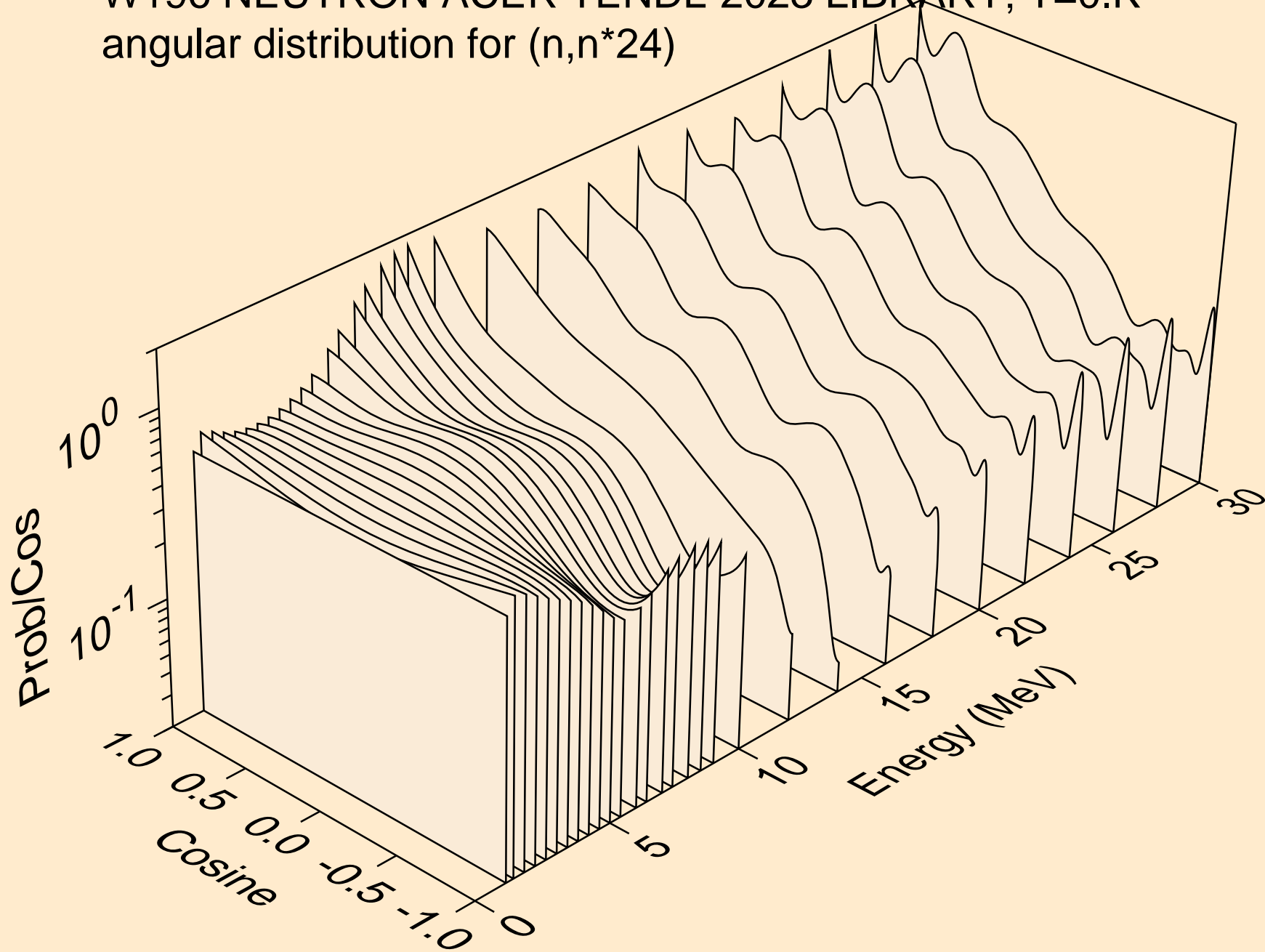

W196 NEUTRON ACER TENDL-2023 LIBRARY; T=0.K
angular distribution for (n,n*25)

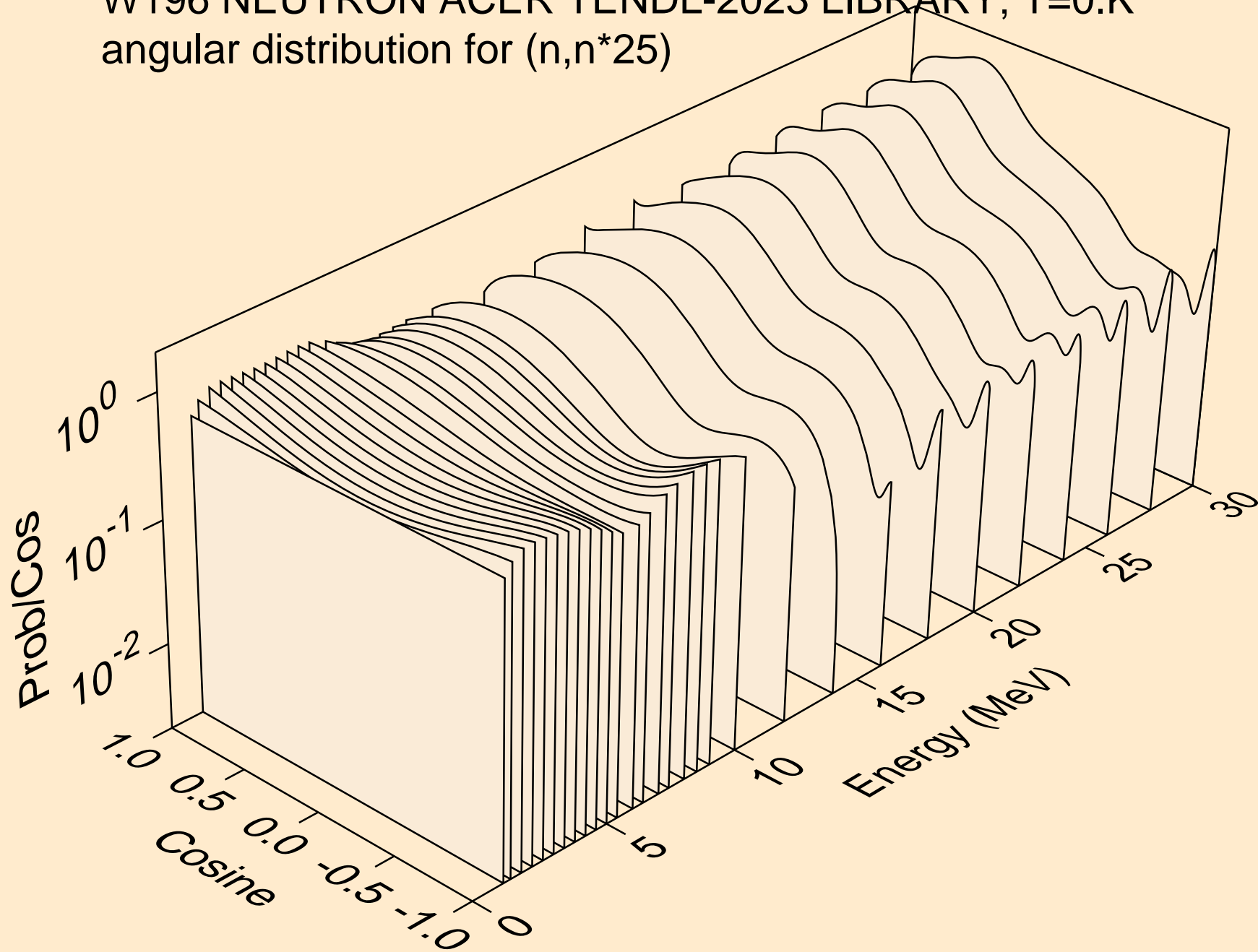

W196 NEUTRON ACER TENDL-2023 LIBRARY; T=0.K
angular distribution for (n,n*26)

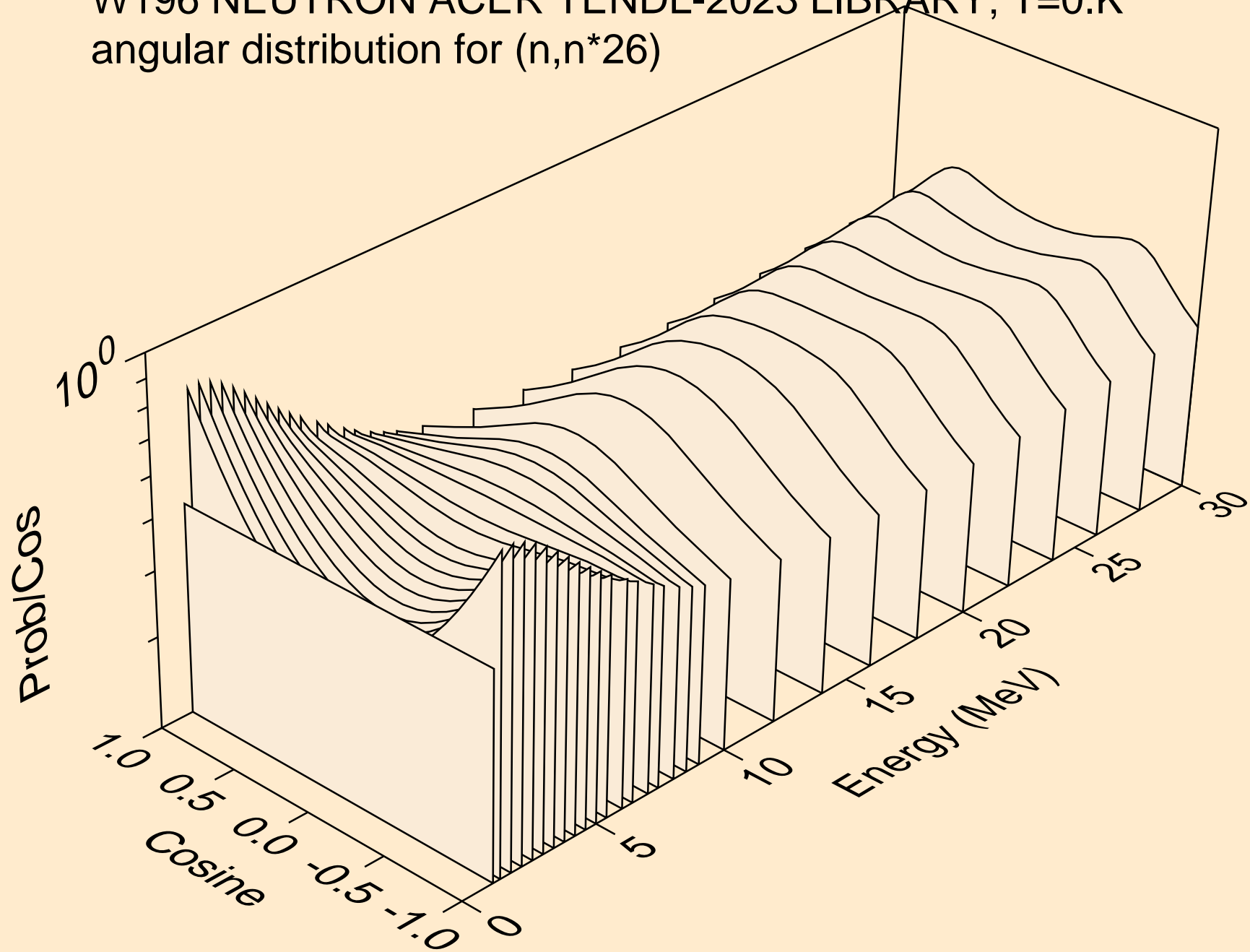

W196 NEUTRON ACER TENDL-2023 LIBRARY; T=0.K
angular distribution for (n,n*27)

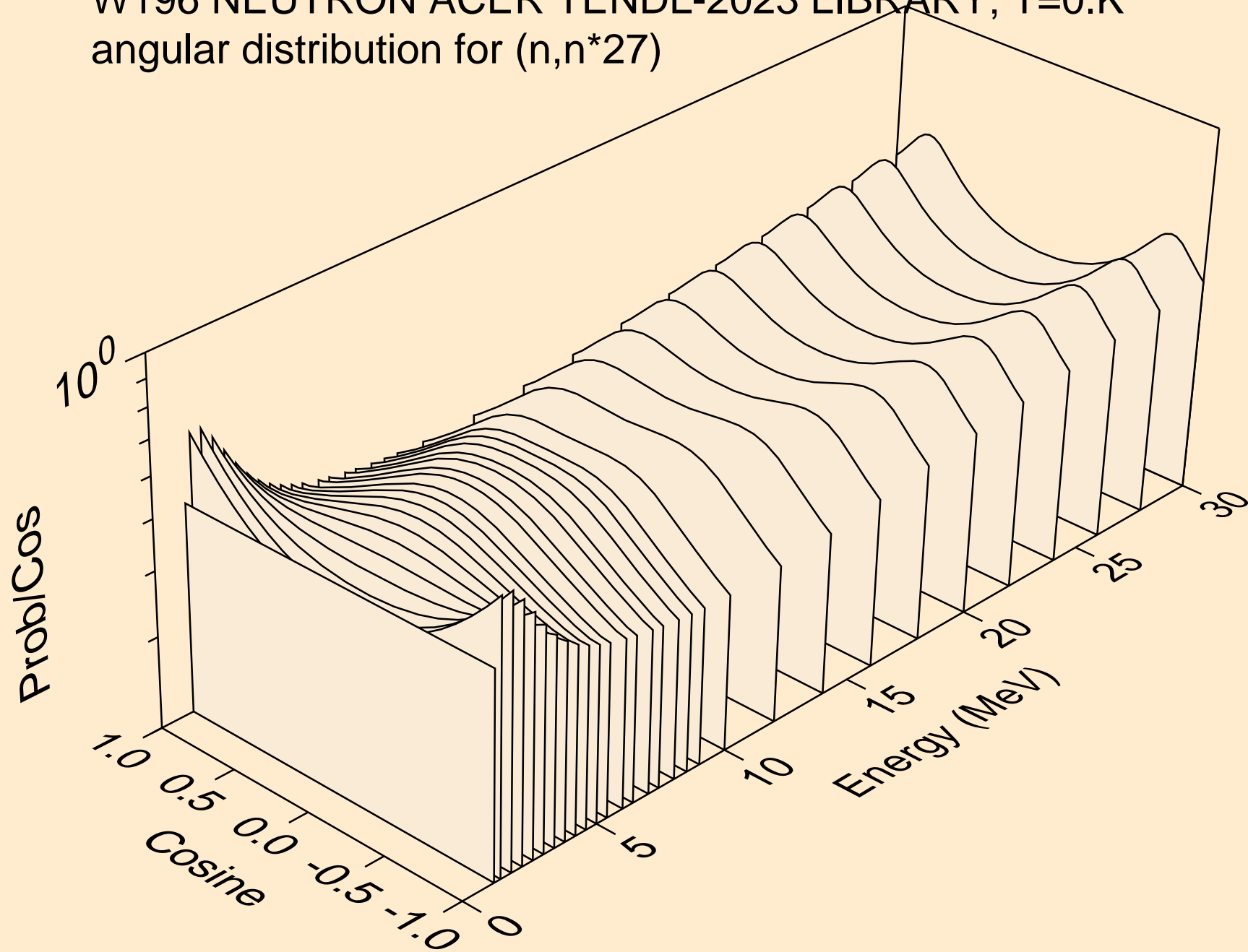

W196 NEUTRON ACER TENDL-2023 LIBRARY; T=0.K
angular distribution for (n,n*28)

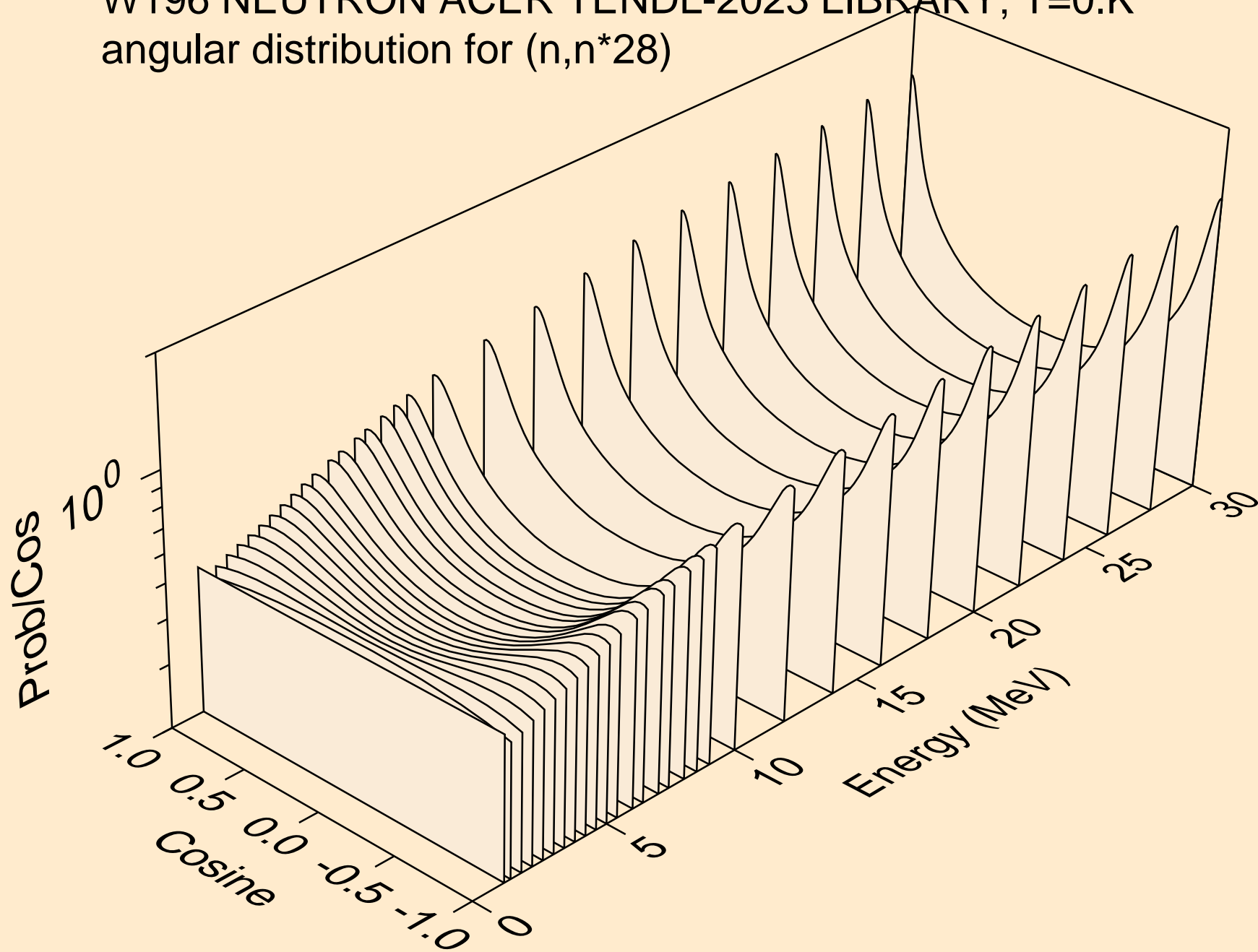

W196 NEUTRON ACER TENDL-2023 LIBRARY; T=0.K
angular distribution for (n,n*29)

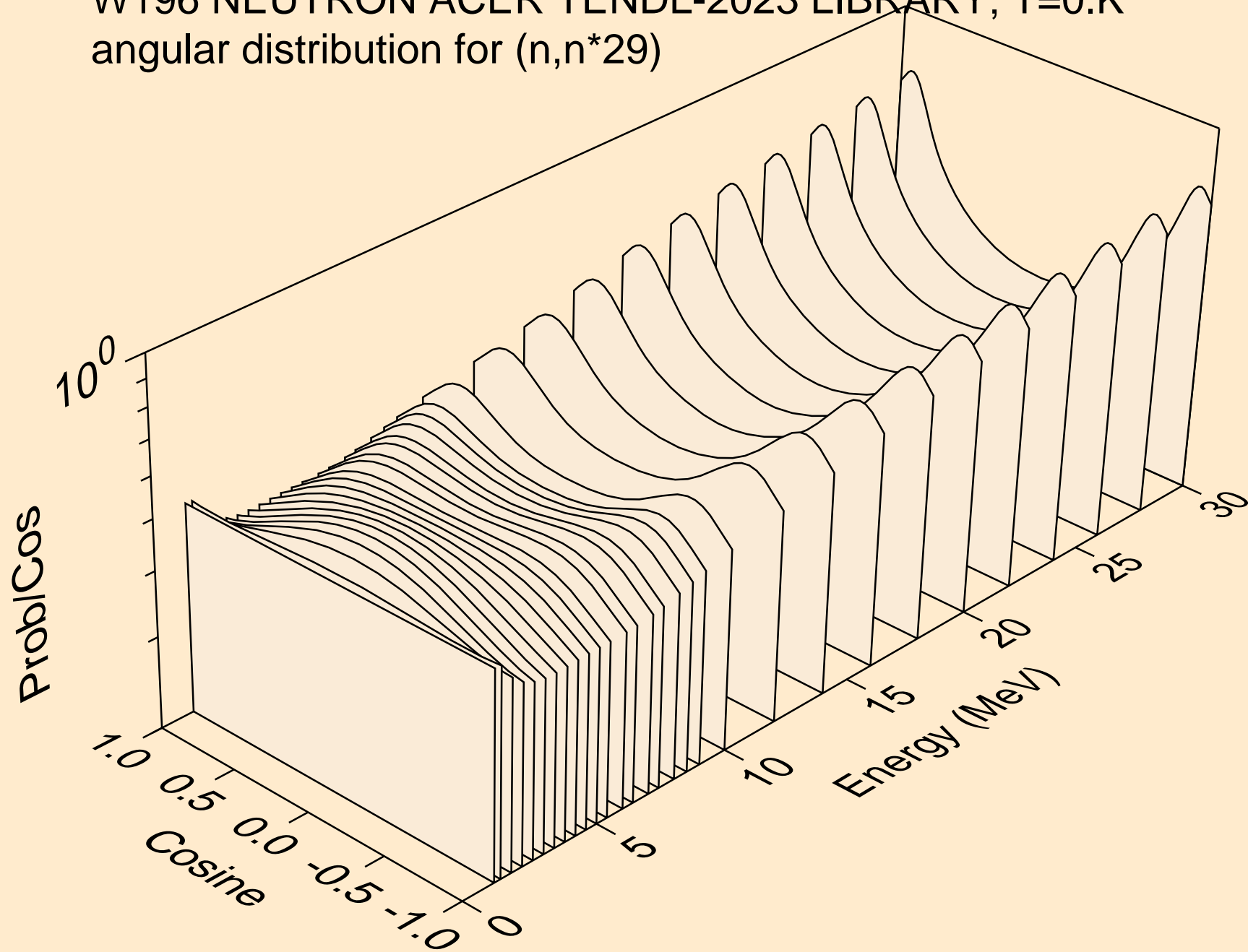

W196 NEUTRON ACER TENDL-2023 LIBRARY; T=0.K
angular distribution for (n,n*30)

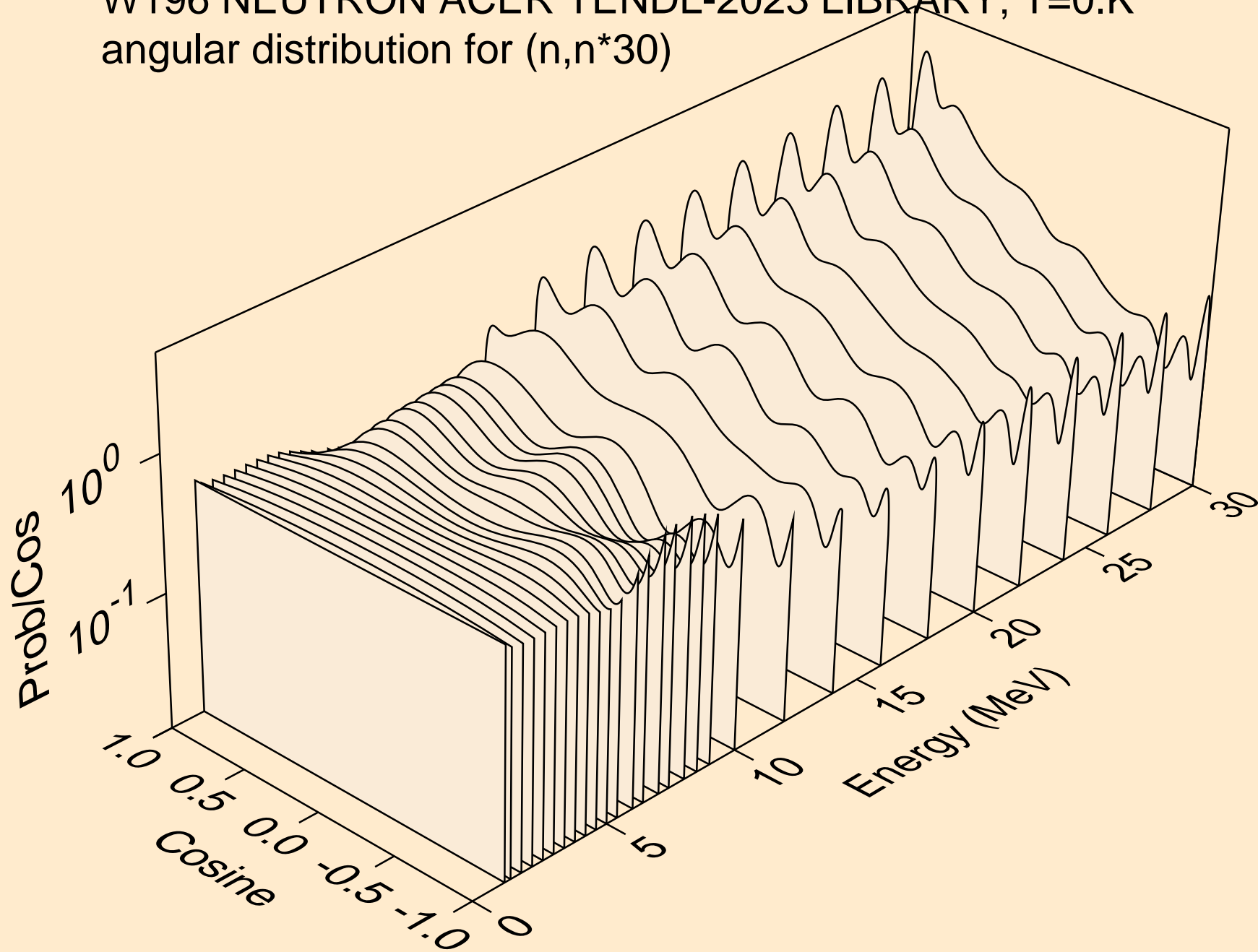

W196 NEUTRON ACER TENDL-2023 LIBRARY; T=0.K
Neutron emission for (n,x)

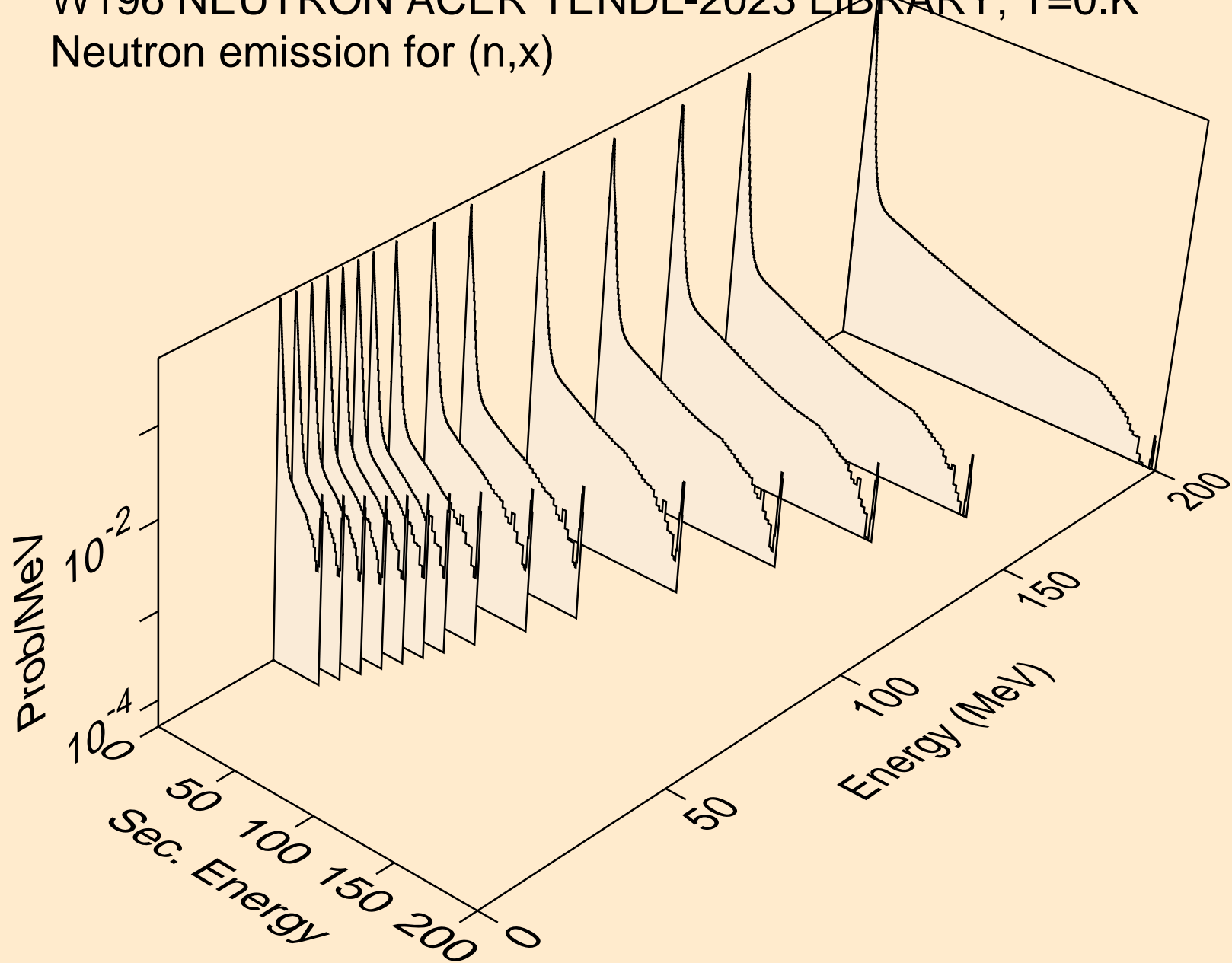

W196 NEUTRON ACER TENDL-2023 LIBRARY; T=0.K
Neutron emission for (n,2nd)

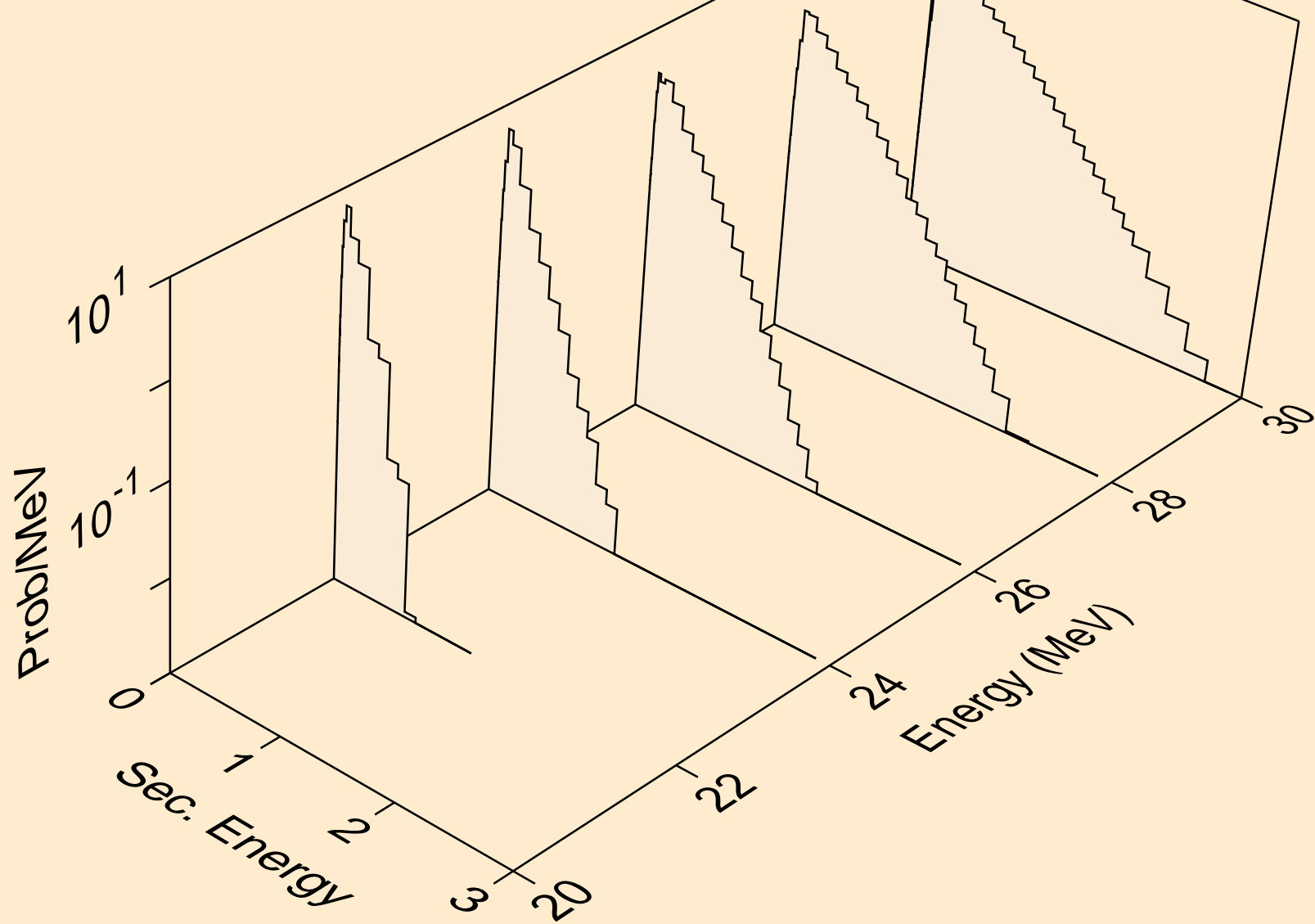

W196 NEUTRON ACER TENDL-2023 LIBRARY; T=0.K
Neutron emission for (n,2n)

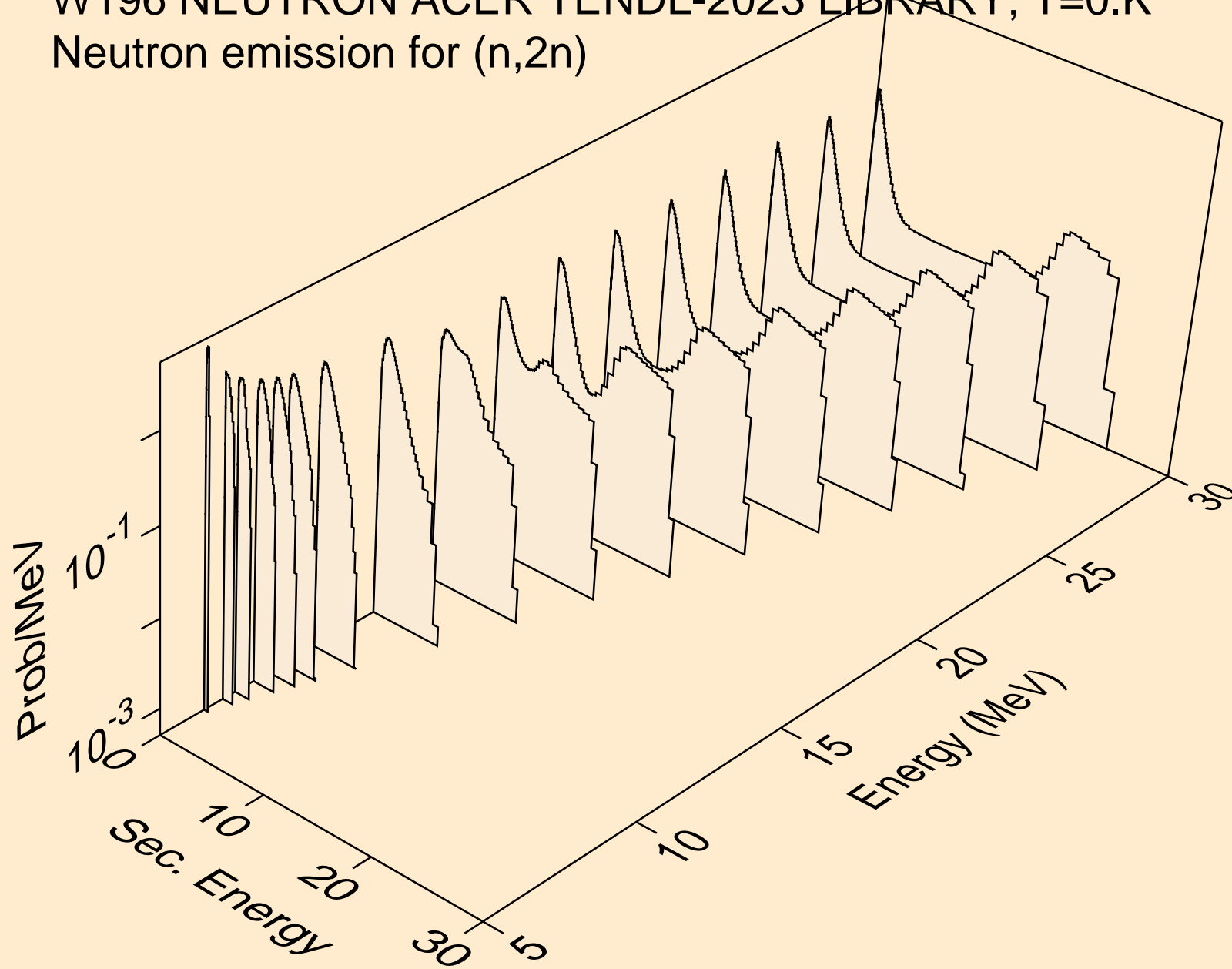

W196 NEUTRON ACER TENDL-2023 LIBRARY; T=0.K
Neutron emission for (n,3n)

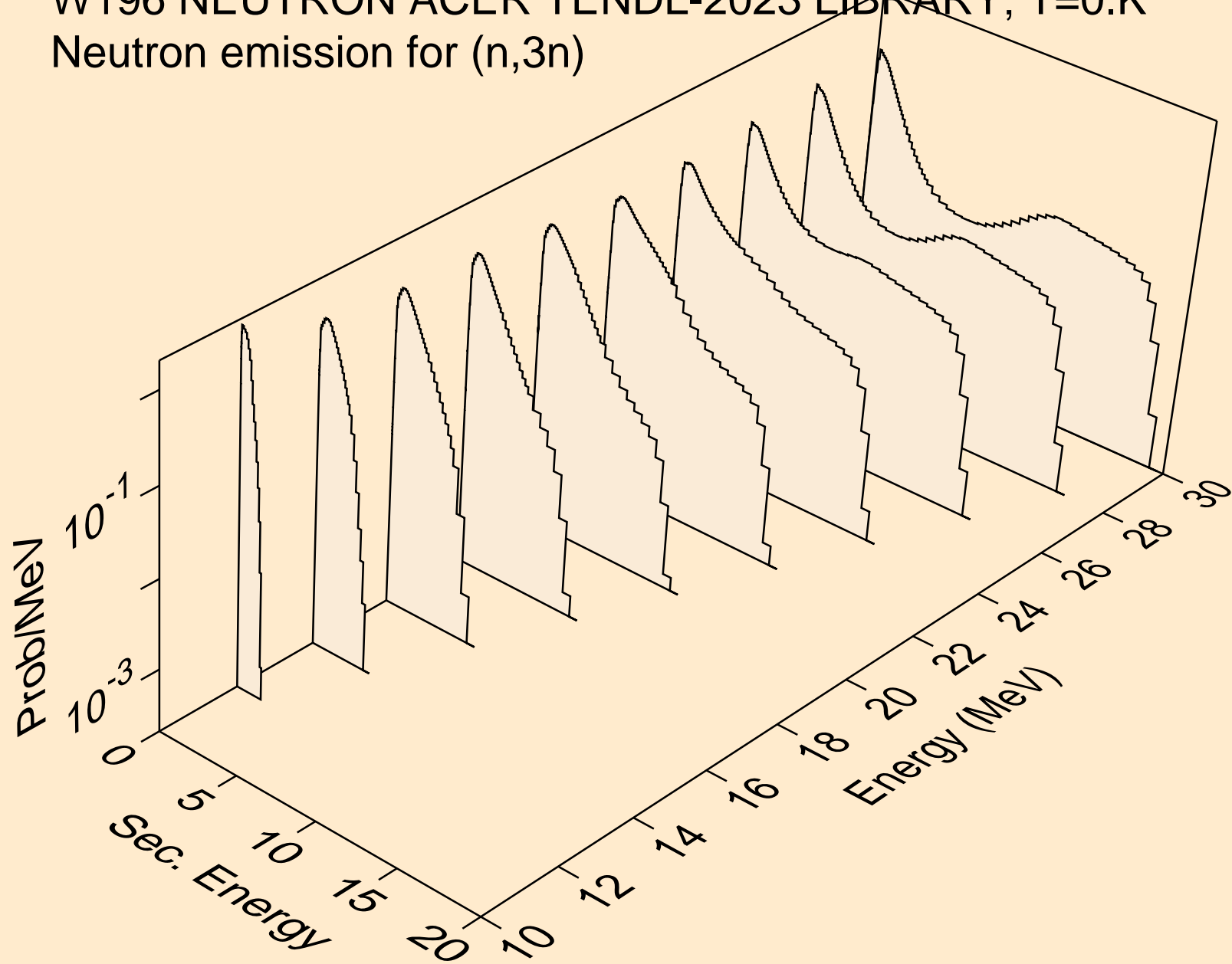

W196 NEUTRON ACER TENDL-2023 LIBRARY; T=0.K
Neutron emission for (n,n*)a

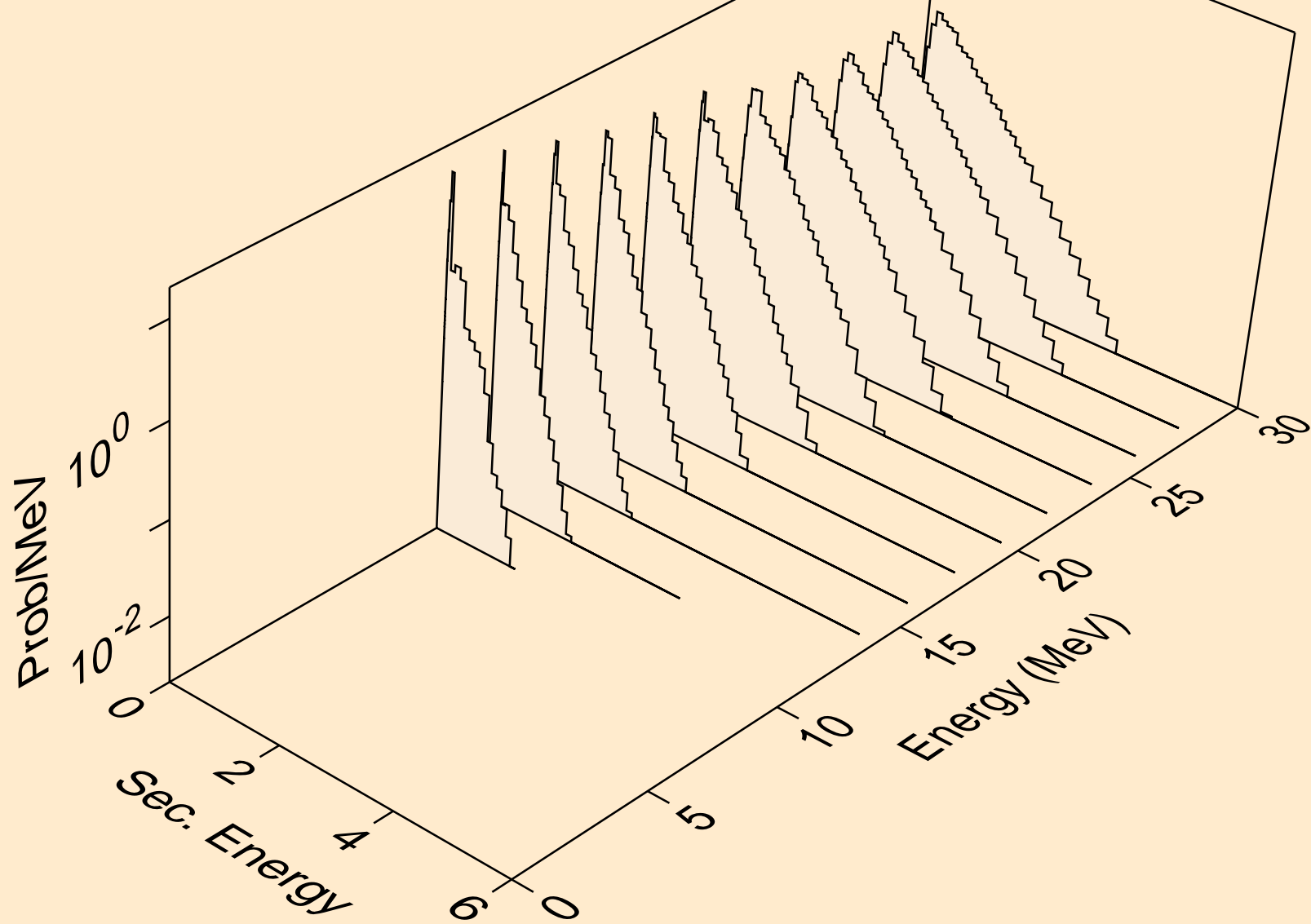

W196 NEUTRON ACER TENDL-2023 LIBRARY; T=0.K
Neutron emission for (n,2n)a

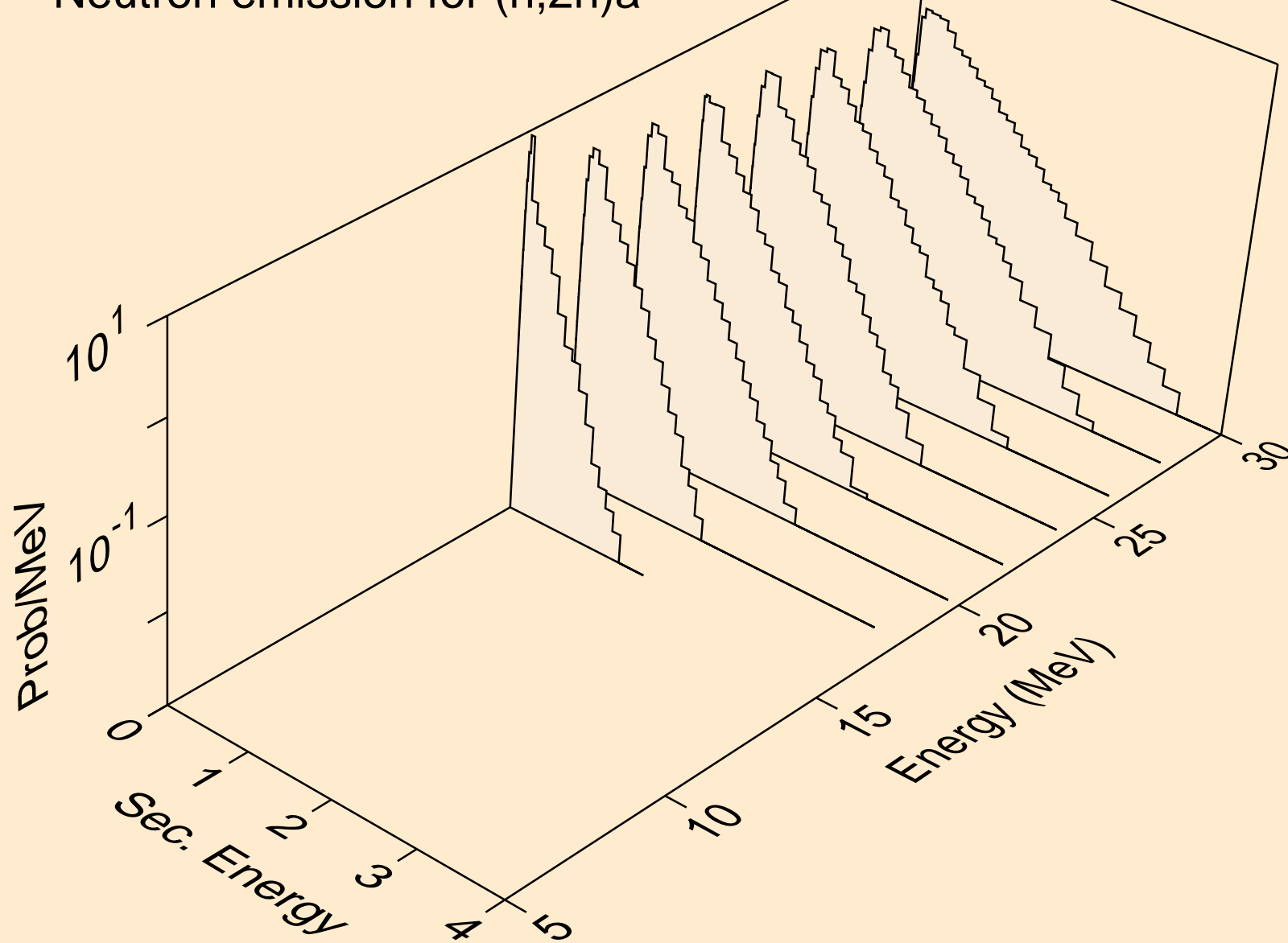

W196 NEUTRON ACER TENDL-2023 LIBRARY; T=0.K
Neutron emission for (n,3n)a

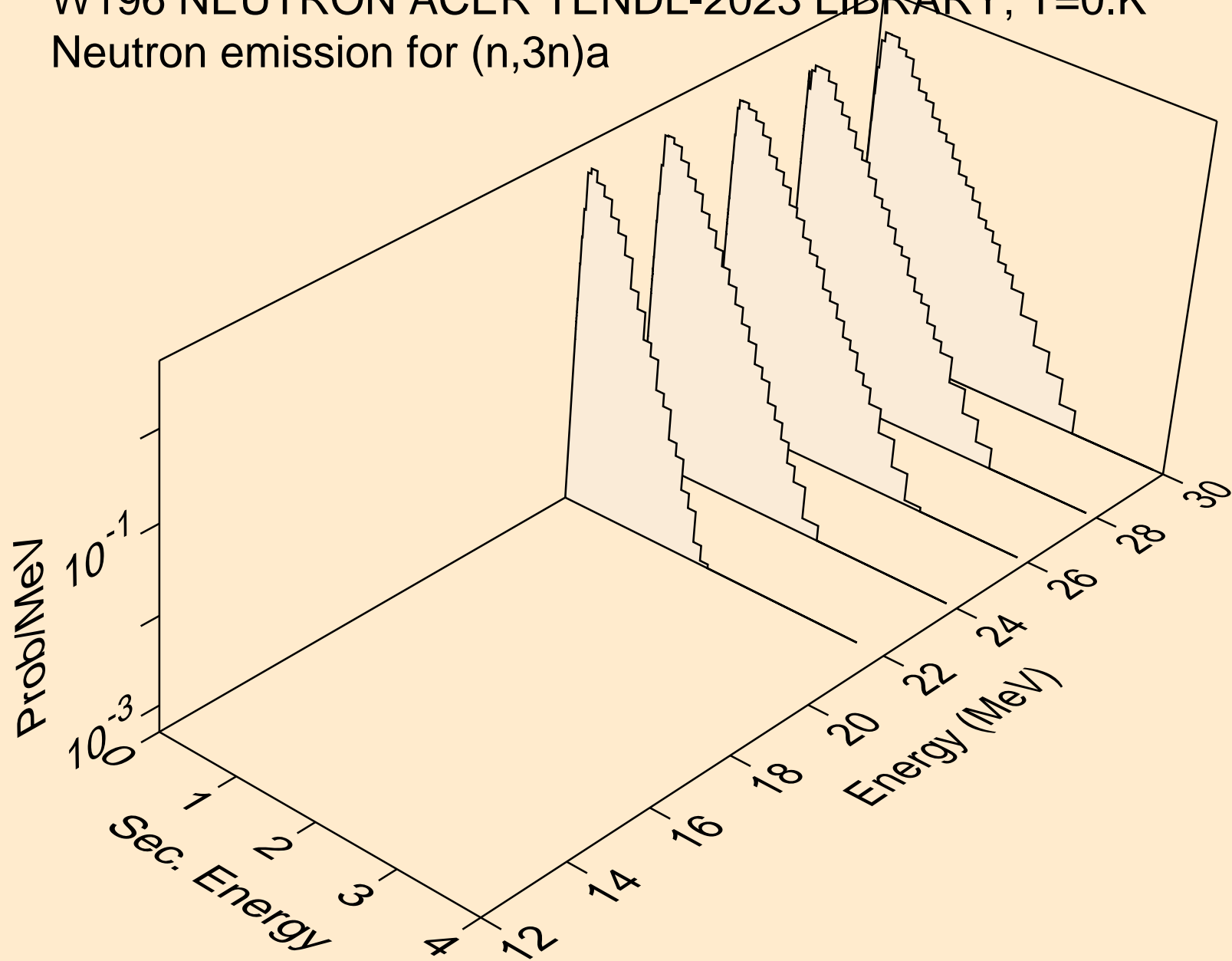

W196 NEUTRON ACER TENDL-2023 LIBRARY; T=0.K
Neutron emission for (n,n*)p

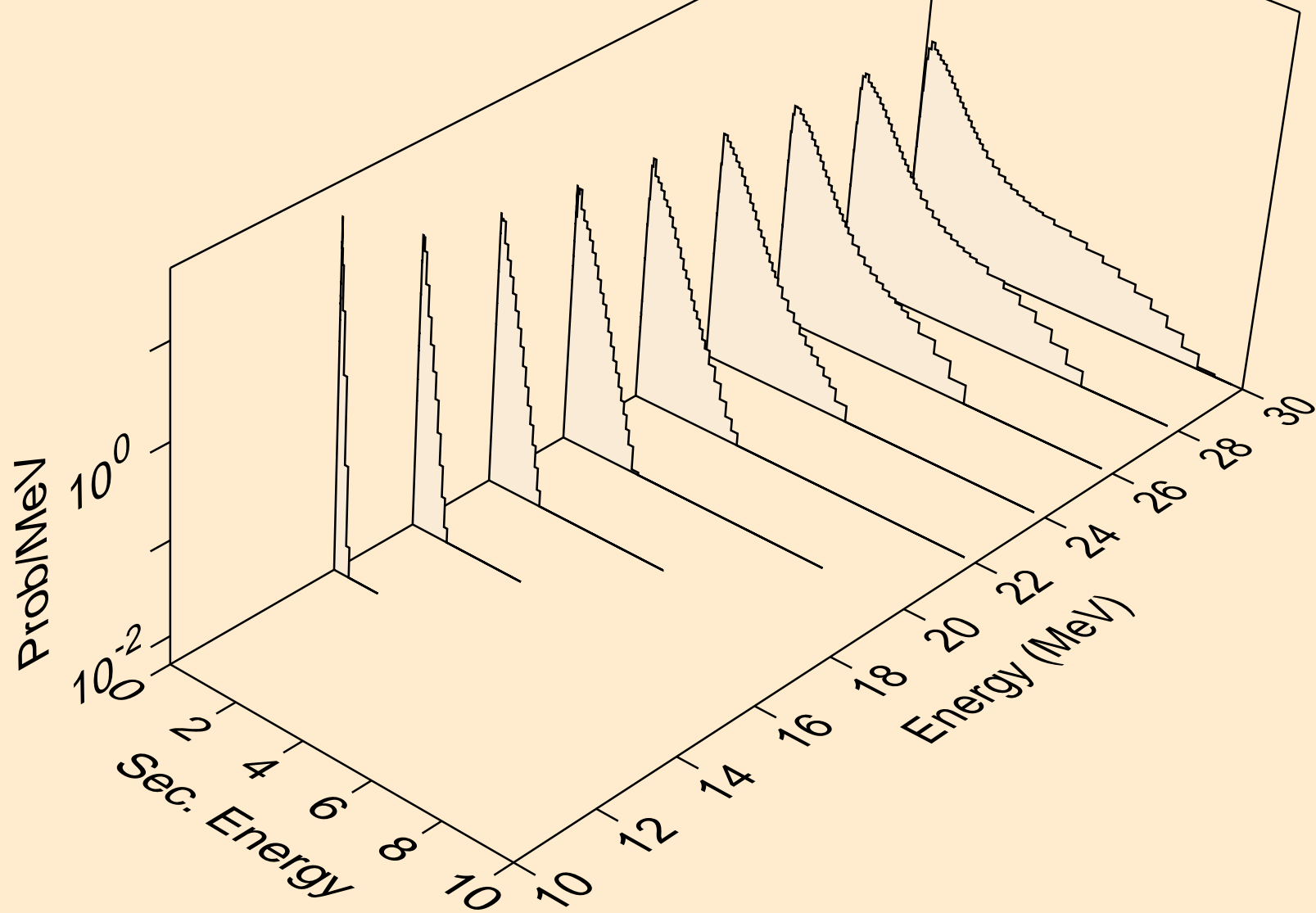

W196 NEUTRON ACER TENDL-2023 LIBRARY; T=0.K
Neutron emission for (n,n*)d

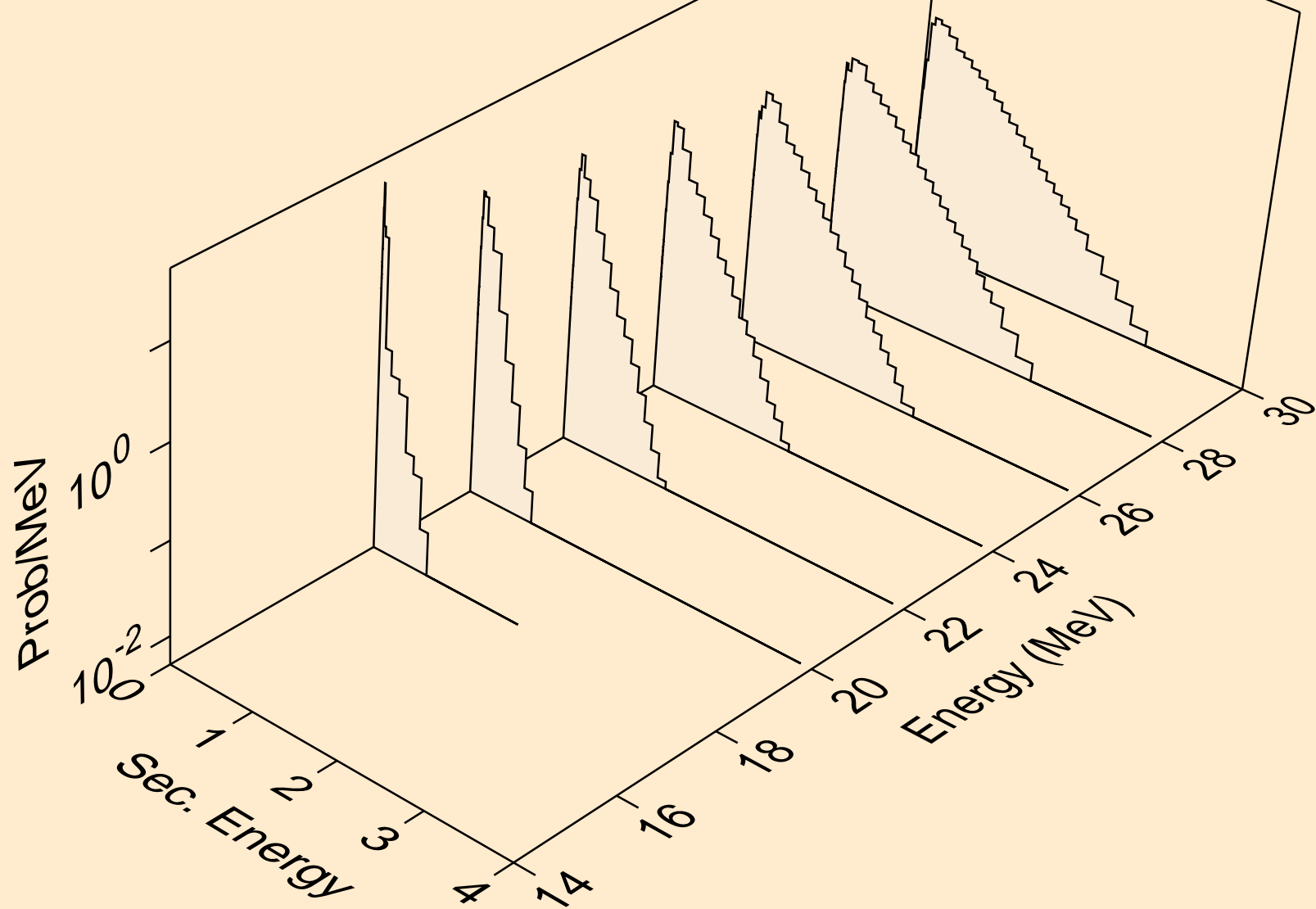

W196 NEUTRON ACER TENDL-2023 LIBRARY; T=0.K
Neutron emission for (n,n*)t

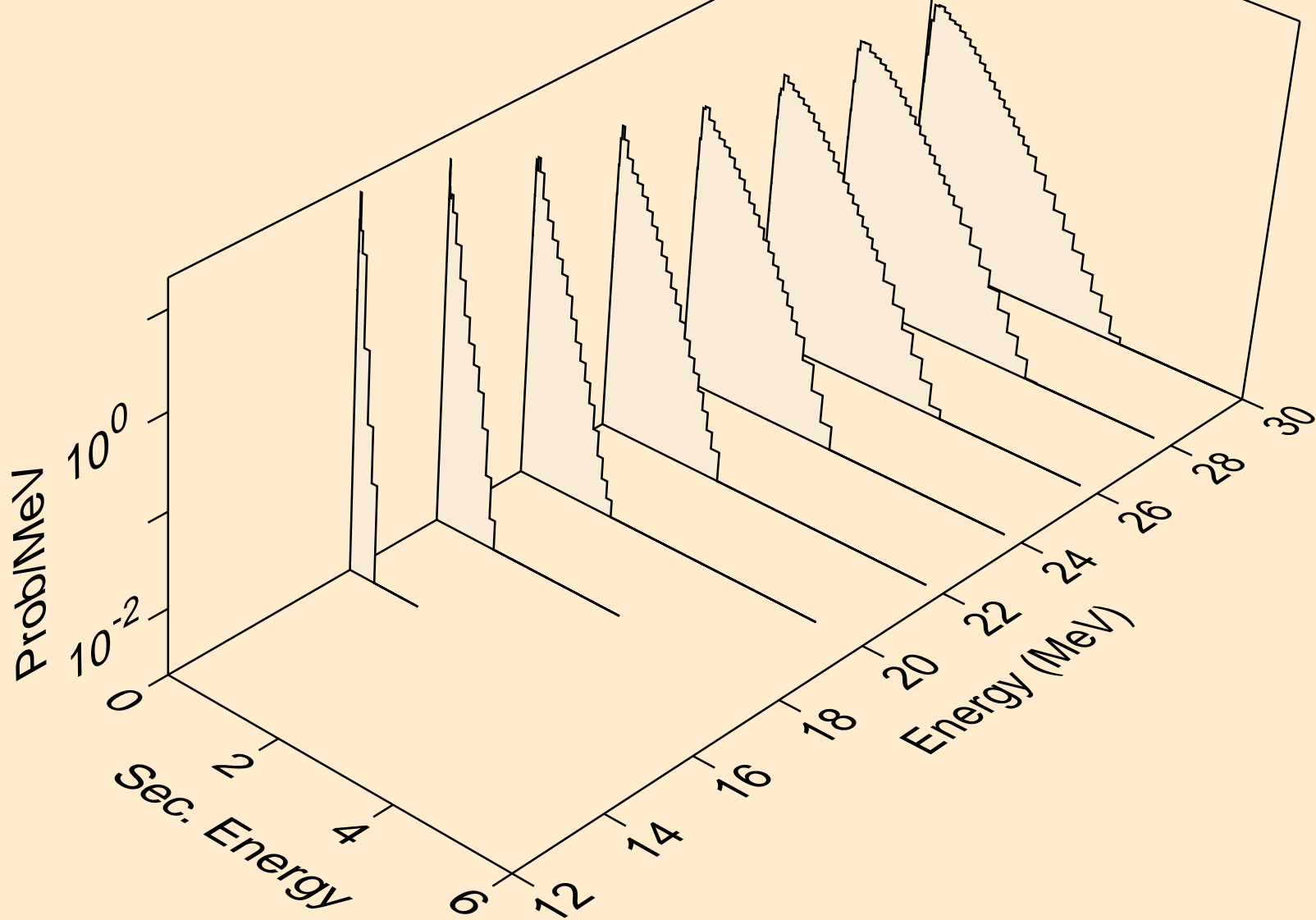

W196 NEUTRON ACER TENDL-2023 LIBRARY; T=0.K
Neutron emission for (n,4n)

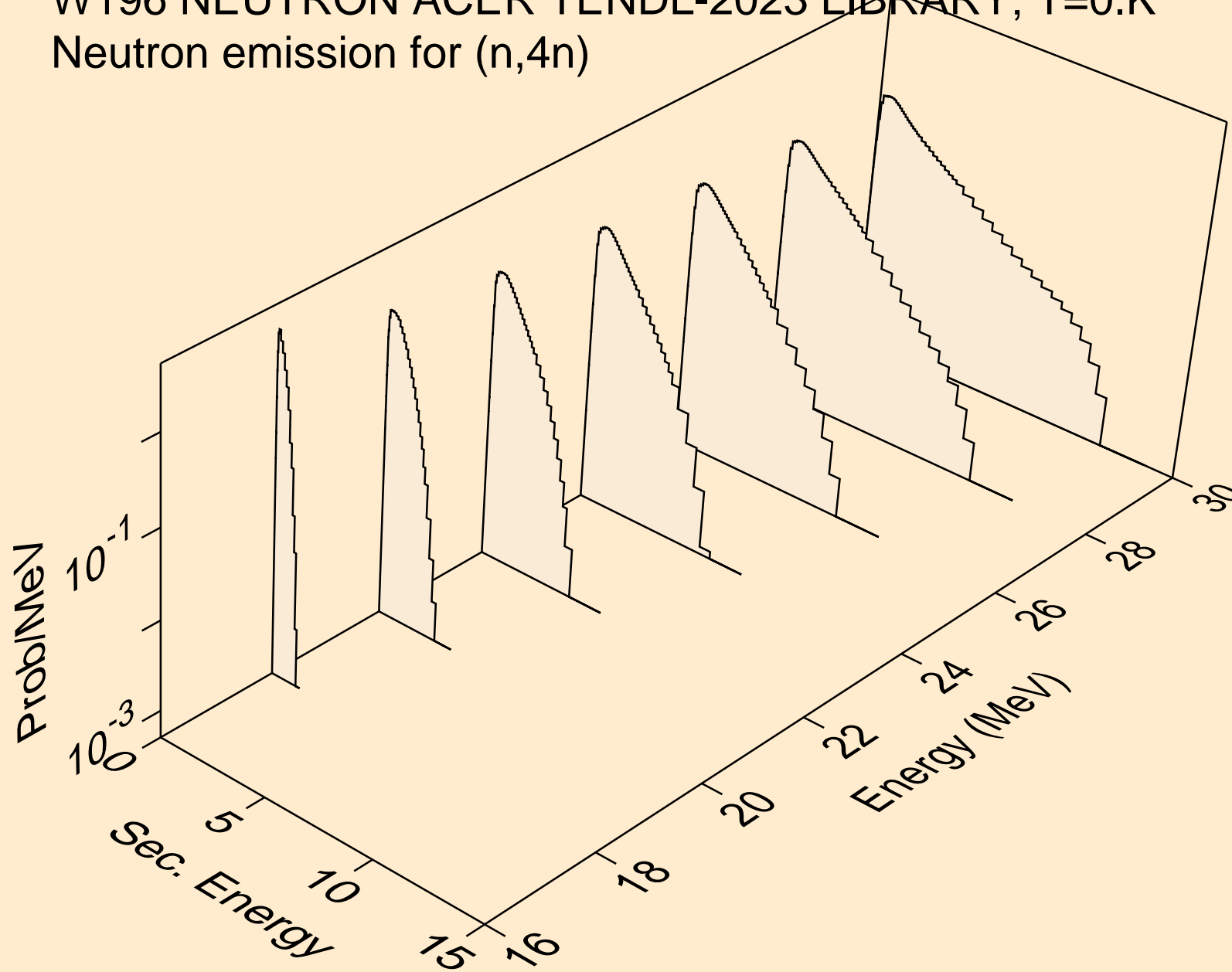

W196 NEUTRON ACER TENDL-2023 LIBRARY; T=0.K
Neutron emission for (n,2np)

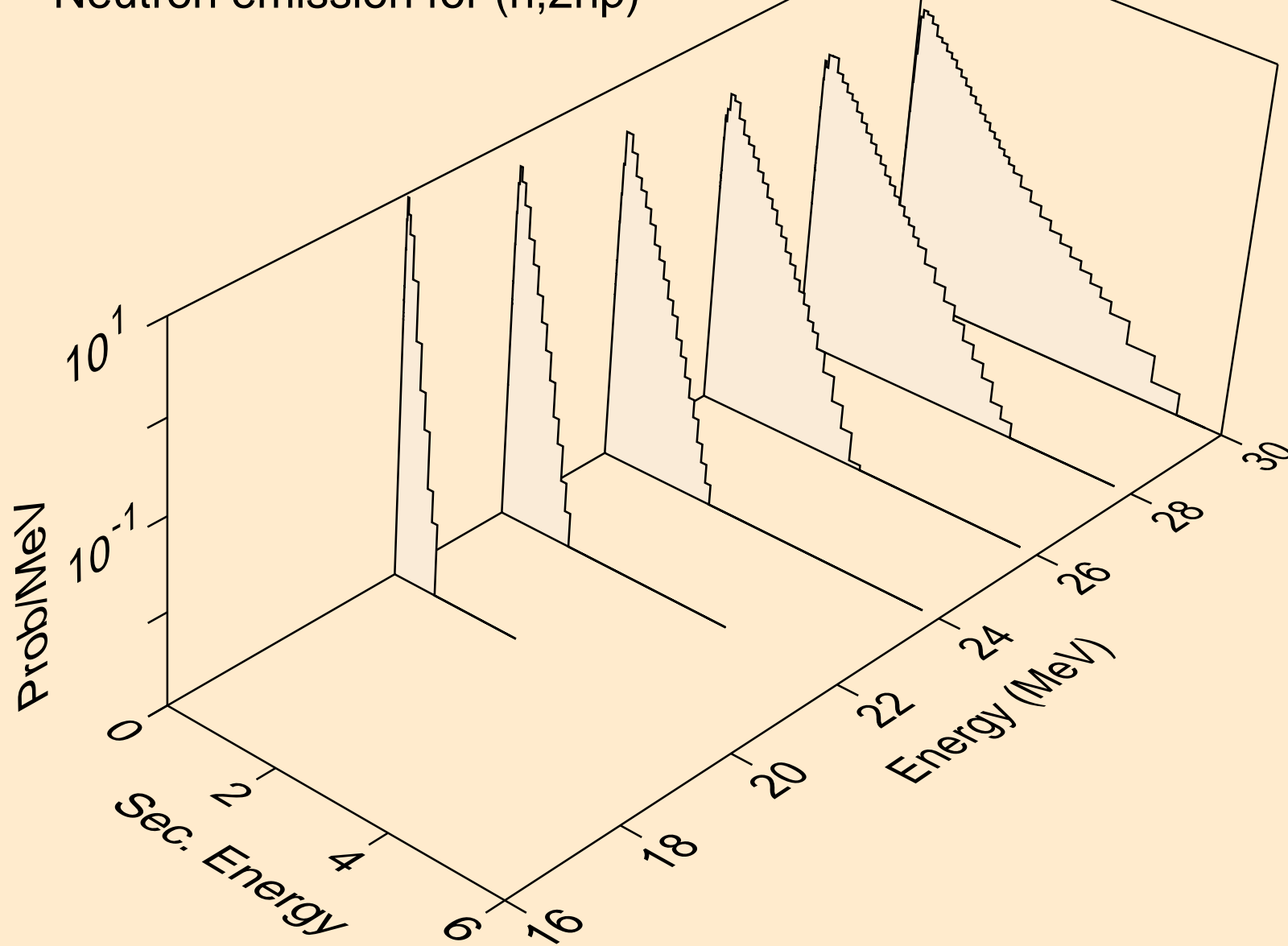

W196 NEUTRON ACER TENDL-2023 LIBRARY; T=0.K
Neutron emission for (n,3np)

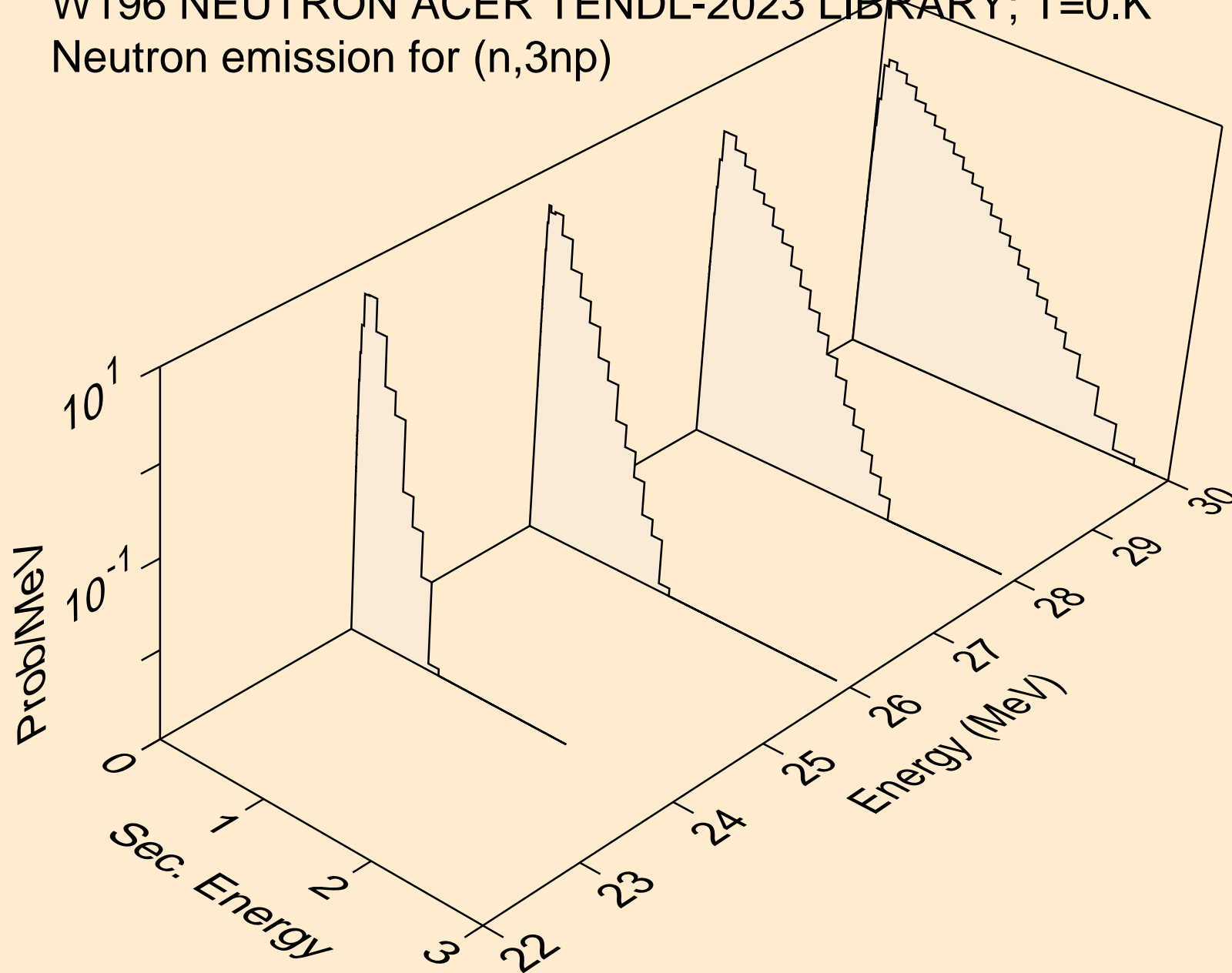

W196 NEUTRON ACER TENDL-2023 LIBRARY; T=0.K
Neutron emission for (n,n*c)

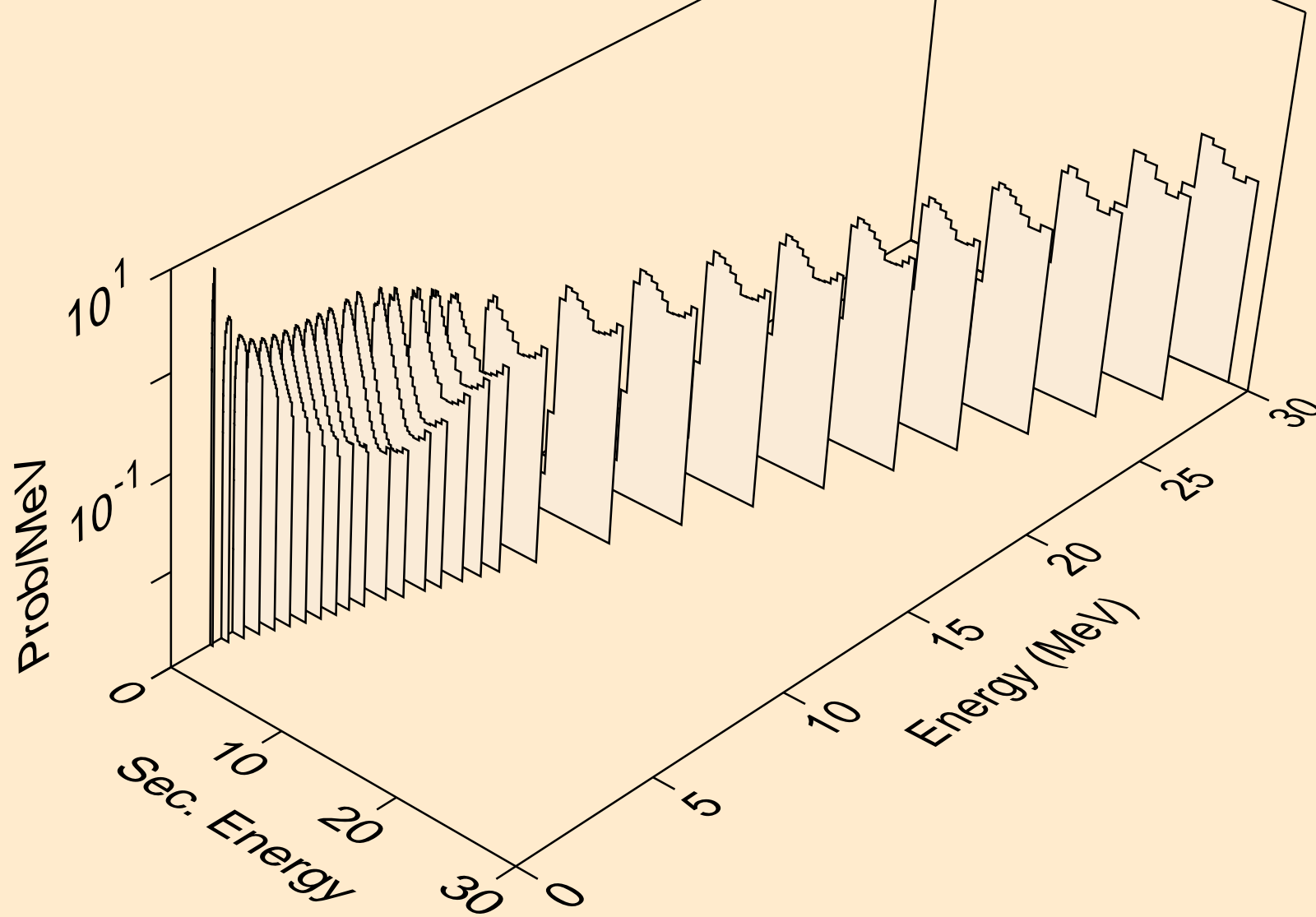

W196 NEUTRON ACER TENDL-2023 LIBRARY; T=0.K
Photon emission for (n,x)

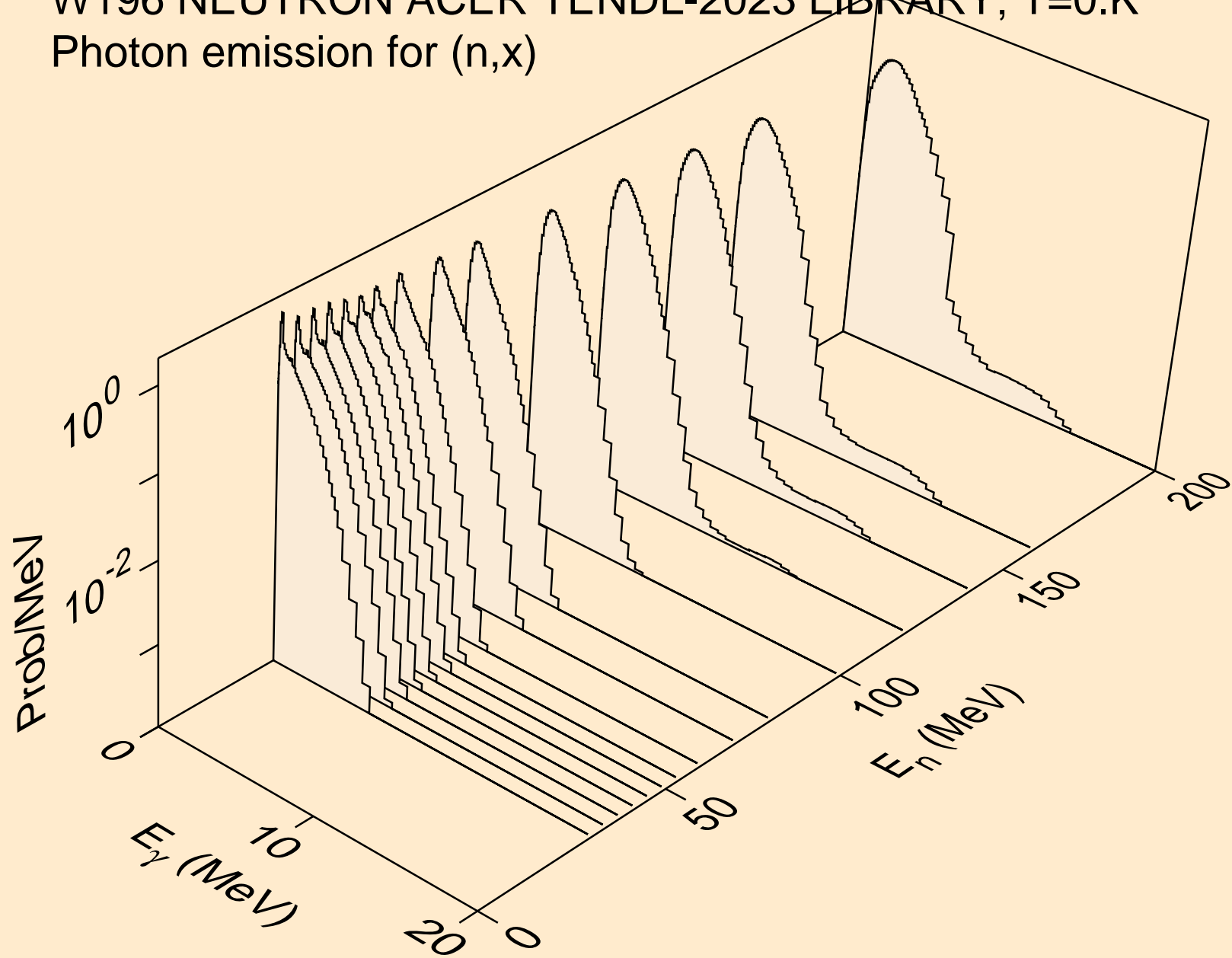

W196 NEUTRON ACER TENDL-2023 LIBRARY; T=0.K
Photon emission for (n,2nd)

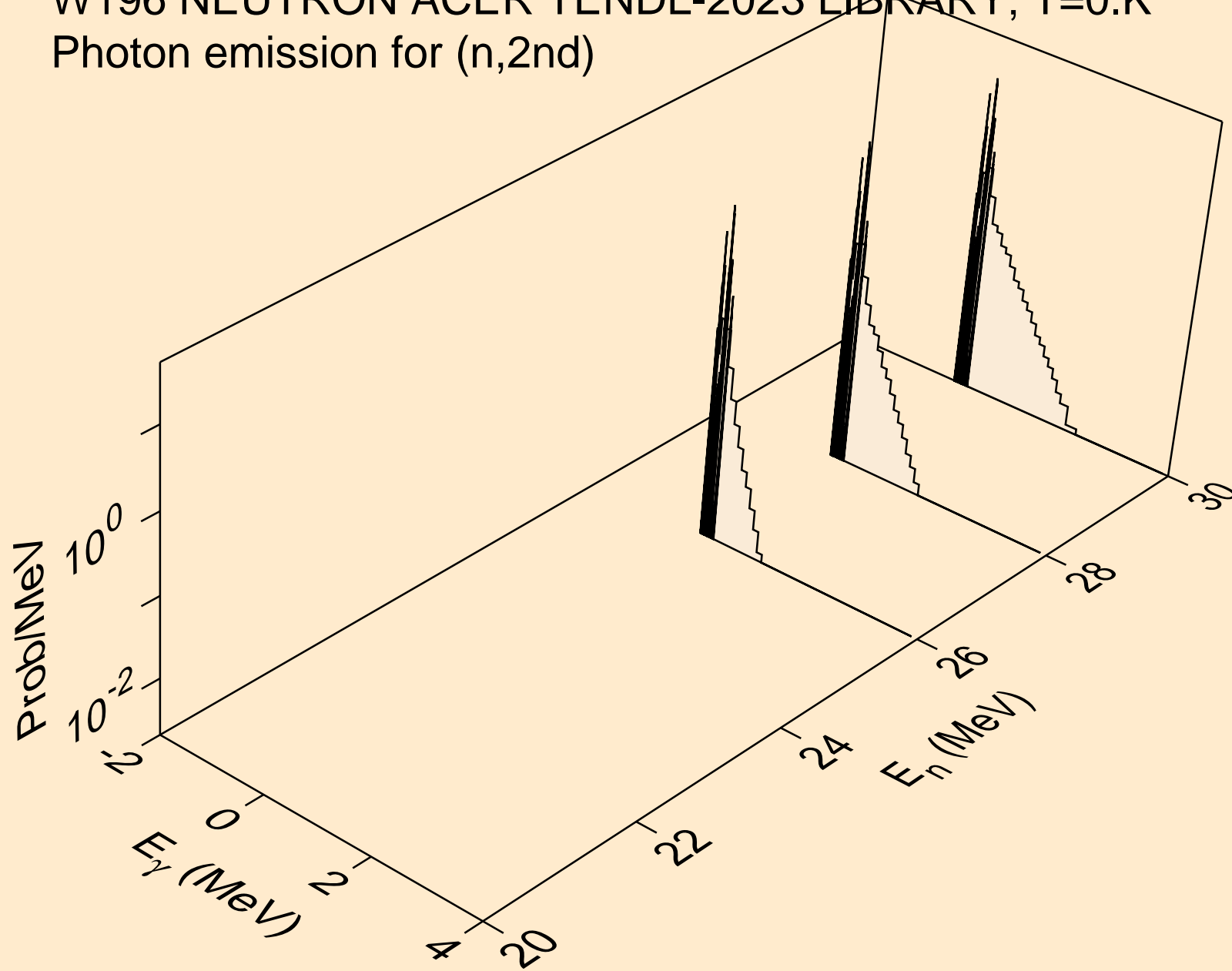

W196 NEUTRON ACER TENDL-2023 LIBRARY; T=0.K
Photon emission for (n,2n)

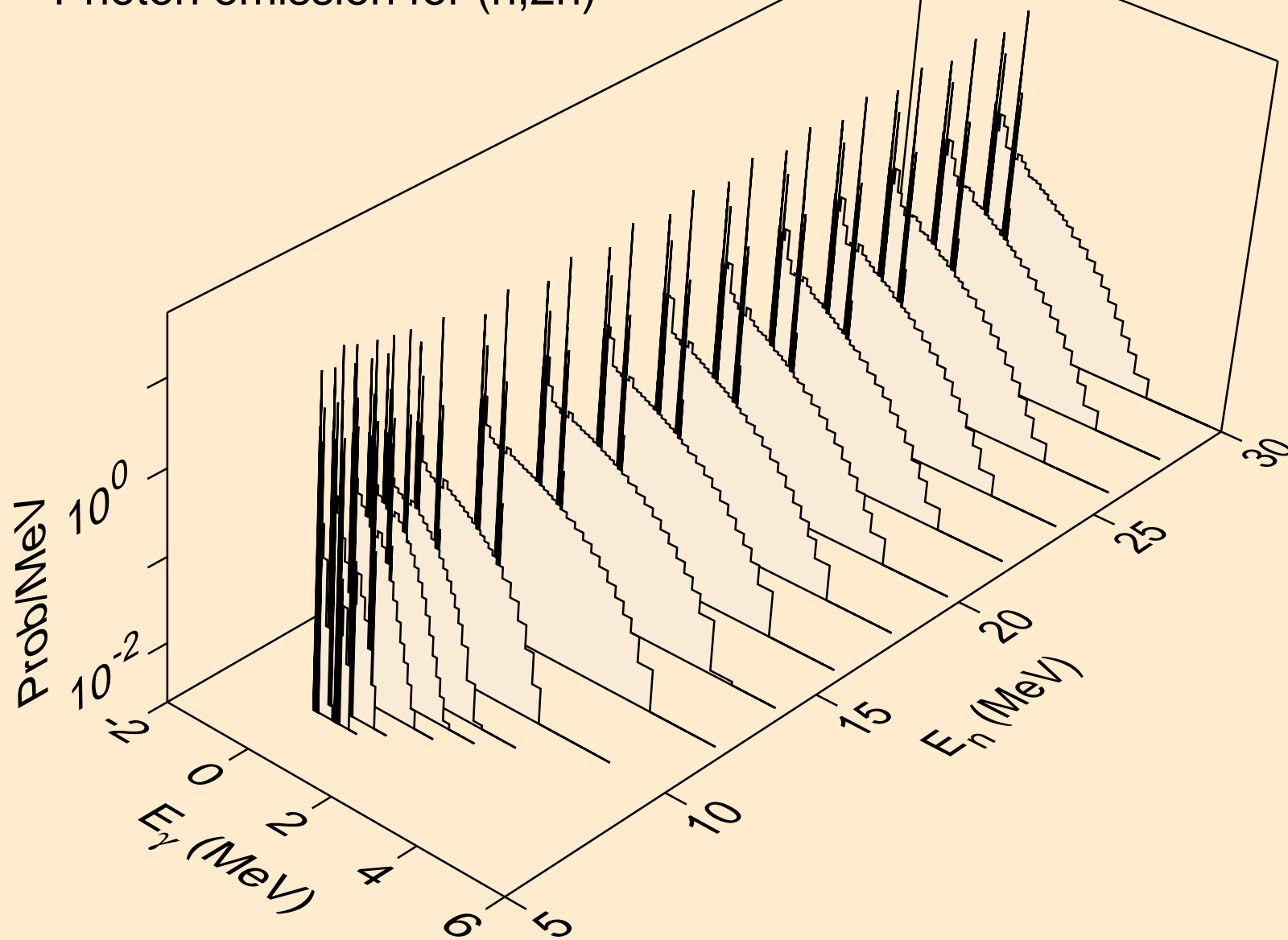

W196 NEUTRON ACER TENDL-2023 LIBRARY; T=0.K
Photon emission for (n,3n)

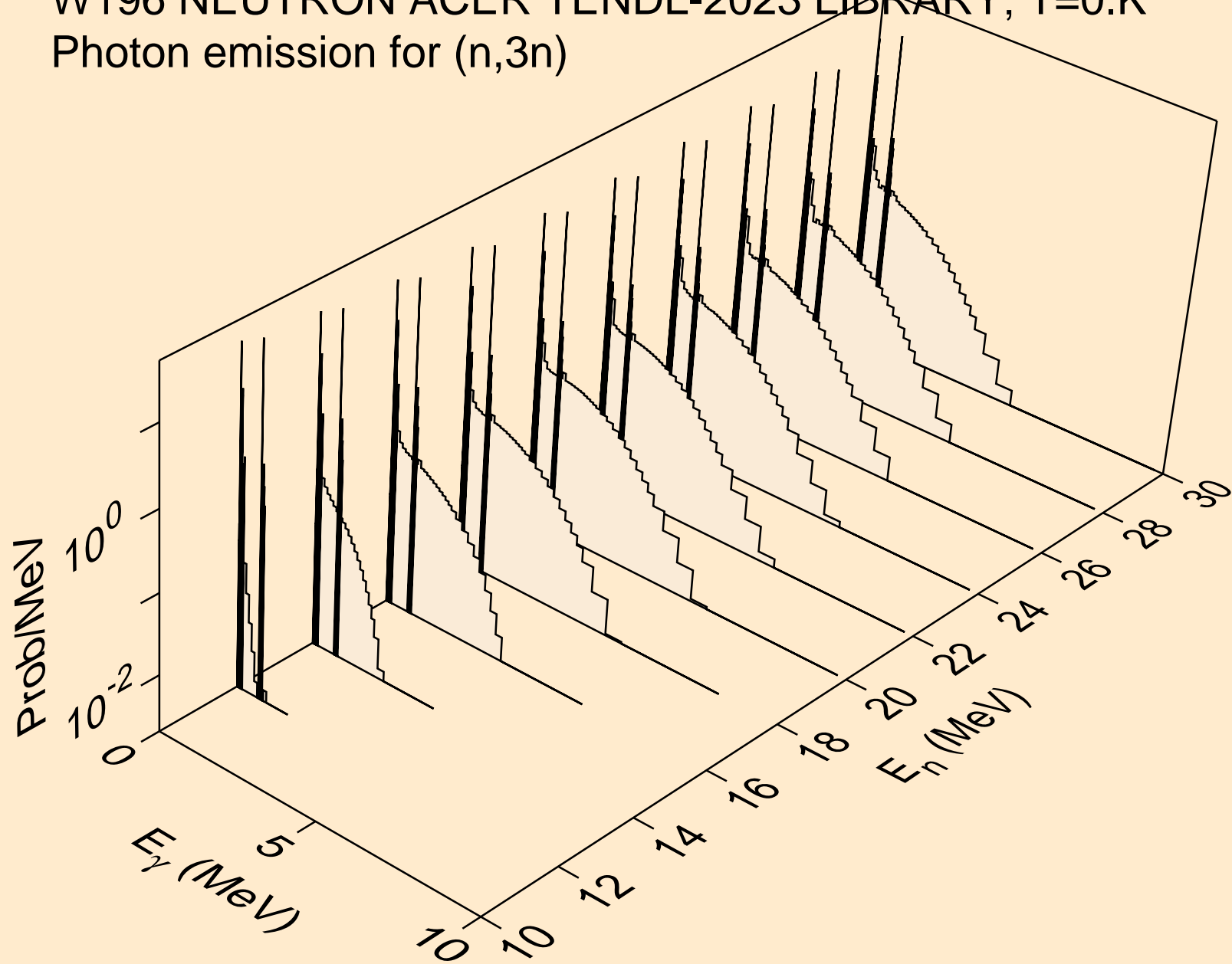

W196 NEUTRON ACER TENDL-2023 LIBRARY; T=0.K
Photon emission for (n,n*)a

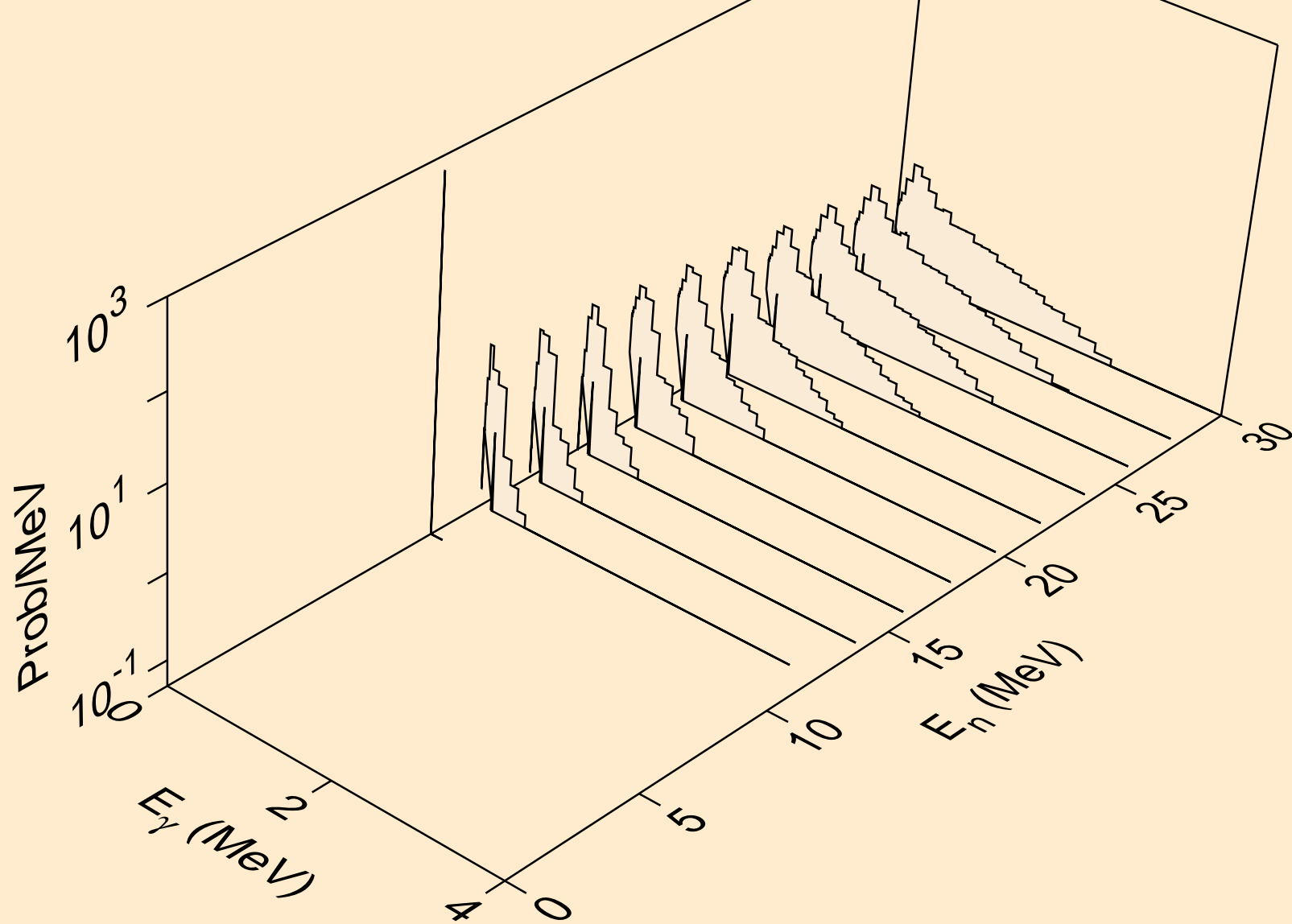

W196 NEUTRON ACER TENDL-2023 LIBRARY; T=0.K
Photon emission for (n,2n)a

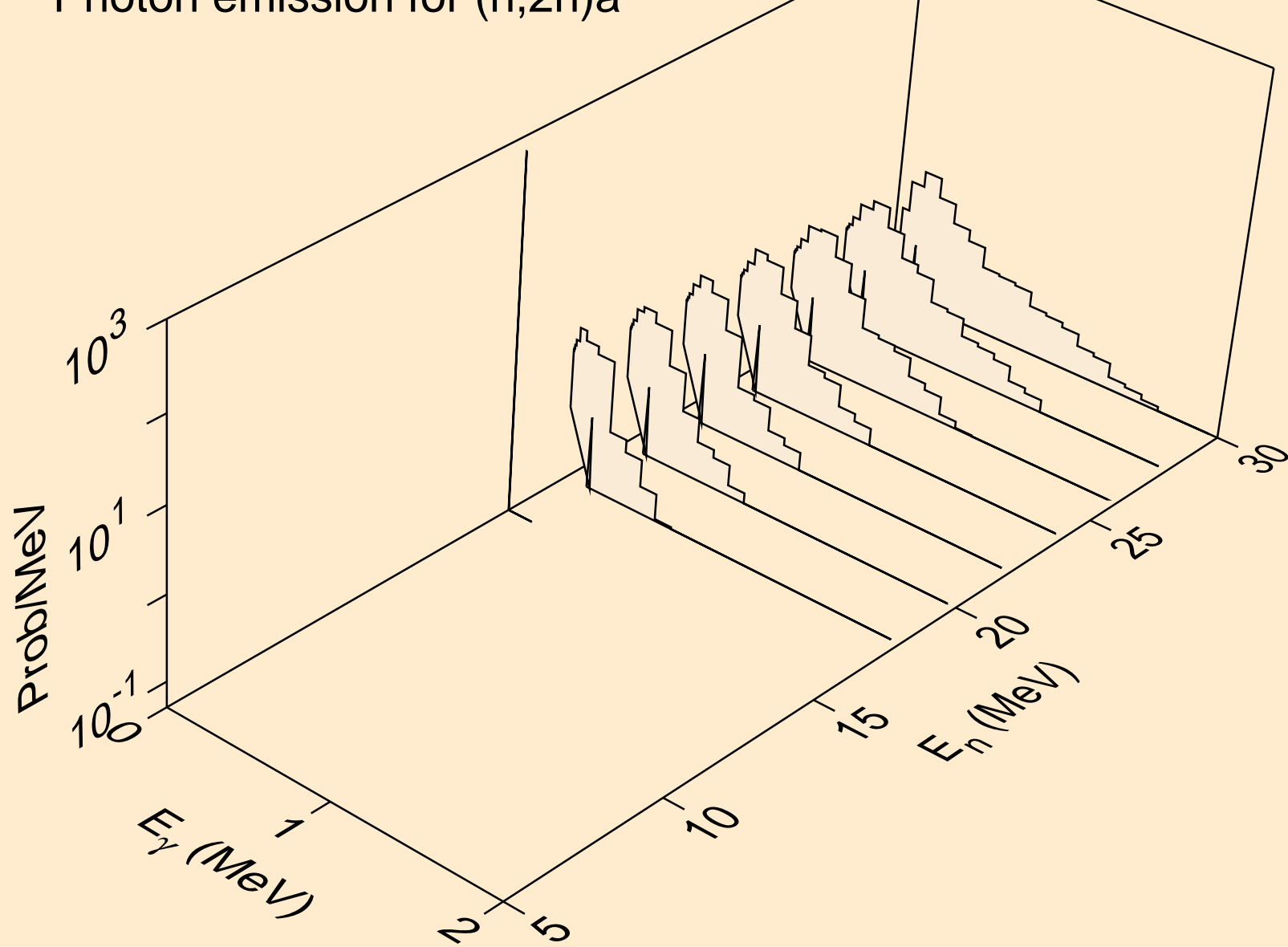

W196 NEUTRON ACER TENDL-2023 LIBRARY; T=0.K
Photon emission for (n,3n)a

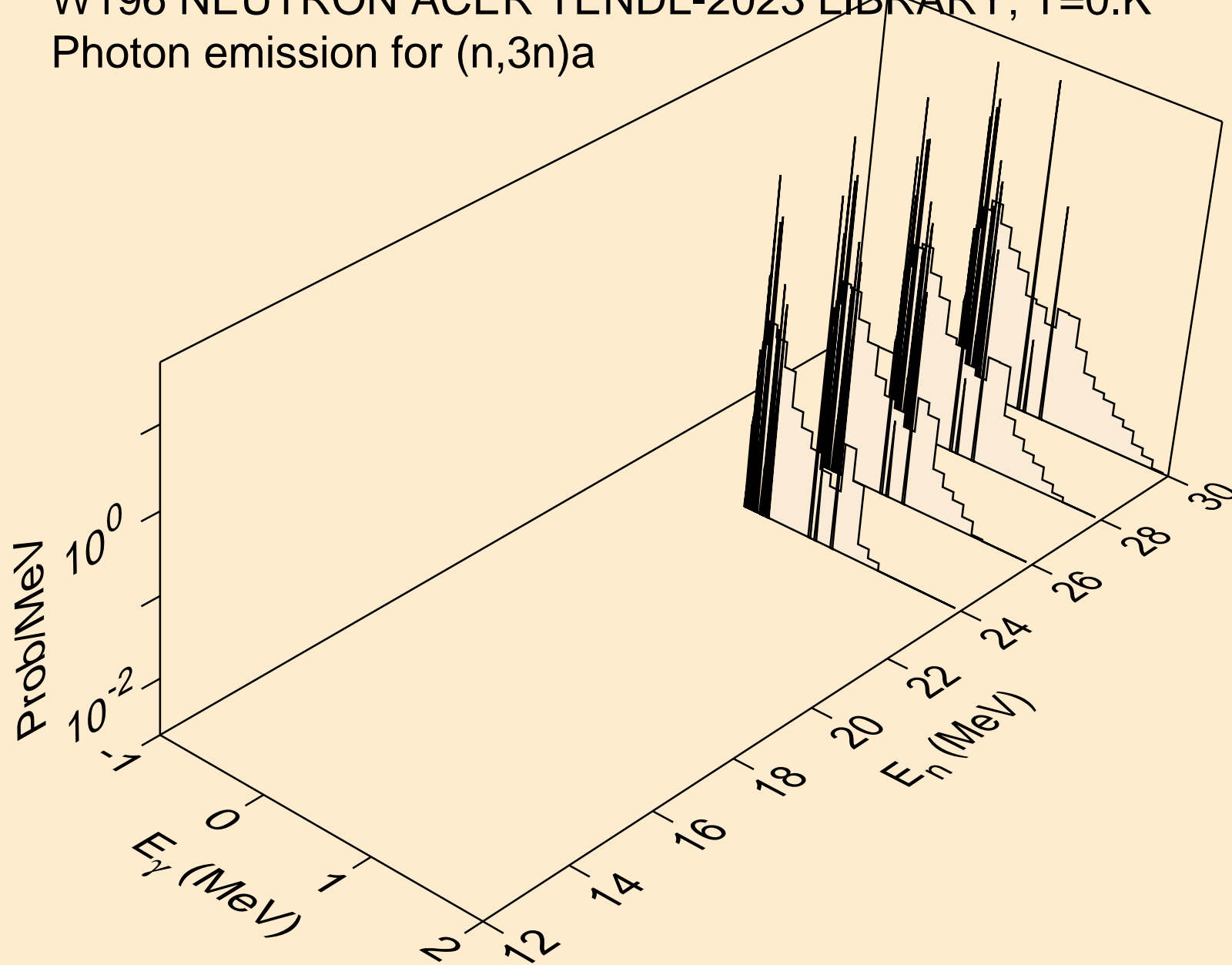

W196 NEUTRON ACER TENDL-2023 LIBRARY; T=0.K
Photon emission for (n,n*)p

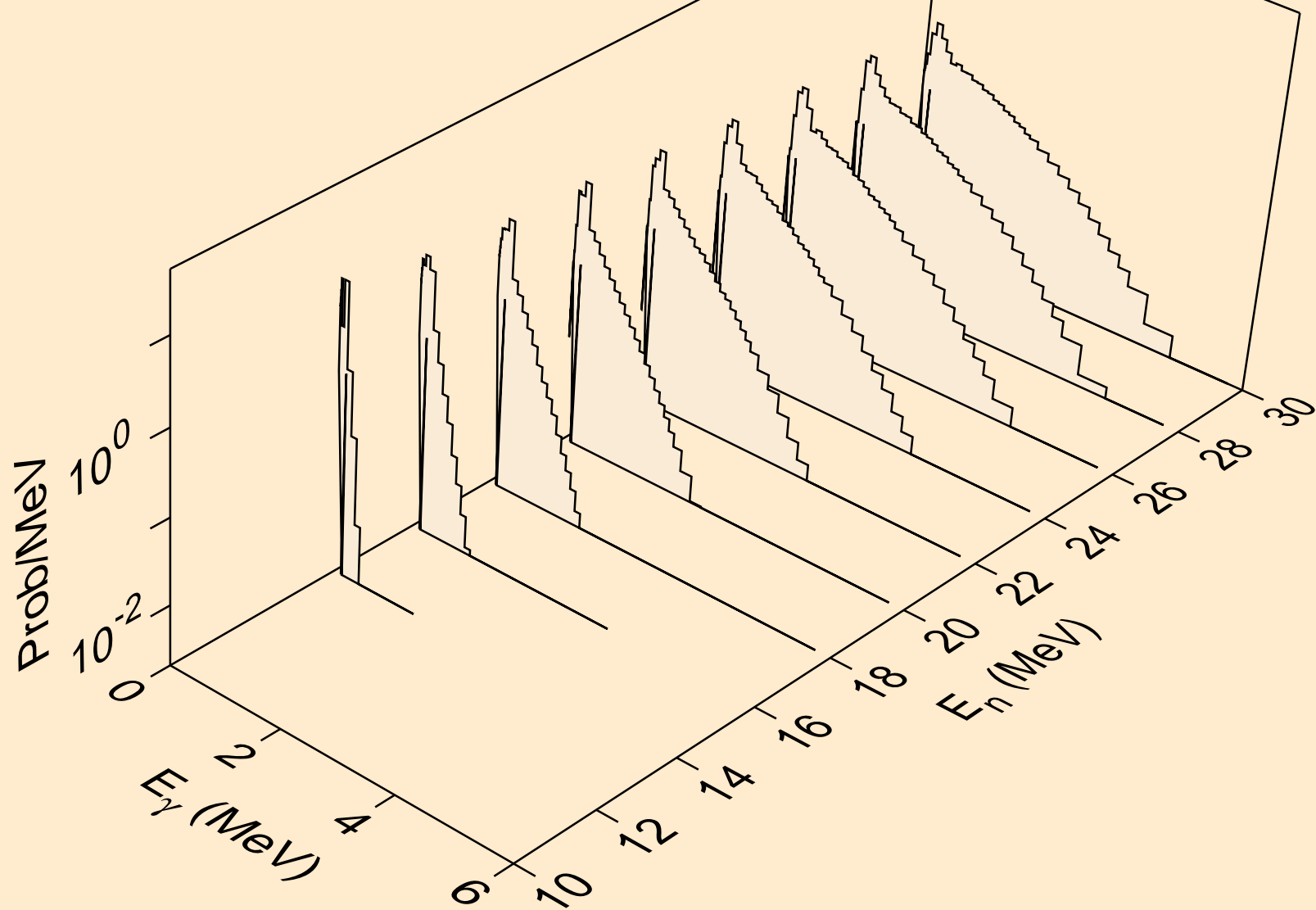

W196 NEUTRON ACER TENDL-2023 LIBRARY; T=0.K
Photon emission for (n,n*)d

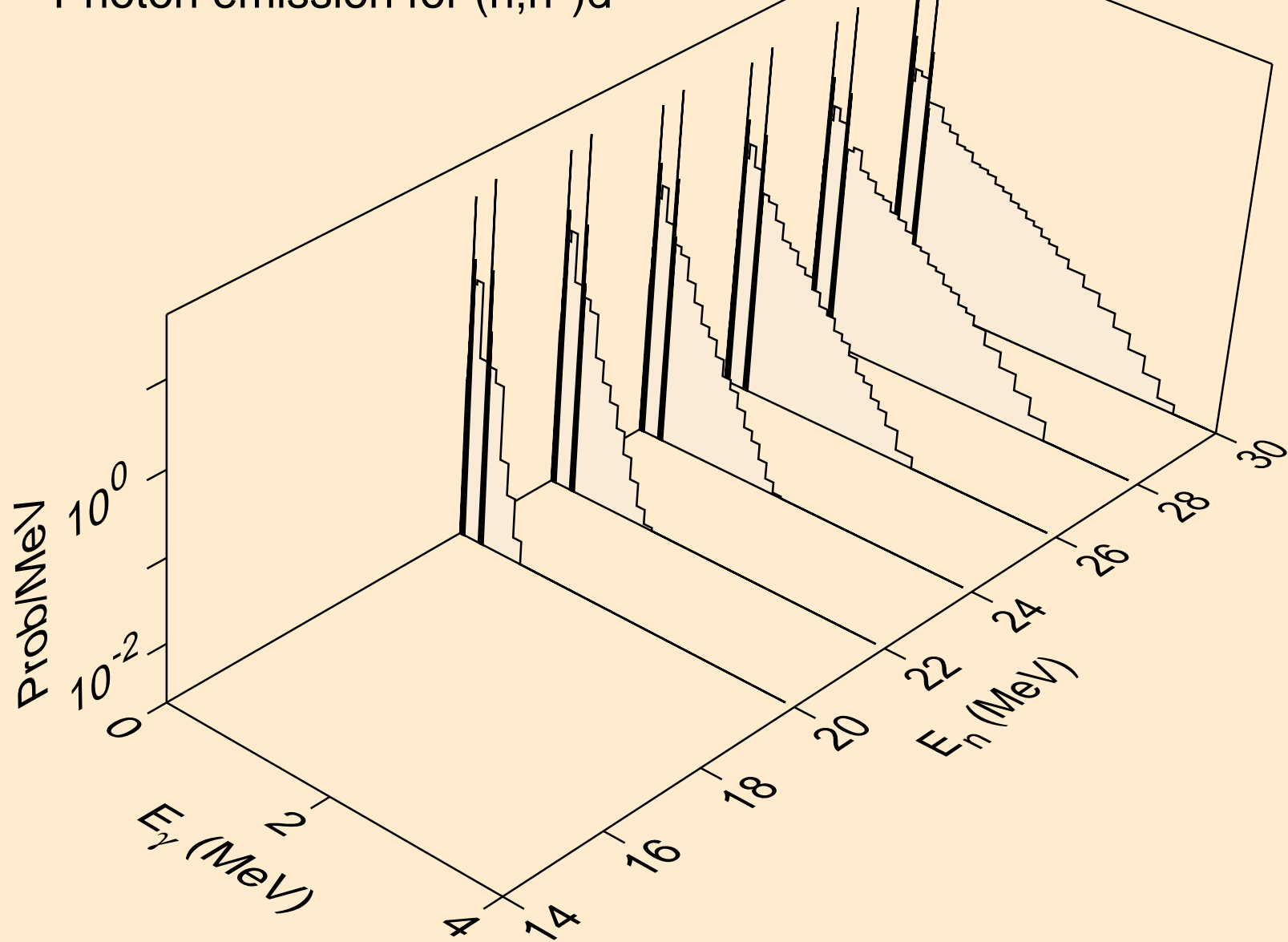

W196 NEUTRON ACER TENDL-2023 LIBRARY; T=0.K
Photon emission for (n,n*)t

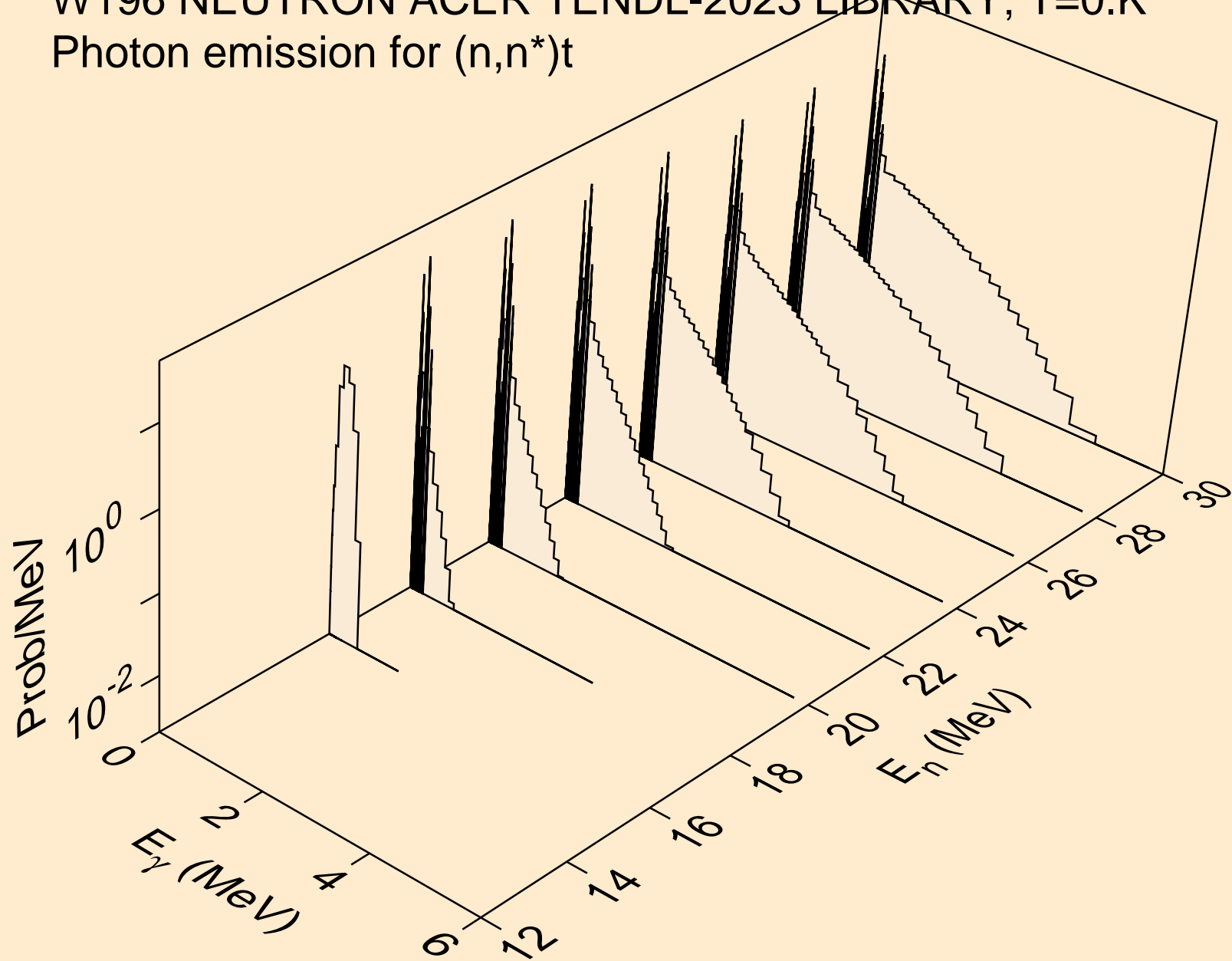

W196 NEUTRON ACER TENDL-2023 LIBRARY; T=0.K
Photon emission for (n,4n)

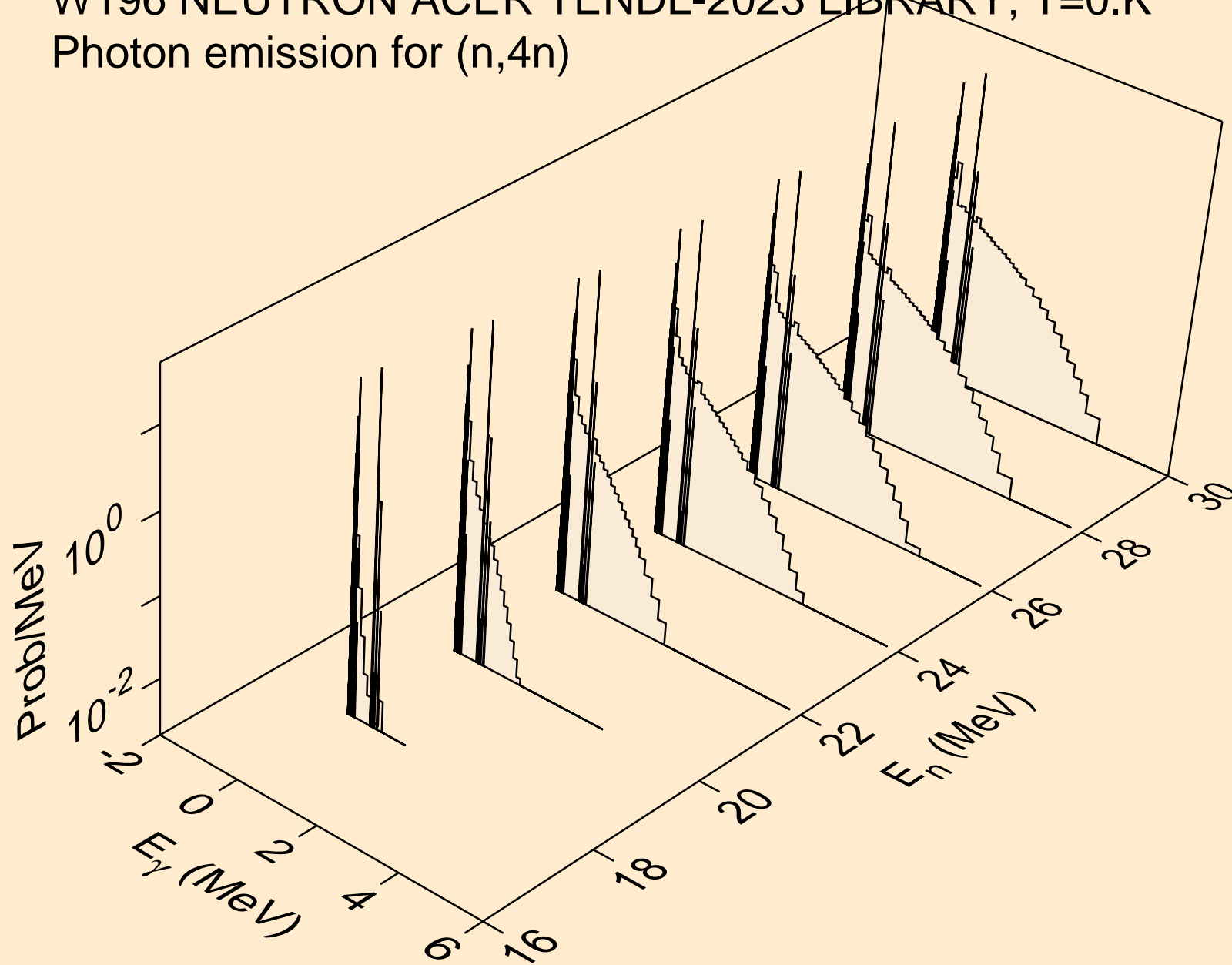

W196 NEUTRON ACER TENDL-2023 LIBRARY; T=0.K
Photon emission for (n,2np)

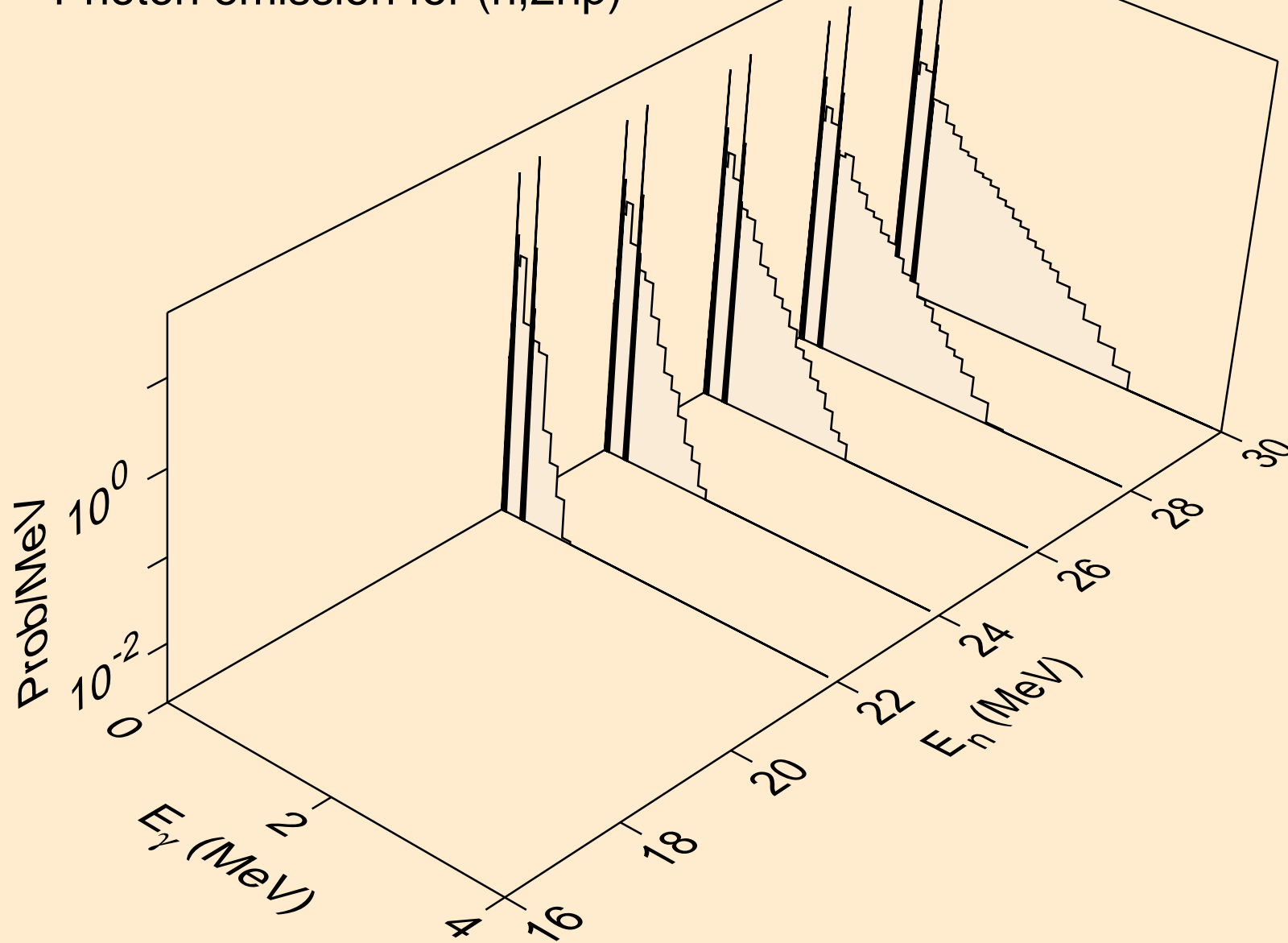

W196 NEUTRON ACER TENDL-2023 LIBRARY; T=0.K
Photon emission for (n,3np)

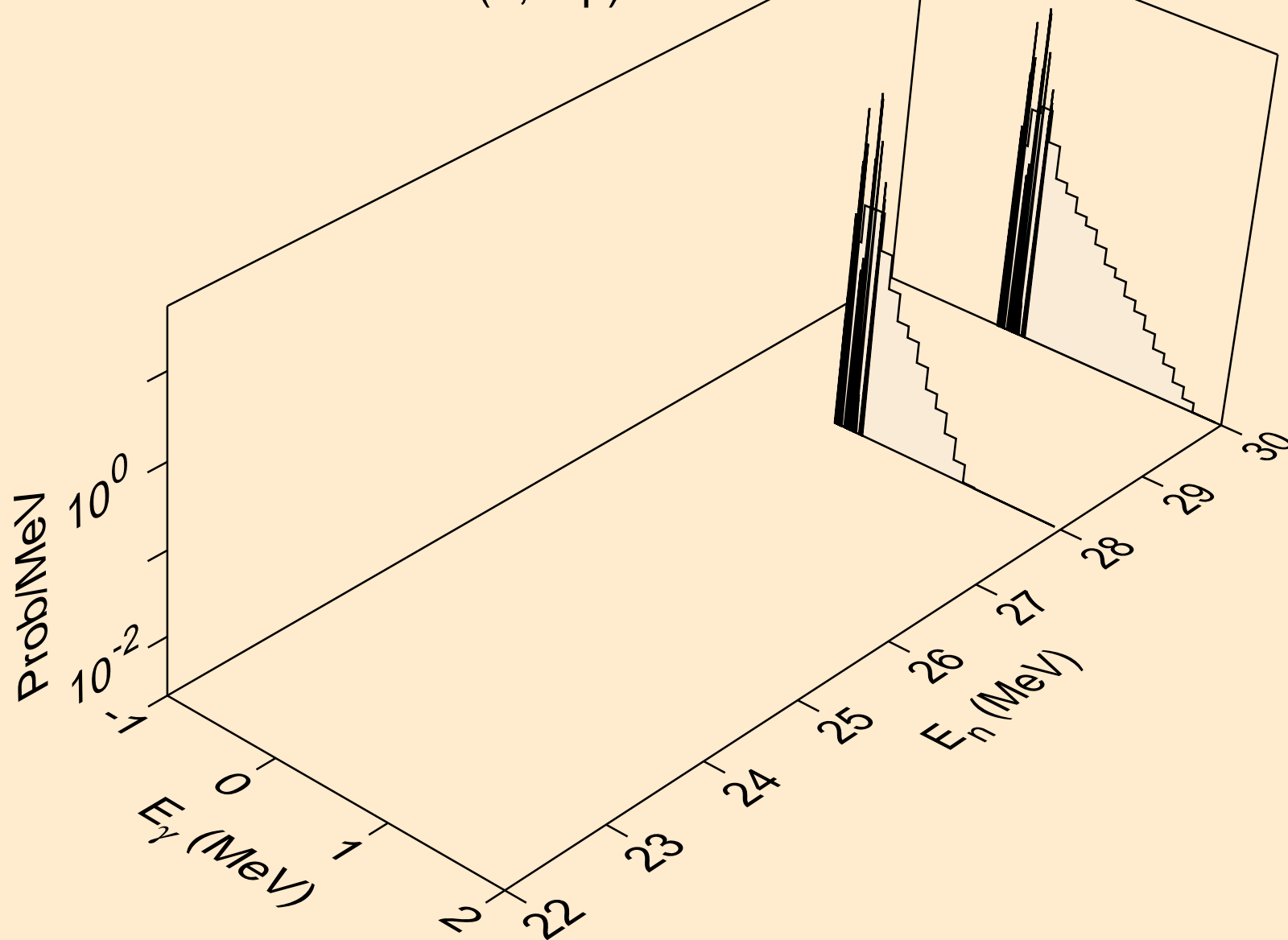

W196 NEUTRON ACER TENDL-2023 LIBRARY; T=0.K
Photon emission for (n,n*c)

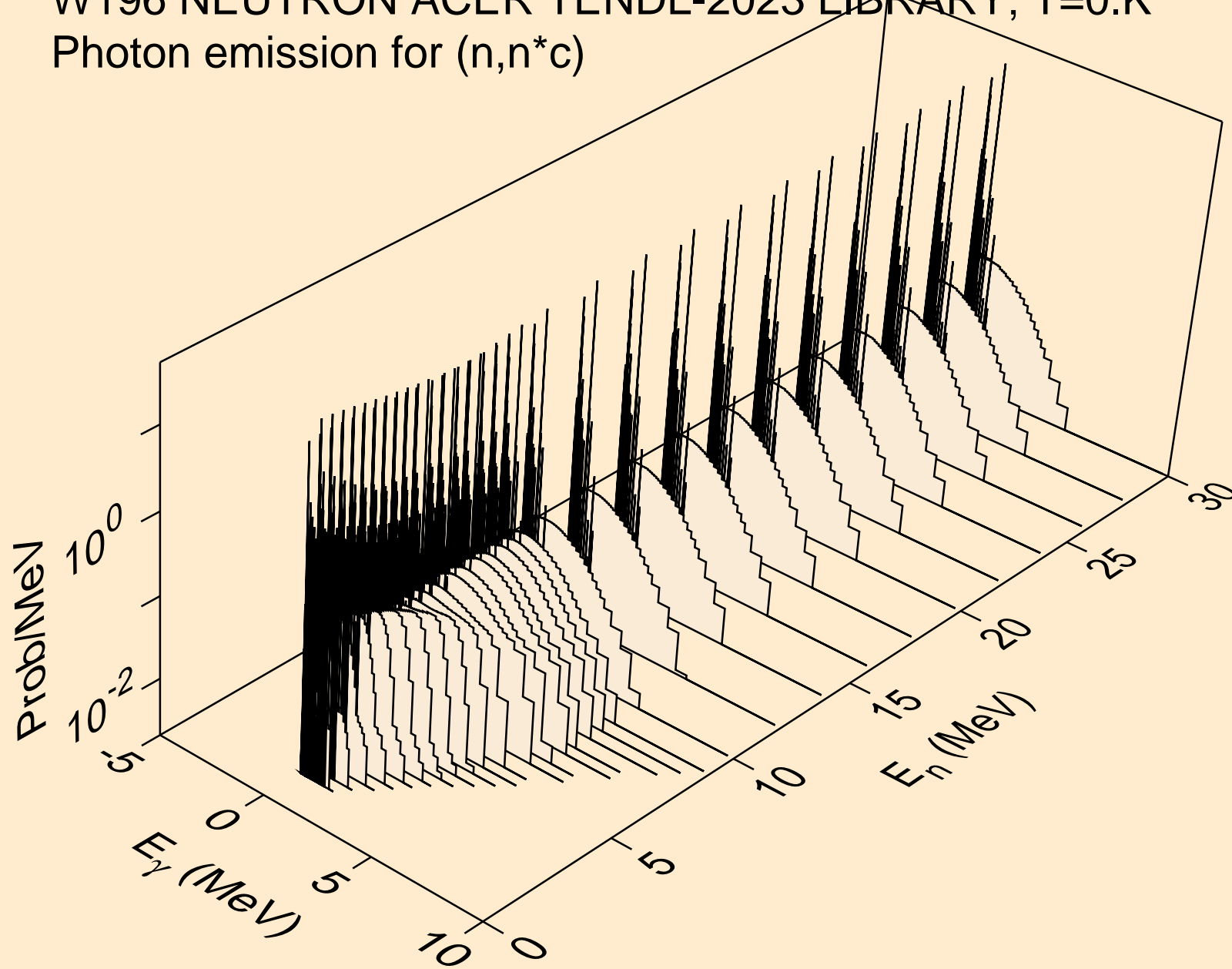

W196 NEUTRON ACER TENDL-2023 LIBRARY; T=0.K
Photon emission for (n,gma)

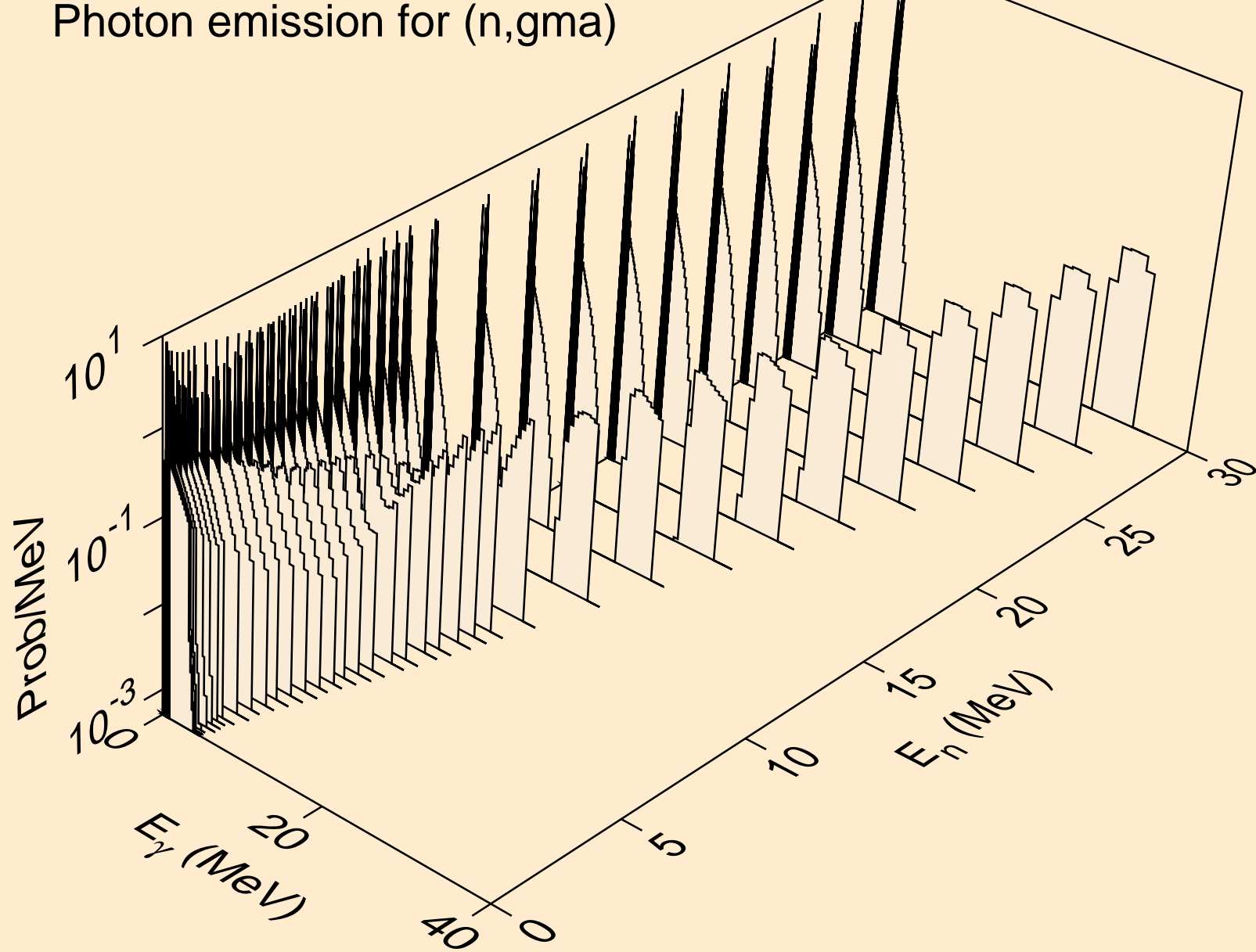

W196 NEUTRON ACER TENDL-2023 LIBRARY; T=0.K
Photon emission for (n,p)

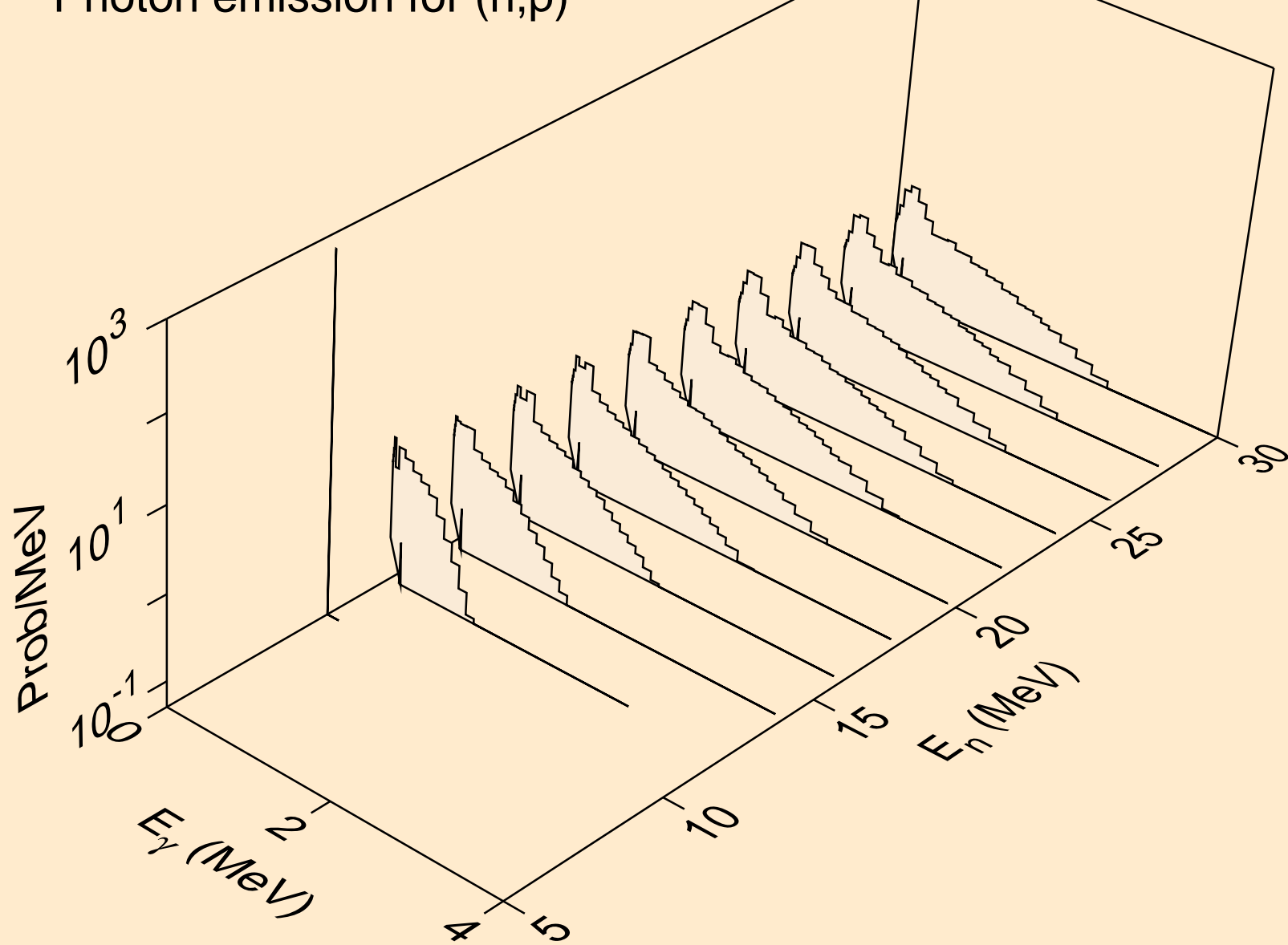

W196 NEUTRON ACER TENDL-2023 LIBRARY; T=0.K
Photon emission for (n,d)

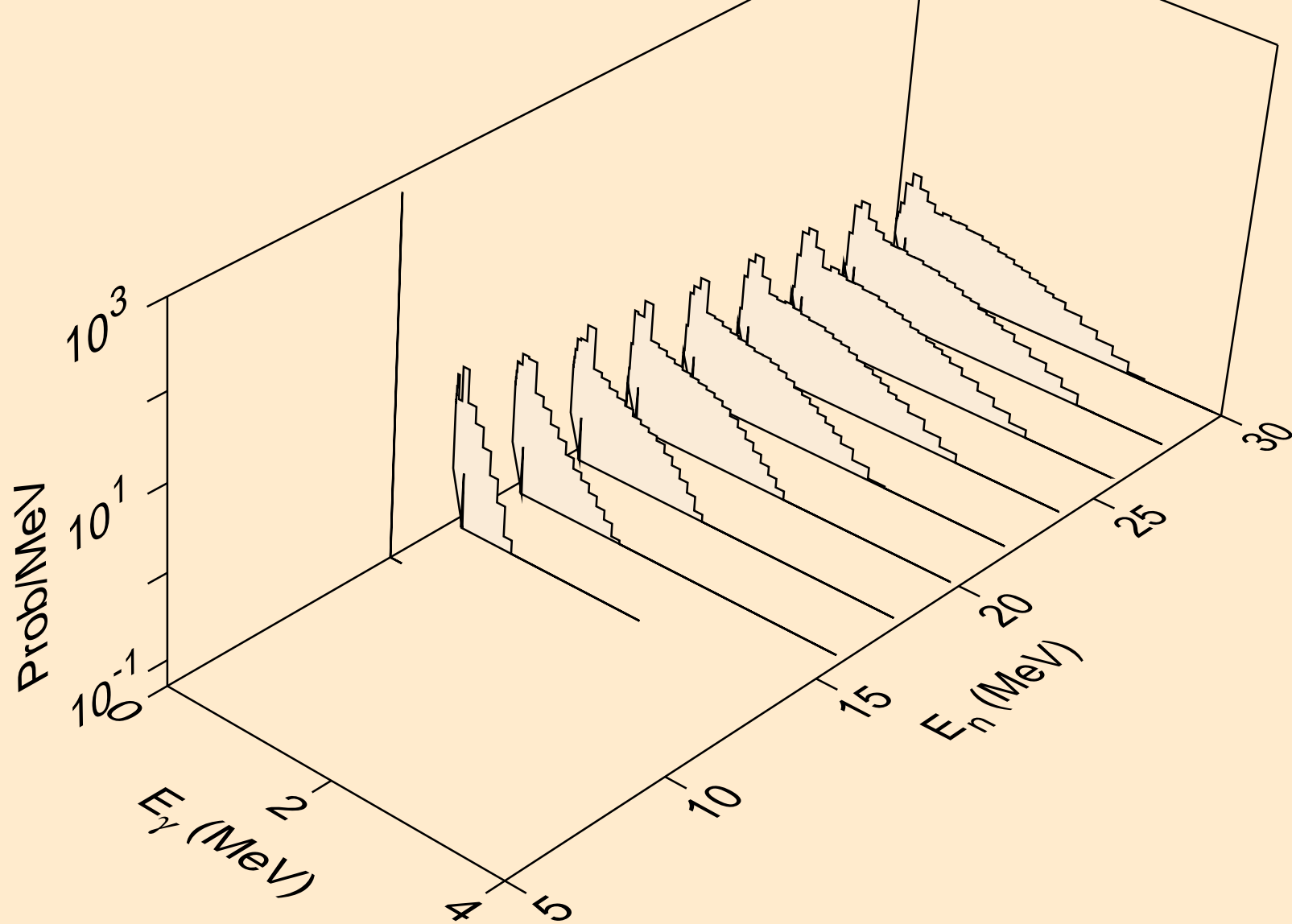

W196 NEUTRON ACER TENDL-2023 LIBRARY; T=0.K
Photon emission for (n,t)

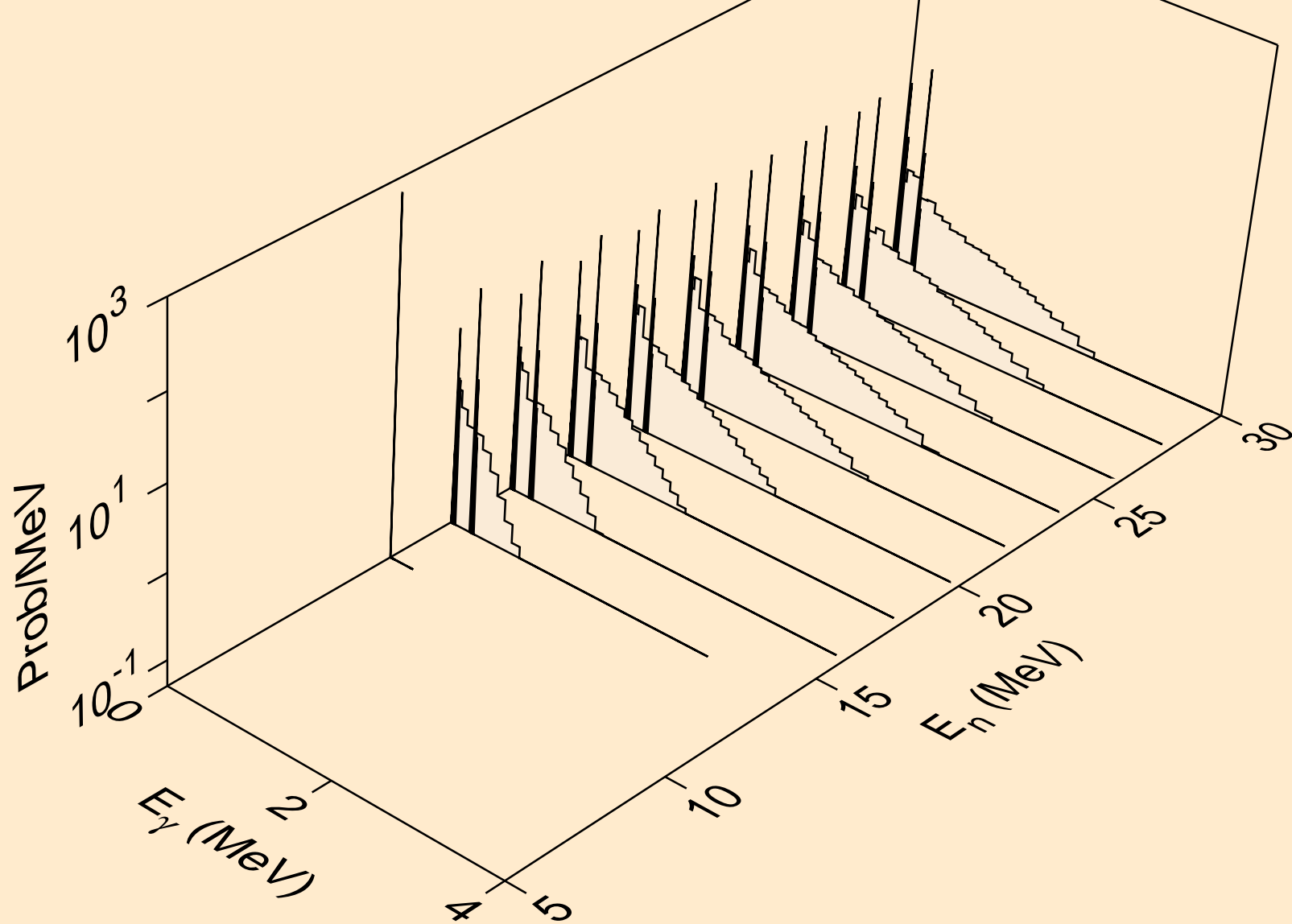

W196 NEUTRON ACER TENDL-2023 LIBRARY; T=0.K
Photon emission for (n,he3)

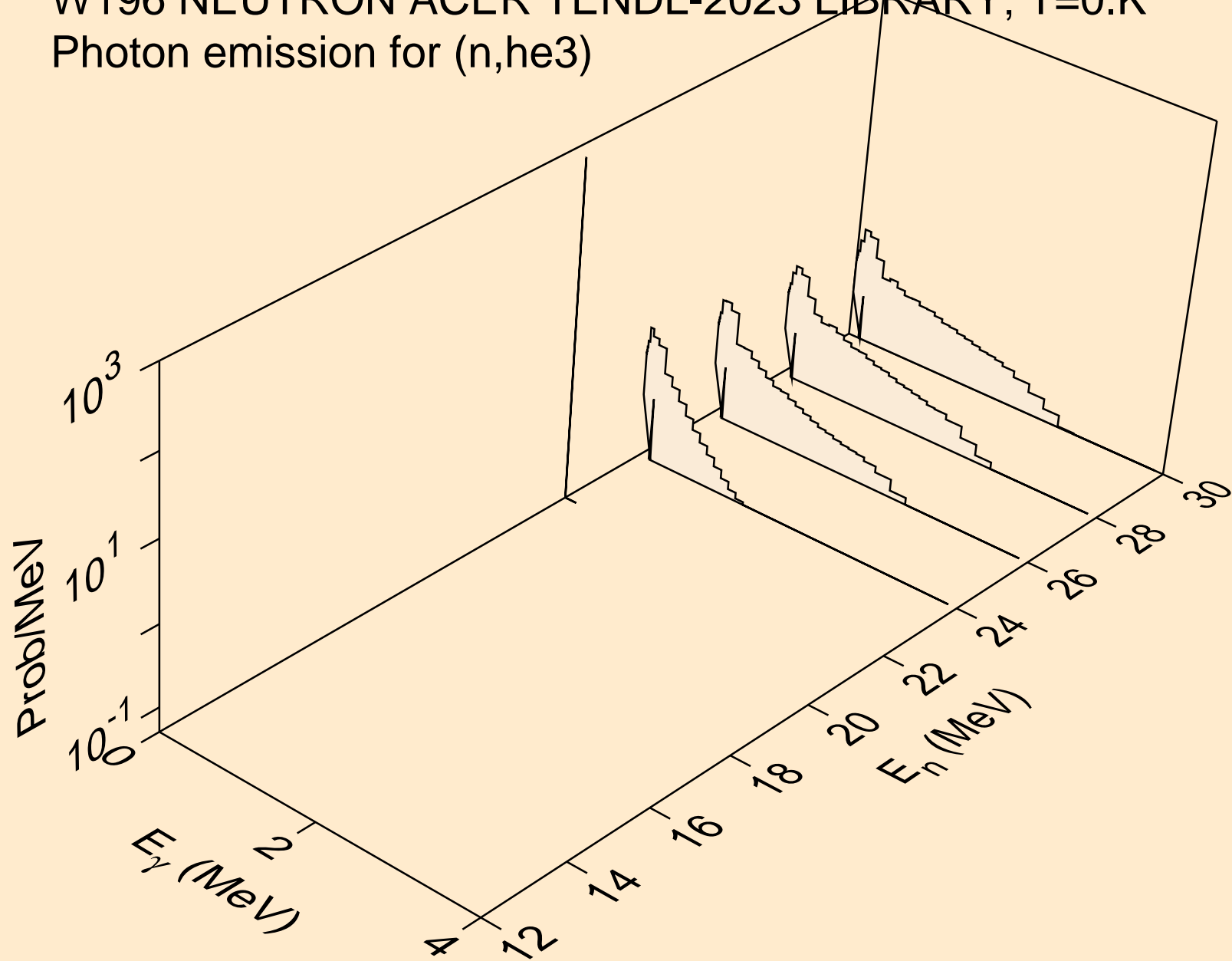

W196 NEUTRON ACER TENDL-2023 LIBRARY; T=0.K
Photon emission for (n,a)

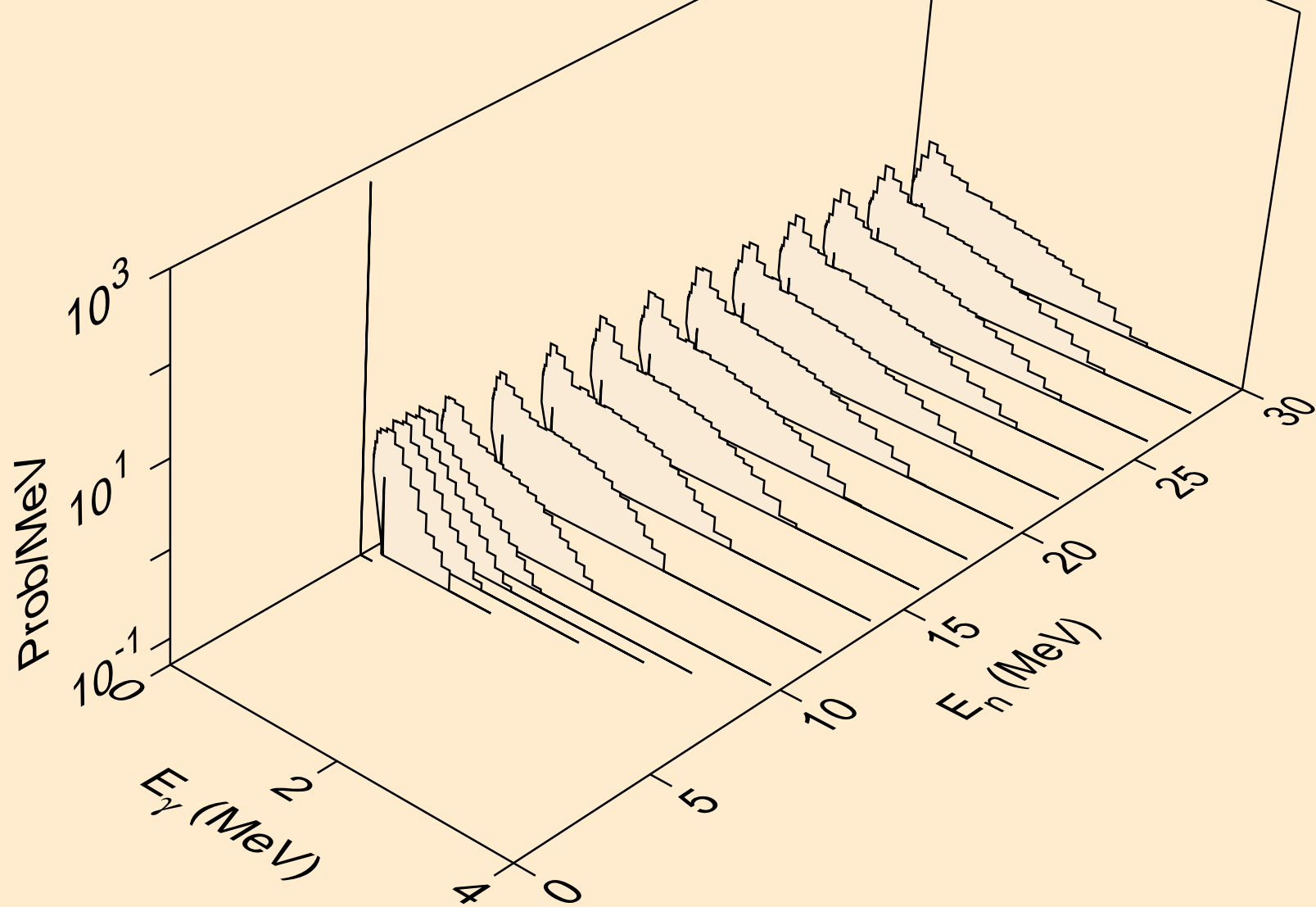

W196 NEUTRON ACER TENDL-2023 LIBRARY; T=0.K
thermal capture photon spectrum

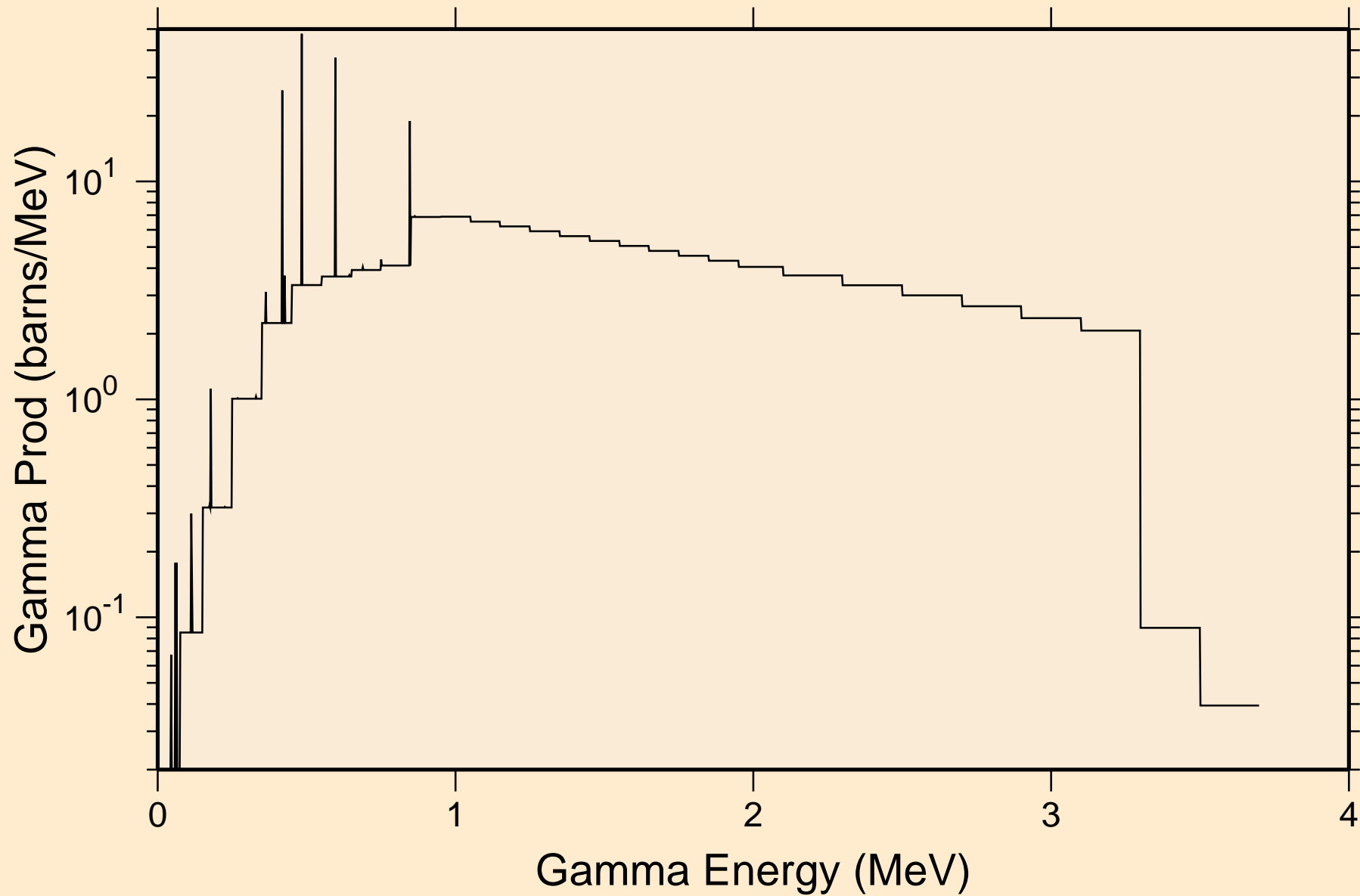

W196 NEUTRON ACER TENDL-2023 LIBRARY; T=0.K
14 MeV photon spectrum

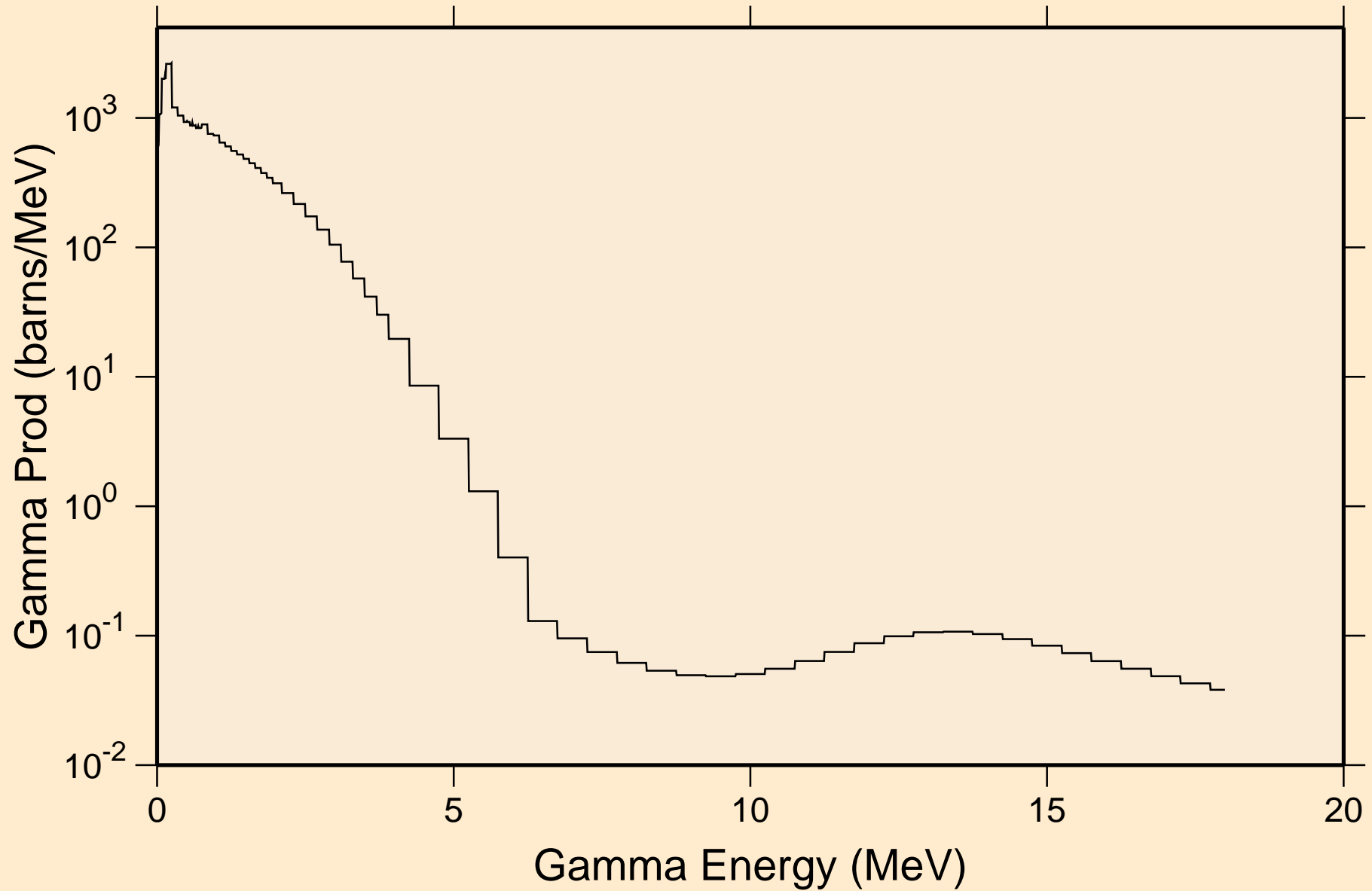

W196 NEUTRON ACER TENDL-2023 LIBRARY; T=0.K
Particle heating contributions

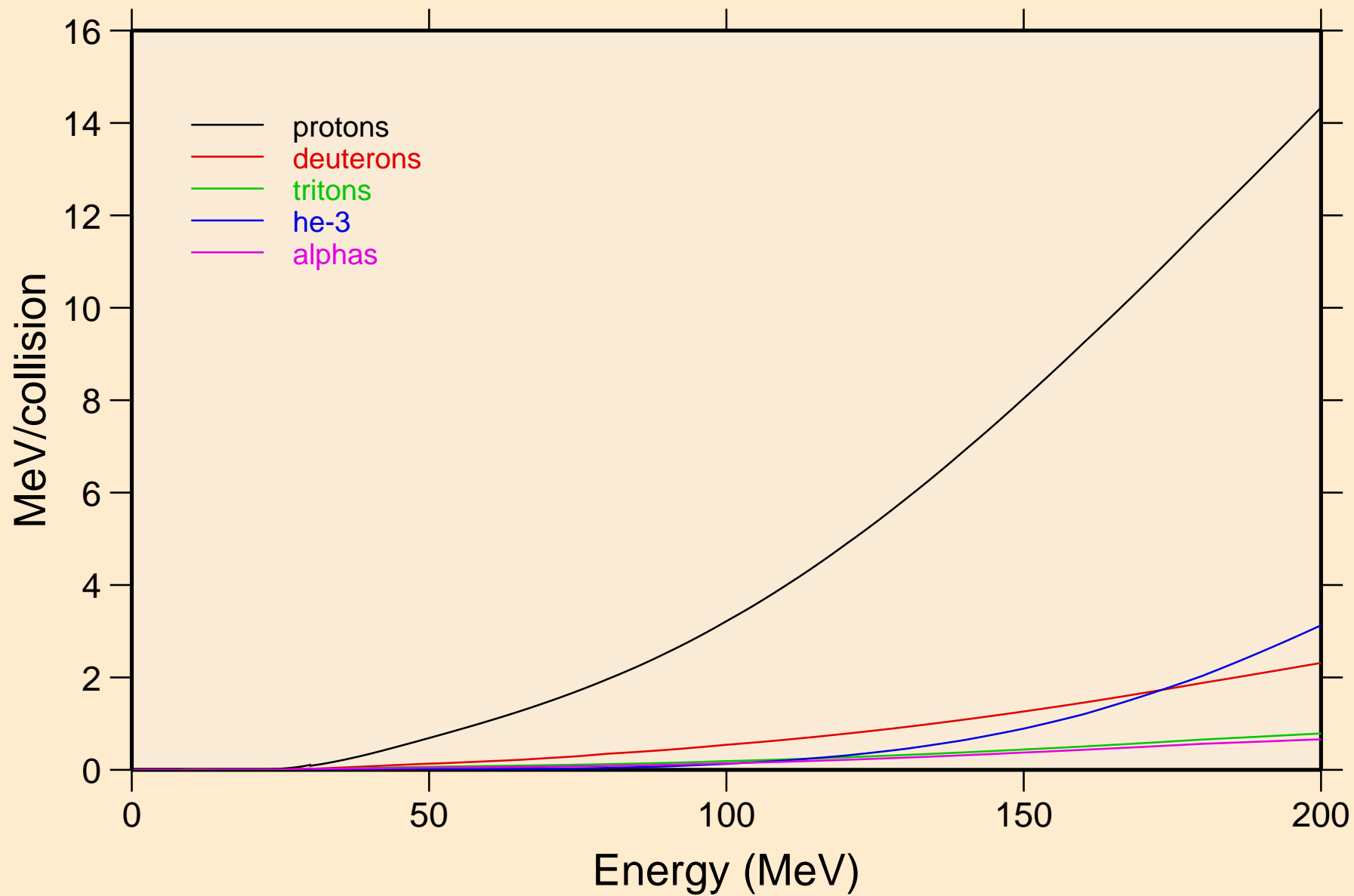

W196 NEUTRON ACER TENDL-2023 LIBRARY; T=0.K
Recoil Heating

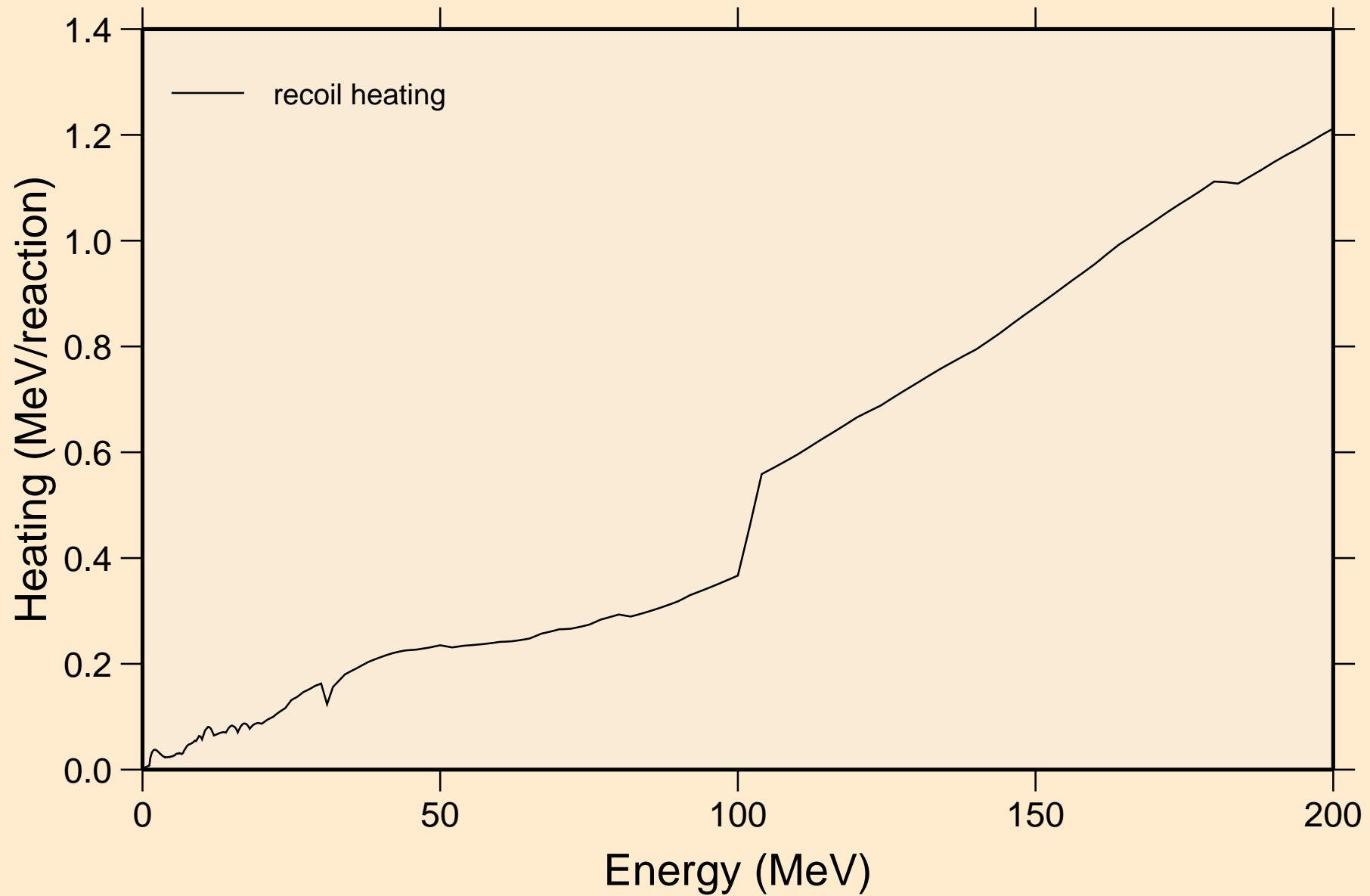

W196 NEUTRON ACER TENDL-2023 LIBRARY; T=0.K
Particle production cross sections

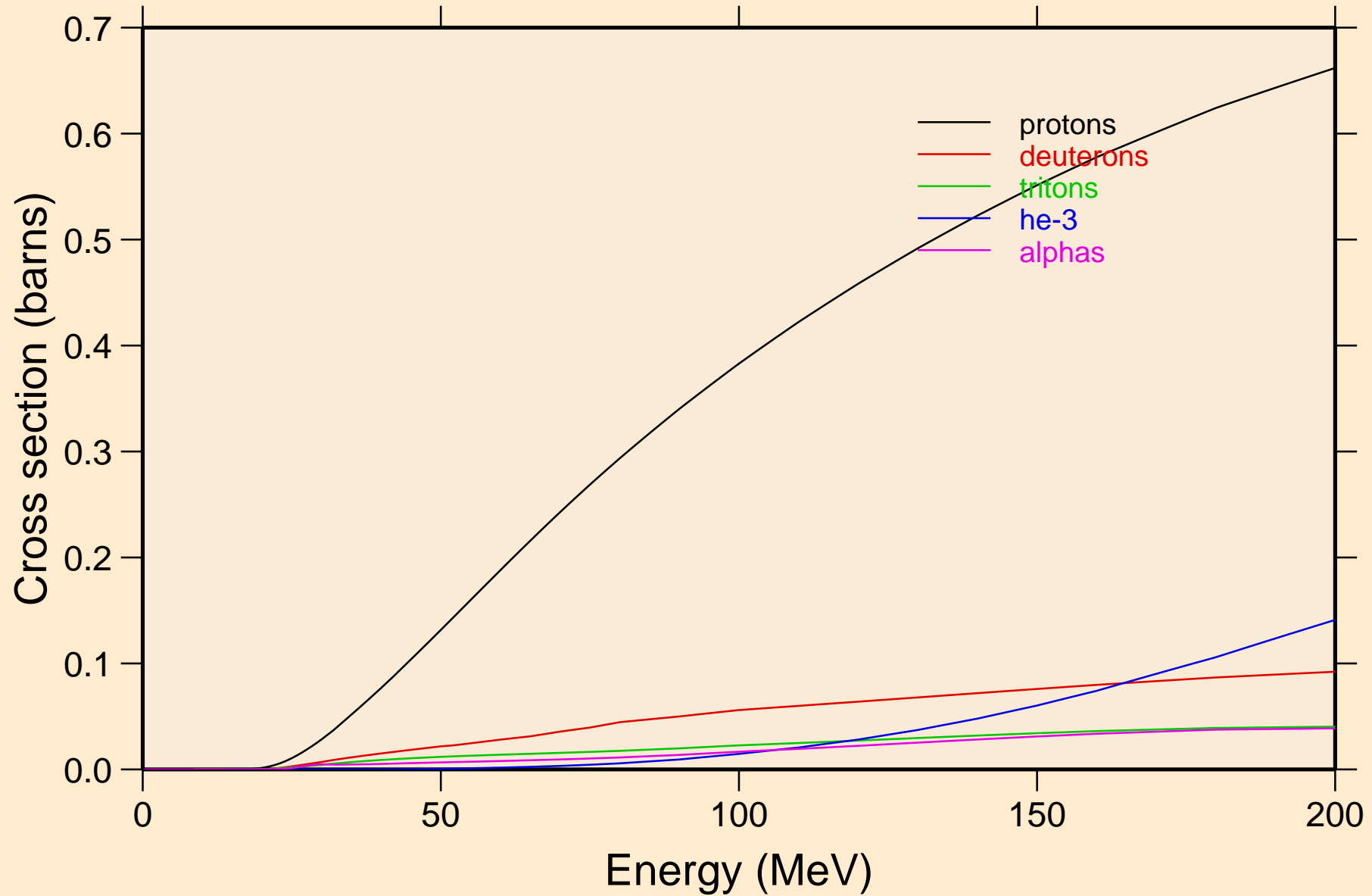

W196 NEUTRON ACER TENDL-2023 LIBRARY; T=0.K
protons from (n,x)

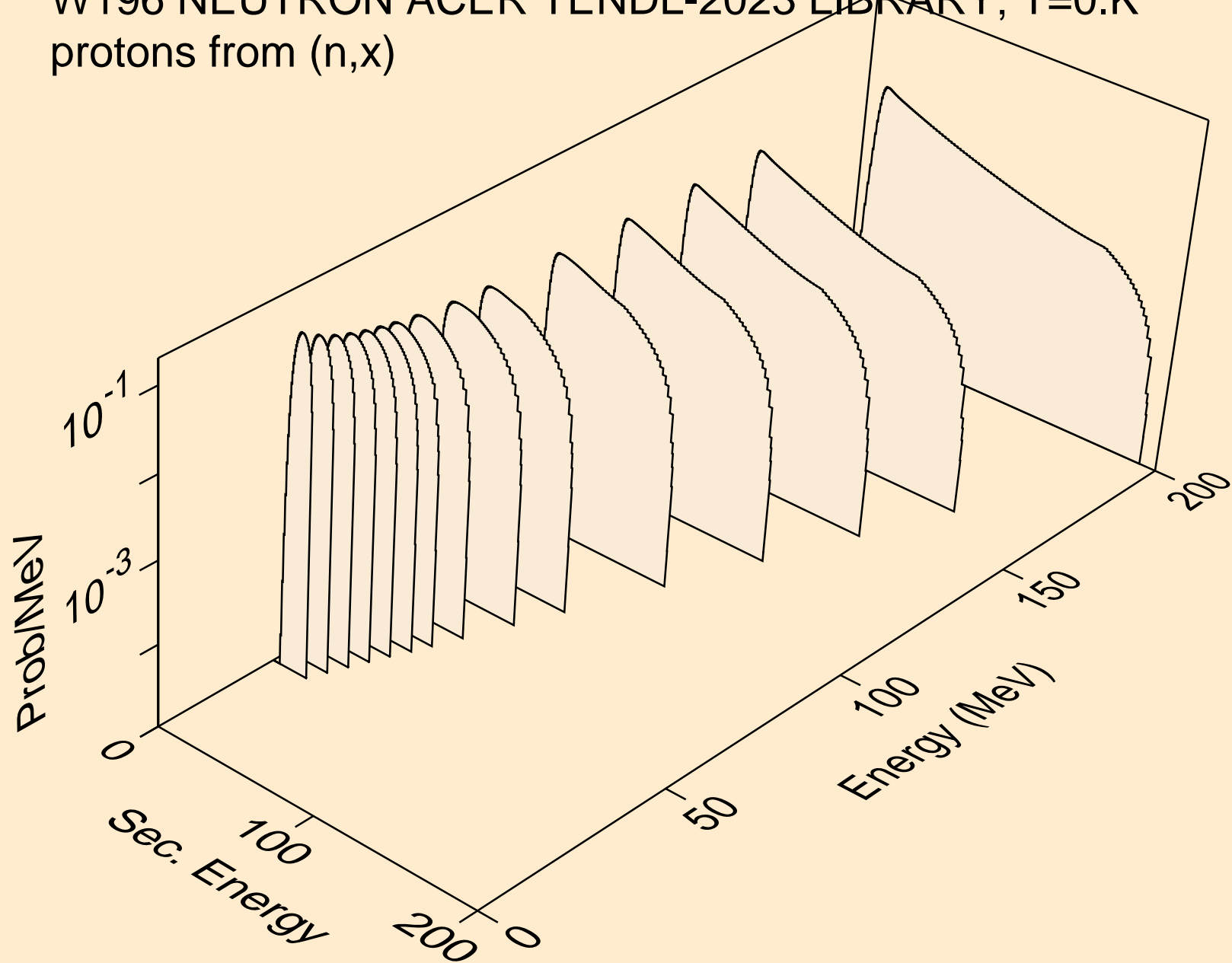

W196 NEUTRON ACER TENDL-2023 LIBRARY; T=0.K
protons from (n,n*)p

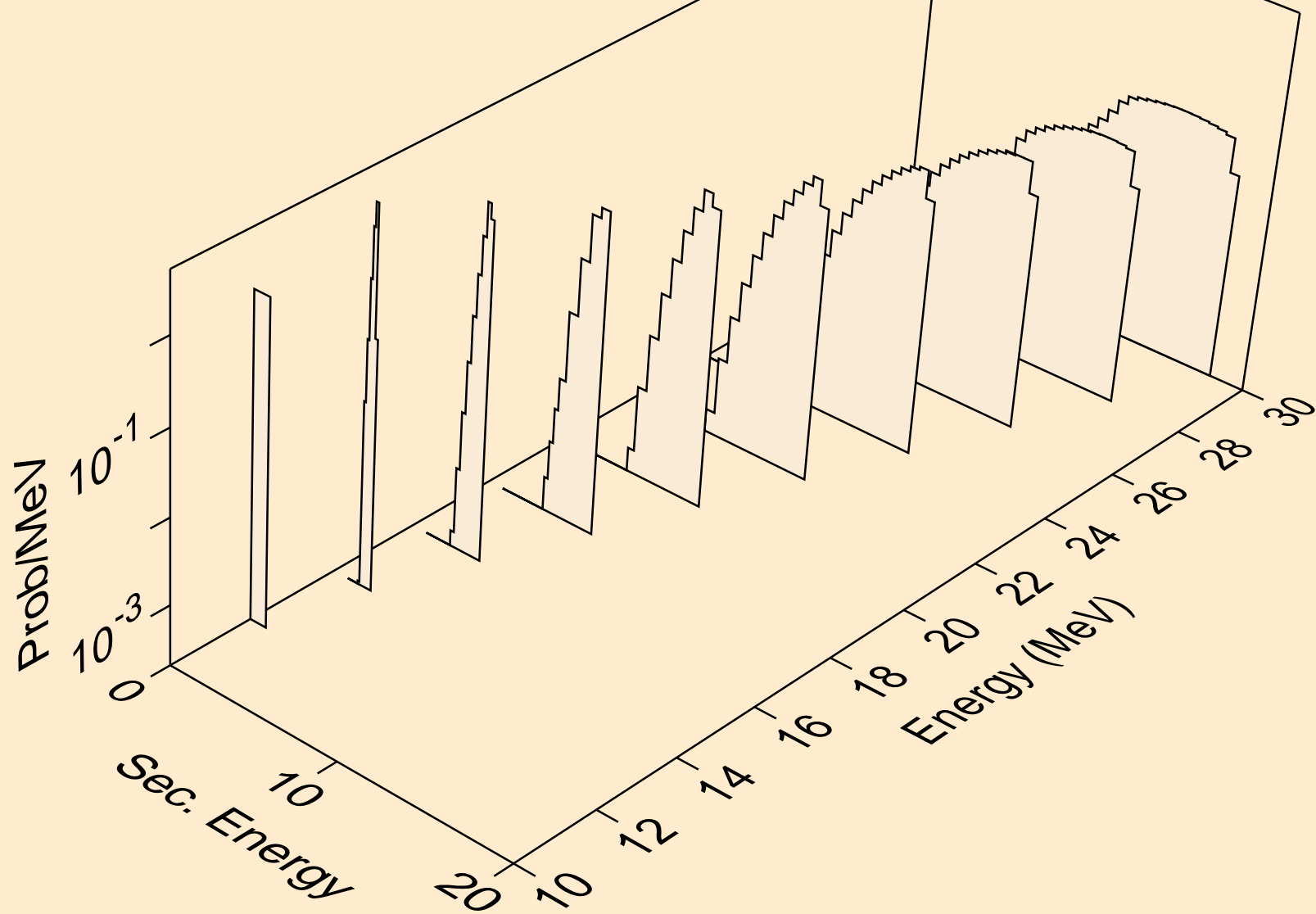

W196 NEUTRON ACER TENDL-2023 LIBRARY; T=0.K
protons from (n,2np)

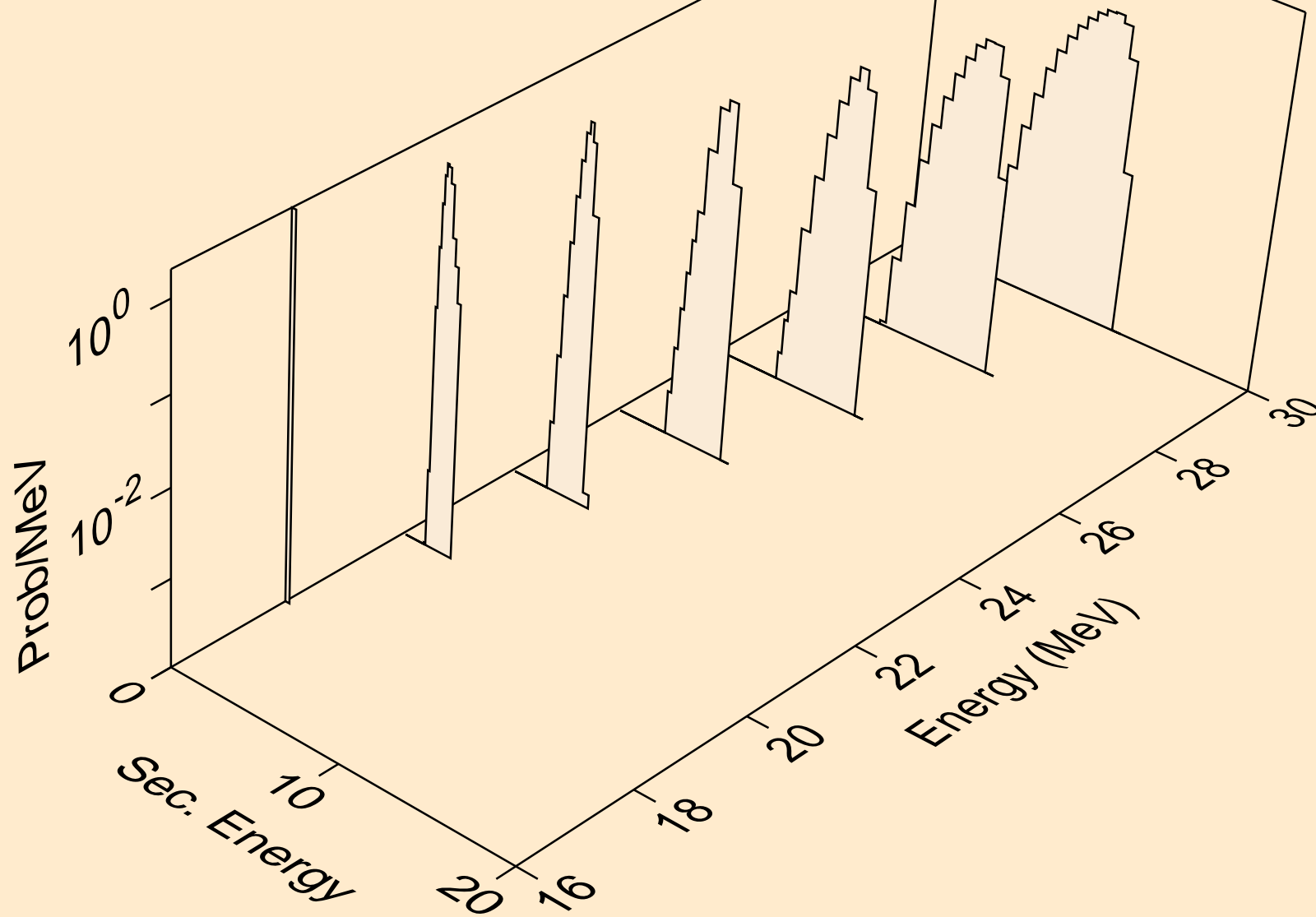

W196 NEUTRON ACER TENDL-2023 LIBRARY; T=0.K
protons from (n,3np)

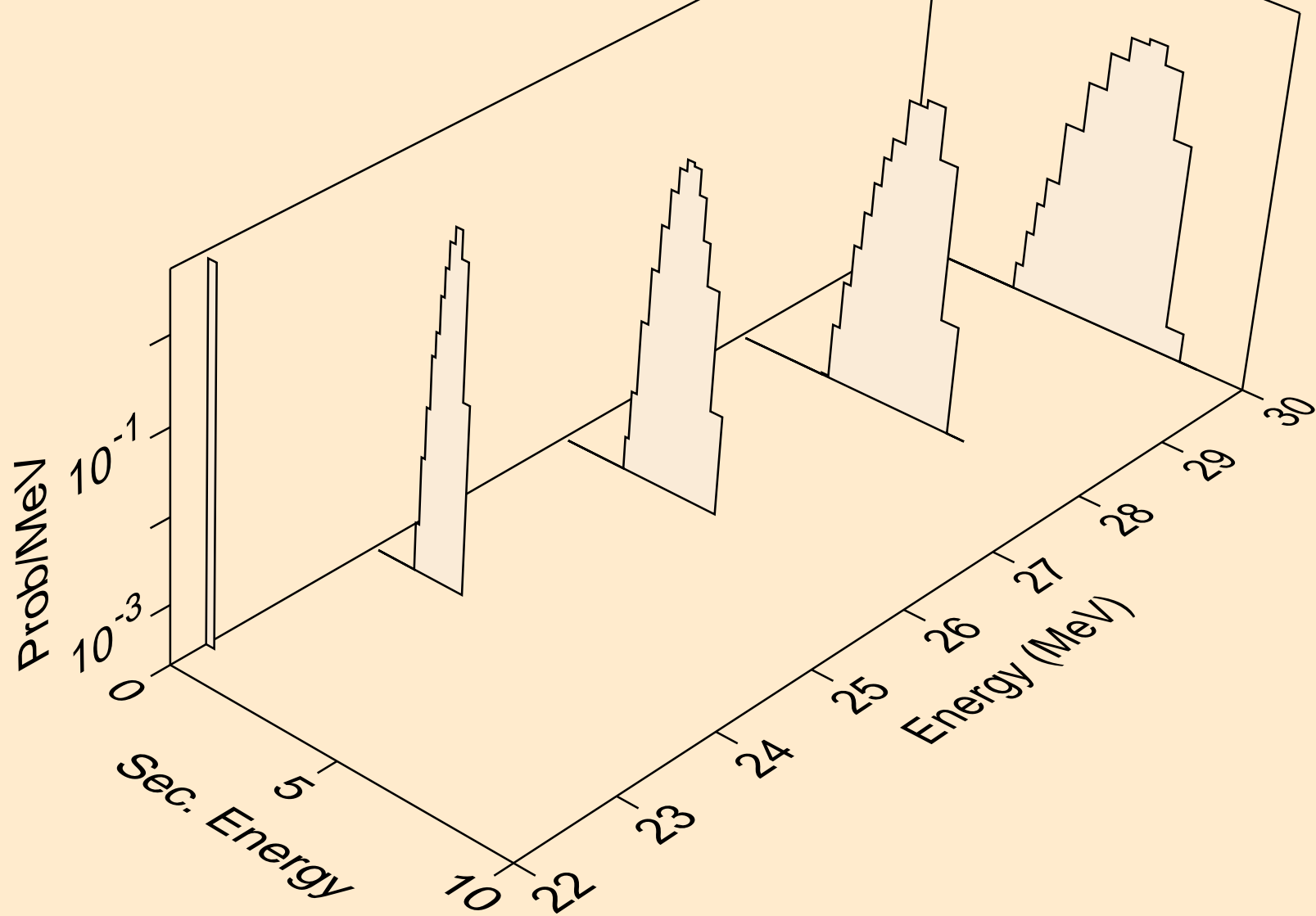

W196 NEUTRON ACER TENDL-2023 LIBRARY; T=0.K
protons from (n,p)

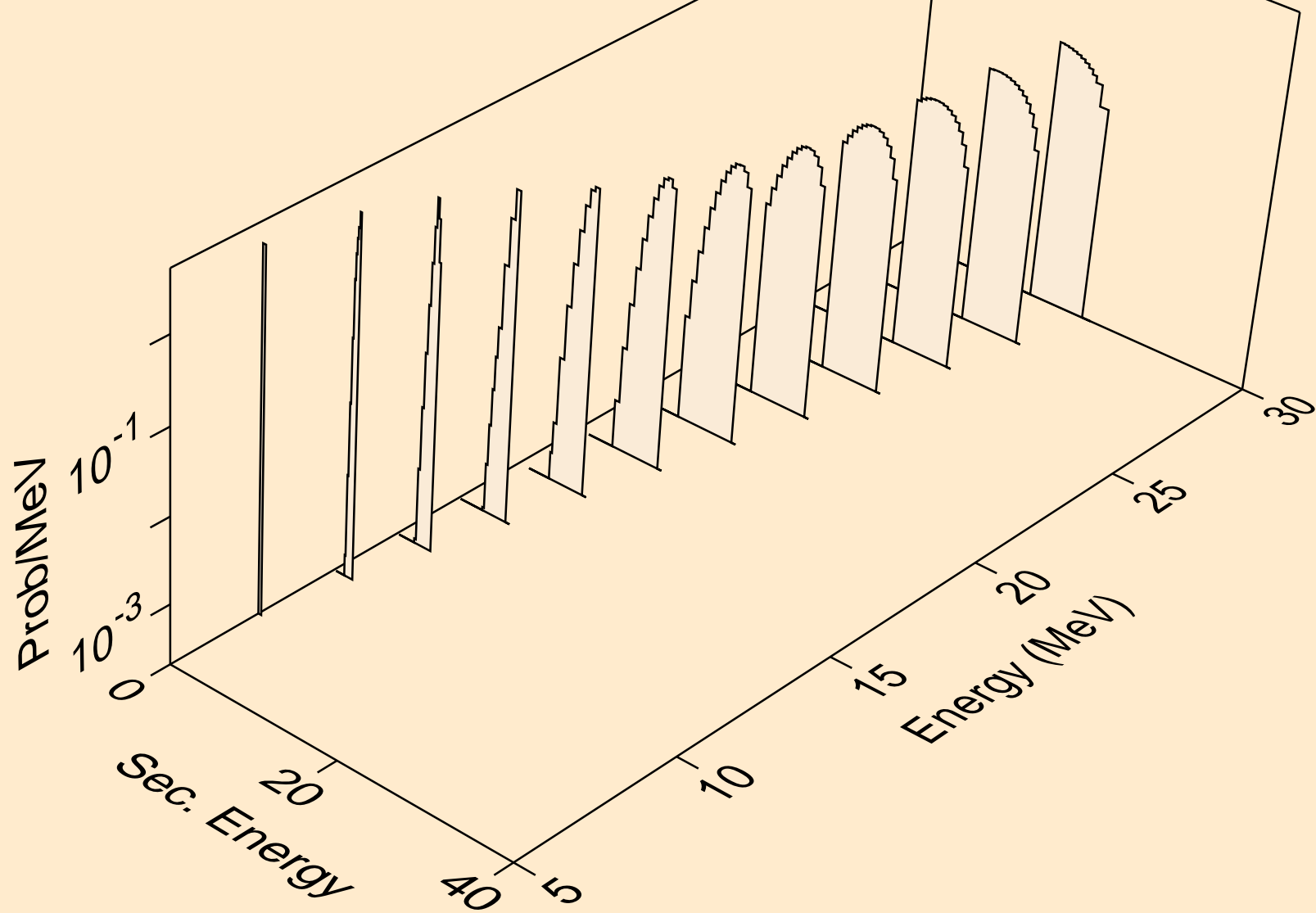

W196 NEUTRON ACER TENDL-2023 LIBRARY; T=0.K
deuterons from (n,x)

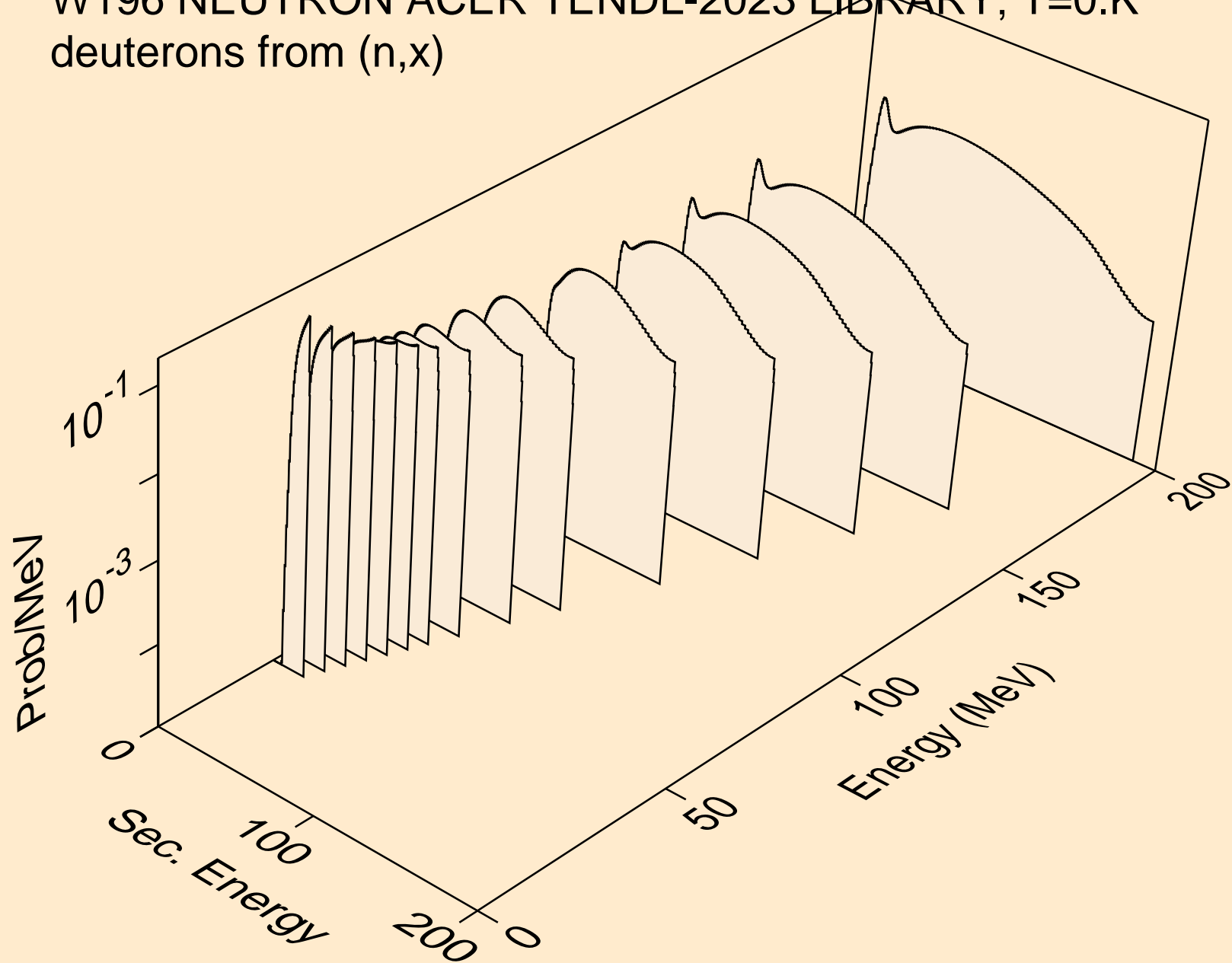

W196 NEUTRON ACER TENDL-2023 LIBRARY; T=0.K
deuterons from (n,2nd)

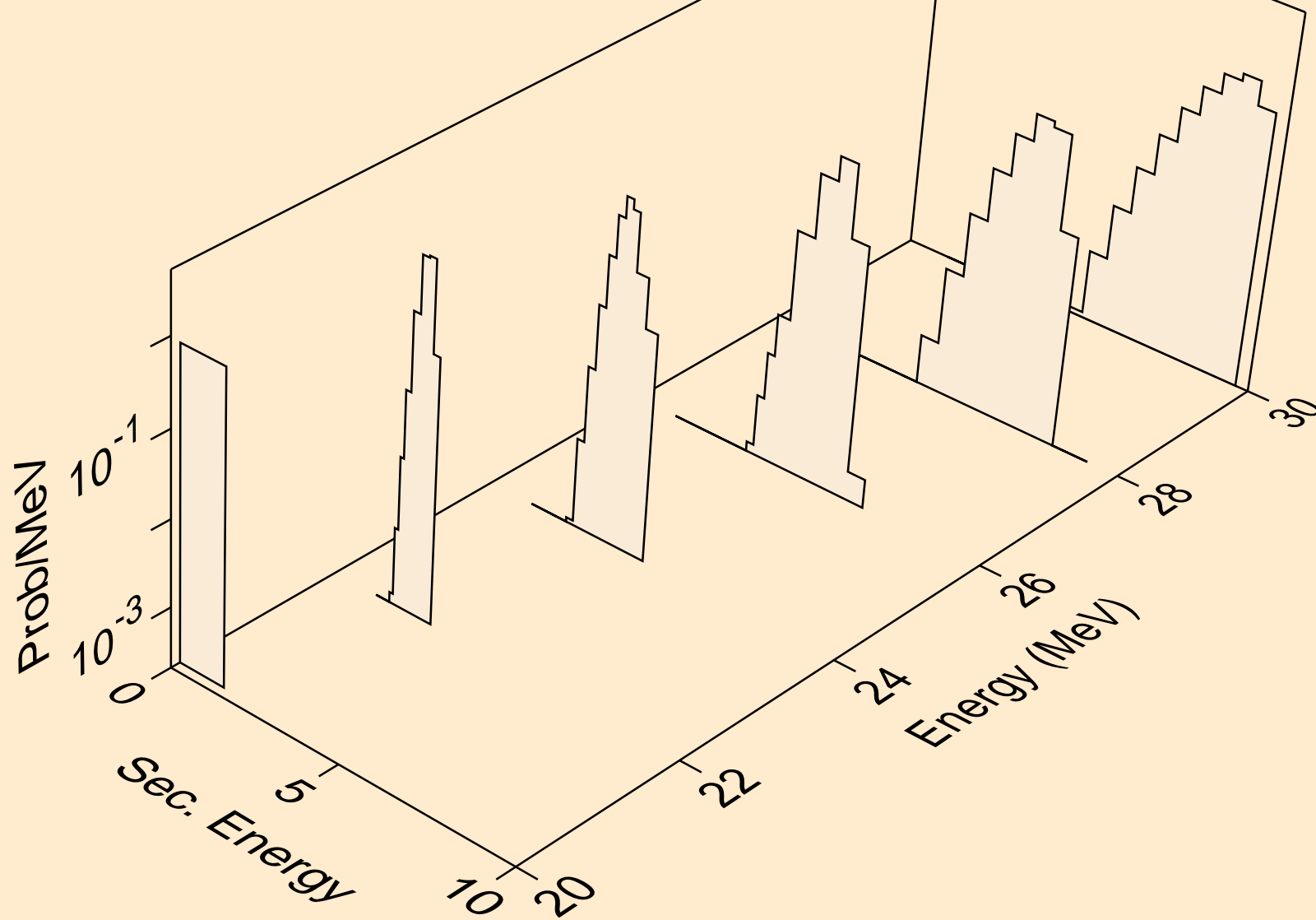

W196 NEUTRON ACER TENDL-2023 LIBRARY; T=0.K
deuterons from (n,n*)d

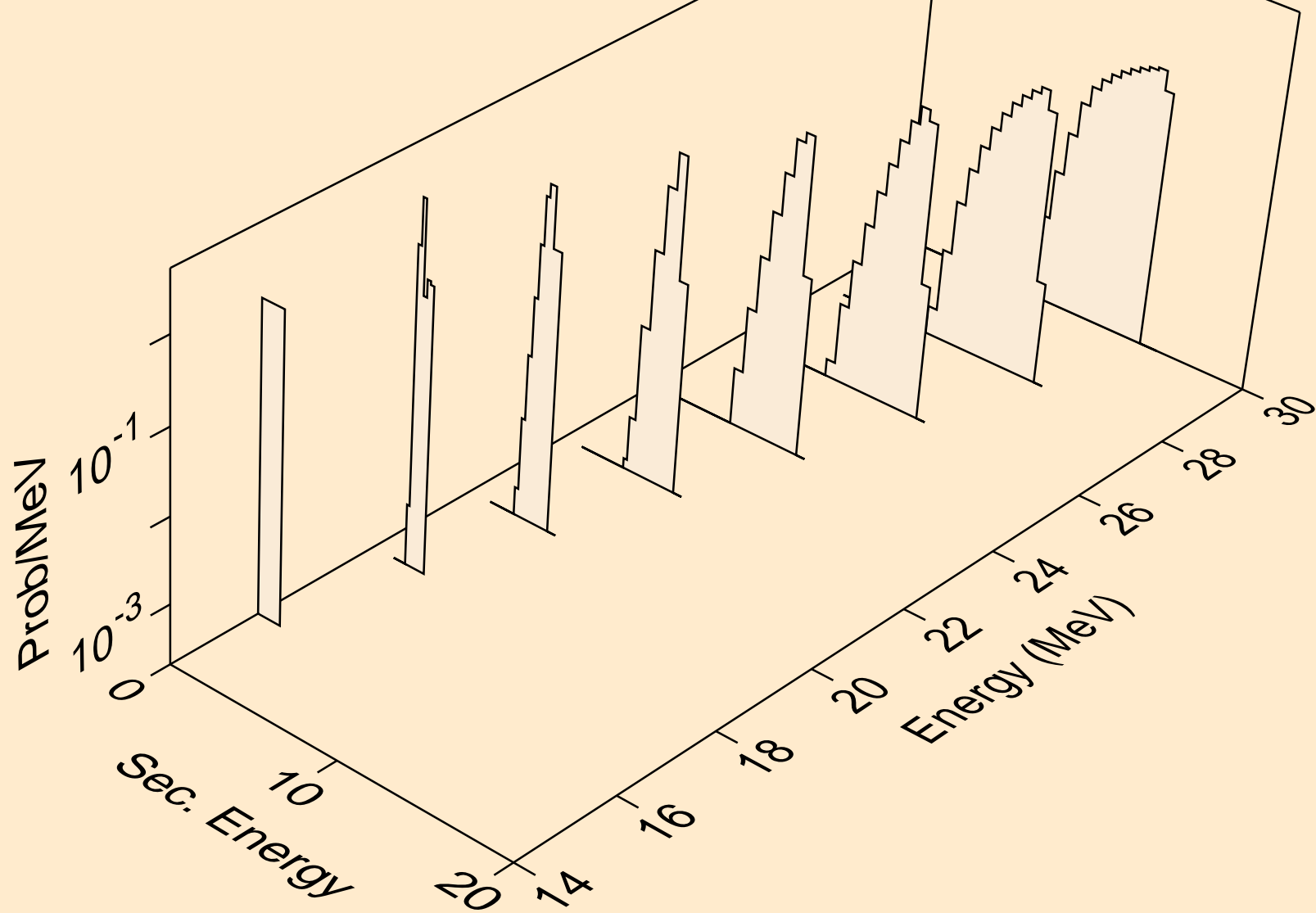

W196 NEUTRON ACER TENDL-2023 LIBRARY; T=0.K
deuterons from (n,d)

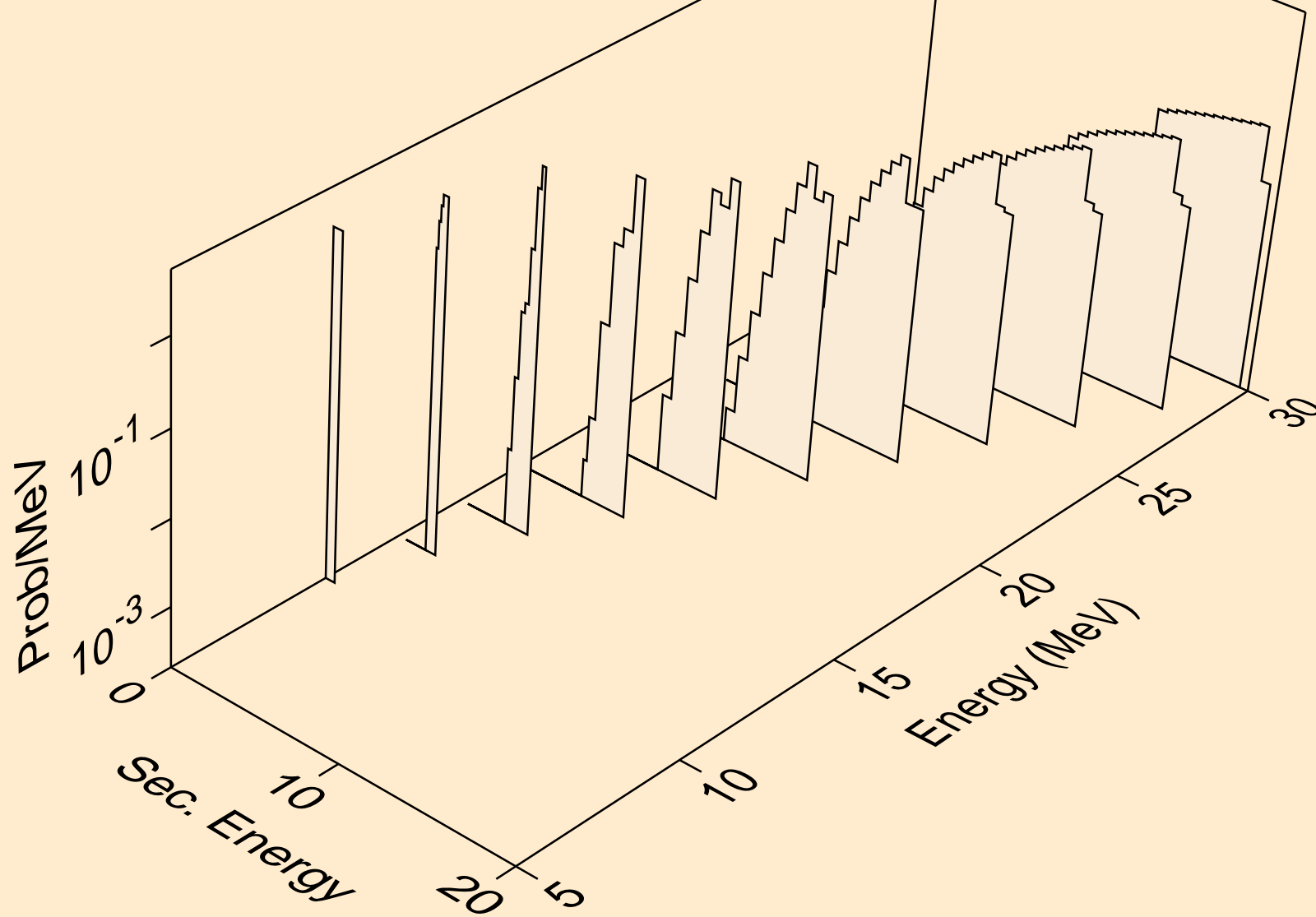

W196 NEUTRON ACER TENDL-2023 LIBRARY; T=0.K
tritons from (n,x)

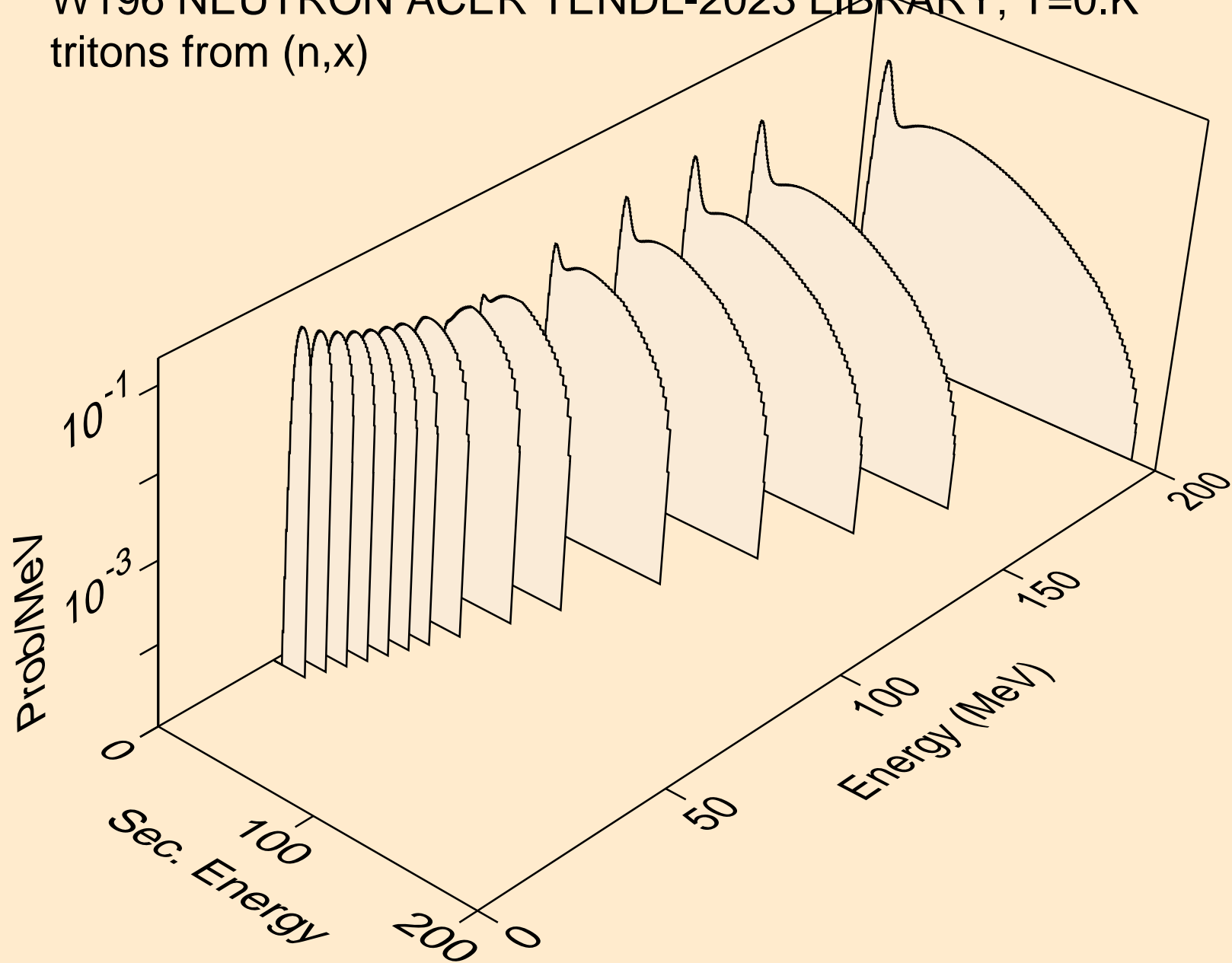

W196 NEUTRON ACER TENDL-2023 LIBRARY; T=0.K
tritons from (n,n*)t

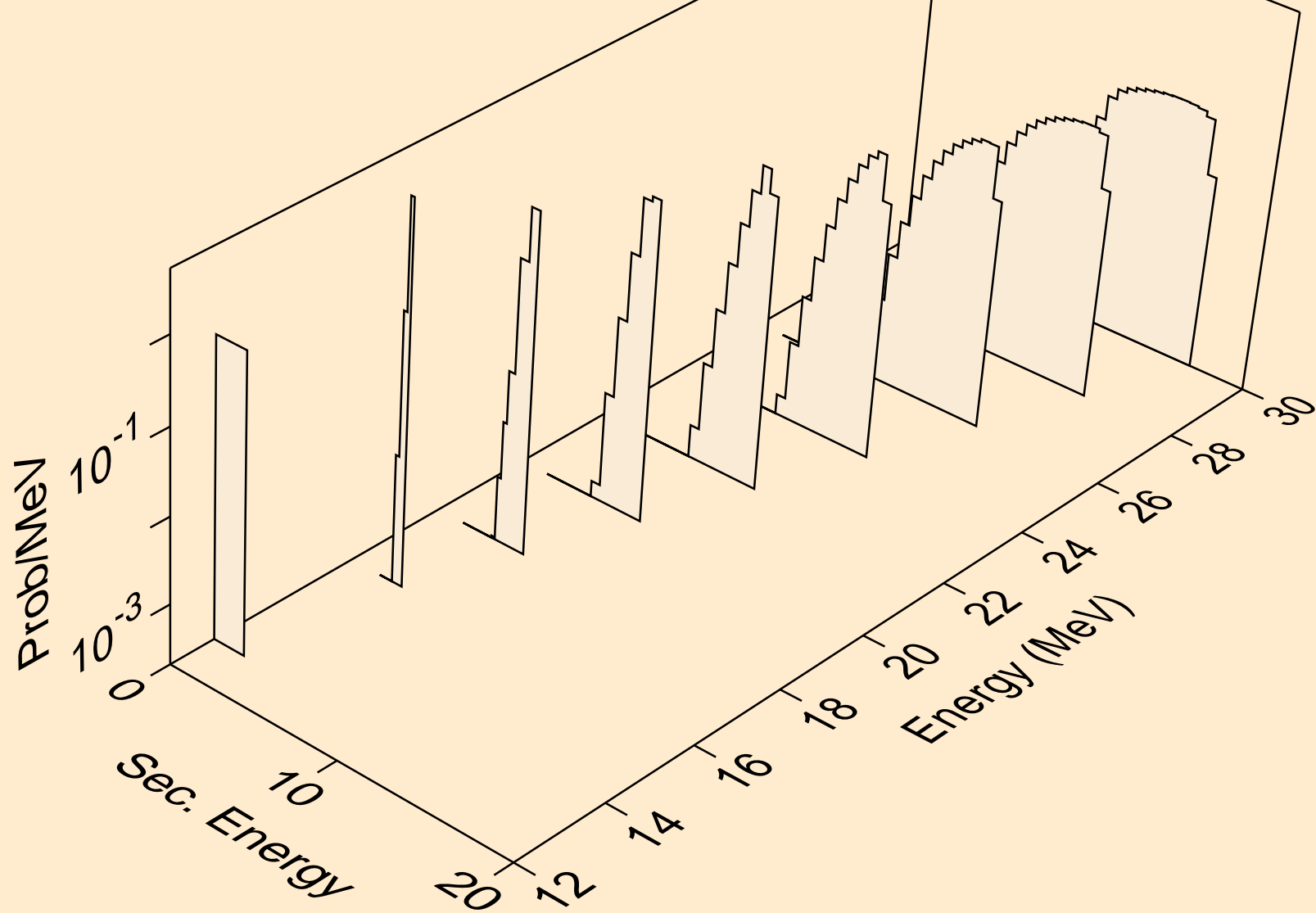

W196 NEUTRON ACER TENDL-2023 LIBRARY; T=0.K
tritons from (n,t)

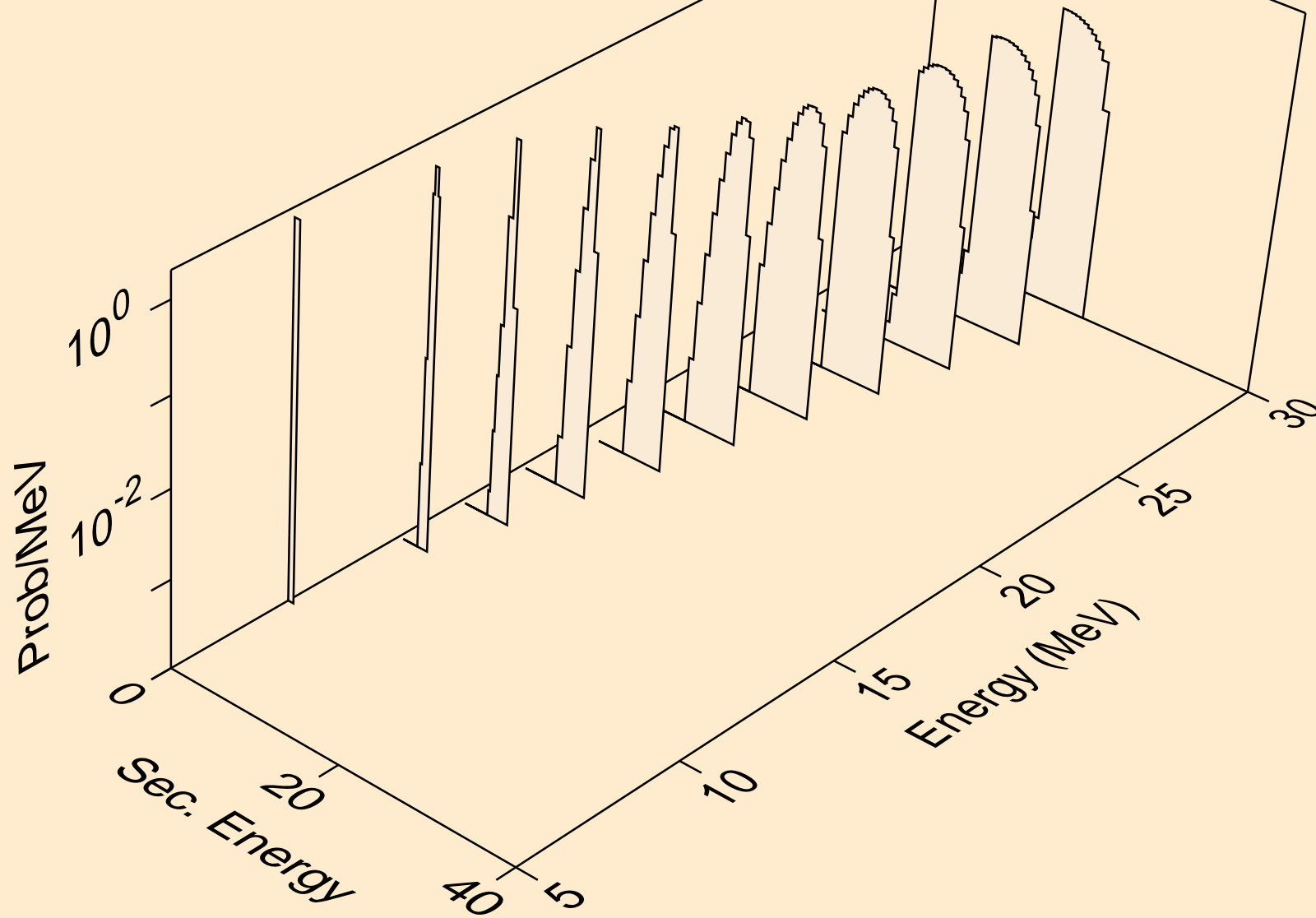

W196 NEUTRON ACER TENDL-2023 LIBRARY; T=0.K
he3s from (n,x)

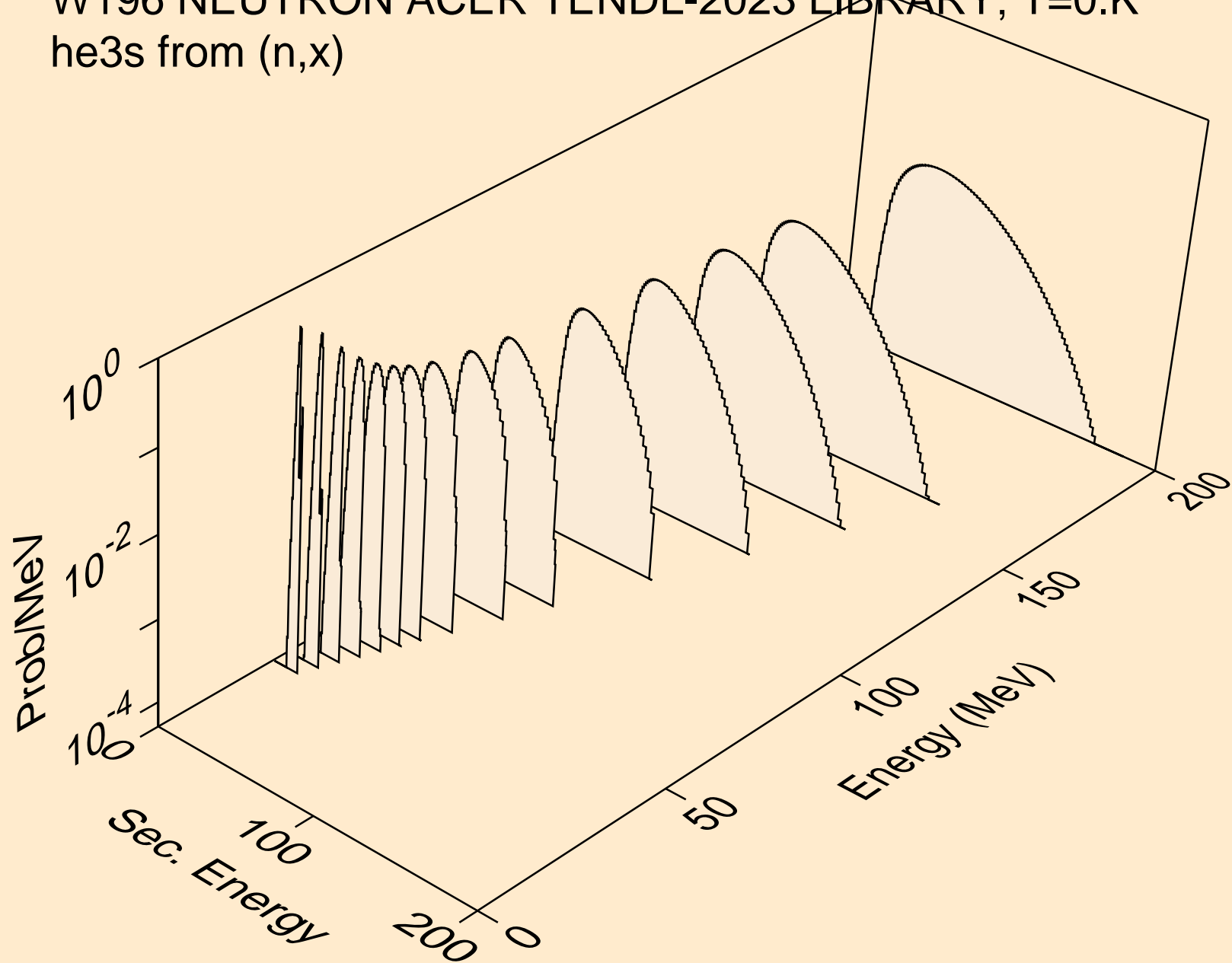

W196 NEUTRON ACER TENDL-2023 LIBRARY; T=0.K
he3s from (n,he3)

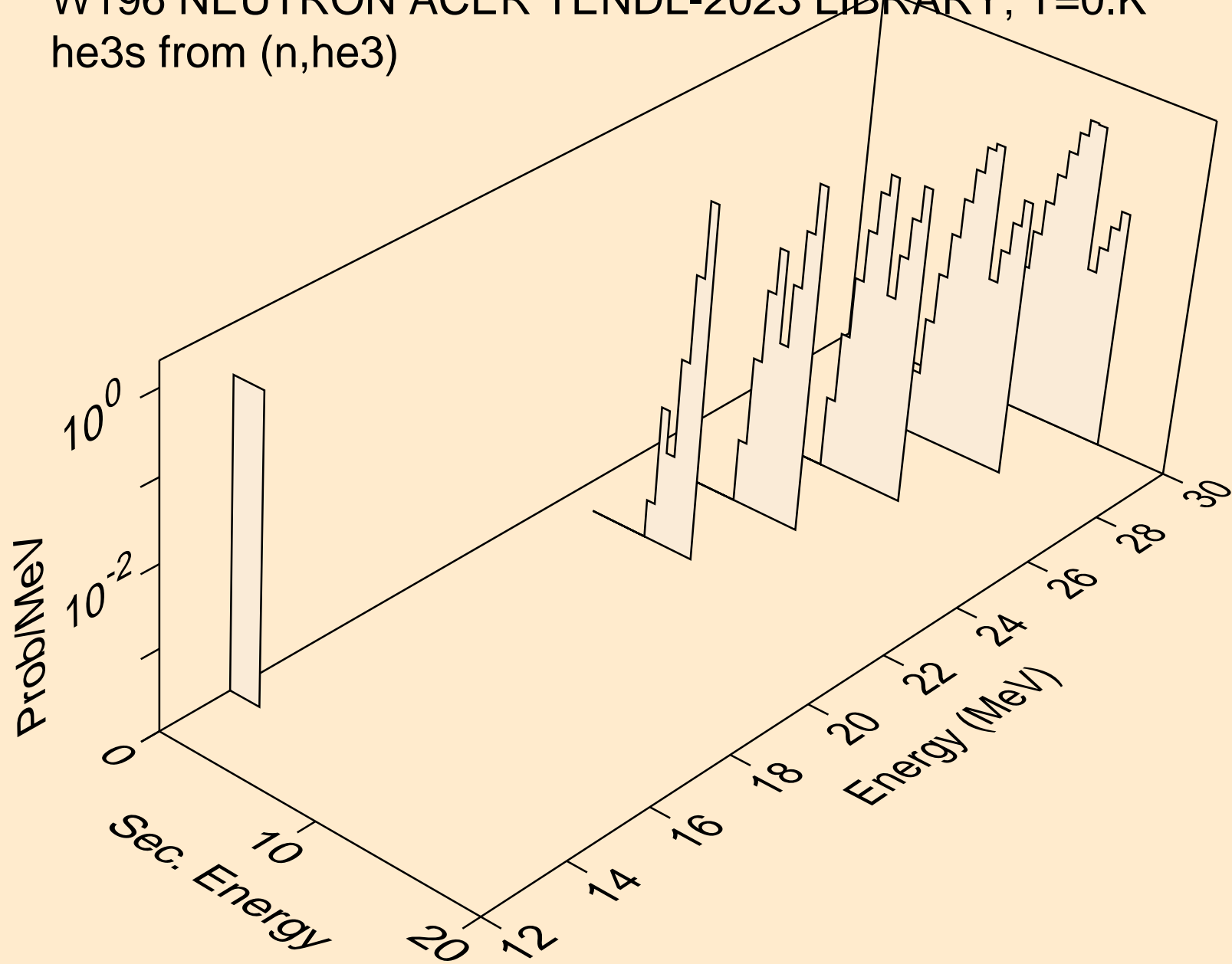

W196 NEUTRON ACER TENDL-2023 LIBRARY; T=0.K
alphas from (n,x)

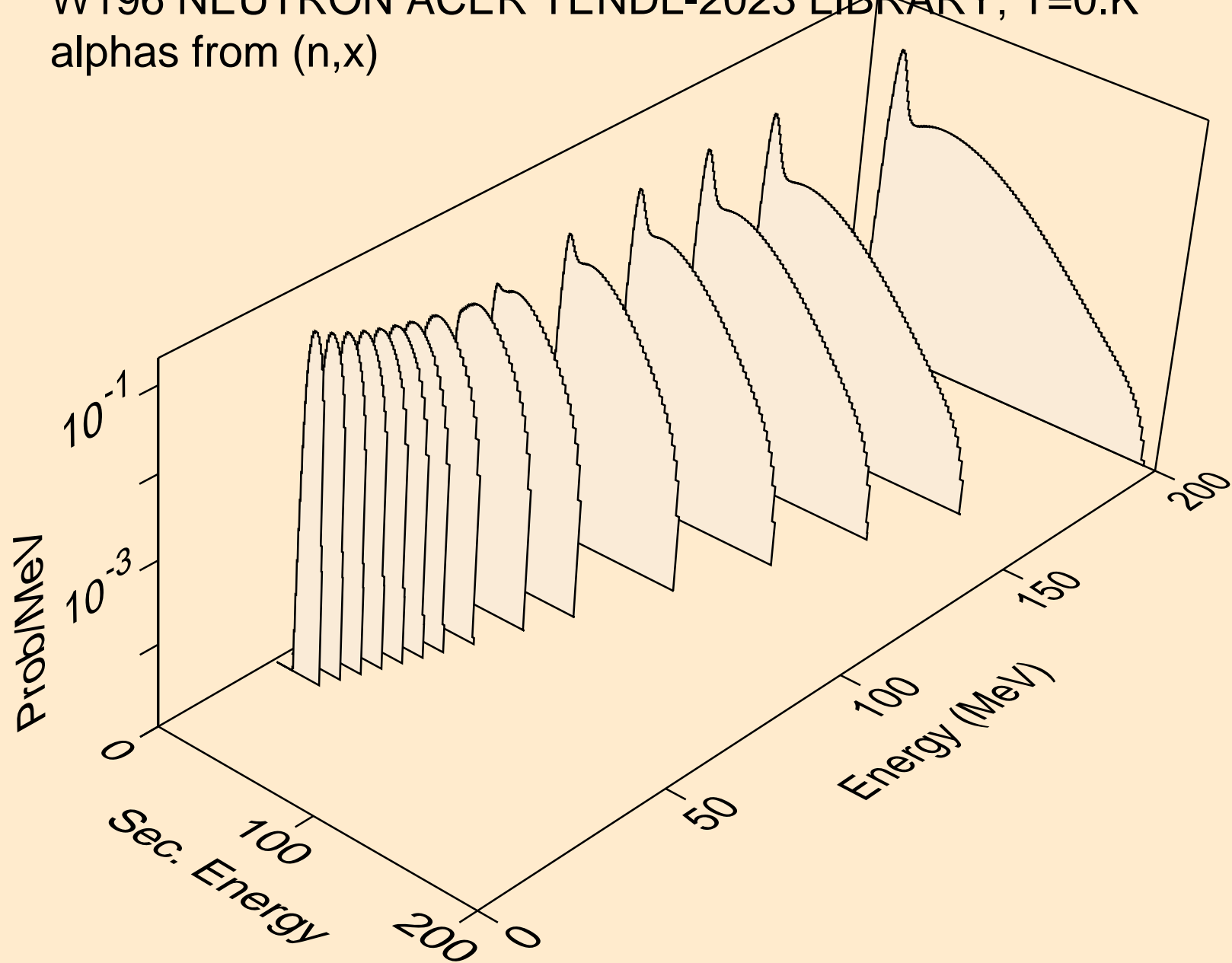

W196 NEUTRON ACER TENDL-2023 LIBRARY; T=0.K
alphas from (n,n*)a

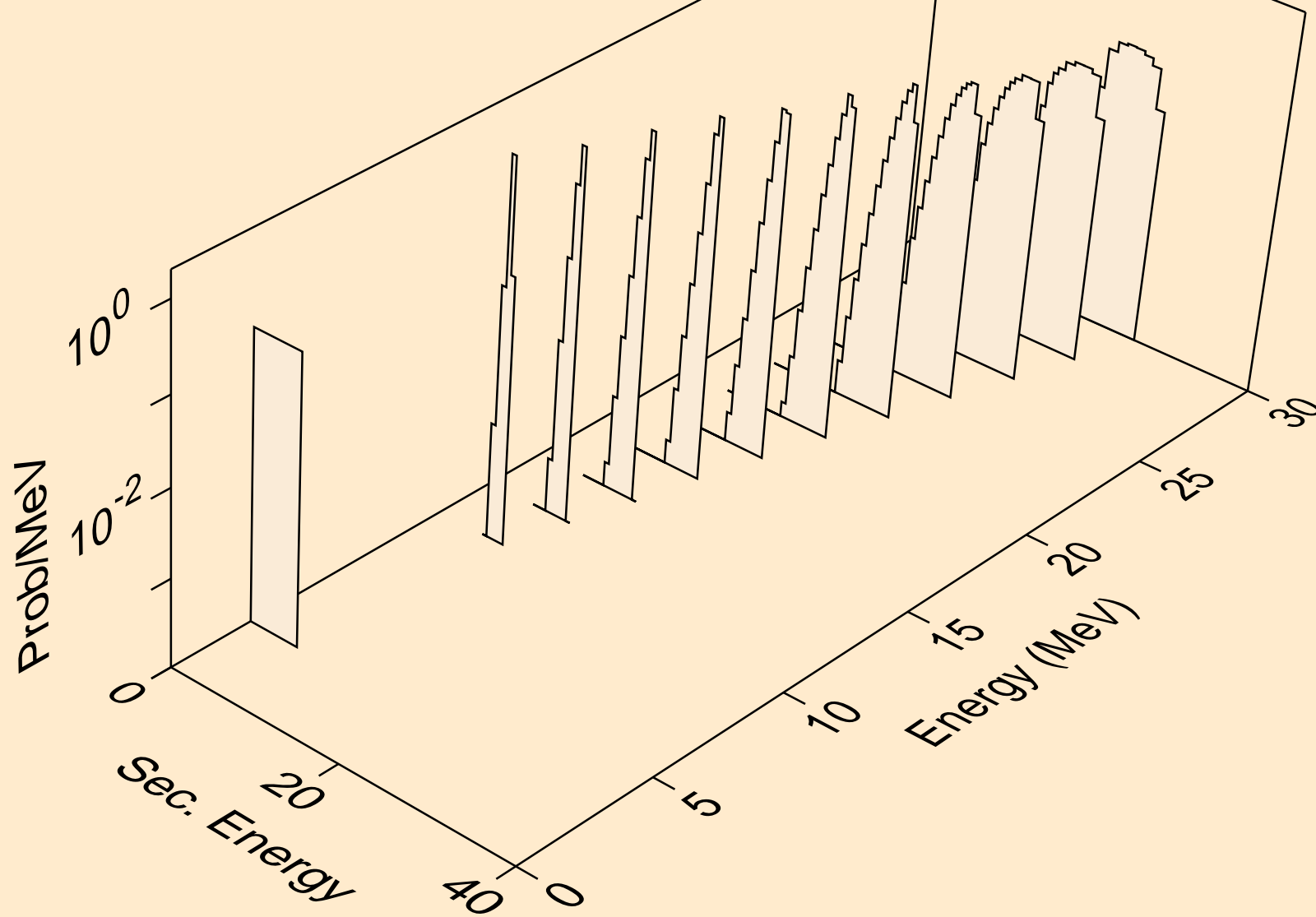

W196 NEUTRON ACER TENDL-2023 LIBRARY; T=0.K
alphas from (n,2n)a

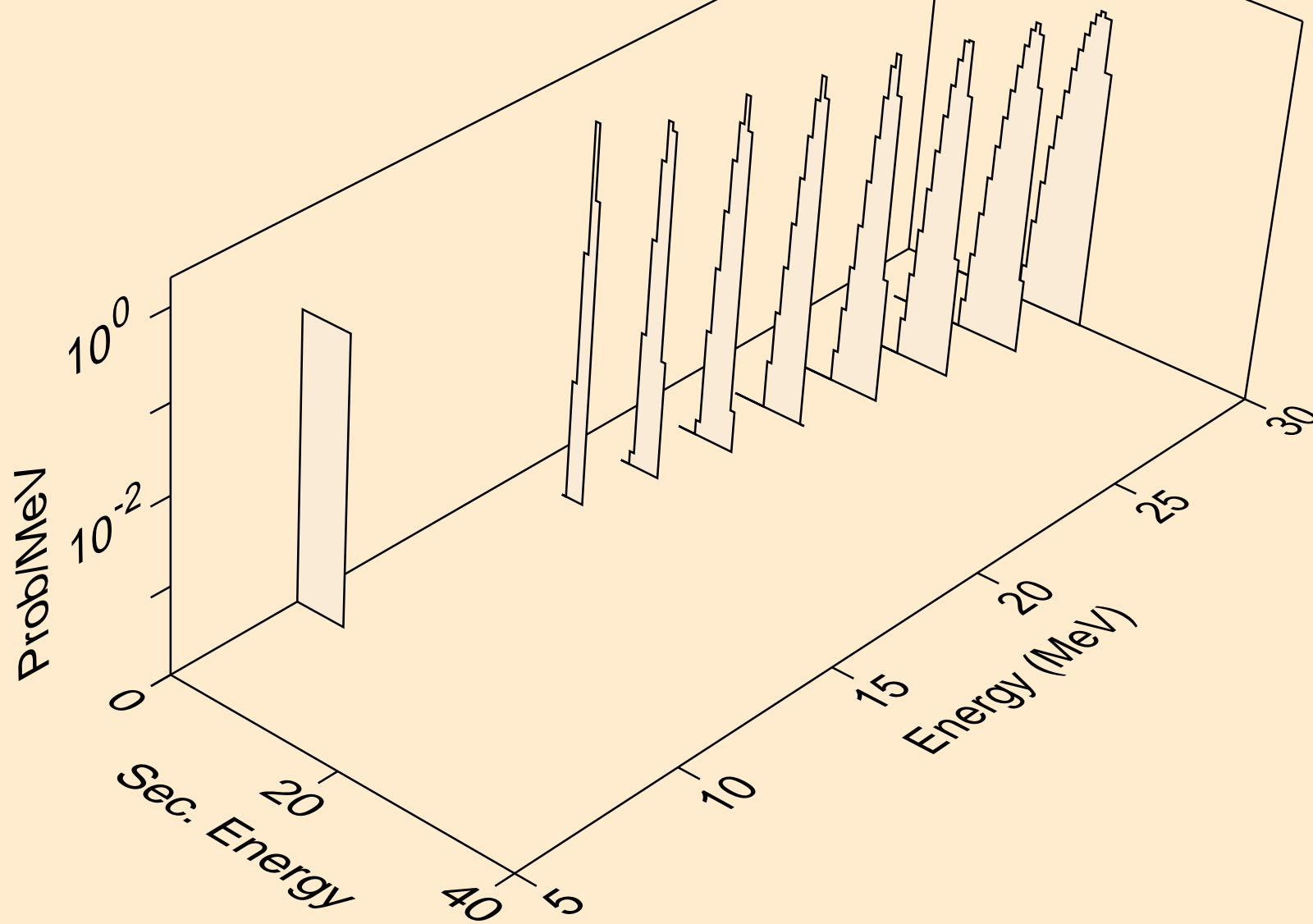

W196 NEUTRON ACER TENDL-2023 LIBRARY; T=0.K
alphas from (n,3n)a

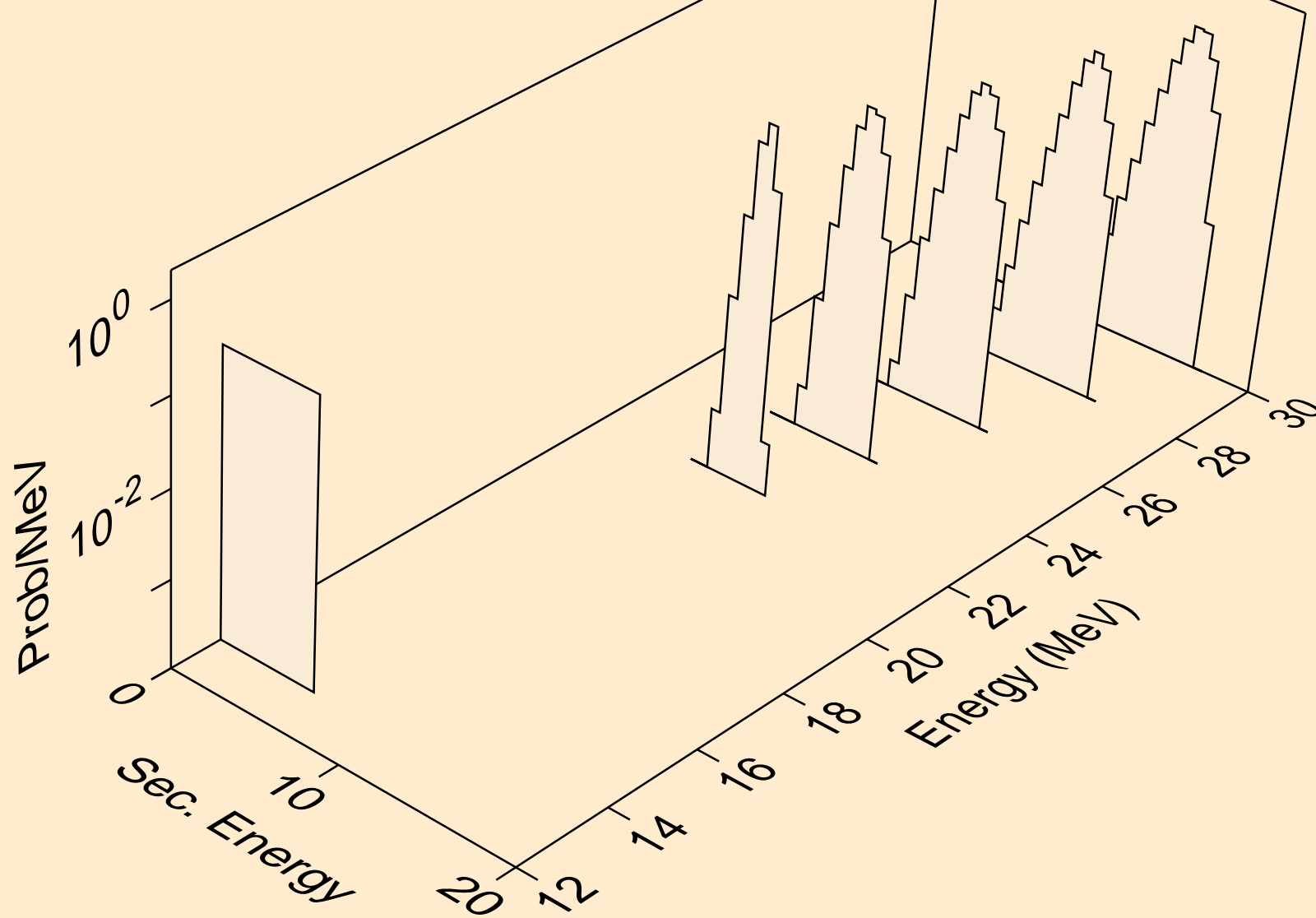

W196 NEUTRON ACER TENDL-2023 LIBRARY; T=0.K
alphas from (n,a)

