

# XE128 NEUTRON ACER TENDL-2023 LIBRARY; T=0.K

## Principal cross sections

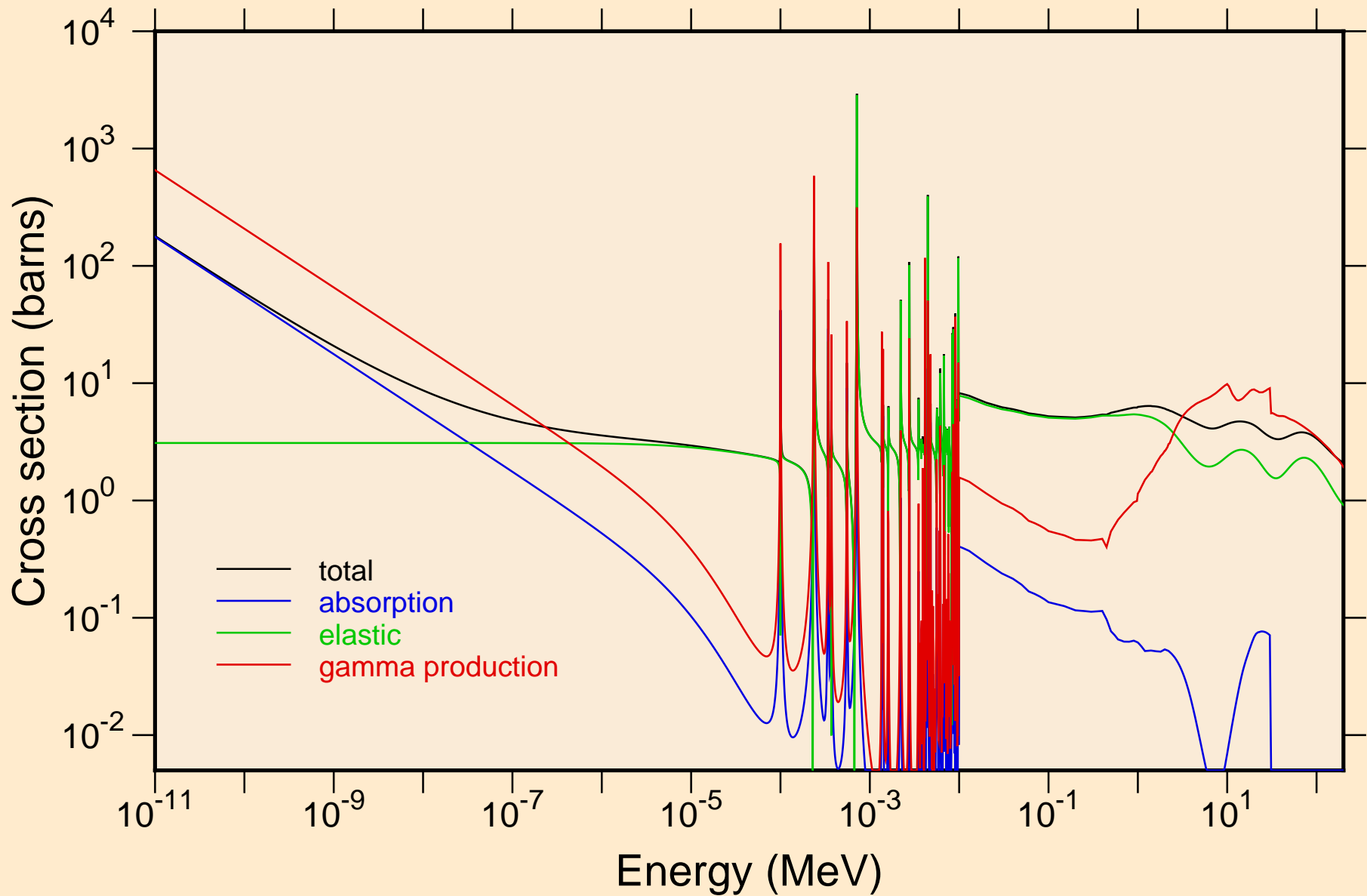

XE128 NEUTRON ACER TENDL-2023 LIBRARY; T=0.K  
resonance total cross section

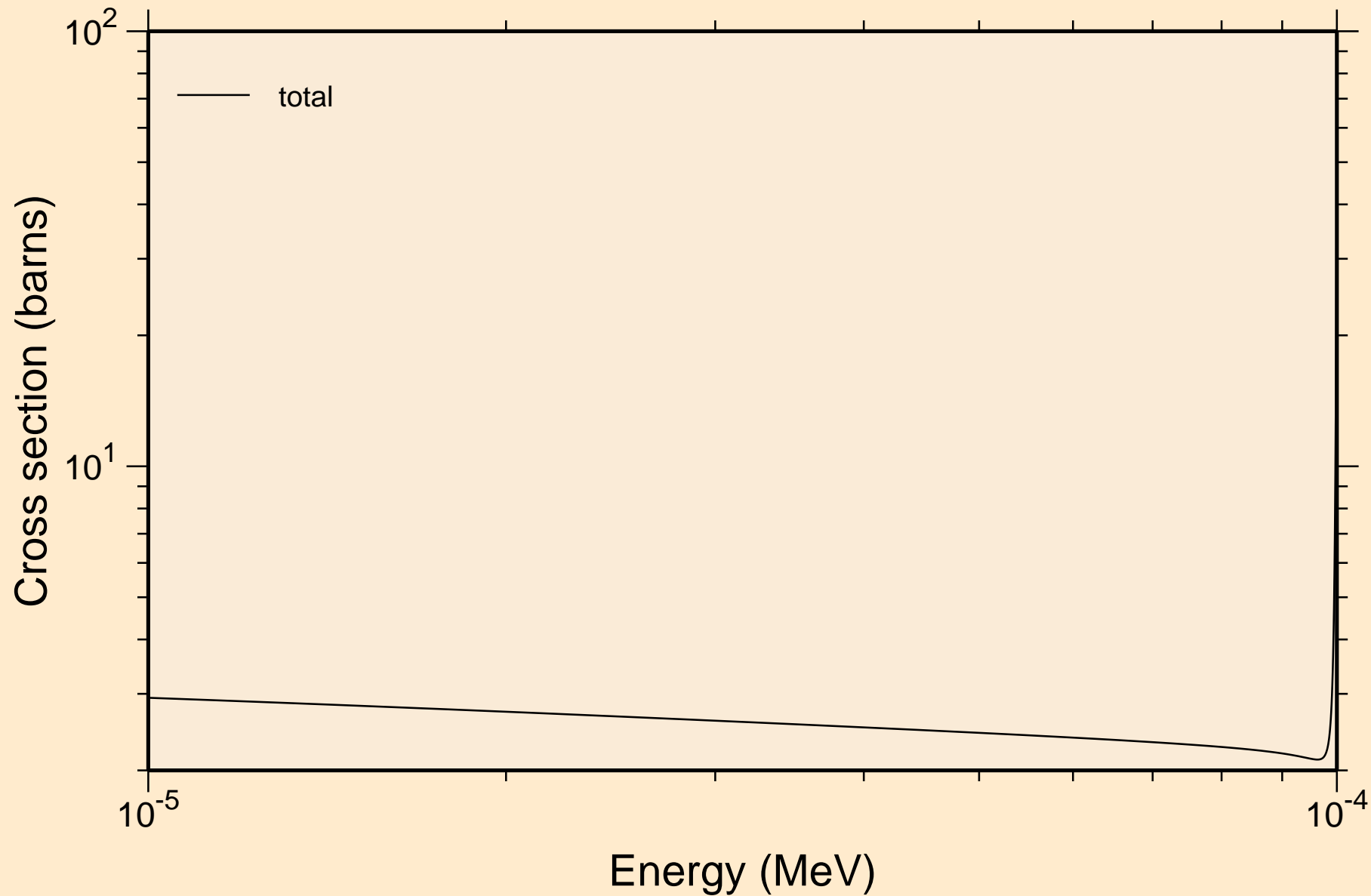

XE128 NEUTRON ACER TENDL-2023 LIBRARY; T=0.K  
resonance total cross section

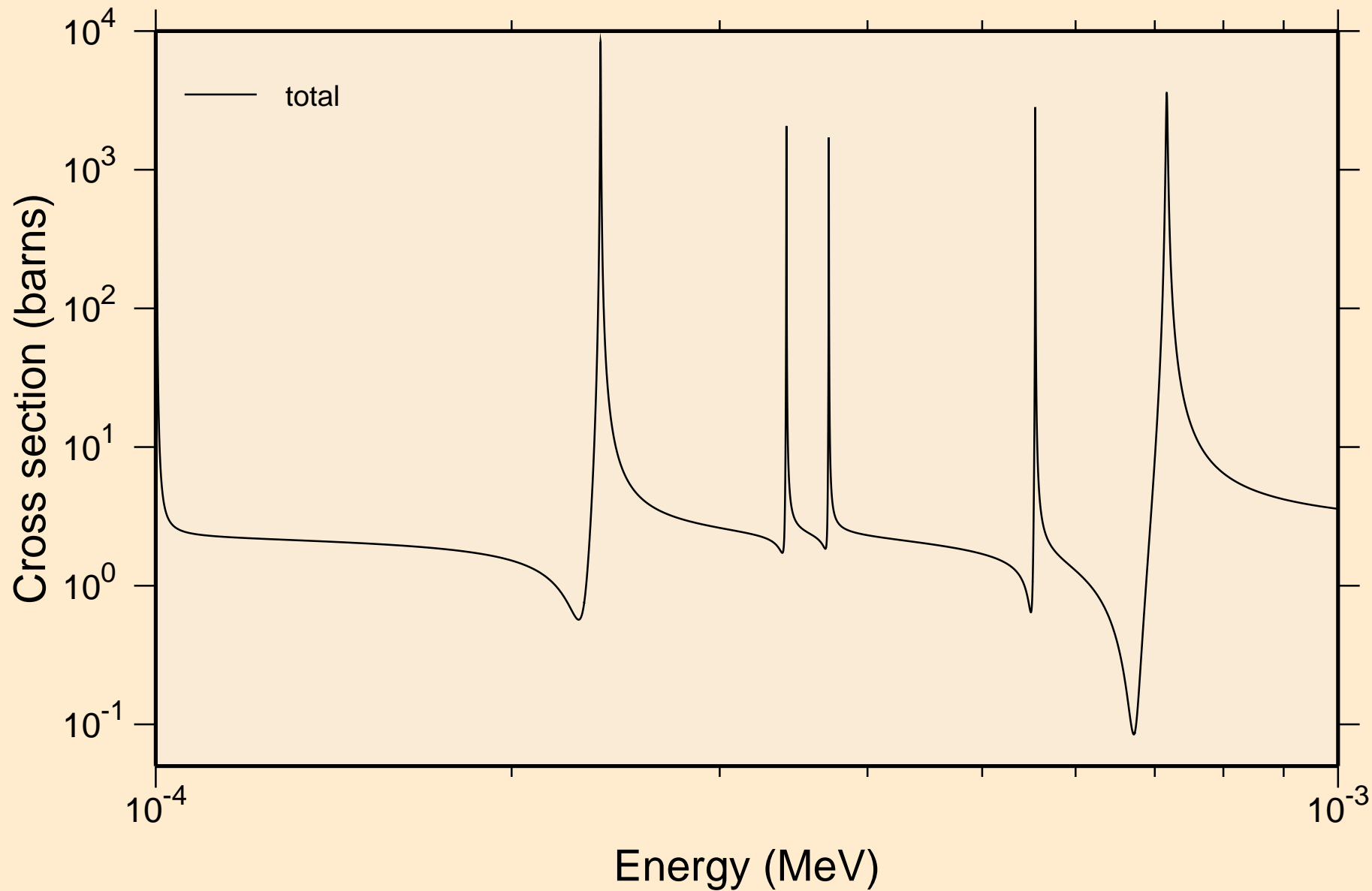

XE128 NEUTRON ACER TENDL-2023 LIBRARY; T=0.K  
resonance total cross section

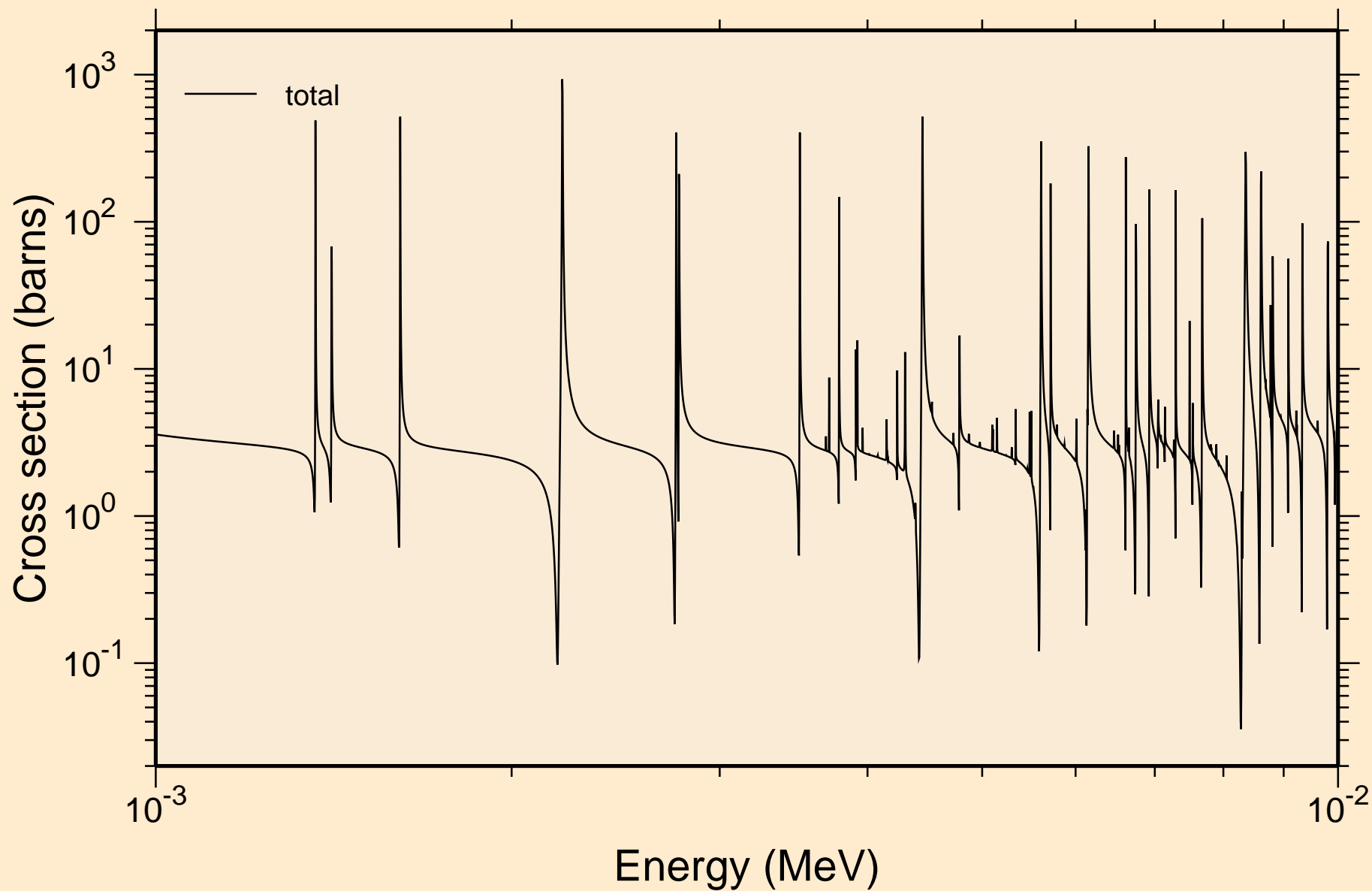

XE128 NEUTRON ACER TENDL-2023 LIBRARY; T=0.K  
resonance total cross section

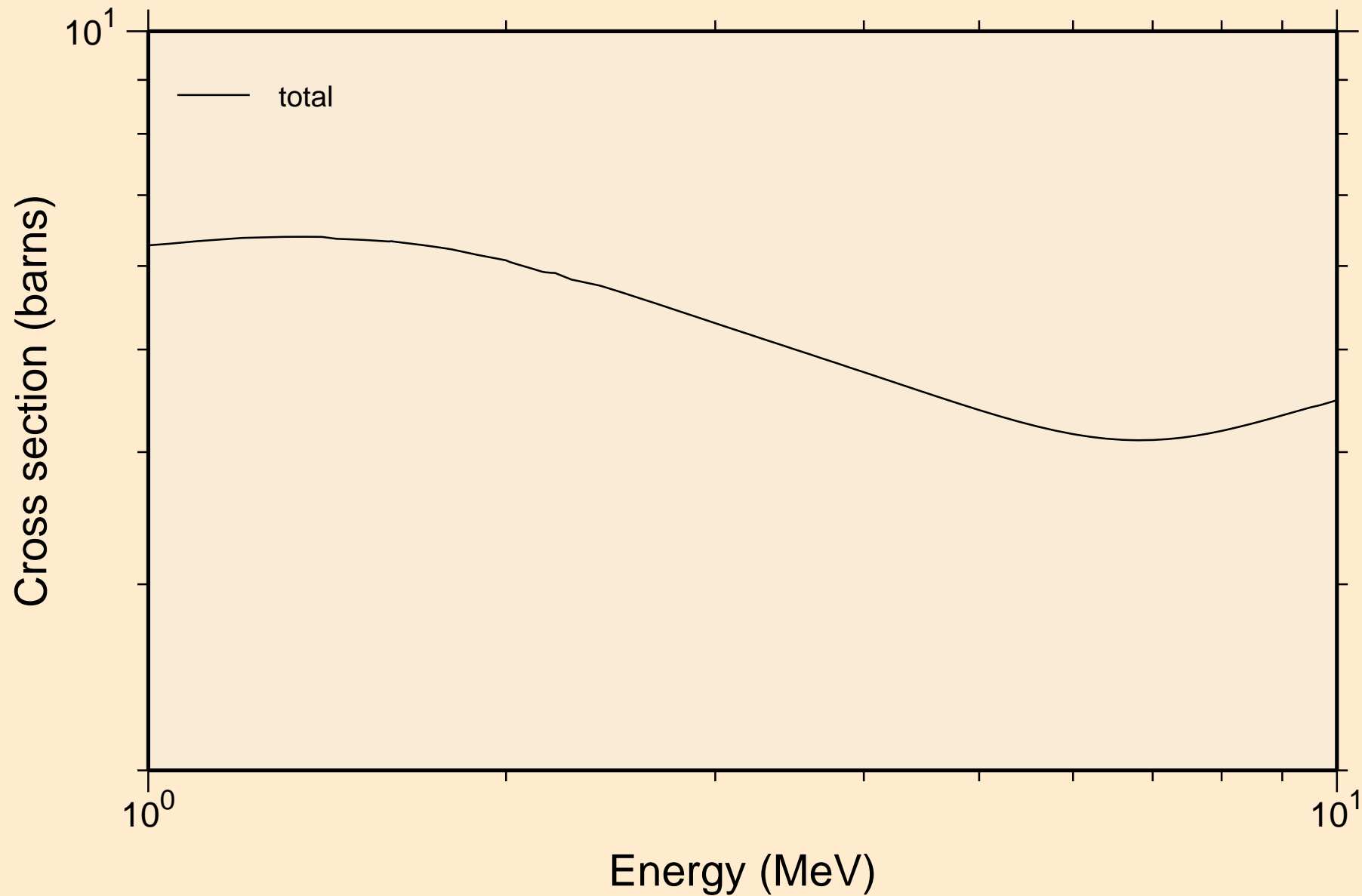

XE128 NEUTRON ACER TENDL-2023 LIBRARY; T=0.K  
resonance absorption cross sections

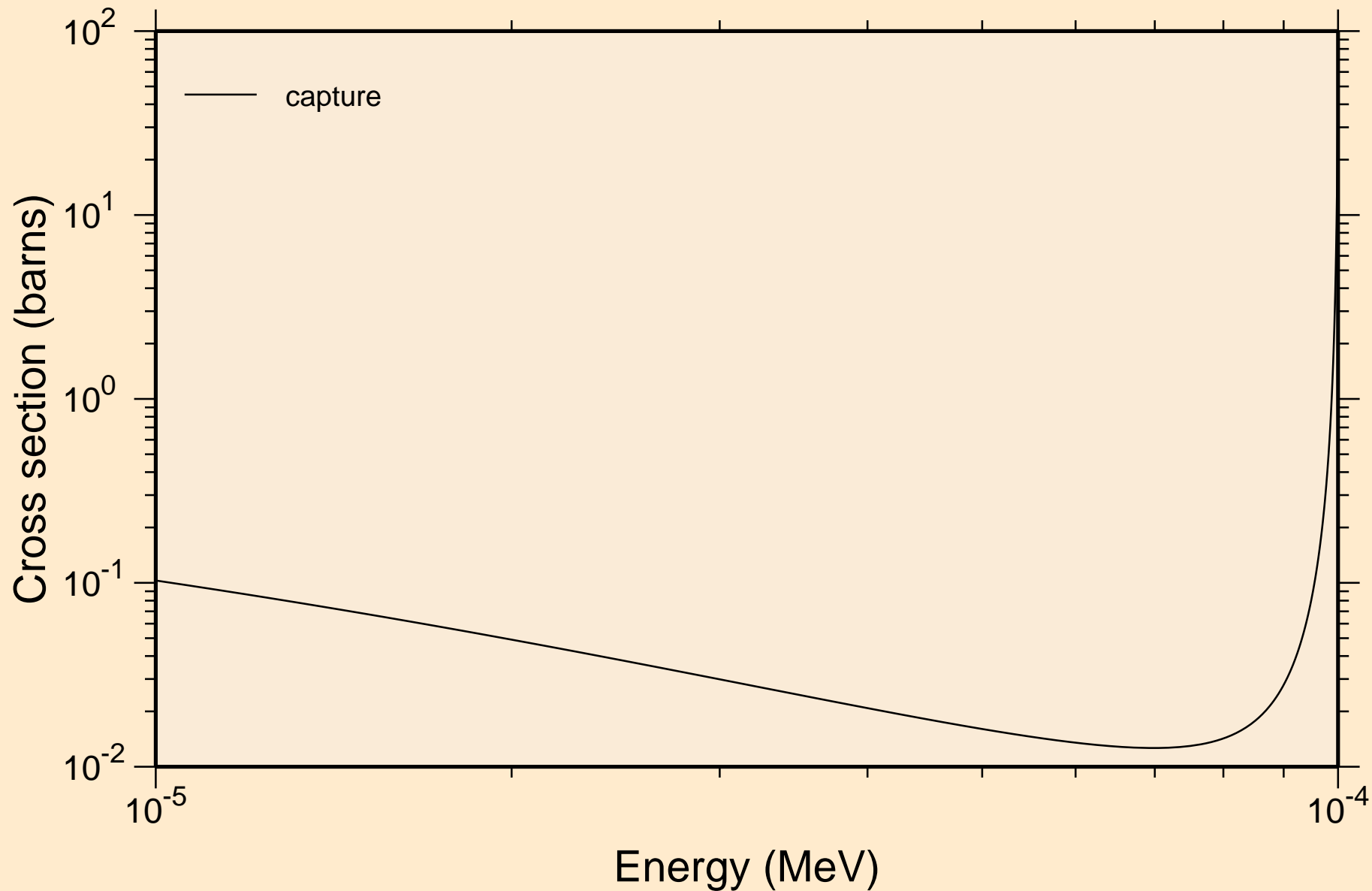

XE128 NEUTRON ACER TENDL-2023 LIBRARY; T=0.K  
resonance absorption cross sections

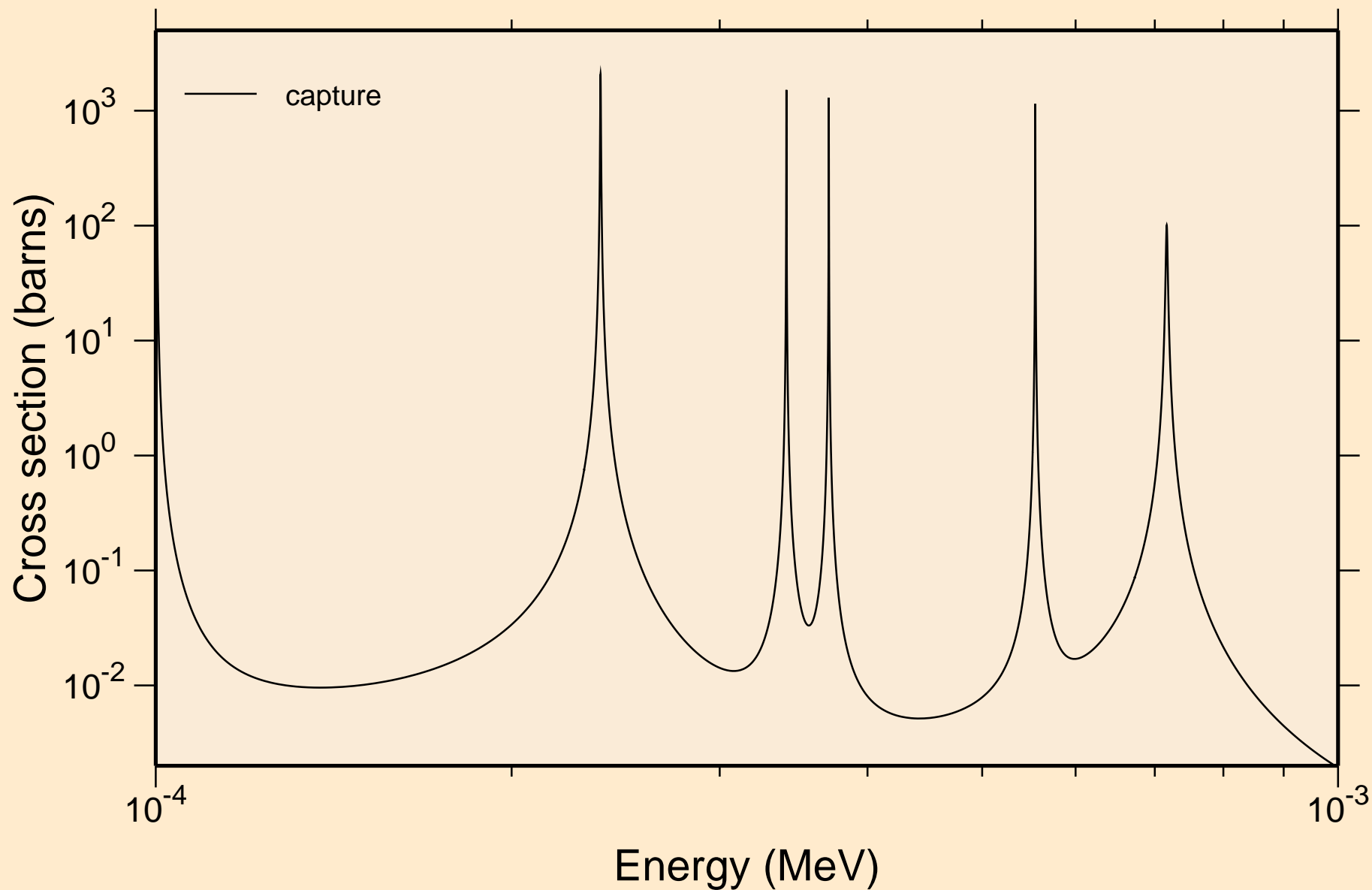

XE128 NEUTRON ACER TENDL-2023 LIBRARY; T=0.K  
resonance absorption cross sections

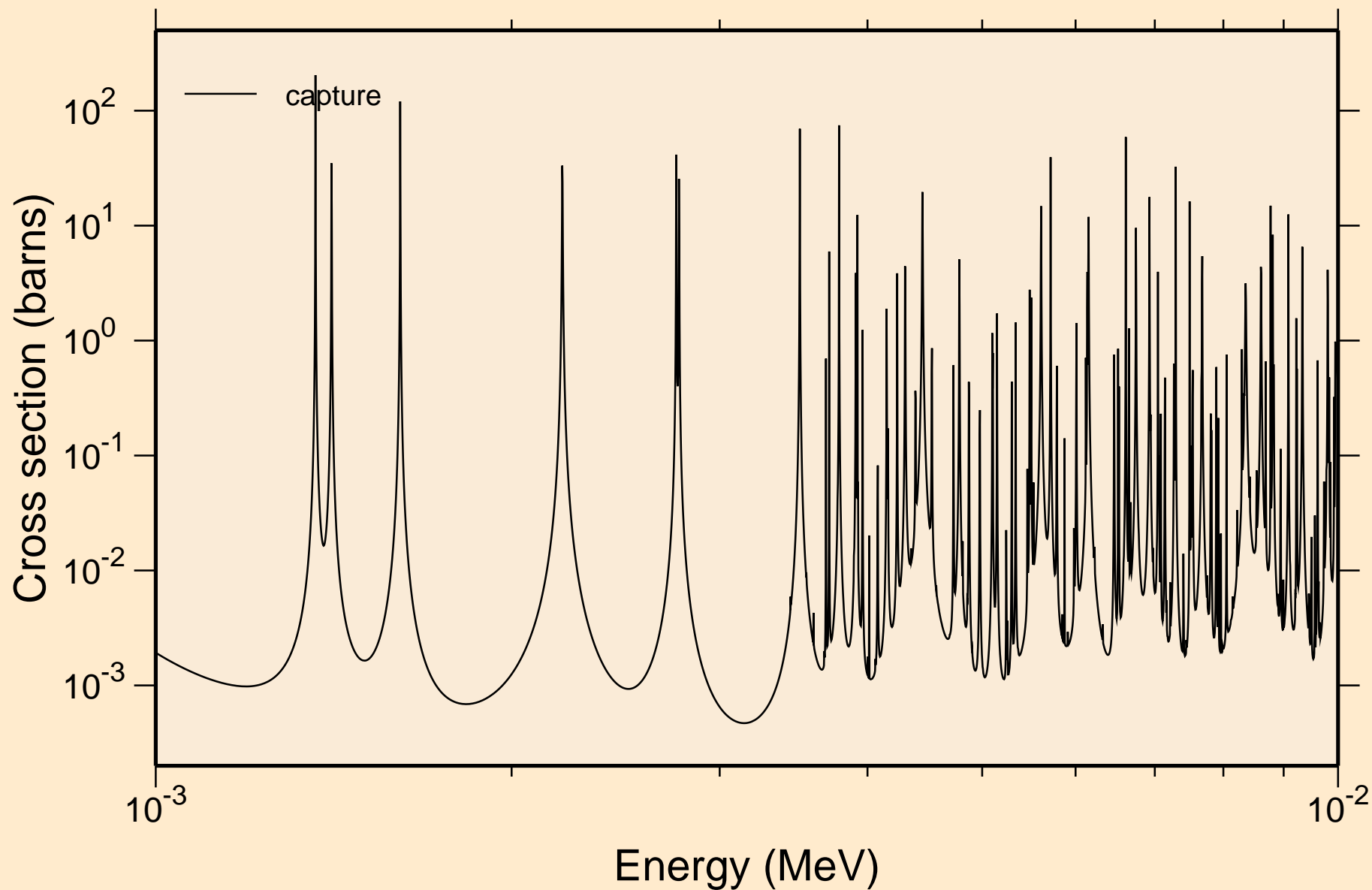

XE128 NEUTRON ACER TENDL-2023 LIBRARY; T=0.K  
resonance absorption cross sections

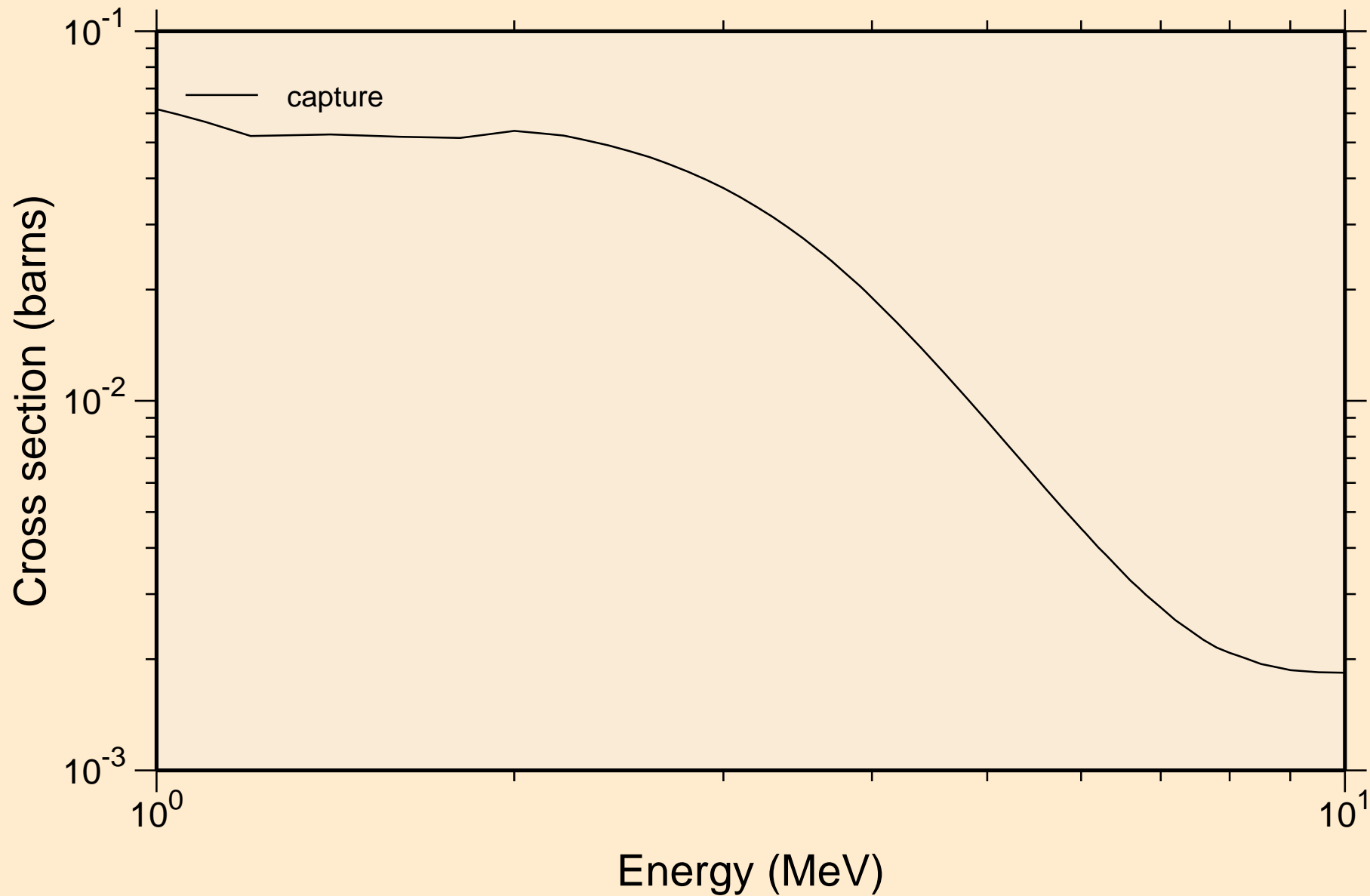

XE128 NEUTRON ACER TENDL-2023 LIBRARY; T=0.K  
Heating

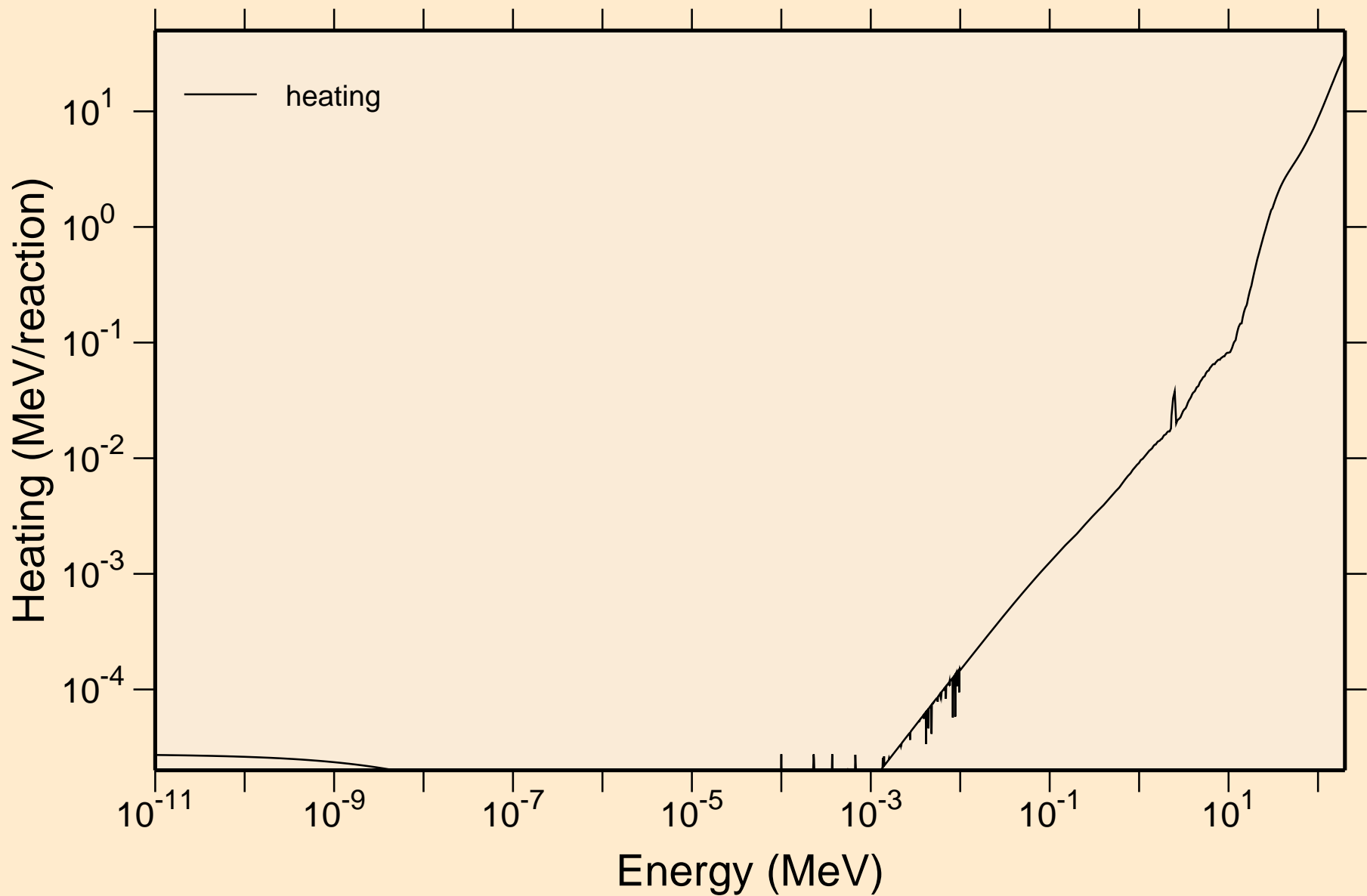

# XE128 NEUTRON ACER TENDL-2023 LIBRARY; T=0.K

## Damage

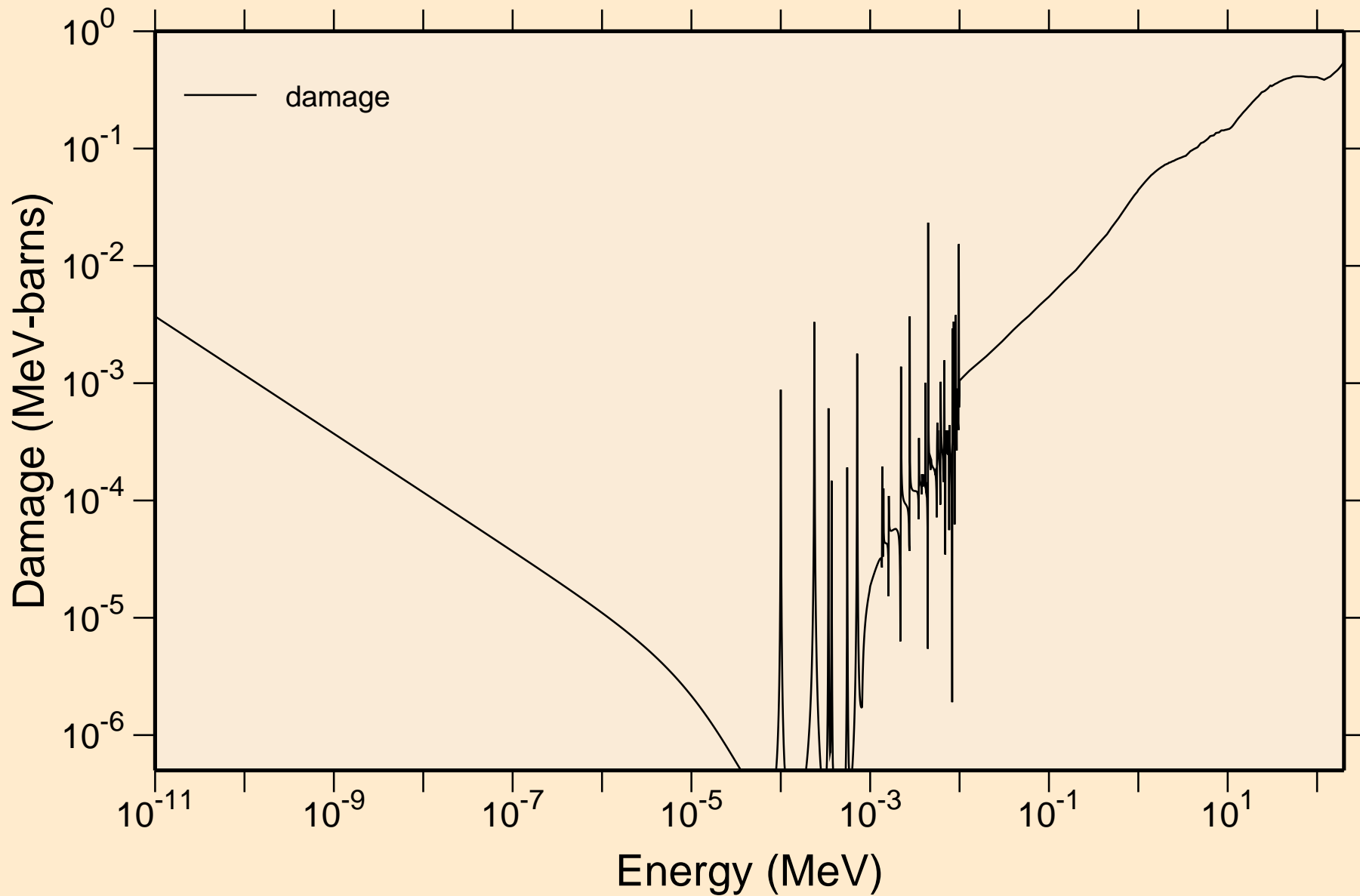

XE128 NEUTRON ACER TENDL-2023 LIBRARY; T=0.K  
Non-threshold reactions

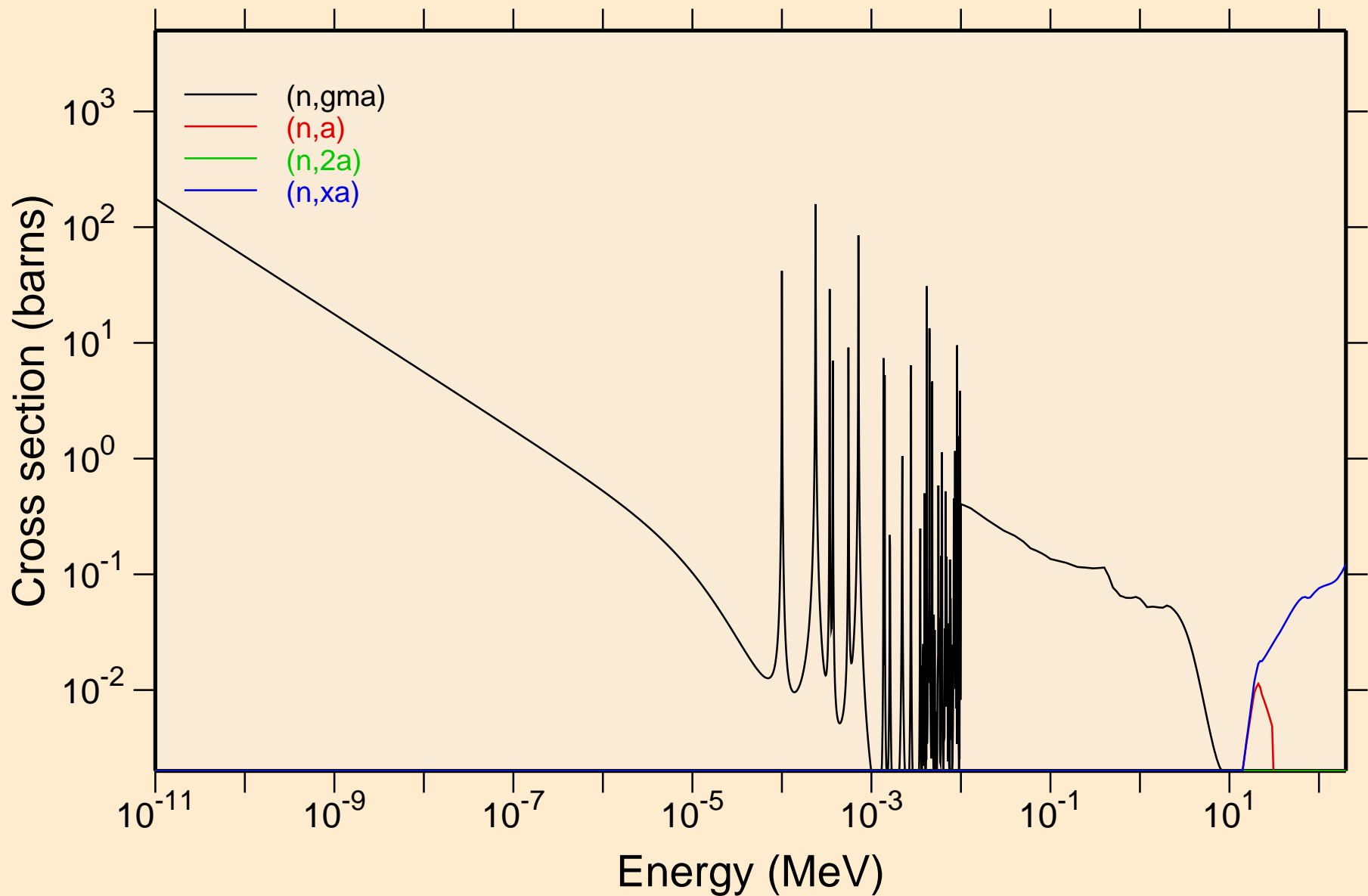

# XE128 NEUTRON ACER TENDL-2023 LIBRARY; T=0.K

## Principal cross sections

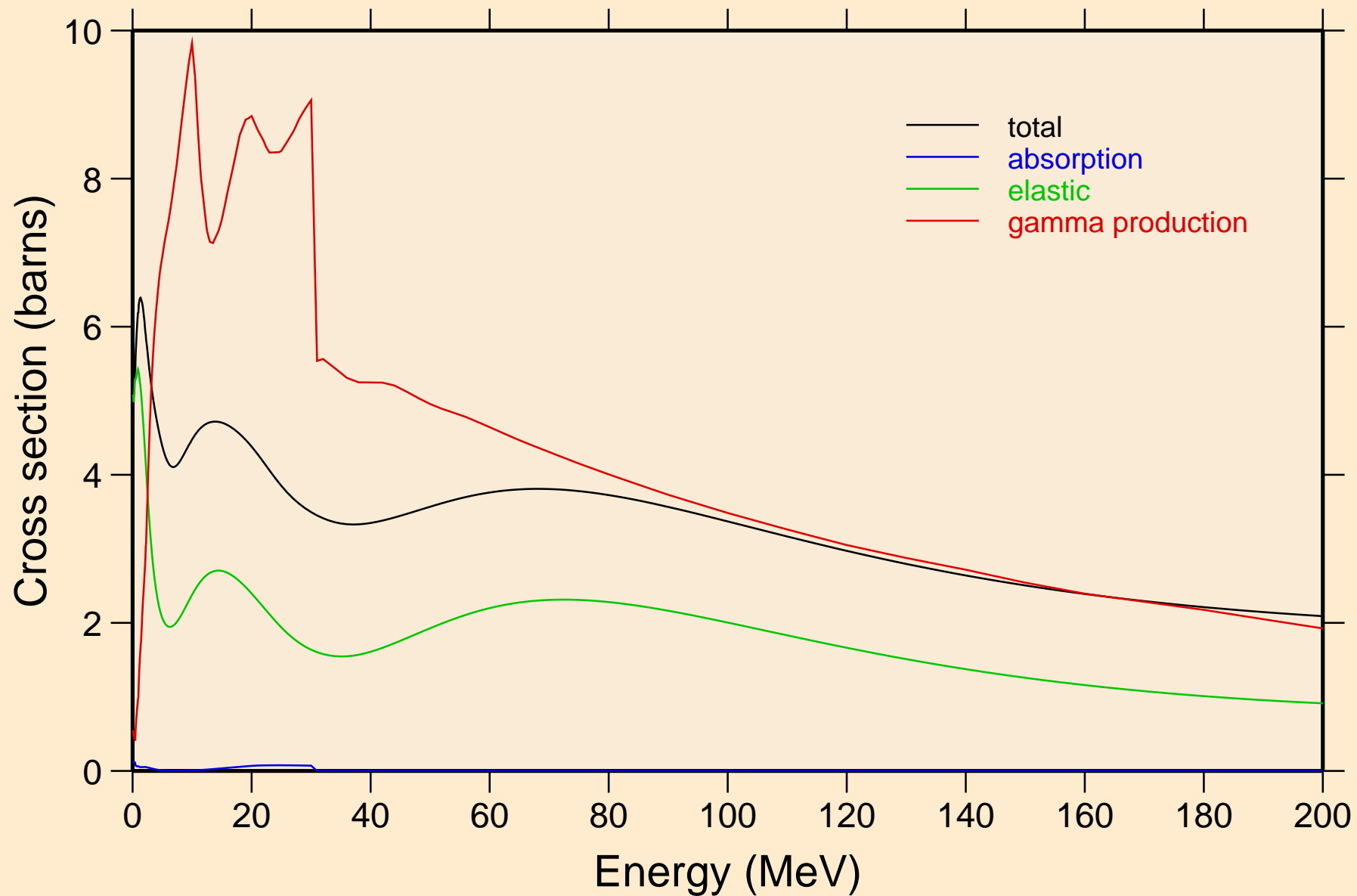

XE128 NEUTRON ACER TENDL-2023 LIBRARY; T=0.K  
Heating

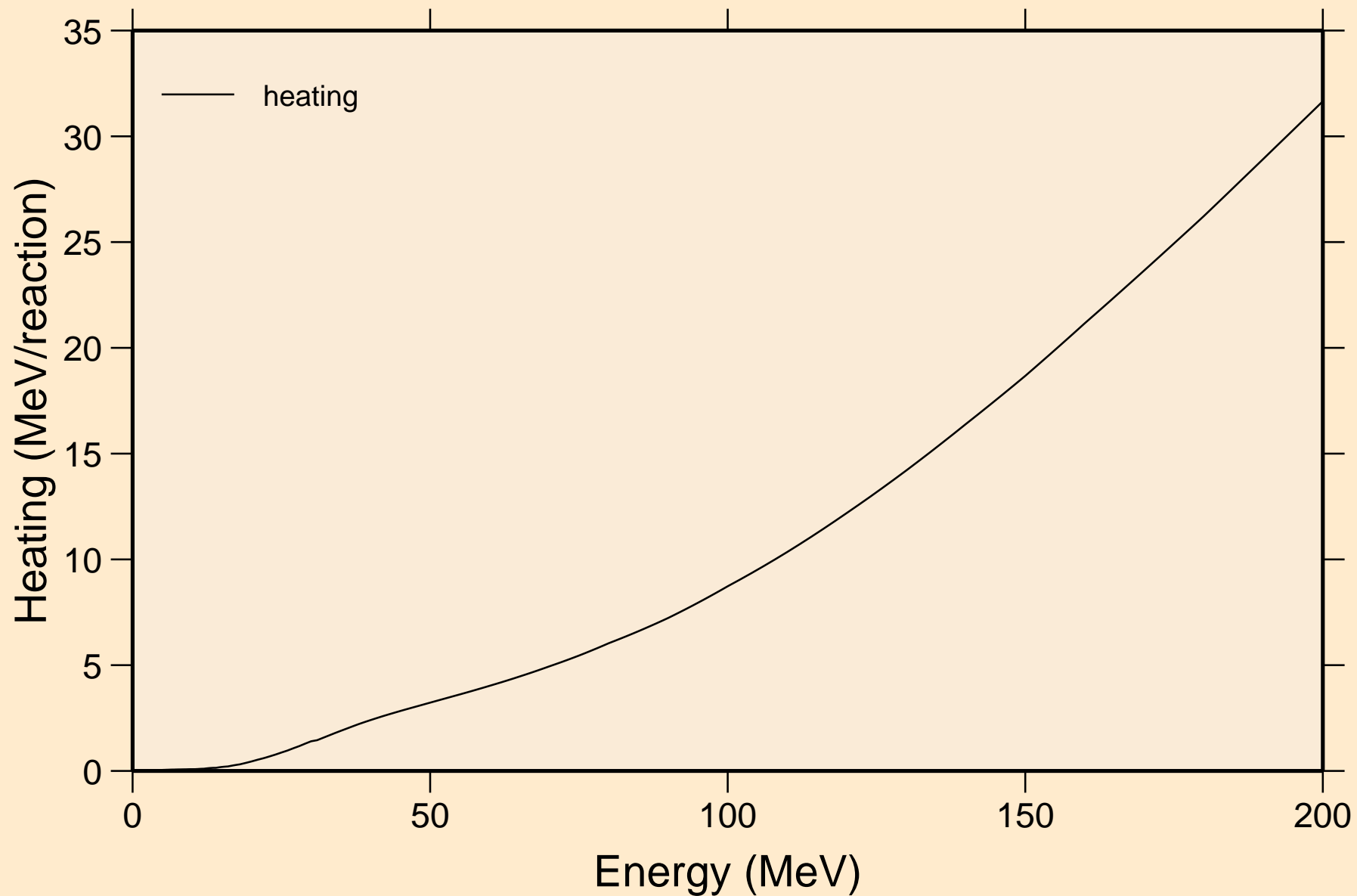

XE128 NEUTRON ACER TENDL-2023 LIBRARY; T=0.K  
Damage

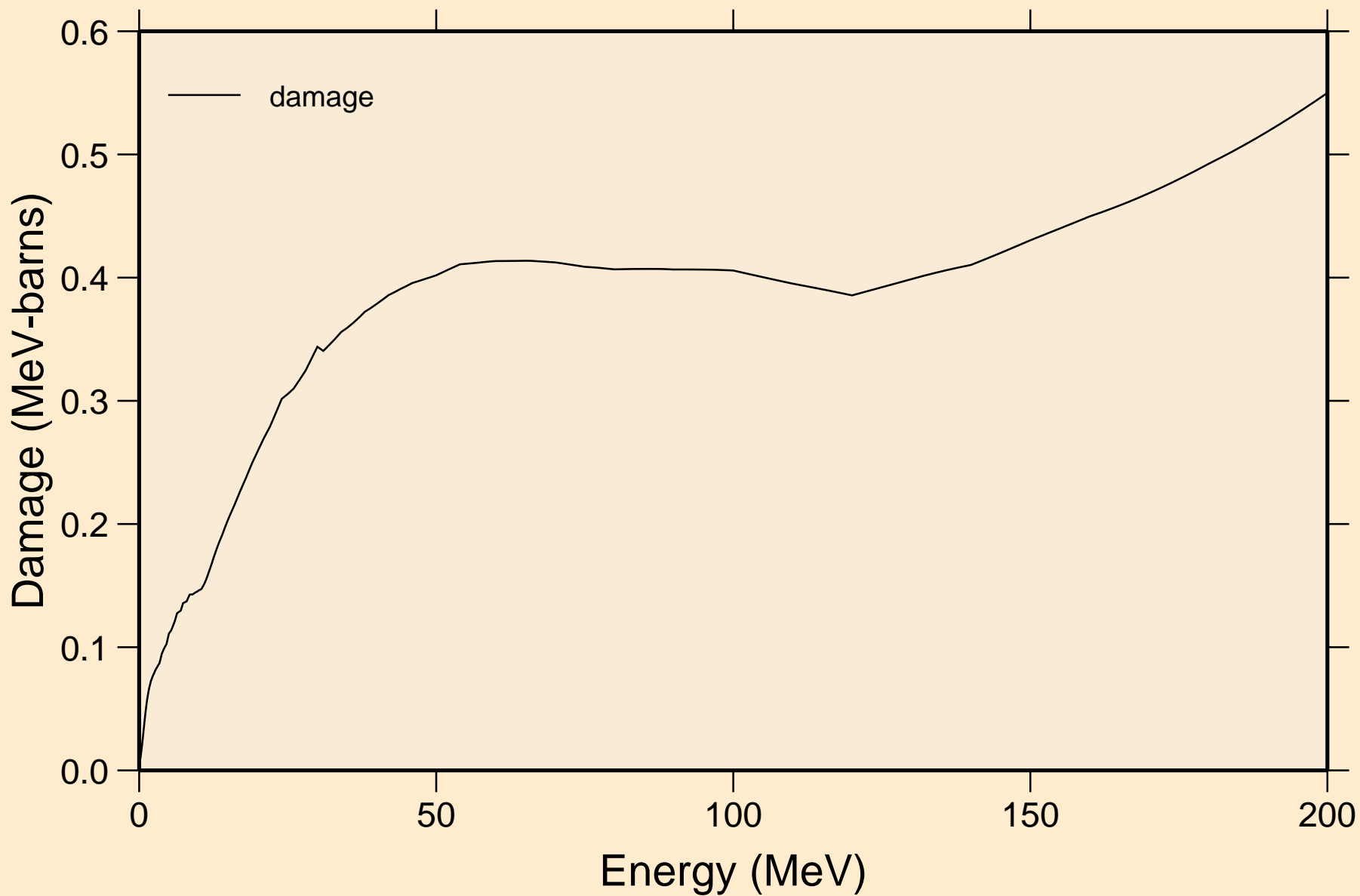

XE128 NEUTRON ACER TENDL-2023 LIBRARY; T=0.K  
Non-threshold reactions

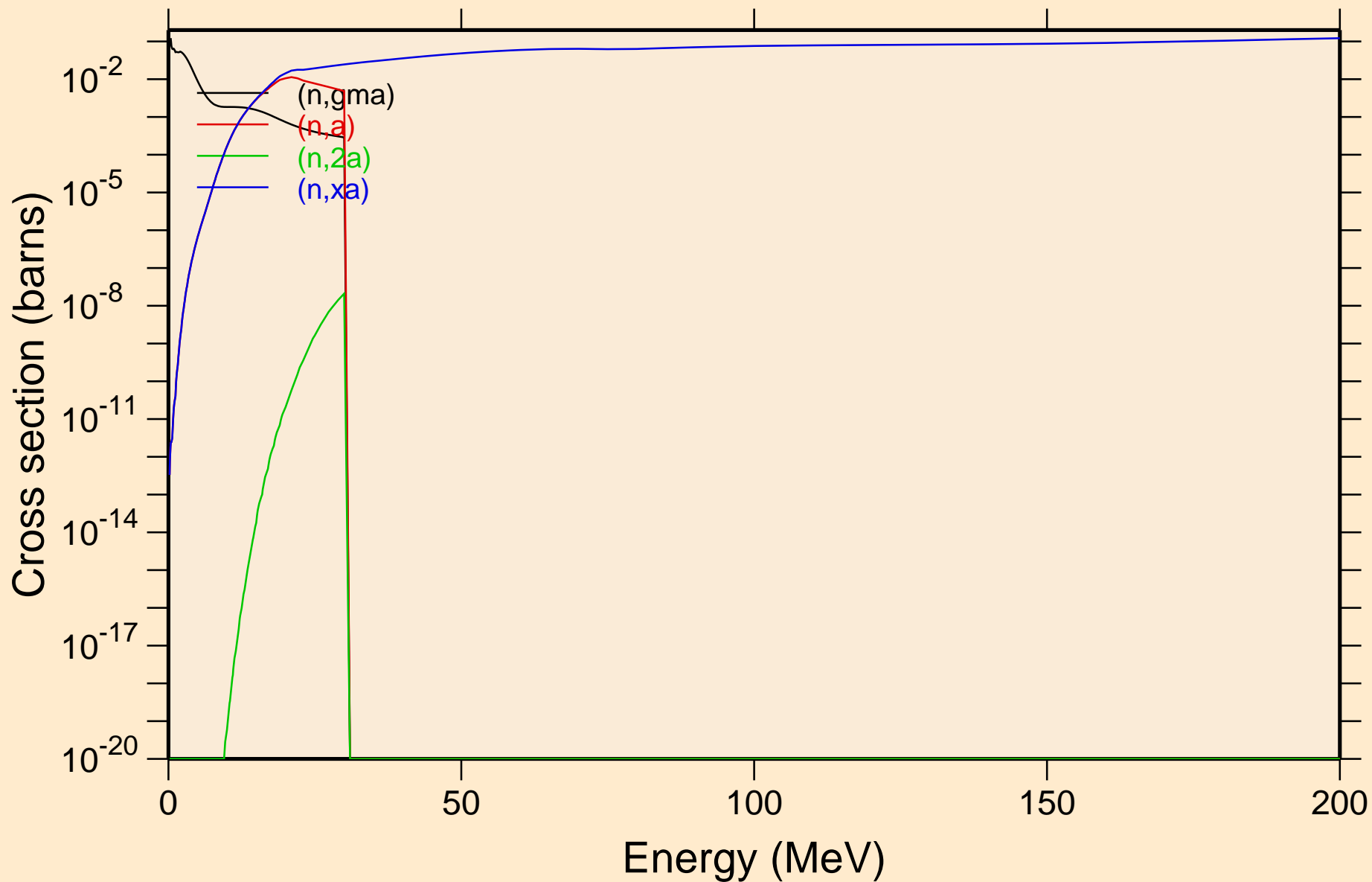

XE128 NEUTRON ACER TENDL-2023 LIBRARY; T=0.K  
Inelastic levels

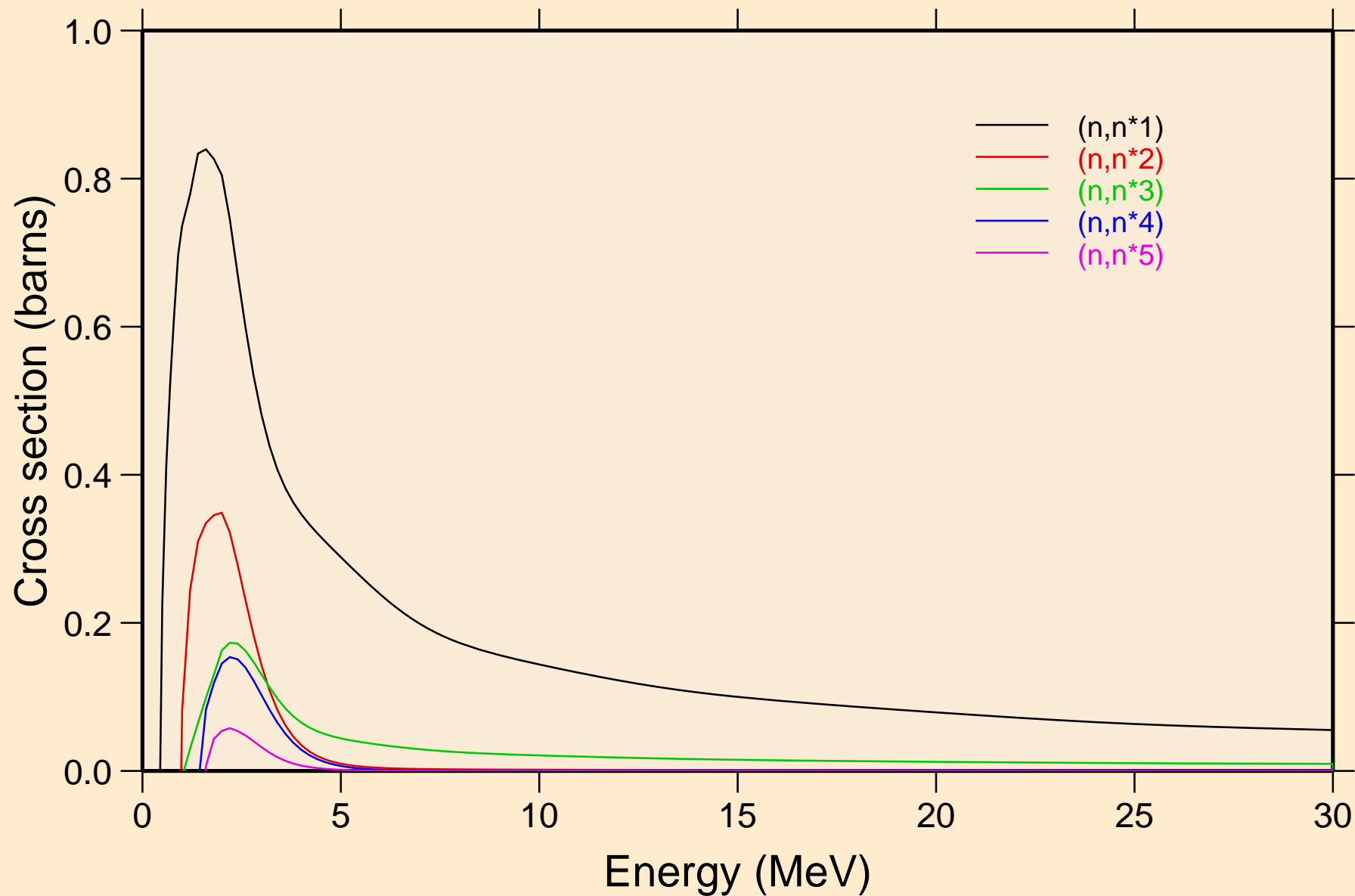

XE128 NEUTRON ACER TENDL-2023 LIBRARY; T=0.K  
Inelastic levels

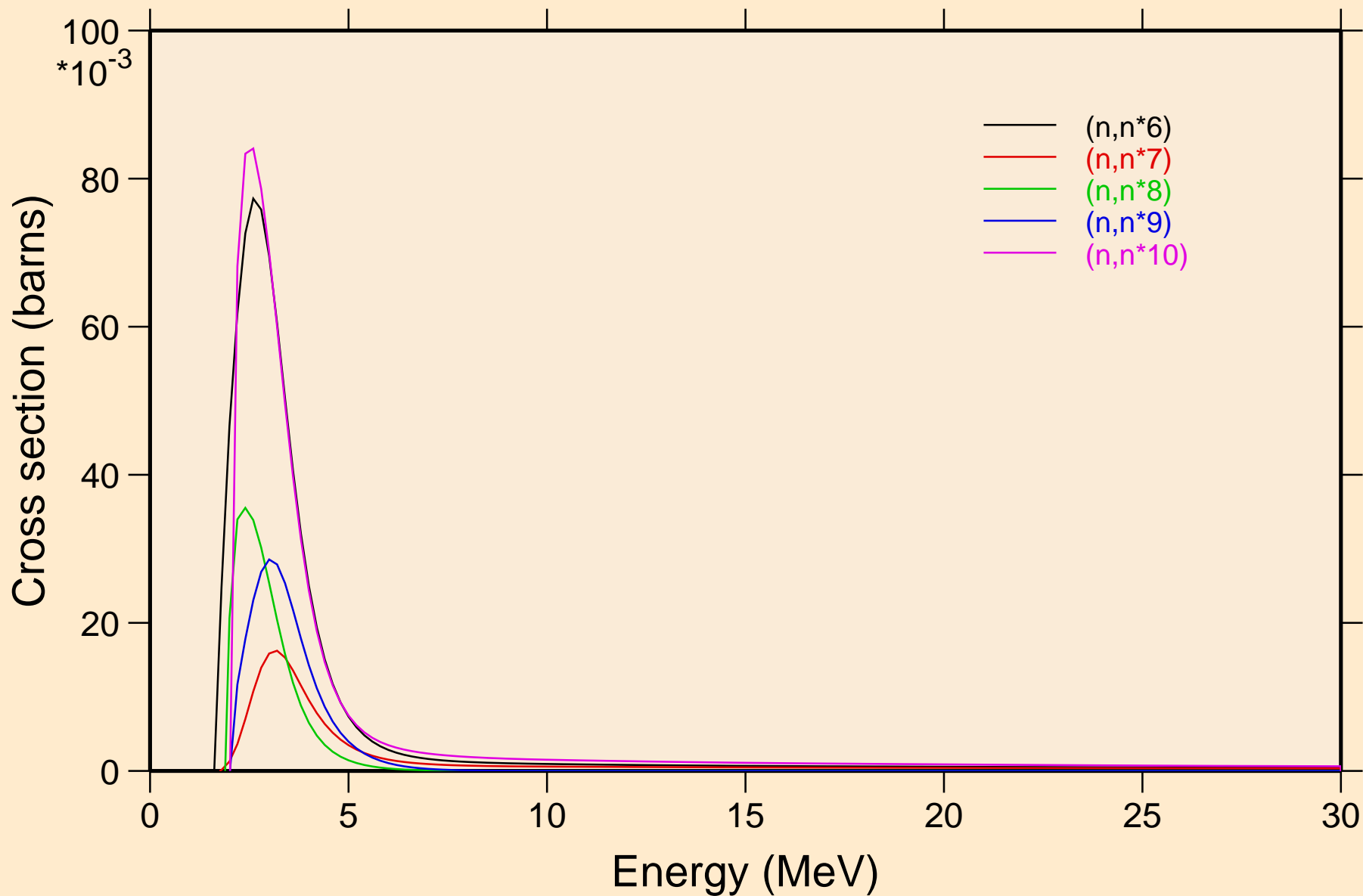

XE128 NEUTRON ACER TENDL-2023 LIBRARY; T=0.K  
Inelastic levels

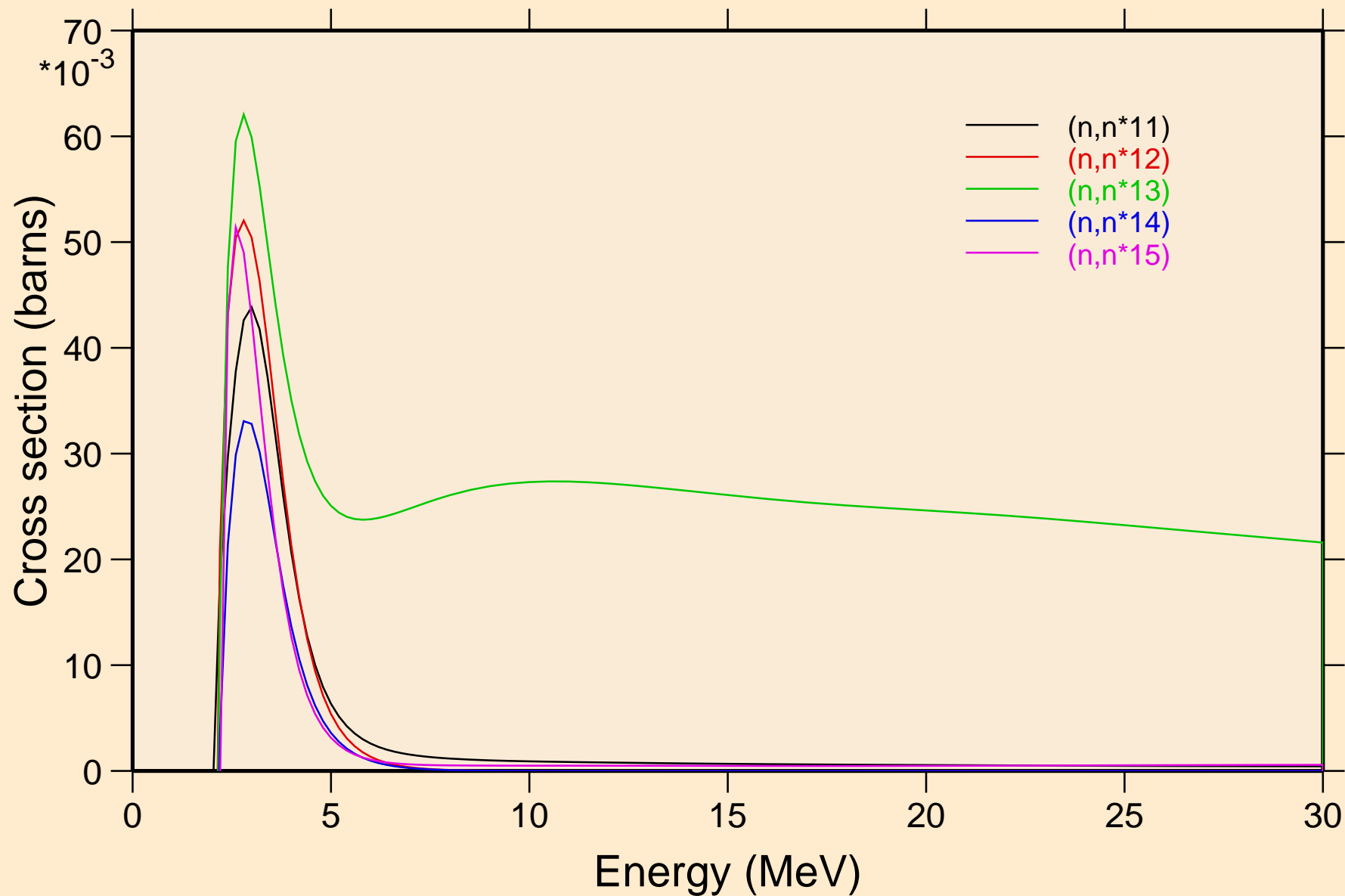

XE128 NEUTRON ACER TENDL-2023 LIBRARY; T=0.K  
Inelastic levels

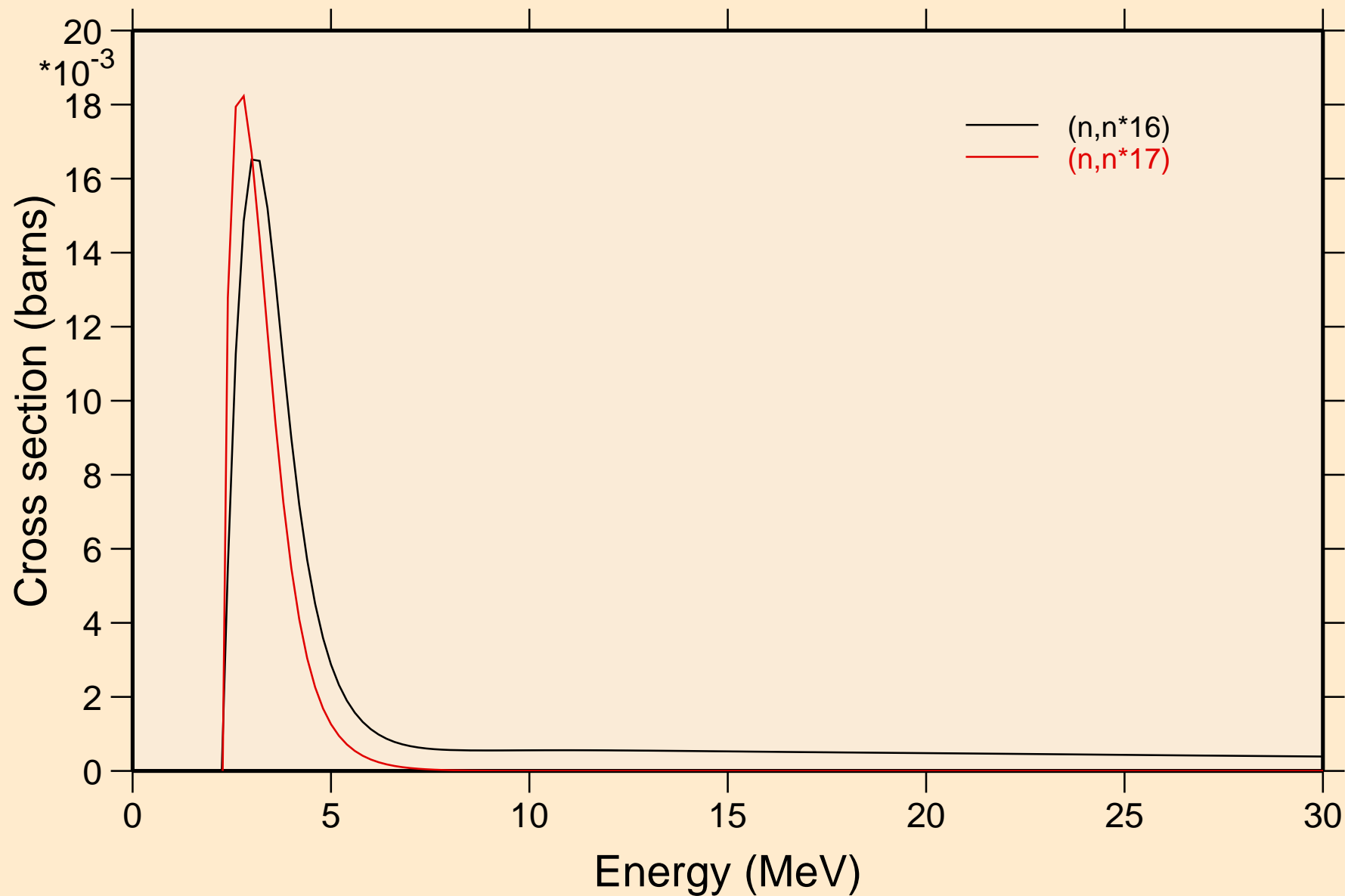

XE128 NEUTRON ACER TENDL-2023 LIBRARY; T=0.K  
Threshold reactions

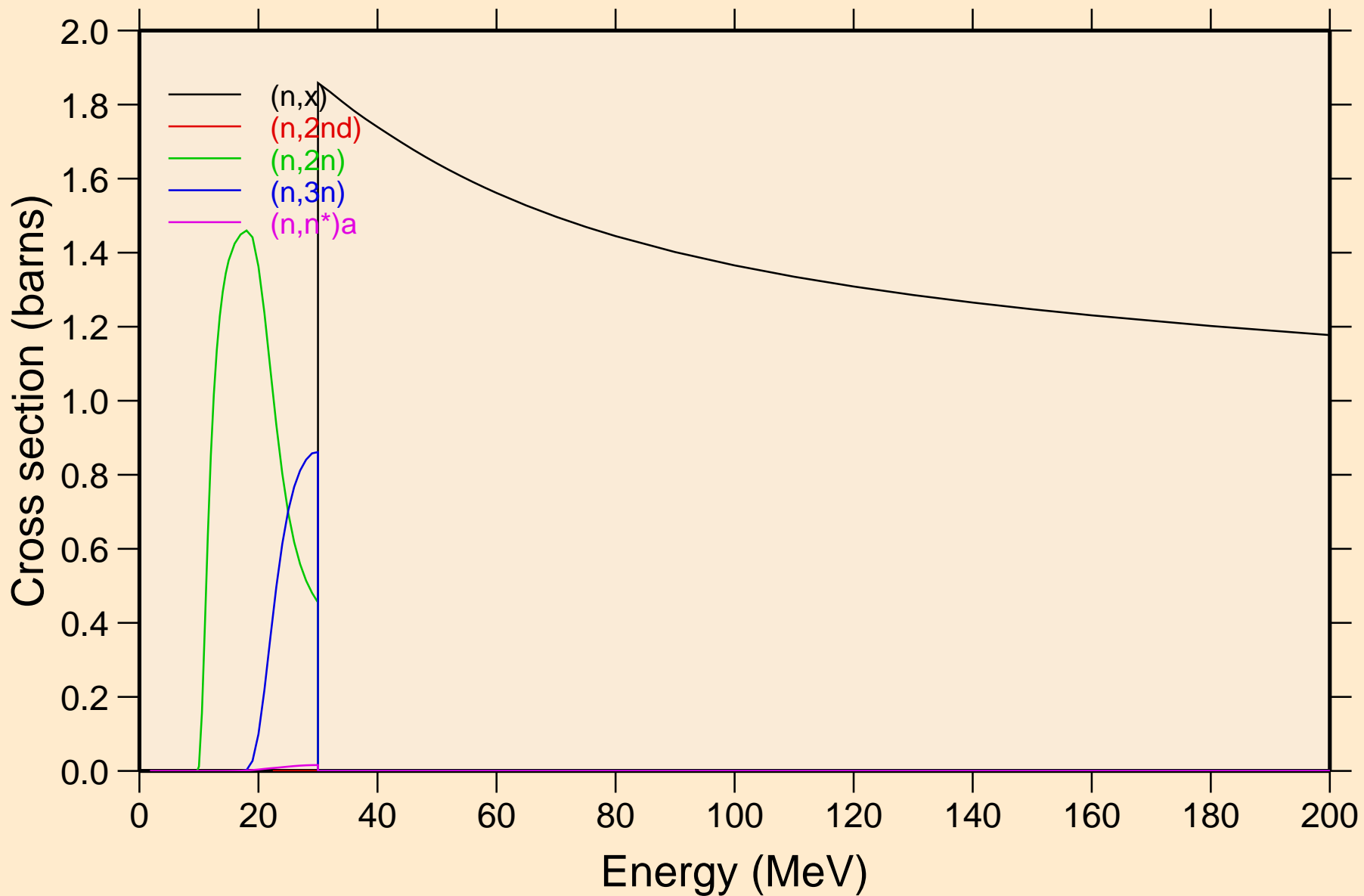

# XE128 NEUTRON ACER TENDL-2023 LIBRARY; T=0.K

## Threshold reactions

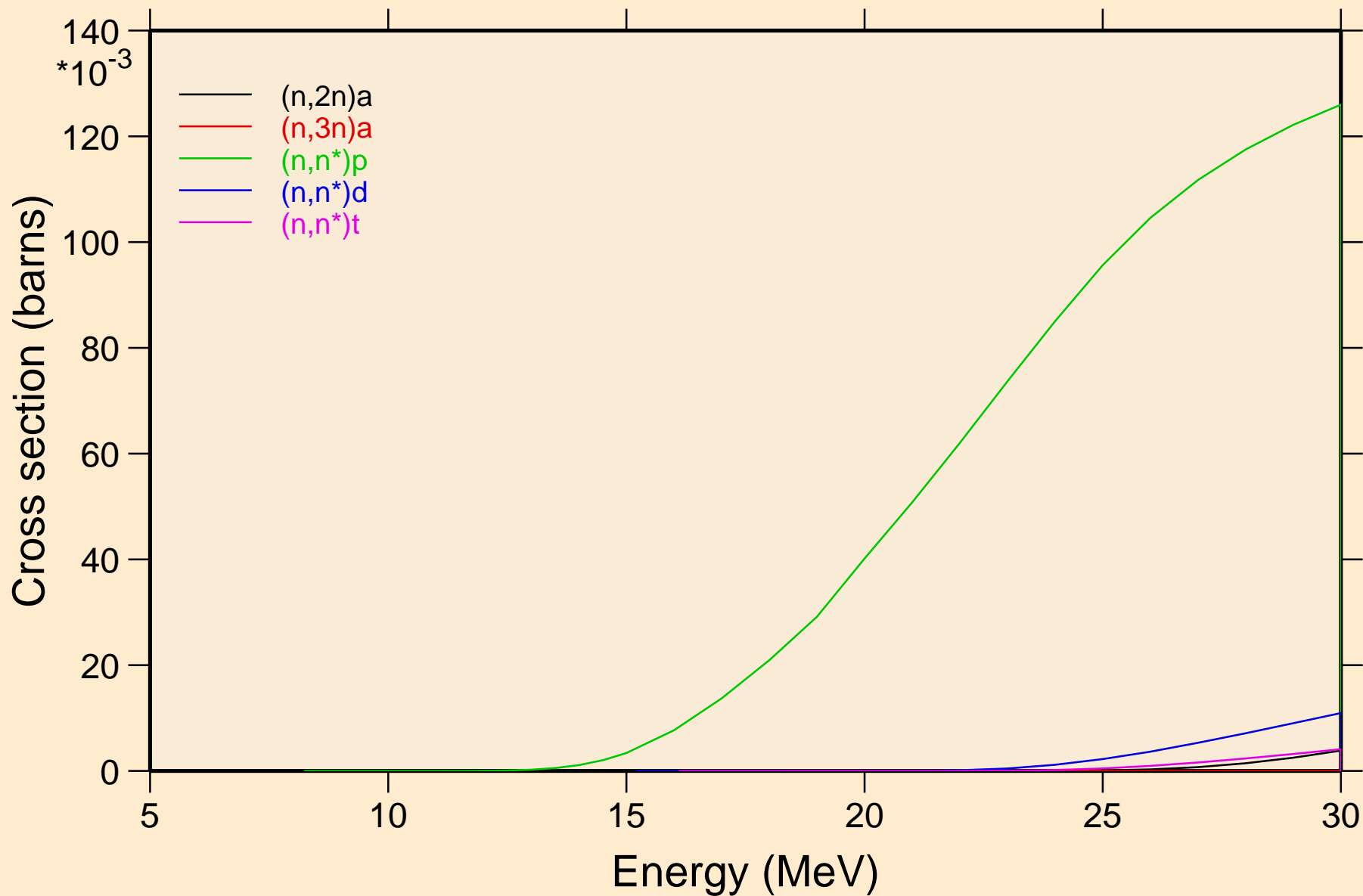

XE128 NEUTRON ACER TENDL-2023 LIBRARY; T=0.K  
Threshold reactions

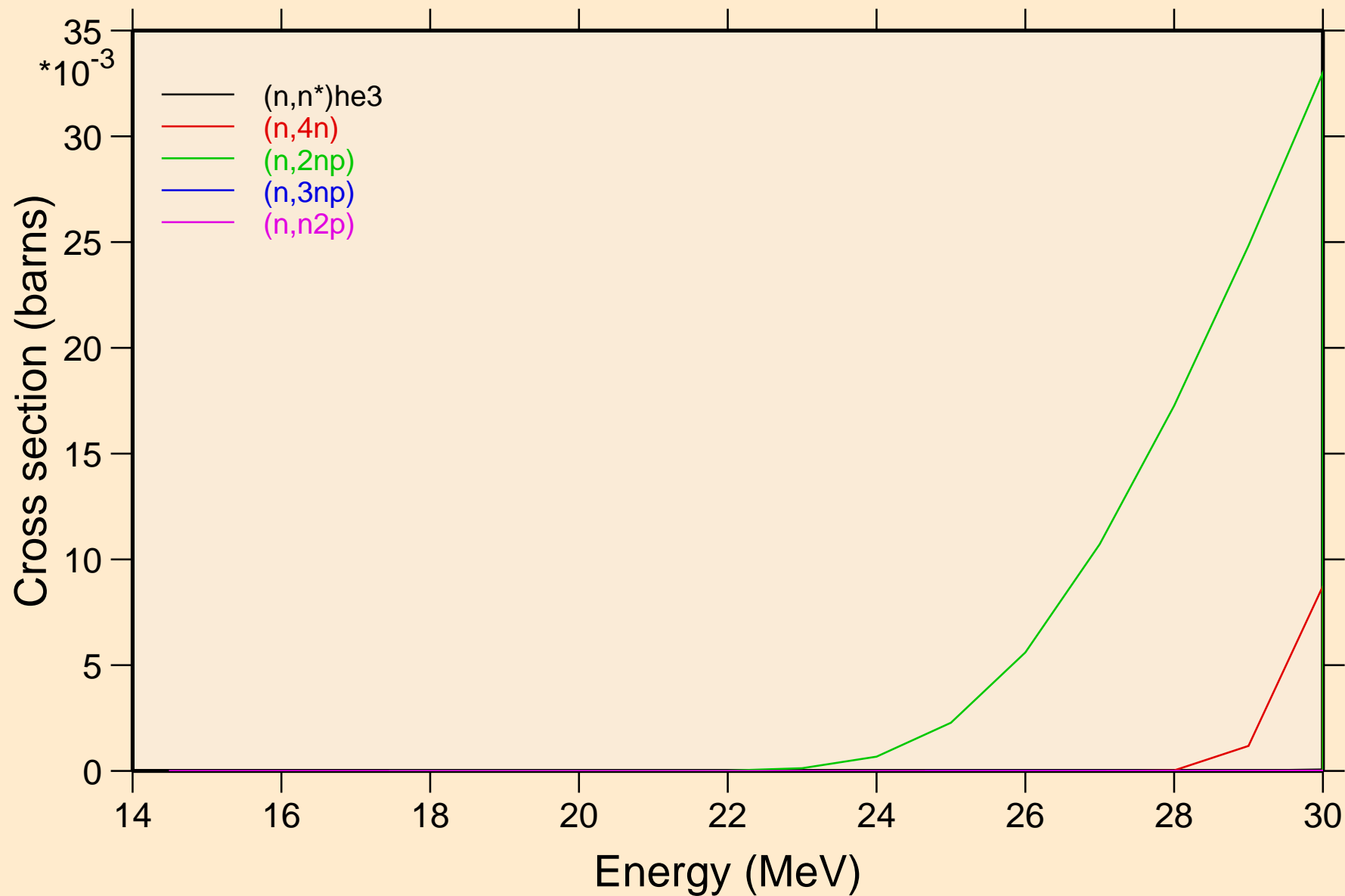

XE128 NEUTRON ACER TENDL-2023 LIBRARY; T=0.K  
Threshold reactions

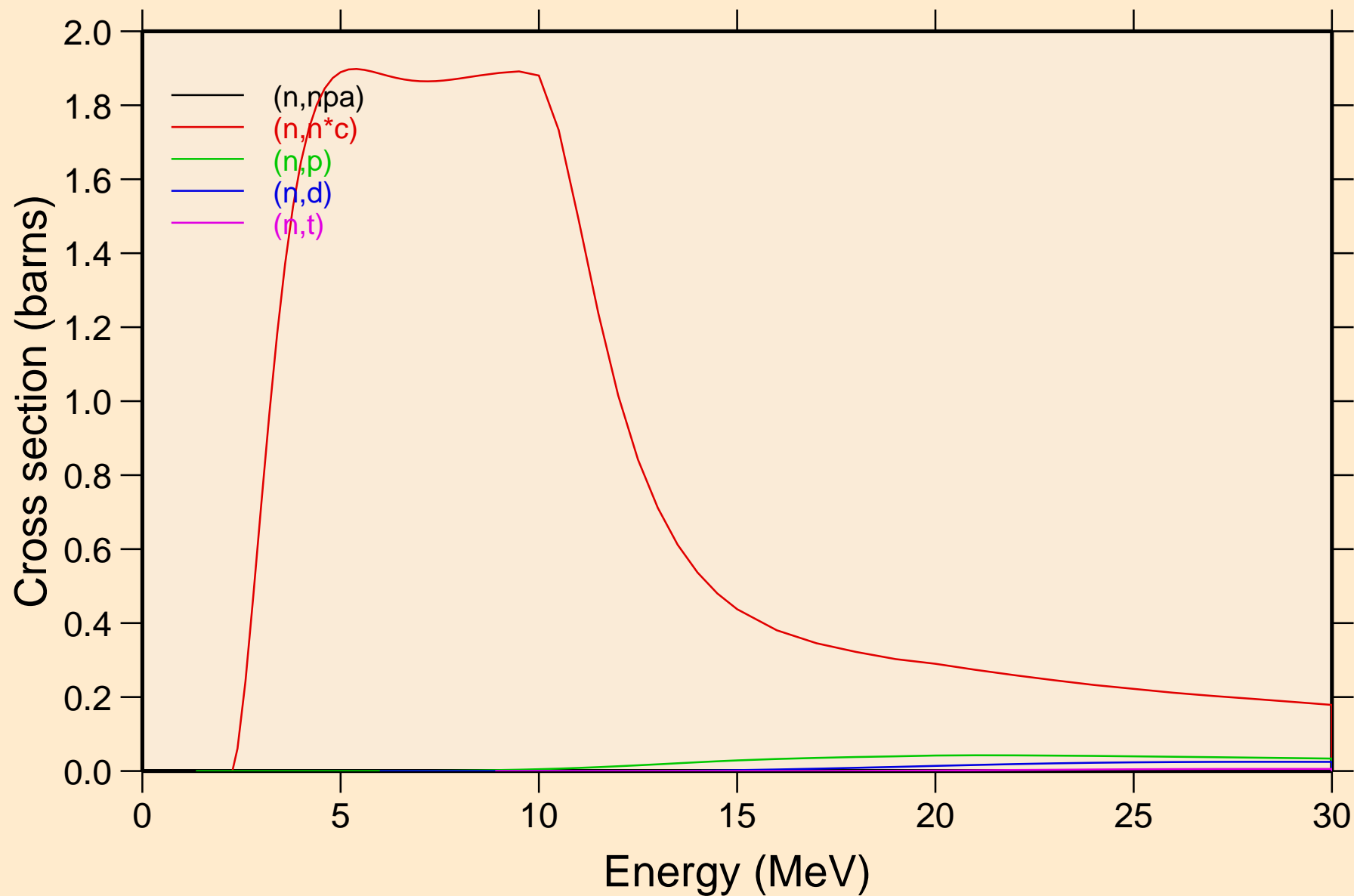

# XE128 NEUTRON ACER TENDL-2023 LIBRARY; T=0.K

## Threshold reactions

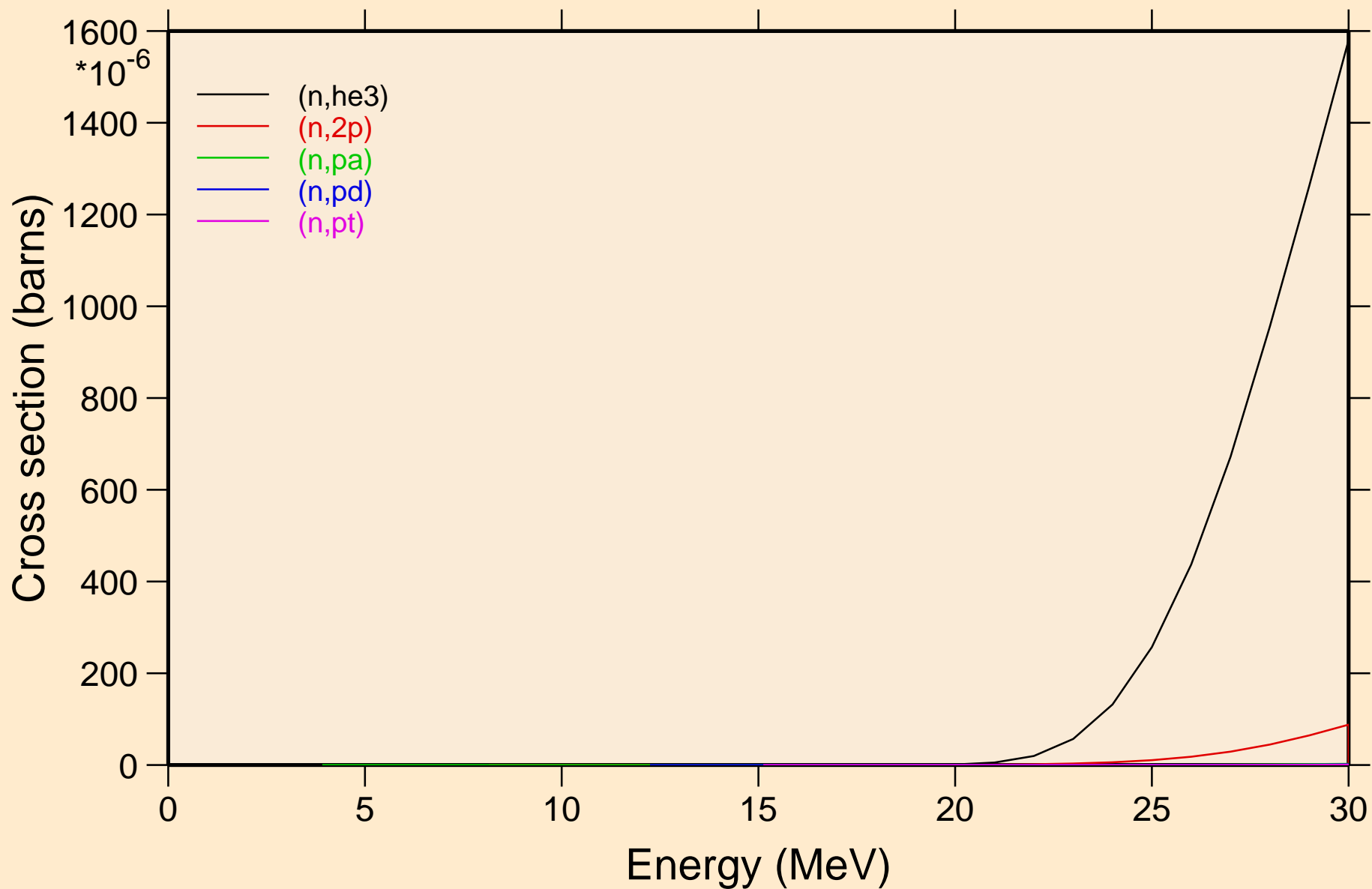

XE128 NEUTRON ACER TENDL-2023 LIBRARY; T=0.K  
Threshold reactions

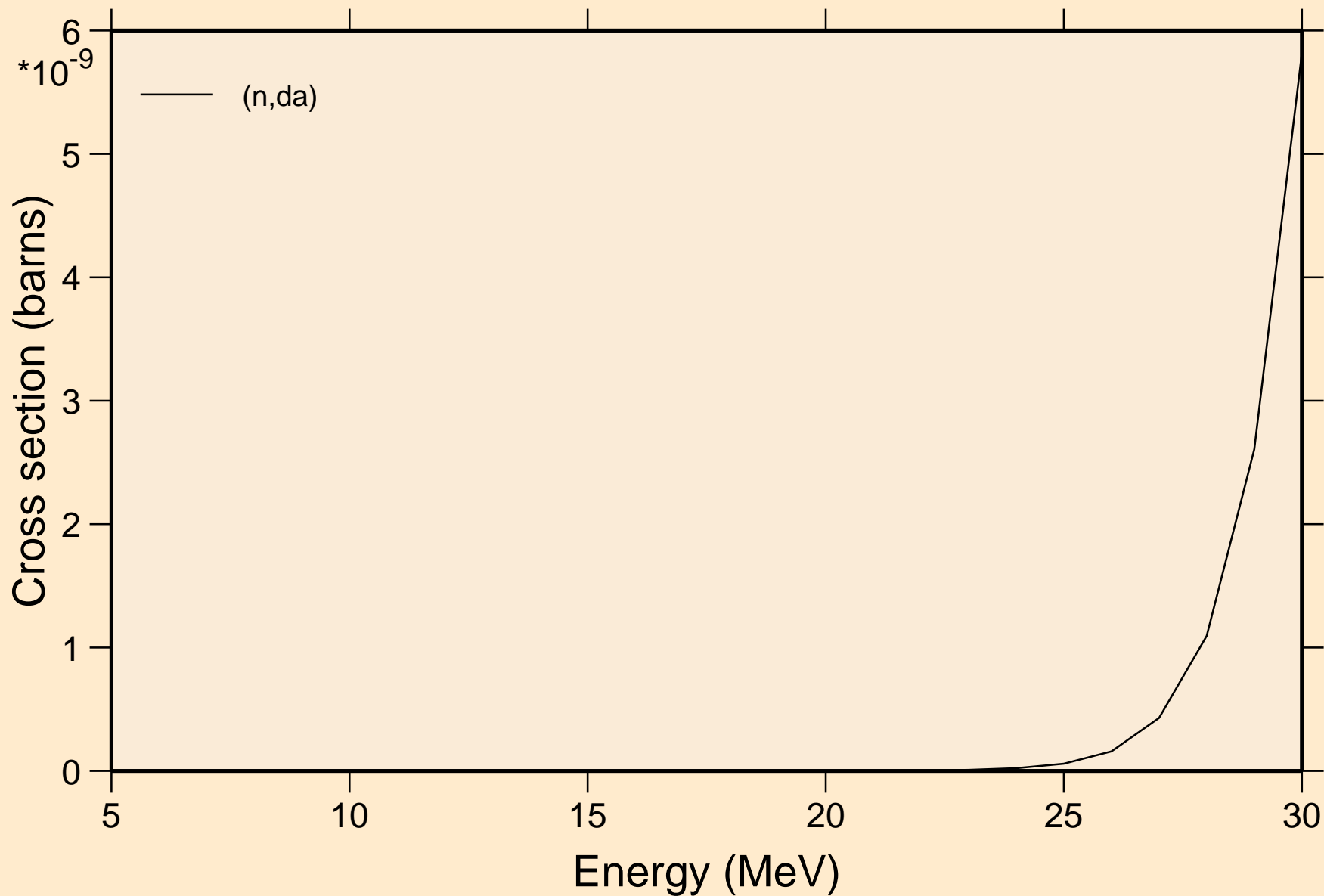

XE128 NEUTRON ACER TENDL-2023 LIBRARY; T=0.K  
Threshold reactions

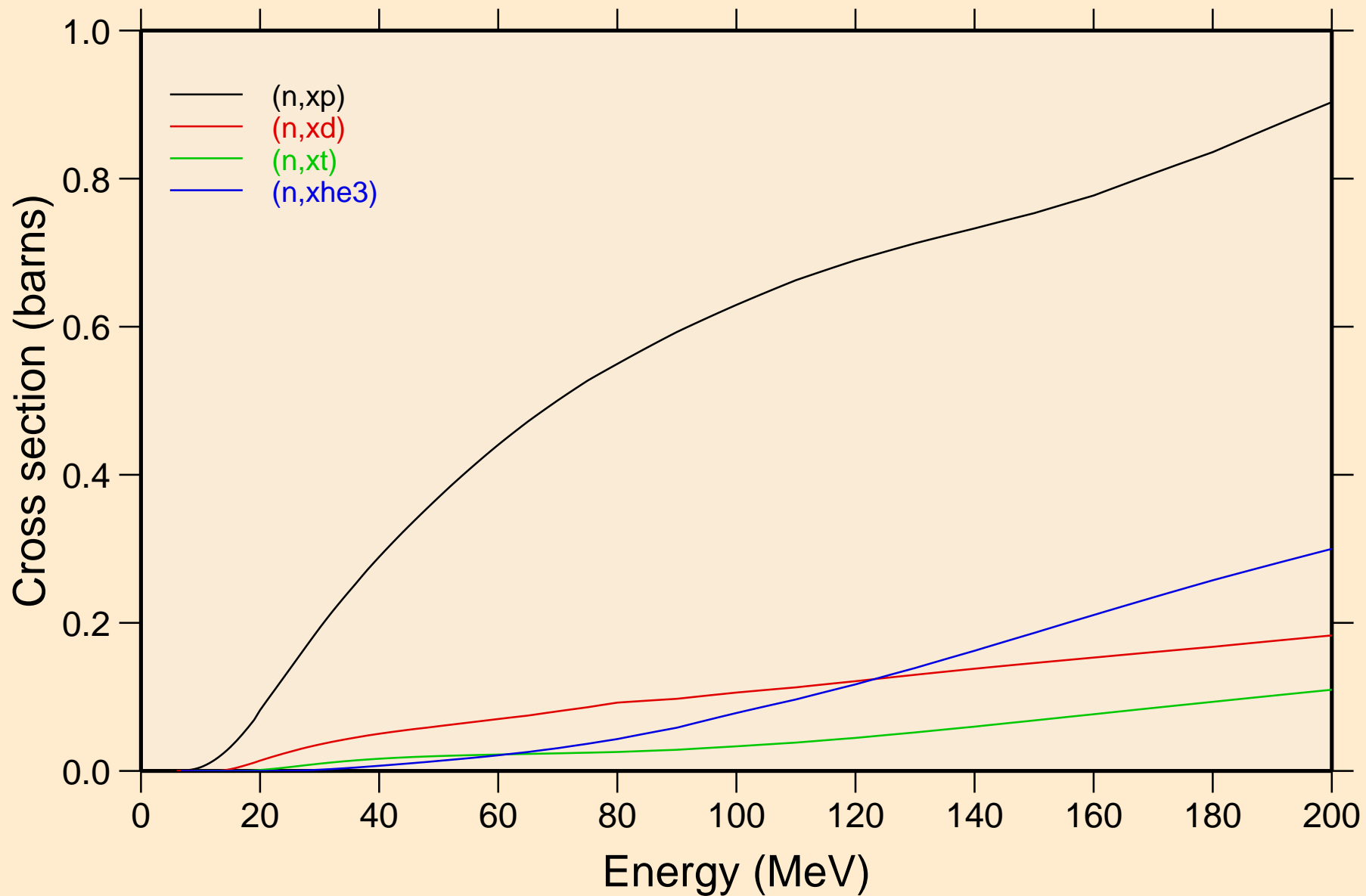

XE128 NEUTRON ACER TENDL-2023 LIBRARY; T=0.K  
angular distribution for elastic

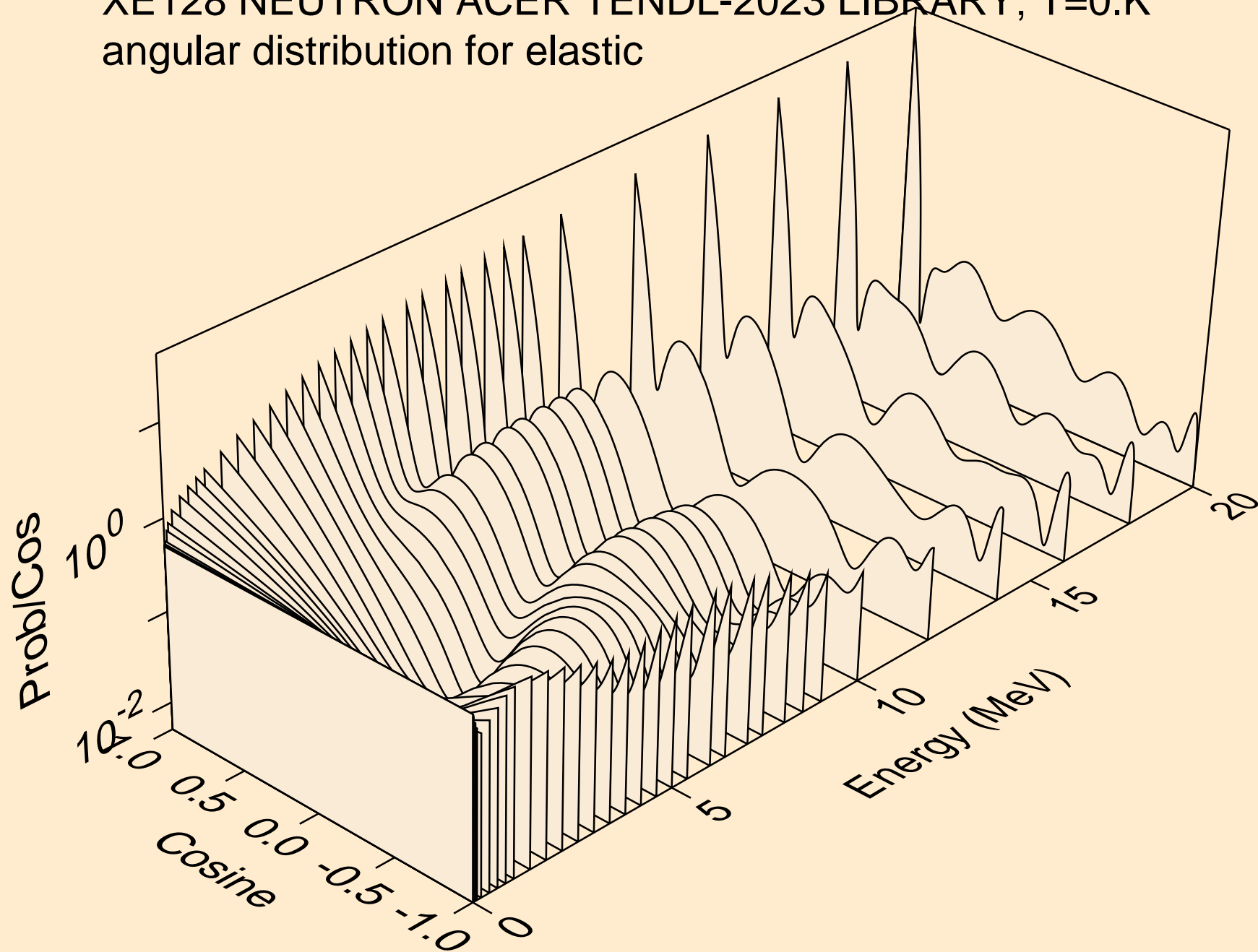

XE128 NEUTRON ACER TENDL-2023 LIBRARY; T=0.K  
angular distribution for elastic

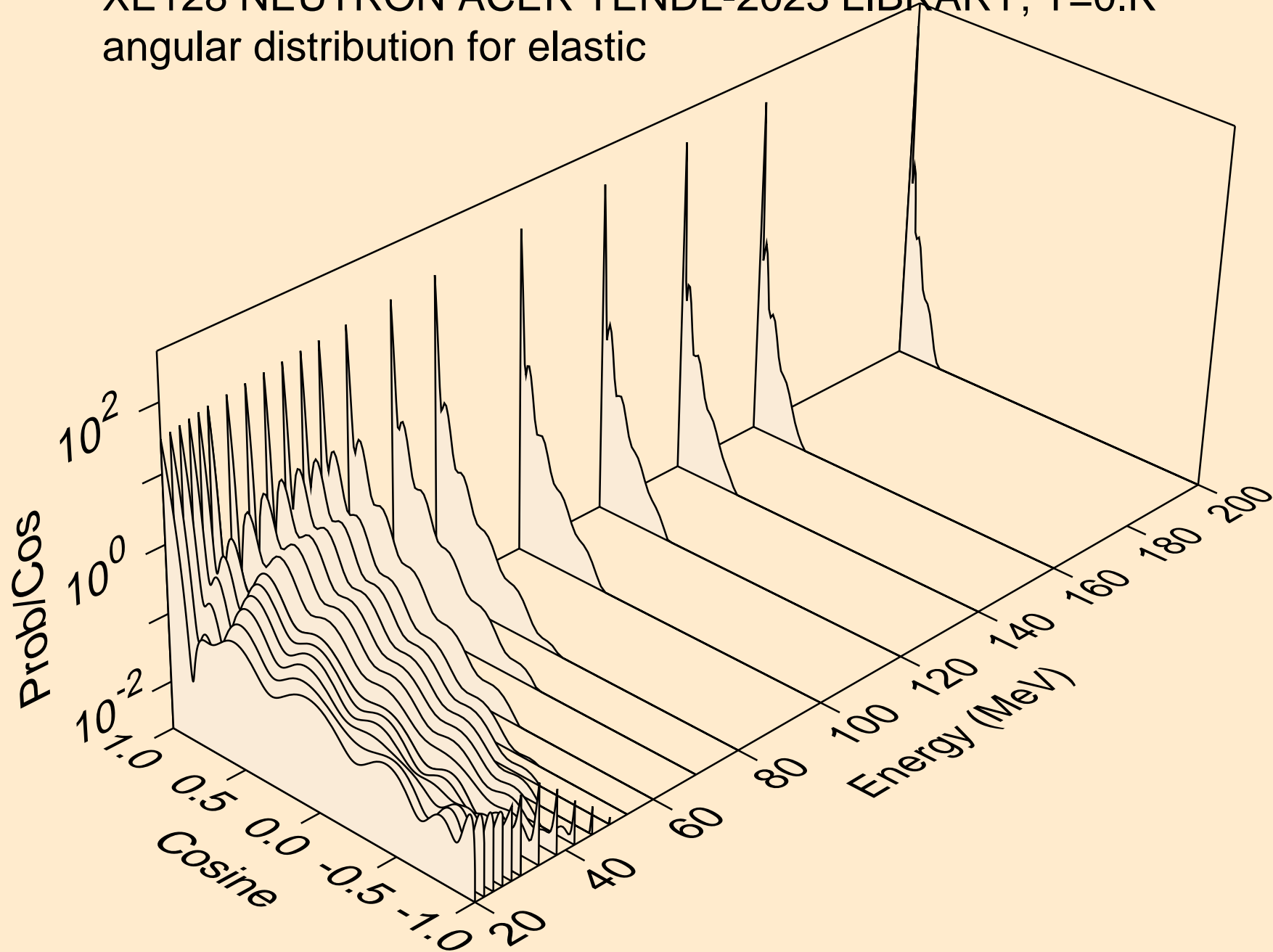

XE128 NEUTRON ACER TENDL-2023 LIBRARY; T=0.K  
angular distribution for (n,n\*1)

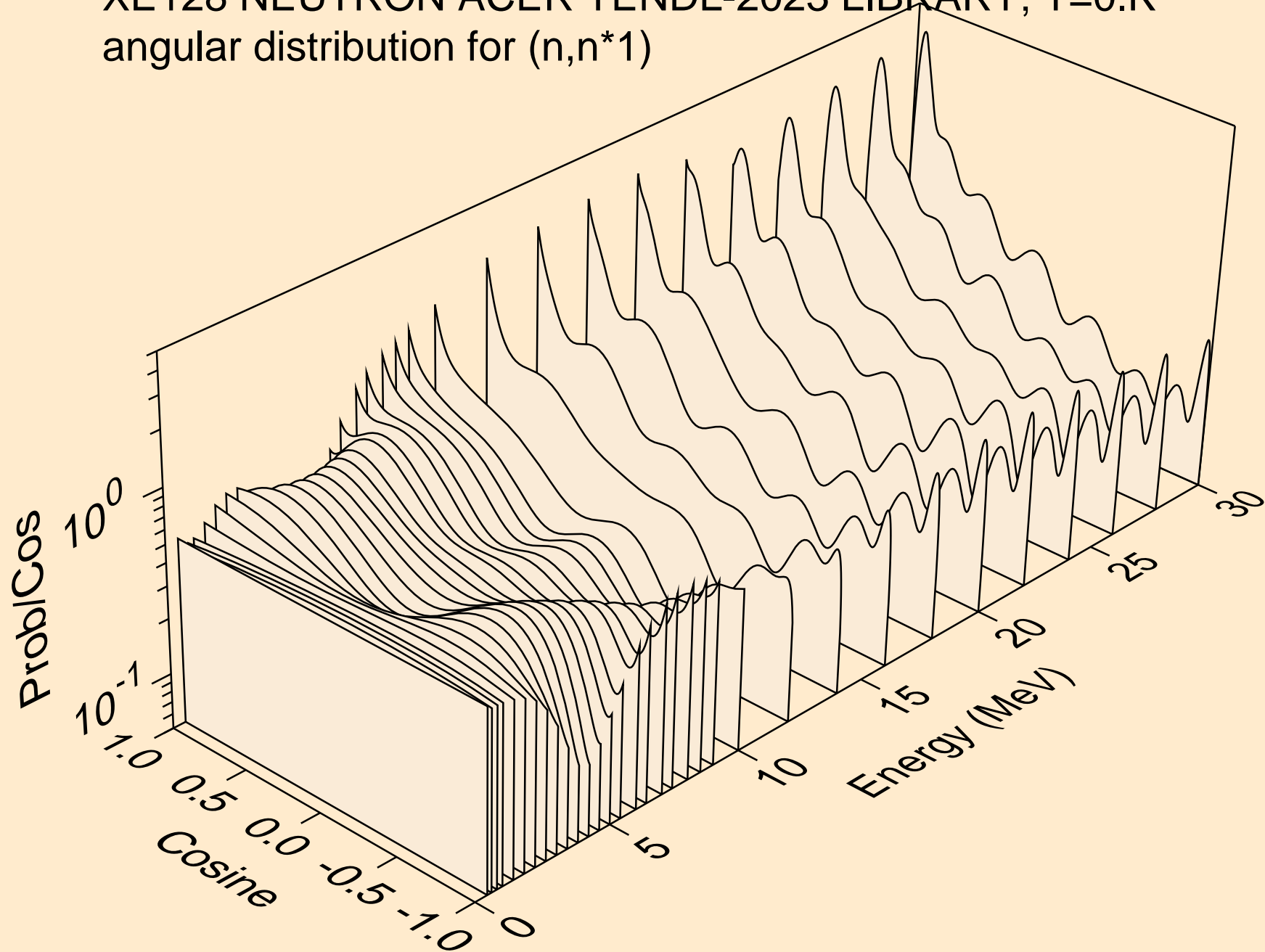

XE128 NEUTRON ACER TENDL-2023 LIBRARY; T=0.K  
angular distribution for (n,n\*2)

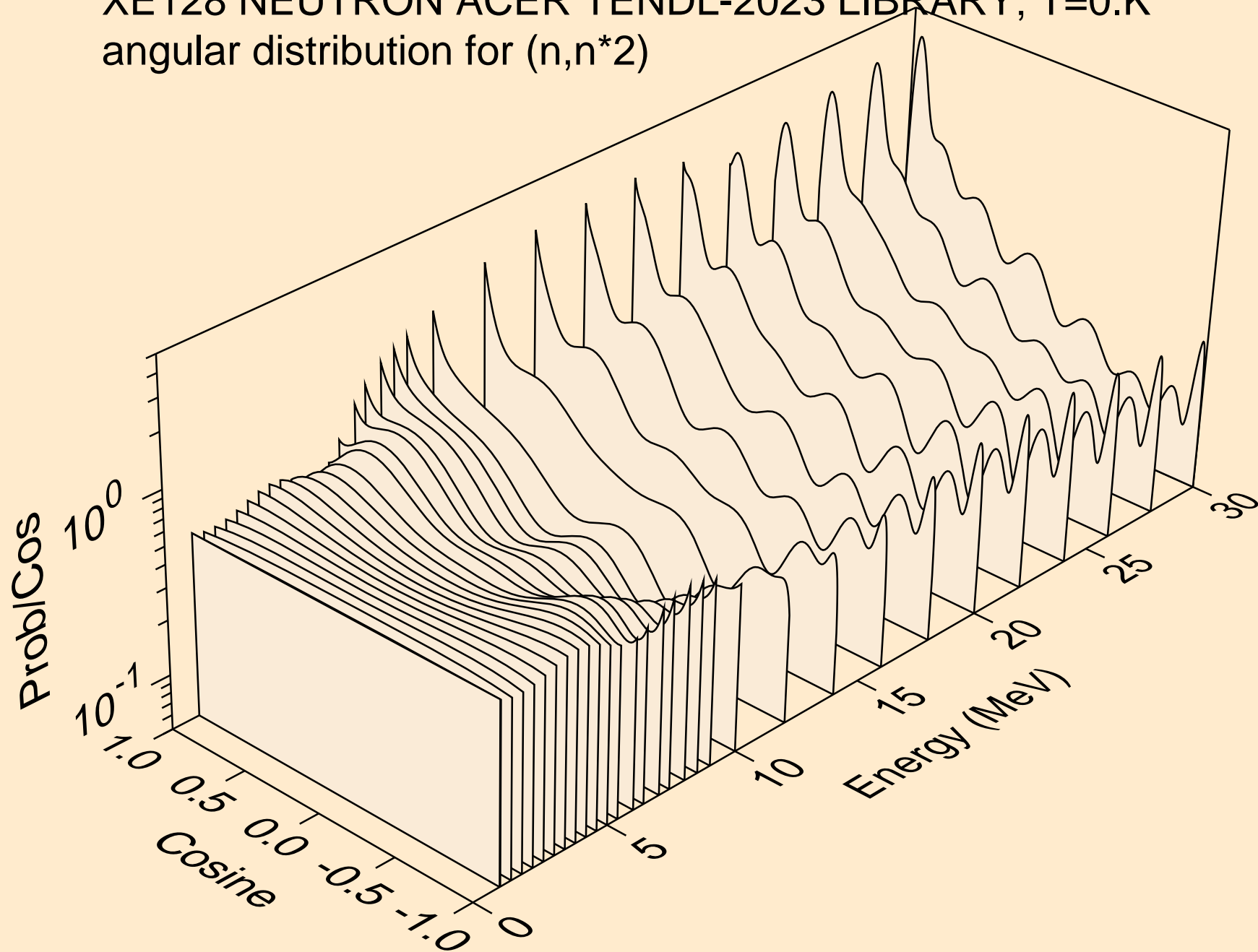

XE128 NEUTRON ACER TENDL-2023 LIBRARY; T=0.K  
angular distribution for (n,n\*3)

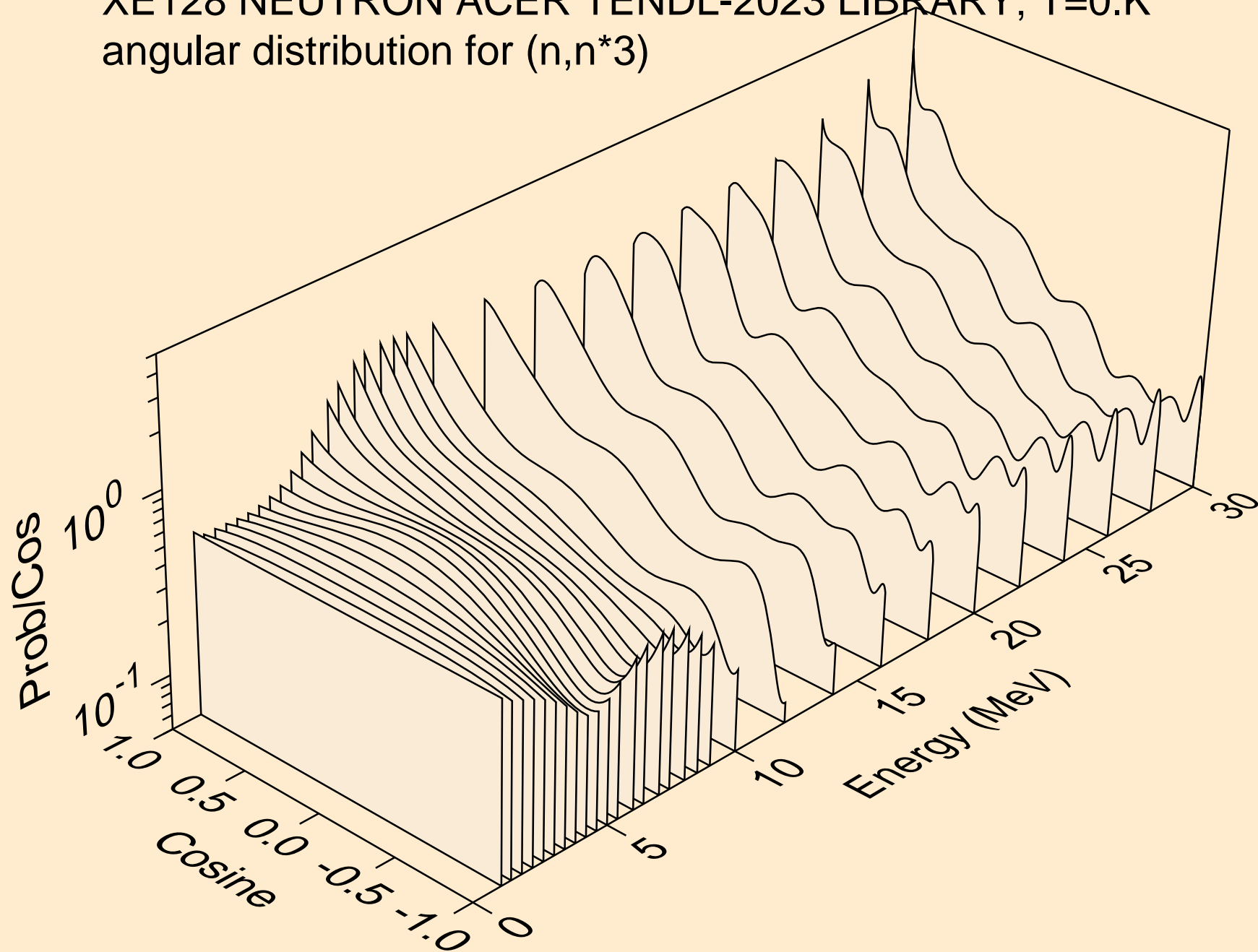

XE128 NEUTRON ACER TENDL-2023 LIBRARY; T=0.K  
angular distribution for (n,n\*4)

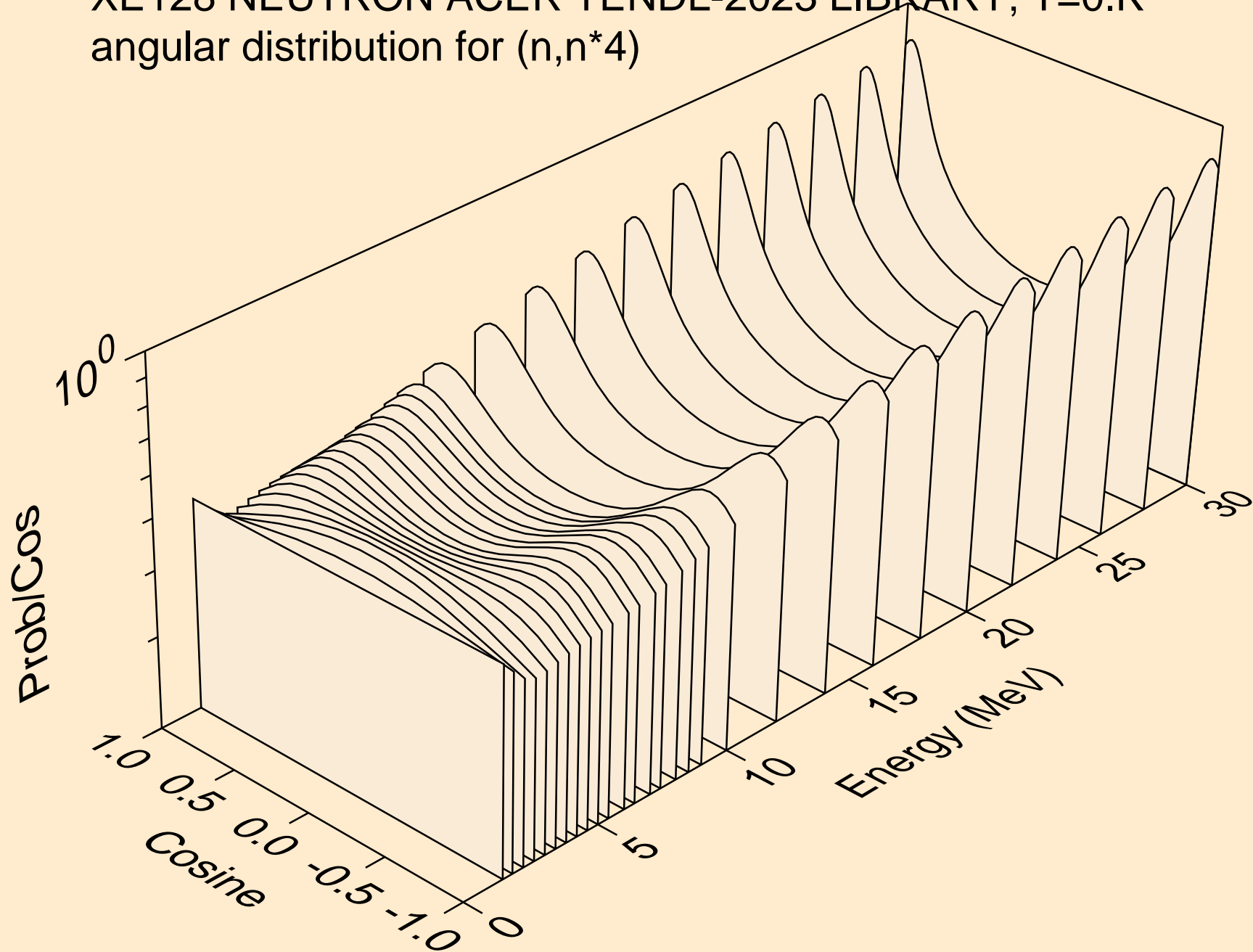

XE128 NEUTRON ACER TENDL-2023 LIBRARY; T=0.K  
angular distribution for (n,n\*5)

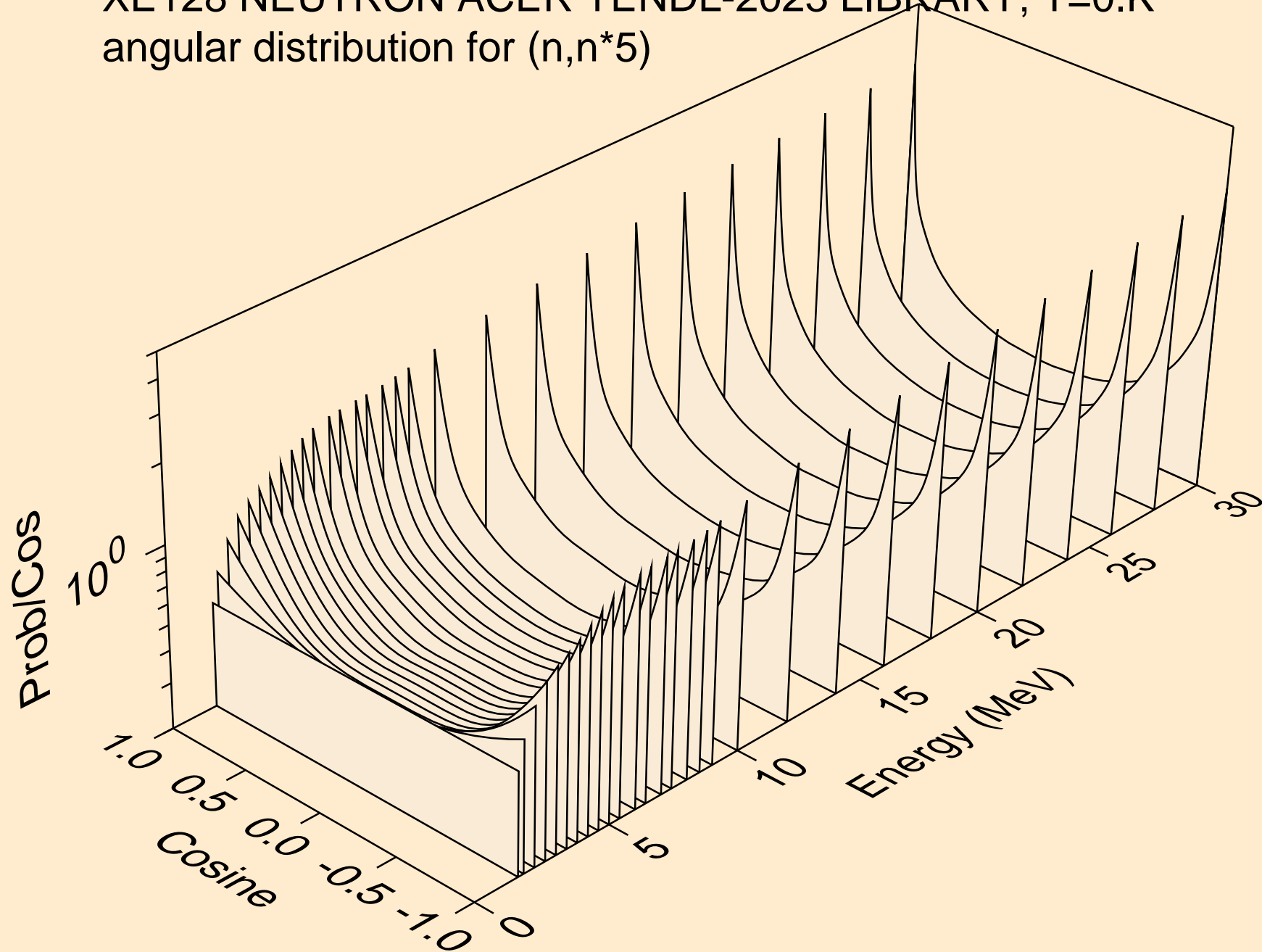

XE128 NEUTRON ACER TENDL-2023 LIBRARY; T=0.K  
angular distribution for (n,n\*6)

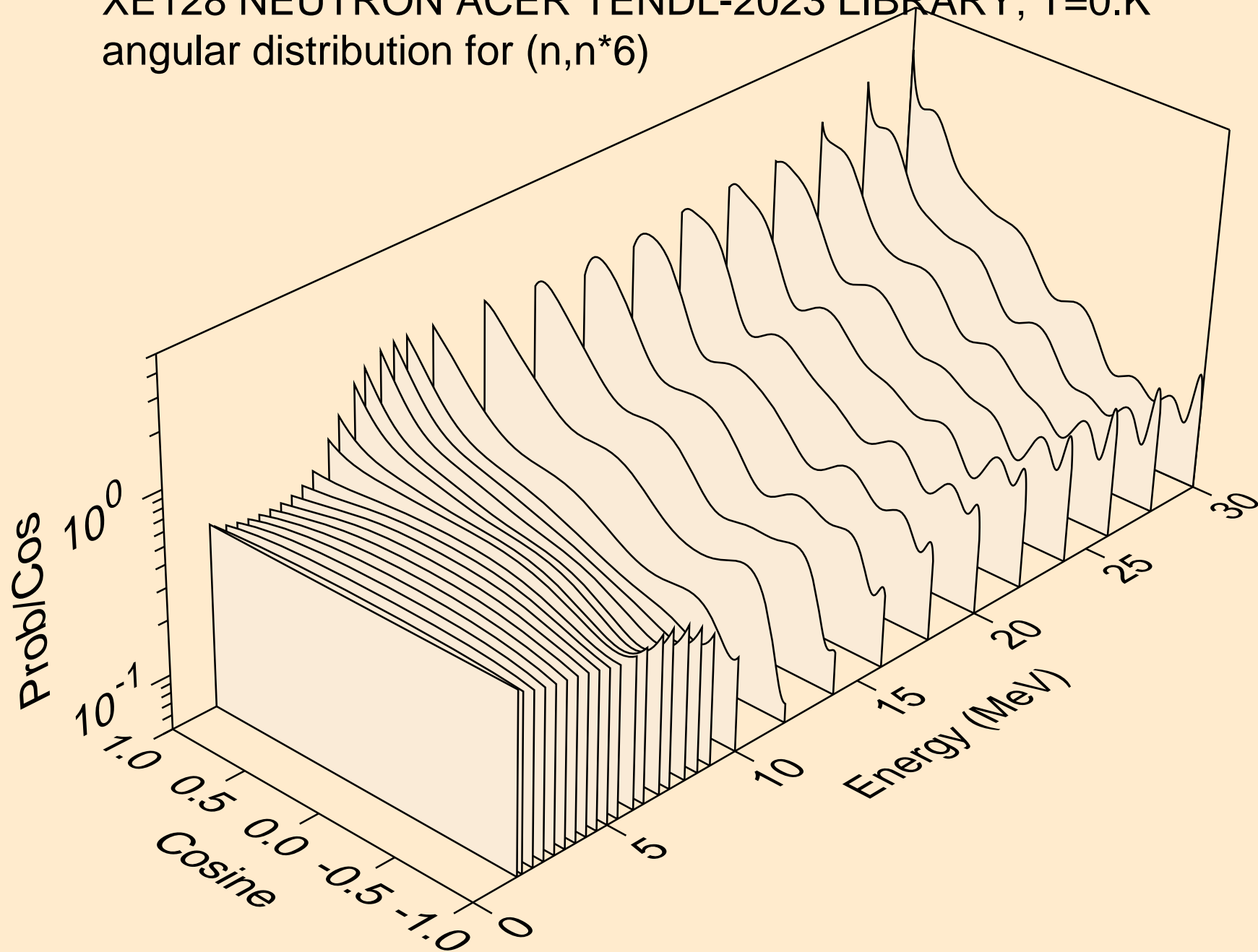

XE128 NEUTRON ACER TENDL-2023 LIBRARY; T=0.K  
angular distribution for (n,n\*7)

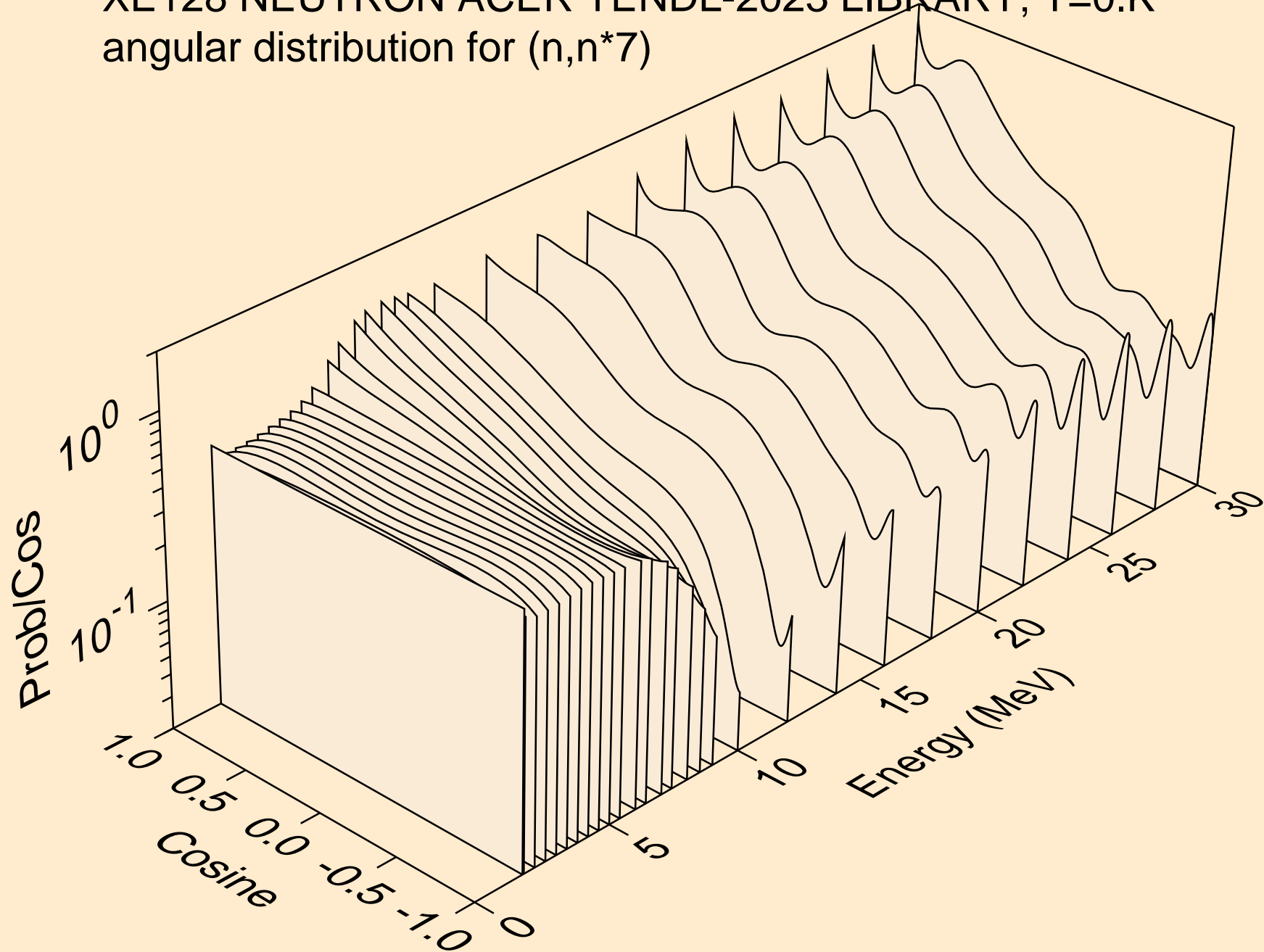

XE128 NEUTRON ACER TENDL-2023 LIBRARY; T=0.K  
angular distribution for (n,n\*8)

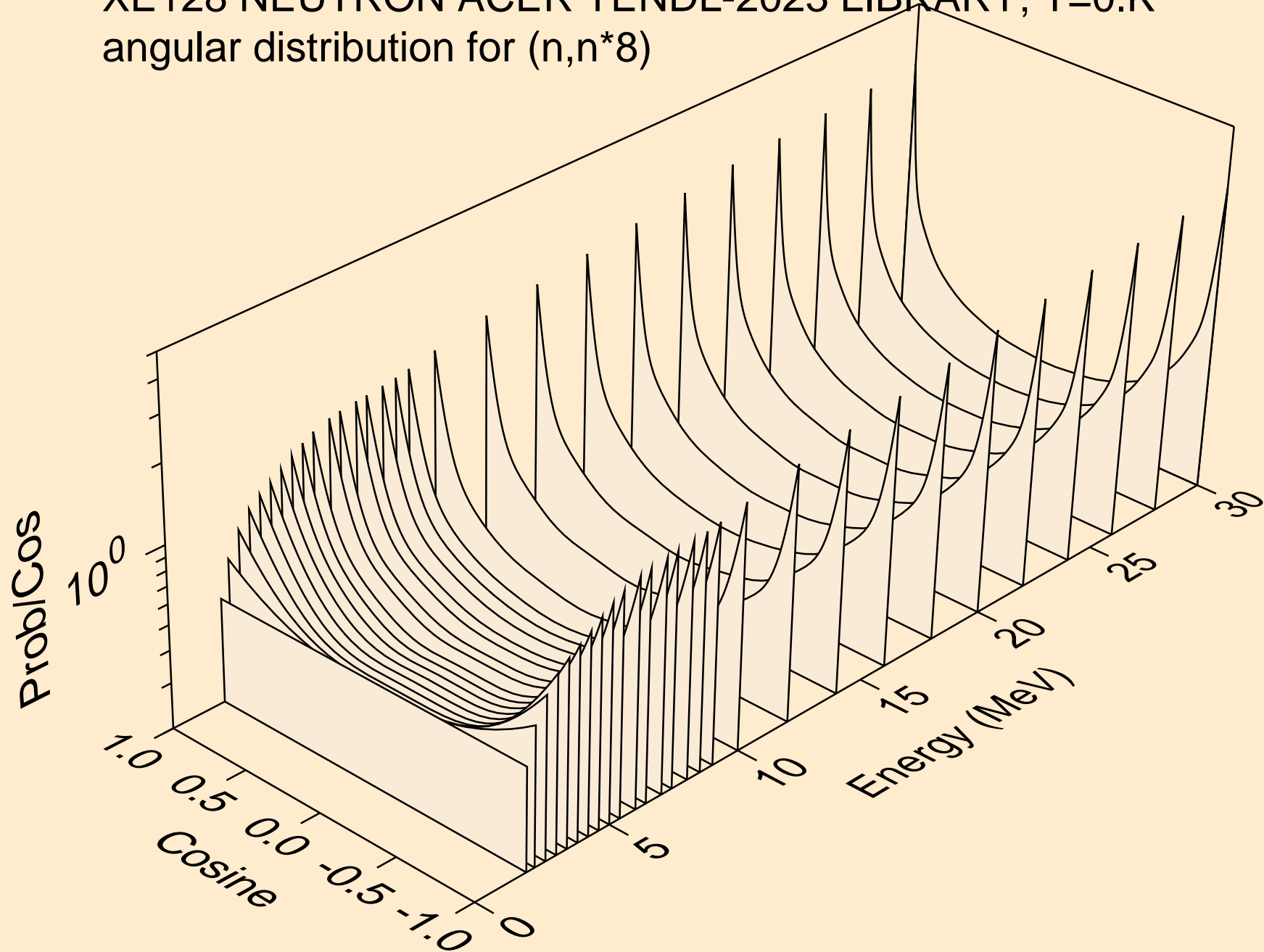

XE128 NEUTRON ACER TENDL-2023 LIBRARY; T=0.K  
angular distribution for (n,n\*9)

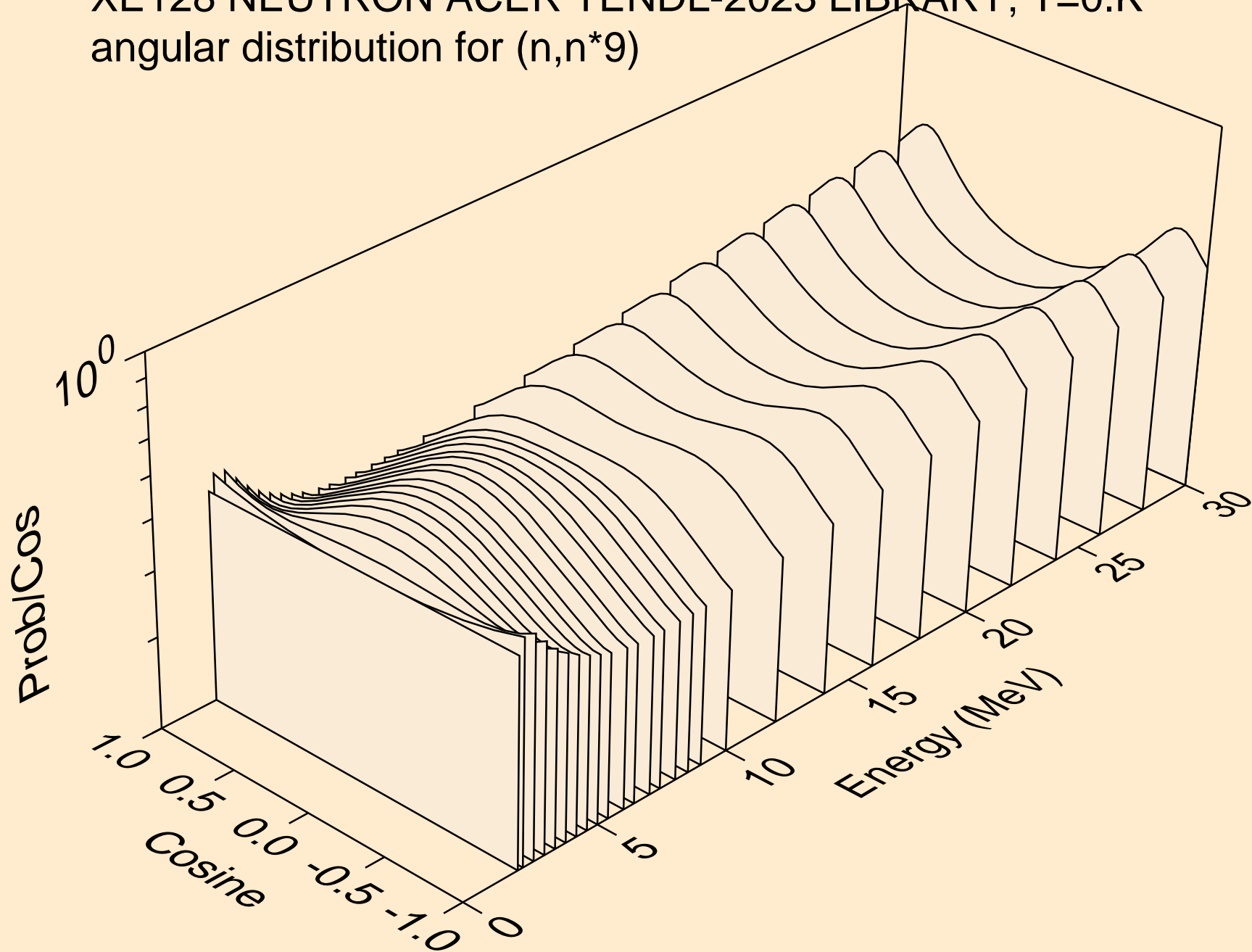

XE128 NEUTRON ACER TENDL-2023 LIBRARY; T=0.K  
angular distribution for (n,n\*10)

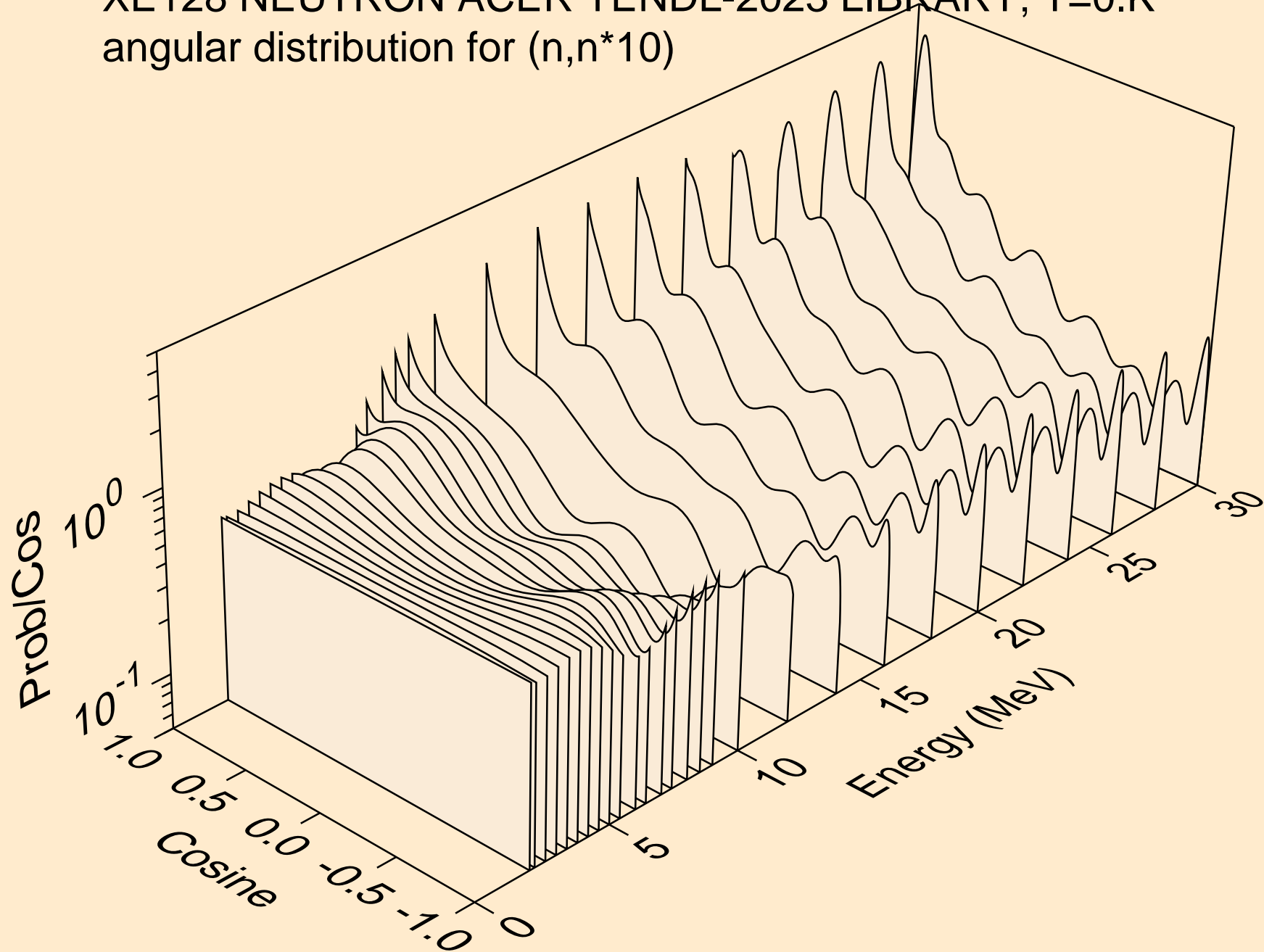

XE128 NEUTRON ACER TENDL-2023 LIBRARY; T=0.K  
angular distribution for (n,n\*11)

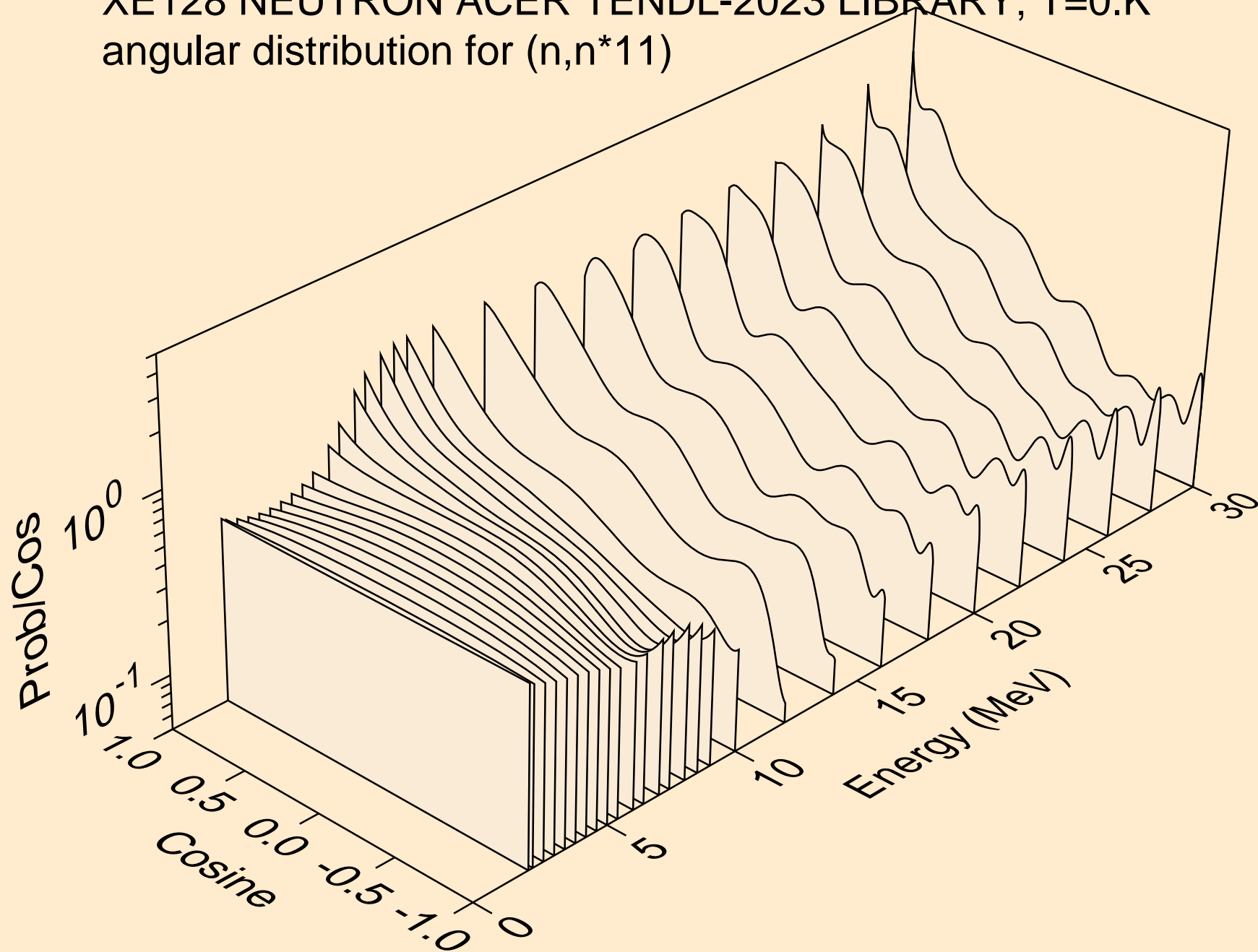

XE128 NEUTRON ACER TENDL-2023 LIBRARY; T=0.K  
angular distribution for (n,n\*12)

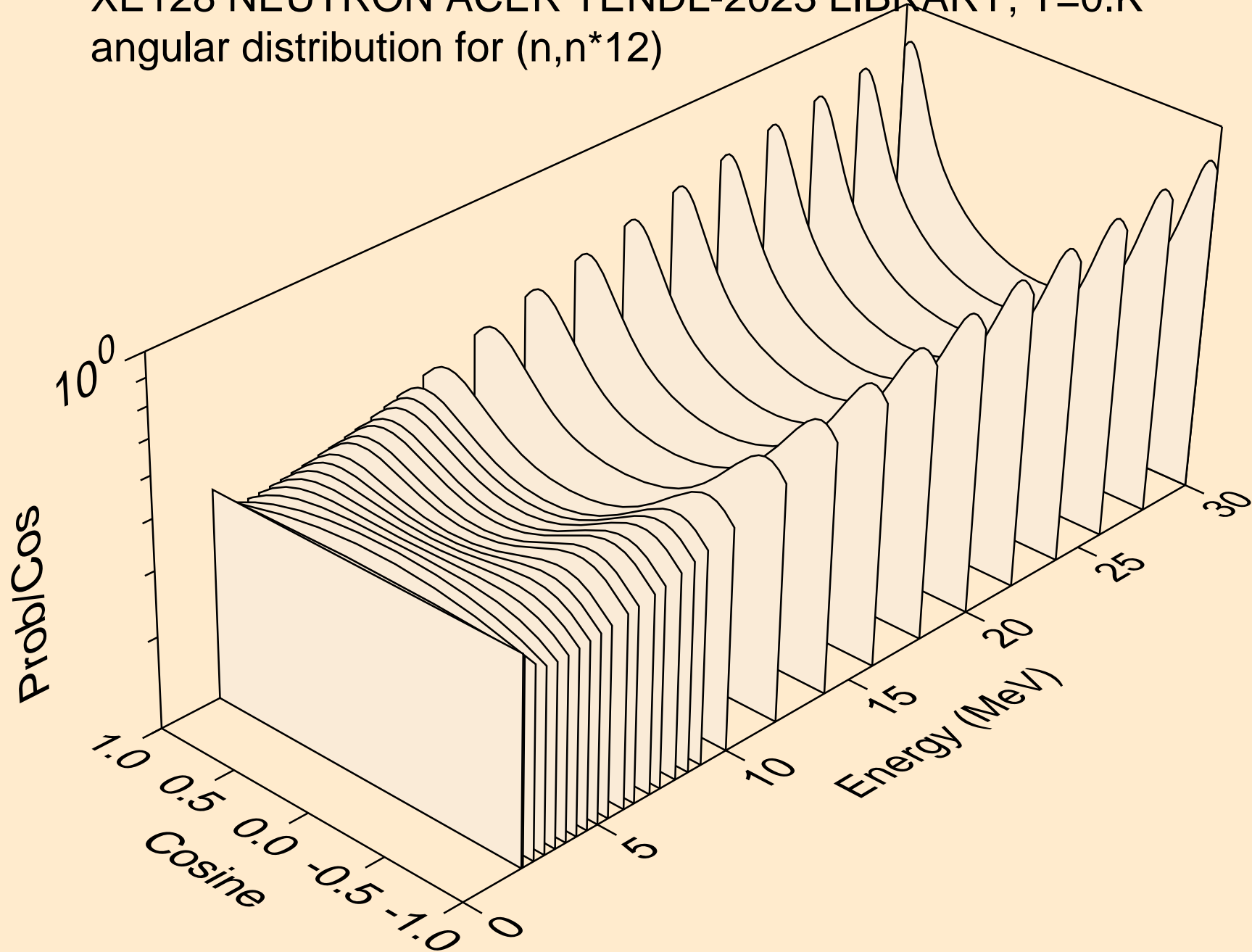

XE128 NEUTRON ACER TENDL-2023 LIBRARY; T=0.K  
angular distribution for (n,n\*13)

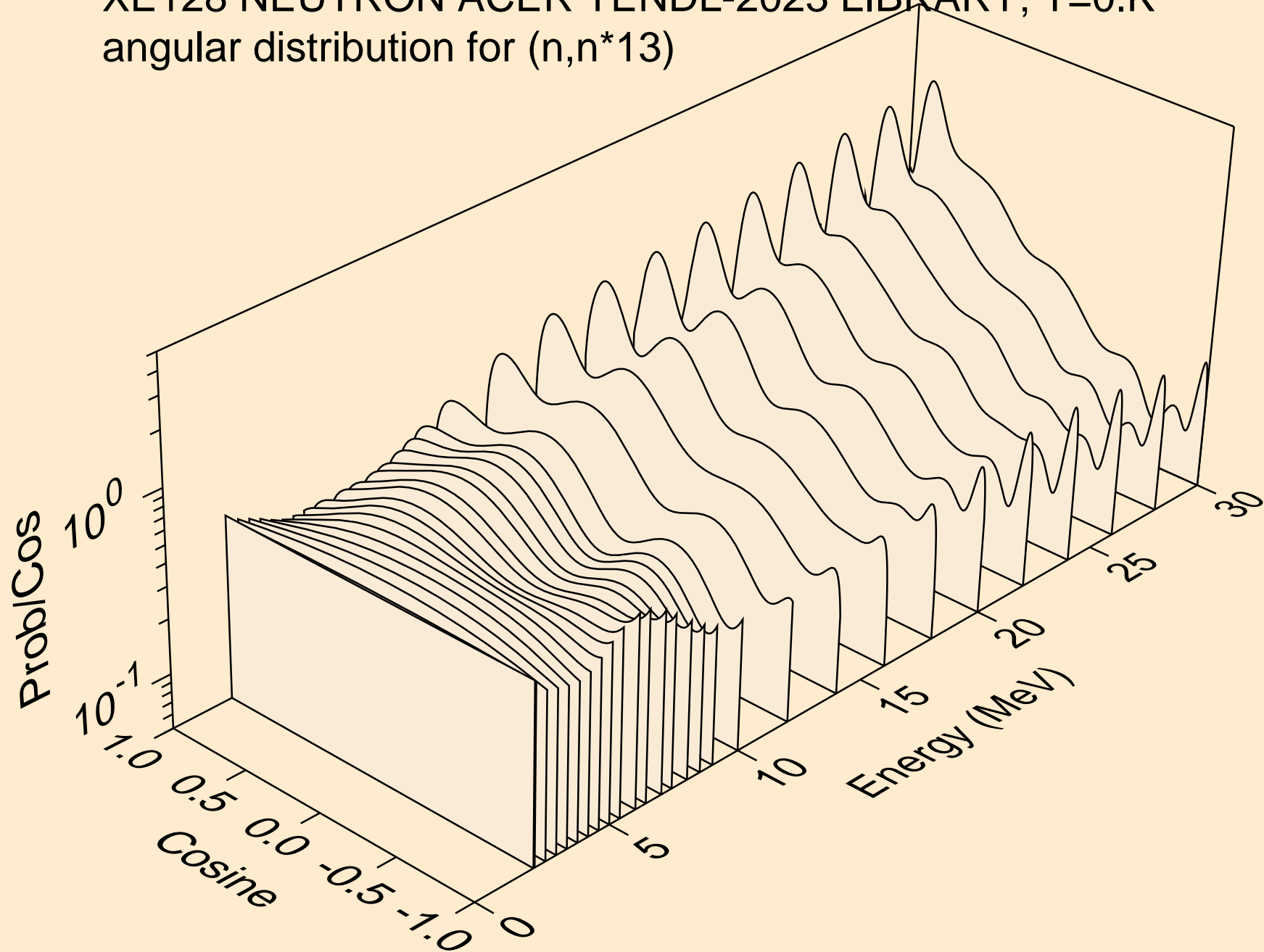

XE128 NEUTRON ACER TENDL-2023 LIBRARY; T=0.K  
angular distribution for (n,n\*14)

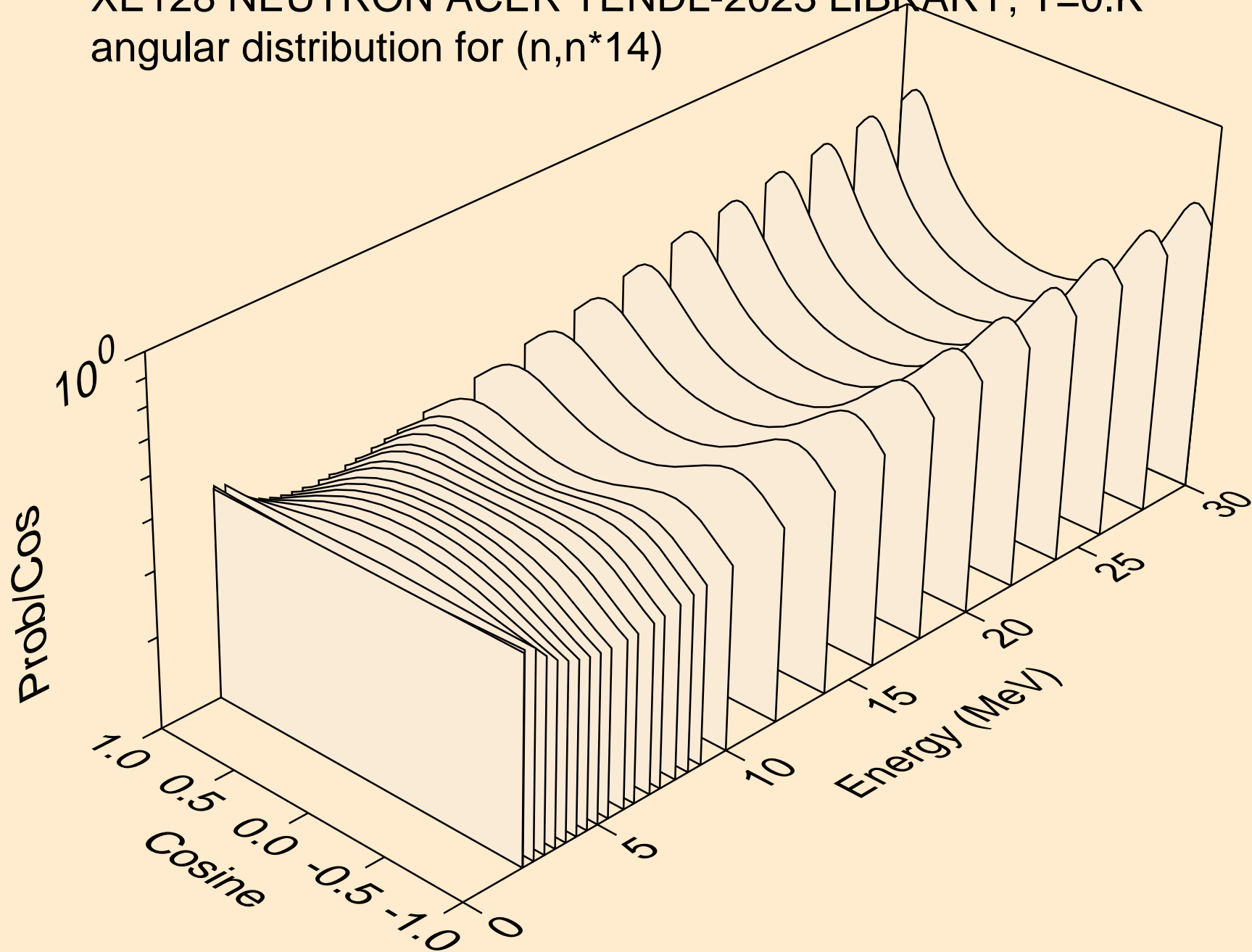

XE128 NEUTRON ACER TENDL-2023 LIBRARY; T=0.K  
angular distribution for (n,n\*15)

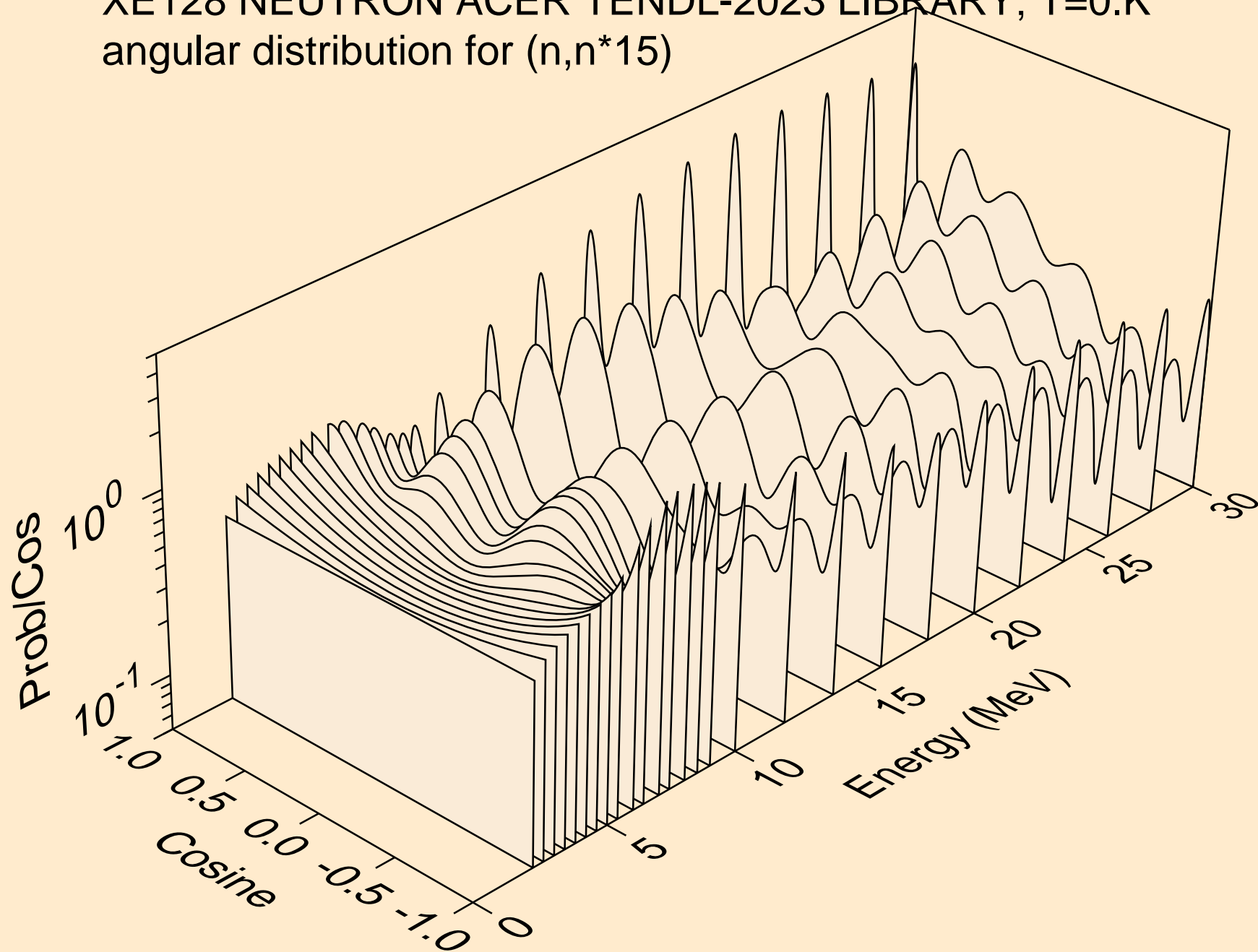

XE128 NEUTRON ACER TENDL-2023 LIBRARY; T=0.K  
angular distribution for (n,n\*16)

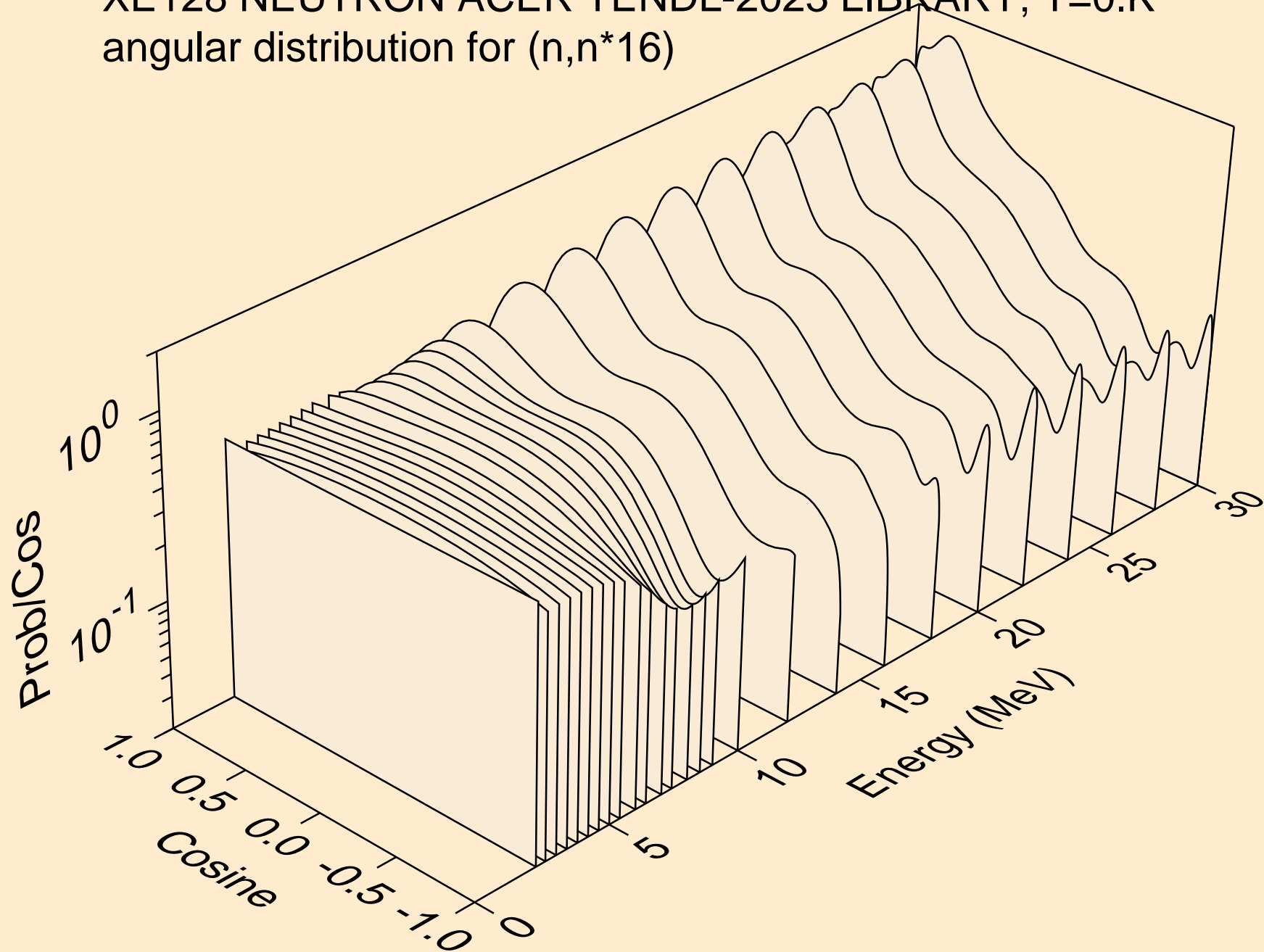

XE128 NEUTRON ACER TENDL-2023 LIBRARY; T=0.K  
angular distribution for (n,n\*17)

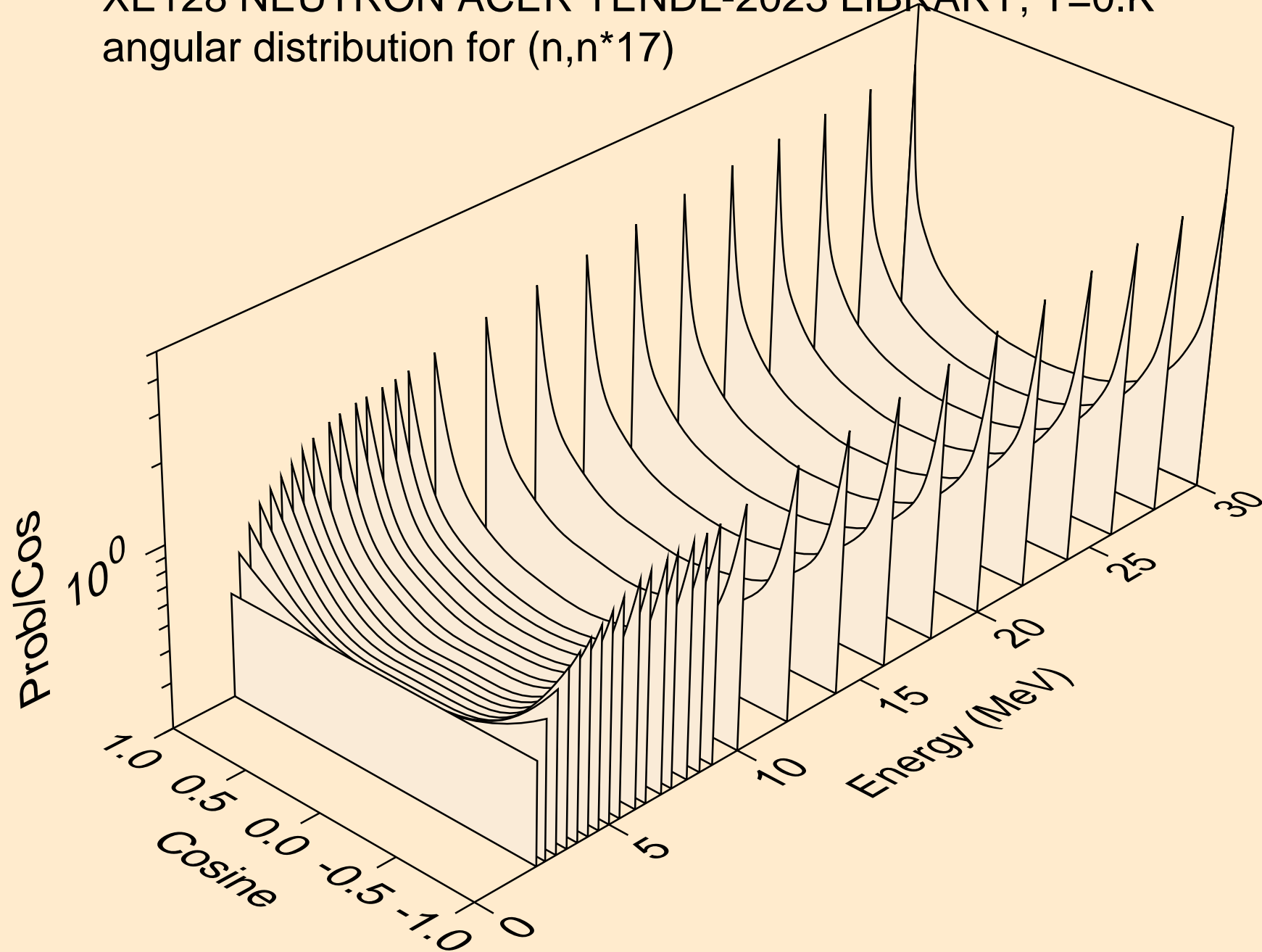

XE128 NEUTRON ACER TENDL-2023 LIBRARY; T=0.K  
Neutron emission for (n,x)

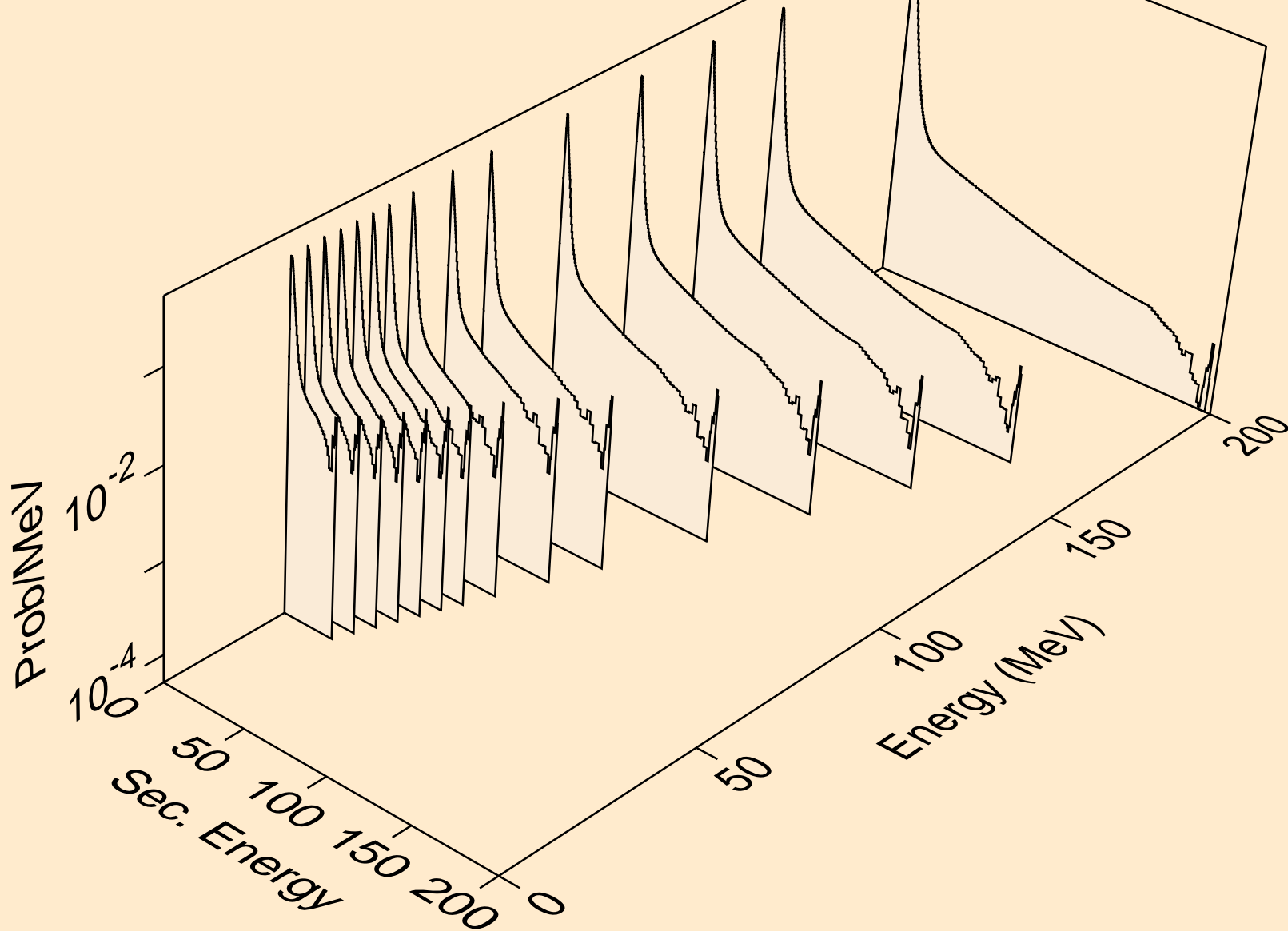

XE128 NEUTRON ACER TENDL-2023 LIBRARY; T=0.K  
Neutron emission for (n,2nd)

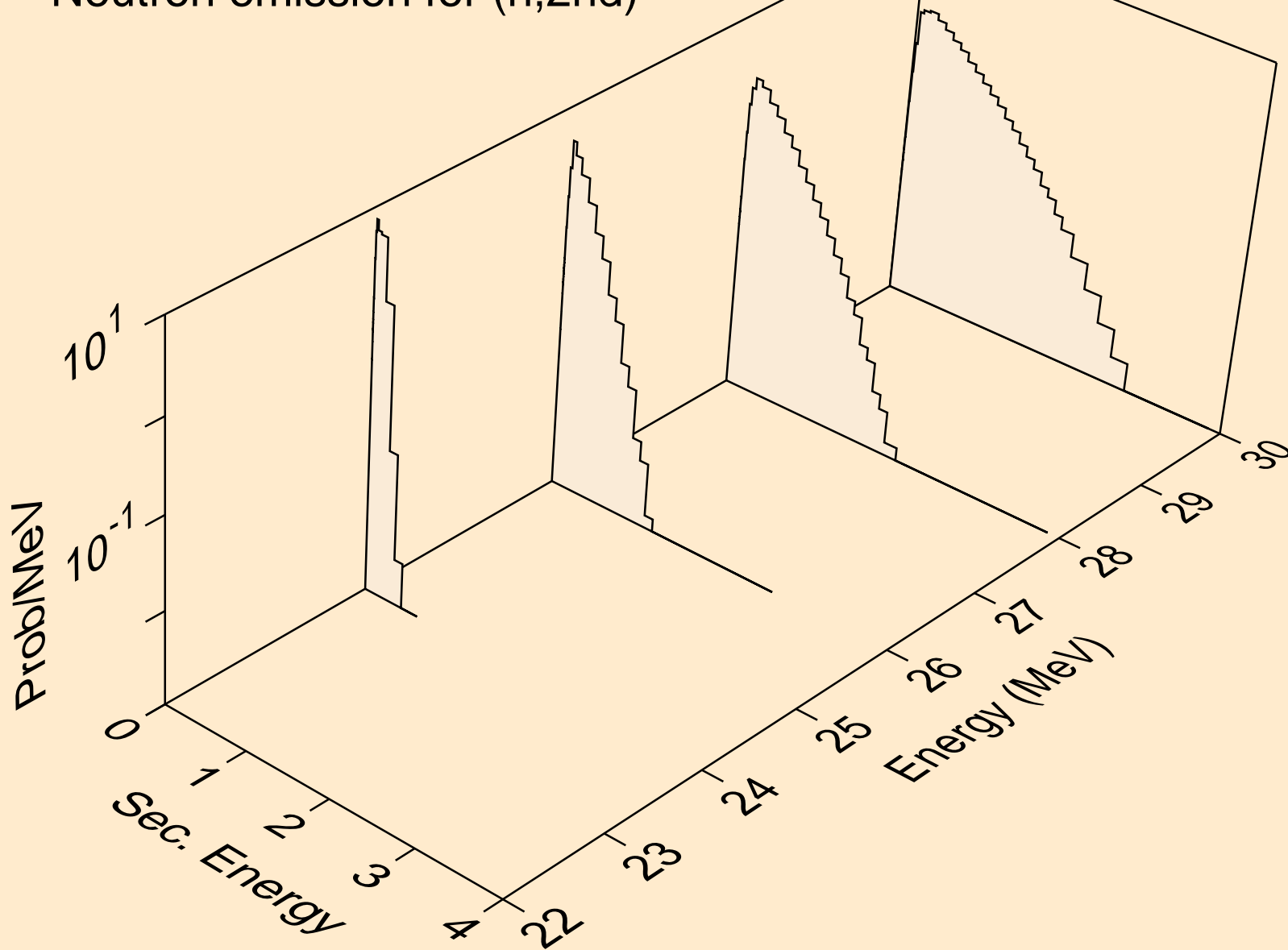

XE128 NEUTRON ACER TENDL-2023 LIBRARY; T=0.K  
Neutron emission for (n,2n)

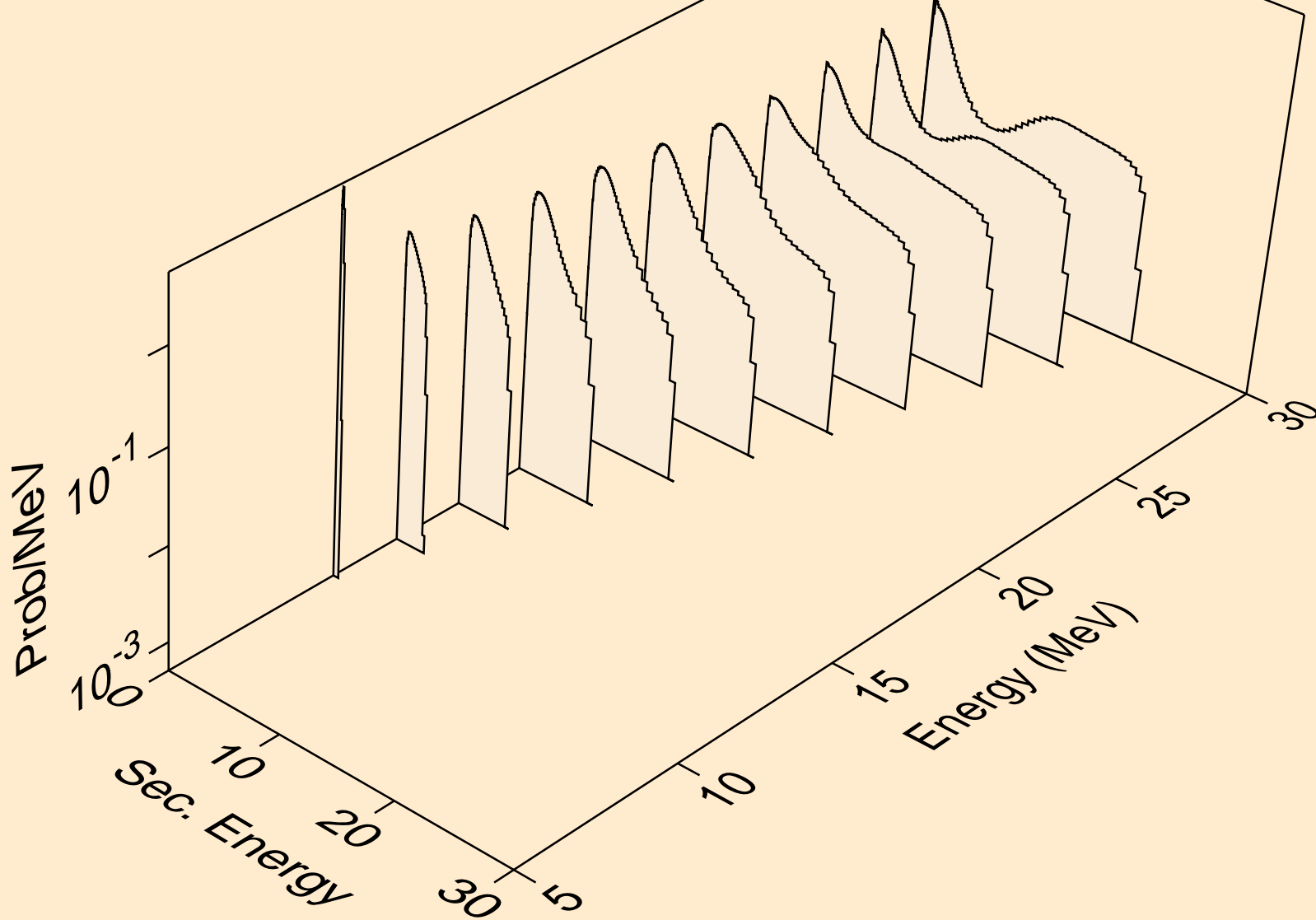

XE128 NEUTRON ACER TENDL-2023 LIBRARY; T=0.K  
Neutron emission for (n,3n)

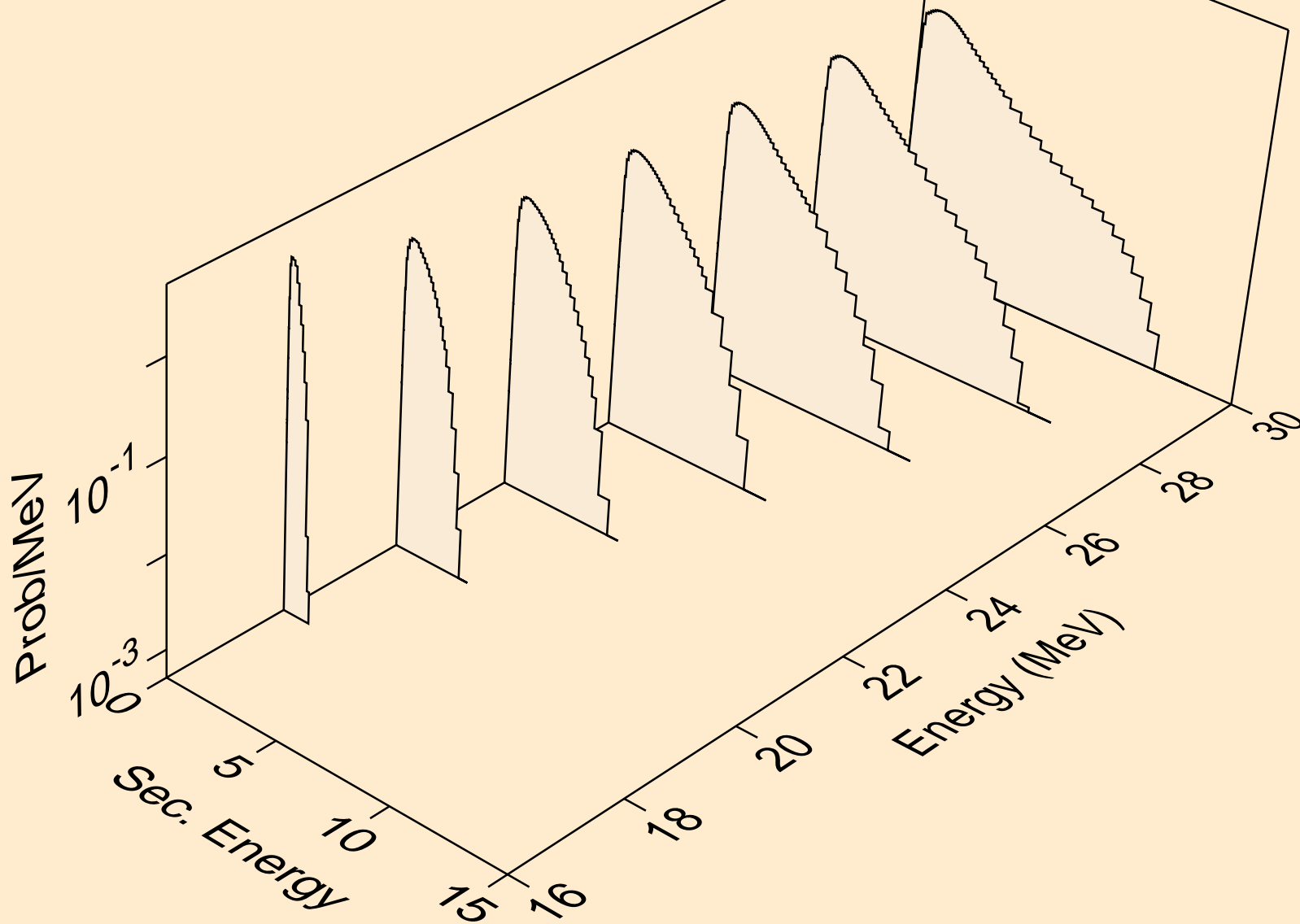

XE128 NEUTRON ACER TENDL-2023 LIBRARY; T=0.K  
Neutron emission for (n,n\*)a

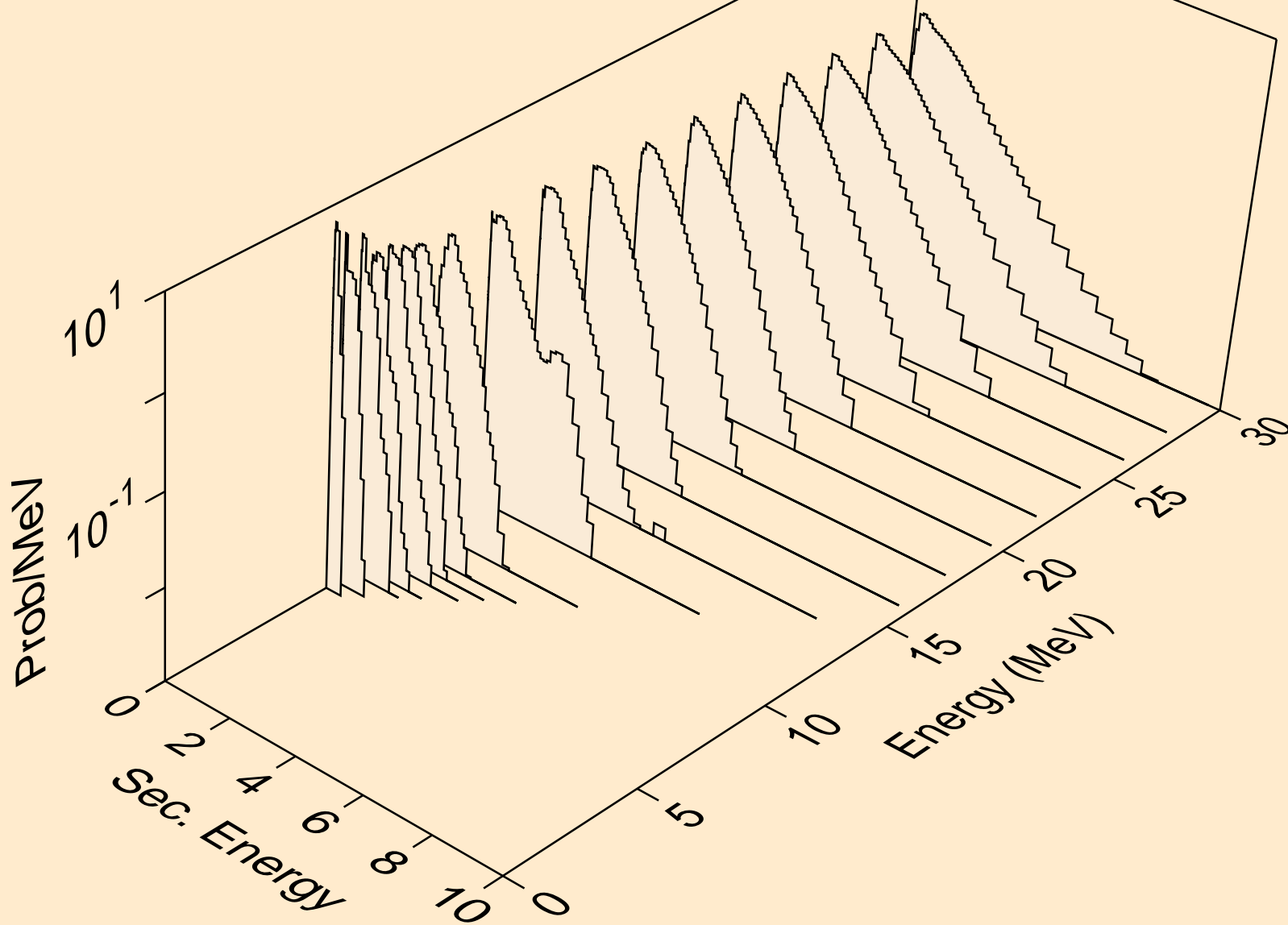

XE128 NEUTRON ACER TENDL-2023 LIBRARY; T=0.K  
Neutron emission for (n,2n)a

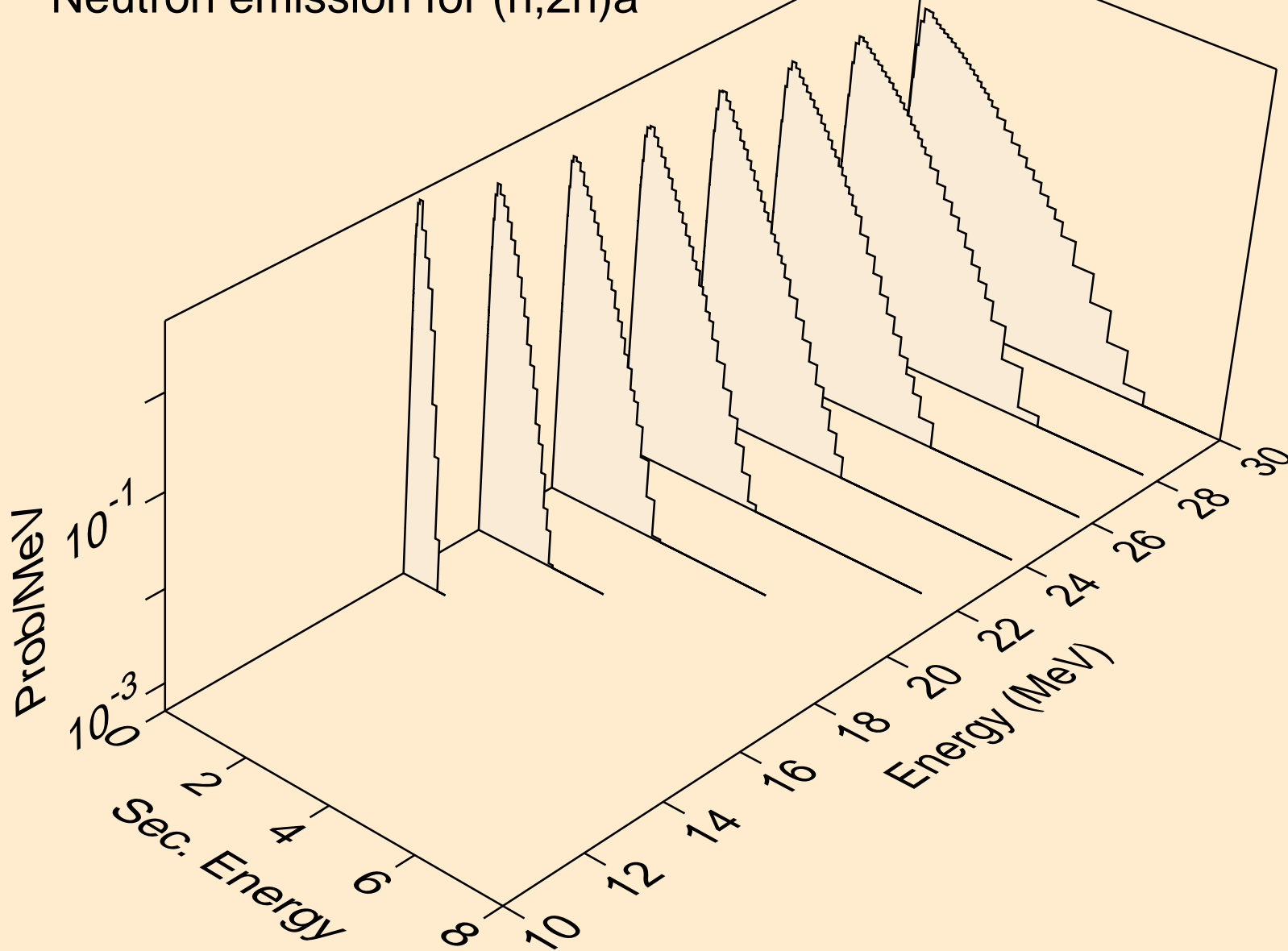

XE128 NEUTRON ACER TENDL-2023 LIBRARY; T=0.K  
Neutron emission for (n,3n)a

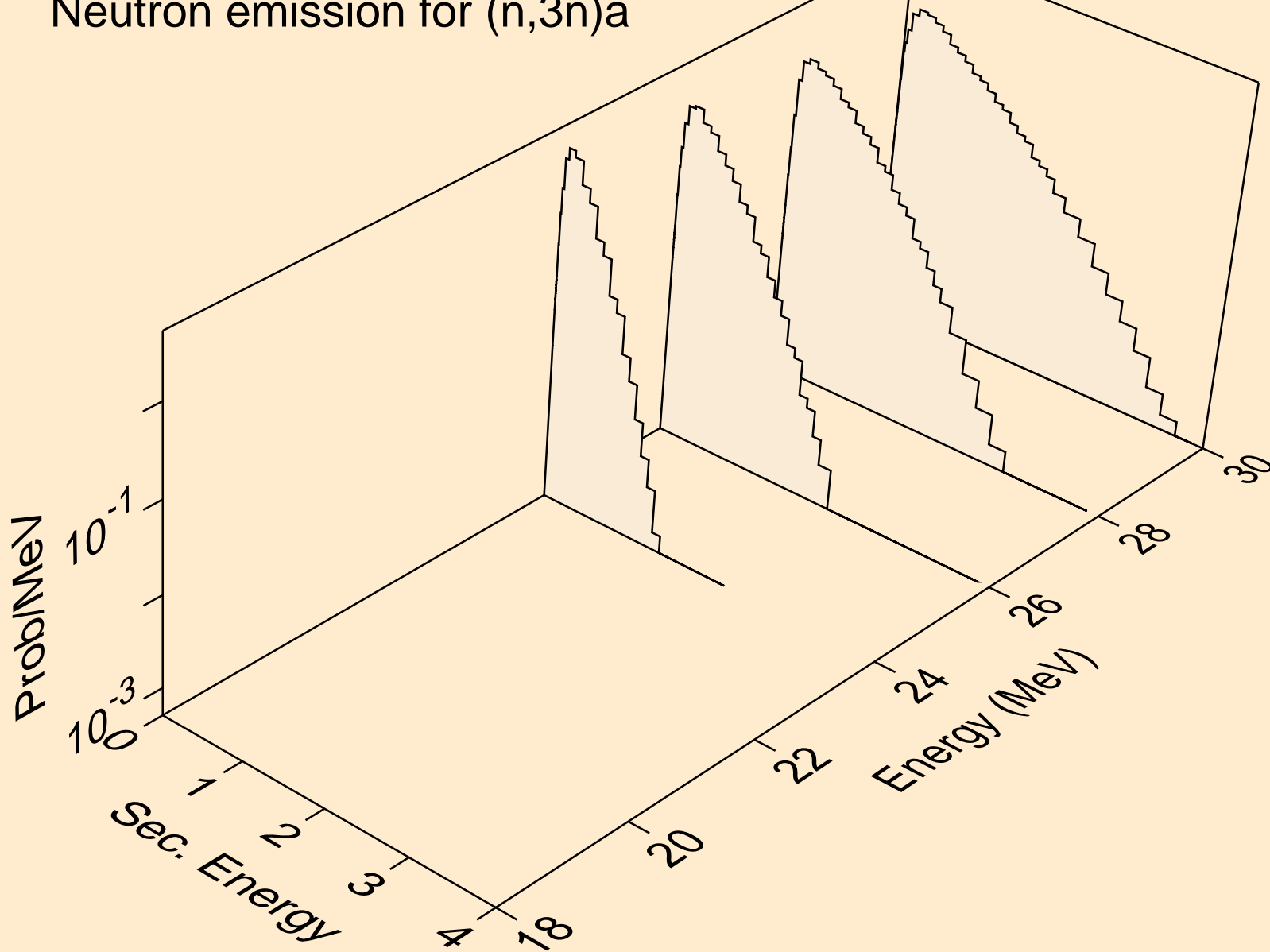

XE128 NEUTRON ACER TENDL-2023 LIBRARY; T=0.K  
Neutron emission for (n,n\*)p

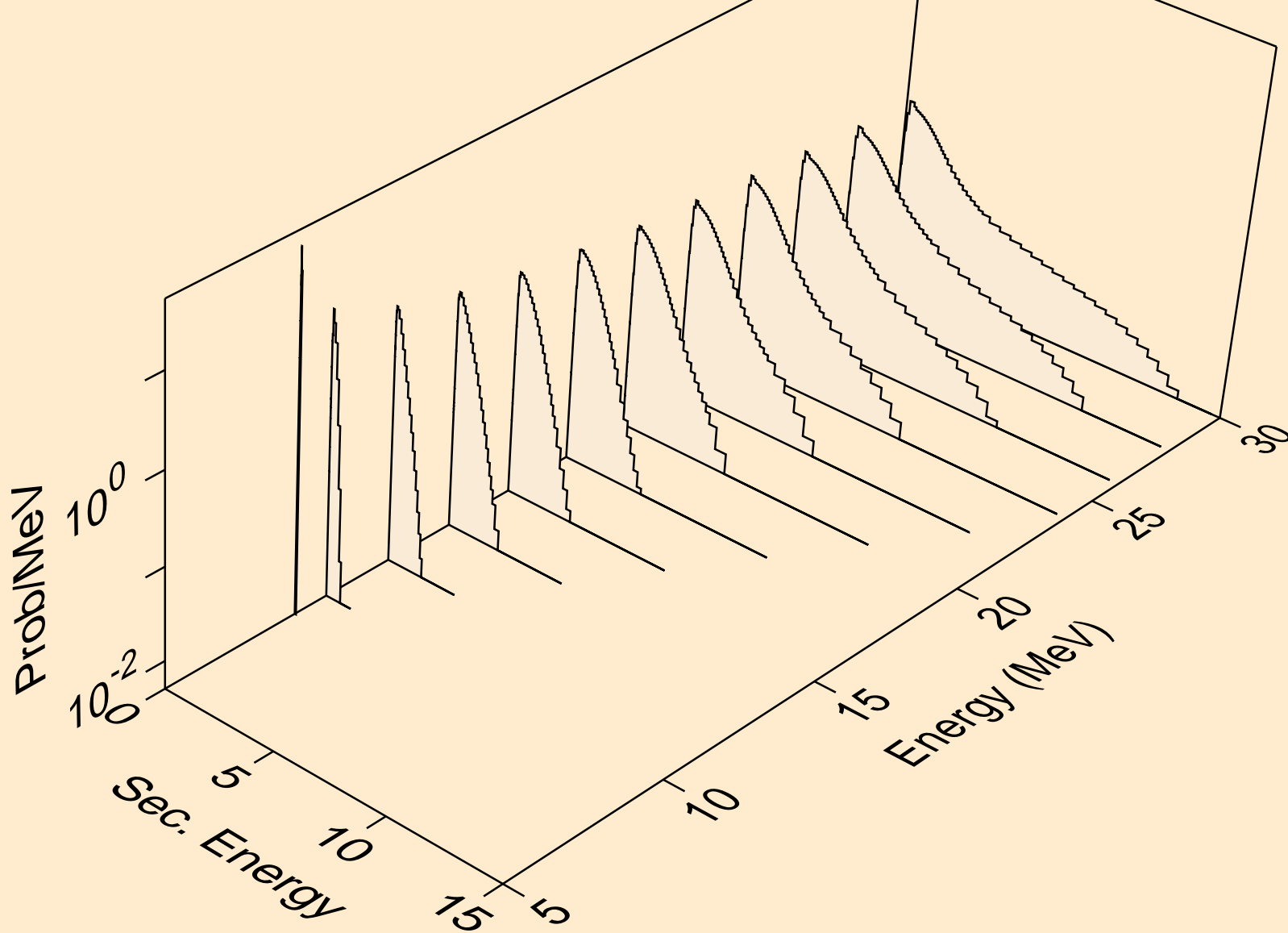

XE128 NEUTRON ACER TENDL-2023 LIBRARY; T=0.K  
Neutron emission for (n,n\*)d

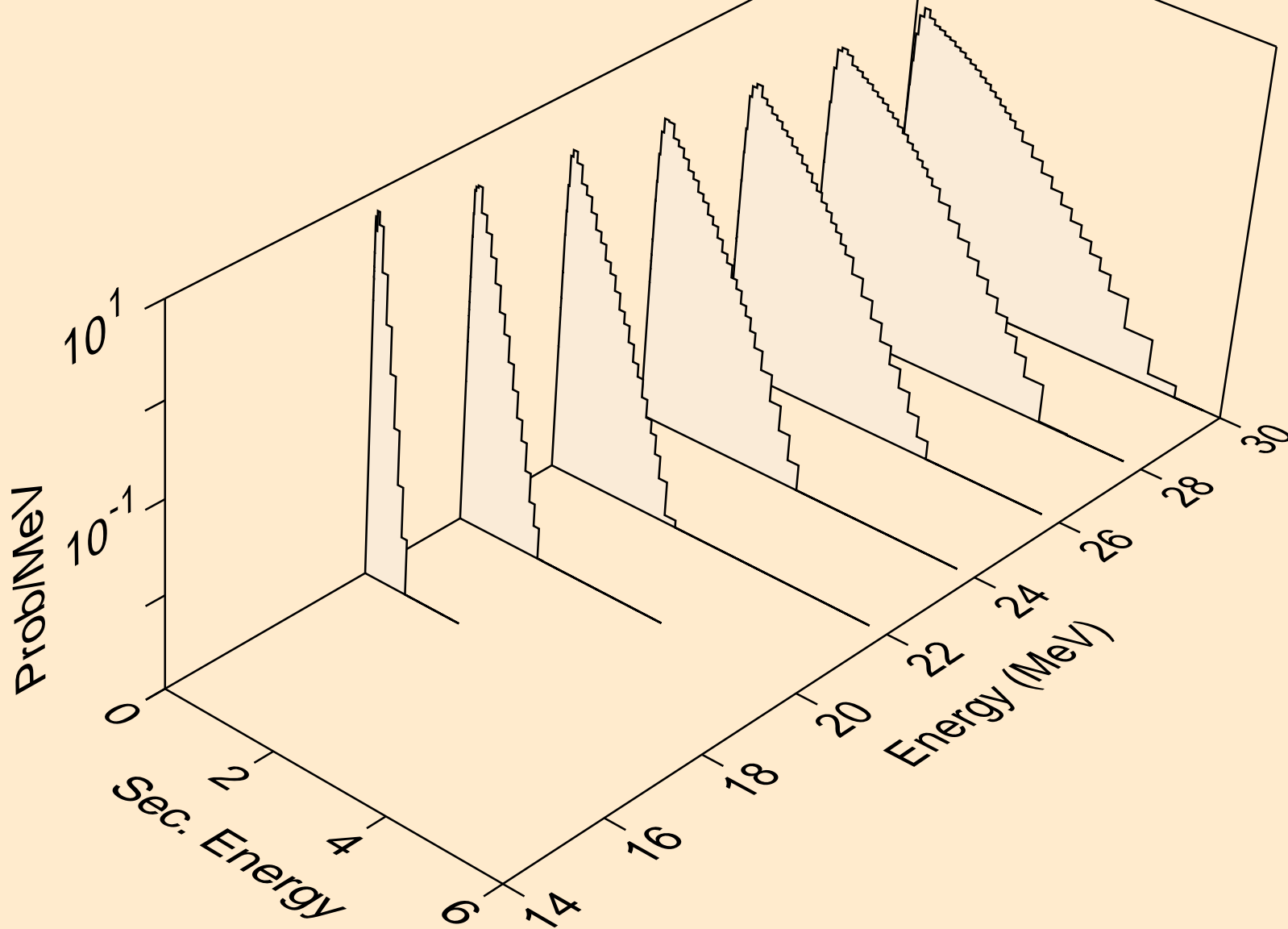

XE128 NEUTRON ACER TENDL-2023 LIBRARY; T=0.K  
Neutron emission for (n,n\*)t

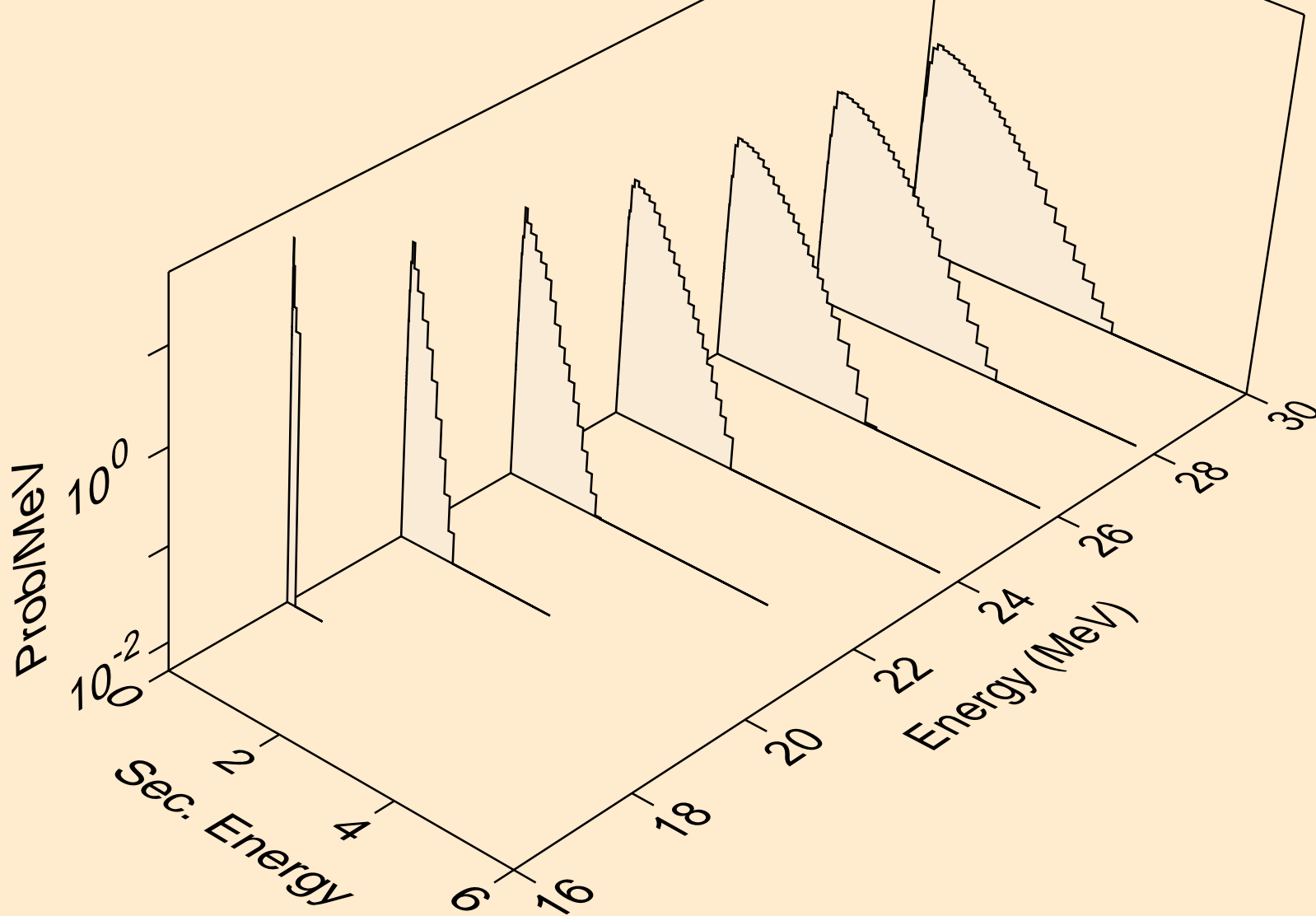

XE128 NEUTRON ACER TENDL-2023 LIBRARY; T=0.K  
Neutron emission for (n,n\*)he3

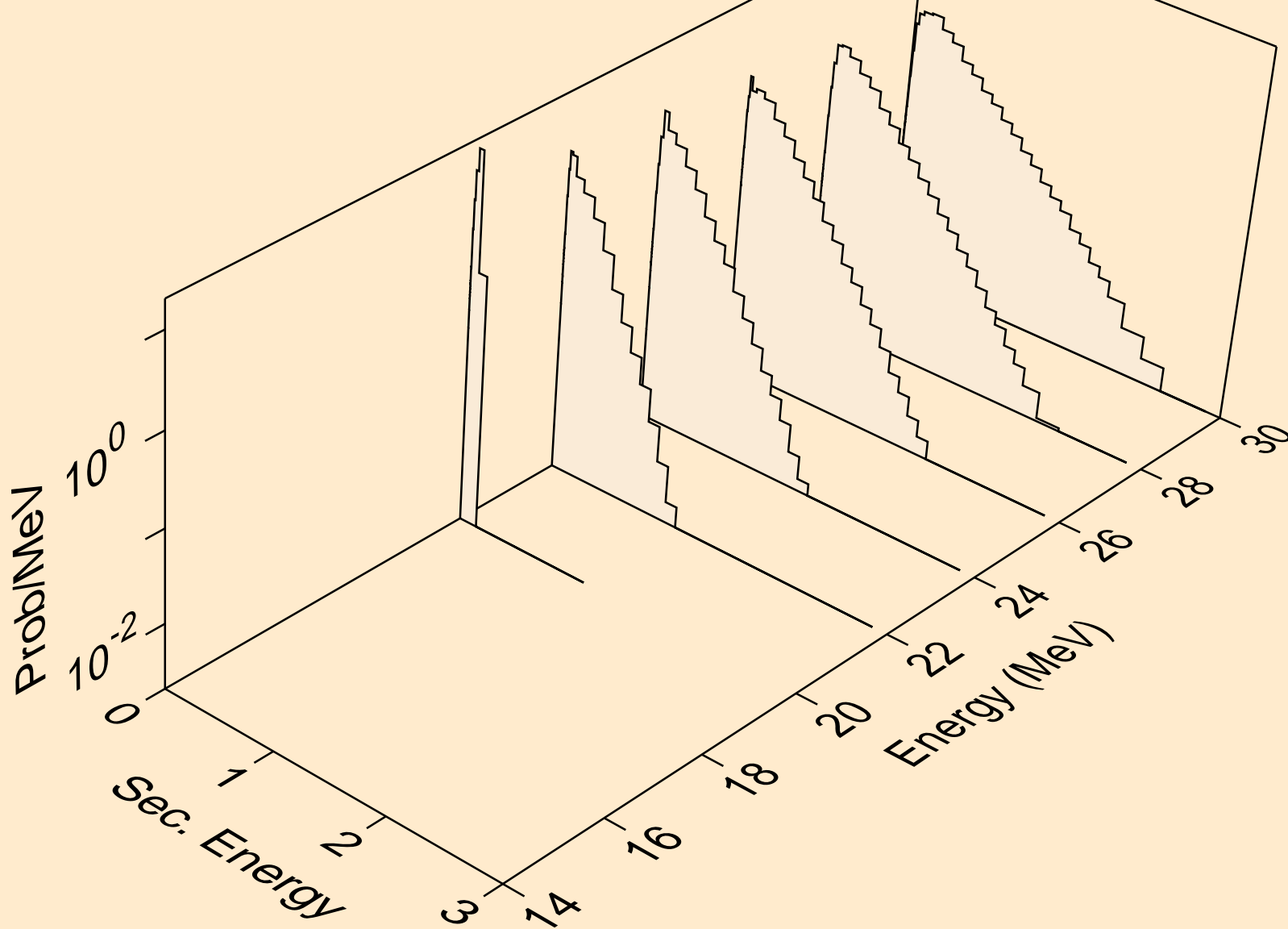

XE128 NEUTRON ACER TENDL-2023 LIBRARY; T=0.K  
Neutron emission for (n,4n)

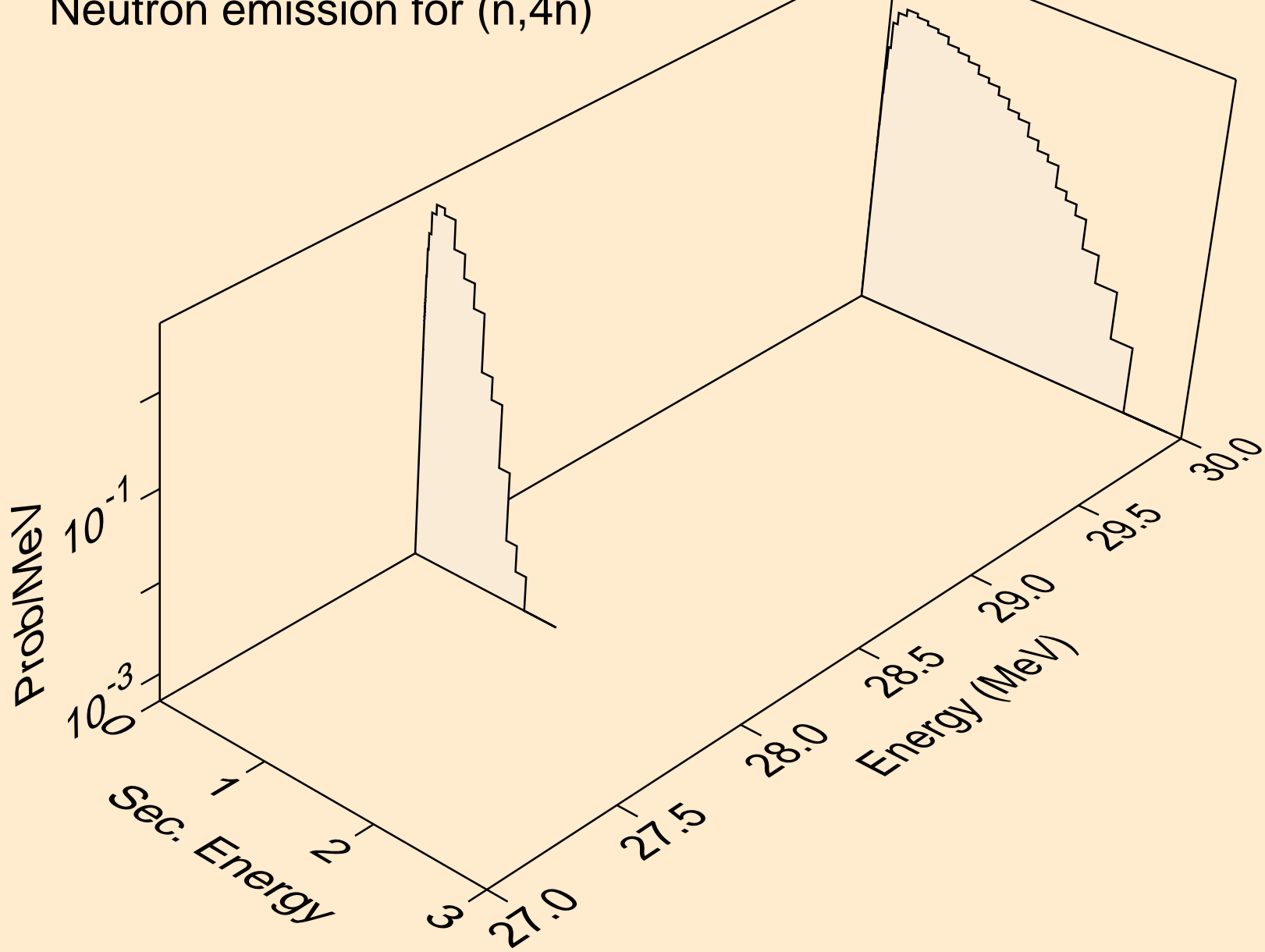

XE128 NEUTRON ACER TENDL-2023 LIBRARY; T=0.K  
Neutron emission for (n,2np)

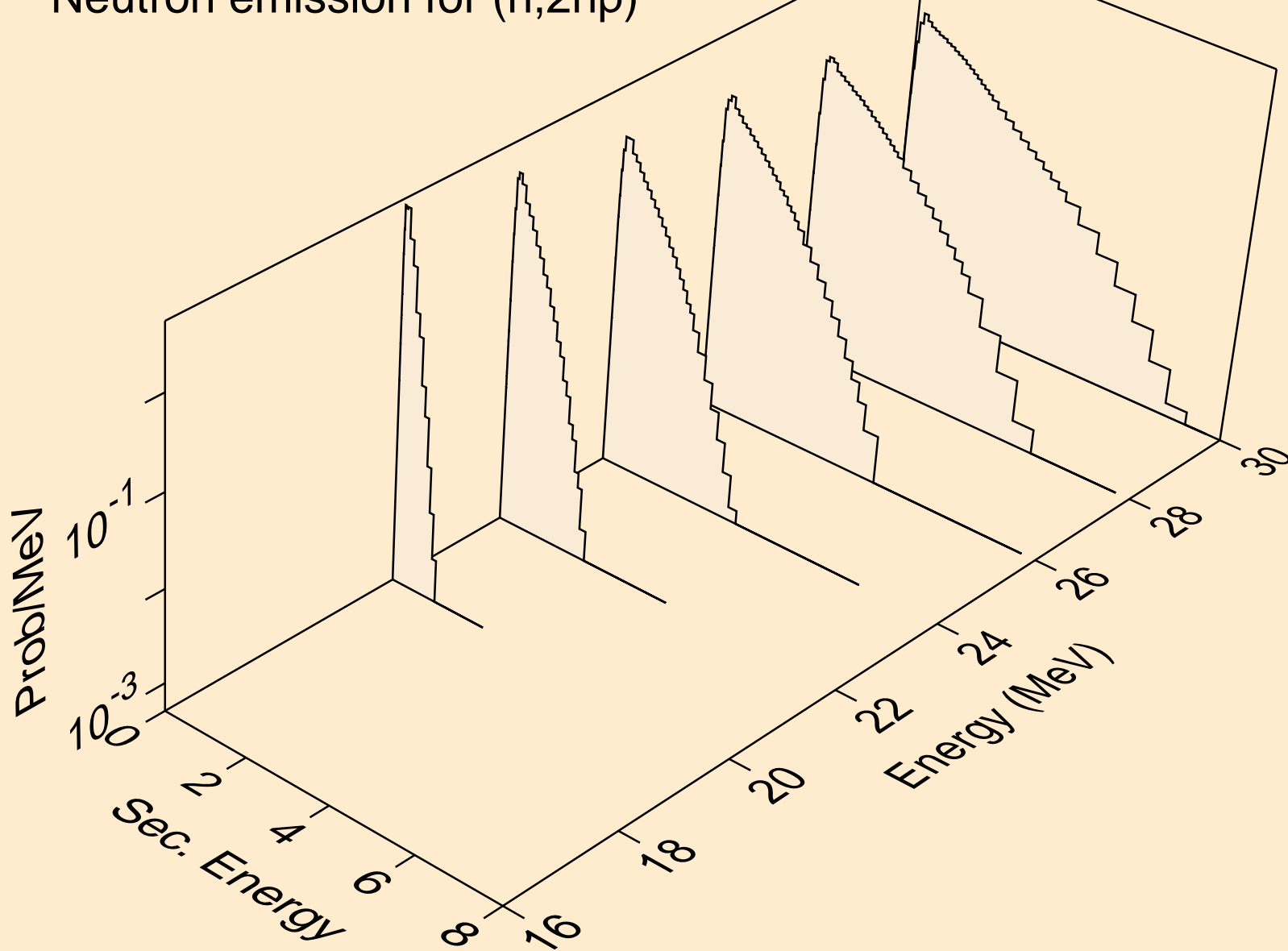

XE128 NEUTRON ACER TENDL-2023 LIBRARY; T=0.K  
Neutron emission for (n,3np)

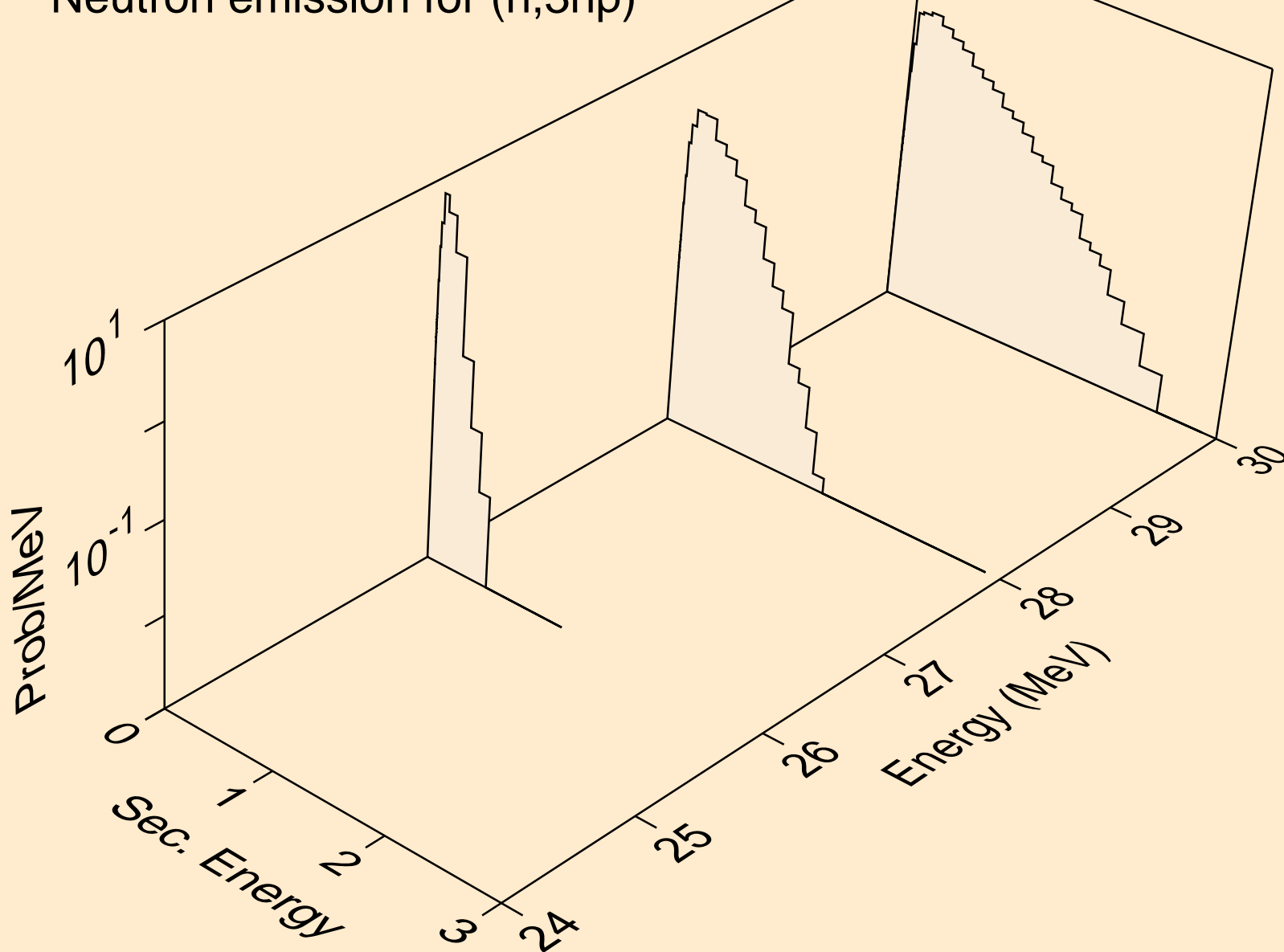

XE128 NEUTRON ACER TENDL-2023 LIBRARY; T=0.K  
Neutron emission for (n,n2p)

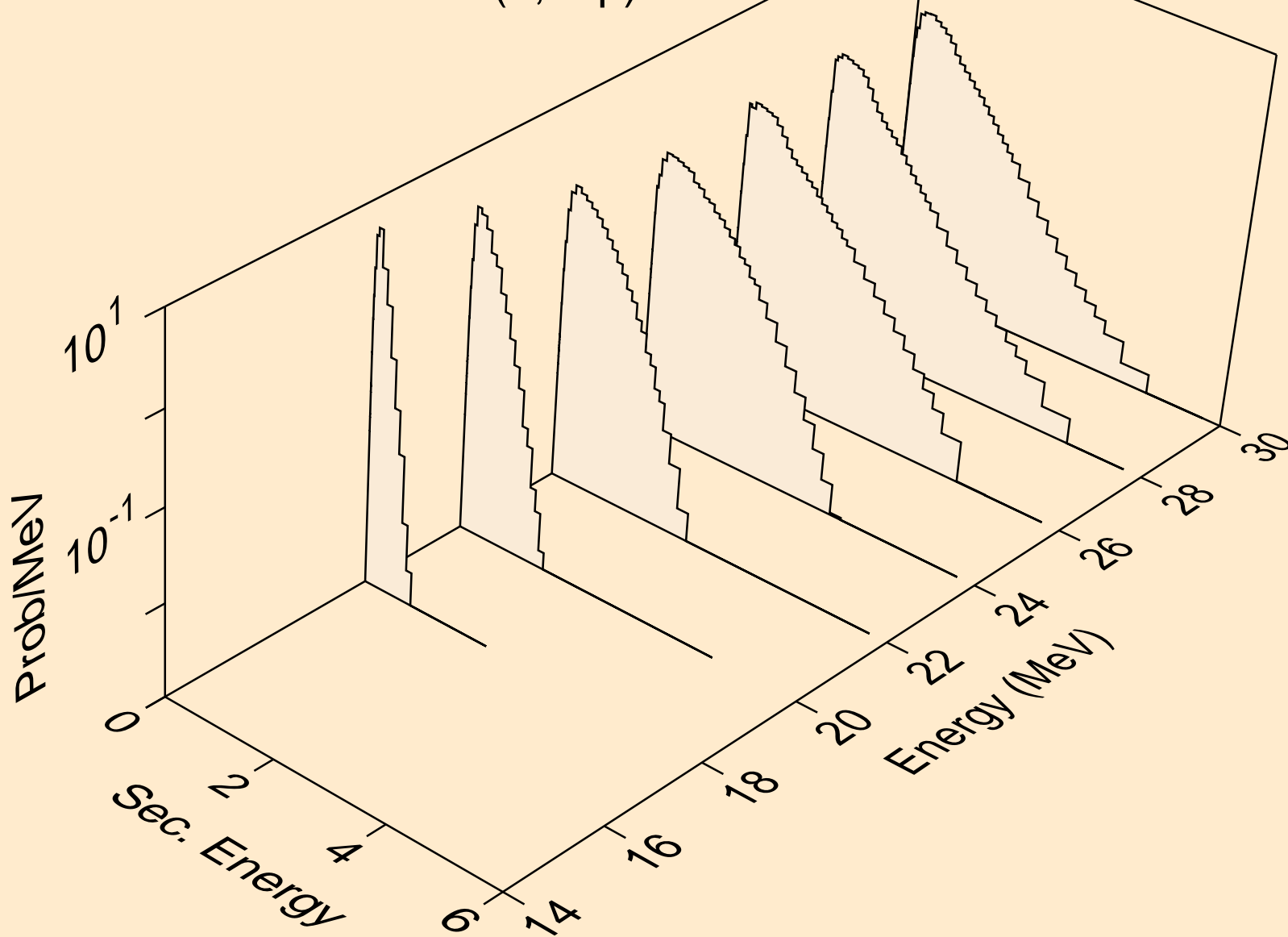

XE128 NEUTRON ACER TENDL-2023 LIBRARY; T=0.K  
Neutron emission for (n,npa)

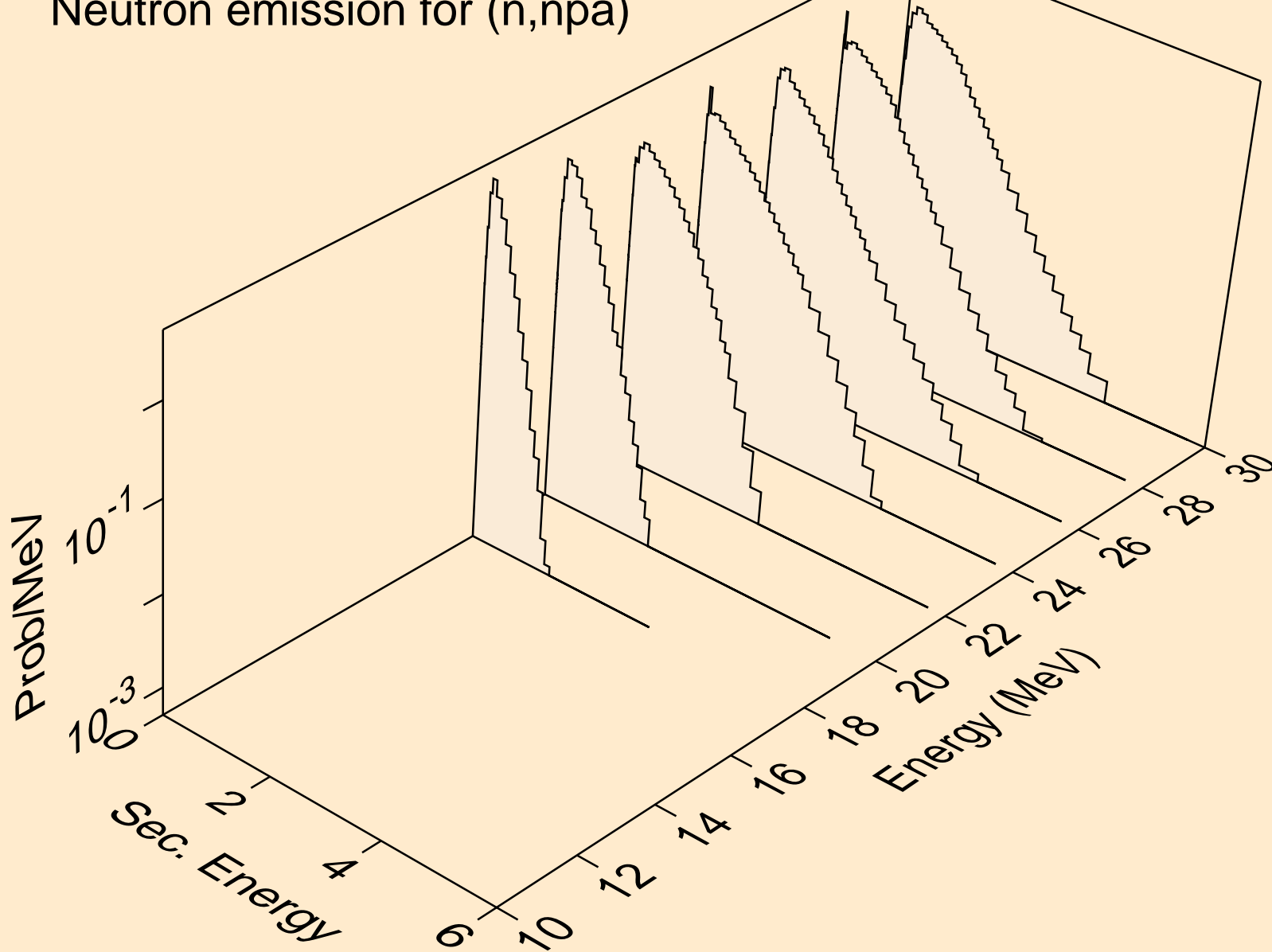

XE128 NEUTRON ACER TENDL-2023 LIBRARY; T=0.K  
Neutron emission for (n,n\*c)

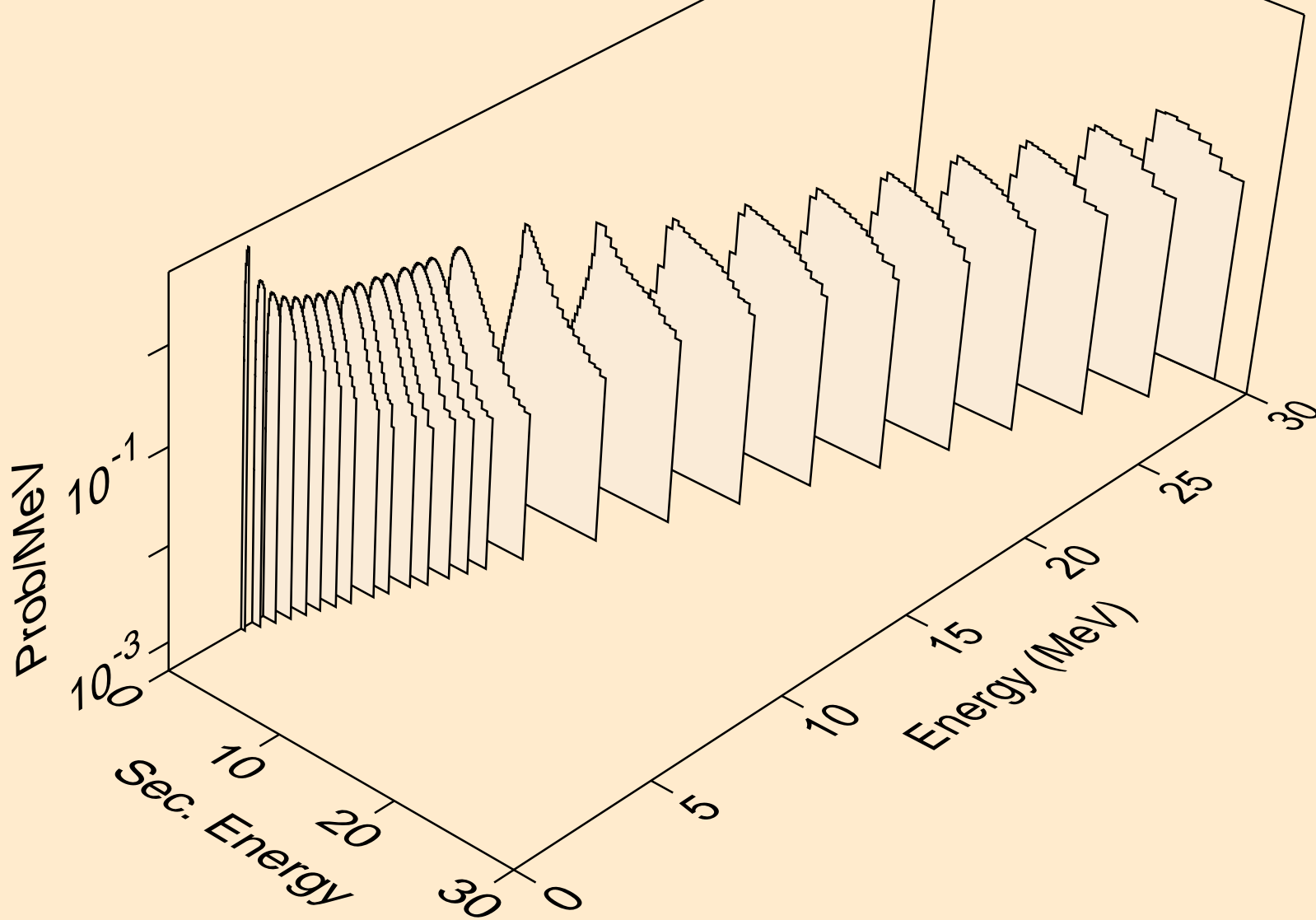

XE128 NEUTRON ACER TENDL-2023 LIBRARY; T=0.K  
Photon emission for (n,x)

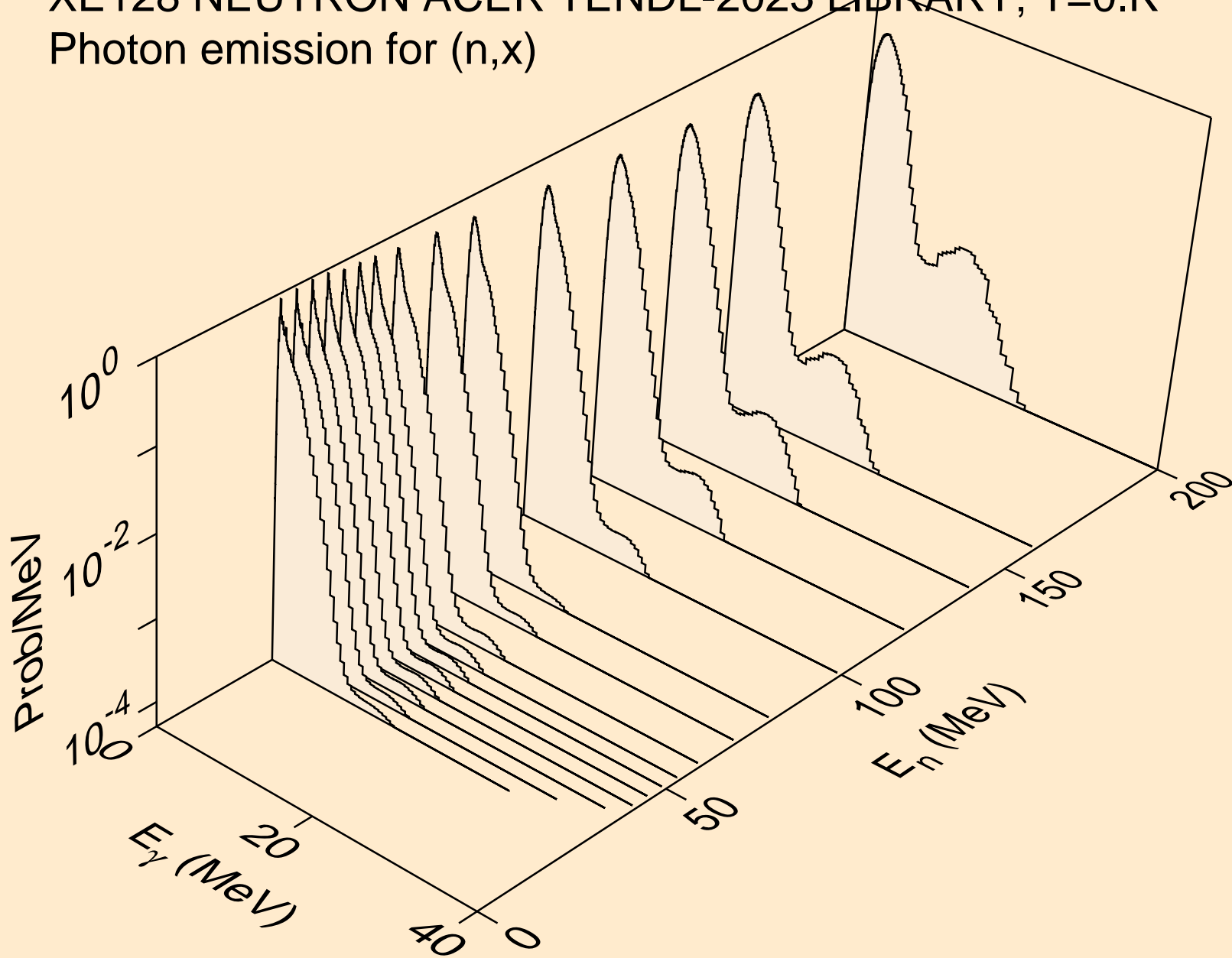

XE128 NEUTRON ACER TENDL-2023 LIBRARY; T=0.K  
Photon emission for (n,2nd)

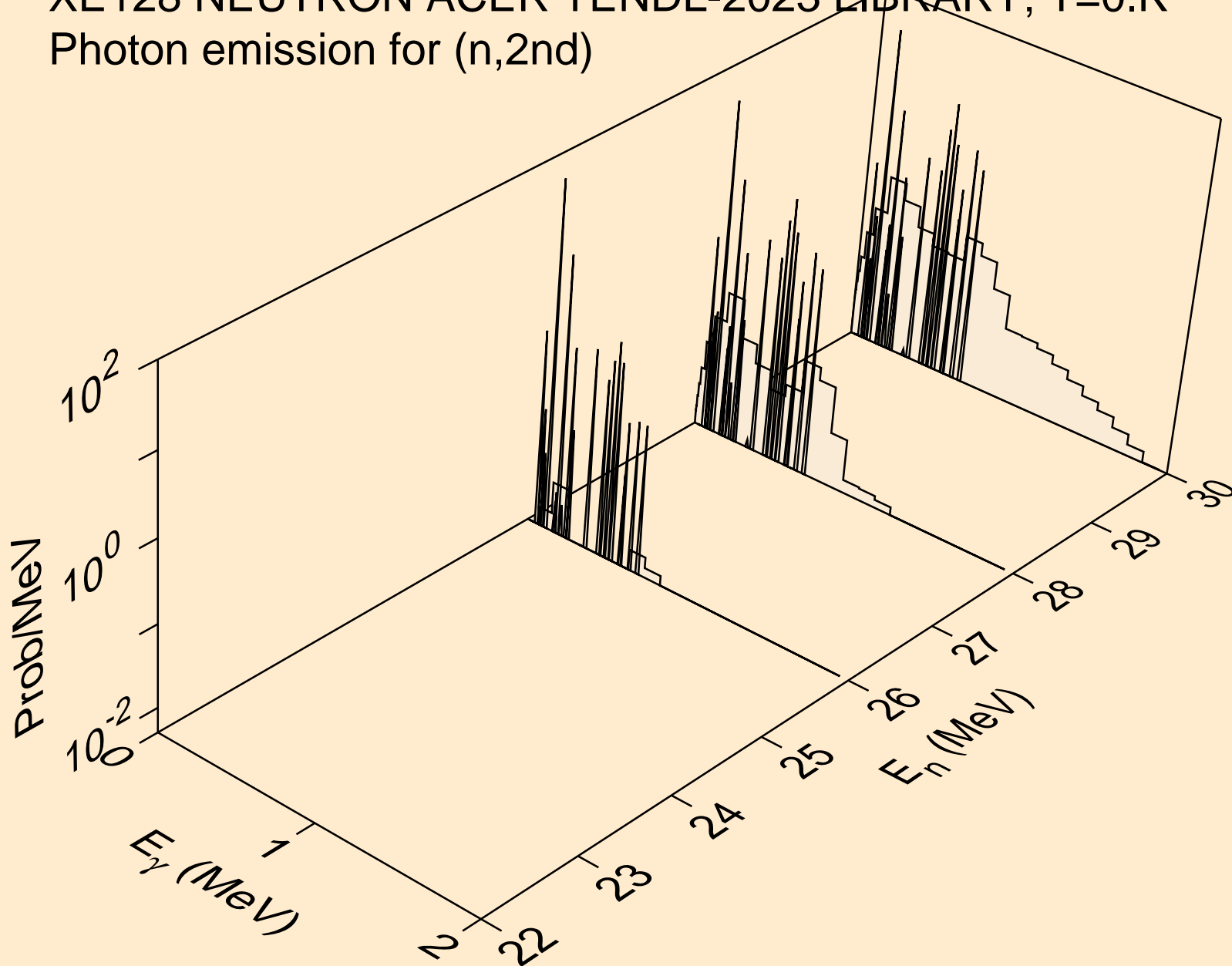

XE128 NEUTRON ACER TENDL-2023 LIBRARY; T=0.K  
Photon emission for (n,2n)

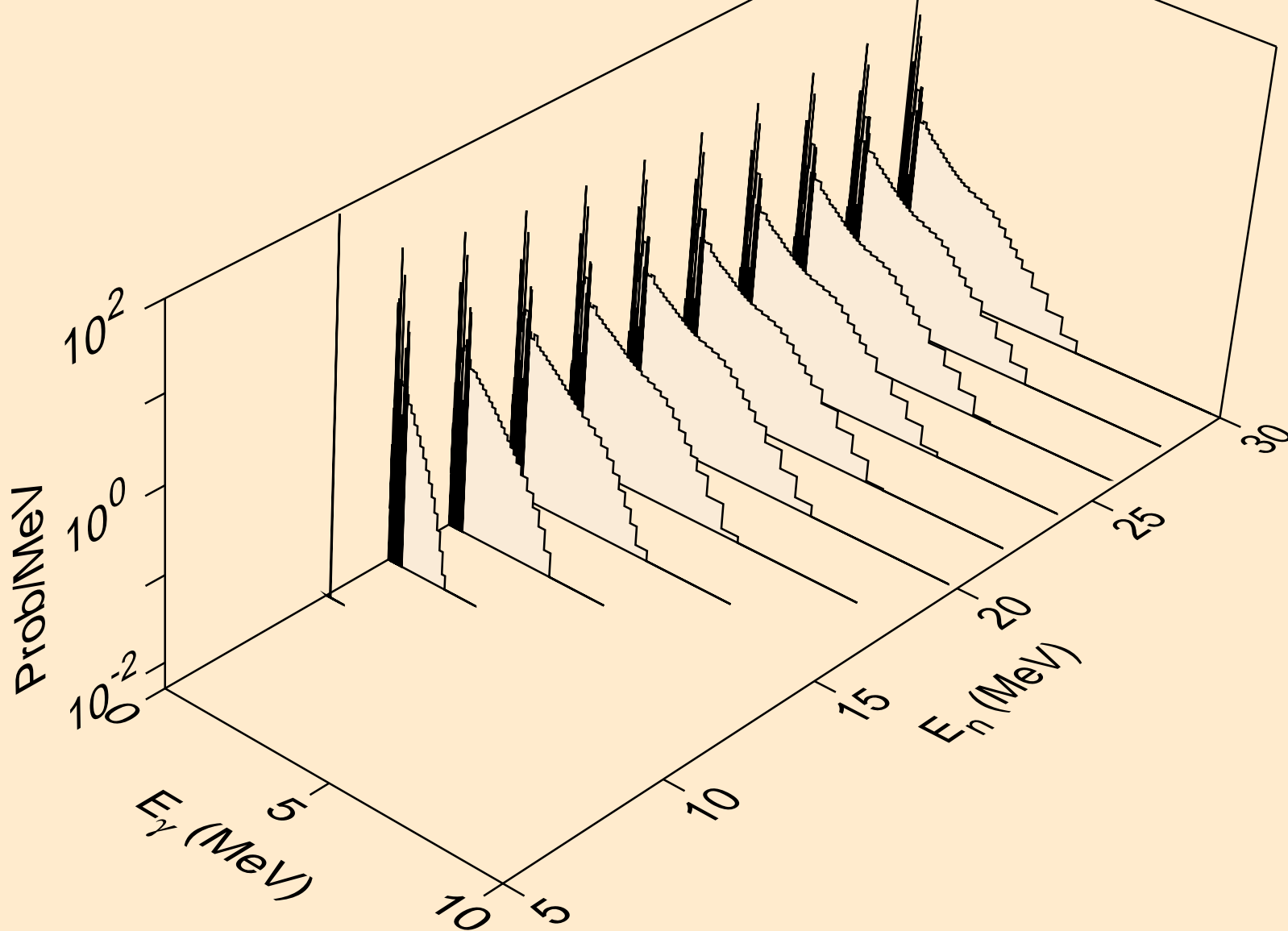

XE128 NEUTRON ACER TENDL-2023 LIBRARY; T=0.K  
Photon emission for (n,3n)

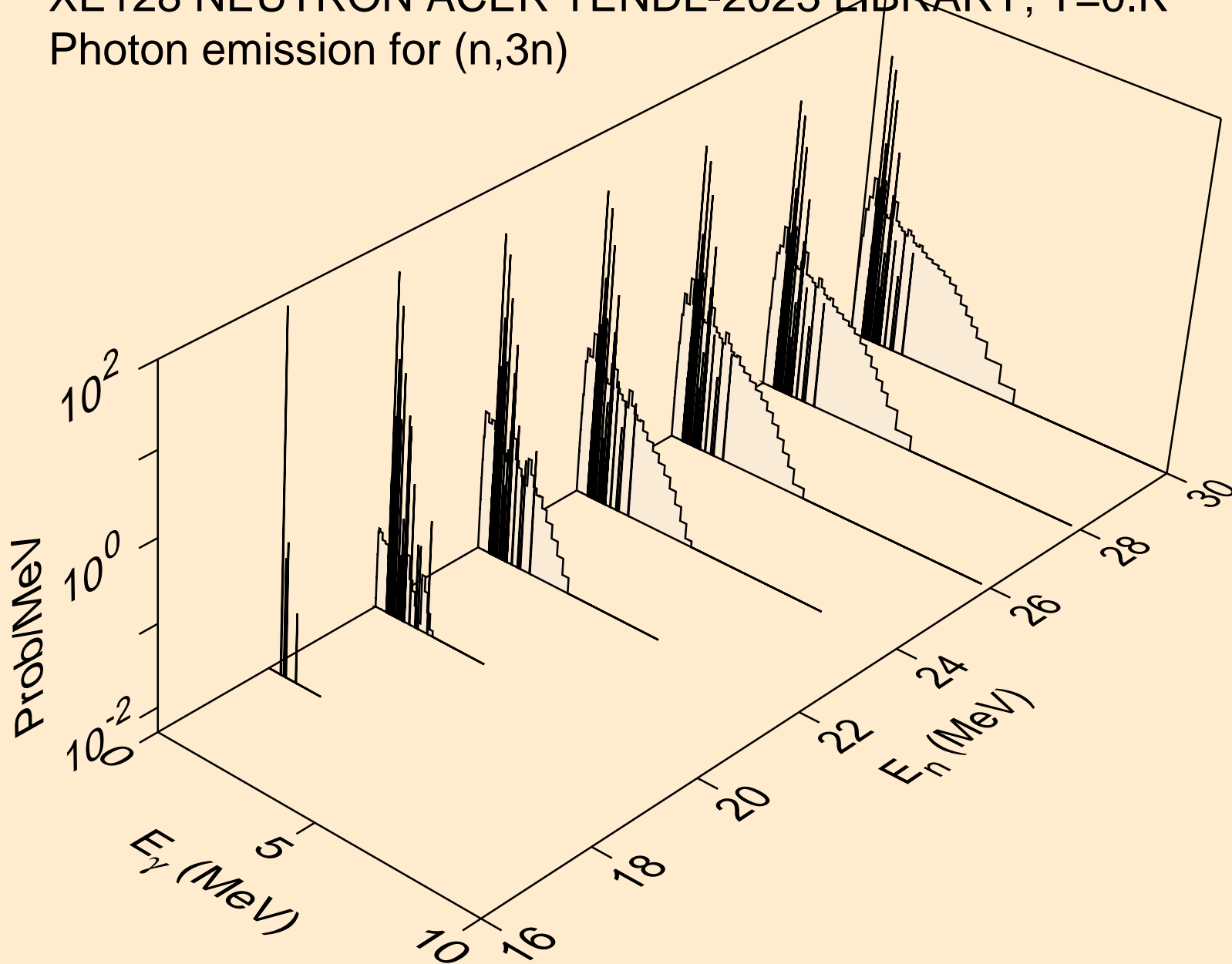

XE128 NEUTRON ACER TENDL-2023 LIBRARY; T=0.K  
Photon emission for (n,n\*)a

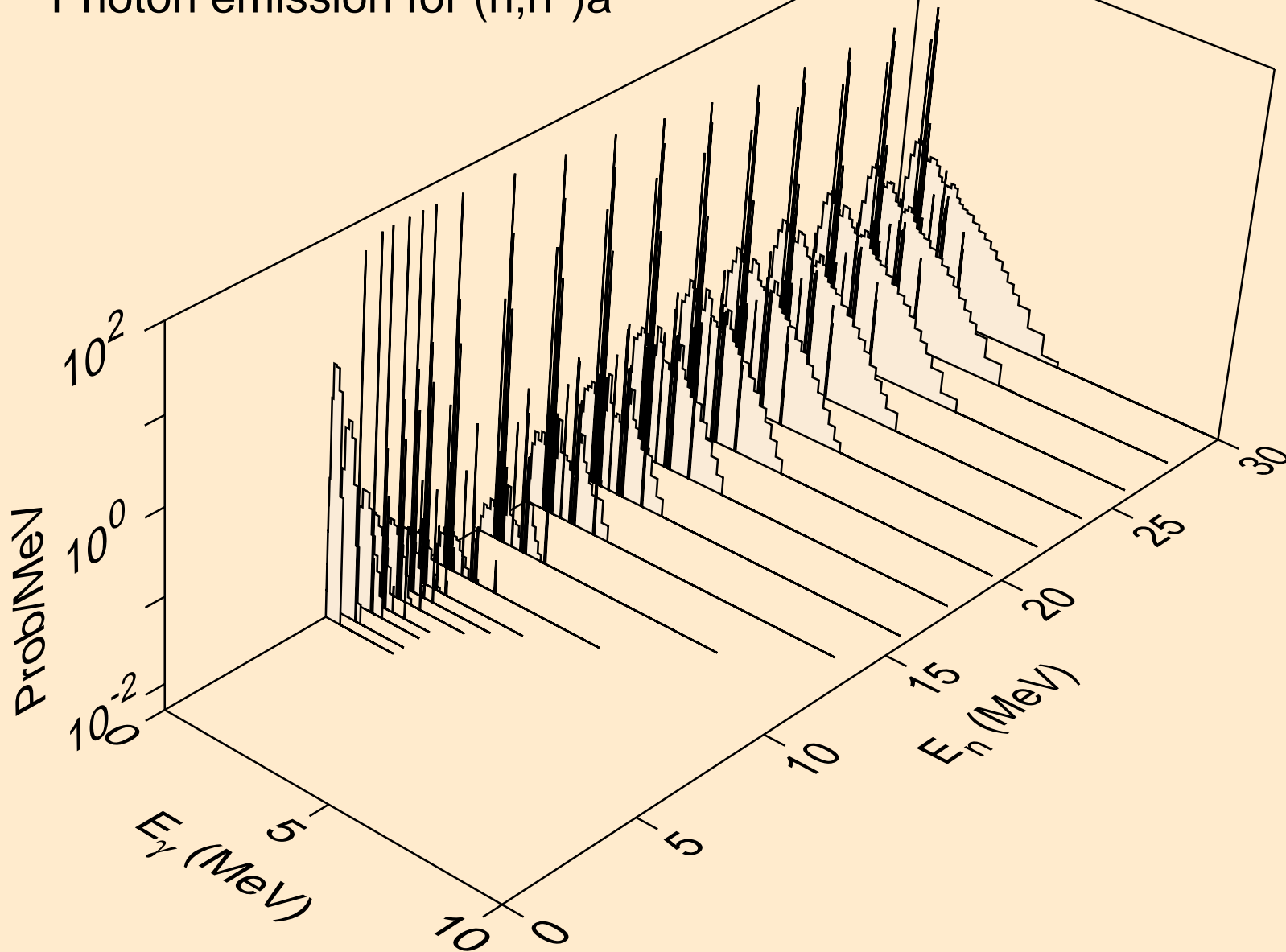

XE128 NEUTRON ACER TENDL-2023 LIBRARY; T=0.K  
Photon emission for (n,2n)a

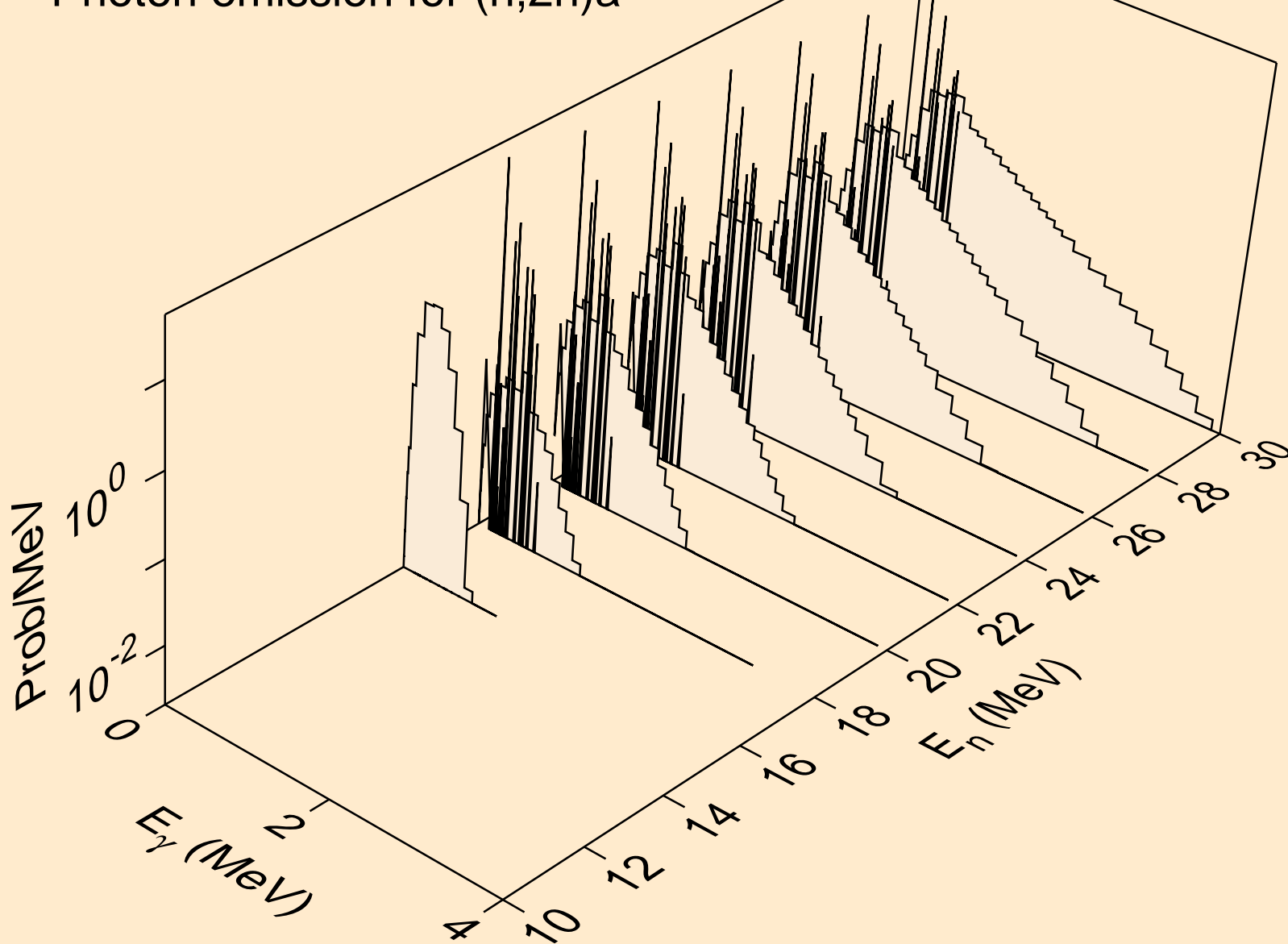

XE128 NEUTRON ACER TENDL-2023 LIBRARY; T=0.K  
Photon emission for (n,3n)a

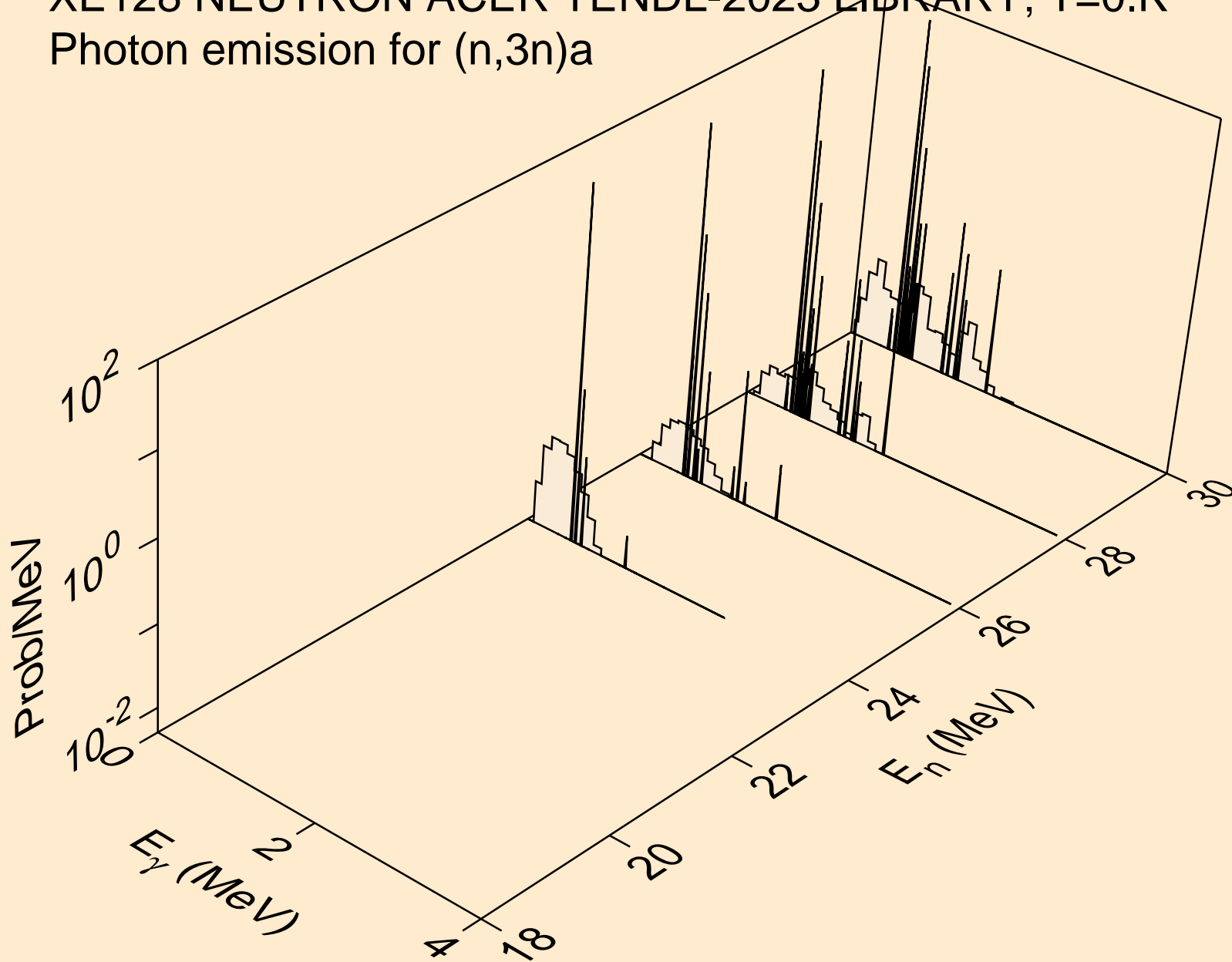

XE128 NEUTRON ACER TENDL-2023 LIBRARY; T=0.K  
Photon emission for (n,n\*)p

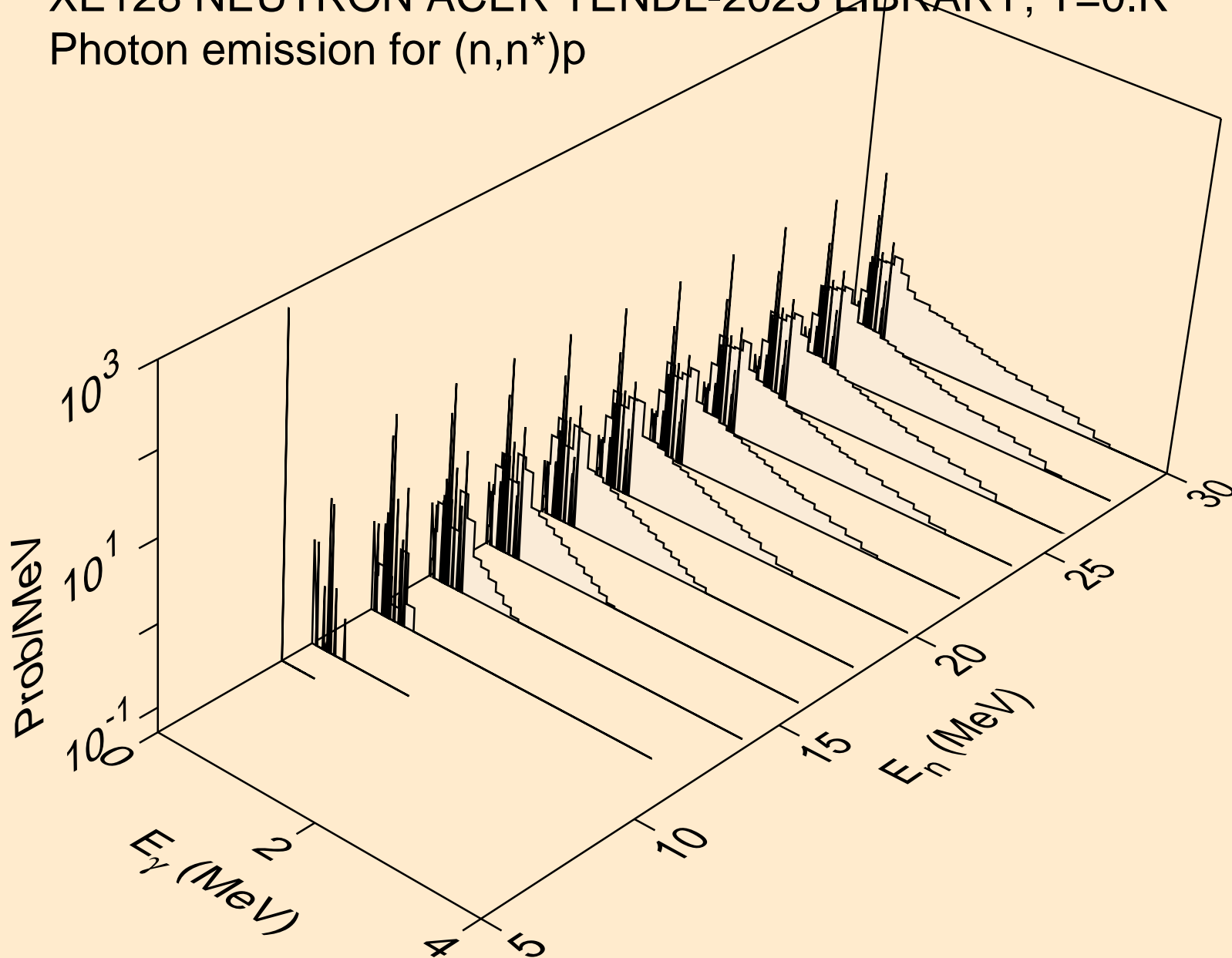

XE128 NEUTRON ACER TENDL-2023 LIBRARY; T=0.K  
Photon emission for (n,n\*)d

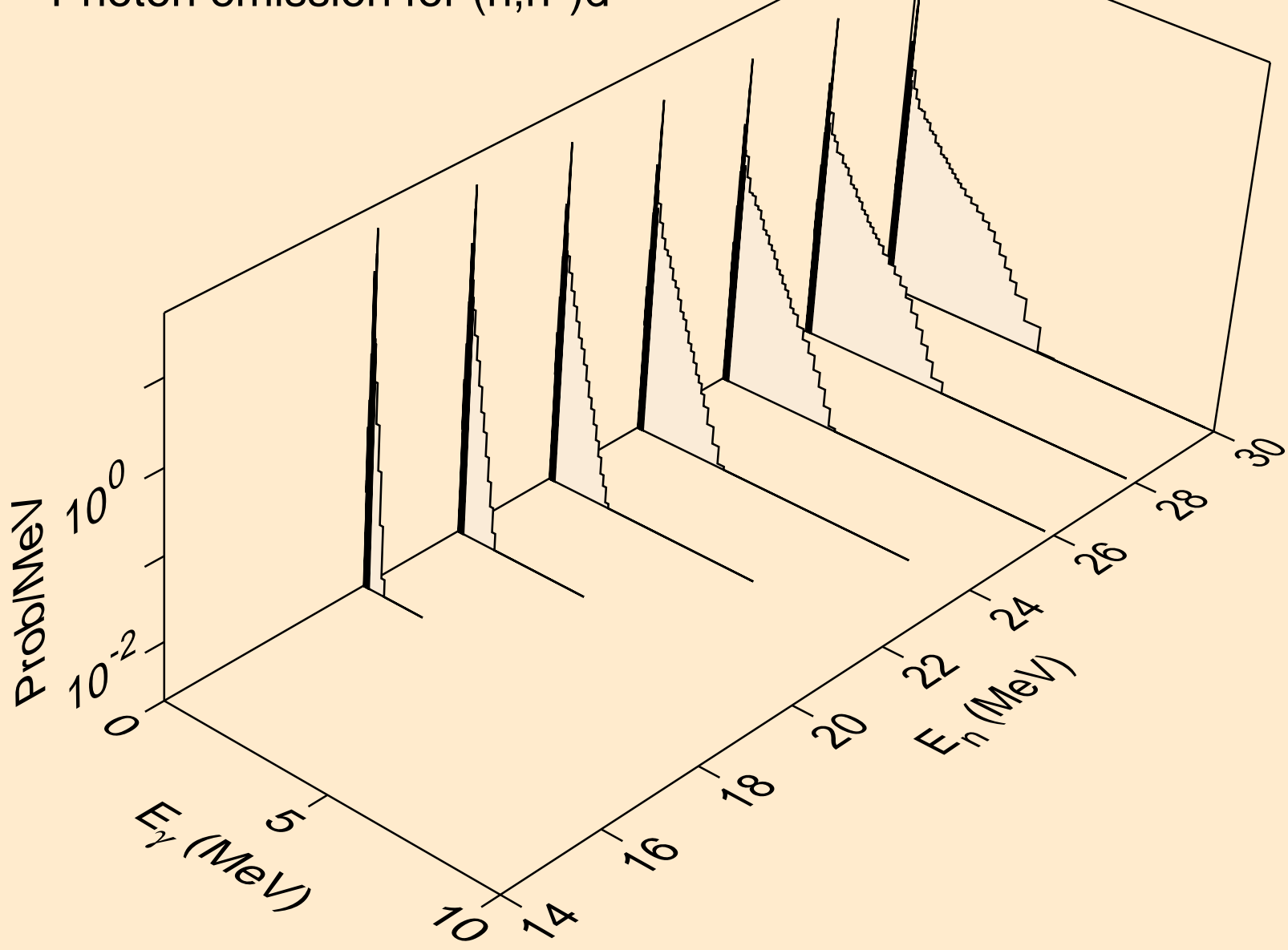

XE128 NEUTRON ACER TENDL-2023 LIBRARY; T=0.K  
Photon emission for (n,n\*)t

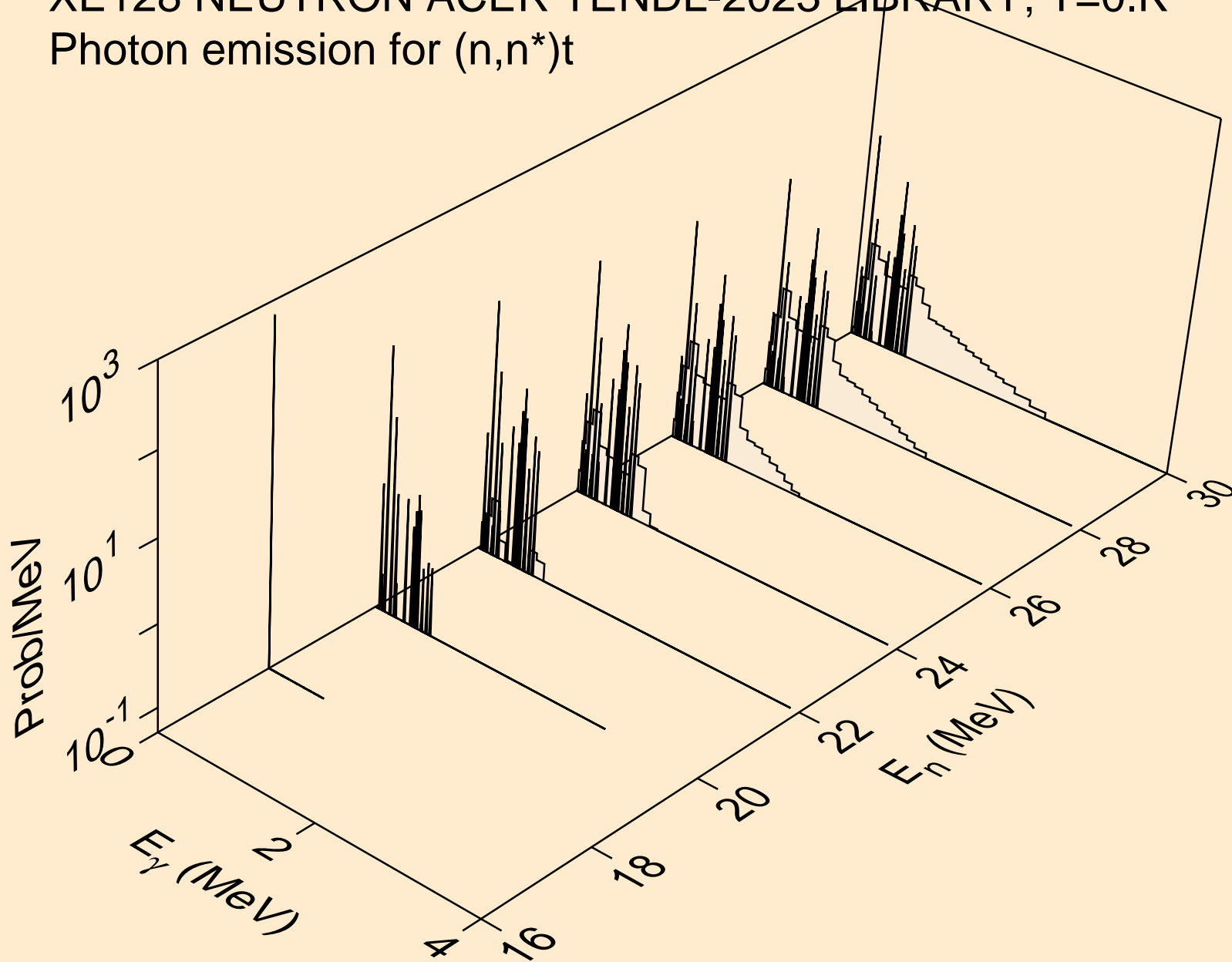

XE128 NEUTRON ACER TENDL-2023 LIBRARY; T=0.K  
Photon emission for (n,n\*)he3

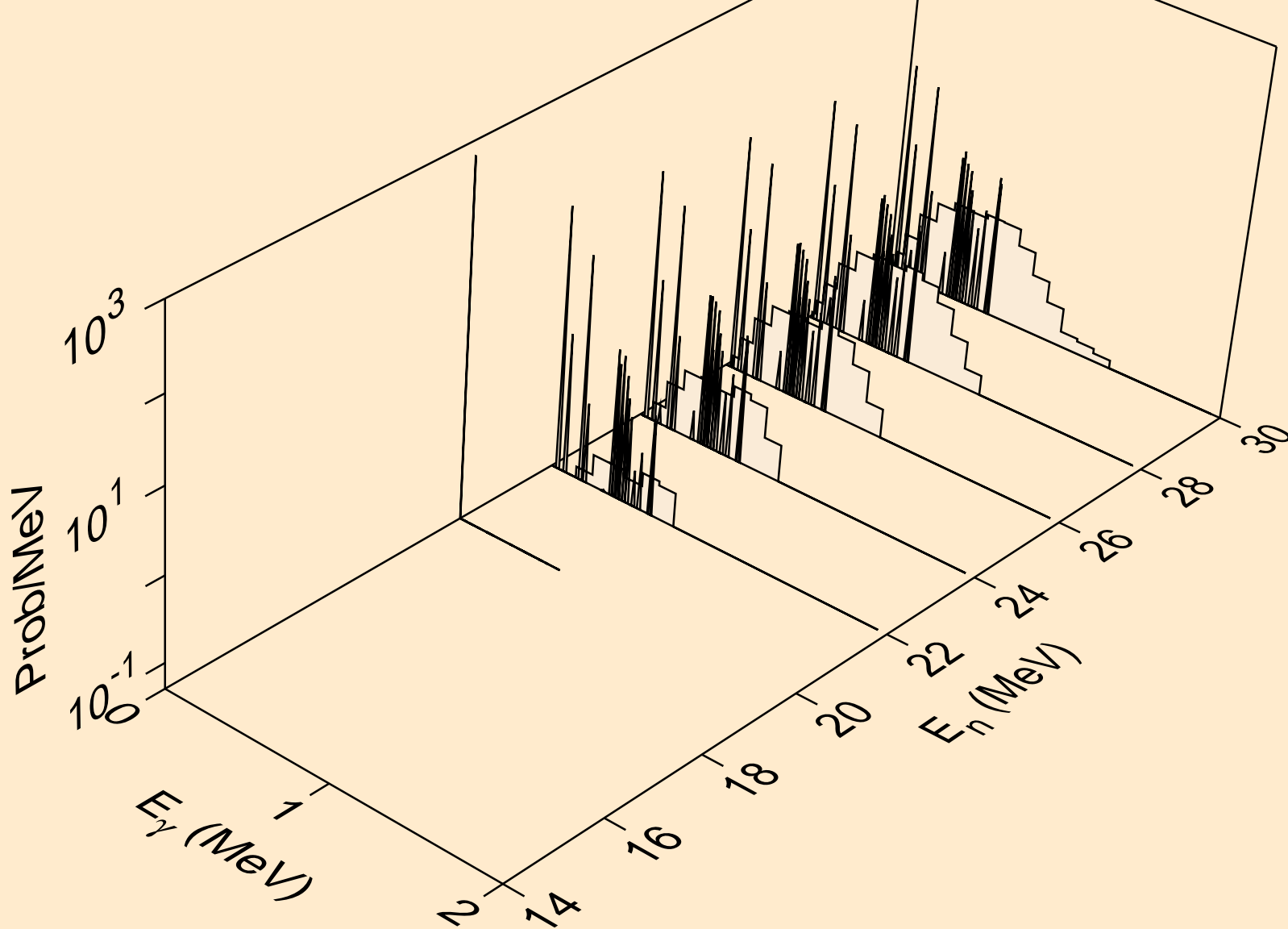

XE128 NEUTRON ACER TENDL-2023 LIBRARY; T=0.K  
Photon emission for (n,4n)

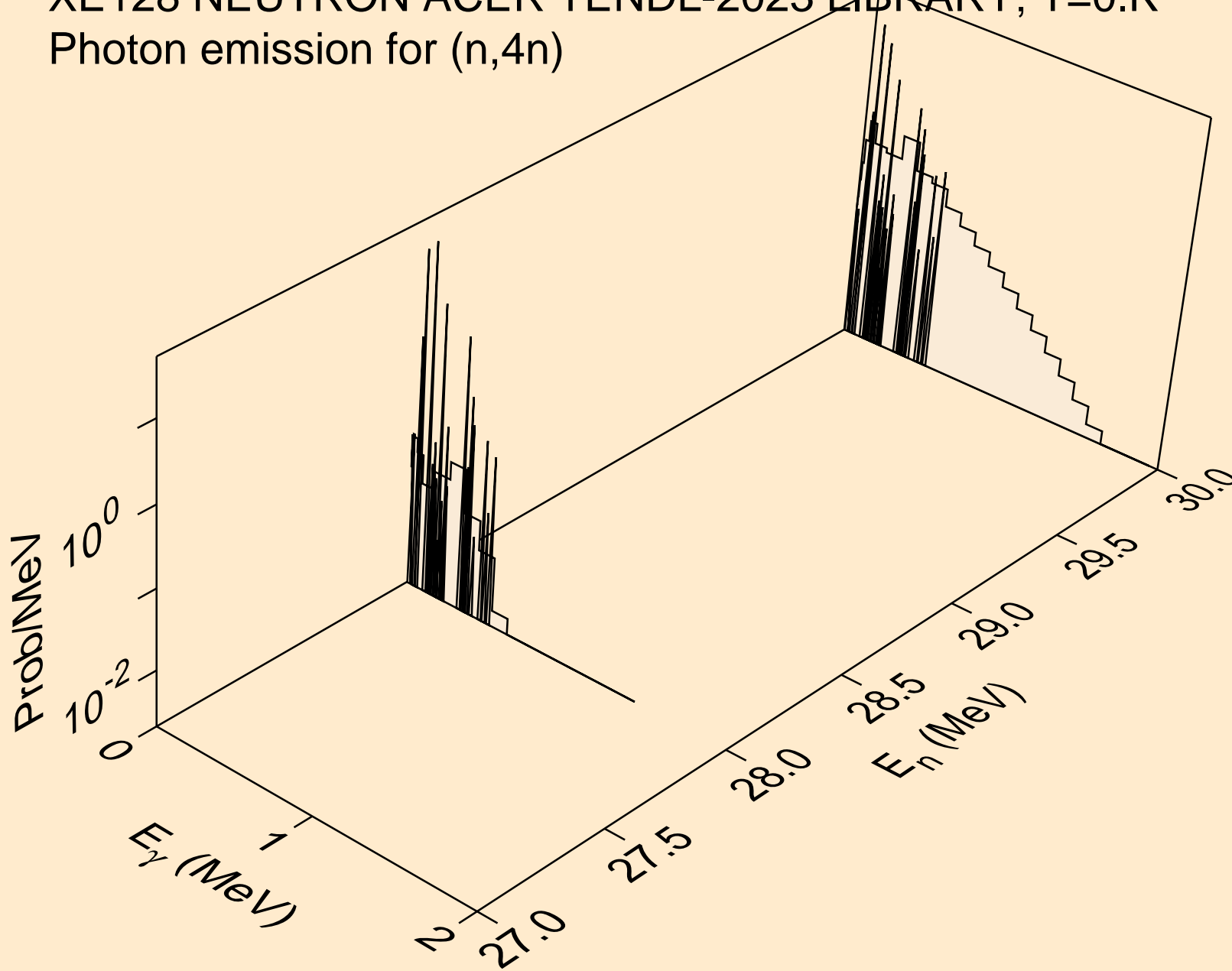

XE128 NEUTRON ACER TENDL-2023 LIBRARY; T=0.K  
Photon emission for (n,2np)

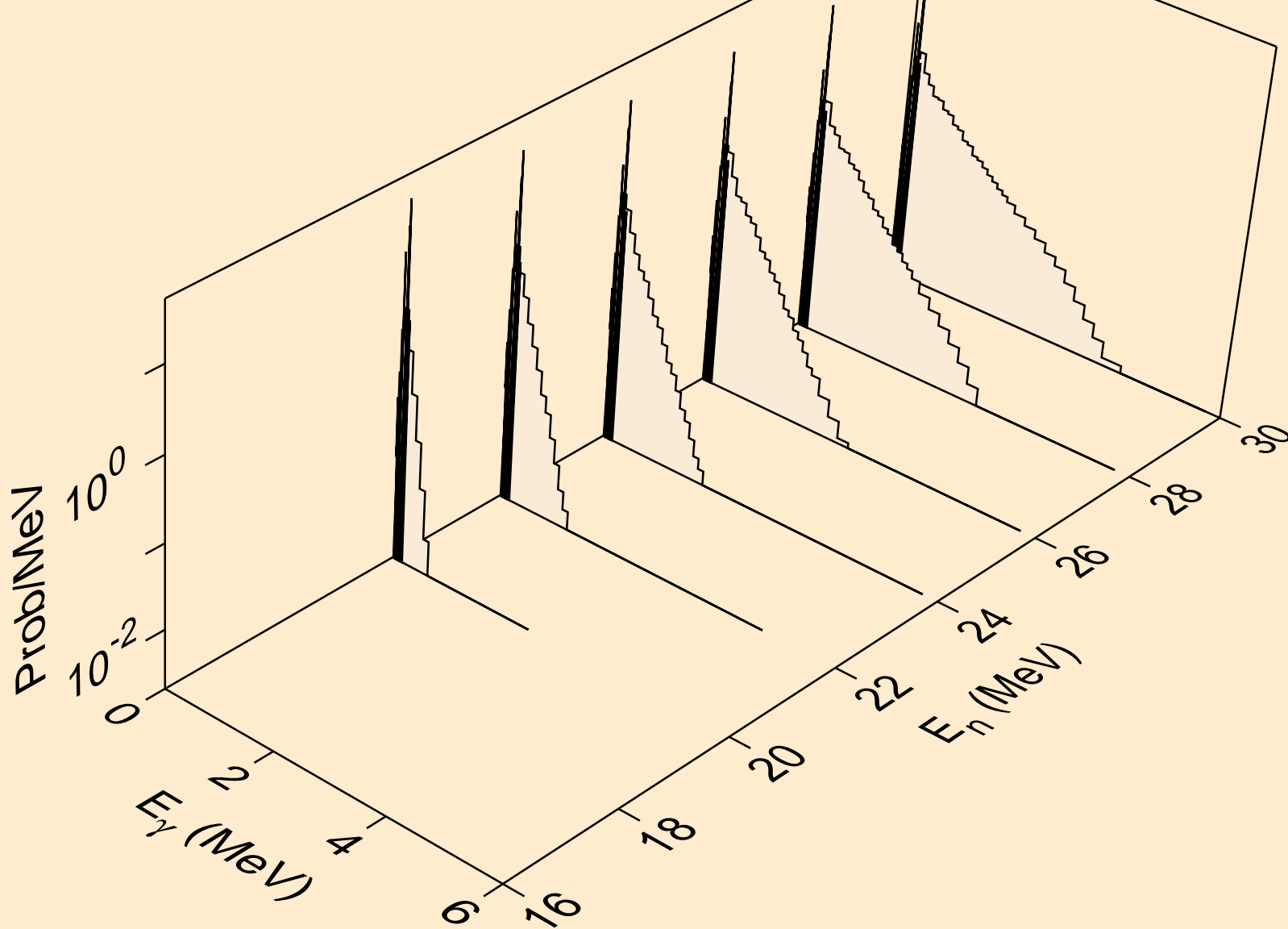

XE128 NEUTRON ACER TENDL-2023 LIBRARY; T=0.K  
Photon emission for (n,3np)

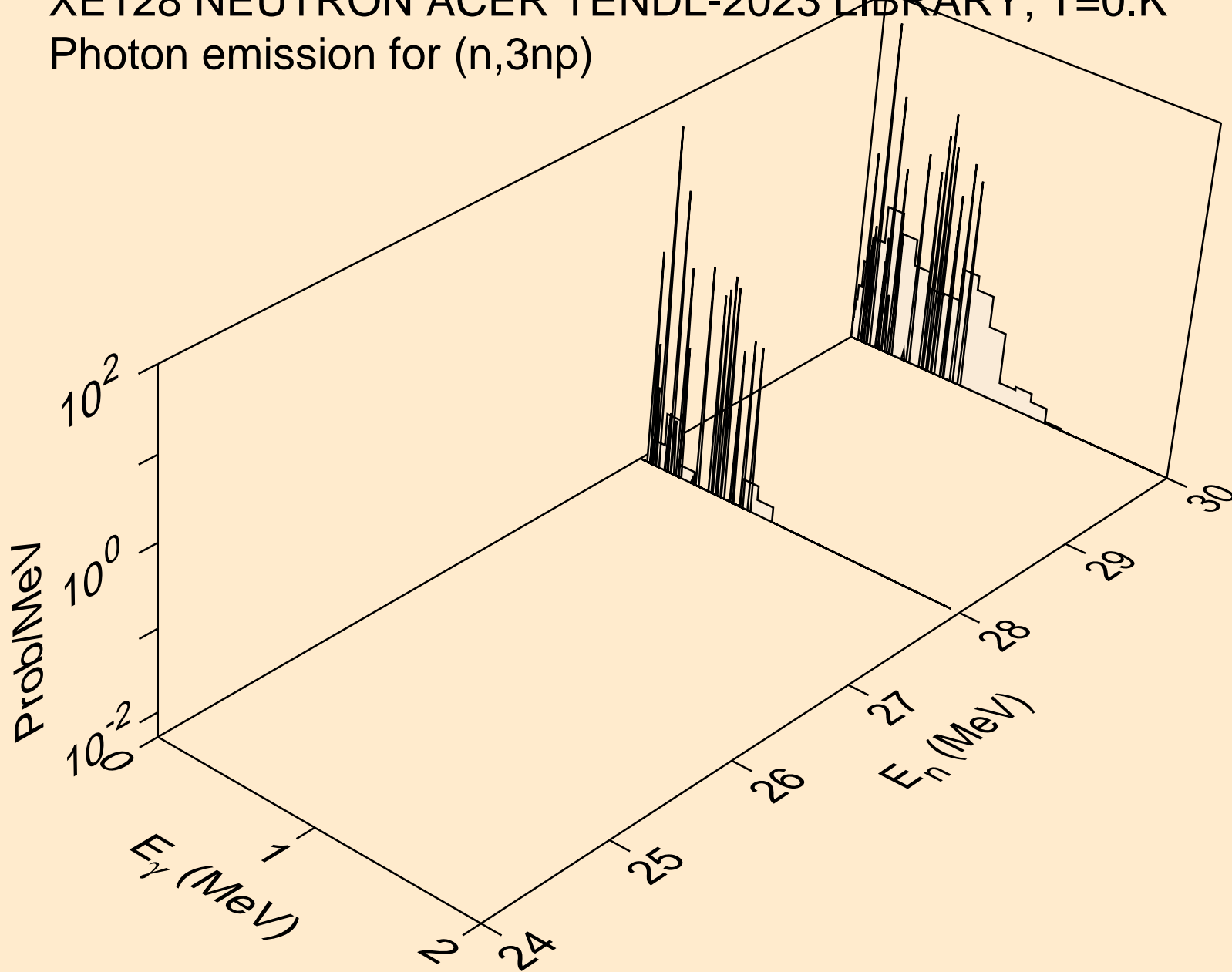

XE128 NEUTRON ACER TENDL-2023 LIBRARY; T=0.K  
Photon emission for (n,n2p)

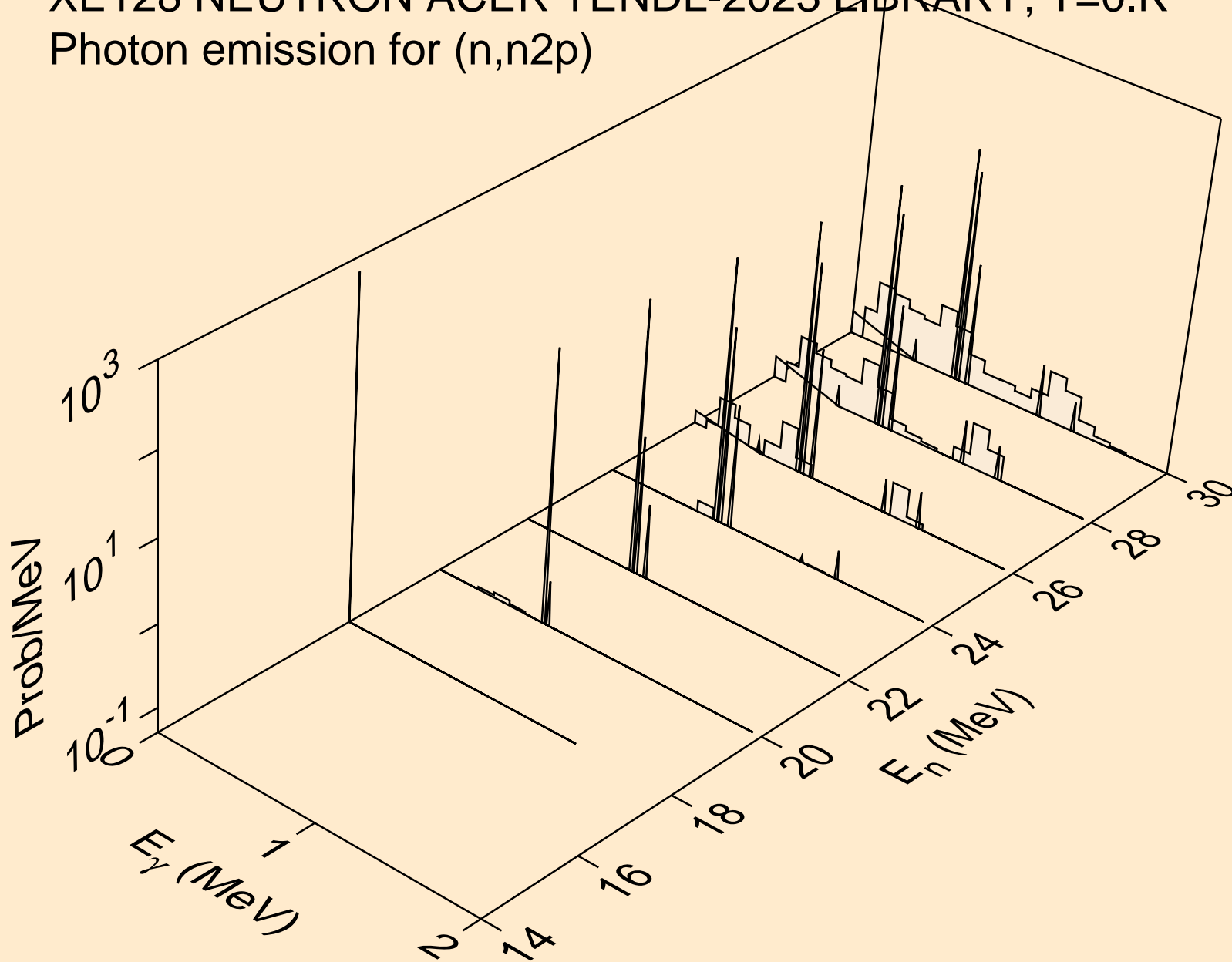

XE128 NEUTRON ACER TENDL-2023 LIBRARY; T=0.K  
Photon emission for (n,npa)

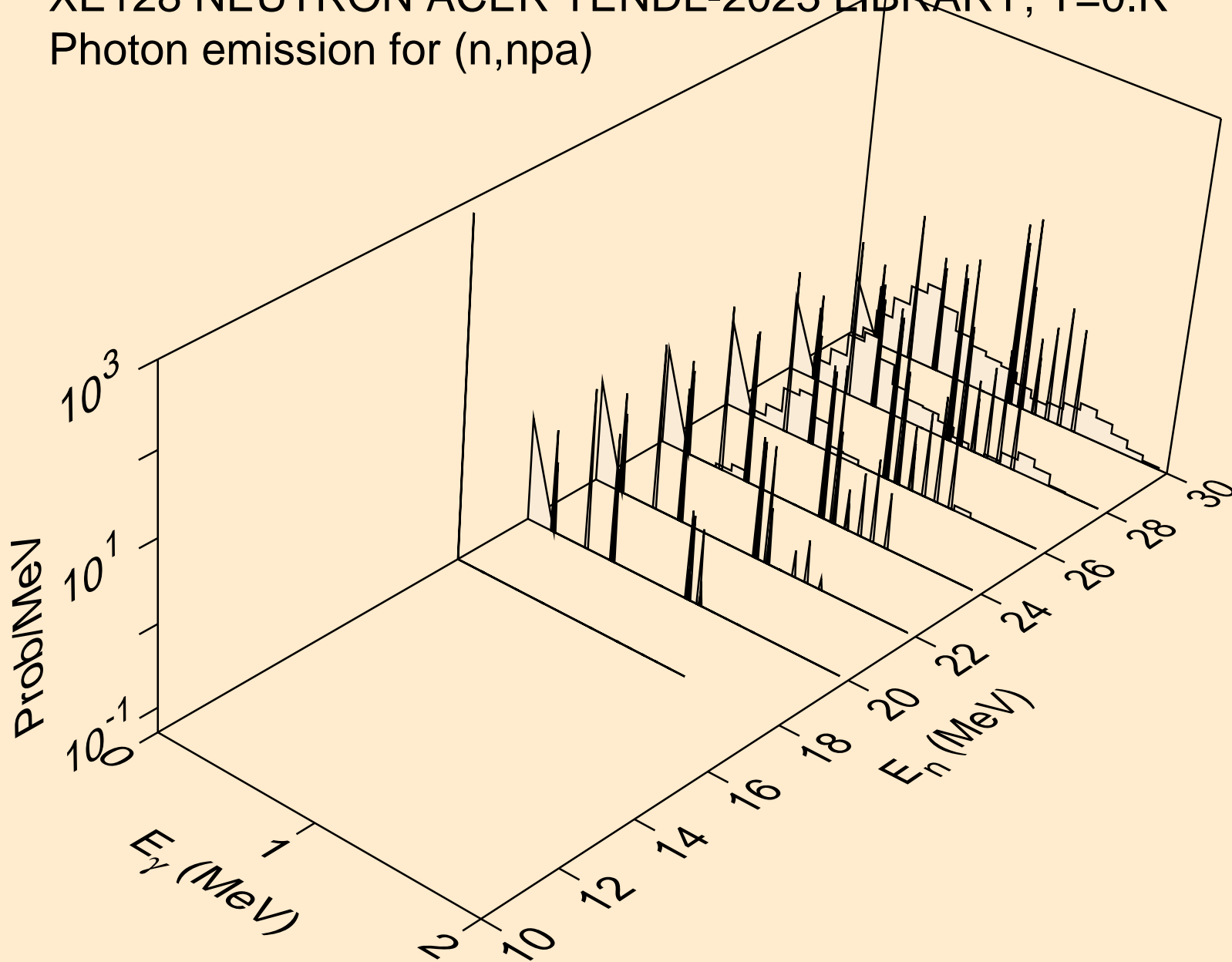

XE128 NEUTRON ACER TENDL-2023 LIBRARY; T=0.K  
Photon emission for (n,n\*c)

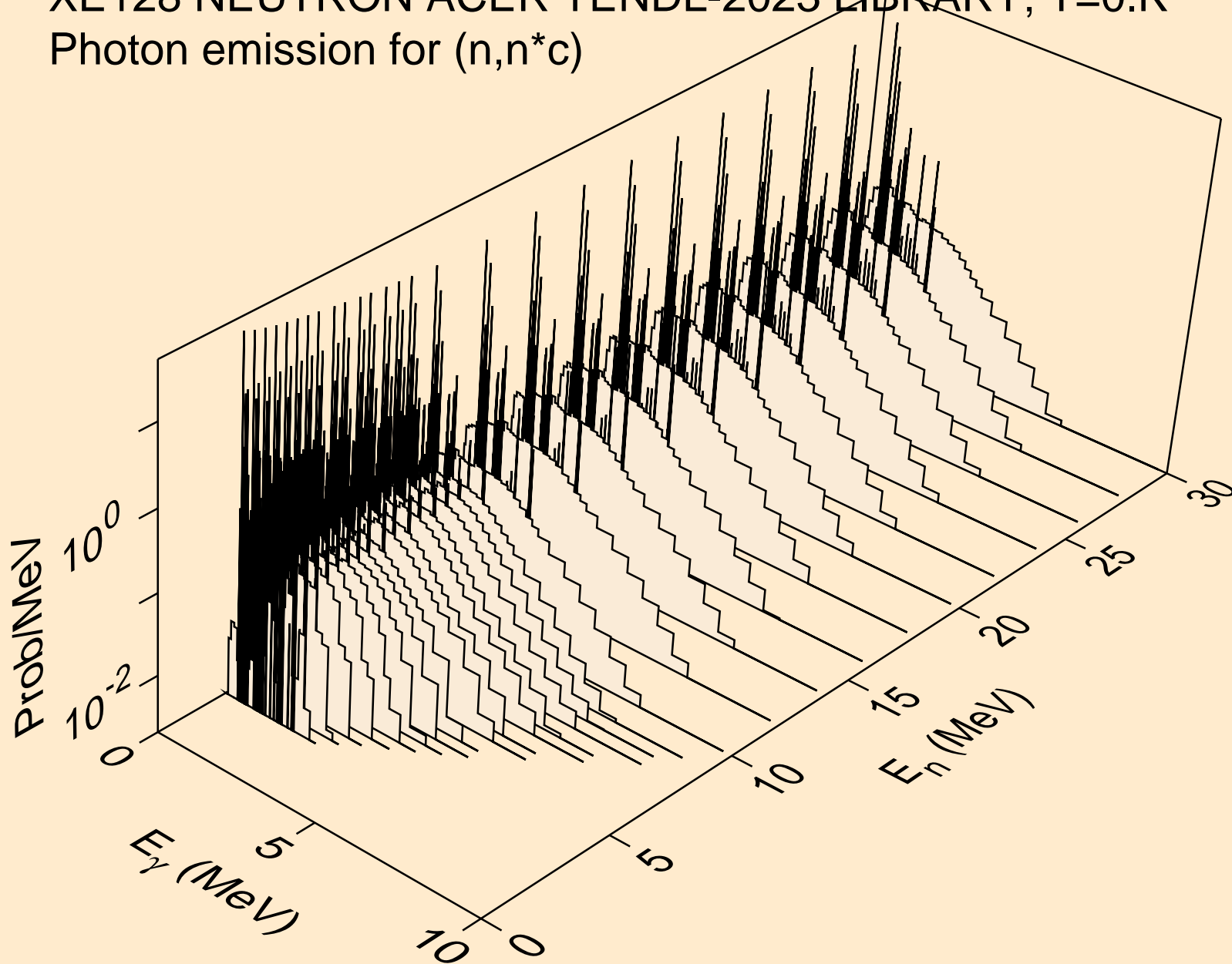

XE128 NEUTRON ACER TENDL-2023 LIBRARY; T=0.K  
Photon emission for (n,gma)

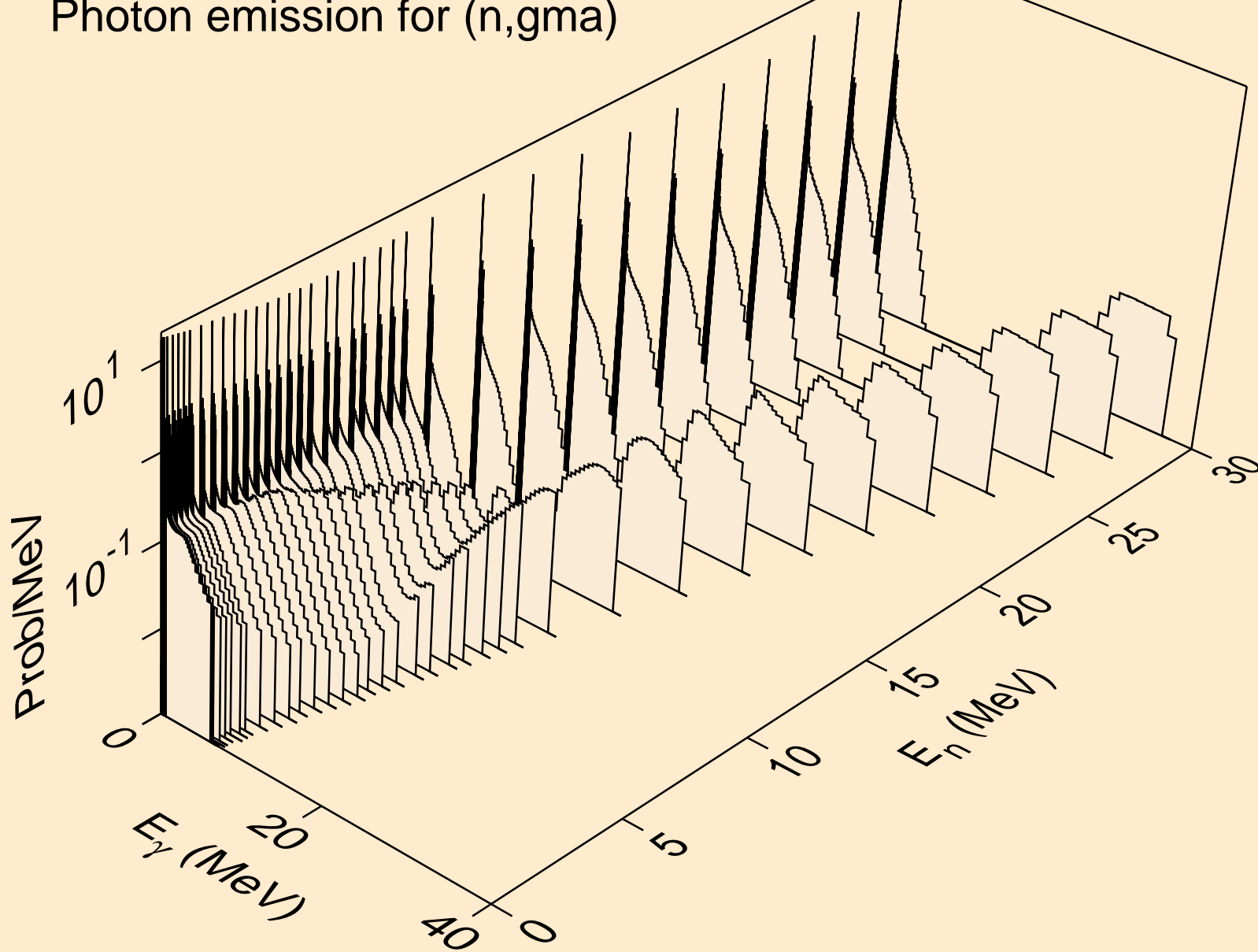

XE128 NEUTRON ACER TENDL-2023 LIBRARY; T=0.K  
Photon emission for (n,p)

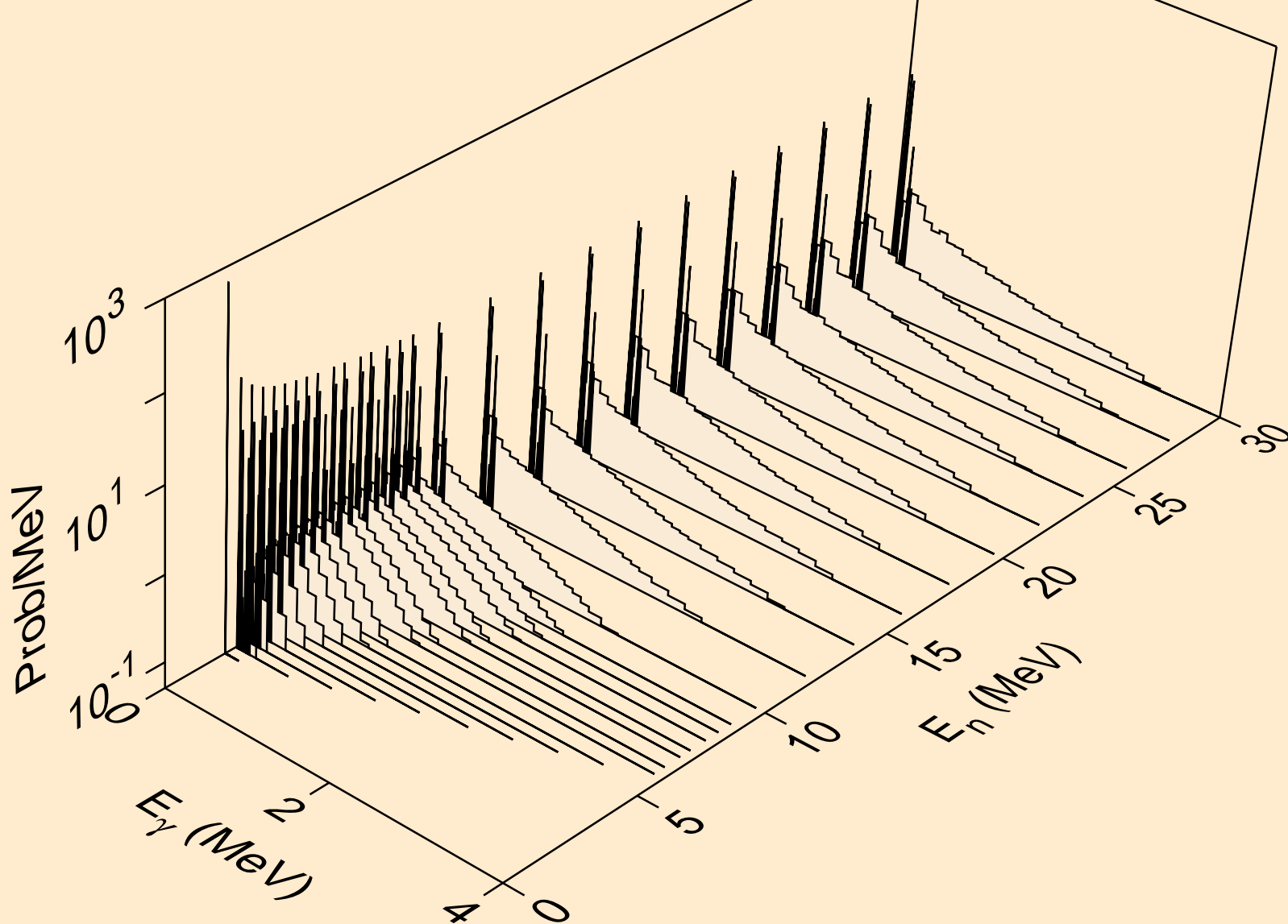

XE128 NEUTRON ACER TENDL-2023 LIBRARY; T=0.K  
Photon emission for (n,d)

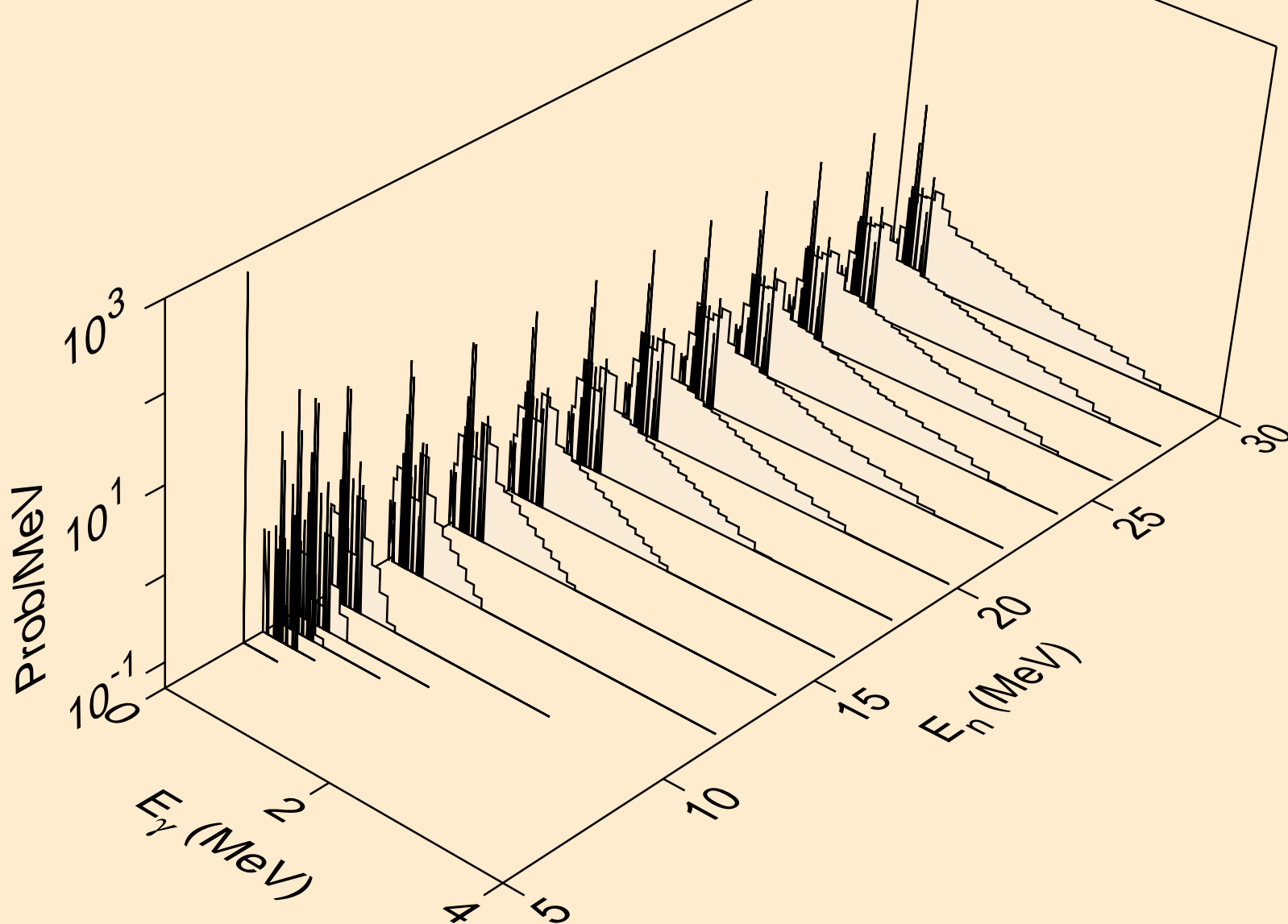

XE128 NEUTRON ACER TENDL-2023 LIBRARY; T=0.K  
Photon emission for (n,t)

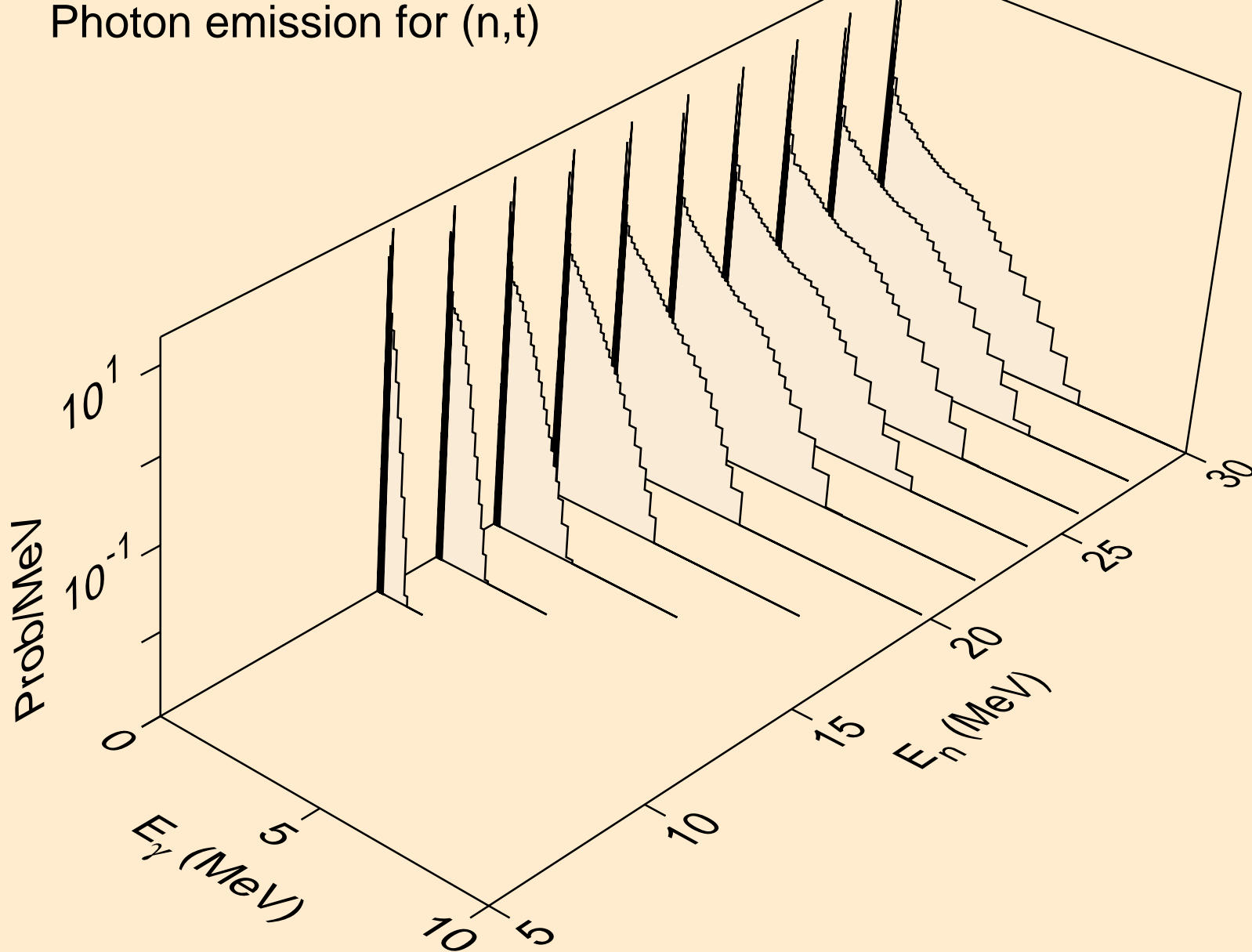

XE128 NEUTRON ACER TENDL-2023 LIBRARY; T=0.K  
Photon emission for (n,he3)

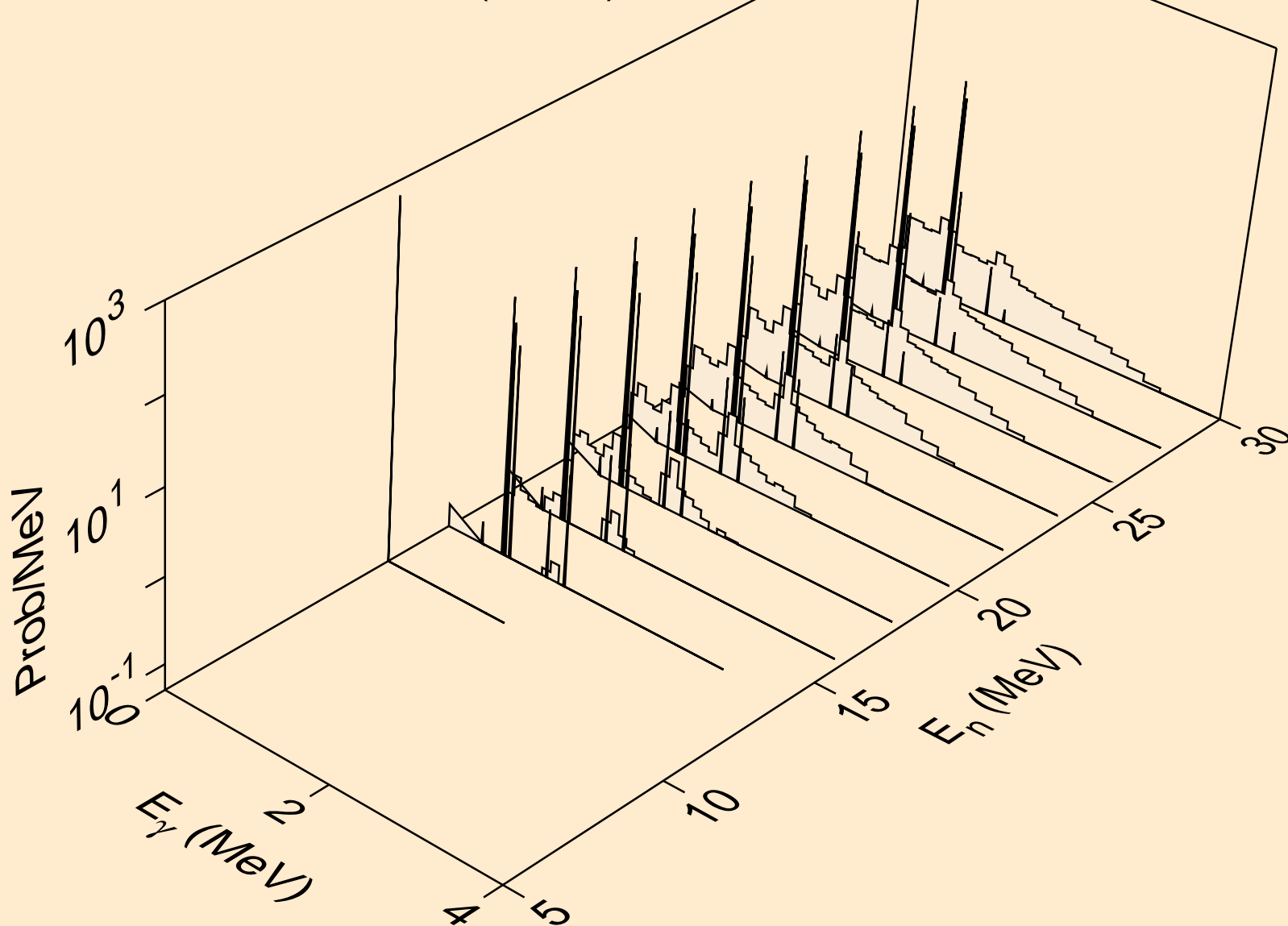

XE128 NEUTRON ACER TENDL-2023 LIBRARY; T=0.K  
Photon emission for (n,a)

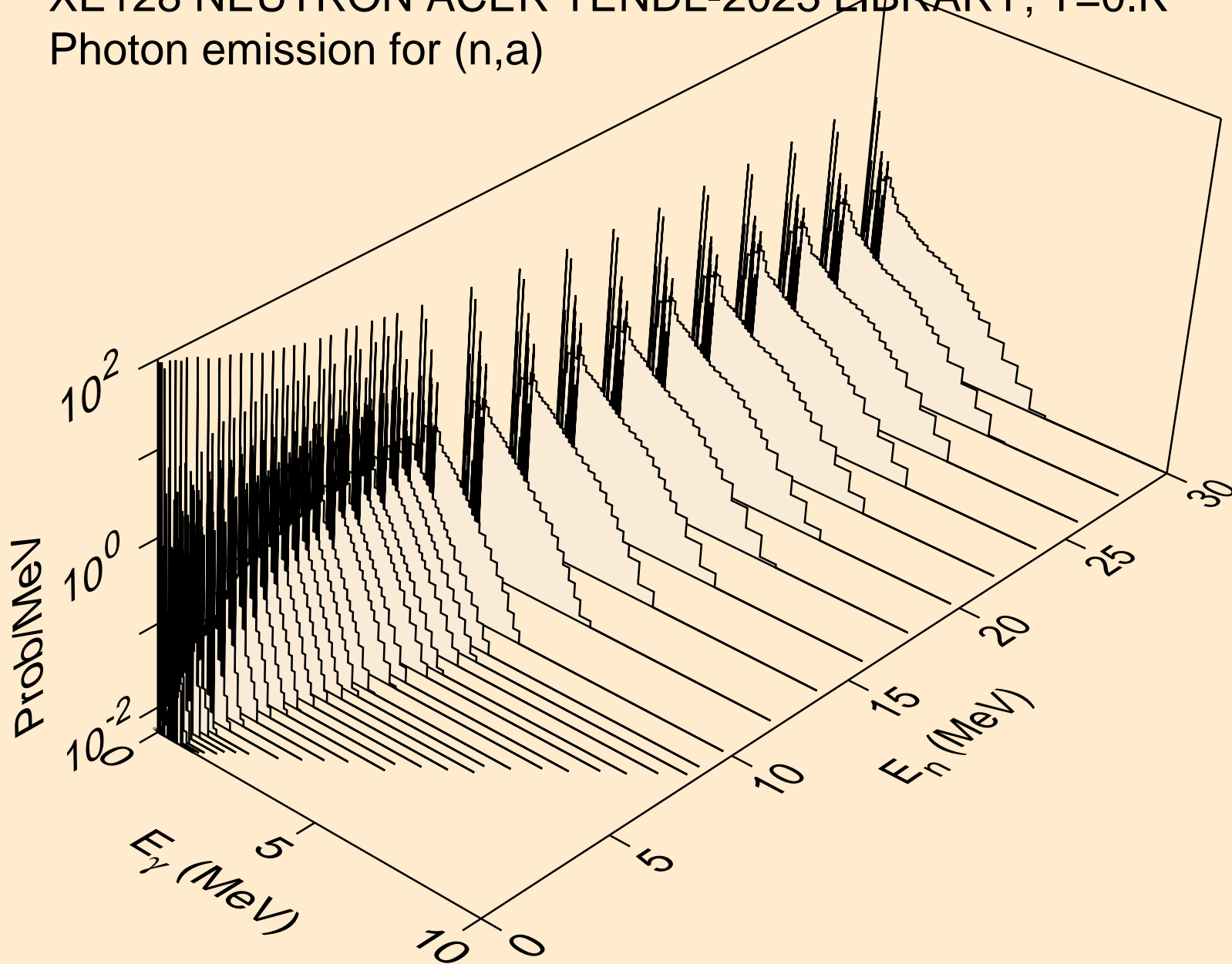

XE128 NEUTRON ACER TENDL-2023 LIBRARY; T=0.K  
Photon emission for (n,2a)

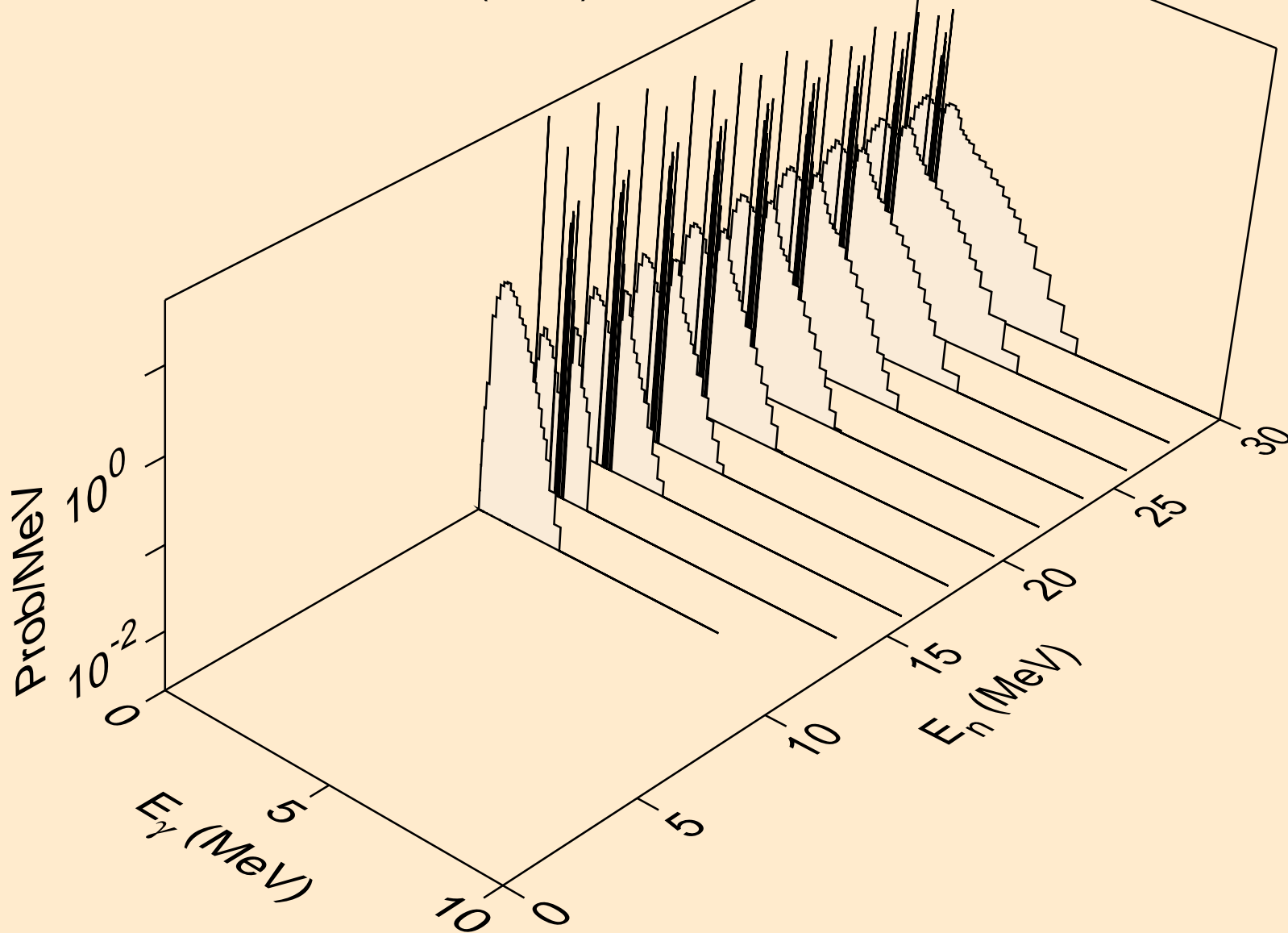

XE128 NEUTRON ACER TENDL-2023 LIBRARY; T=0.K  
Photon emission for (n,2p)

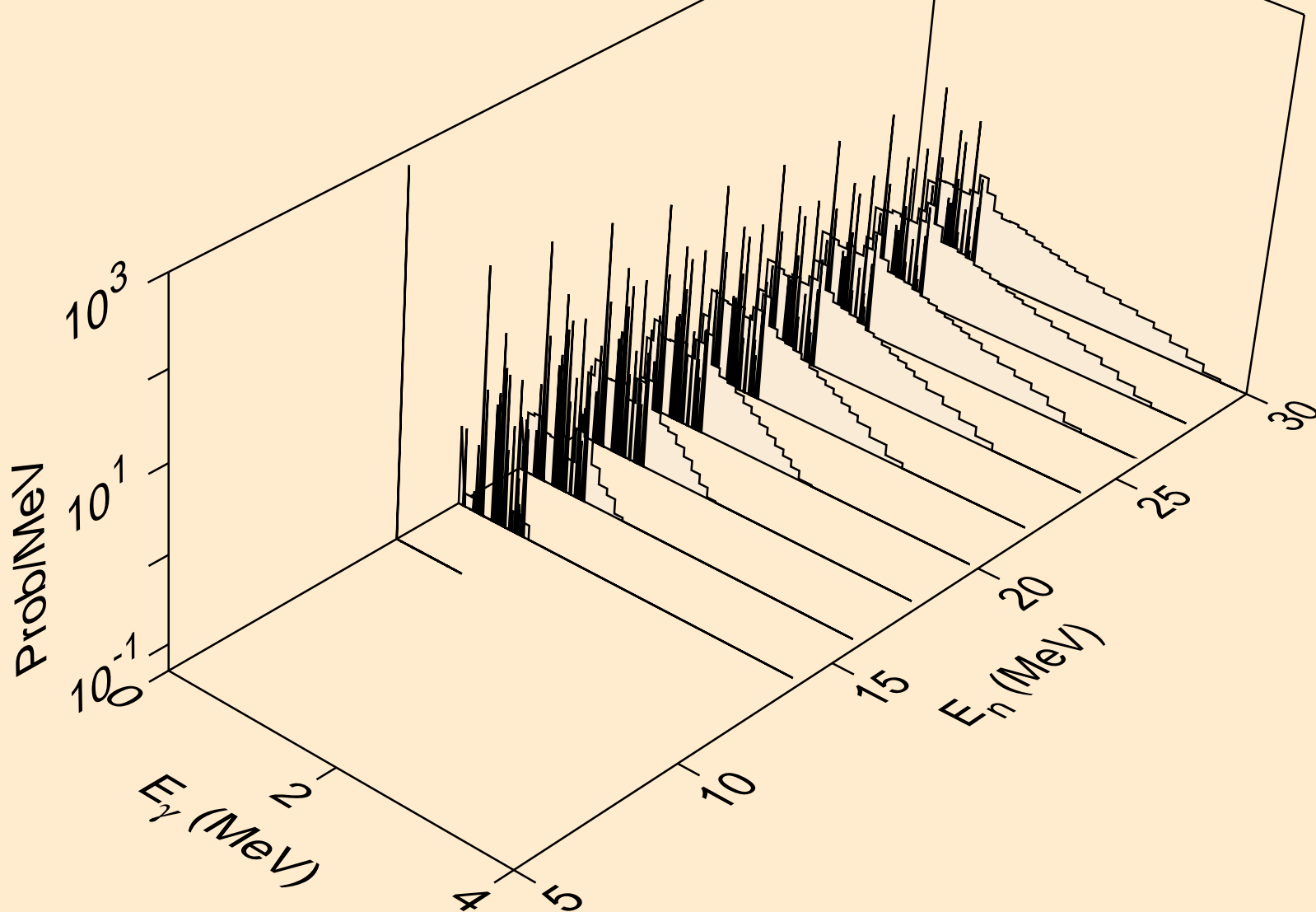

XE128 NEUTRON ACER TENDL-2023 LIBRARY; T=0.K  
Photon emission for (n,p $\alpha$ )

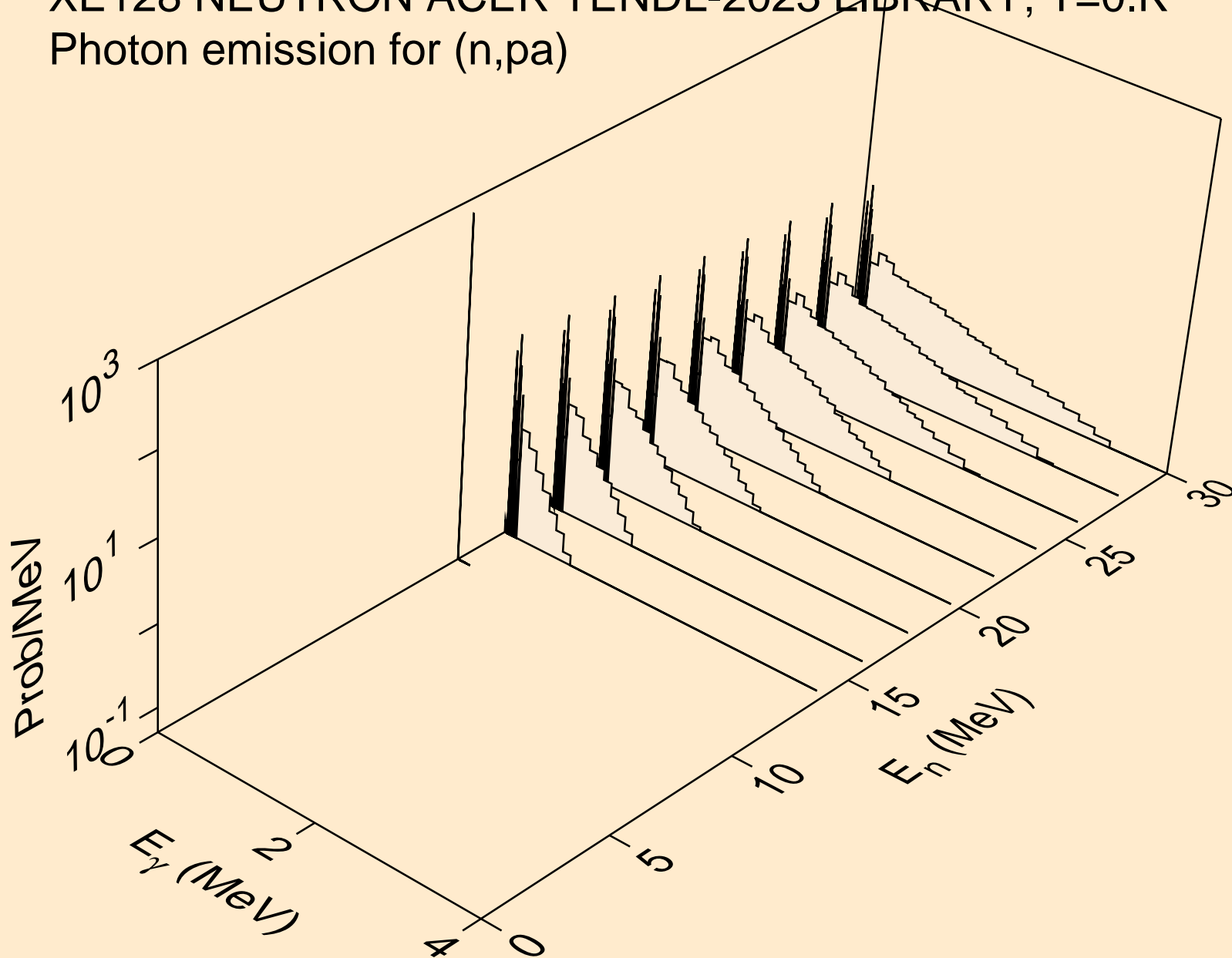

XE128 NEUTRON ACER TENDL-2023 LIBRARY; T=0.K  
Photon emission for (n,pd)

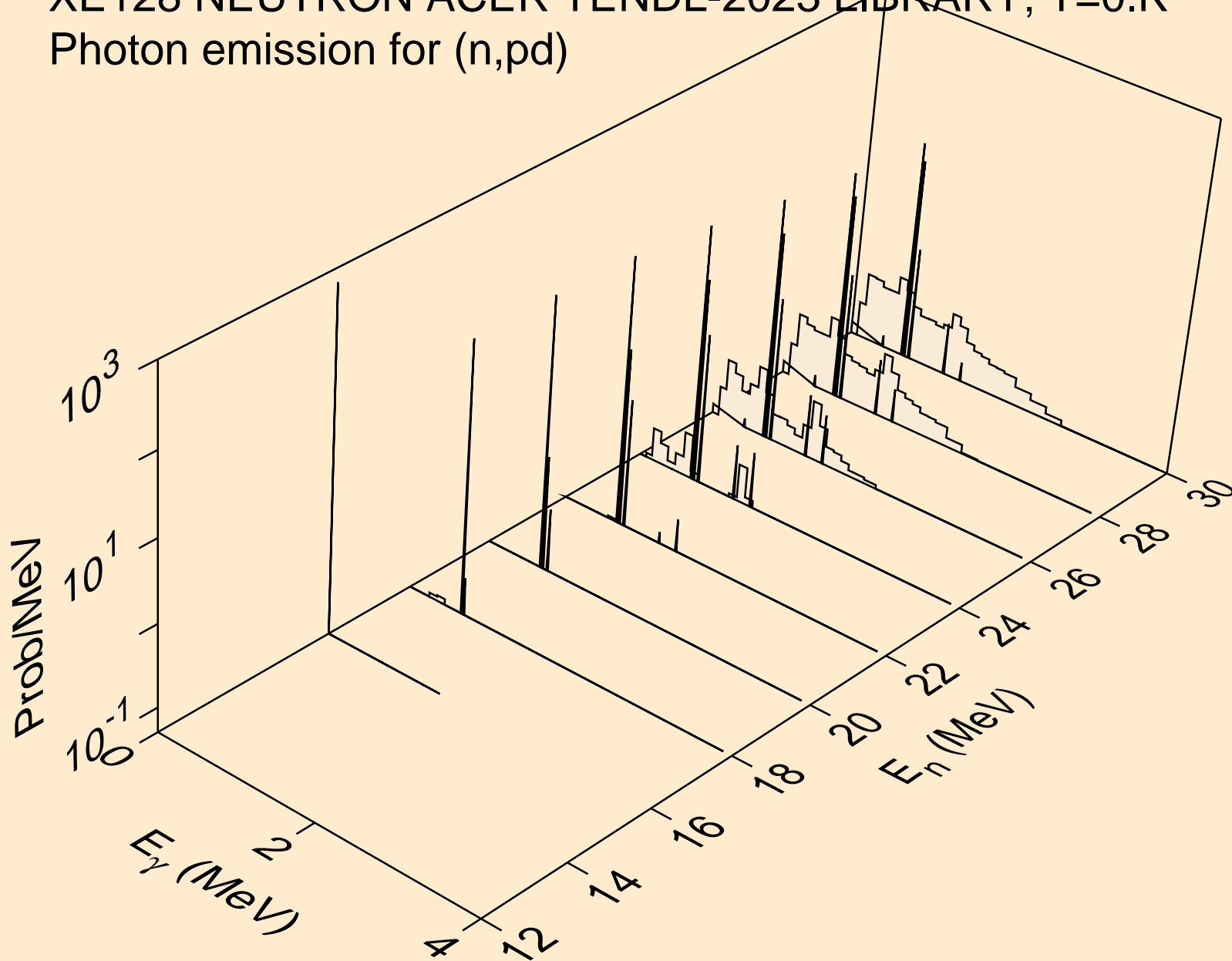

XE128 NEUTRON ACER TENDL-2023 LIBRARY; T=0.K  
Photon emission for (n,pt)

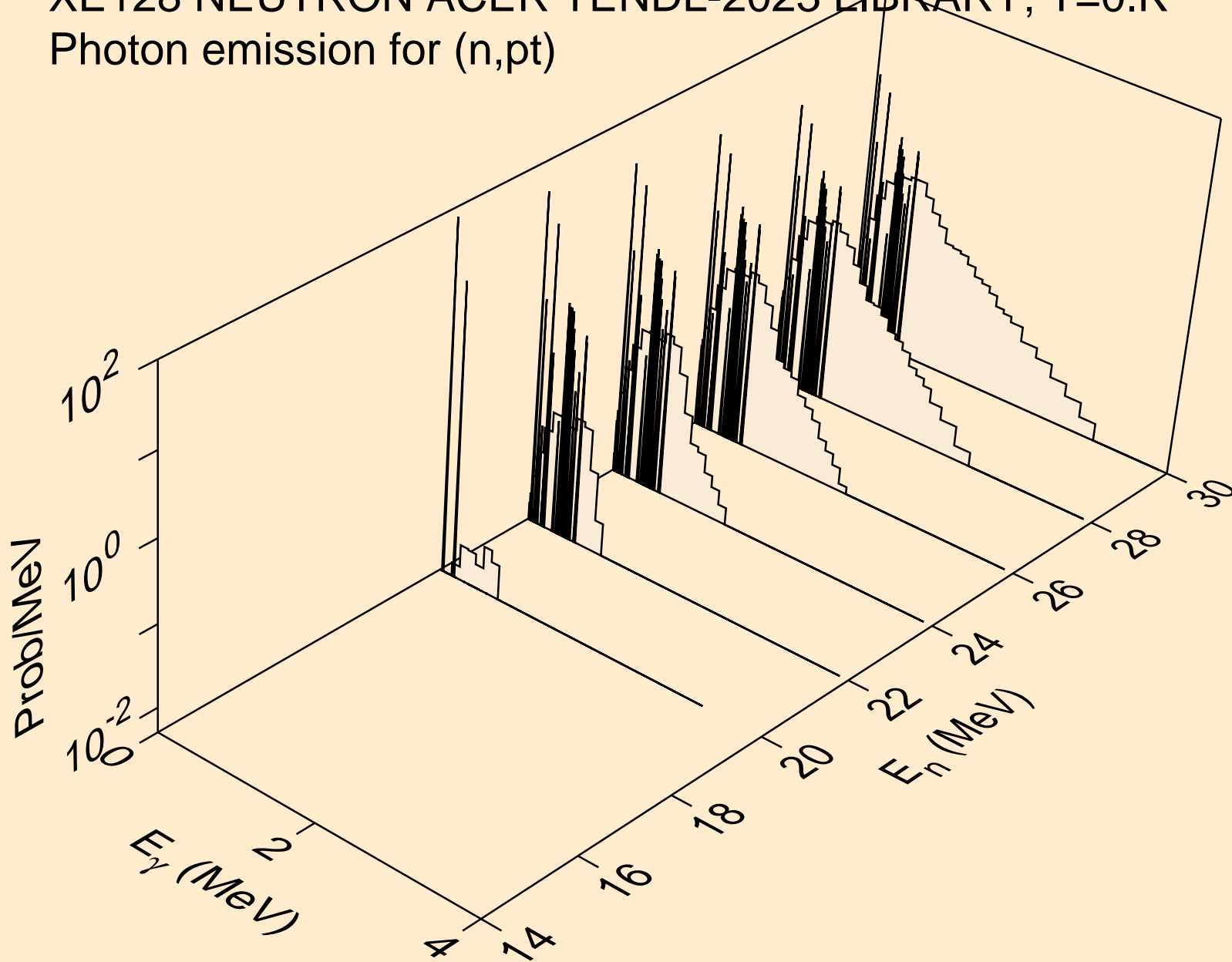

XE128 NEUTRON ACER TENDL-2023 LIBRARY; T=0.K  
Photon emission for (n,da)

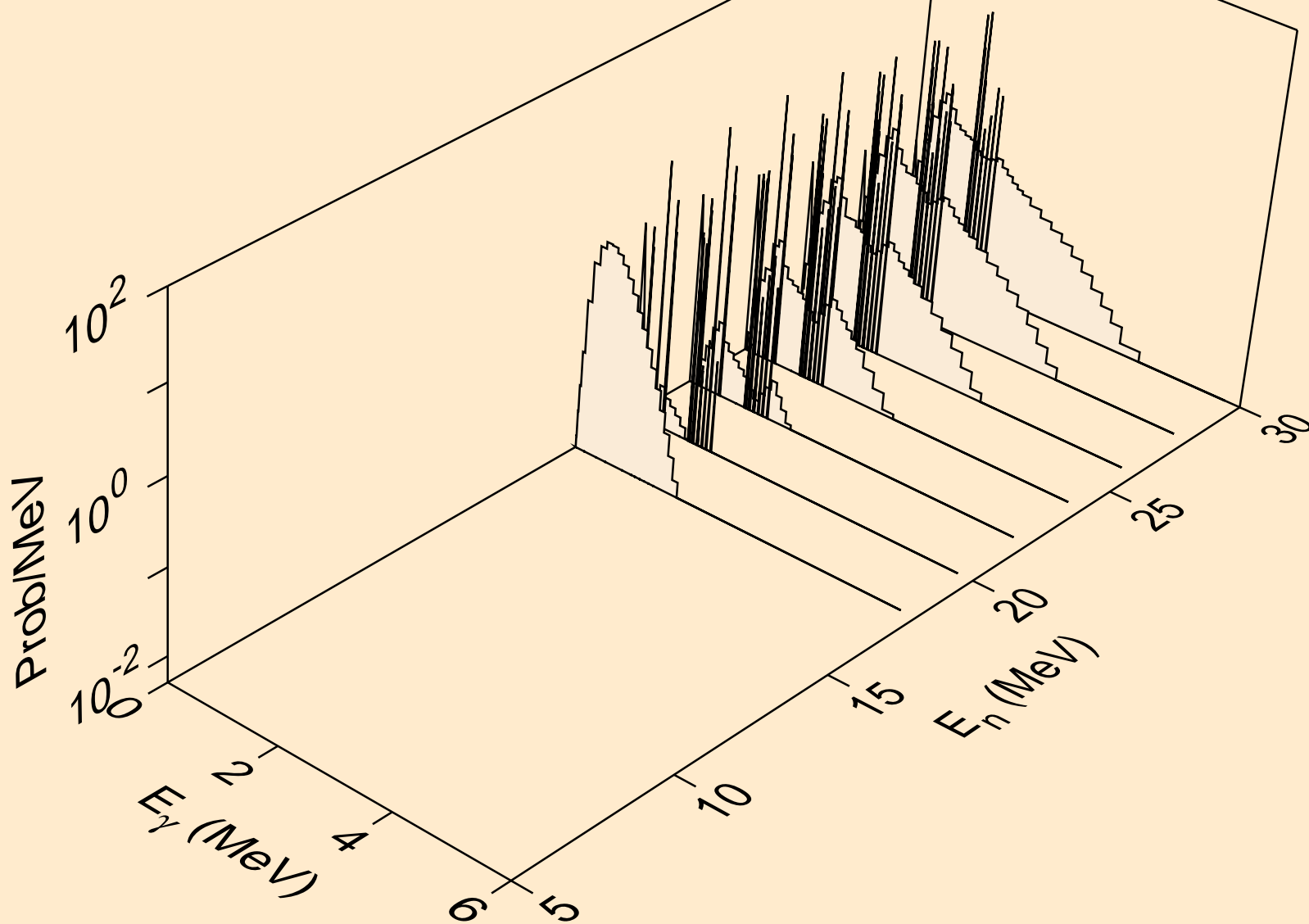

XE128 NEUTRON ACER TENDL-2023 LIBRARY; T=0.K  
thermal capture photon spectrum

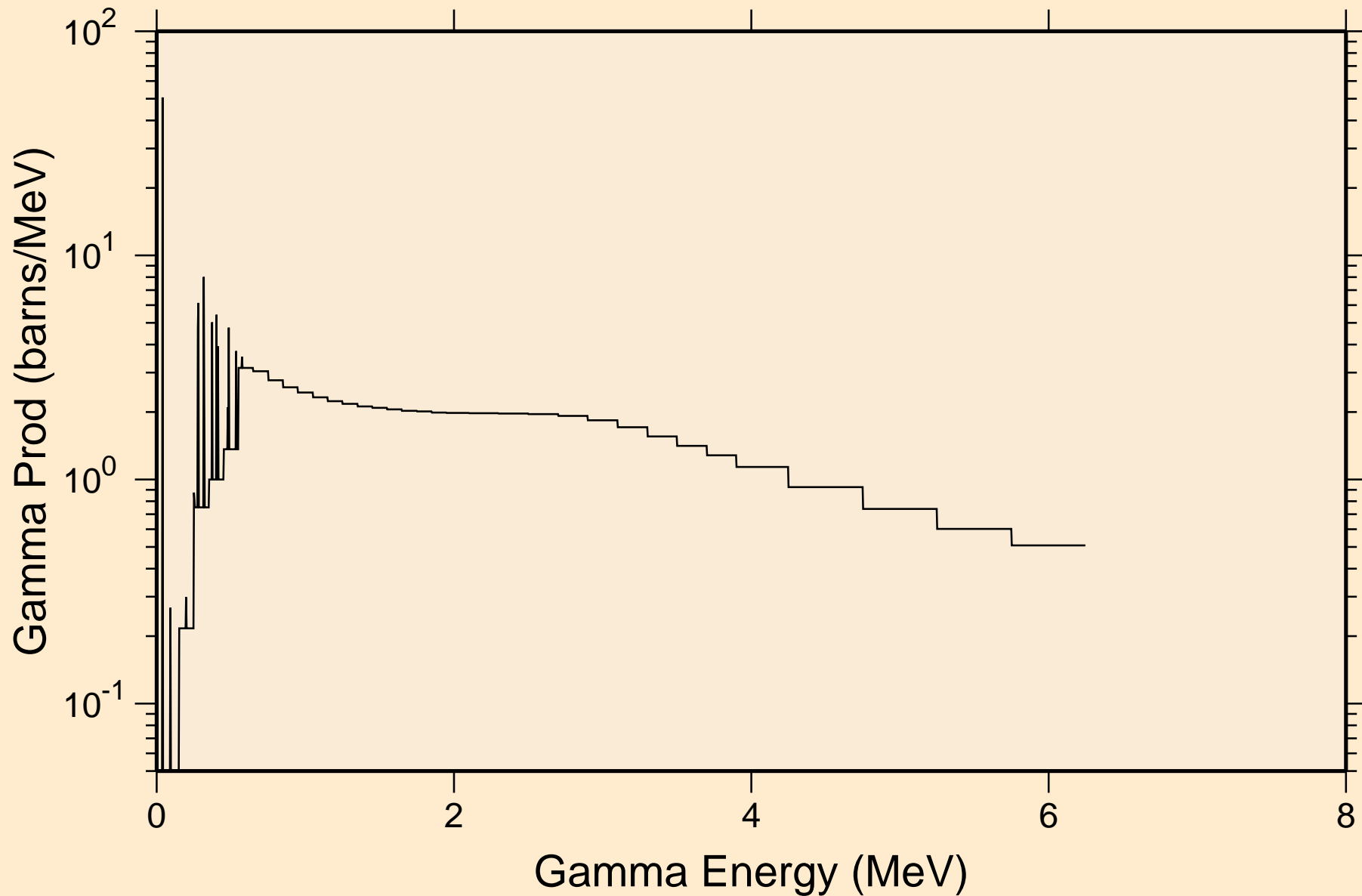

XE128 NEUTRON ACER TENDL-2023 LIBRARY; T=0.K  
14 MeV photon spectrum

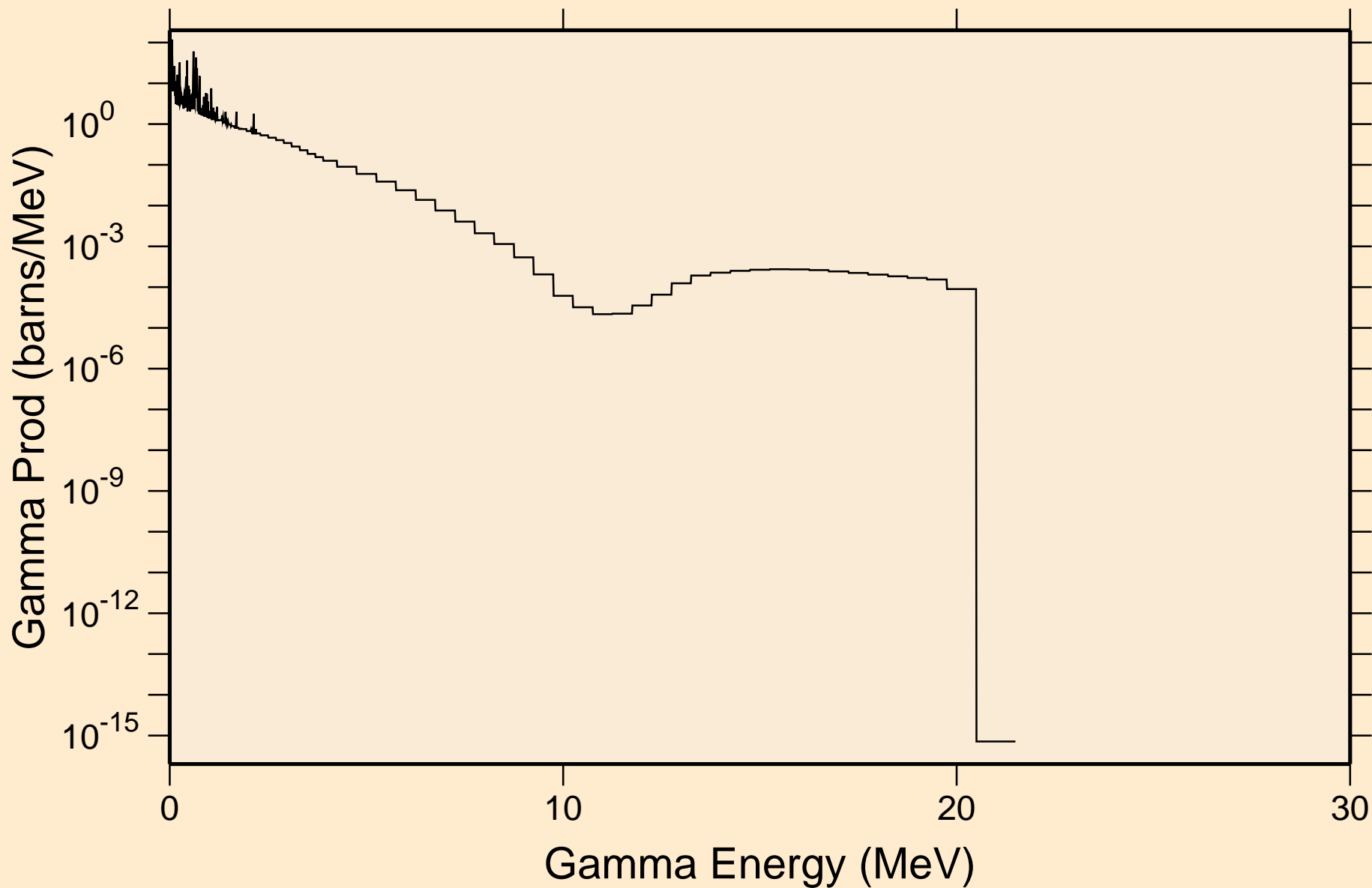

# XE128 NEUTRON ACER TENDL-2023 LIBRARY; T=0.K

## Particle heating contributions

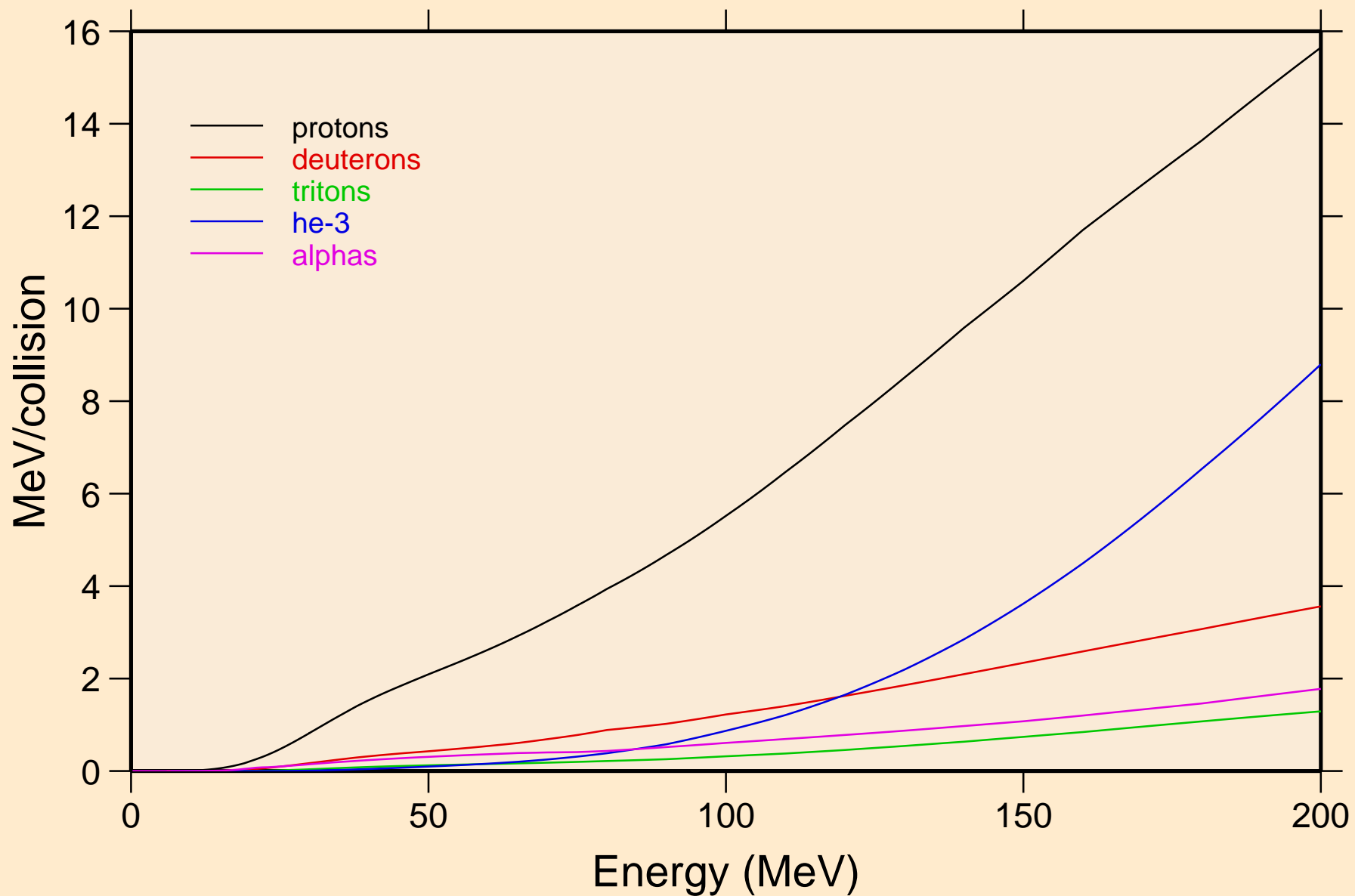

XE128 NEUTRON ACER TENDL-2023 LIBRARY; T=0.K  
Recoil Heating

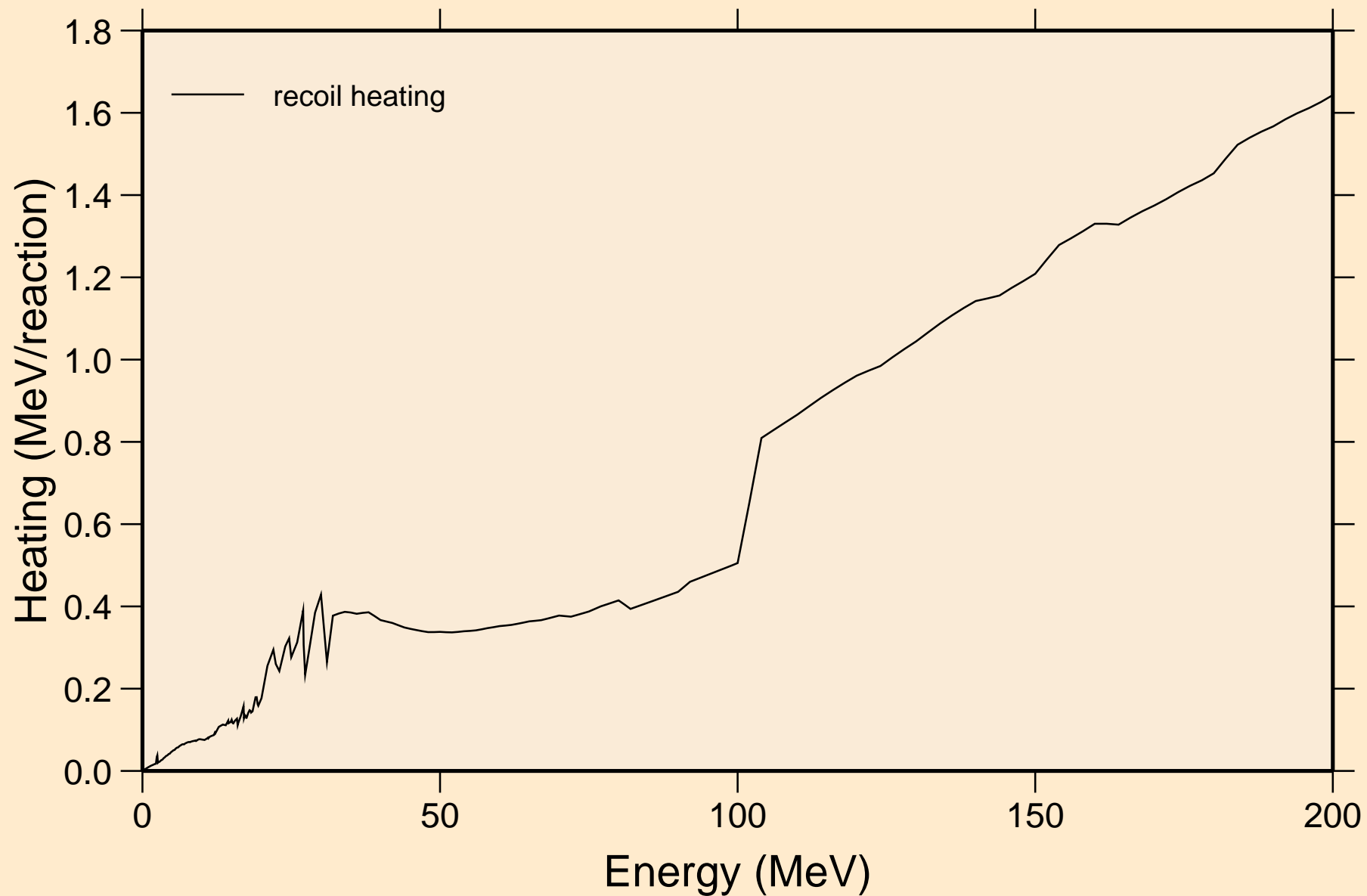

# XE128 NEUTRON ACER TENDL-2023 LIBRARY; T=0.K

## Particle production cross sections

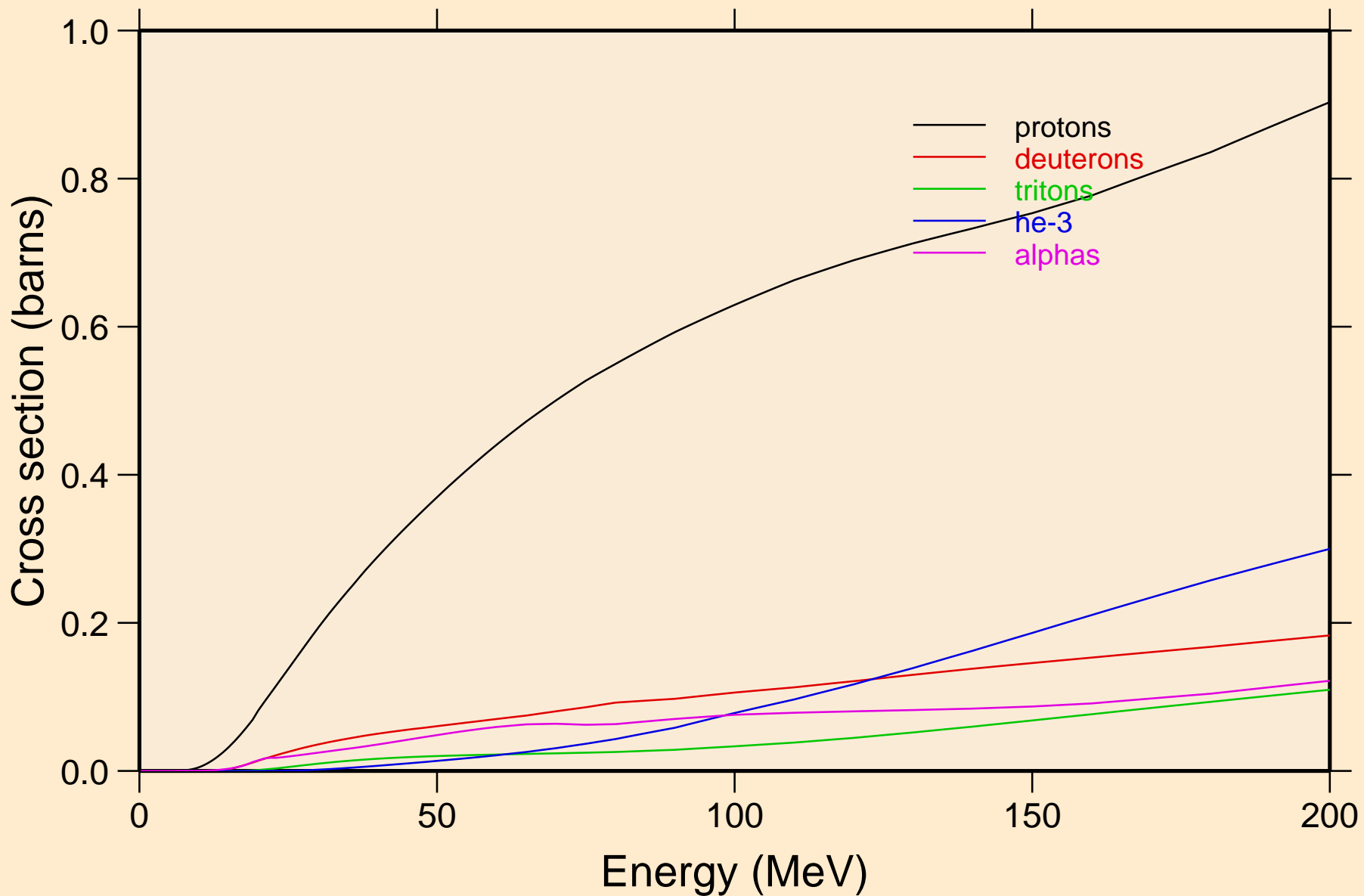

XE128 NEUTRON ACER TENDL-2023 LIBRARY; T=0.K  
protons from (n,x)

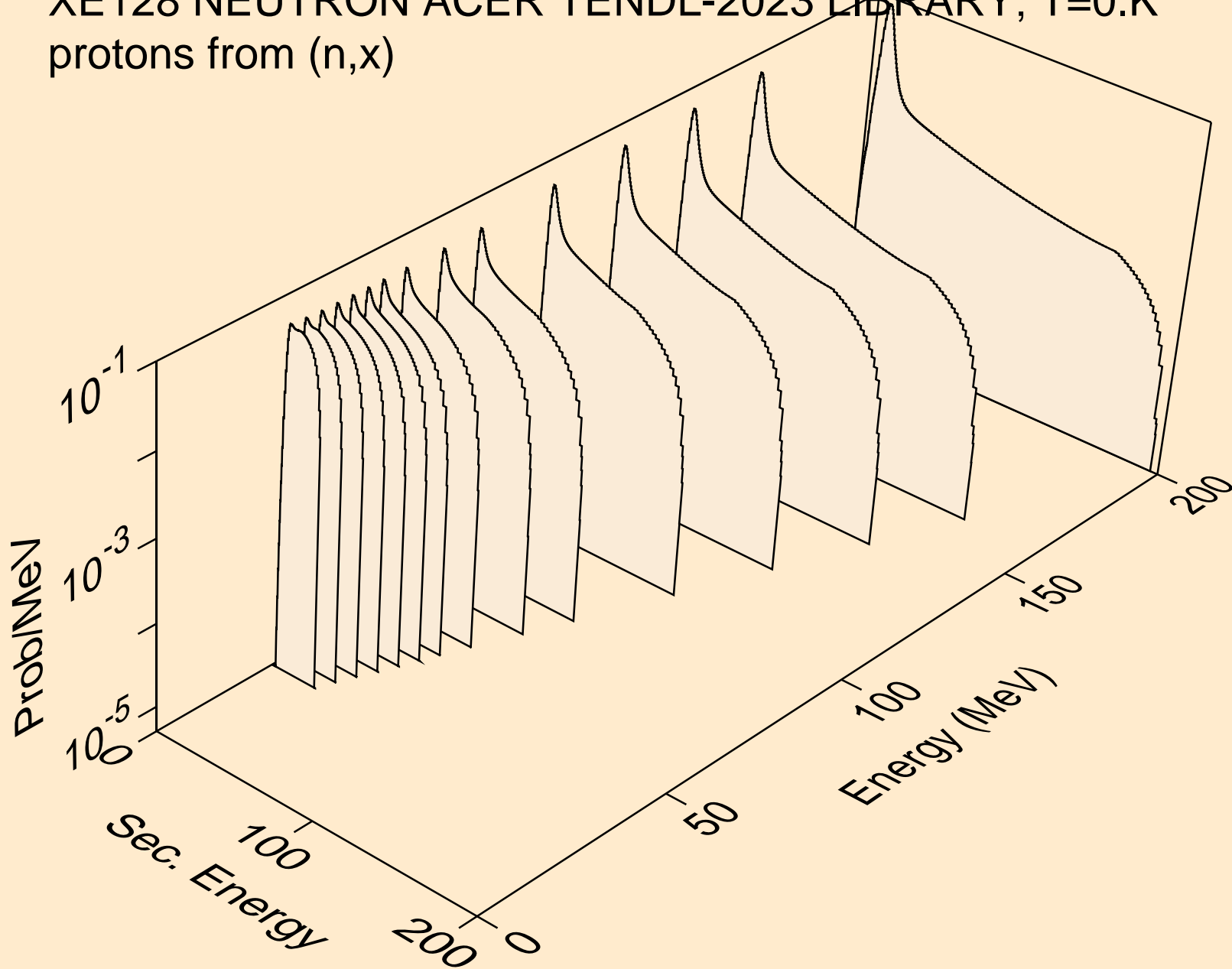

XE128 NEUTRON ACER TENDL-2023 LIBRARY; T=0.K  
protons from (n,n\*)p

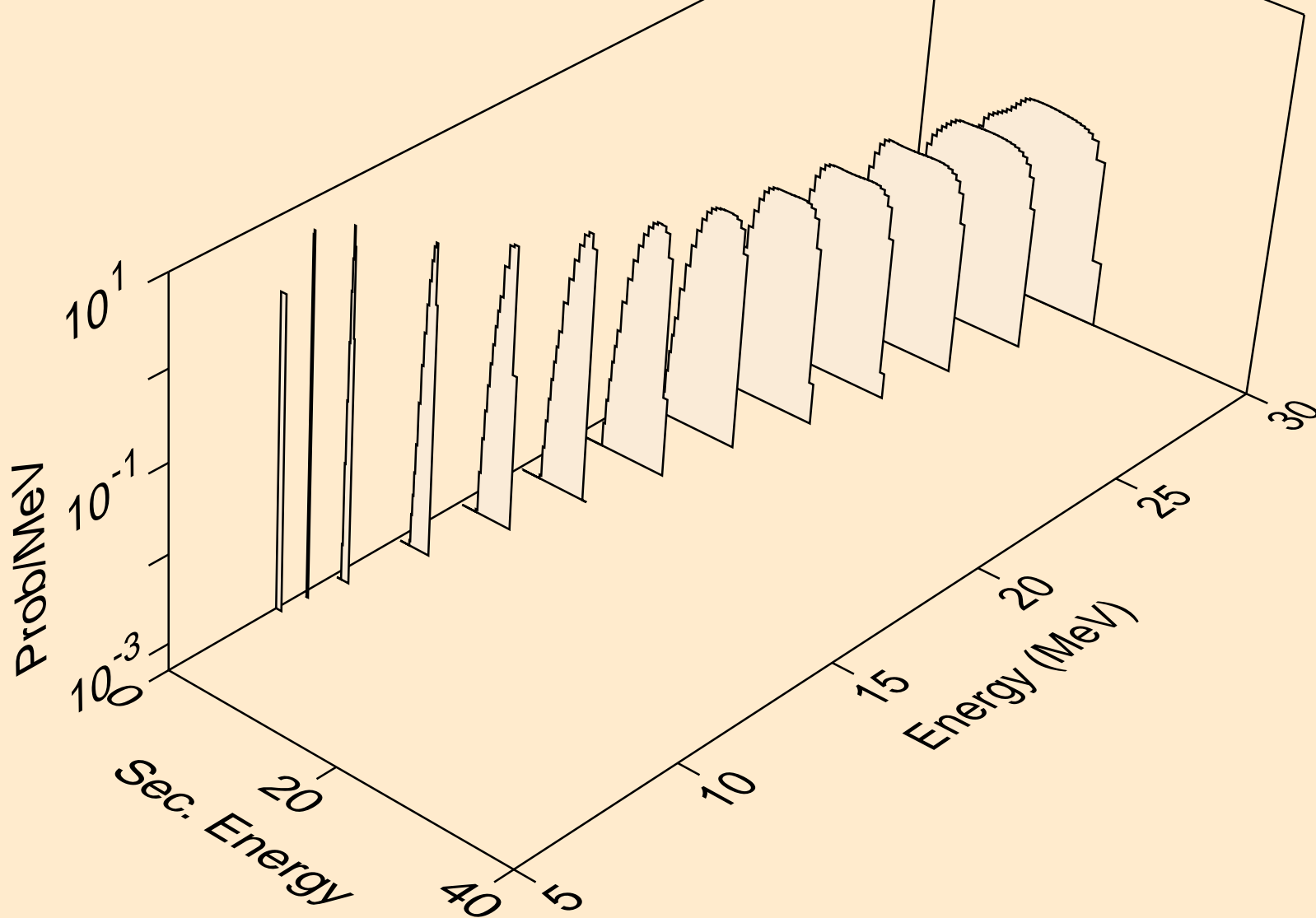

XE128 NEUTRON ACER TENDL-2023 LIBRARY; T=0.K  
protons from (n,2np)

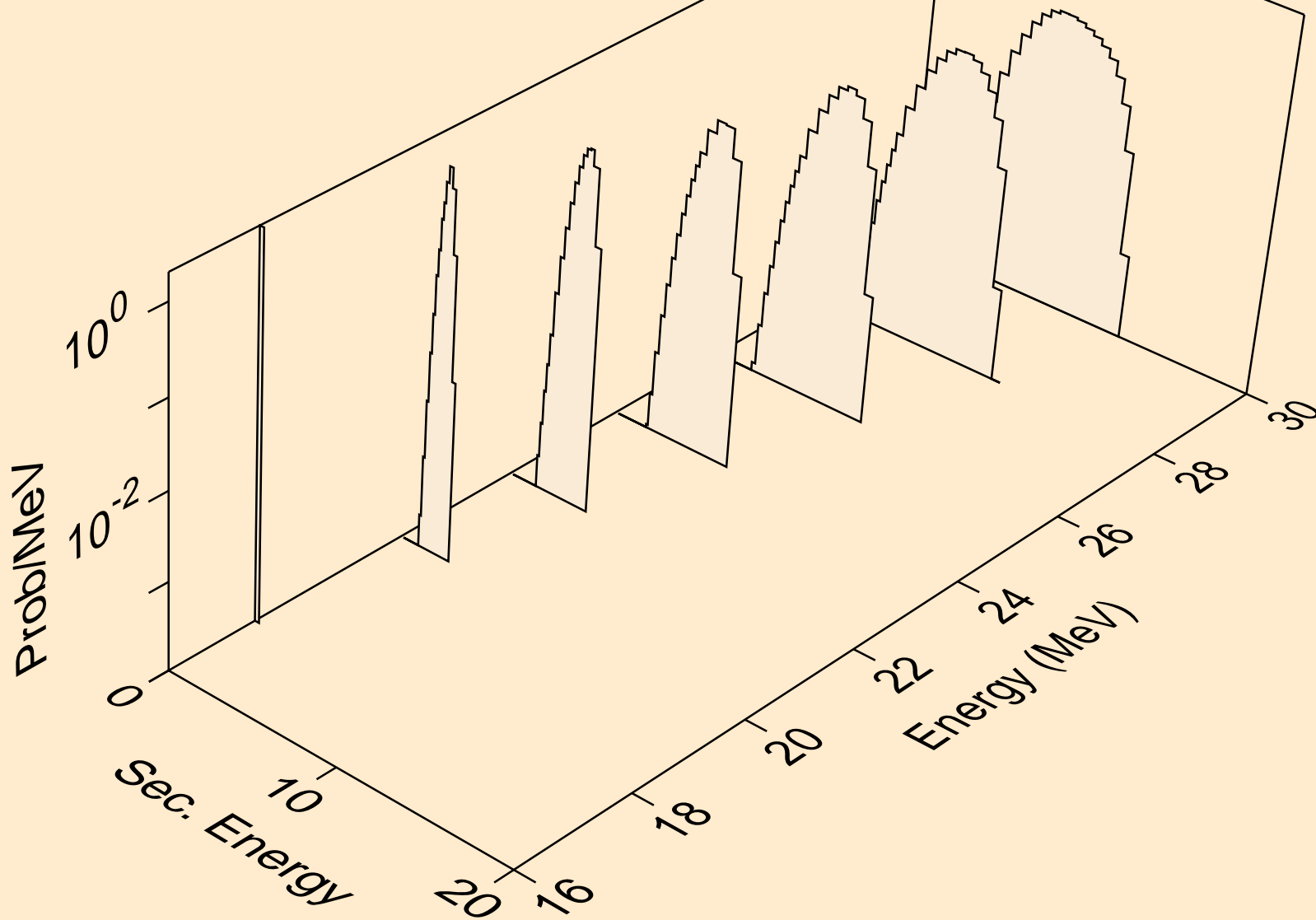

XE128 NEUTRON ACER TENDL-2023 LIBRARY; T=0.K  
protons from (n,3np)

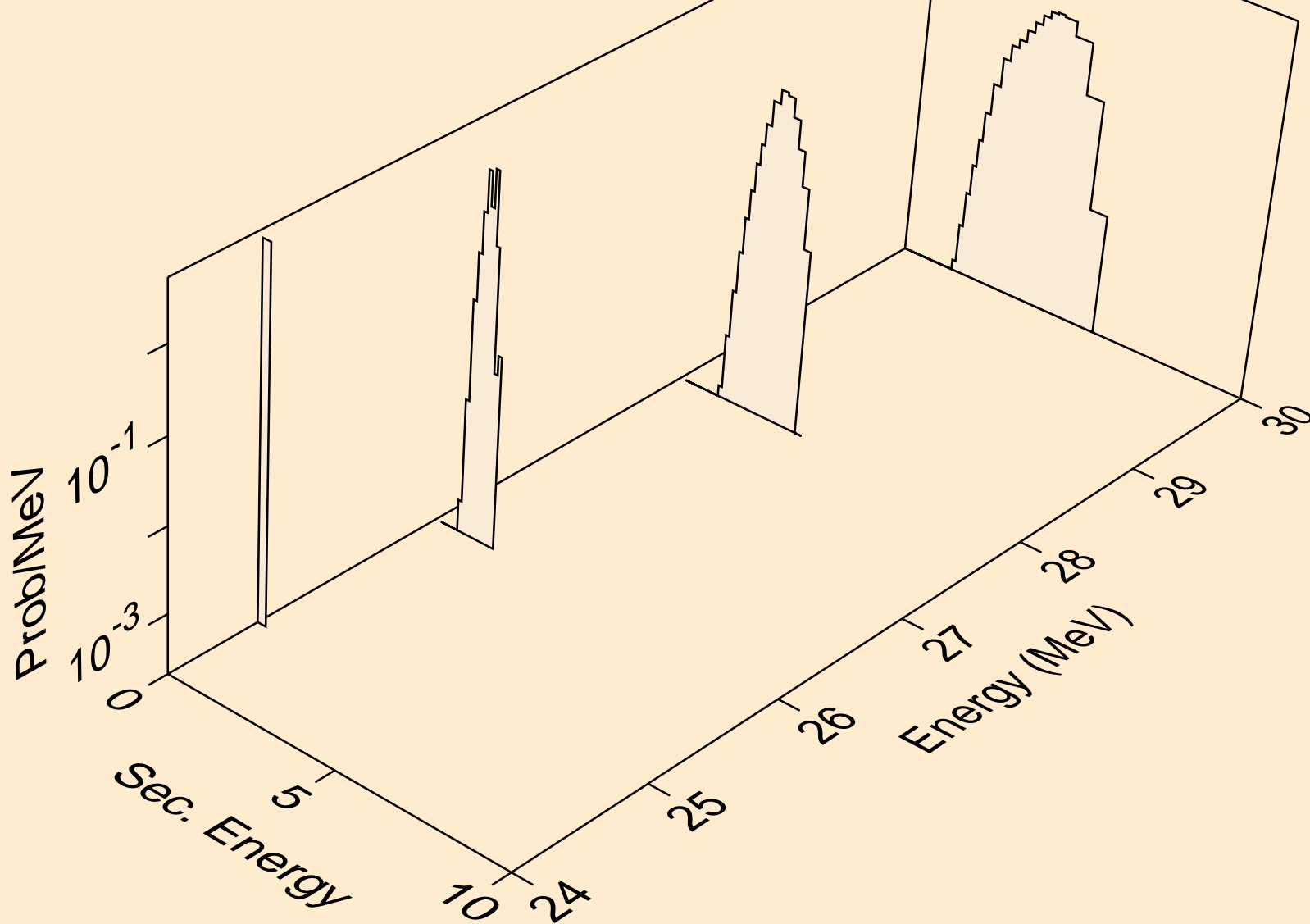

XE128 NEUTRON ACER TENDL-2023 LIBRARY; T=0.K  
protons from (n,n2p)

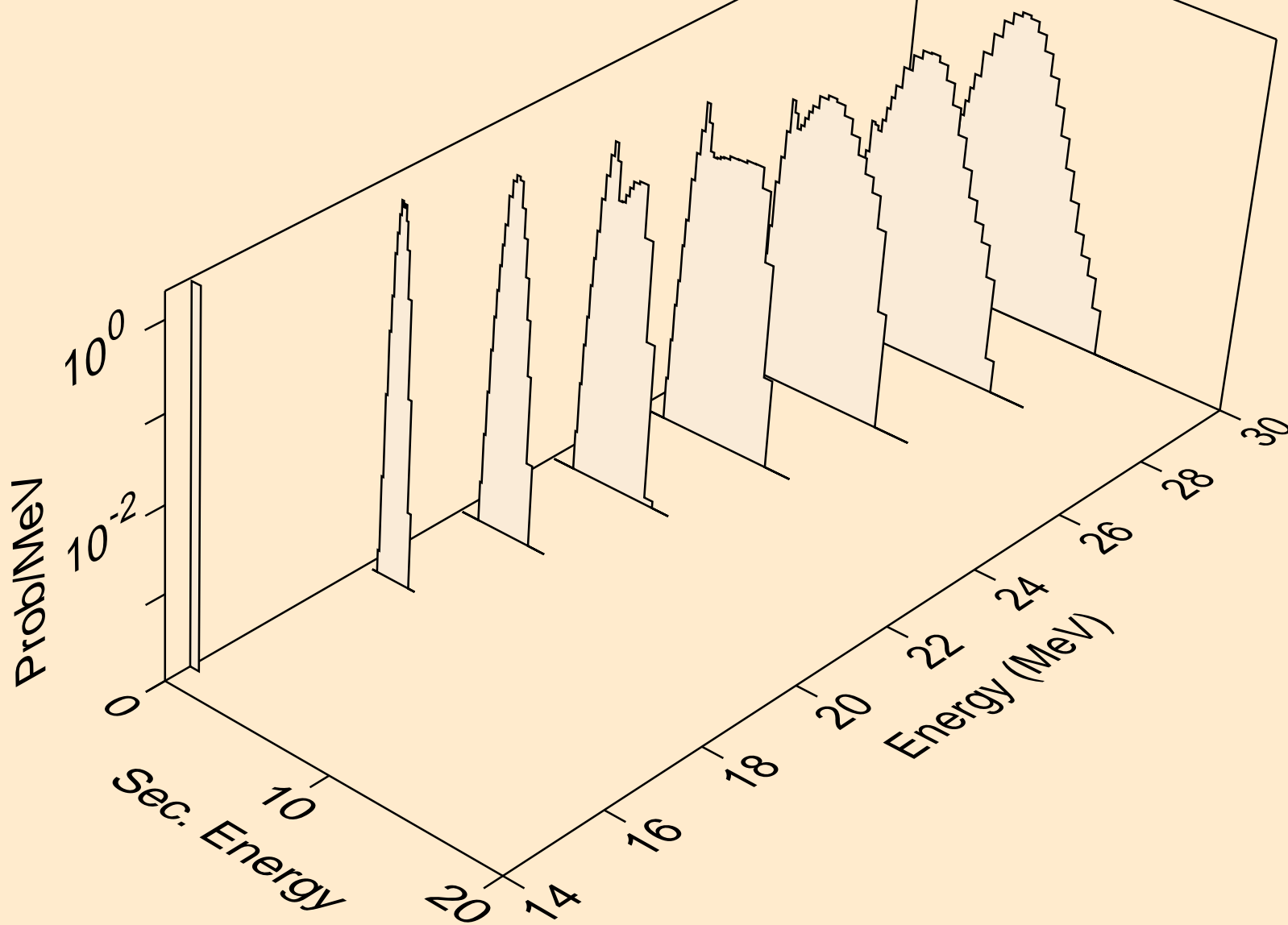

XE128 NEUTRON ACER TENDL-2023 LIBRARY; T=0.K  
protons from (n,npa)

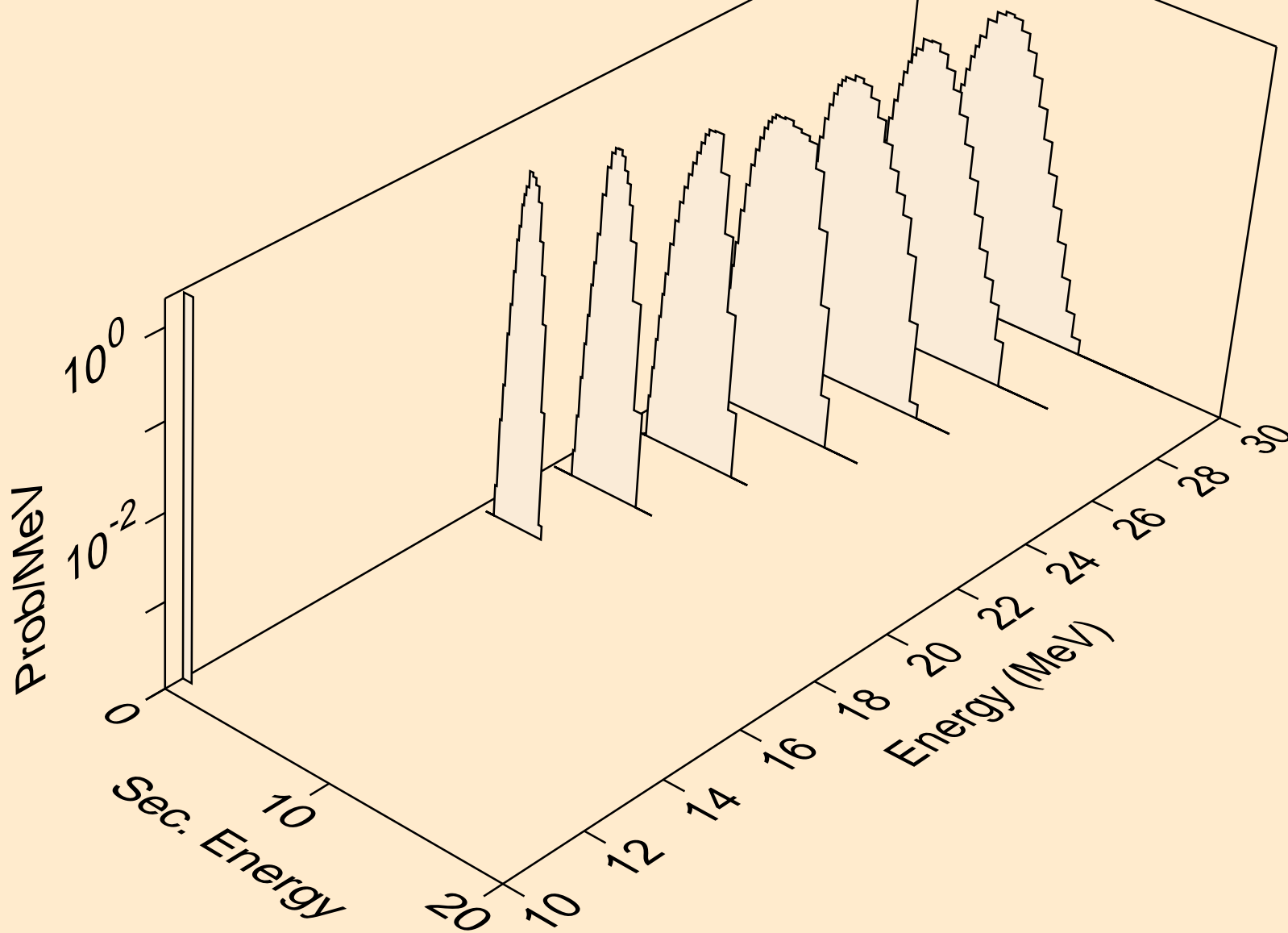

XE128 NEUTRON ACER TENDL-2023 LIBRARY; T=0.K  
protons from (n,p)

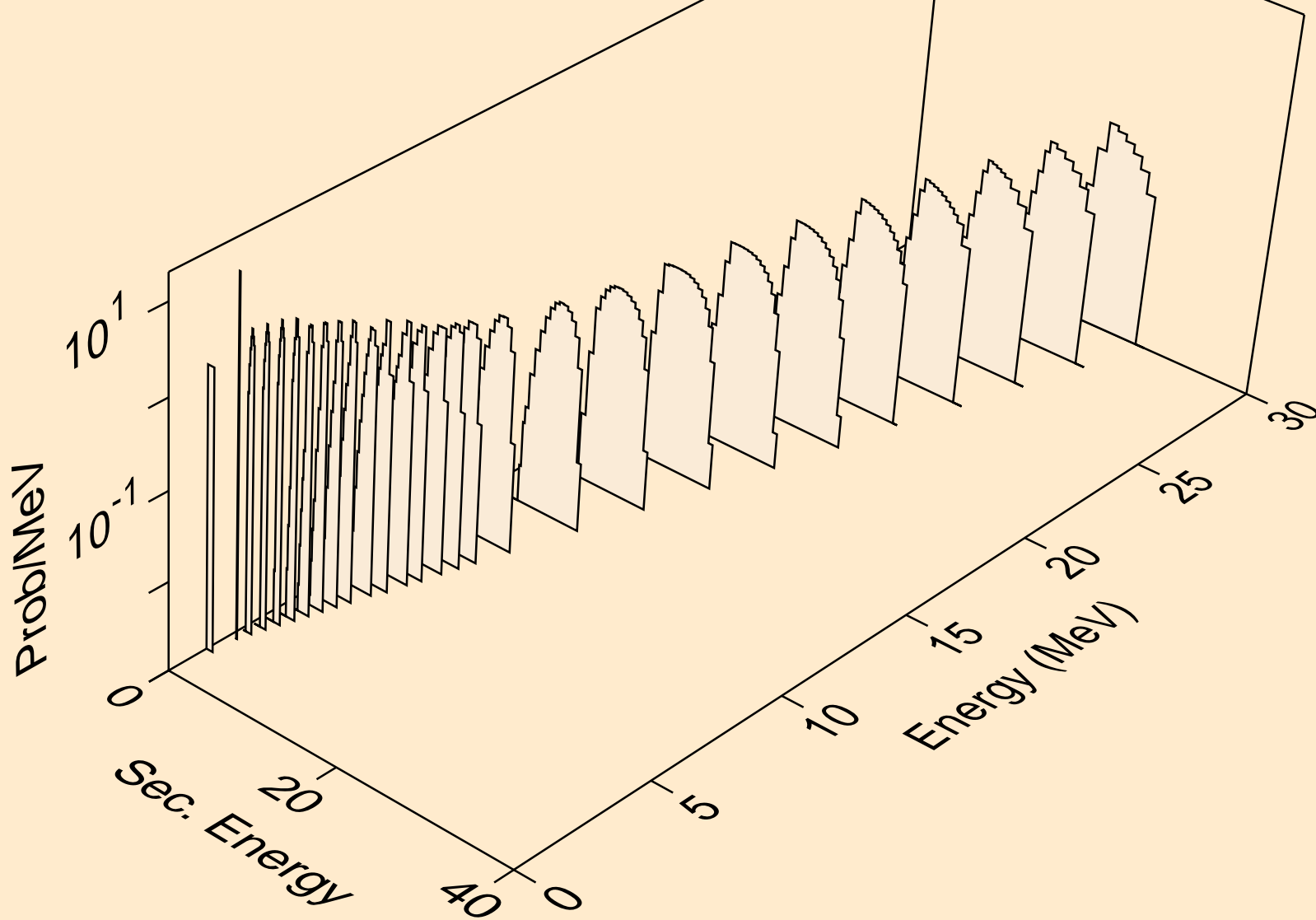

XE128 NEUTRON ACER TENDL-2023 LIBRARY; T=0.K  
protons from (n,2p)

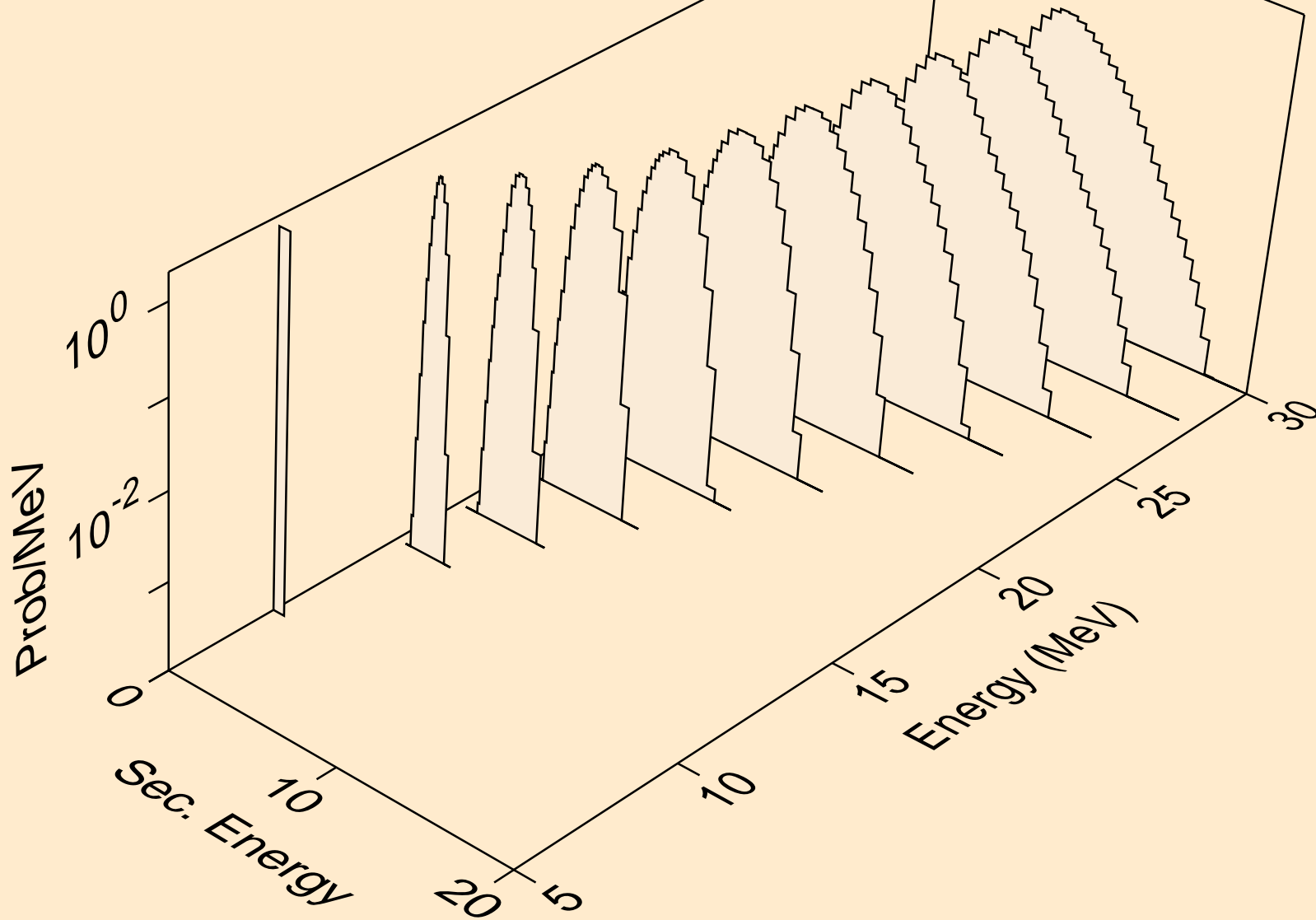

XE128 NEUTRON ACER TENDL-2023 LIBRARY; T=0.K  
protons from (n,pa)

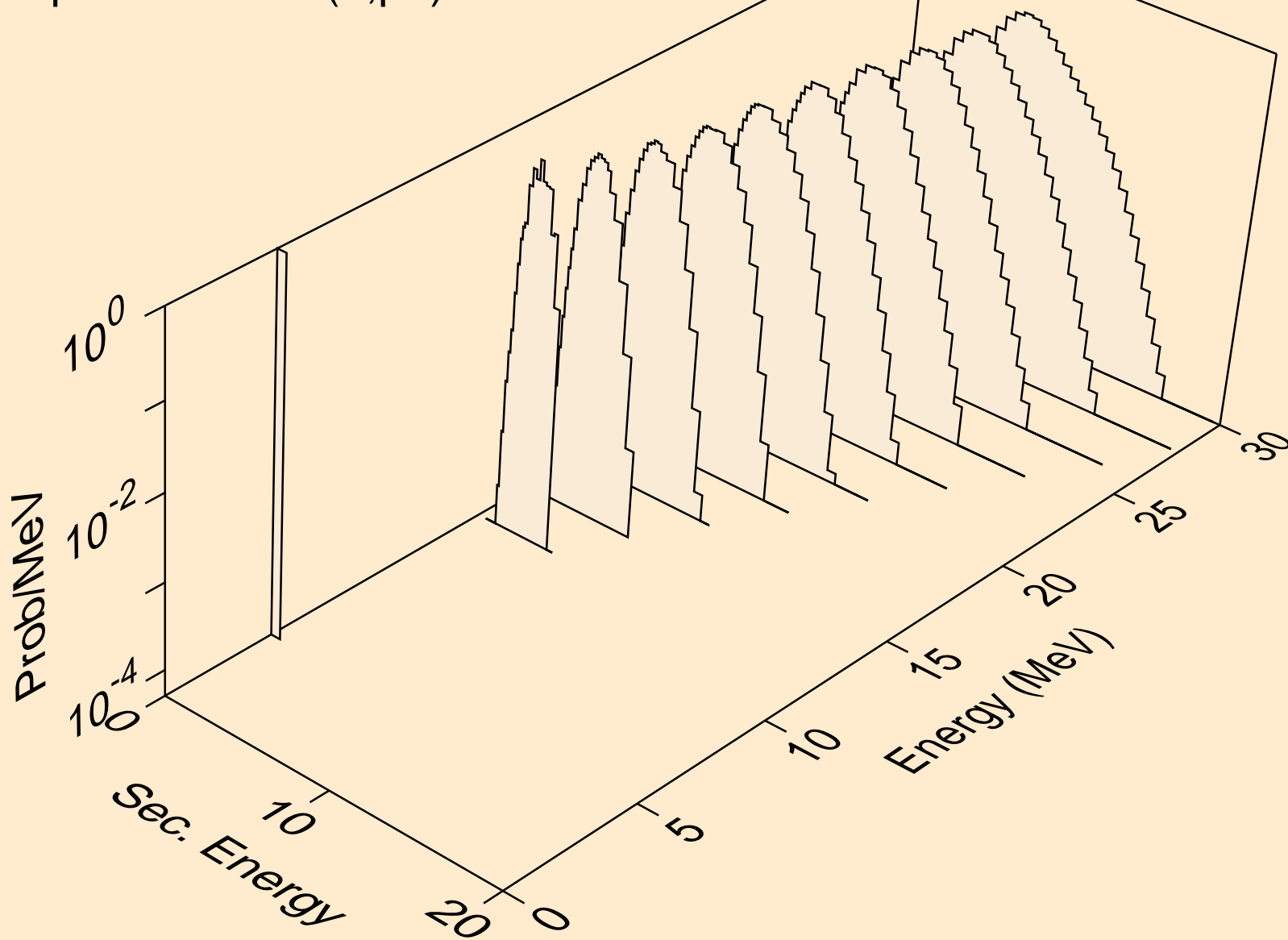

XE128 NEUTRON ACER TENDL-2023 LIBRARY; T=0.K  
protons from (n,pd)

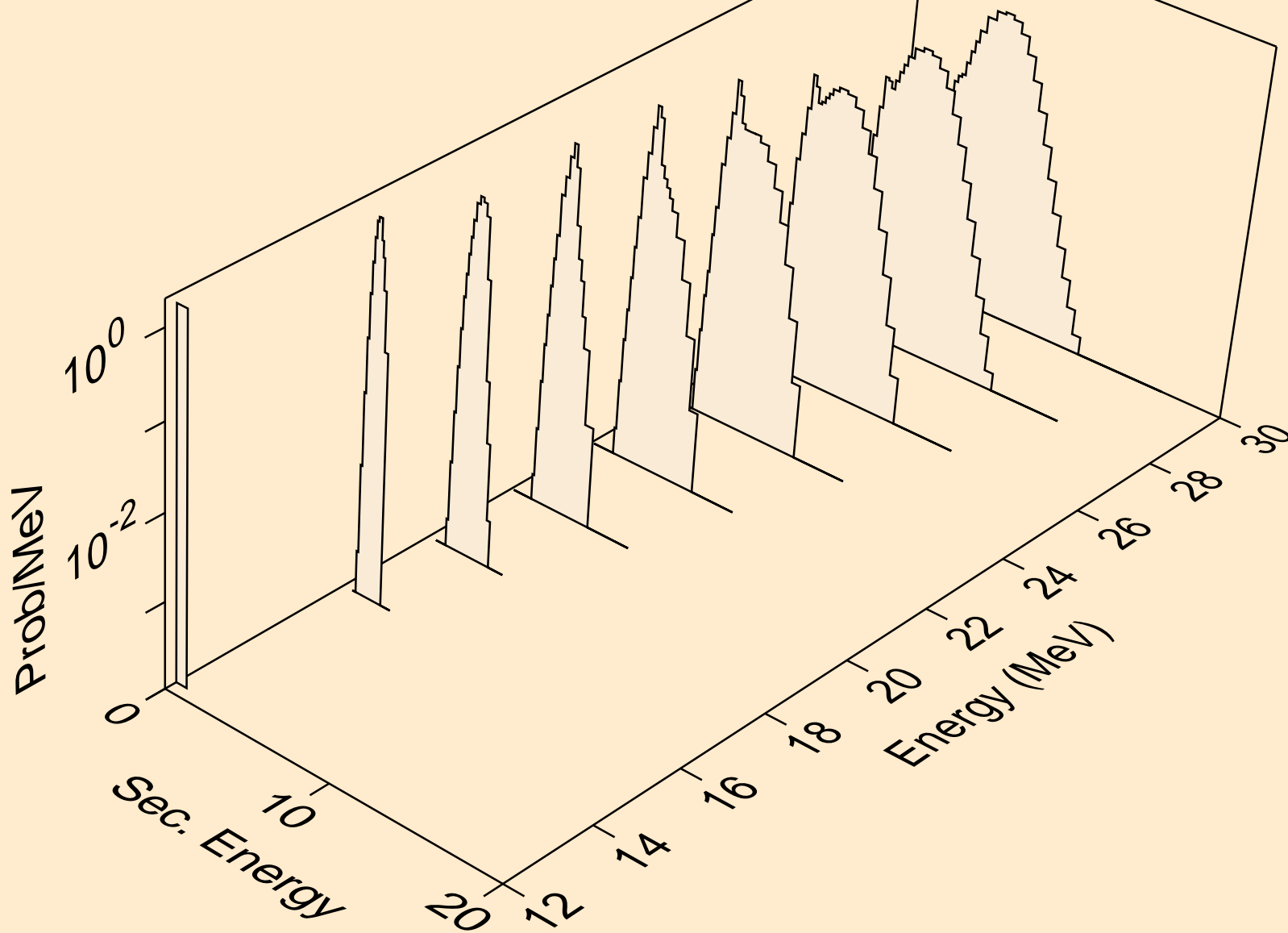

XE128 NEUTRON ACER TENDL-2023 LIBRARY; T=0.K  
protons from (n,pt)

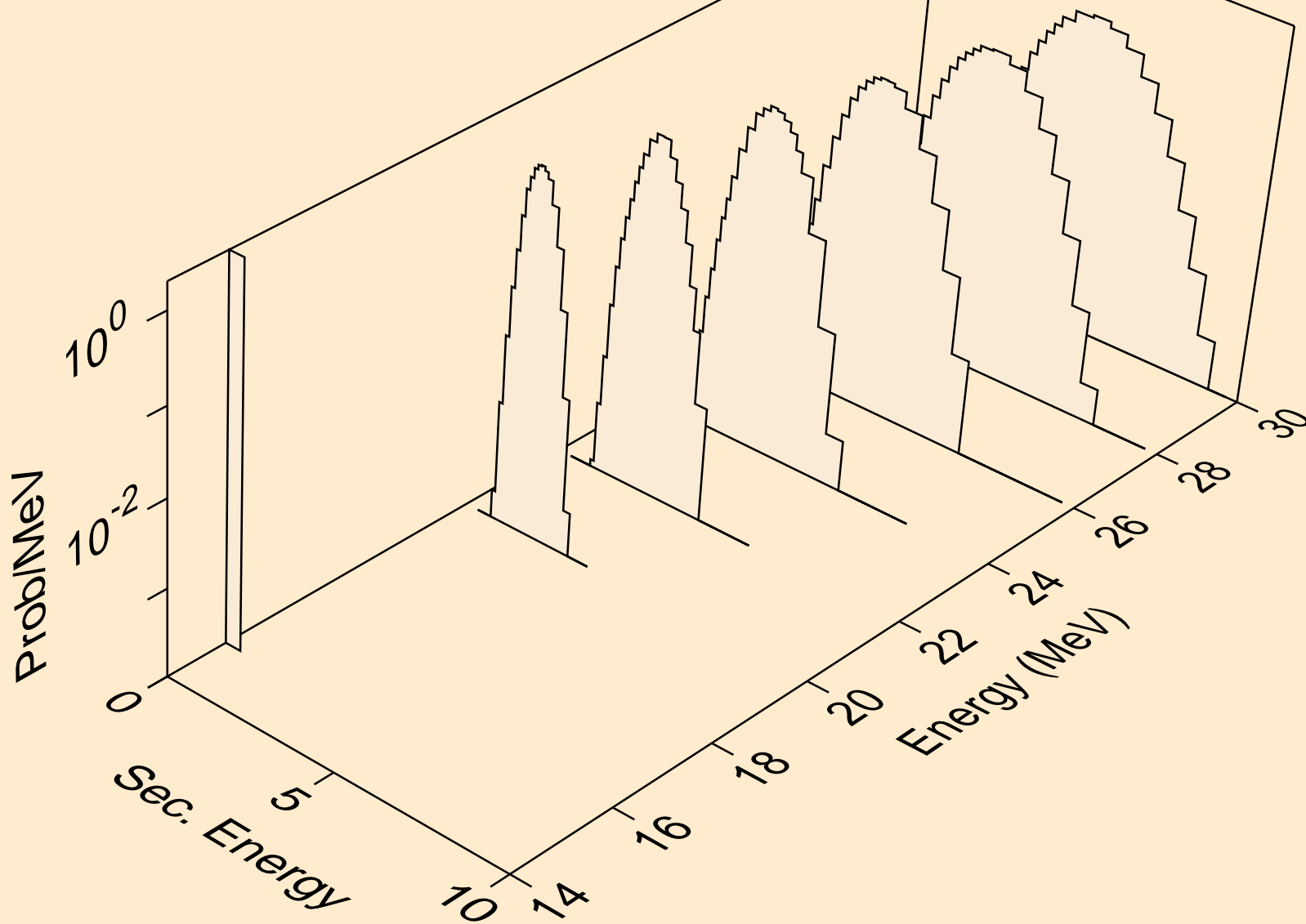

XE128 NEUTRON ACER TENDL-2023 LIBRARY; T=0.K  
deuterons from (n,x)

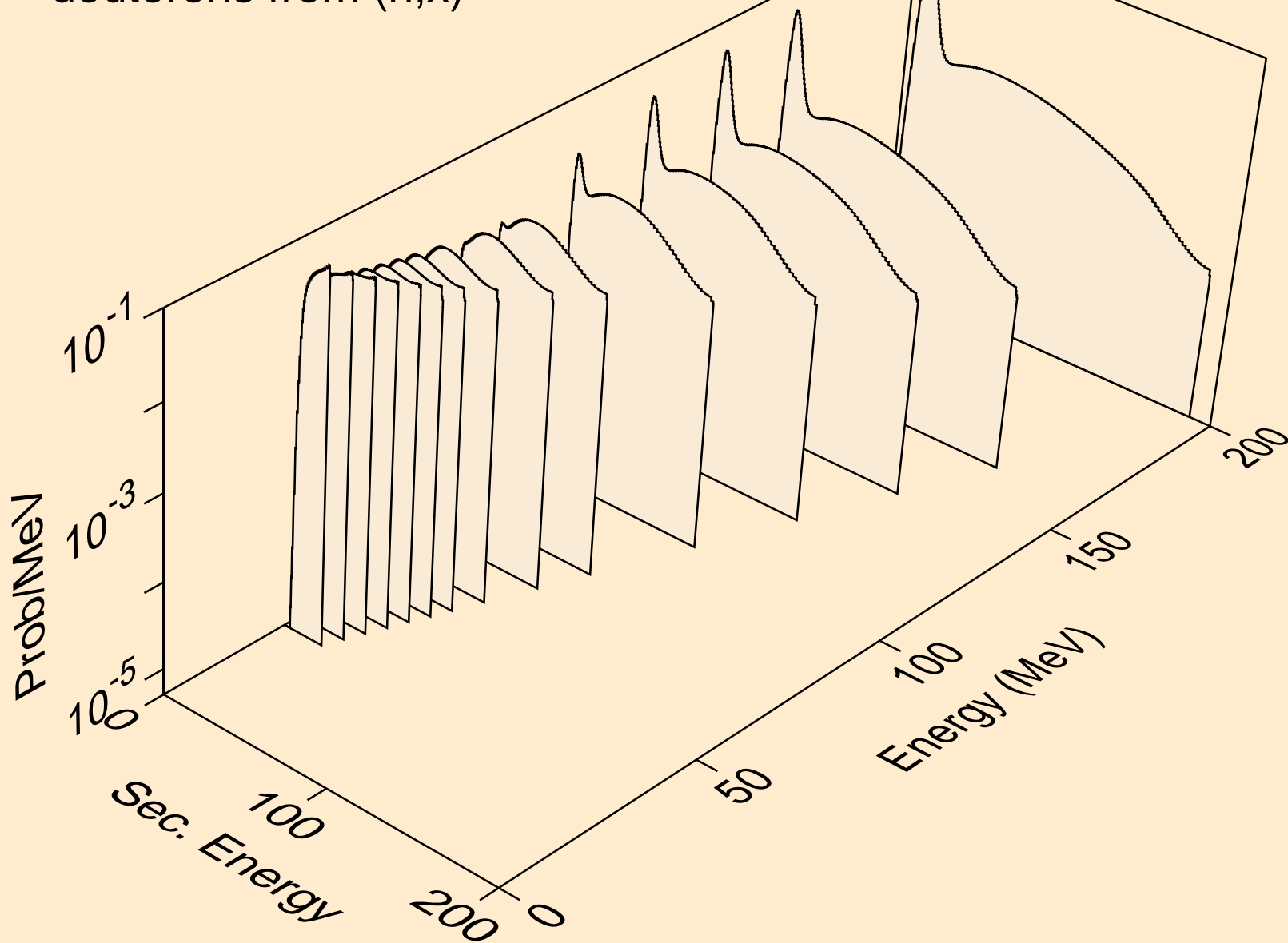

XE128 NEUTRON ACER TENDL-2023 LIBRARY; T=0.K  
deuterons from (n,2nd)

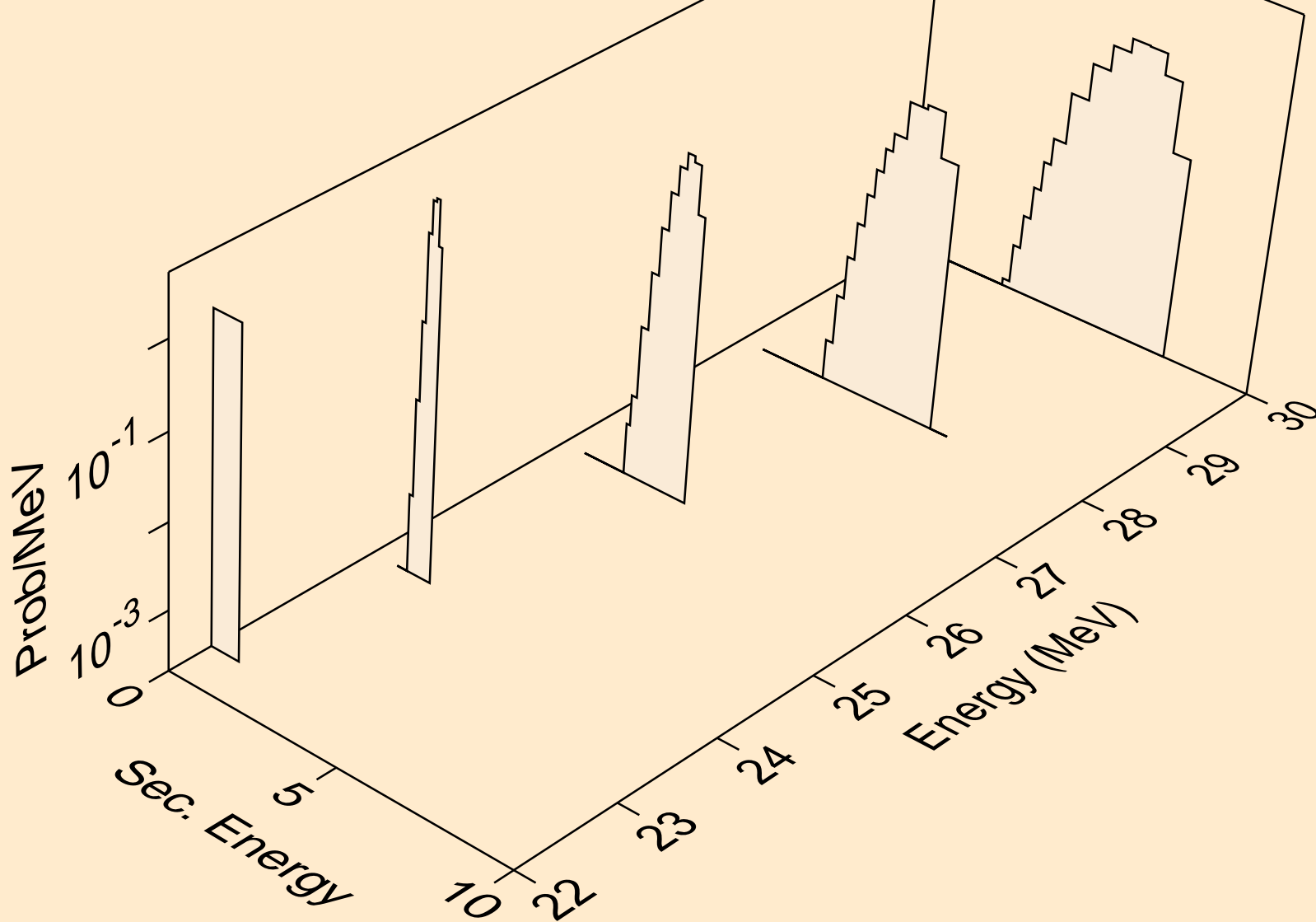

XE128 NEUTRON ACER TENDL-2023 LIBRARY; T=0.K  
deuterons from (n,n\*)d

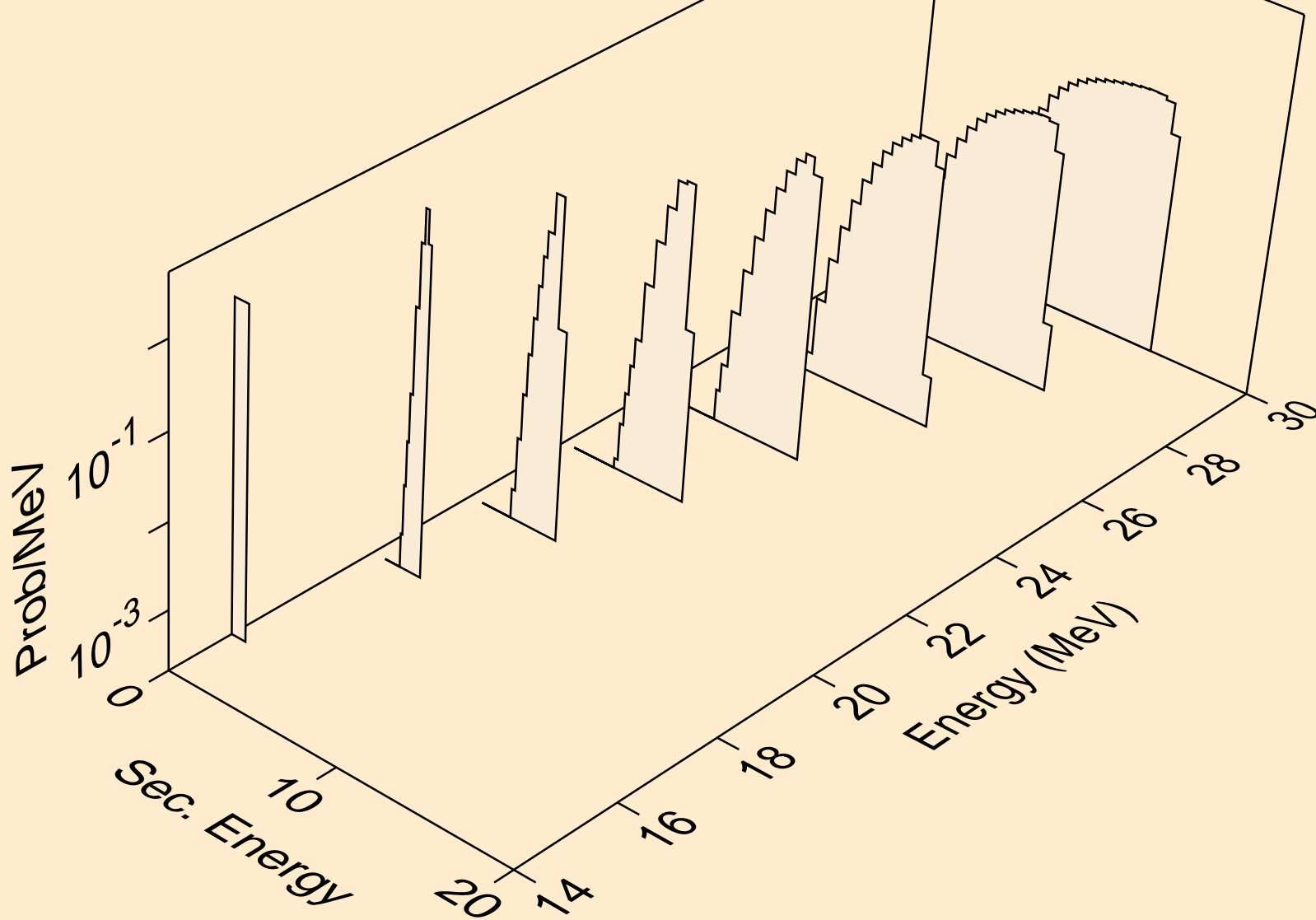

XE128 NEUTRON ACER TENDL-2023 LIBRARY; T=0.K  
deuterons from (n,d)

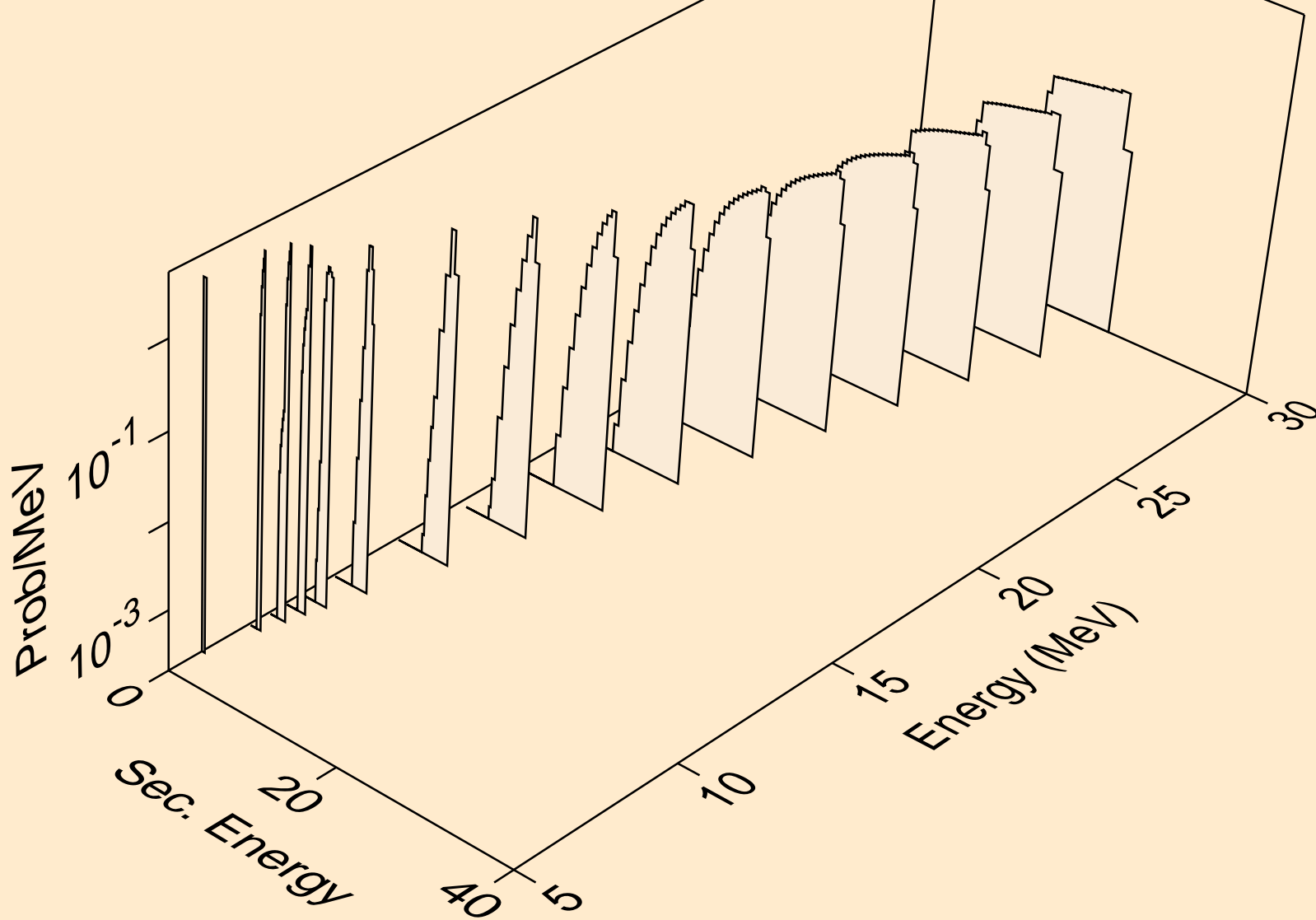

XE128 NEUTRON ACER TENDL-2023 LIBRARY; T=0.K  
deuterons from (n,pd)

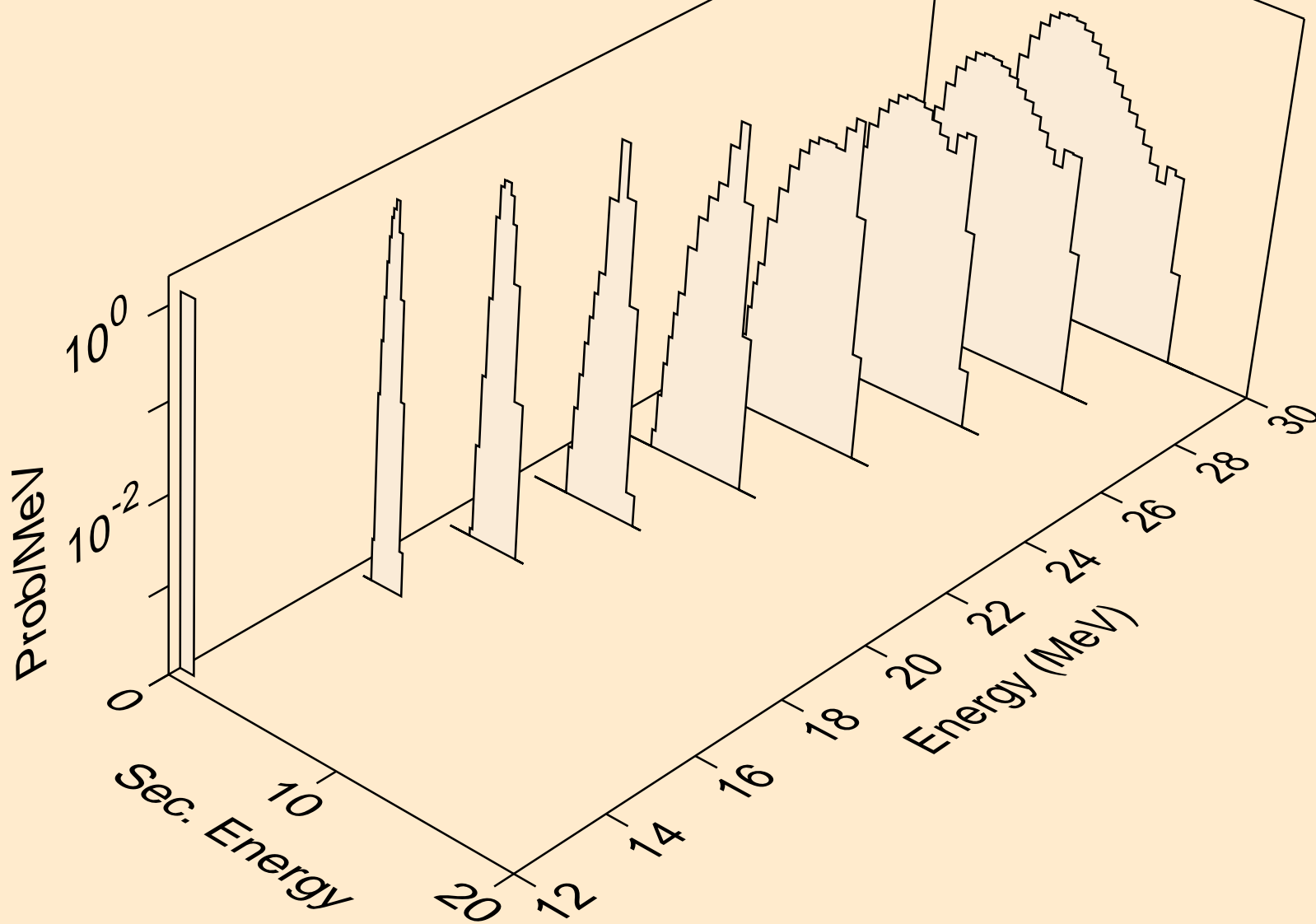

XE128 NEUTRON ACER TENDL-2023 LIBRARY; T=0.K  
deuterons from (n,da)

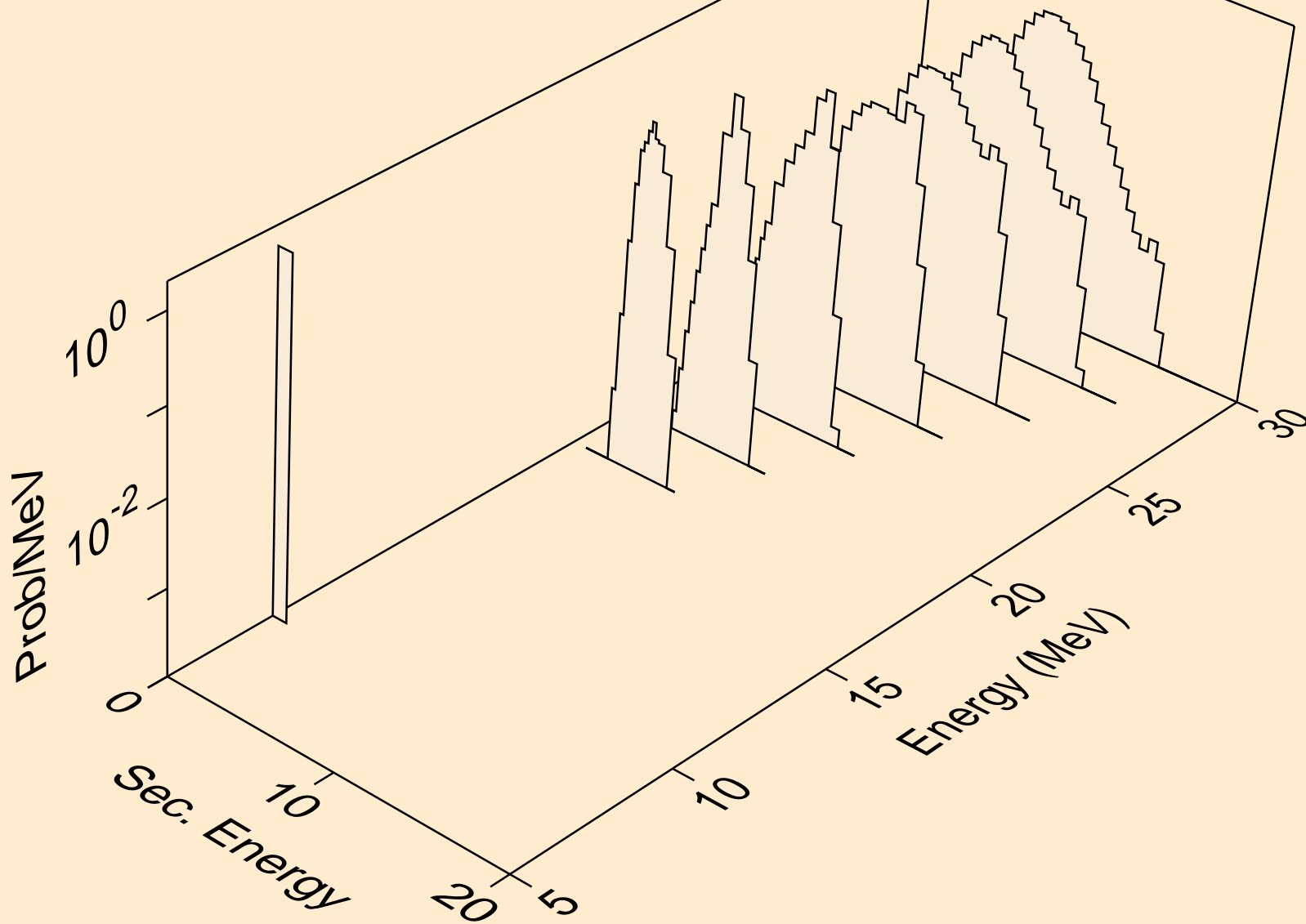

XE128 NEUTRON ACER TENDL-2023 LIBRARY; T=0.K  
tritons from (n,x)

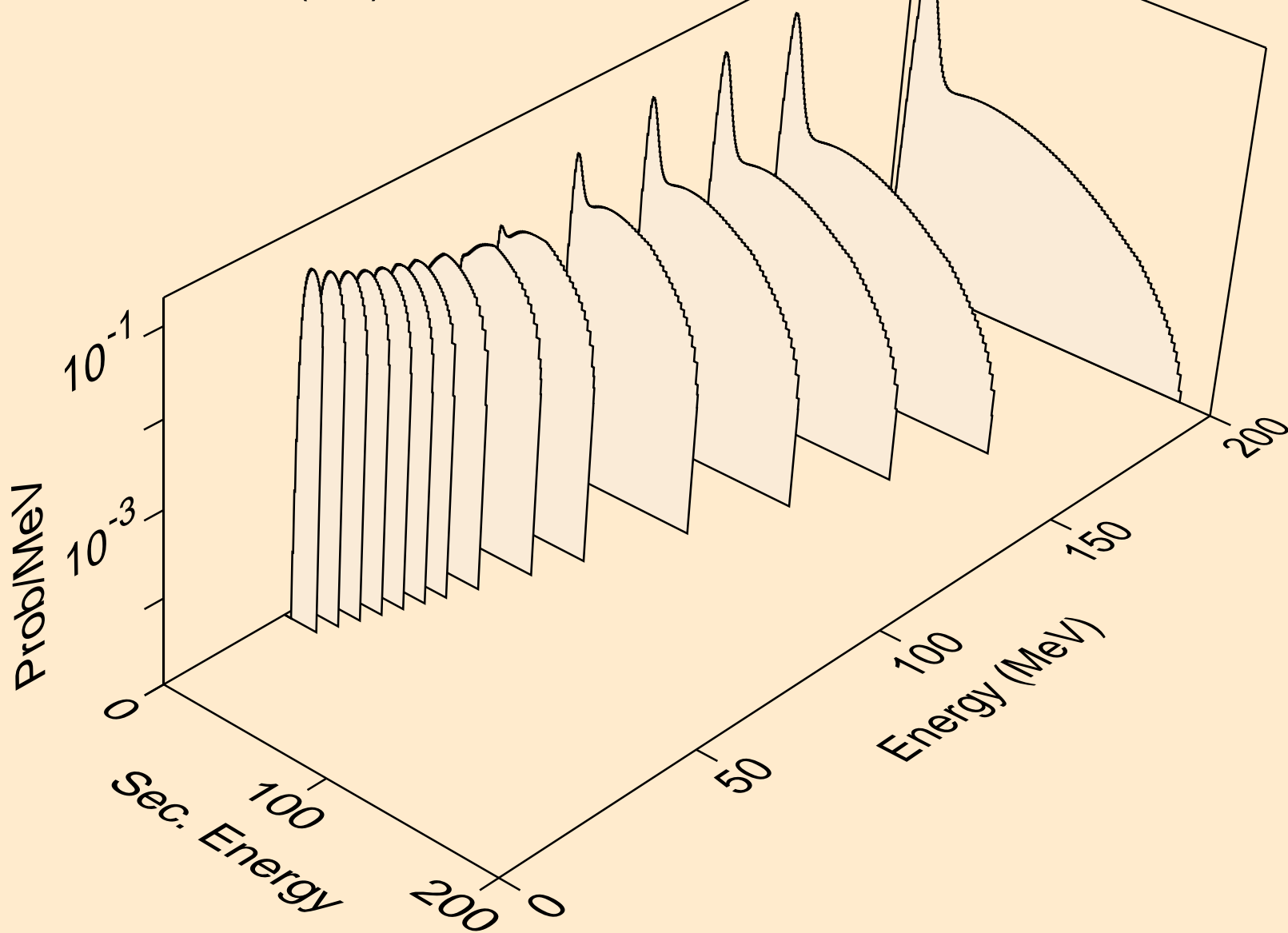

XE128 NEUTRON ACER TENDL-2023 LIBRARY; T=0.K  
tritons from (n,n\*)t

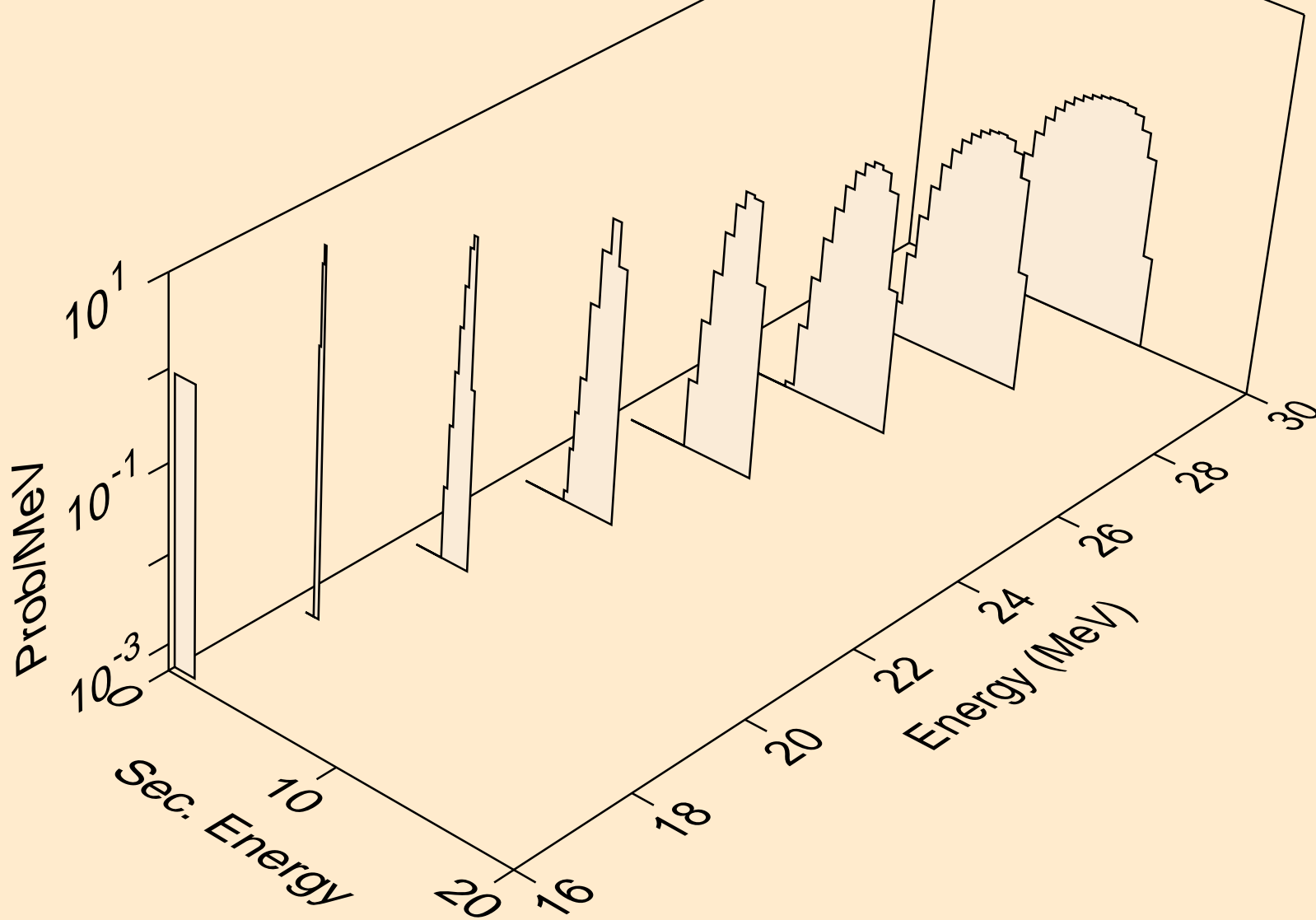

XE128 NEUTRON ACER TENDL-2023 LIBRARY; T=0.K  
tritons from (n,t)

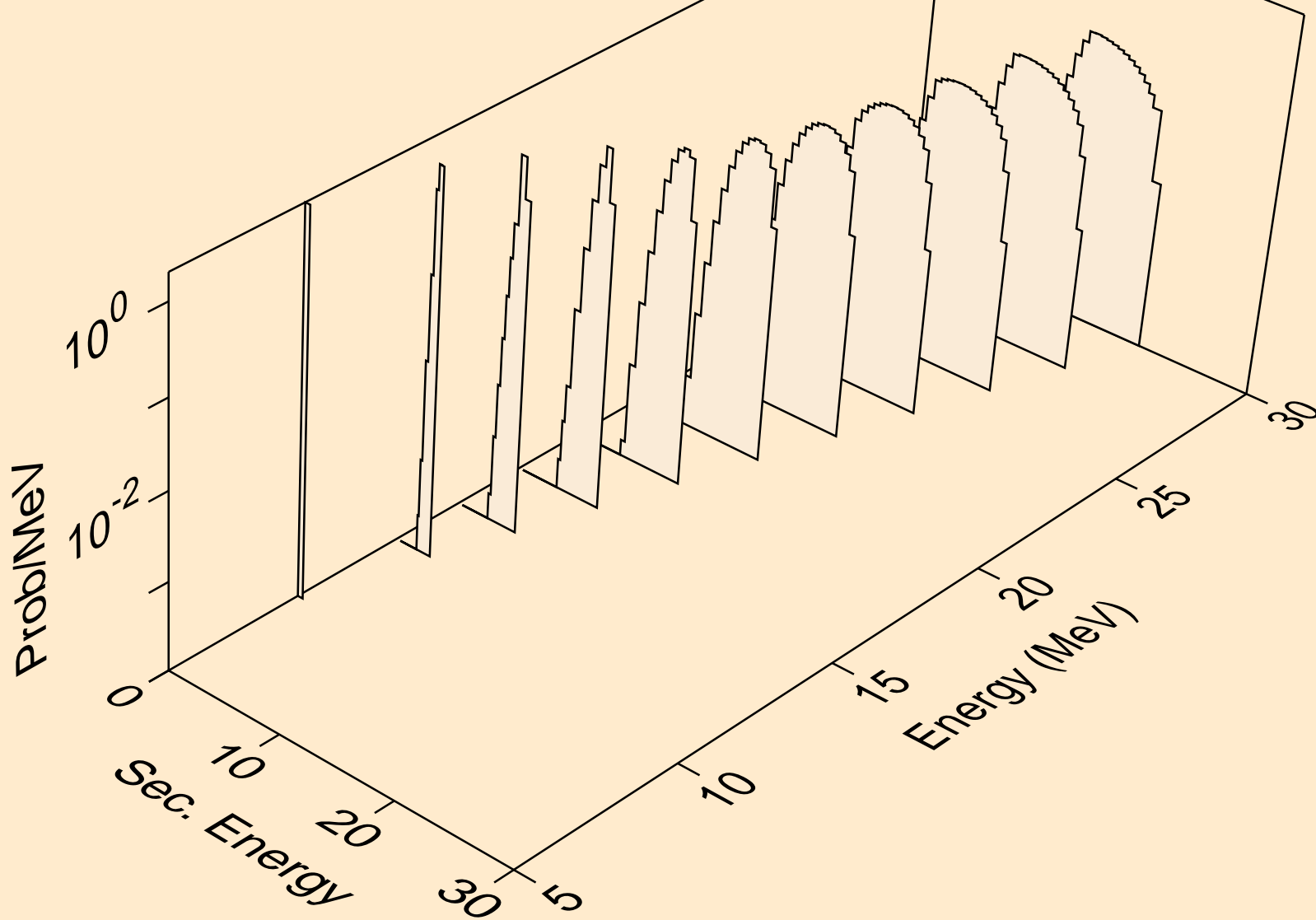

XE128 NEUTRON ACER TENDL-2023 LIBRARY; T=0.K  
tritons from (n,pt)

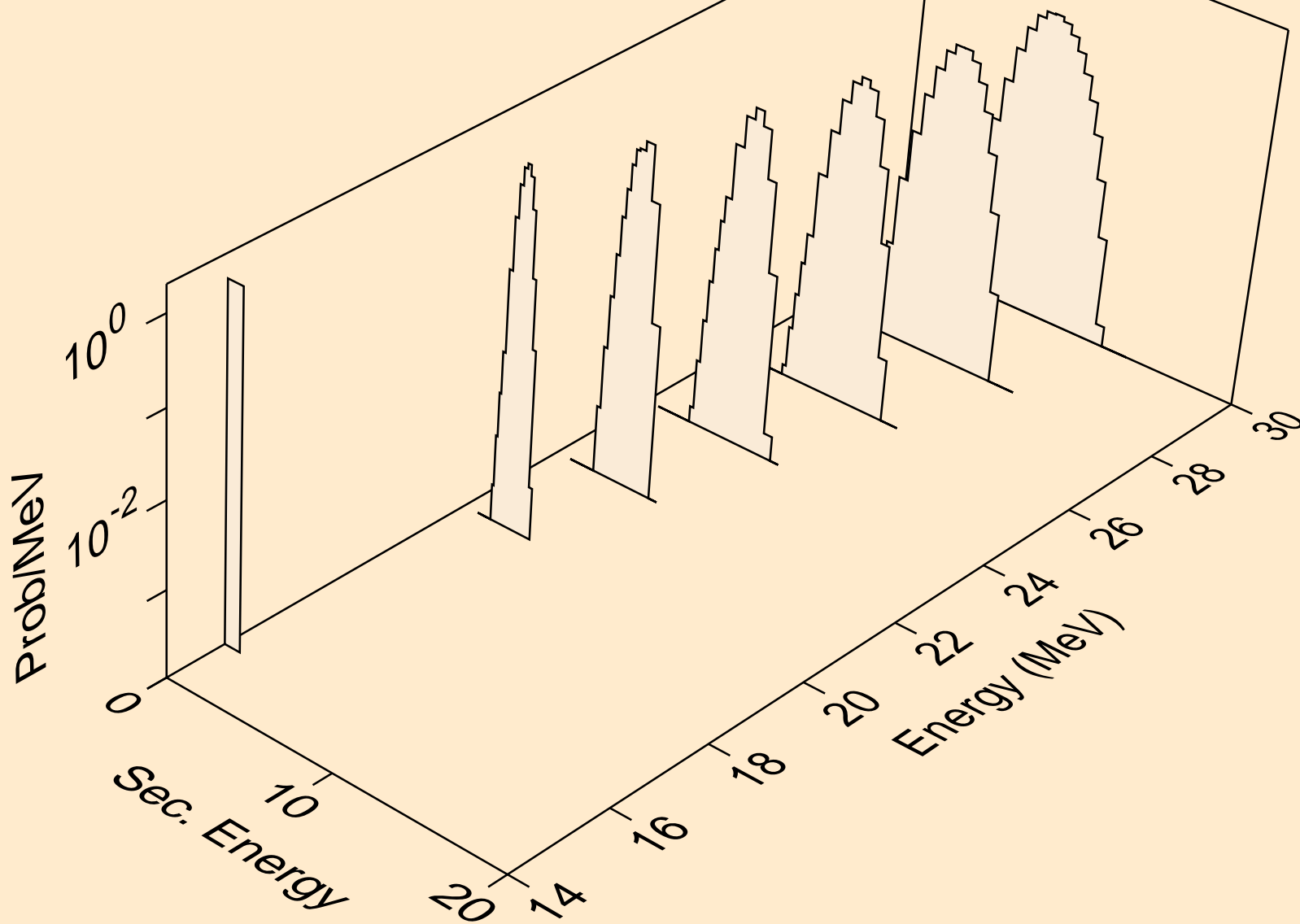

XE128 NEUTRON ACER TENDL-2023 LIBRARY; T=0.K  
he3s from (n,x)

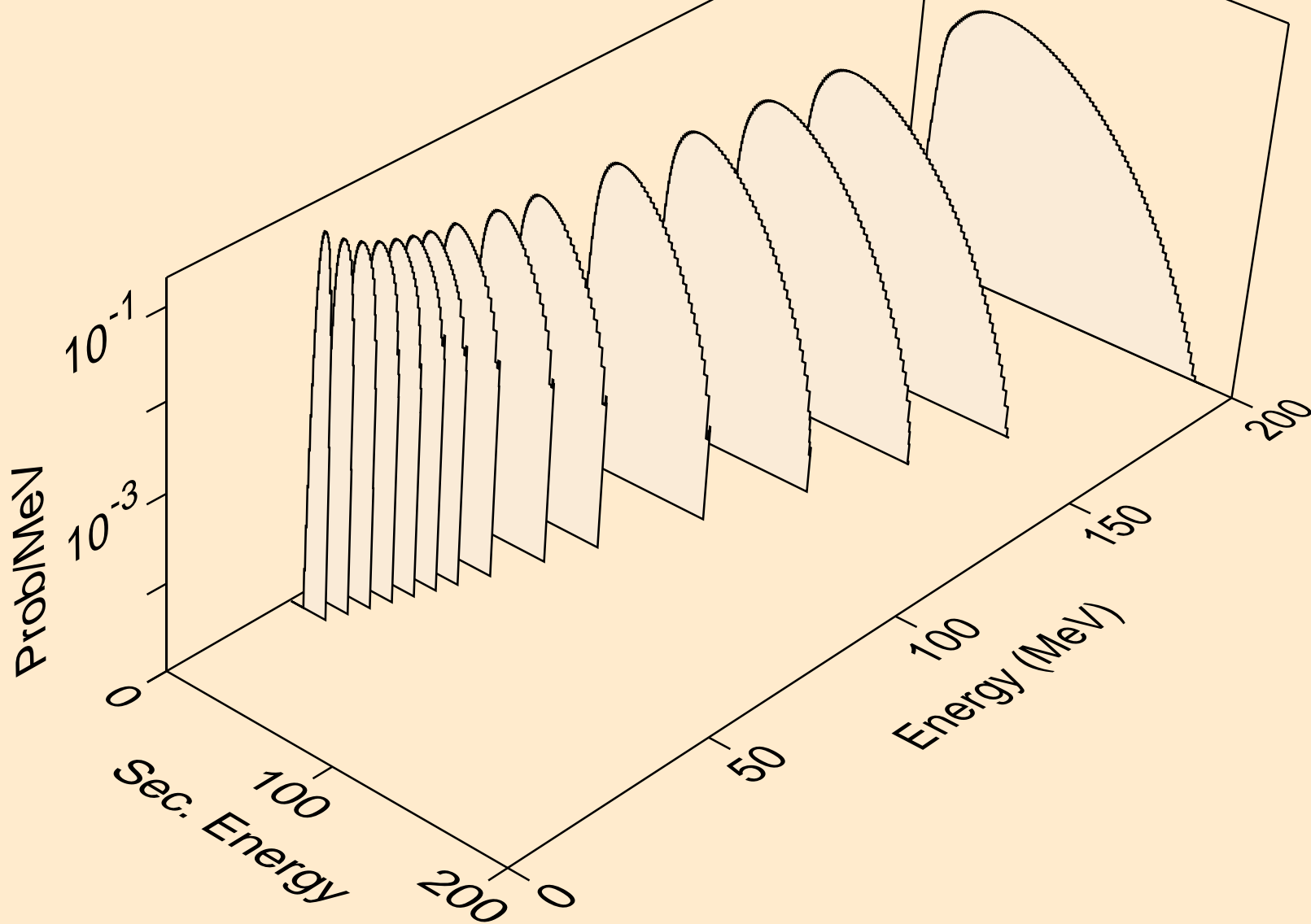

XE128 NEUTRON ACER TENDL-2023 LIBRARY; T=0.K  
he3s from (n,n\*)he3

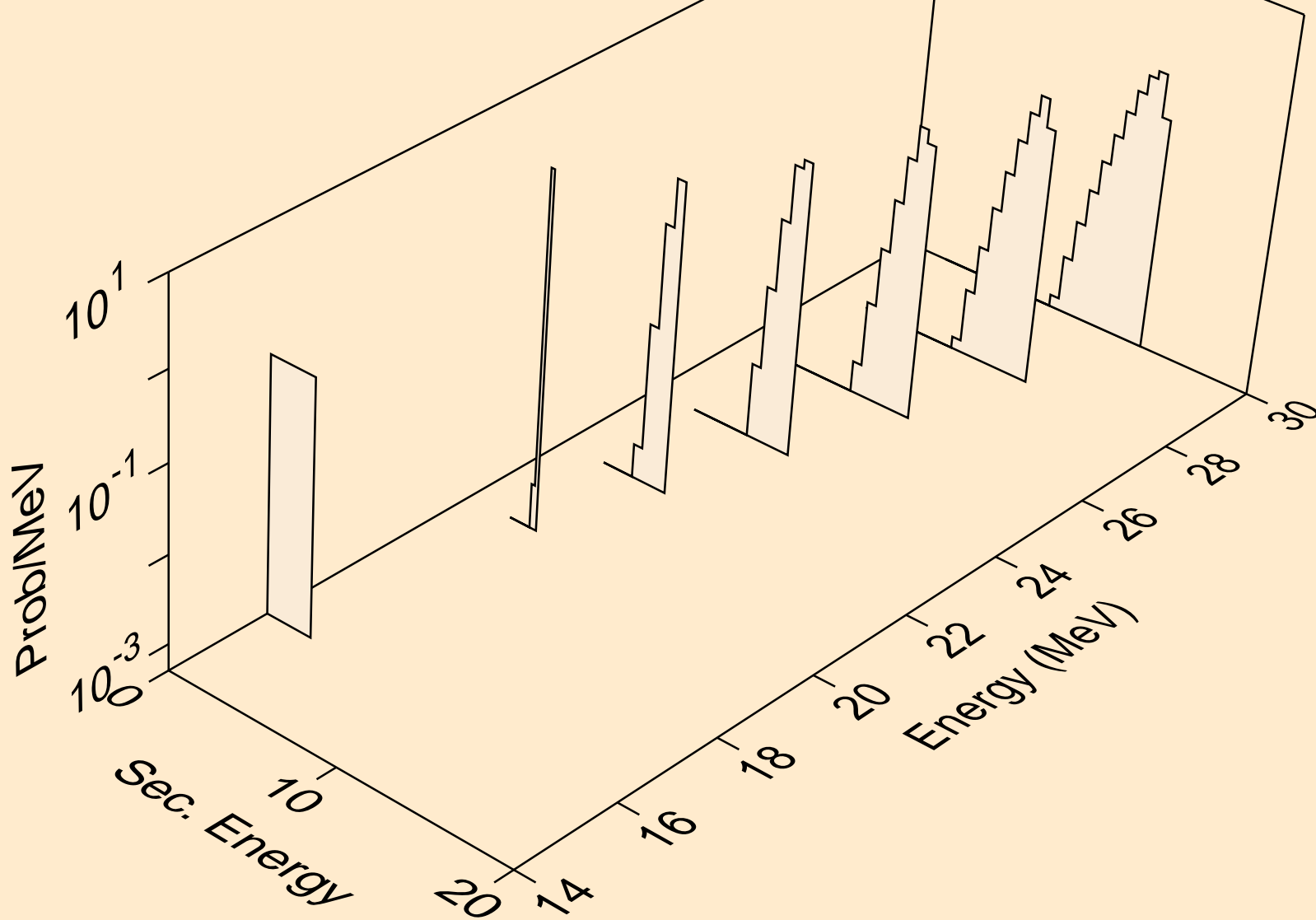

XE128 NEUTRON ACER TENDL-2023 LIBRARY; T=0.K  
he3s from (n,he3)

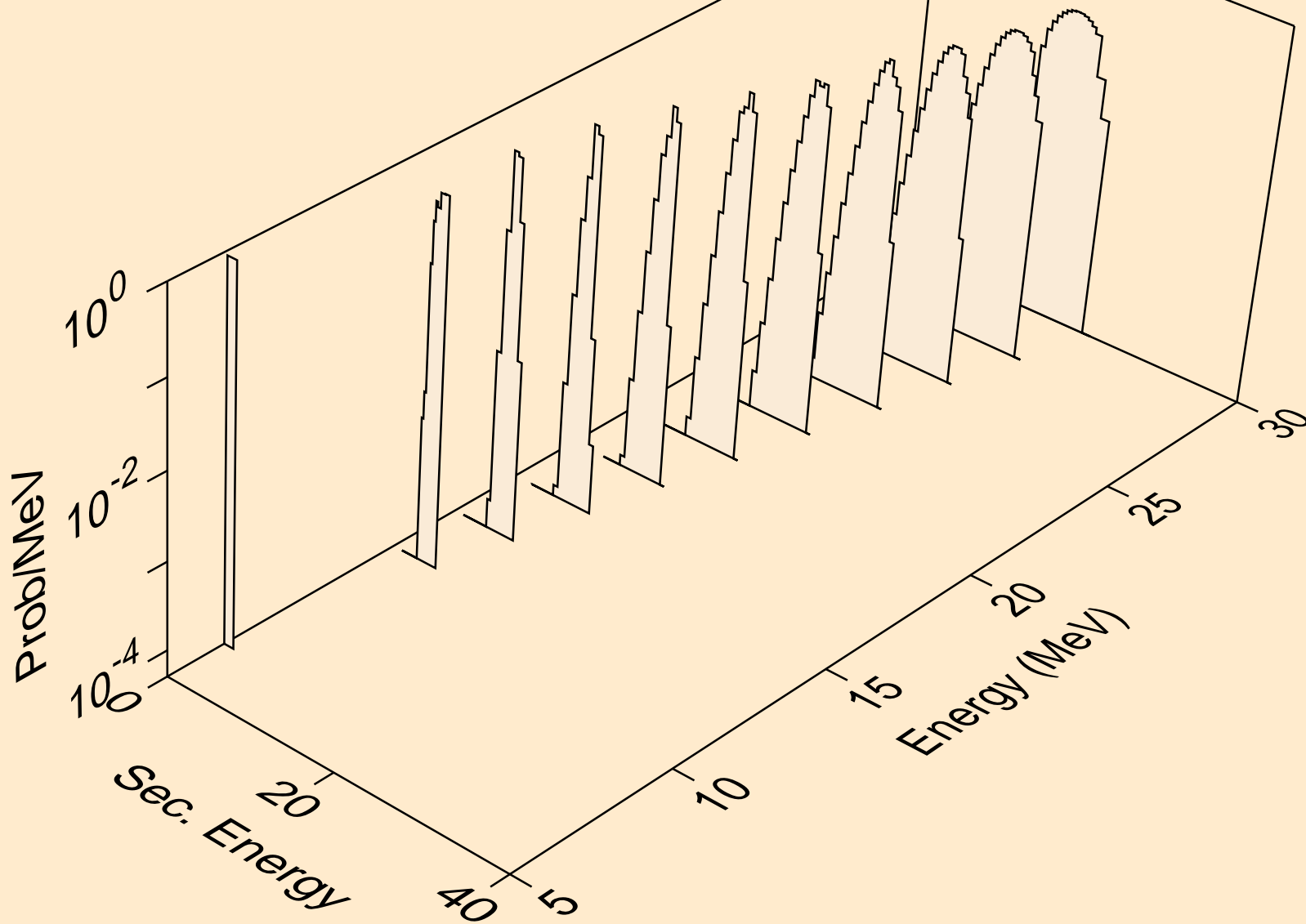

XE128 NEUTRON ACER TENDL-2023 LIBRARY; T=0.K  
alphas from (n,x)

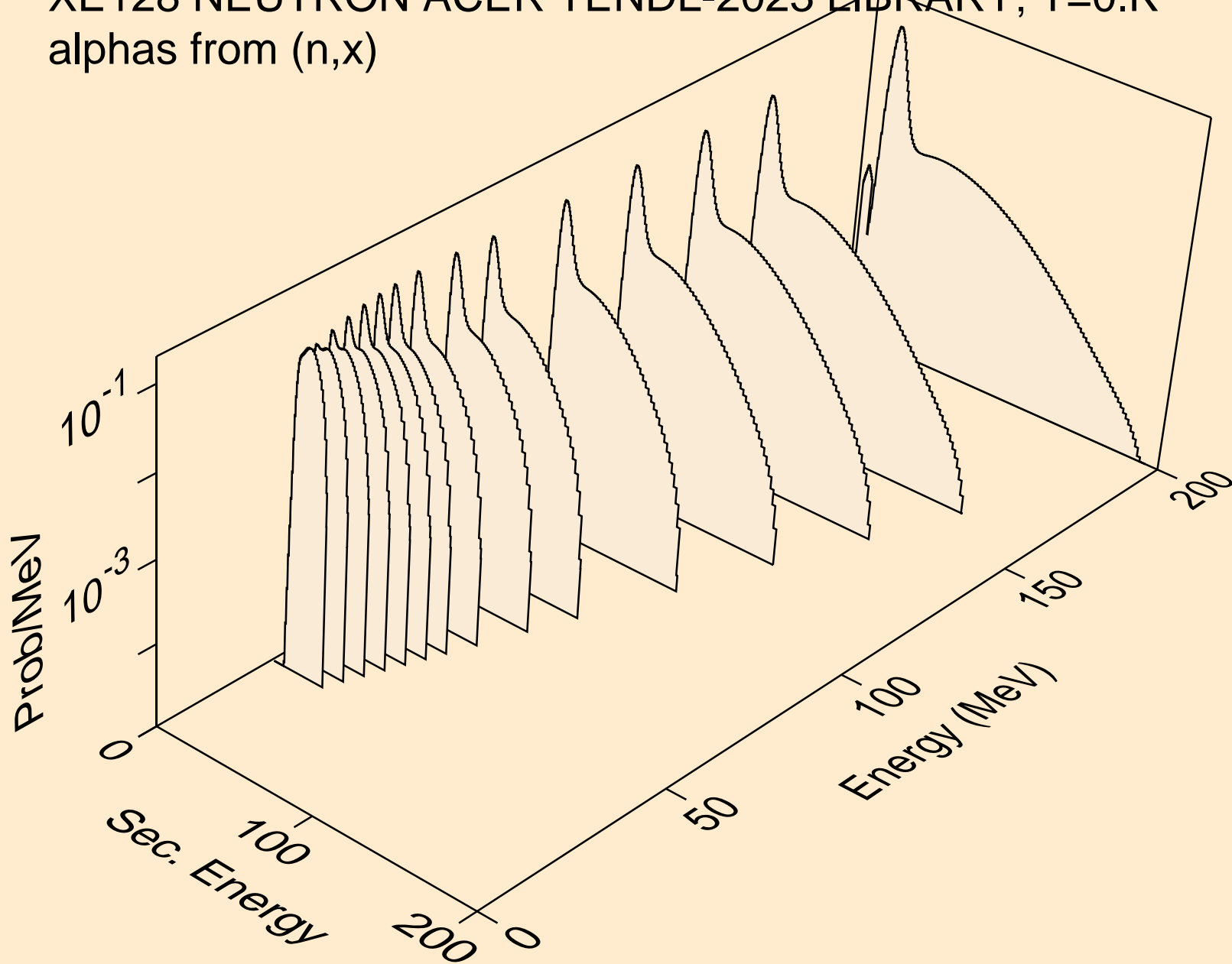

XE128 NEUTRON ACER TENDL-2023 LIBRARY; T=0.K  
alphas from (n,n\*)a

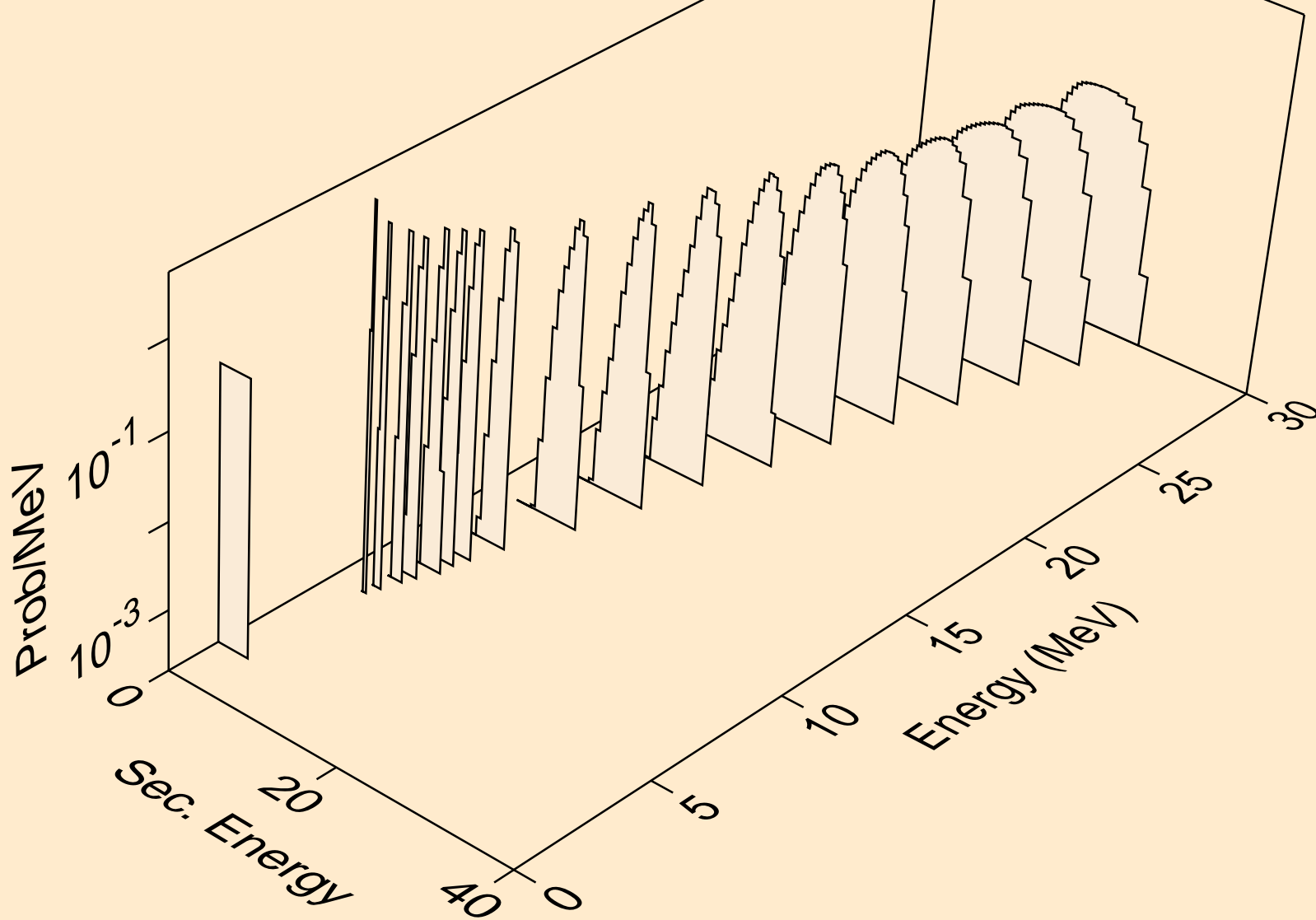

XE128 NEUTRON ACER TENDL-2023 LIBRARY; T=0.K  
alphas from (n,2n)a

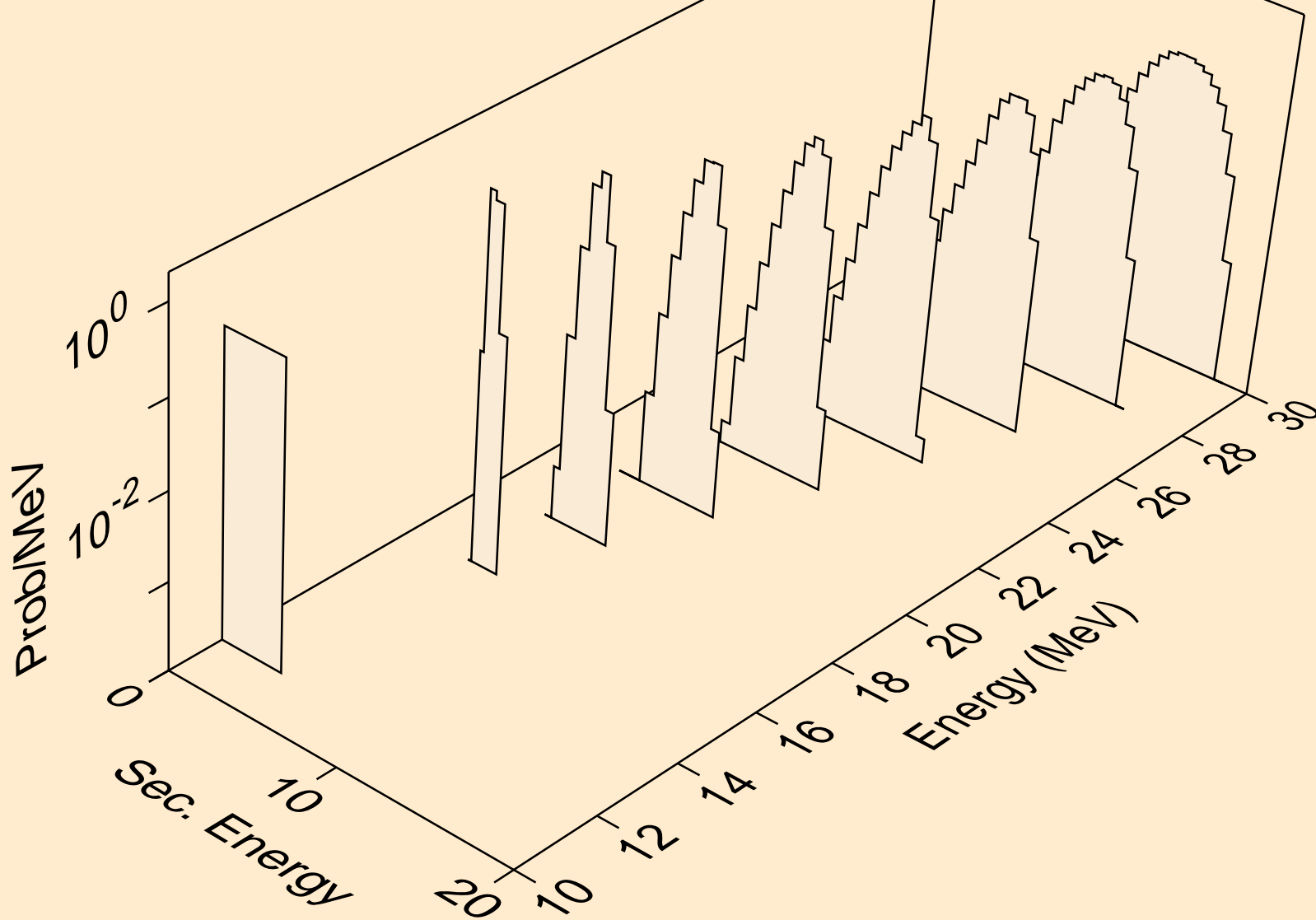

XE128 NEUTRON ACER TENDL-2023 LIBRARY; T=0.K  
alphas from (n,3n)a

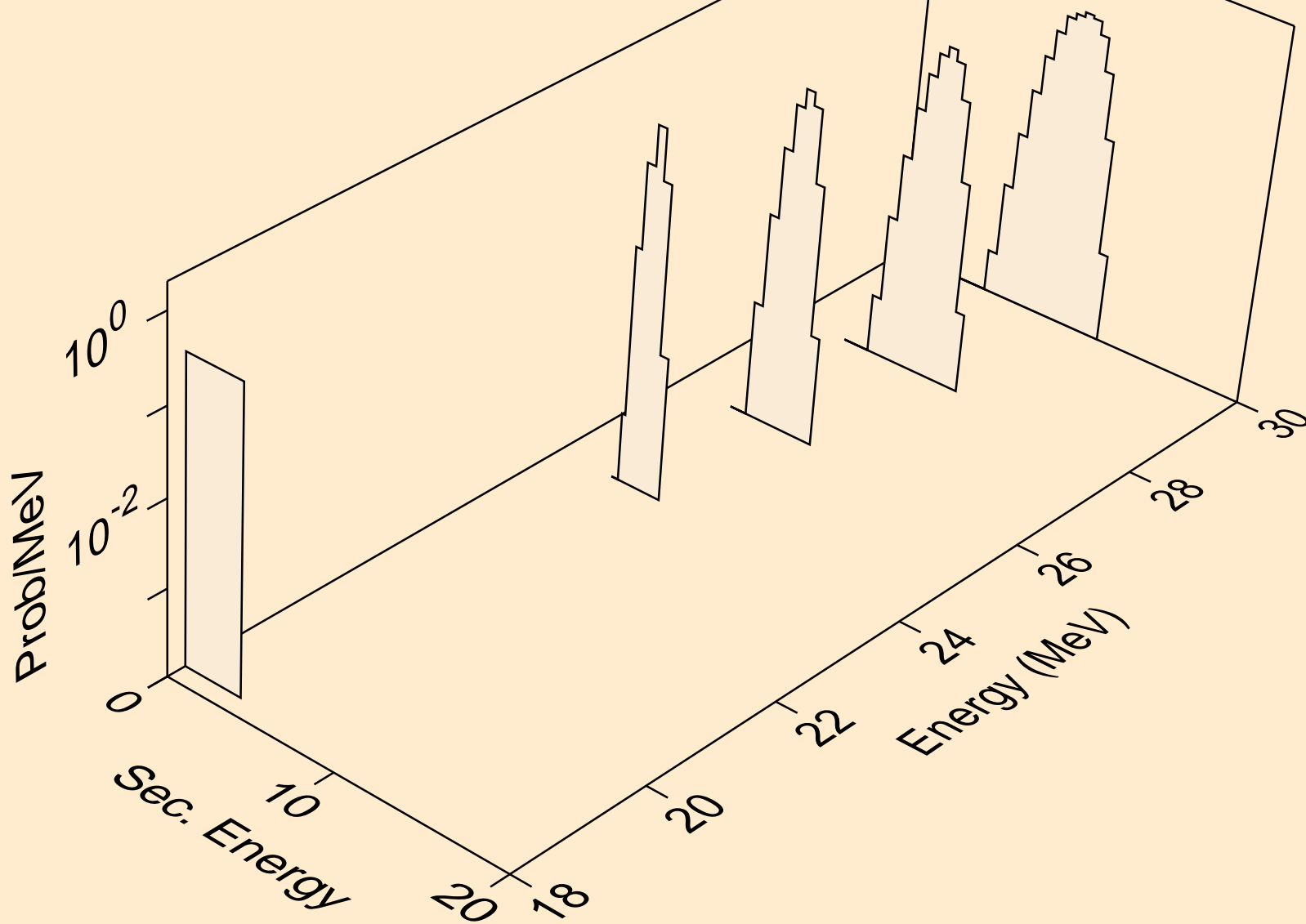

XE128 NEUTRON ACER TENDL-2023 LIBRARY; T=0.K  
alphas from (n,npa)

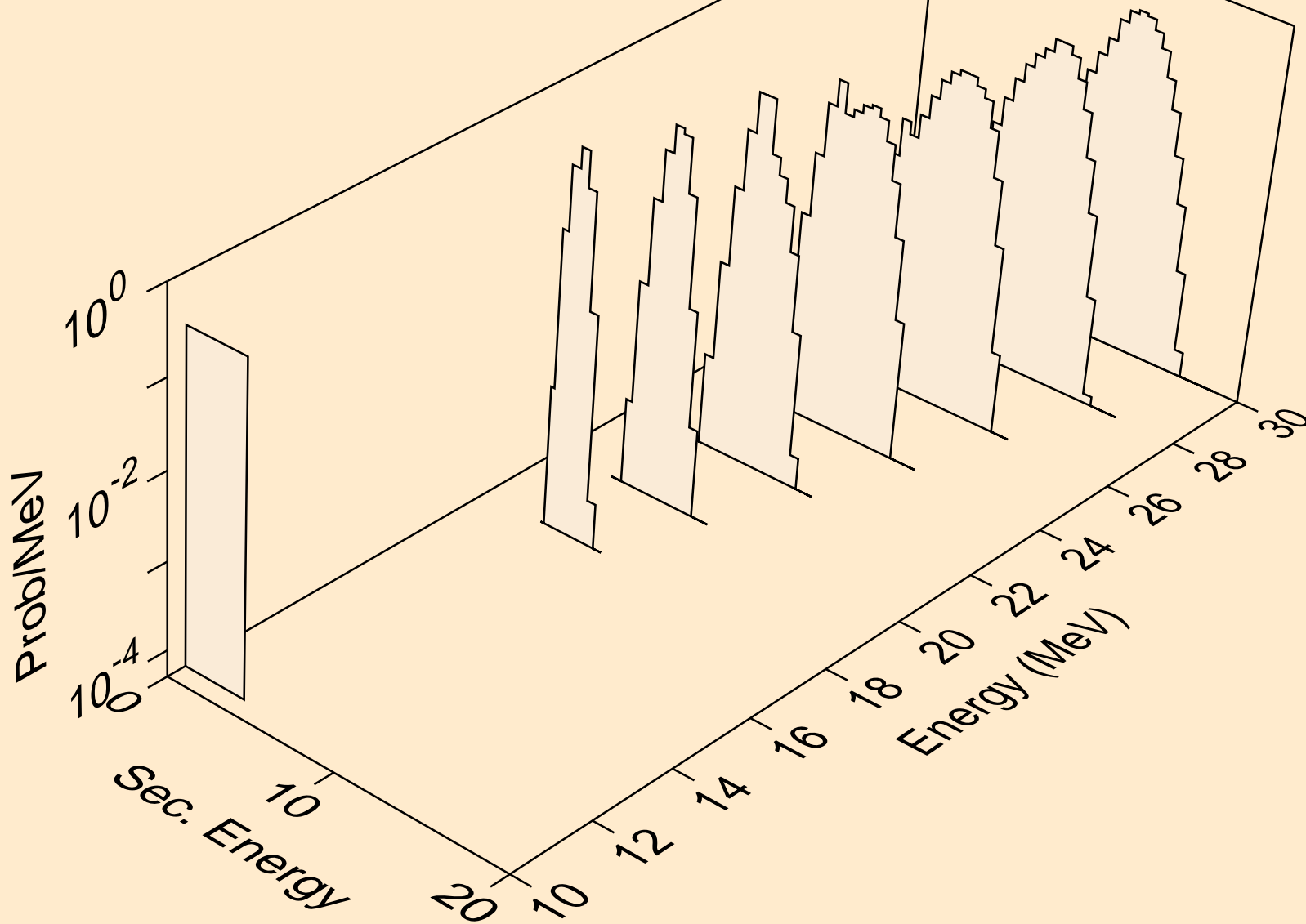

XE128 NEUTRON ACER TENDL-2023 LIBRARY; T=0.K  
alphas from (n,a)

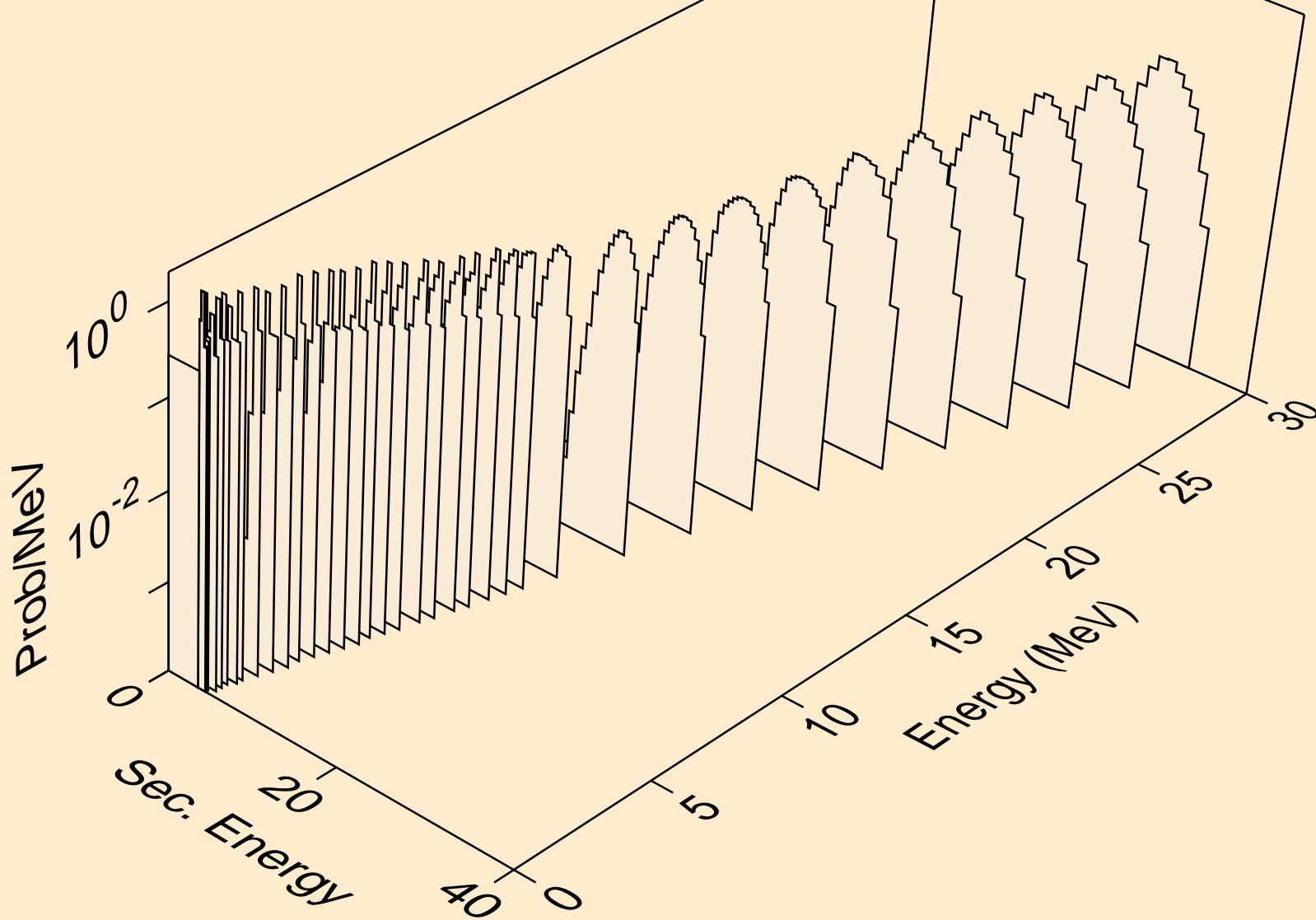

XE128 NEUTRON ACER TENDL-2023 LIBRARY; T=0.K  
alphas from (n,2a)

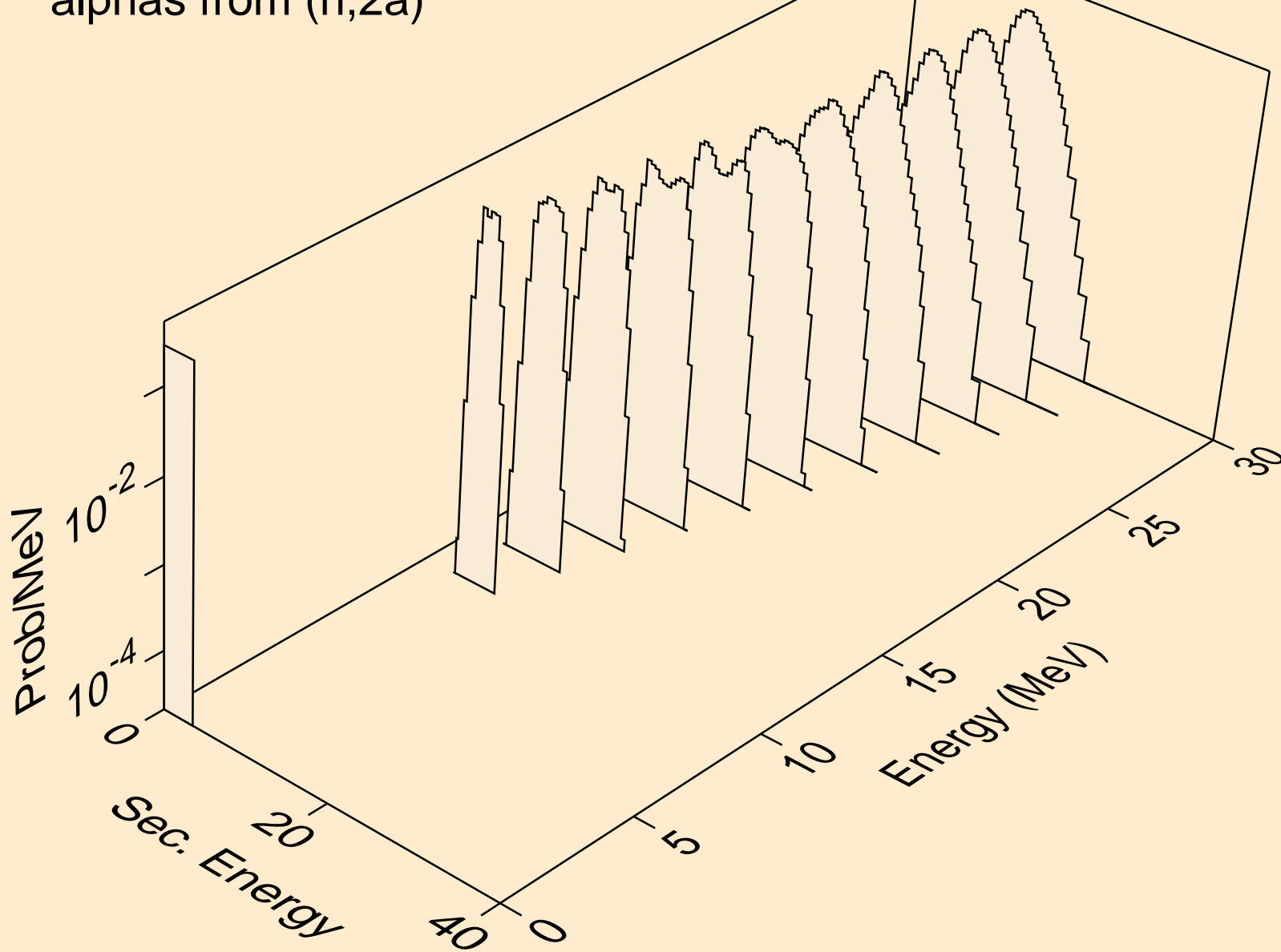

XE128 NEUTRON ACER TENDL-2023 LIBRARY; T=0.K  
alphas from (n,pa)

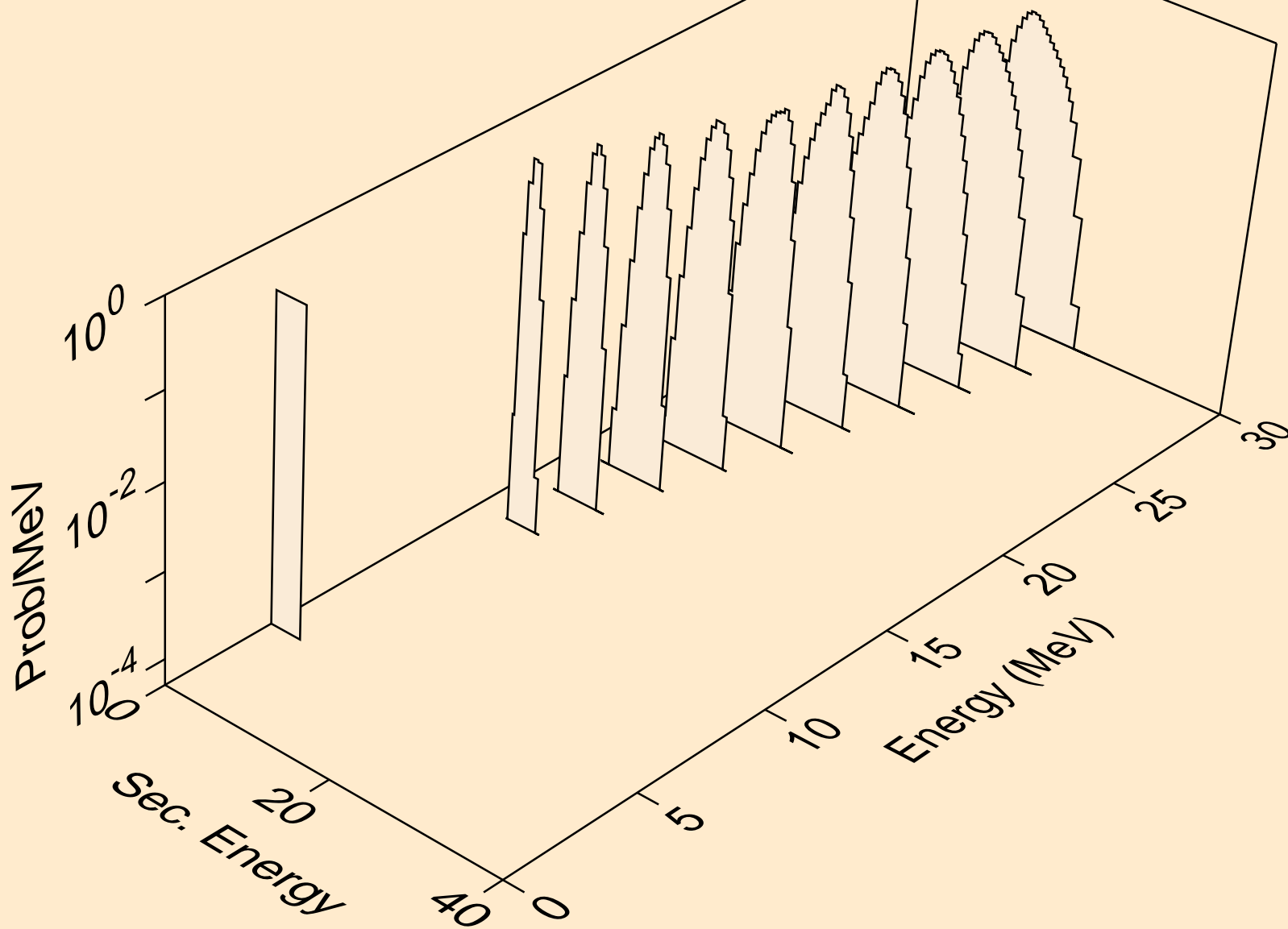

XE128 NEUTRON ACER TENDL-2023 LIBRARY; T=0.K  
alphas from (n,da)

