

YB164 NEUTRON ACER TENDL-2023 LIBRARY; T=0.K

Principal cross sections

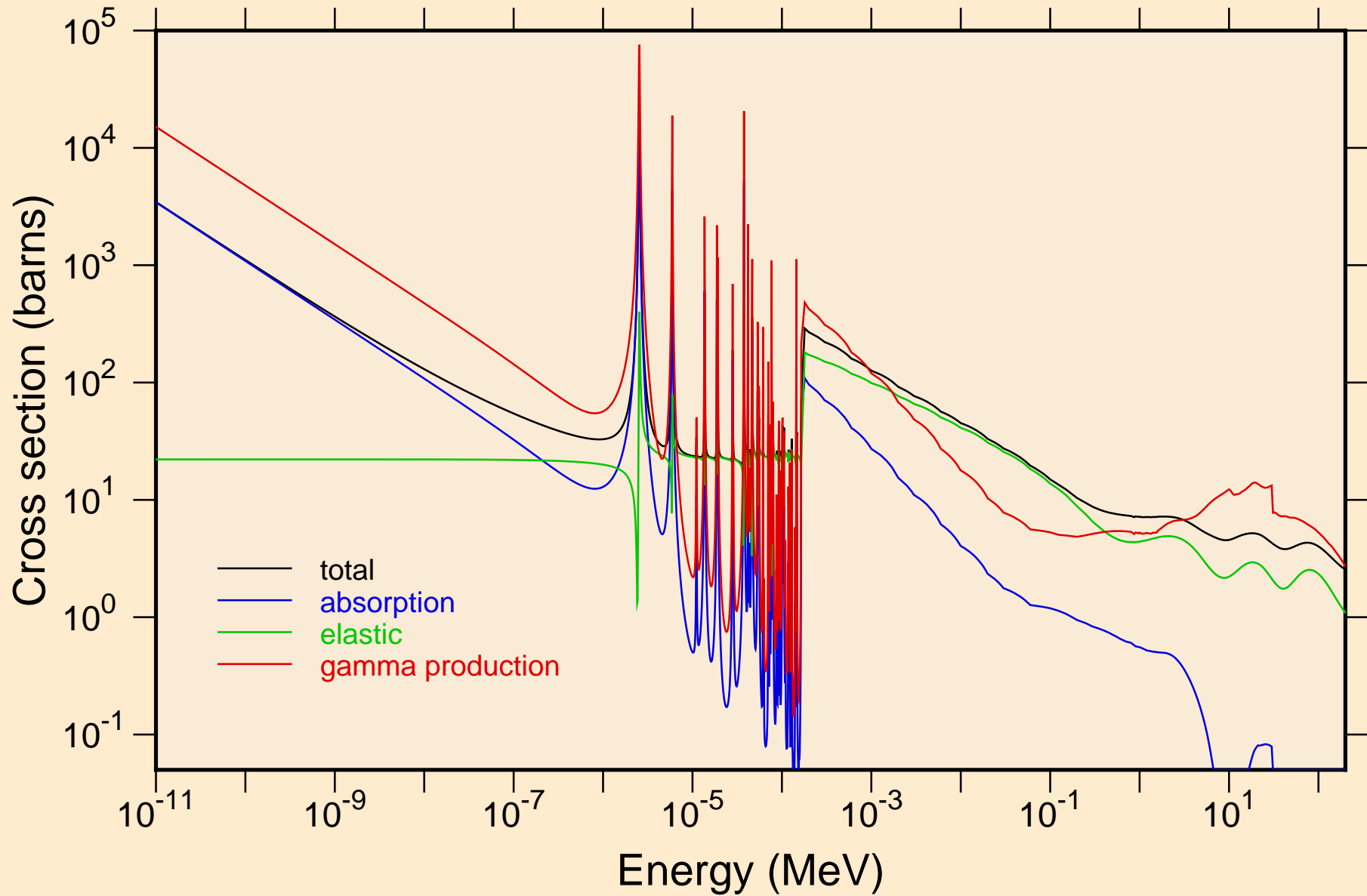

YB164 NEUTRON ACER TENDL-2023 LIBRARY; T=0.K
resonance total cross section

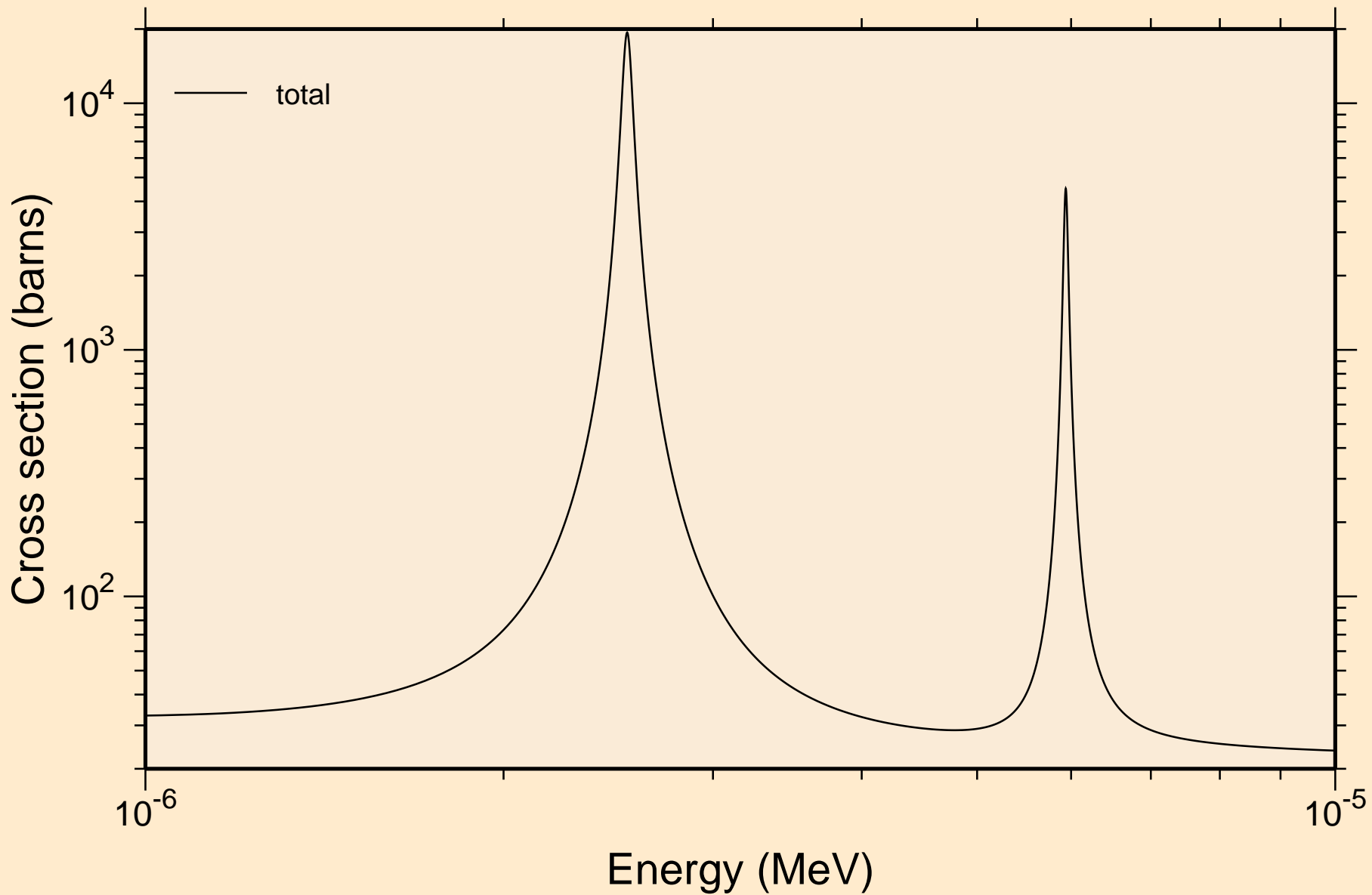

YB164 NEUTRON ACER TENDL-2023 LIBRARY; T=0.K
resonance total cross section

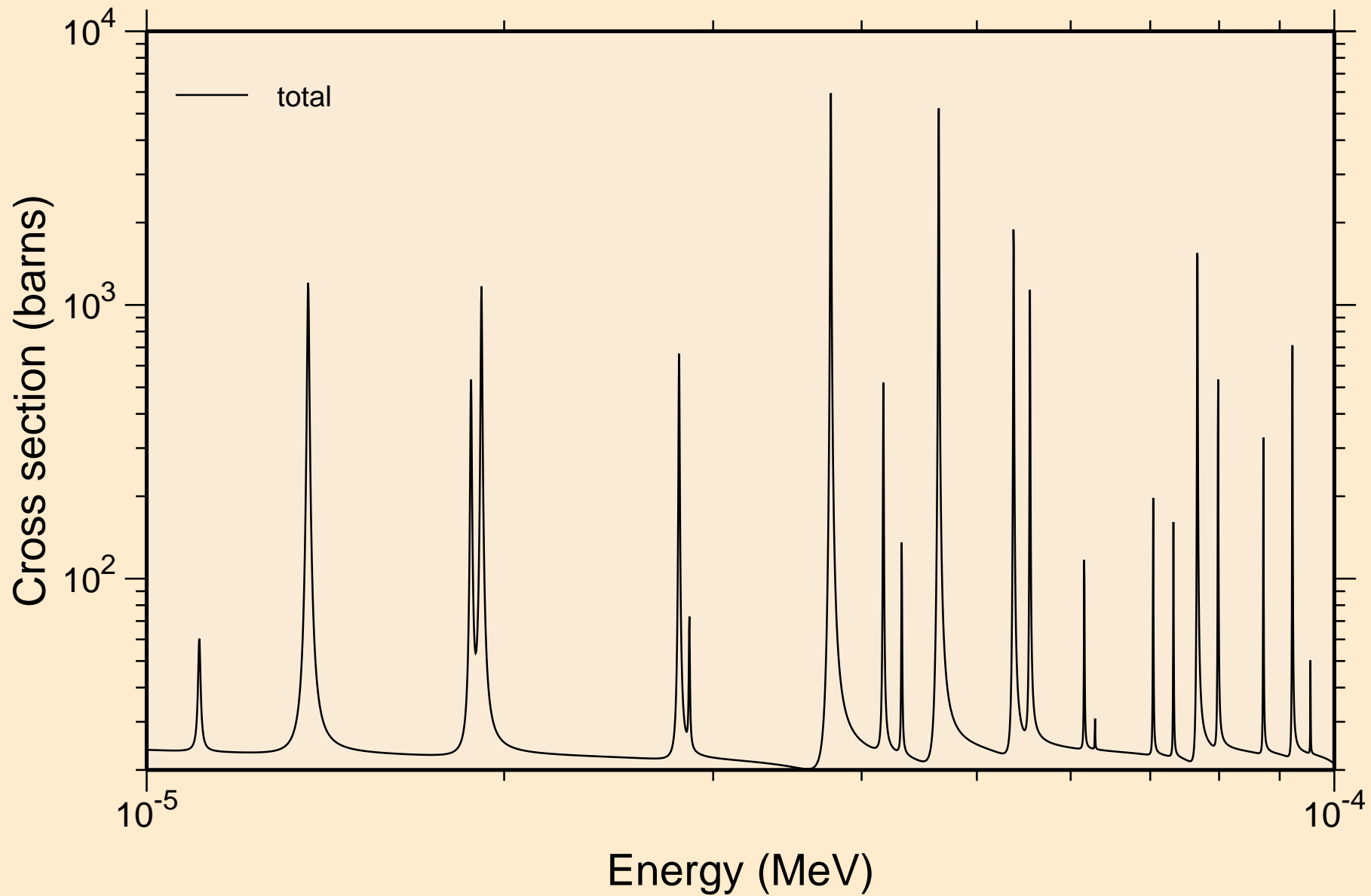

YB164 NEUTRON ACER TENDL-2023 LIBRARY; T=0.K
resonance total cross section

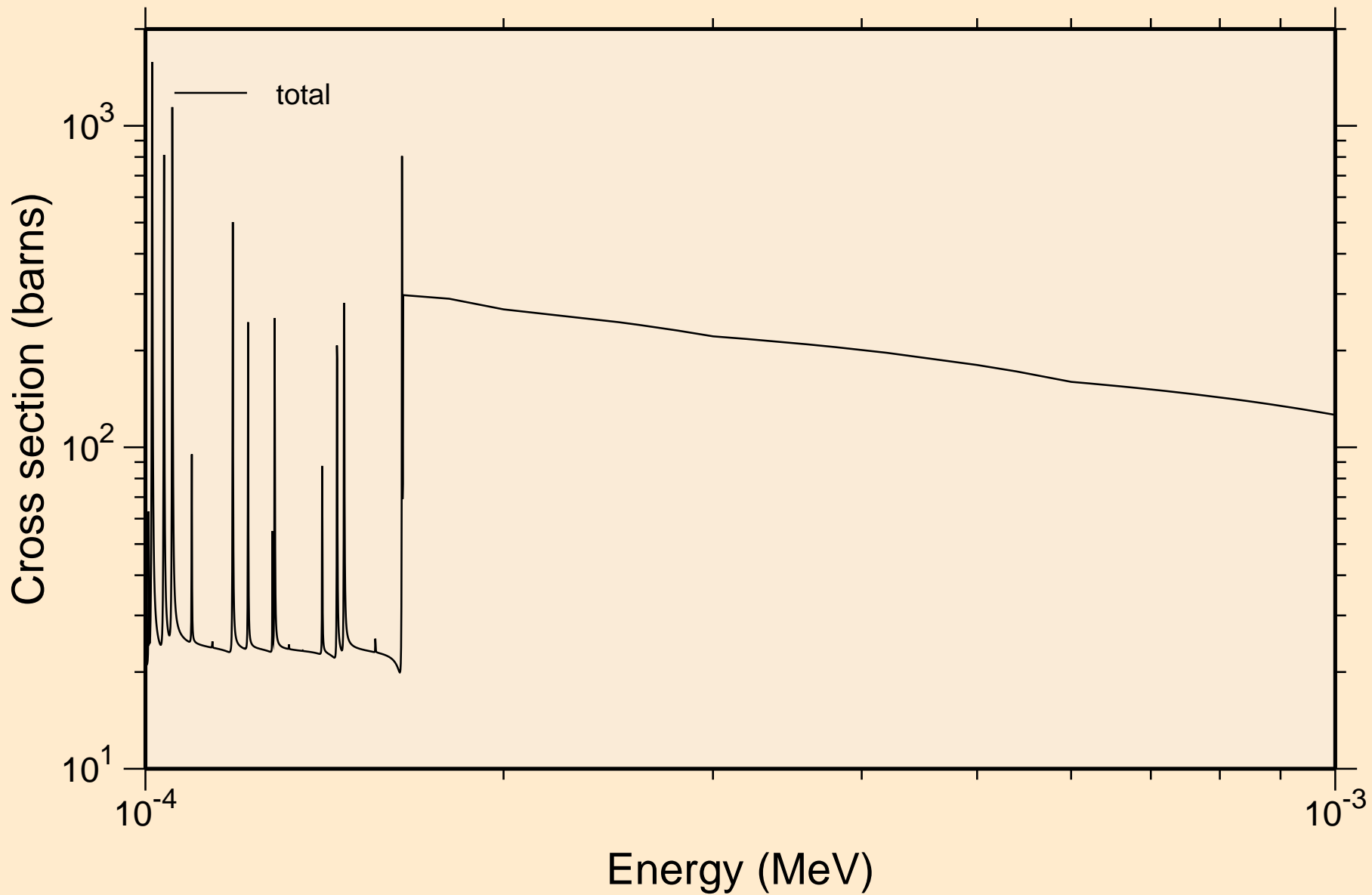

YB164 NEUTRON ACER TENDL-2023 LIBRARY; T=0.K
resonance total cross section

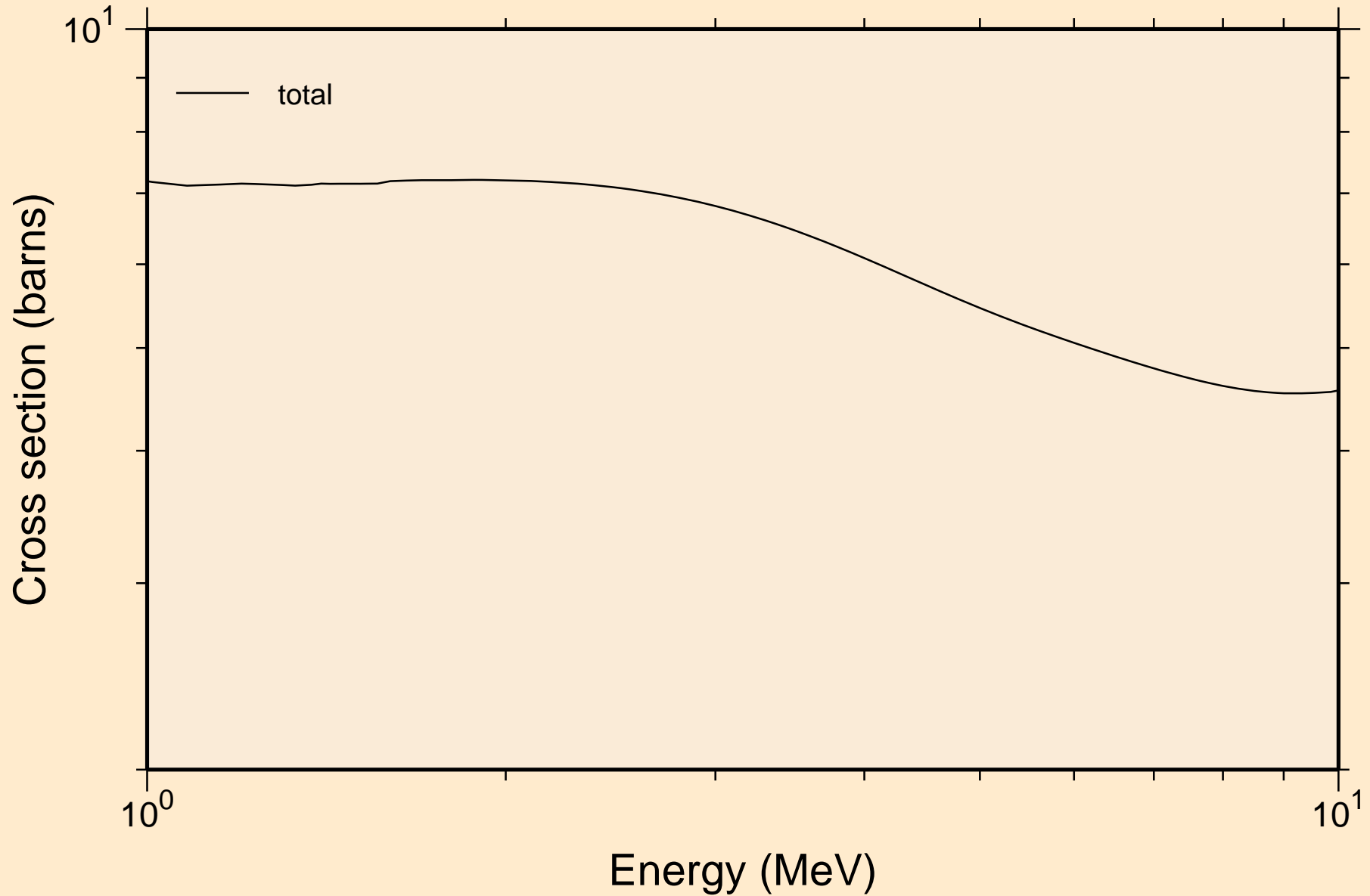

YB164 NEUTRON ACER TENDL-2023 LIBRARY; T=0.K
resonance absorption cross sections

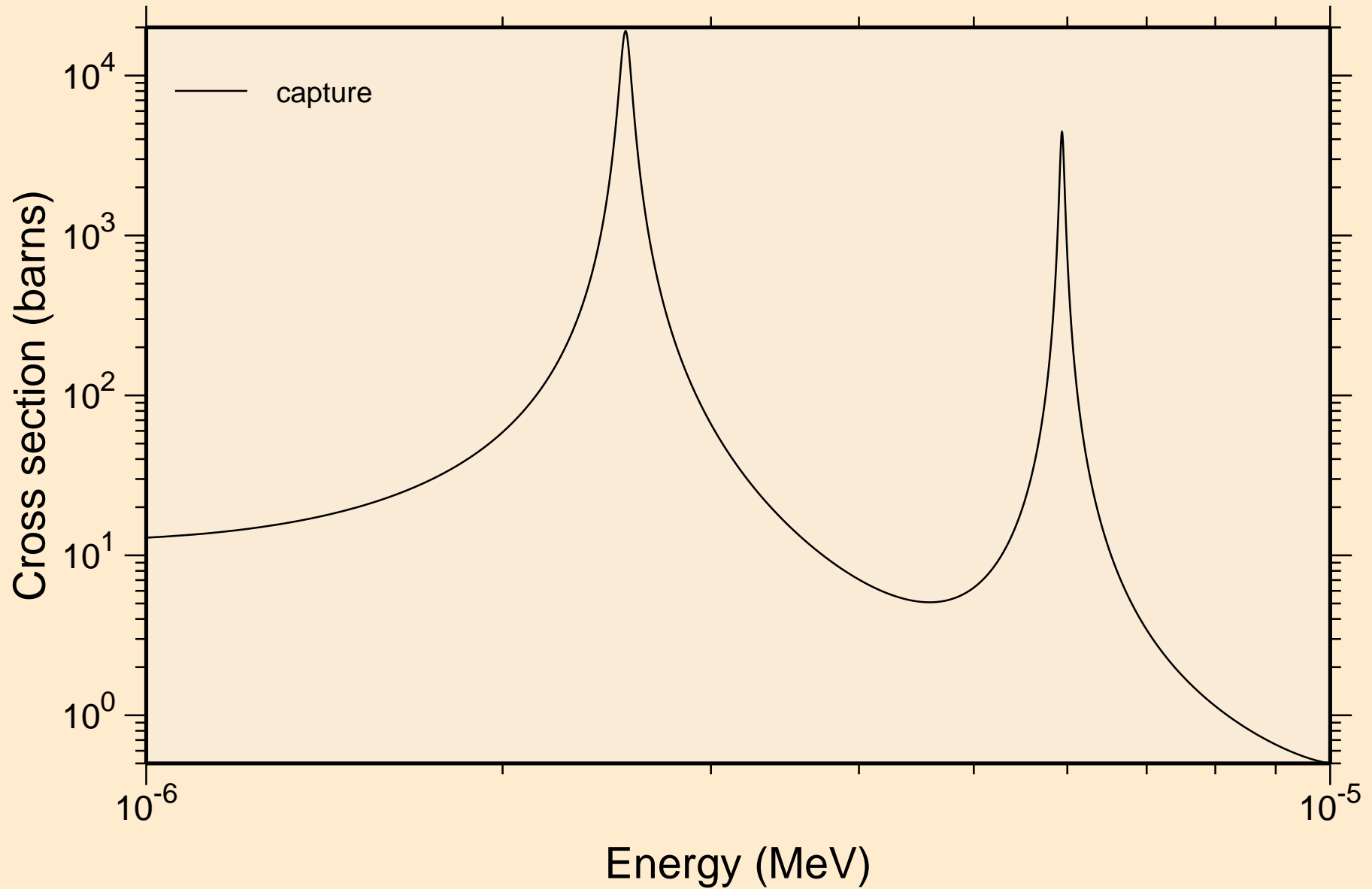

YB164 NEUTRON ACER TENDL-2023 LIBRARY; T=0.K
resonance absorption cross sections

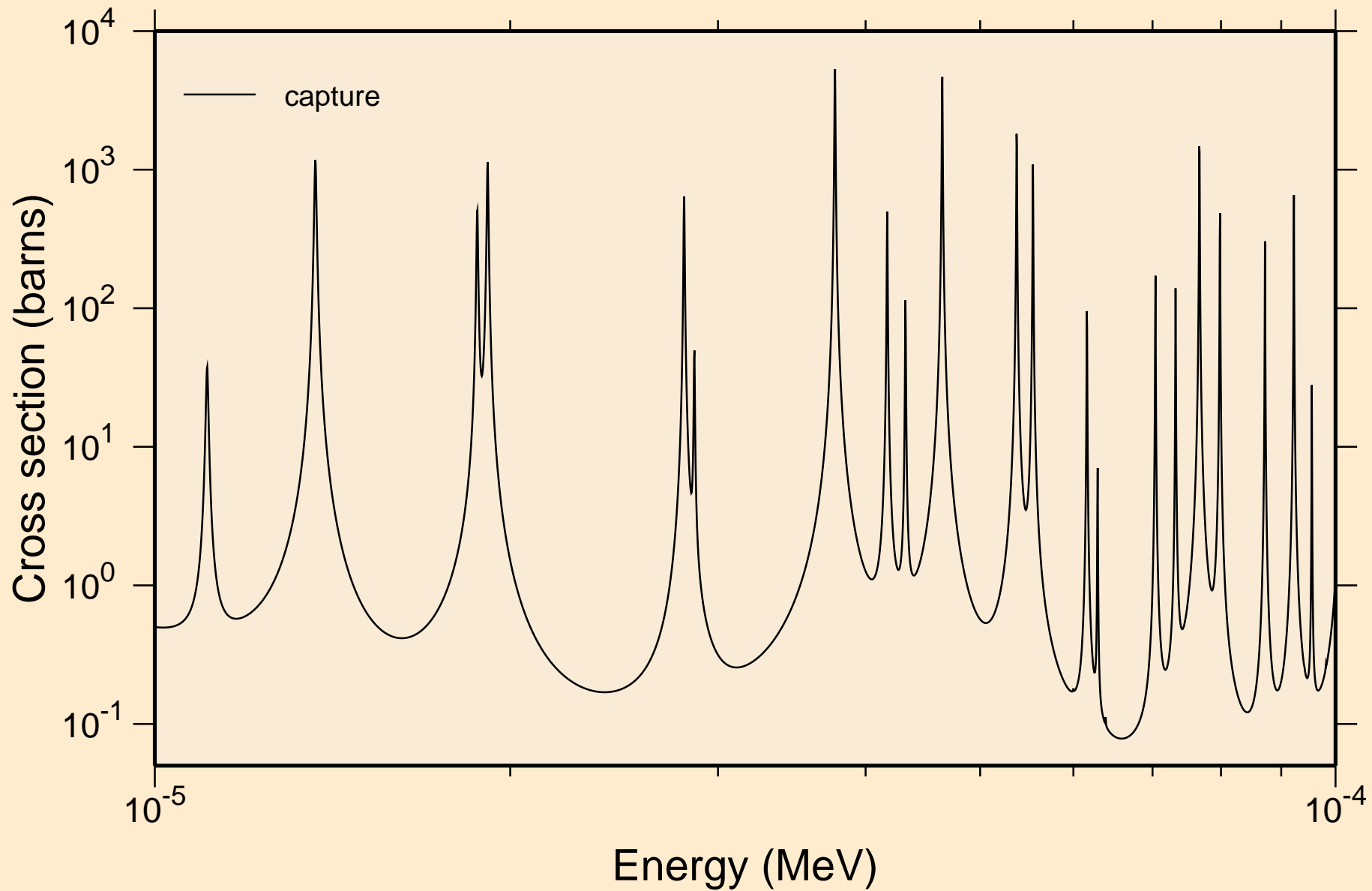

YB164 NEUTRON ACER TENDL-2023 LIBRARY; T=0.K
resonance absorption cross sections

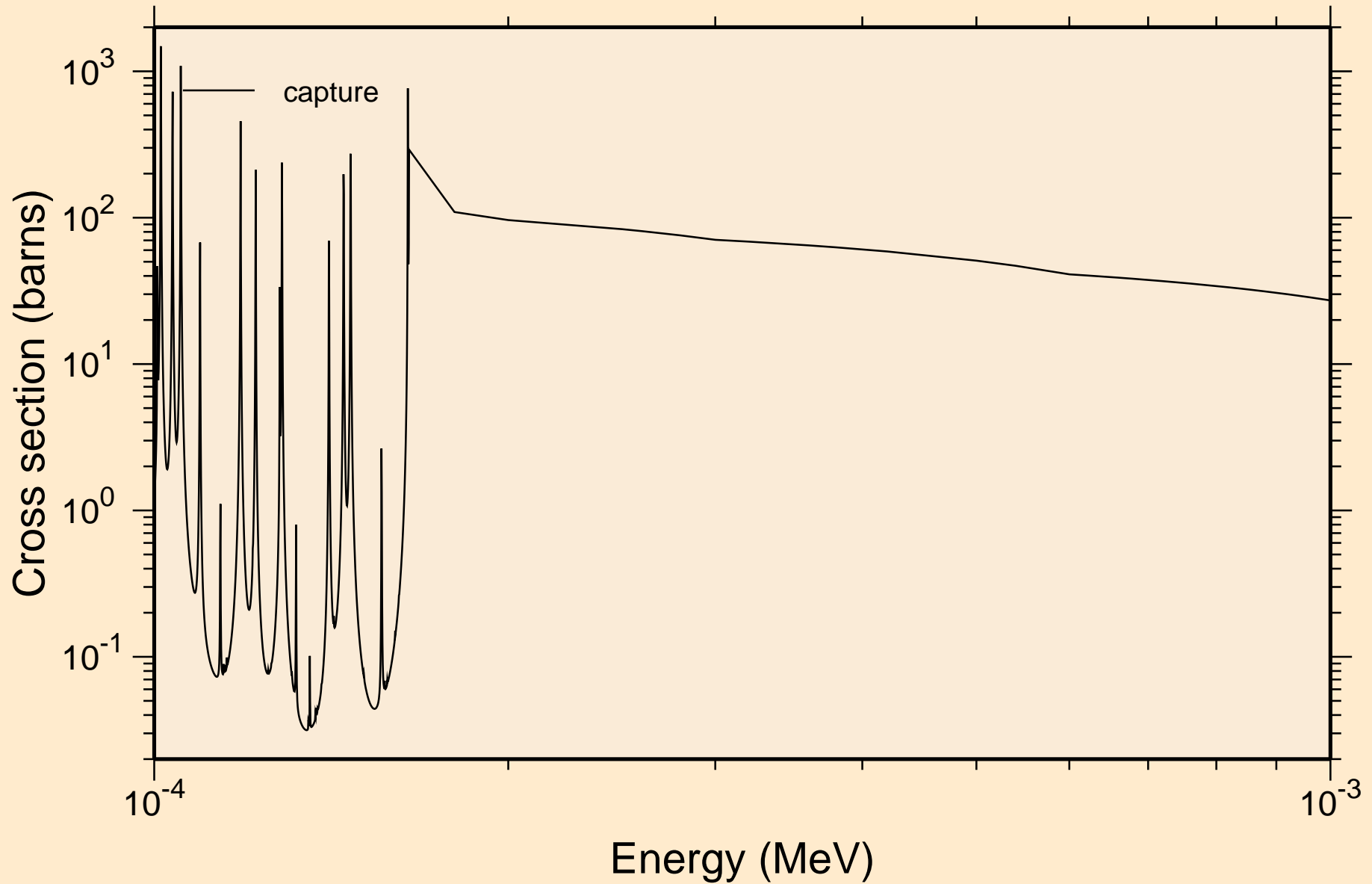

YB164 NEUTRON ACER TENDL-2023 LIBRARY; T=0.K
resonance absorption cross sections

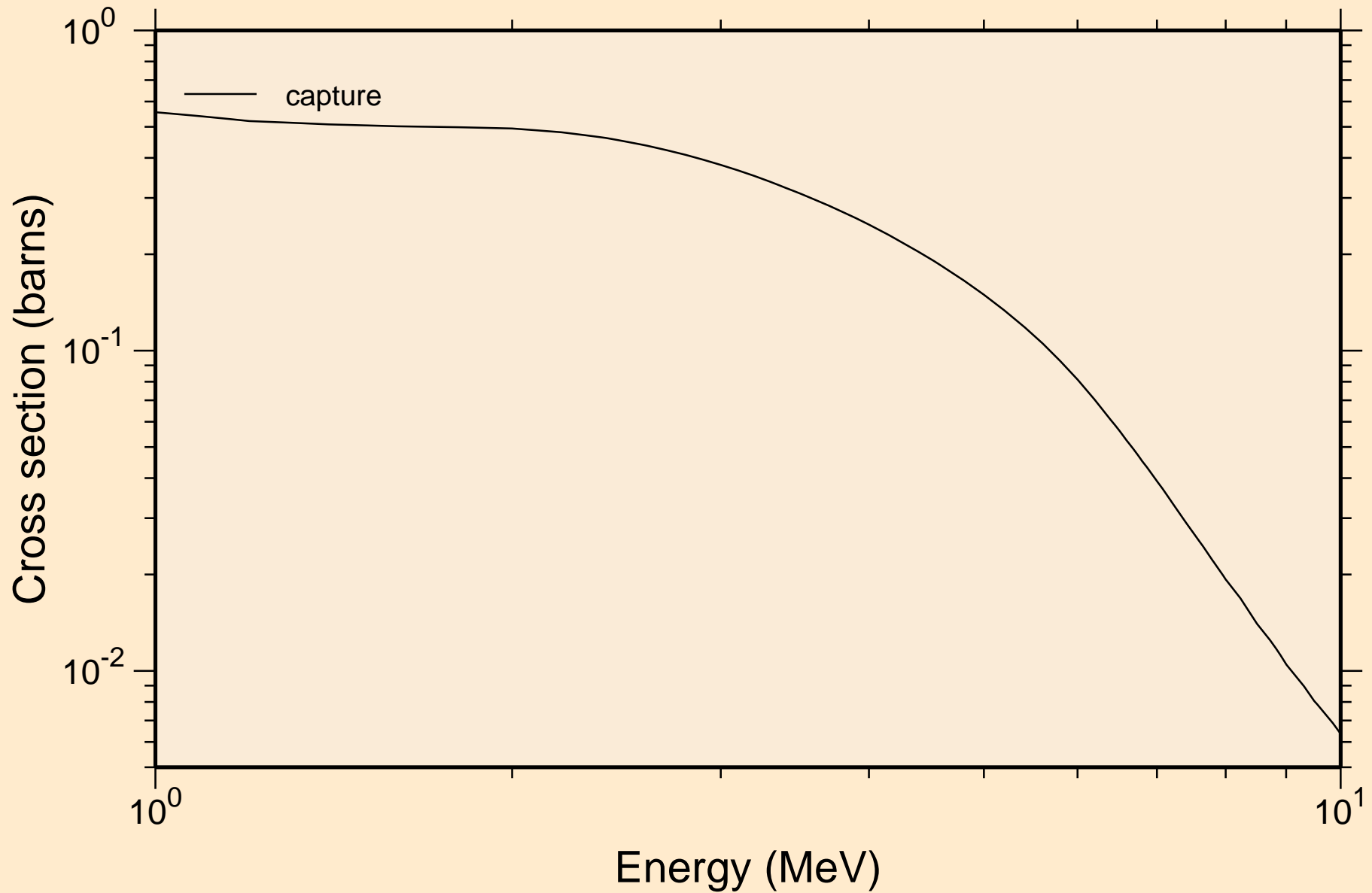

YB164 NEUTRON ACER TENDL-2023 LIBRARY; T=0.K
Heating

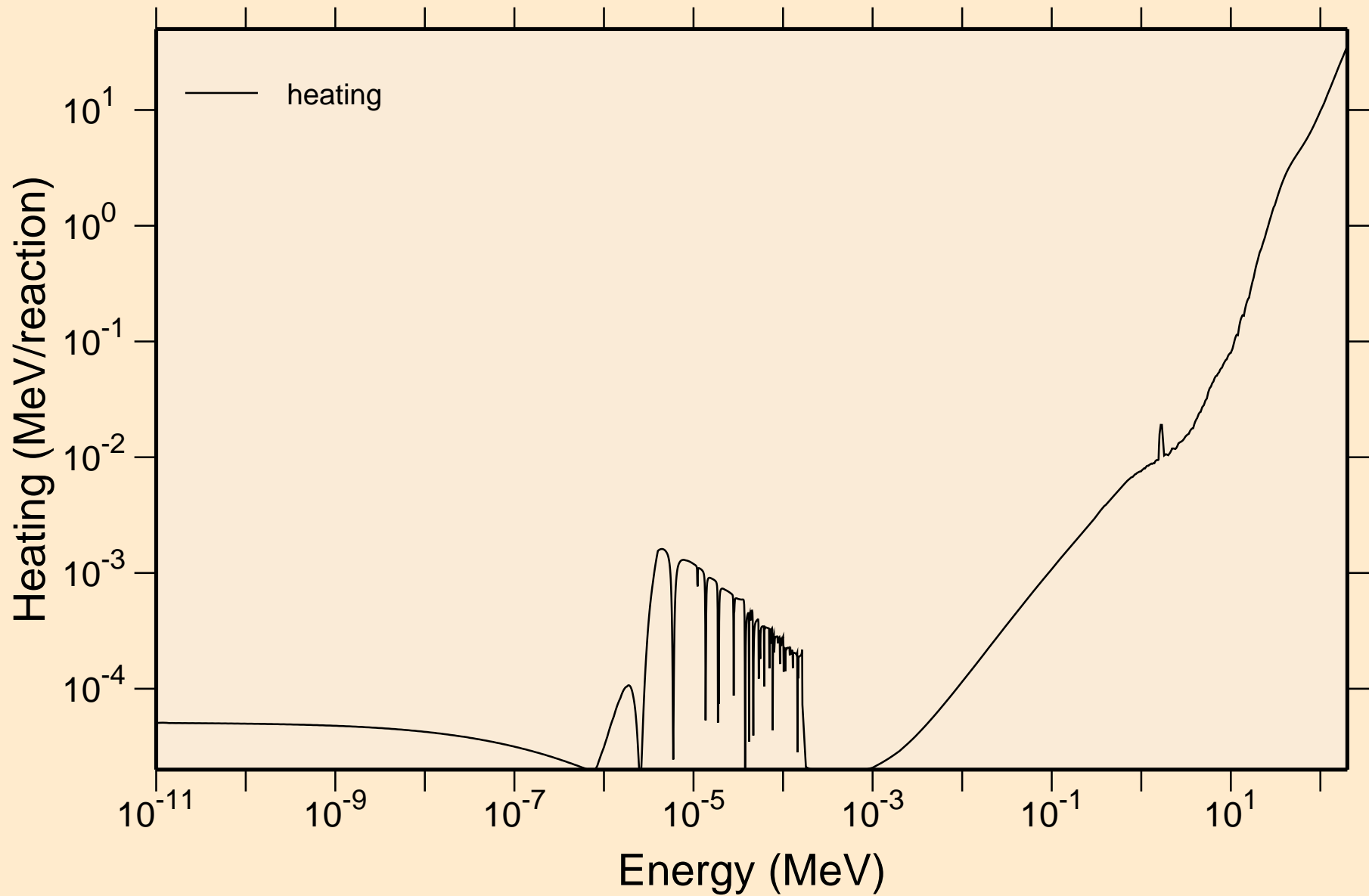

YB164 NEUTRON ACER TENDL-2023 LIBRARY; T=0.K

Damage

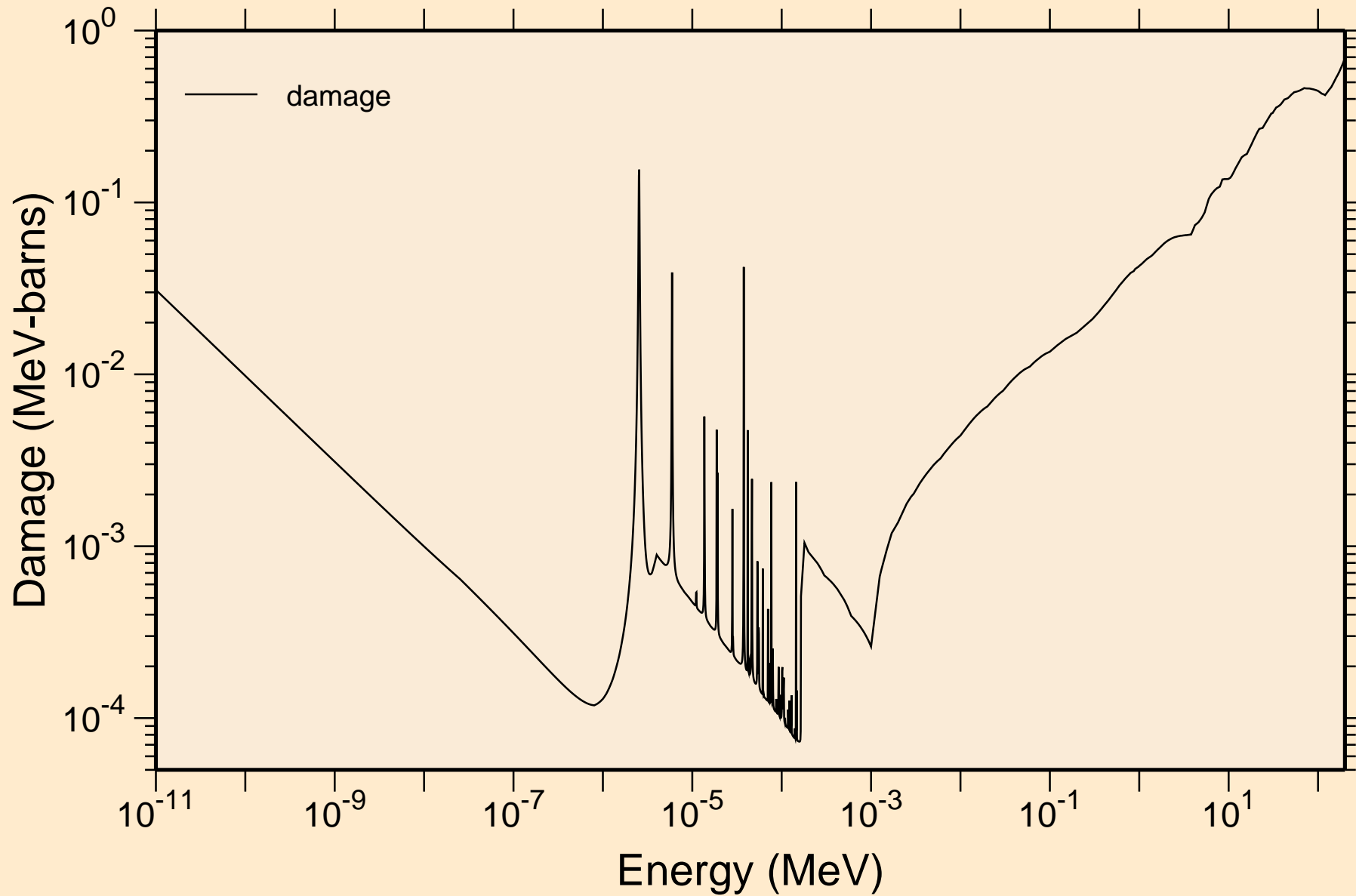

YB164 NEUTRON ACER TENDL-2023 LIBRARY; T=0.K

Non-threshold reactions

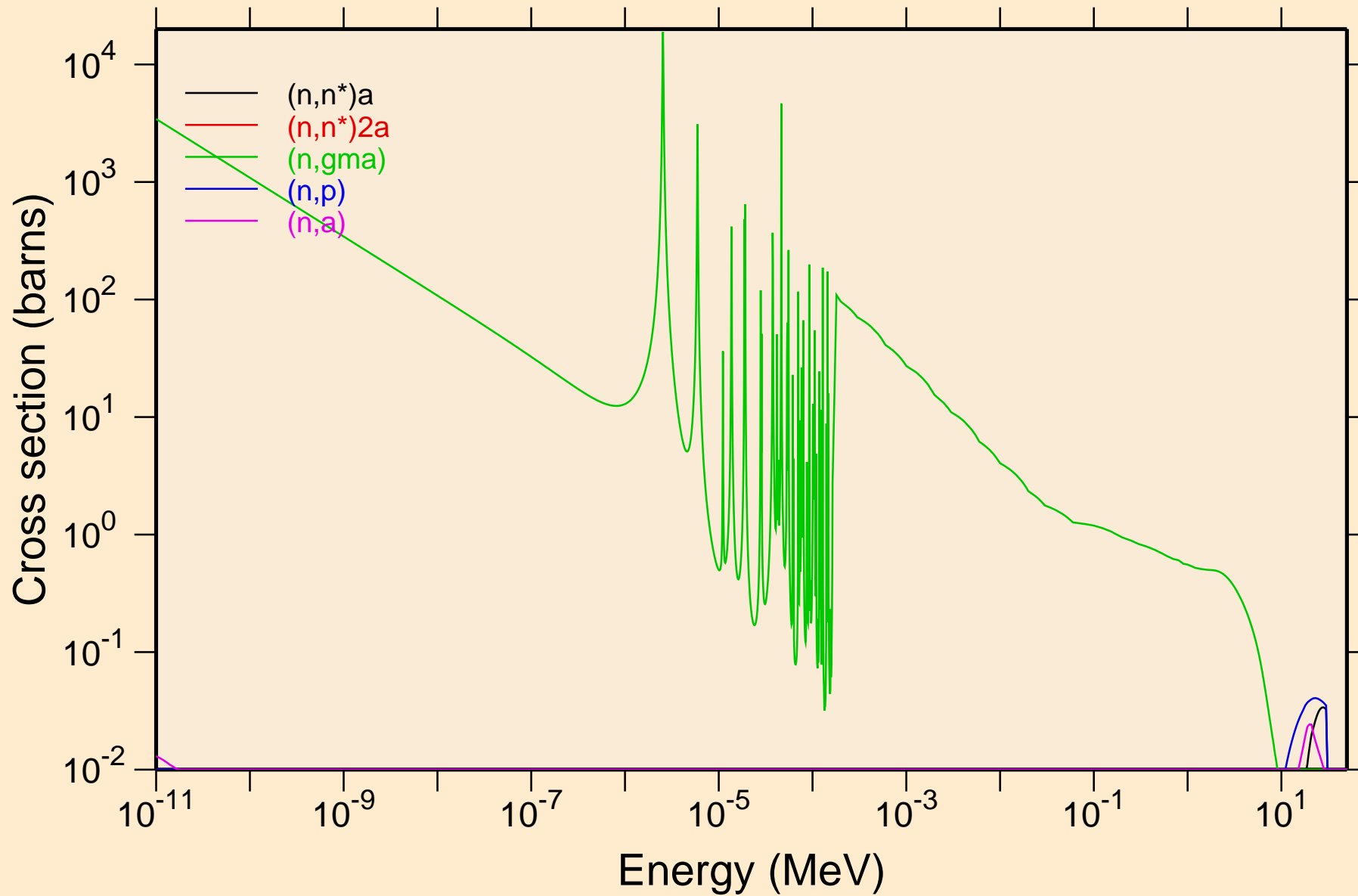

YB164 NEUTRON ACER TENDL-2023 LIBRARY; T=0.K
Non-threshold reactions

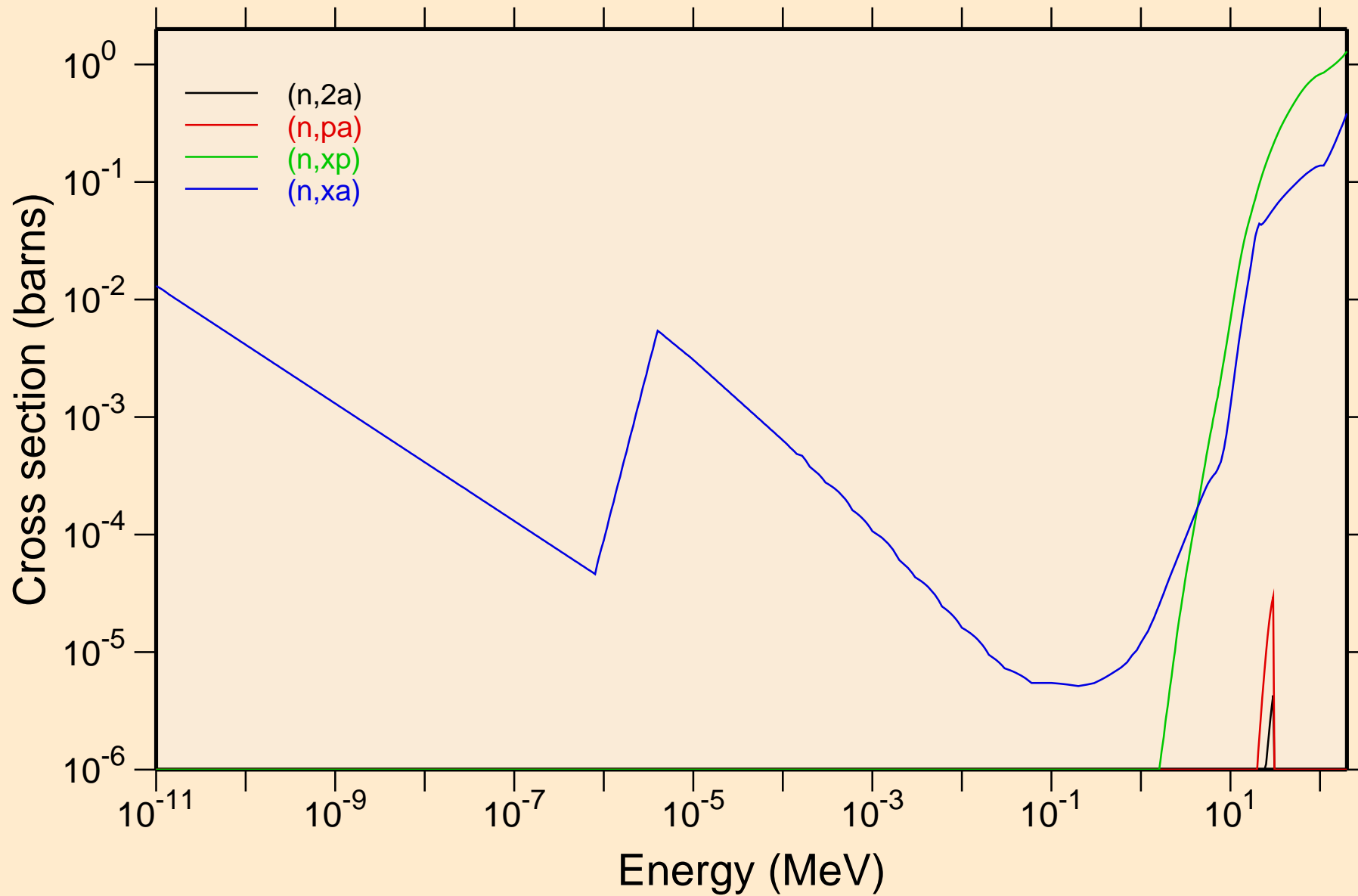

YB164 NEUTRON ACER TENDL-2023 LIBRARY; T=0.K

Principal cross sections

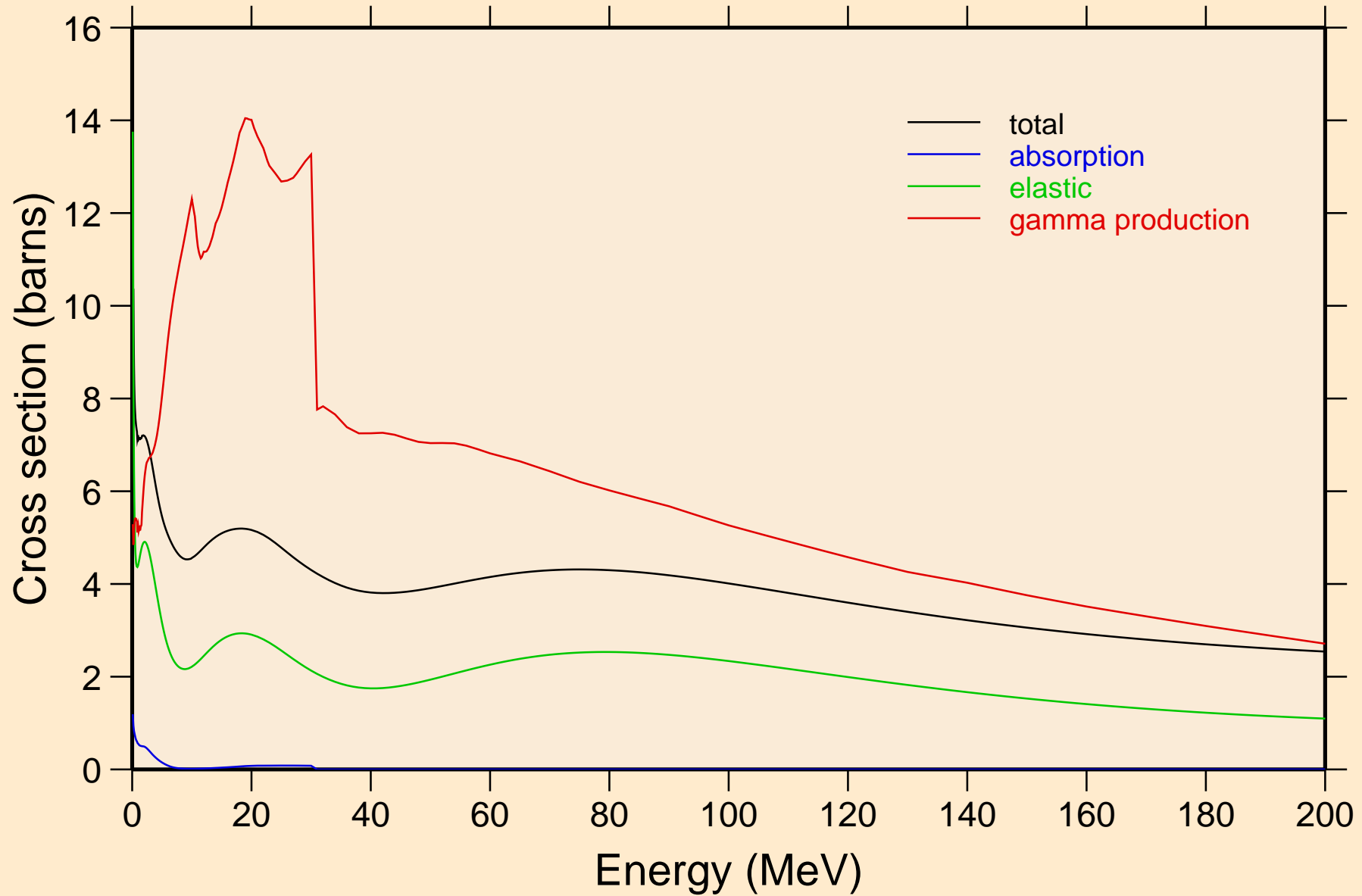

YB164 NEUTRON ACER TENDL-2023 LIBRARY; T=0.K

Heating

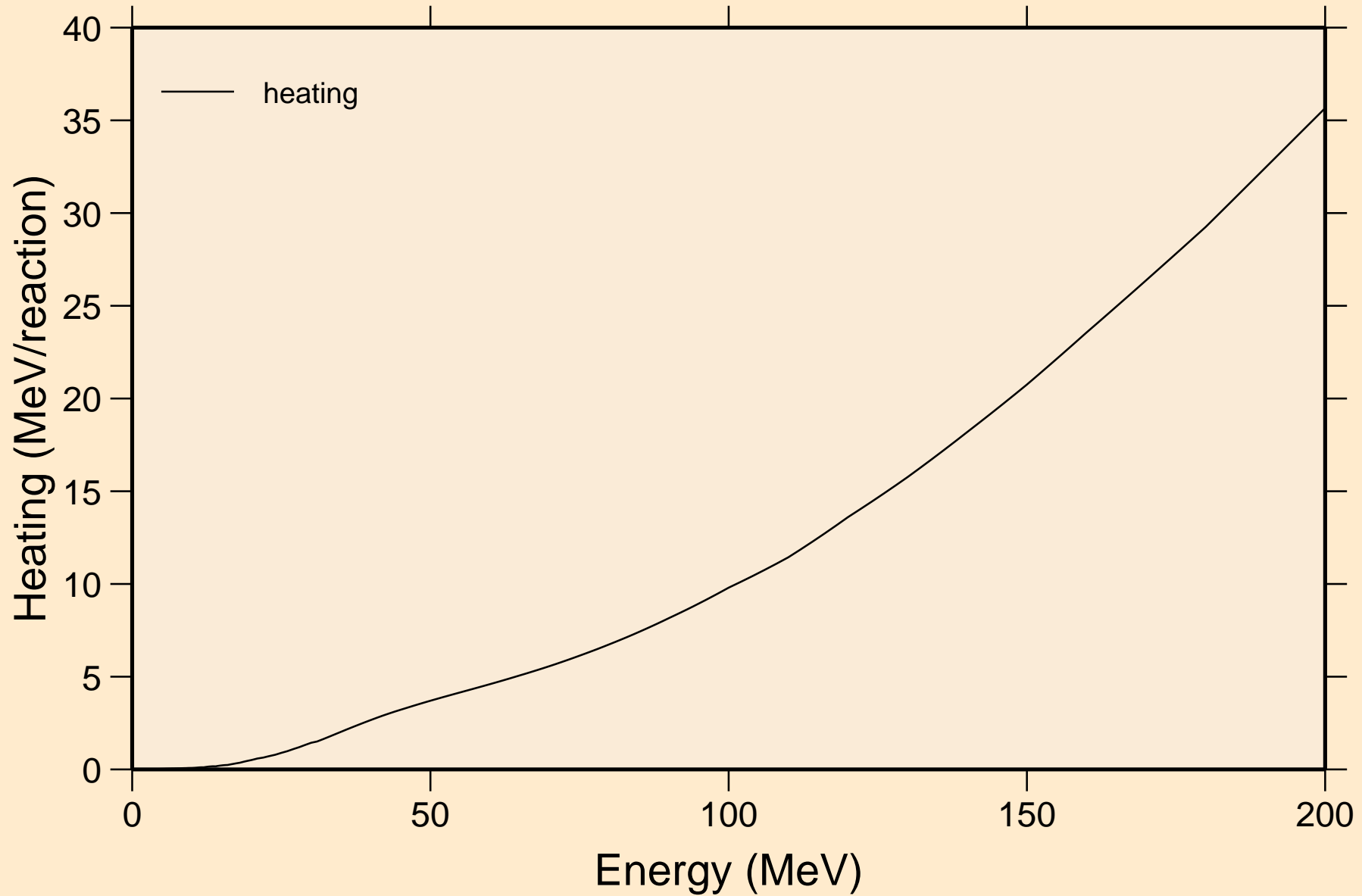

YB164 NEUTRON ACER TENDL-2023 LIBRARY; T=0.K
Damage

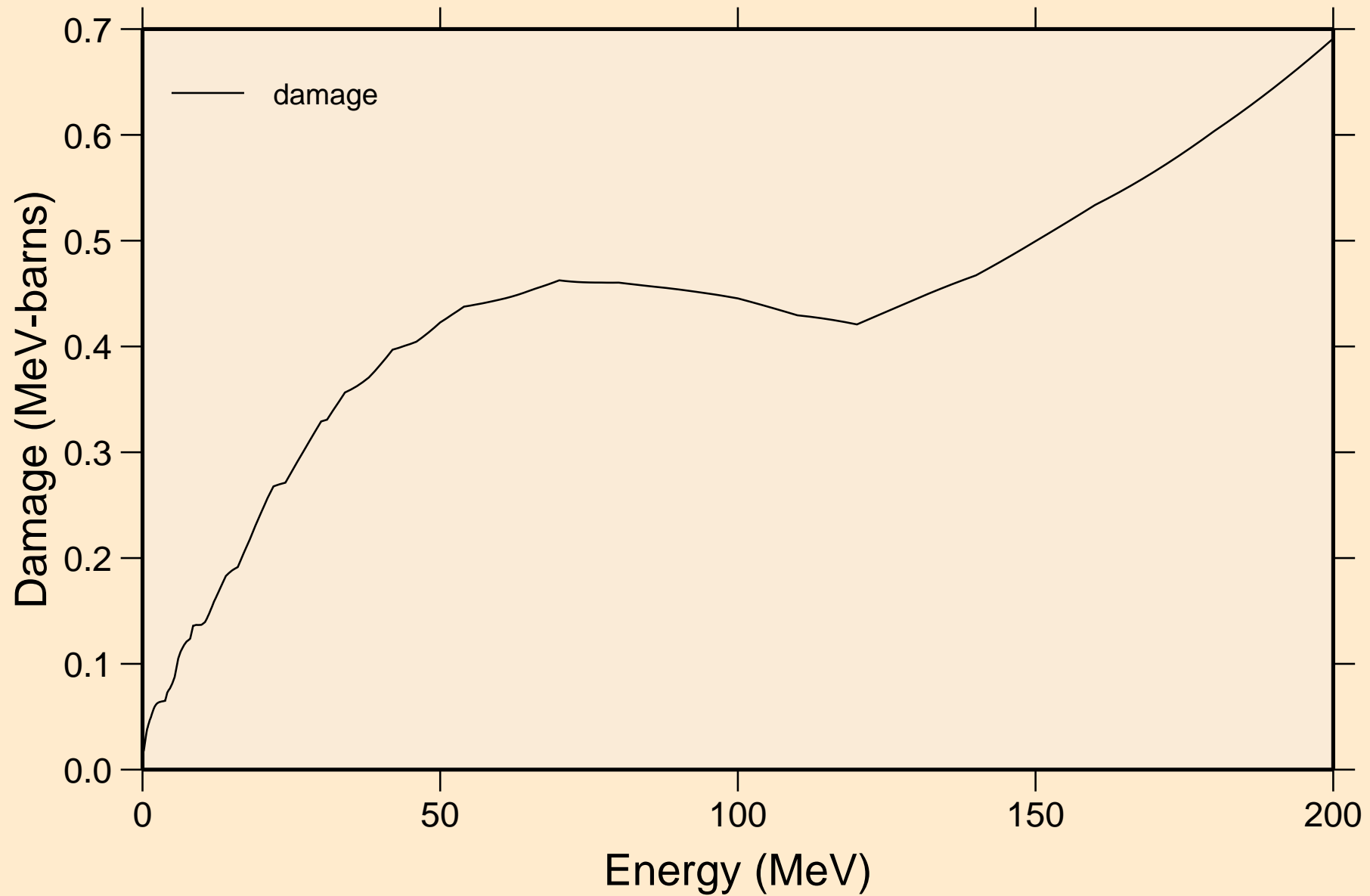

YB164 NEUTRON ACER TENDL-2023 LIBRARY; T=0.K
Non-threshold reactions

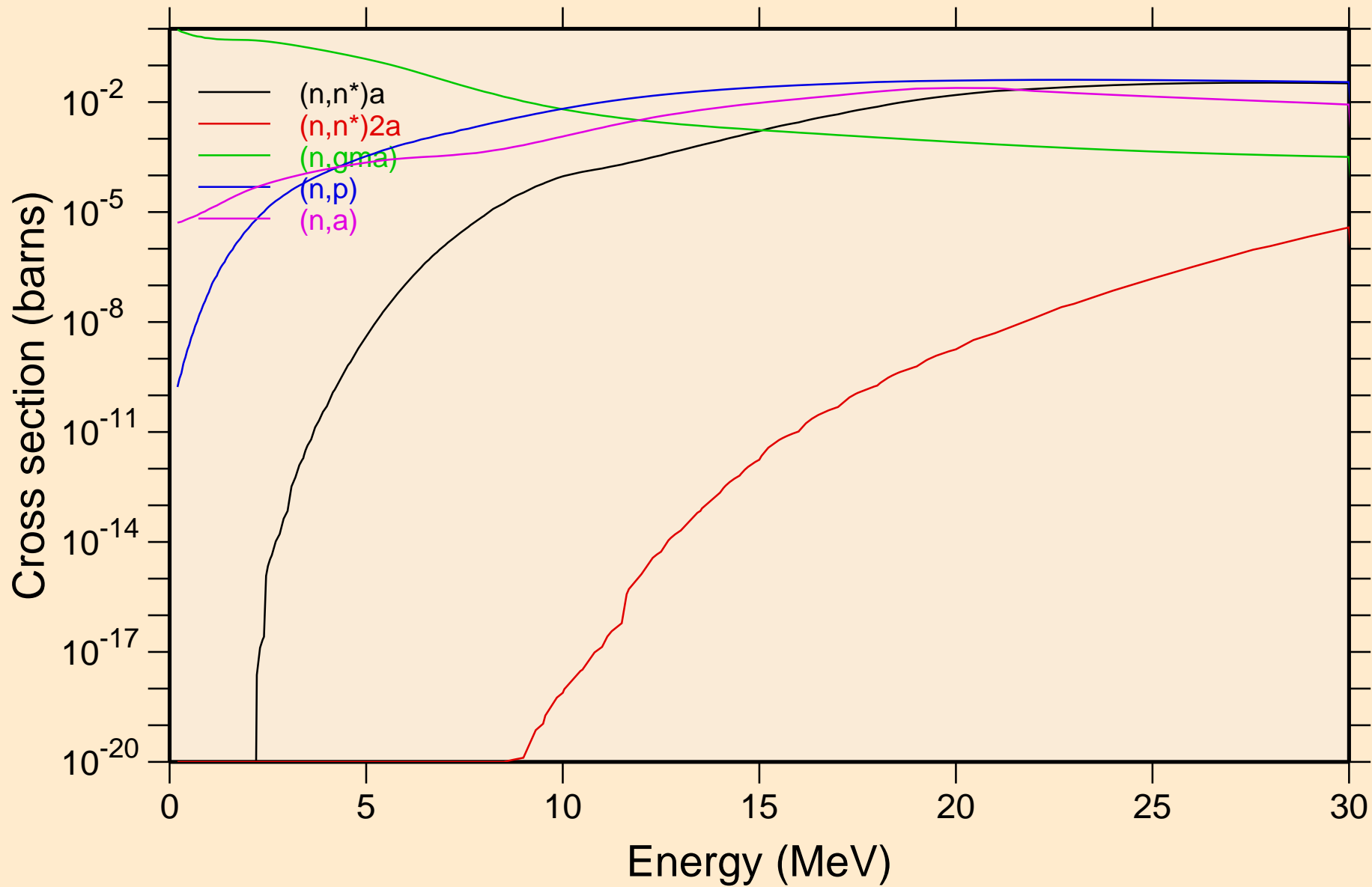

YB164 NEUTRON ACER TENDL-2023 LIBRARY; T=0.K

Non-threshold reactions

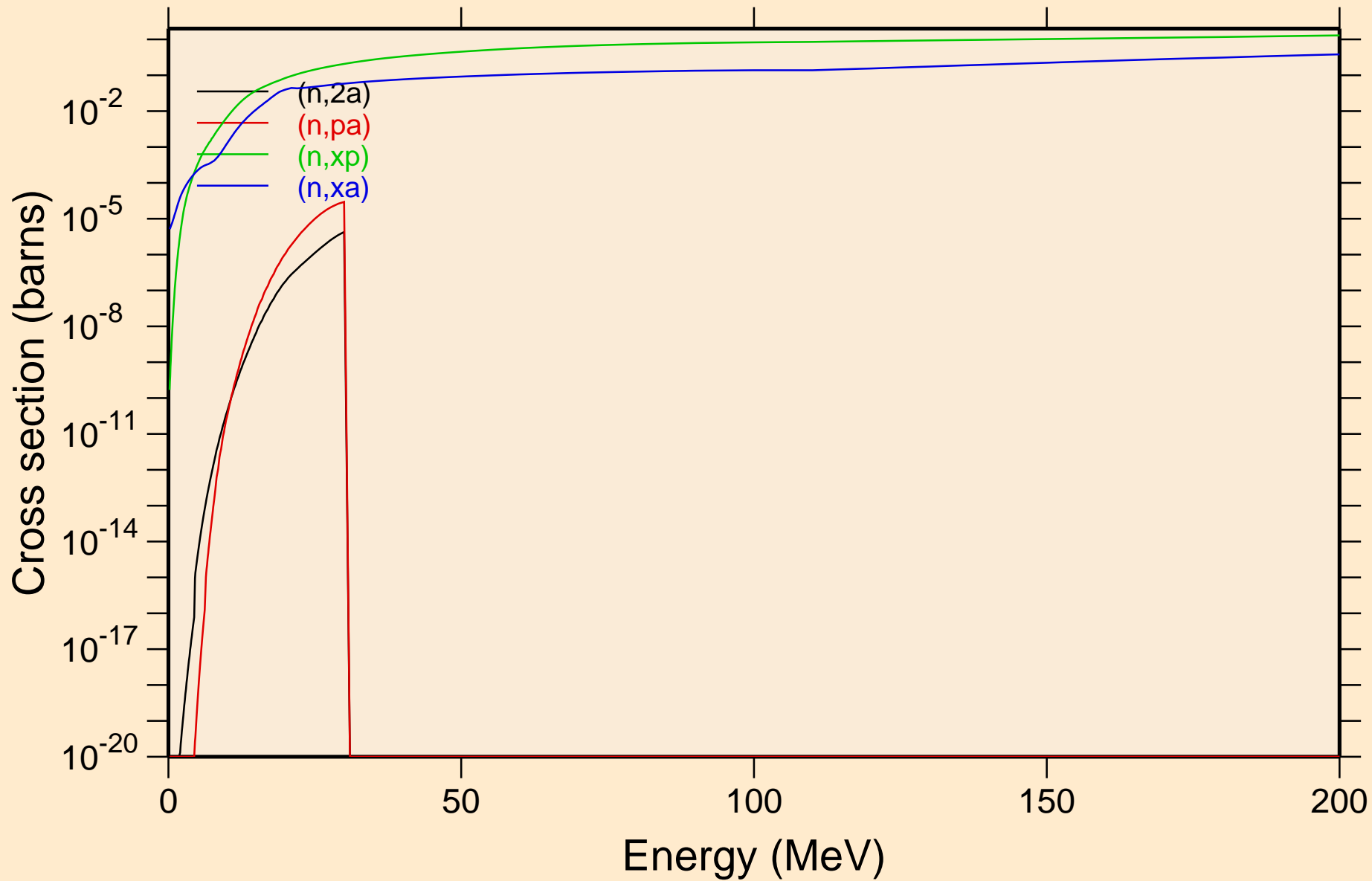

YB164 NEUTRON ACER TENDL-2023 LIBRARY; T=0.K
Inelastic levels

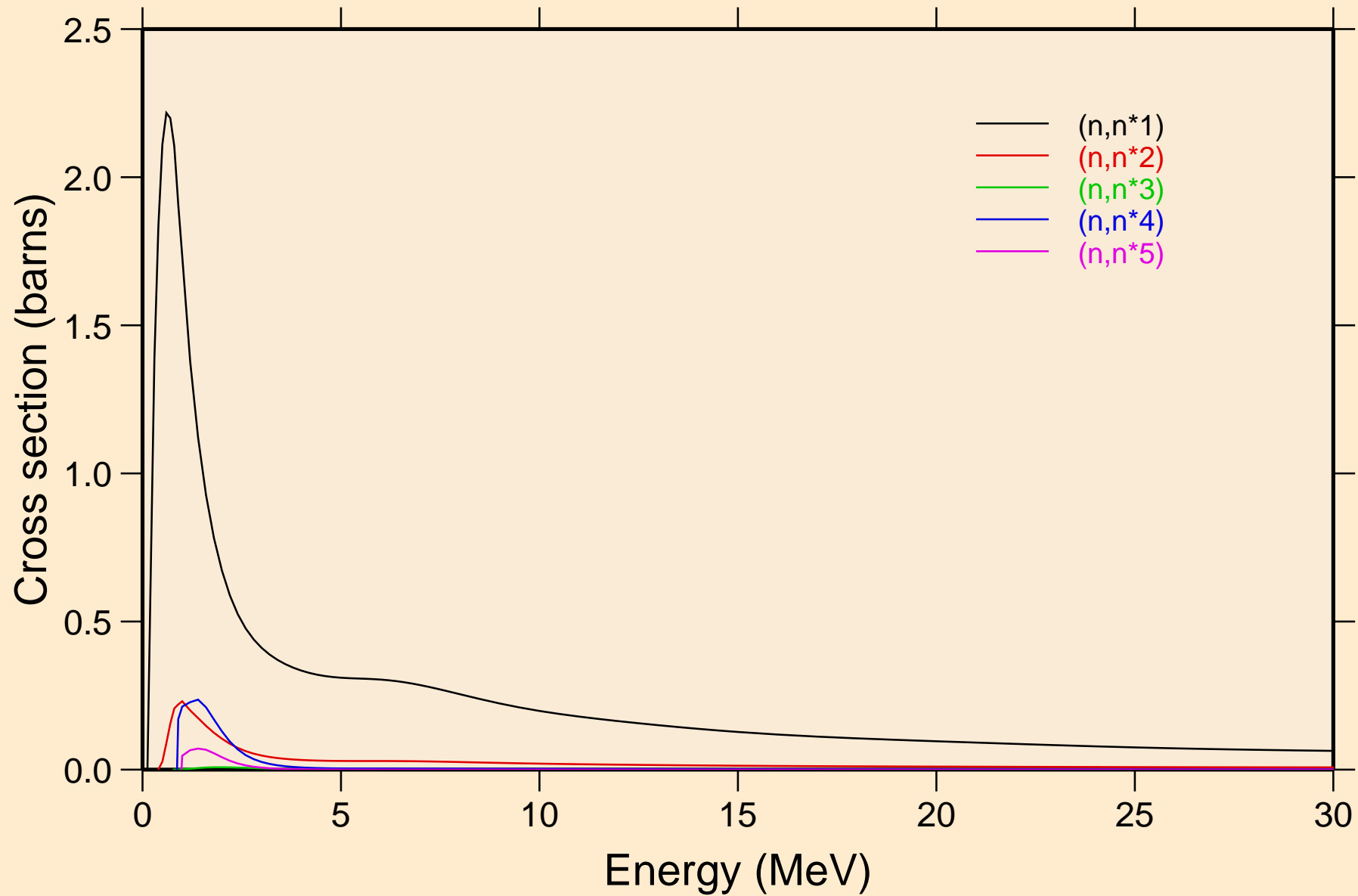

YB164 NEUTRON ACER TENDL-2023 LIBRARY; T=0.K
Inelastic levels

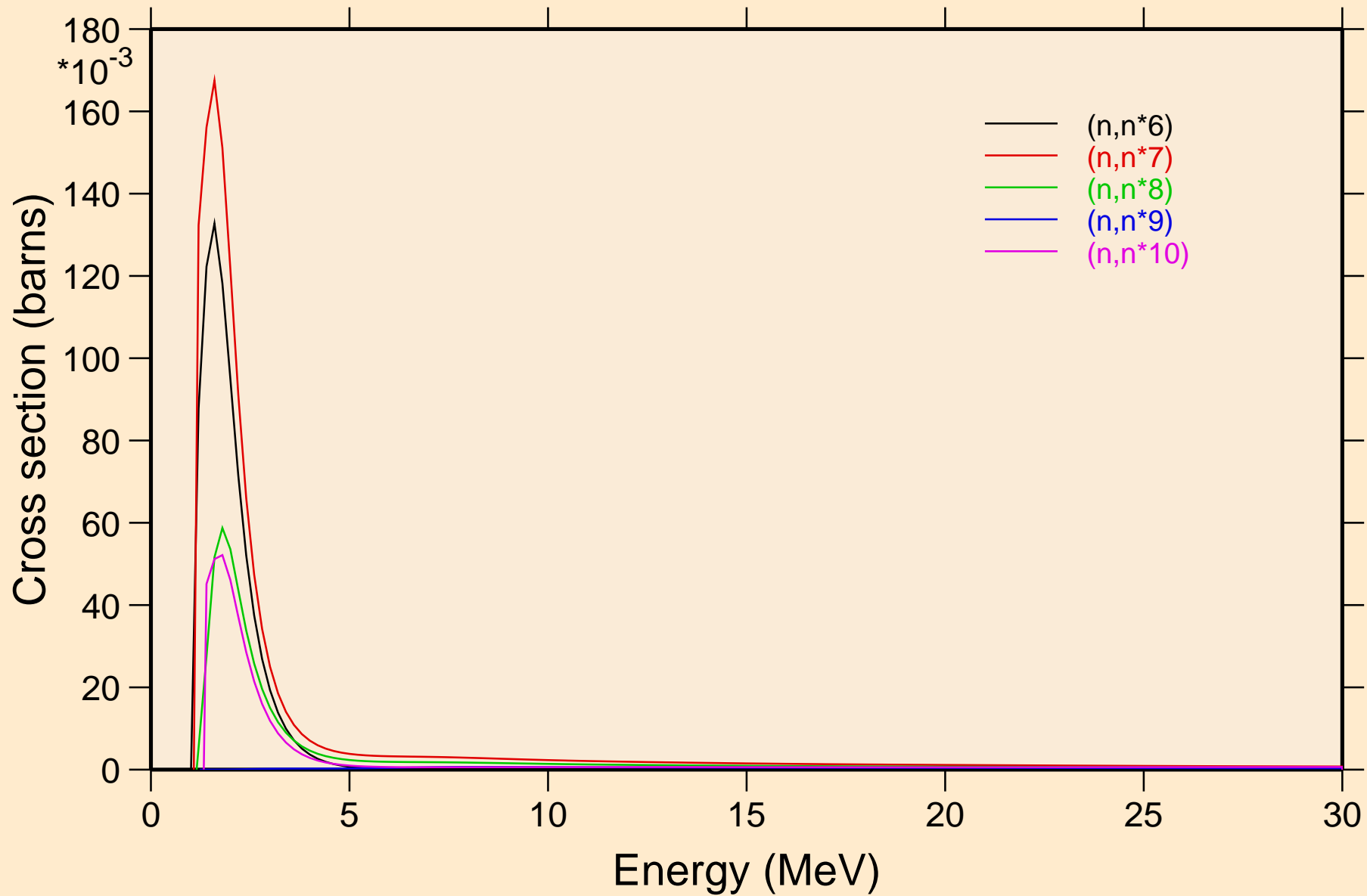

YB164 NEUTRON ACER TENDL-2023 LIBRARY; T=0.K
Inelastic levels

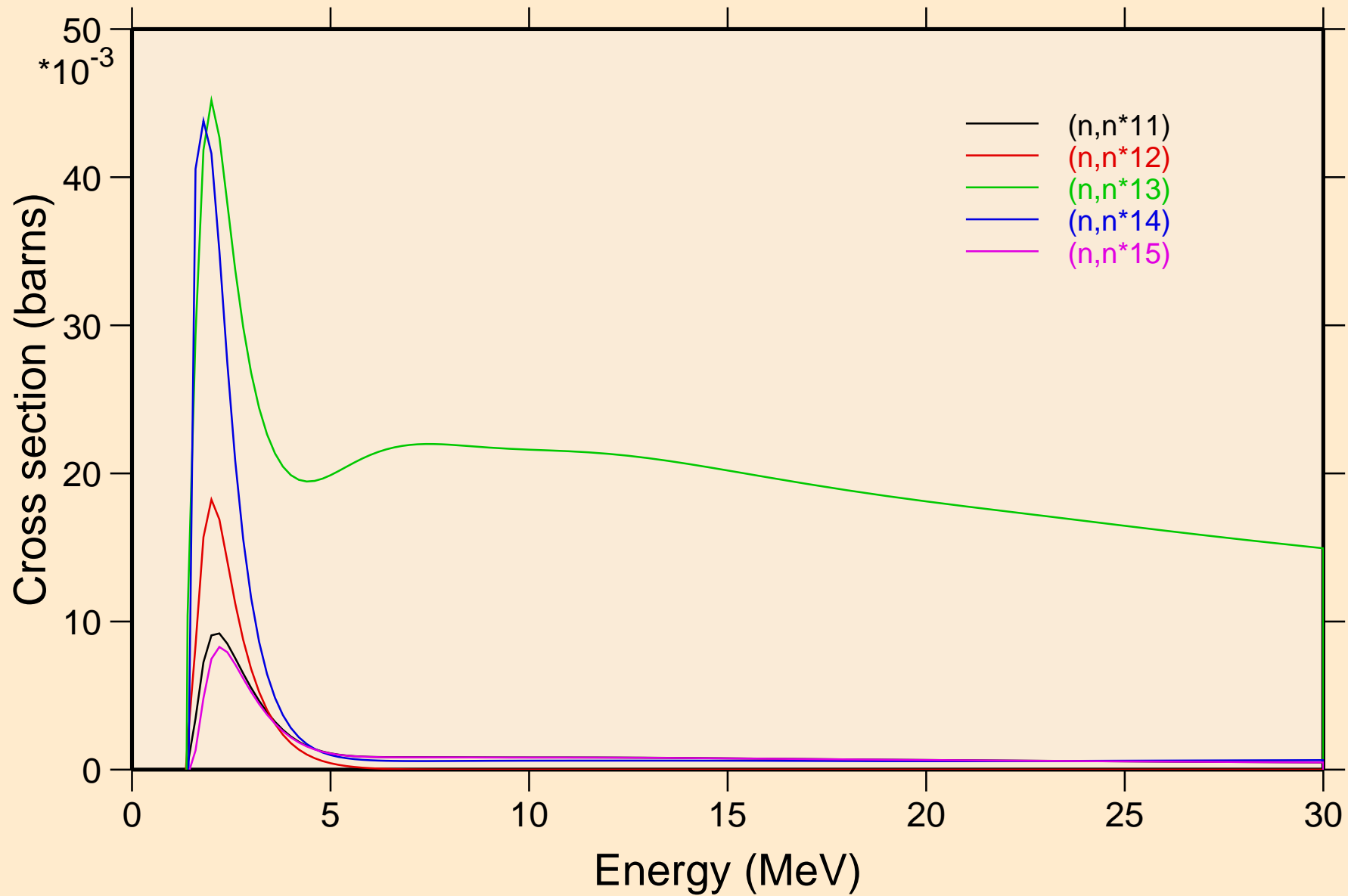

YB164 NEUTRON ACER TENDL-2023 LIBRARY; T=0.K

Inelastic levels

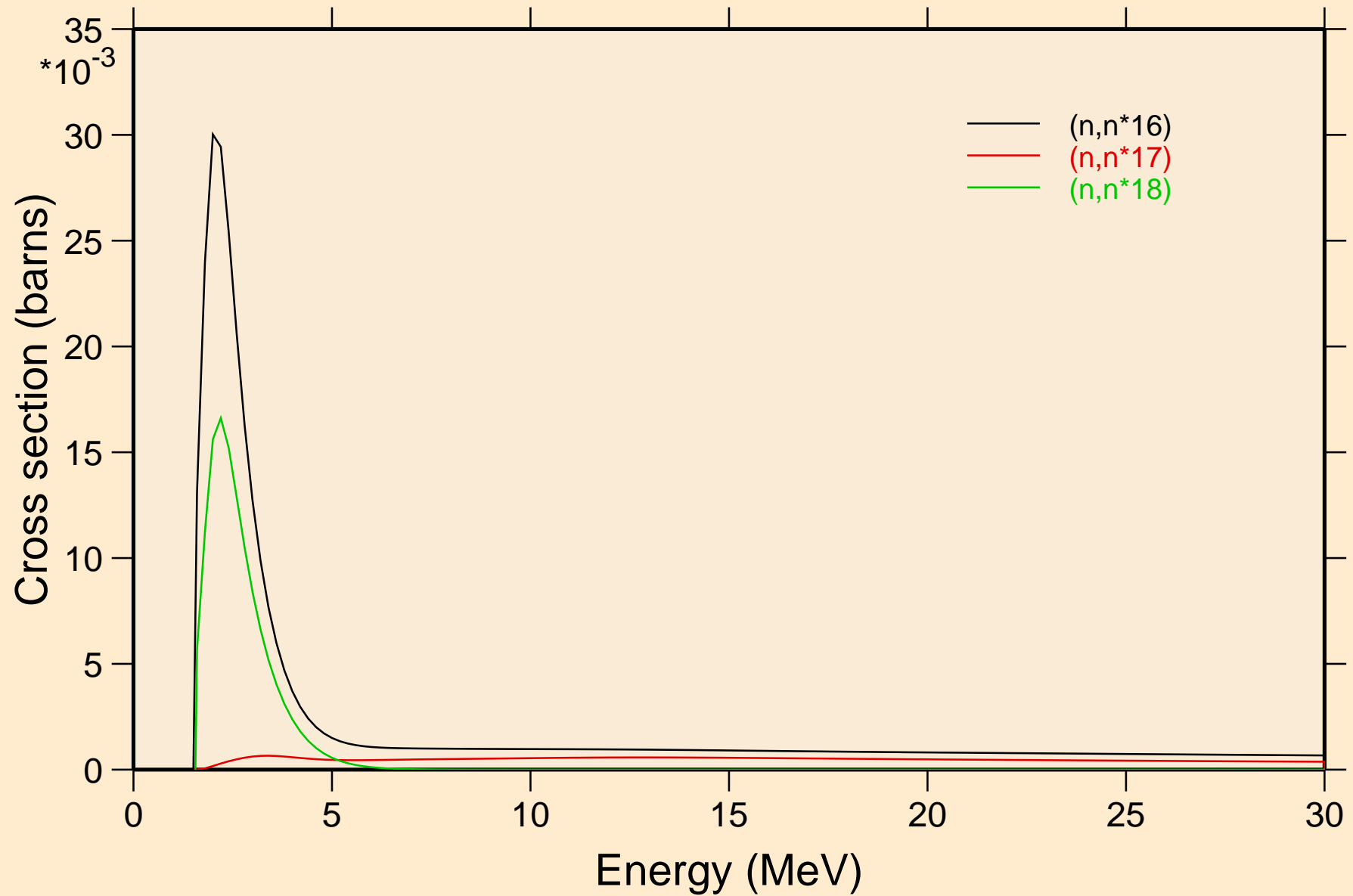

YB164 NEUTRON ACER TENDL-2023 LIBRARY; T=0.K
Threshold reactions

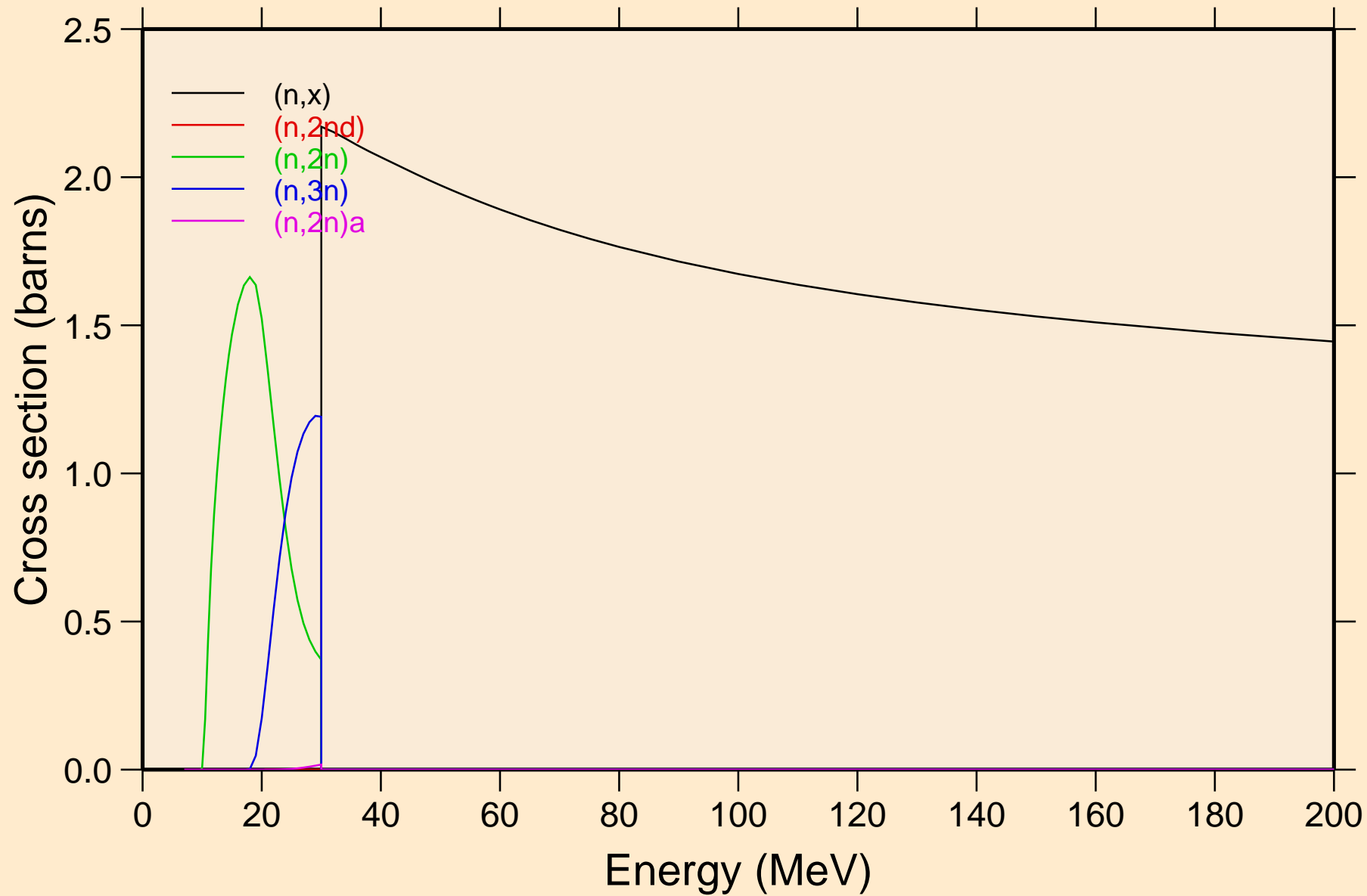

YB164 NEUTRON ACER TENDL-2023 LIBRARY; T=0.K
Threshold reactions

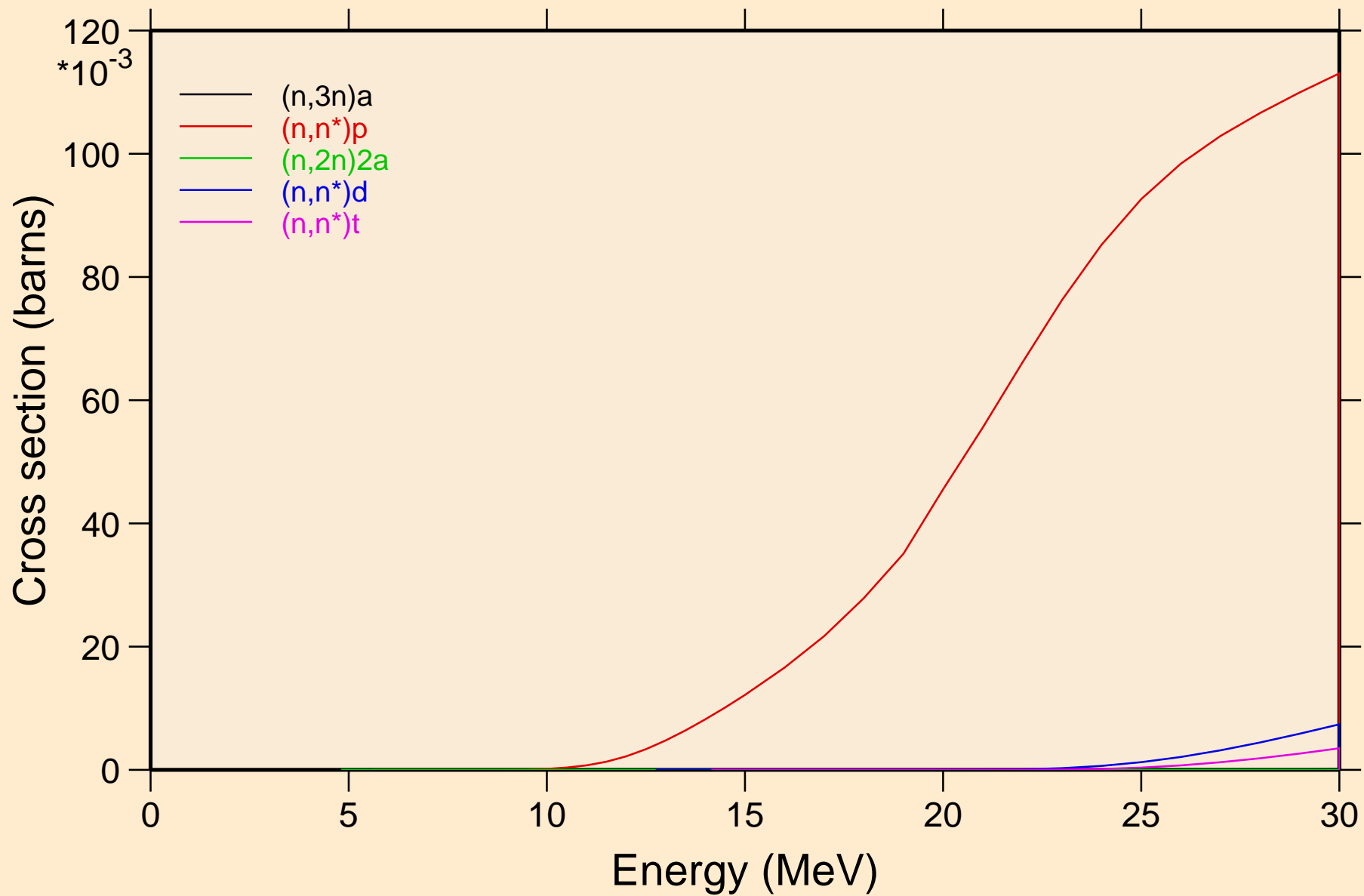

YB164 NEUTRON ACER TENDL-2023 LIBRARY; T=0.K
Threshold reactions

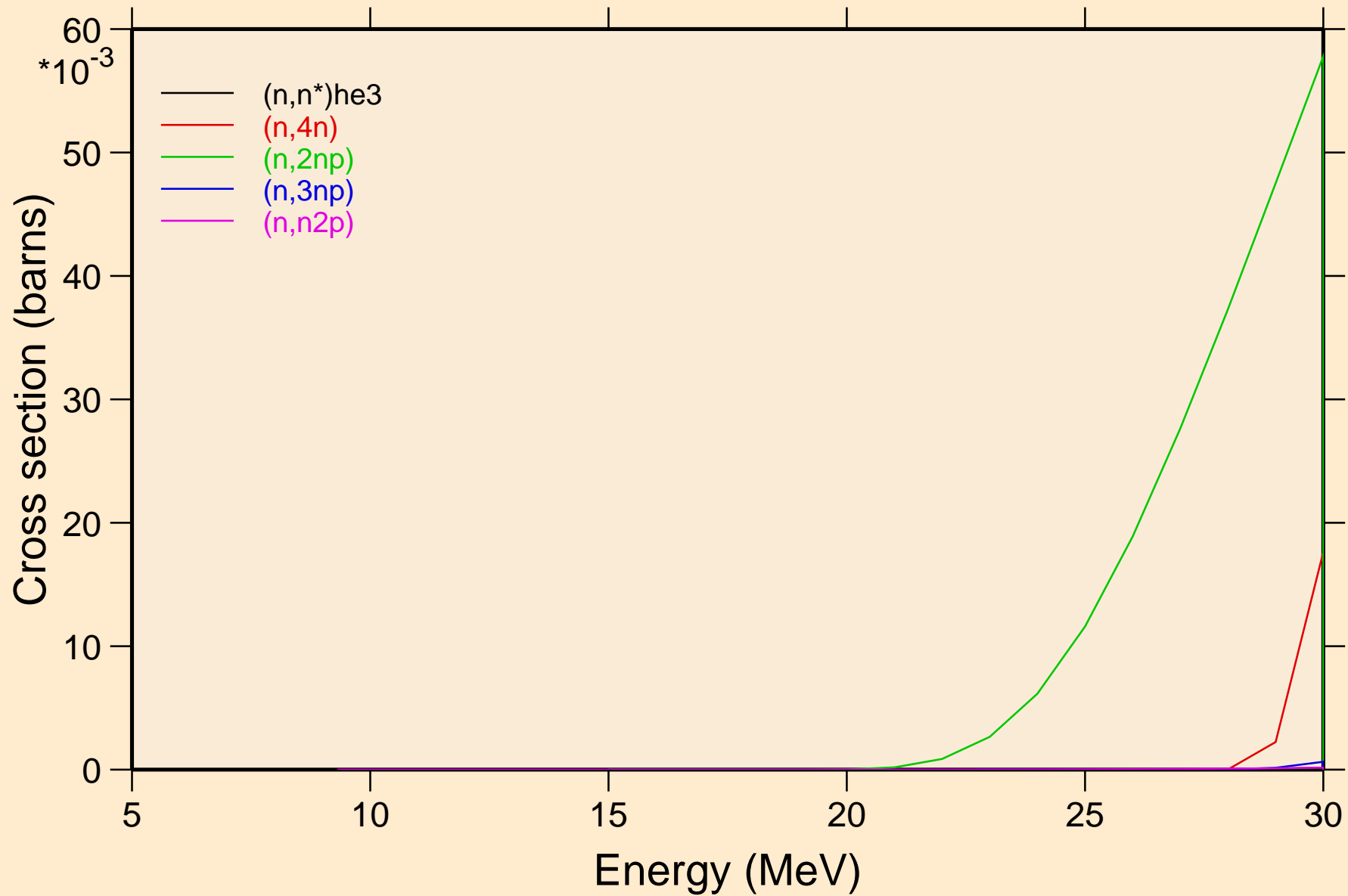

YB164 NEUTRON ACER TENDL-2023 LIBRARY; T=0.K
Threshold reactions

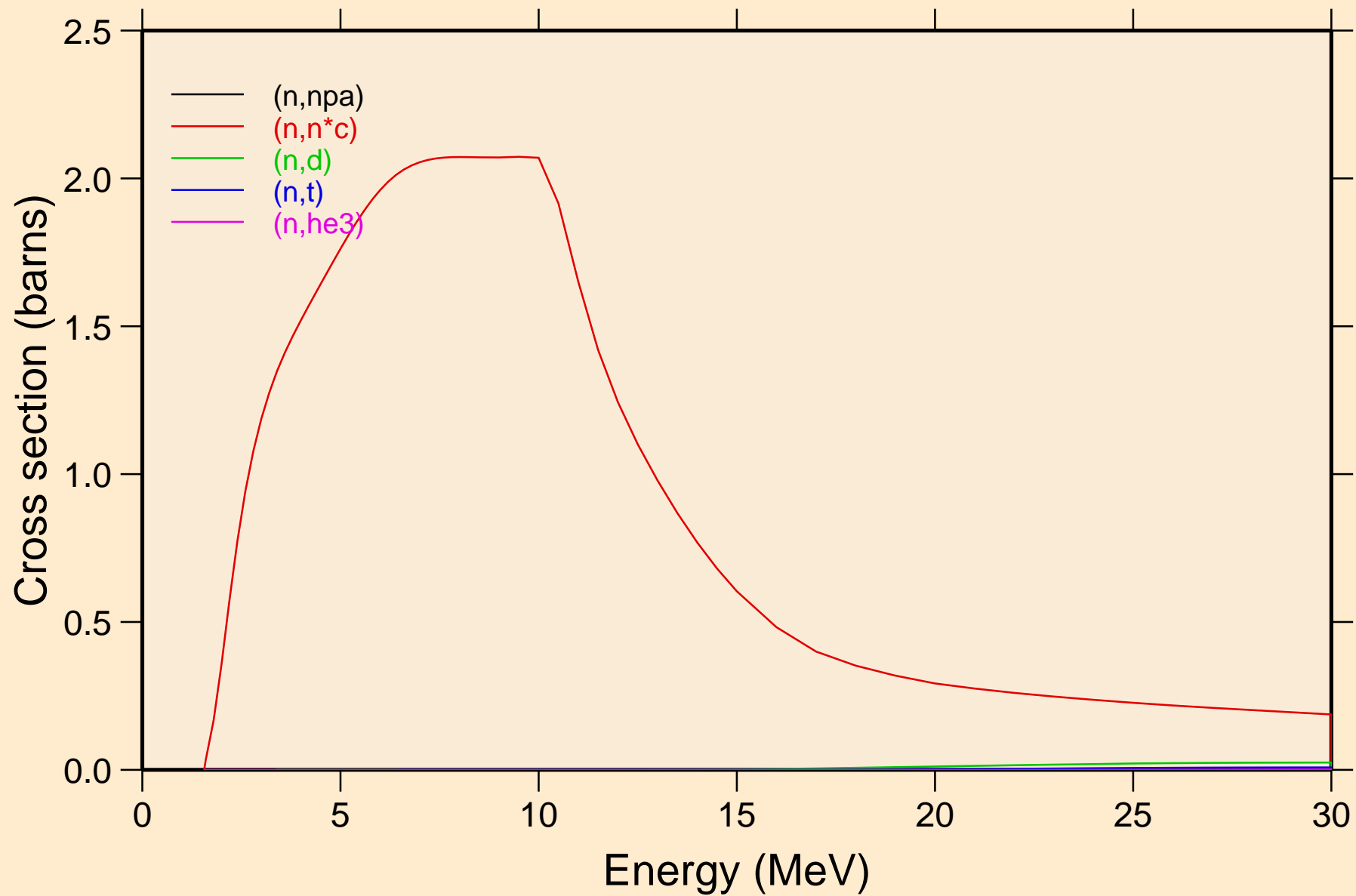

YB164 NEUTRON ACER TENDL-2023 LIBRARY; T=0.K
Threshold reactions

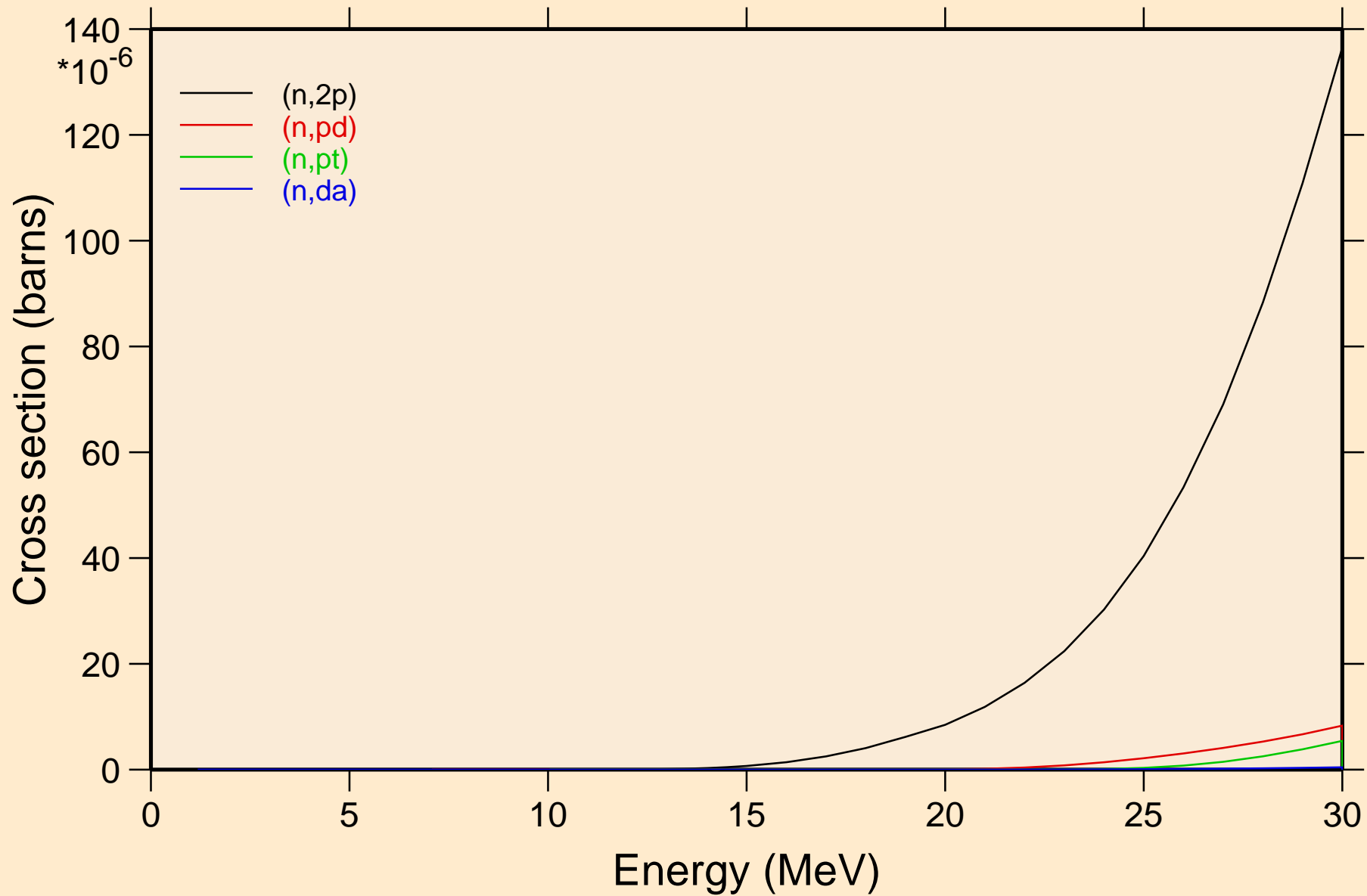

YB164 NEUTRON ACER TENDL-2023 LIBRARY; T=0.K

Threshold reactions

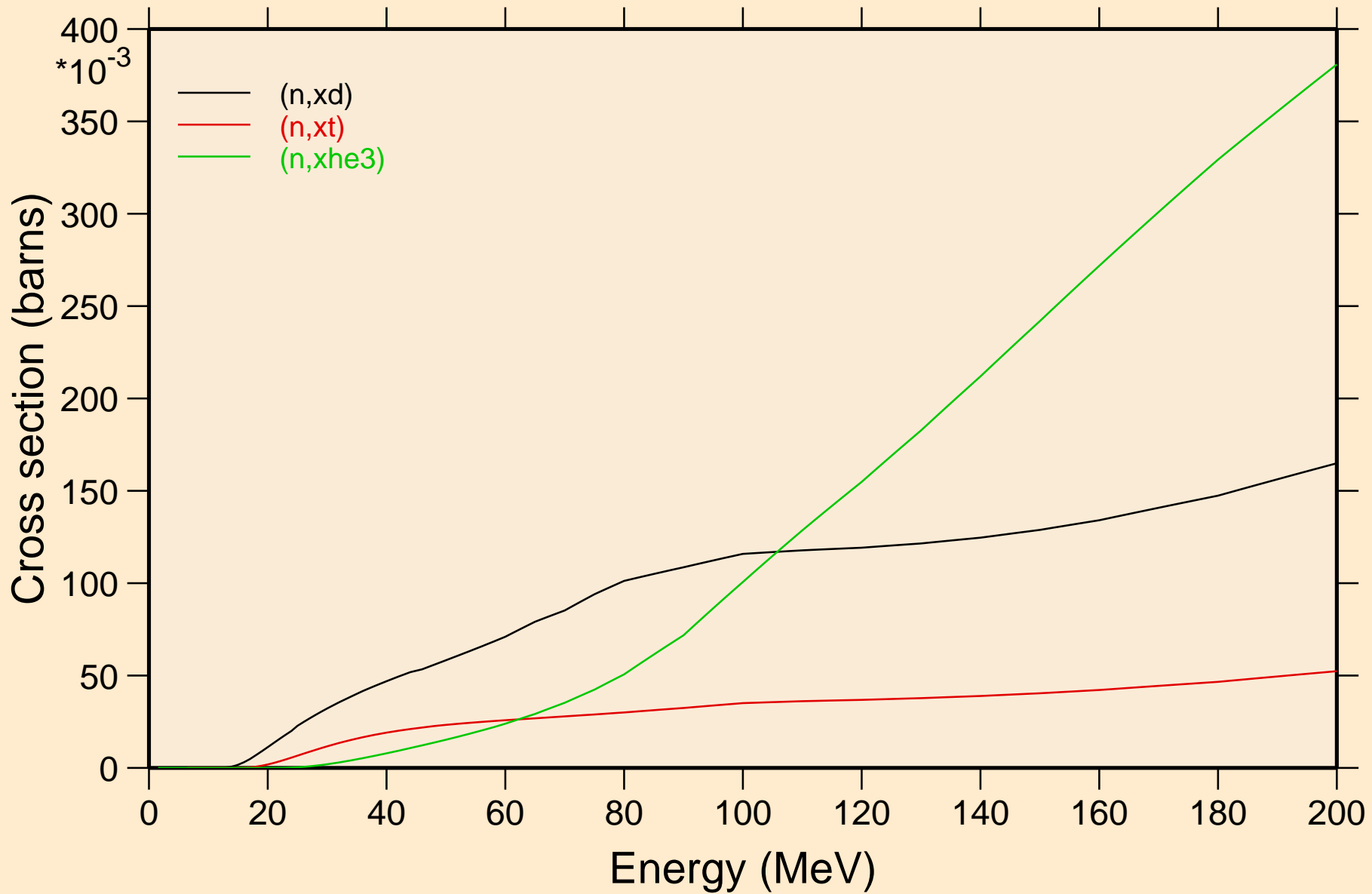

YB164 NEUTRON ACER TENDL-2023 LIBRARY; T=0.K
angular distribution for elastic

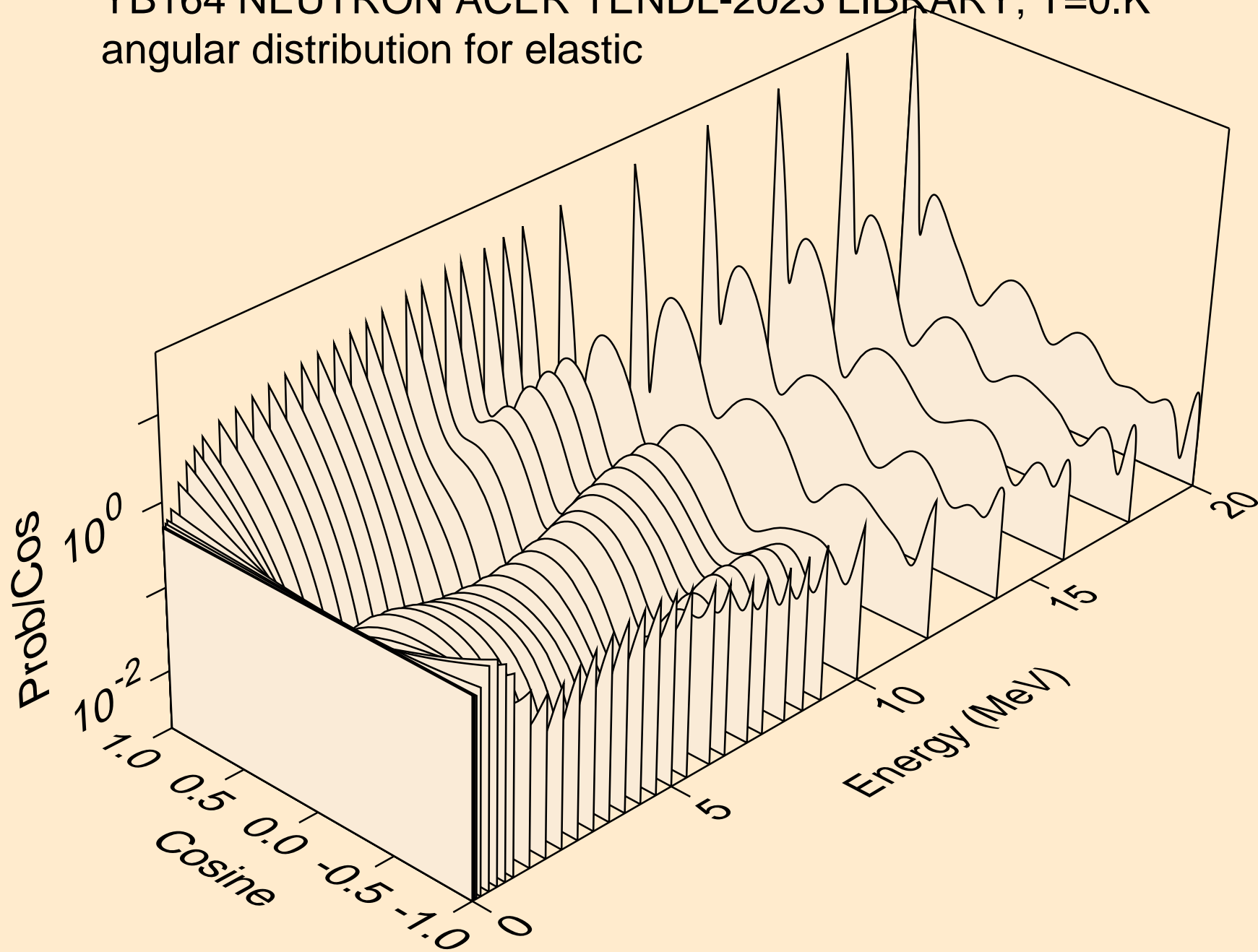

YB164 NEUTRON ACER TENDL-2023 LIBRARY; T=0.K
angular distribution for elastic

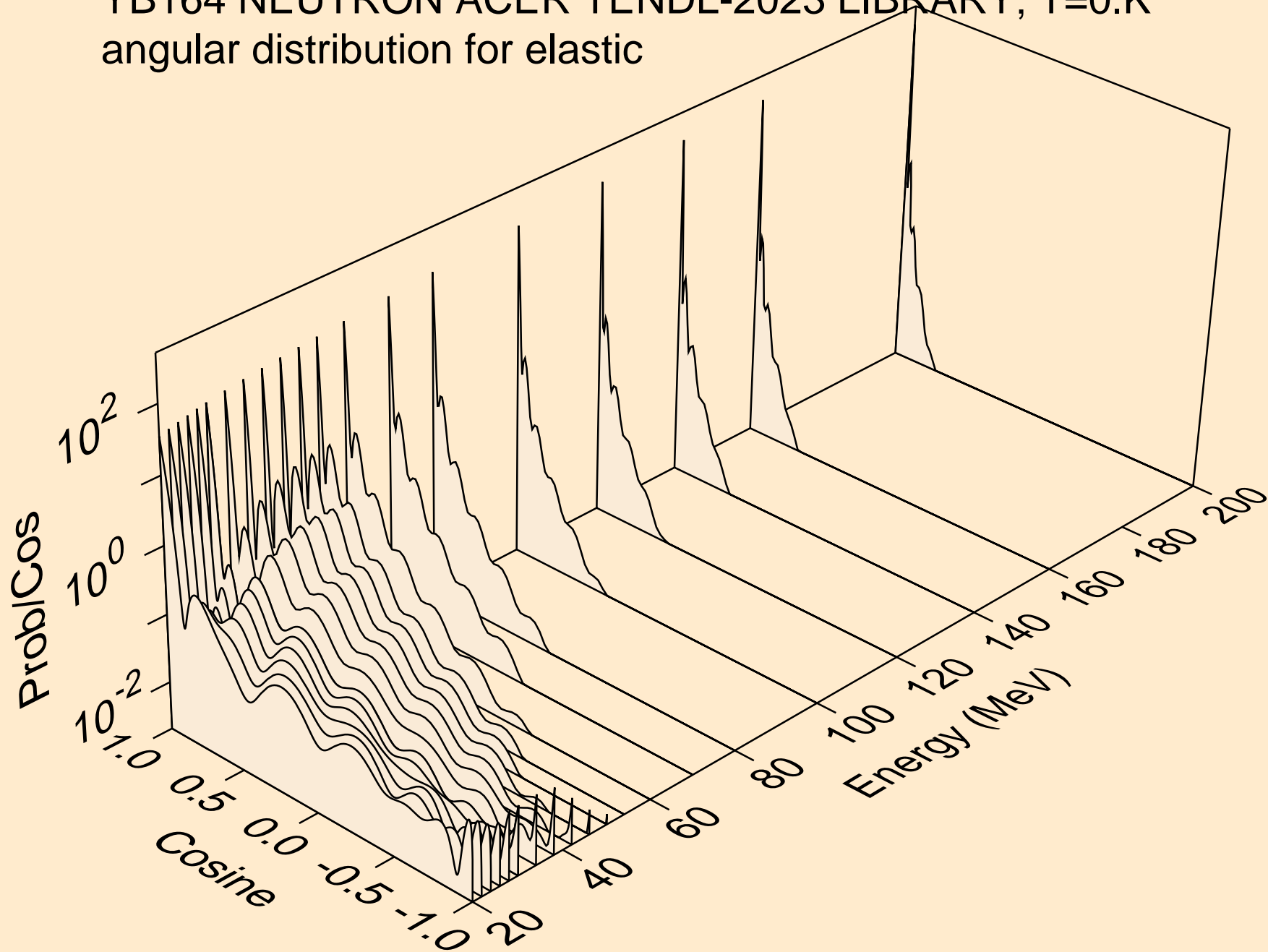

YB164 NEUTRON ACER TENDL-2023 LIBRARY; T=0.K
angular distribution for (n,n*1)

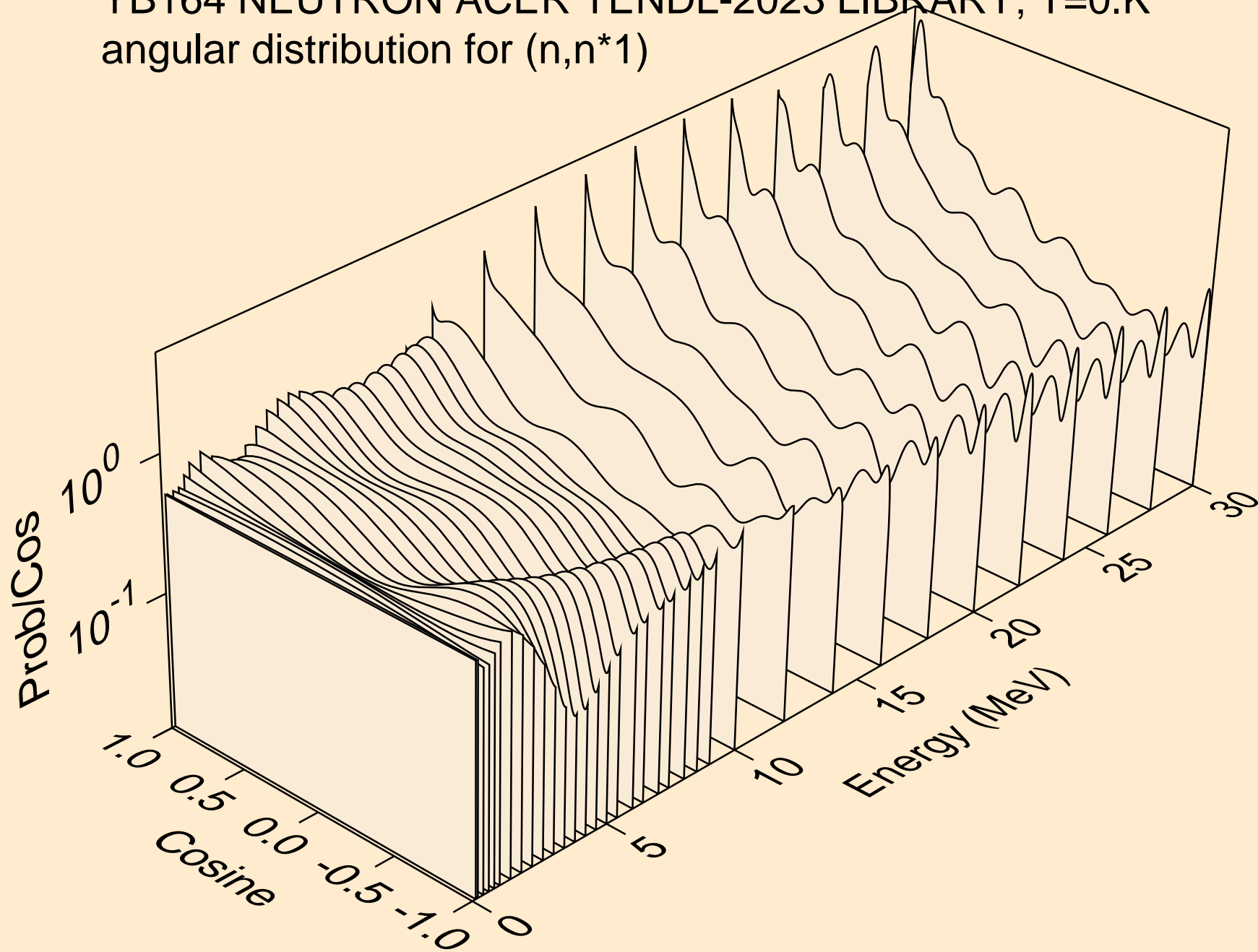

YB164 NEUTRON ACER TENDL-2023 LIBRARY; T=0.K
angular distribution for (n,n*2)

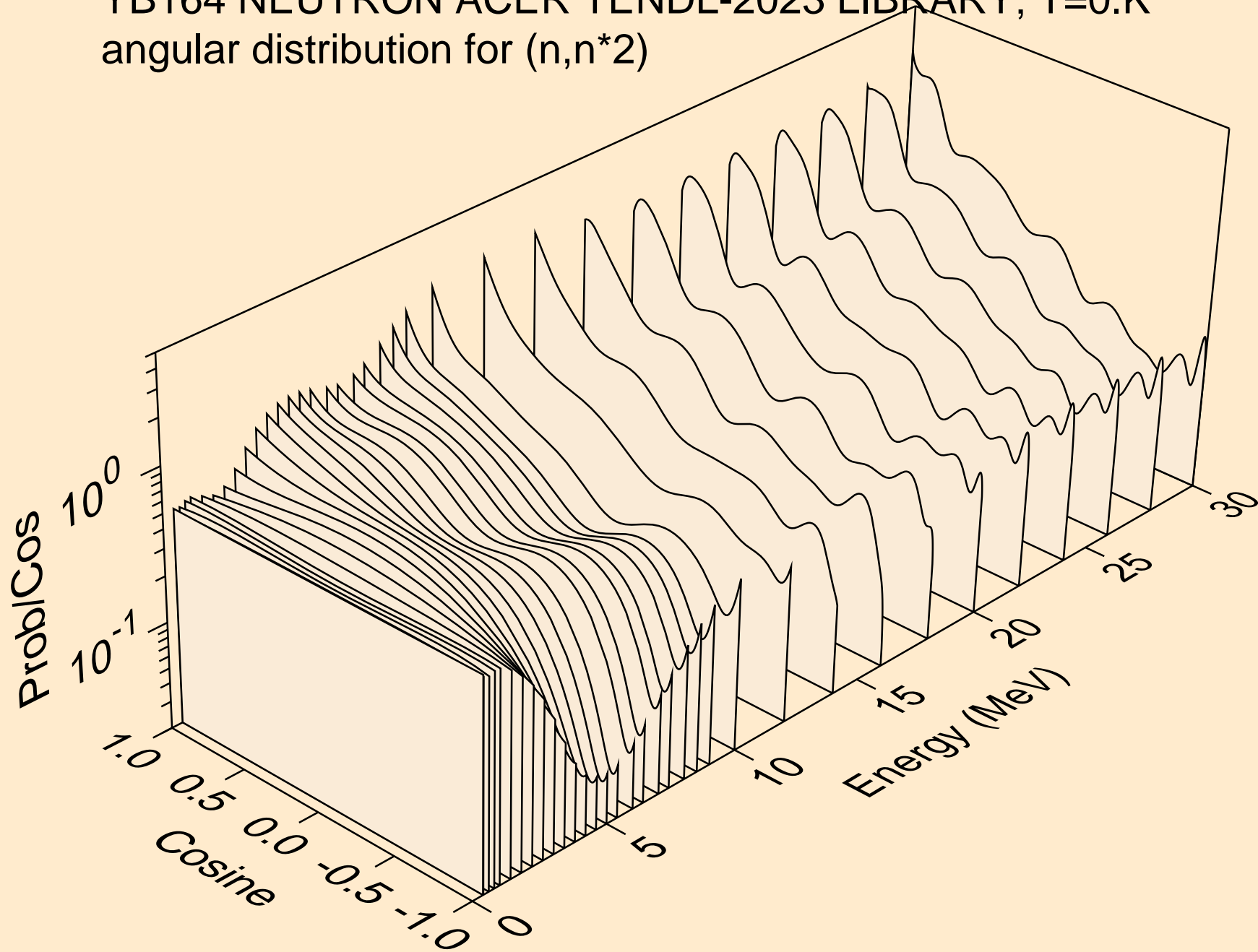

YB164 NEUTRON ACER TENDL-2023 LIBRARY; T=0.K
angular distribution for (n,n*3)

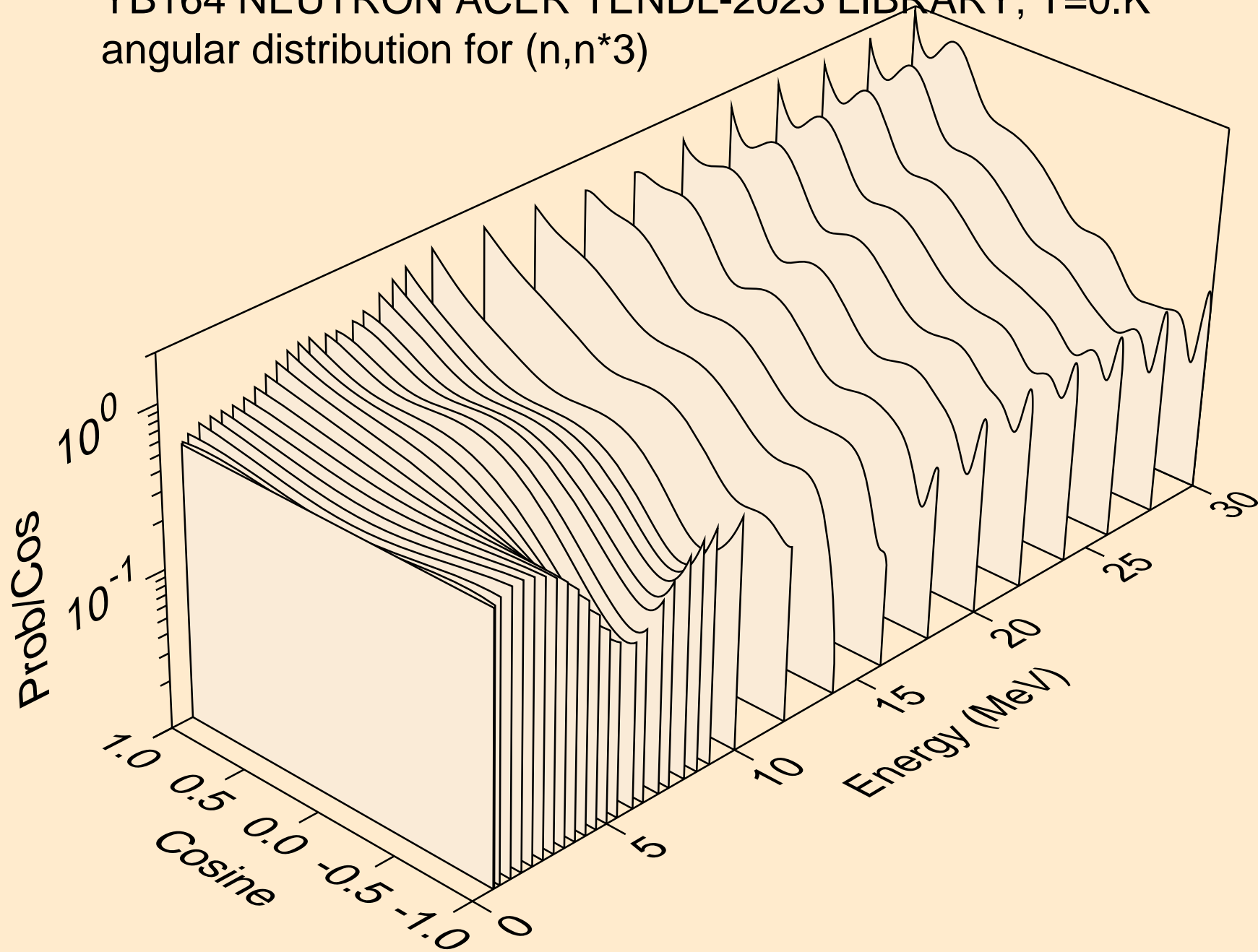

YB164 NEUTRON ACER TENDL-2023 LIBRARY; T=0.K
angular distribution for (n,n*4)

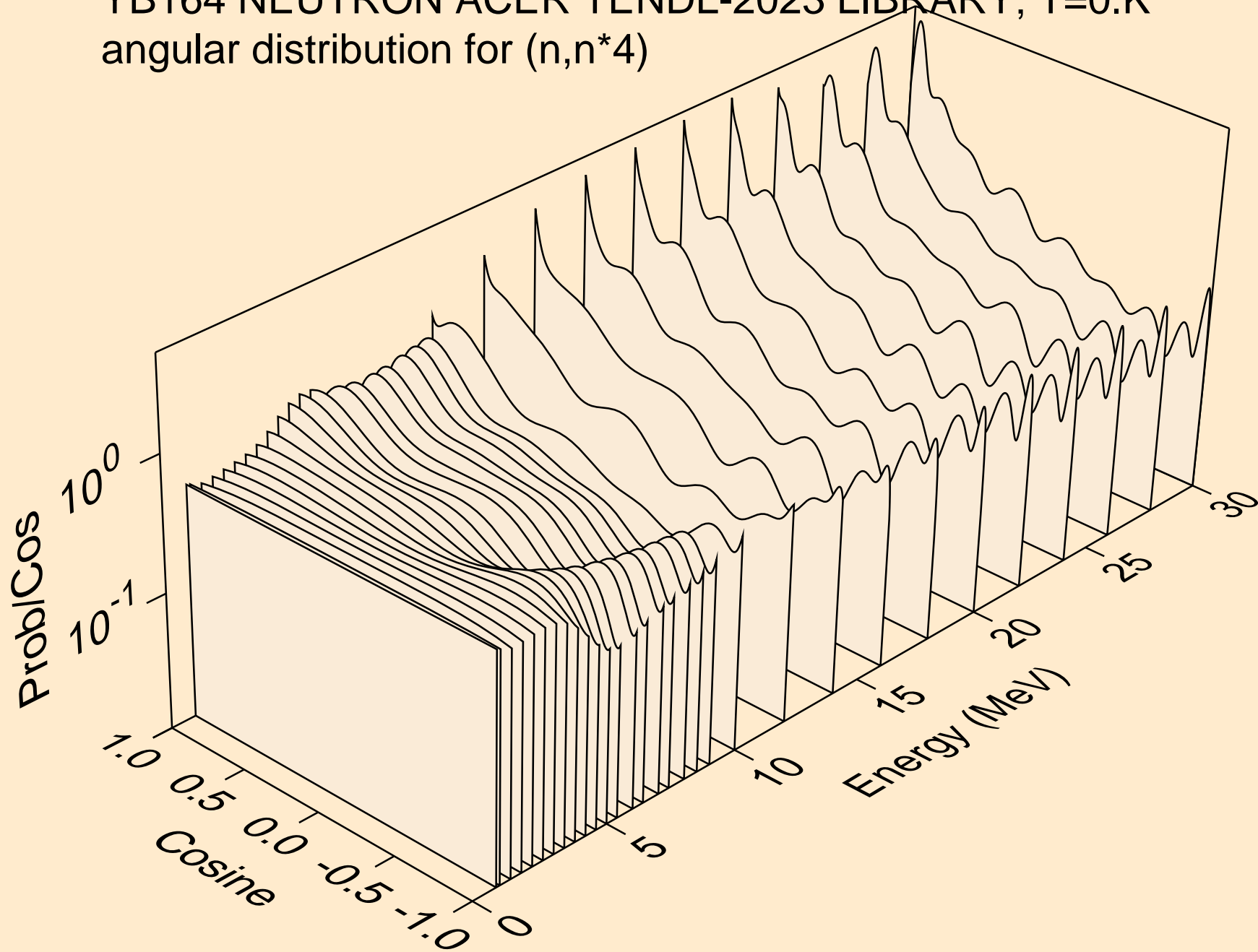

YB164 NEUTRON ACER TENDL-2023 LIBRARY; T=0.K
angular distribution for (n,n*5)

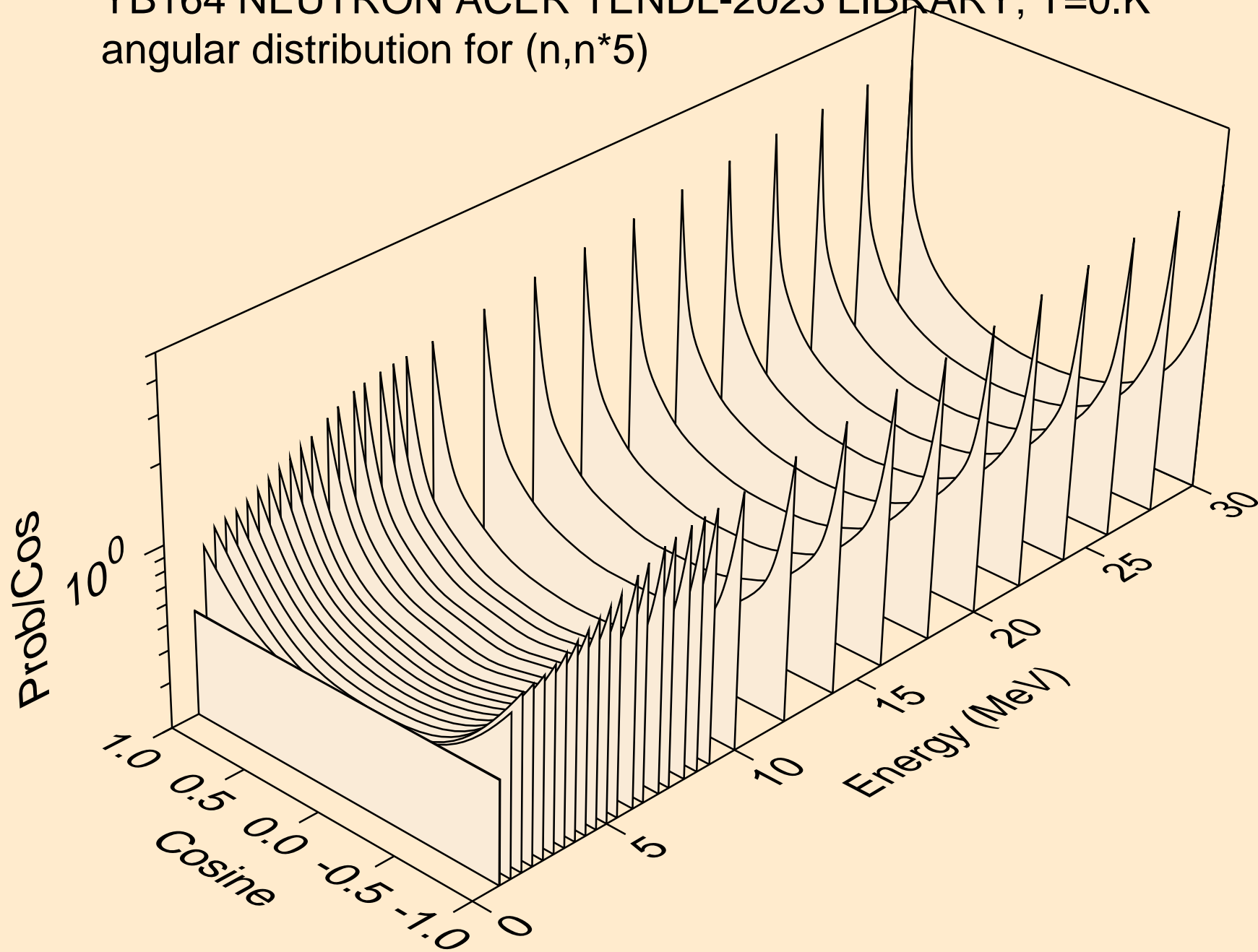

YB164 NEUTRON ACER TENDL-2023 LIBRARY; T=0.K
angular distribution for (n,n*6)

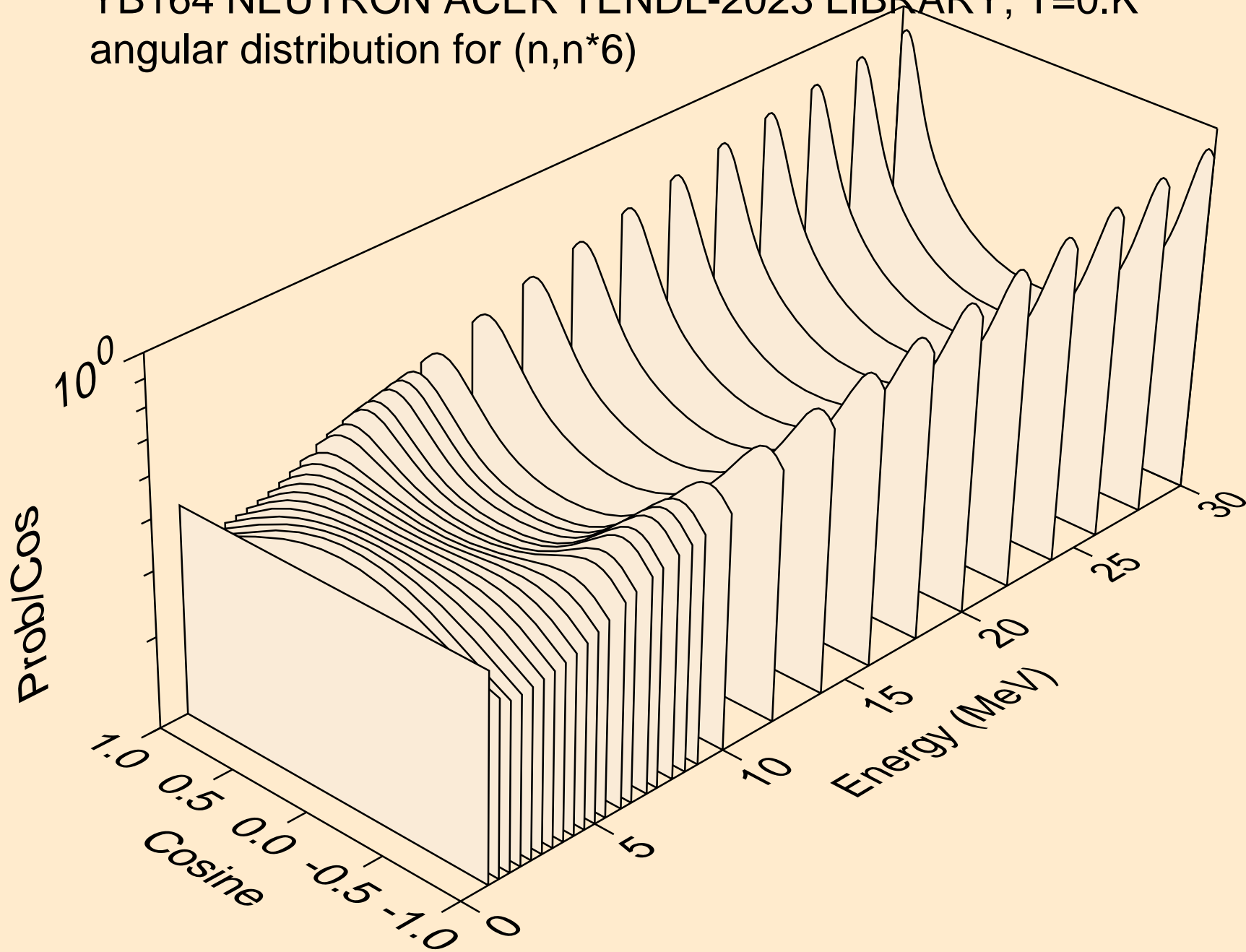

YB164 NEUTRON ACER TENDL-2023 LIBRARY; T=0.K
angular distribution for (n,n*7)

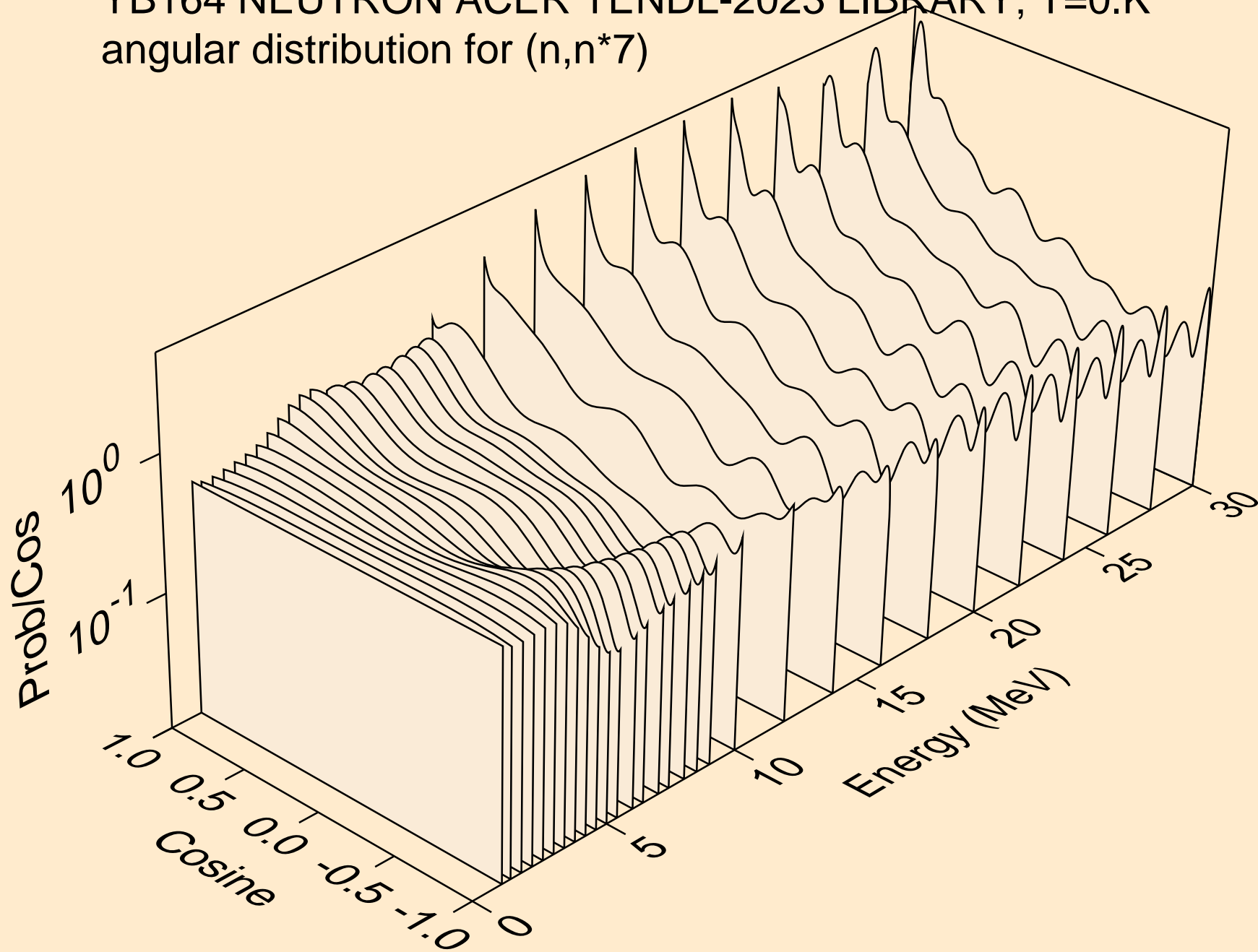

YB164 NEUTRON ACER TENDL-2023 LIBRARY; T=0.K
angular distribution for (n,n*8)

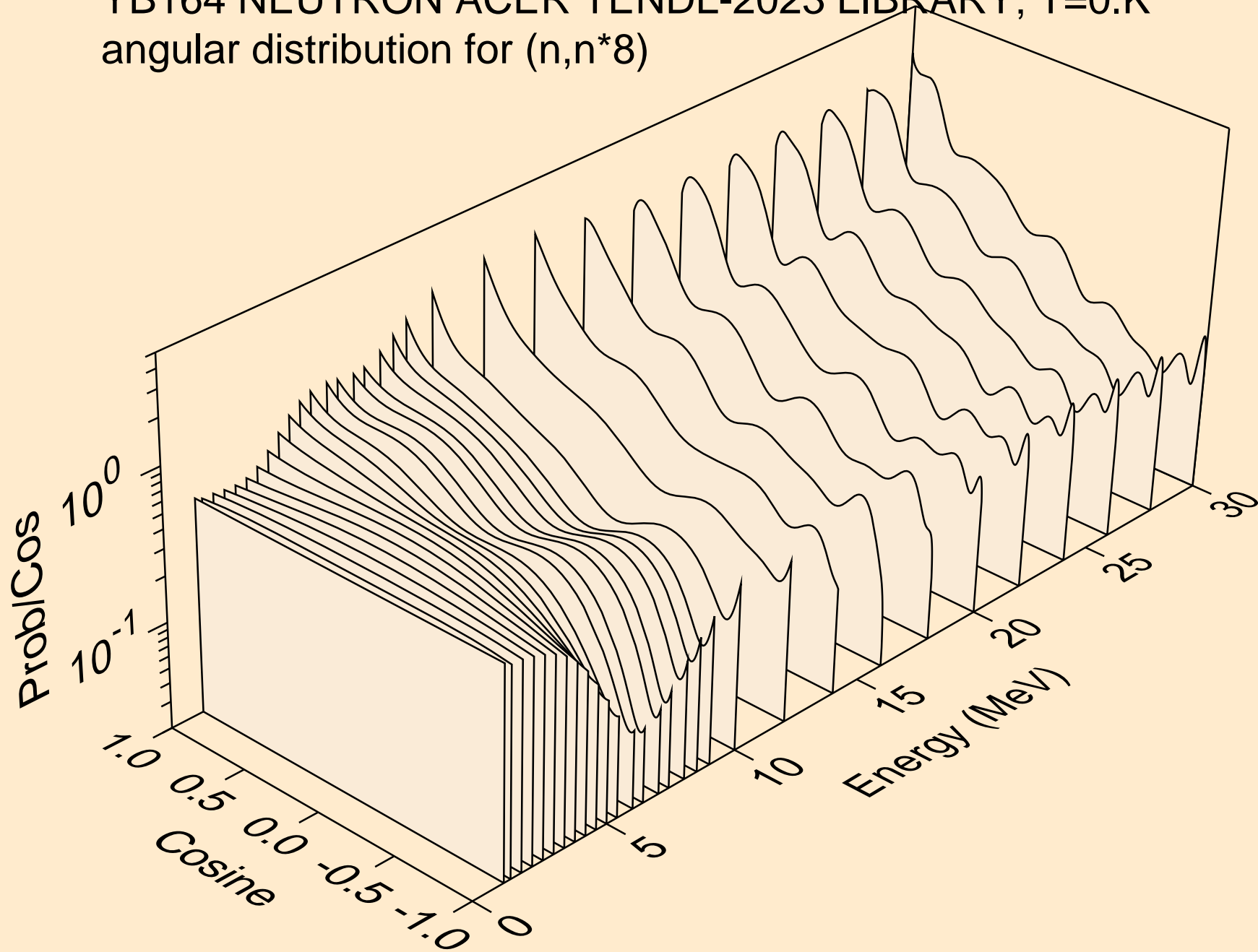

YB164 NEUTRON ACER TENDL-2023 LIBRARY; T=0.K
angular distribution for (n,n*9)

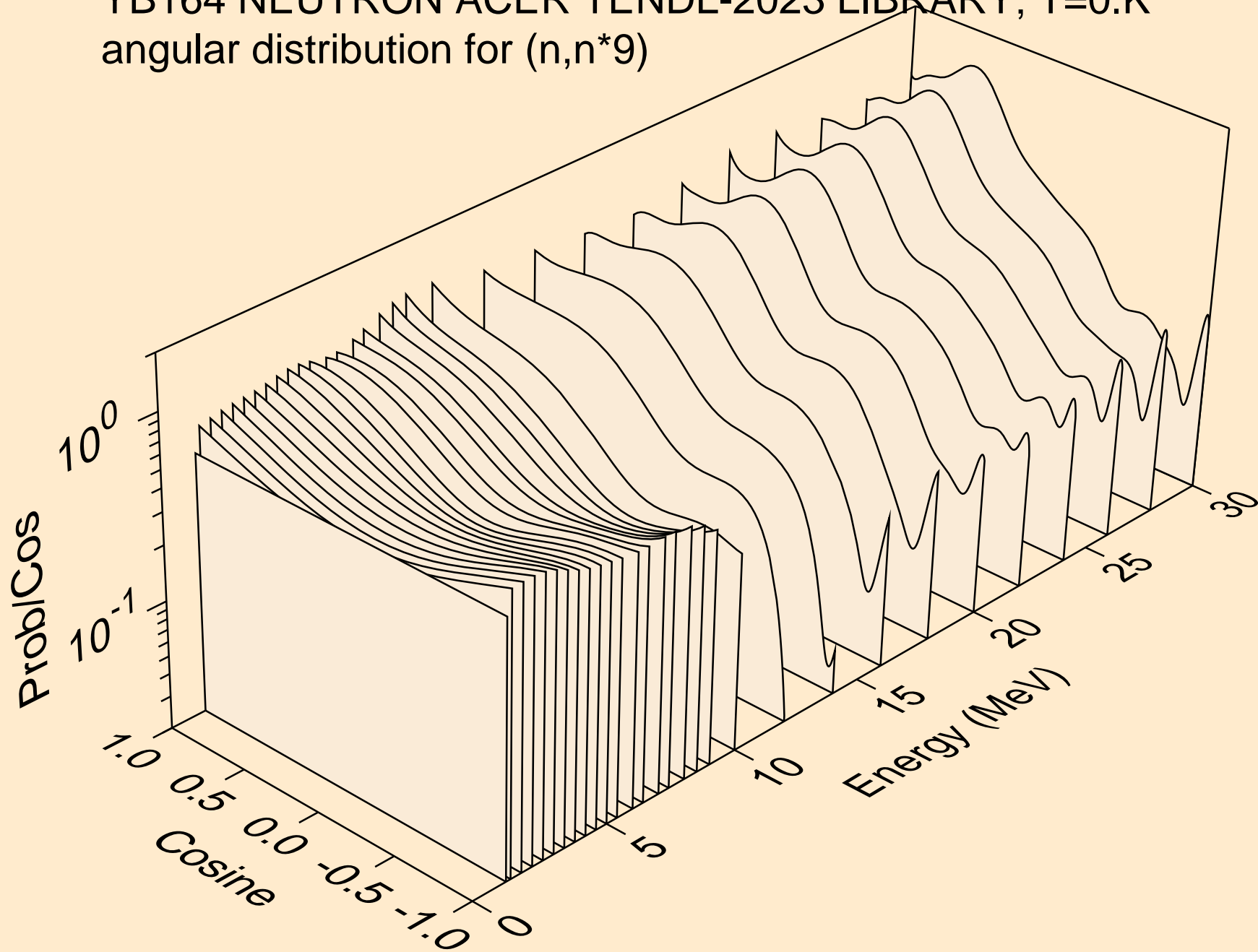

YB164 NEUTRON ACER TENDL-2023 LIBRARY; T=0.K
angular distribution for (n,n*10)

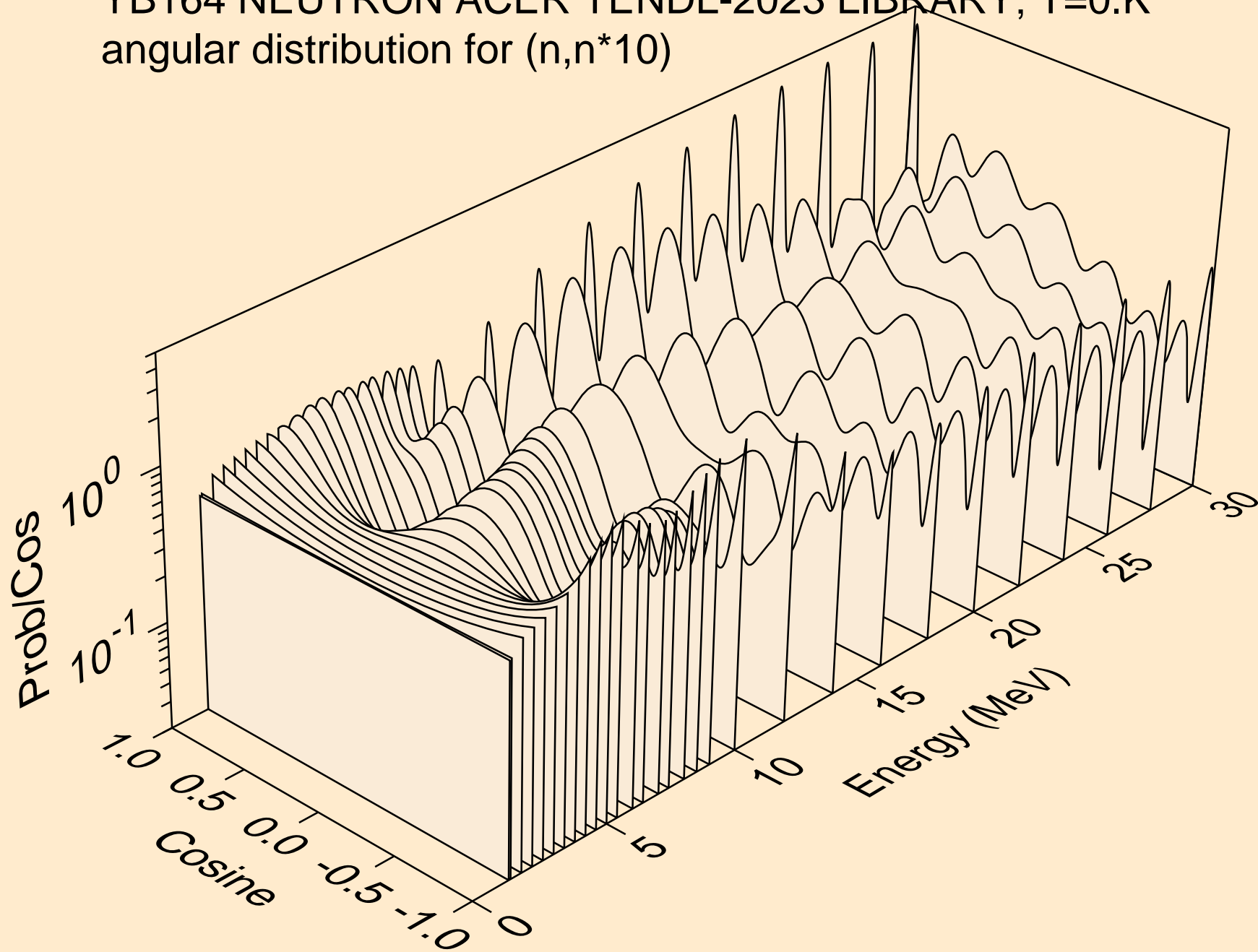

YB164 NEUTRON ACER TENDL-2023 LIBRARY; T=0.K
angular distribution for (n,n*11)

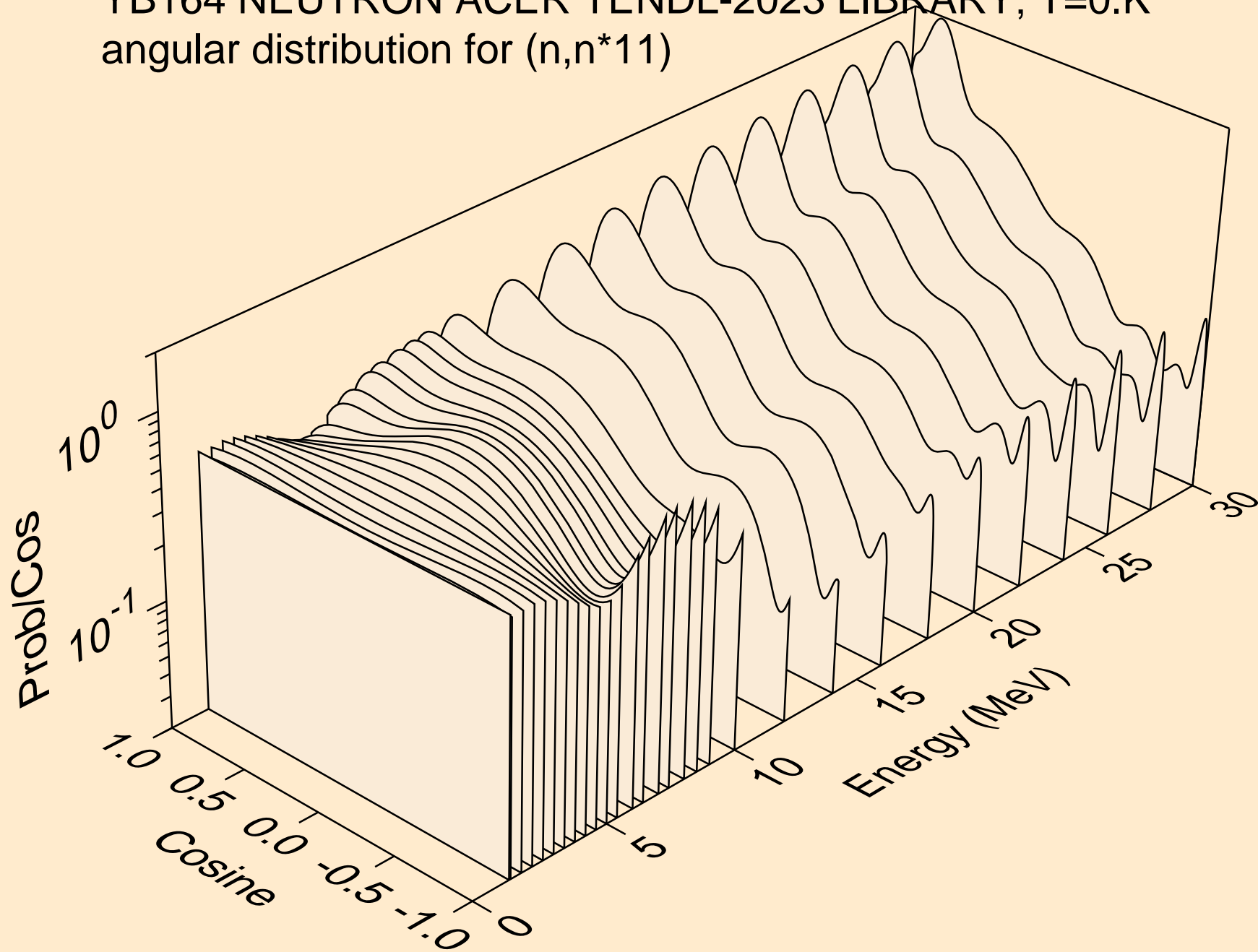

YB164 NEUTRON ACER TENDL-2023 LIBRARY; T=0.K
angular distribution for (n,n*12)

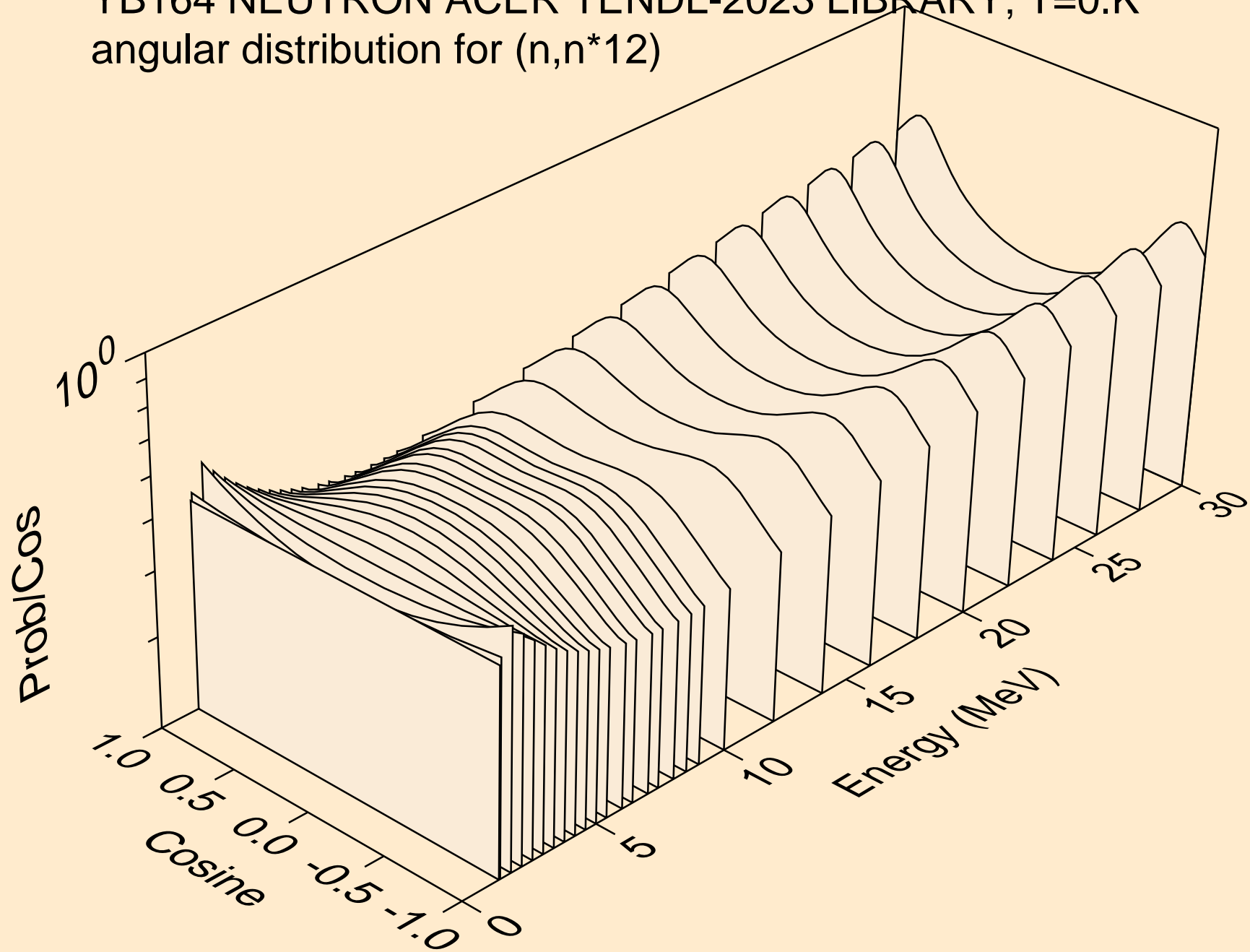

YB164 NEUTRON ACER TENDL-2023 LIBRARY; T=0.K
angular distribution for (n,n*13)

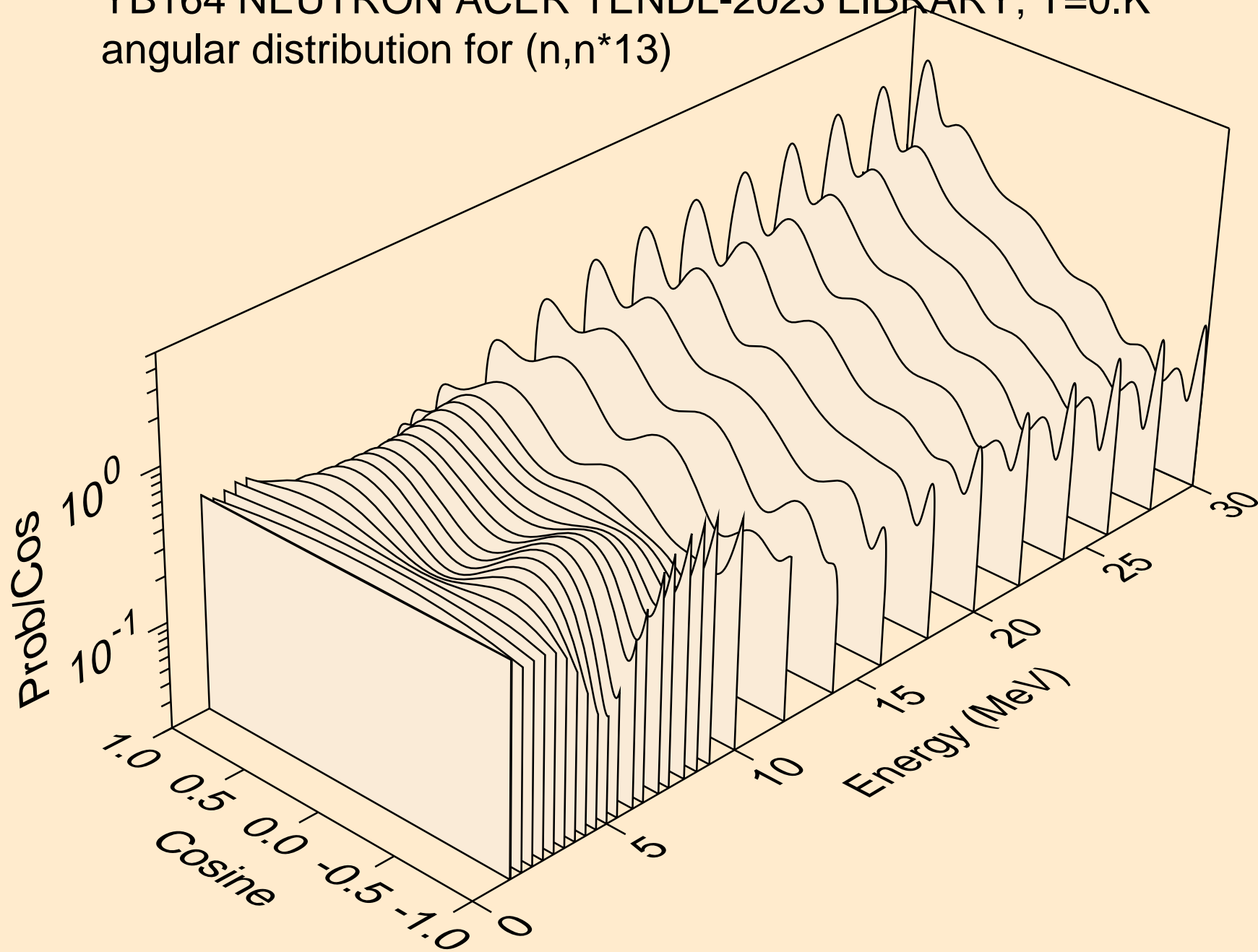

YB164 NEUTRON ACER TENDL-2023 LIBRARY; T=0.K
angular distribution for (n,n*14)

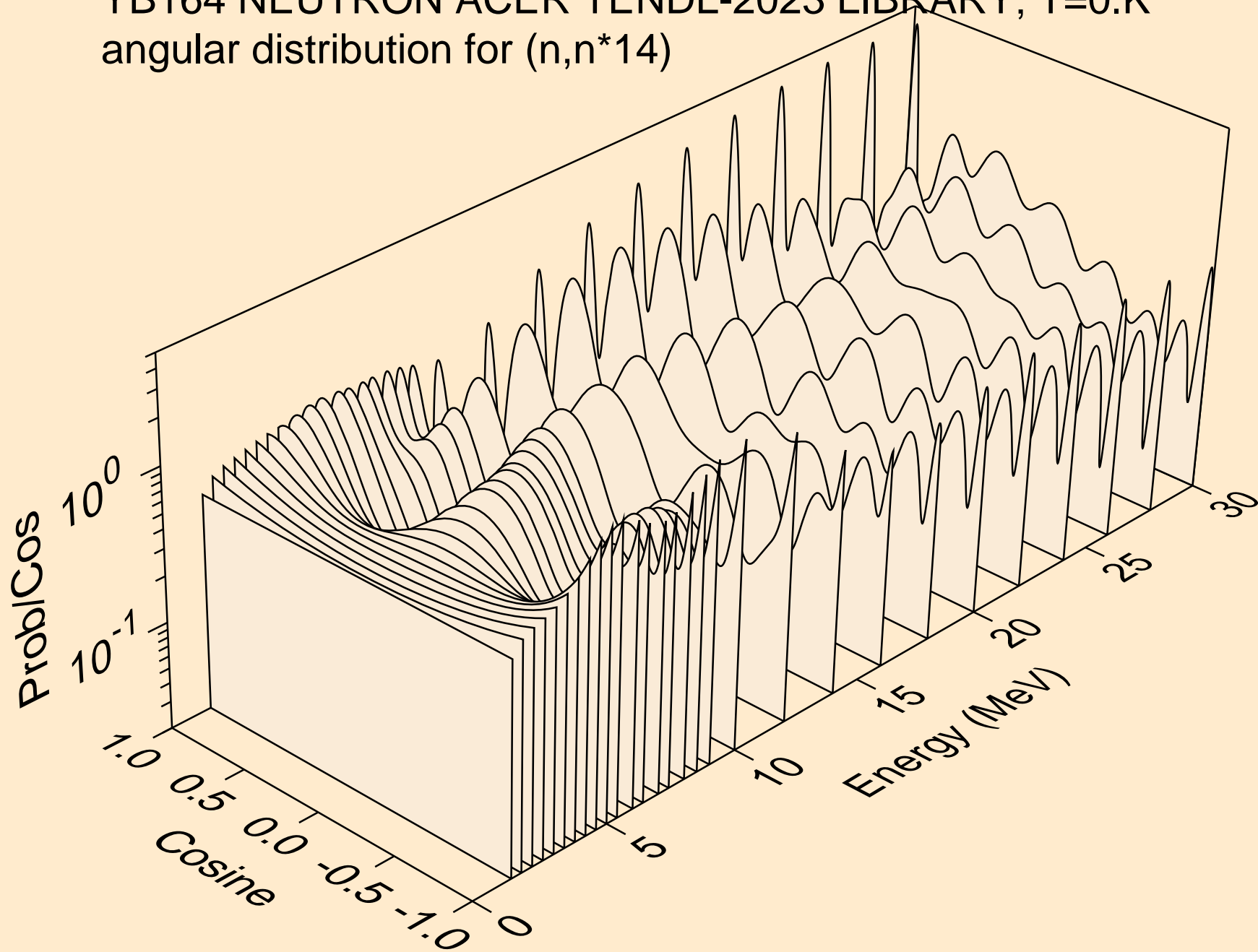

YB164 NEUTRON ACER TENDL-2023 LIBRARY; T=0.K
angular distribution for (n,n*15)

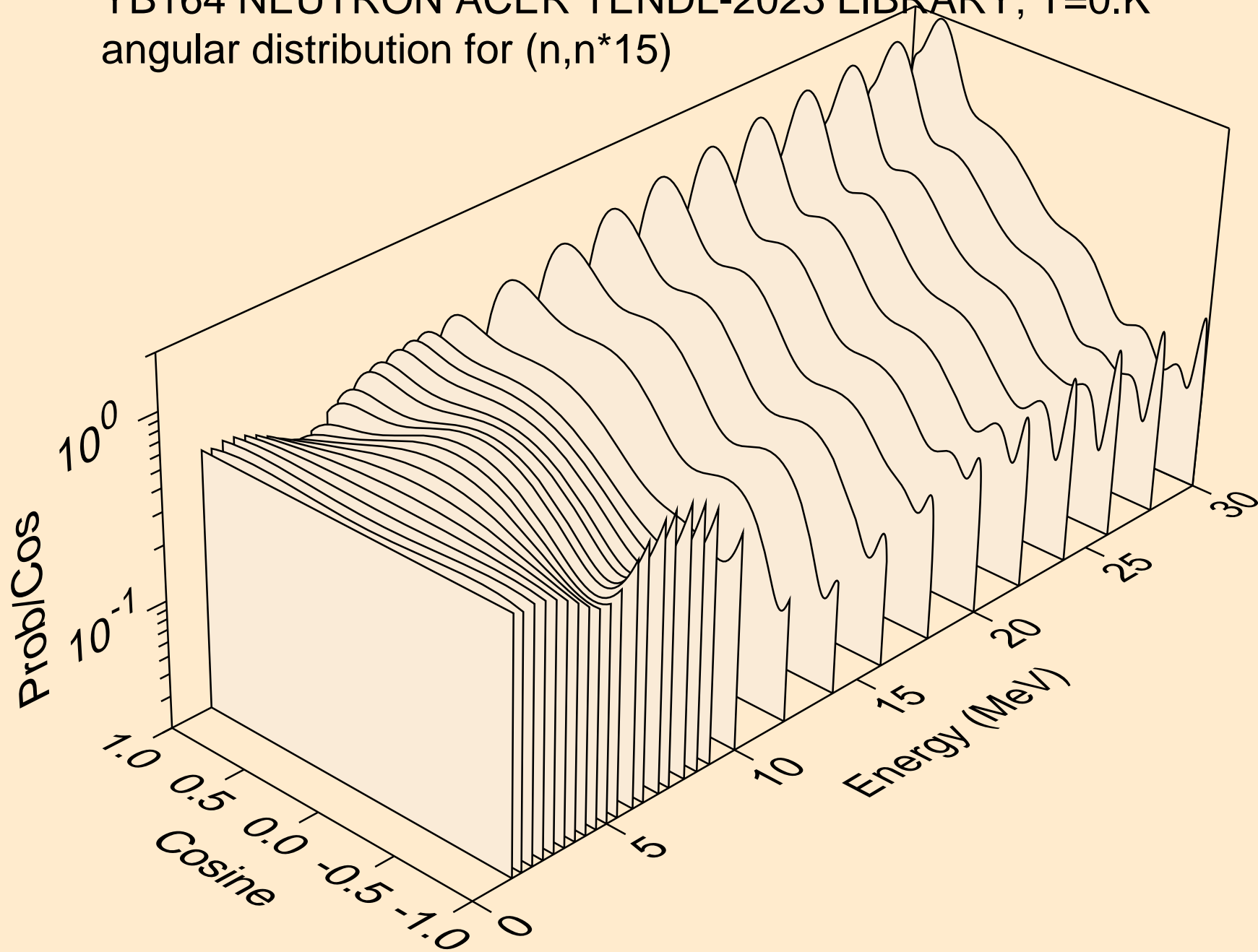

YB164 NEUTRON ACER TENDL-2023 LIBRARY; T=0.K
angular distribution for (n,n*16)

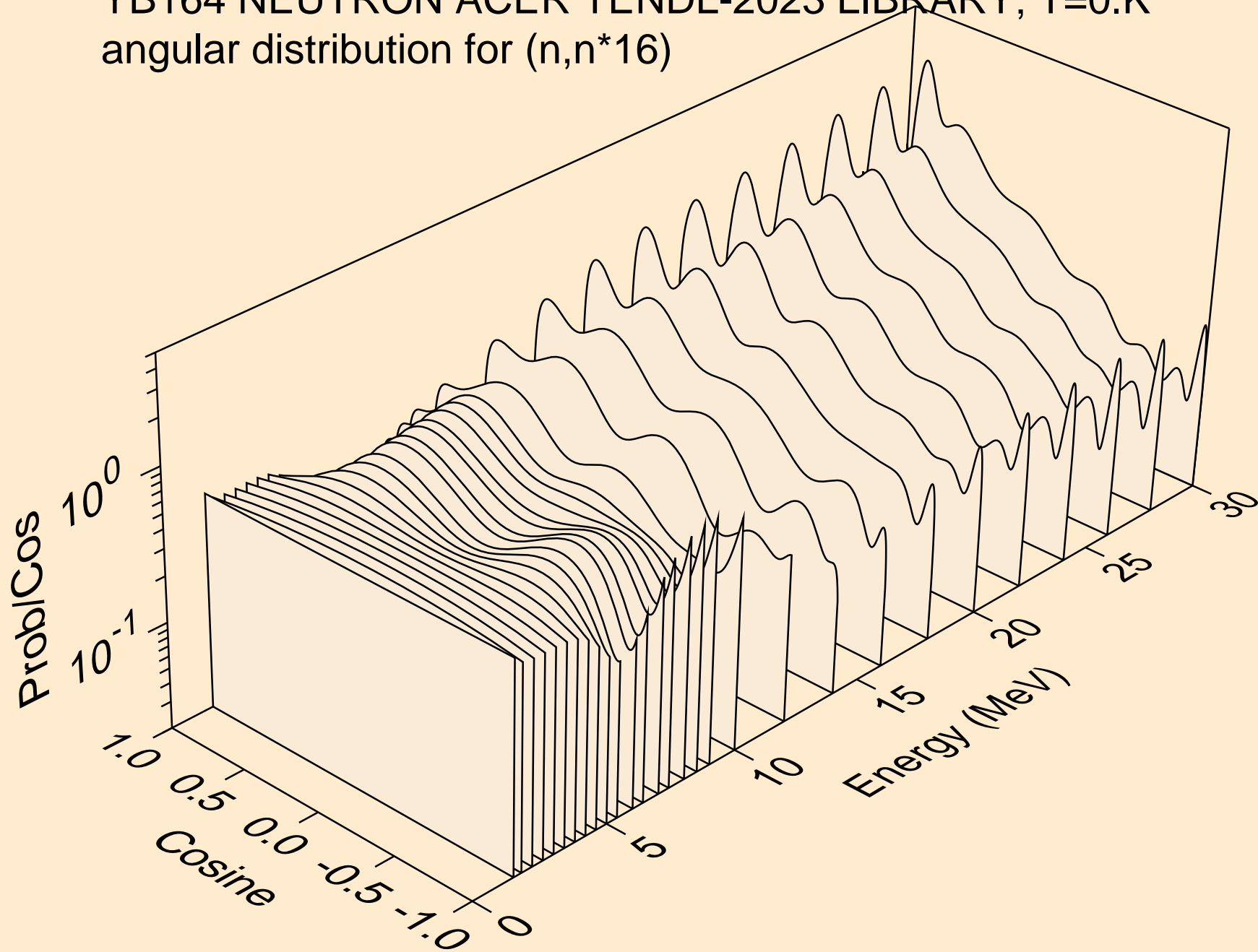

YB164 NEUTRON ACER TENDL-2023 LIBRARY; T=0.K
angular distribution for (n,n*17)

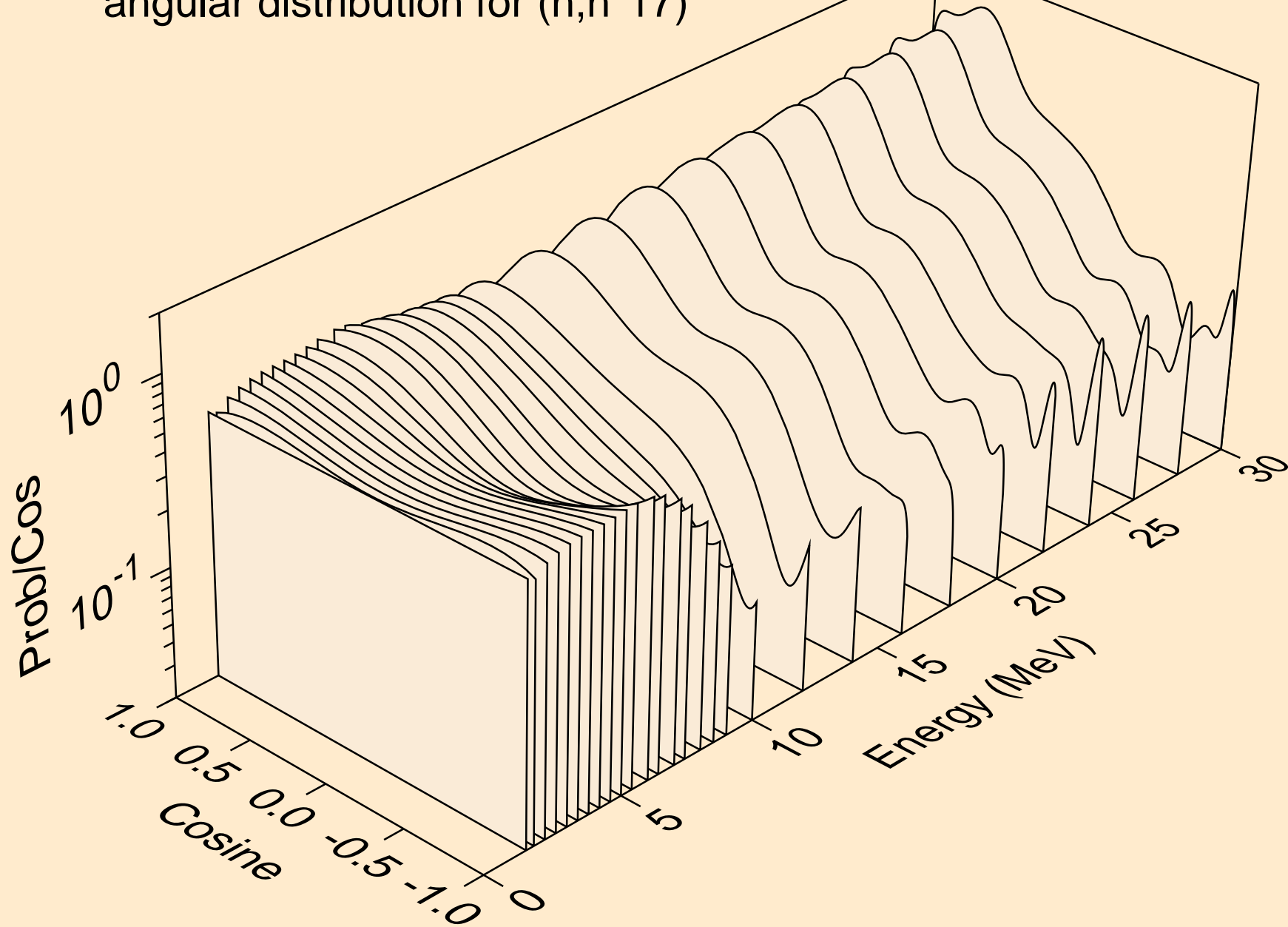

YB164 NEUTRON ACER TENDL-2023 LIBRARY; T=0.K
angular distribution for (n,n*18)

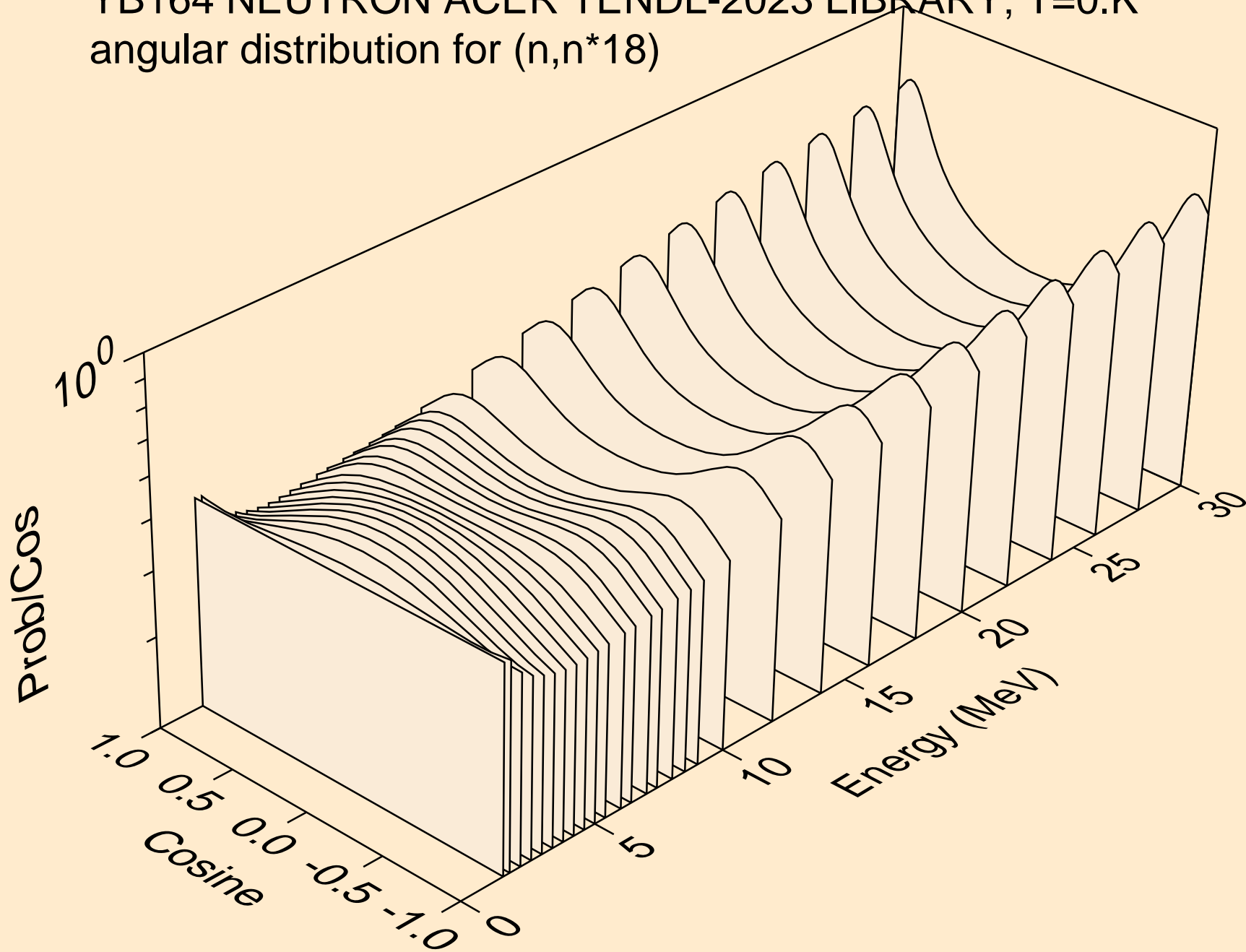

YB164 NEUTRON ACER TENDL-2023 LIBRARY; T=0.K
Neutron emission for (n,x)

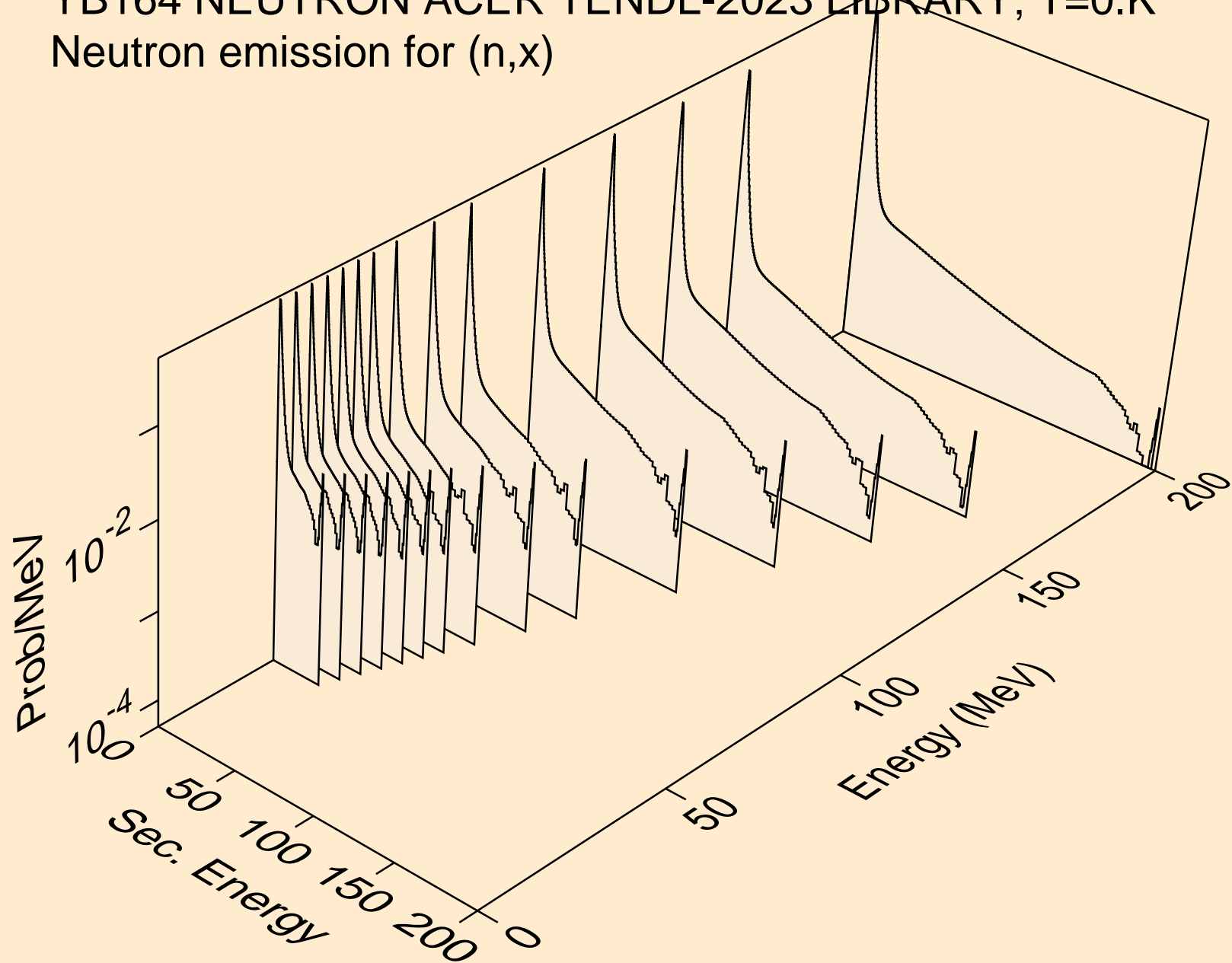

YB164 NEUTRON ACER TENDL-2023 LIBRARY; T=0.K
Neutron emission for (n,2nd)

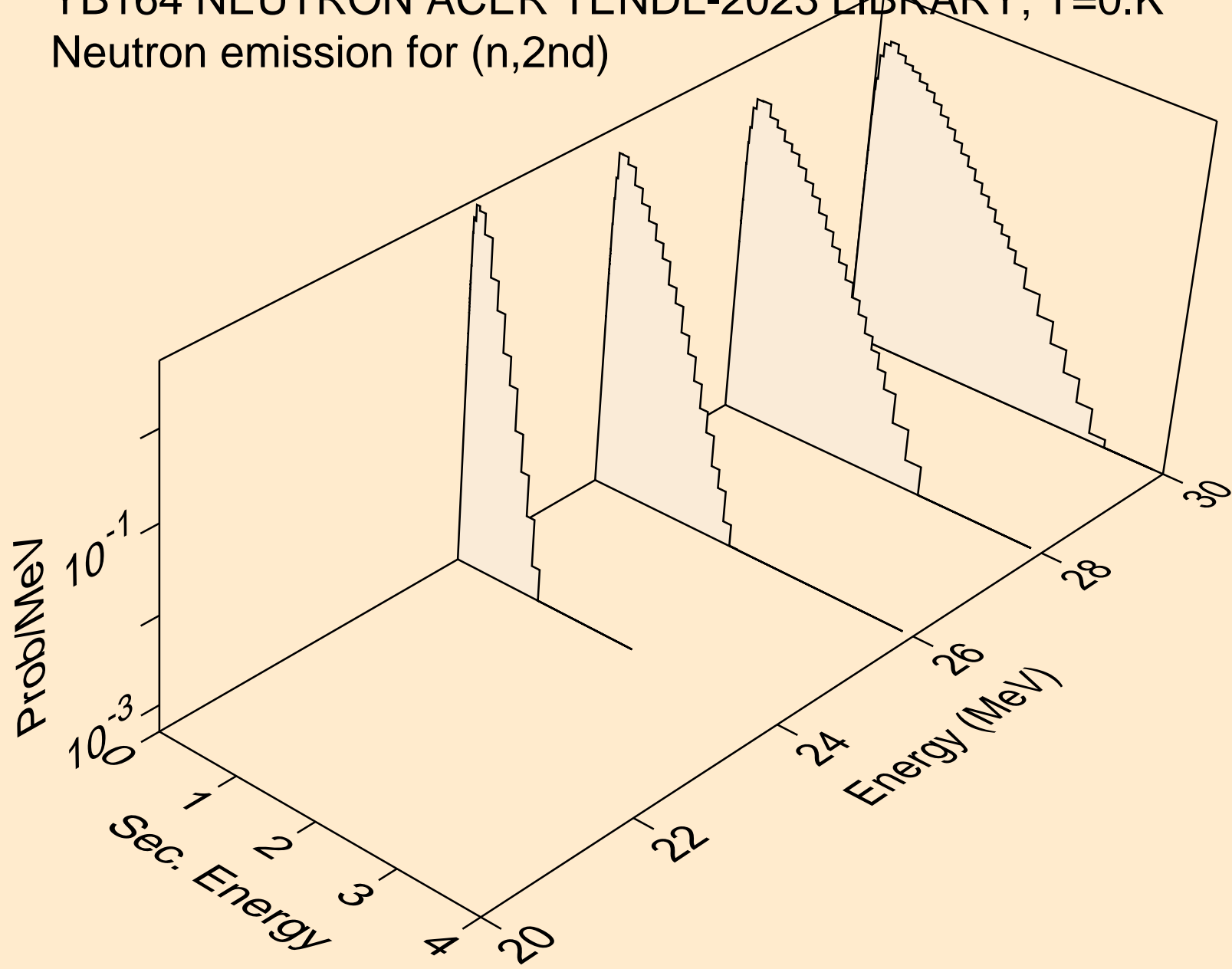

YB164 NEUTRON ACER TENDL-2023 LIBRARY; T=0.K
Neutron emission for (n,2n)

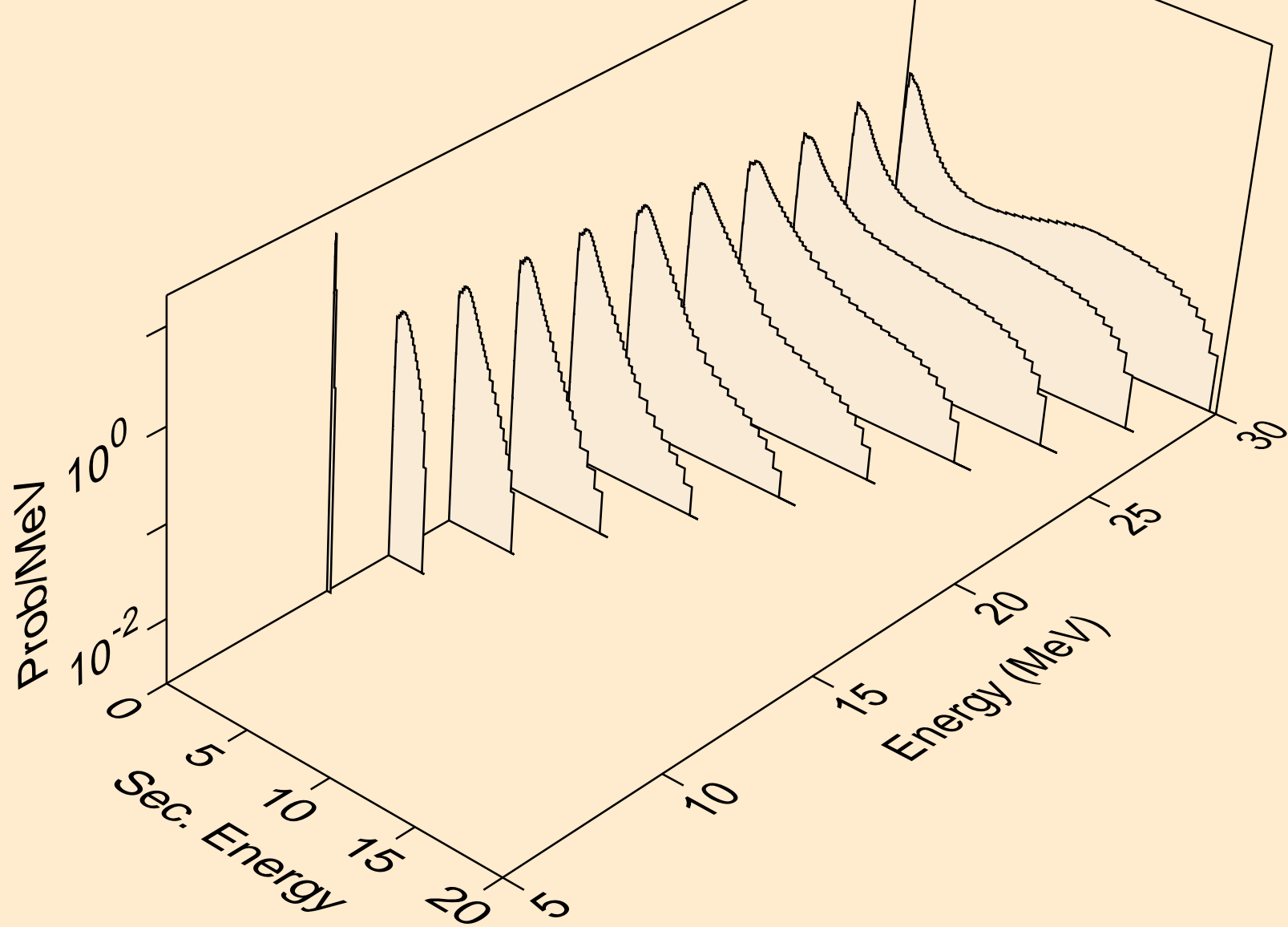

YB164 NEUTRON ACER TENDL-2023 LIBRARY; T=0.K
Neutron emission for (n,3n)

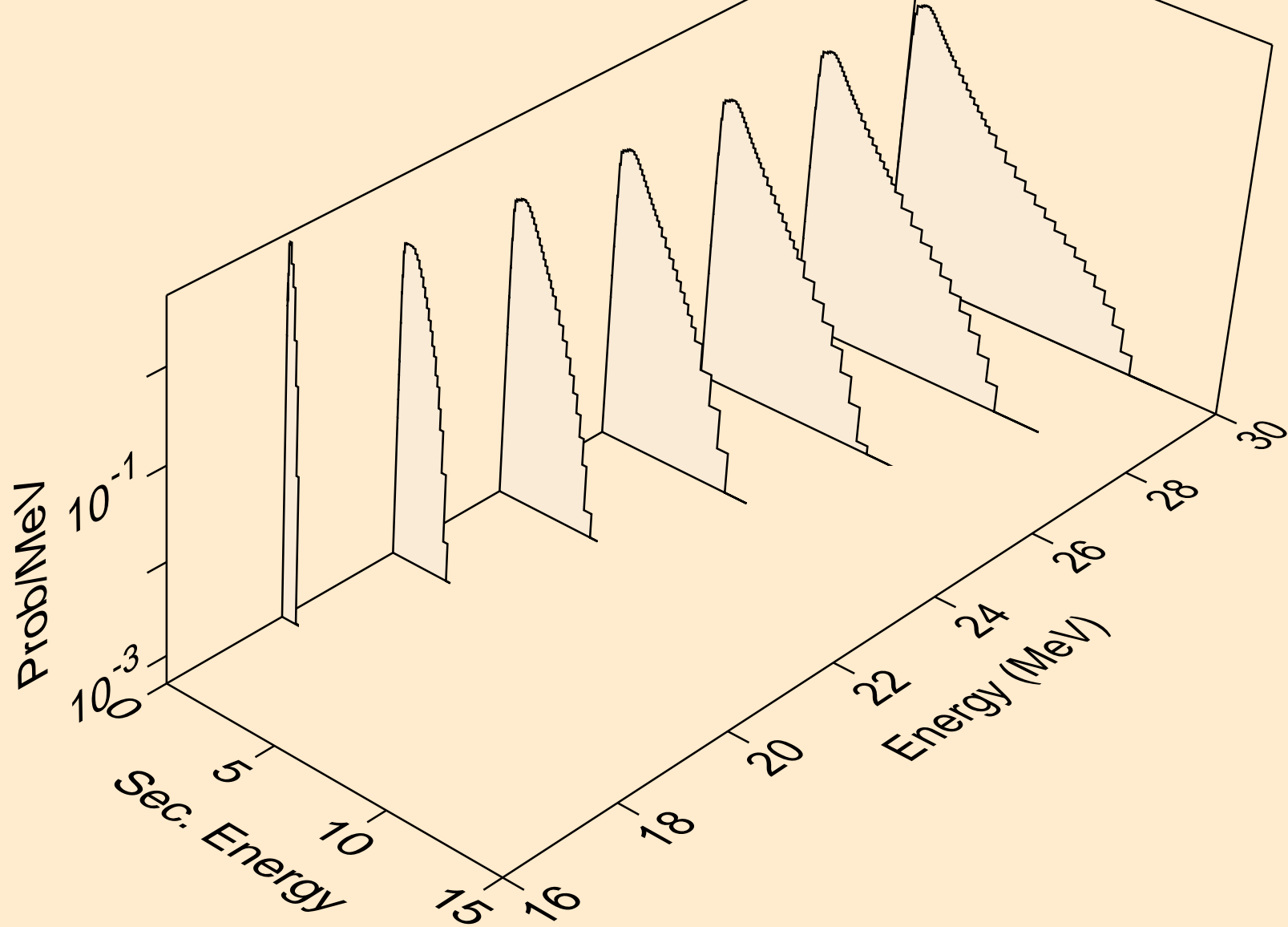

YB164 NEUTRON ACER TENDL-2023 LIBRARY; T=0.K
Neutron emission for (n,n*)a

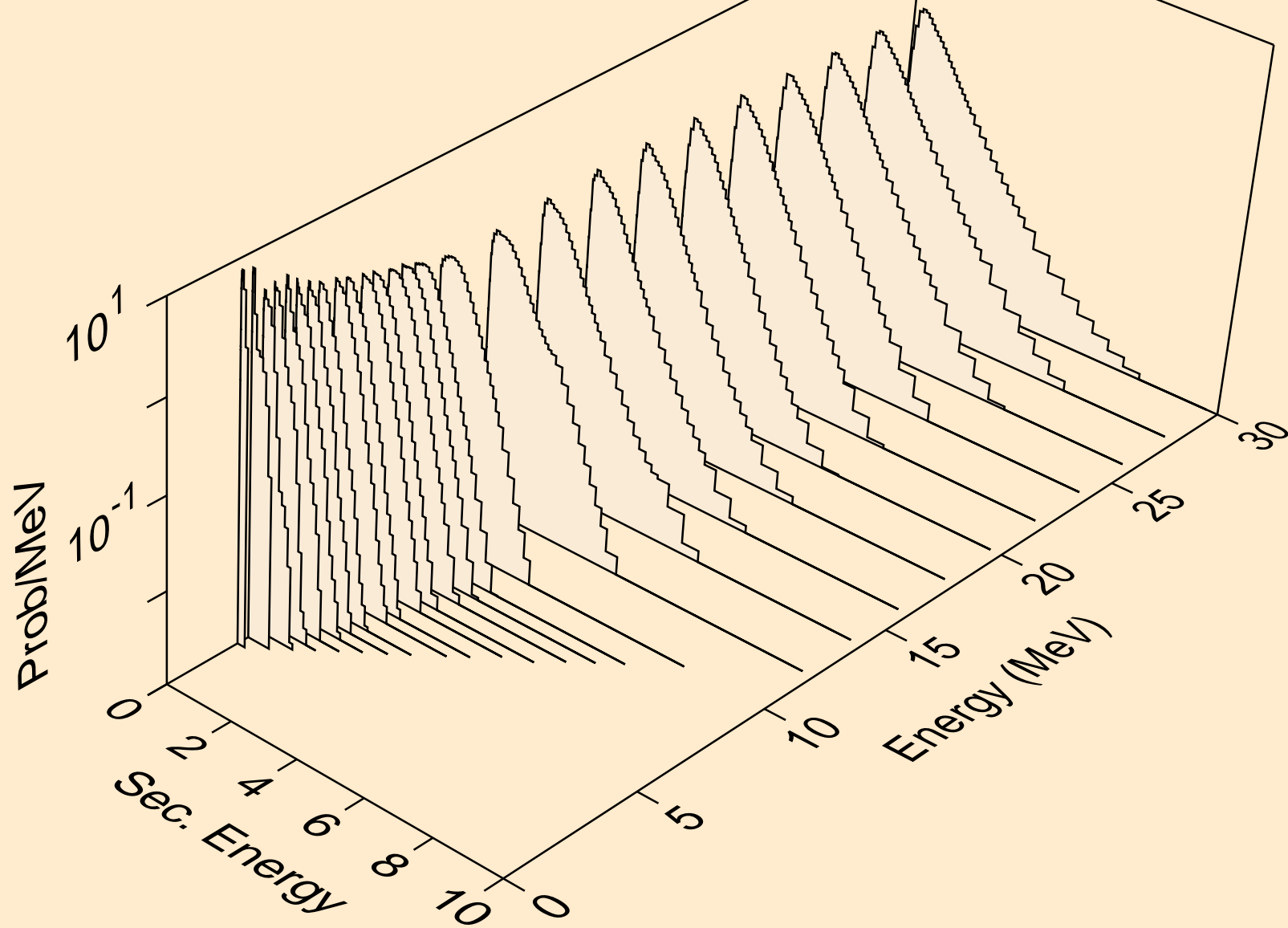

YB164 NEUTRON ACER TENDL-2023 LIBRARY; T=0.K
Neutron emission for (n,2n)a

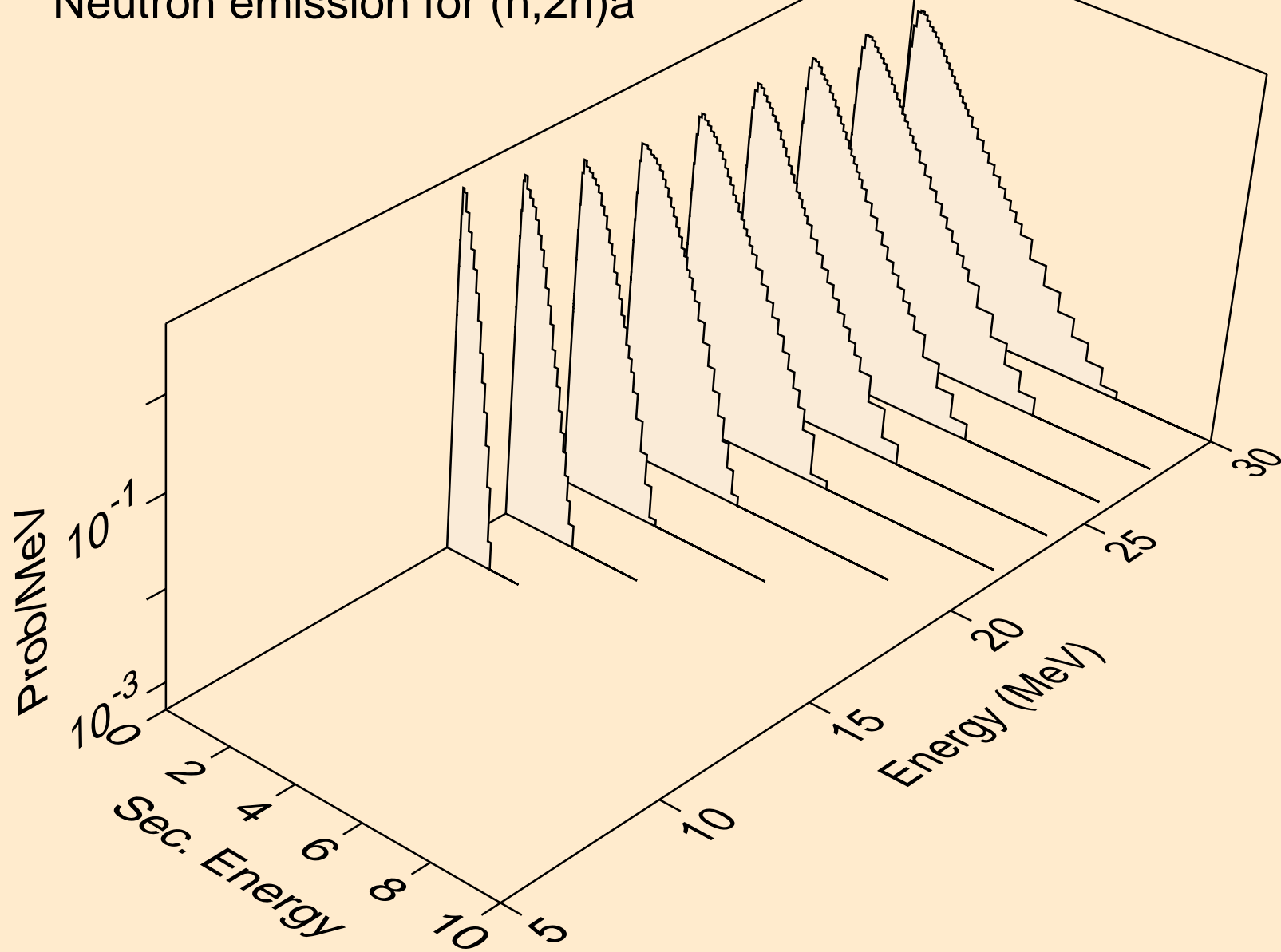

YB164 NEUTRON ACER TENDL-2023 LIBRARY; T=0.K
Neutron emission for (n,3n)a

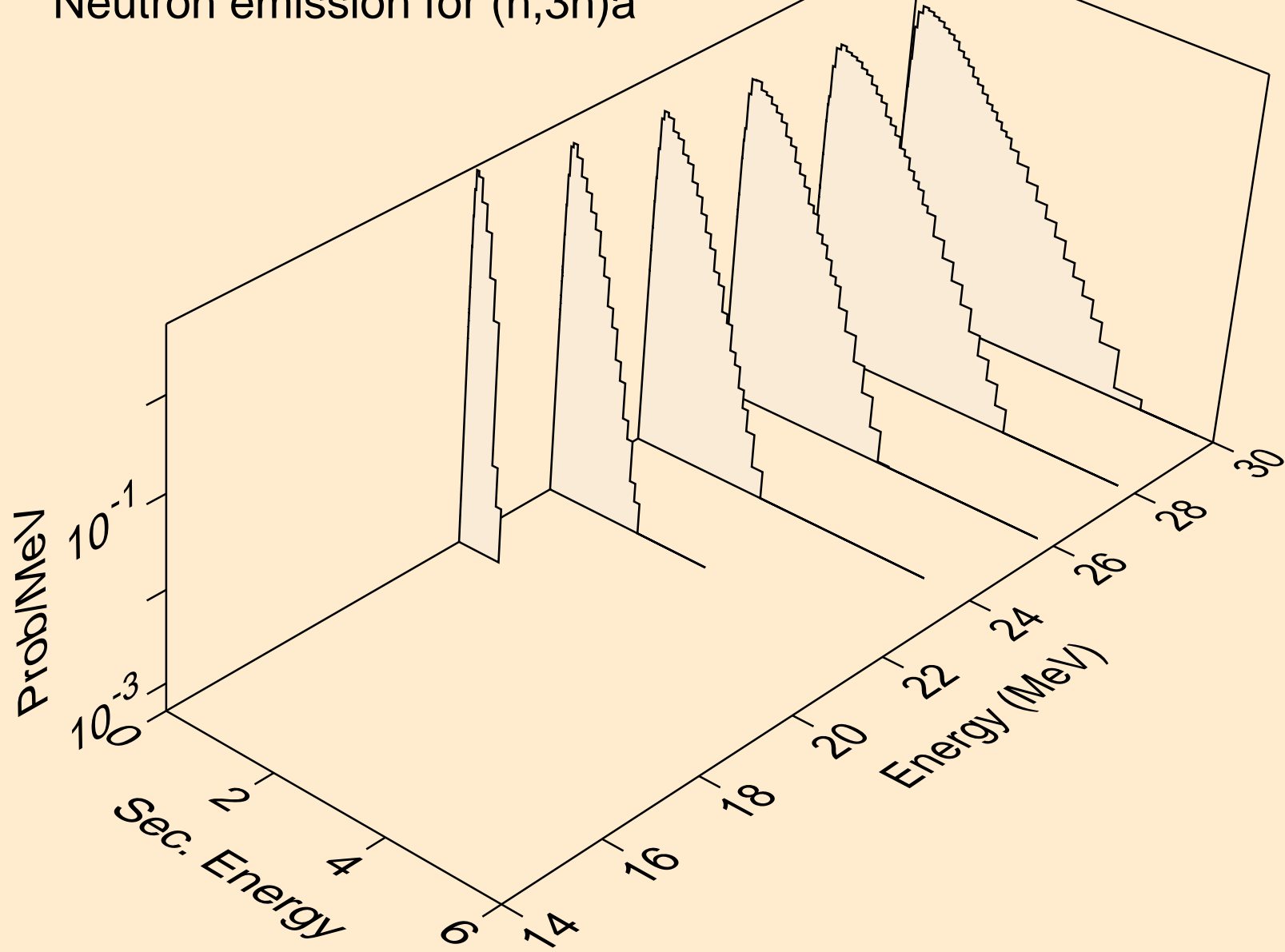

YB164 NEUTRON ACER TENDL-2023 LIBRARY; T=0.K
Neutron emission for (n,n*)p

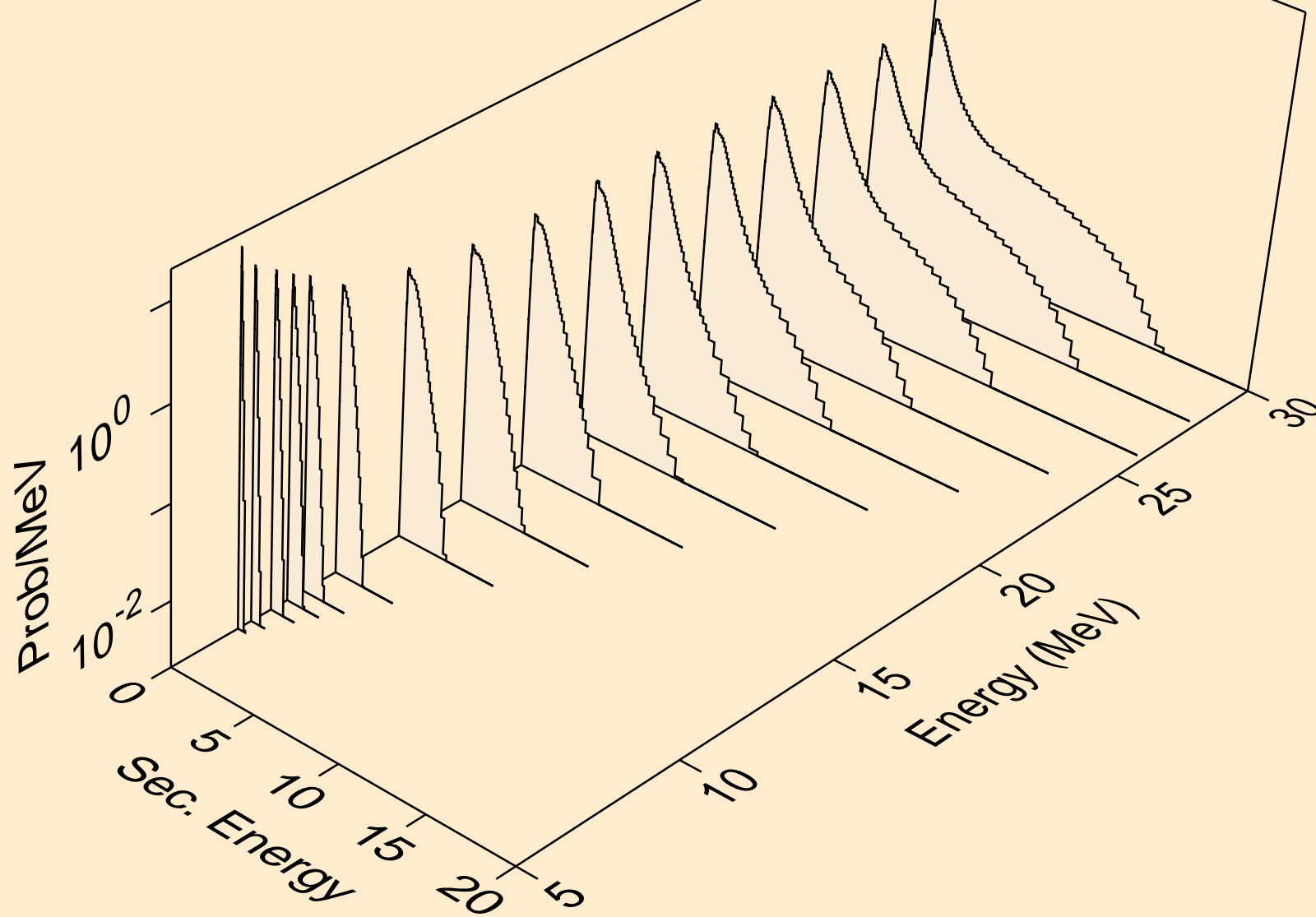

YB164 NEUTRON ACER TENDL-2023 LIBRARY; T=0.K
Neutron emission for (n,n*)2a

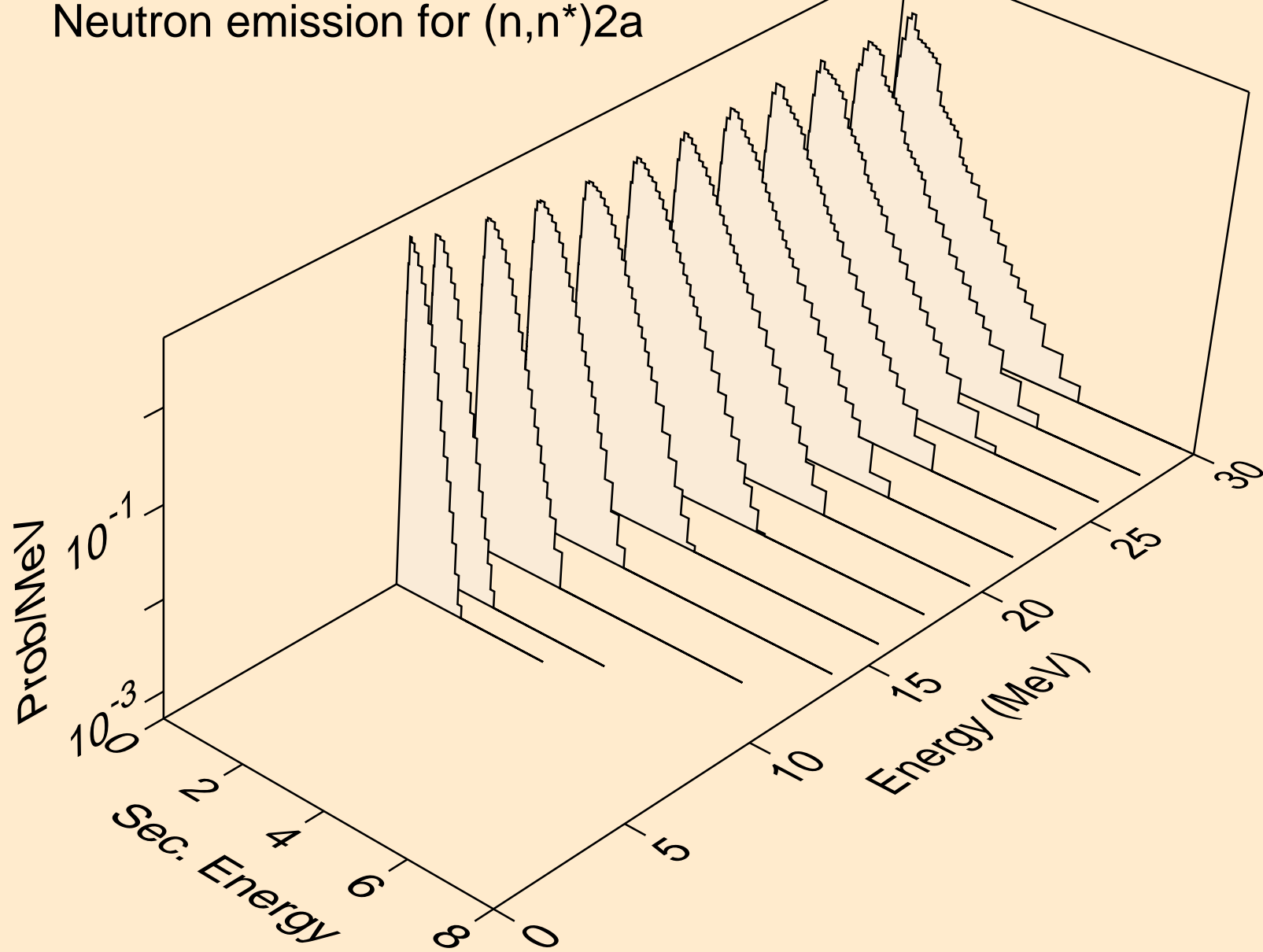

YB164 NEUTRON ACER TENDL-2023 LIBRARY; T=0.K
Neutron emission for (n,2n)2a

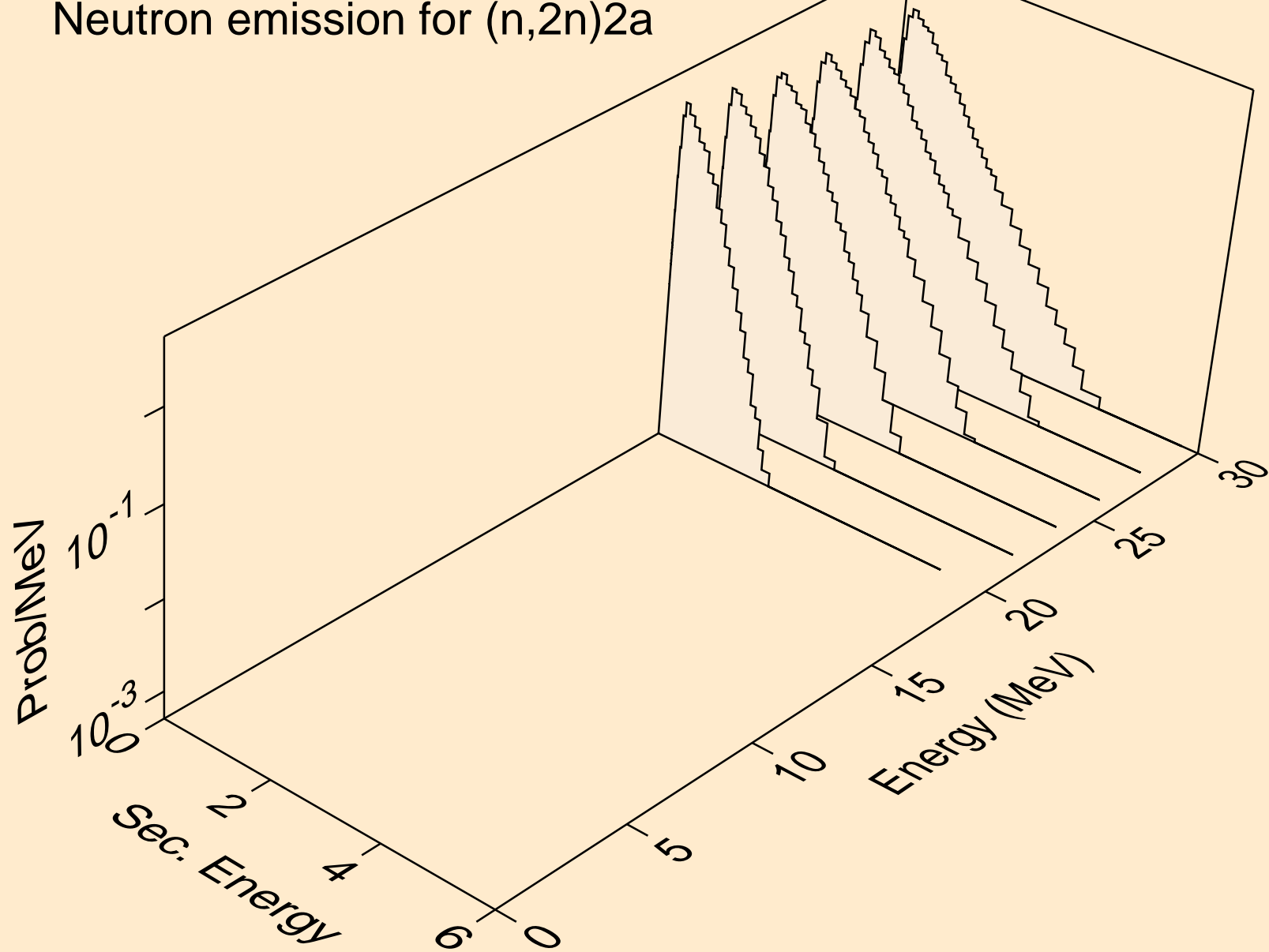

YB164 NEUTRON ACER TENDL-2023 LIBRARY; T=0.K
Neutron emission for (n,n*)d

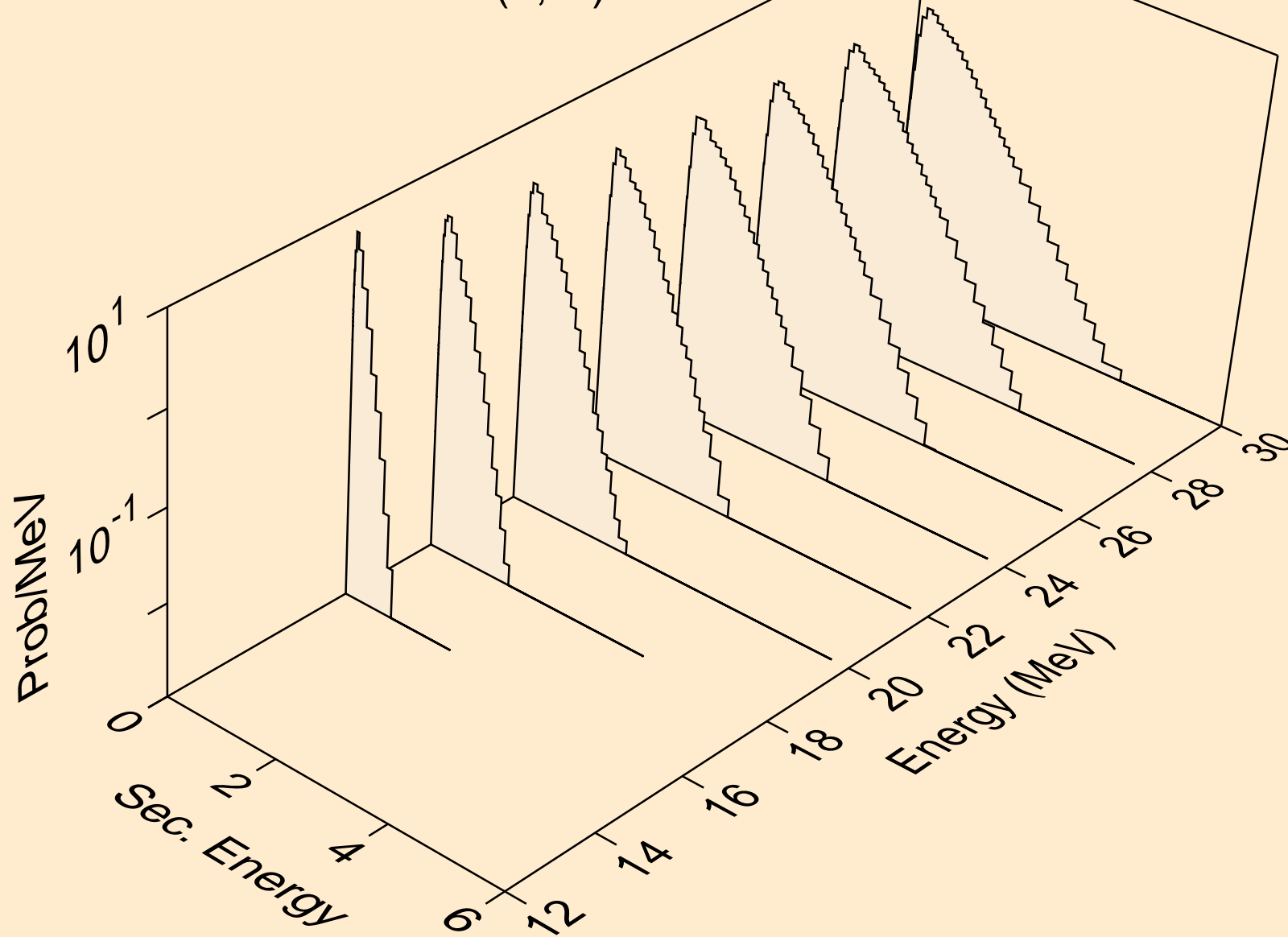

YB164 NEUTRON ACER TENDL-2023 LIBRARY; T=0.K
Neutron emission for (n,n*)t

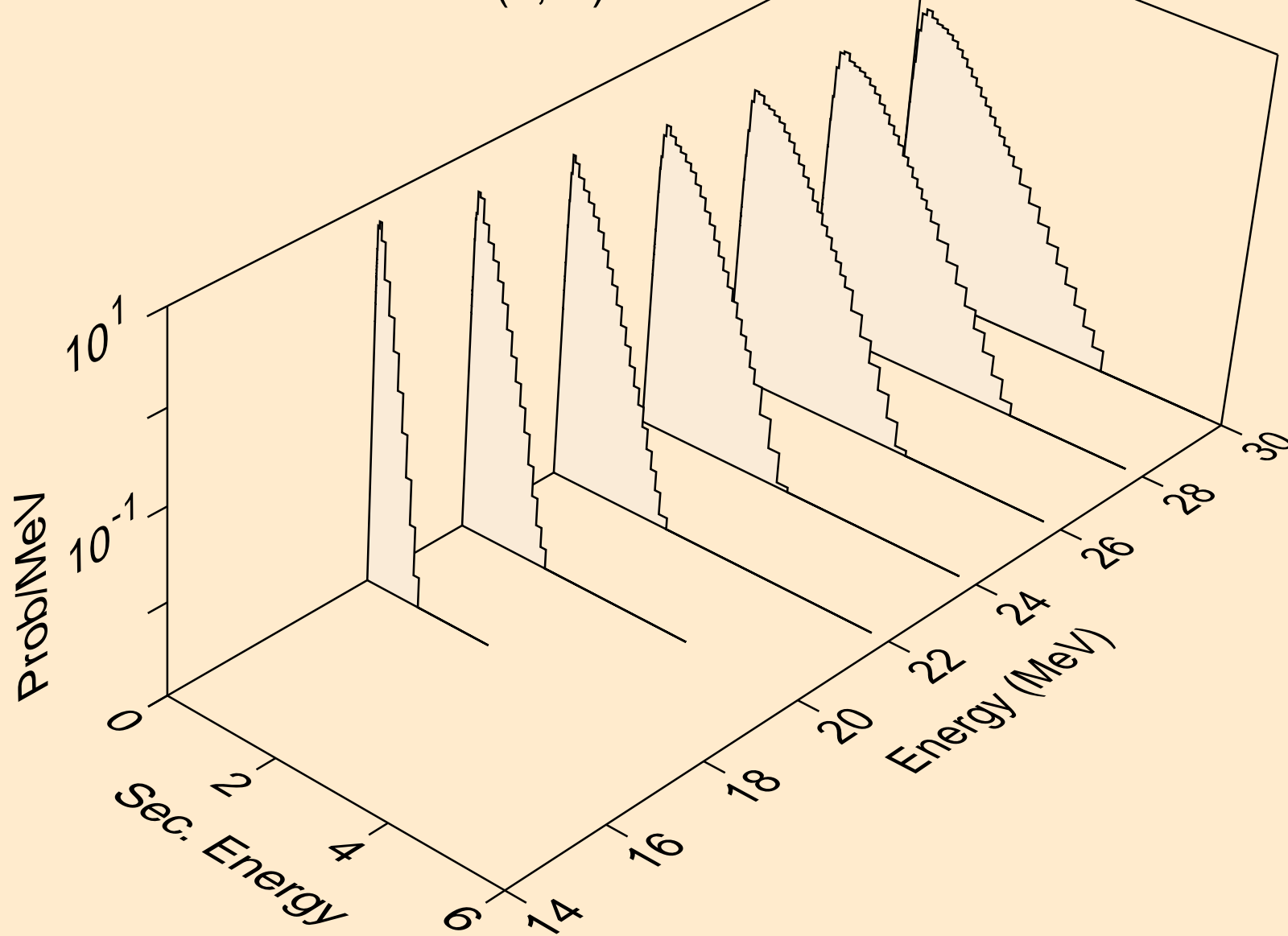

YB164 NEUTRON ACER TENDL-2023 LIBRARY; T=0.K
Neutron emission for (n,n*)he3

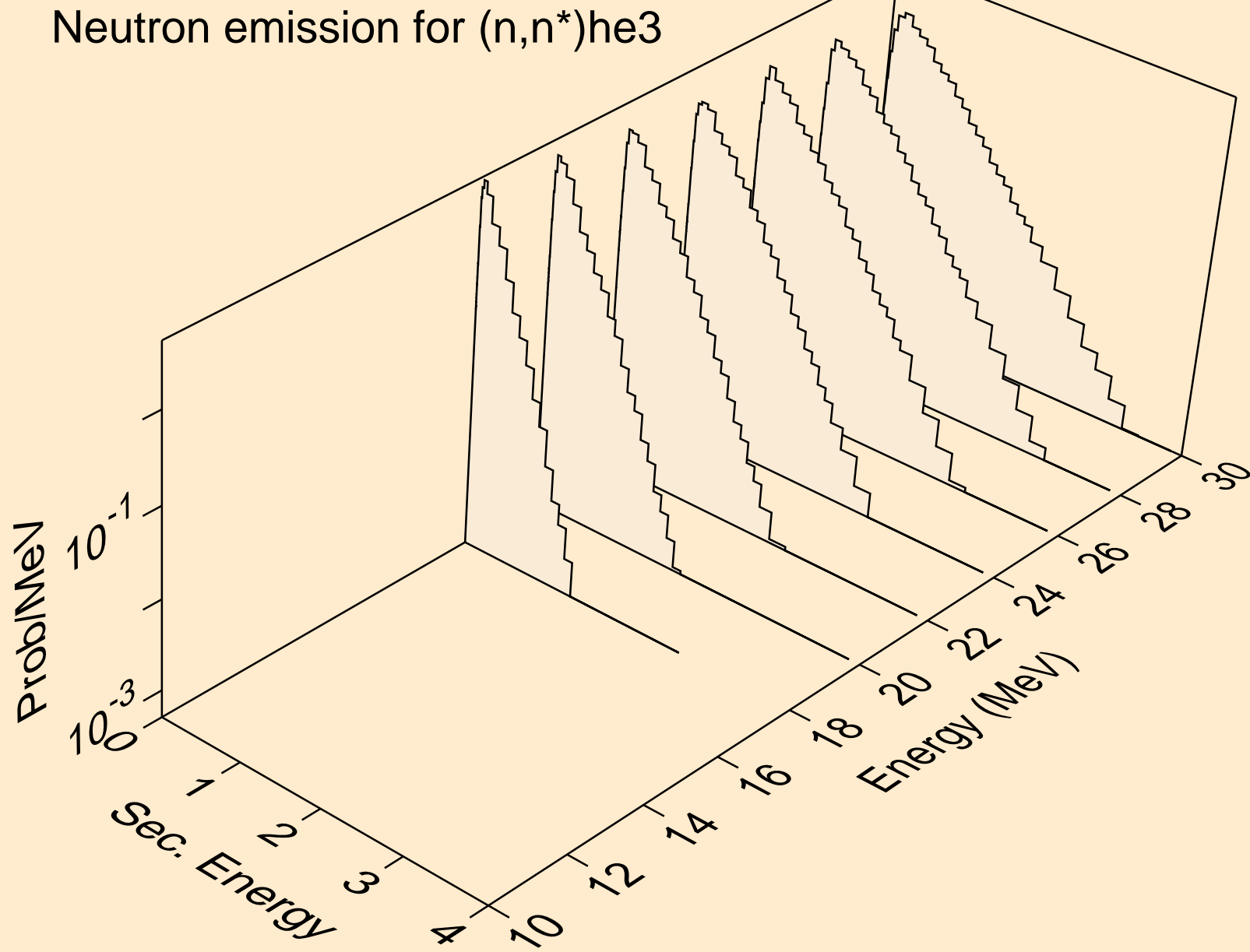

YB164 NEUTRON ACER TENDL-2023 LIBRARY; T=0.K
Neutron emission for (n,4n)

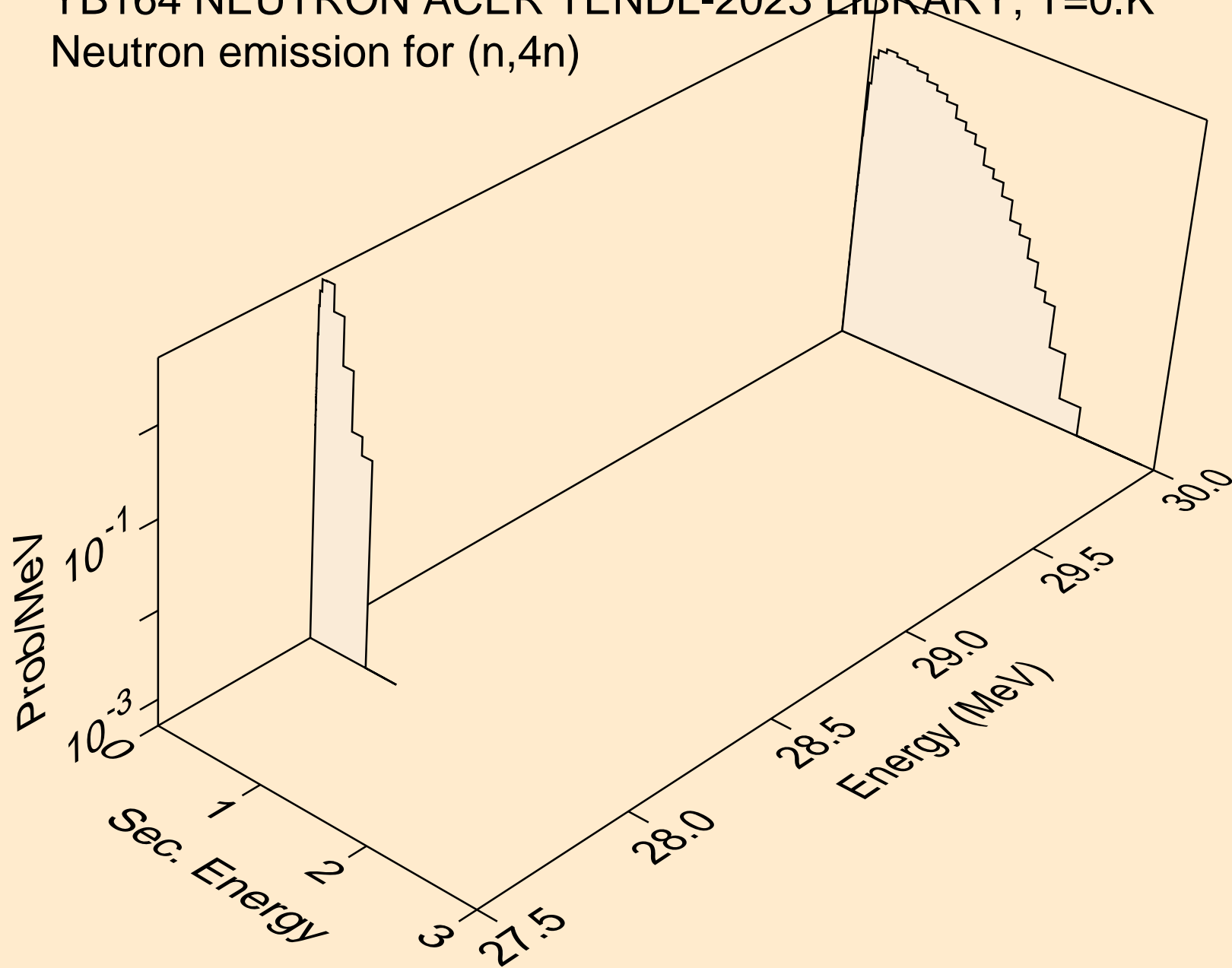

YB164 NEUTRON ACER TENDL-2023 LIBRARY; T=0.K
Neutron emission for (n,2np)

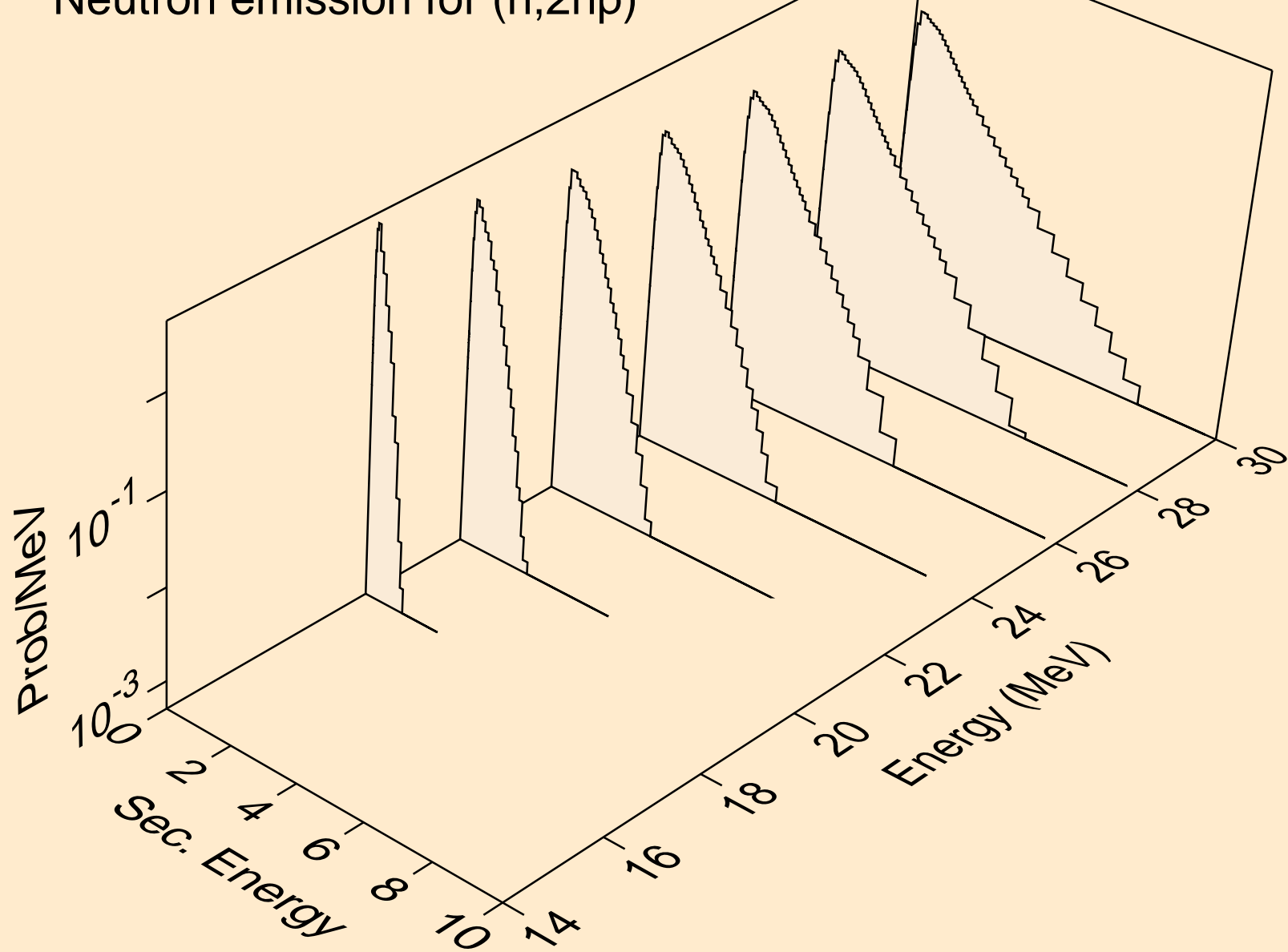

YB164 NEUTRON ACER TENDL-2023 LIBRARY; T=0.K
Neutron emission for (n,3np)

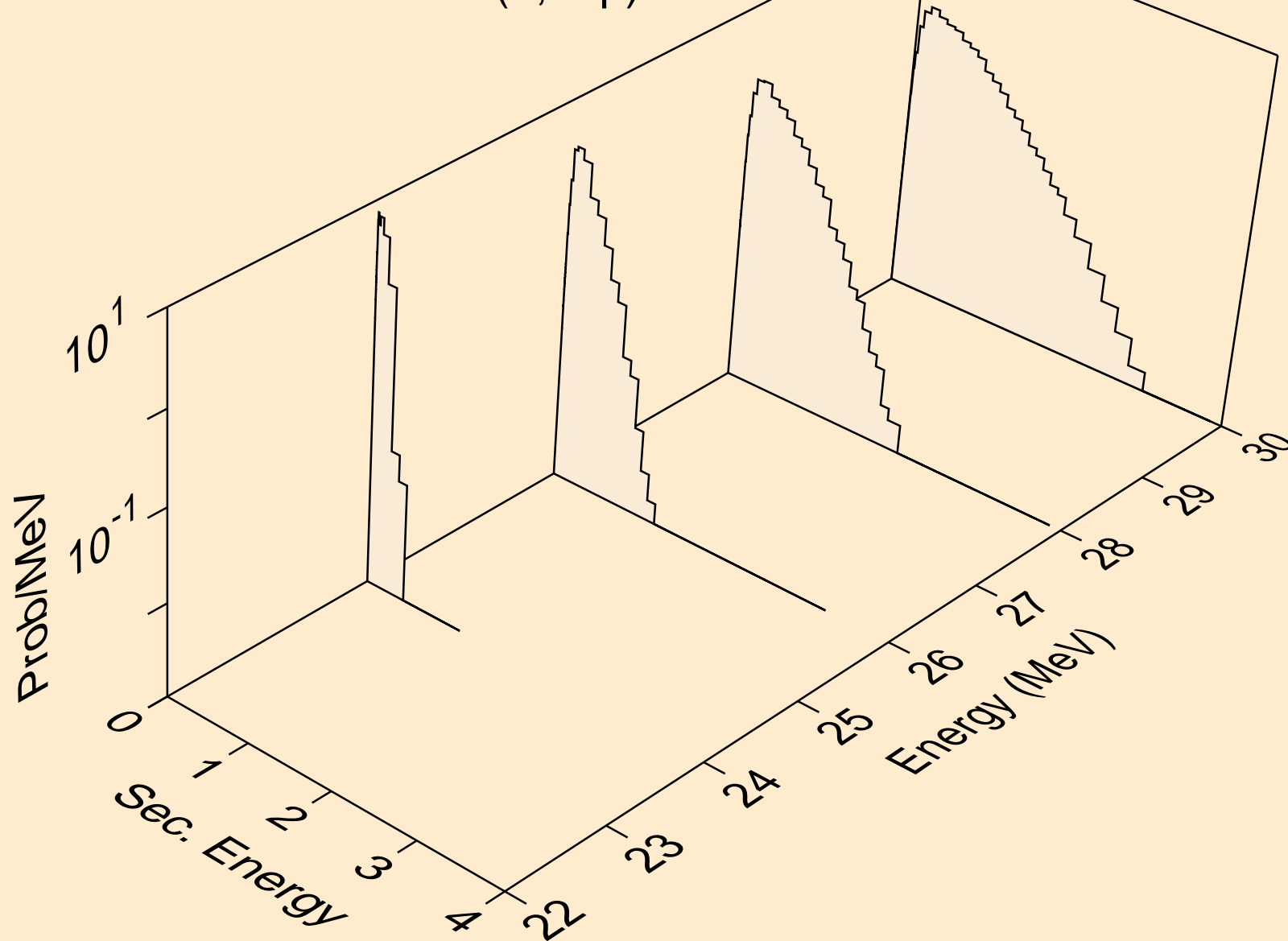

YB164 NEUTRON ACER TENDL-2023 LIBRARY; T=0.K
Neutron emission for (n,n2p)

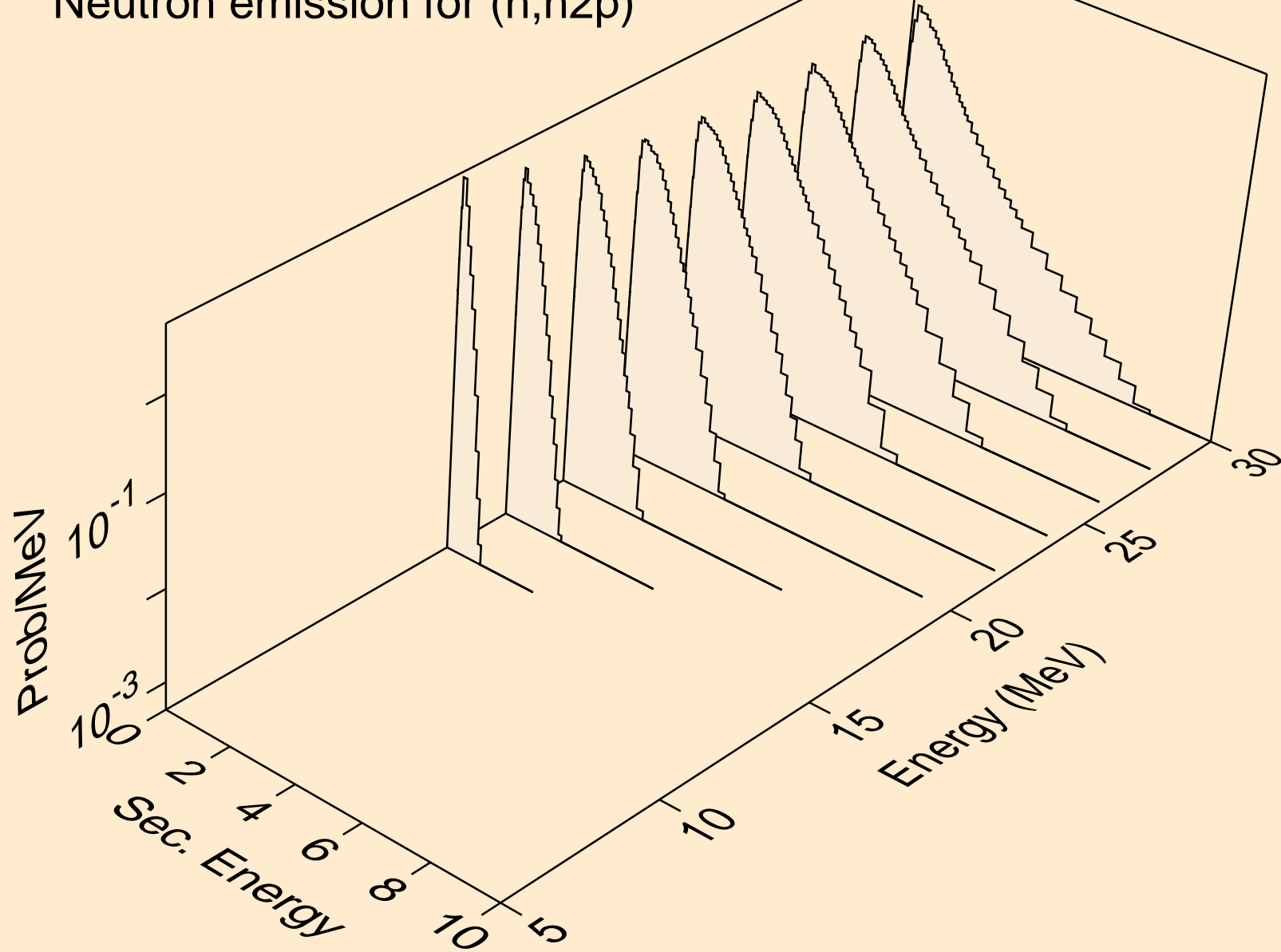

YB164 NEUTRON ACER TENDL-2023 LIBRARY; T=0.K
Neutron emission for (n,npa)

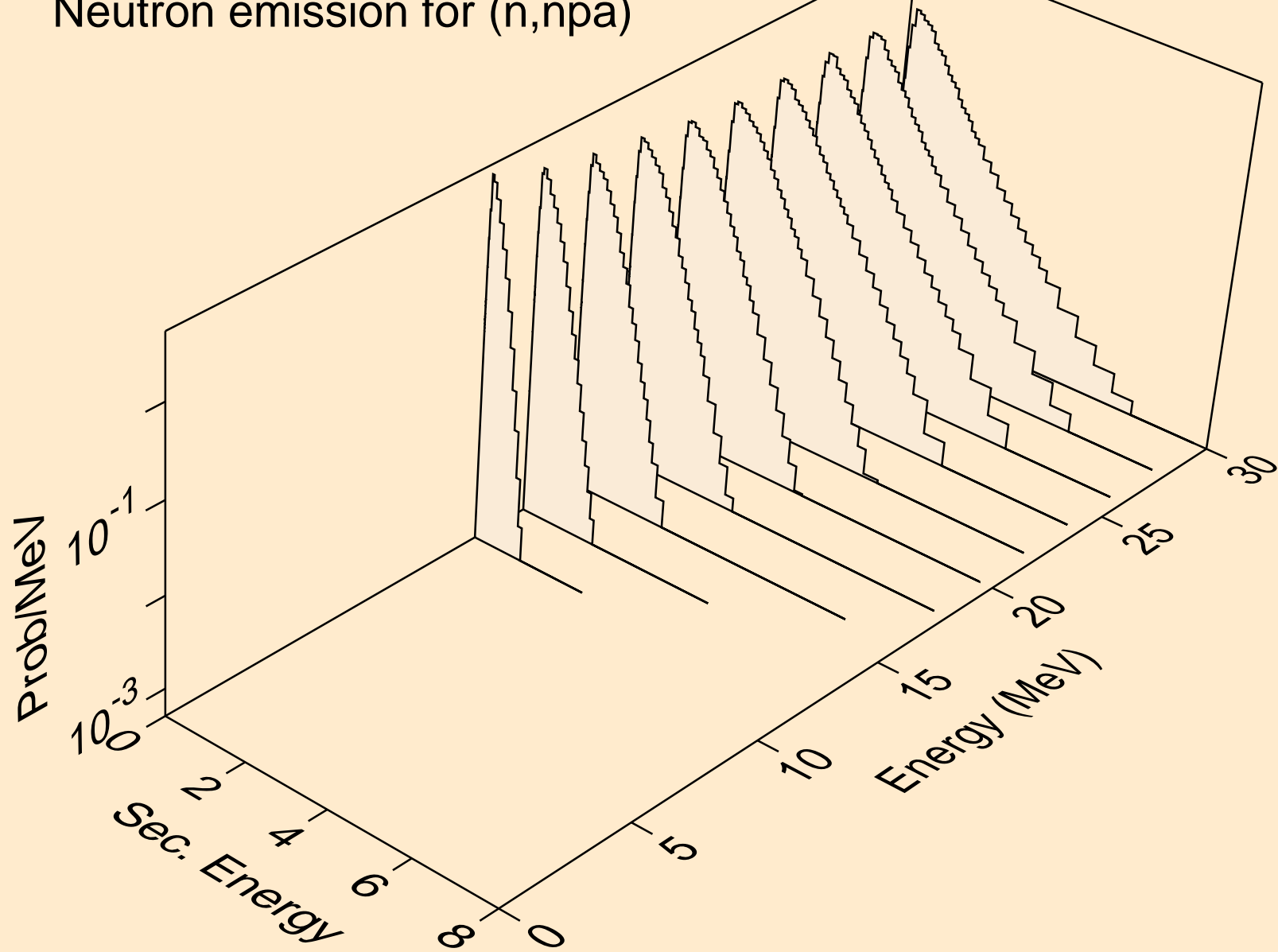

YB164 NEUTRON ACER TENDL-2023 LIBRARY; T=0.K
Neutron emission for (n,n*c)

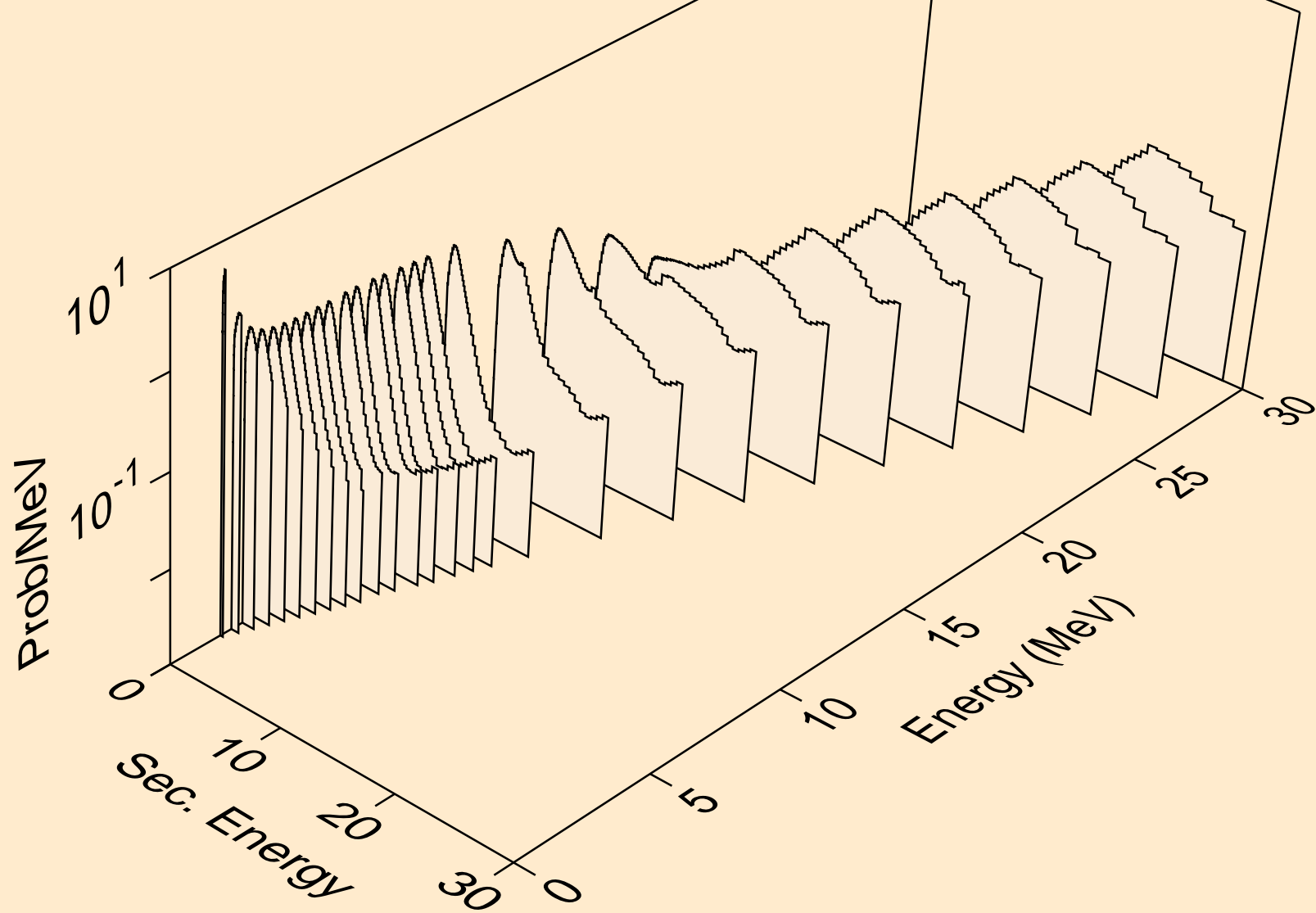

YB164 NEUTRON ACER TENDL-2023 LIBRARY; T=0.K
Photon emission for (n,x)

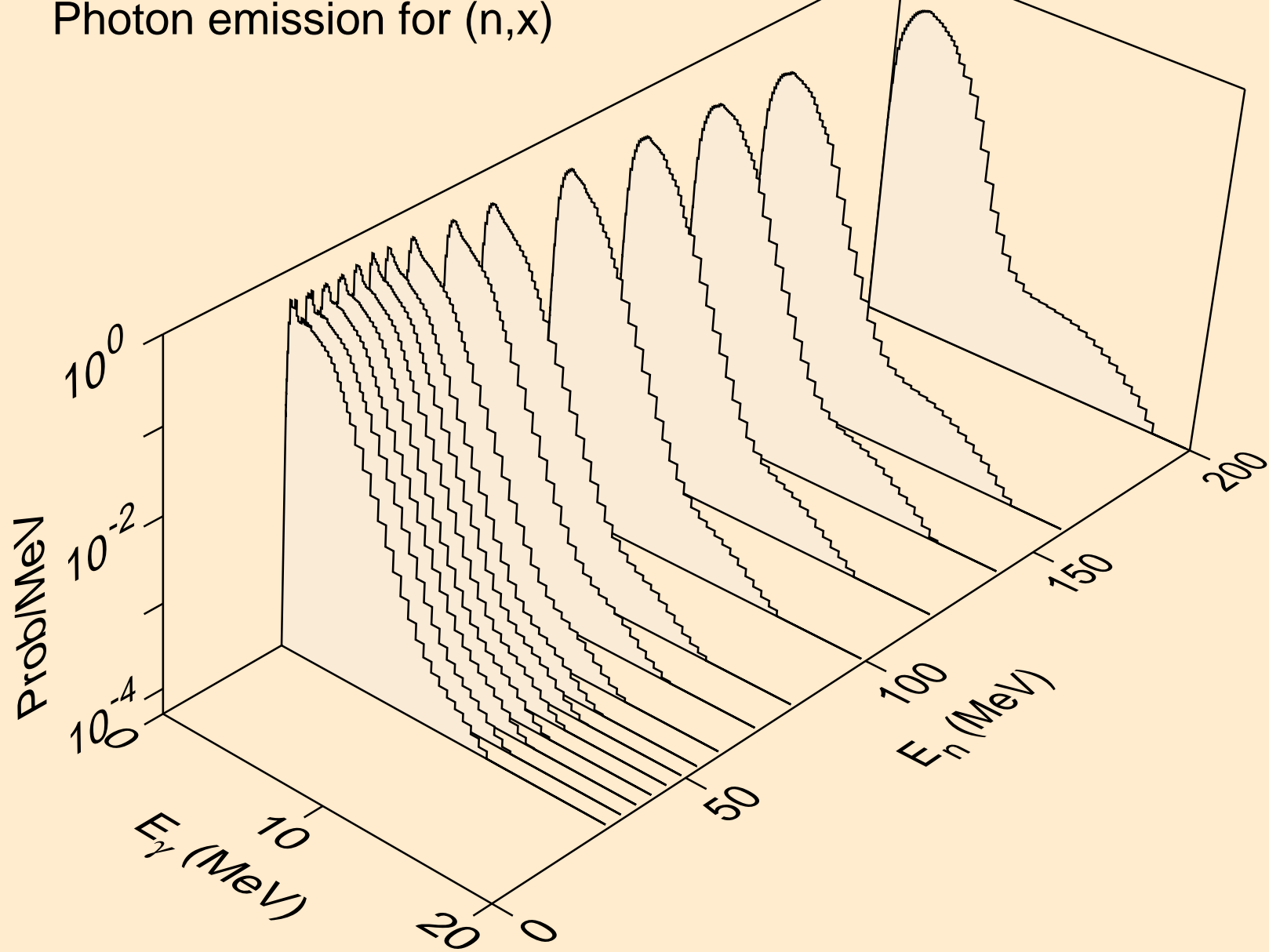

YB164 NEUTRON ACER TENDL-2023 LIBRARY; T=0.K
Photon emission for (n,2nd)

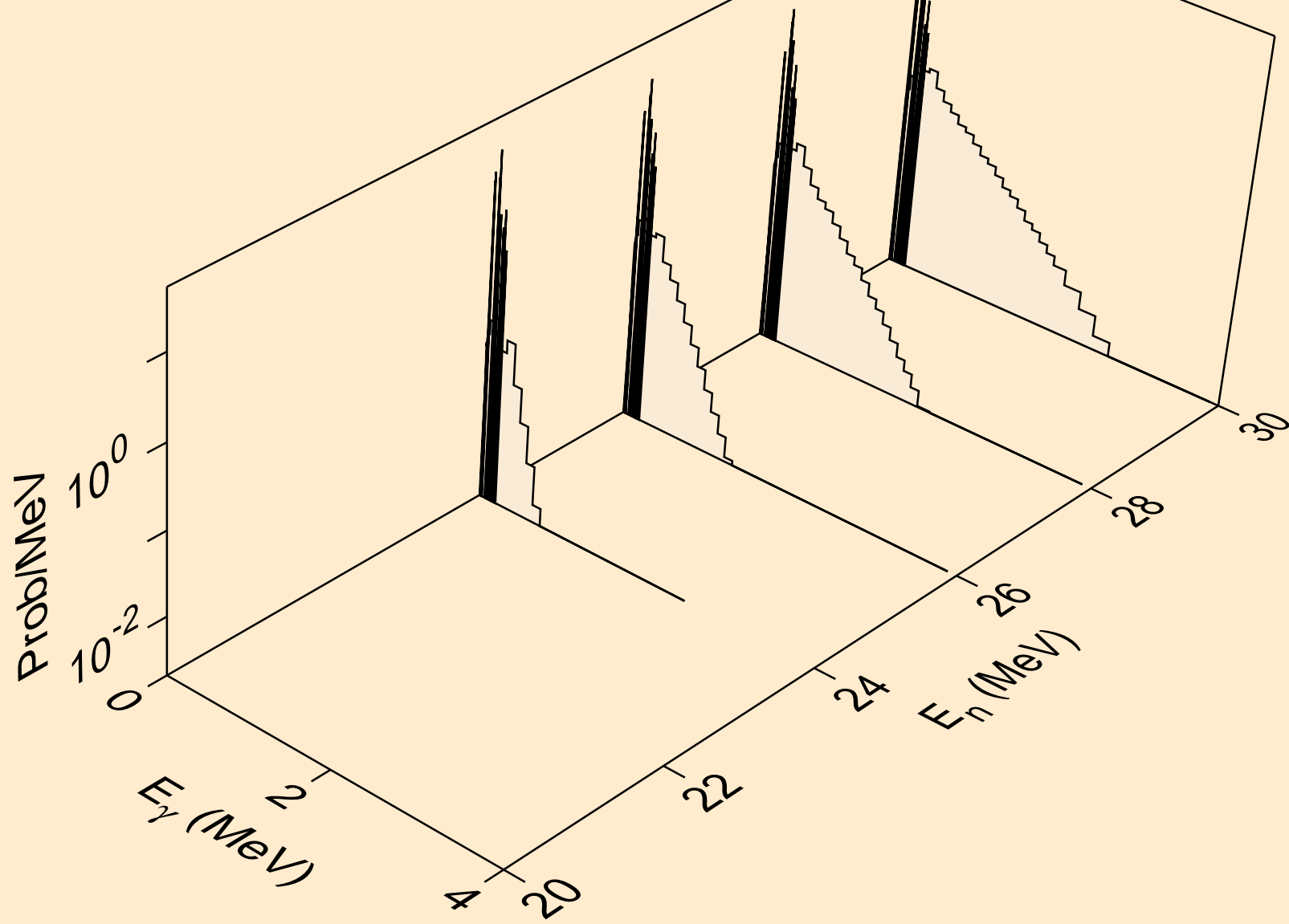

YB164 NEUTRON ACER TENDL-2023 LIBRARY; T=0.K
Photon emission for (n,2n)

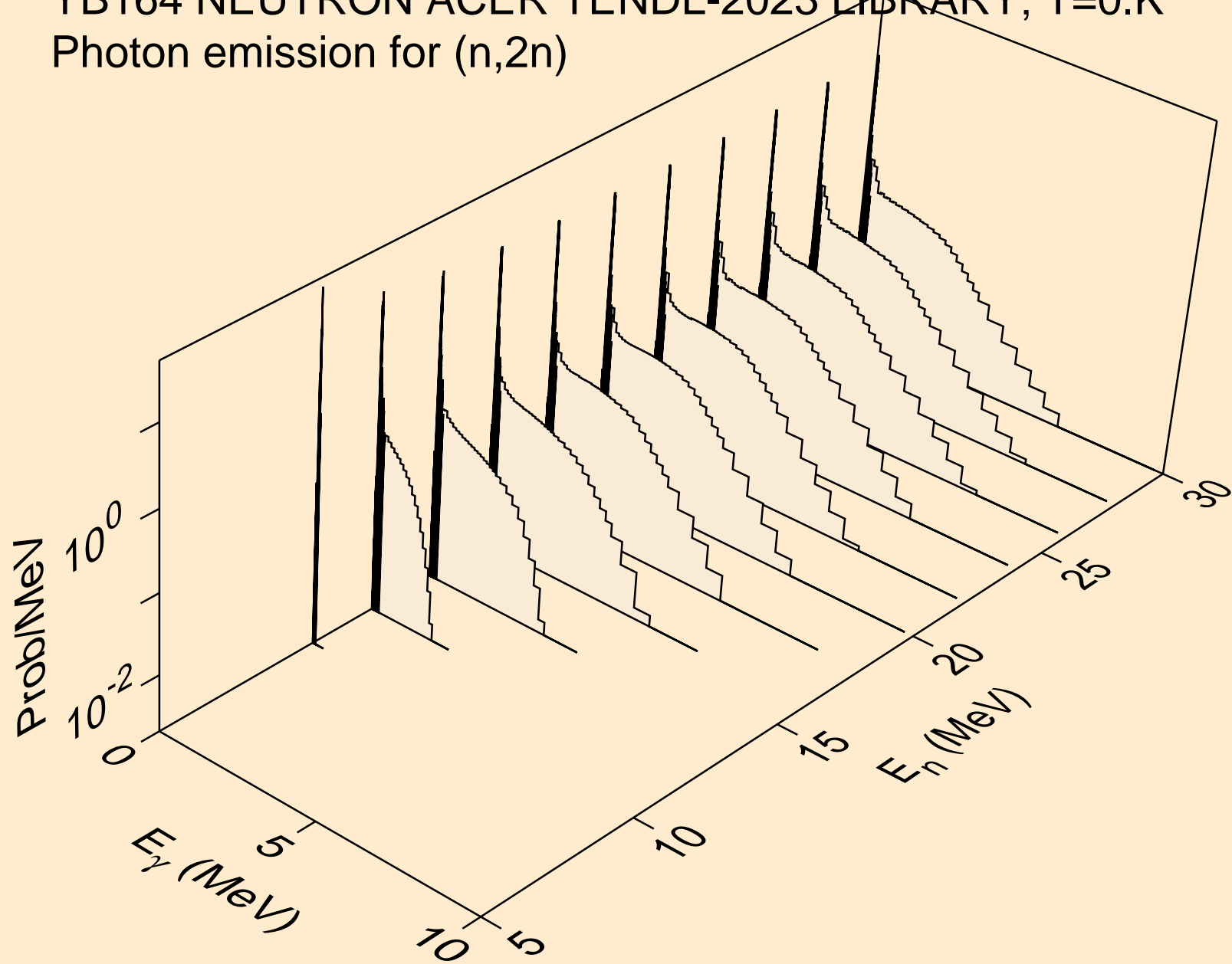

YB164 NEUTRON ACER TENDL-2023 LIBRARY; T=0.K
Photon emission for (n,3n)

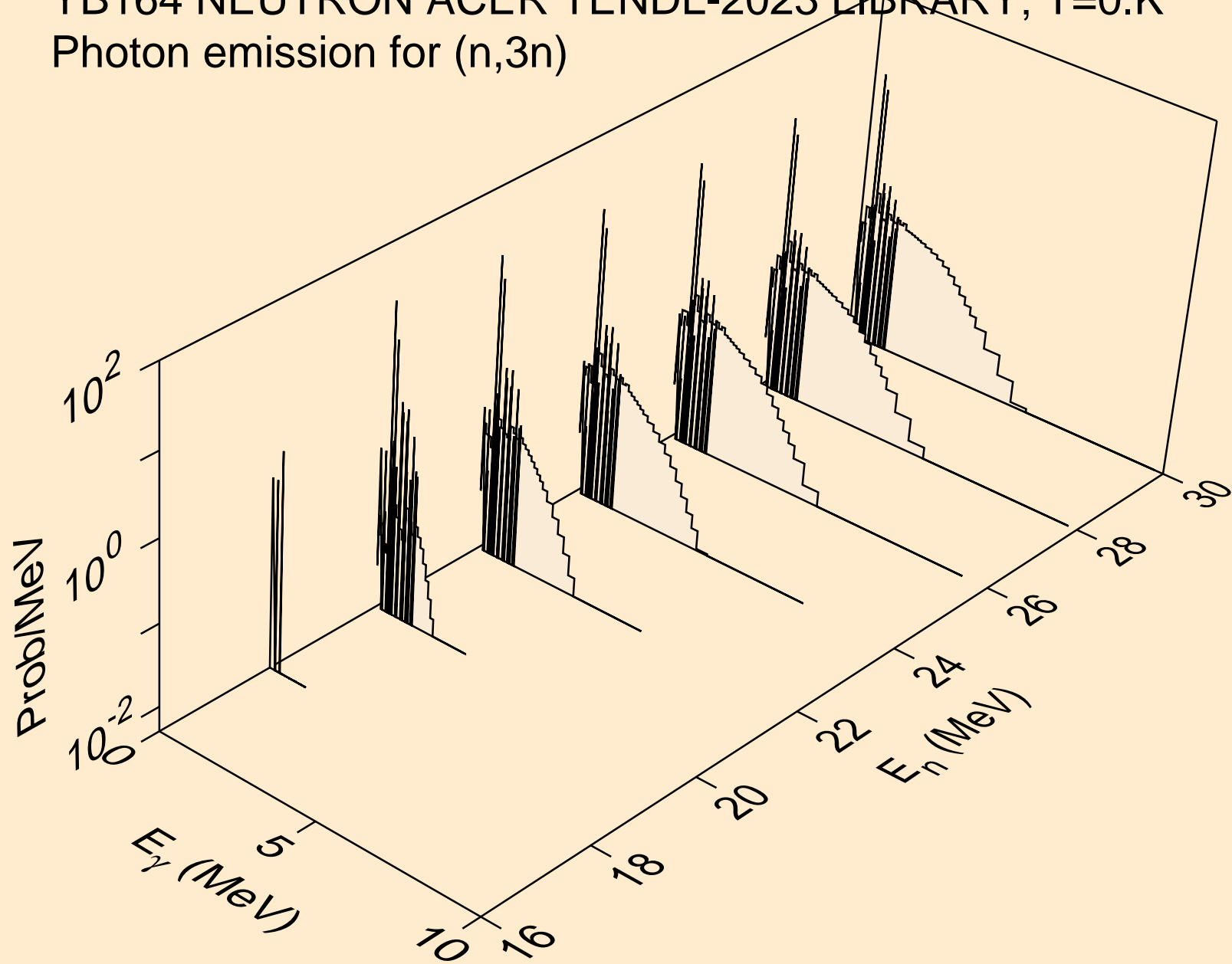

YB164 NEUTRON ACER TENDL-2023 LIBRARY; T=0.K
Photon emission for (n,n*)a

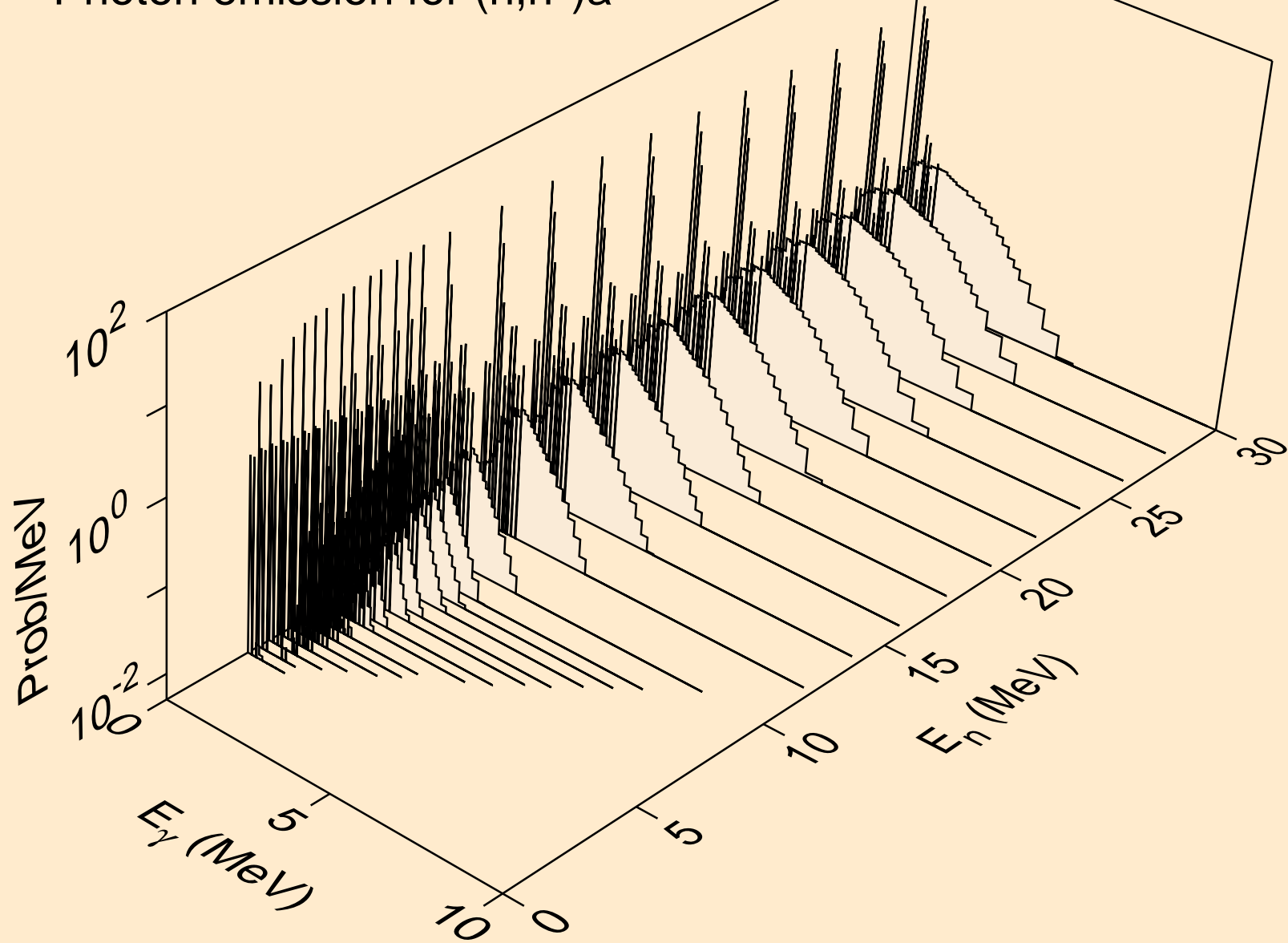

YB164 NEUTRON ACER TENDL-2023 LIBRARY; T=0.K
Photon emission for (n,2n)a

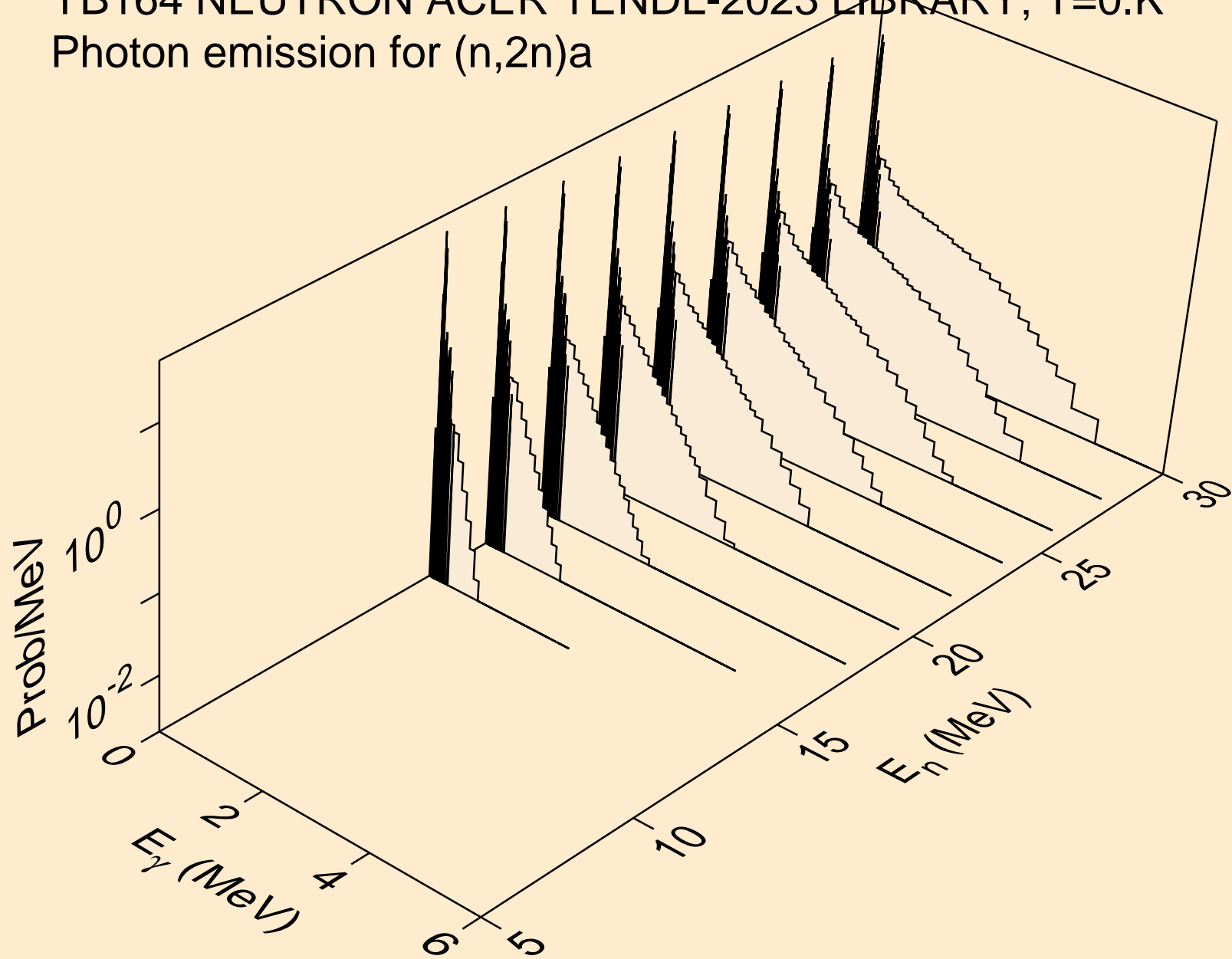

YB164 NEUTRON ACER TENDL-2023 LIBRARY; T=0.K
Photon emission for (n,3n)a

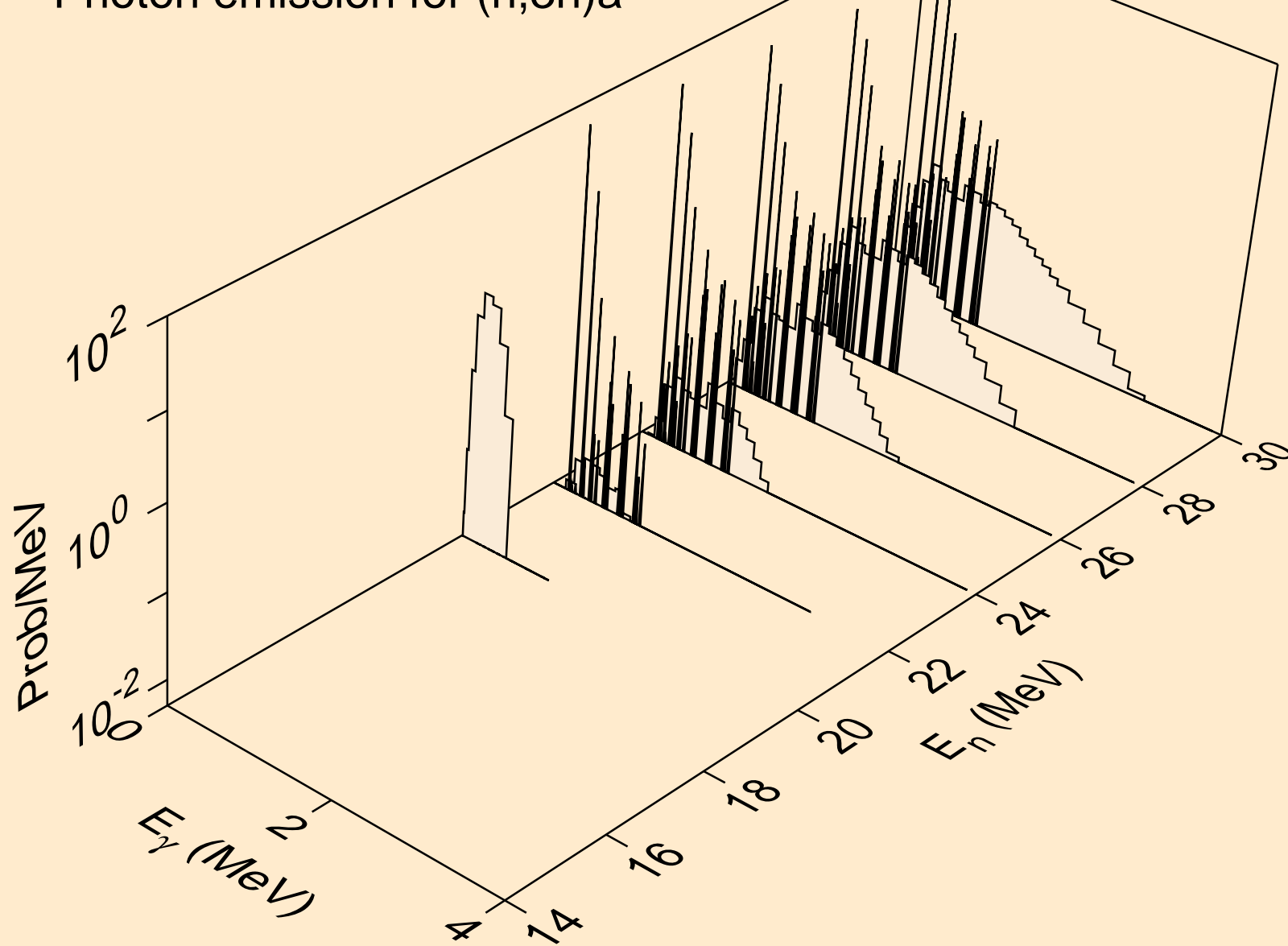

YB164 NEUTRON ACER TENDL-2023 LIBRARY; T=0.K
Photon emission for (n,n*)p

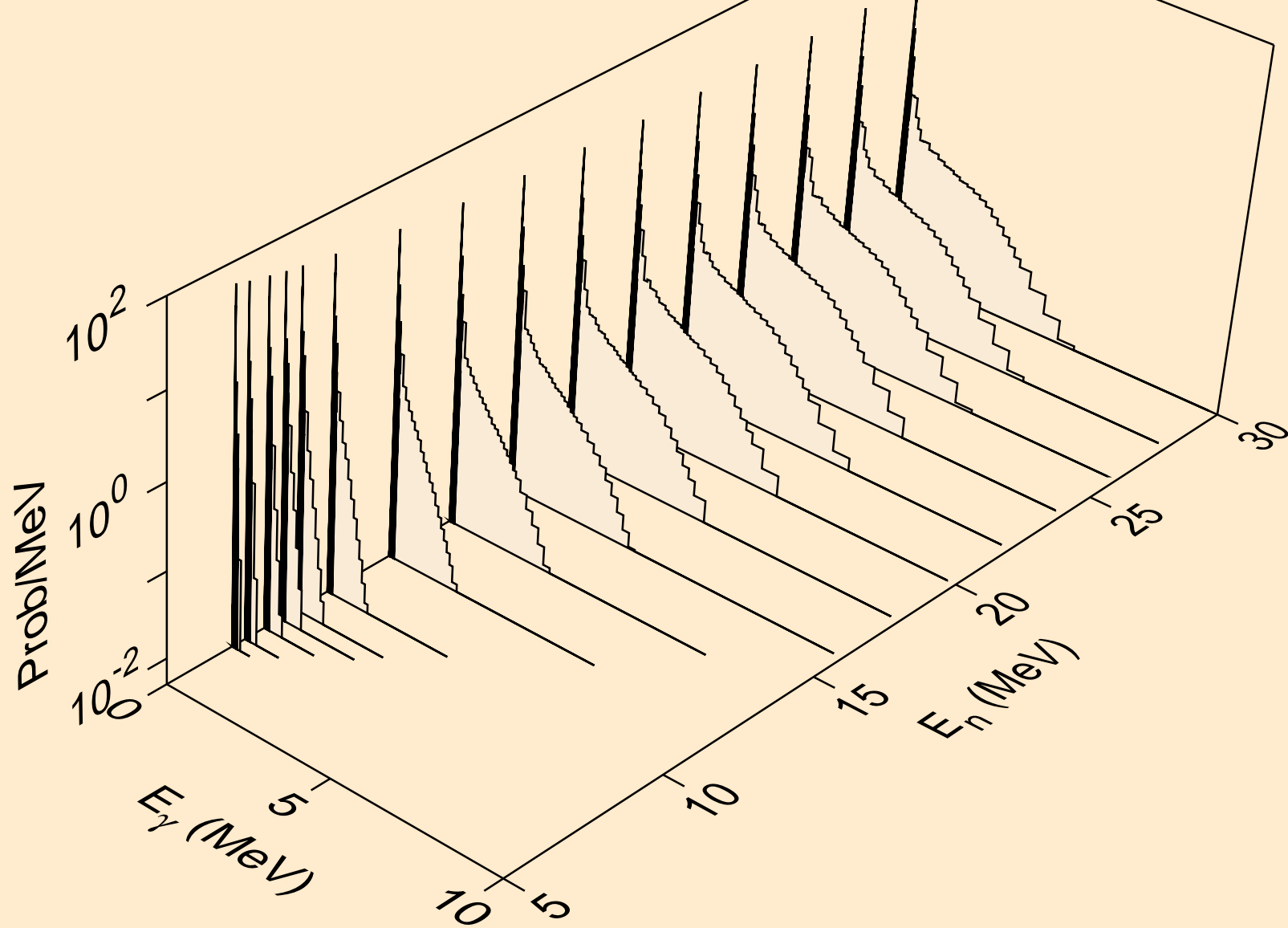

YB164 NEUTRON ACER TENDL-2023 LIBRARY; T=0.K
Photon emission for (n,n*)2a

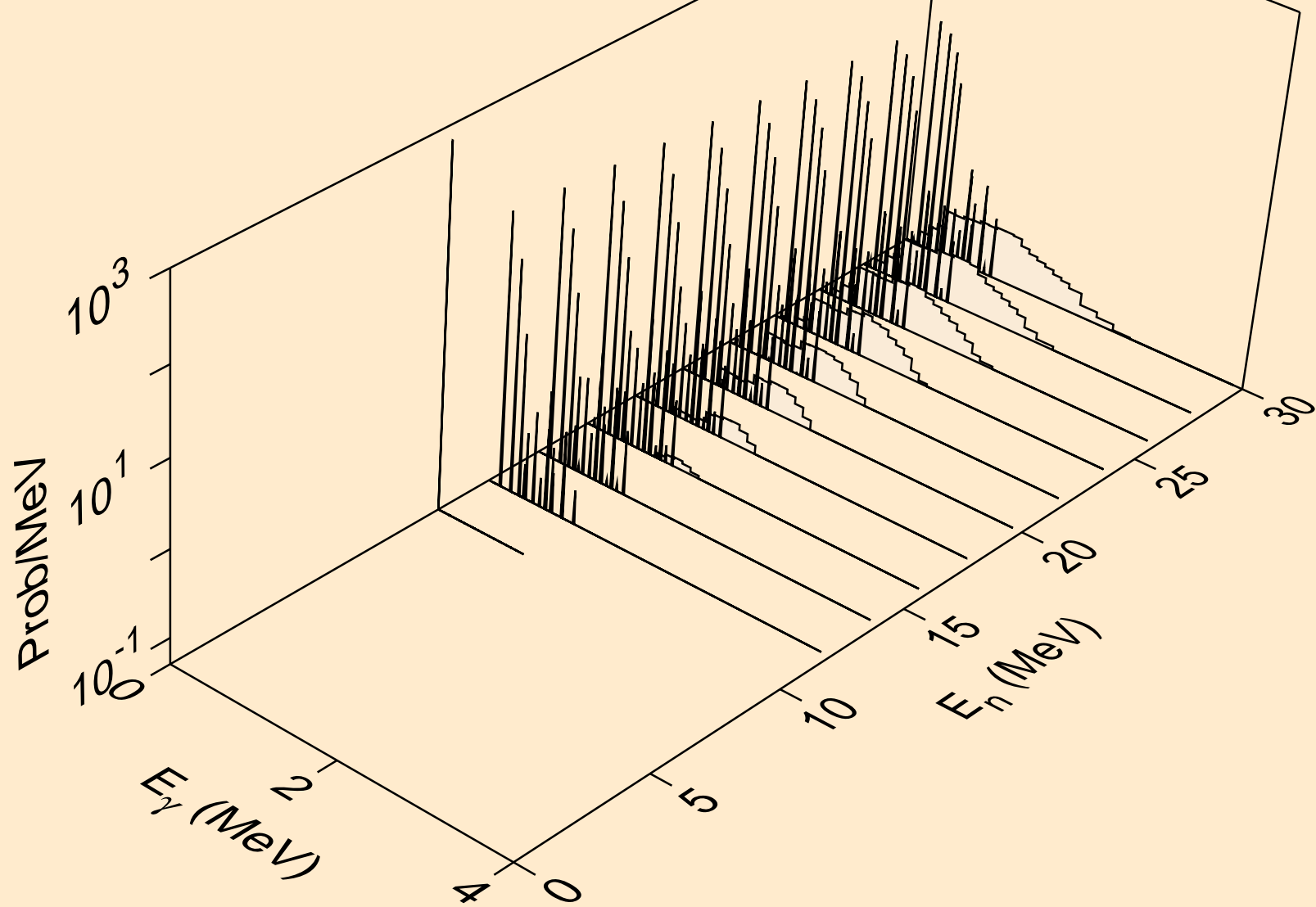

YB164 NEUTRON ACER TENDL-2023 LIBRARY; T=0.K
Photon emission for (n,2n)2a

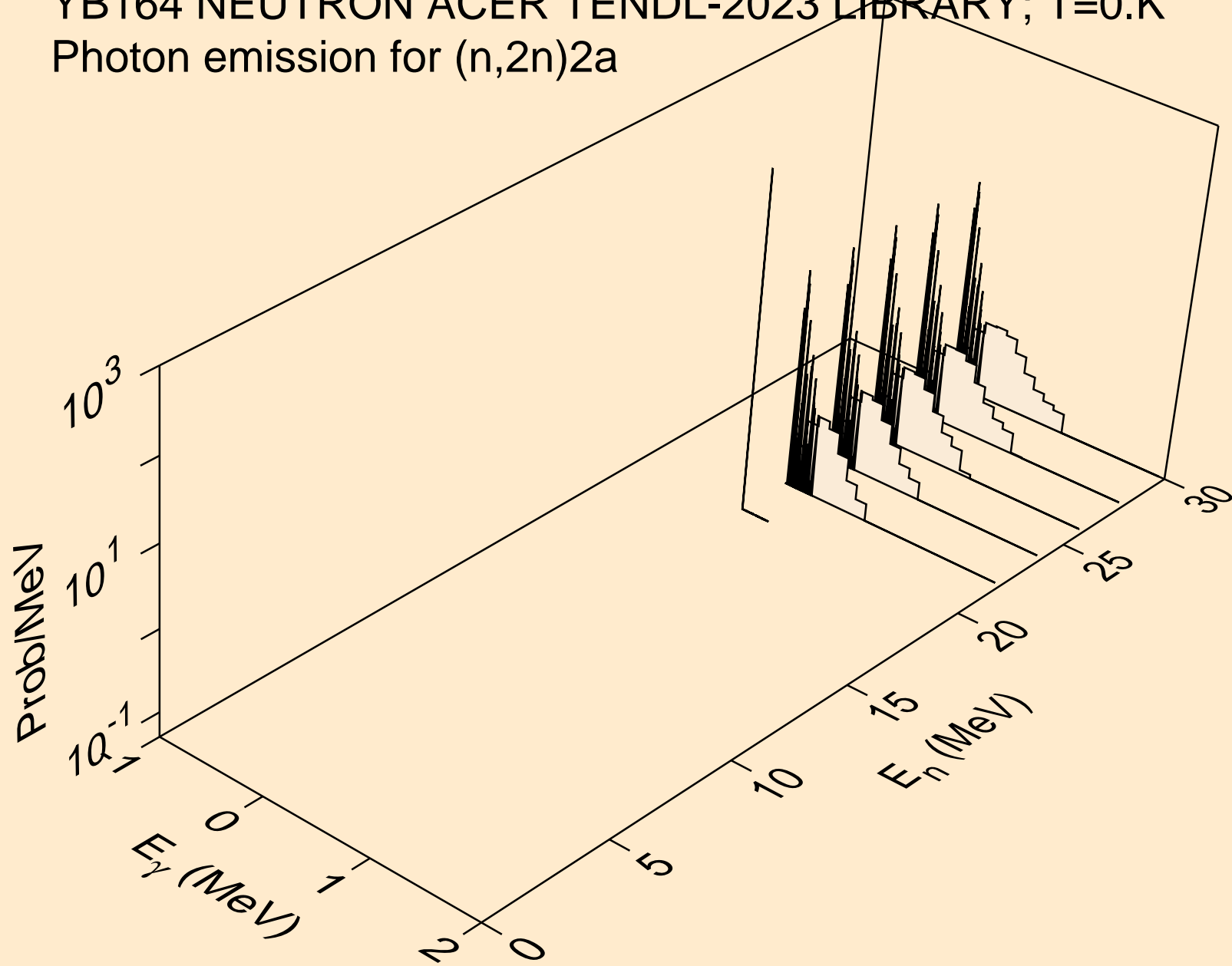

YB164 NEUTRON ACER TENDL-2023 LIBRARY; T=0.K
Photon emission for (n,n*)d

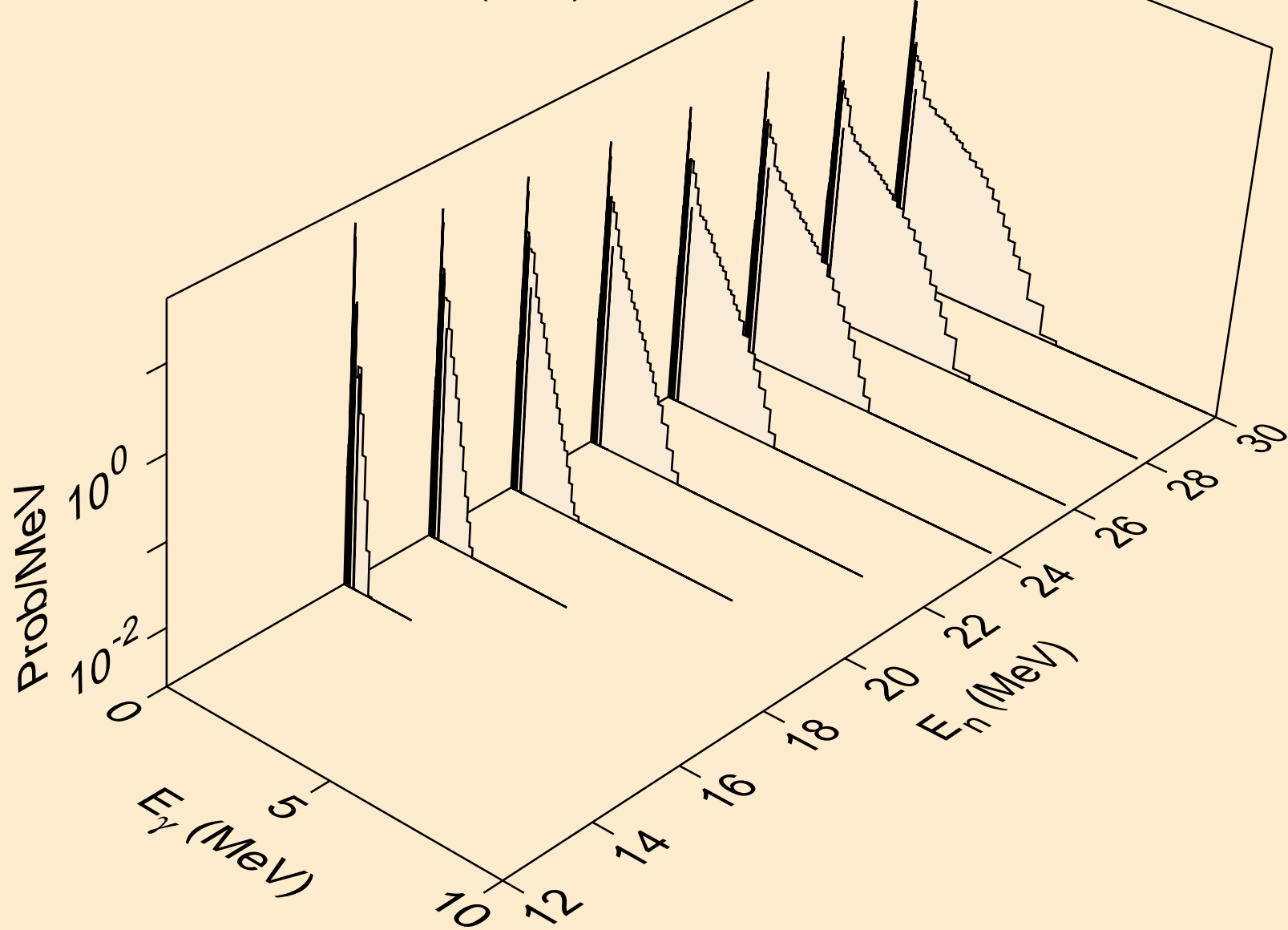

YB164 NEUTRON ACER TENDL-2023 LIBRARY; T=0.K
Photon emission for (n,n*)t

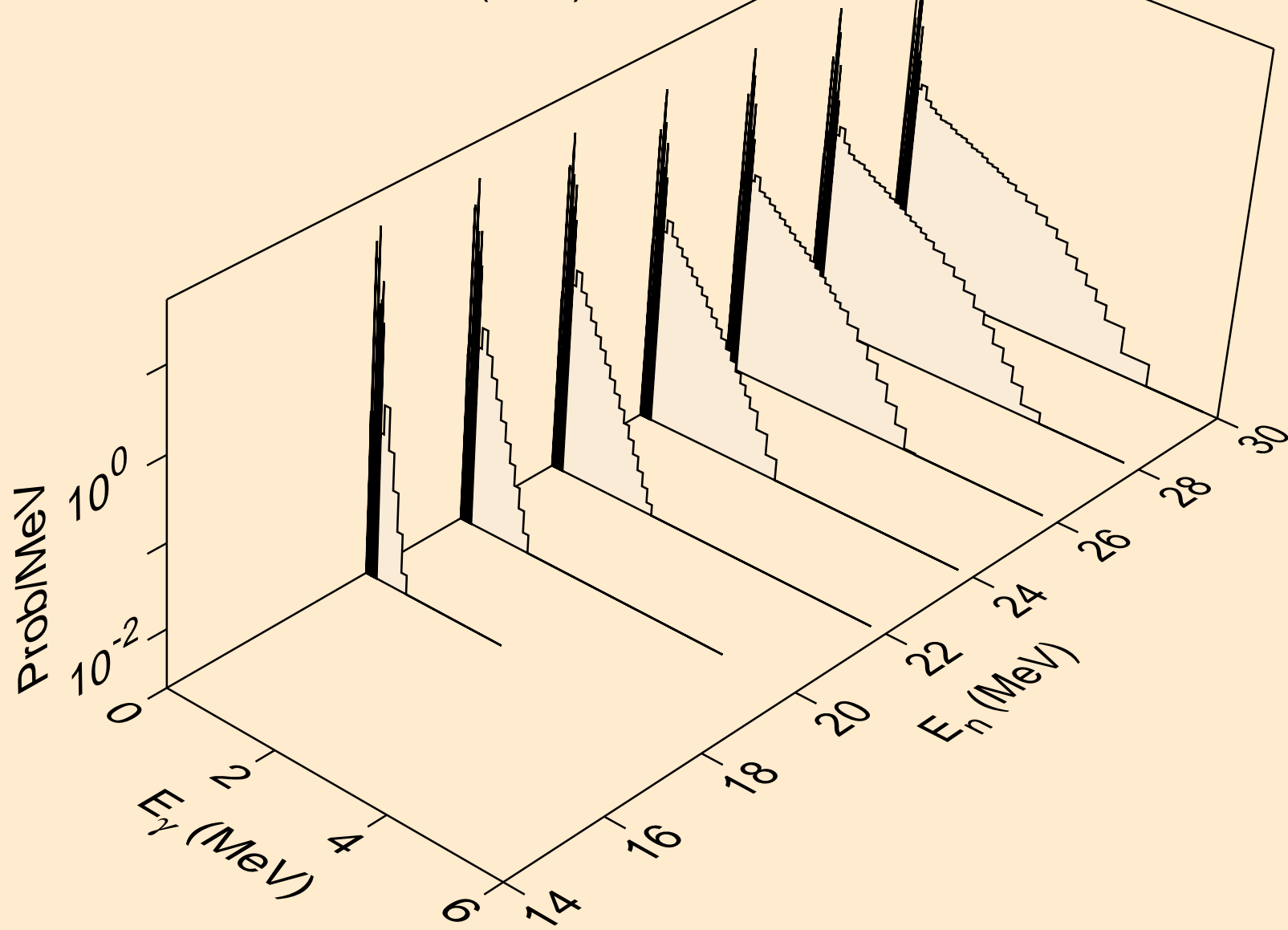

YB164 NEUTRON ACER TENDL-2023 LIBRARY; T=0.K
Photon emission for (n,n*)he3

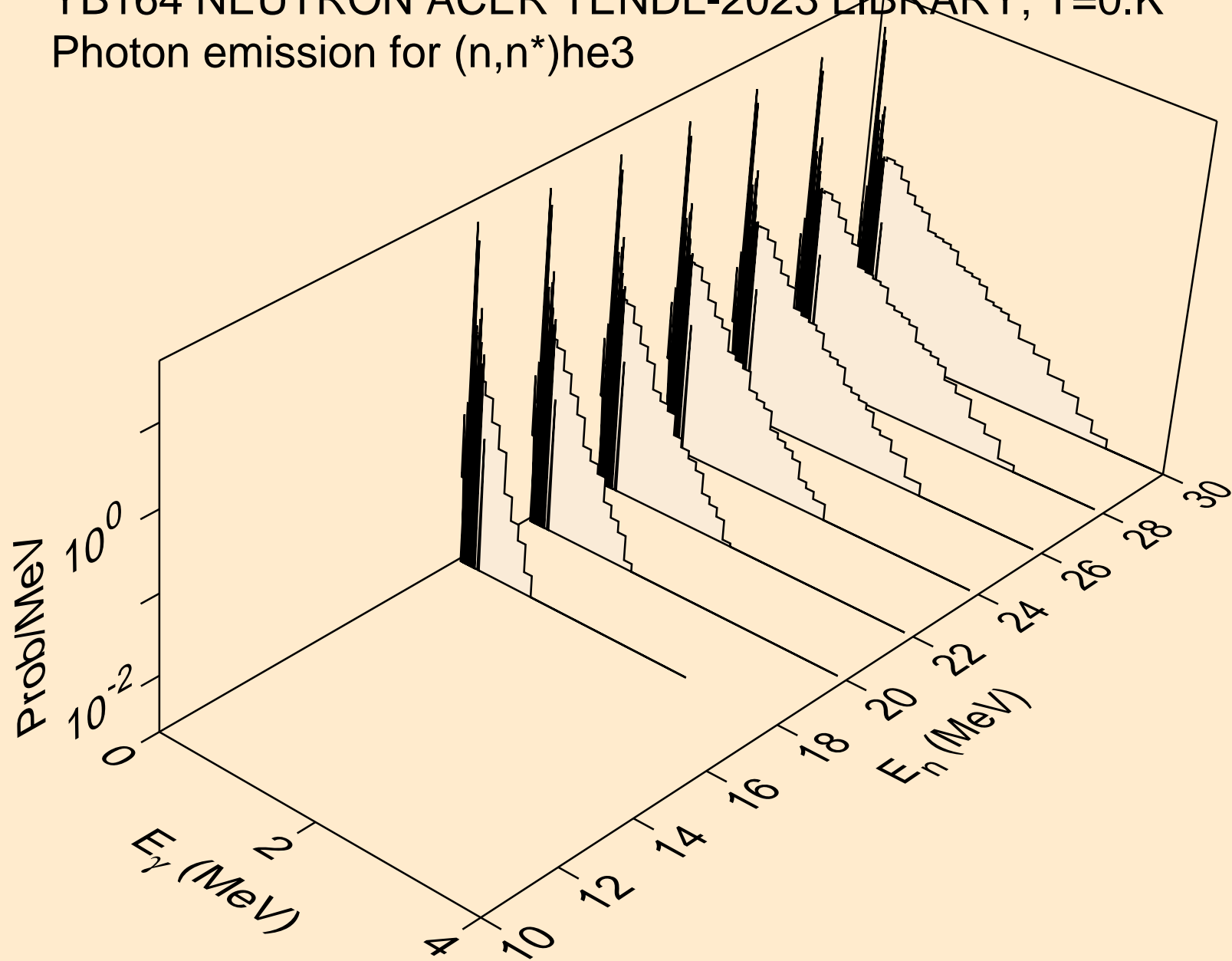

YB164 NEUTRON ACER TENDL-2023 LIBRARY; T=0.K
Photon emission for (n,4n)

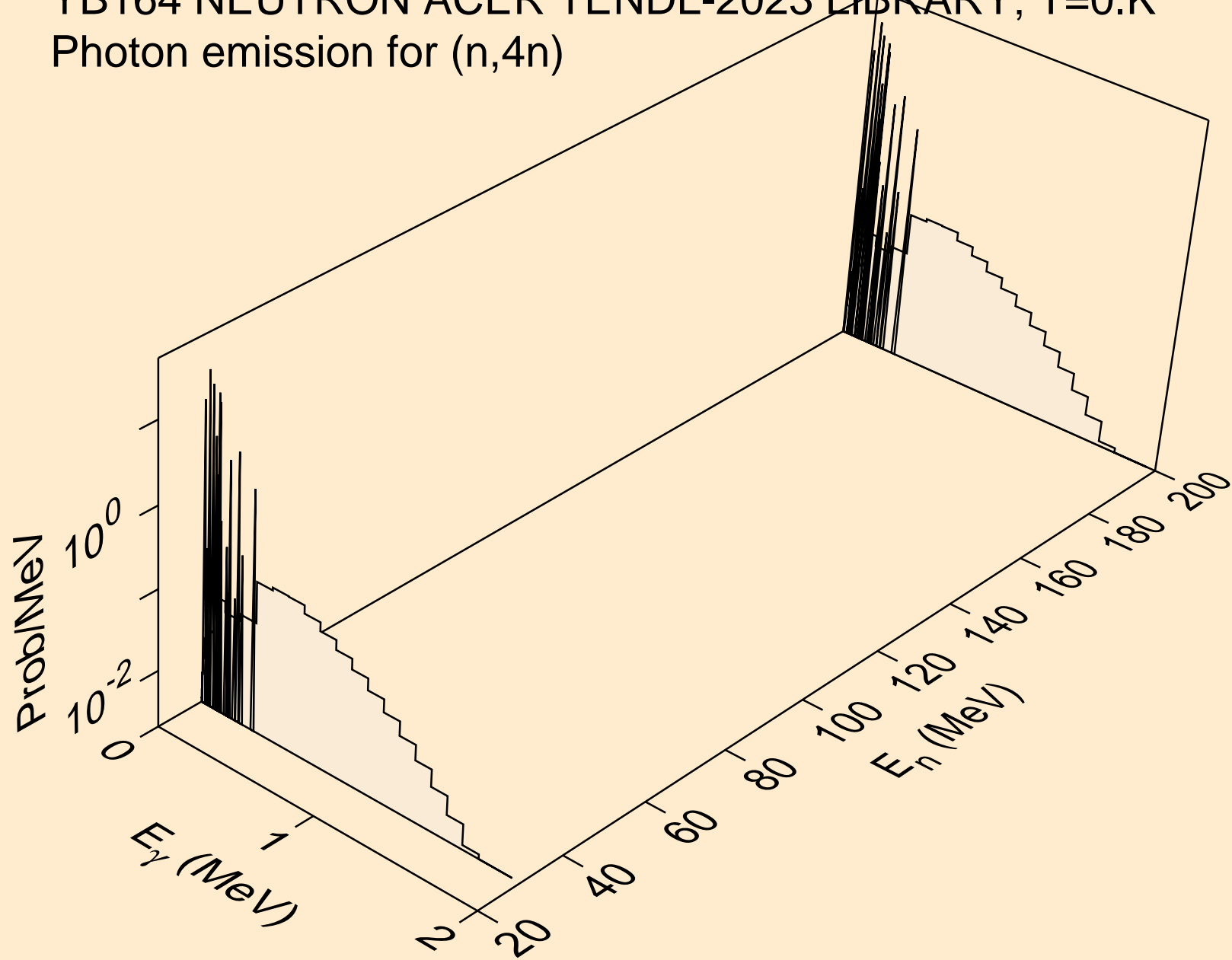

YB164 NEUTRON ACER TENDL-2023 LIBRARY; T=0.K
Photon emission for (n,2np)

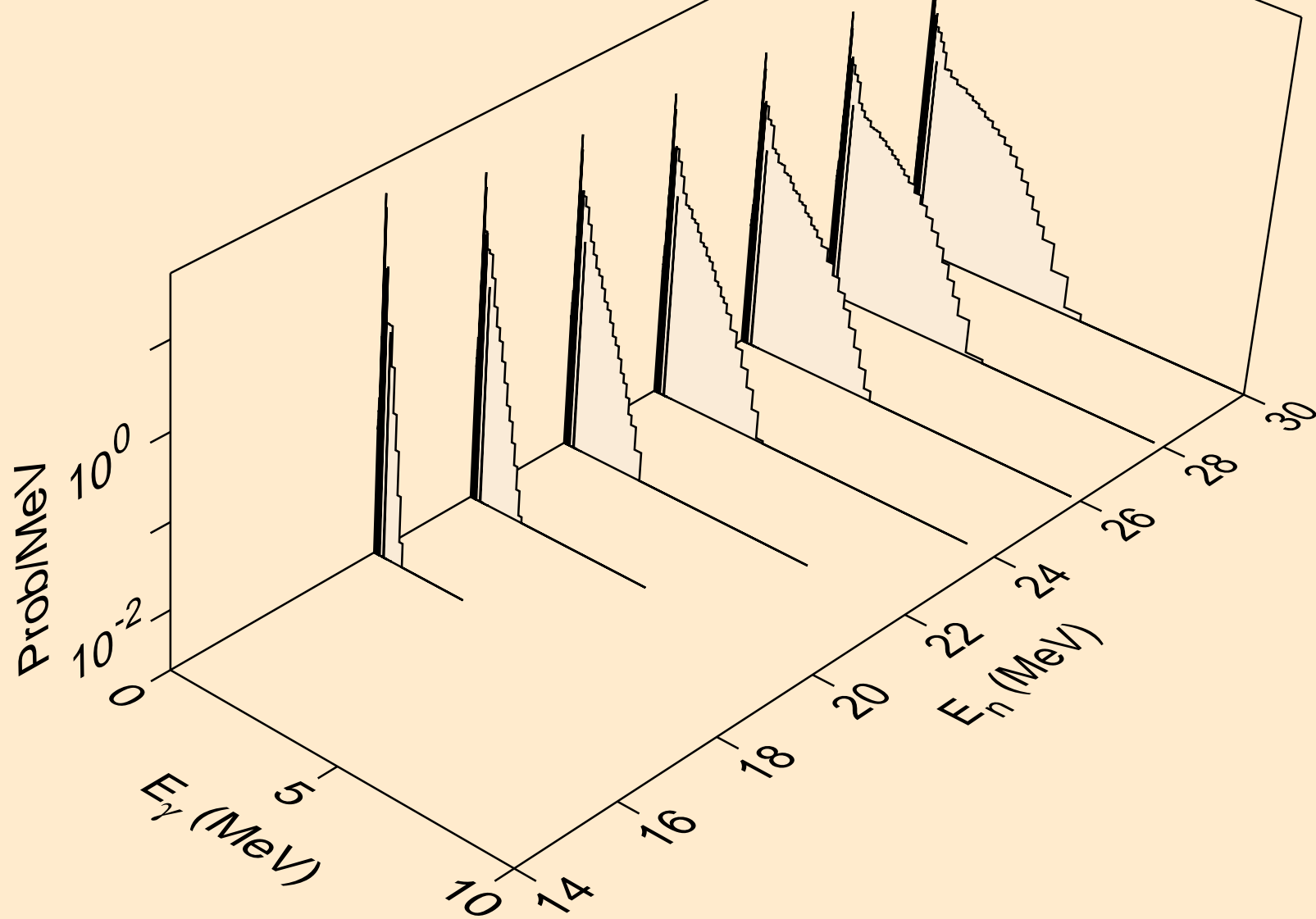

YB164 NEUTRON ACER TENDL-2023 LIBRARY; T=0.K
Photon emission for (n,3np)

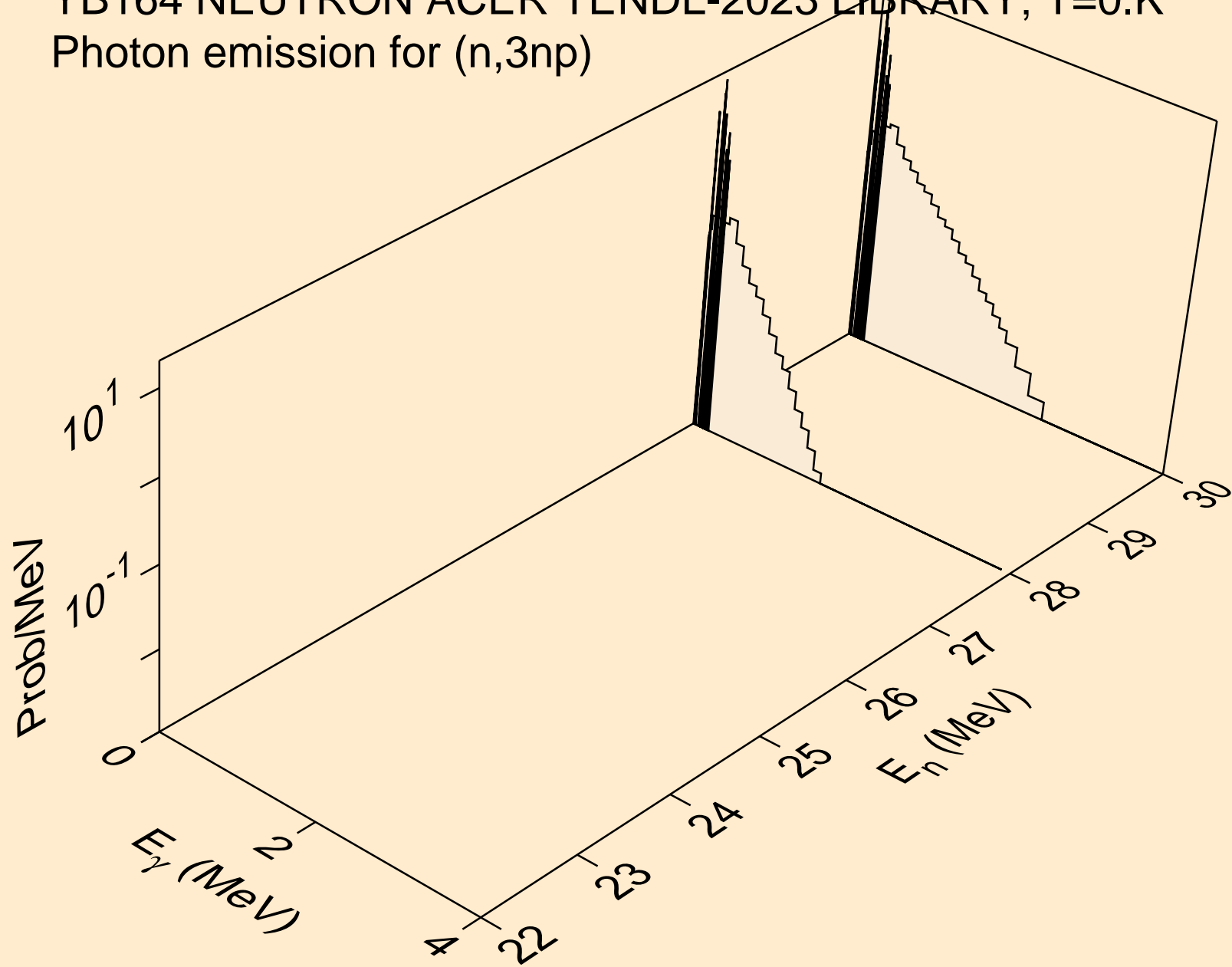

YB164 NEUTRON ACER TENDL-2023 LIBRARY; T=0.K
Photon emission for (n,n2p)

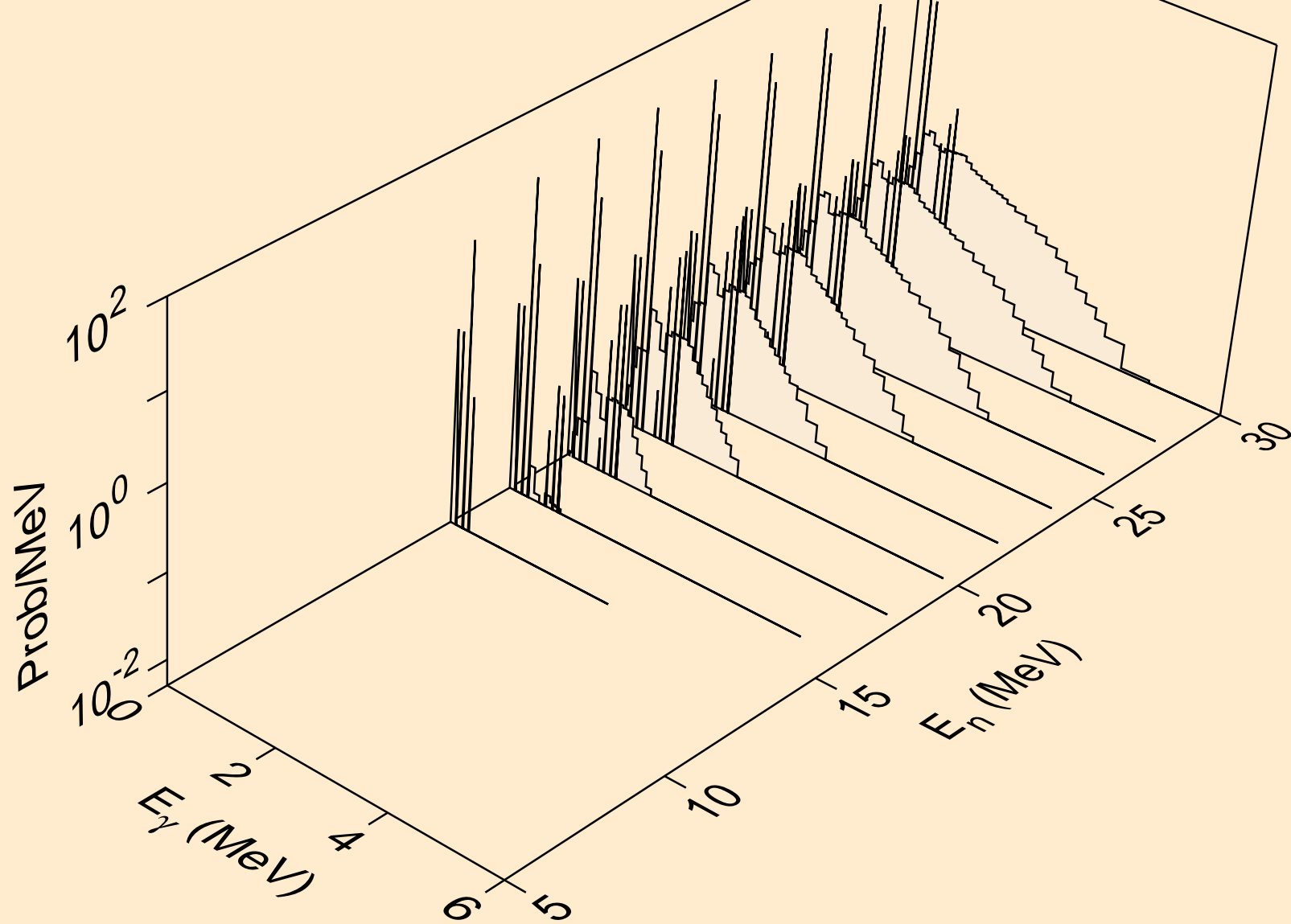

YB164 NEUTRON ACER TENDL-2023 LIBRARY; T=0.K
Photon emission for (n,npa)

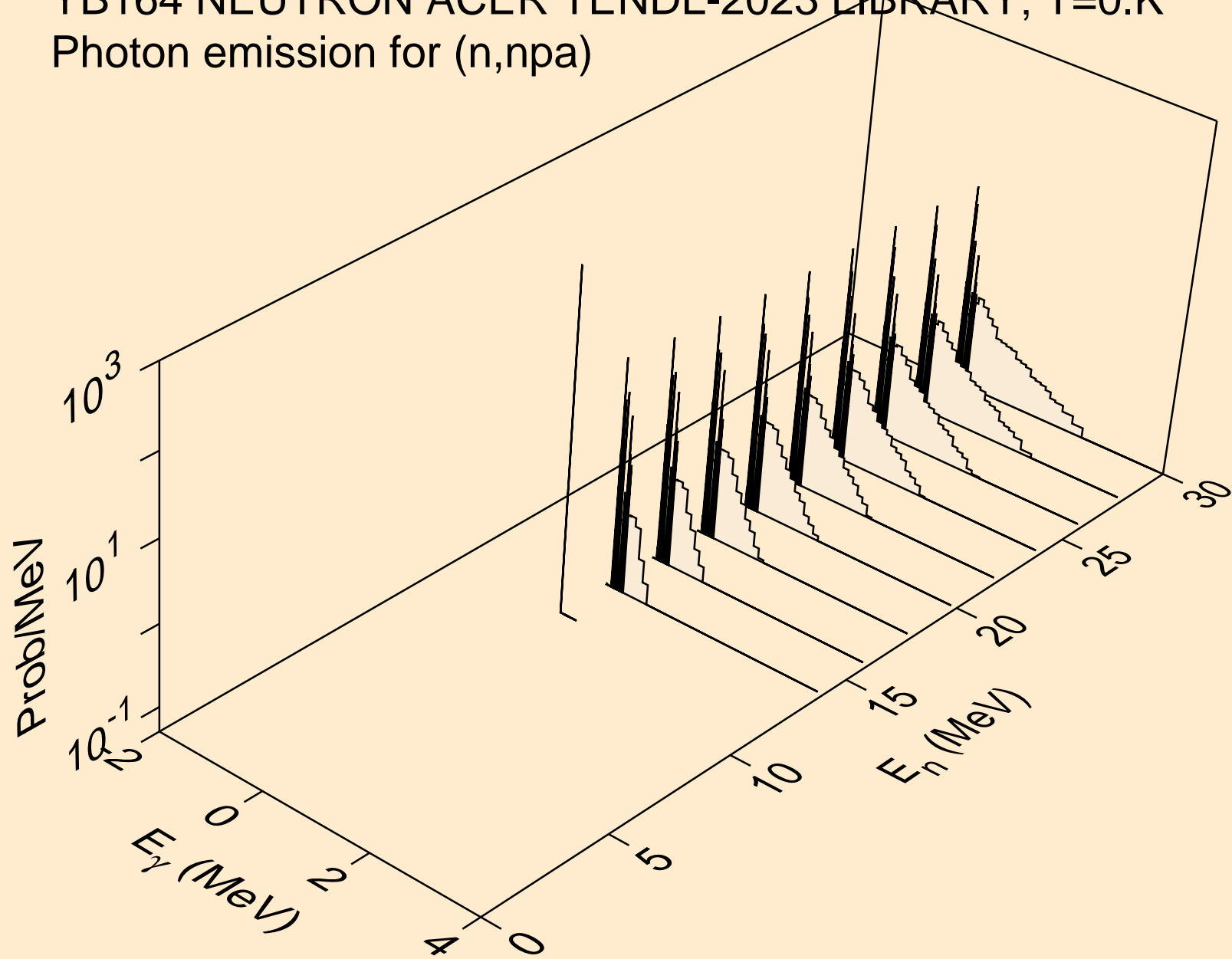

YB164 NEUTRON ACER TENDL-2023 LIBRARY; T=0.K
Photon emission for (n,n*c)

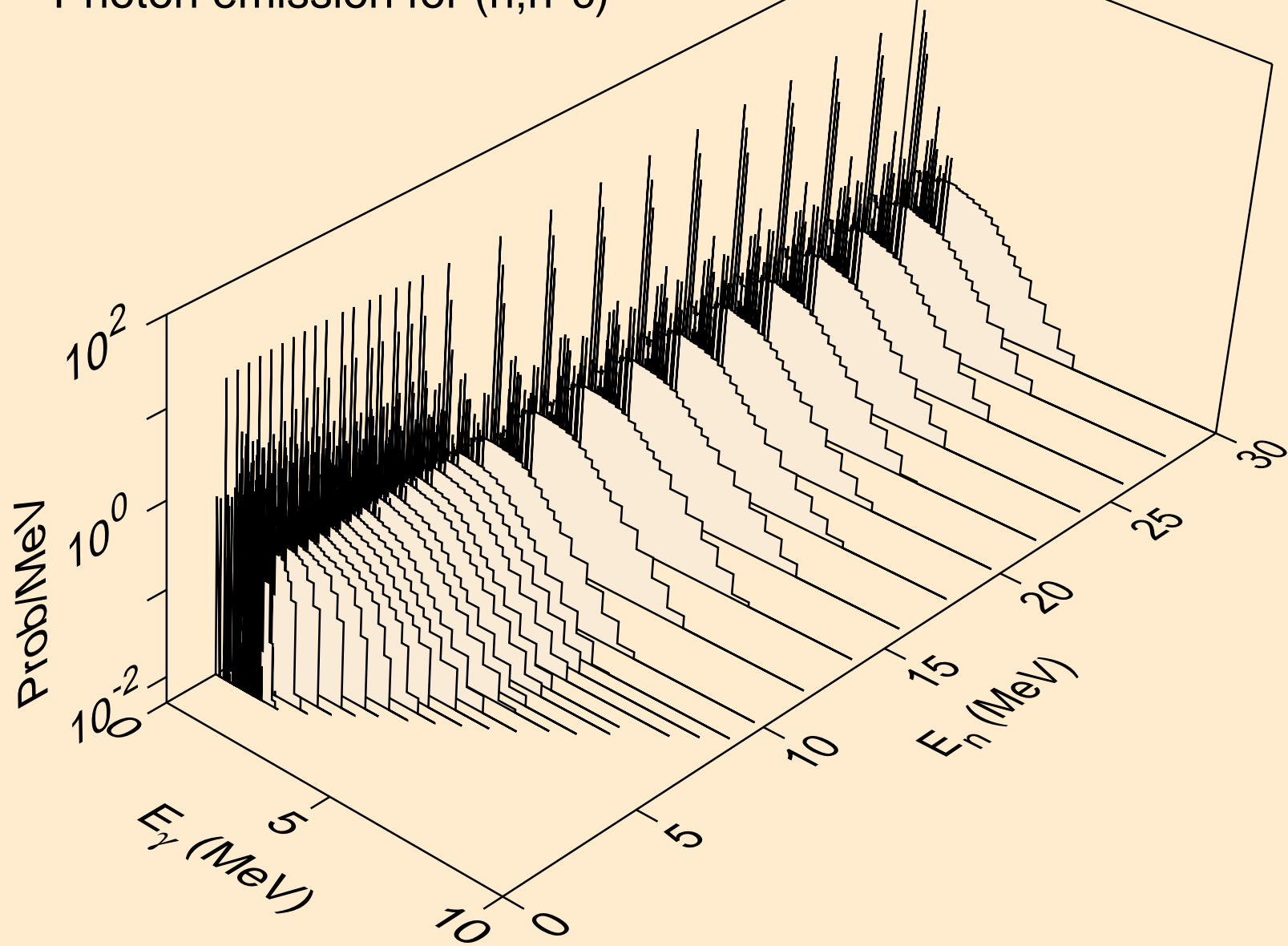

YB164 NEUTRON ACER TENDL-2023 LIBRARY; T=0.K
Photon emission for (n,gma)

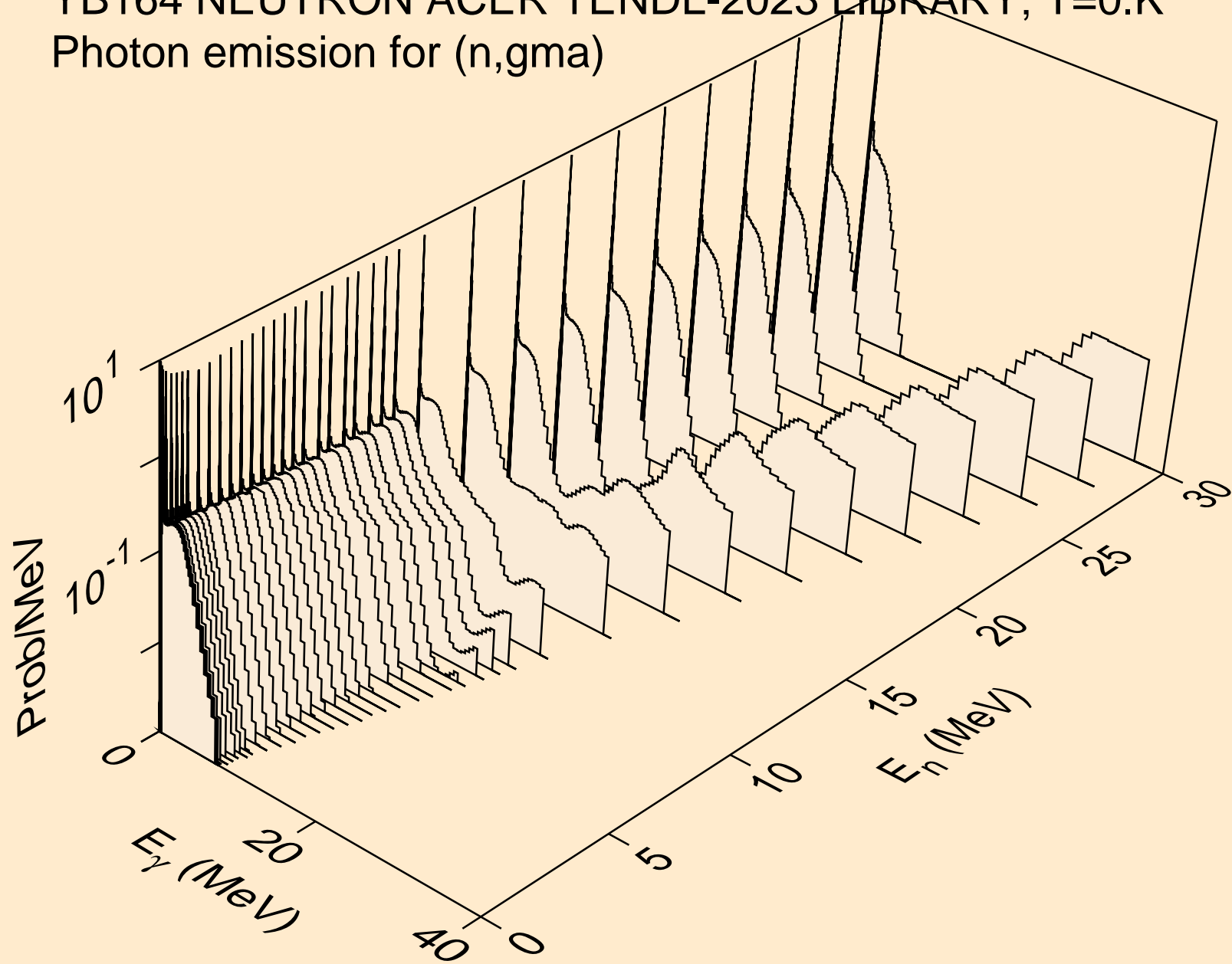

YB164 NEUTRON ACER TENDL-2023 LIBRARY; T=0.K
Photon emission for (n,p)

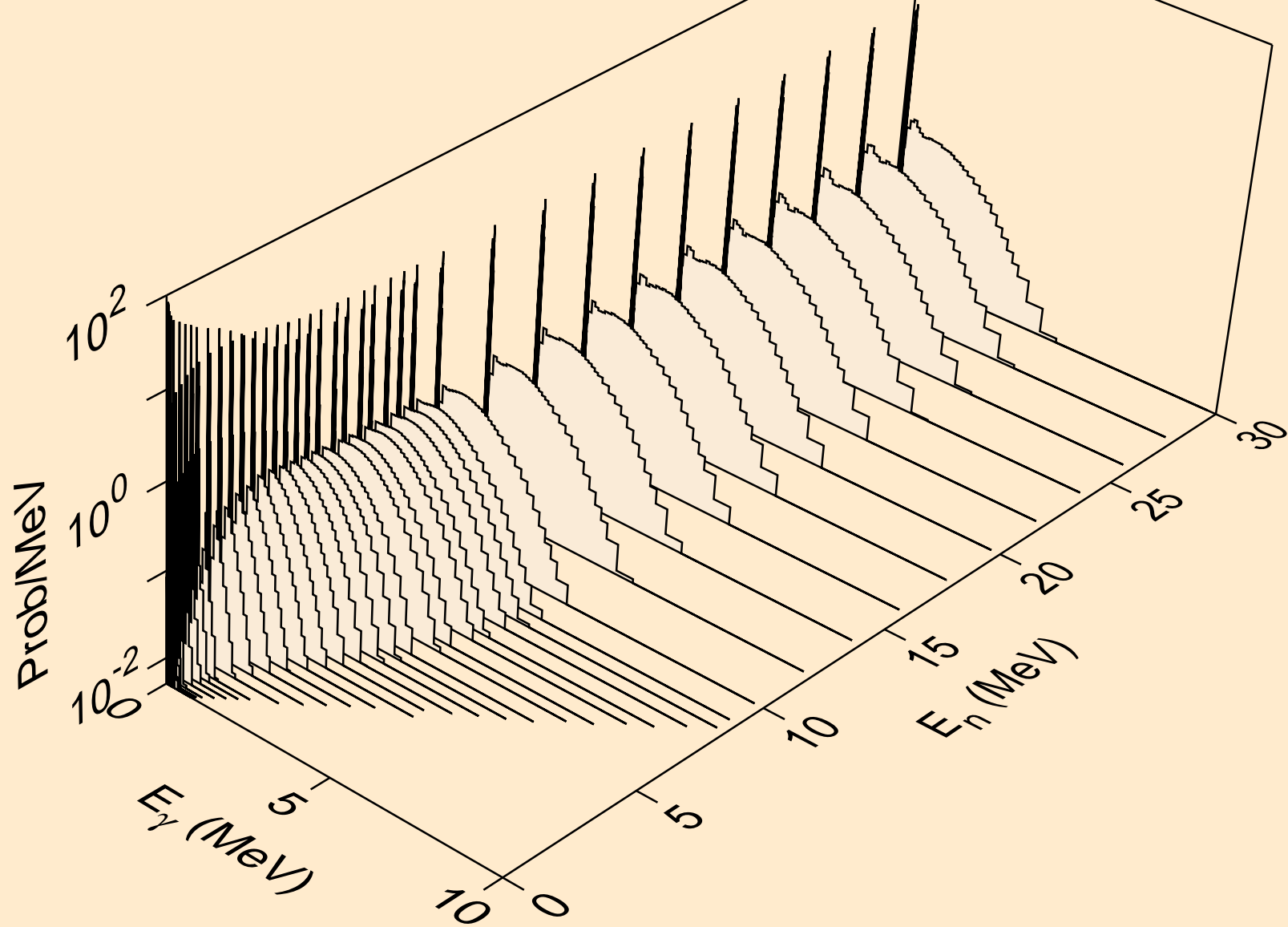

YB164 NEUTRON ACER TENDL-2023 LIBRARY; T=0.K
Photon emission for (n,d)

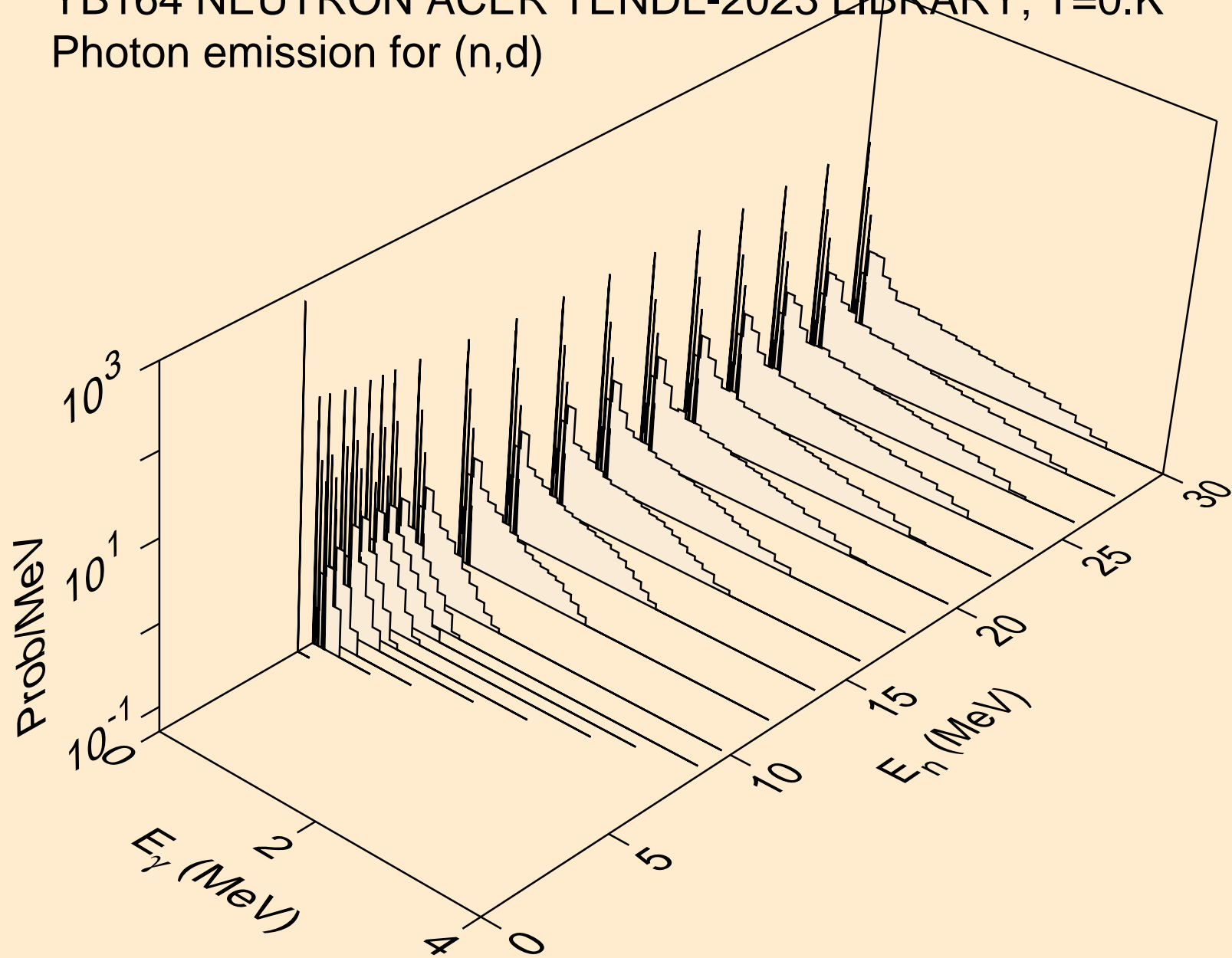

YB164 NEUTRON ACER TENDL-2023 LIBRARY; T=0.K
Photon emission for (n,t)

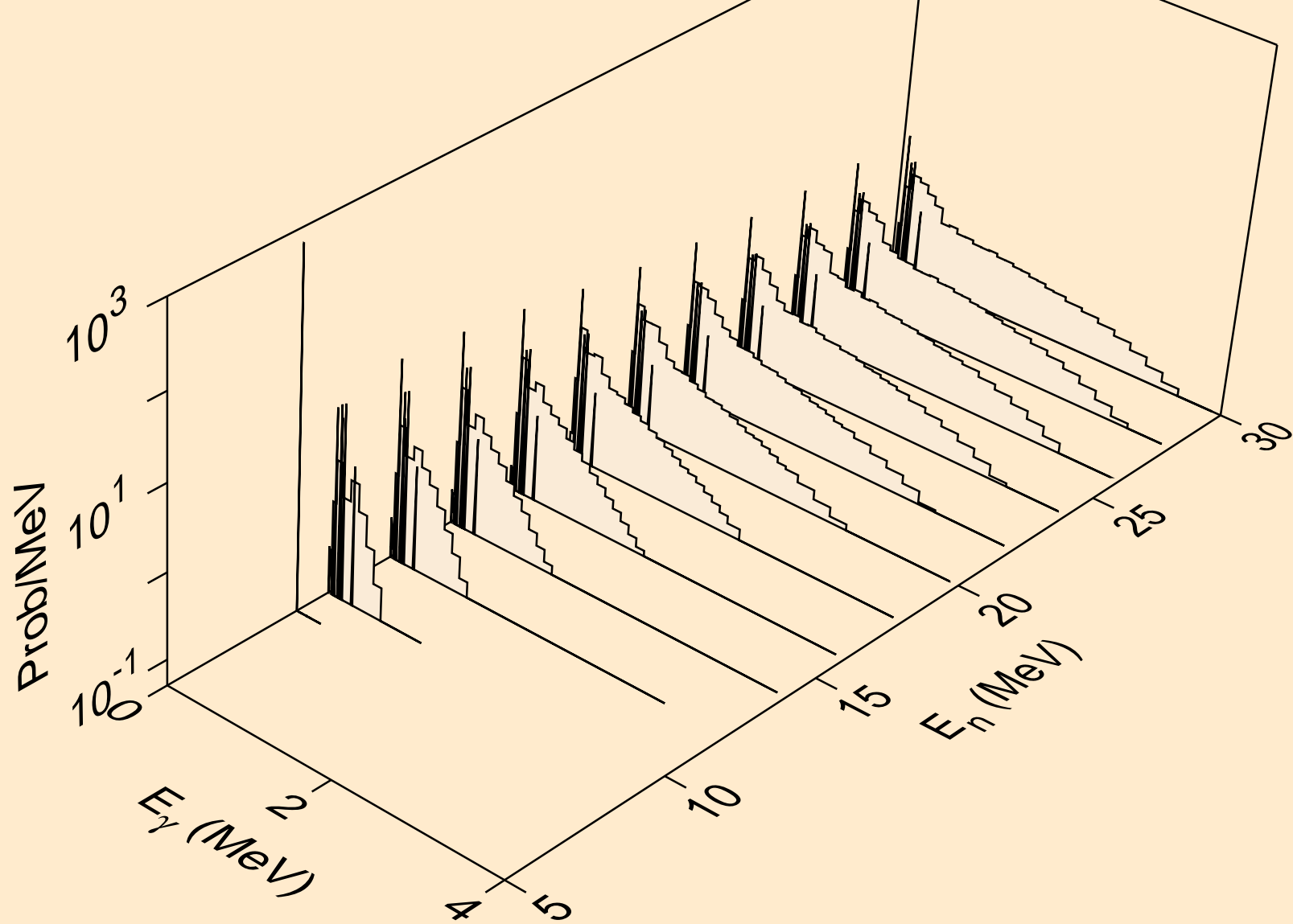

YB164 NEUTRON ACER TENDL-2023 LIBRARY; T=0.K
Photon emission for (n,he3)

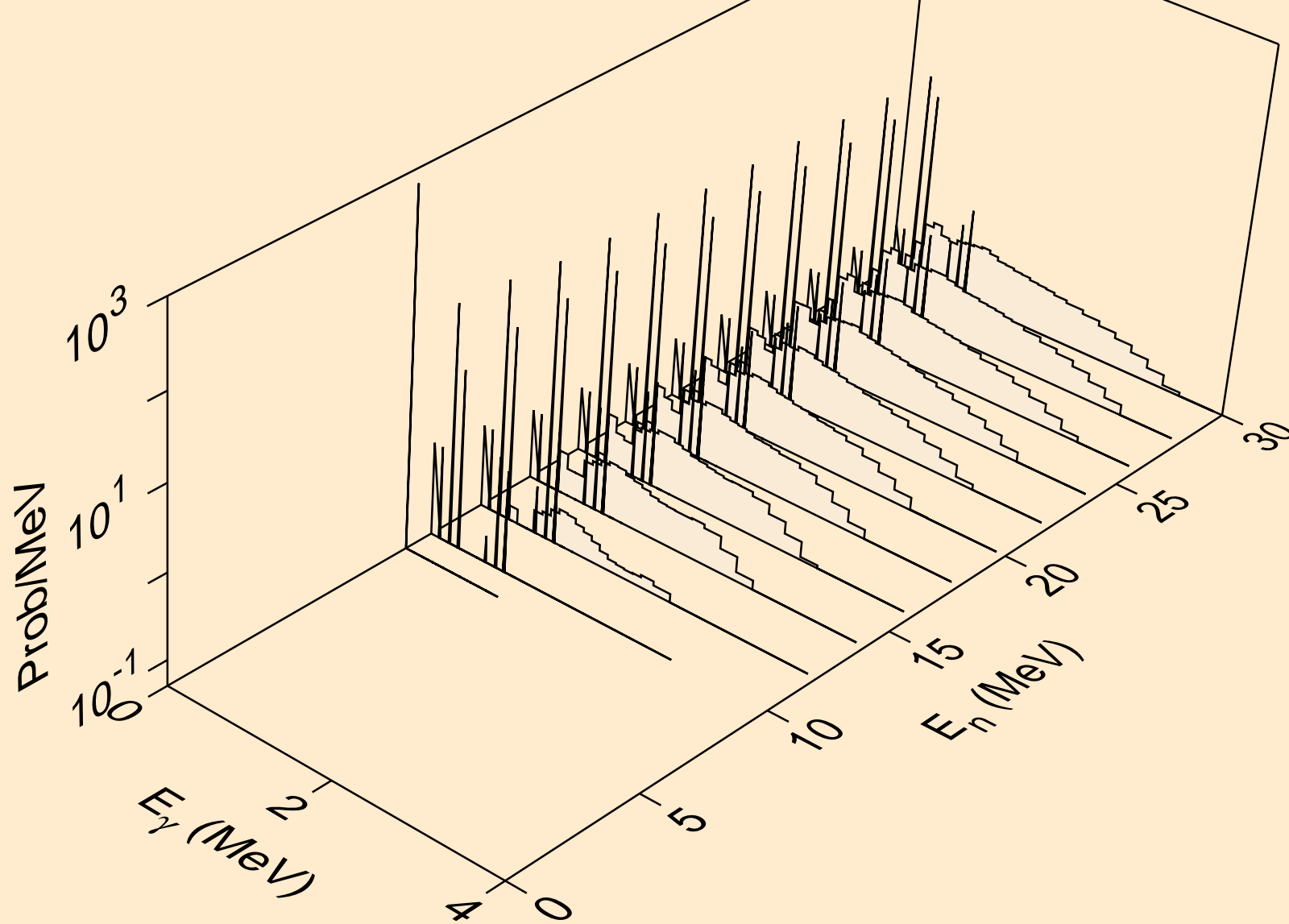

YB164 NEUTRON ACER TENDL-2023 LIBRARY; T=0.K
Photon emission for (n,a)

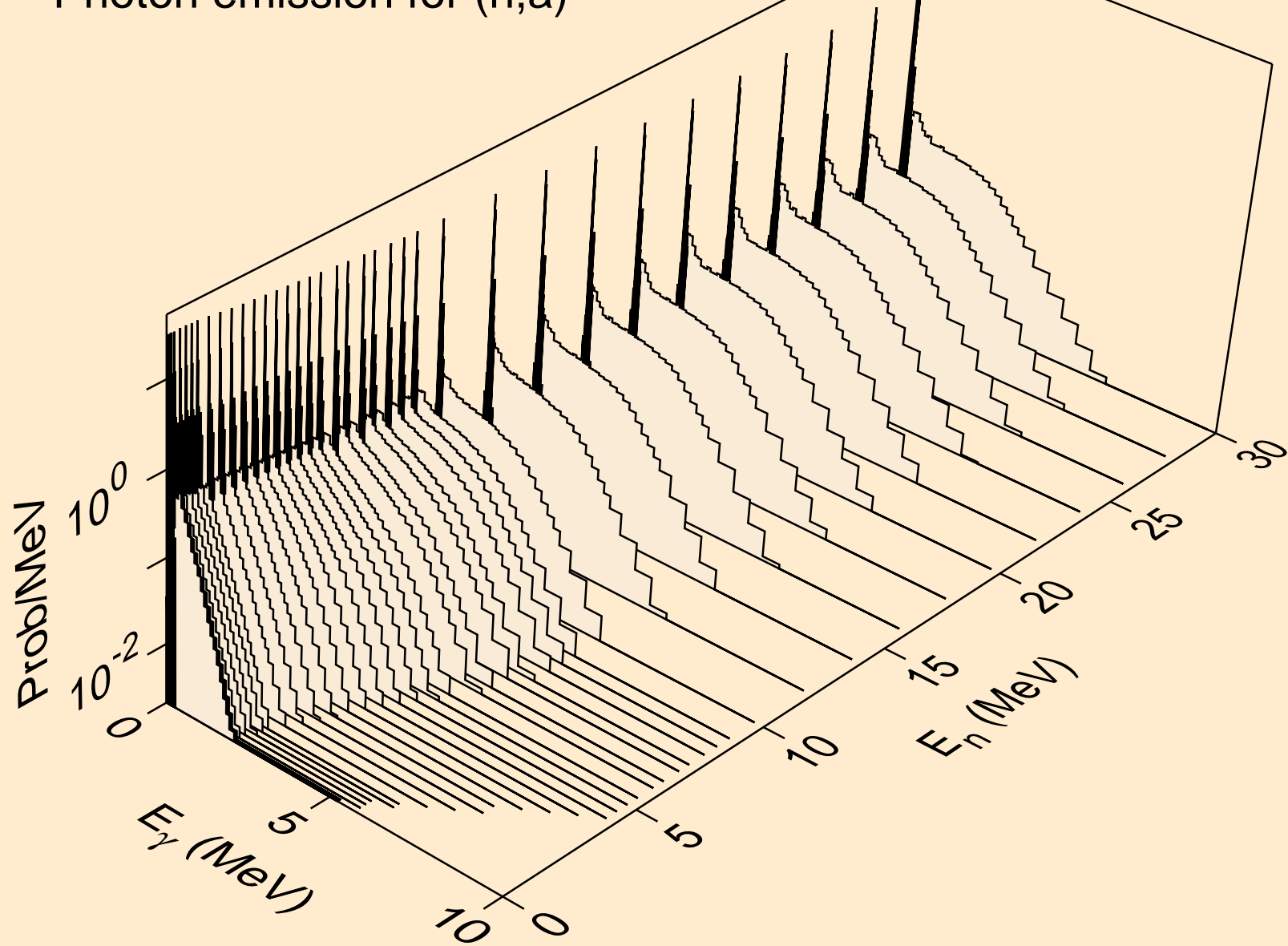

YB164 NEUTRON ACER TENDL-2023 LIBRARY; T=0.K
Photon emission for (n,2a)

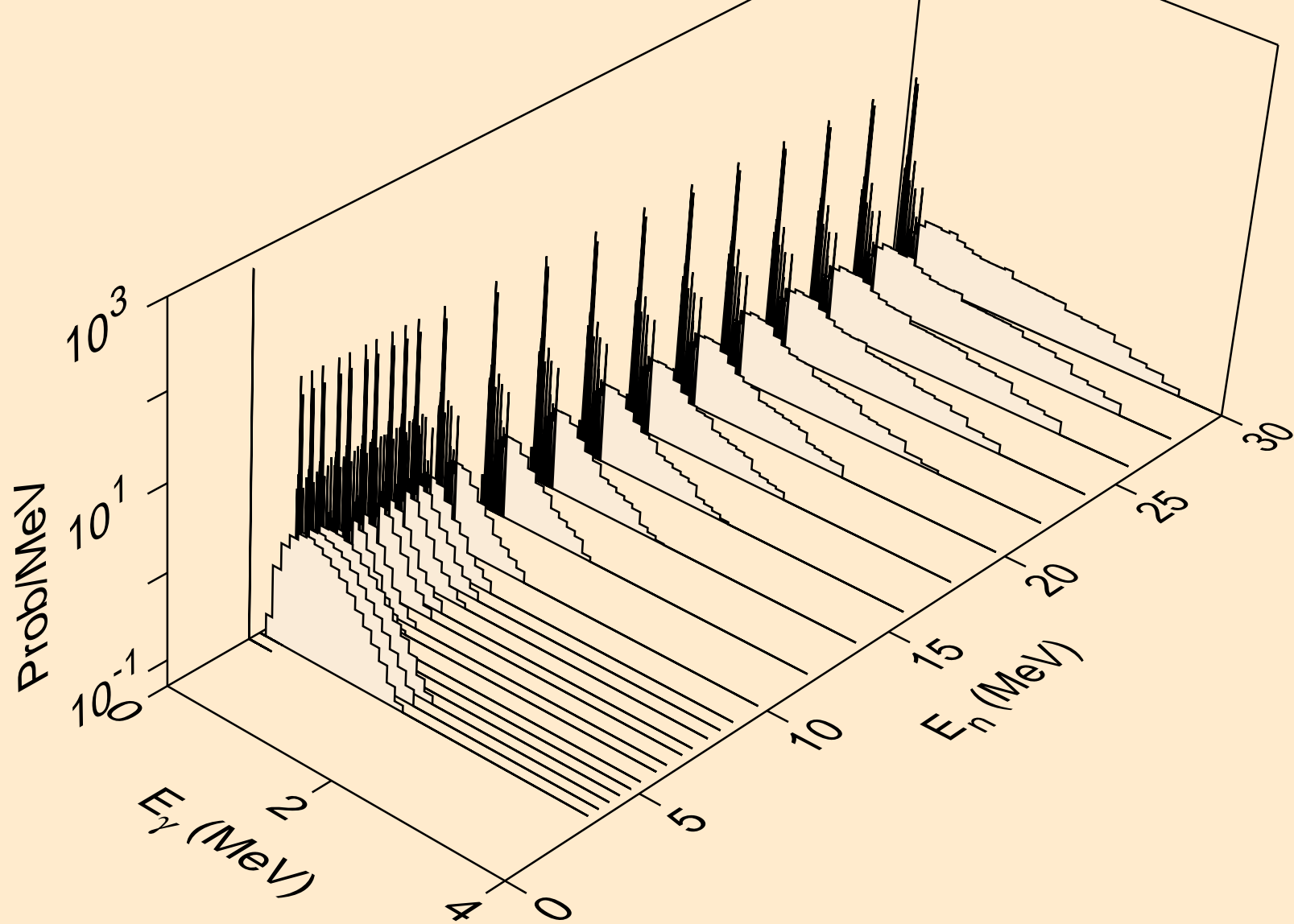

YB164 NEUTRON ACER TENDL-2023 LIBRARY; T=0.K
Photon emission for (n,2p)

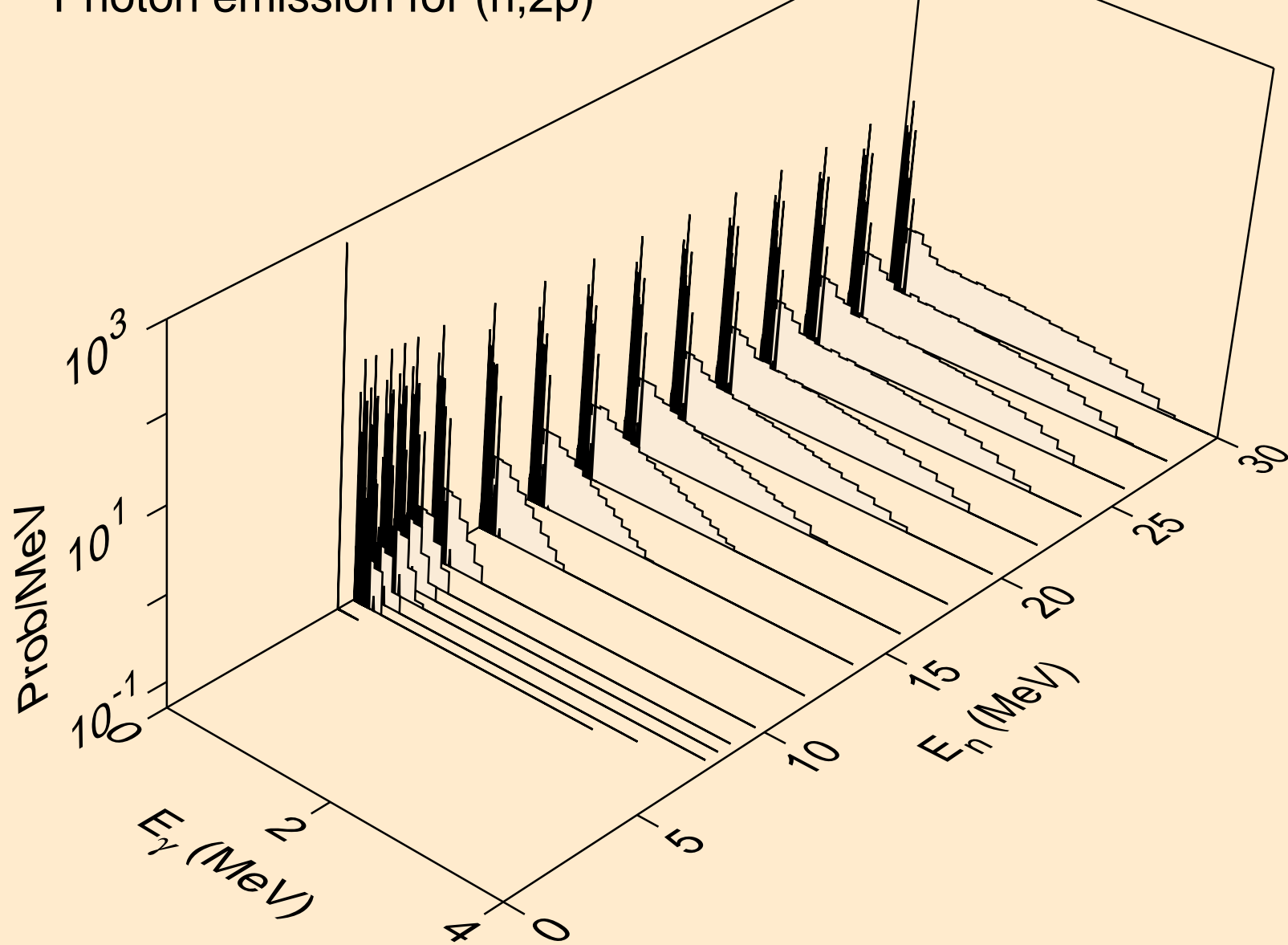

YB164 NEUTRON ACER TENDL-2023 LIBRARY; T=0.K
Photon emission for (n,p α)

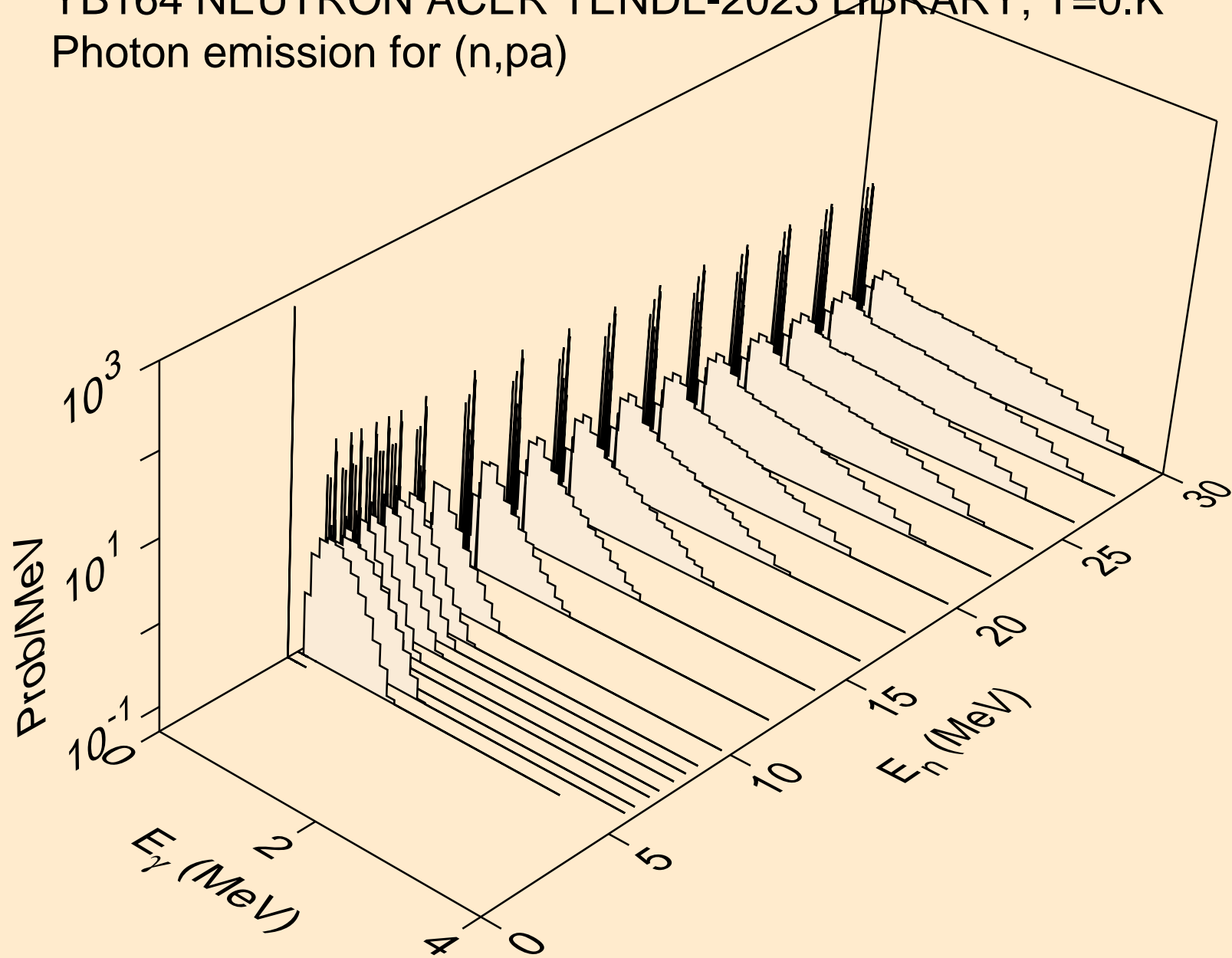

YB164 NEUTRON ACER TENDL-2023 LIBRARY; T=0.K
Photon emission for (n,pd)

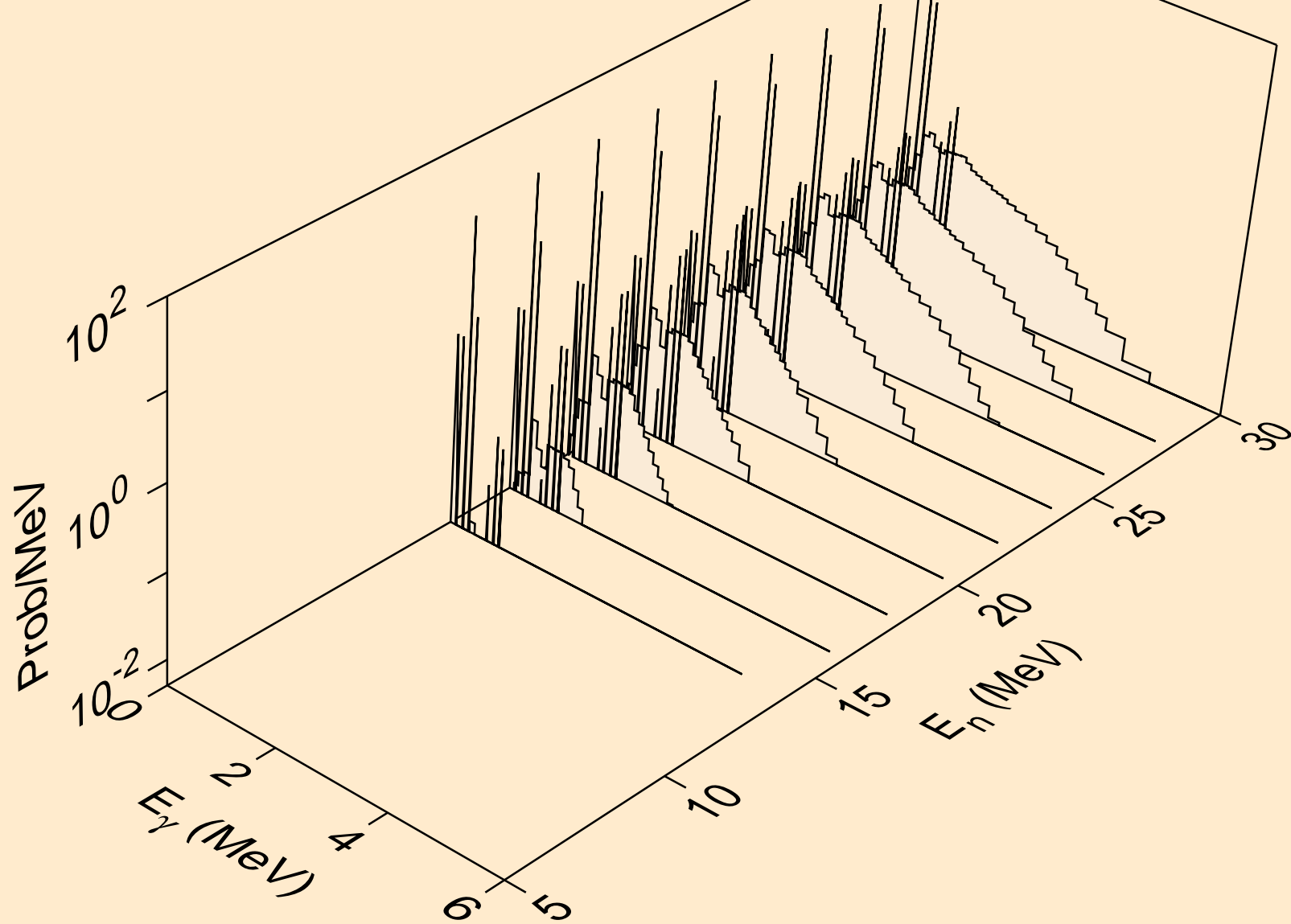

YB164 NEUTRON ACER TENDL-2023 LIBRARY; T=0.K
Photon emission for (n,pt)

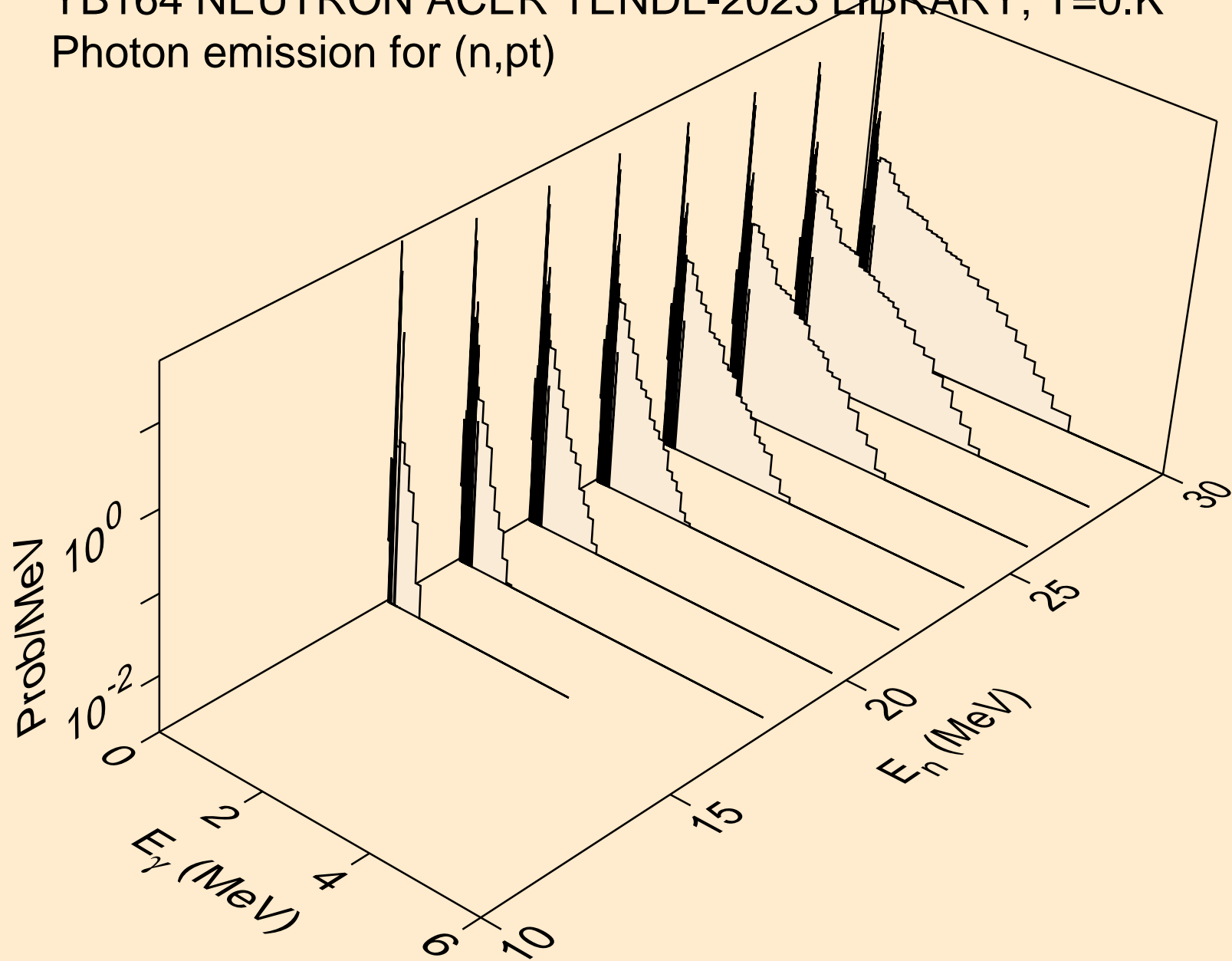

YB164 NEUTRON ACER TENDL-2023 LIBRARY; T=0.K
Photon emission for (n,da)

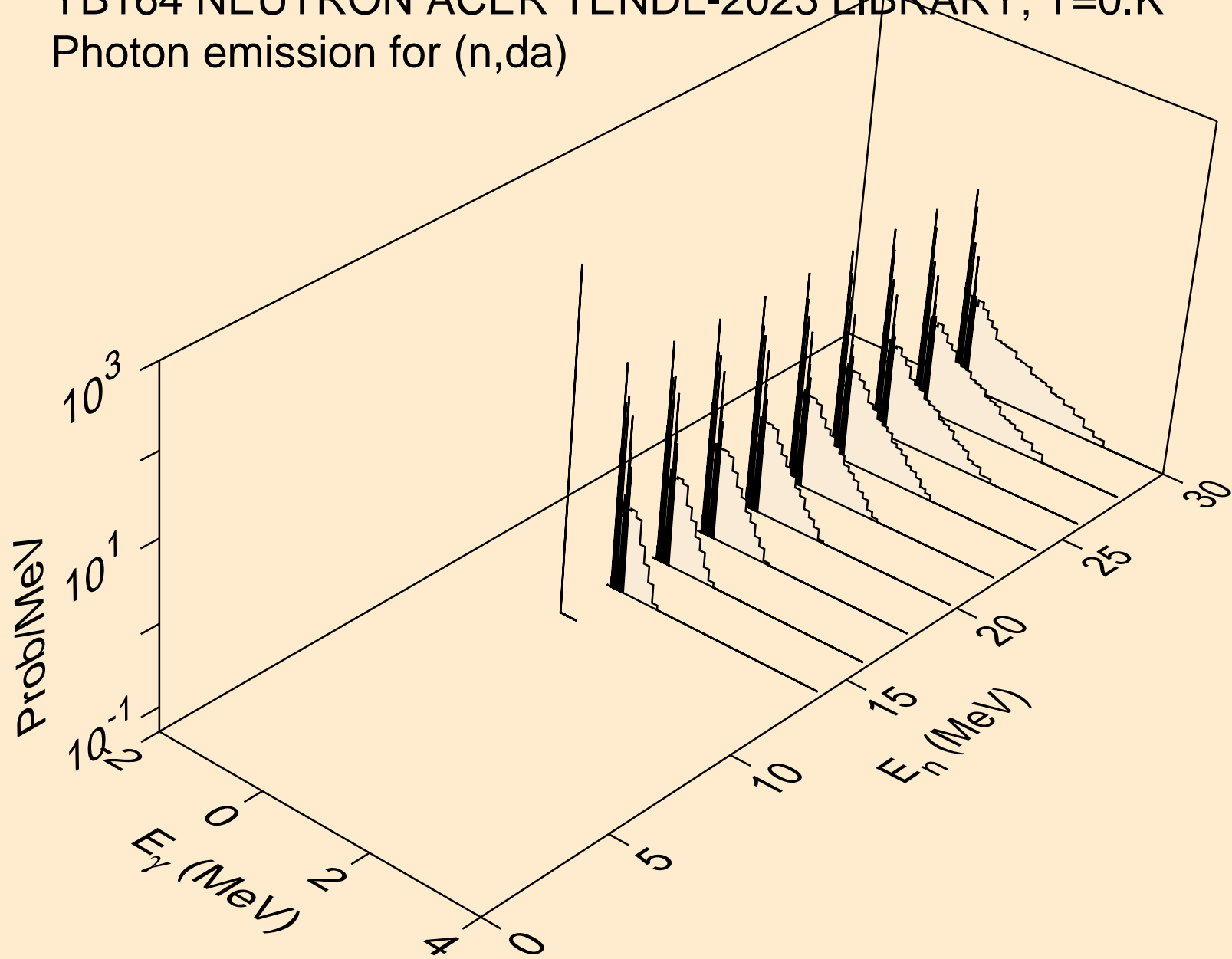

YB164 NEUTRON ACER TENDL-2023 LIBRARY; T=0.K
thermal capture photon spectrum

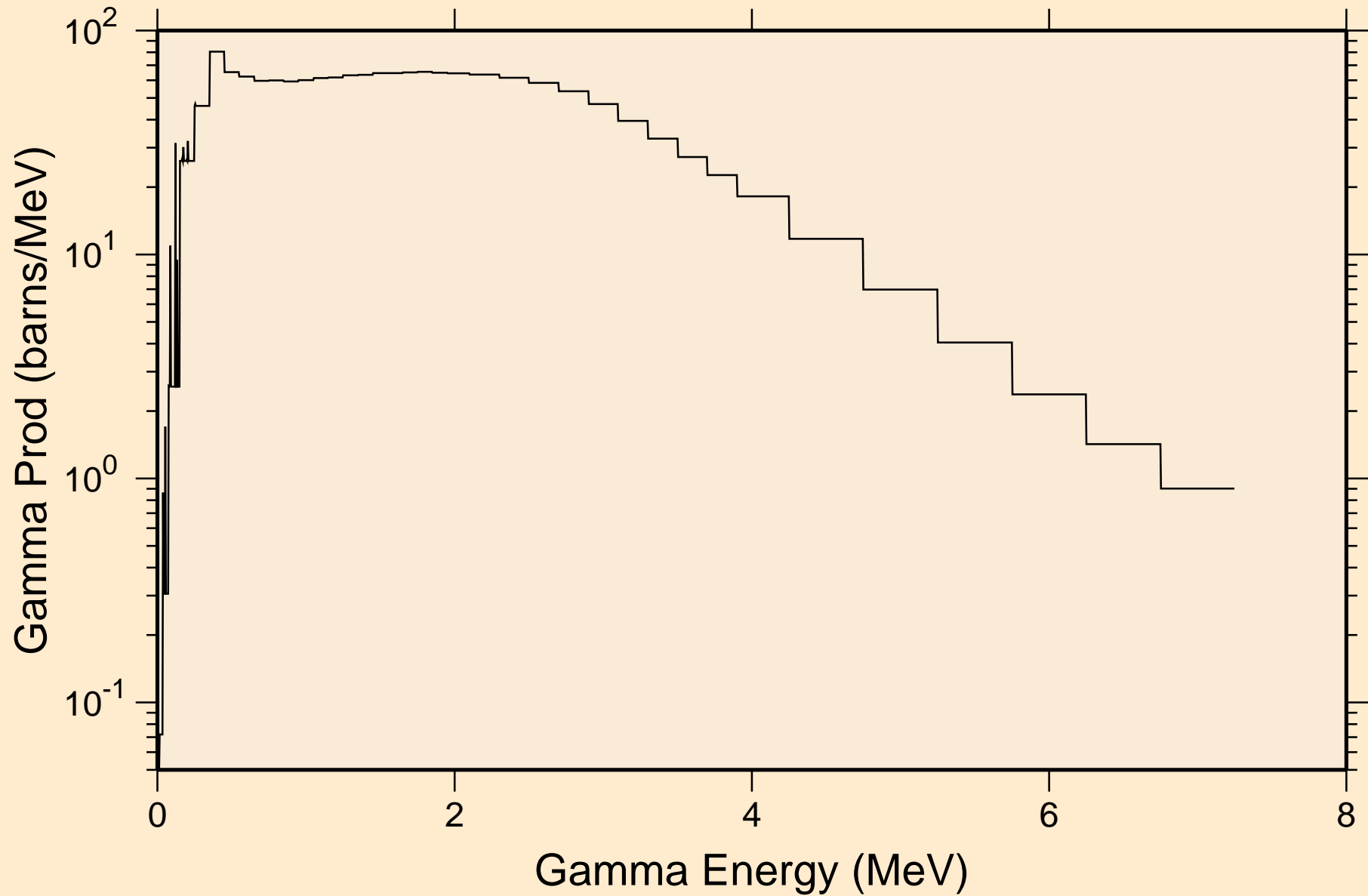

YB164 NEUTRON ACER TENDL-2023 LIBRARY; T=0.K
14 MeV photon spectrum

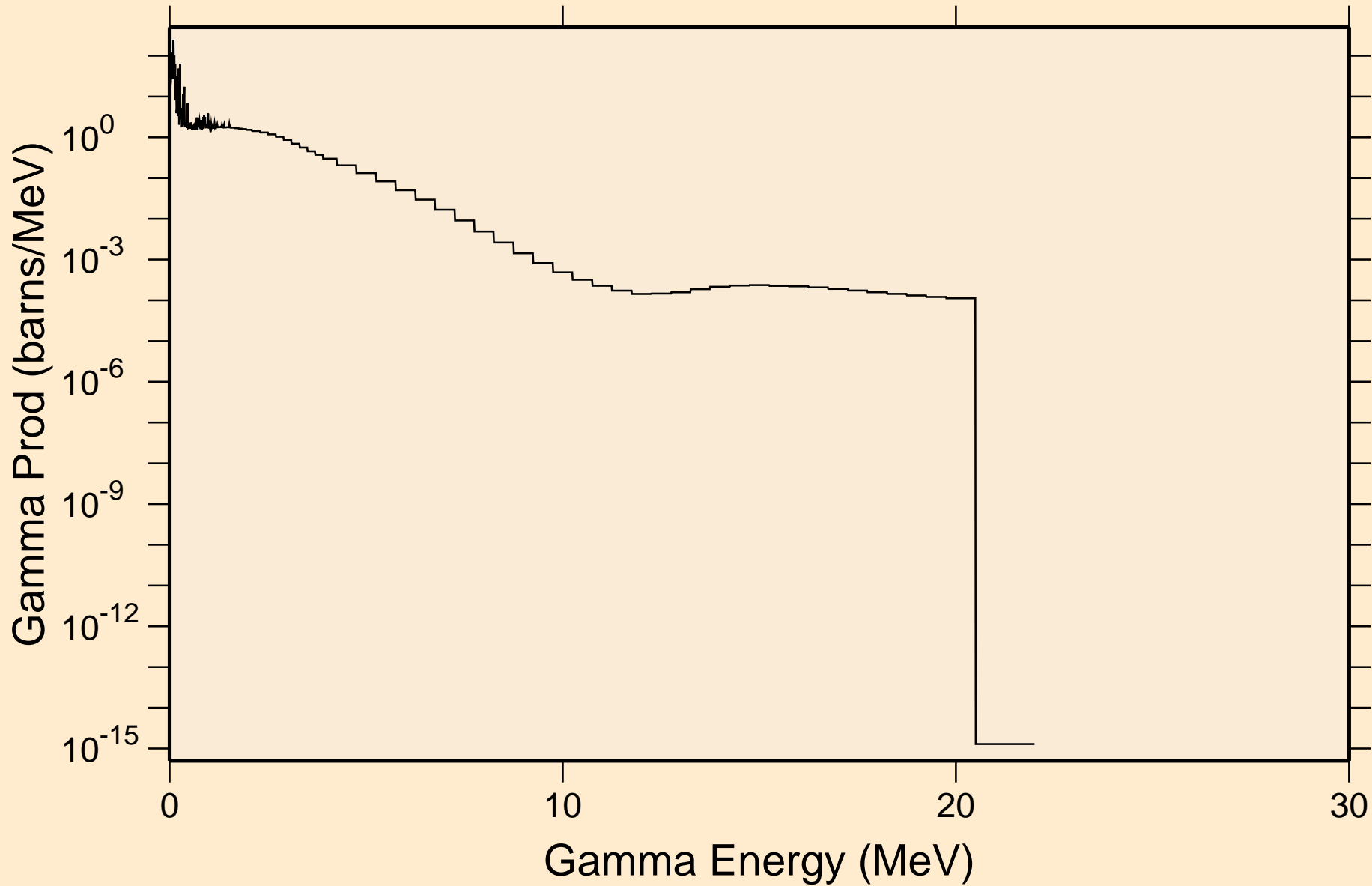

YB164 NEUTRON ACER TENDL-2023 LIBRARY; T=0.K

Particle heating contributions

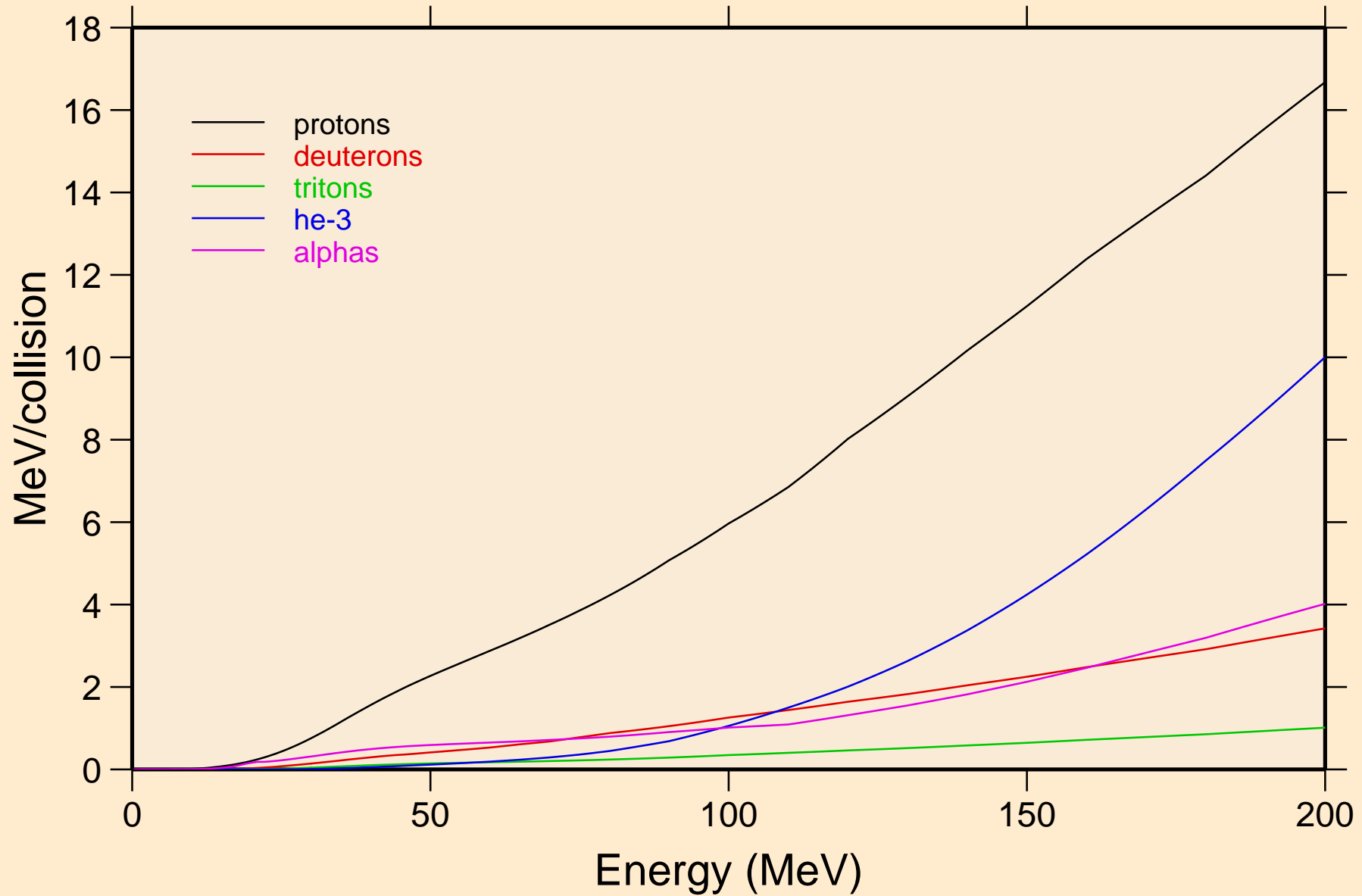

YB164 NEUTRON ACER TENDL-2023 LIBRARY; T=0.K
Recoil Heating

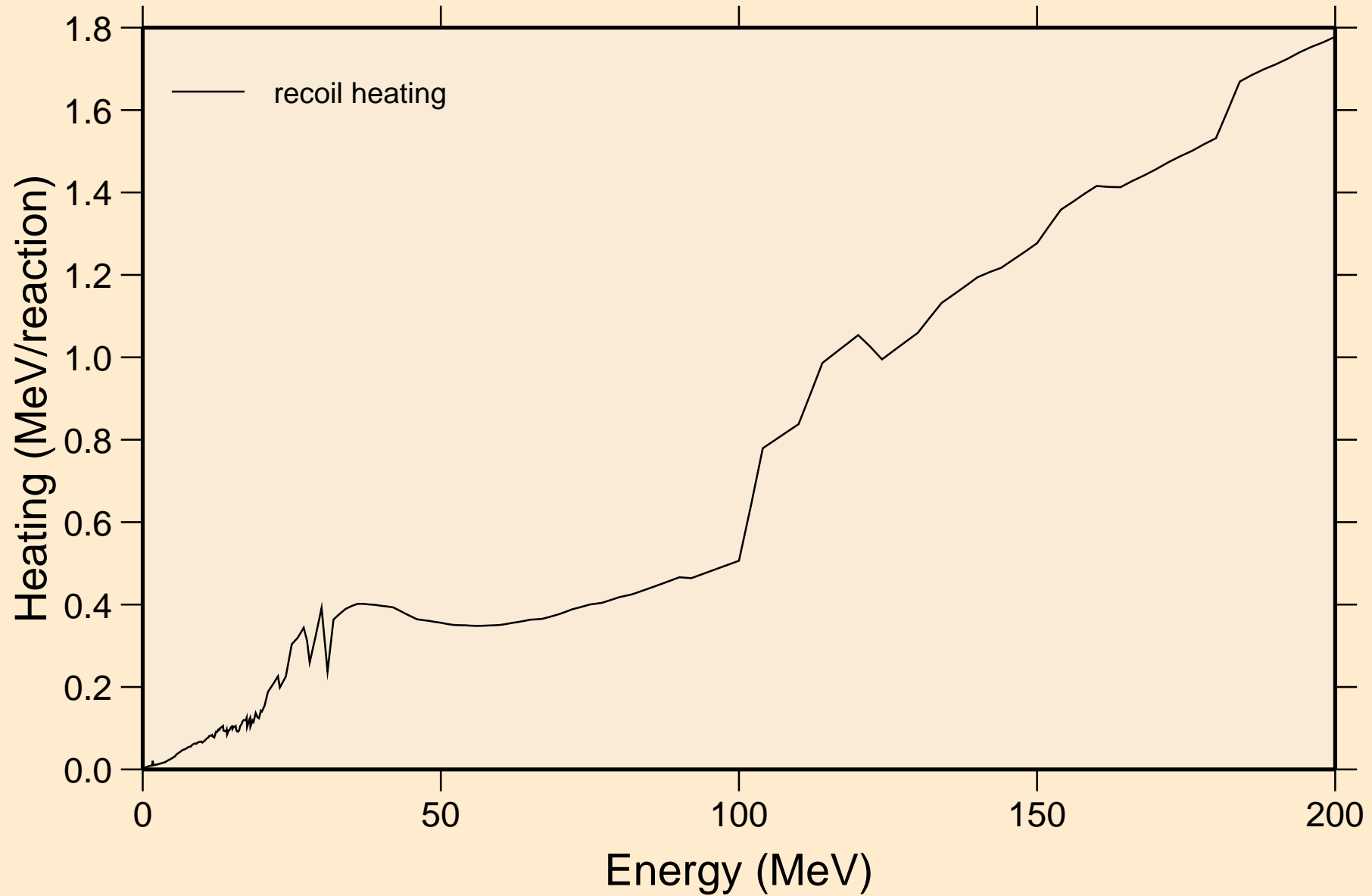

YB164 NEUTRON ACER TENDL-2023 LIBRARY; T=0.K
Particle production cross sections

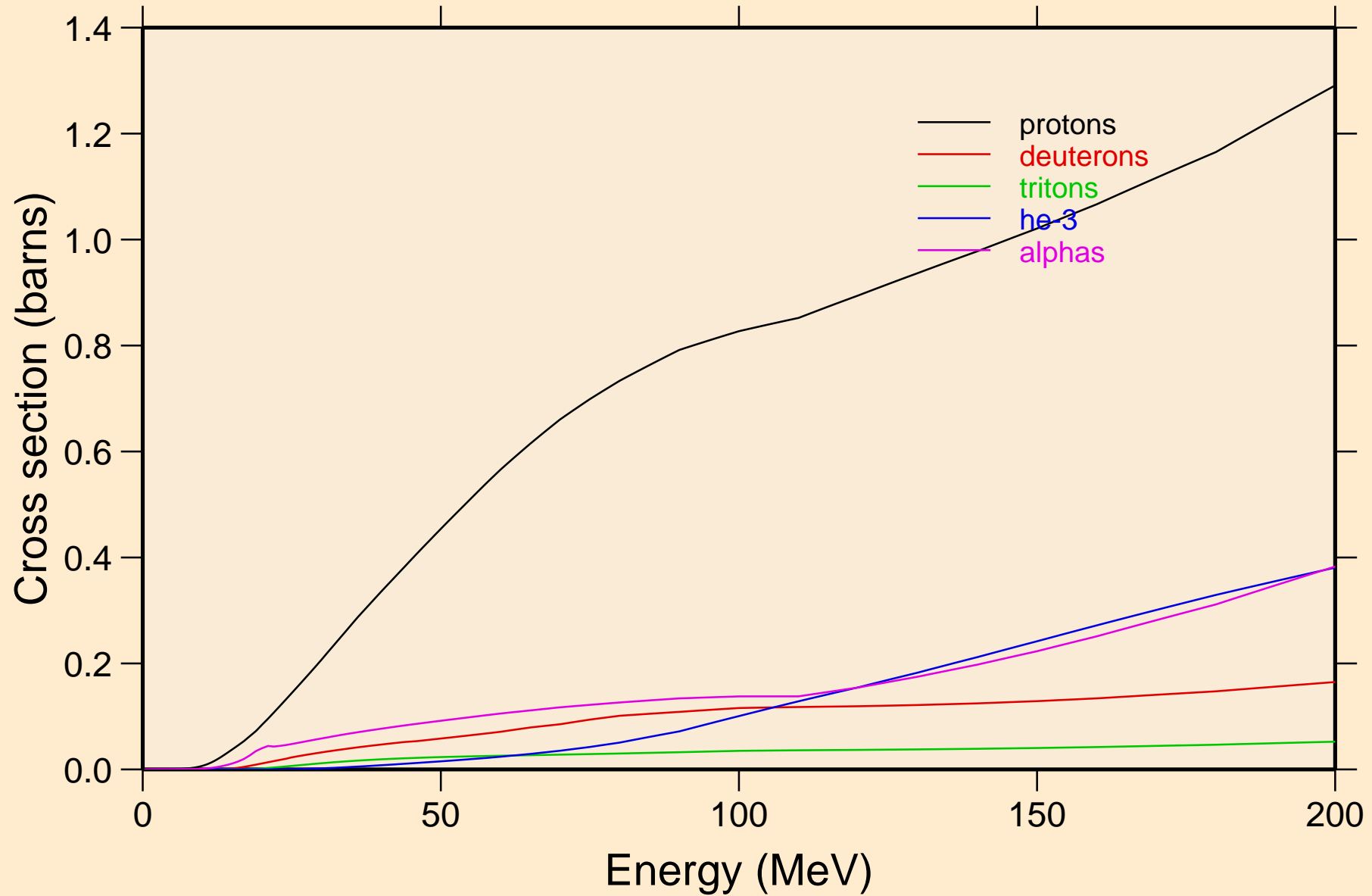

YB164 NEUTRON ACER TENDL-2023 LIBRARY; T=0.K
protons from (n,x)

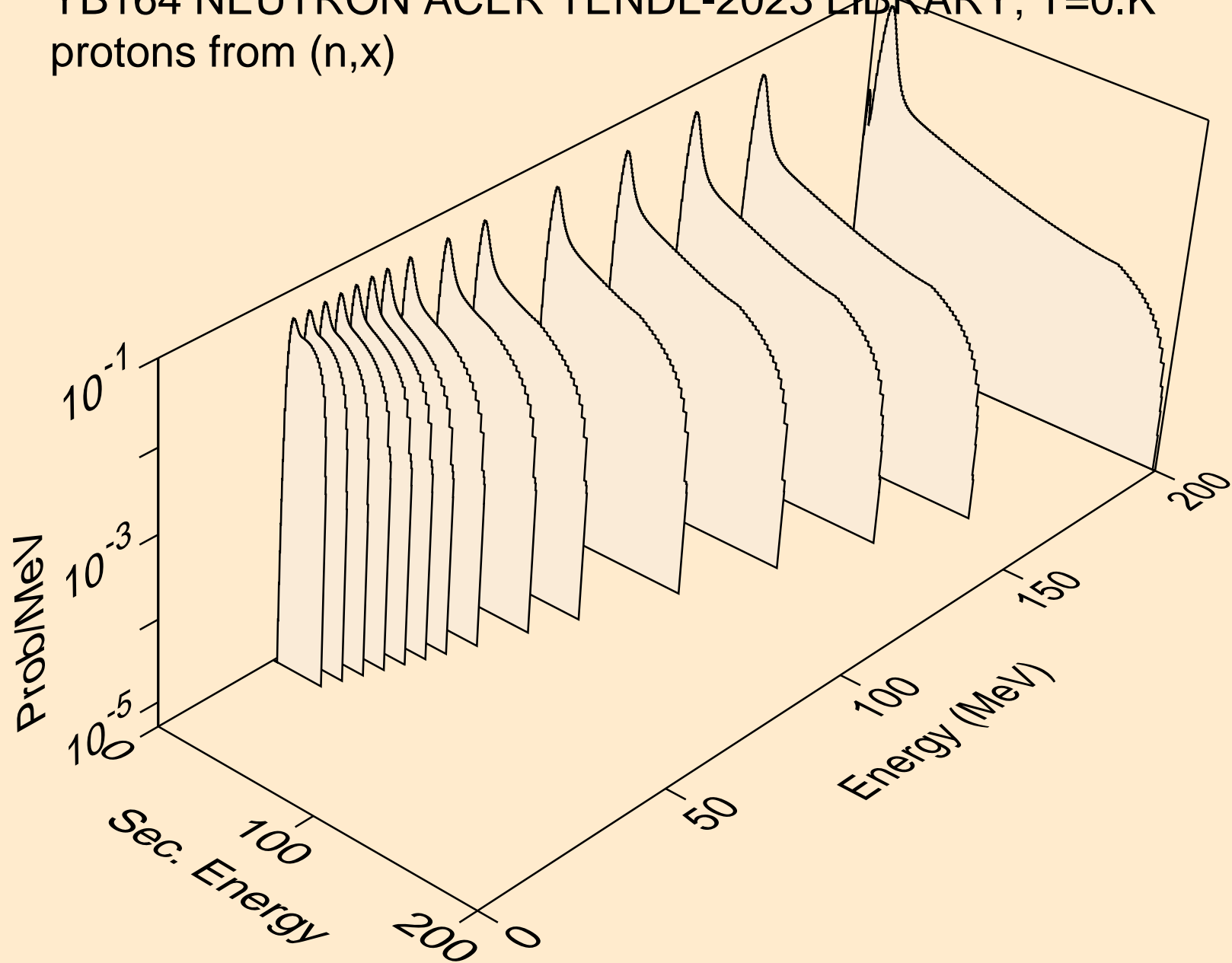

YB164 NEUTRON ACER TENDL-2023 LIBRARY; T=0.K
protons from (n,n*)p

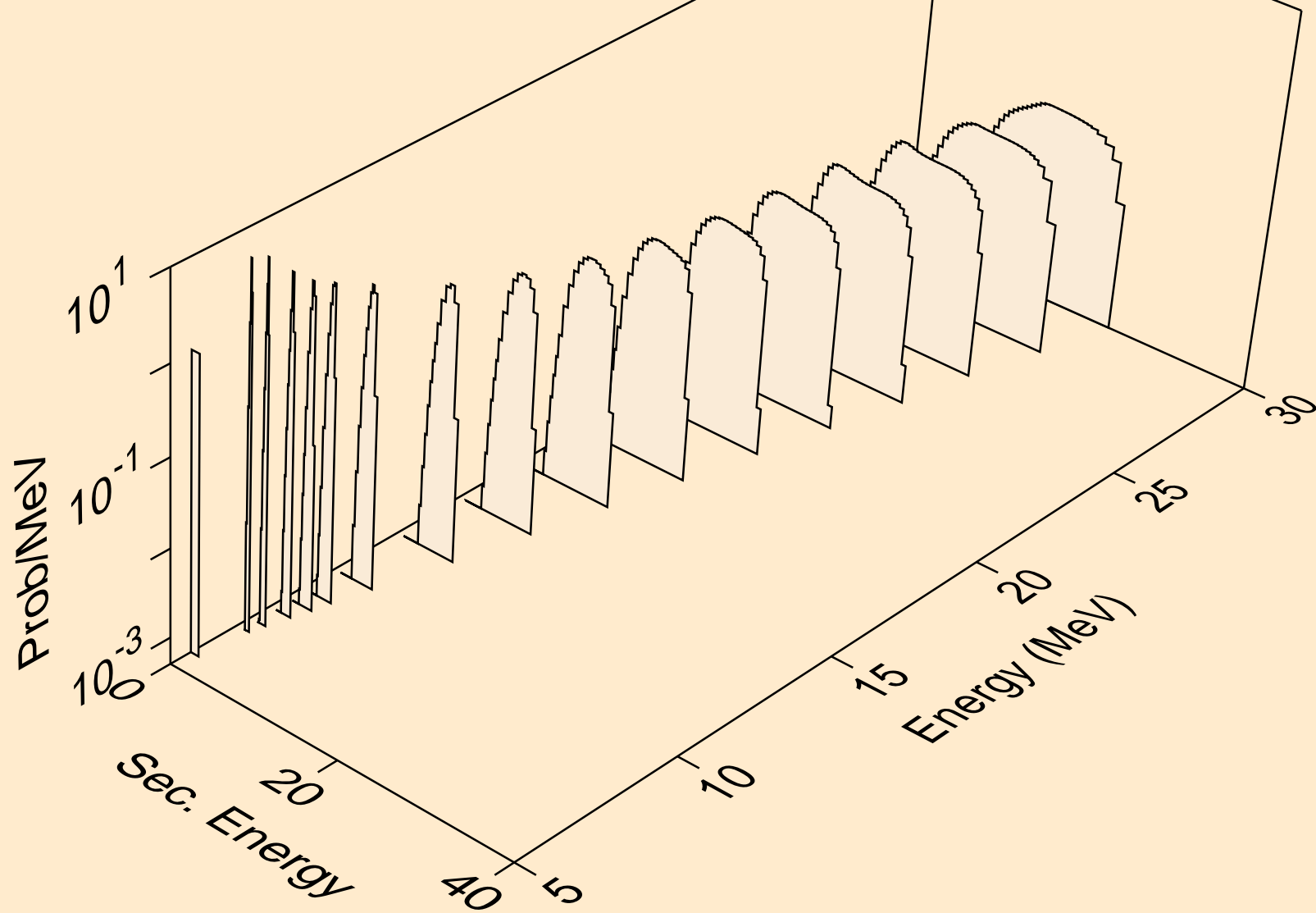

YB164 NEUTRON ACER TENDL-2023 LIBRARY; T=0.K
protons from (n,2np)

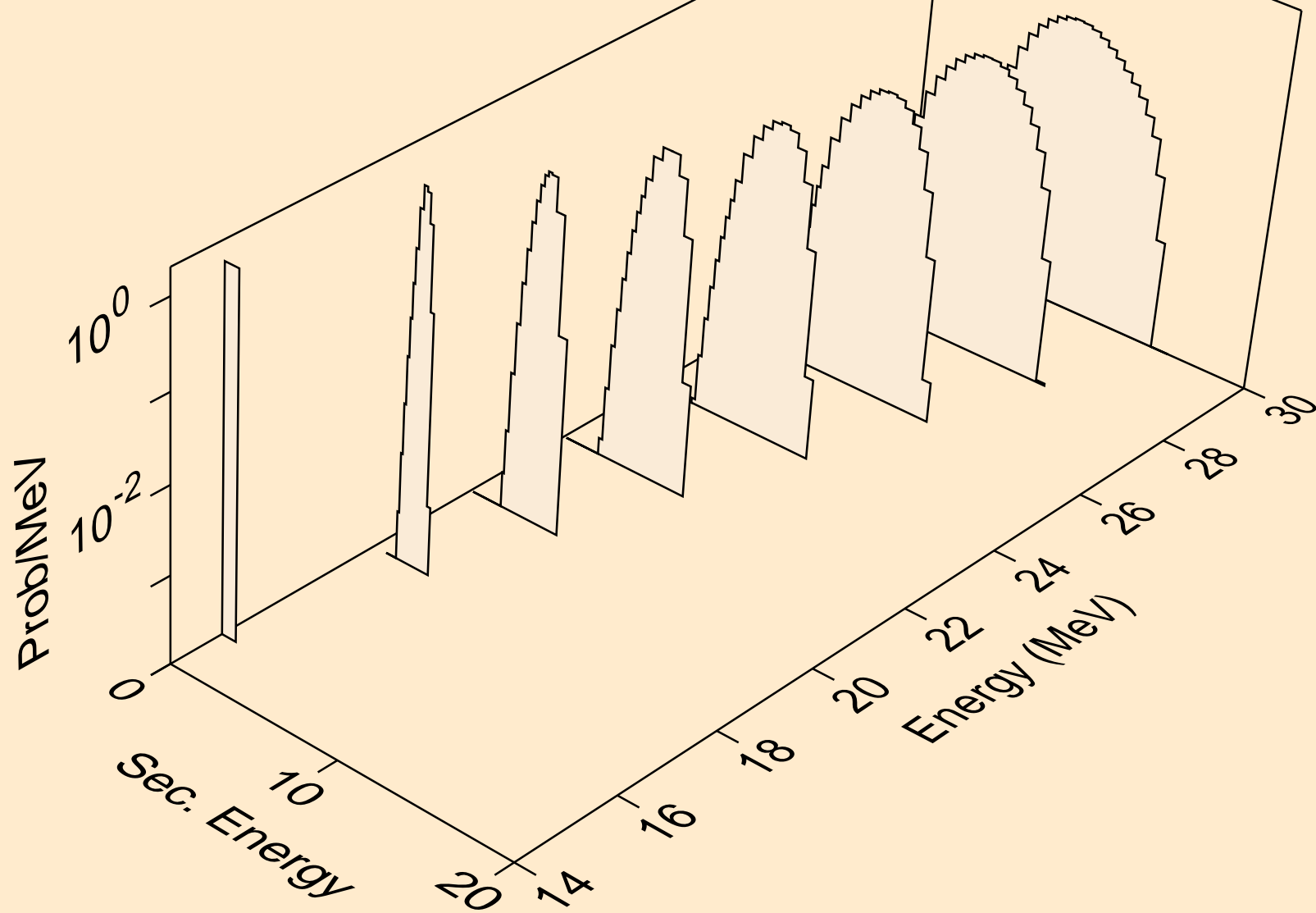

YB164 NEUTRON ACER TENDL-2023 LIBRARY; T=0.K
protons from (n,3np)

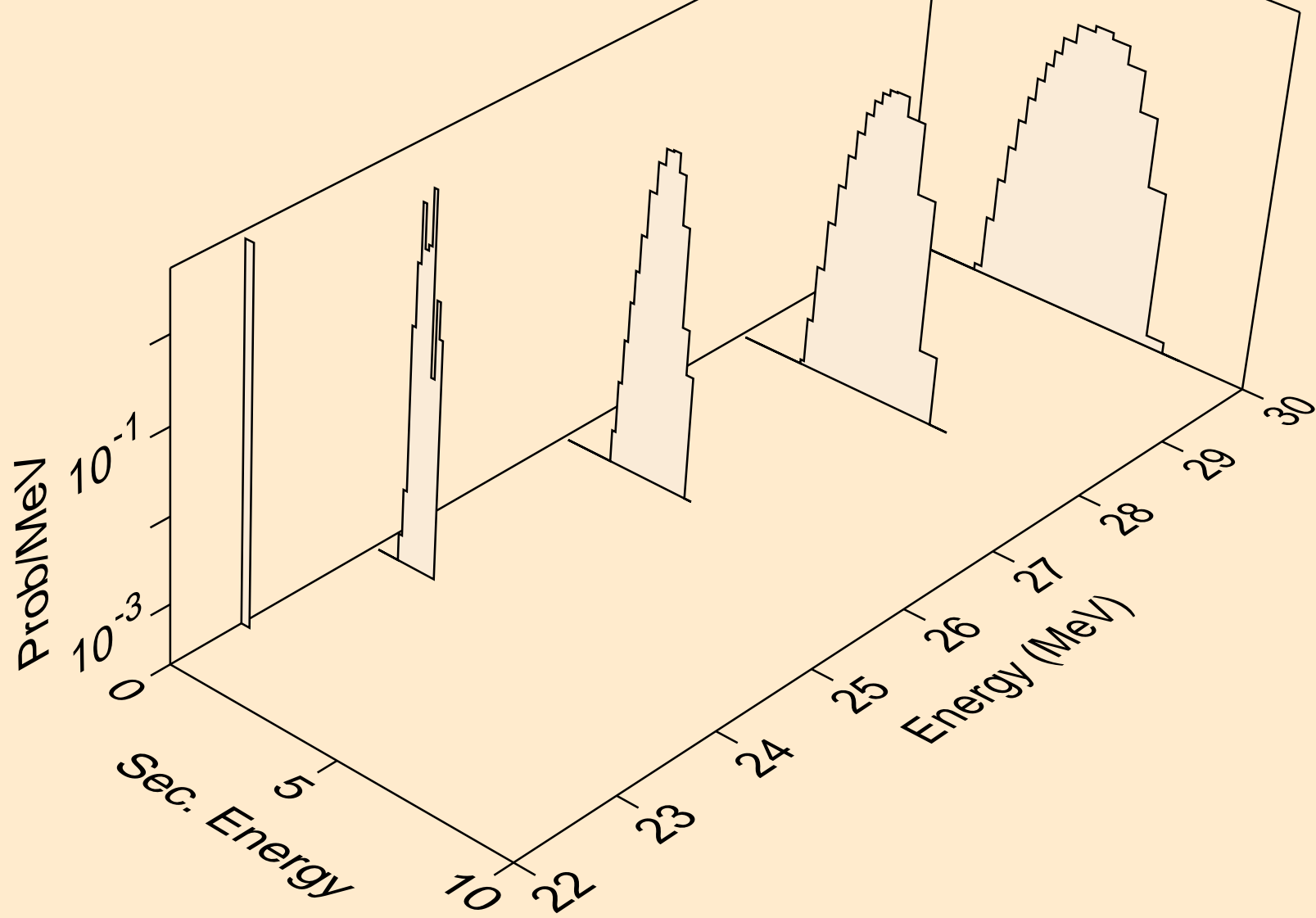

YB164 NEUTRON ACER TENDL-2023 LIBRARY; T=0.K
protons from (n,n2p)

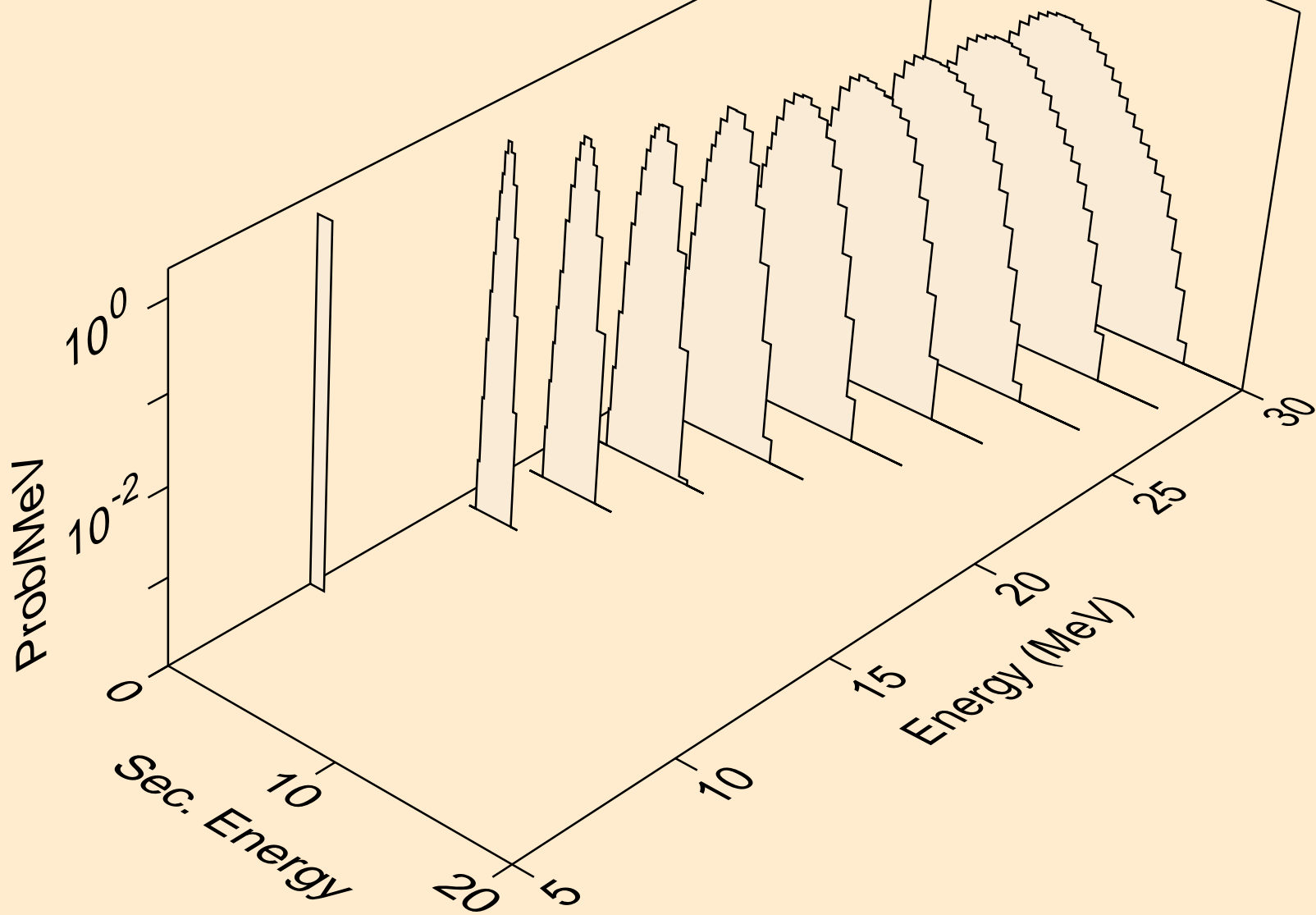

YB164 NEUTRON ACER TENDL-2023 LIBRARY; T=0.K
protons from (n,npa)

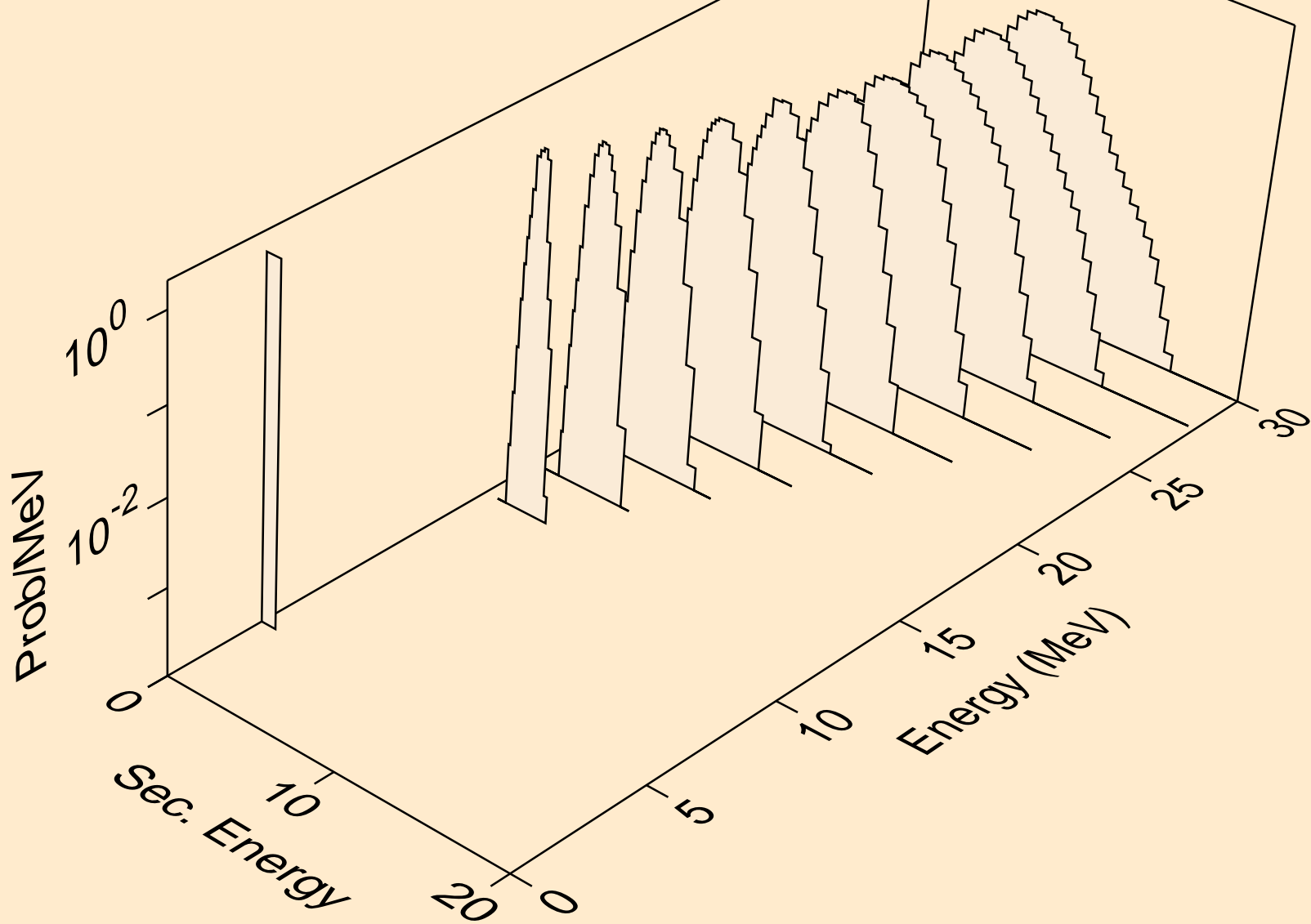

YB164 NEUTRON ACER TENDL-2023 LIBRARY; T=0.K
protons from (n,p)

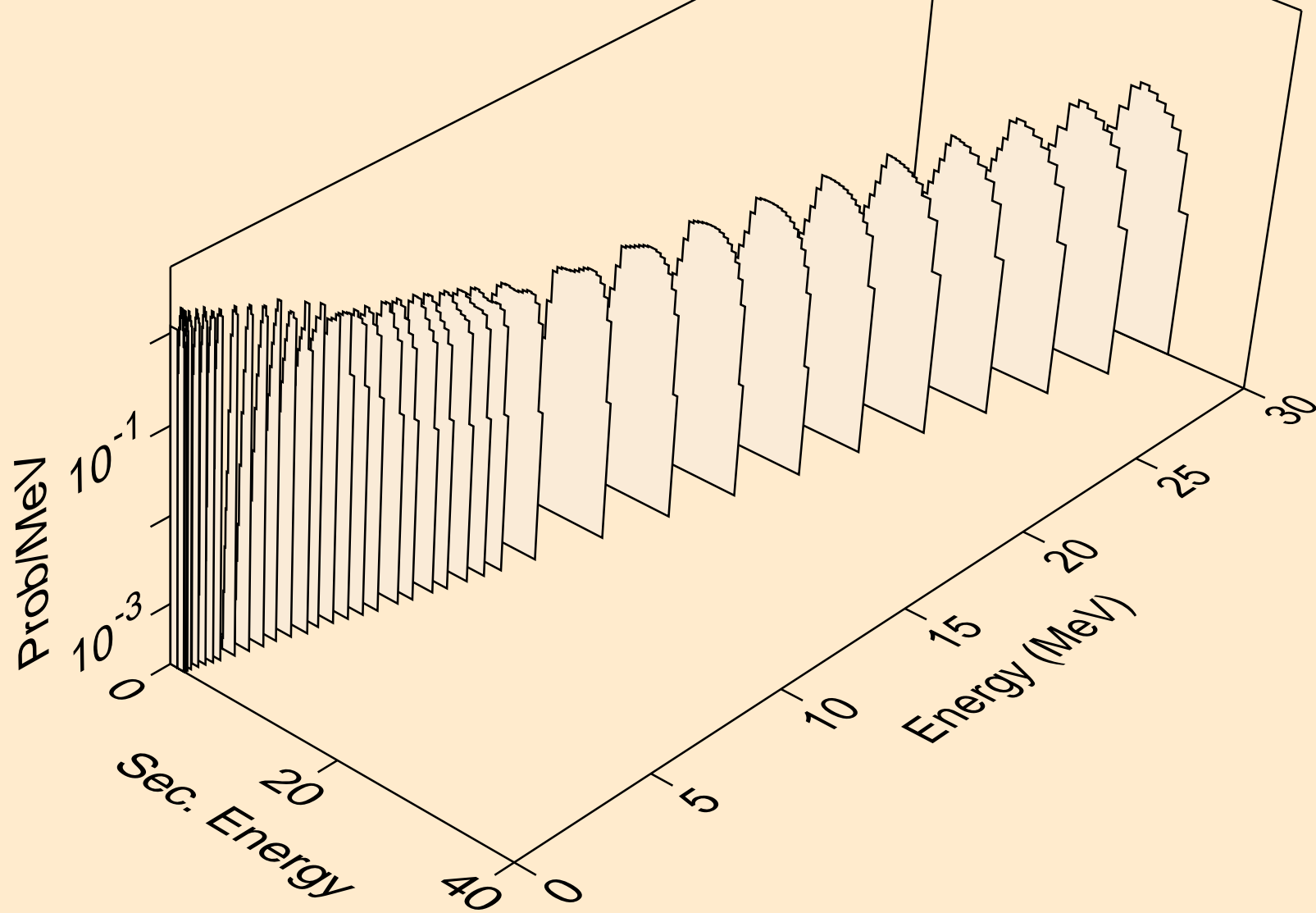

YB164 NEUTRON ACER TENDL-2023 LIBRARY; T=0.K
protons from (n,2p)

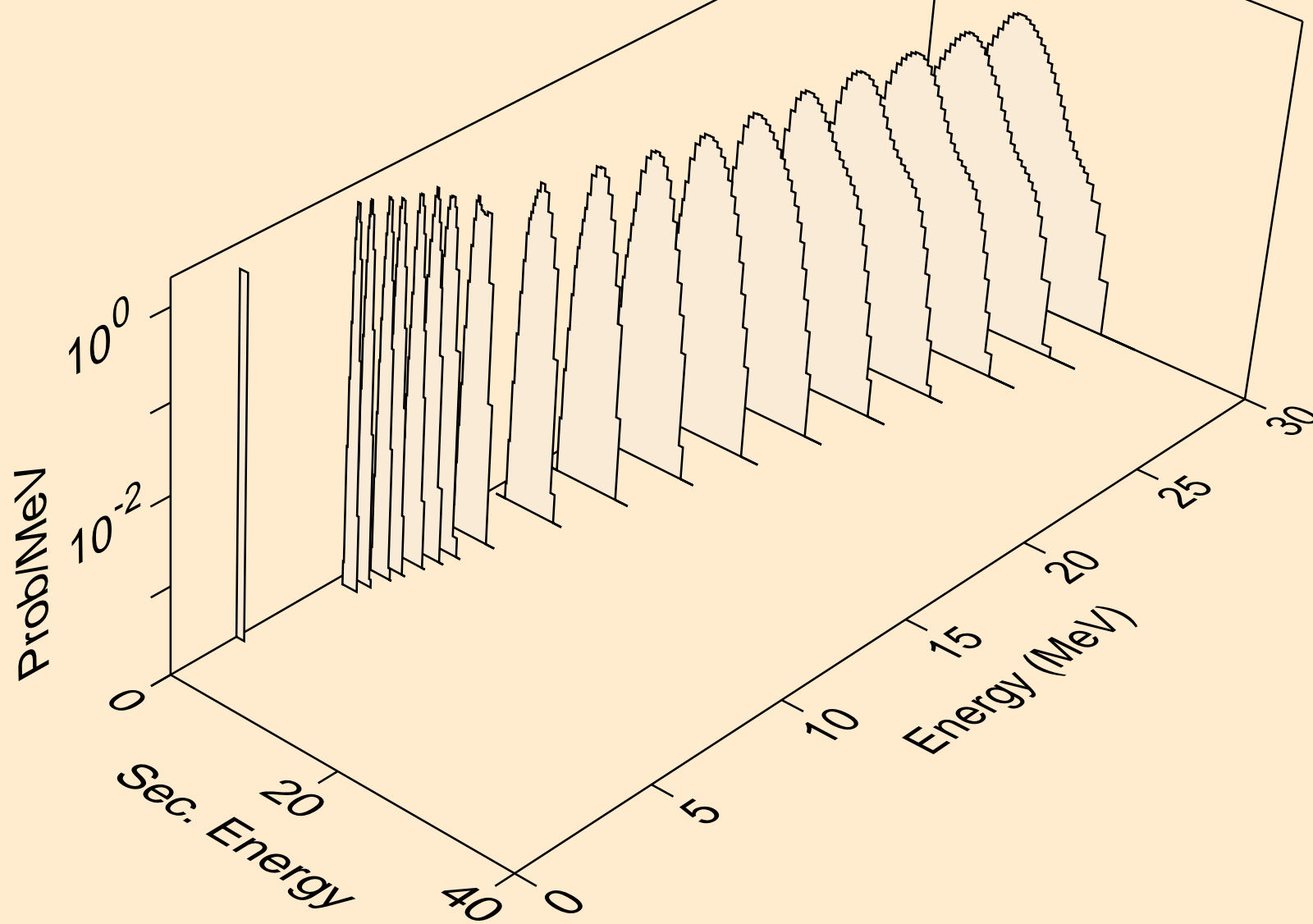

YB164 NEUTRON ACER TENDL-2023 LIBRARY; T=0.K
protons from (n,p)

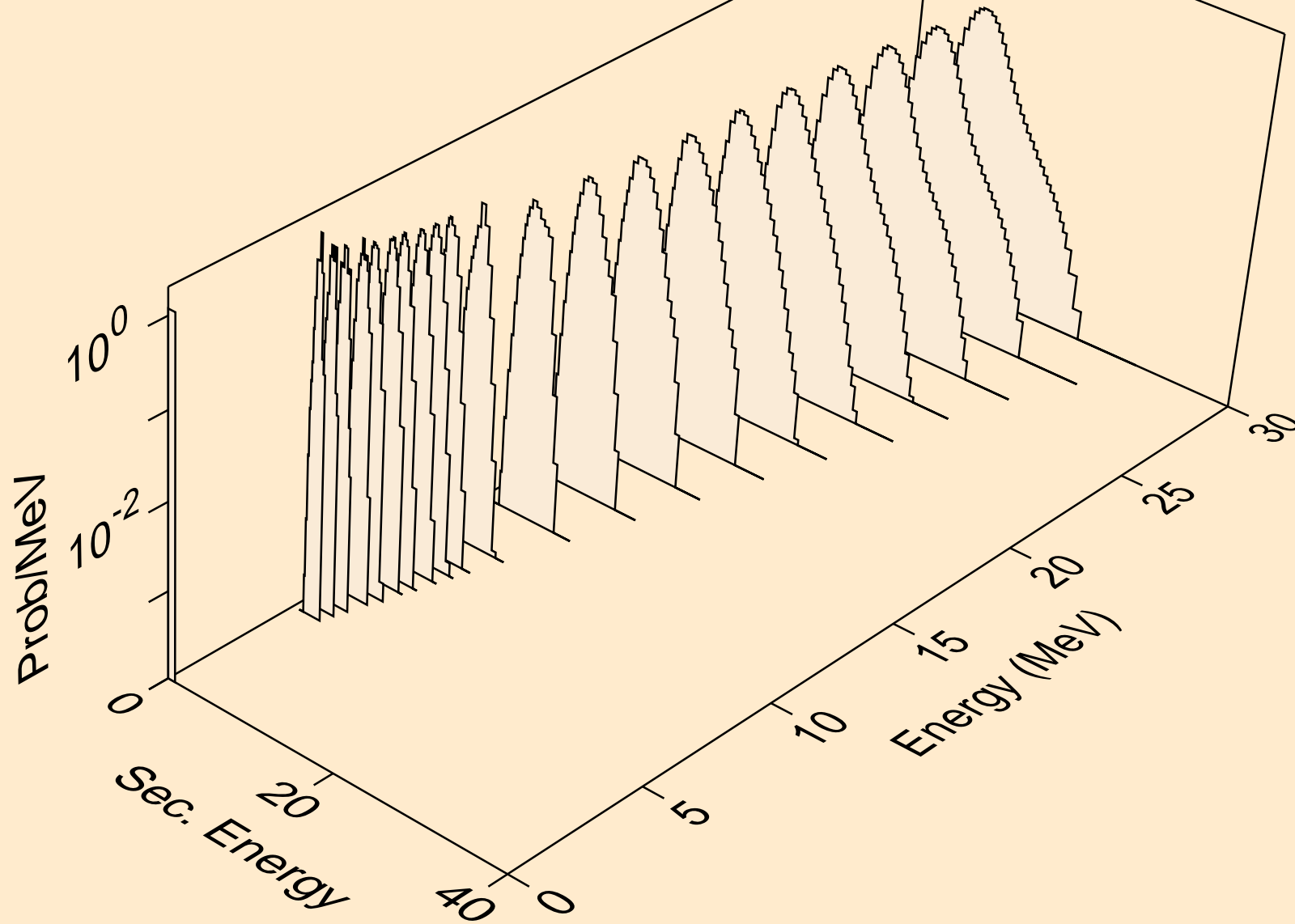

YB164 NEUTRON ACER TENDL-2023 LIBRARY; T=0.K
protons from (n,pd)

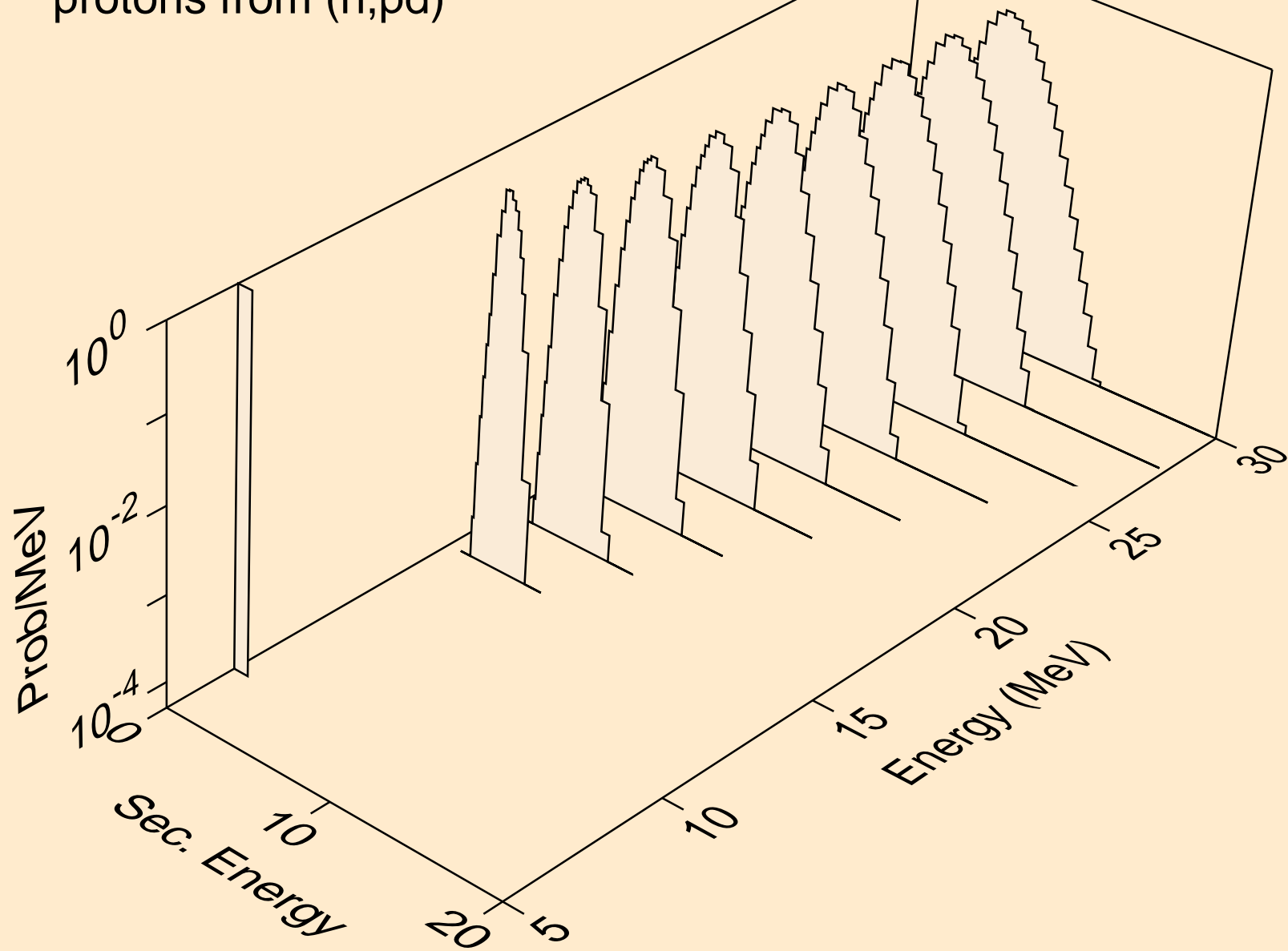

YB164 NEUTRON ACER TENDL-2023 LIBRARY; T=0.K
protons from (n,pt)

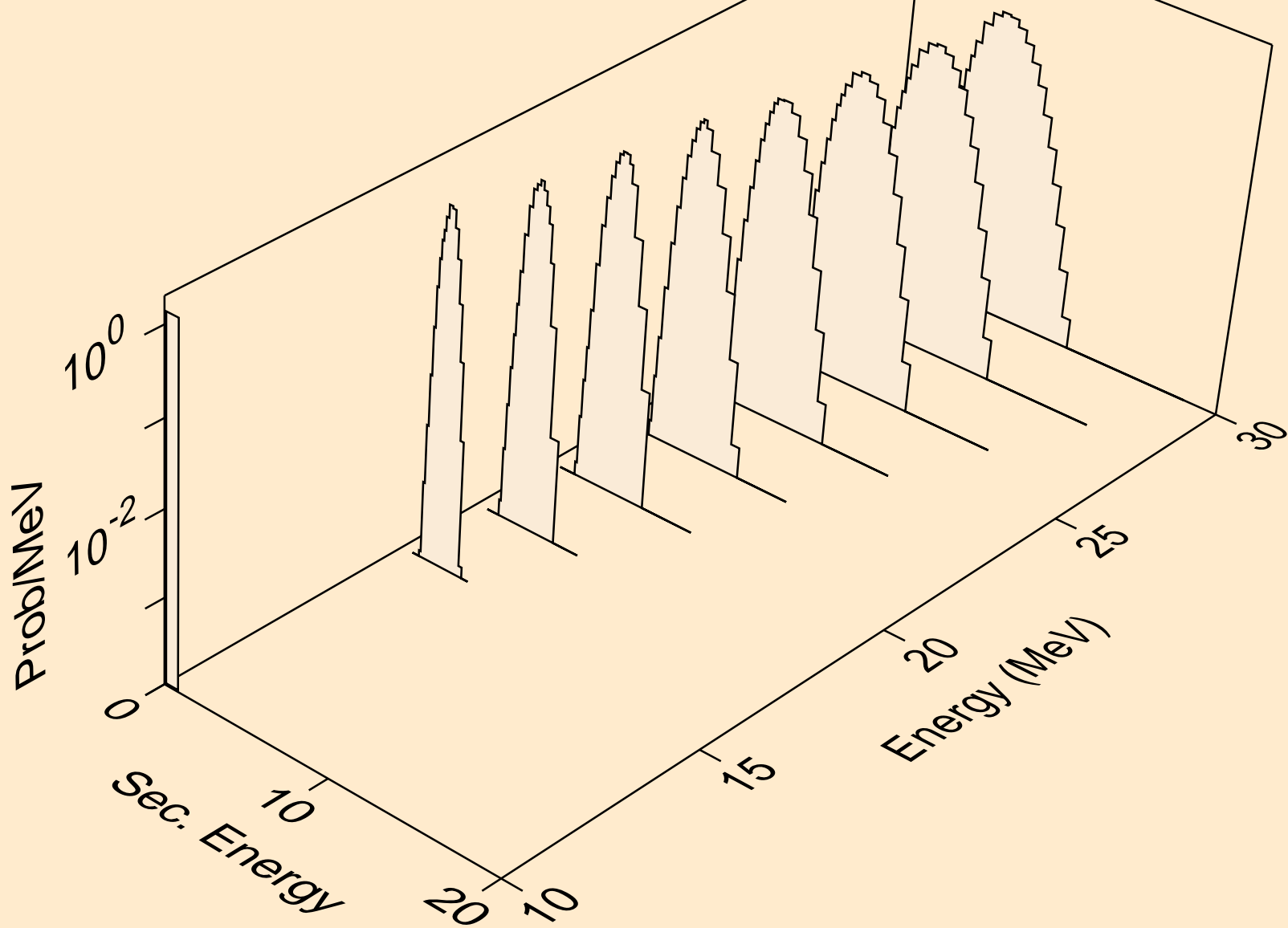

YB164 NEUTRON ACER TENDL-2023 LIBRARY; T=0.K
deuterons from (n,x)

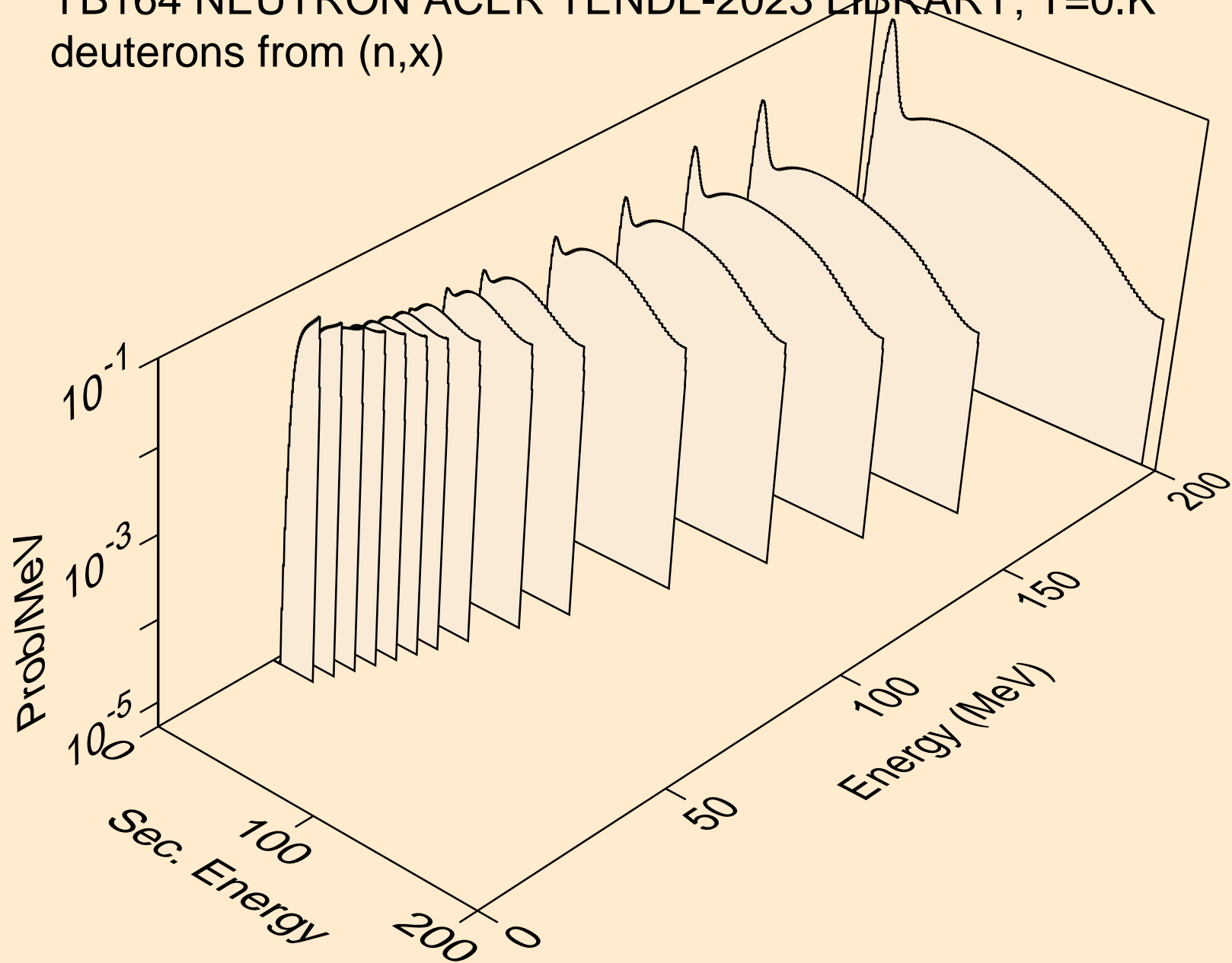

YB164 NEUTRON ACER TENDL-2023 LIBRARY; T=0.K
deuterons from (n,2nd)

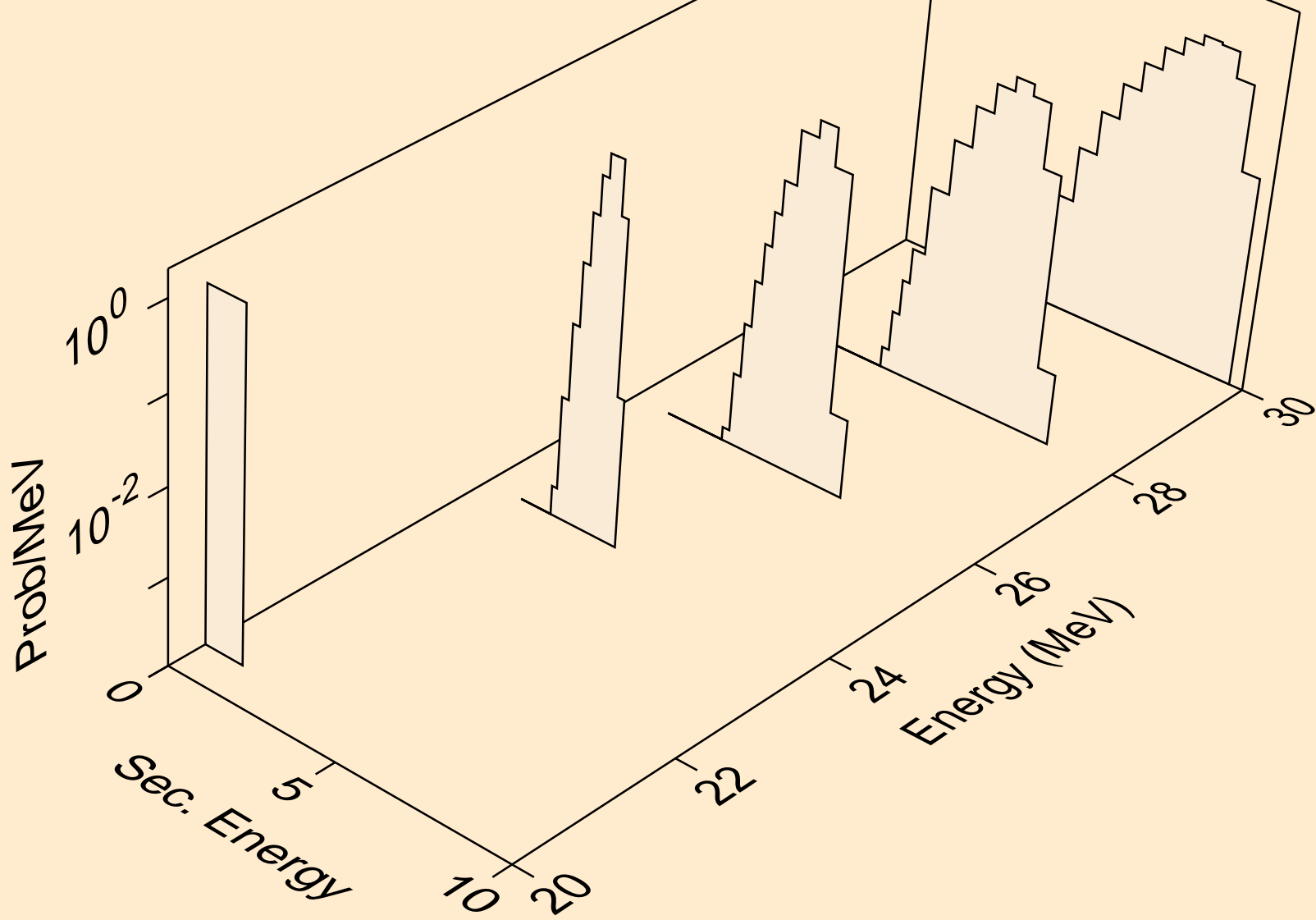

YB164 NEUTRON ACER TENDL-2023 LIBRARY; T=0.K
deuterons from (n,n*)d

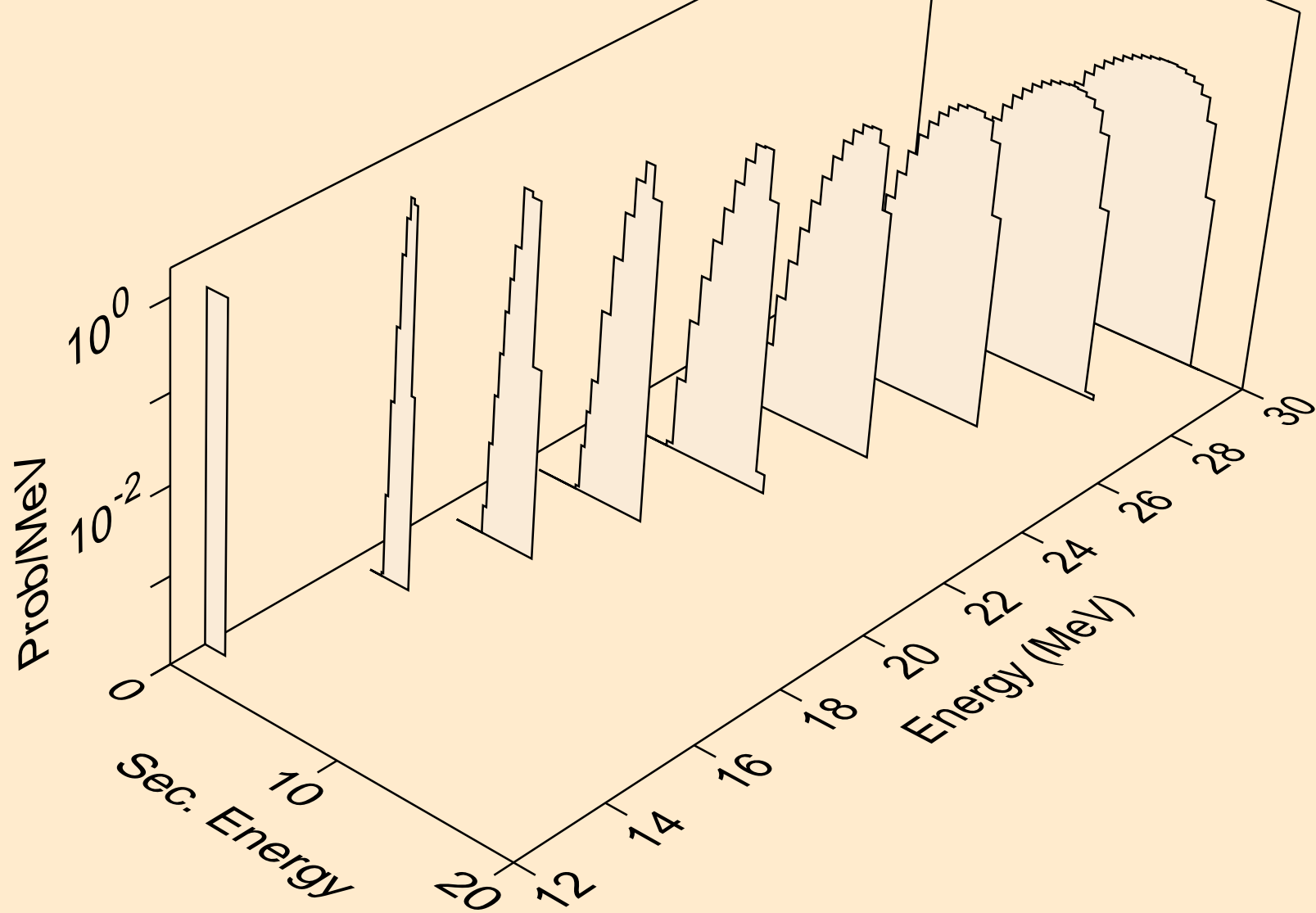

YB164 NEUTRON ACER TENDL-2023 LIBRARY; T=0.K
deuterons from (n,d)

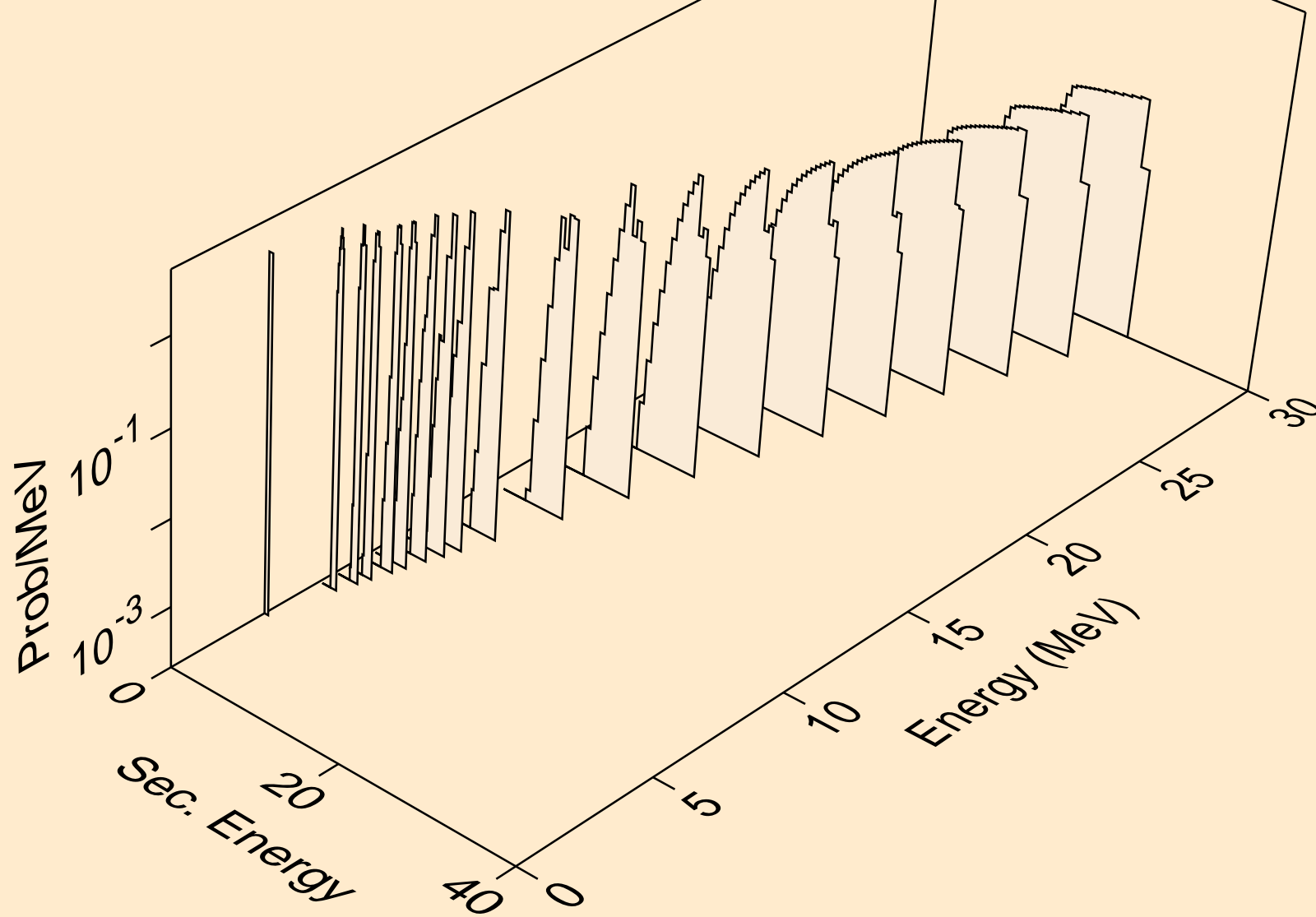

YB164 NEUTRON ACER TENDL-2023 LIBRARY; T=0.K
deuterons from (n,pd)

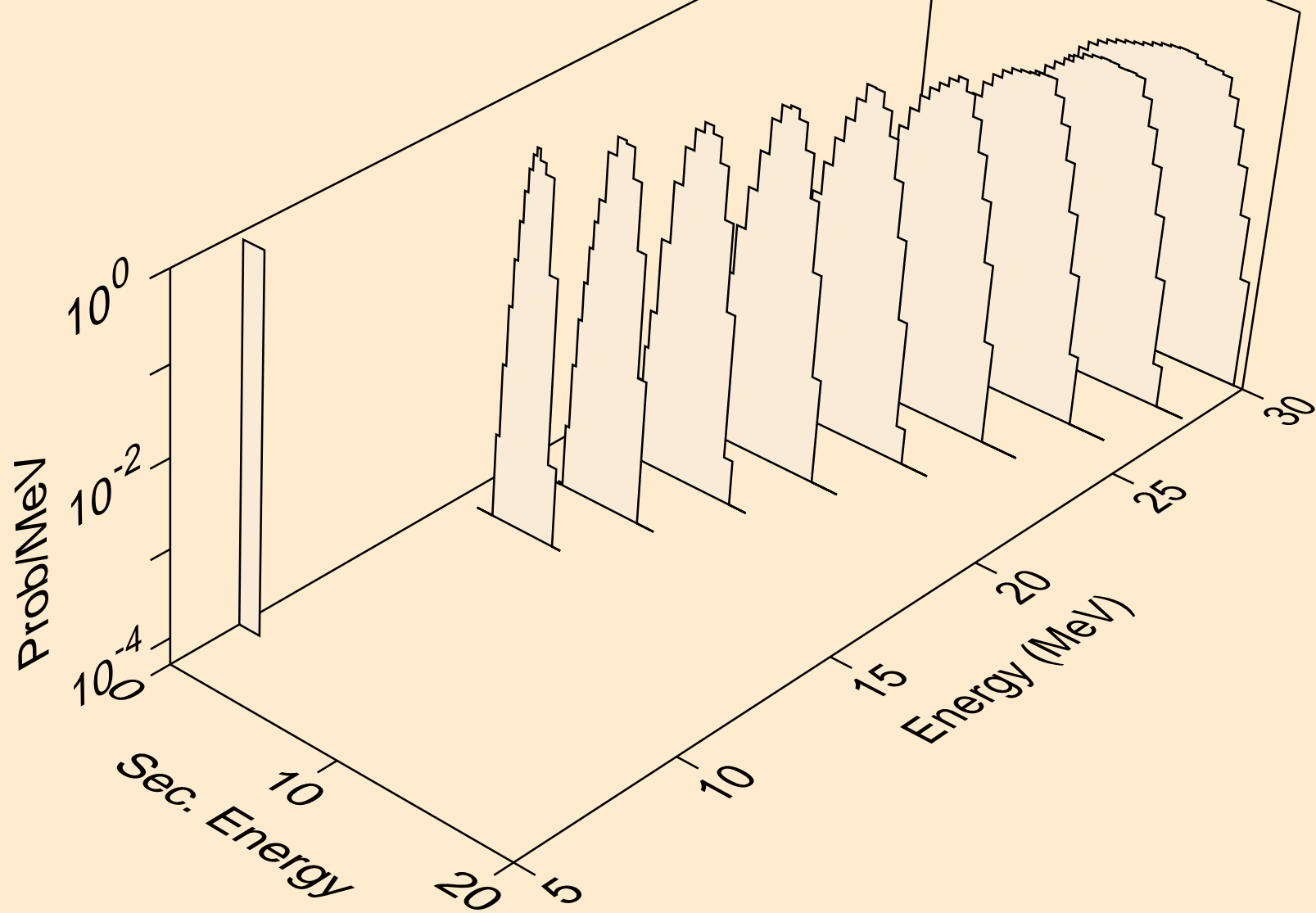

YB164 NEUTRON ACER TENDL-2023 LIBRARY; T=0.K
deuterons from (n,da)

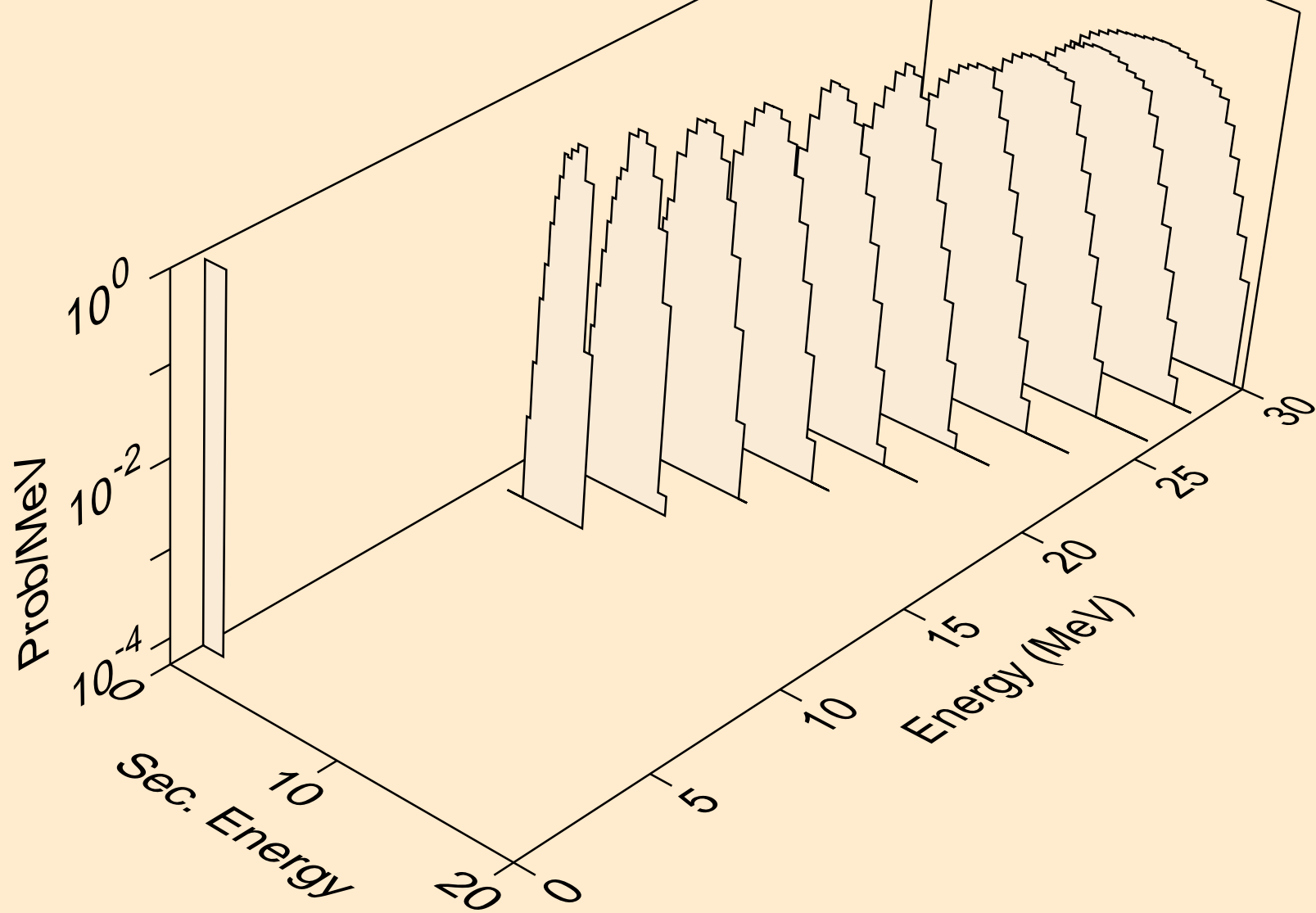

YB164 NEUTRON ACER TENDL-2023 LIBRARY; T=0.K
tritons from (n,x)

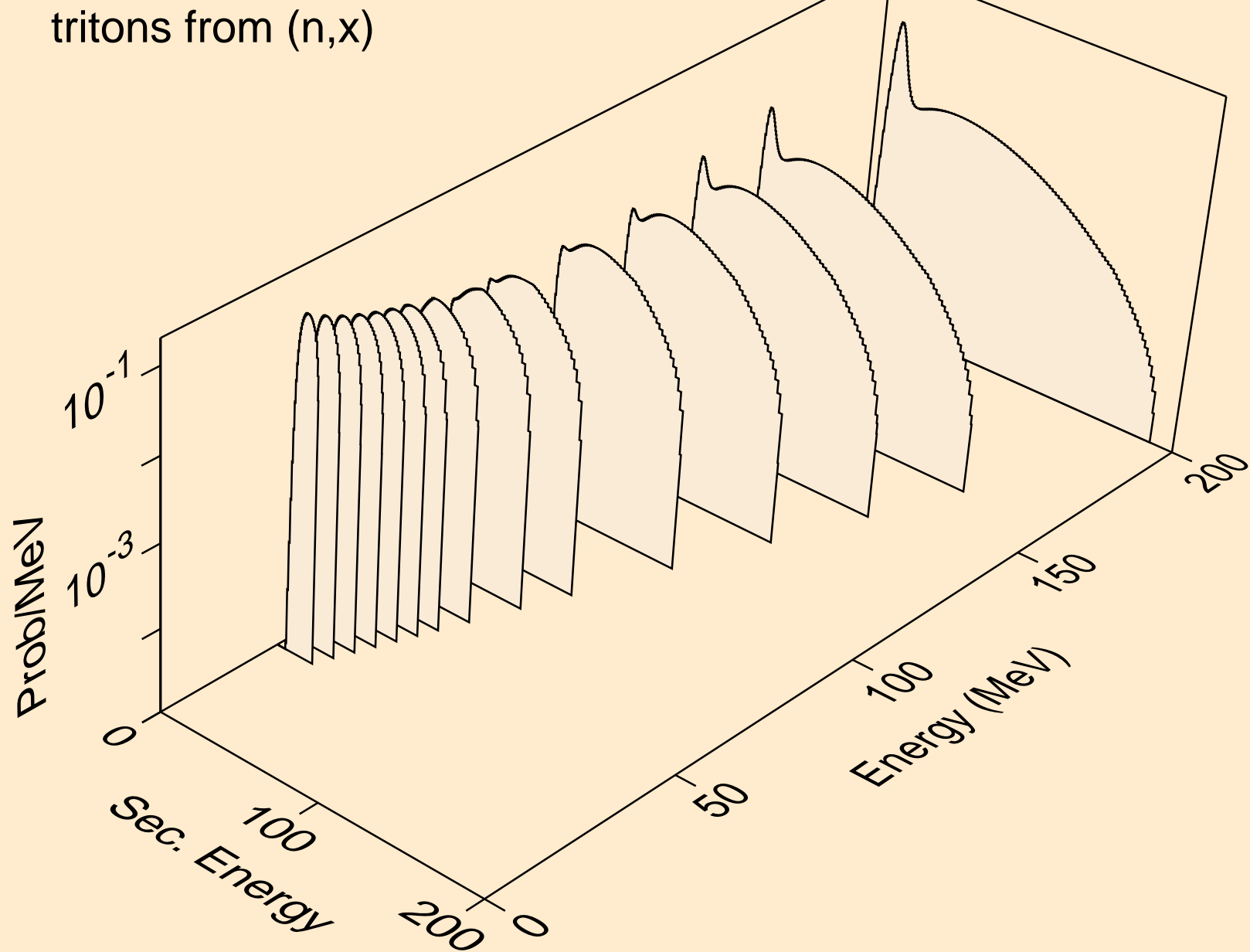

YB164 NEUTRON ACER TENDL-2023 LIBRARY; T=0.K
tritons from (n,n*)t

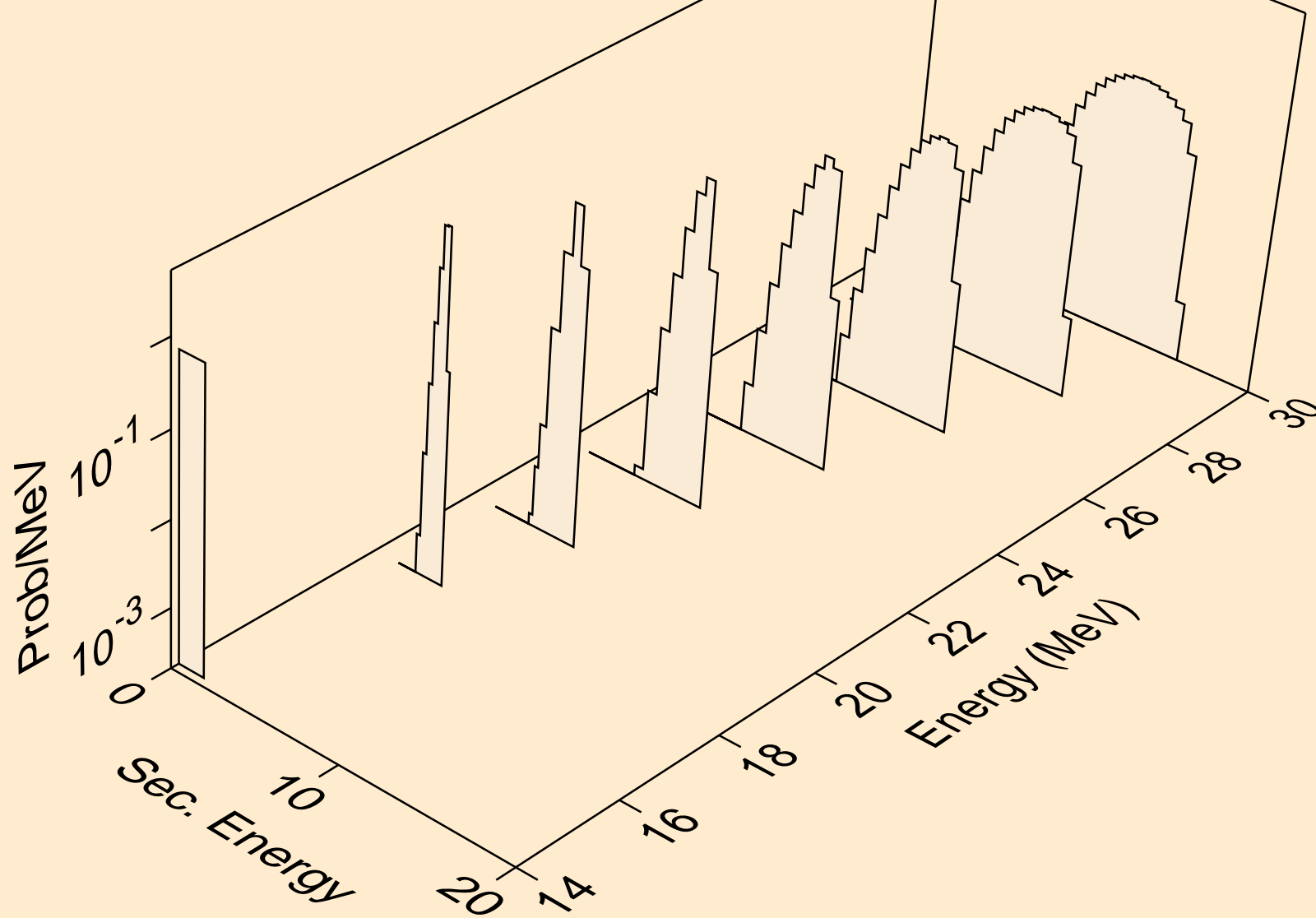

YB164 NEUTRON ACER TENDL-2023 LIBRARY; T=0.K
tritons from (n,t)

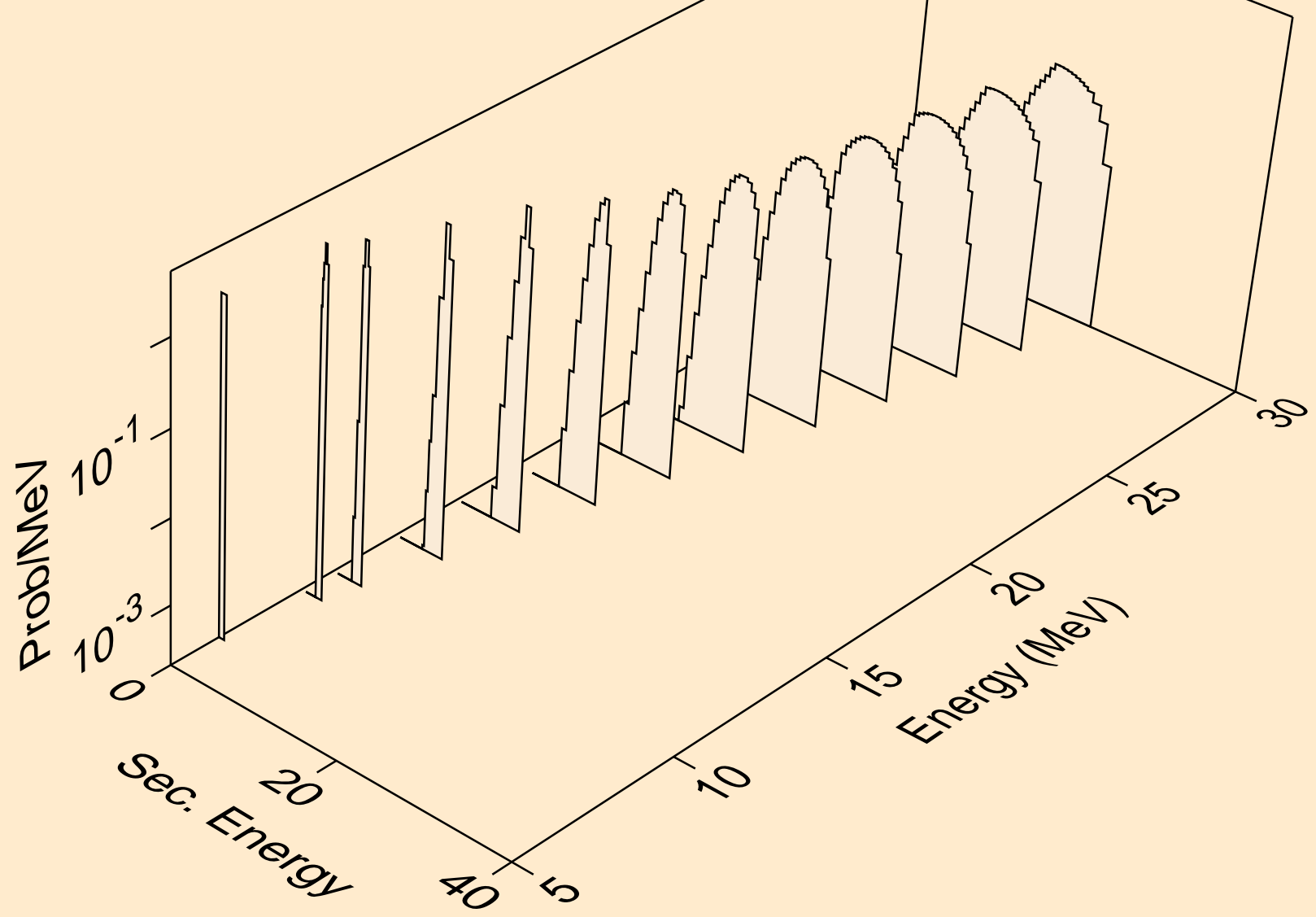

YB164 NEUTRON ACER TENDL-2023 LIBRARY; T=0.K
tritons from (n,pt)

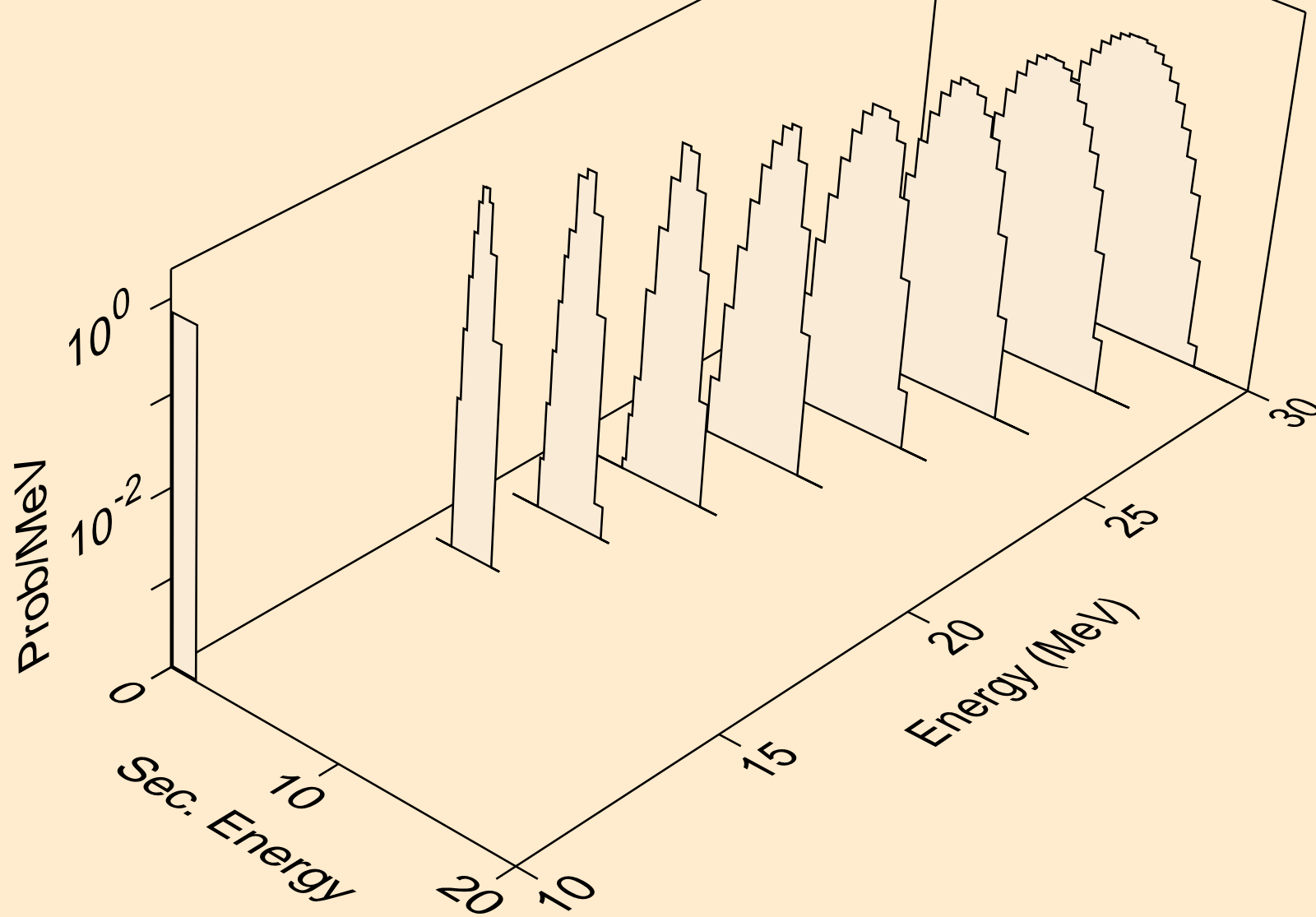

YB164 NEUTRON ACER TENDL-2023 LIBRARY; T=0.K
he3s from (n,x)

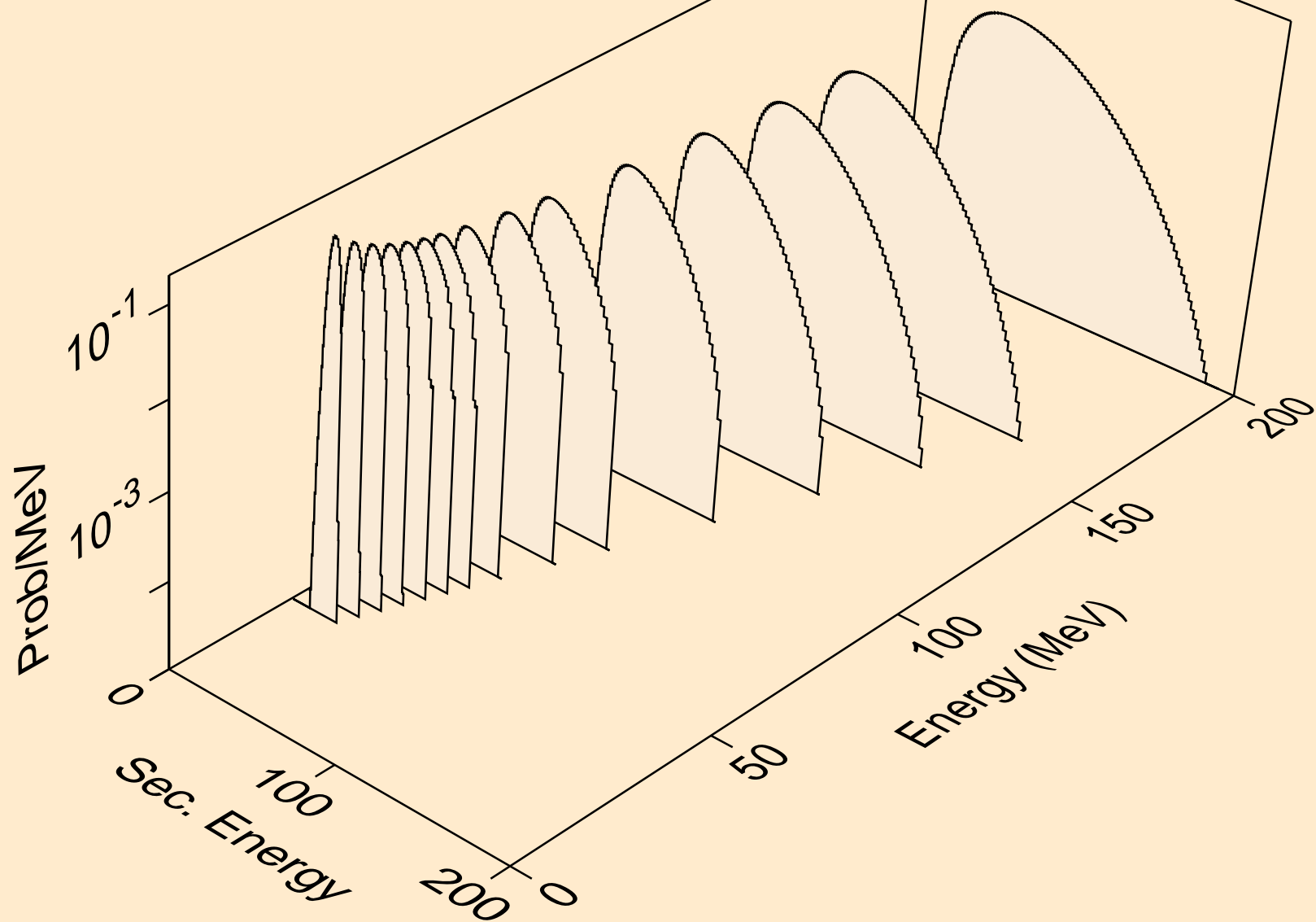

YB164 NEUTRON ACER TENDL-2023 LIBRARY; T=0.K
he3s from (n,n*)he3

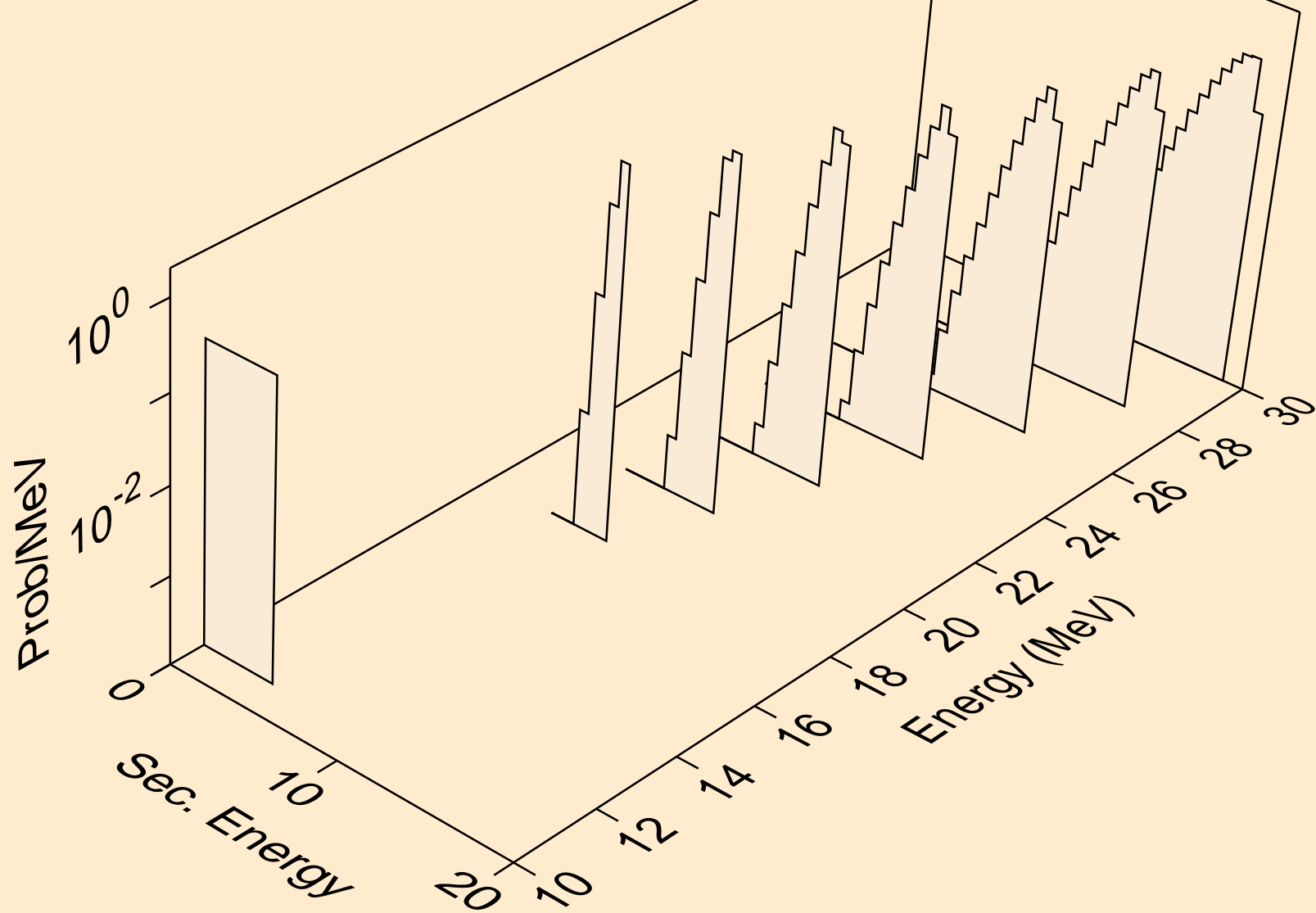

YB164 NEUTRON ACER TENDL-2023 LIBRARY; T=0.K
he3s from (n,he3)

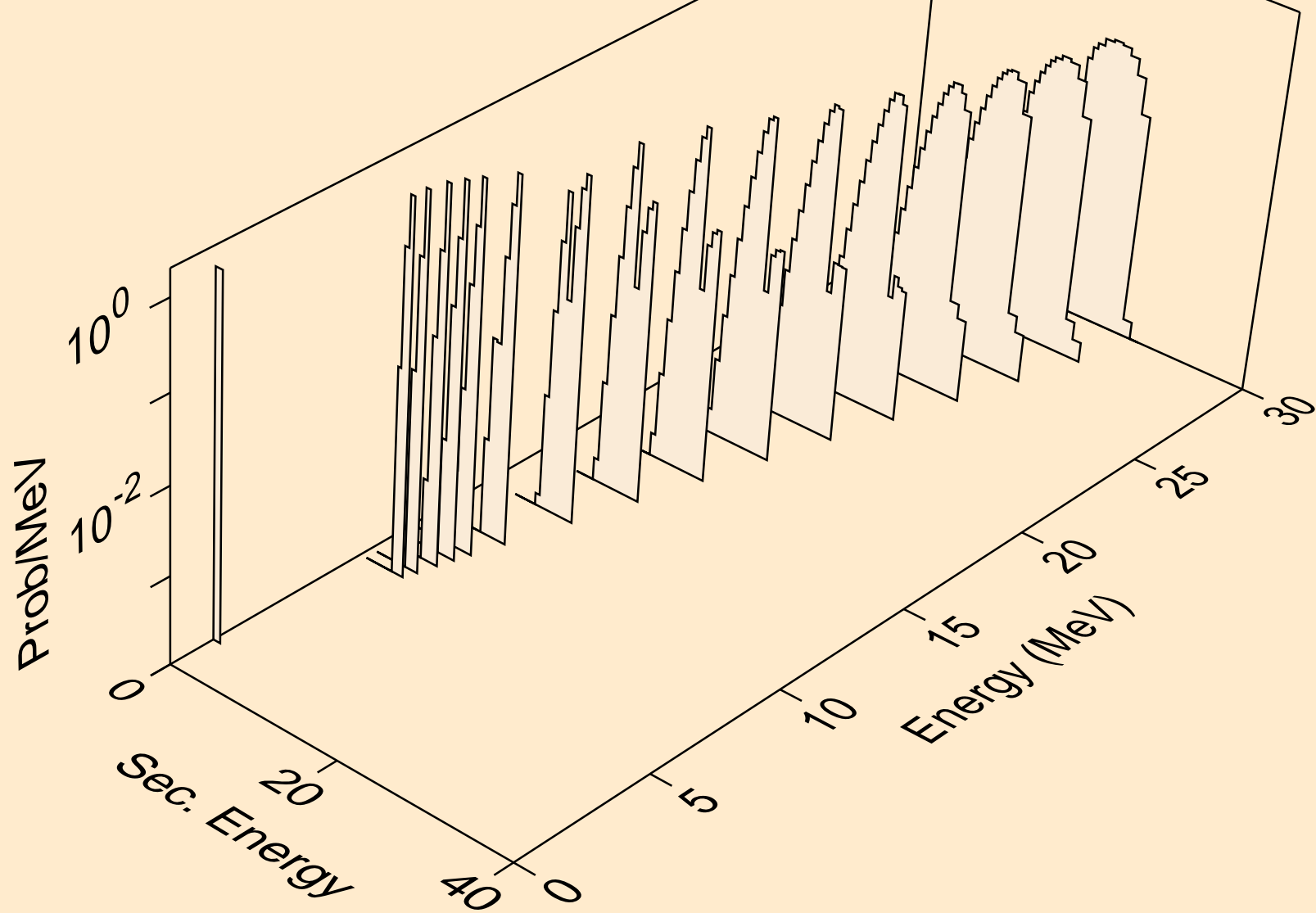

YB164 NEUTRON ACER TENDL-2023 LIBRARY; T=0.K
alphas from (n,x)

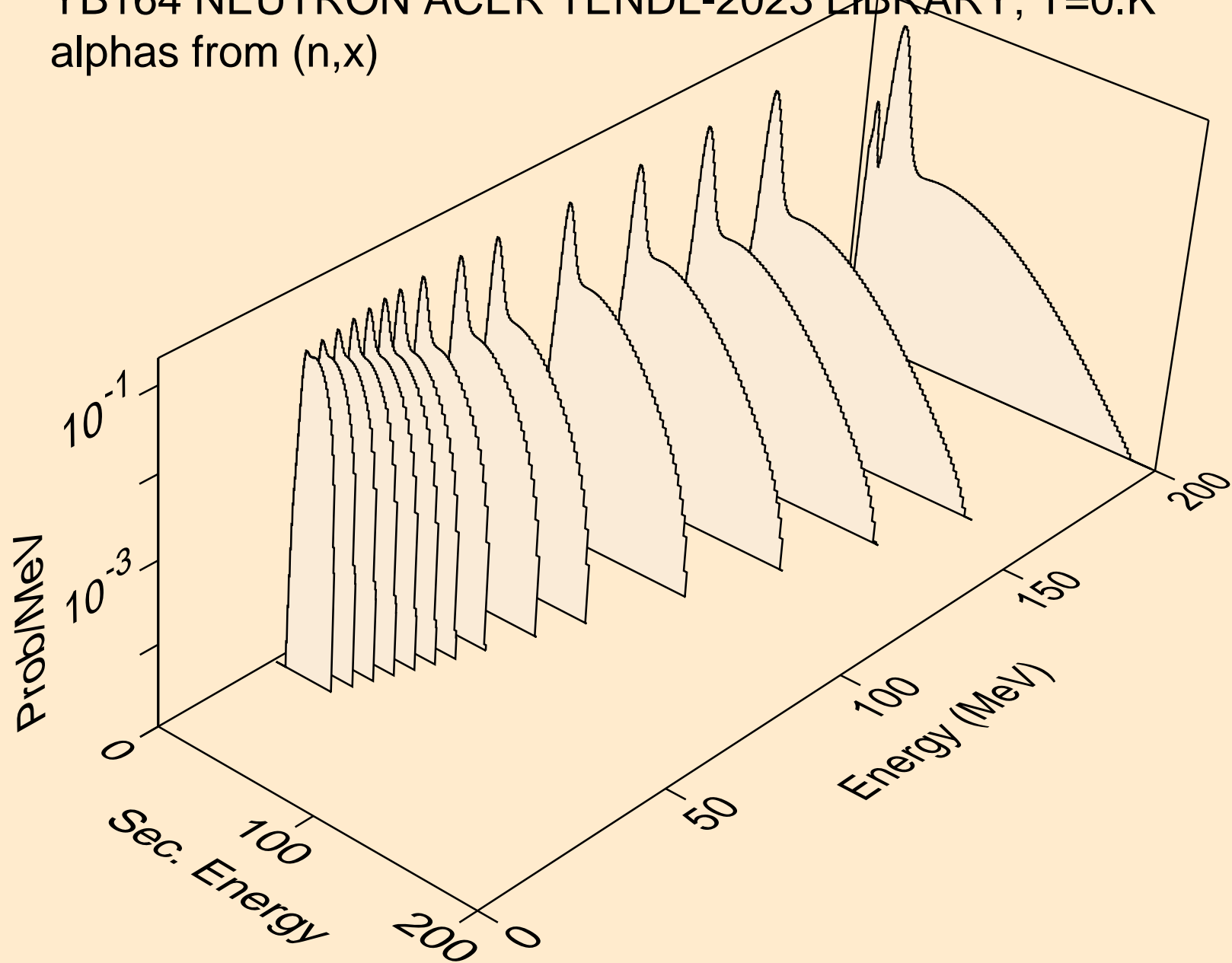

YB164 NEUTRON ACER TENDL-2023 LIBRARY; T=0.K
alphas from (n,n*)a

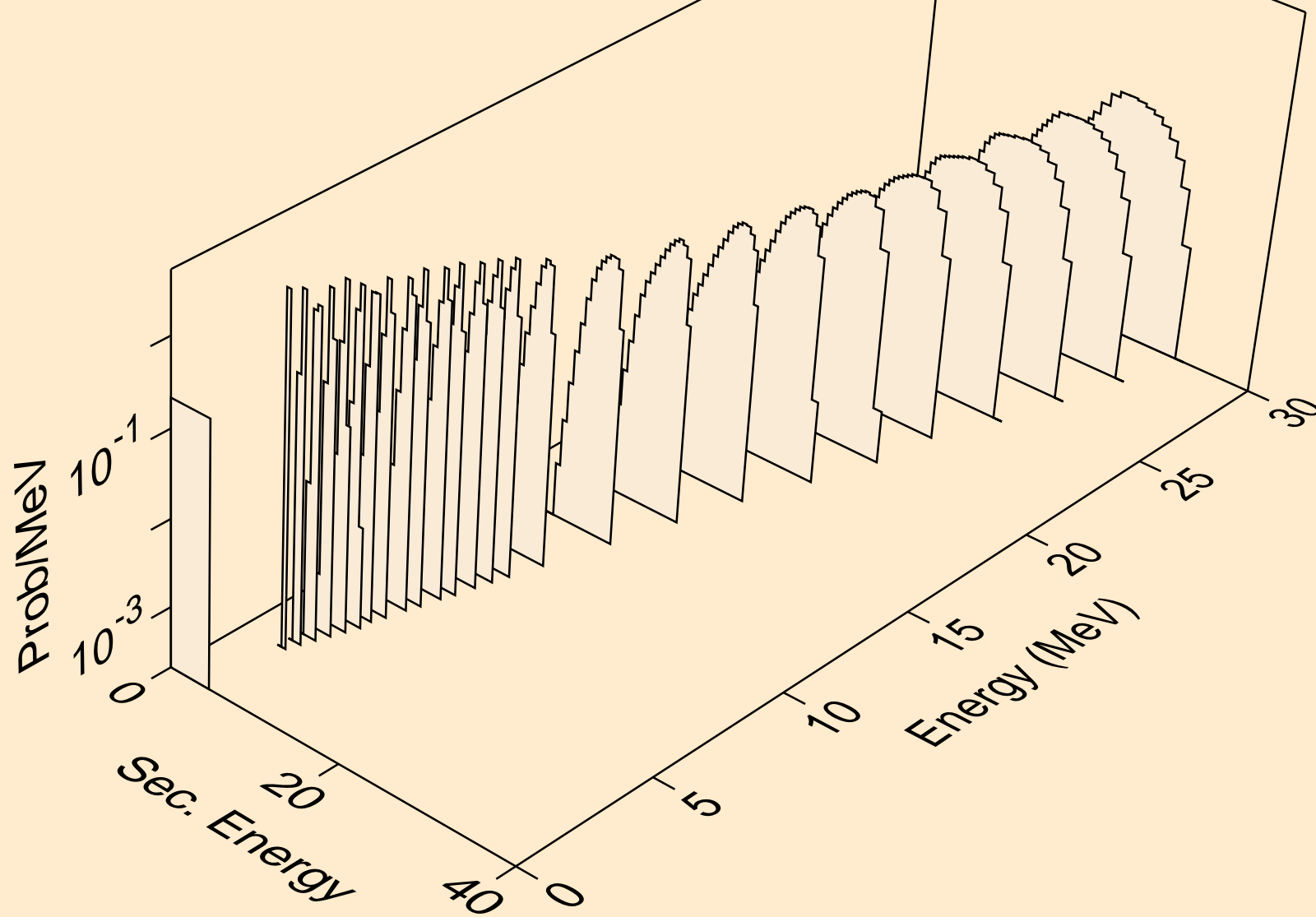

YB164 NEUTRON ACER TENDL-2023 LIBRARY; T=0.K
alphas from (n,2n)a

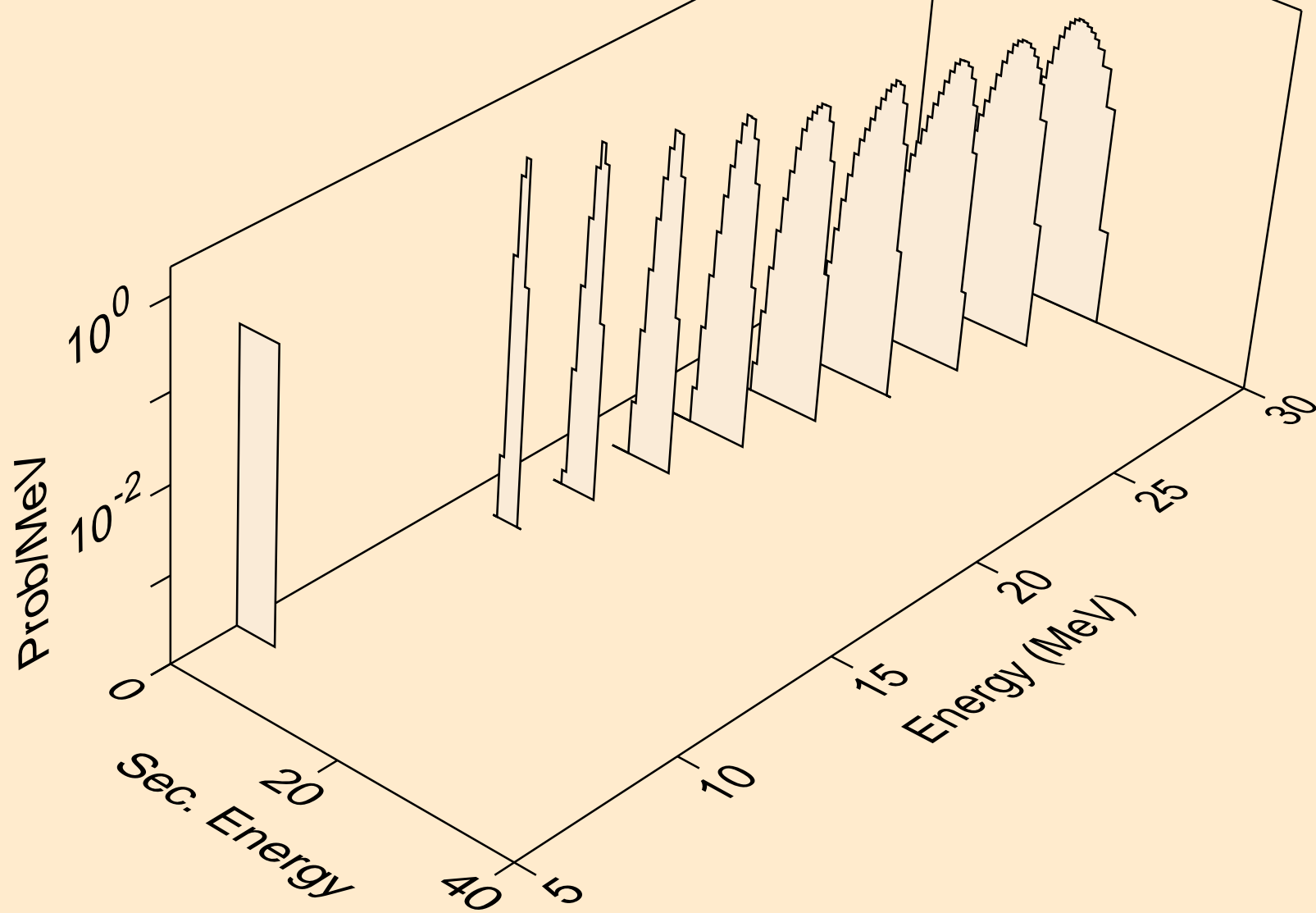

YB164 NEUTRON ACER TENDL-2023 LIBRARY; T=0.K
alphas from (n,3n)a

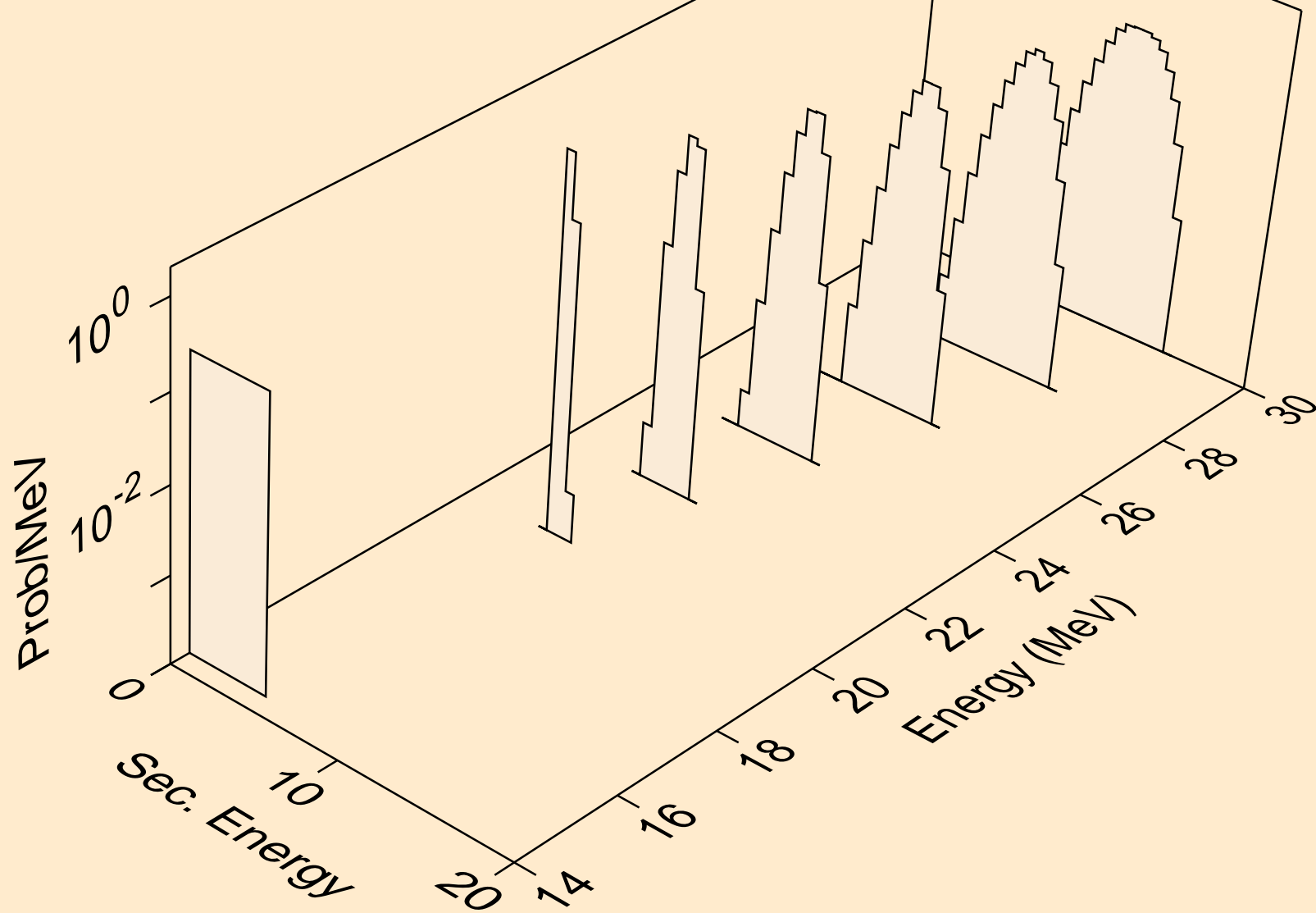

YB164 NEUTRON ACER TENDL-2023 LIBRARY; T=0.K
alphas from (n,n*)2a

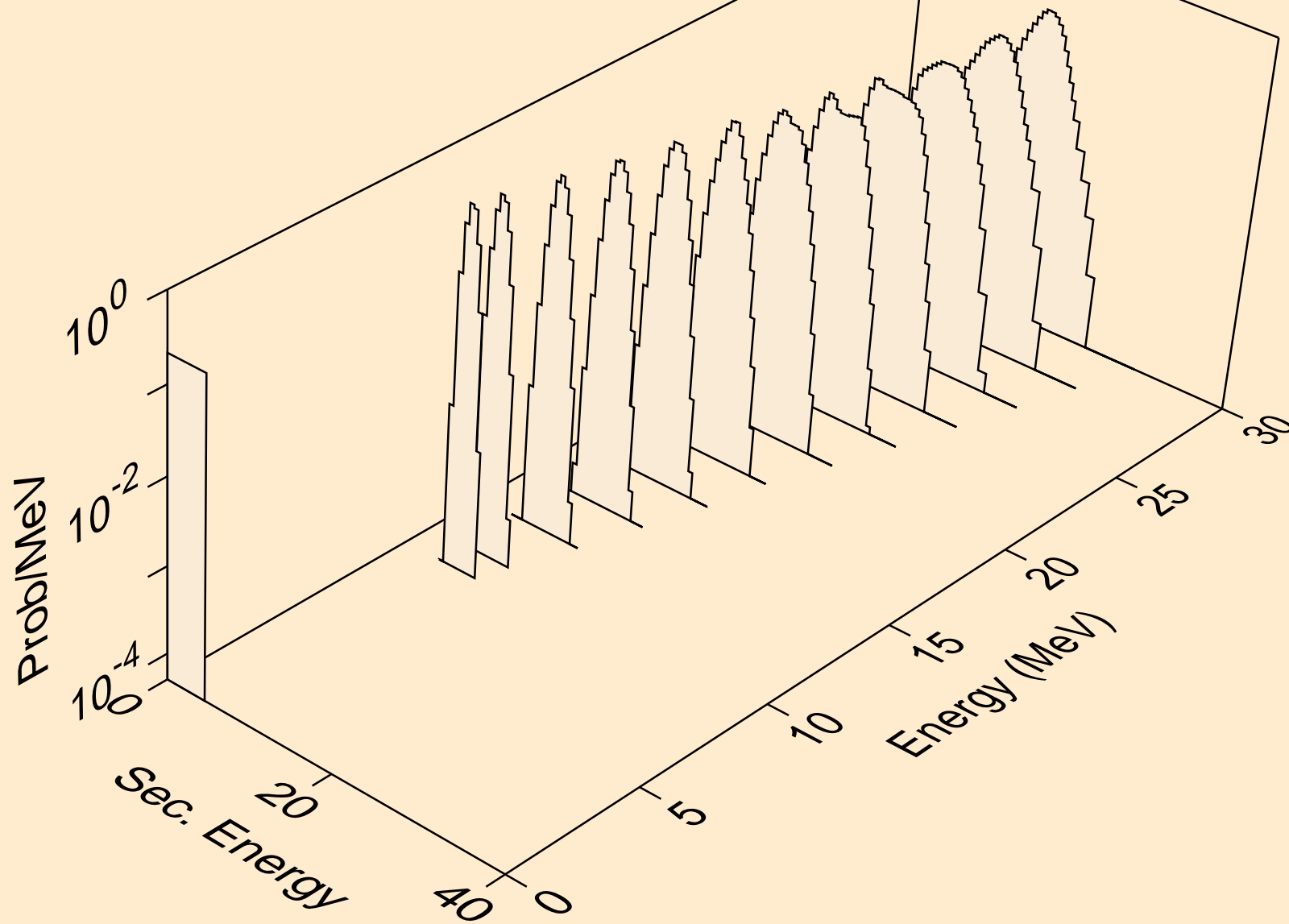

YB164 NEUTRON ACER TENDL-2023 LIBRARY; T=0.K
alphas from (n,2n)2a

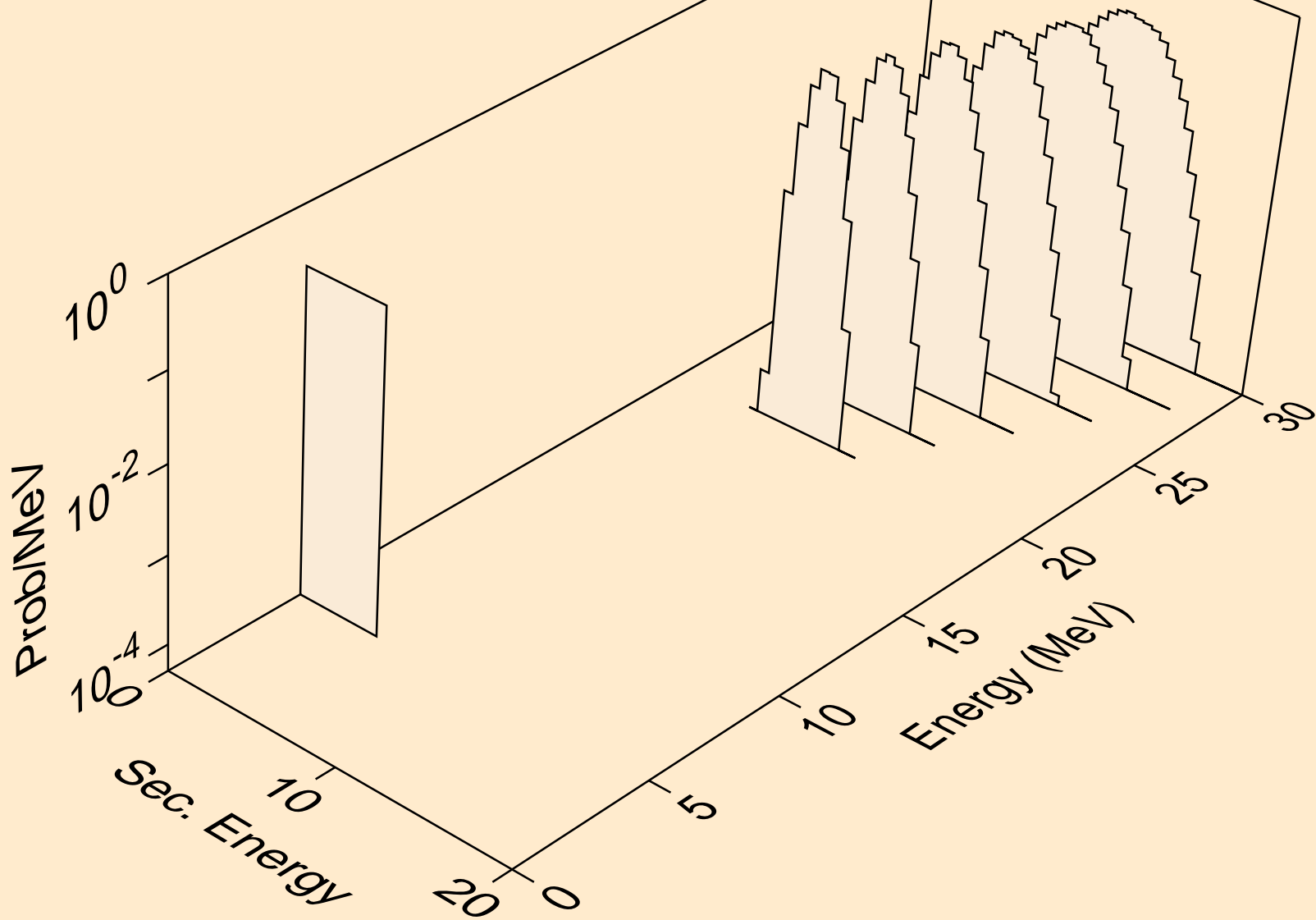

YB164 NEUTRON ACER TENDL-2023 LIBRARY; T=0.K
alphas from (n,npa)

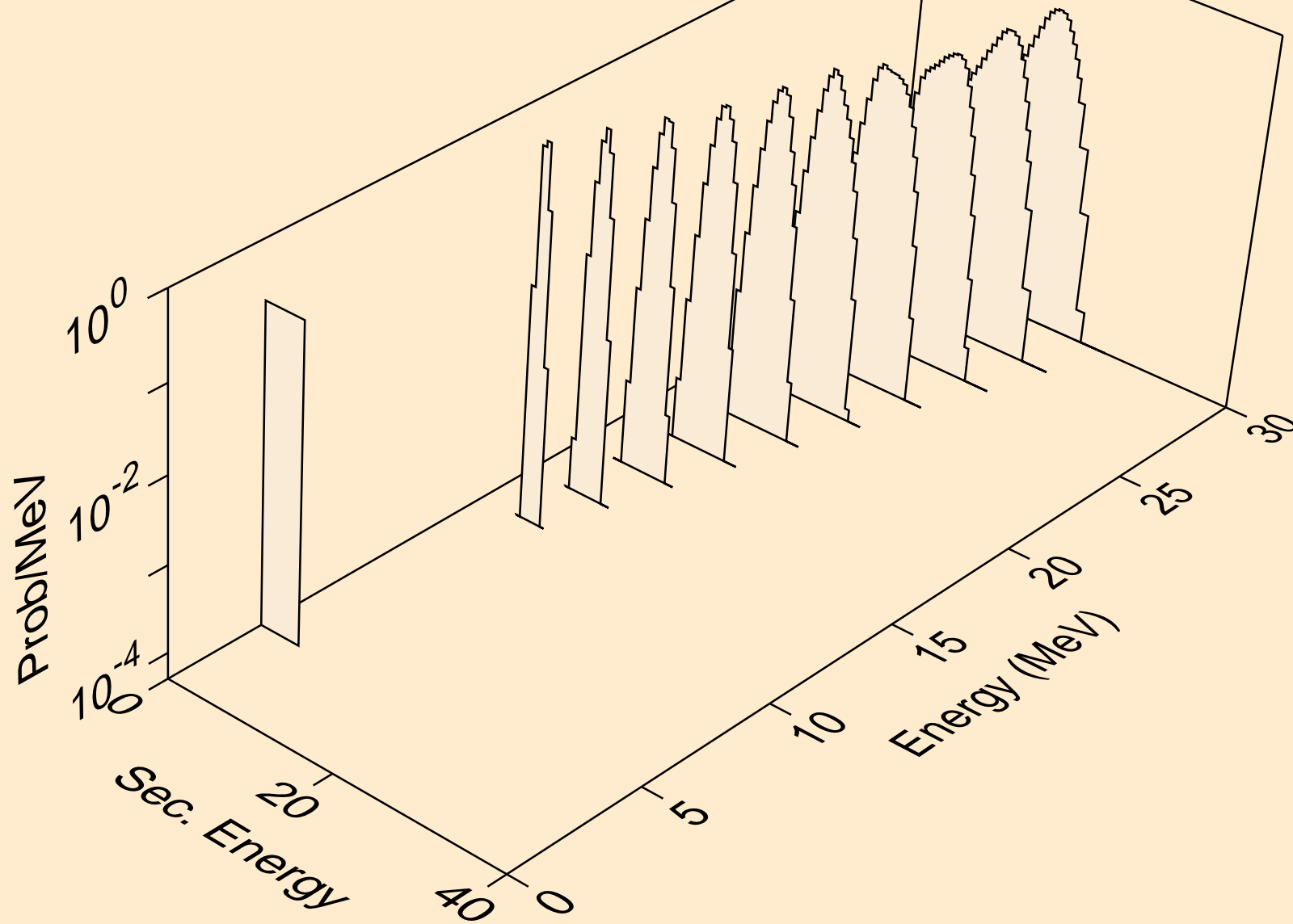

YB164 NEUTRON ACER TENDL-2023 LIBRARY; T=0.K
alphas from (n,a)

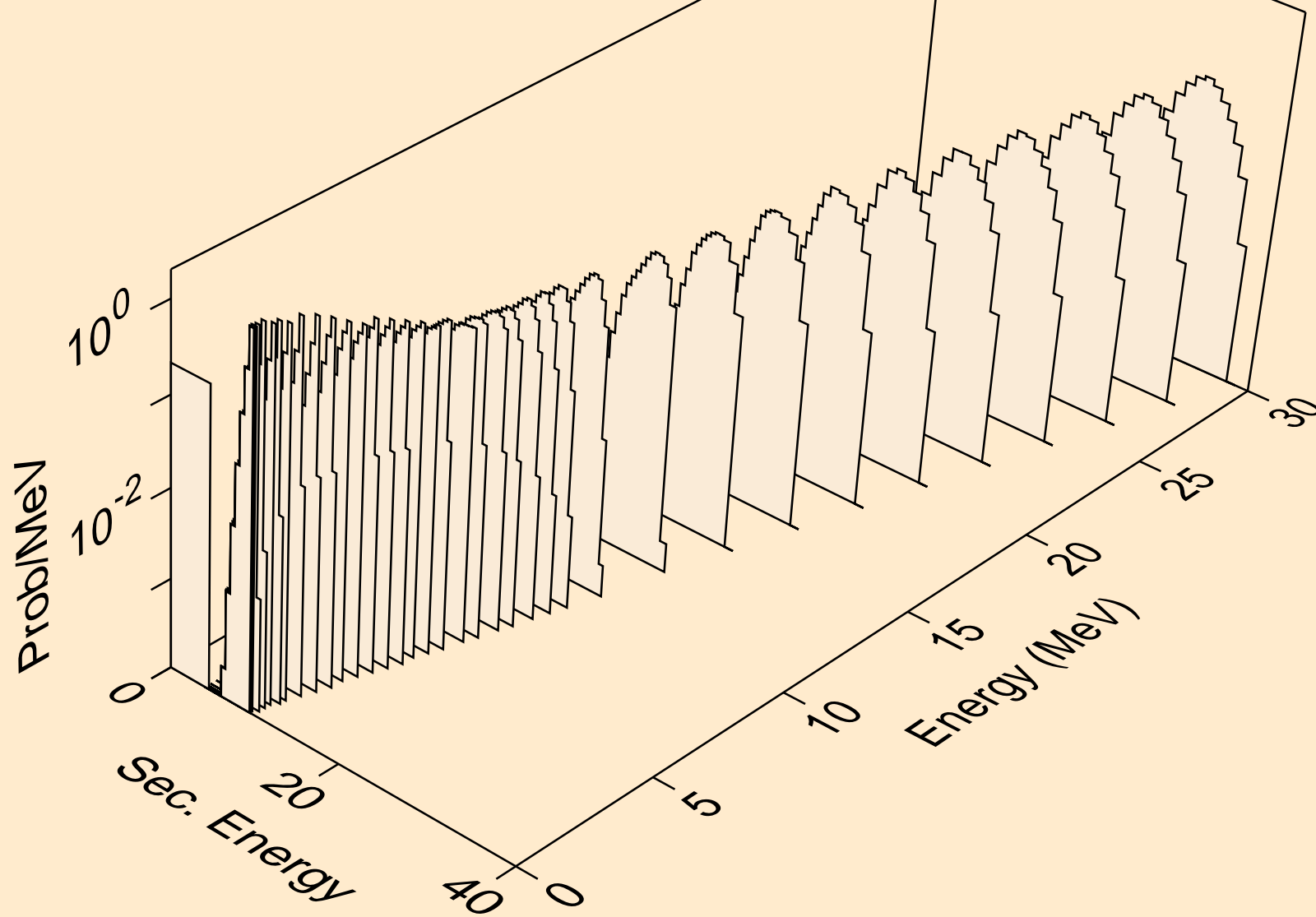

YB164 NEUTRON ACER TENDL-2023 LIBRARY; T=0.K
alphas from (n,2a)

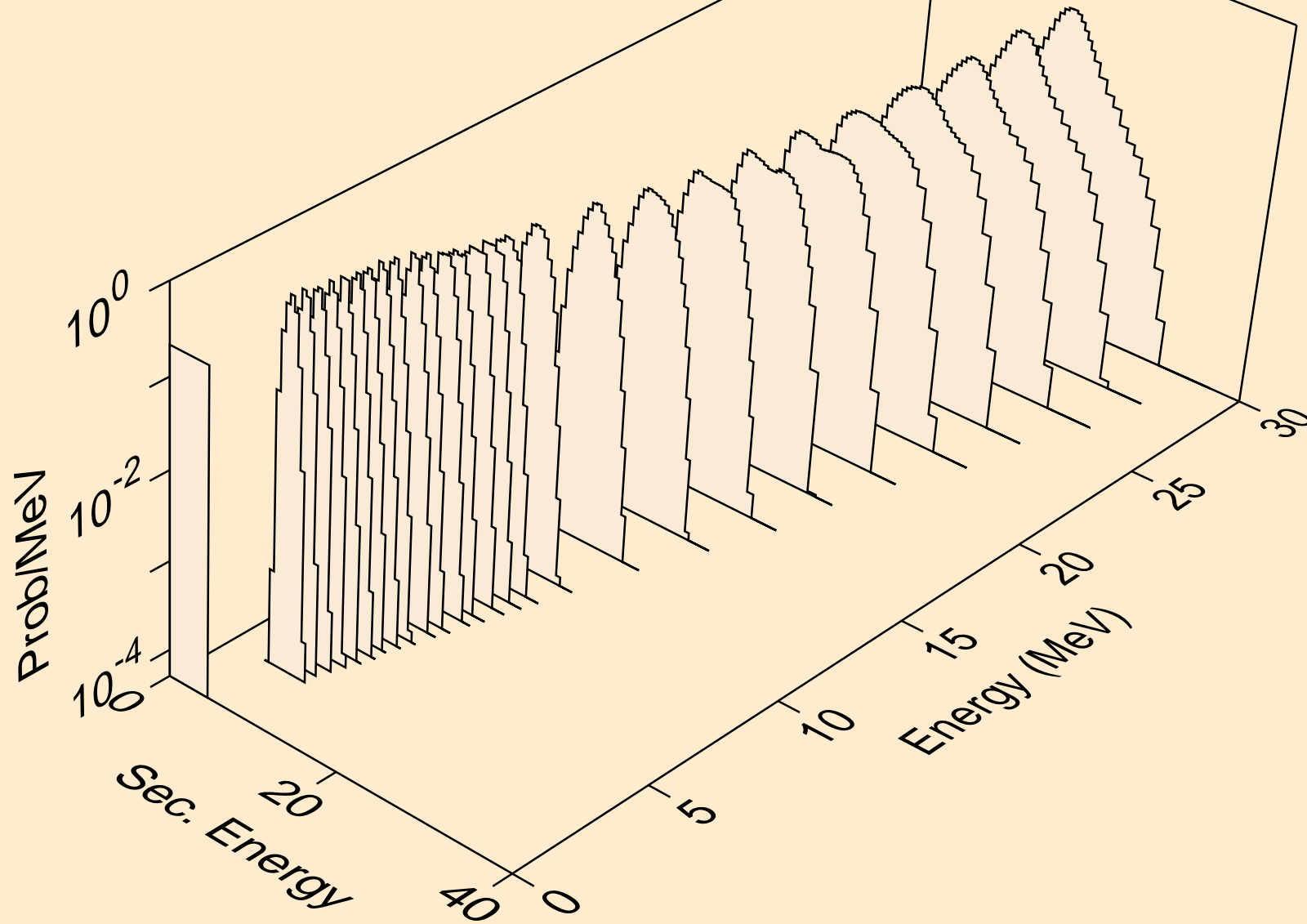

YB164 NEUTRON ACER TENDL-2023 LIBRARY; T=0.K
alphas from (n,pa)

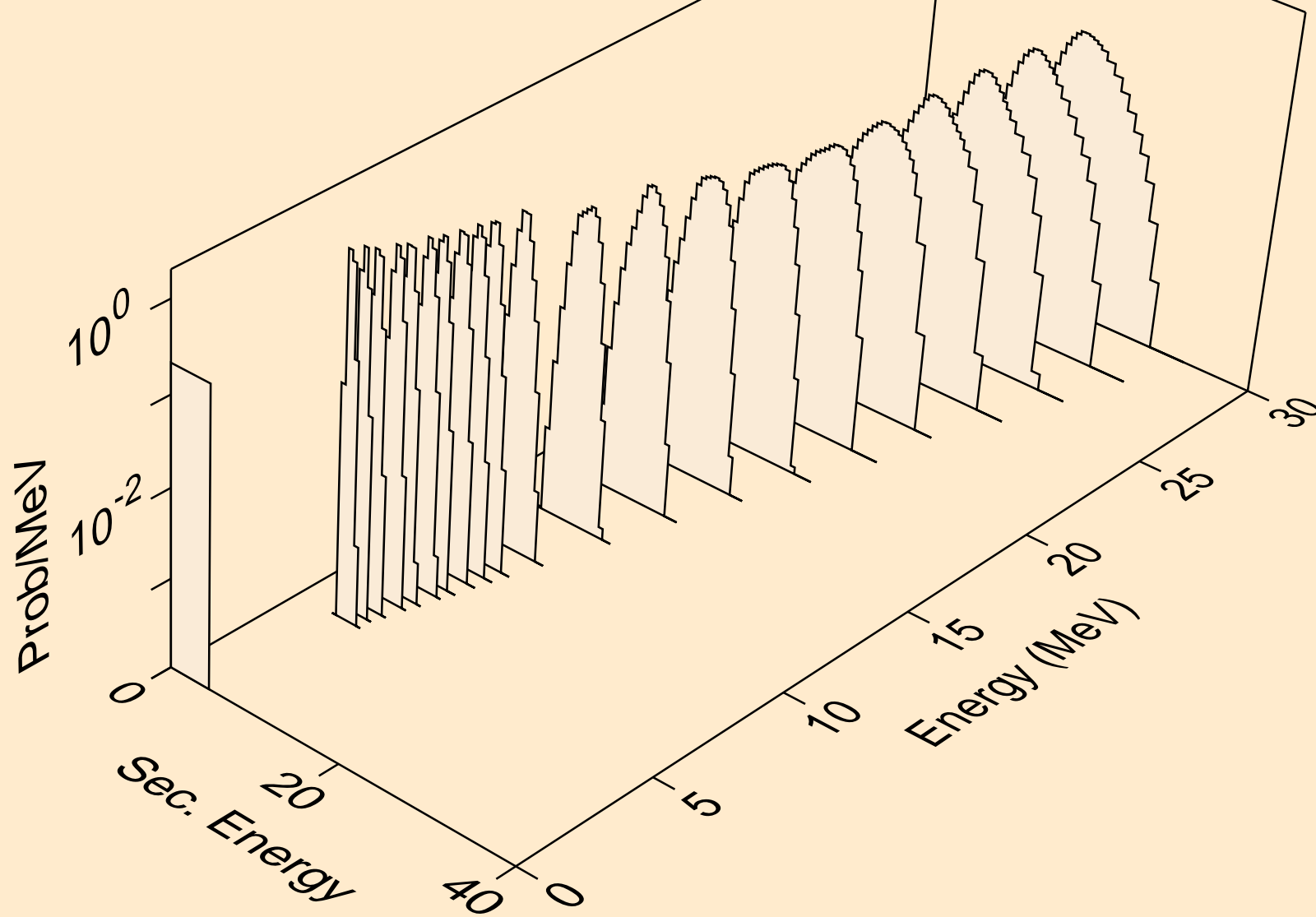

YB164 NEUTRON ACER TENDL-2023 LIBRARY; T=0.K
alphas from (n,da)

