

# ZR094 NEUTRON ACER TENDL-2023 LIBRARY; T=0.K

## Principal cross sections

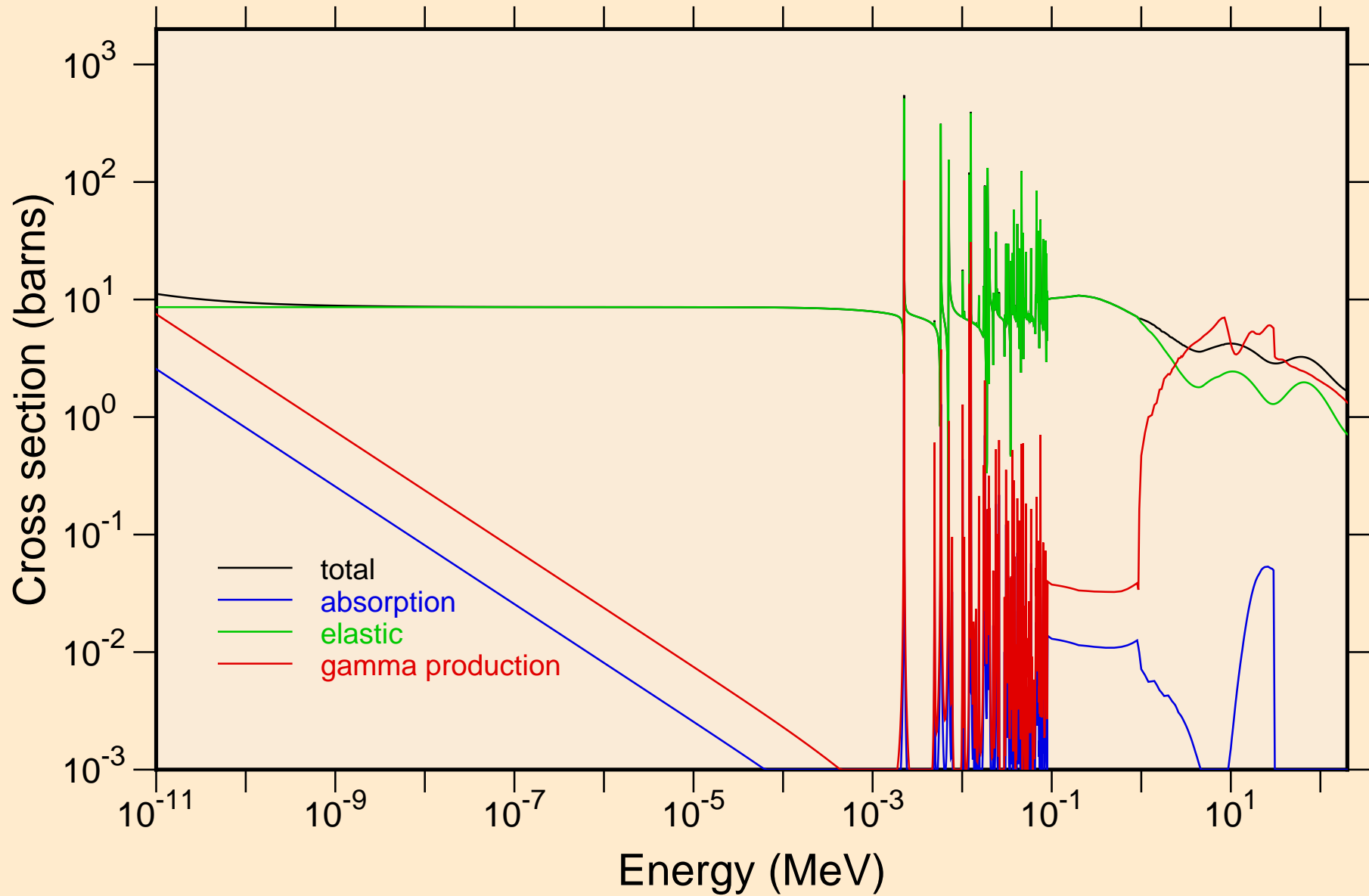

ZR094 NEUTRON ACER TENDL-2023 LIBRARY; T=0.K  
resonance total cross section

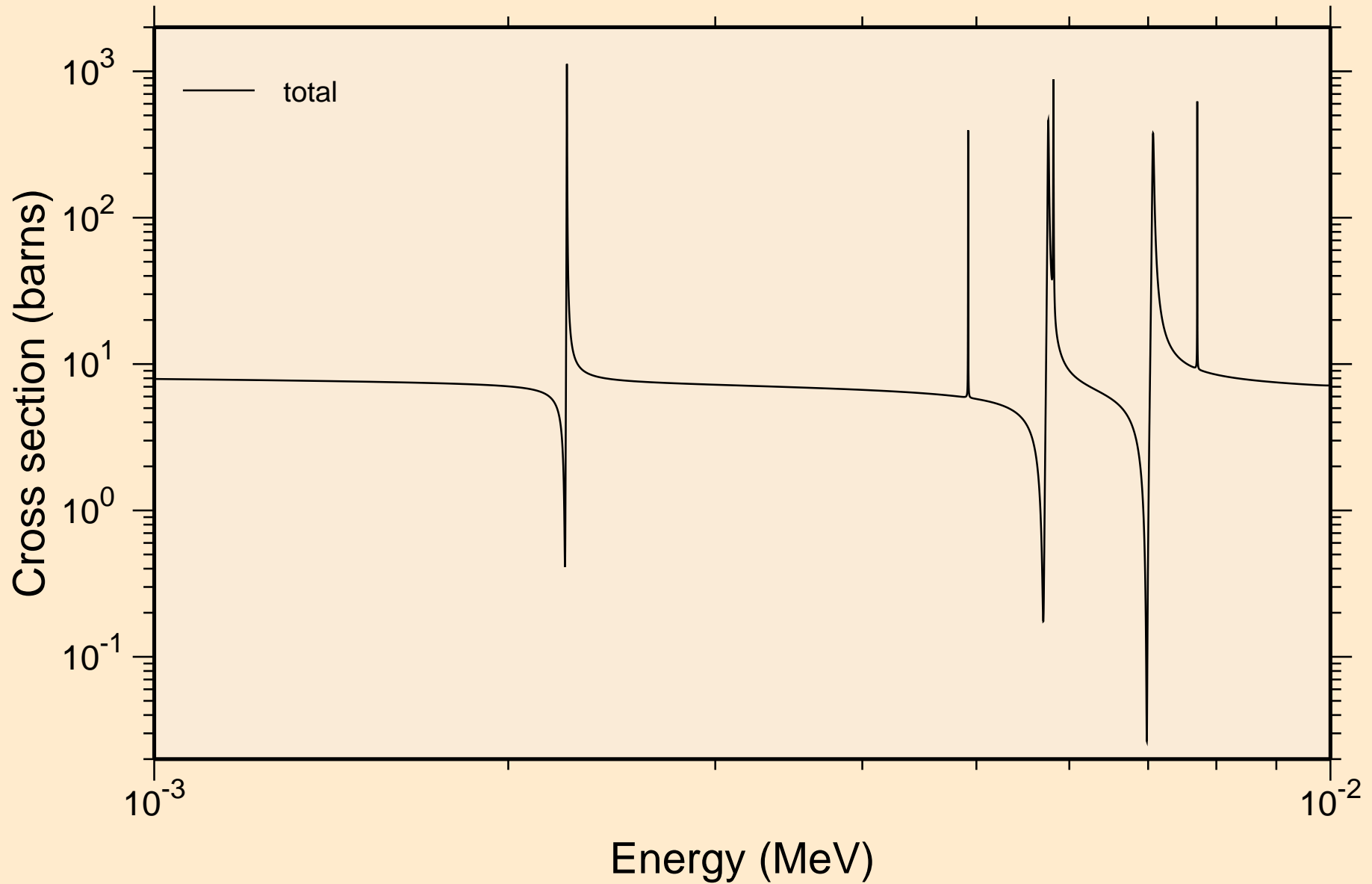

ZR094 NEUTRON ACER TENDL-2023 LIBRARY; T=0.K  
resonance total cross section

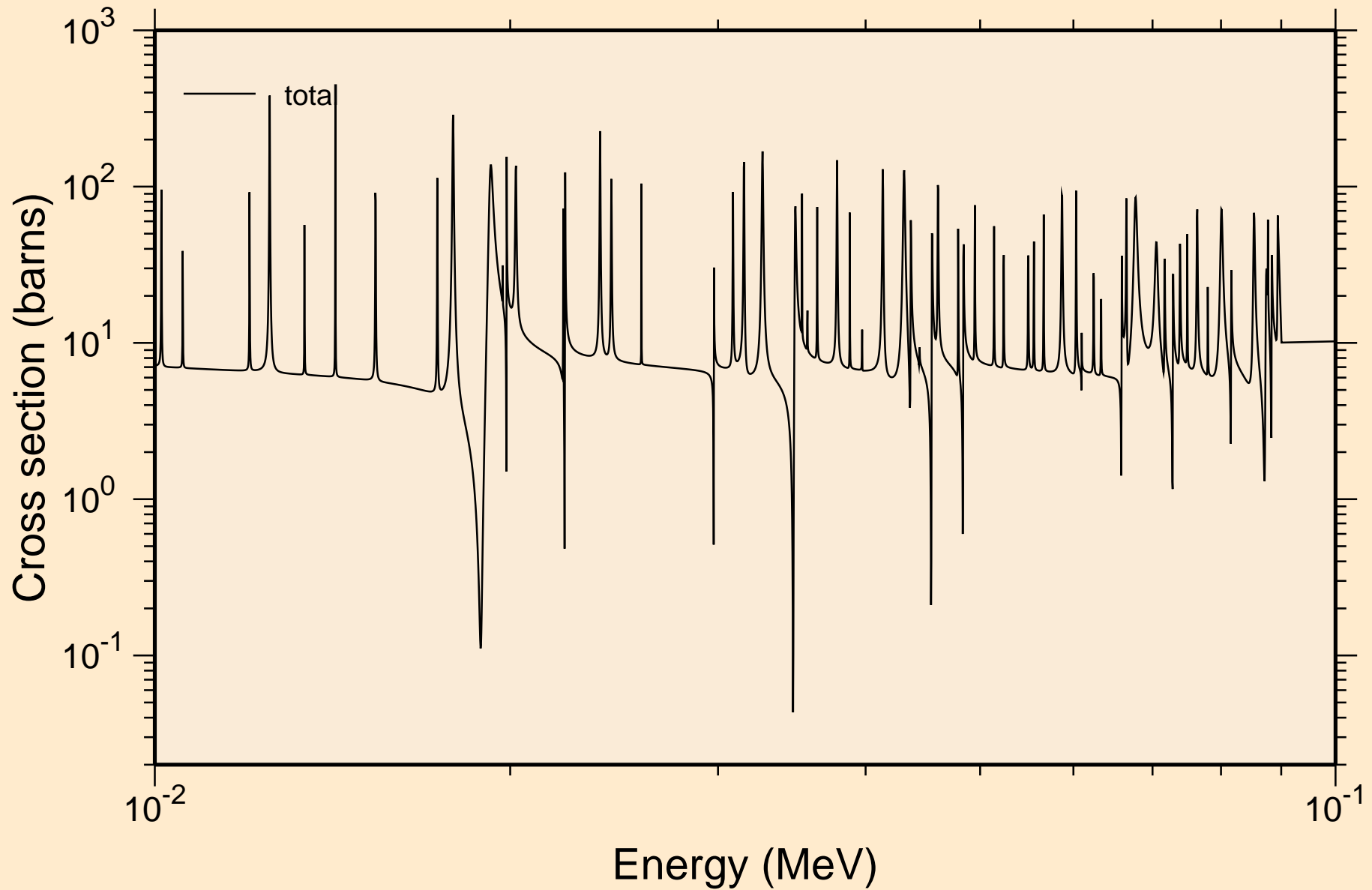

ZR094 NEUTRON ACER TENDL-2023 LIBRARY; T=0.K  
resonance total cross section

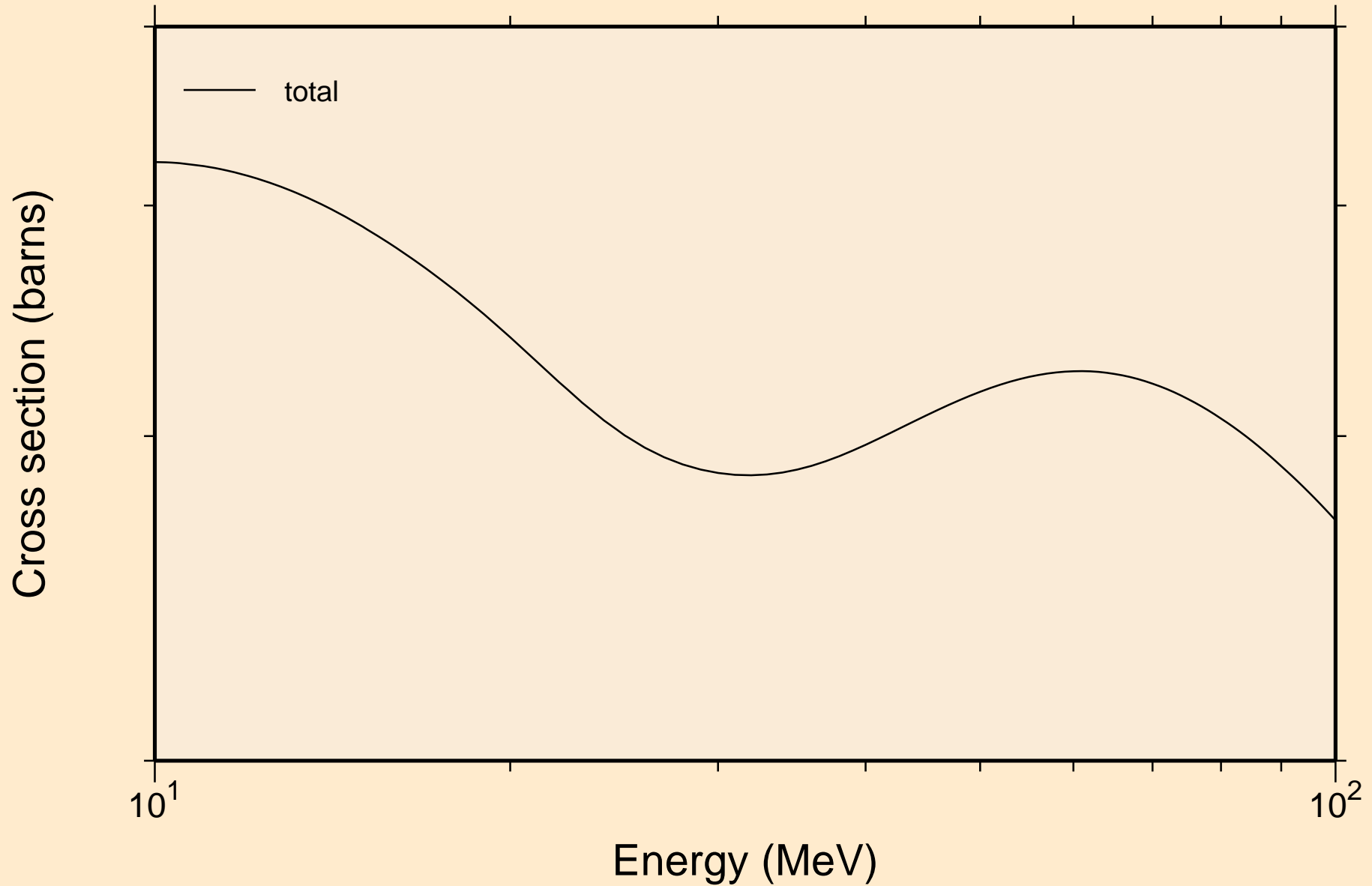

ZR094 NEUTRON ACER TENDL-2023 LIBRARY; T=0.K  
resonance absorption cross sections

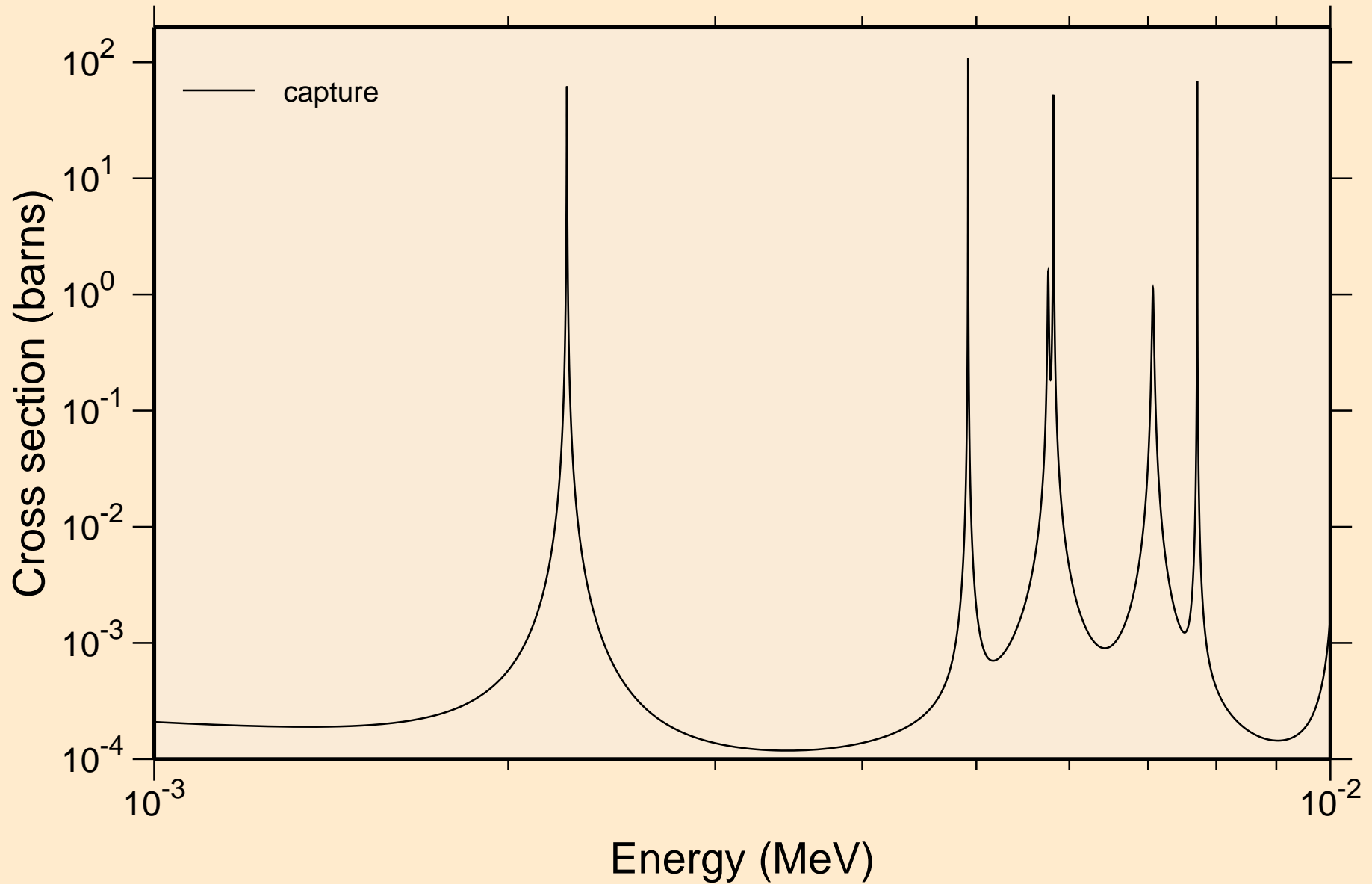

ZR094 NEUTRON ACER TENDL-2023 LIBRARY; T=0.K  
resonance absorption cross sections

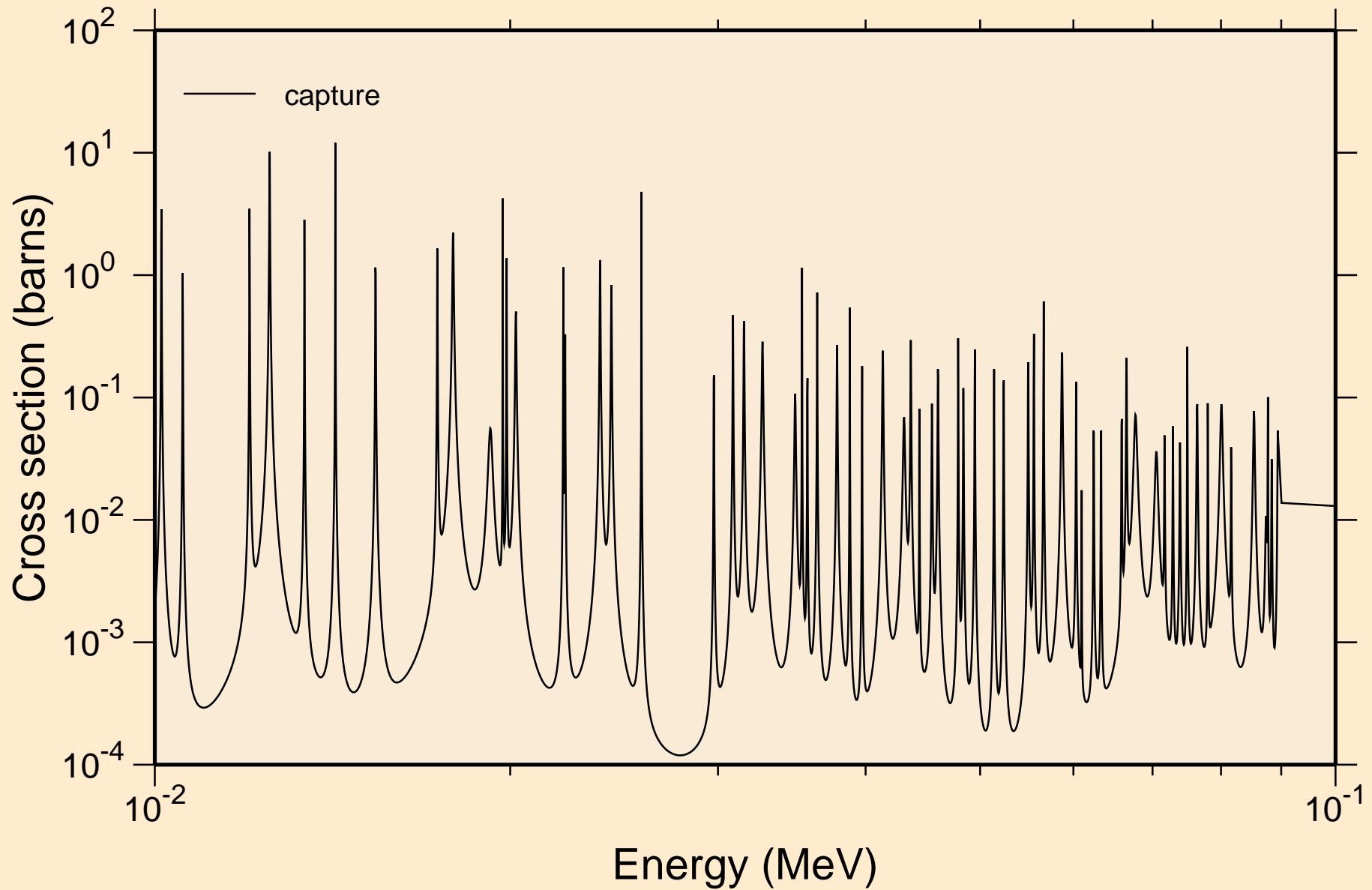

ZR094 NEUTRON ACER TENDL-2023 LIBRARY; T=0.K  
resonance absorption cross sections

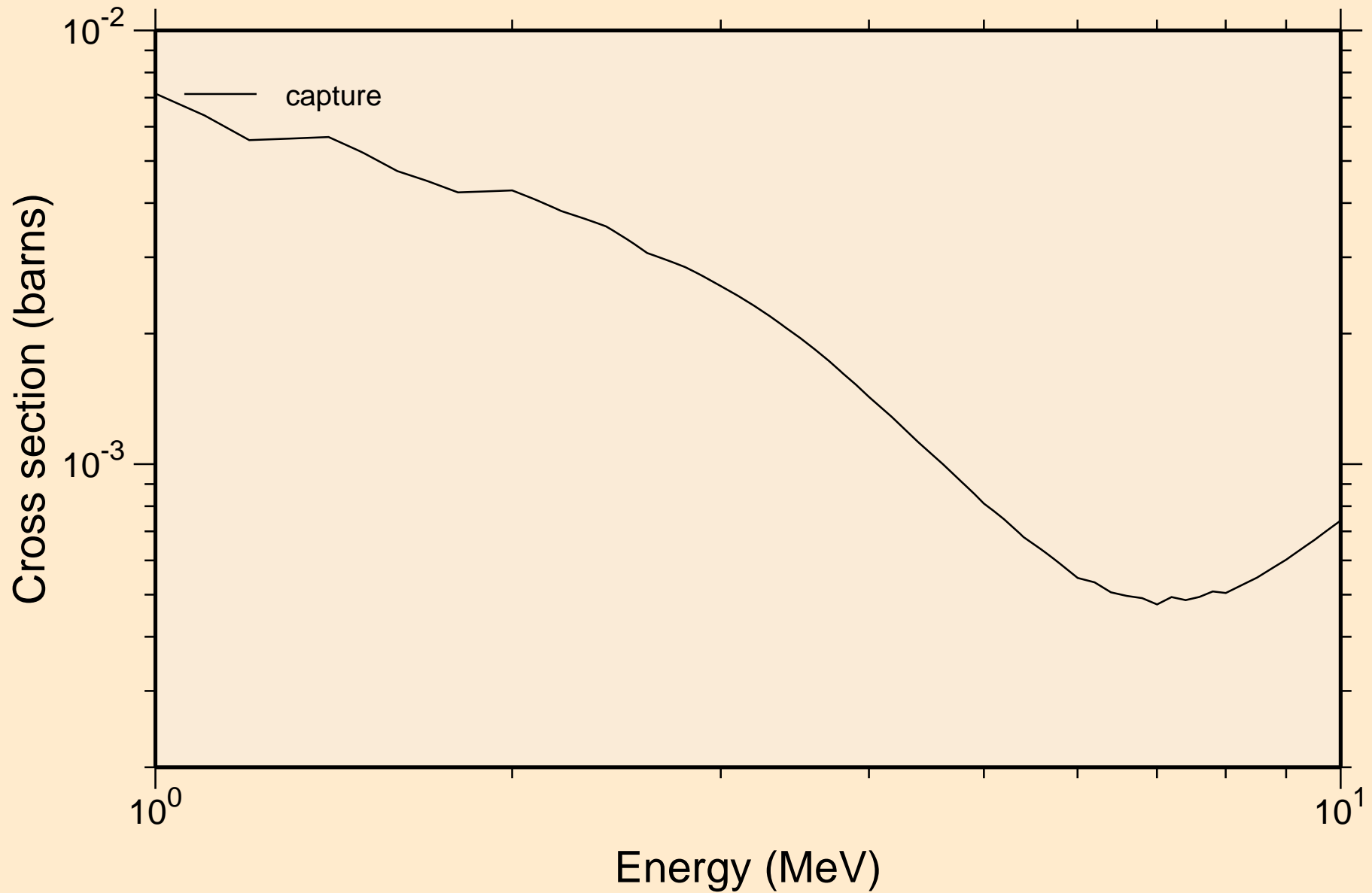

ZR094 NEUTRON ACER TENDL-2023 LIBRARY; T=0.K  
Heating

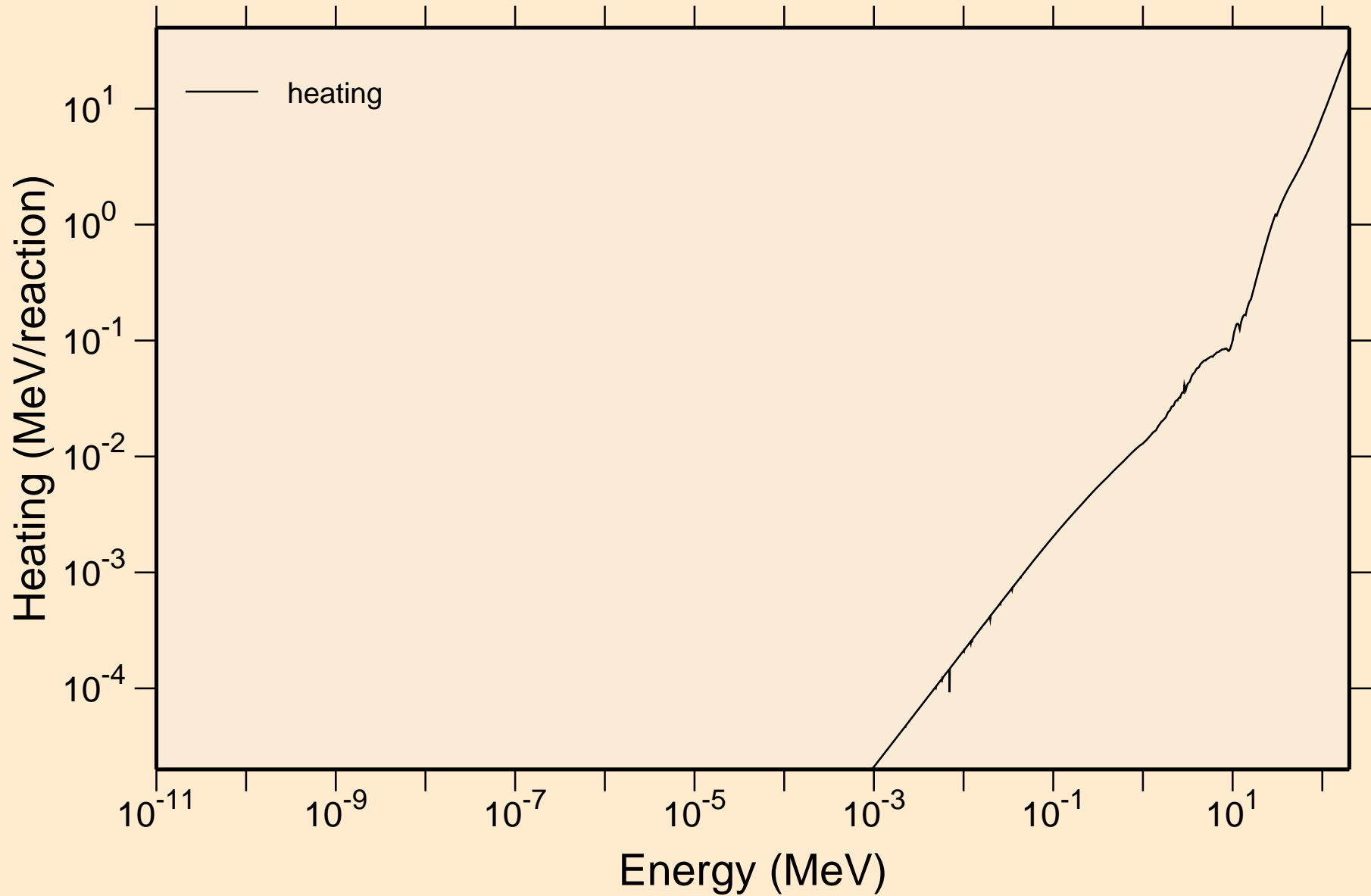

ZR094 NEUTRON ACER TENDL-2023 LIBRARY; T=0.K  
Damage

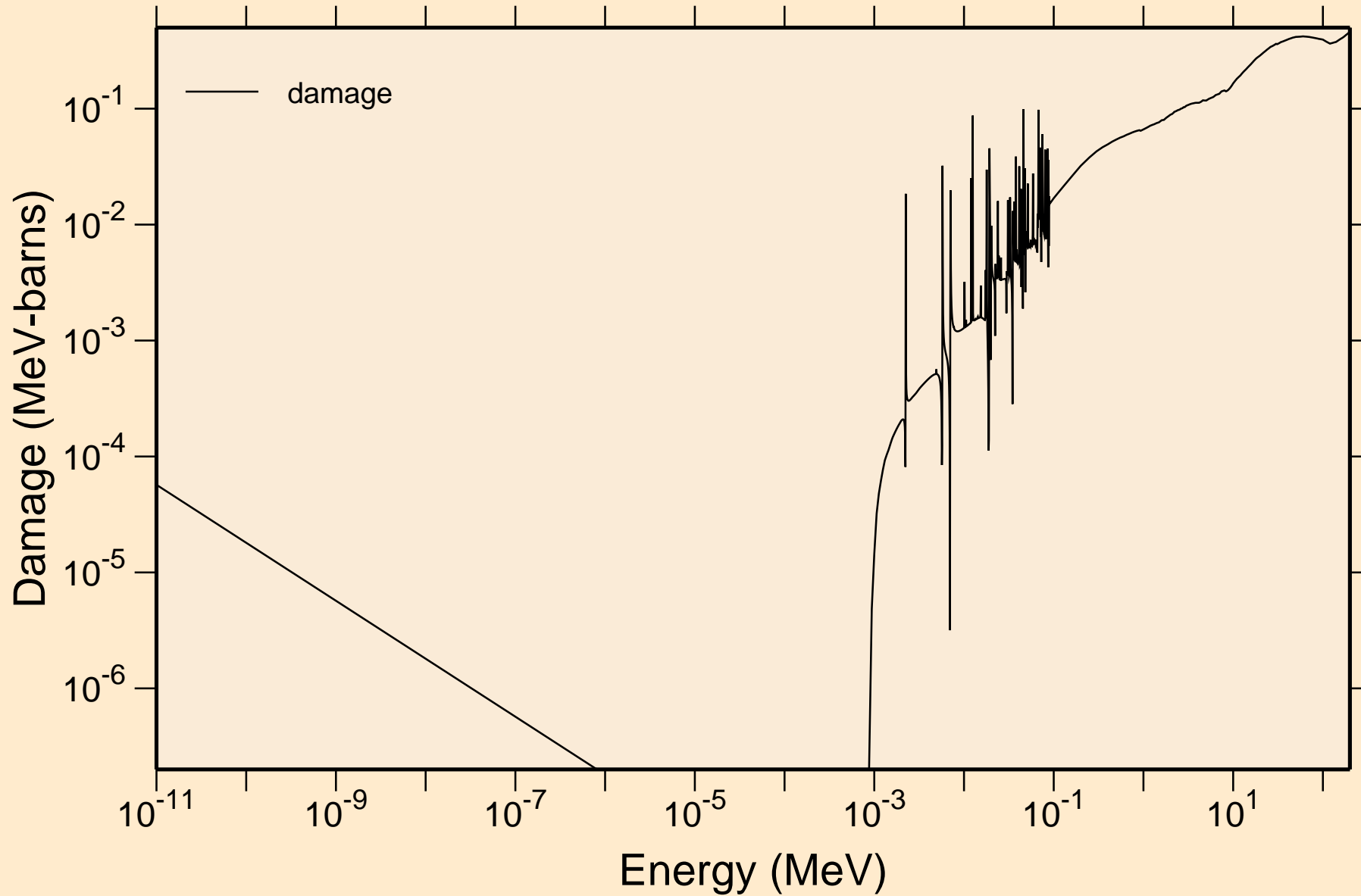

ZR094 NEUTRON ACER TENDL-2023 LIBRARY; T=0.K  
Non-threshold reactions

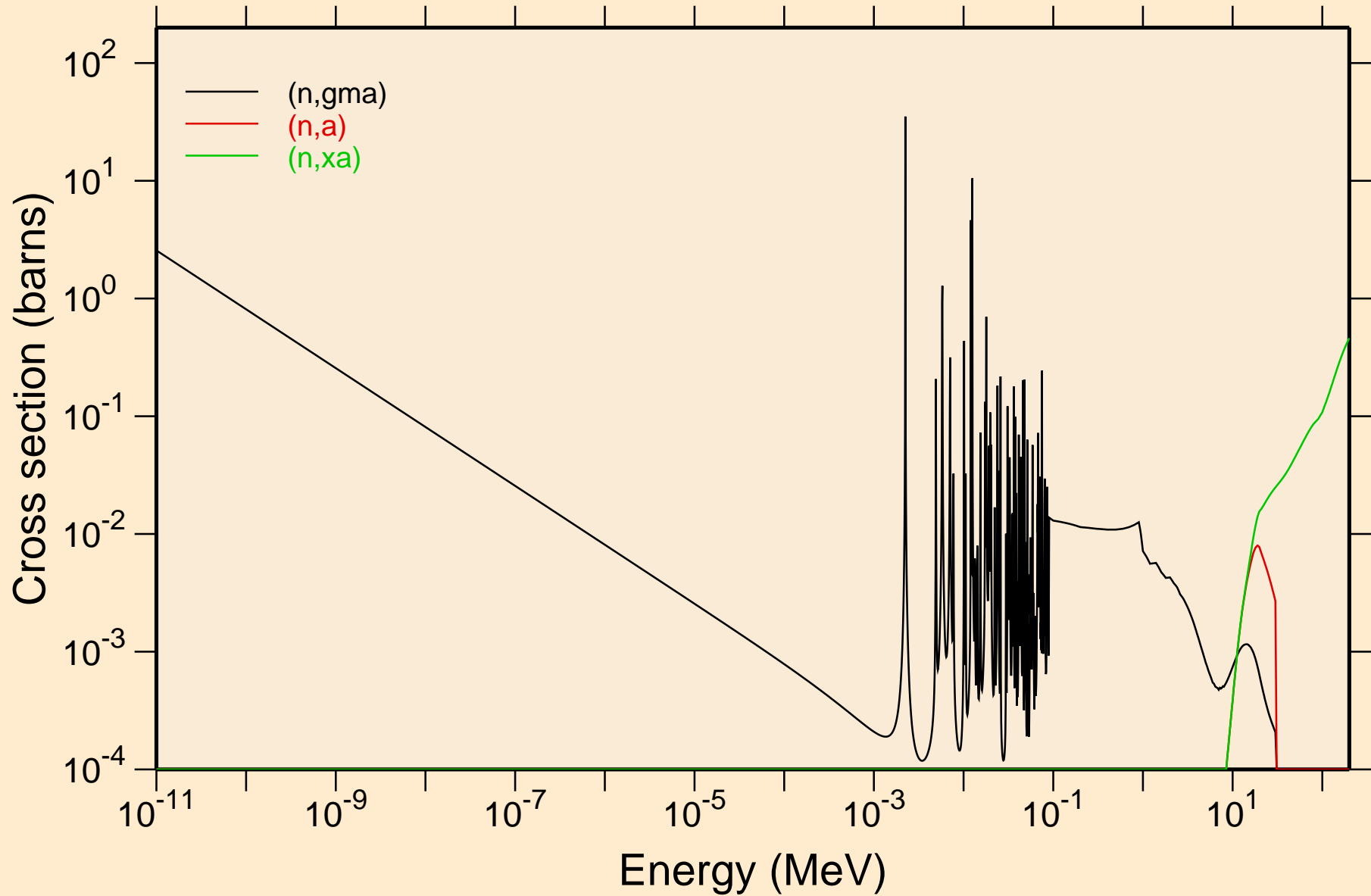

# ZR094 NEUTRON ACER TENDL-2023 LIBRARY; T=0.K

## Principal cross sections

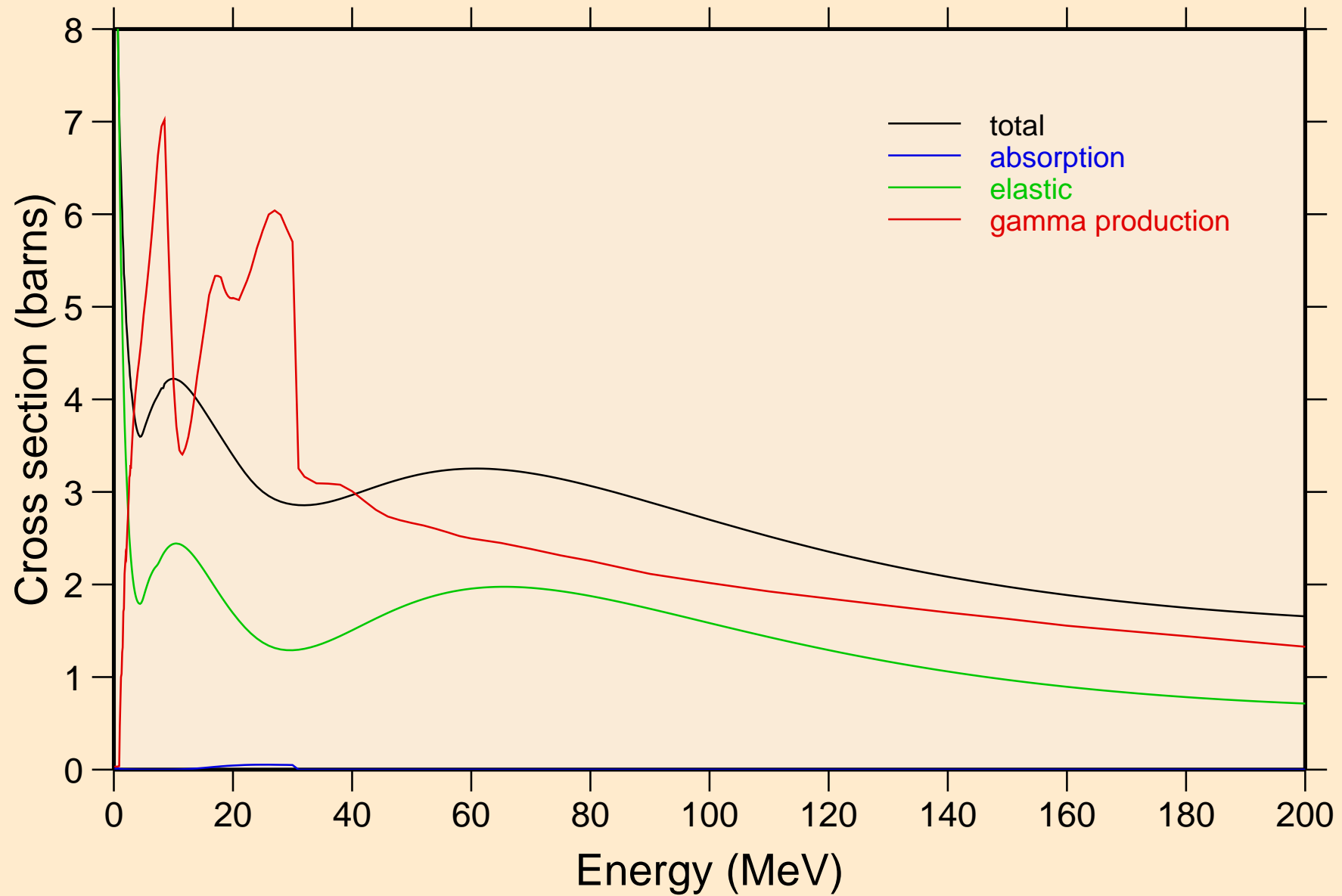

# ZR094 NEUTRON ACER TENDL-2023 LIBRARY; T=0.K

## Heating

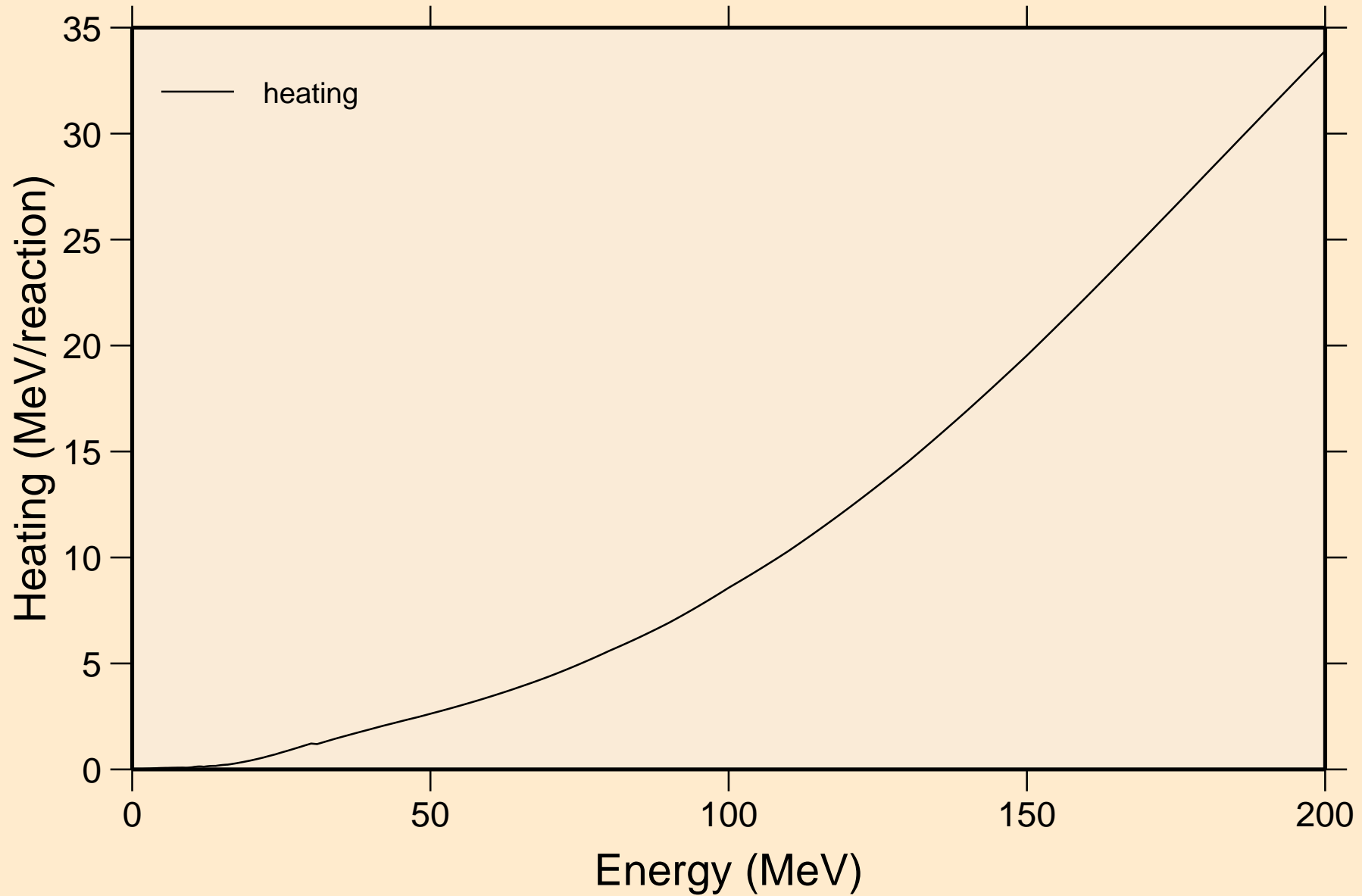

# ZR094 NEUTRON ACER TENDL-2023 LIBRARY; T=0.K

## Damage

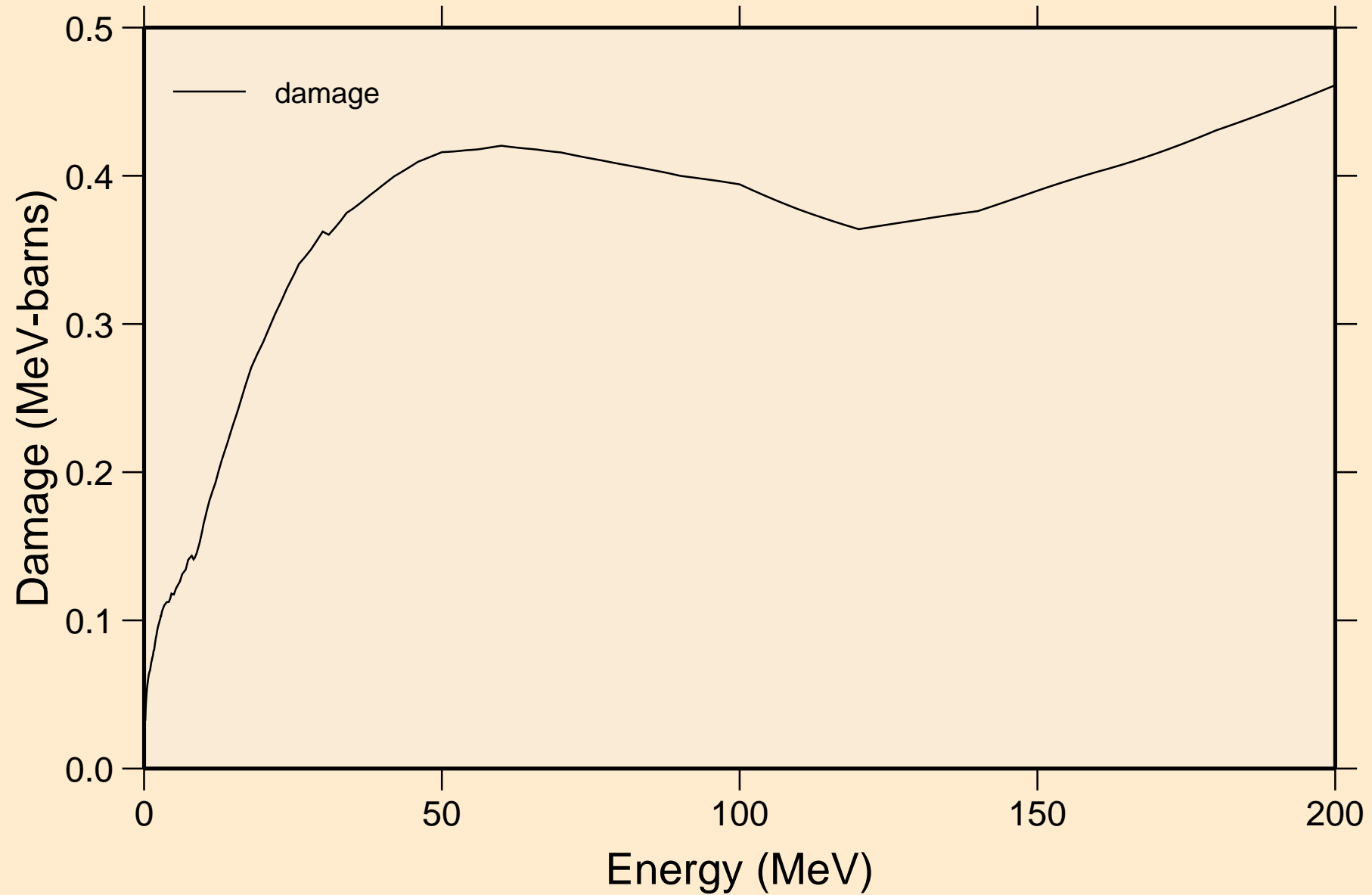

ZR094 NEUTRON ACER TENDL-2023 LIBRARY; T=0.K  
Non-threshold reactions

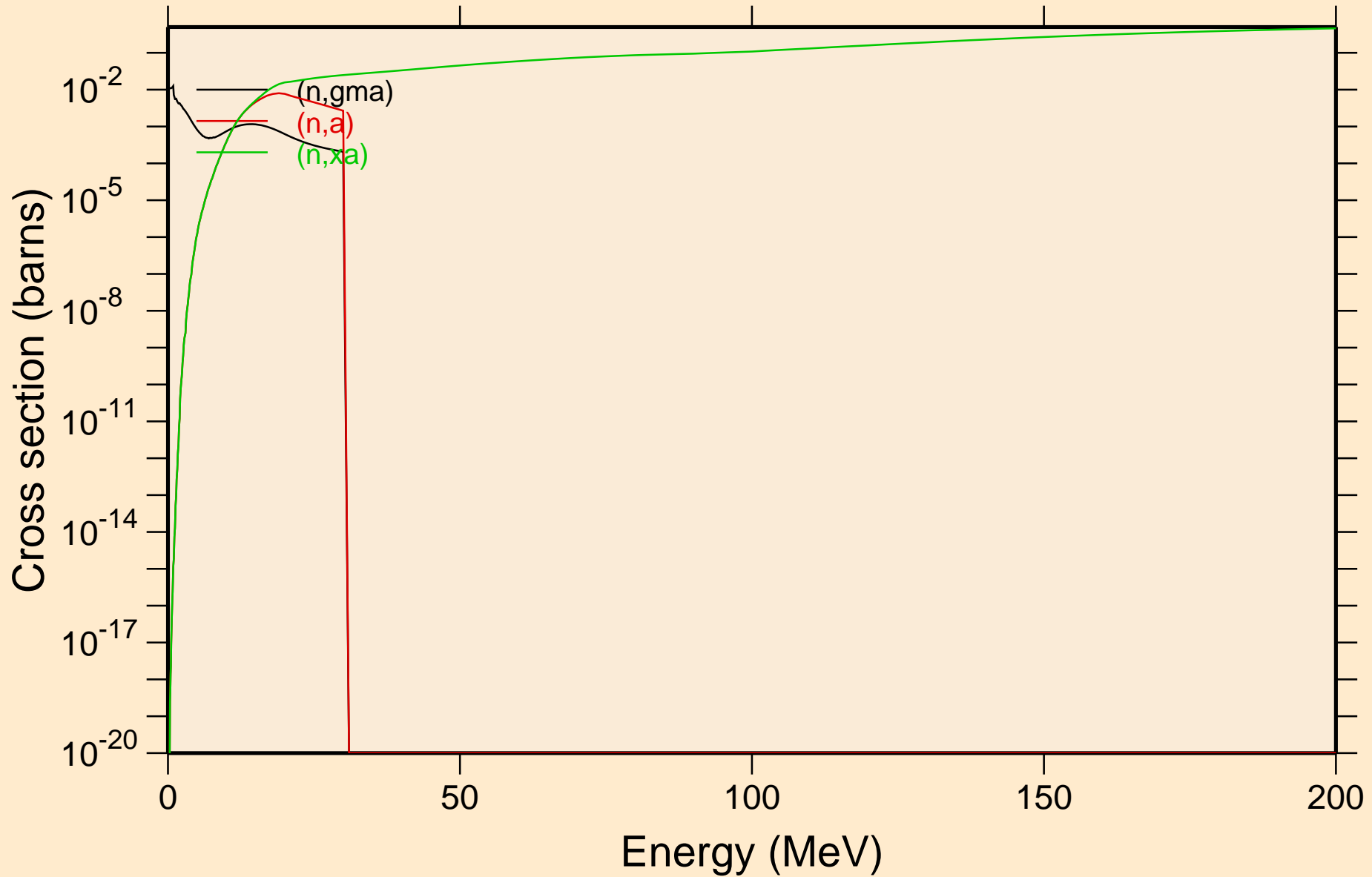

ZR094 NEUTRON ACER TENDL-2023 LIBRARY; T=0.K  
Inelastic levels

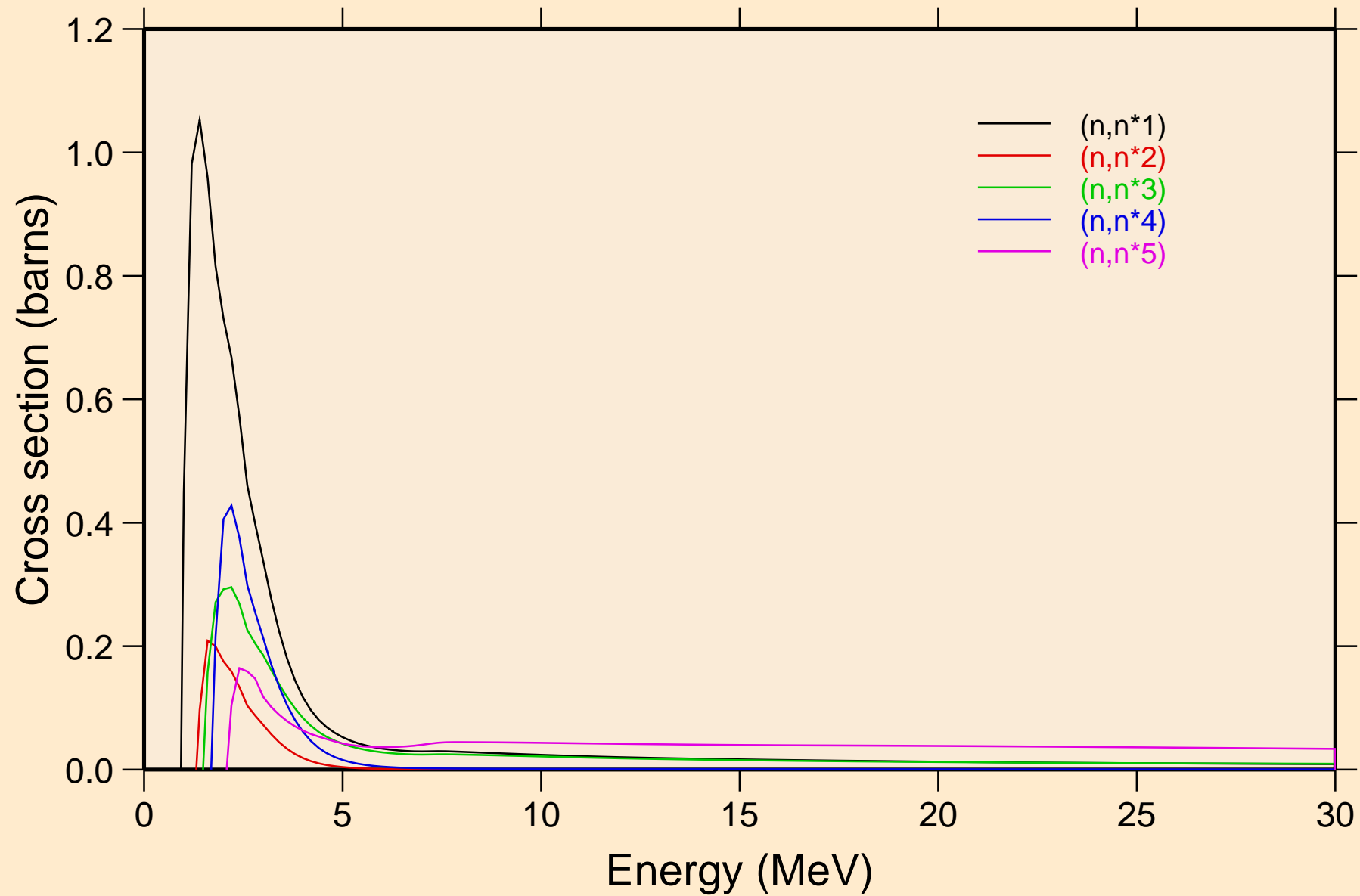

ZR094 NEUTRON ACER TENDL-2023 LIBRARY; T=0.K  
Inelastic levels

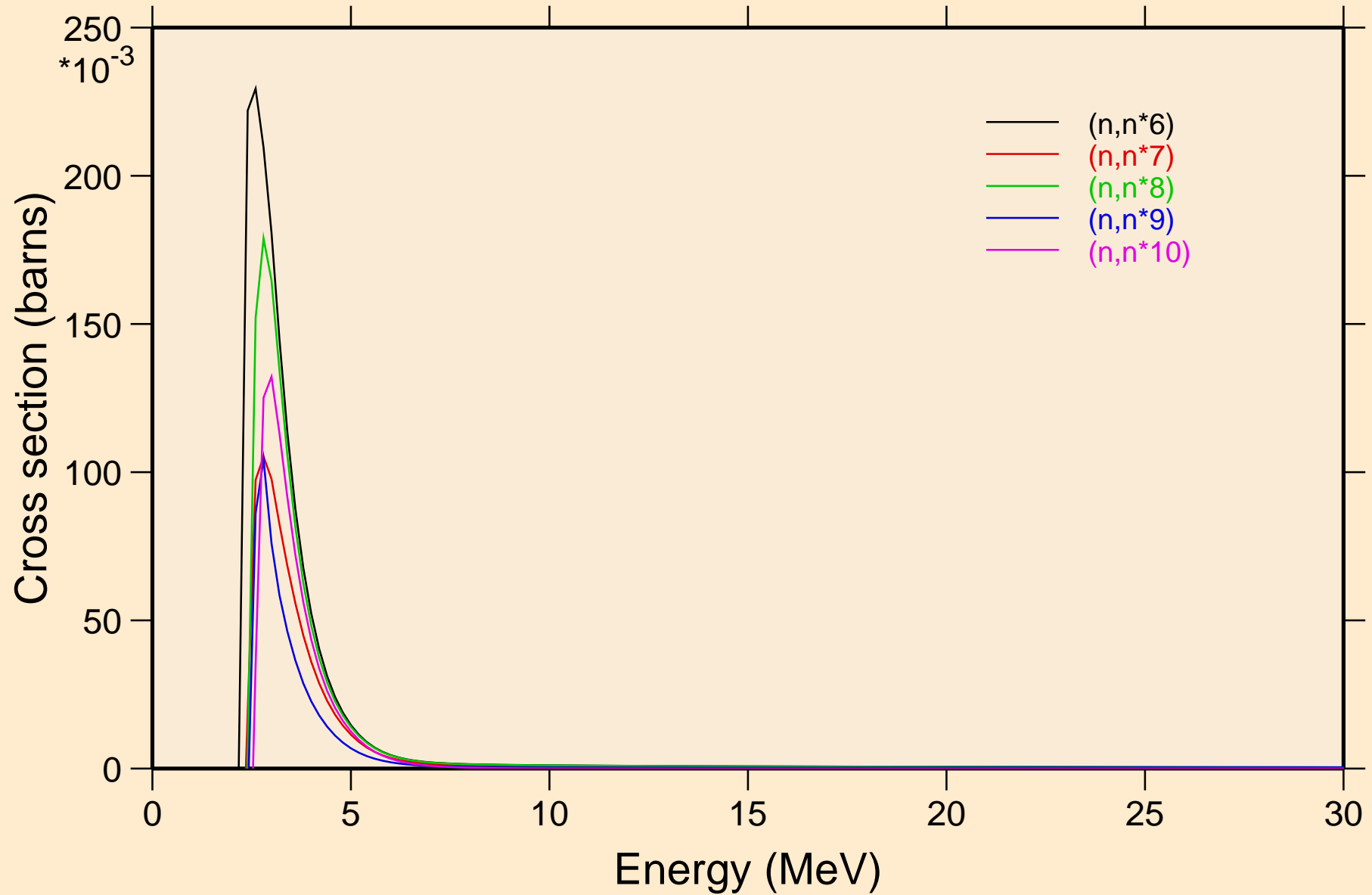

ZR094 NEUTRON ACER TENDL-2023 LIBRARY; T=0.K  
Inelastic levels

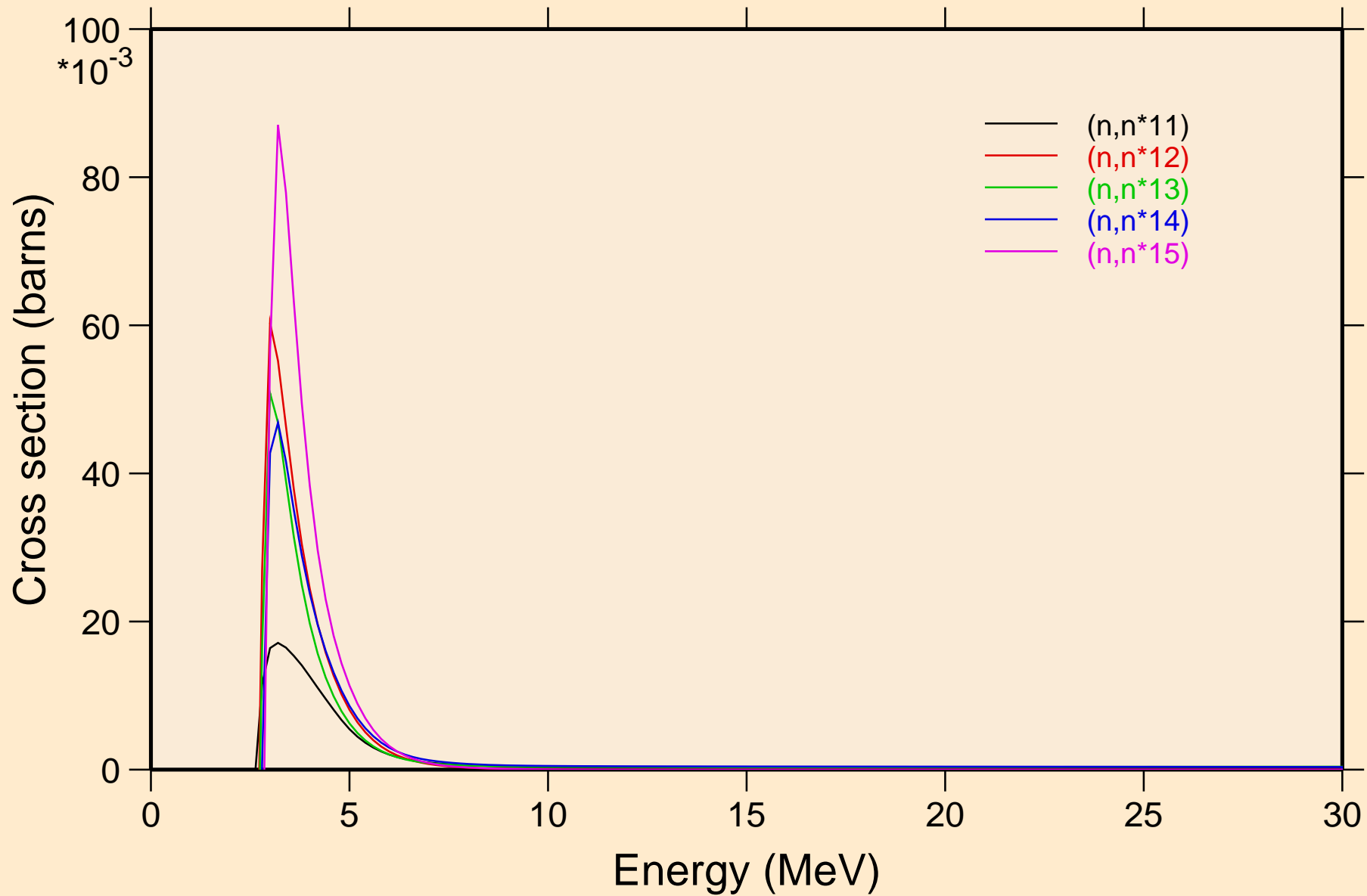

ZR094 NEUTRON ACER TENDL-2023 LIBRARY; T=0.K  
Inelastic levels

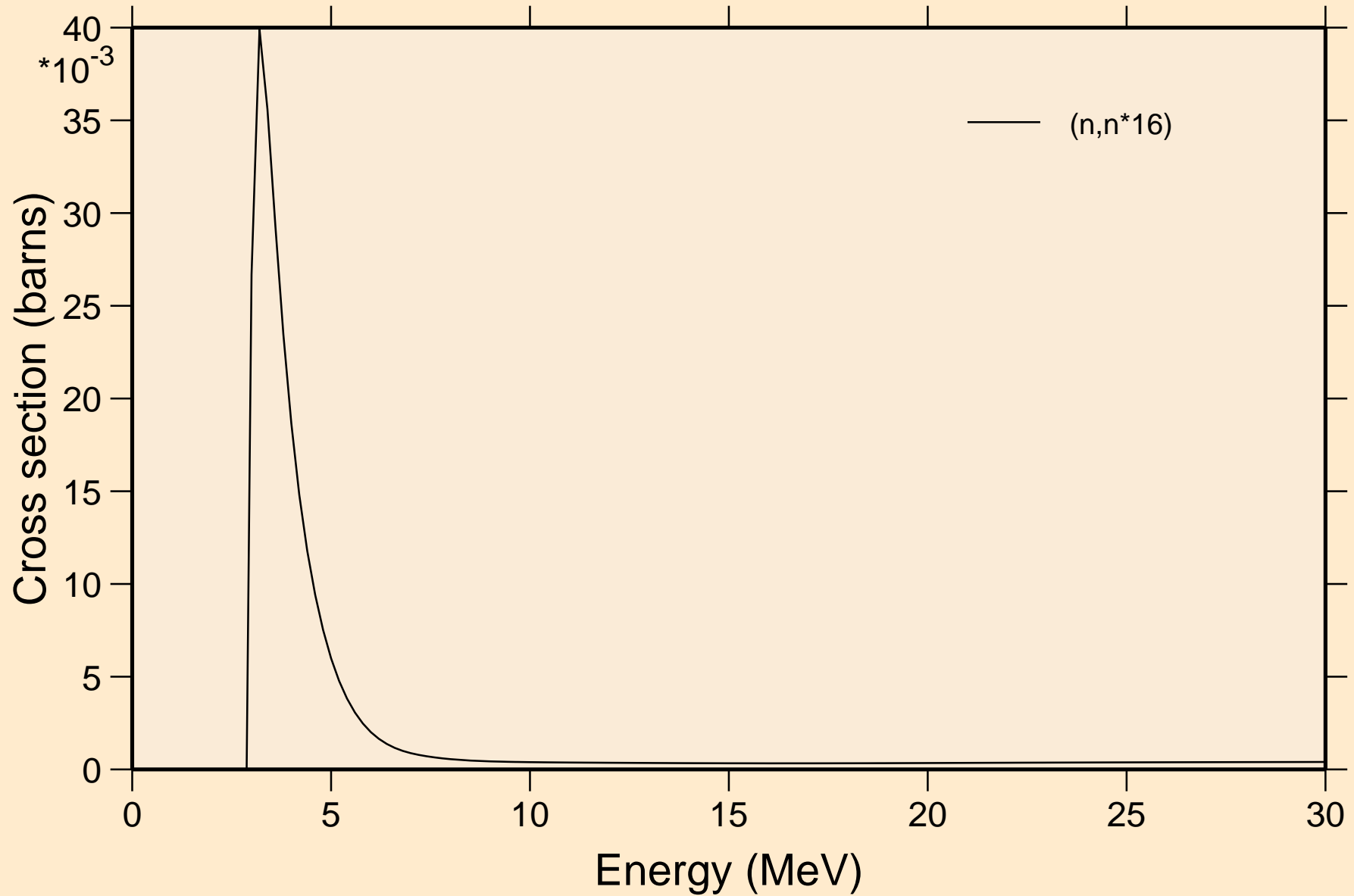

ZR094 NEUTRON ACER TENDL-2023 LIBRARY; T=0.K  
Threshold reactions

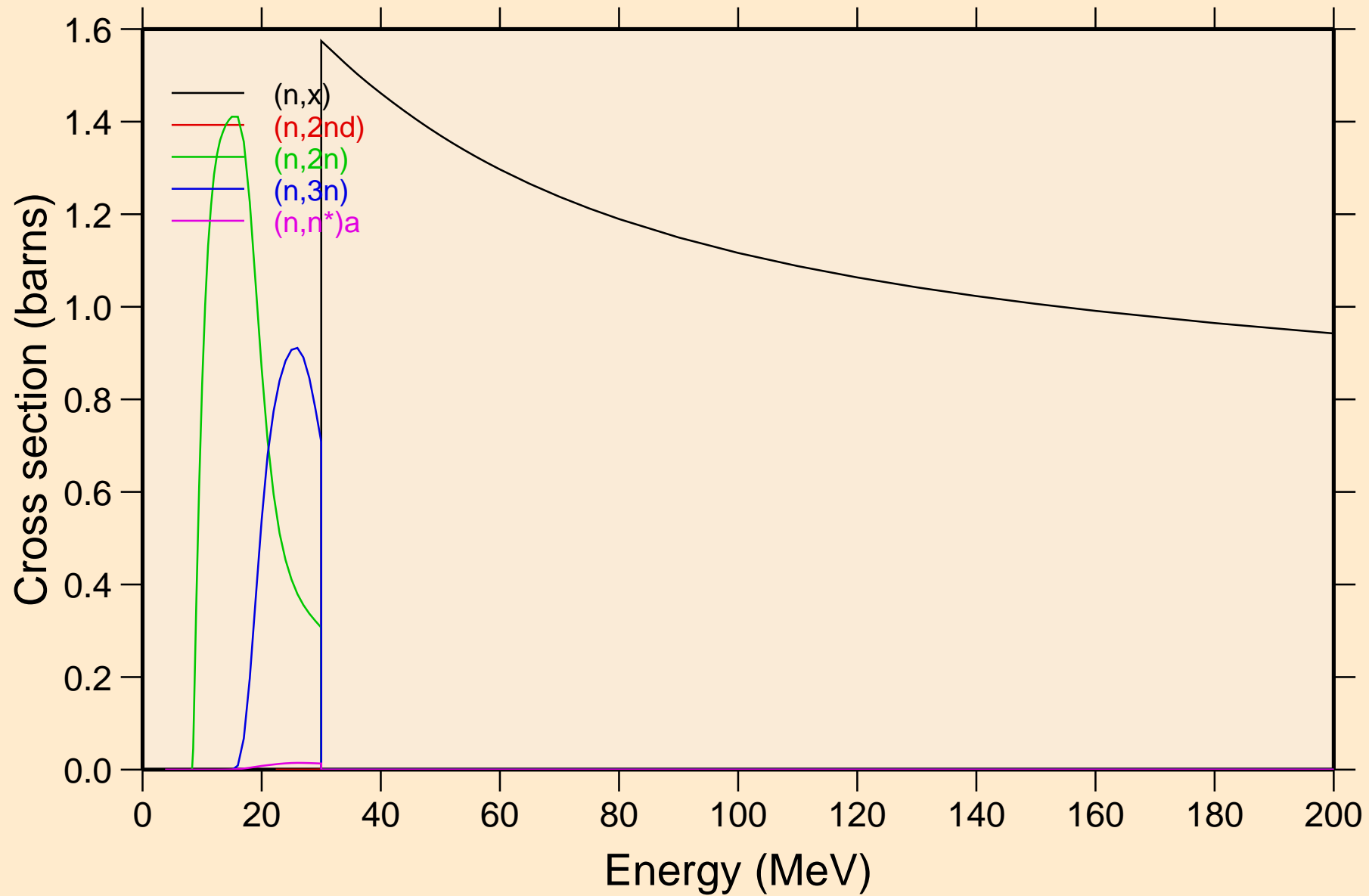

ZR094 NEUTRON ACER TENDL-2023 LIBRARY; T=0.K  
Threshold reactions

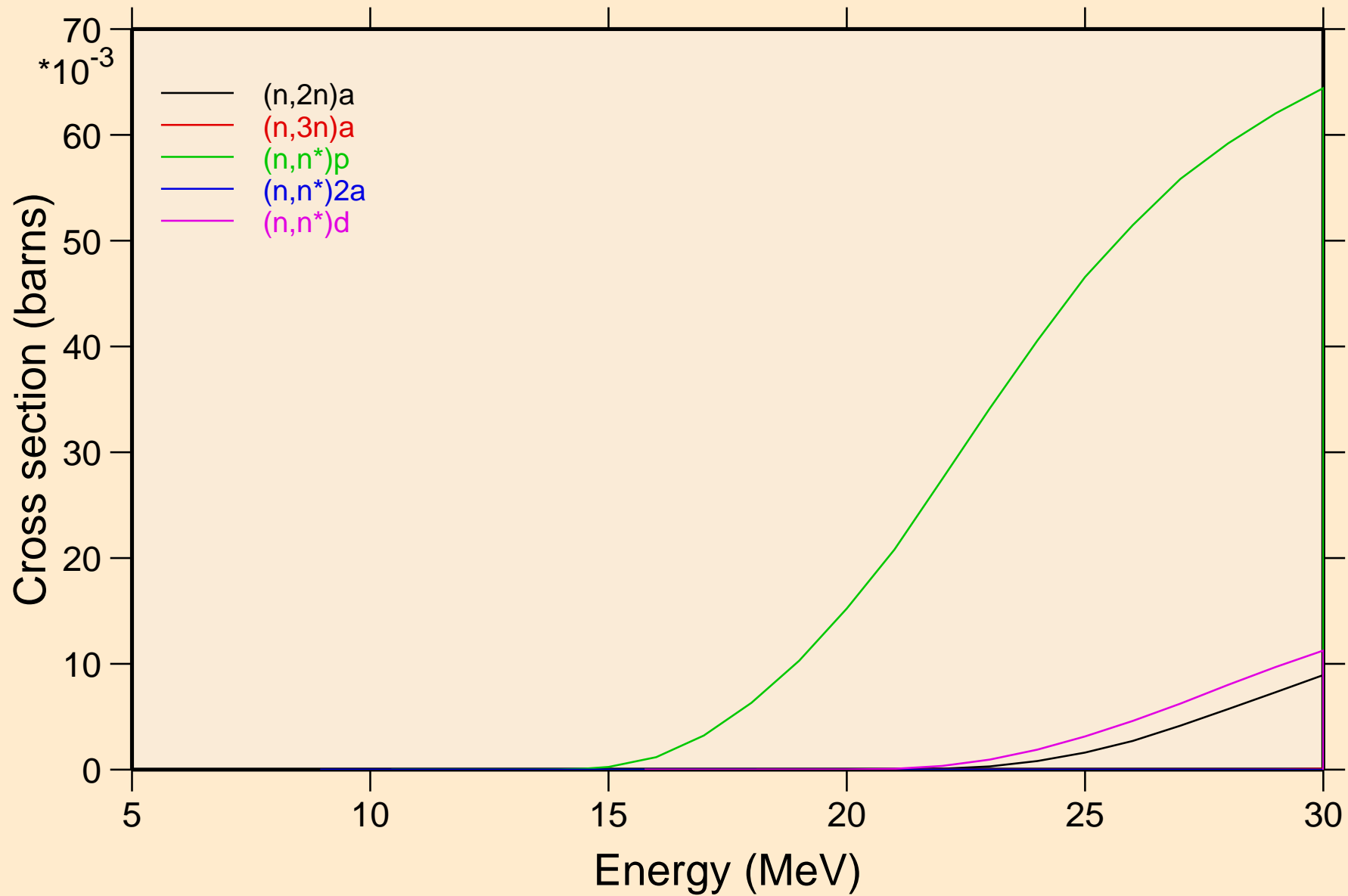

# ZR094 NEUTRON ACER TENDL-2023 LIBRARY; T=0.K

## Threshold reactions

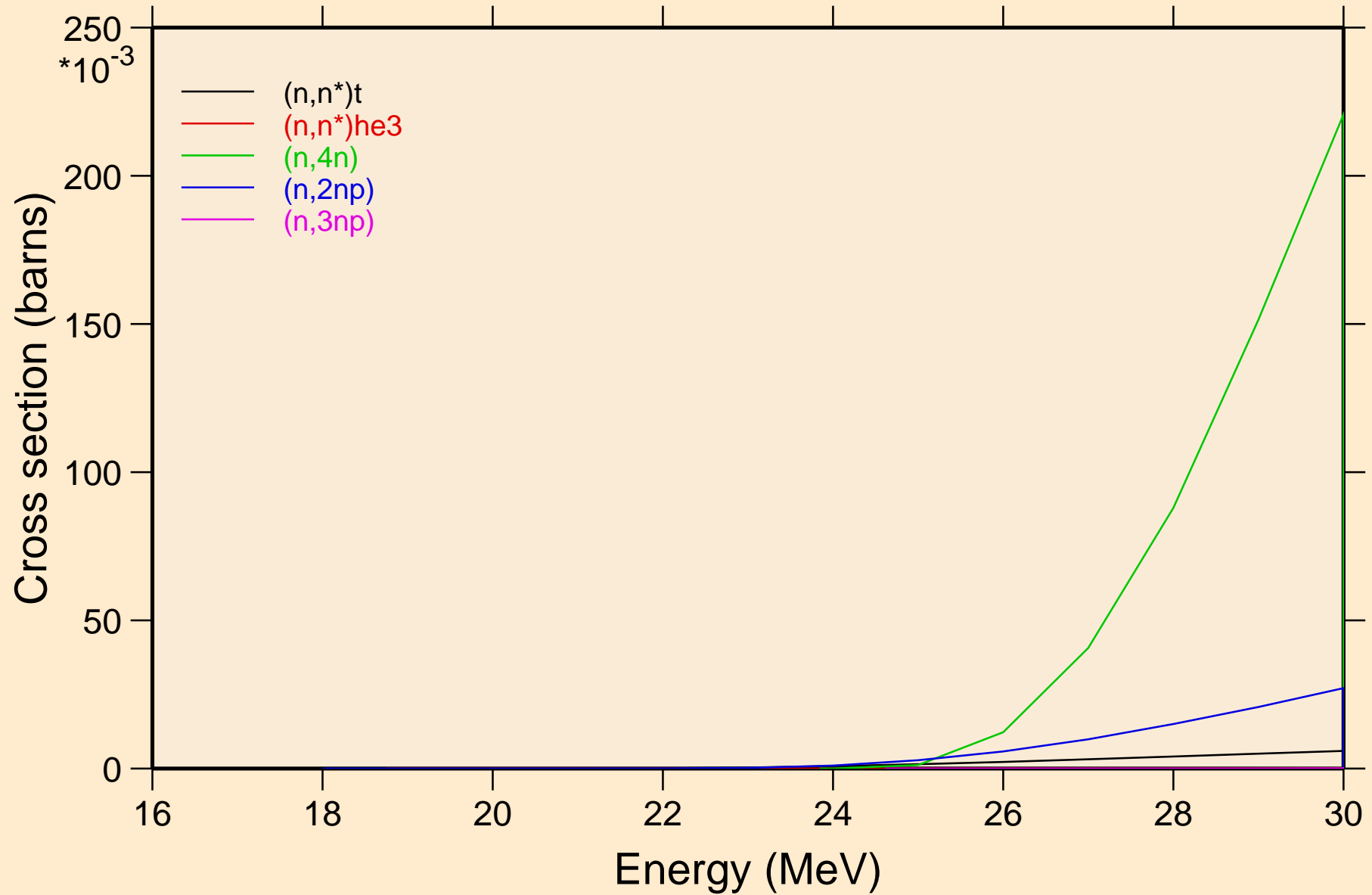

ZR094 NEUTRON ACER TENDL-2023 LIBRARY; T=0.K  
Threshold reactions

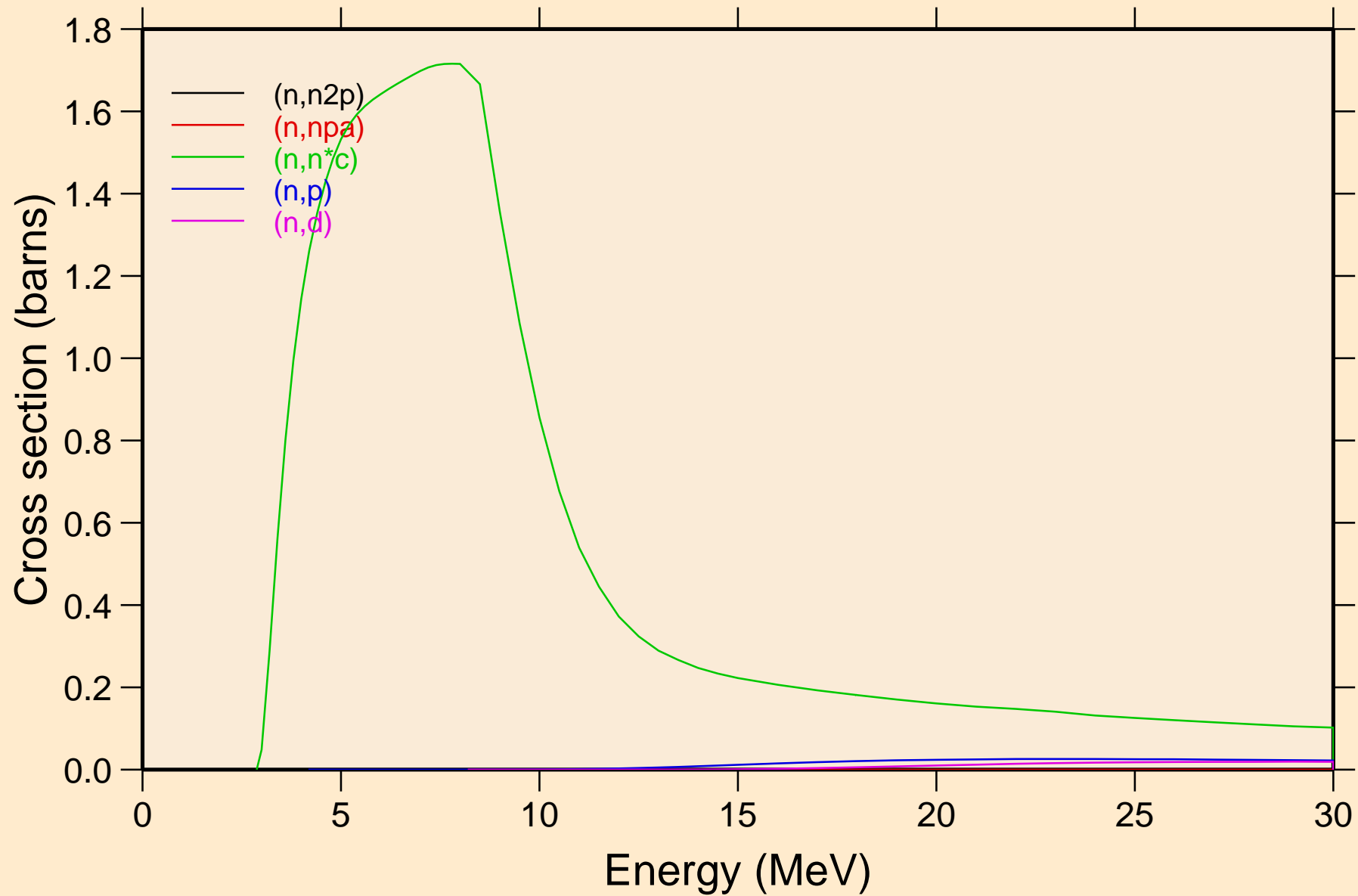

ZR094 NEUTRON ACER TENDL-2023 LIBRARY; T=0.K  
Threshold reactions

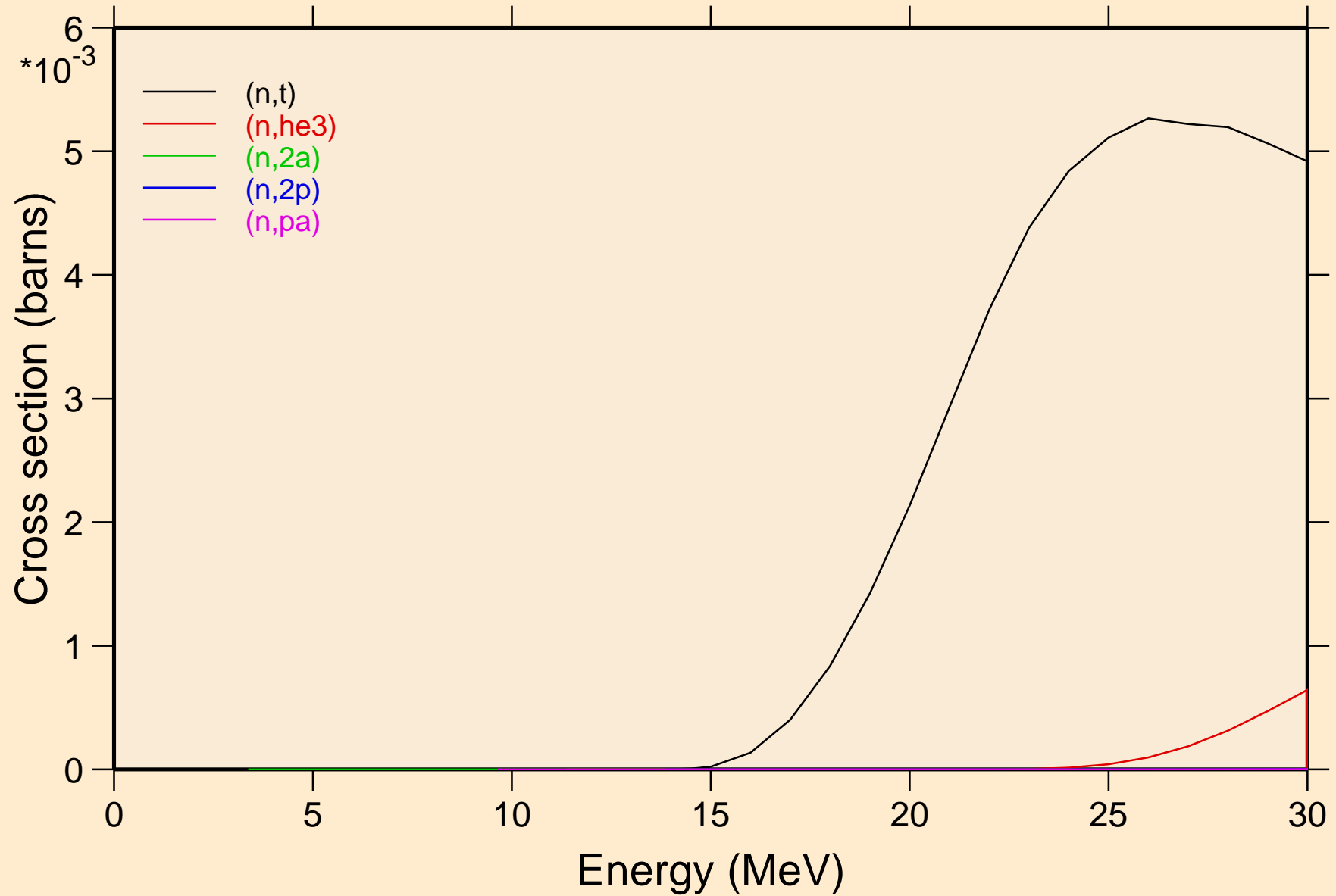

# ZR094 NEUTRON ACER TENDL-2023 LIBRARY; T=0.K

## Threshold reactions

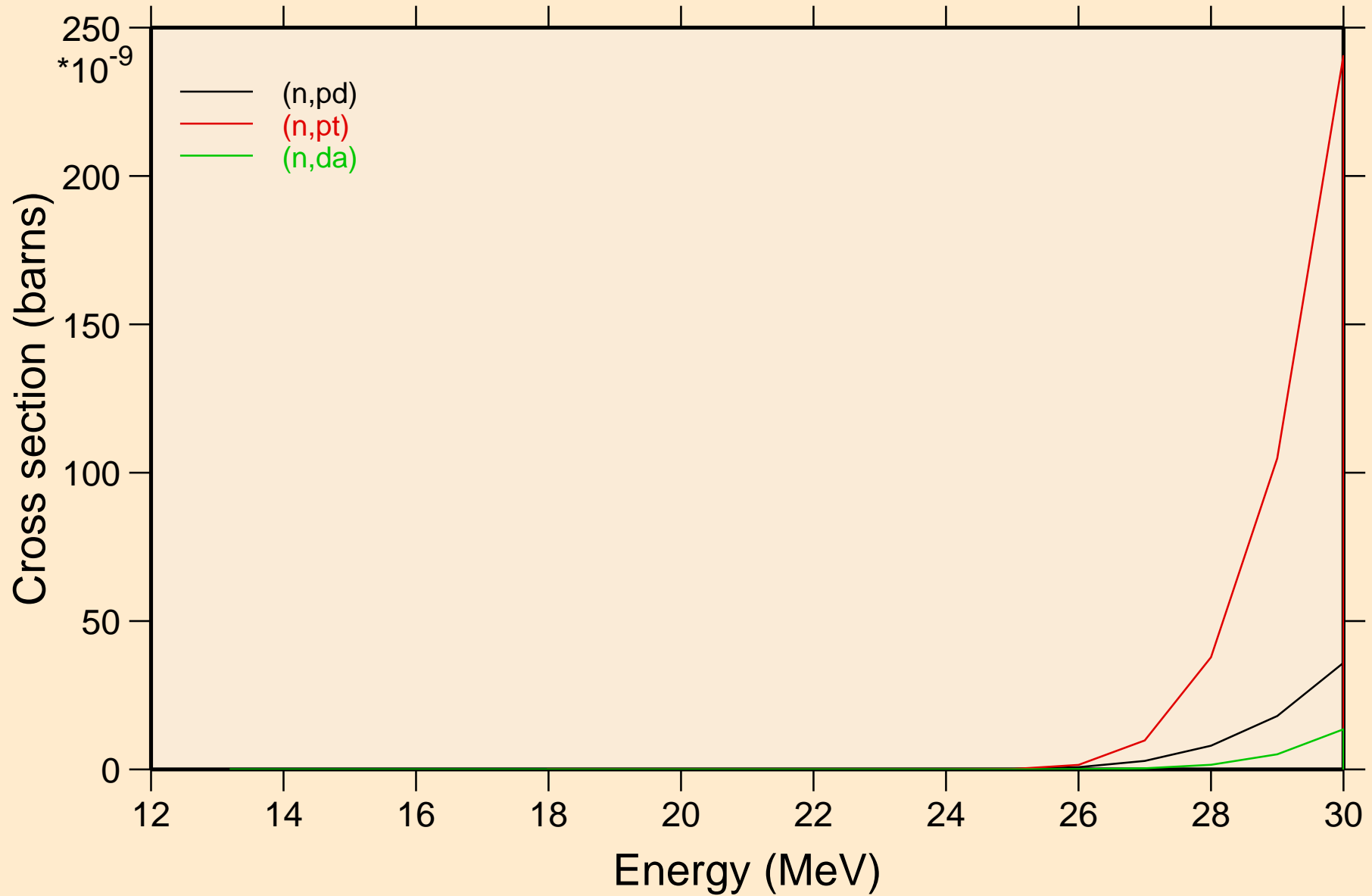

ZR094 NEUTRON ACER TENDL-2023 LIBRARY; T=0.K  
Threshold reactions

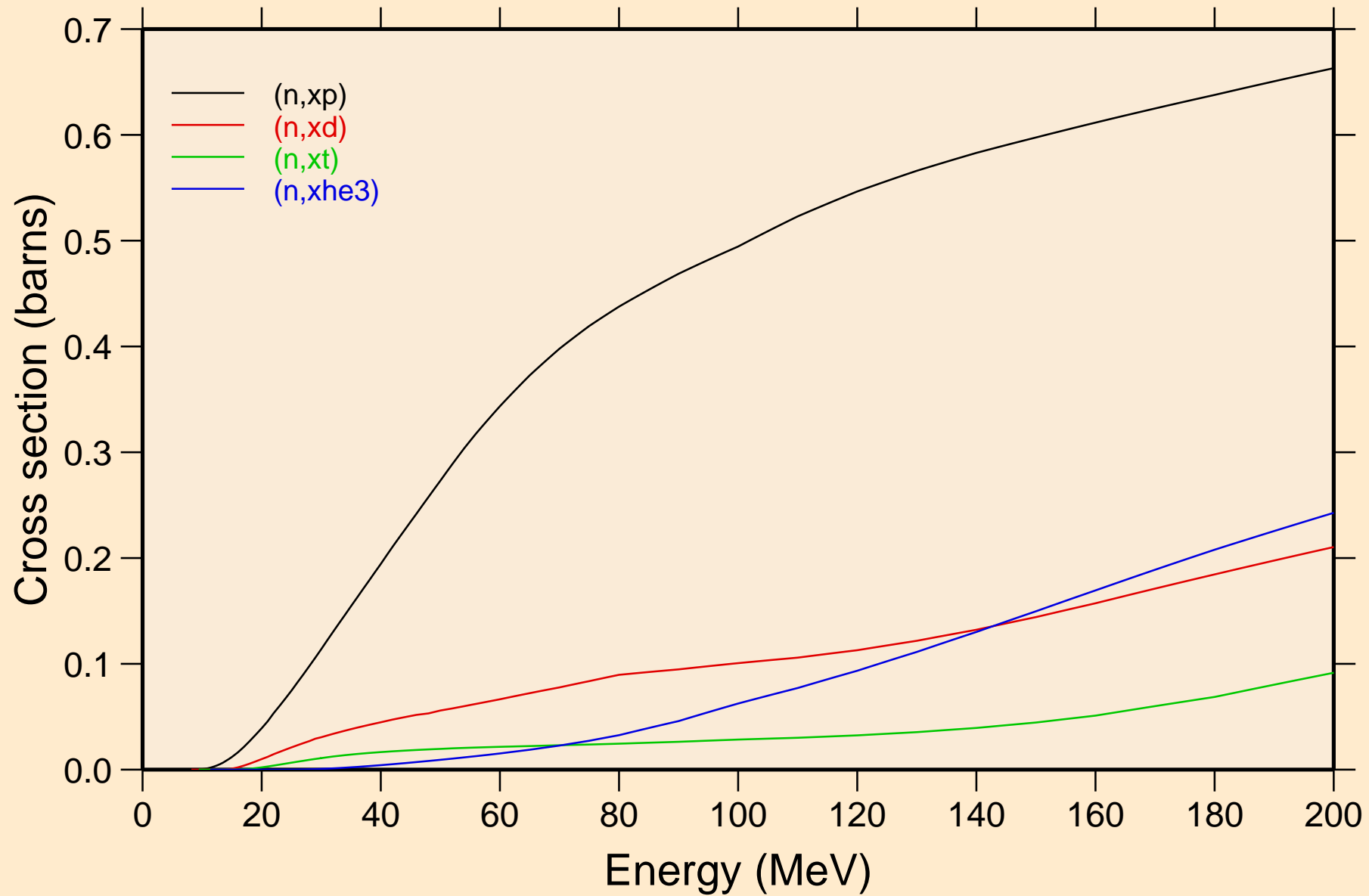

ZR094 NEUTRON ACER TENDL-2023 LIBRARY; T=0.K  
angular distribution for elastic

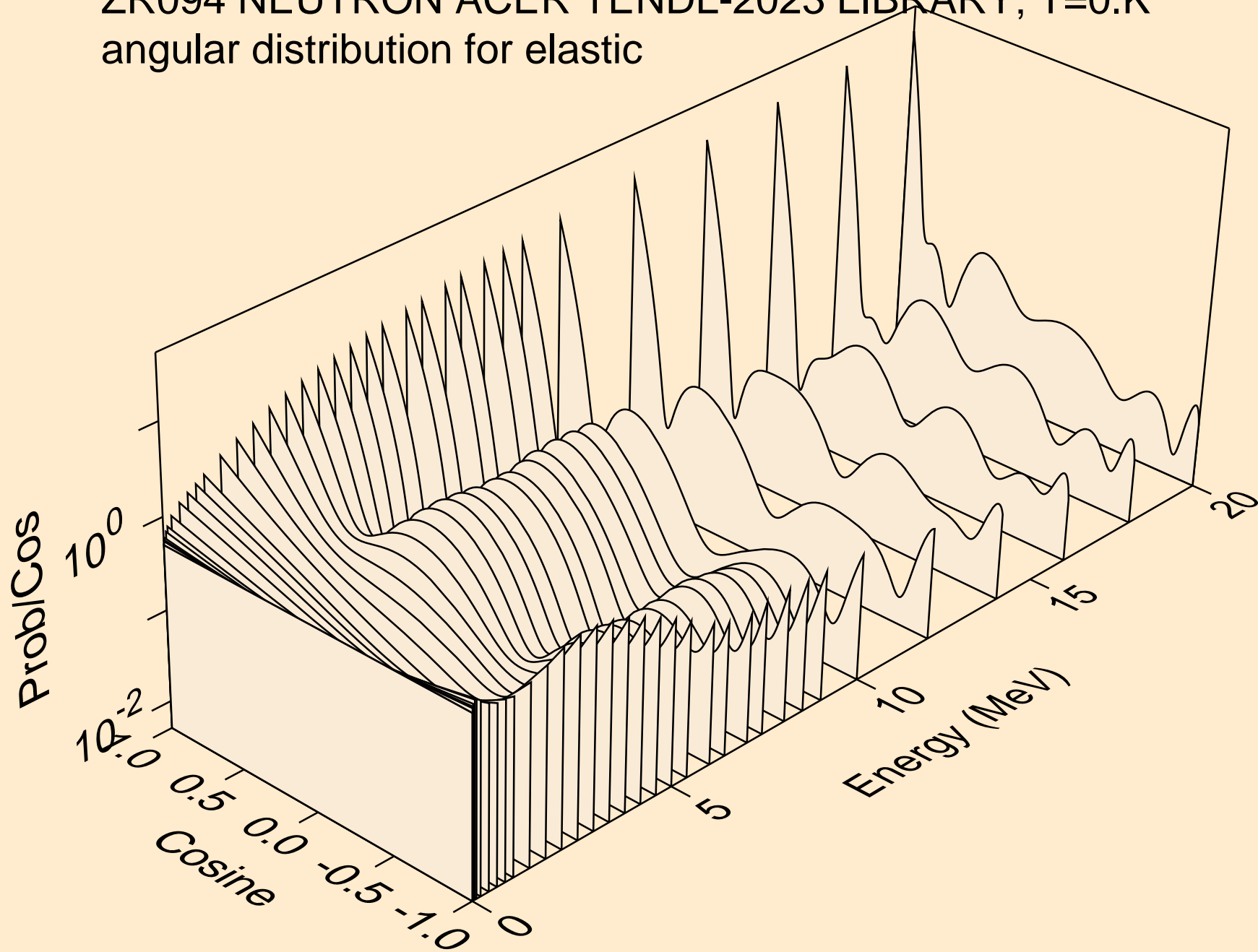

ZR094 NEUTRON ACER TENDL-2023 LIBRARY; T=0.K  
angular distribution for elastic

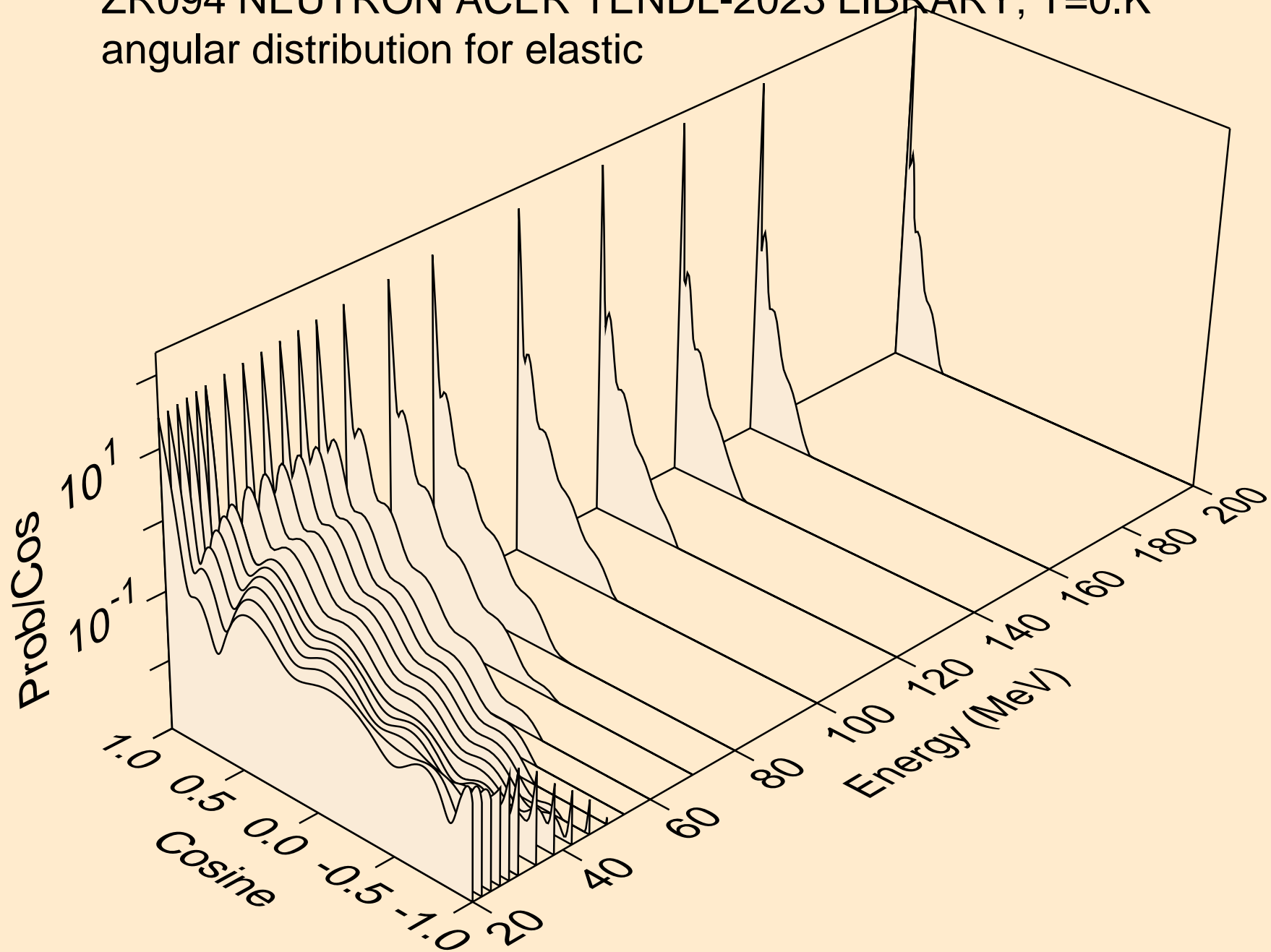

ZR094 NEUTRON ACER TENDL-2023 LIBRARY; T=0.K  
angular distribution for (n,n\*1)

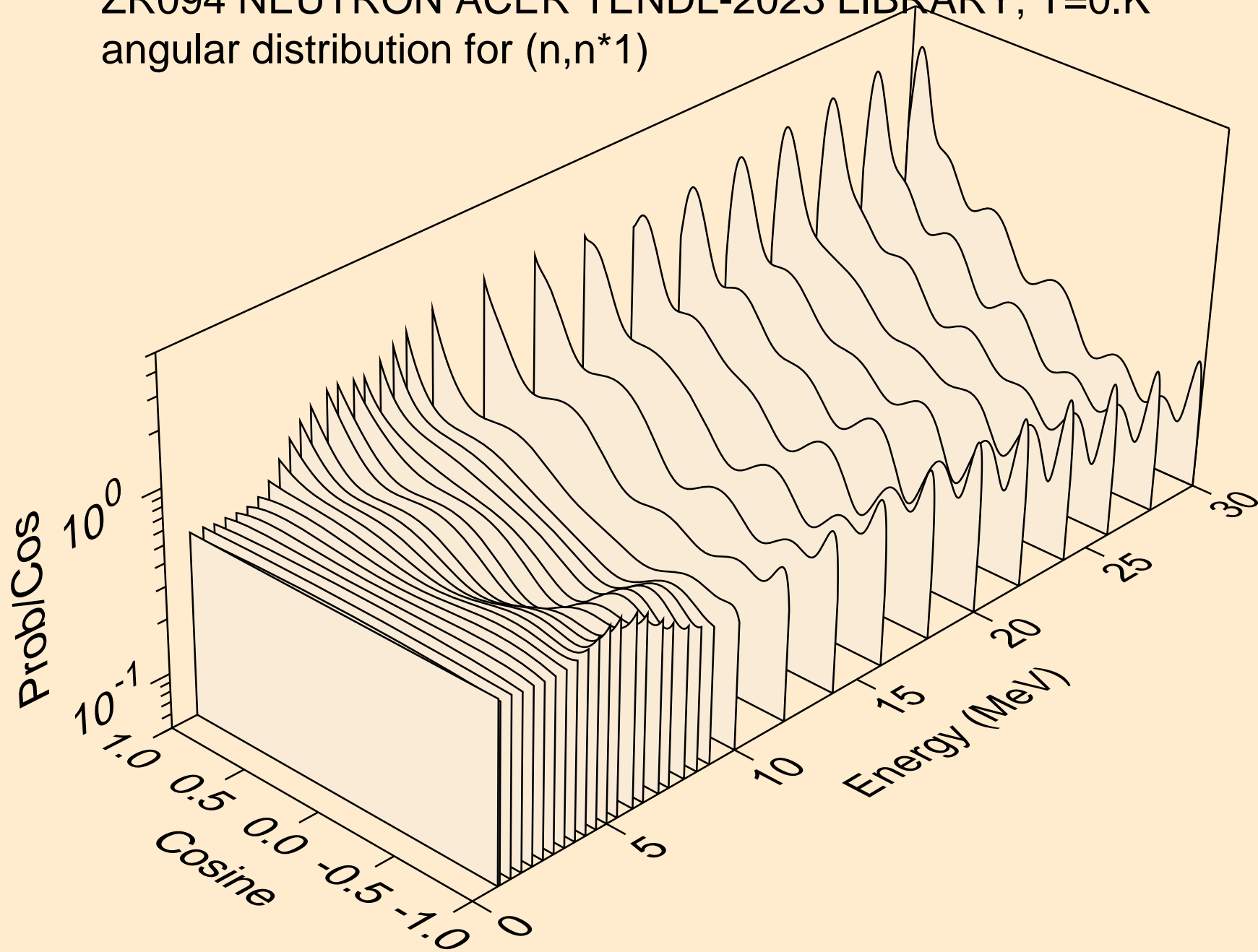

ZR094 NEUTRON ACER TENDL-2023 LIBRARY; T=0.K  
angular distribution for (n,n\*2)

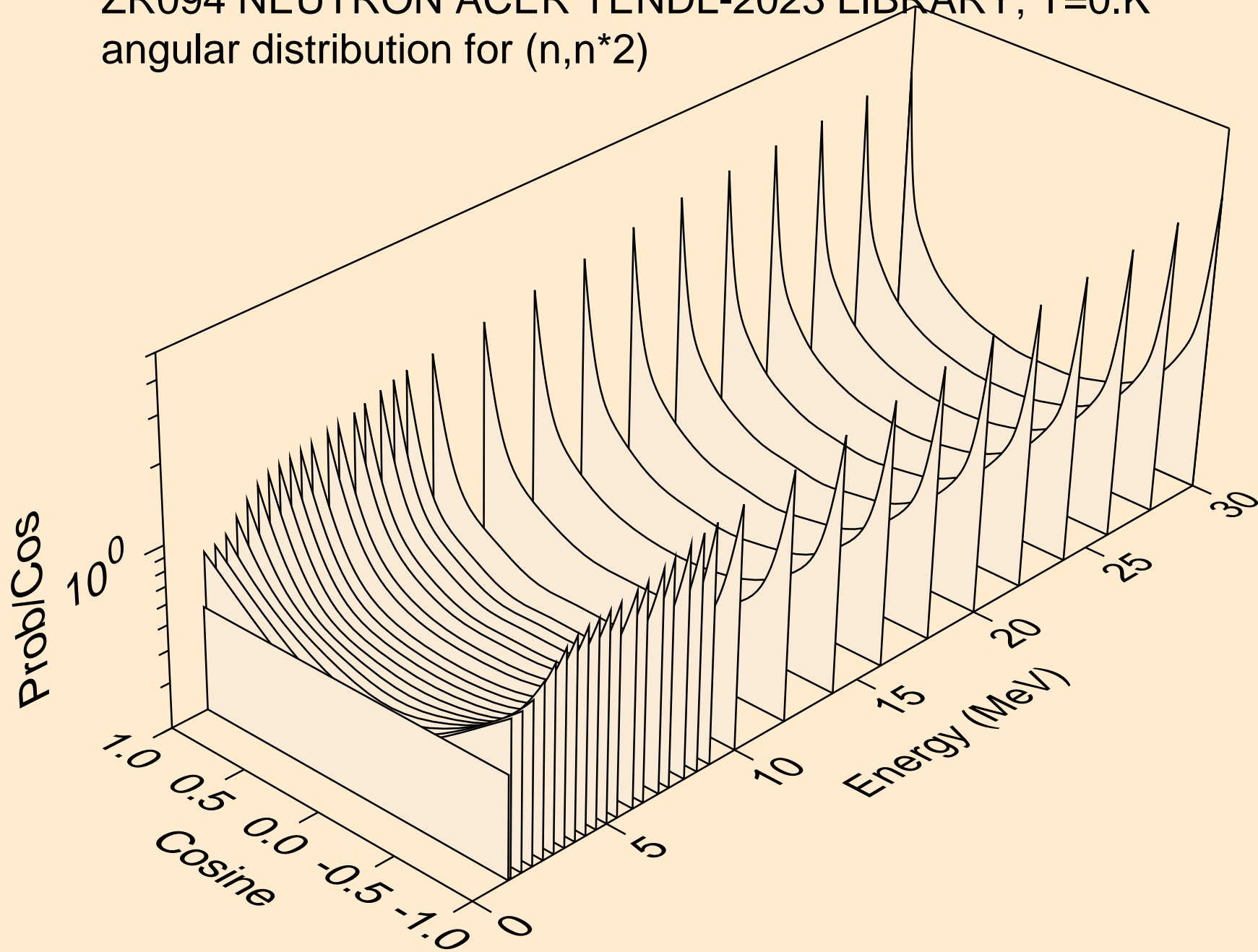

ZR094 NEUTRON ACER TENDL-2023 LIBRARY; T=0.K  
angular distribution for (n,n\*3)

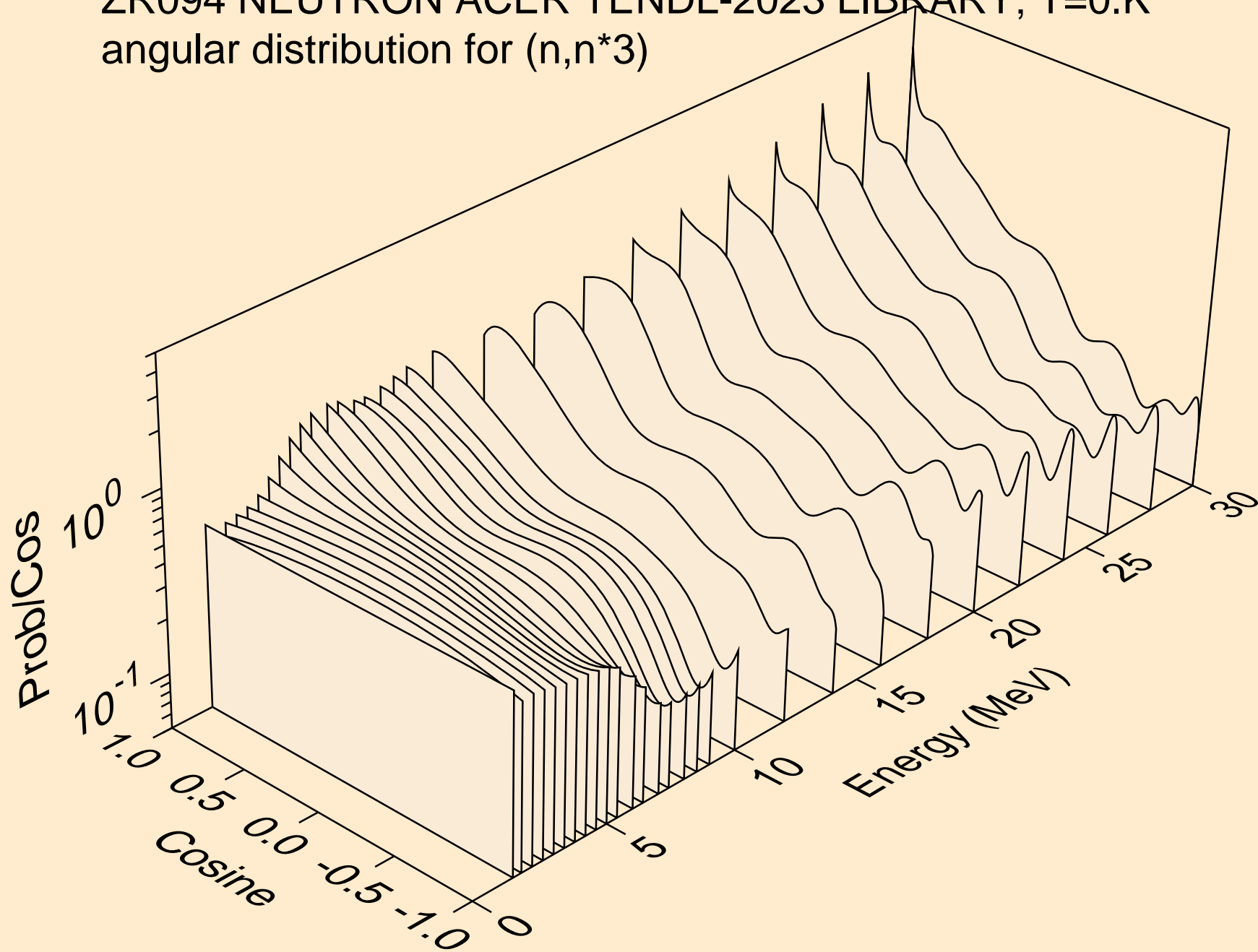

ZR094 NEUTRON ACER TENDL-2023 LIBRARY; T=0.K  
angular distribution for (n,n\*4)

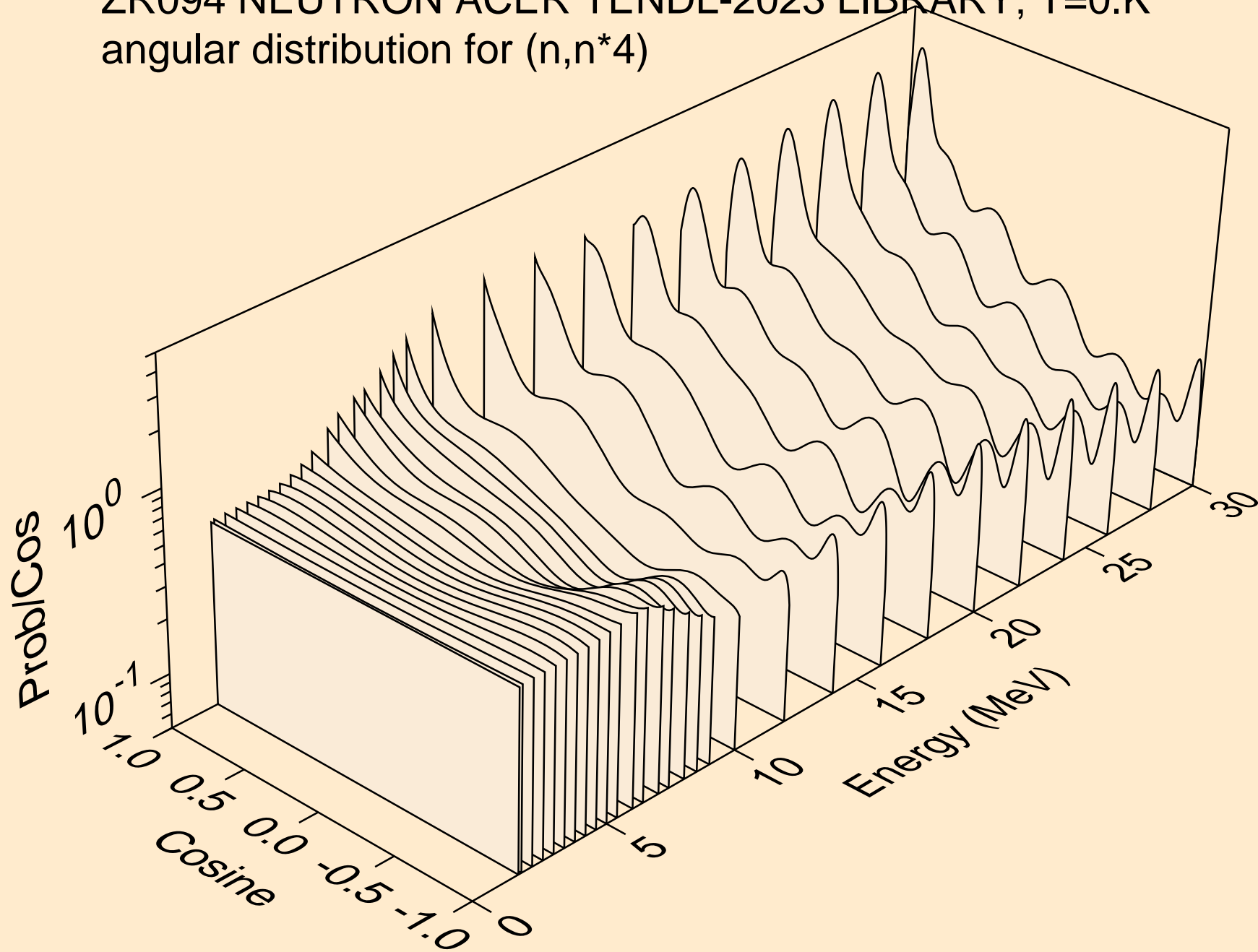

ZR094 NEUTRON ACER TENDL-2023 LIBRARY; T=0.K  
angular distribution for (n,n\*5)

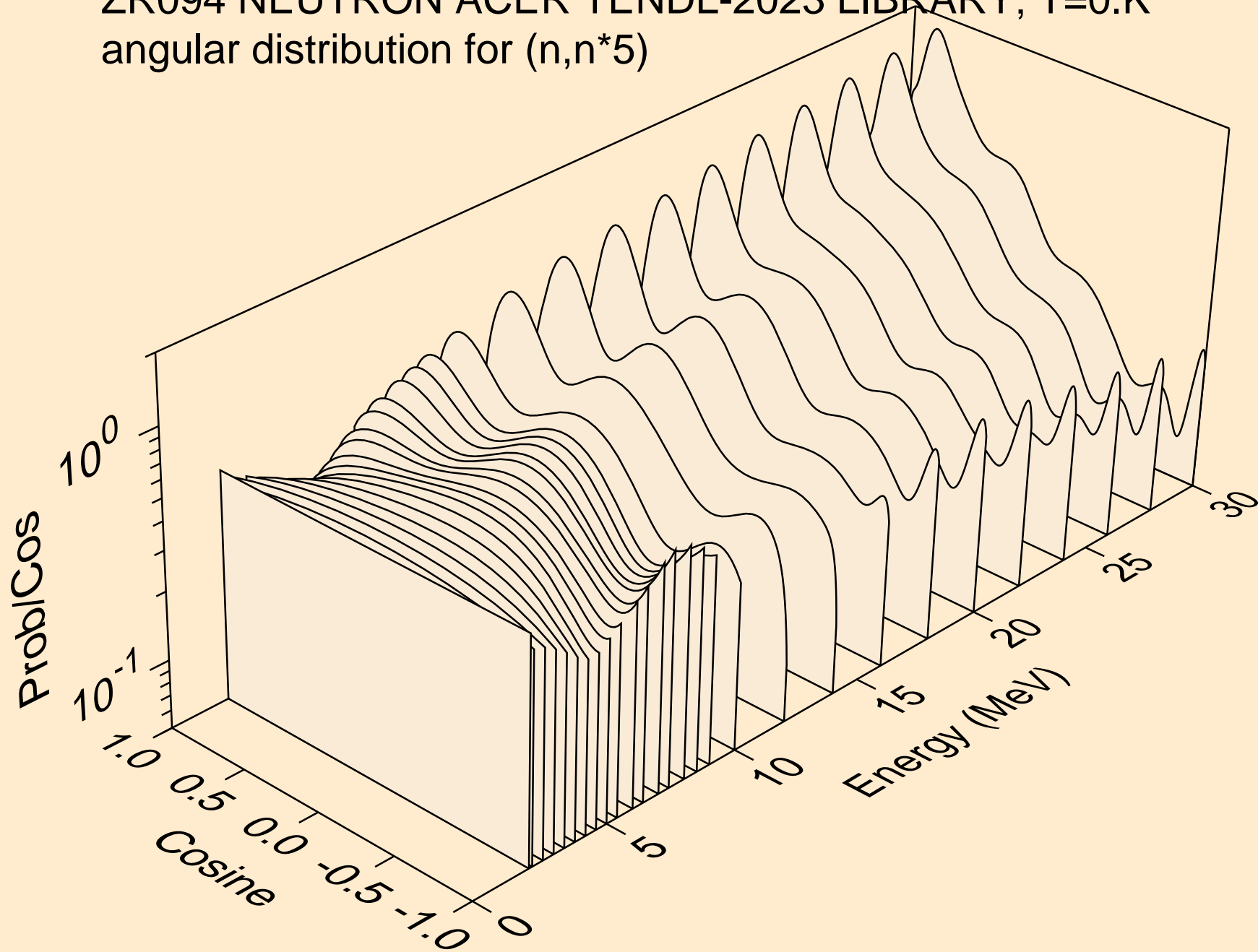

ZR094 NEUTRON ACER TENDL-2023 LIBRARY; T=0.K  
angular distribution for (n,n\*6)

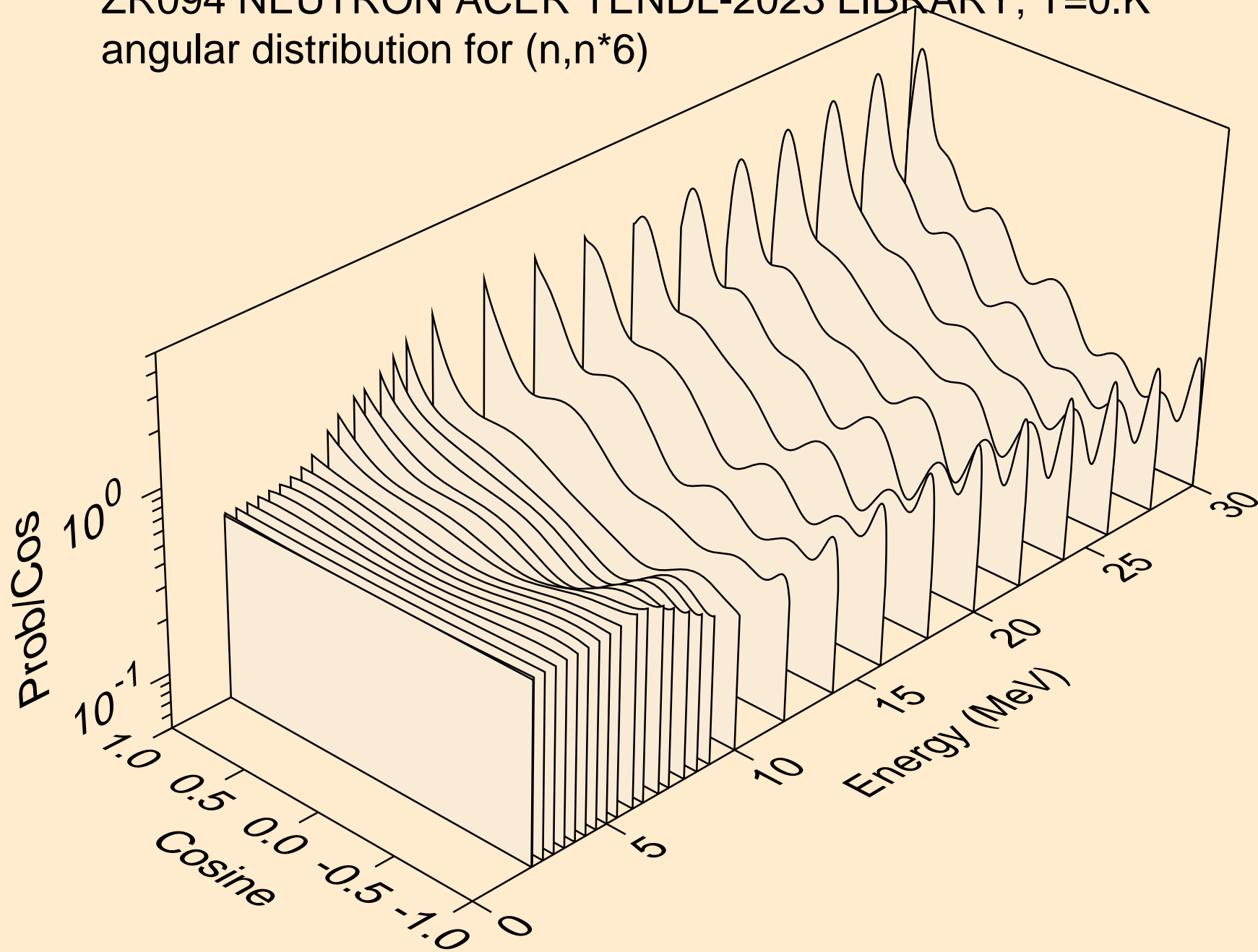

ZR094 NEUTRON ACER TENDL-2023 LIBRARY; T=0.K  
angular distribution for (n,n\*7)

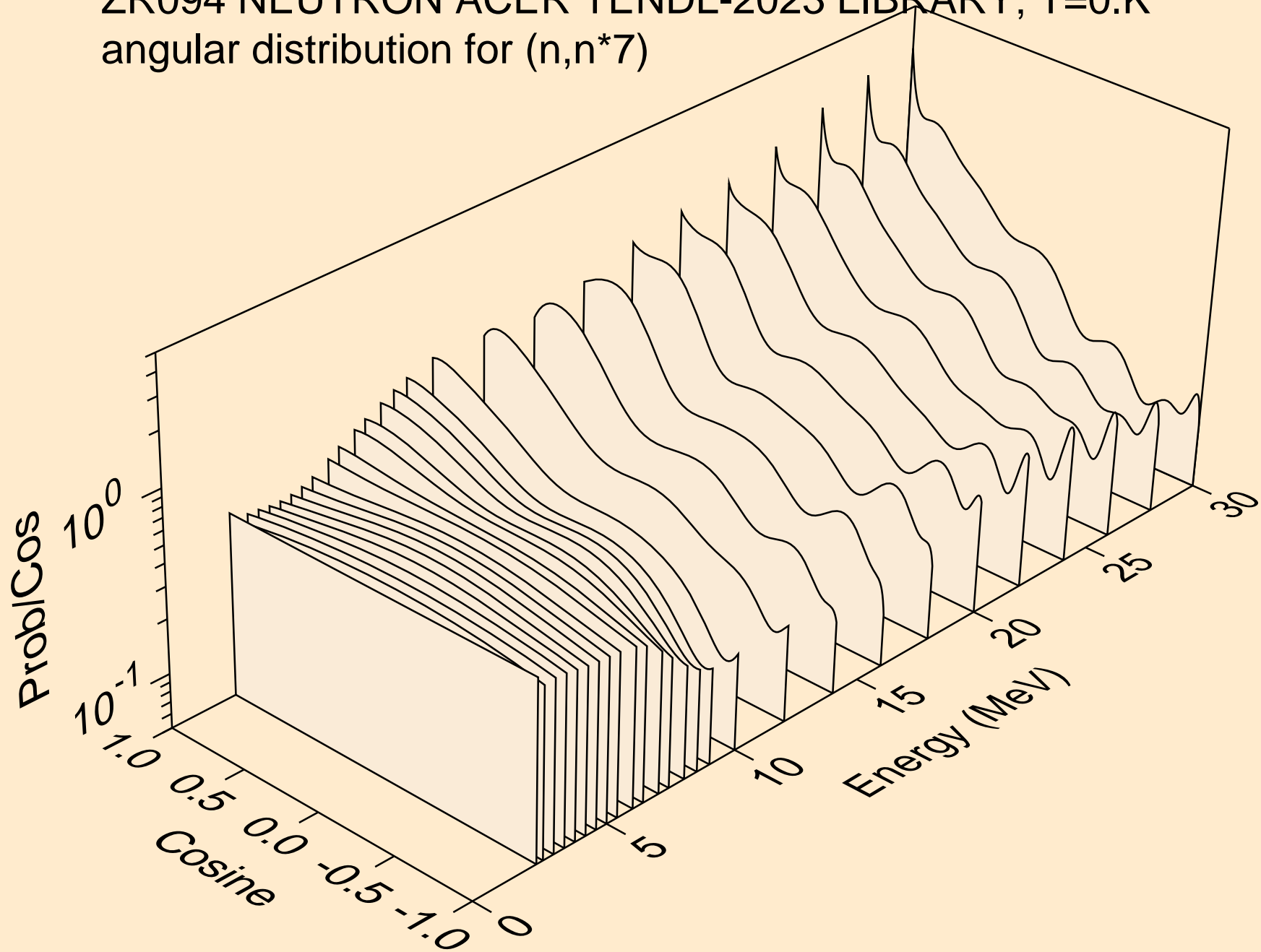

ZR094 NEUTRON ACER TENDL-2023 LIBRARY; T=0.K  
angular distribution for (n,n\*8)

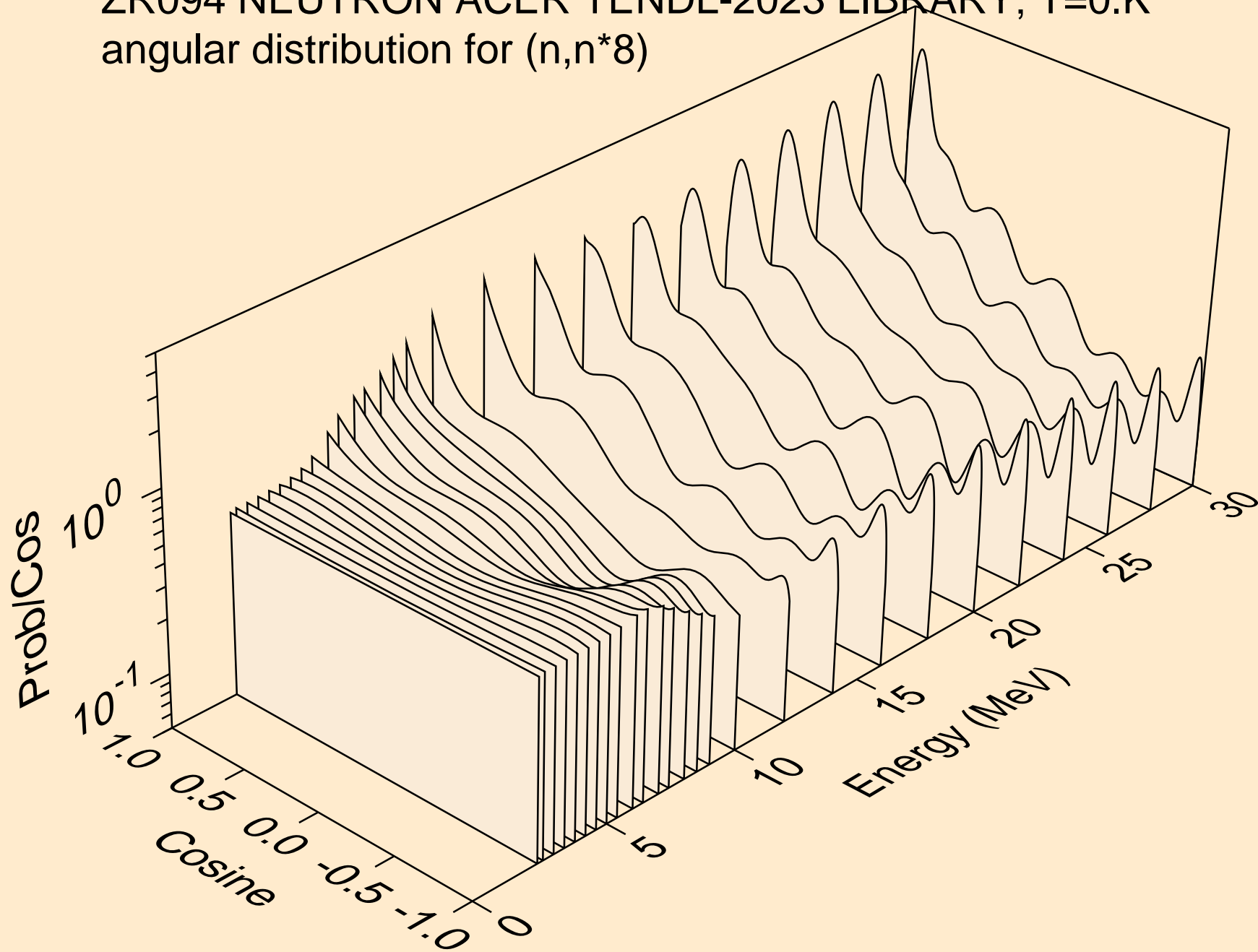

ZR094 NEUTRON ACER TENDL-2023 LIBRARY; T=0.K  
angular distribution for (n,n\*9)

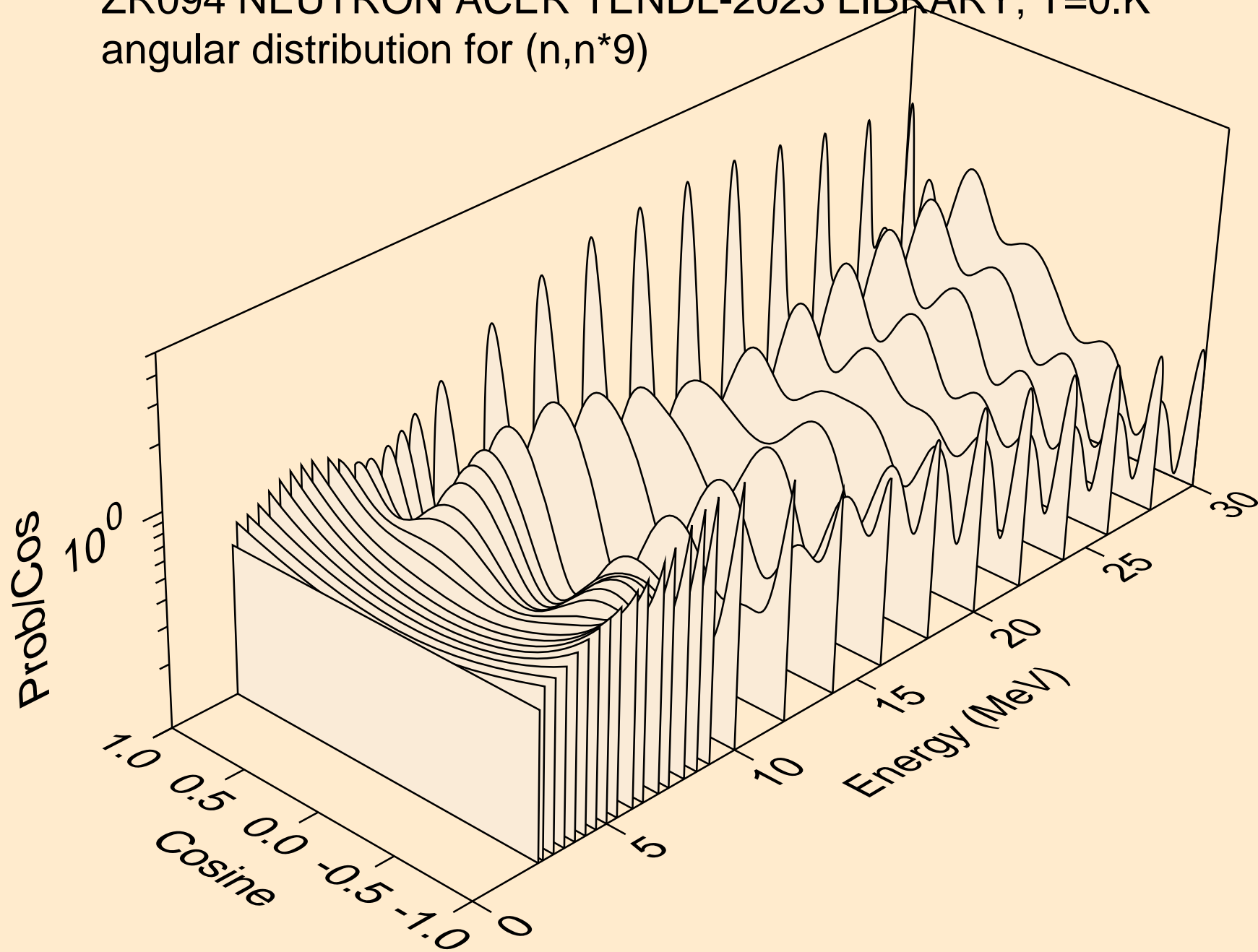

ZR094 NEUTRON ACER TENDL-2023 LIBRARY; T=0.K  
angular distribution for (n,n\*10)

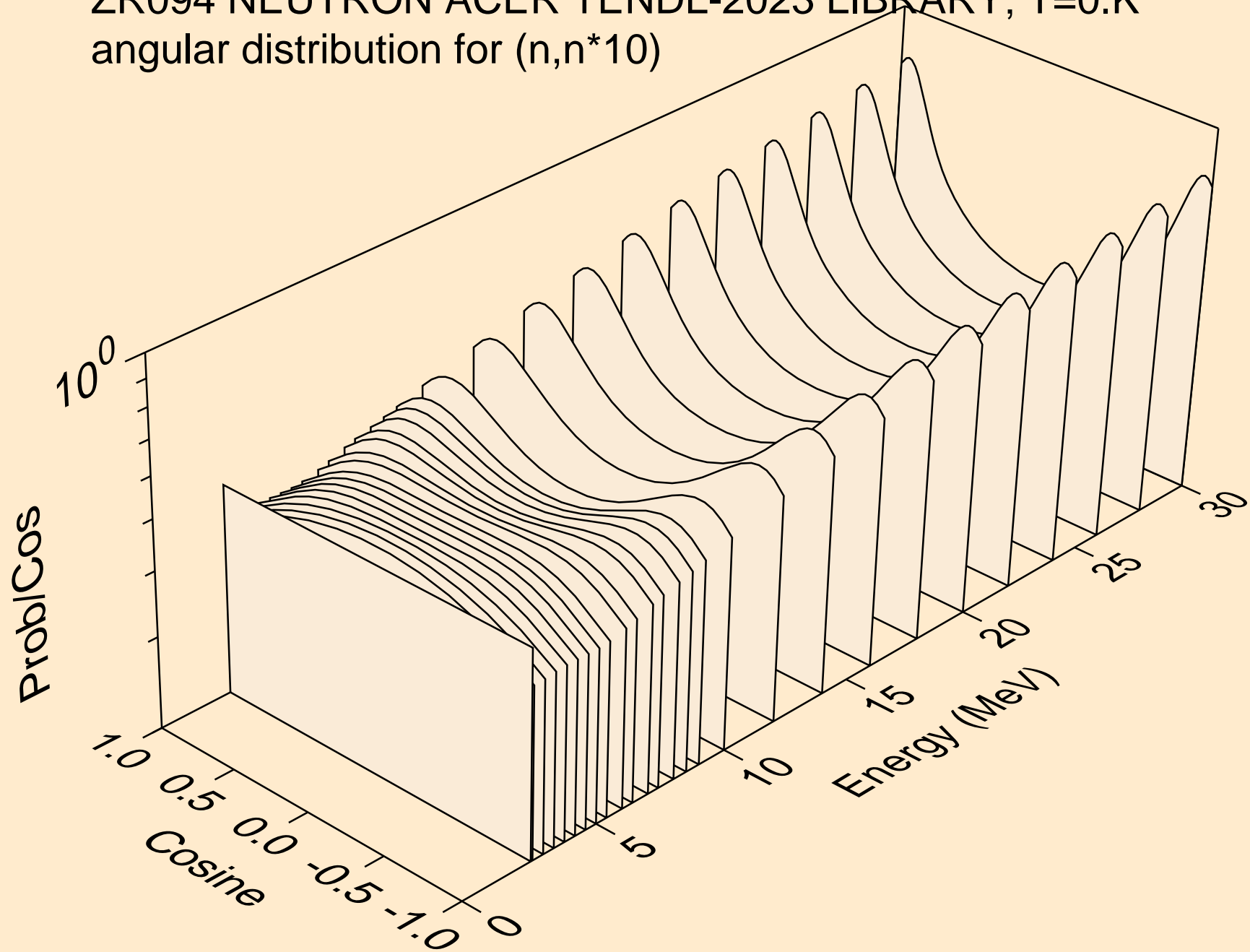

ZR094 NEUTRON ACER TENDL-2023 LIBRARY; T=0.K  
angular distribution for (n,n\*11)

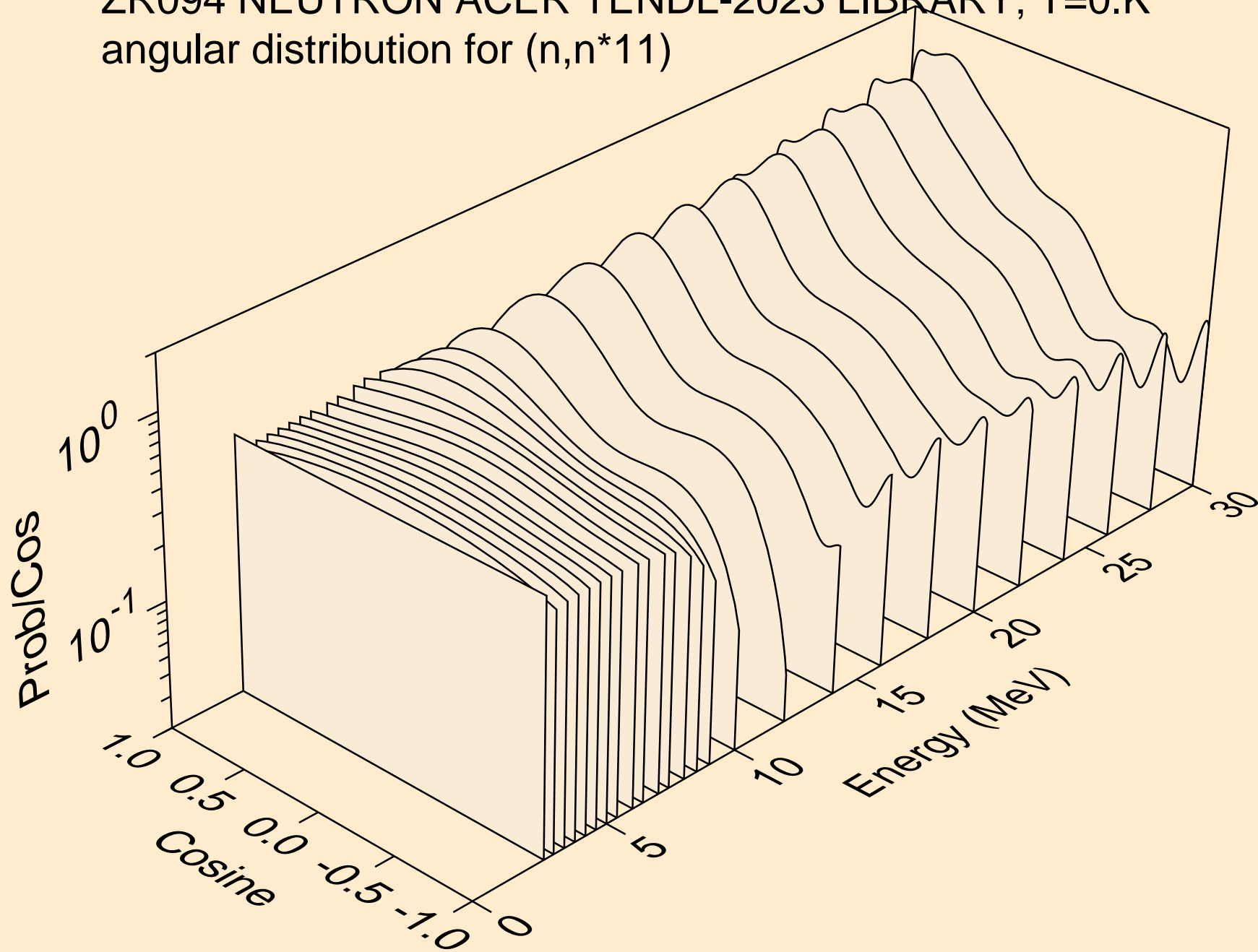

ZR094 NEUTRON ACER TENDL-2023 LIBRARY; T=0.K  
angular distribution for (n,n\*12)

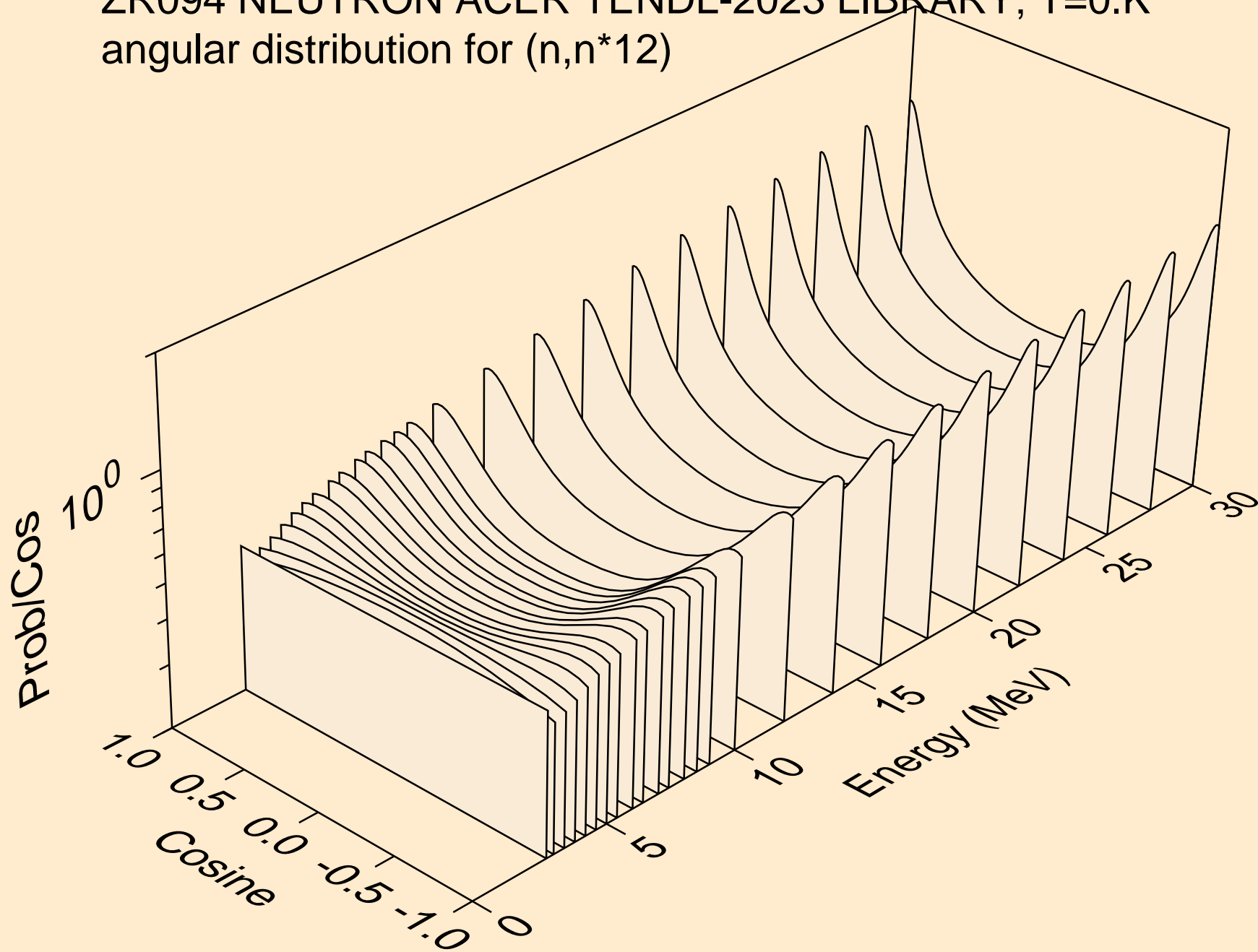

ZR094 NEUTRON ACER TENDL-2023 LIBRARY; T=0.K  
angular distribution for (n,n\*13)

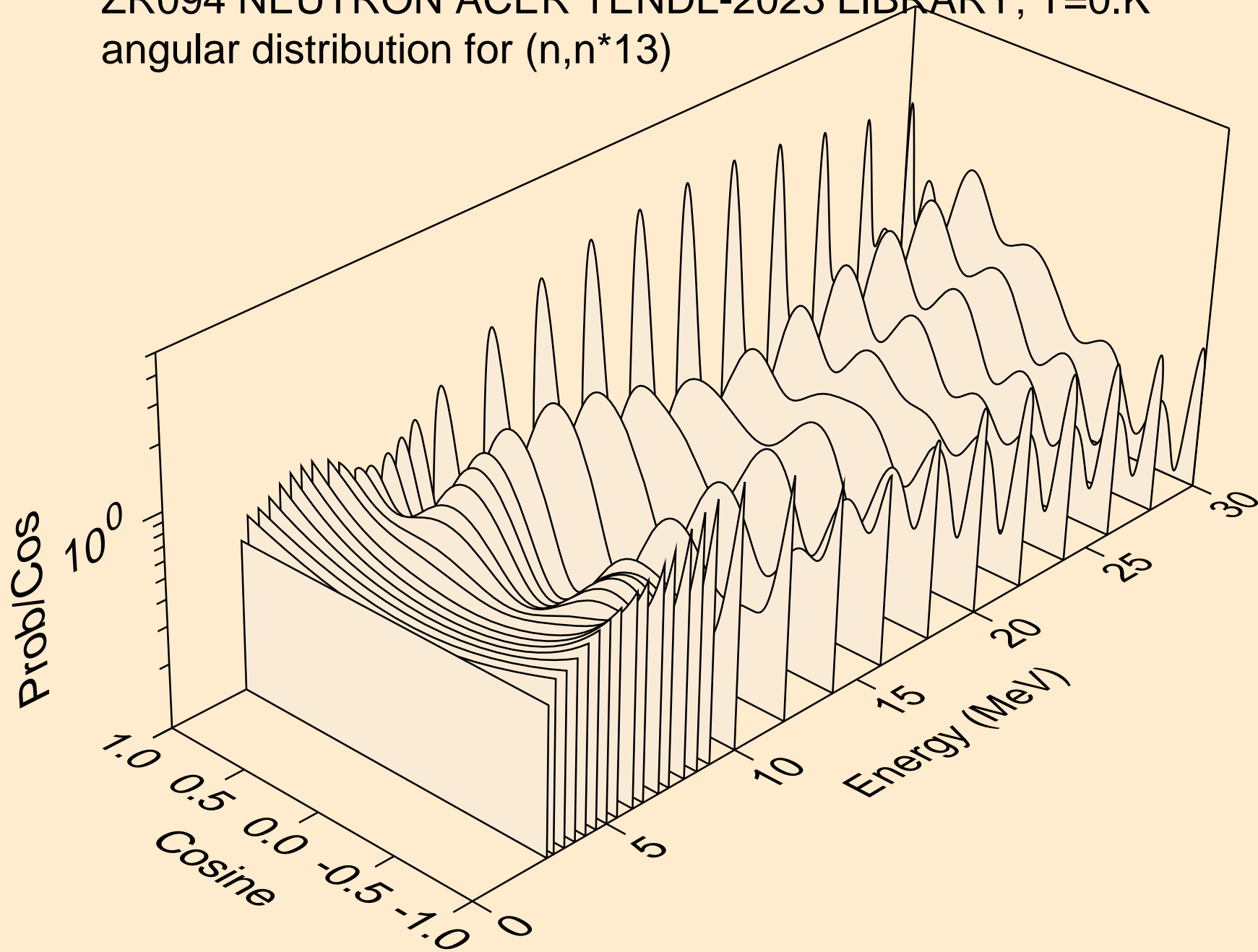

ZR094 NEUTRON ACER TENDL-2023 LIBRARY; T=0.K  
angular distribution for (n,n\*14)

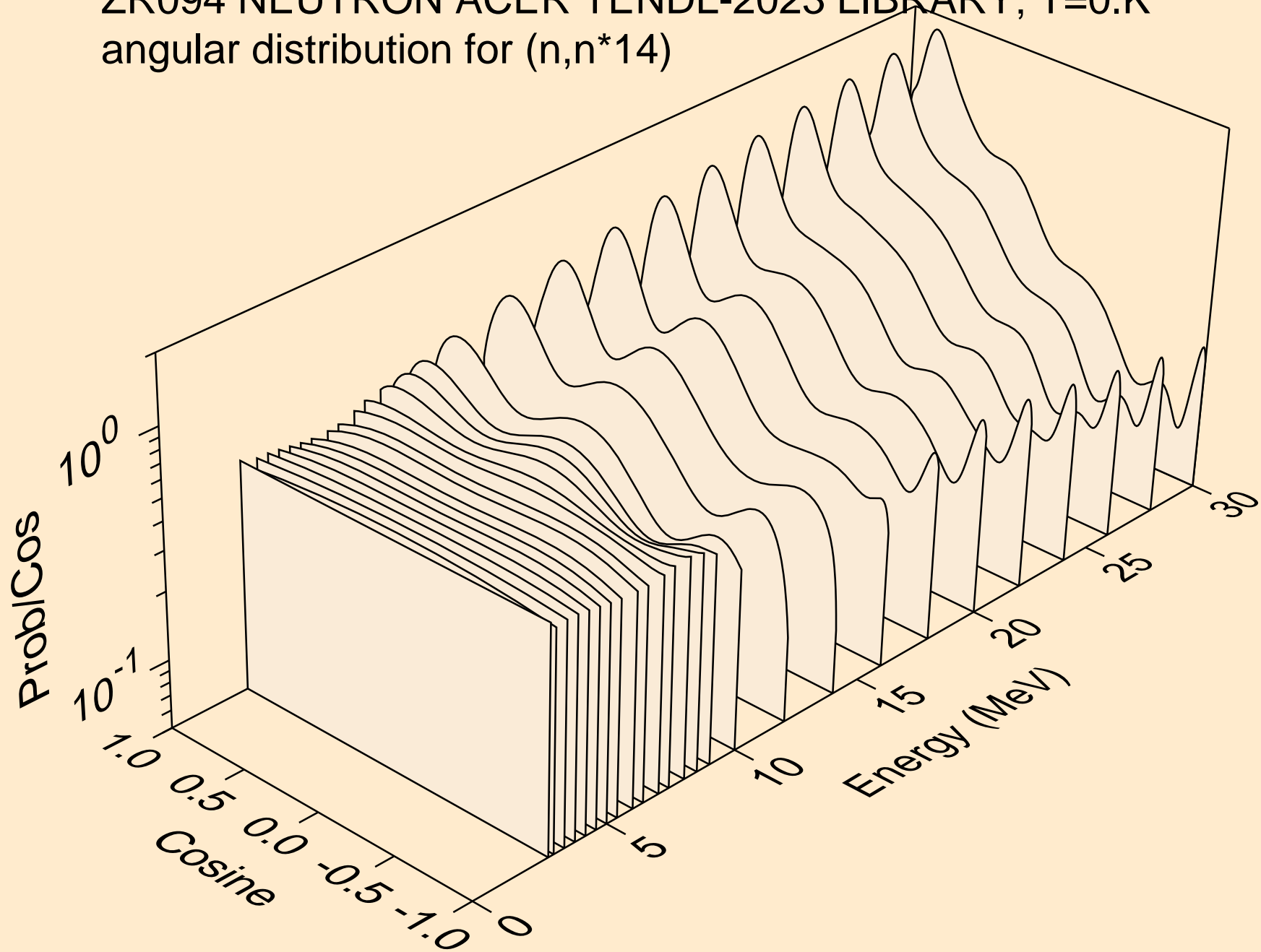

ZR094 NEUTRON ACER TENDL-2023 LIBRARY; T=0.K  
angular distribution for (n,n\*15)

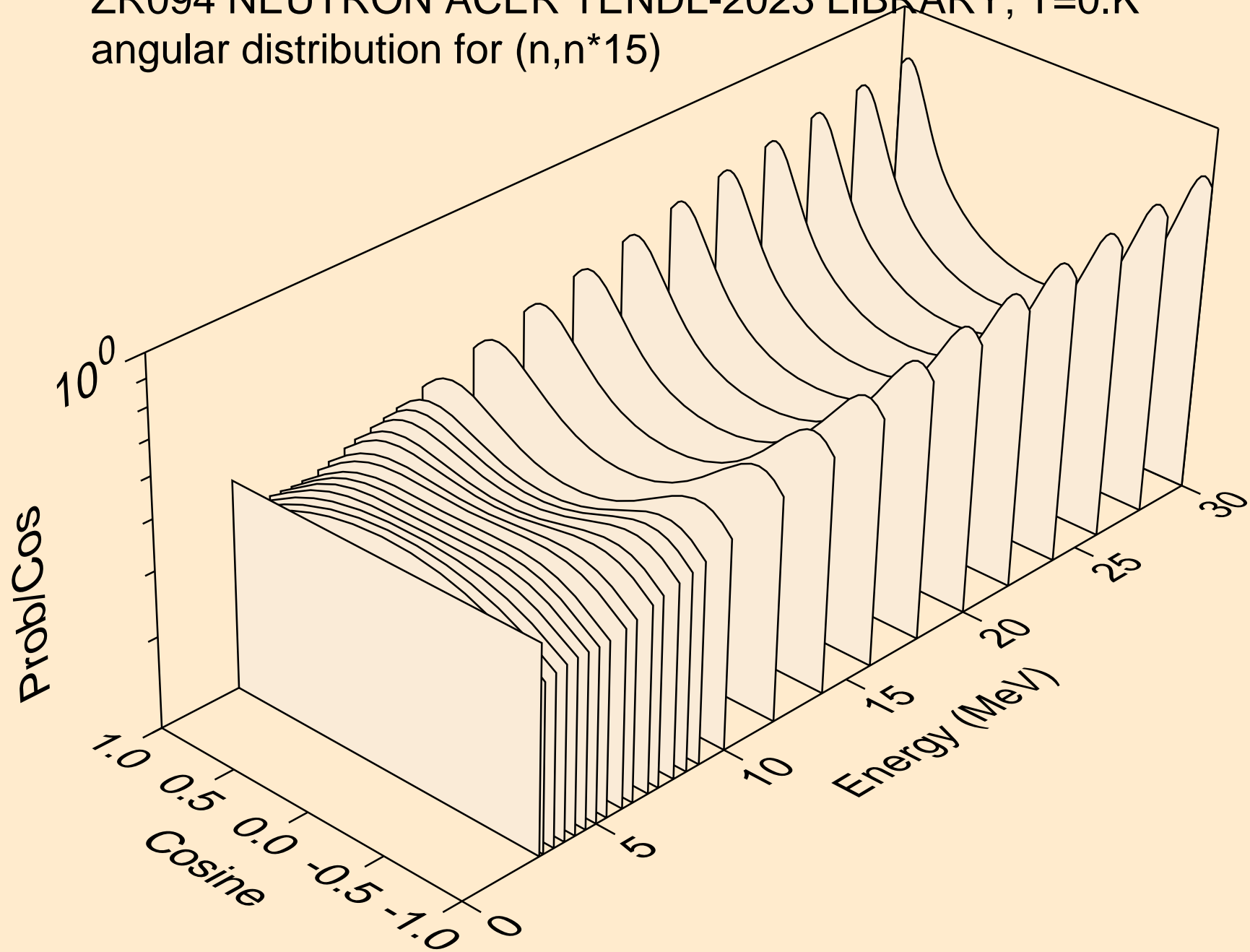

ZR094 NEUTRON ACER TENDL-2023 LIBRARY; T=0.K  
angular distribution for (n,n\*16)

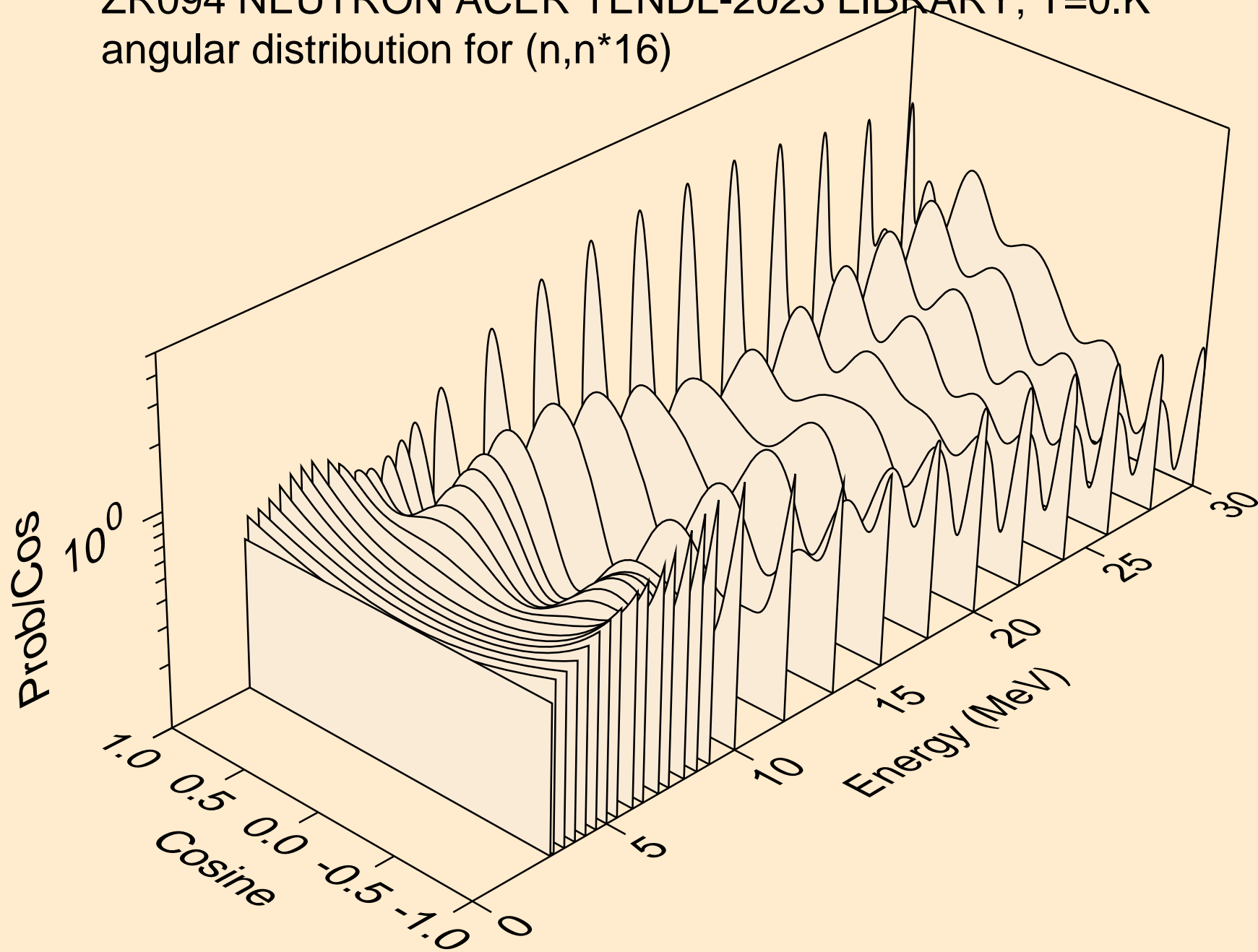

ZR094 NEUTRON ACER TENDL-2023 LIBRARY; T=0.K  
Neutron emission for (n,x)

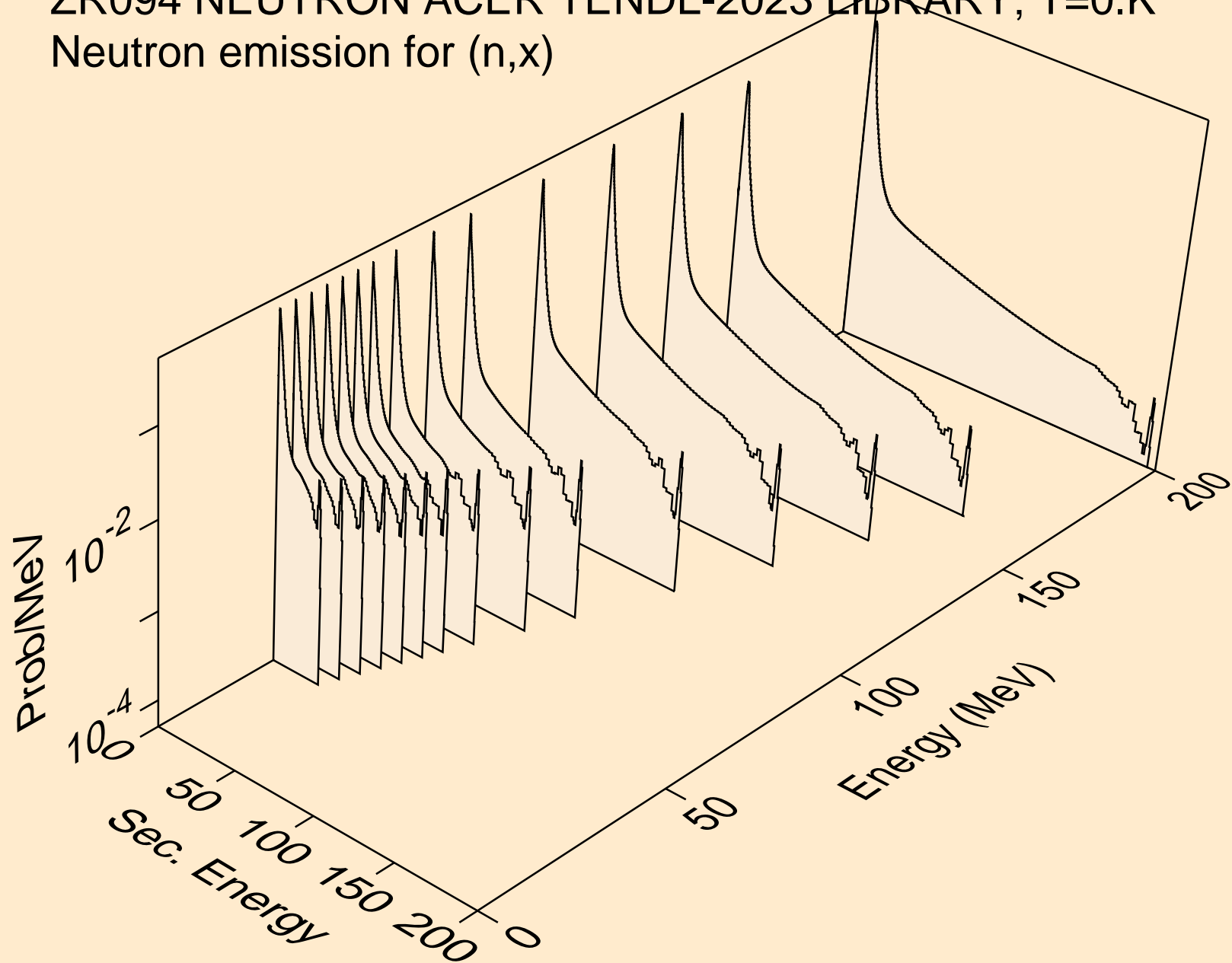

ZR094 NEUTRON ACER TENDL-2023 LIBRARY; T=0.K  
Neutron emission for (n,2nd)

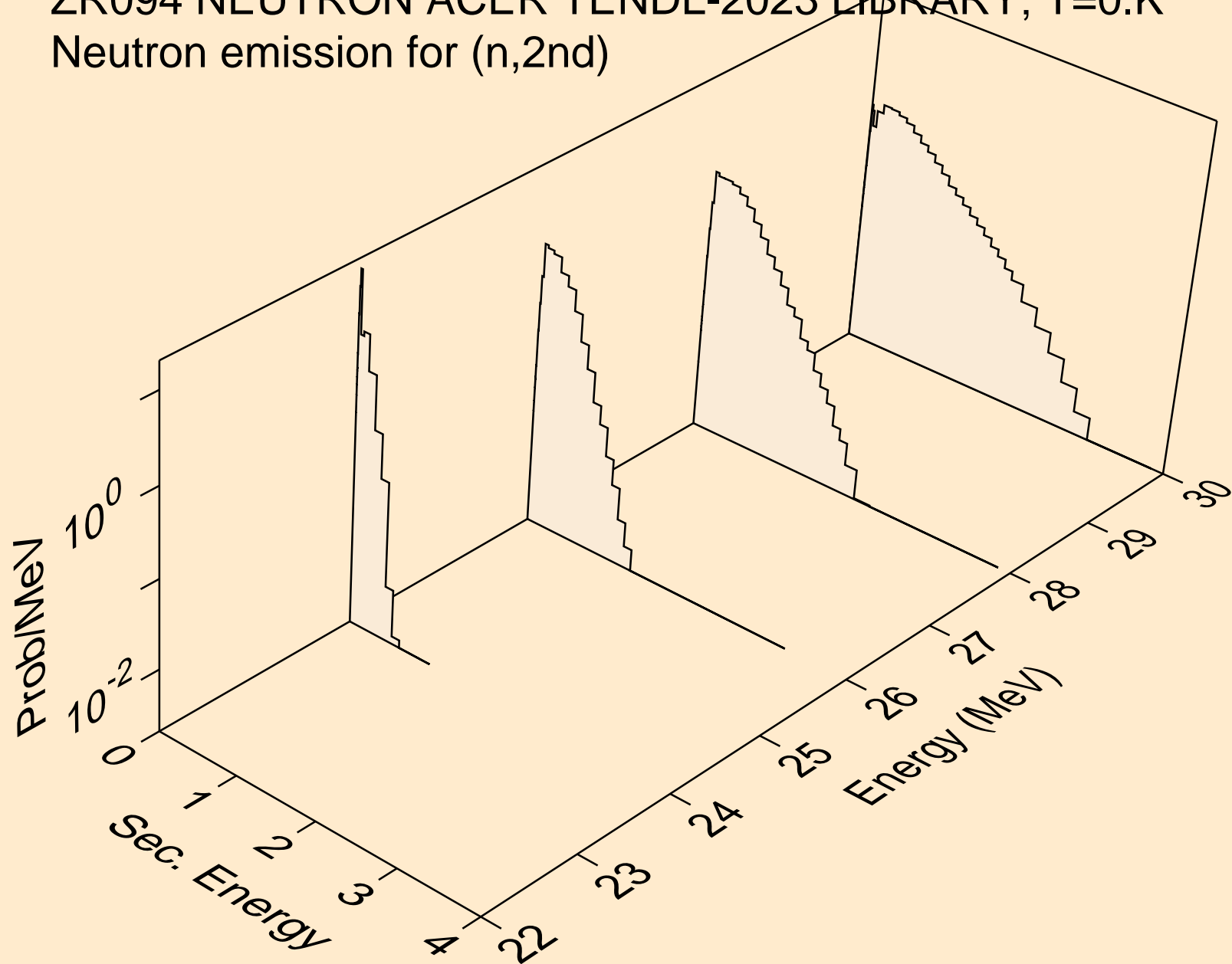

ZR094 NEUTRON ACER TENDL-2023 LIBRARY; T=0.K  
Neutron emission for (n,2n)

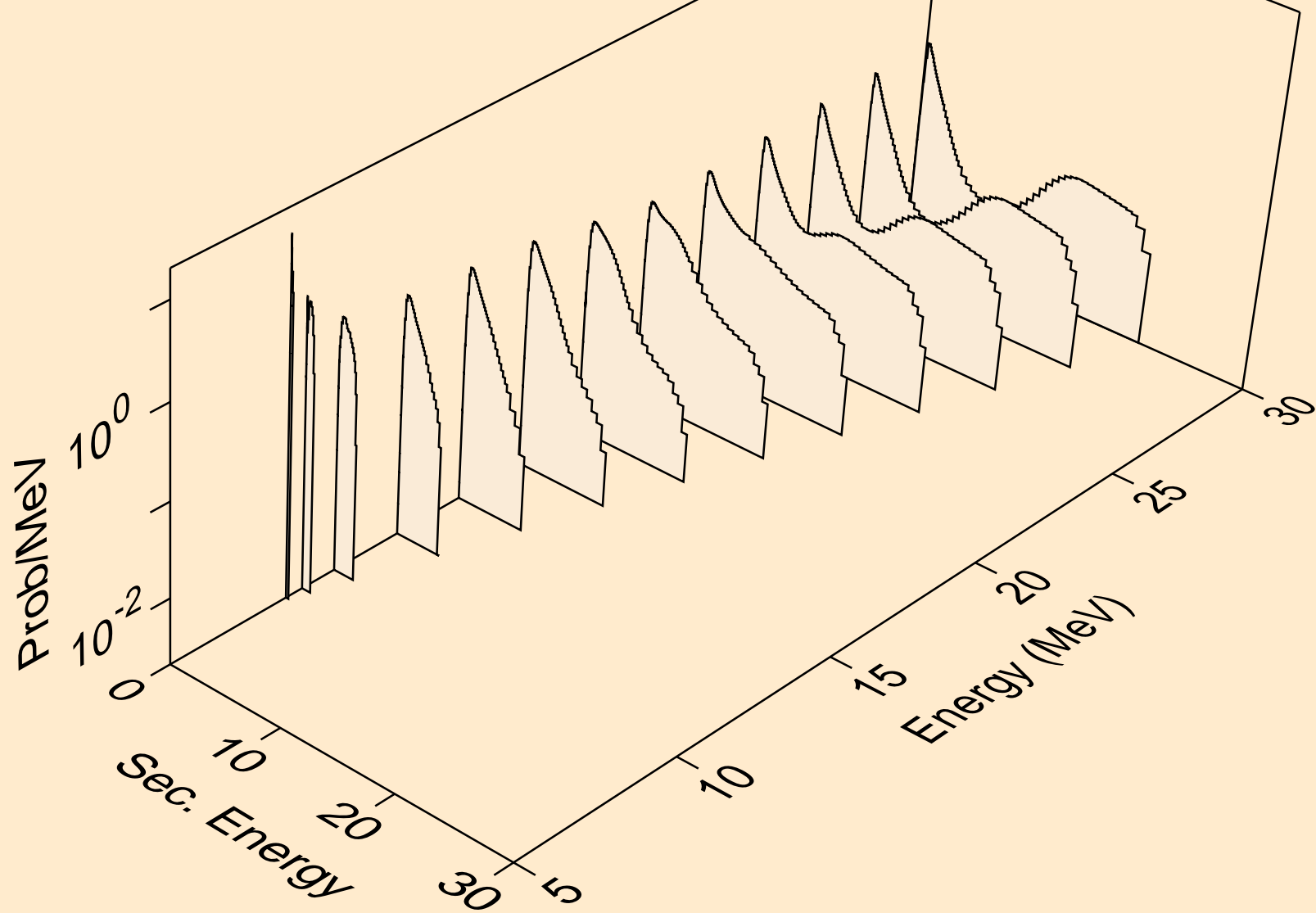

ZR094 NEUTRON ACER TENDL-2023 LIBRARY; T=0.K  
Neutron emission for (n,3n)

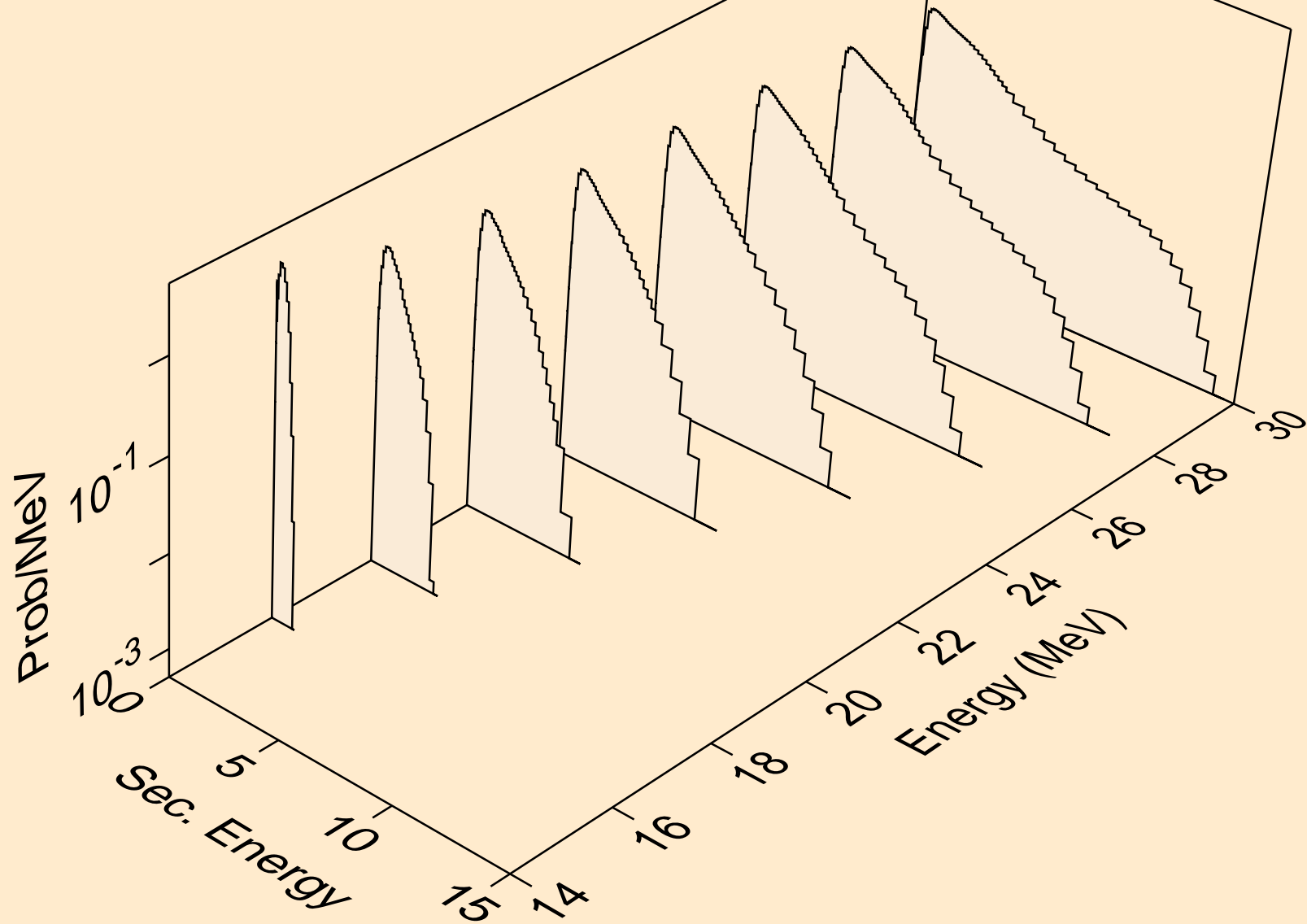

ZR094 NEUTRON ACER TENDL-2023 LIBRARY; T=0.K  
Neutron emission for (n,n\*)a

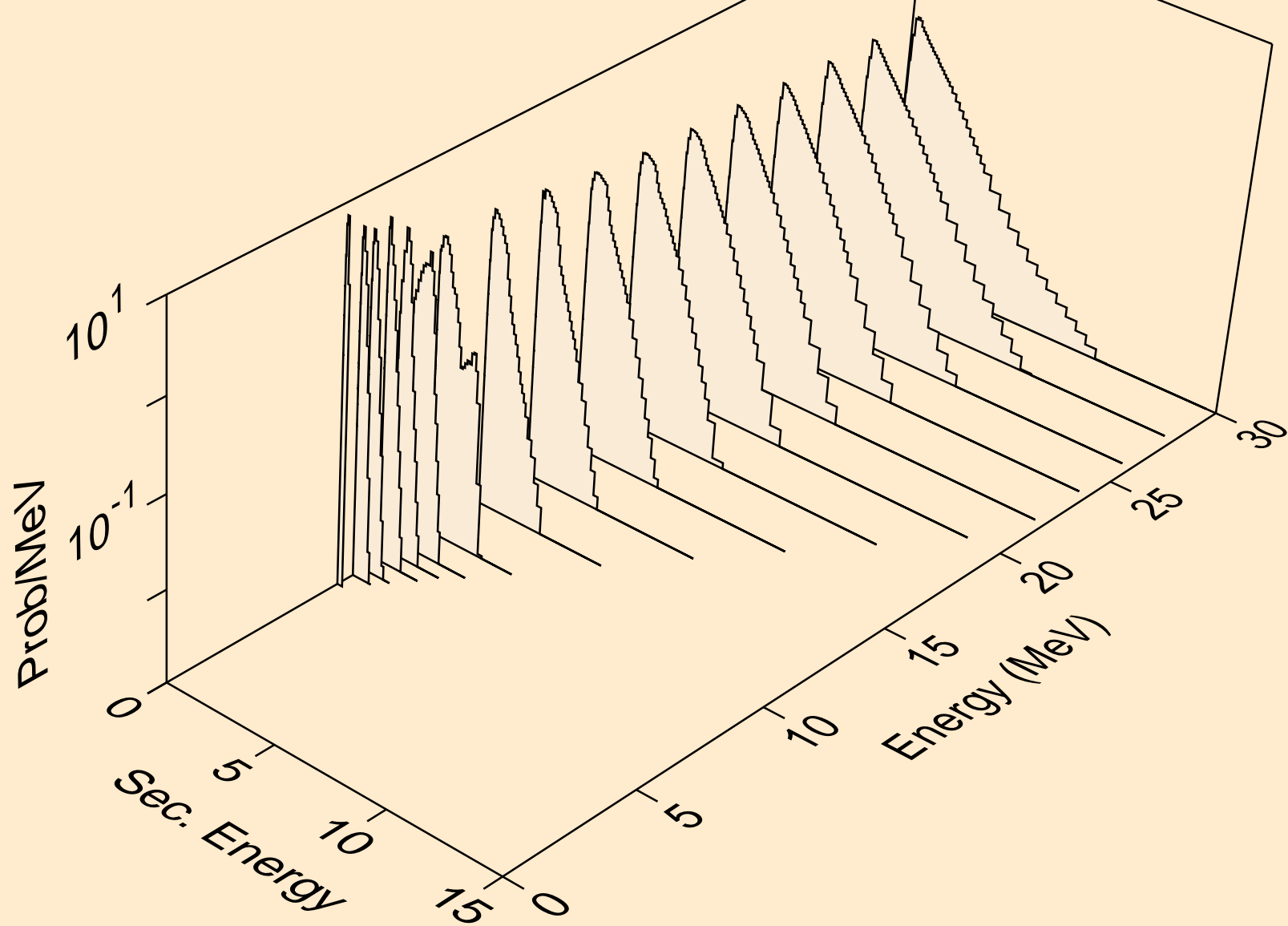

ZR094 NEUTRON ACER TENDL-2023 LIBRARY; T=0.K  
Neutron emission for (n,2n)<sub>a</sub>

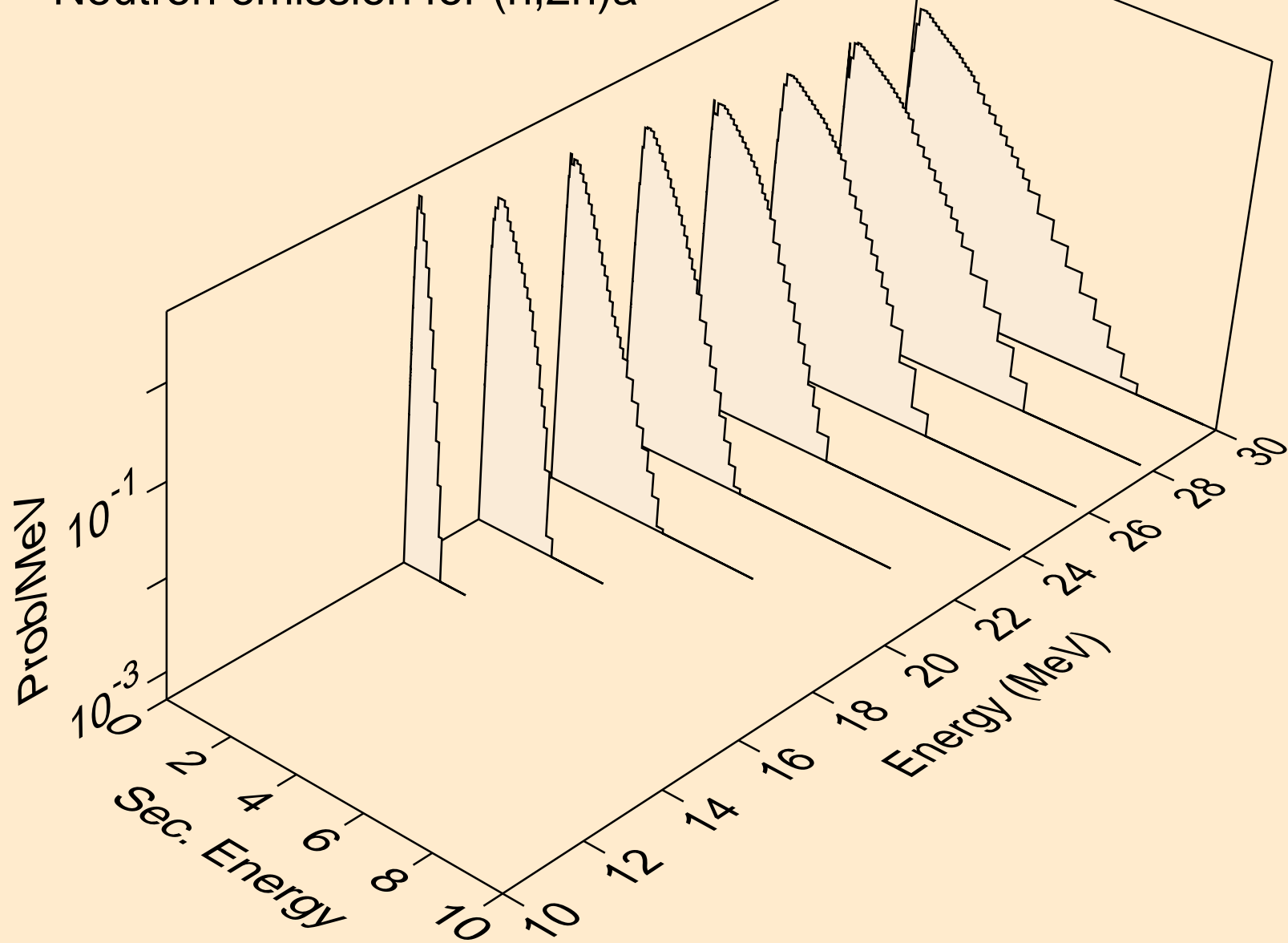

ZR094 NEUTRON ACER TENDL-2023 LIBRARY; T=0.K  
Neutron emission for (n,3n)a

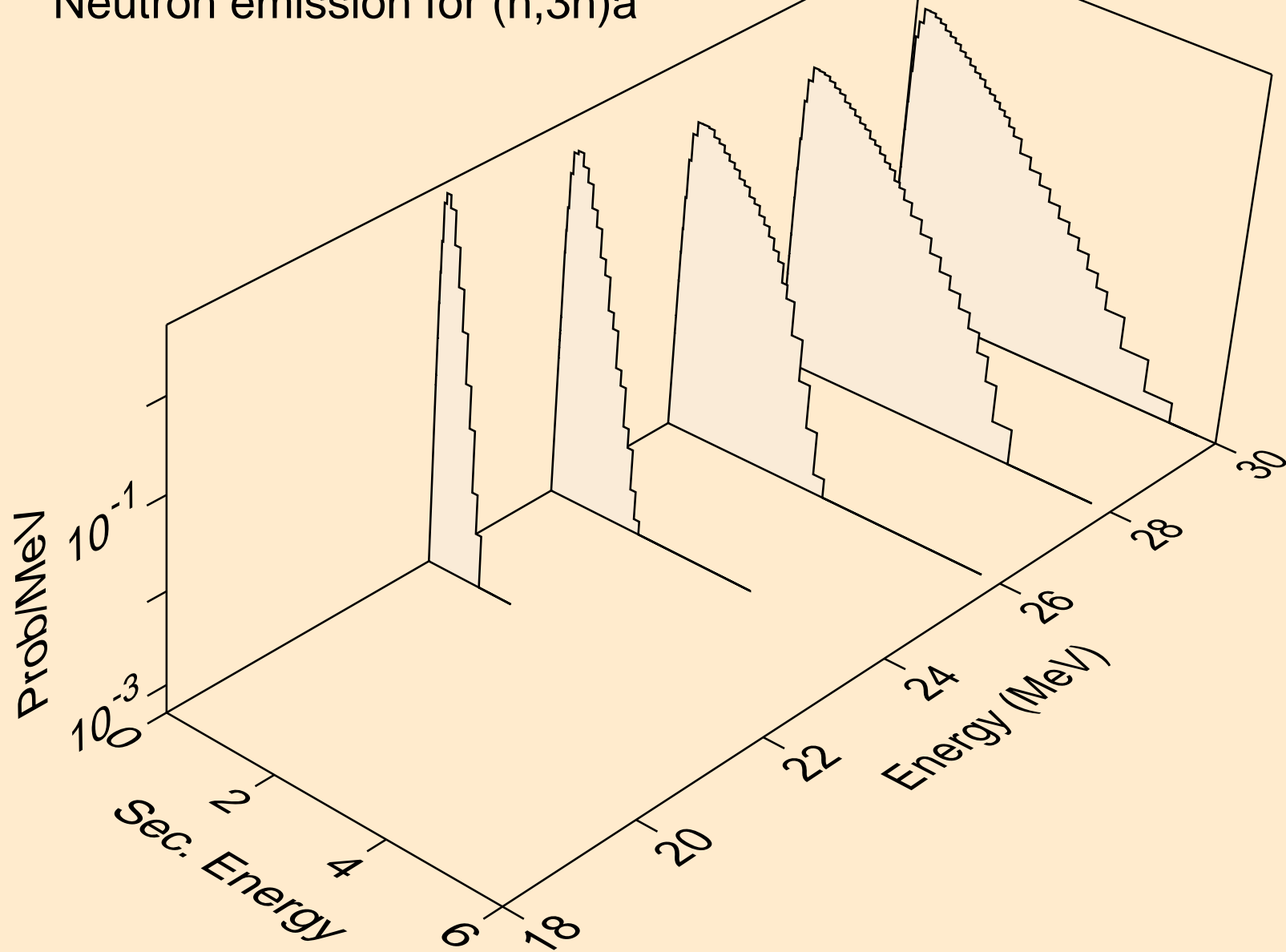

ZR094 NEUTRON ACER TENDL-2023 LIBRARY; T=0.K  
Neutron emission for (n,n\*)p

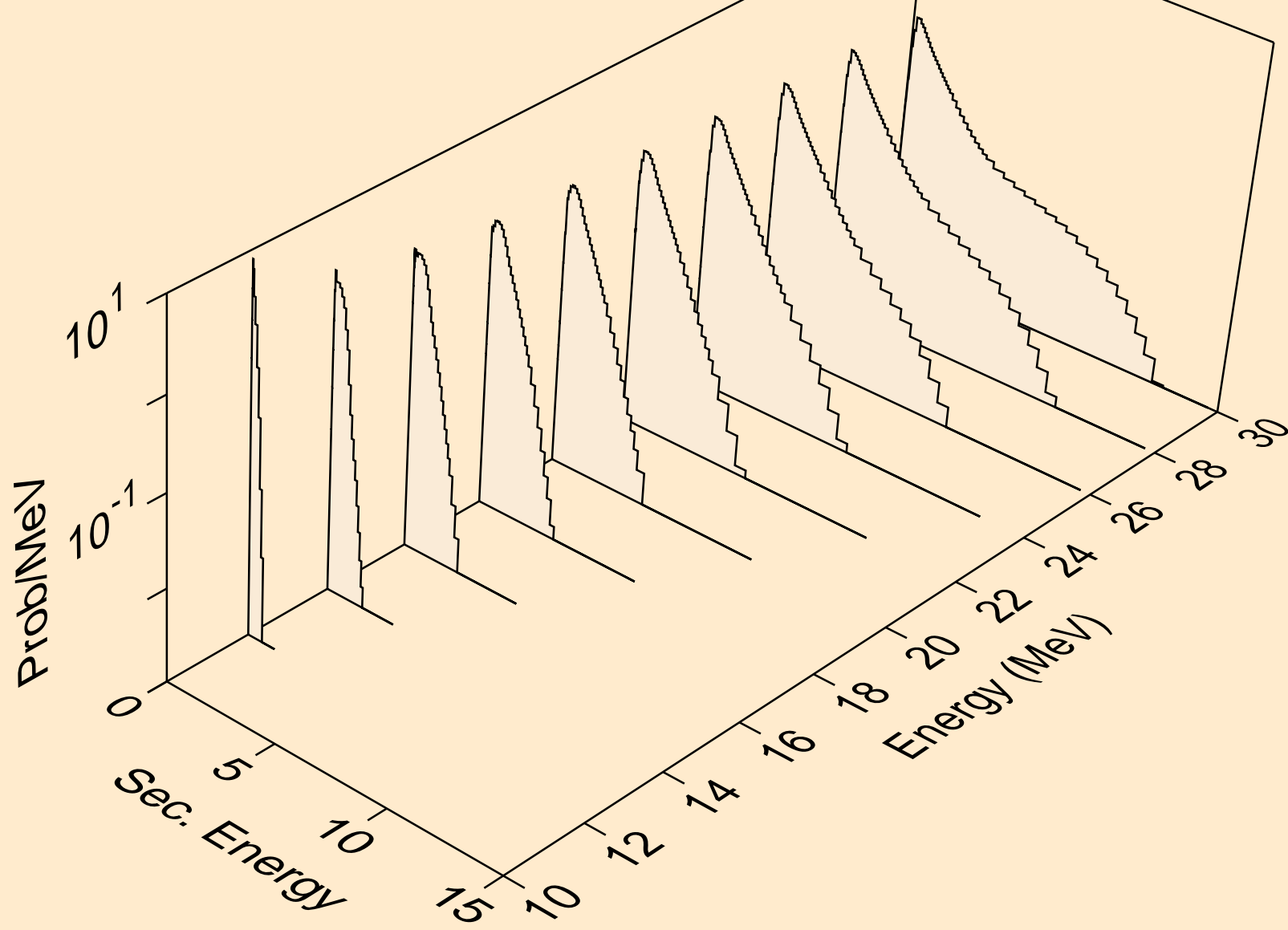

ZR094 NEUTRON ACER TENDL-2023 LIBRARY; T=0.K  
Neutron emission for (n,n\*)2a

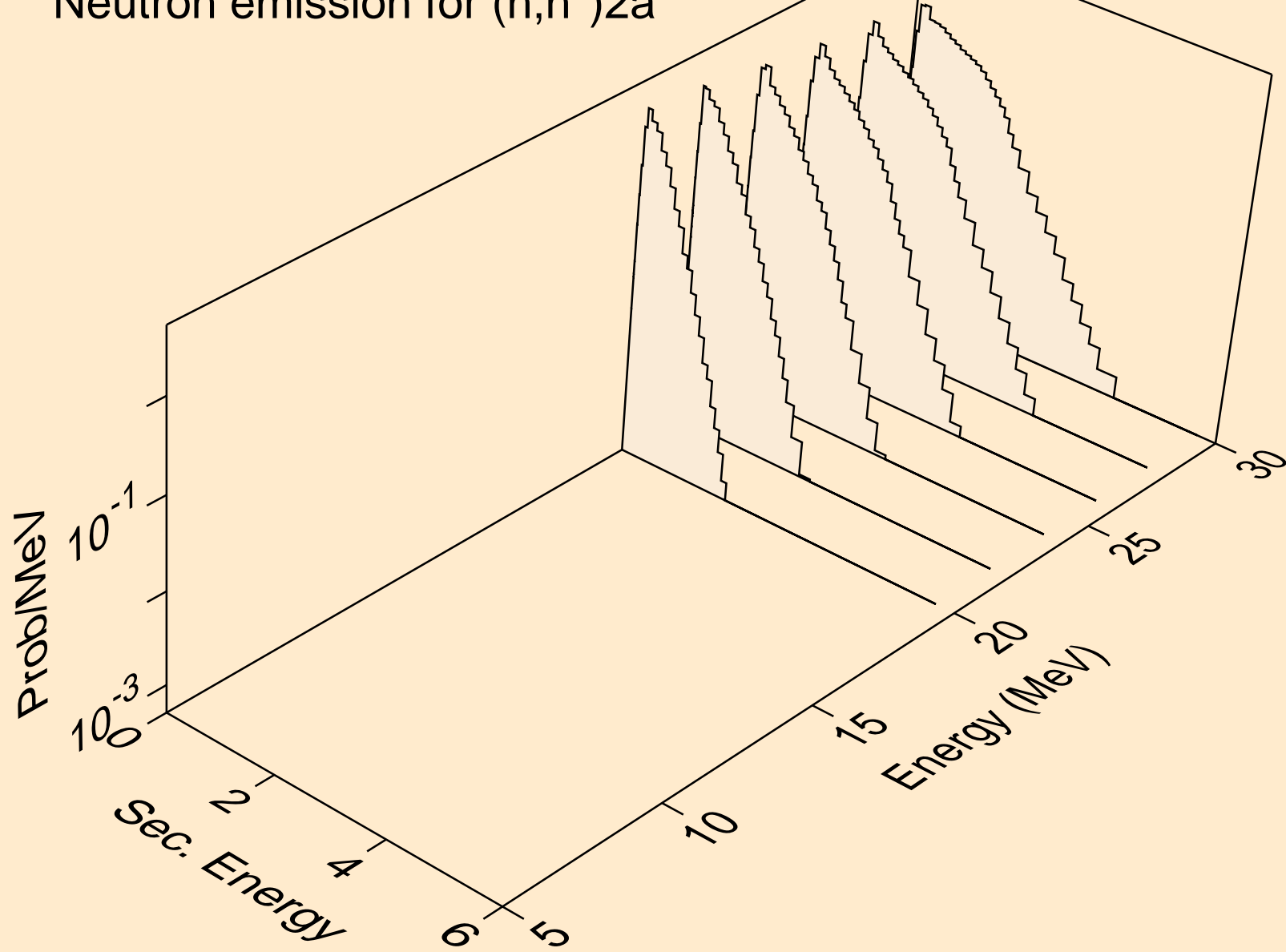

ZR094 NEUTRON ACER TENDL-2023 LIBRARY; T=0.K  
Neutron emission for (n,n\*)d

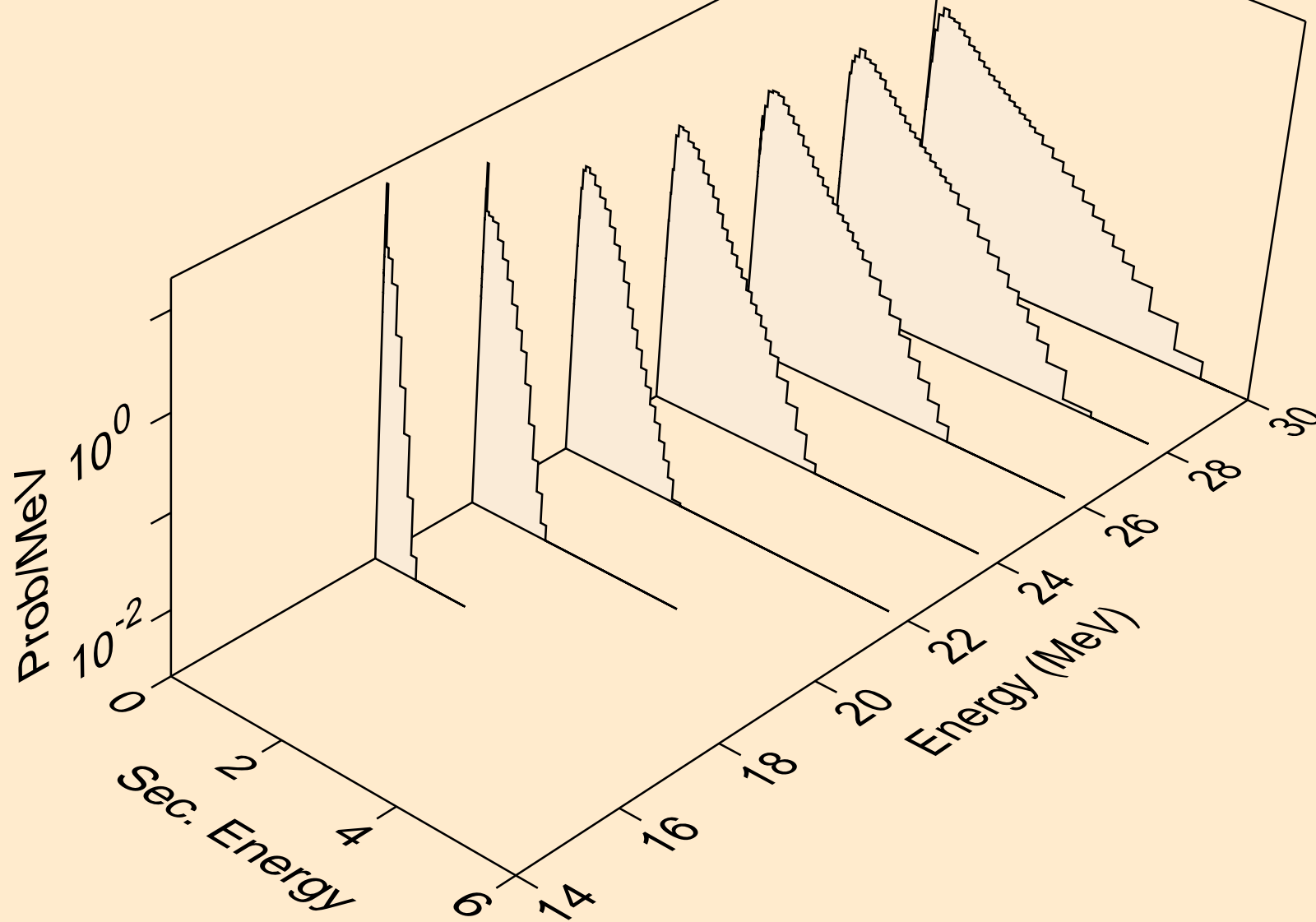

ZR094 NEUTRON ACER TENDL-2023 LIBRARY; T=0.K  
Neutron emission for (n,n\*)t

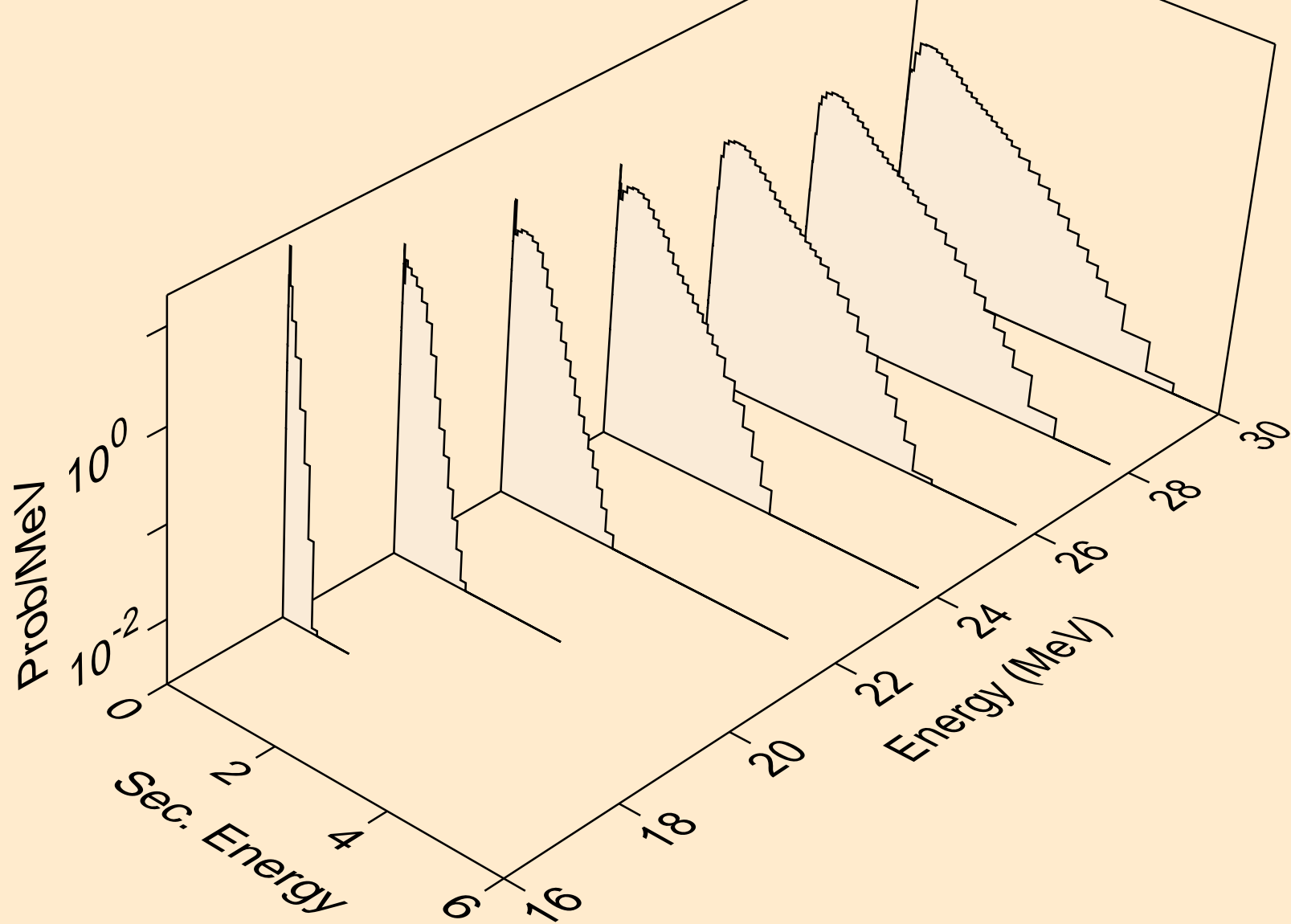

ZR094 NEUTRON ACER TENDL-2023 LIBRARY; T=0.K  
Neutron emission for (n,n\*)he3

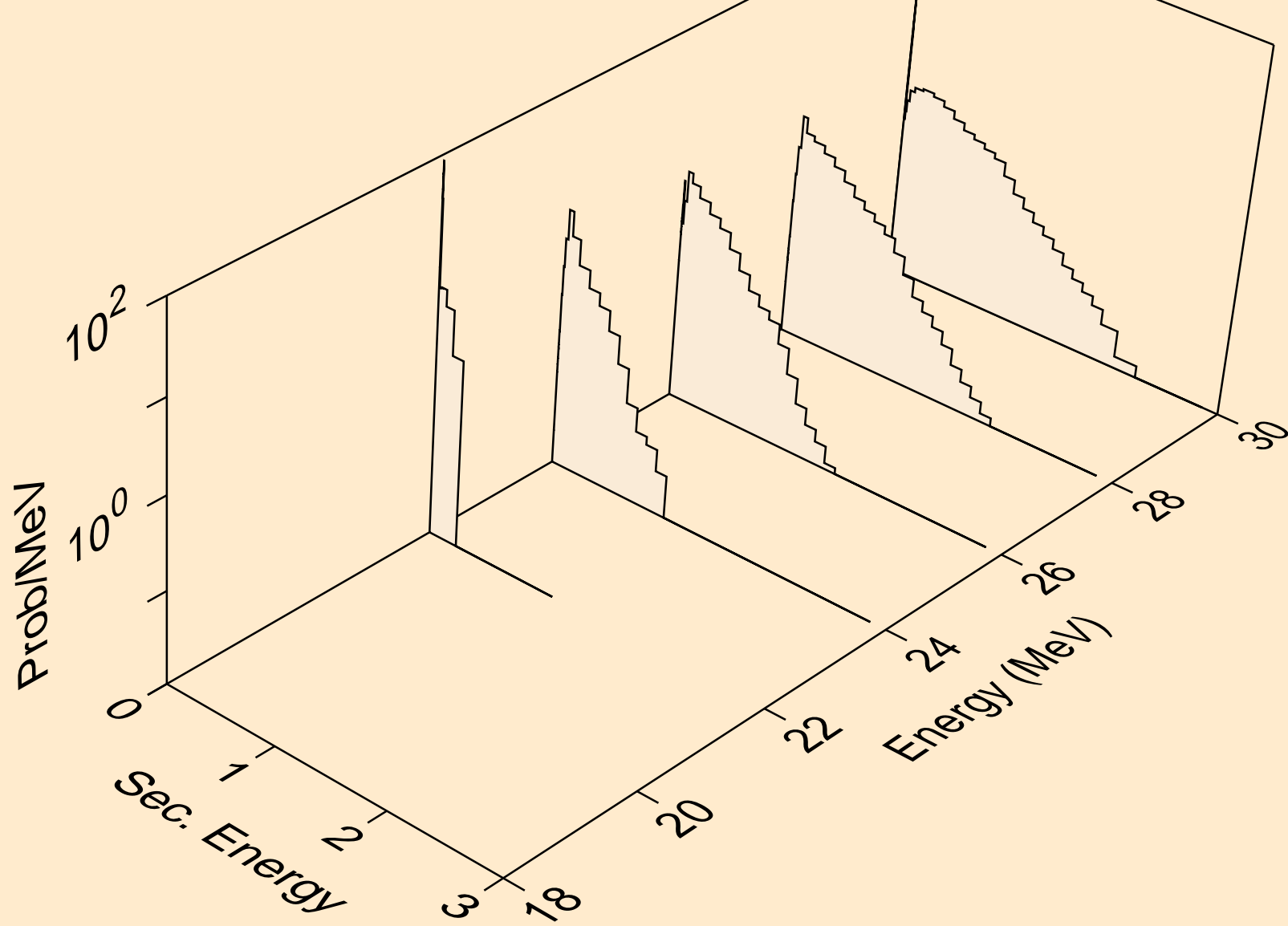

ZR094 NEUTRON ACER TENDL-2023 LIBRARY; T=0.K  
Neutron emission for (n,4n)

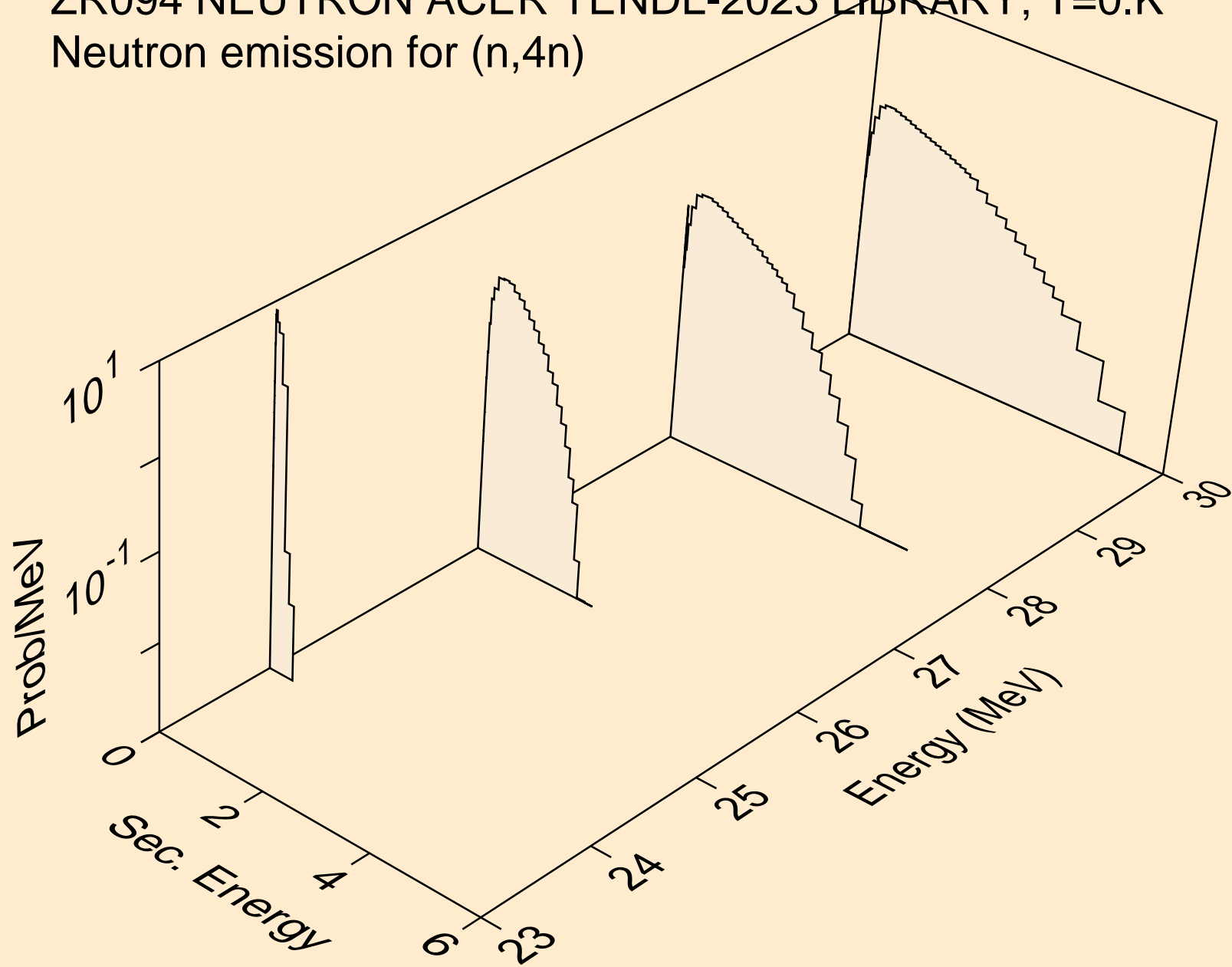

ZR094 NEUTRON ACER TENDL-2023 LIBRARY; T=0.K  
Neutron emission for (n,2np)

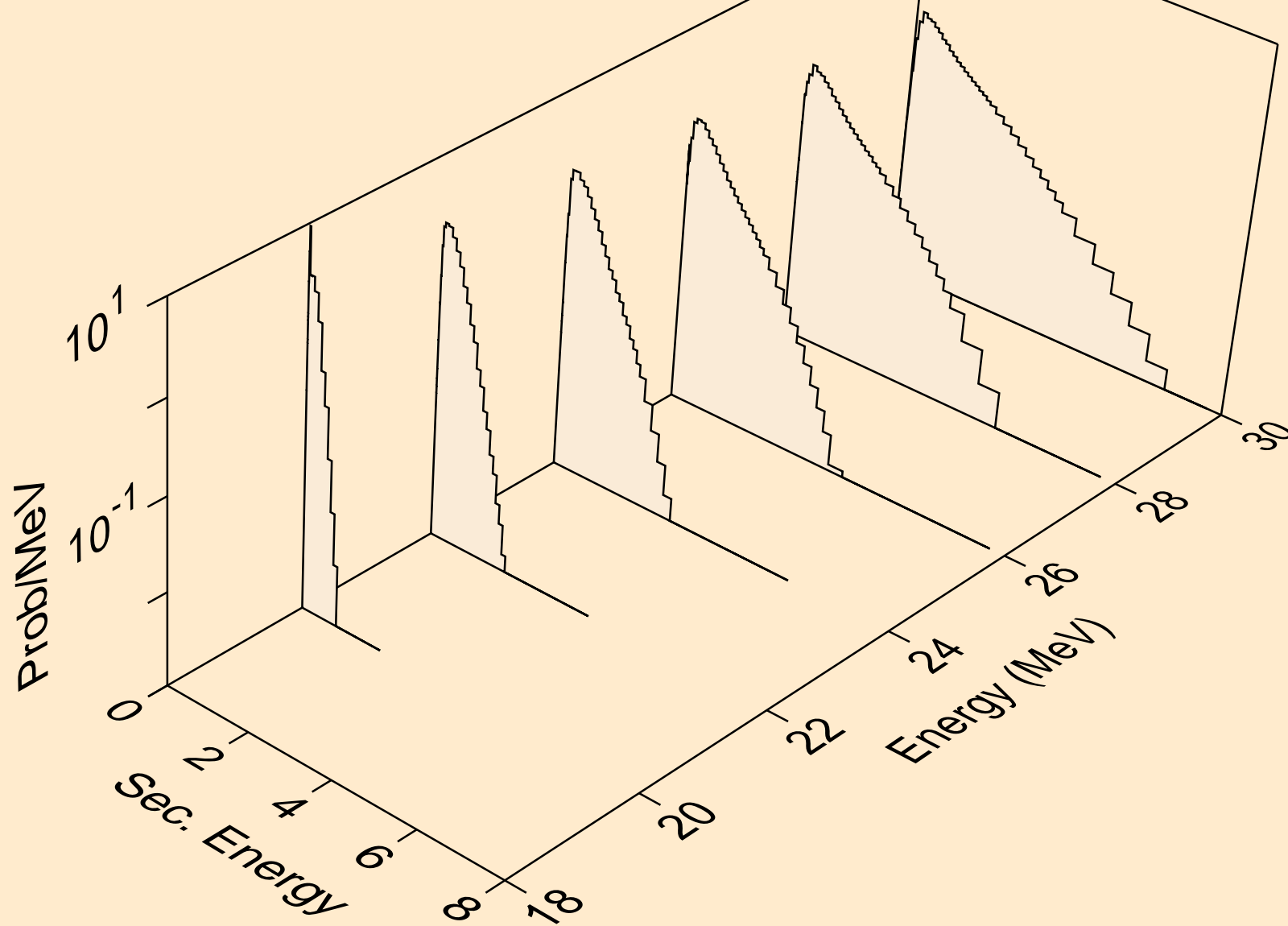

ZR094 NEUTRON ACER TENDL-2023 LIBRARY; T=0.K  
Neutron emission for (n,3np)

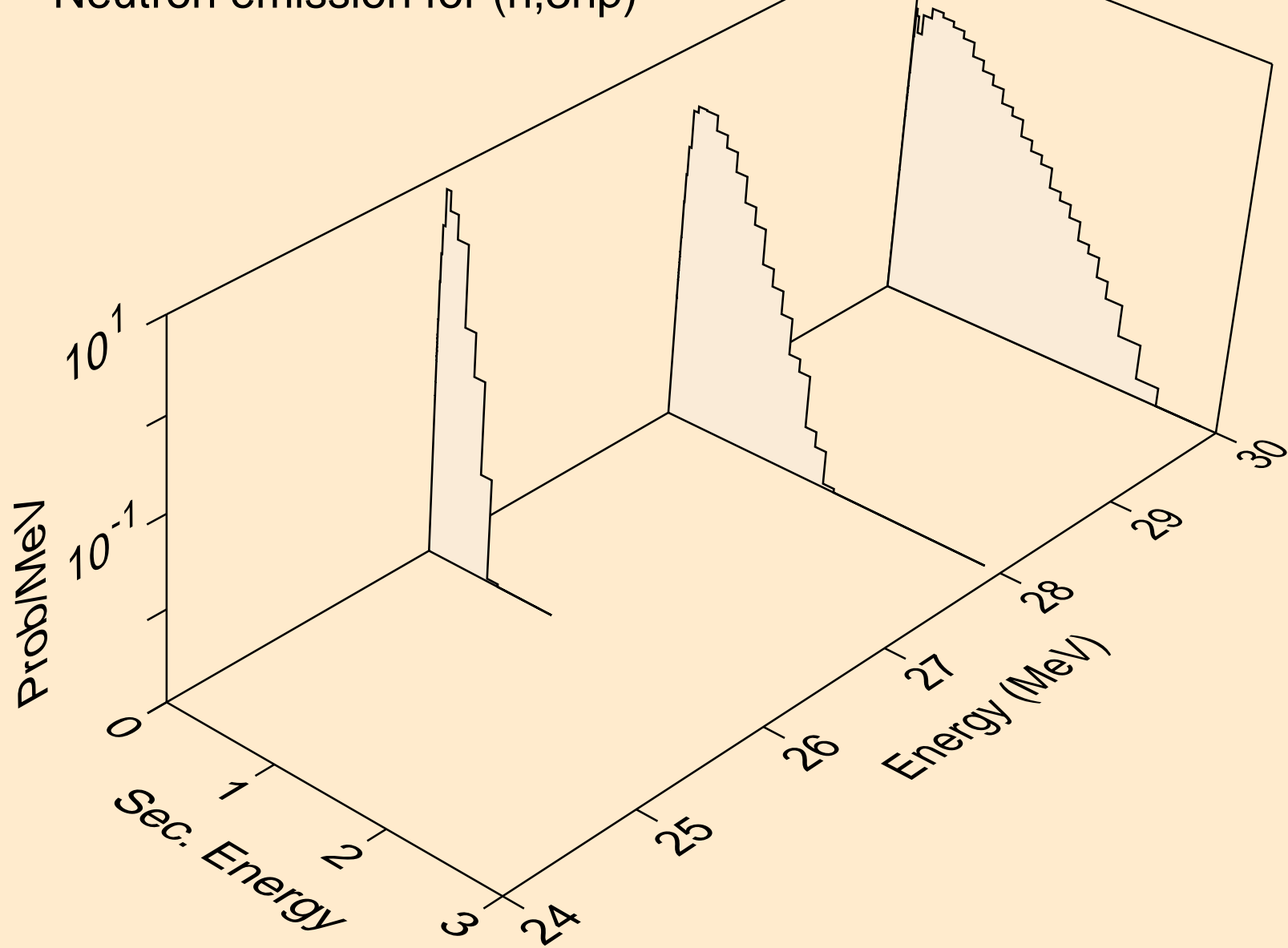

ZR094 NEUTRON ACER TENDL-2023 LIBRARY; T=0.K  
Neutron emission for (n,n2p)

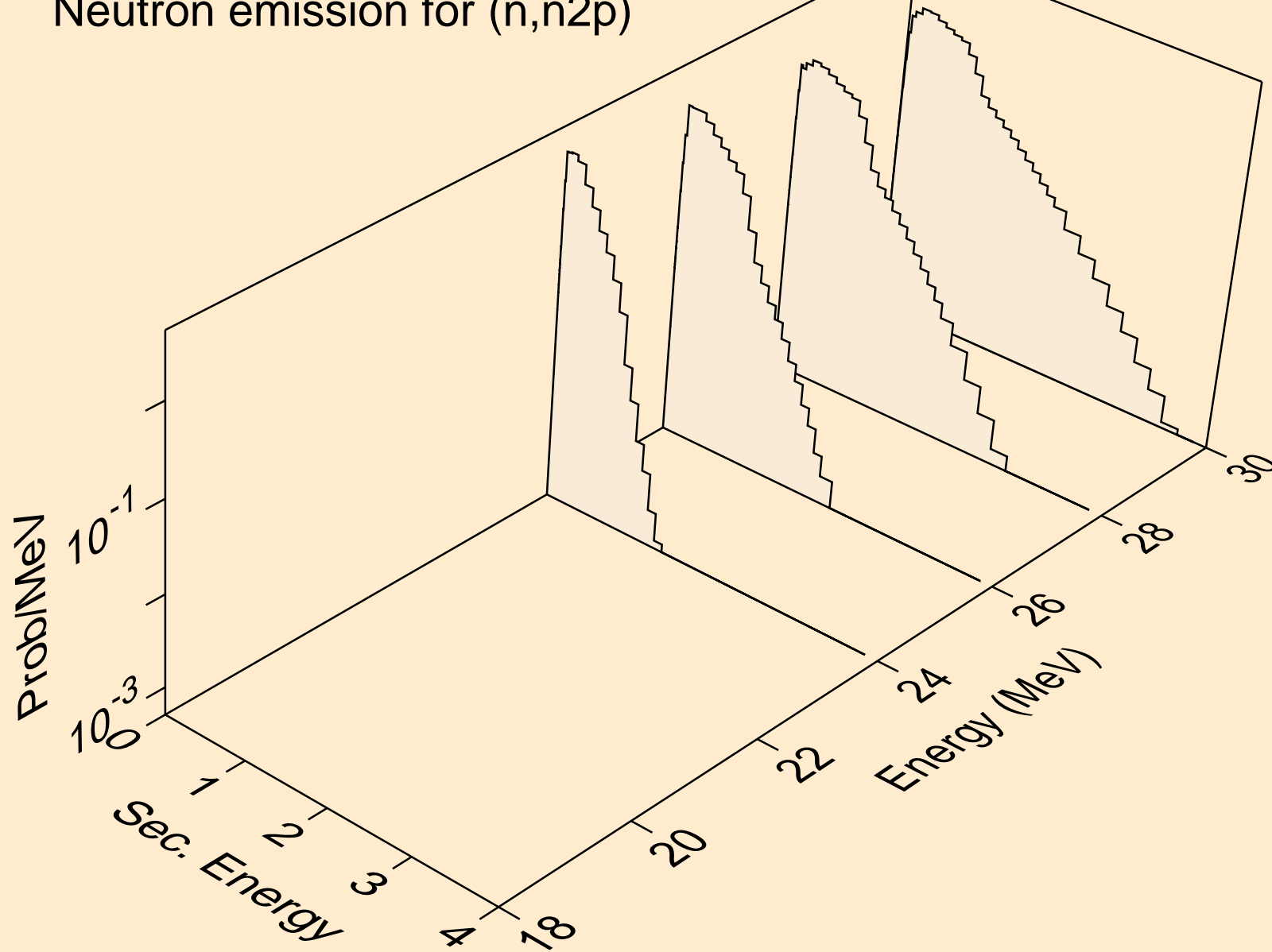

ZR094 NEUTRON ACER TENDL-2023 LIBRARY; T=0.K  
Neutron emission for (n,npa)

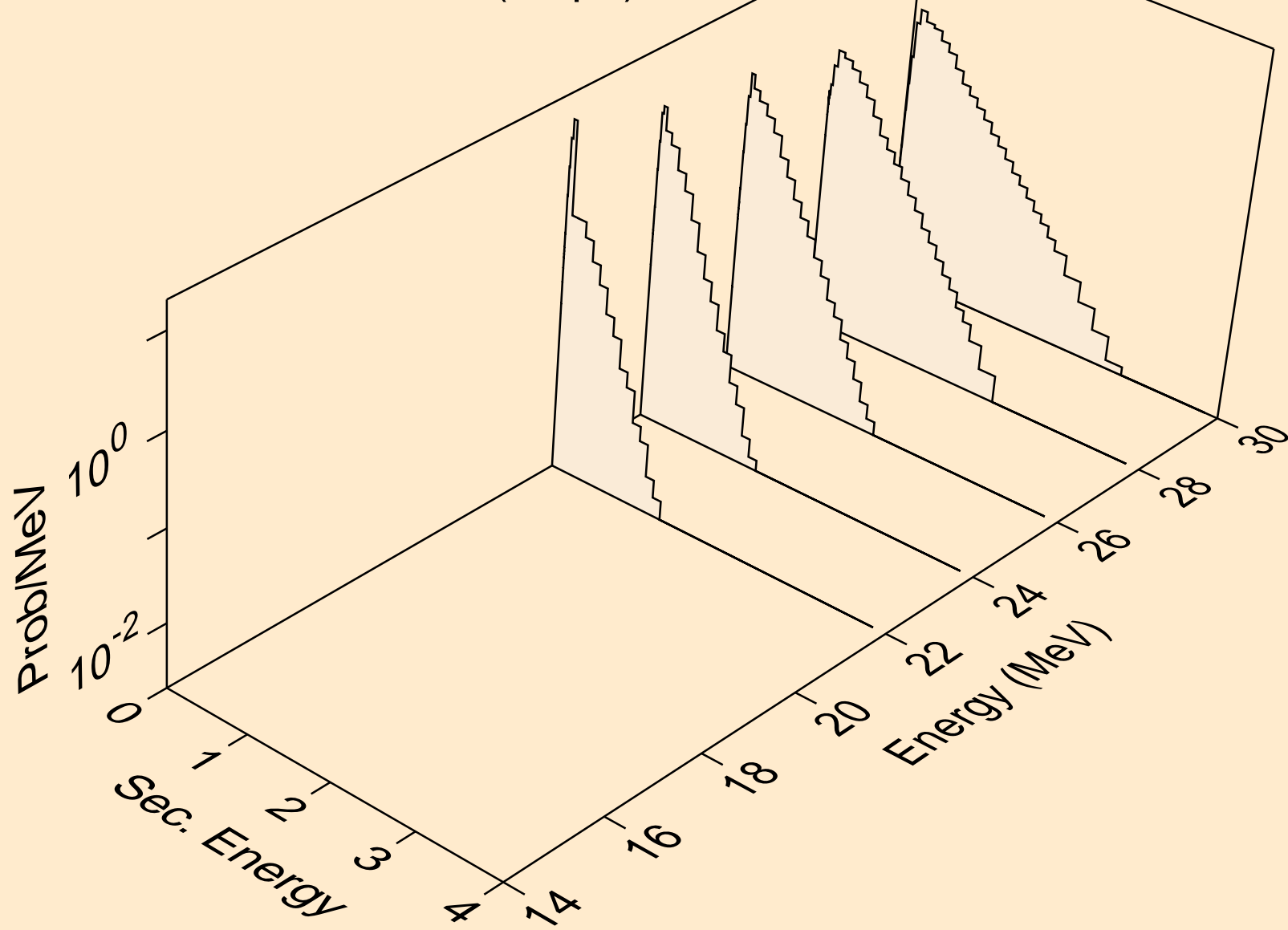

ZR094 NEUTRON ACER TENDL-2023 LIBRARY; T=0.K  
Neutron emission for (n,n\*c)

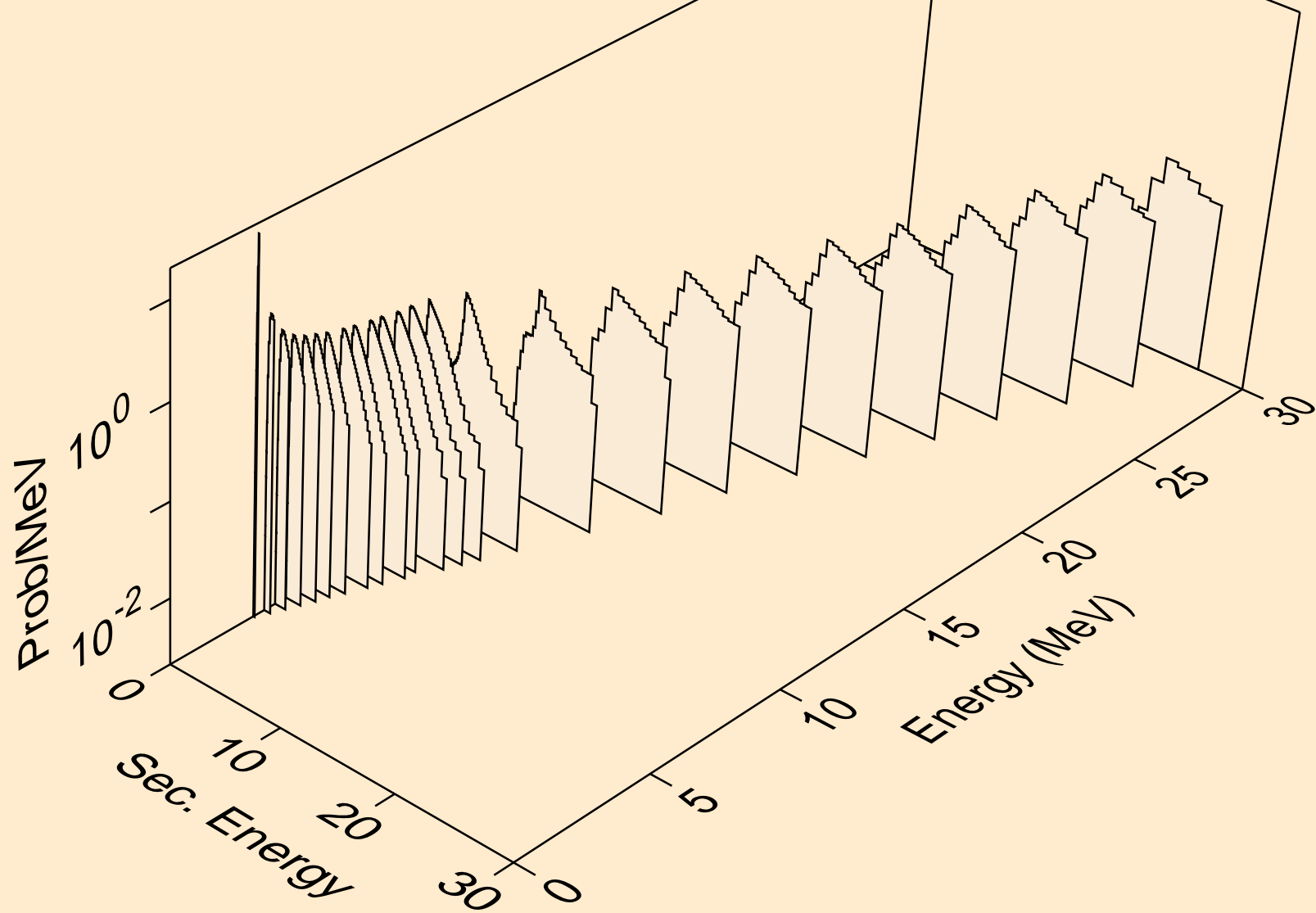

ZR094 NEUTRON ACER TENDL-2023 LIBRARY; T=0.K  
Photon emission for (n,x)

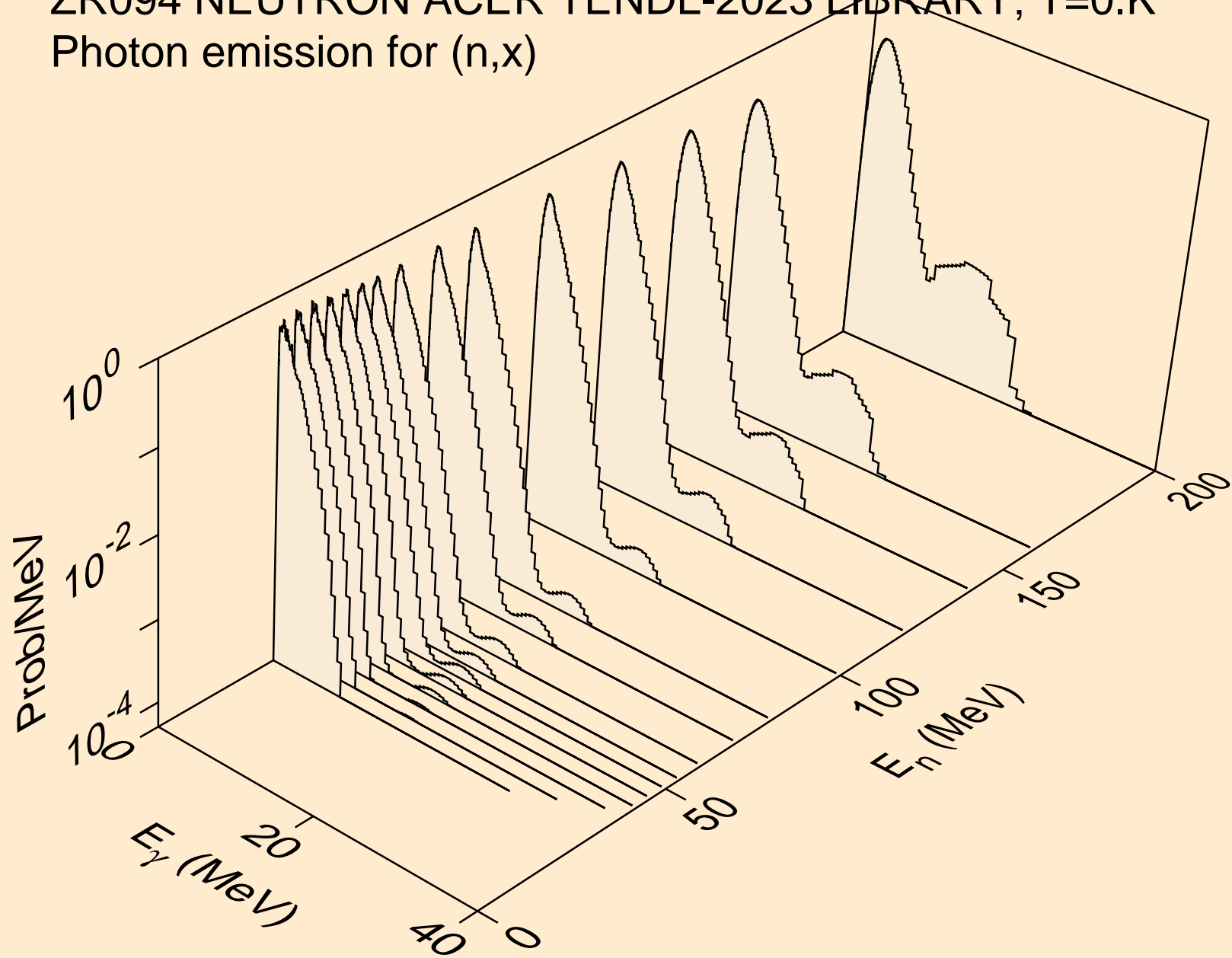

ZR094 NEUTRON ACER TENDL-2023 LIBRARY; T=0.K  
Photon emission for (n,2nd)

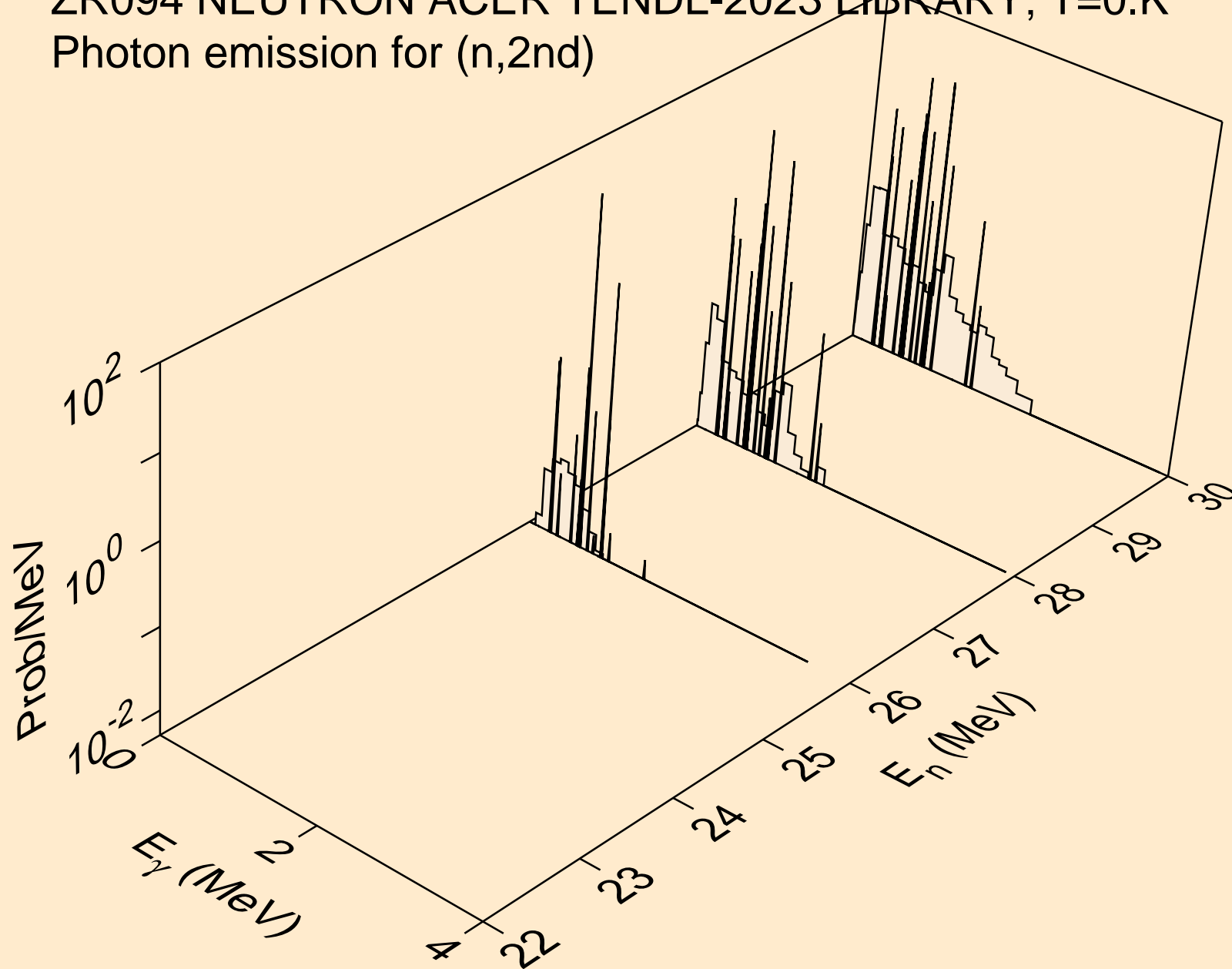

ZR094 NEUTRON ACER TENDL-2023 LIBRARY; T=0.K  
Photon emission for (n,2n)

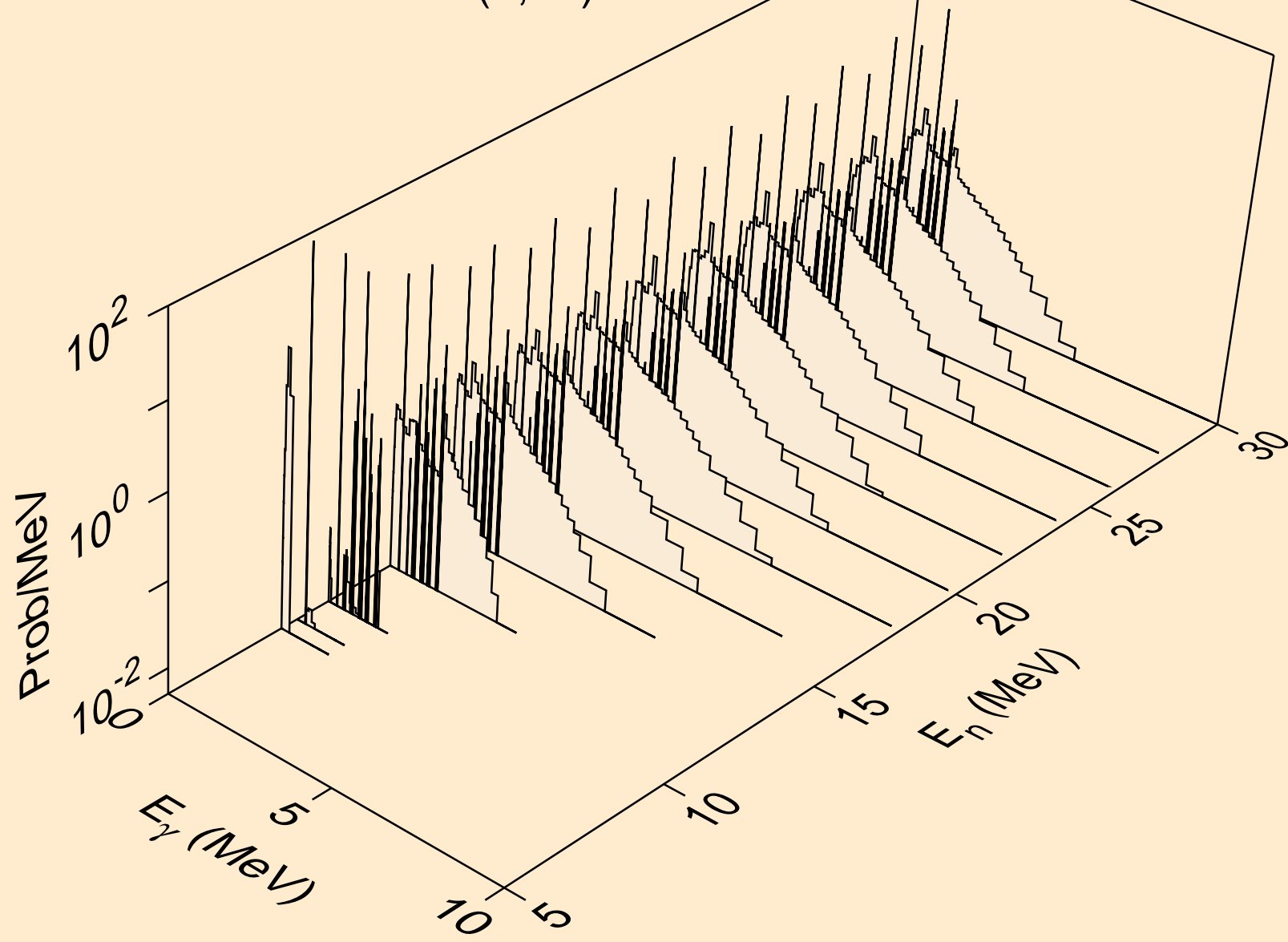

ZR094 NEUTRON ACER TENDL-2023 LIBRARY; T=0.K  
Photon emission for (n,3n)

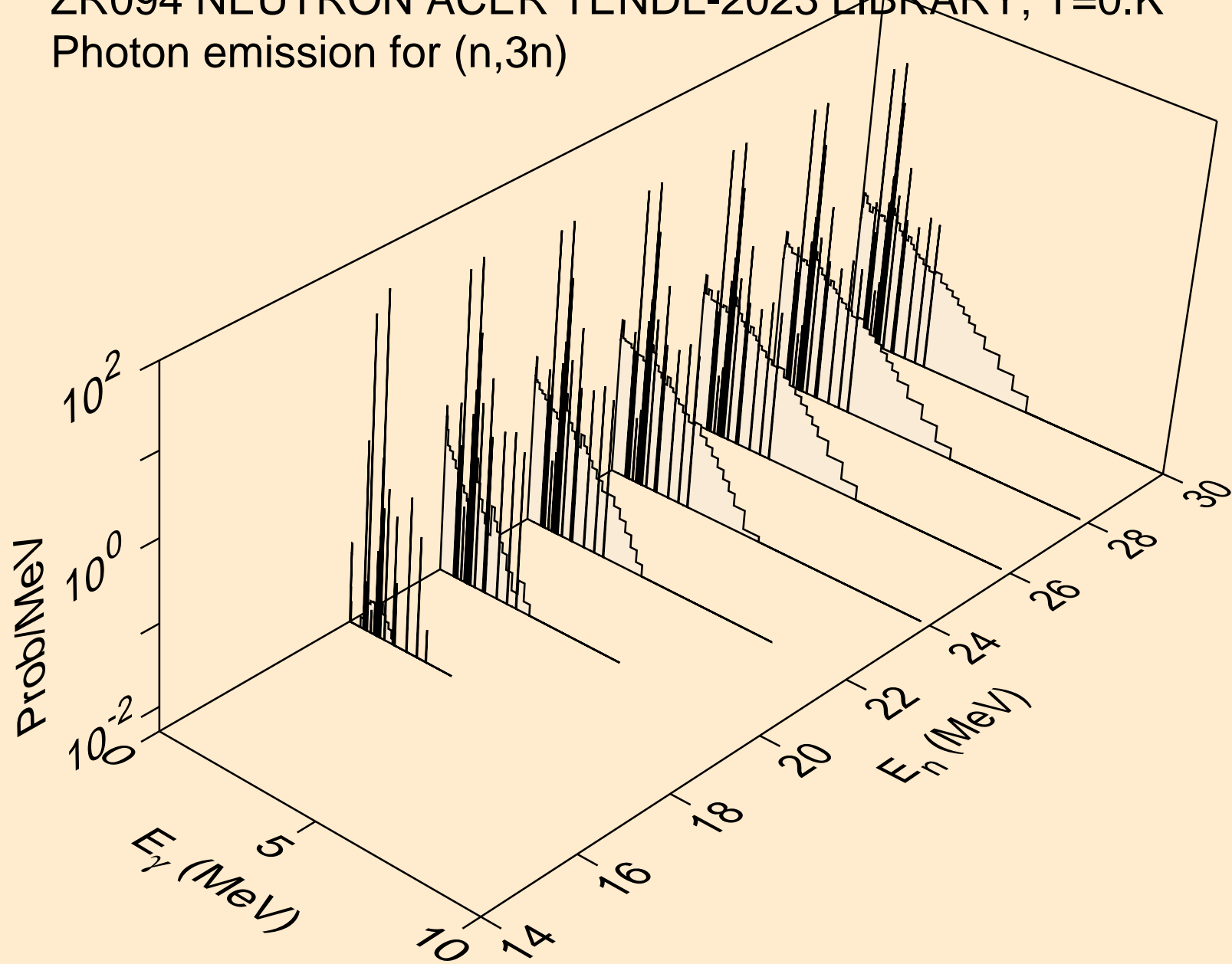

ZR094 NEUTRON ACER TENDL-2023 LIBRARY; T=0.K  
Photon emission for (n,n\*)a

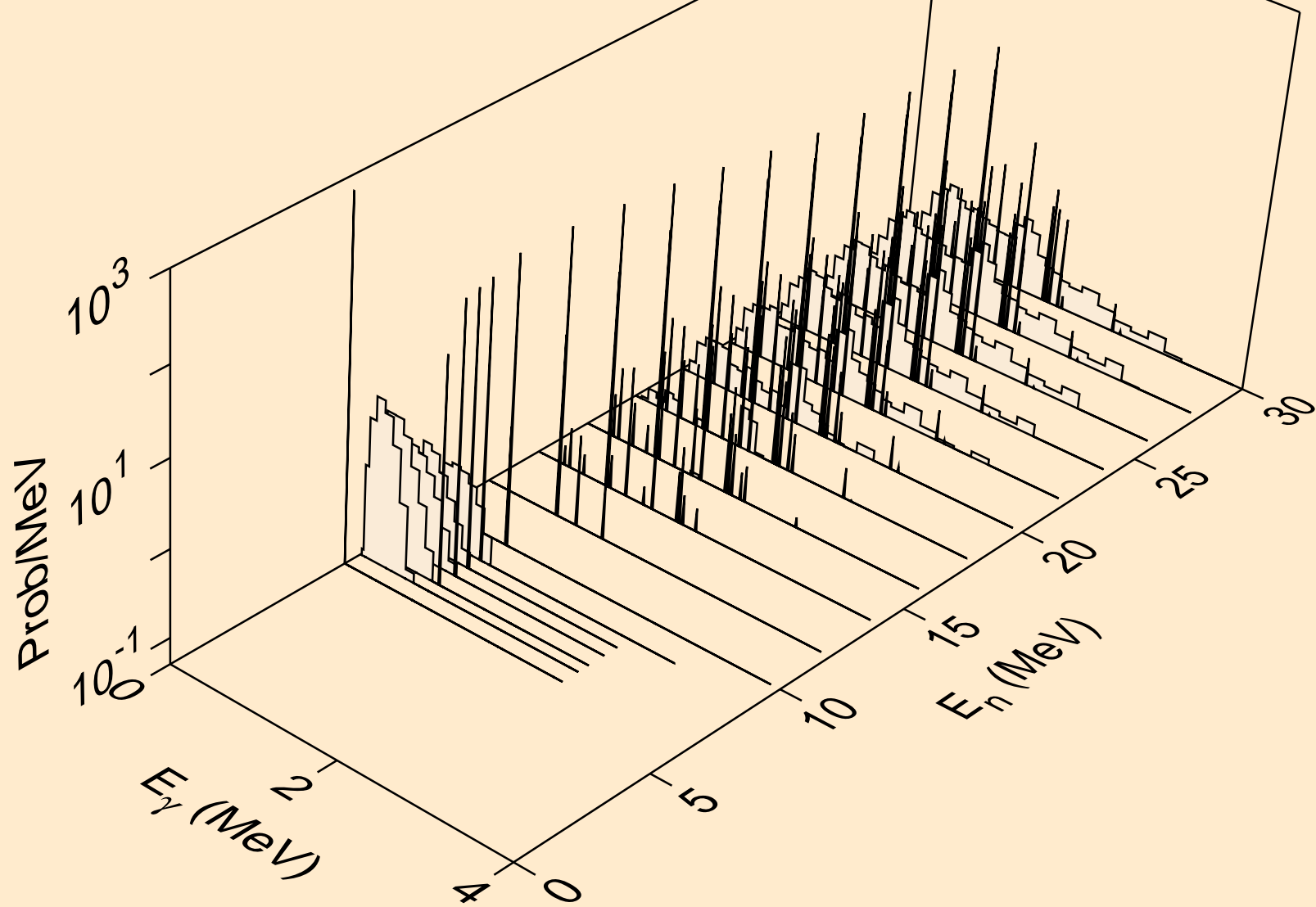

ZR094 NEUTRON ACER TENDL-2023 LIBRARY; T=0.K  
Photon emission for (n,2n)a

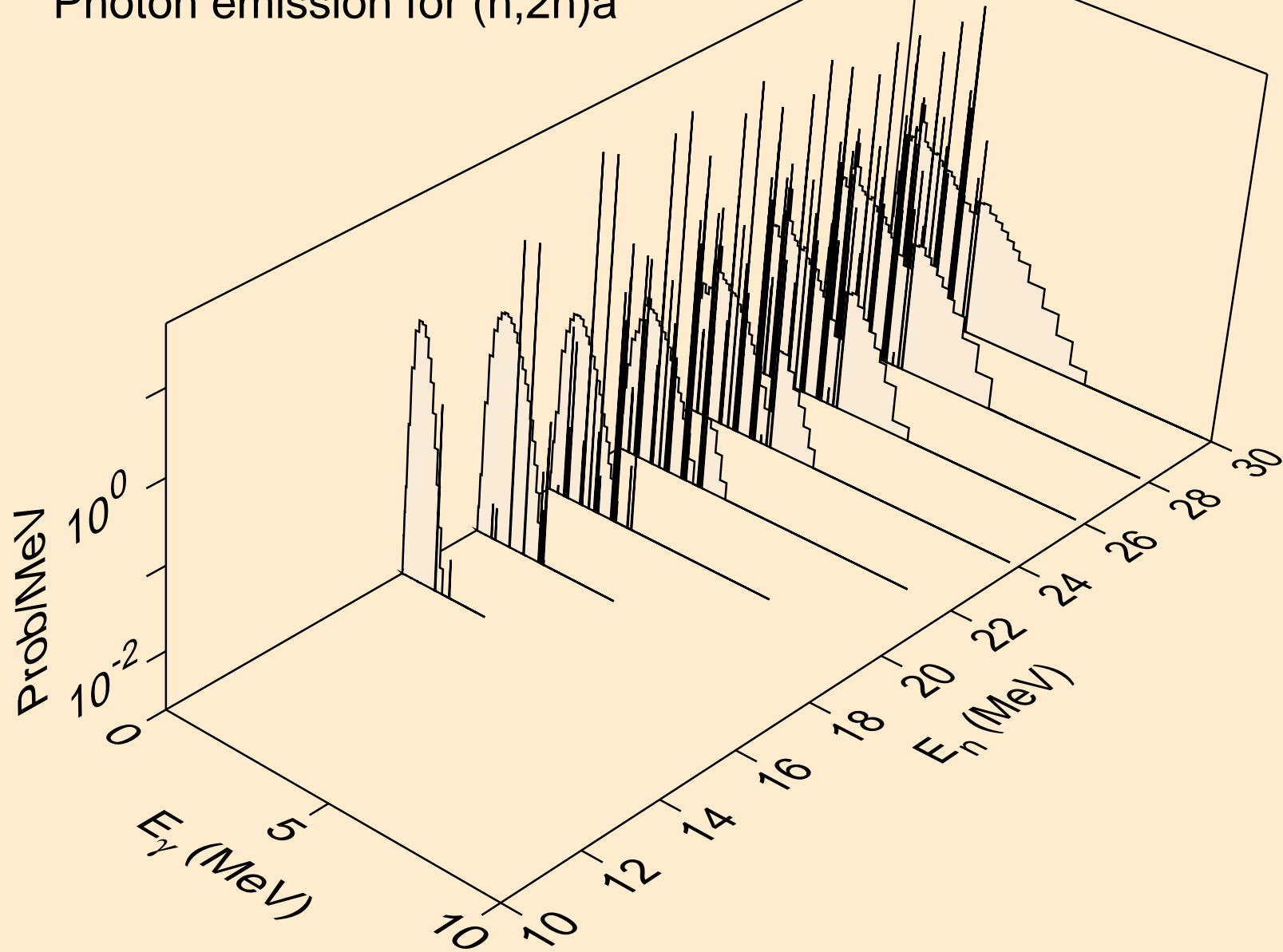

ZR094 NEUTRON ACER TENDL-2023 LIBRARY; T=0.K  
Photon emission for (n,3n)a

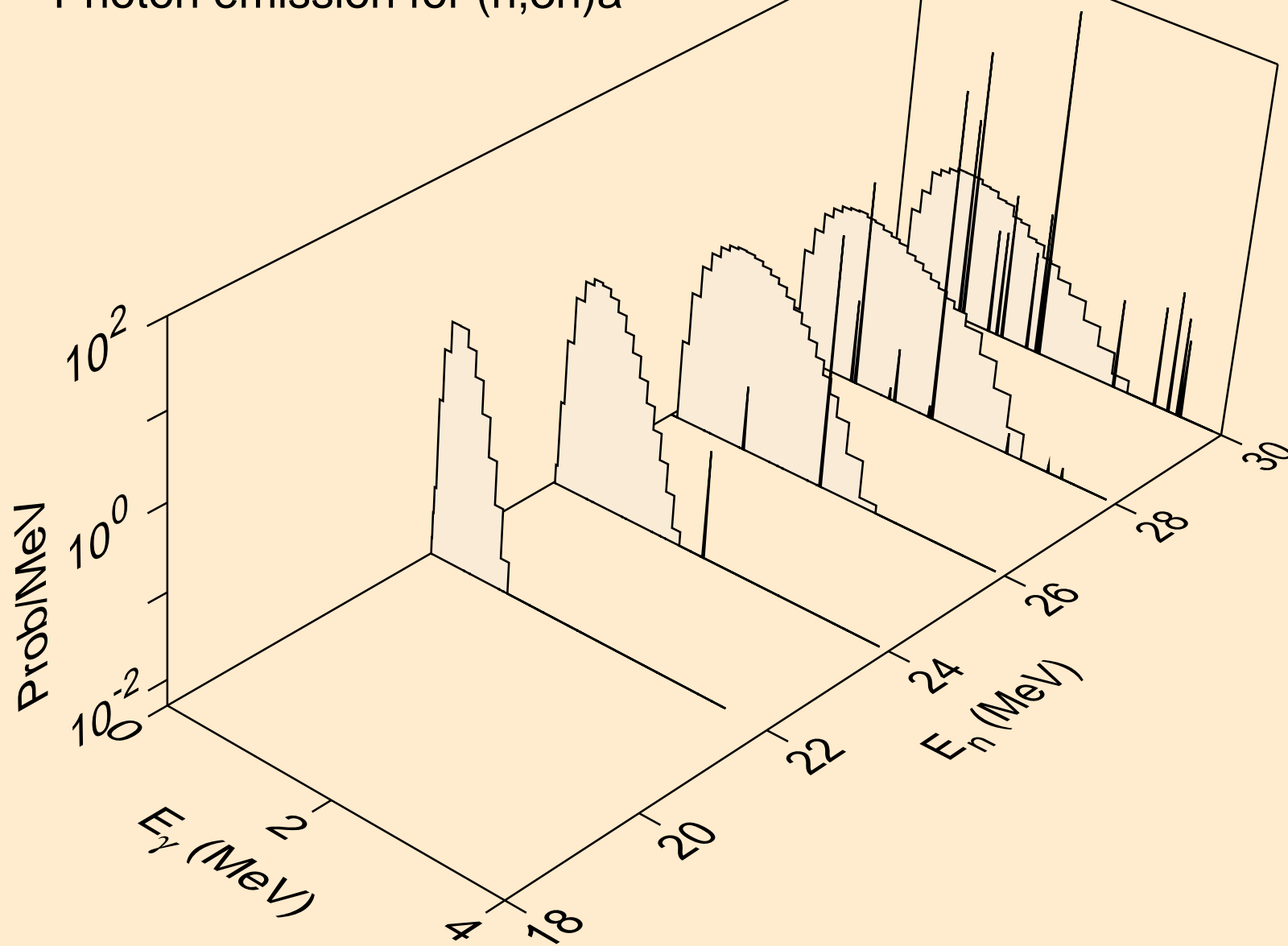

ZR094 NEUTRON ACER TENDL-2023 LIBRARY; T=0.K  
Photon emission for (n,n\*)p

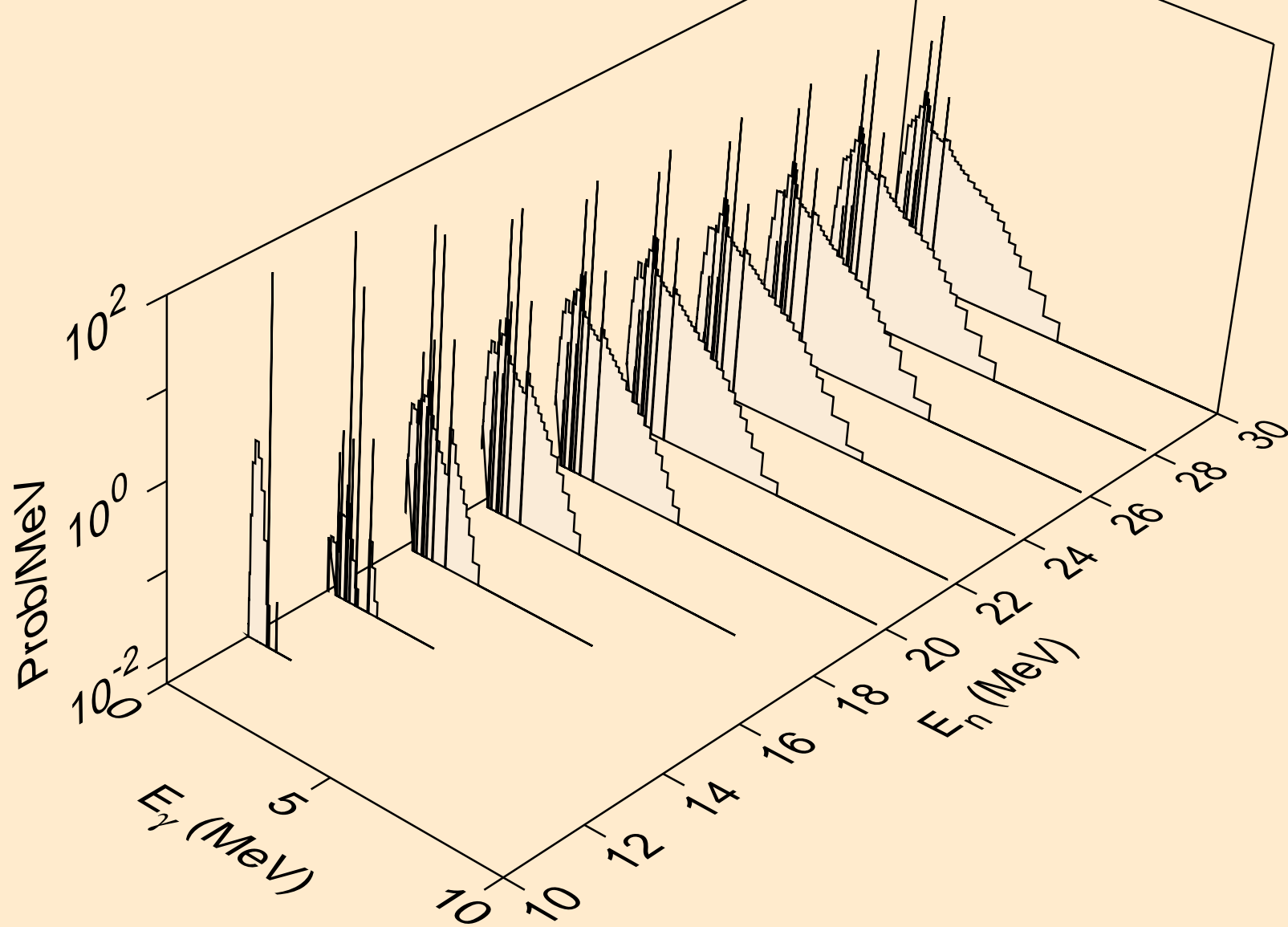

ZR094 NEUTRON ACER TENDL-2023 LIBRARY; T=0.K  
Photon emission for (n,n\*)2a

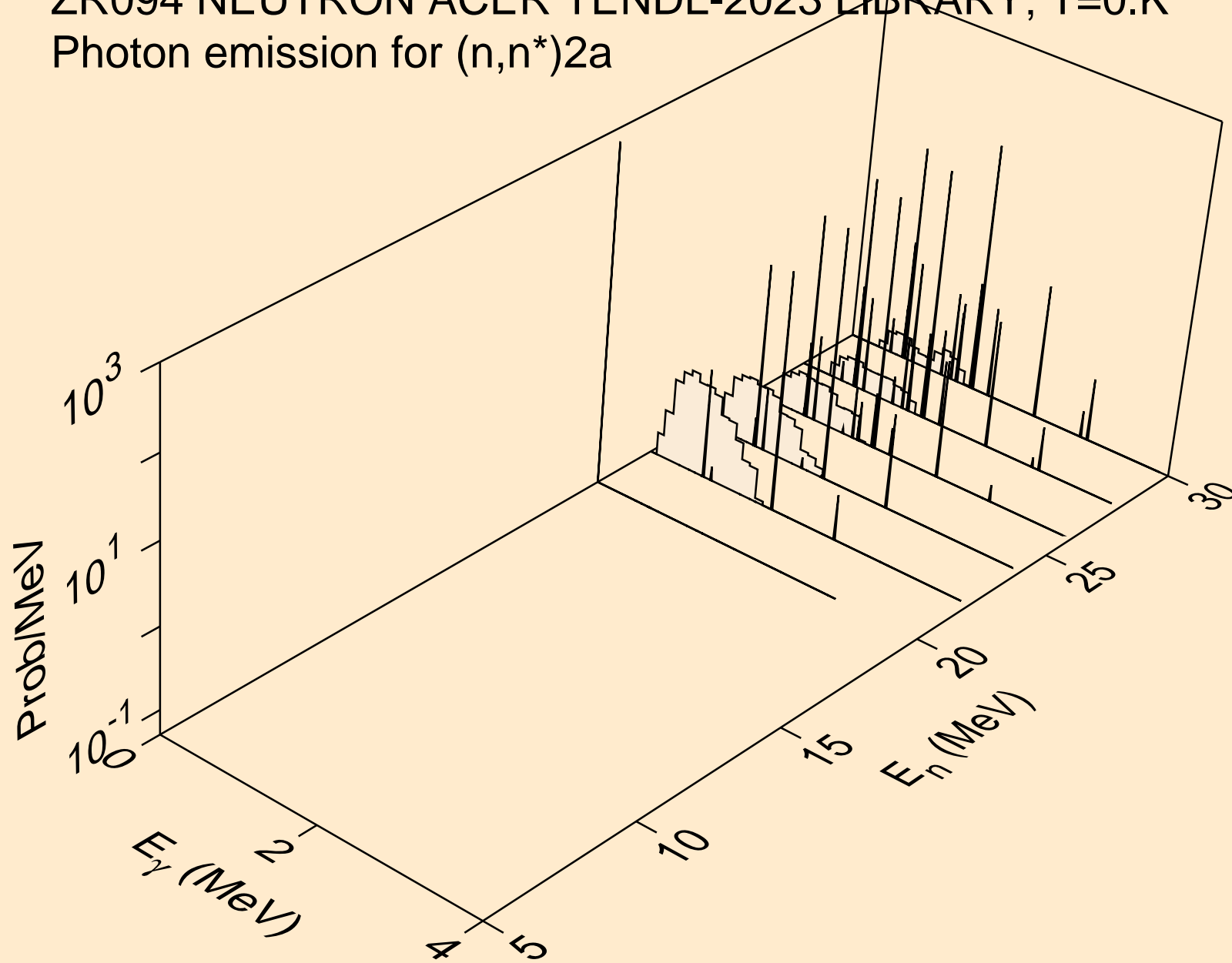

ZR094 NEUTRON ACER TENDL-2023 LIBRARY; T=0.K  
Photon emission for (n,n\*)d

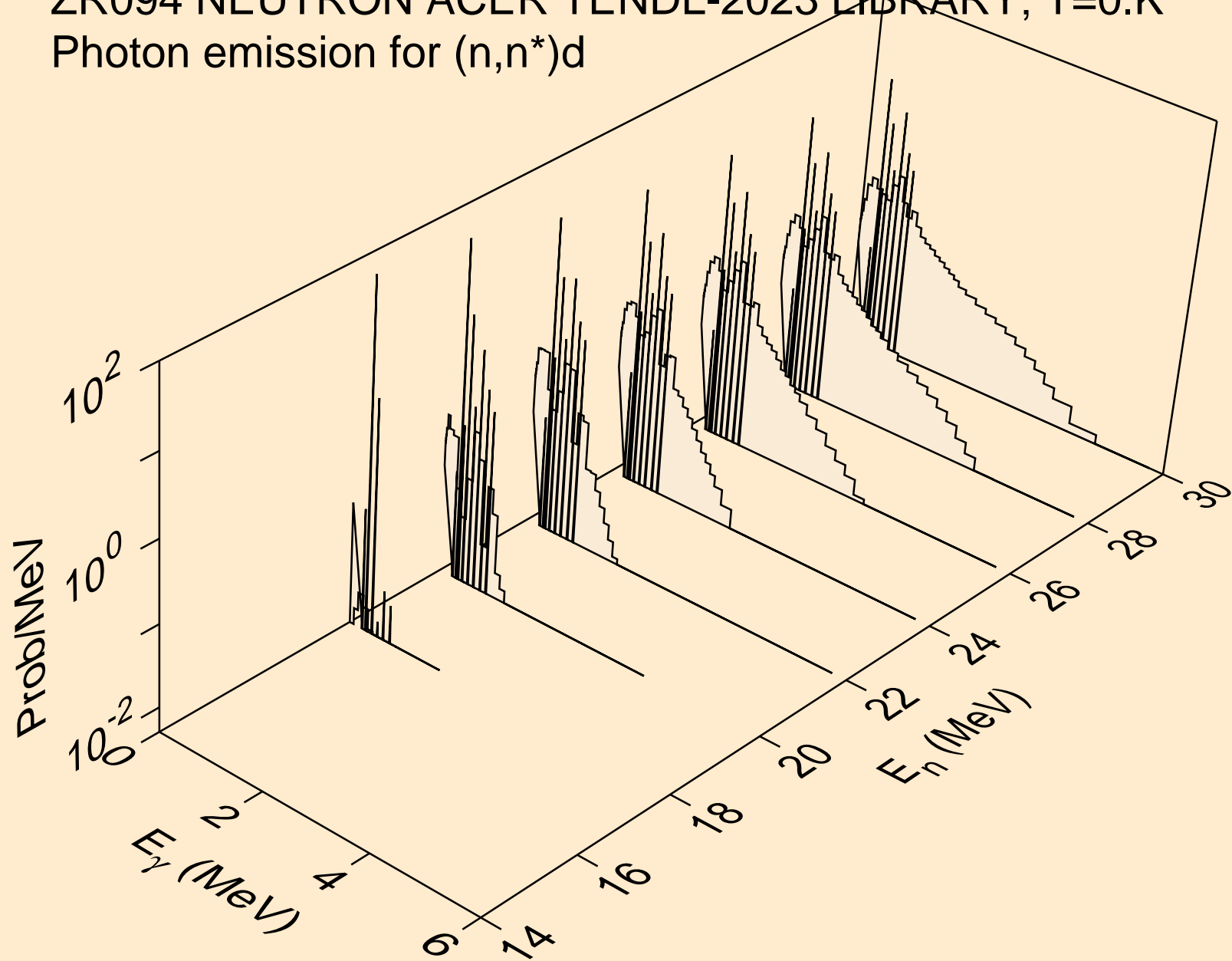

ZR094 NEUTRON ACER TENDL-2023 LIBRARY; T=0.K  
Photon emission for (n,n\*)t

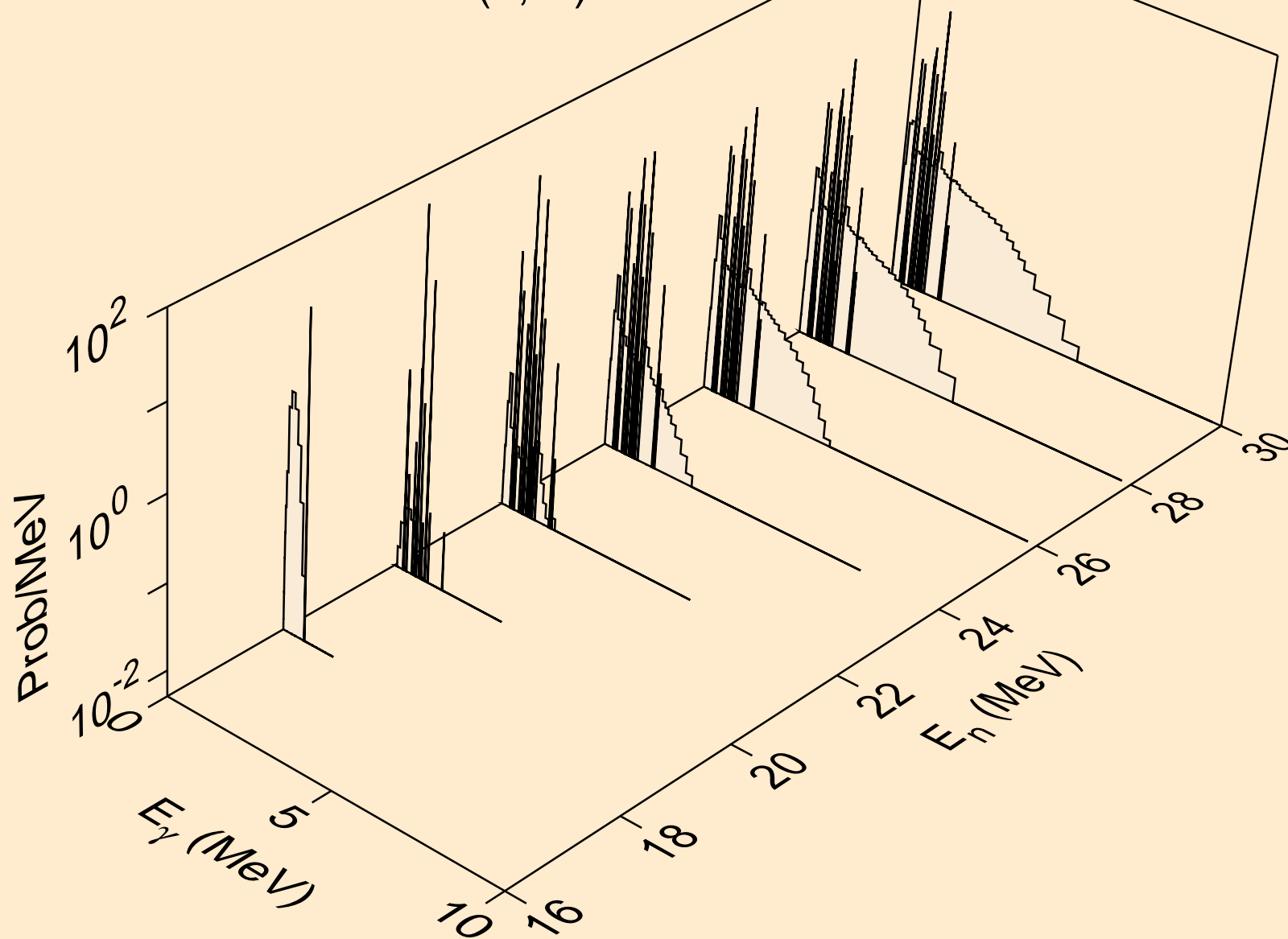

ZR094 NEUTRON ACER TENDL-2023 LIBRARY; T=0.K  
Photon emission for (n,n\*)he3

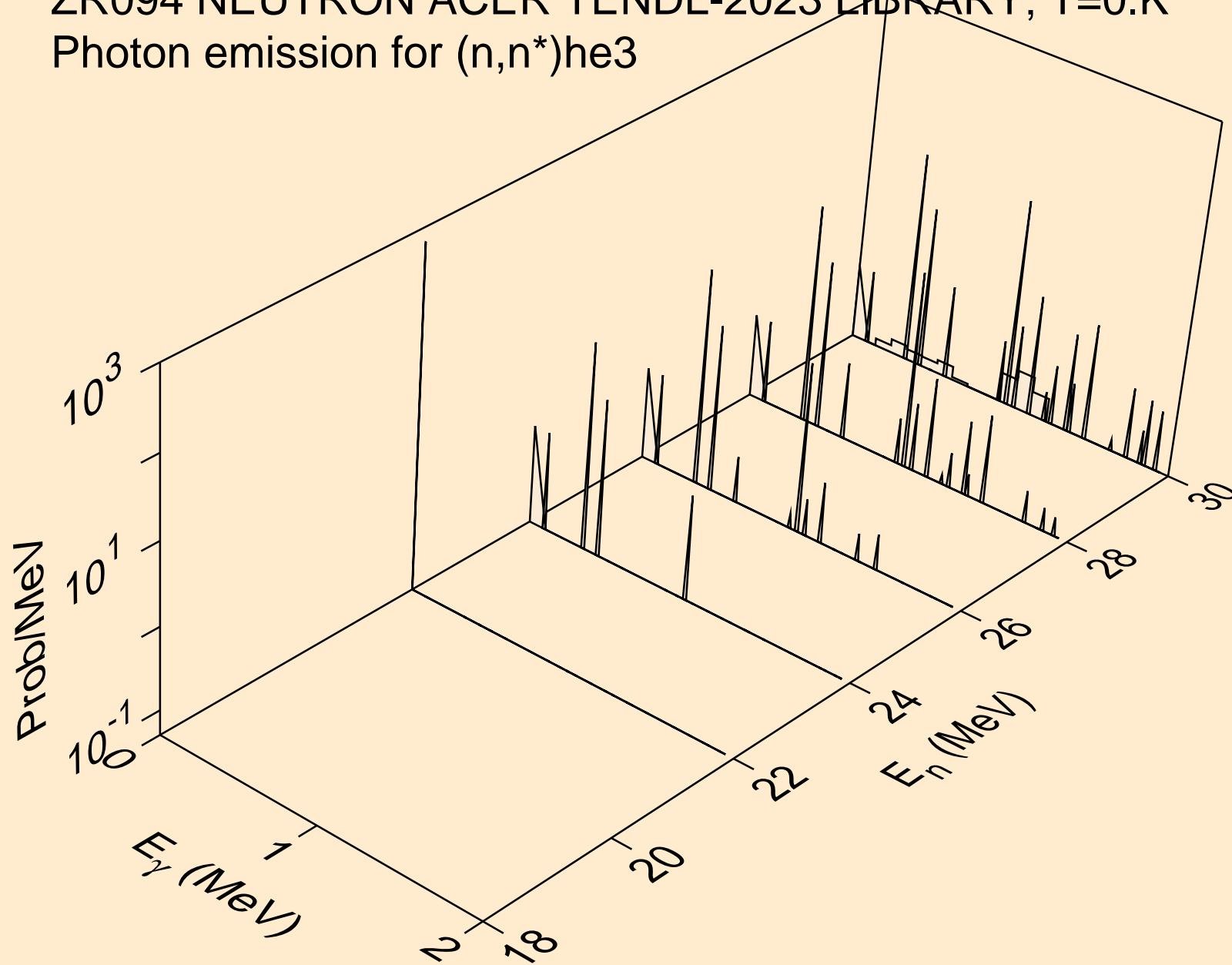

ZR094 NEUTRON ACER TENDL-2023 LIBRARY; T=0.K  
Photon emission for (n,4n)

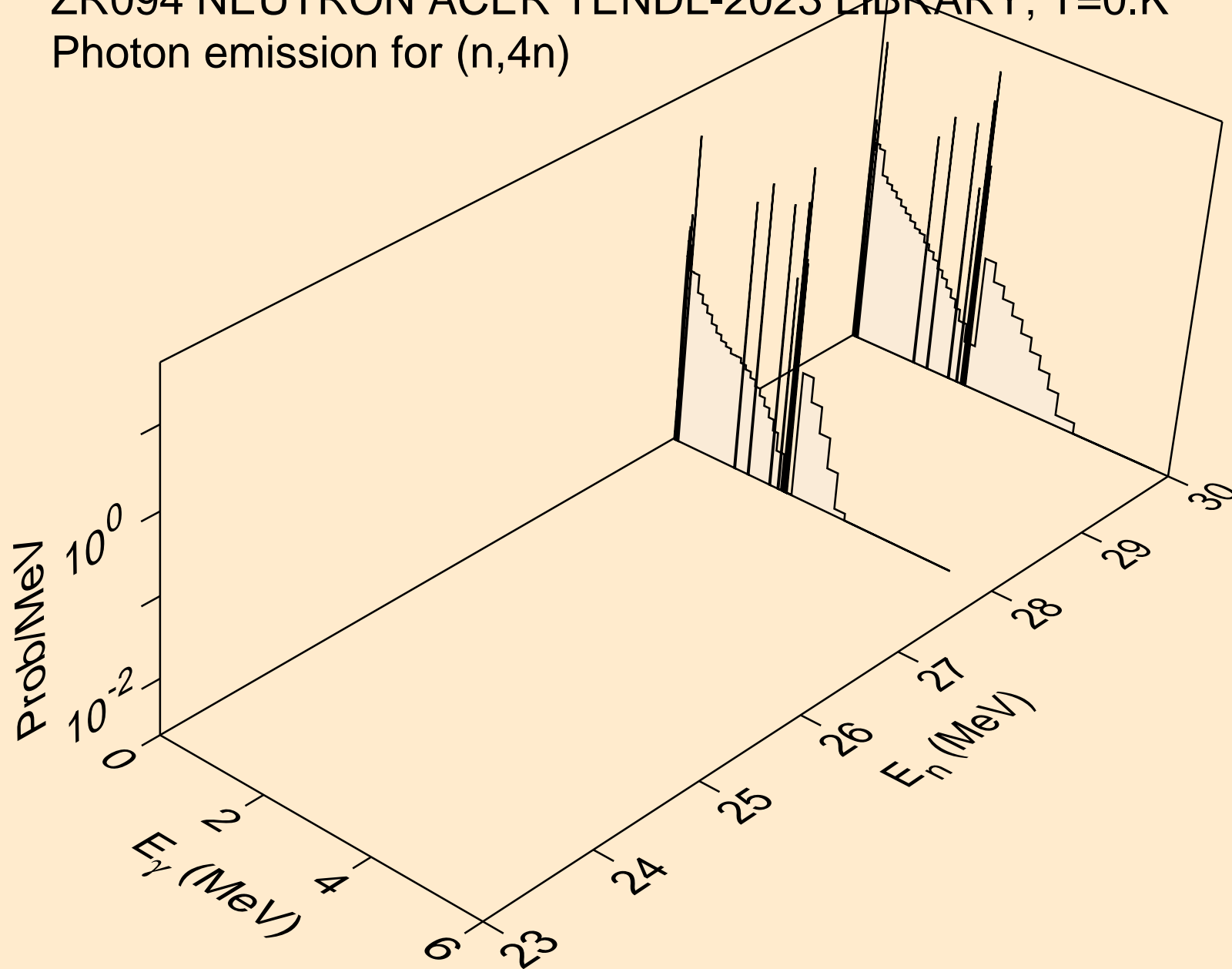

ZR094 NEUTRON ACER TENDL-2023 LIBRARY; T=0.K  
Photon emission for (n,2np)

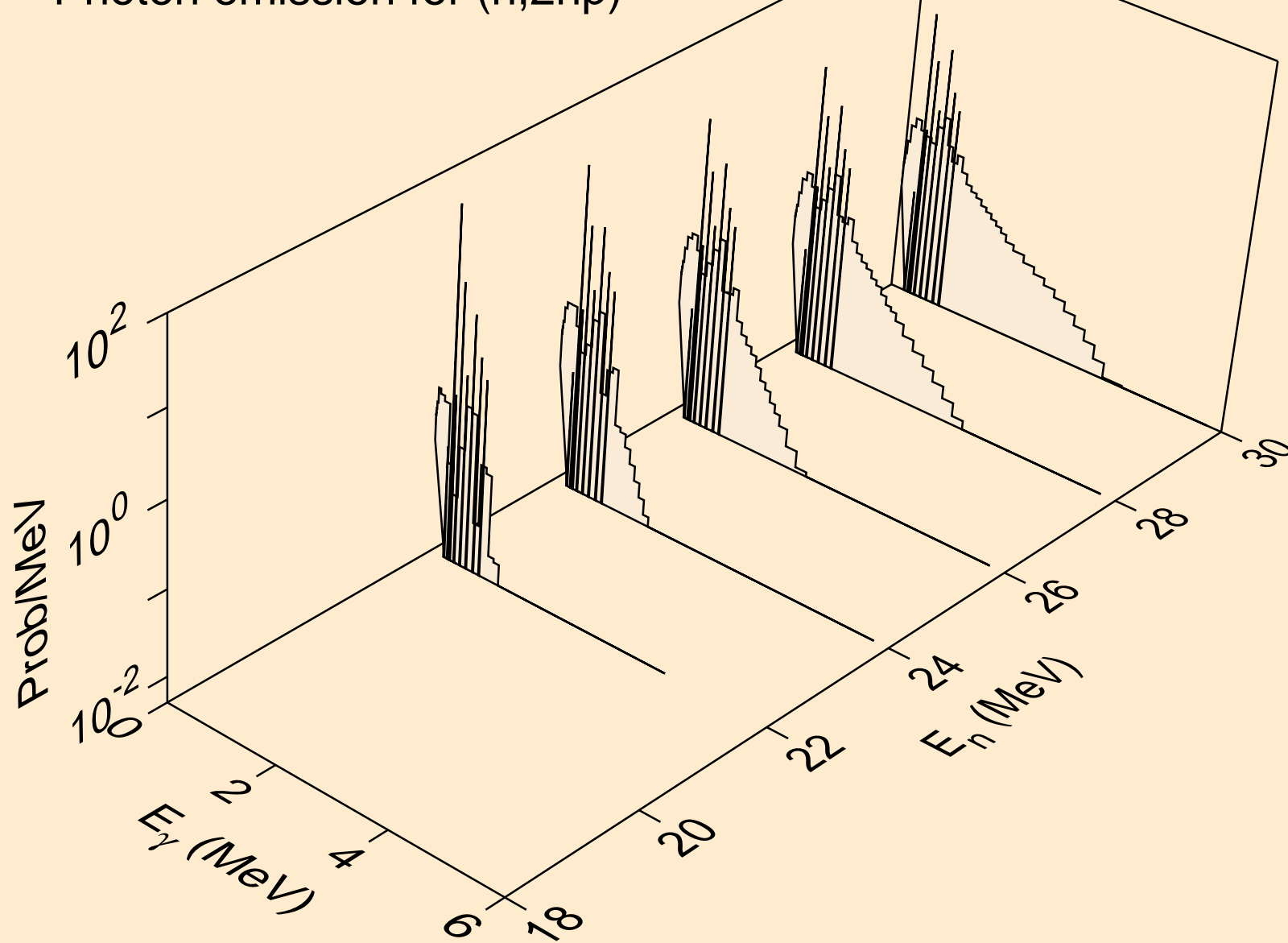

ZR094 NEUTRON ACER TENDL-2023 LIBRARY; T=0.K  
Photon emission for (n,3np)

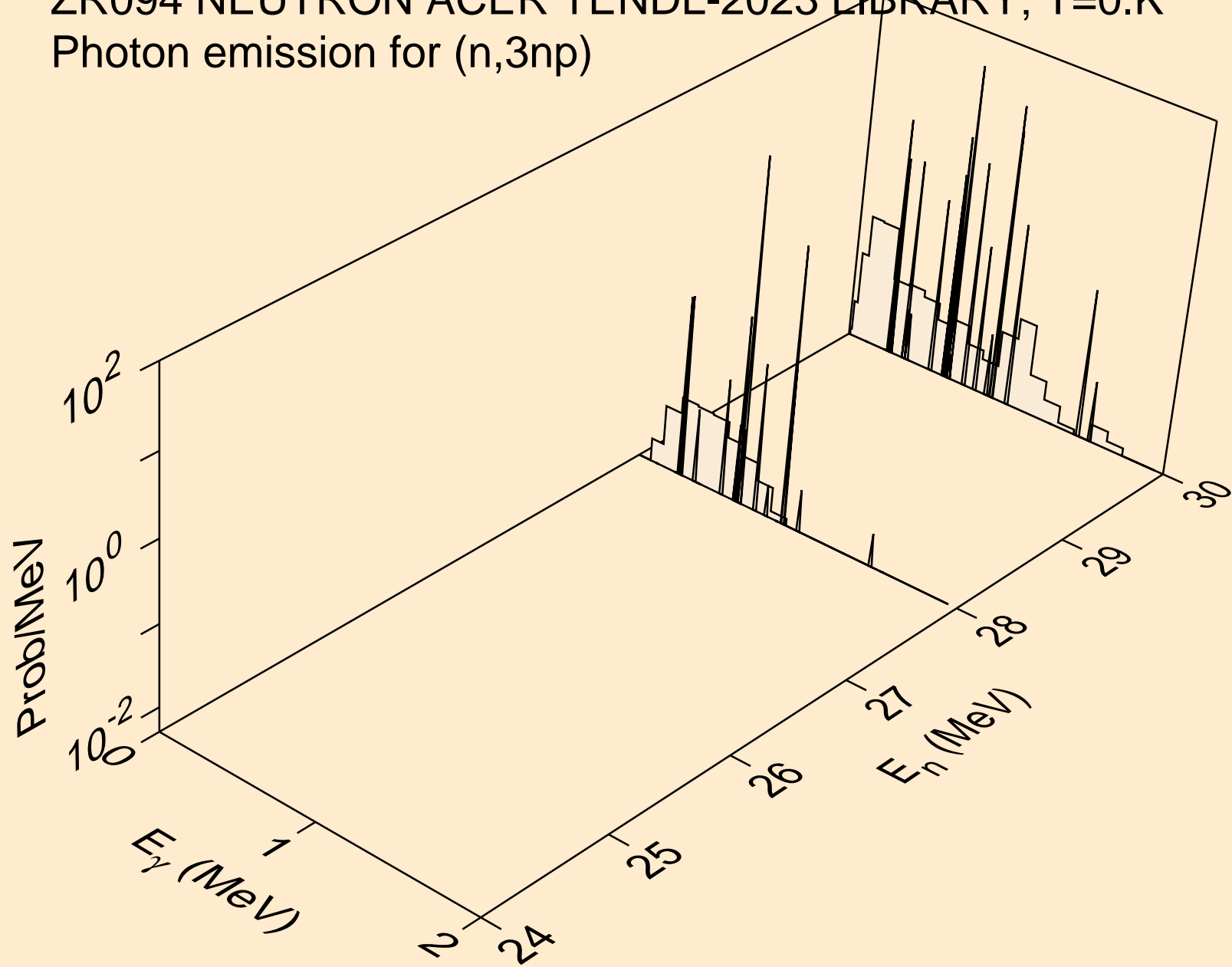

ZR094 NEUTRON ACER TENDL-2023 LIBRARY; T=0.K  
Photon emission for (n,n2p)

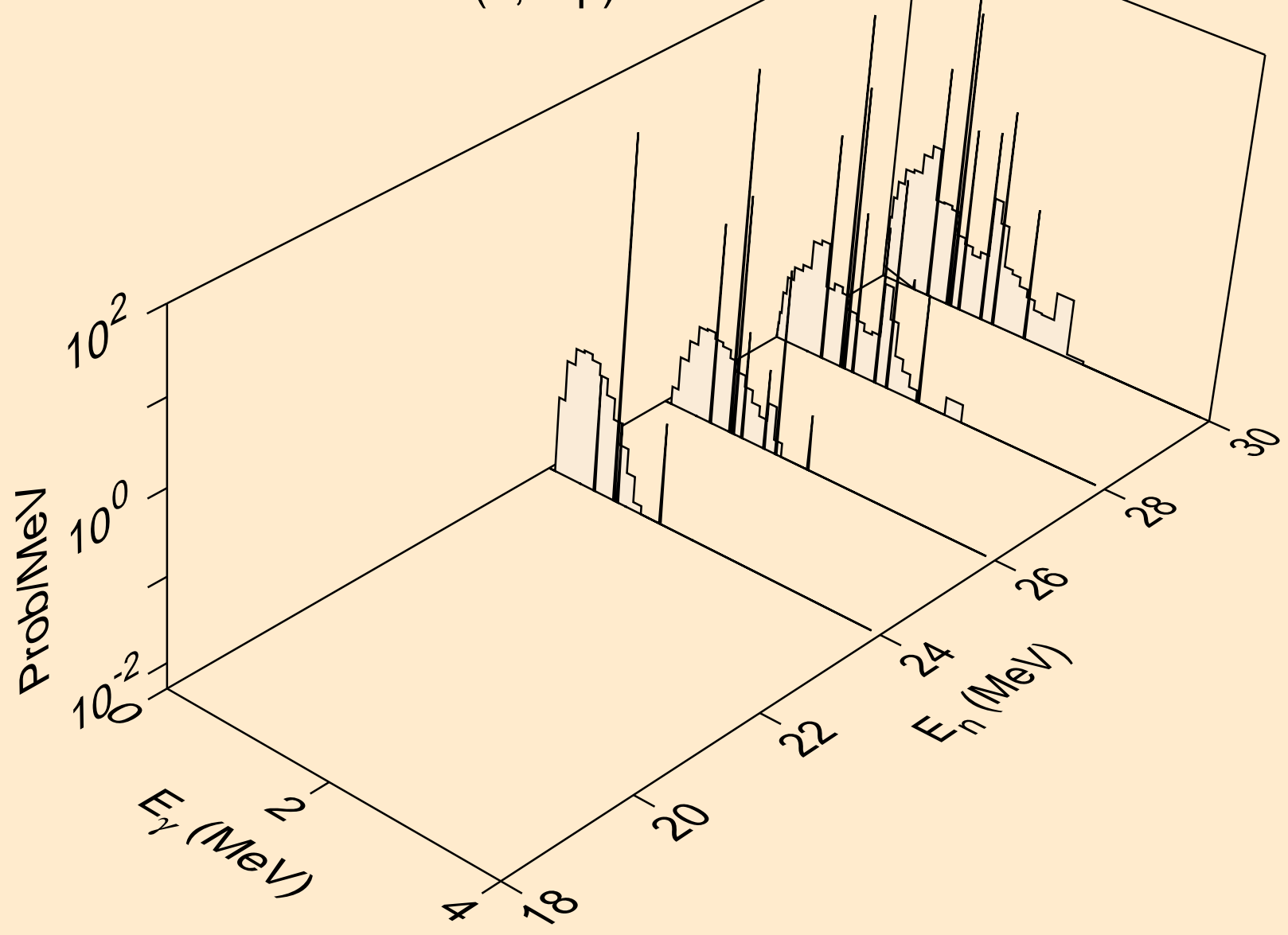

ZR094 NEUTRON ACER TENDL-2023 LIBRARY; T=0.K  
Photon emission for (n,npa)

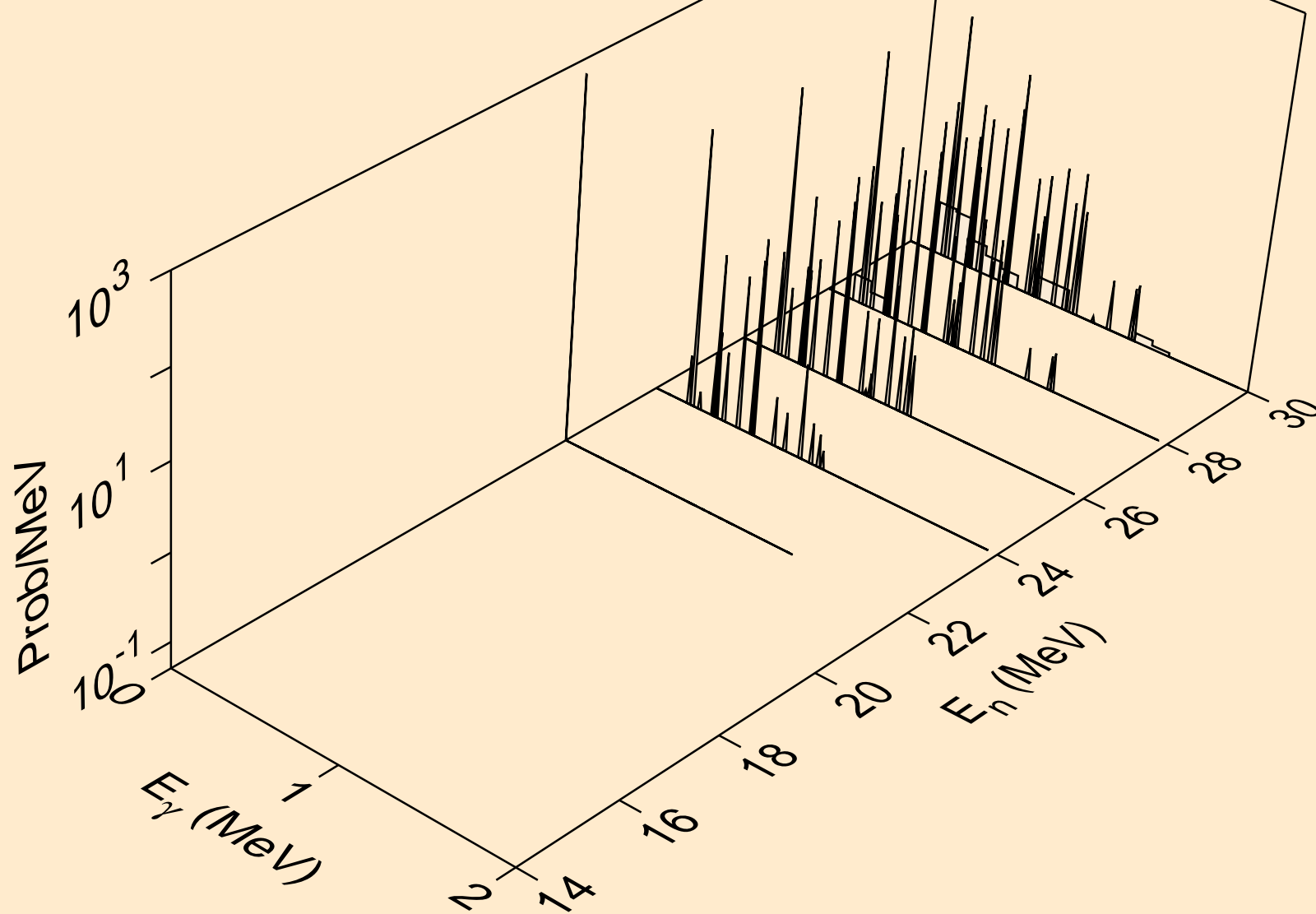

ZR094 NEUTRON ACER TENDL-2023 LIBRARY; T=0.K  
Photon emission for (n,n\*c)

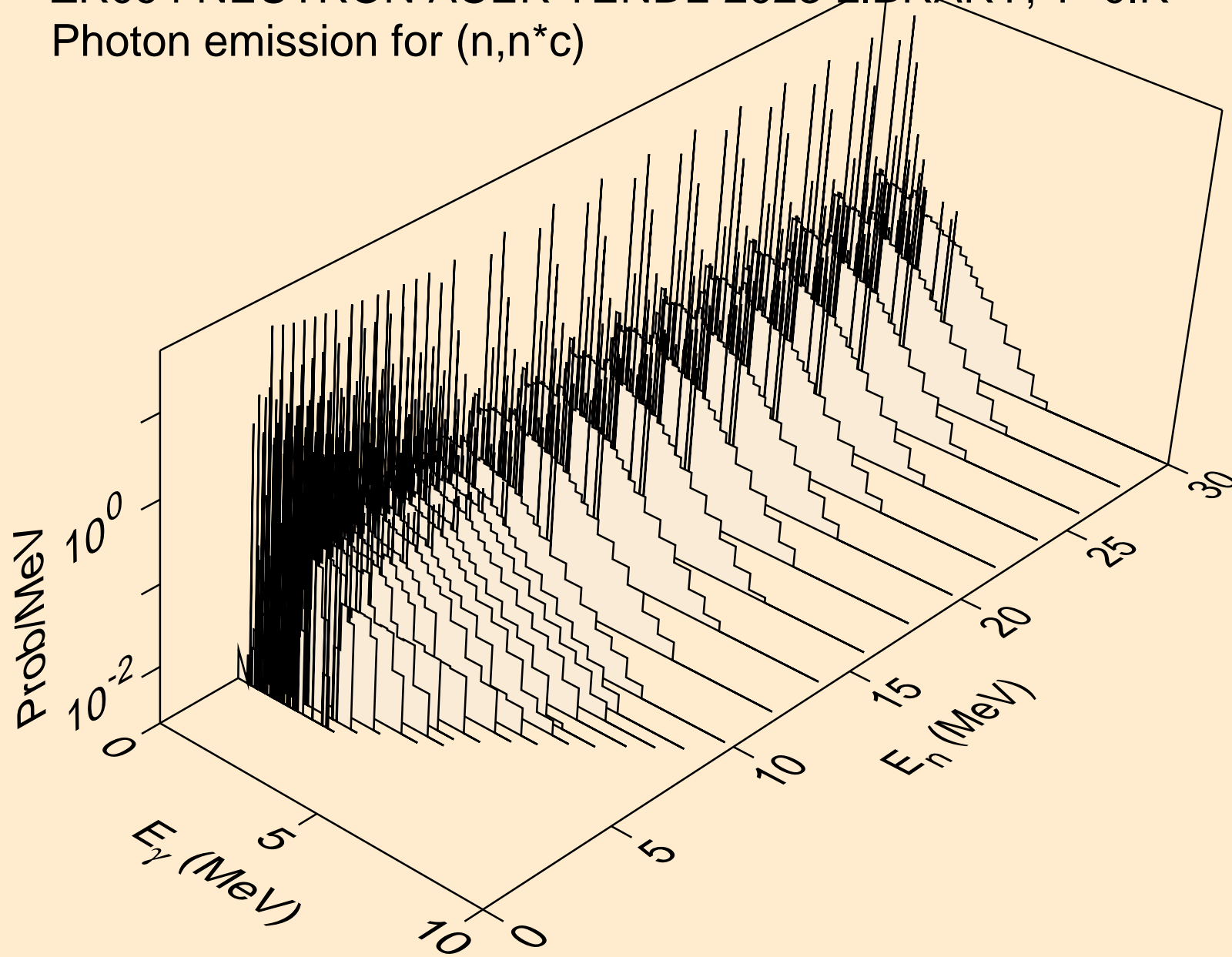

ZR094 NEUTRON ACER TENDL-2023 LIBRARY; T=0.K  
Photon emission for (n,gma)

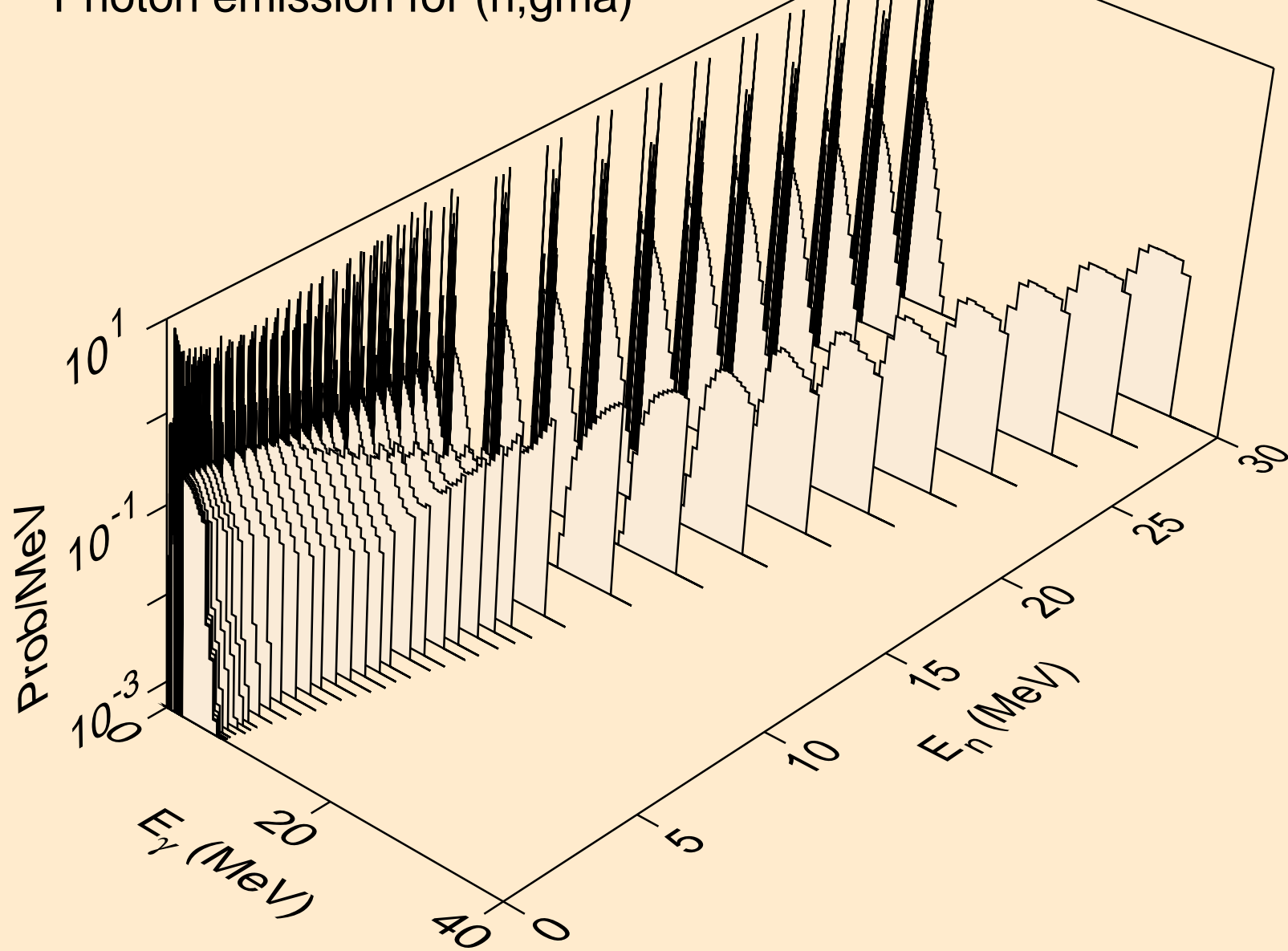

ZR094 NEUTRON ACER TENDL-2023 LIBRARY; T=0.K  
Photon emission for (n,p)

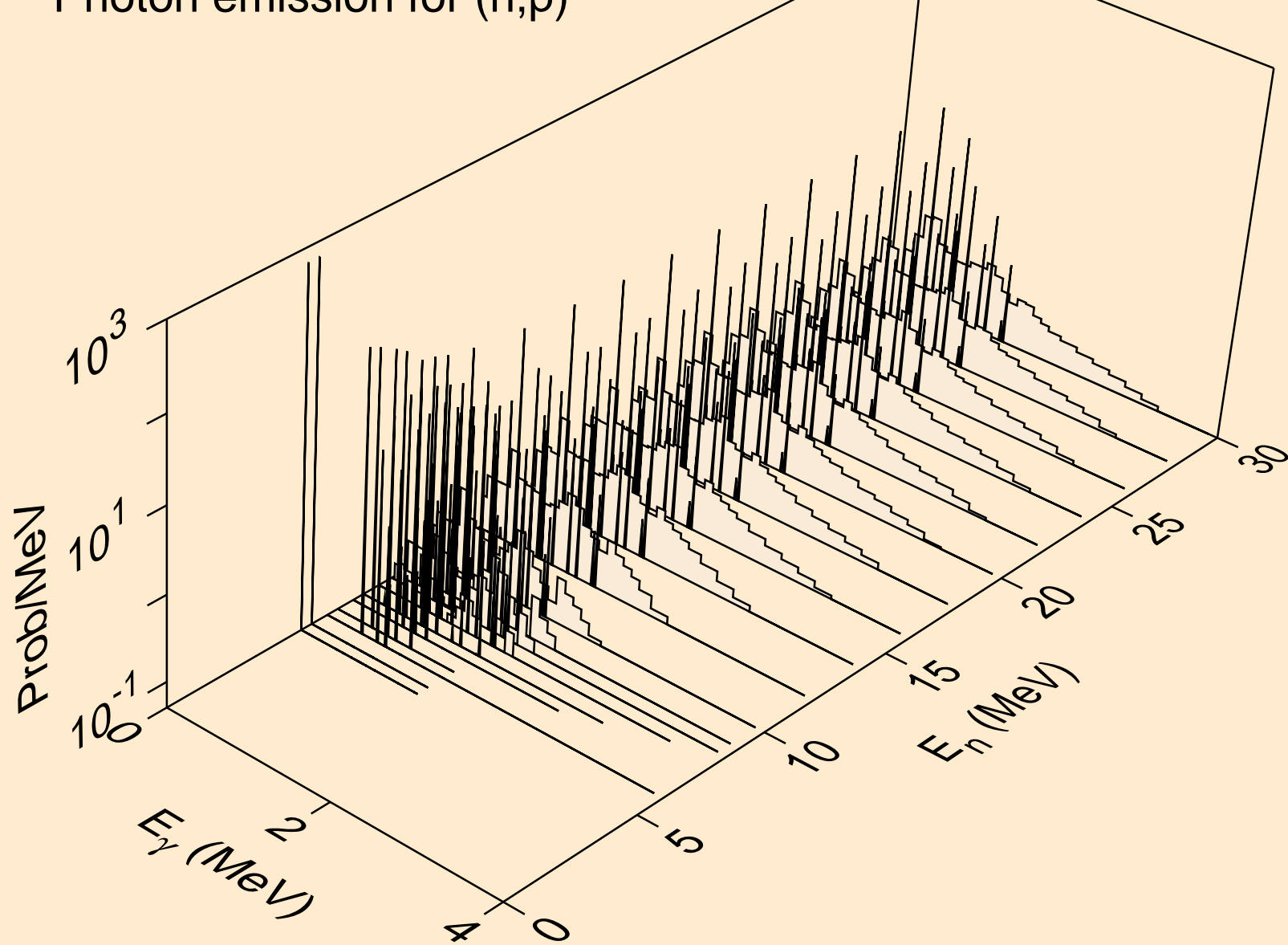

ZR094 NEUTRON ACER TENDL-2023 LIBRARY; T=0.K  
Photon emission for (n,d)

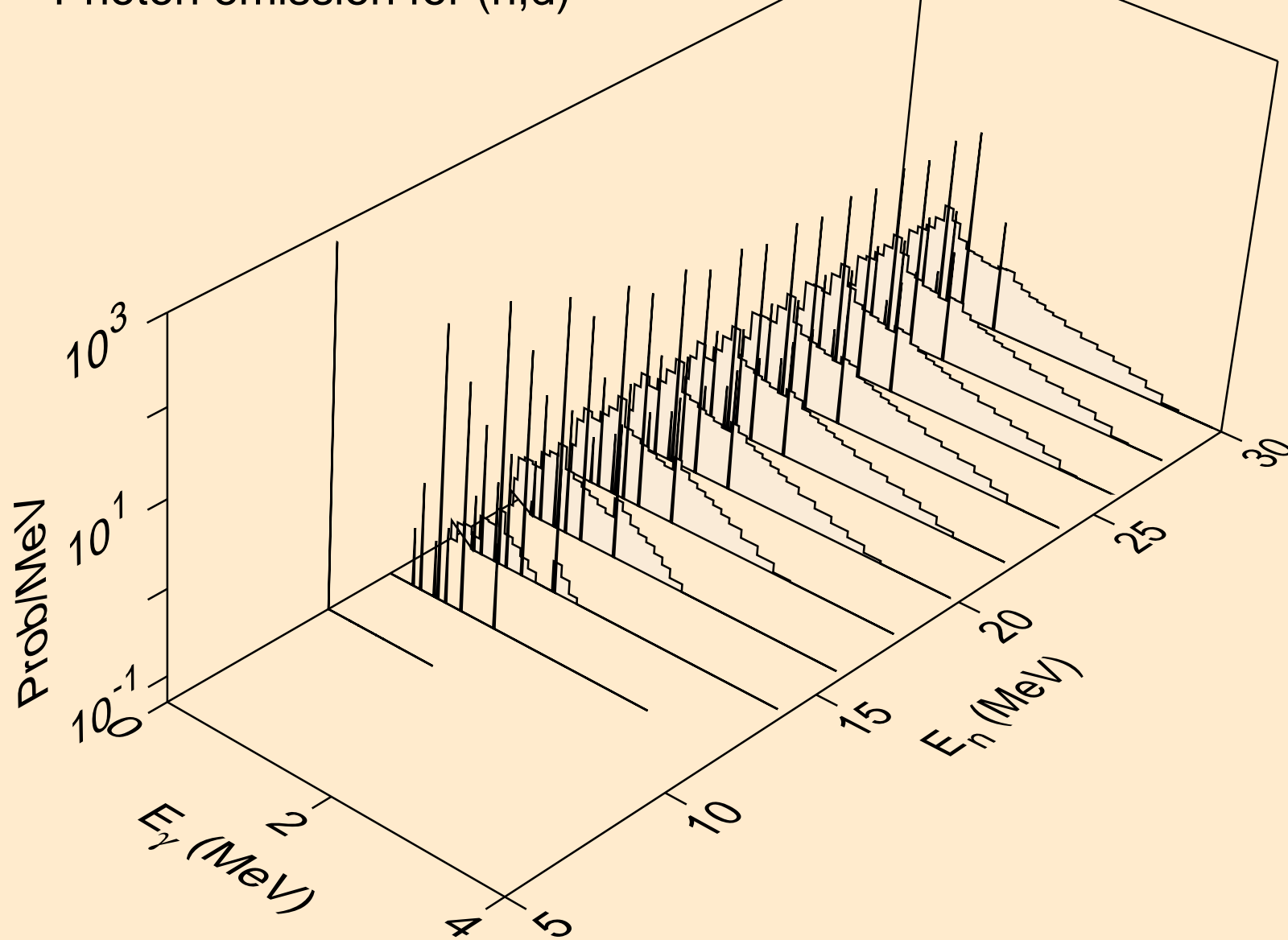

ZR094 NEUTRON ACER TENDL-2023 LIBRARY; T=0.K  
Photon emission for (n,t)

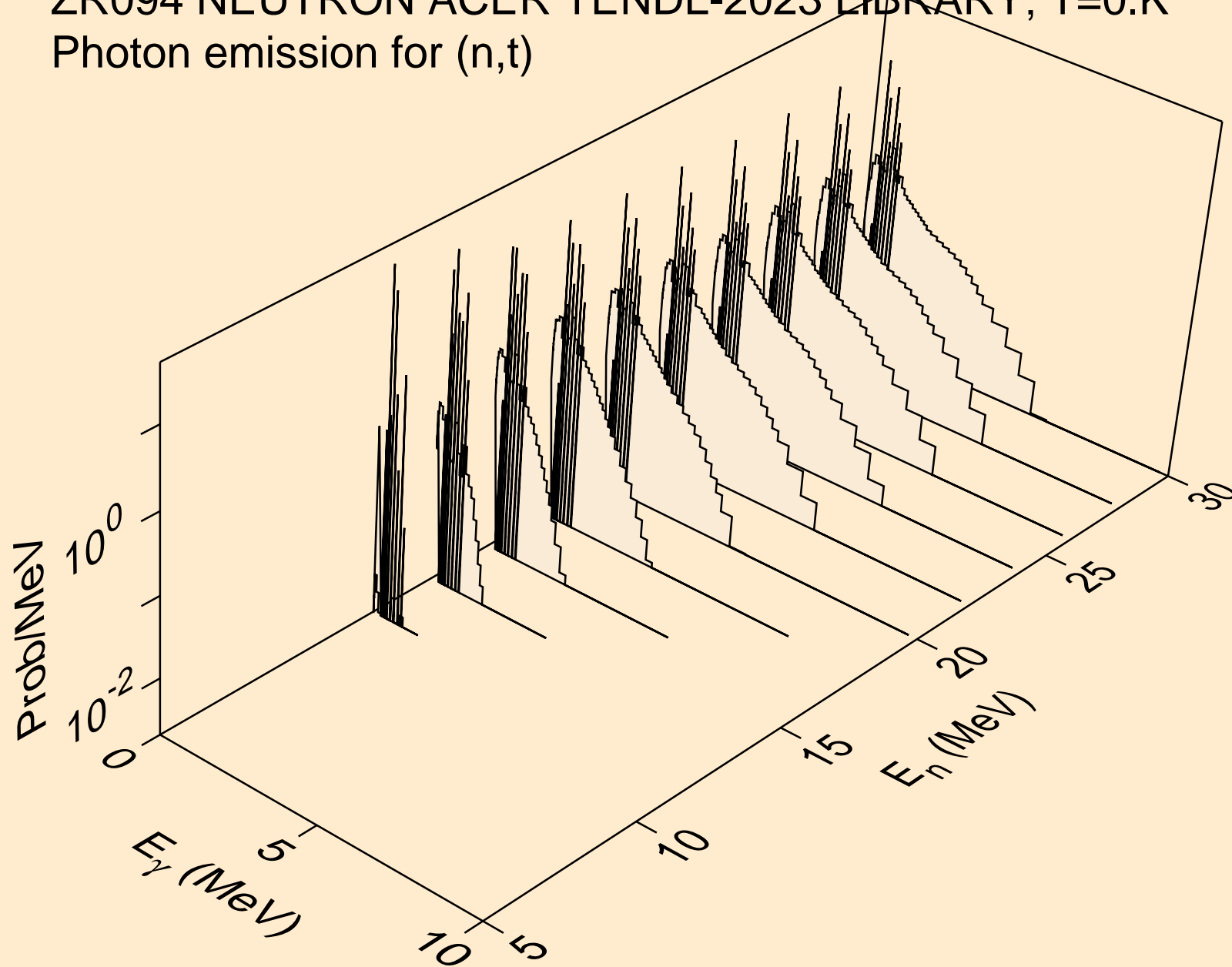

ZR094 NEUTRON ACER TENDL-2023 LIBRARY; T=0.K  
Photon emission for (n,he3)

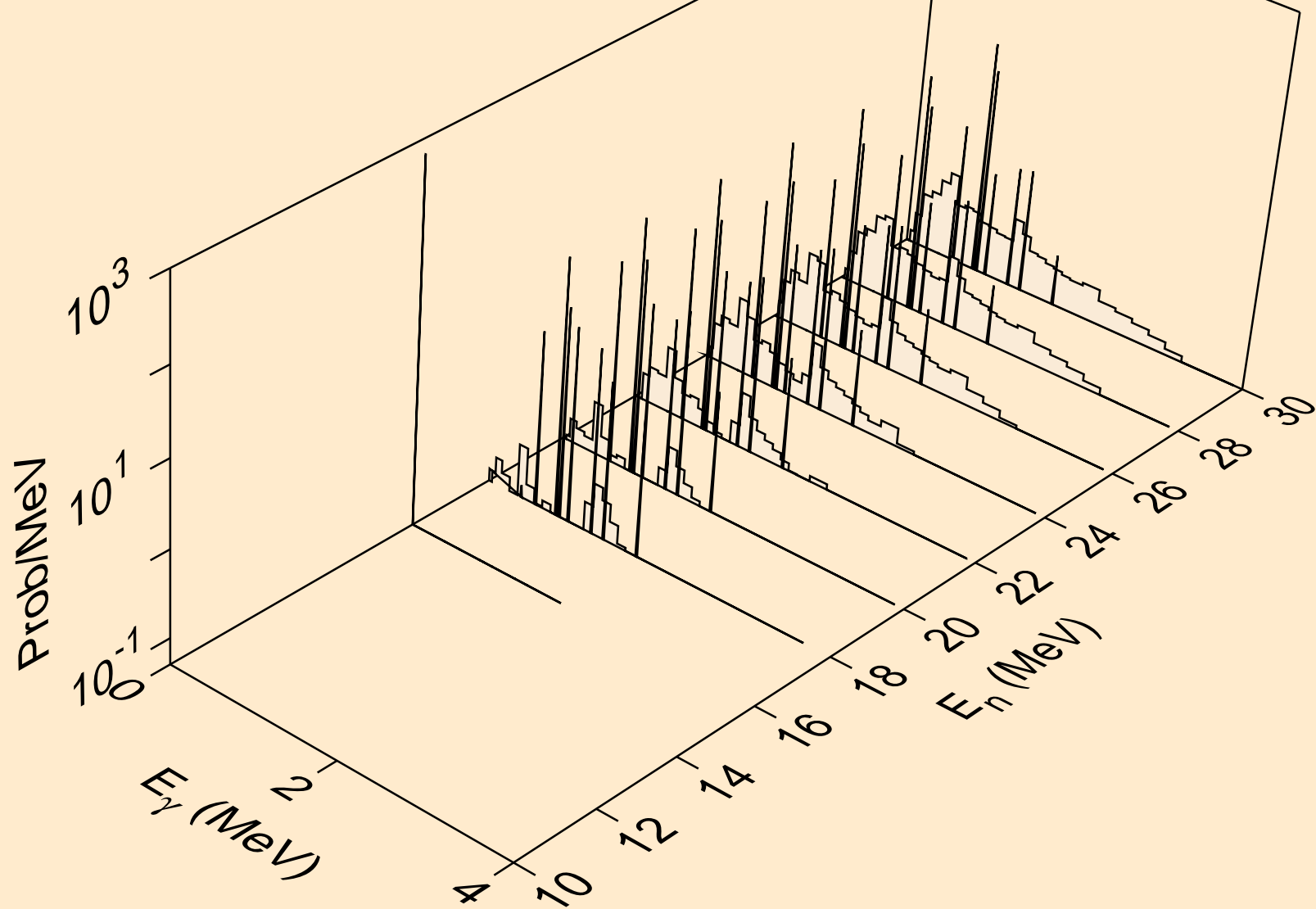

ZR094 NEUTRON ACER TENDL-2023 LIBRARY; T=0.K  
Photon emission for (n,a)

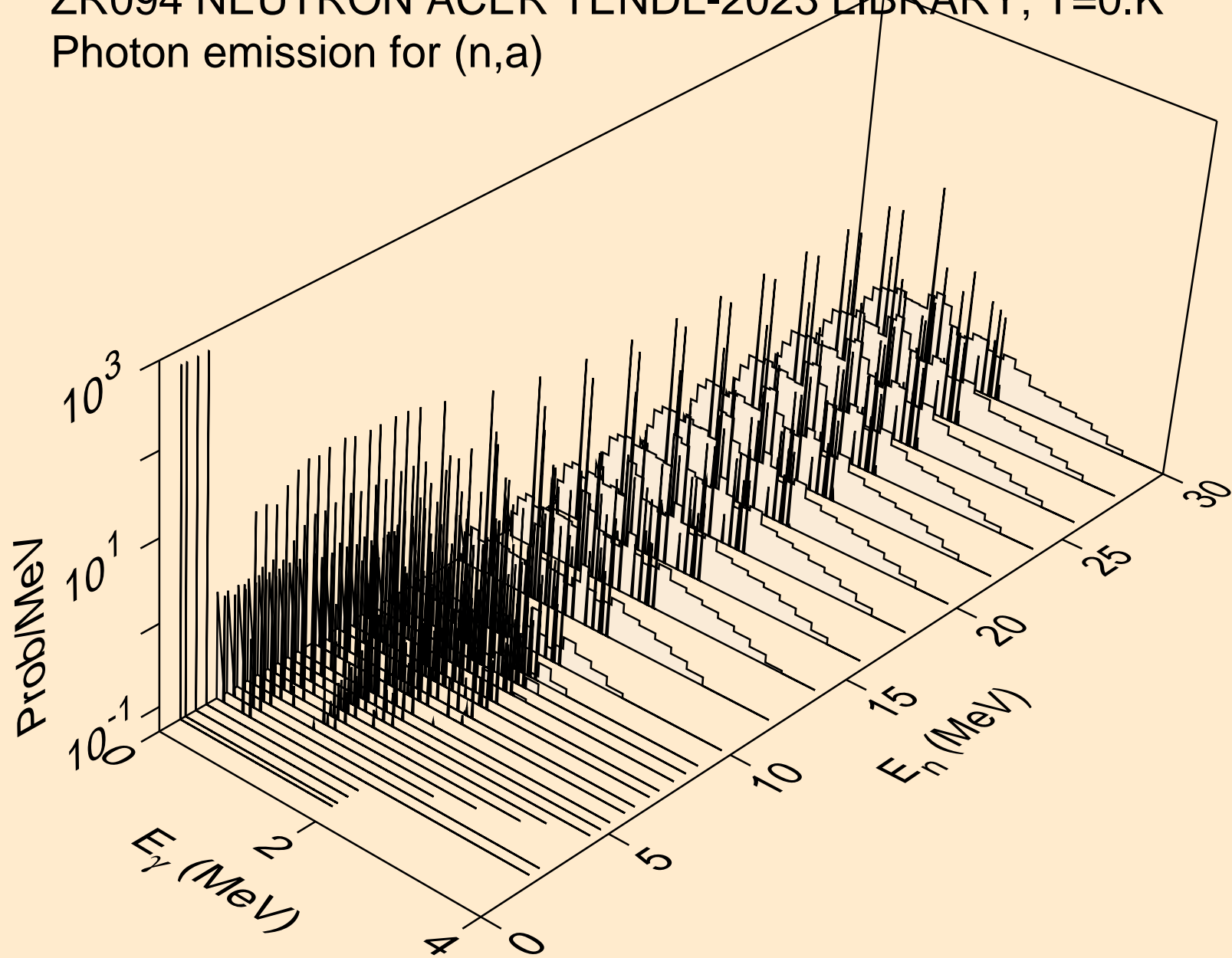

ZR094 NEUTRON ACER TENDL-2023 LIBRARY; T=0.K  
Photon emission for (n,2a)

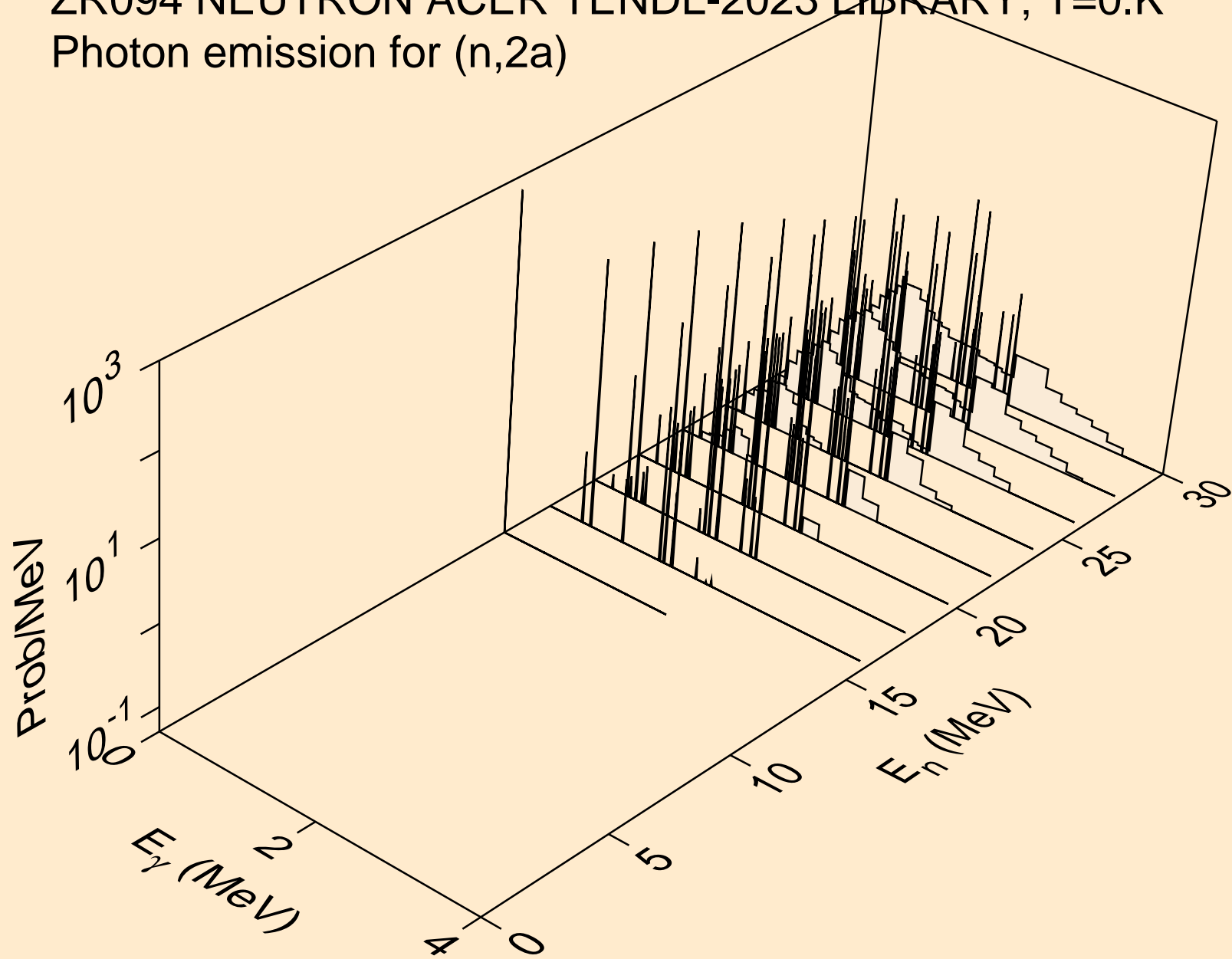

ZR094 NEUTRON ACER TENDL-2023 LIBRARY; T=0.K  
Photon emission for (n,2p)

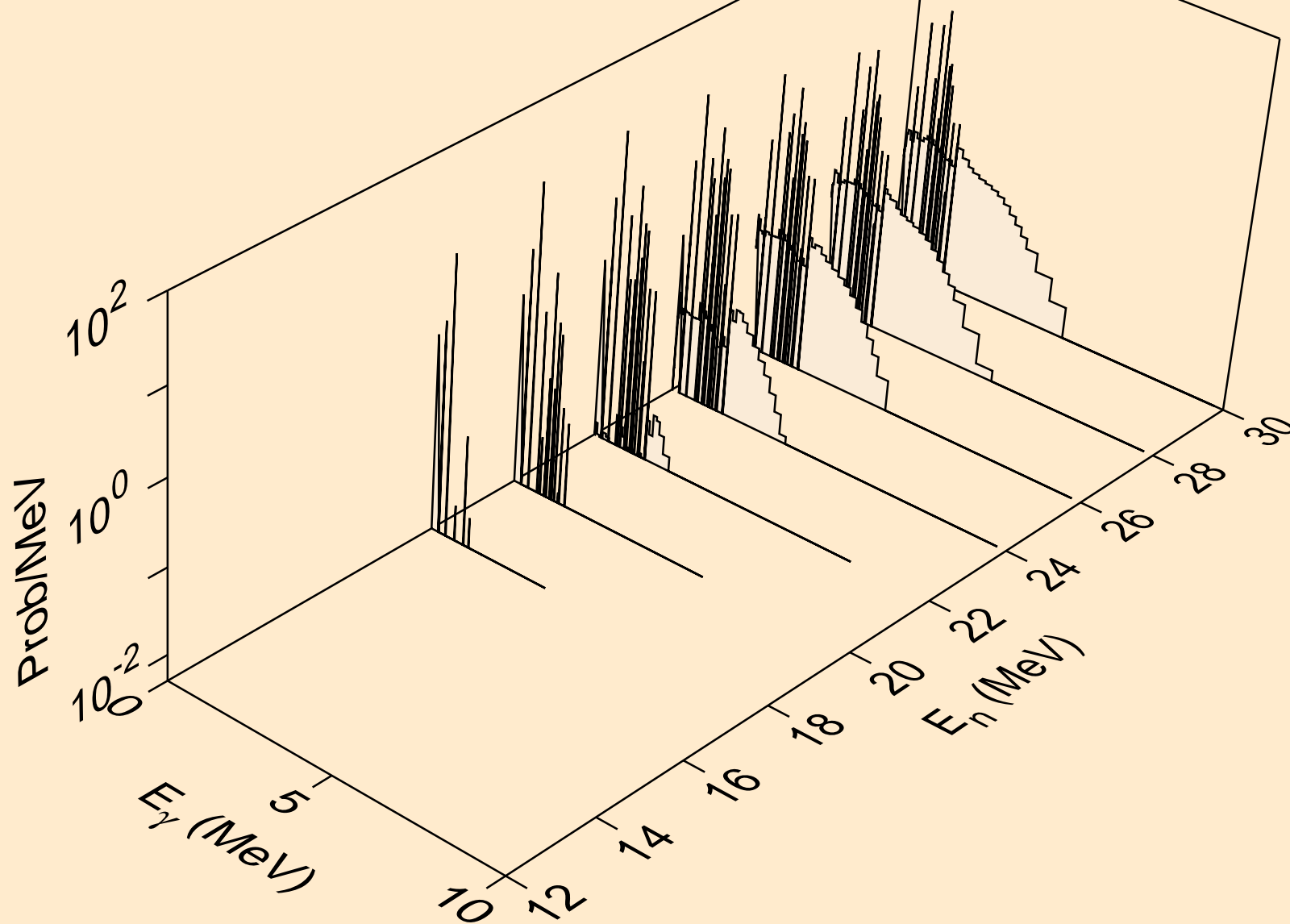

ZR094 NEUTRON ACER TENDL-2023 LIBRARY; T=0.K  
Photon emission for (n,p $\alpha$ )

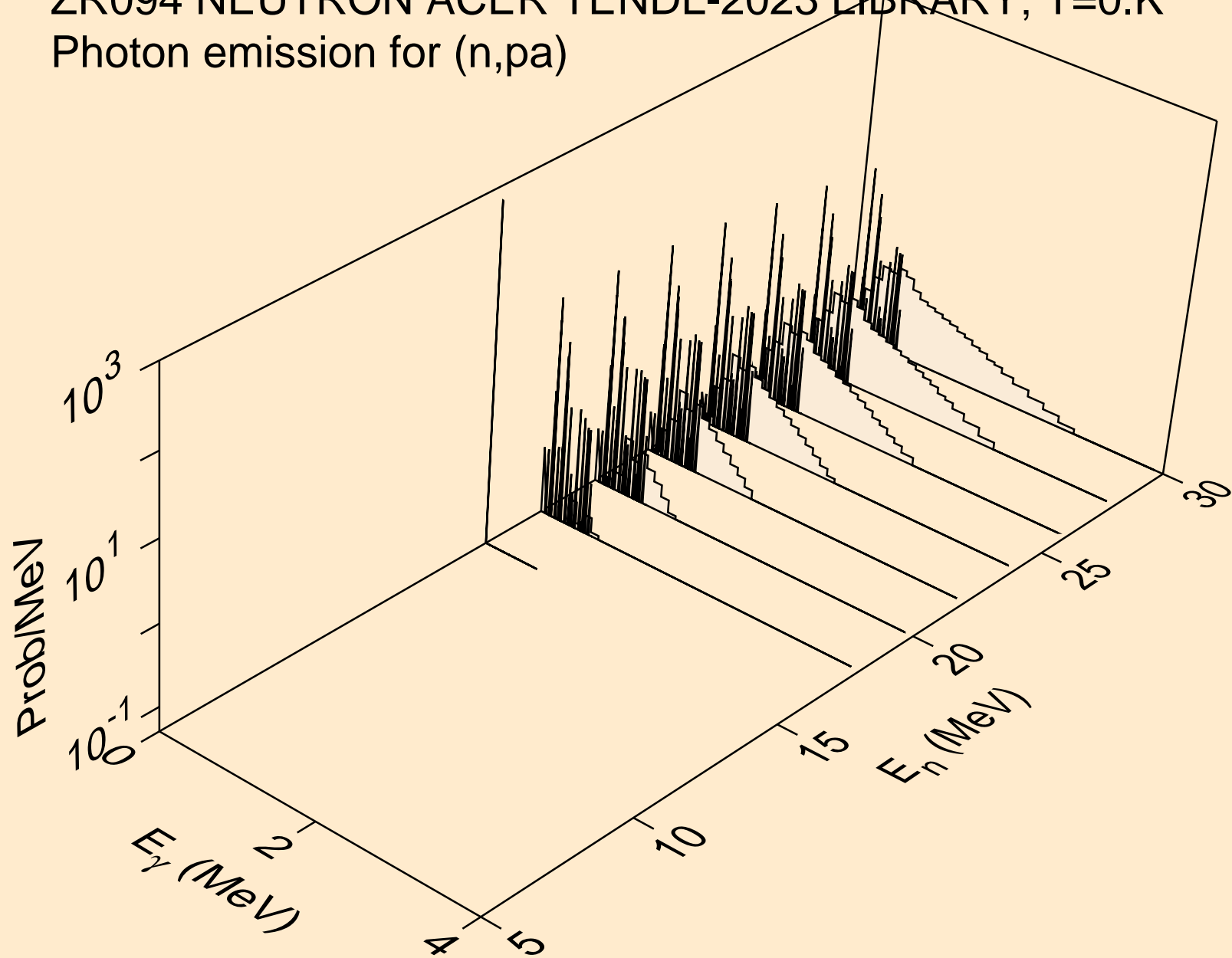

ZR094 NEUTRON ACER TENDL-2023 LIBRARY; T=0.K  
Photon emission for (n,pd)

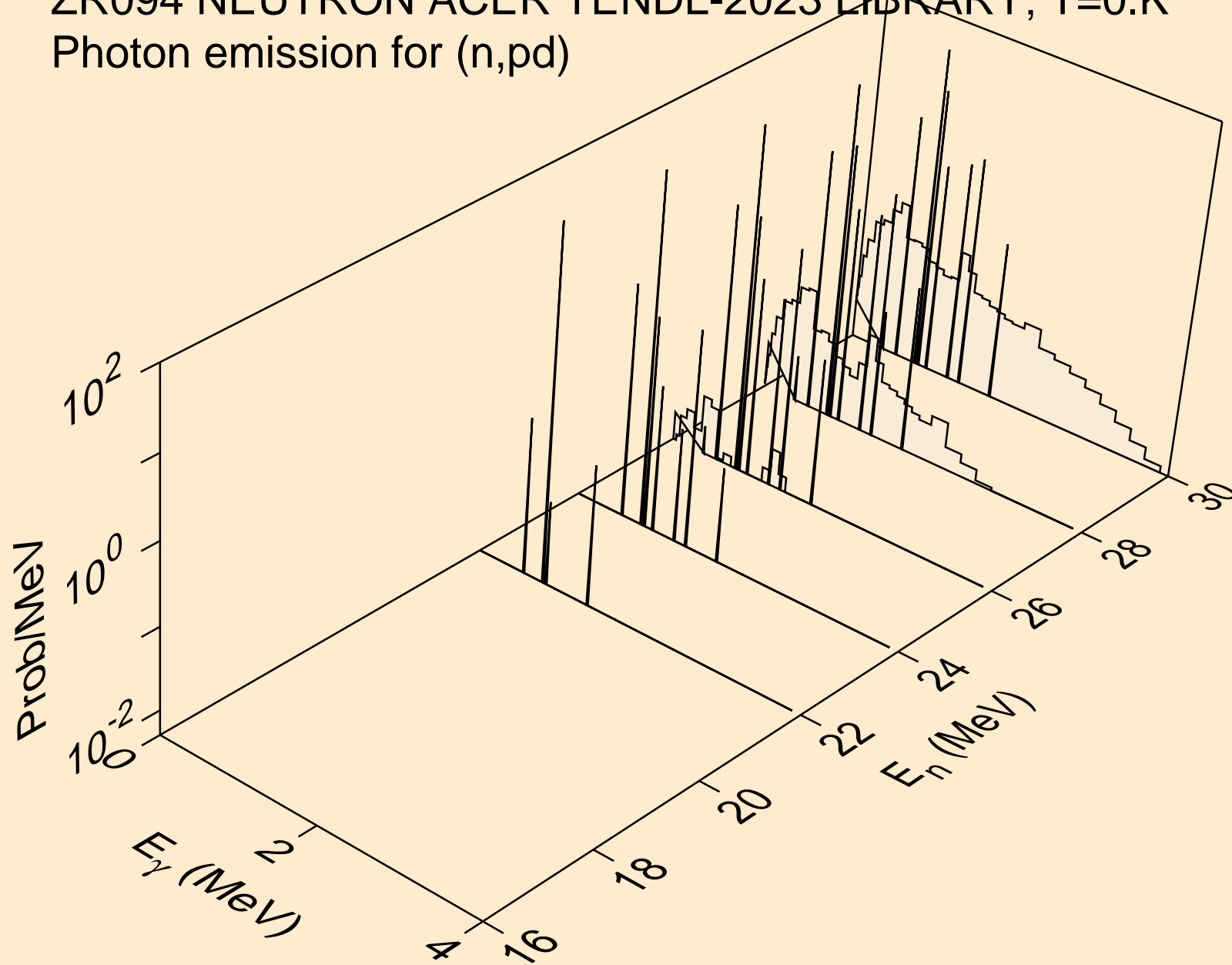

ZR094 NEUTRON ACER TENDL-2023 LIBRARY; T=0.K  
Photon emission for (n,pt)

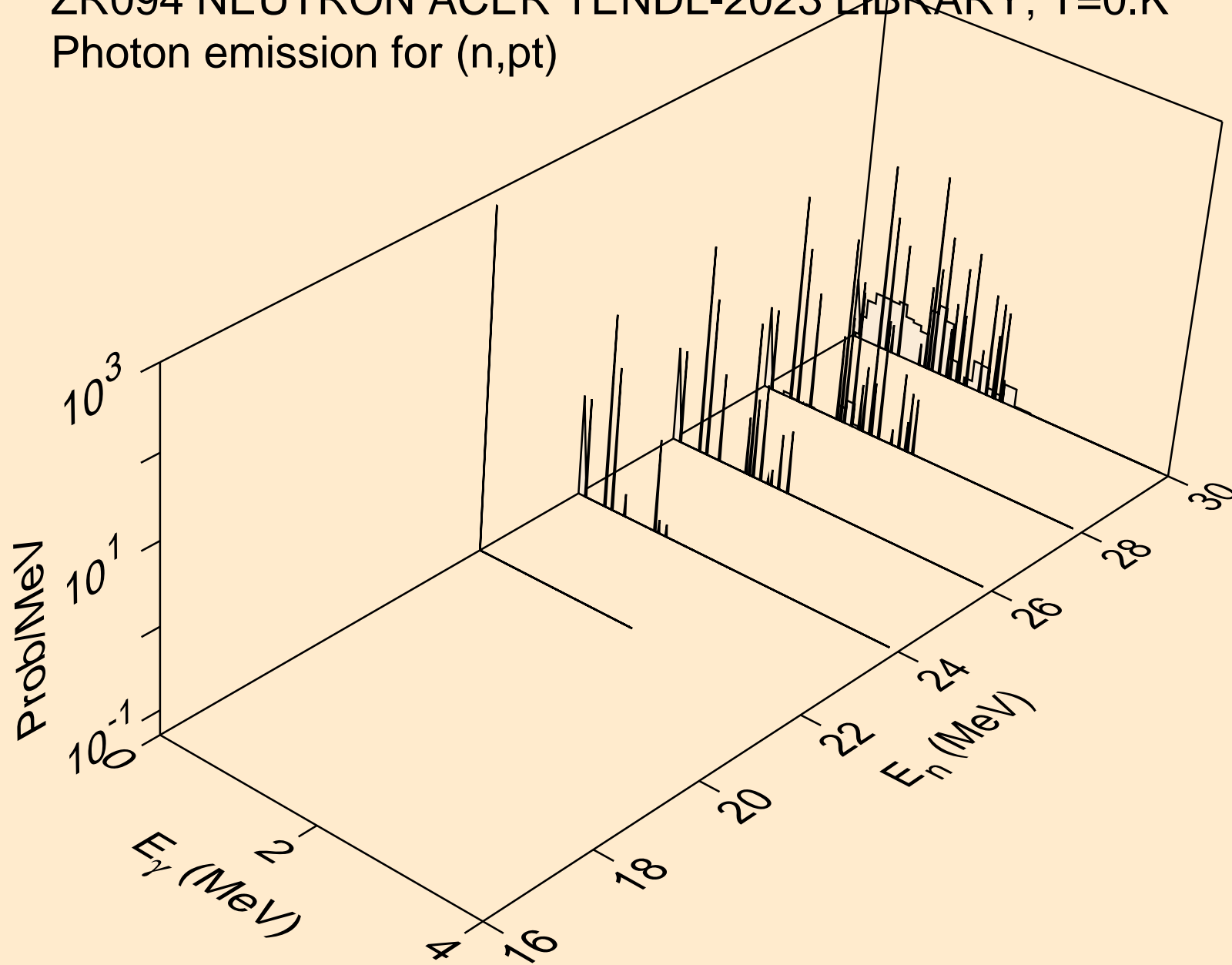

ZR094 NEUTRON ACER TENDL-2023 LIBRARY; T=0.K  
Photon emission for (n,da)

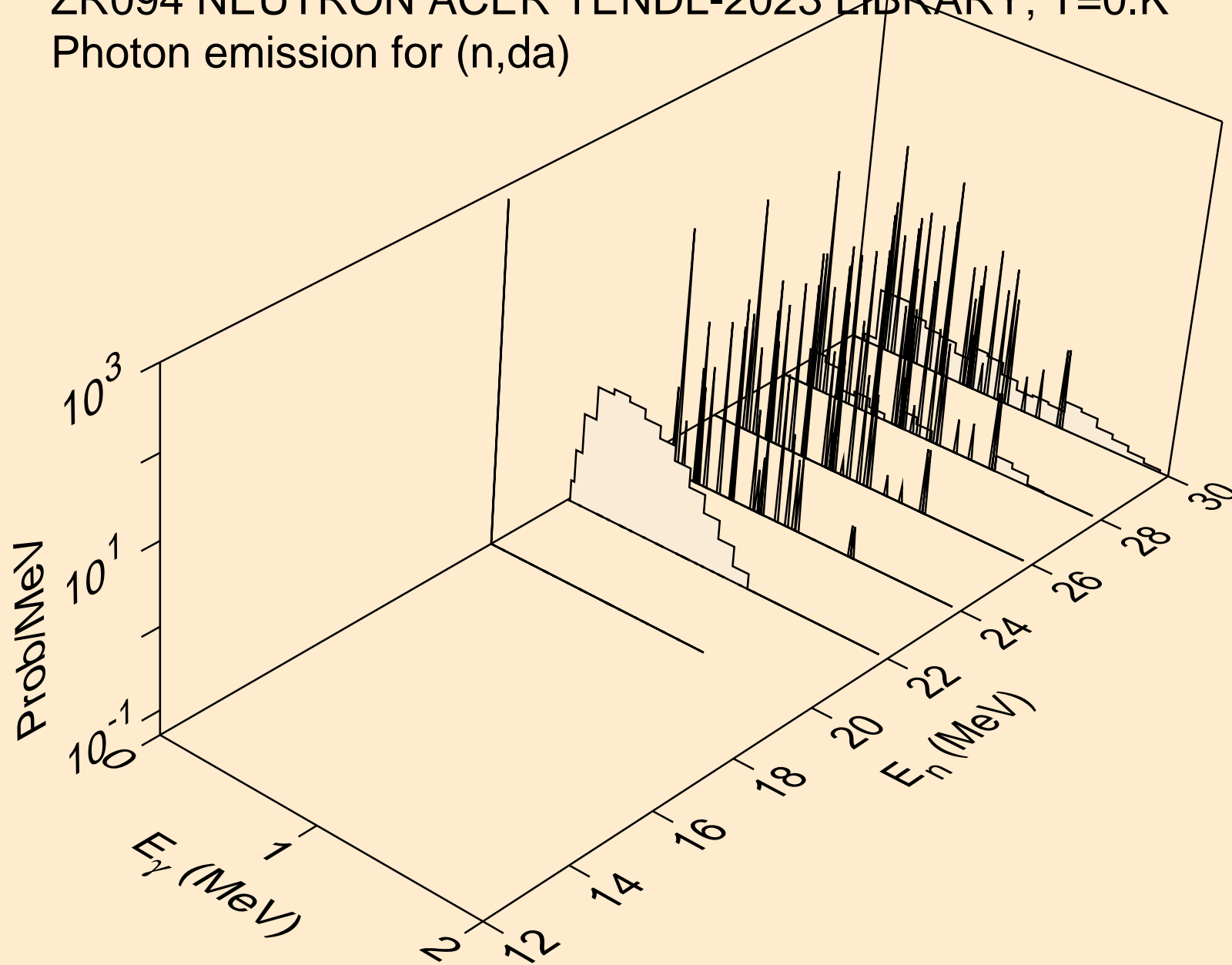

ZR094 NEUTRON ACER TENDL-2023 LIBRARY; T=0.K  
thermal capture photon spectrum

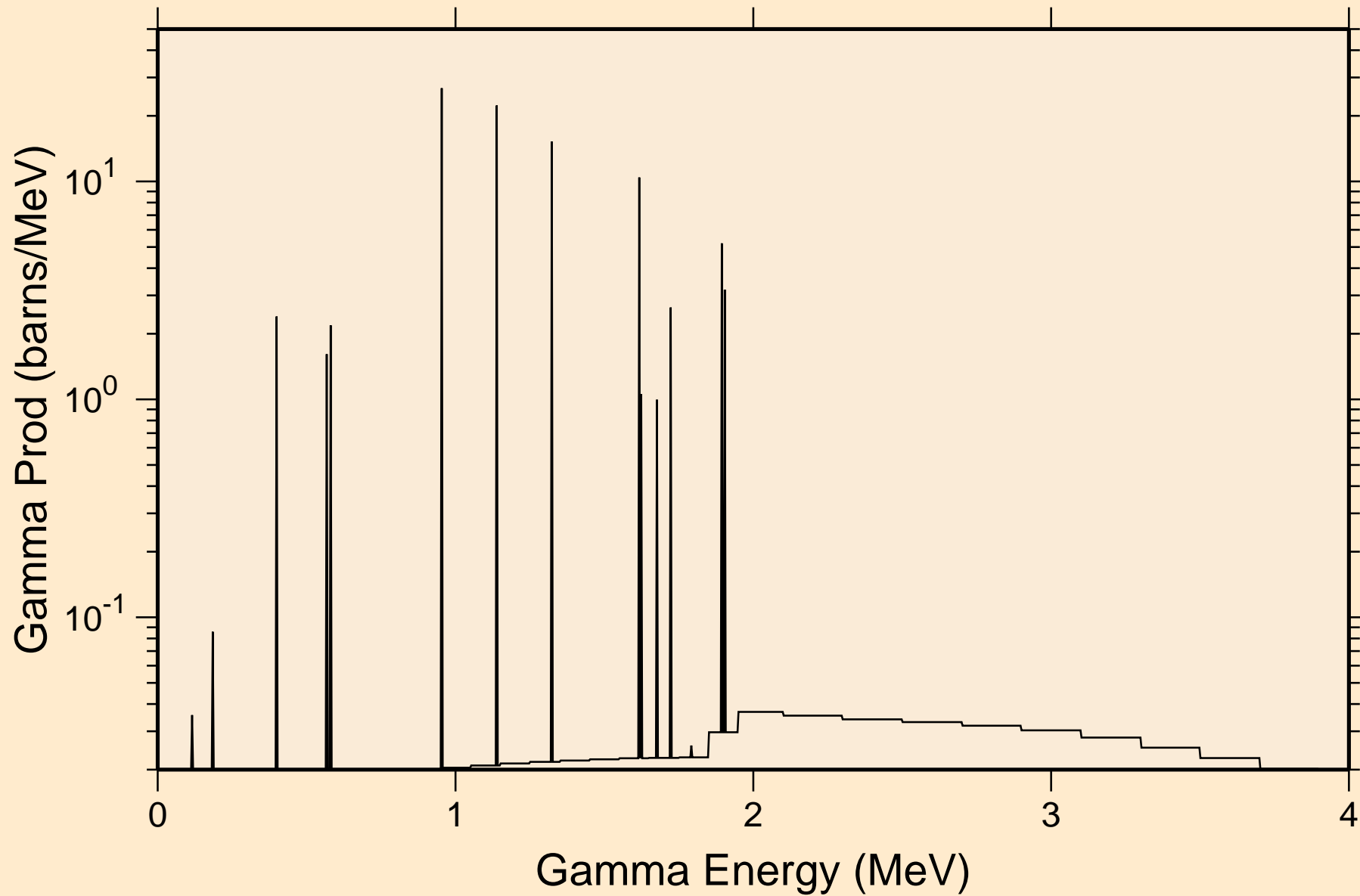

ZR094 NEUTRON ACER TENDL-2023 LIBRARY; T=0.K  
14 MeV photon spectrum

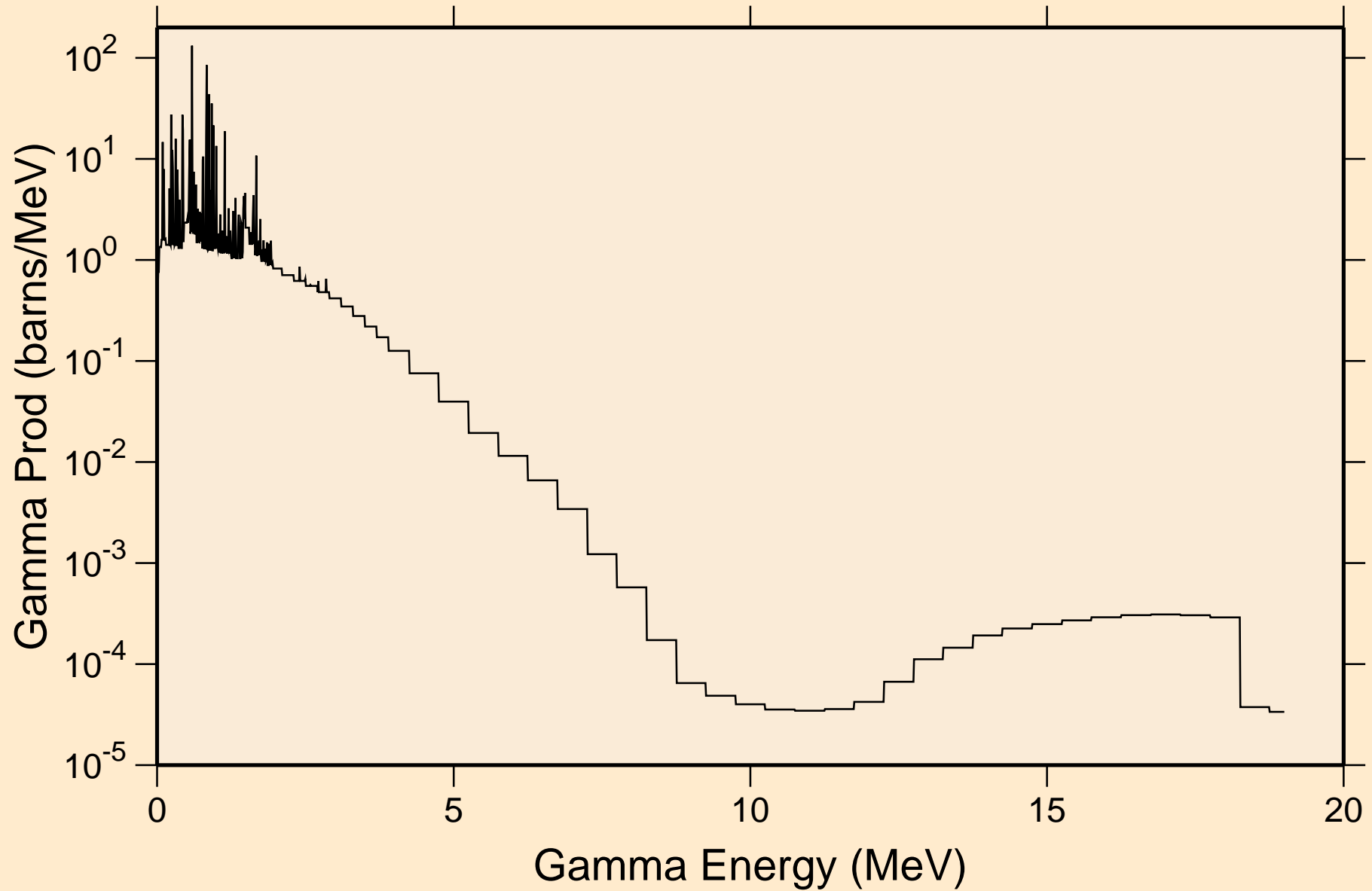

# ZR094 NEUTRON ACER TENDL-2023 LIBRARY; T=0.K

## Particle heating contributions

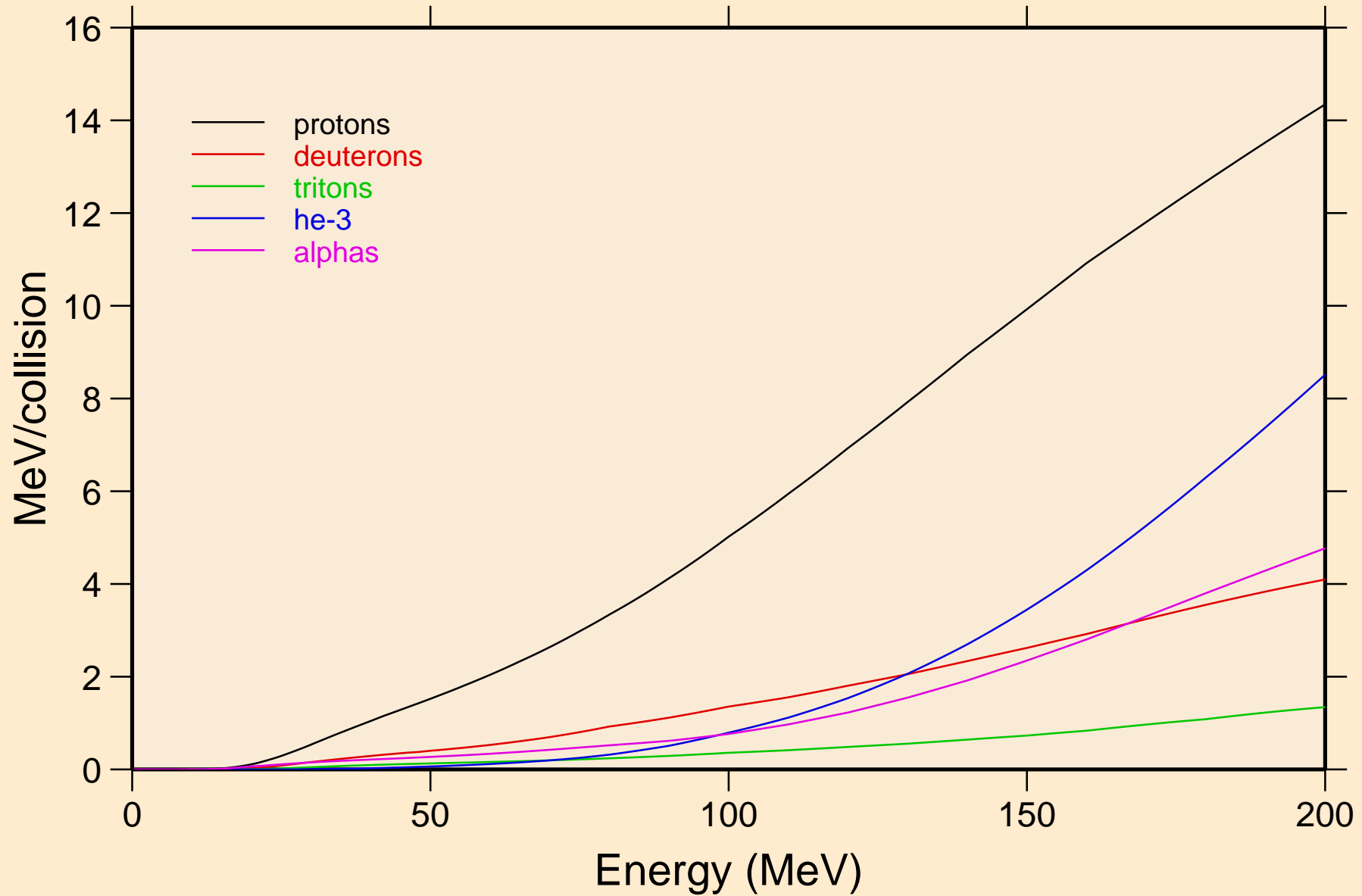

ZR094 NEUTRON ACER TENDL-2023 LIBRARY; T=0.K  
Recoil Heating

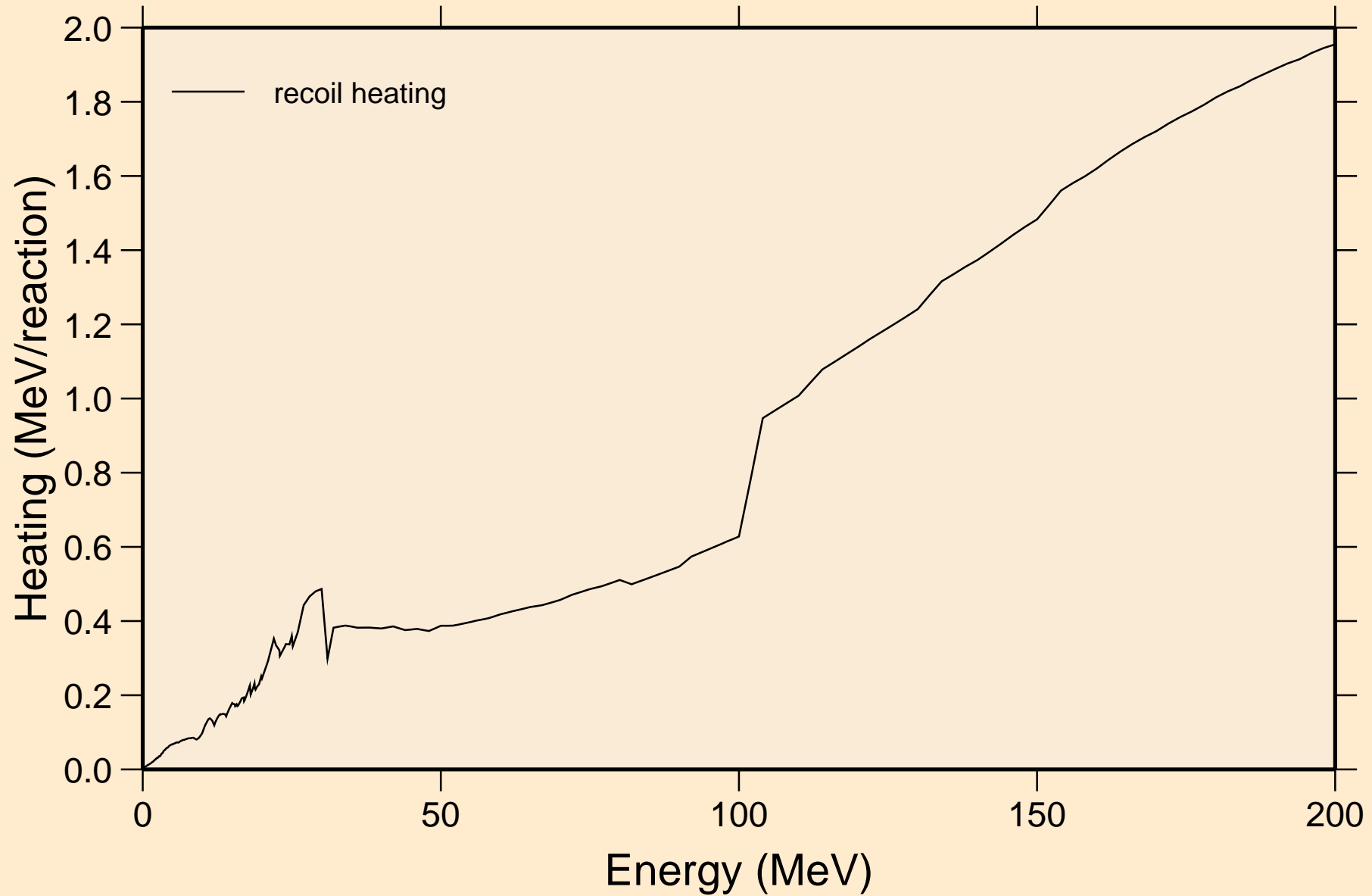

# ZR094 NEUTRON ACER TENDL-2023 LIBRARY; T=0.K

## Particle production cross sections

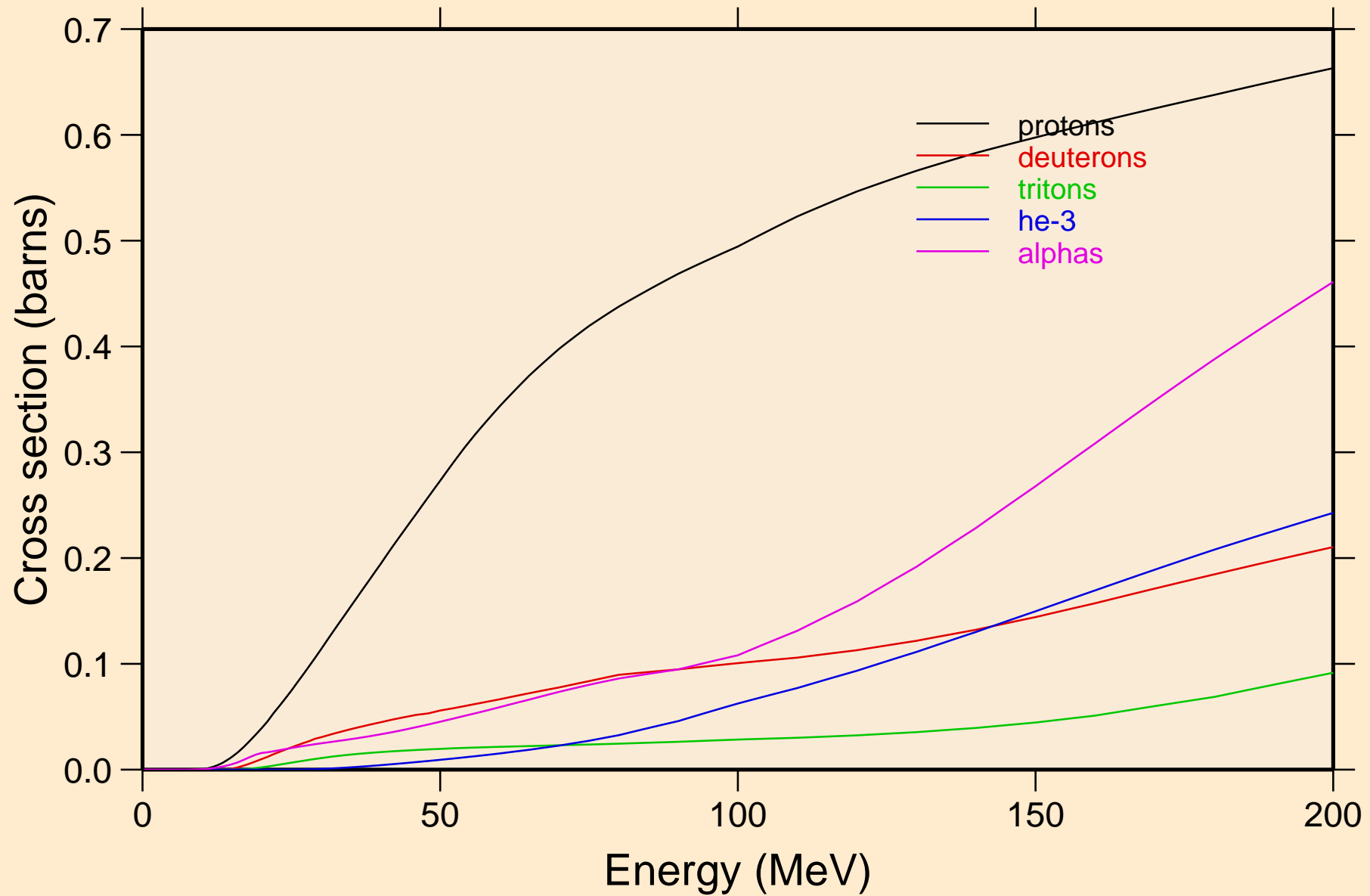

ZR094 NEUTRON ACER TENDL-2023 LIBRARY; T=0.K  
protons from (n,x)

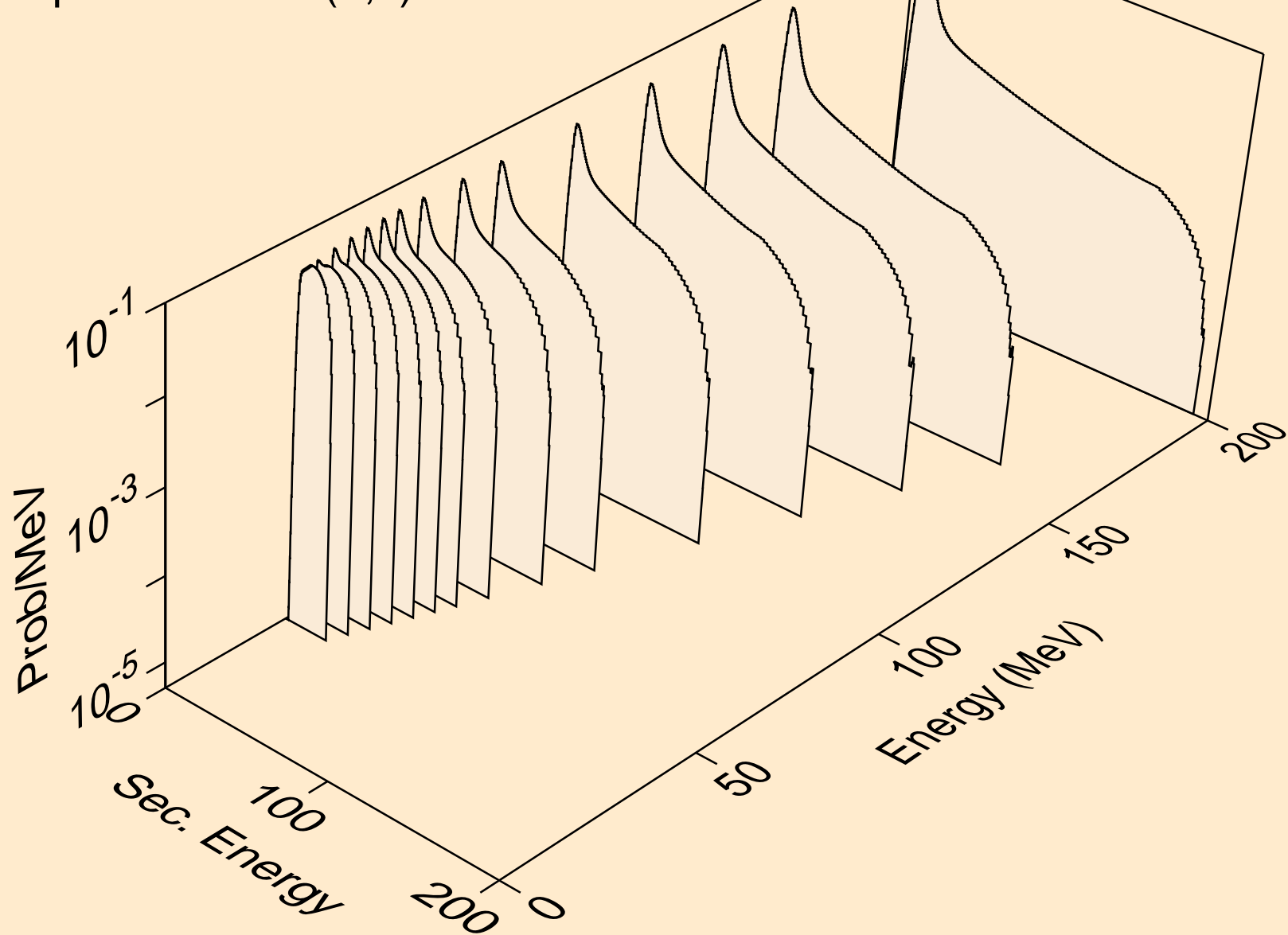

ZR094 NEUTRON ACER TENDL-2023 LIBRARY; T=0.K  
protons from (n,n\*)p

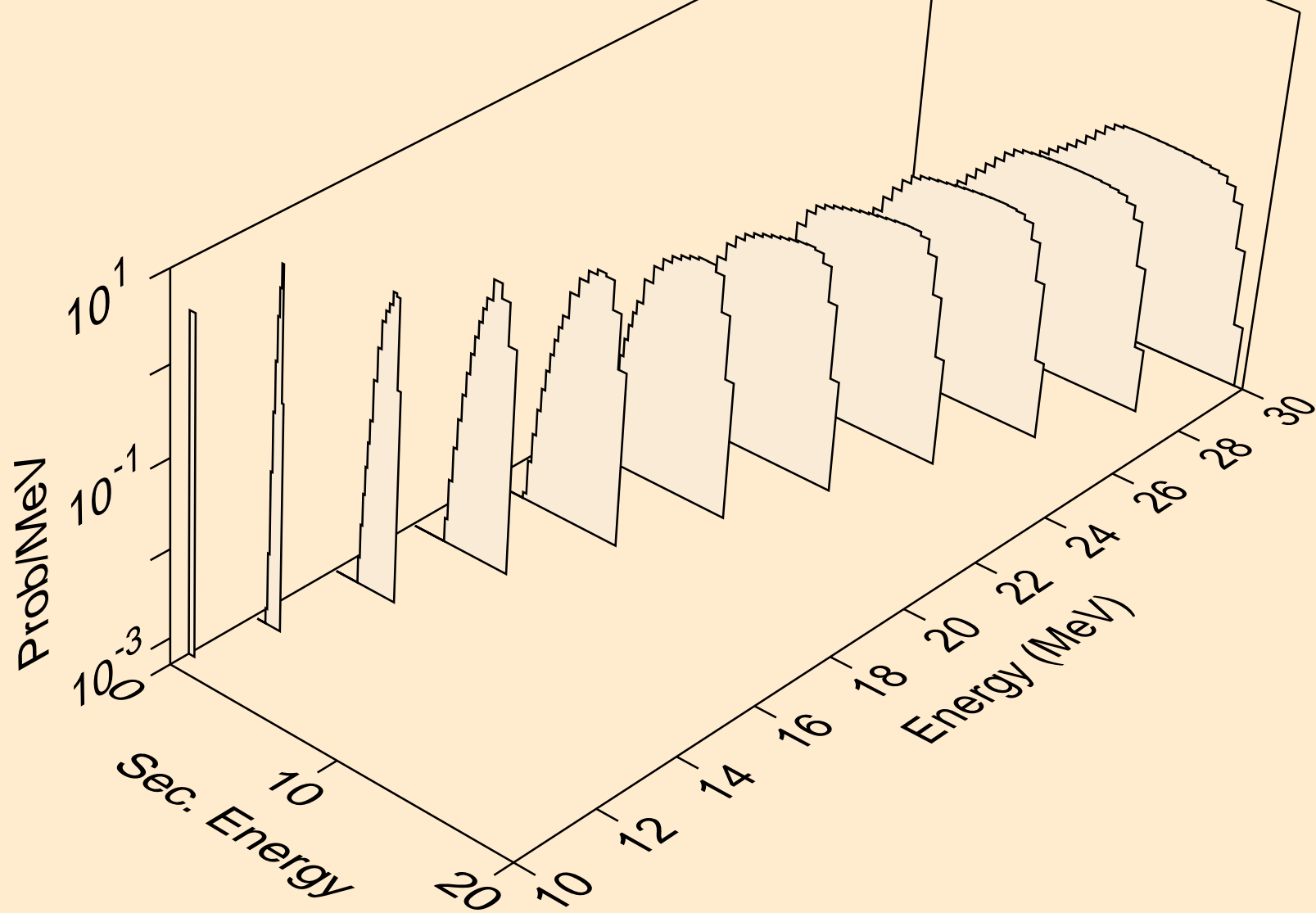

ZR094 NEUTRON ACER TENDL-2023 LIBRARY; T=0.K  
protons from (n,2np)

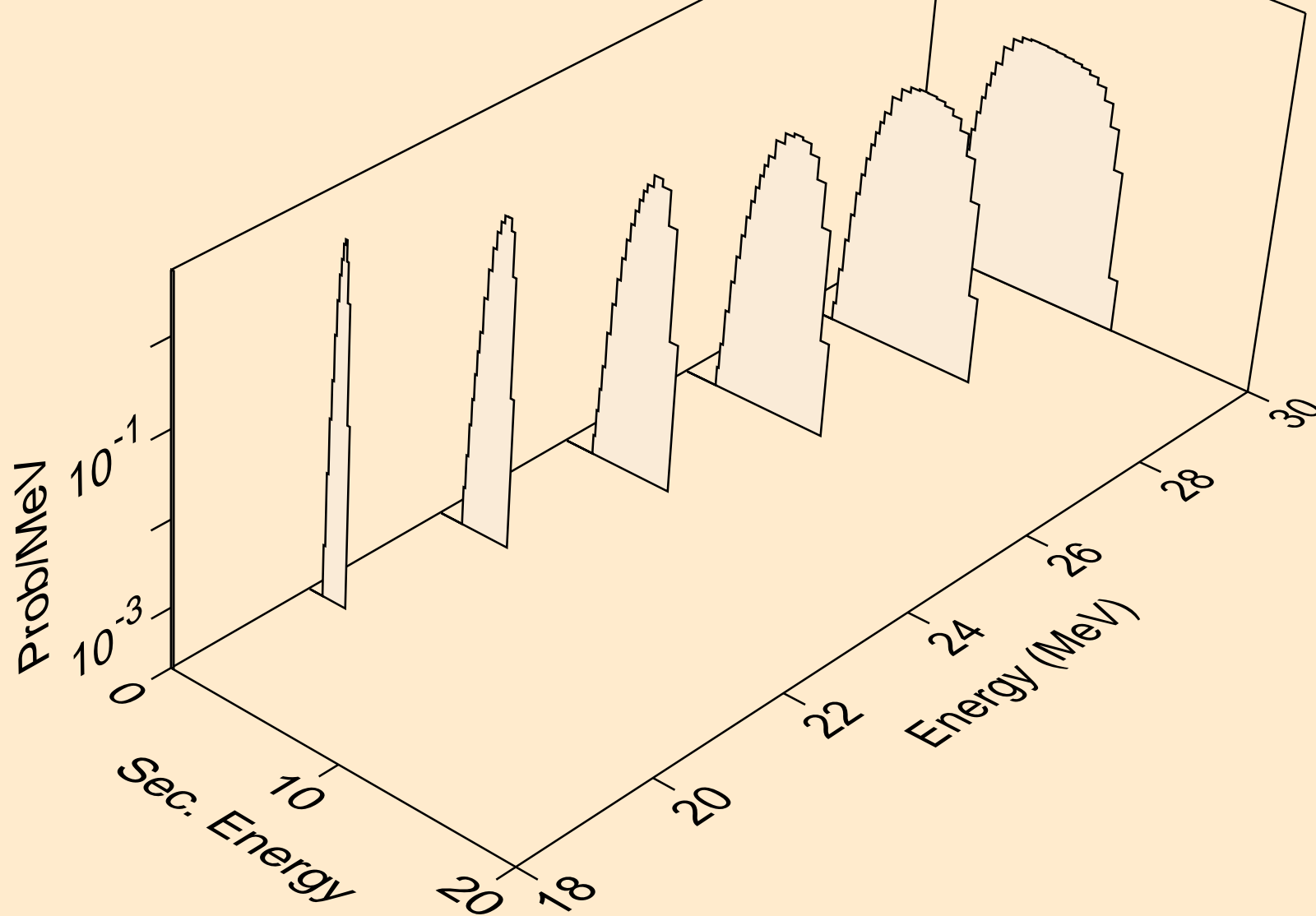

ZR094 NEUTRON ACER TENDL-2023 LIBRARY; T=0.K  
protons from (n,3np)

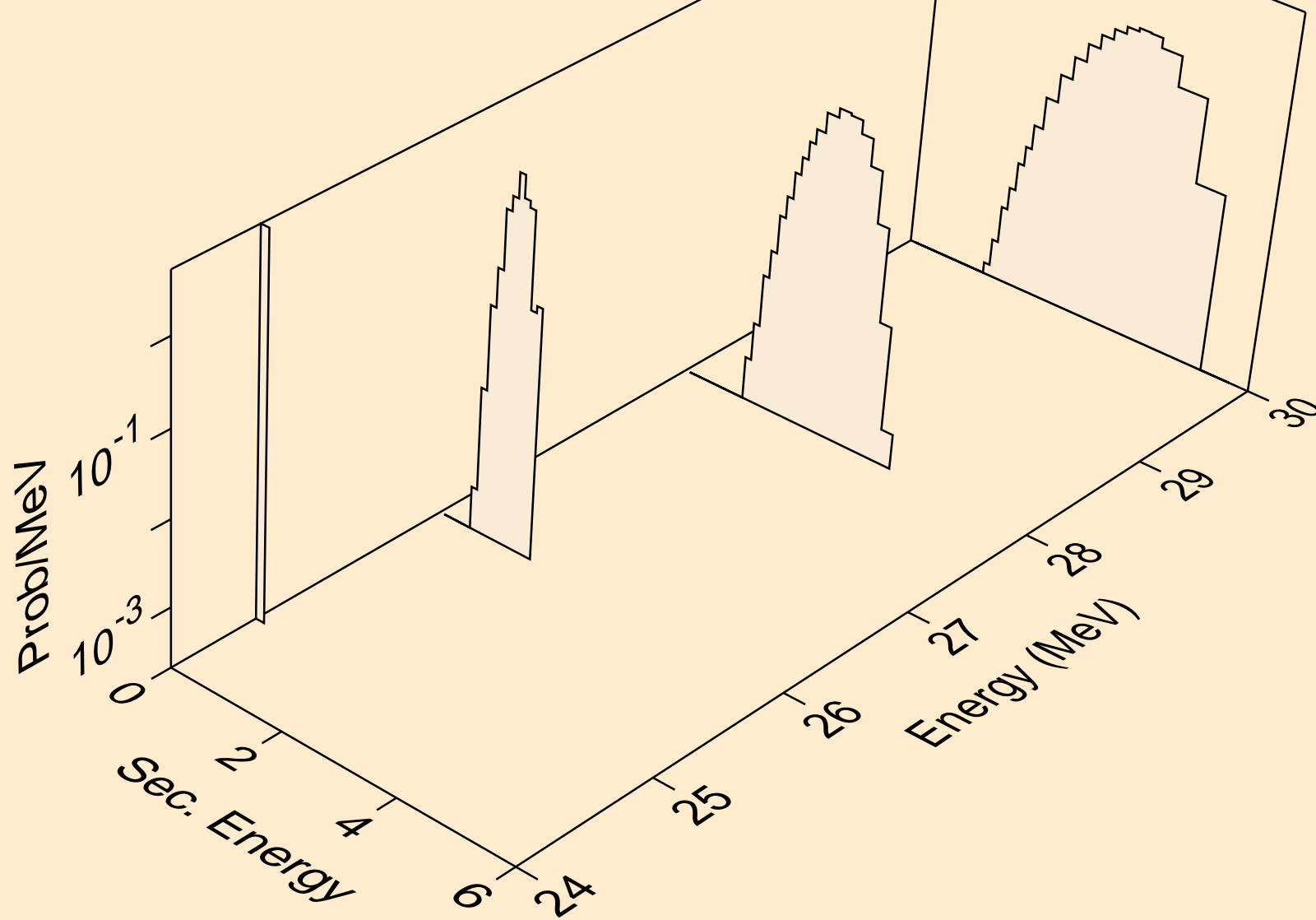

ZR094 NEUTRON ACER TENDL-2023 LIBRARY; T=0.K  
protons from (n,n2p)

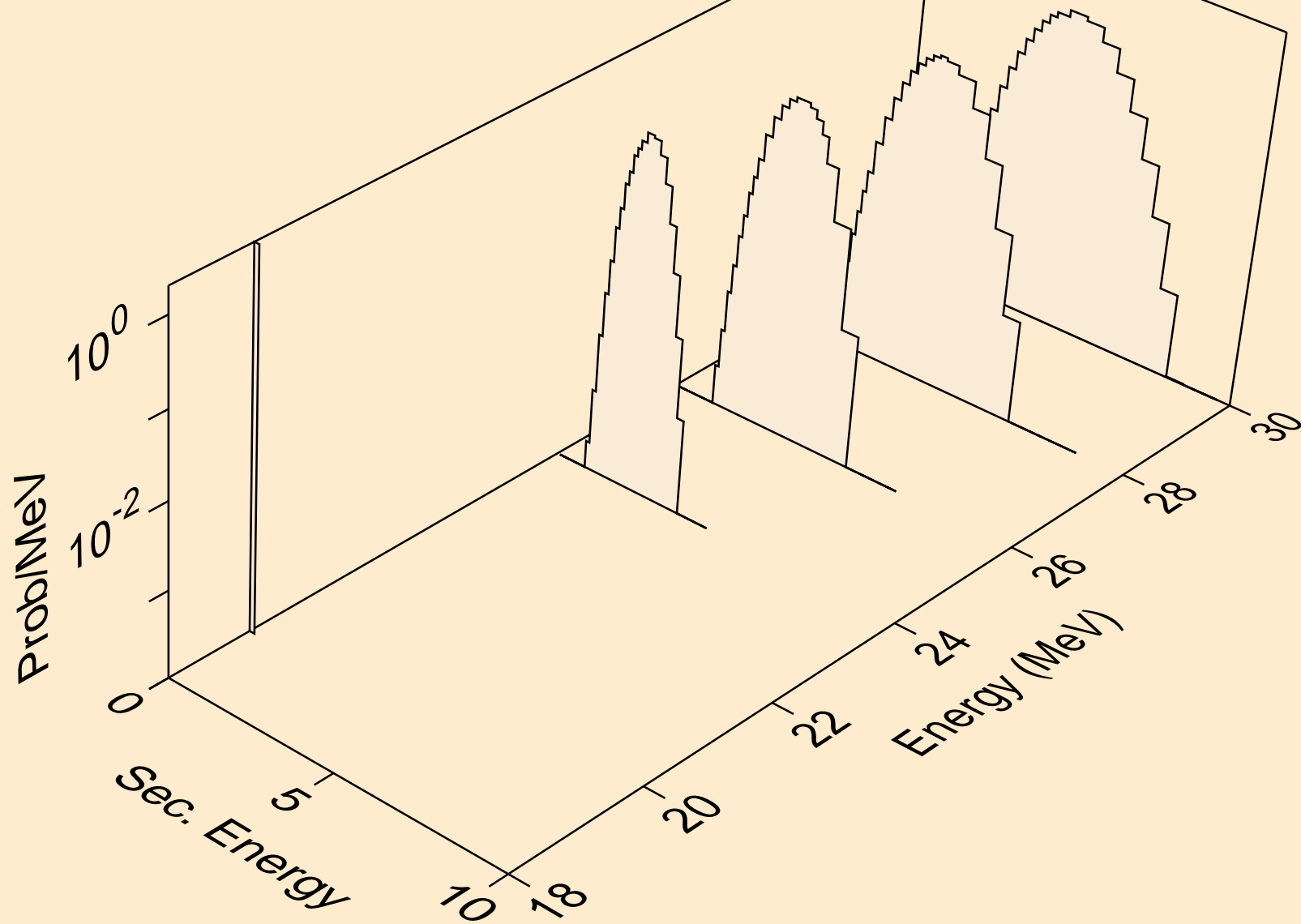

ZR094 NEUTRON ACER TENDL-2023 LIBRARY; T=0.K  
protons from (n,npa)

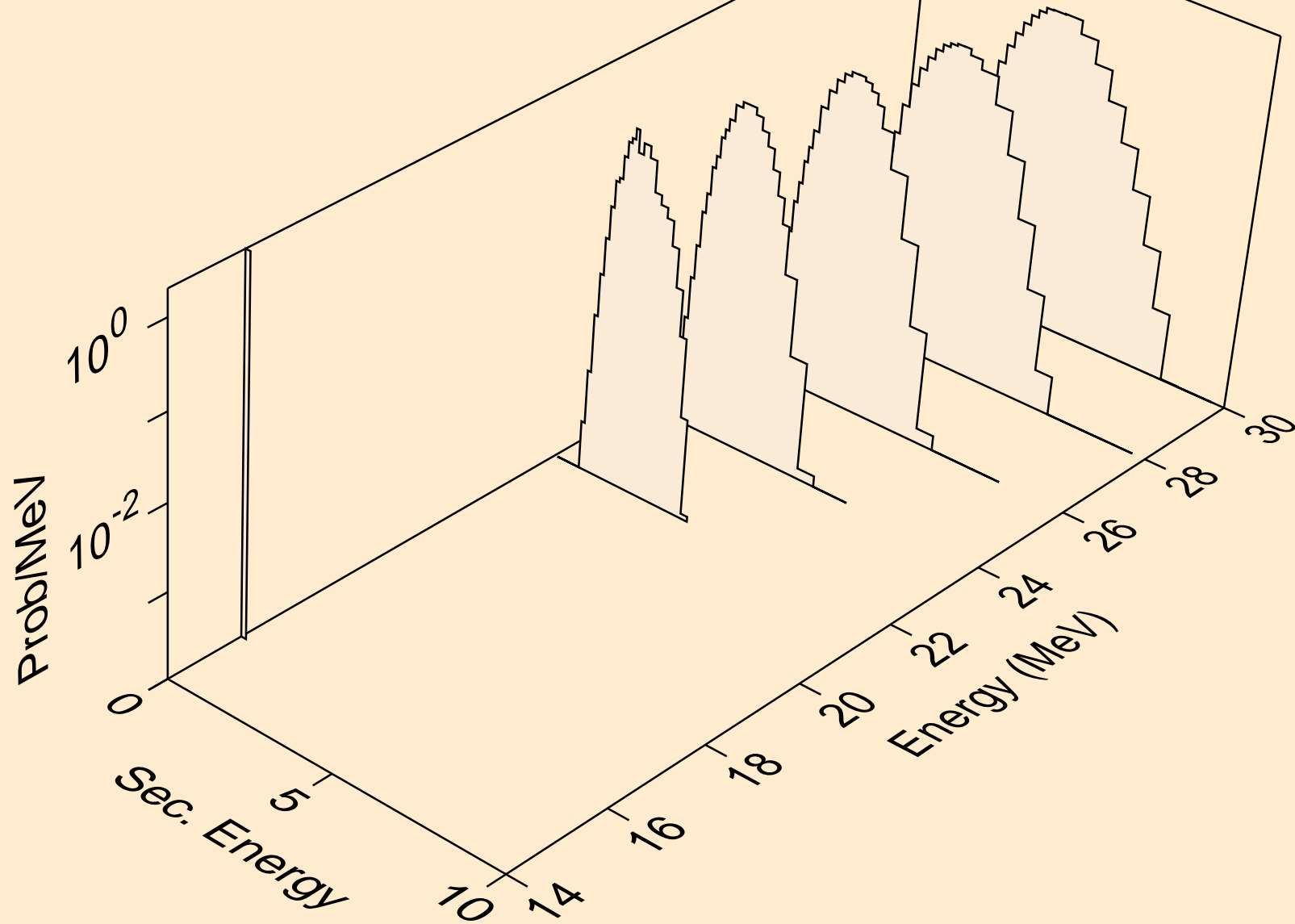

ZR094 NEUTRON ACER TENDL-2023 LIBRARY; T=0.K  
protons from (n,p)

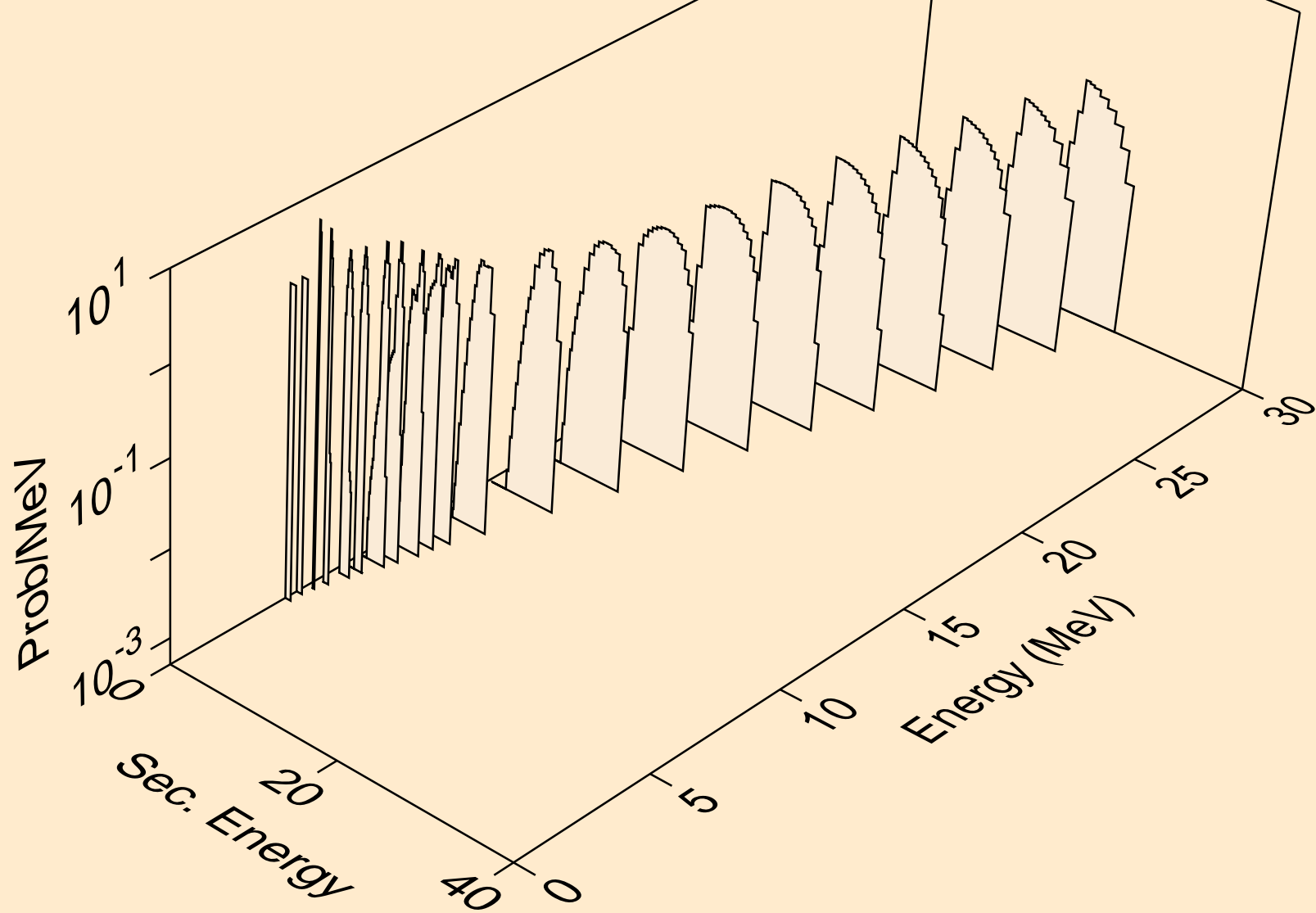

ZR094 NEUTRON ACER TENDL-2023 LIBRARY; T=0.K  
protons from (n,2p)

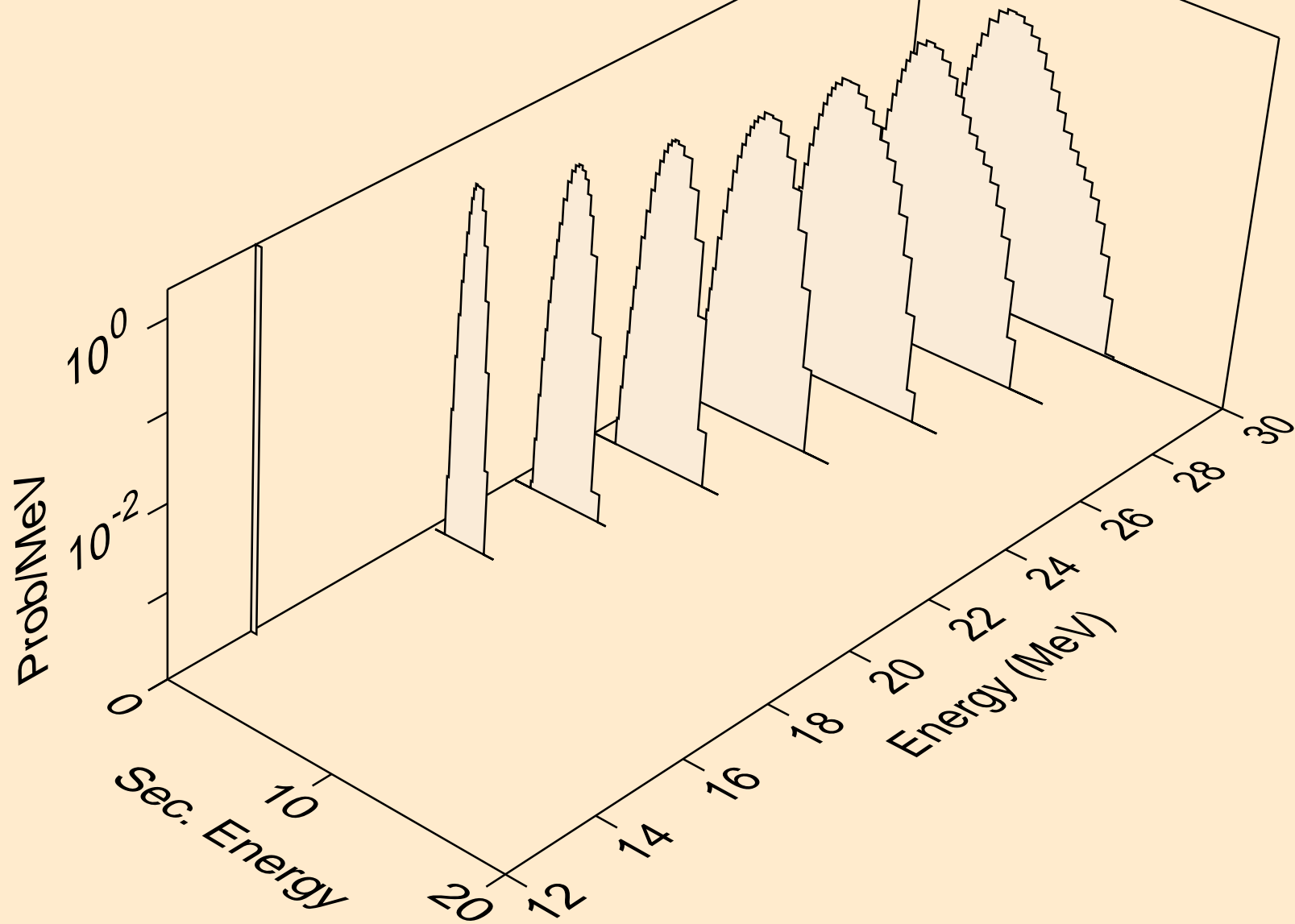

ZR094 NEUTRON ACER TENDL-2023 LIBRARY; T=0.K  
protons from (n,pa)

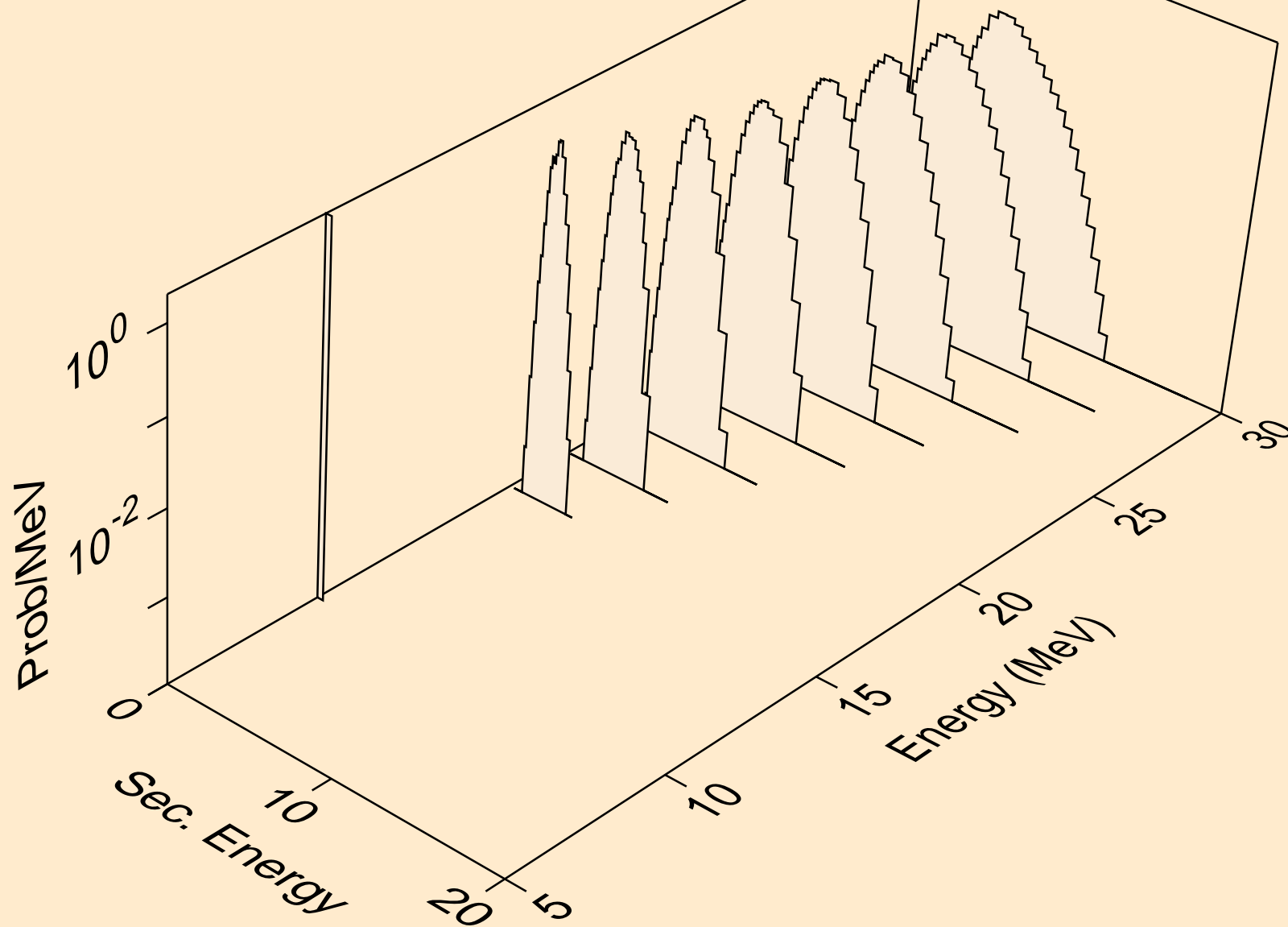

ZR094 NEUTRON ACER TENDL-2023 LIBRARY; T=0.K  
protons from (n,pd)

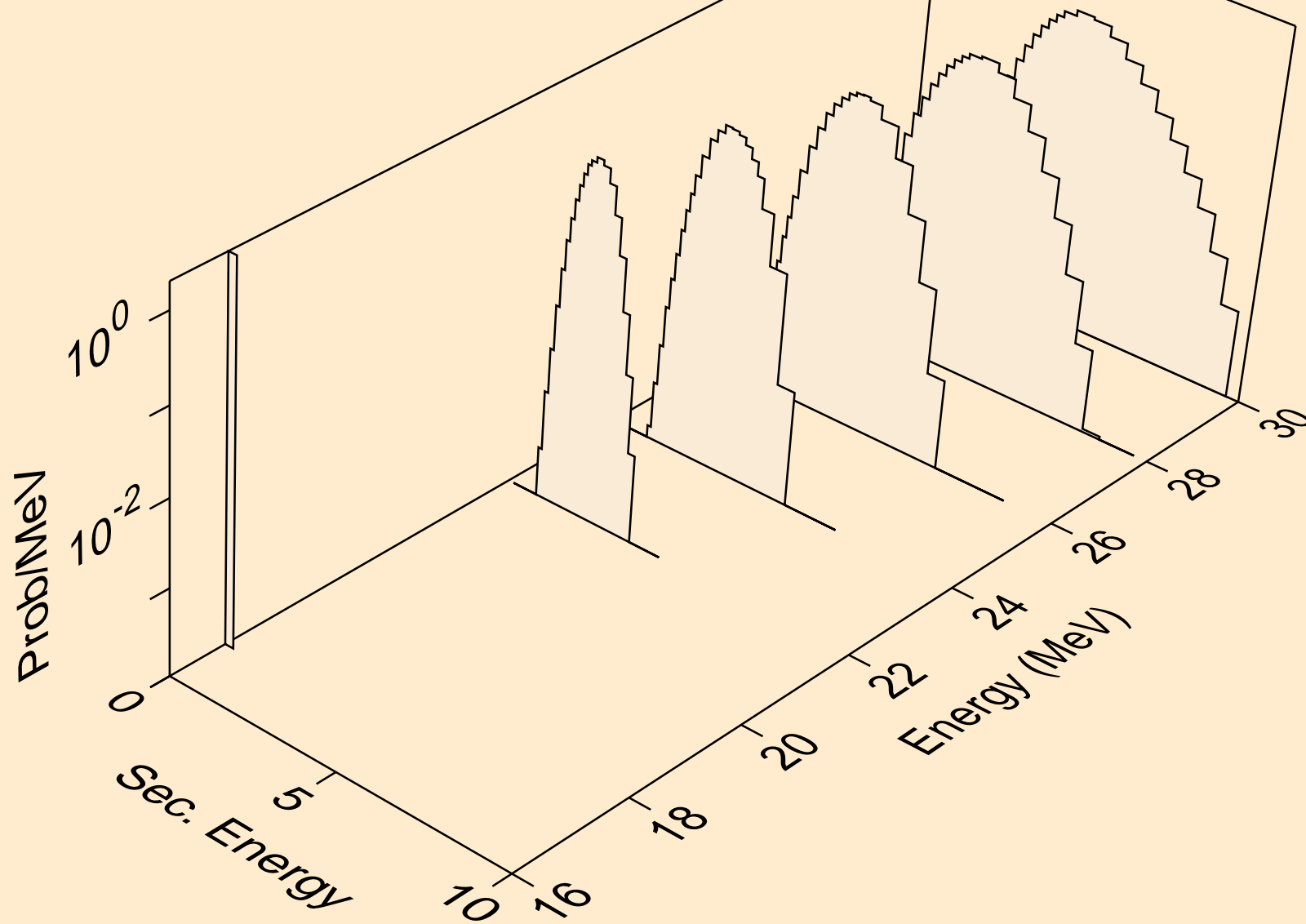

ZR094 NEUTRON ACER TENDL-2023 LIBRARY; T=0.K  
protons from (n,pt)

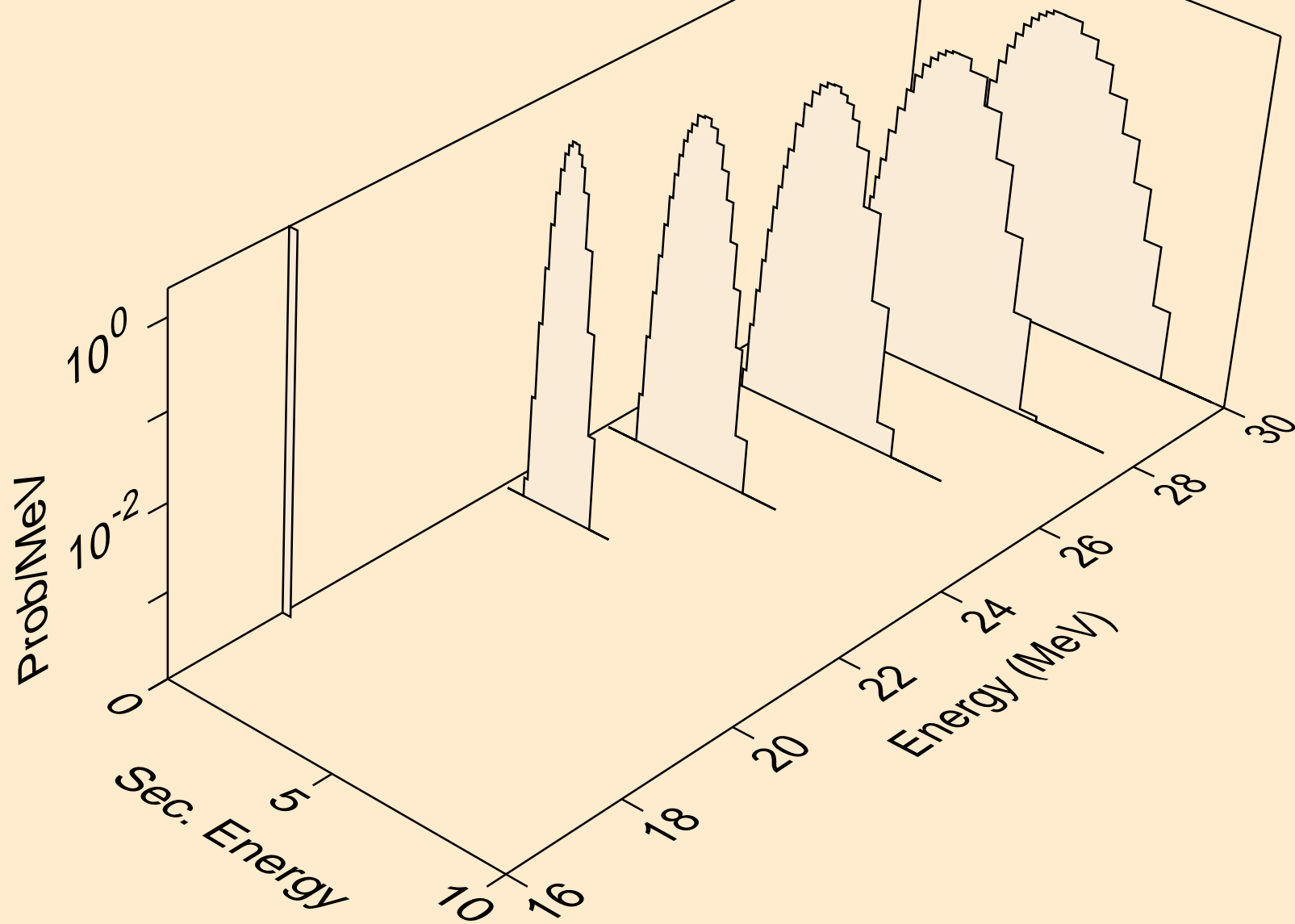

ZR094 NEUTRON ACER TENDL-2023 LIBRARY; T=0.K  
deuterons from (n,x)

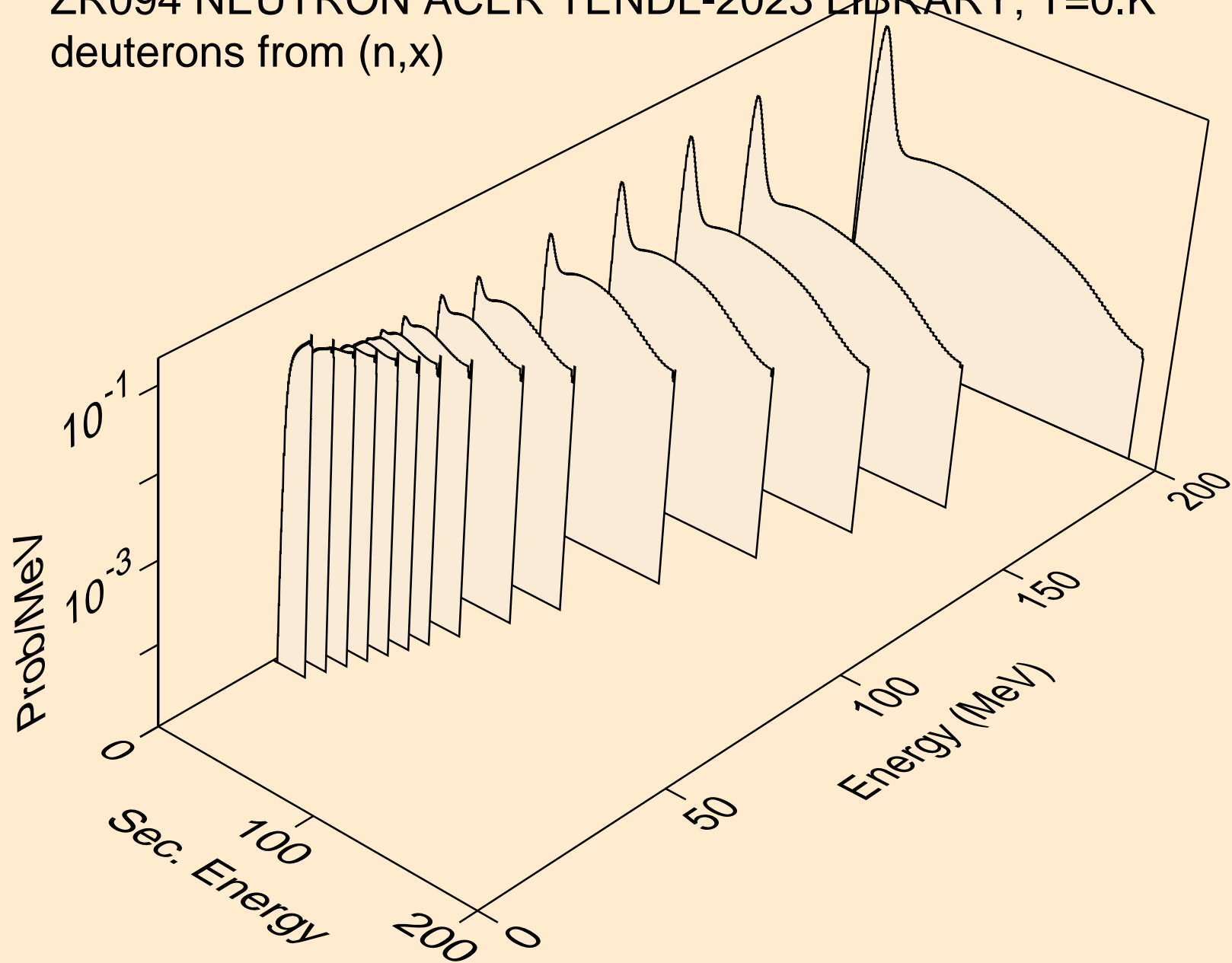

ZR094 NEUTRON ACER TENDL-2023 LIBRARY; T=0.K  
deuterons from (n,2nd)

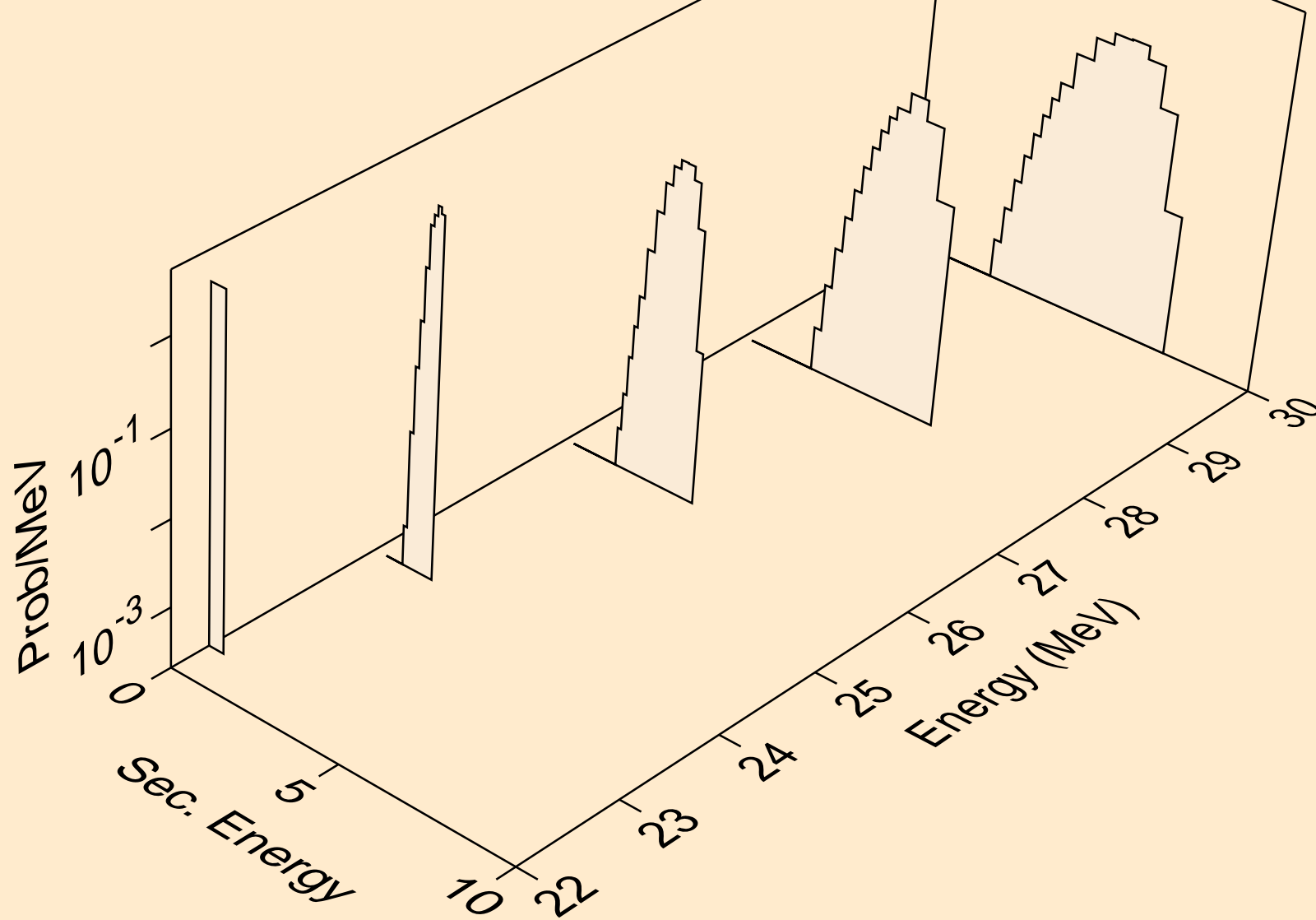

ZR094 NEUTRON ACER TENDL-2023 LIBRARY; T=0.K  
deuterons from (n,n\*)d

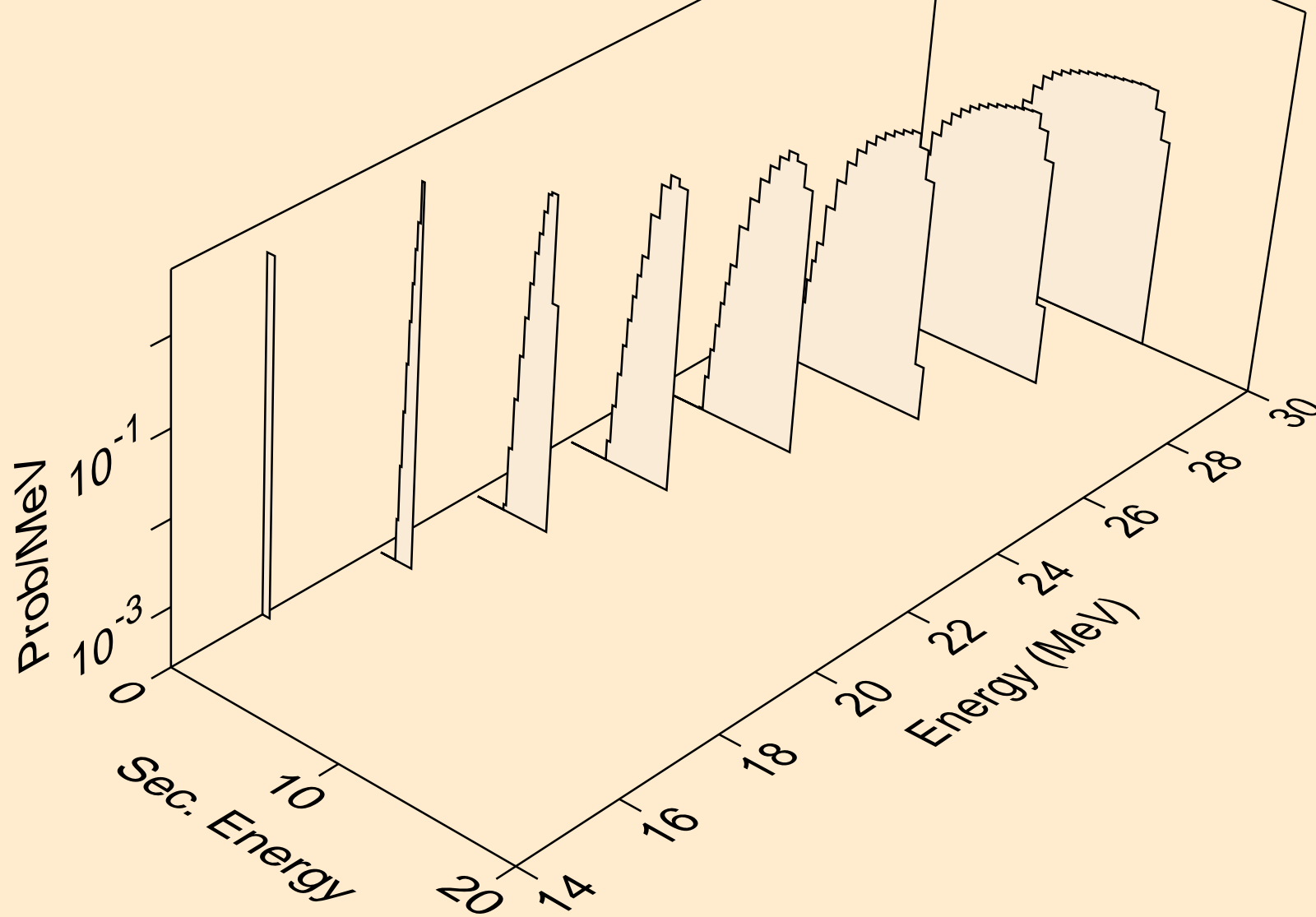

ZR094 NEUTRON ACER TENDL-2023 LIBRARY; T=0.K  
deuterons from (n,d)

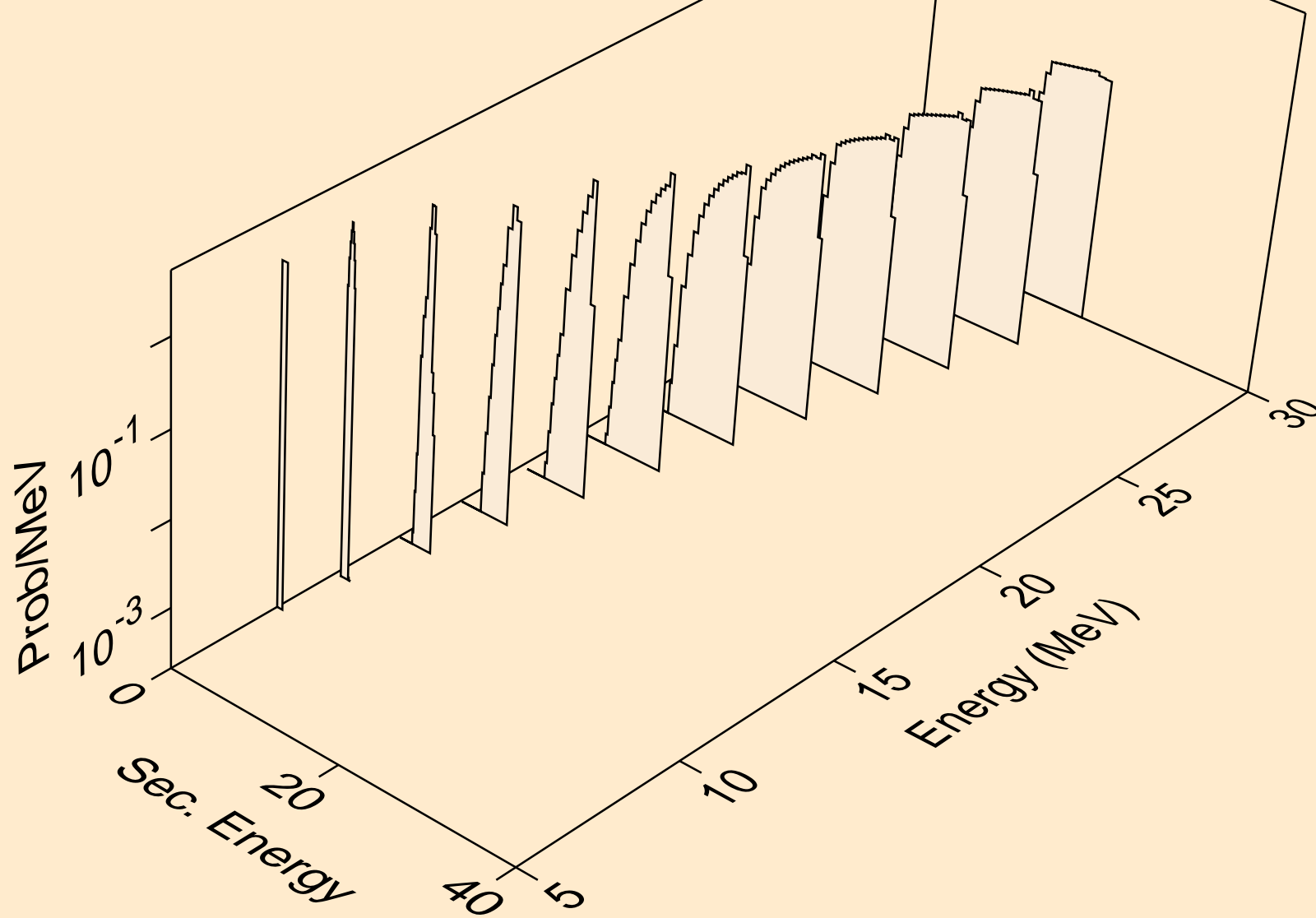

ZR094 NEUTRON ACER TENDL-2023 LIBRARY; T=0.K  
deuterons from (n,pd)

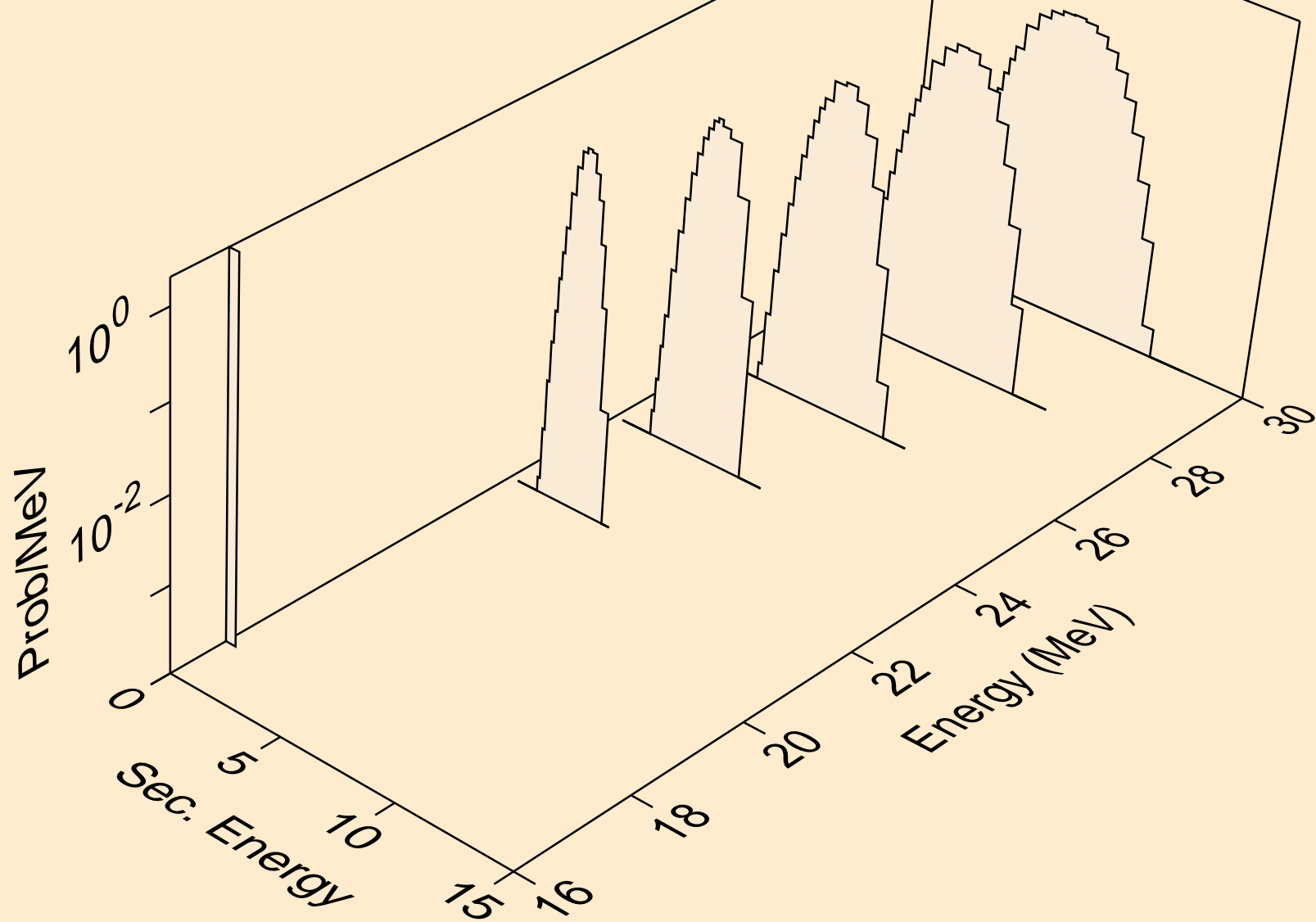

ZR094 NEUTRON ACER TENDL-2023 LIBRARY; T=0.K  
deuterons from (n,da)

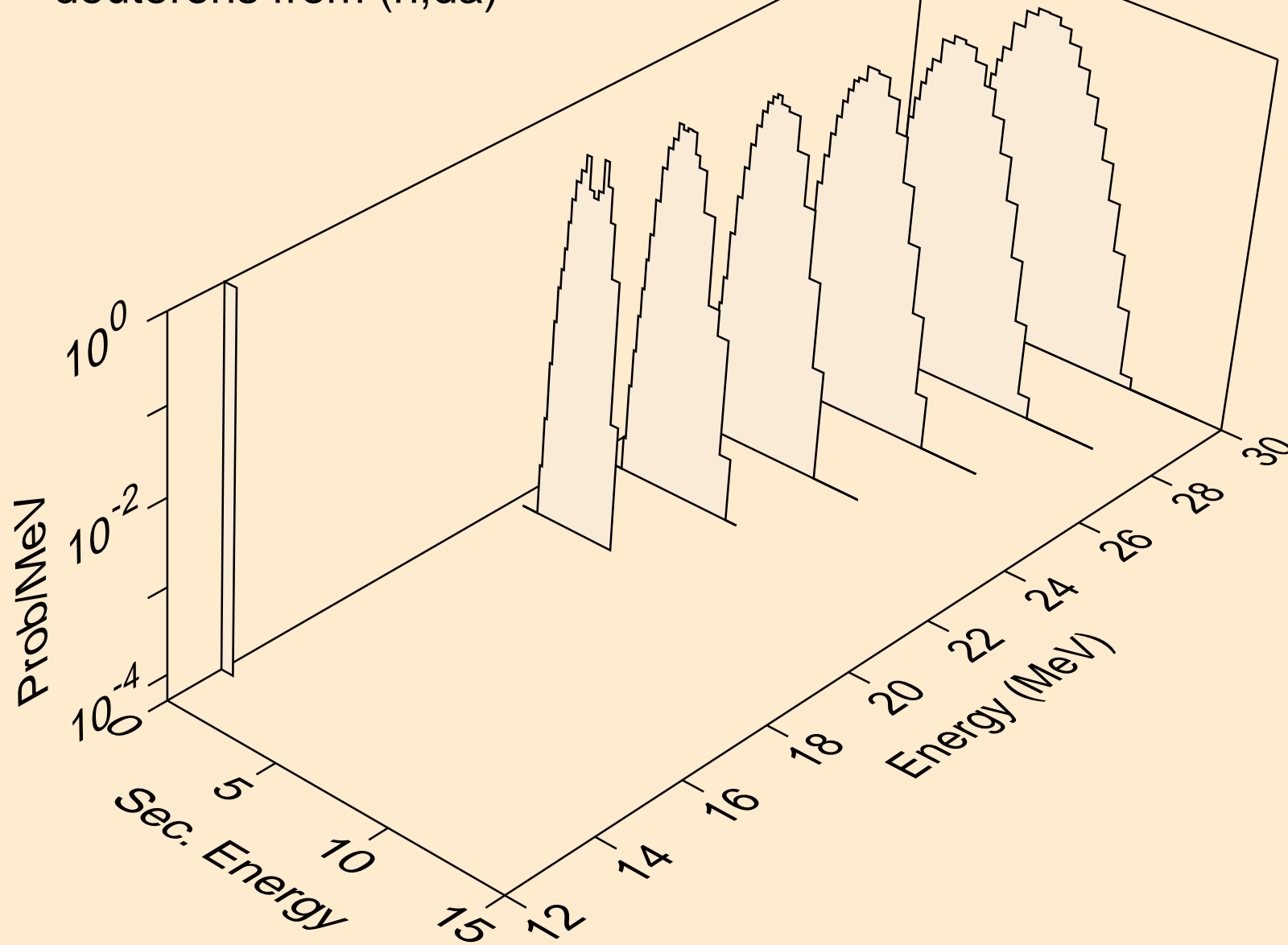

ZR094 NEUTRON ACER TENDL-2023 LIBRARY; T=0.K  
tritons from (n,x)

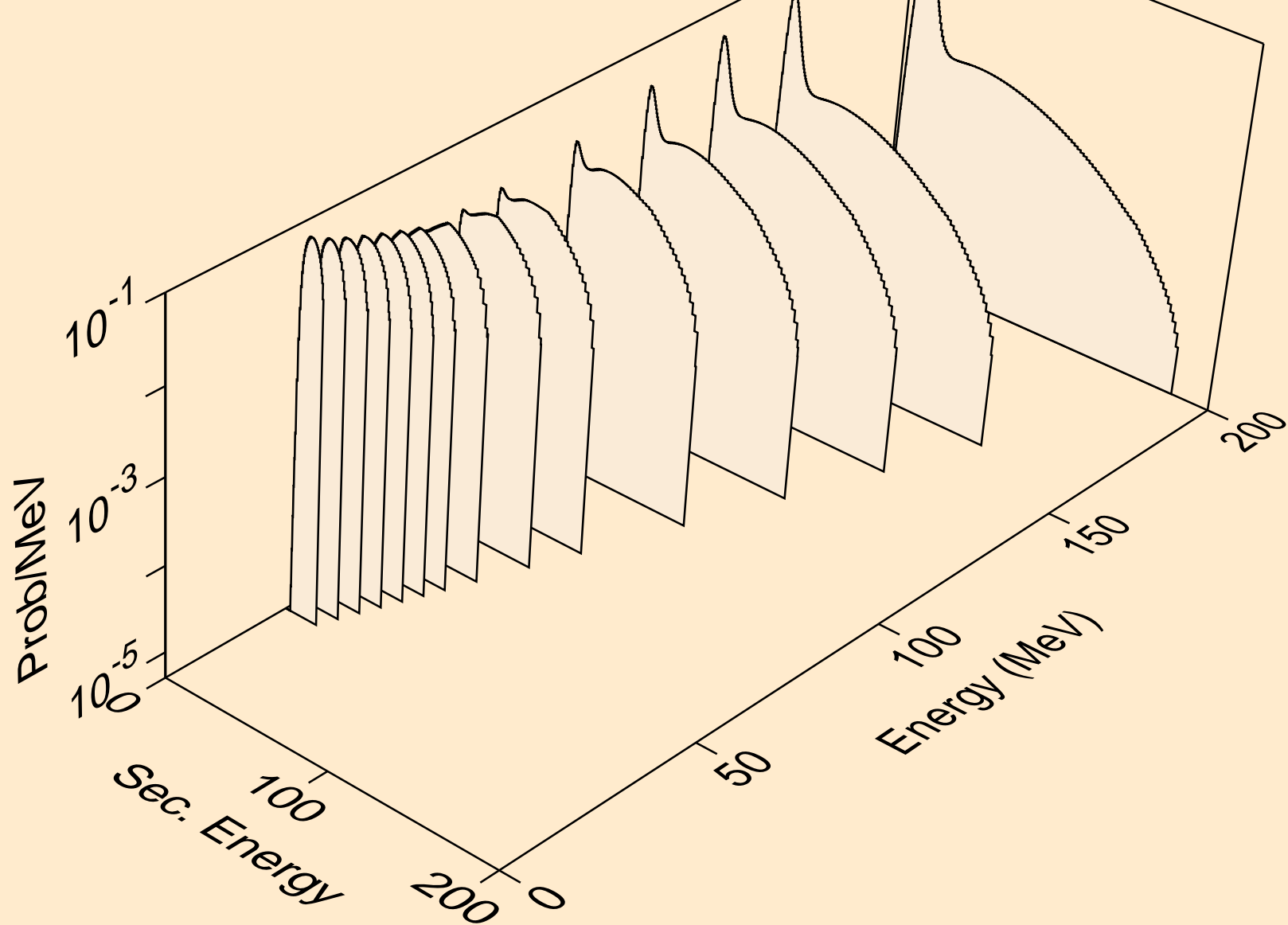

ZR094 NEUTRON ACER TENDL-2023 LIBRARY; T=0.K  
tritons from (n,n\*)t

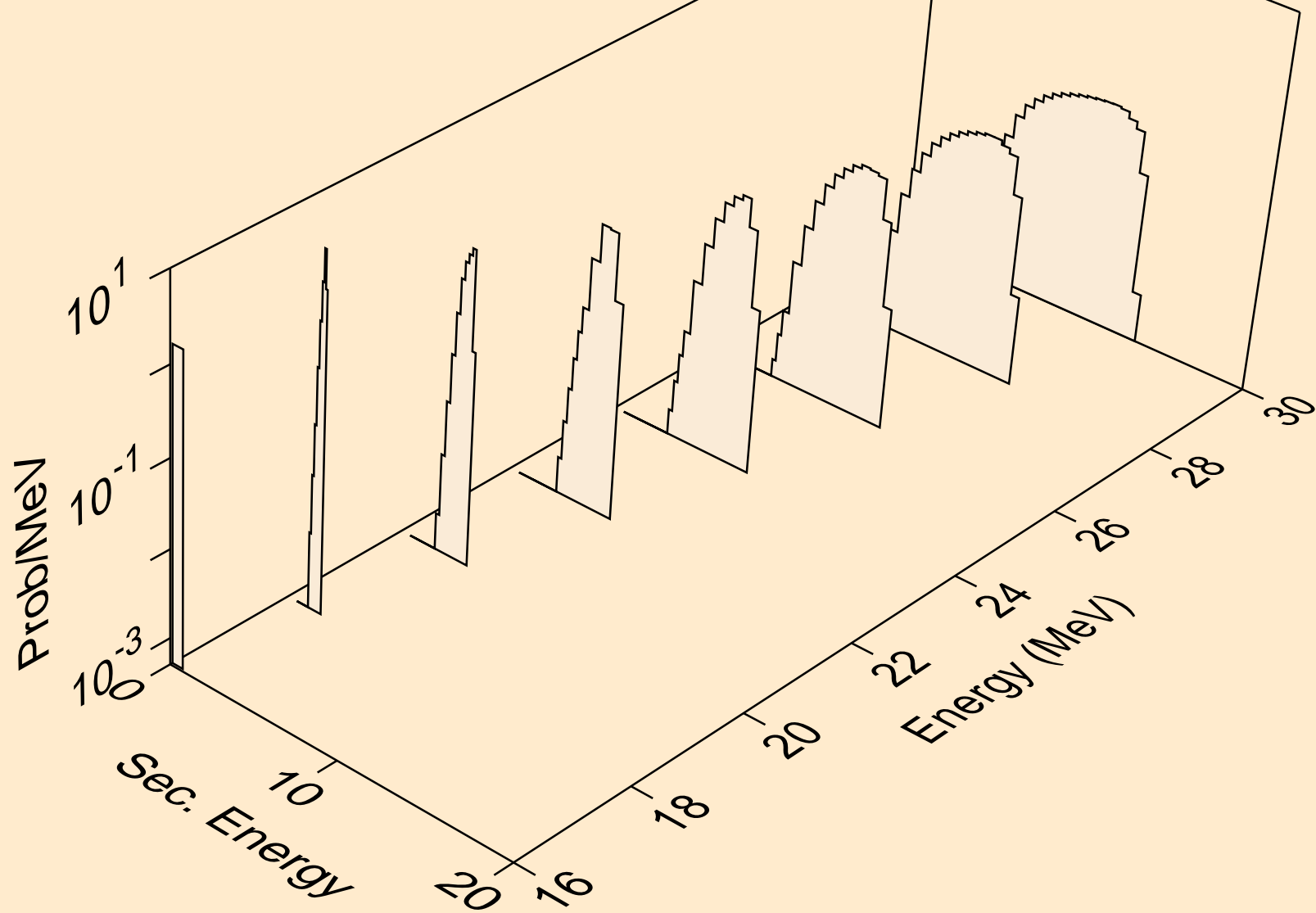

ZR094 NEUTRON ACER TENDL-2023 LIBRARY; T=0.K  
tritons from (n,t)

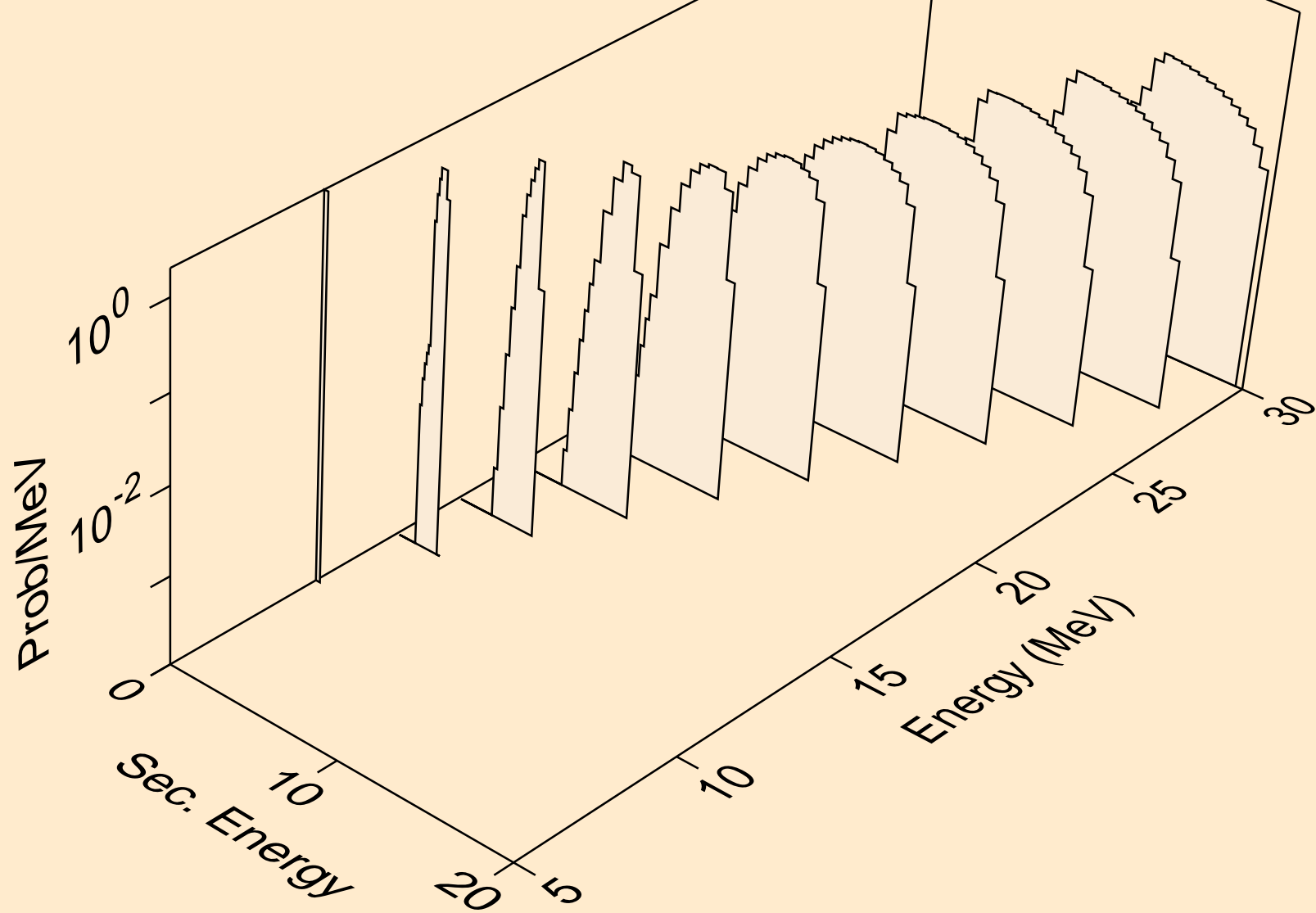

ZR094 NEUTRON ACER TENDL-2023 LIBRARY; T=0.K  
tritons from (n,pt)

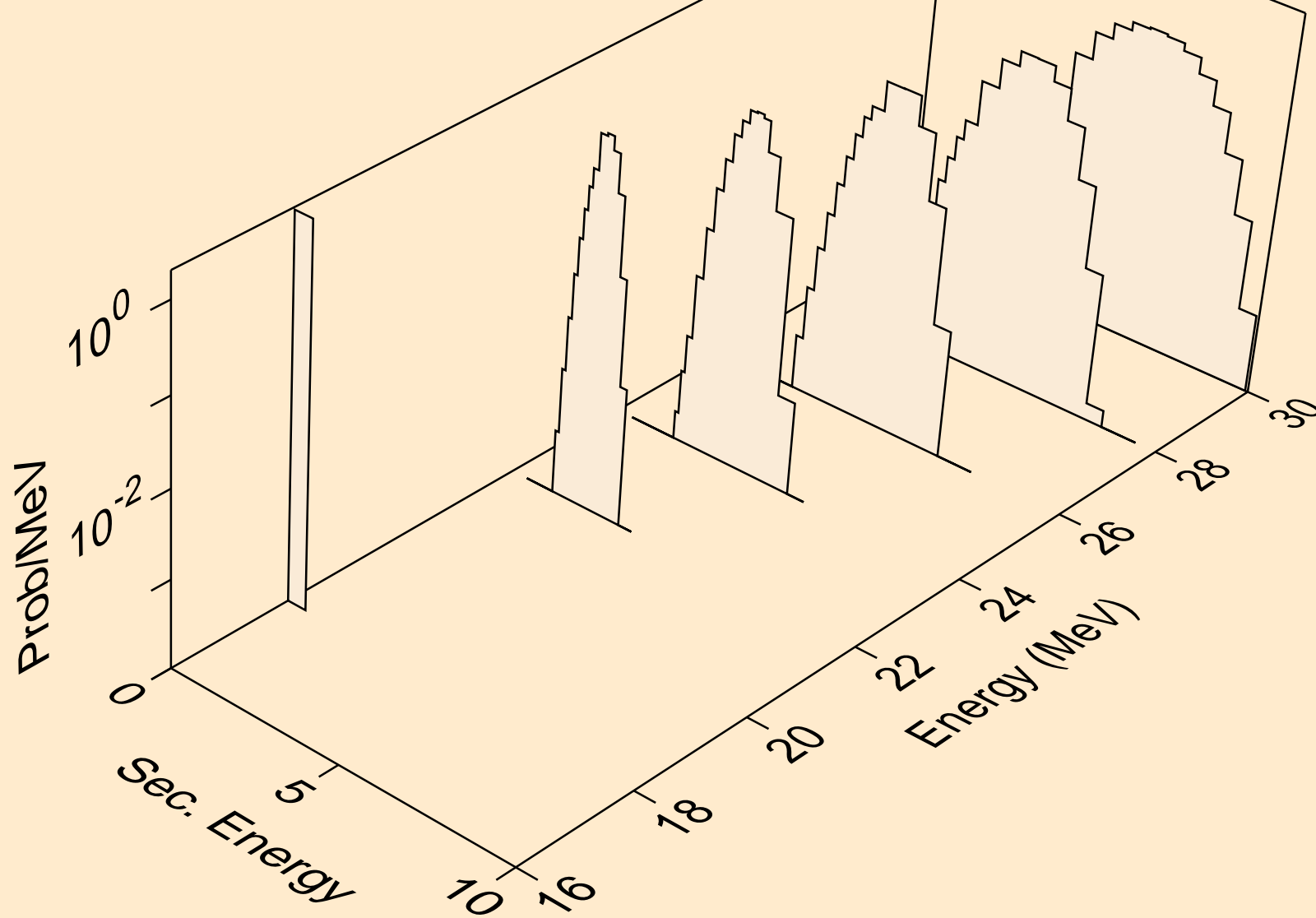

ZR094 NEUTRON ACER TENDL-2023 LIBRARY; T=0.K  
he3s from (n,x)

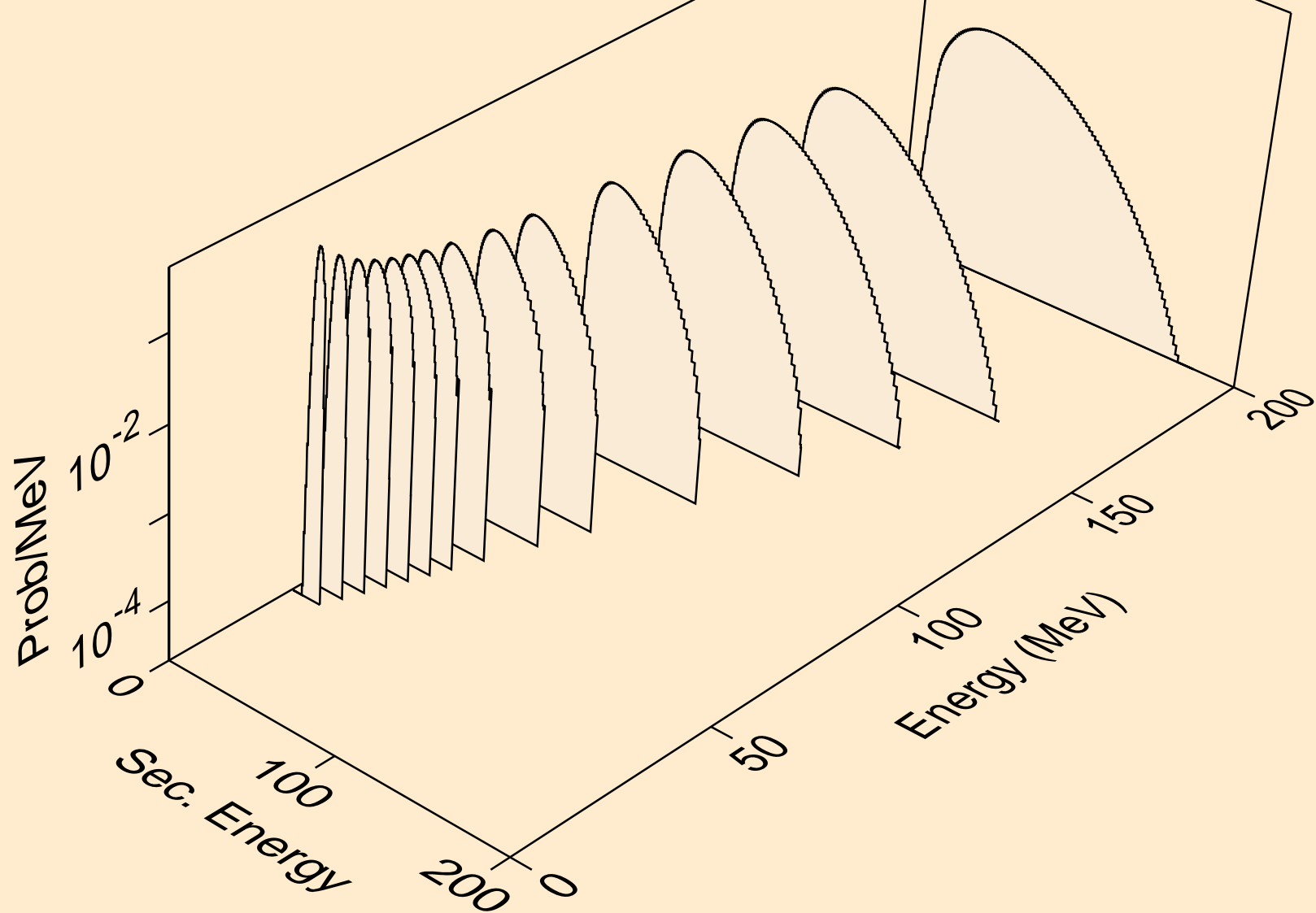

ZR094 NEUTRON ACER TENDL-2023 LIBRARY; T=0.K  
he3s from (n,n\*)he3

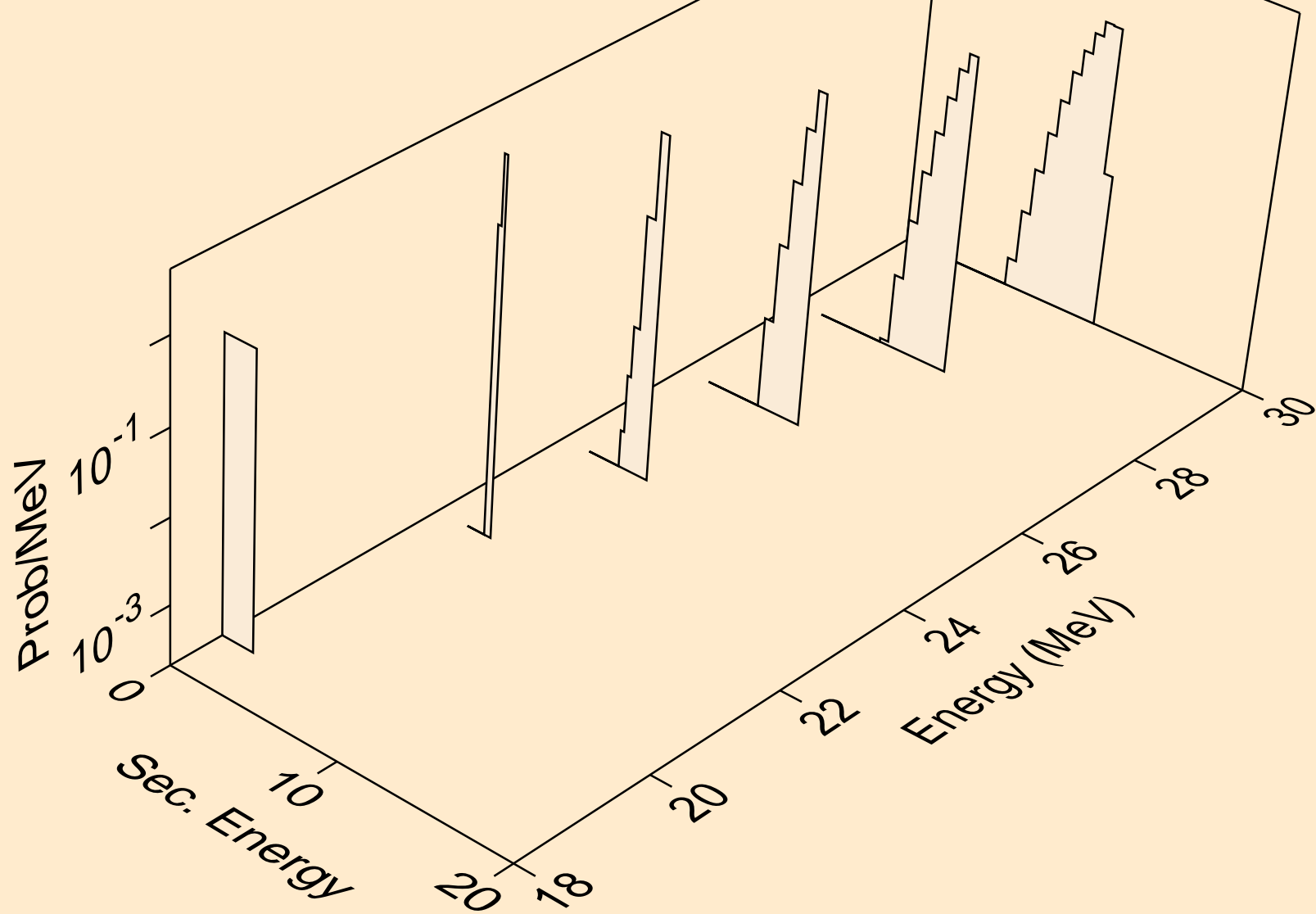

ZR094 NEUTRON ACER TENDL-2023 LIBRARY; T=0.K  
he3s from (n,he3)

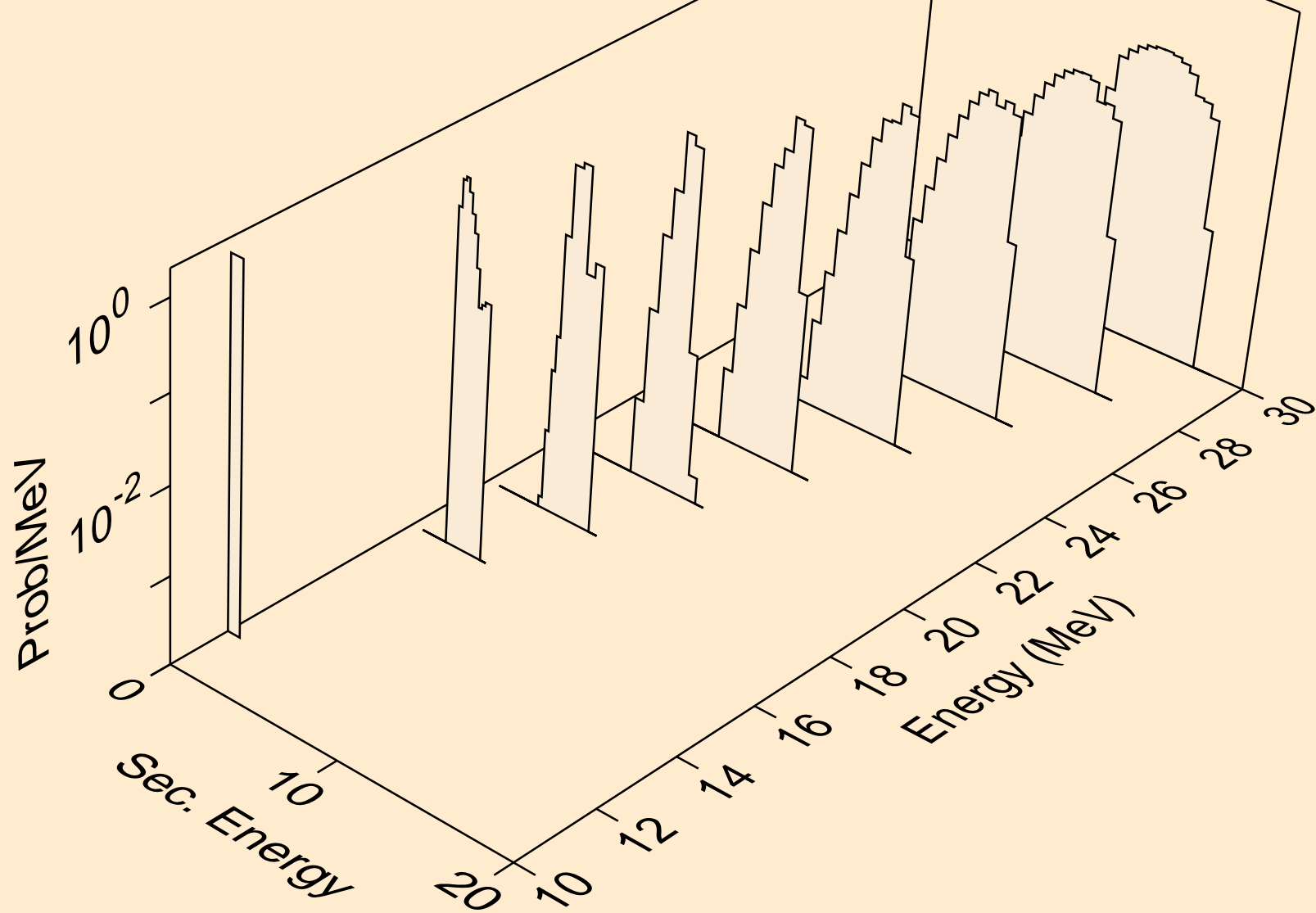

ZR094 NEUTRON ACER TENDL-2023 LIBRARY; T=0.K  
alphas from (n,x)

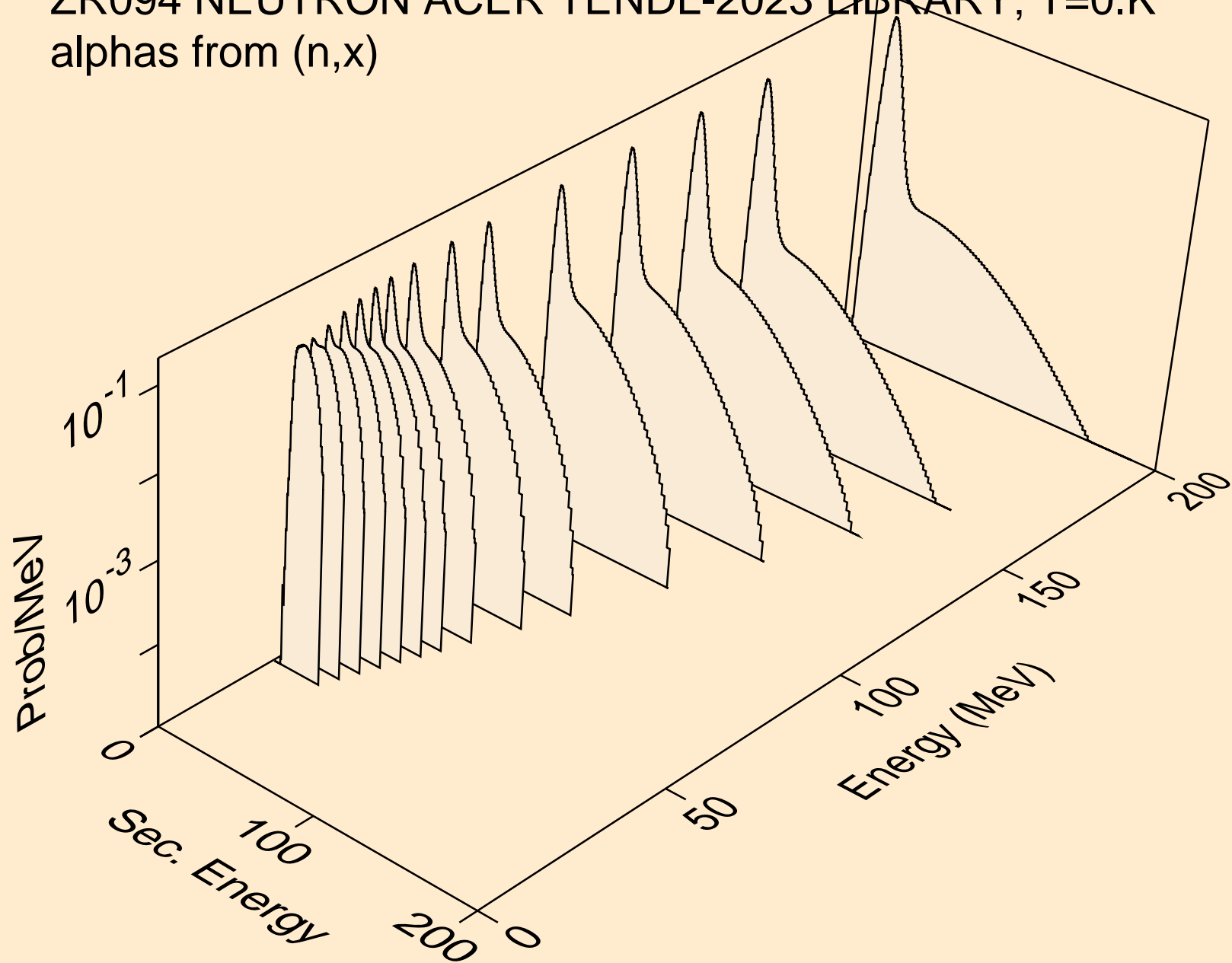

ZR094 NEUTRON ACER TENDL-2023 LIBRARY; T=0.K  
alphas from (n,n\*)a

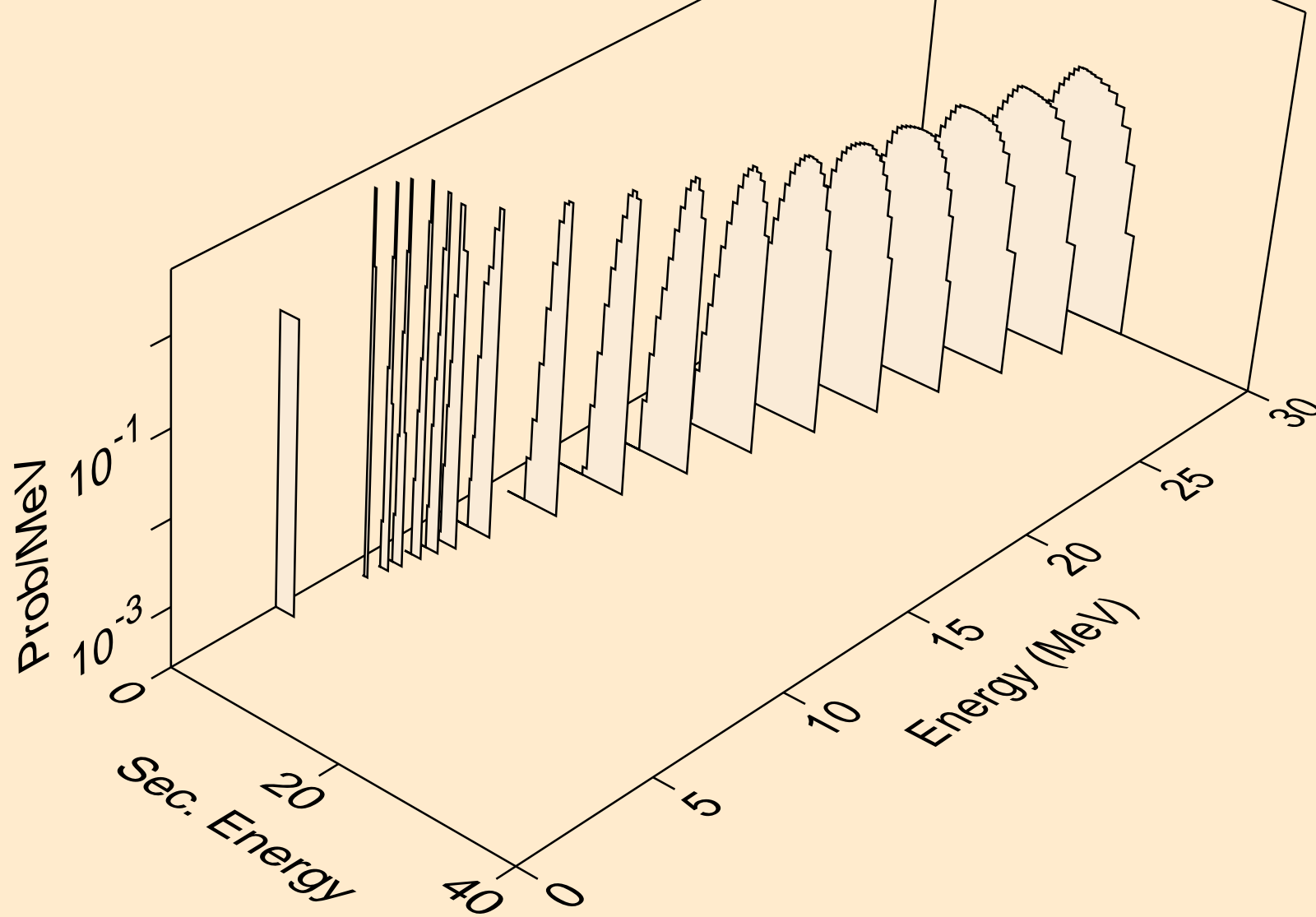

ZR094 NEUTRON ACER TENDL-2023 LIBRARY; T=0.K  
alphas from (n,2n)a

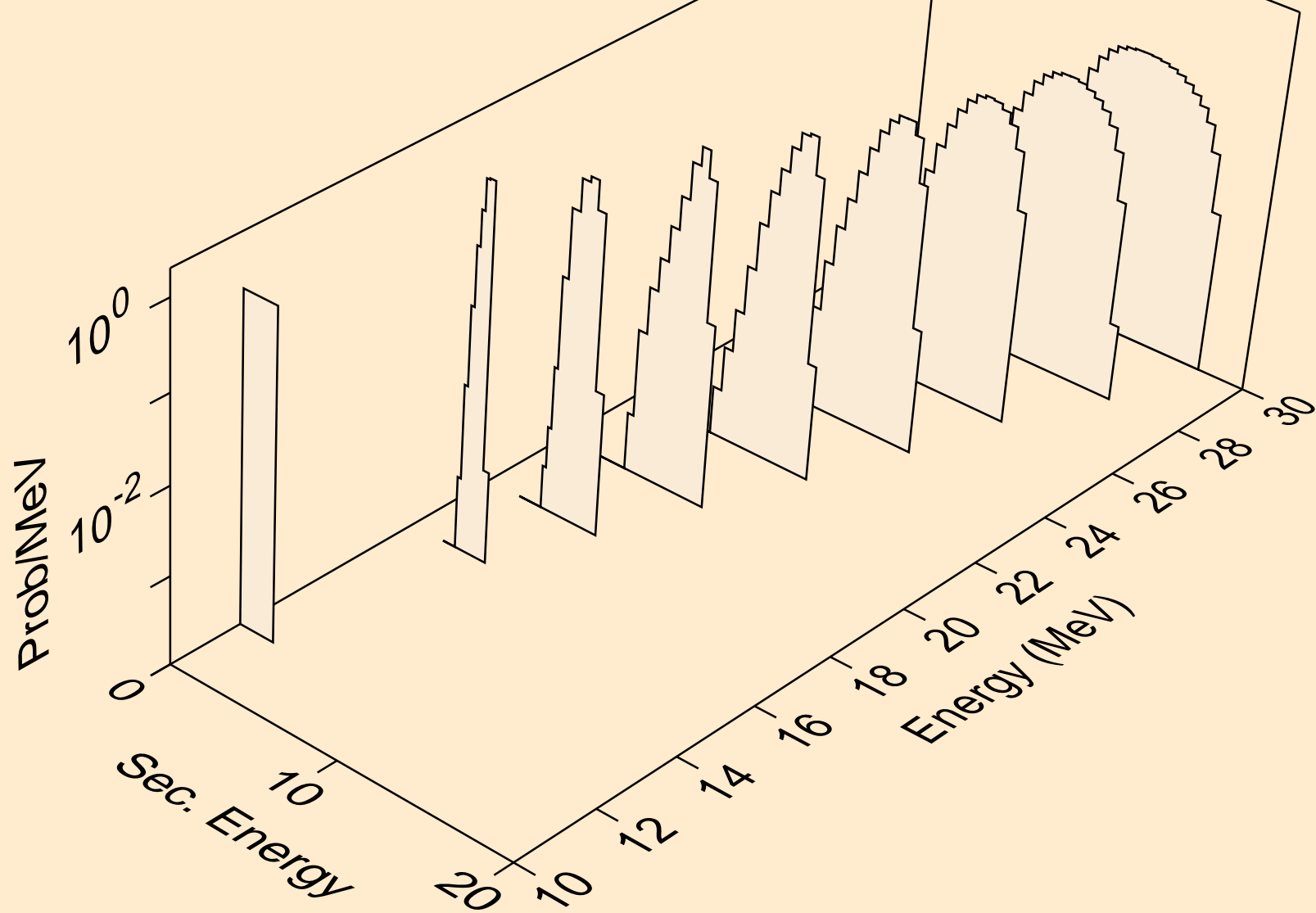

ZR094 NEUTRON ACER TENDL-2023 LIBRARY; T=0.K  
alphas from (n,3n)a

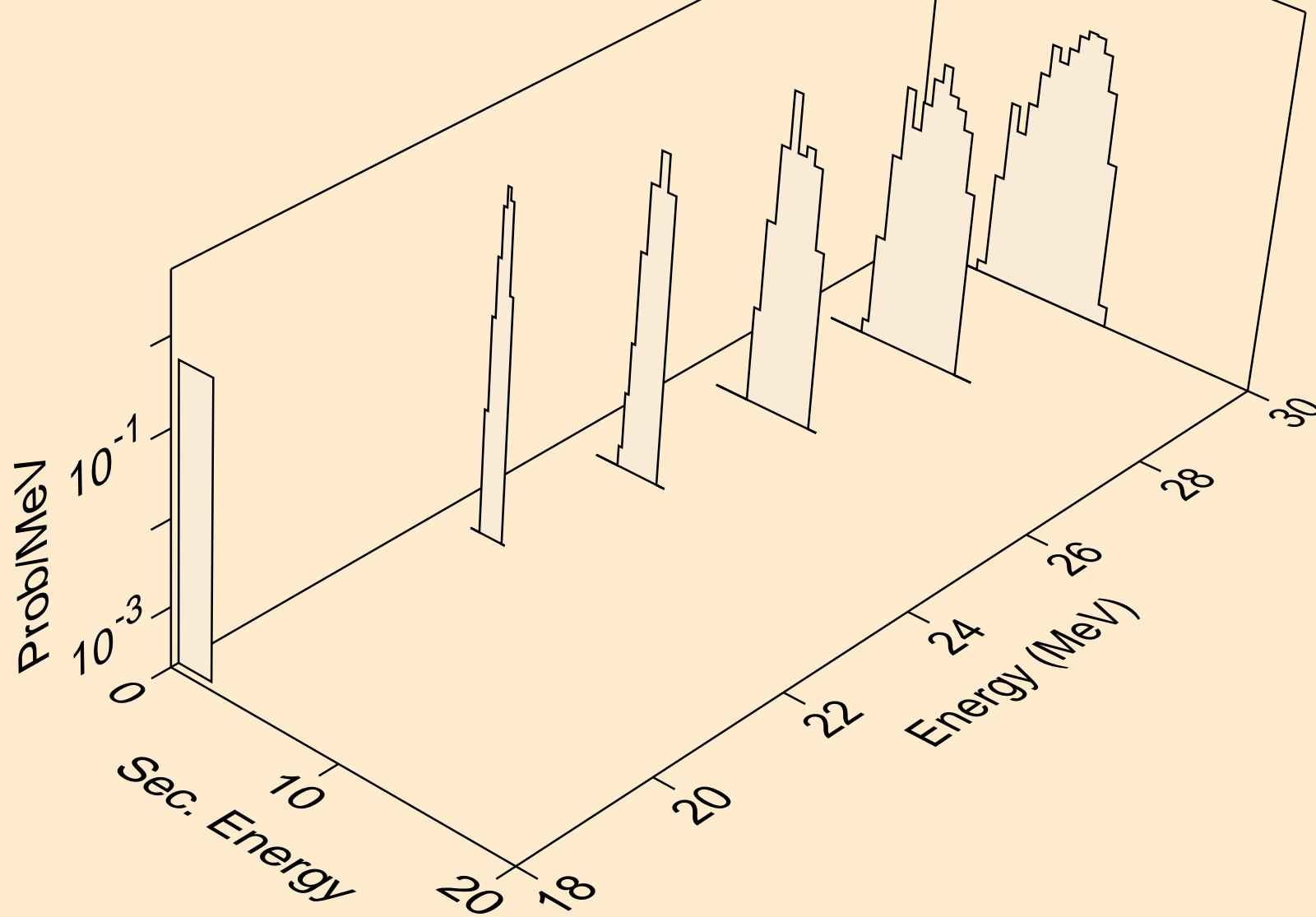

ZR094 NEUTRON ACER TENDL-2023 LIBRARY; T=0.K  
alphas from (n,n\*)2a

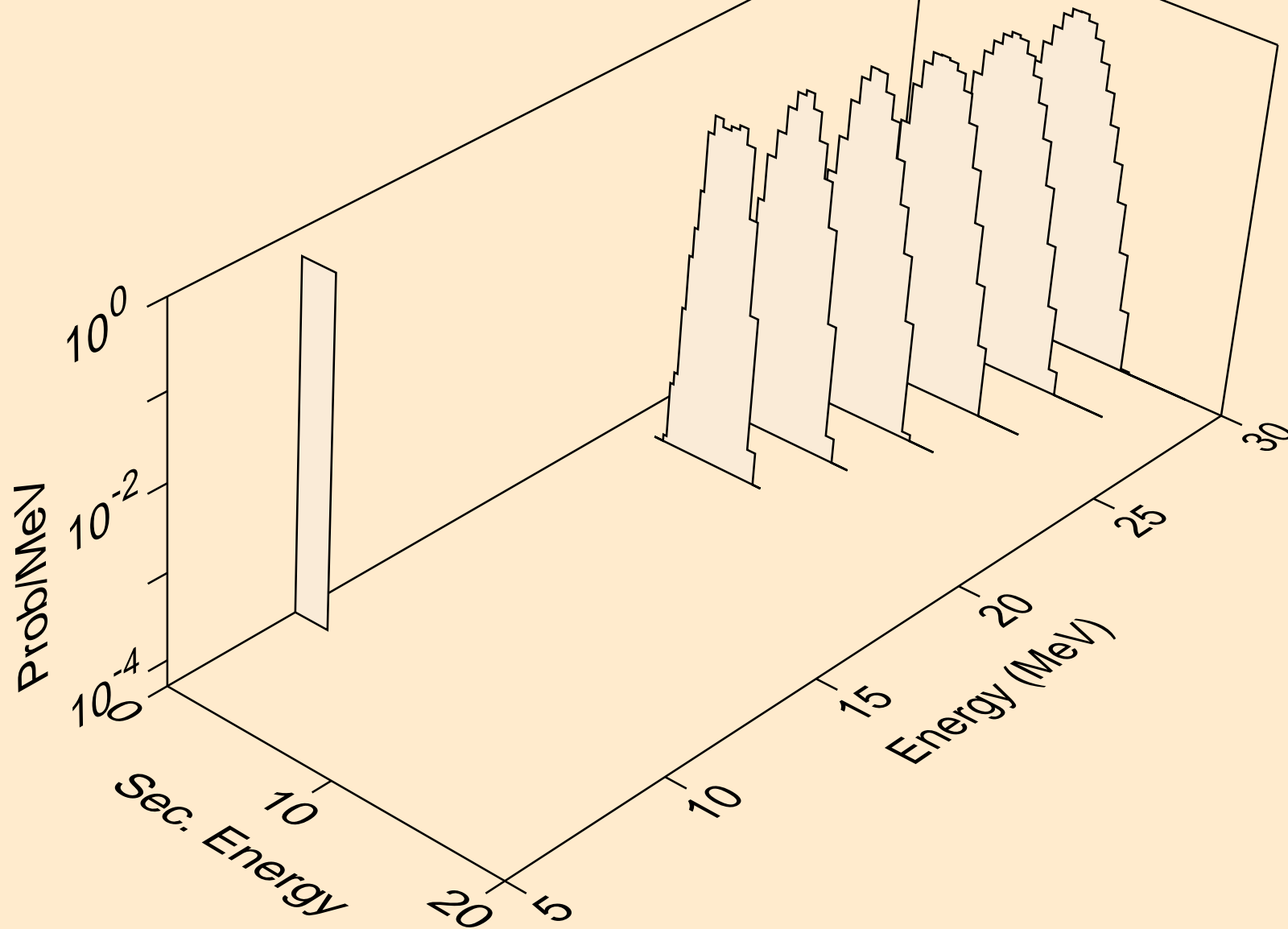

ZR094 NEUTRON ACER TENDL-2023 LIBRARY; T=0.K  
alphas from (n,npa)

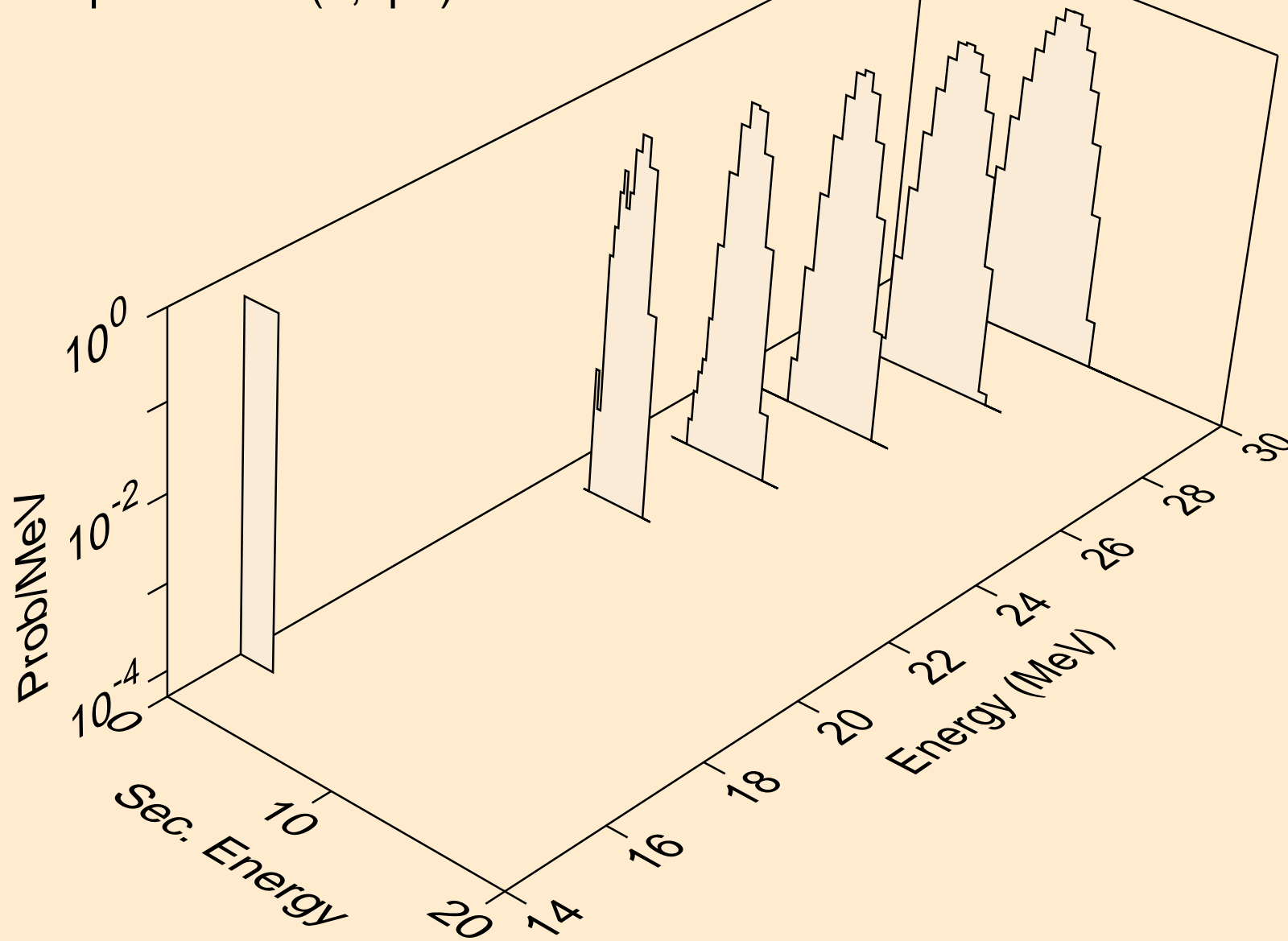

ZR094 NEUTRON ACER TENDL-2023 LIBRARY; T=0.K  
alphas from (n,a)

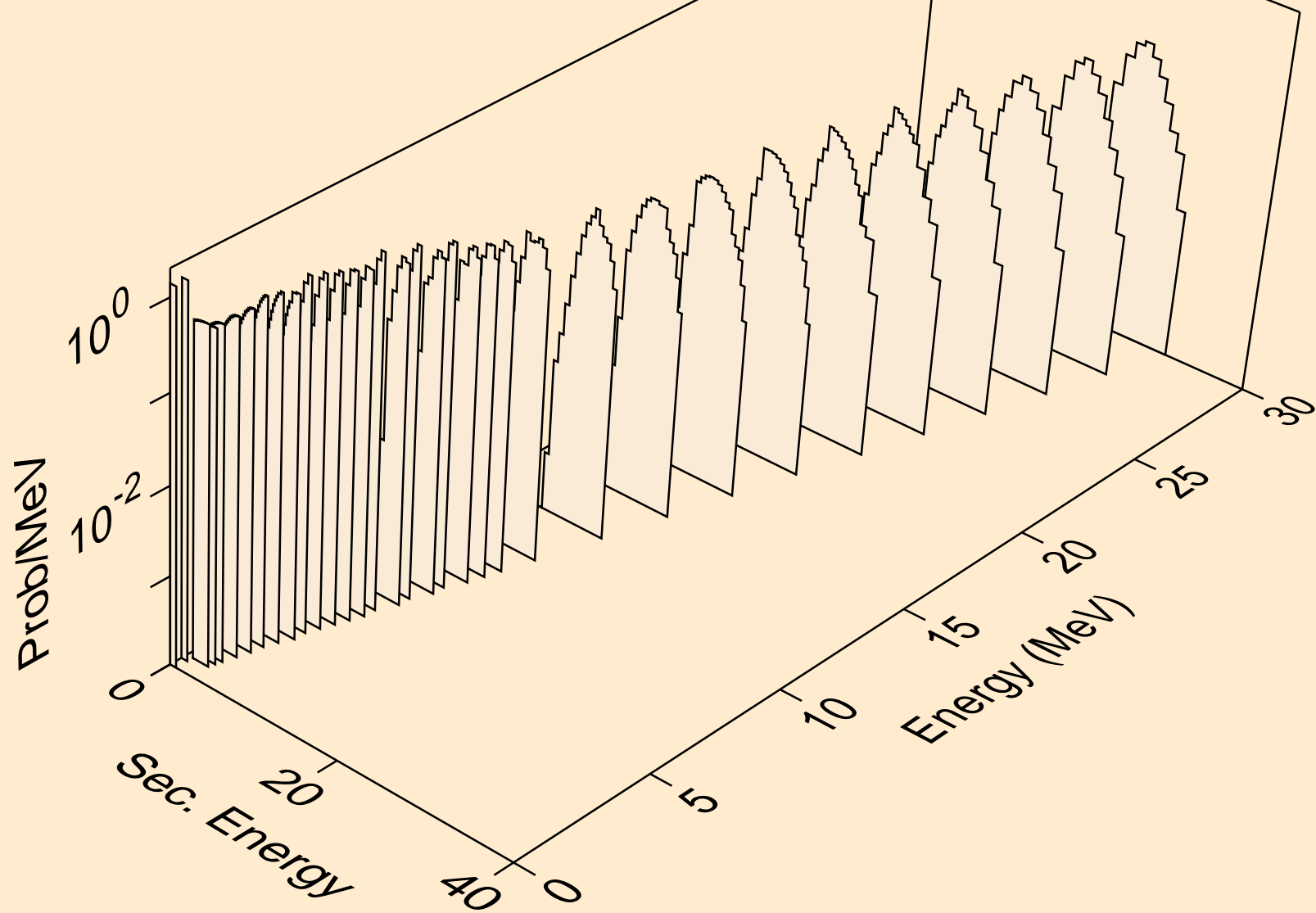

ZR094 NEUTRON ACER TENDL-2023 LIBRARY; T=0.K  
alphas from (n,2a)

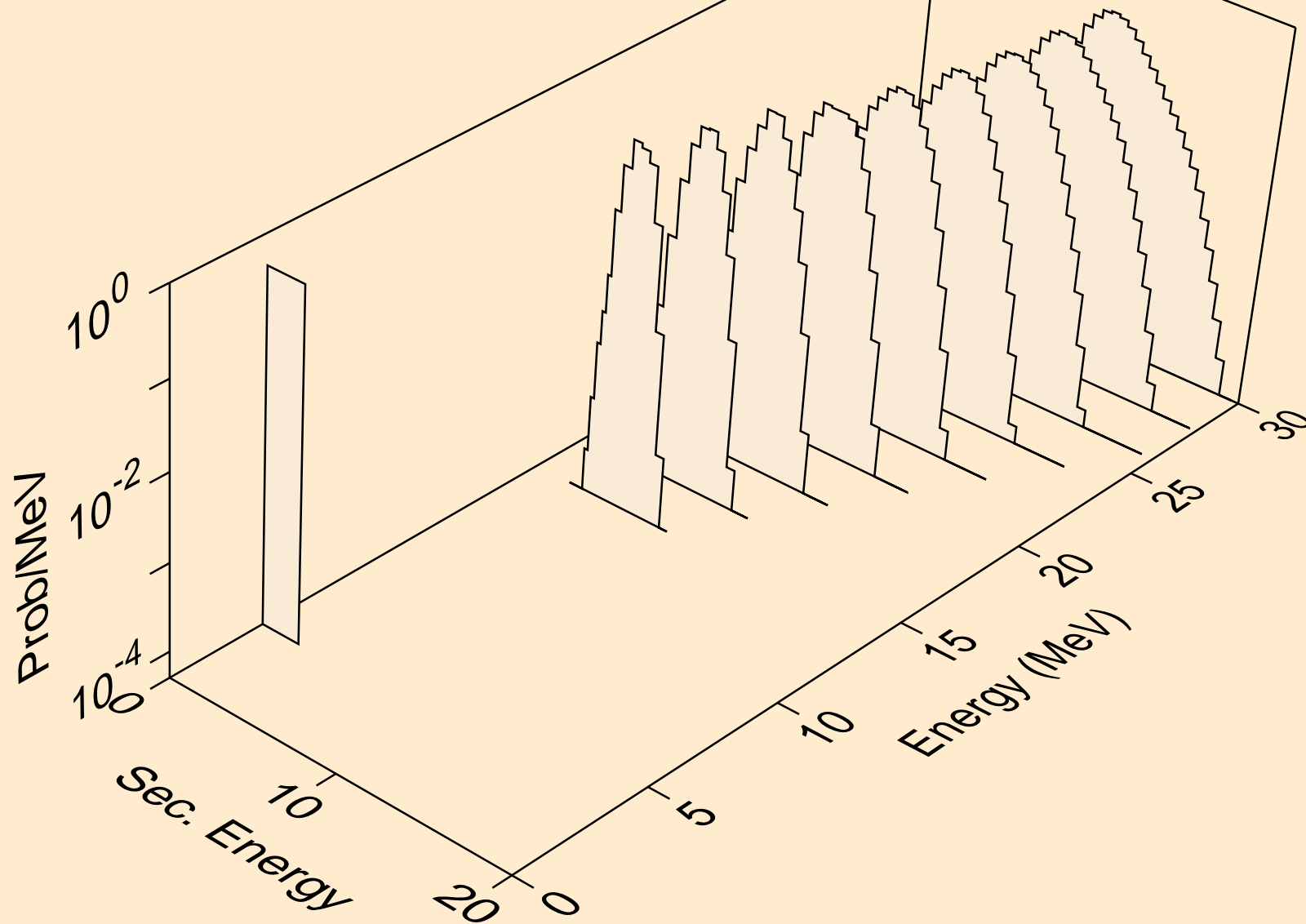

ZR094 NEUTRON ACER TENDL-2023 LIBRARY; T=0.K  
alphas from (n,pa)

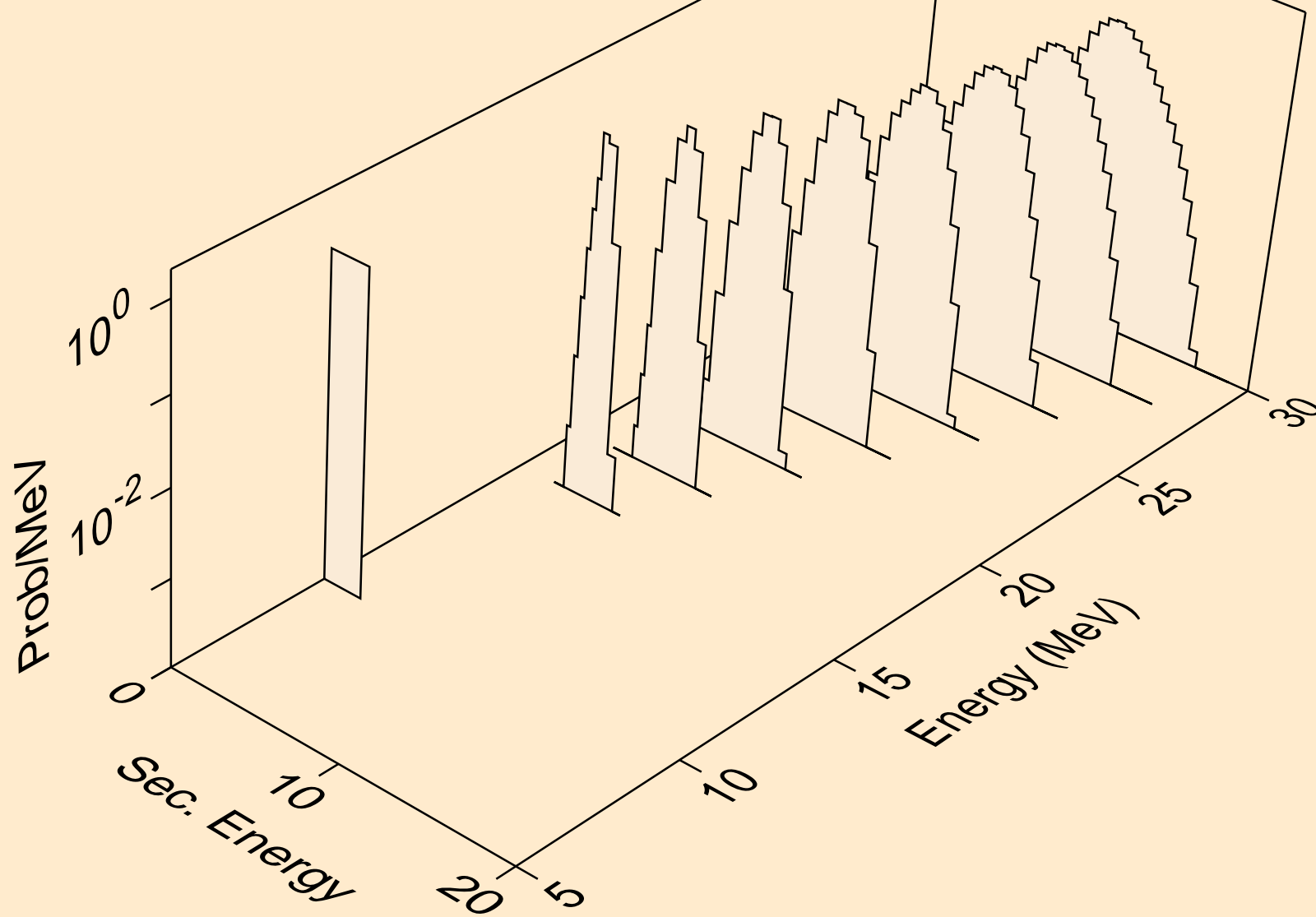

ZR094 NEUTRON ACER TENDL-2023 LIBRARY; T=0.K  
alphas from (n,da)

