

AL024 NEUTRON ACER TENDL-2024 LIBRARY; T=0.K

Principal cross sections

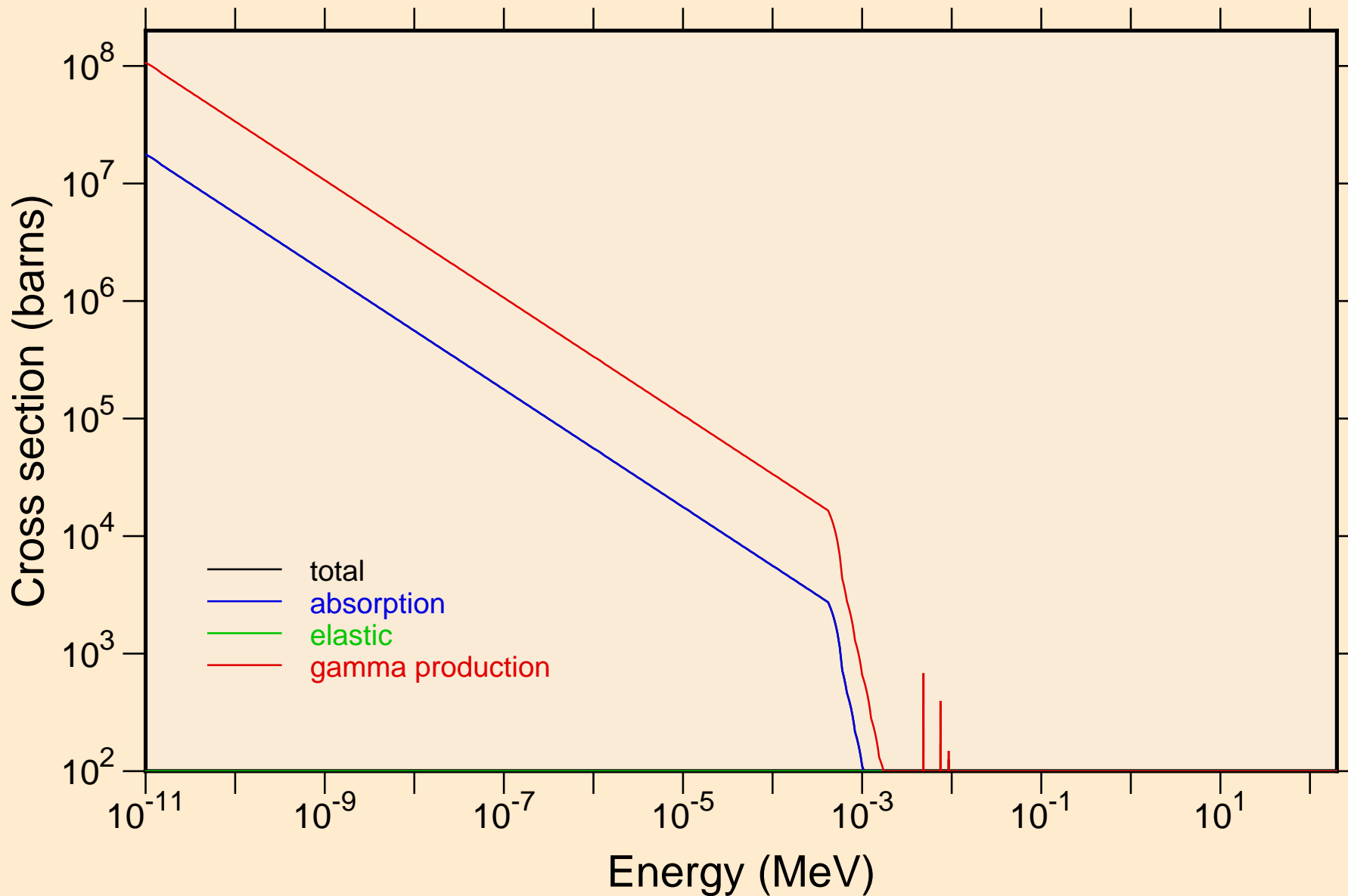

AL024 NEUTRON ACER TENDL-2024 LIBRARY; T=0.K
resonance total cross section

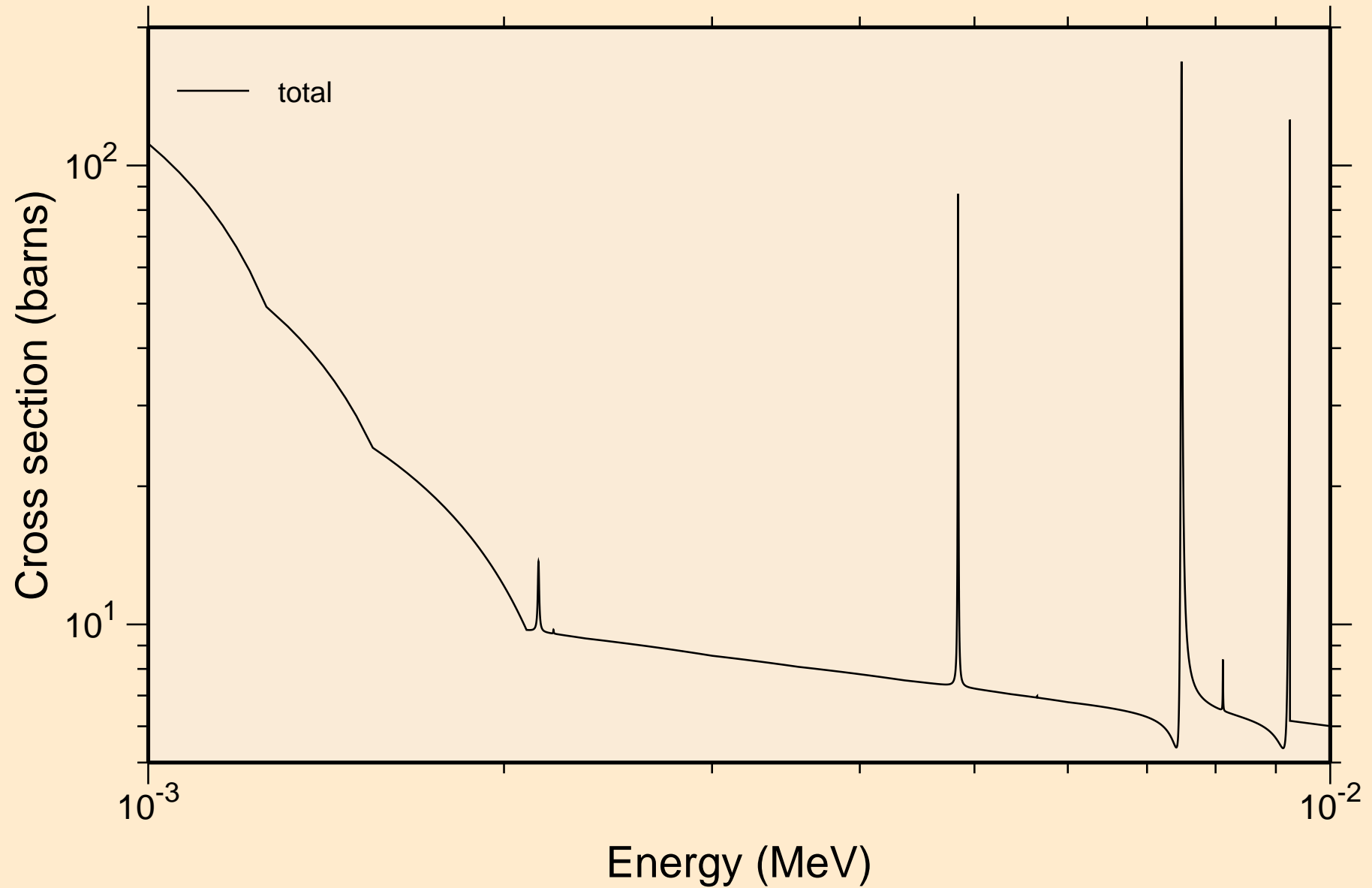

AL024 NEUTRON ACER TENDL-2024 LIBRARY; T=0.K
resonance total cross section

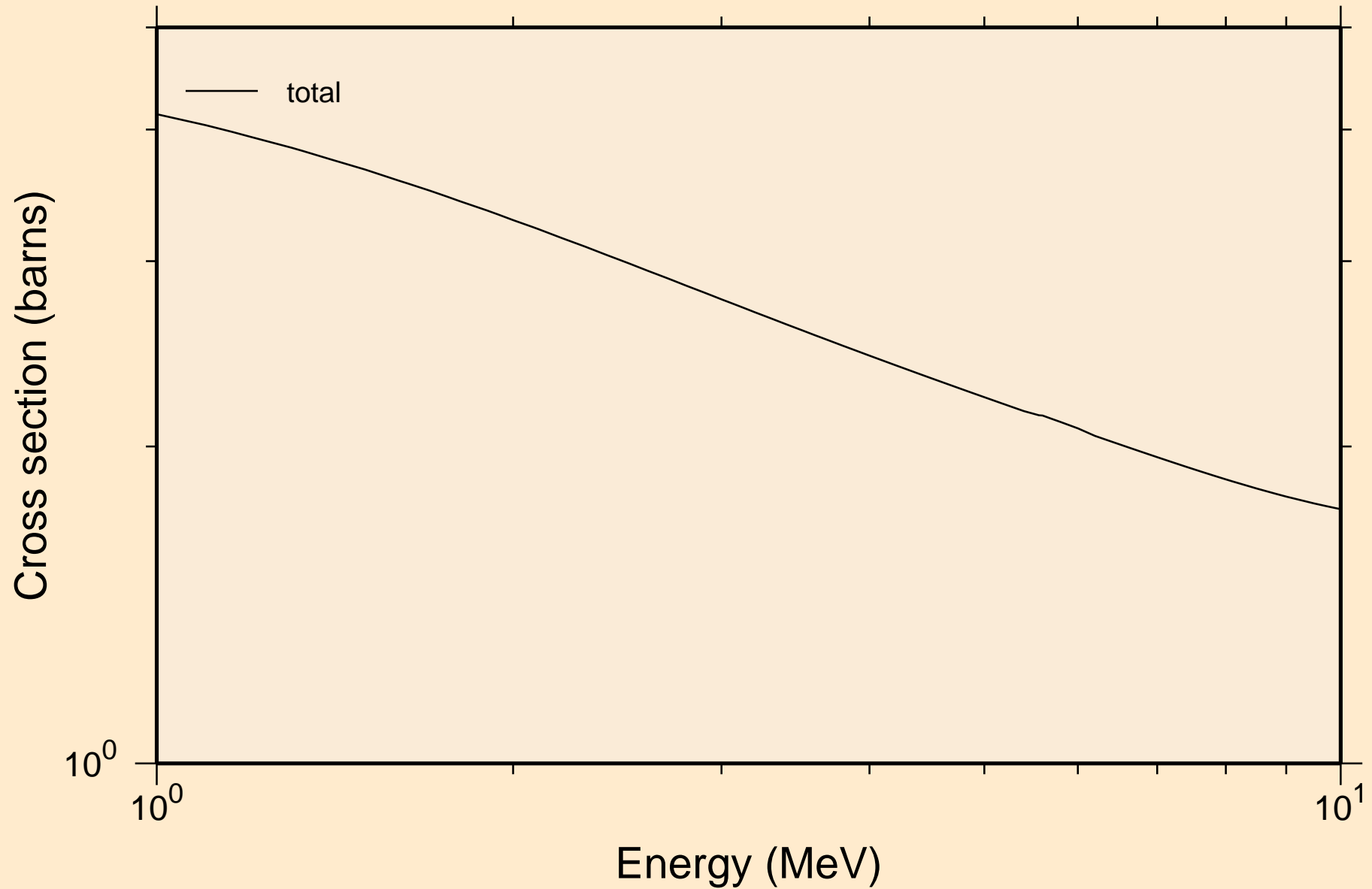

AL024 NEUTRON ACER TENDL-2024 LIBRARY; T=0.K
resonance absorption cross sections

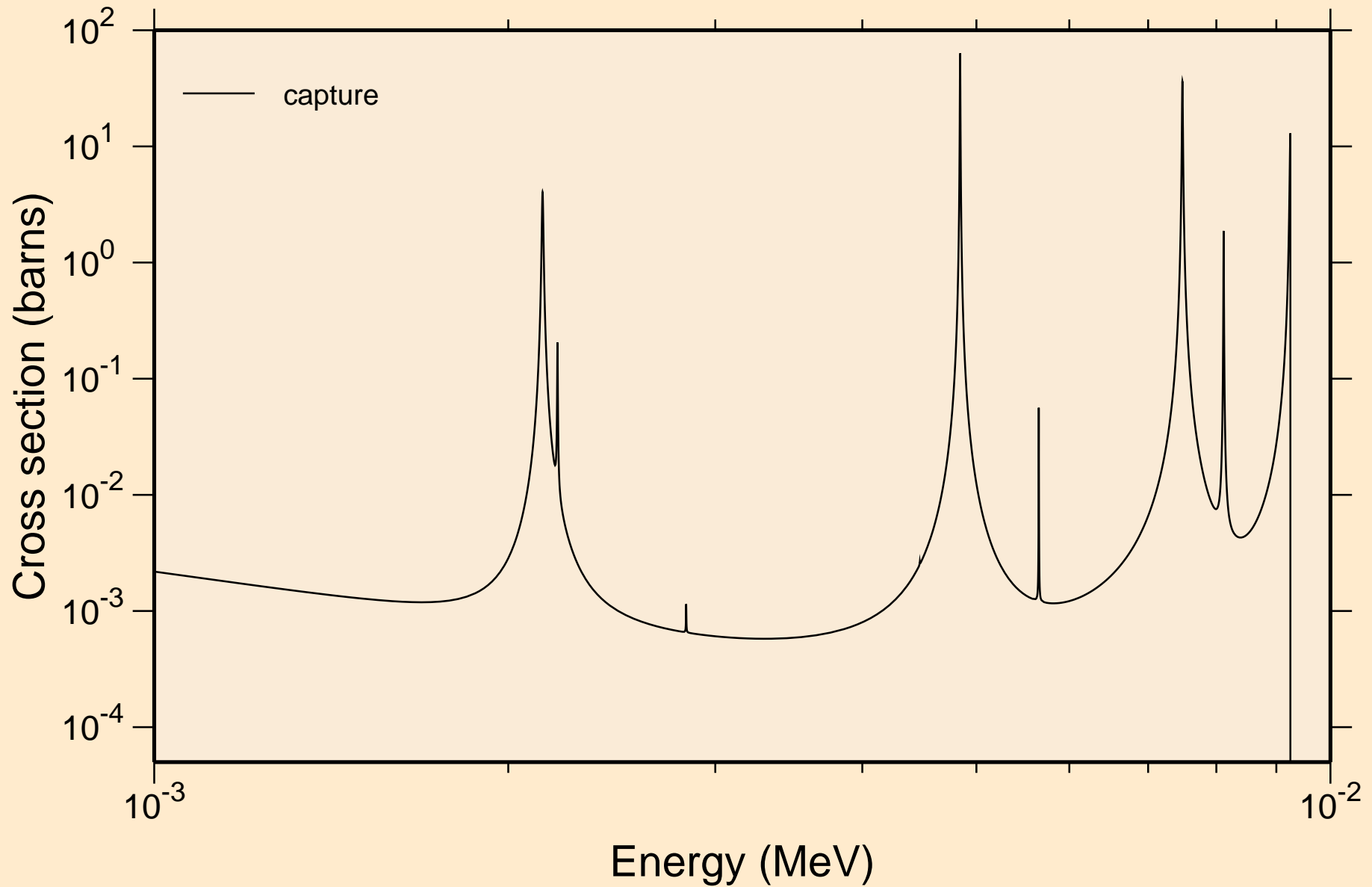

AL024 NEUTRON ACER TENDL-2024 LIBRARY; T=0.K
resonance absorption cross sections

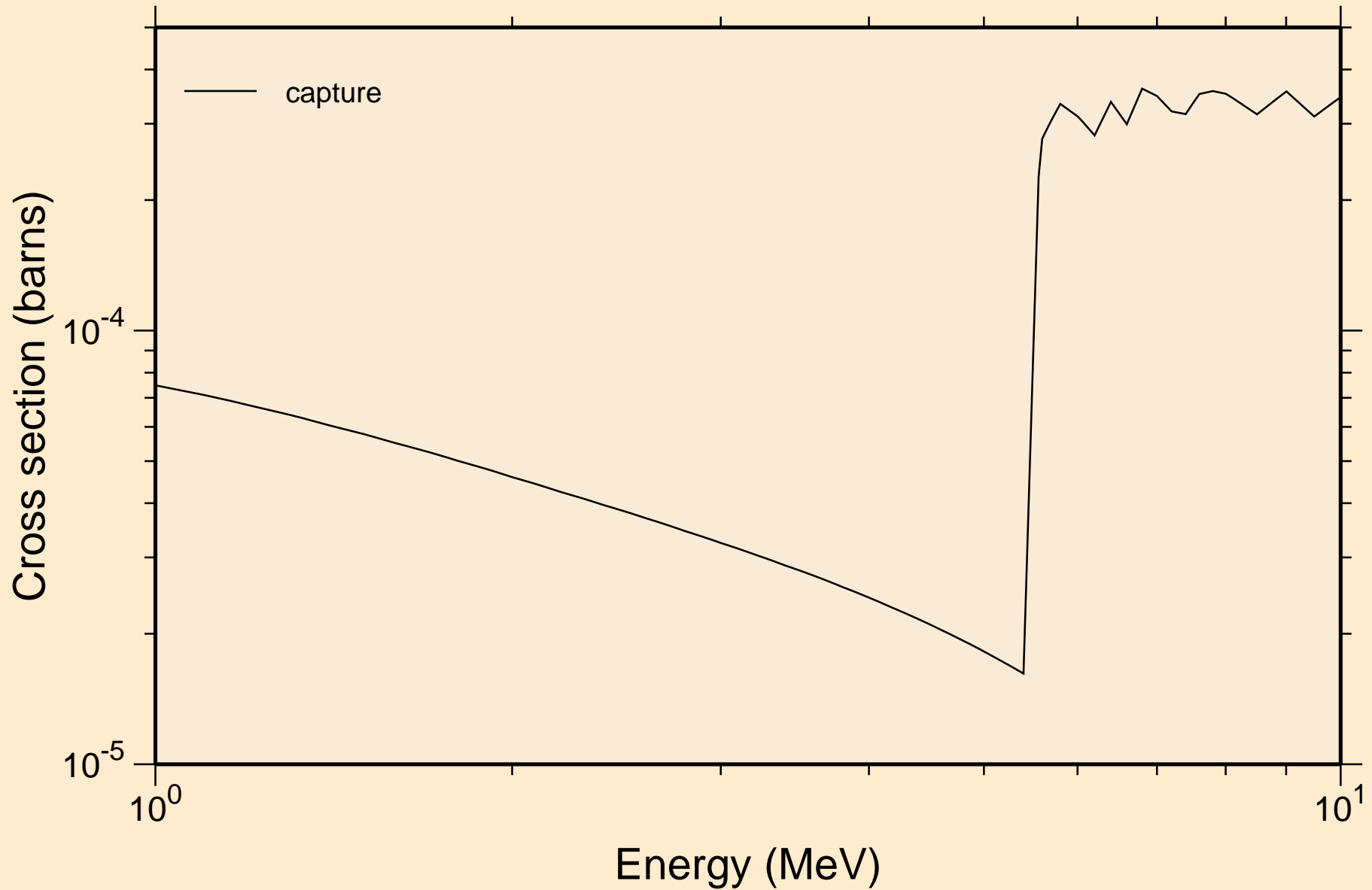

AL024 NEUTRON ACER TENDL-2024 LIBRARY; T=0.K

Heating

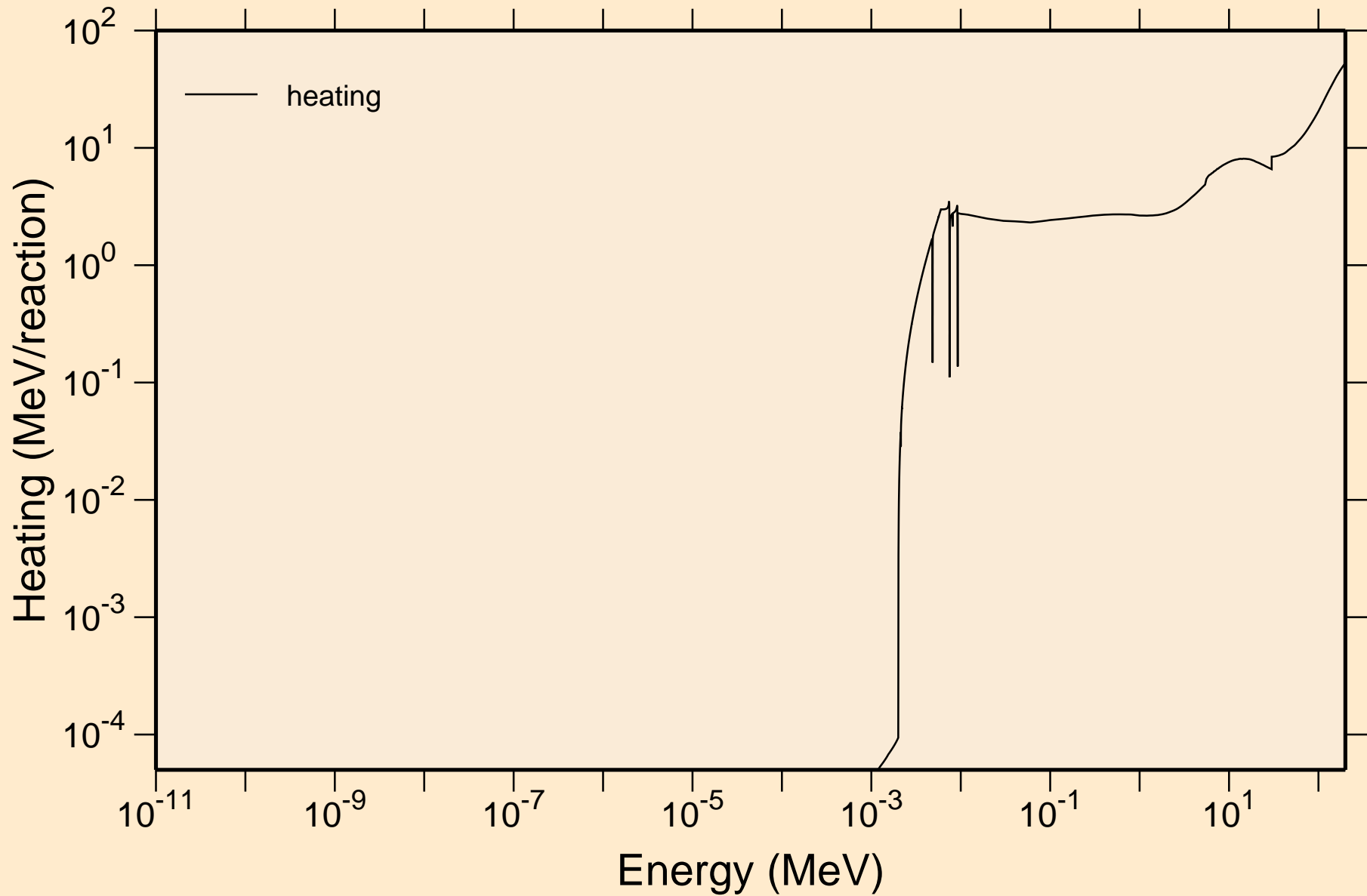

AL024 NEUTRON ACER TENDL-2024 LIBRARY; T=0.K

Damage

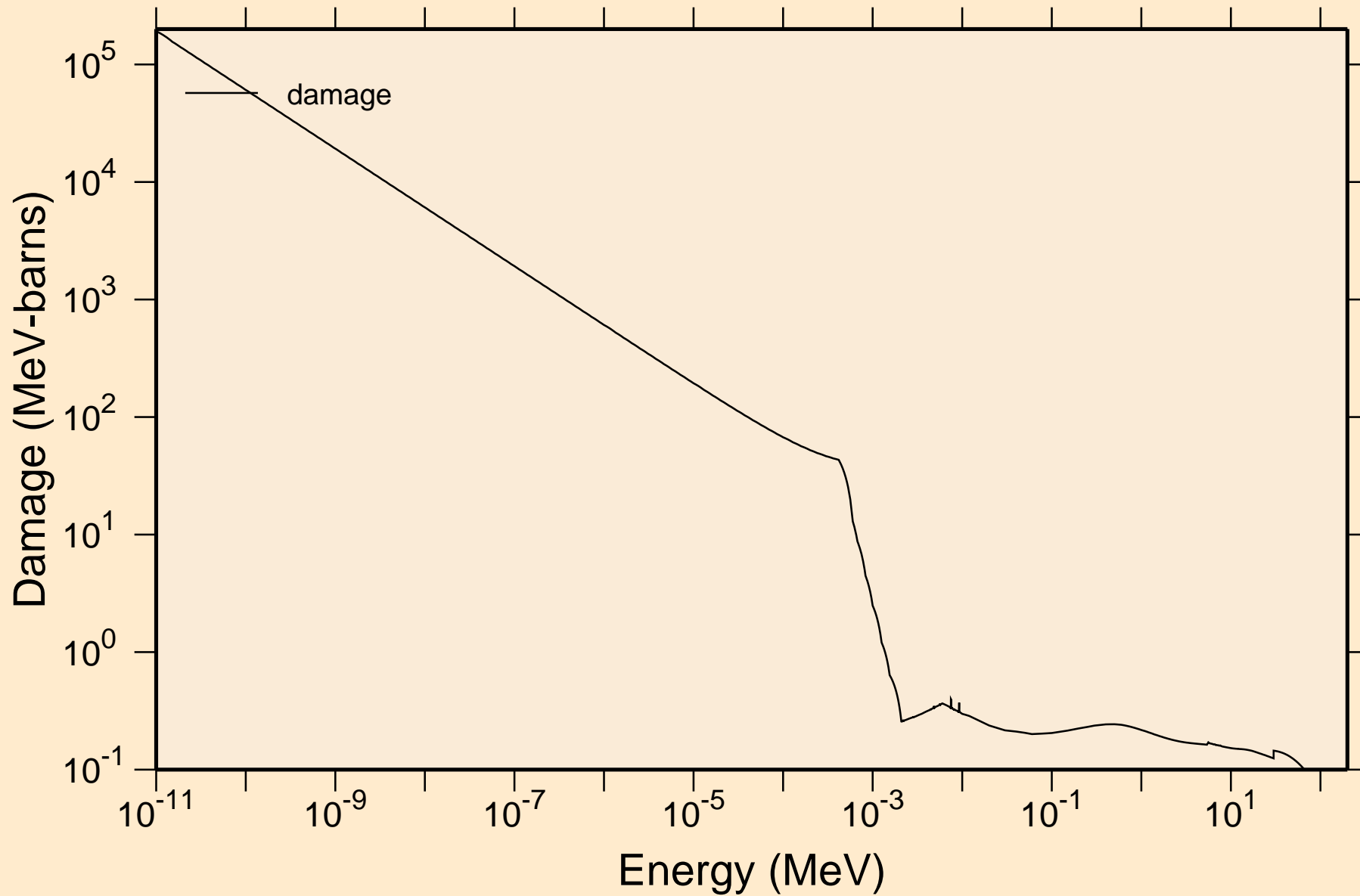

AL024 NEUTRON ACER TENDL-2024 LIBRARY; T=0.K

Non-threshold reactions

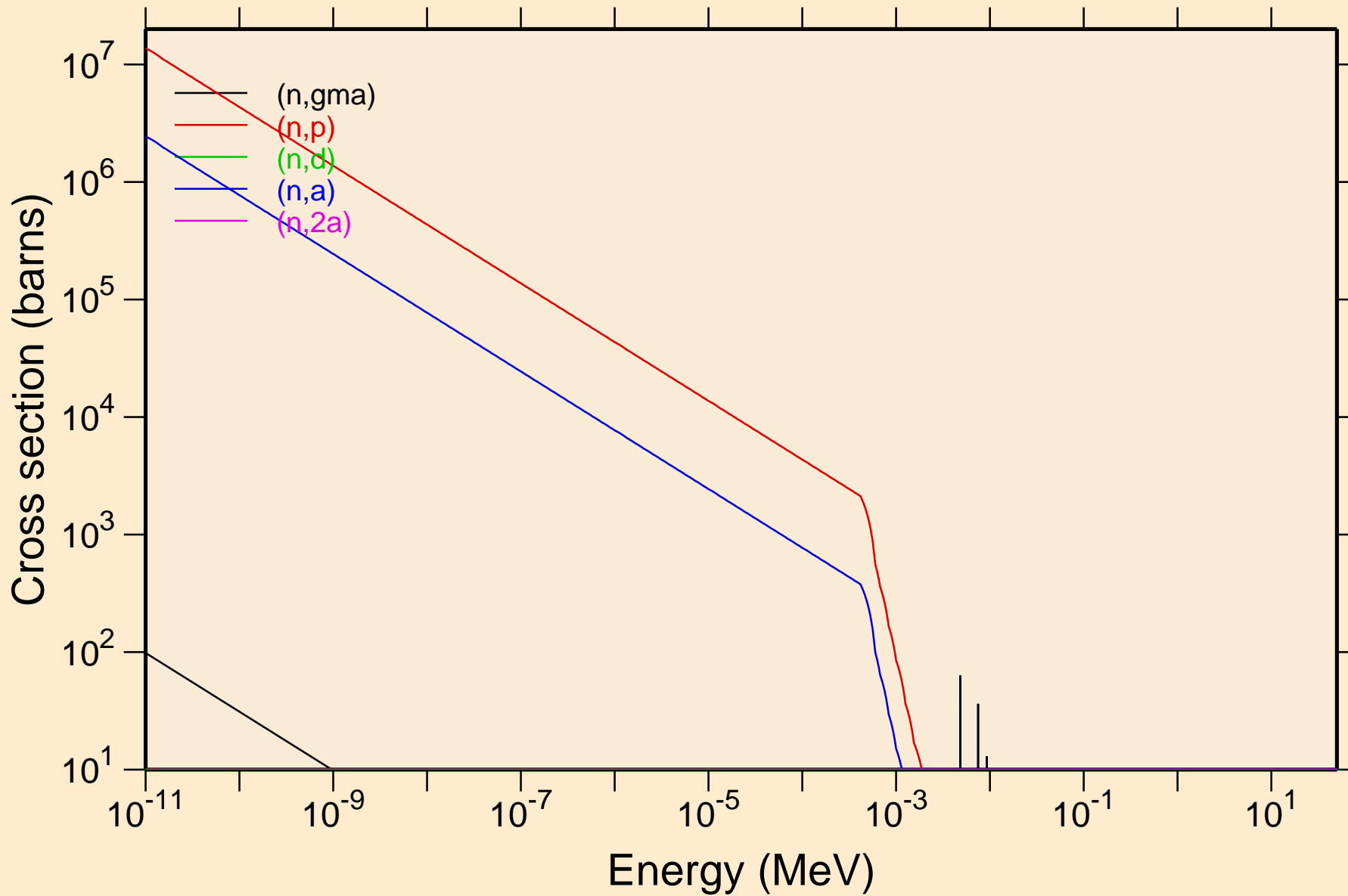

AL024 NEUTRON ACER TENDL-2024 LIBRARY; T=0.K

Non-threshold reactions

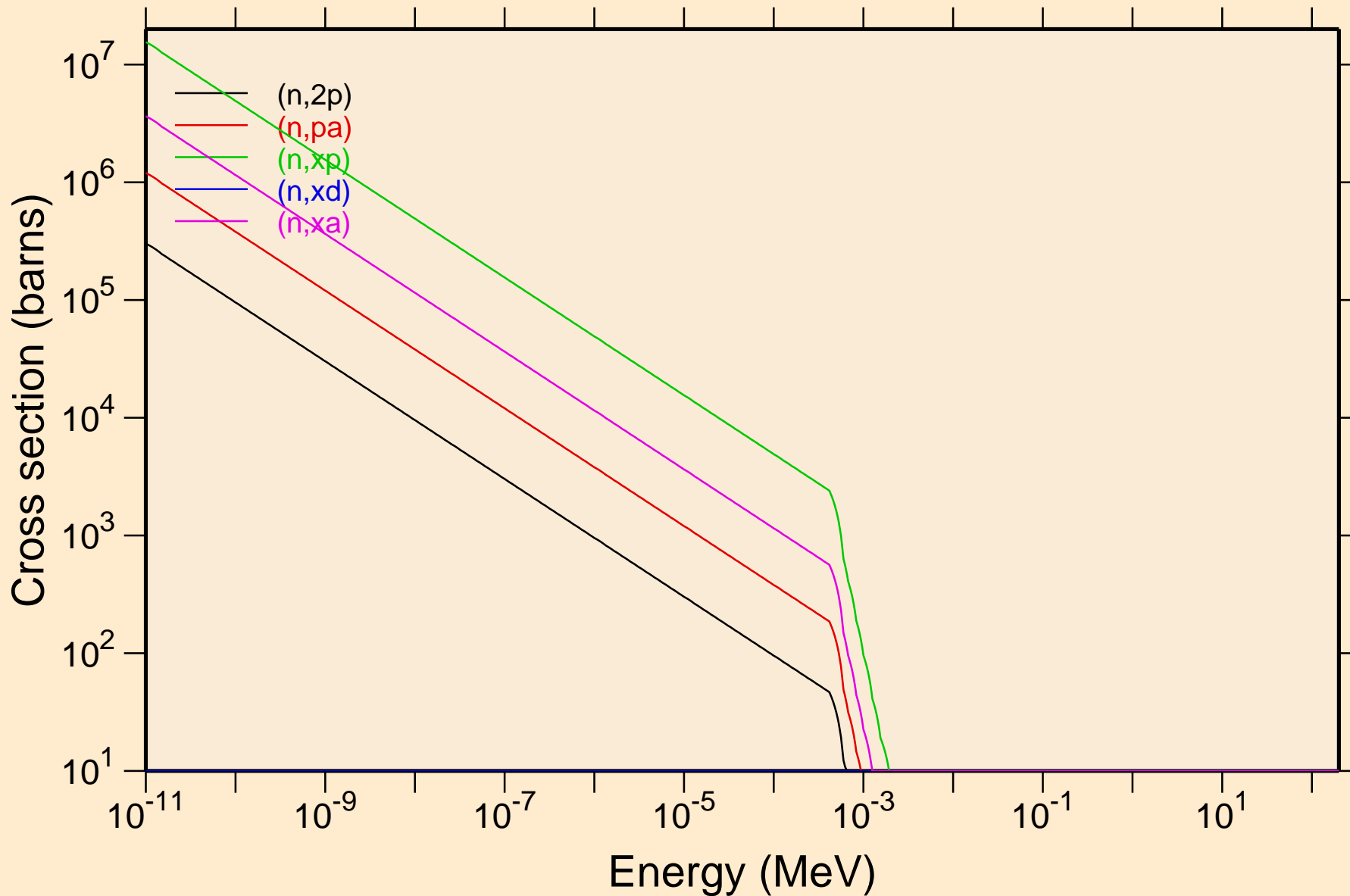

AL024 NEUTRON ACER TENDL-2024 LIBRARY; T=0.K

Principal cross sections

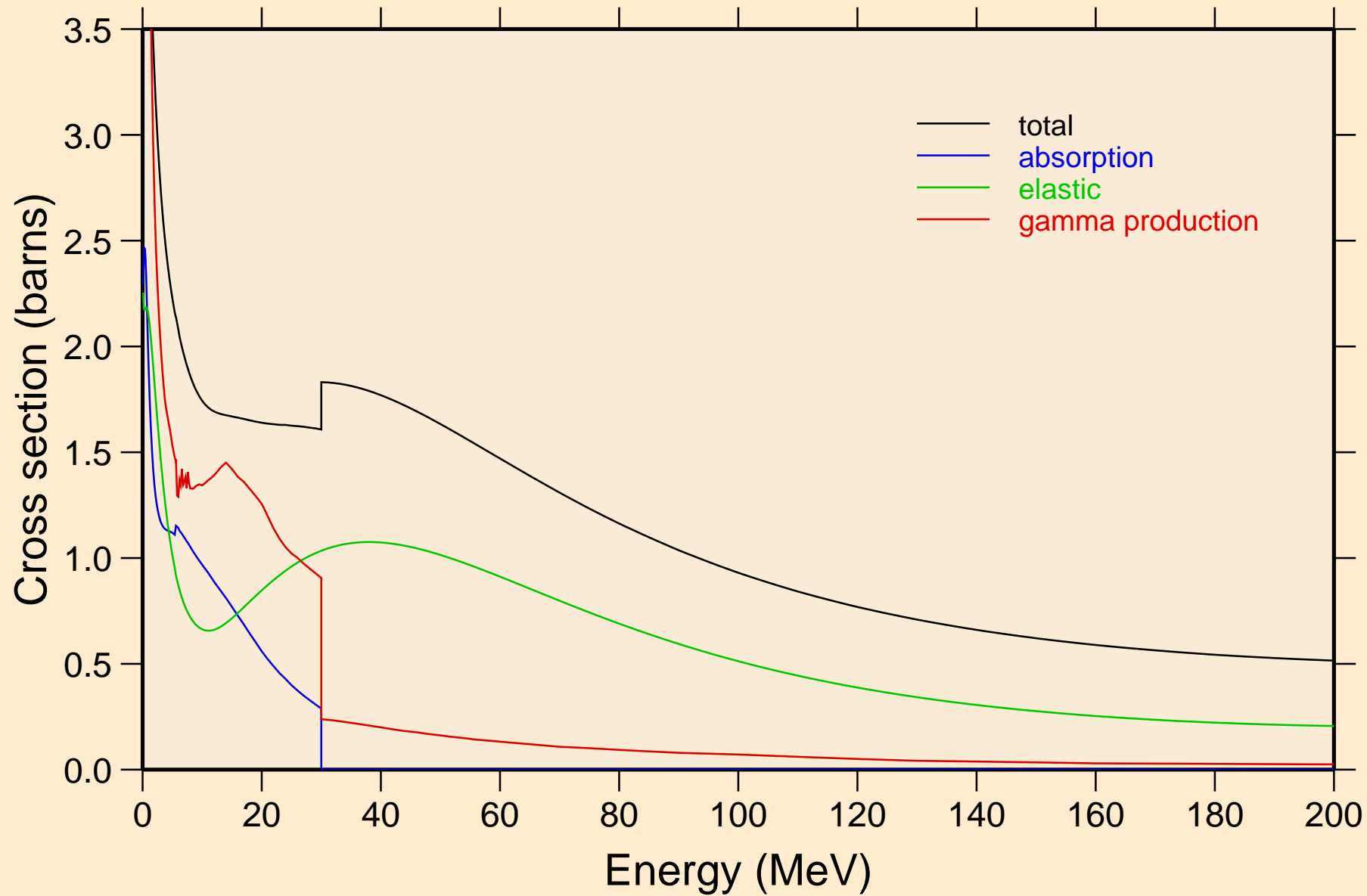

AL024 NEUTRON ACER TENDL-2024 LIBRARY; T=0.K

Heating

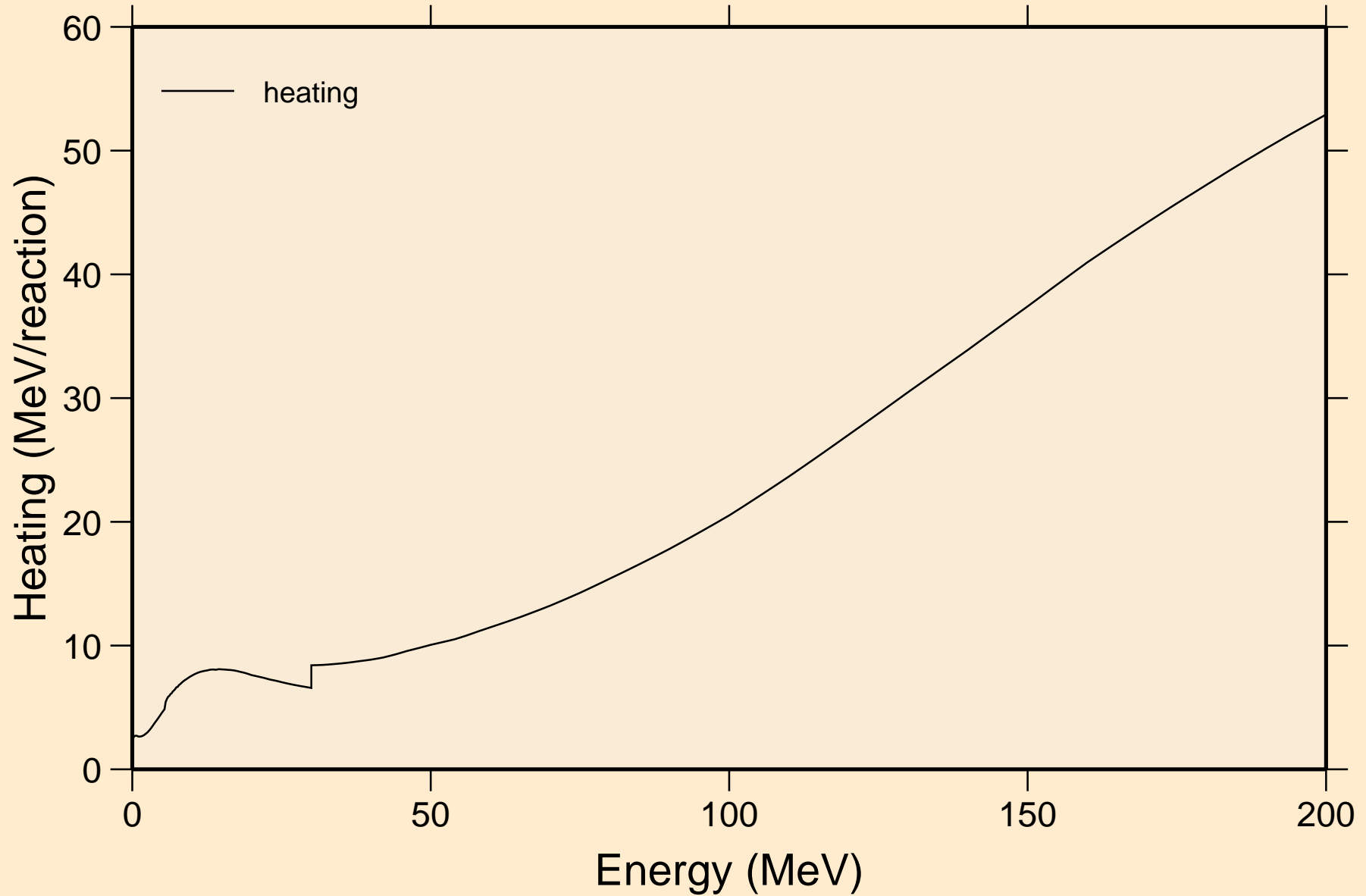

AL024 NEUTRON ACER TENDL-2024 LIBRARY; T=0.K
Damage

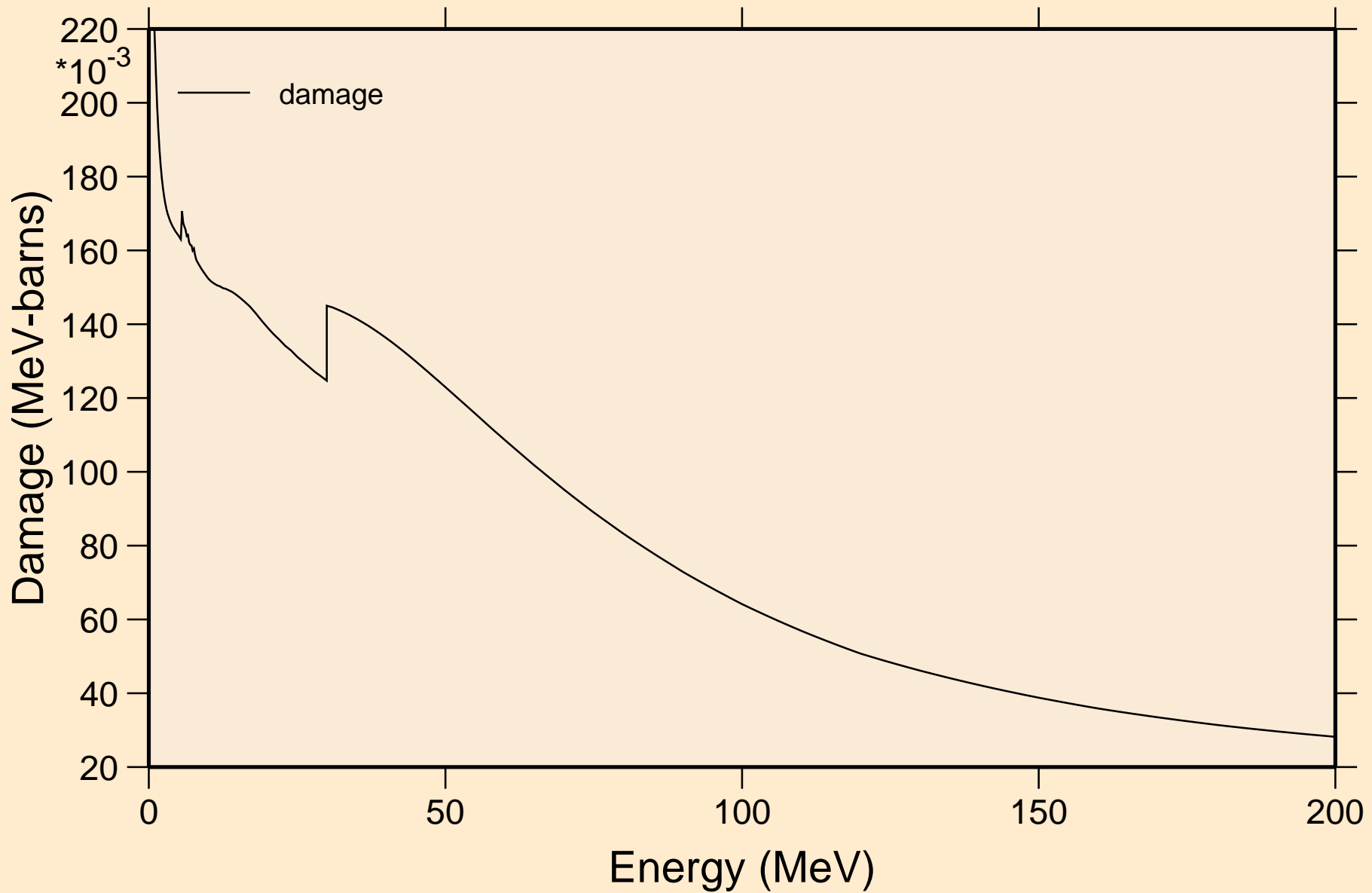

AL024 NEUTRON ACER TENDL-2024 LIBRARY; T=0.K
Non-threshold reactions

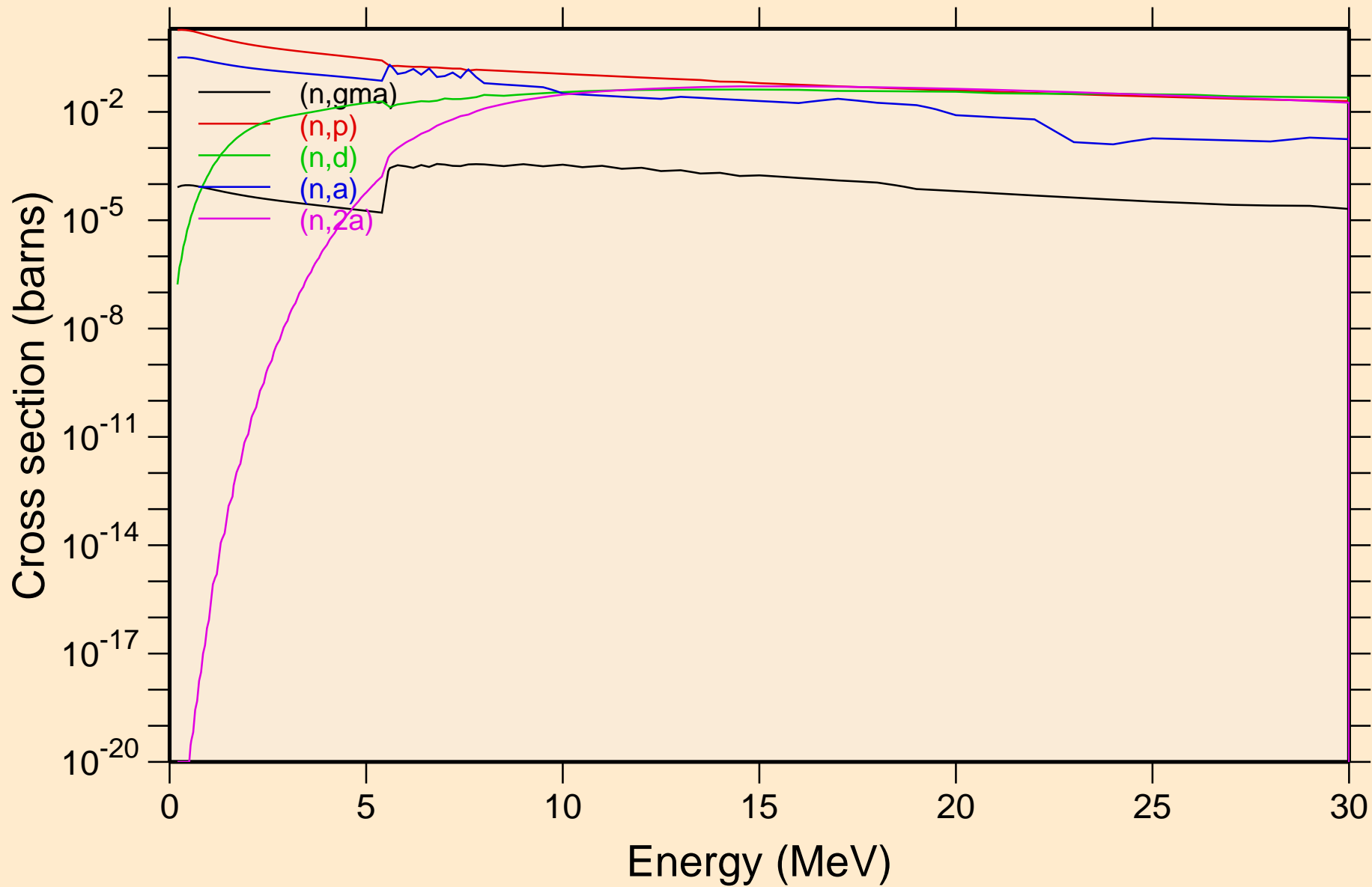

AL024 NEUTRON ACER TENDL-2024 LIBRARY; T=0.K
Non-threshold reactions

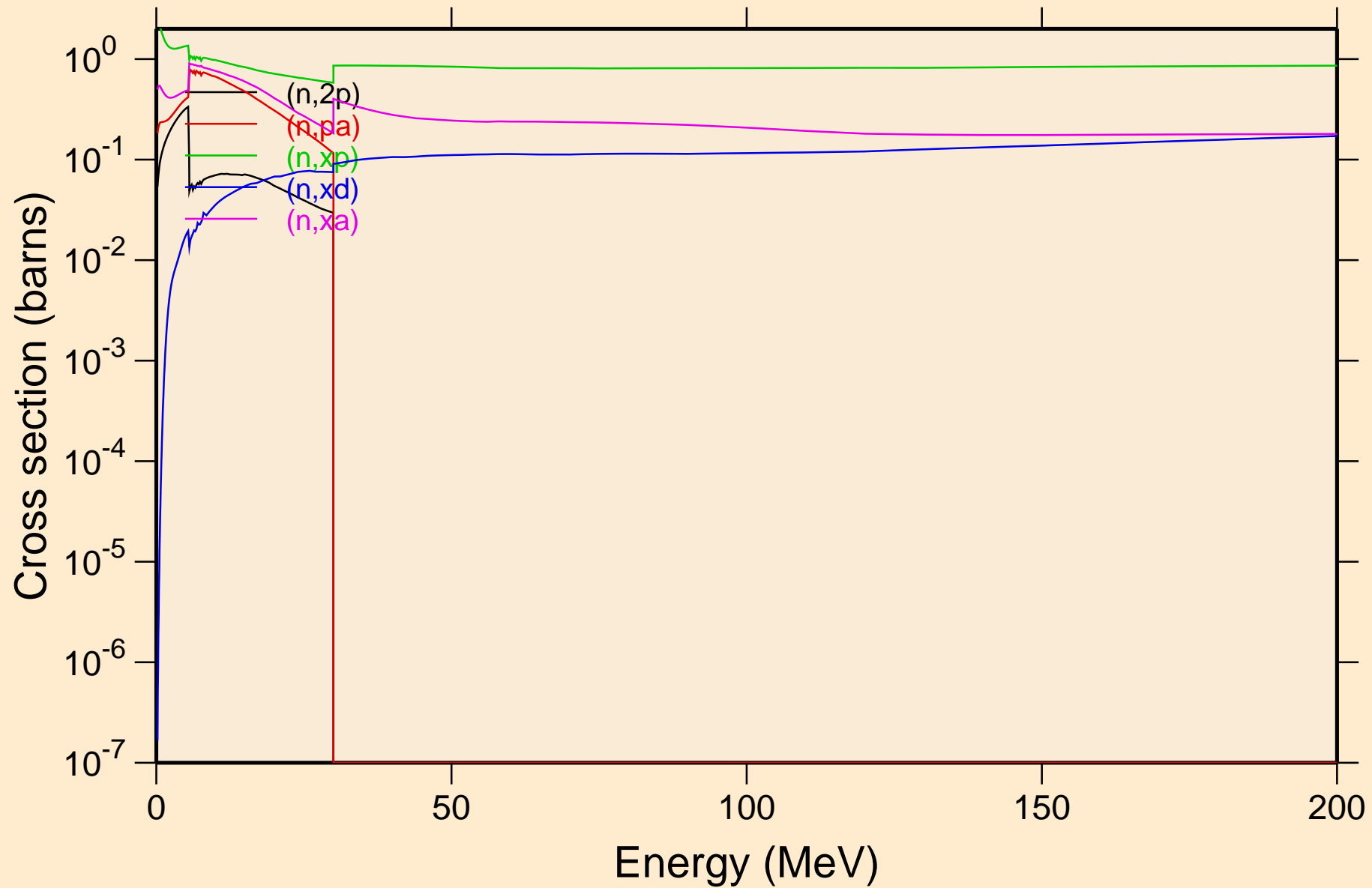

AL024 NEUTRON ACER TENDL-2024 LIBRARY; T=0.K
Inelastic levels

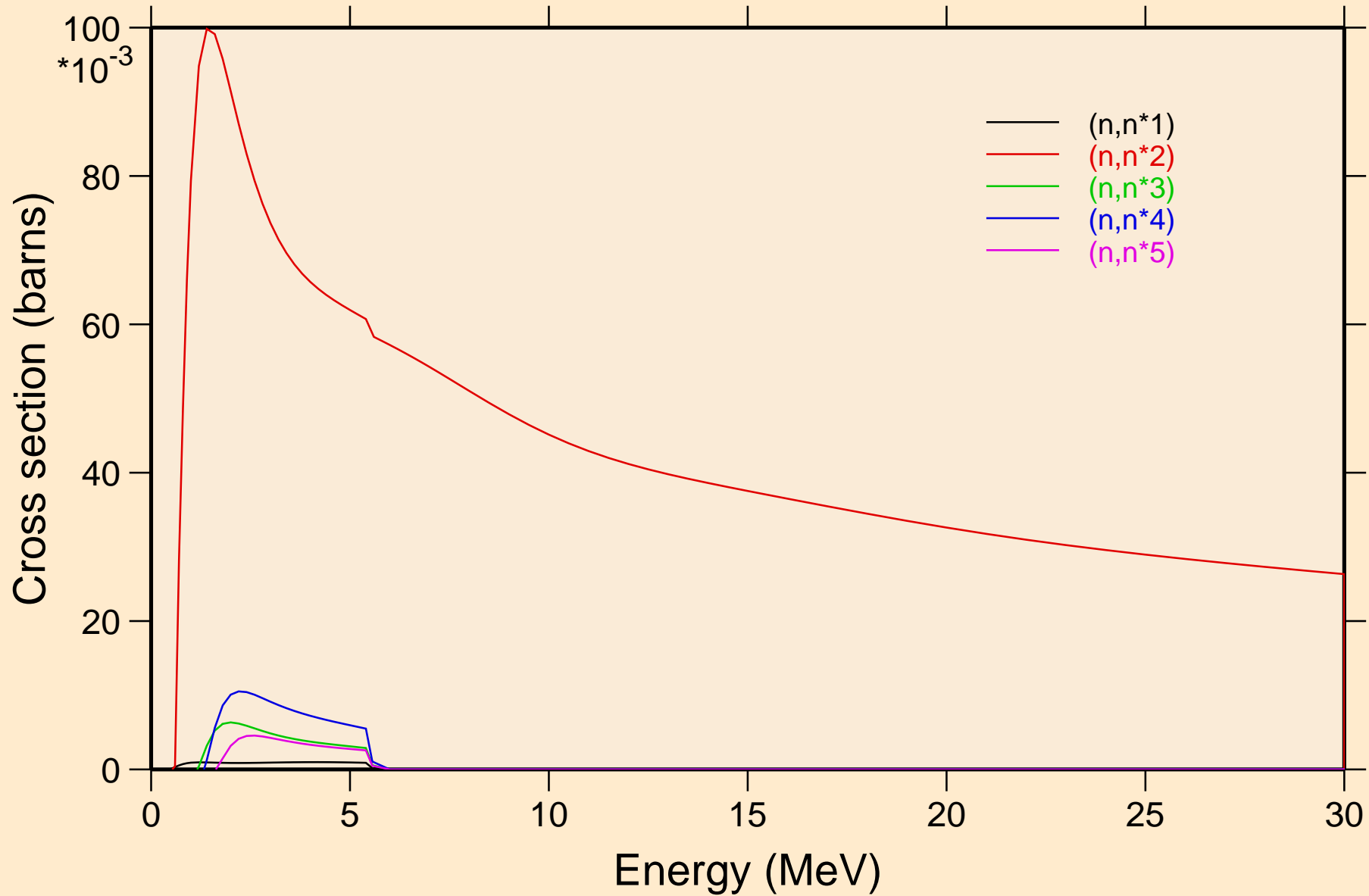

AL024 NEUTRON ACER TENDL-2024 LIBRARY; T=0.K
Inelastic levels

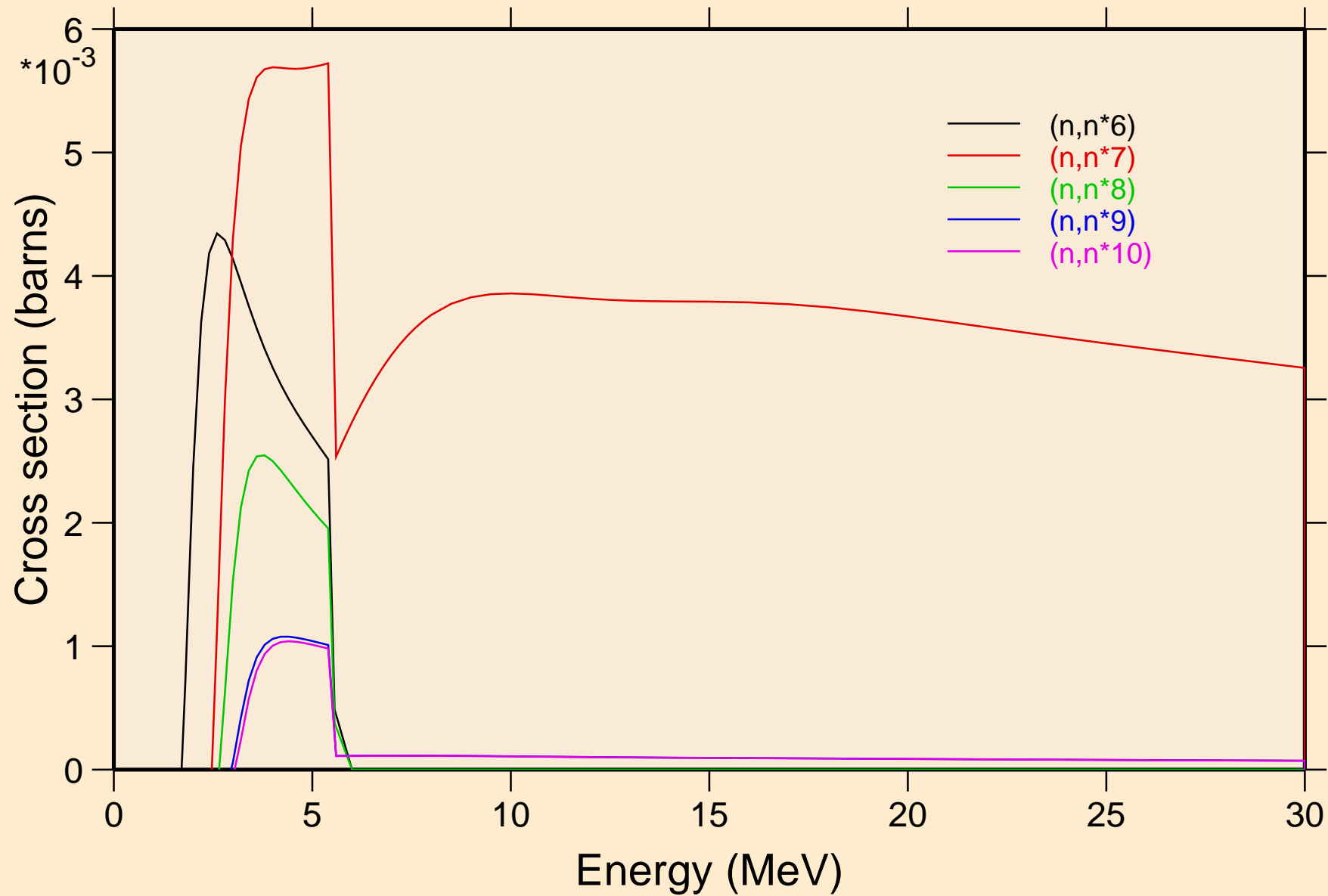

AL024 NEUTRON ACER TENDL-2024 LIBRARY; T=0.K
Inelastic levels

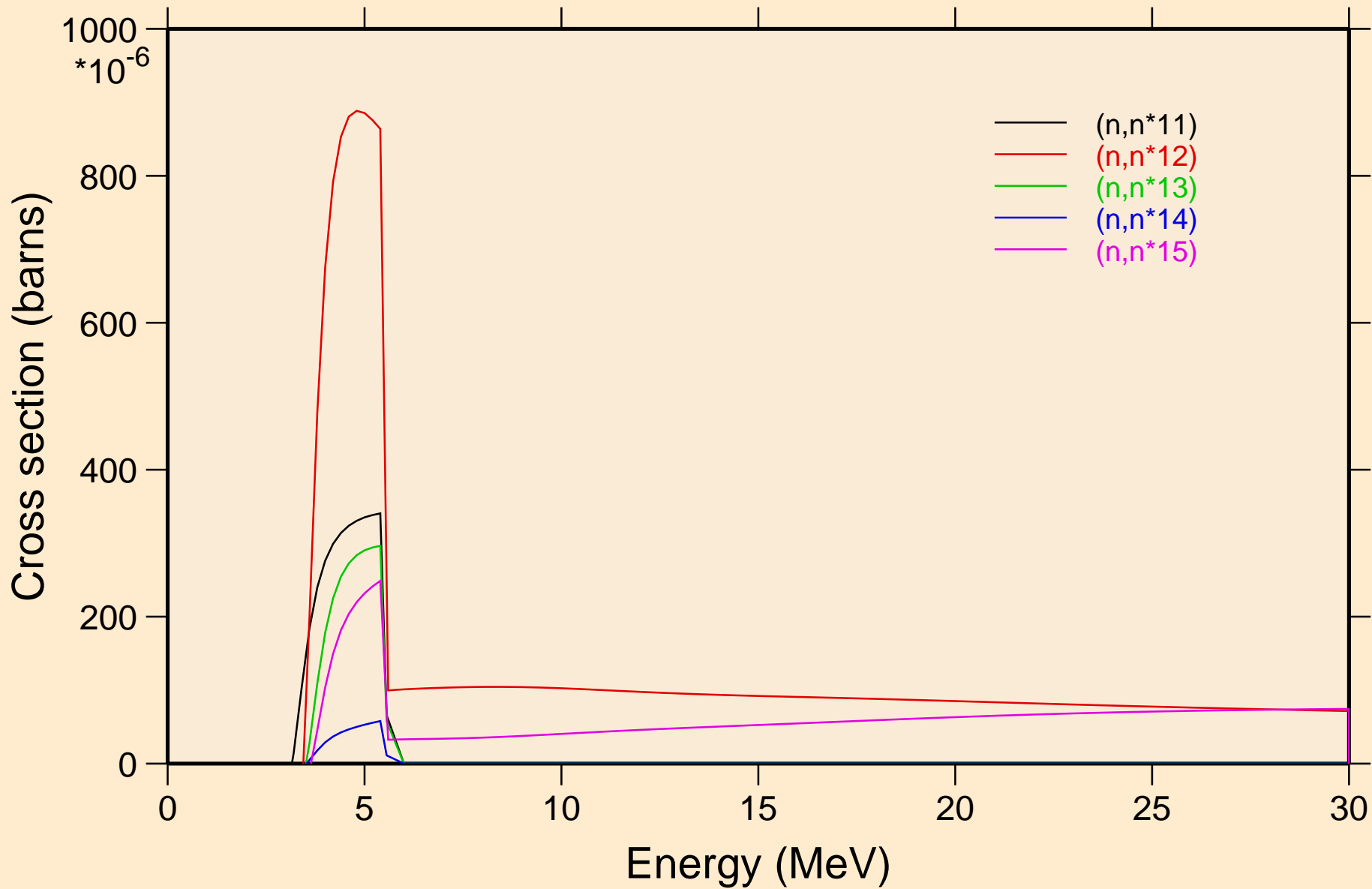

AL024 NEUTRON ACER TENDL-2024 LIBRARY; T=0.K
Inelastic levels

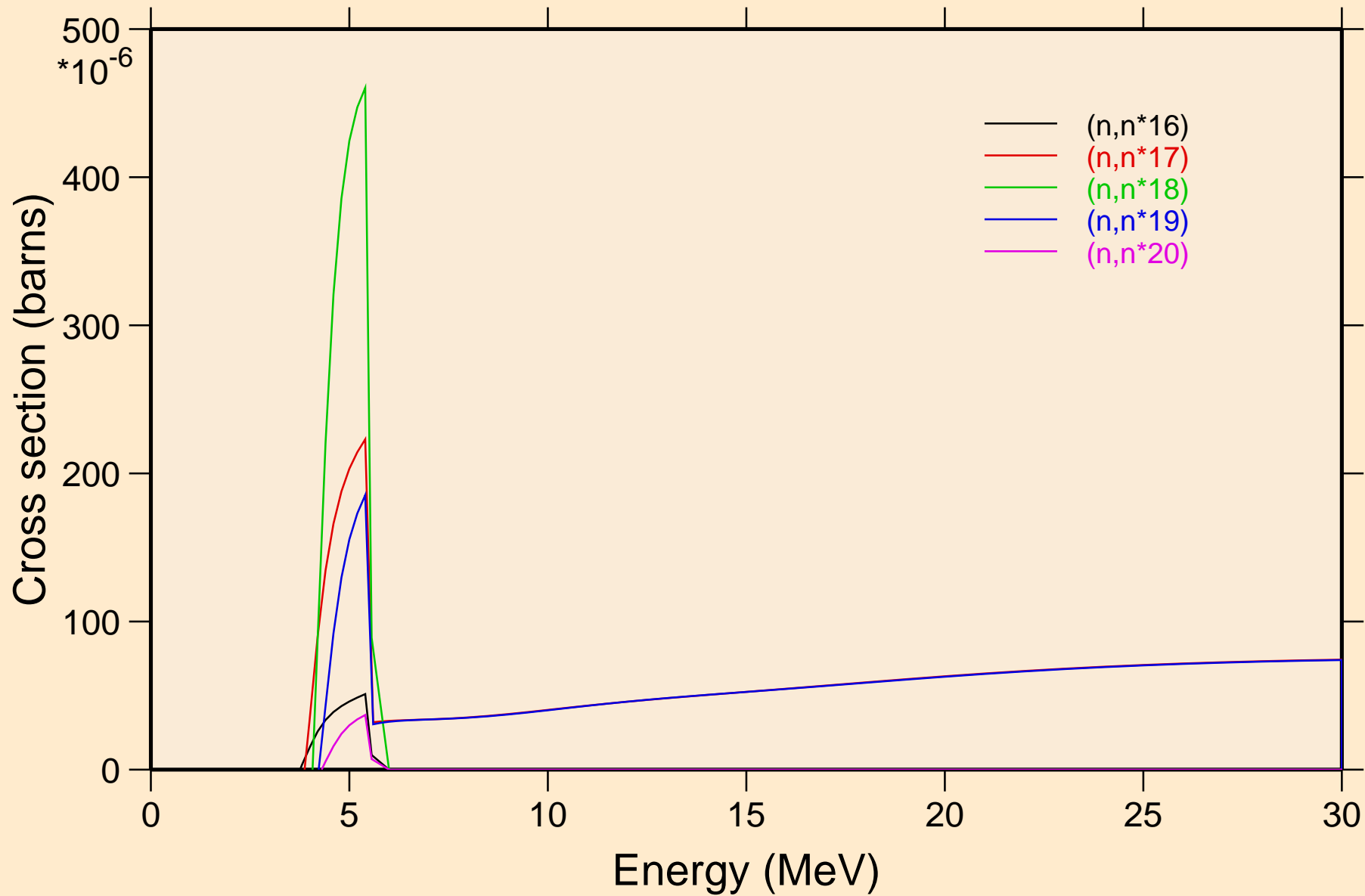

AL024 NEUTRON ACER TENDL-2024 LIBRARY; T=0.K
Inelastic levels

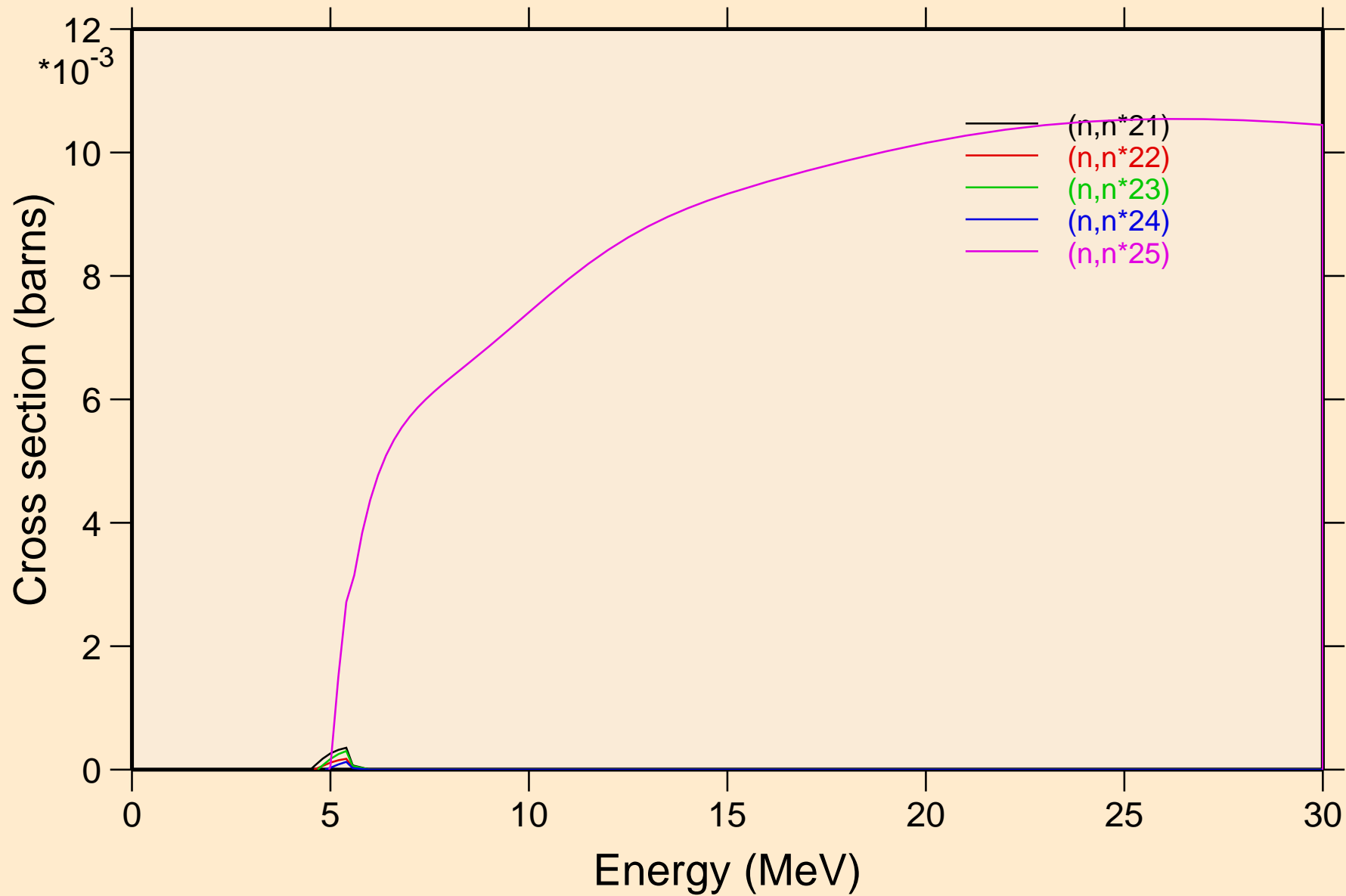

AL024 NEUTRON ACER TENDL-2024 LIBRARY; T=0.K
Threshold reactions

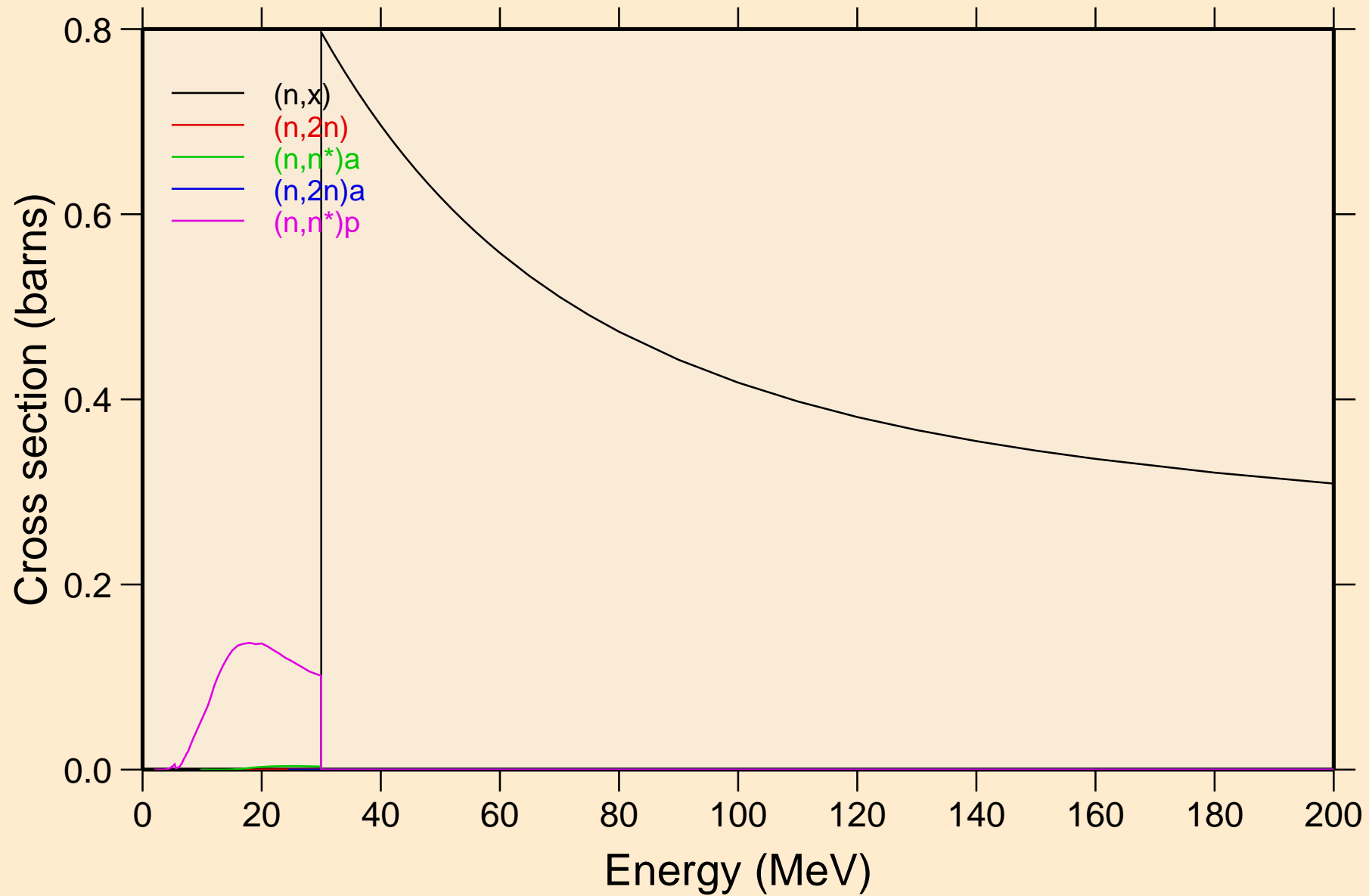

AL024 NEUTRON ACER TENDL-2024 LIBRARY; T=0.K
Threshold reactions

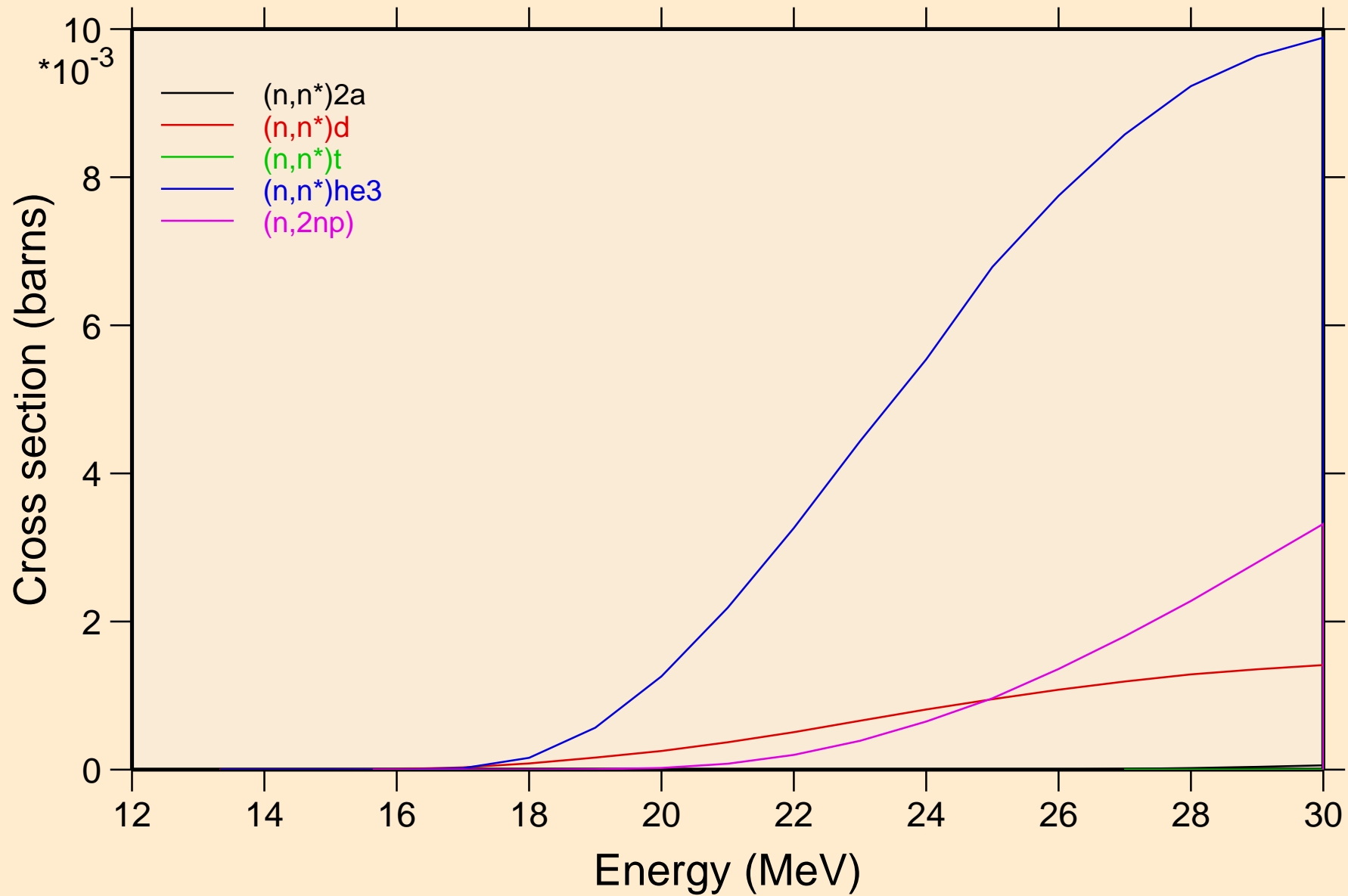

AL024 NEUTRON ACER TENDL-2024 LIBRARY; T=0.K

Threshold reactions

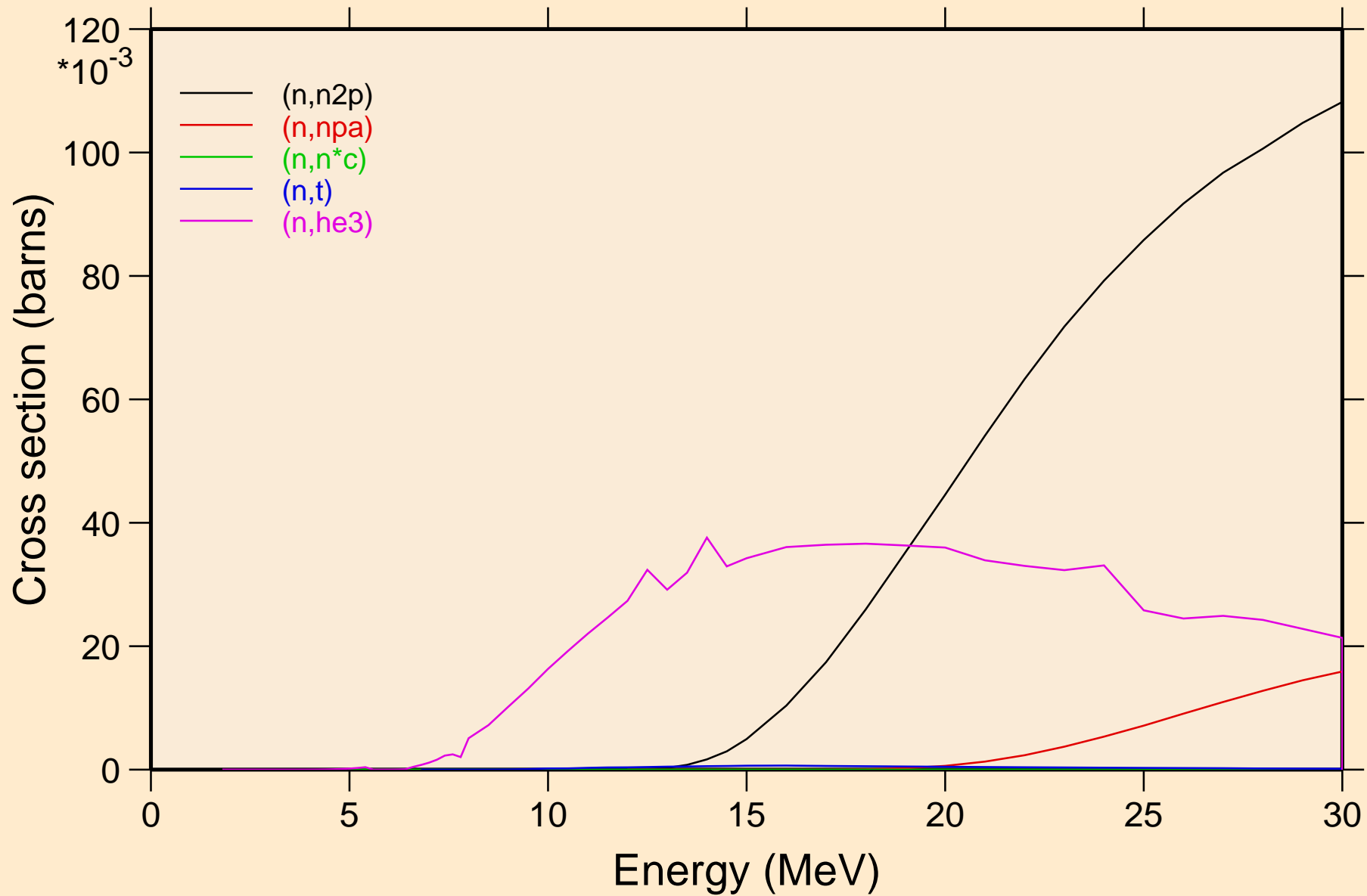

AL024 NEUTRON ACER TENDL-2024 LIBRARY; T=0.K
Threshold reactions

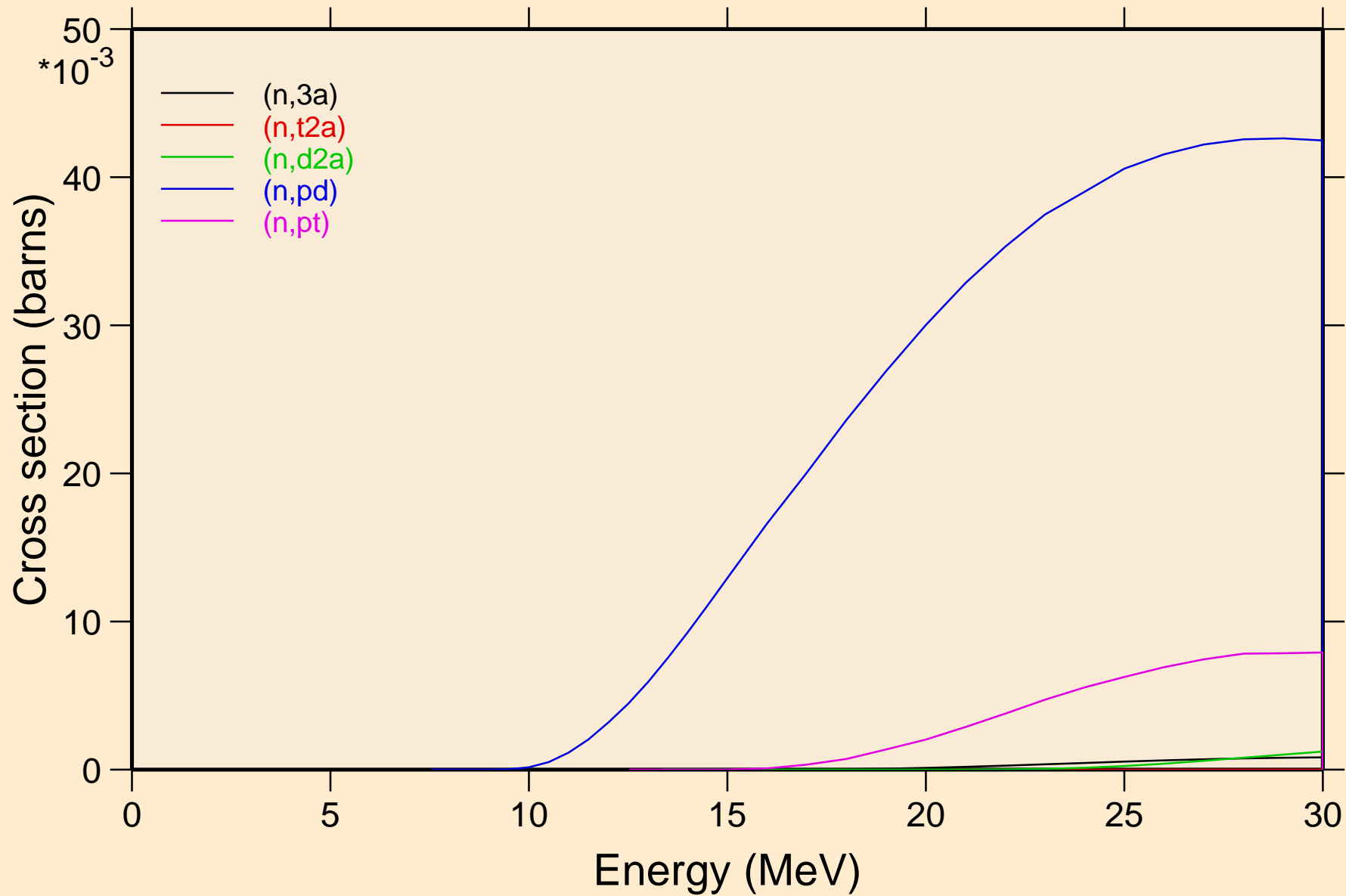

AL024 NEUTRON ACER TENDL-2024 LIBRARY; T=0.K
Threshold reactions

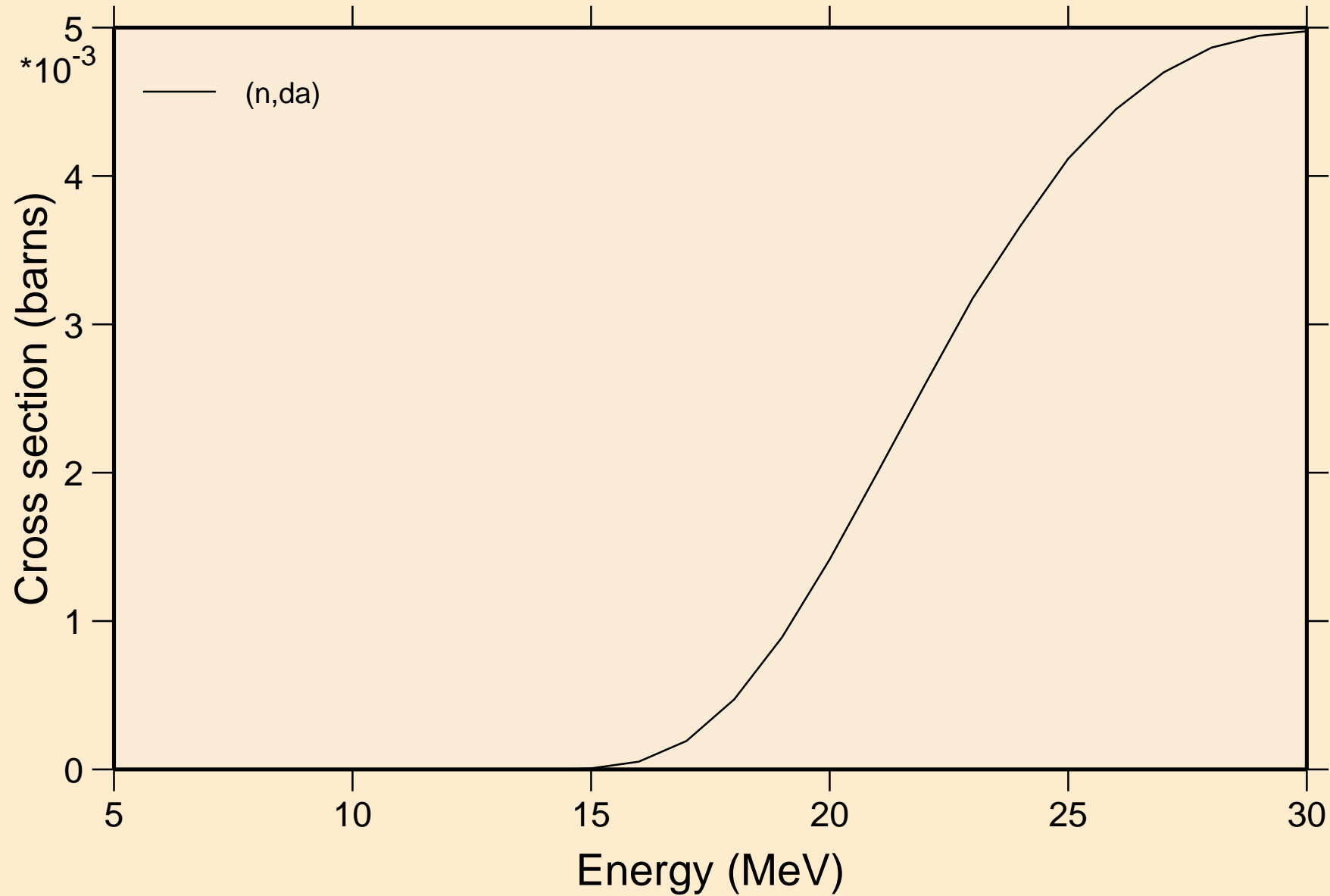

AL024 NEUTRON ACER TENDL-2024 LIBRARY; T=0.K

Threshold reactions

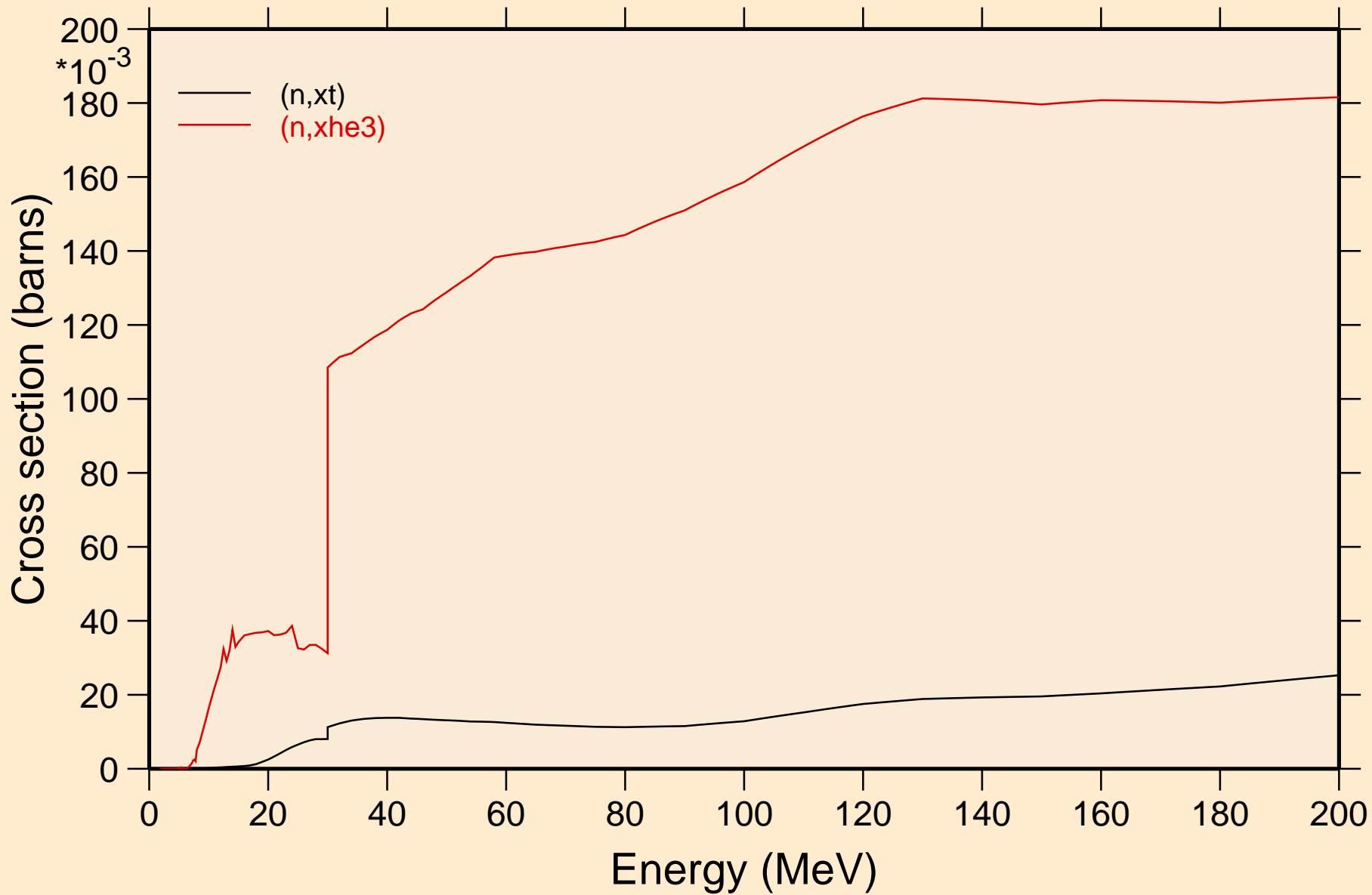

AL024 NEUTRON ACER TENDL-2024 LIBRARY; T=0.K
angular distribution for elastic

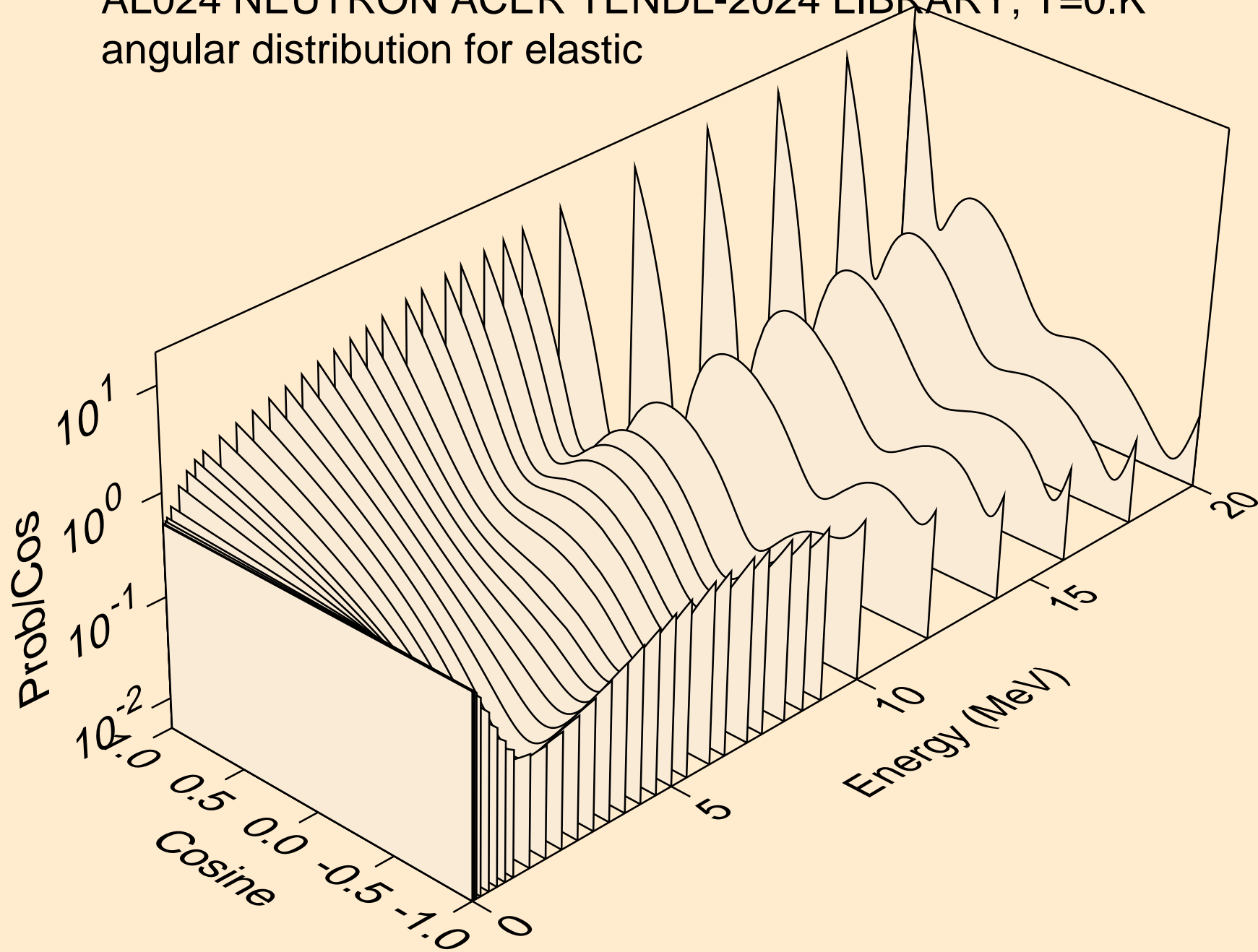

AL024 NEUTRON ACER TENDL-2024 LIBRARY; T=0.K
angular distribution for elastic

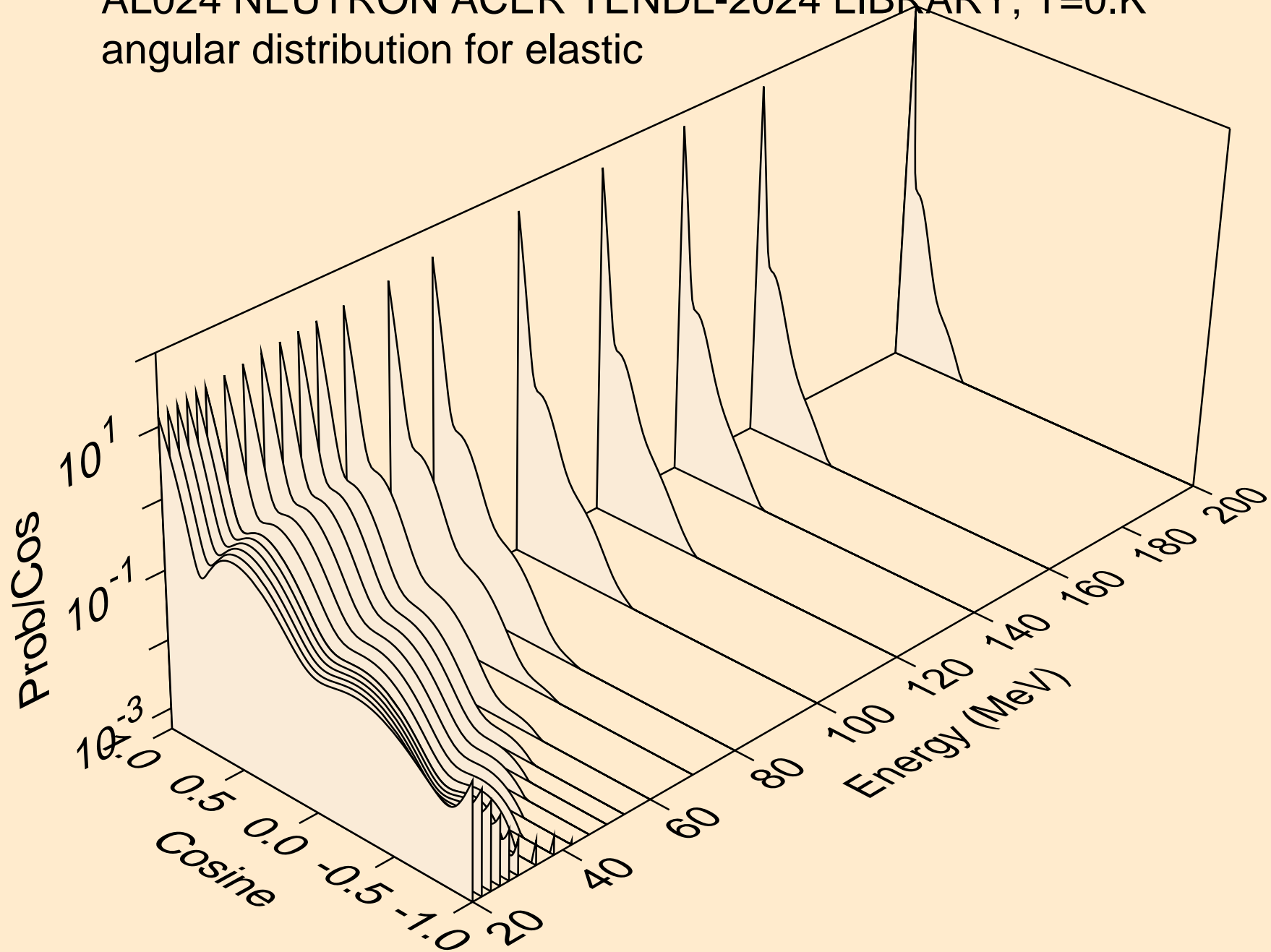

AL024 NEUTRON ACER TENDL-2024 LIBRARY; T=0.K
angular distribution for (n,n*1)

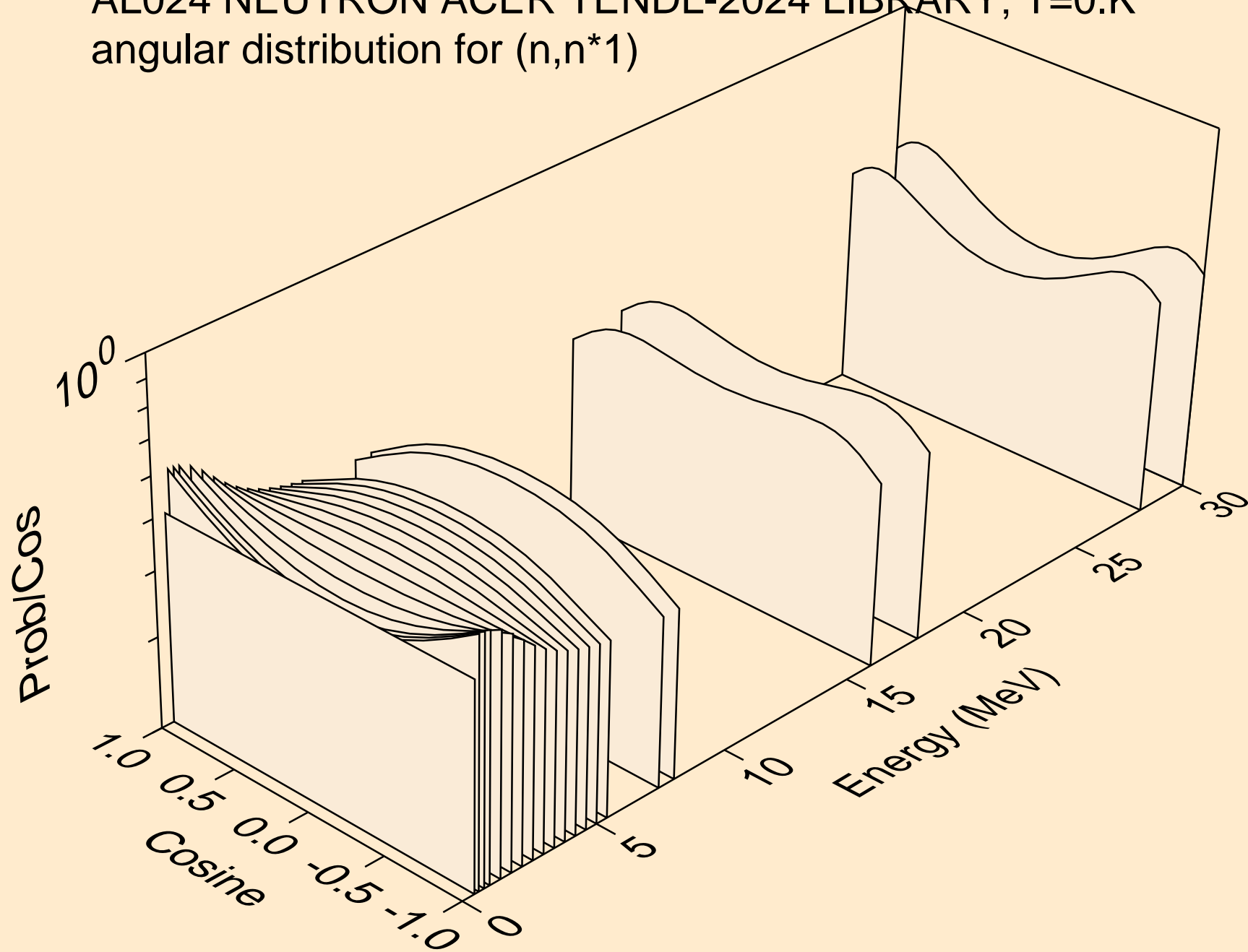

AL024 NEUTRON ACER TENDL-2024 LIBRARY; T=0.K
angular distribution for (n,n*2)

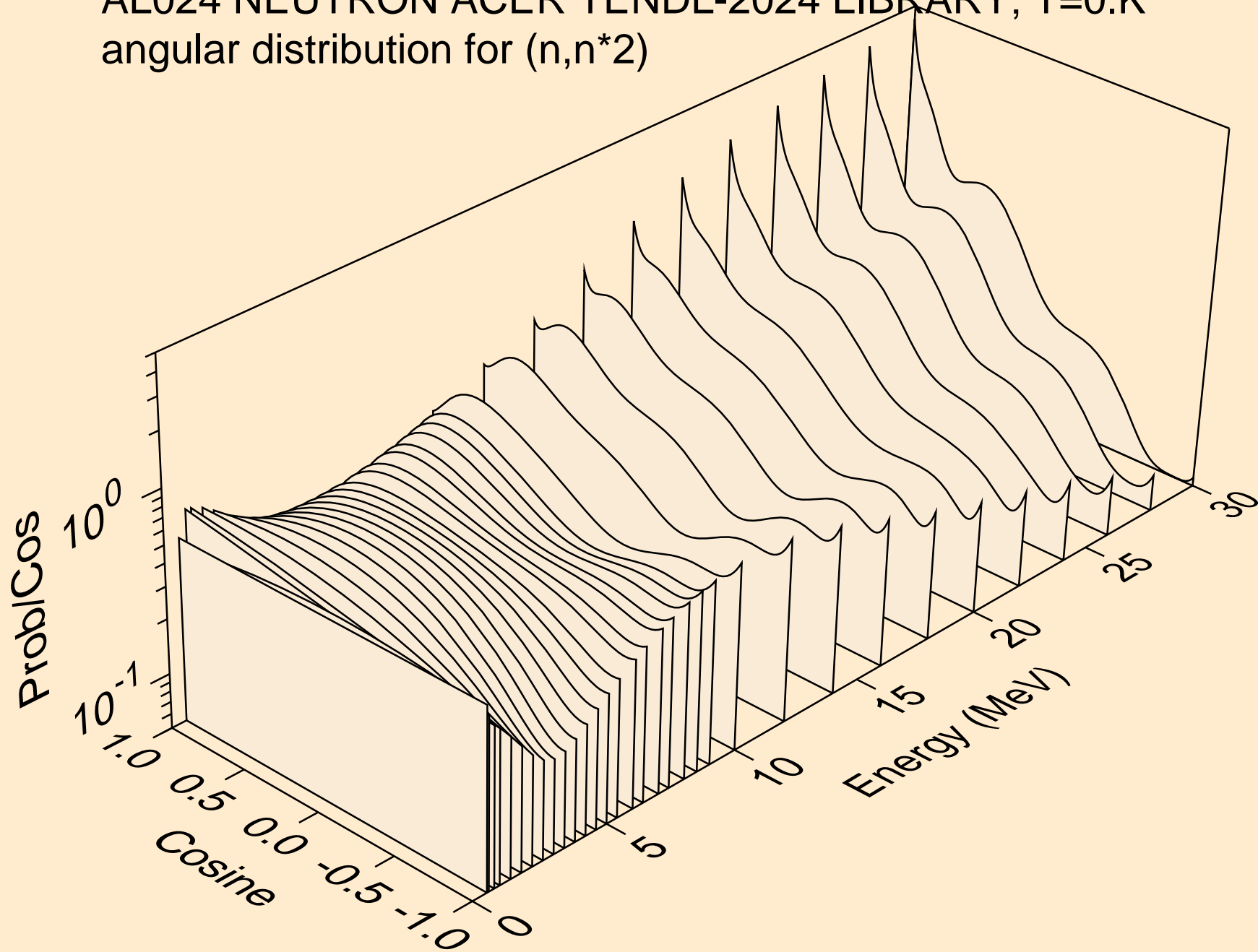

AL024 NEUTRON ACER TENDL-2024 LIBRARY; T=0.K
angular distribution for (n,n*3)

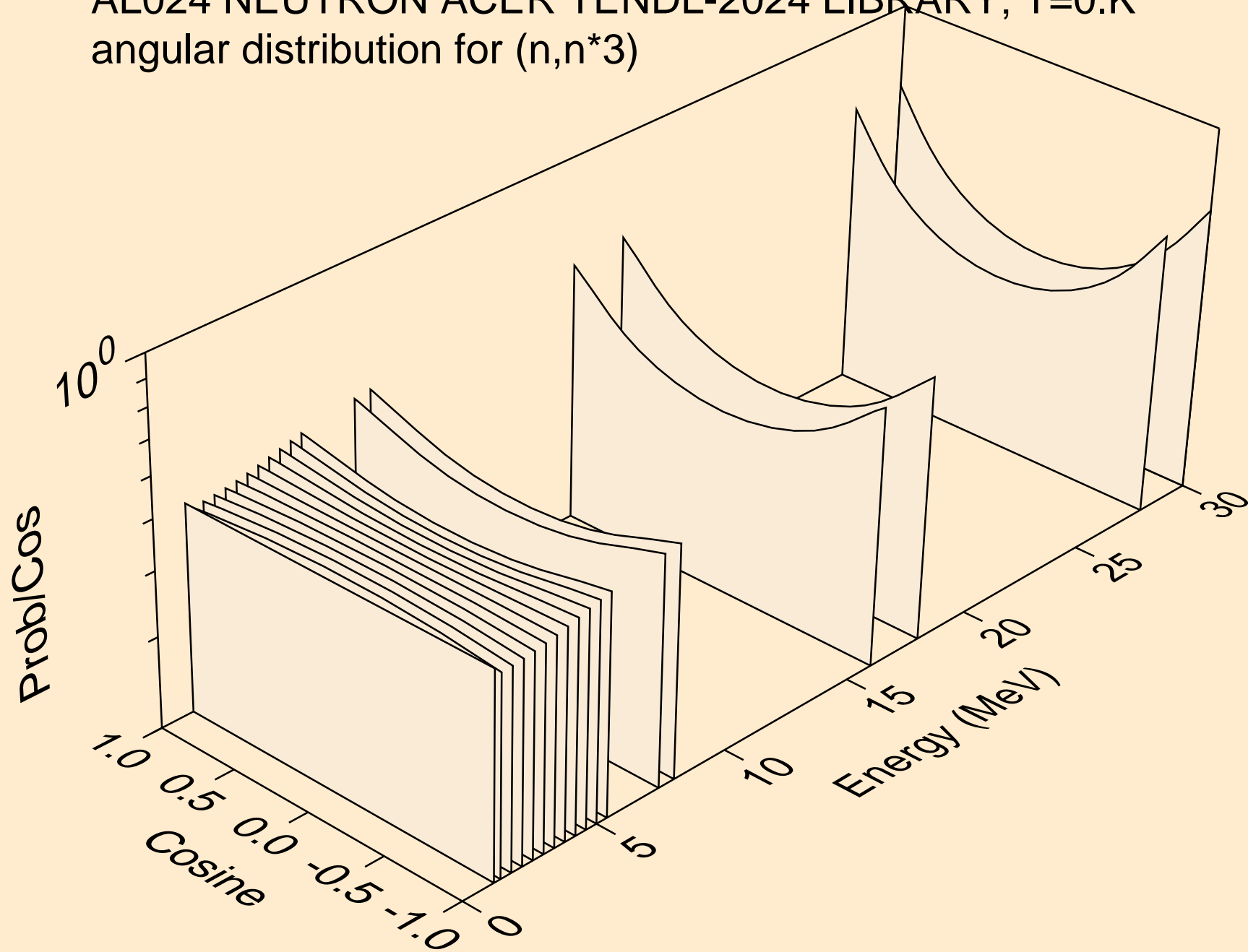

AL024 NEUTRON ACER TENDL-2024 LIBRARY; T=0.K
angular distribution for (n,n*4)

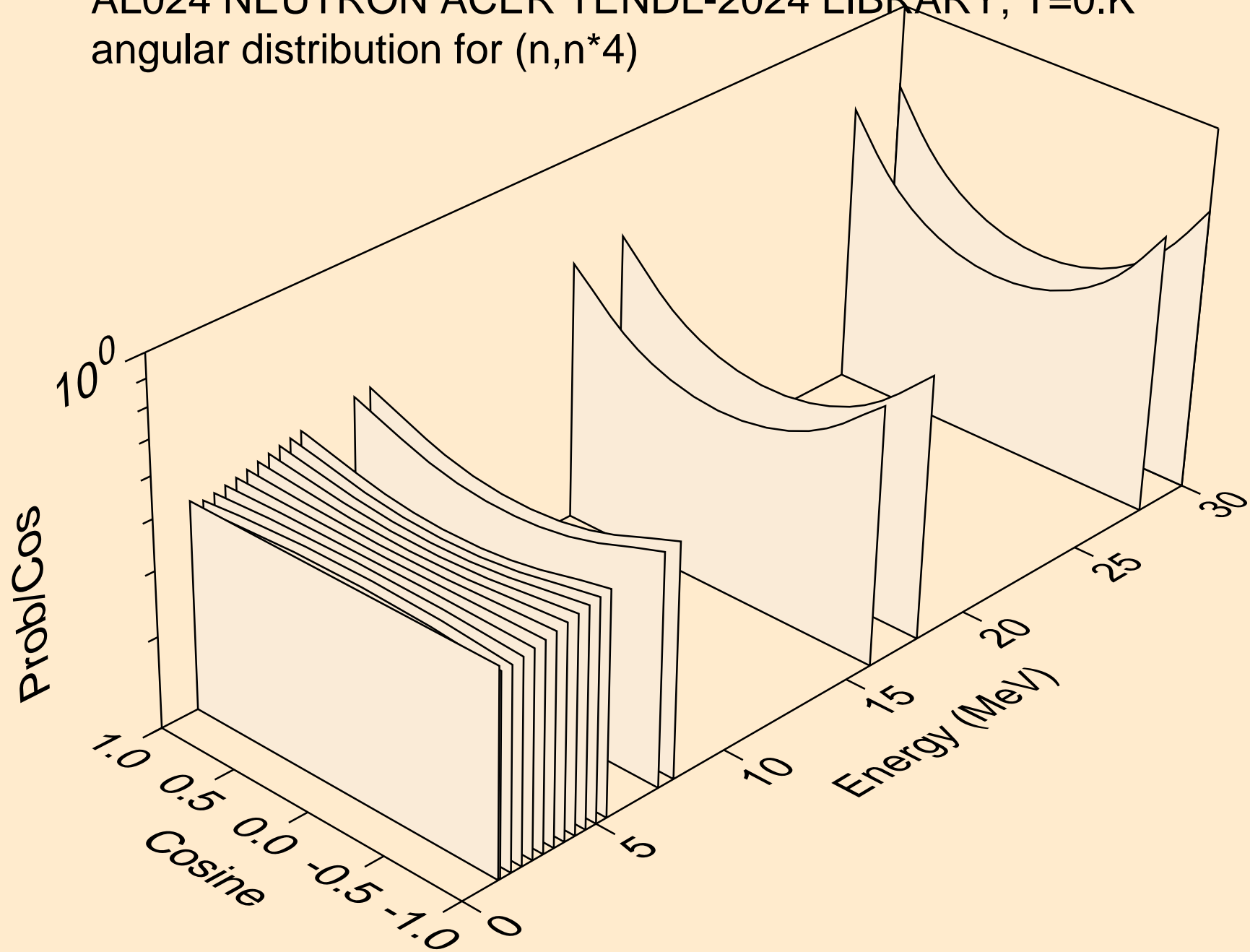

AL024 NEUTRON ACER TENDL-2024 LIBRARY; T=0.K
angular distribution for (n,n*5)

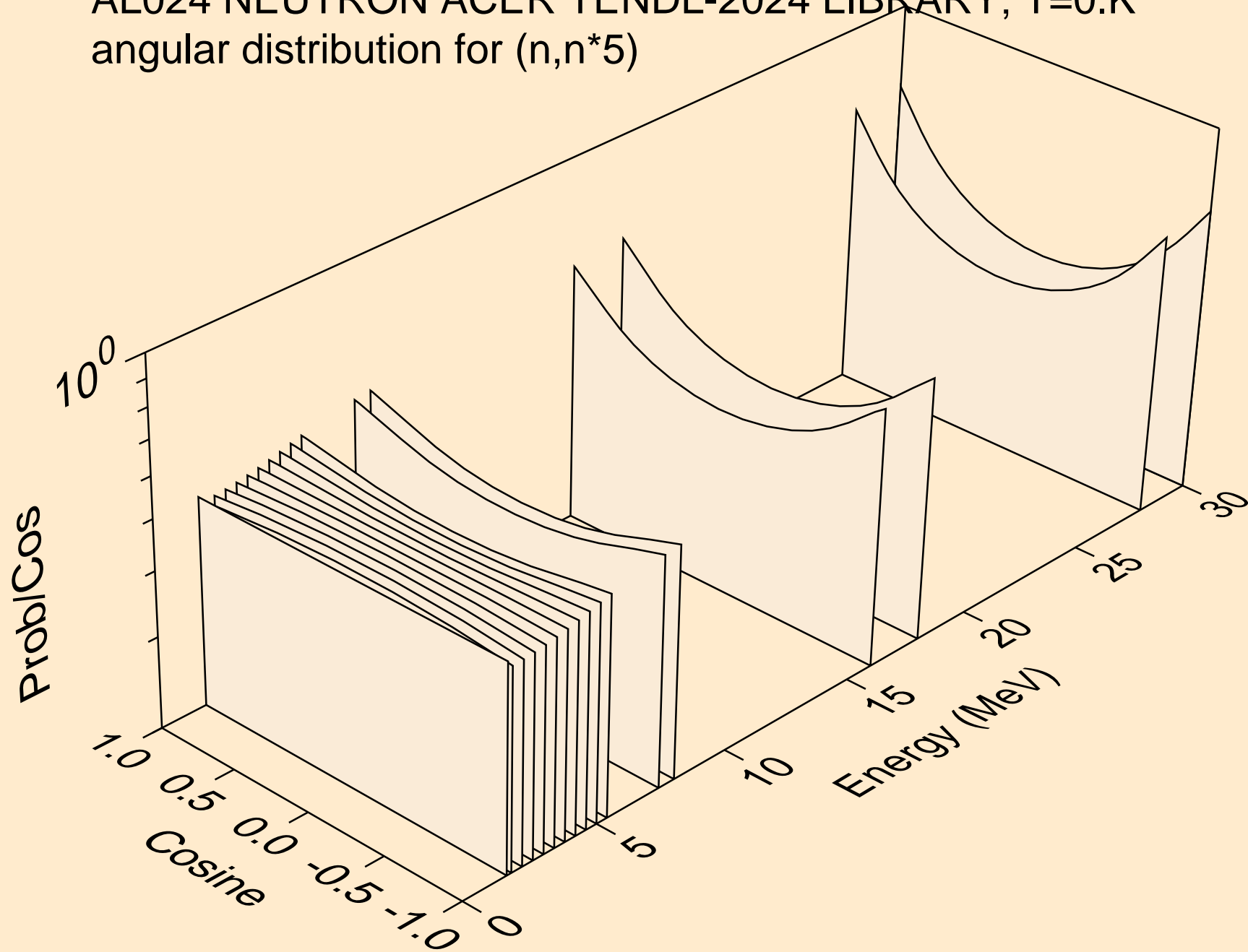

AL024 NEUTRON ACER TENDL-2024 LIBRARY; T=0.K
angular distribution for (n,n*6)

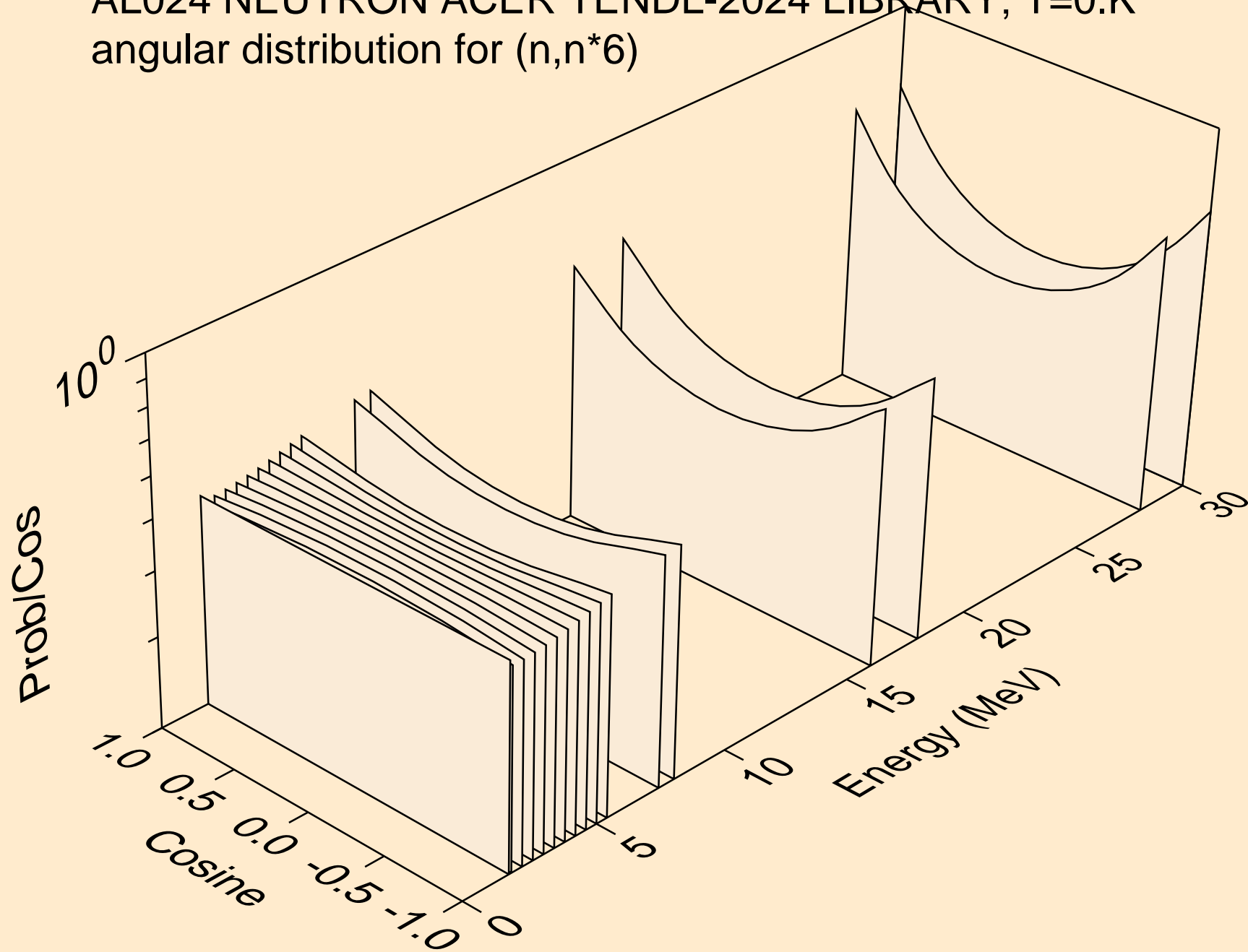

AL024 NEUTRON ACER TENDL-2024 LIBRARY; T=0.K
angular distribution for (n,n*7)

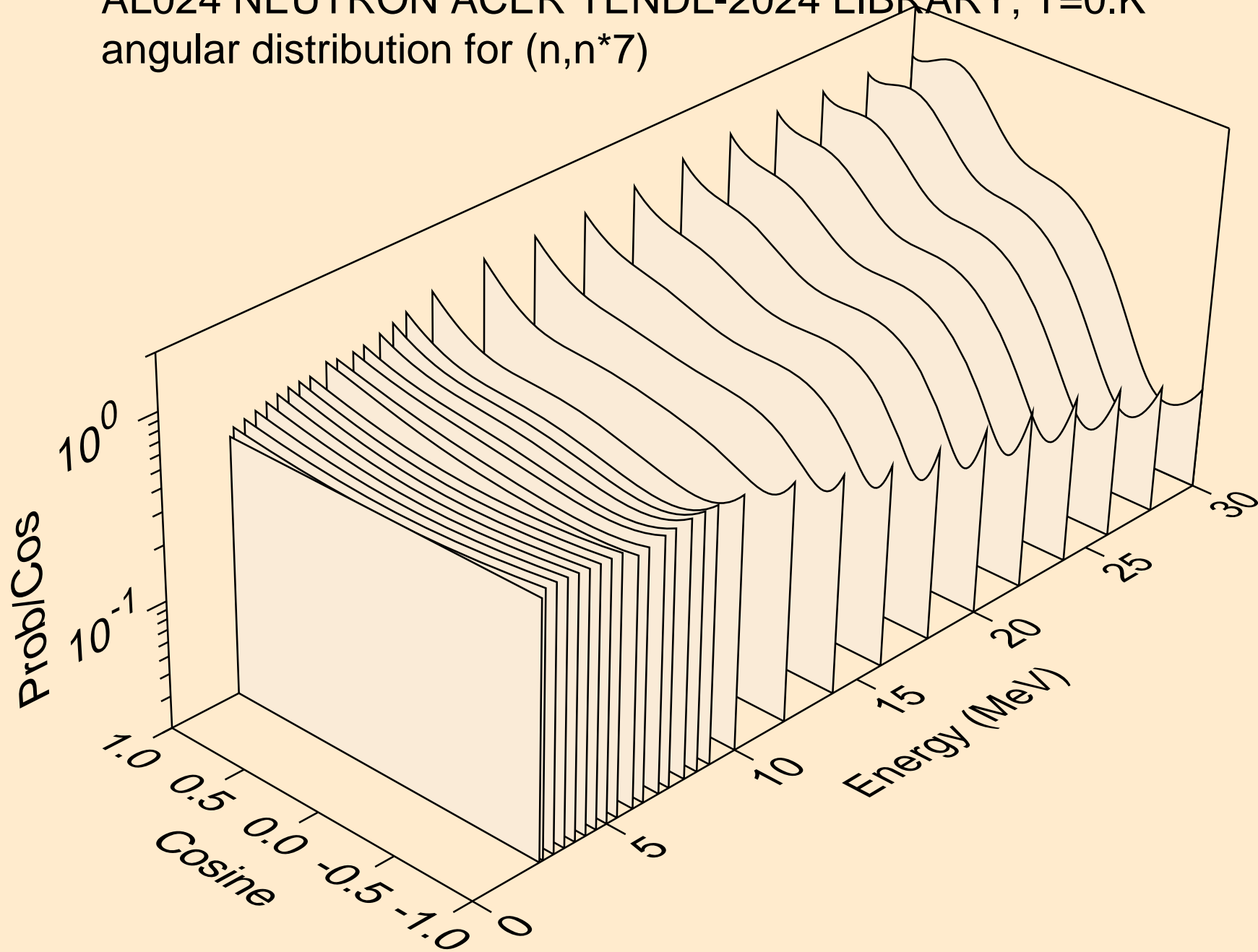

AL024 NEUTRON ACER TENDL-2024 LIBRARY; T=0.K
angular distribution for (n,n*8)

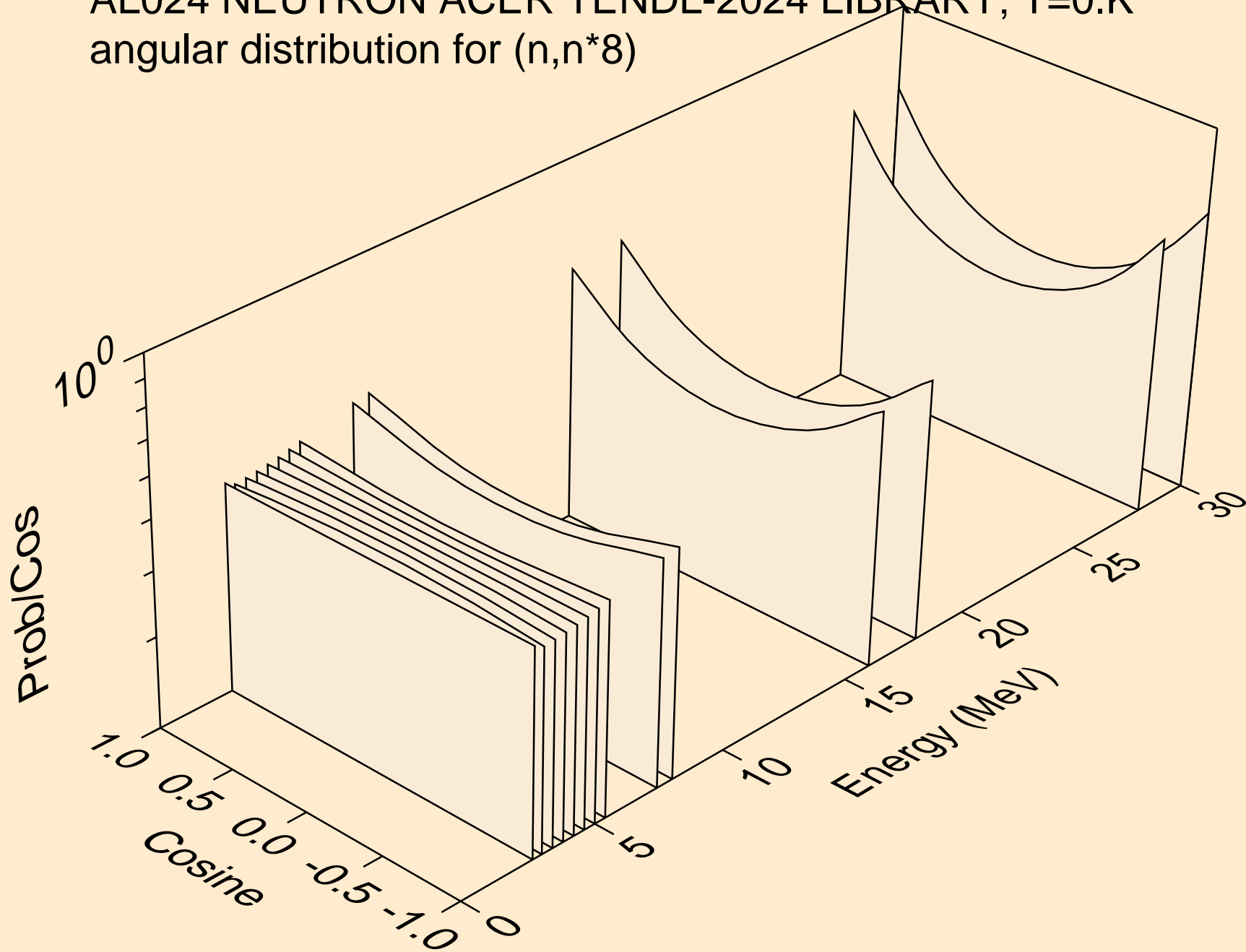

AL024 NEUTRON ACER TENDL-2024 LIBRARY; T=0.K
angular distribution for (n,n*9)

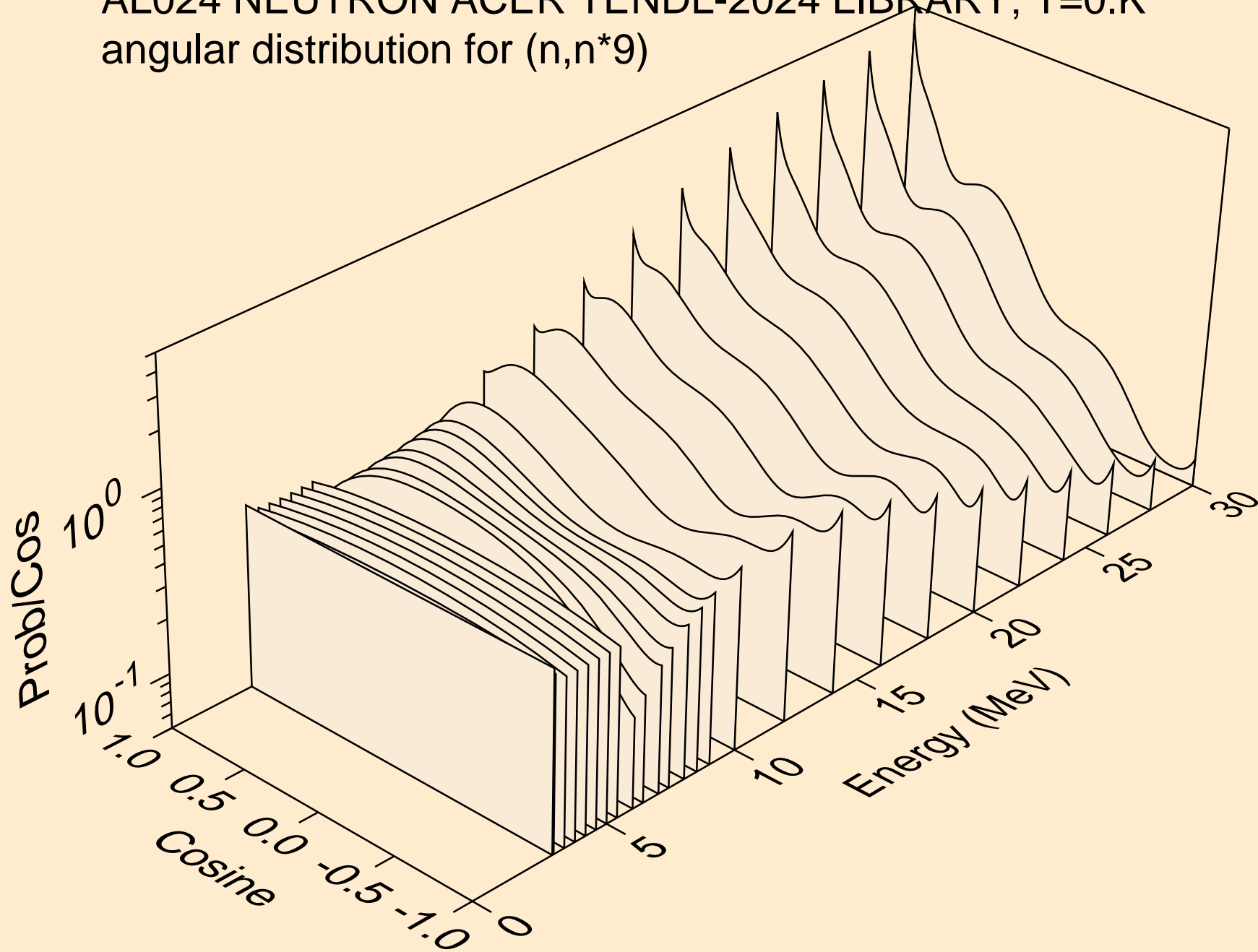

AL024 NEUTRON ACER TENDL-2024 LIBRARY; T=0.K
angular distribution for (n,n*10)

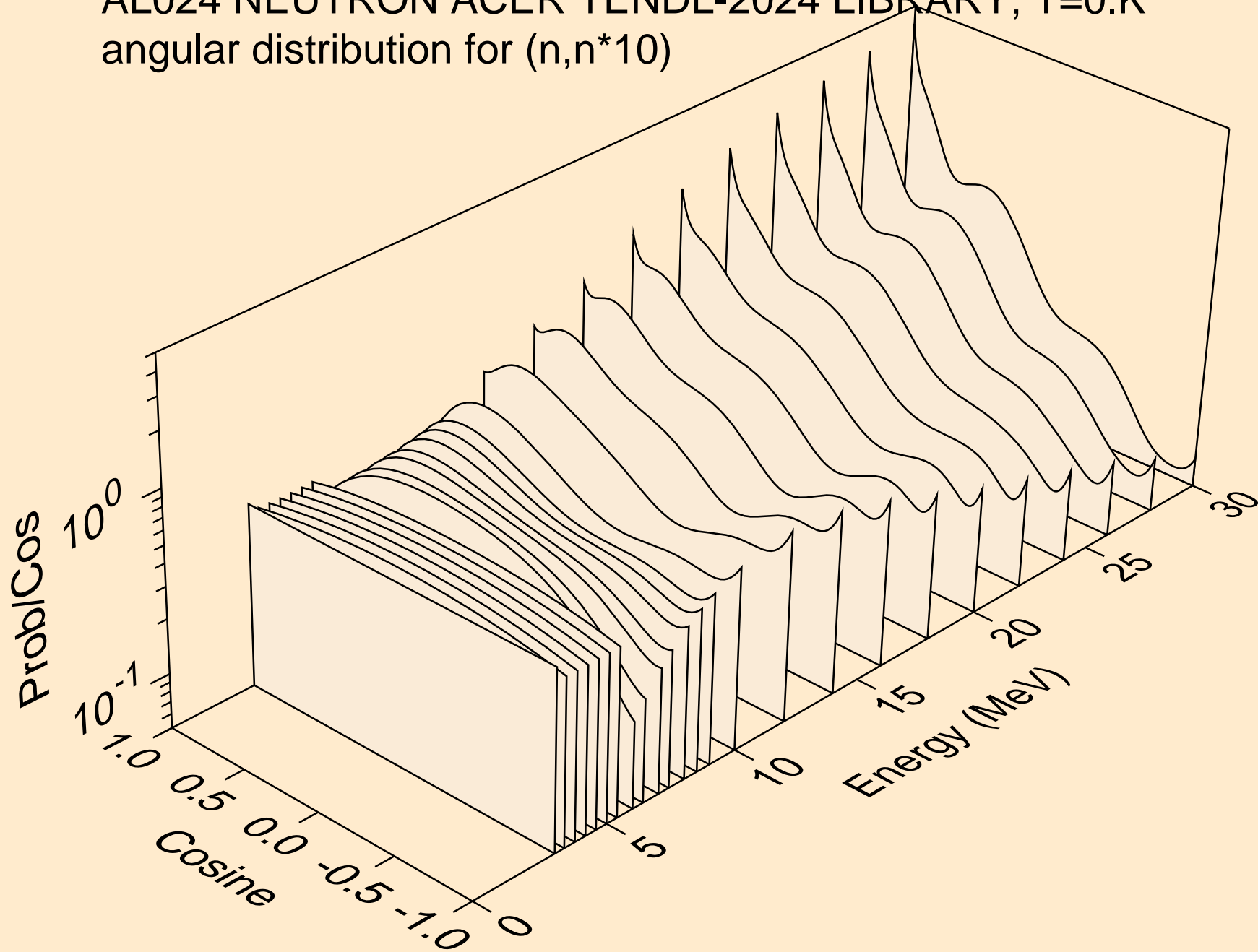

AL024 NEUTRON ACER TENDL-2024 LIBRARY; T=0.K
angular distribution for (n,n*11)

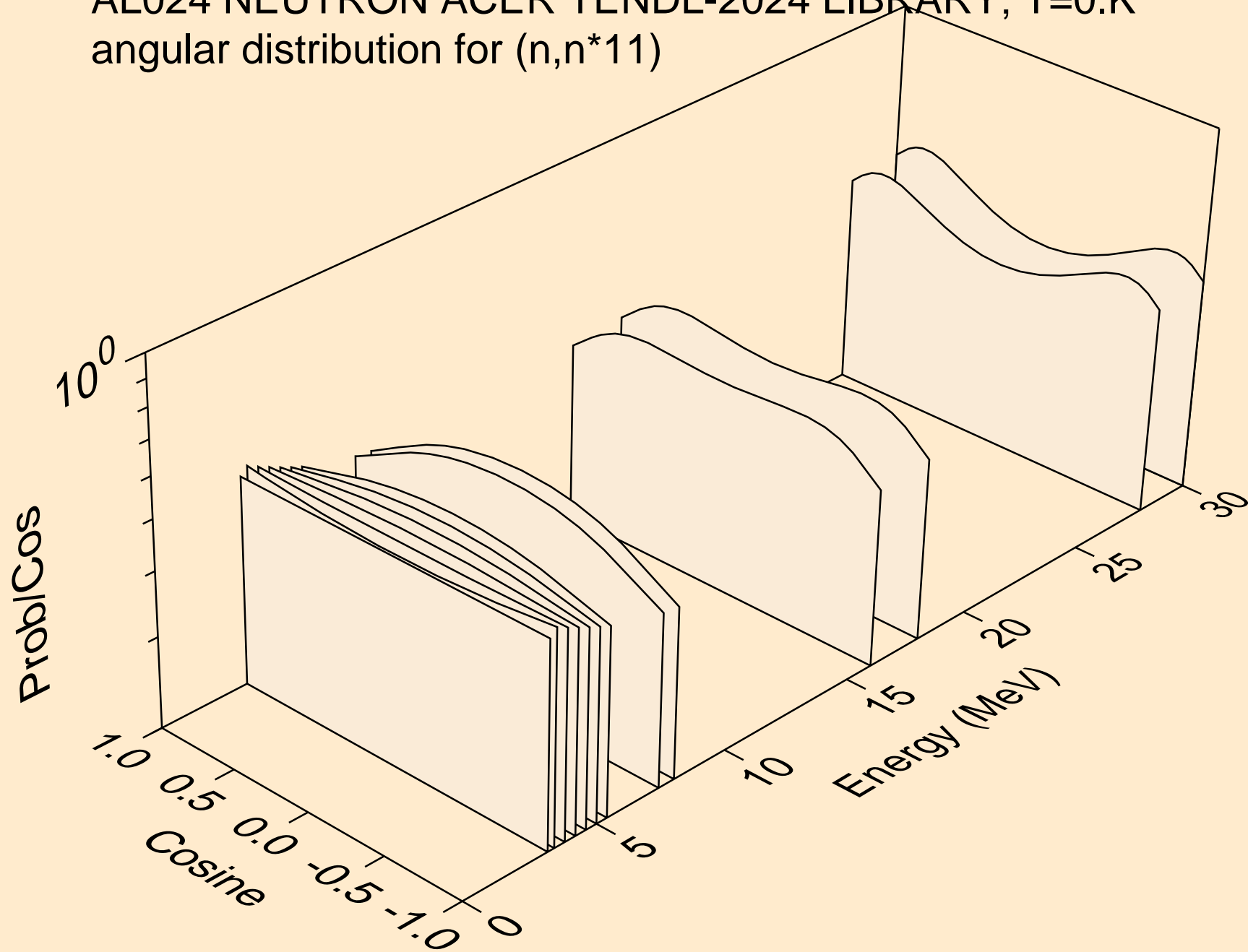

AL024 NEUTRON ACER TENDL-2024 LIBRARY; T=0.K
angular distribution for (n,n*12)

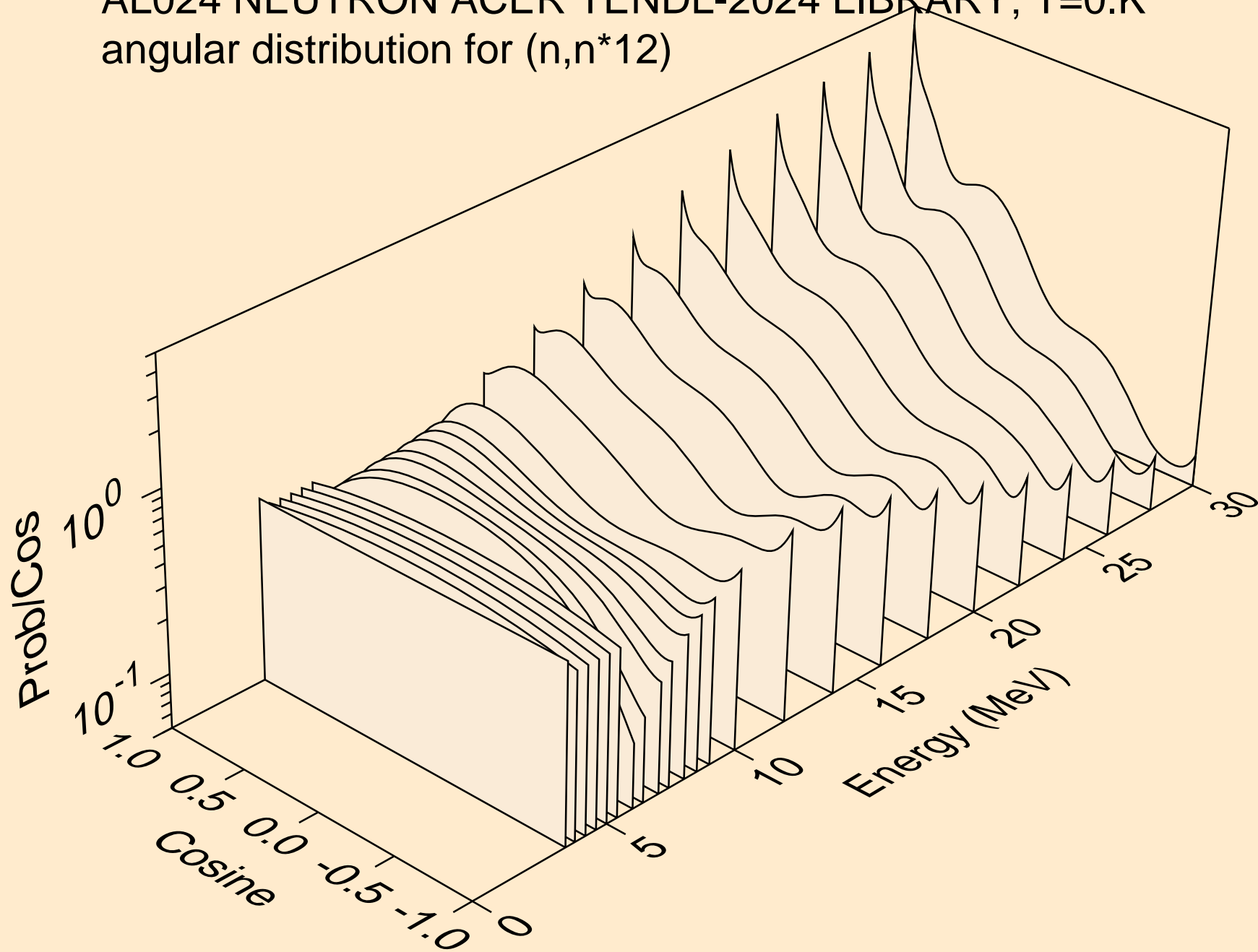

AL024 NEUTRON ACER TENDL-2024 LIBRARY; T=0.K
angular distribution for (n,n*13)

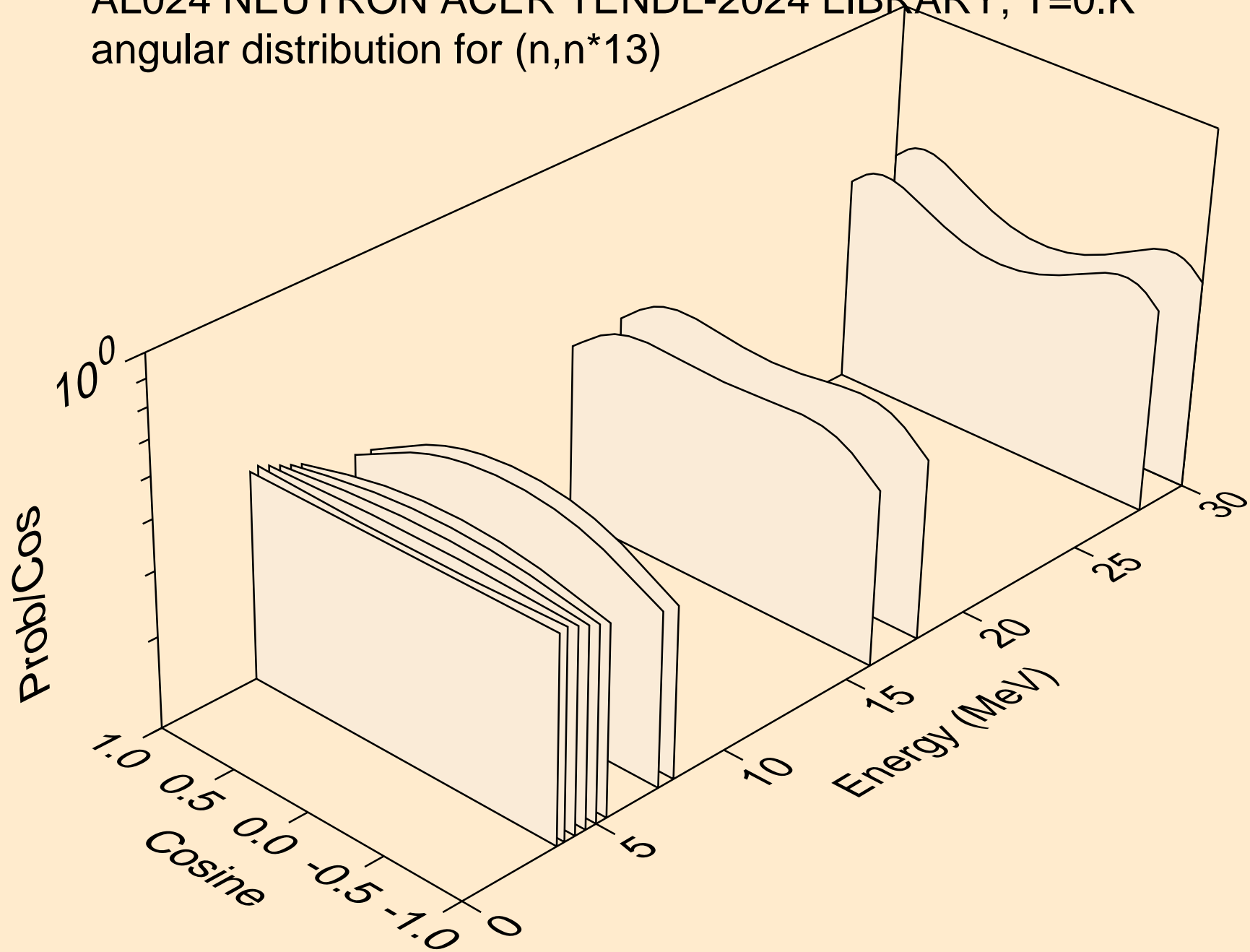

AL024 NEUTRON ACER TENDL-2024 LIBRARY; T=0.K
angular distribution for (n,n*14)

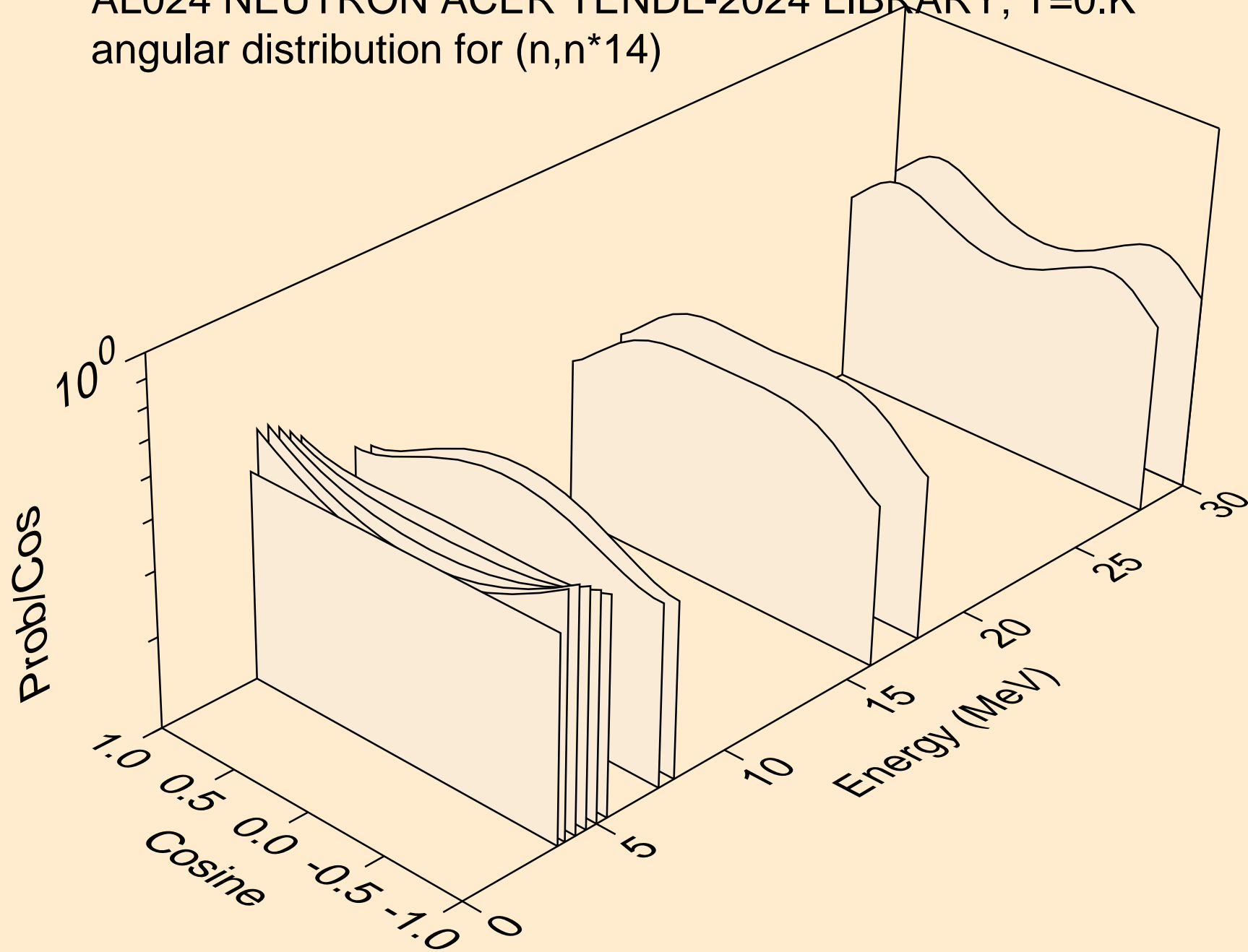

AL024 NEUTRON ACER TENDL-2024 LIBRARY; T=0.K
angular distribution for (n,n*15)

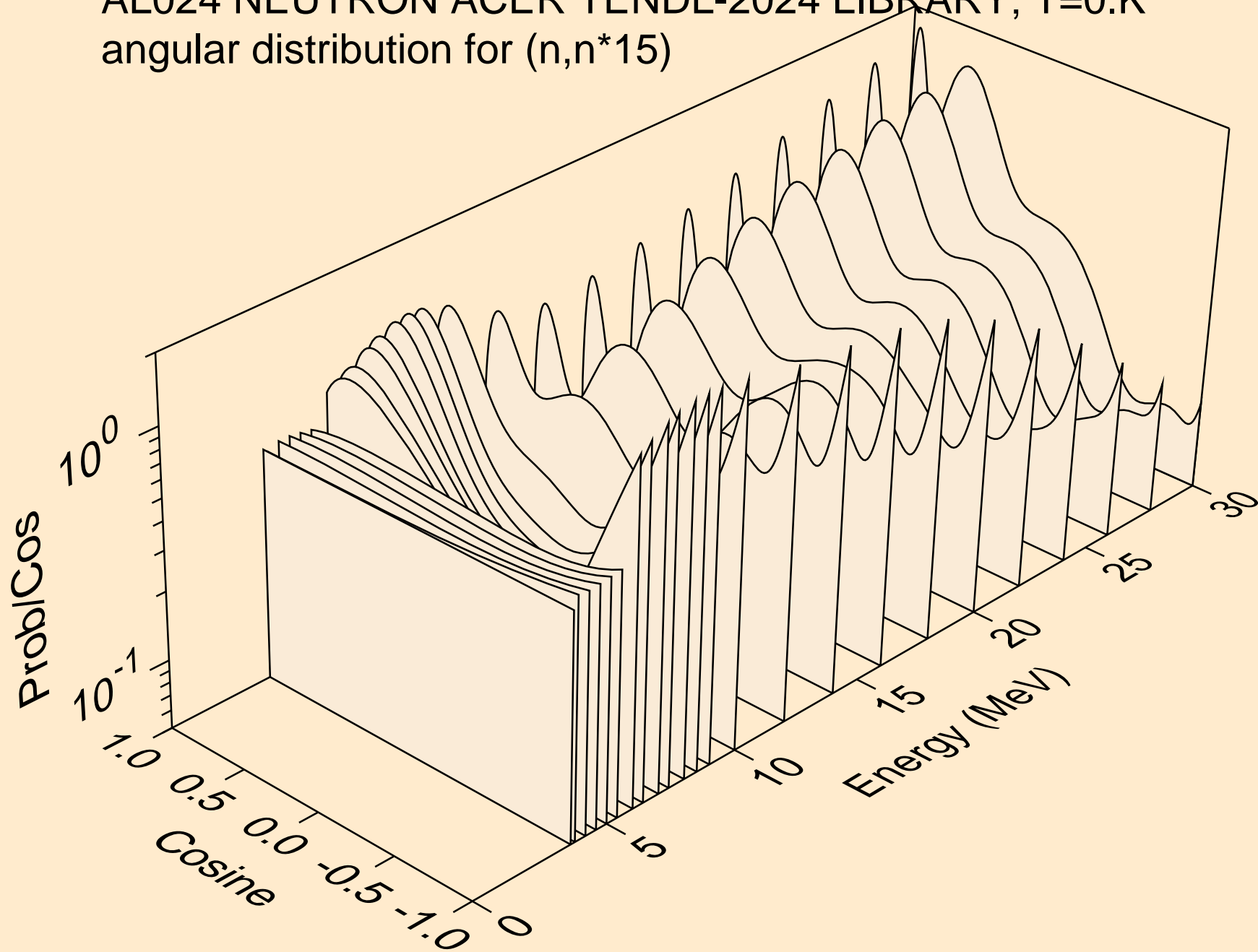

AL024 NEUTRON ACER TENDL-2024 LIBRARY; T=0.K
angular distribution for (n,n*16)

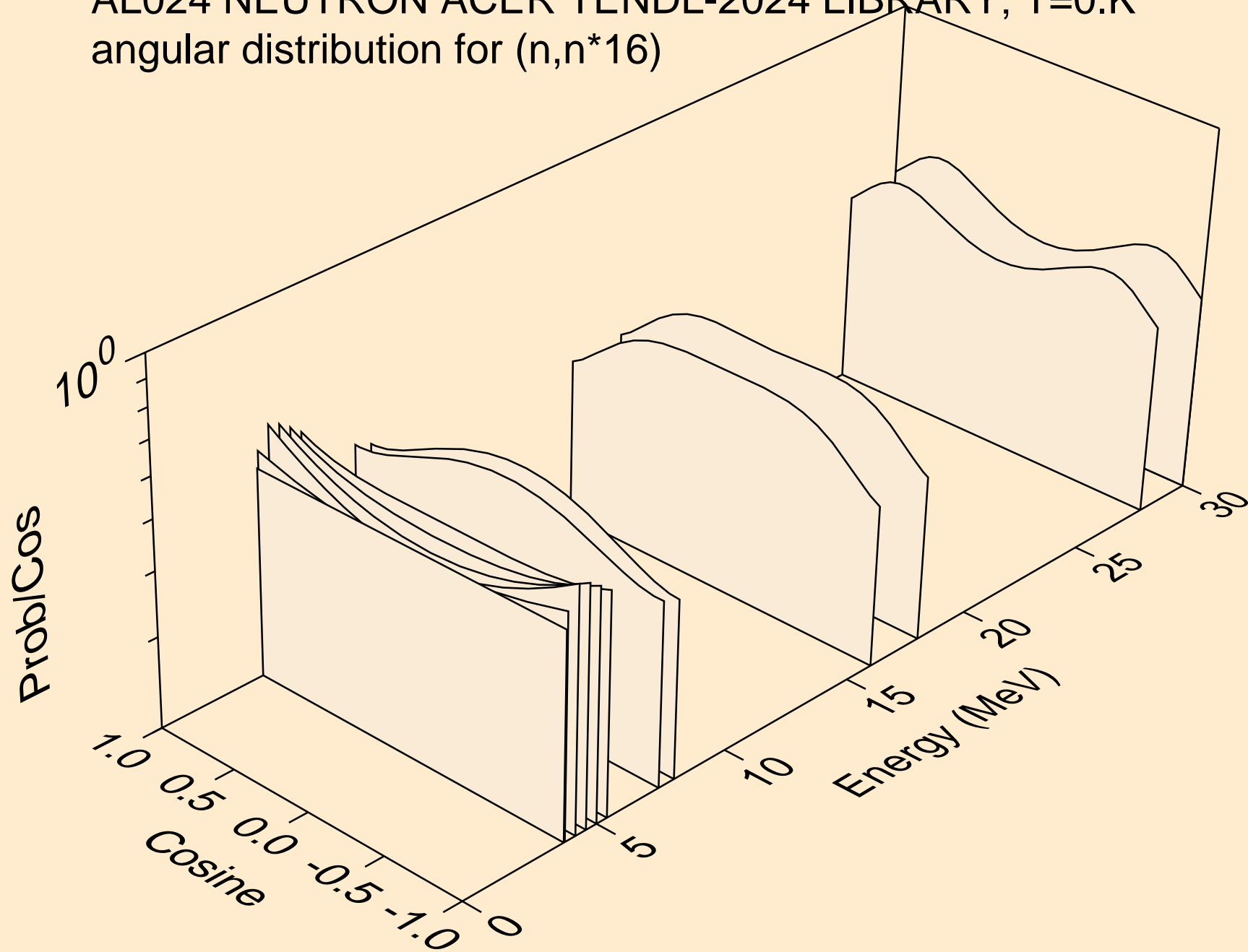

AL024 NEUTRON ACER TENDL-2024 LIBRARY; T=0.K
angular distribution for (n,n*17)

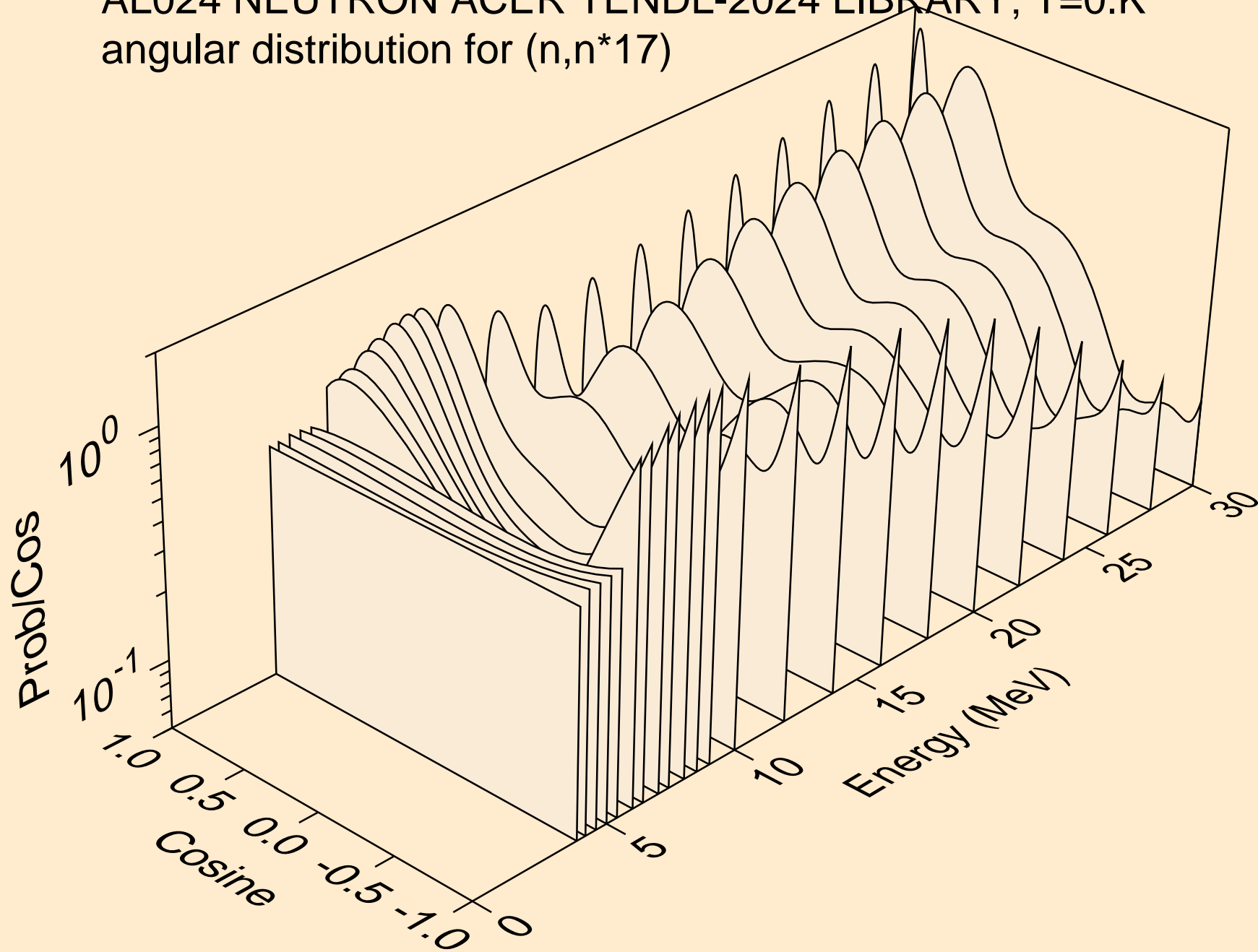

AL024 NEUTRON ACER TENDL-2024 LIBRARY; T=0.K
angular distribution for (n,n*18)

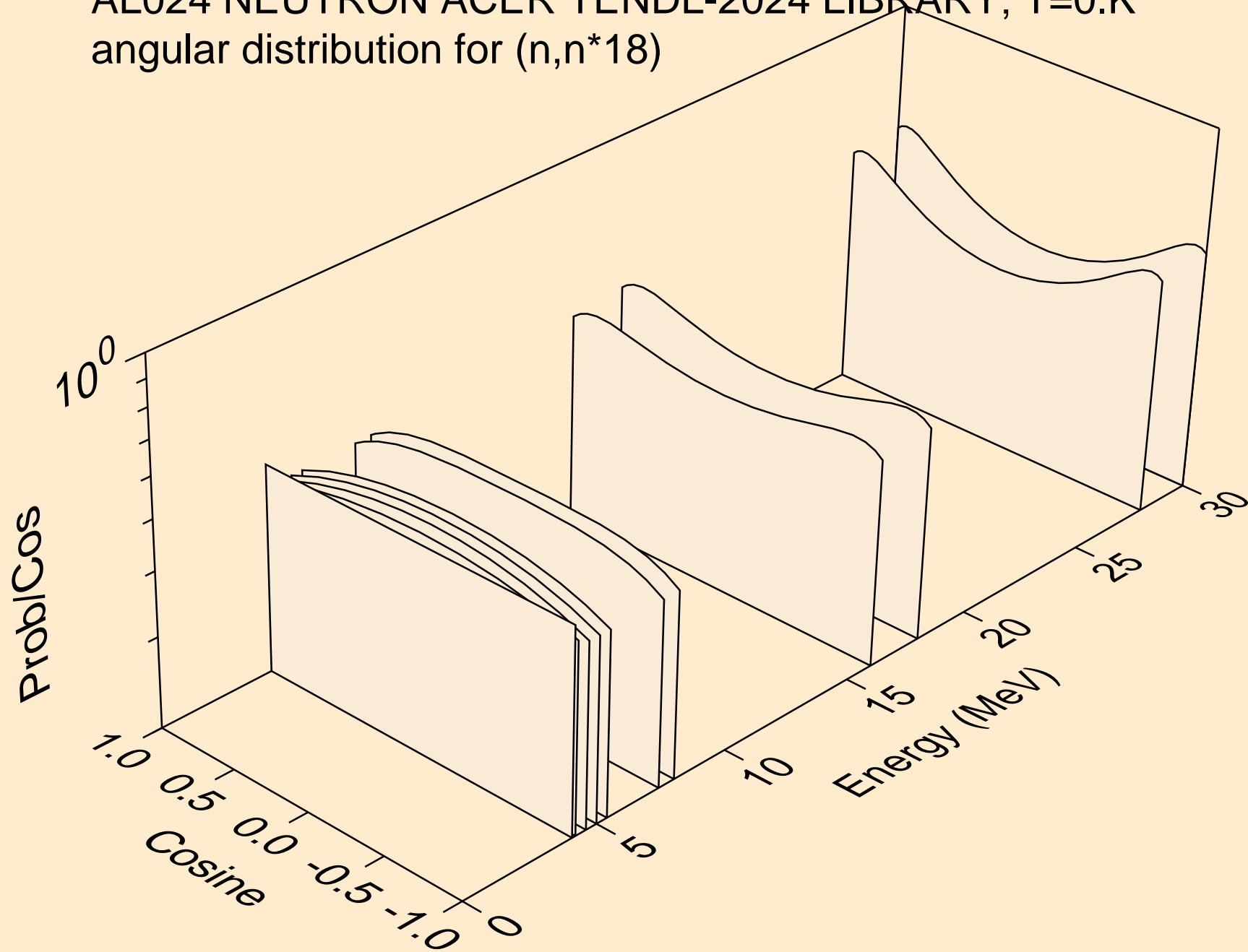

AL024 NEUTRON ACER TENDL-2024 LIBRARY; T=0.K
angular distribution for (n,n*19)

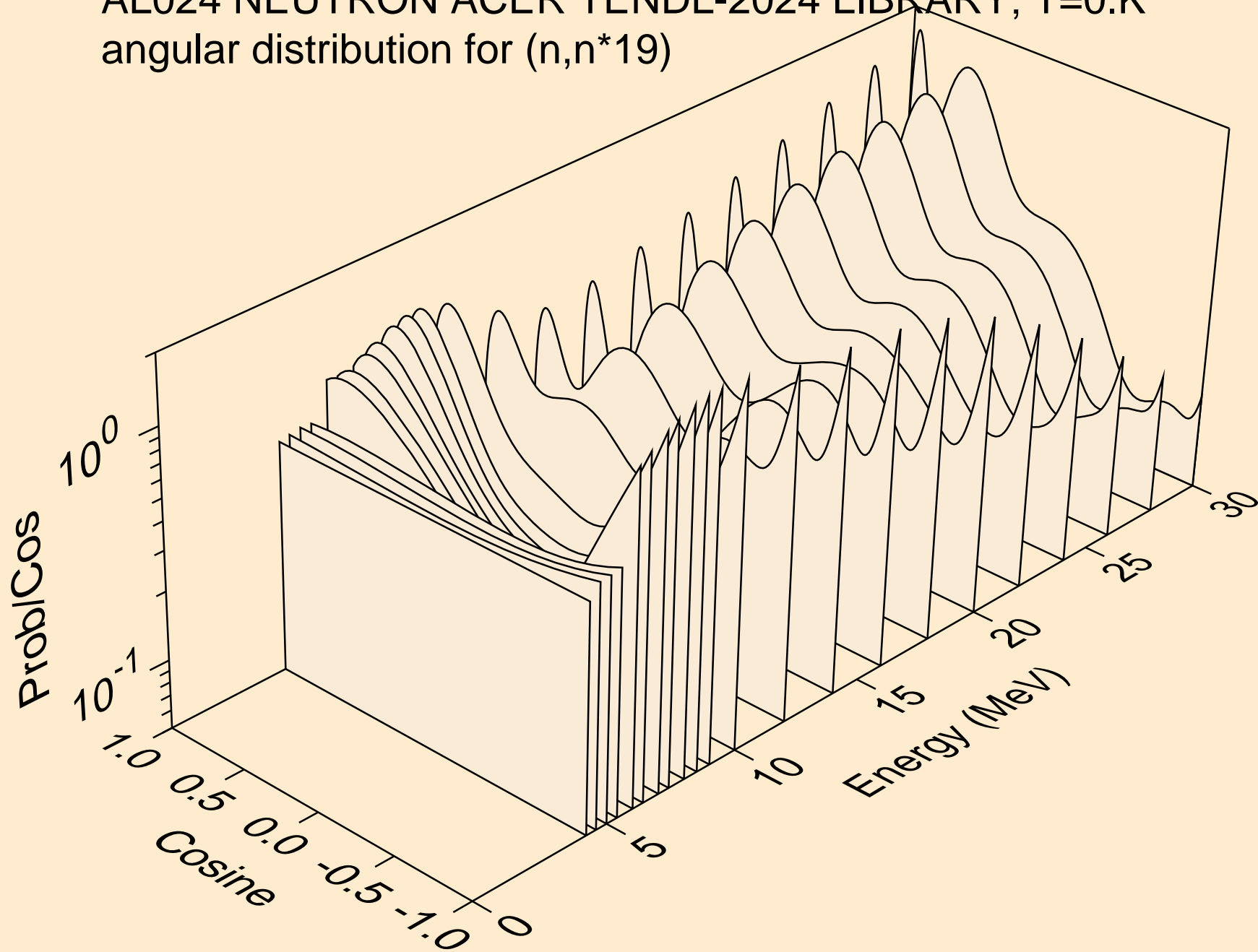

AL024 NEUTRON ACER TENDL-2024 LIBRARY; T=0.K
angular distribution for (n,n*20)

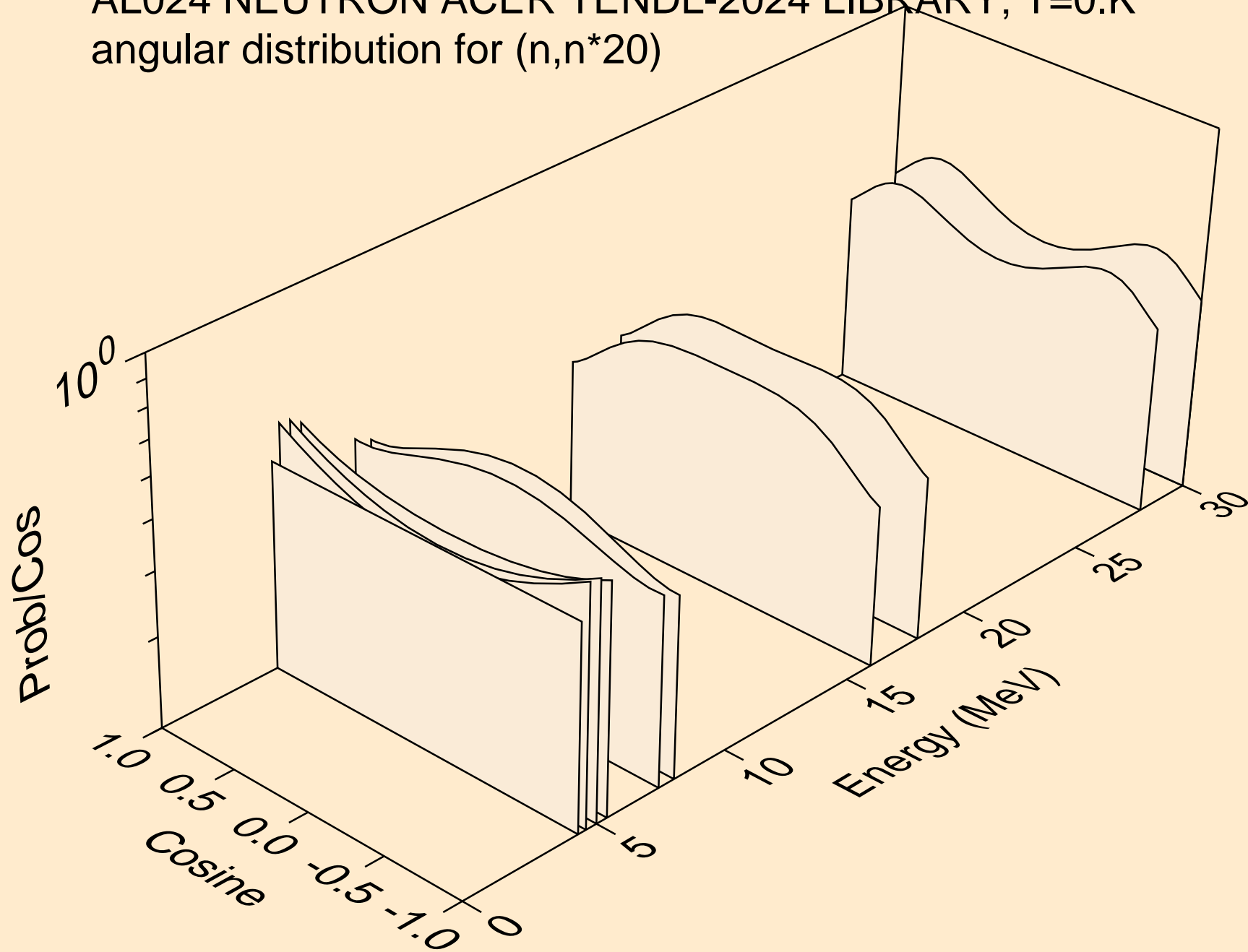

AL024 NEUTRON ACER TENDL-2024 LIBRARY; T=0.K
angular distribution for (n,n*21)

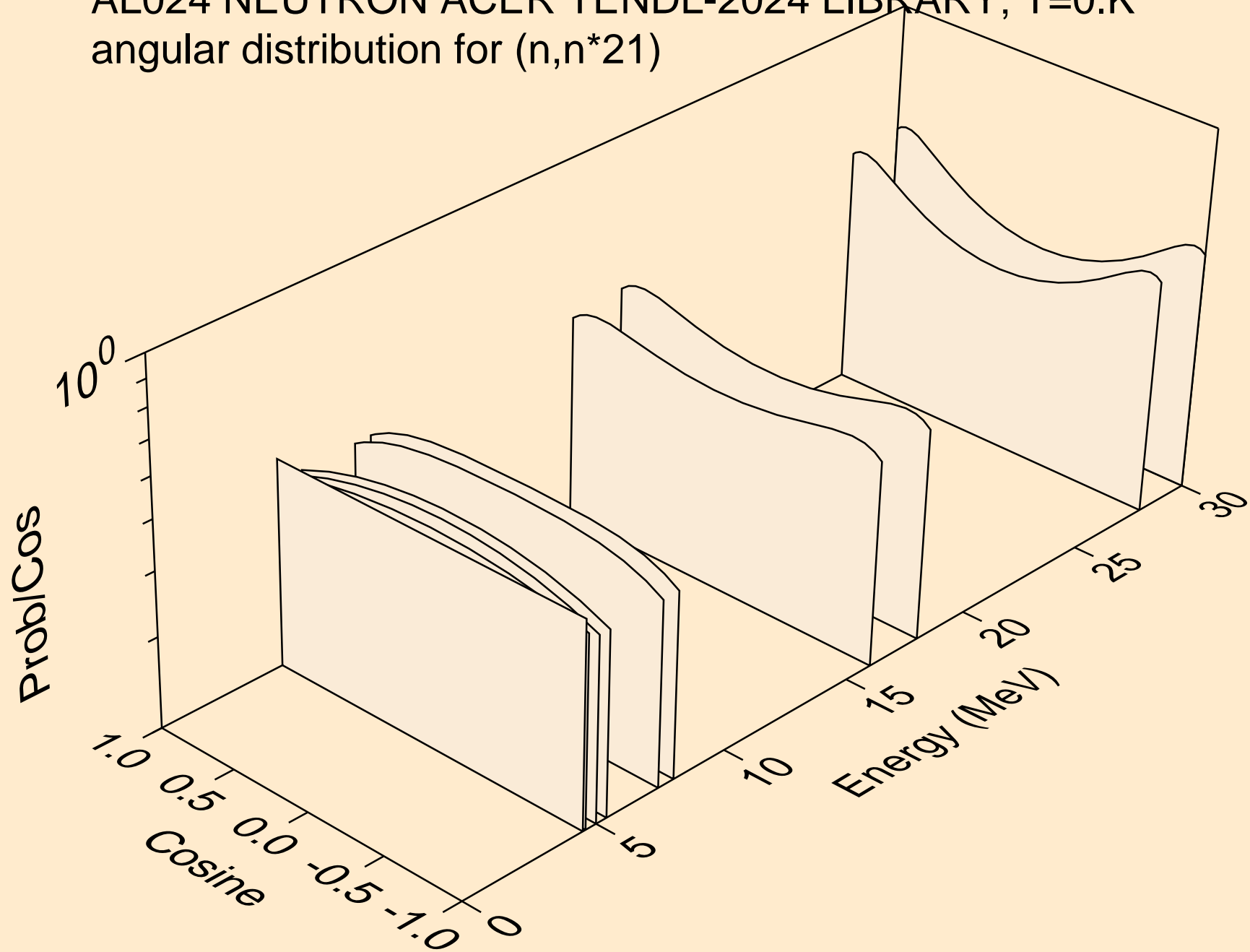

AL024 NEUTRON ACER TENDL-2024 LIBRARY; T=0.K
angular distribution for (n,n*22)

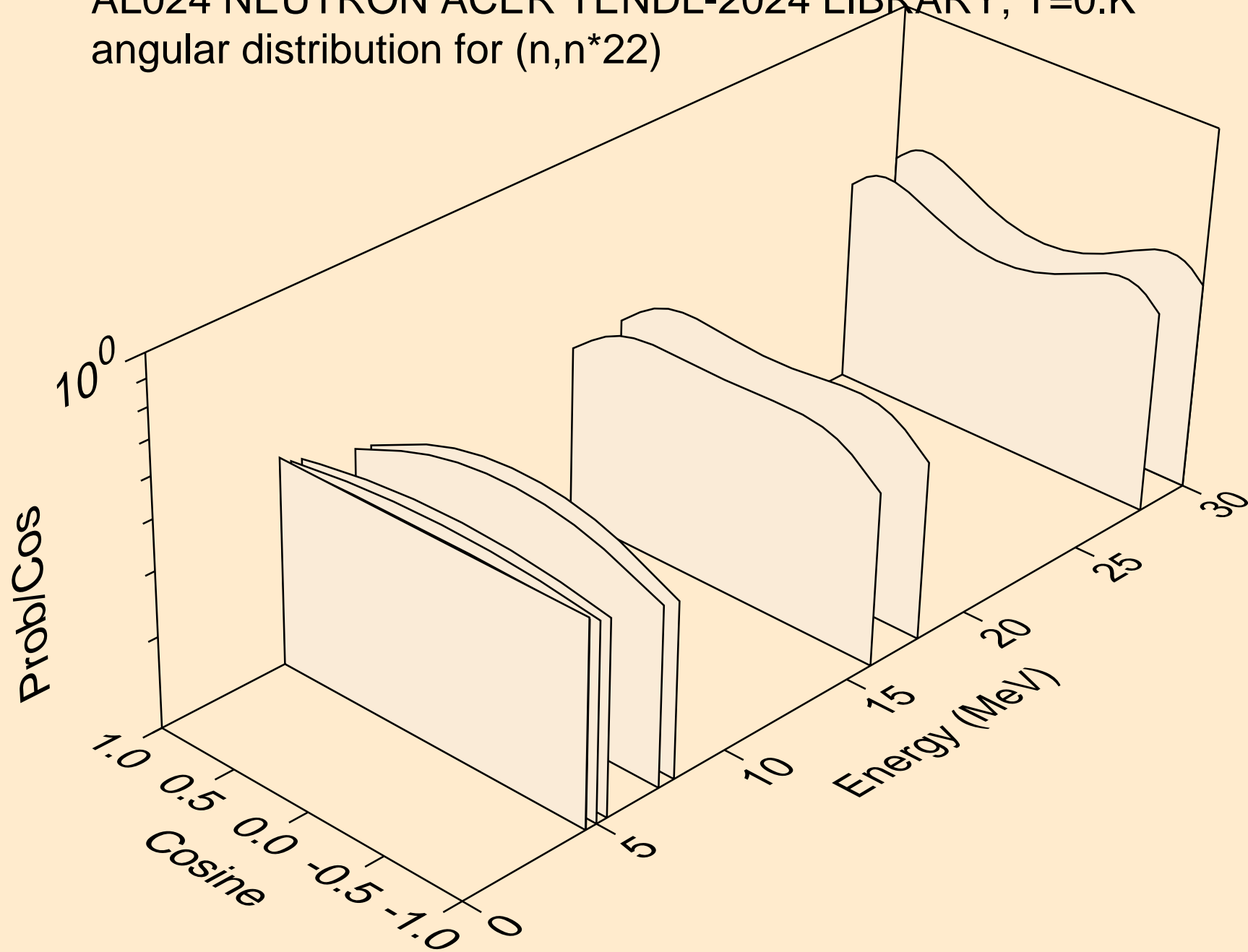

AL024 NEUTRON ACER TENDL-2024 LIBRARY; T=0.K
angular distribution for (n,n*23)

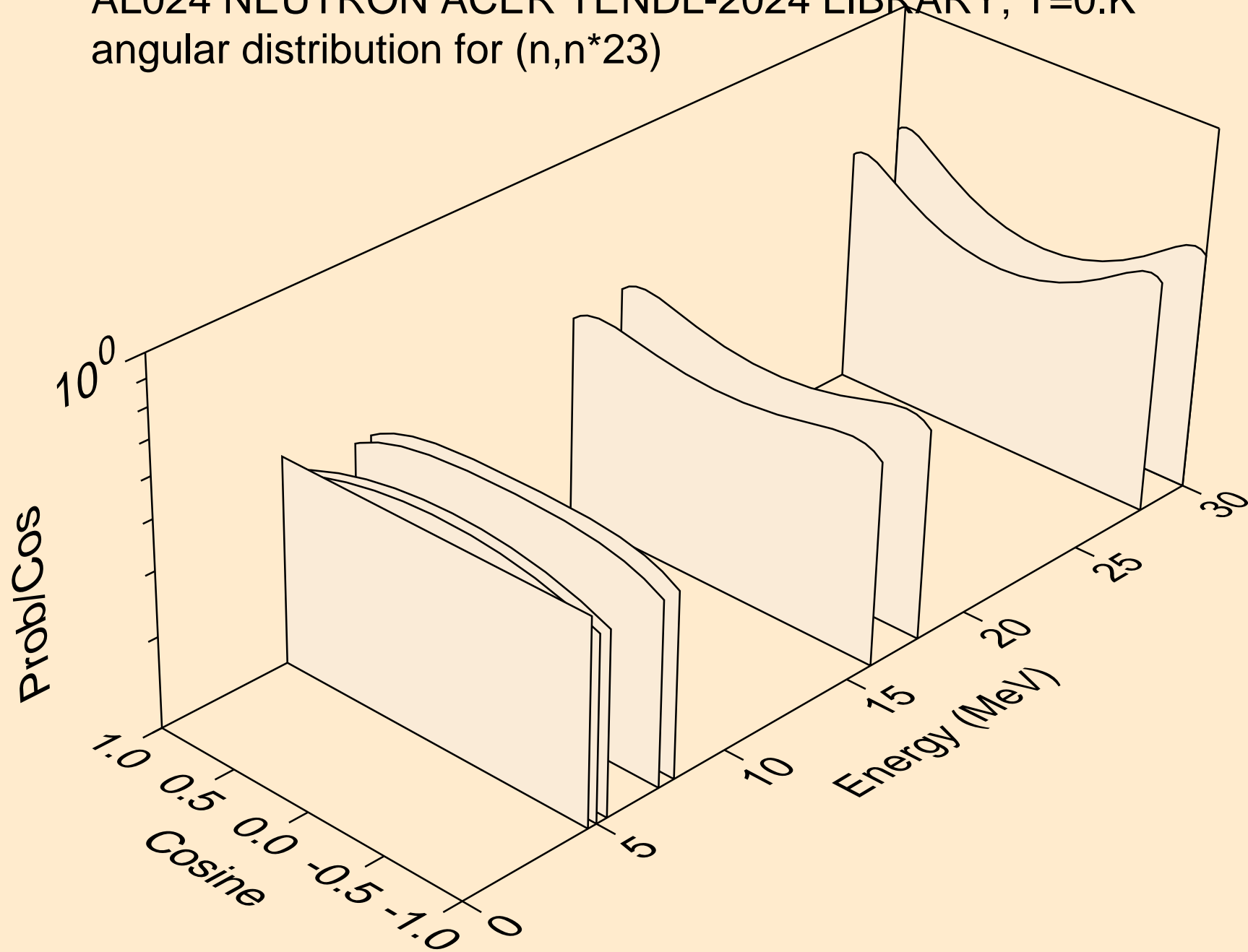

AL024 NEUTRON ACER TENDL-2024 LIBRARY; T=0.K
angular distribution for (n,n*24)

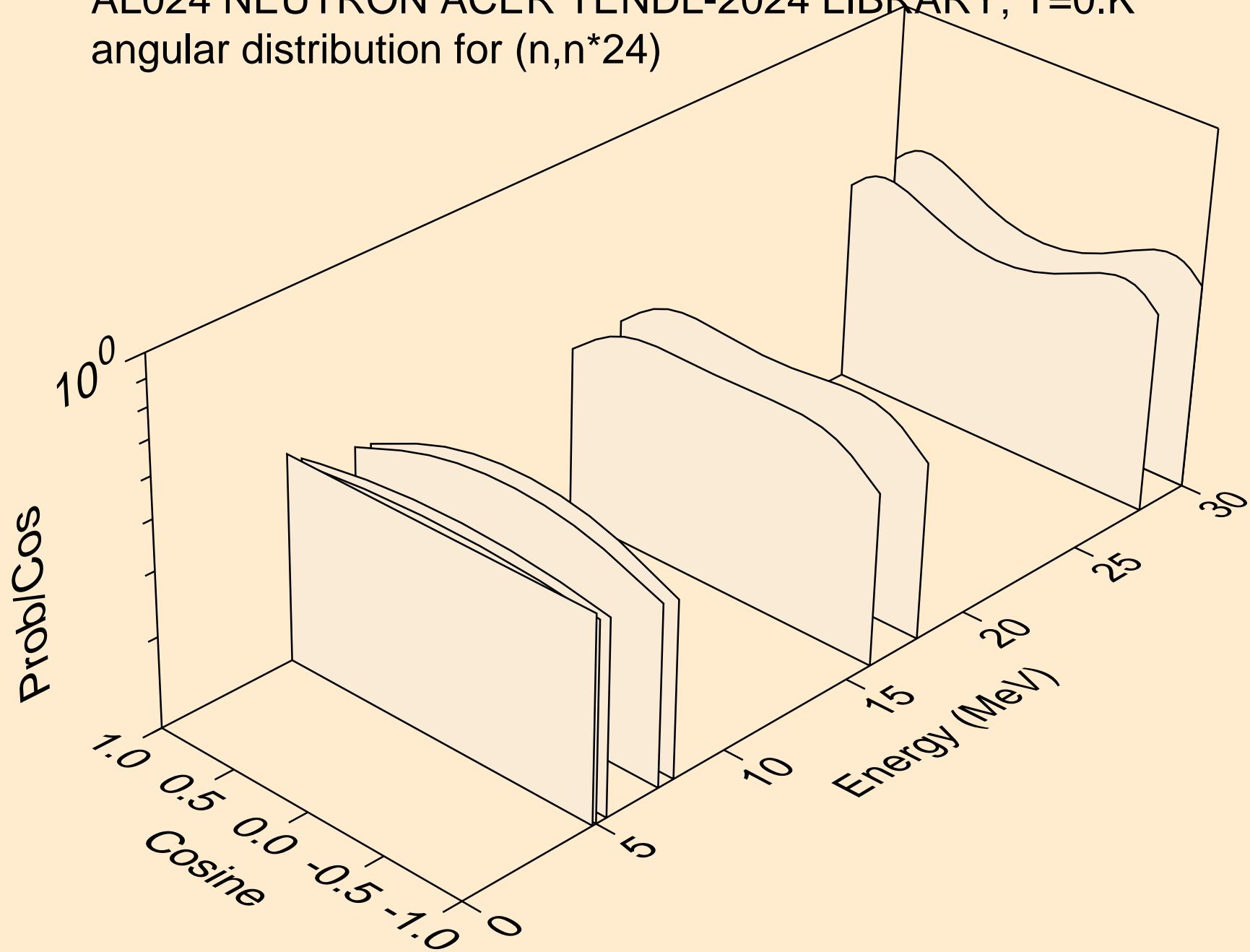

AL024 NEUTRON ACER TENDL-2024 LIBRARY; T=0.K
angular distribution for (n,n*25)

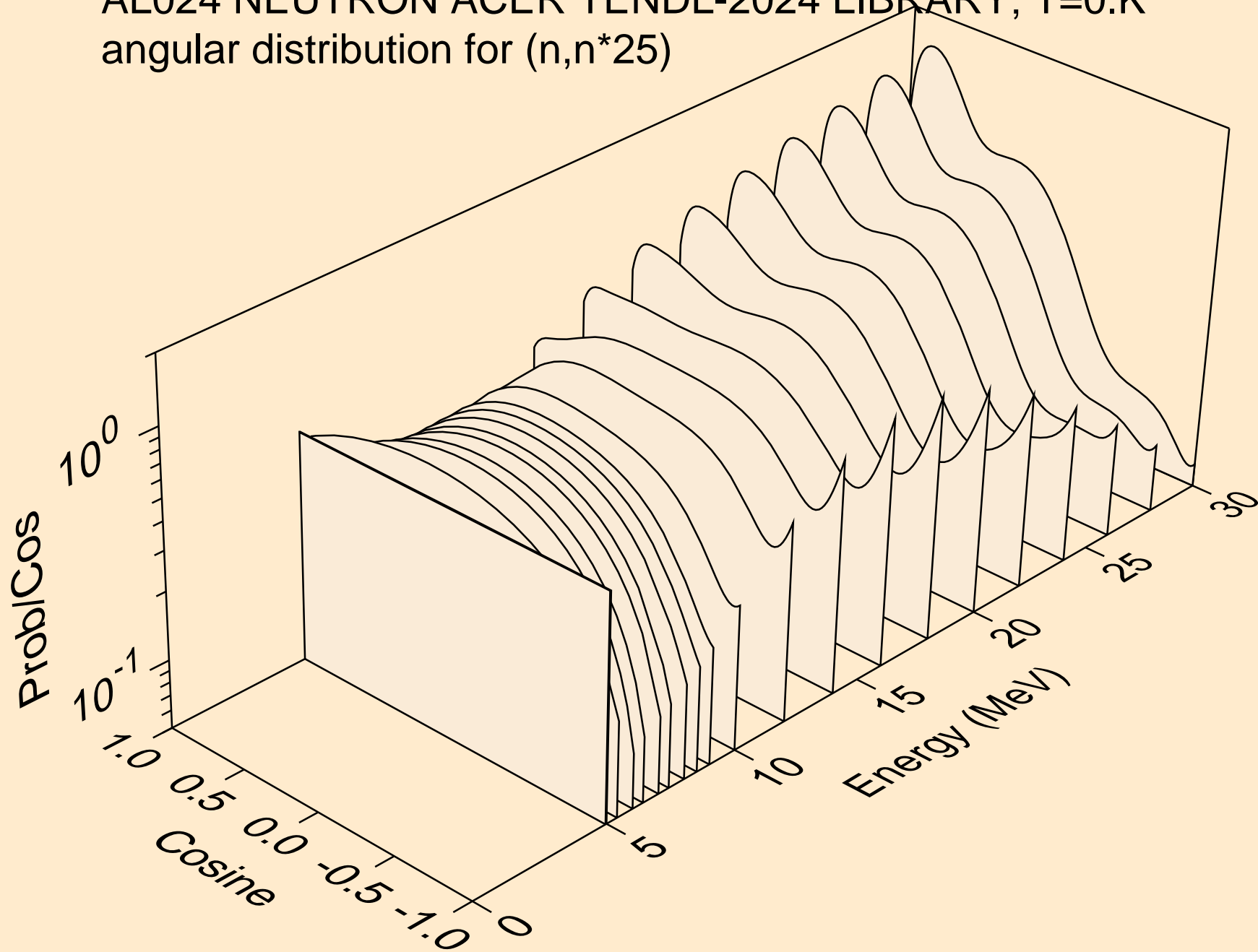

AL024 NEUTRON ACER TENDL-2024 LIBRARY; T=0.K
Neutron emission for (n,x)

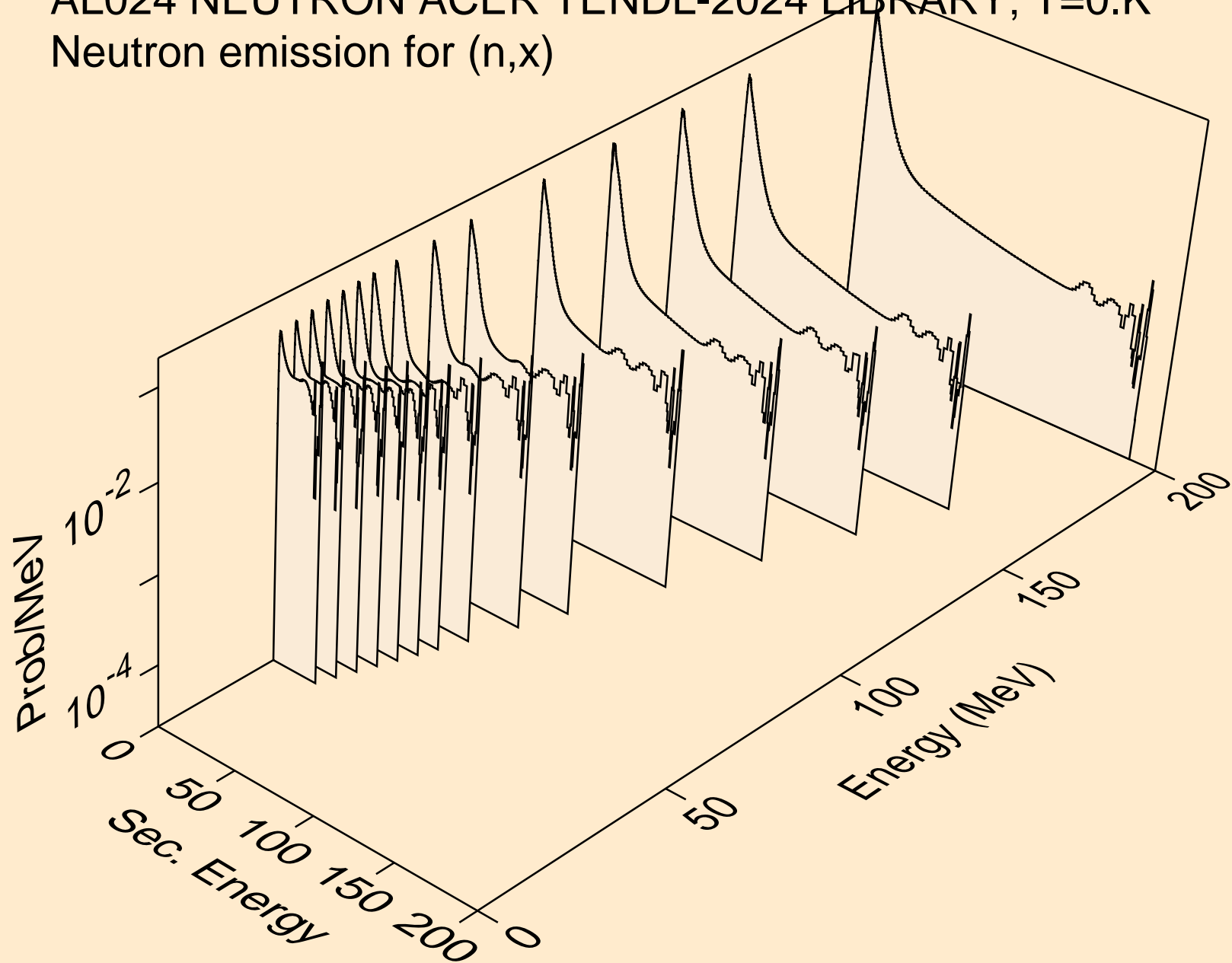

AL024 NEUTRON ACER TENDL-2024 LIBRARY; T=0.K
Neutron emission for (n,2n)

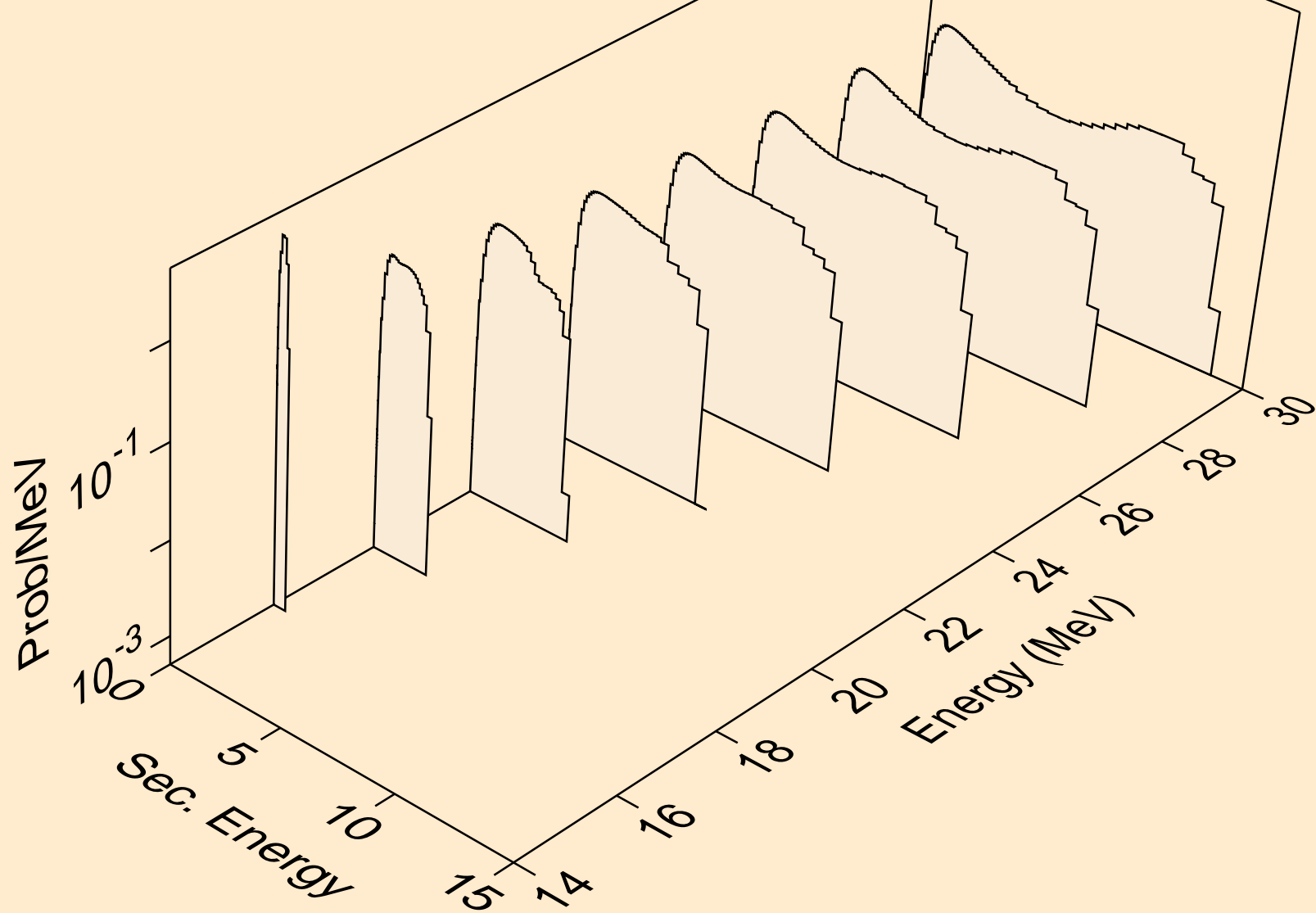

AL024 NEUTRON ACER TENDL-2024 LIBRARY; T=0.K
Neutron emission for (n,n*)a

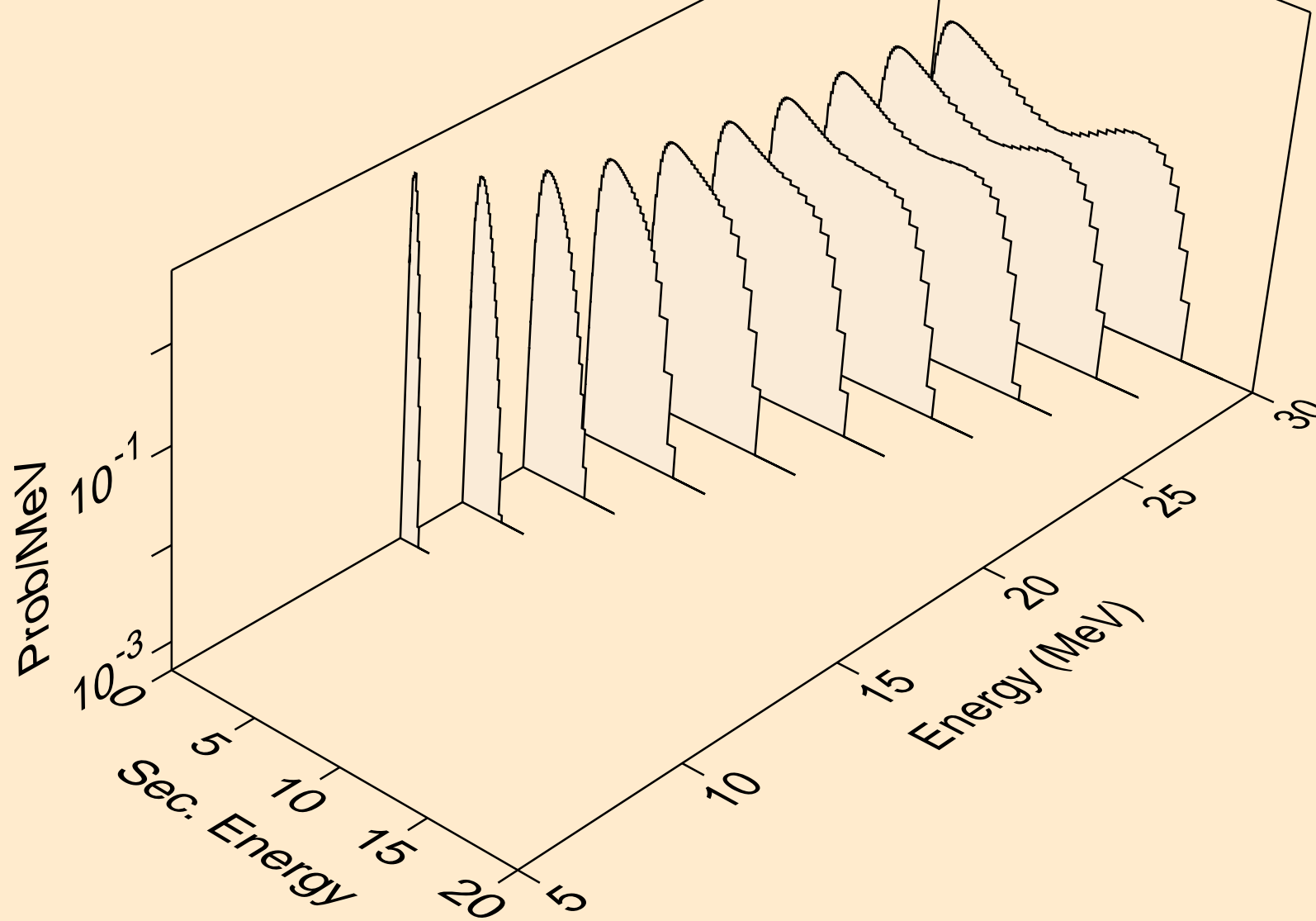

AL024 NEUTRON ACER TENDL-2024 LIBRARY; T=0.K
Neutron emission for (n,2n)a

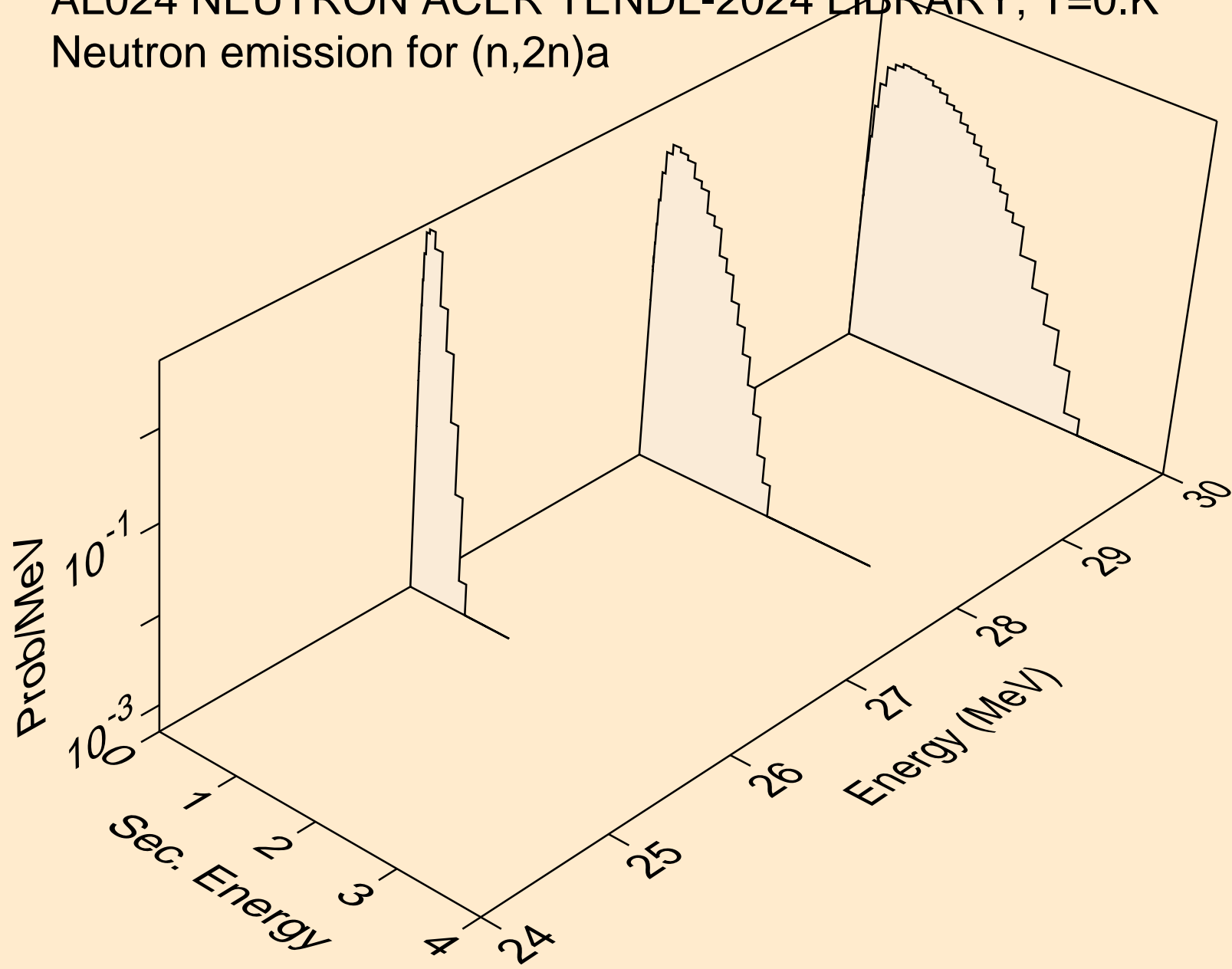

AL024 NEUTRON ACER TENDL-2024 LIBRARY; T=0.K
Neutron emission for (n,n*)p

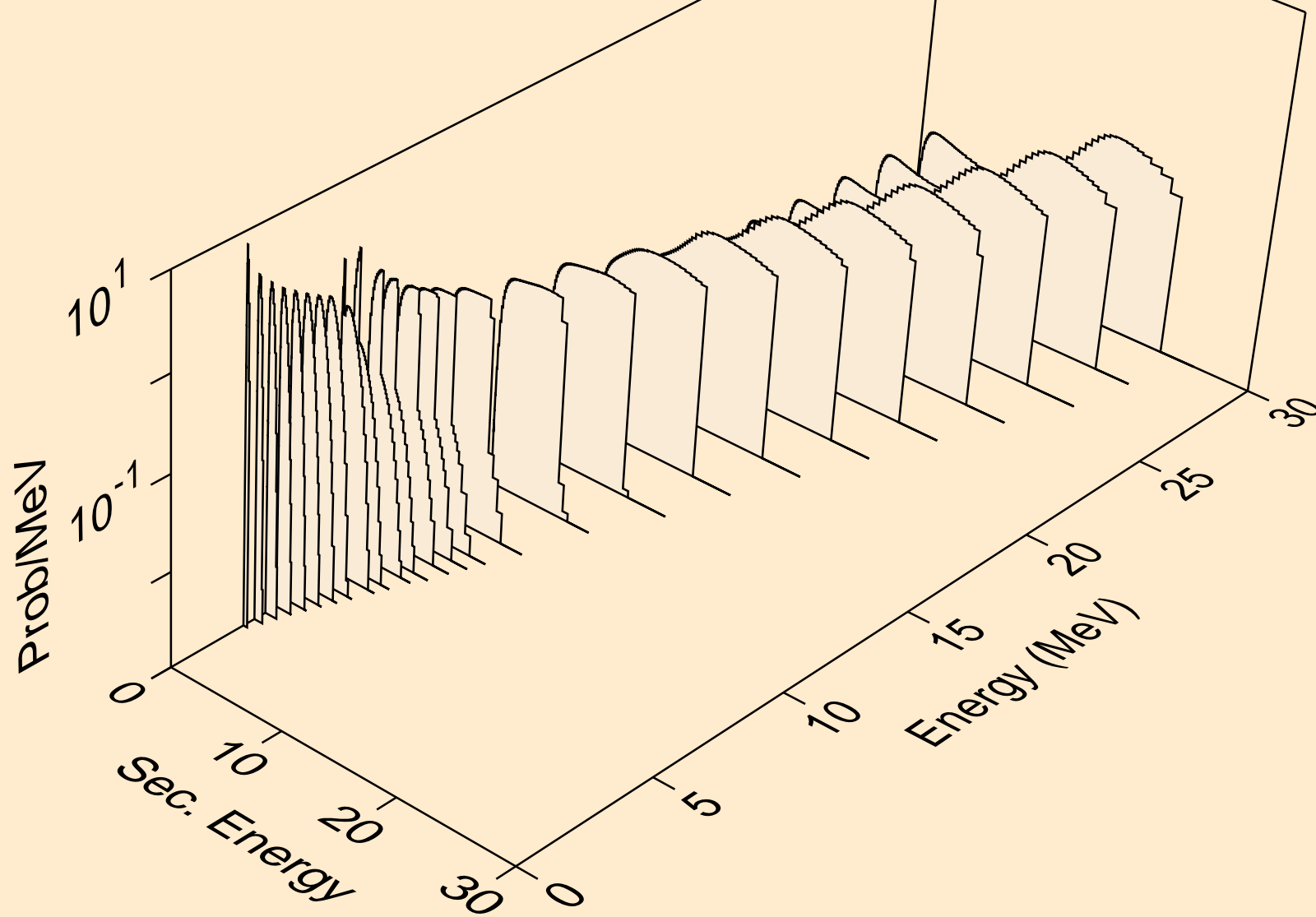

AL024 NEUTRON ACER TENDL-2024 LIBRARY; T=0.K
Neutron emission for (n,n*)2a

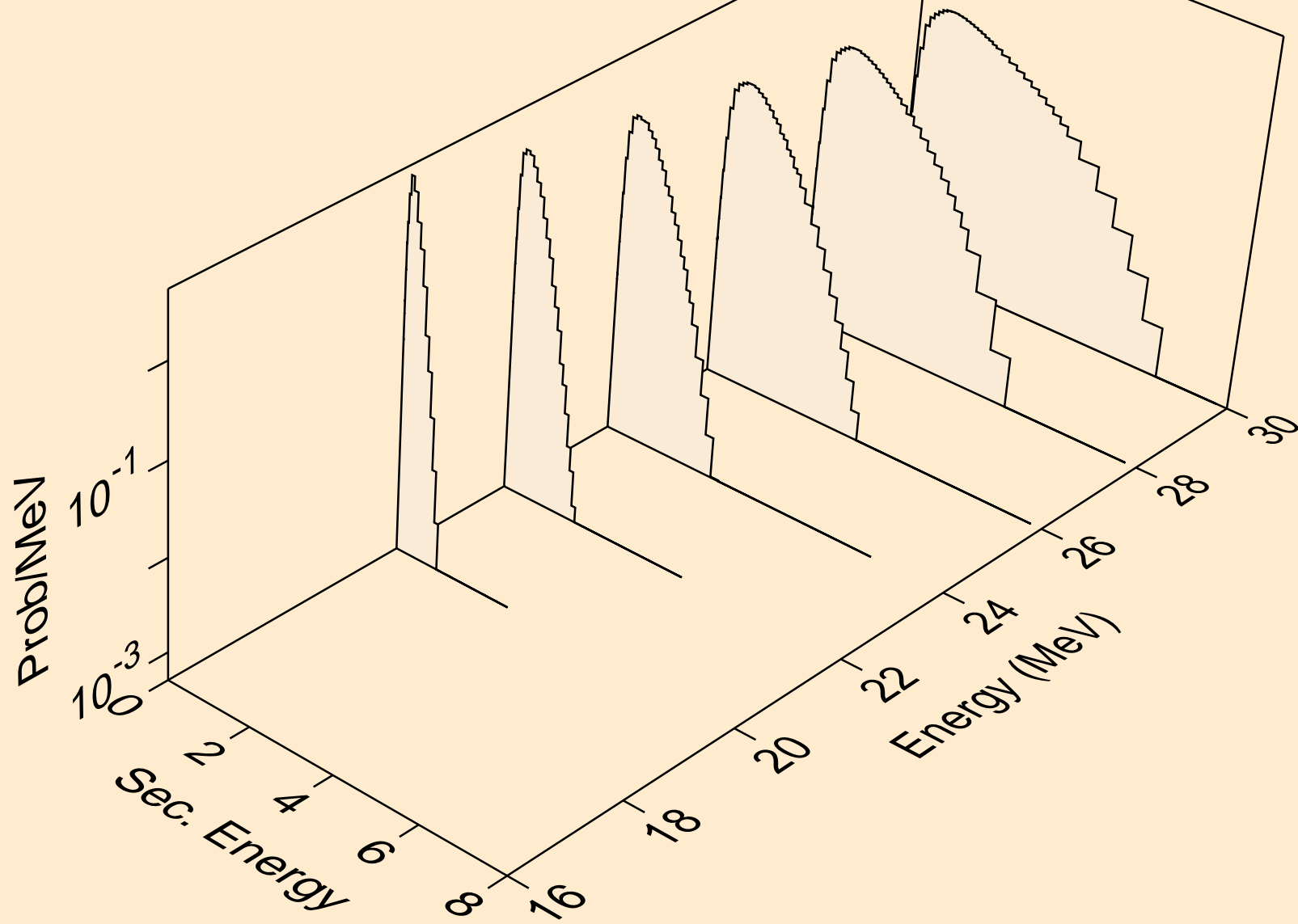

AL024 NEUTRON ACER TENDL-2024 LIBRARY; T=0.K
Neutron emission for (n,n*)d

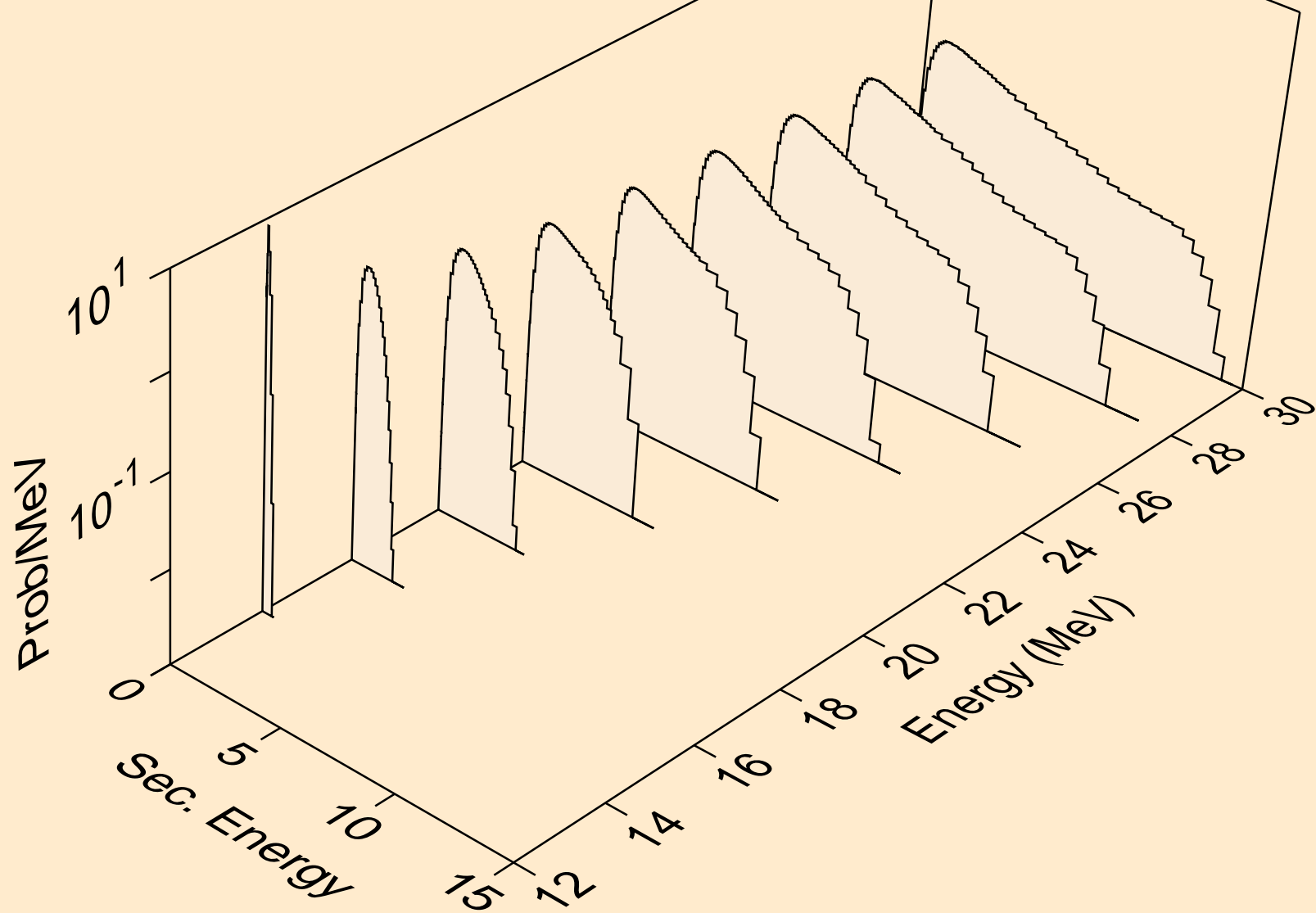

AL024 NEUTRON ACER TENDL-2024 LIBRARY; T=0.K
Neutron emission for (n,n*)t

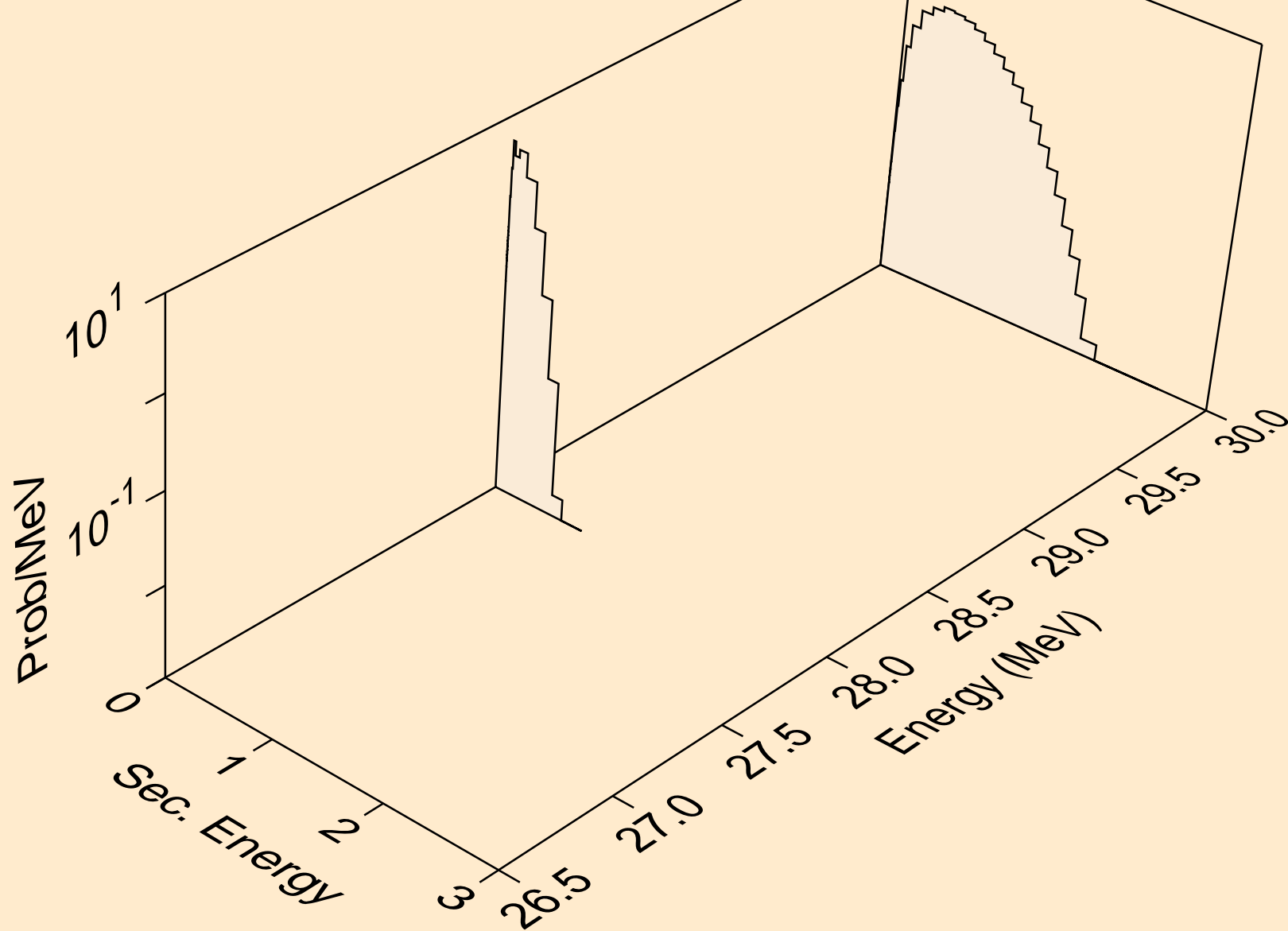

AL024 NEUTRON ACER TENDL-2024 LIBRARY; T=0.K
Neutron emission for (n,n*)he3

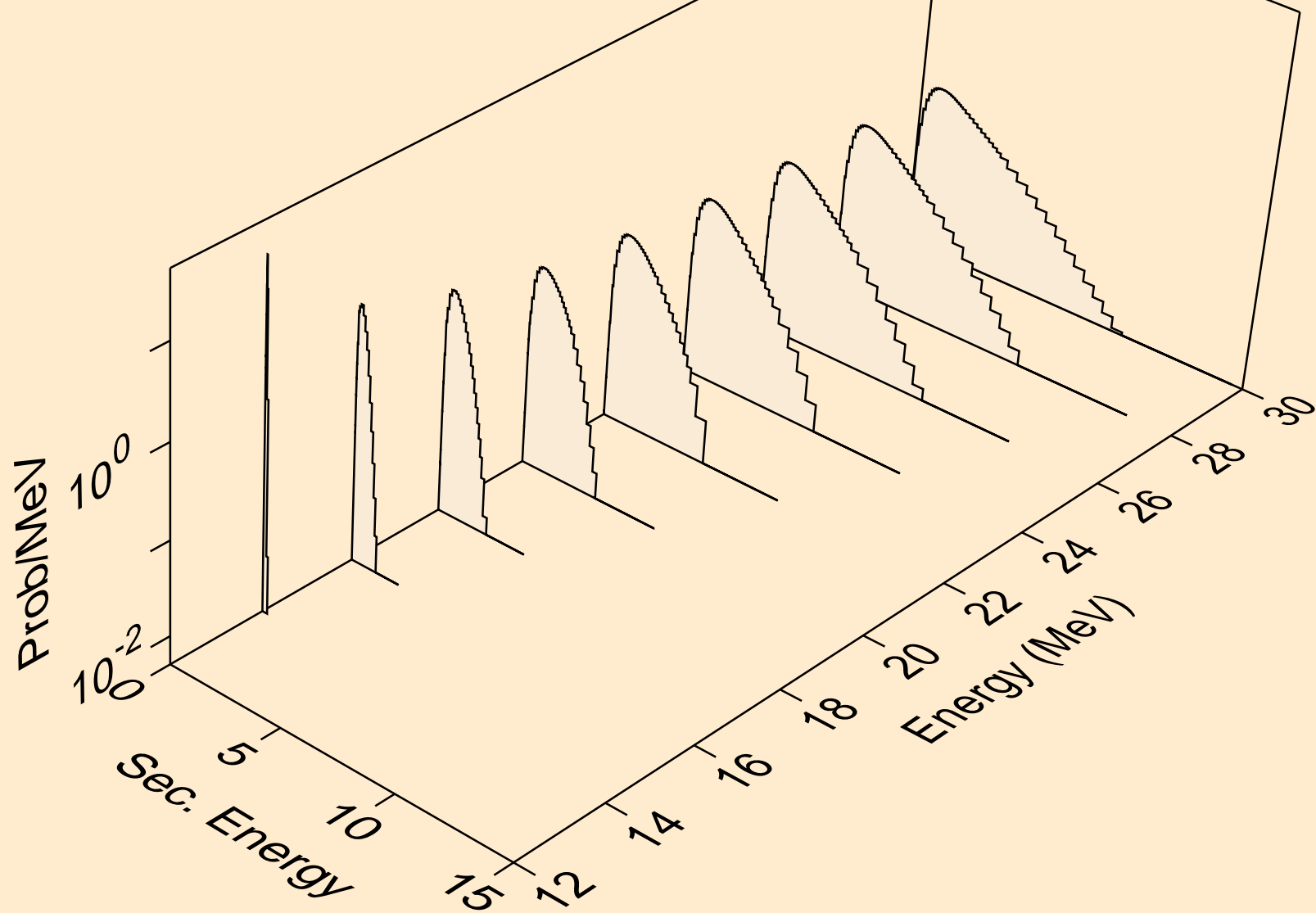

AL024 NEUTRON ACER TENDL-2024 LIBRARY; T=0.K
Neutron emission for (n,2np)

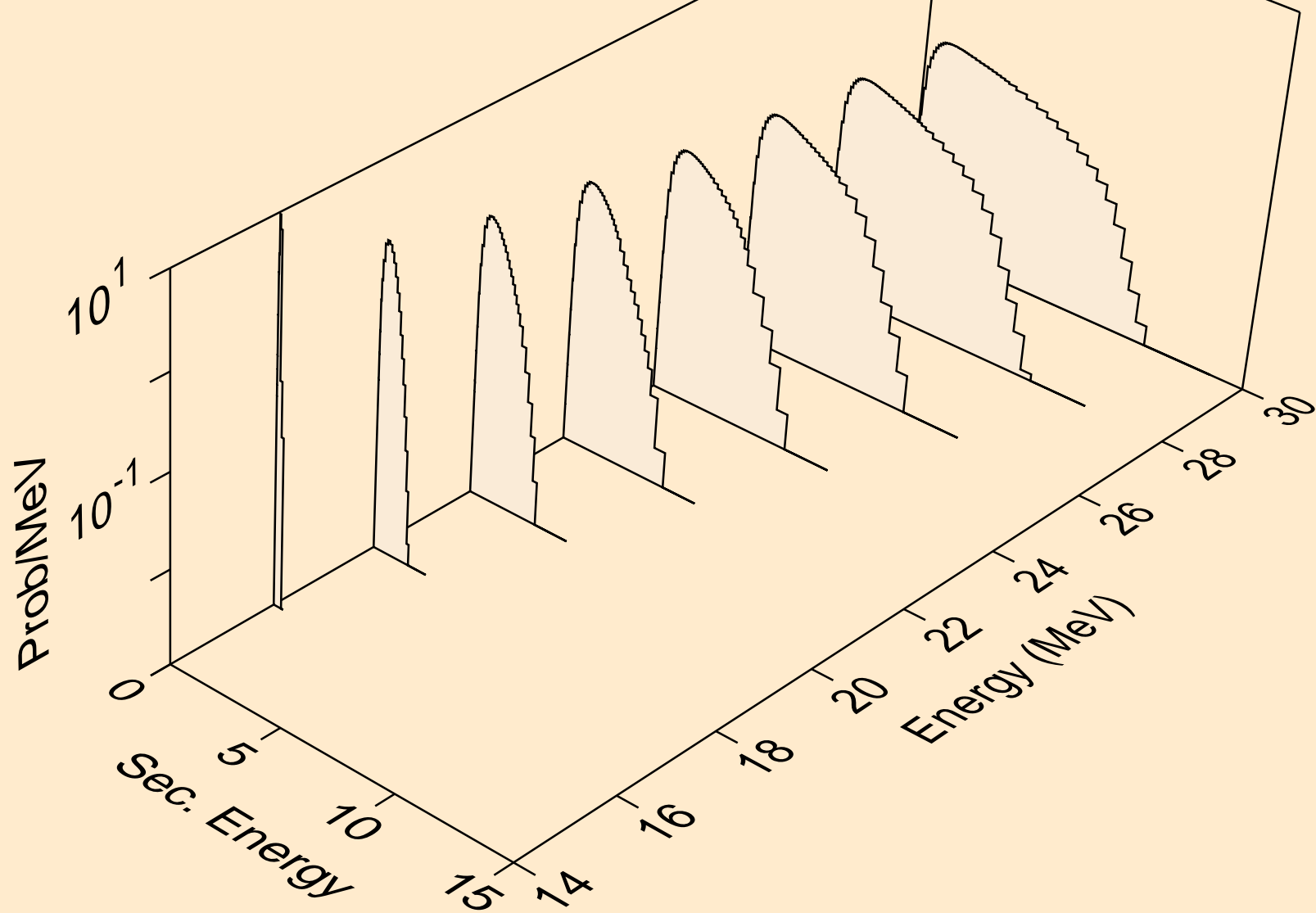

AL024 NEUTRON ACER TENDL-2024 LIBRARY; T=0.K
Neutron emission for (n,n2p)

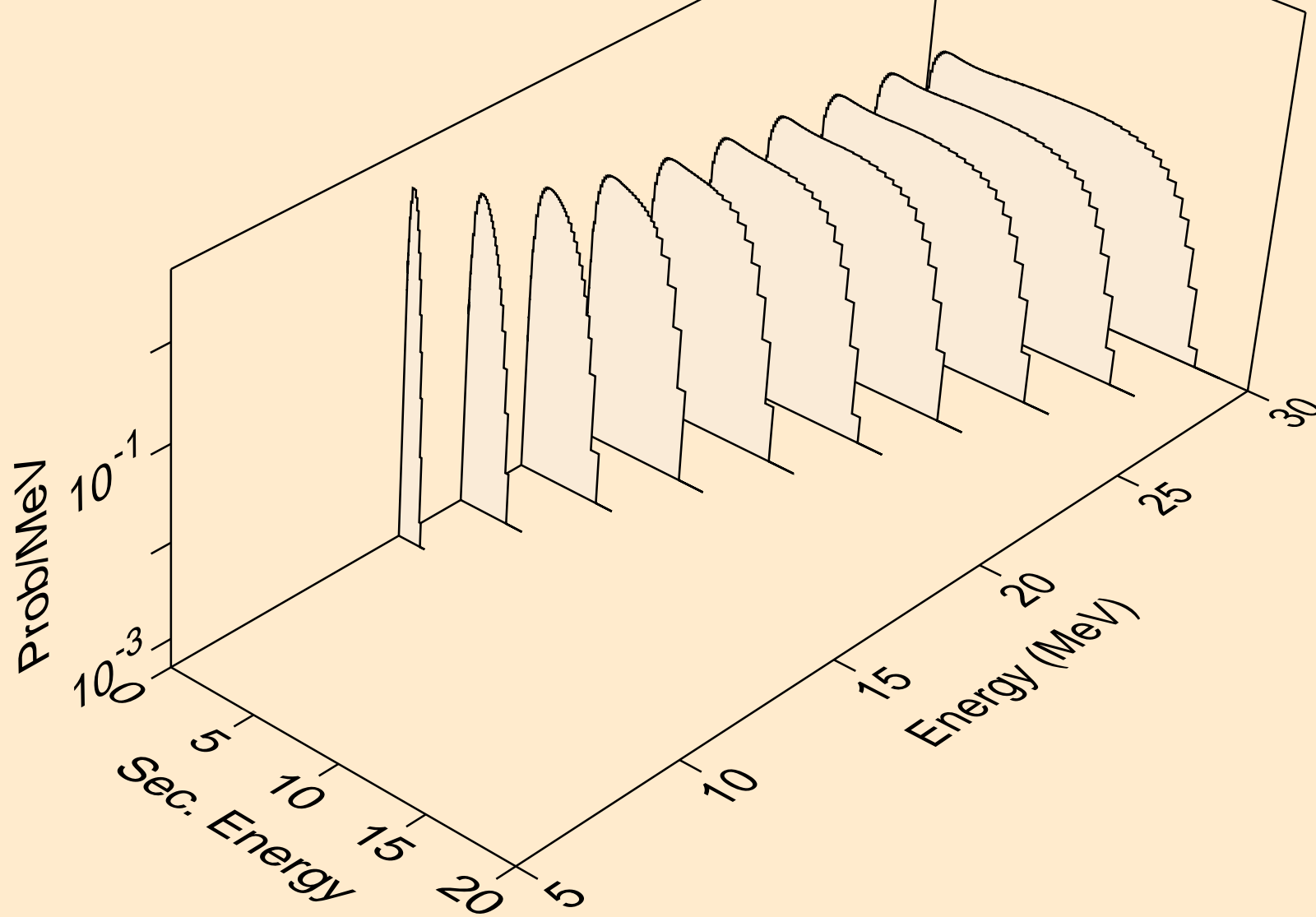

AL024 NEUTRON ACER TENDL-2024 LIBRARY; T=0.K
Neutron emission for (n,npa)

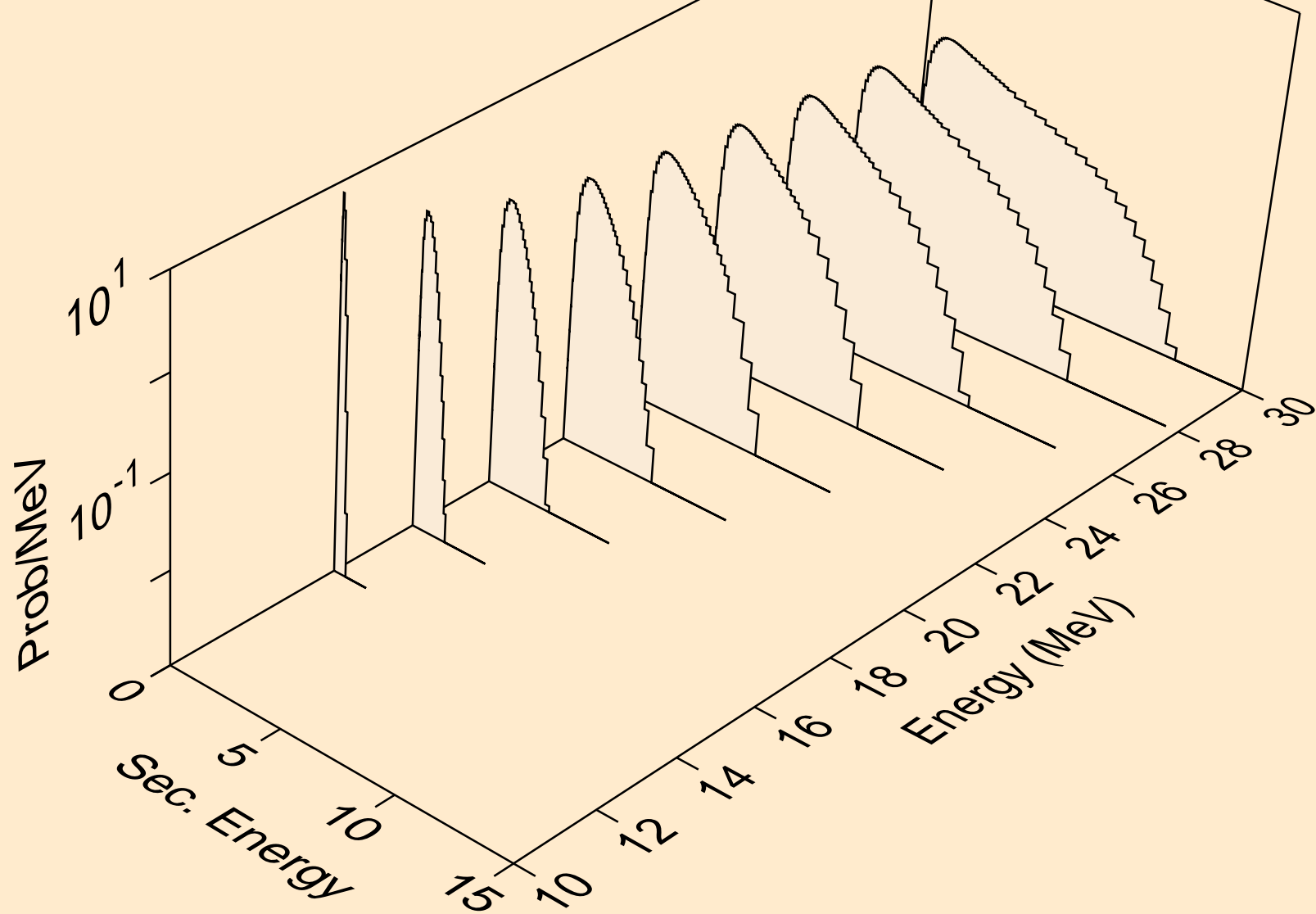

AL024 NEUTRON ACER TENDL-2024 LIBRARY; T=0.K
Neutron emission for (n,n*c)

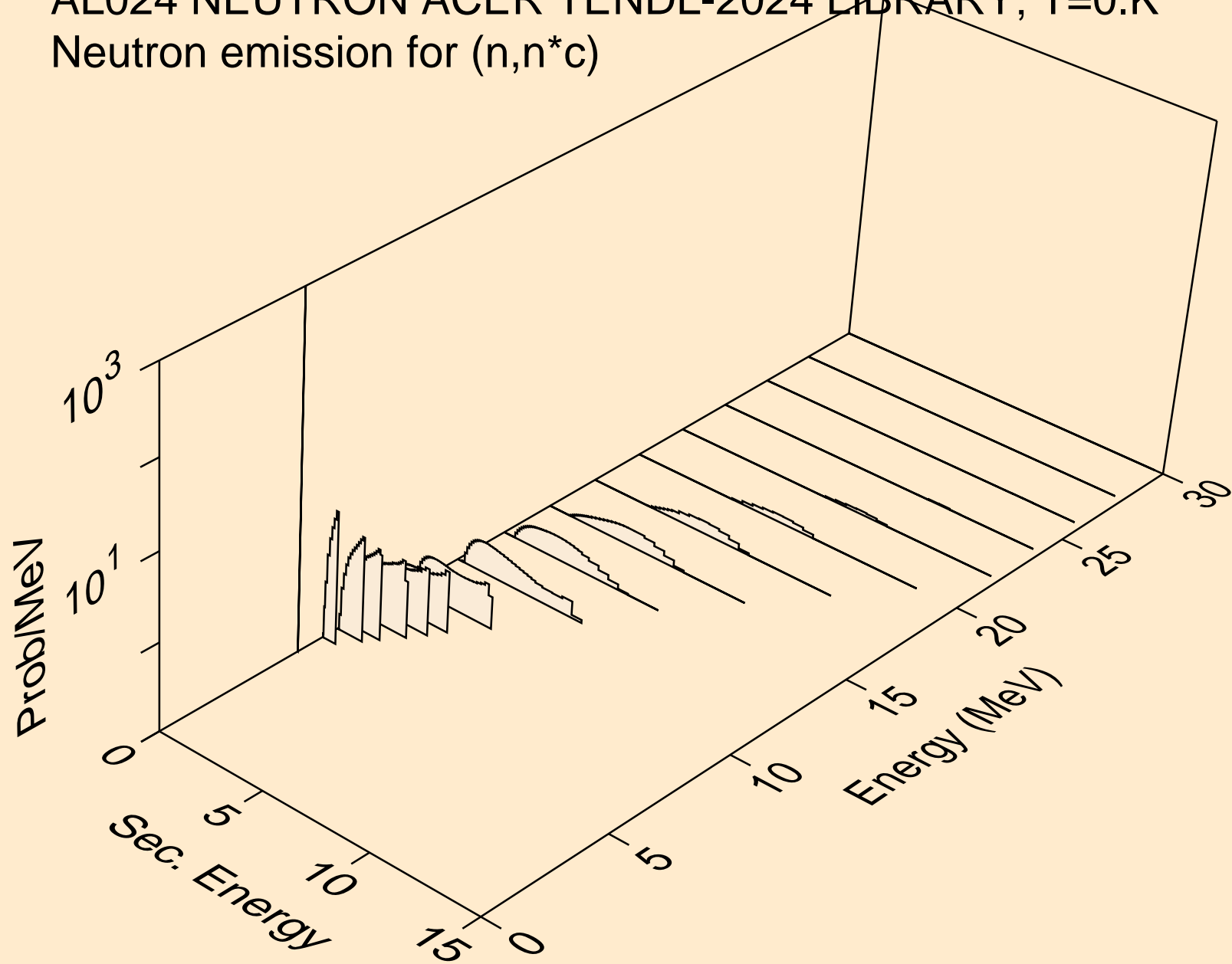

AL024 NEUTRON ACER TENDL-2024 LIBRARY; T=0.K
Photon emission for (n,x)

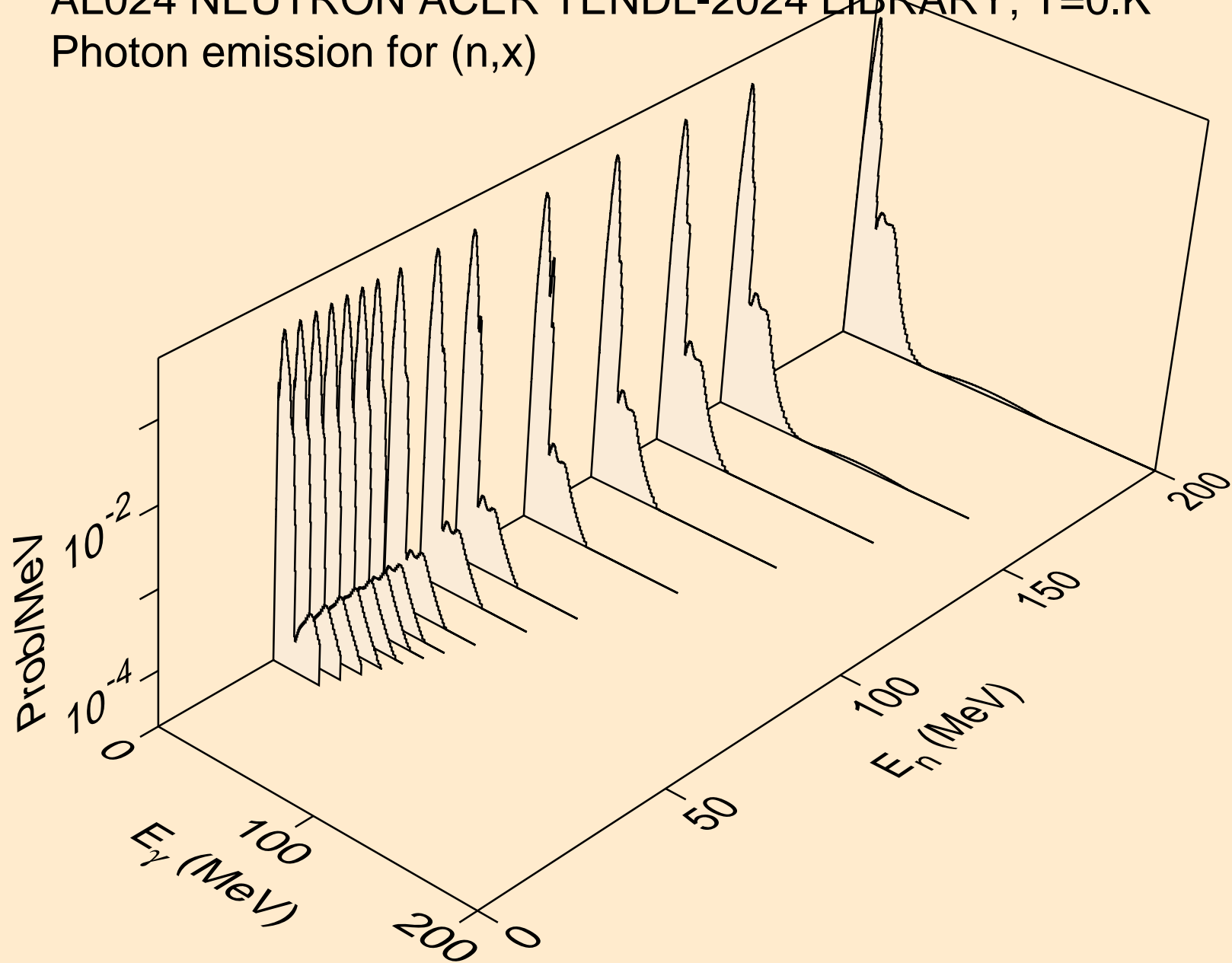

AL024 NEUTRON ACER TENDL-2024 LIBRARY; T=0.K
Photon emission for (n,2n)

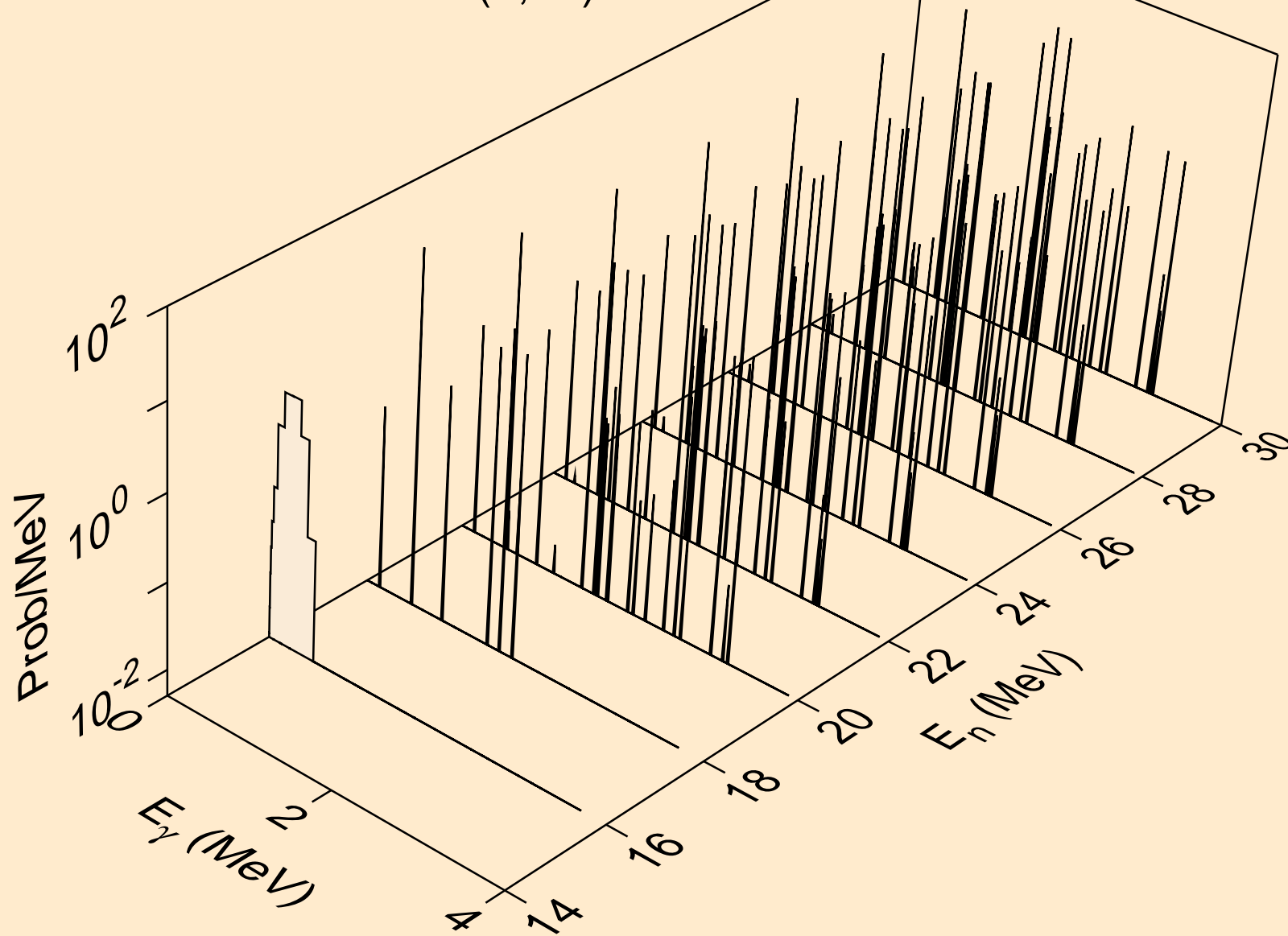

AL024 NEUTRON ACER TENDL-2024 LIBRARY; T=0.K
Photon emission for (n,n*)a

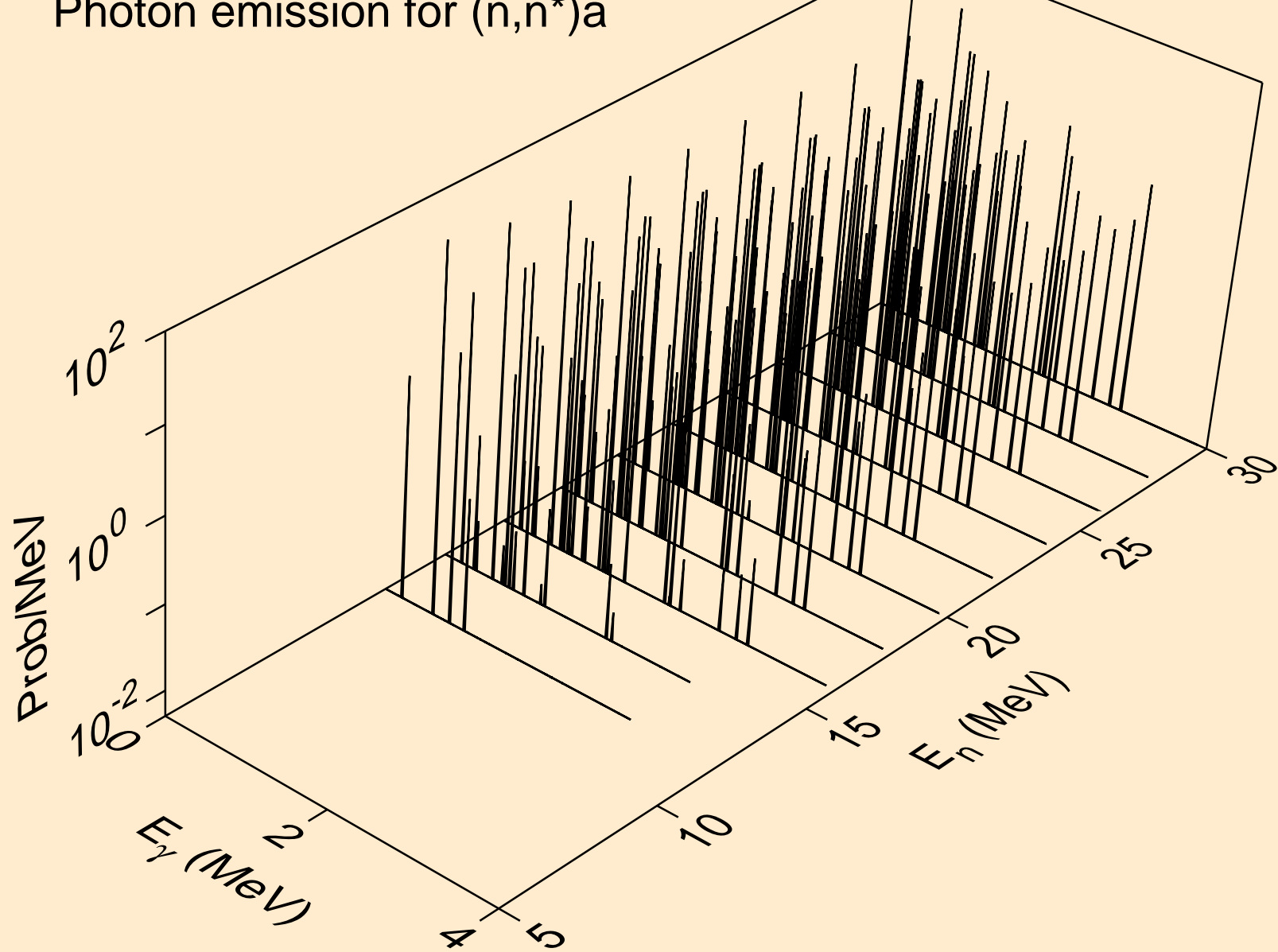

AL024 NEUTRON ACER TENDL-2024 LIBRARY; T=0.K
Photon emission for (n,2n)a

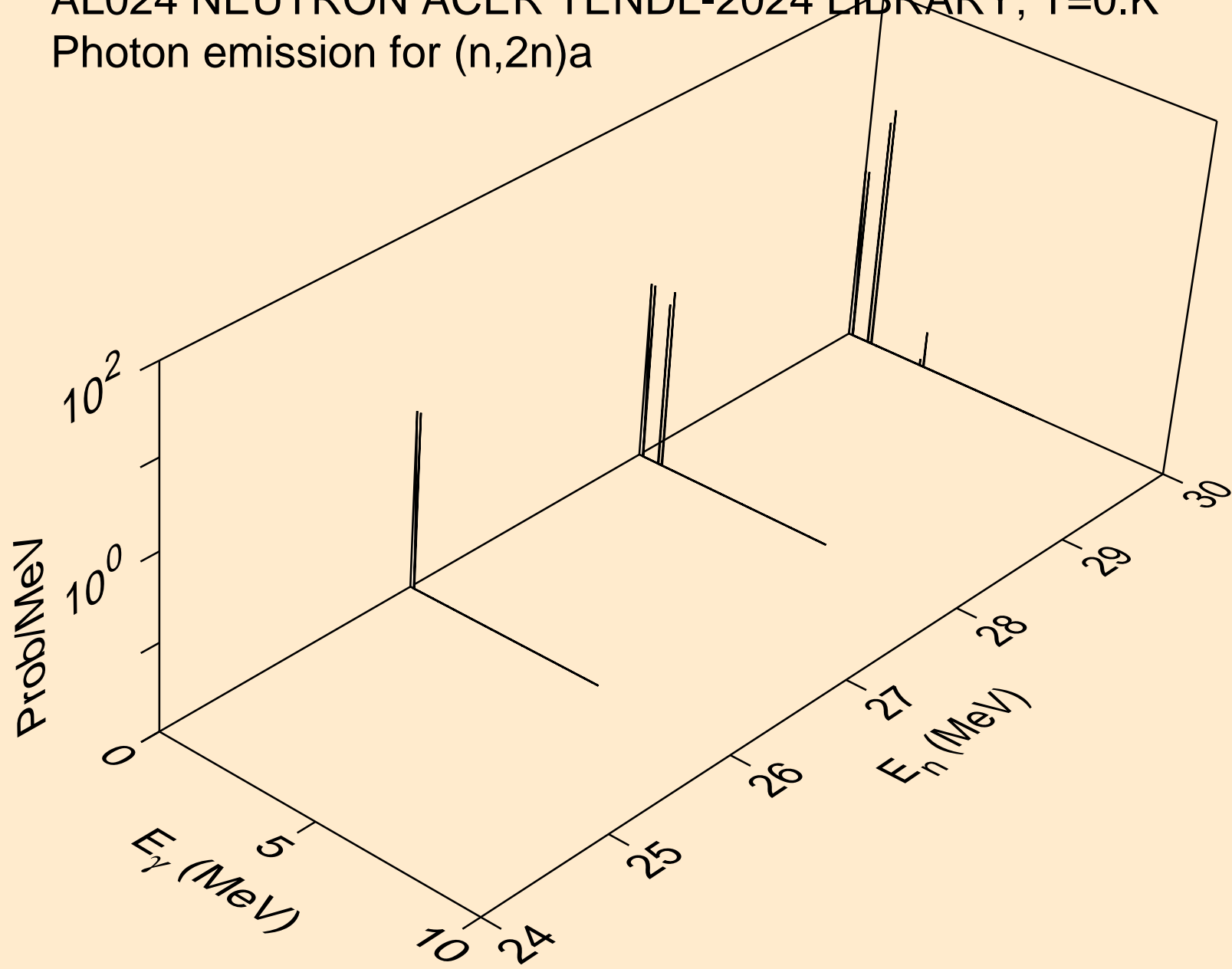

AL024 NEUTRON ACER TENDL-2024 LIBRARY; T=0.K
Photon emission for (n,n*)p

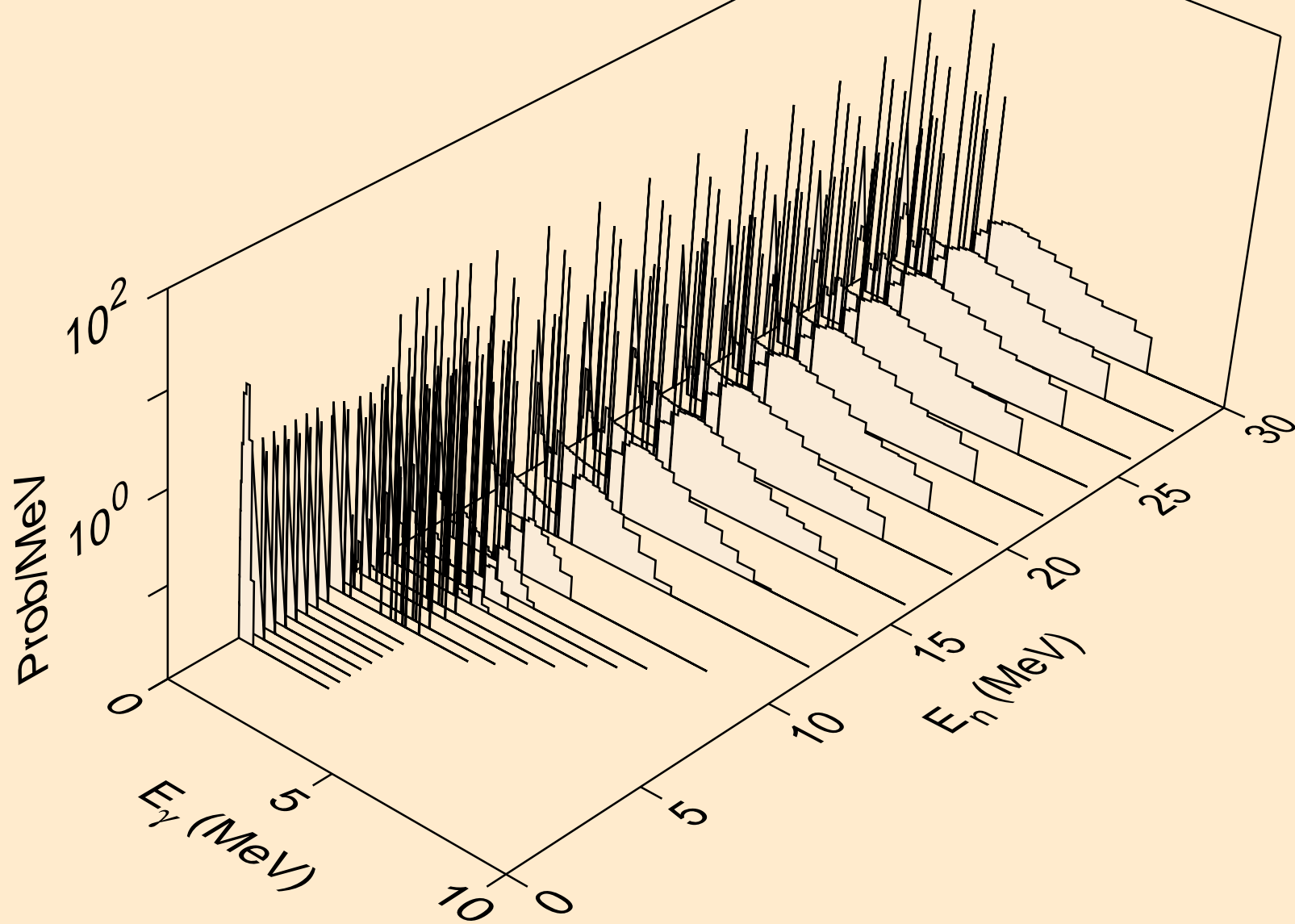

AL024 NEUTRON ACER TENDL-2024 LIBRARY; T=0.K
Photon emission for (n,n*)2a

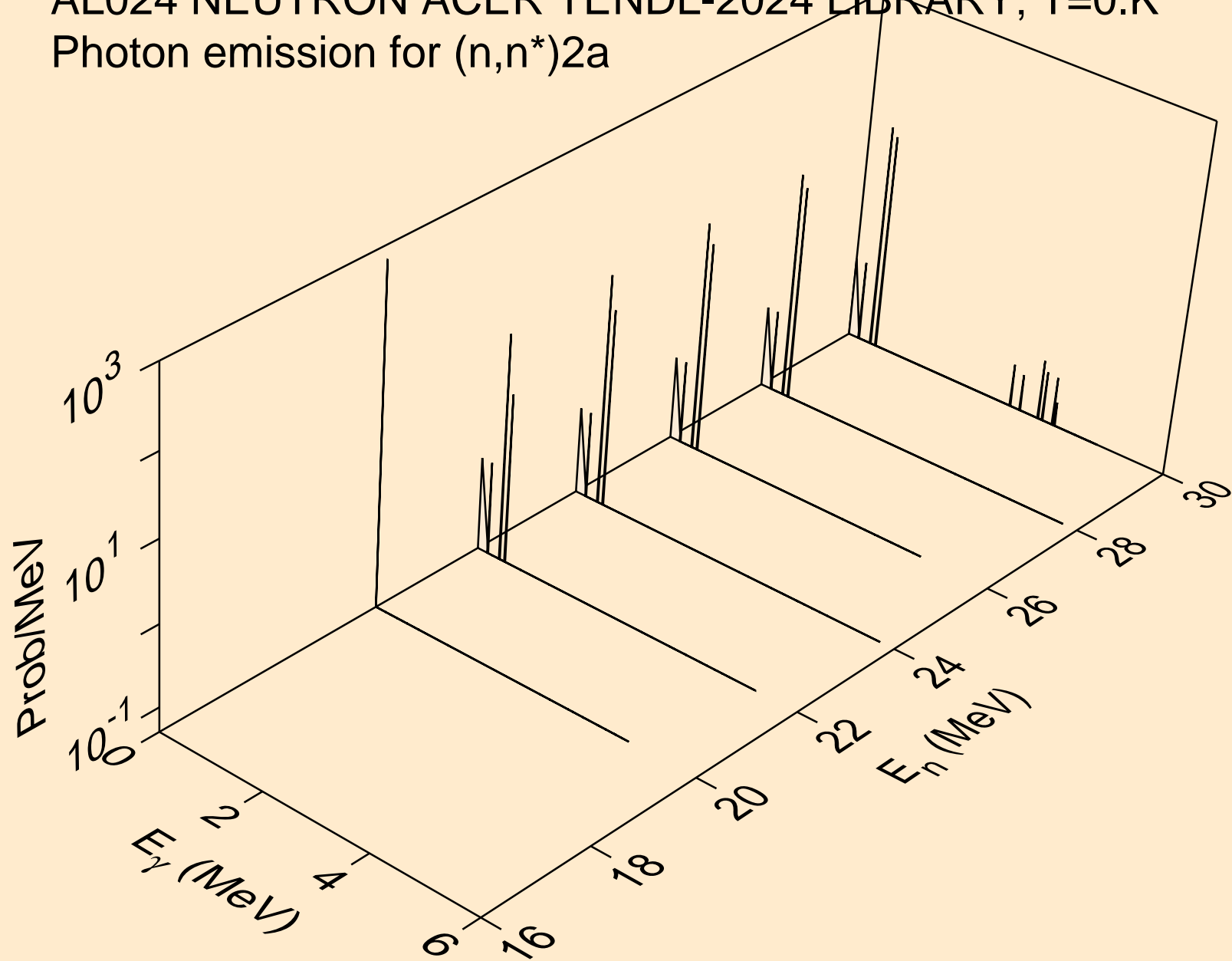

AL024 NEUTRON ACER TENDL-2024 LIBRARY; T=0.K
Photon emission for (n,n*)d

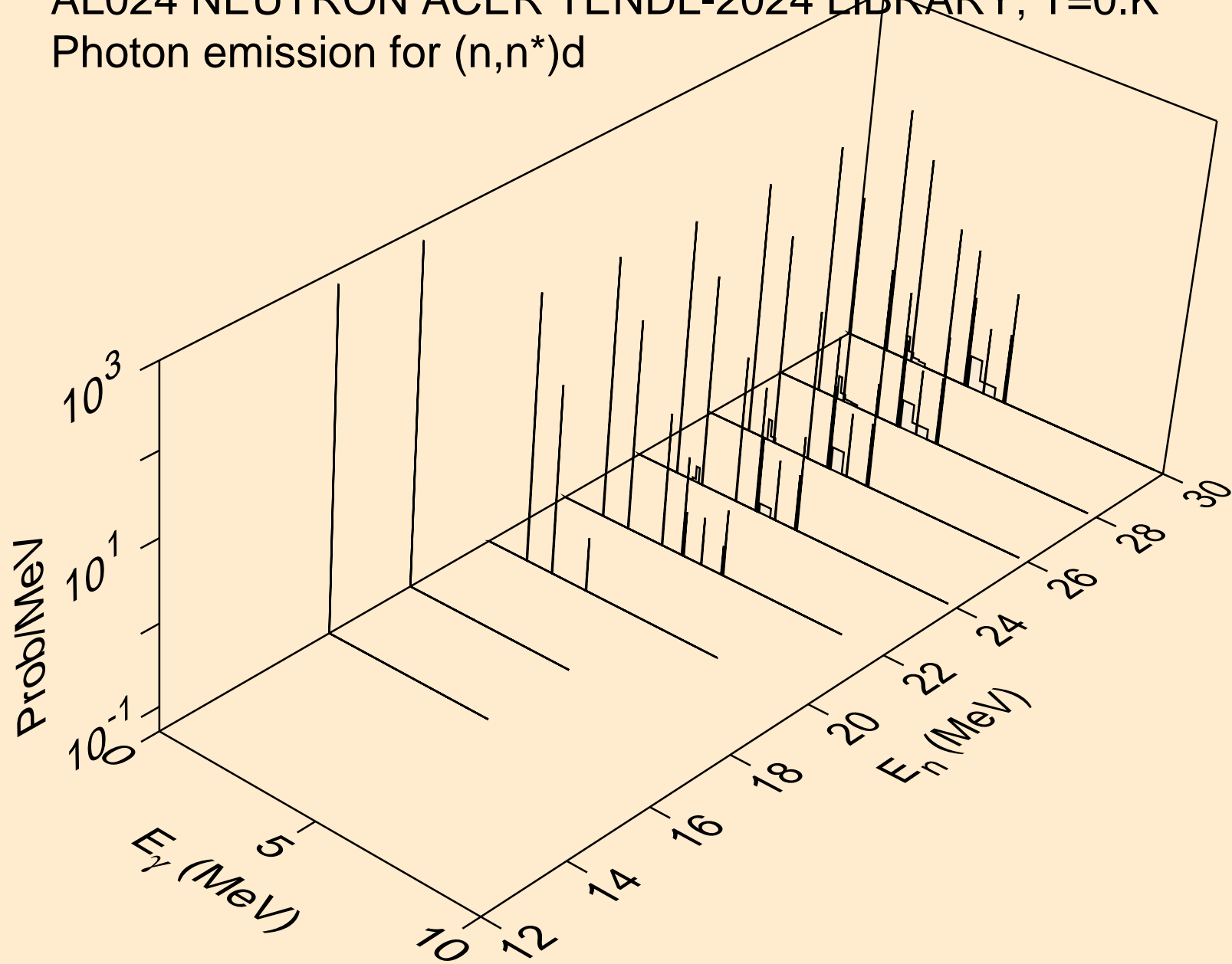

AL024 NEUTRON ACER TENDL-2024 LIBRARY; T=0.K
Photon emission for (n,n*)t

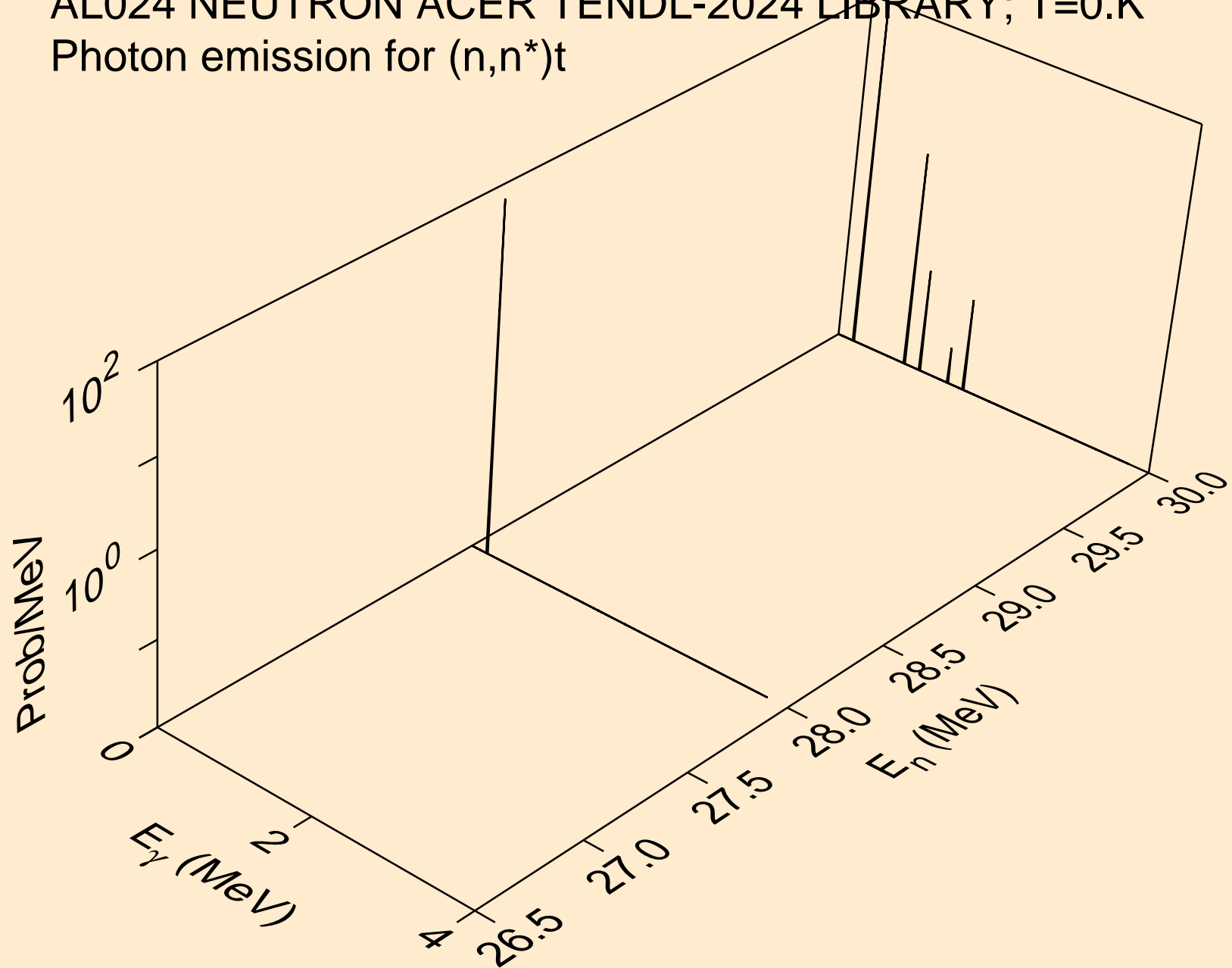

AL024 NEUTRON ACER TENDL-2024 LIBRARY; T=0.K
Photon emission for (n,n*)he3

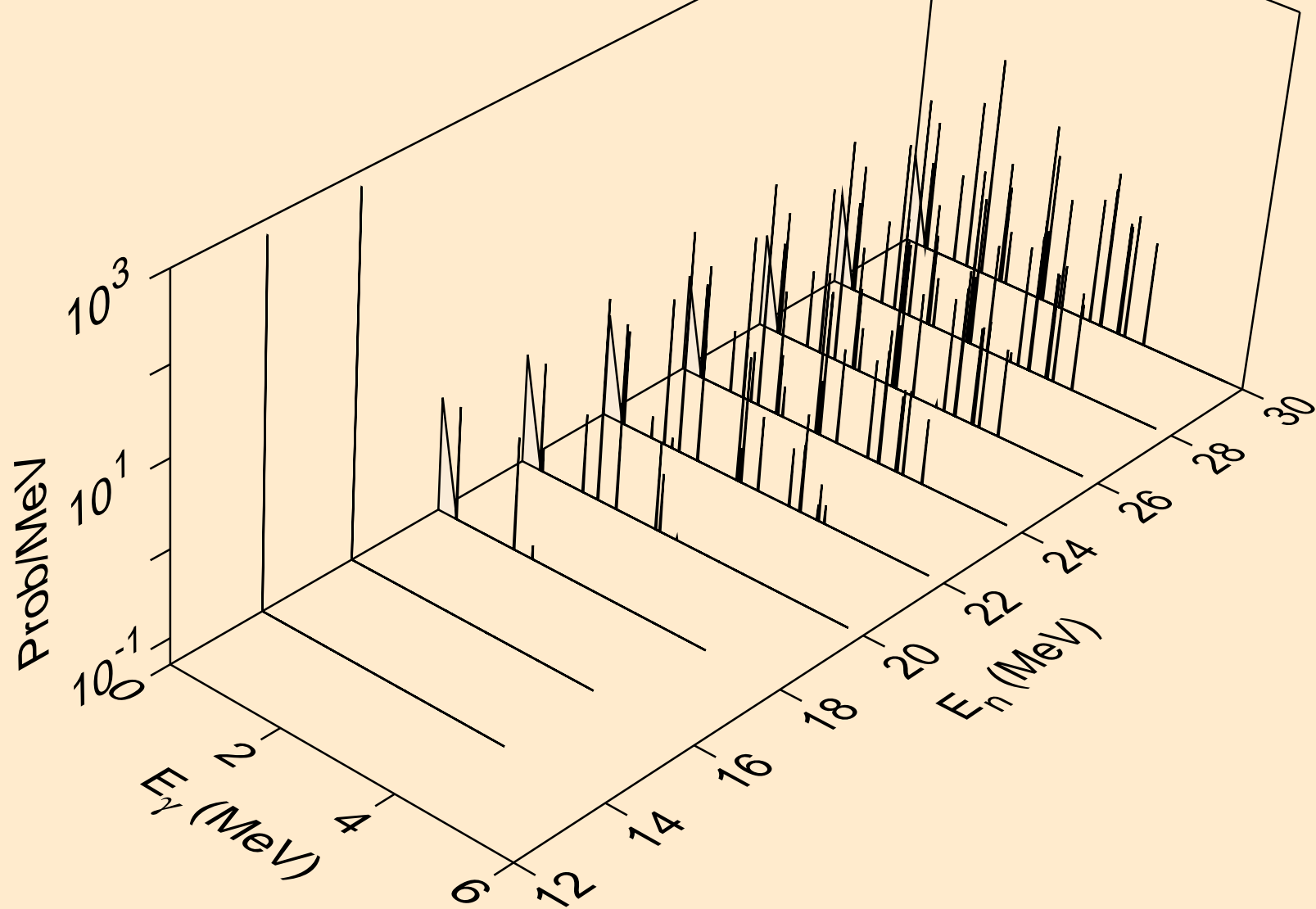

AL024 NEUTRON ACER TENDL-2024 LIBRARY; T=0.K
Photon emission for (n,2np)

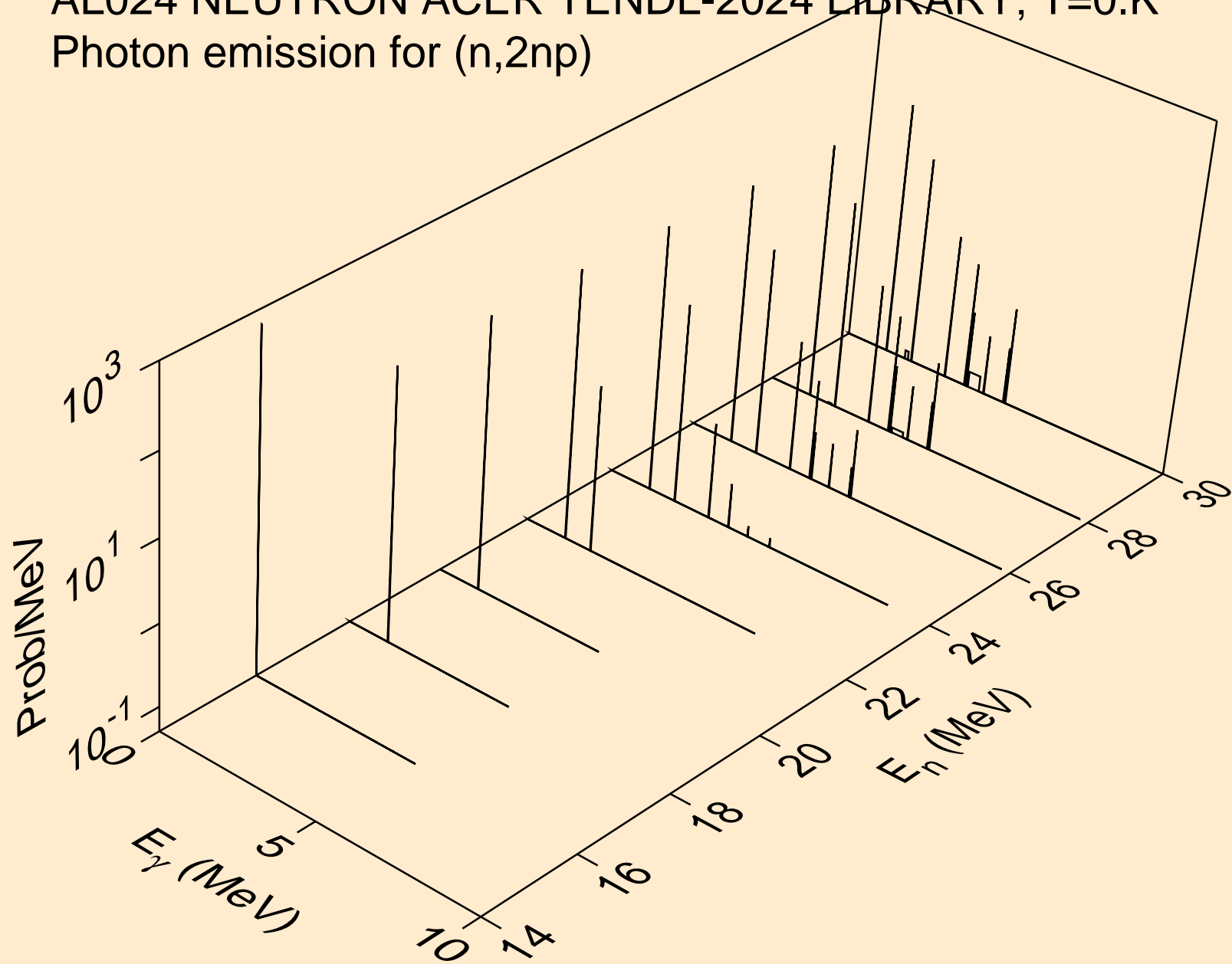

AL024 NEUTRON ACER TENDL-2024 LIBRARY; T=0.K
Photon emission for (n,n2p)

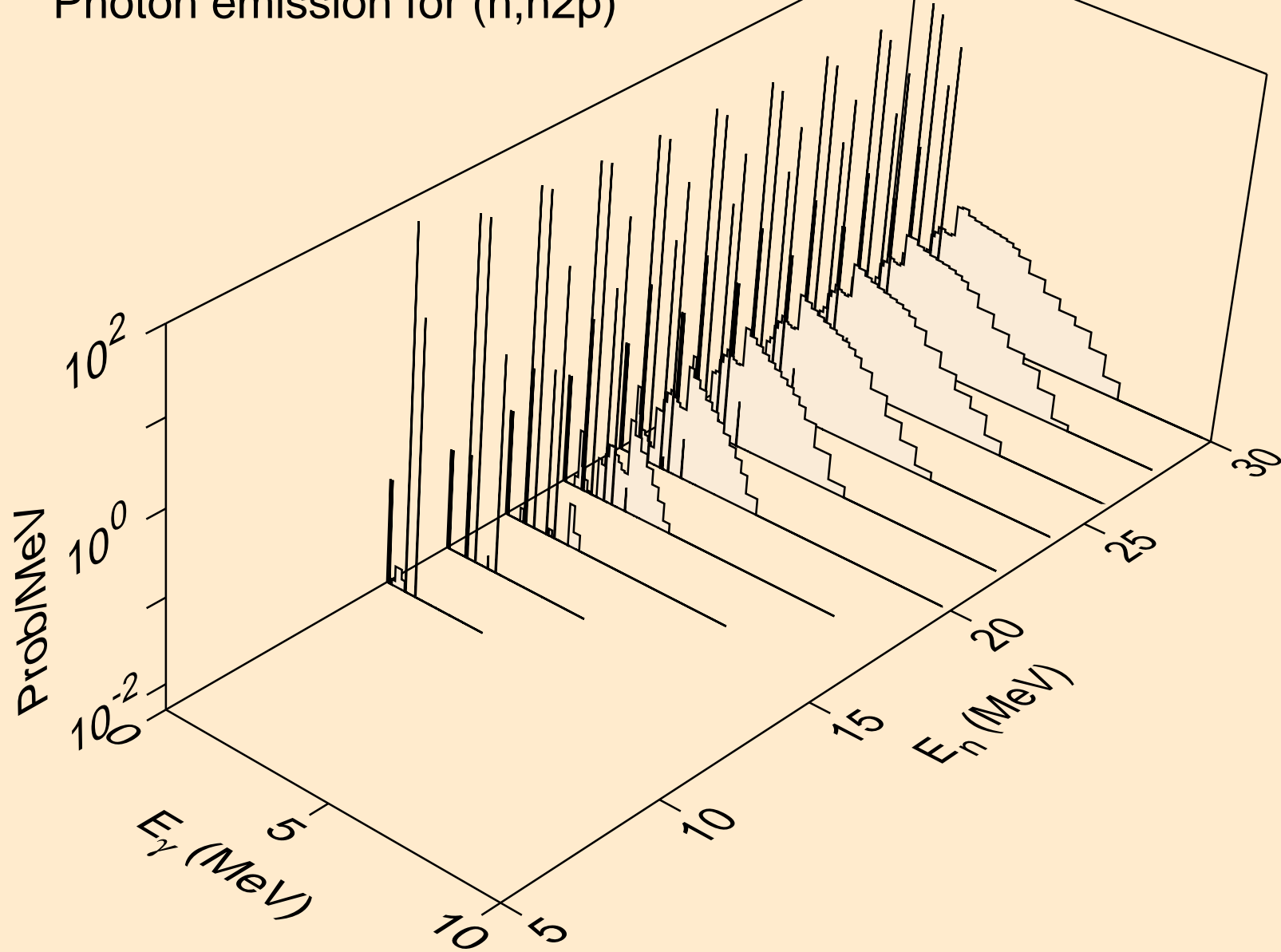

AL024 NEUTRON ACER TENDL-2024 LIBRARY; T=0.K
Photon emission for (n,npa)

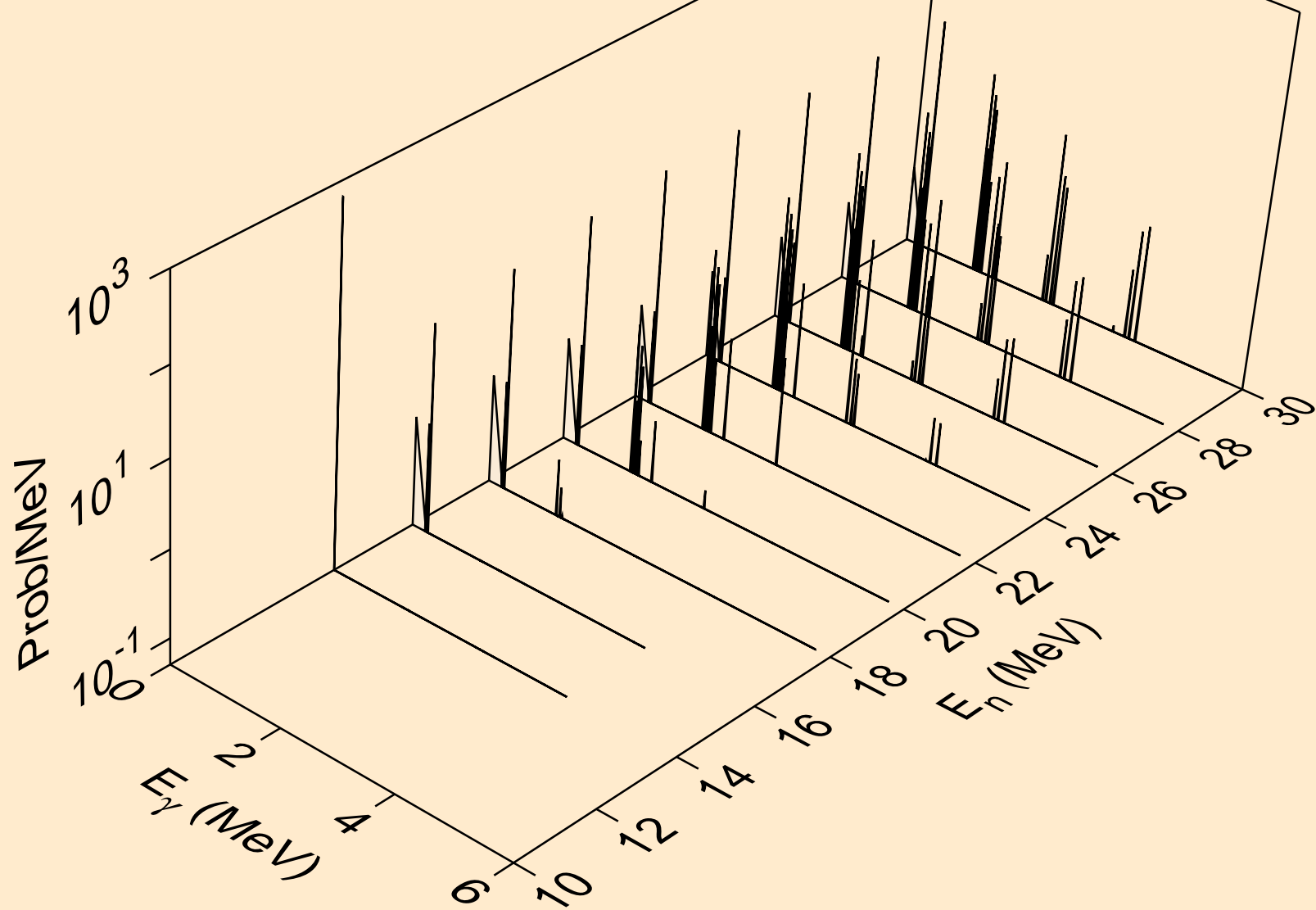

AL024 NEUTRON ACER TENDL-2024 LIBRARY; T=0.K
Photon emission for (n,n*c)

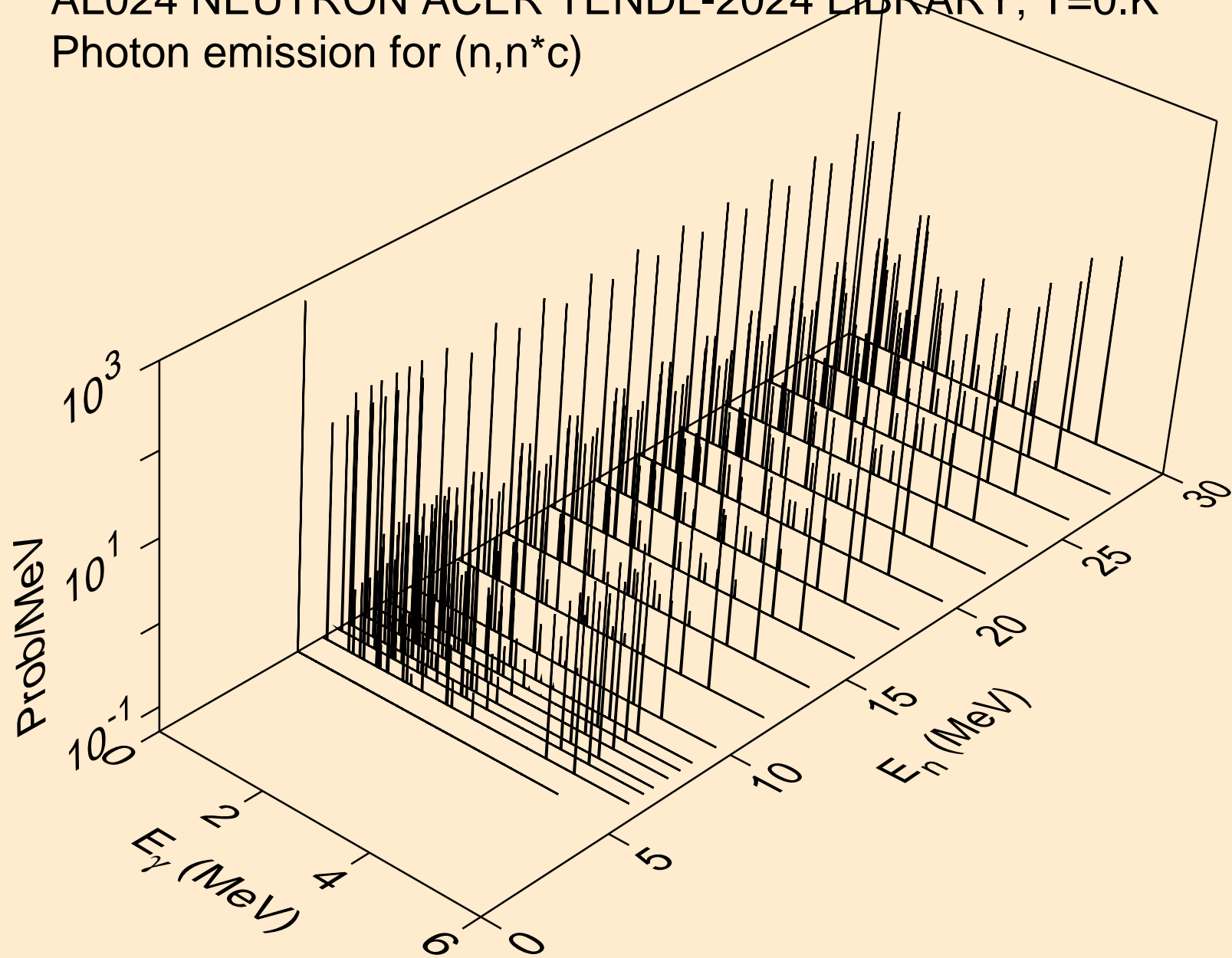

AL024 NEUTRON ACER TENDL-2024 LIBRARY; T=0.K
Photon emission for (n,gma)

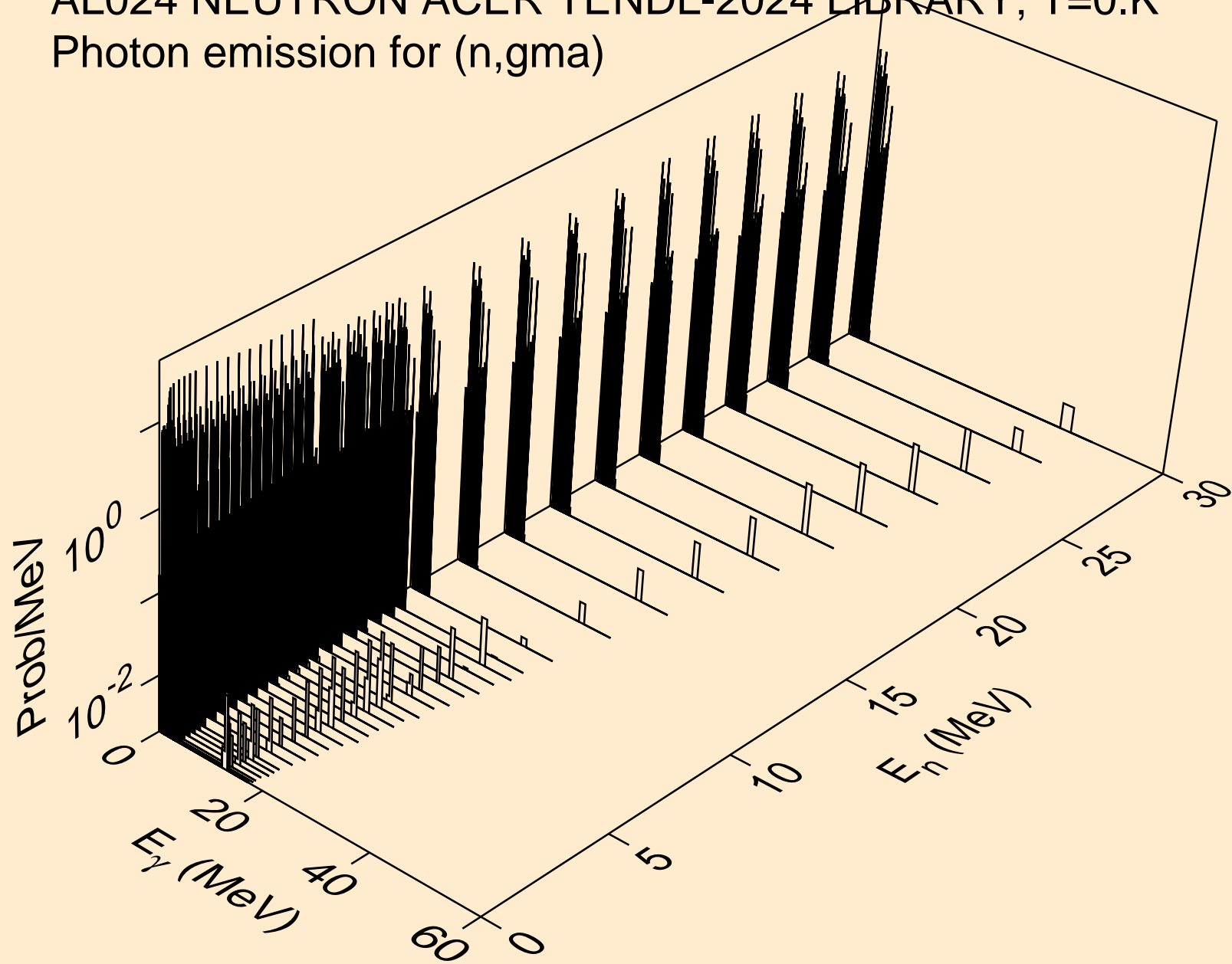

AL024 NEUTRON ACER TENDL-2024 LIBRARY; T=0.K
Photon emission for (n,p)

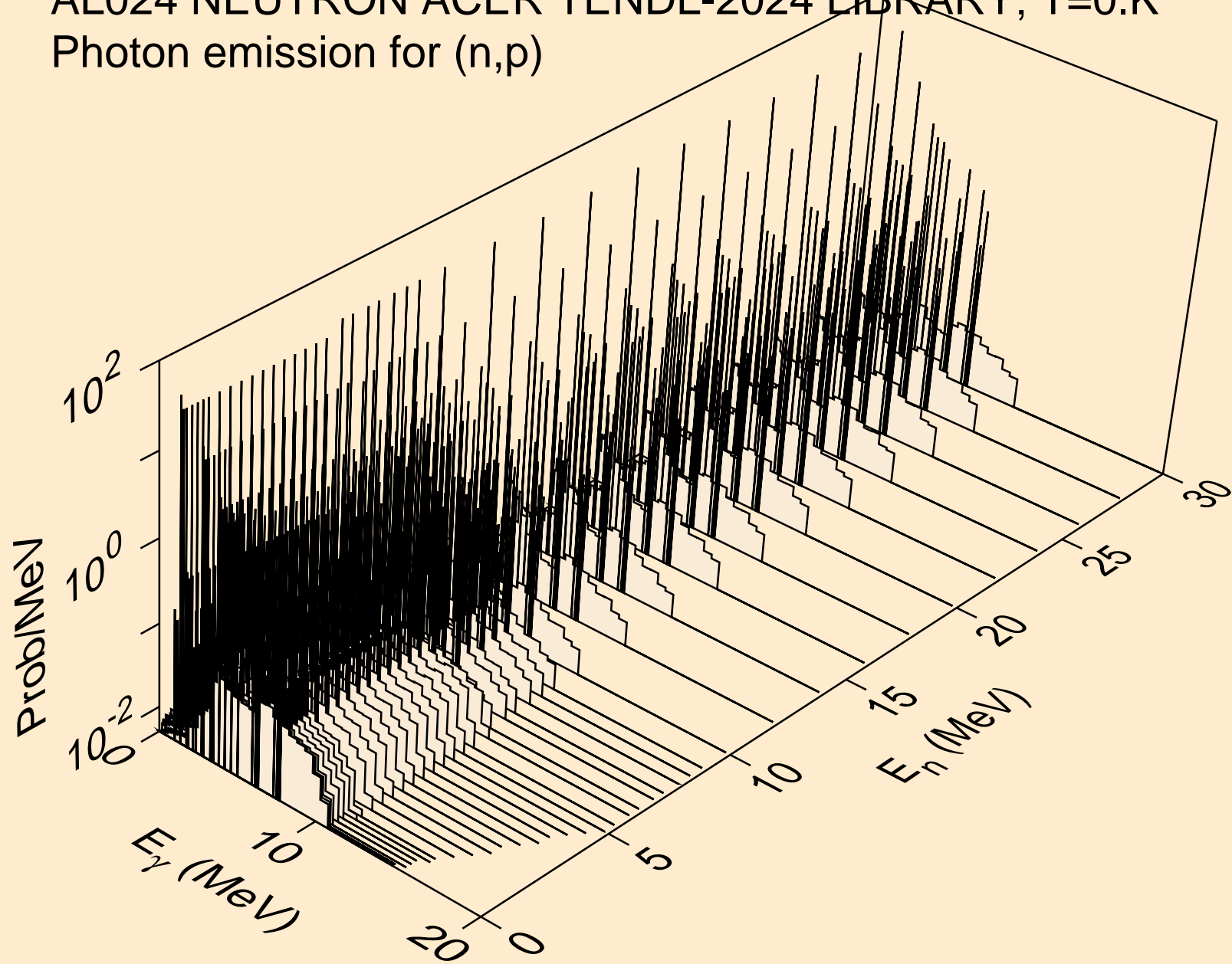

AL024 NEUTRON ACER TENDL-2024 LIBRARY; T=0.K
Photon emission for (n,d)

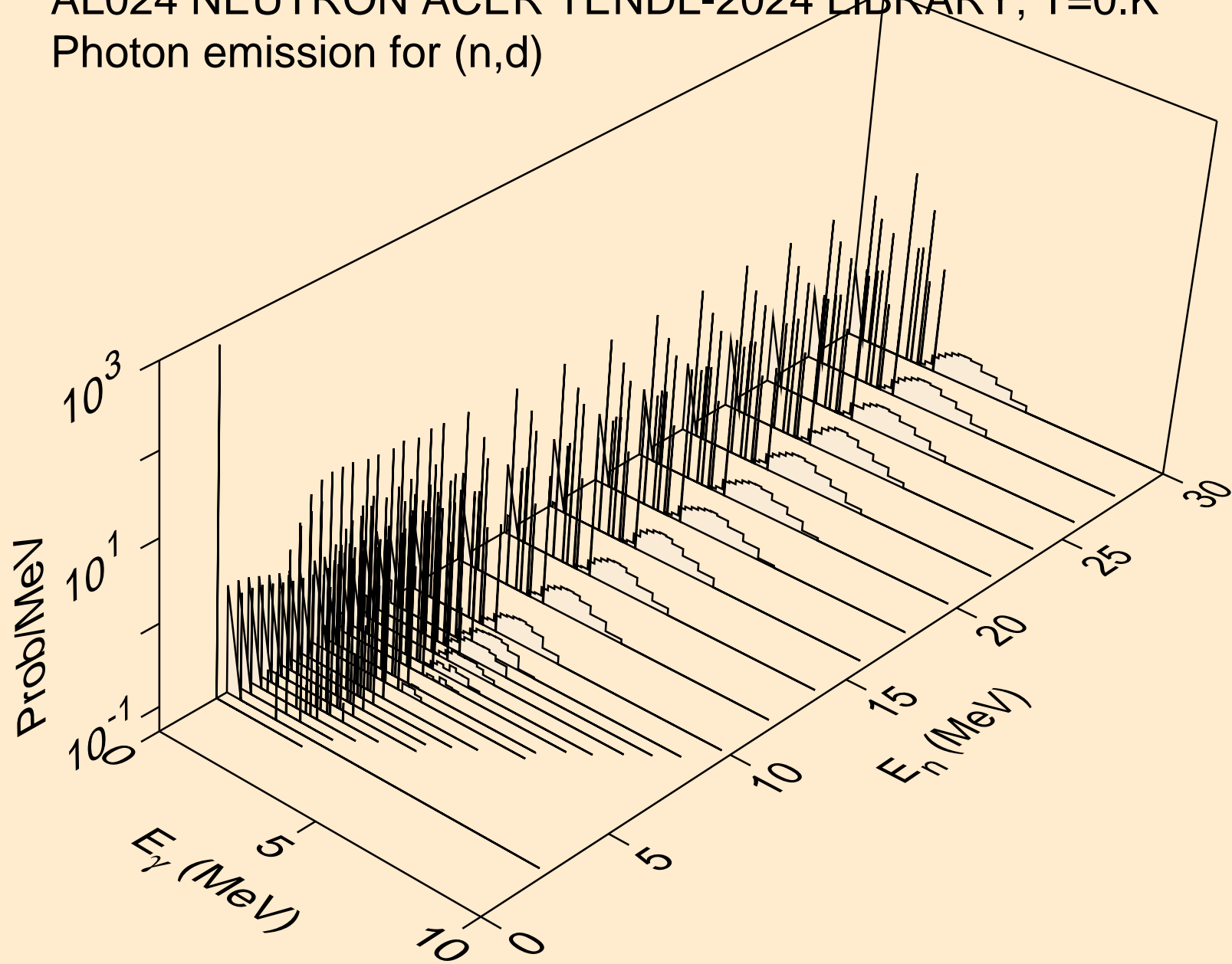

AL024 NEUTRON ACER TENDL-2024 LIBRARY; T=0.K
Photon emission for (n,t)

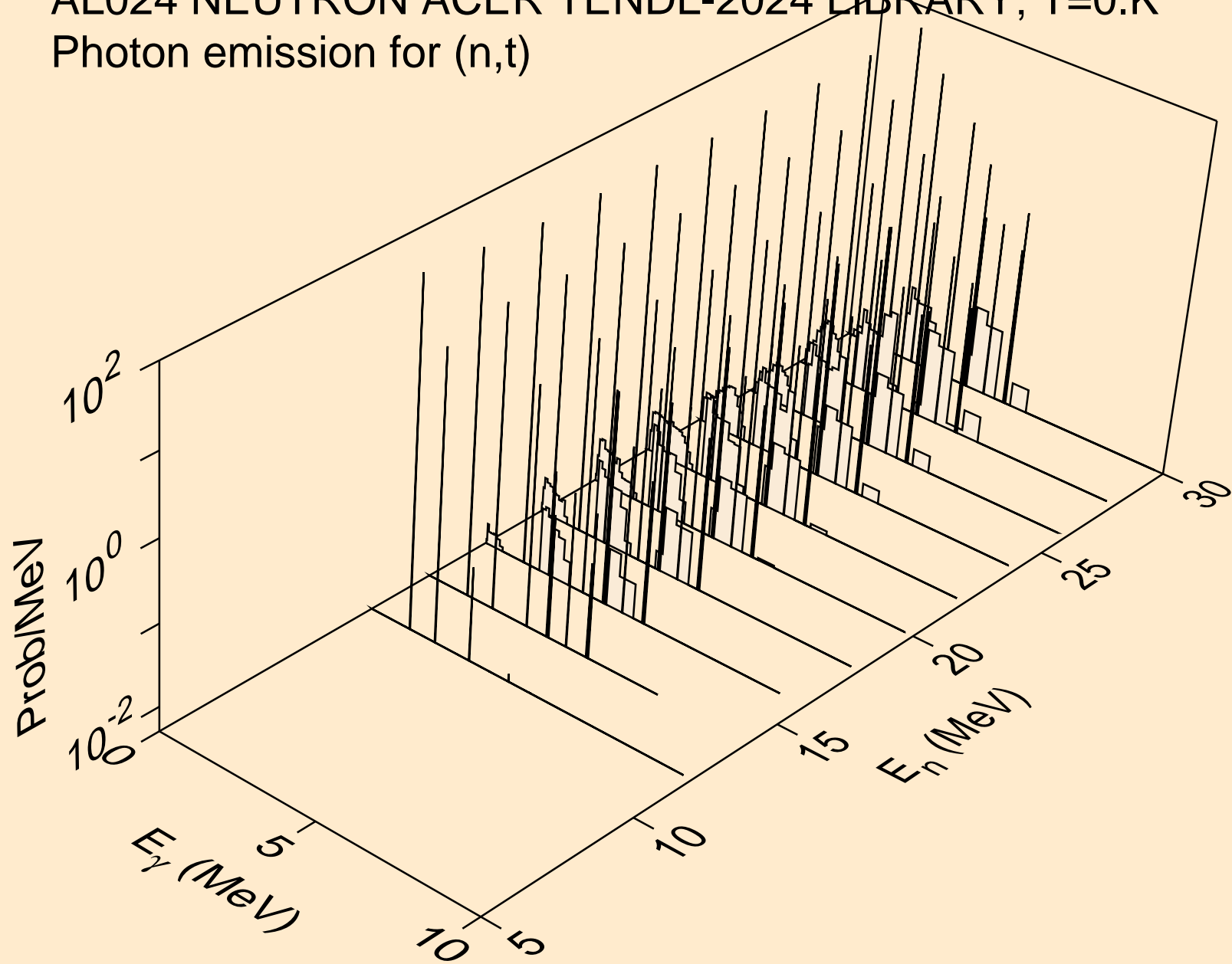

AL024 NEUTRON ACER TENDL-2024 LIBRARY; T=0.K
Photon emission for (n,he3)

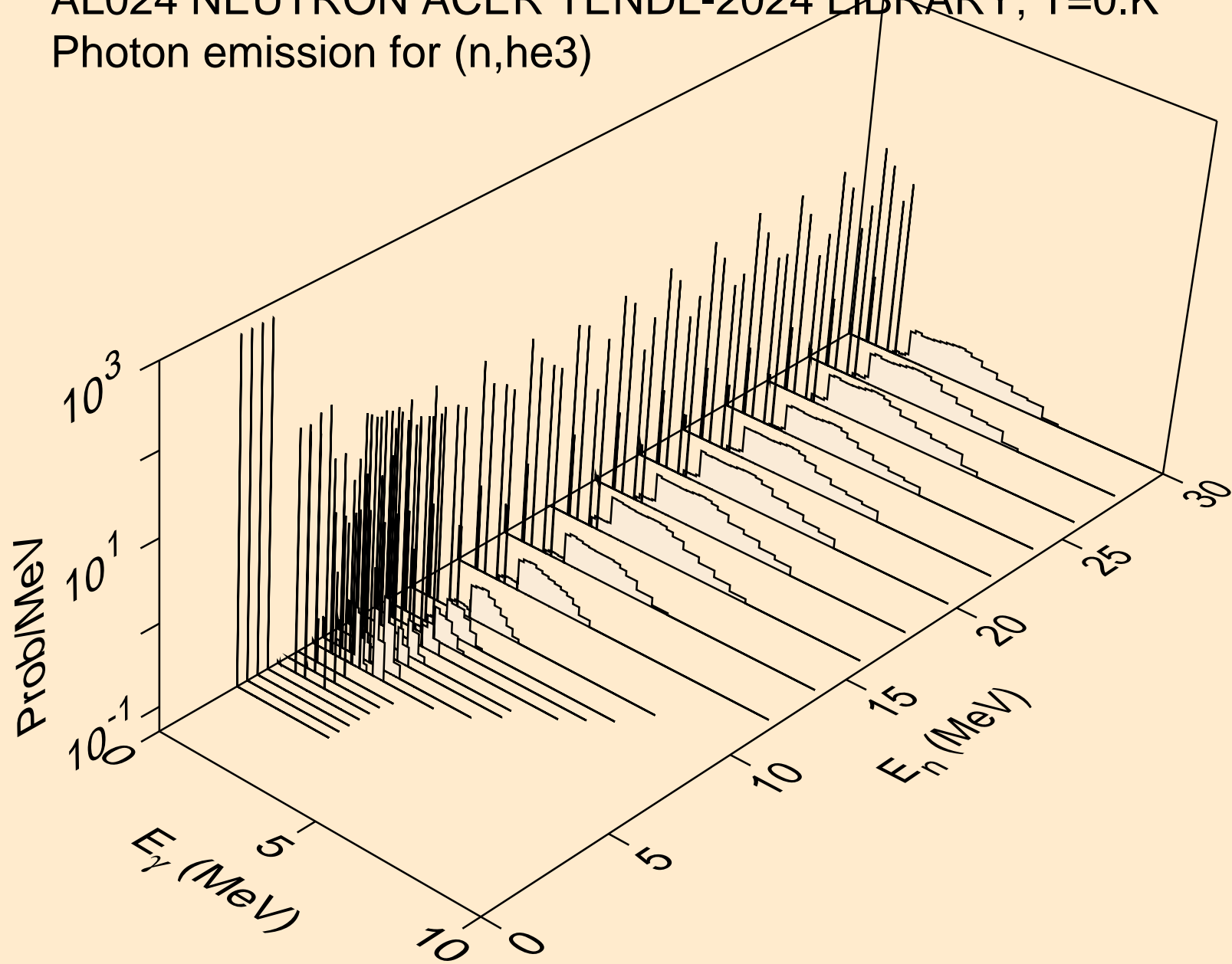

AL024 NEUTRON ACER TENDL-2024 LIBRARY; T=0.K
Photon emission for (n,a)

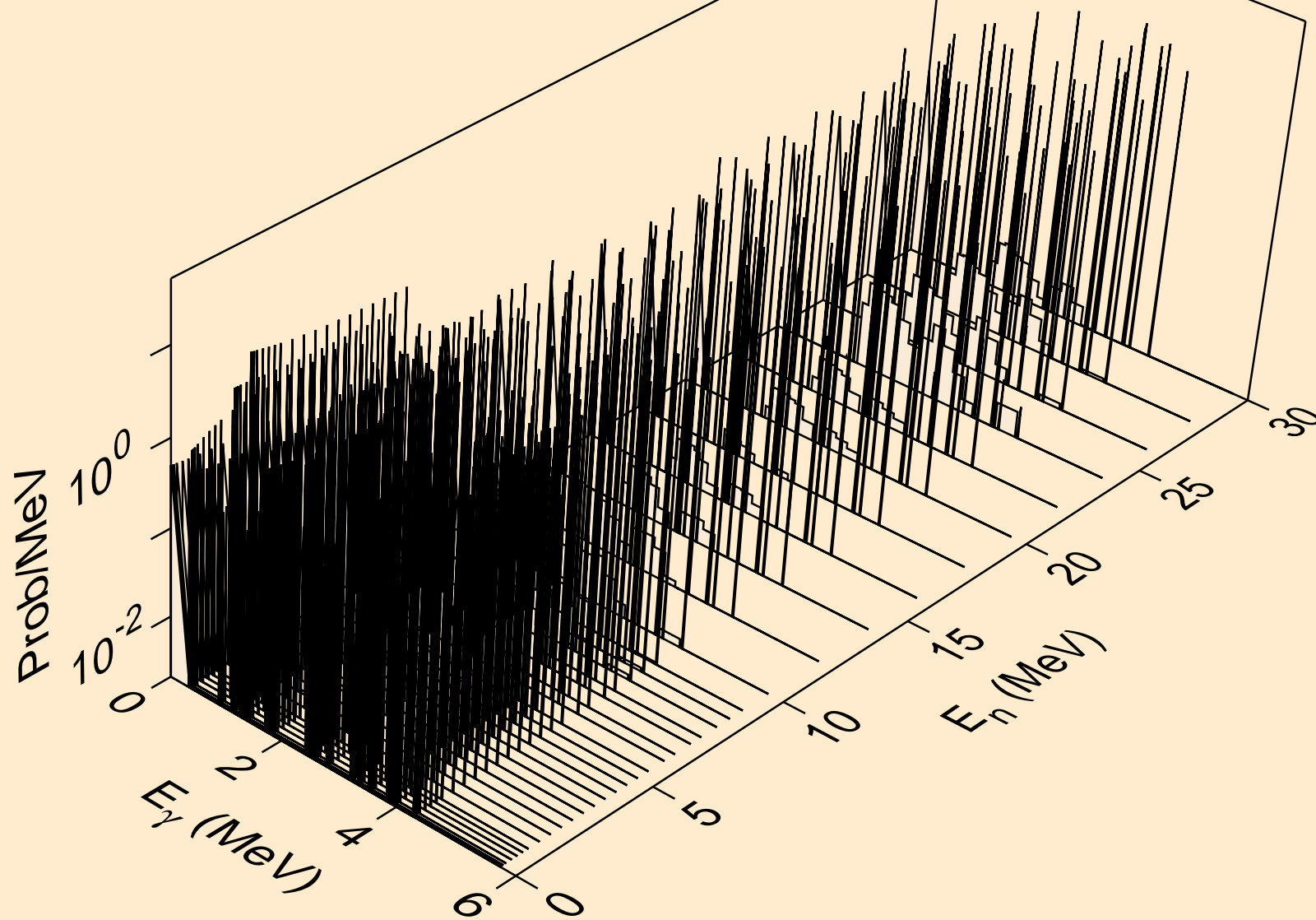

AL024 NEUTRON ACER TENDL-2024 LIBRARY; T=0.K
Photon emission for (n,2a)

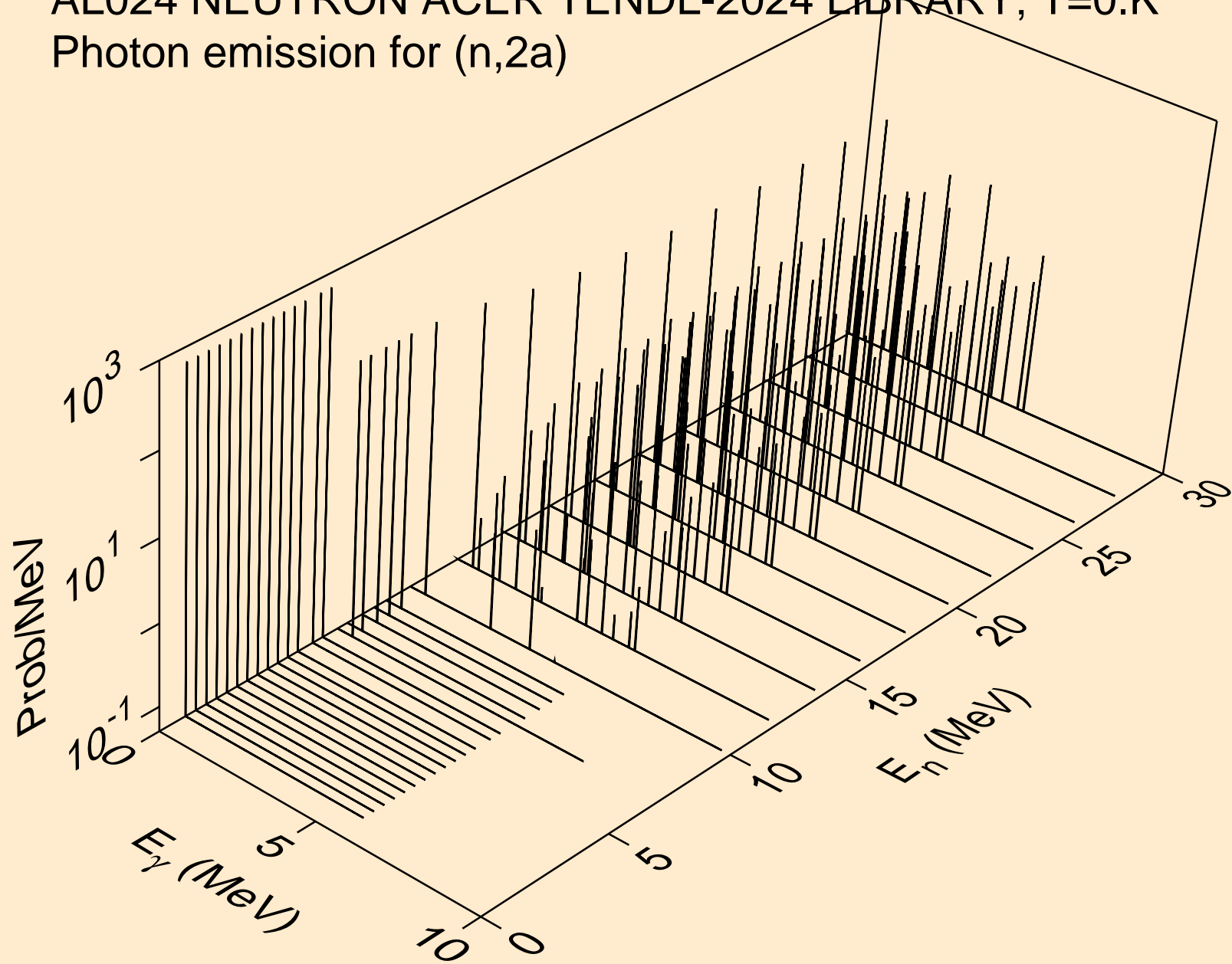

AL024 NEUTRON ACER TENDL-2024 LIBRARY; T=0.K
Photon emission for (n,3a)

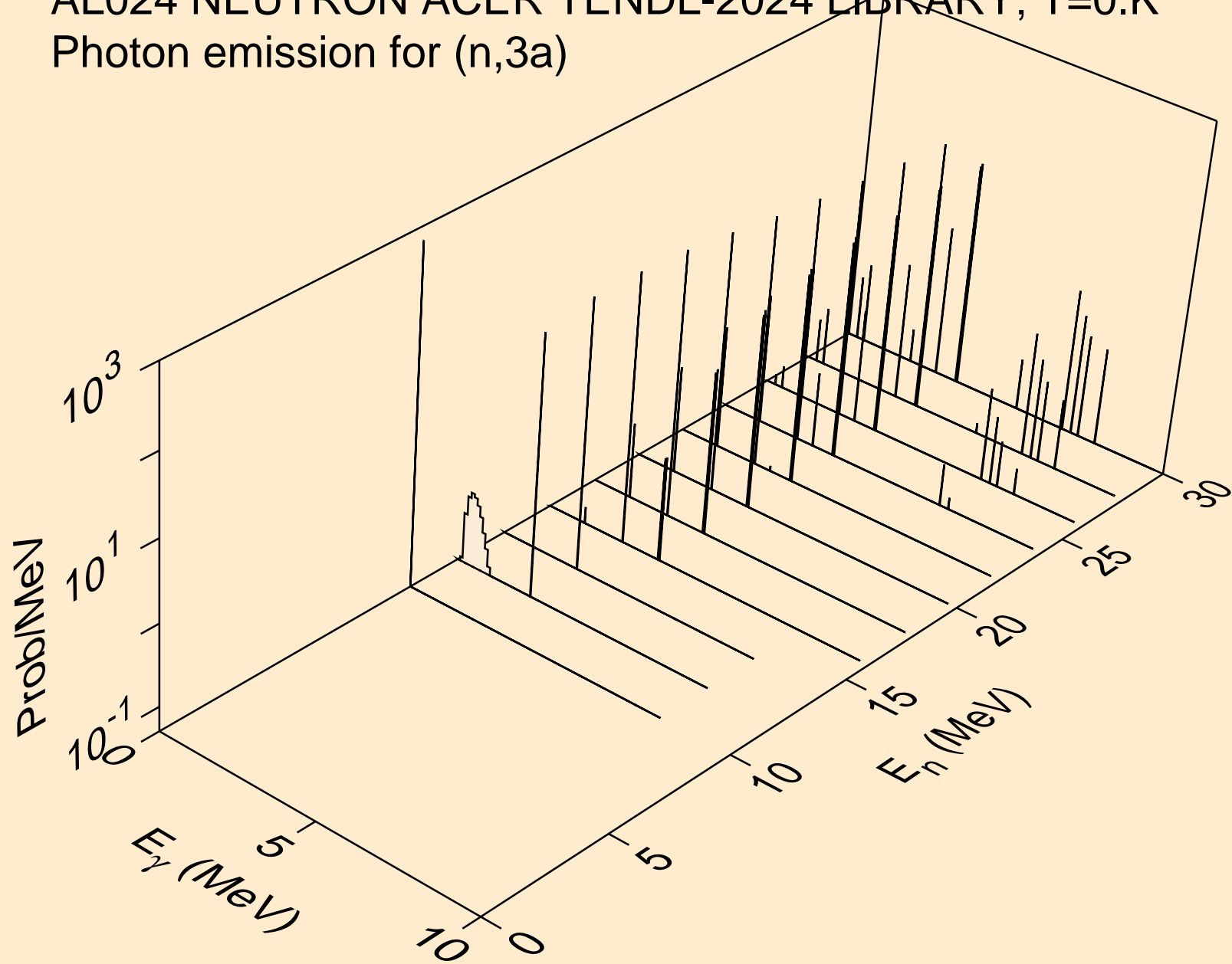

AL024 NEUTRON ACER TENDL-2024 LIBRARY; T=0.K
Photon emission for (n,2p)

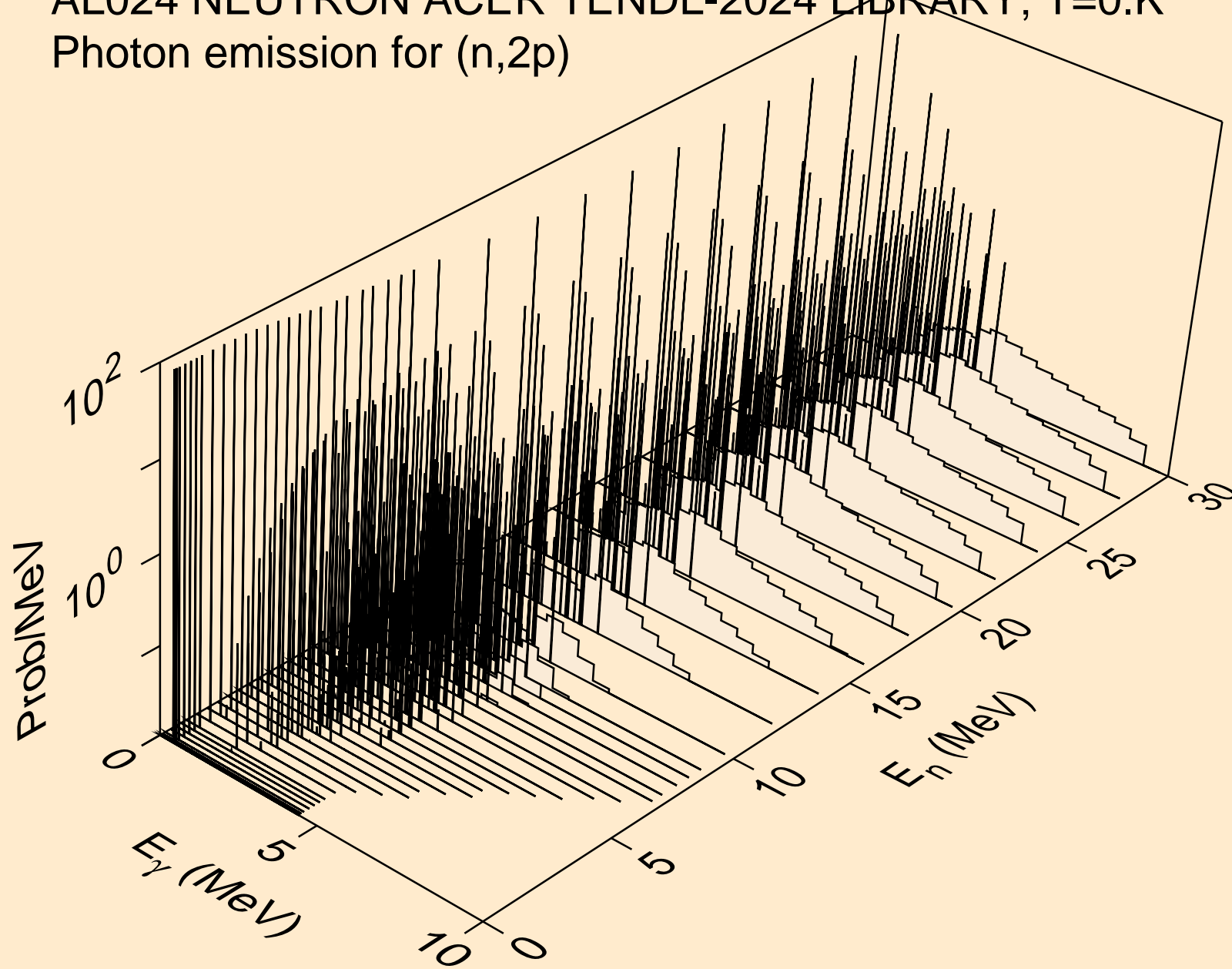

AL024 NEUTRON ACER TENDL-2024 LIBRARY; T=0.K
Photon emission for (n,p α)

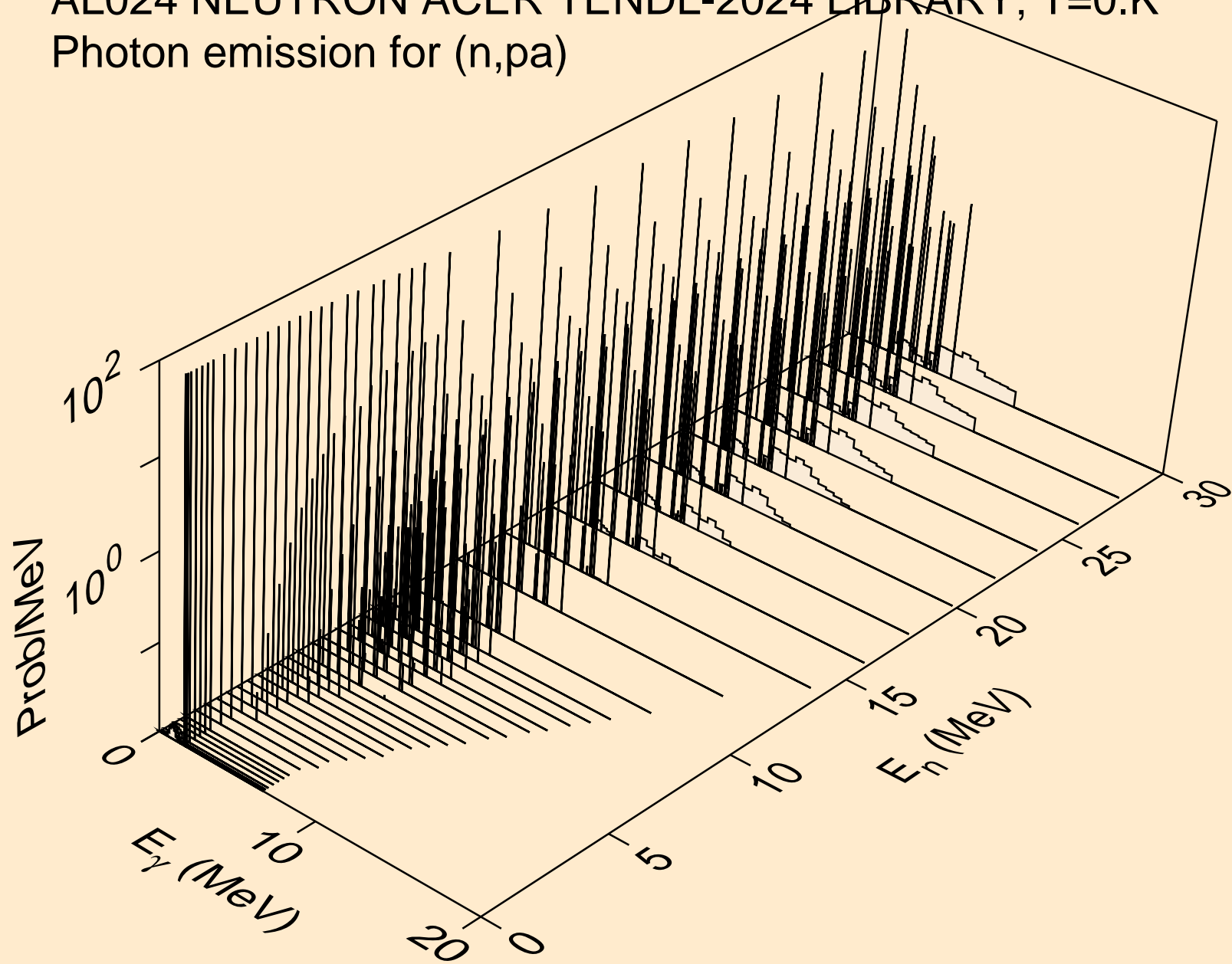

AL024 NEUTRON ACER TENDL-2024 LIBRARY; T=0.K
Photon emission for (n,t2a)

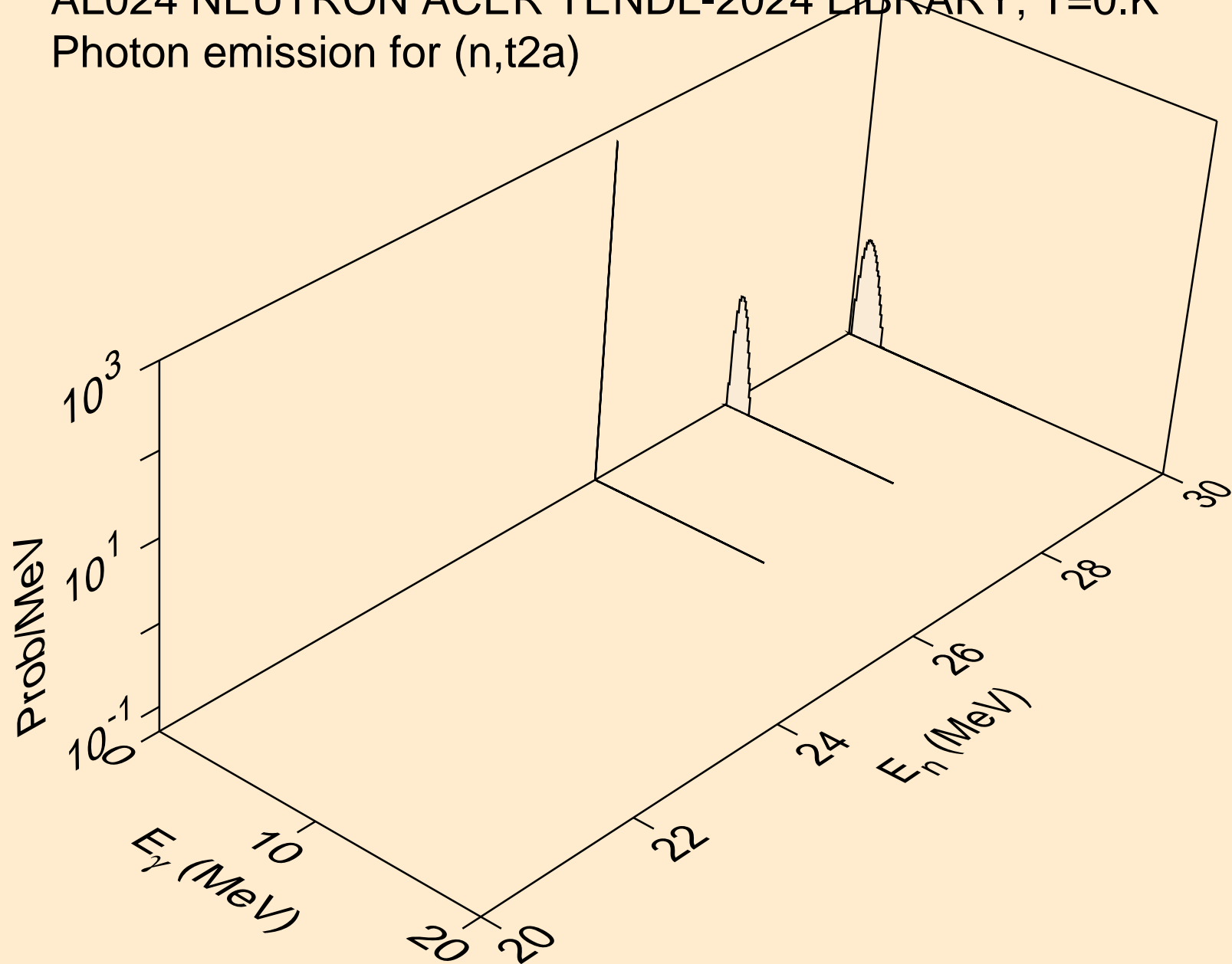

AL024 NEUTRON ACER TENDL-2024 LIBRARY; T=0.K
Photon emission for (n,d2a)

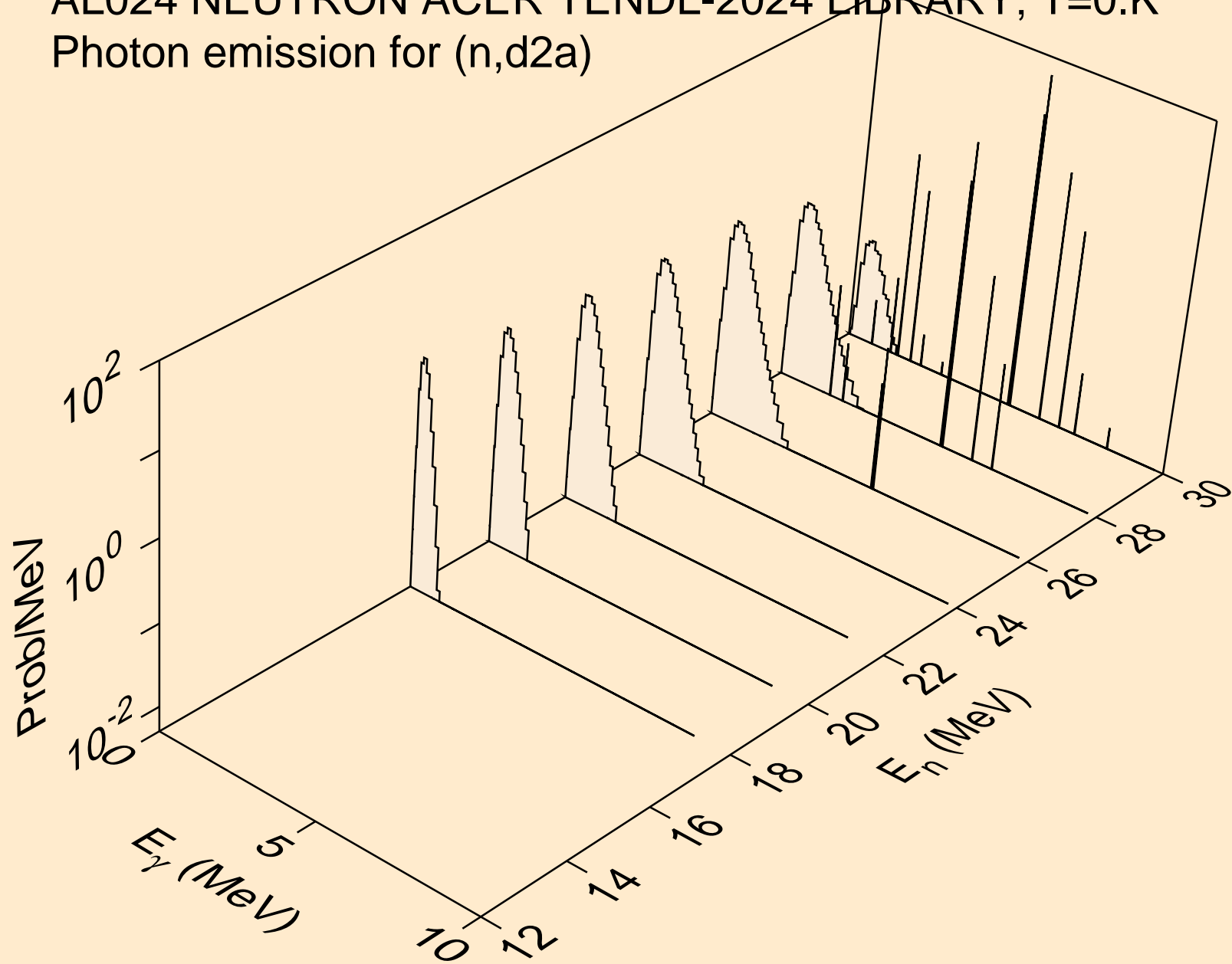

AL024 NEUTRON ACER TENDL-2024 LIBRARY; T=0.K
Photon emission for (n,pd)

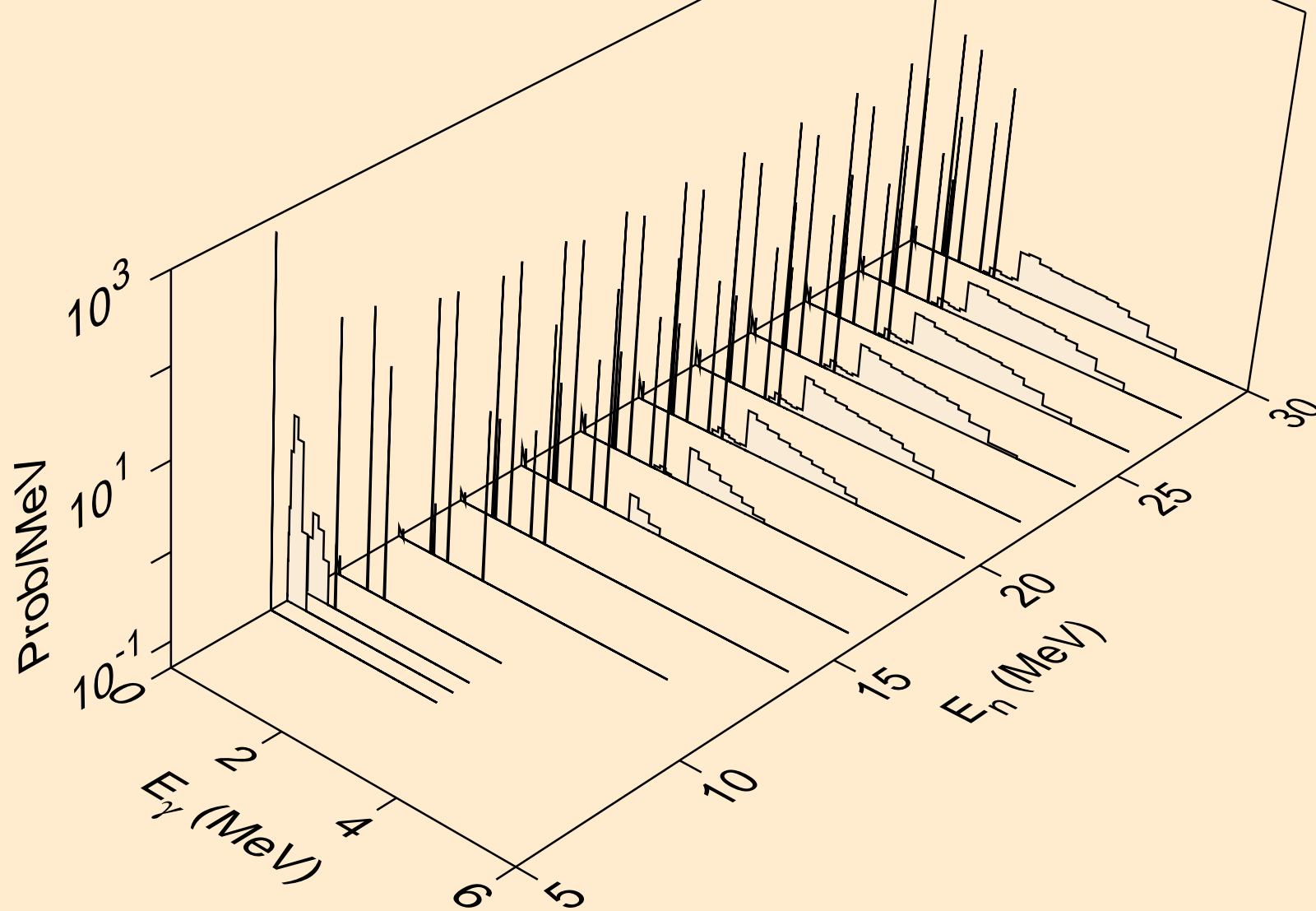

AL024 NEUTRON ACER TENDL-2024 LIBRARY; T=0.K
Photon emission for (n,pt)

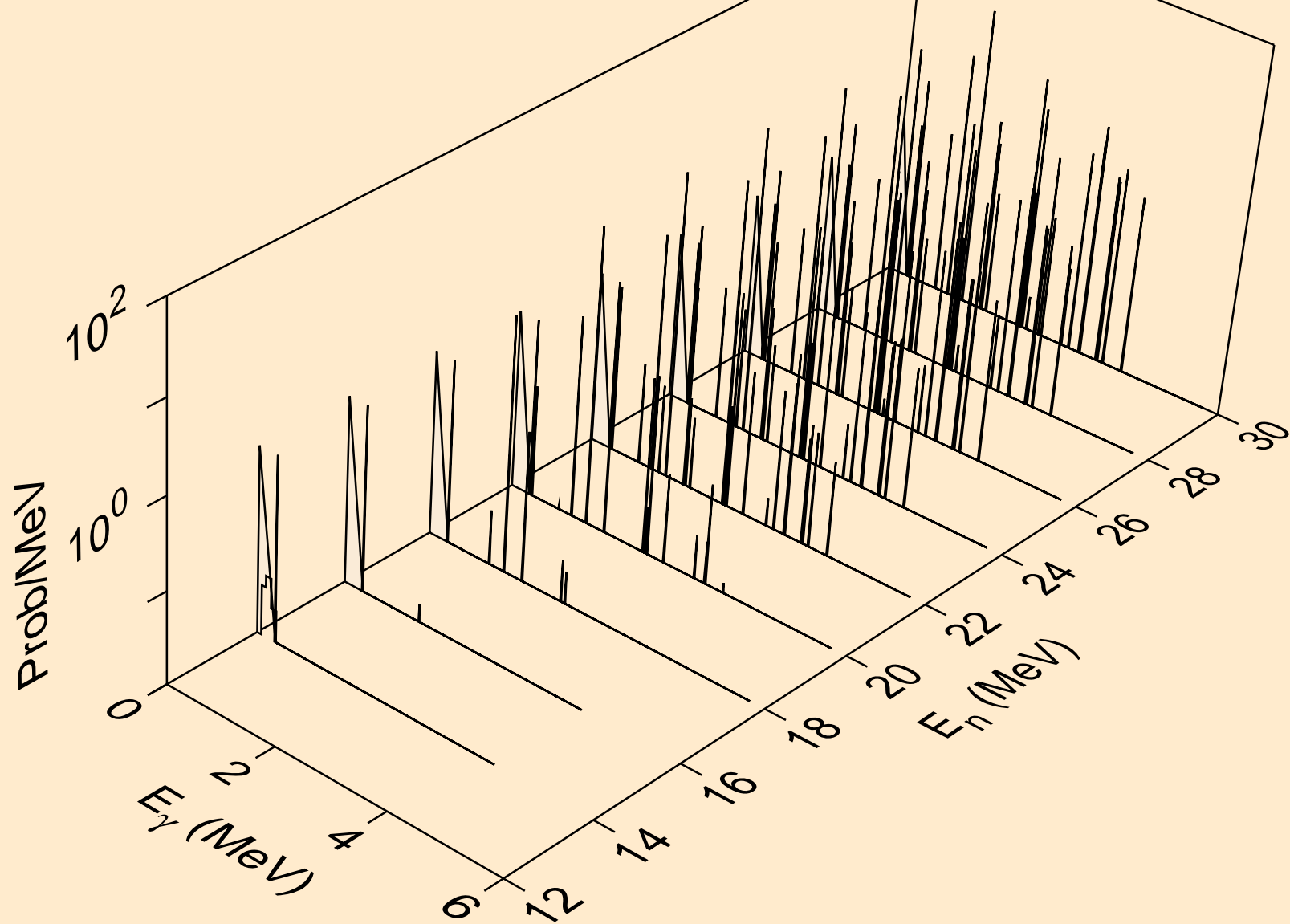

AL024 NEUTRON ACER TENDL-2024 LIBRARY; T=0.K
Photon emission for (n,da)

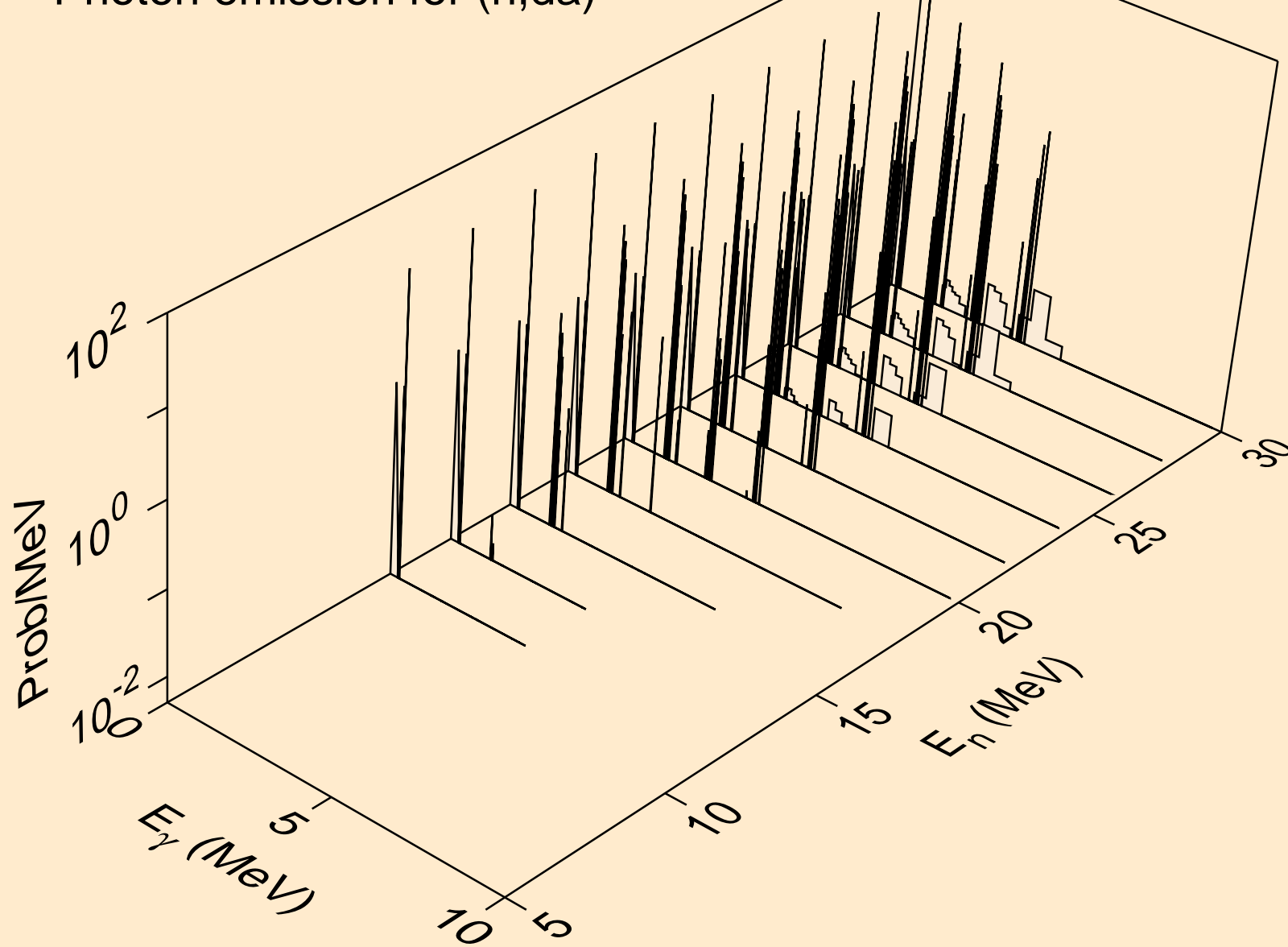

AL024 NEUTRON ACER TENDL-2024 LIBRARY; T=0.K
thermal capture photon spectrum

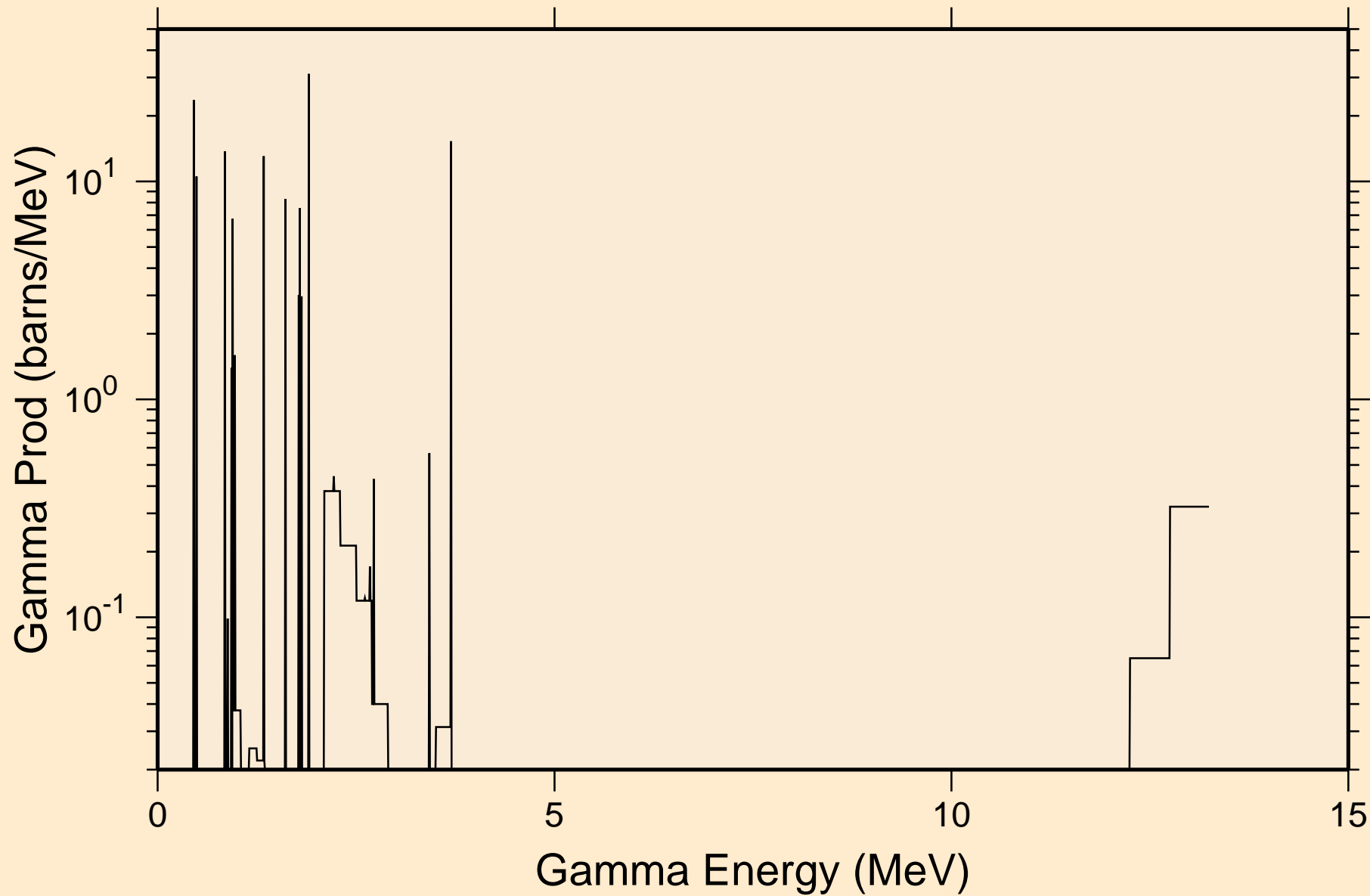

AL024 NEUTRON ACER TENDL-2024 LIBRARY; T=0.K
14 MeV photon spectrum

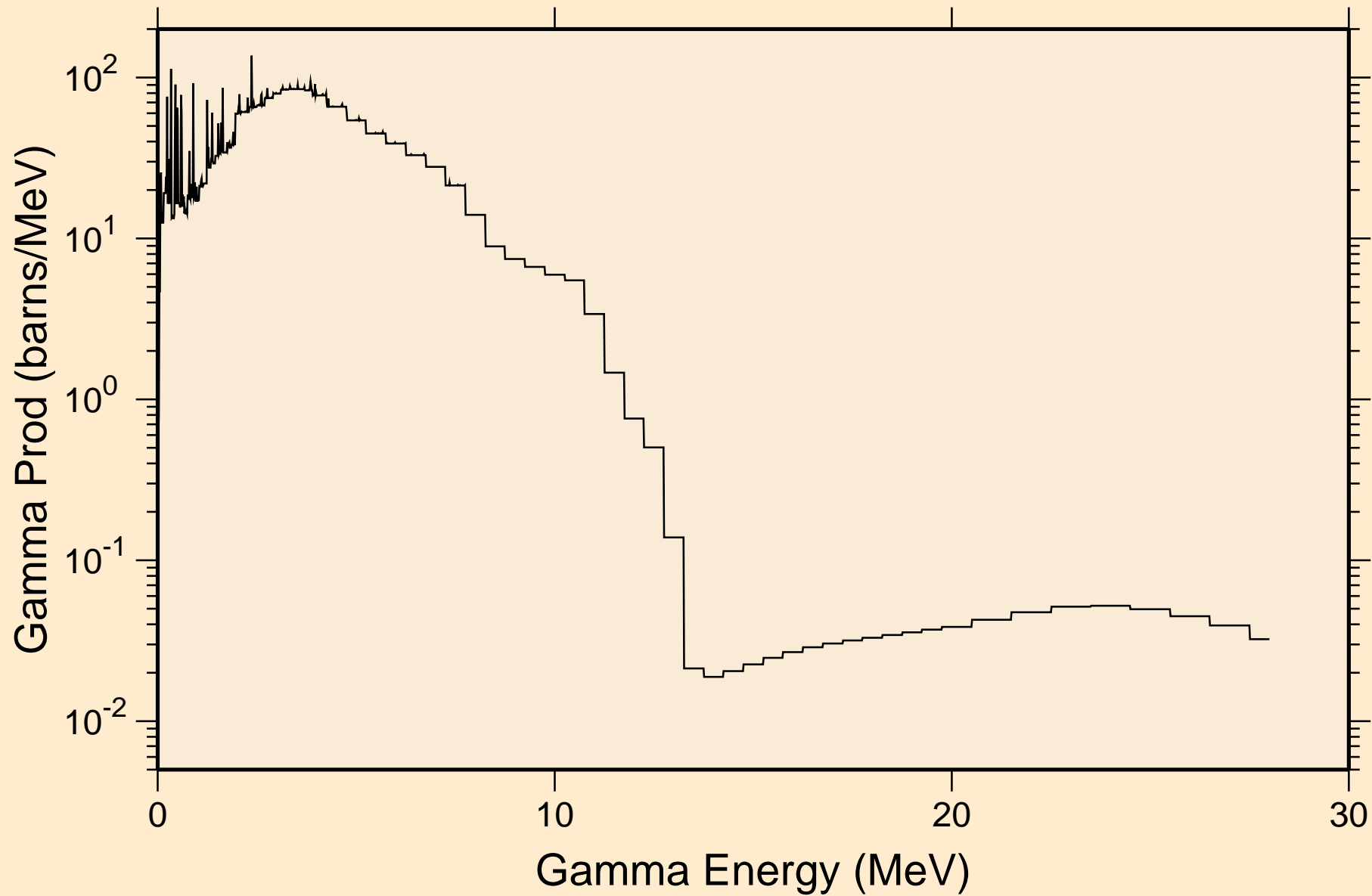

AL024 NEUTRON ACER TENDL-2024 LIBRARY; T=0.K

Particle heating contributions

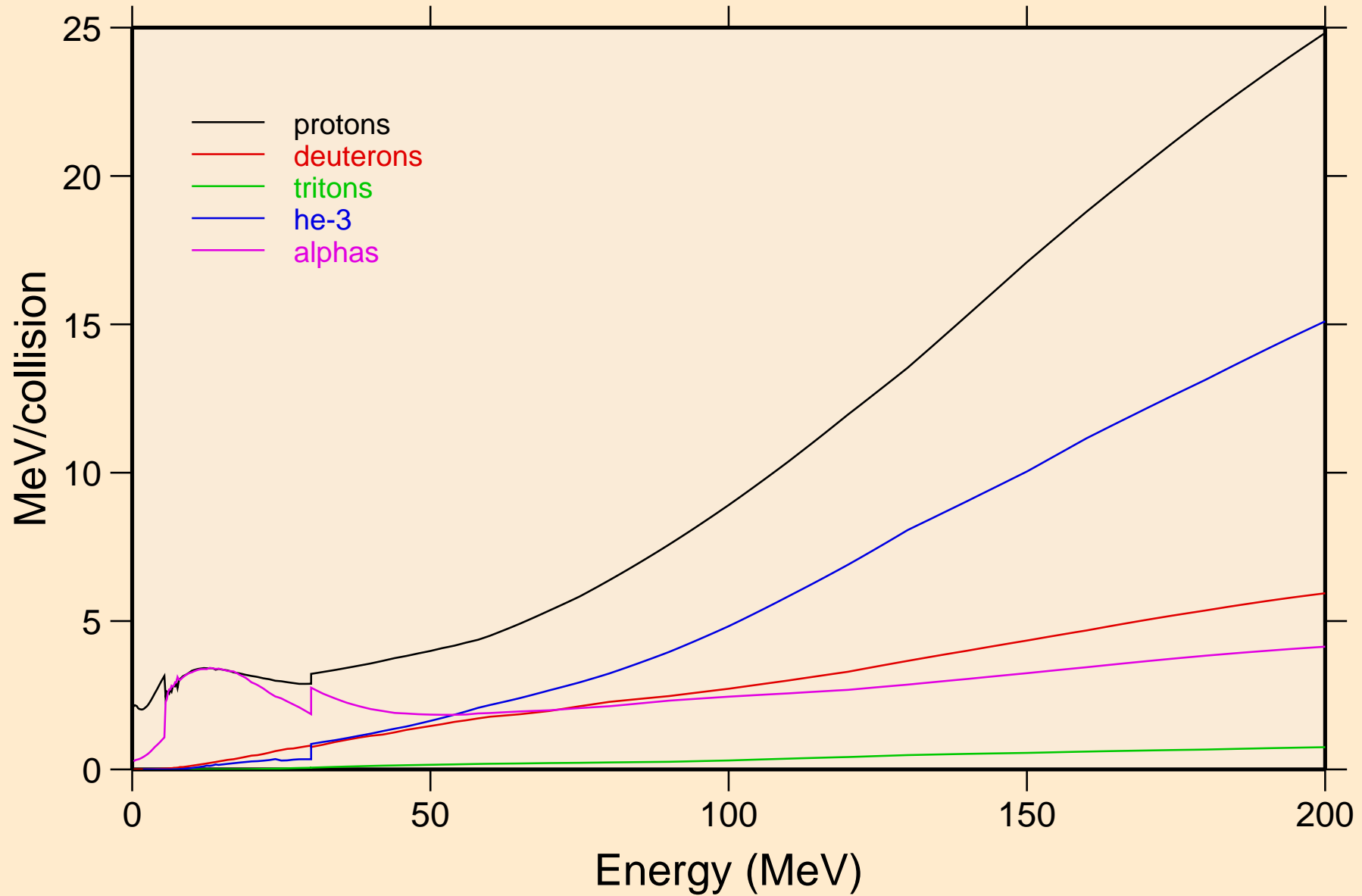

AL024 NEUTRON ACER TENDL-2024 LIBRARY; T=0.K
Recoil Heating

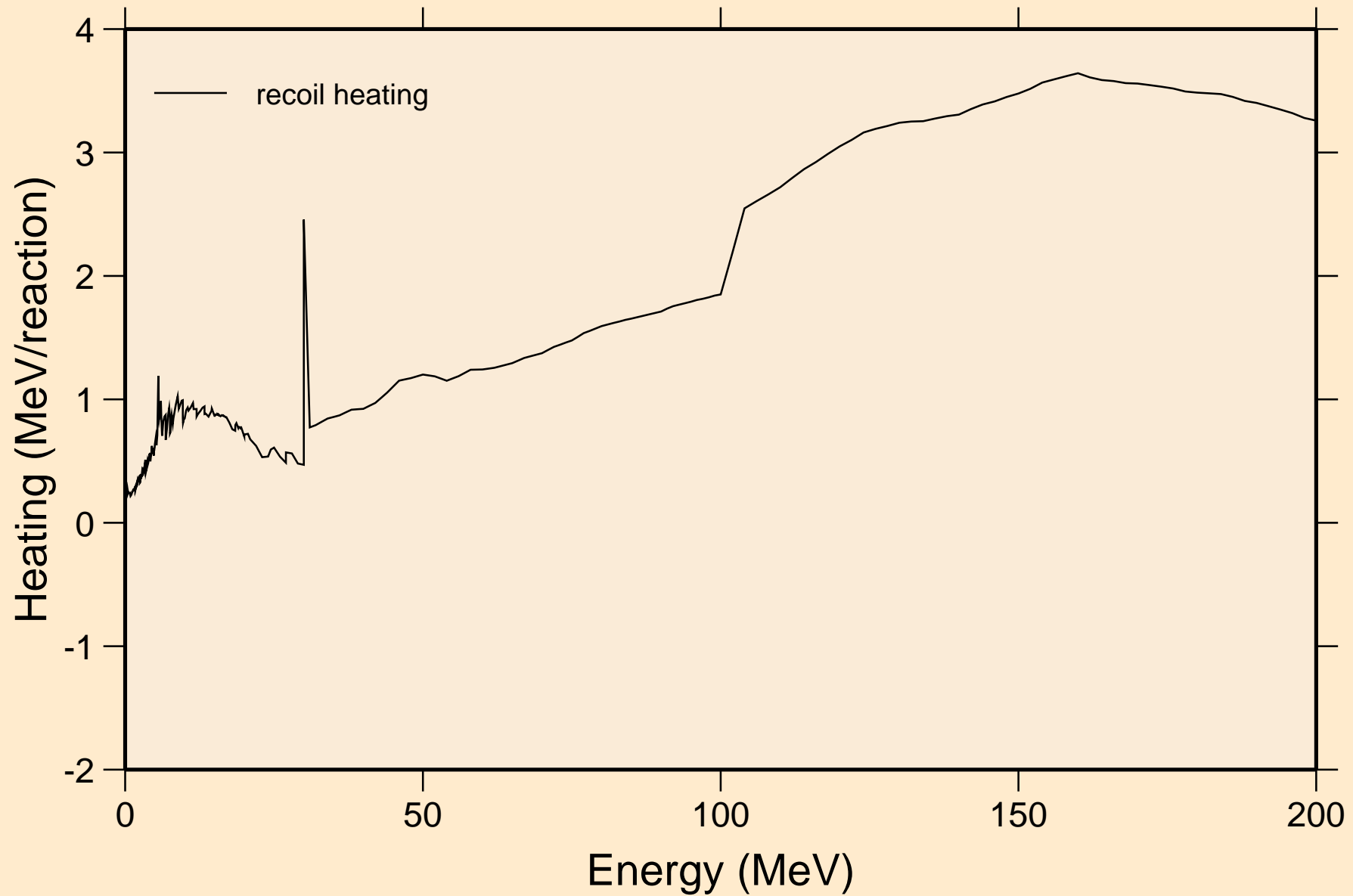

AL024 NEUTRON ACER TENDL-2024 LIBRARY; T=0.K

Particle production cross sections

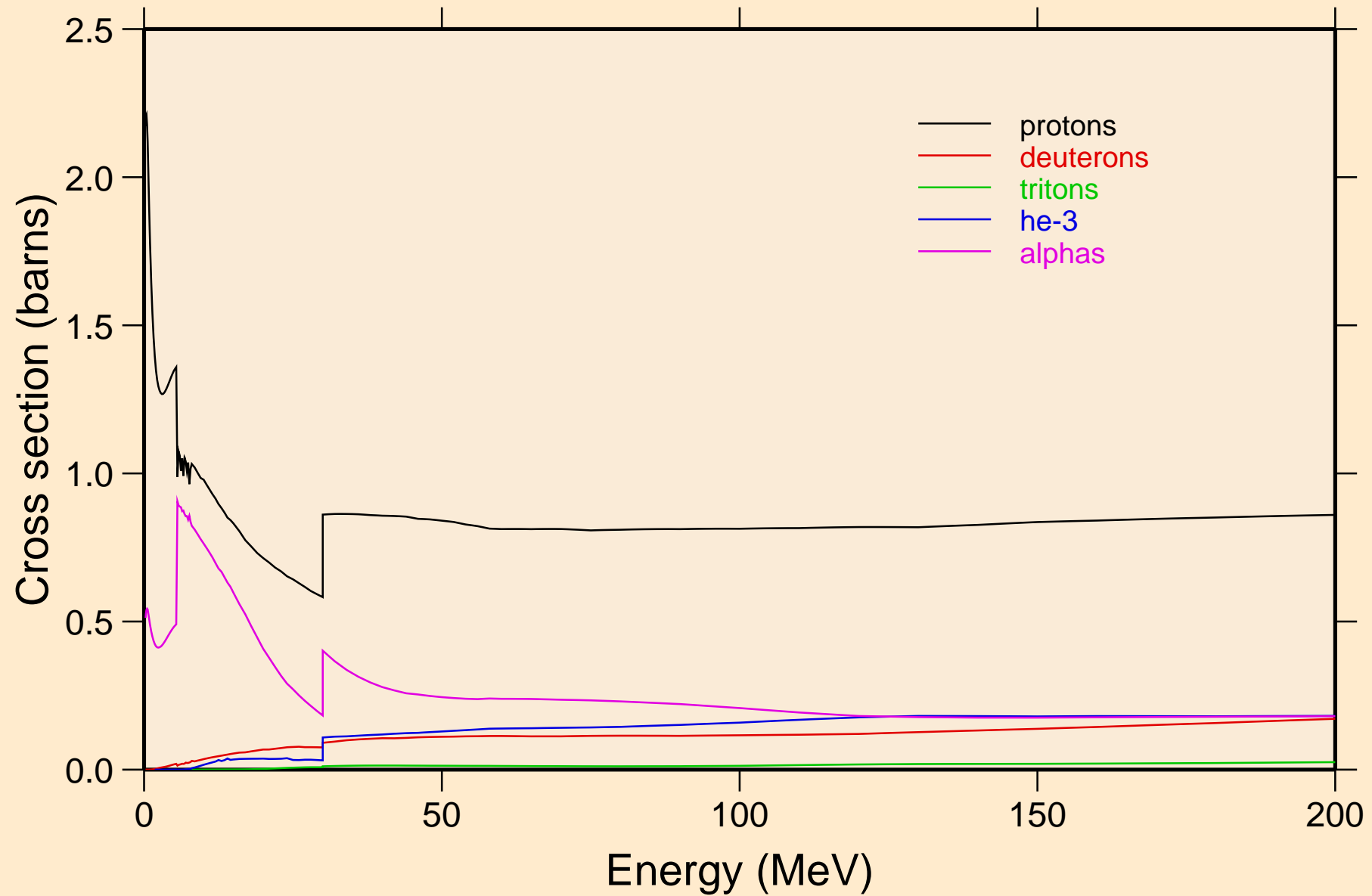

AL024 NEUTRON ACER TENDL-2024 LIBRARY; T=0.K
protons from (n,x)

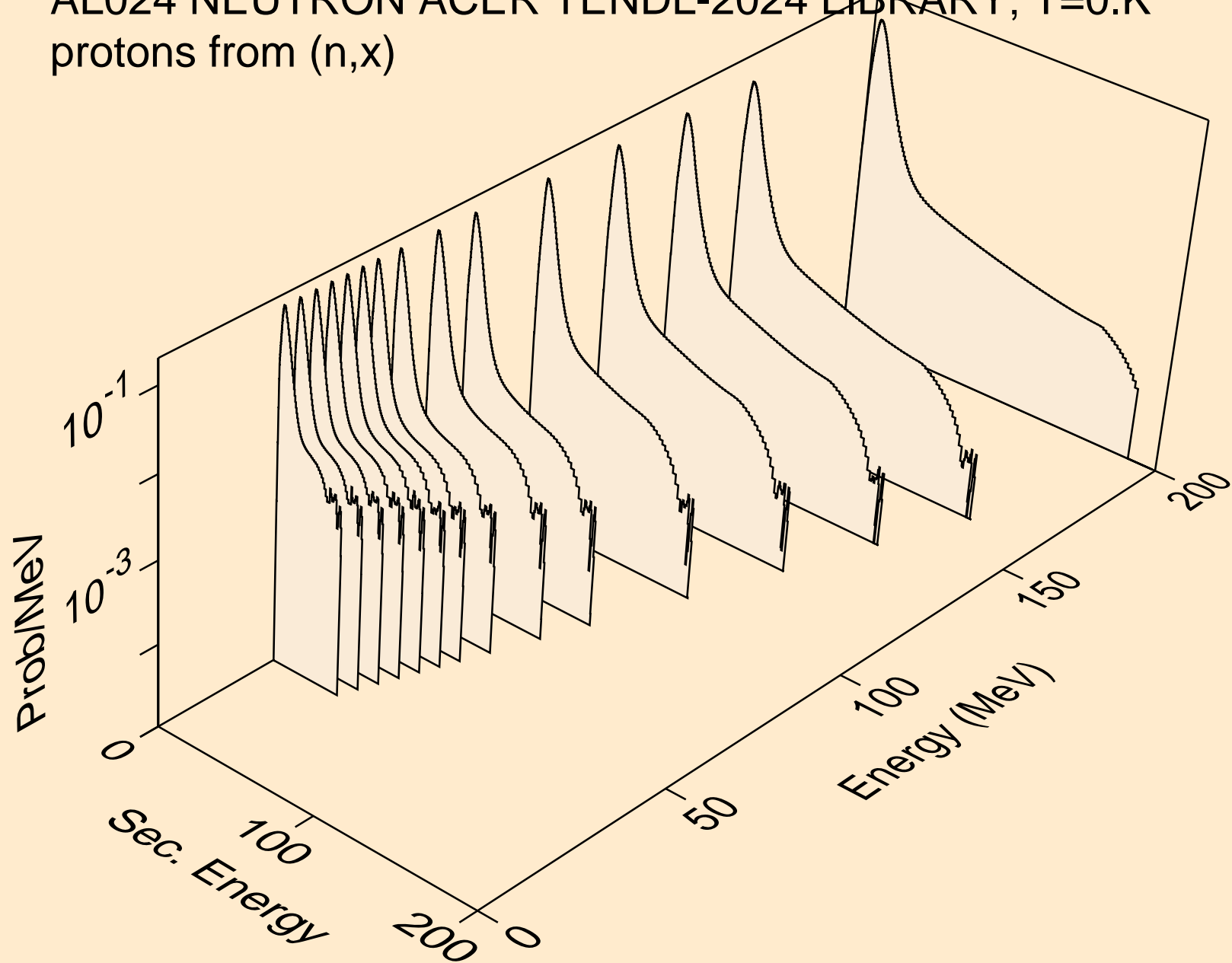

AL024 NEUTRON ACER TENDL-2024 LIBRARY; T=0.K
protons from (n,n*)p

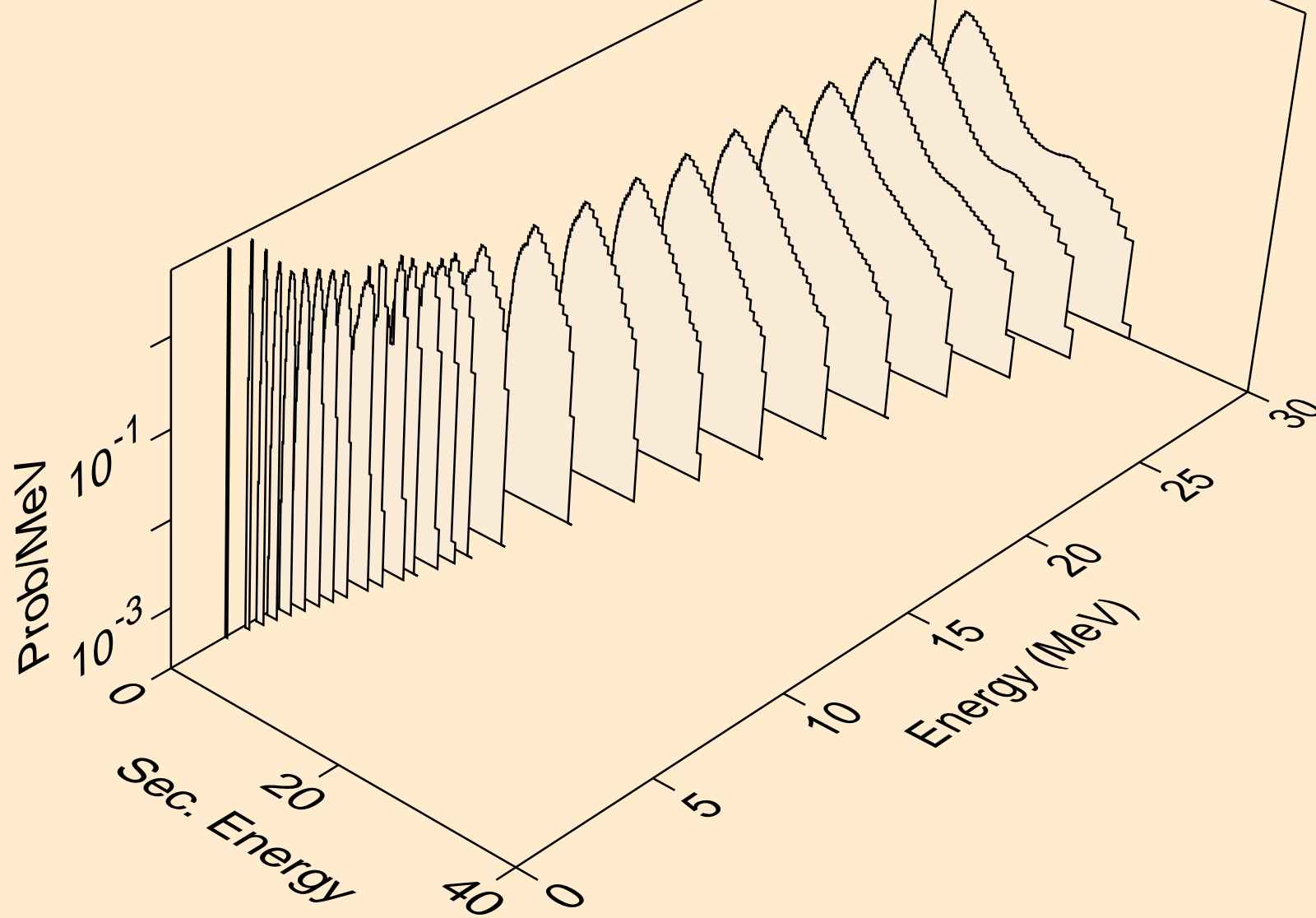

AL024 NEUTRON ACER TENDL-2024 LIBRARY; T=0.K
protons from (n,2np)

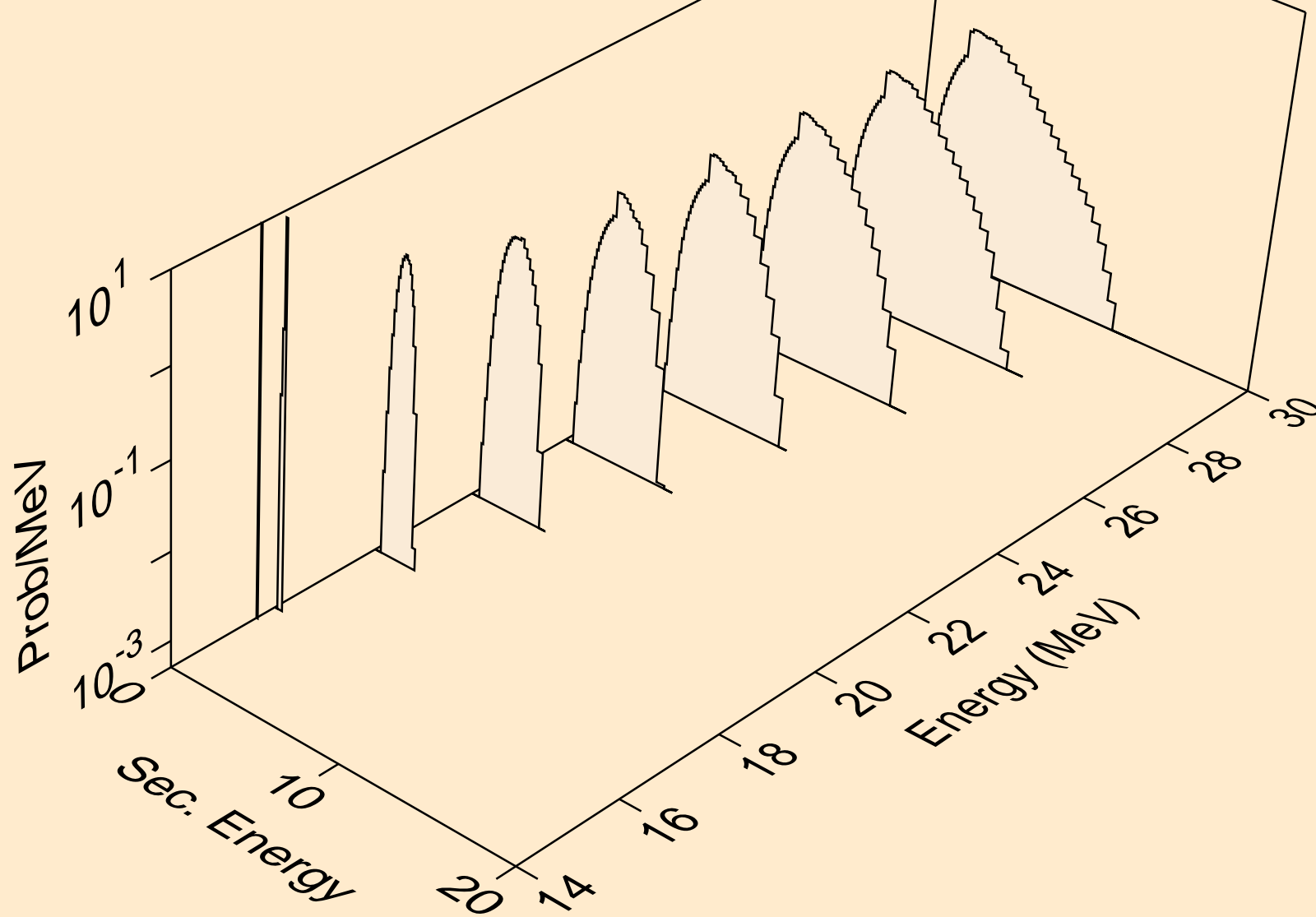

AL024 NEUTRON ACER TENDL-2024 LIBRARY; T=0.K
protons from (n,n2p)

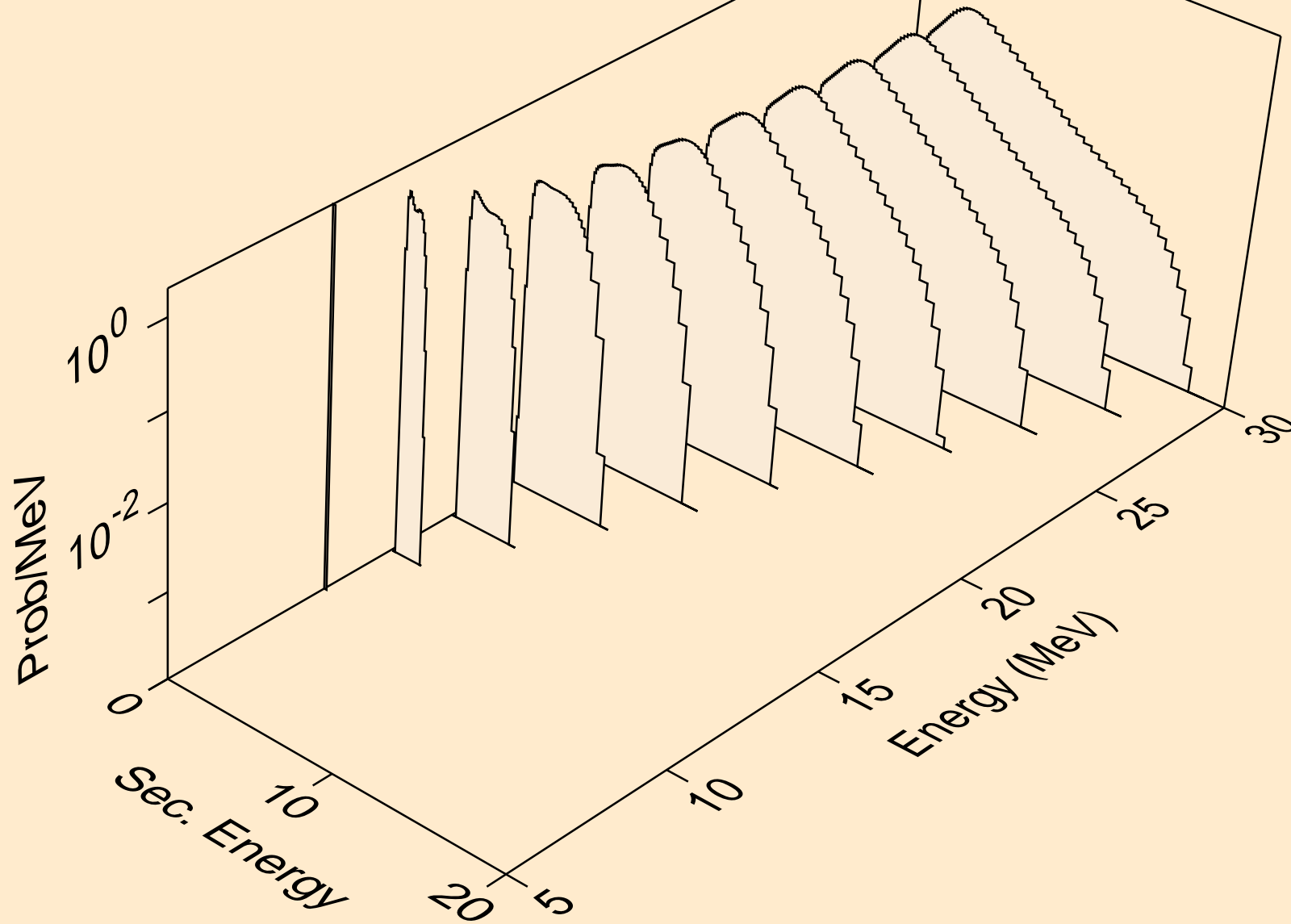

AL024 NEUTRON ACER TENDL-2024 LIBRARY; T=0.K
protons from (n,npa)

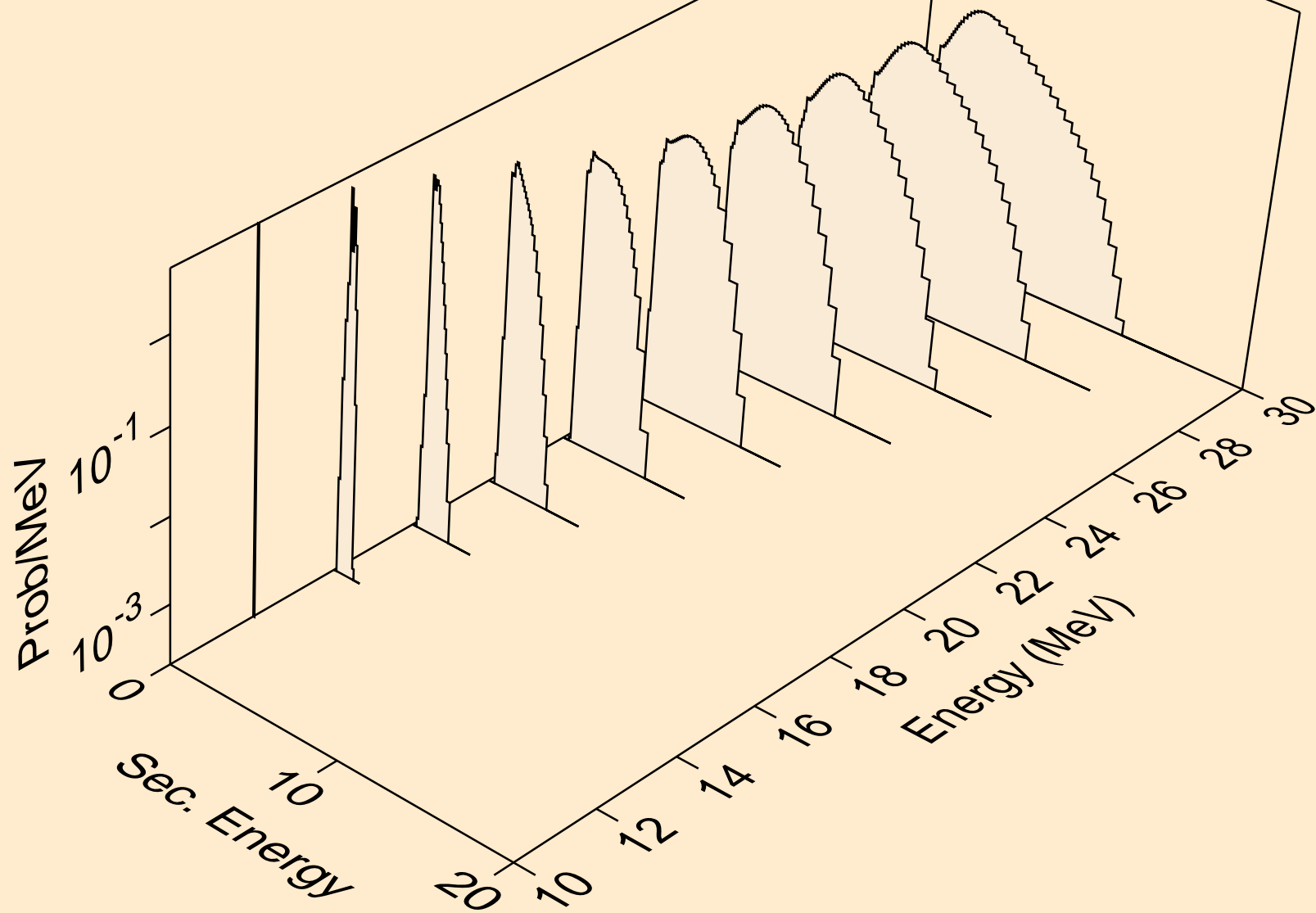

AL024 NEUTRON ACER TENDL-2024 LIBRARY; T=0.K
protons from (n,p)

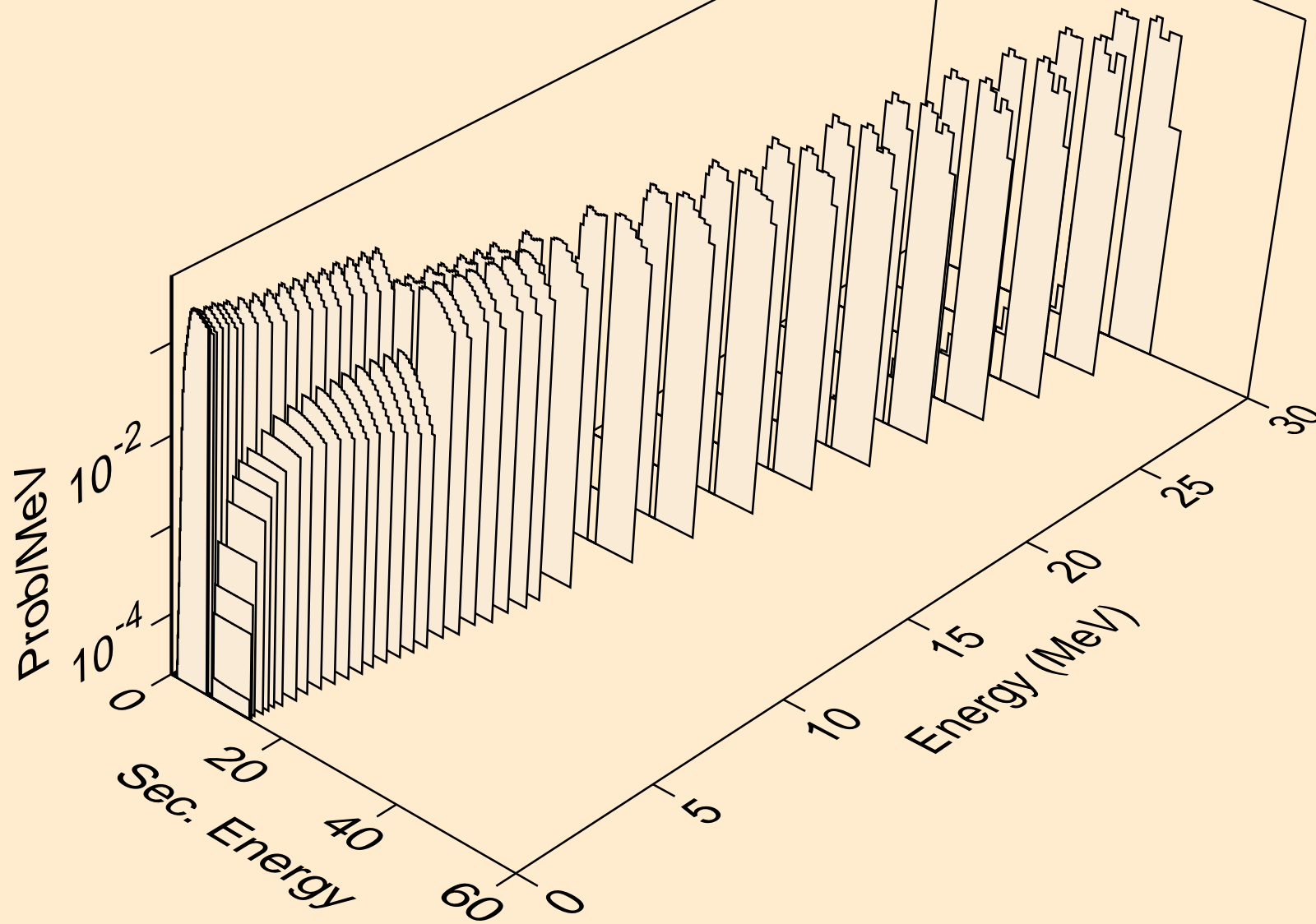

AL024 NEUTRON ACER TENDL-2024 LIBRARY; T=0.K
protons from (n,2p)

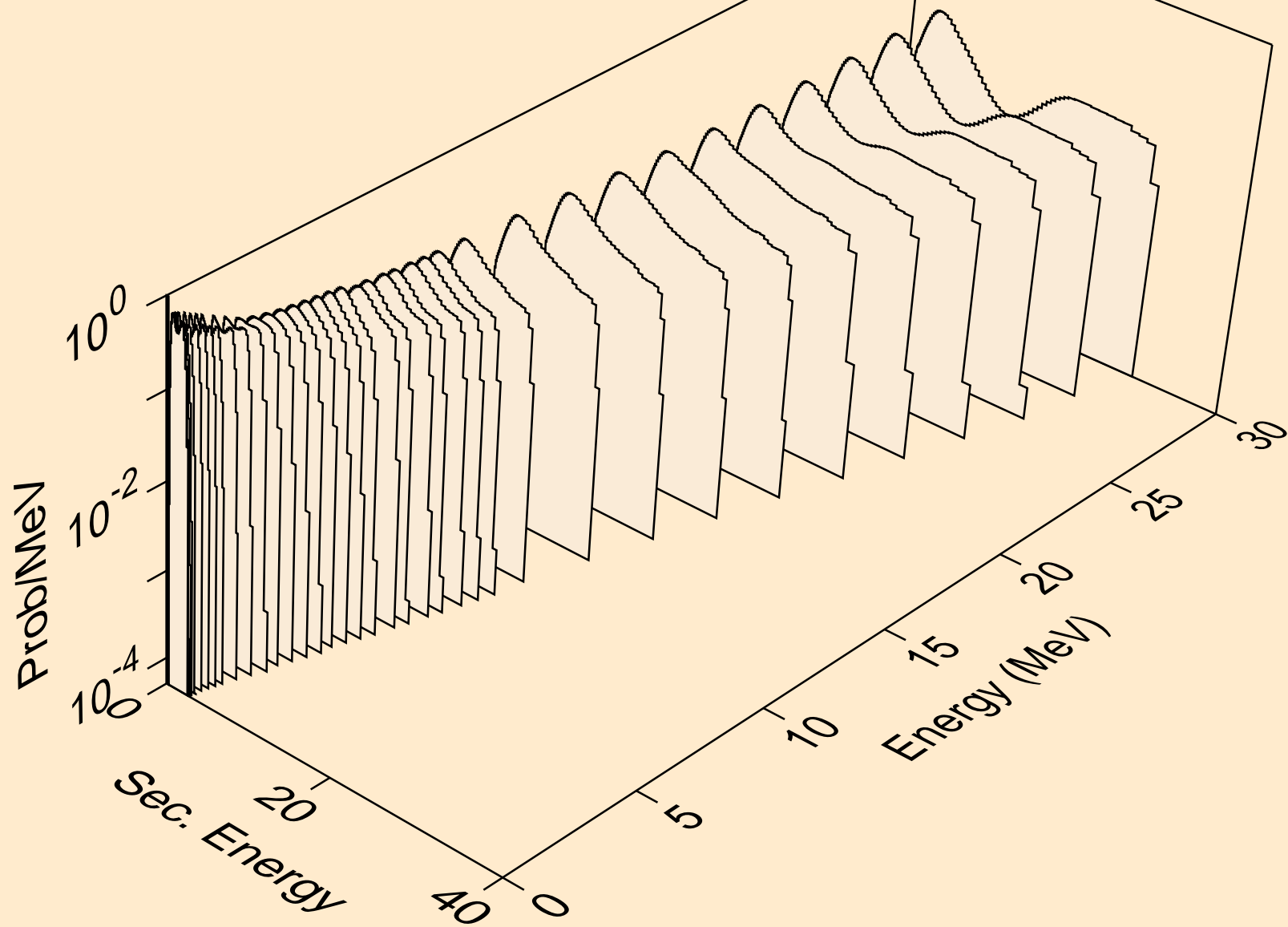

AL024 NEUTRON ACER TENDL-2024 LIBRARY; T=0.K
protons from (n,p)

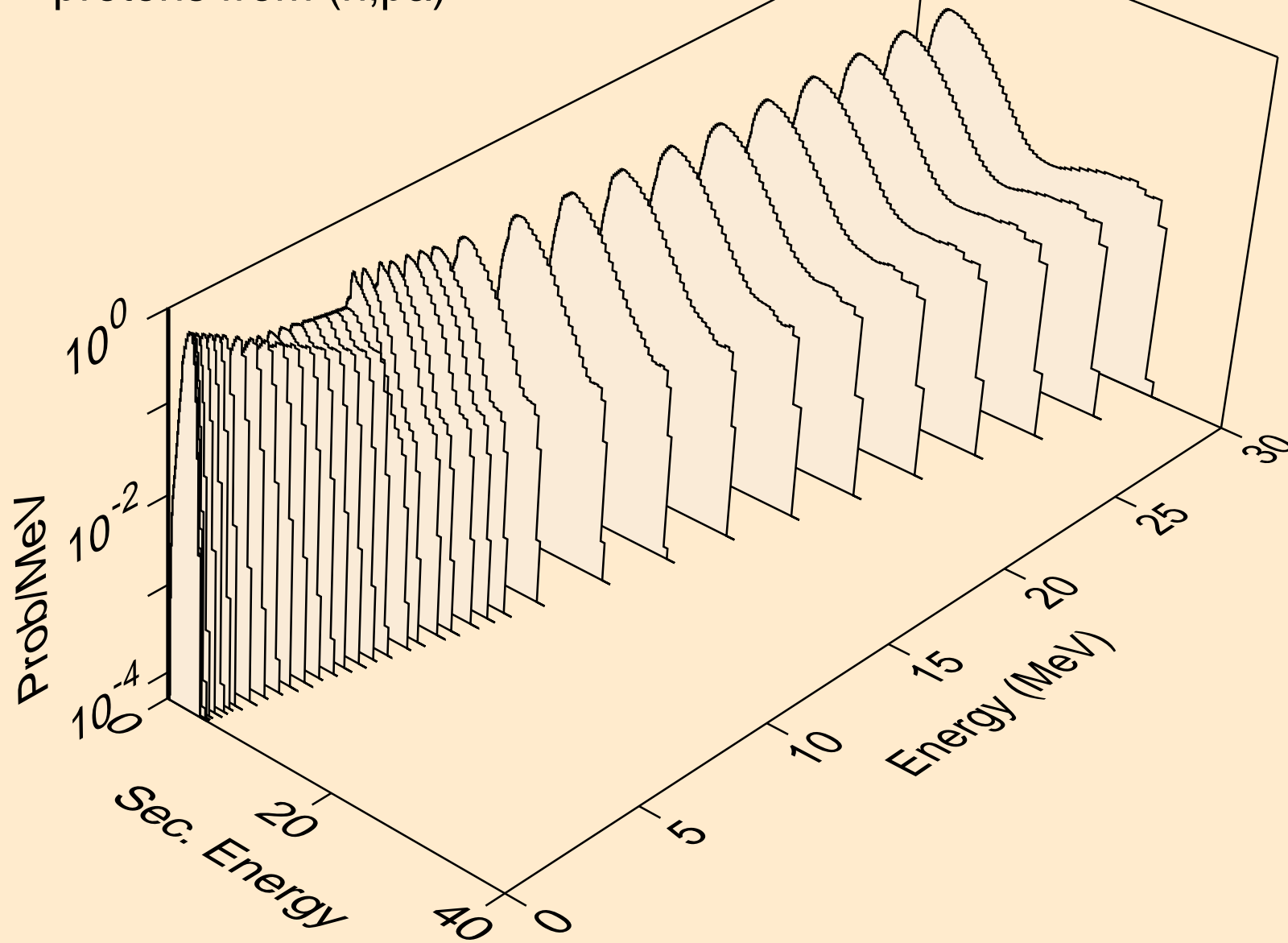

AL024 NEUTRON ACER TENDL-2024 LIBRARY; T=0.K
protons from (n,pd)

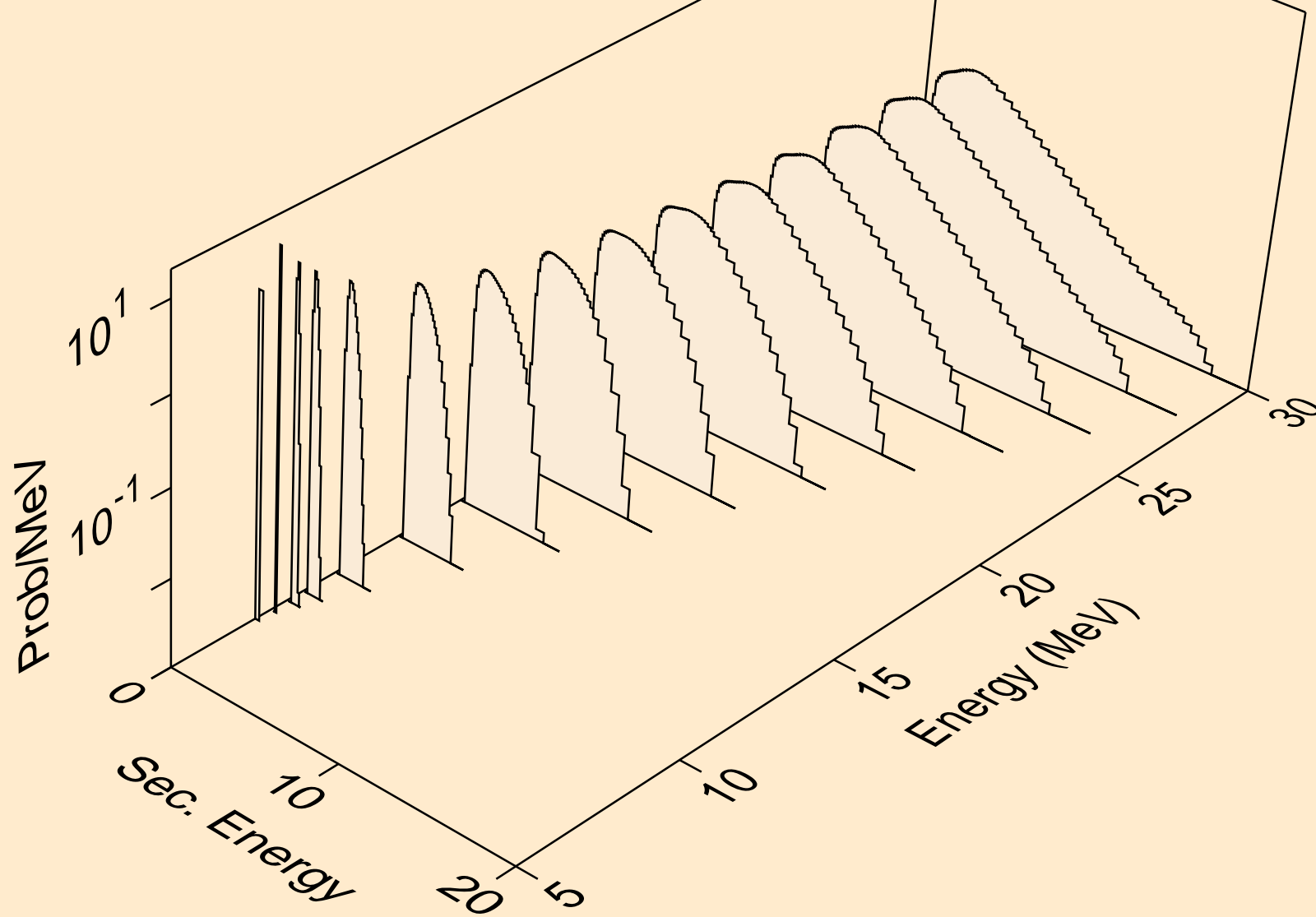

AL024 NEUTRON ACER TENDL-2024 LIBRARY; T=0.K
protons from (n,pt)

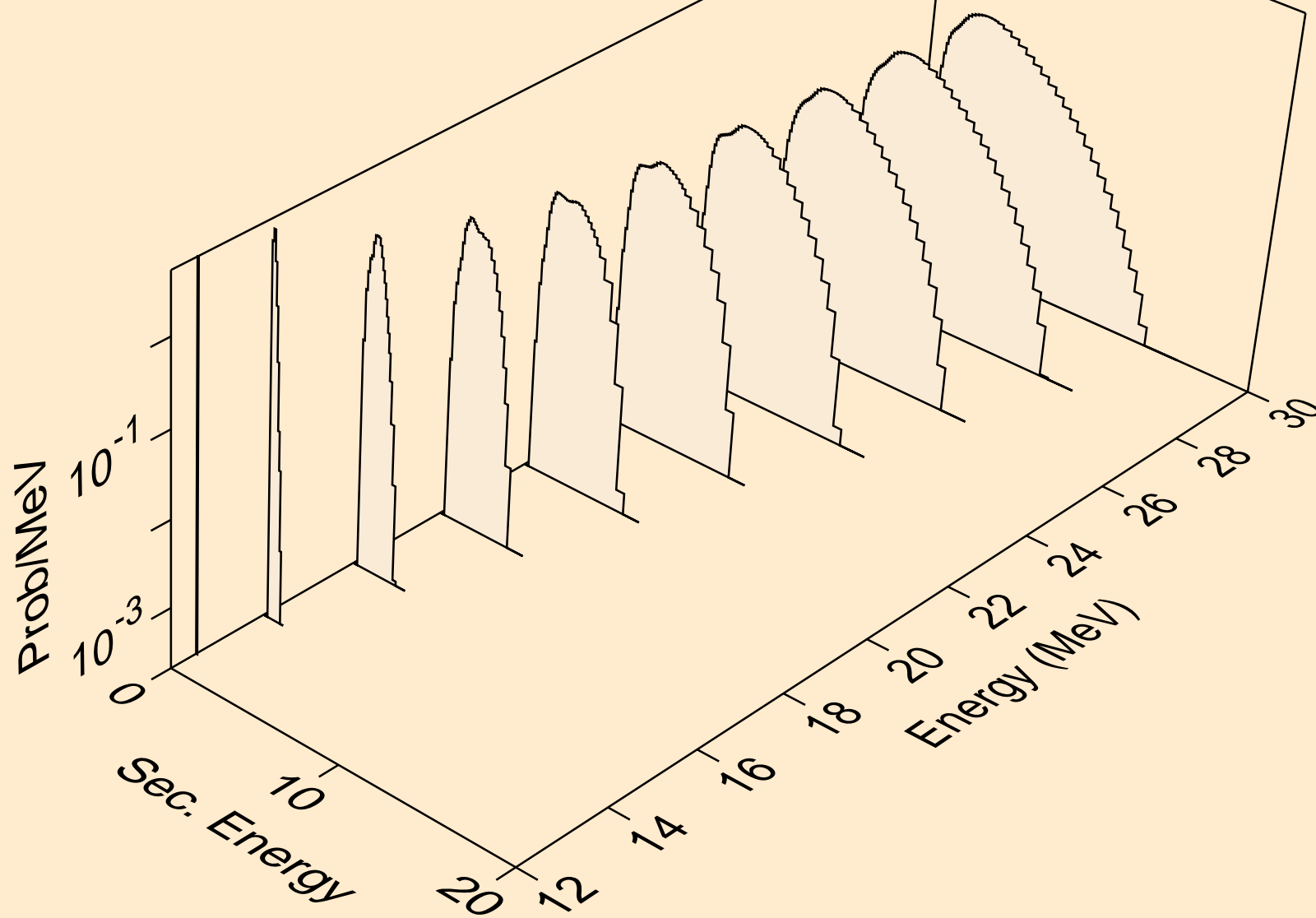

AL024 NEUTRON ACER TENDL-2024 LIBRARY; T=0.K
deuterons from (n,x)

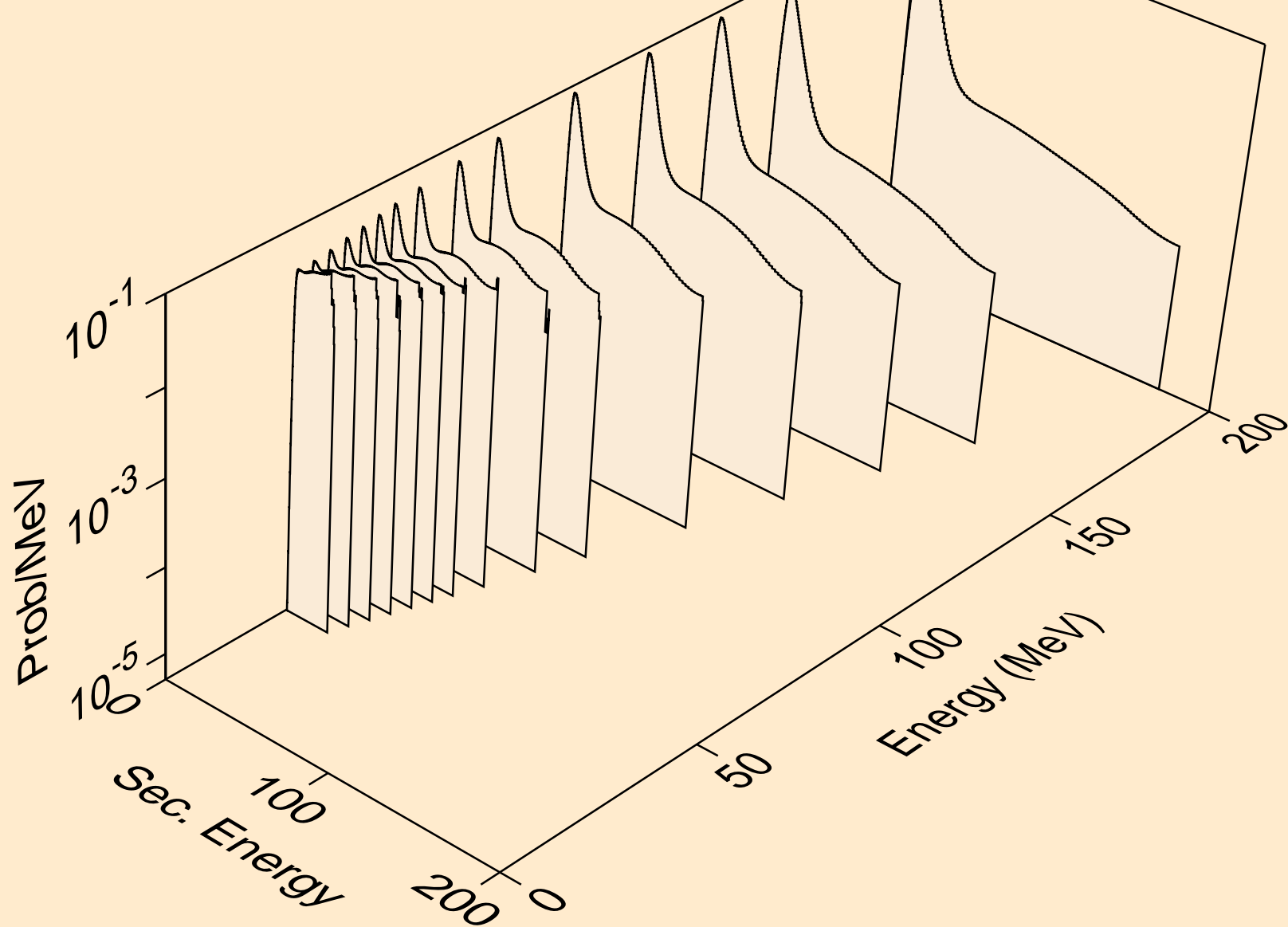

AL024 NEUTRON ACER TENDL-2024 LIBRARY; T=0.K
deuterons from (n,n*)d

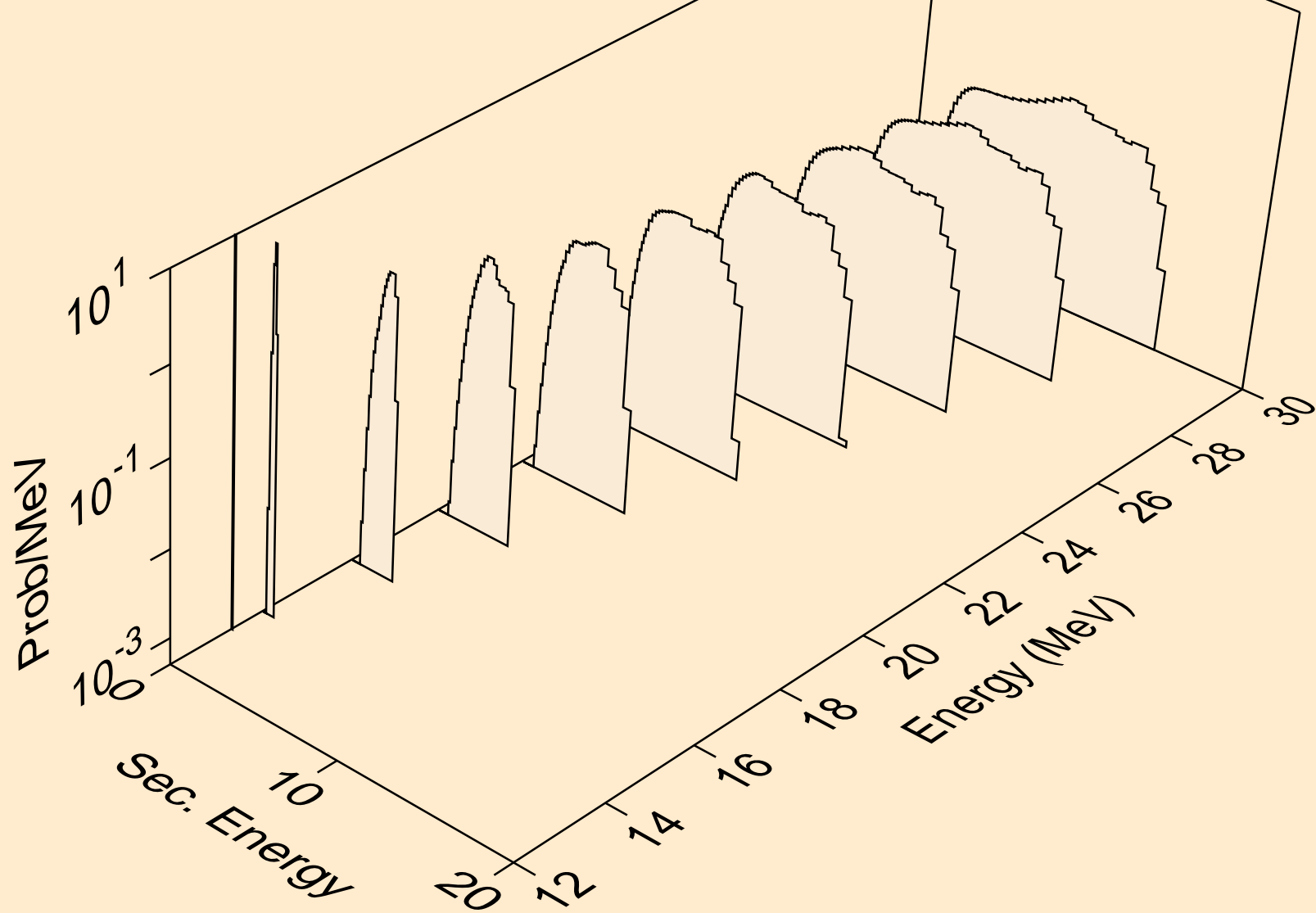

AL024 NEUTRON ACER TENDL-2024 LIBRARY; T=0.K
deuterons from (n,d)

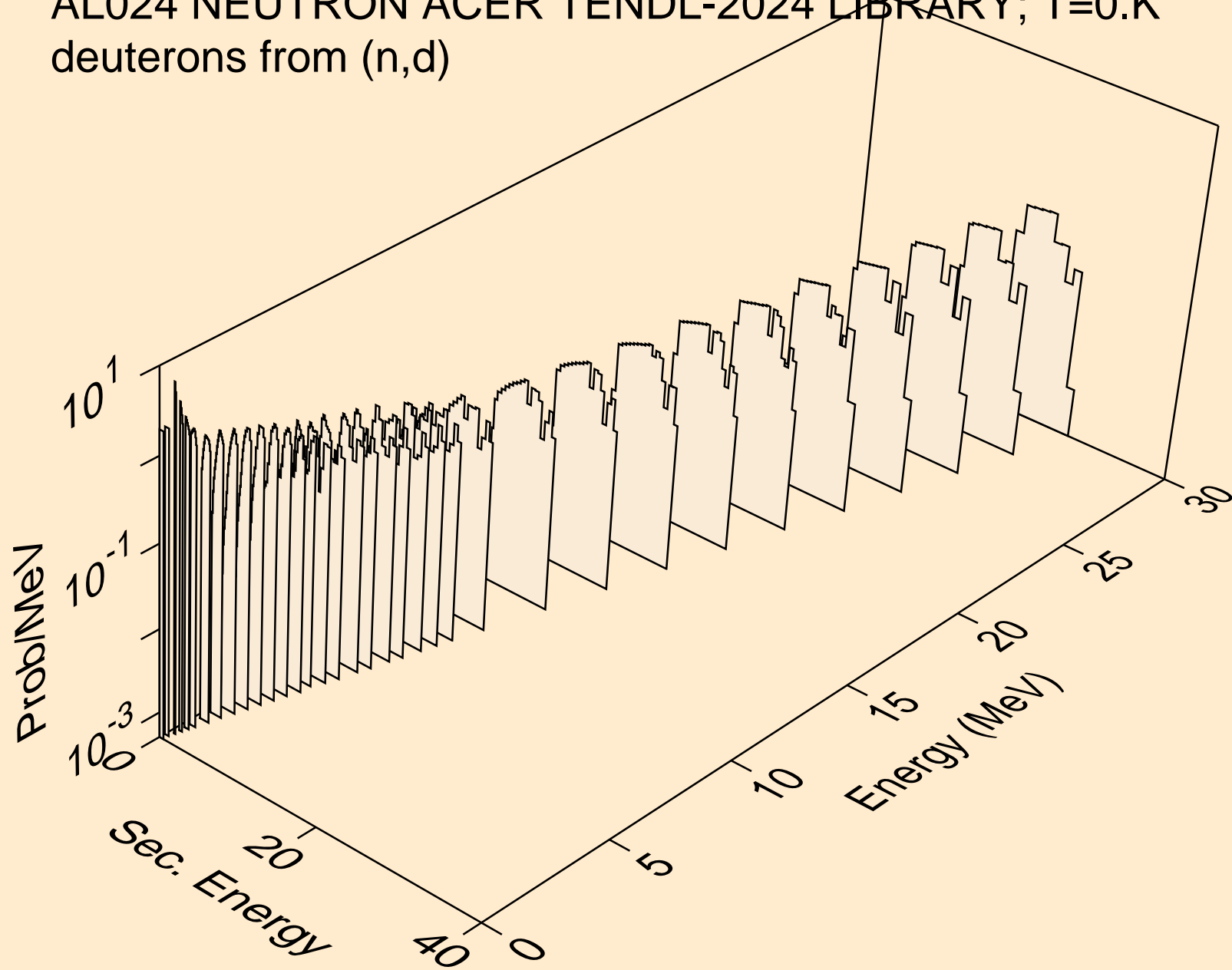

AL024 NEUTRON ACER TENDL-2024 LIBRARY; T=0.K
deuterons from (n,d2a)

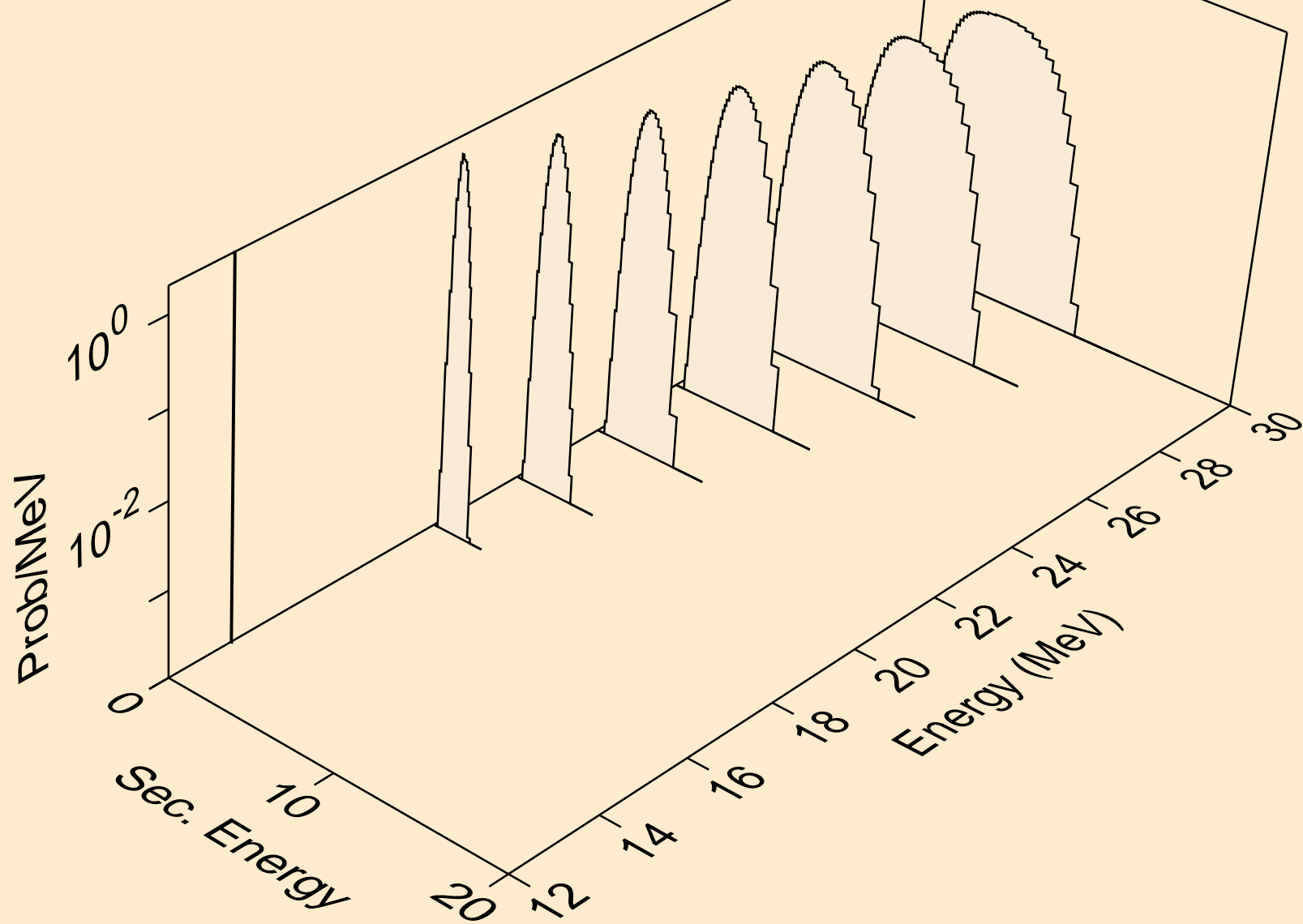

AL024 NEUTRON ACER TENDL-2024 LIBRARY; T=0.K
deuterons from (n,pd)

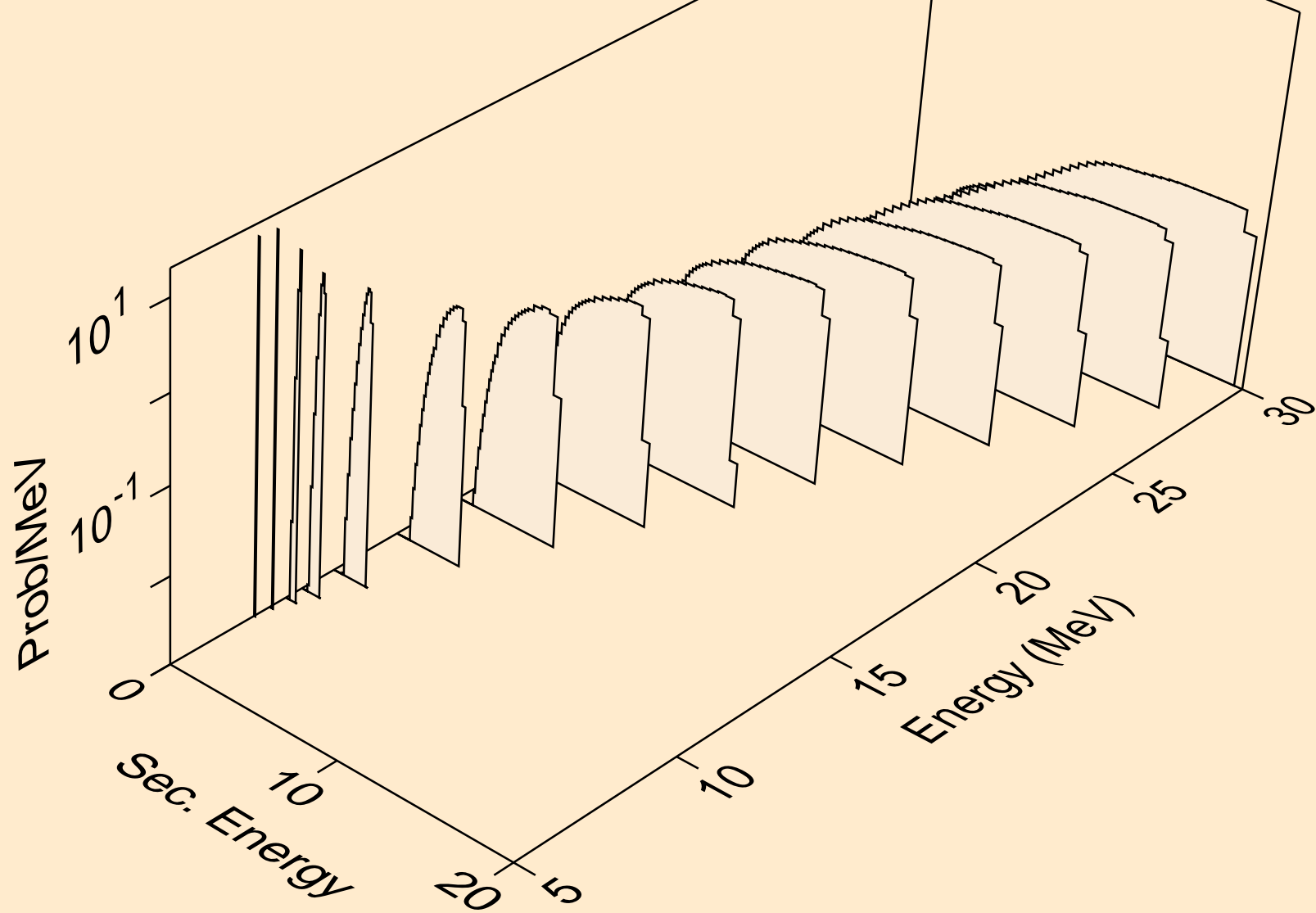

AL024 NEUTRON ACER TENDL-2024 LIBRARY; T=0.K
deuterons from (n,da)

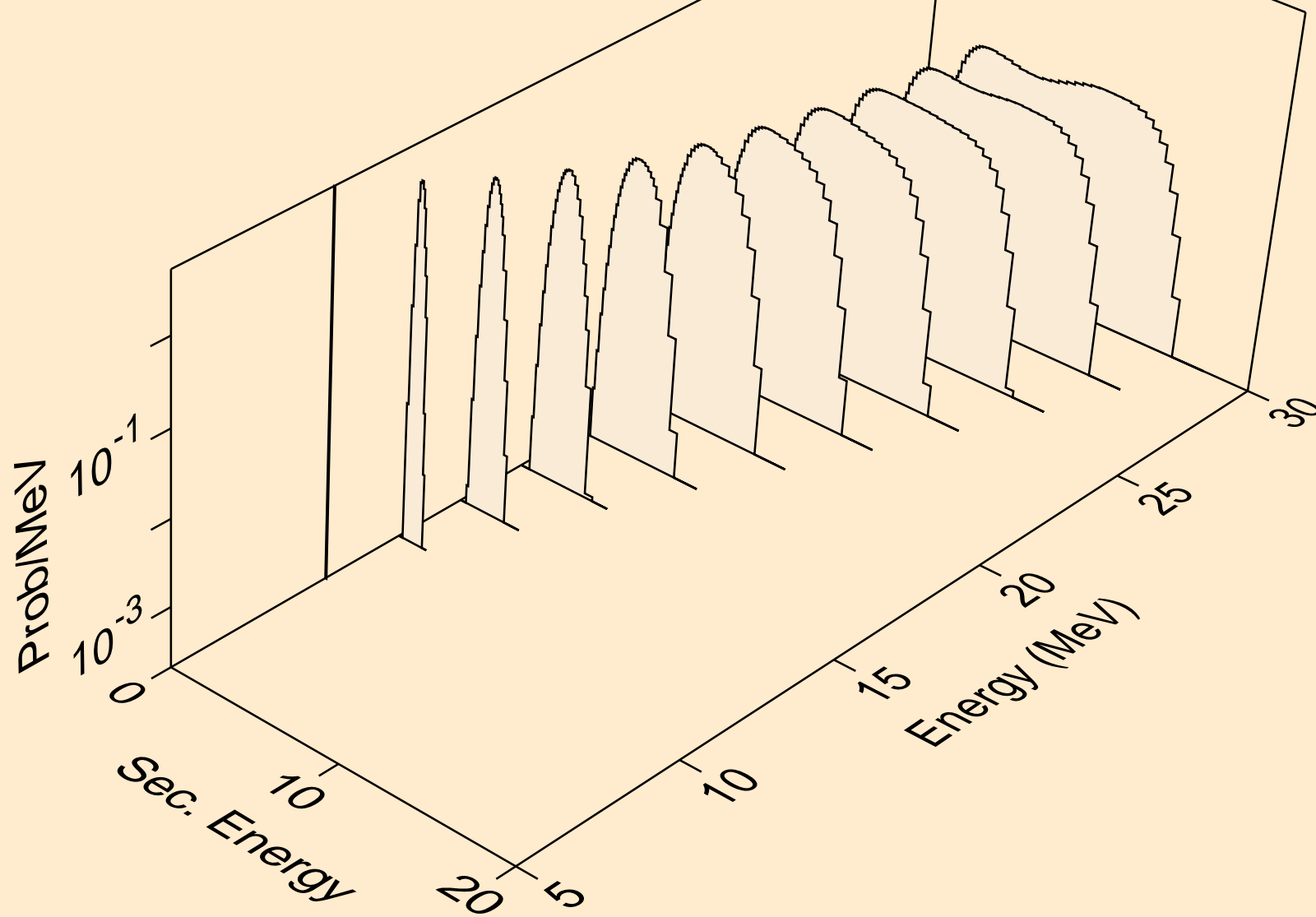

AL024 NEUTRON ACER TENDL-2024 LIBRARY; T=0.K
tritons from (n,x)

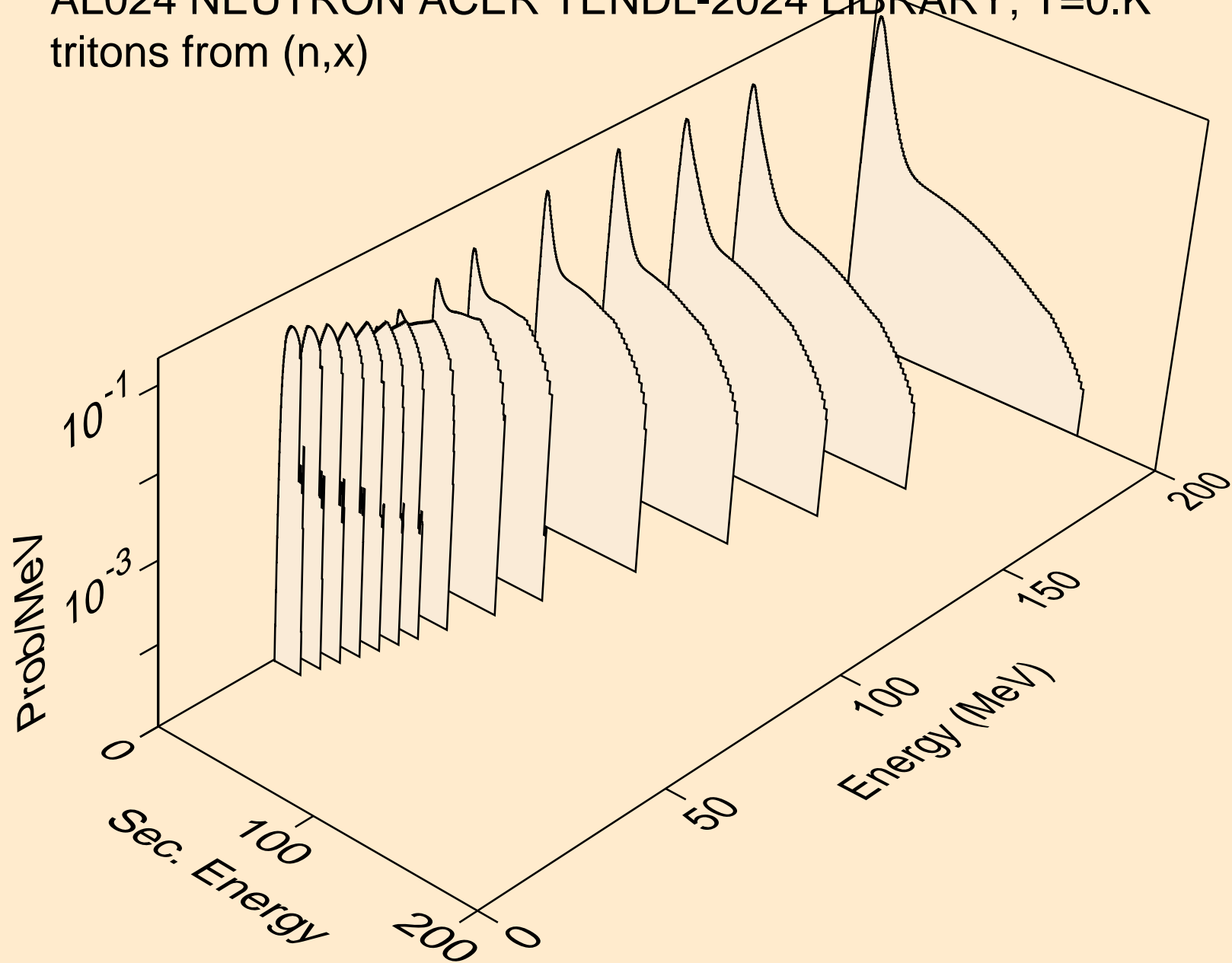

AL024 NEUTRON ACER TENDL-2024 LIBRARY; T=0.K
tritons from (n,n*)t

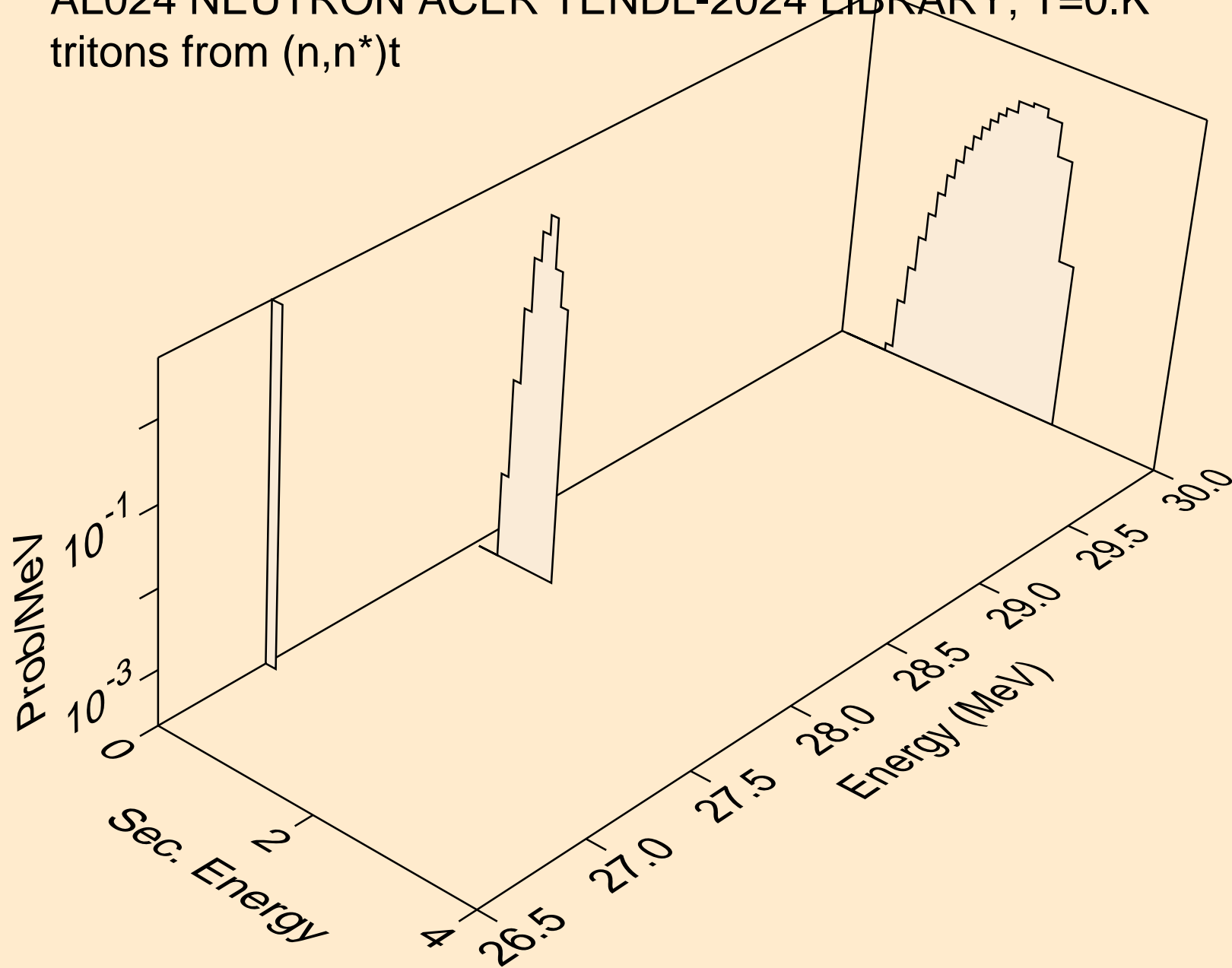

AL024 NEUTRON ACER TENDL-2024 LIBRARY; T=0.K
tritons from (n,t)

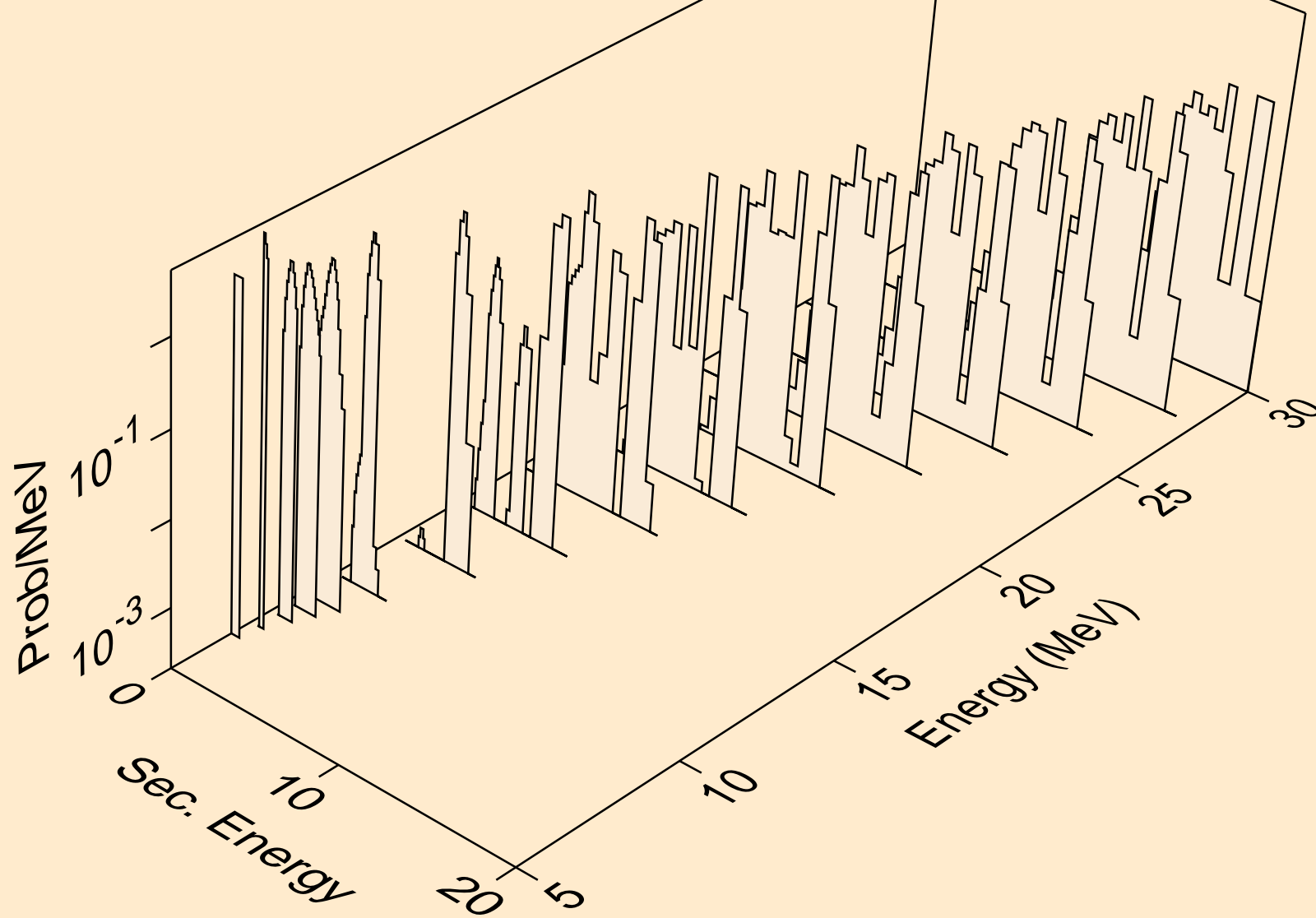

AL024 NEUTRON ACER TENDL-2024 LIBRARY; T=0.K
tritons from (n,t2a)

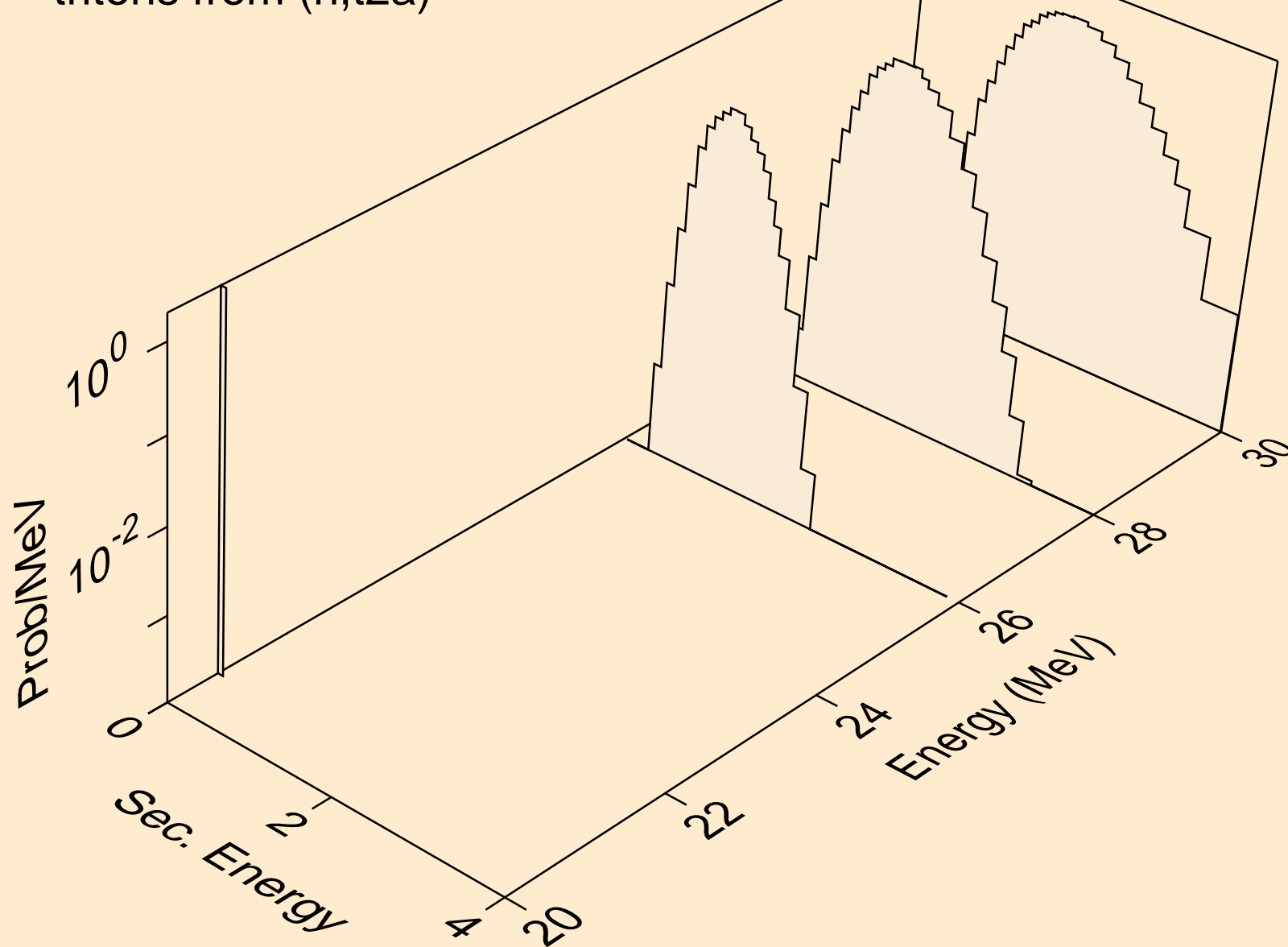

AL024 NEUTRON ACER TENDL-2024 LIBRARY; T=0.K
tritons from (n,pt)

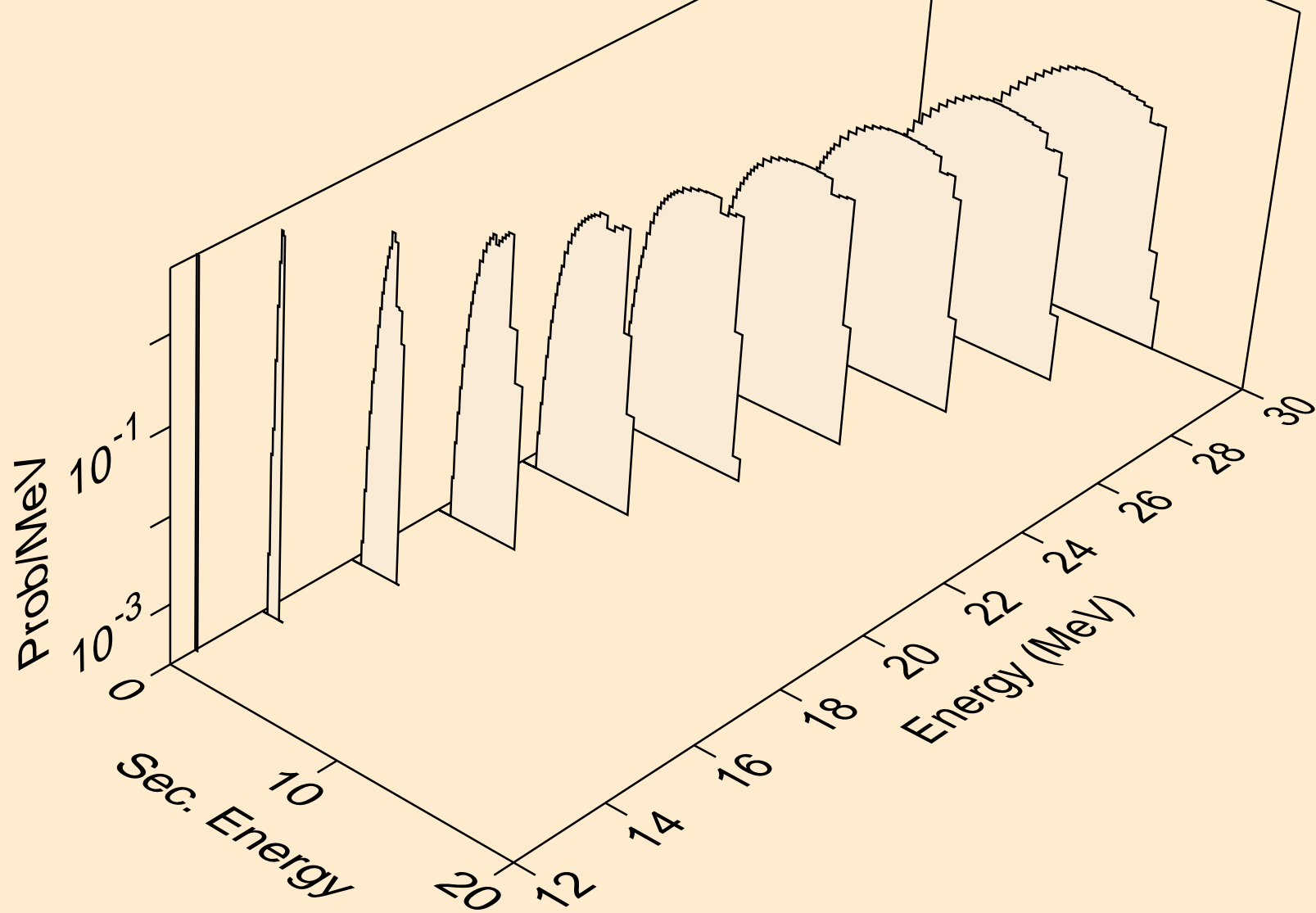

AL024 NEUTRON ACER TENDL-2024 LIBRARY; T=0.K
he3s from (n,x)

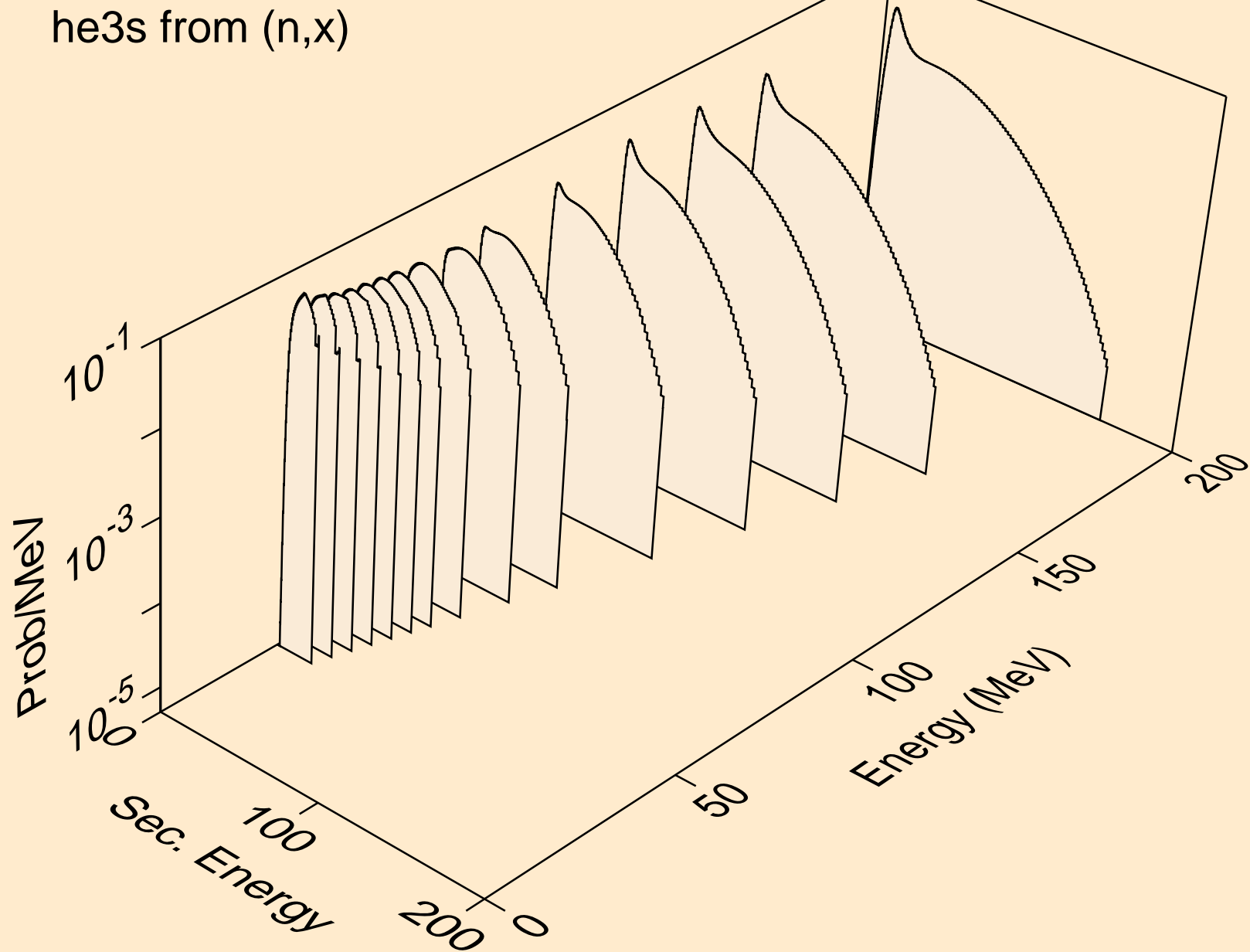

AL024 NEUTRON ACER TENDL-2024 LIBRARY; T=0.K
he3s from (n,n*)he3

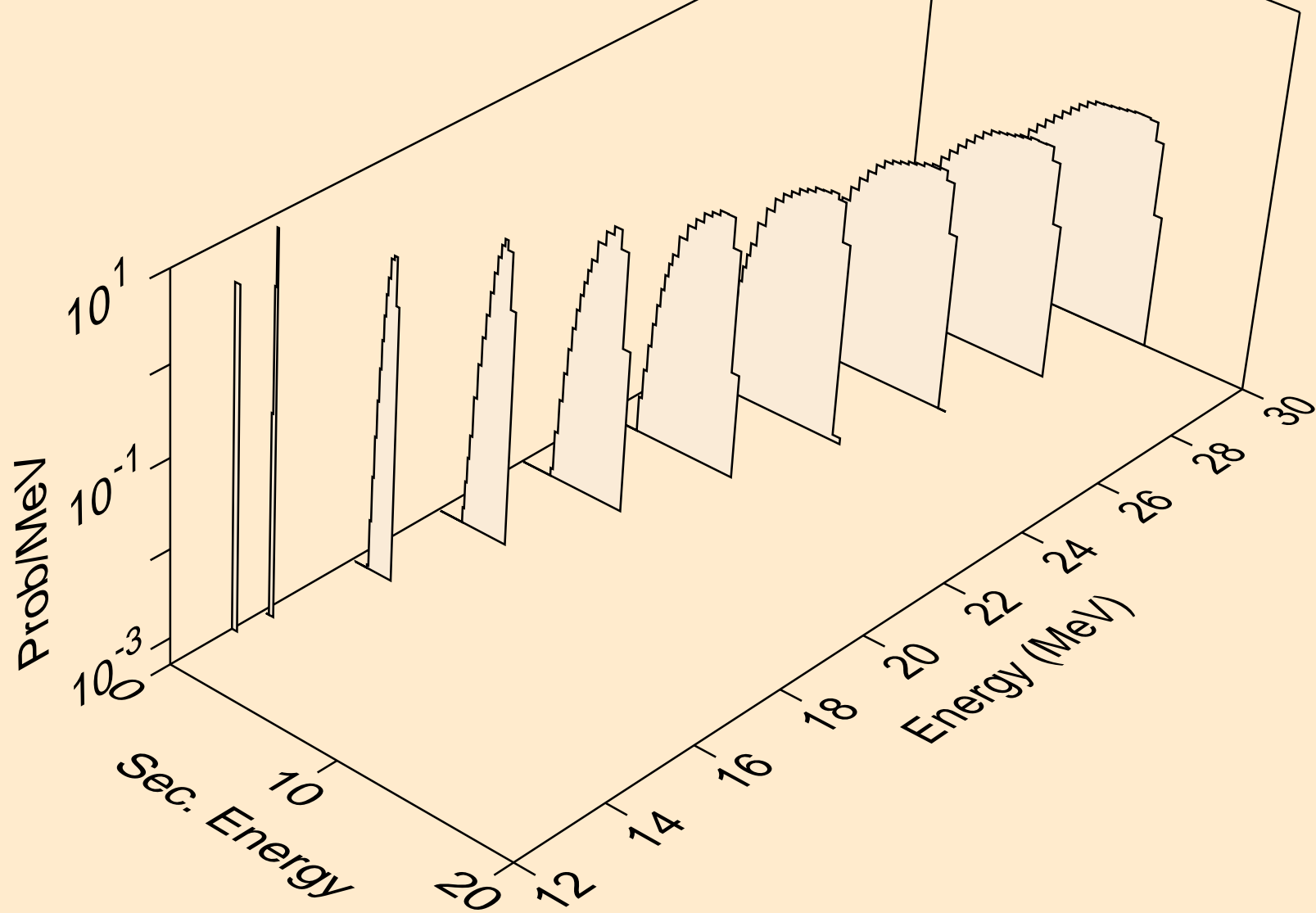

AL024 NEUTRON ACER TENDL-2024 LIBRARY; T=0.K
he3s from (n,he3)

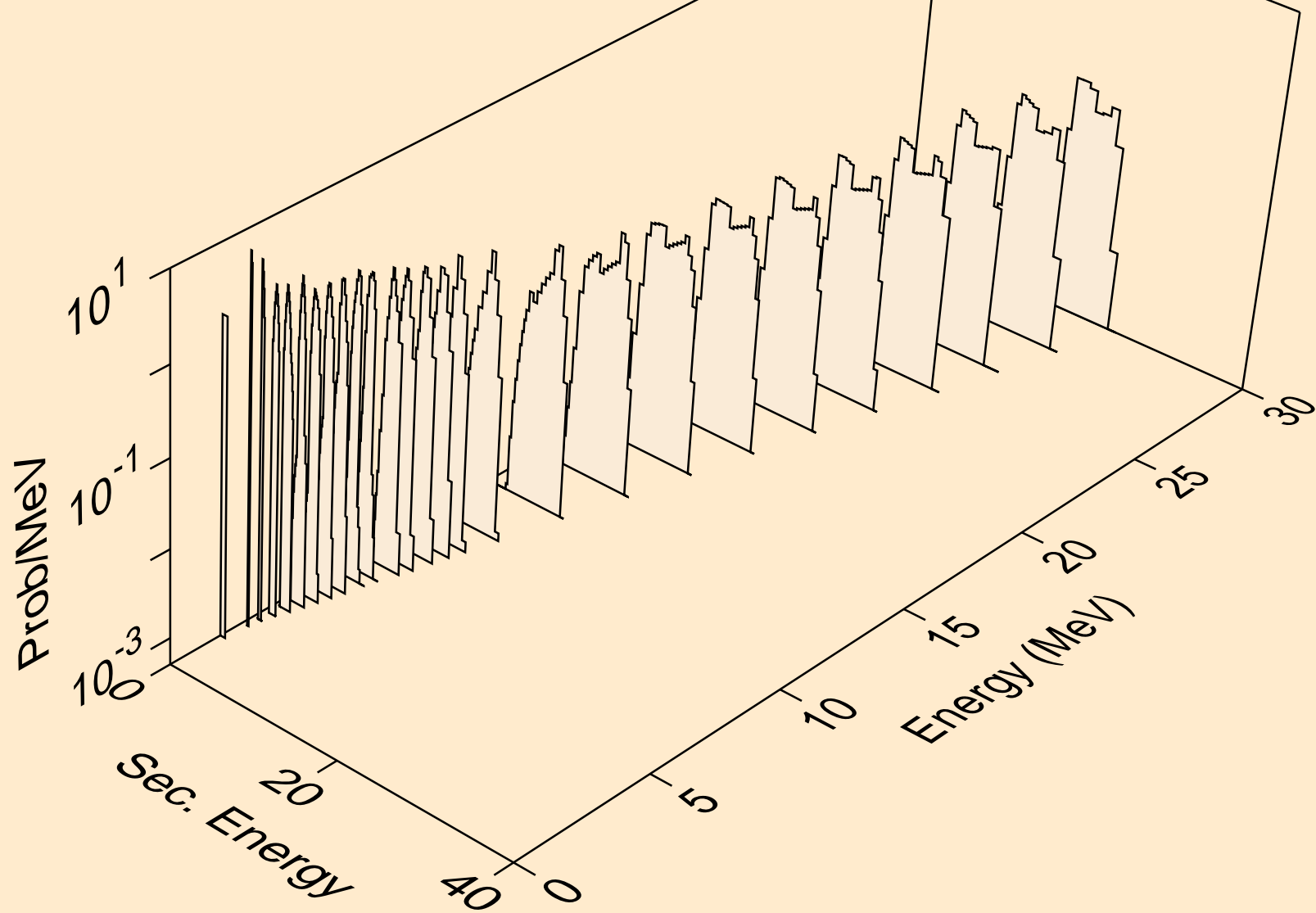

AL024 NEUTRON ACER TENDL-2024 LIBRARY; T=0.K
alphas from (n,x)

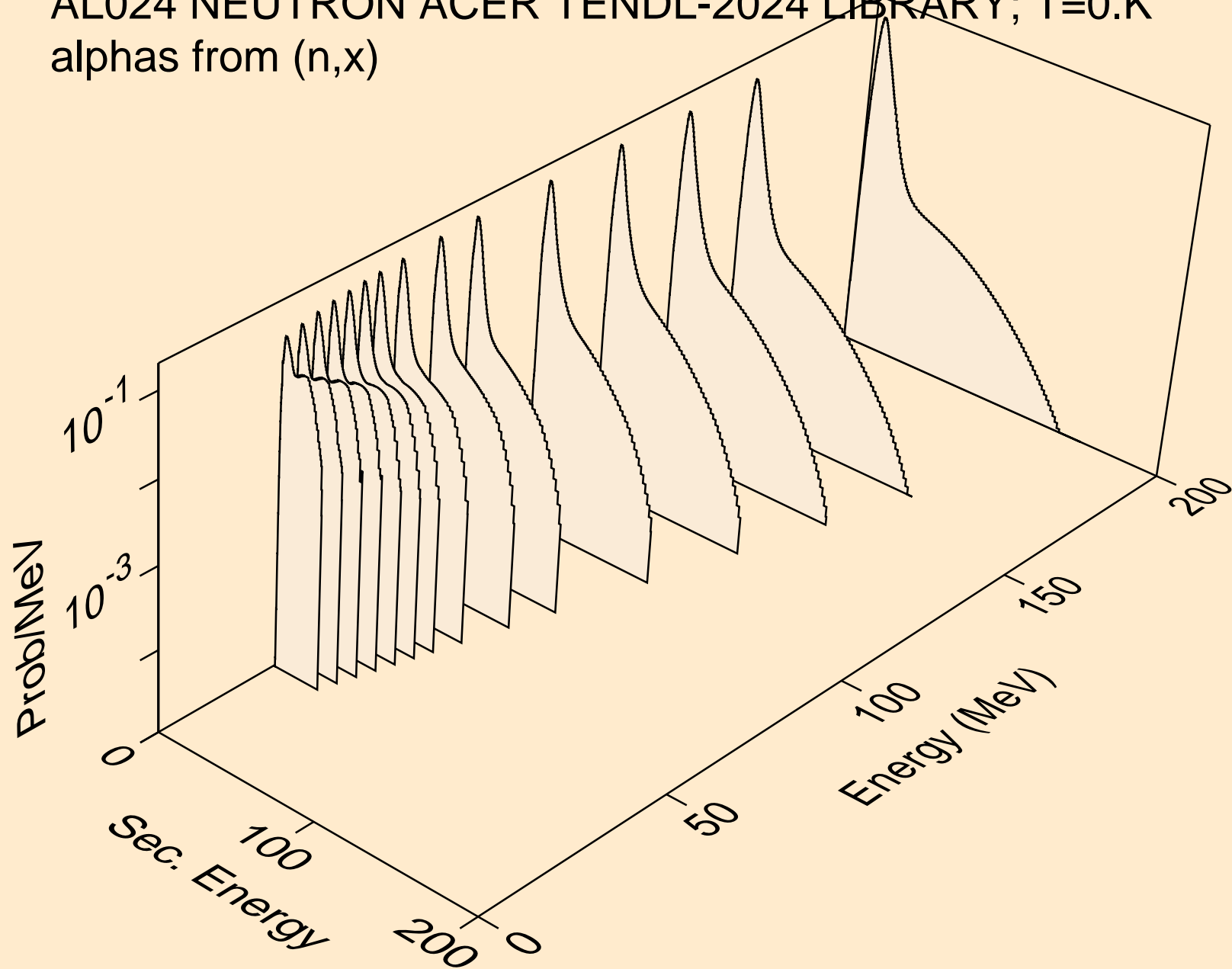

AL024 NEUTRON ACER TENDL-2024 LIBRARY; T=0.K
alphas from (n,n*)a

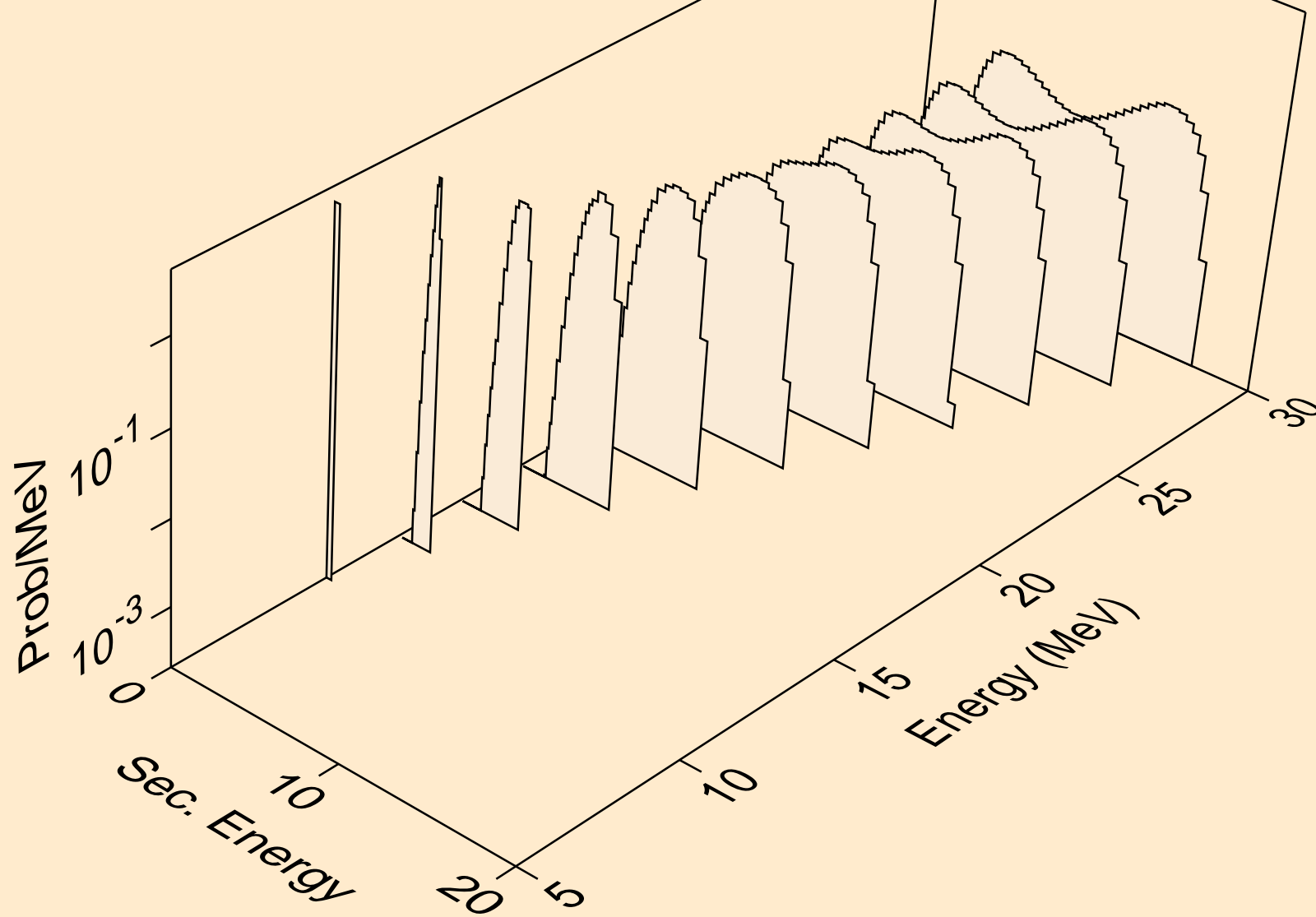

AL024 NEUTRON ACER TENDL-2024 LIBRARY; T=0.K
alphas from (n,2n)a

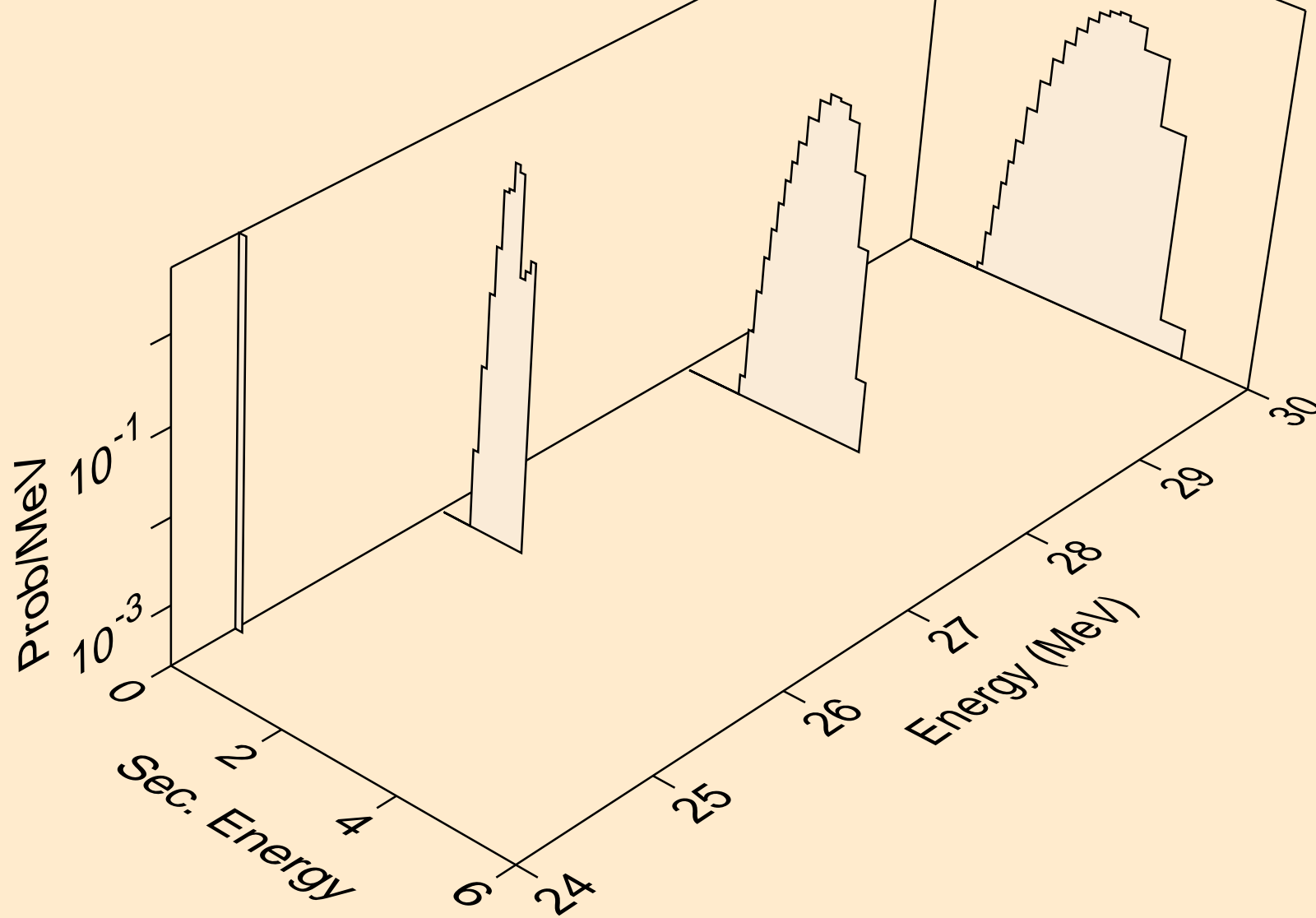

AL024 NEUTRON ACER TENDL-2024 LIBRARY; T=0.K
alphas from (n,n*)2a

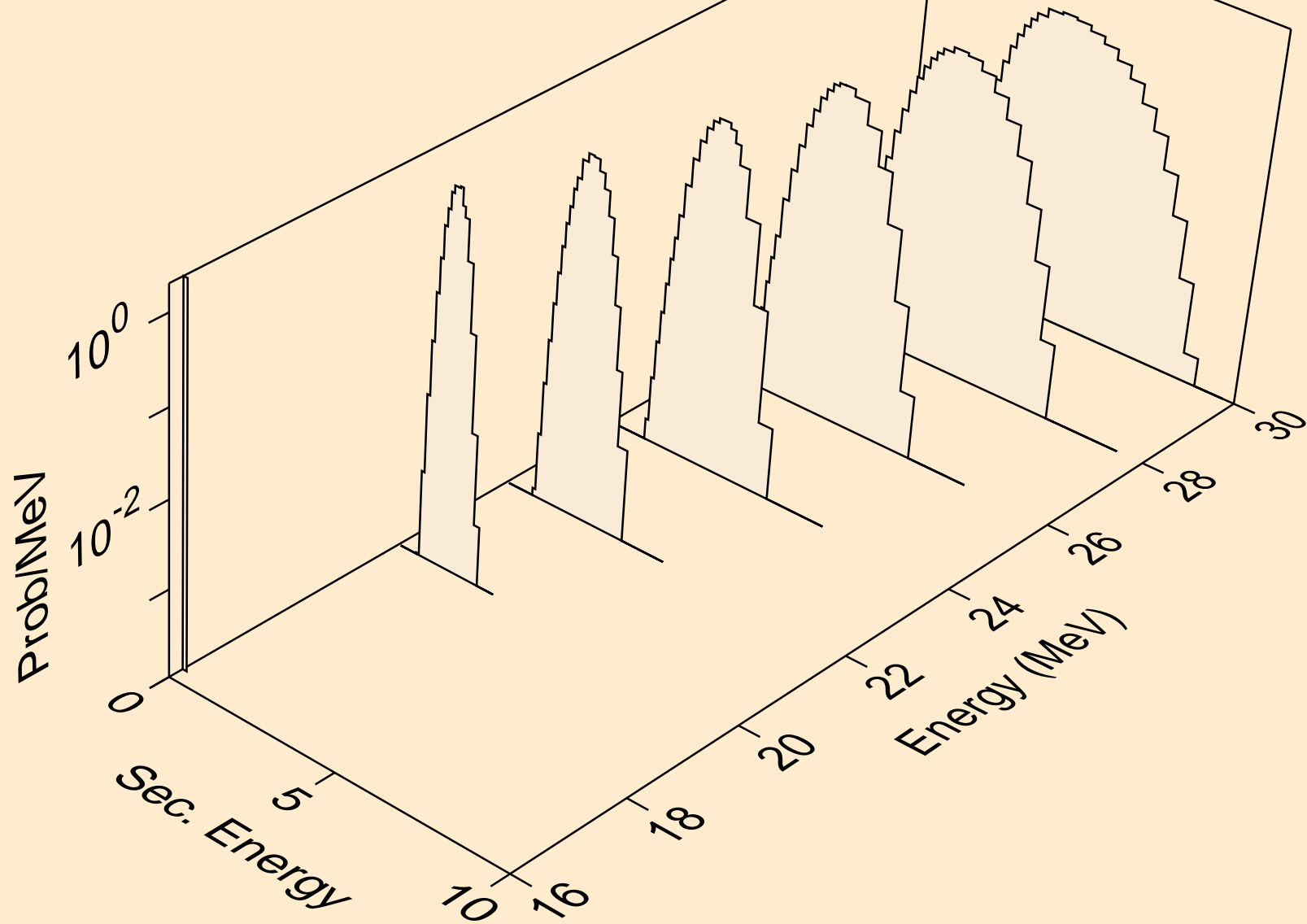

AL024 NEUTRON ACER TENDL-2024 LIBRARY; T=0.K
alphas from (n,npa)

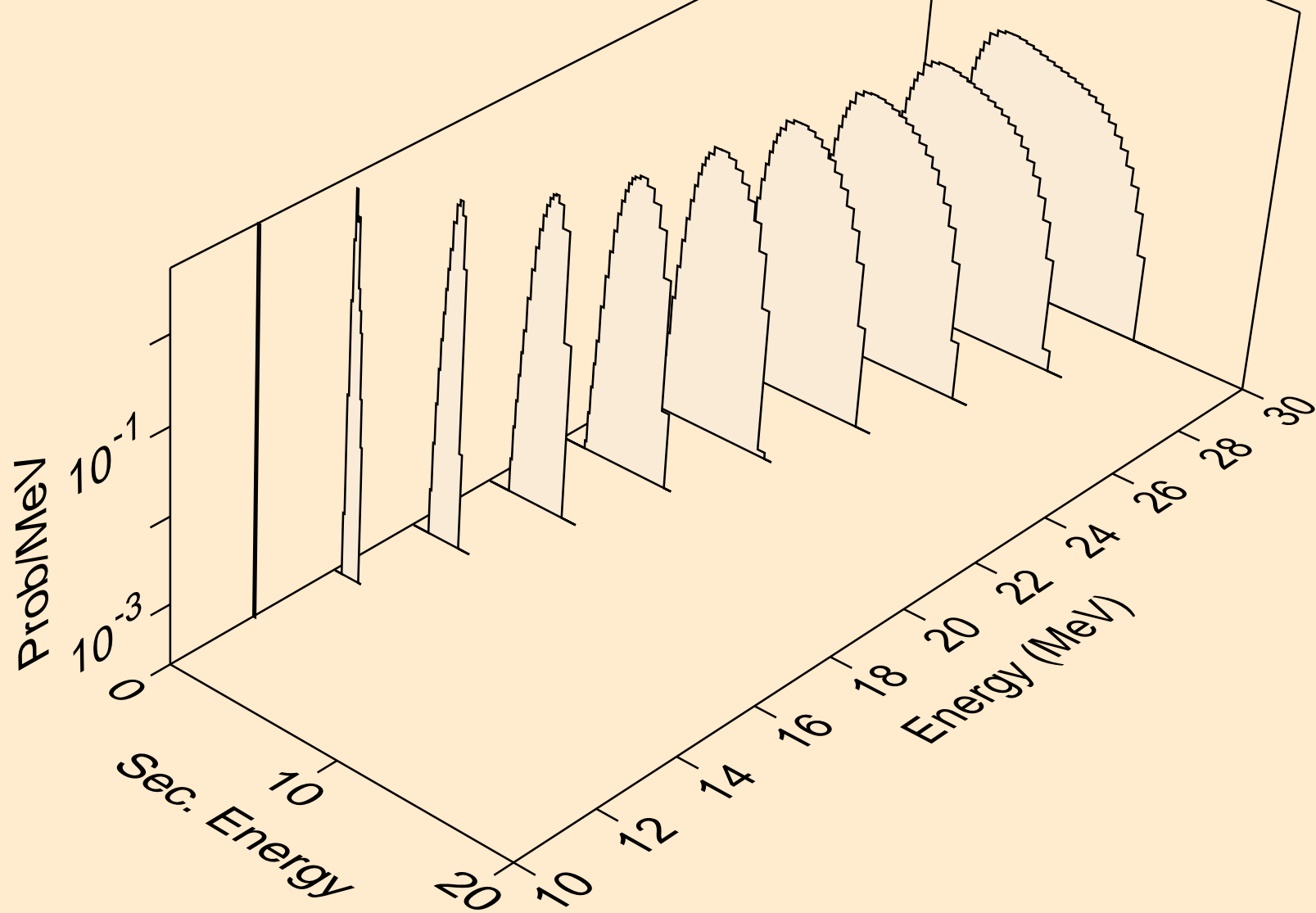

AL024 NEUTRON ACER TENDL-2024 LIBRARY; T=0.K
alphas from (n,a)

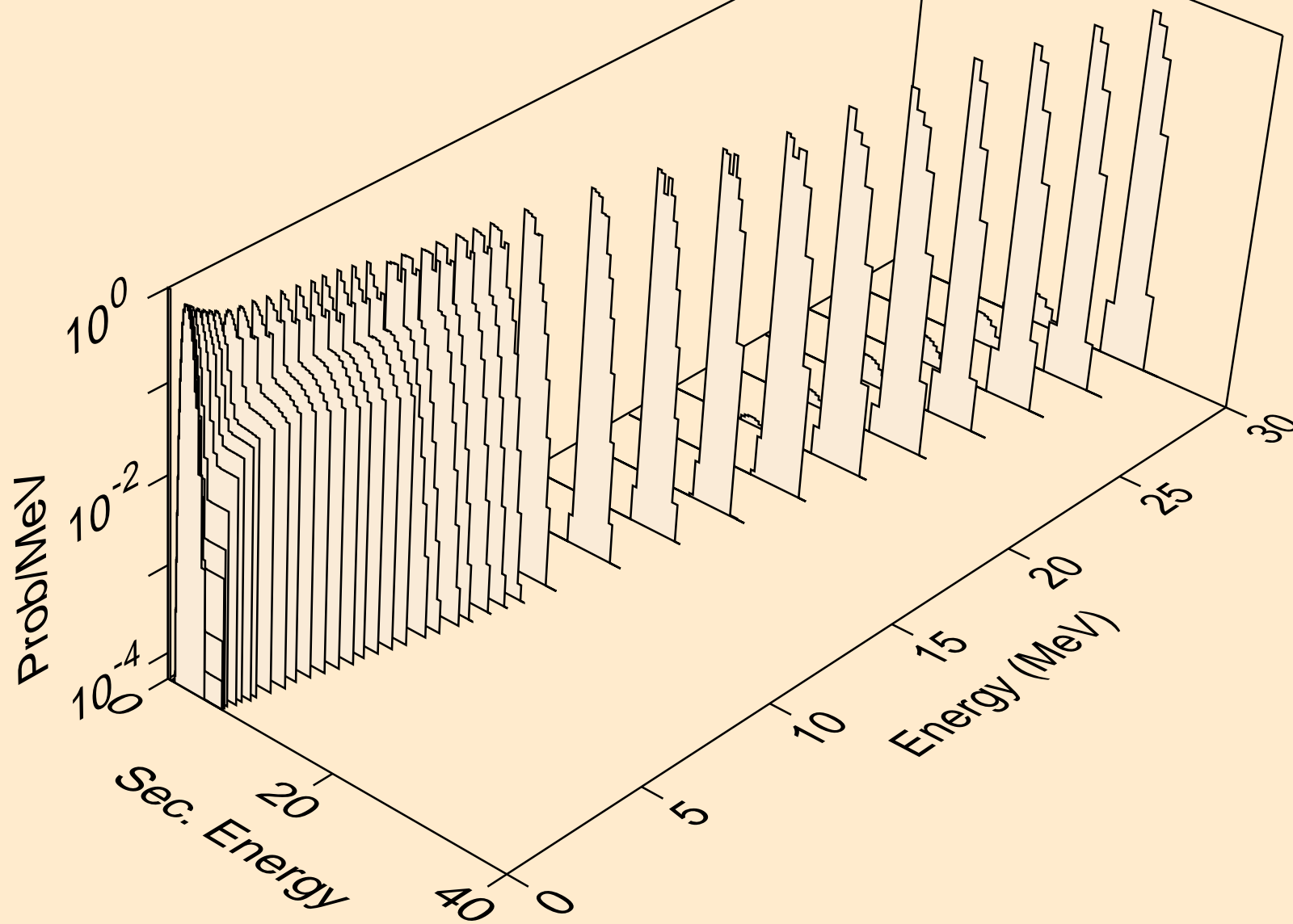

AL024 NEUTRON ACER TENDL-2024 LIBRARY; T=0.K
alphas from (n,2a)

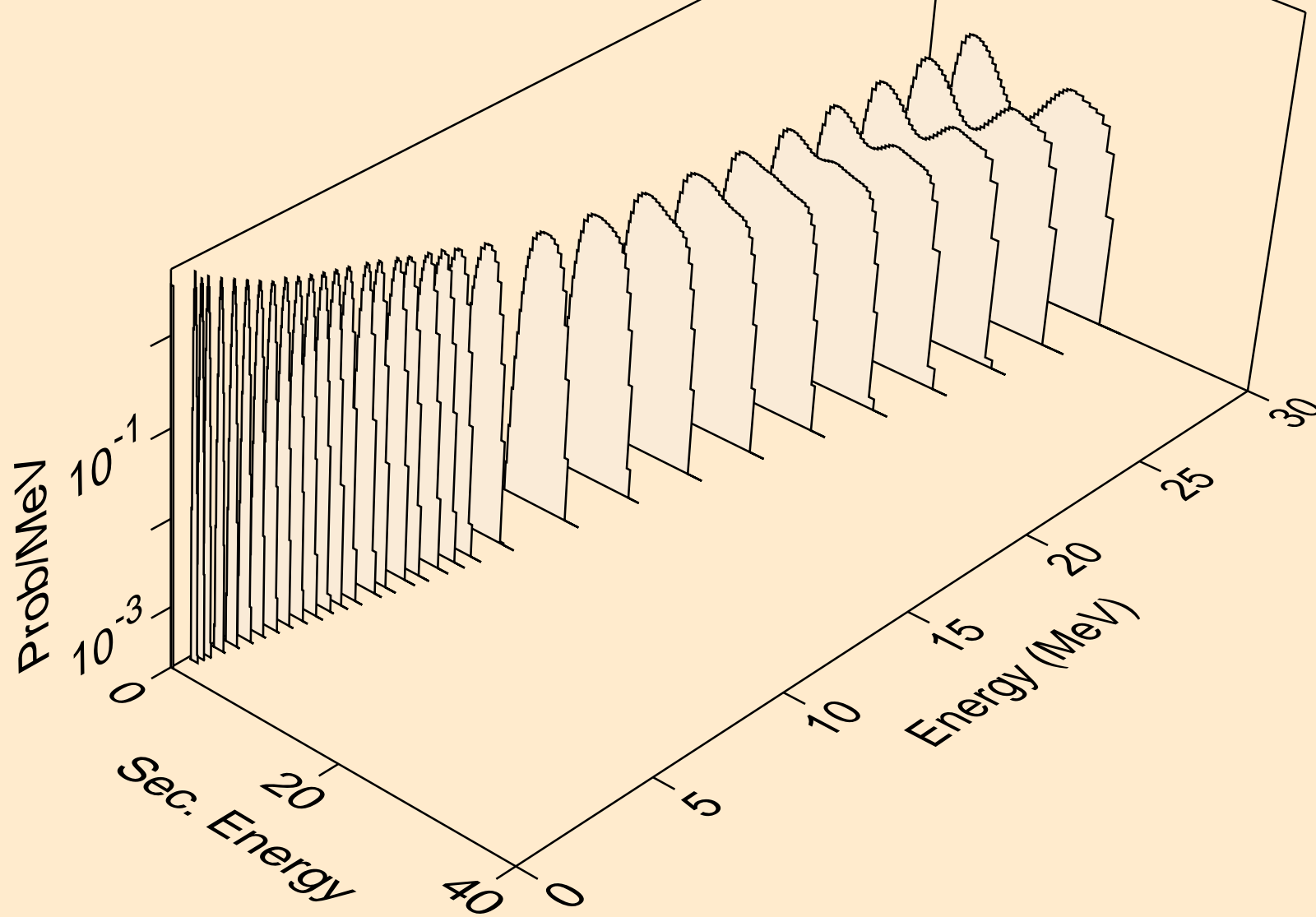

AL024 NEUTRON ACER TENDL-2024 LIBRARY; T=0.K
alphas from (n,3a)

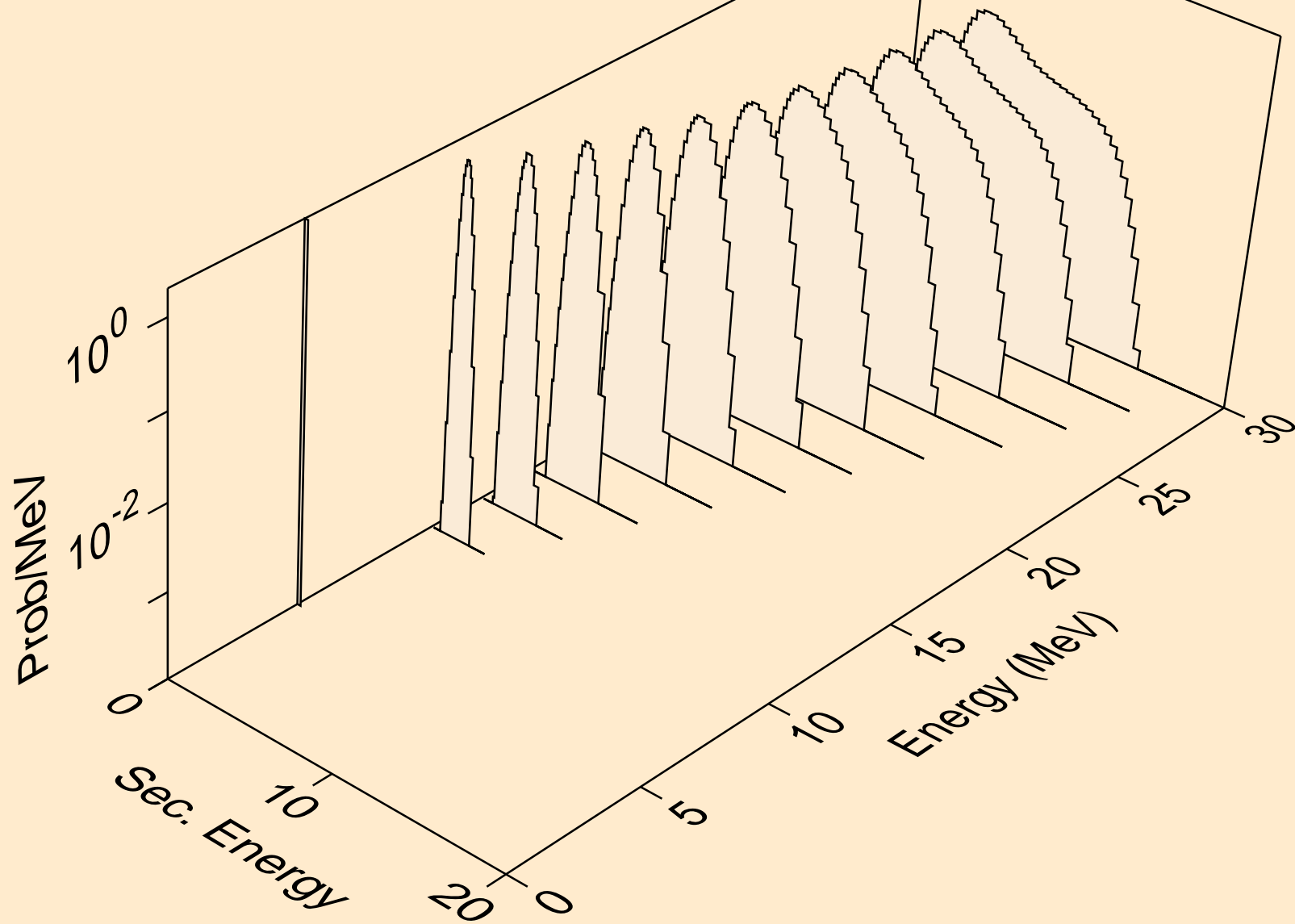

AL024 NEUTRON ACER TENDL-2024 LIBRARY; T=0.K
alphas from (n,pa)

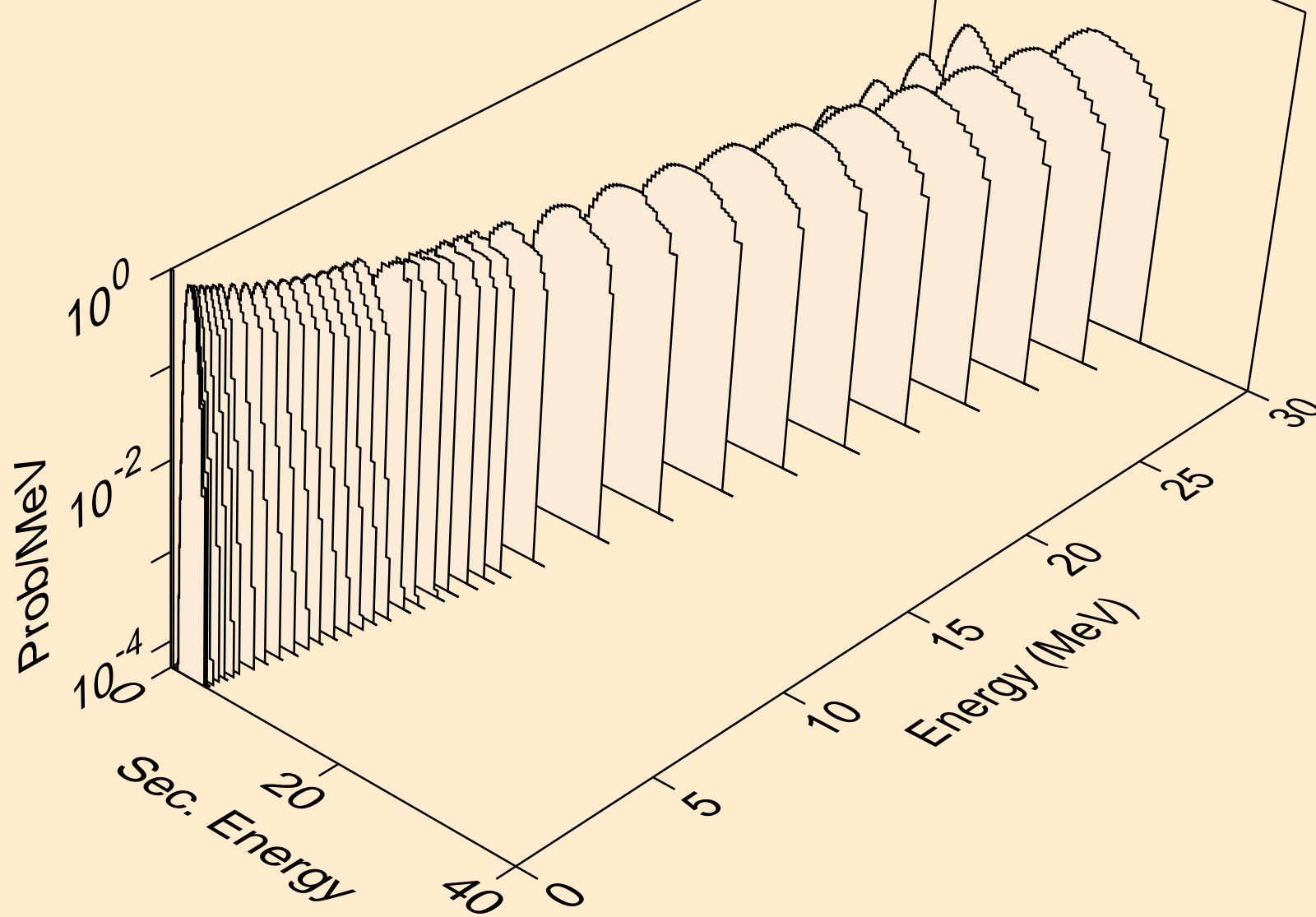

AL024 NEUTRON ACER TENDL-2024 LIBRARY; T=0.K
alphas from (n,t2a)

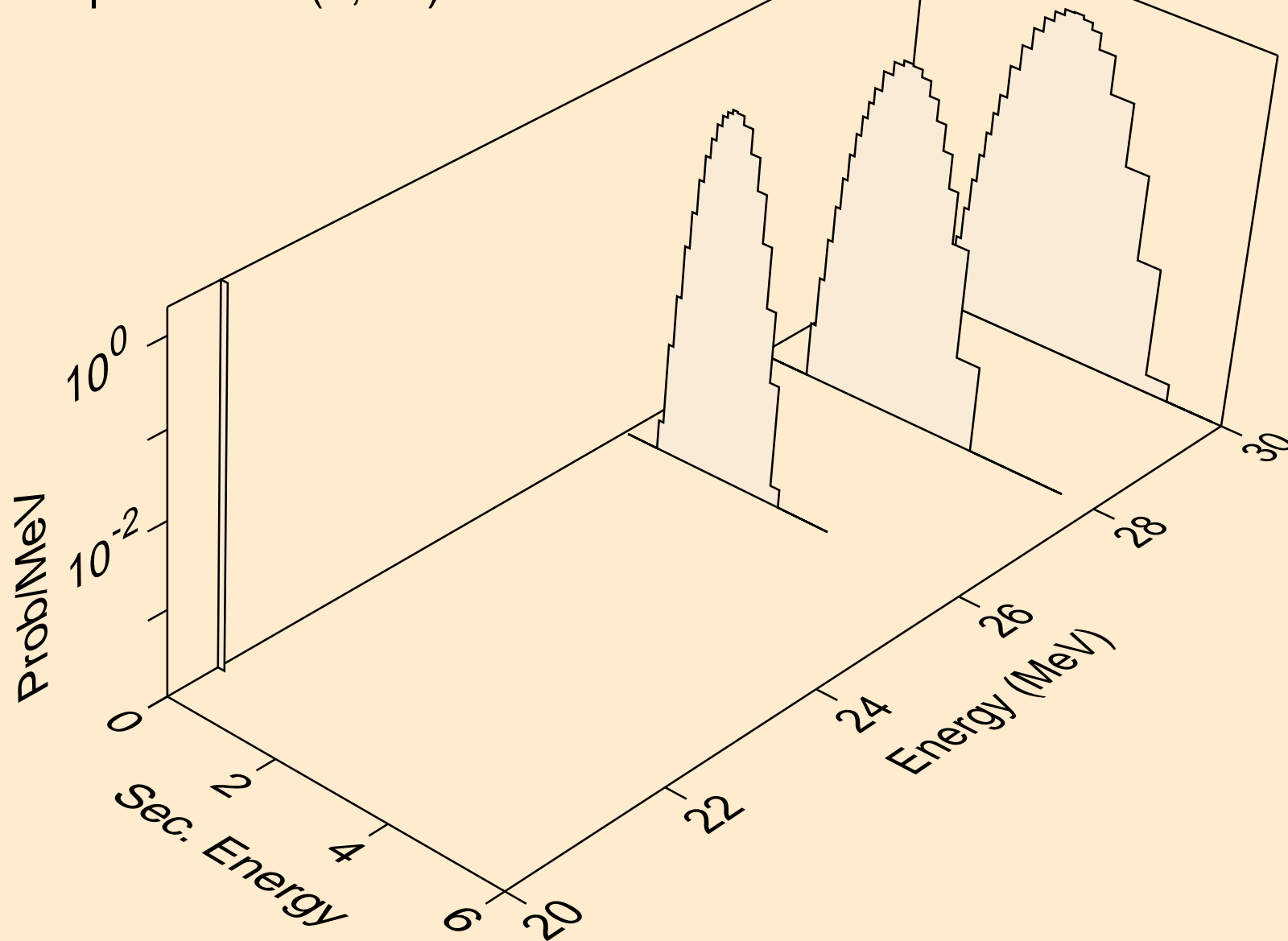

AL024 NEUTRON ACER TENDL-2024 LIBRARY; T=0.K
alphas from (n,d2a)

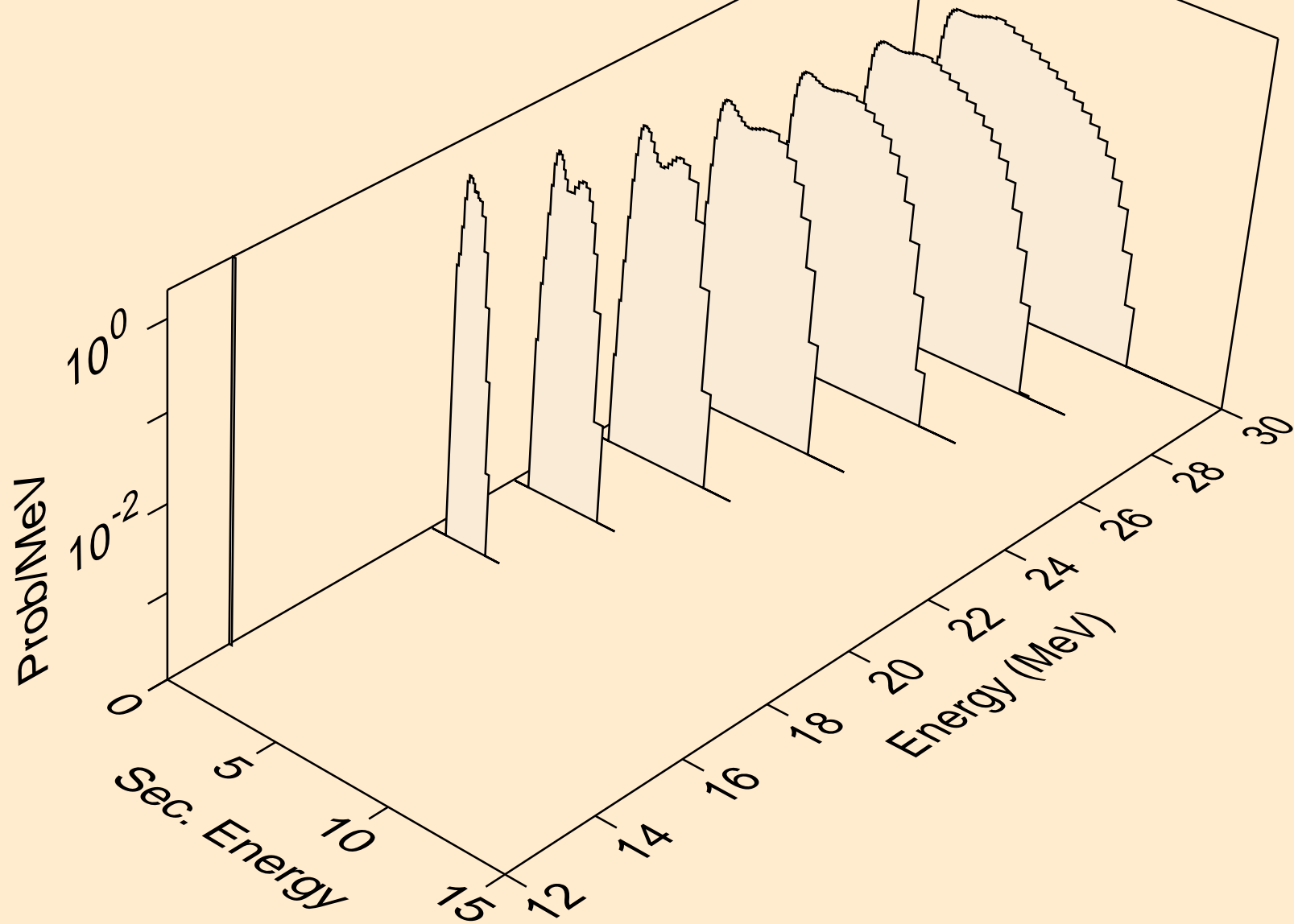

AL024 NEUTRON ACER TENDL-2024 LIBRARY; T=0.K
alphas from (n,da)

