

# AR044 NEUTRON ACER TENDL-2024 LIBRARY; T=0.K

## Principal cross sections

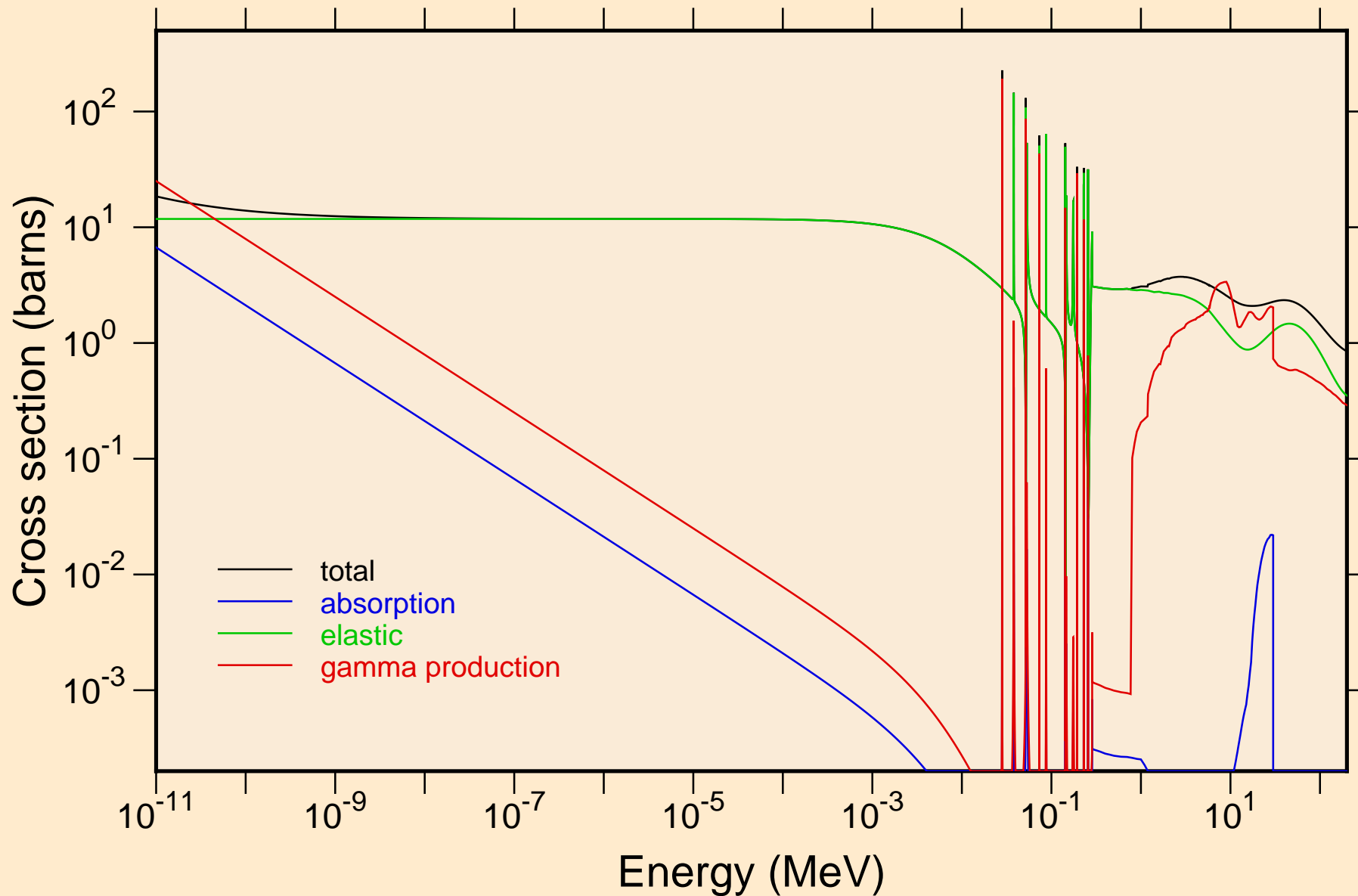

AR044 NEUTRON ACER TENDL-2024 LIBRARY; T=0.K  
resonance total cross section

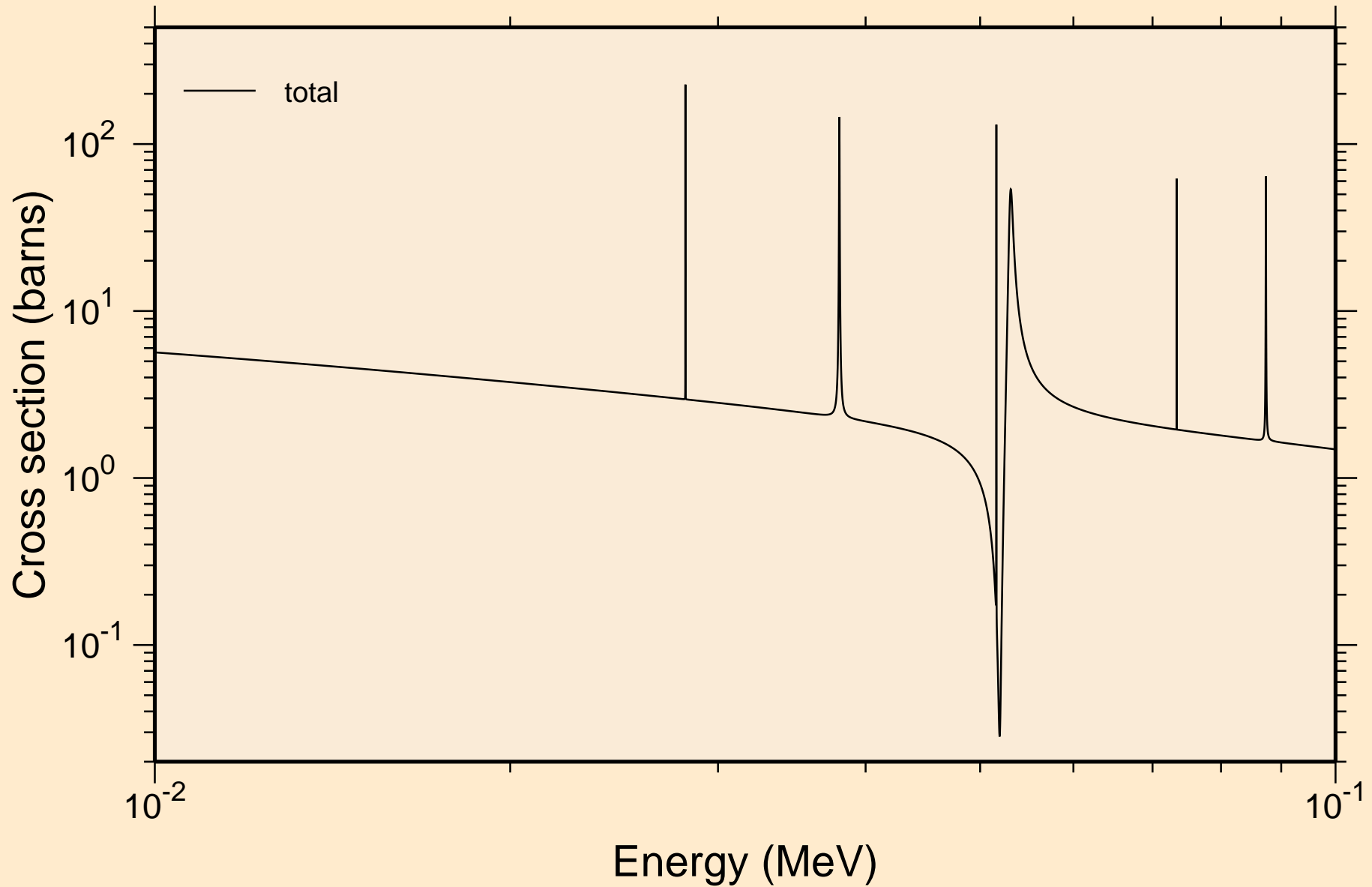

AR044 NEUTRON ACER TENDL-2024 LIBRARY; T=0.K  
resonance total cross section

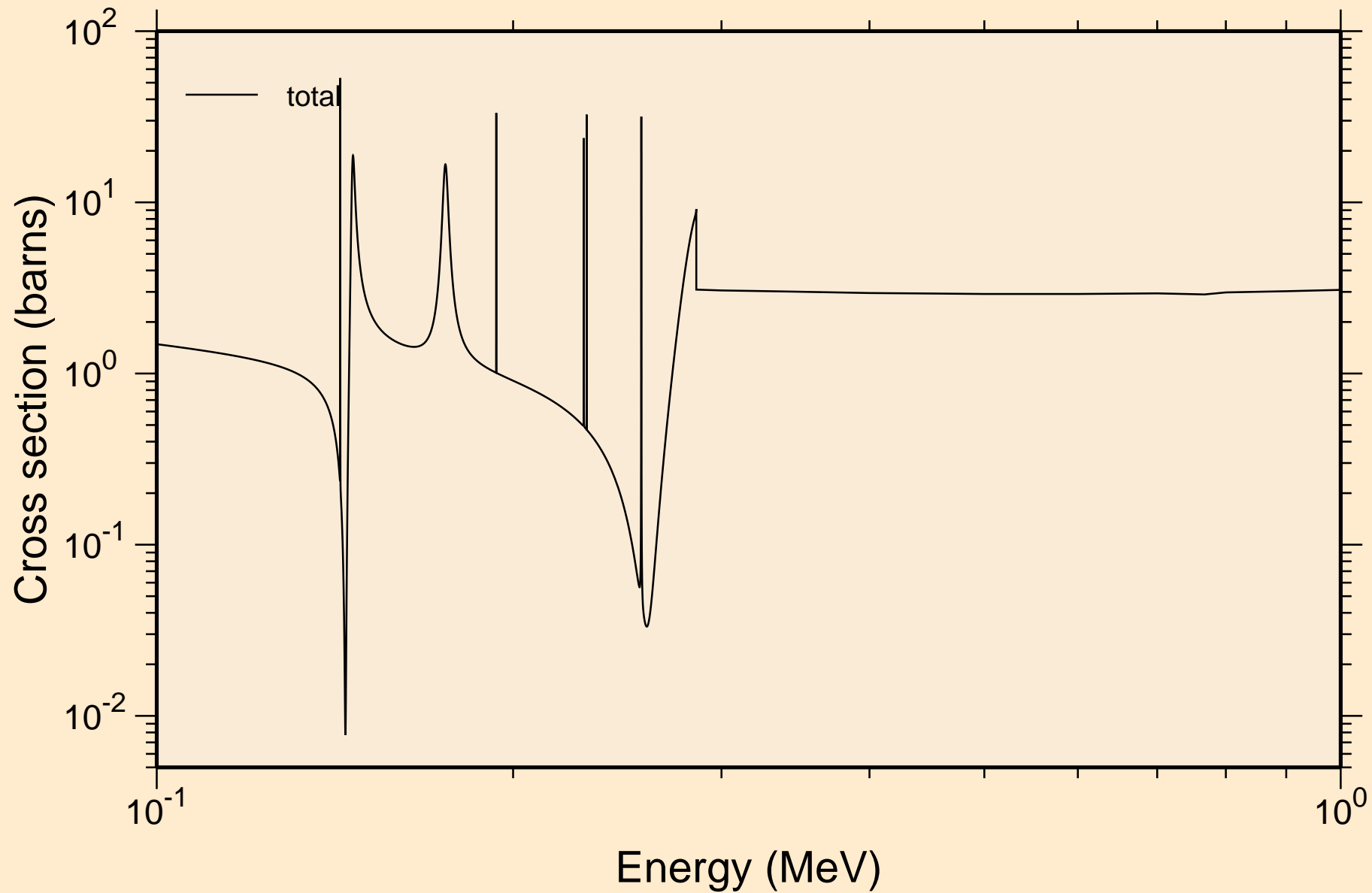

AR044 NEUTRON ACER TENDL-2024 LIBRARY; T=0.K  
resonance total cross section

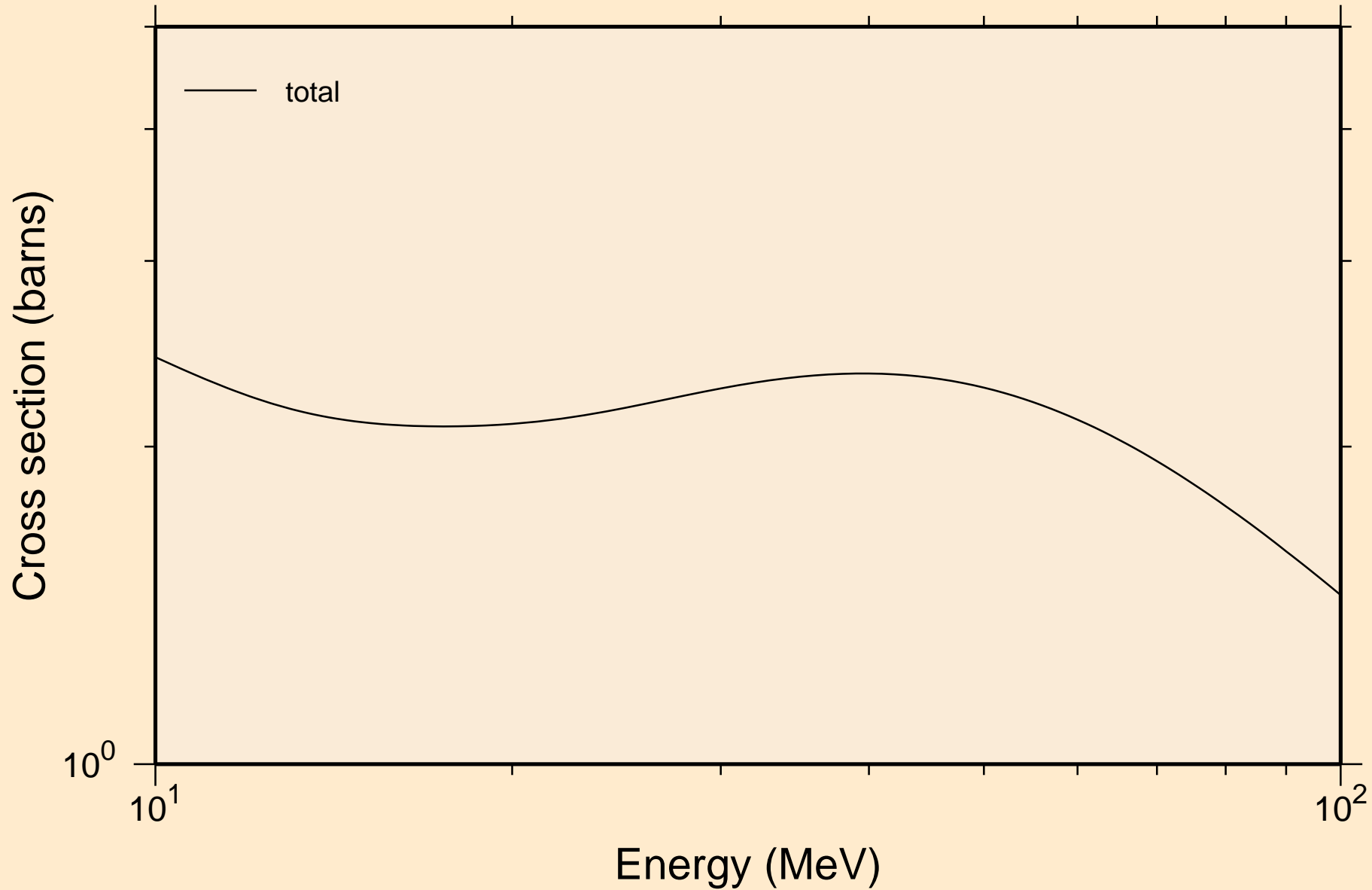

AR044 NEUTRON ACER TENDL-2024 LIBRARY; T=0.K  
resonance absorption cross sections

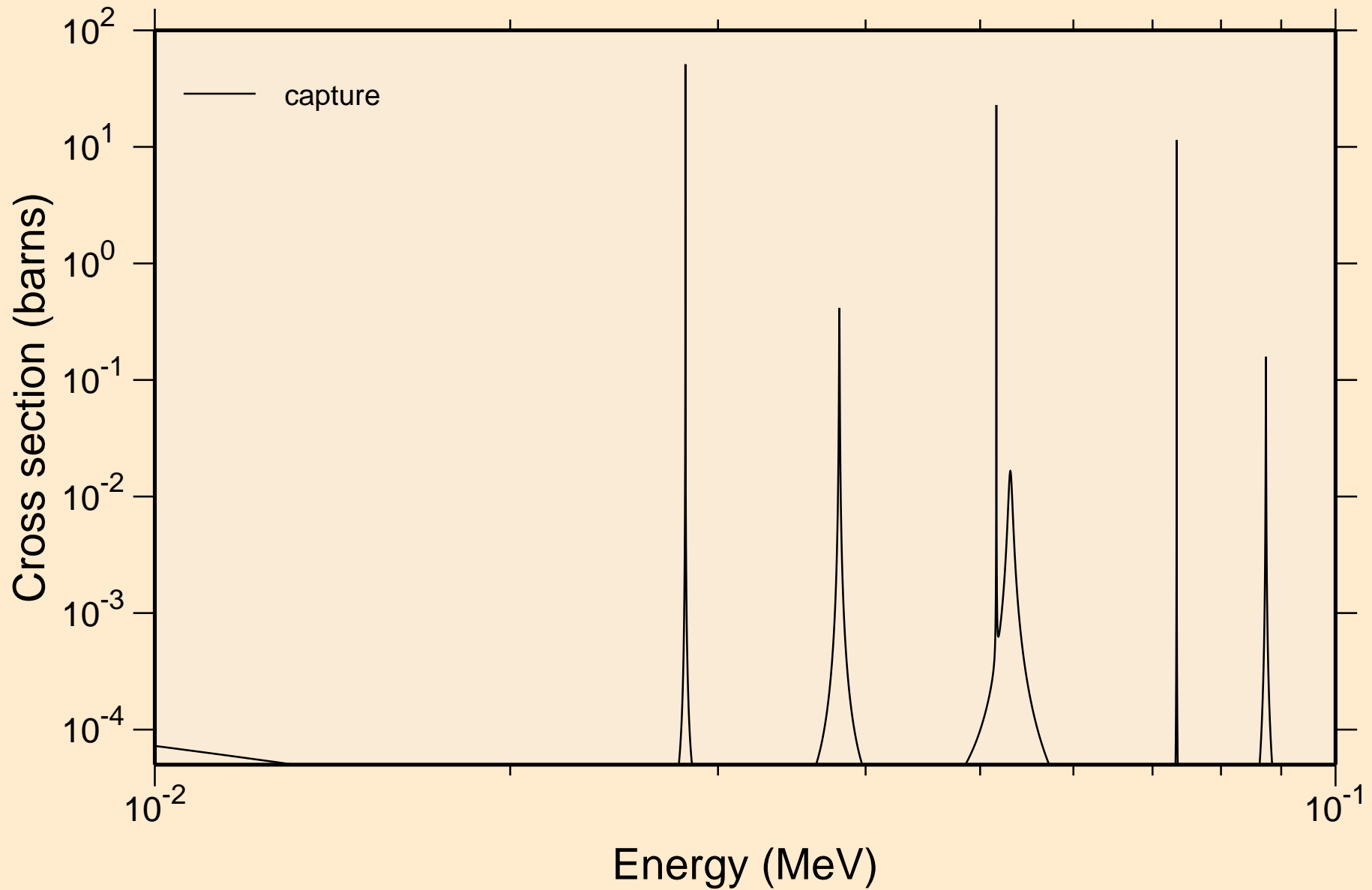

AR044 NEUTRON ACER TENDL-2024 LIBRARY; T=0.K  
resonance absorption cross sections

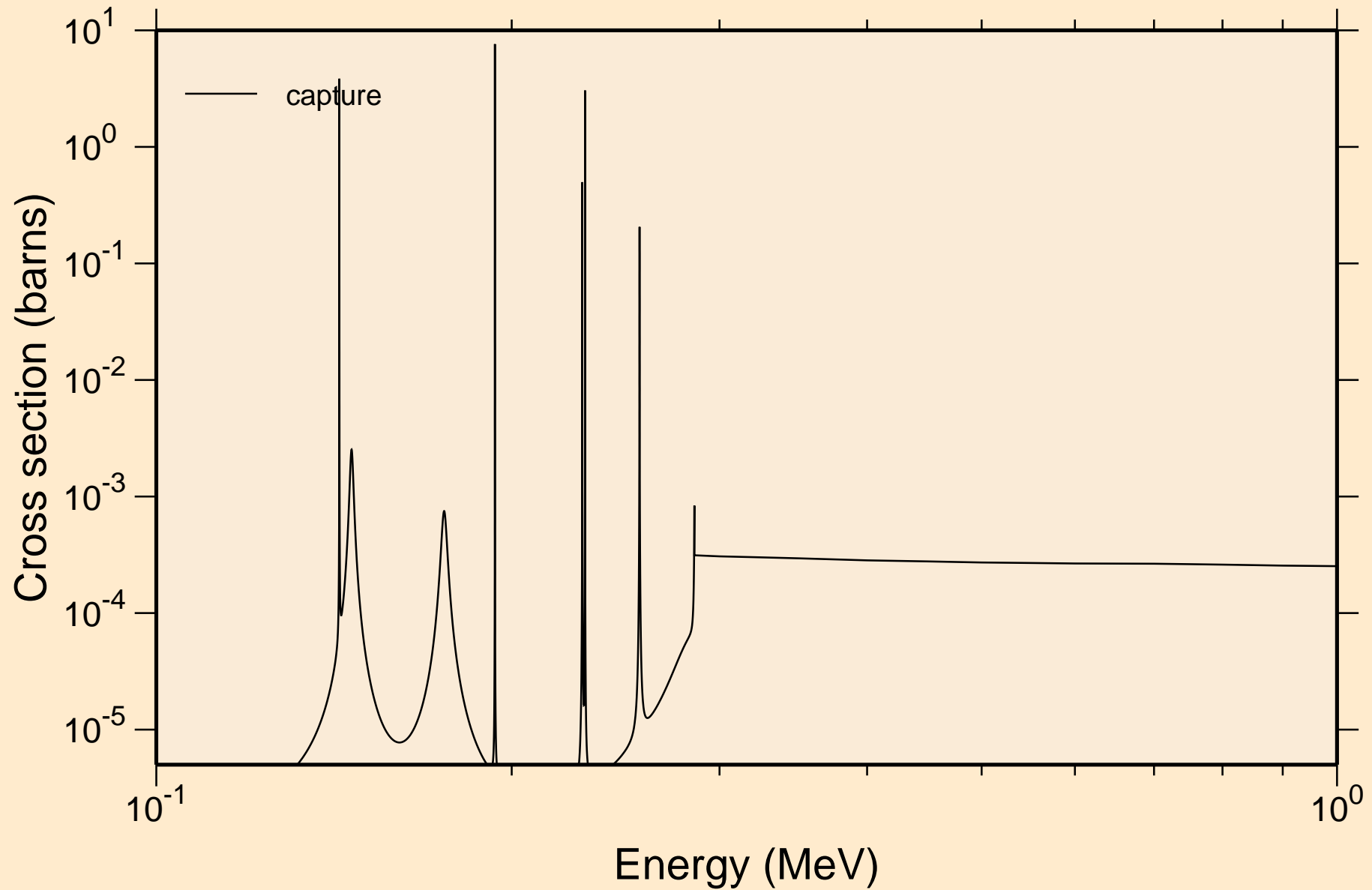

AR044 NEUTRON ACER TENDL-2024 LIBRARY; T=0.K  
resonance absorption cross sections

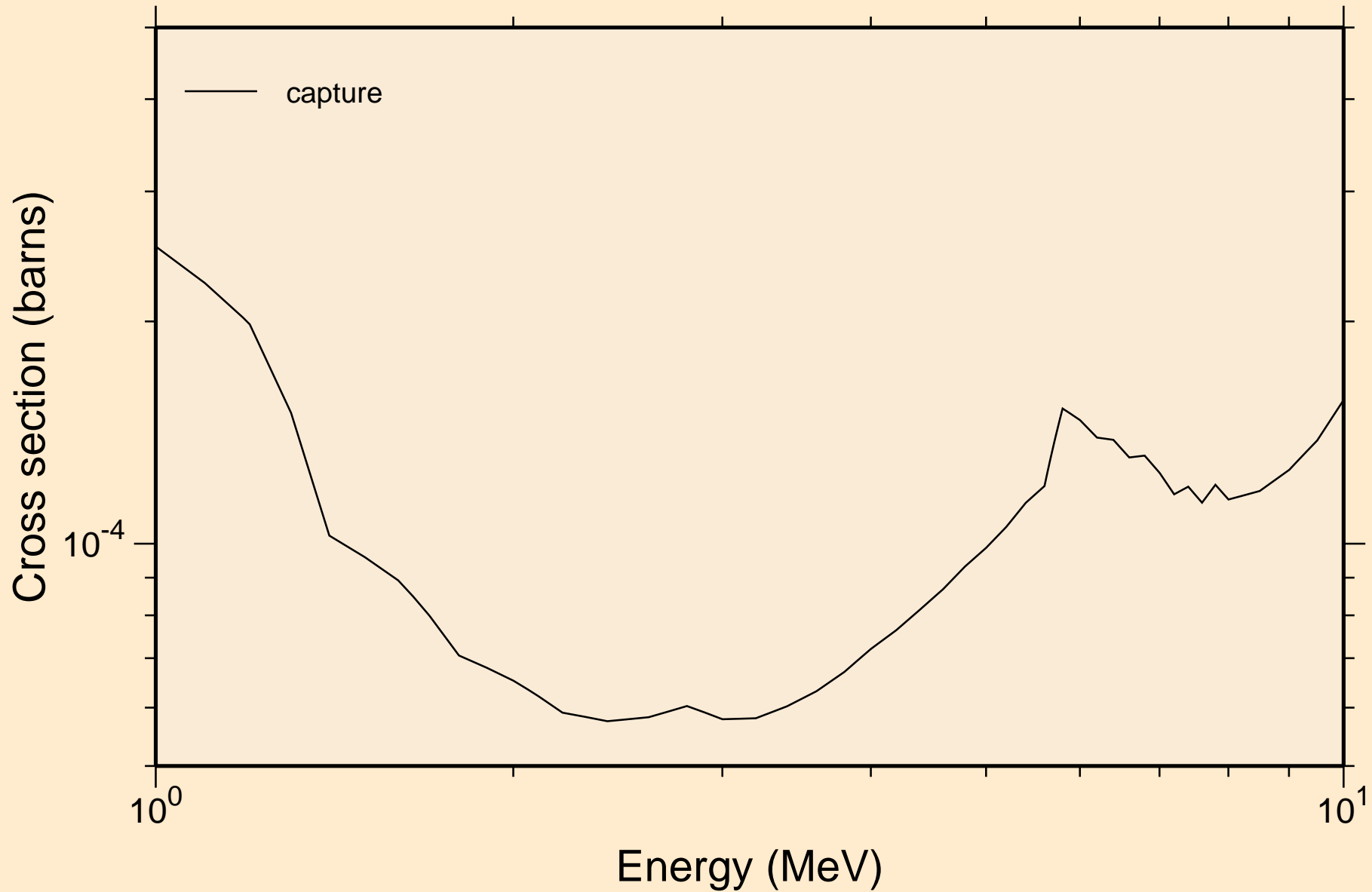

AR044 NEUTRON ACER TENDL-2024 LIBRARY; T=0.K  
Heating

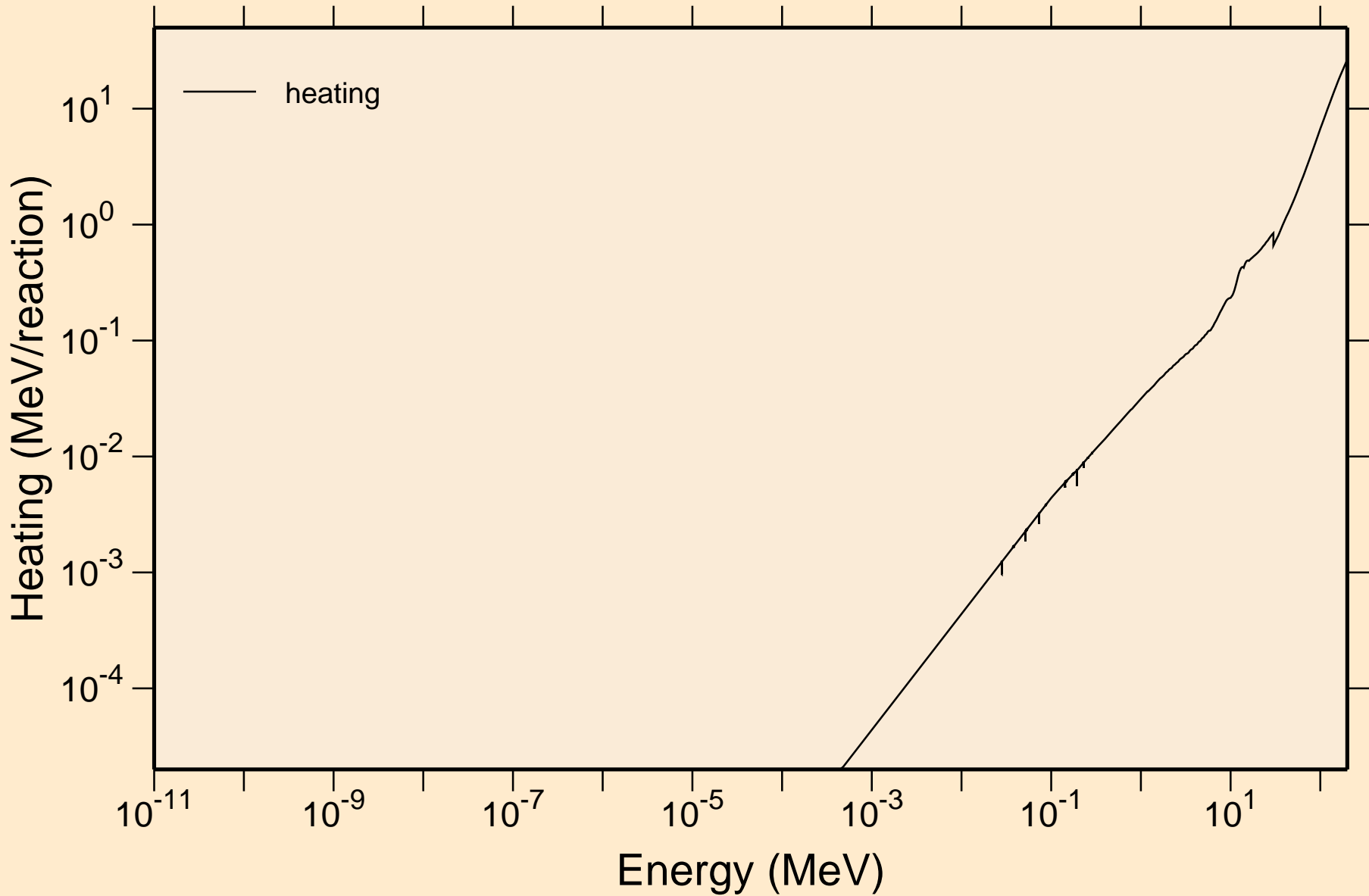

AR044 NEUTRON ACER TENDL-2024 LIBRARY; T=0.K  
Damage

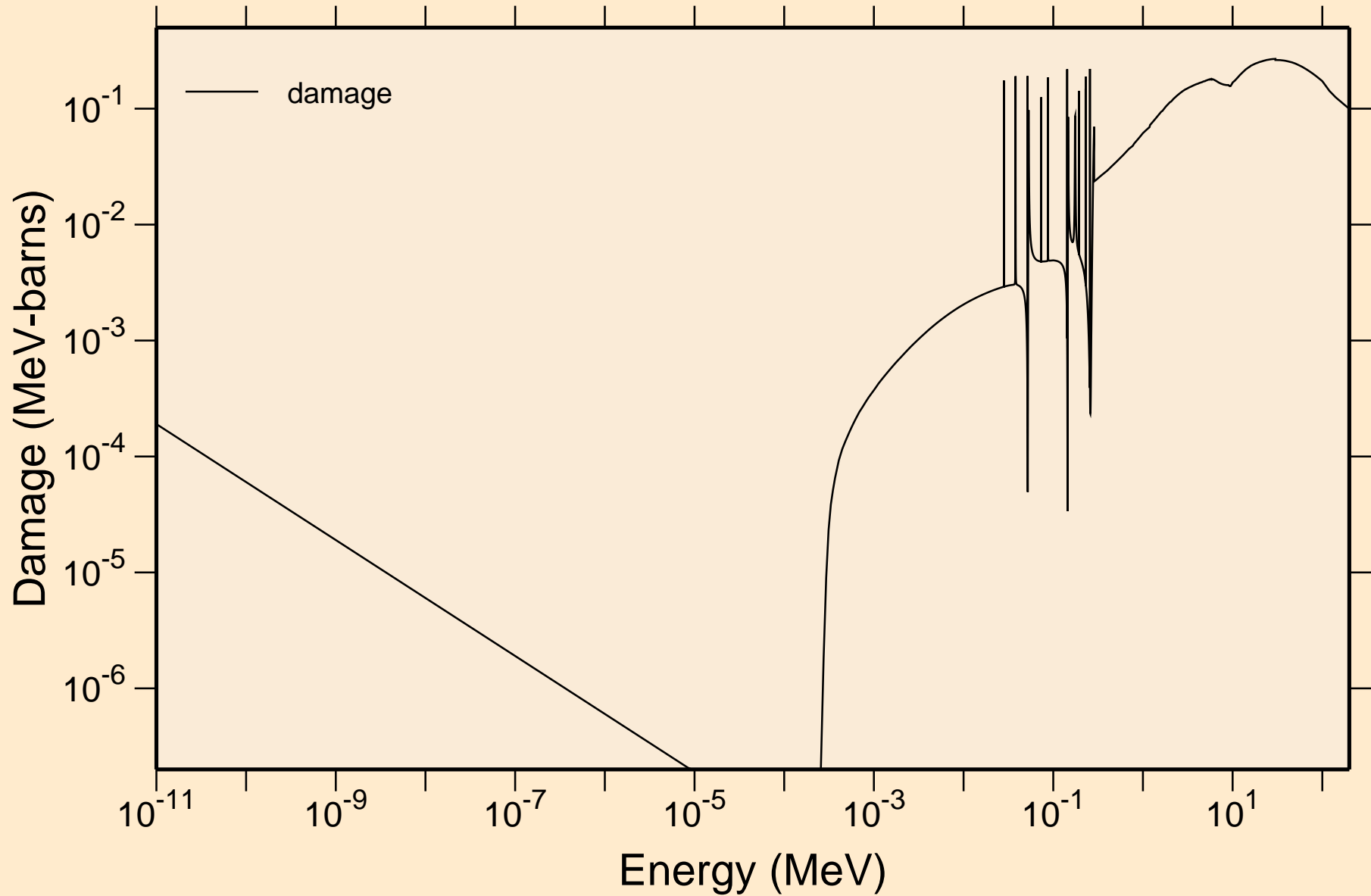

AR044 NEUTRON ACER TENDL-2024 LIBRARY; T=0.K  
Non-threshold reactions

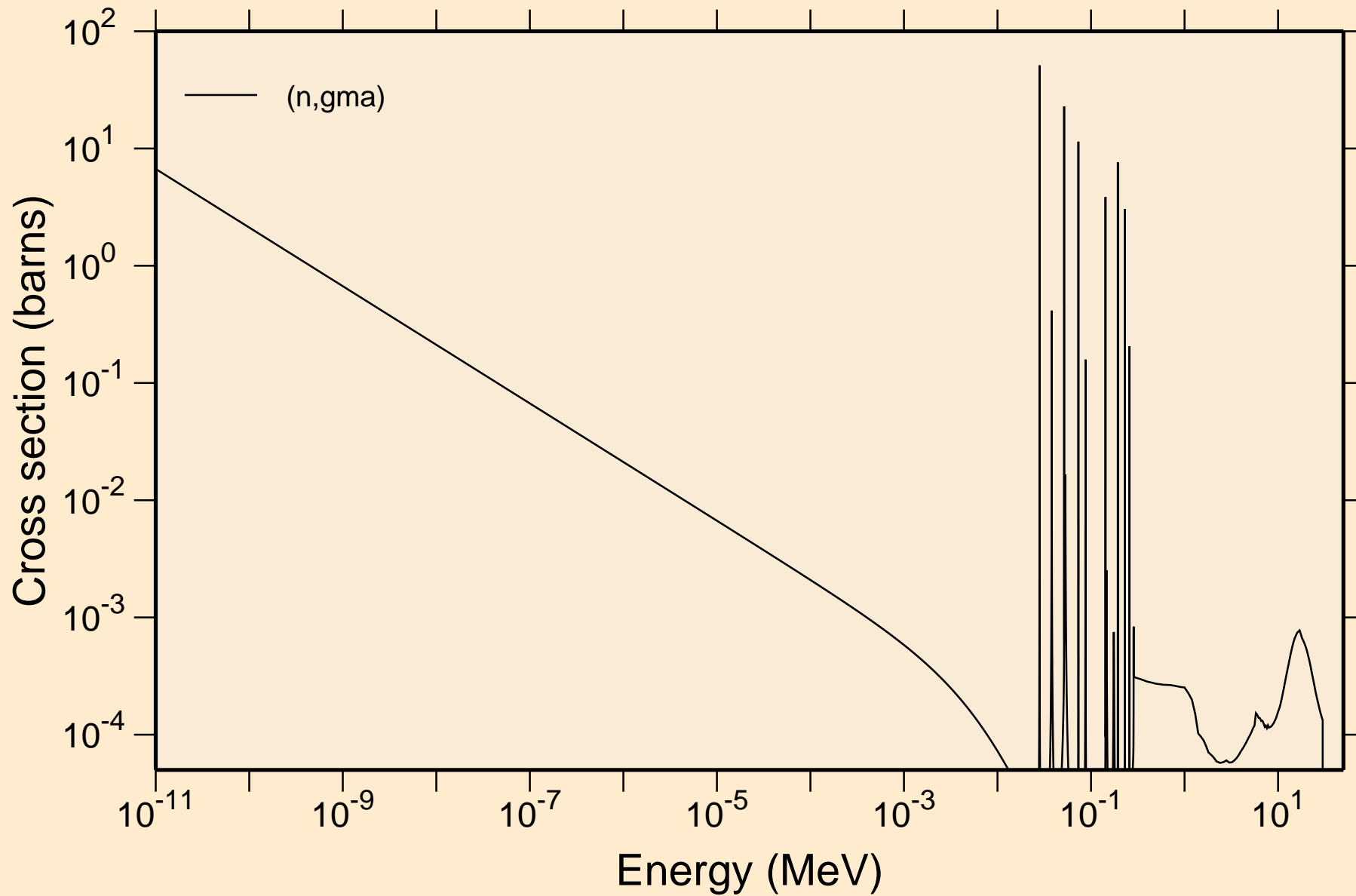

# AR044 NEUTRON ACER TENDL-2024 LIBRARY; T=0.K

## Principal cross sections

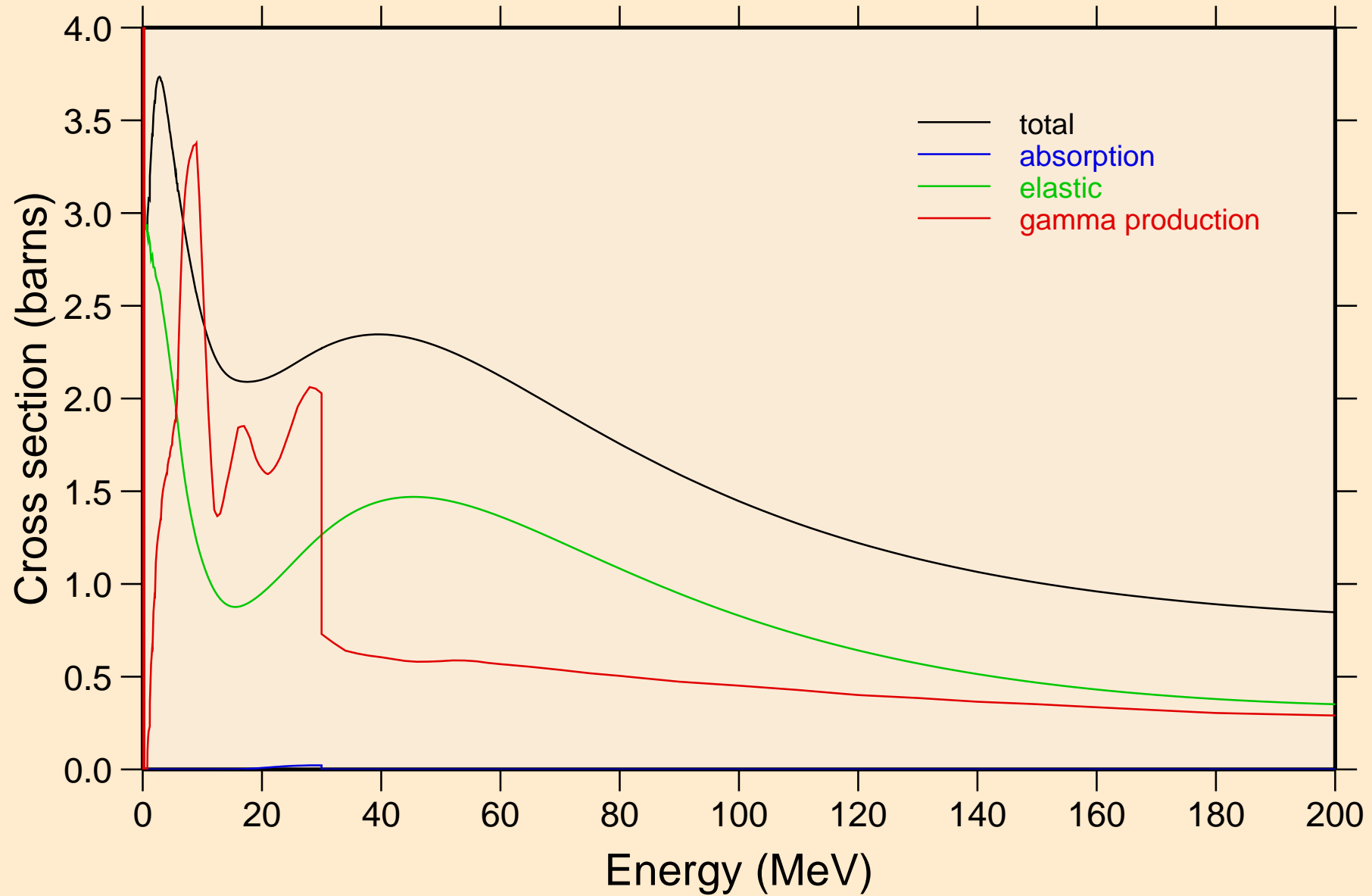

# AR044 NEUTRON ACER TENDL-2024 LIBRARY; T=0.K

## Heating

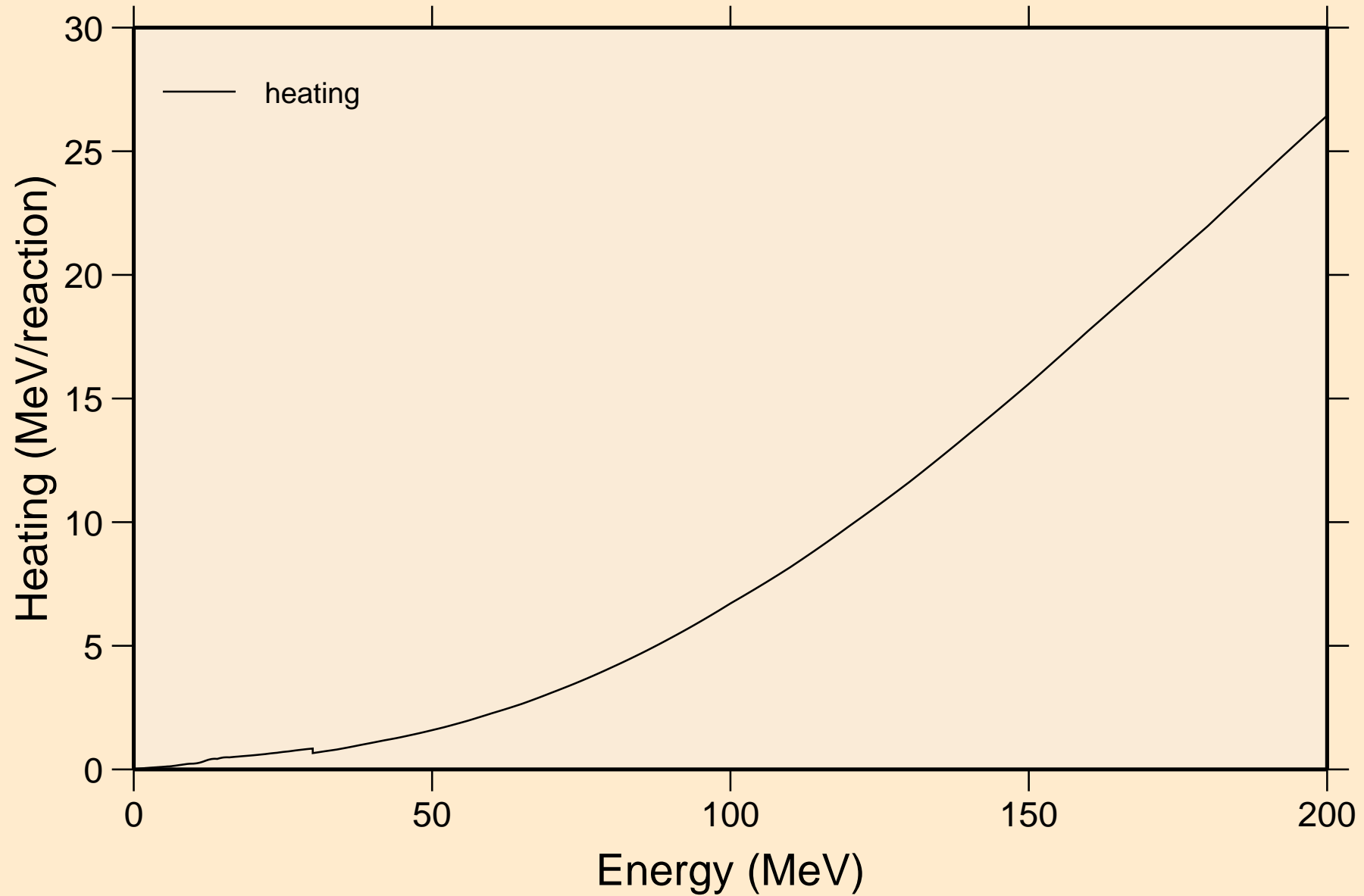

# AR044 NEUTRON ACER TENDL-2024 LIBRARY; T=0.K

## Damage

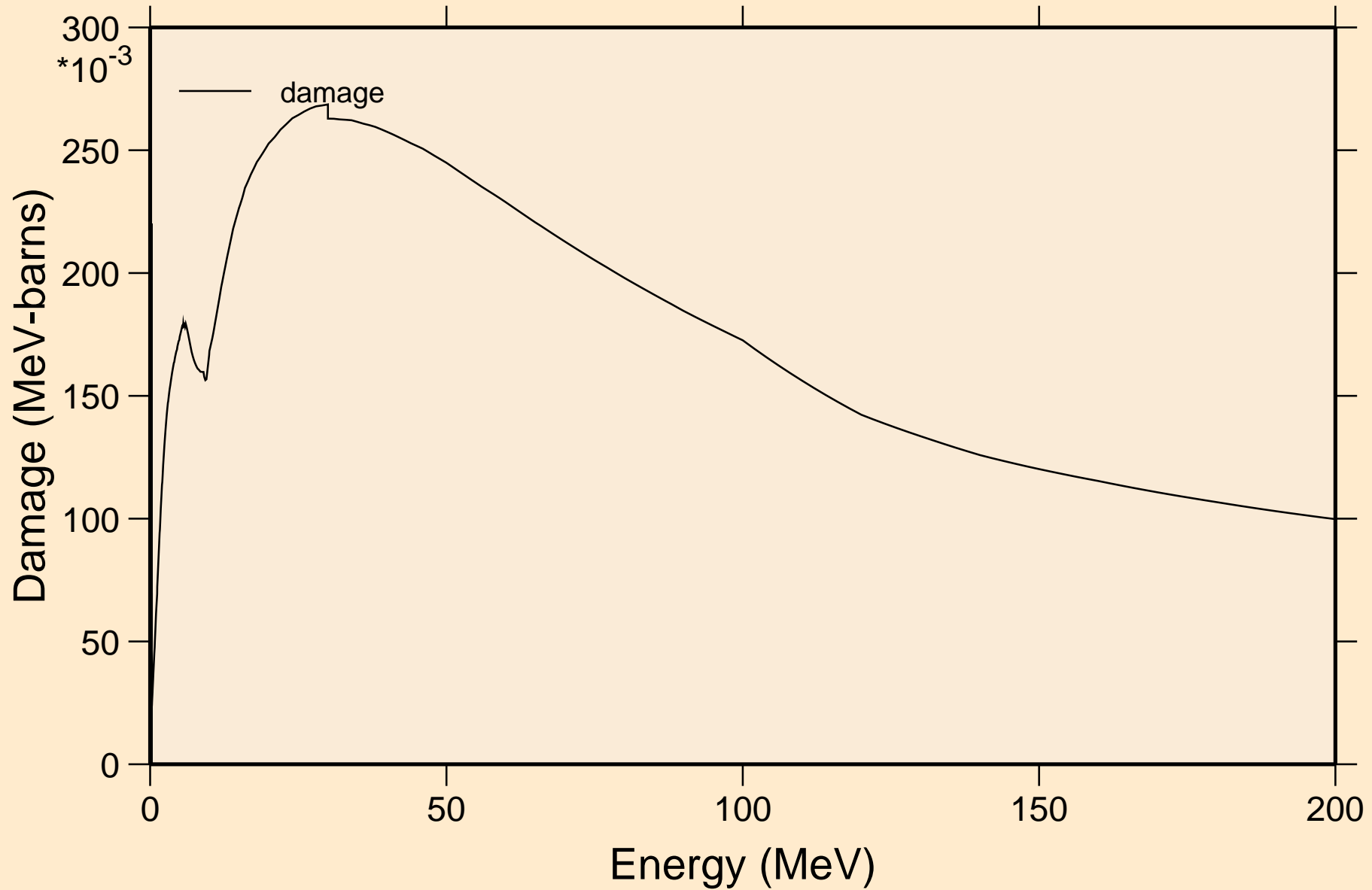

AR044 NEUTRON ACER TENDL-2024 LIBRARY; T=0.K  
Non-threshold reactions

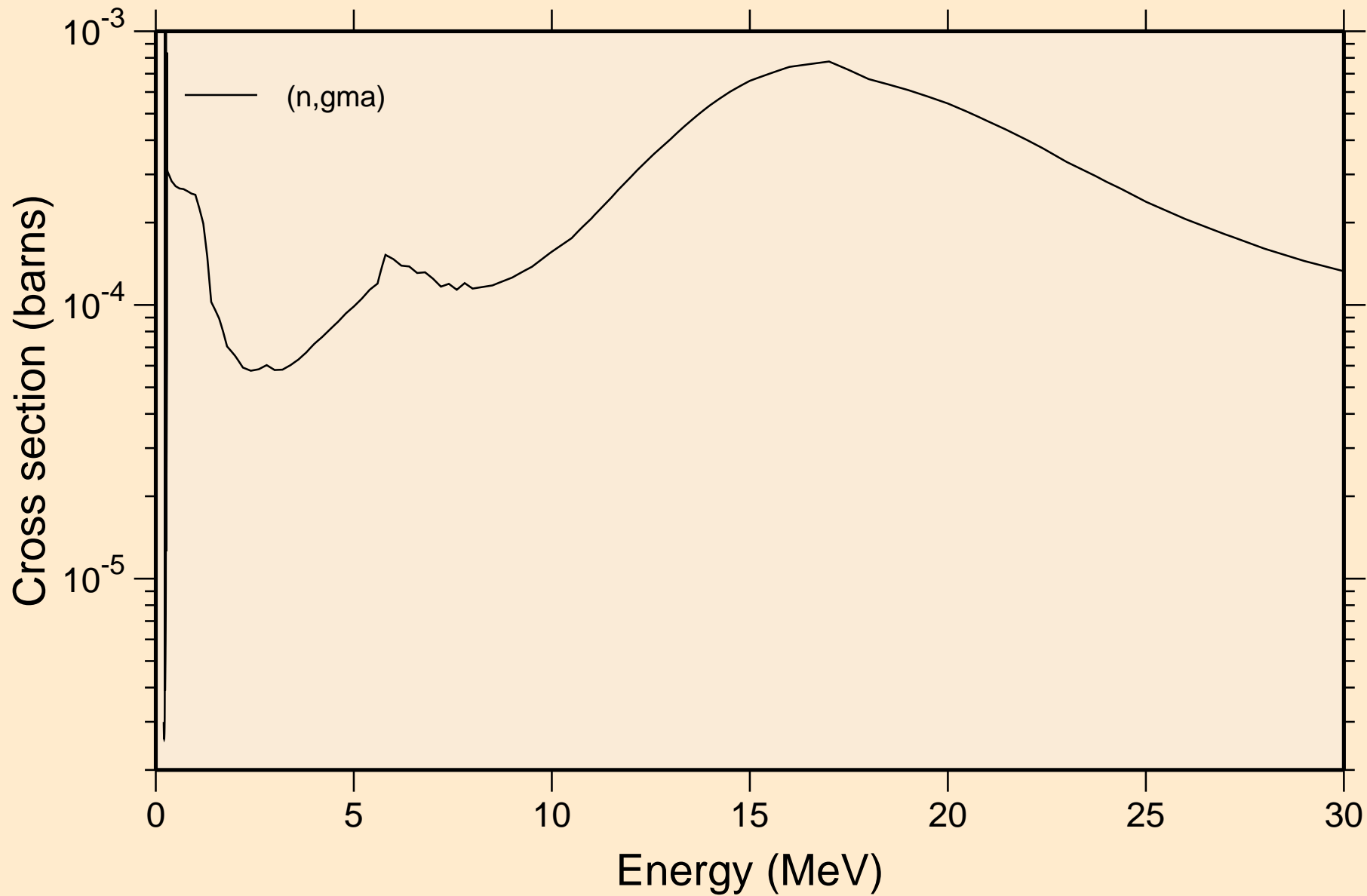

AR044 NEUTRON ACER TENDL-2024 LIBRARY; T=0.K  
Inelastic levels

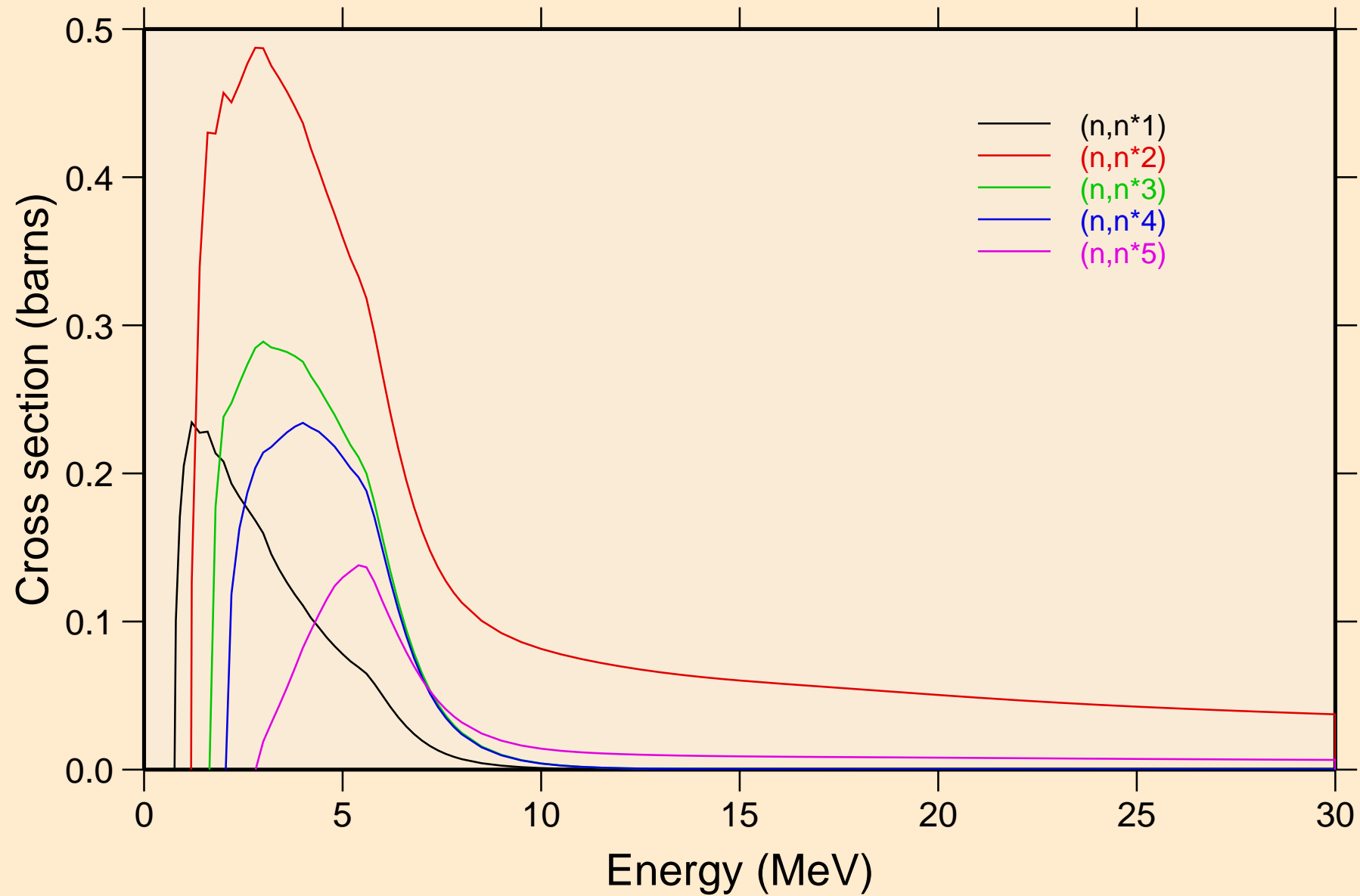

AR044 NEUTRON ACER TENDL-2024 LIBRARY; T=0.K  
Inelastic levels

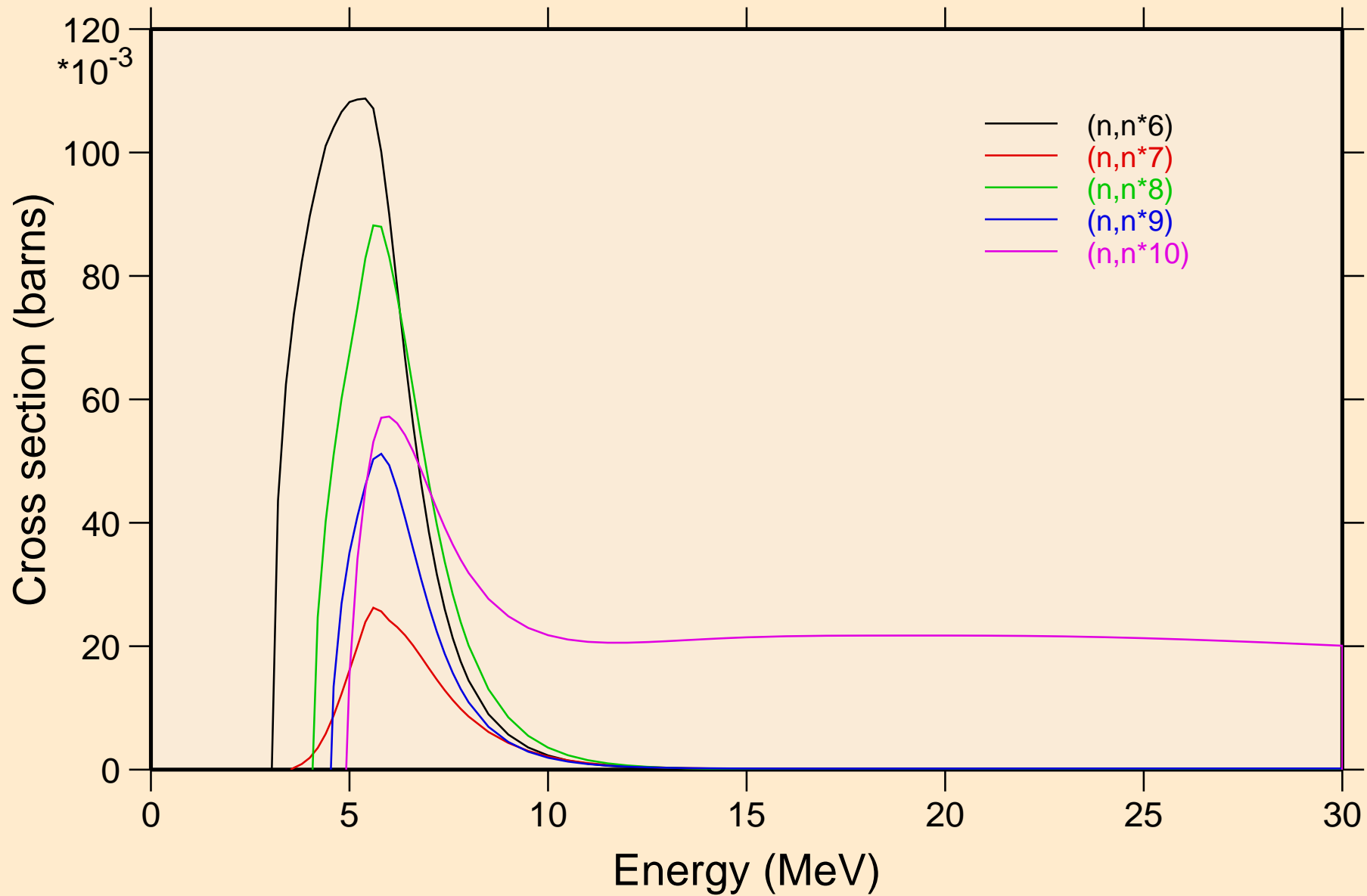

AR044 NEUTRON ACER TENDL-2024 LIBRARY; T=0.K  
Inelastic levels

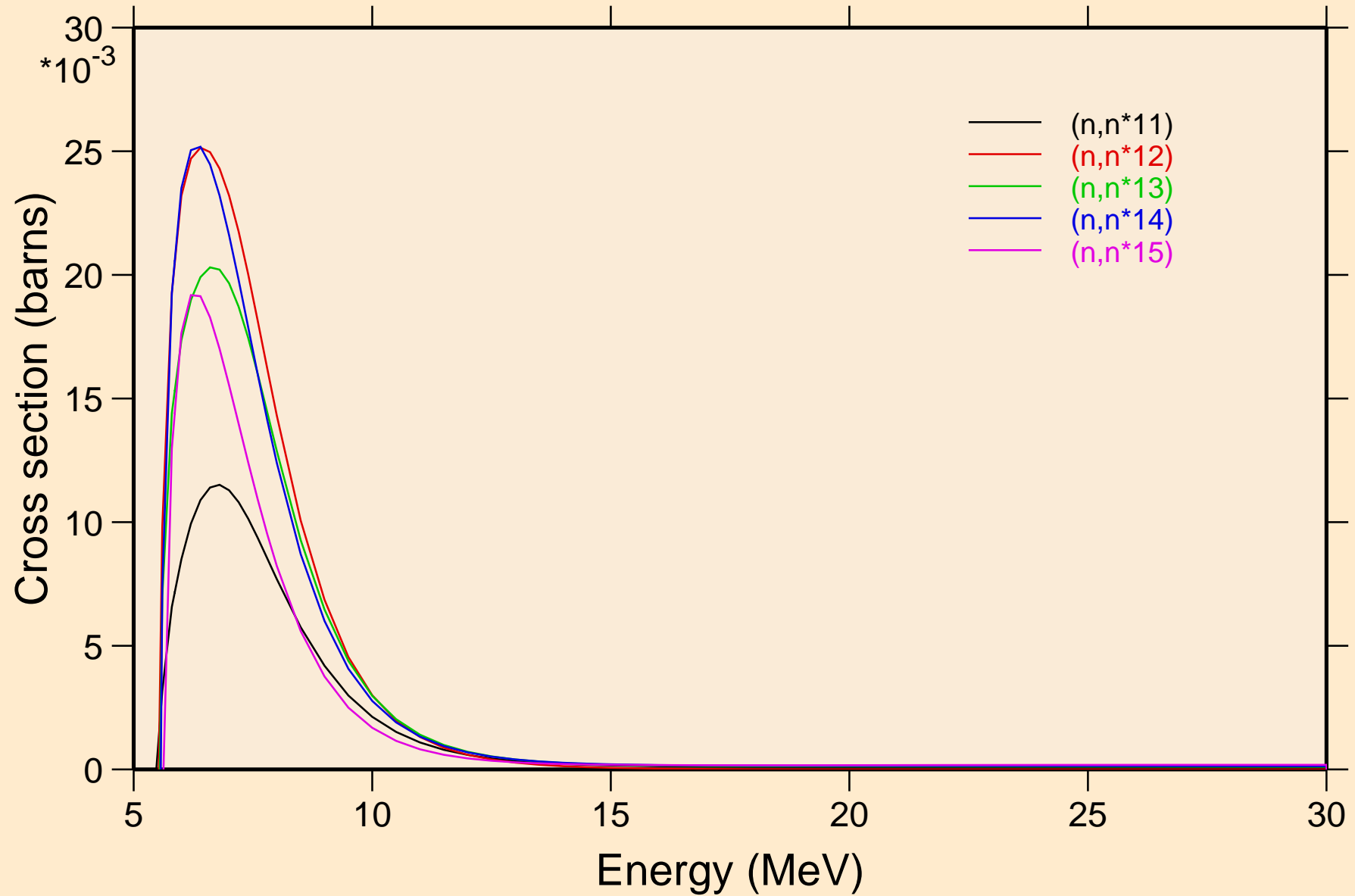

AR044 NEUTRON ACER TENDL-2024 LIBRARY; T=0.K  
Inelastic levels

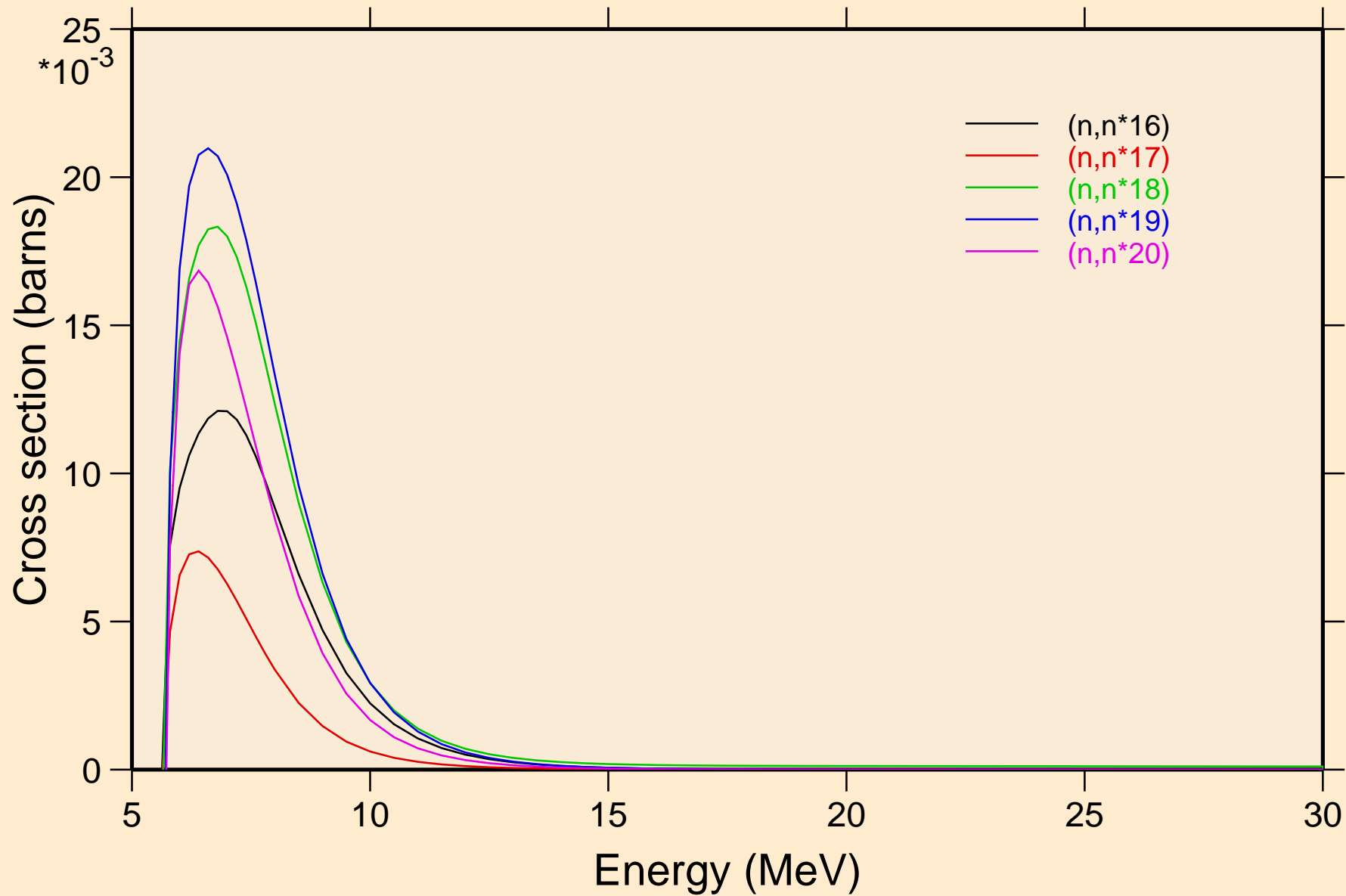

AR044 NEUTRON ACER TENDL-2024 LIBRARY; T=0.K  
Inelastic levels

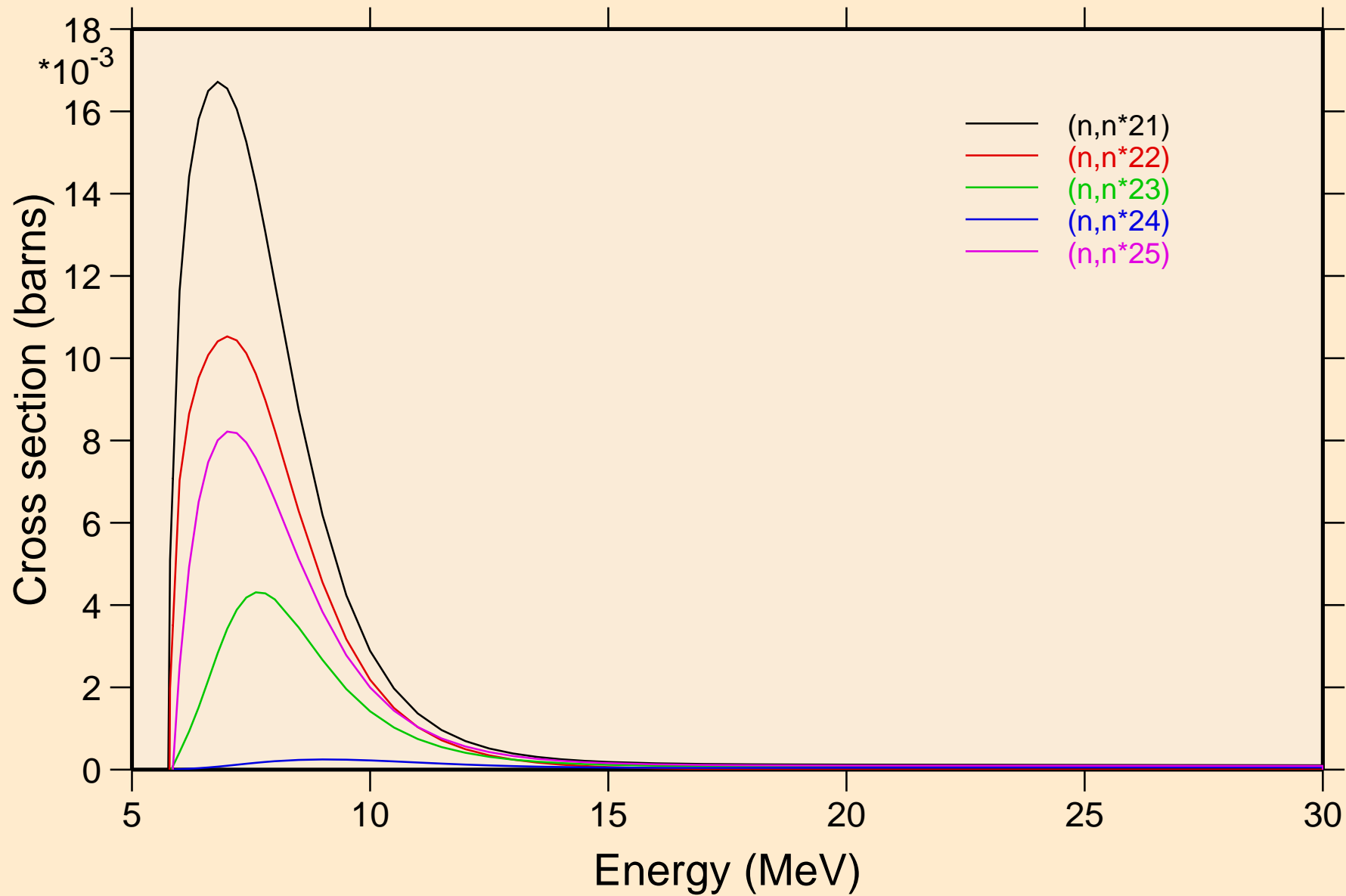

AR044 NEUTRON ACER TENDL-2024 LIBRARY; T=0.K  
Inelastic levels

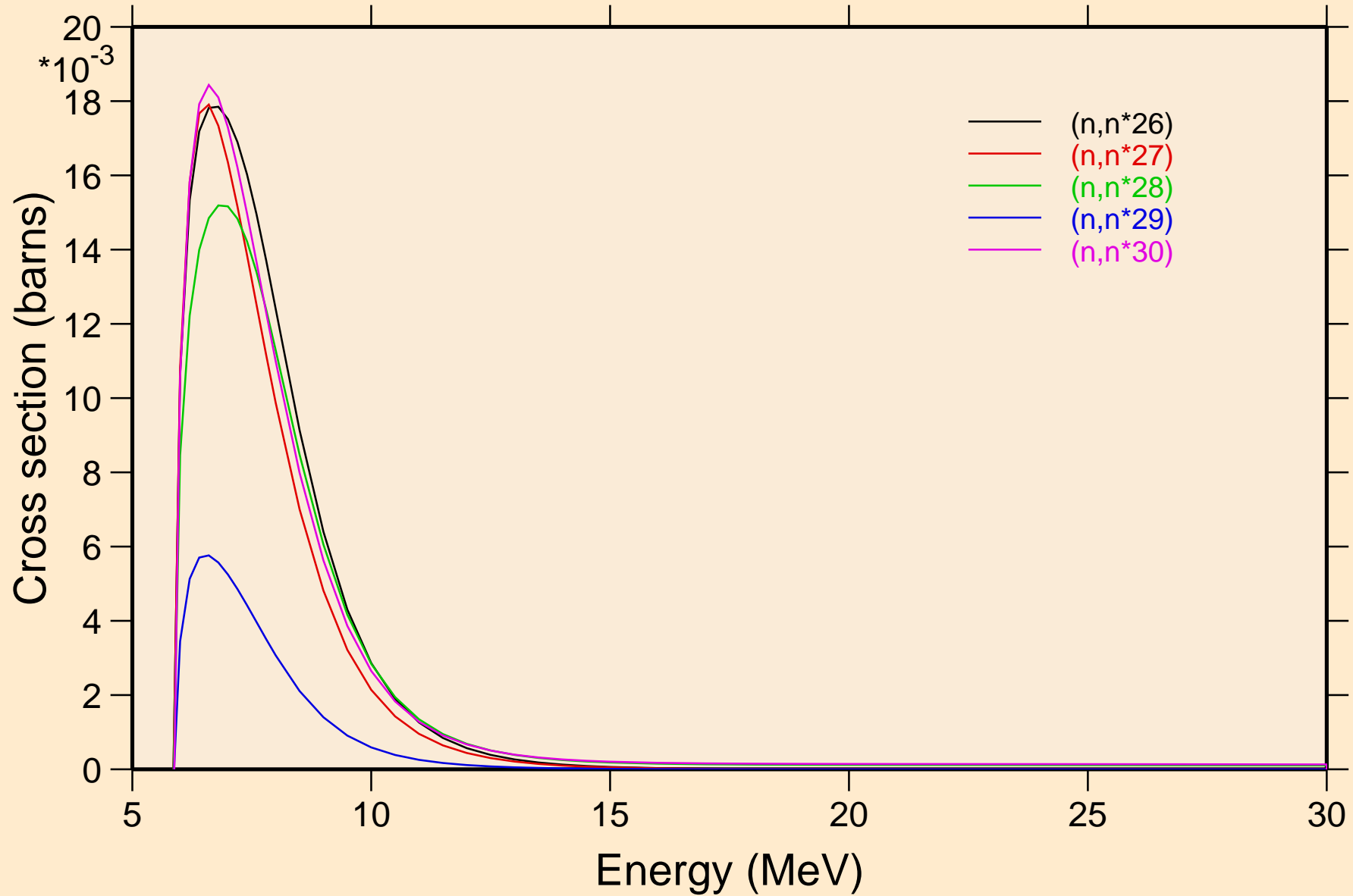

# AR044 NEUTRON ACER TENDL-2024 LIBRARY; T=0.K

## Threshold reactions

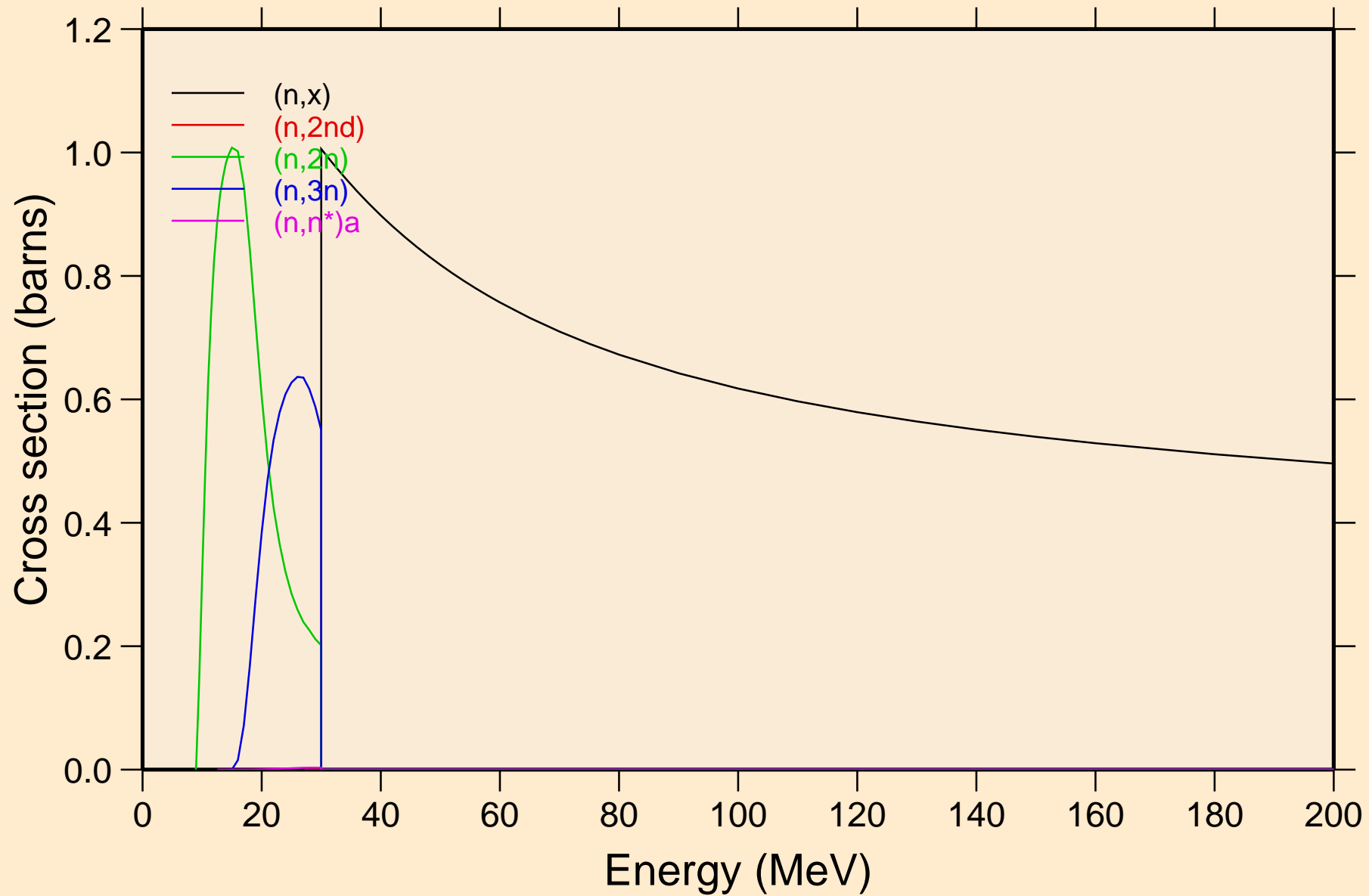

AR044 NEUTRON ACER TENDL-2024 LIBRARY; T=0.K  
Threshold reactions

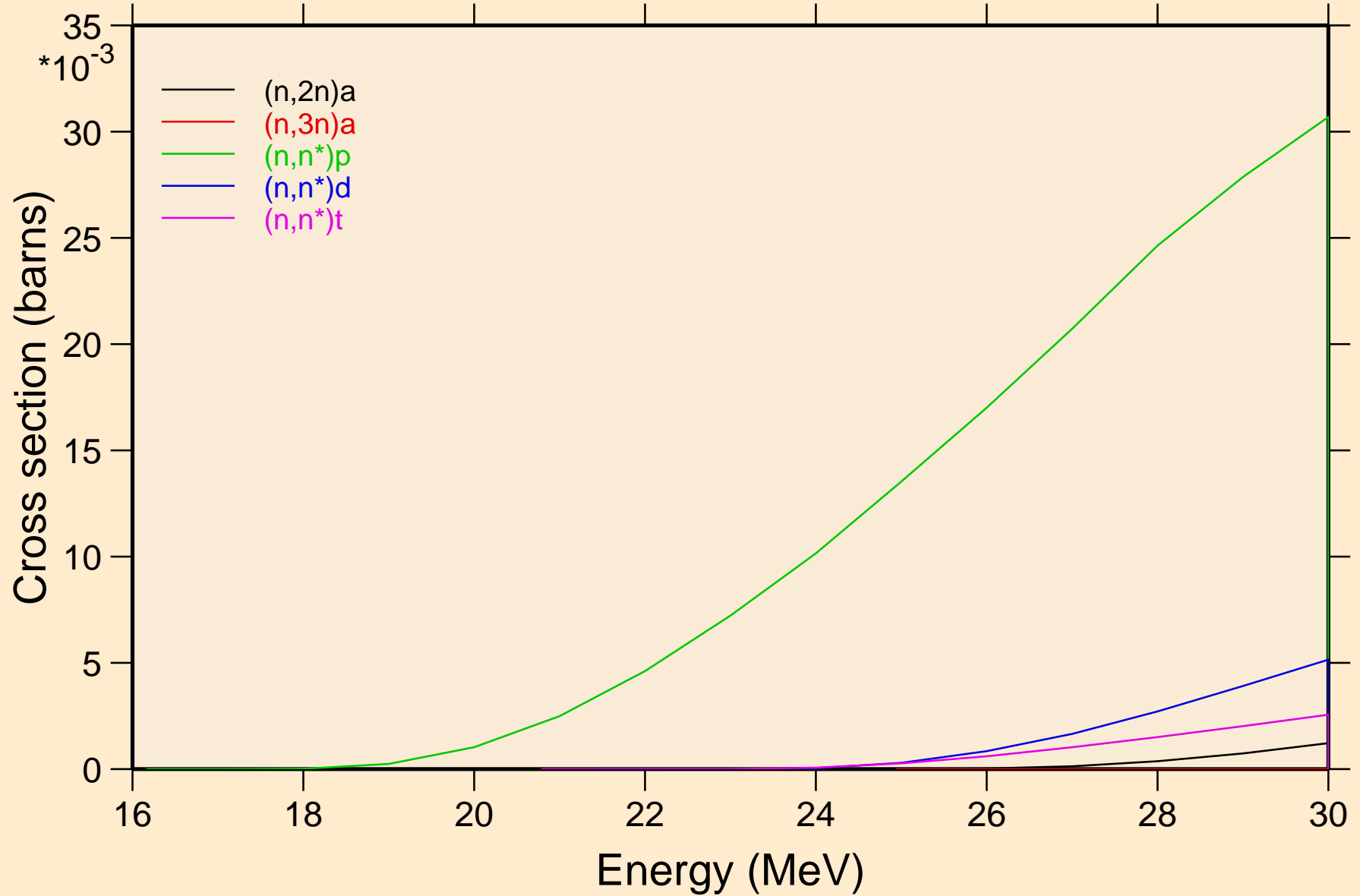

AR044 NEUTRON ACER TENDL-2024 LIBRARY; T=0.K  
Threshold reactions

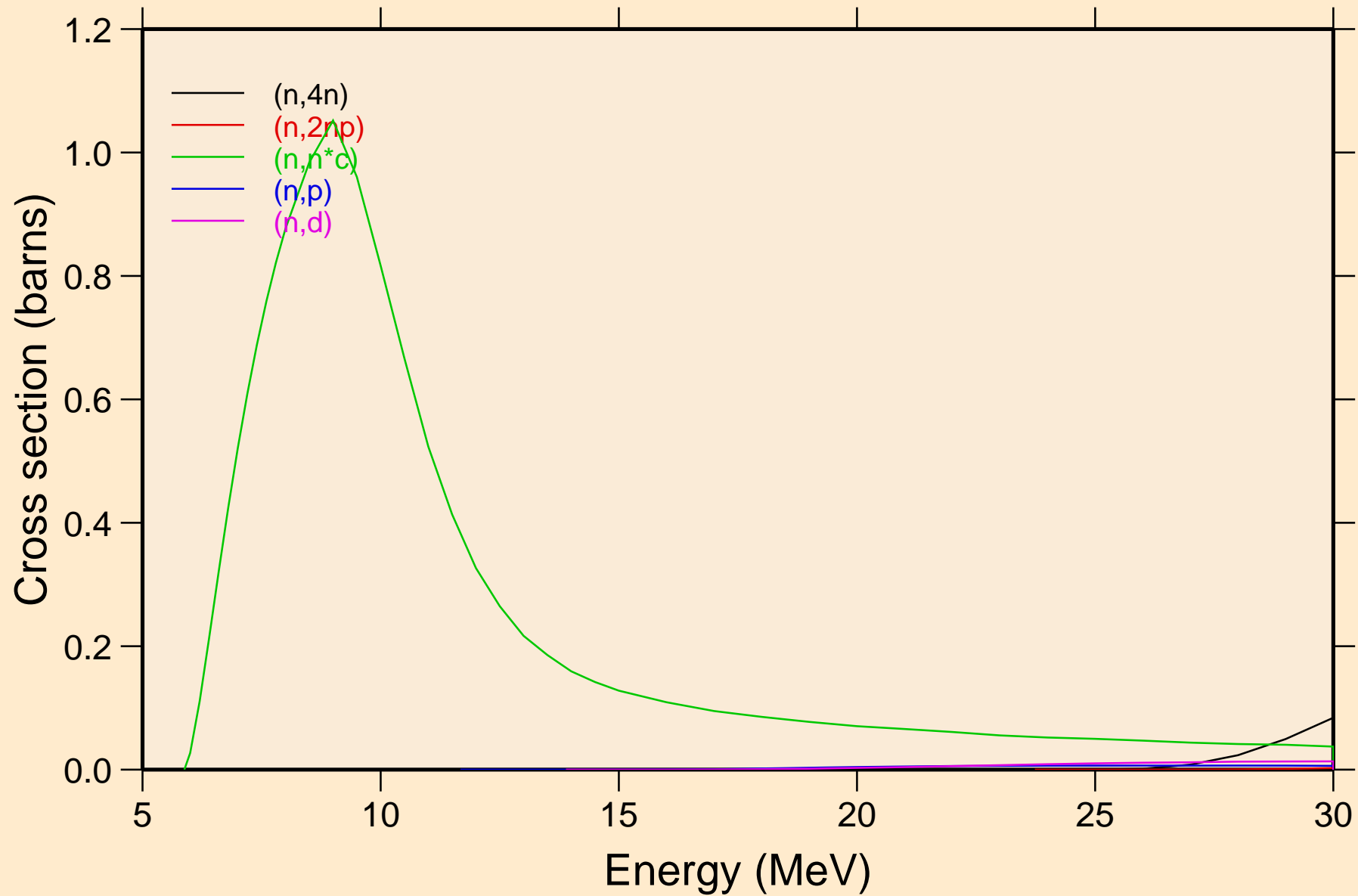

AR044 NEUTRON ACER TENDL-2024 LIBRARY; T=0.K  
Threshold reactions

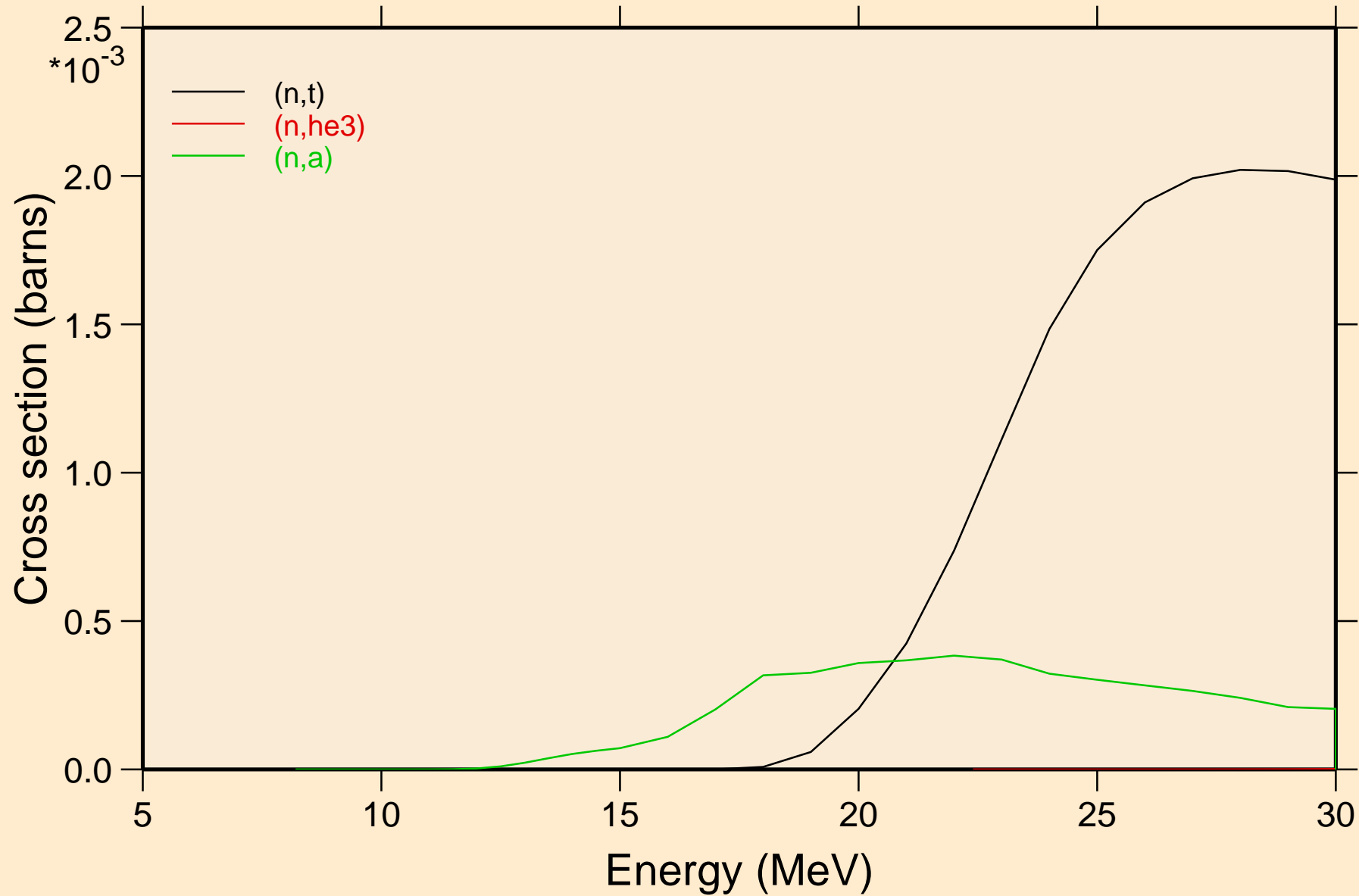

# AR044 NEUTRON ACER TENDL-2024 LIBRARY; T=0.K

## Threshold reactions

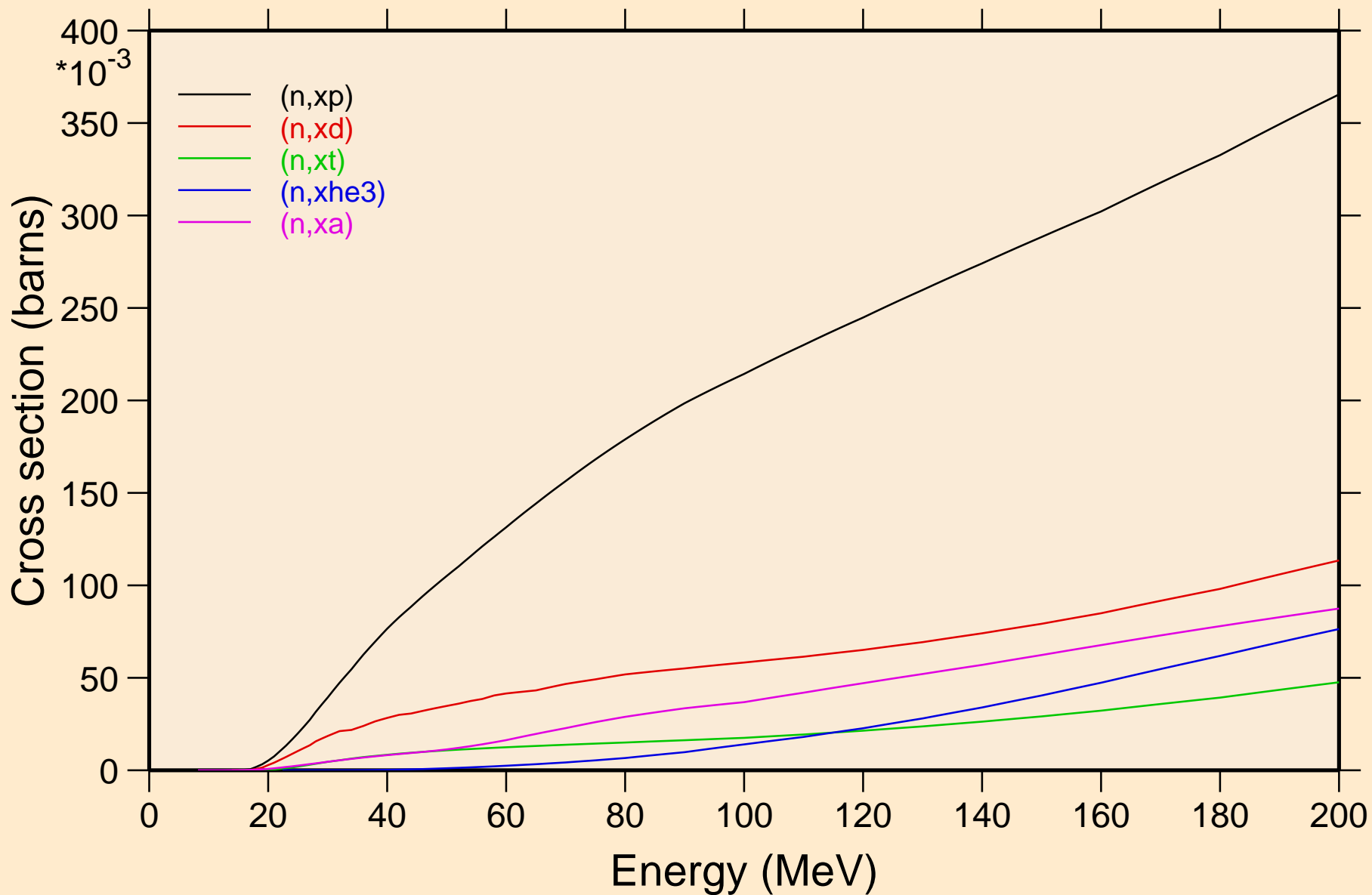

AR044 NEUTRON ACER TENDL-2024 LIBRARY; T=0.K  
angular distribution for elastic

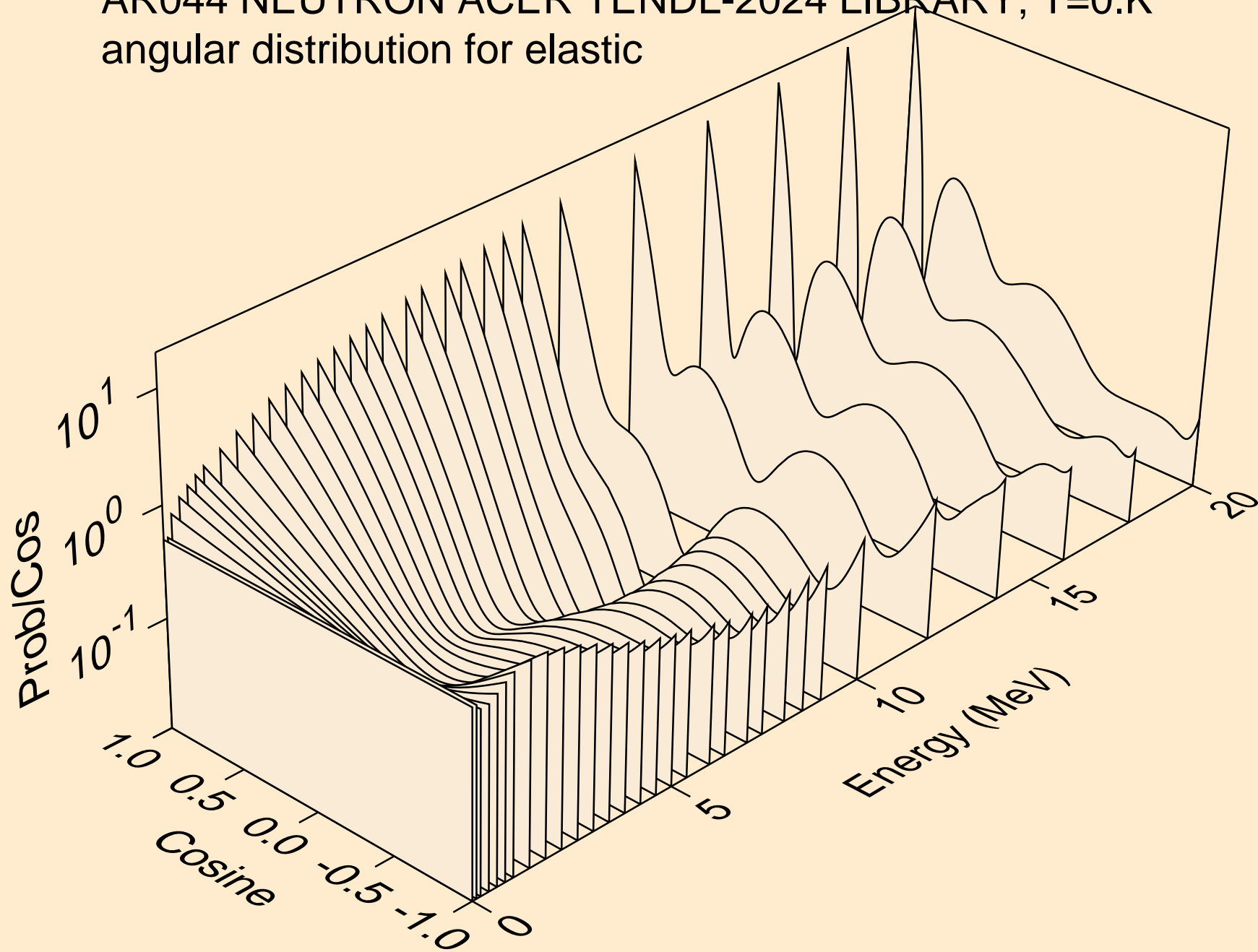

AR044 NEUTRON ACER TENDL-2024 LIBRARY; T=0.K  
angular distribution for elastic

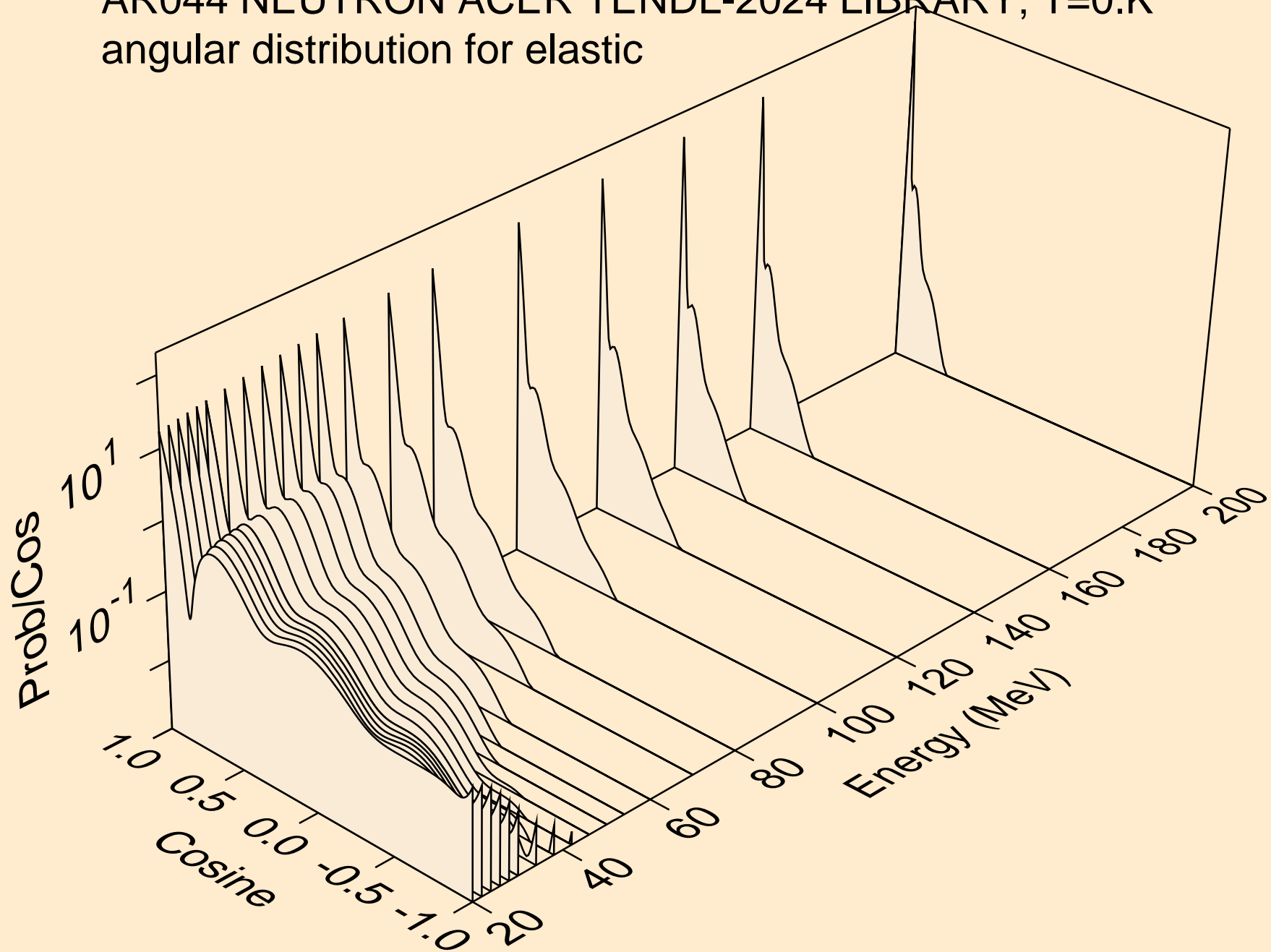

AR044 NEUTRON ACER TENDL-2024 LIBRARY; T=0.K  
angular distribution for (n,n\*1)

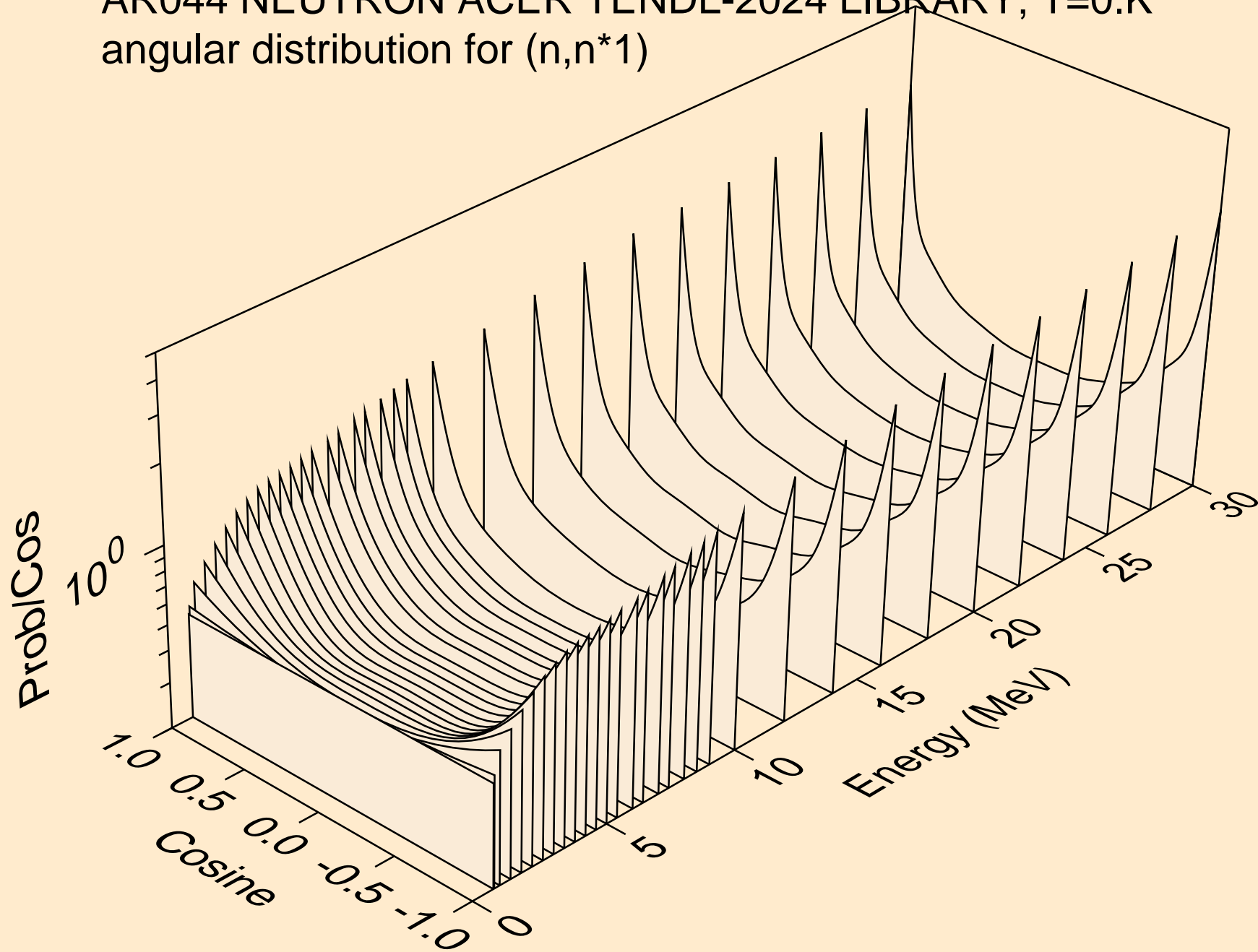

AR044 NEUTRON ACER TENDL-2024 LIBRARY; T=0.K  
angular distribution for (n,n\*2)

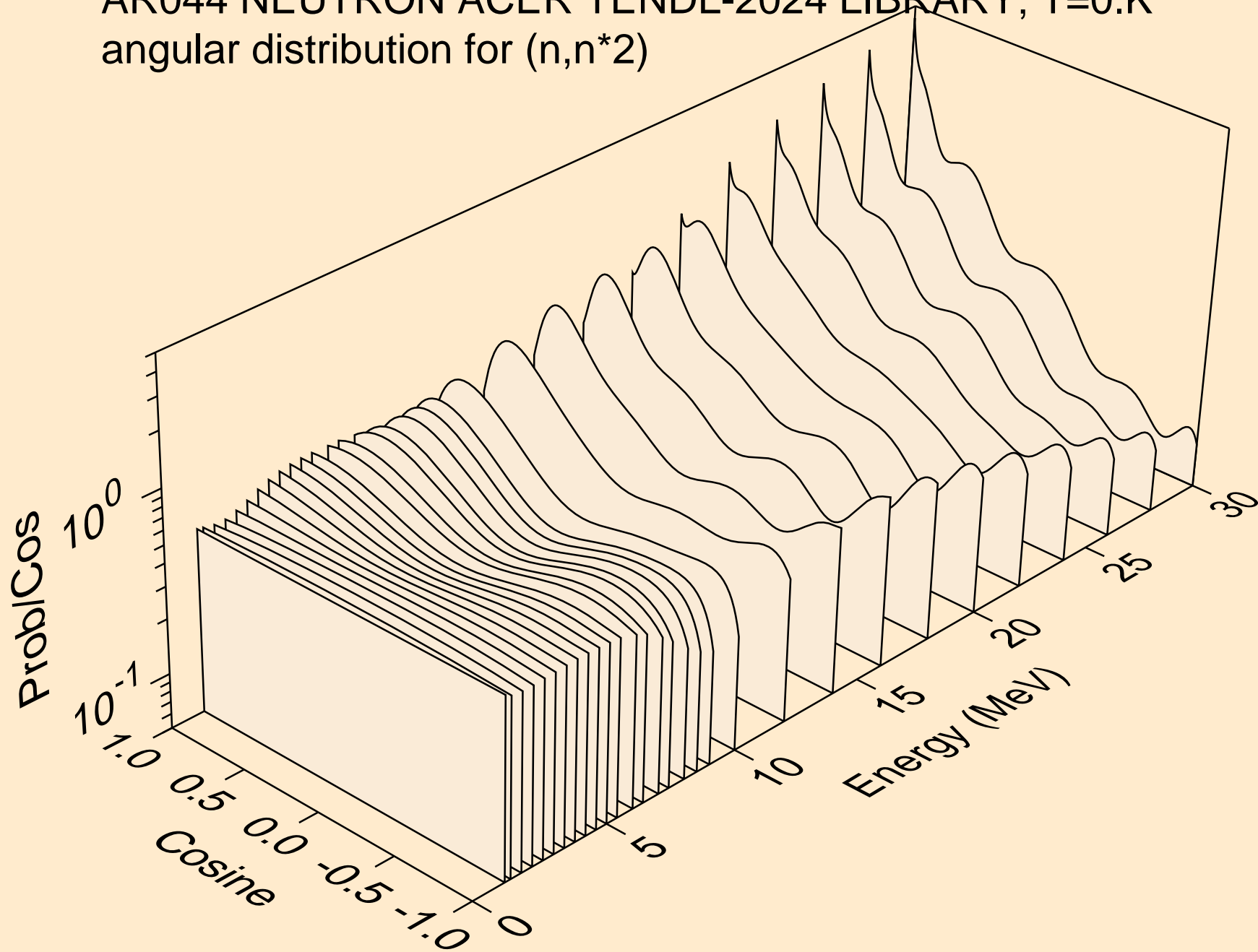

AR044 NEUTRON ACER TENDL-2024 LIBRARY; T=0.K  
angular distribution for (n,n\*3)

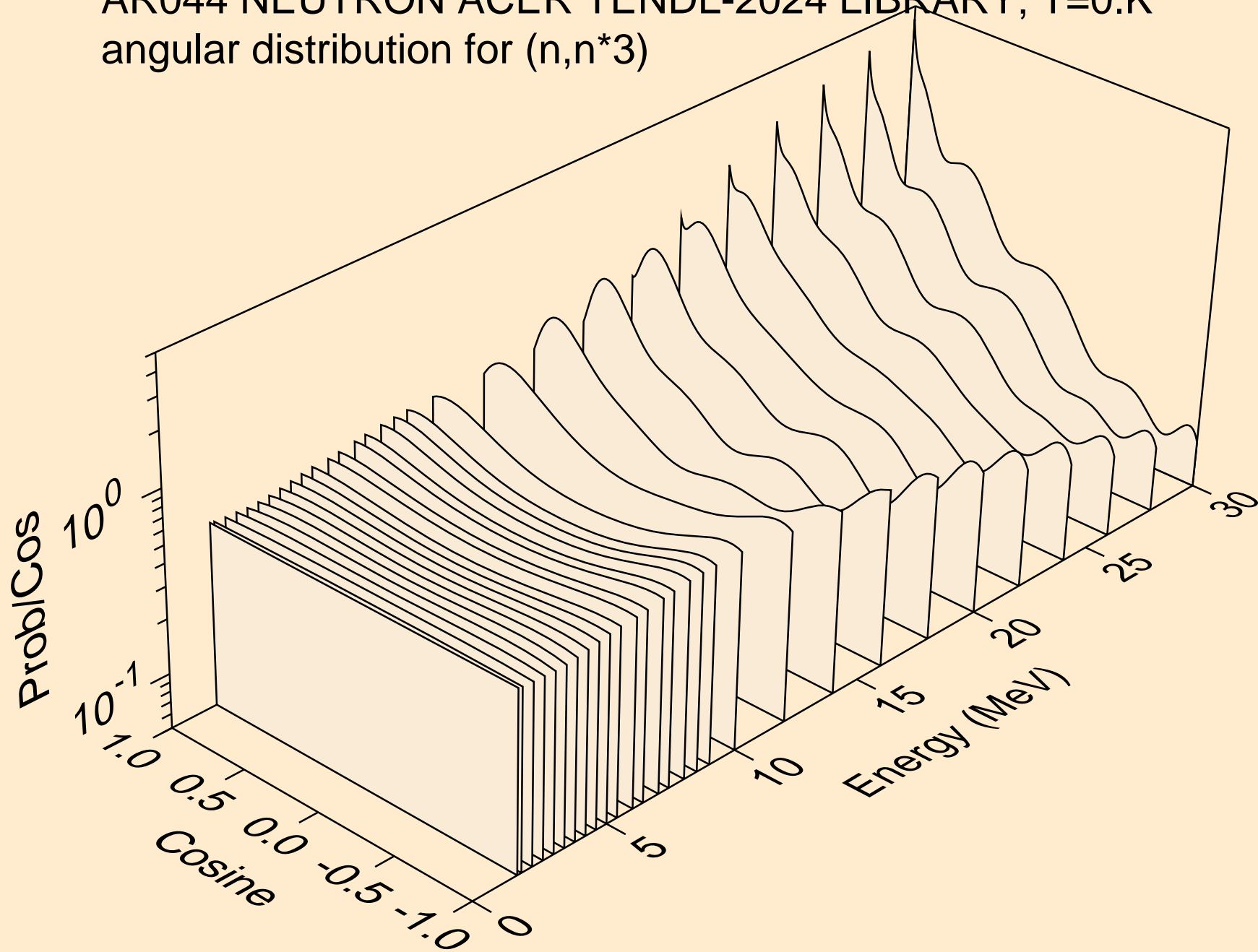

AR044 NEUTRON ACER TENDL-2024 LIBRARY; T=0.K  
angular distribution for (n,n\*4)

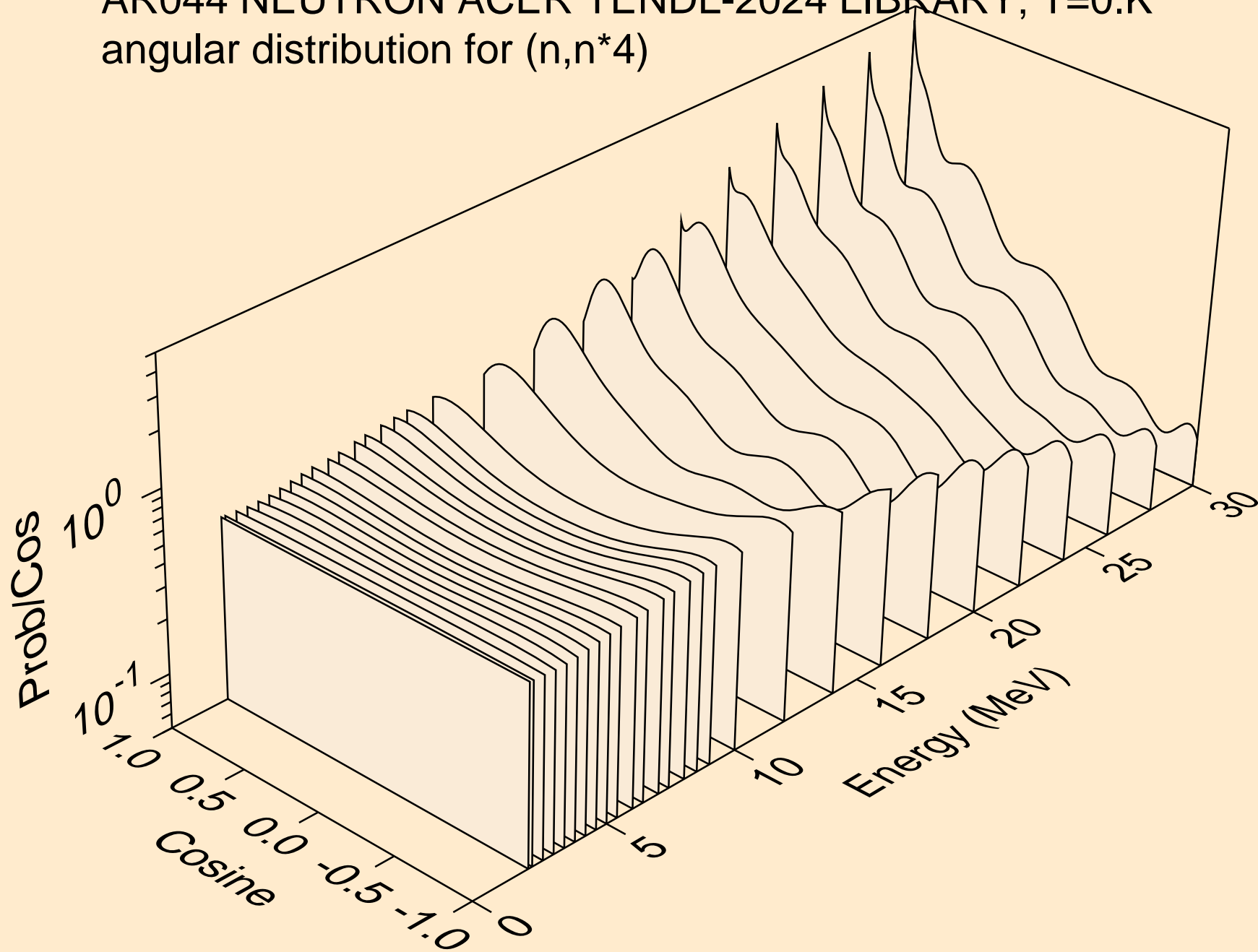

AR044 NEUTRON ACER TENDL-2024 LIBRARY; T=0.K  
angular distribution for (n,n\*5)

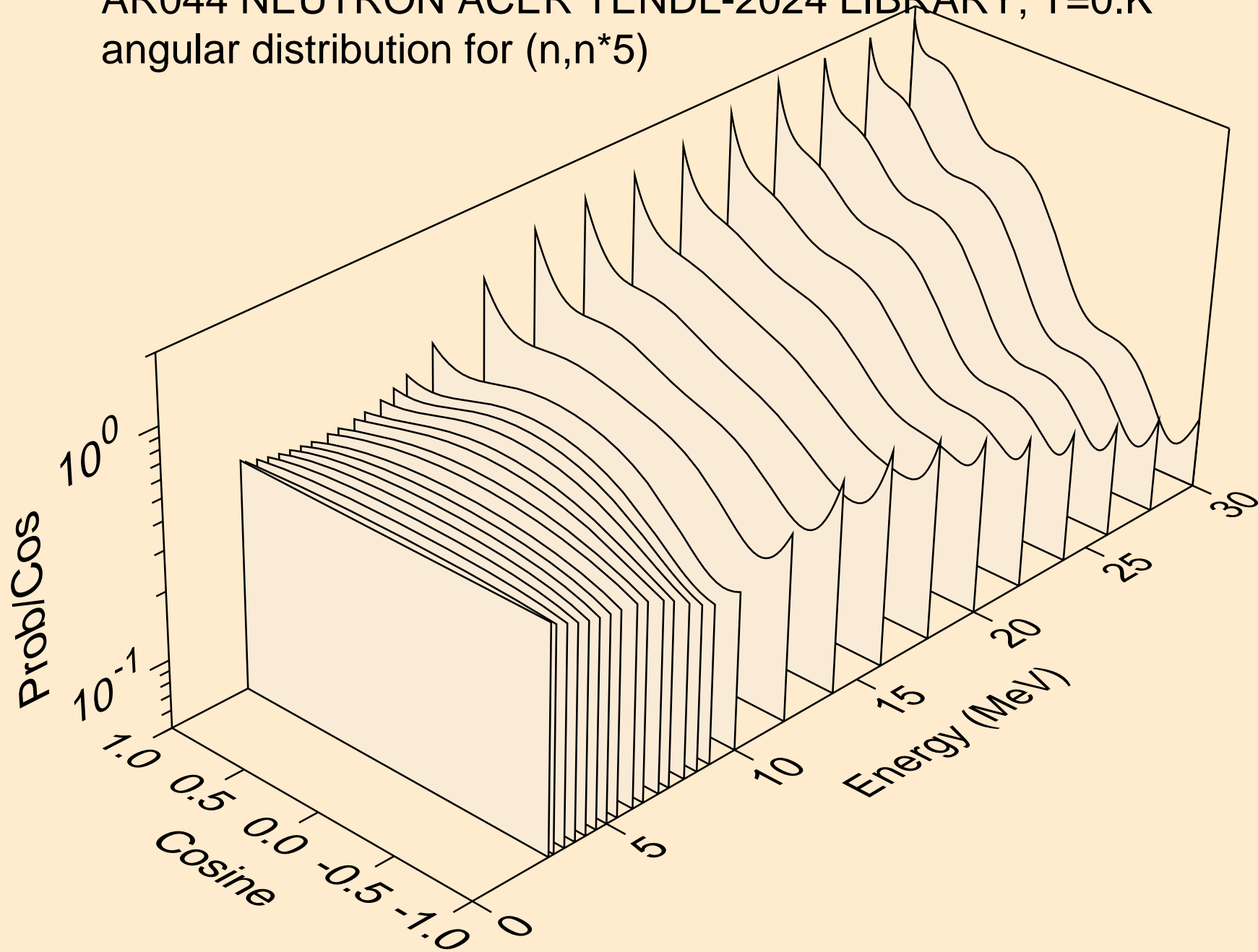

AR044 NEUTRON ACER TENDL-2024 LIBRARY; T=0.K  
angular distribution for (n,n\*6)

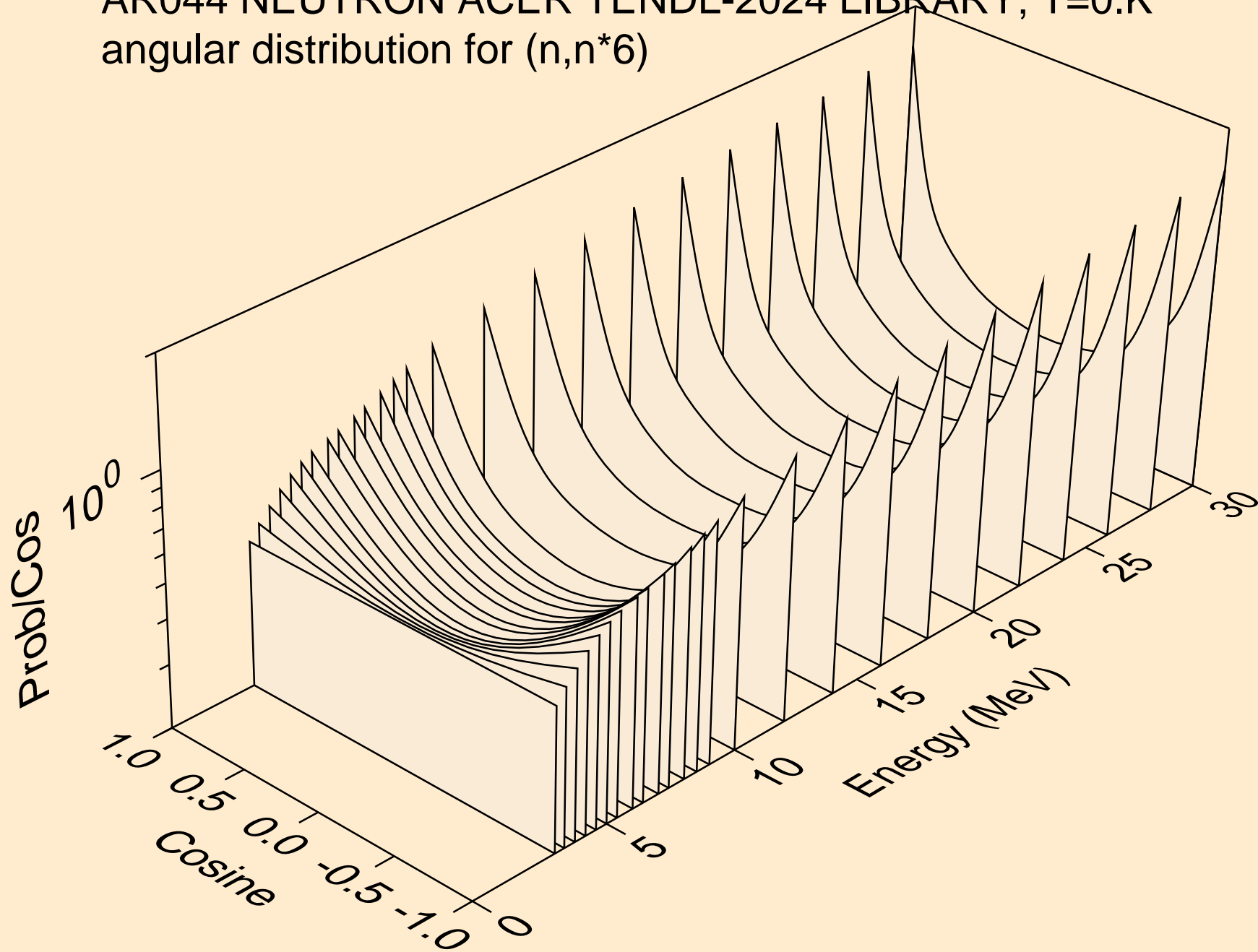

AR044 NEUTRON ACER TENDL-2024 LIBRARY; T=0.K  
angular distribution for (n,n\*7)

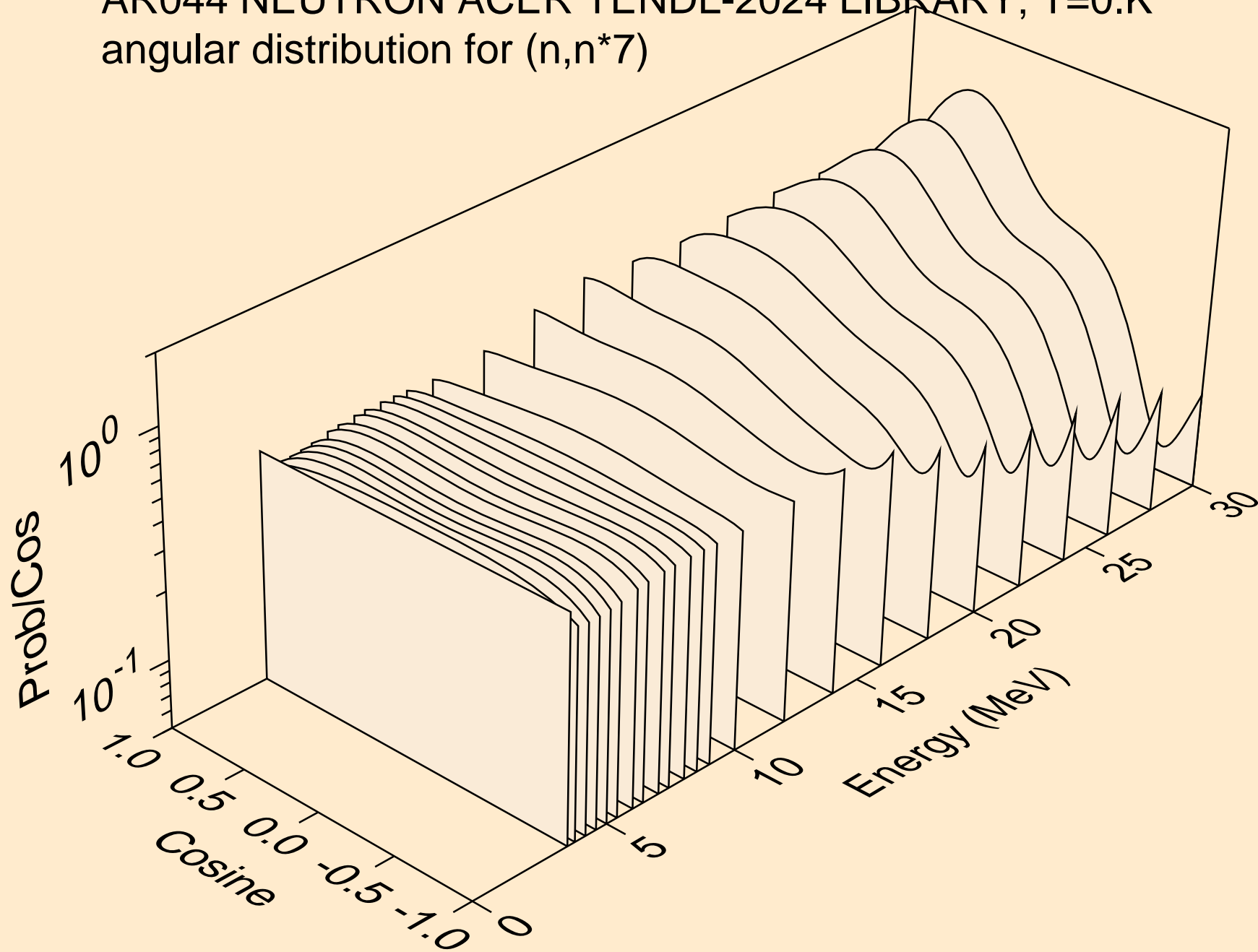

AR044 NEUTRON ACER TENDL-2024 LIBRARY; T=0.K  
angular distribution for (n,n\*8)

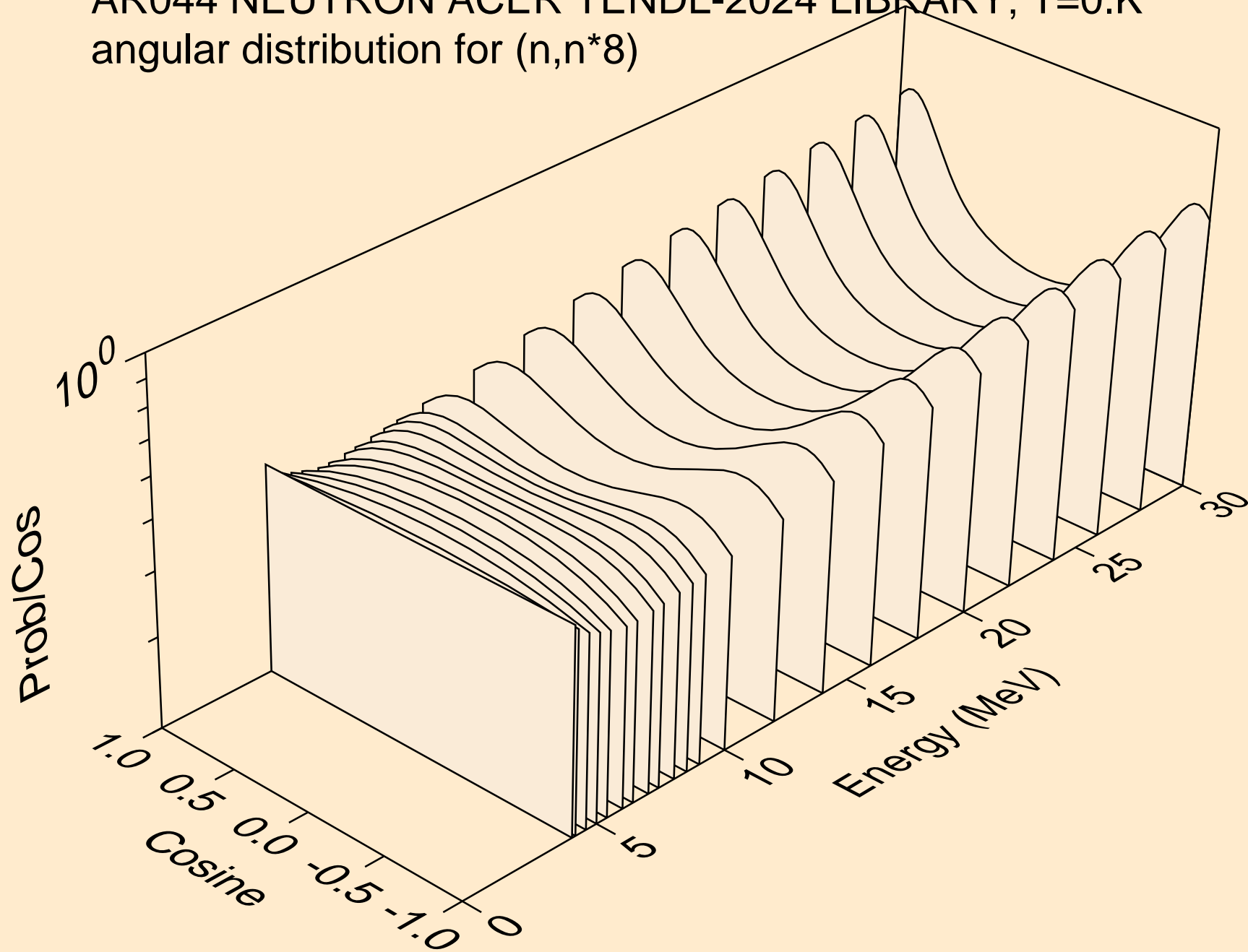

AR044 NEUTRON ACER TENDL-2024 LIBRARY; T=0.K  
angular distribution for (n,n\*9)

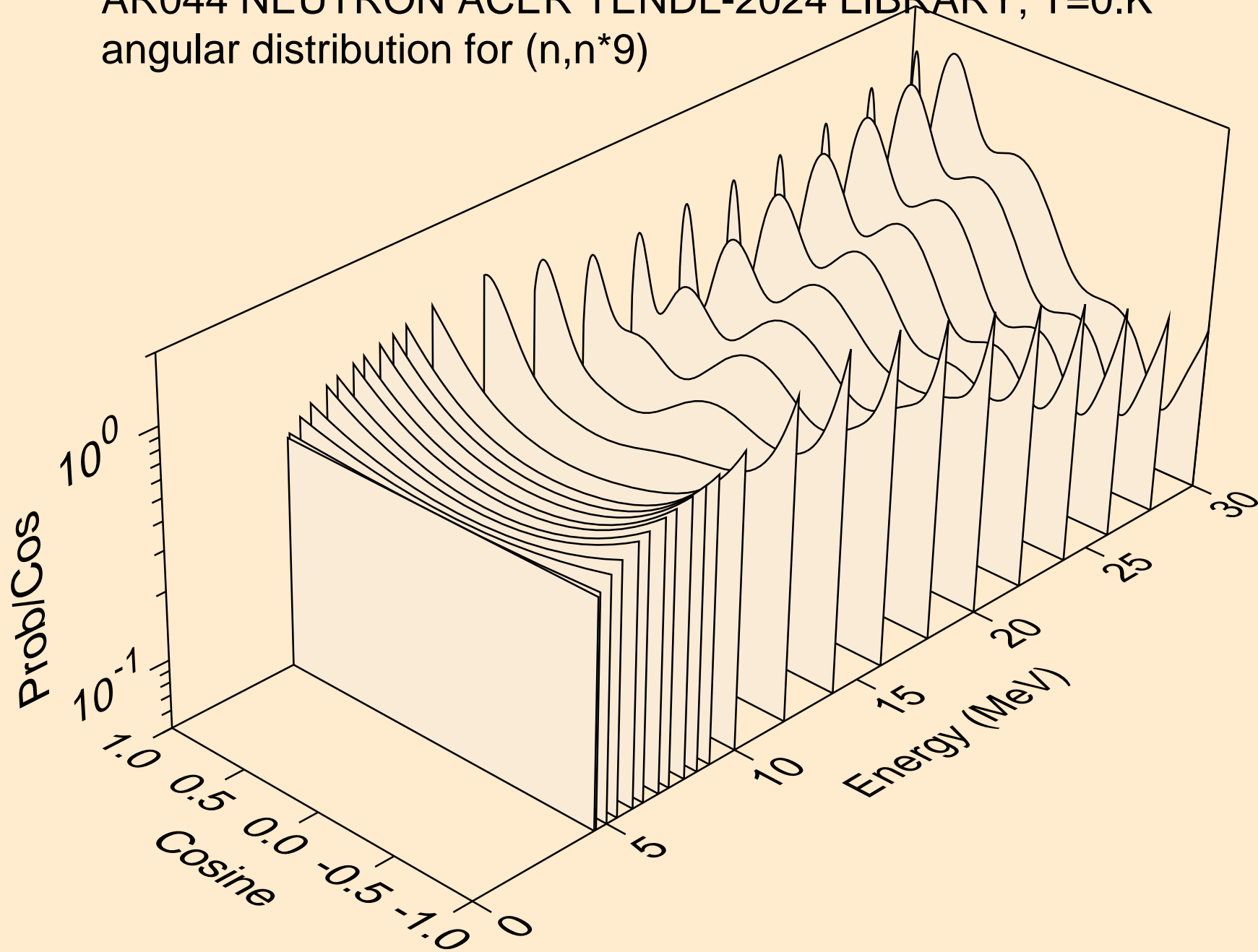

AR044 NEUTRON ACER TENDL-2024 LIBRARY; T=0.K  
angular distribution for (n,n\*10)

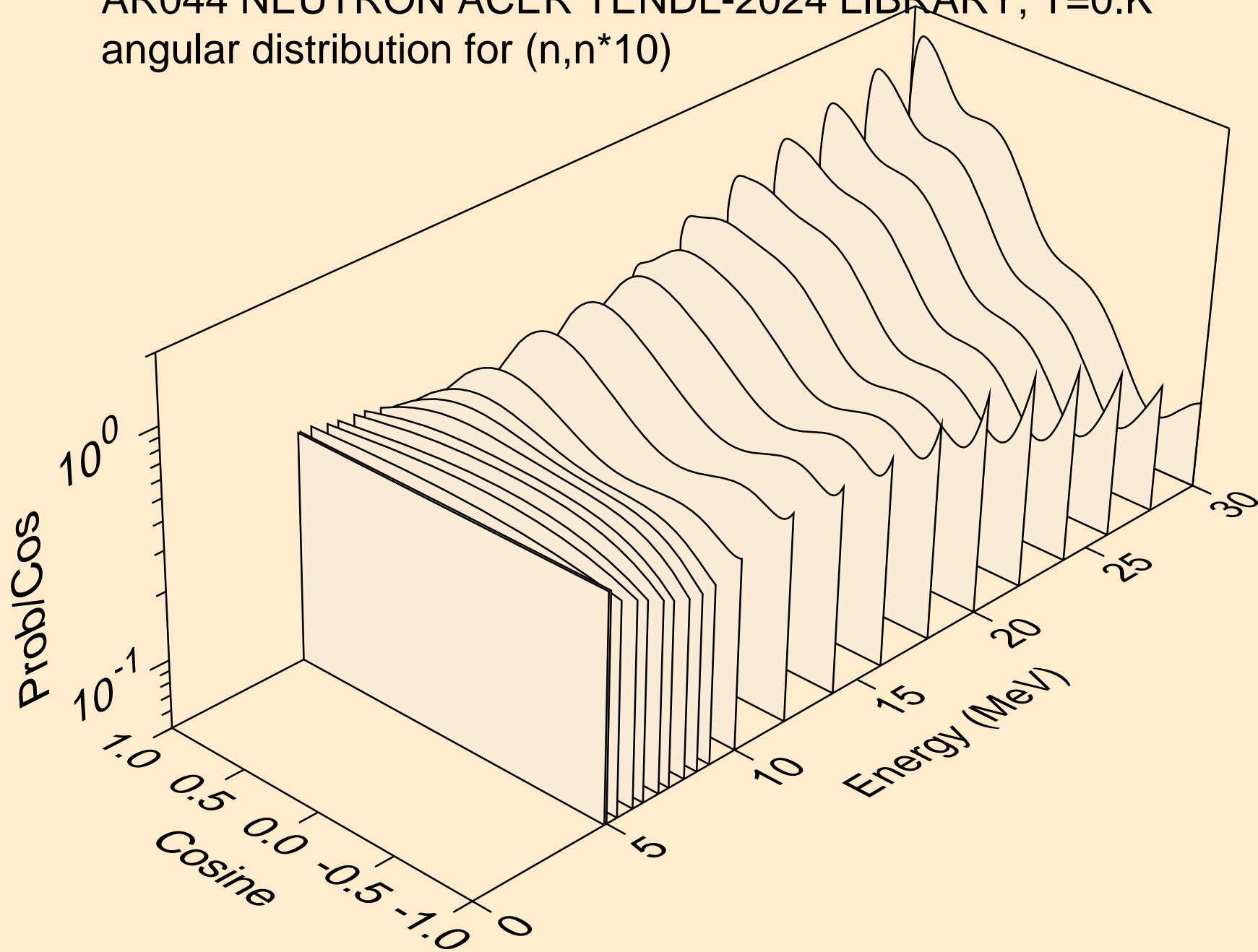

AR044 NEUTRON ACER TENDL-2024 LIBRARY; T=0.K  
angular distribution for (n,n\*11)

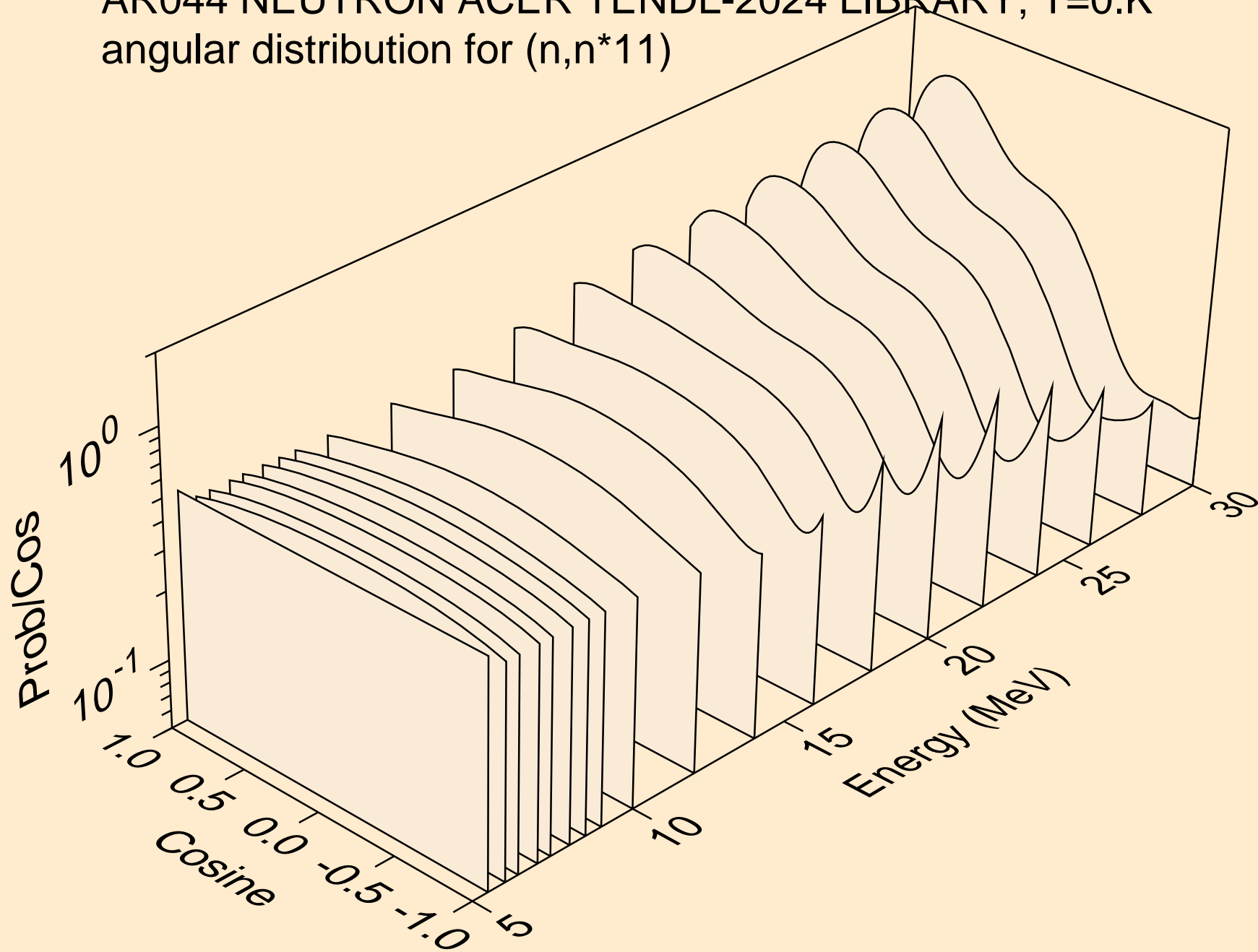

AR044 NEUTRON ACER TENDL-2024 LIBRARY; T=0.K  
angular distribution for (n,n\*12)

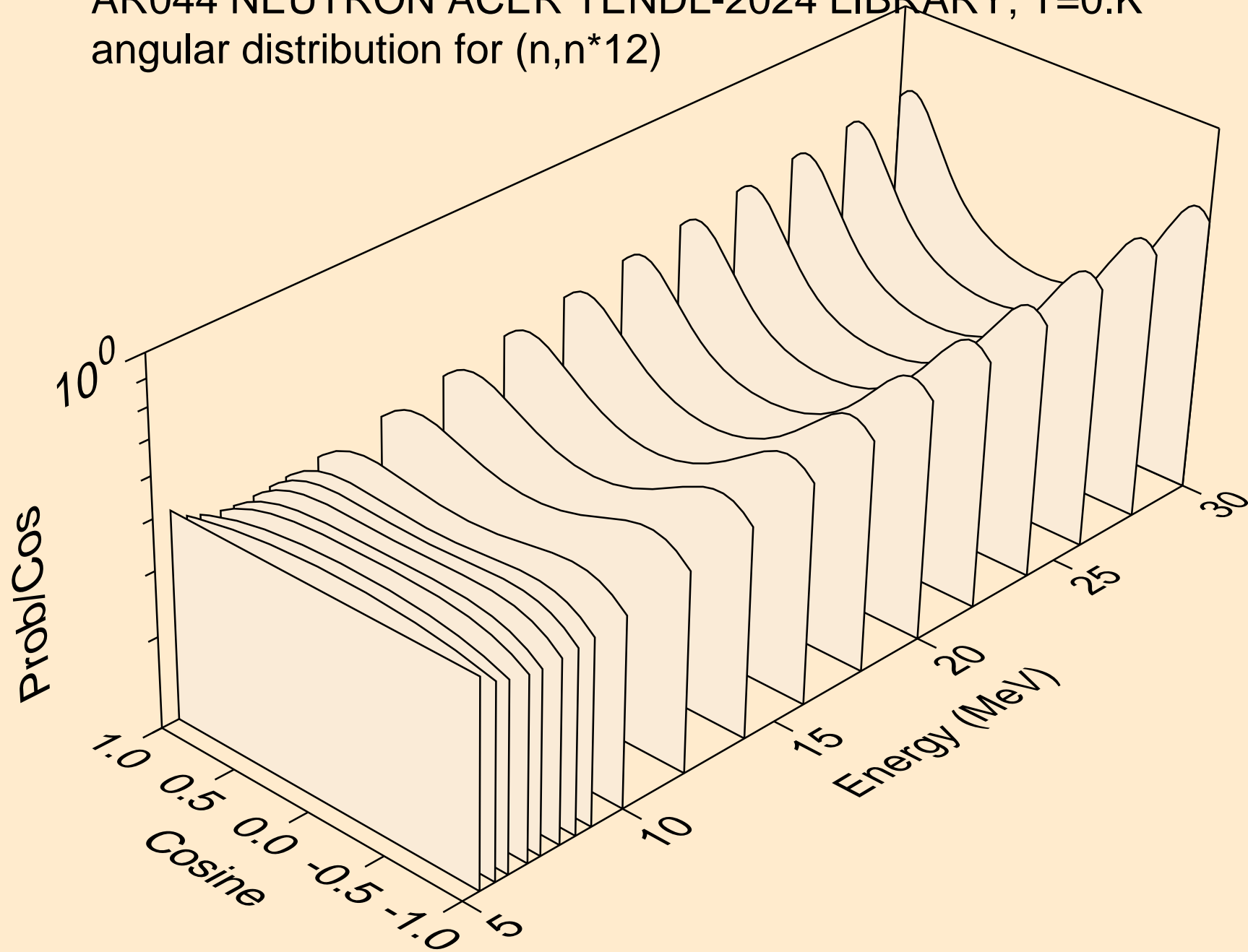

AR044 NEUTRON ACER TENDL-2024 LIBRARY; T=0.K  
angular distribution for (n,n\*13)

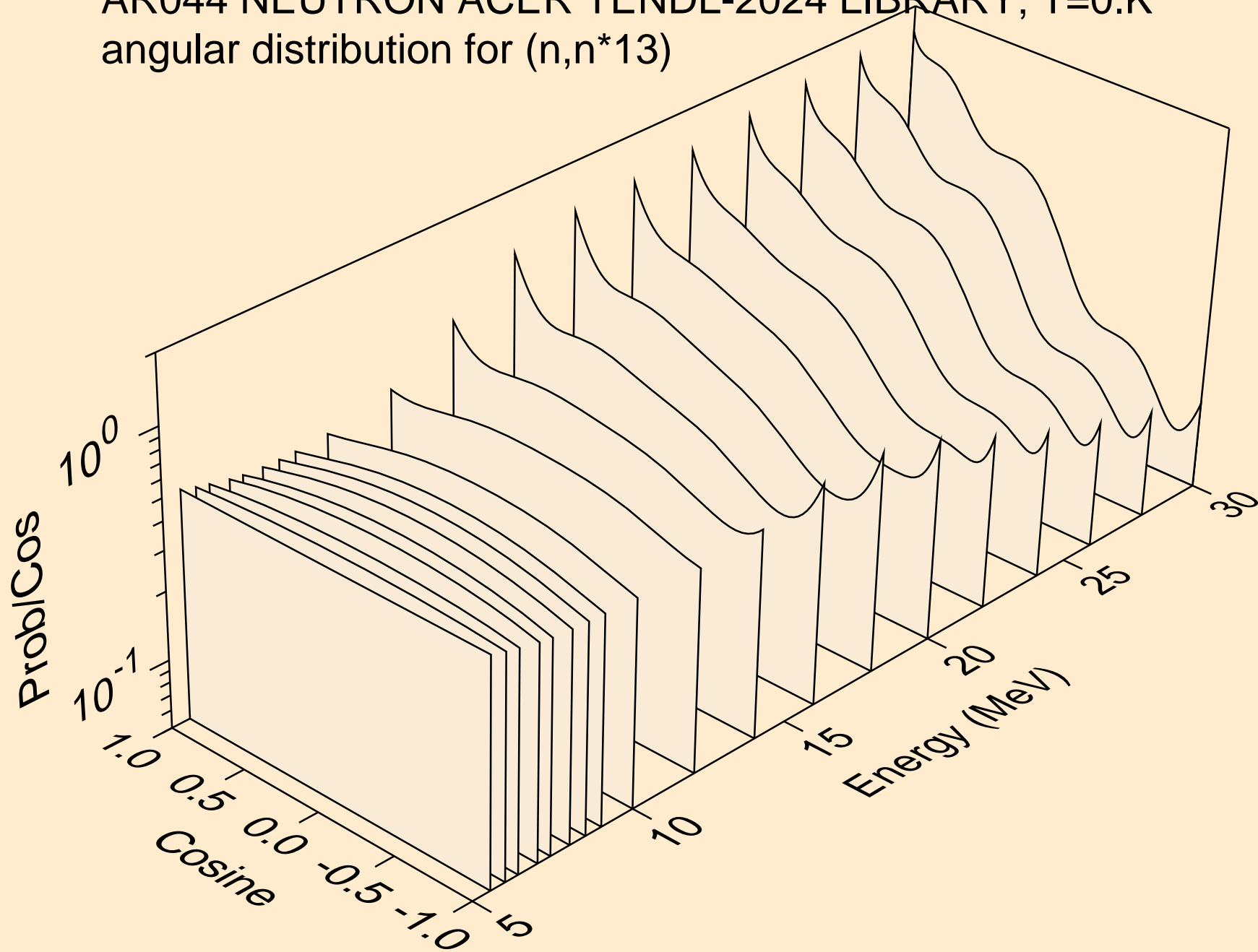

AR044 NEUTRON ACER TENDL-2024 LIBRARY; T=0.K  
angular distribution for (n,n\*14)

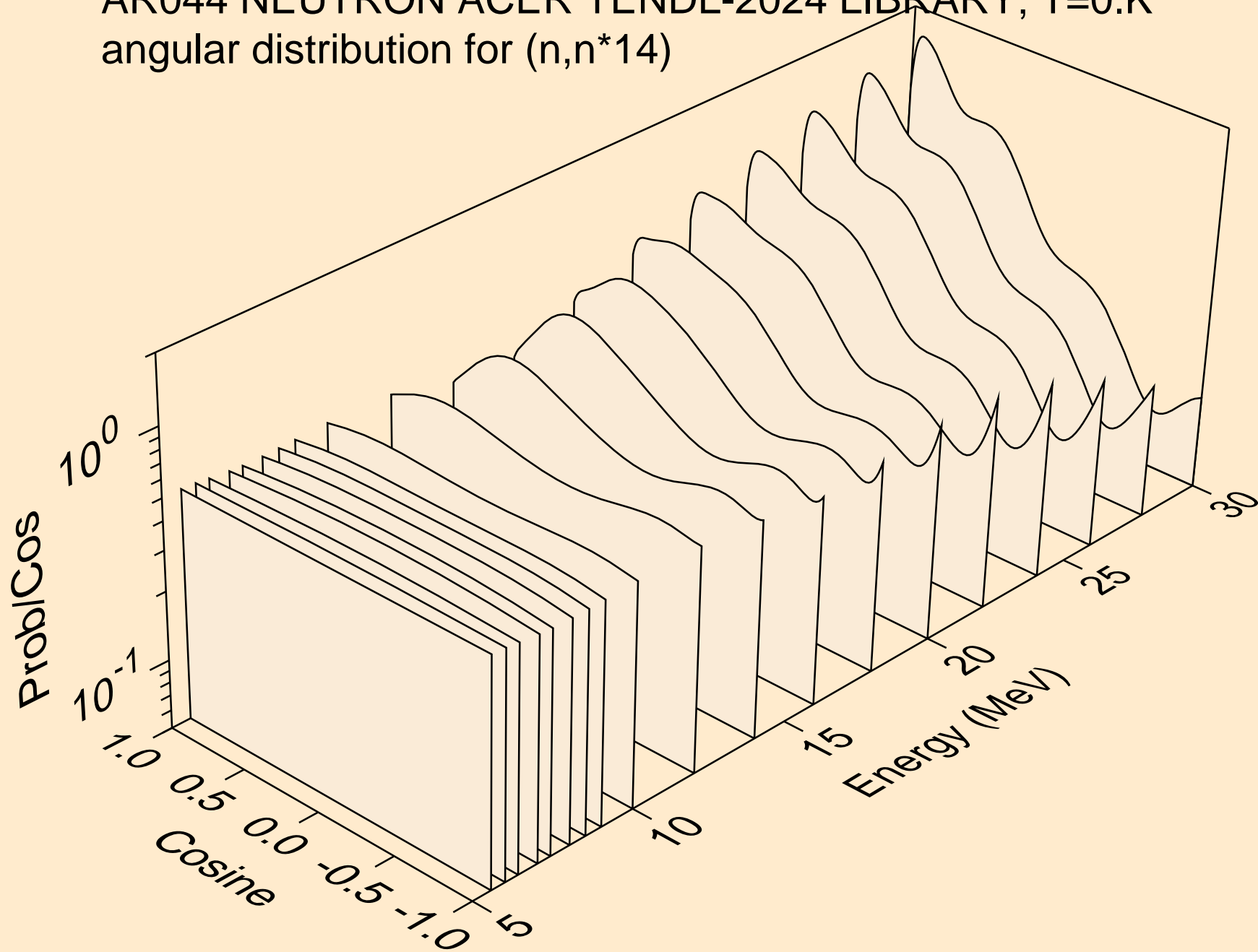

AR044 NEUTRON ACER TENDL-2024 LIBRARY; T=0.K  
angular distribution for (n,n\*15)

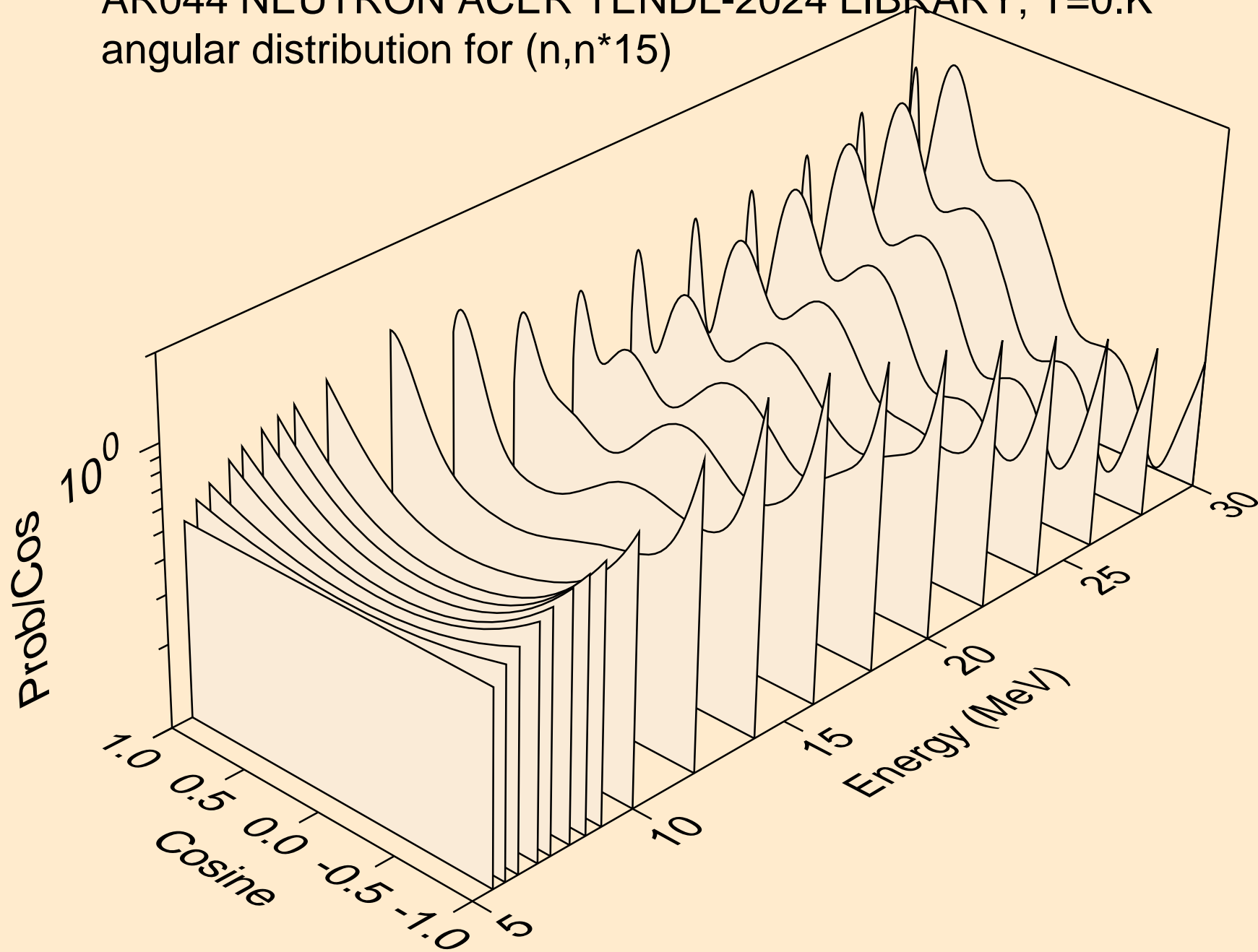

AR044 NEUTRON ACER TENDL-2024 LIBRARY; T=0.K  
angular distribution for (n,n\*16)

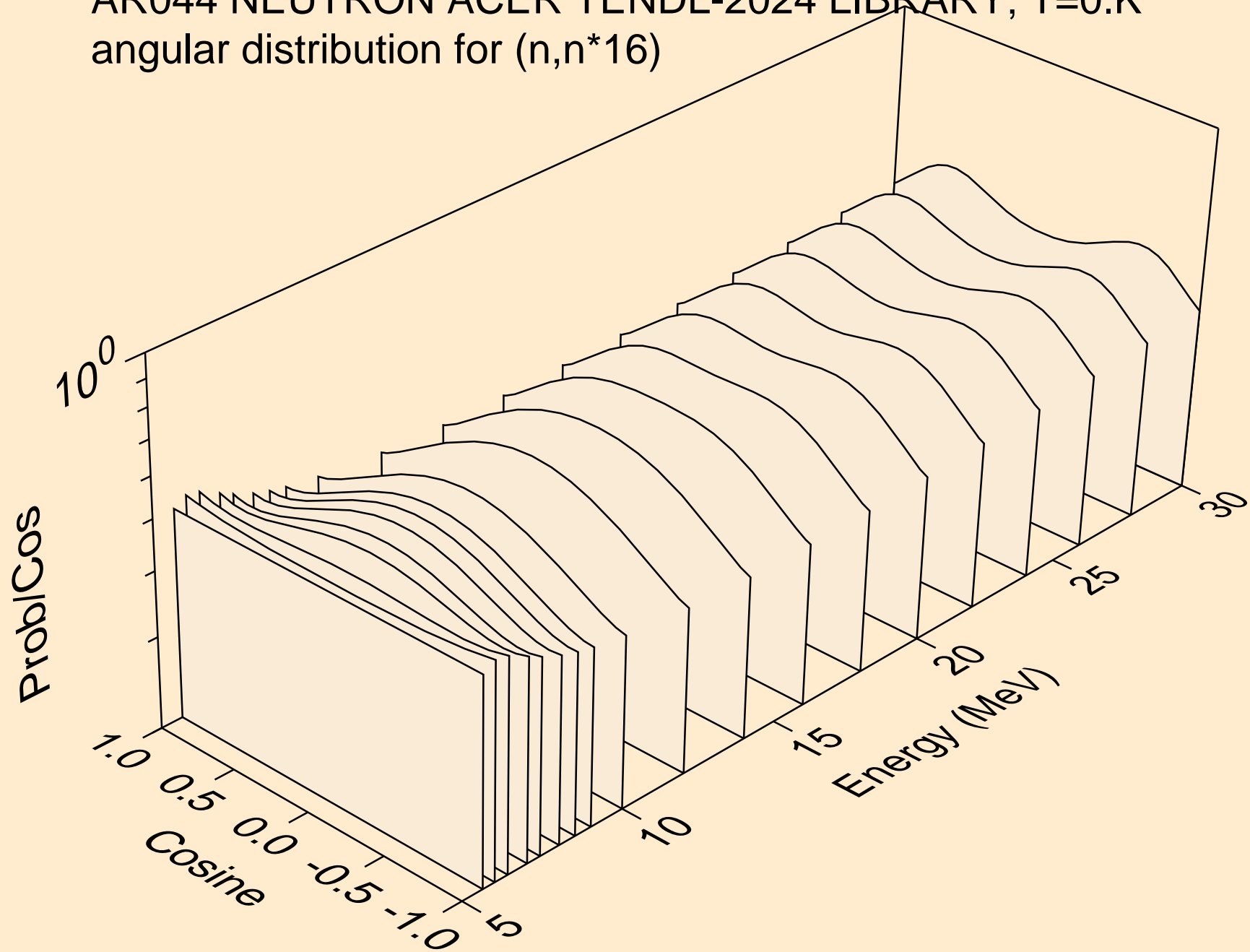

AR044 NEUTRON ACER TENDL-2024 LIBRARY; T=0.K  
angular distribution for (n,n\*17)

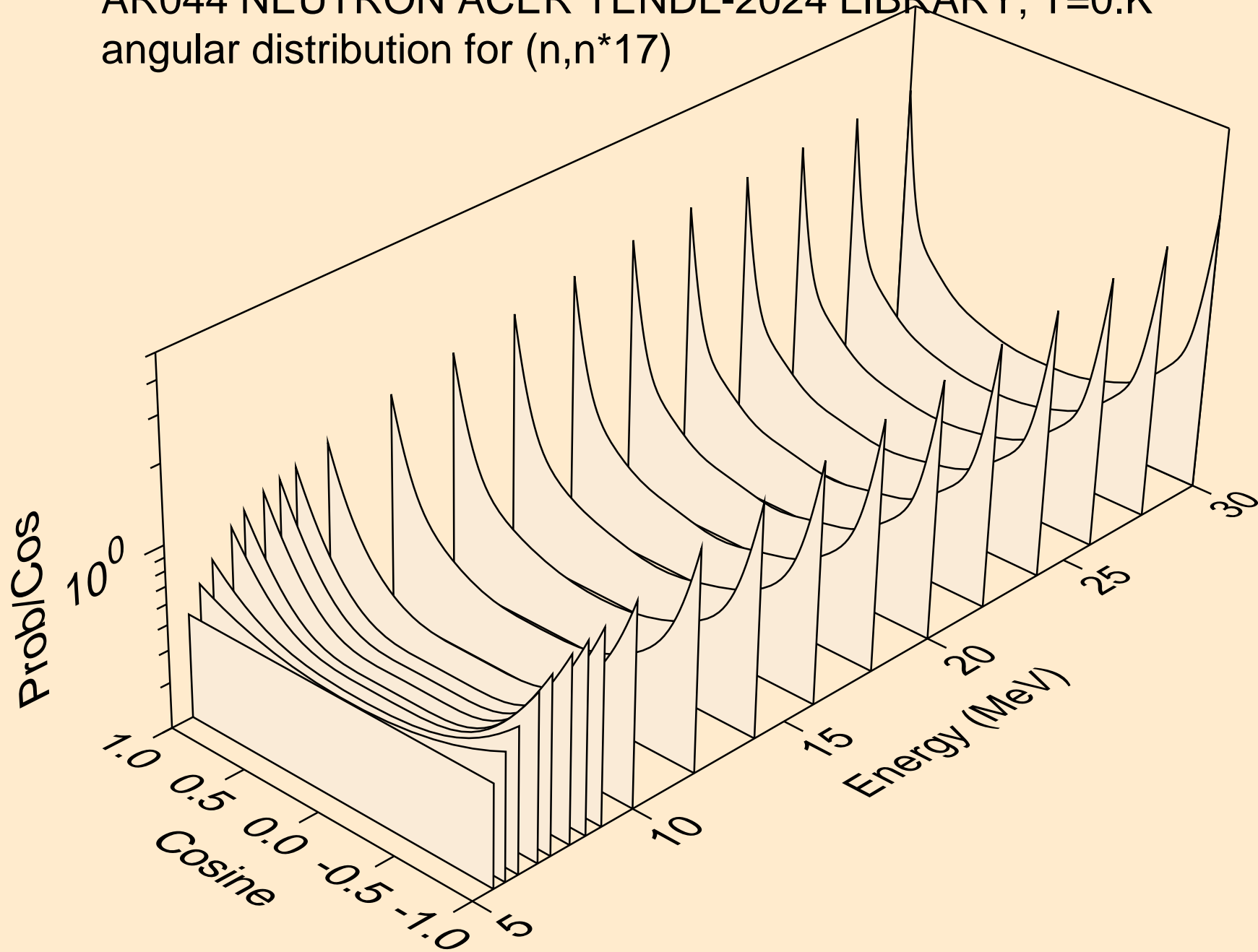

AR044 NEUTRON ACER TENDL-2024 LIBRARY; T=0.K  
angular distribution for (n,n\*18)

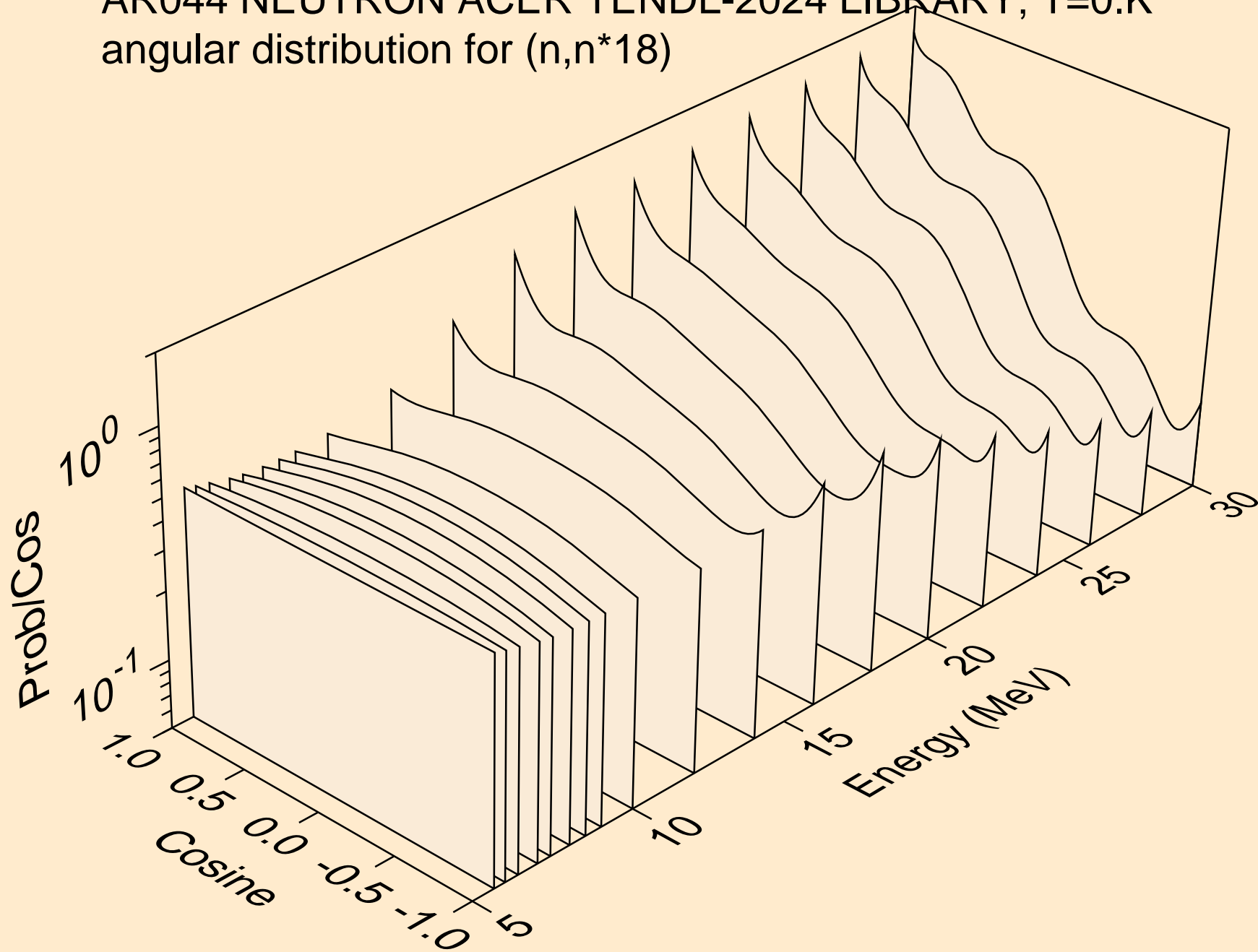

AR044 NEUTRON ACER TENDL-2024 LIBRARY; T=0.K  
angular distribution for (n,n\*19)

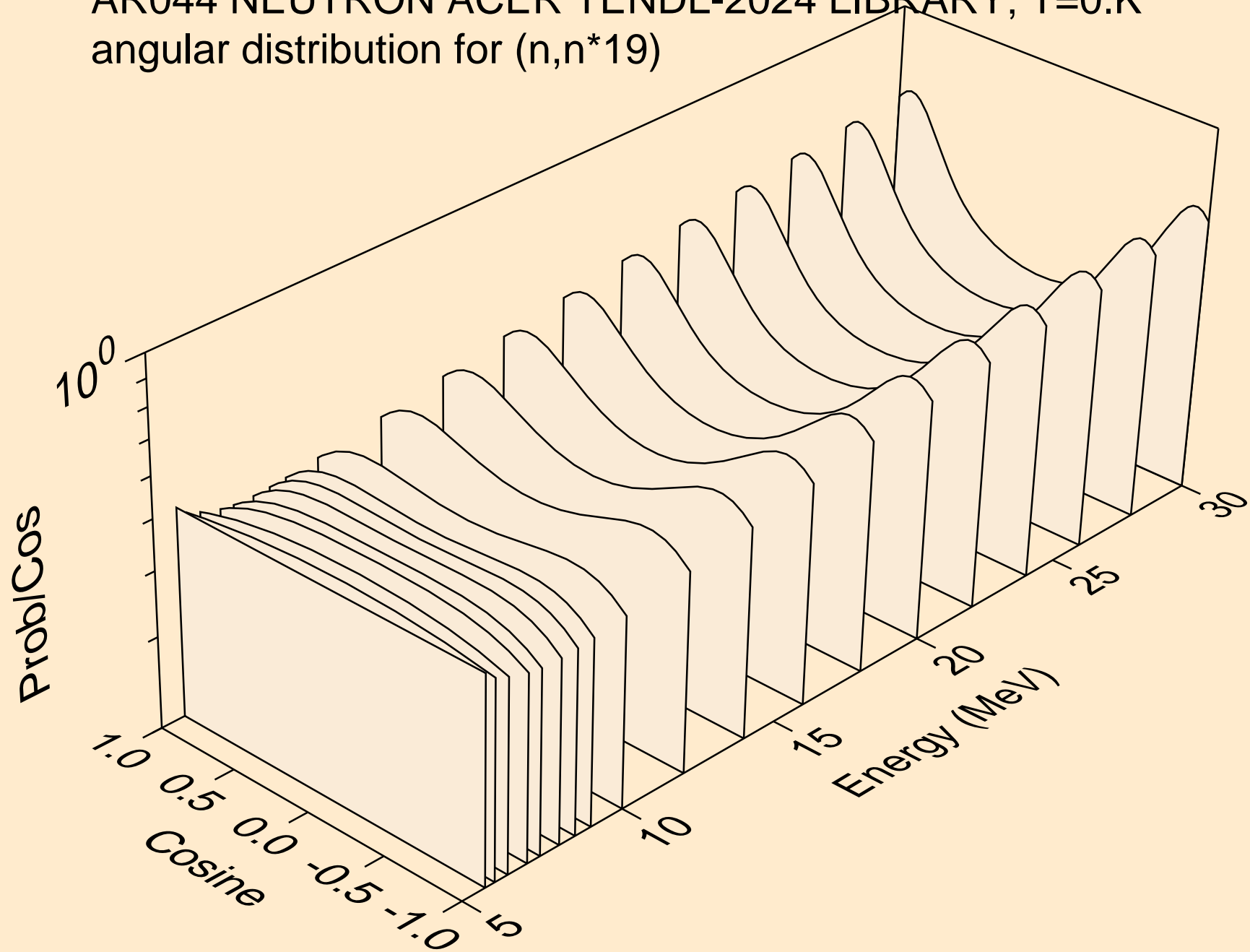

AR044 NEUTRON ACER TENDL-2024 LIBRARY; T=0.K  
angular distribution for (n,n\*20)

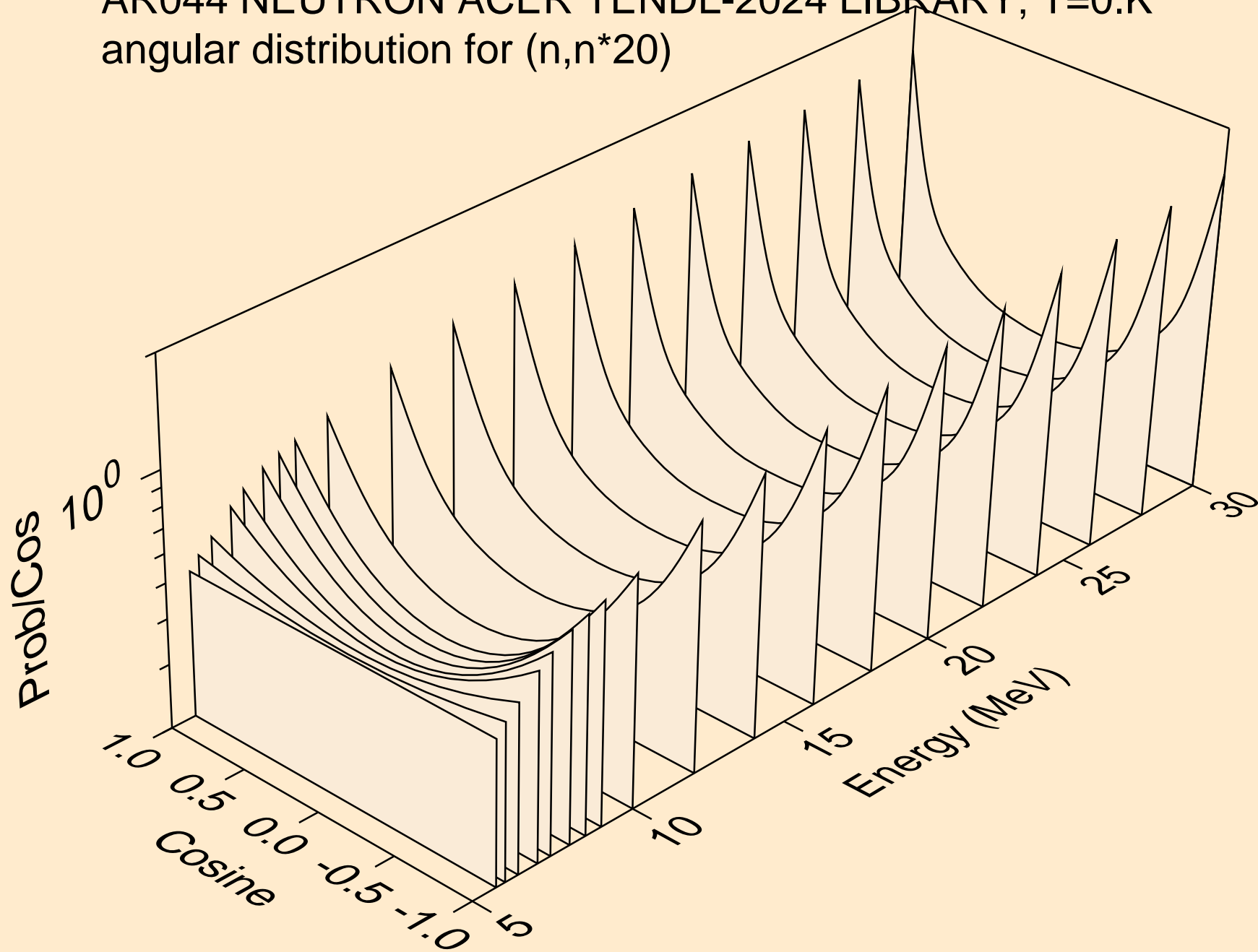

AR044 NEUTRON ACER TENDL-2024 LIBRARY; T=0.K  
angular distribution for (n,n\*21)

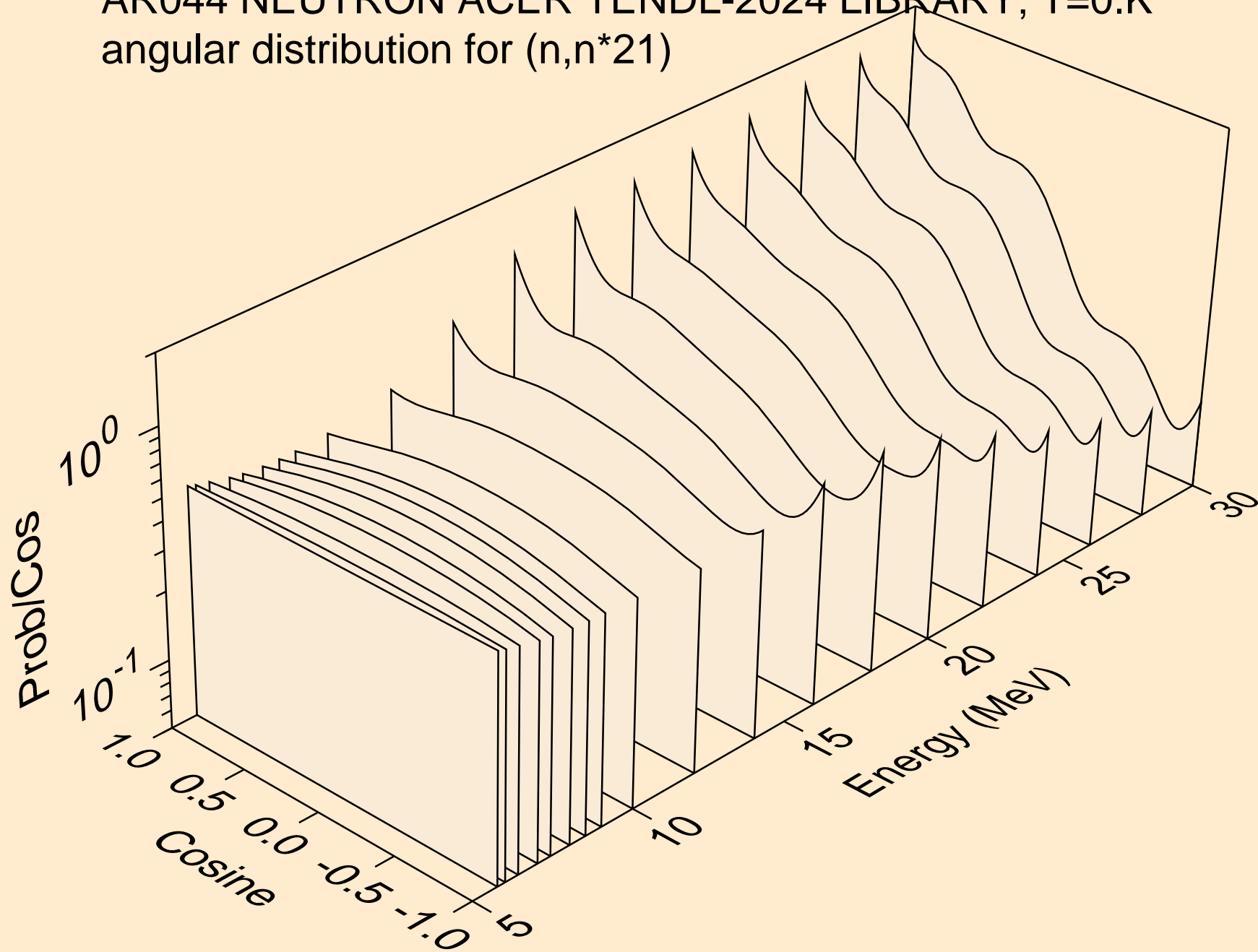

AR044 NEUTRON ACER TENDL-2024 LIBRARY; T=0.K  
angular distribution for (n,n\*22)

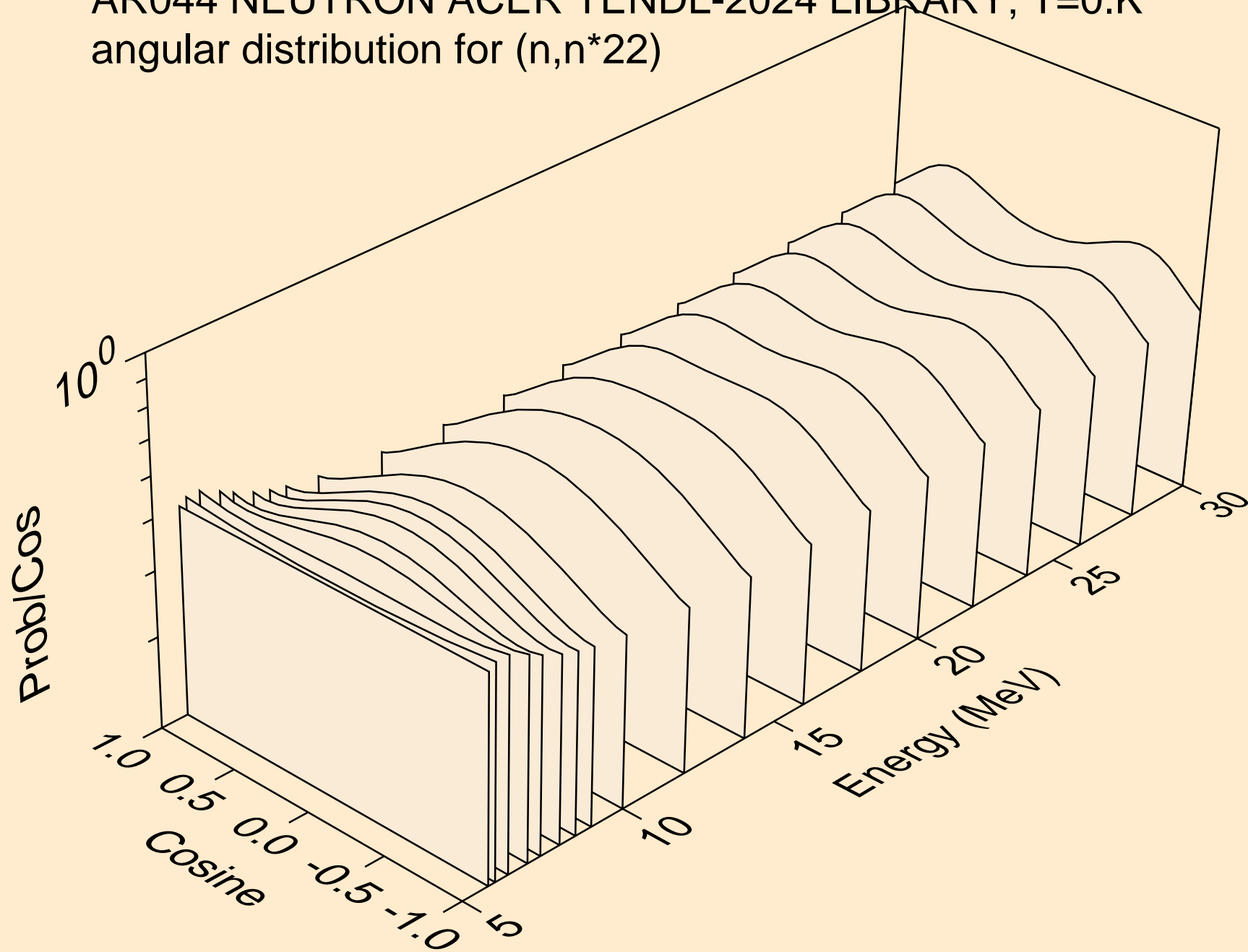

AR044 NEUTRON ACER TENDL-2024 LIBRARY; T=0.K  
angular distribution for (n,n\*23)

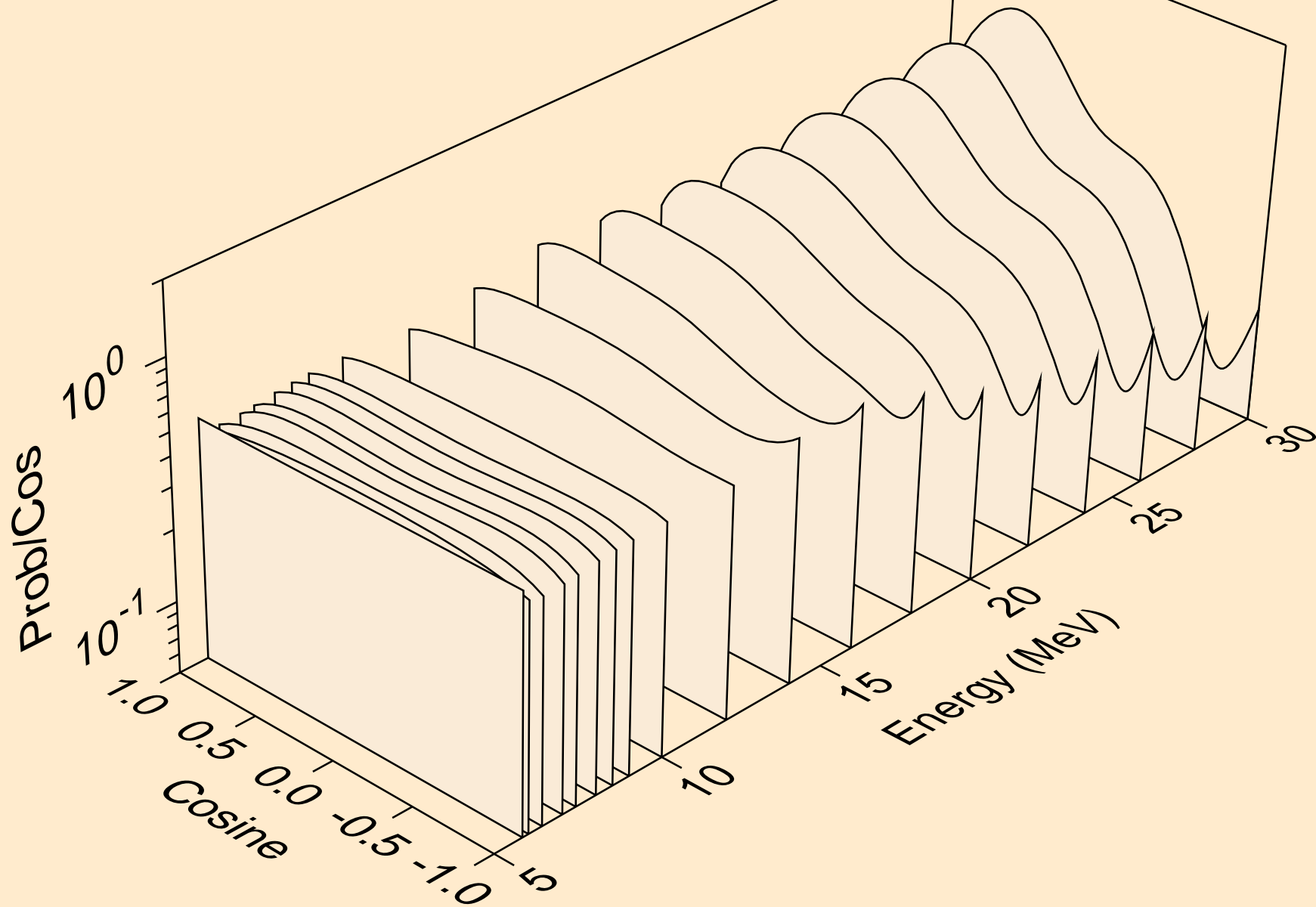

AR044 NEUTRON ACER TENDL-2024 LIBRARY; T=0.K  
angular distribution for (n,n\*24)

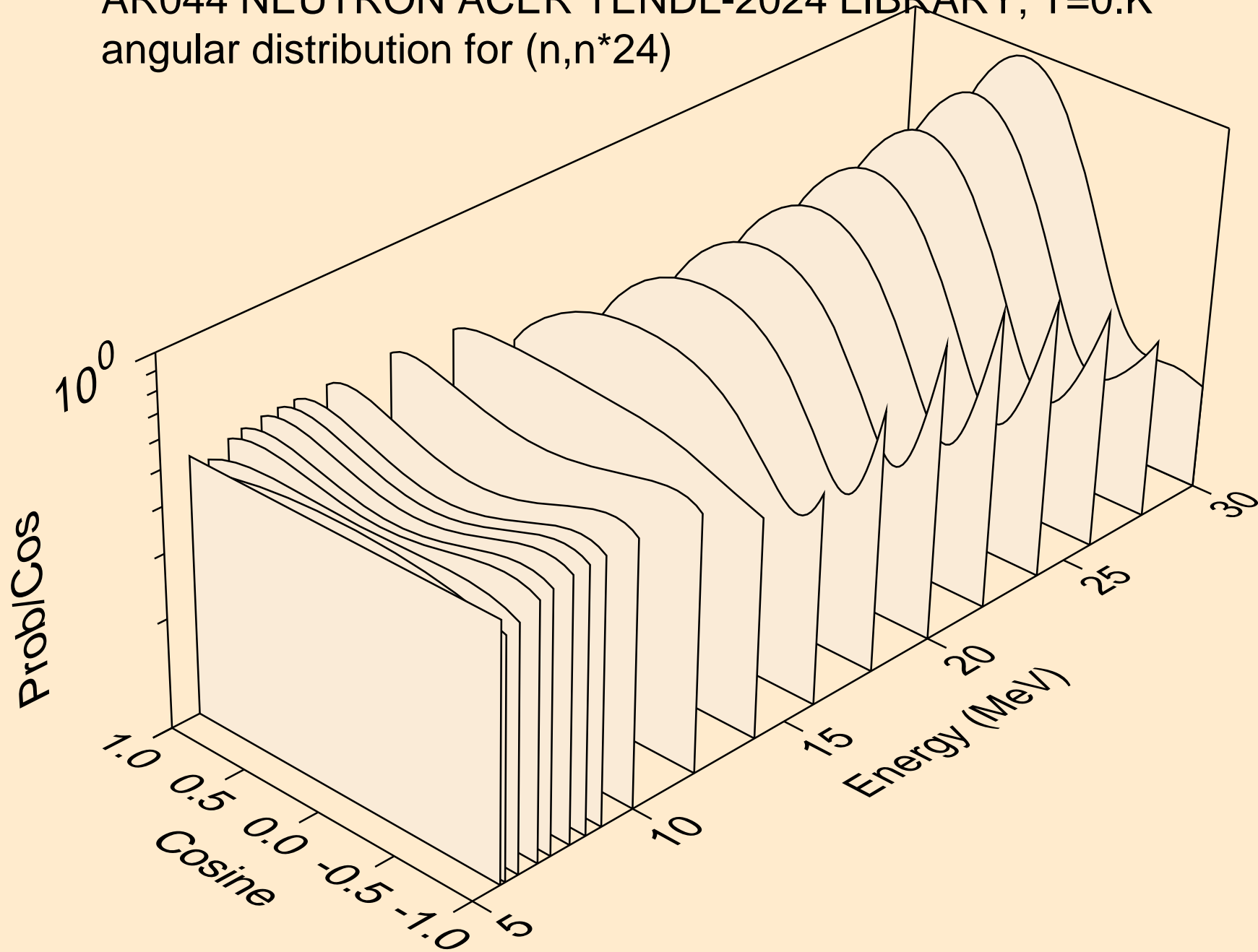

AR044 NEUTRON ACER TENDL-2024 LIBRARY; T=0.K  
angular distribution for (n,n\*25)

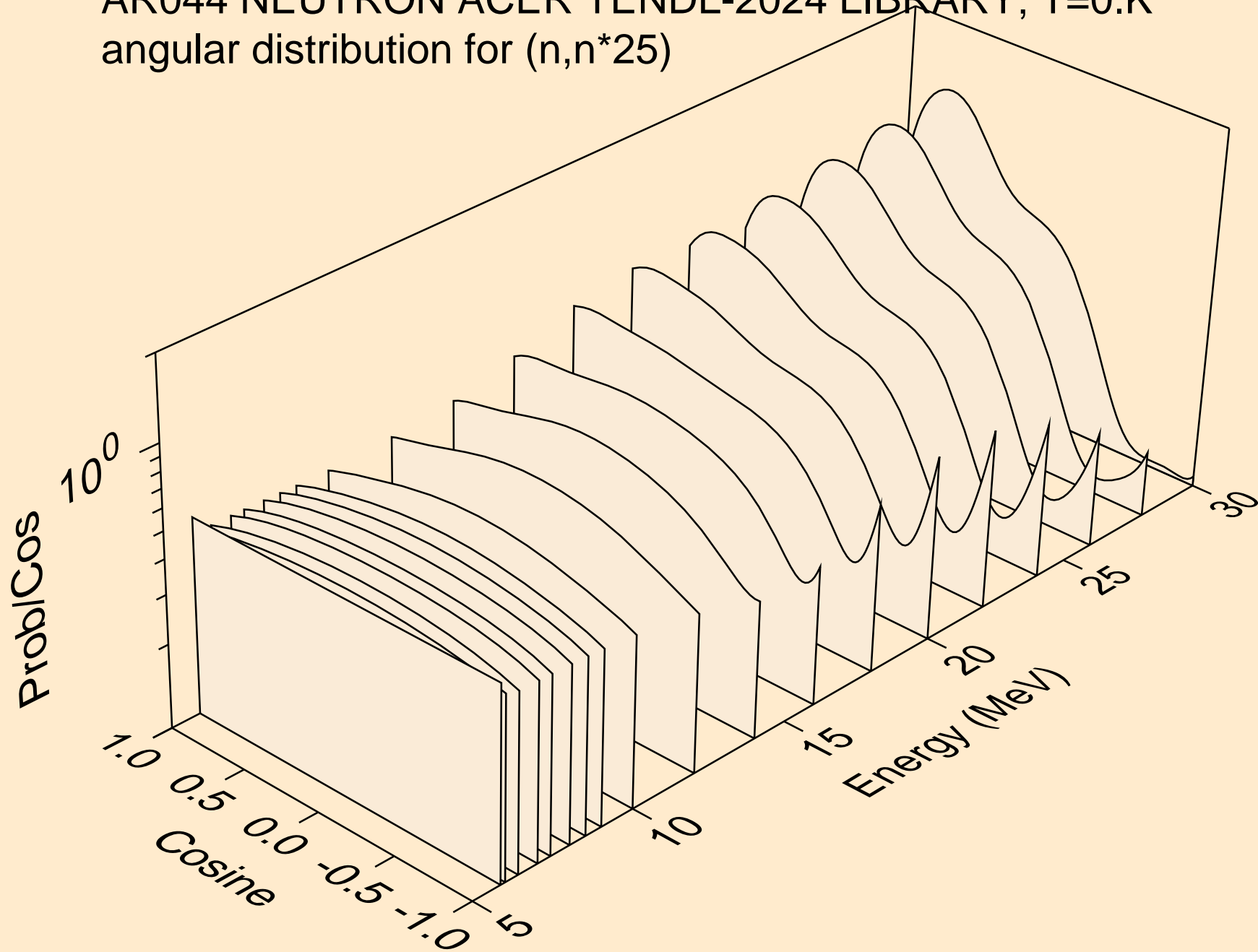

AR044 NEUTRON ACER TENDL-2024 LIBRARY; T=0.K  
angular distribution for (n,n\*26)

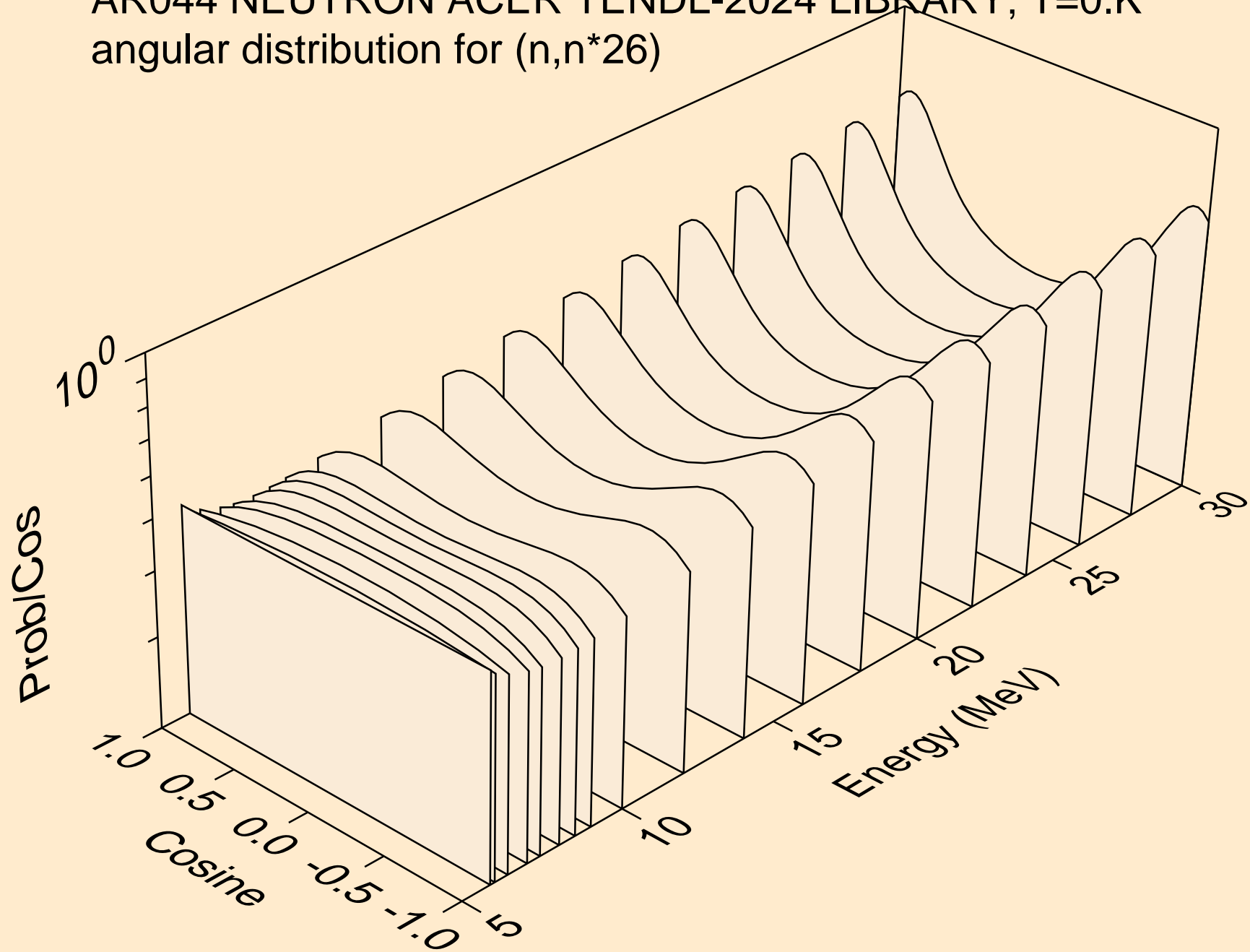

AR044 NEUTRON ACER TENDL-2024 LIBRARY; T=0.K  
angular distribution for (n,n\*27)

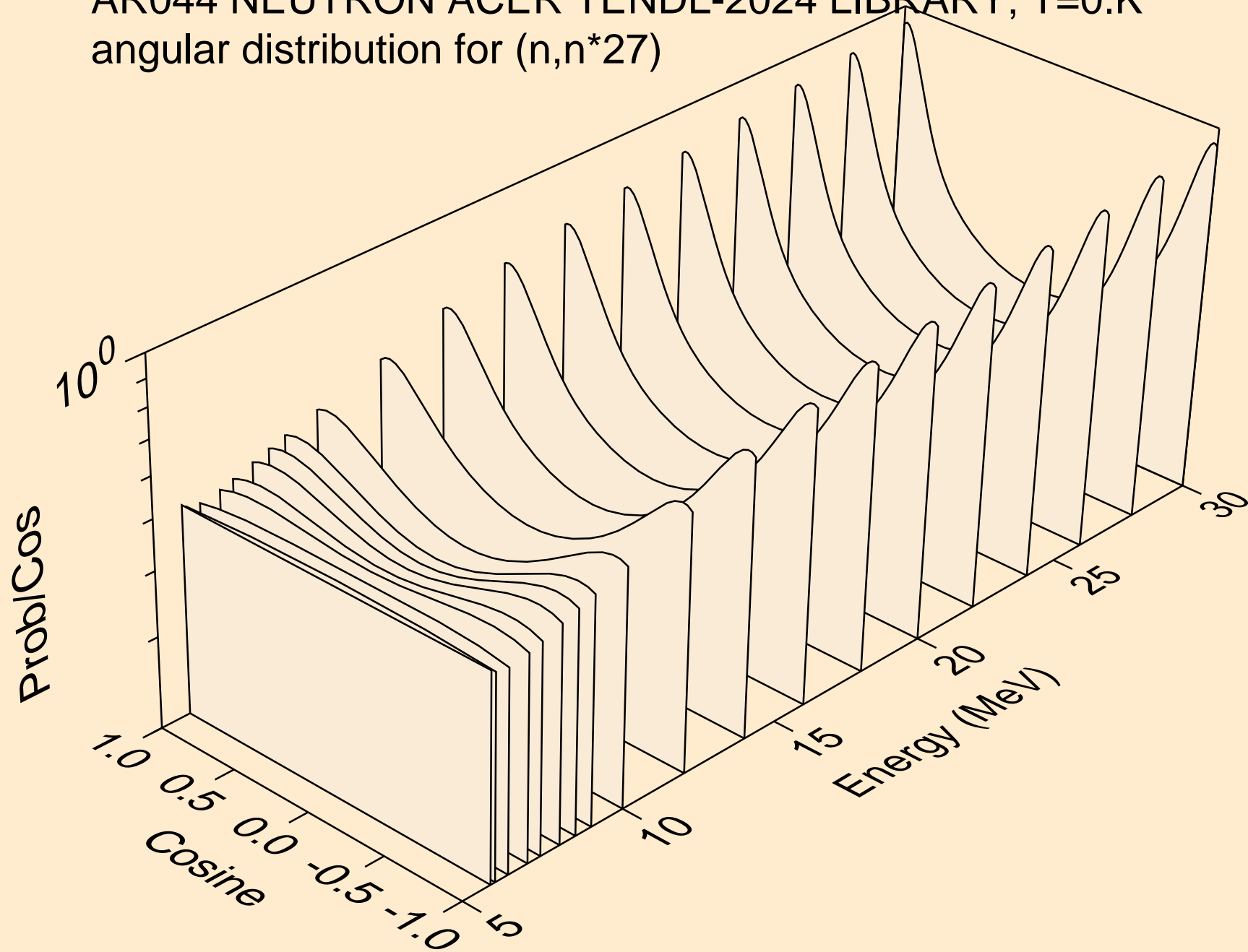

AR044 NEUTRON ACER TENDL-2024 LIBRARY; T=0.K  
angular distribution for (n,n\*28)

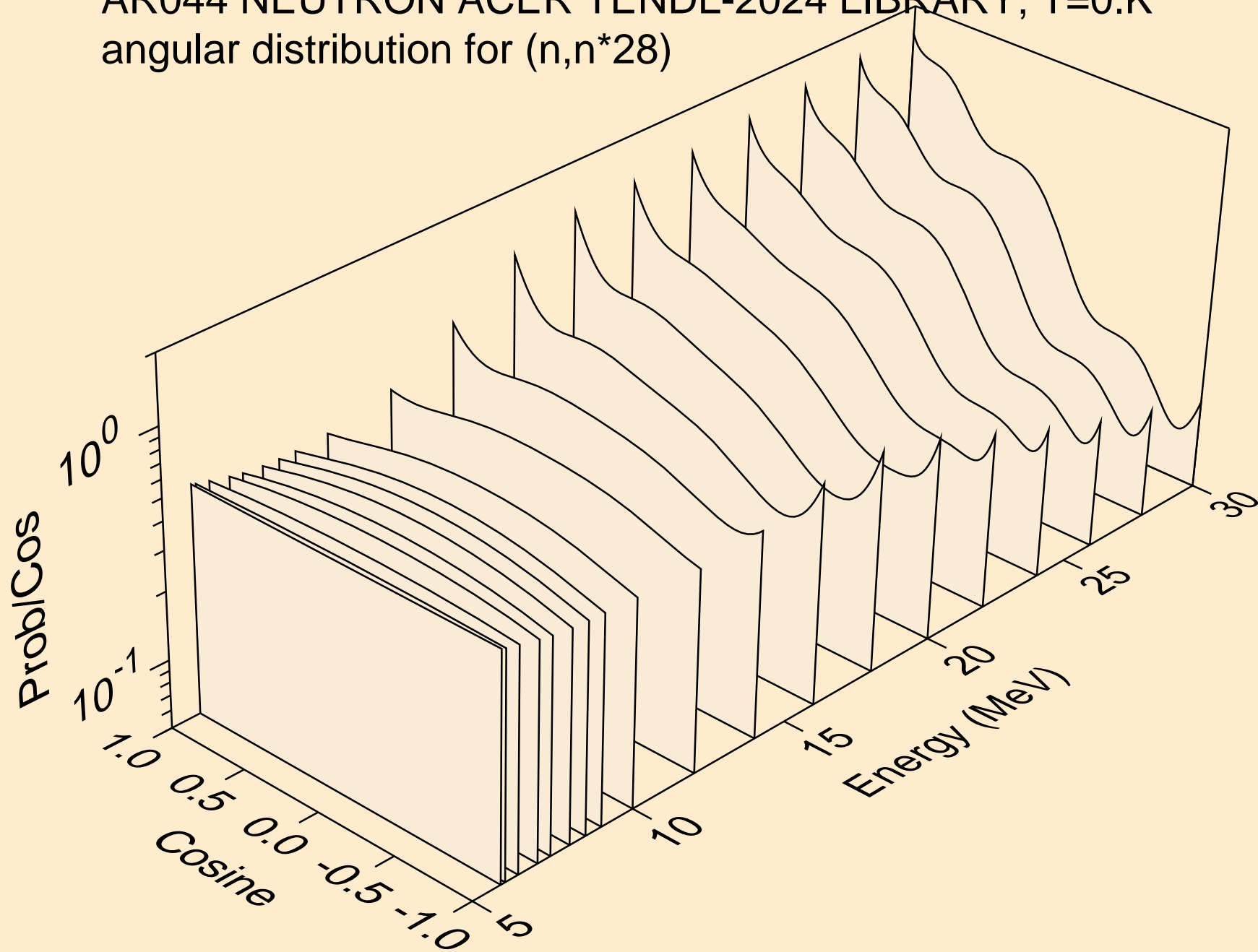

AR044 NEUTRON ACER TENDL-2024 LIBRARY; T=0.K  
angular distribution for (n,n\*29)

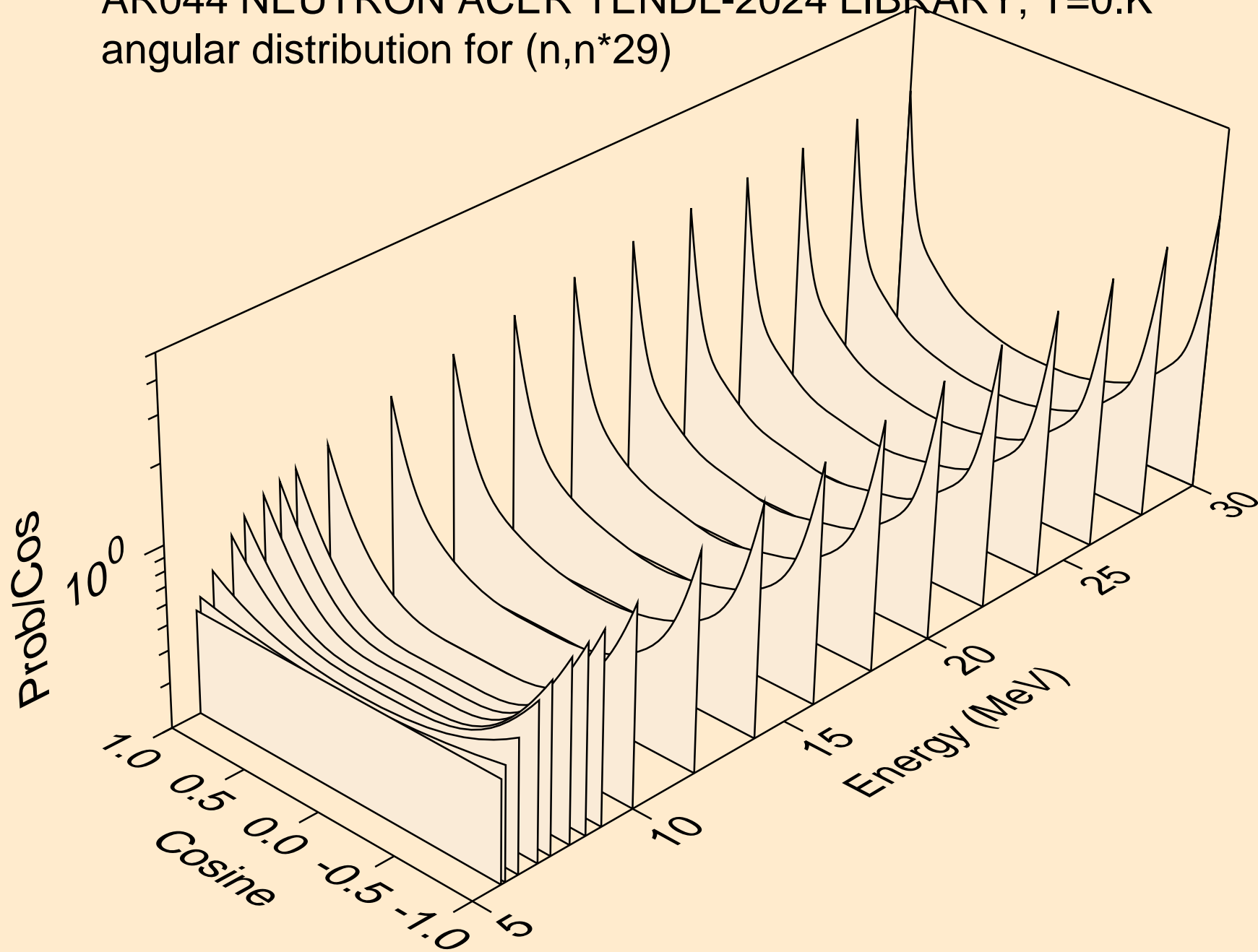

AR044 NEUTRON ACER TENDL-2024 LIBRARY; T=0.K  
angular distribution for (n,n\*30)

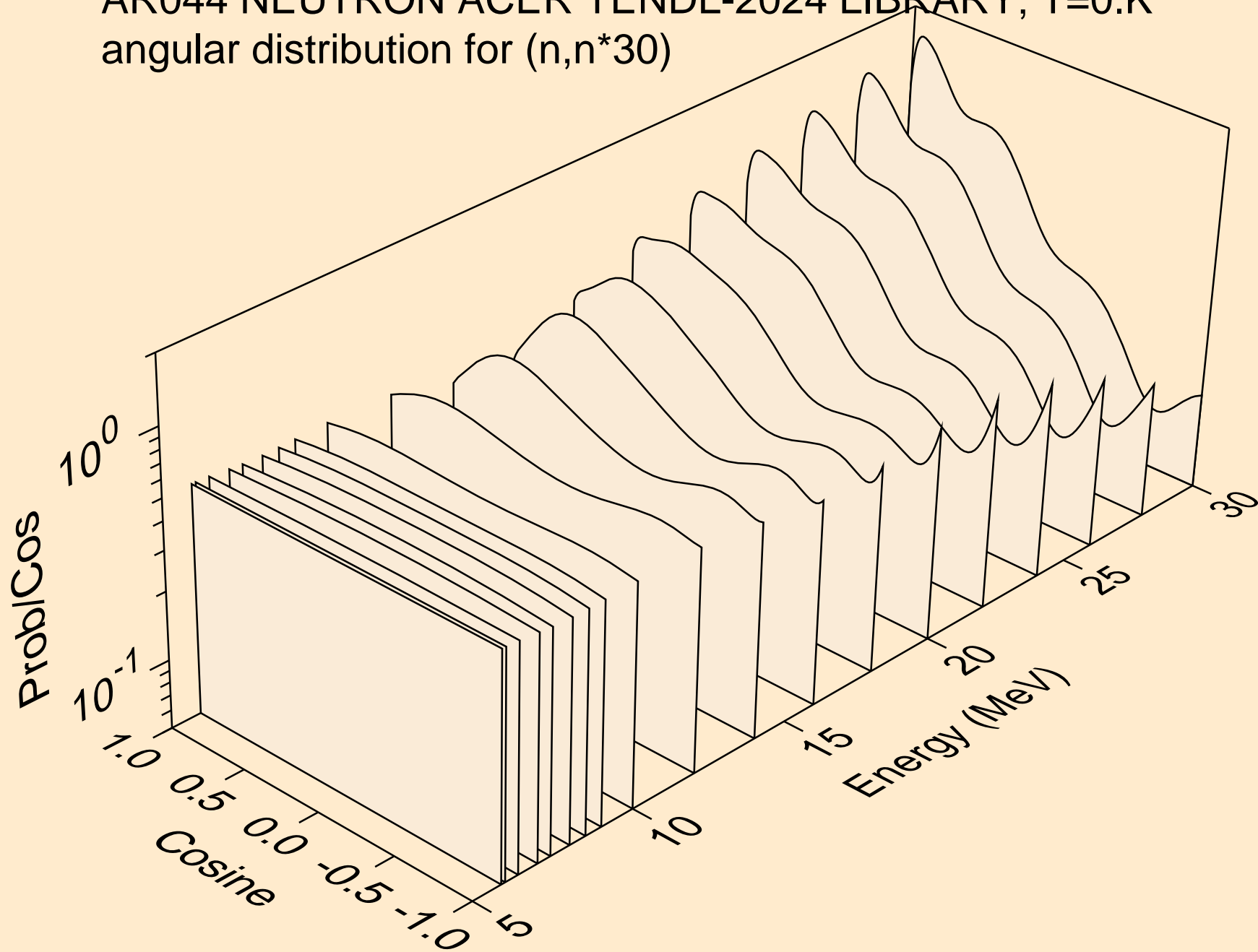

AR044 NEUTRON ACER TENDL-2024 LIBRARY; T=0.K  
Neutron emission for (n,x)

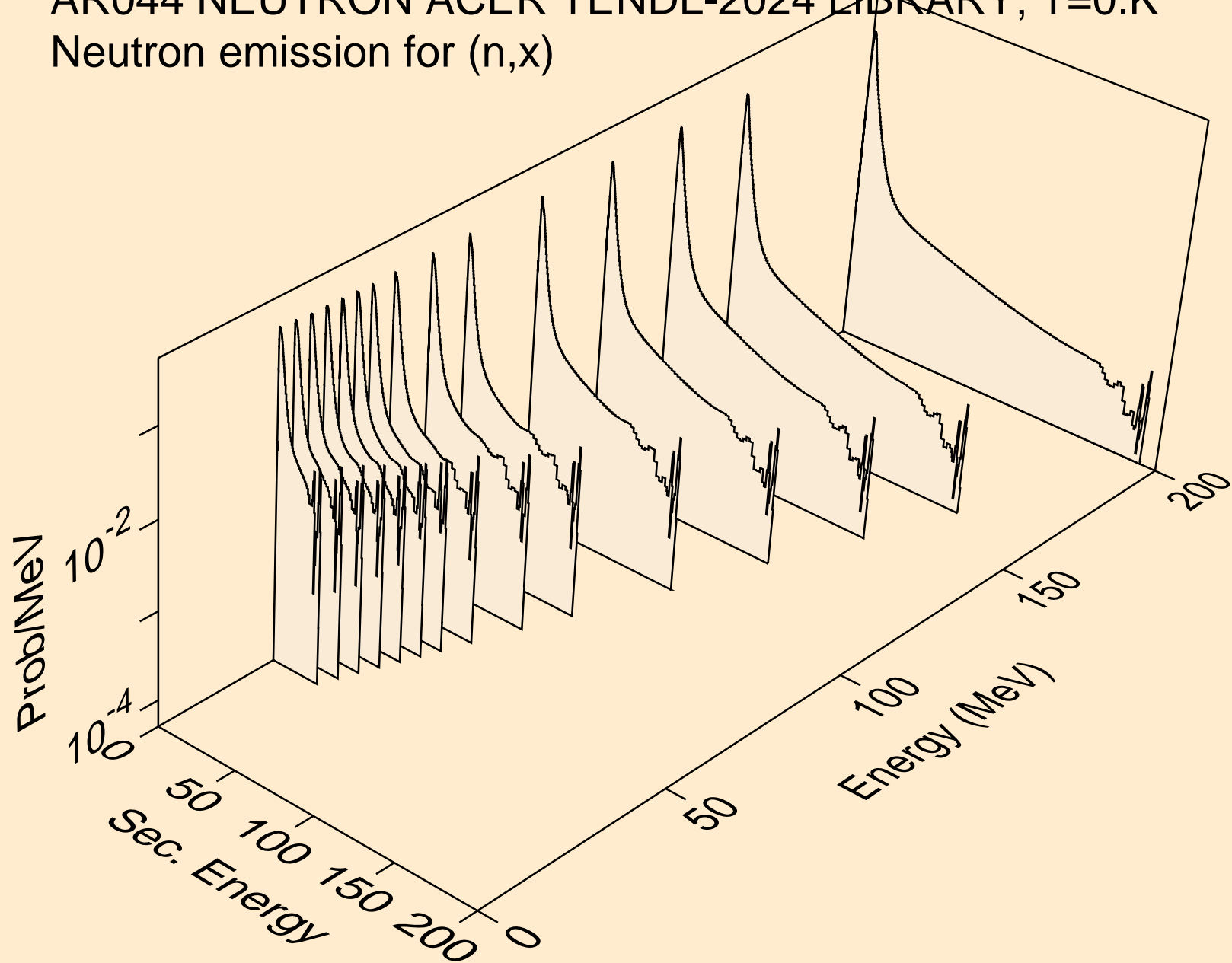

AR044 NEUTRON ACER TENDL-2024 LIBRARY; T=0.K  
Neutron emission for (n,2nd)

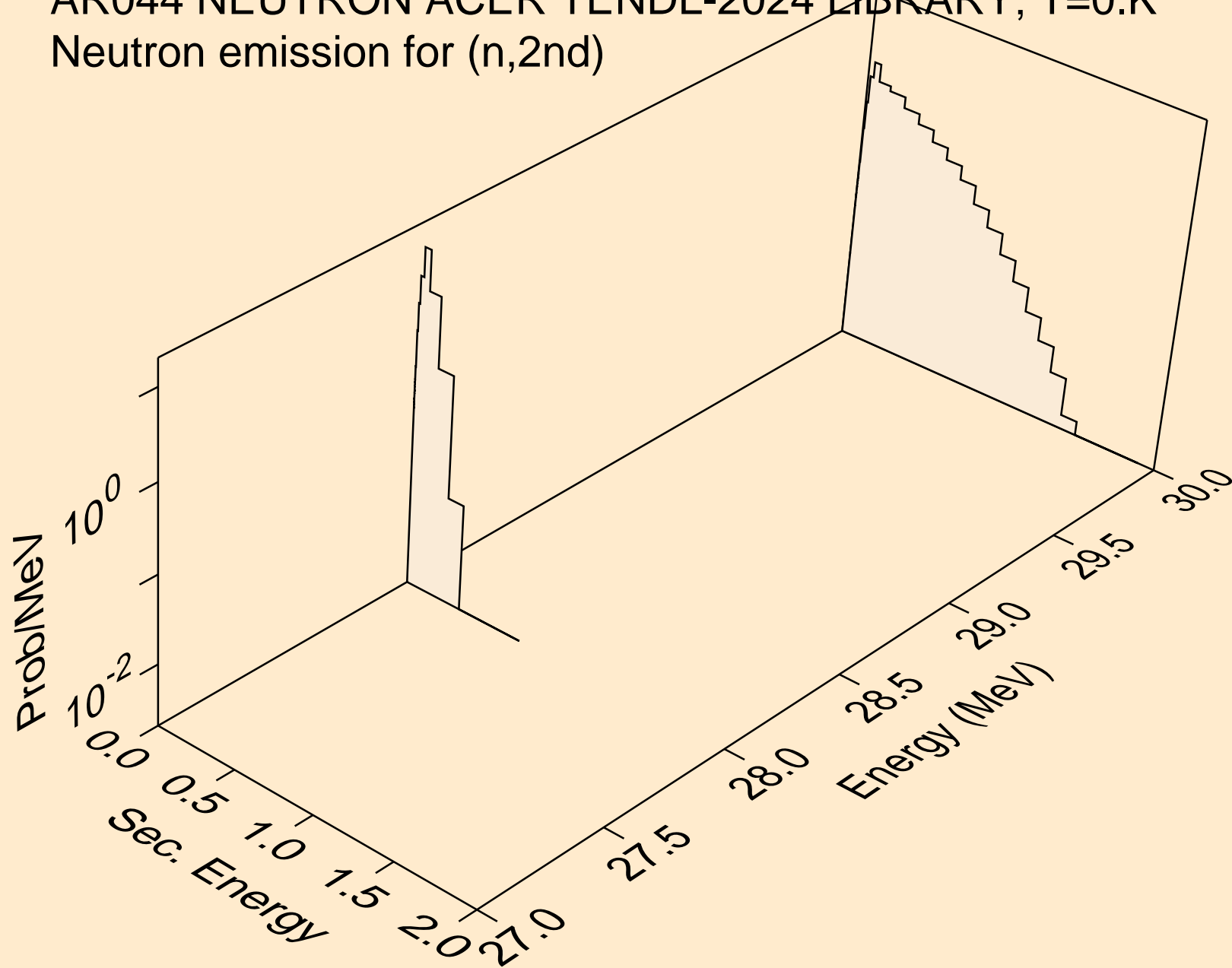

AR044 NEUTRON ACER TENDL-2024 LIBRARY; T=0.K  
Neutron emission for (n,2n)

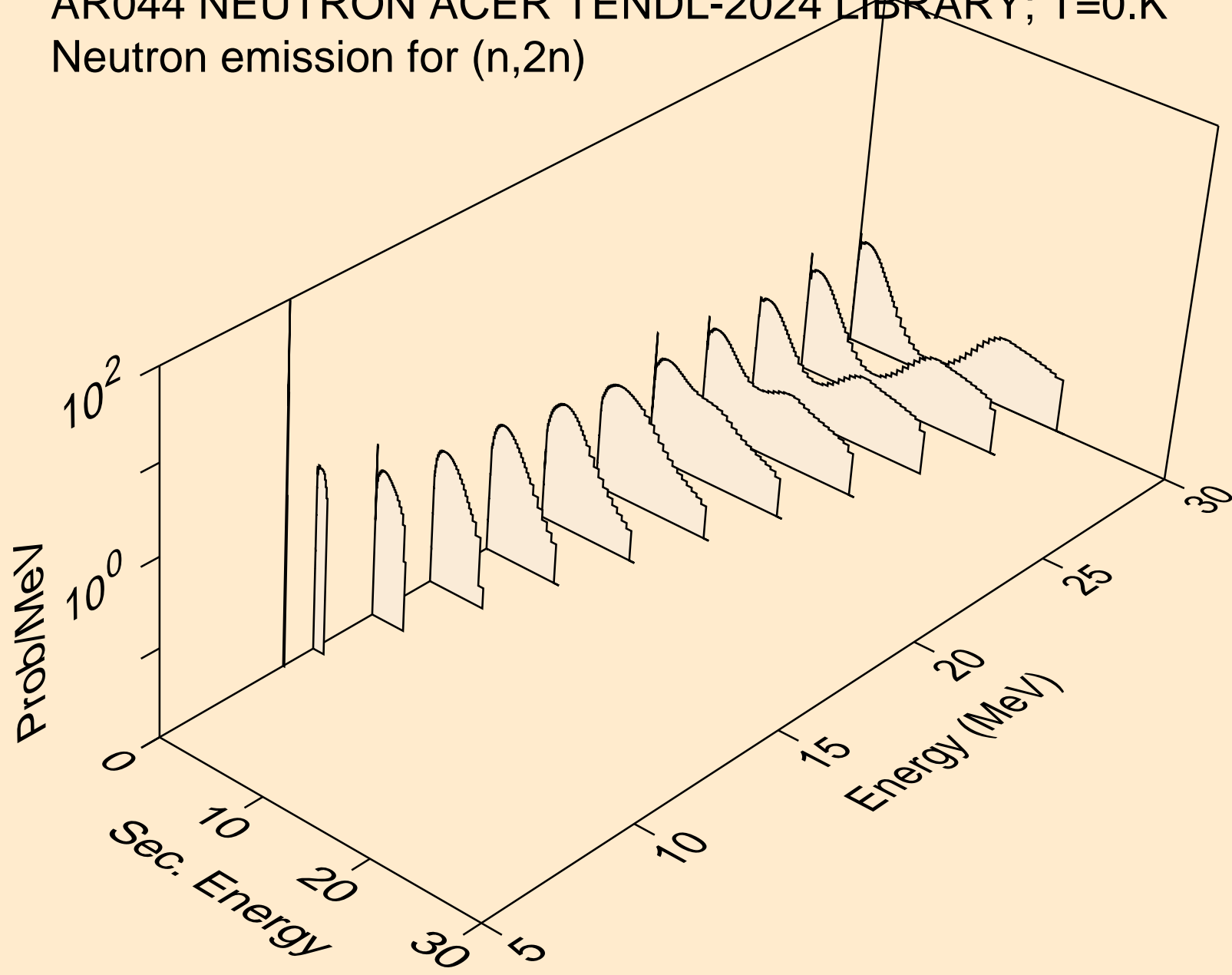

AR044 NEUTRON ACER TENDL-2024 LIBRARY; T=0.K  
Neutron emission for (n,3n)

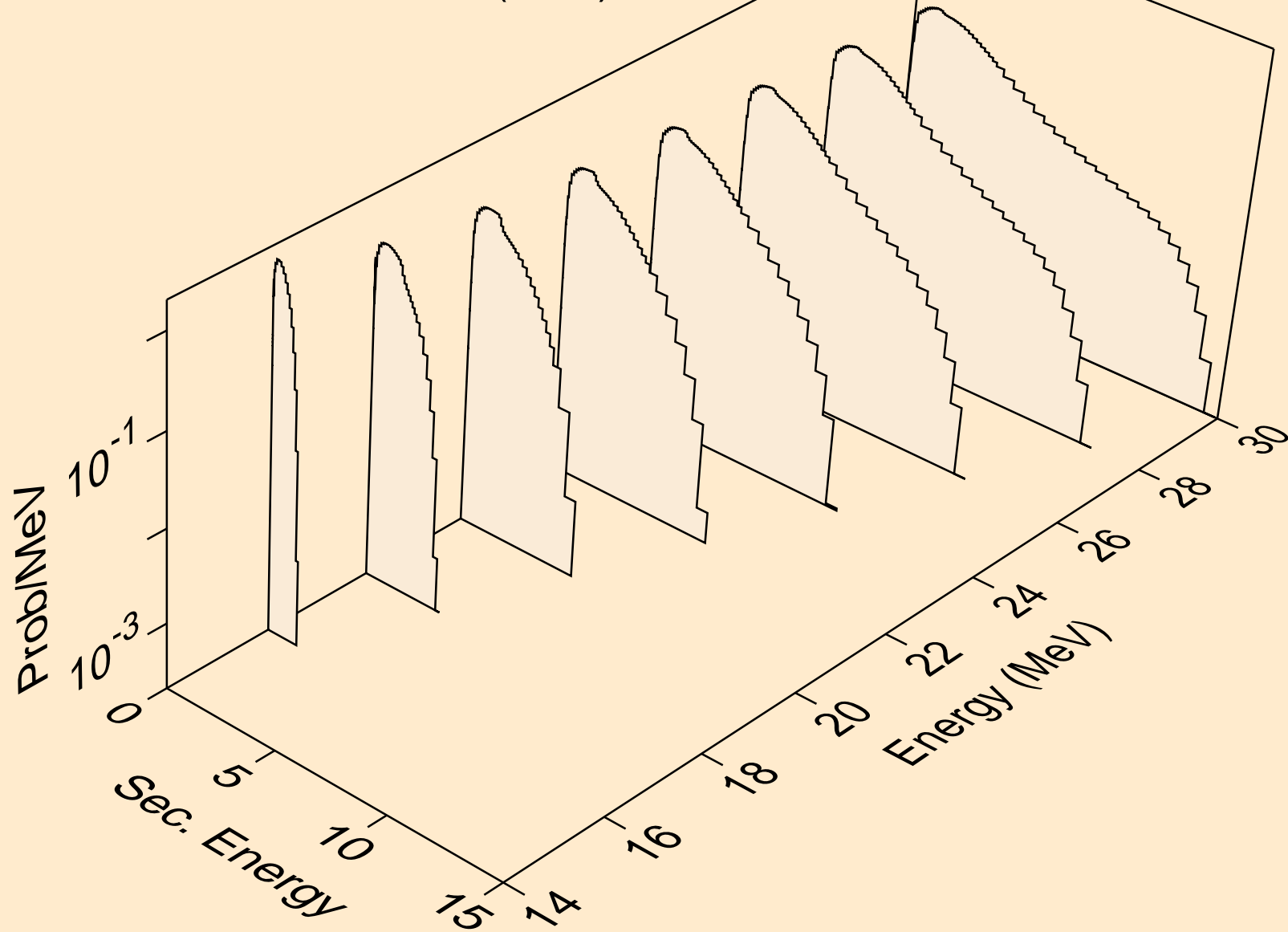

AR044 NEUTRON ACER TENDL-2024 LIBRARY; T=0.K  
Neutron emission for (n,n\*)a

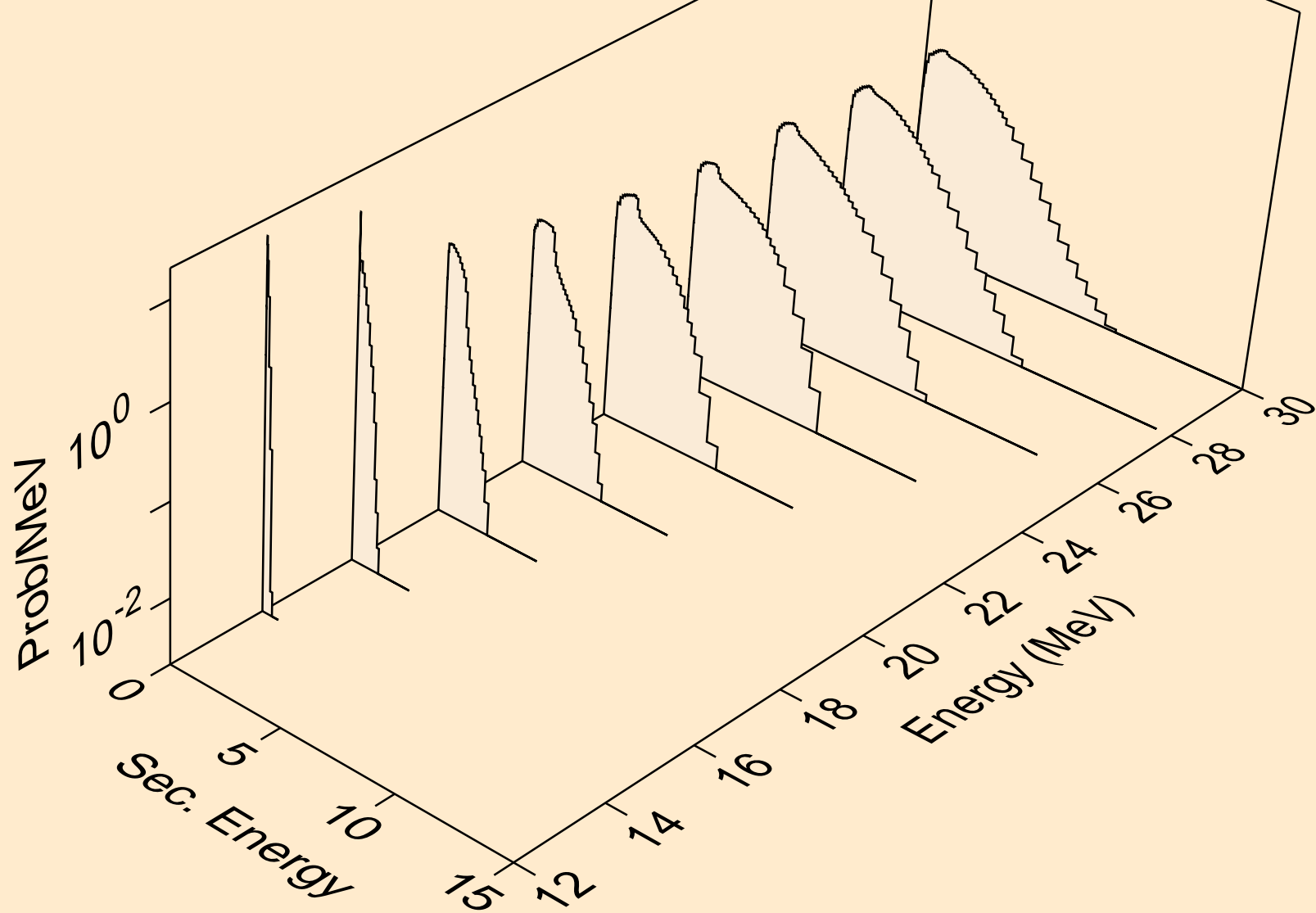

AR044 NEUTRON ACER TENDL-2024 LIBRARY; T=0.K  
Neutron emission for (n,2n)a

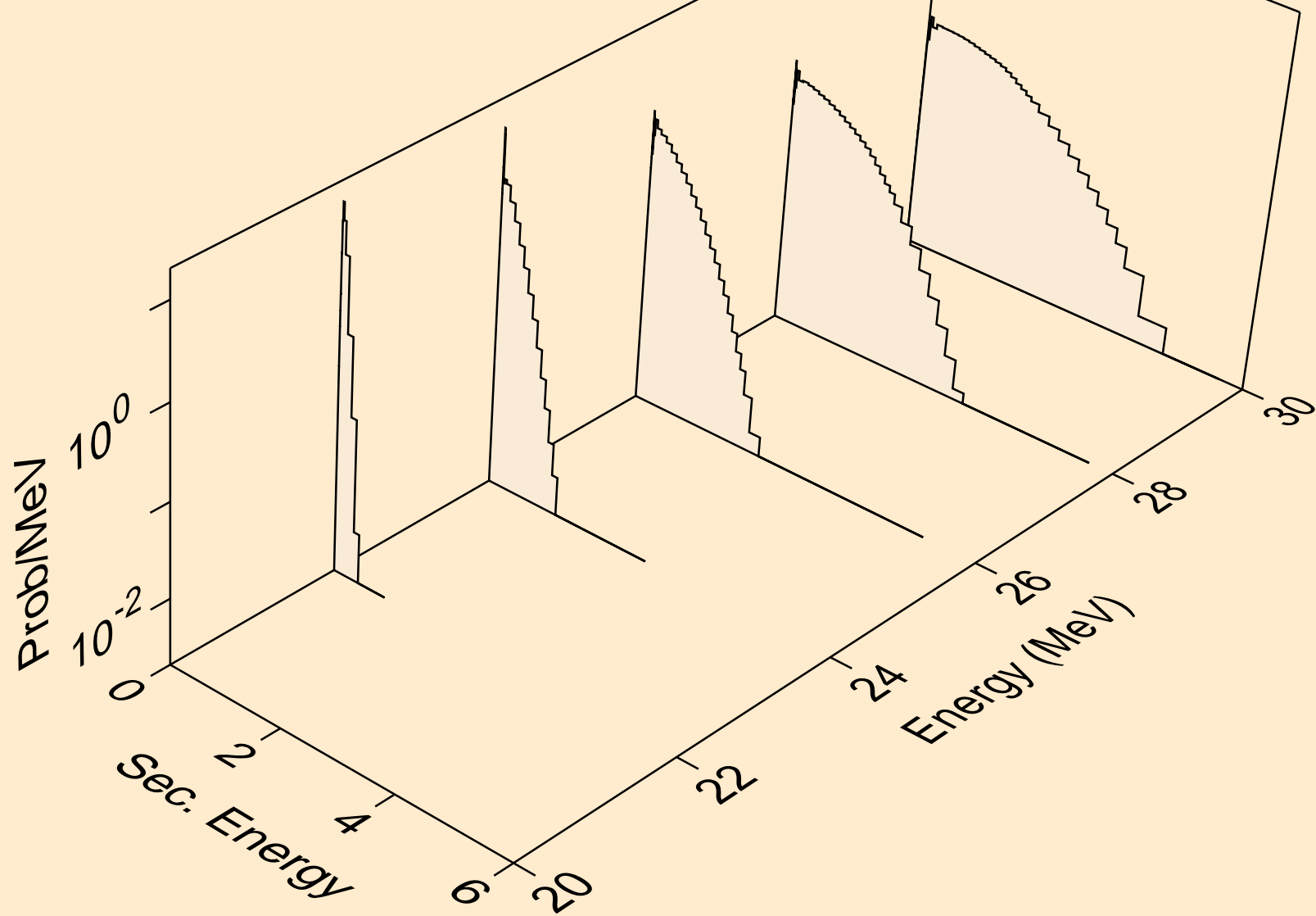

AR044 NEUTRON ACER TENDL-2024 LIBRARY; T=0.K  
Neutron emission for (n,3n)a

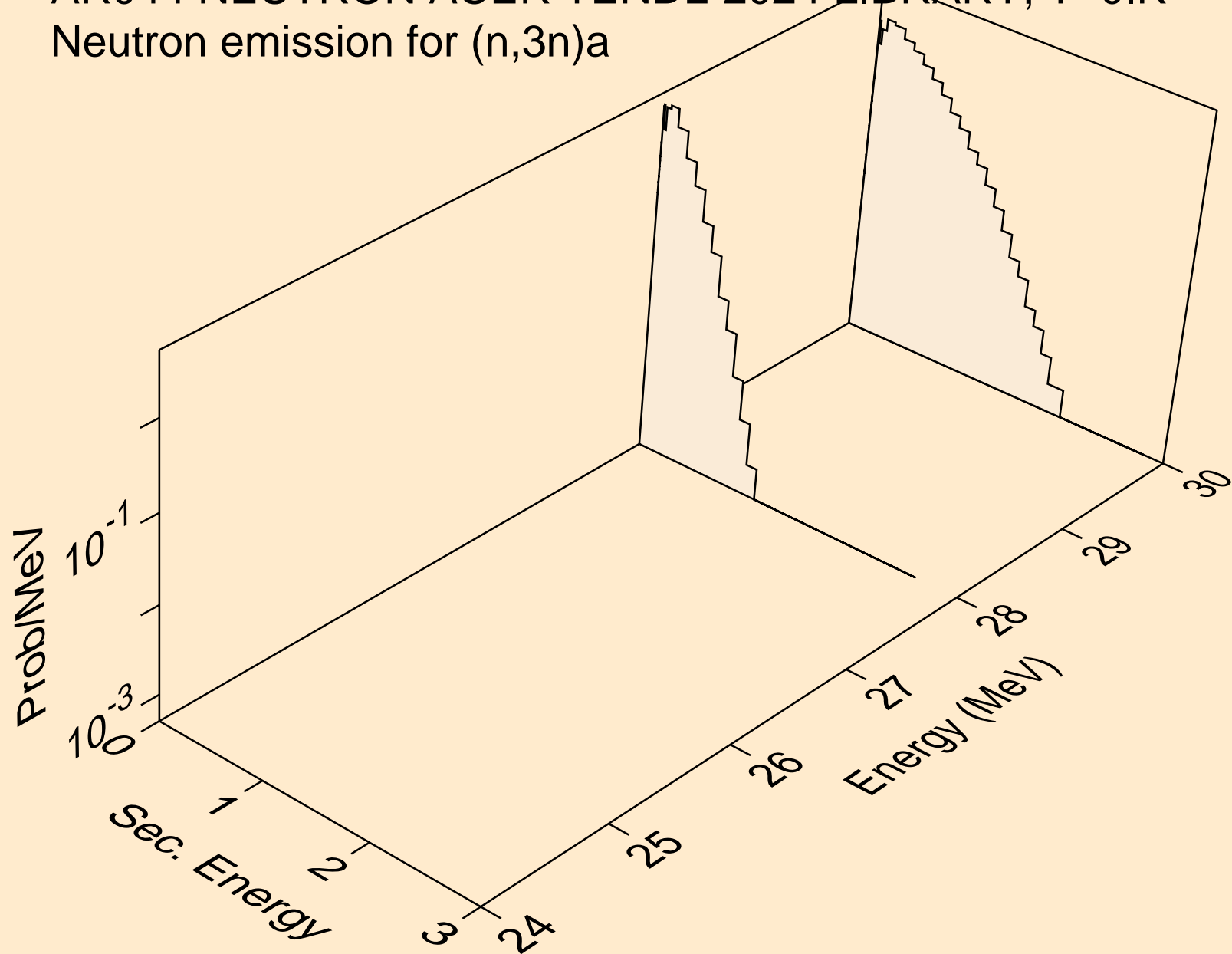

AR044 NEUTRON ACER TENDL-2024 LIBRARY; T=0.K  
Neutron emission for (n,n\*)p

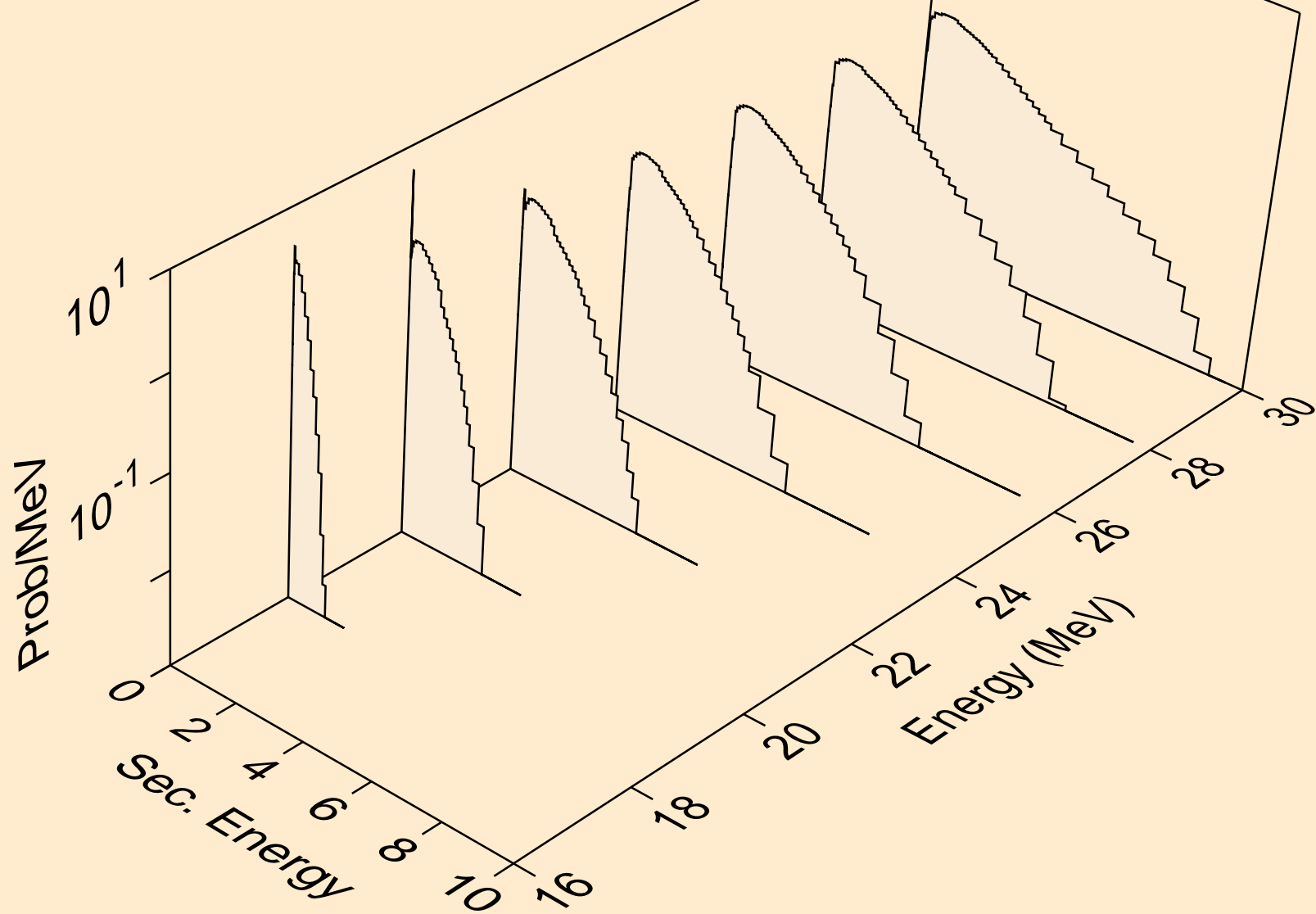

AR044 NEUTRON ACER TENDL-2024 LIBRARY; T=0.K  
Neutron emission for (n,n\*)d

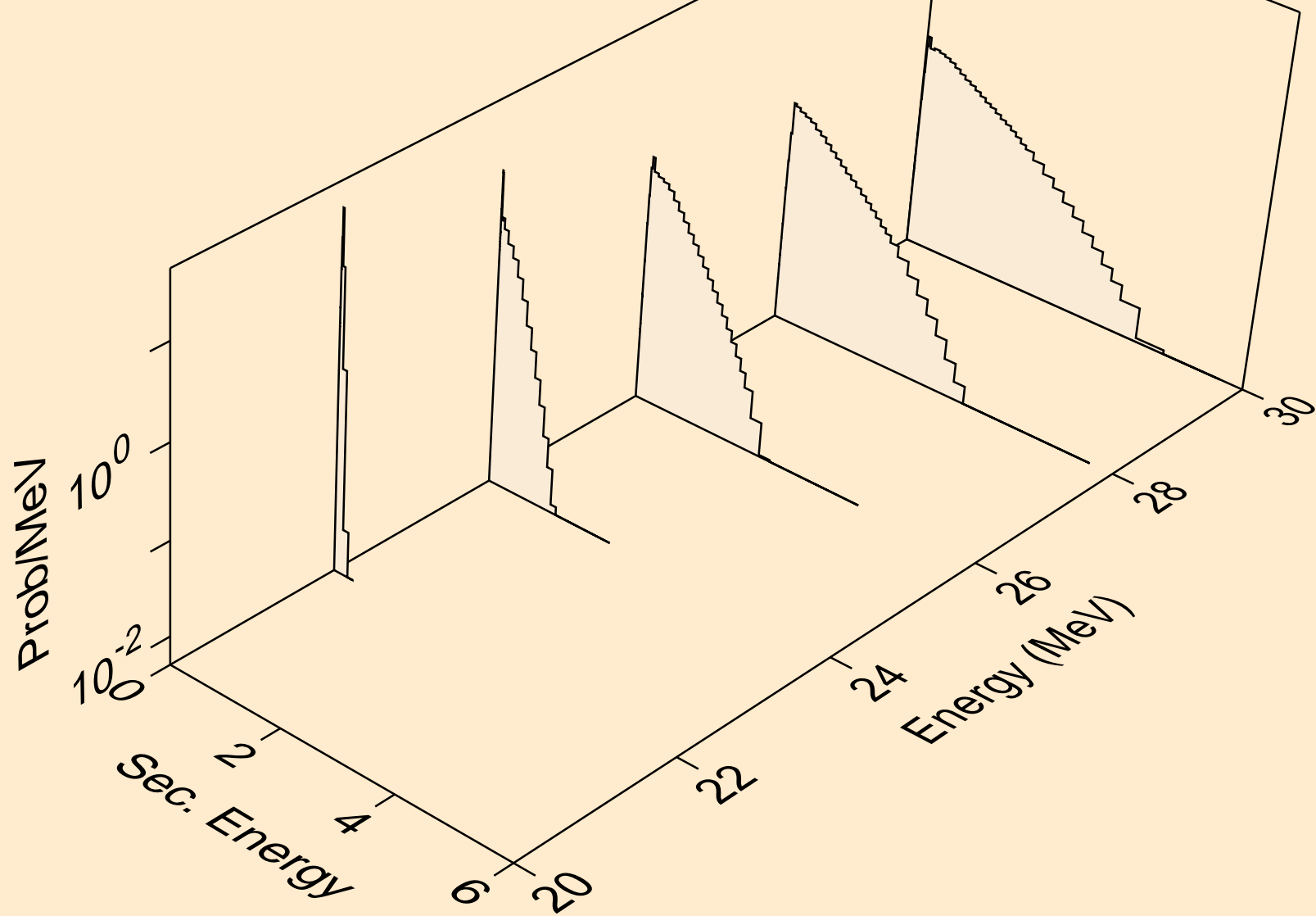

AR044 NEUTRON ACER TENDL-2024 LIBRARY; T=0.K  
Neutron emission for (n,n\*)t

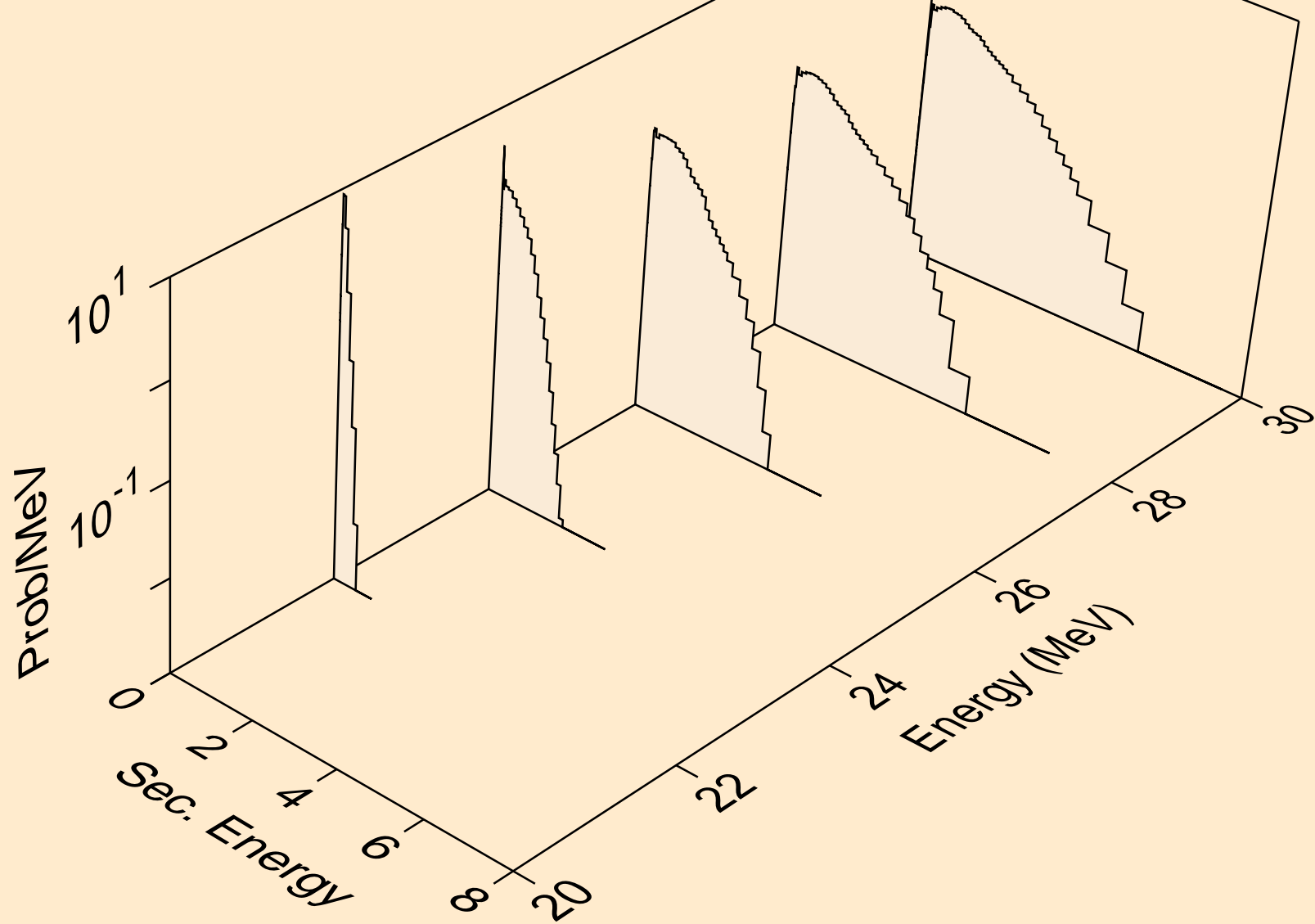

AR044 NEUTRON ACER TENDL-2024 LIBRARY; T=0.K  
Neutron emission for (n,4n)

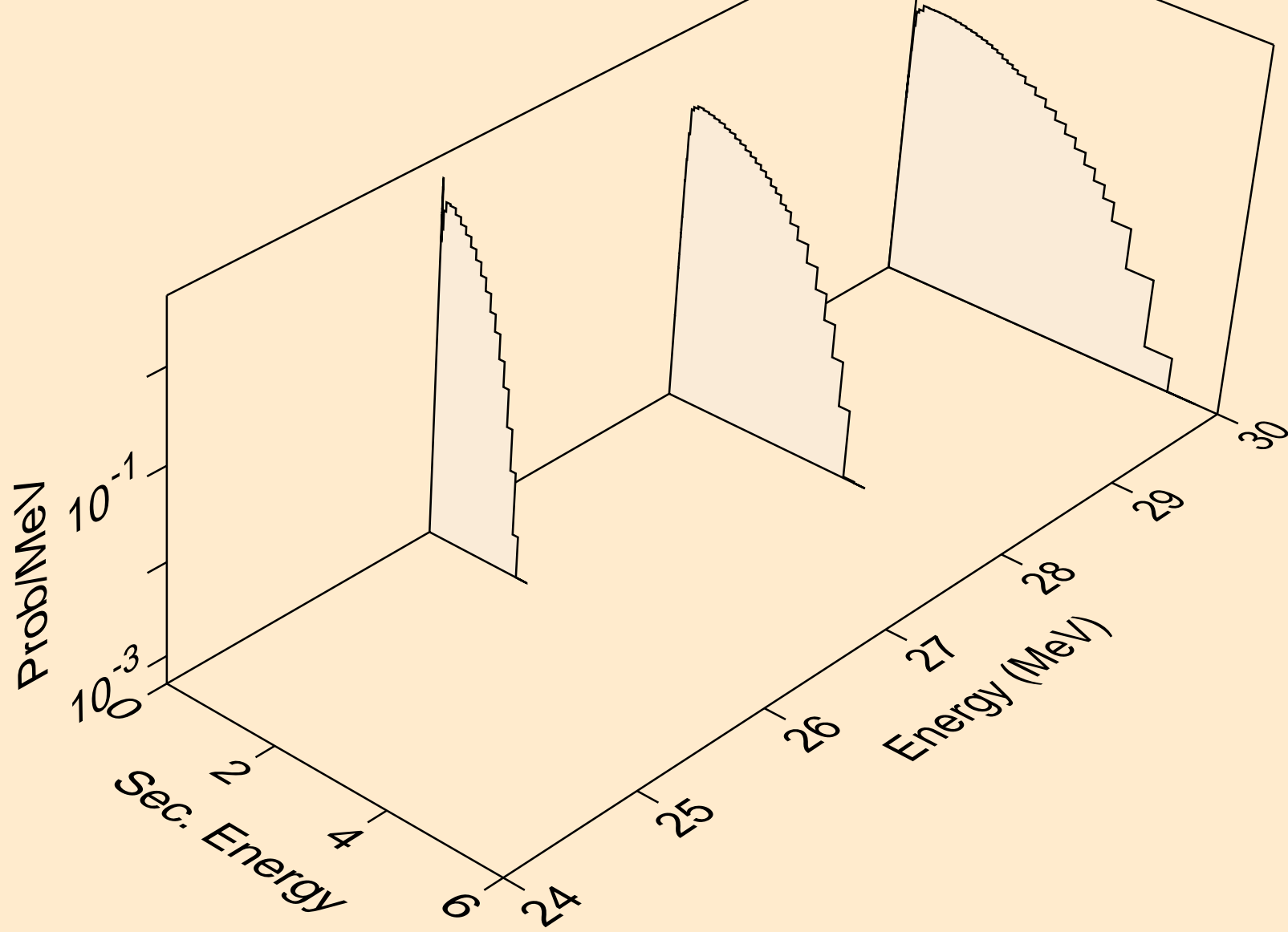

AR044 NEUTRON ACER TENDL-2024 LIBRARY; T=0.K  
Neutron emission for (n,2np)

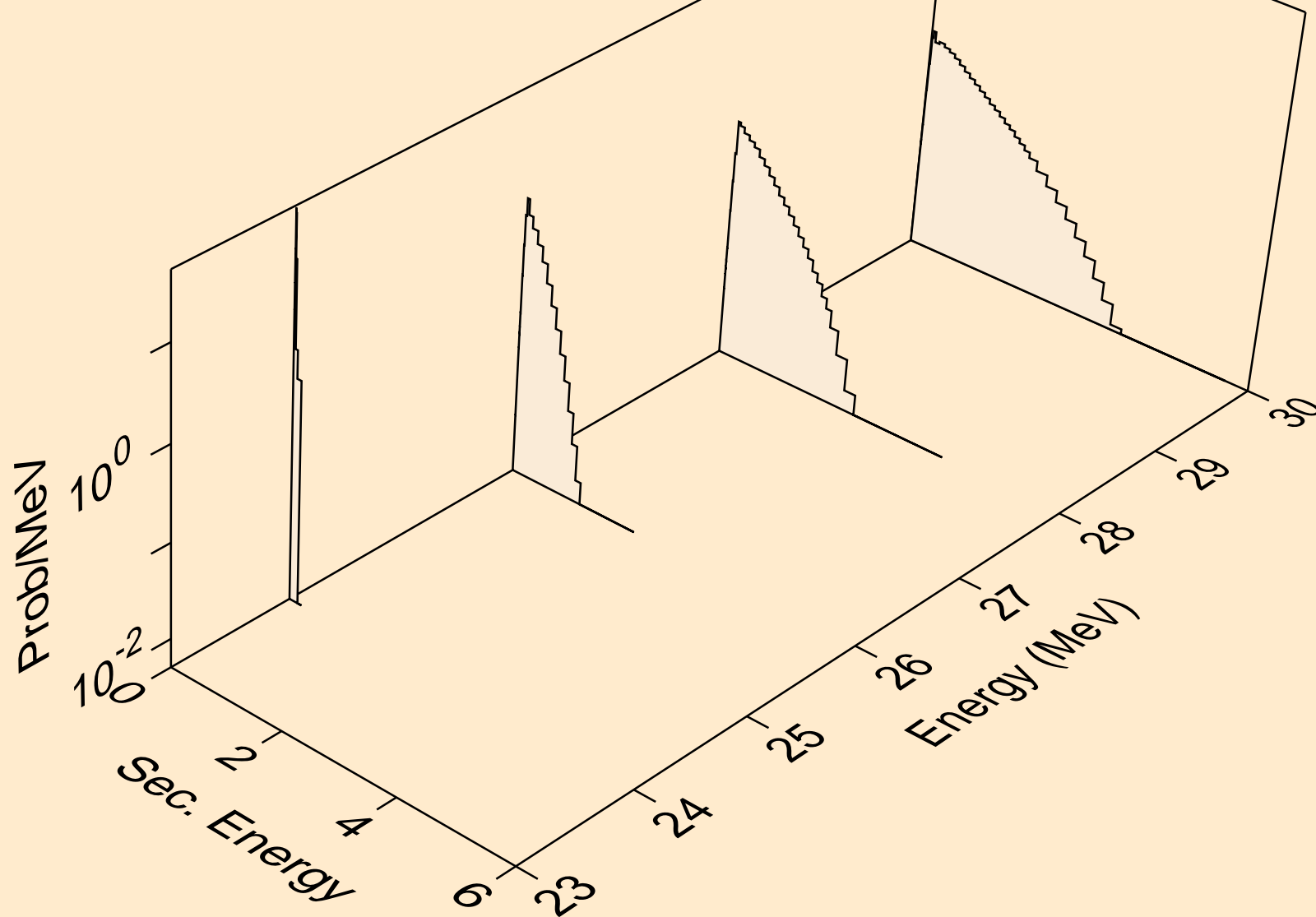

AR044 NEUTRON ACER TENDL-2024 LIBRARY; T=0.K  
Neutron emission for (n,n\*c)

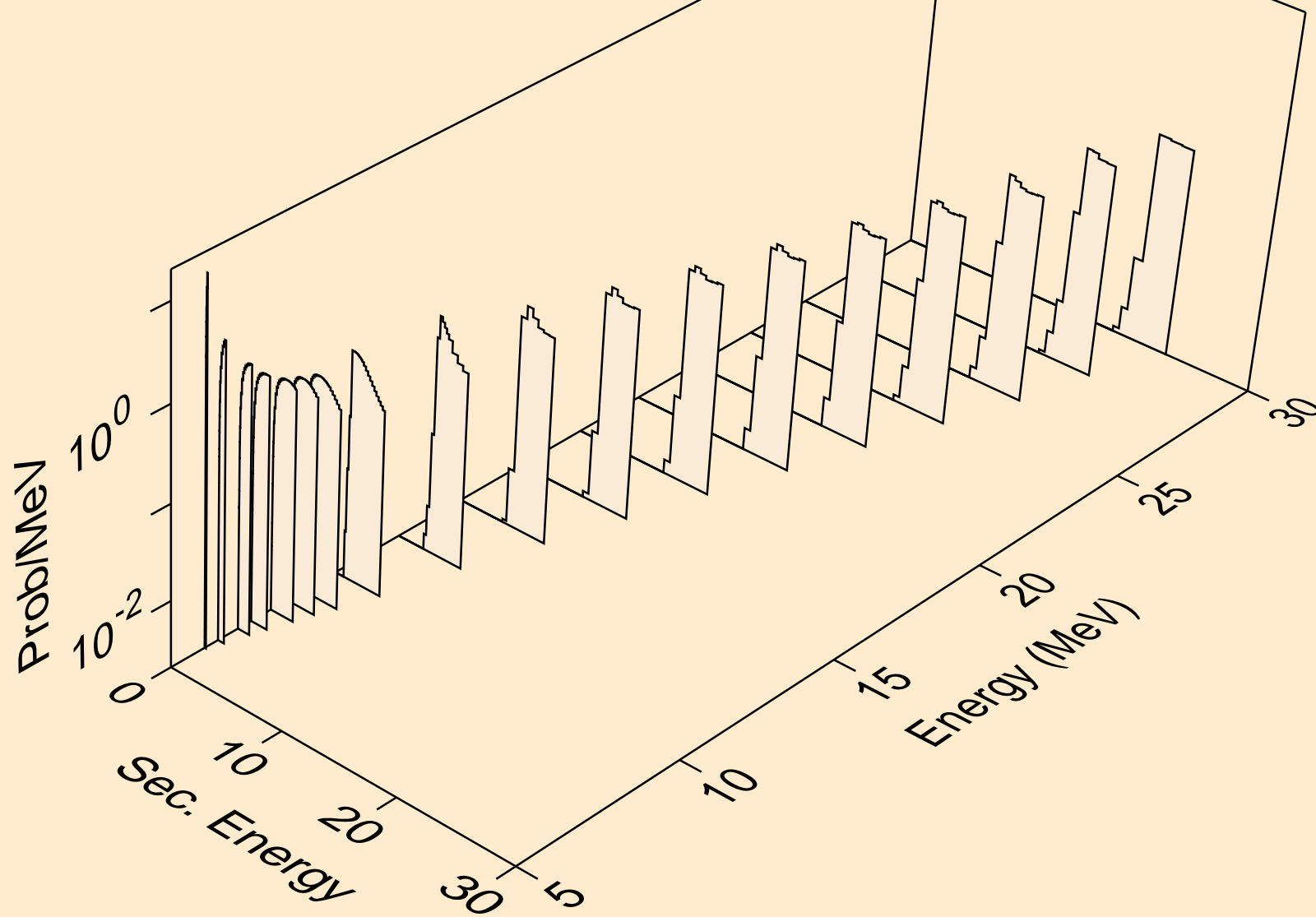

AR044 NEUTRON ACER TENDL-2024 LIBRARY; T=0.K  
Photon emission for (n,x)

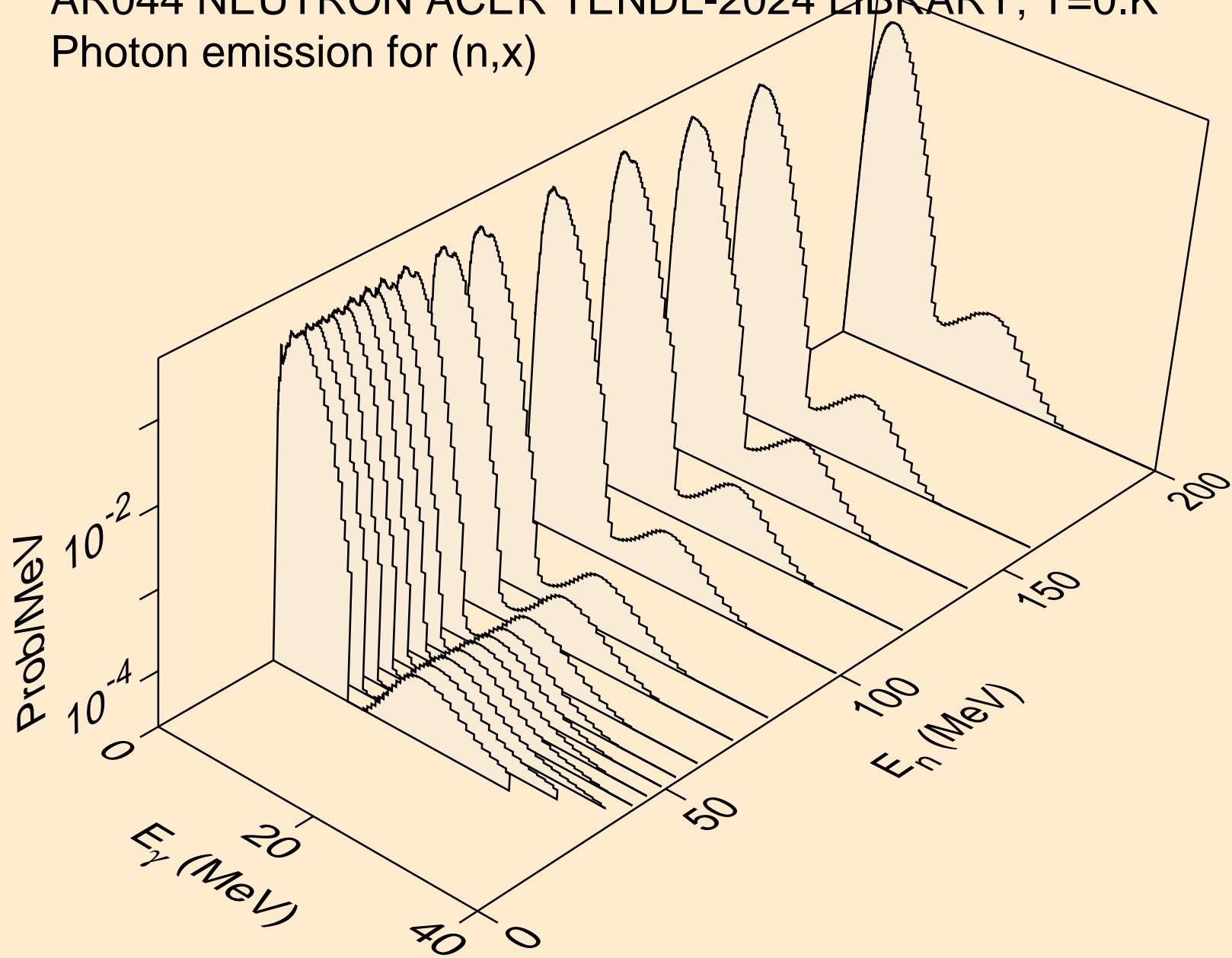

AR044 NEUTRON ACER TENDL-2024 LIBRARY; T=0.K  
Photon emission for (n,2nd)

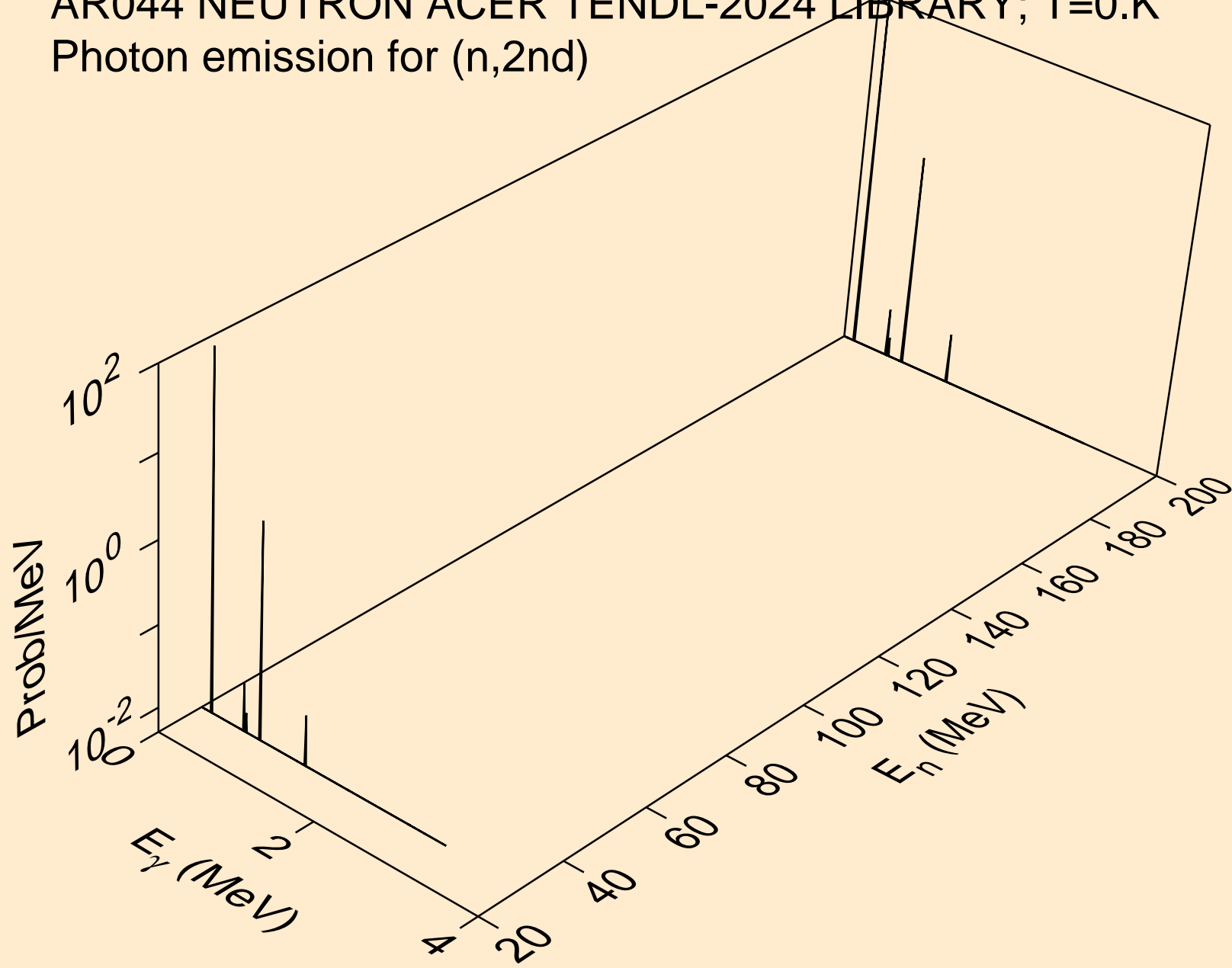

AR044 NEUTRON ACER TENDL-2024 LIBRARY; T=0.K  
Photon emission for (n,2n)

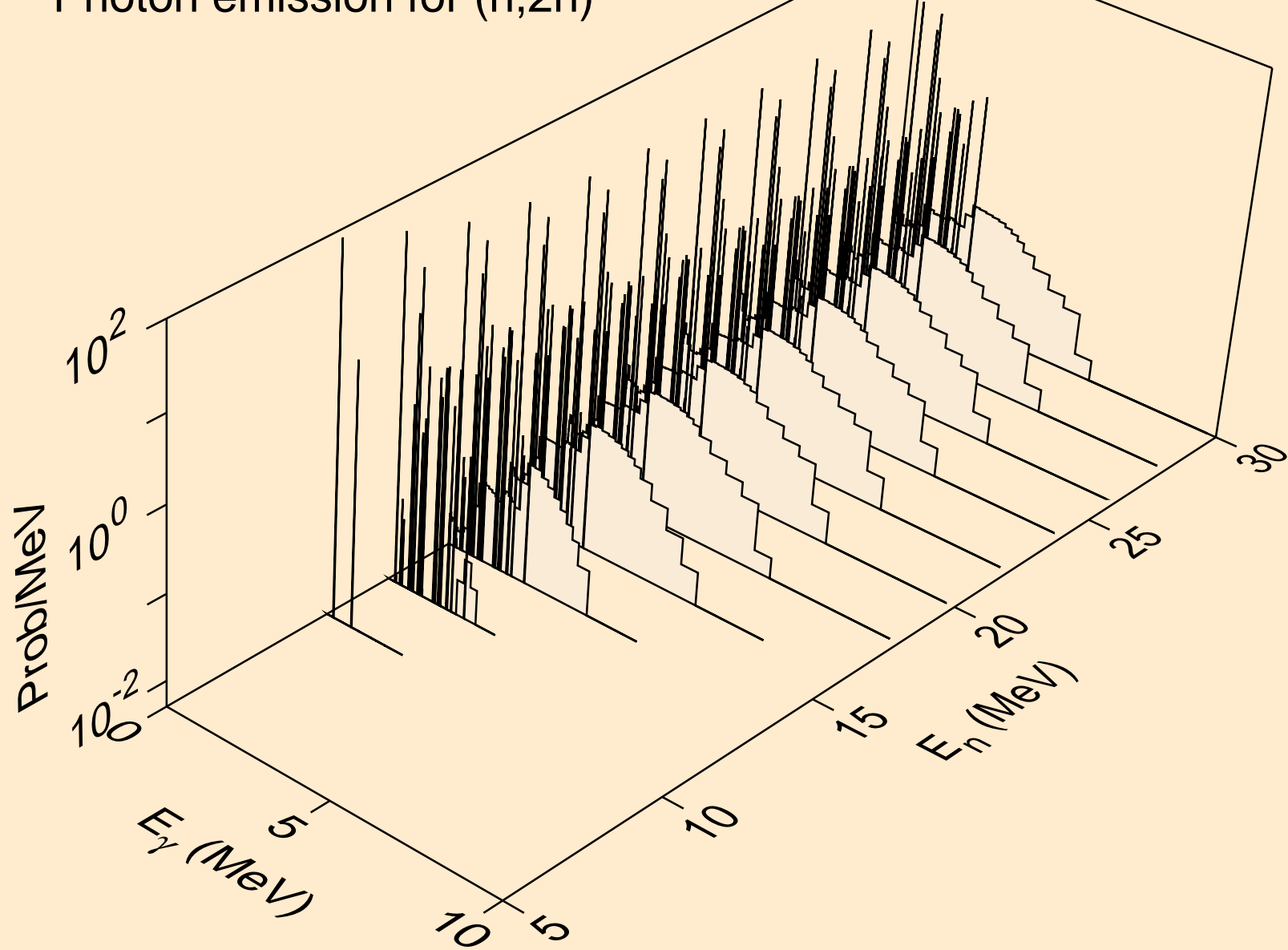

AR044 NEUTRON ACER TENDL-2024 LIBRARY; T=0.K  
Photon emission for (n,3n)

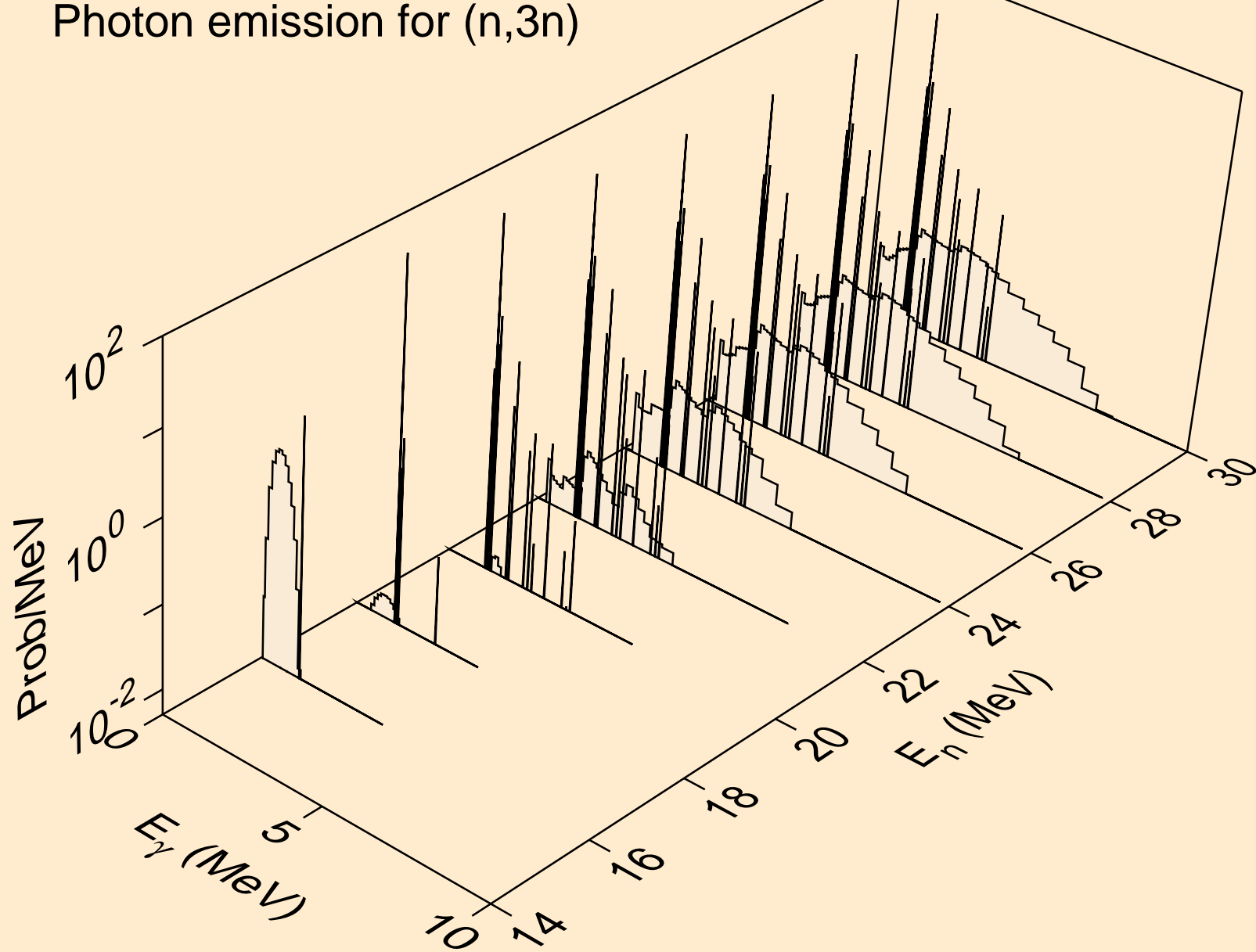

AR044 NEUTRON ACER TENDL-2024 LIBRARY; T=0.K  
Photon emission for (n,n\*)a

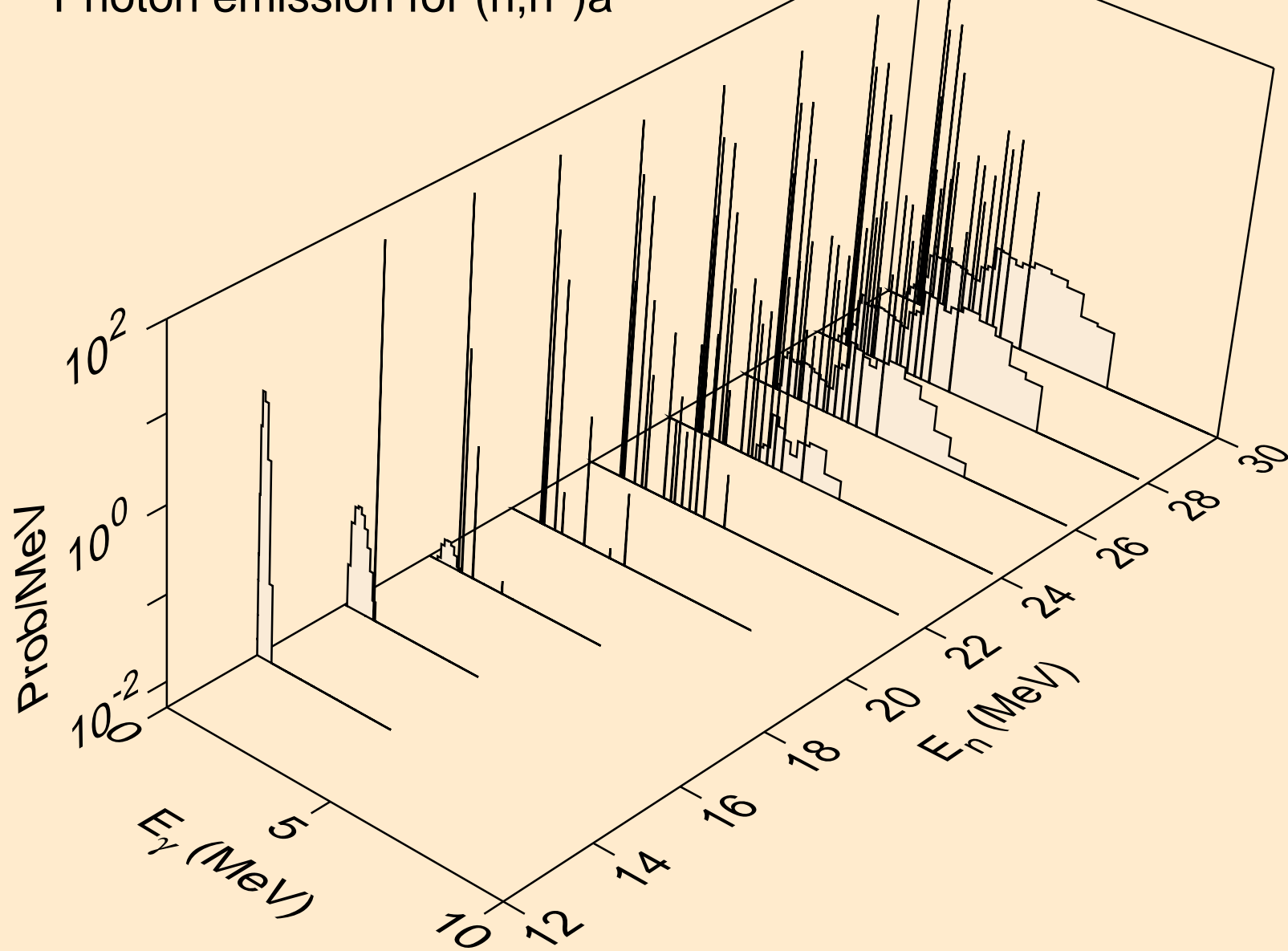

AR044 NEUTRON ACER TENDL-2024 LIBRARY; T=0.K  
Photon emission for (n,2n)a

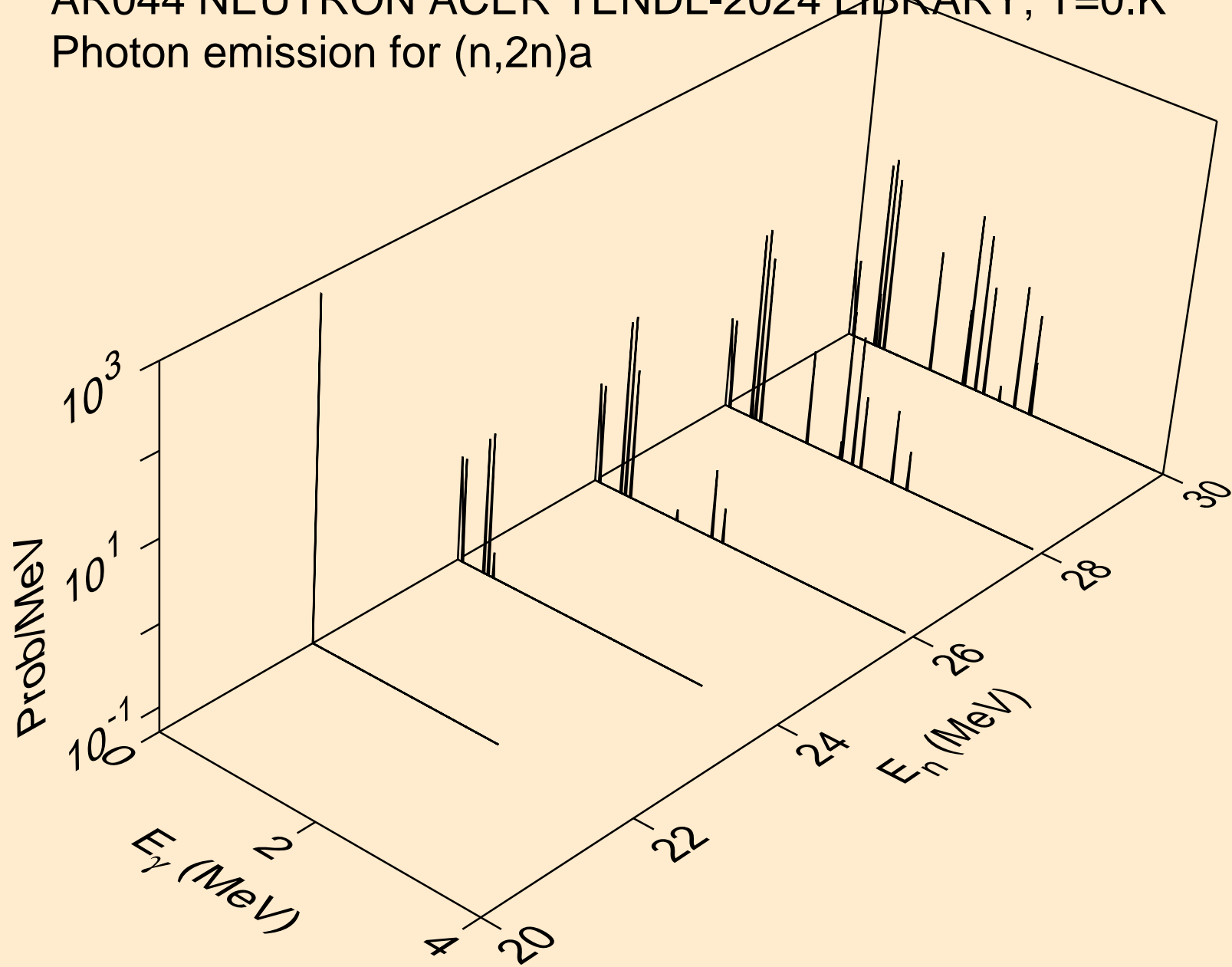

AR044 NEUTRON ACER TENDL-2024 LIBRARY; T=0.K  
Photon emission for (n,3n)a

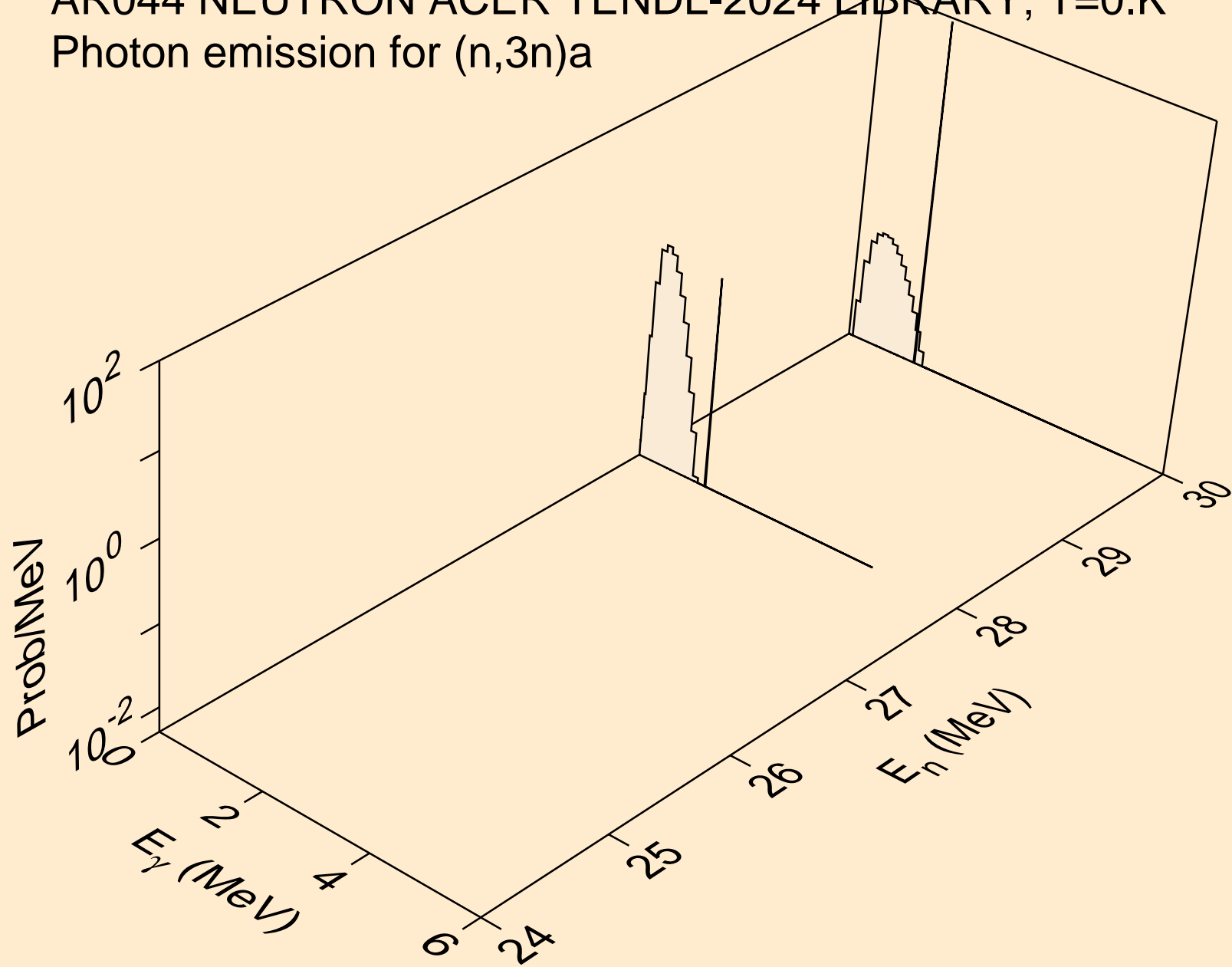

AR044 NEUTRON ACER TENDL-2024 LIBRARY; T=0.K  
Photon emission for (n,n\*)p

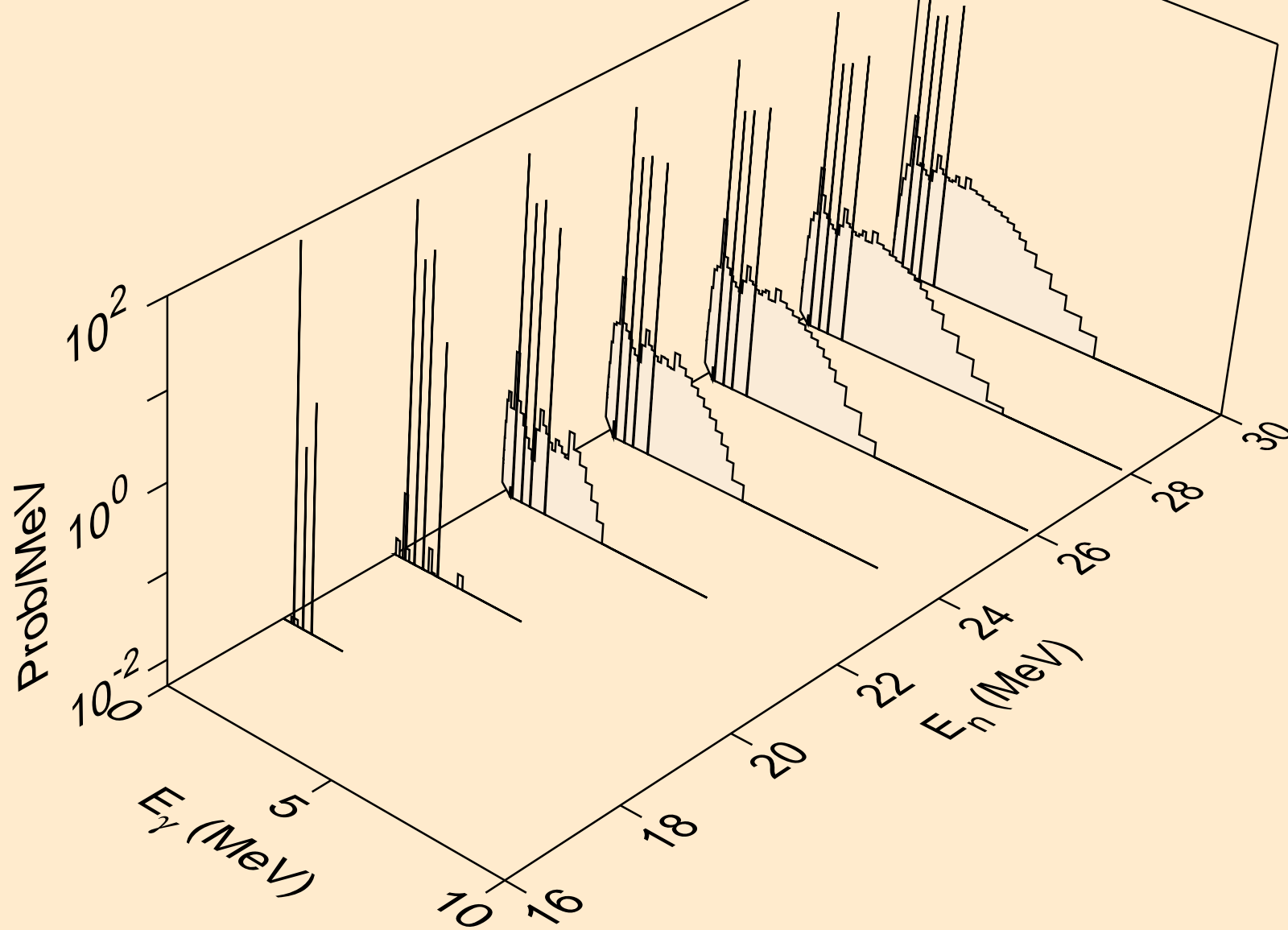

AR044 NEUTRON ACER TENDL-2024 LIBRARY; T=0.K  
Photon emission for (n,n\*)d

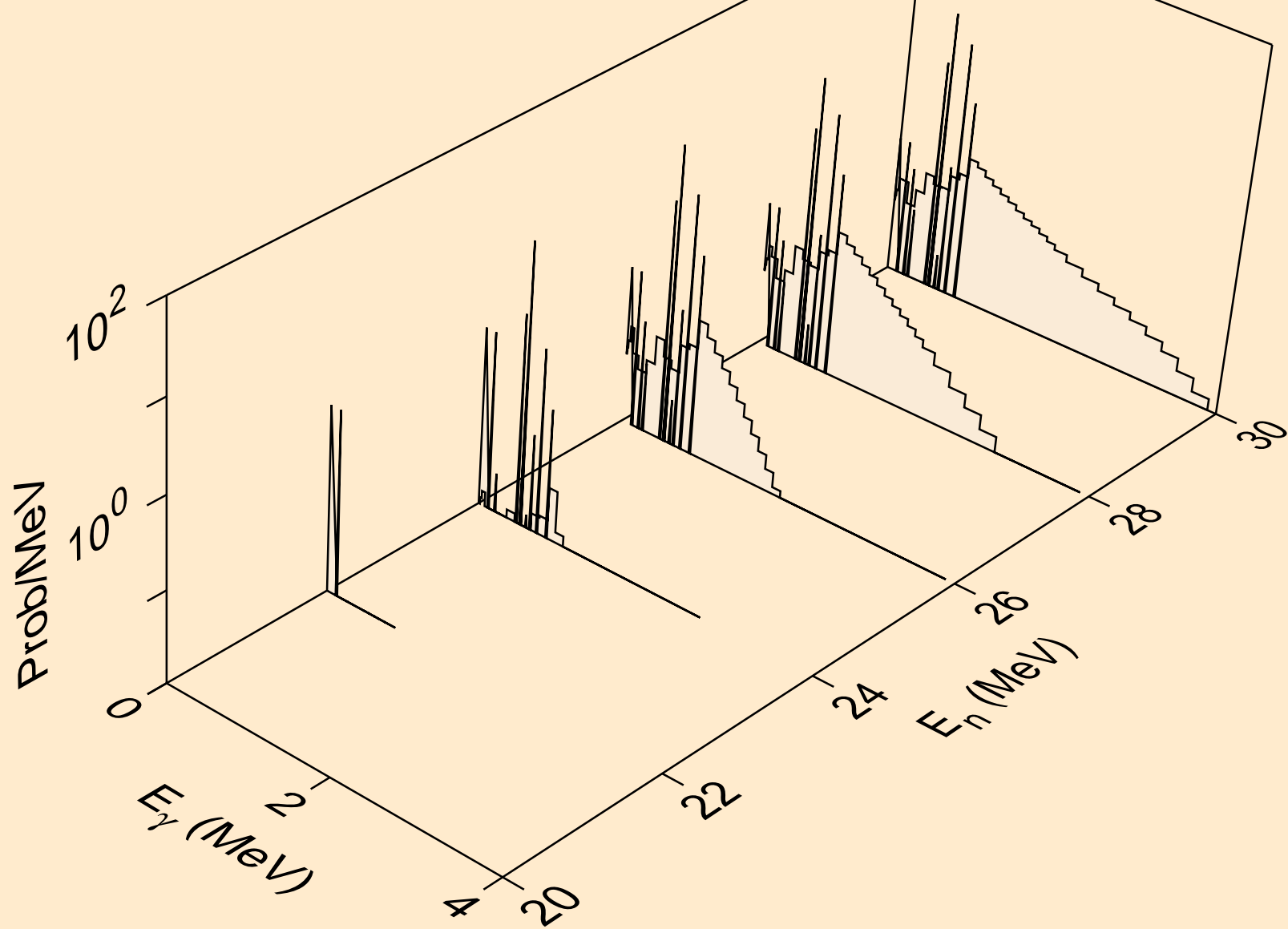

AR044 NEUTRON ACER TENDL-2024 LIBRARY; T=0.K  
Photon emission for (n,n\*)t

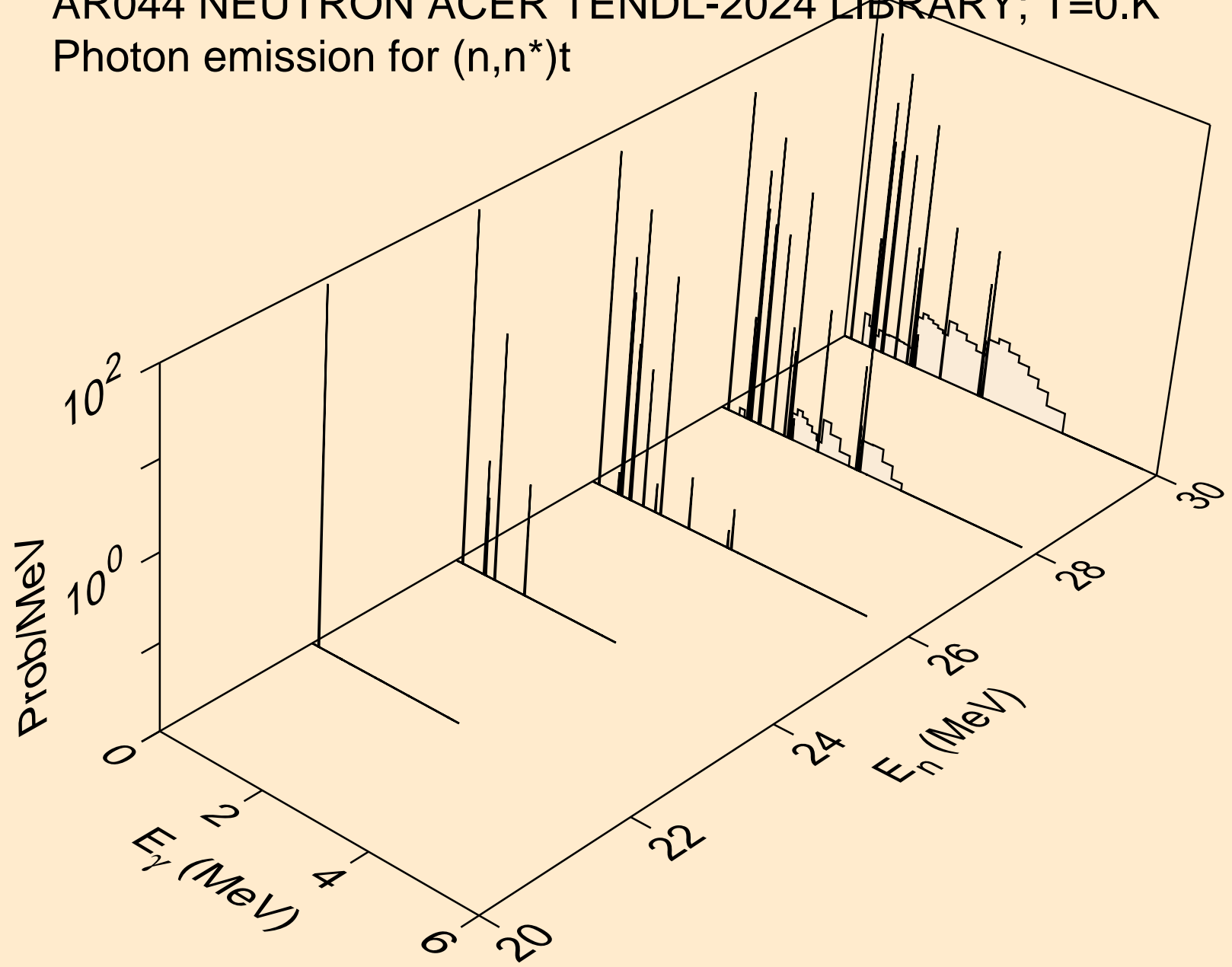

AR044 NEUTRON ACER TENDL-2024 LIBRARY; T=0.K  
Photon emission for (n,4n)

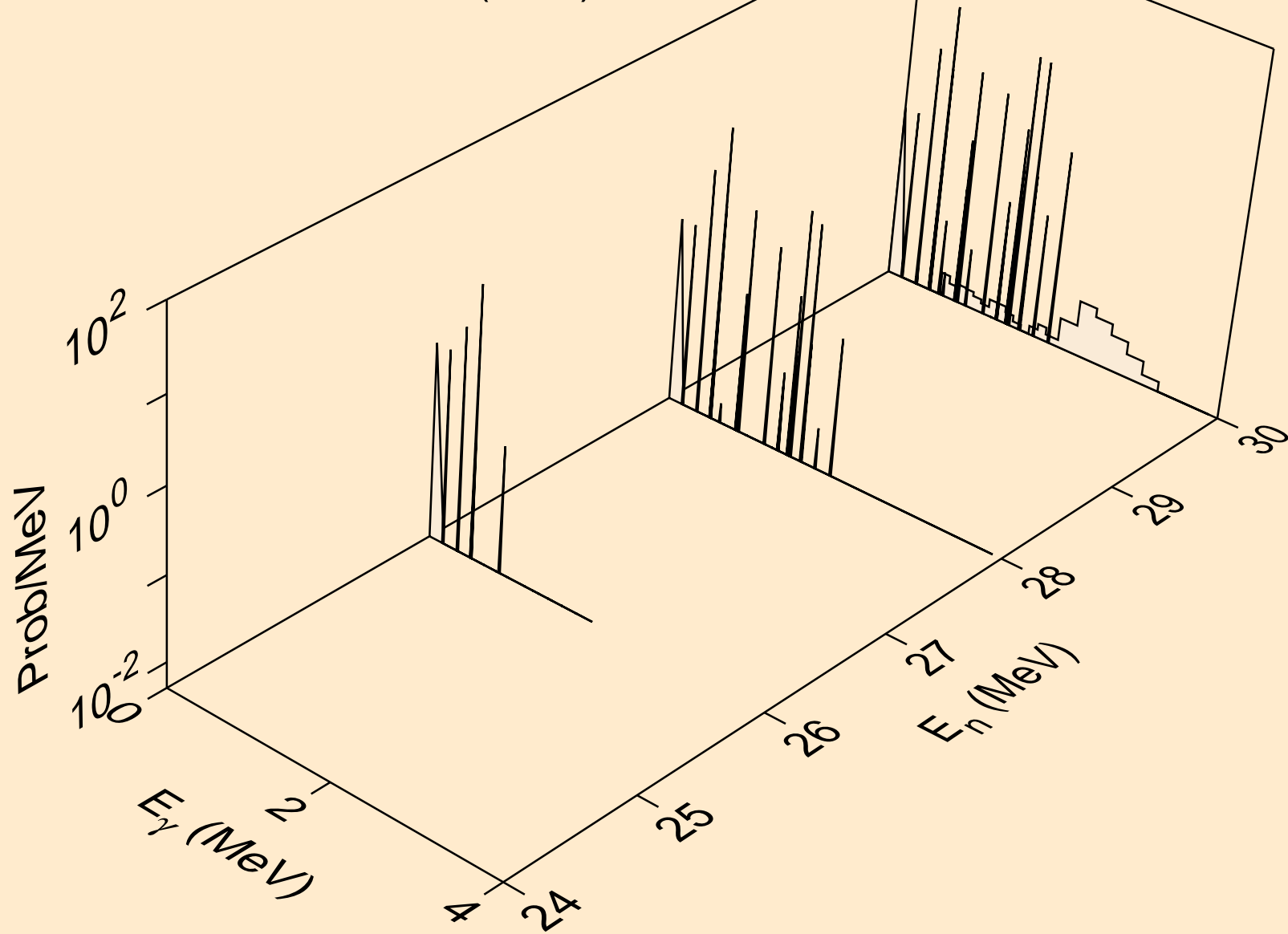

AR044 NEUTRON ACER TENDL-2024 LIBRARY; T=0.K  
Photon emission for (n,2np)

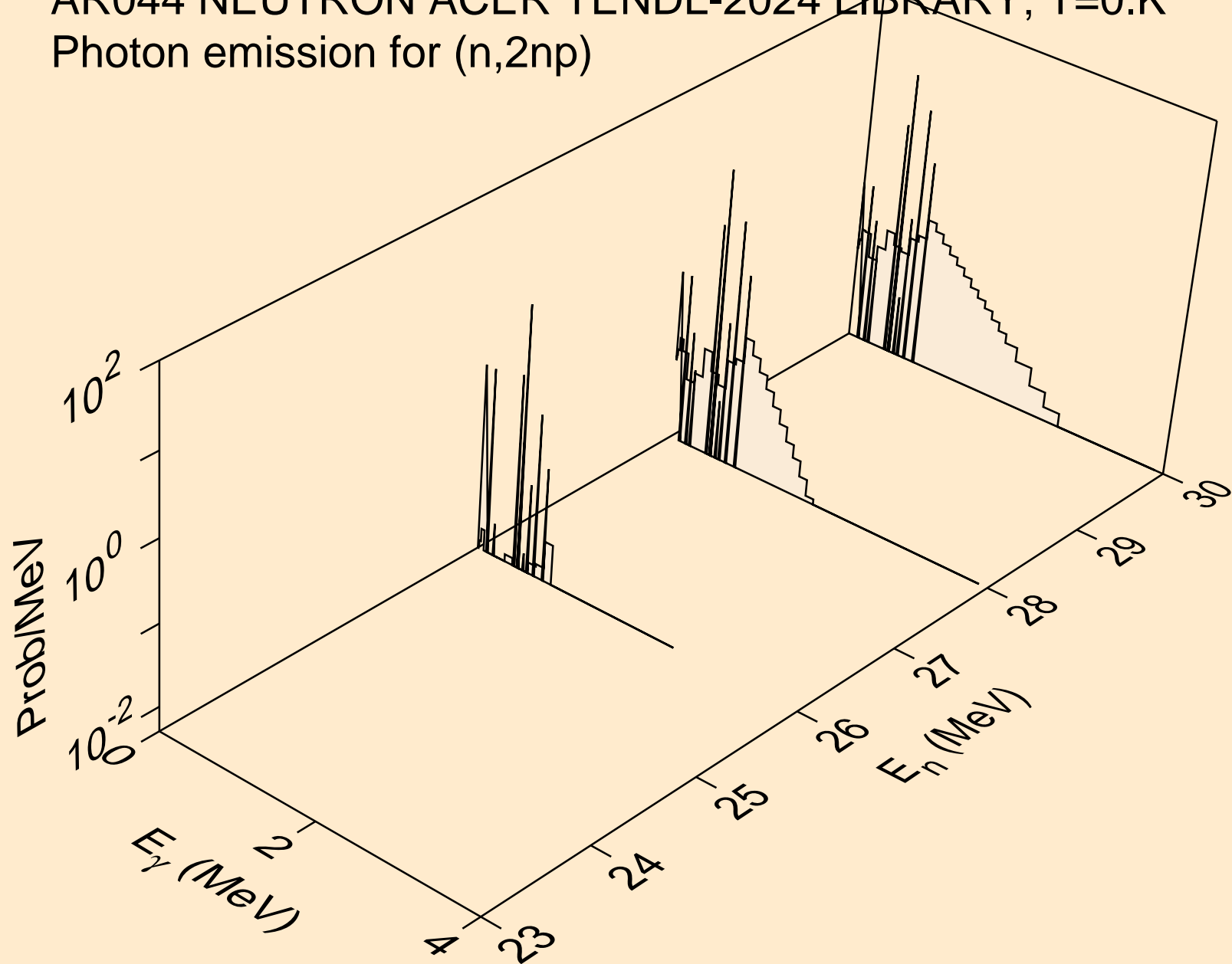

AR044 NEUTRON ACER TENDL-2024 LIBRARY; T=0.K  
Photon emission for (n,n\*c)

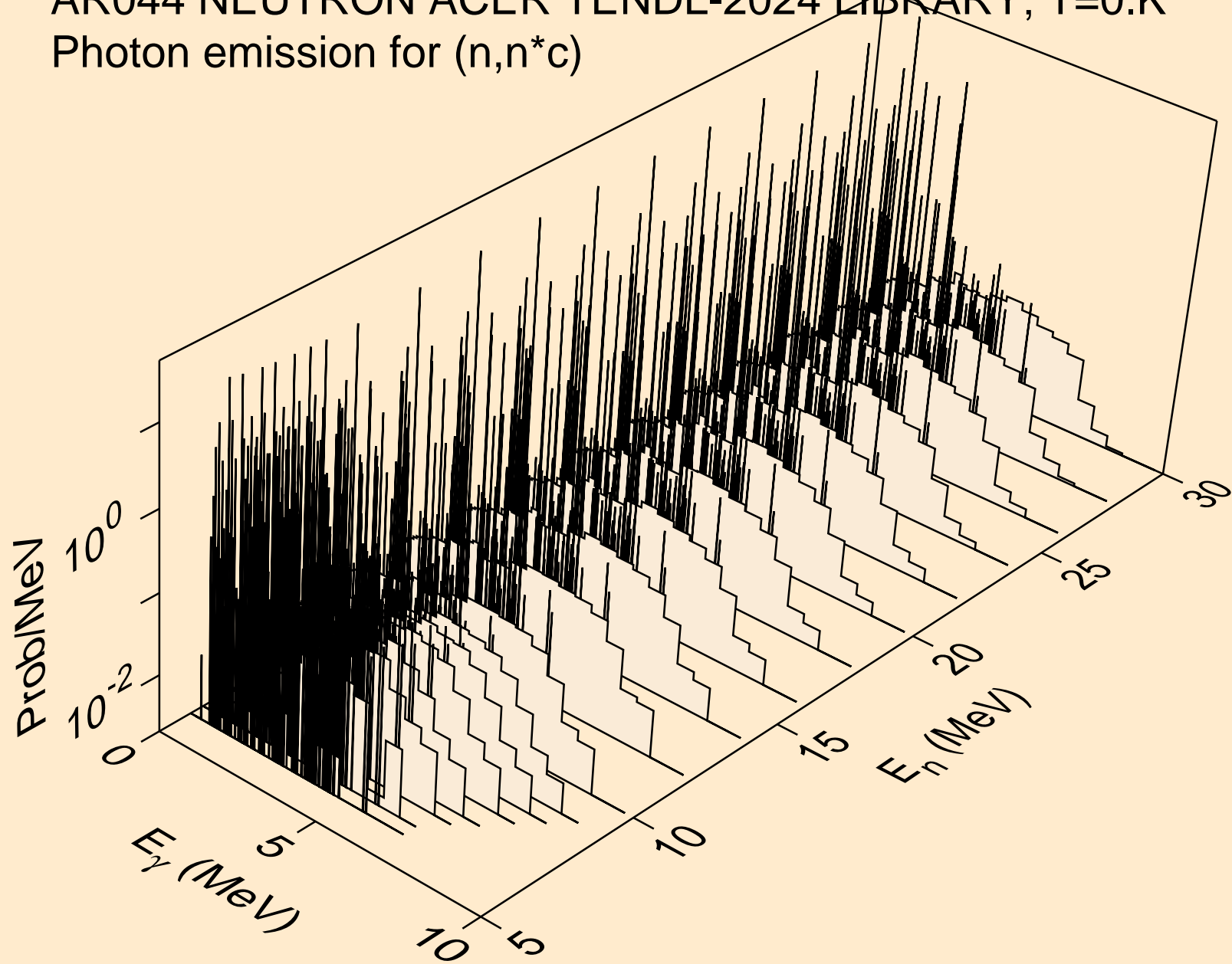

AR044 NEUTRON ACER TENDL-2024 LIBRARY; T=0.K  
Photon emission for (n,gma)

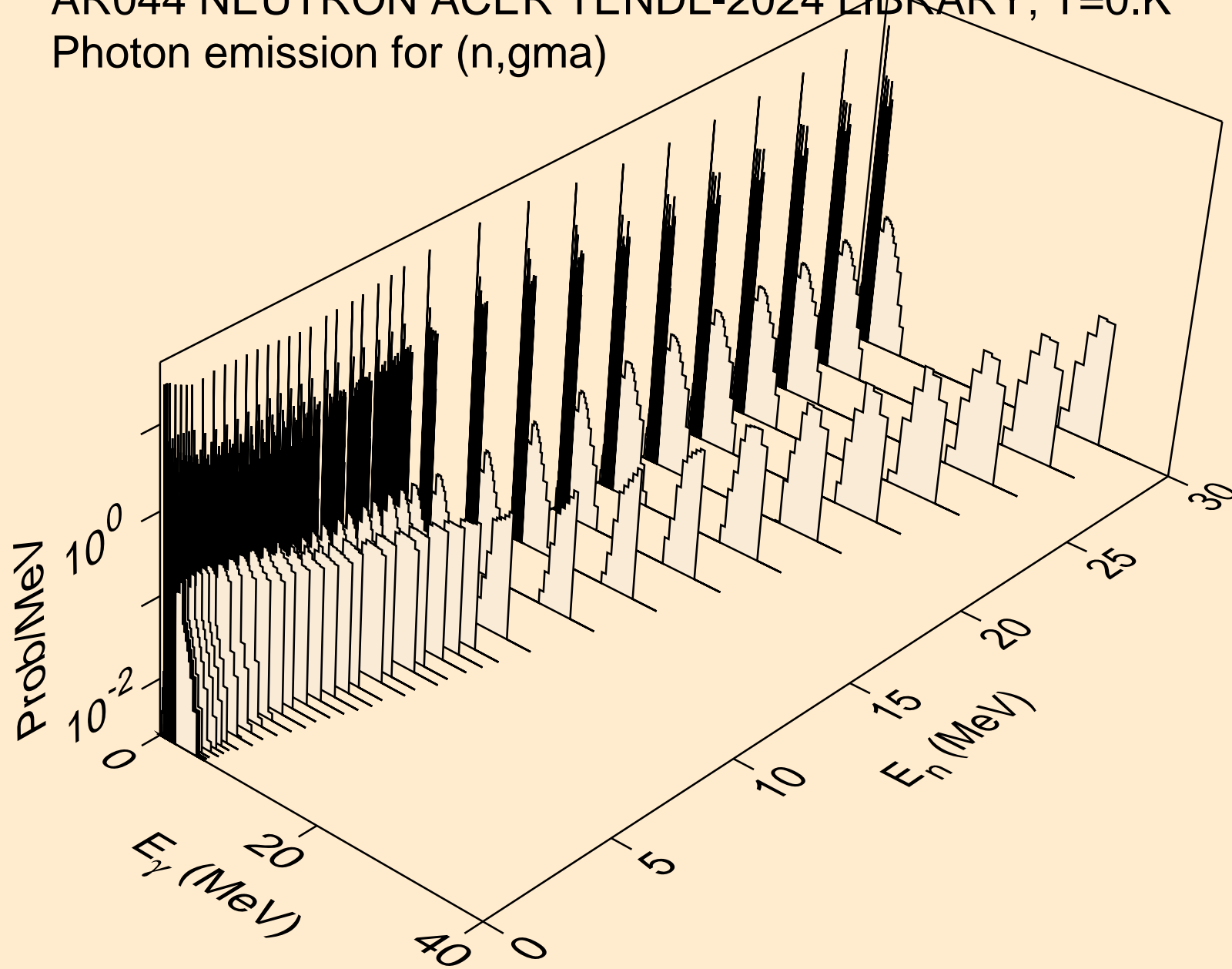

AR044 NEUTRON ACER TENDL-2024 LIBRARY; T=0.K  
Photon emission for (n,p)

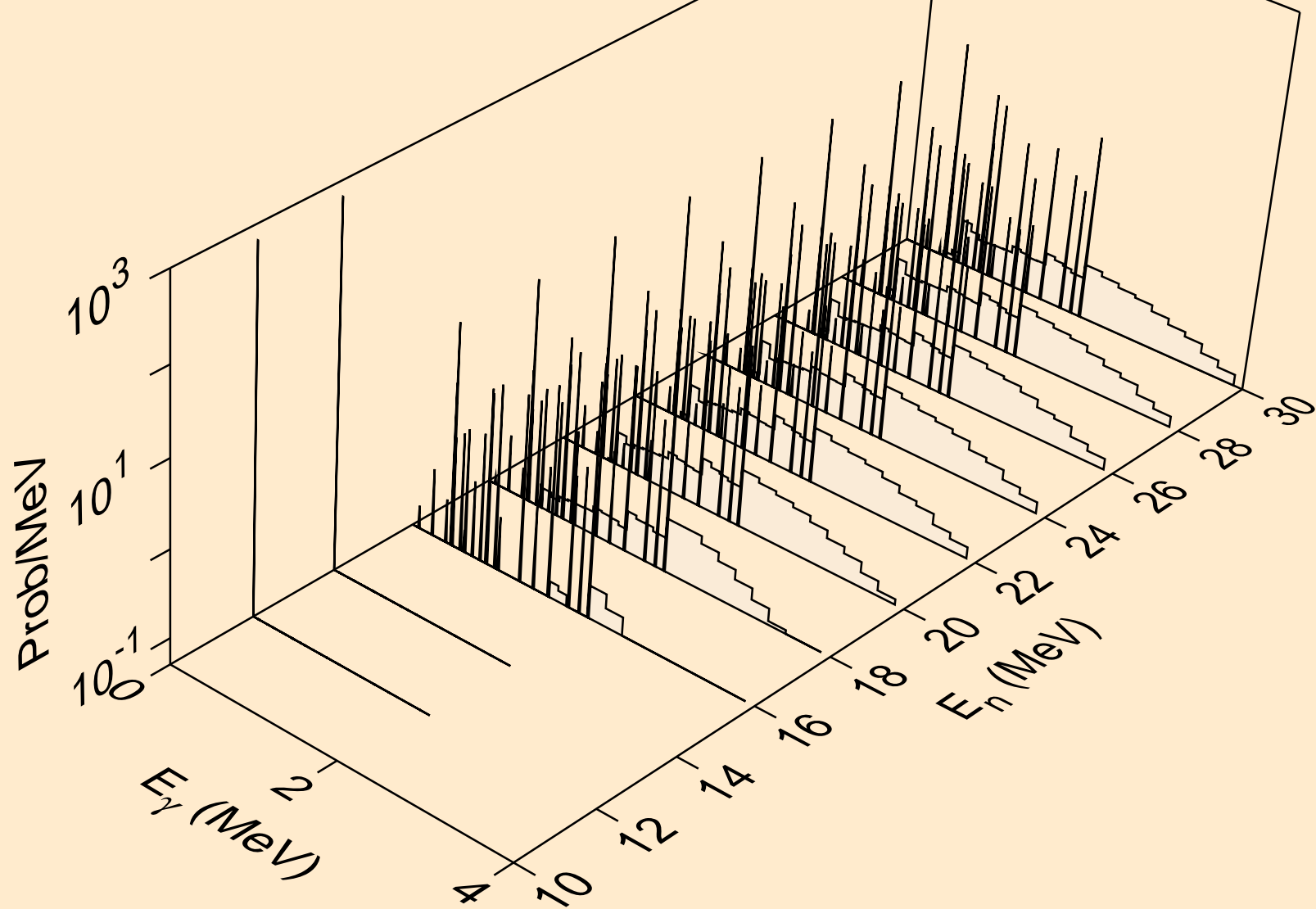

AR044 NEUTRON ACER TENDL-2024 LIBRARY; T=0.K  
Photon emission for (n,d)

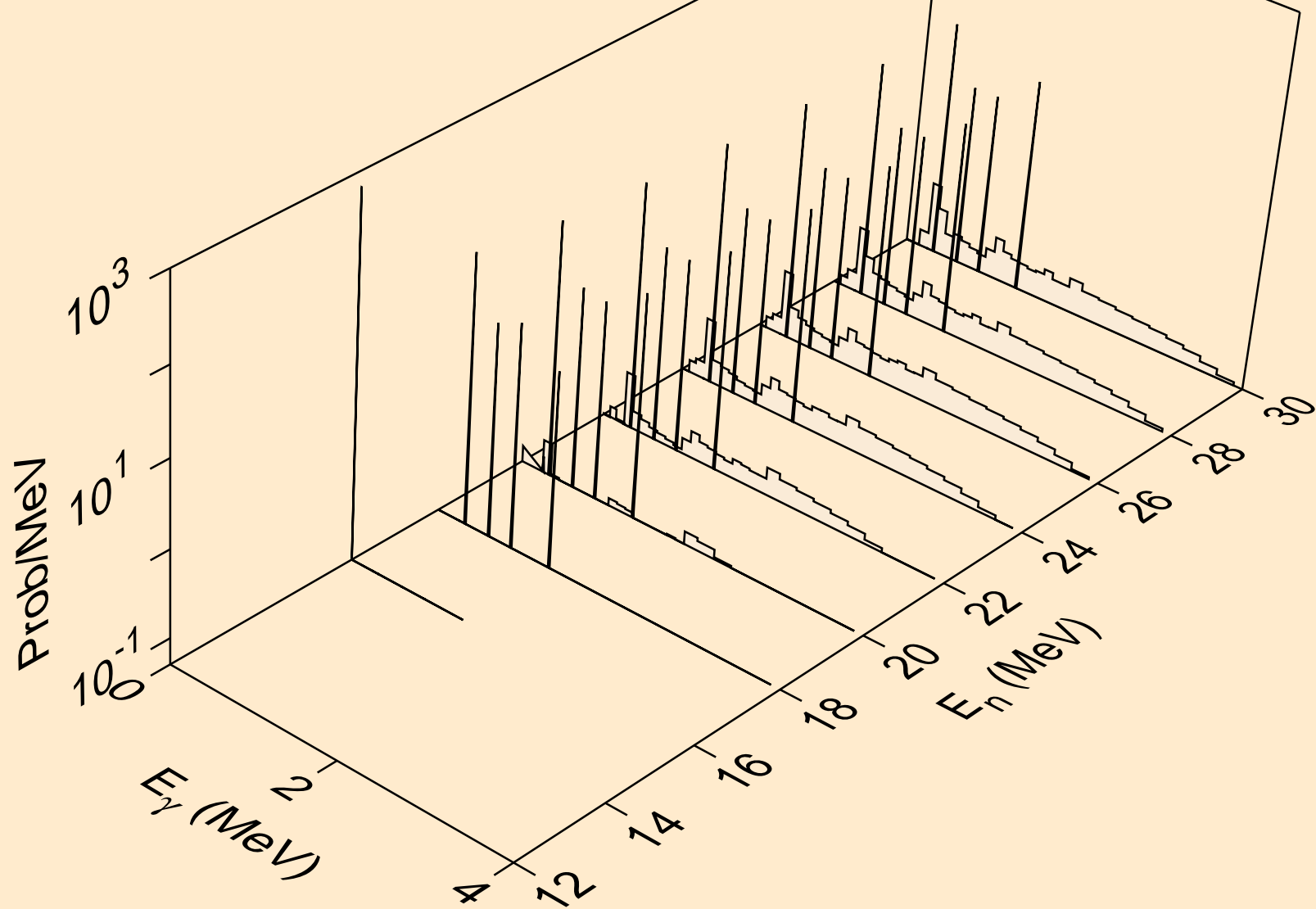

AR044 NEUTRON ACER TENDL-2024 LIBRARY; T=0.K  
Photon emission for (n,t)

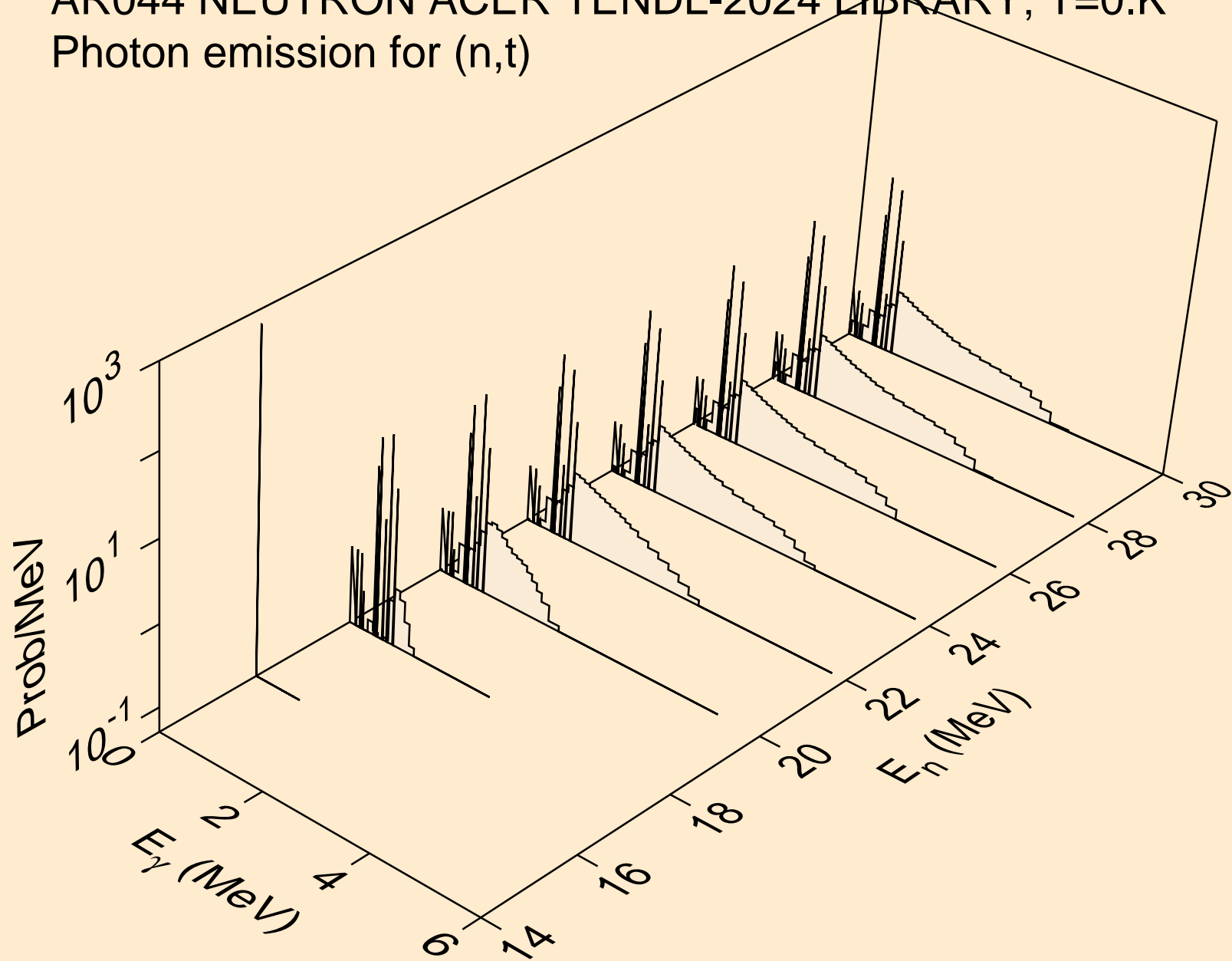

AR044 NEUTRON ACER TENDL-2024 LIBRARY; T=0.K  
Photon emission for (n,he3)

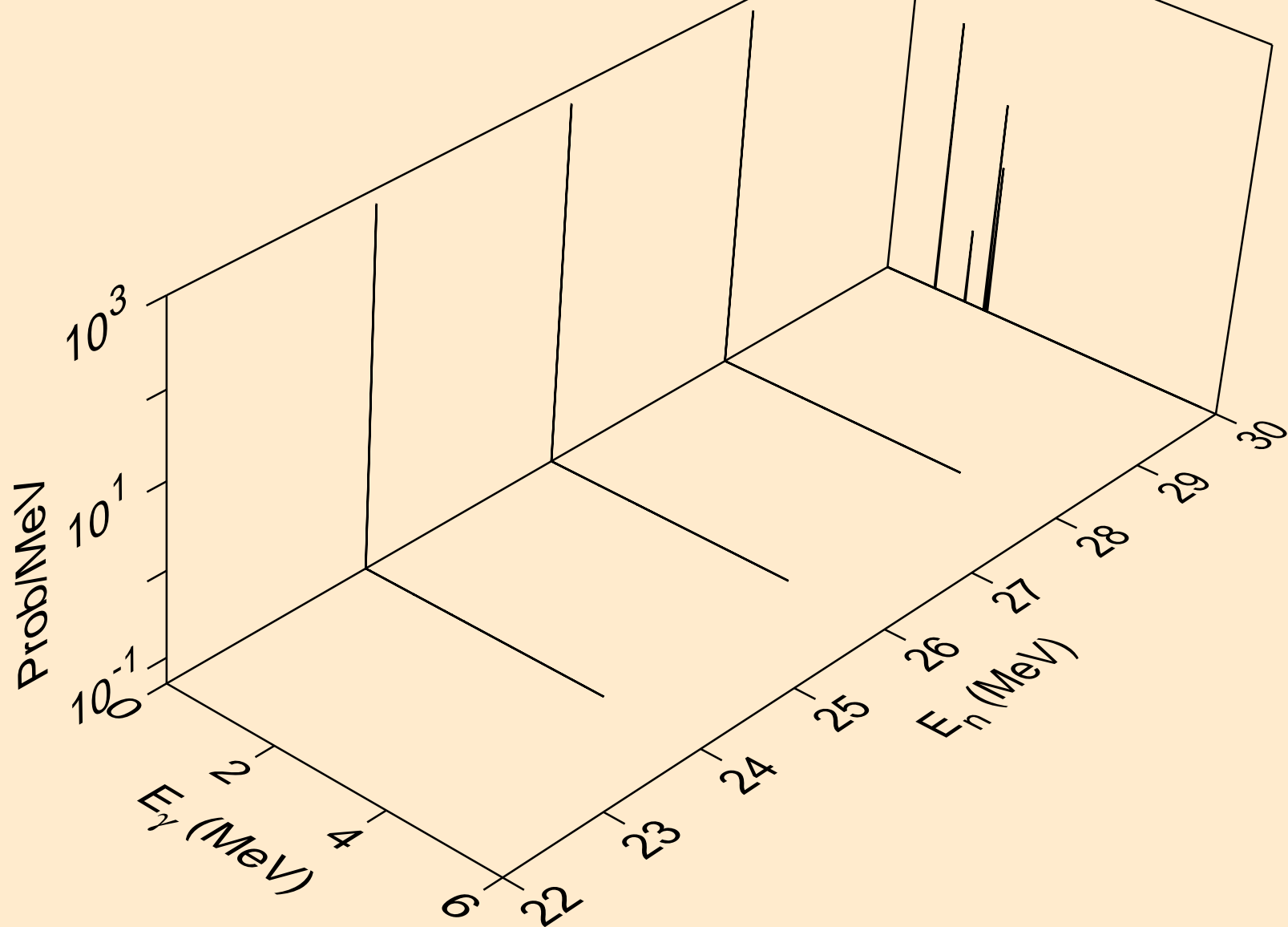

AR044 NEUTRON ACER TENDL-2024 LIBRARY; T=0.K  
Photon emission for (n,a)

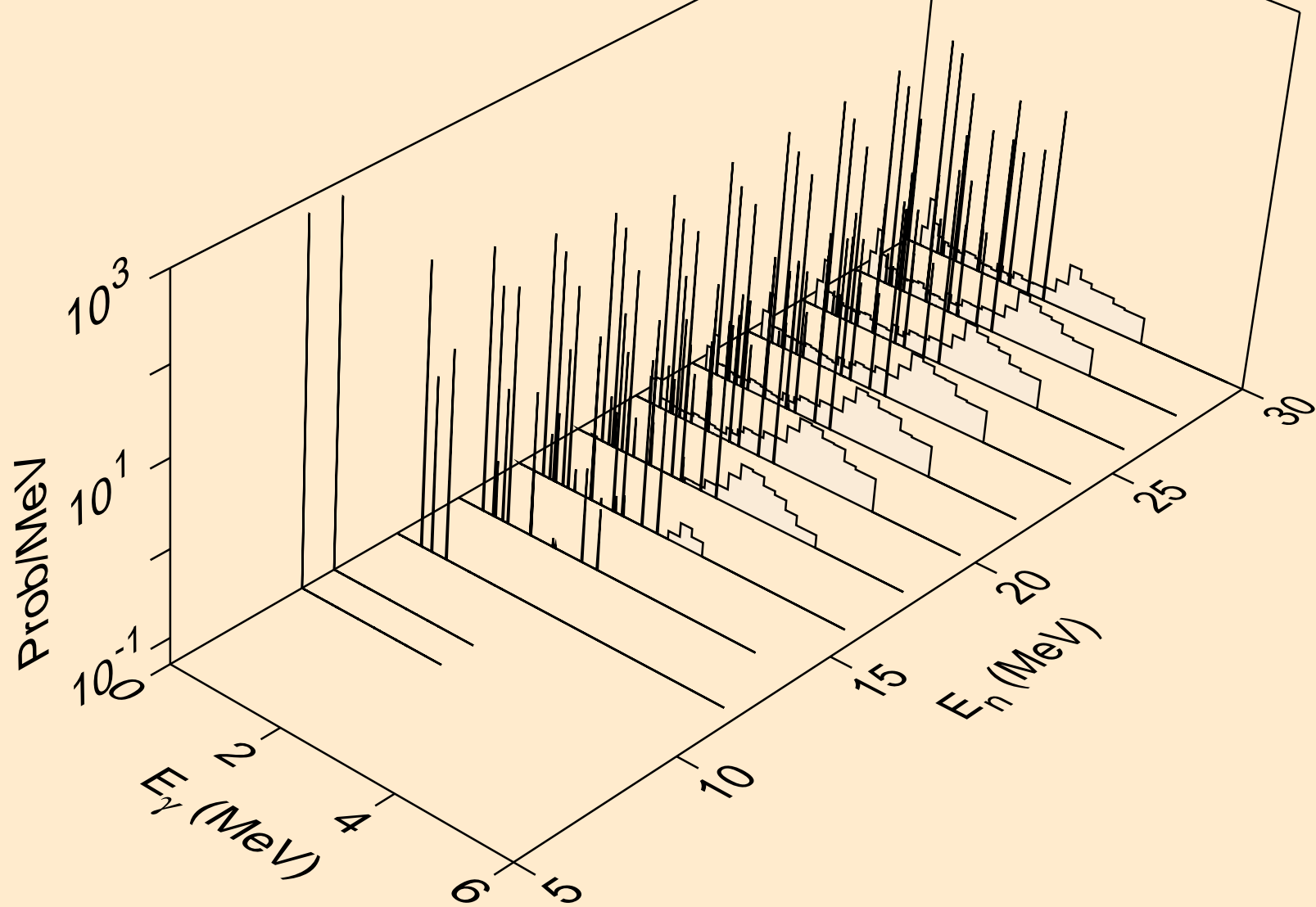

AR044 NEUTRON ACER TENDL-2024 LIBRARY; T=0.K  
thermal capture photon spectrum

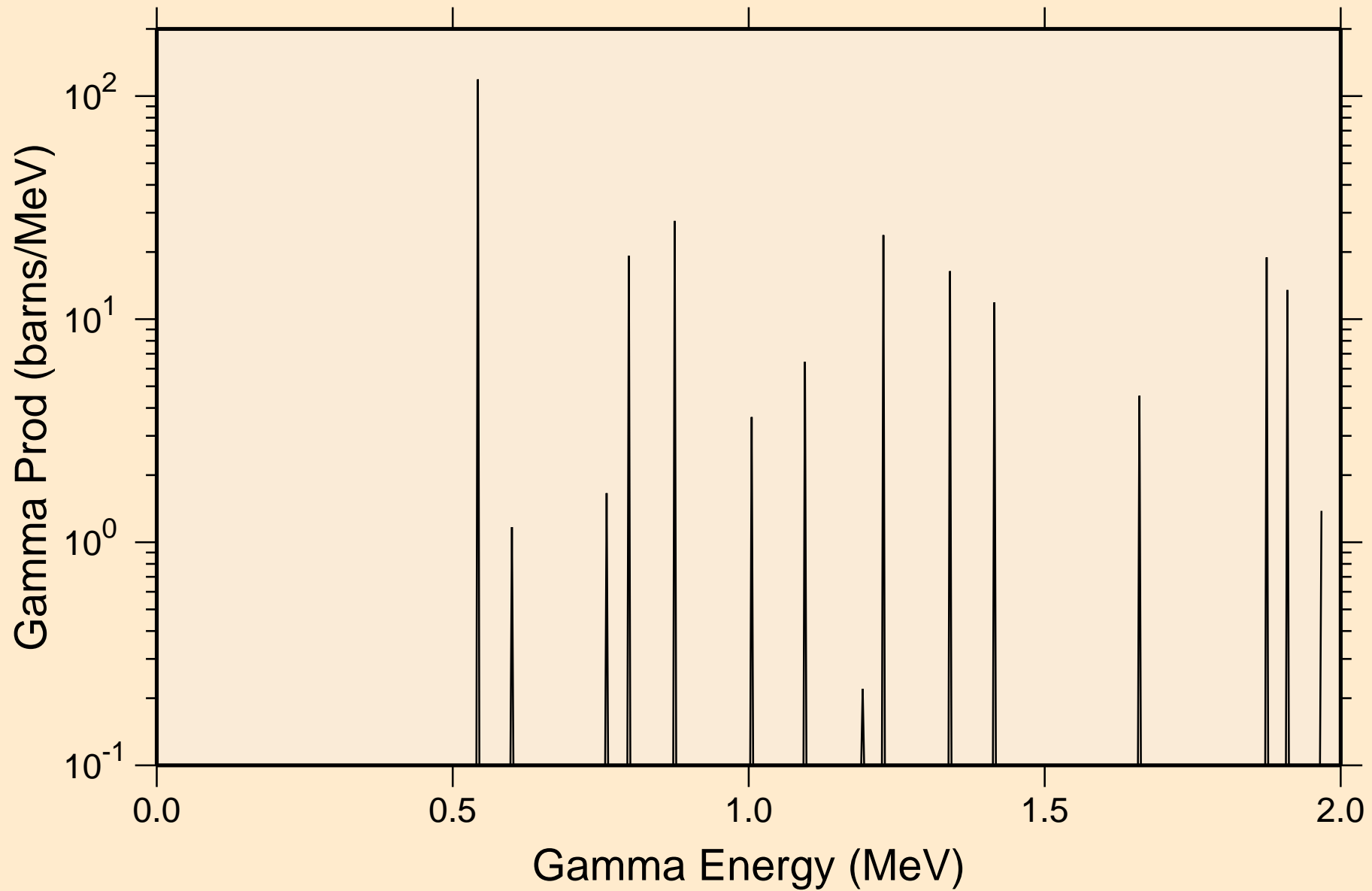

AR044 NEUTRON ACER TENDL-2024 LIBRARY; T=0.K  
14 MeV photon spectrum

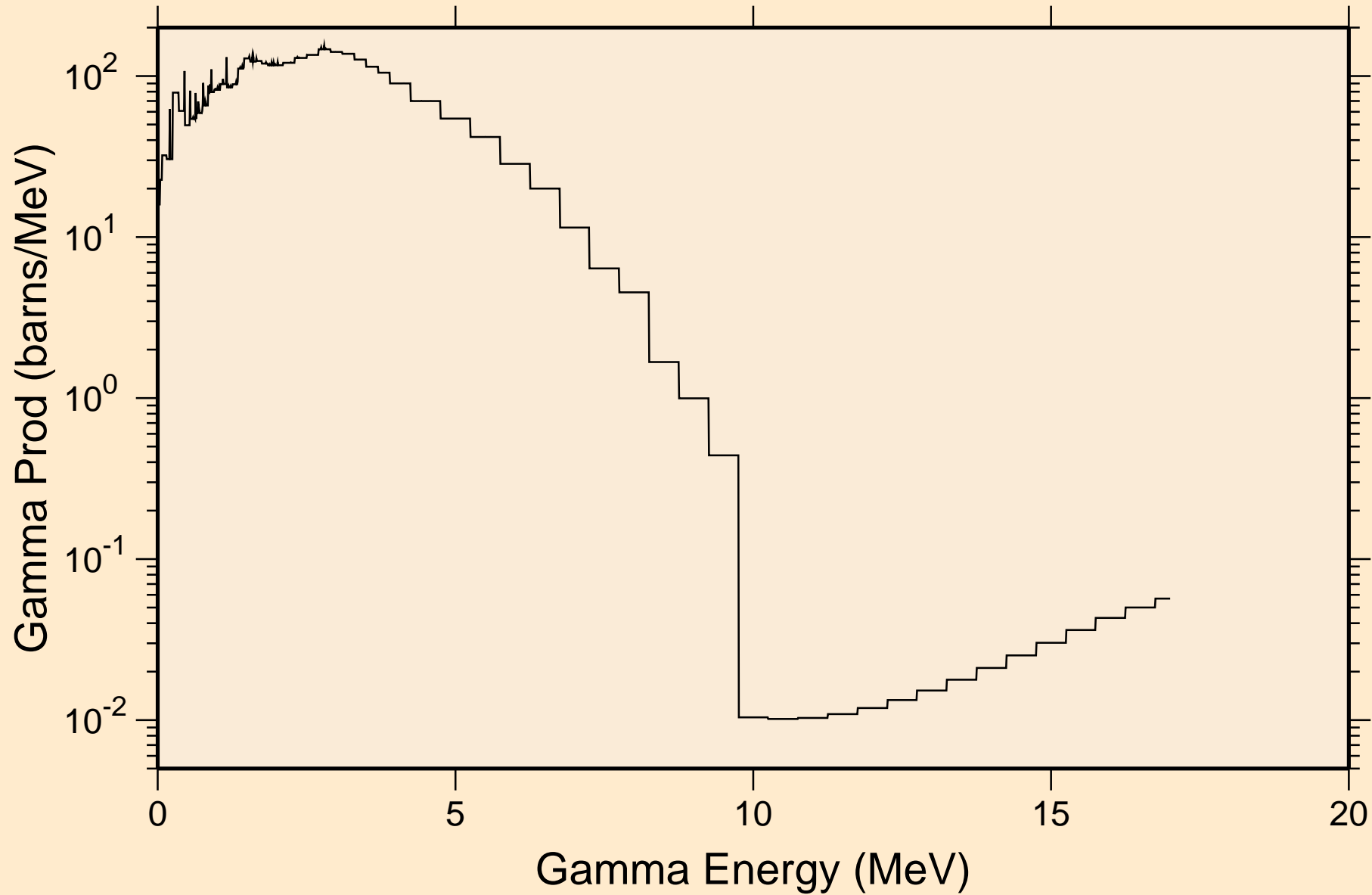

# AR044 NEUTRON ACER TENDL-2024 LIBRARY; T=0.K

## Particle heating contributions

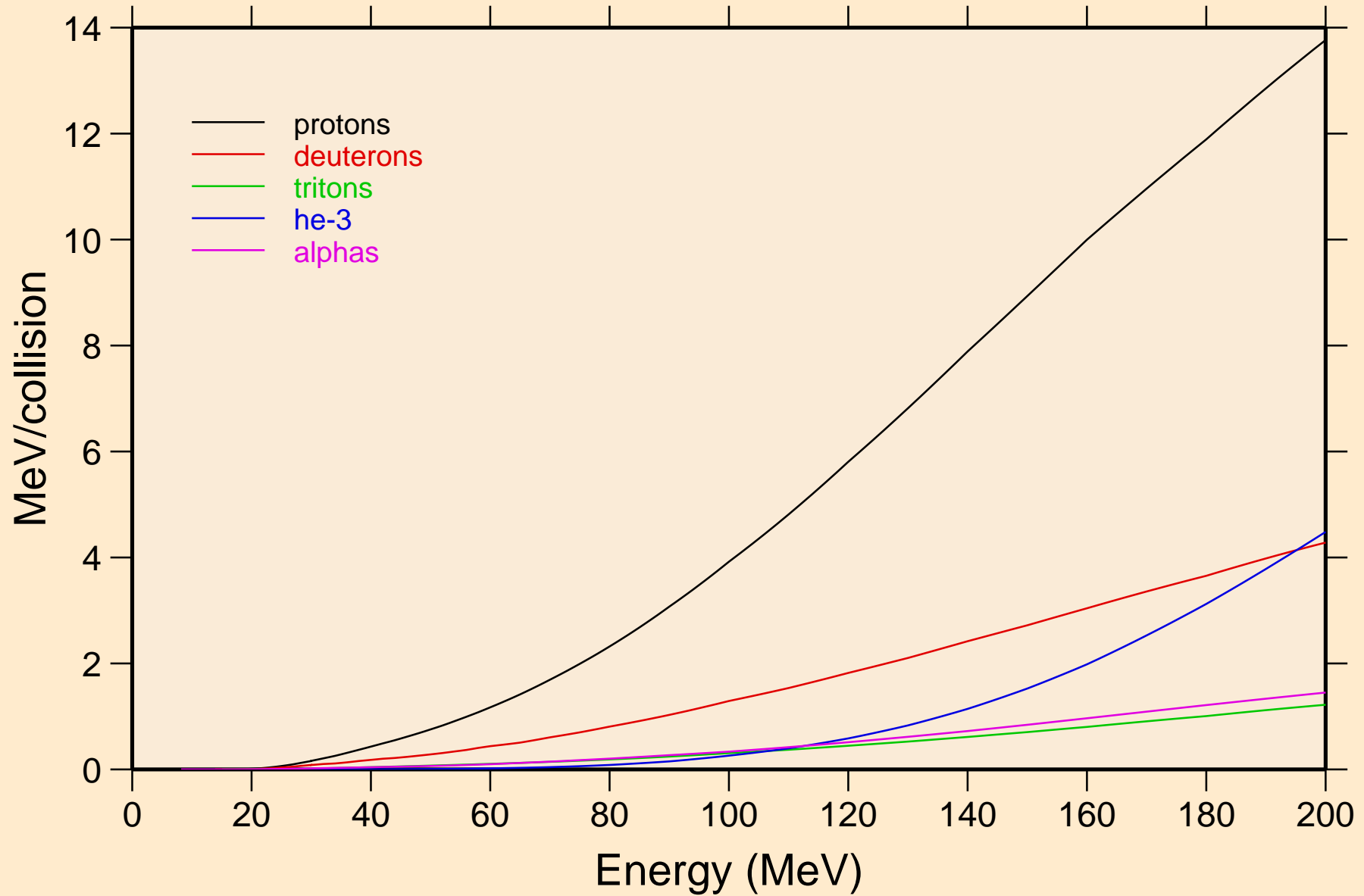

AR044 NEUTRON ACER TENDL-2024 LIBRARY; T=0.K  
Recoil Heating

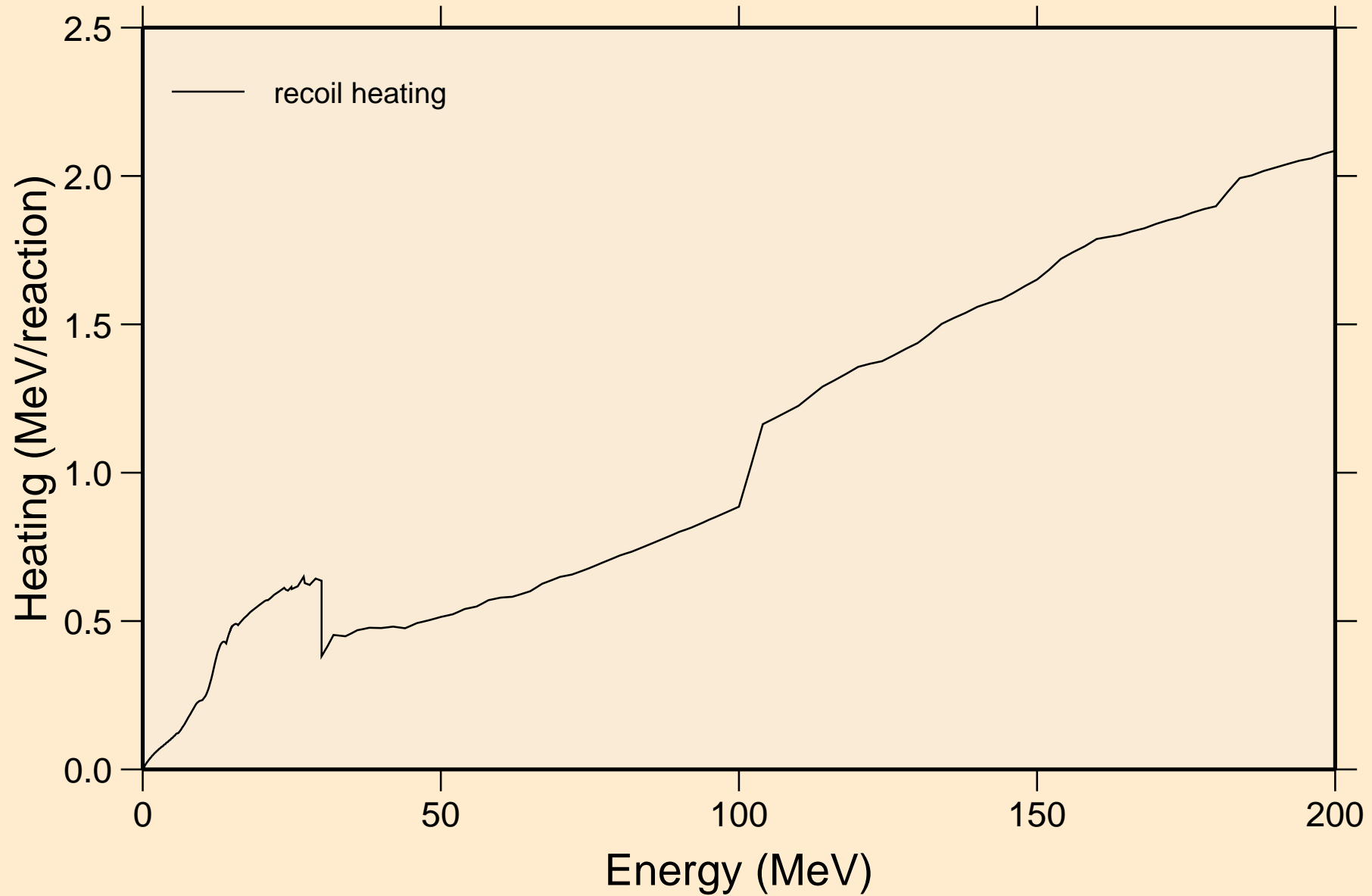

AR044 NEUTRON ACER TENDL-2024 LIBRARY; T=0.K  
Particle production cross sections

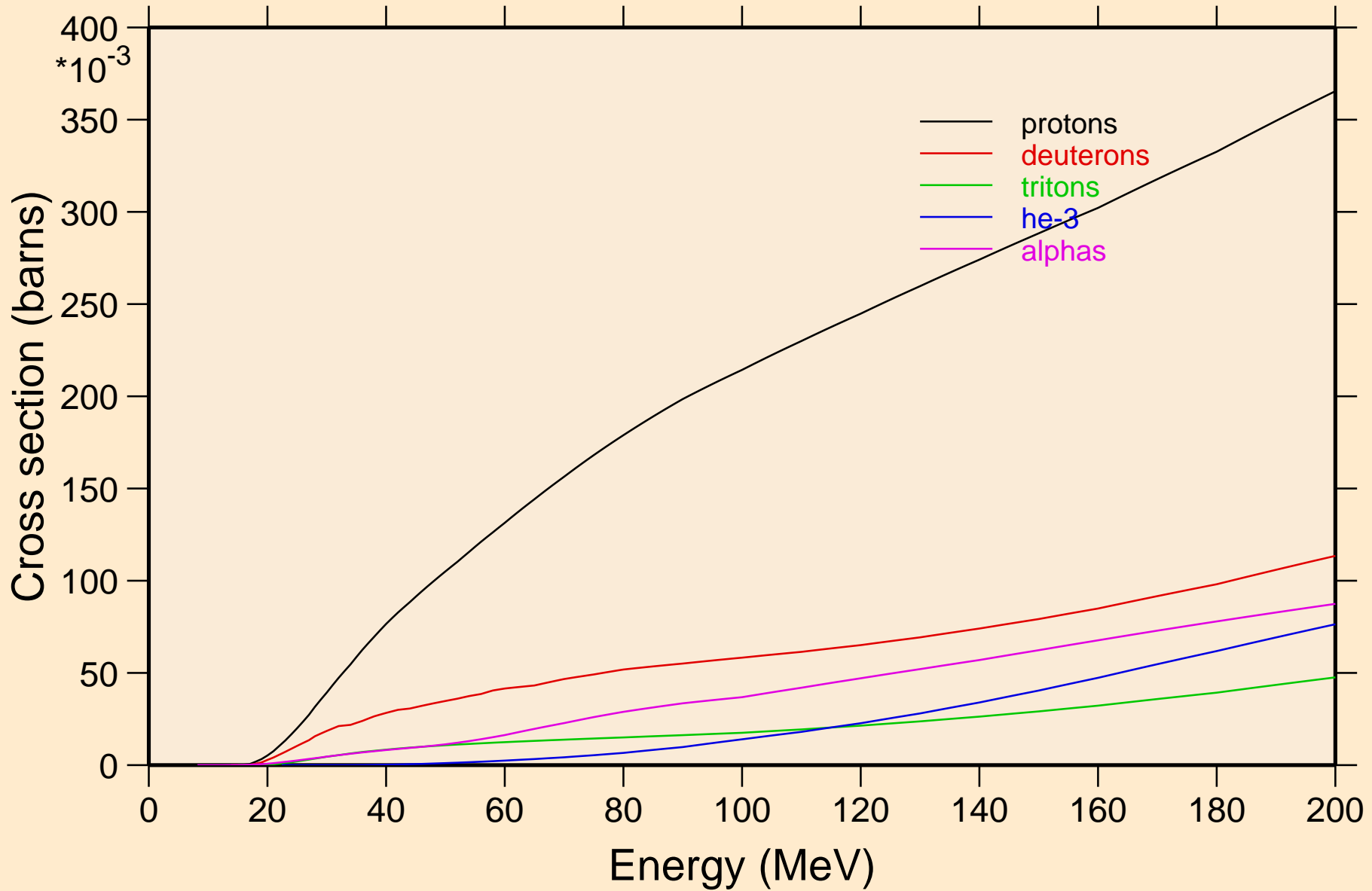

AR044 NEUTRON ACER TENDL-2024 LIBRARY; T=0.K  
protons from (n,x)

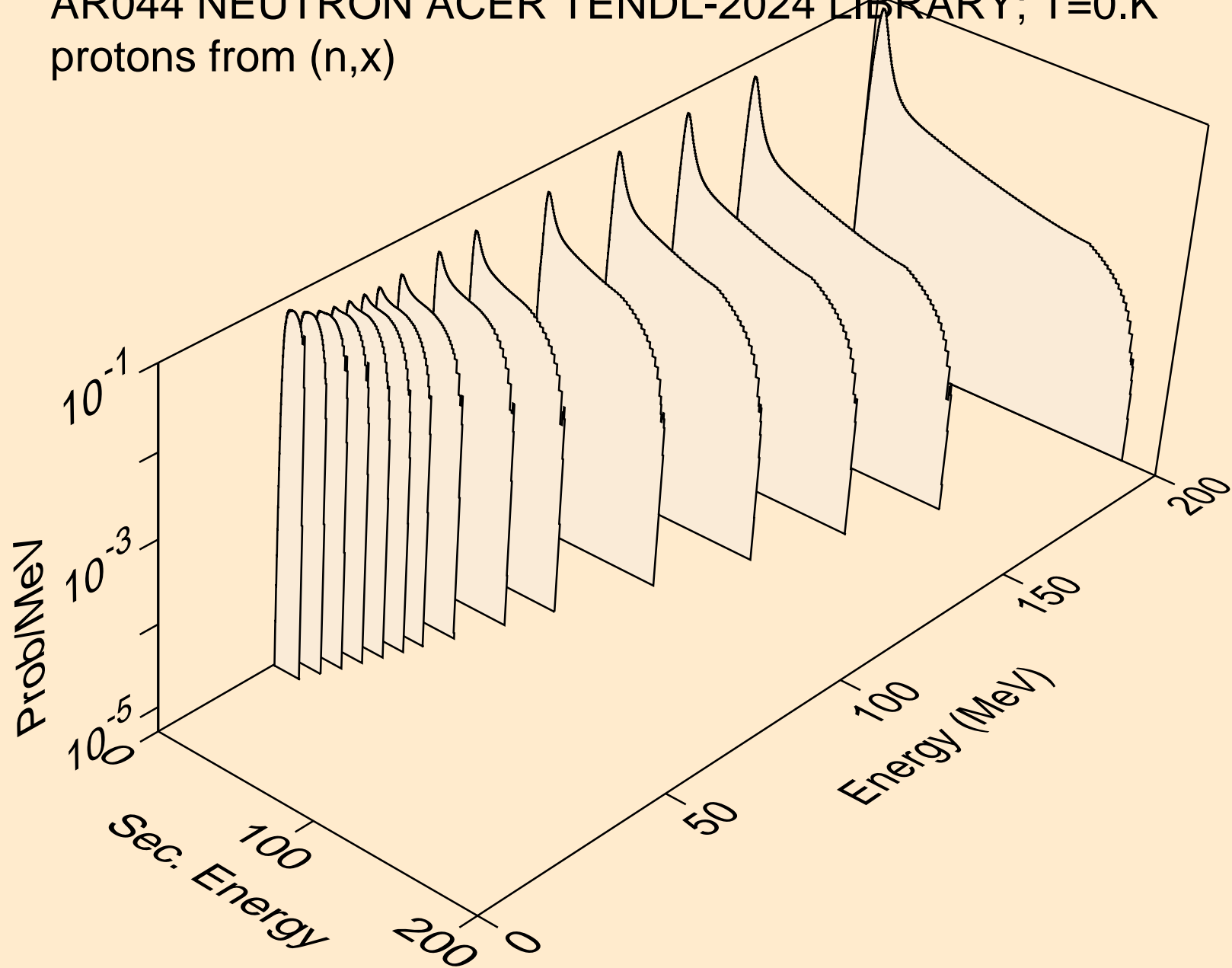

AR044 NEUTRON ACER TENDL-2024 LIBRARY; T=0.K  
protons from (n,n\*)p

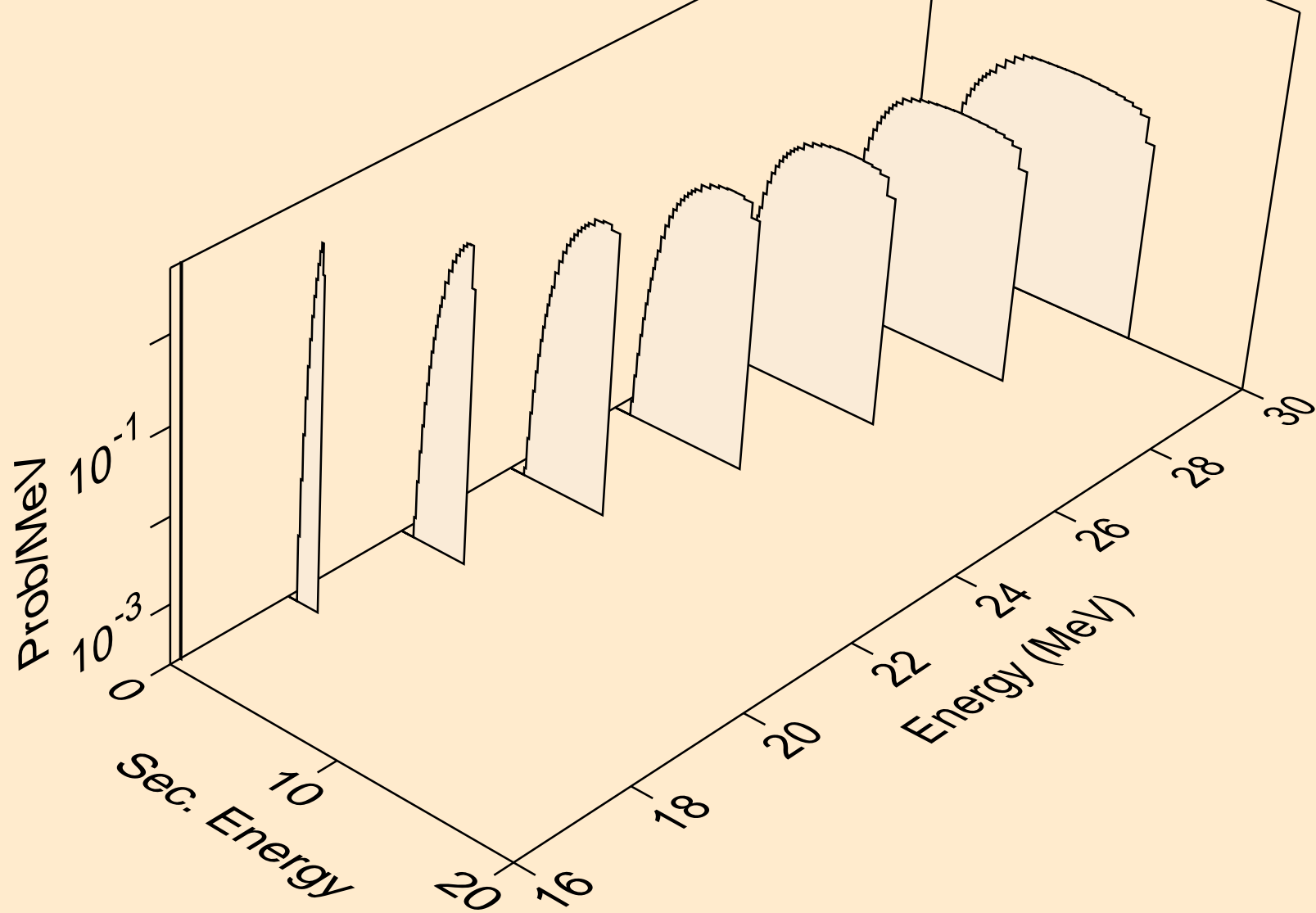

AR044 NEUTRON ACER TENDL-2024 LIBRARY; T=0.K  
protons from (n,2np)

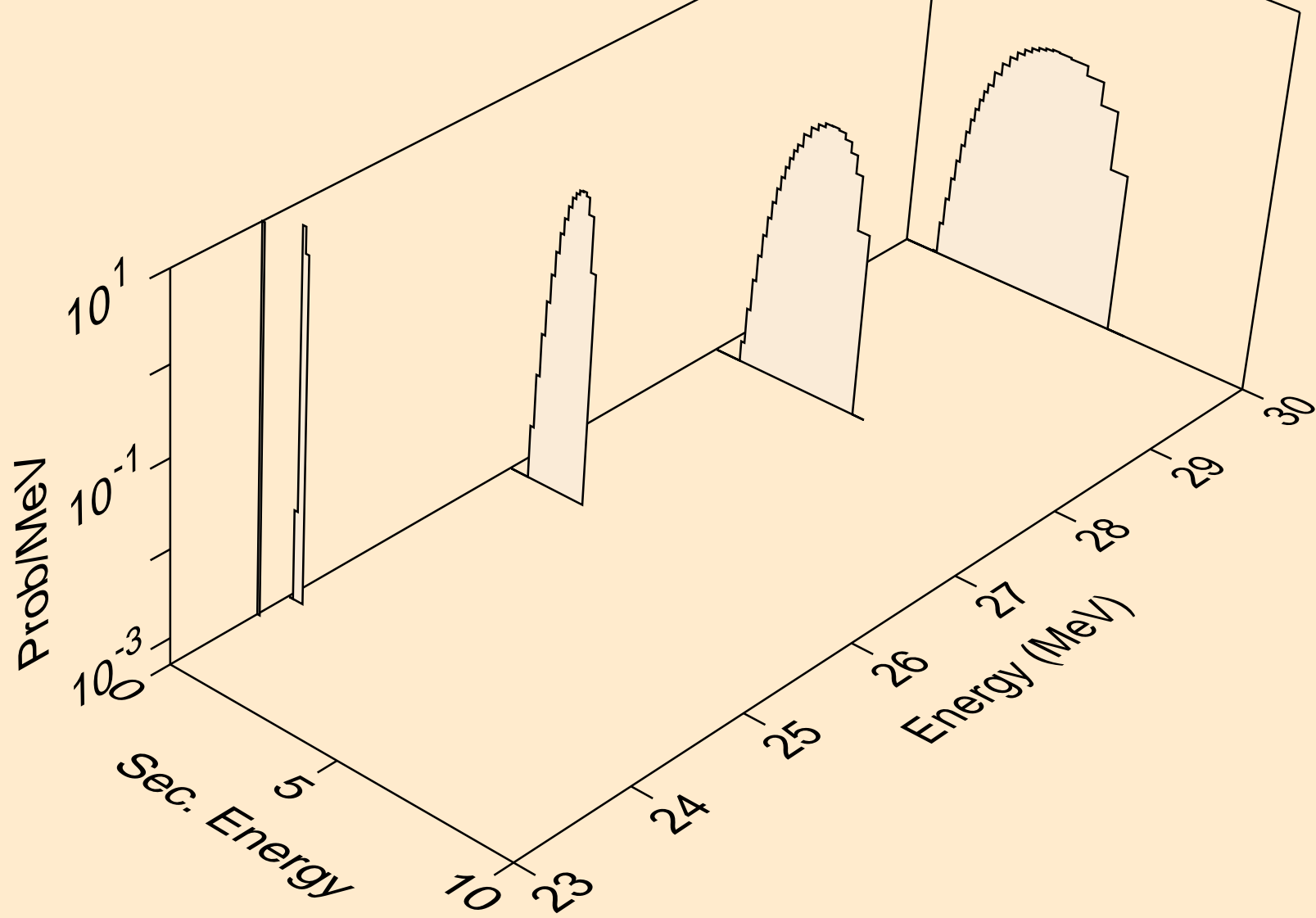

AR044 NEUTRON ACER TENDL-2024 LIBRARY; T=0.K  
protons from (n,p)

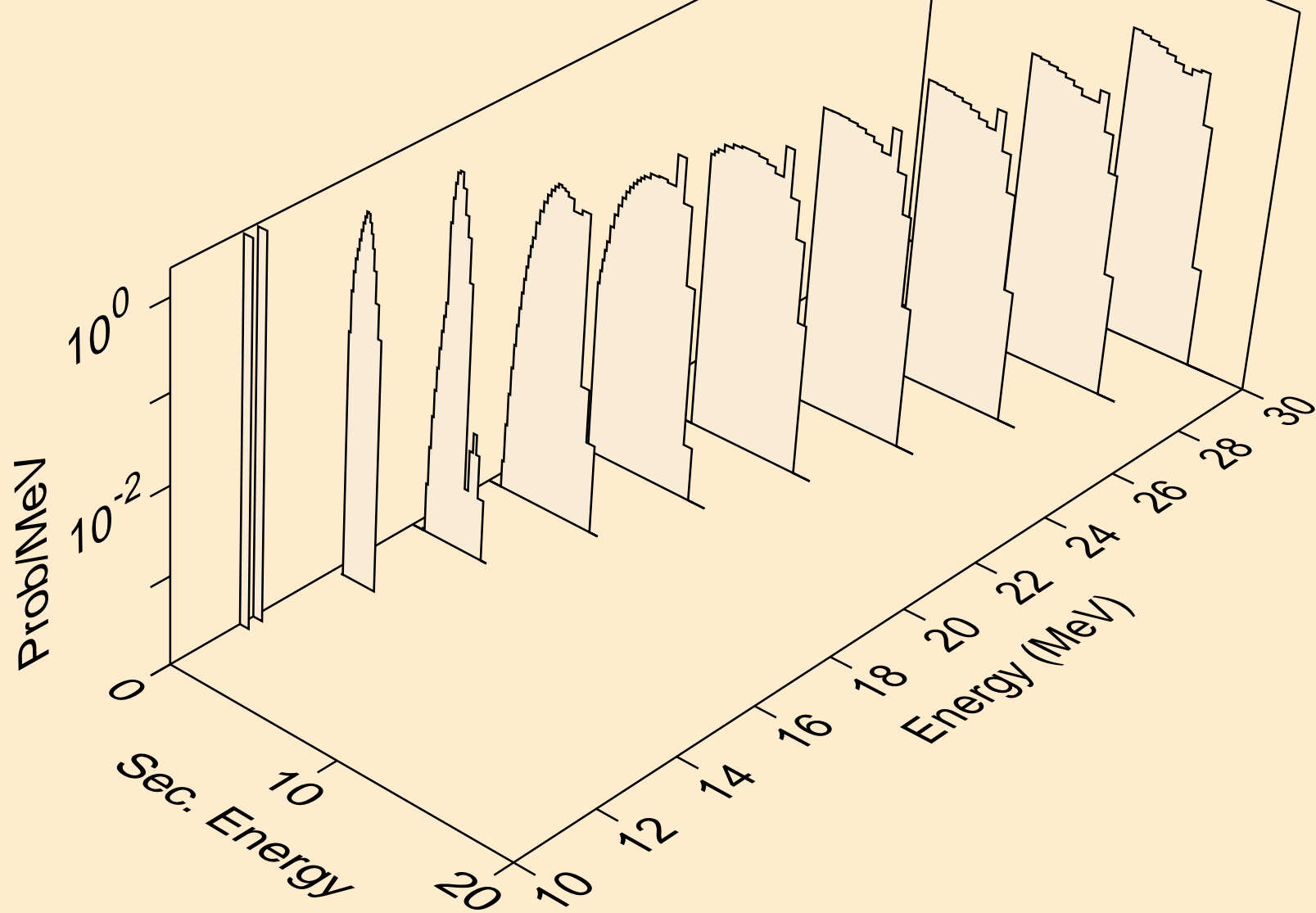

AR044 NEUTRON ACER TENDL-2024 LIBRARY; T=0.K  
deuterons from (n,x)

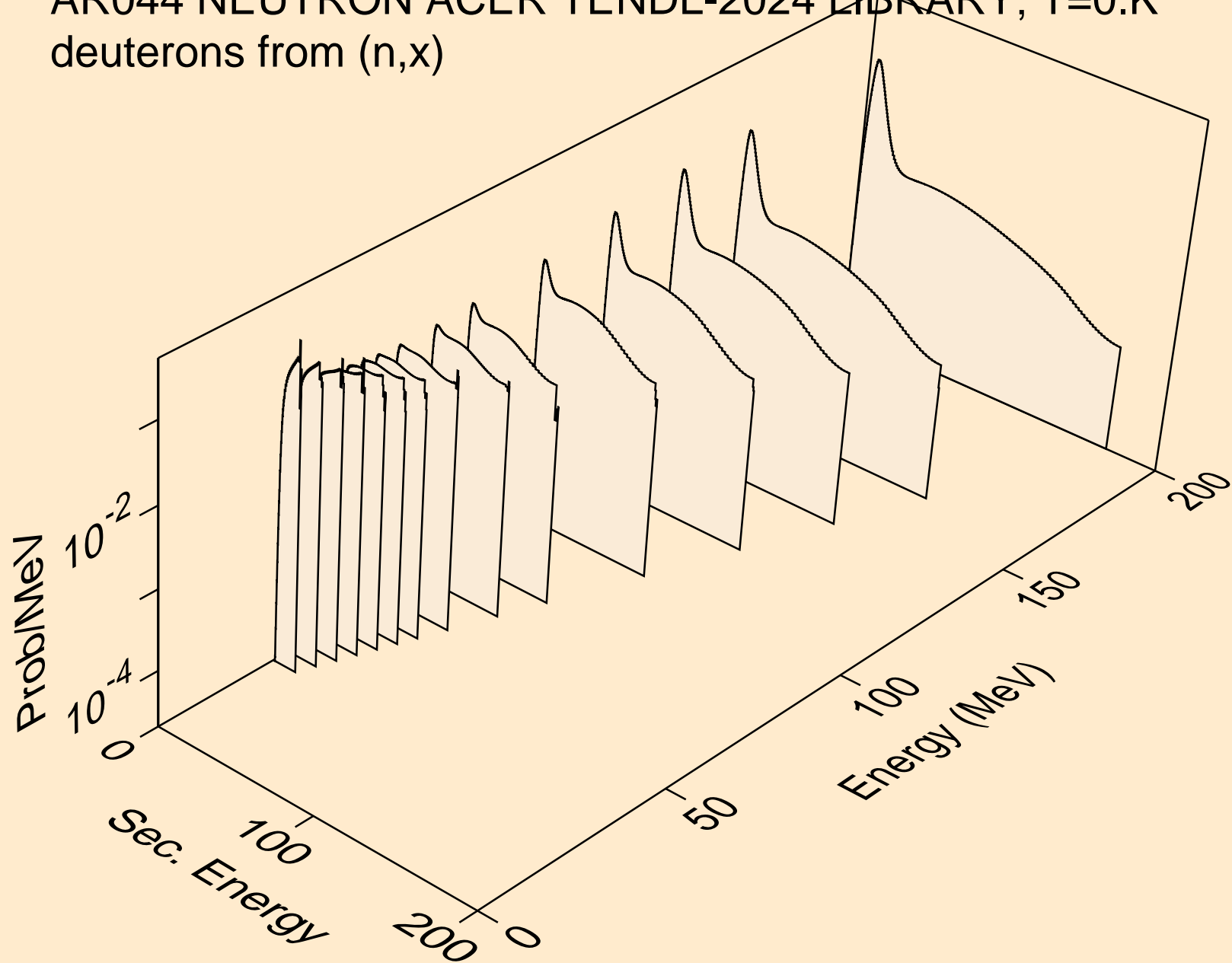

AR044 NEUTRON ACER TENDL-2024 LIBRARY; T=0.K  
deuterons from (n,2nd)

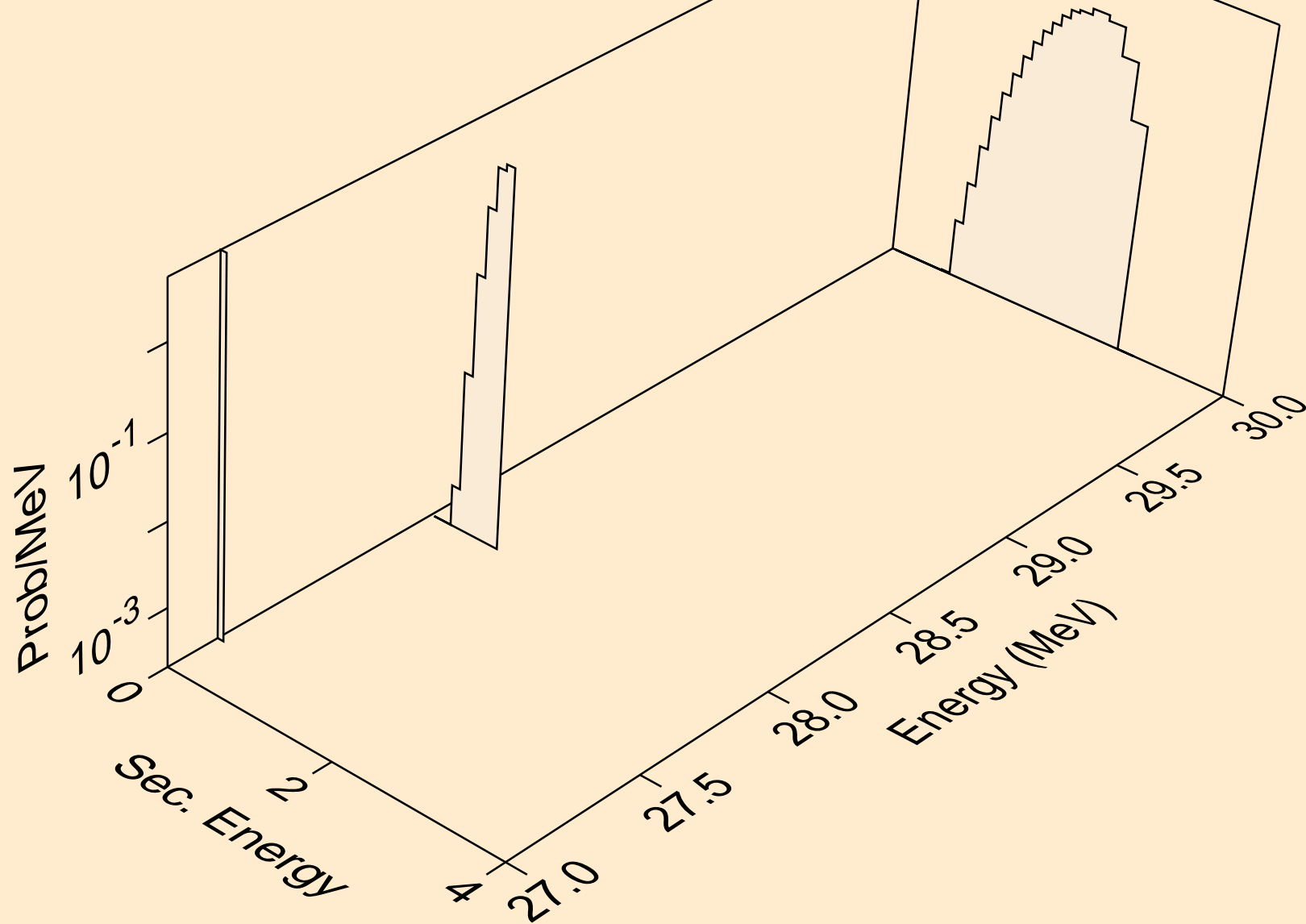

AR044 NEUTRON ACER TENDL-2024 LIBRARY; T=0.K  
deuterons from (n,n\*)d

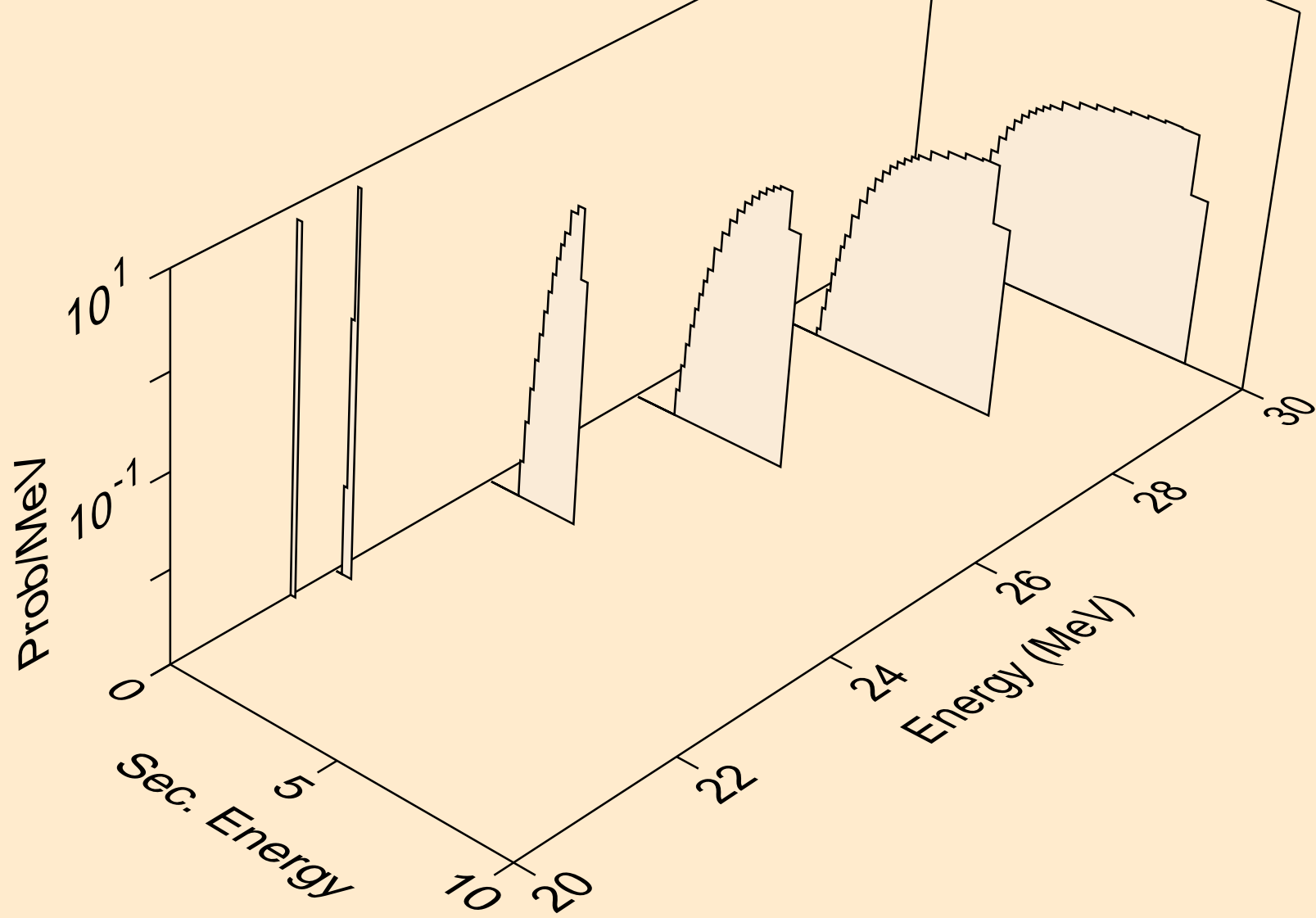

AR044 NEUTRON ACER TENDL-2024 LIBRARY; T=0.K  
deuterons from (n,d)

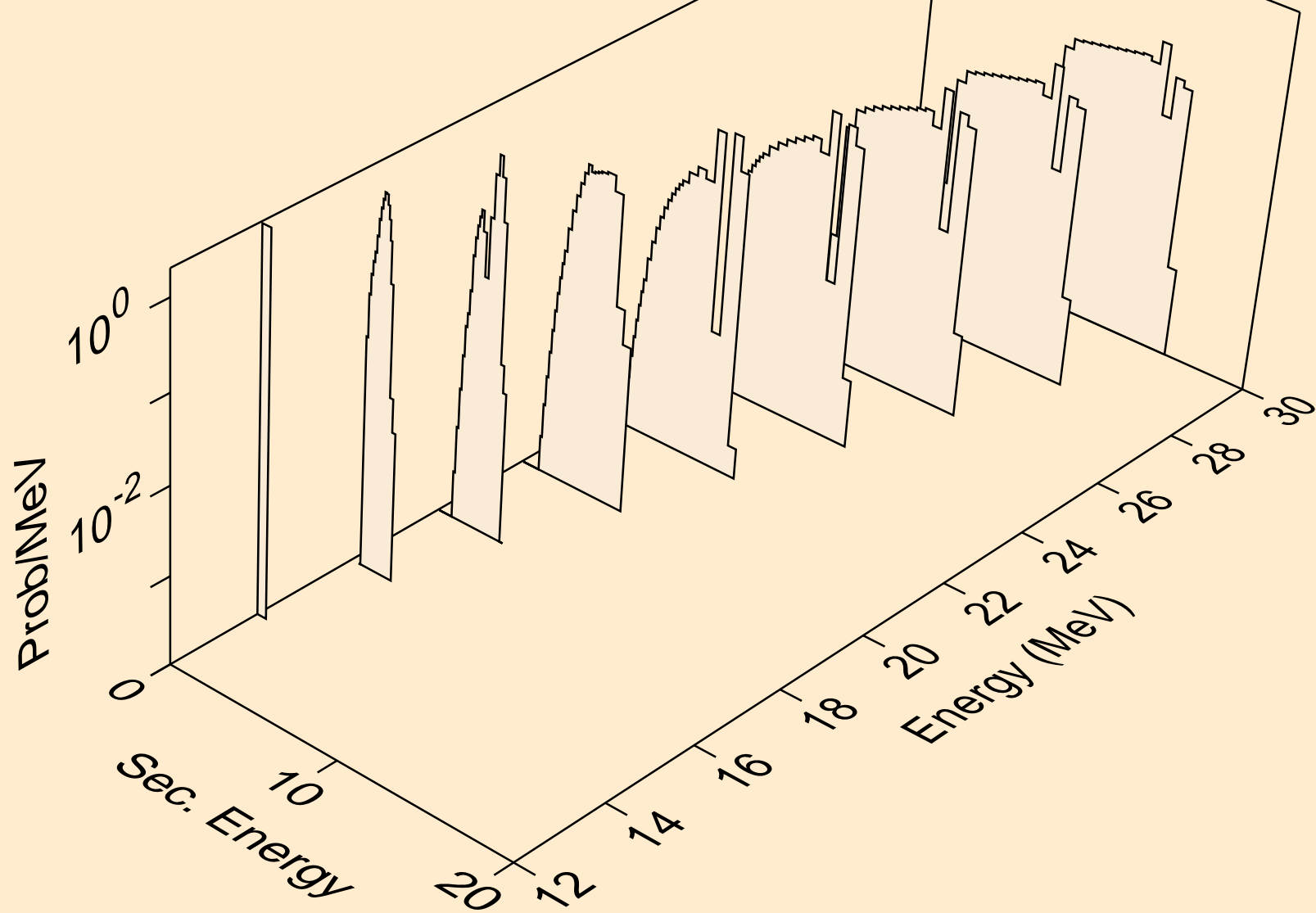

AR044 NEUTRON ACER TENDL-2024 LIBRARY; T=0.K  
tritons from (n,x)

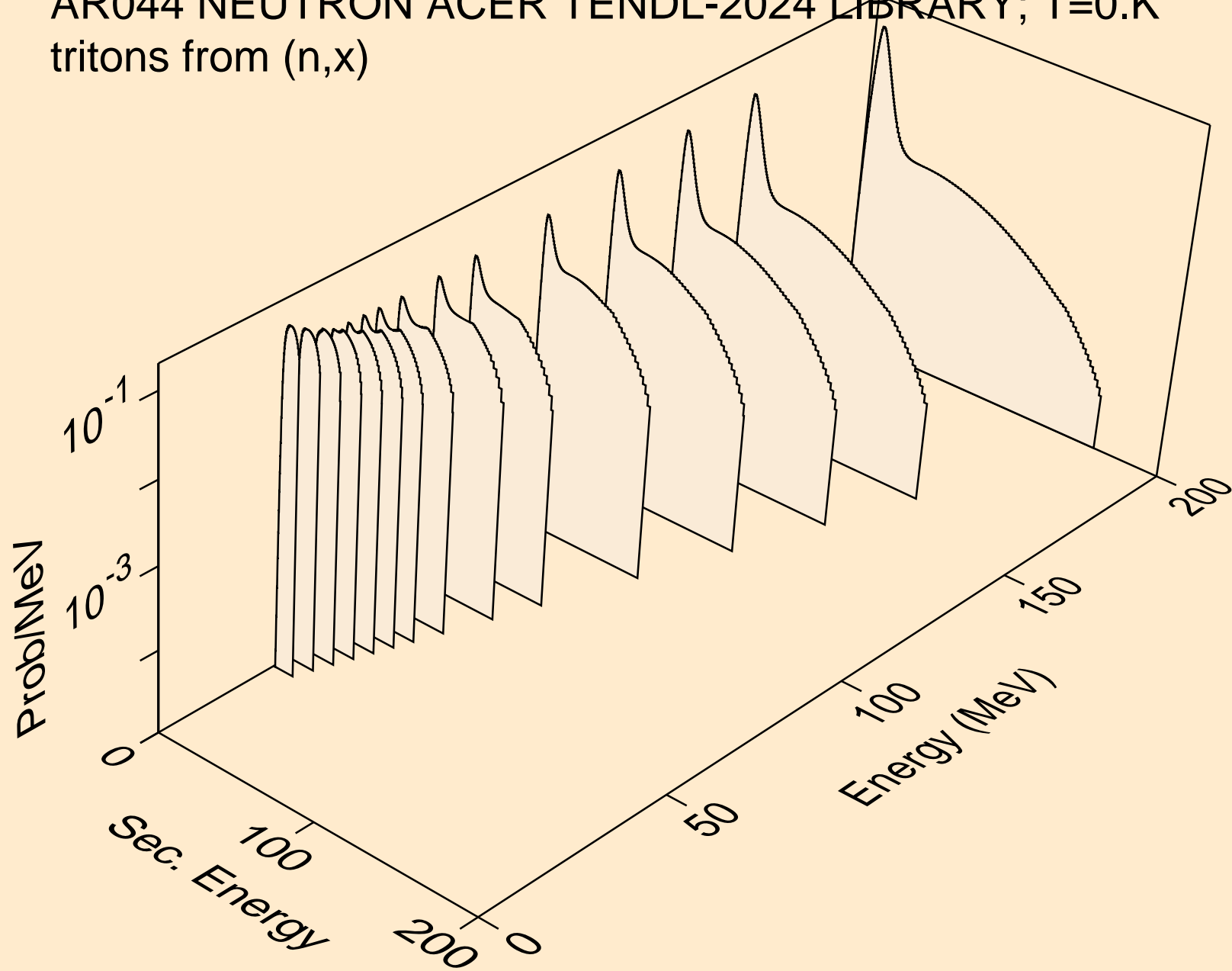

AR044 NEUTRON ACER TENDL-2024 LIBRARY; T=0.K  
tritons from (n,n\*)t

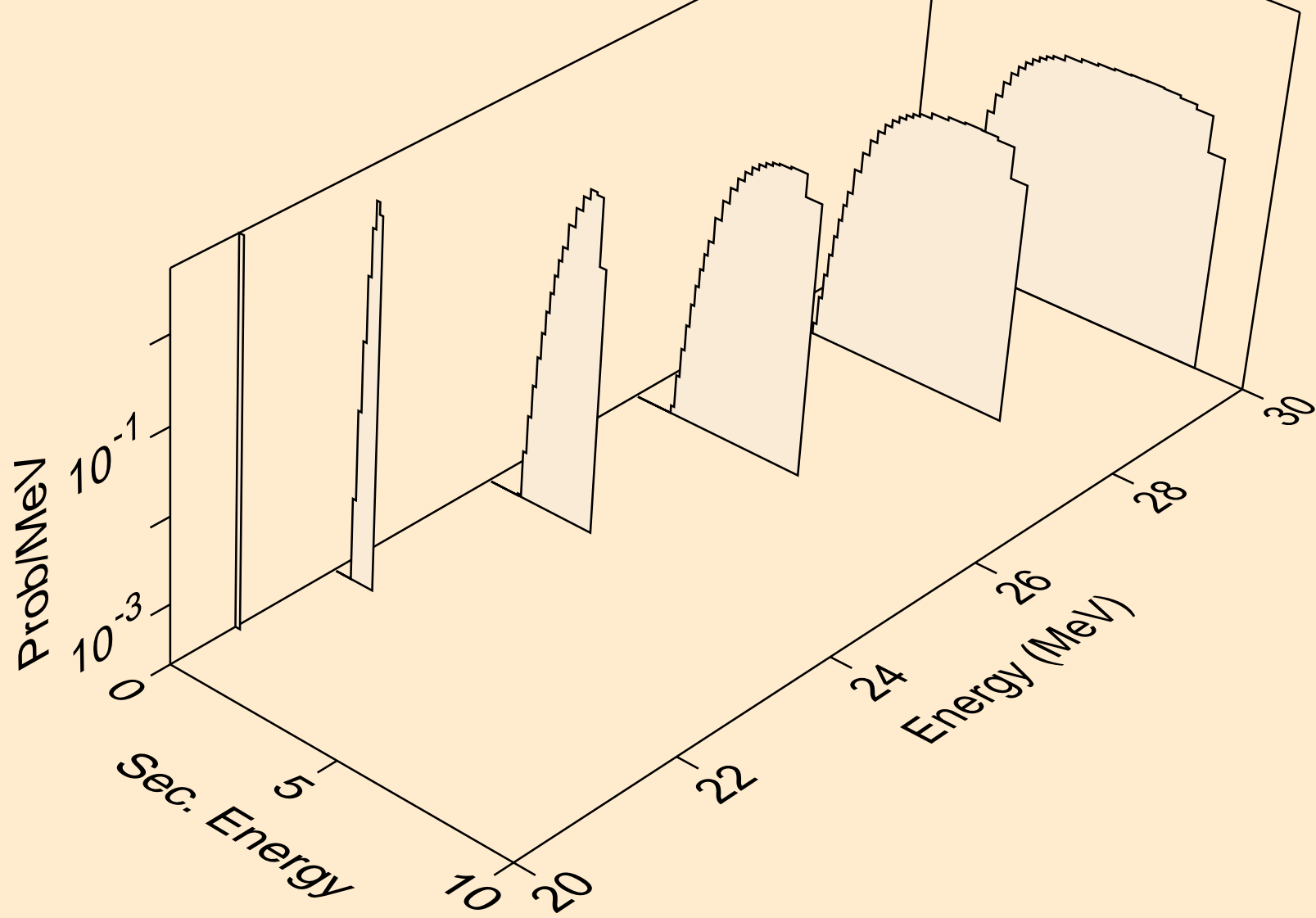

AR044 NEUTRON ACER TENDL-2024 LIBRARY; T=0.K  
tritons from (n,t)

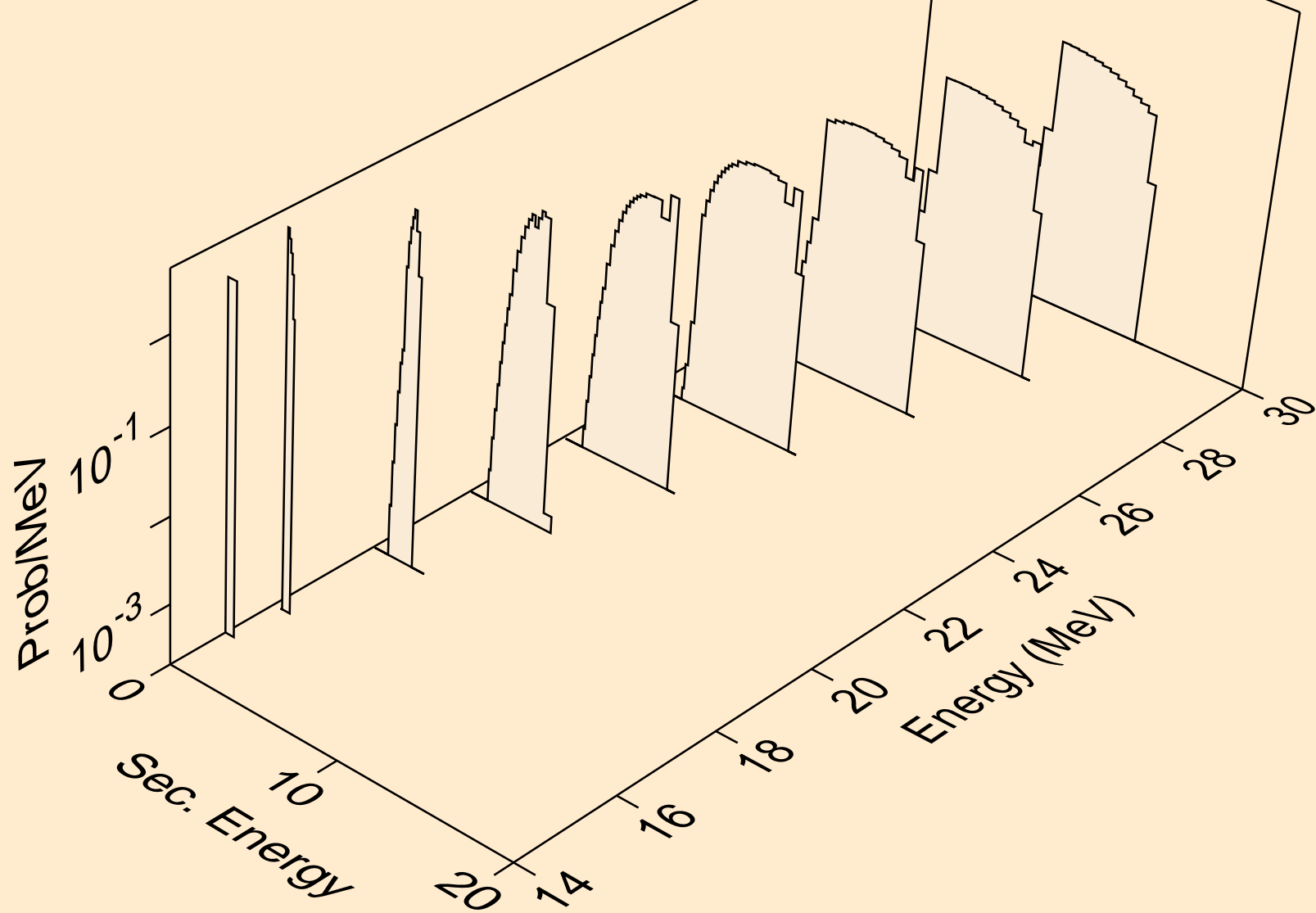

AR044 NEUTRON ACER TENDL-2024 LIBRARY; T=0.K  
he3s from (n,x)

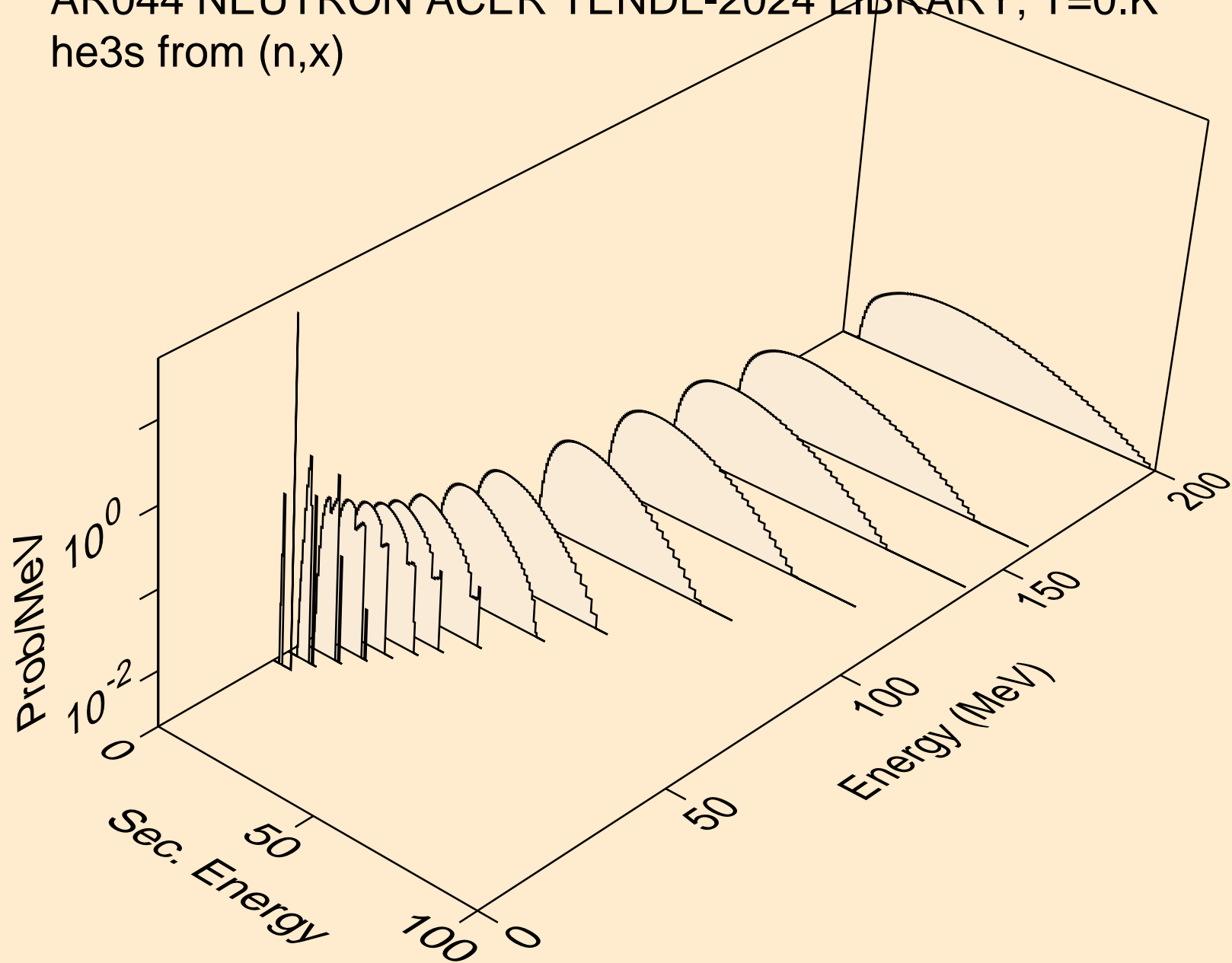

AR044 NEUTRON ACER TENDL-2024 LIBRARY; T=0.K  
he3s from (n,he3)

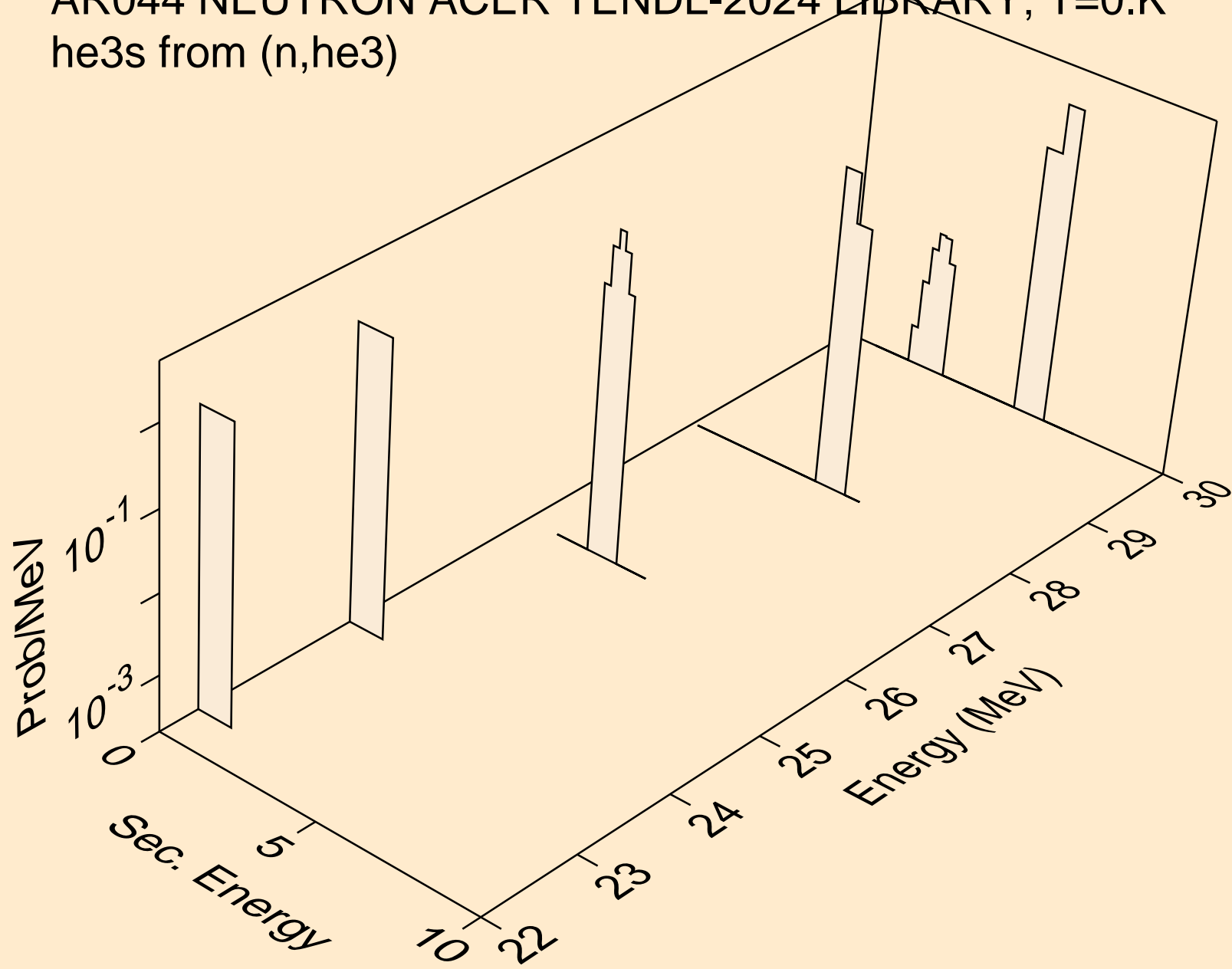

AR044 NEUTRON ACER TENDL-2024 LIBRARY; T=0.K  
alphas from (n,x)

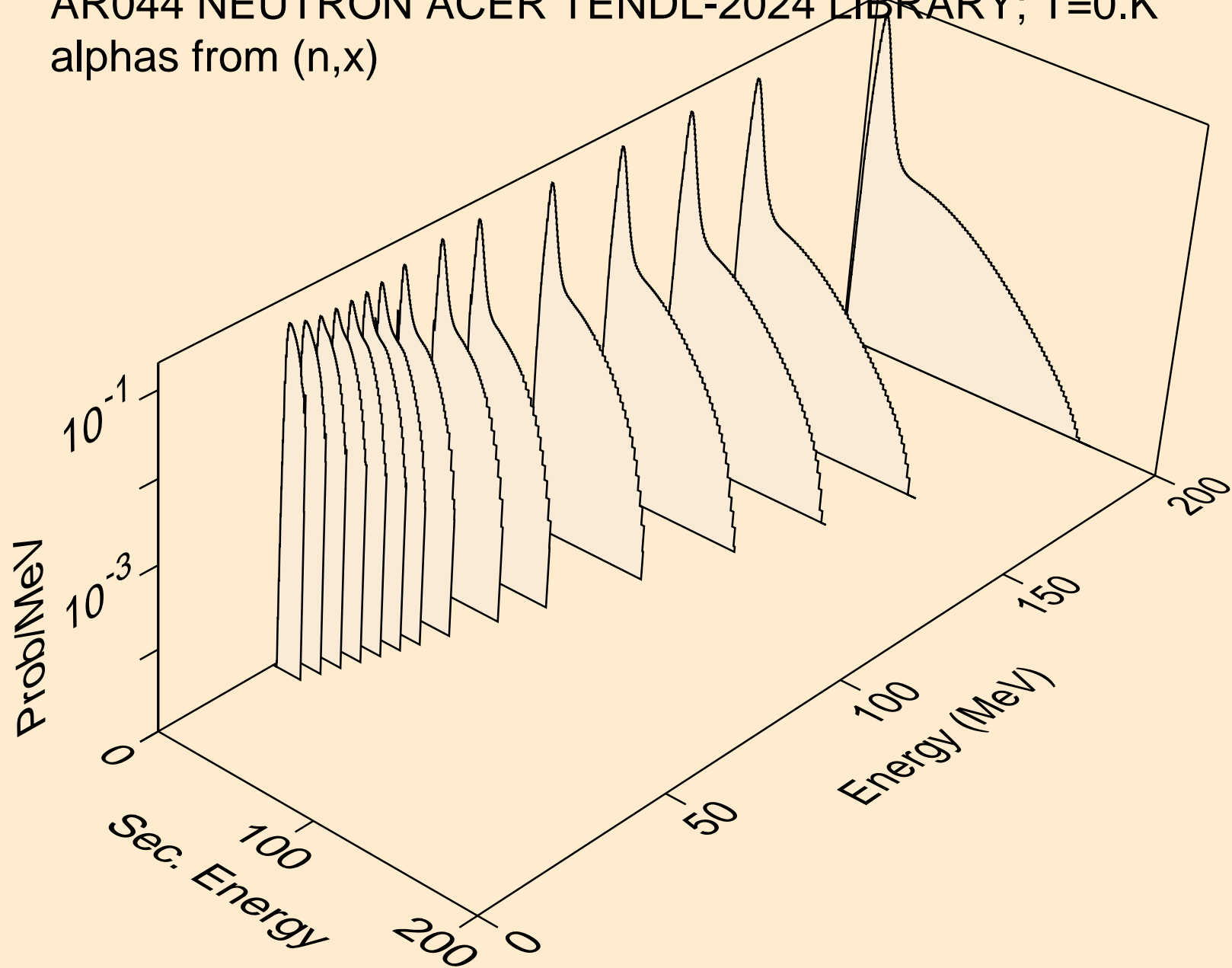

AR044 NEUTRON ACER TENDL-2024 LIBRARY; T=0.K  
alphas from (n,n\*)a

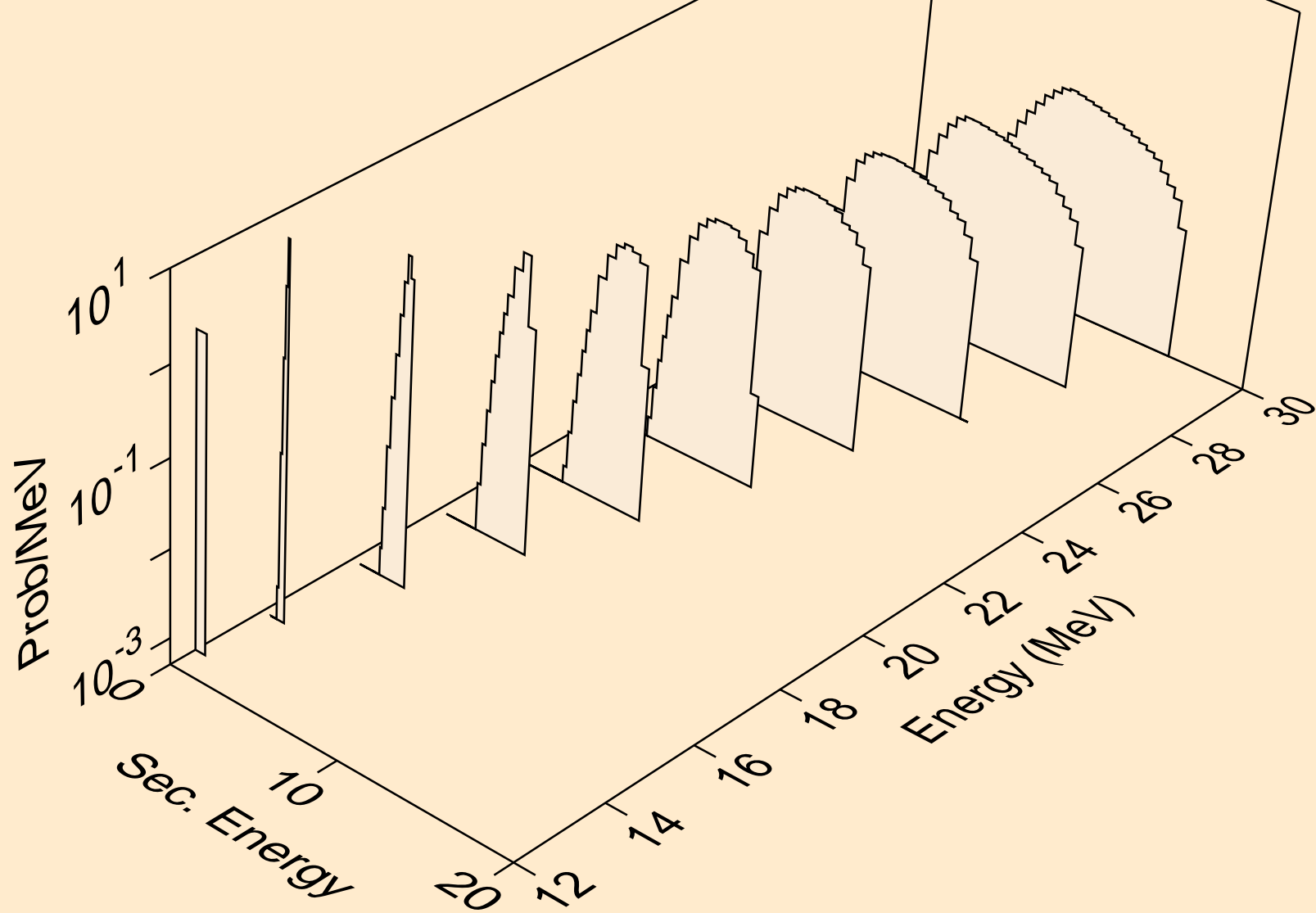

AR044 NEUTRON ACER TENDL-2024 LIBRARY; T=0.K  
alphas from (n,2n)a

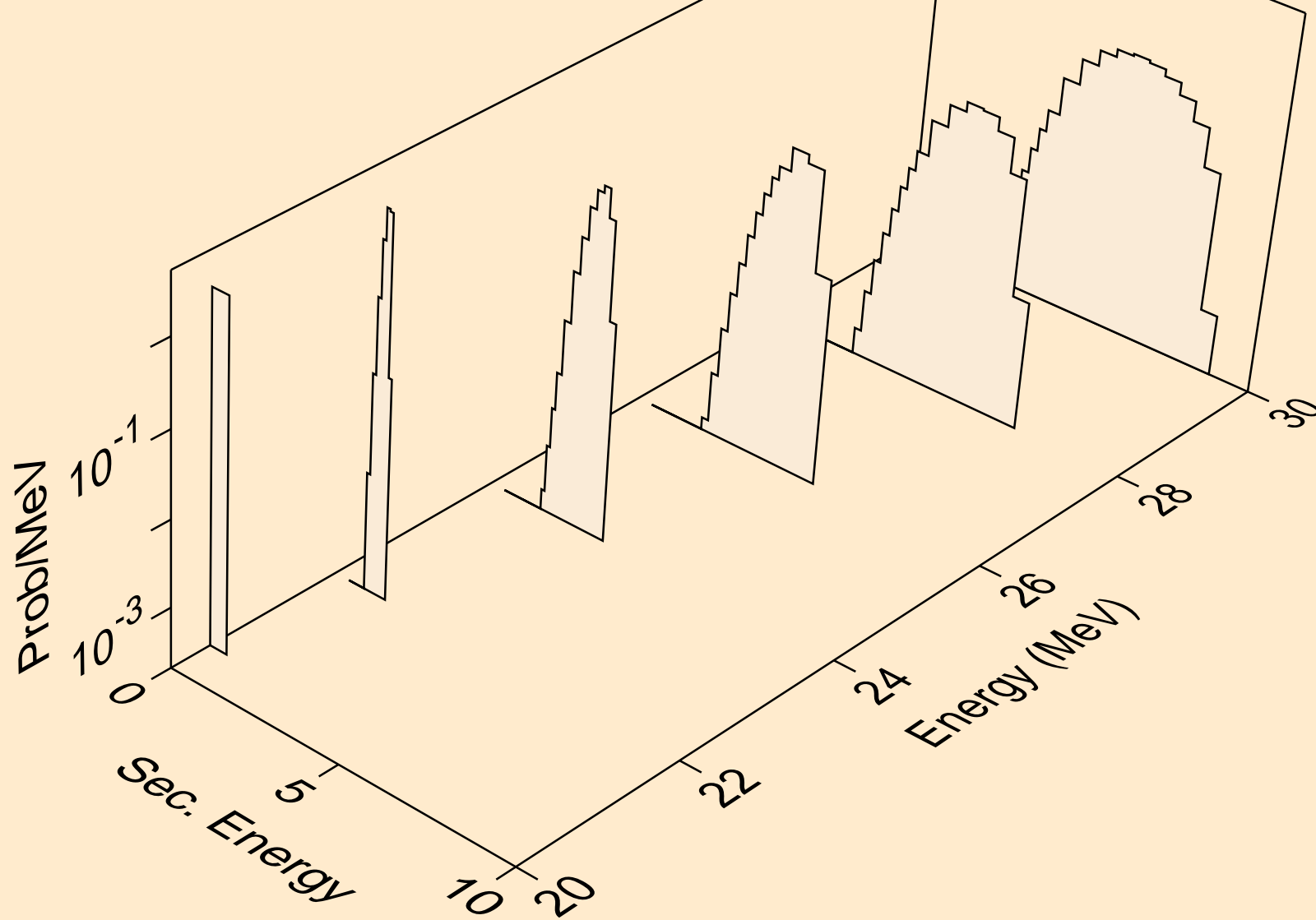

AR044 NEUTRON ACER TENDL-2024 LIBRARY; T=0.K  
alphas from (n,3n)a

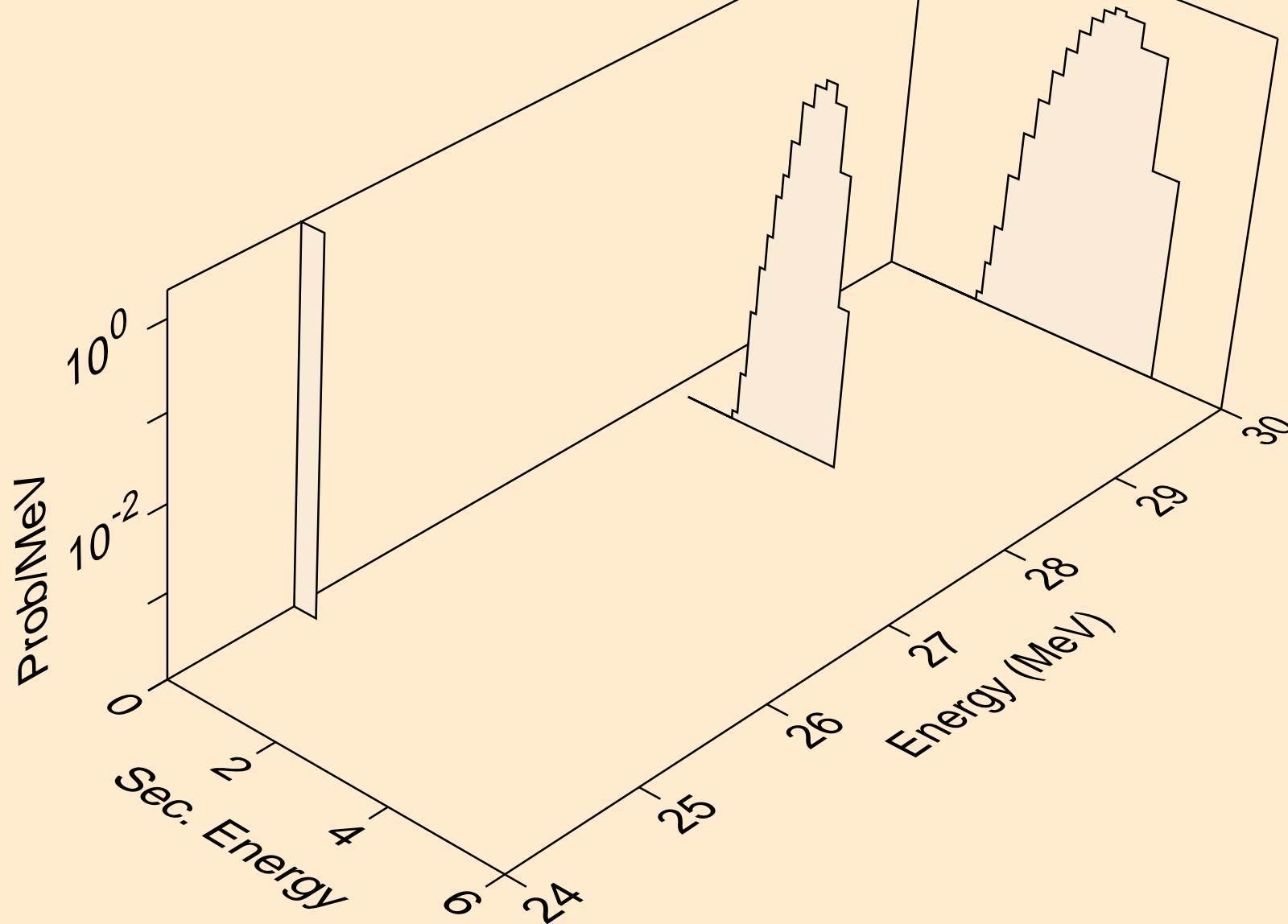

AR044 NEUTRON ACER TENDL-2024 LIBRARY; T=0.K  
alphas from (n,a)

