

AT204 NEUTRON ACER TENDL-2024 LIBRARY; T=0.K

Principal cross sections

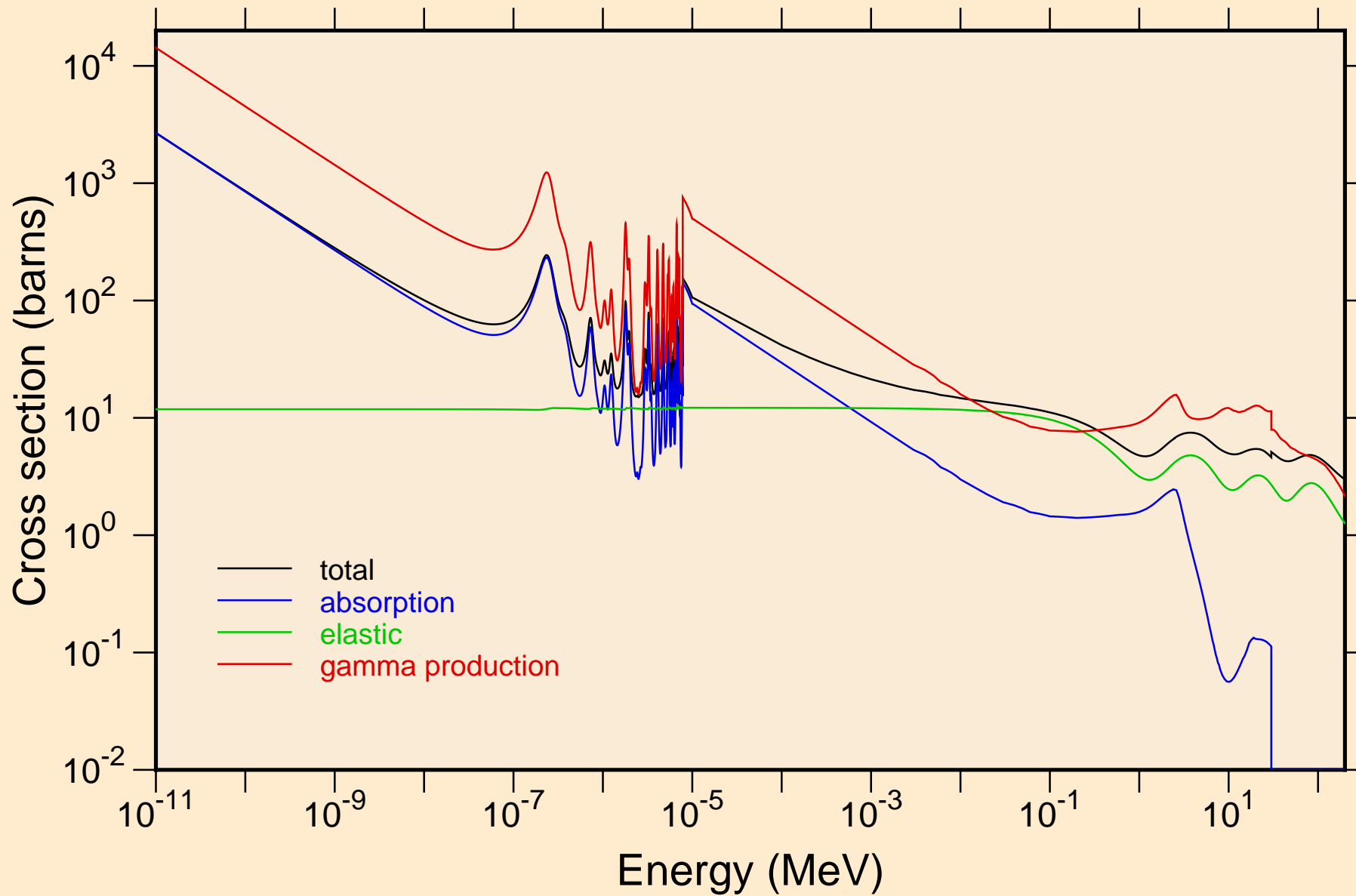

AT204 NEUTRON ACER TENDL-2024 LIBRARY; T=0.K
resonance total cross section

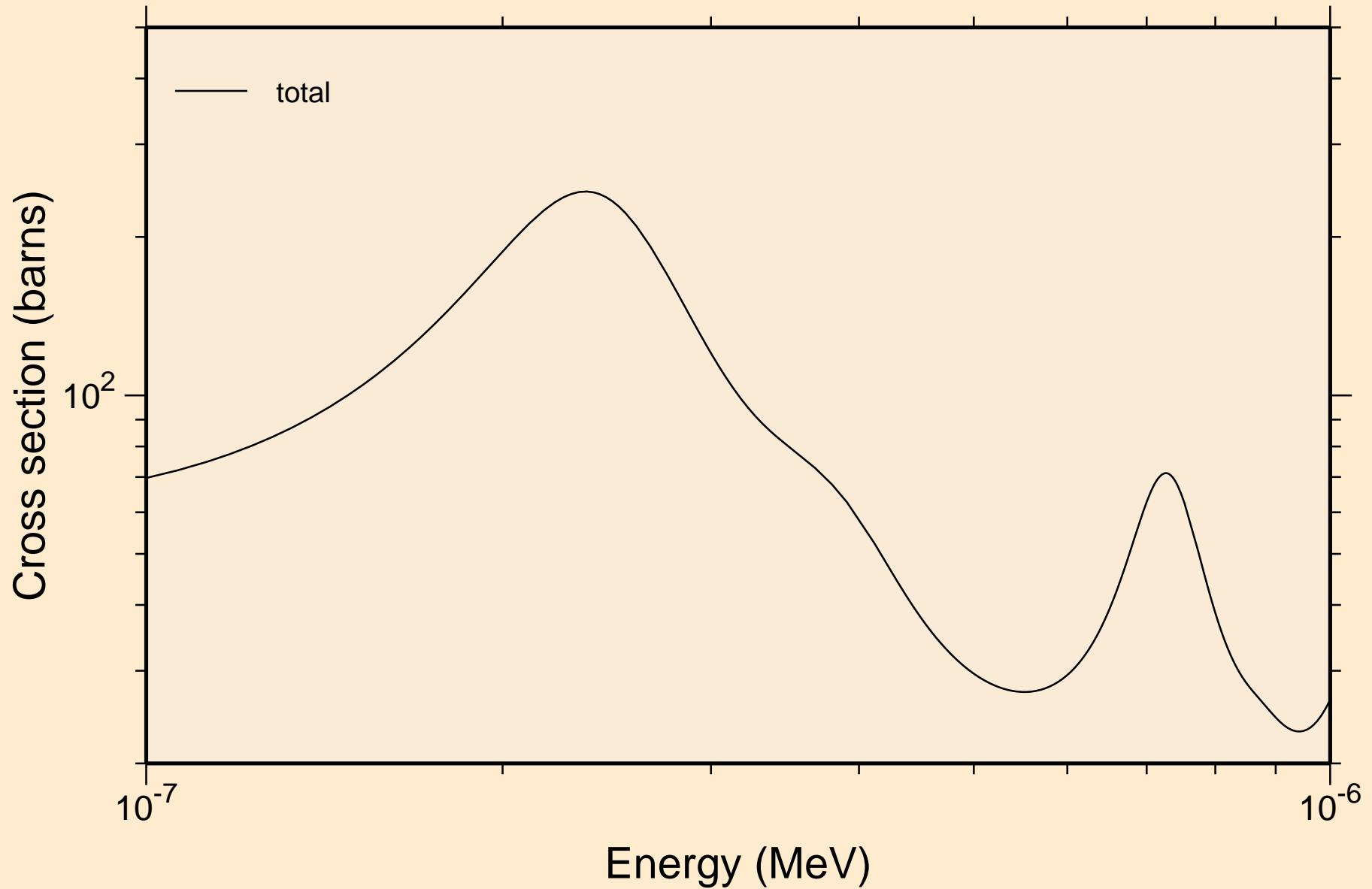

AT204 NEUTRON ACER TENDL-2024 LIBRARY; T=0.K
resonance total cross section

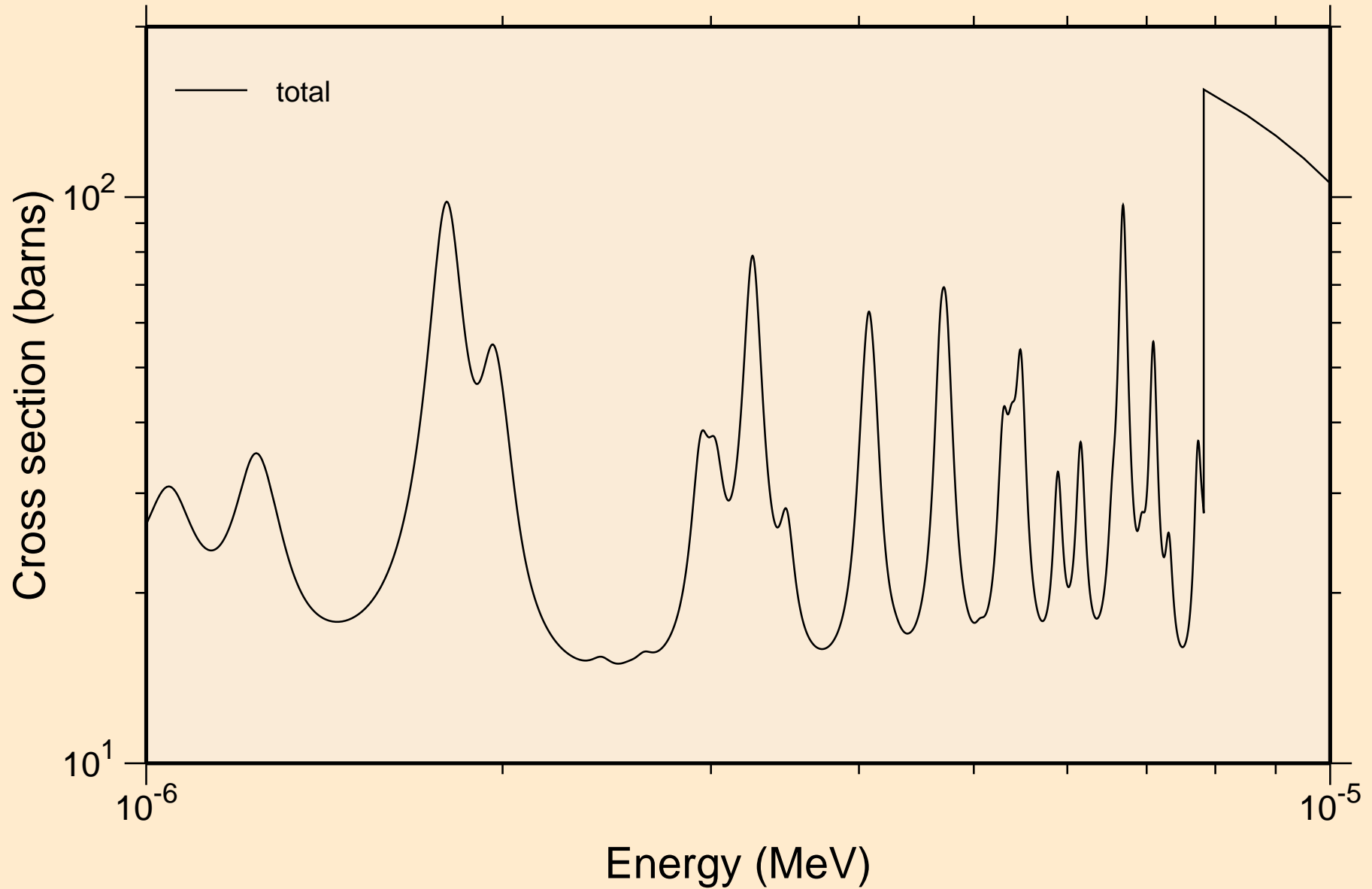

AT204 NEUTRON ACER TENDL-2024 LIBRARY; T=0.K
resonance total cross section

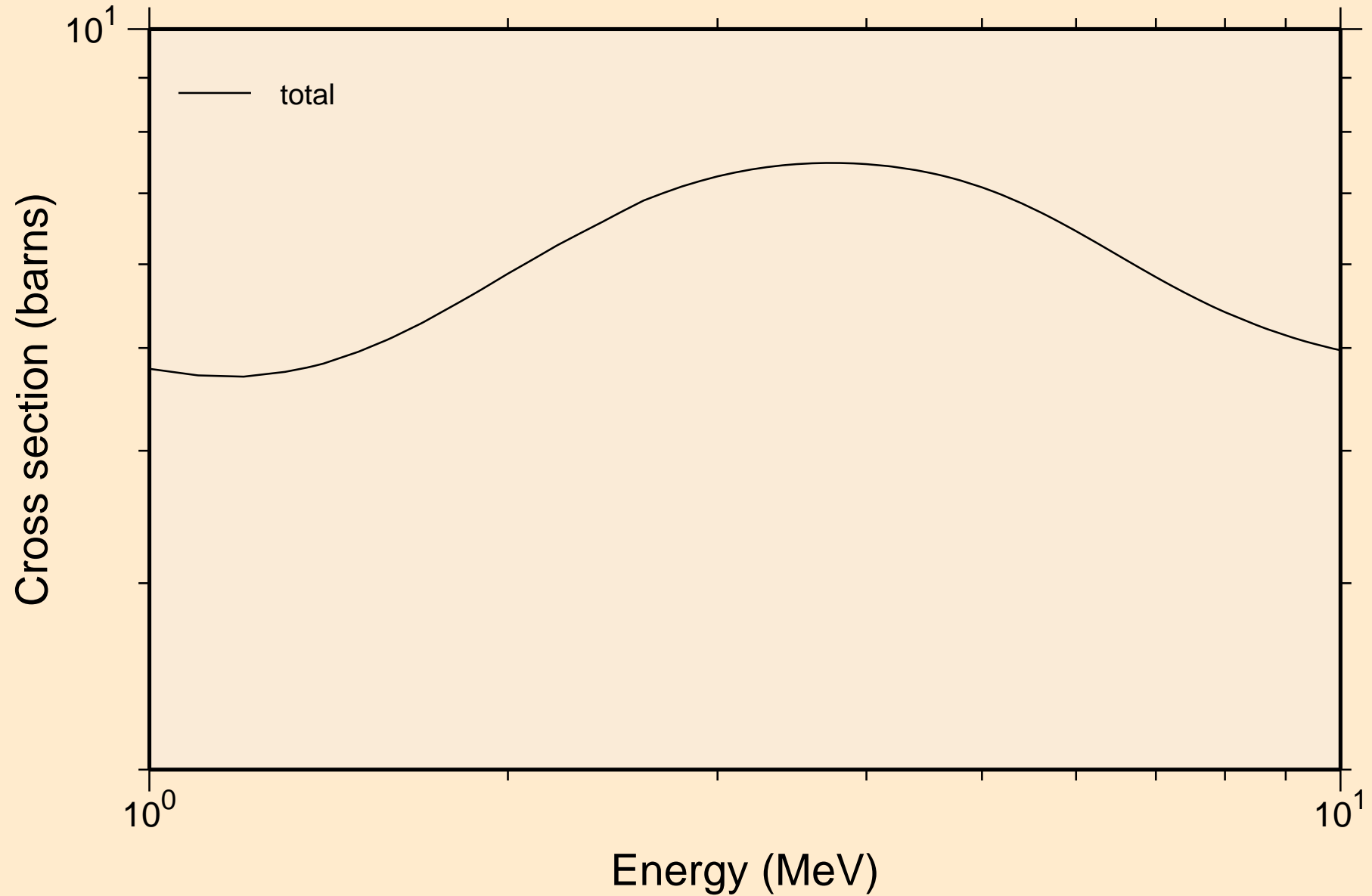

AT204 NEUTRON ACER TENDL-2024 LIBRARY; T=0.K
resonance absorption cross sections

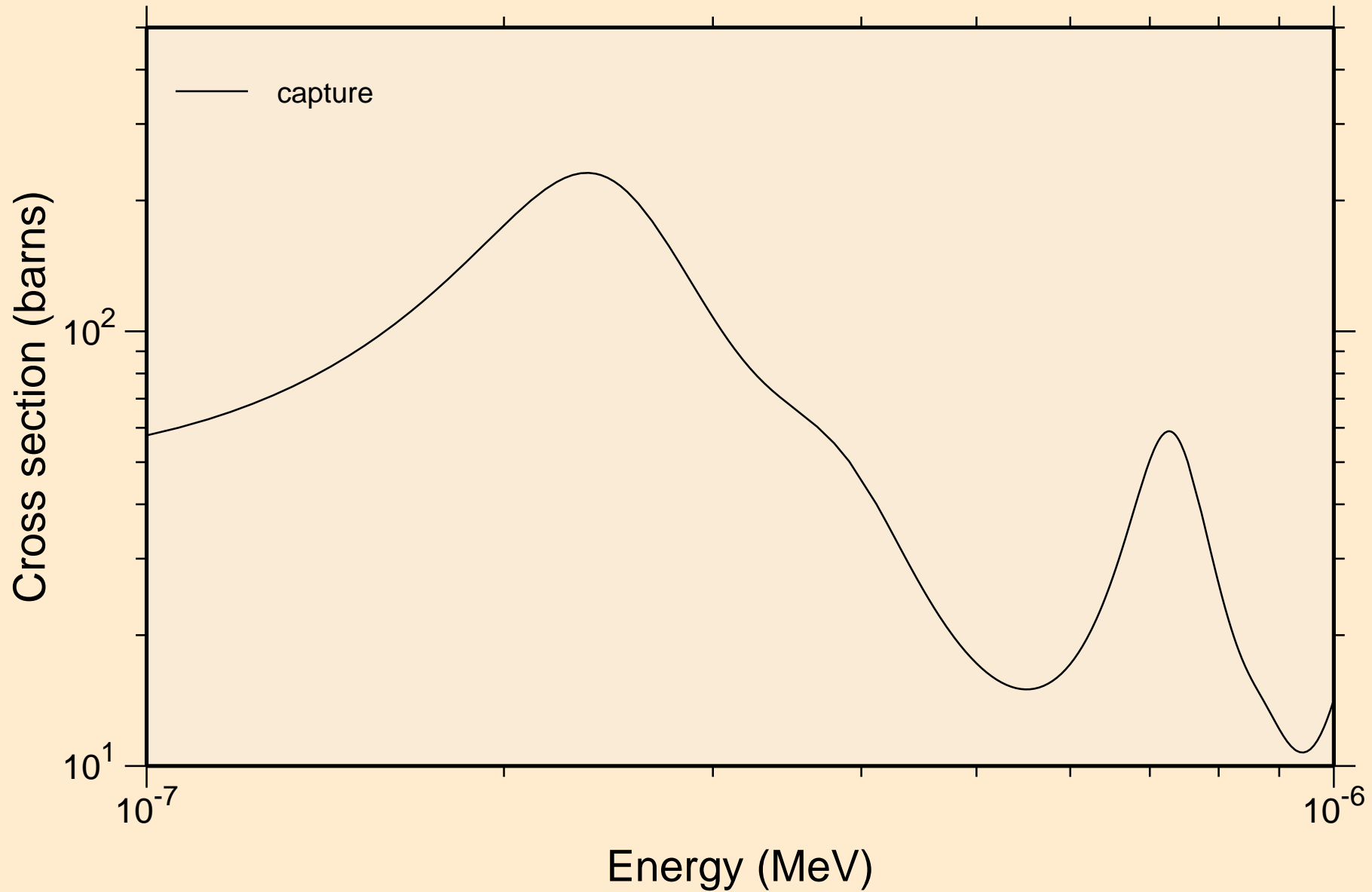

AT204 NEUTRON ACER TENDL-2024 LIBRARY; T=0.K
resonance absorption cross sections

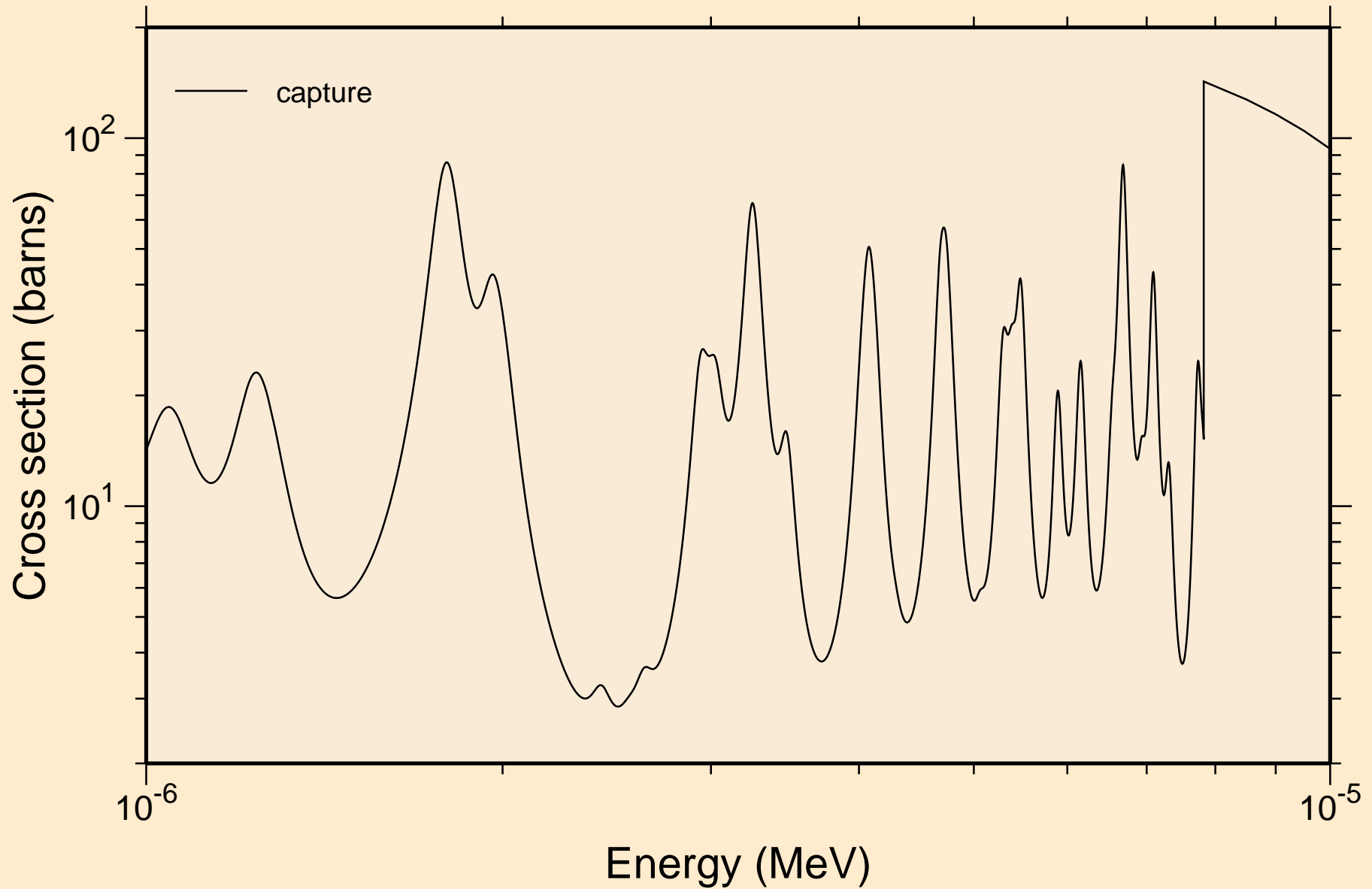

AT204 NEUTRON ACER TENDL-2024 LIBRARY; T=0.K
resonance absorption cross sections

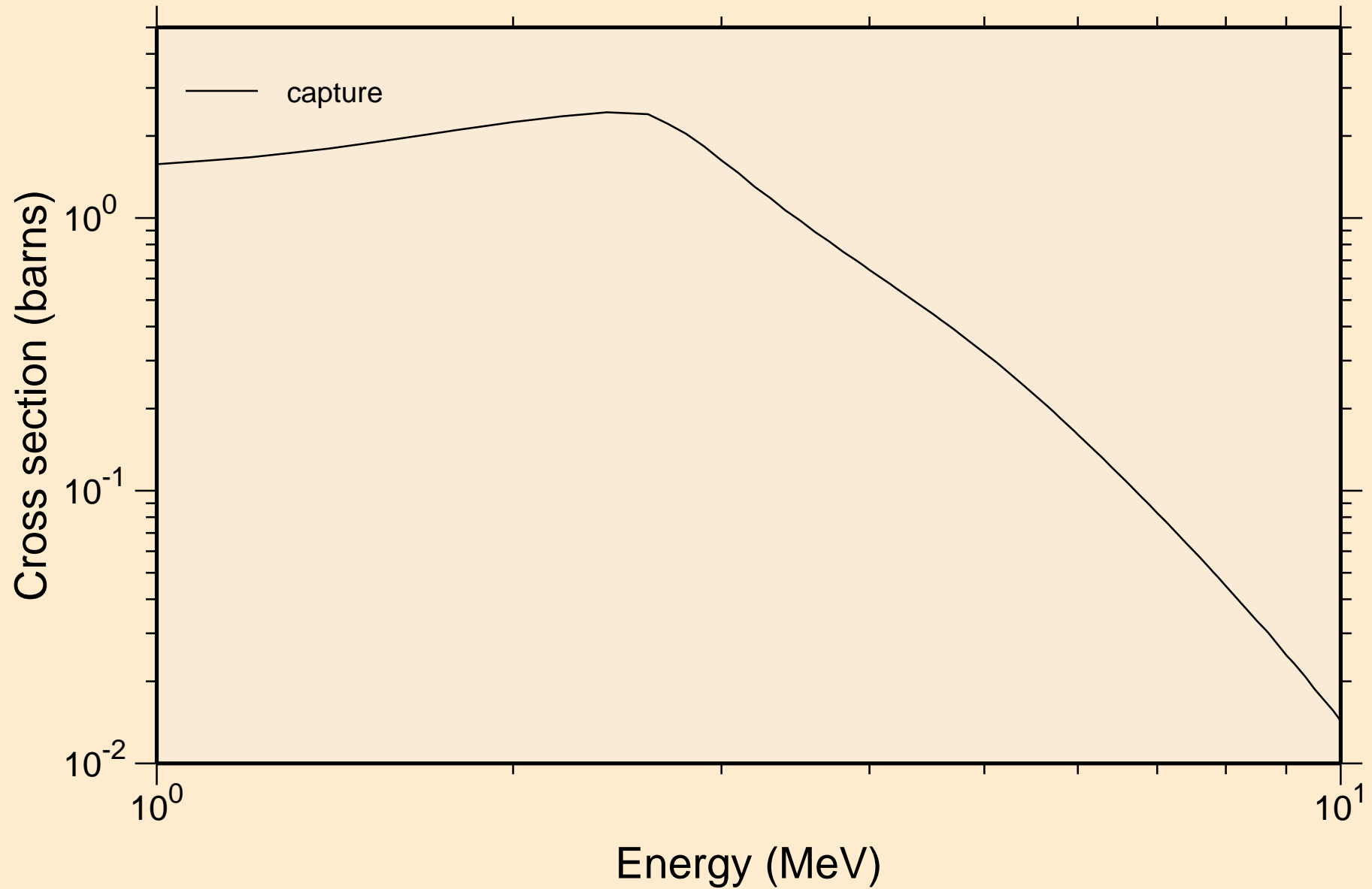

AT204 NEUTRON ACER TENDL-2024 LIBRARY; T=0.K
Heating

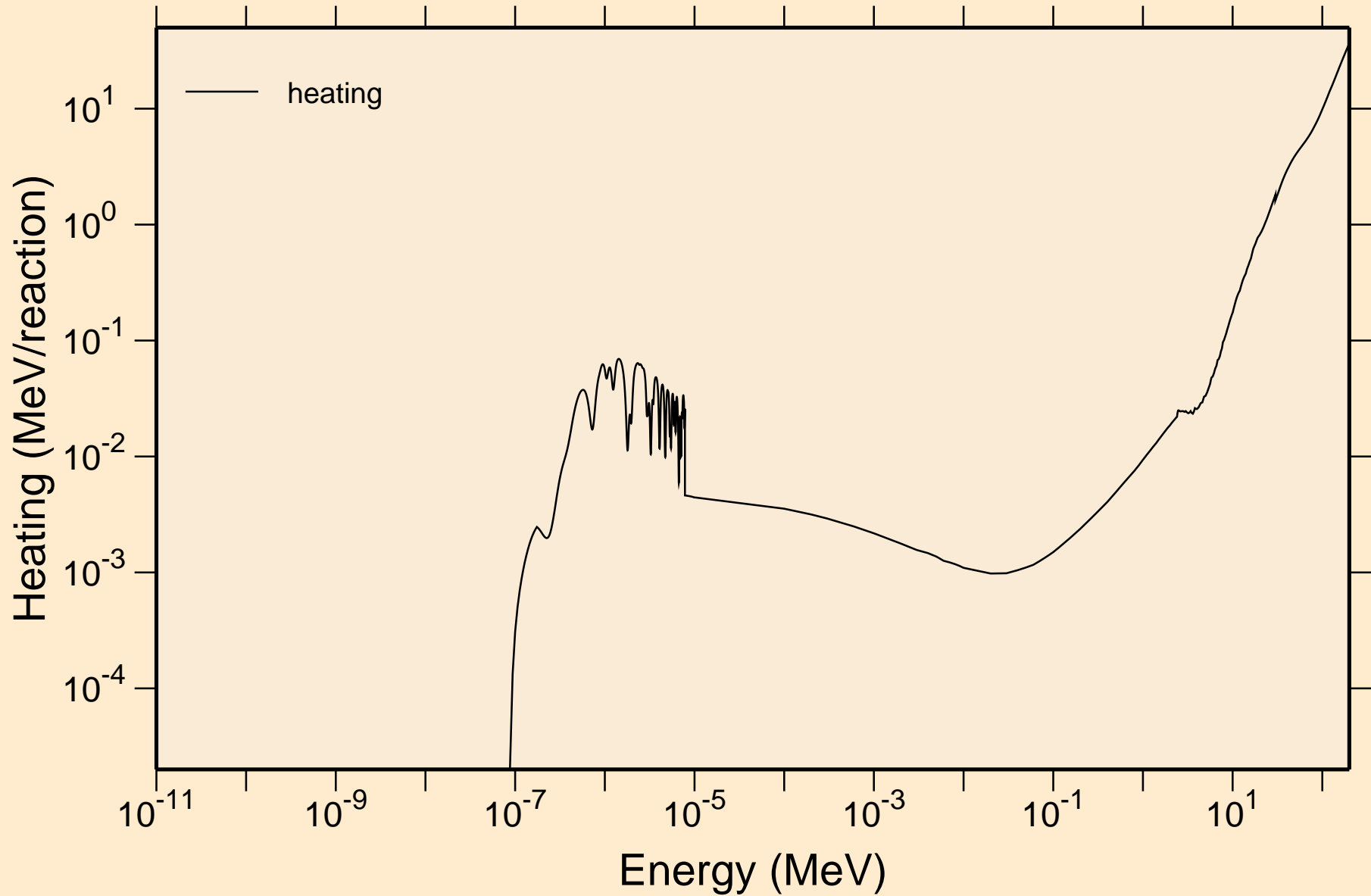

AT204 NEUTRON ACER TENDL-2024 LIBRARY; T=0.K
Damage

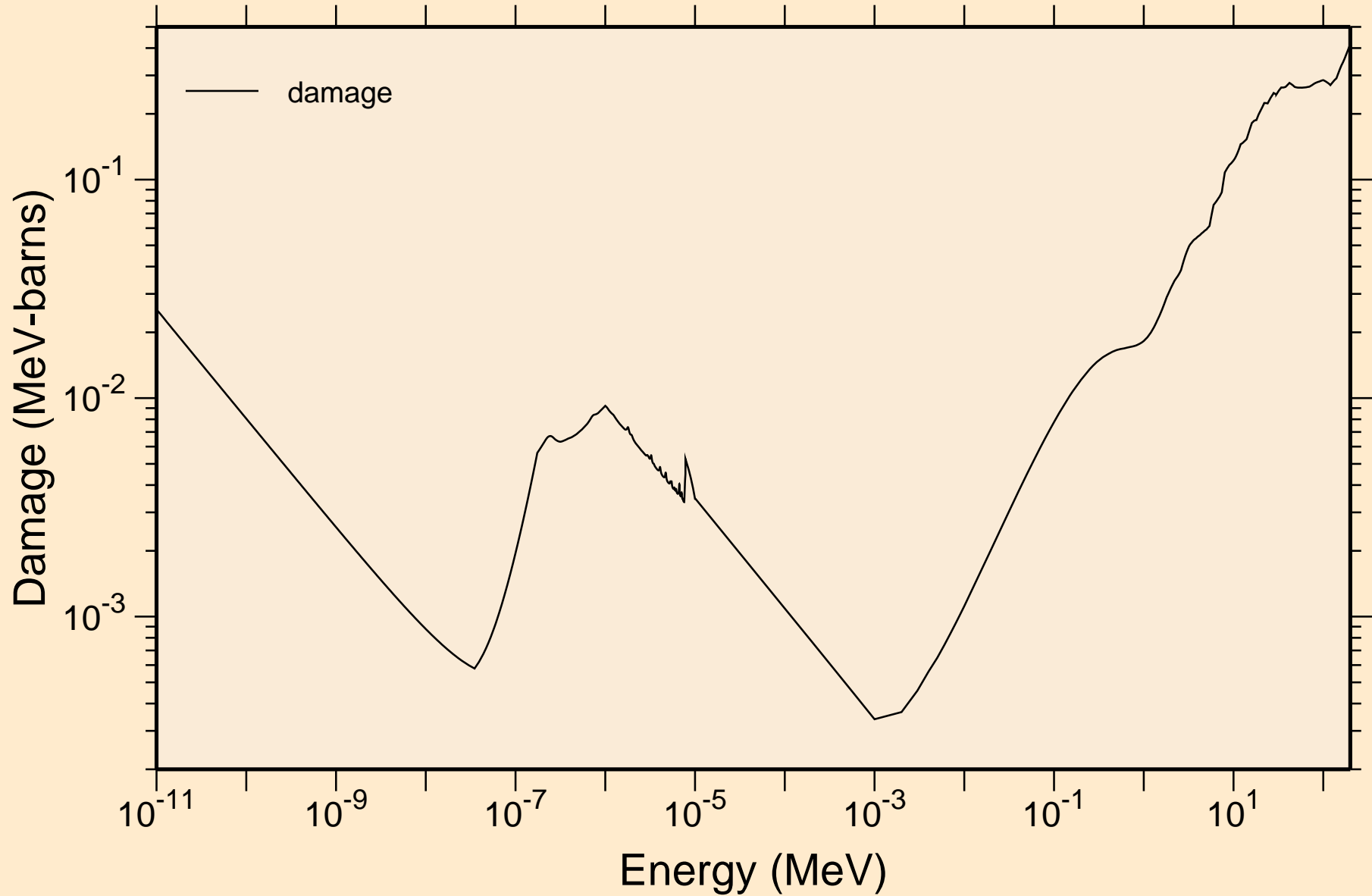

AT204 NEUTRON ACER TENDL-2024 LIBRARY; T=0.K
Non-threshold reactions

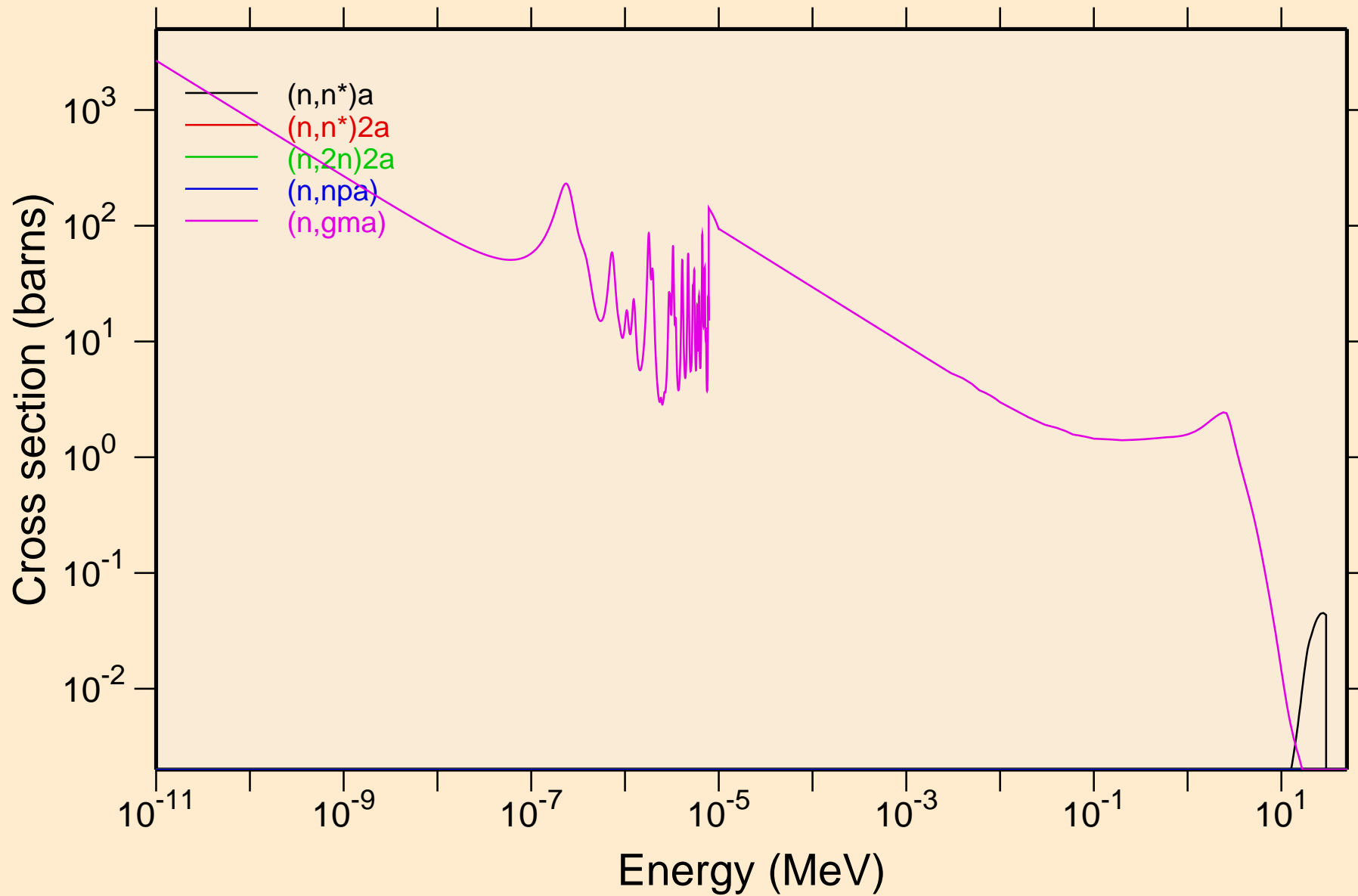

AT204 NEUTRON ACER TENDL-2024 LIBRARY; T=0.K
Non-threshold reactions

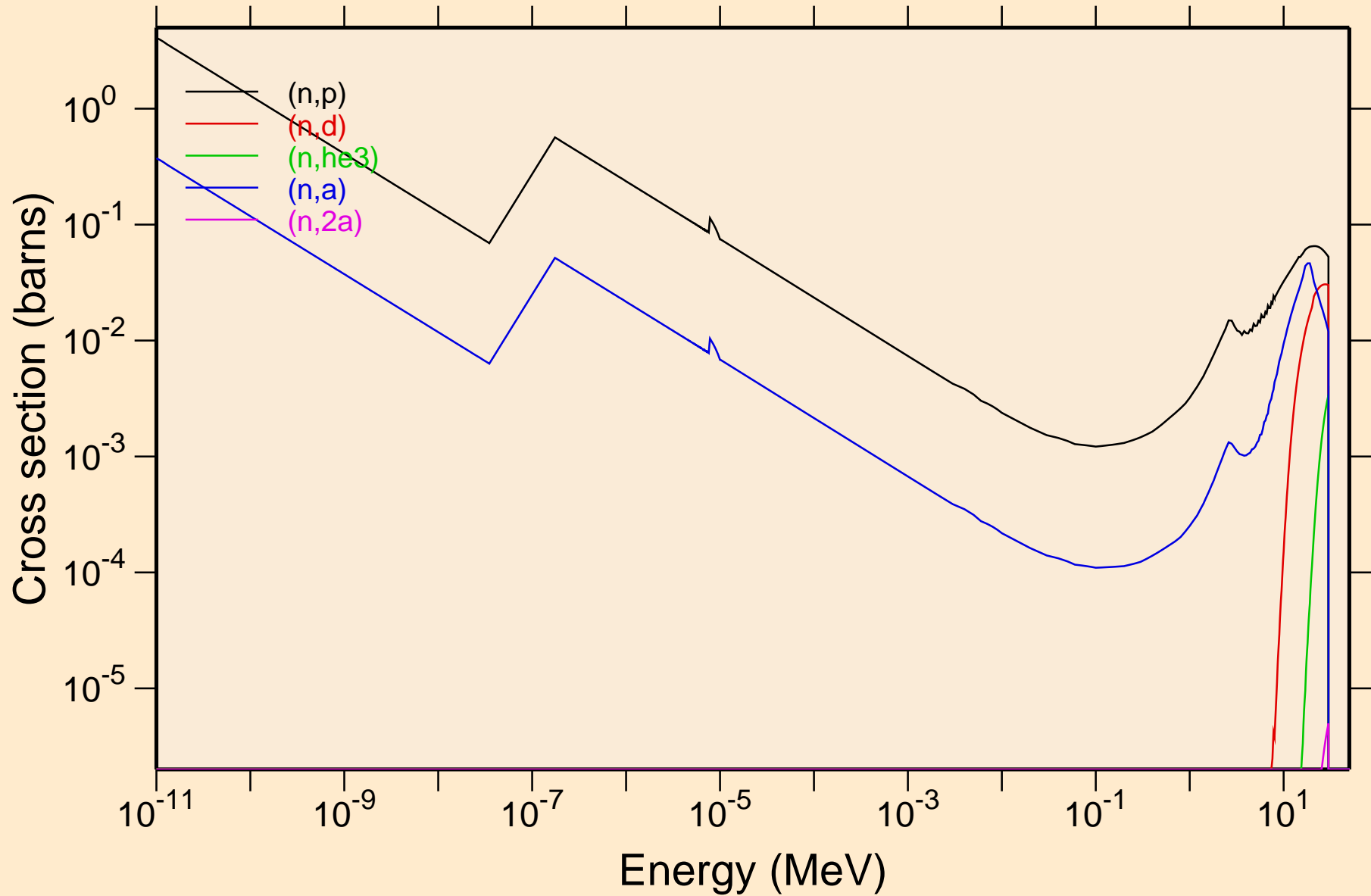

AT204 NEUTRON ACER TENDL-2024 LIBRARY; T=0.K
Non-threshold reactions

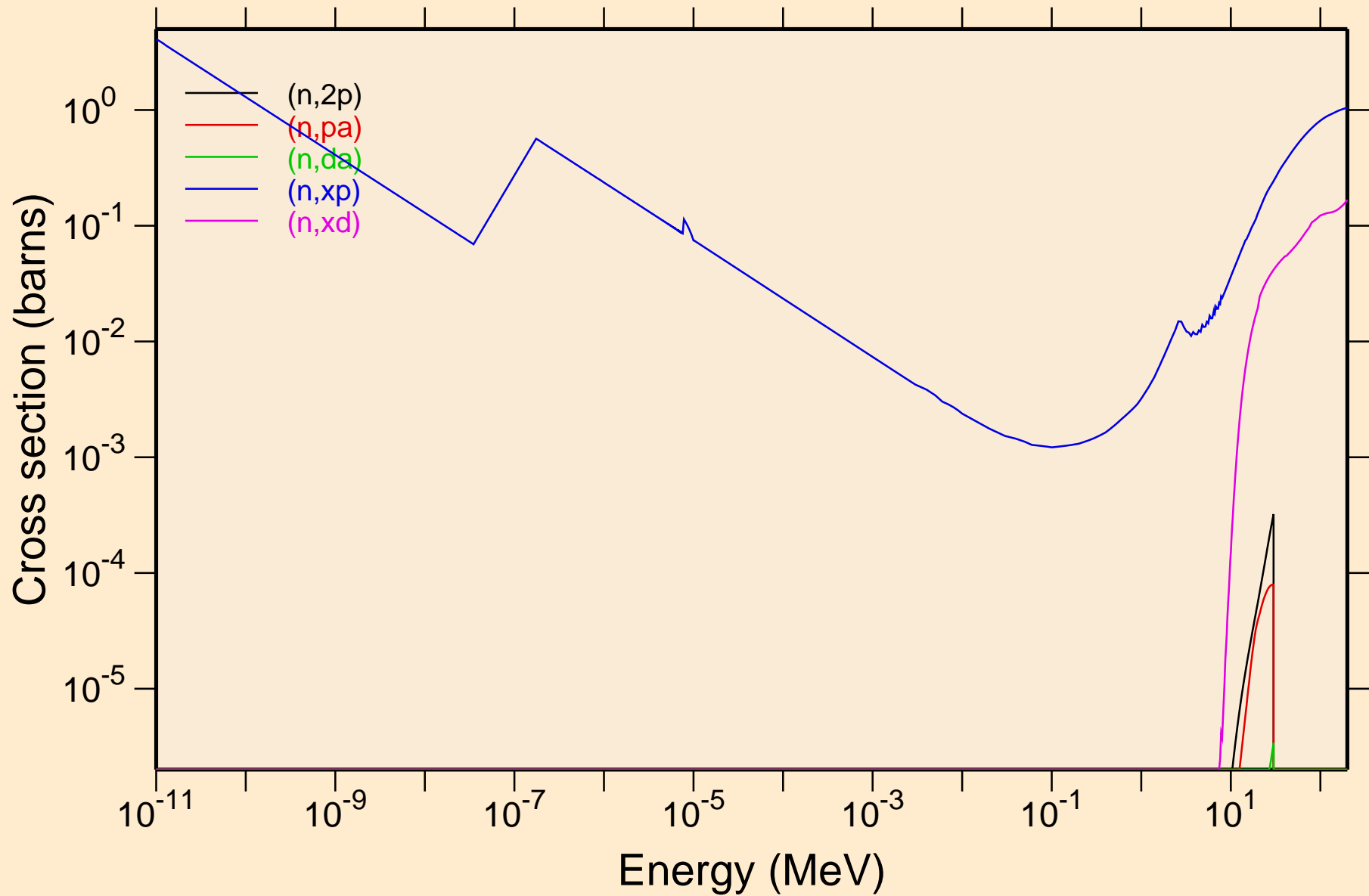

AT204 NEUTRON ACER TENDL-2024 LIBRARY; T=0.K
Non-threshold reactions

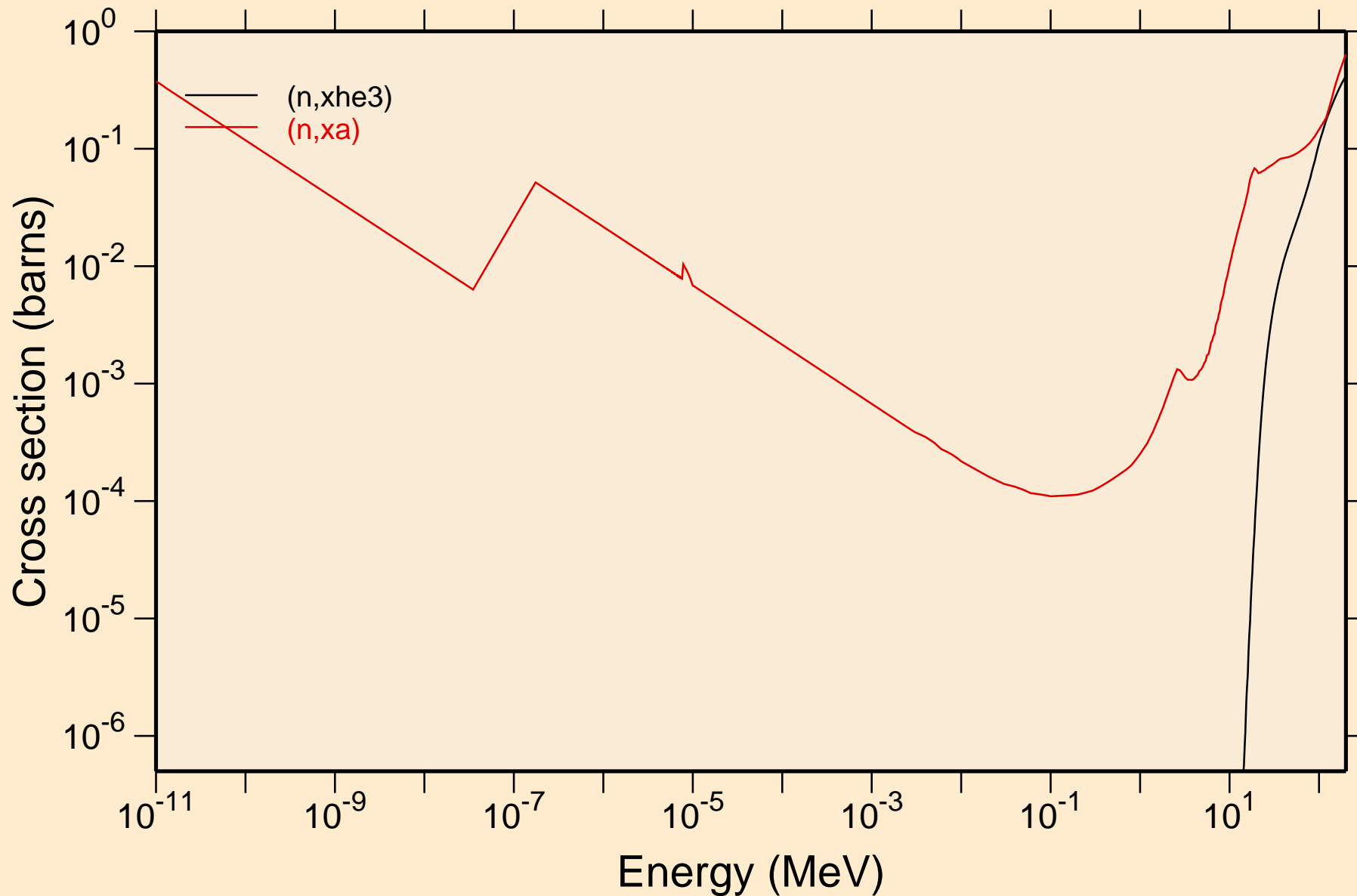

AT204 NEUTRON ACER TENDL-2024 LIBRARY; T=0.K

Principal cross sections

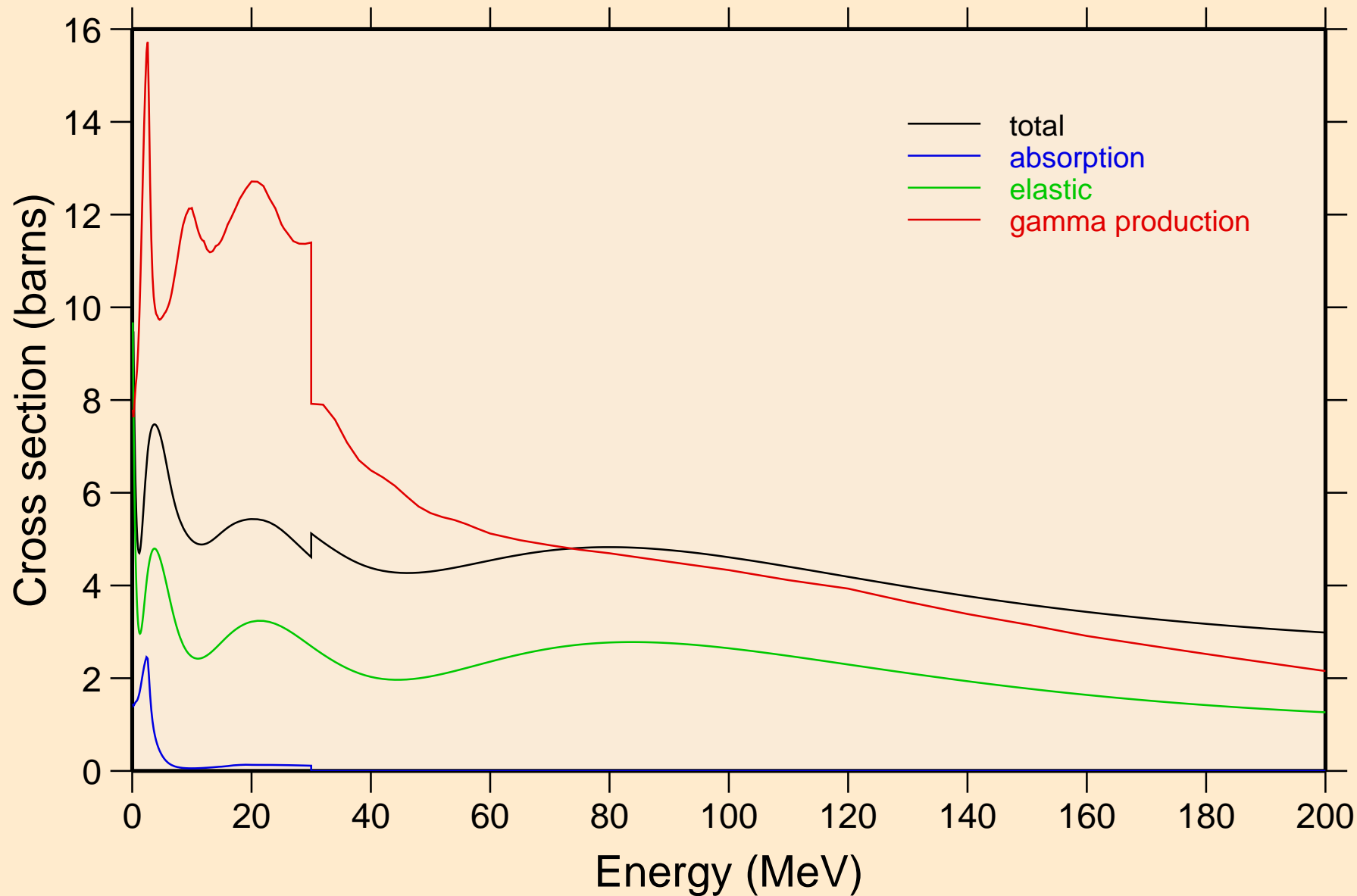

AT204 NEUTRON ACER TENDL-2024 LIBRARY; T=0.K

Heating

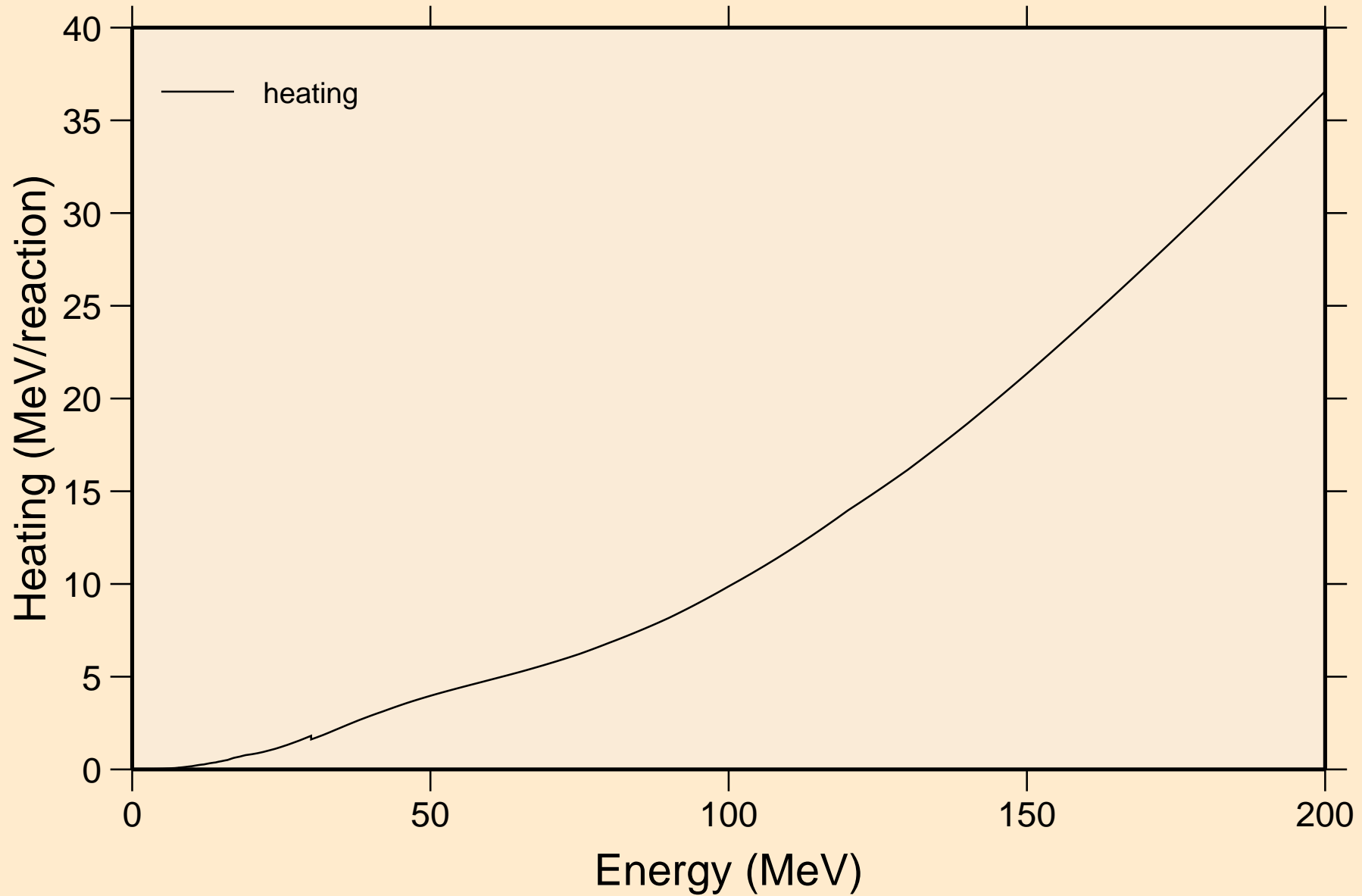

AT204 NEUTRON ACER TENDL-2024 LIBRARY; T=0.K
Damage

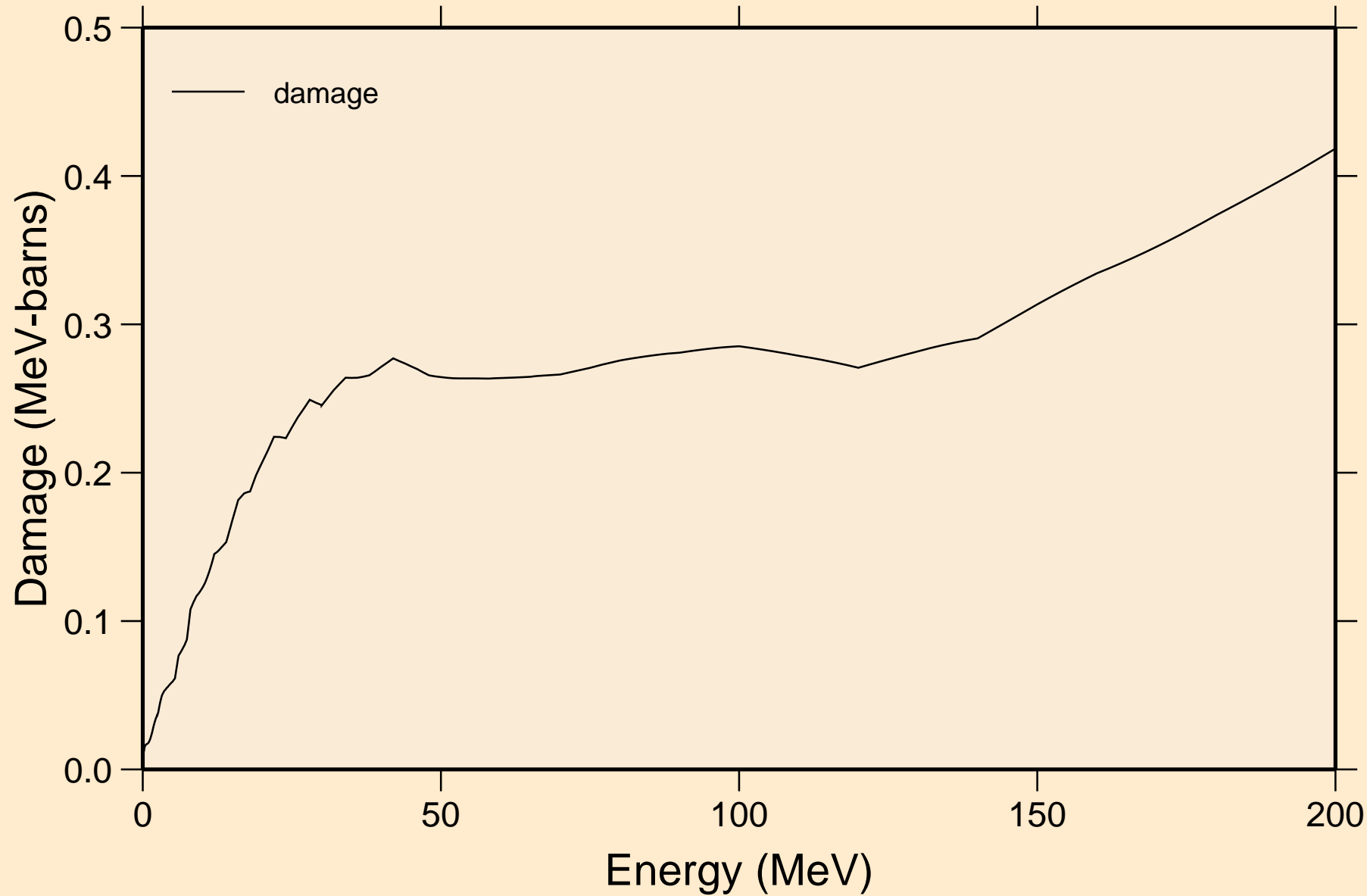

AT204 NEUTRON ACER TENDL-2024 LIBRARY; T=0.K
Non-threshold reactions

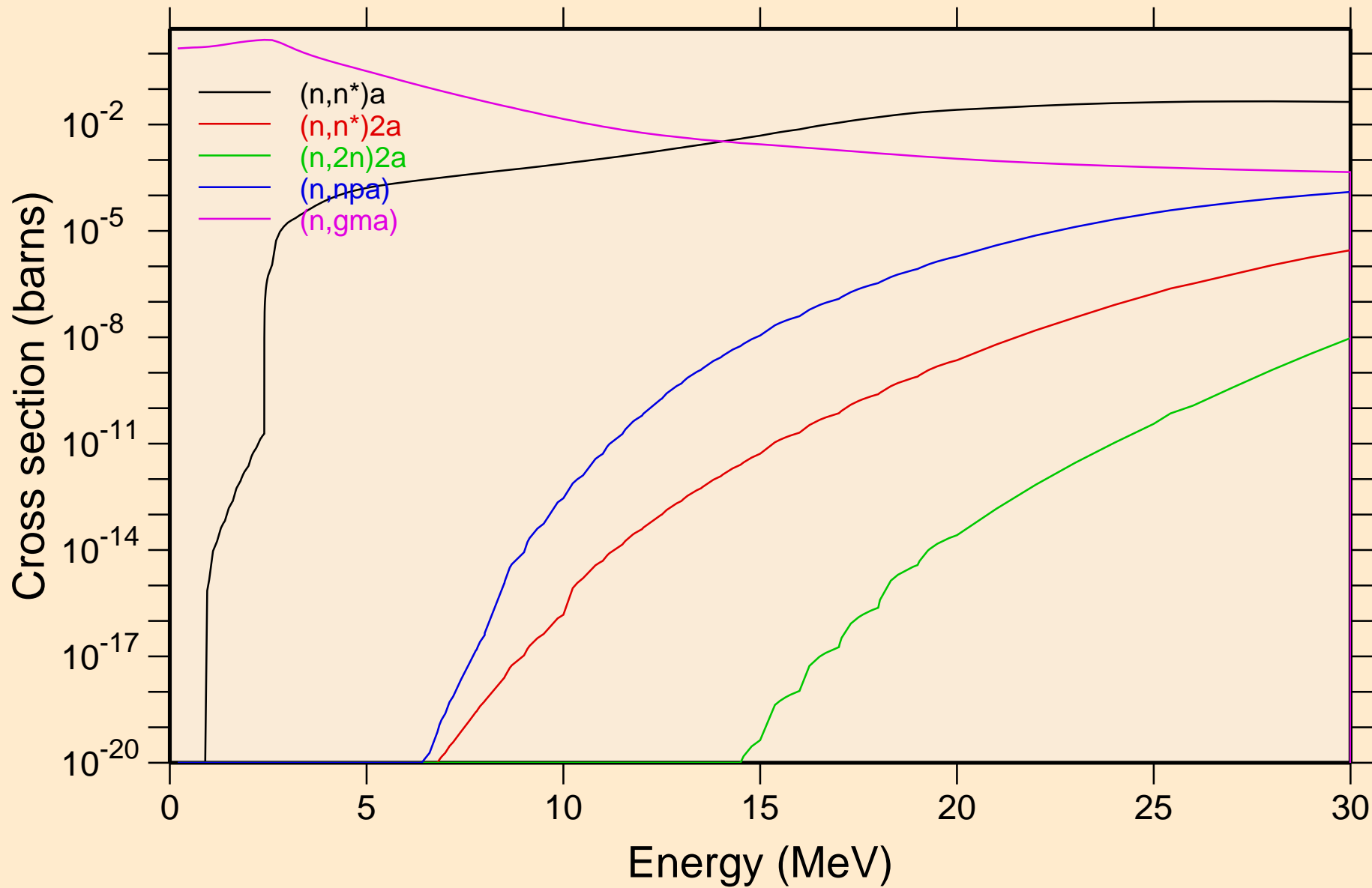

AT204 NEUTRON ACER TENDL-2024 LIBRARY; T=0.K
Non-threshold reactions

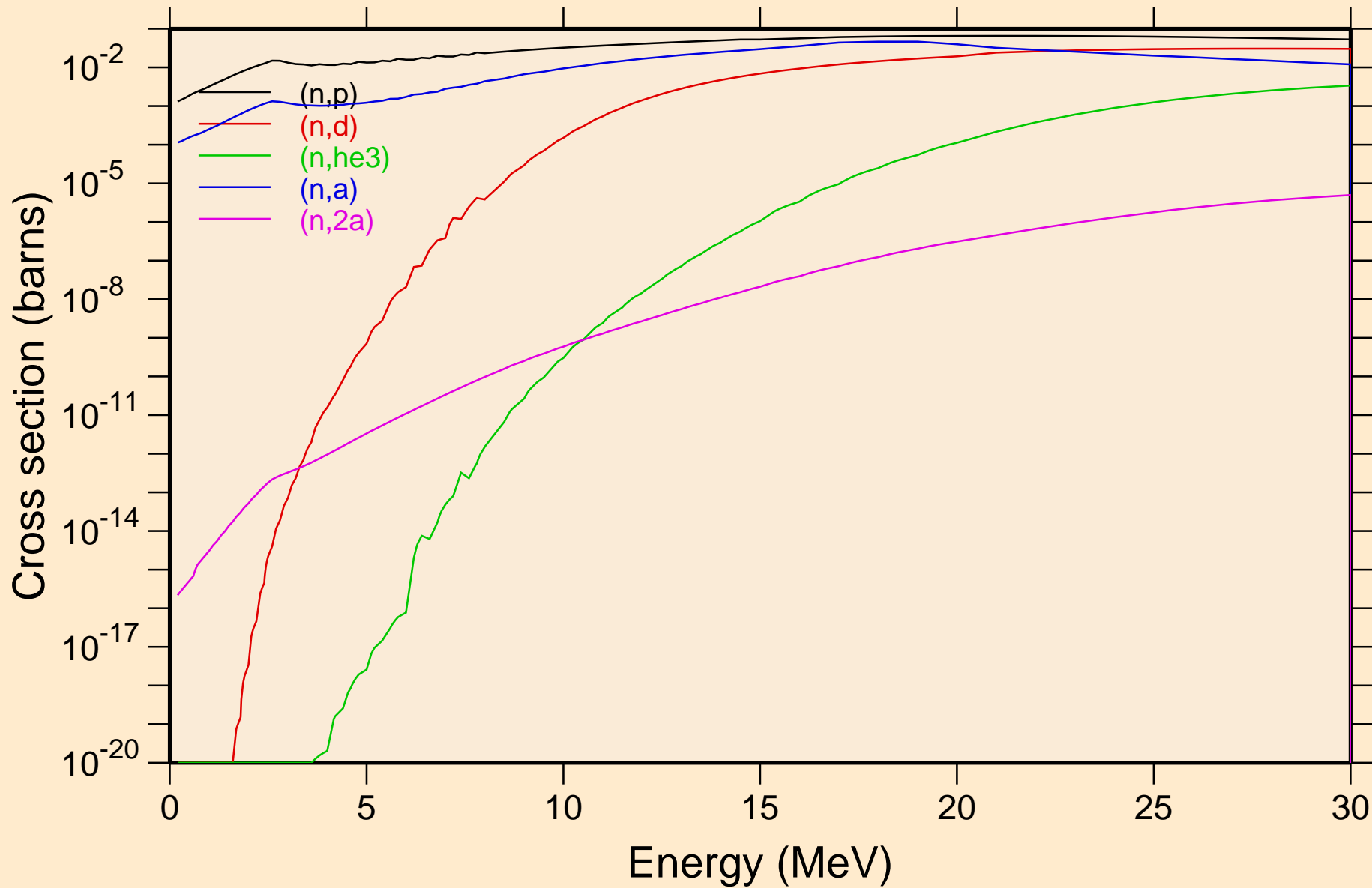

AT204 NEUTRON ACER TENDL-2024 LIBRARY; T=0.K
Non-threshold reactions

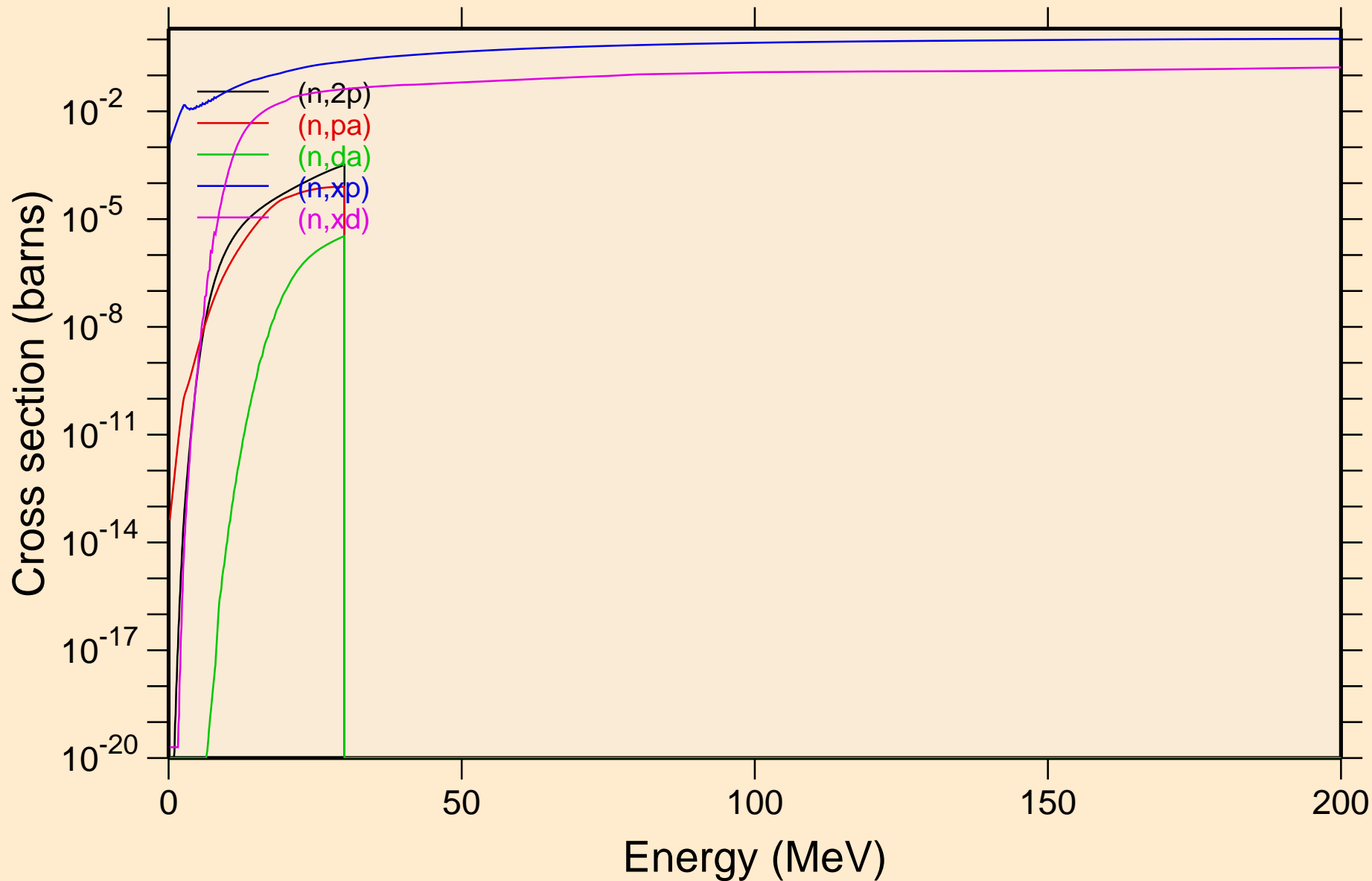

AT204 NEUTRON ACER TENDL-2024 LIBRARY; T=0.K
Non-threshold reactions

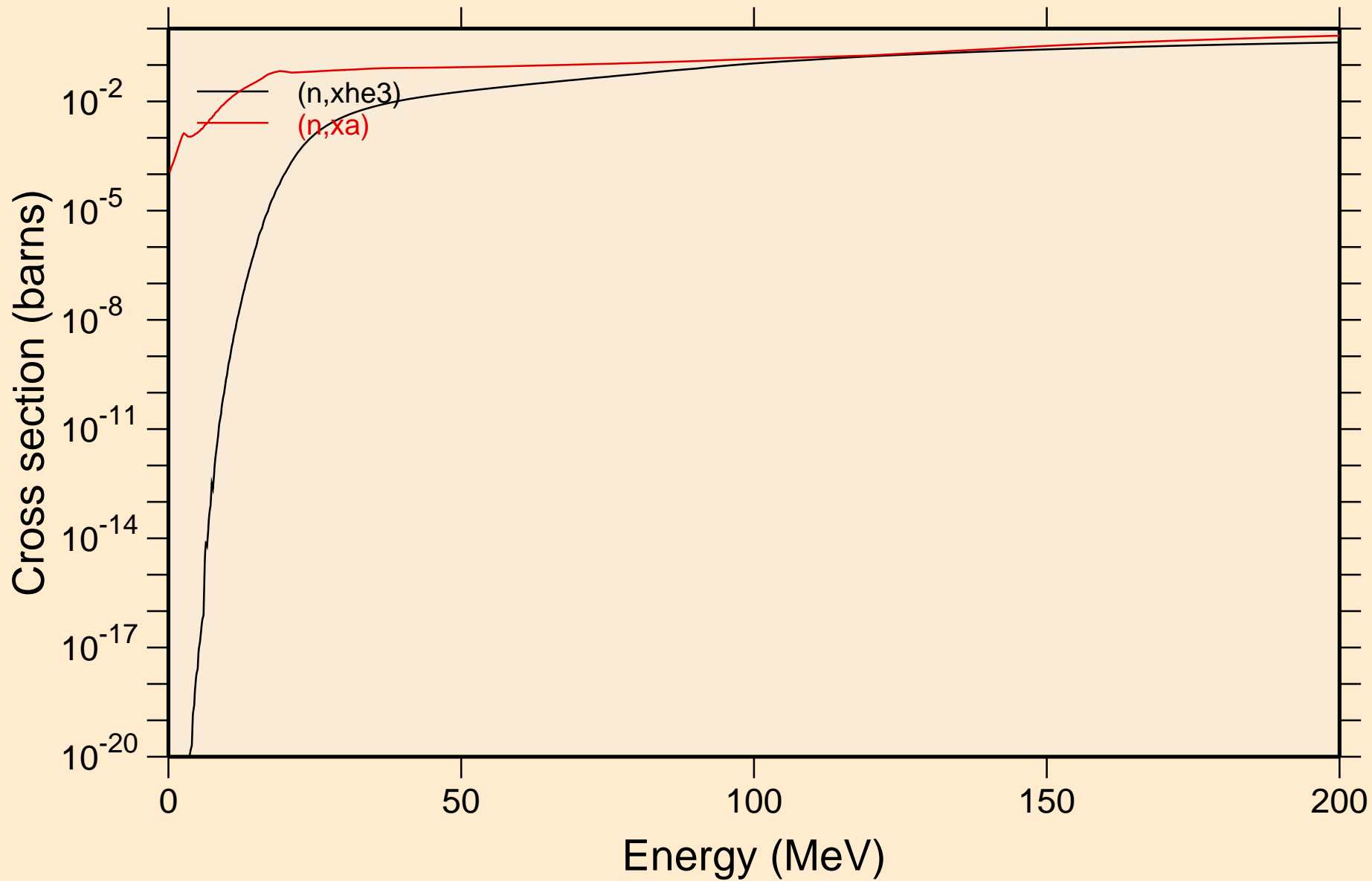

AT204 NEUTRON ACER TENDL-2024 LIBRARY; T=0.K
Inelastic levels

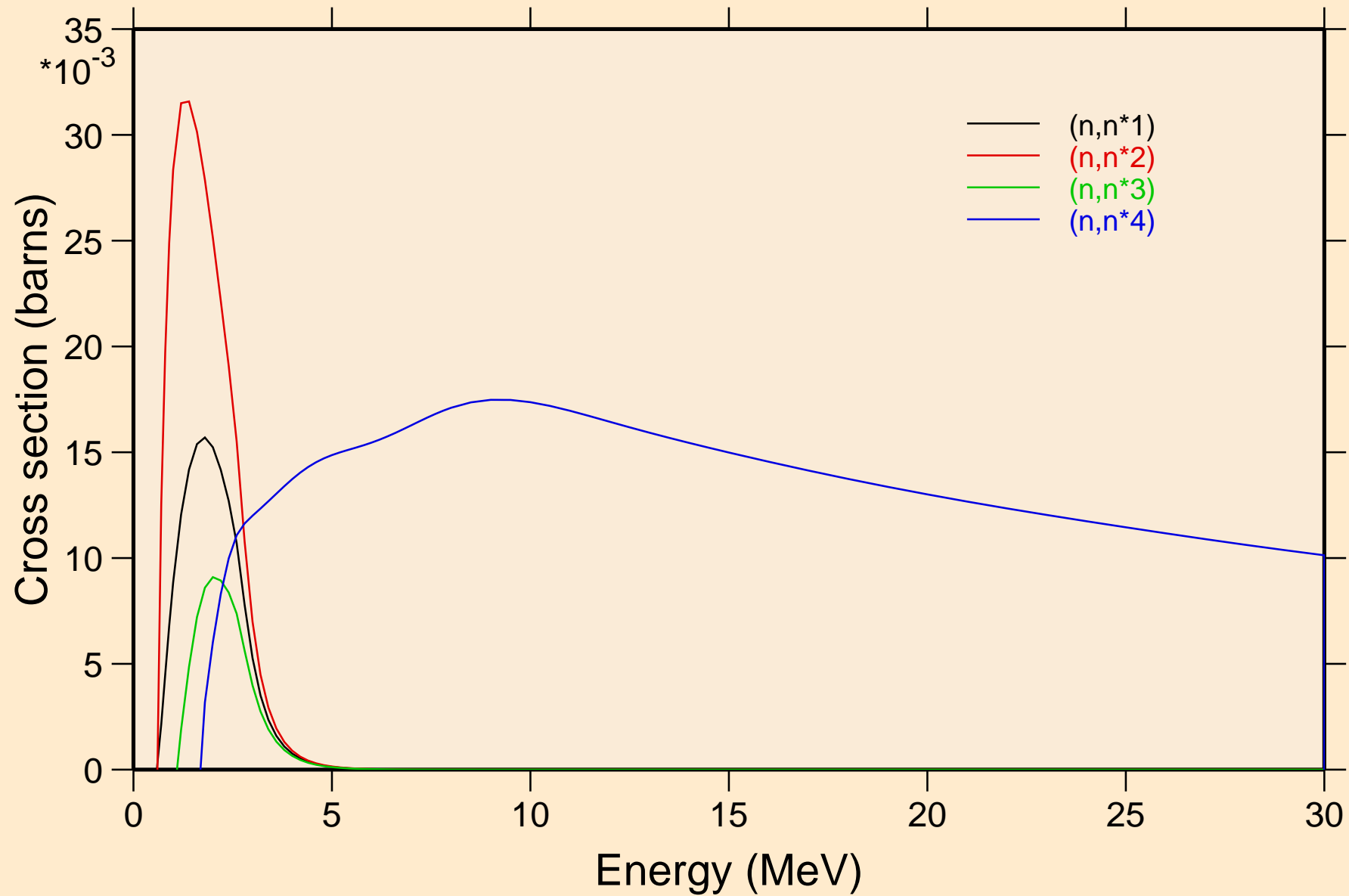

AT204 NEUTRON ACER TENDL-2024 LIBRARY; T=0.K
Threshold reactions

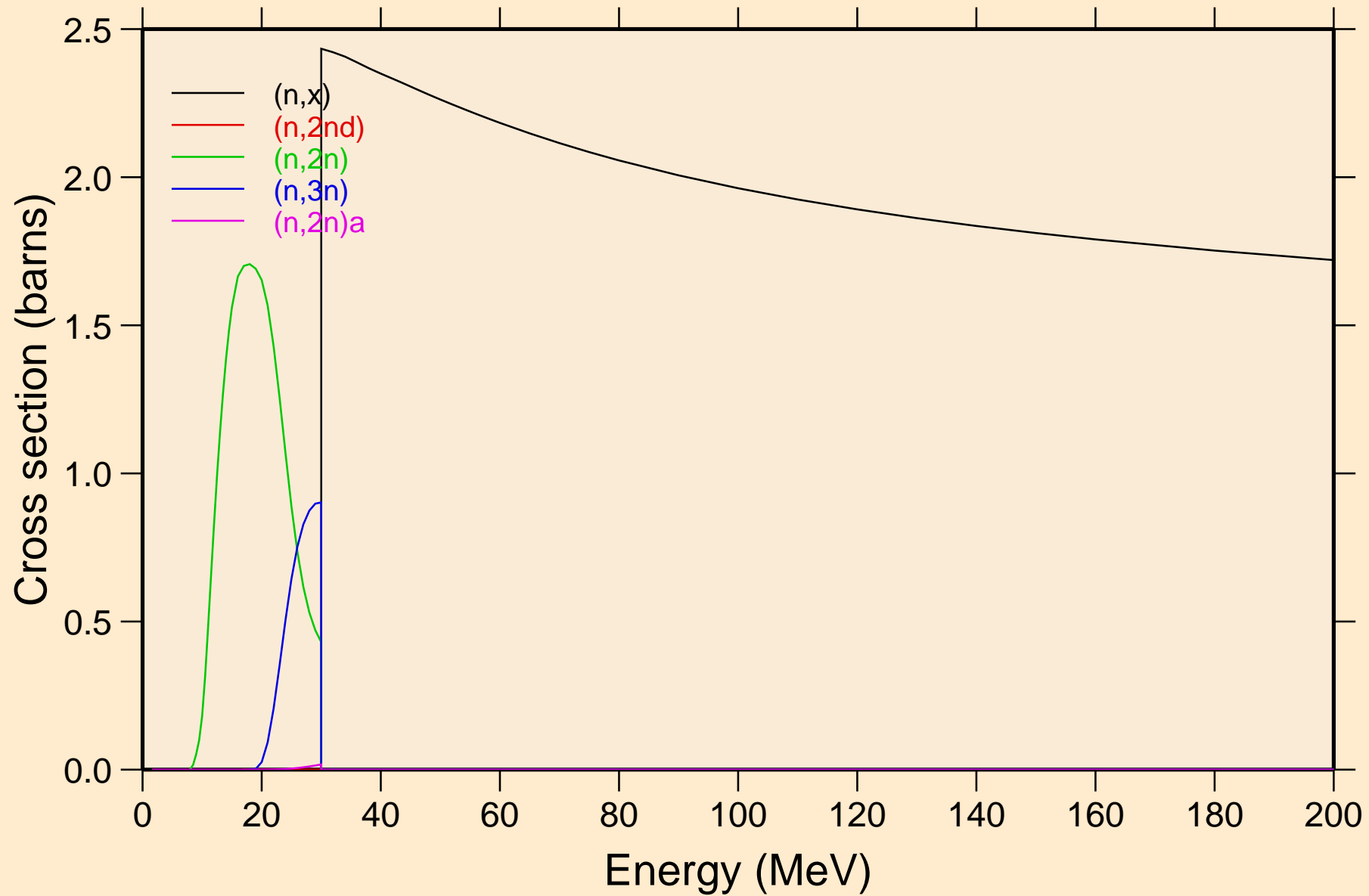

AT204 NEUTRON ACER TENDL-2024 LIBRARY; T=0.K
Threshold reactions

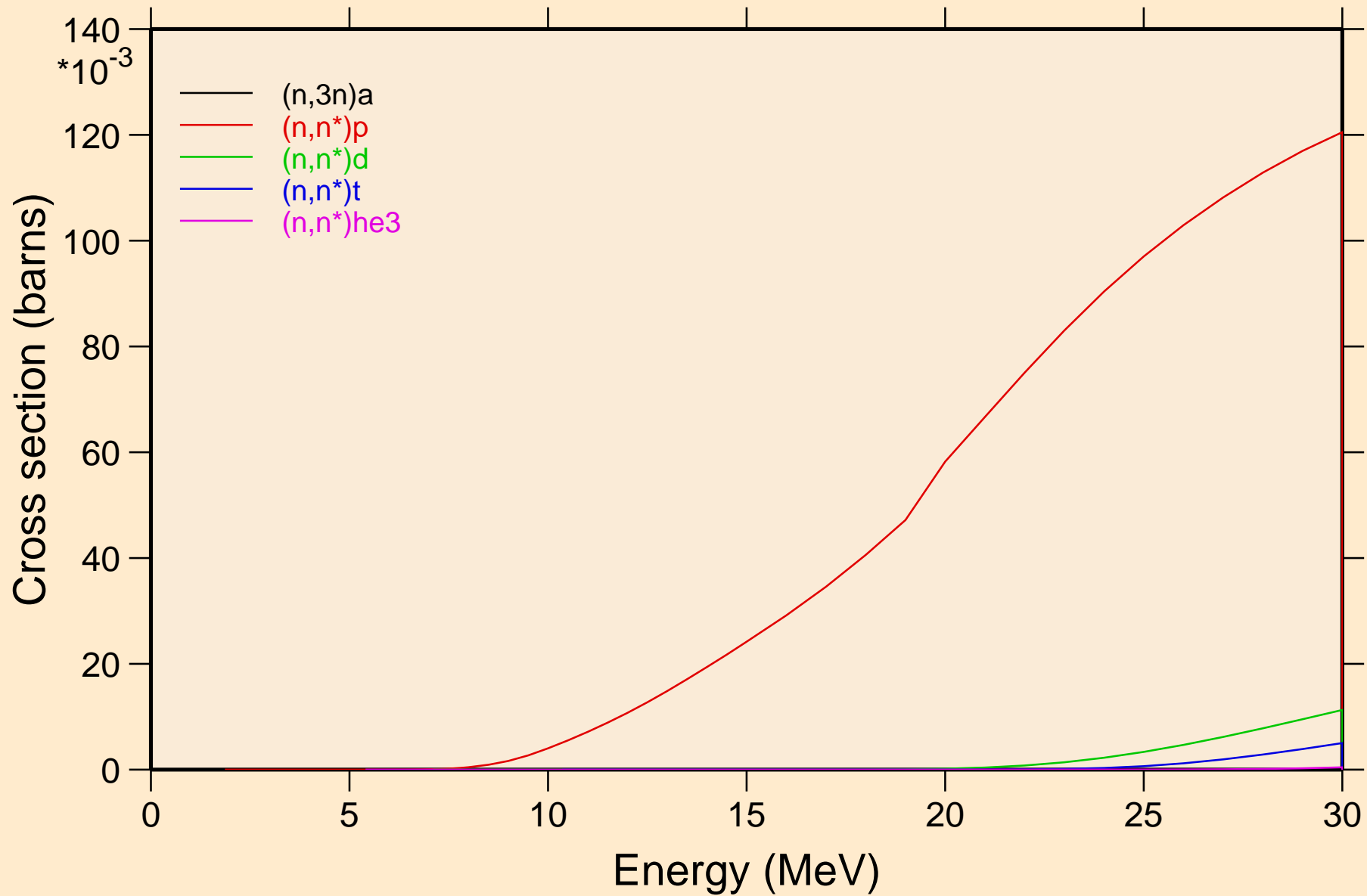

AT204 NEUTRON ACER TENDL-2024 LIBRARY; T=0.K
Threshold reactions

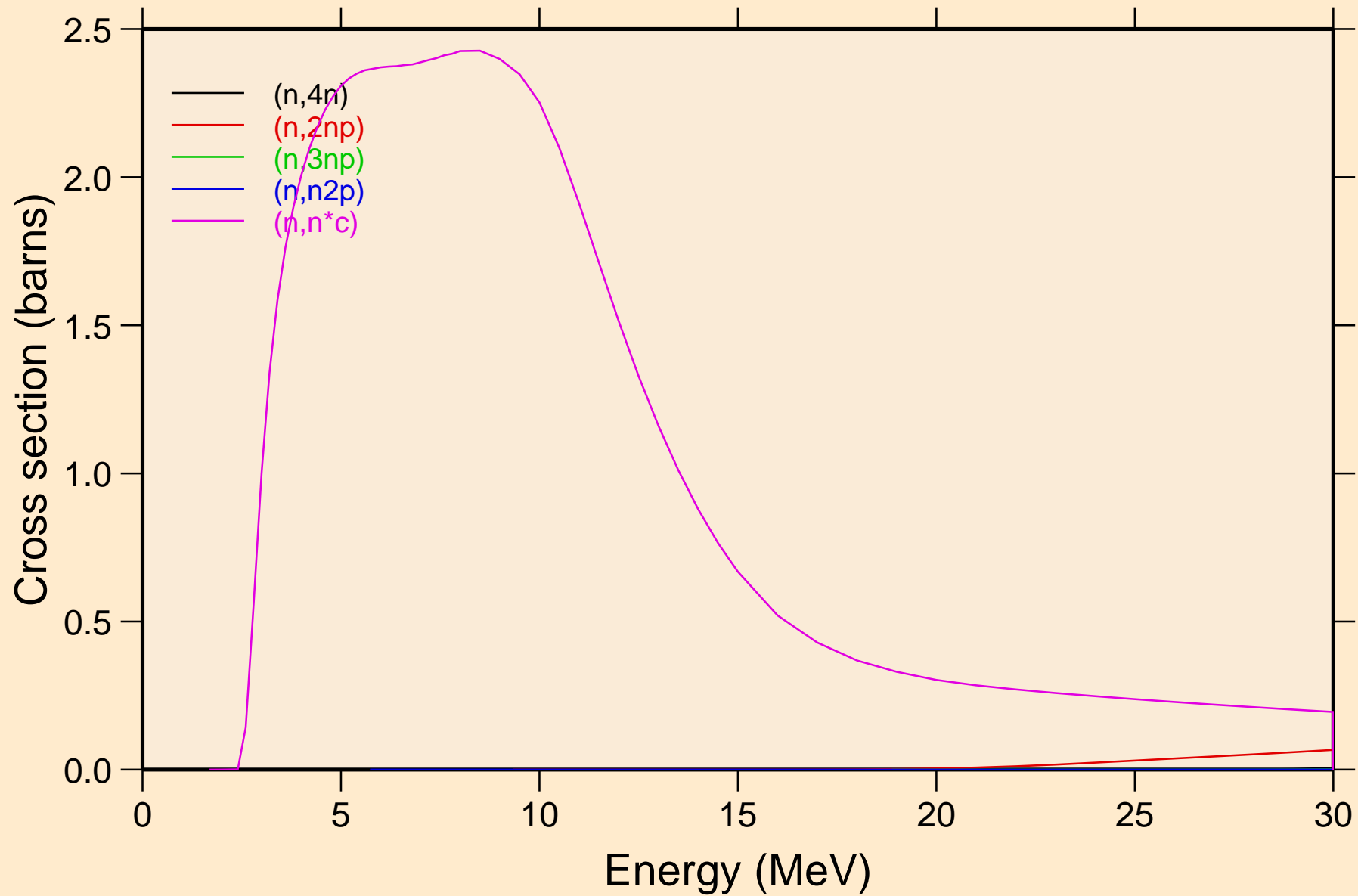

AT204 NEUTRON ACER TENDL-2024 LIBRARY; T=0.K
Threshold reactions

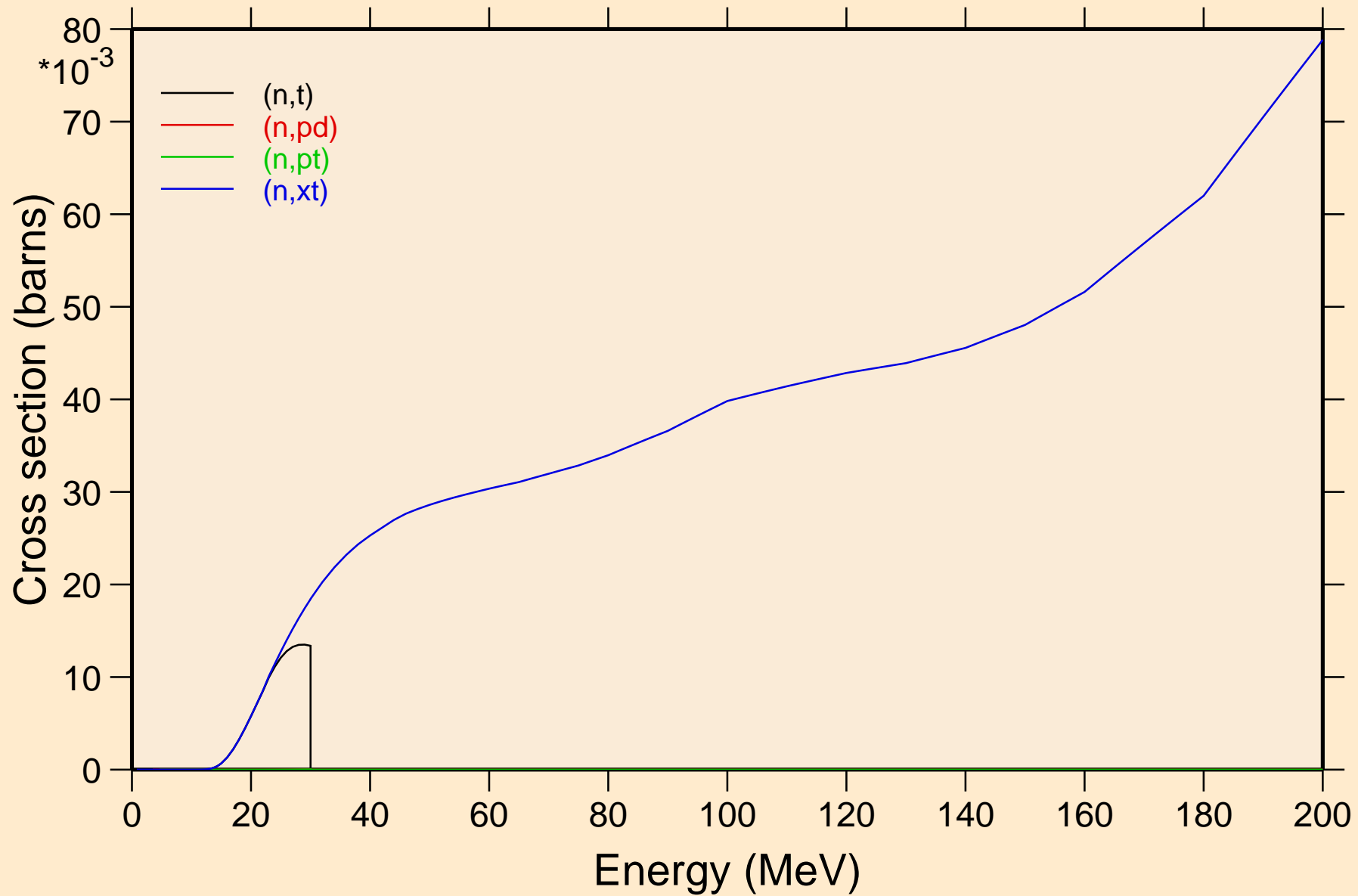

AT204 NEUTRON ACER TENDL-2024 LIBRARY; T=0.K
angular distribution for elastic

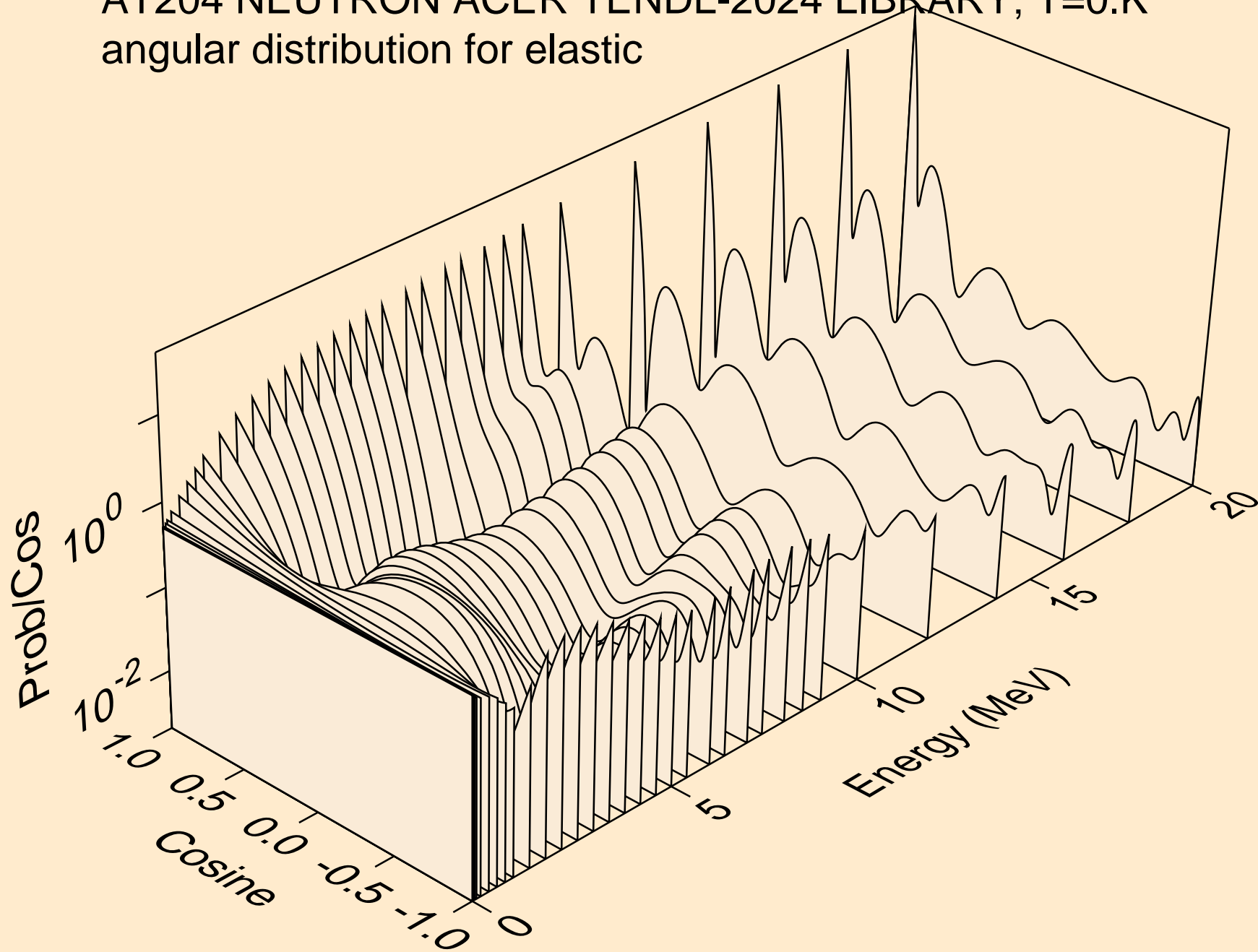

AT204 NEUTRON ACER TENDL-2024 LIBRARY; T=0.K
angular distribution for elastic

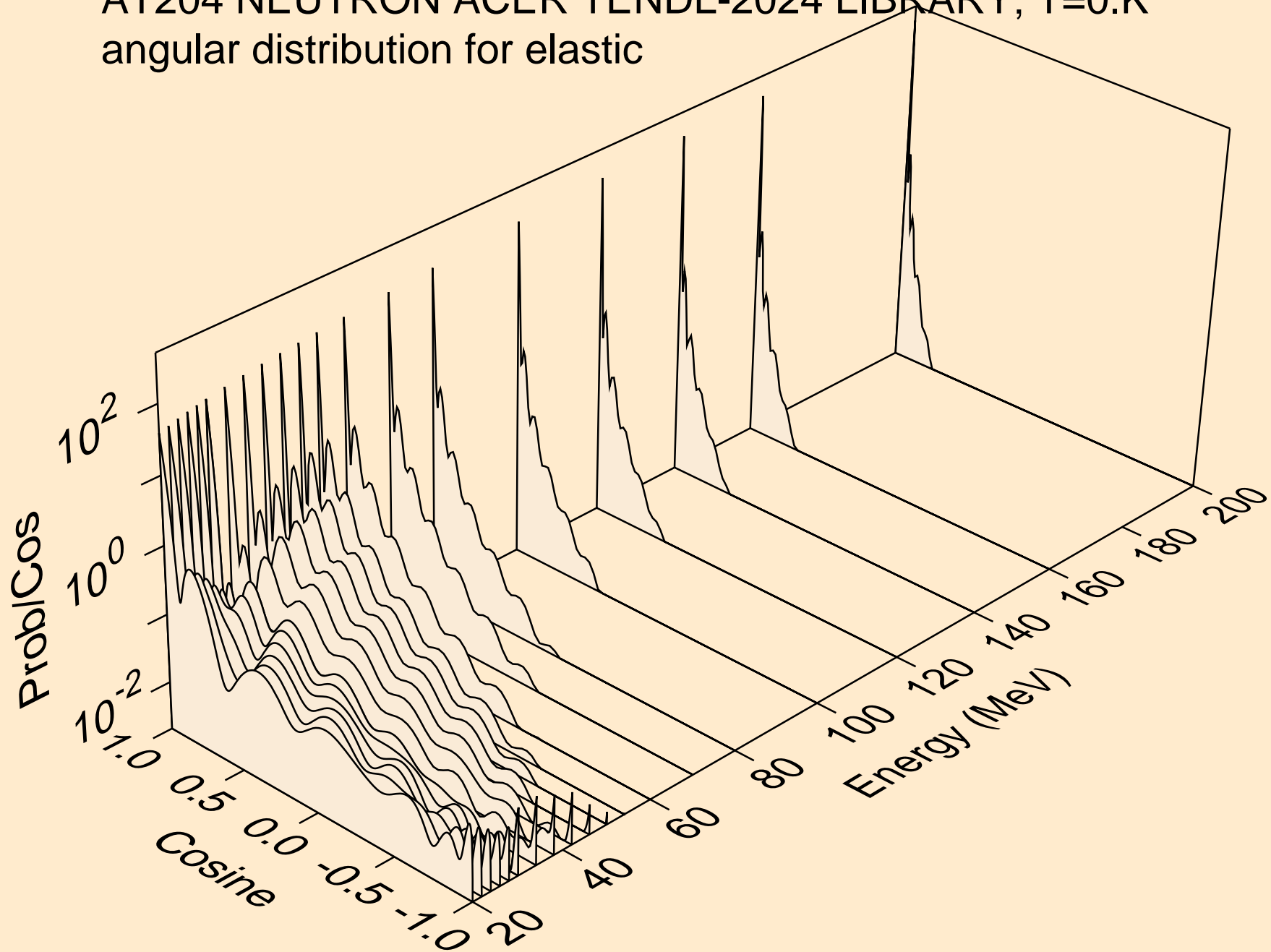

AT204 NEUTRON ACER TENDL-2024 LIBRARY; T=0.K
angular distribution for (n,n*1)

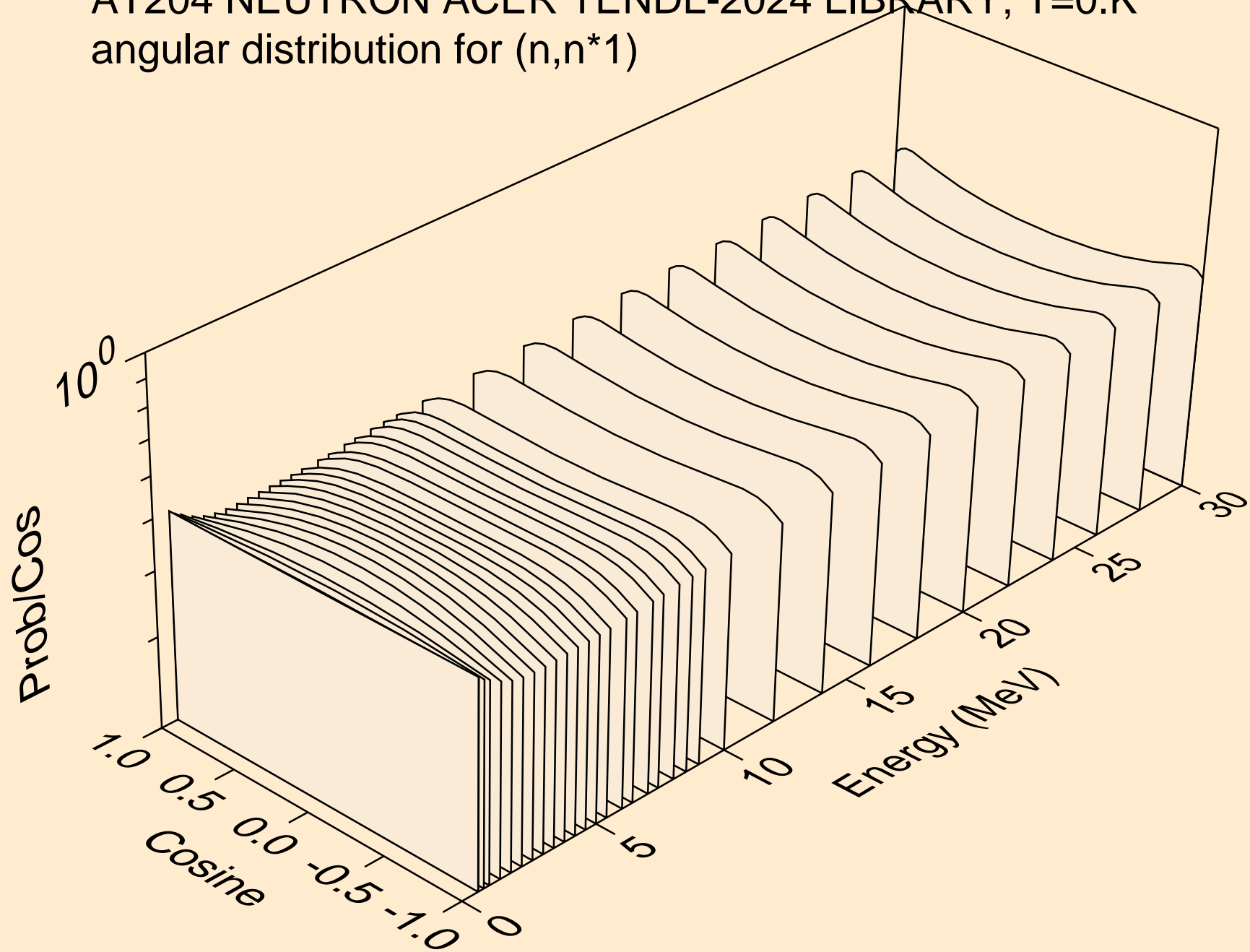

AT204 NEUTRON ACER TENDL-2024 LIBRARY; T=0.K
angular distribution for (n,n*2)

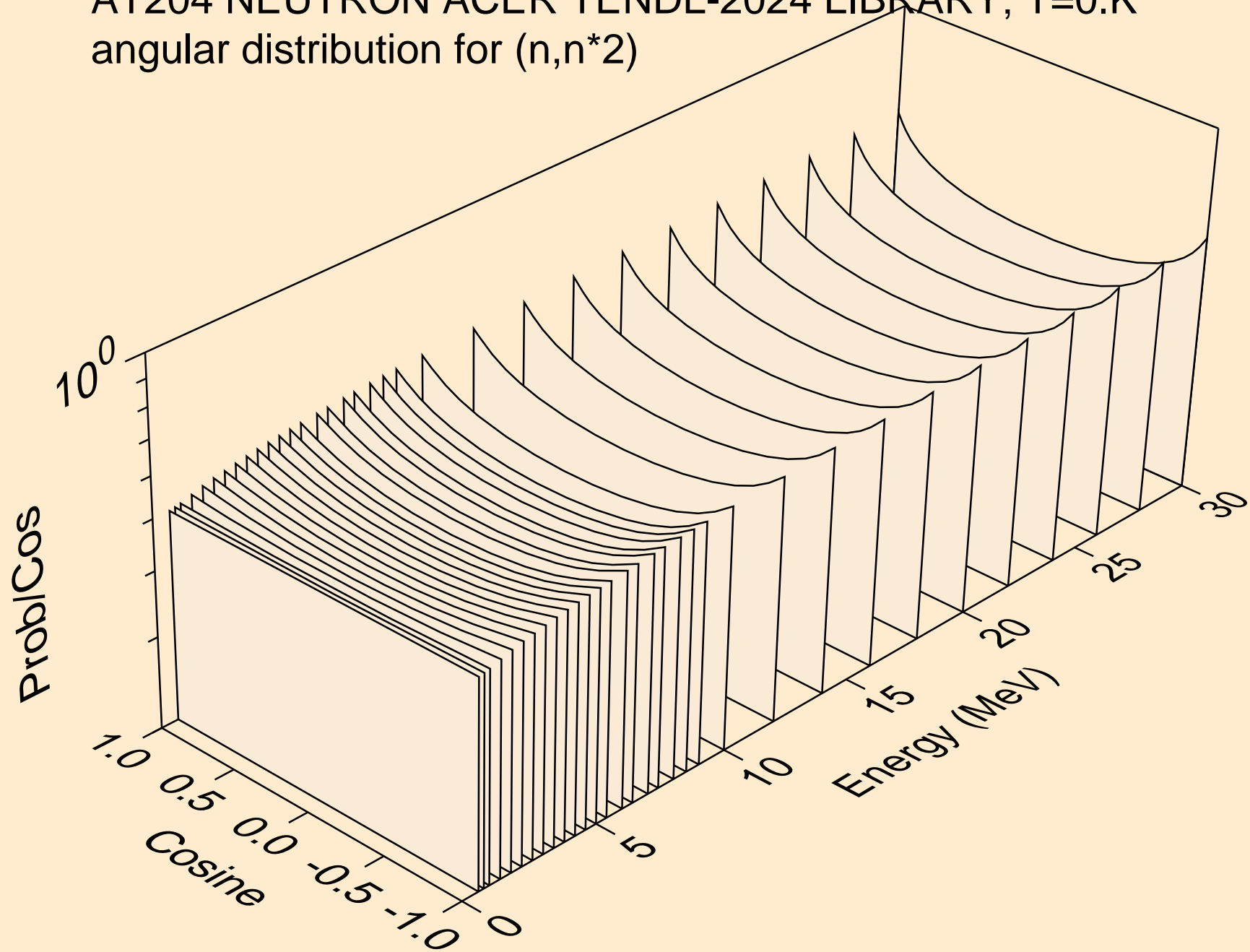

AT204 NEUTRON ACER TENDL-2024 LIBRARY; T=0.K
angular distribution for (n,n*3)

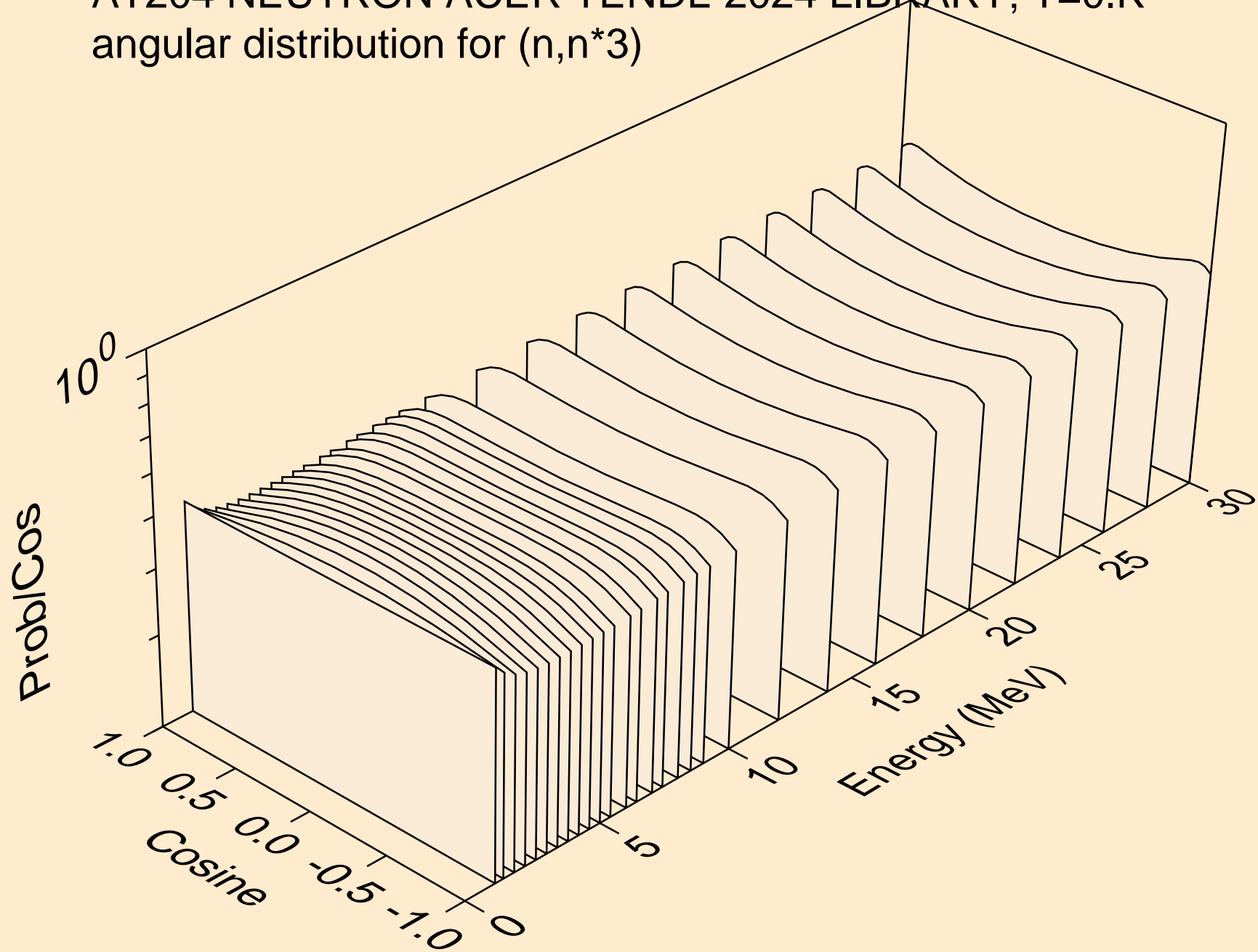

AT204 NEUTRON ACER TENDL-2024 LIBRARY; T=0.K
angular distribution for (n,n*4)

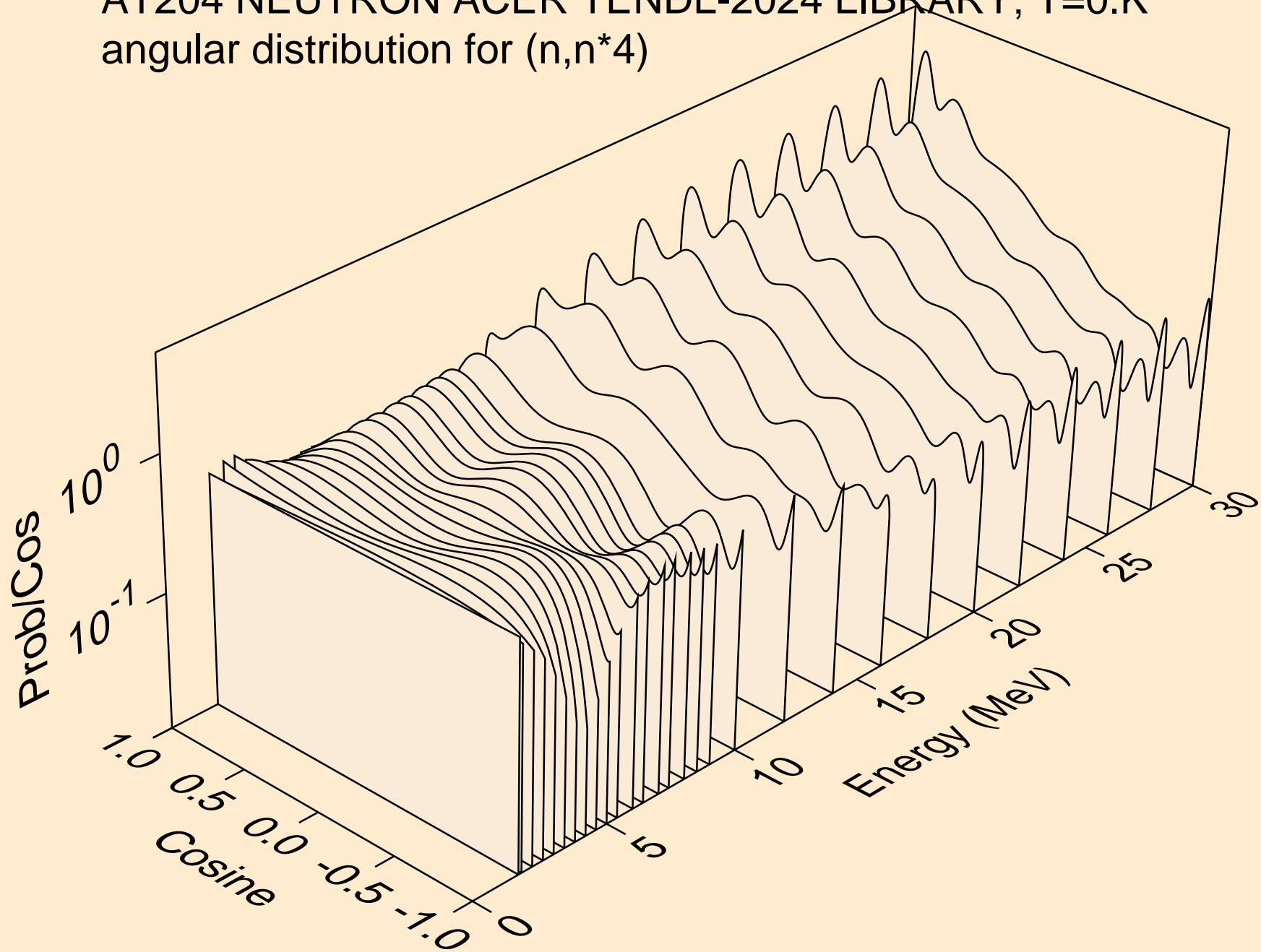

AT204 NEUTRON ACER TENDL-2024 LIBRARY; T=0.K
Neutron emission for (n,x)

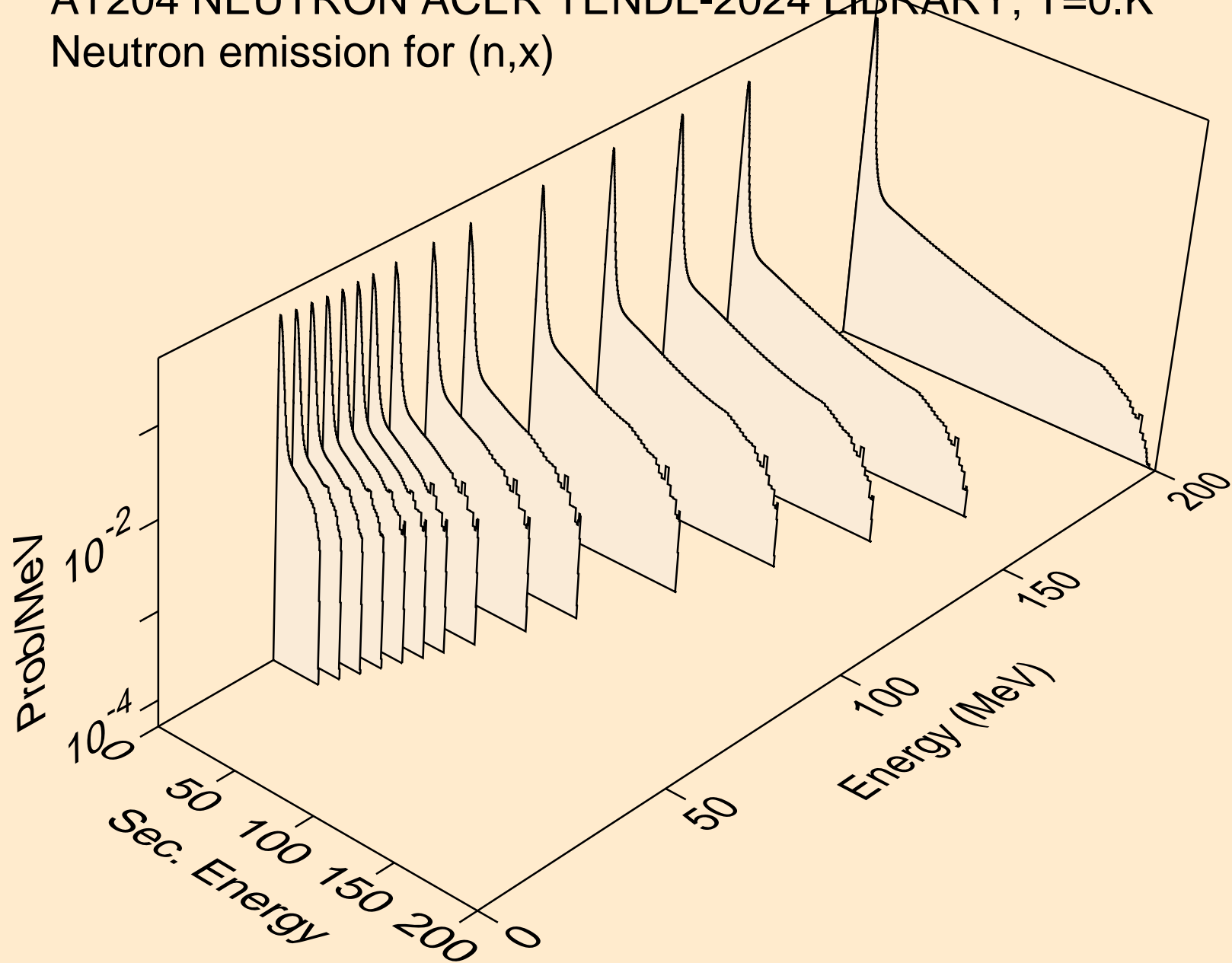

AT204 NEUTRON ACER TENDL-2024 LIBRARY; T=0.K
Neutron emission for (n,2nd)

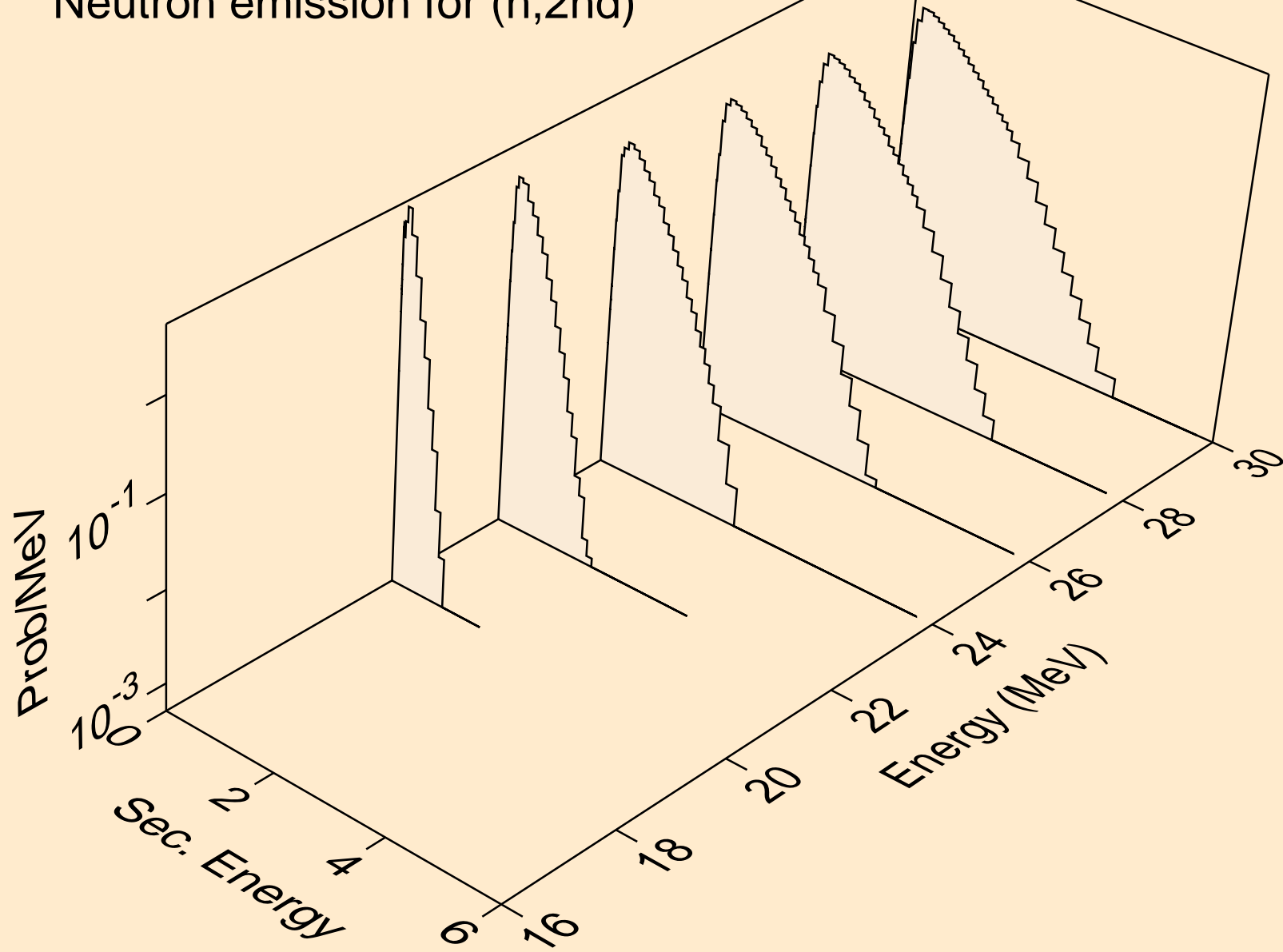

AT204 NEUTRON ACER TENDL-2024 LIBRARY; T=0.K
Neutron emission for (n,2n)

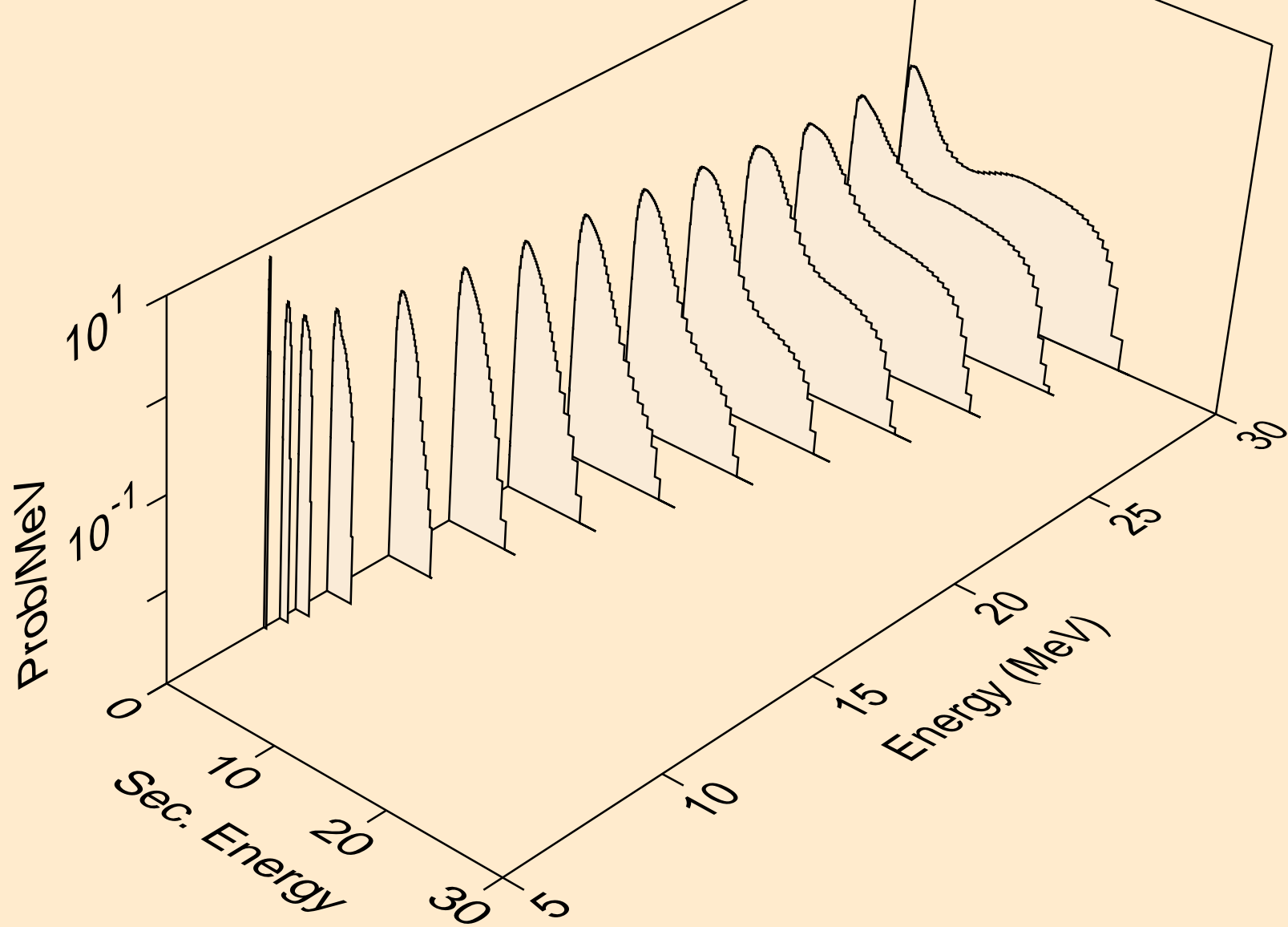

AT204 NEUTRON ACER TENDL-2024 LIBRARY; T=0.K
Neutron emission for (n,3n)

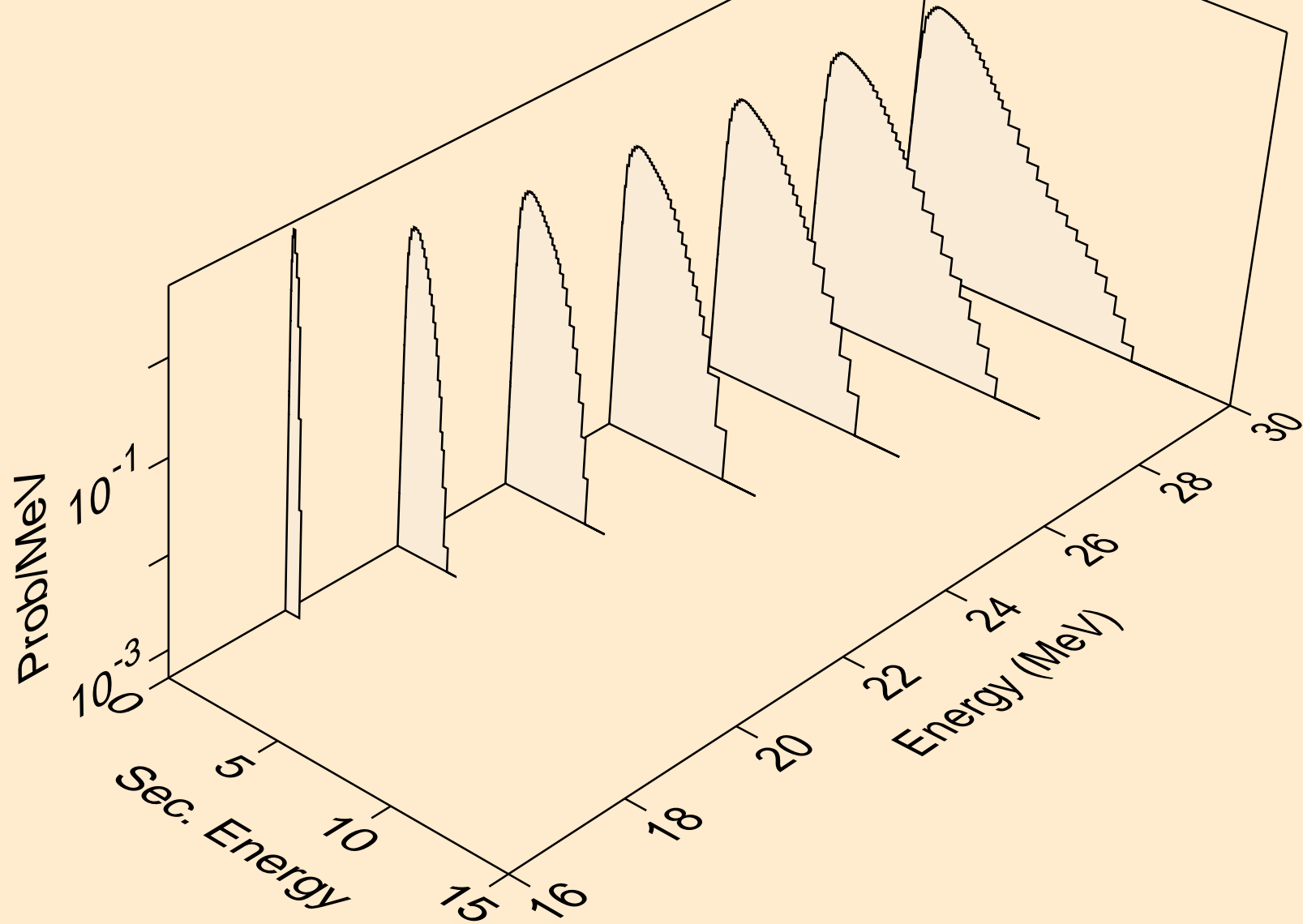

AT204 NEUTRON ACER TENDL-2024 LIBRARY; T=0.K
Neutron emission for (n,n*)a

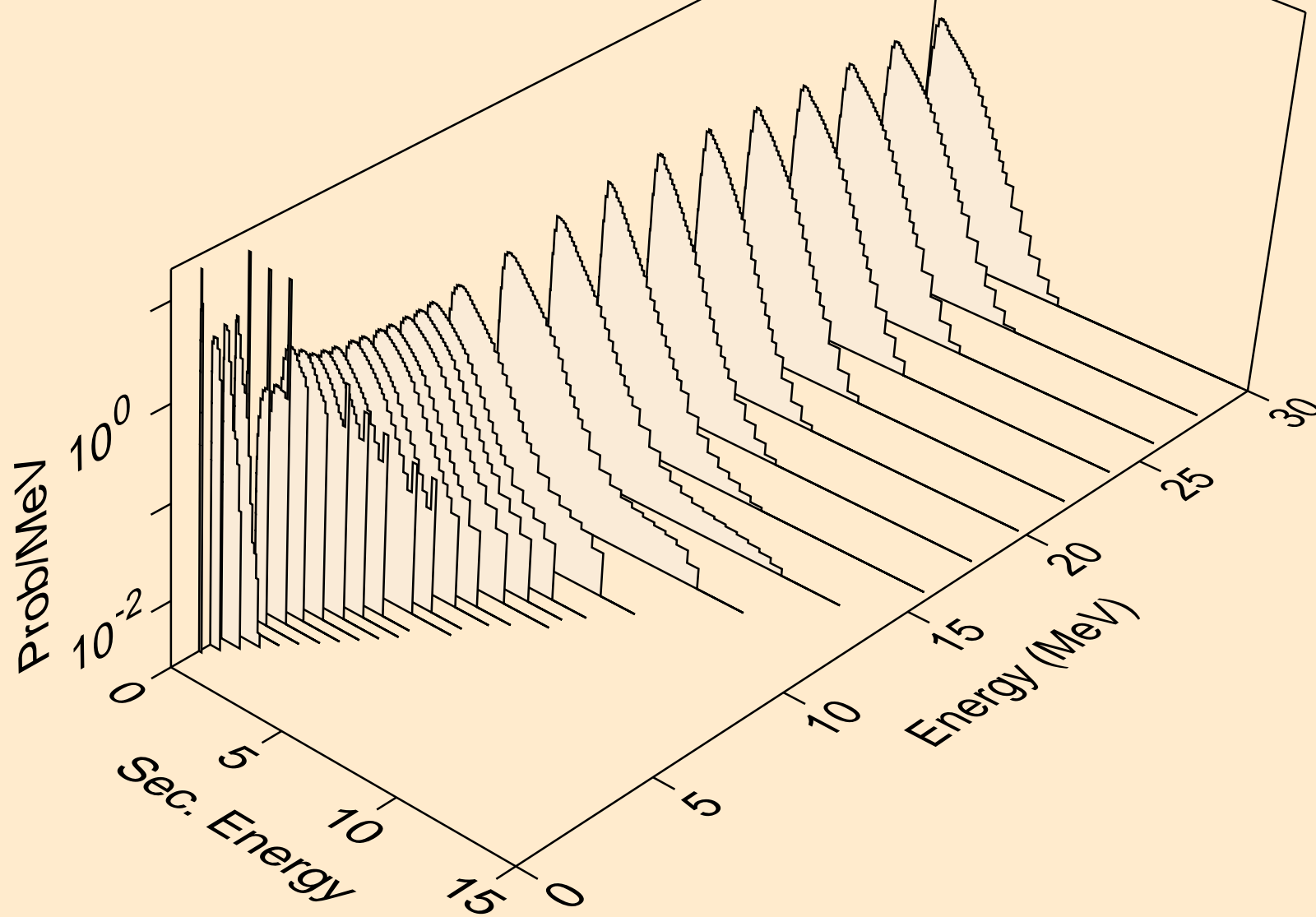

AT204 NEUTRON ACER TENDL-2024 LIBRARY; T=0.K
Neutron emission for (n,2n)a

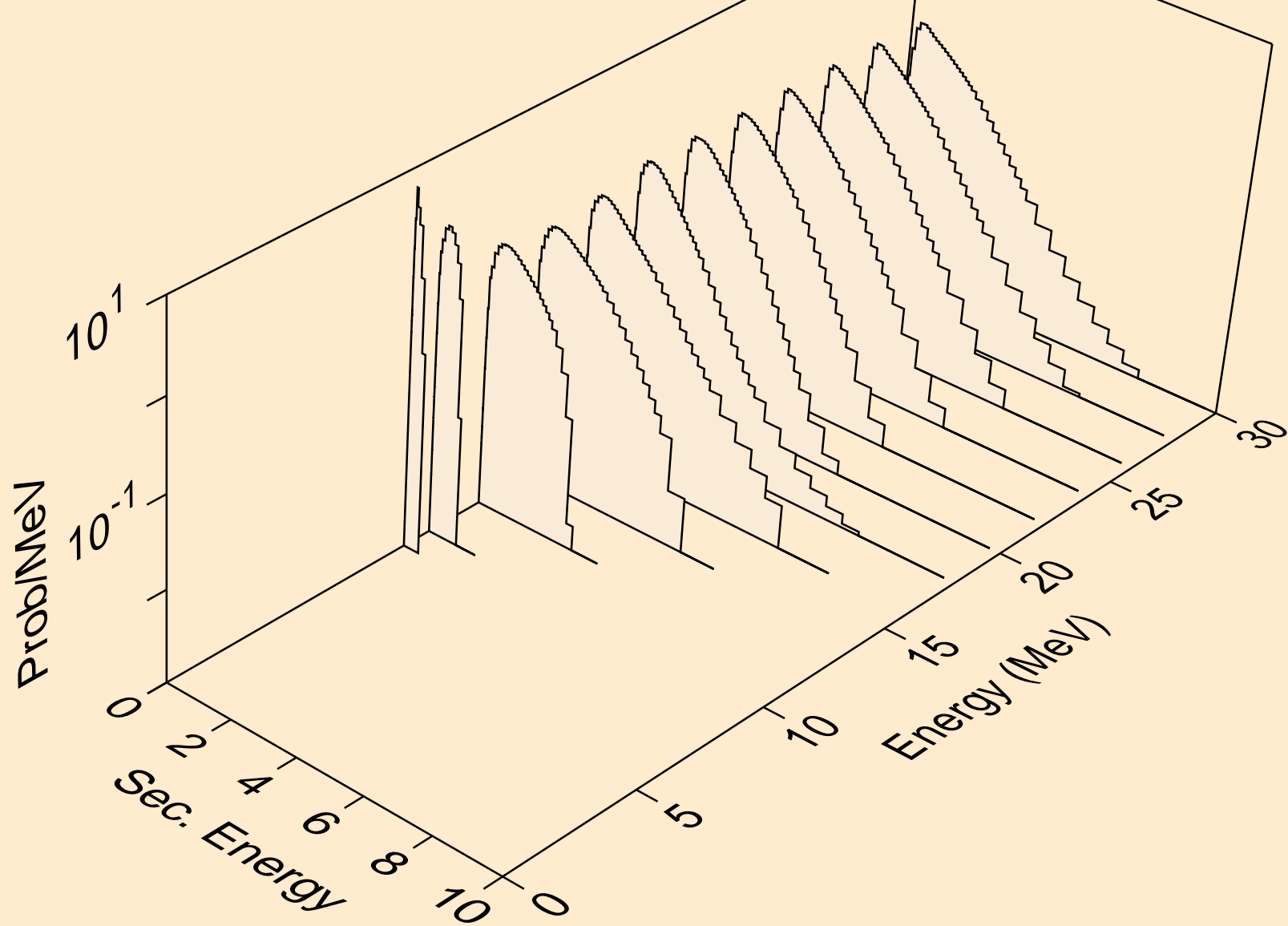

AT204 NEUTRON ACER TENDL-2024 LIBRARY; T=0.K
Neutron emission for (n,3n)a

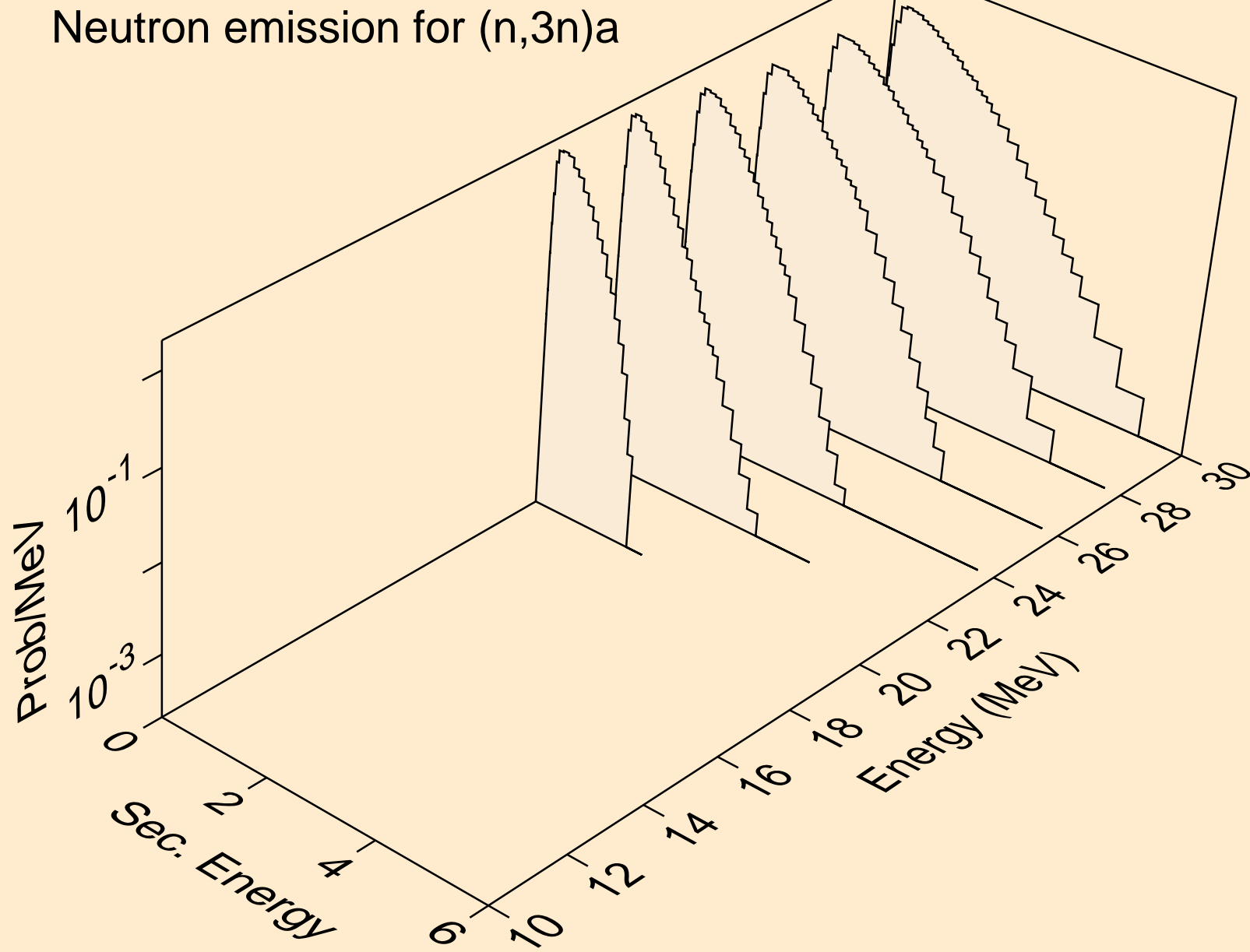

AT204 NEUTRON ACER TENDL-2024 LIBRARY; T=0.K
Neutron emission for (n,n*)p

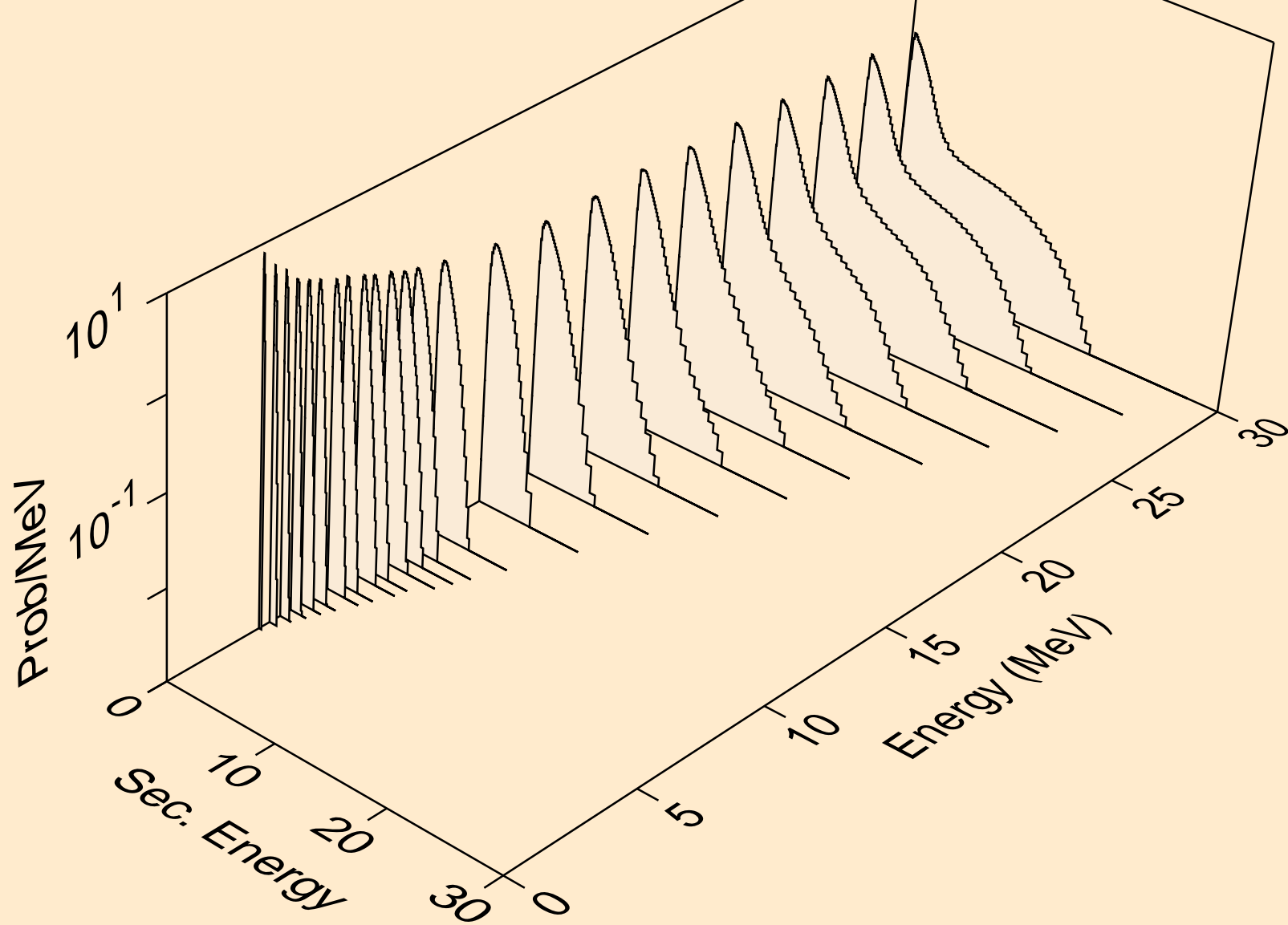

AT204 NEUTRON ACER TENDL-2024 LIBRARY; T=0.K
Neutron emission for (n,n*)2a

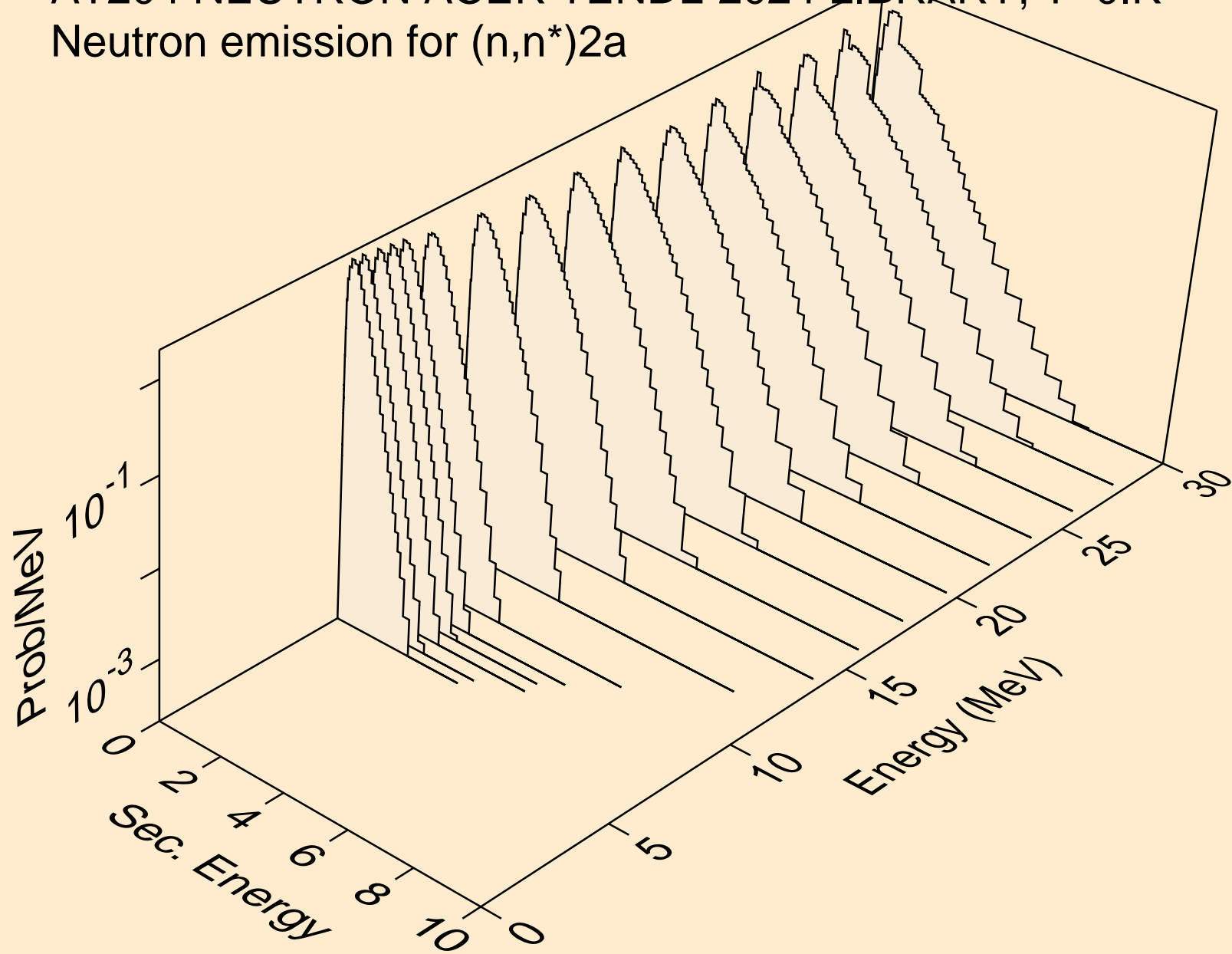

AT204 NEUTRON ACER TENDL-2024 LIBRARY; T=0.K
Neutron emission for (n,2n)2a

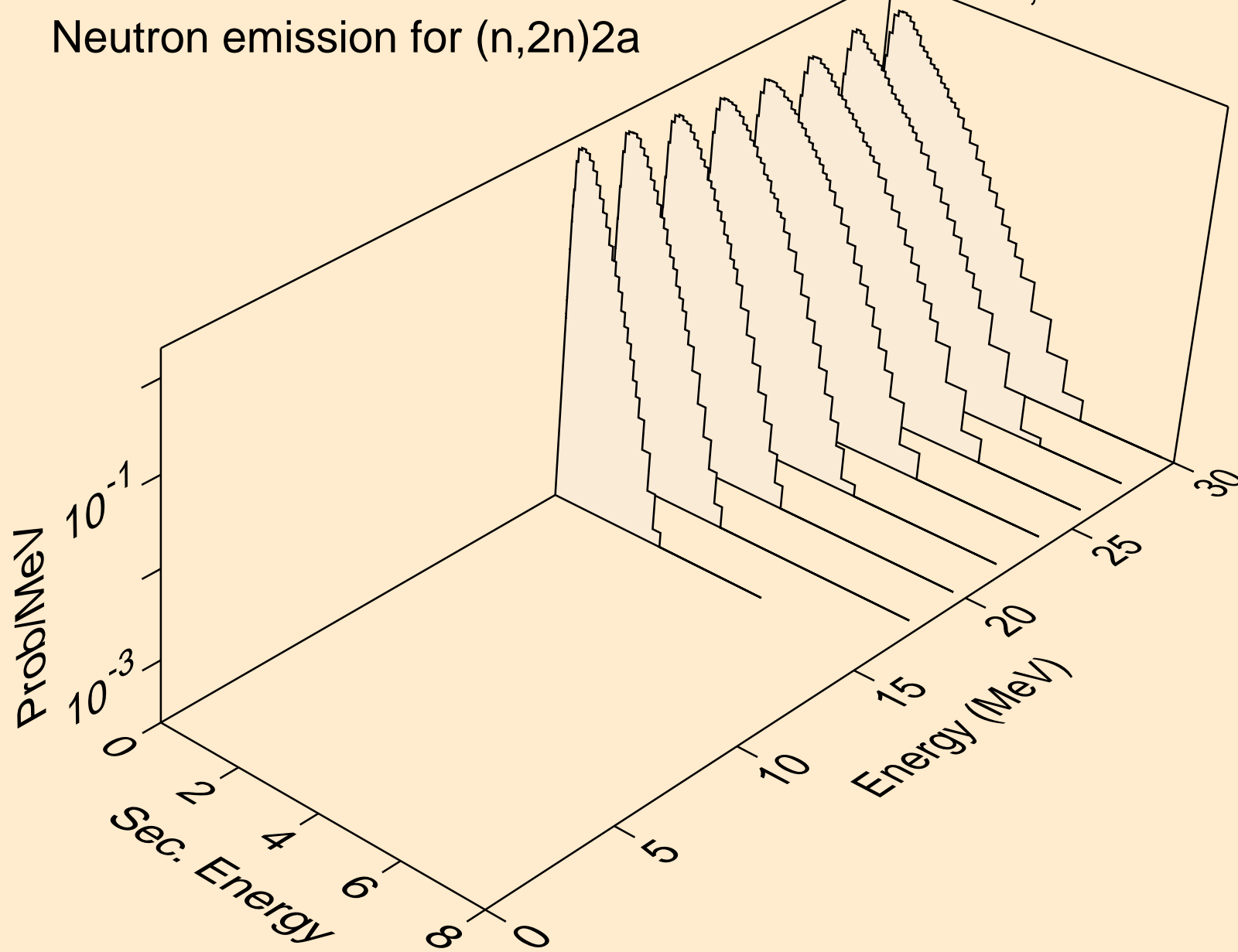

AT204 NEUTRON ACER TENDL-2024 LIBRARY; T=0.K
Neutron emission for (n,n*)d

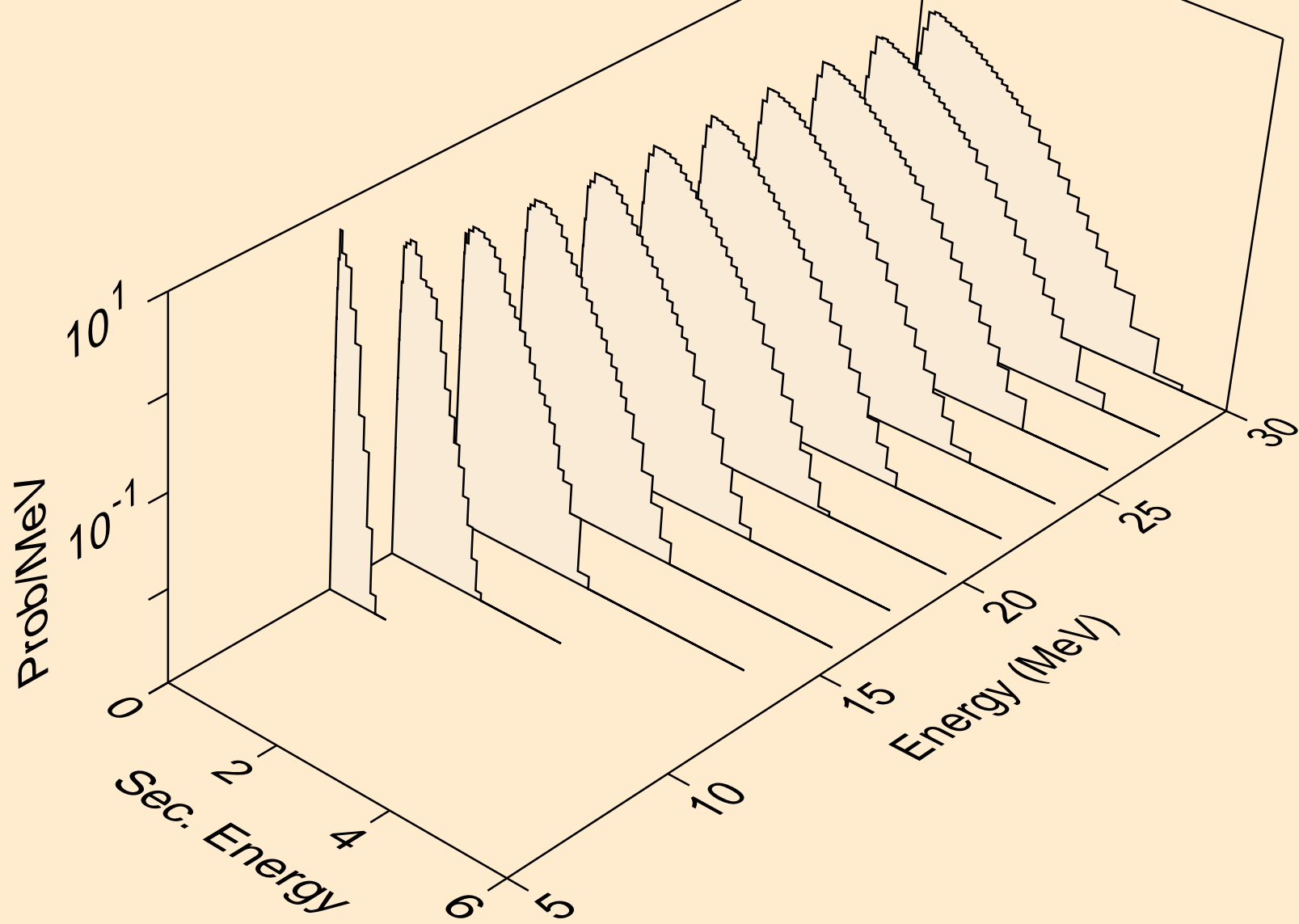

AT204 NEUTRON ACER TENDL-2024 LIBRARY; T=0.K
Neutron emission for (n,n*)t

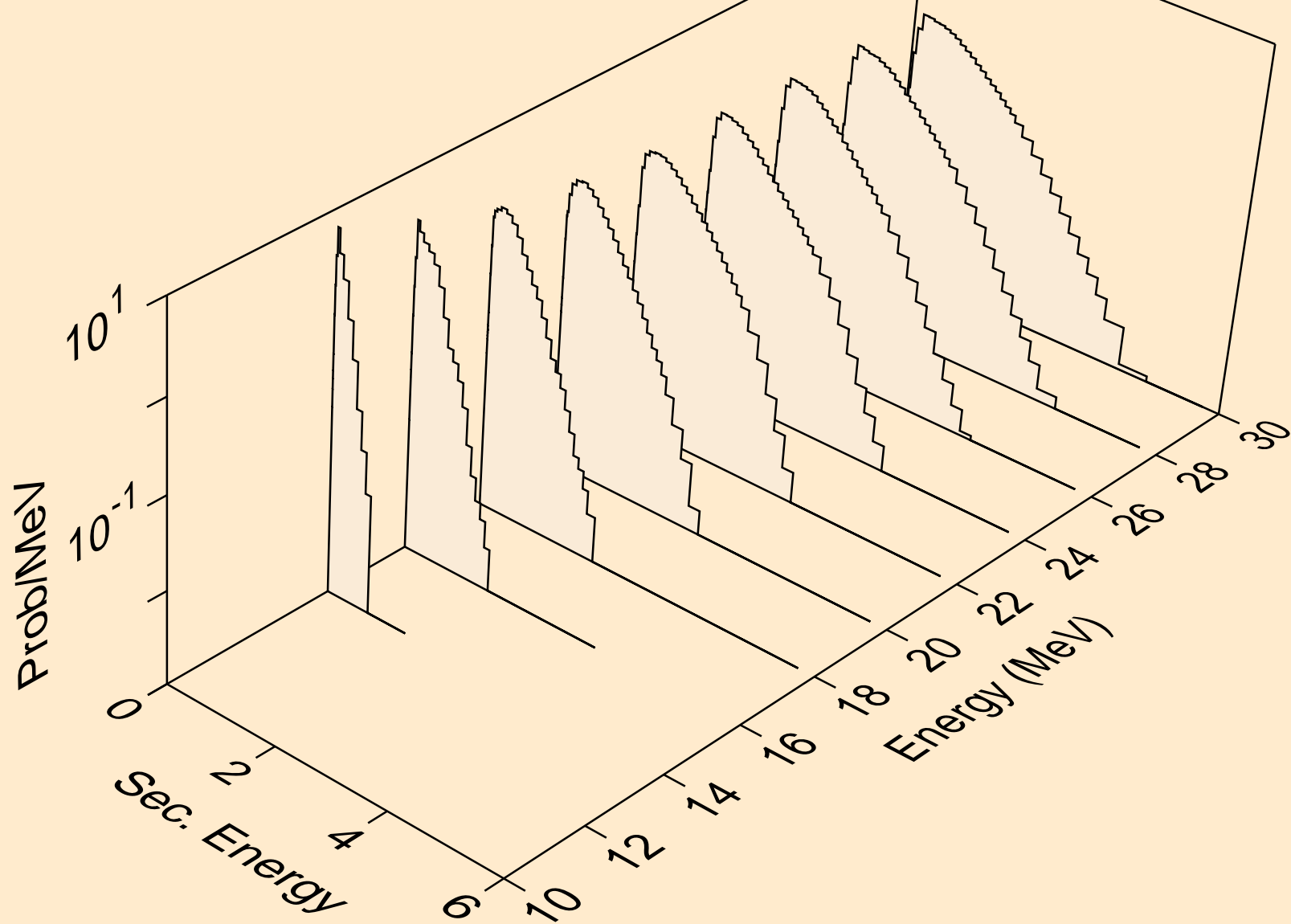

AT204 NEUTRON ACER TENDL-2024 LIBRARY; T=0.K
Neutron emission for (n,n*)he3

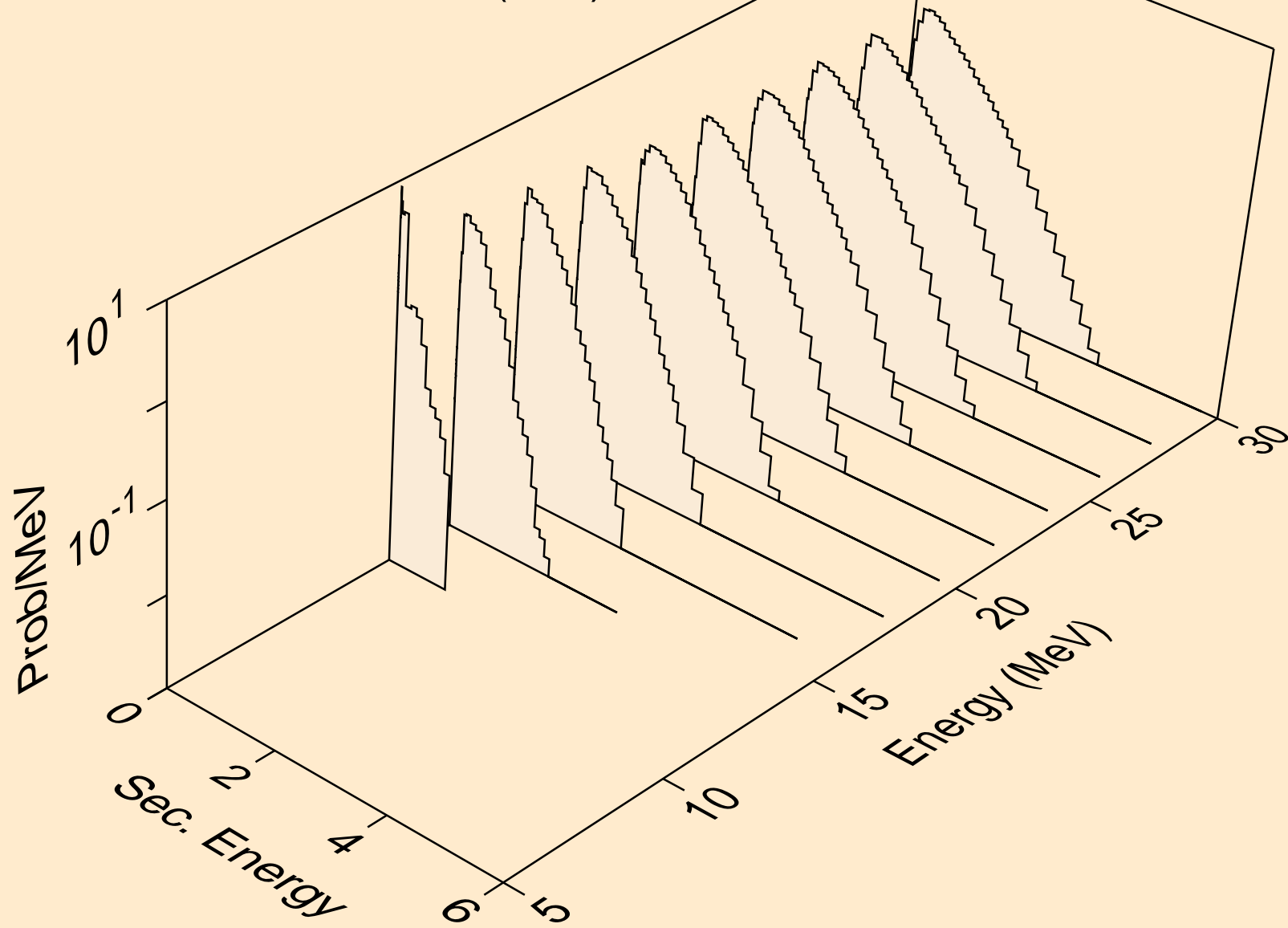

AT204 NEUTRON ACER TENDL-2024 LIBRARY; T=0.K
Neutron emission for (n,4n)

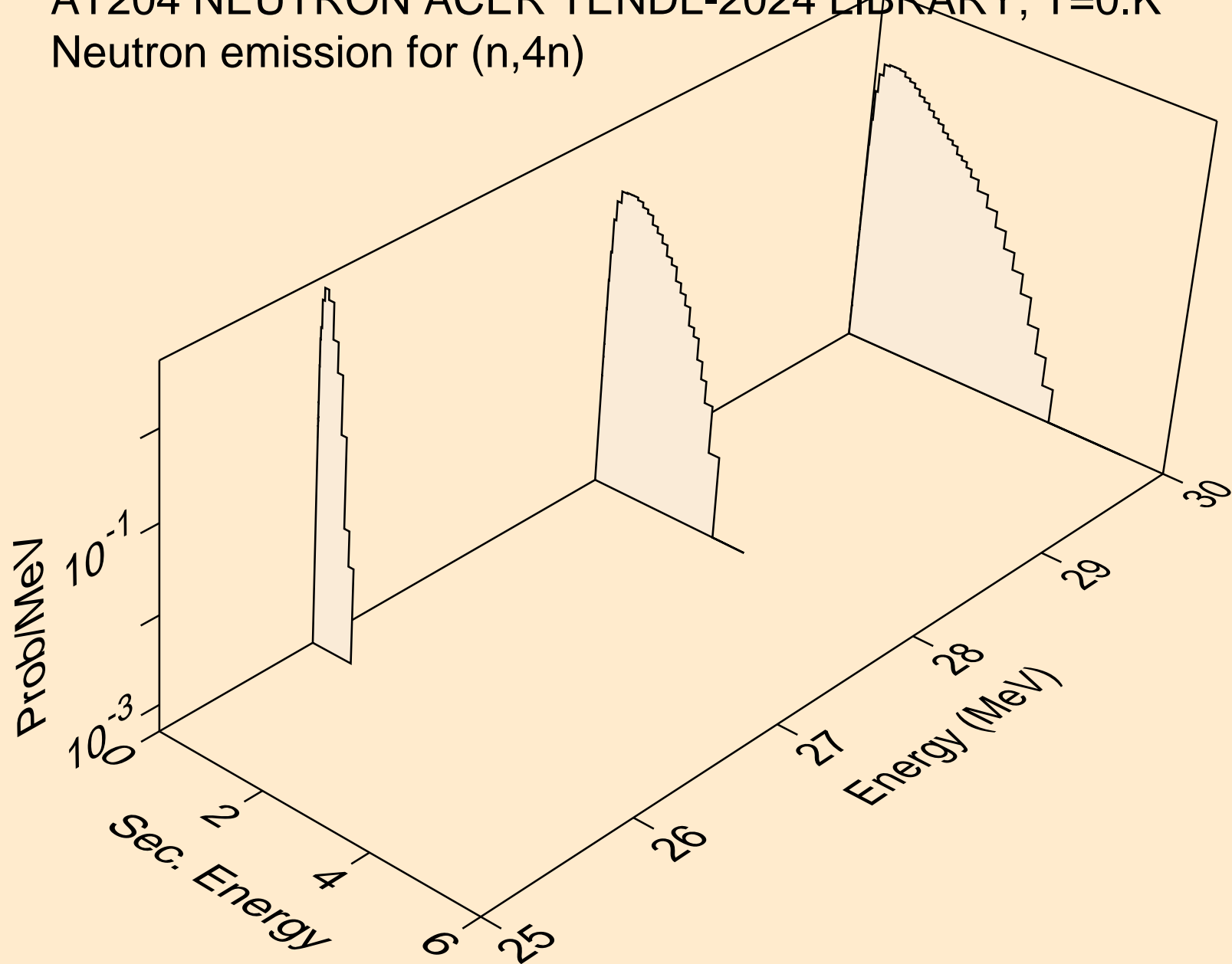

AT204 NEUTRON ACER TENDL-2024 LIBRARY; T=0.K
Neutron emission for (n,2np)

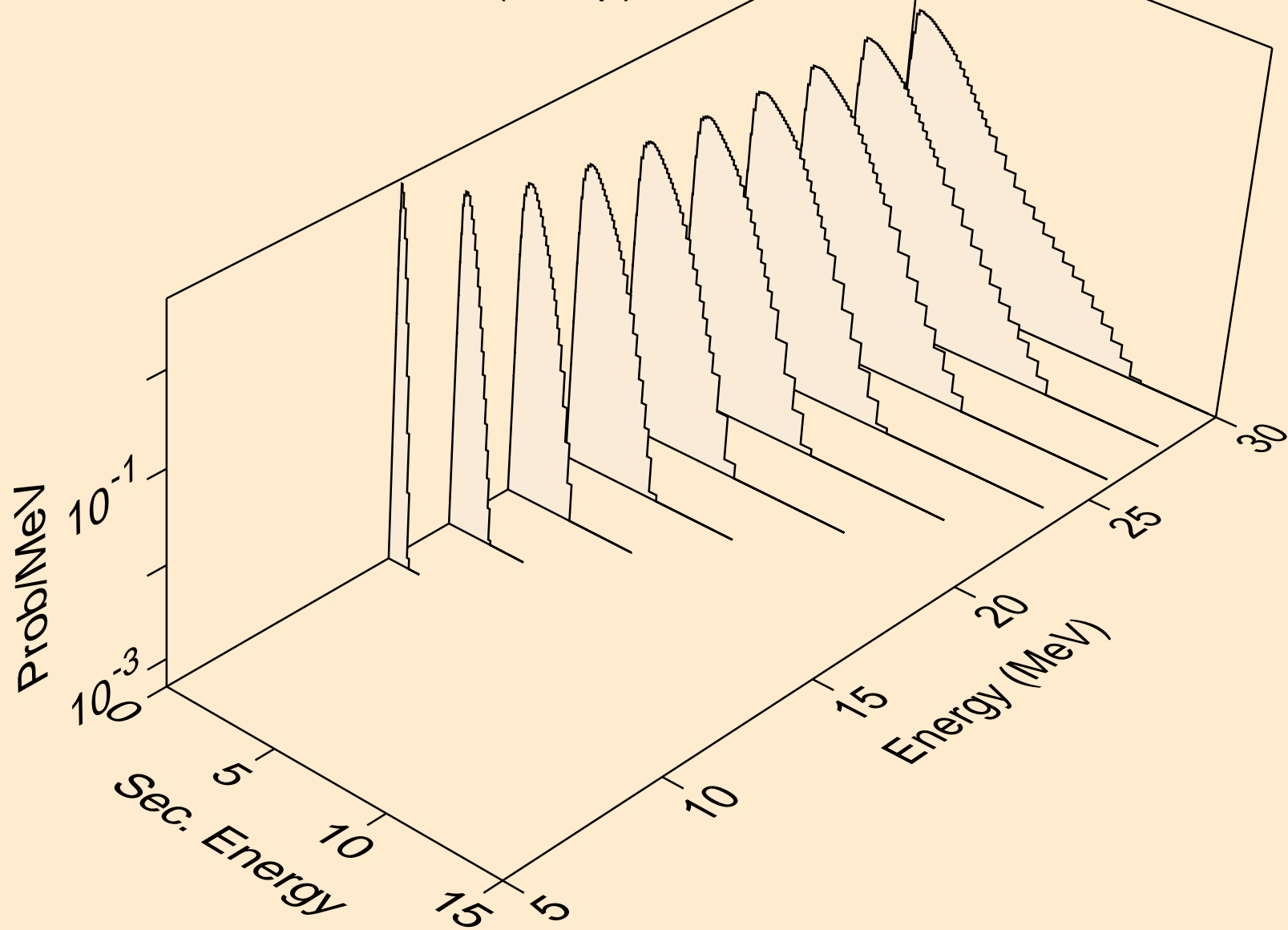

AT204 NEUTRON ACER TENDL-2024 LIBRARY; T=0.K
Neutron emission for (n,3np)

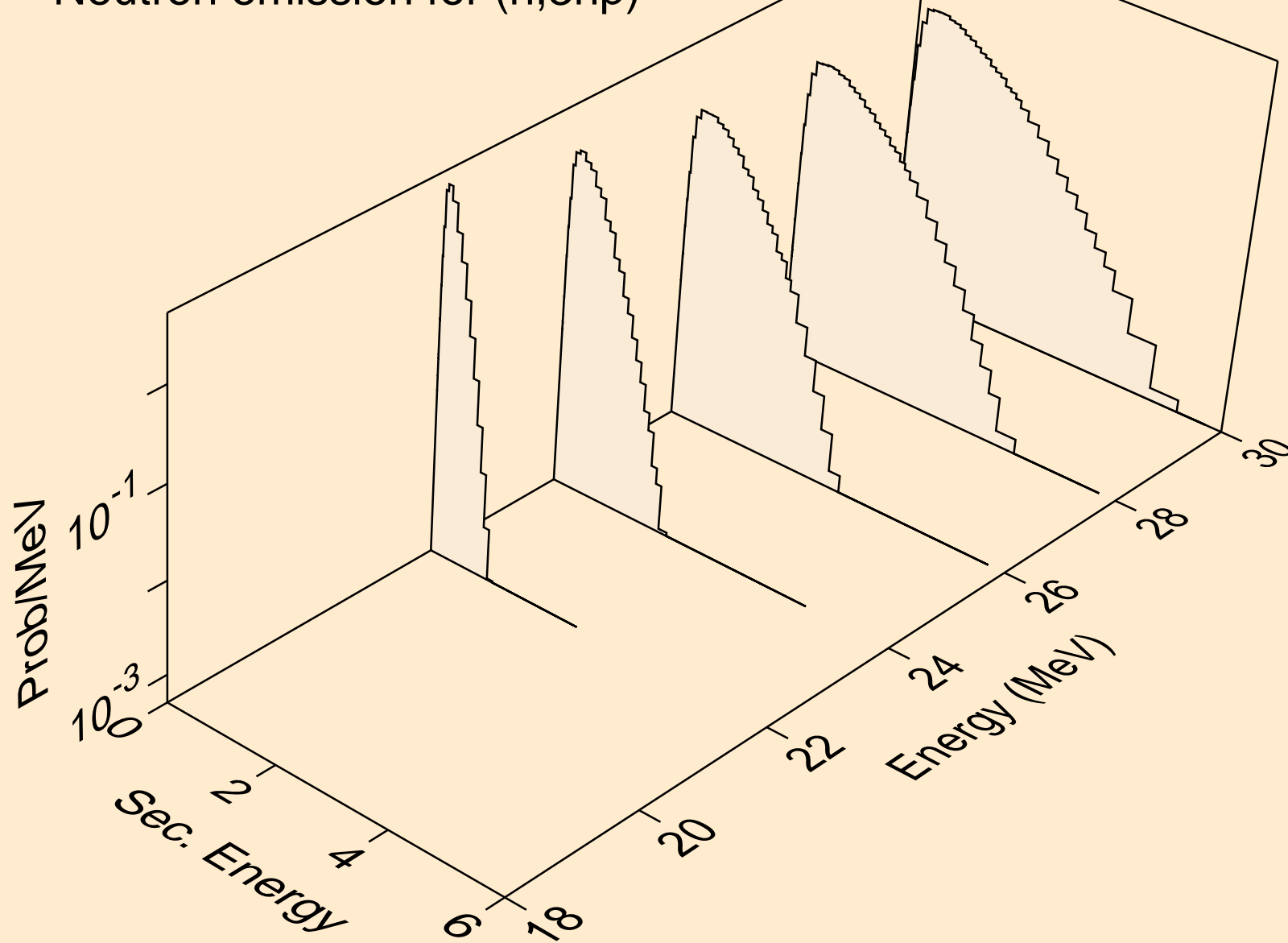

AT204 NEUTRON ACER TENDL-2024 LIBRARY; T=0.K
Neutron emission for (n,n2p)

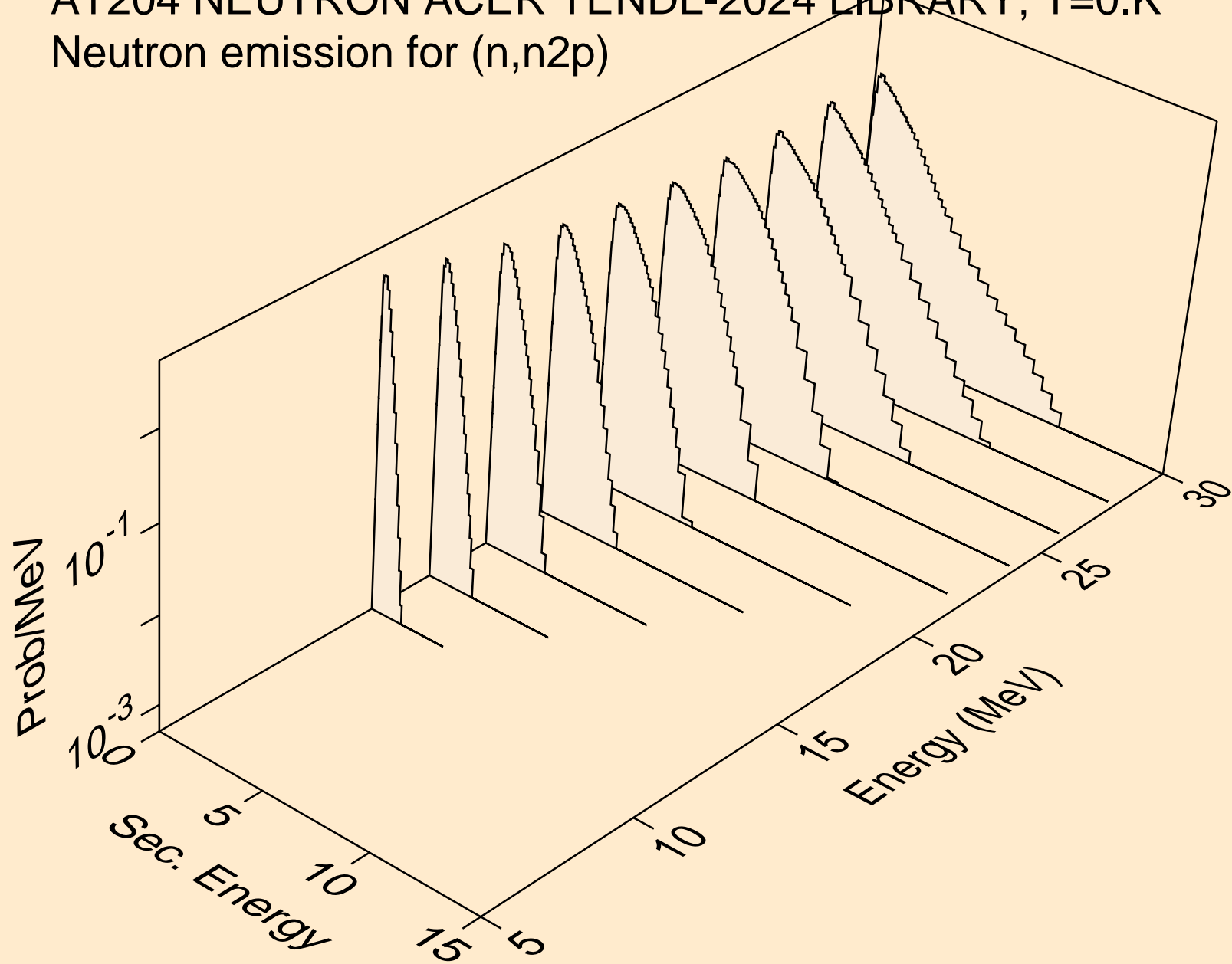

AT204 NEUTRON ACER TENDL-2024 LIBRARY; T=0.K
Neutron emission for (n,npa)

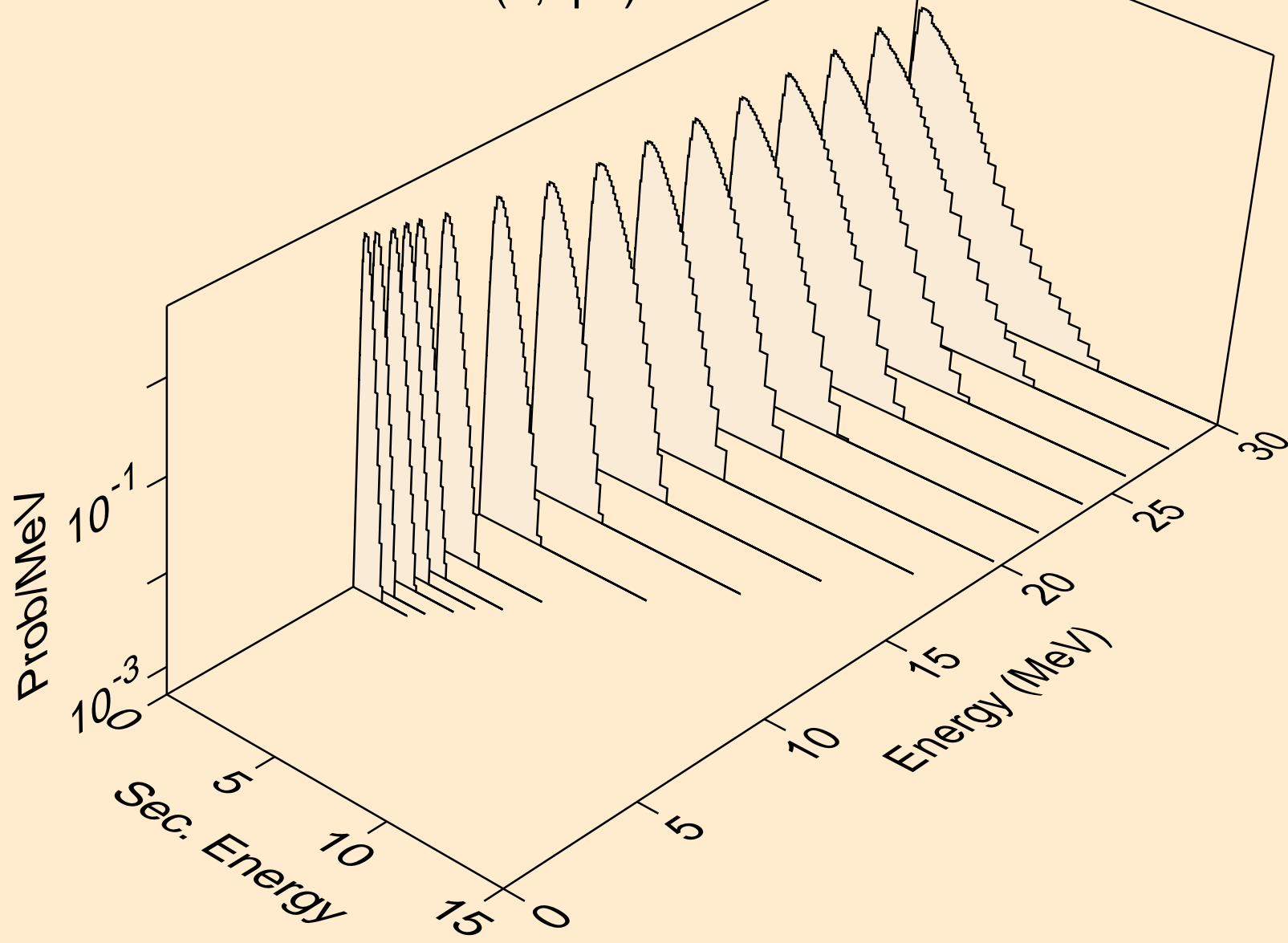

AT204 NEUTRON ACER TENDL-2024 LIBRARY; T=0.K
Neutron emission for (n,n*c)

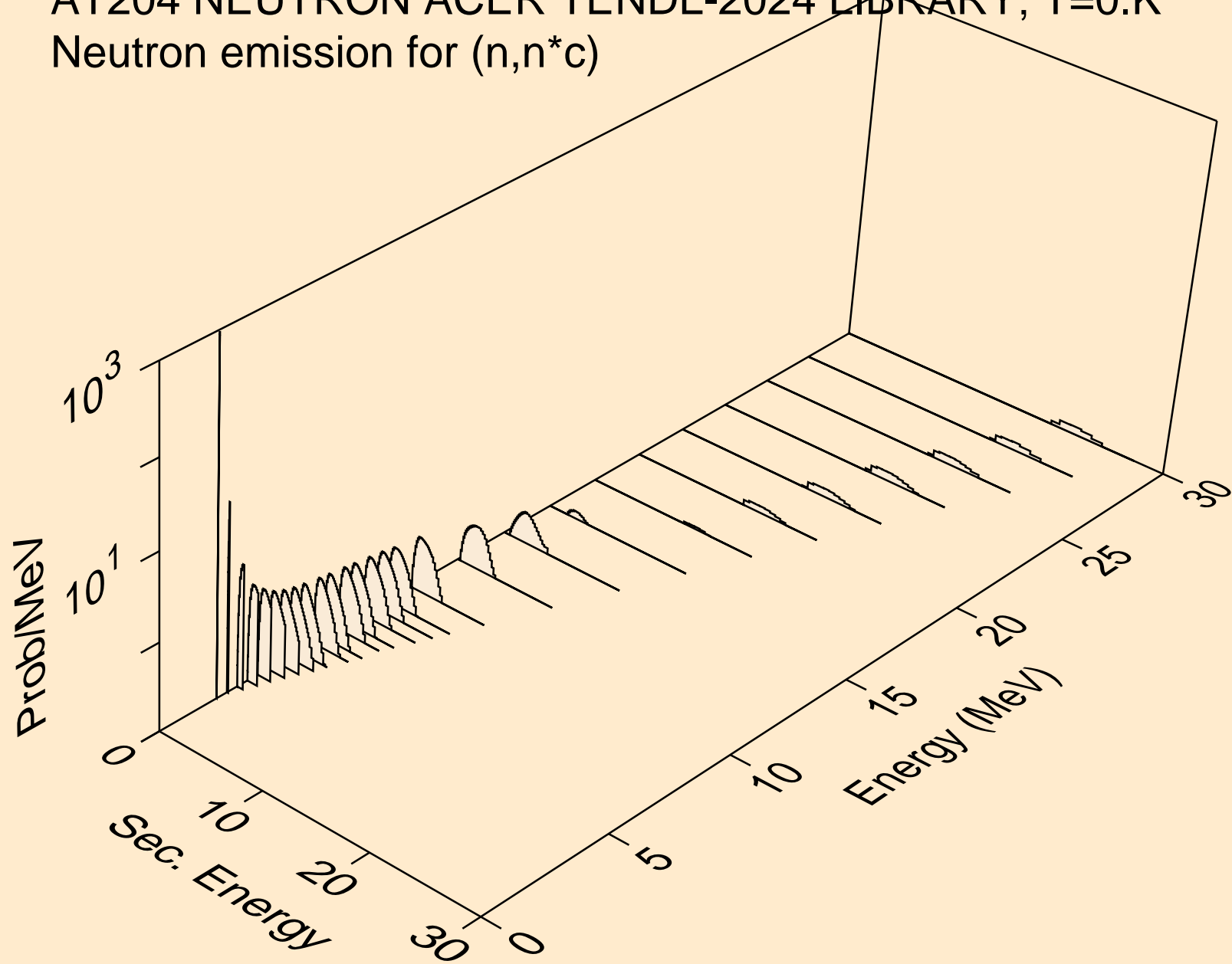

AT204 NEUTRON ACER TENDL-2024 LIBRARY; T=0.K
Photon emission for (n,x)

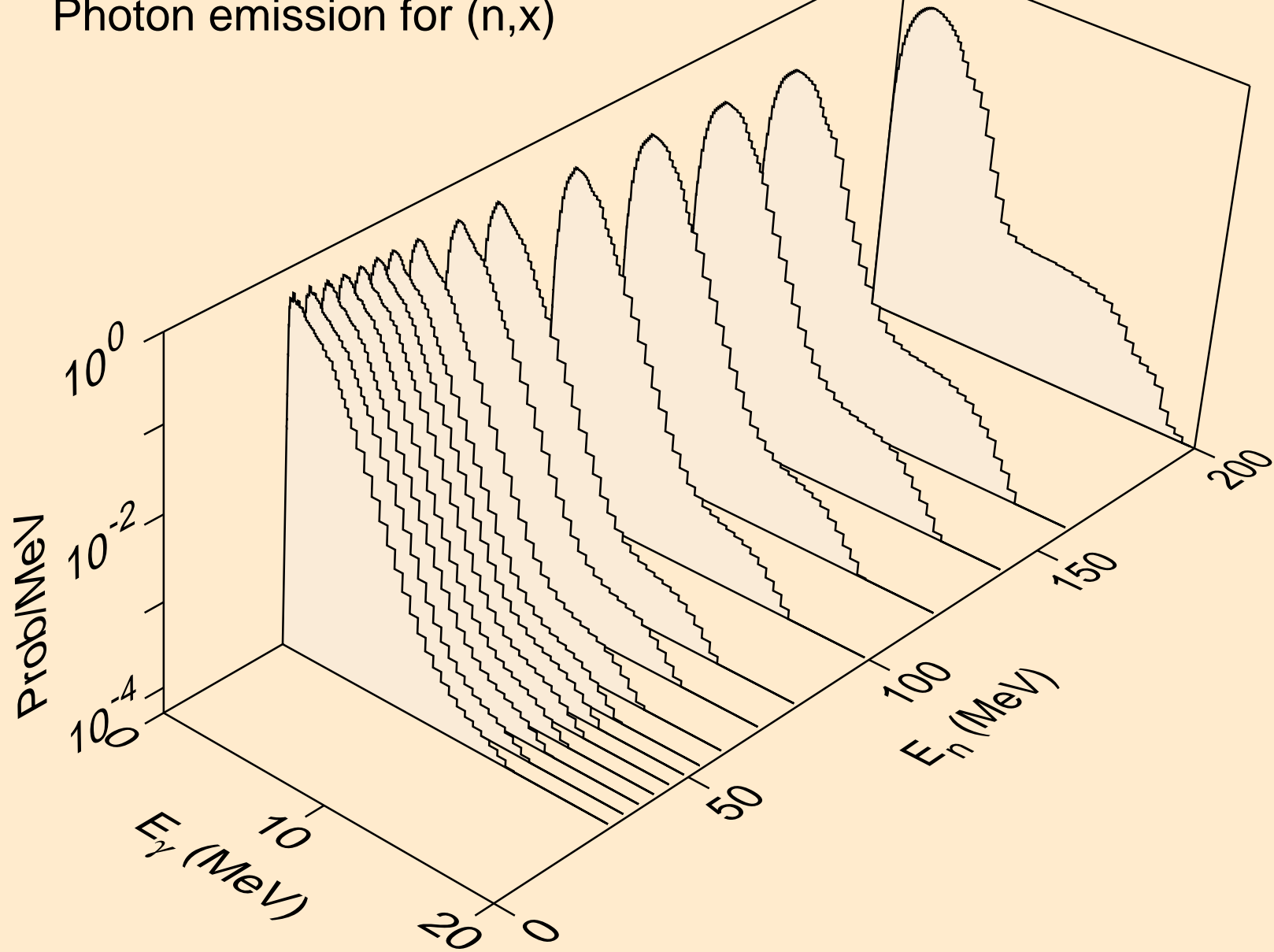

AT204 NEUTRON ACER TENDL-2024 LIBRARY; T=0.K
Photon emission for (n,2nd)

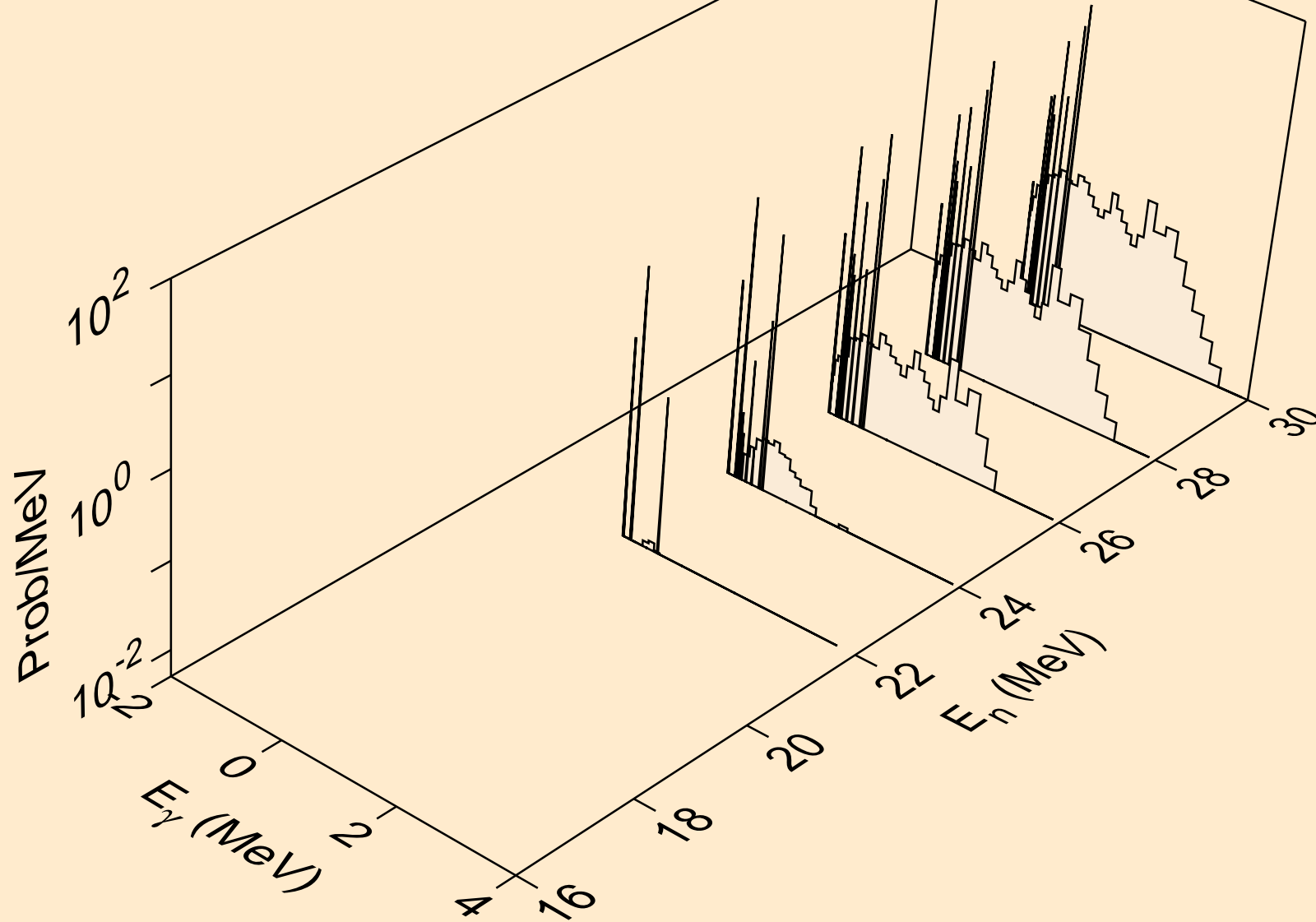

AT204 NEUTRON ACER TENDL-2024 LIBRARY; T=0.K
Photon emission for (n,2n)

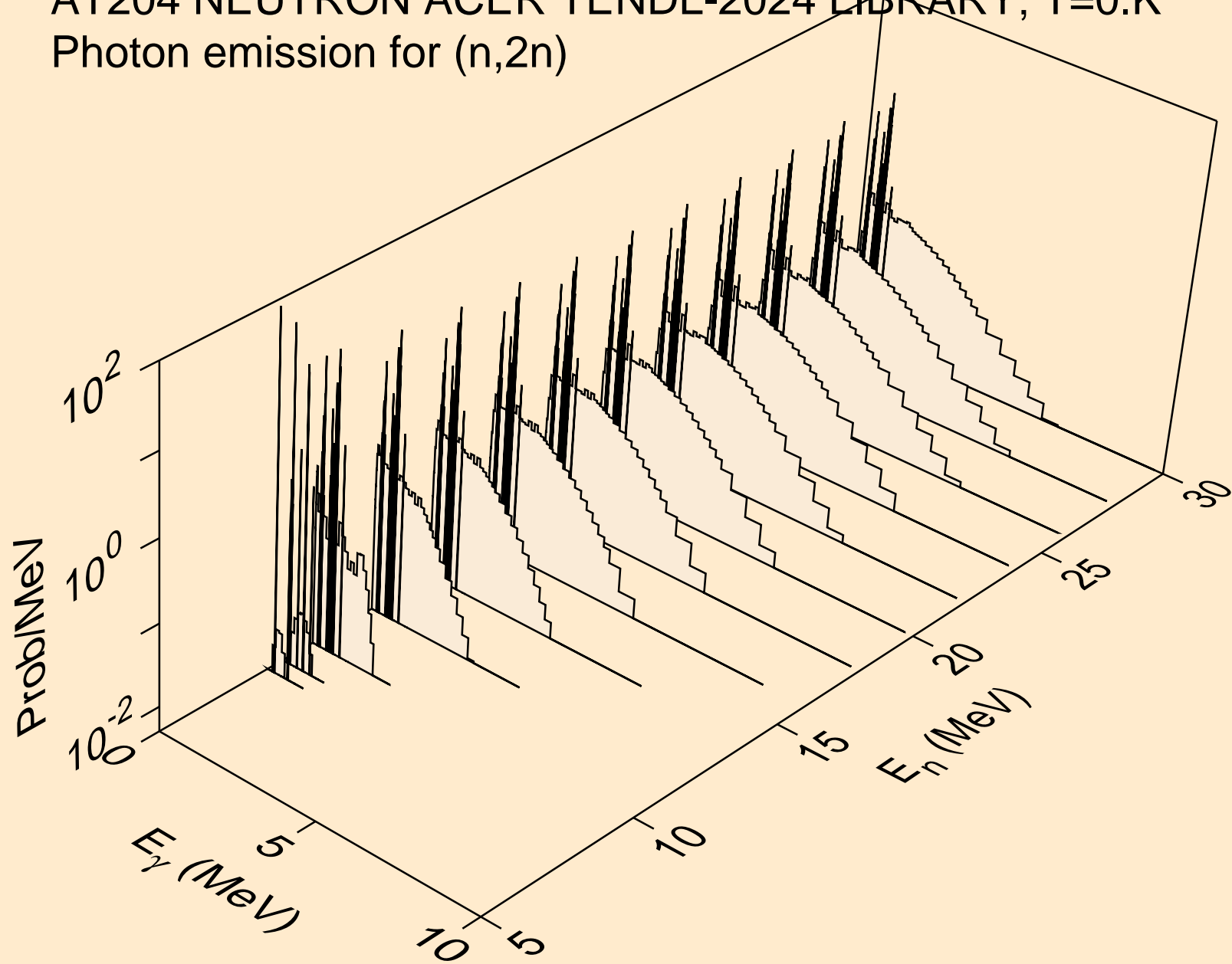

AT204 NEUTRON ACER TENDL-2024 LIBRARY; T=0.K
Photon emission for (n,3n)

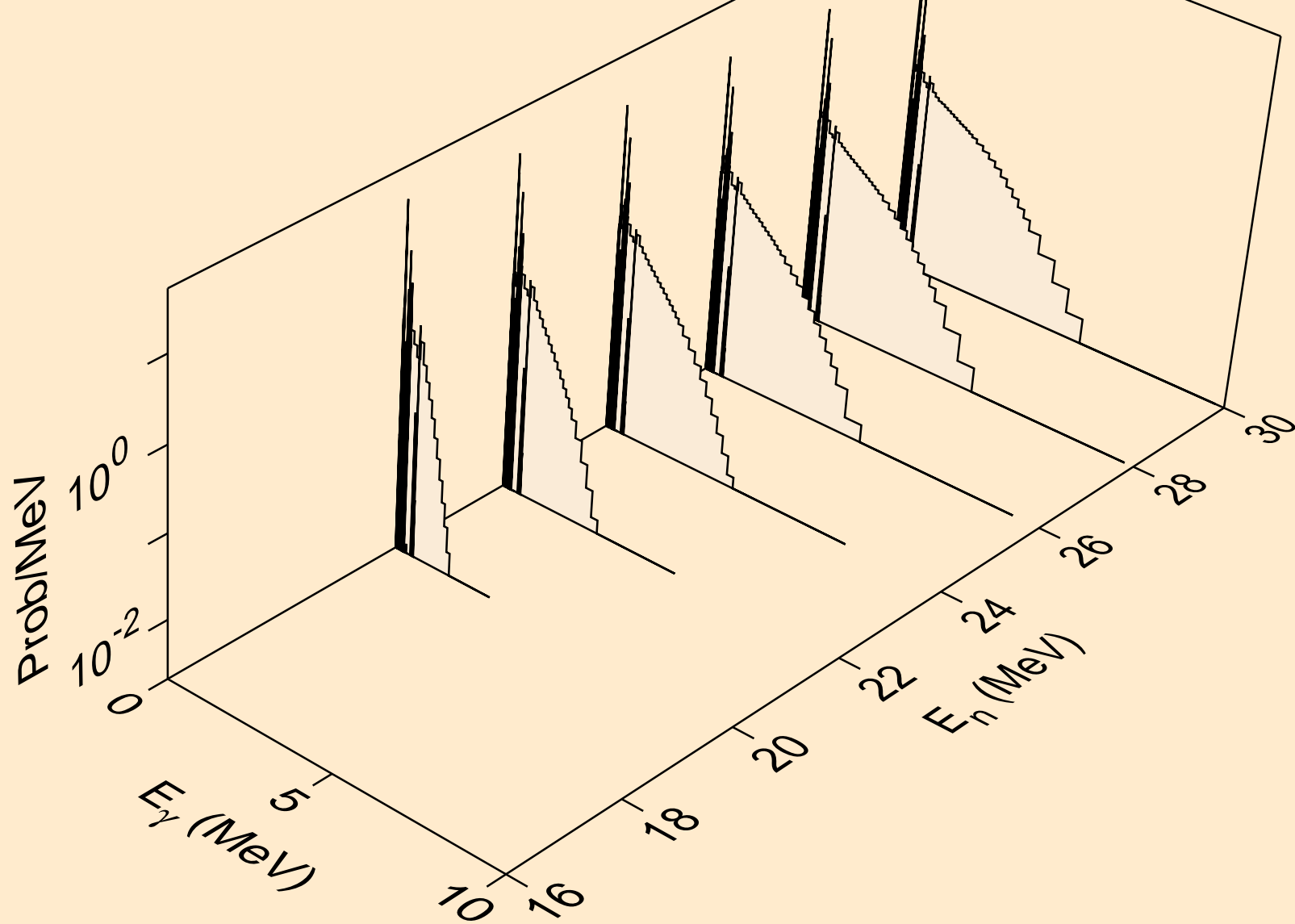

AT204 NEUTRON ACER TENDL-2024 LIBRARY; T=0.K
Photon emission for (n,n*)a

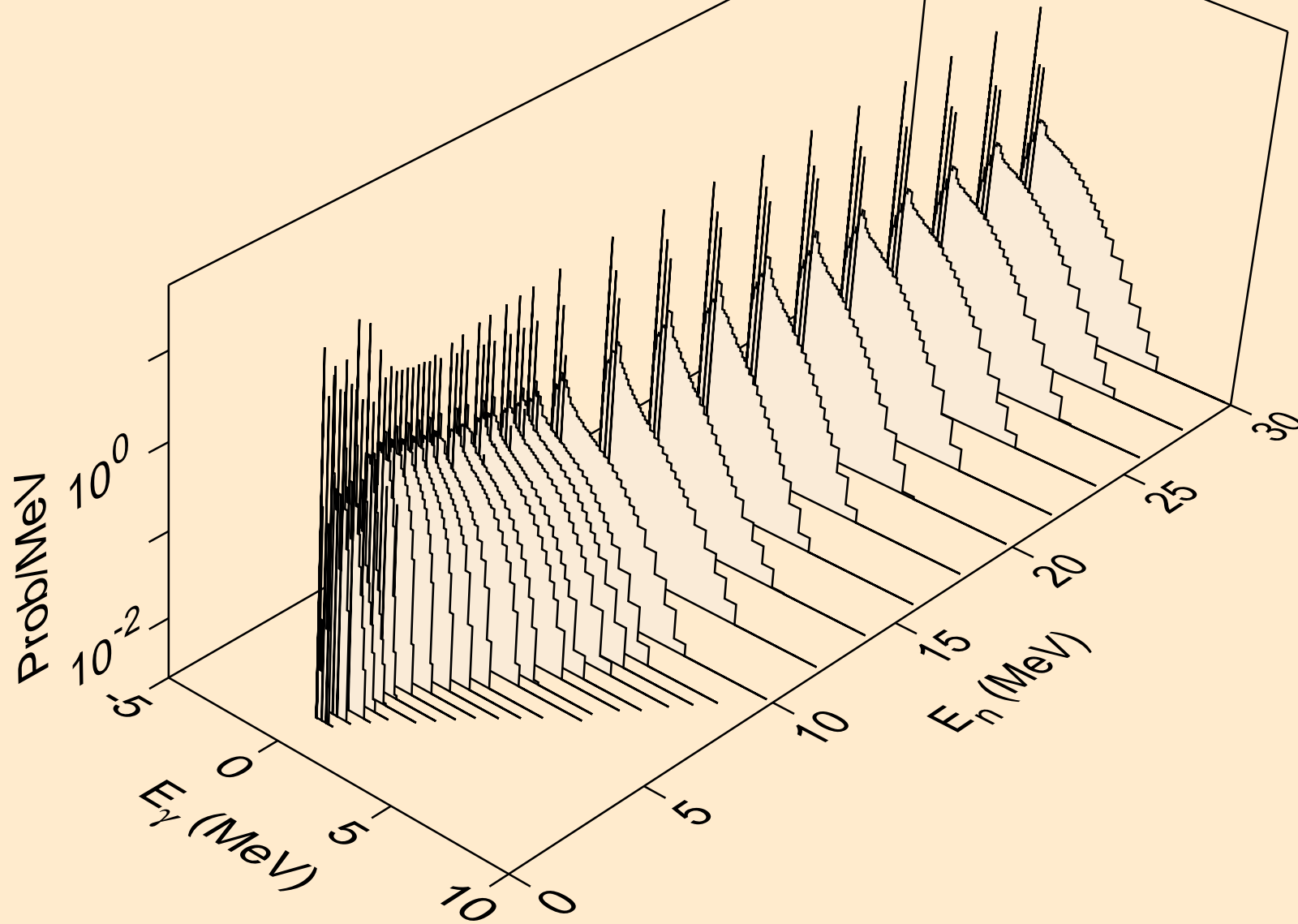

AT204 NEUTRON ACER TENDL-2024 LIBRARY; T=0.K
Photon emission for (n,2n)a

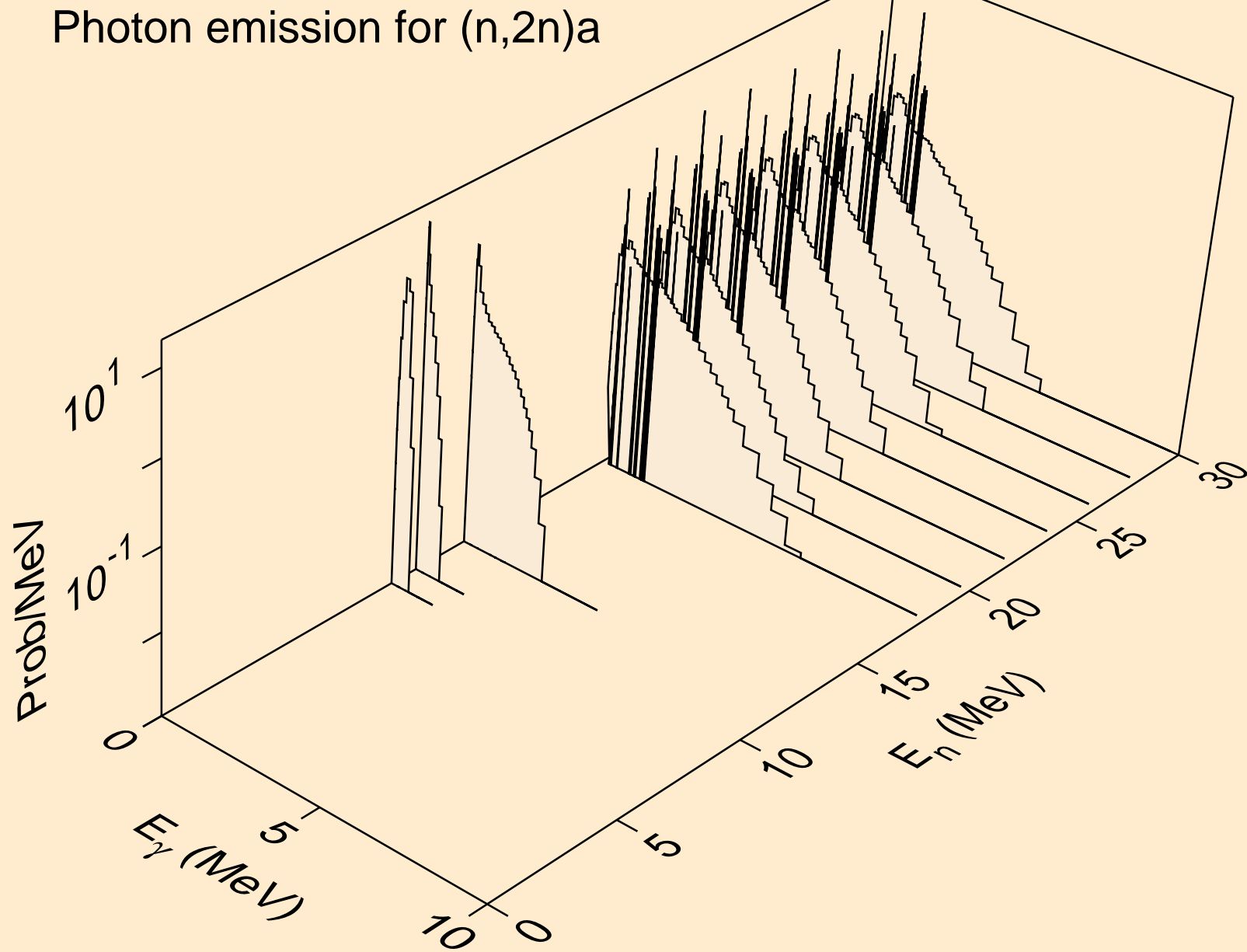

AT204 NEUTRON ACER TENDL-2024 LIBRARY; T=0.K
Photon emission for (n,3n)a

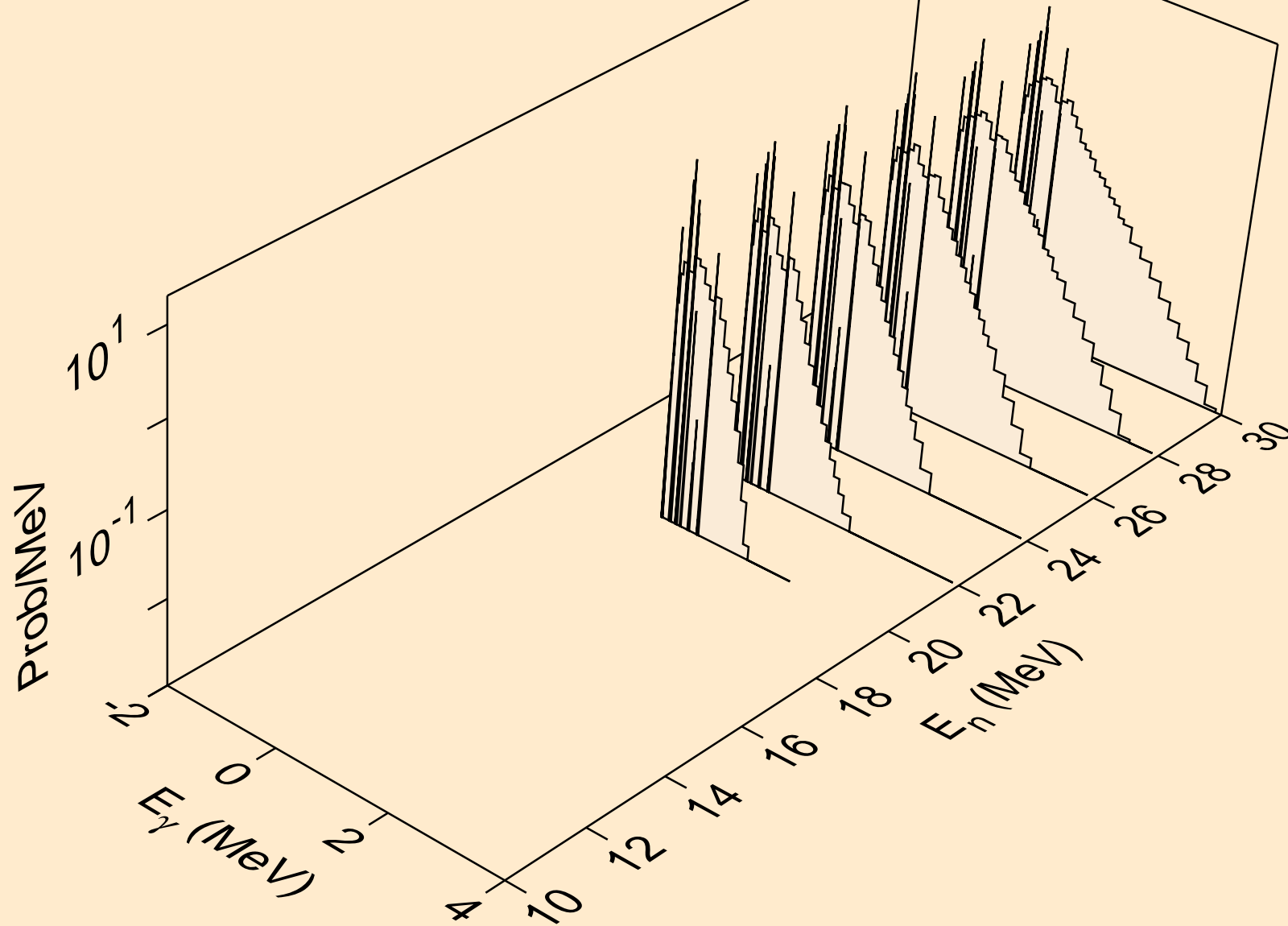

AT204 NEUTRON ACER TENDL-2024 LIBRARY; T=0.K
Photon emission for (n,n*)p

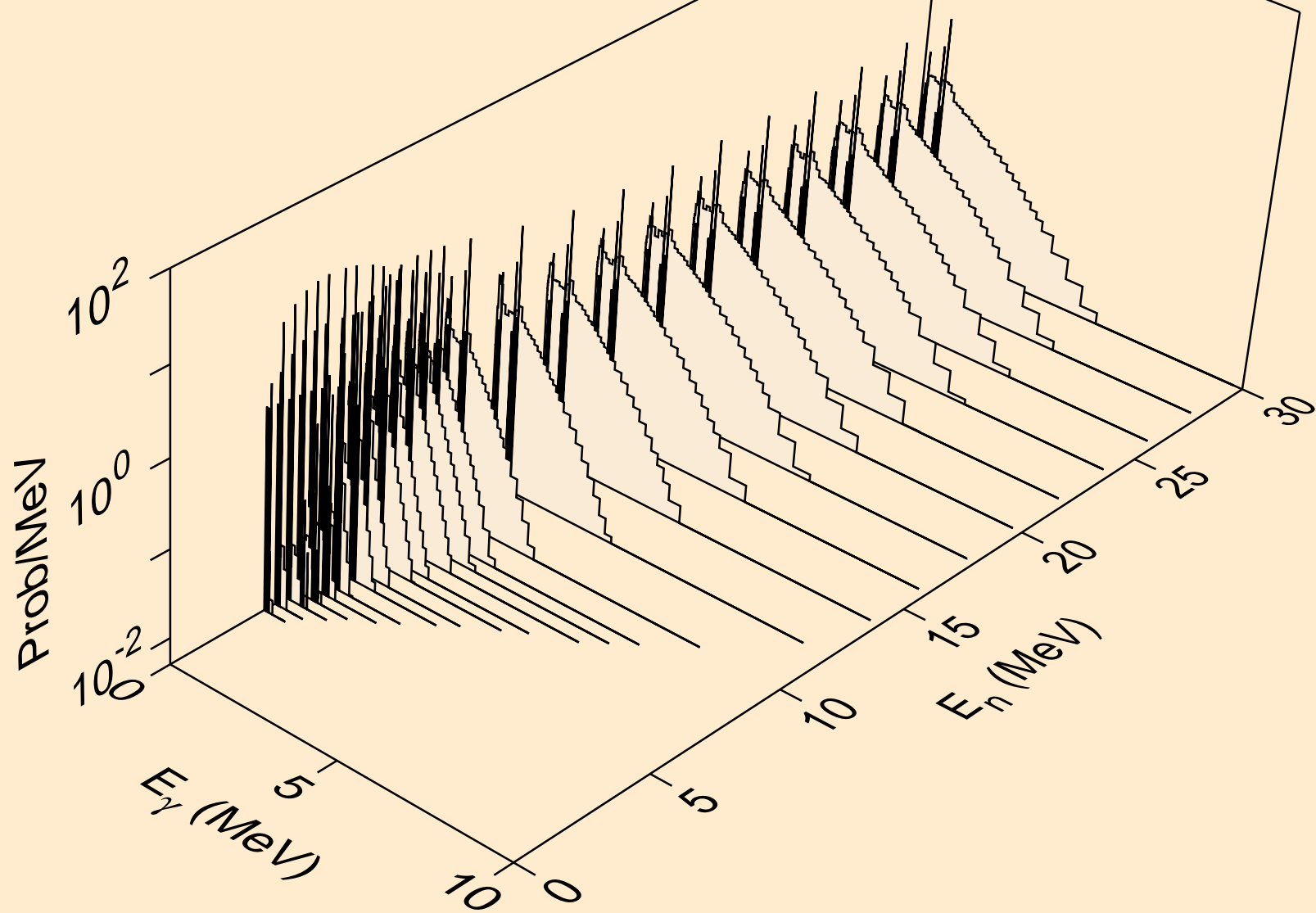

AT204 NEUTRON ACER TENDL-2024 LIBRARY; T=0.K
Photon emission for (n,n*)2a

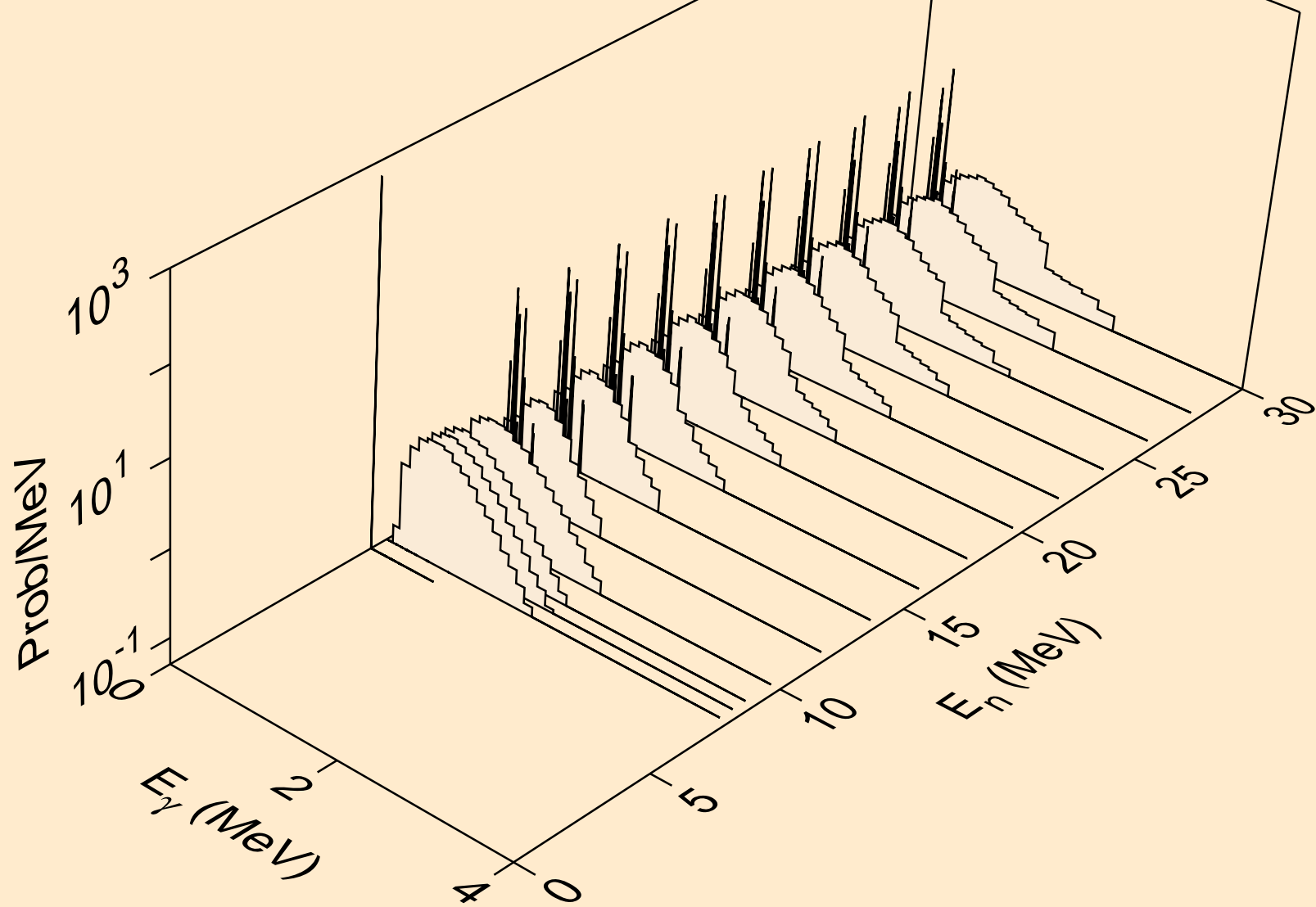

AT204 NEUTRON ACER TENDL-2024 LIBRARY; T=0.K
Photon emission for (n,2n)2a

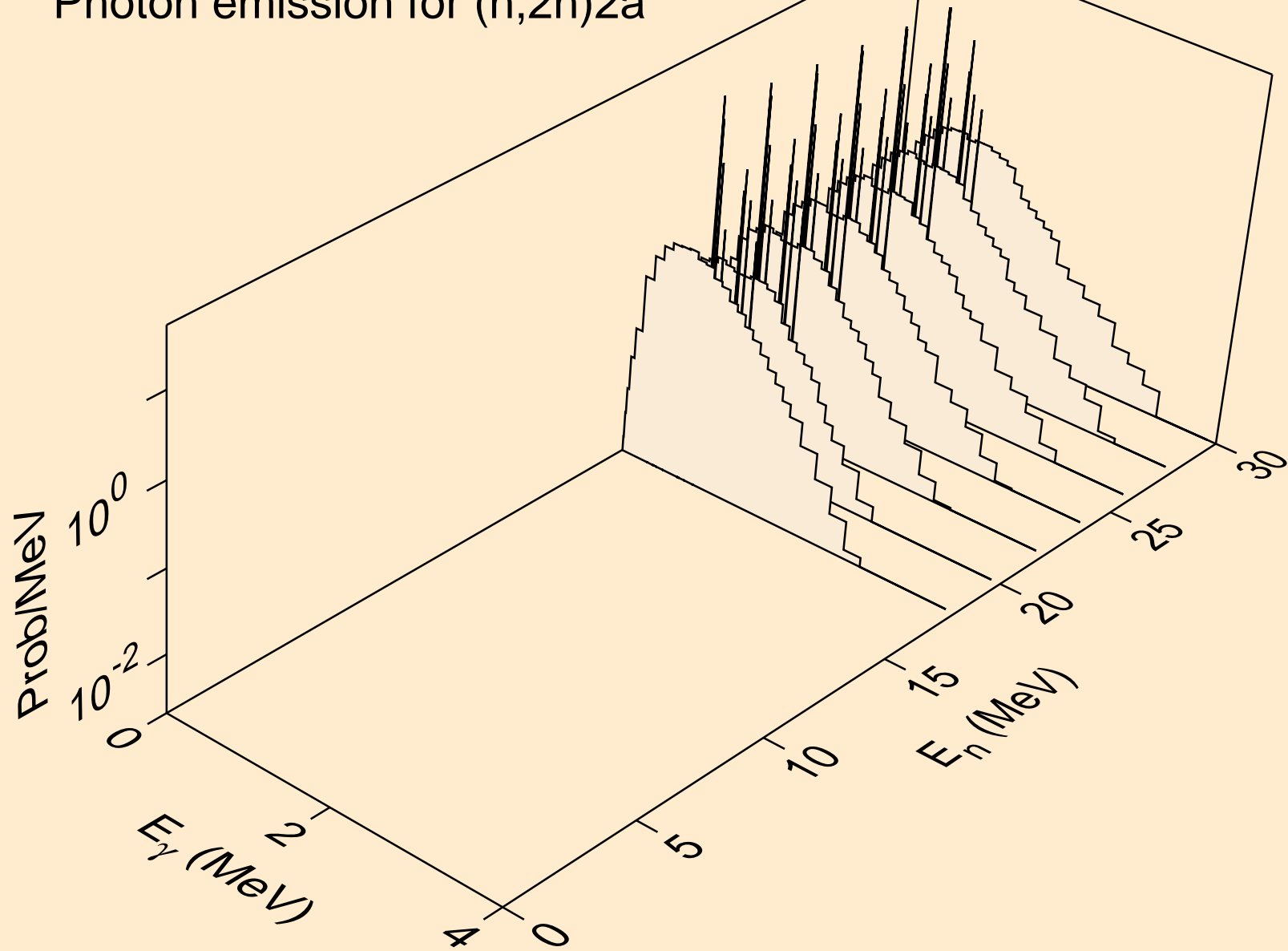

AT204 NEUTRON ACER TENDL-2024 LIBRARY; T=0.K
Photon emission for (n,n*)d

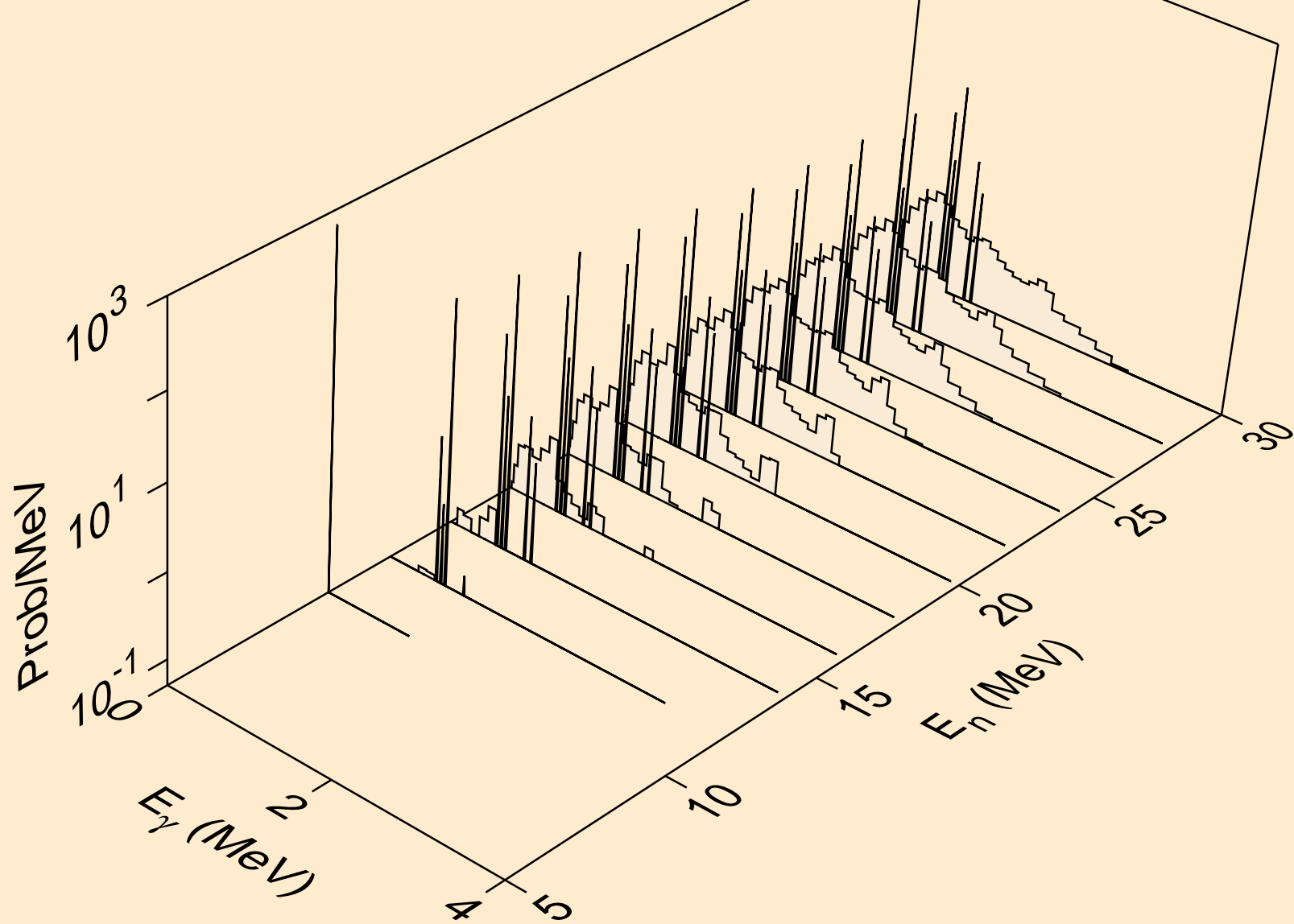

AT204 NEUTRON ACER TENDL-2024 LIBRARY; T=0.K
Photon emission for (n,n*)t

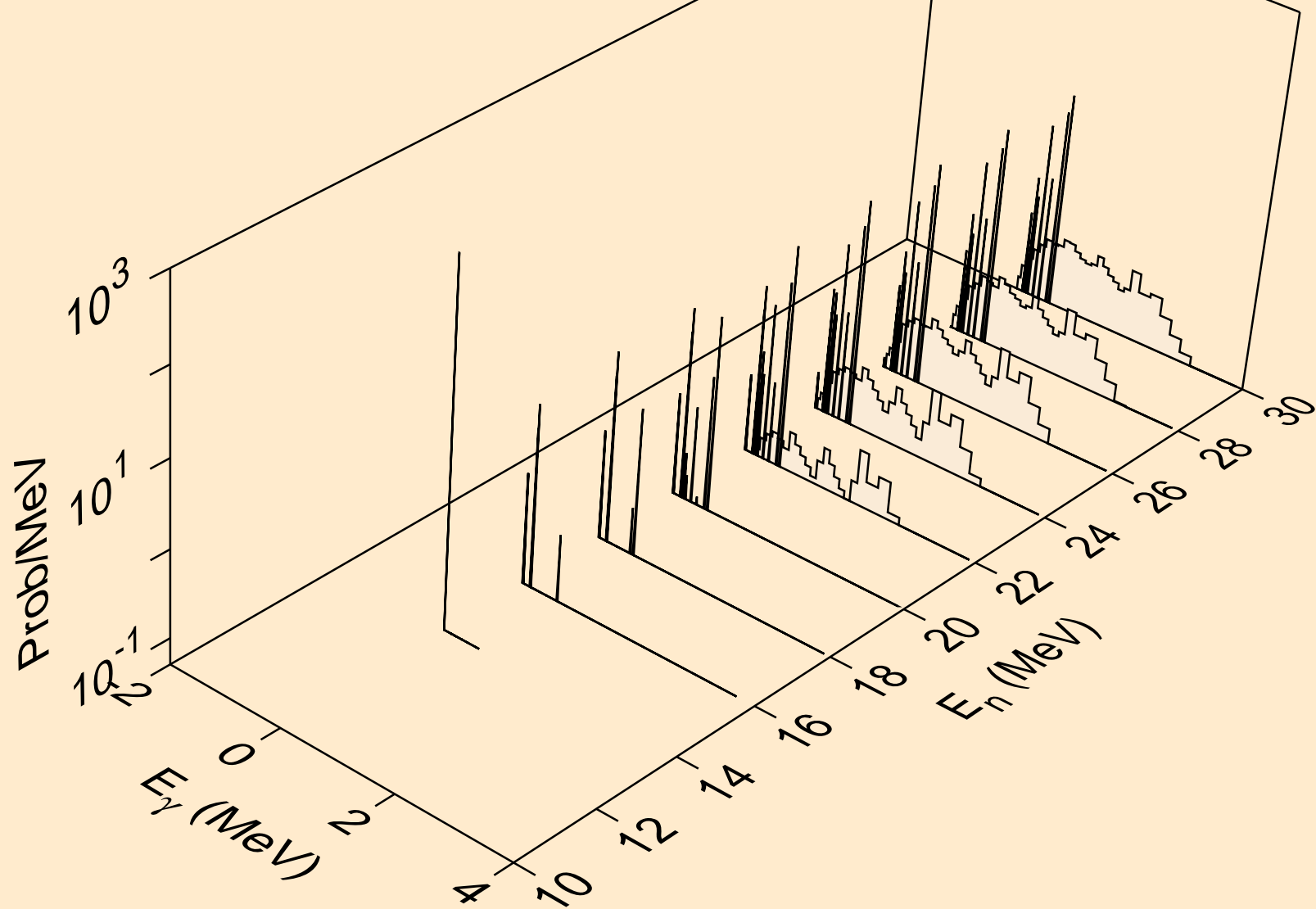

AT204 NEUTRON ACER TENDL-2024 LIBRARY; T=0.K
Photon emission for (n,n*)he3

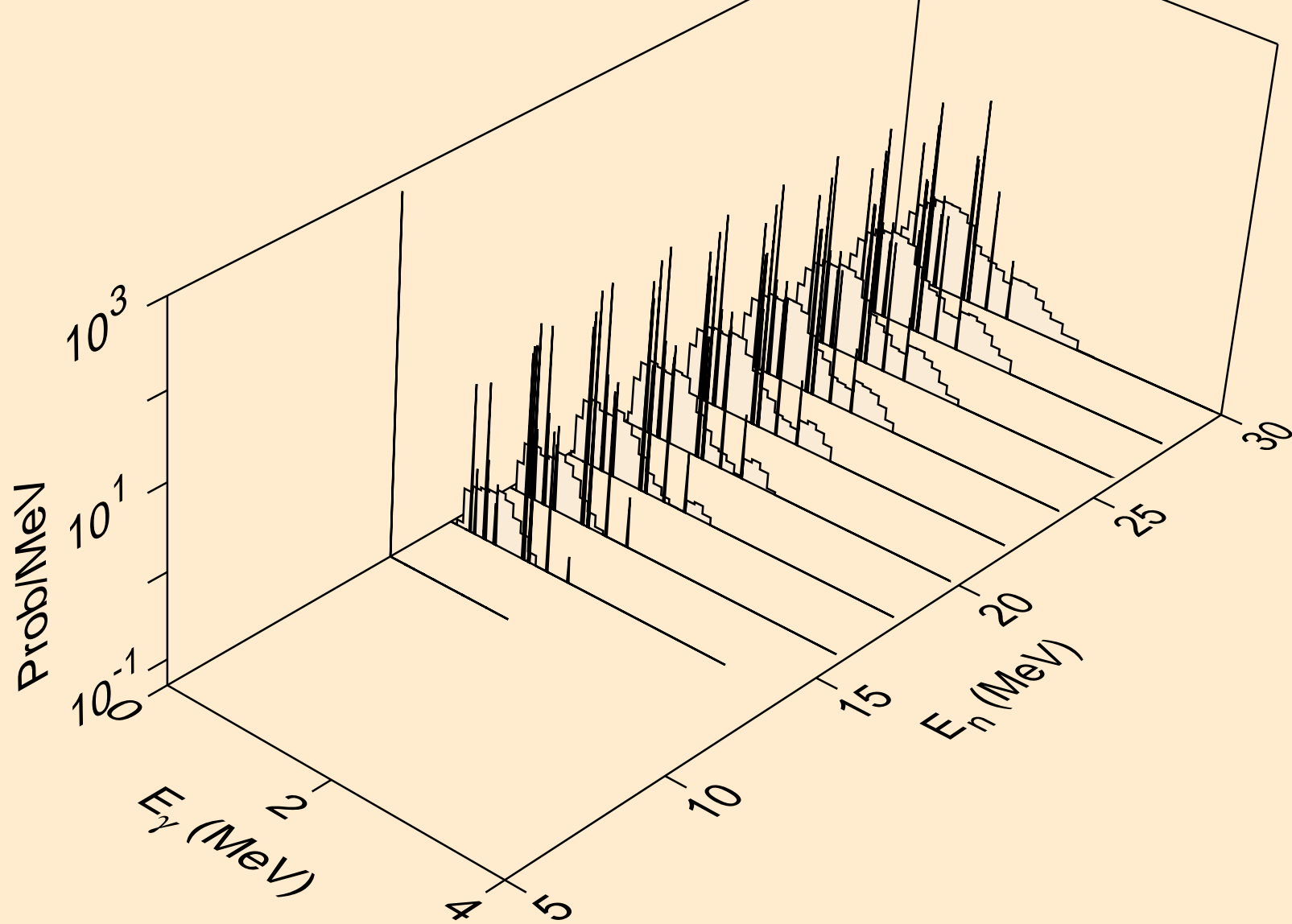

AT204 NEUTRON ACER TENDL-2024 LIBRARY; T=0.K
Photon emission for (n,4n)

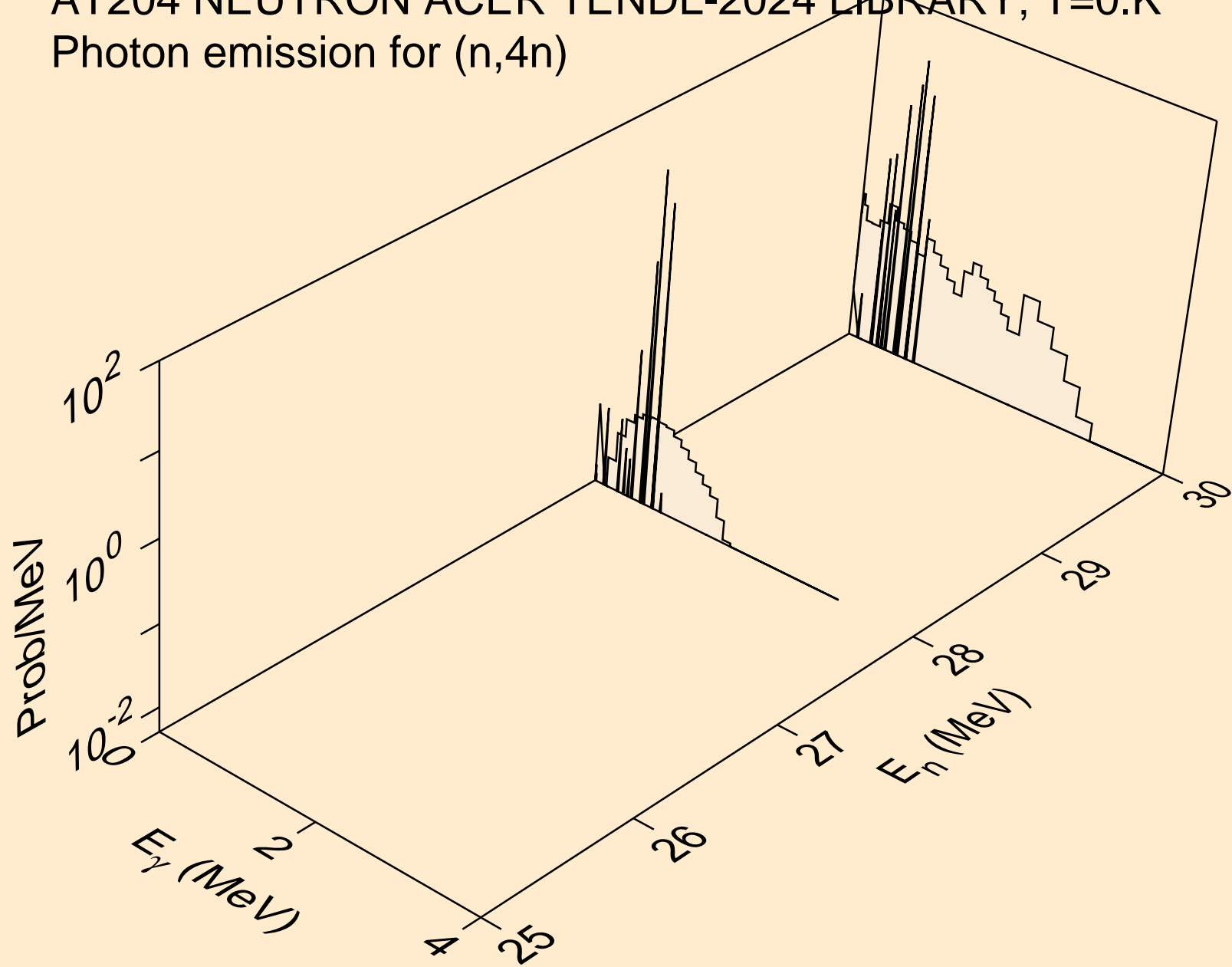

AT204 NEUTRON ACER TENDL-2024 LIBRARY; T=0.K
Photon emission for (n,2np)

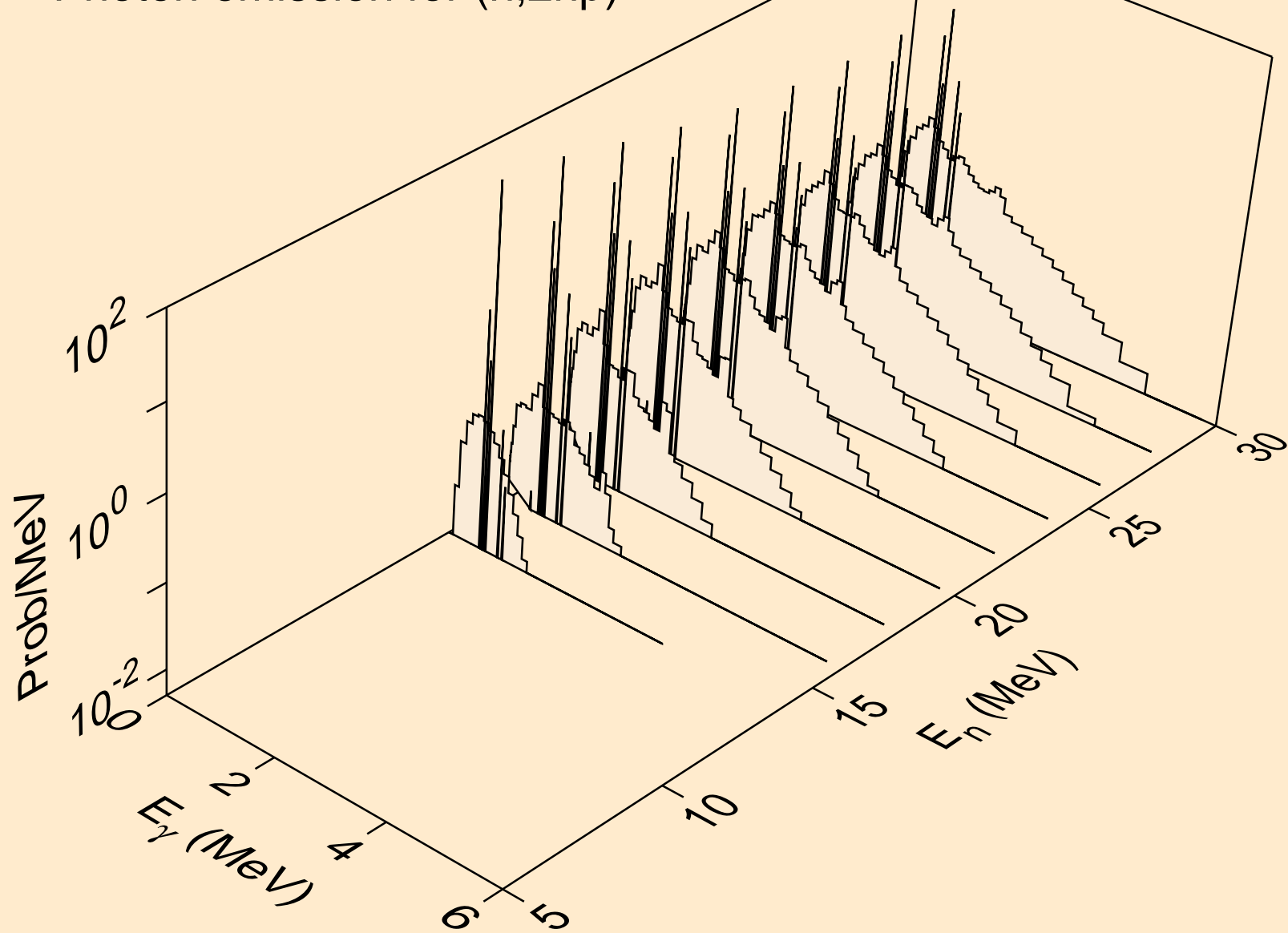

AT204 NEUTRON ACER TENDL-2024 LIBRARY; T=0.K
Photon emission for (n,3np)

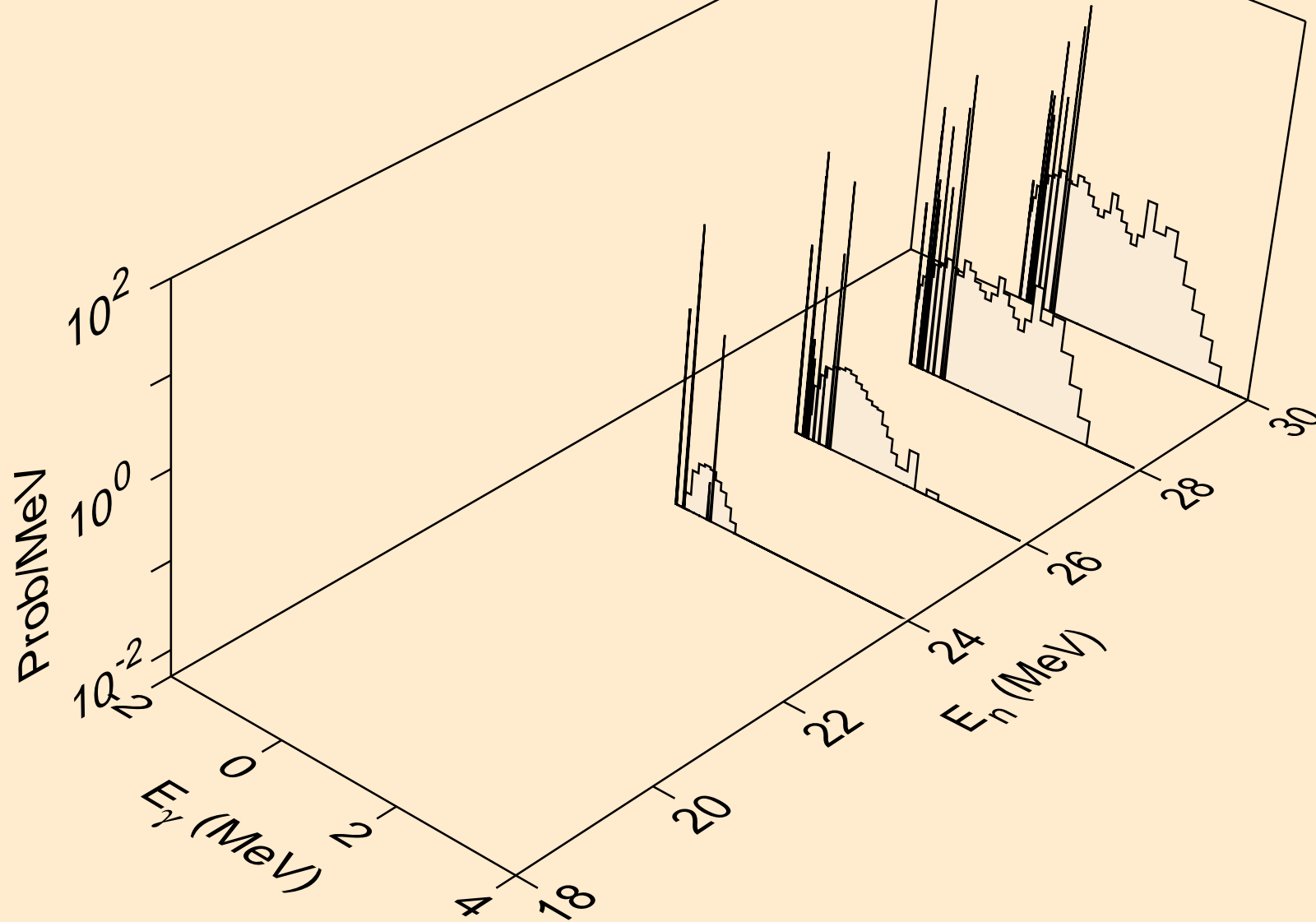

AT204 NEUTRON ACER TENDL-2024 LIBRARY; T=0.K
Photon emission for (n,n2p)

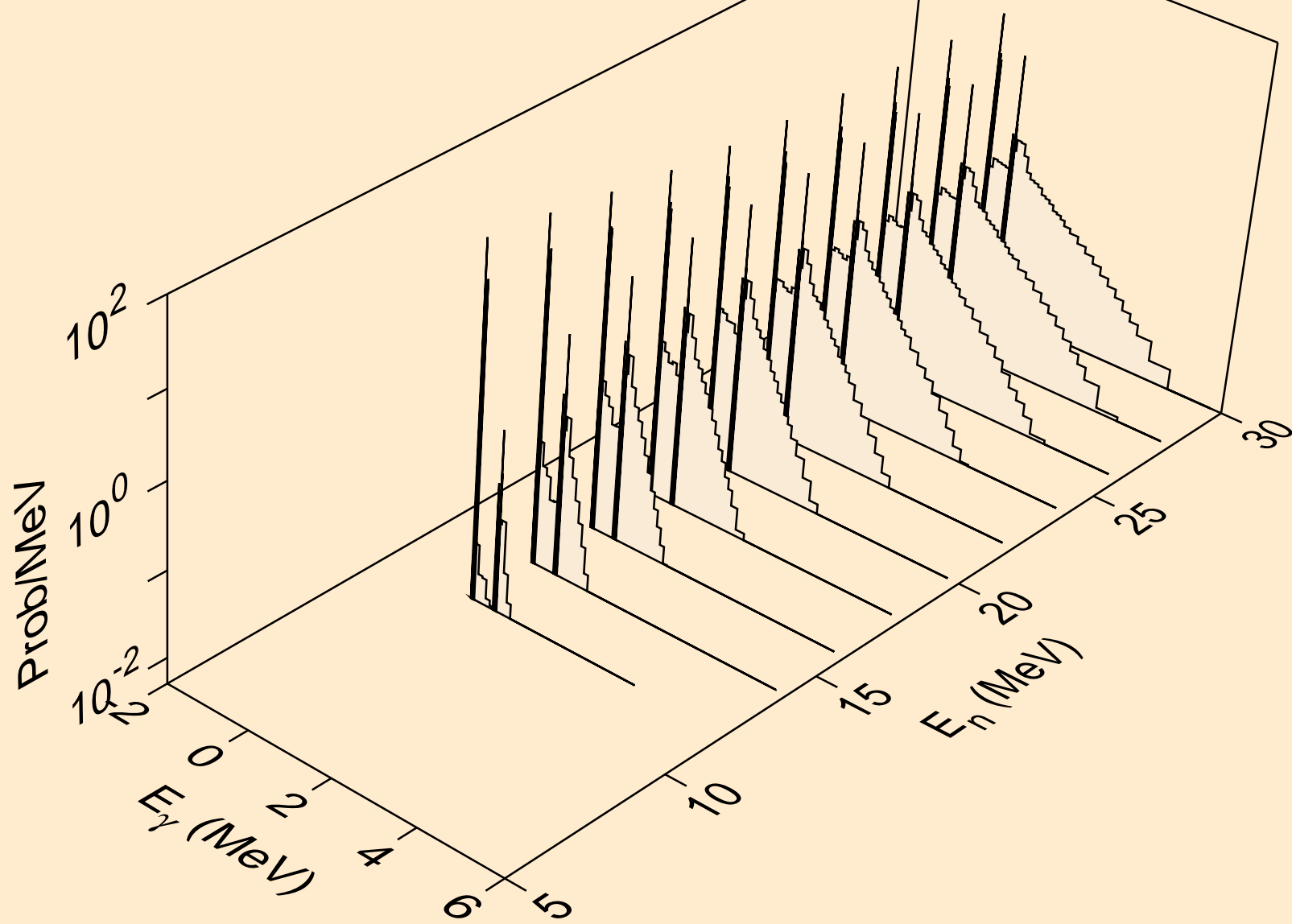

AT204 NEUTRON ACER TENDL-2024 LIBRARY; T=0.K
Photon emission for (n,npa)

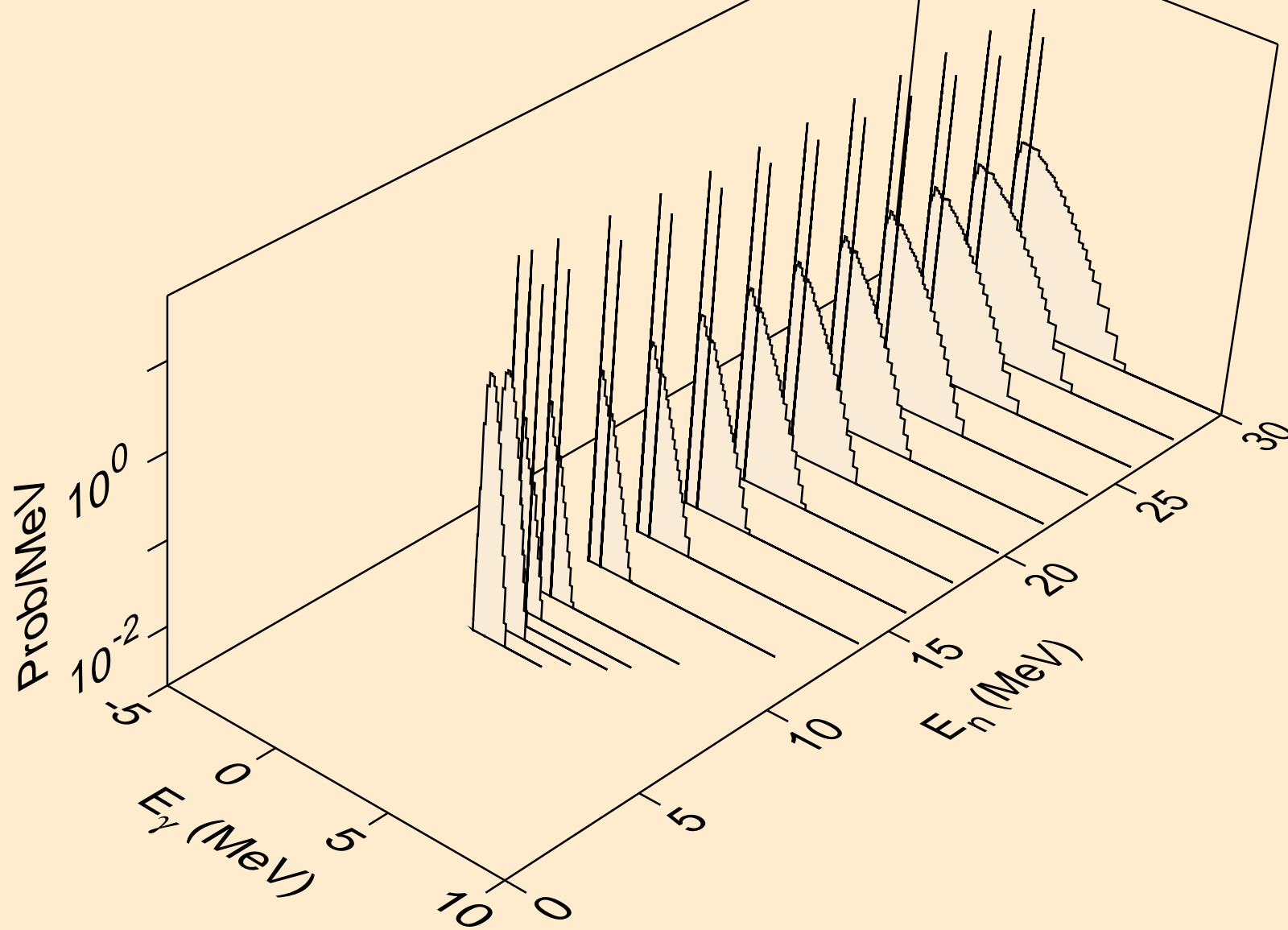

AT204 NEUTRON ACER TENDL-2024 LIBRARY; T=0.K
Photon emission for (n,n*c)

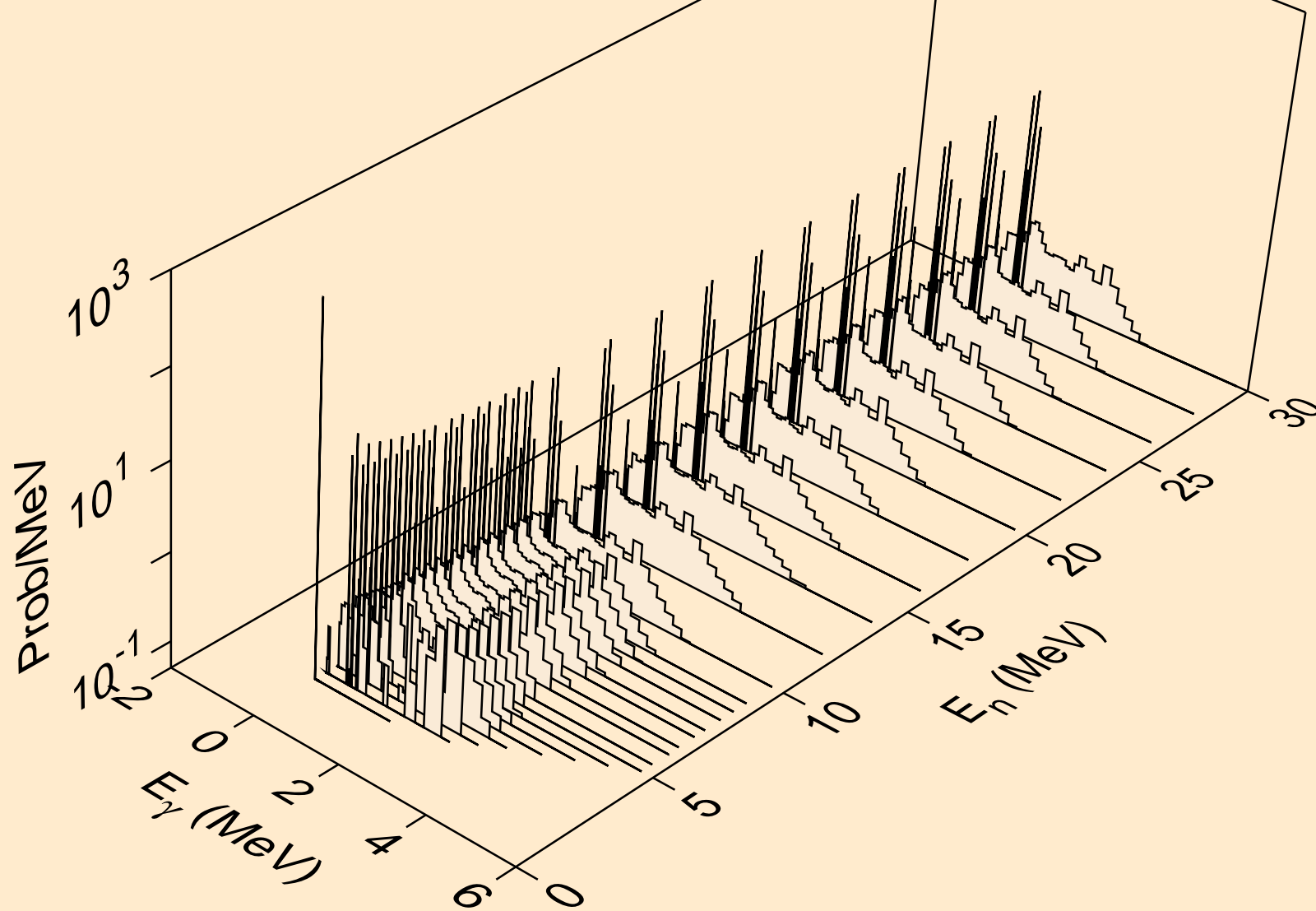

AT204 NEUTRON ACER TENDL-2024 LIBRARY; T=0.K
Photon emission for (n,gma)

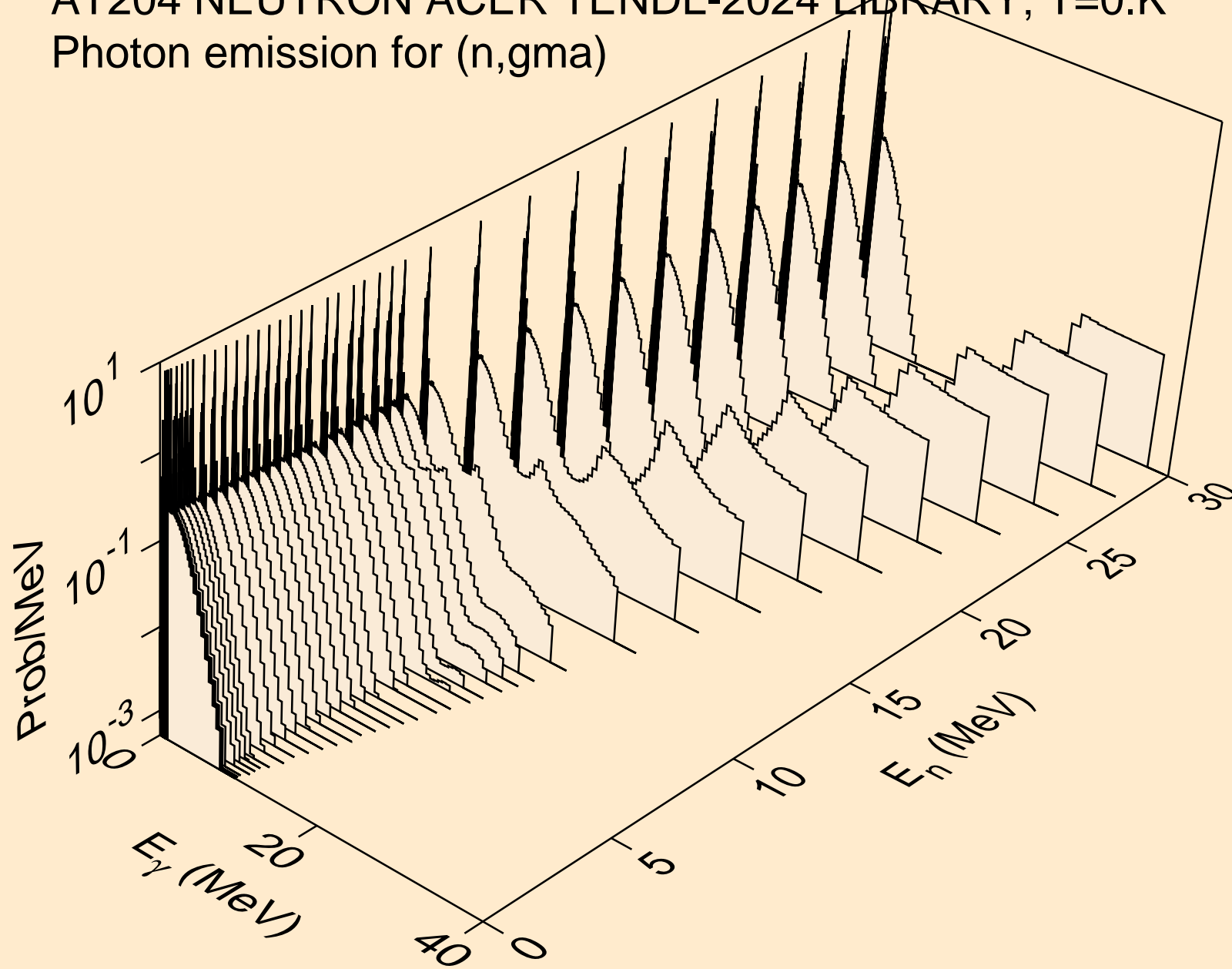

AT204 NEUTRON ACER TENDL-2024 LIBRARY; T=0.K
Photon emission for (n,p)

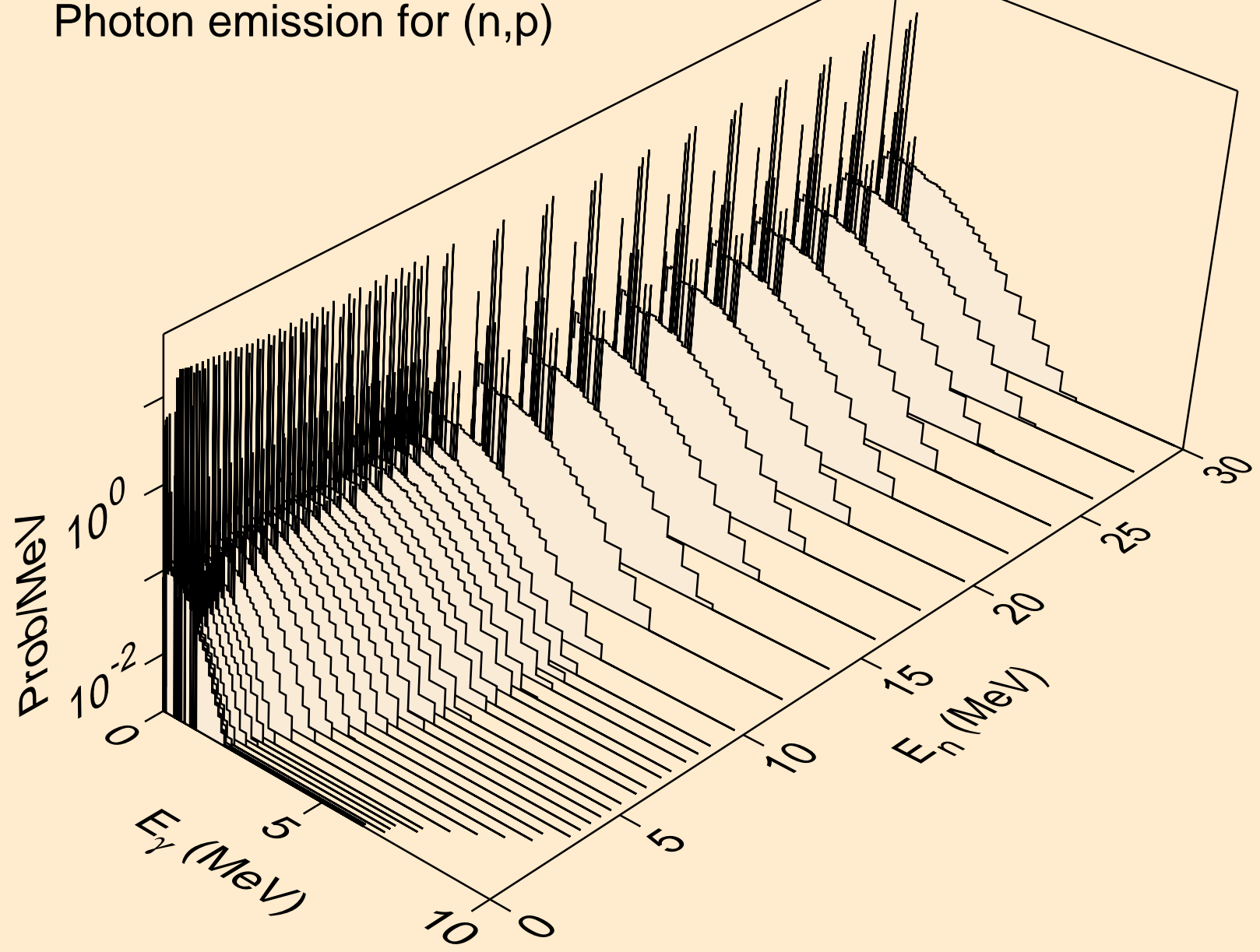

AT204 NEUTRON ACER TENDL-2024 LIBRARY; T=0.K
Photon emission for (n,d)

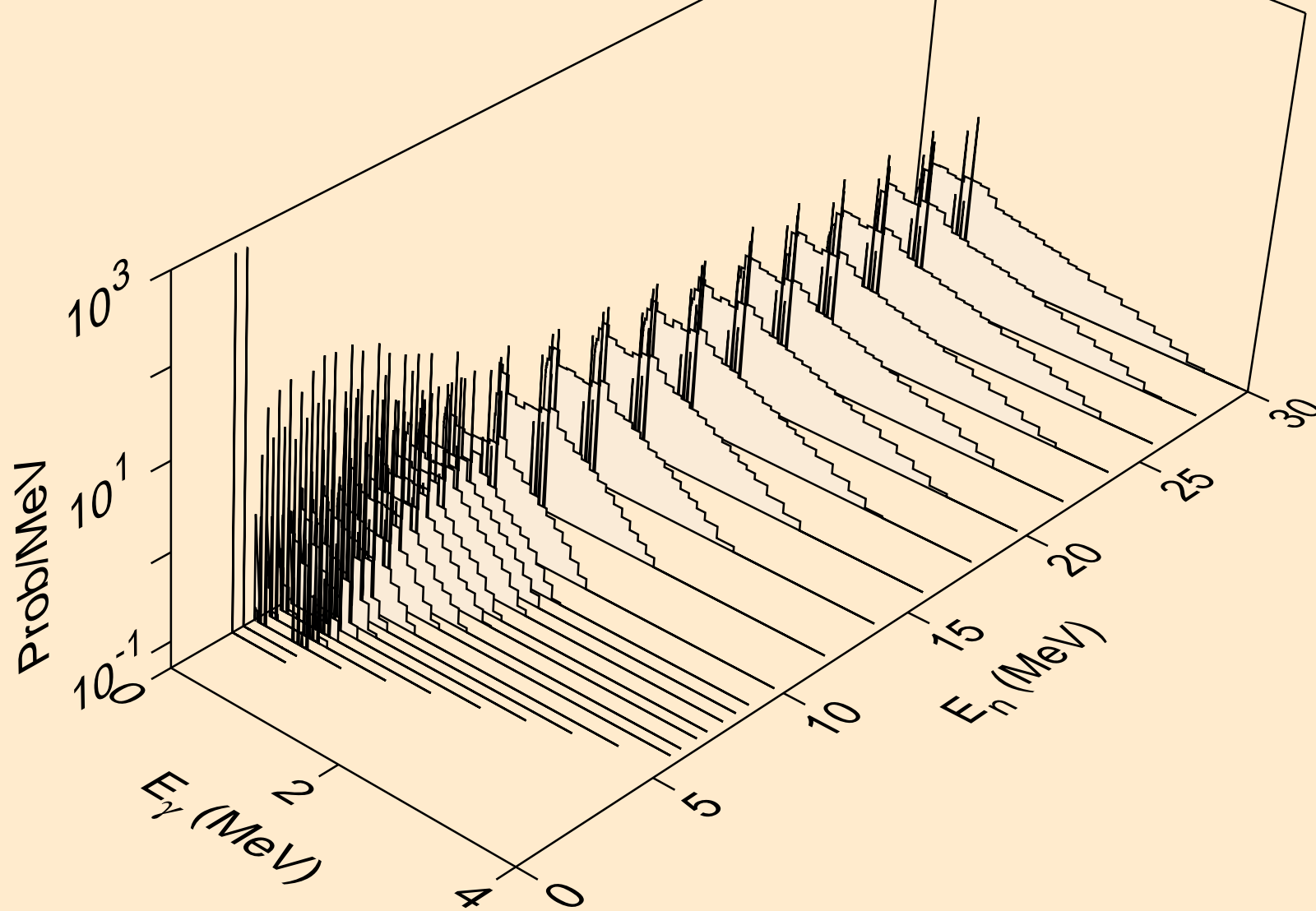

AT204 NEUTRON ACER TENDL-2024 LIBRARY; T=0.K
Photon emission for (n,t)

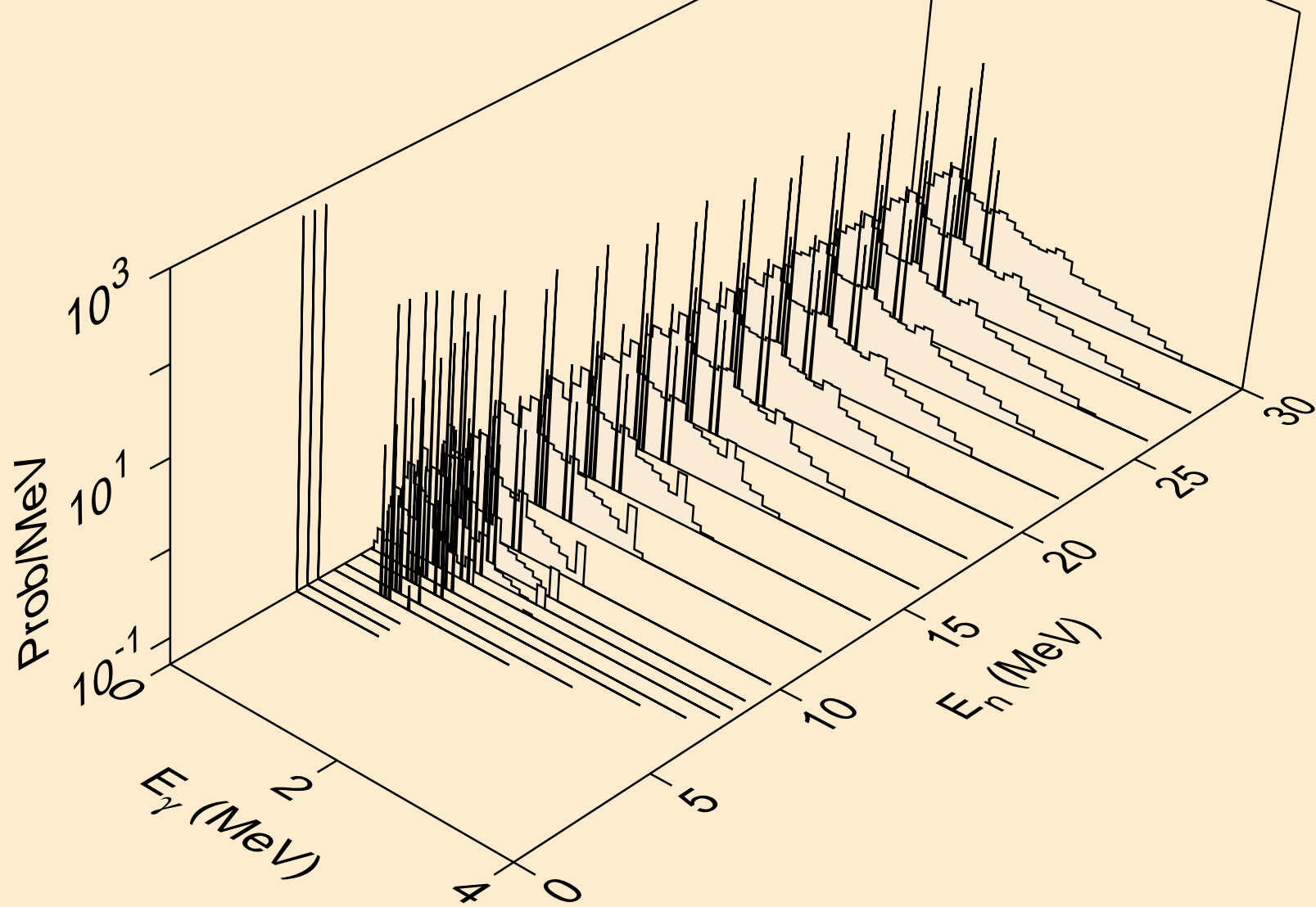

AT204 NEUTRON ACER TENDL-2024 LIBRARY; T=0.K
Photon emission for (n,he3)

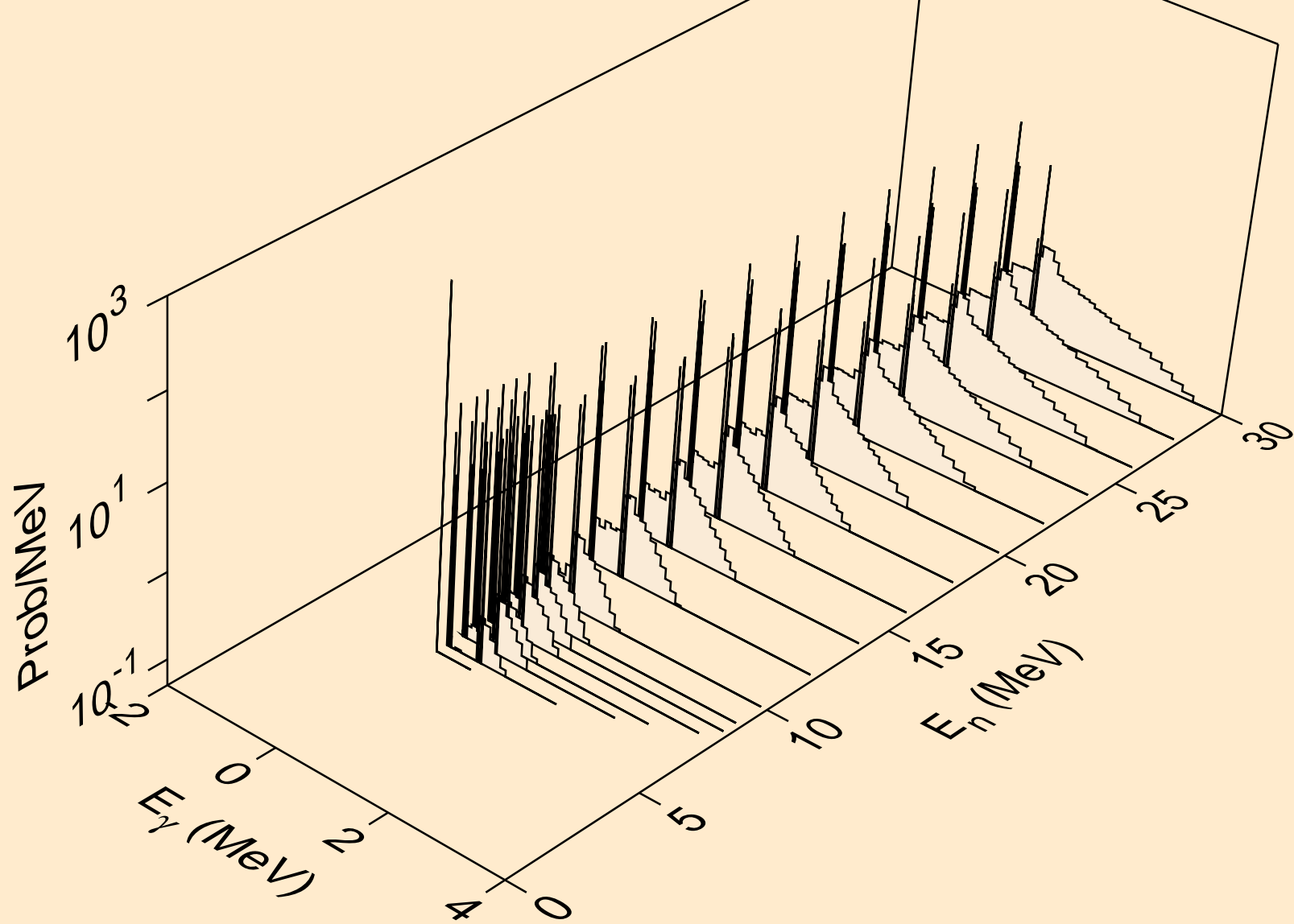

AT204 NEUTRON ACER TENDL-2024 LIBRARY; T=0.K
Photon emission for (n,a)

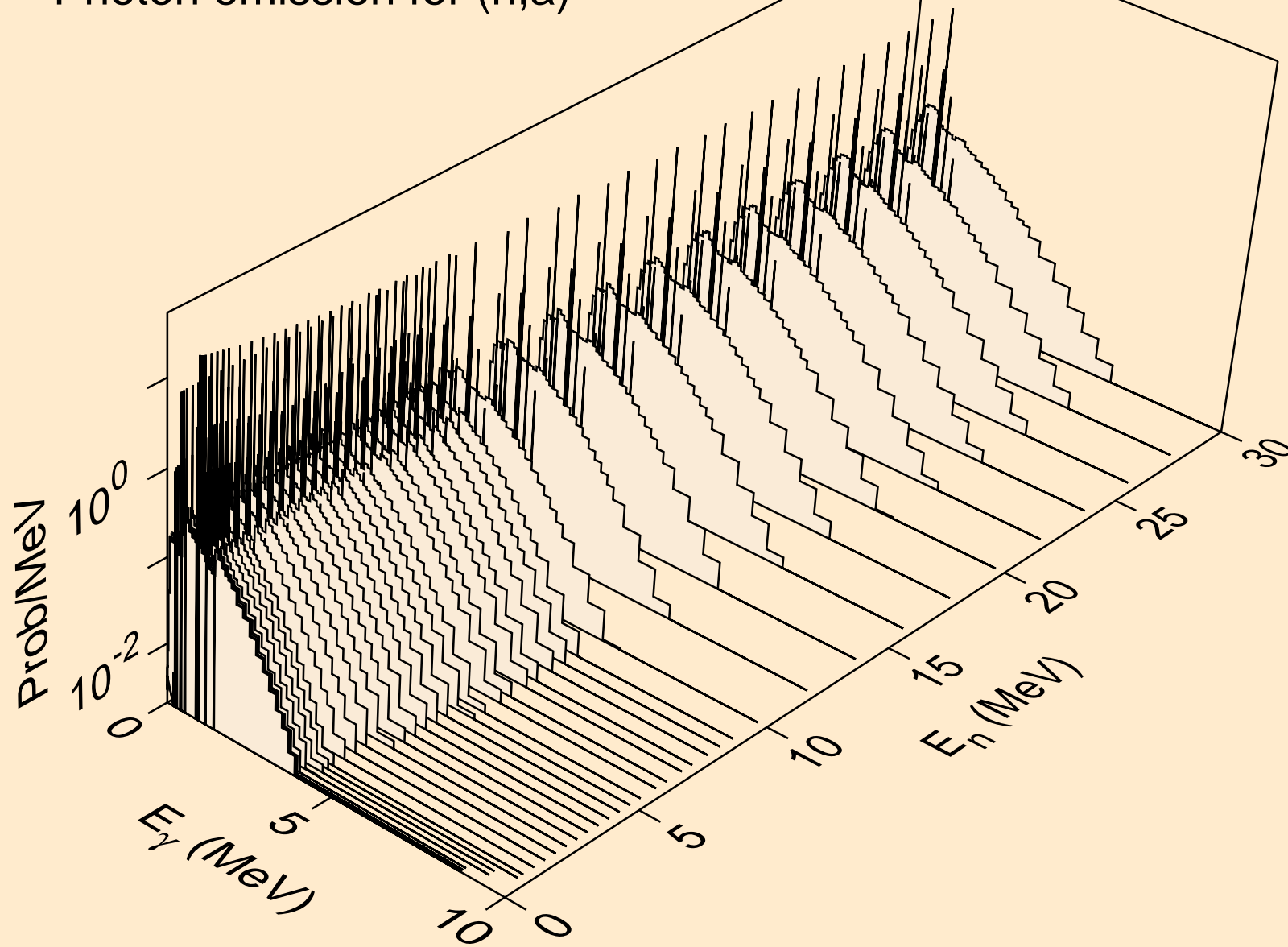

AT204 NEUTRON ACER TENDL-2024 LIBRARY; T=0.K
Photon emission for (n,2a)

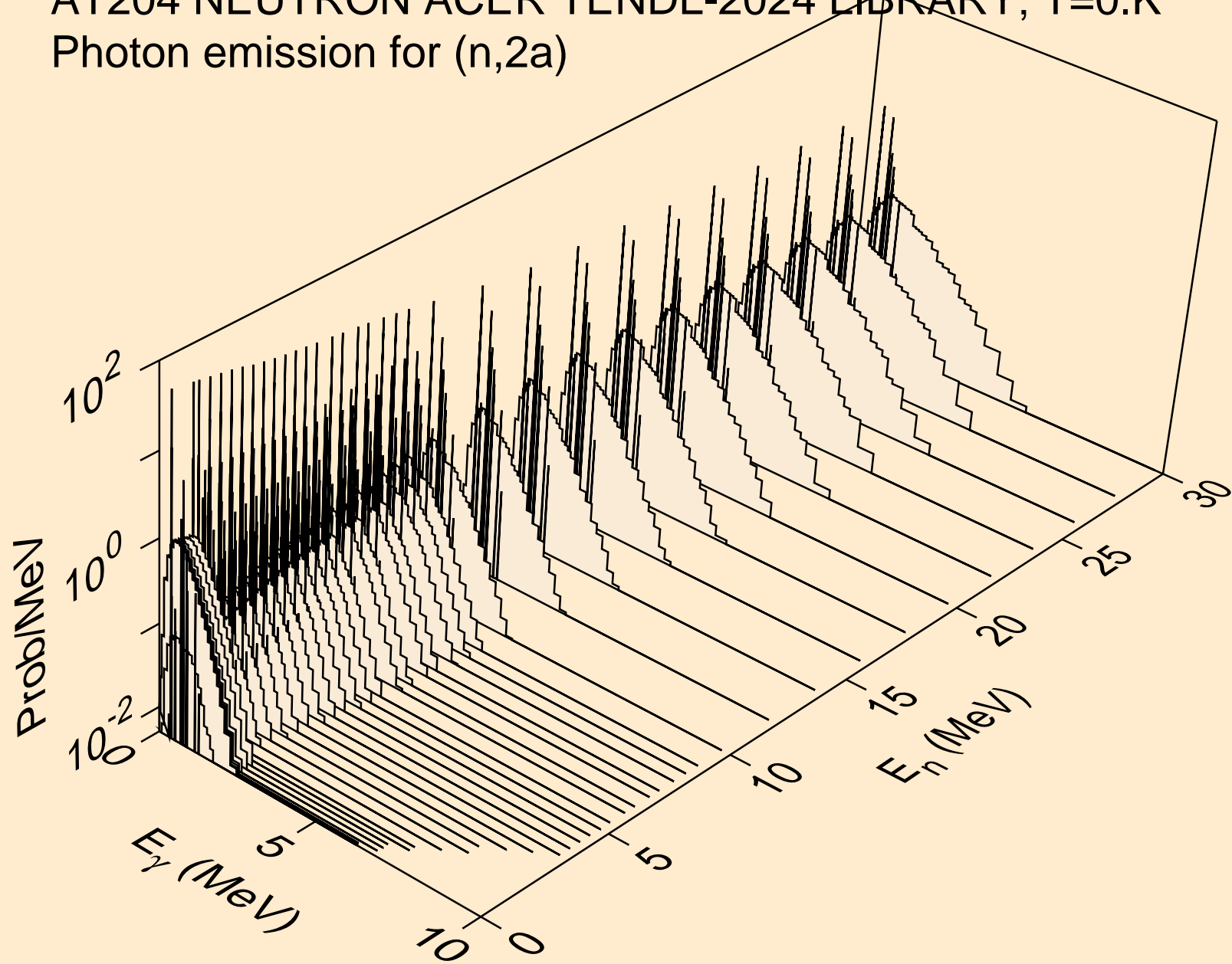

AT204 NEUTRON ACER TENDL-2024 LIBRARY; T=0.K
Photon emission for (n,2p)

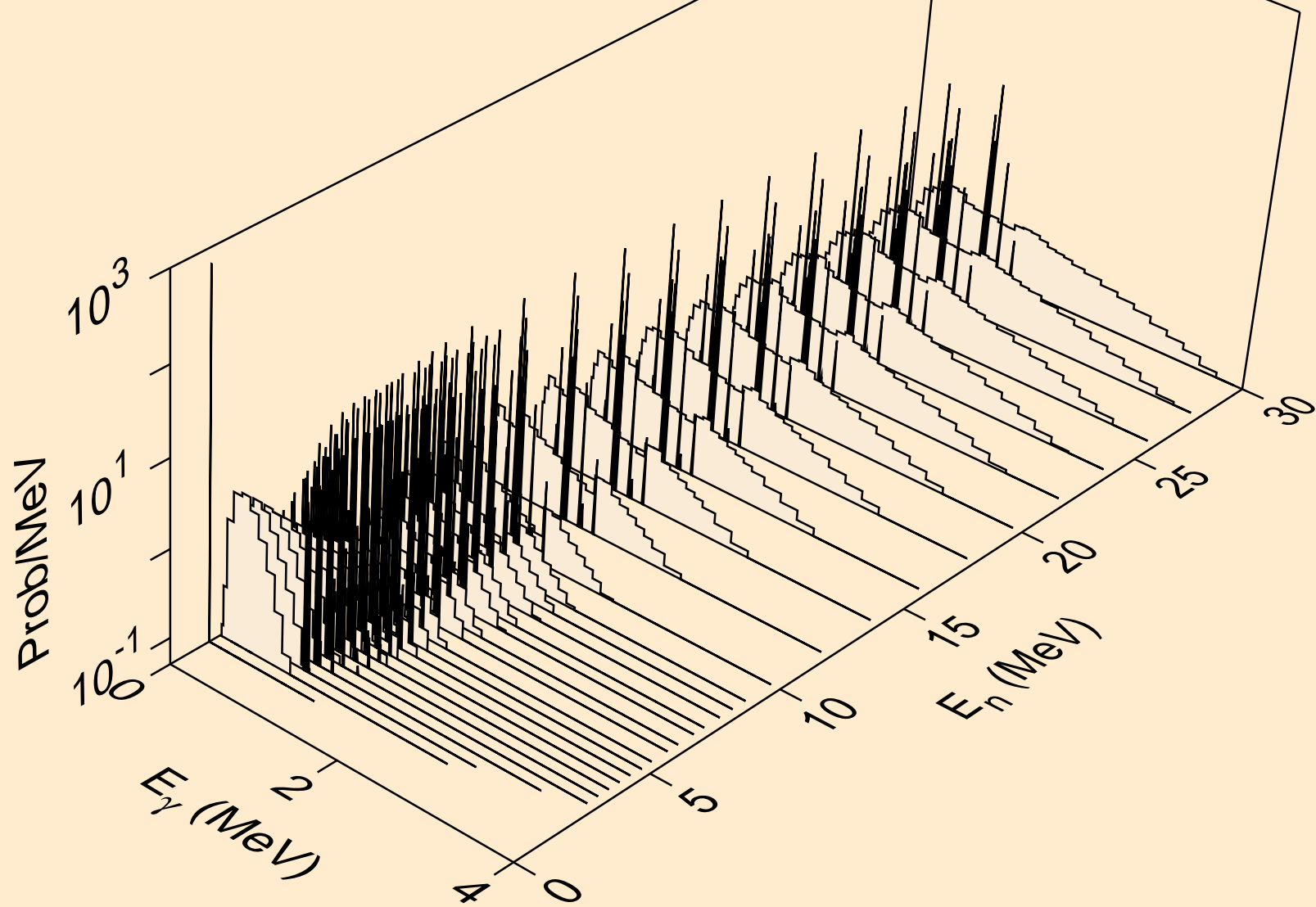

AT204 NEUTRON ACER TENDL-2024 LIBRARY; T=0.K
Photon emission for (n,p α)

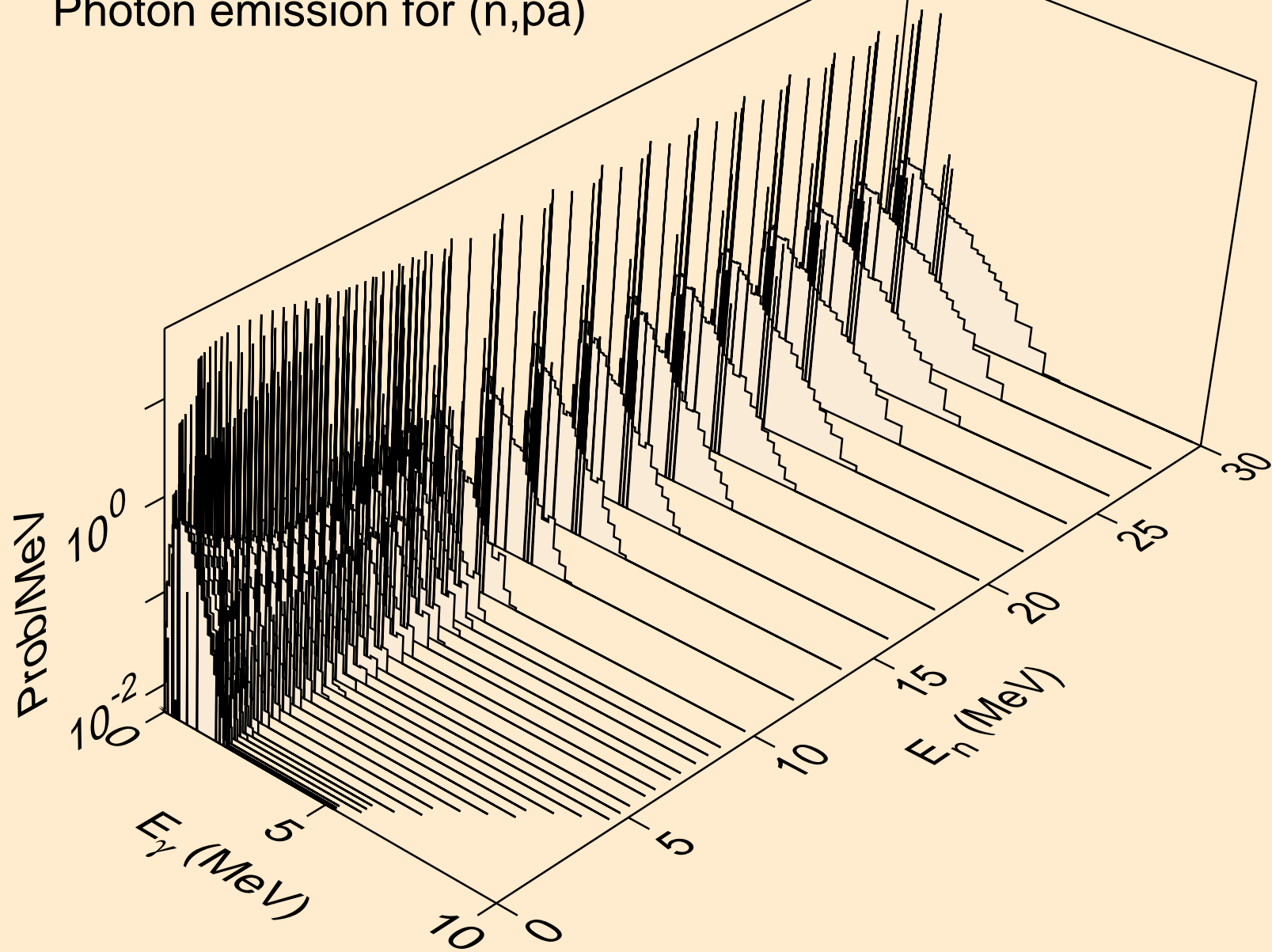

AT204 NEUTRON ACER TENDL-2024 LIBRARY; T=0.K
Photon emission for (n,pd)

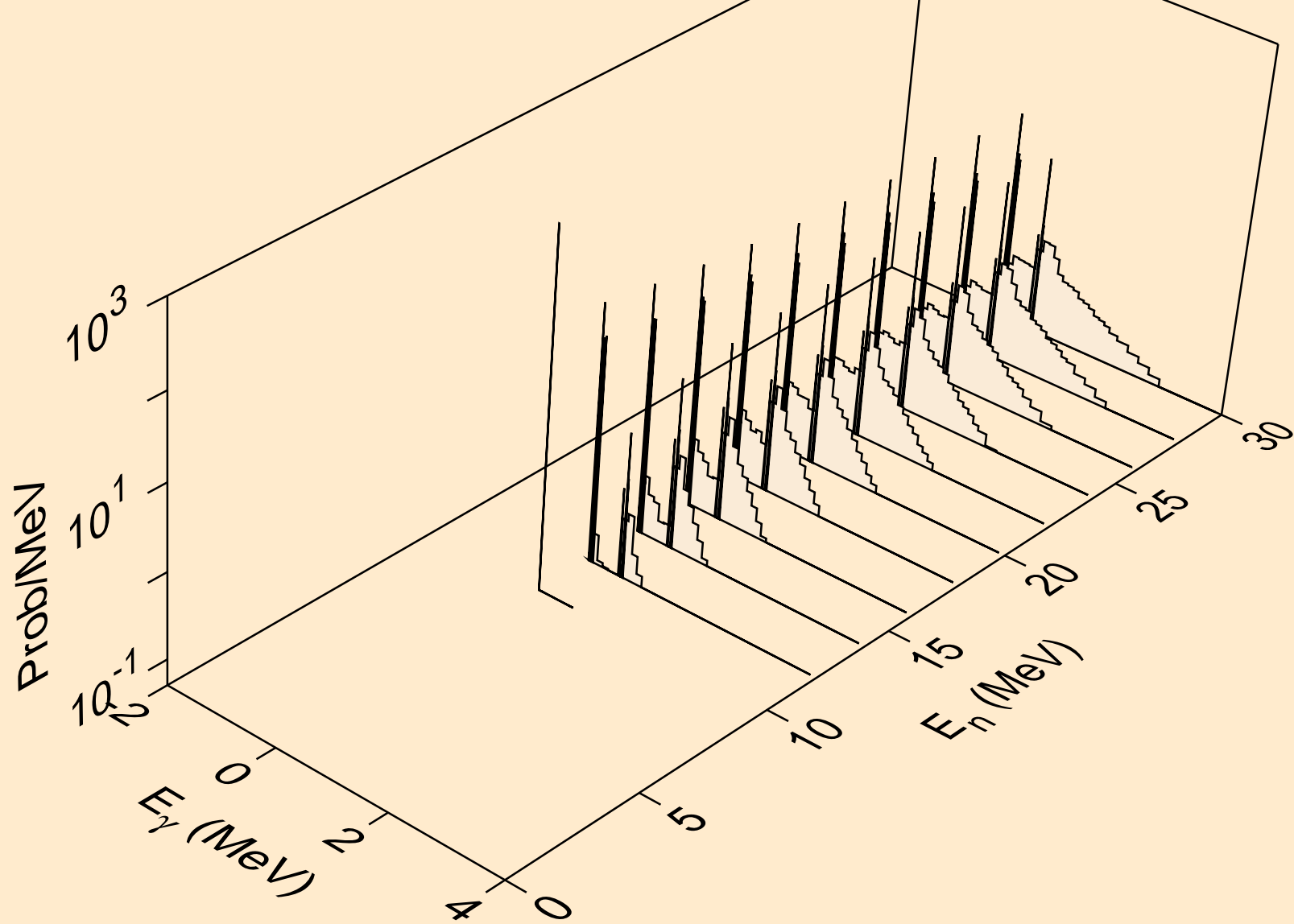

AT204 NEUTRON ACER TENDL-2024 LIBRARY; T=0.K
Photon emission for (n,pt)

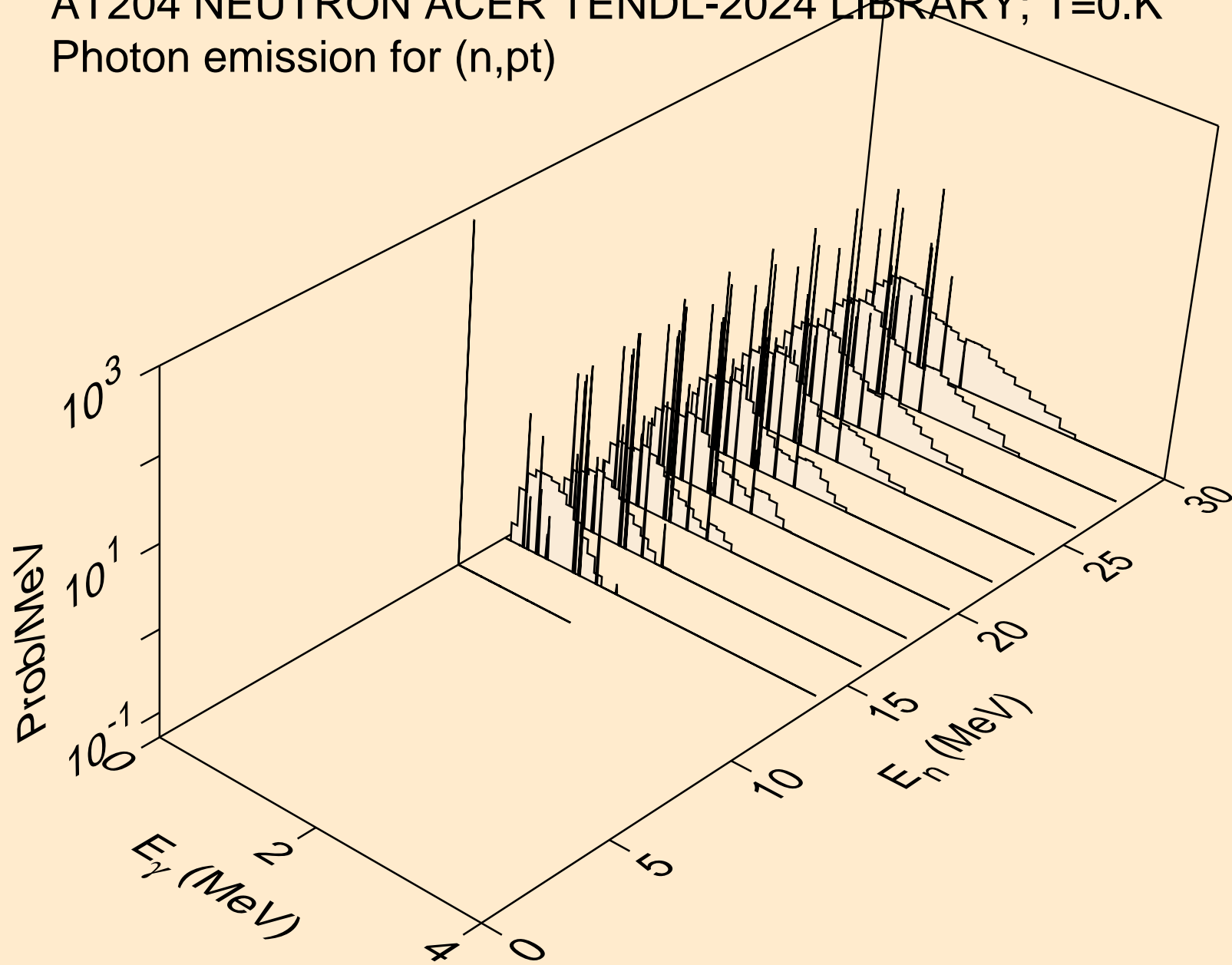

AT204 NEUTRON ACER TENDL-2024 LIBRARY; T=0.K
Photon emission for (n,da)

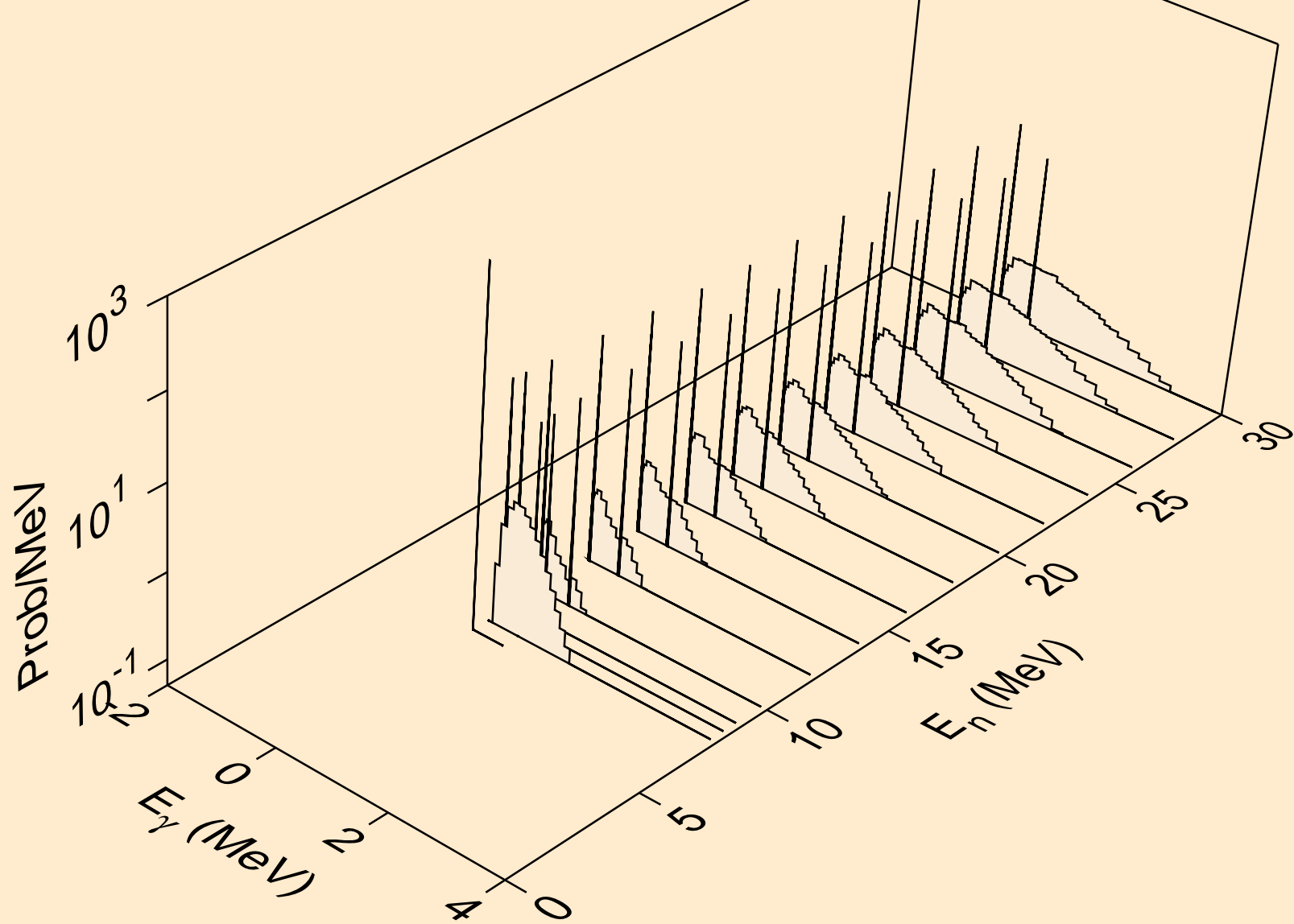

AT204 NEUTRON ACER TENDL-2024 LIBRARY; T=0.K
thermal capture photon spectrum

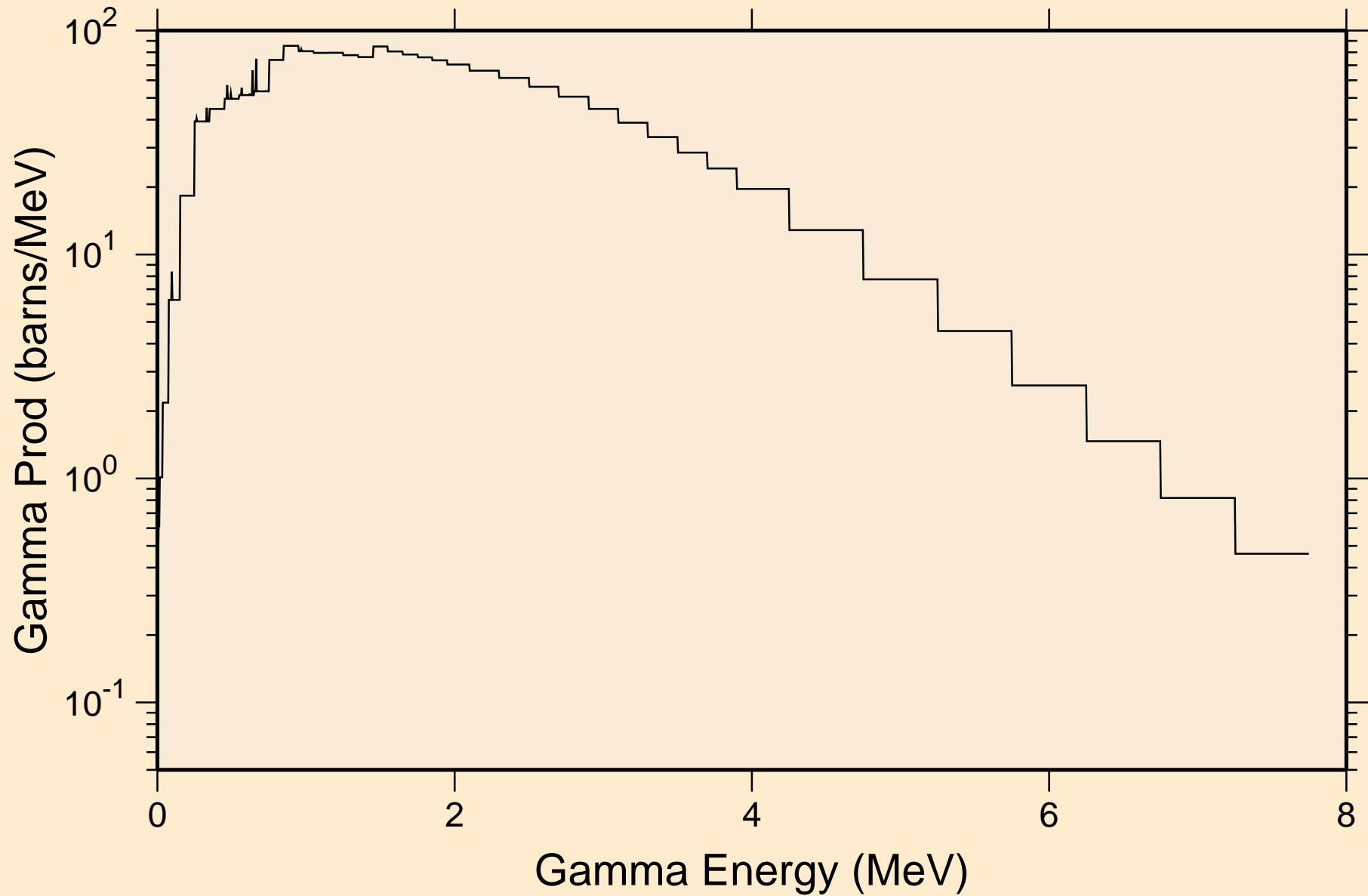

AT204 NEUTRON ACER TENDL-2024 LIBRARY; T=0.K
14 MeV photon spectrum

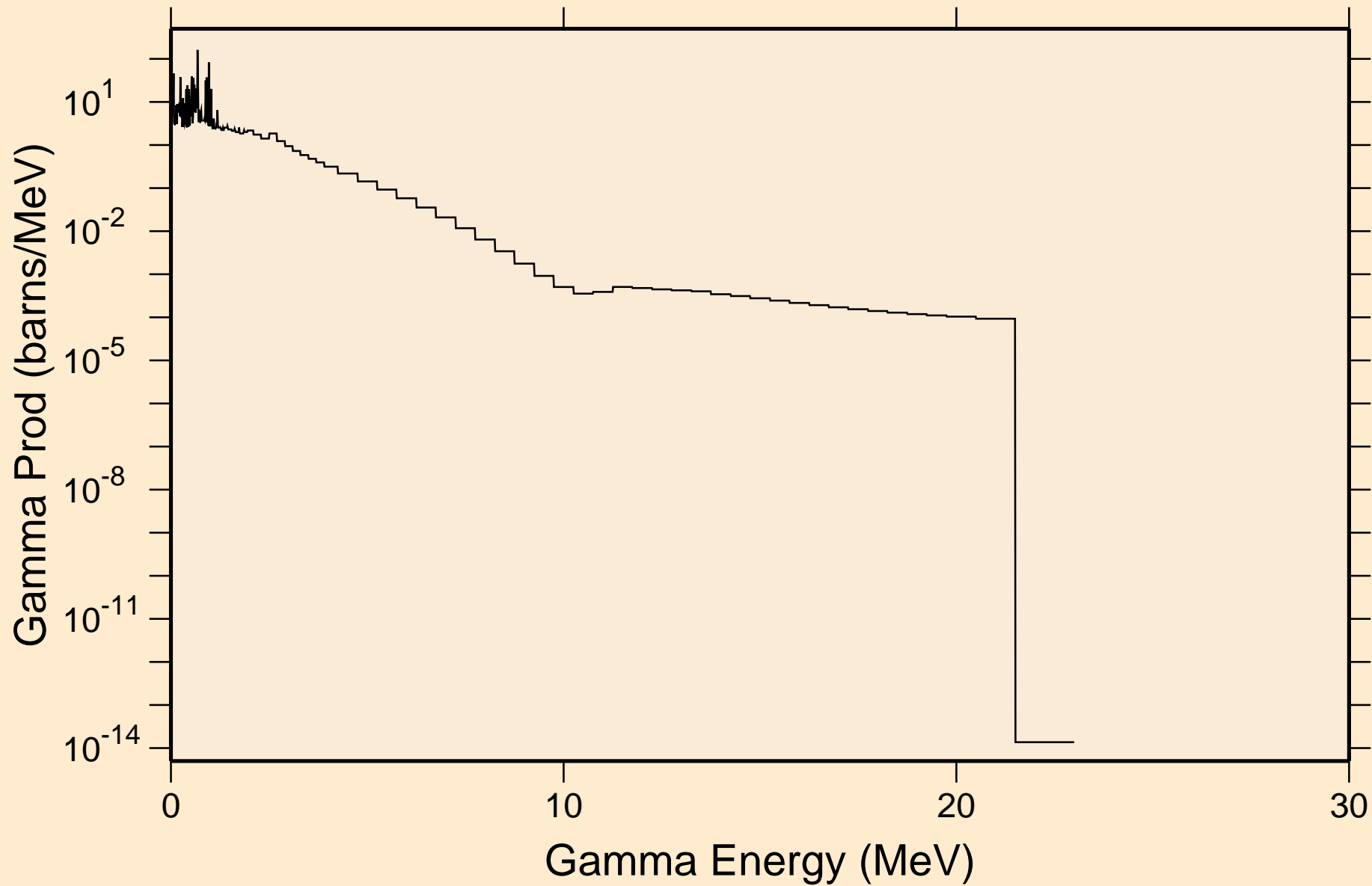

AT204 NEUTRON ACER TENDL-2024 LIBRARY; T=0.K
Particle heating contributions

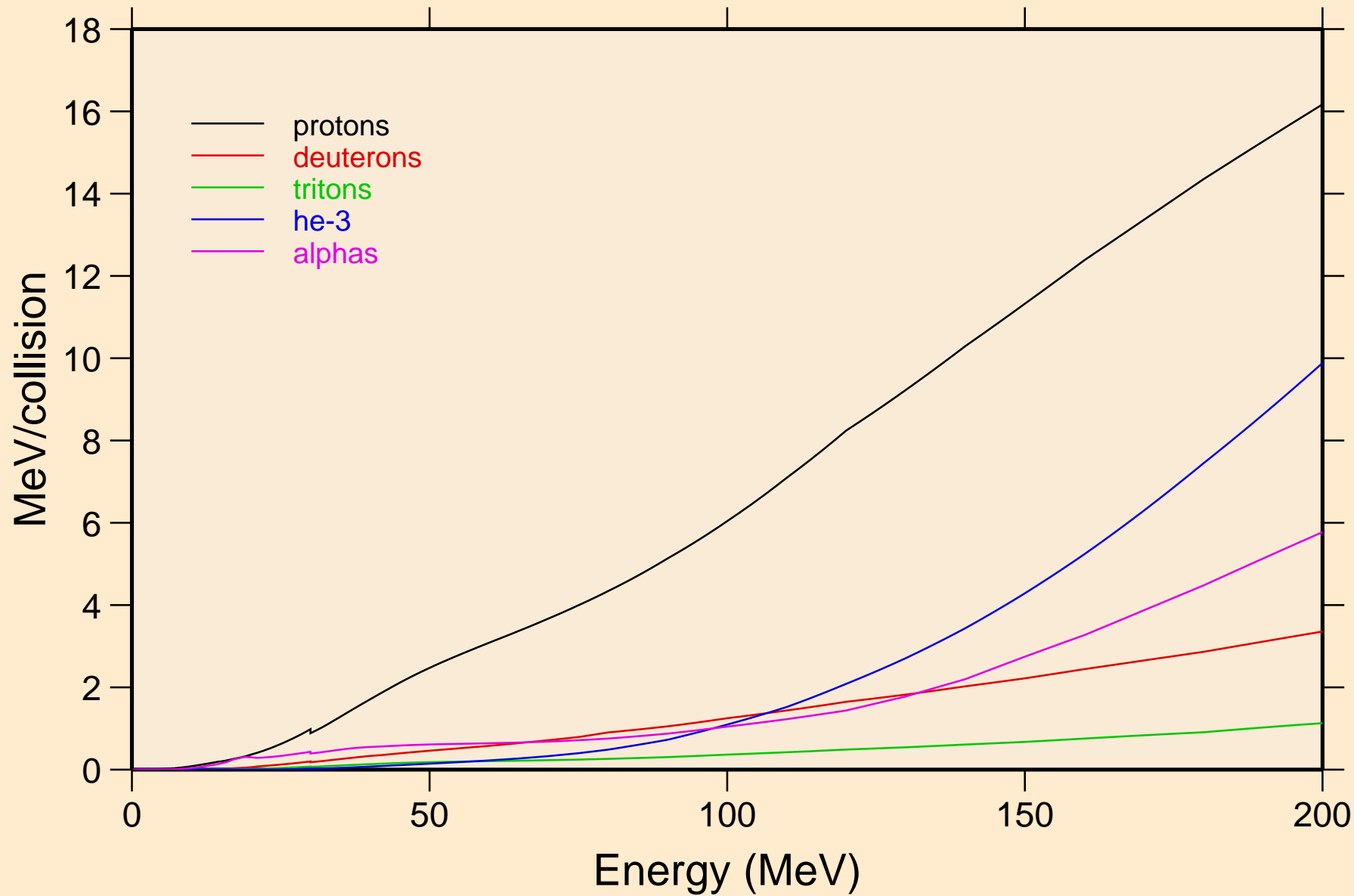

AT204 NEUTRON ACER TENDL-2024 LIBRARY; T=0.K
Recoil Heating

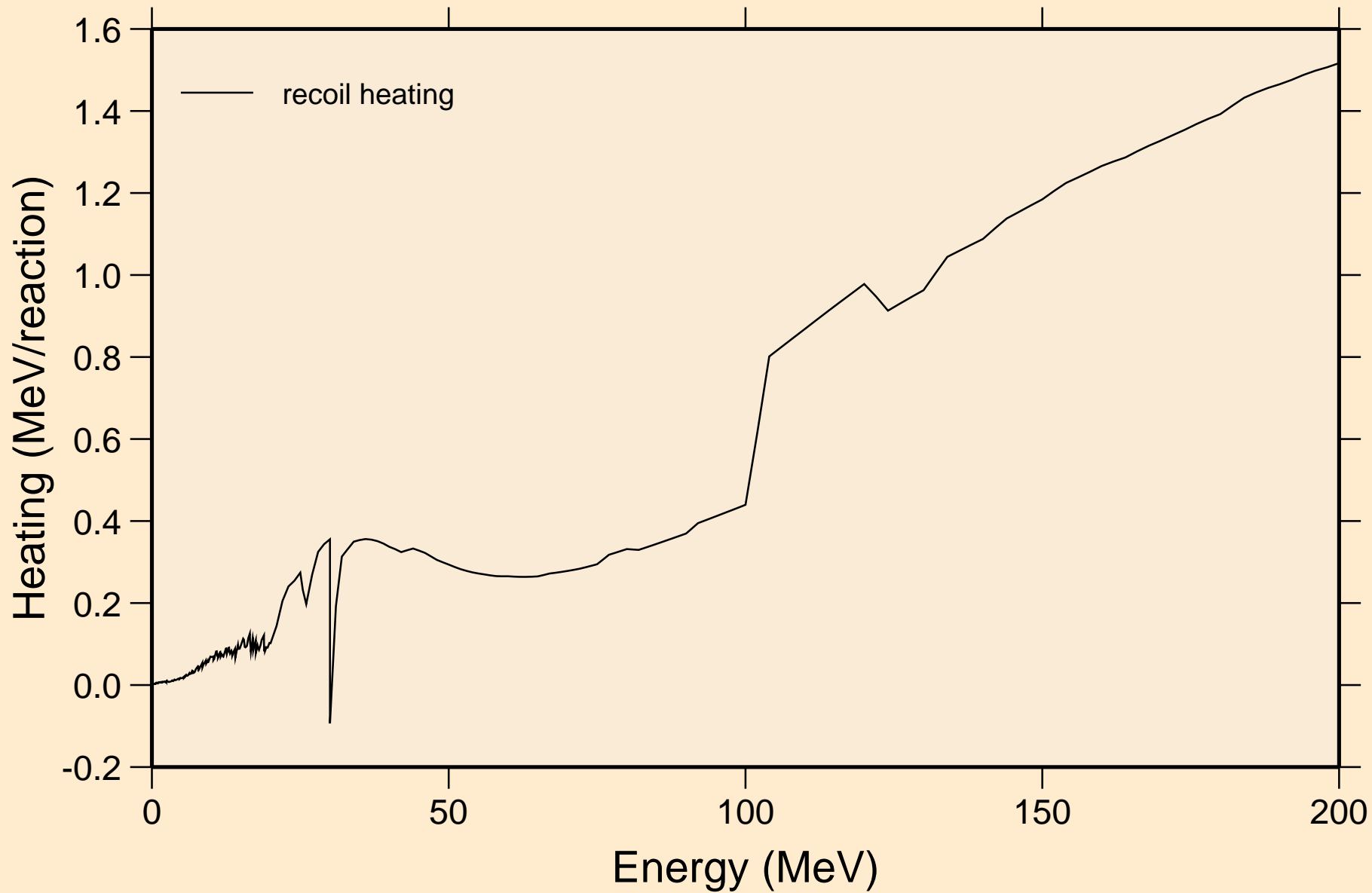

AT204 NEUTRON ACER TENDL-2024 LIBRARY; T=0.K
Particle production cross sections

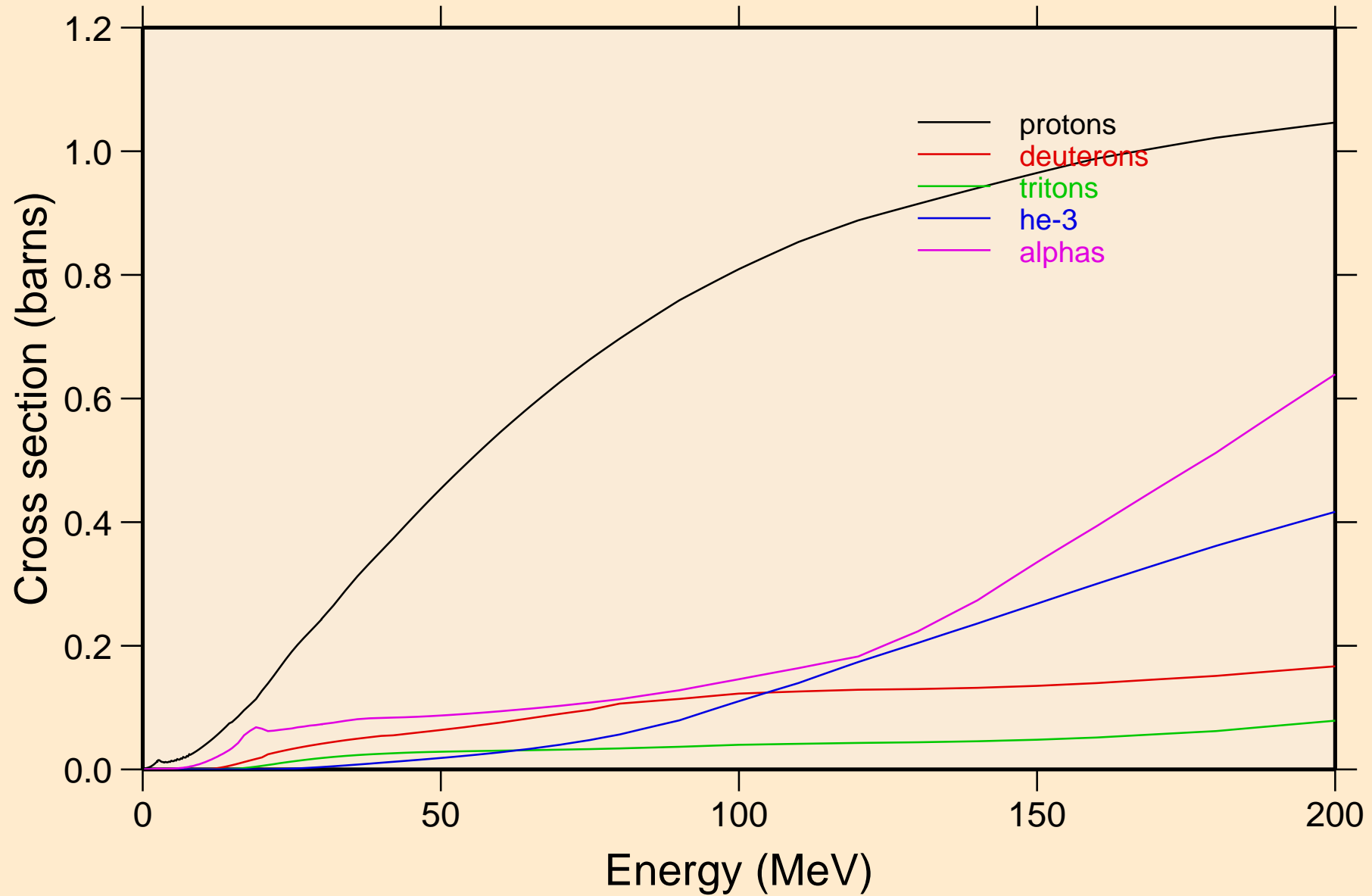

AT204 NEUTRON ACER TENDL-2024 LIBRARY; T=0.K
protons from (n,x)

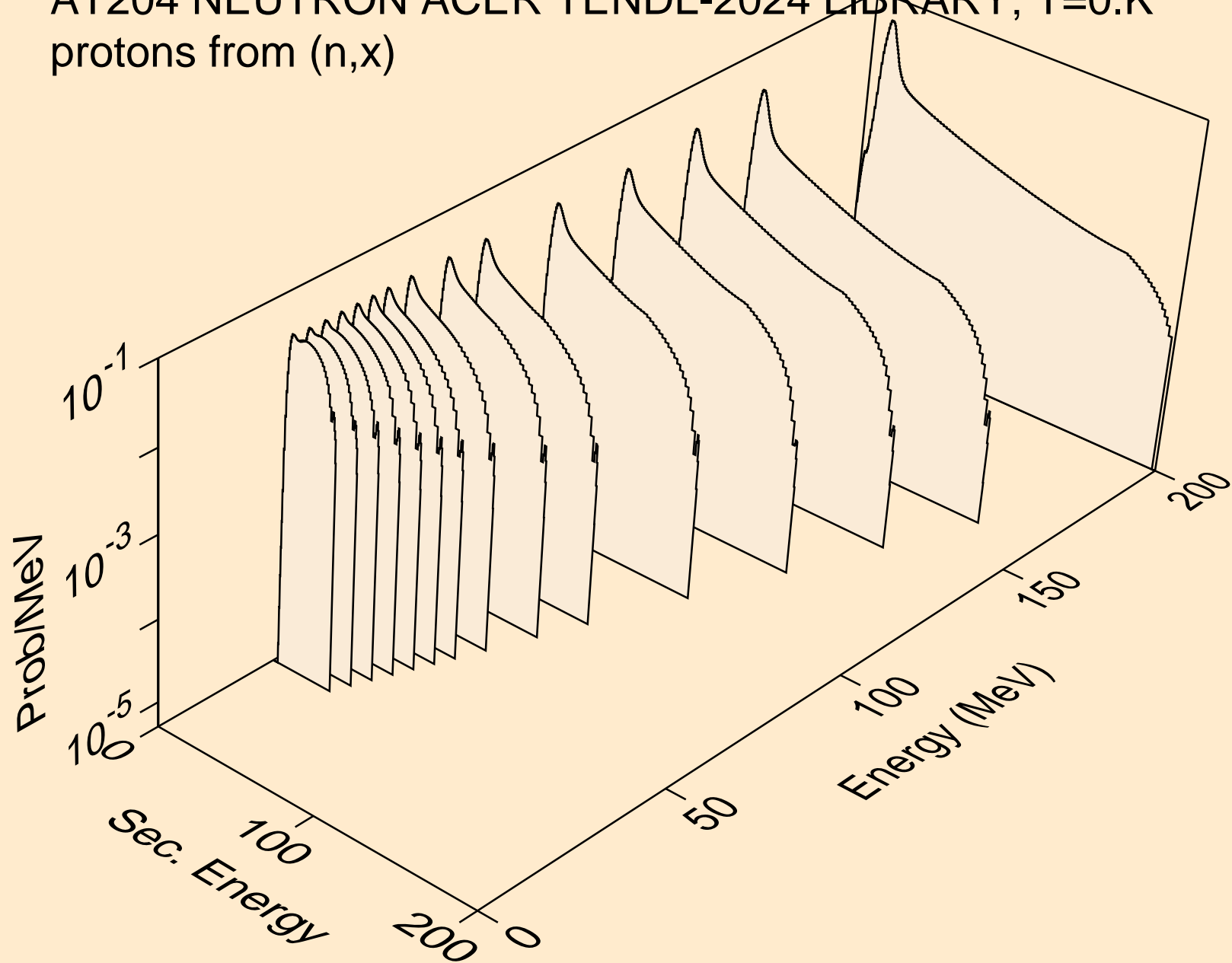

AT204 NEUTRON ACER TENDL-2024 LIBRARY; T=0.K
protons from (n,n*)p

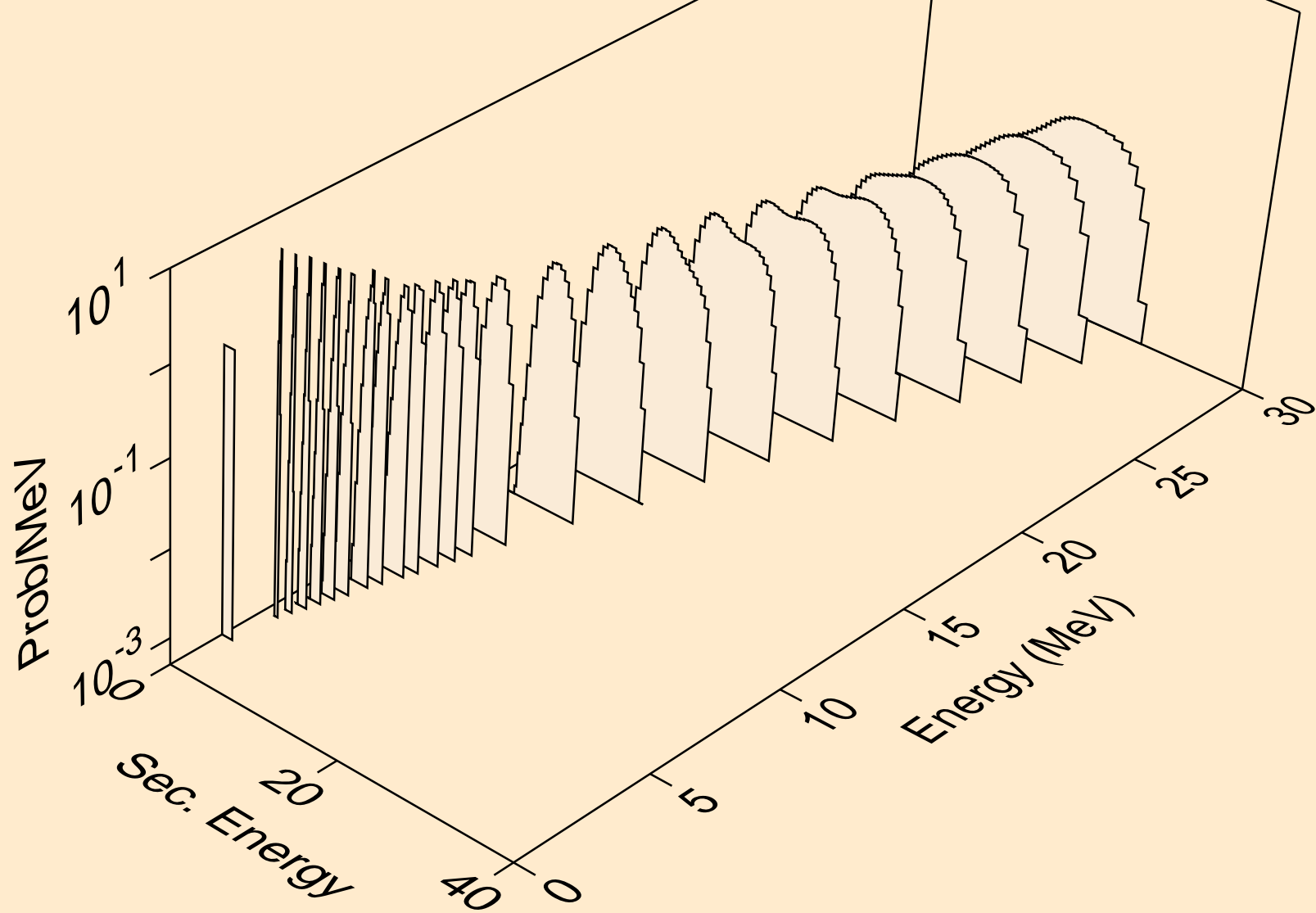

AT204 NEUTRON ACER TENDL-2024 LIBRARY; T=0.K
protons from (n,2np)

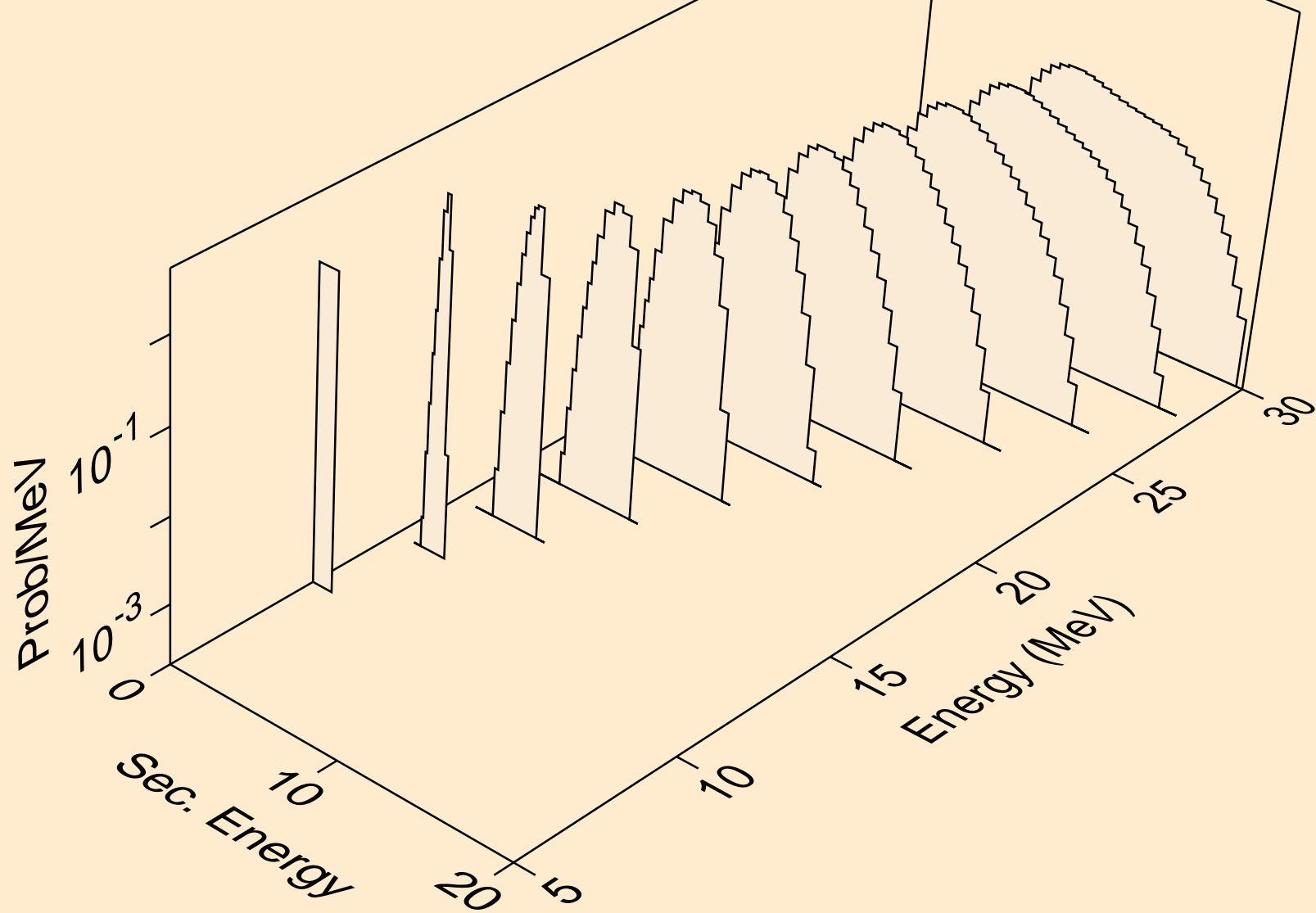

AT204 NEUTRON ACER TENDL-2024 LIBRARY; T=0.K
protons from (n,3np)

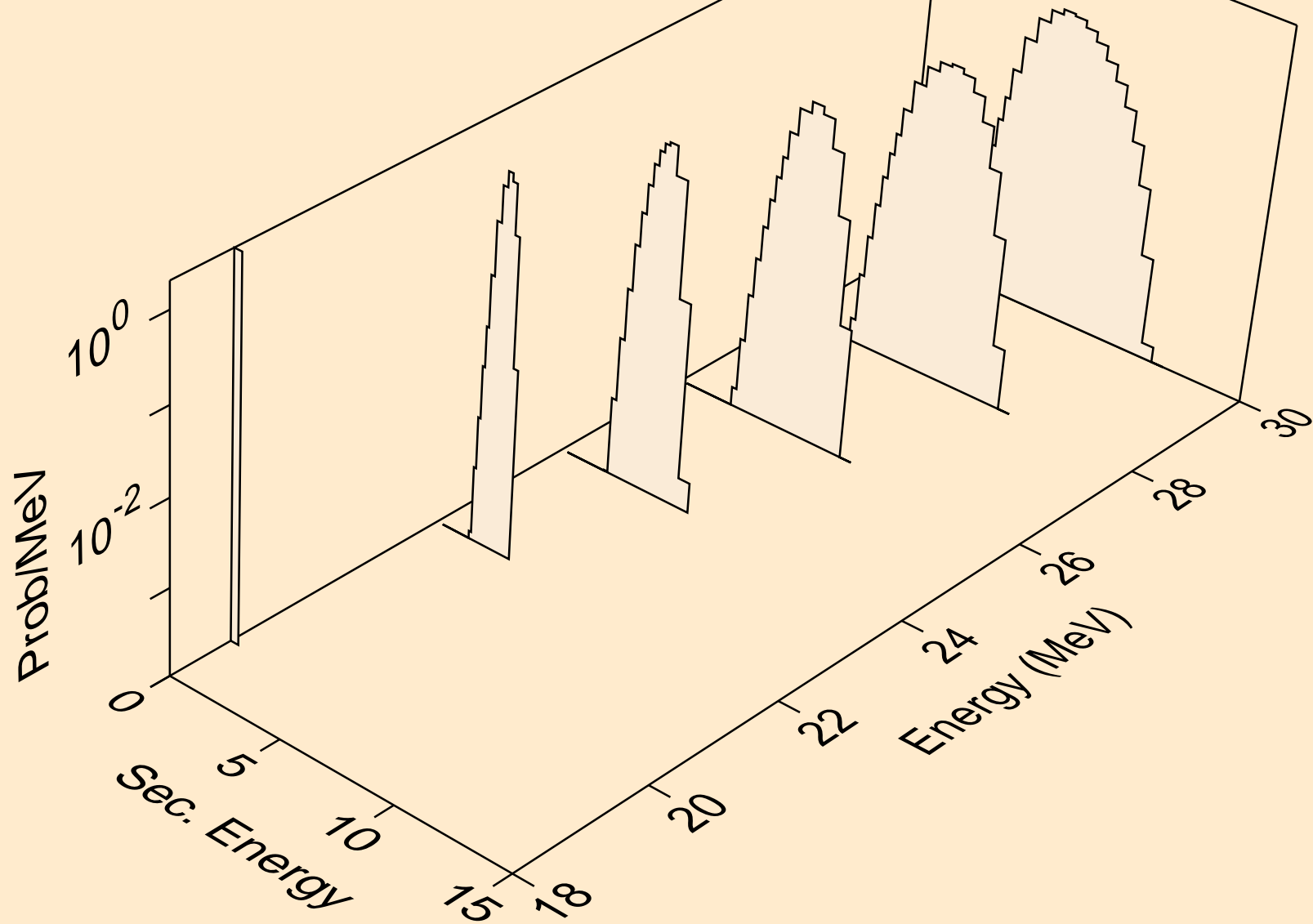

AT204 NEUTRON ACER TENDL-2024 LIBRARY; T=0.K
protons from (n,n2p)

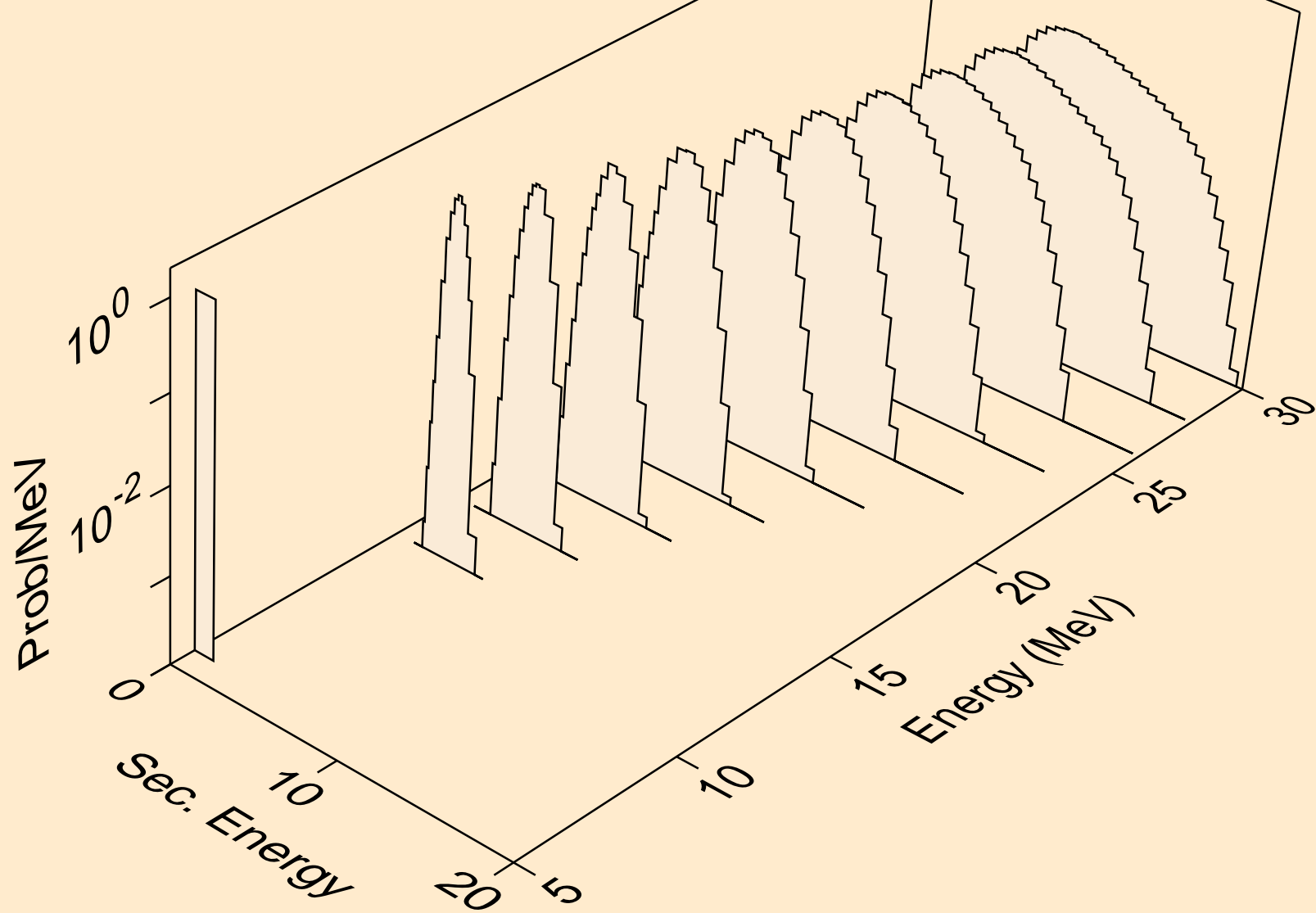

AT204 NEUTRON ACER TENDL-2024 LIBRARY; T=0.K
protons from (n,npa)

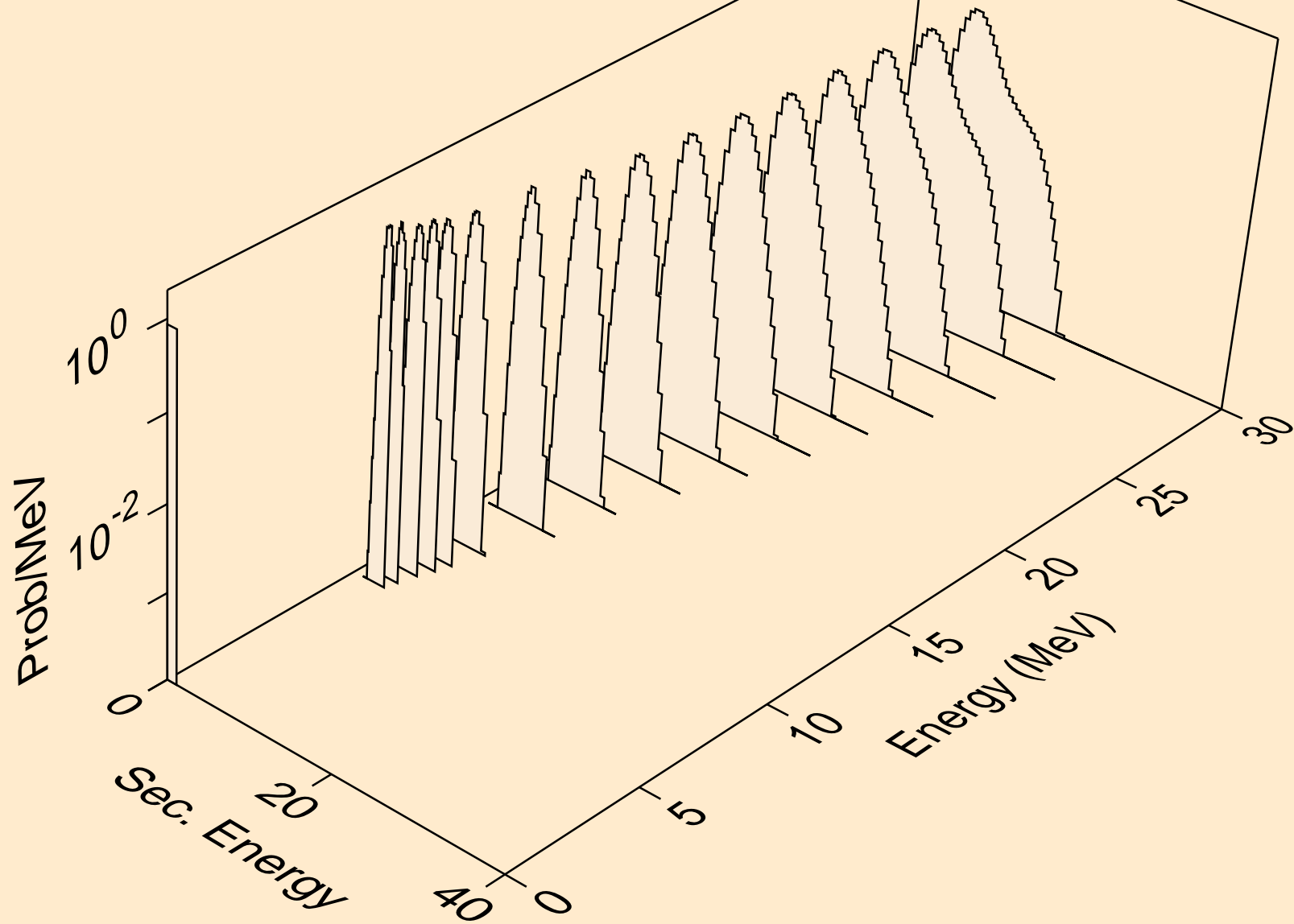

AT204 NEUTRON ACER TENDL-2024 LIBRARY; T=0.K
protons from (n,p)

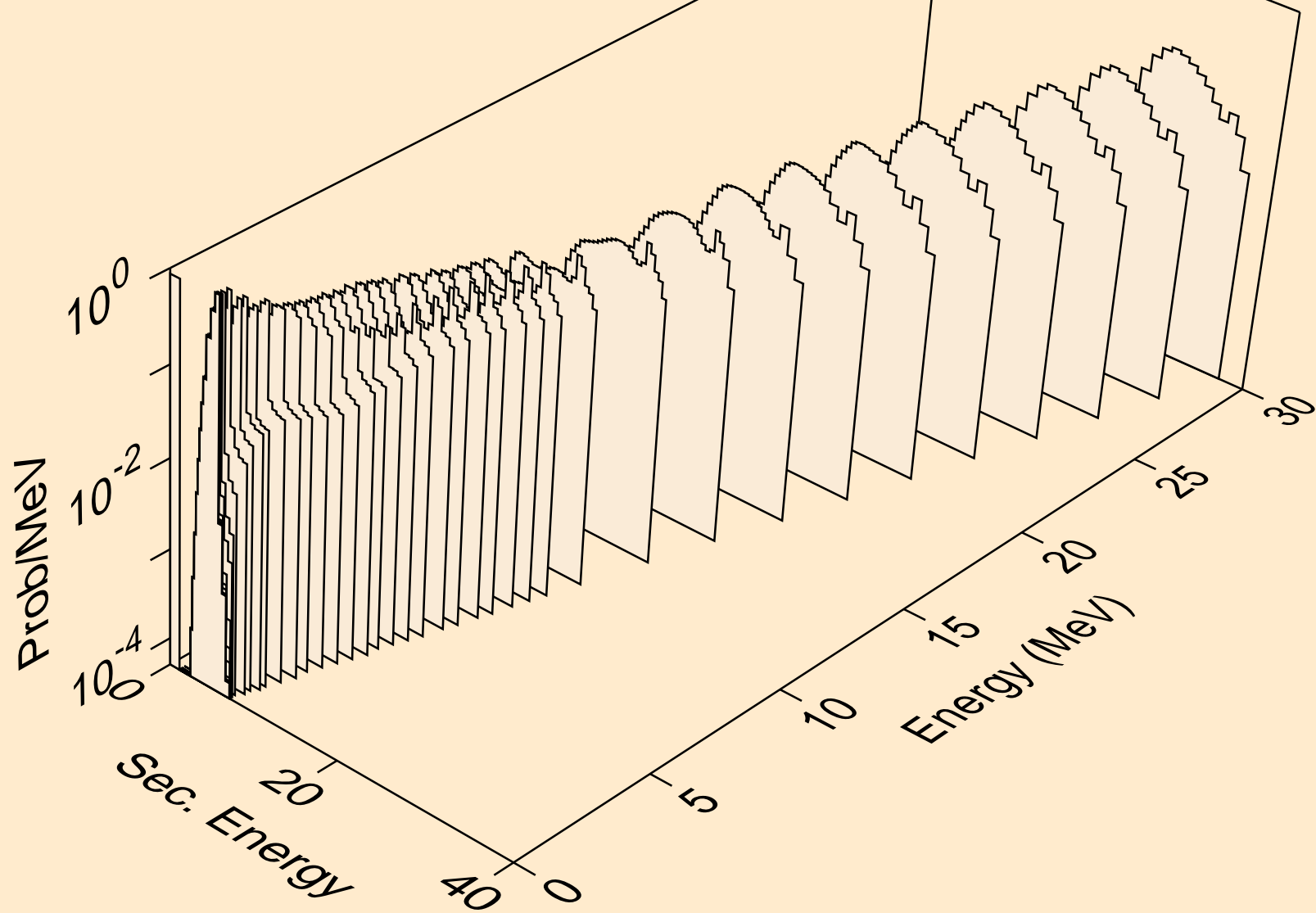

AT204 NEUTRON ACER TENDL-2024 LIBRARY; T=0.K
protons from (n,2p)

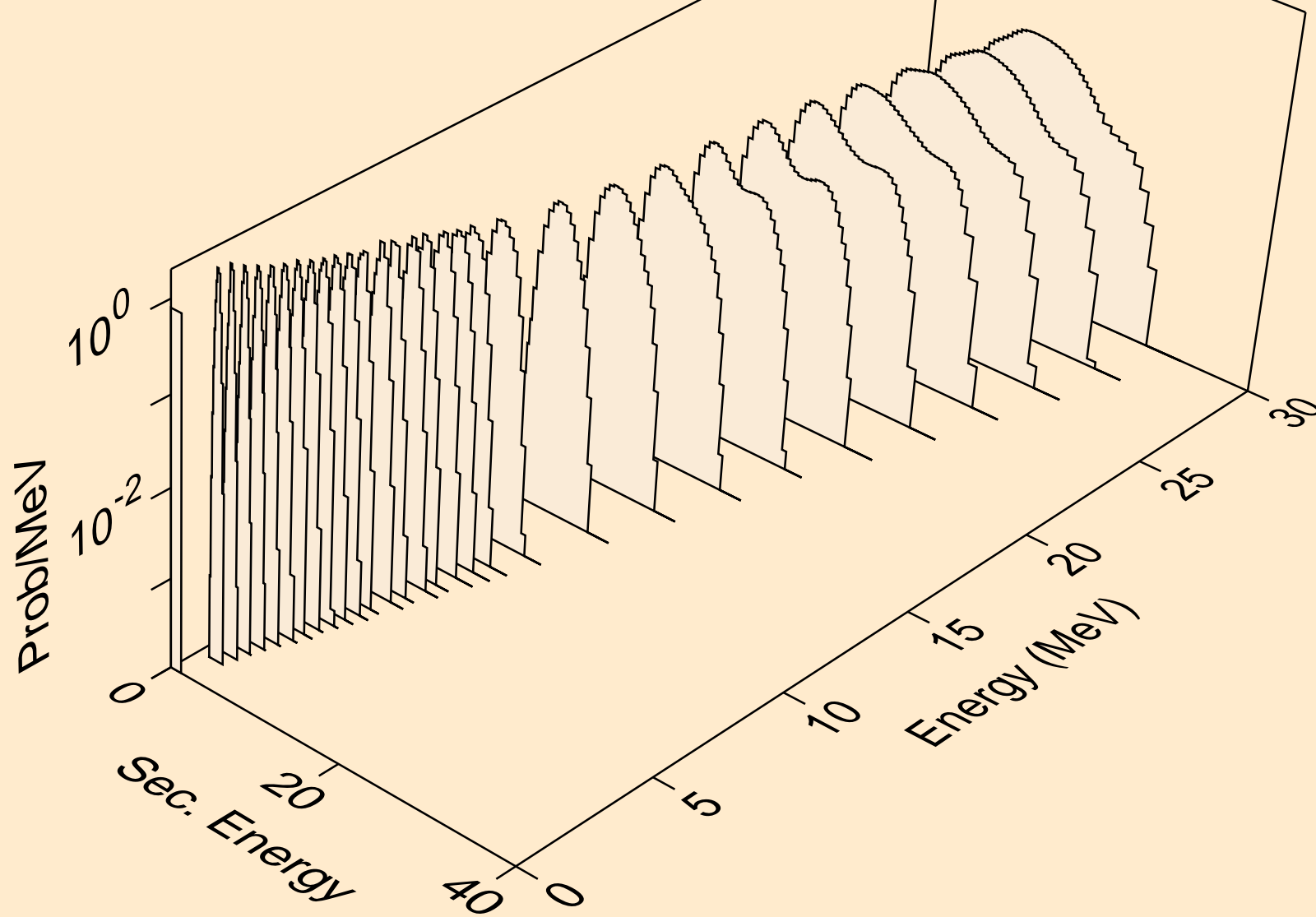

AT204 NEUTRON ACER TENDL-2024 LIBRARY; T=0.K
protons from (n,p)

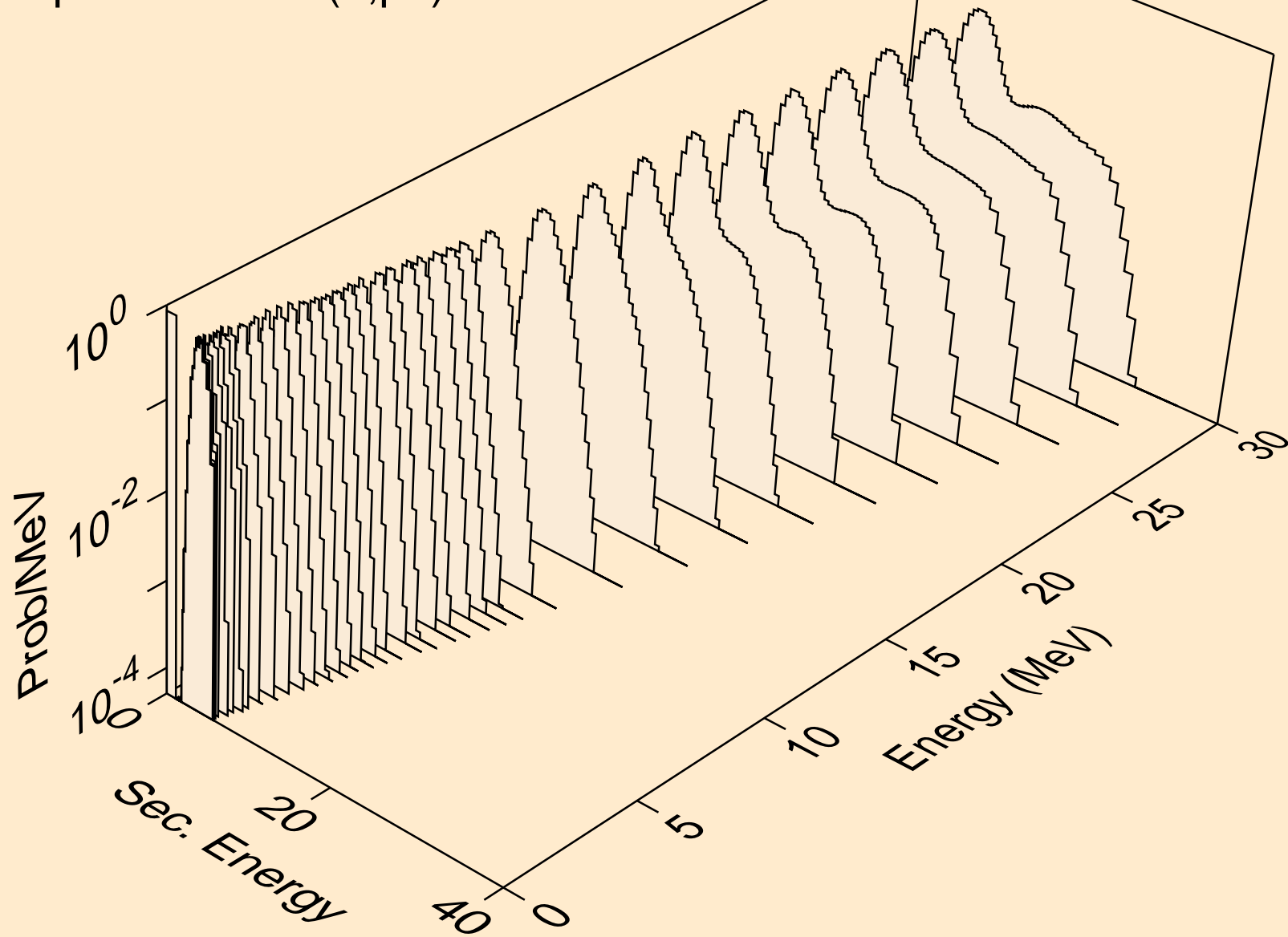

AT204 NEUTRON ACER TENDL-2024 LIBRARY; T=0.K
protons from (n,pd)

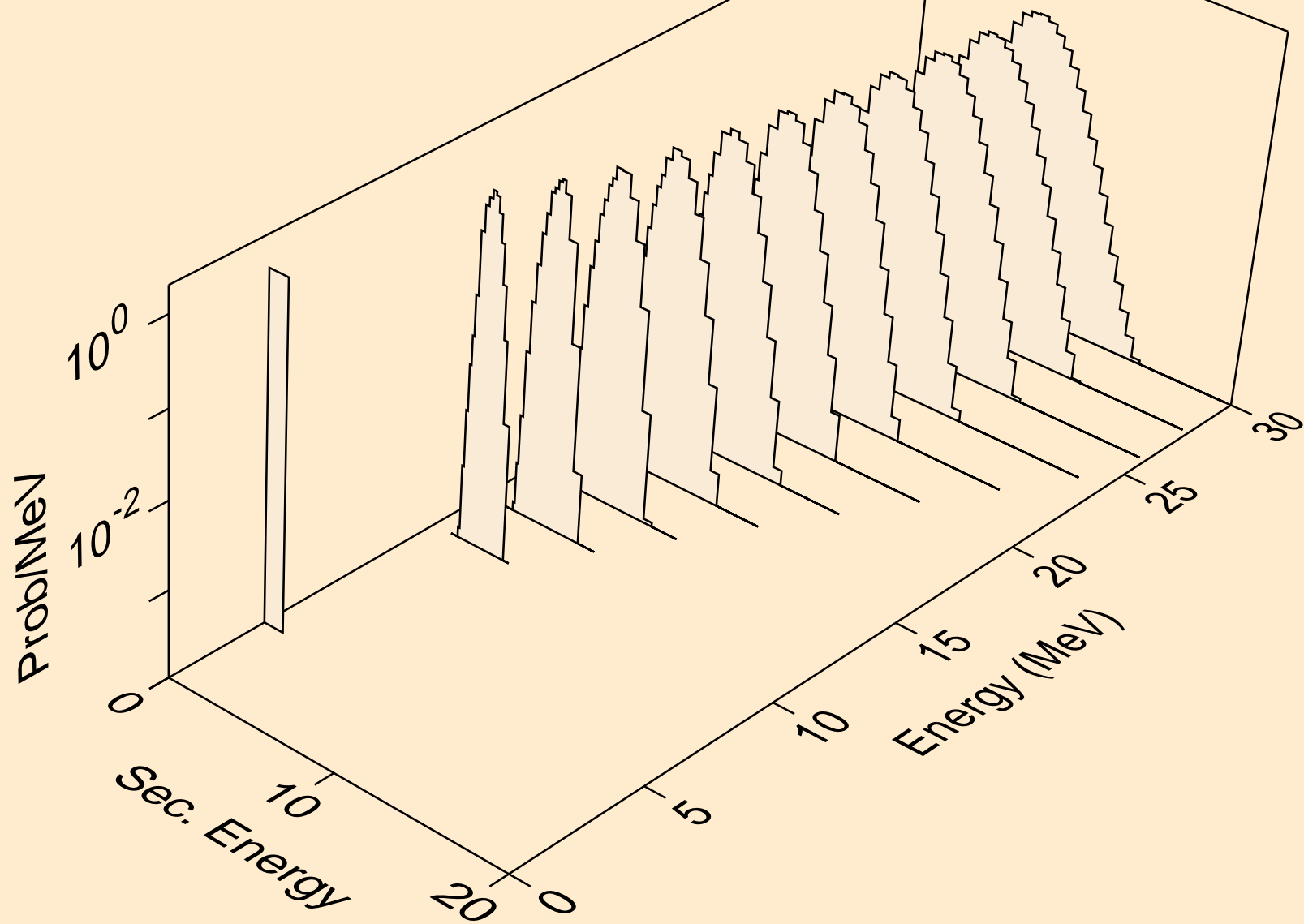

AT204 NEUTRON ACER TENDL-2024 LIBRARY; T=0.K
protons from (n,pt)

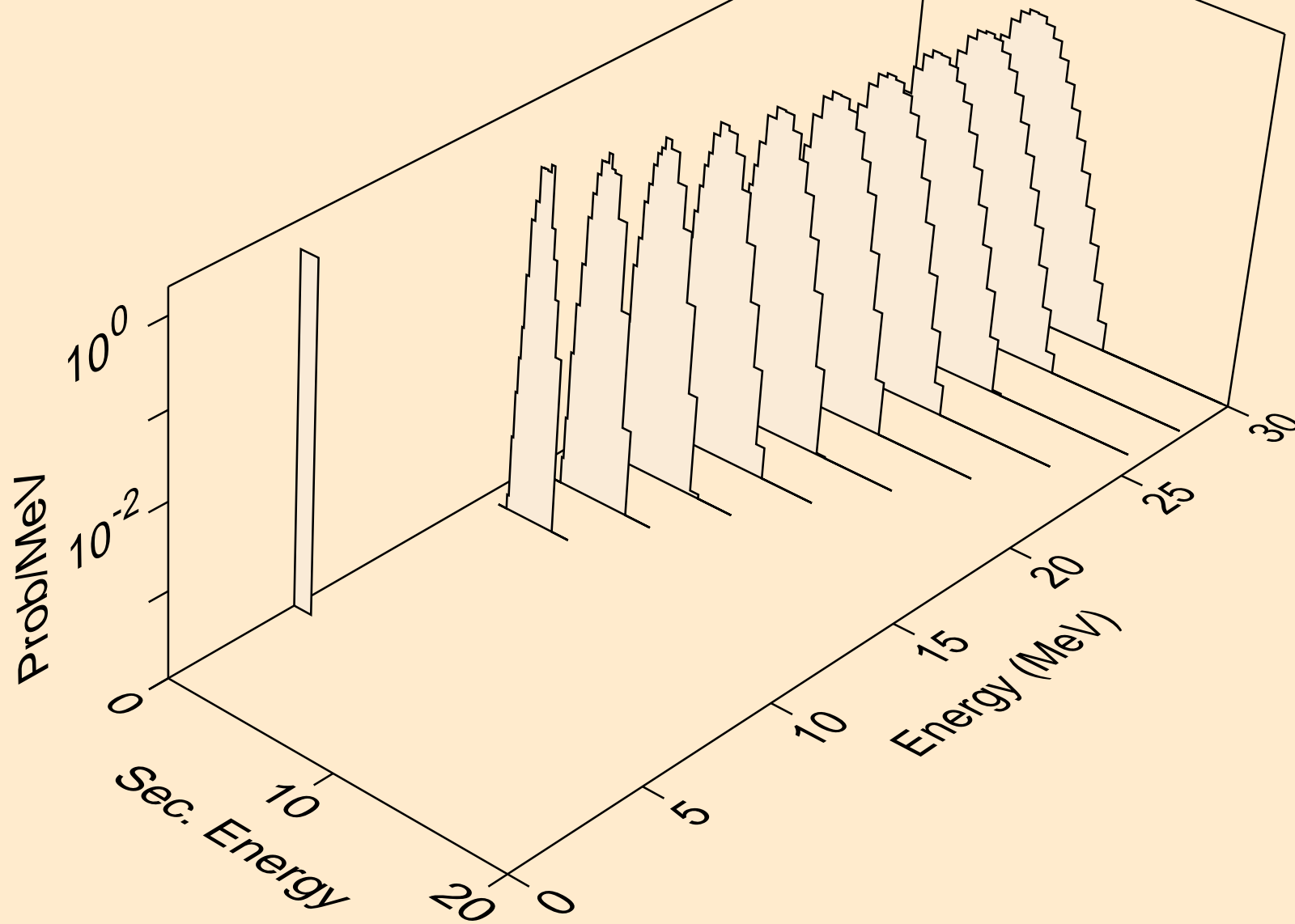

AT204 NEUTRON ACER TENDL-2024 LIBRARY; T=0.K
deuterons from (n,x)

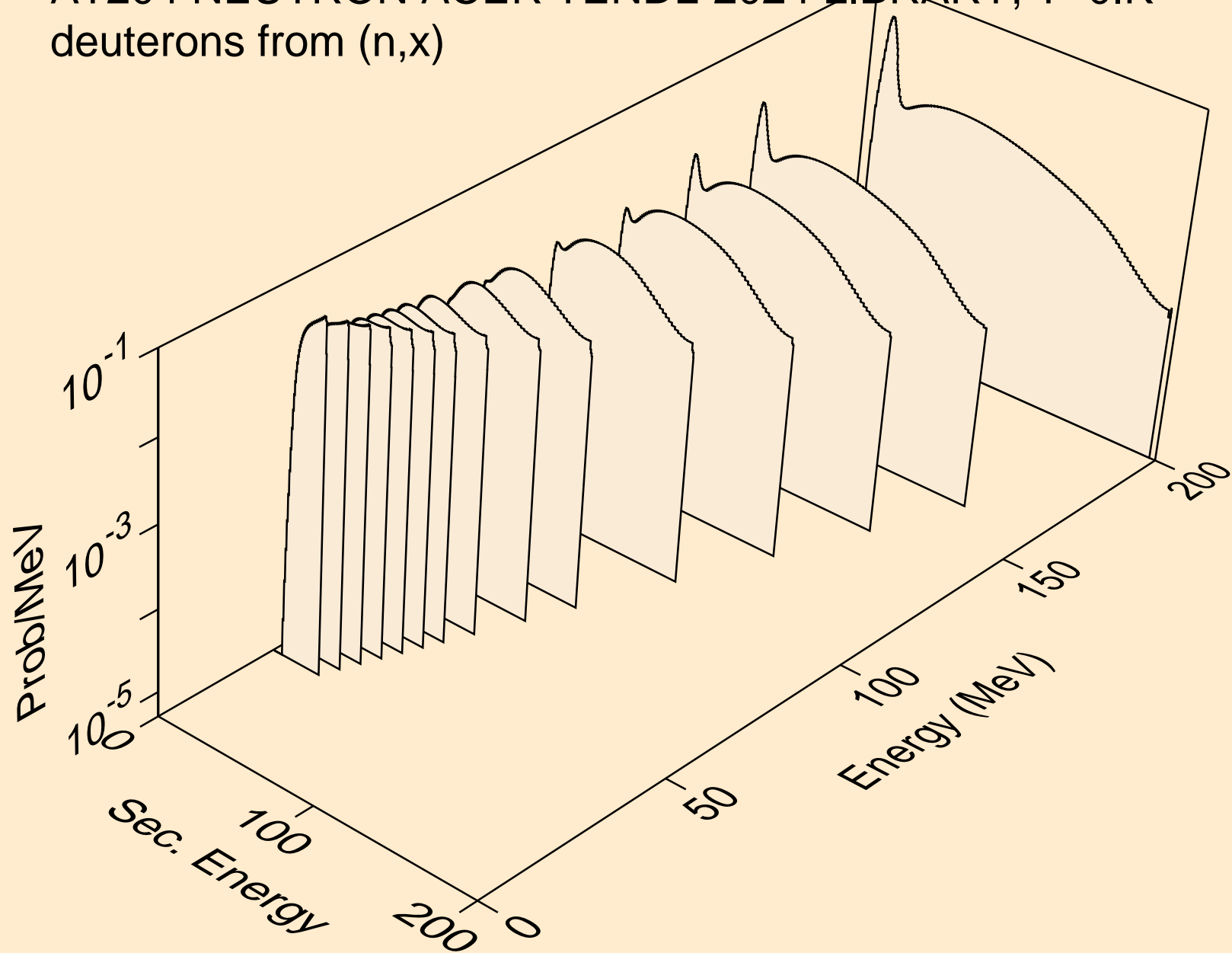

AT204 NEUTRON ACER TENDL-2024 LIBRARY; T=0.K
deuterons from (n,2nd)

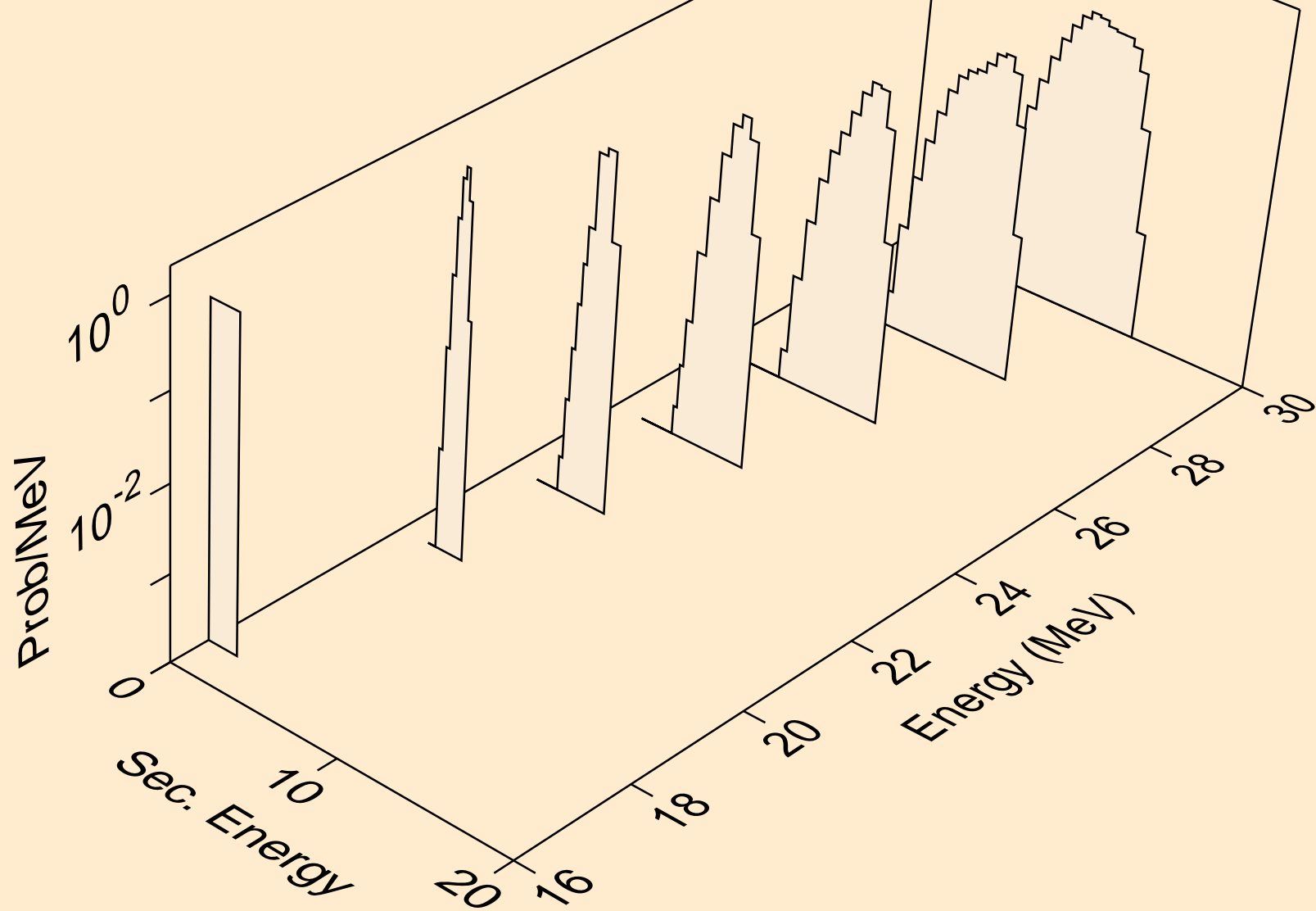

AT204 NEUTRON ACER TENDL-2024 LIBRARY; T=0.K
deuterons from (n,n*)d

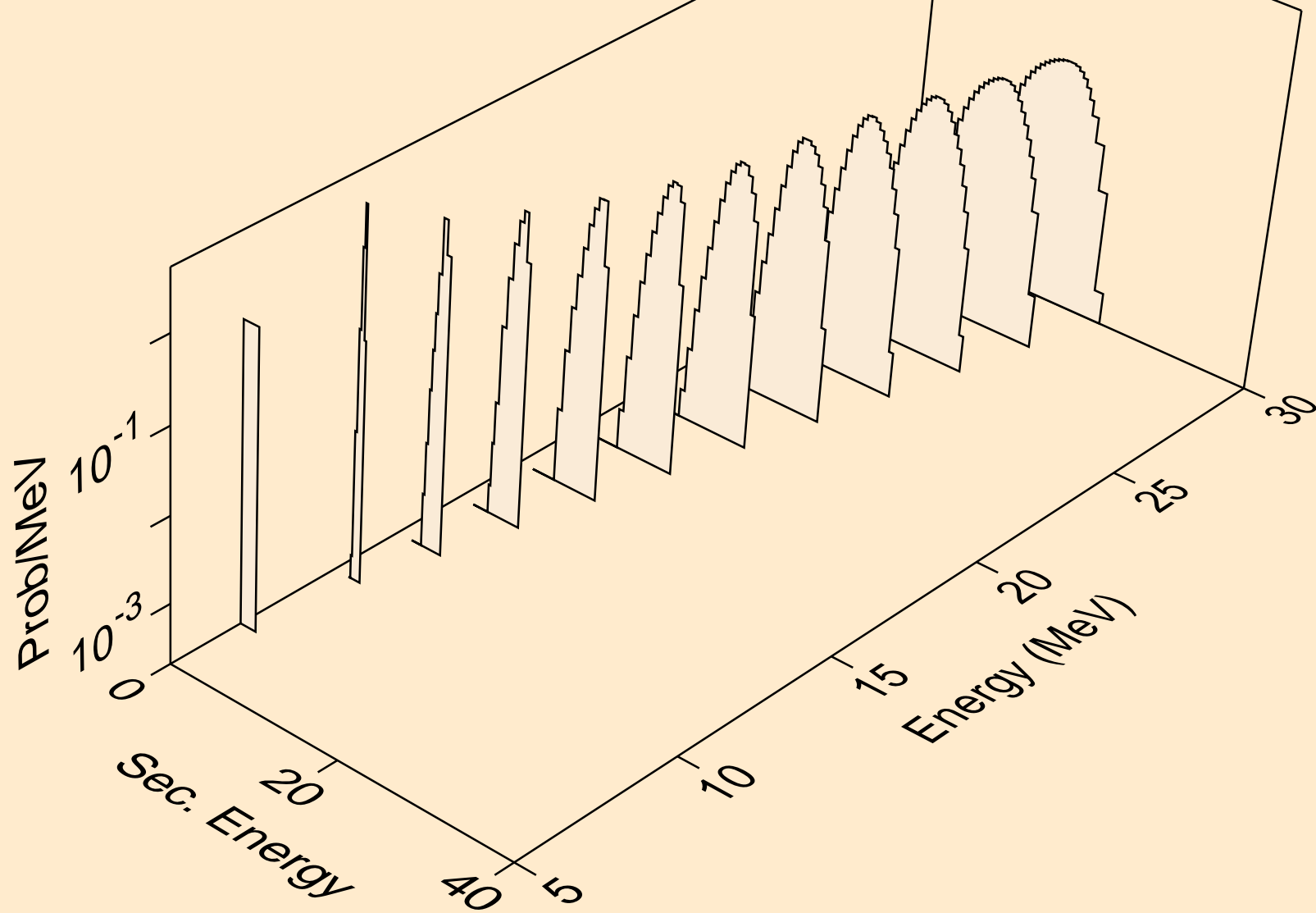

AT204 NEUTRON ACER TENDL-2024 LIBRARY; T=0.K
deuterons from (n,d)

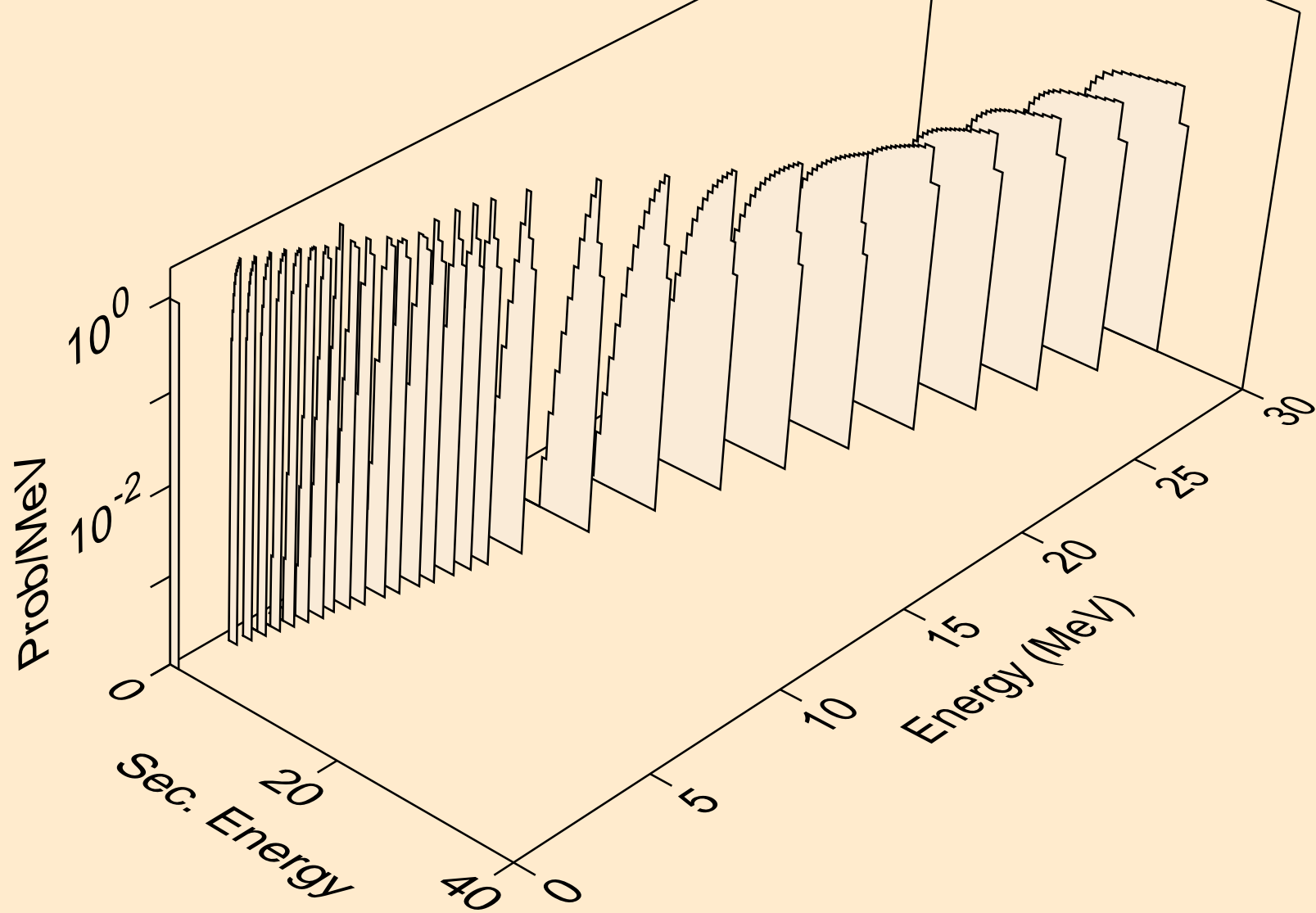

AT204 NEUTRON ACER TENDL-2024 LIBRARY; T=0.K
deuterons from (n,pd)

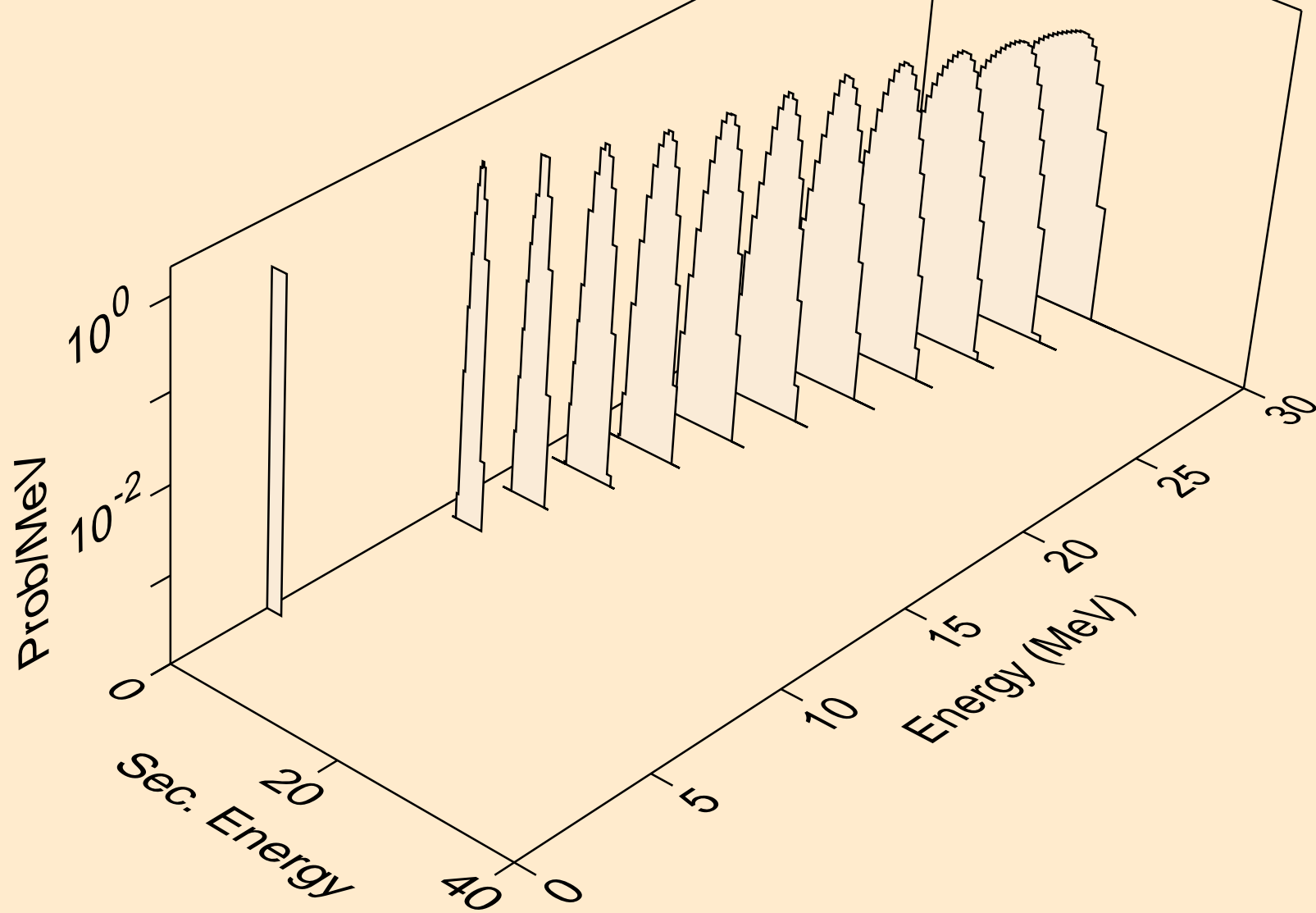

AT204 NEUTRON ACER TENDL-2024 LIBRARY; T=0.K
deuterons from (n,da)

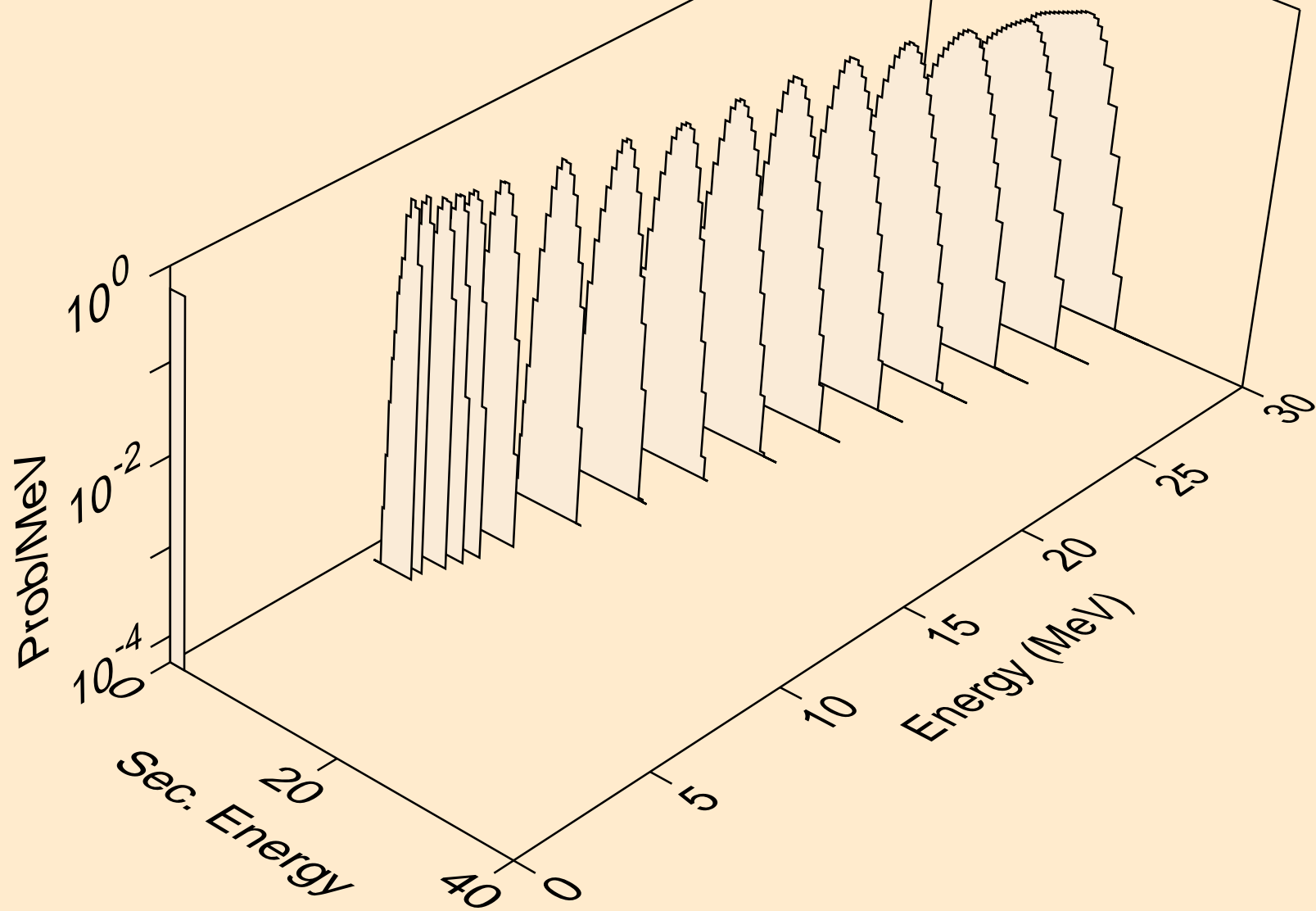

AT204 NEUTRON ACER TENDL-2024 LIBRARY; T=0.K
tritons from (n,x)

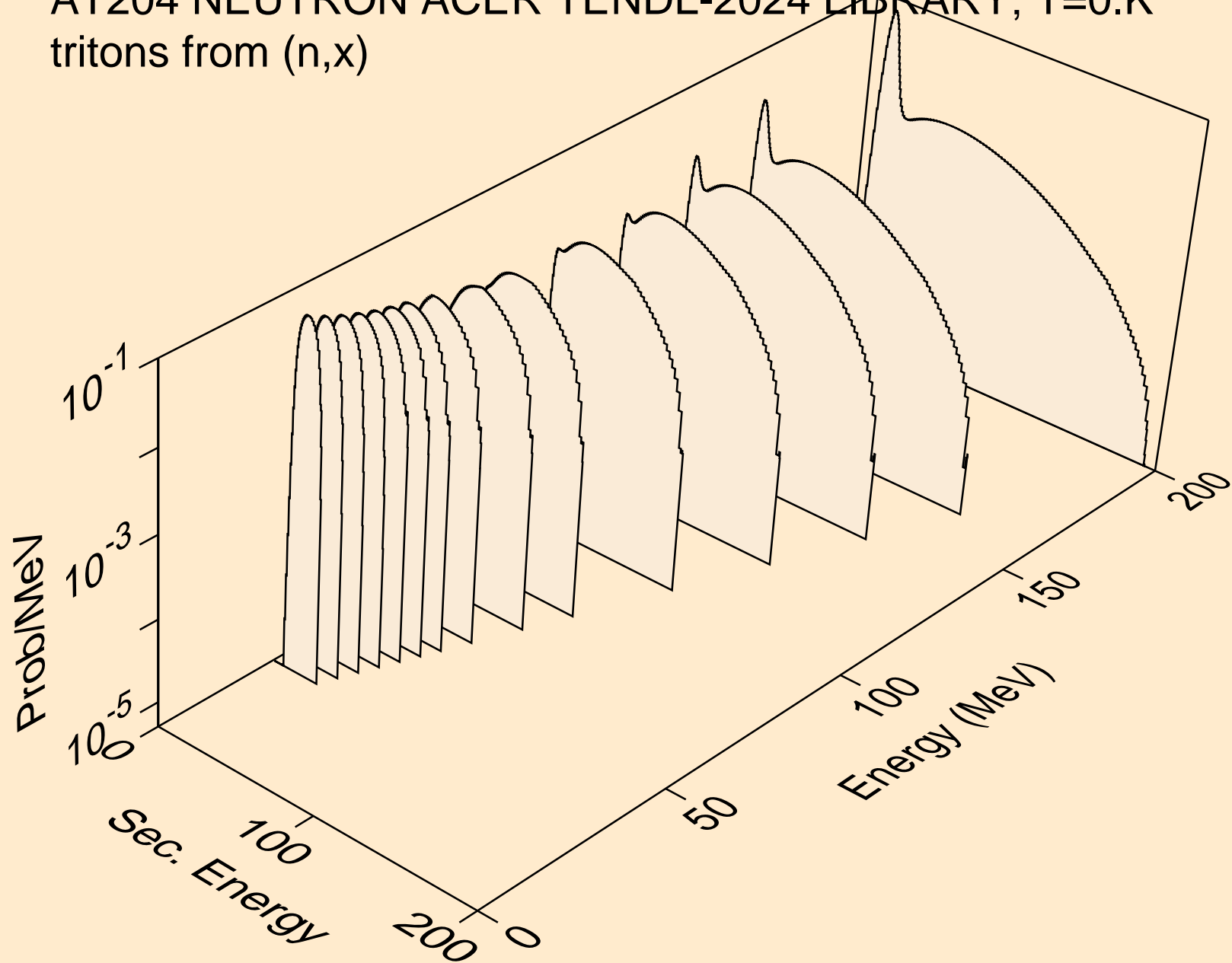

AT204 NEUTRON ACER TENDL-2024 LIBRARY; T=0.K
tritons from (n,n*)t

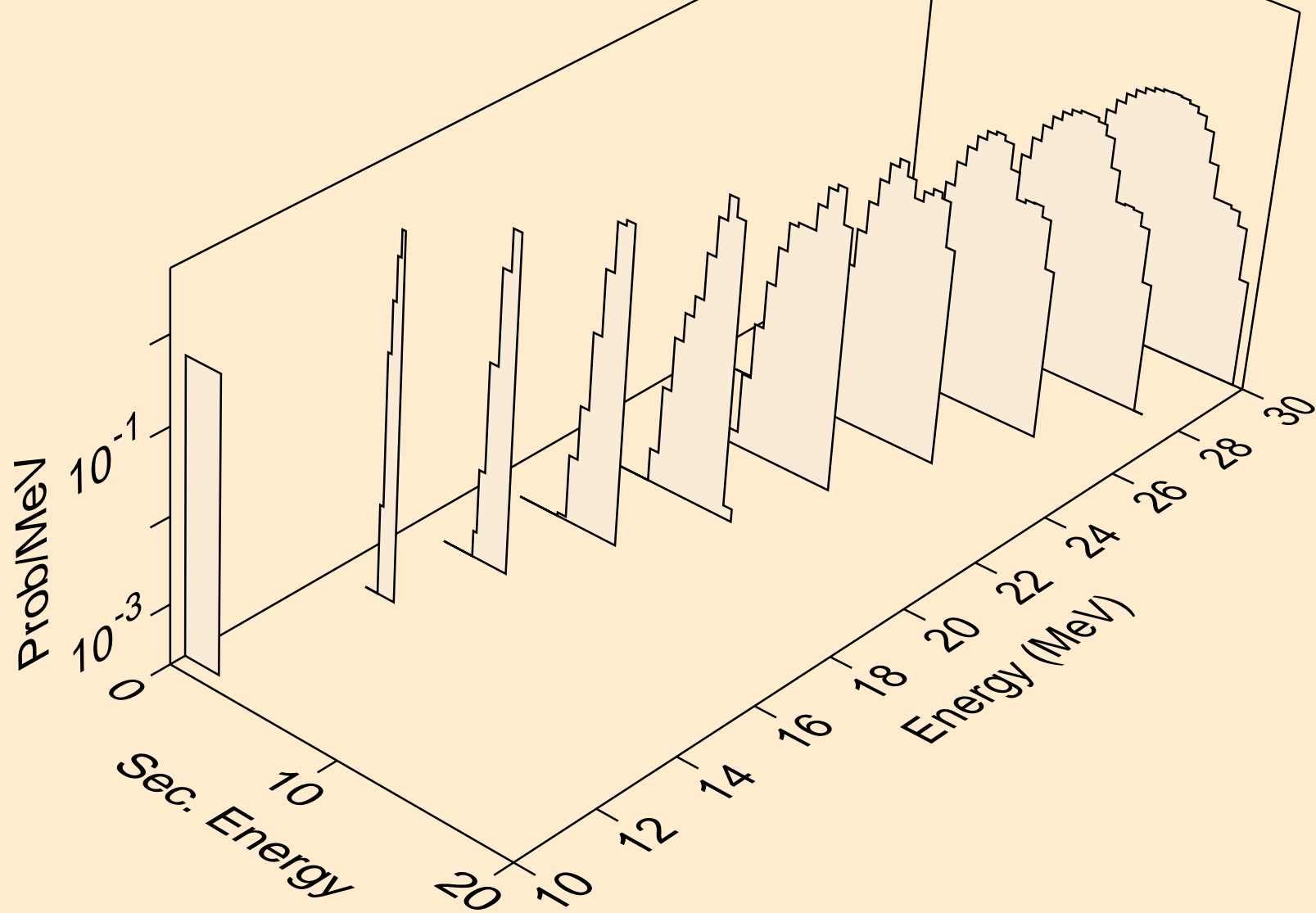

AT204 NEUTRON ACER TENDL-2024 LIBRARY; T=0.K
tritons from (n,t)

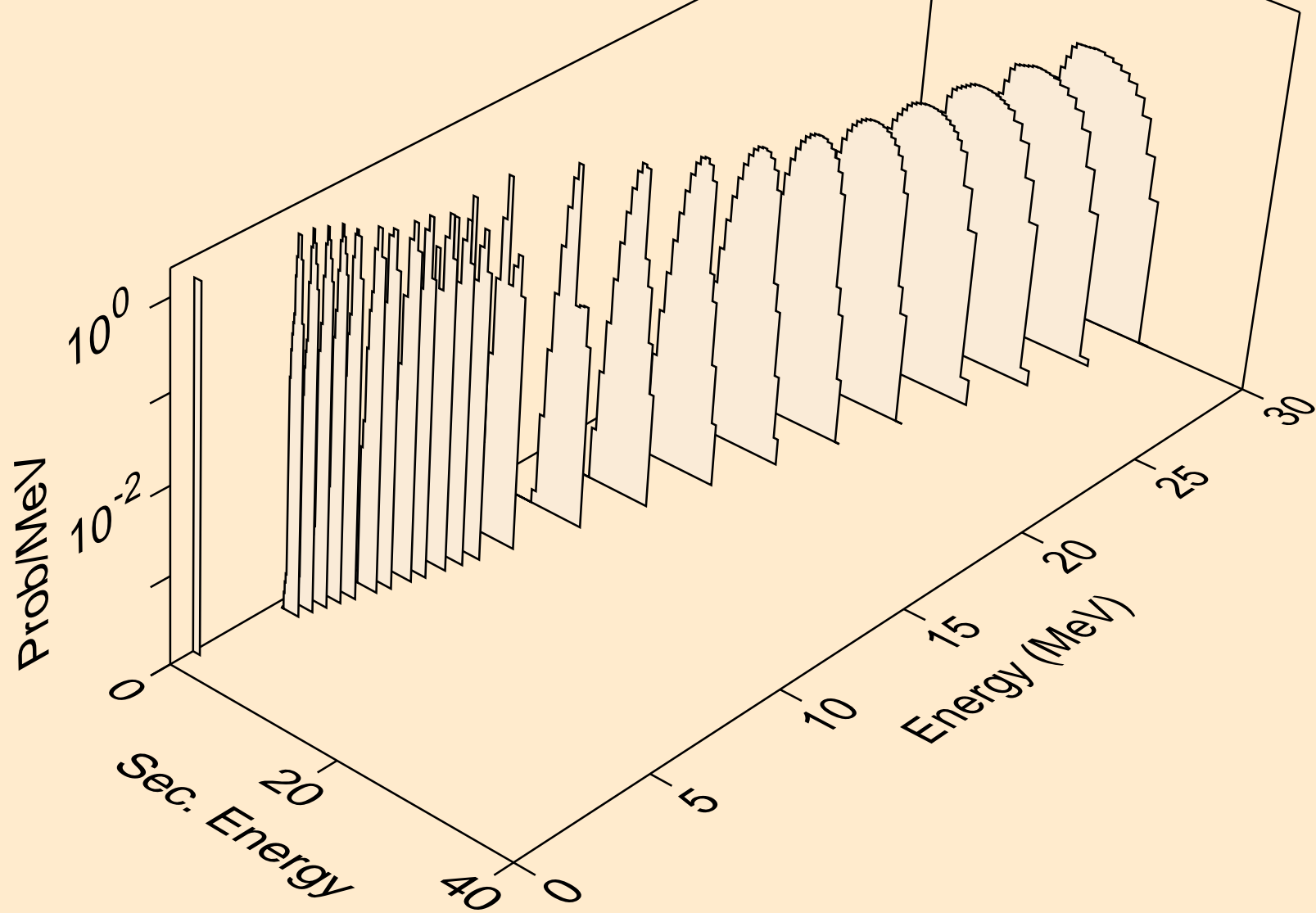

AT204 NEUTRON ACER TENDL-2024 LIBRARY; T=0.K
tritons from (n,pt)

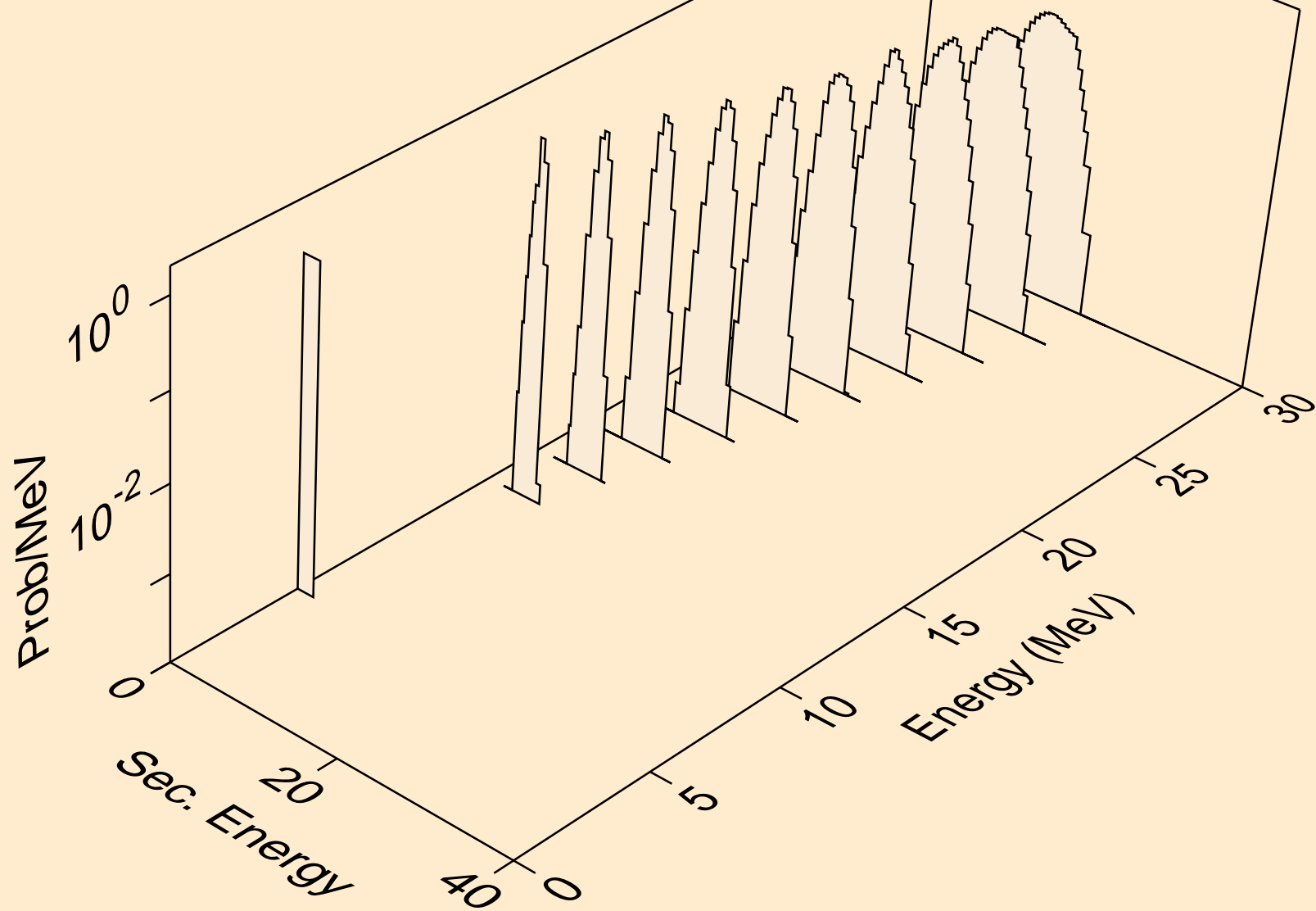

AT204 NEUTRON ACER TENDL-2024 LIBRARY; T=0.K
he3s from (n,x)

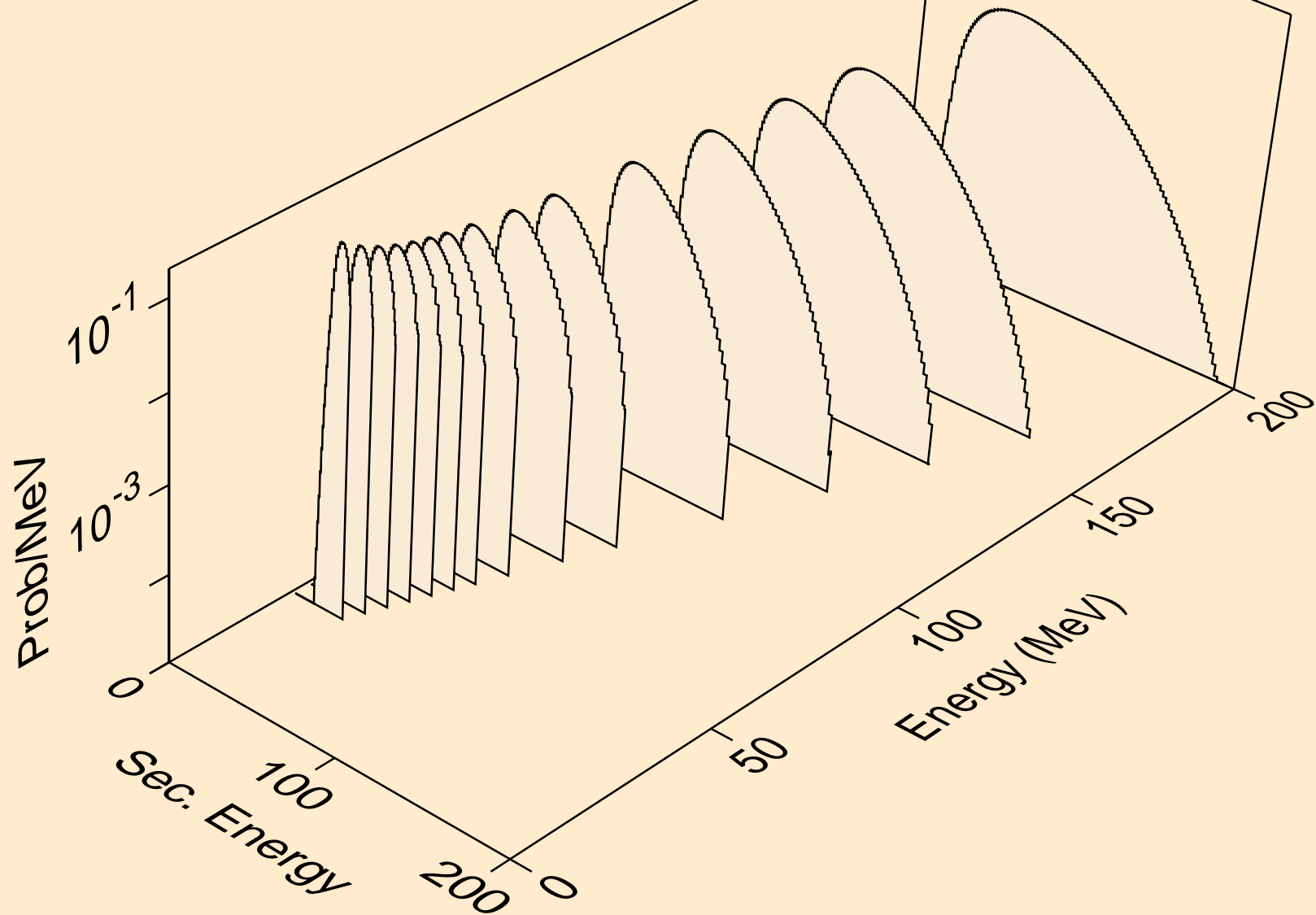

AT204 NEUTRON ACER TENDL-2024 LIBRARY; T=0.K
he3s from (n,n*)he3

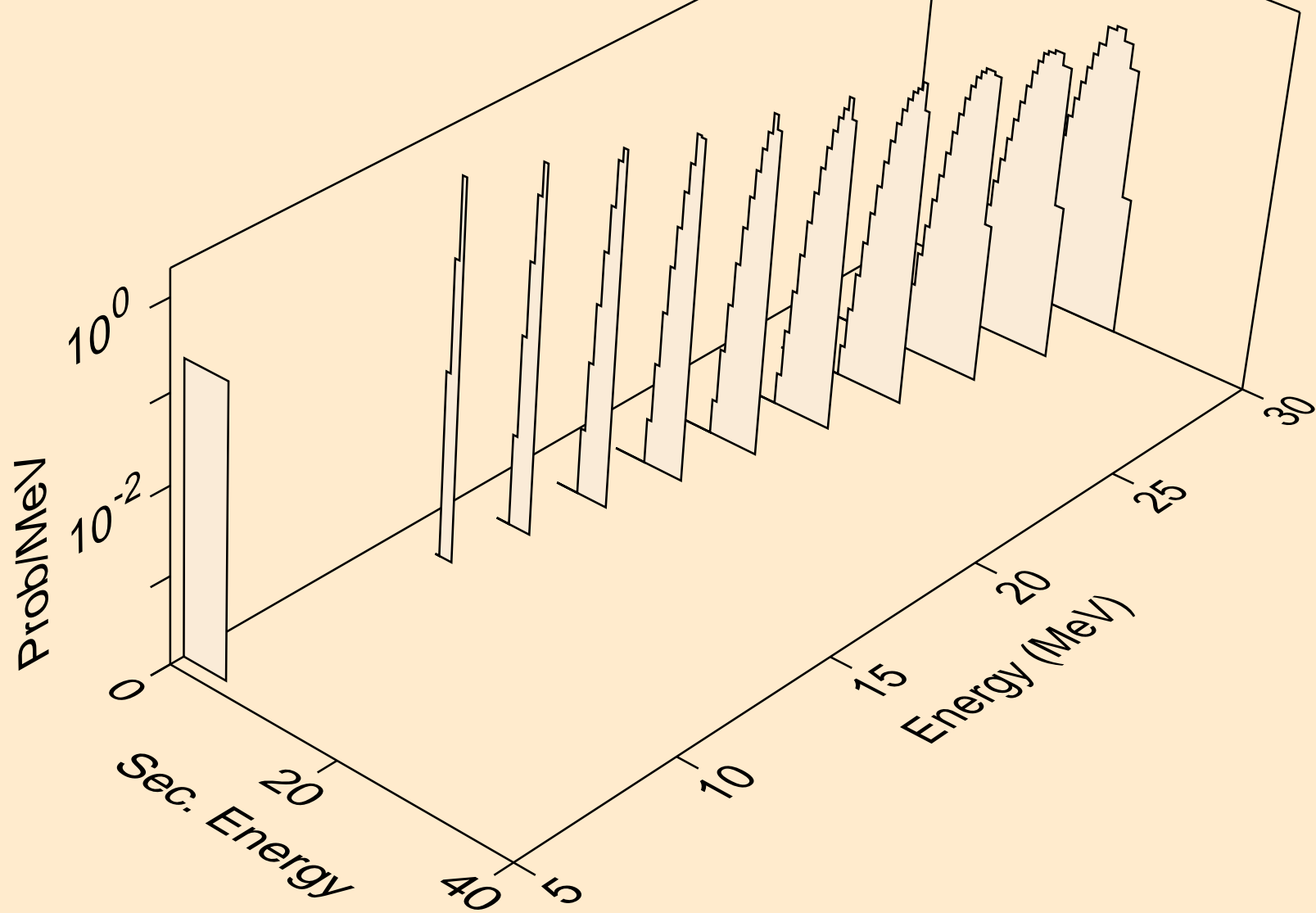

AT204 NEUTRON ACER TENDL-2024 LIBRARY; T=0.K
he3s from (n,he3)

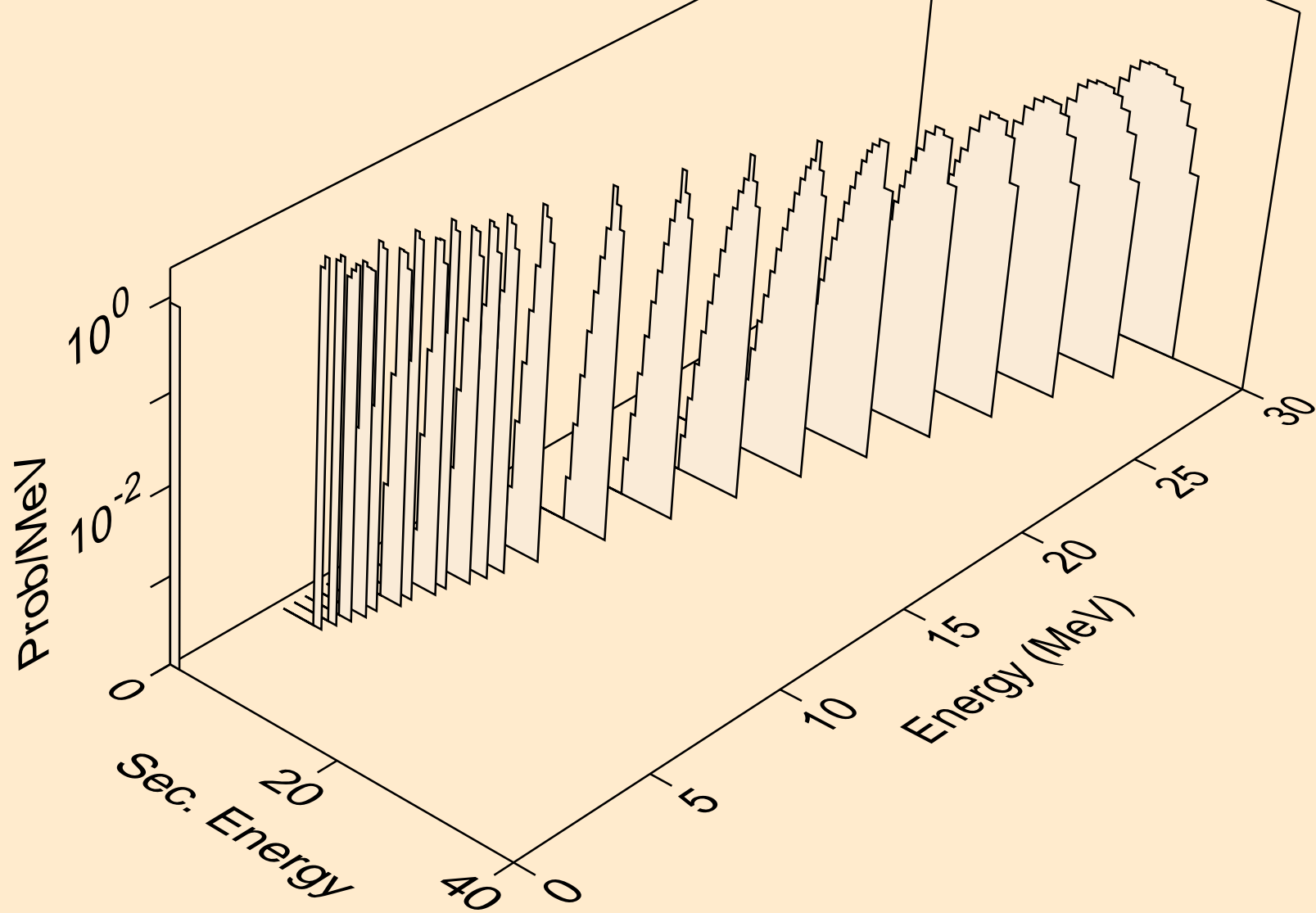

AT204 NEUTRON ACER TENDL-2024 LIBRARY; T=0.K
alphas from (n,x)

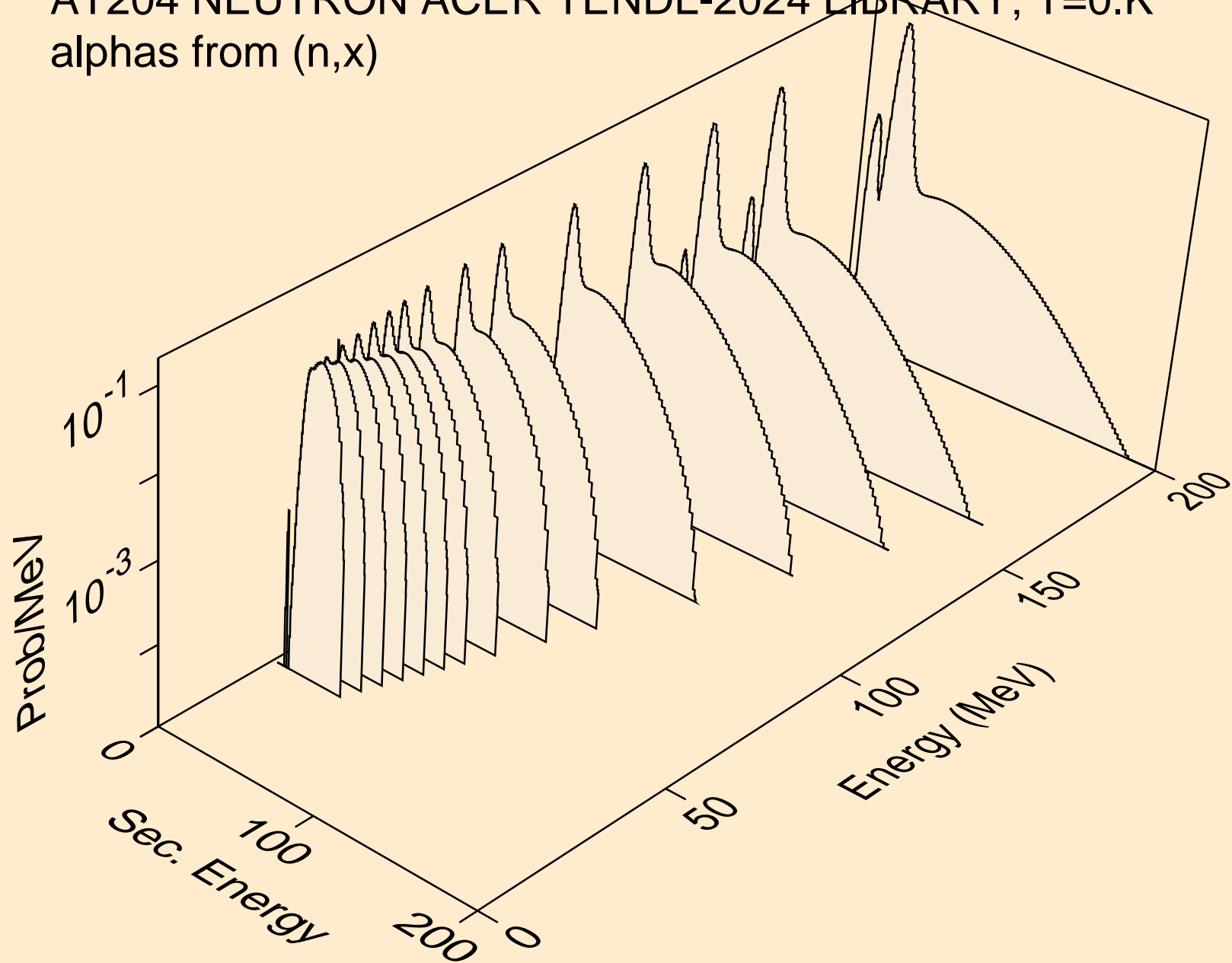

AT204 NEUTRON ACER TENDL-2024 LIBRARY; T=0.K
alphas from (n,n*)a

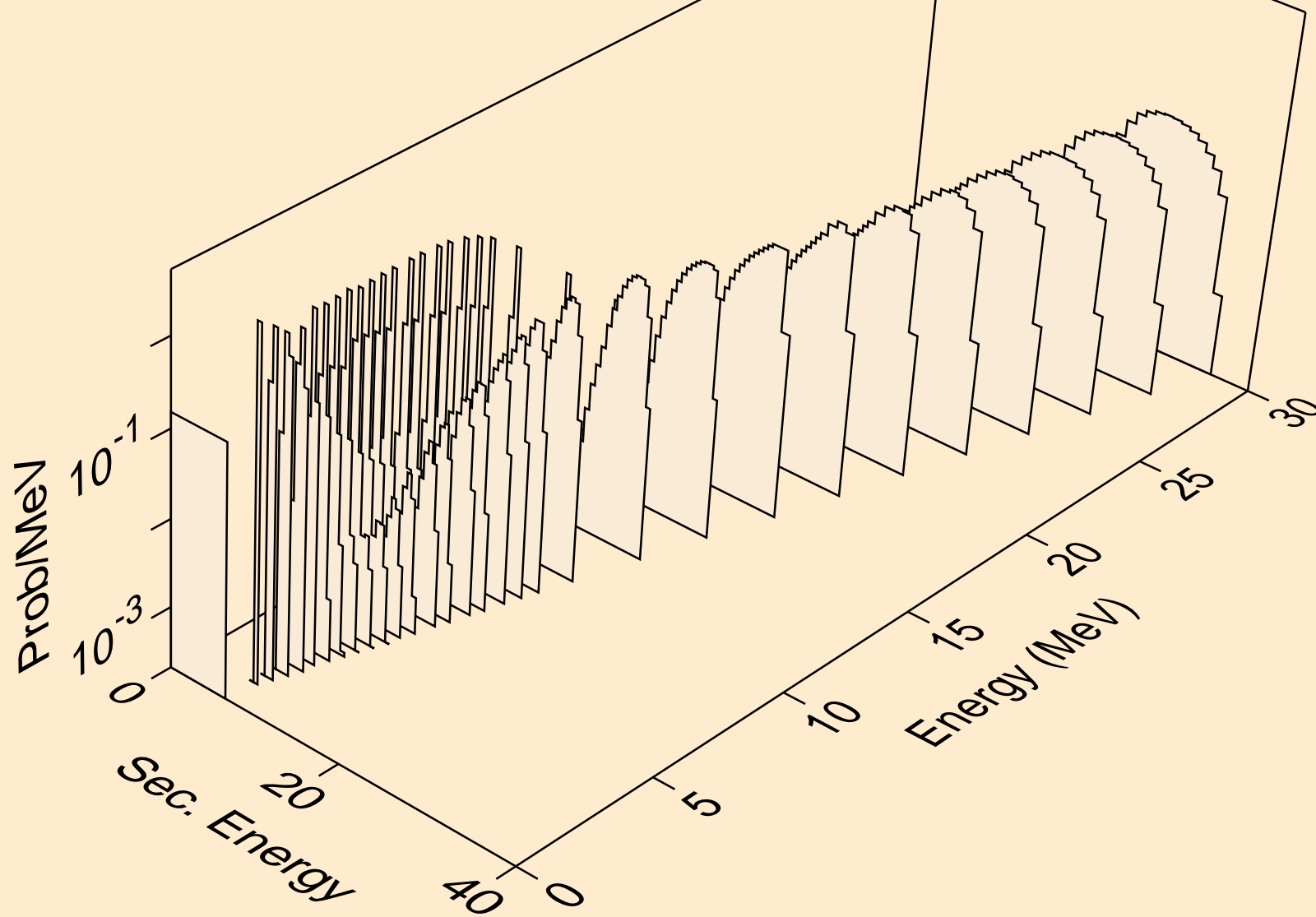

AT204 NEUTRON ACER TENDL-2024 LIBRARY; T=0.K
alphas from (n,2n)a

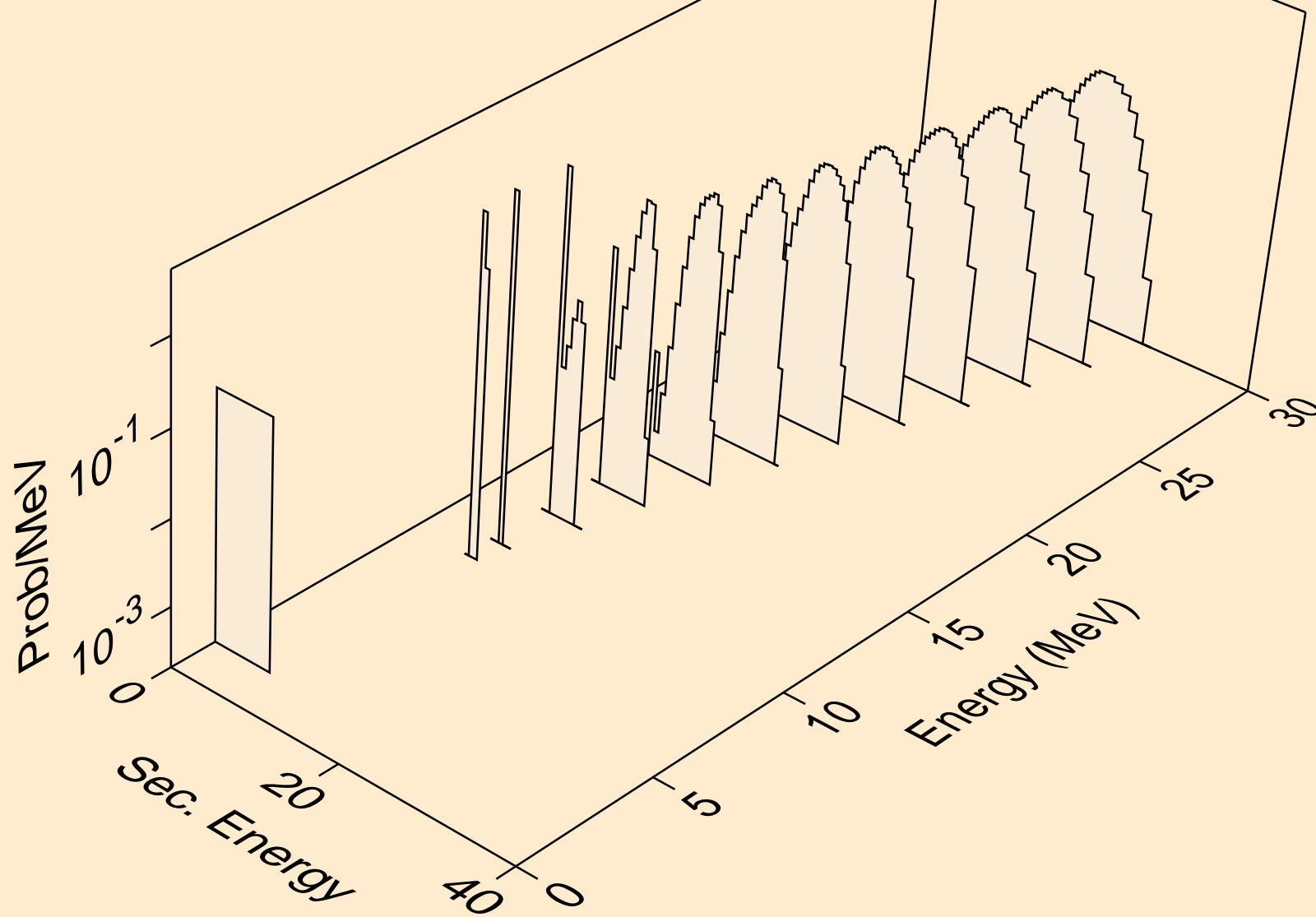

AT204 NEUTRON ACER TENDL-2024 LIBRARY; T=0.K
alphas from (n,3n)a

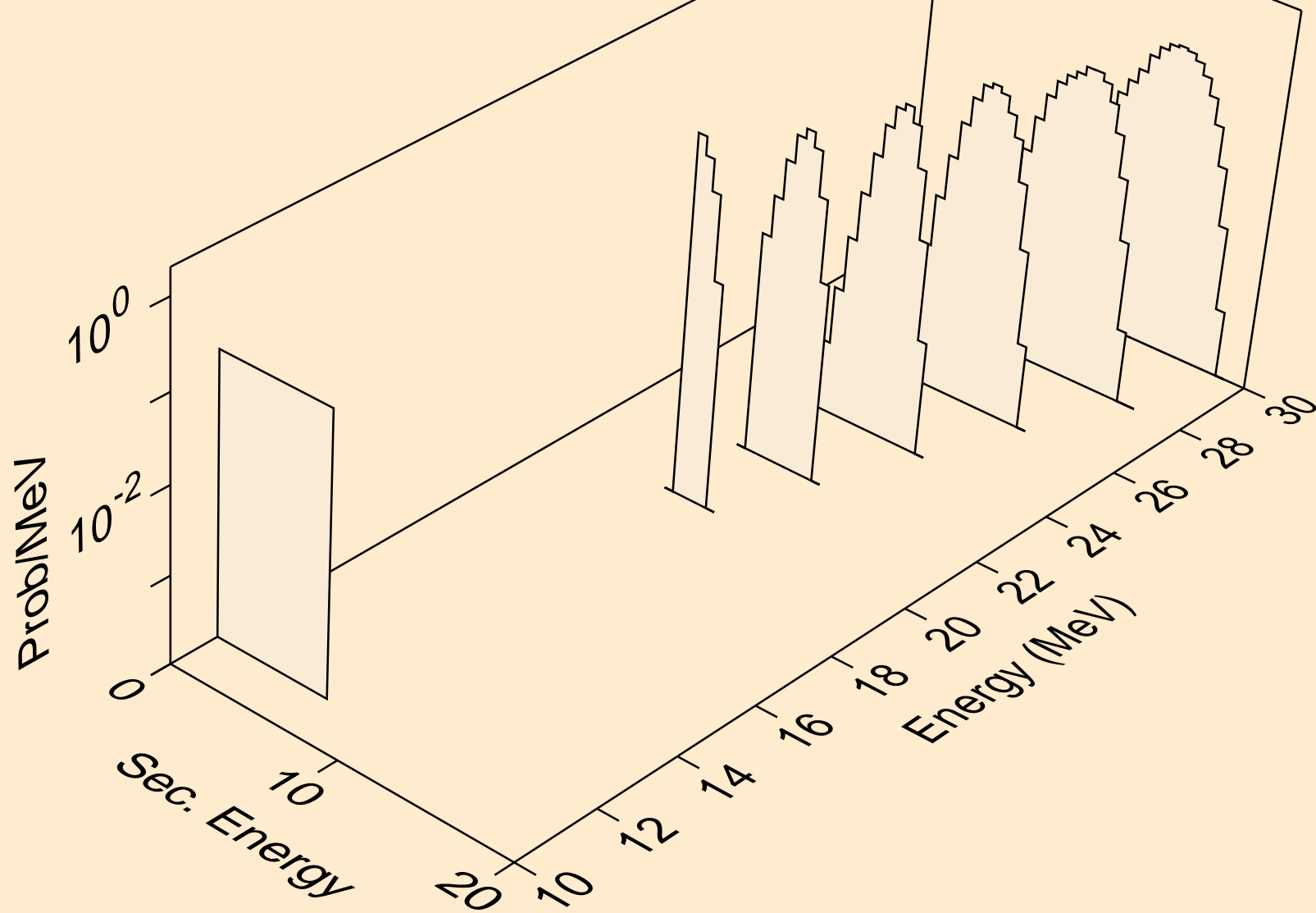

AT204 NEUTRON ACER TENDL-2024 LIBRARY; T=0.K
alphas from (n,n*)2a

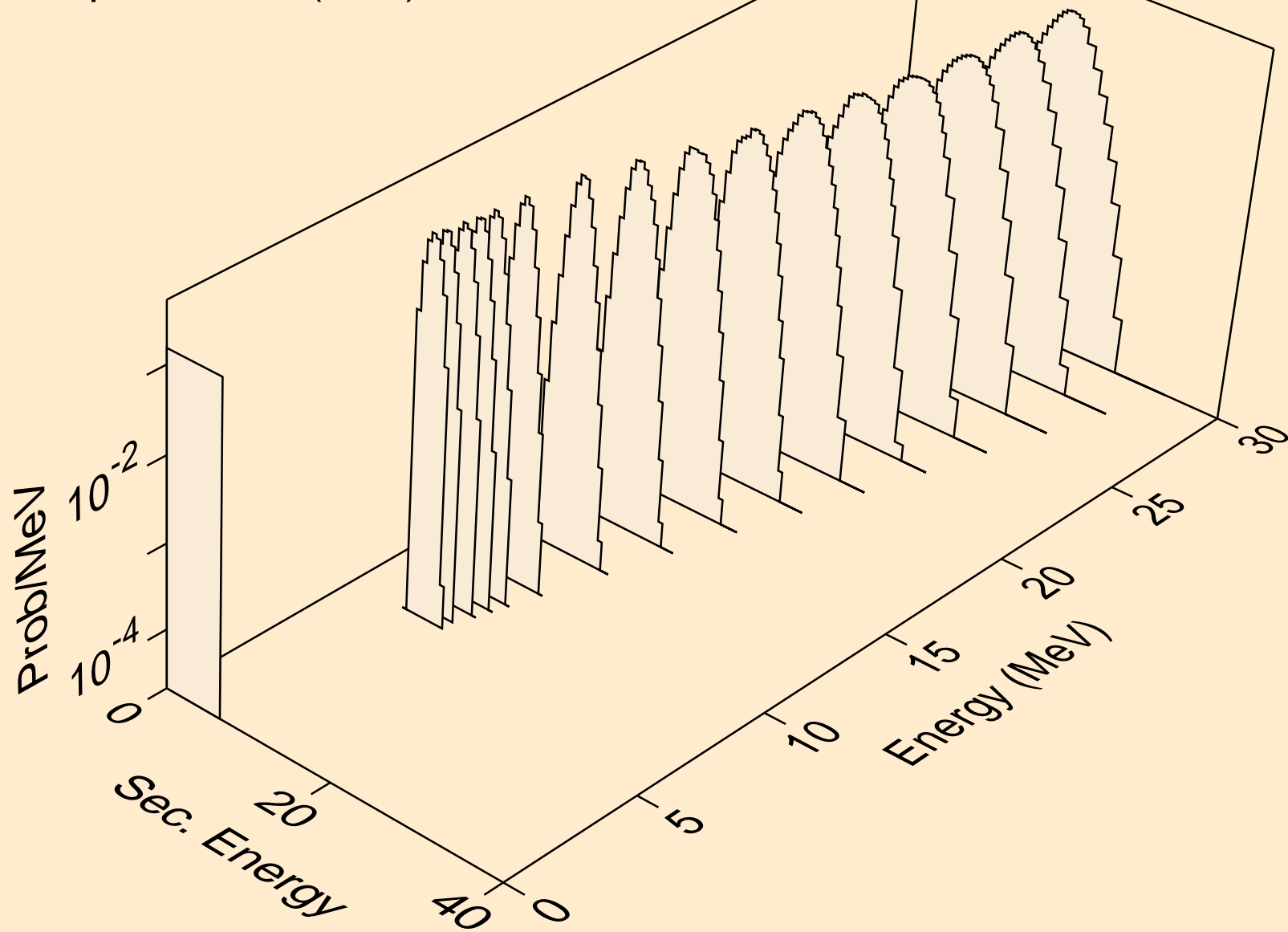

AT204 NEUTRON ACER TENDL-2024 LIBRARY; T=0.K
alphas from (n,2n)2a

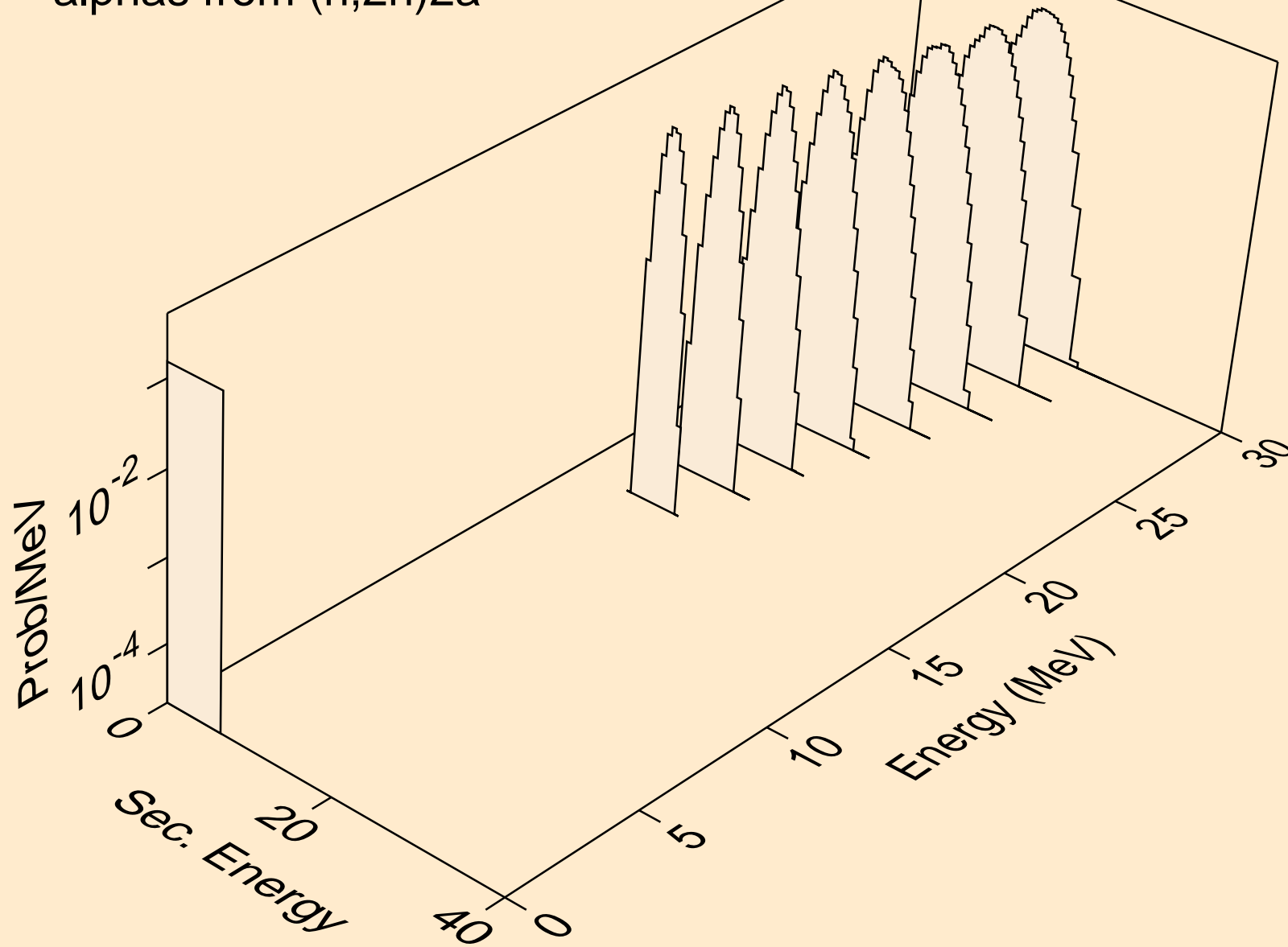

AT204 NEUTRON ACER TENDL-2024 LIBRARY; T=0.K
alphas from (n,npa)

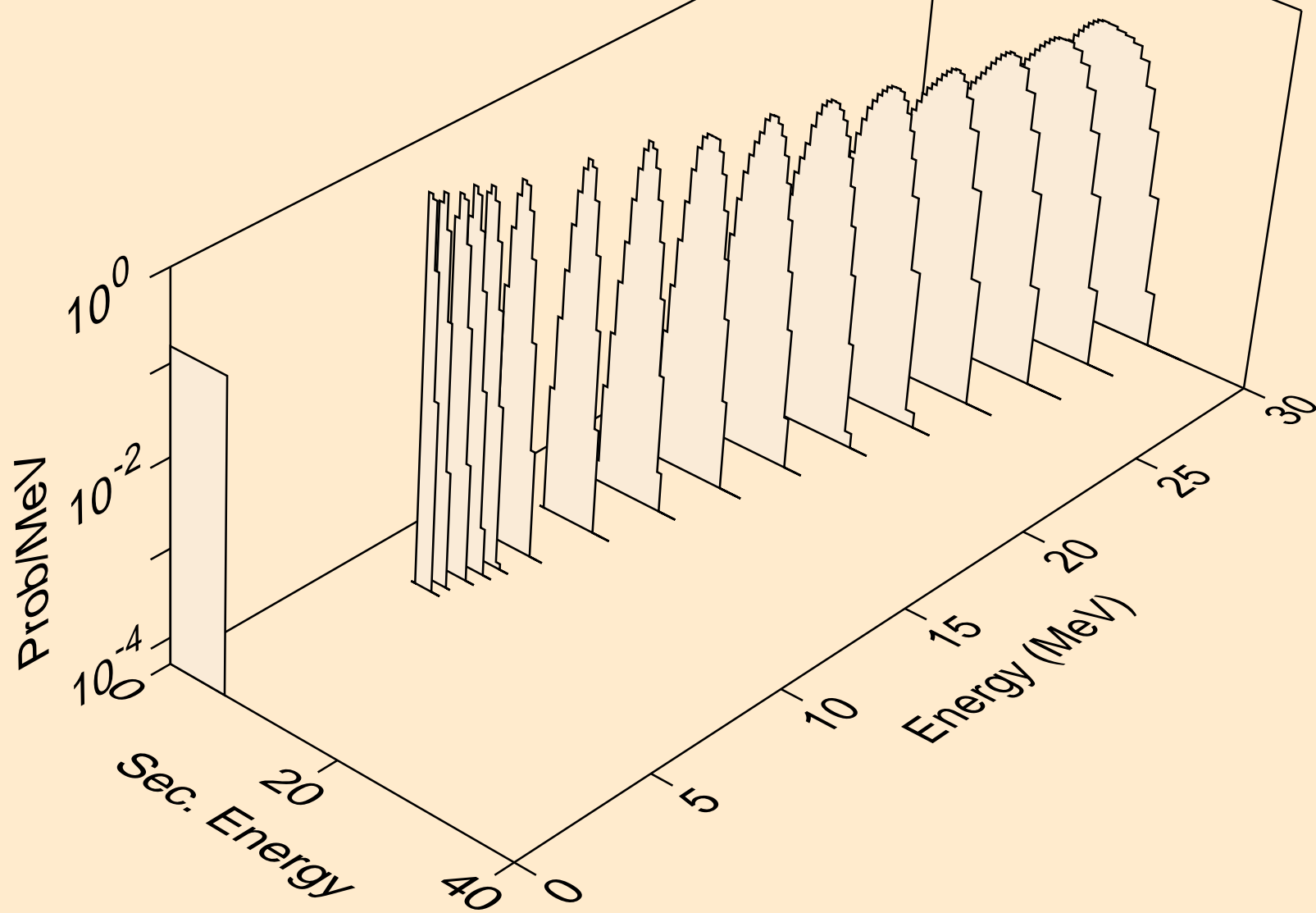

AT204 NEUTRON ACER TENDL-2024 LIBRARY; T=0.K
alphas from (n,a)

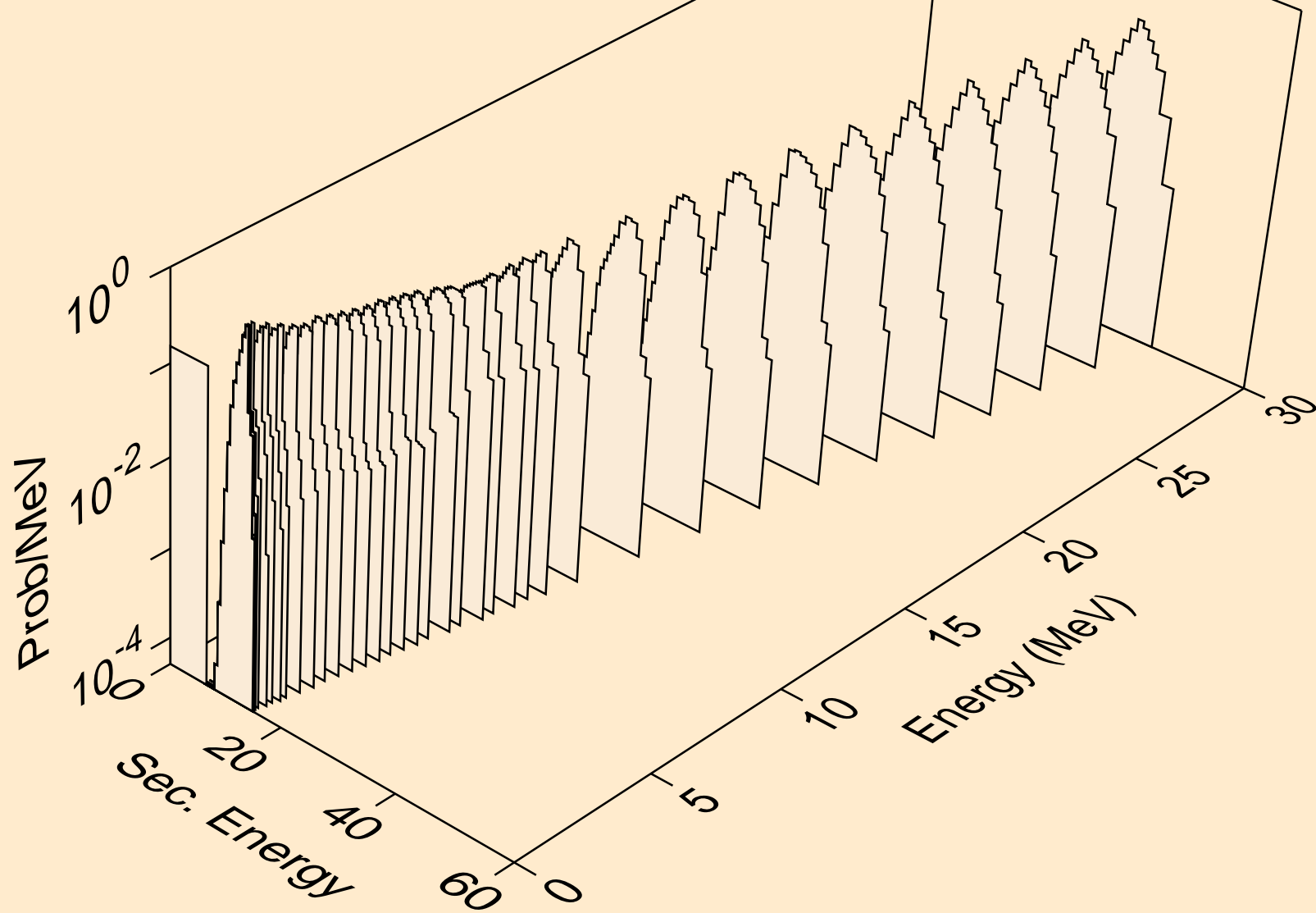

AT204 NEUTRON ACER TENDL-2024 LIBRARY; T=0.K
alphas from (n,2a)

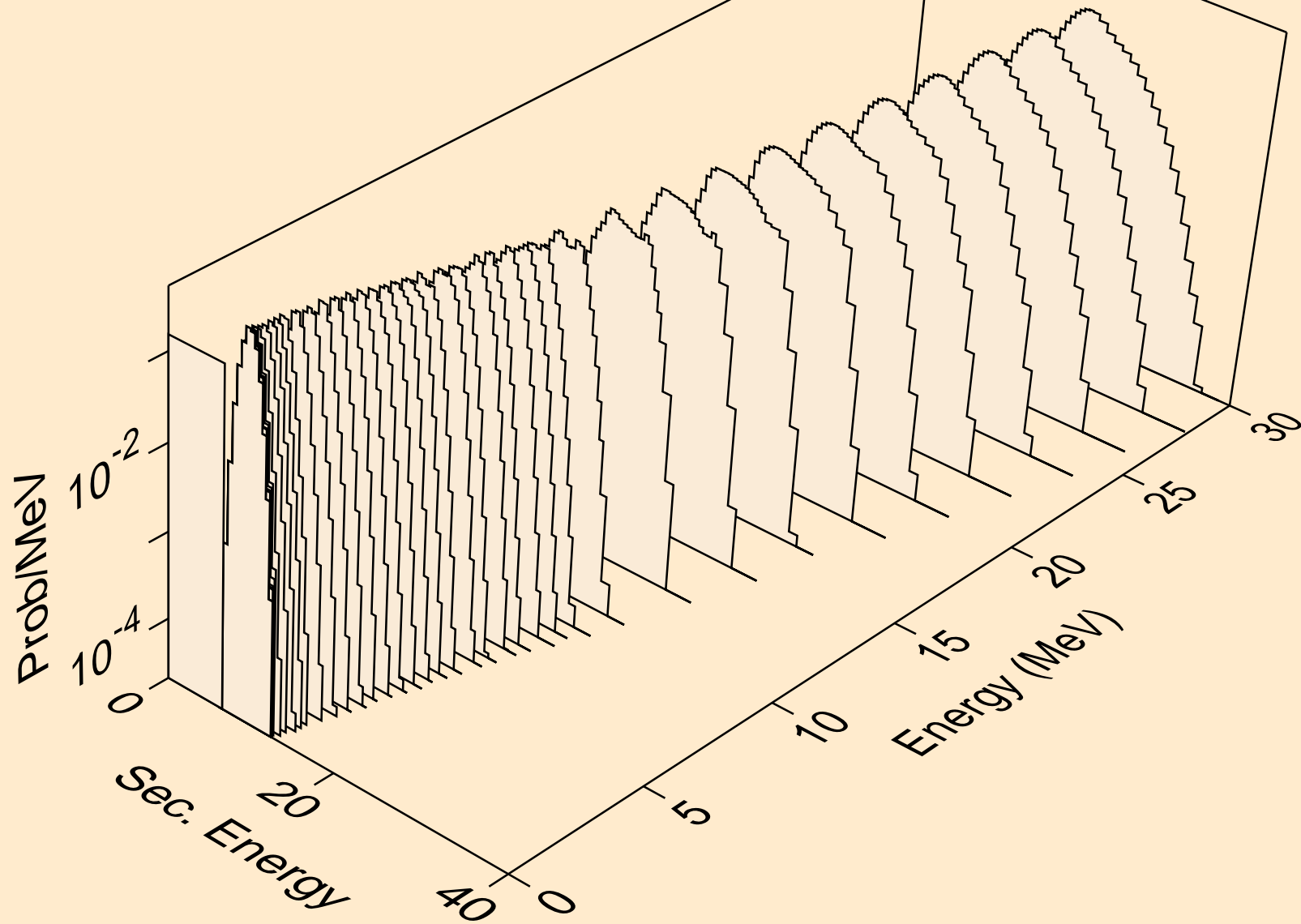

AT204 NEUTRON ACER TENDL-2024 LIBRARY; T=0.K
alphas from (n,pa)

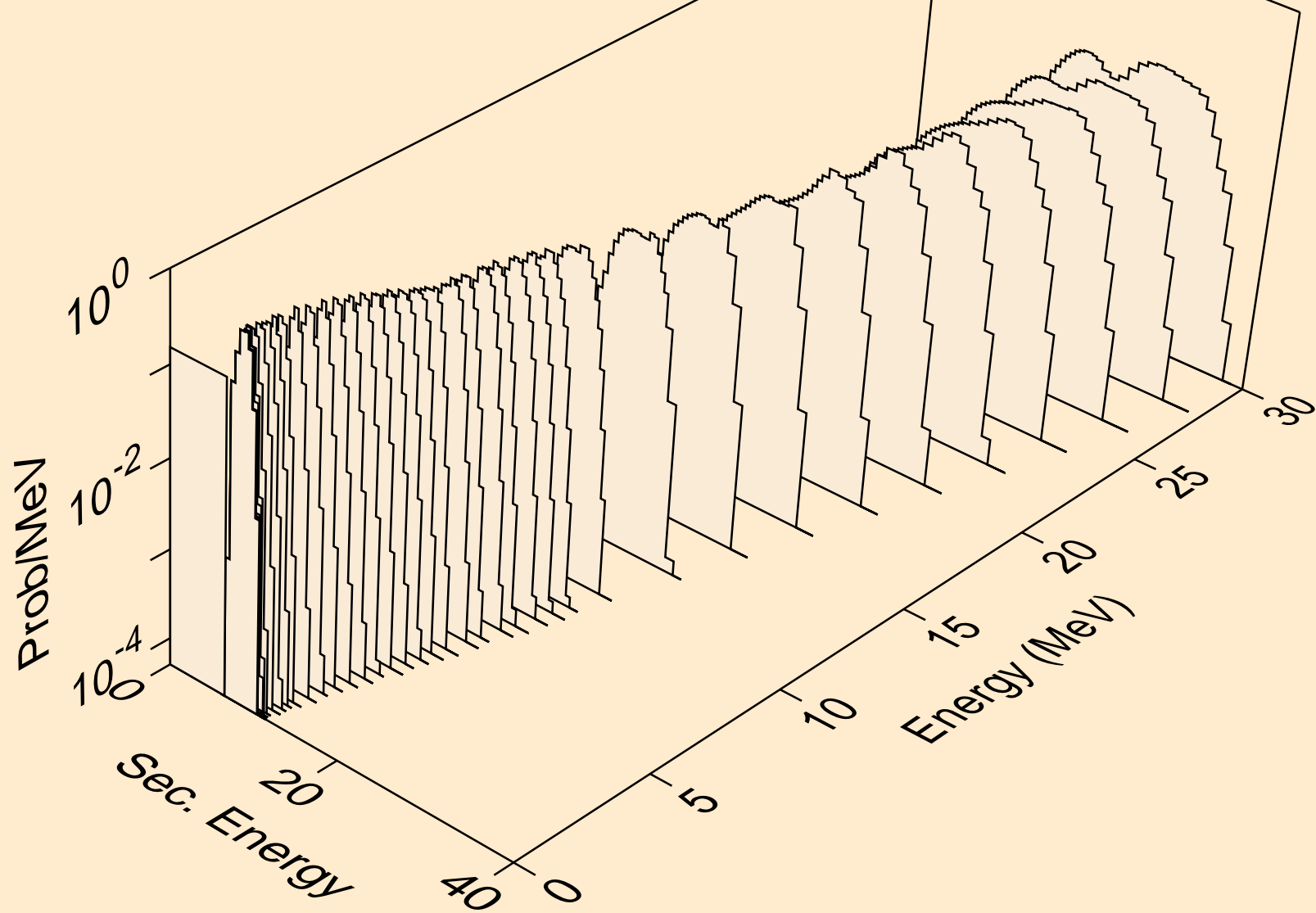

AT204 NEUTRON ACER TENDL-2024 LIBRARY; T=0.K
alphas from (n,da)

