

BI212N NEUTRON ACER TENDL-2024 LIBRARY; T=0.K

Principal cross sections

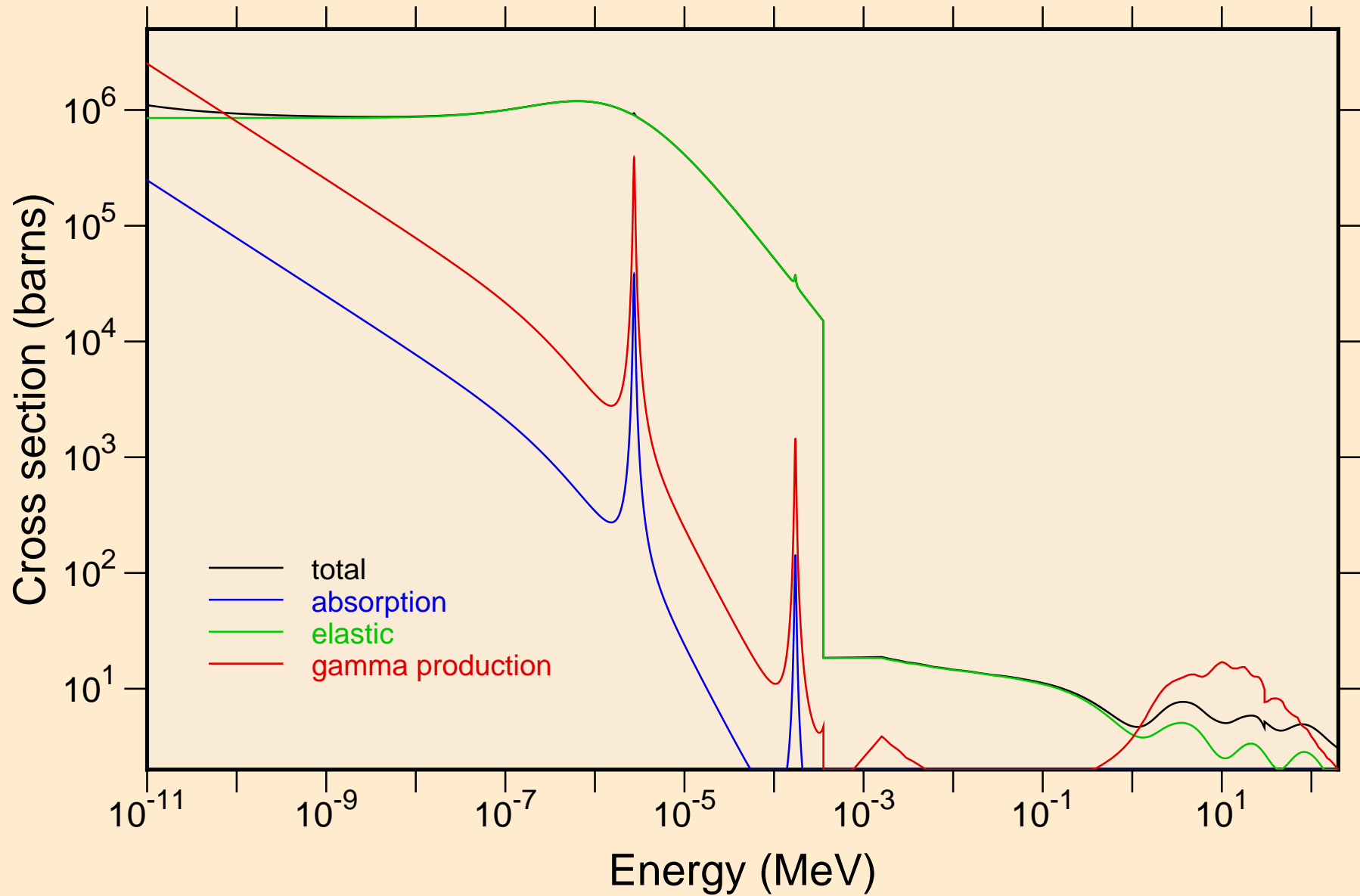

BI212N NEUTRON ACER TENDL-2024 LIBRARY; T=0.K
Heating

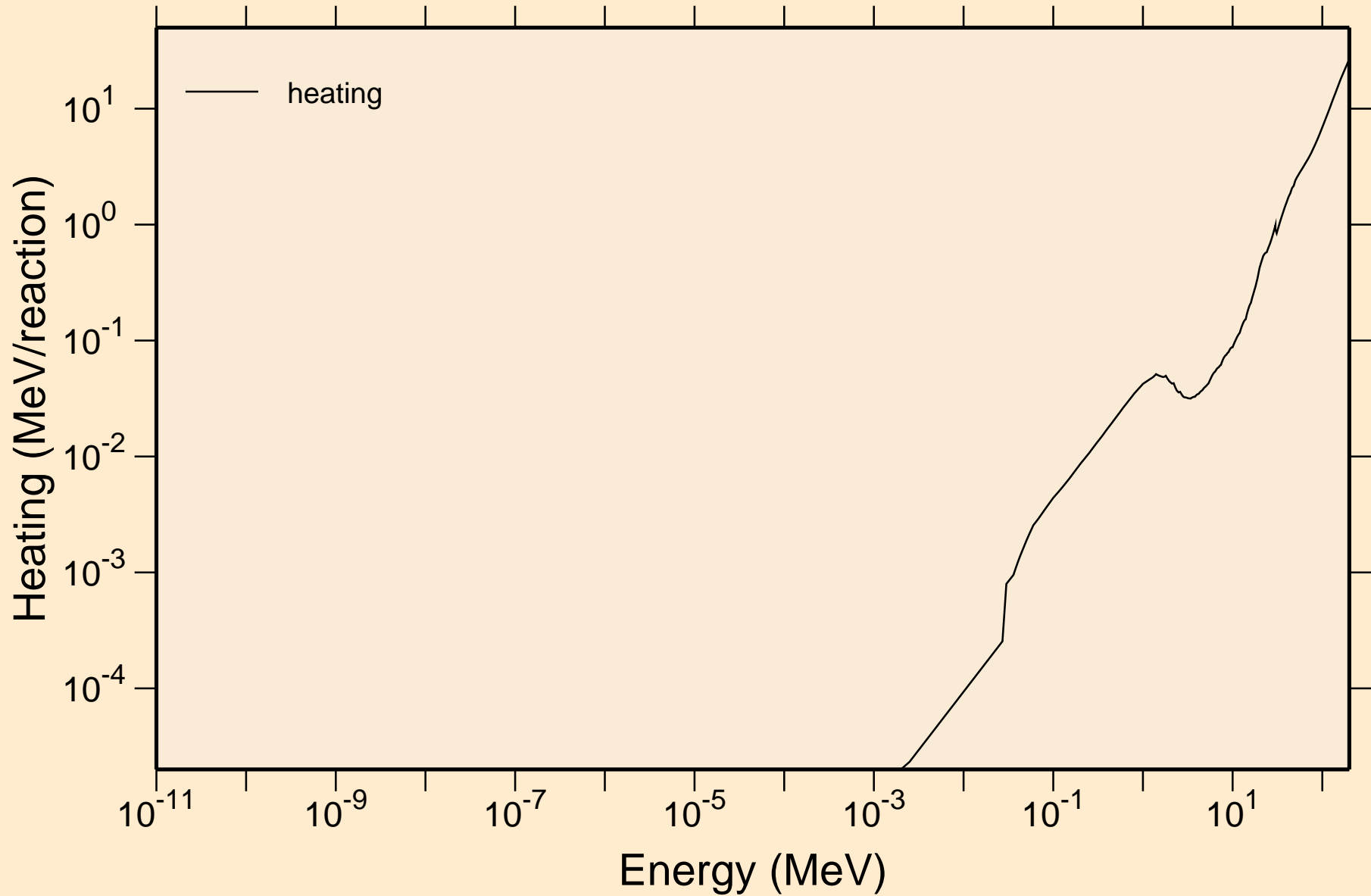

BI212N NEUTRON ACER TENDL-2024 LIBRARY; T=0.K

Damage

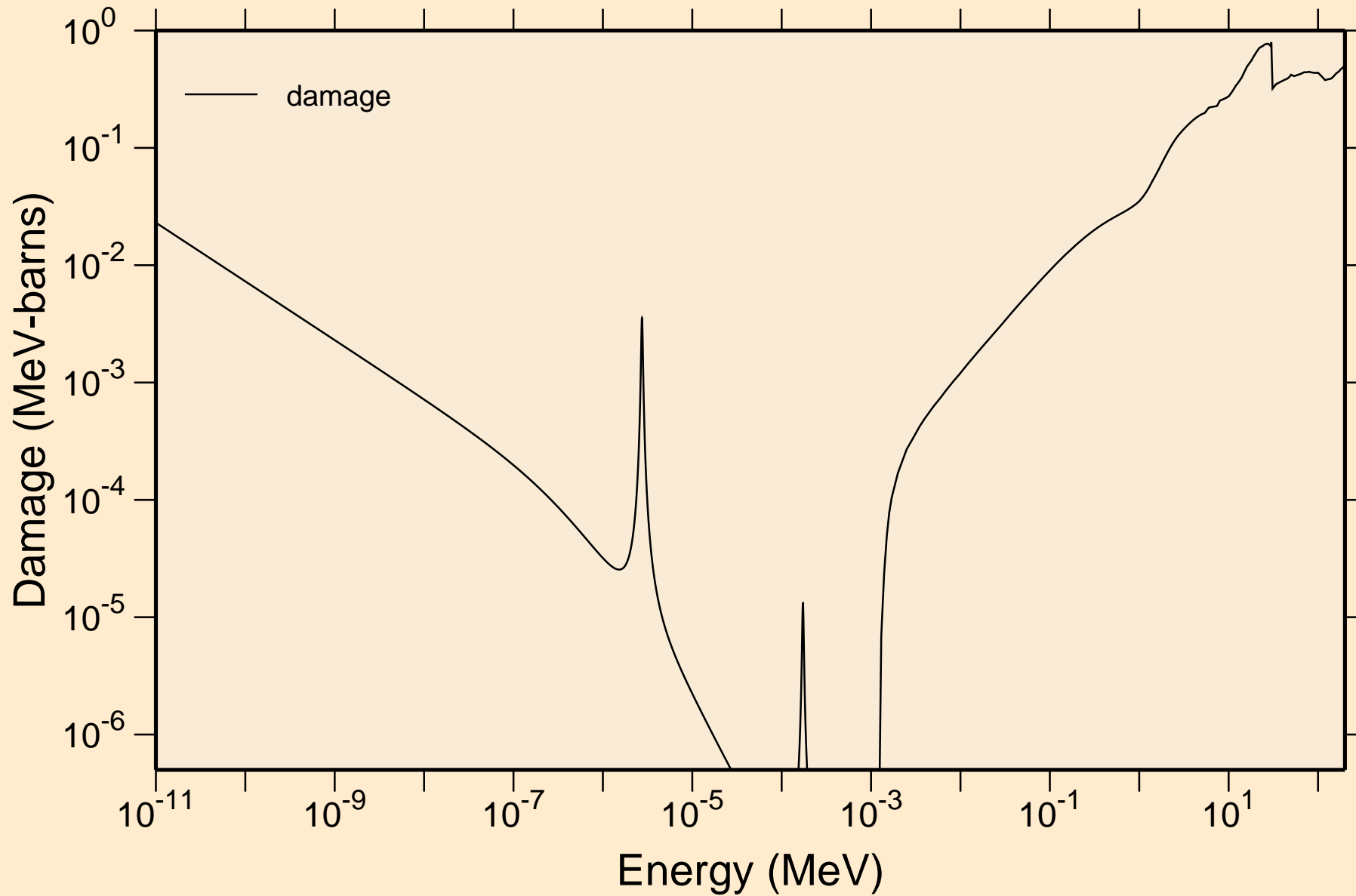

BI212N NEUTRON ACER TENDL-2024 LIBRARY; T=0.K
Non-threshold reactions

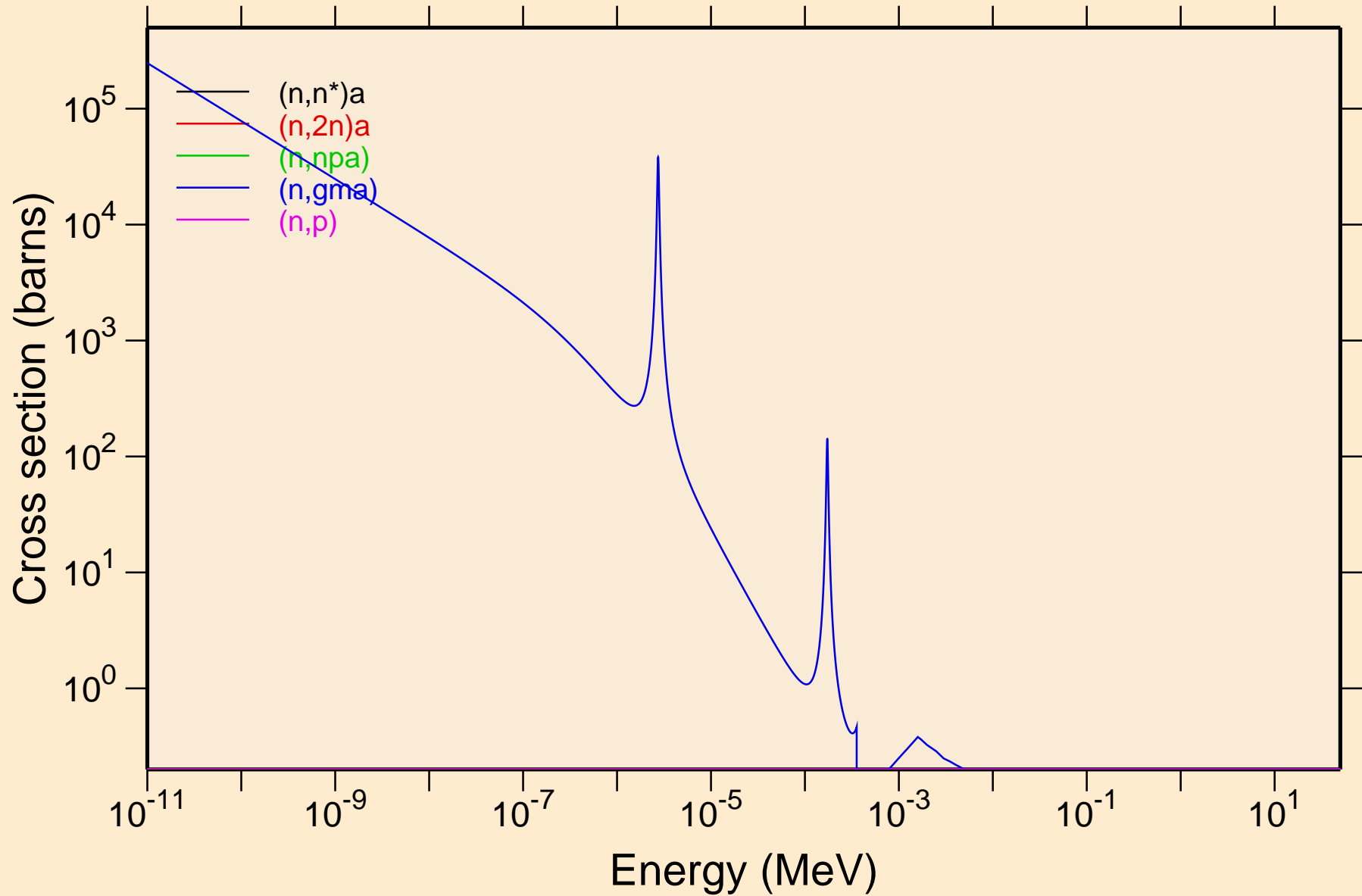

BI212N NEUTRON ACER TENDL-2024 LIBRARY; T=0.K
Non-threshold reactions

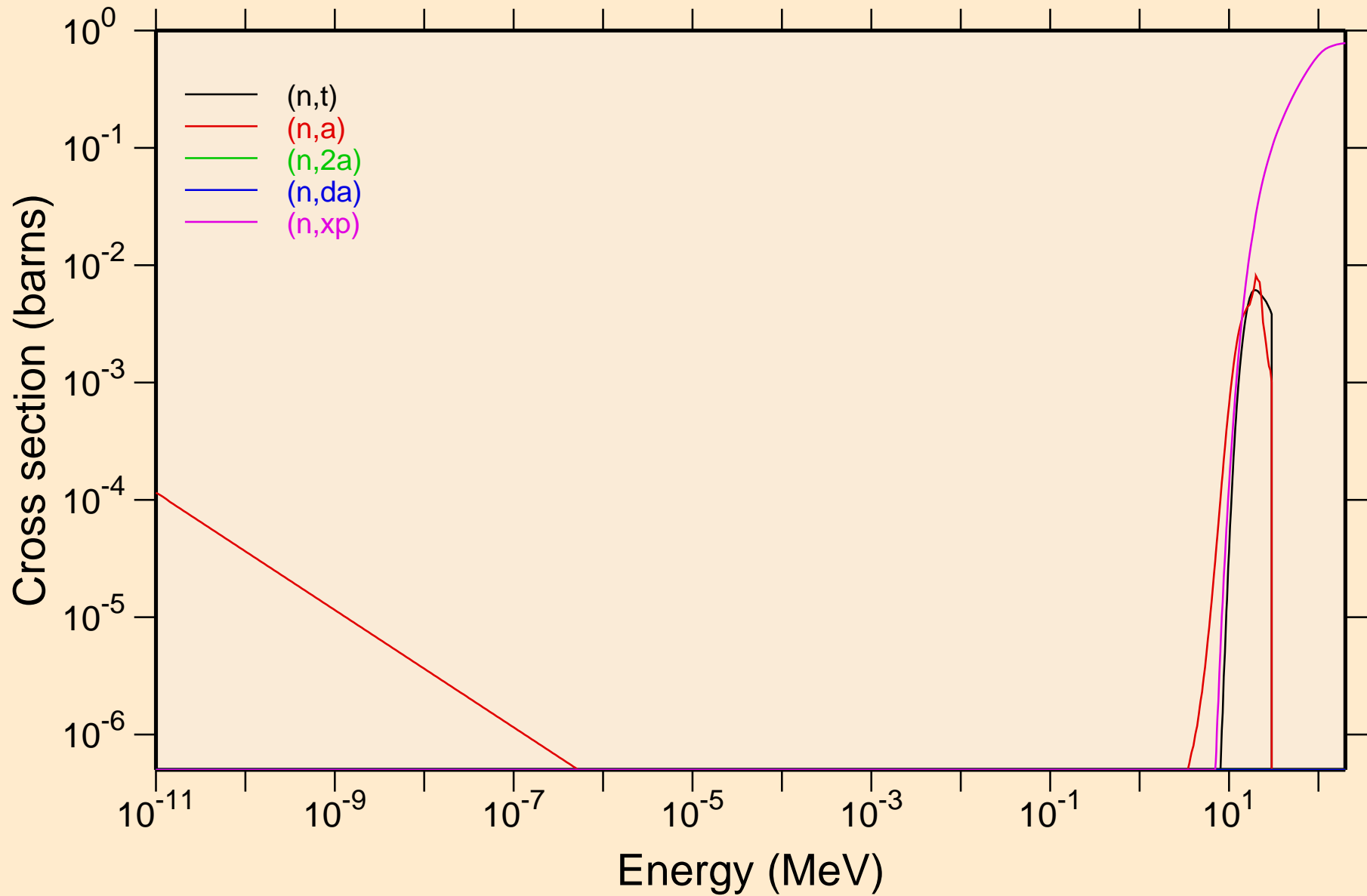

BI212N NEUTRON ACER TENDL-2024 LIBRARY; T=0.K
Non-threshold reactions

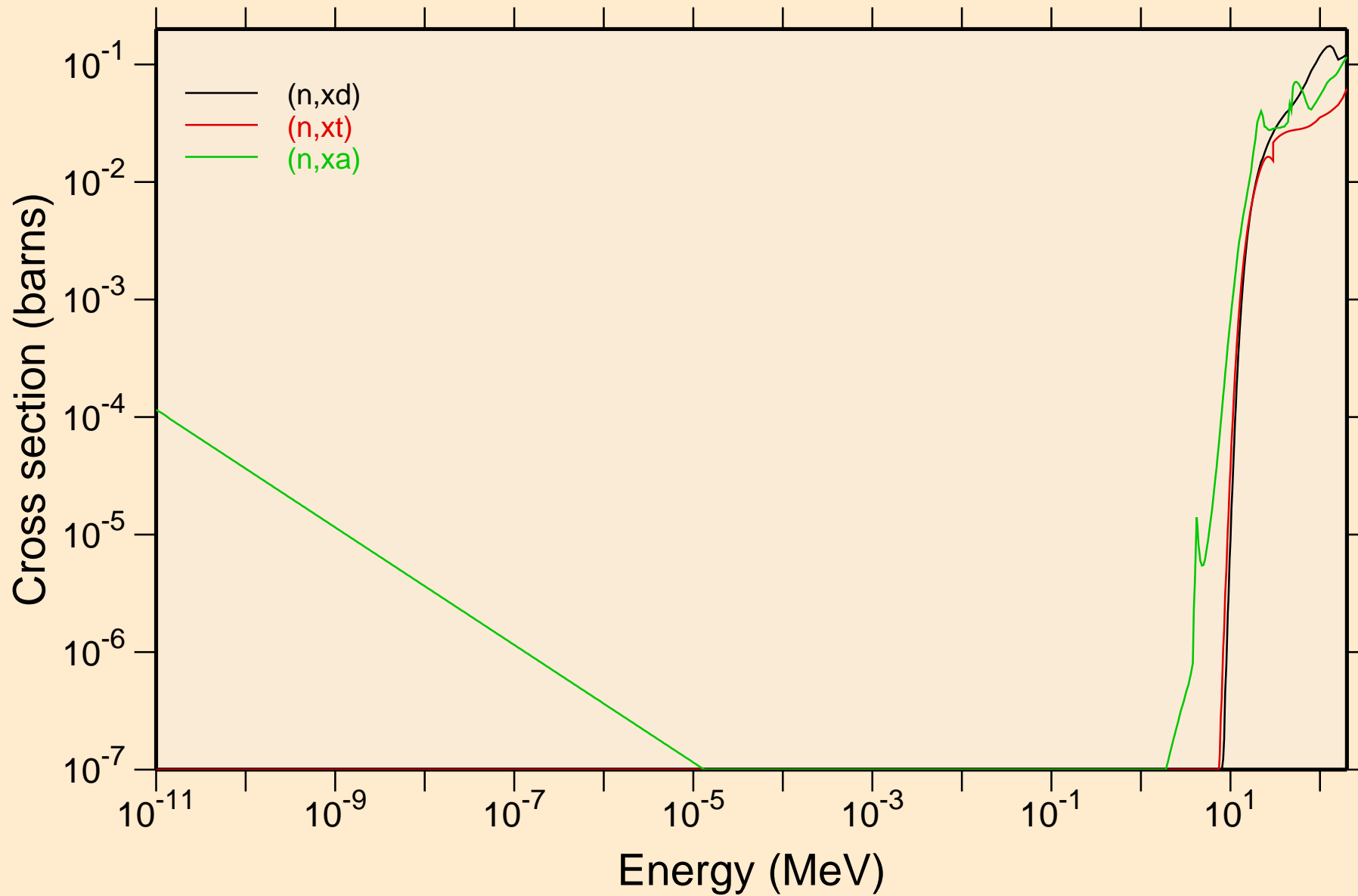

BI212N NEUTRON ACER TENDL-2024 LIBRARY; T=0.K
Principal cross sections

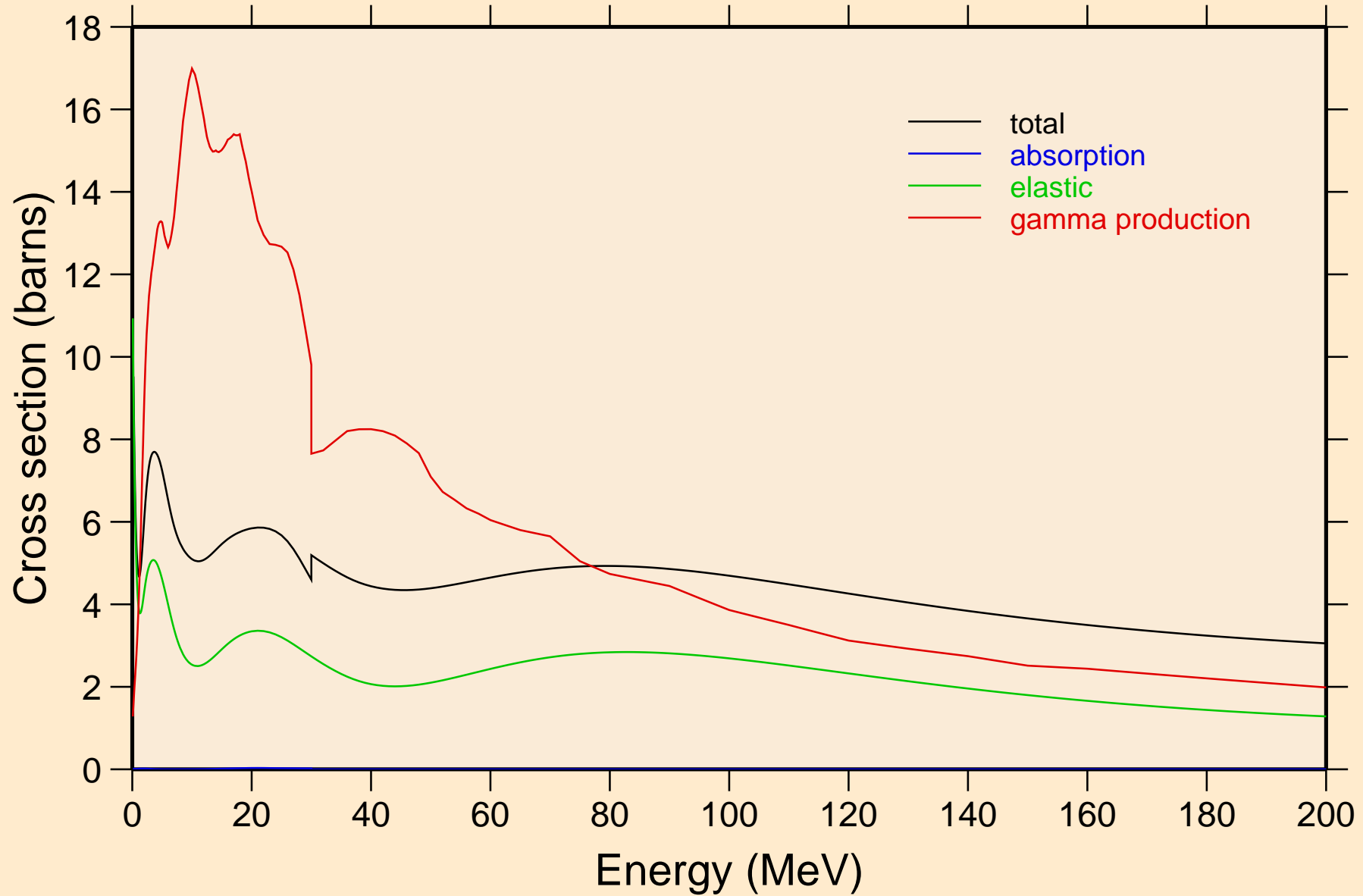

BI212N NEUTRON ACER TENDL-2024 LIBRARY; T=0.K

Heating

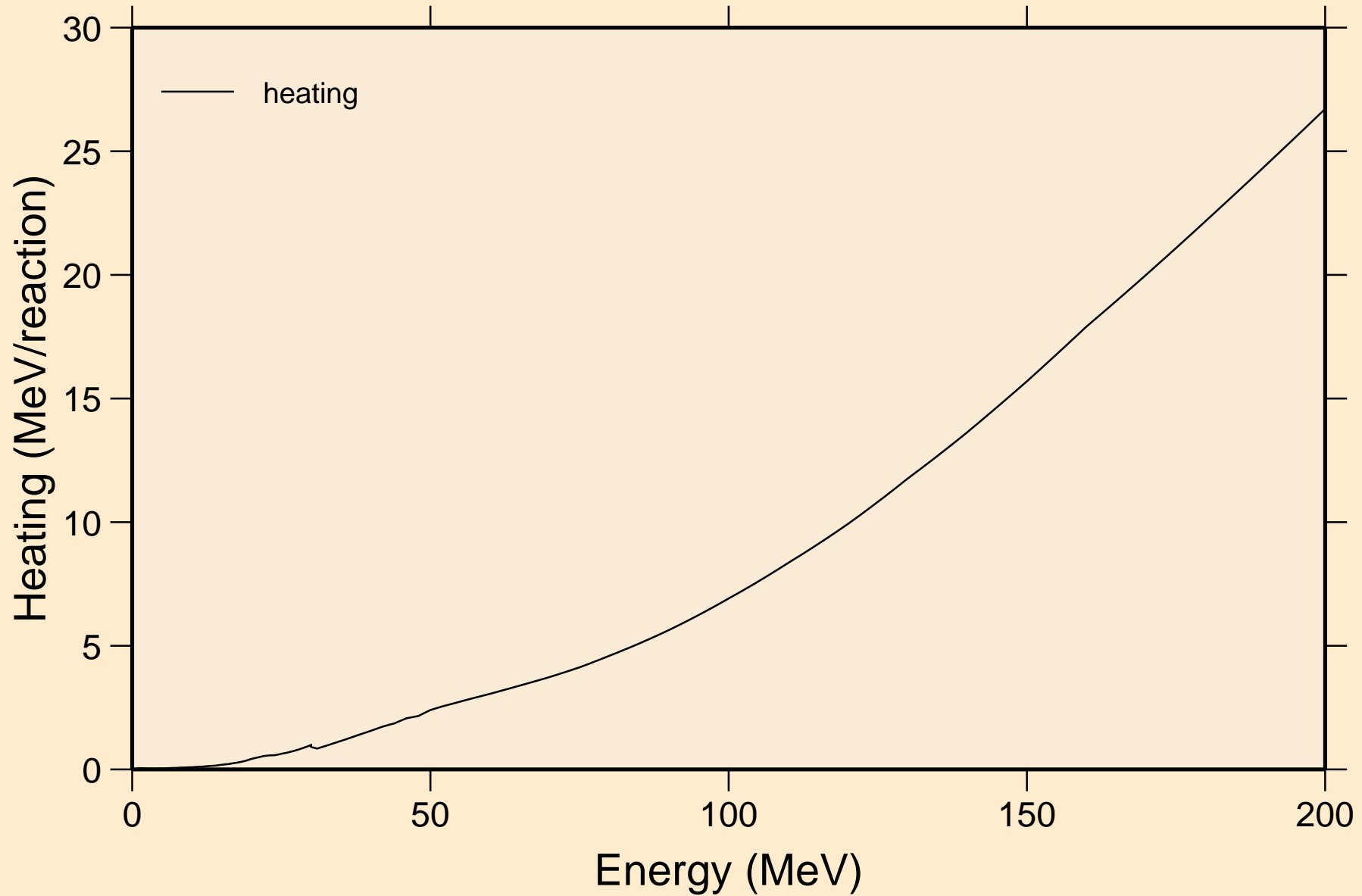

BI212N NEUTRON ACER TENDL-2024 LIBRARY; T=0.K
Damage

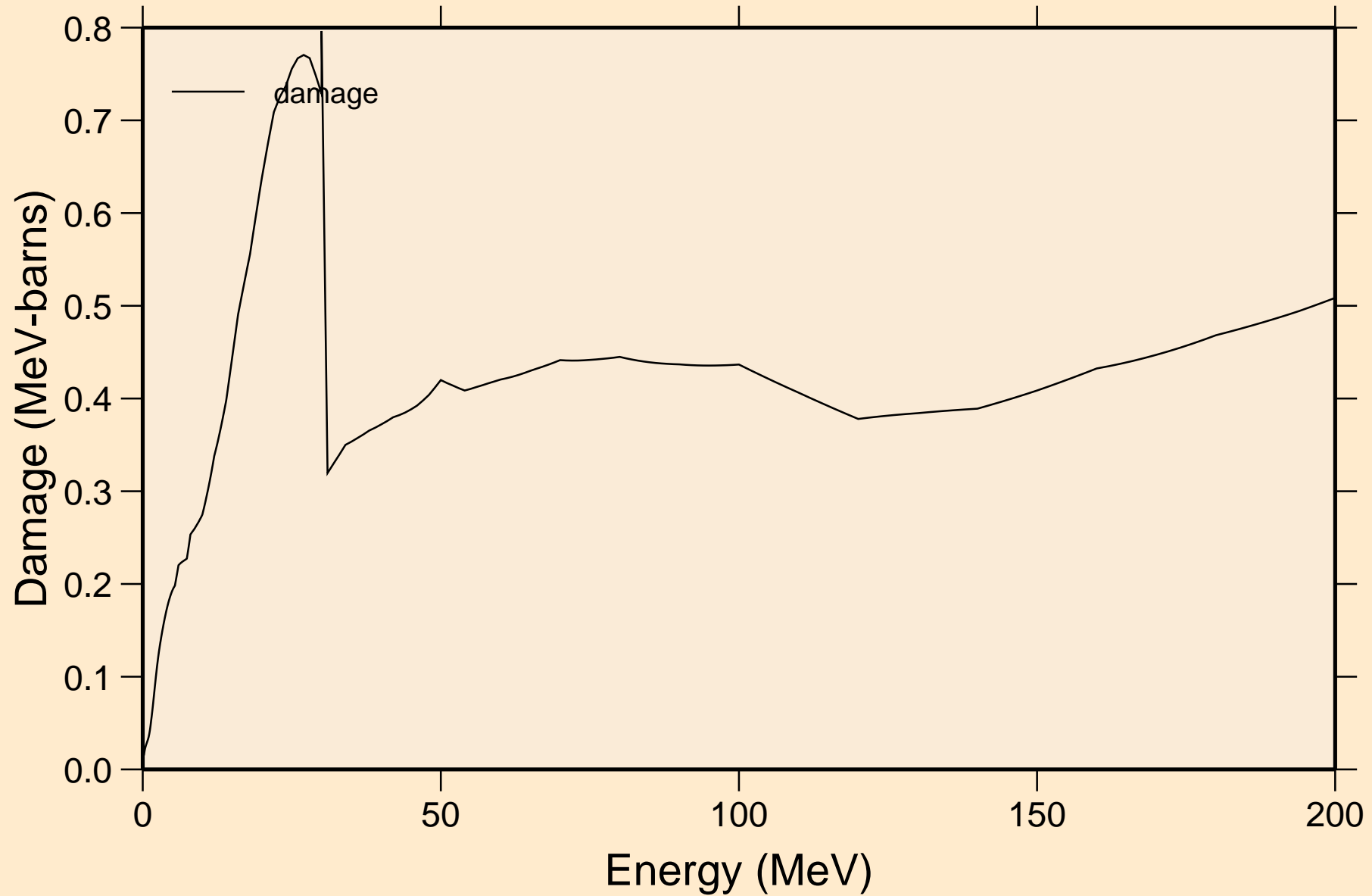

BI212N NEUTRON ACER TENDL-2024 LIBRARY; T=0.K
Non-threshold reactions

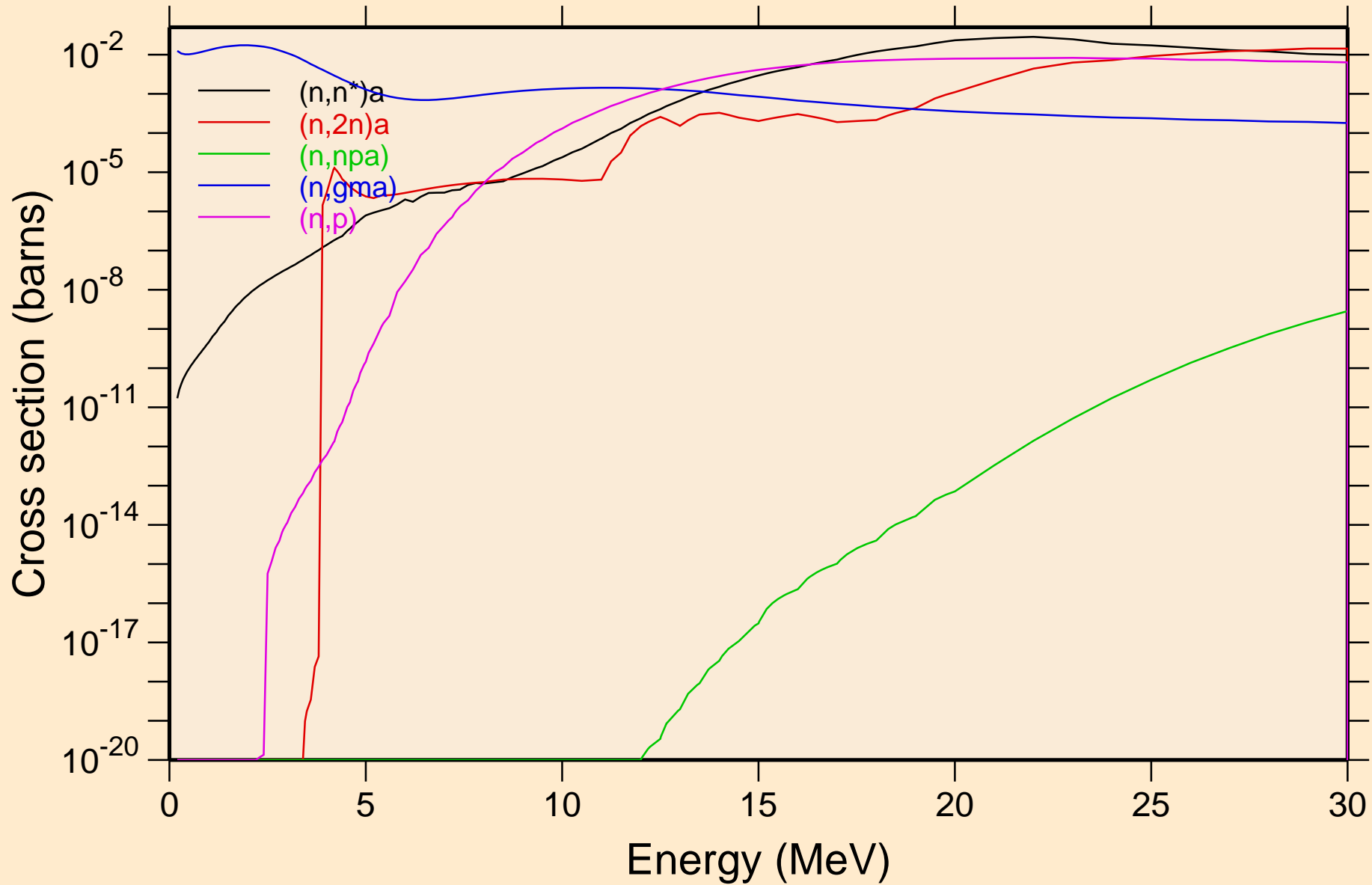

BI212N NEUTRON ACER TENDL-2024 LIBRARY; T=0.K
Non-threshold reactions

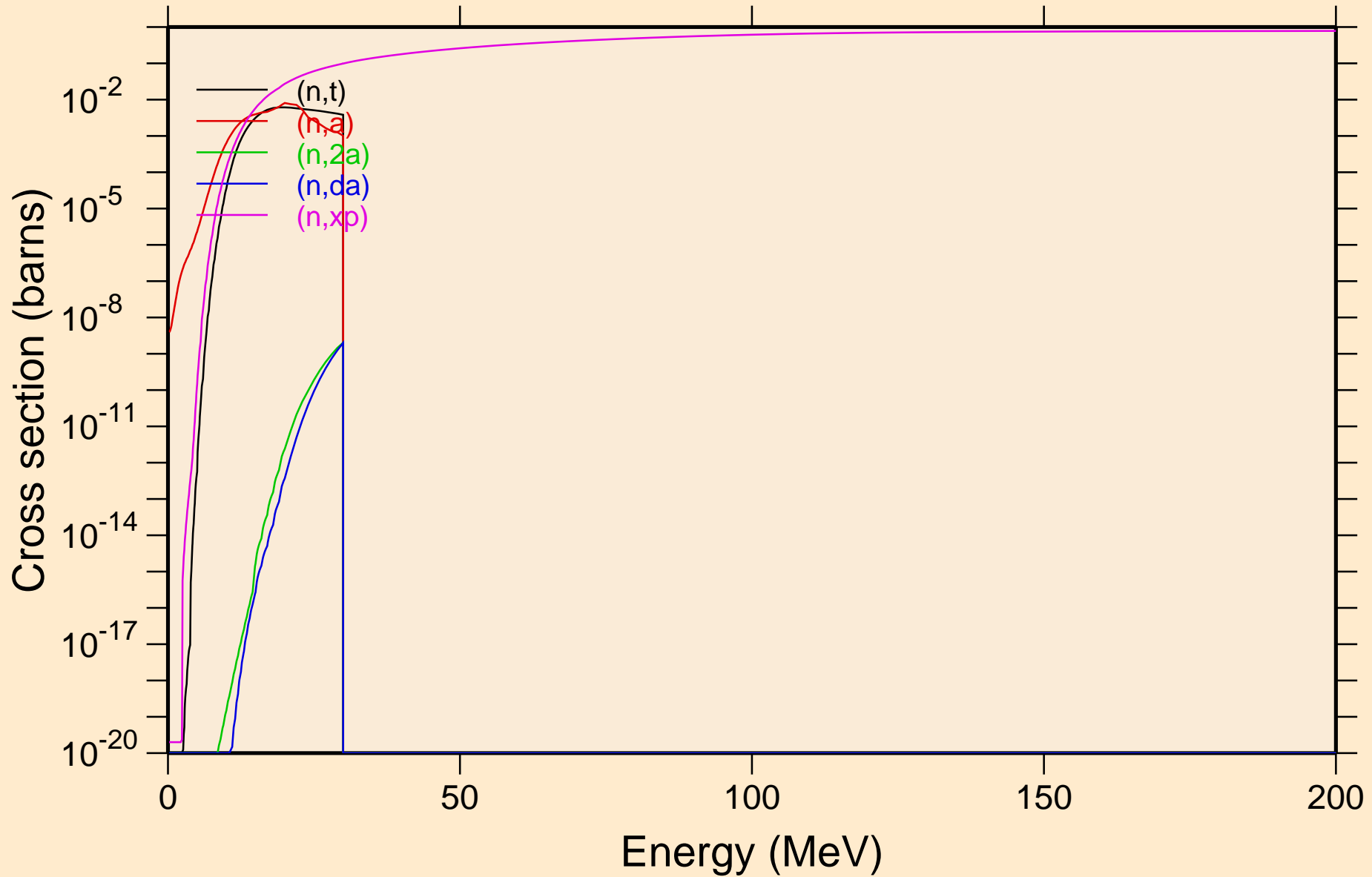

BI212N NEUTRON ACER TENDL-2024 LIBRARY; T=0.K
Non-threshold reactions

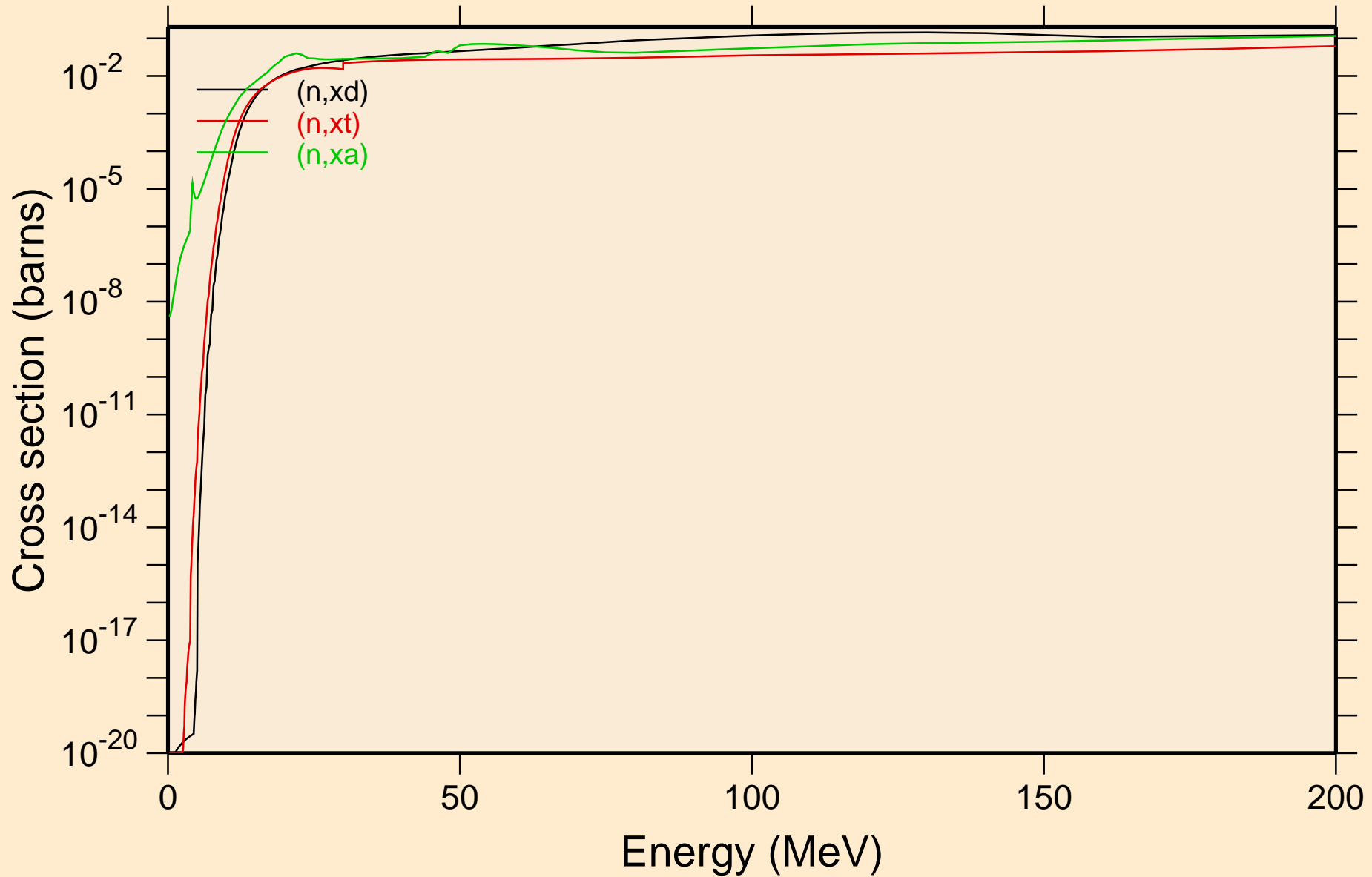

BI212N NEUTRON ACER TENDL-2024 LIBRARY; T=0.K
Inelastic levels

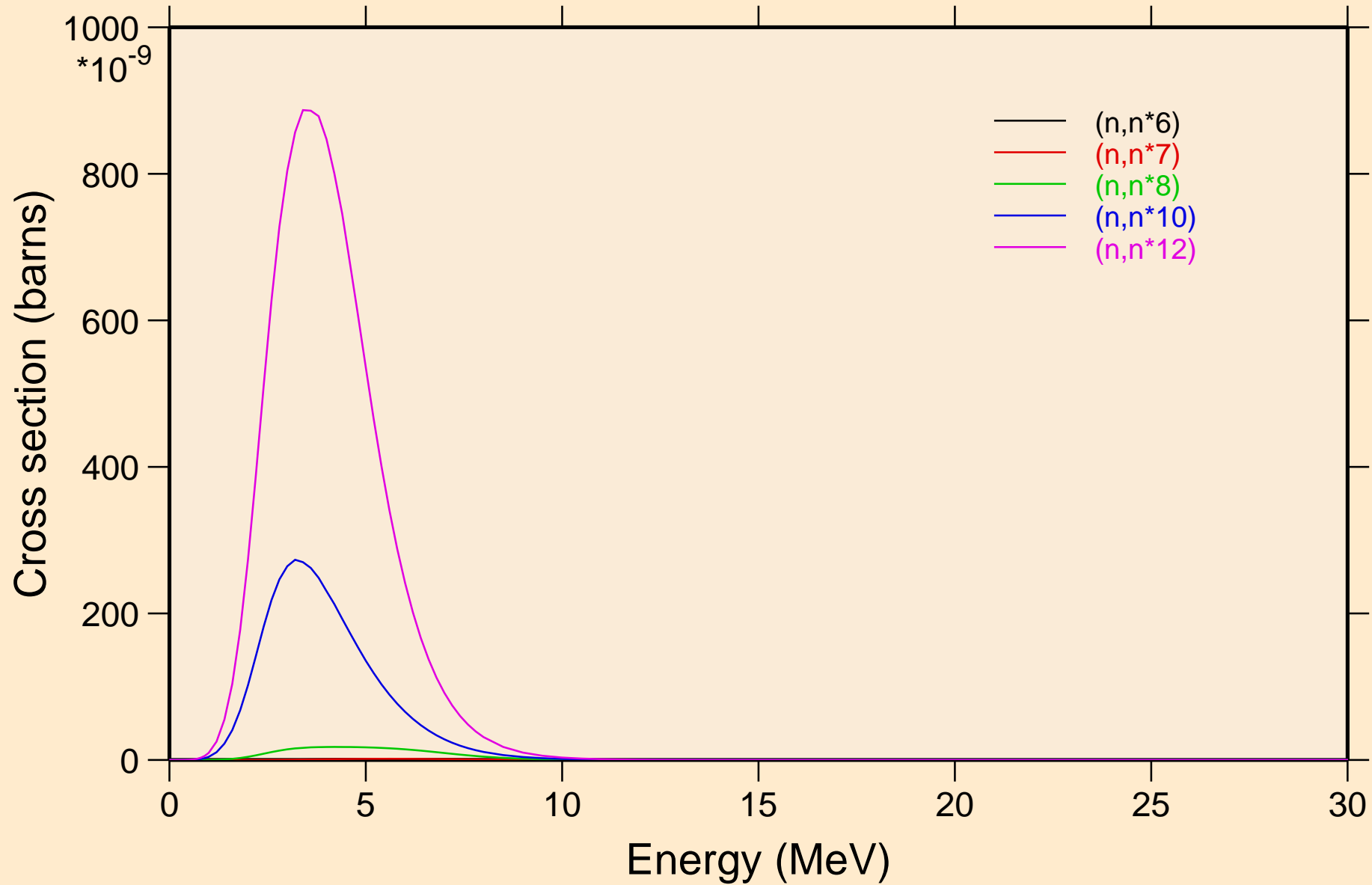

BI212N NEUTRON ACER TENDL-2024 LIBRARY; T=0.K
Inelastic levels

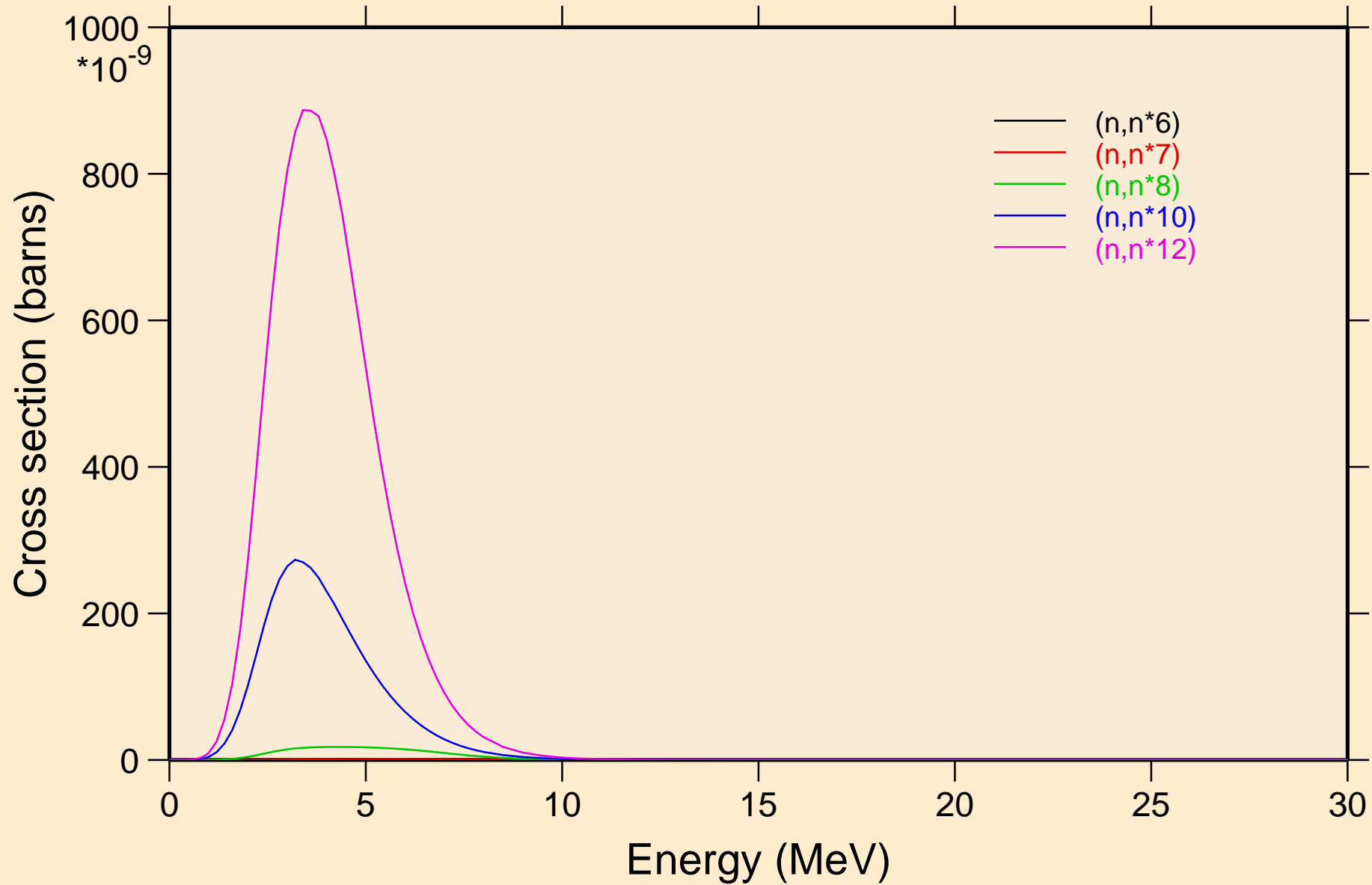

BI212N NEUTRON ACER TENDL-2024 LIBRARY; T=0.K
Inelastic levels

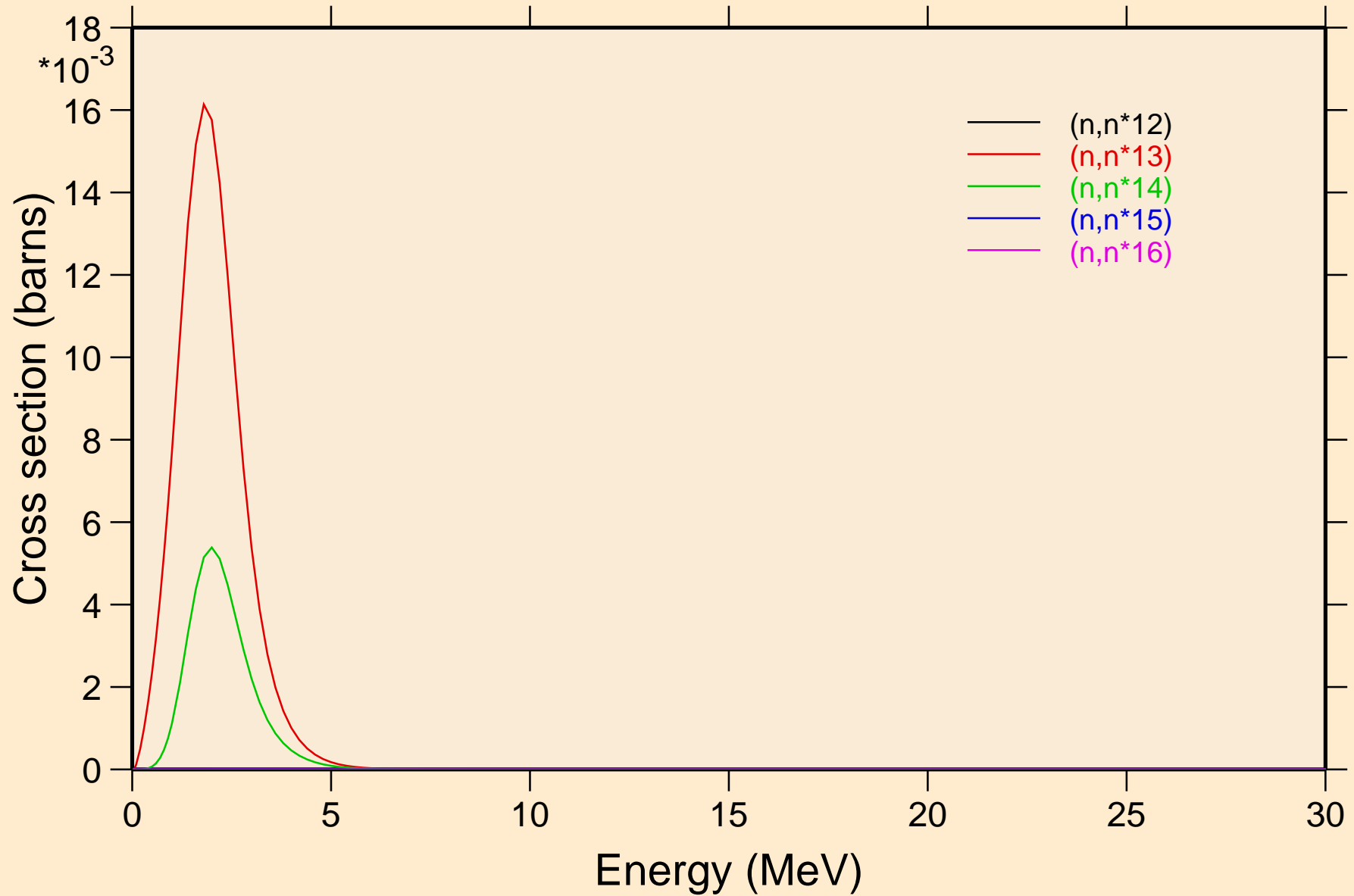

BI212N NEUTRON ACER TENDL-2024 LIBRARY; T=0.K
Inelastic levels

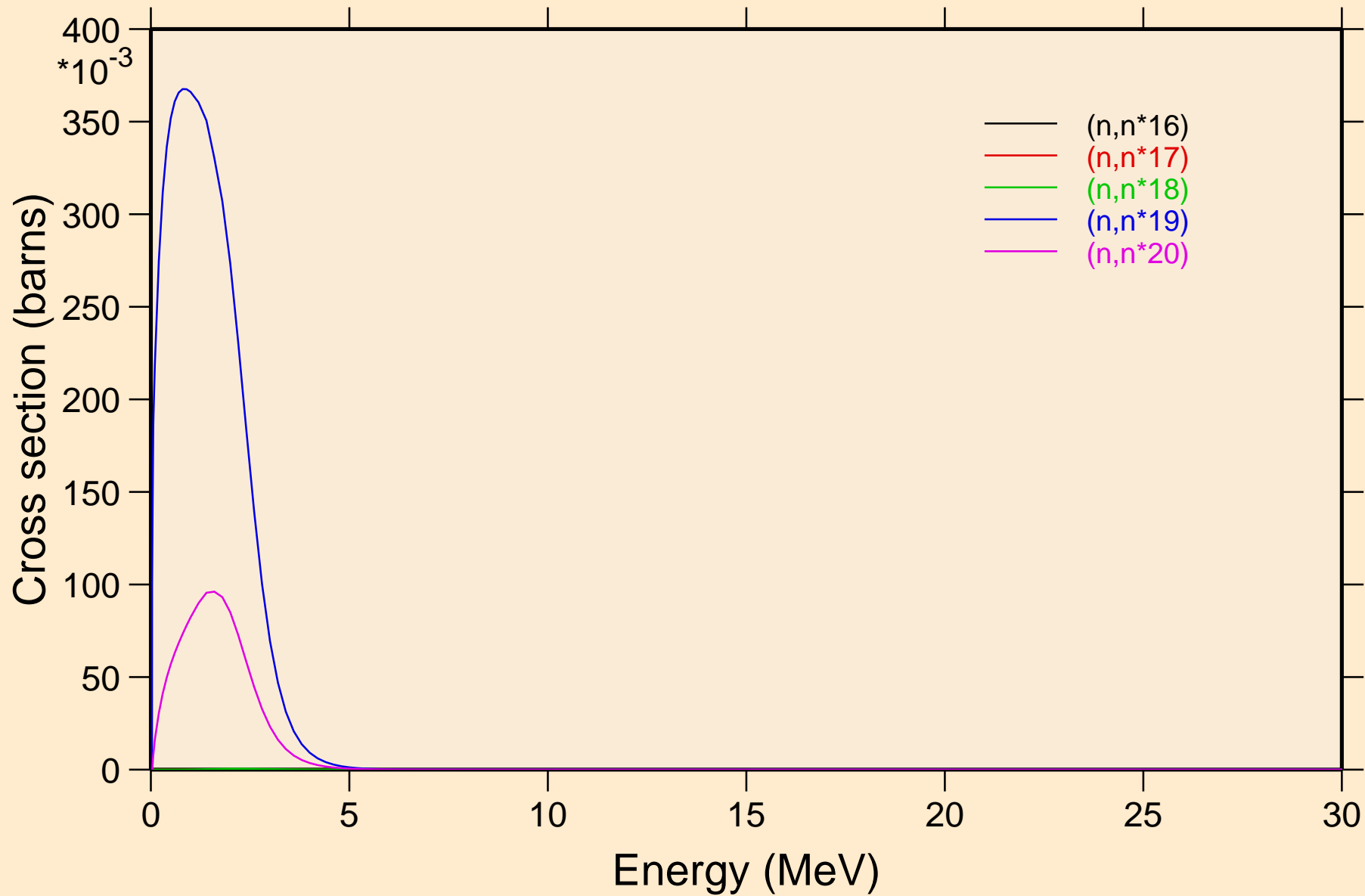

BI212N NEUTRON ACER TENDL-2024 LIBRARY; T=0.K
Inelastic levels

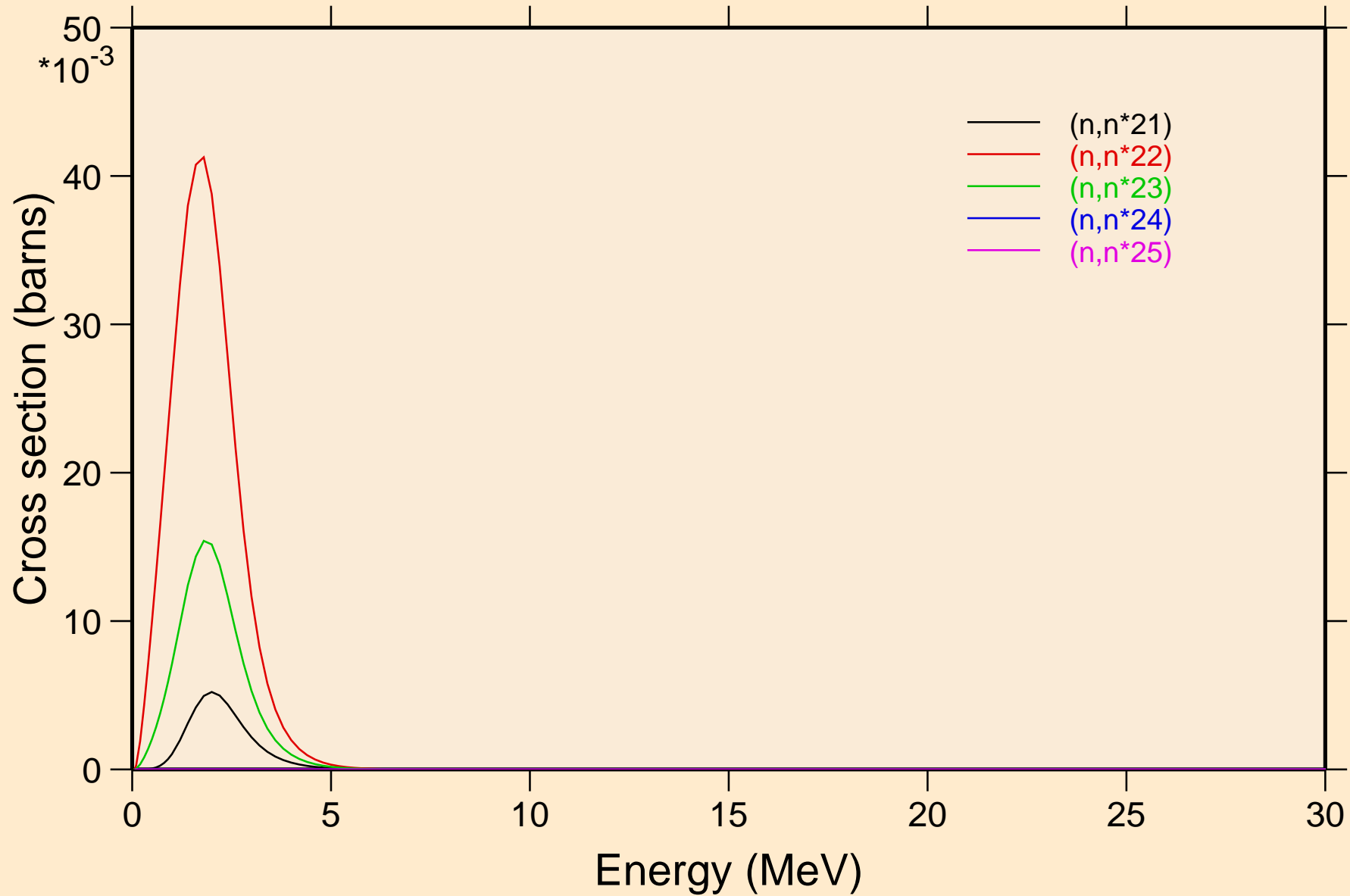

BI212N NEUTRON ACER TENDL-2024 LIBRARY; T=0.K
Inelastic levels

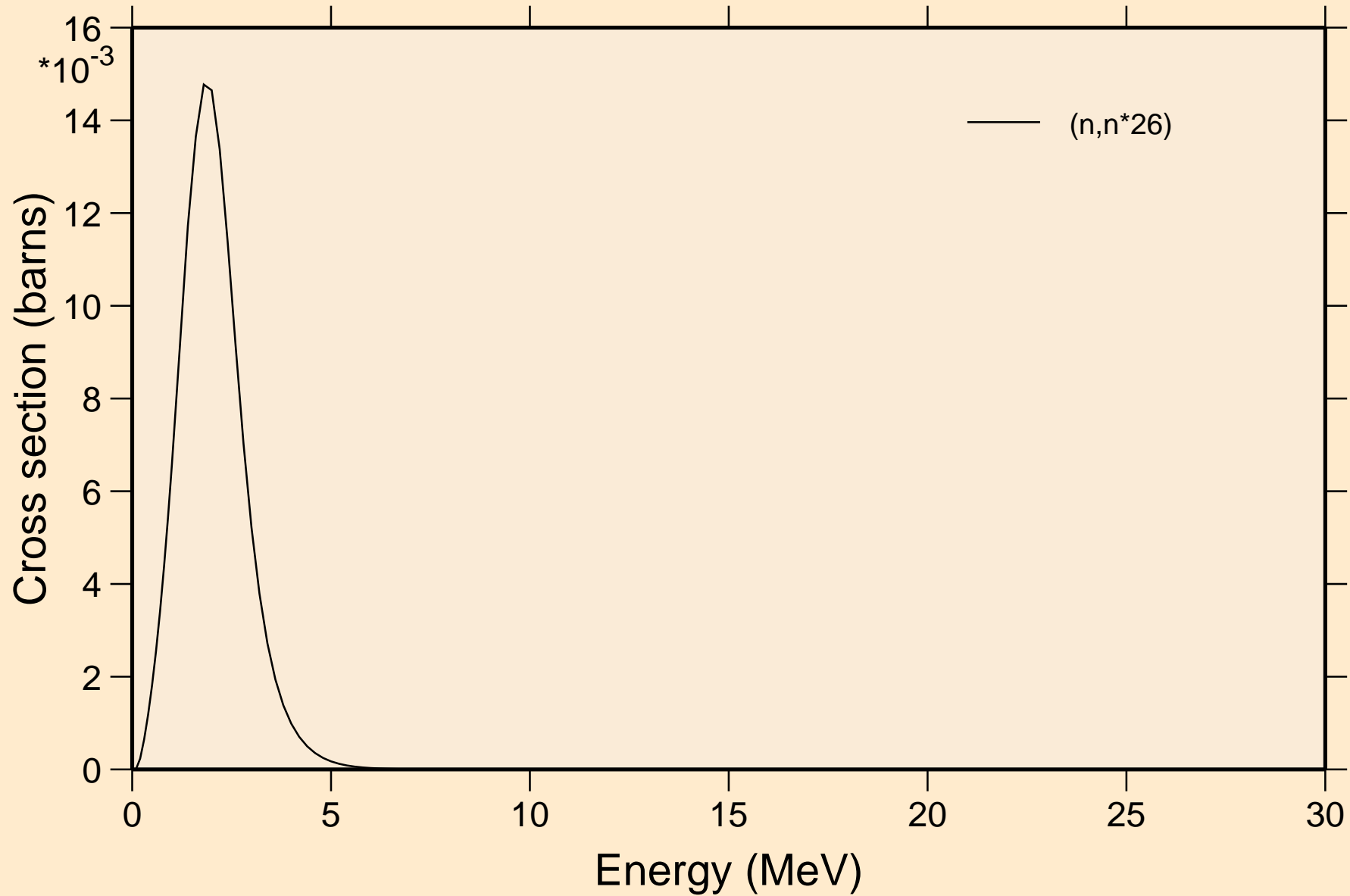

BI212N NEUTRON ACER TENDL-2024 LIBRARY; T=0.K
Threshold reactions

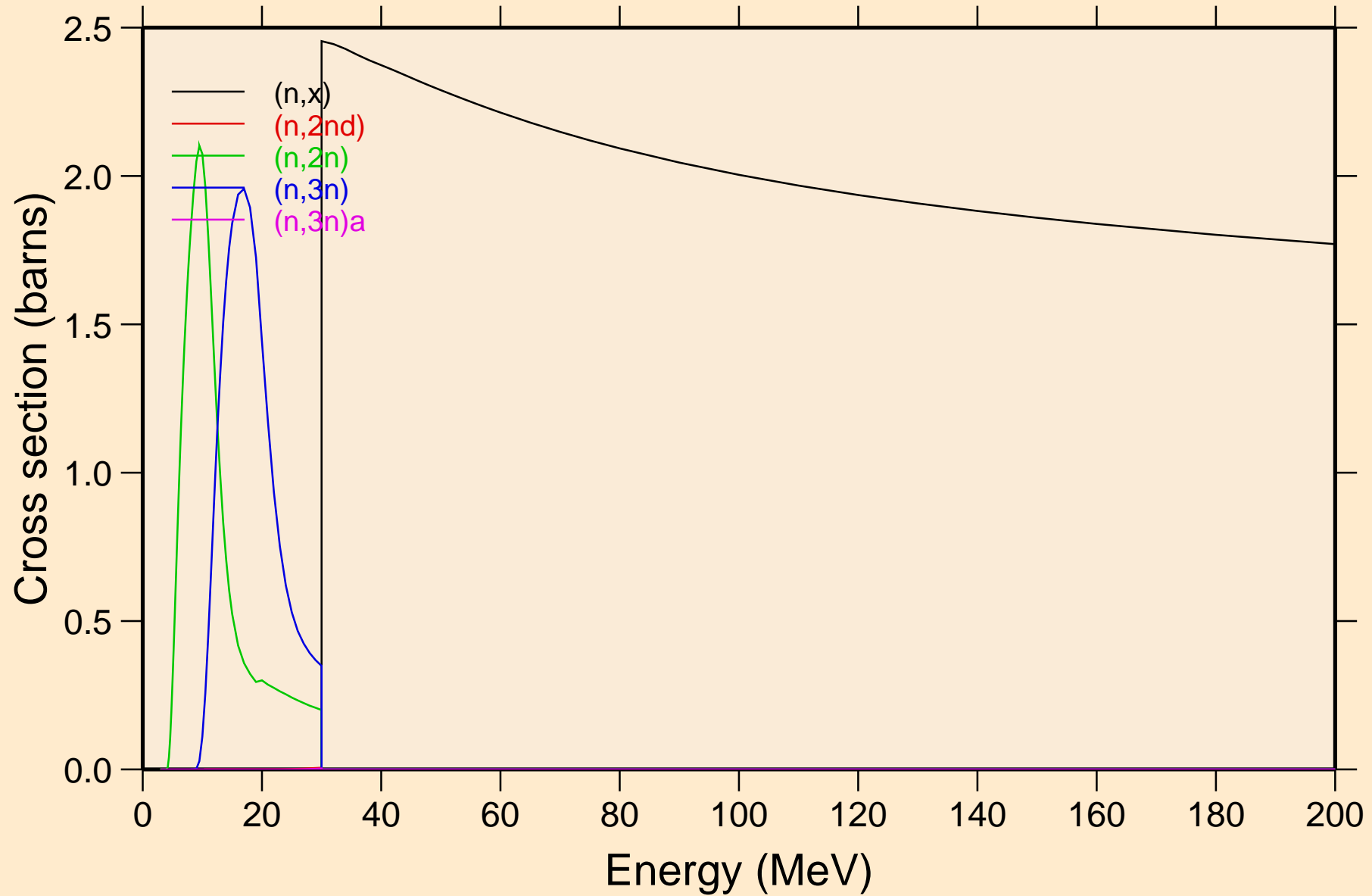

BI212N NEUTRON ACER TENDL-2024 LIBRARY; T=0.K

Threshold reactions

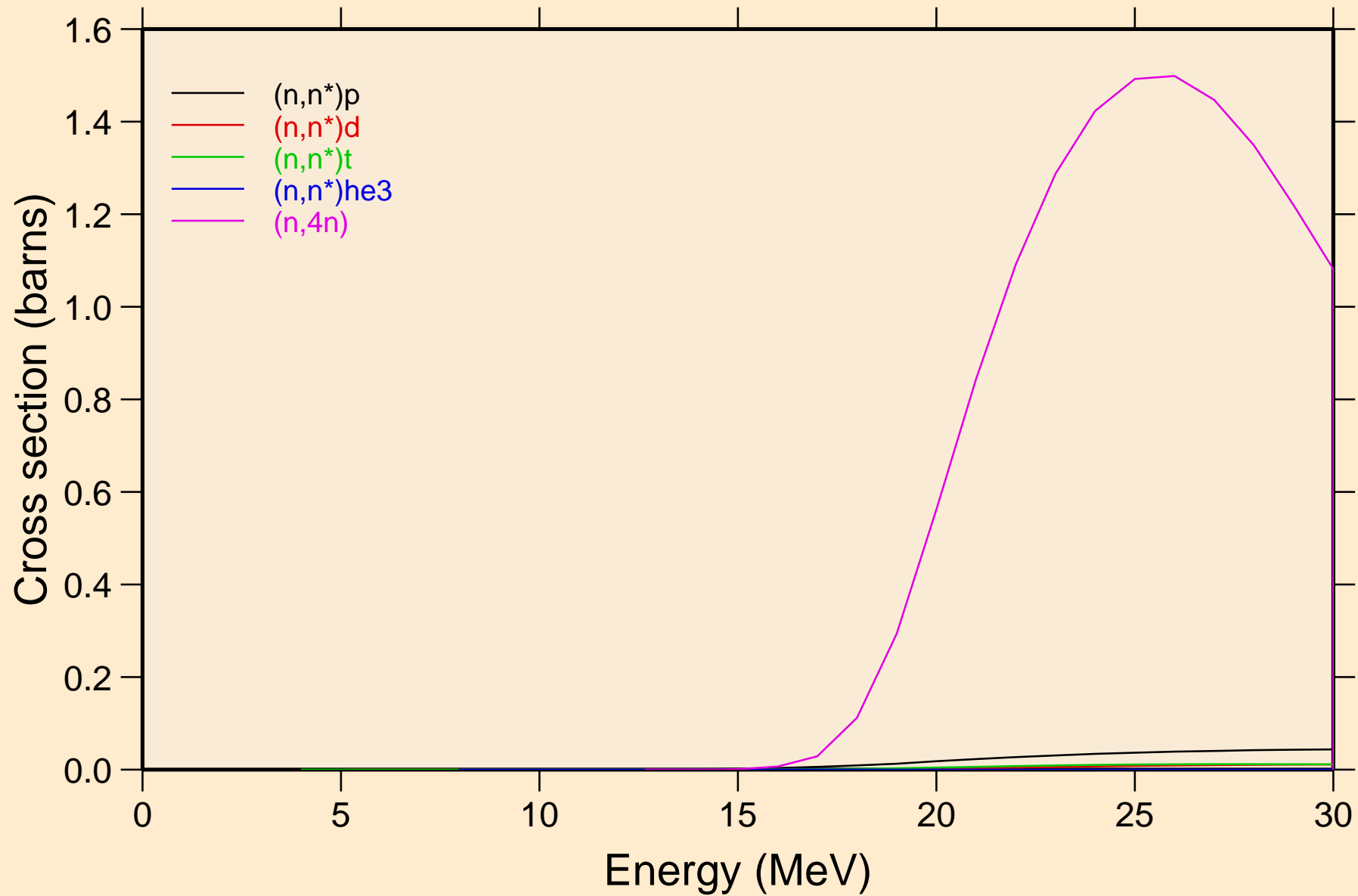

BI212N NEUTRON ACER TENDL-2024 LIBRARY; T=0.K
Threshold reactions

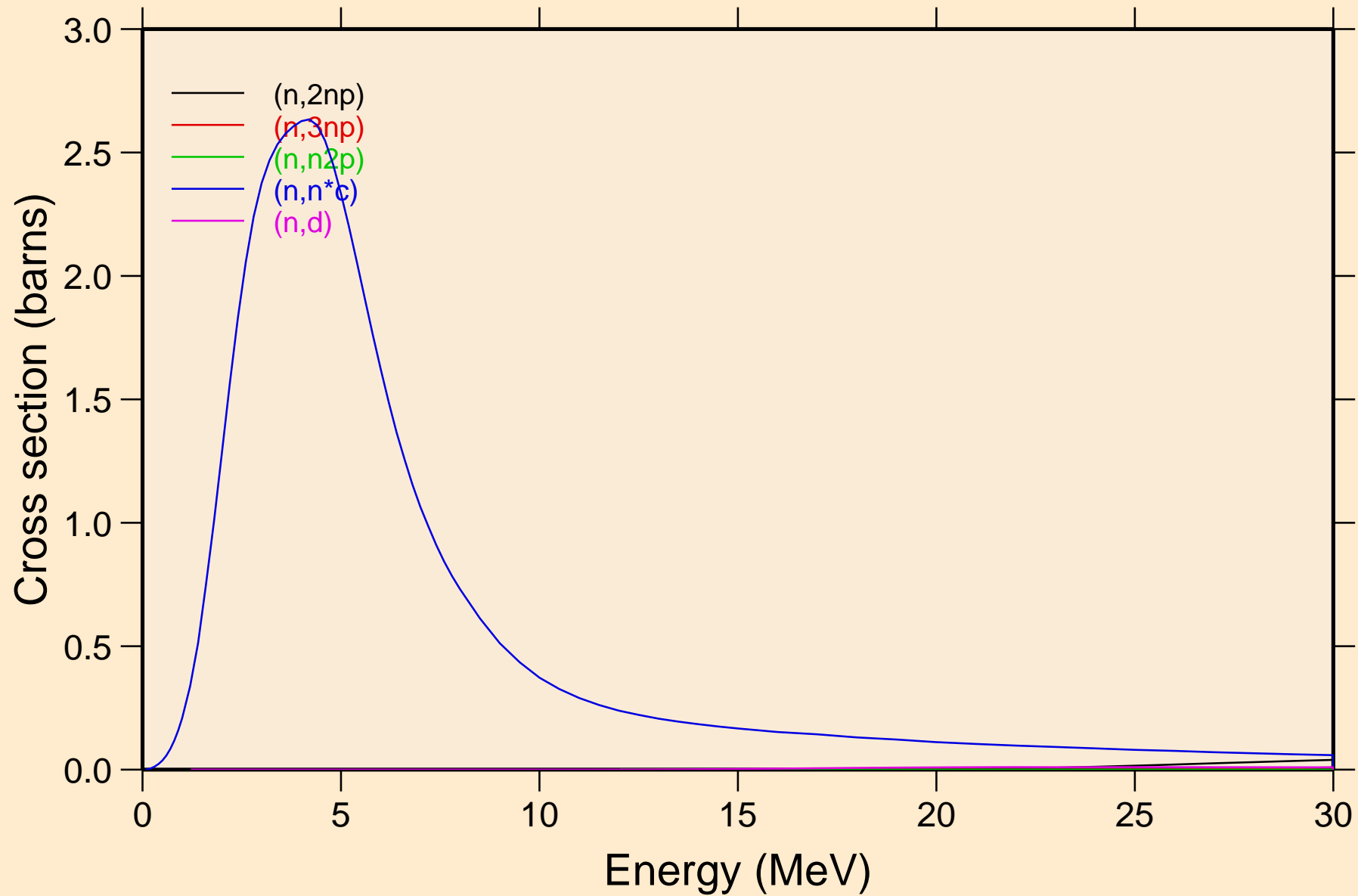

BI212N NEUTRON ACER TENDL-2024 LIBRARY; T=0.K
Threshold reactions

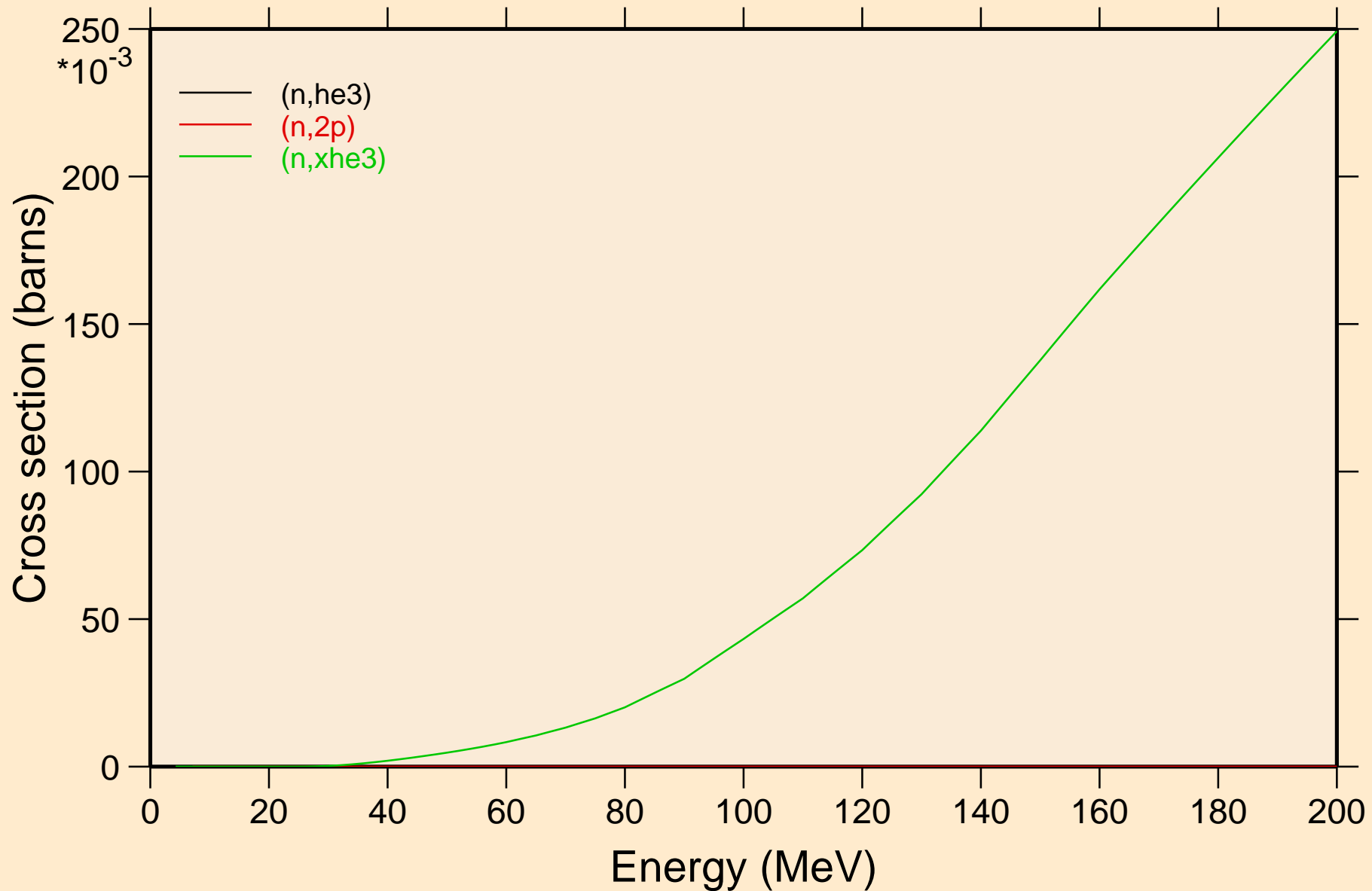

BI212N NEUTRON ACER TENDL-2024 LIBRARY; T=0.K
angular distribution for elastic

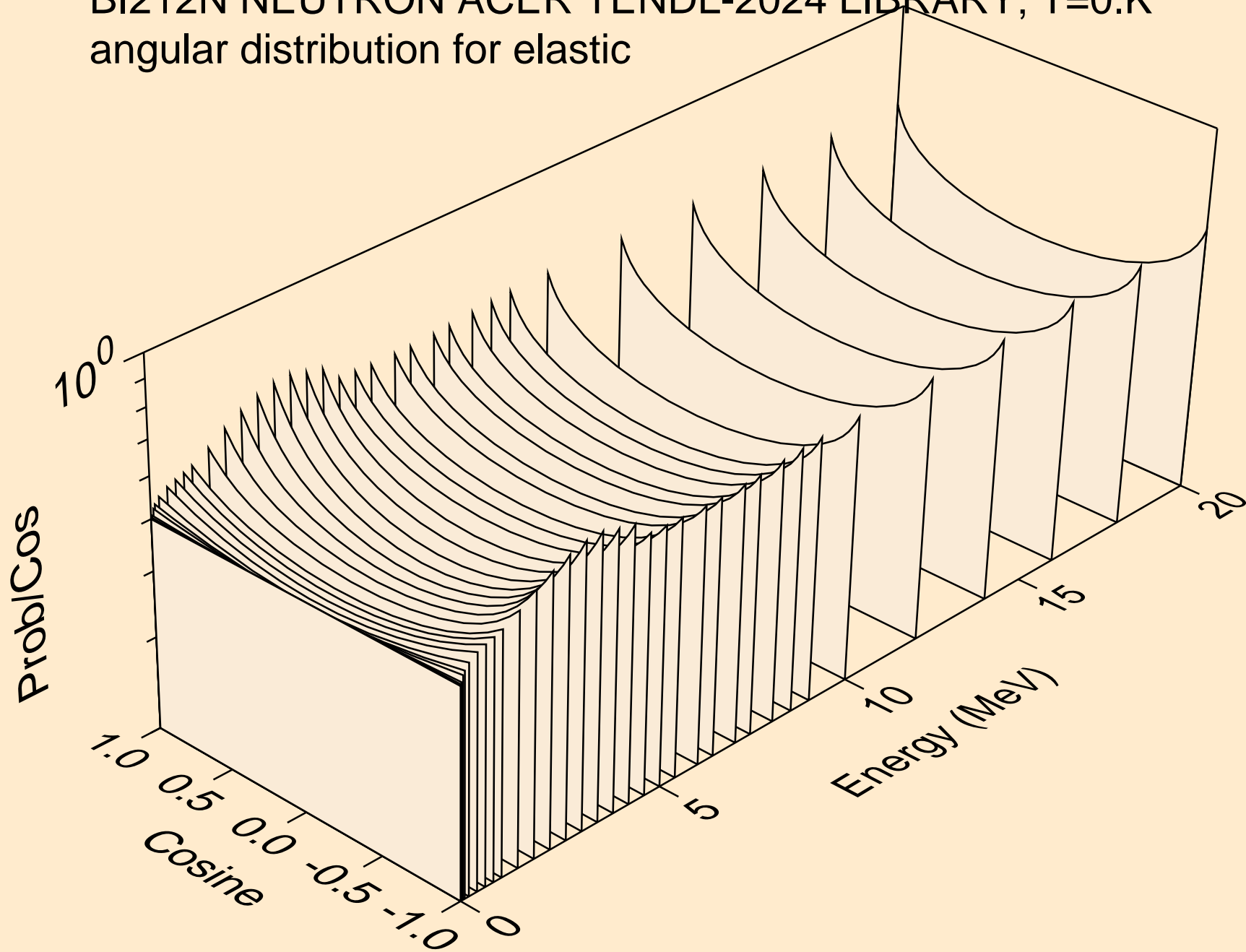

BI212N NEUTRON ACER TENDL-2024 LIBRARY; T=0.K
angular distribution for elastic

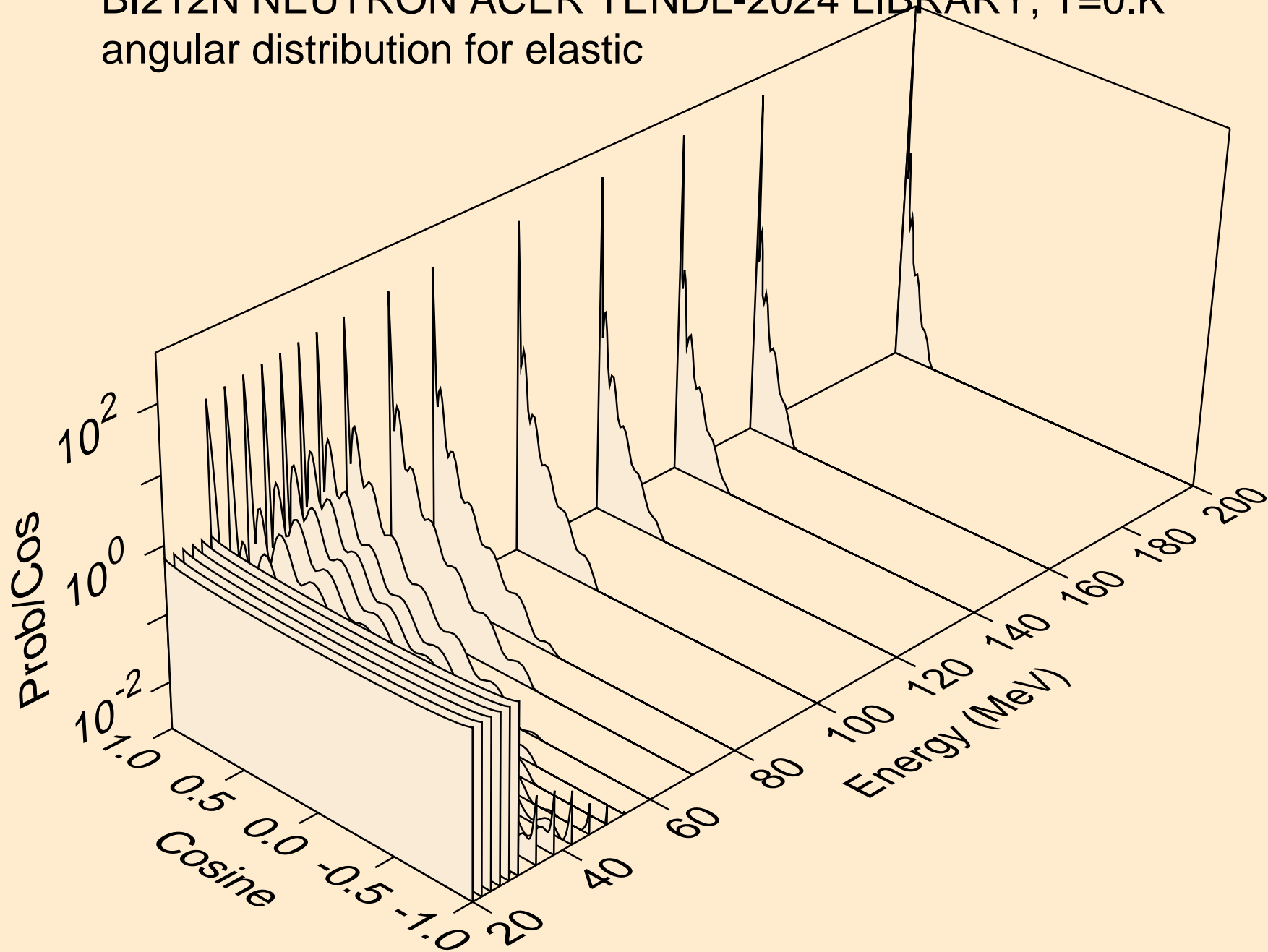

BI212N NEUTRON ACER TENDL-2024 LIBRARY; T=0.K
angular distribution for (n,n*6)

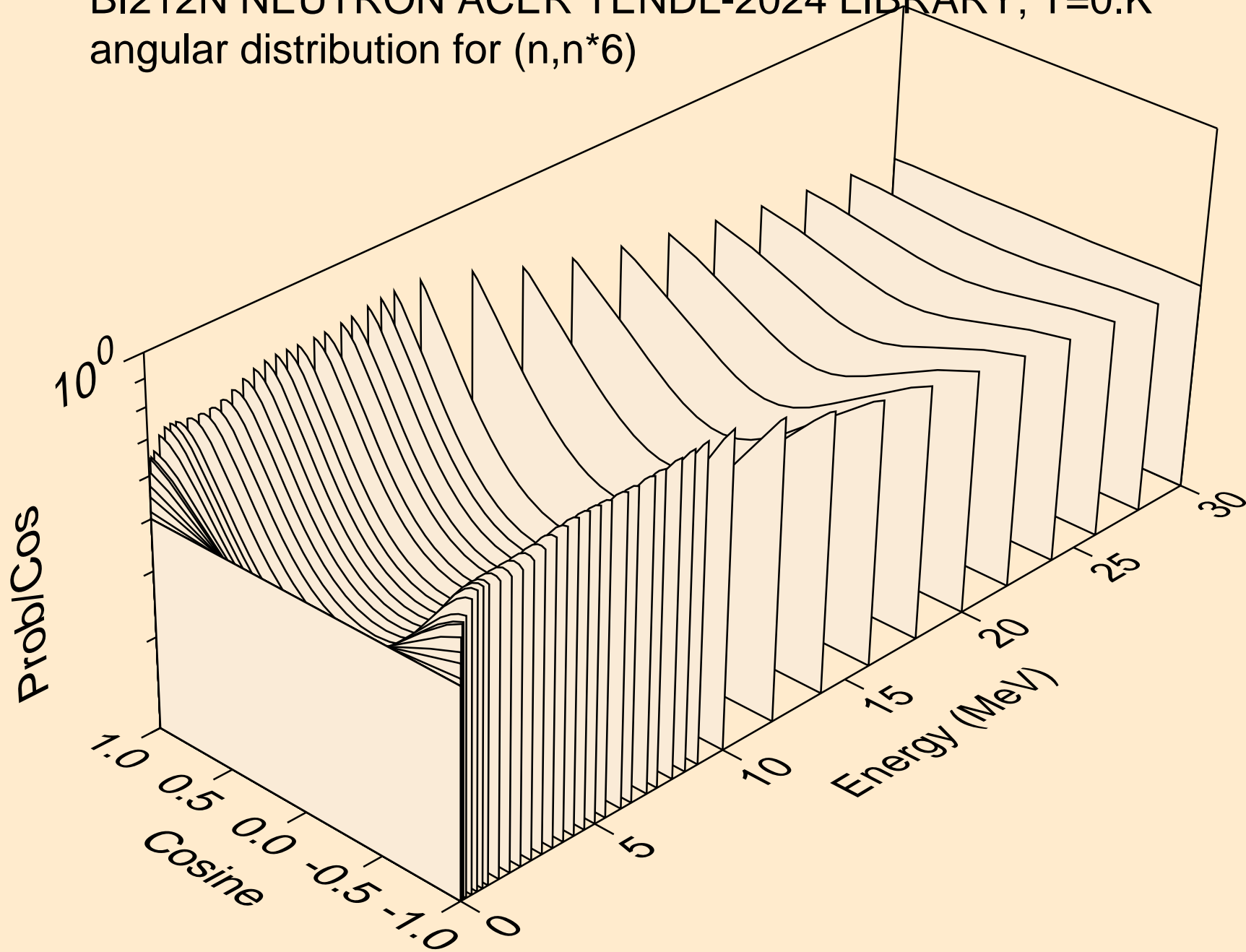

BI212N NEUTRON ACER TENDL-2024 LIBRARY; T=0.K
angular distribution for (n,n*7)

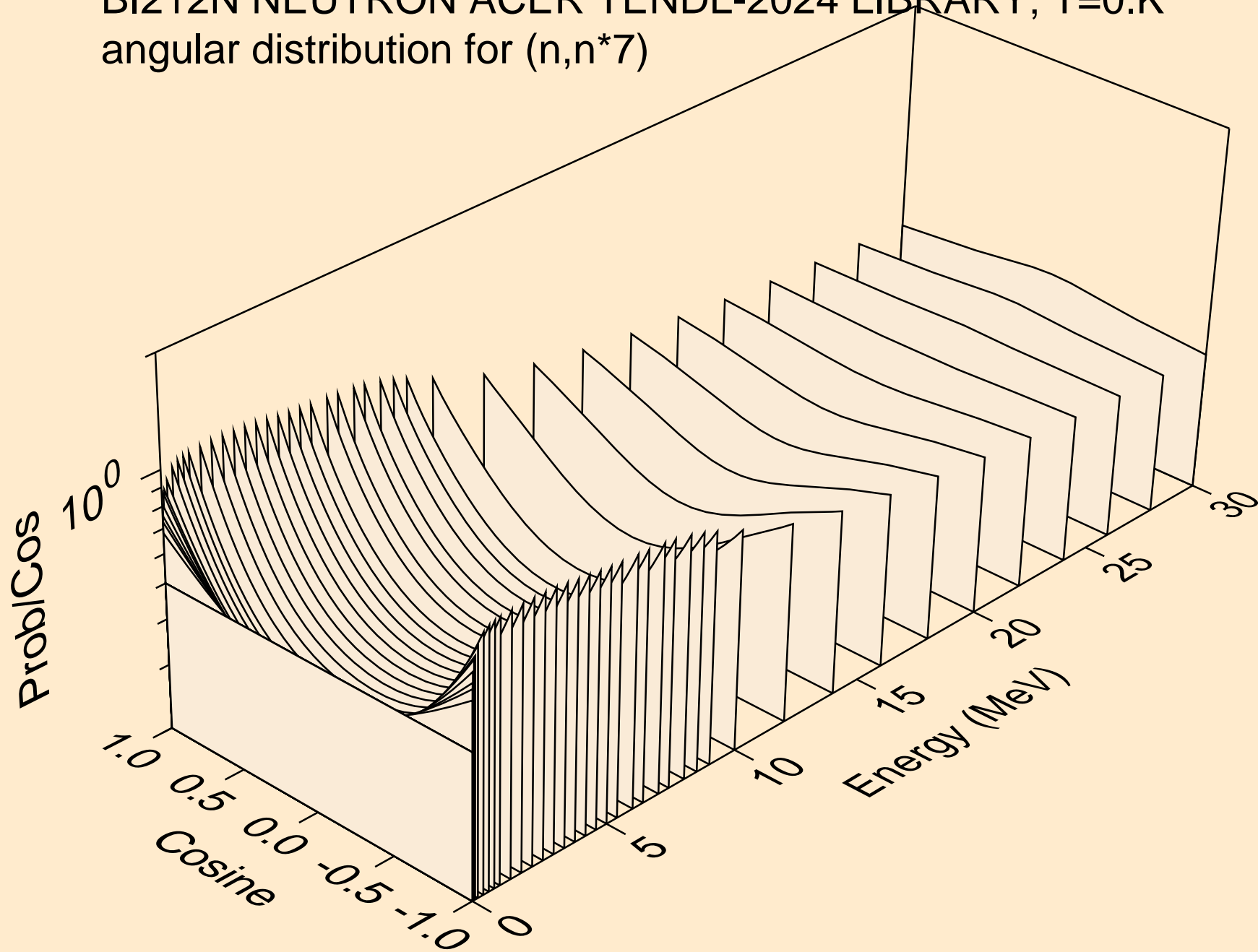

BI212N NEUTRON ACER TENDL-2024 LIBRARY; T=0.K
angular distribution for (n,n*8)

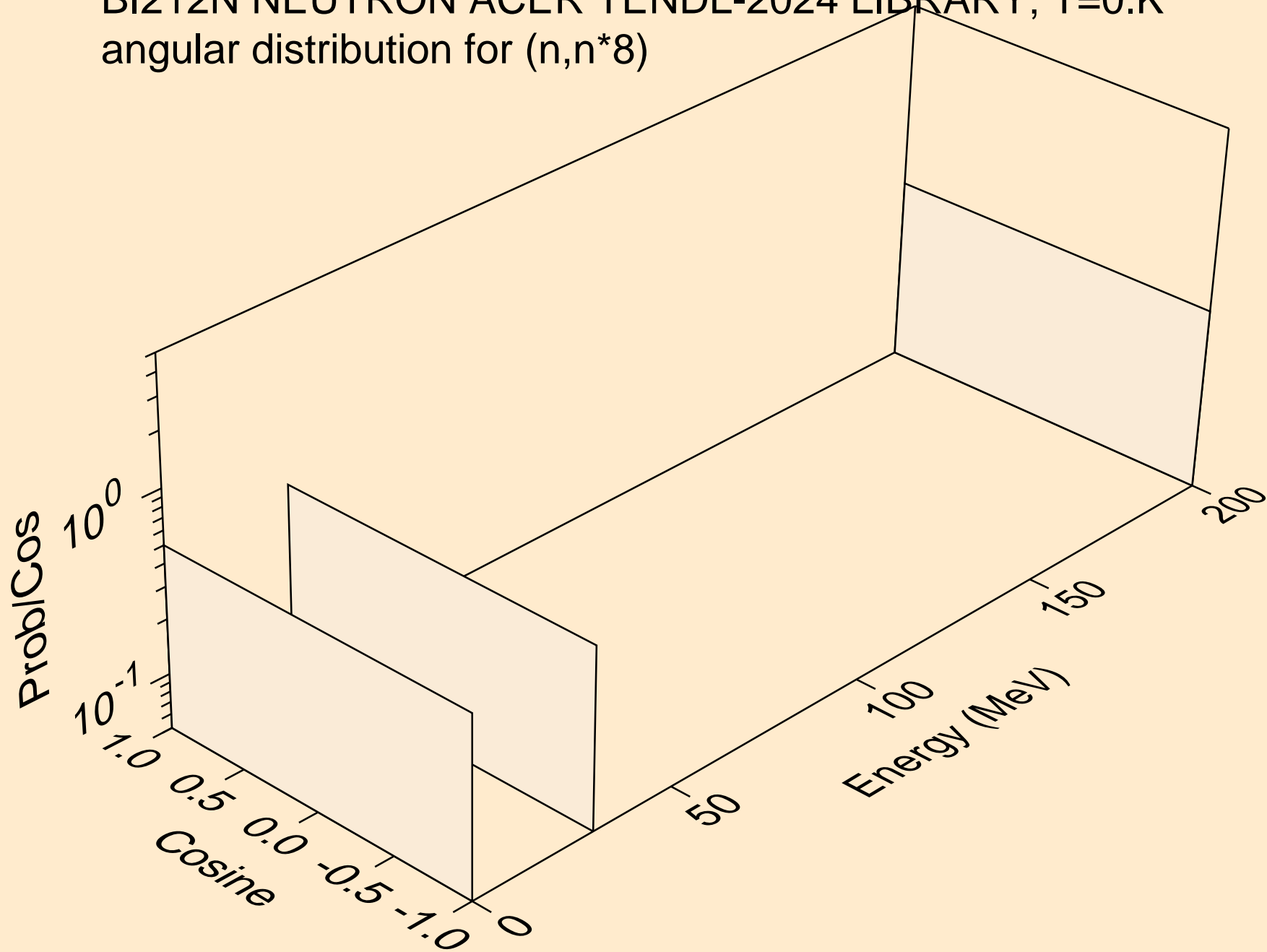

BI212N NEUTRON ACER TENDL-2024 LIBRARY; T=0.K
angular distribution for (n,n*10)

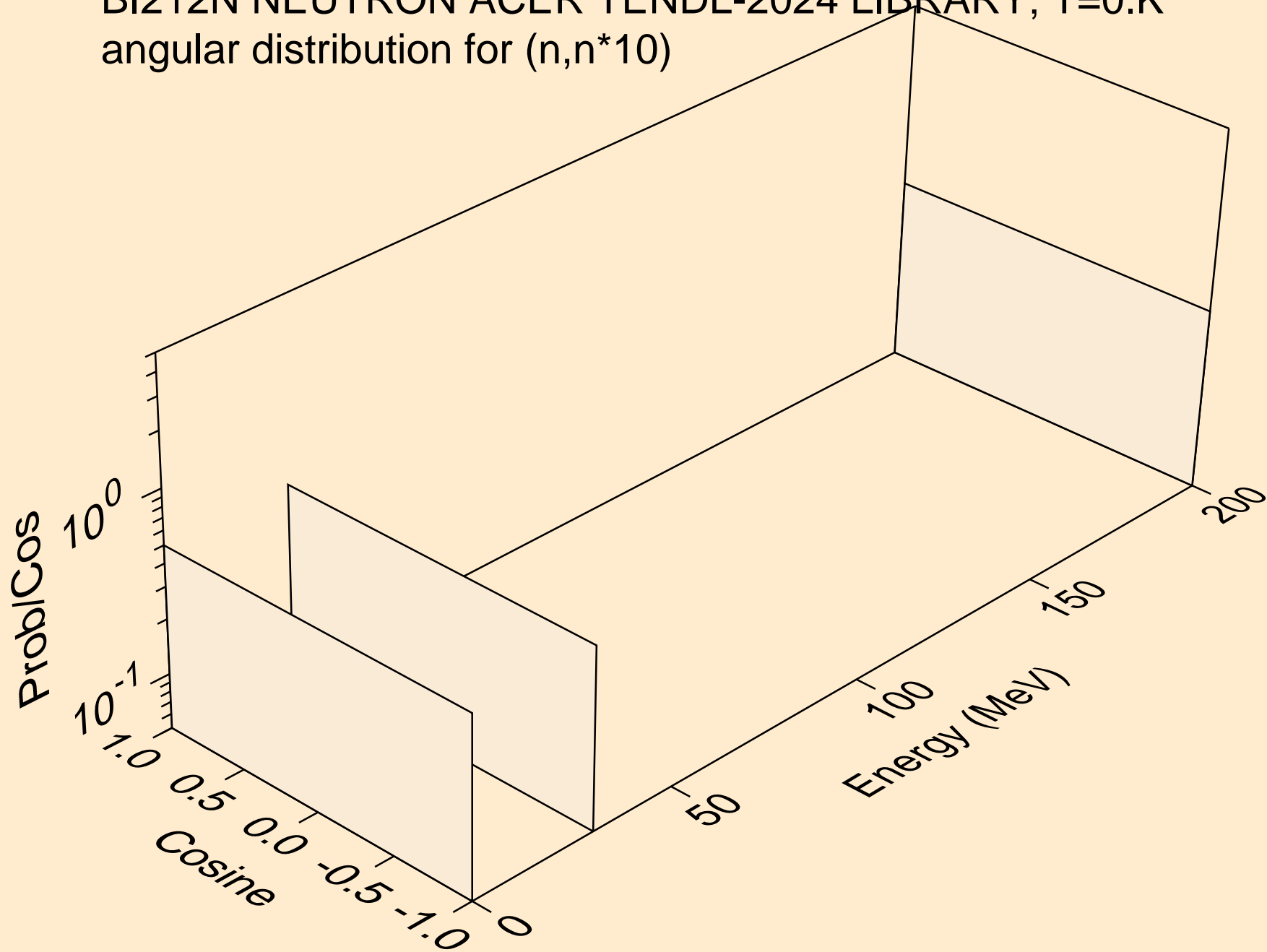

BI212N NEUTRON ACER TENDL-2024 LIBRARY; T=0.K
angular distribution for (n,n*12)

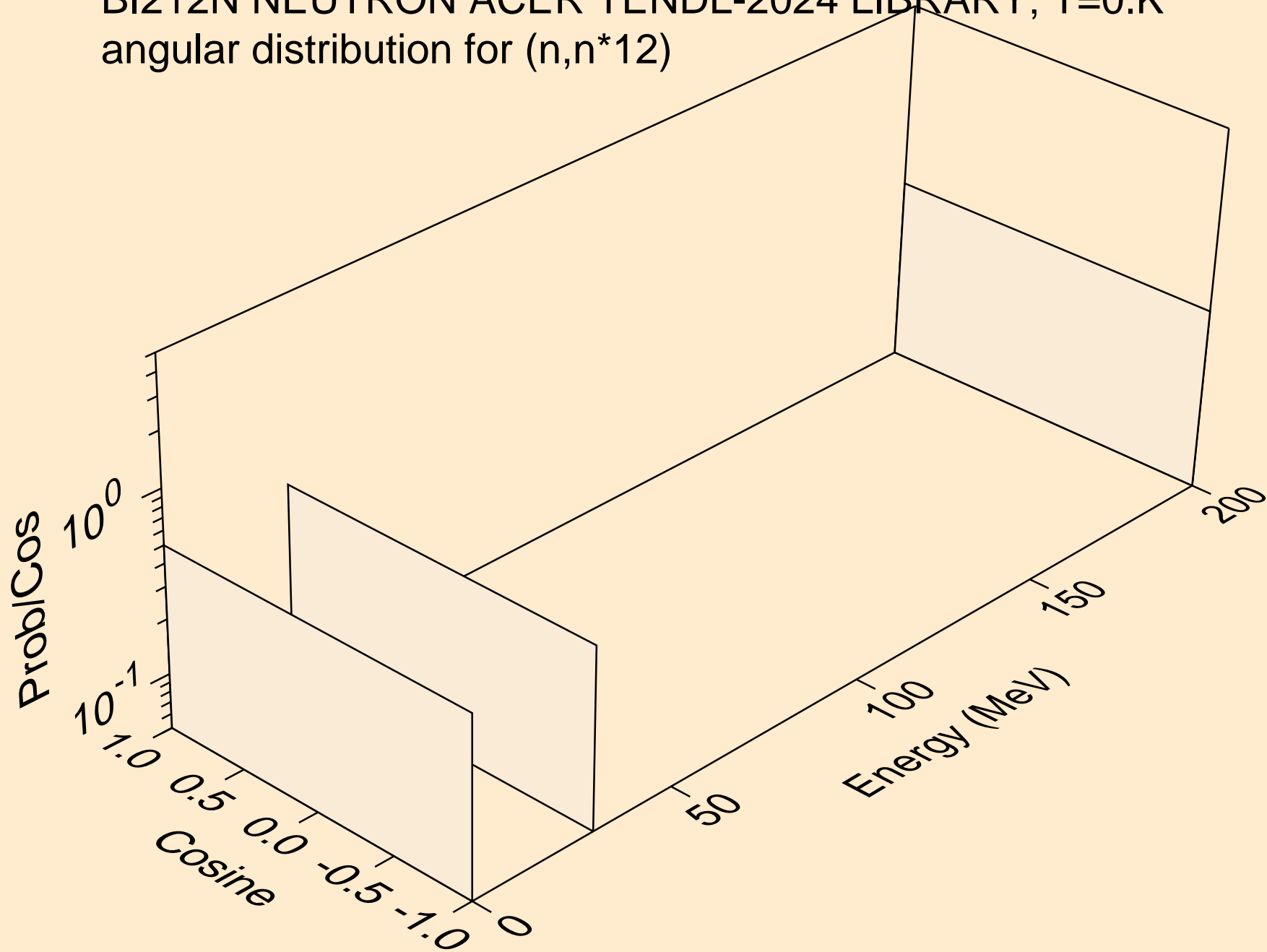

BI212N NEUTRON ACER TENDL-2024 LIBRARY; T=0.K
angular distribution for (n,n*13)

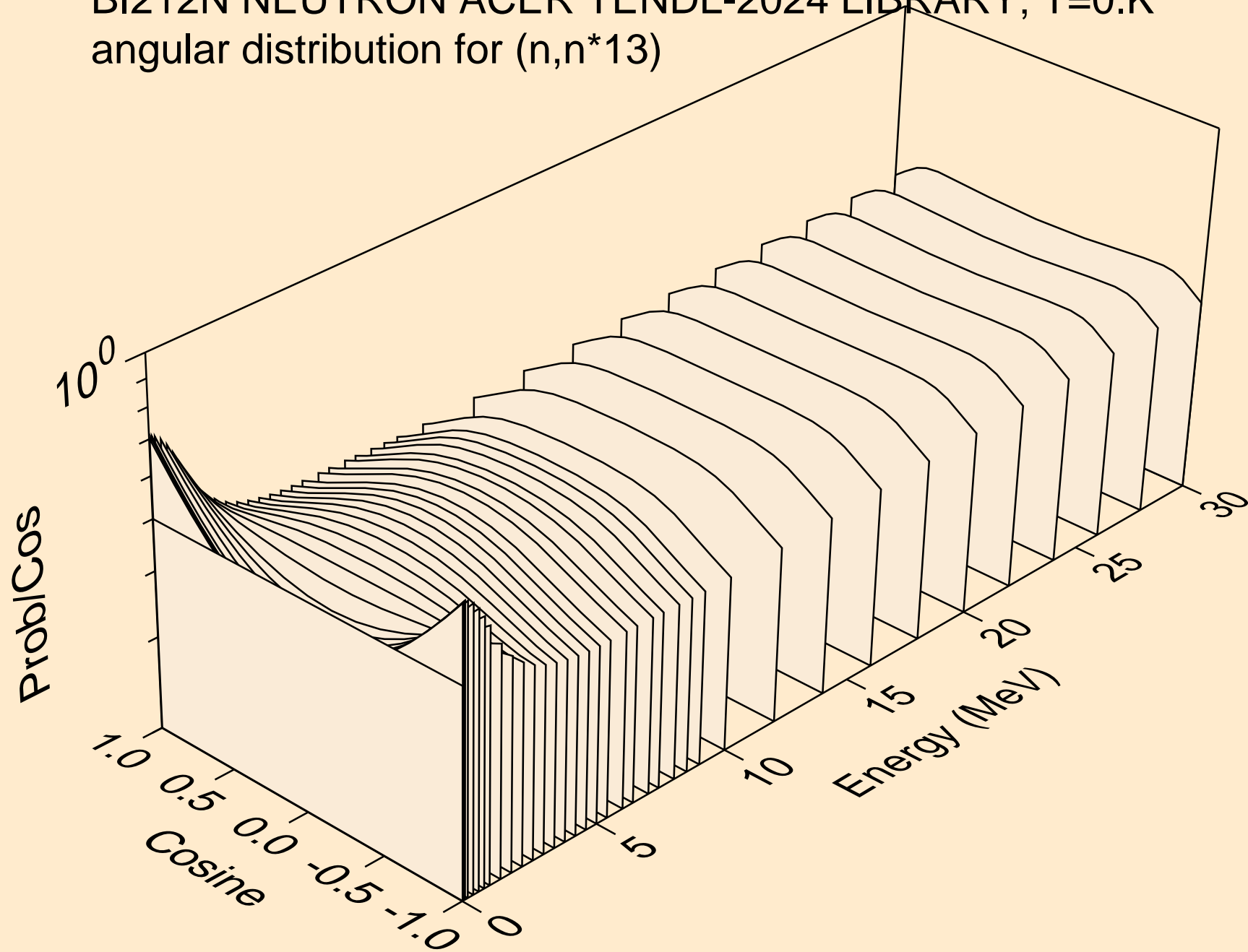

BI212N NEUTRON ACER TENDL-2024 LIBRARY; T=0.K
angular distribution for (n,n*14)

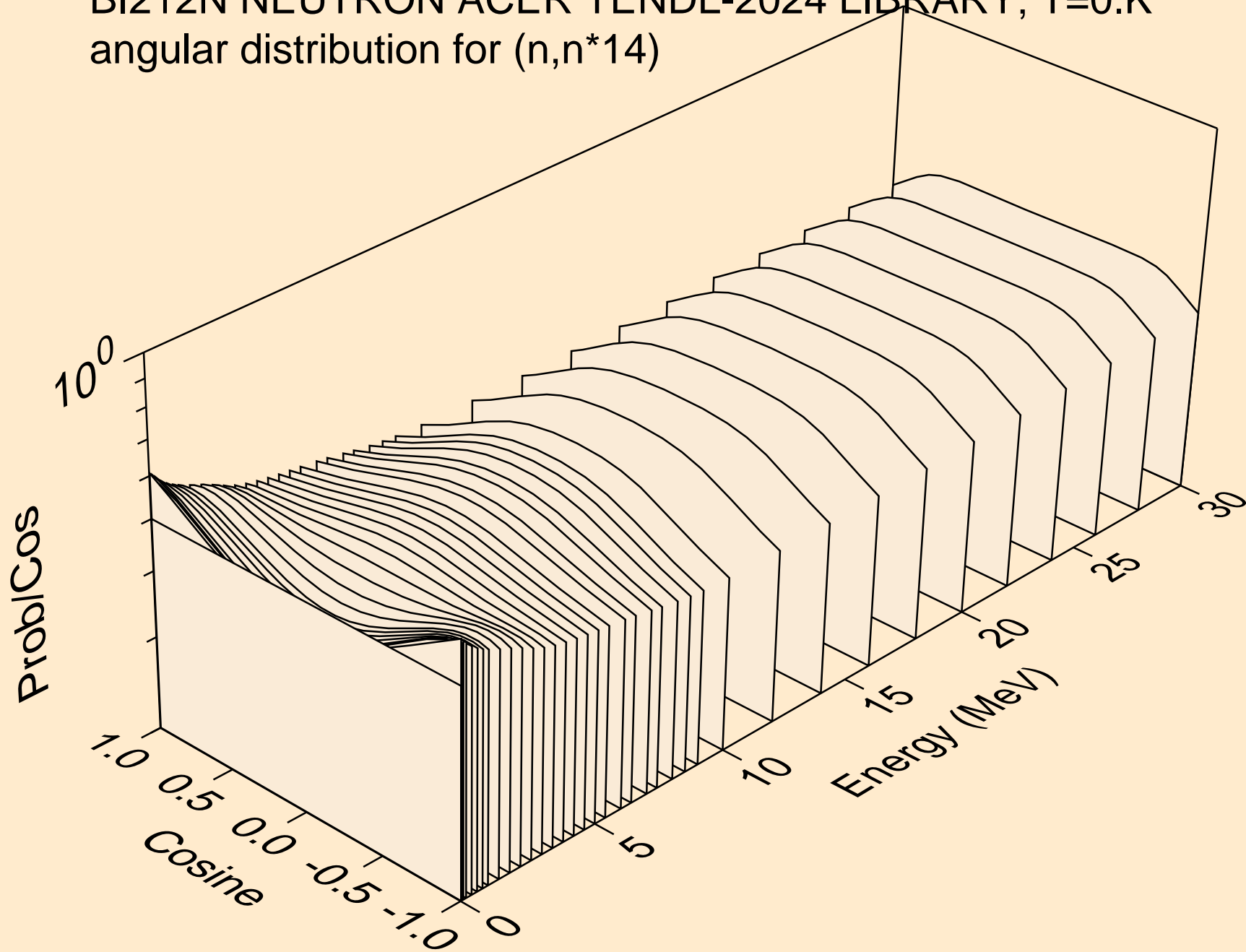

BI212N NEUTRON ACER TENDL-2024 LIBRARY; T=0.K
angular distribution for (n,n*15)

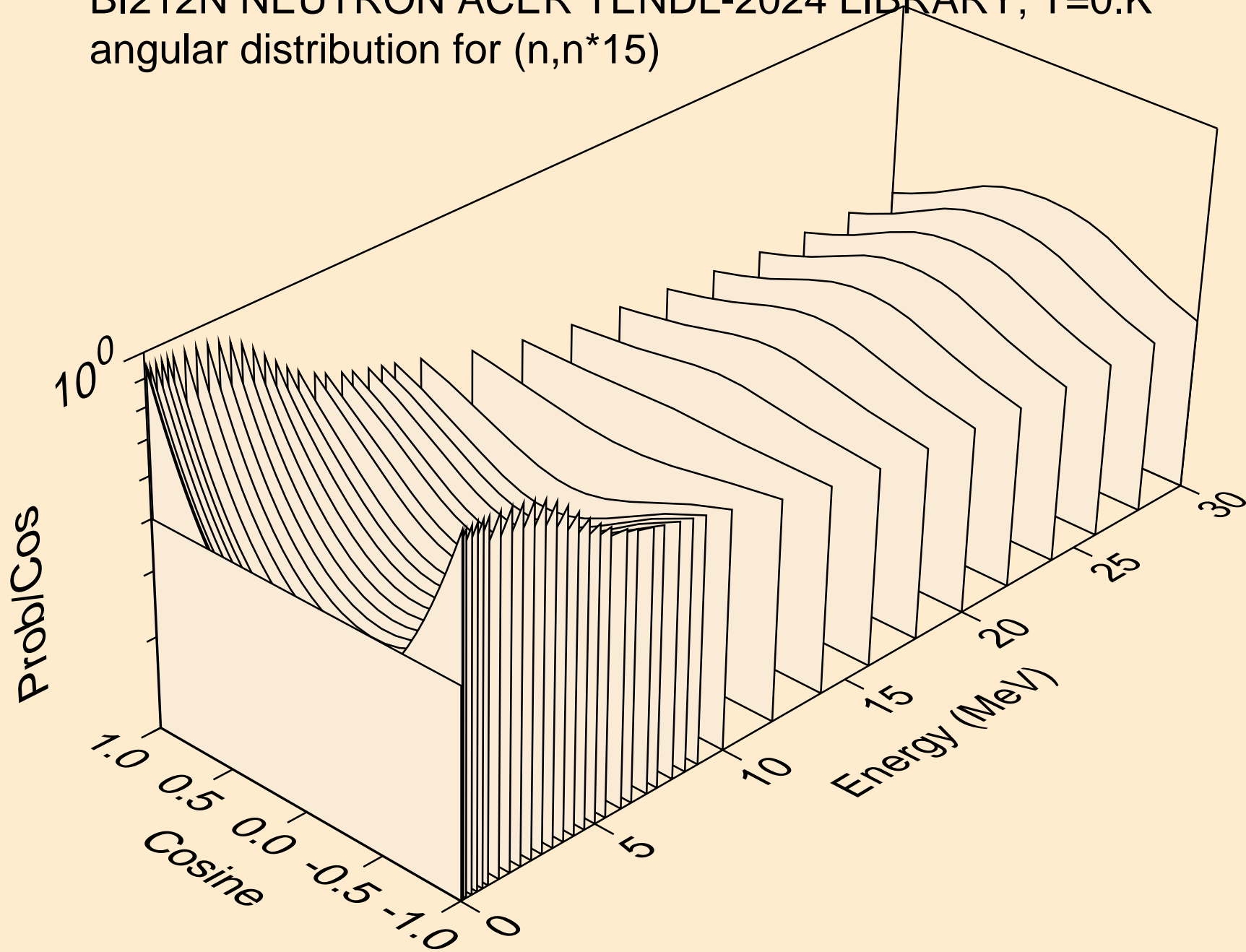

BI212N NEUTRON ACER TENDL-2024 LIBRARY; T=0.K
angular distribution for (n,n*16)

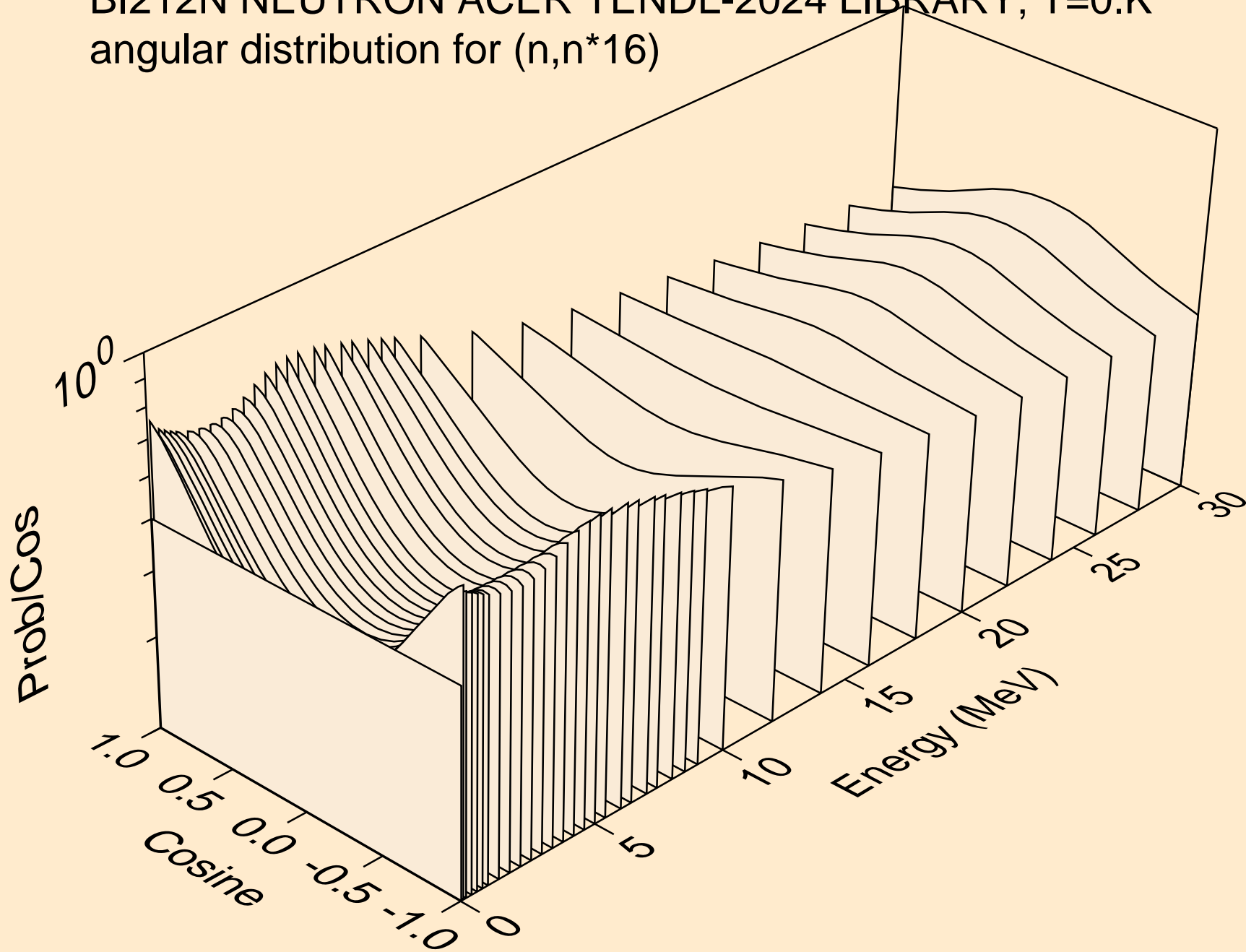

BI212N NEUTRON ACER TENDL-2024 LIBRARY; T=0.K
angular distribution for (n,n*17)

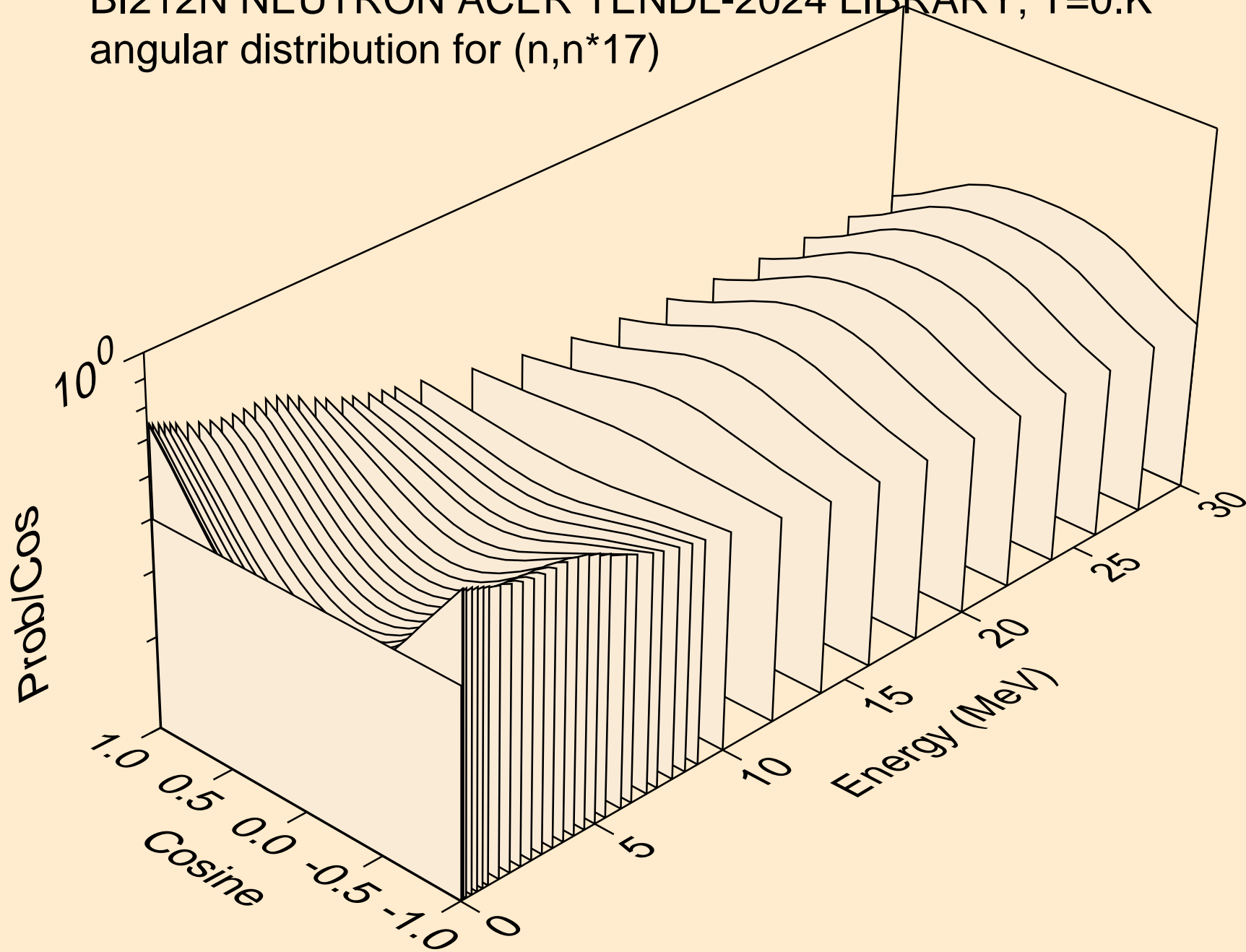

BI212N NEUTRON ACER TENDL-2024 LIBRARY; T=0.K
angular distribution for (n,n*18)

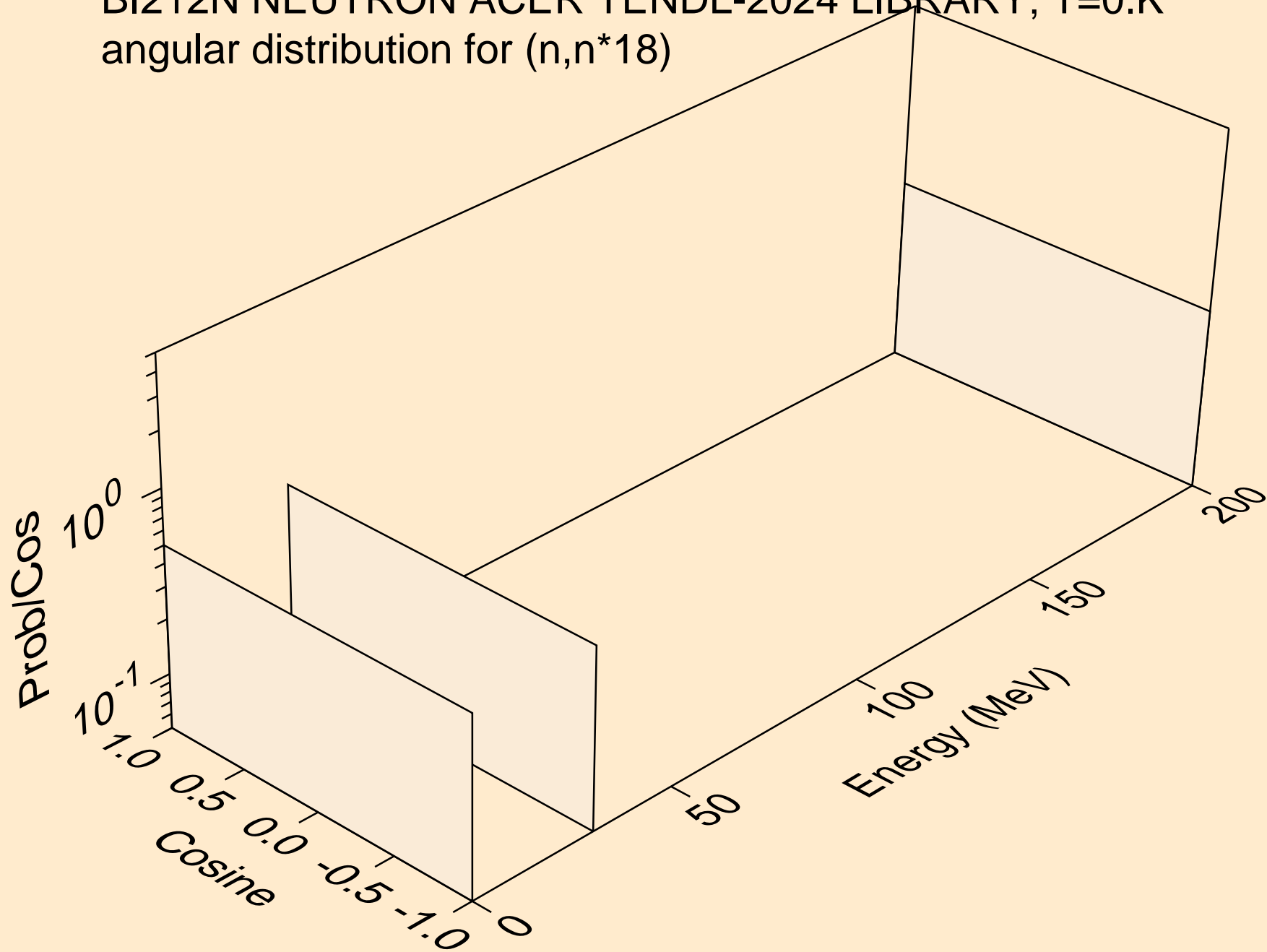

BI212N NEUTRON ACER TENDL-2024 LIBRARY; T=0.K
angular distribution for (n,n*19)

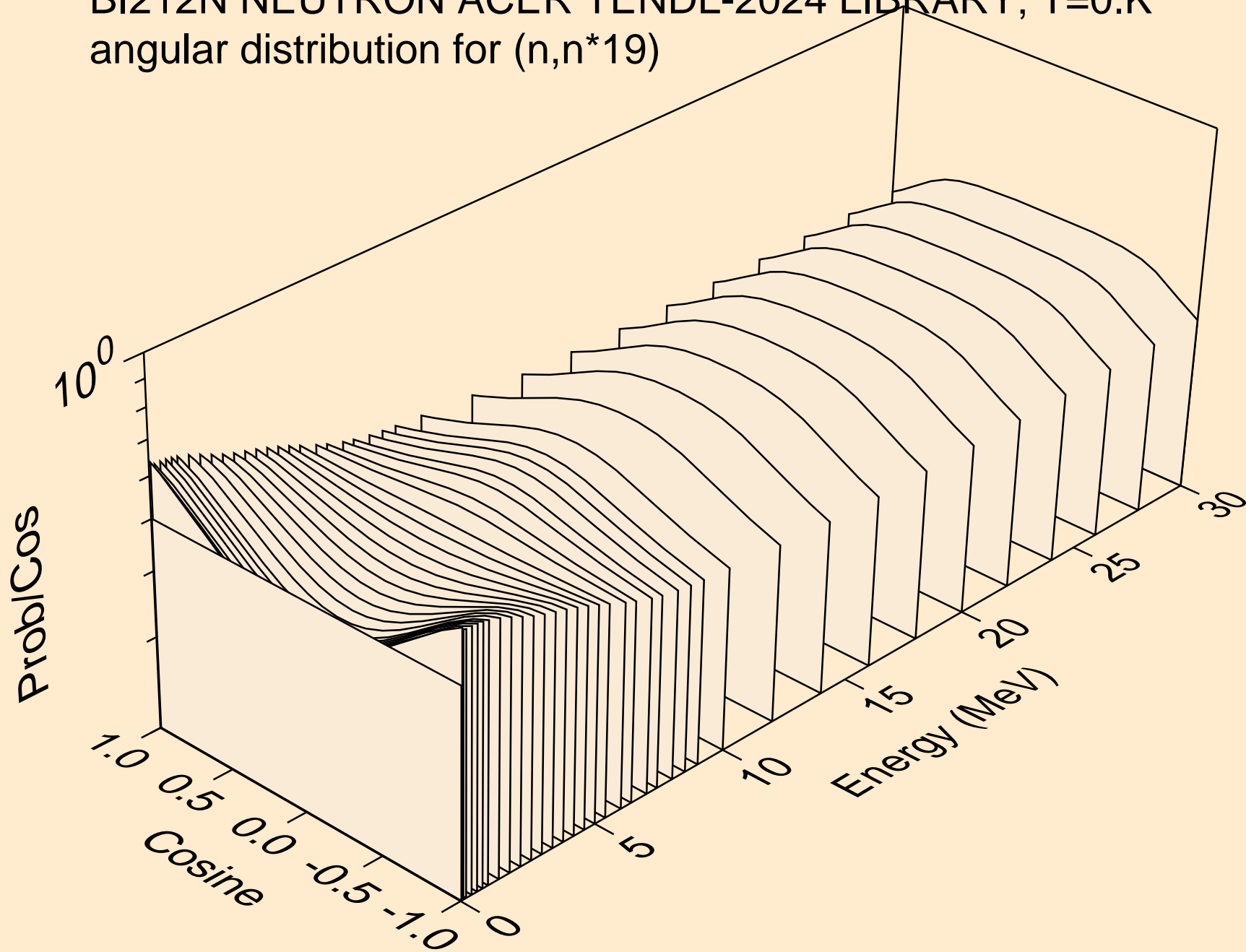

BI212N NEUTRON ACER TENDL-2024 LIBRARY; T=0.K
angular distribution for (n,n*20)

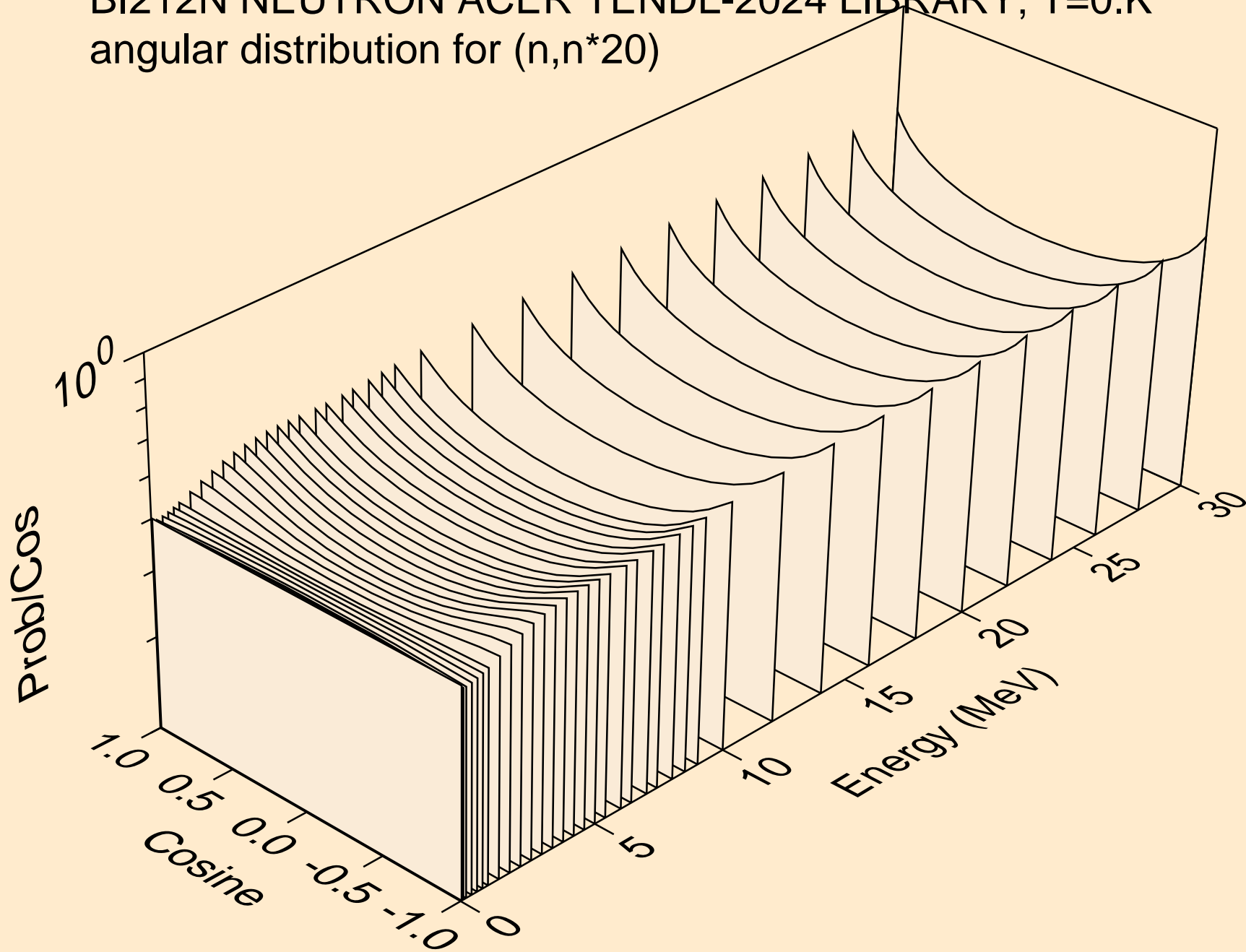

BI212N NEUTRON ACER TENDL-2024 LIBRARY; T=0.K
angular distribution for (n,n*21)

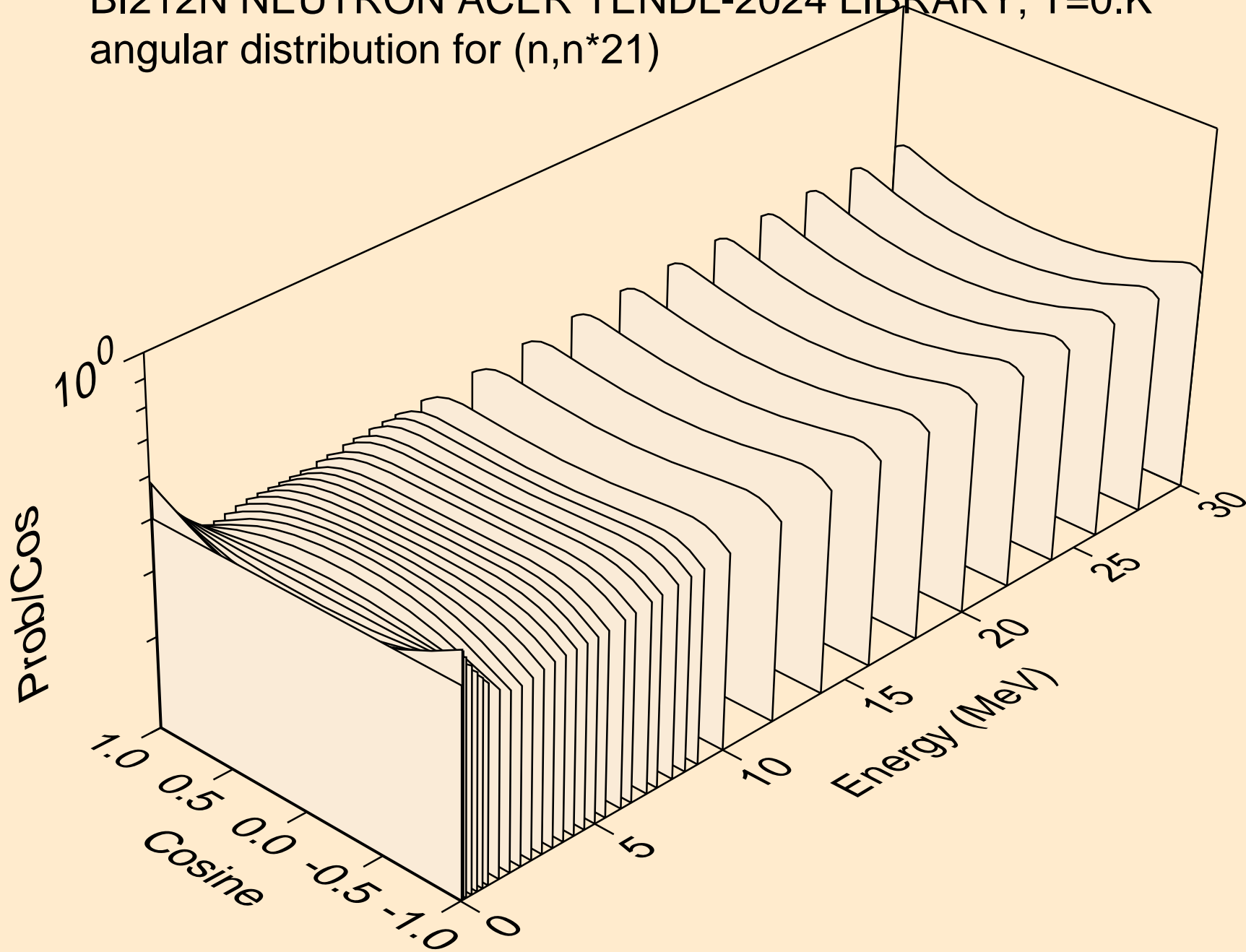

BI212N NEUTRON ACER TENDL-2024 LIBRARY; T=0.K
angular distribution for (n,n*22)

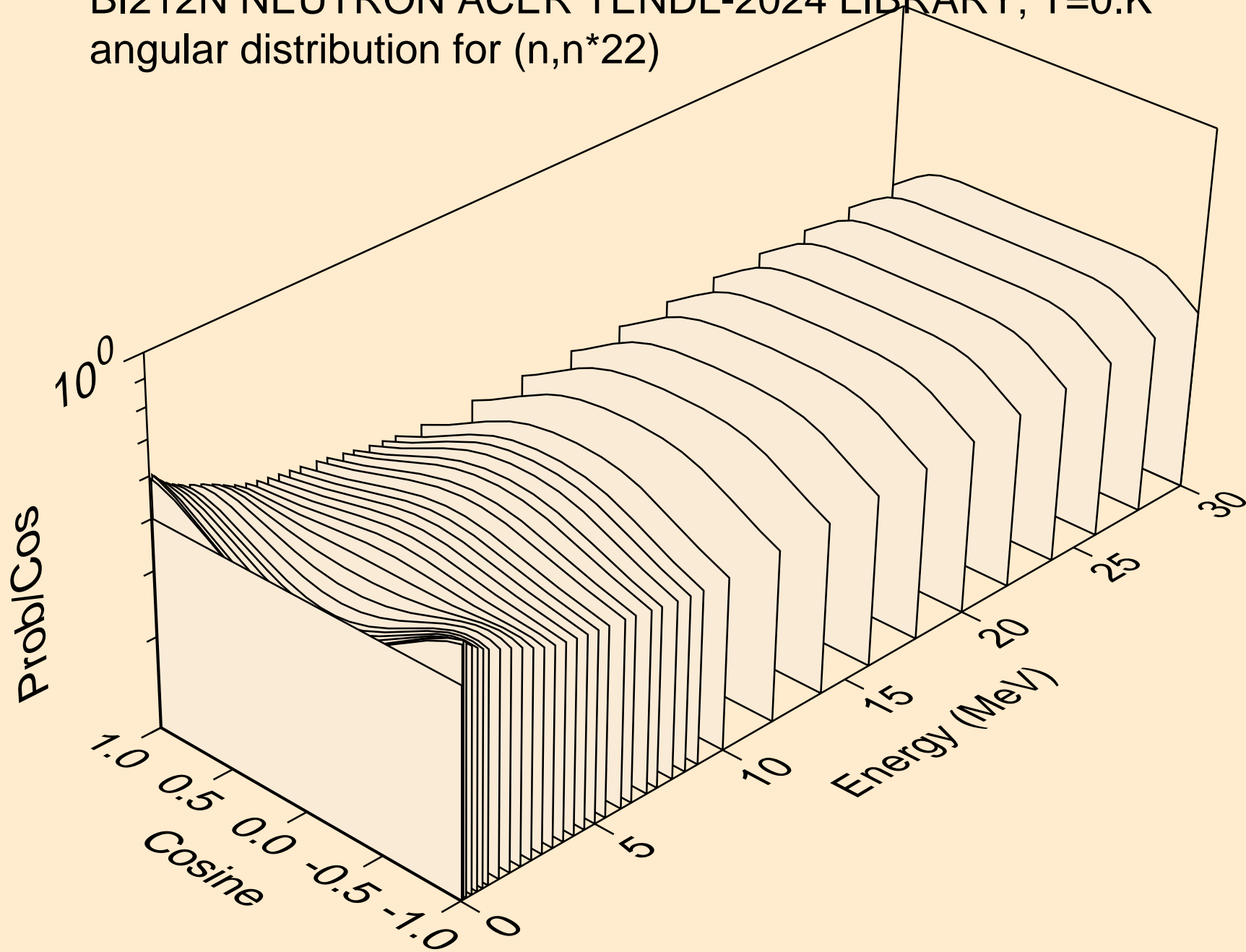

BI212N NEUTRON ACER TENDL-2024 LIBRARY; T=0.K
angular distribution for (n,n*23)

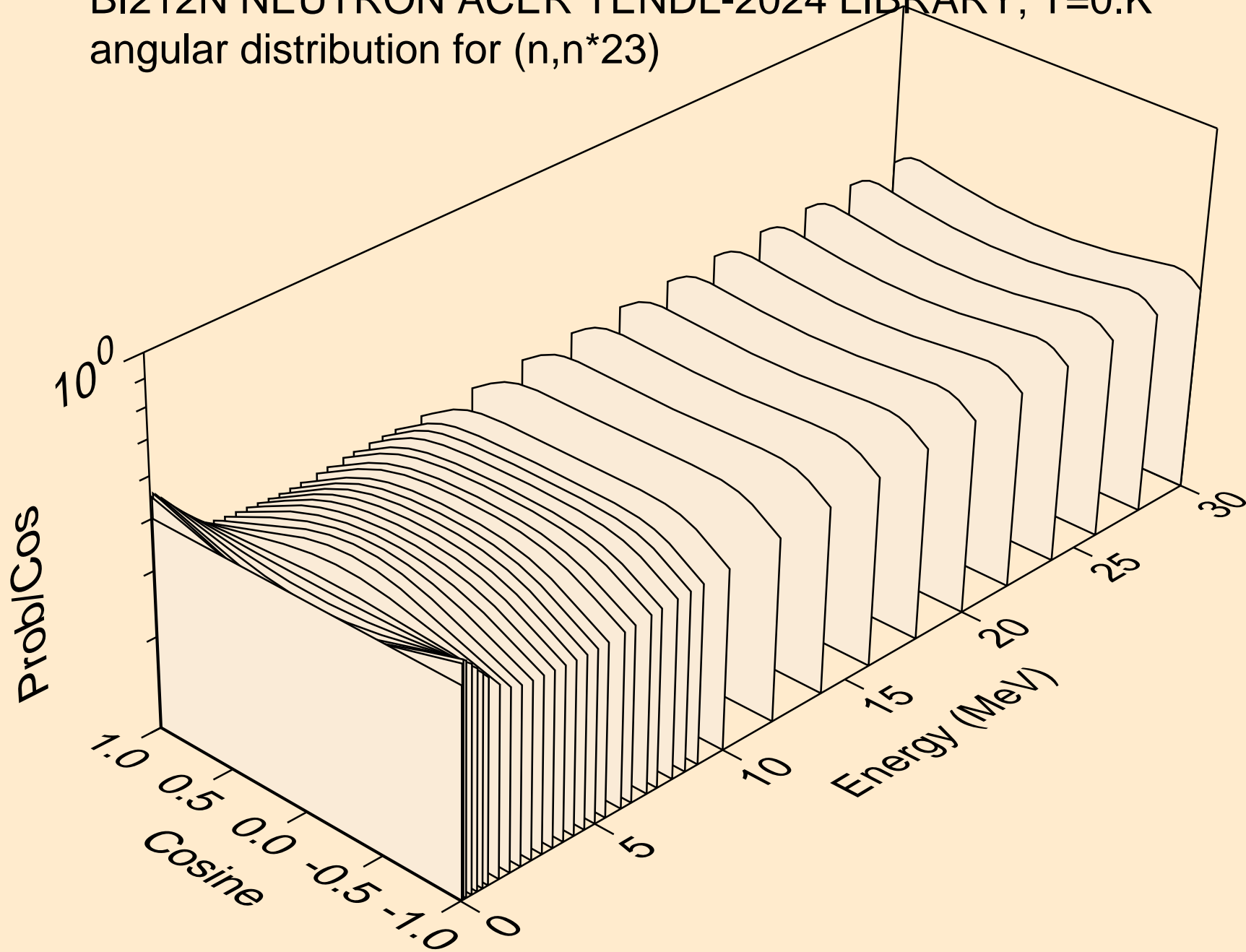

BI212N NEUTRON ACER TENDL-2024 LIBRARY; T=0.K
angular distribution for (n,n*24)

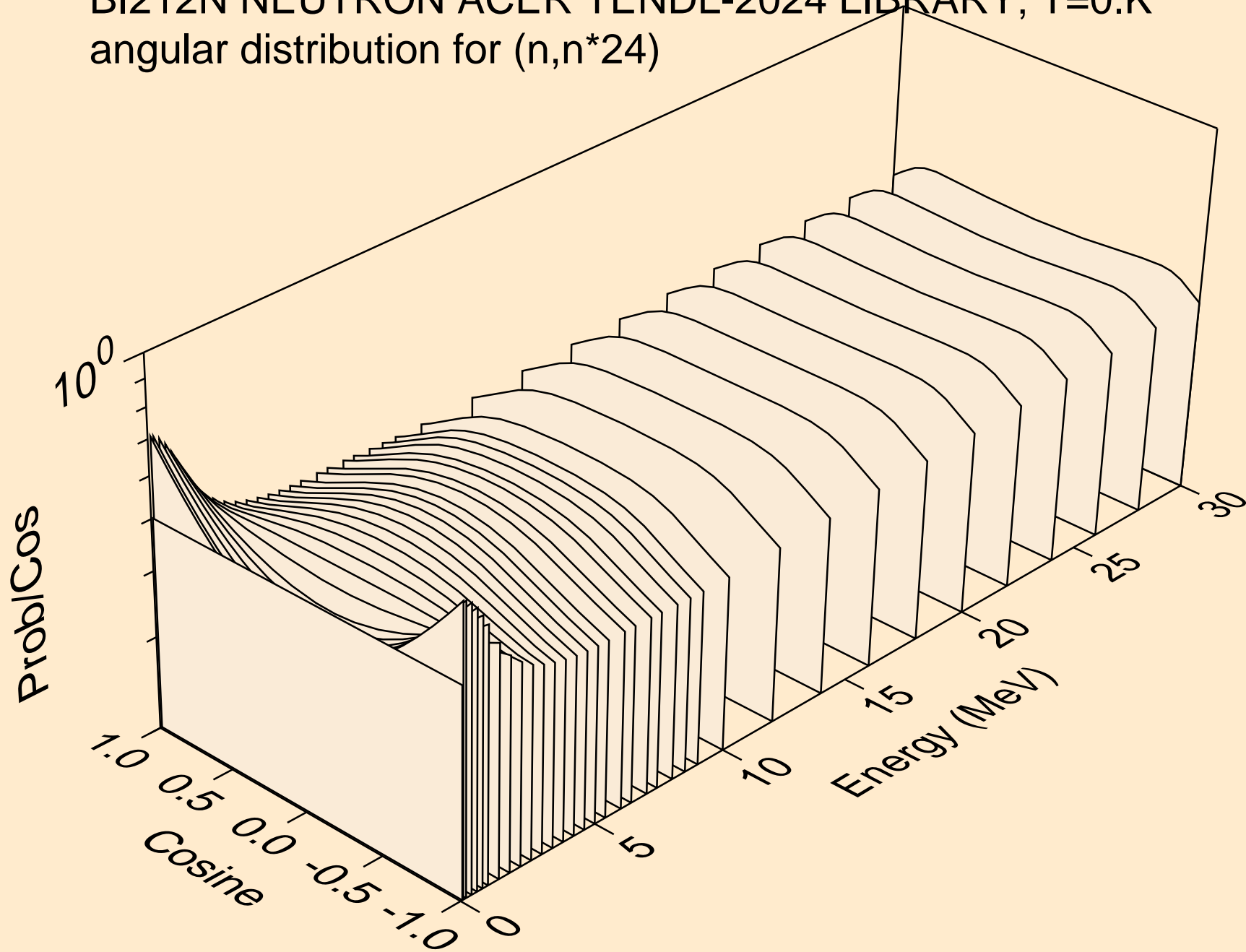

BI212N NEUTRON ACER TENDL-2024 LIBRARY; T=0.K
angular distribution for (n,n*25)

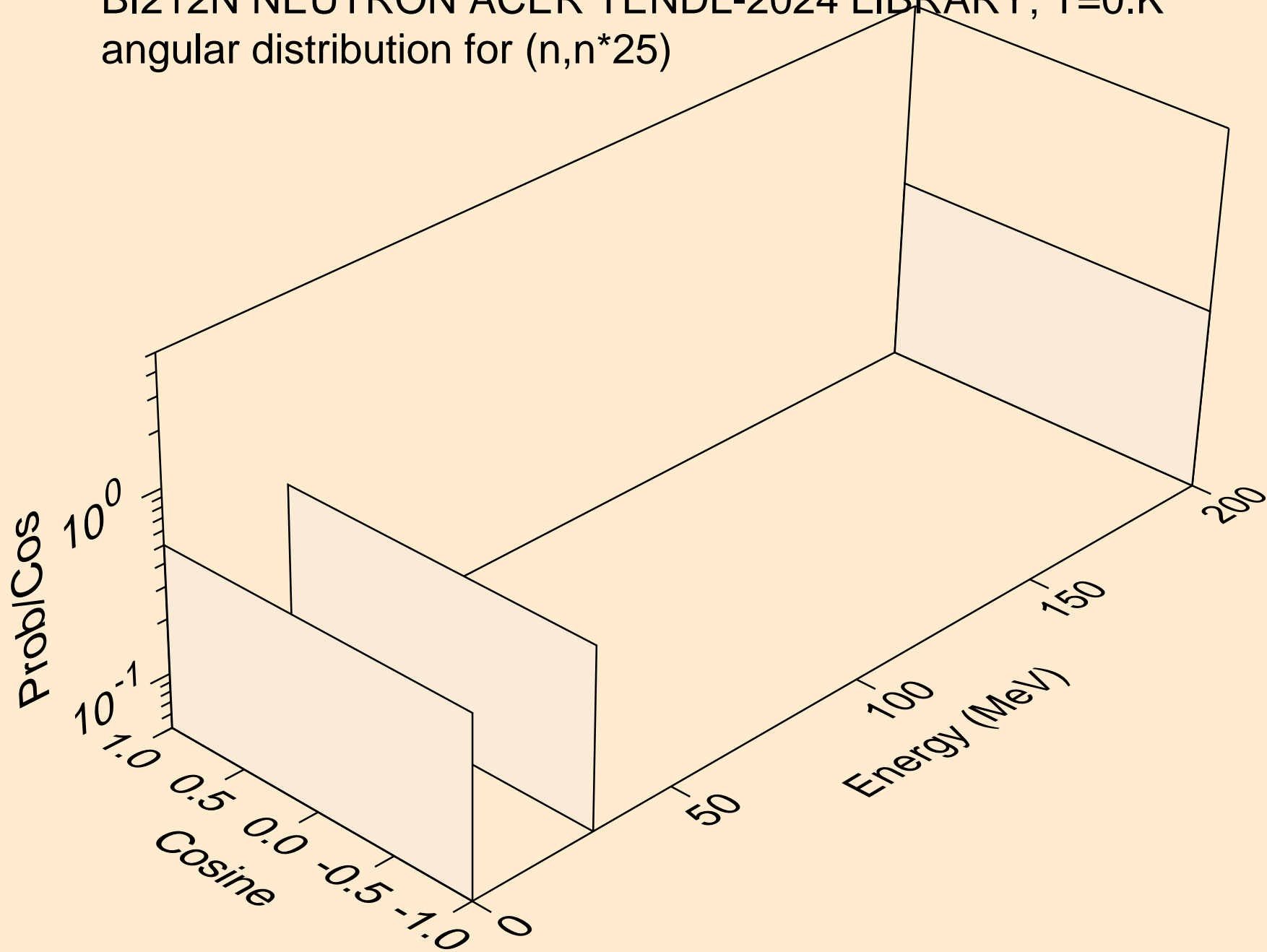

BI212N NEUTRON ACER TENDL-2024 LIBRARY; T=0.K
angular distribution for (n,n*26)

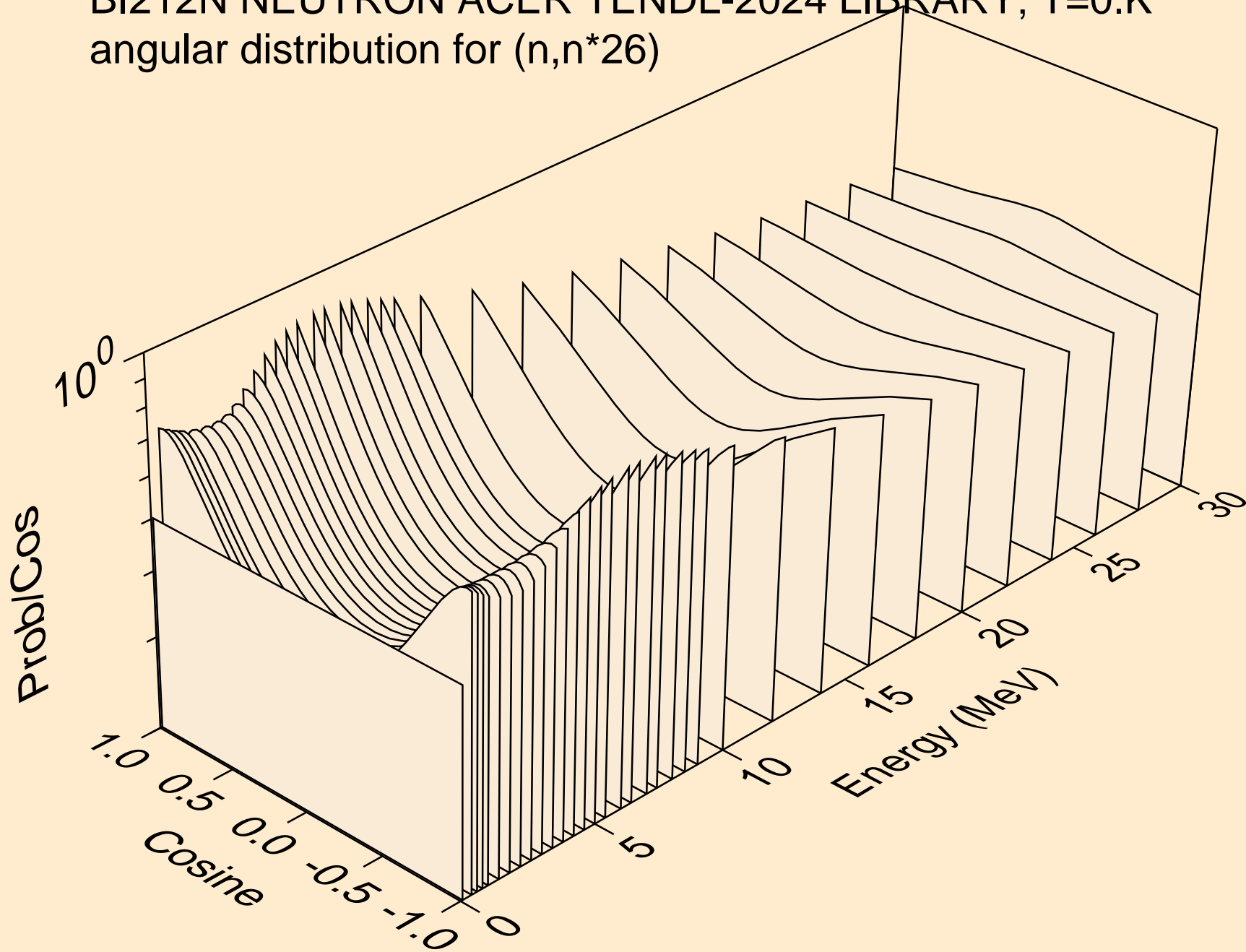

BI212N NEUTRON ACER TENDL-2024 LIBRARY; T=0.K
Neutron emission for (n,x)

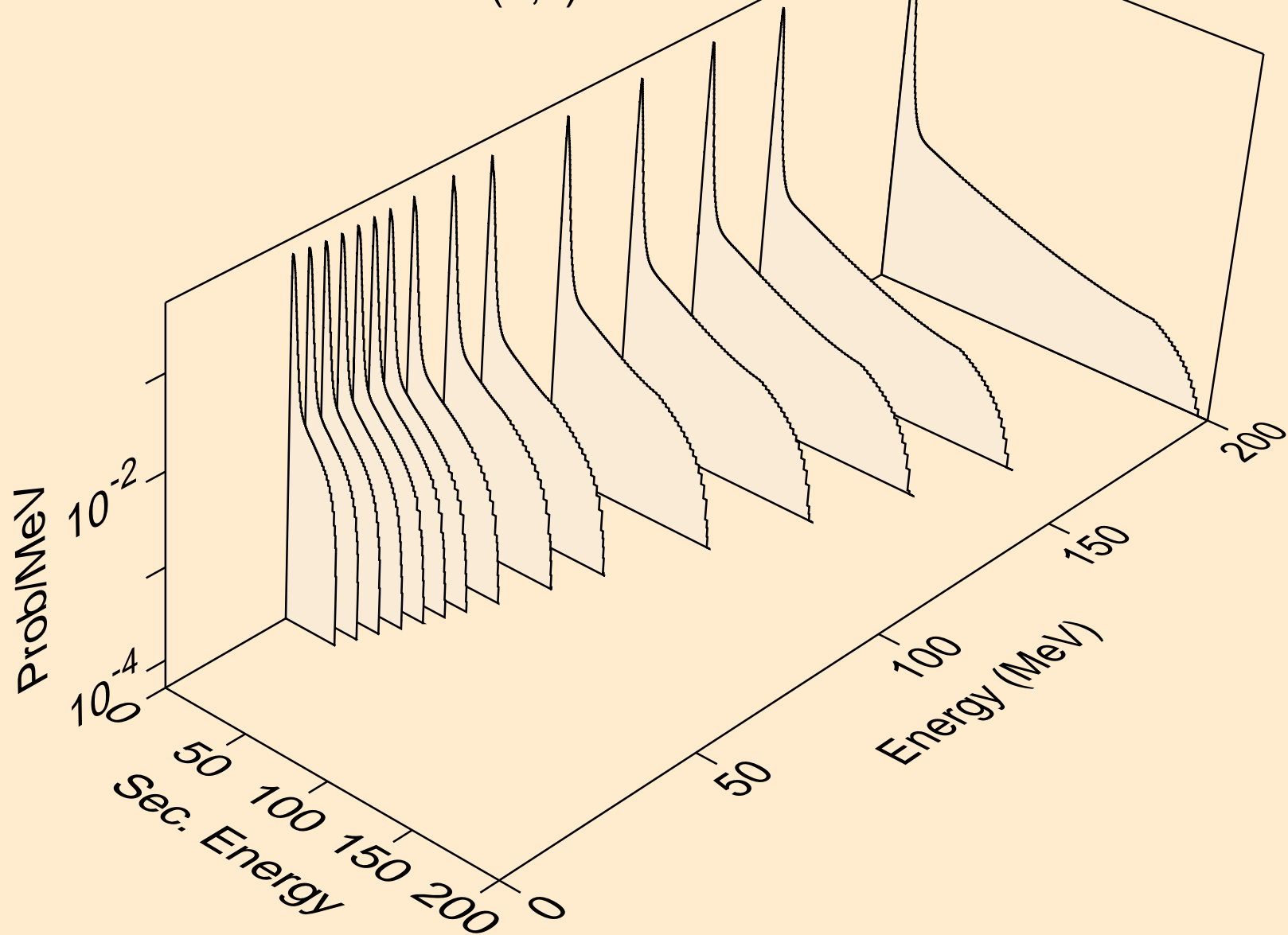

BI212N NEUTRON ACER TENDL-2024 LIBRARY; T=0.K
Neutron emission for (n,2nd)

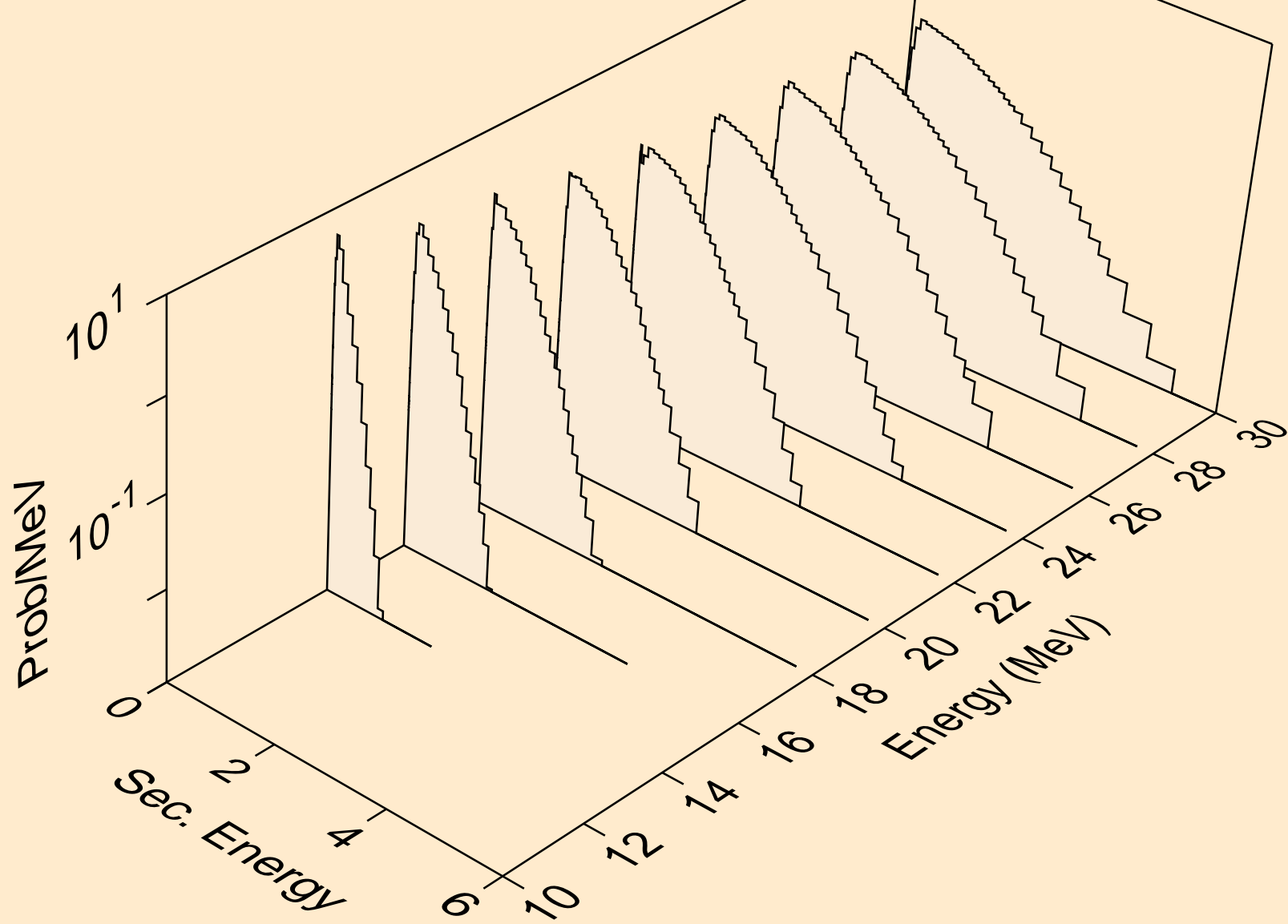

BI212N NEUTRON ACER TENDL-2024 LIBRARY; T=0.K
Neutron emission for (n,2n)

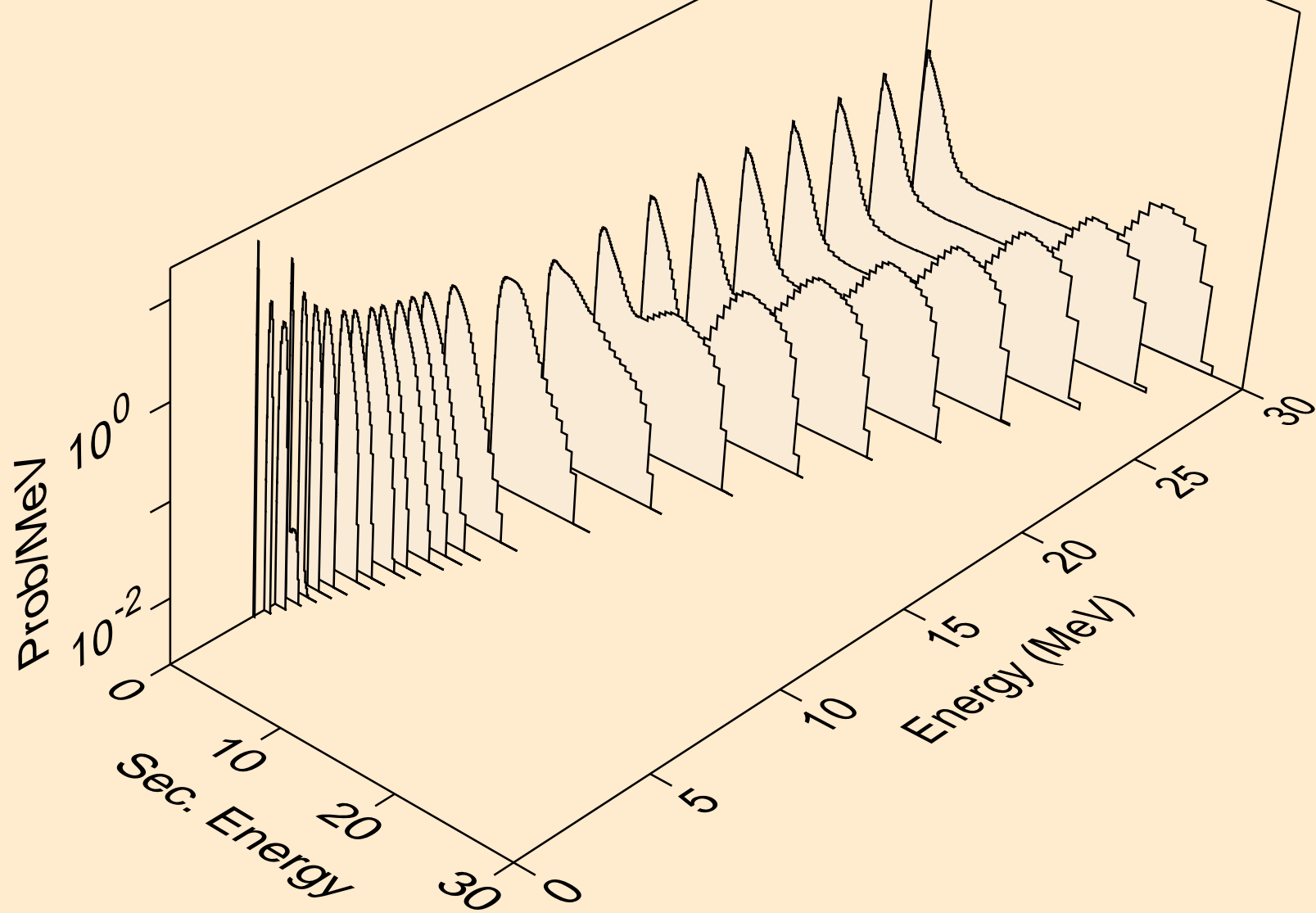

BI212N NEUTRON ACER TENDL-2024 LIBRARY; T=0.K
Neutron emission for (n,3n)

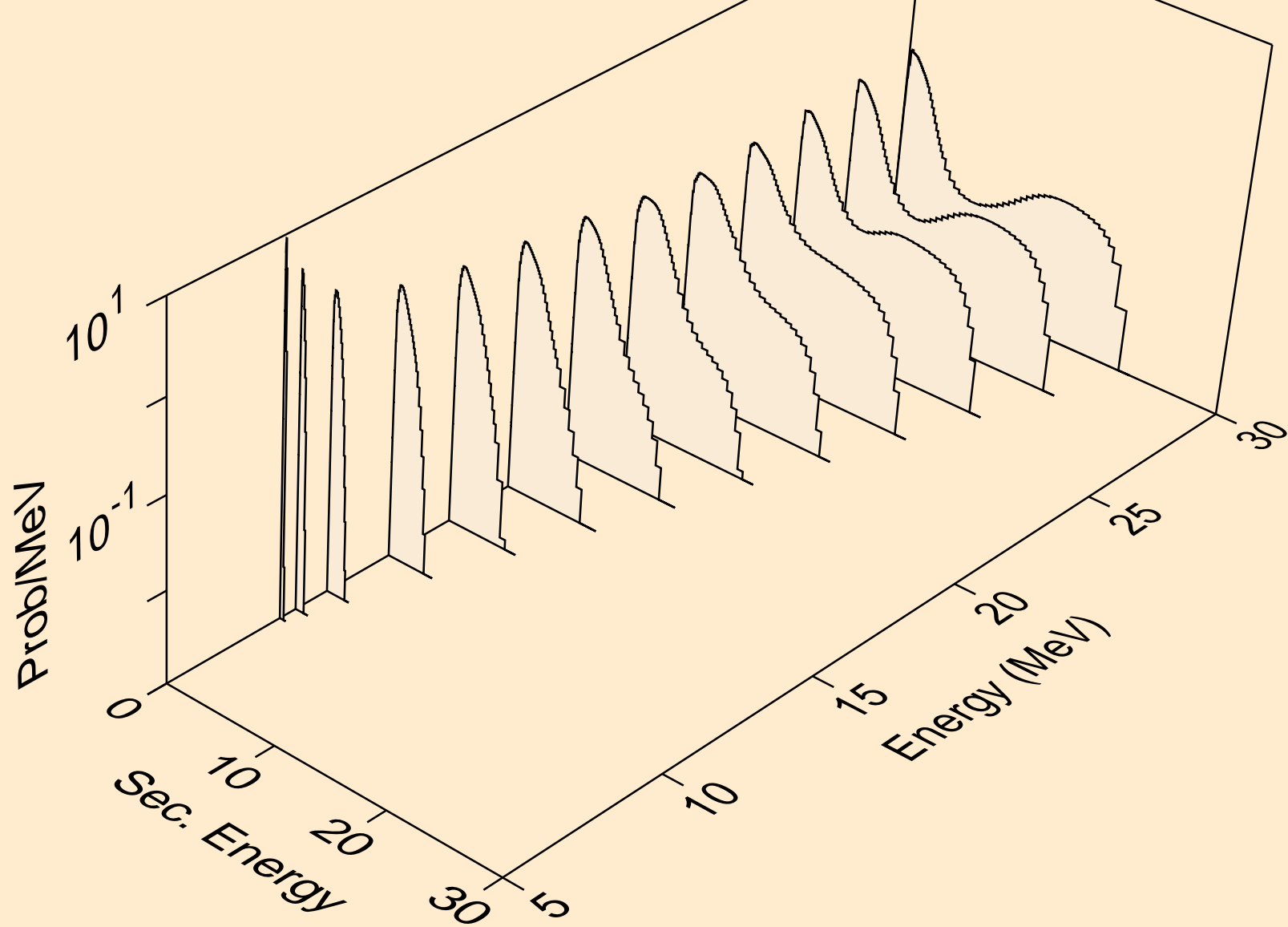

BI212N NEUTRON ACER TENDL-2024 LIBRARY; T=0.K
Neutron emission for (n,n*)a

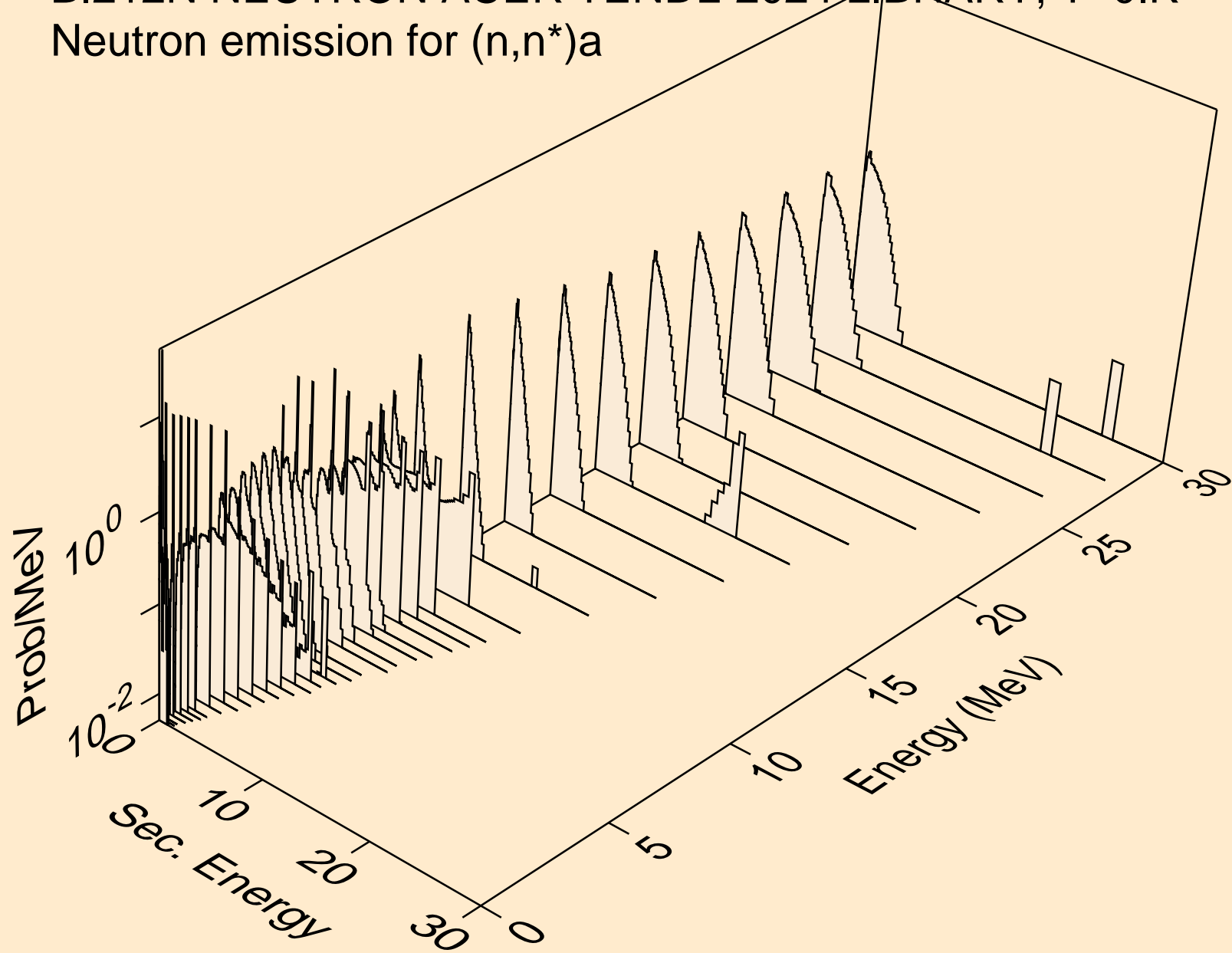

BI212N NEUTRON ACER TENDL-2024 LIBRARY; T=0.K
Neutron emission for (n,2n)a

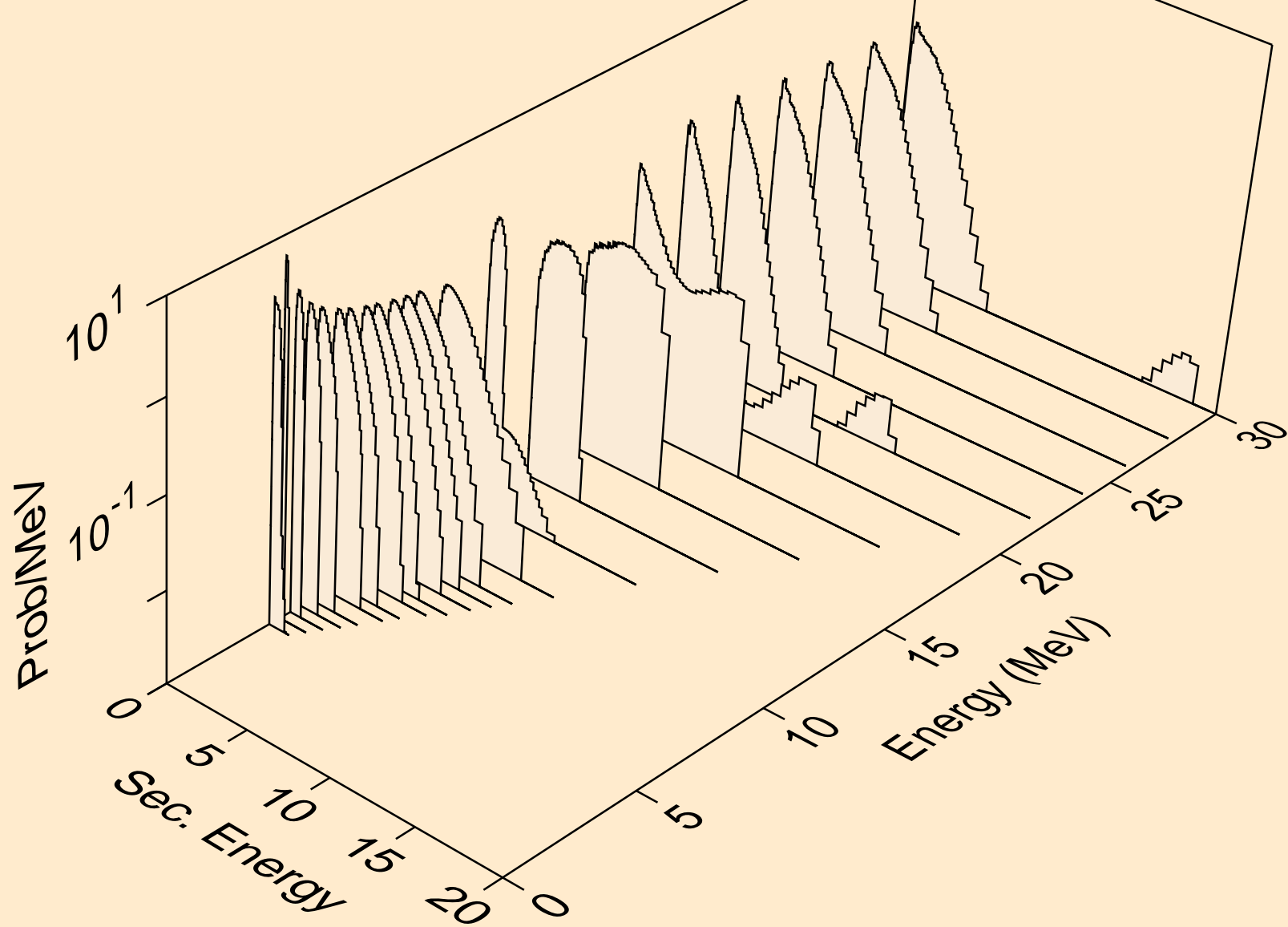

BI212N NEUTRON ACER TENDL-2024 LIBRARY; T=0.K
Neutron emission for (n,3n)a

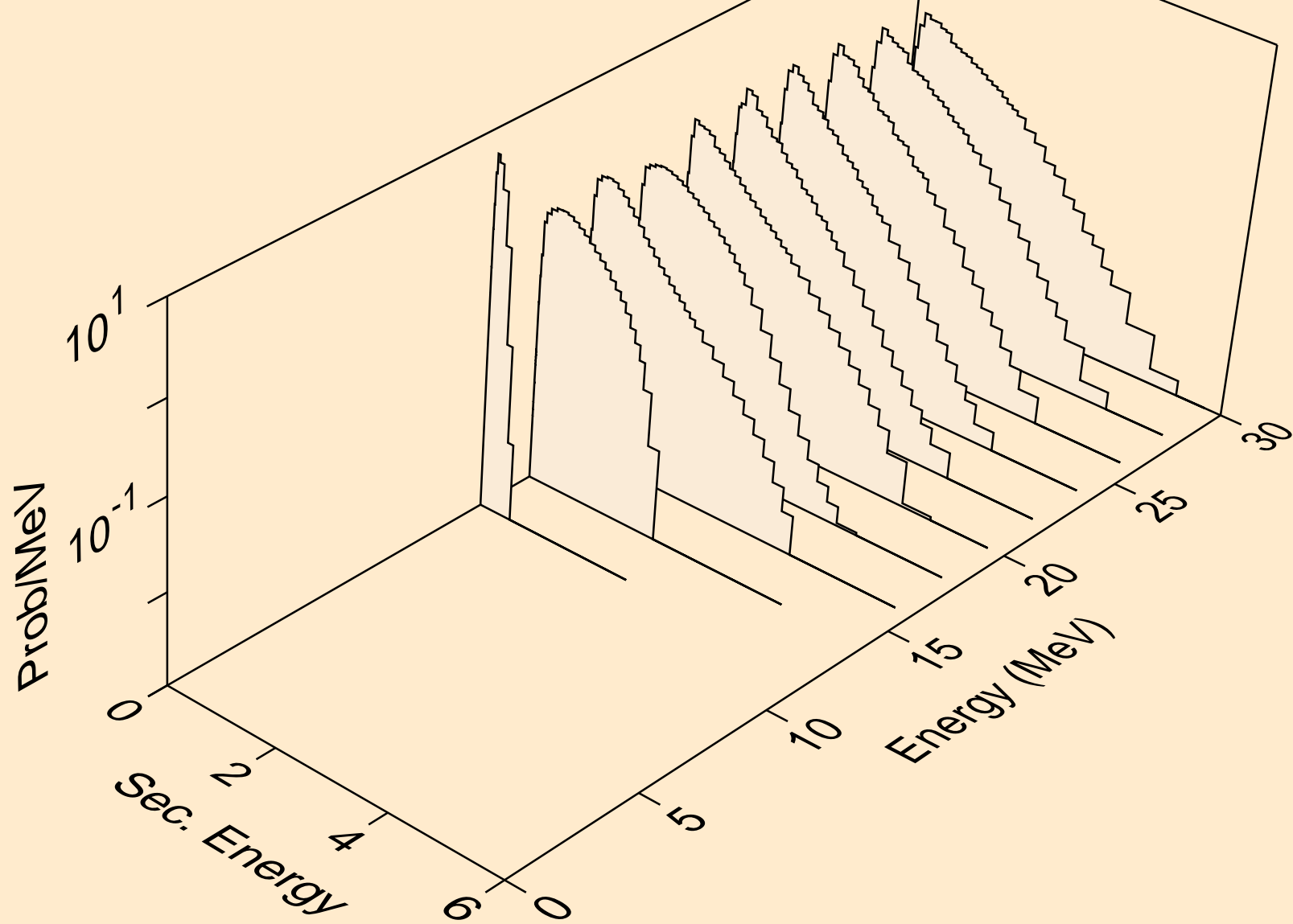

BI212N NEUTRON ACER TENDL-2024 LIBRARY; T=0.K
Neutron emission for (n,n*)p

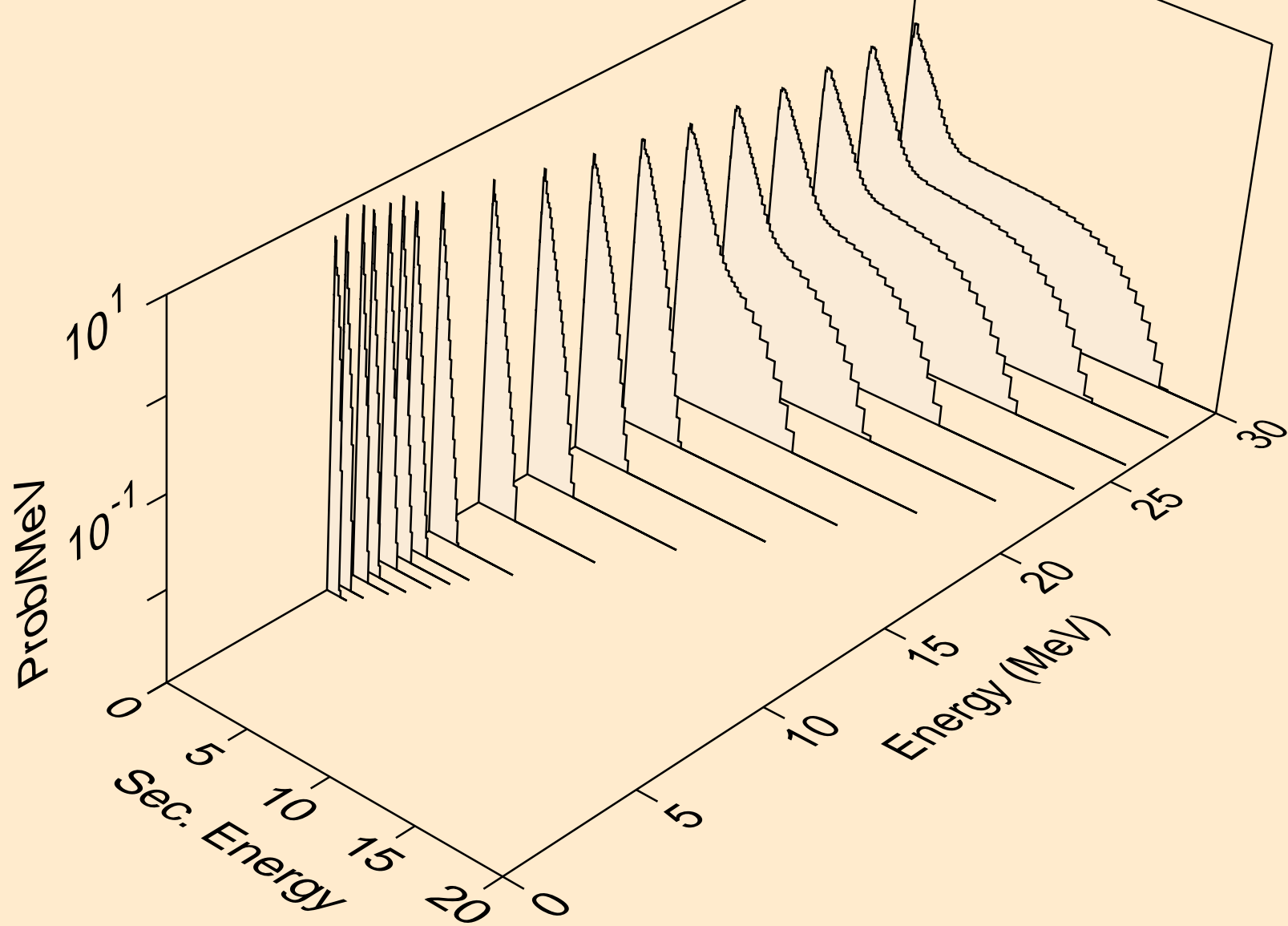

BI212N NEUTRON ACER TENDL-2024 LIBRARY; T=0.K
Neutron emission for (n,n*)d

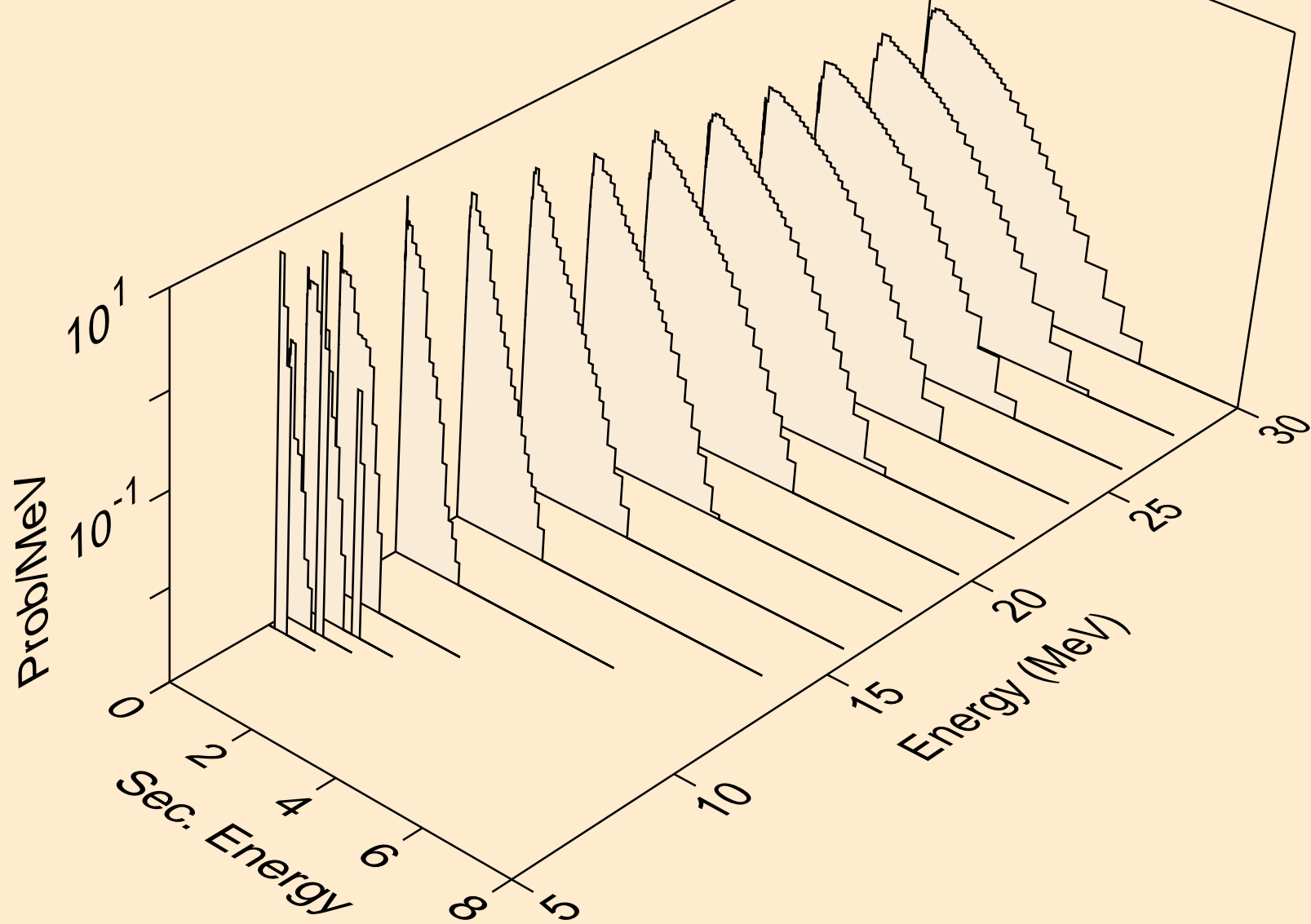

BI212N NEUTRON ACER TENDL-2024 LIBRARY; T=0.K
Neutron emission for (n,n*)t

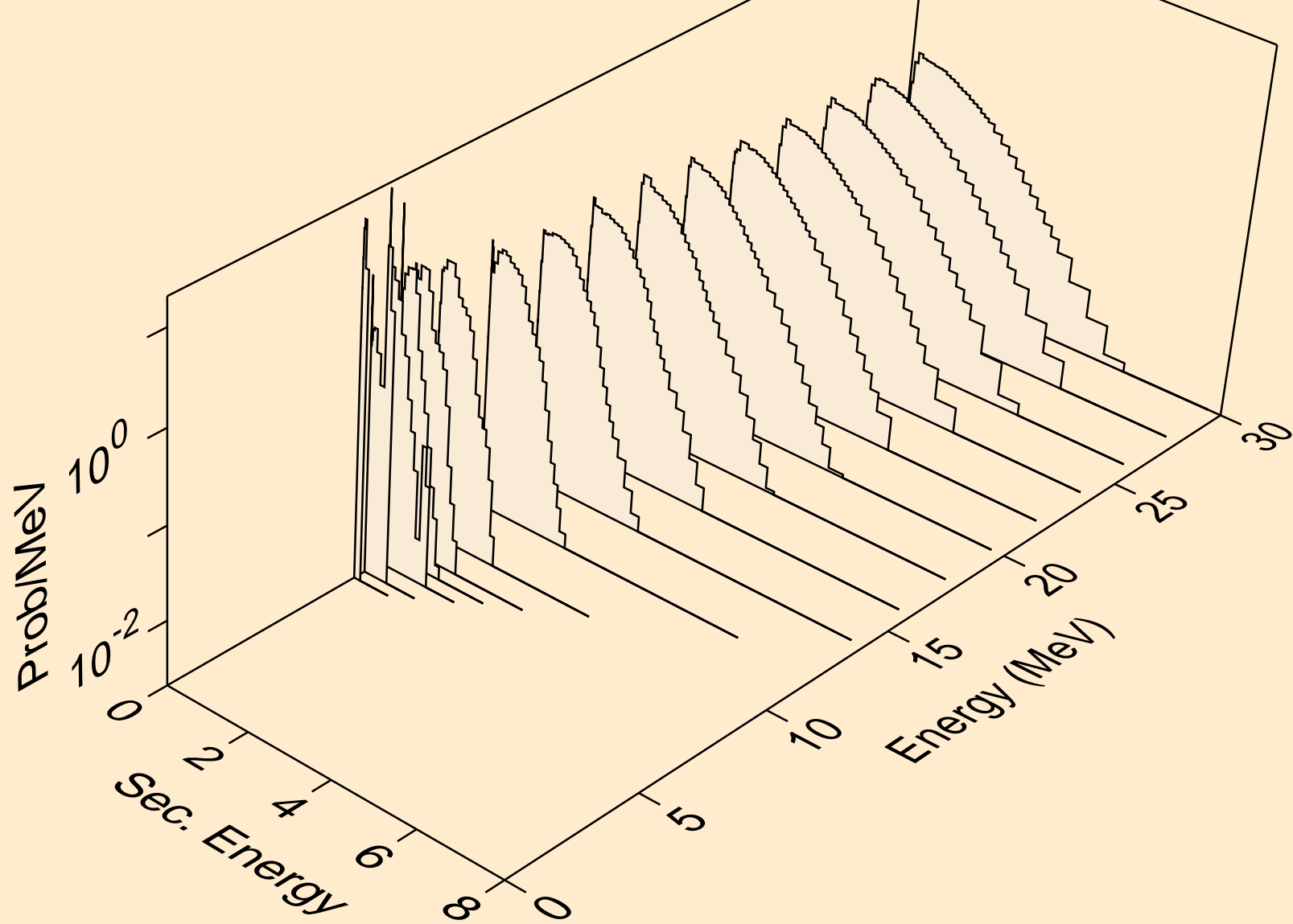

BI212N NEUTRON ACER TENDL-2024 LIBRARY; T=0.K
Neutron emission for (n,n*)he3

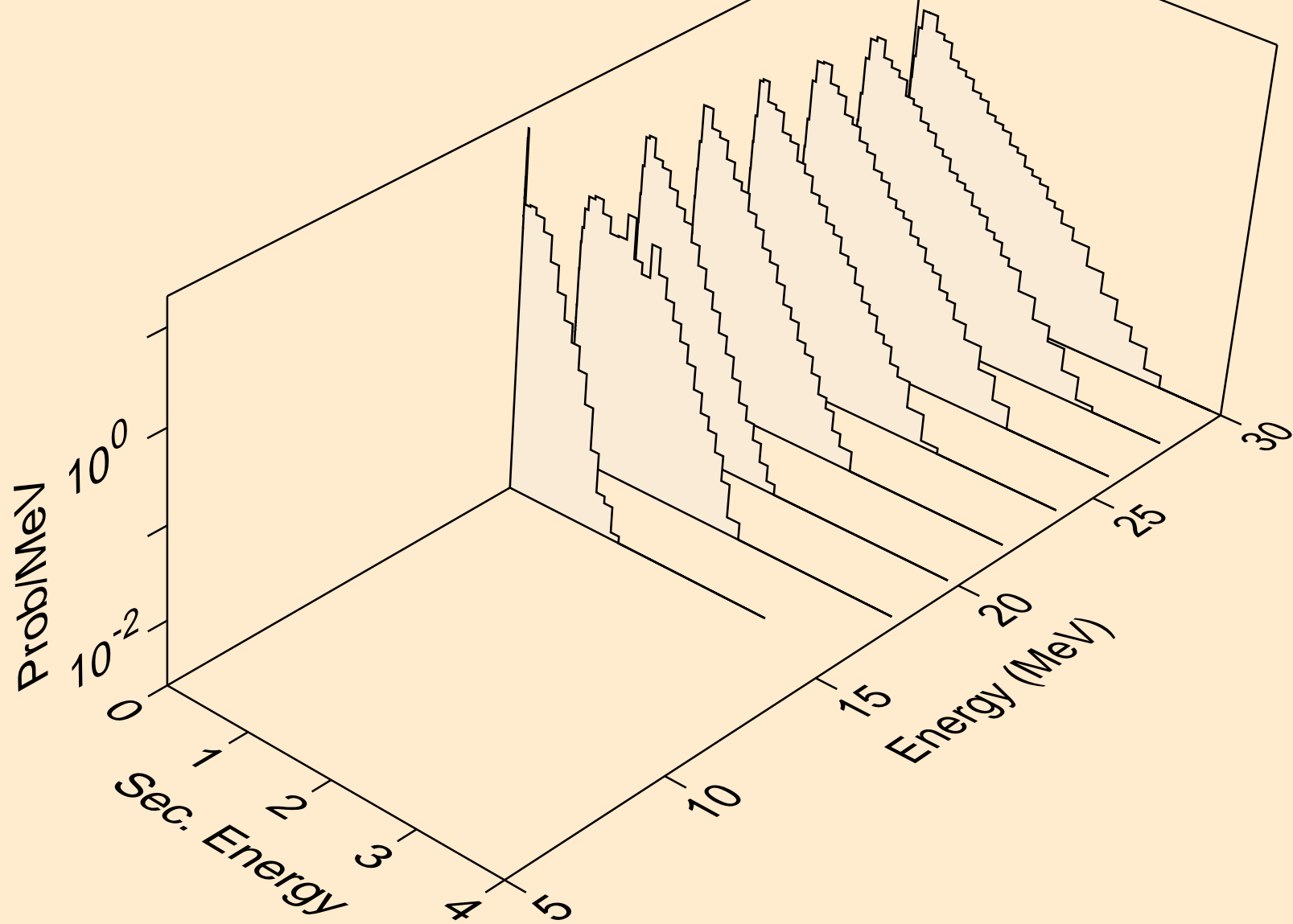

BI212N NEUTRON ACER TENDL-2024 LIBRARY; T=0.K
Neutron emission for (n,4n)

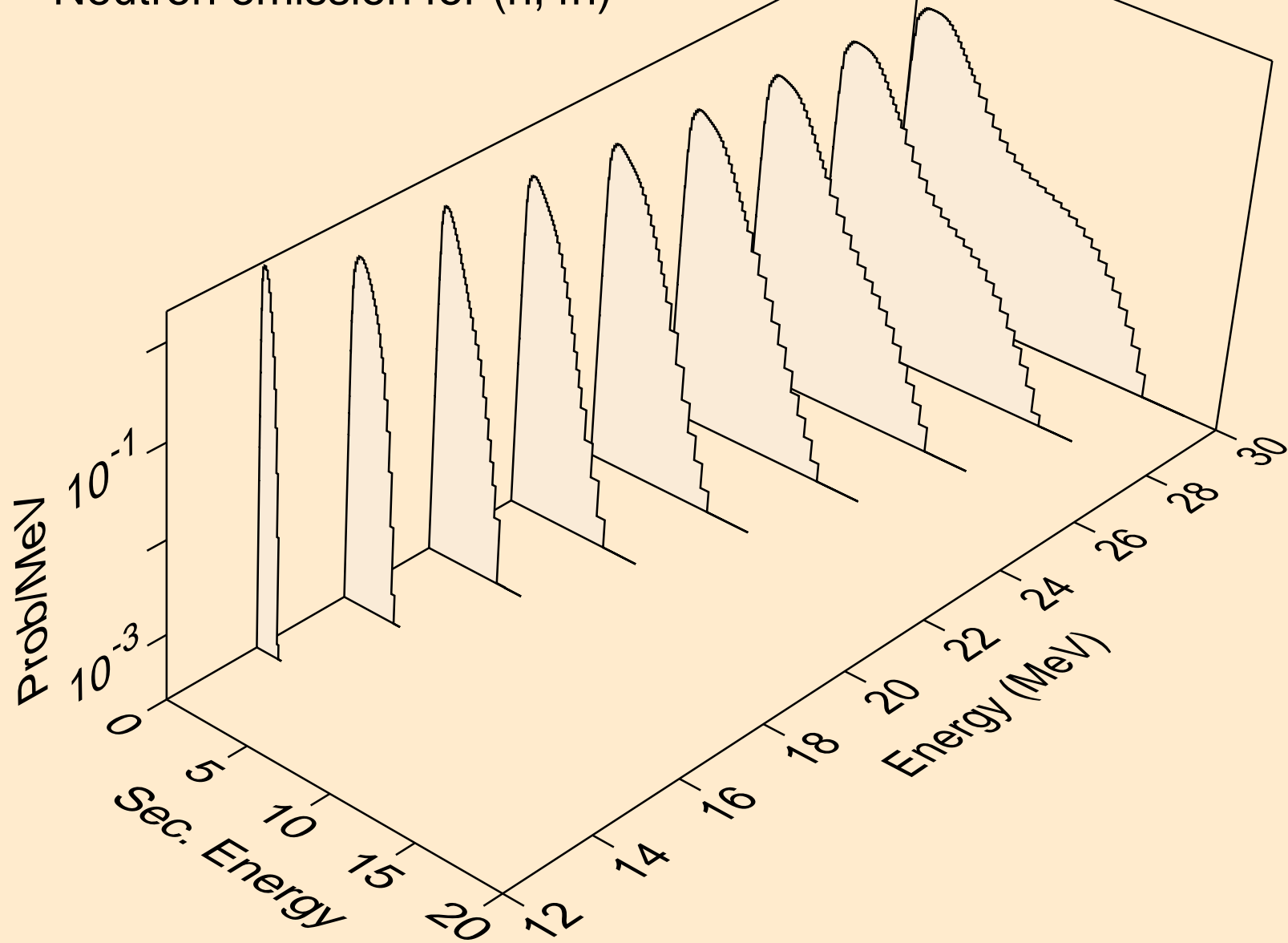

BI212N NEUTRON ACER TENDL-2024 LIBRARY; T=0.K
Neutron emission for (n,2np)

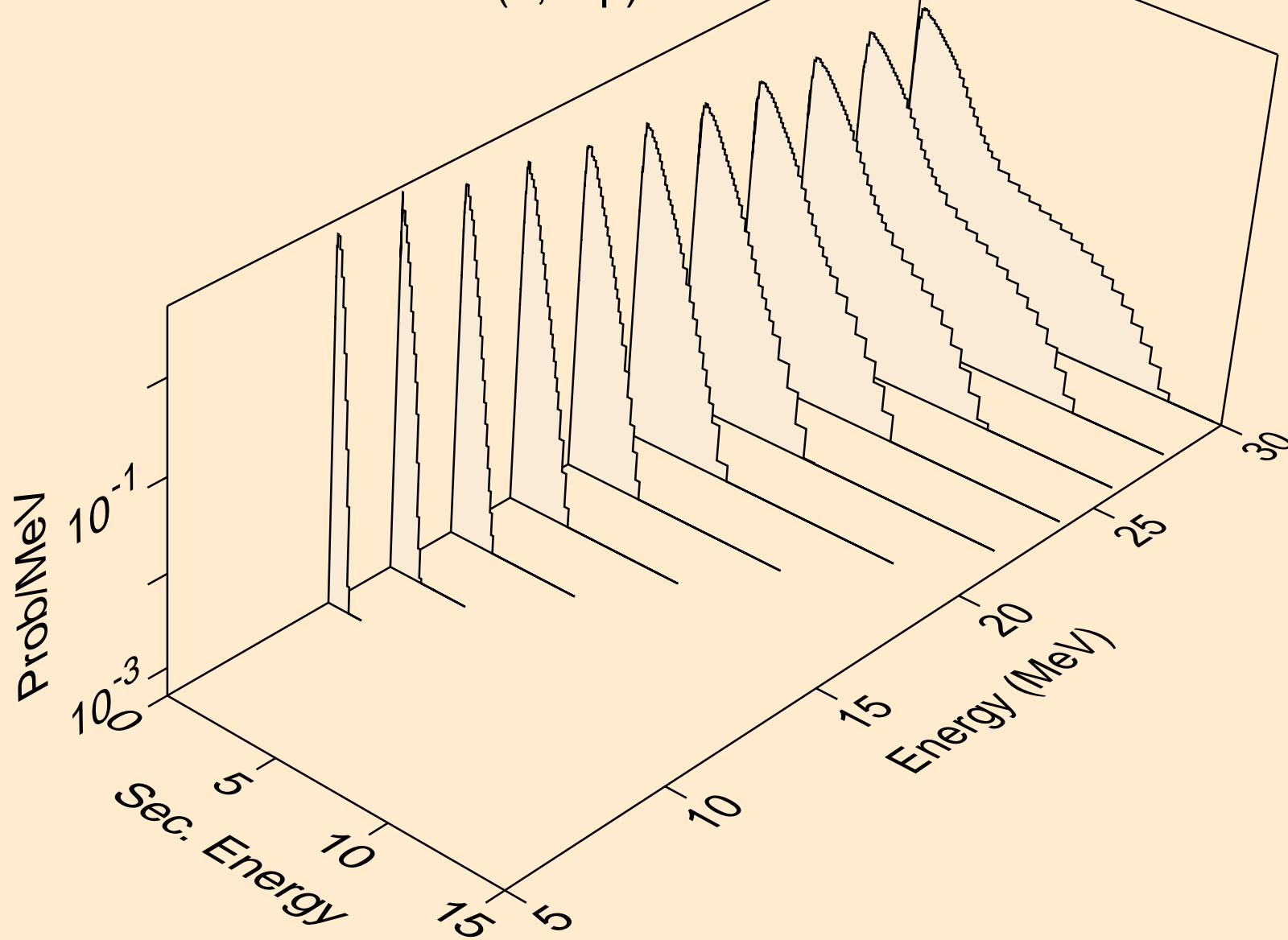

BI212N NEUTRON ACER TENDL-2024 LIBRARY; T=0.K
Neutron emission for (n,3np)

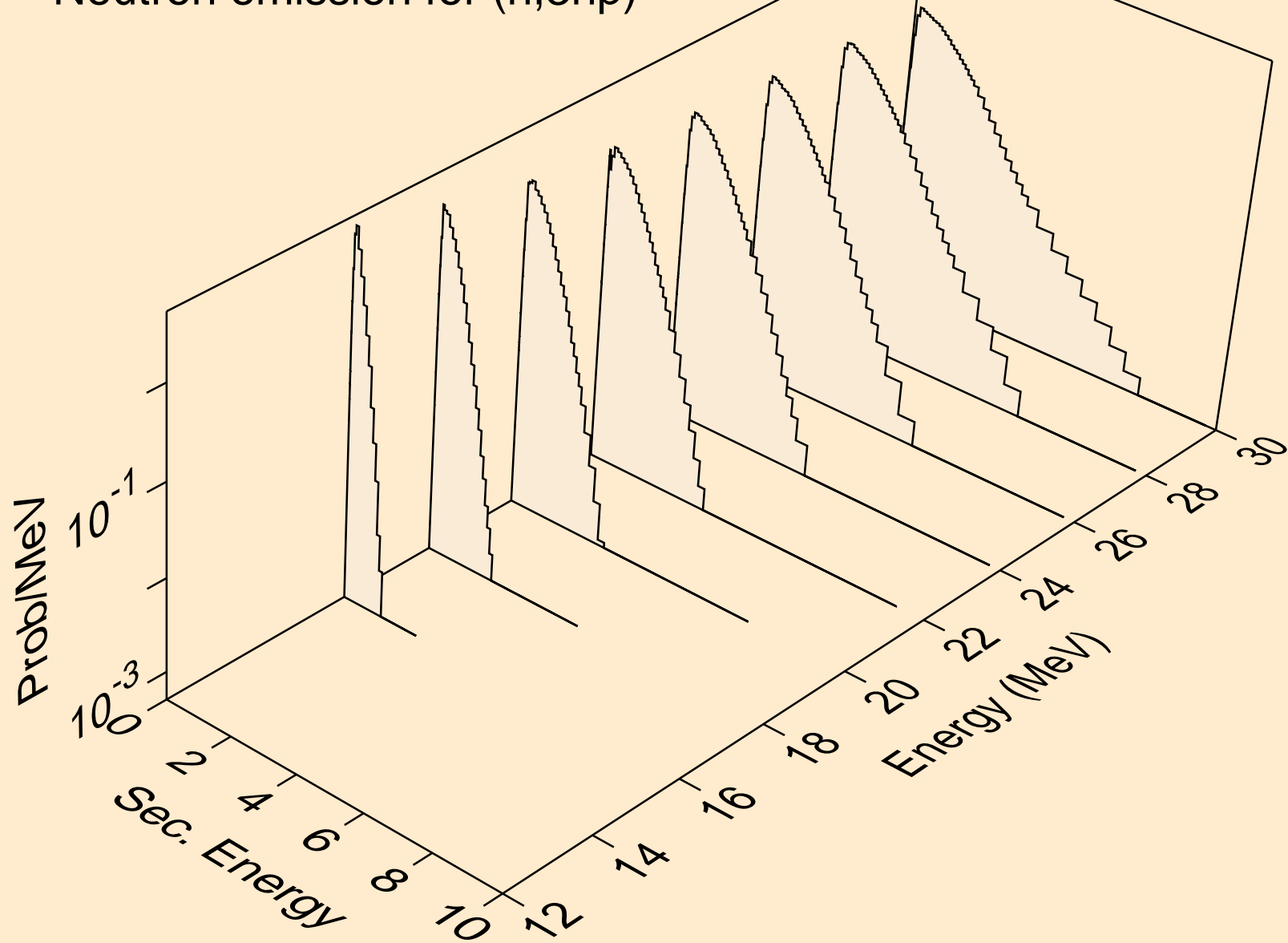

BI212N NEUTRON ACER TENDL-2024 LIBRARY; T=0.K
Neutron emission for (n,n2p)

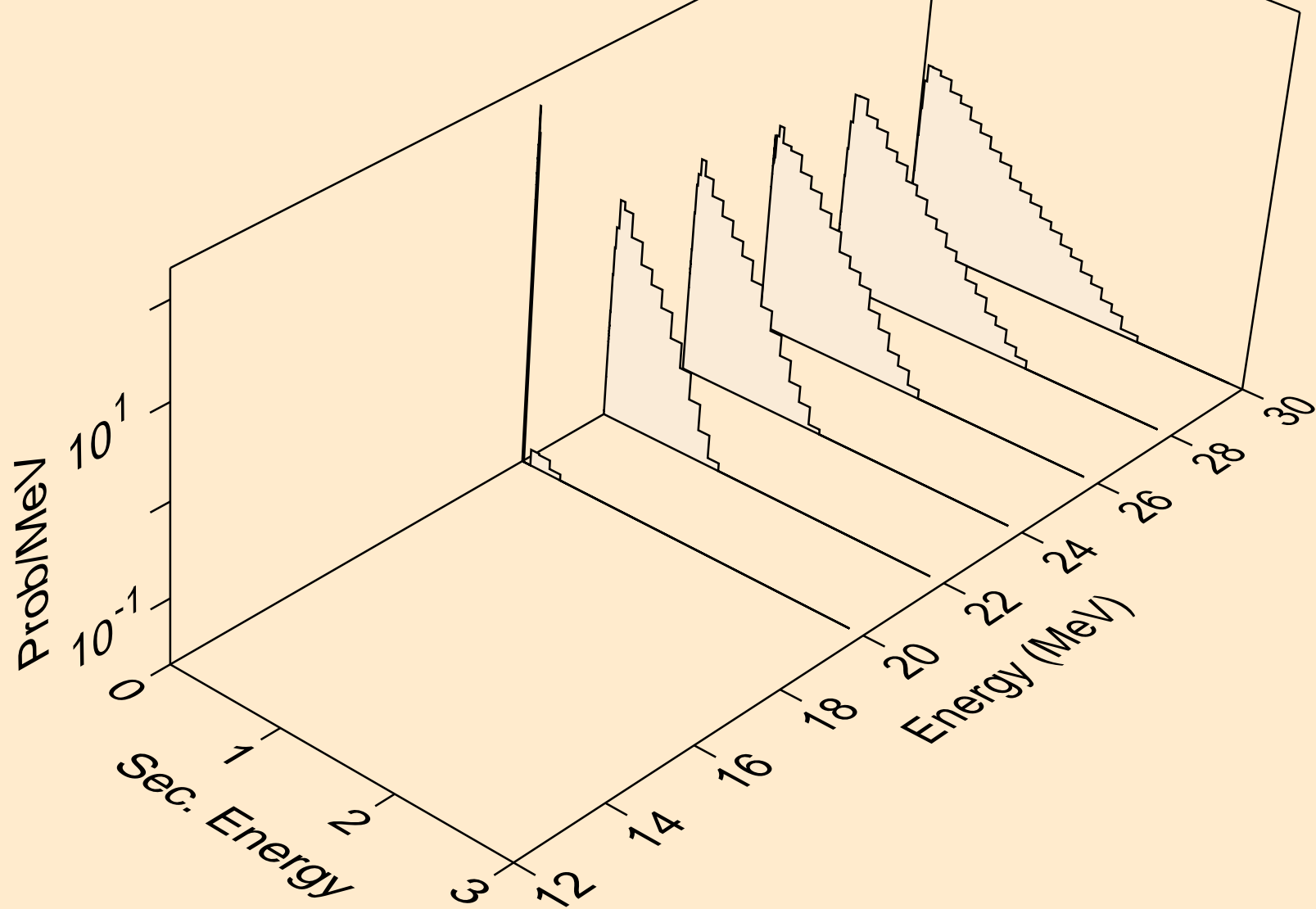

BI212N NEUTRON ACER TENDL-2024 LIBRARY; T=0.K
Neutron emission for (n,npa)

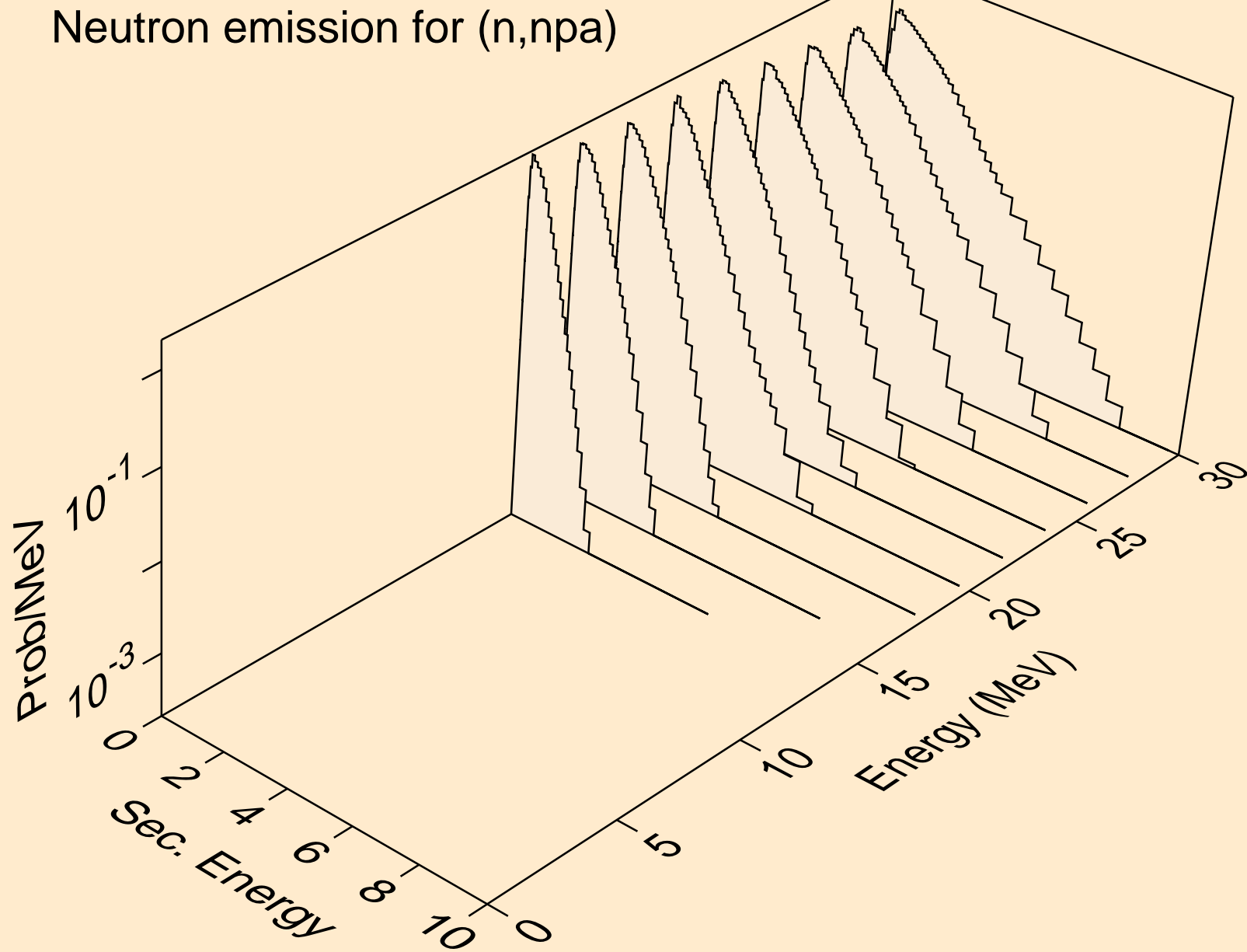

BI212N NEUTRON ACER TENDL-2024 LIBRARY; T=0.K
Neutron emission for (n,n*c)

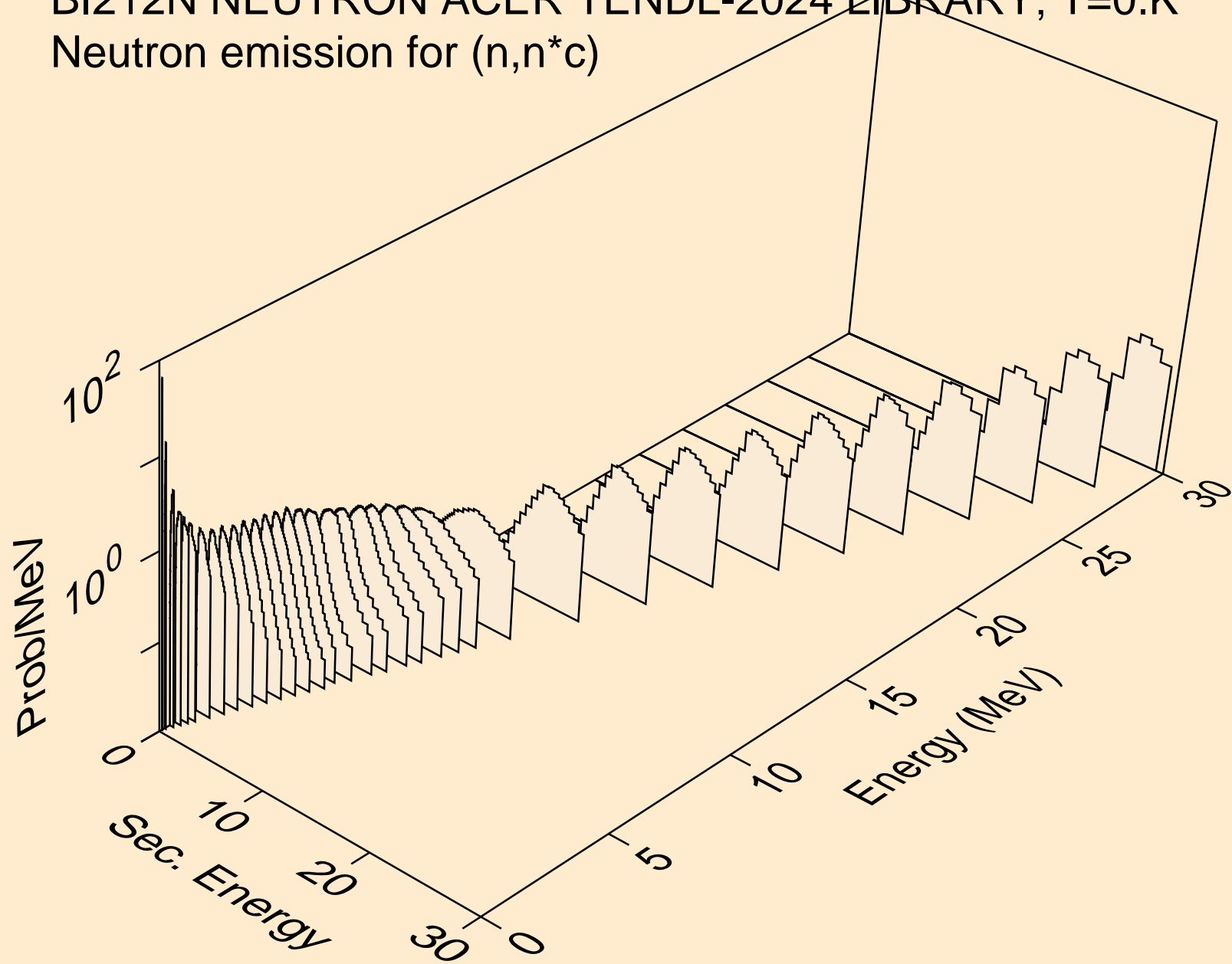

BI212N NEUTRON ACER TENDL-2024 LIBRARY; T=0.K
Photon emission for (n,x)

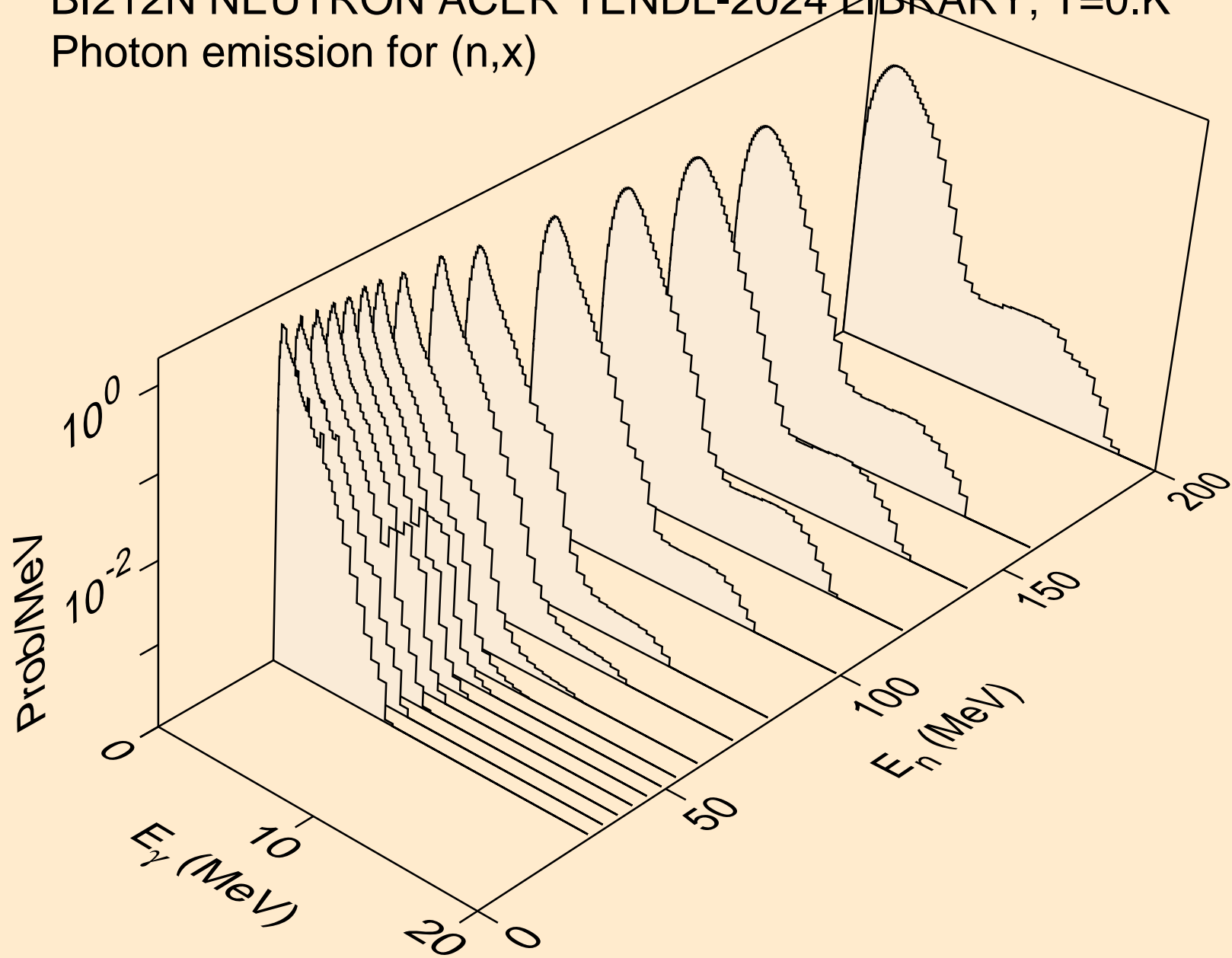

BI212N NEUTRON ACER TENDL-2024 LIBRARY; T=0.K
Photon emission for (n,2nd)

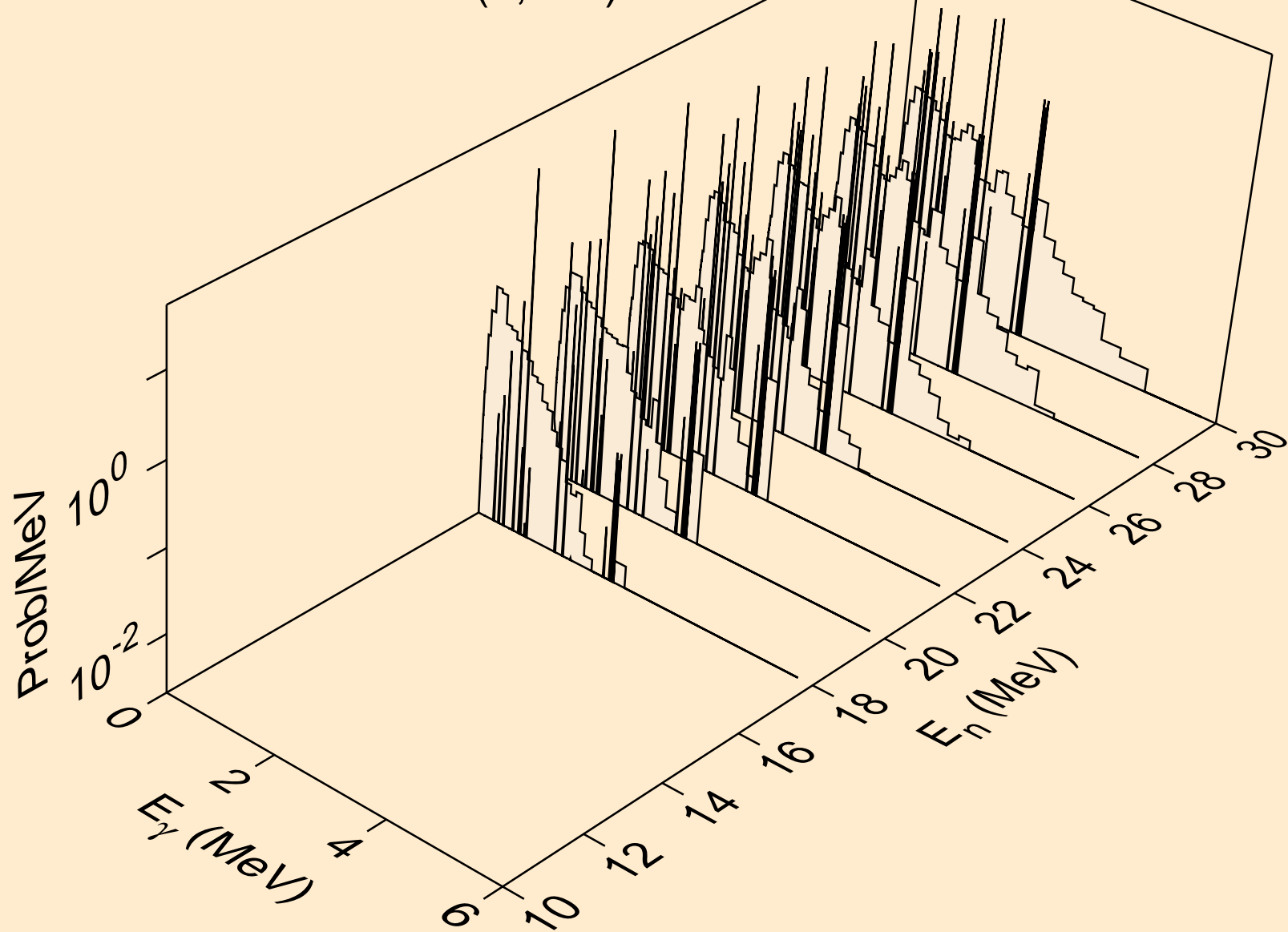

BI212N NEUTRON ACER TENDL-2024 LIBRARY; T=0.K
Photon emission for (n,2n)

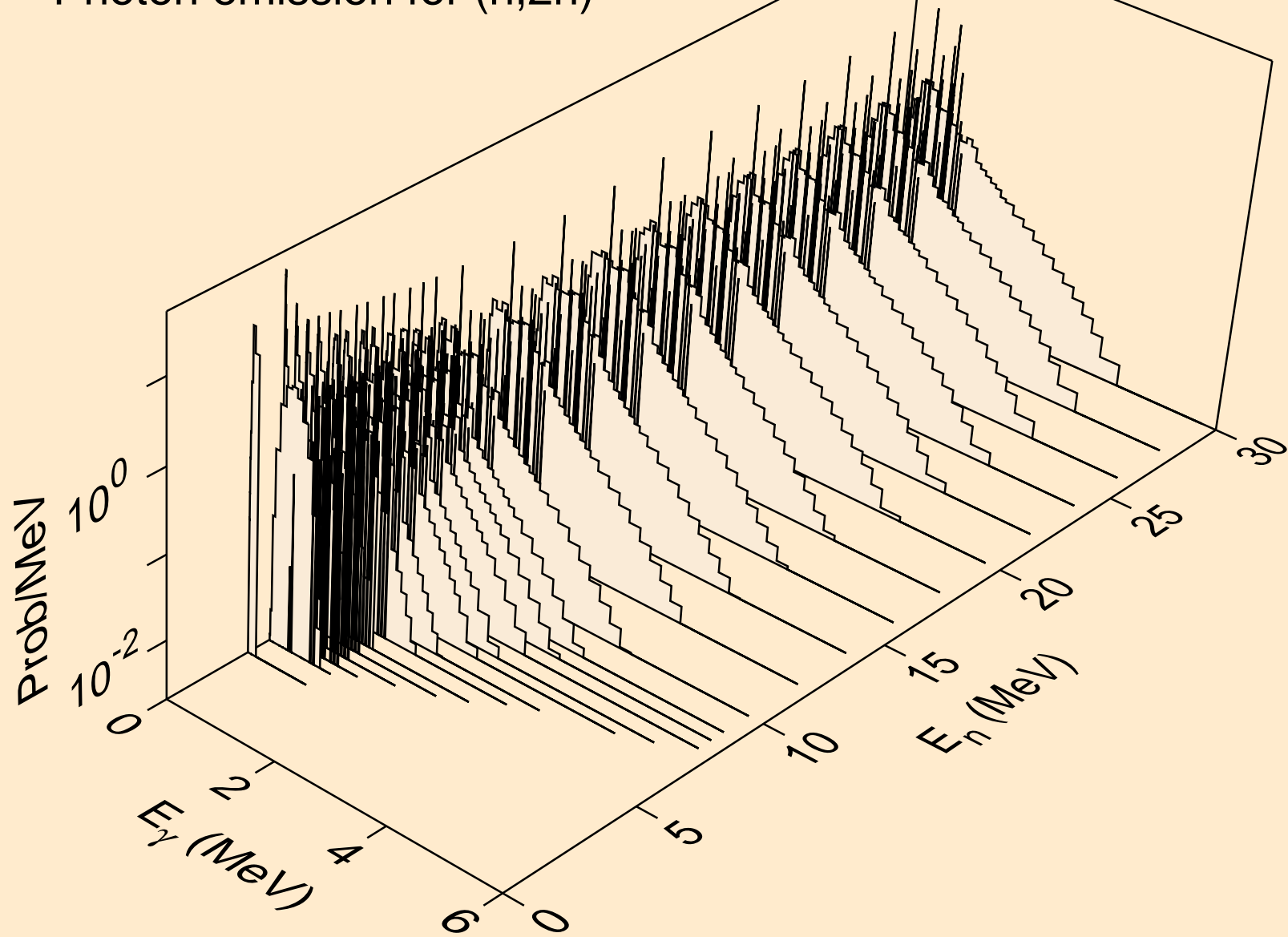

BI212N NEUTRON ACER TENDL-2024 LIBRARY; T=0.K
Photon emission for (n,3n)

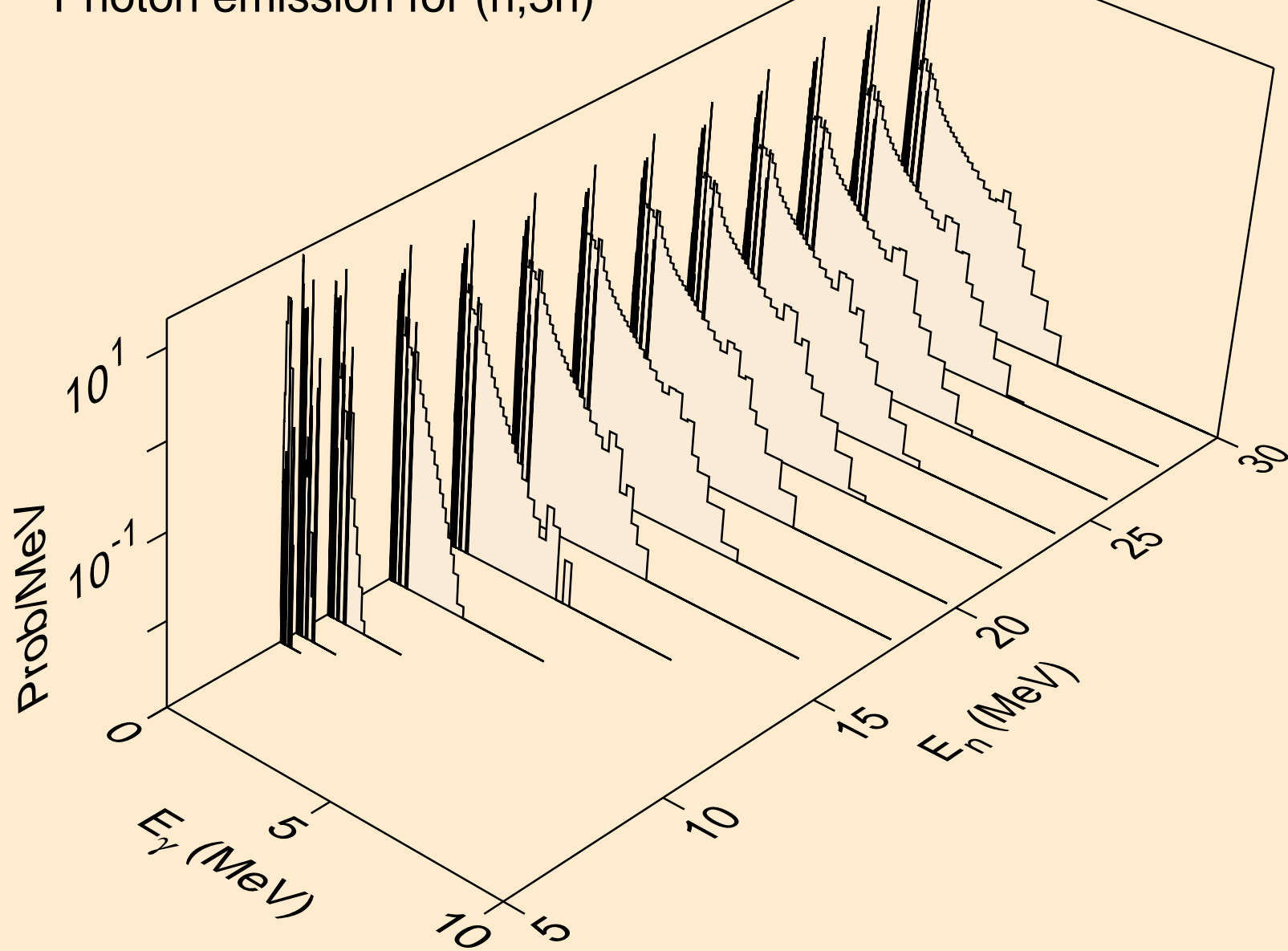

BI212N NEUTRON ACER TENDL-2024 LIBRARY; T=0.K
Photon emission for (n,n*)a

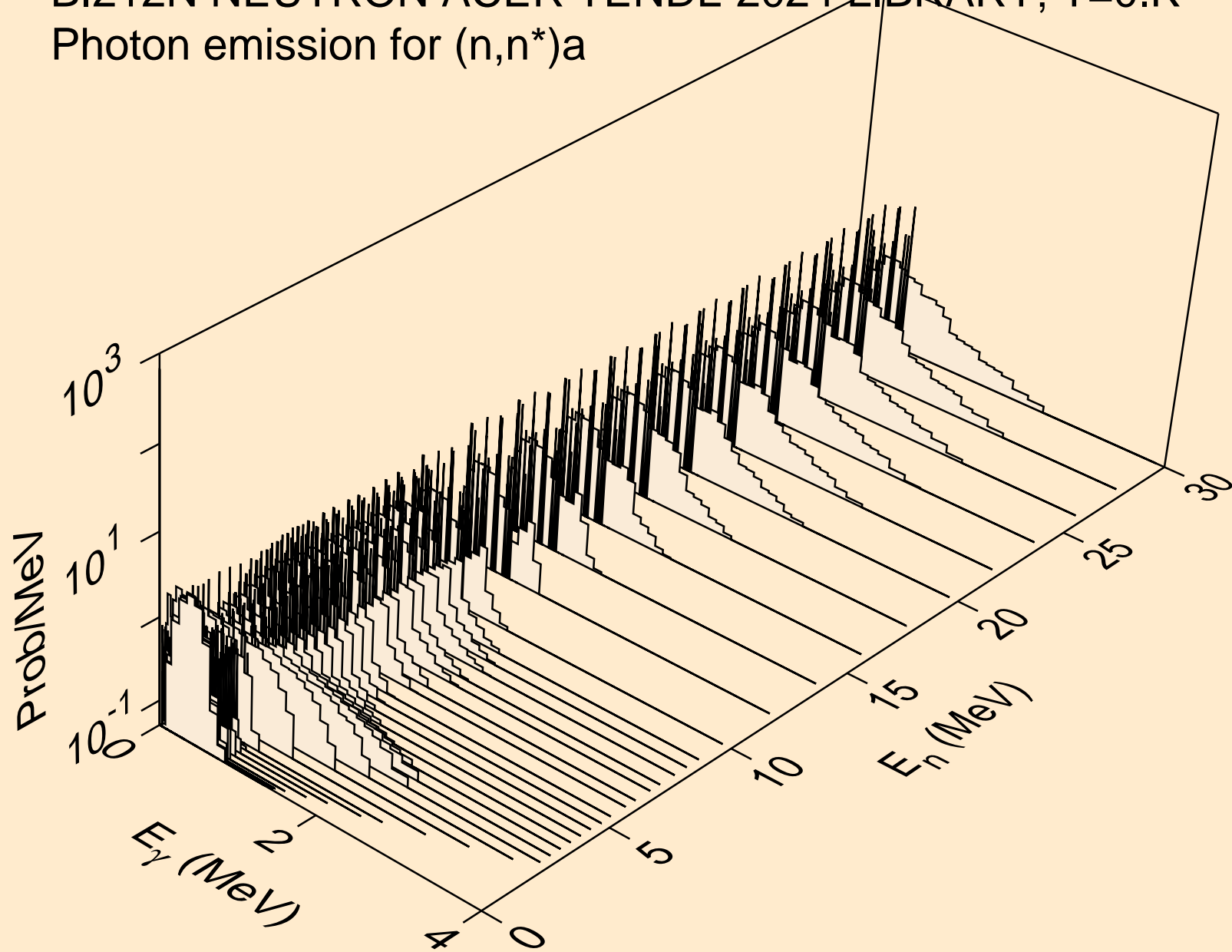

BI212N NEUTRON ACER TENDL-2024 LIBRARY; T=0.K
Photon emission for (n,2n)a

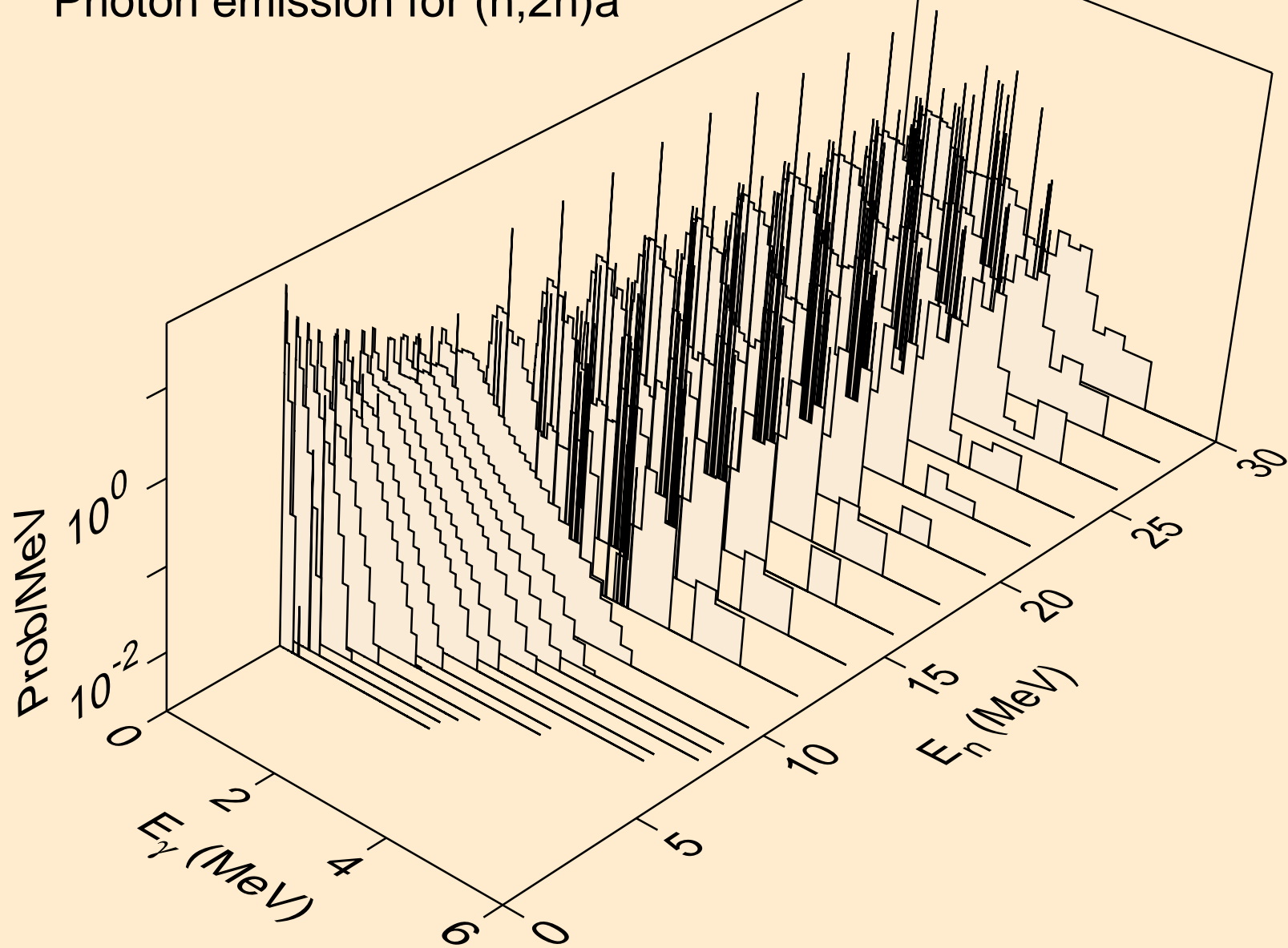

BI212N NEUTRON ACER TENDL-2024 LIBRARY; T=0.K
Photon emission for (n,3n)a

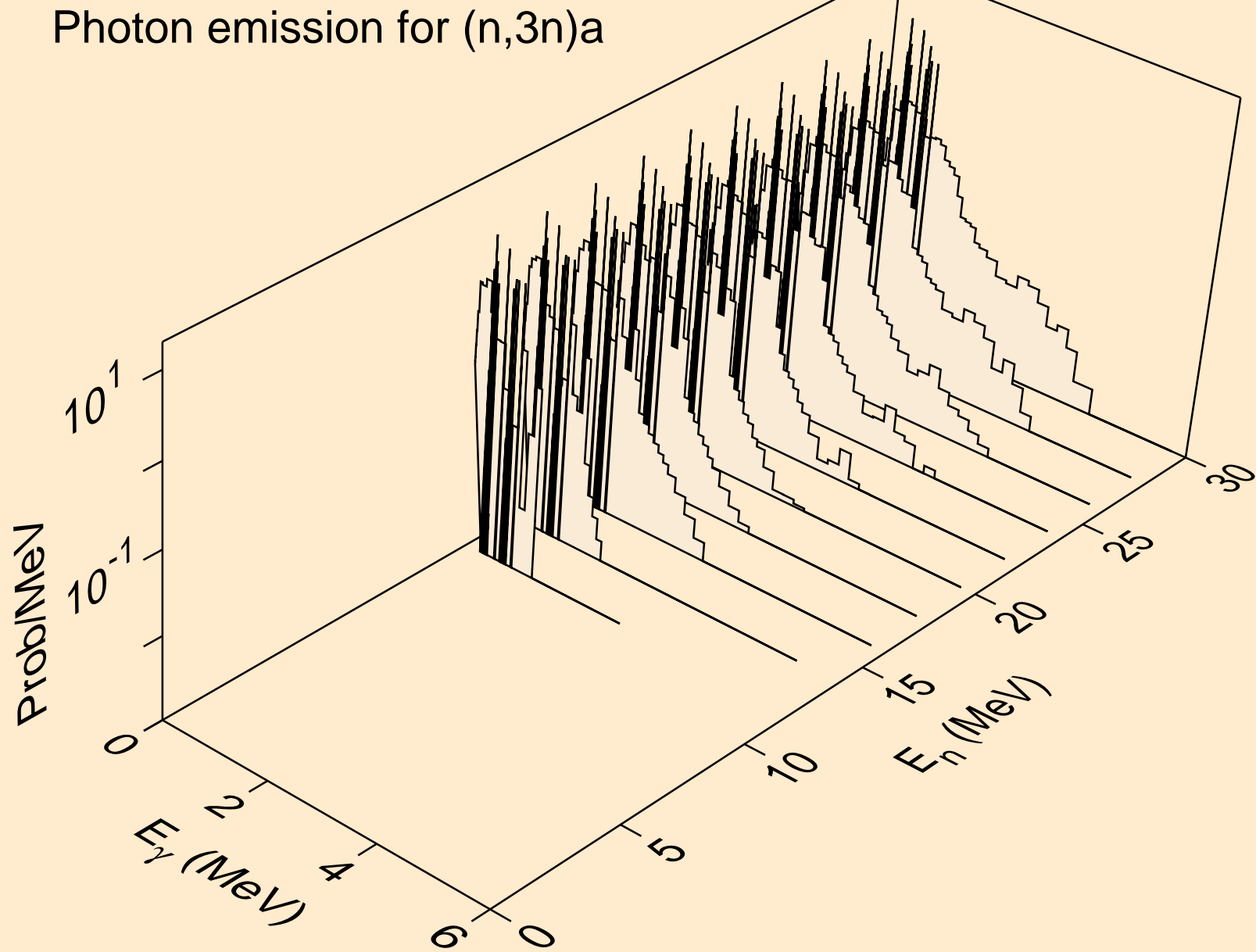

BI212N NEUTRON ACER TENDL-2024 LIBRARY; T=0.K
Photon emission for (n,n*)p

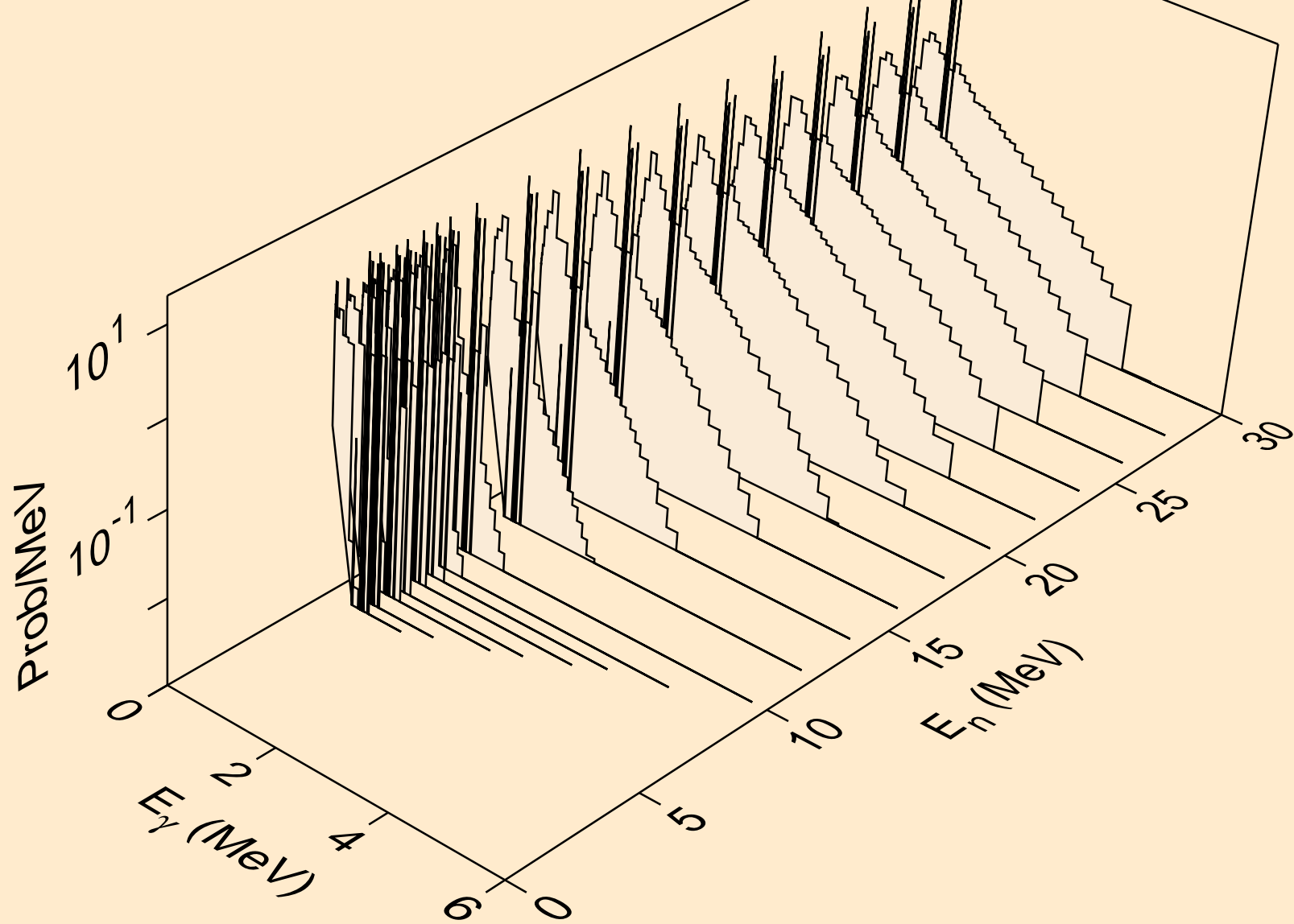

BI212N NEUTRON ACER TENDL-2024 LIBRARY; T=0.K
Photon emission for (n,n*)d

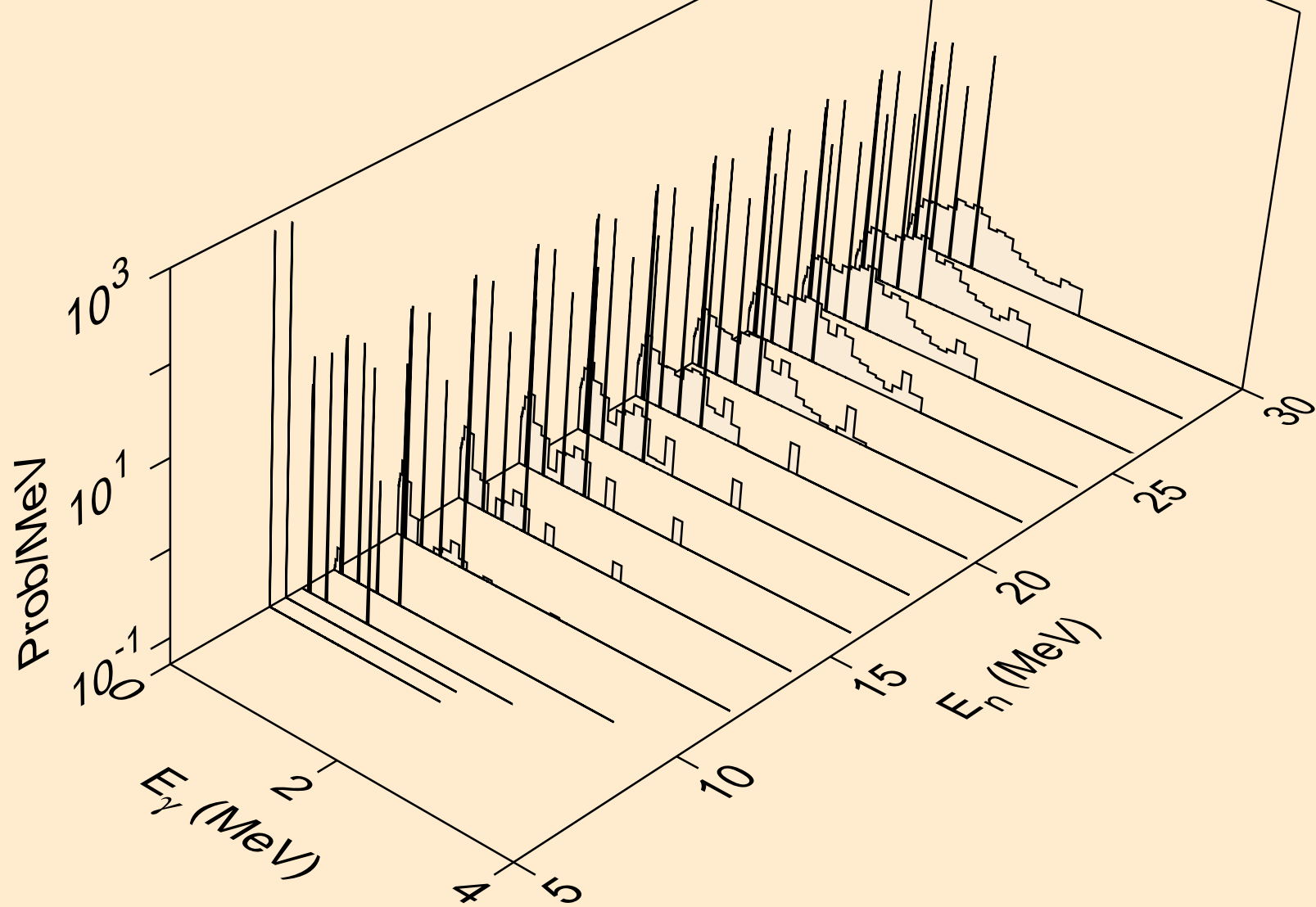

BI212N NEUTRON ACER TENDL-2024 LIBRARY; T=0.K
Photon emission for (n,n*)t

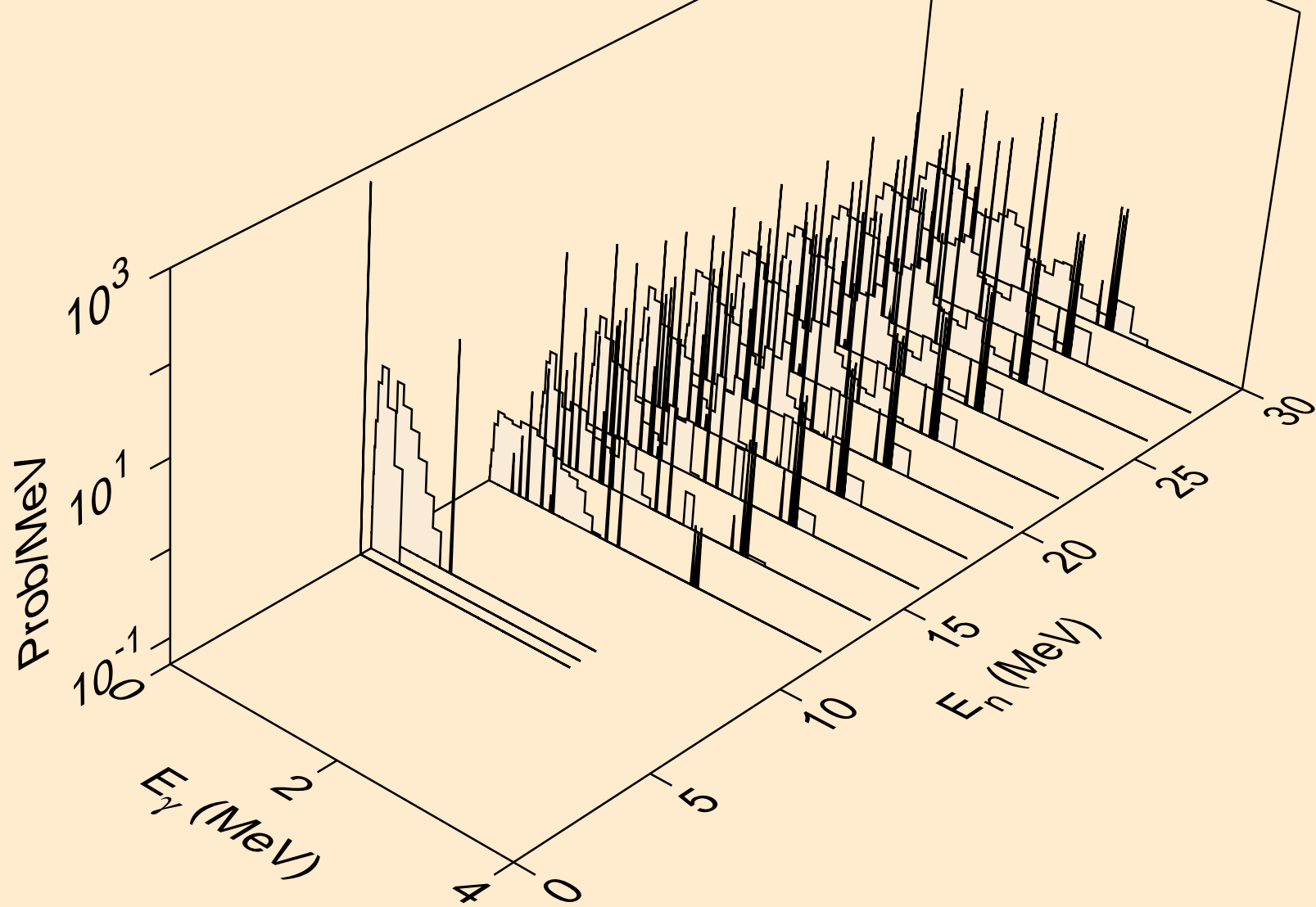

BI212N NEUTRON ACER TENDL-2024 LIBRARY; T=0.K
Photon emission for (n,n*)he3

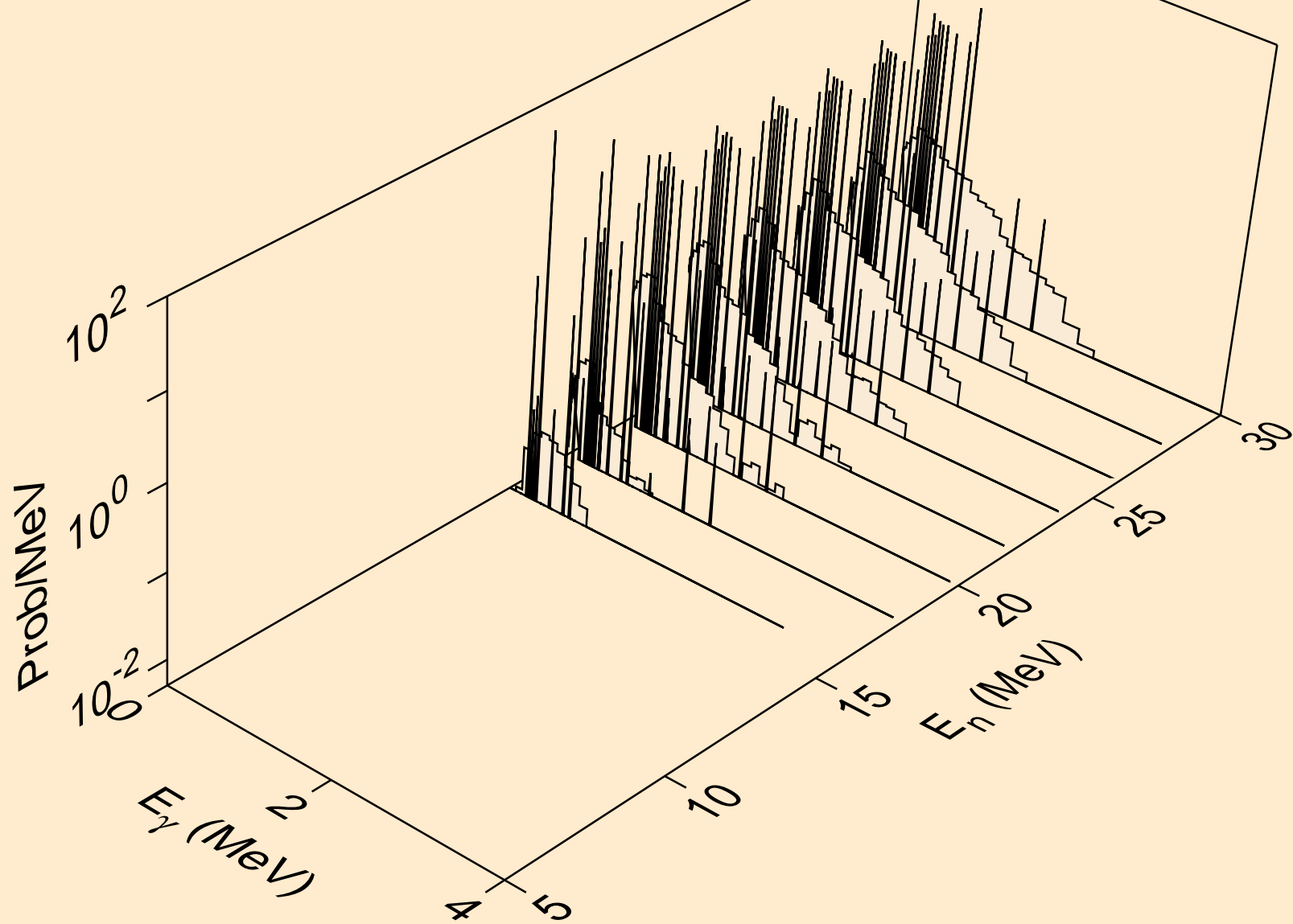

BI212N NEUTRON ACER TENDL-2024 LIBRARY; T=0.K
Photon emission for (n,4n)

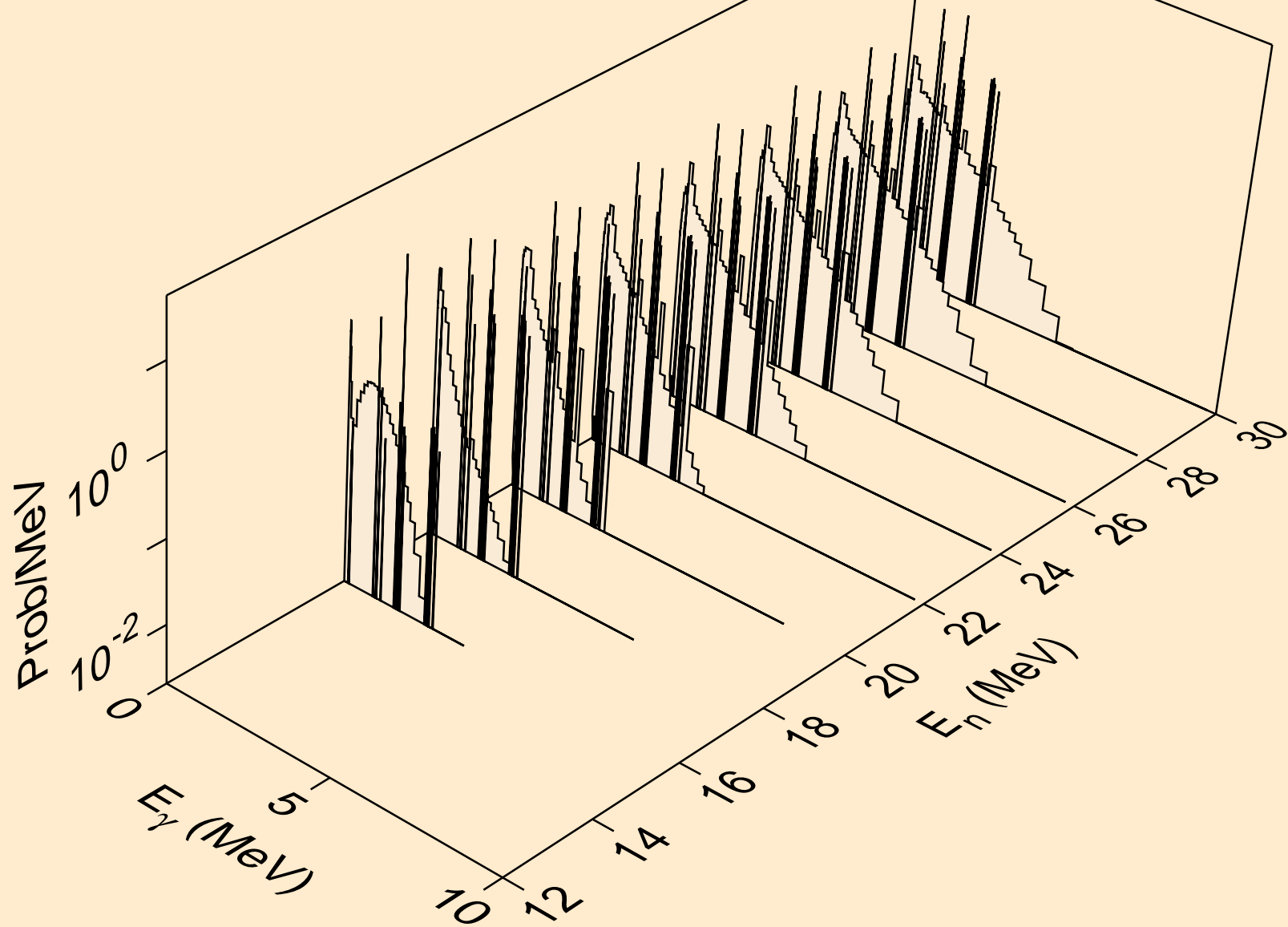

BI212N NEUTRON ACER TENDL-2024 LIBRARY; T=0.K
Photon emission for (n,2np)

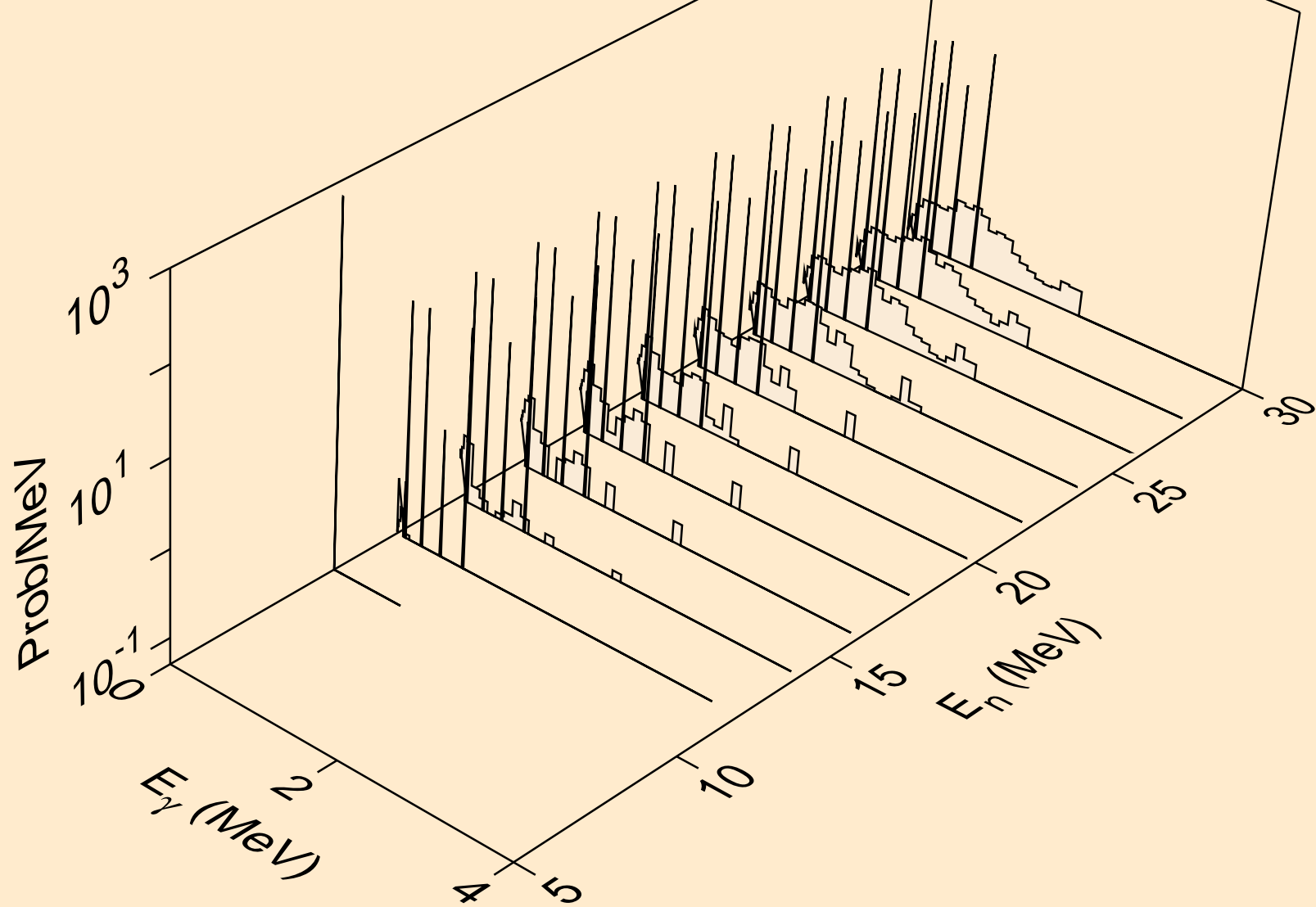

BI212N NEUTRON ACER TENDL-2024 LIBRARY; T=0.K
Photon emission for (n,3np)

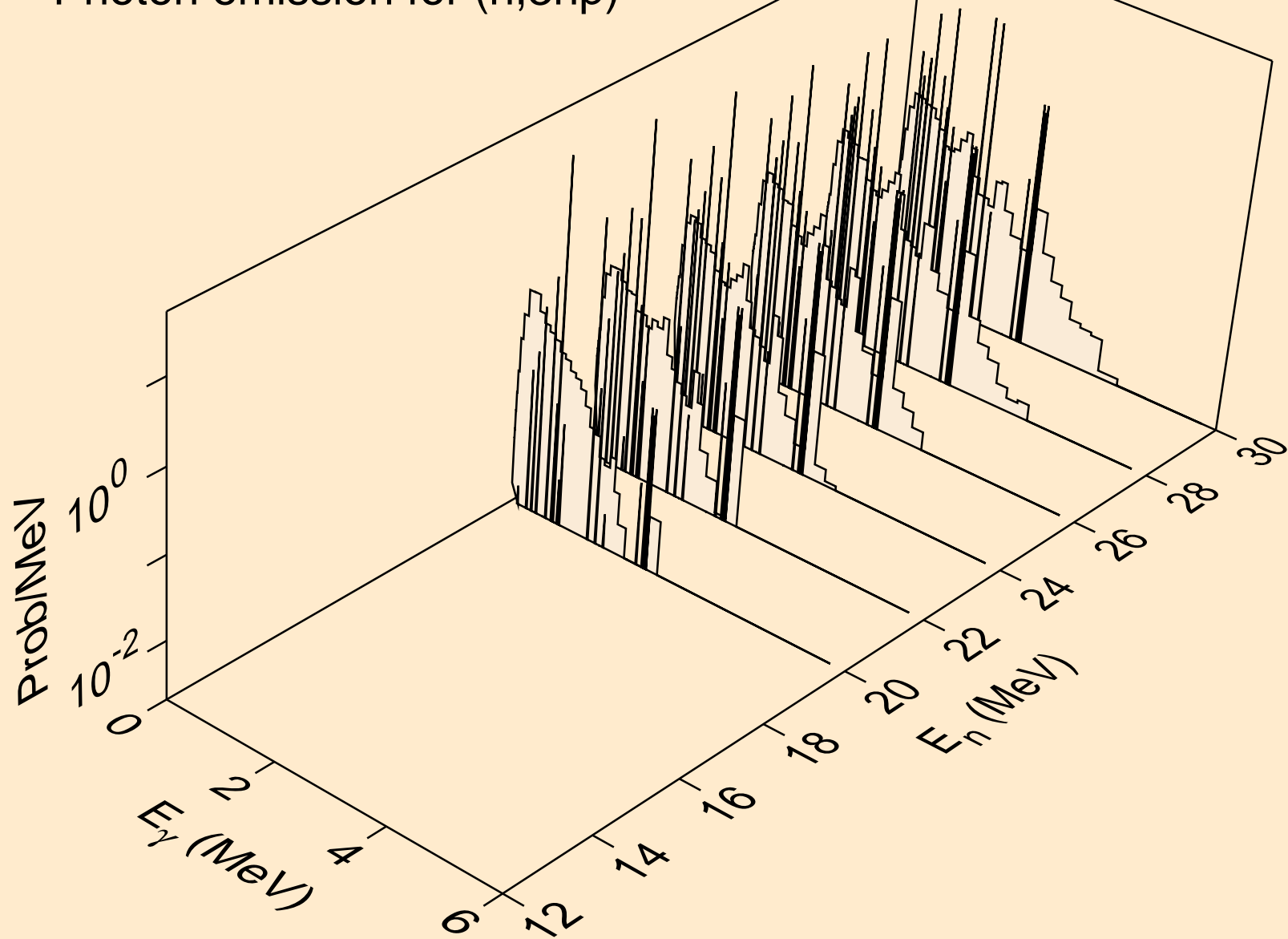

BI212N NEUTRON ACER TENDL-2024 LIBRARY; T=0.K
Photon emission for (n,n2p)

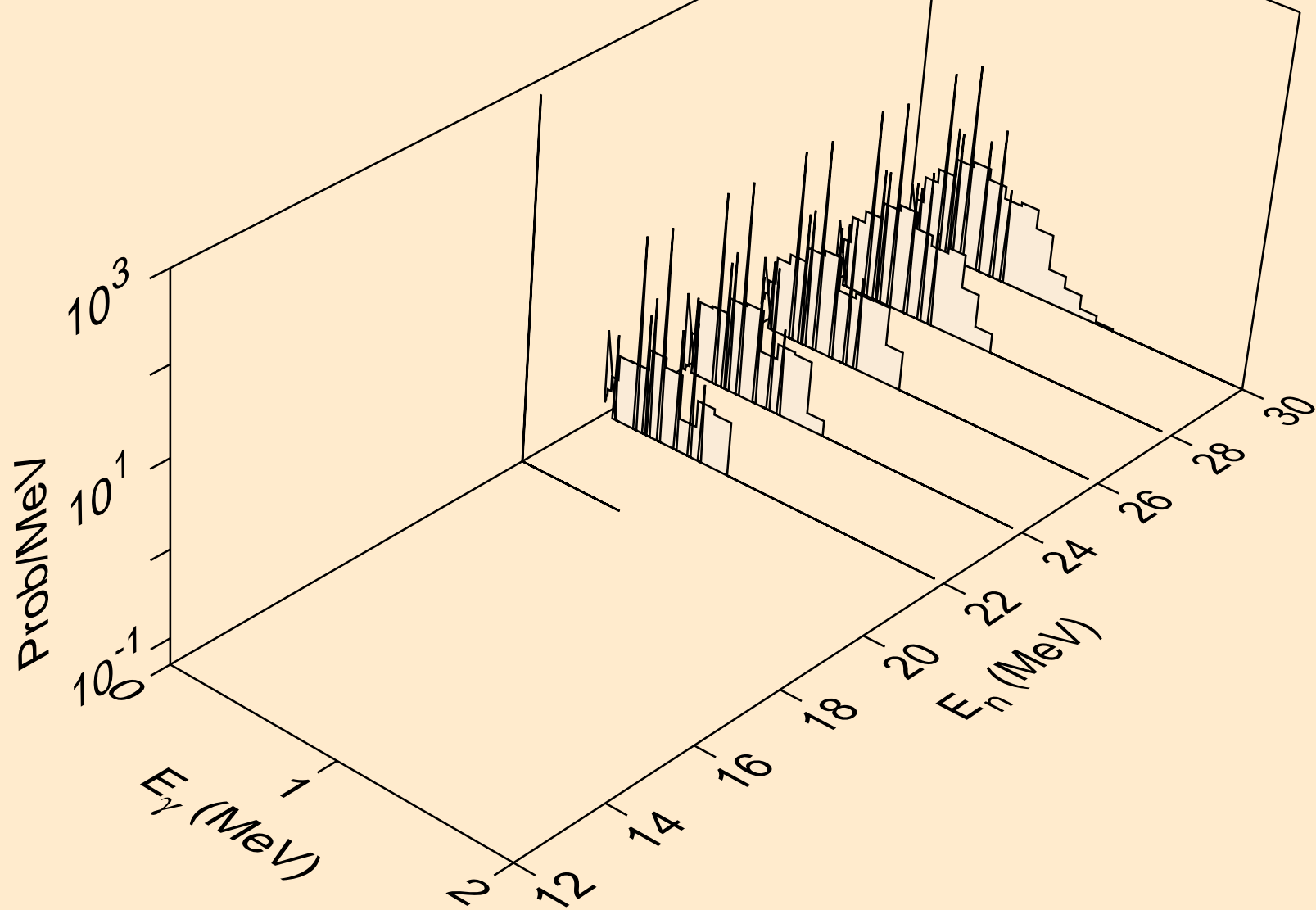

BI212N NEUTRON ACER TENDL-2024 LIBRARY; T=0.K
Photon emission for (n,npa)

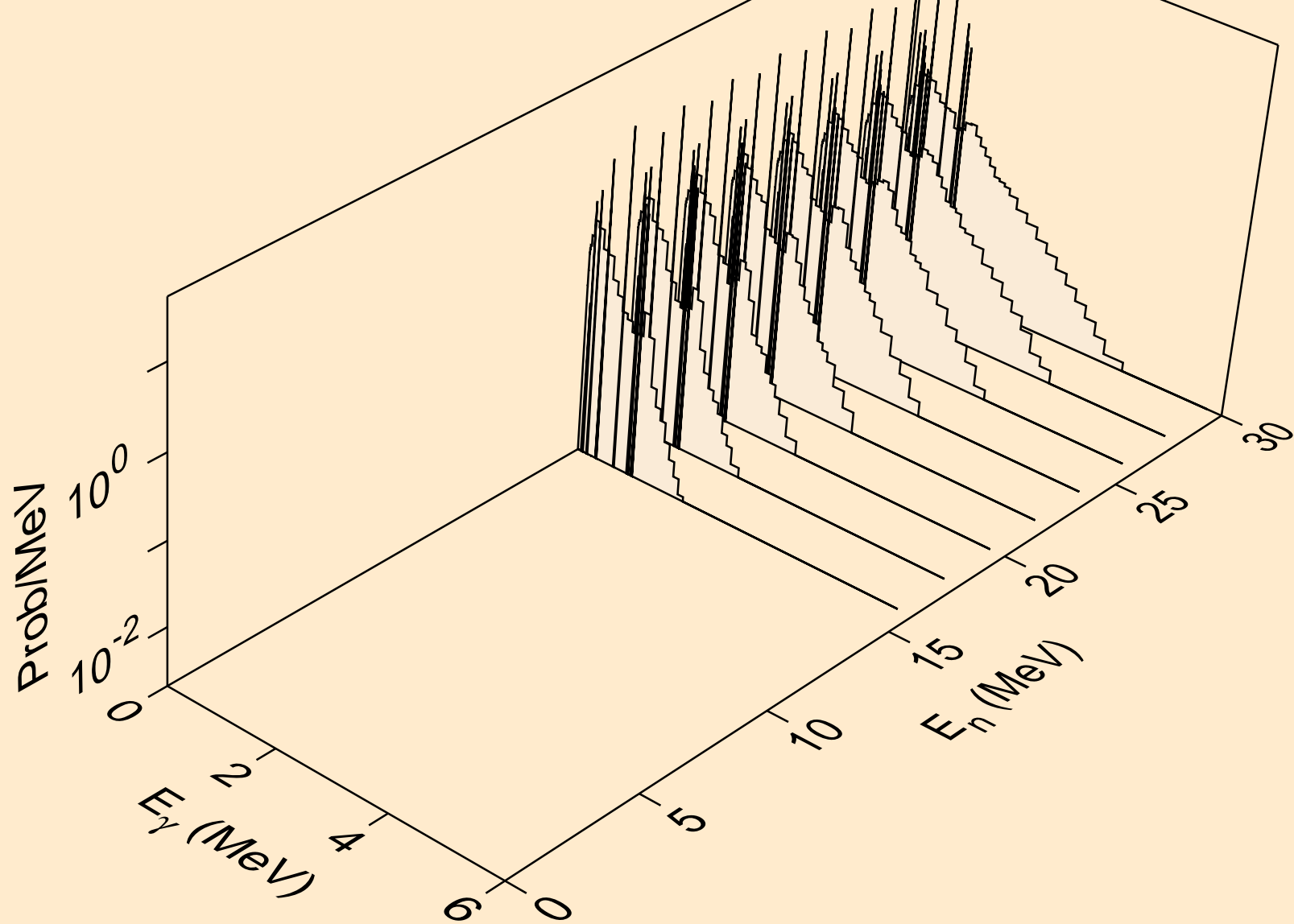

BI212N NEUTRON ACER TENDL-2024 LIBRARY; T=0.K
Photon emission for (n,n*6)

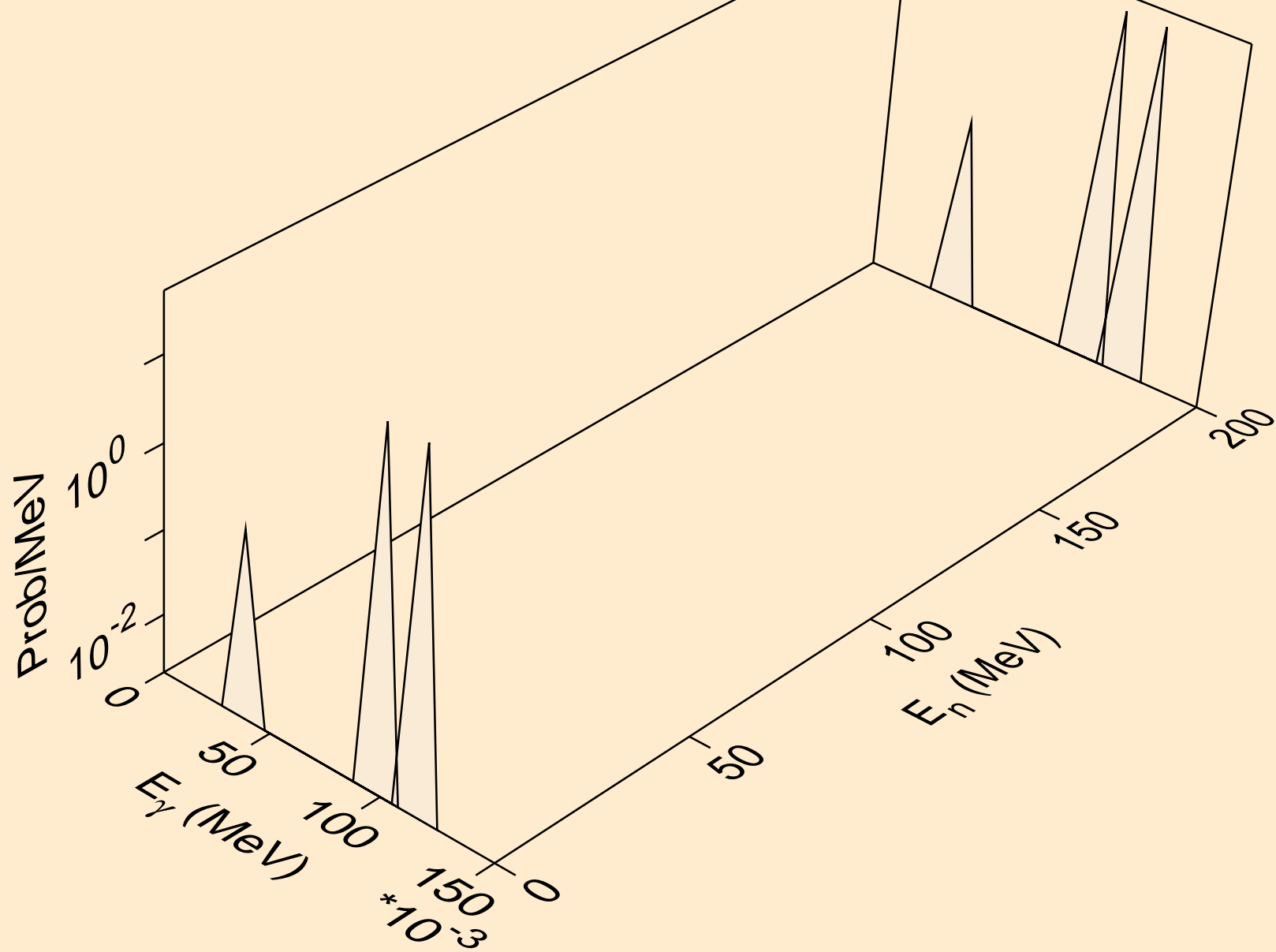

BI212N NEUTRON ACER TENDL-2024 LIBRARY; T=0.K
Photon emission for (n,n*7)

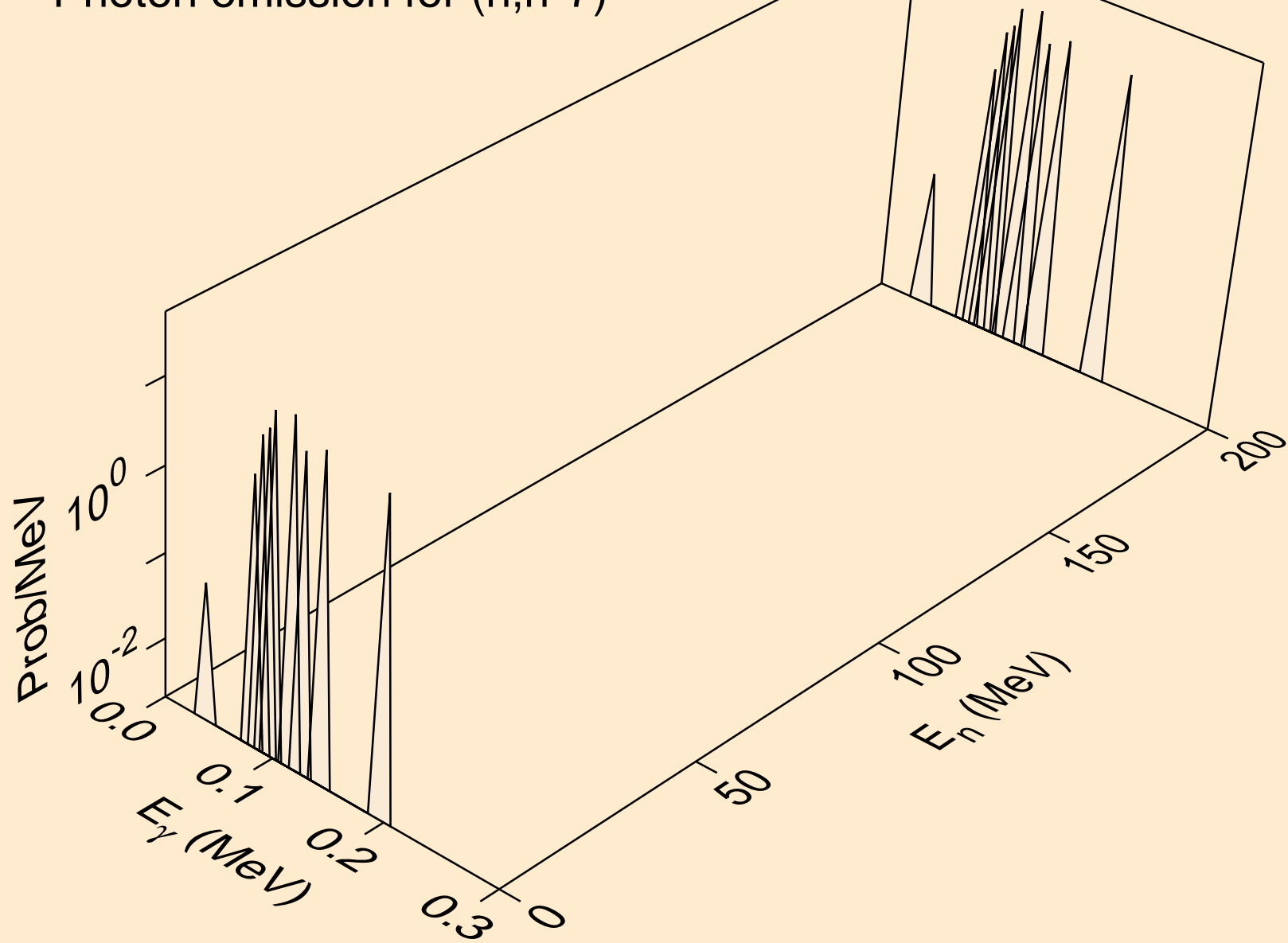

BI212N NEUTRON ACER TENDL-2024 LIBRARY; T=0.K
Photon emission for (n,n*8)

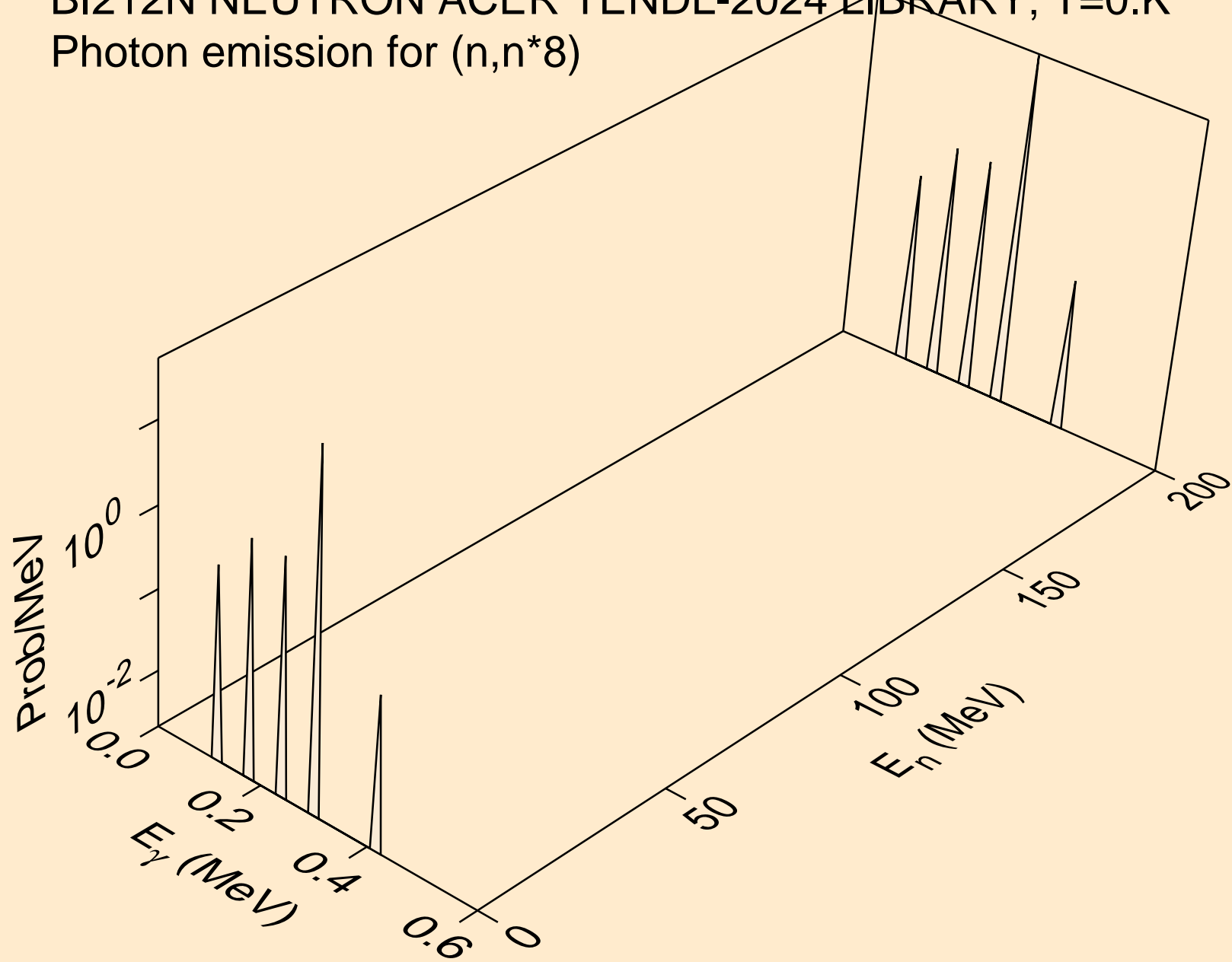

BI212N NEUTRON ACER TENDL-2024 LIBRARY; T=0.K
Photon emission for (n,n*10)

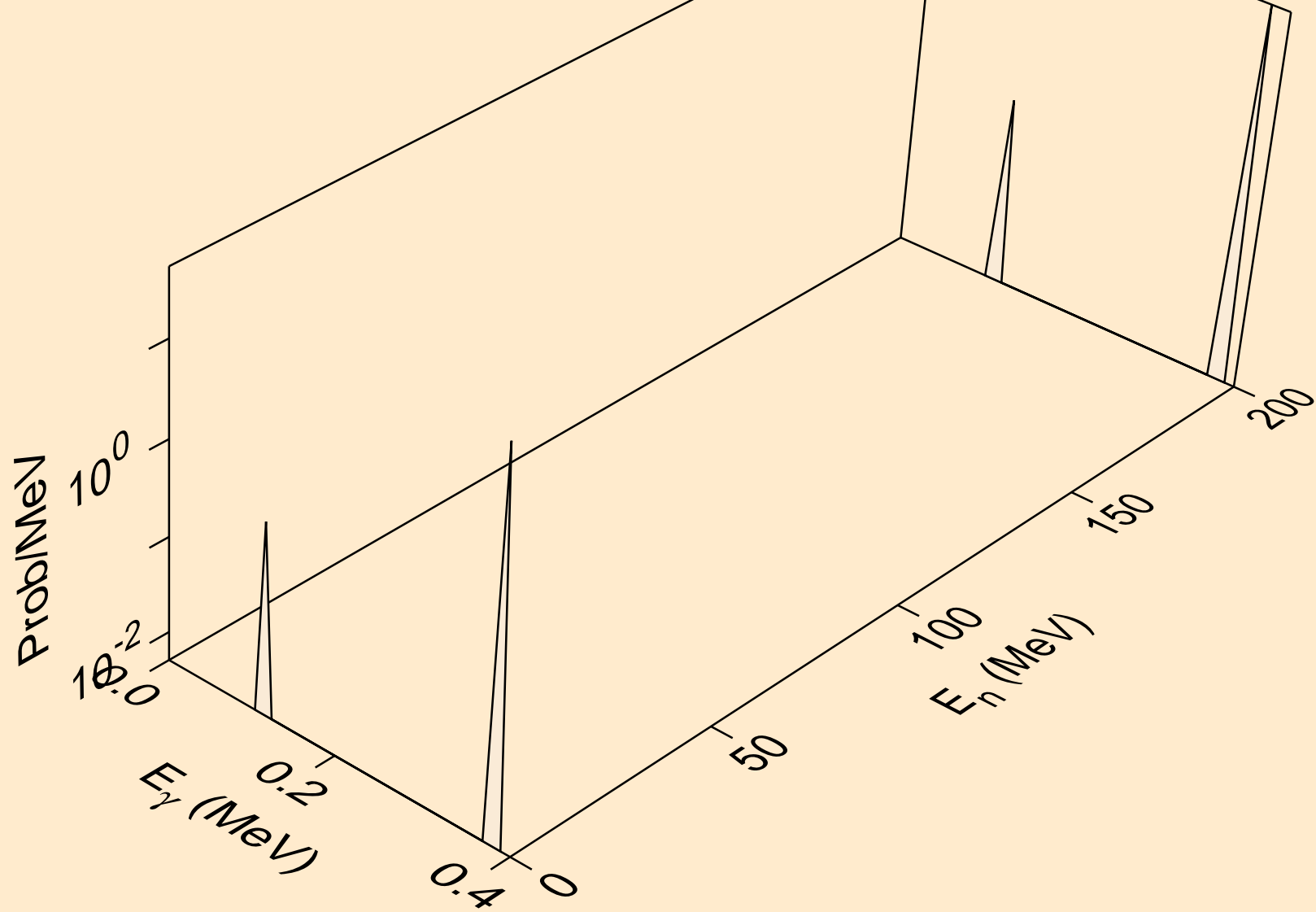

BI212N NEUTRON ACER TENDL-2024 LIBRARY; T=0.K
Photon emission for (n,n*13)

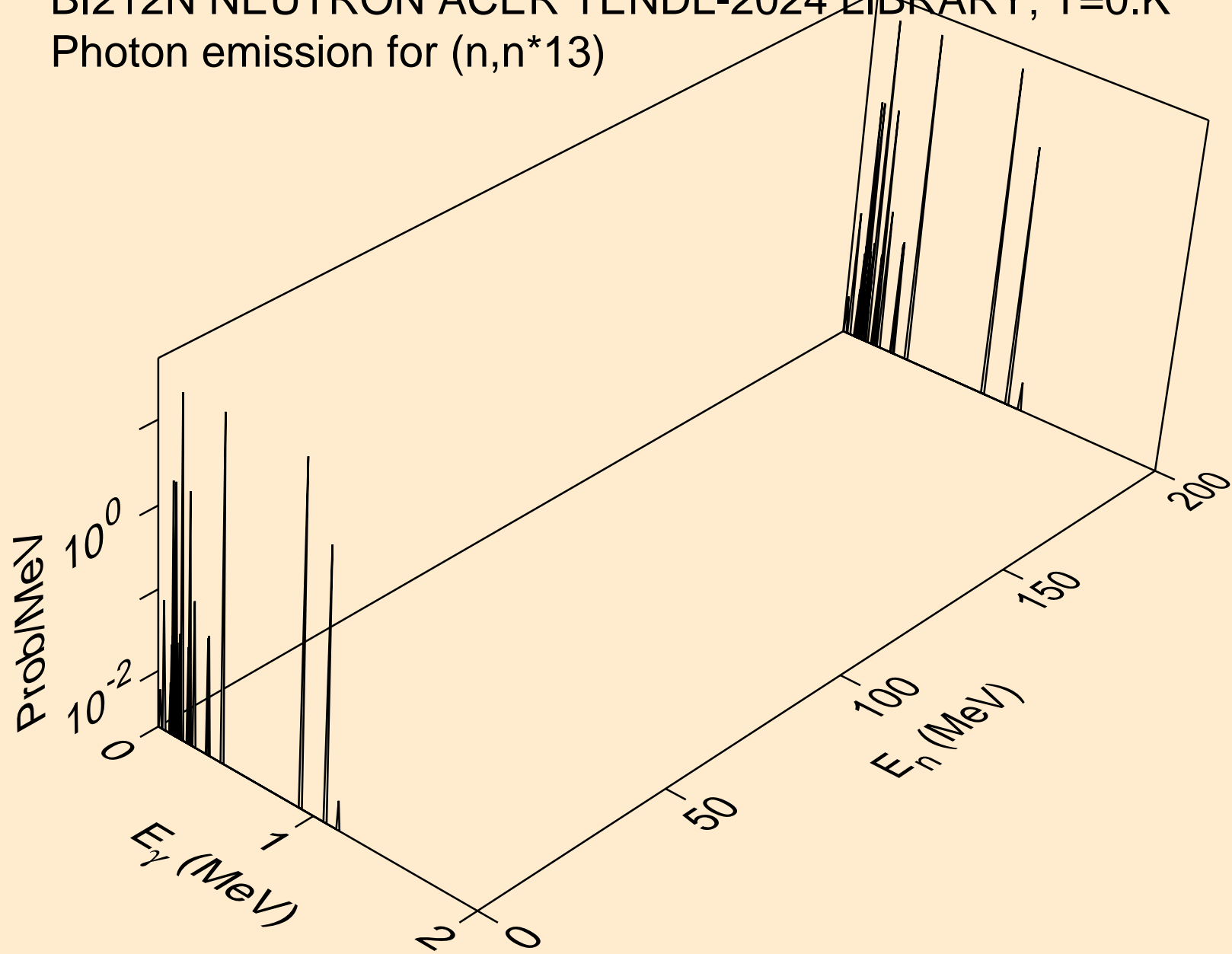

BI212N NEUTRON ACER TENDL-2024 LIBRARY; T=0.K
Photon emission for (n,n*14)

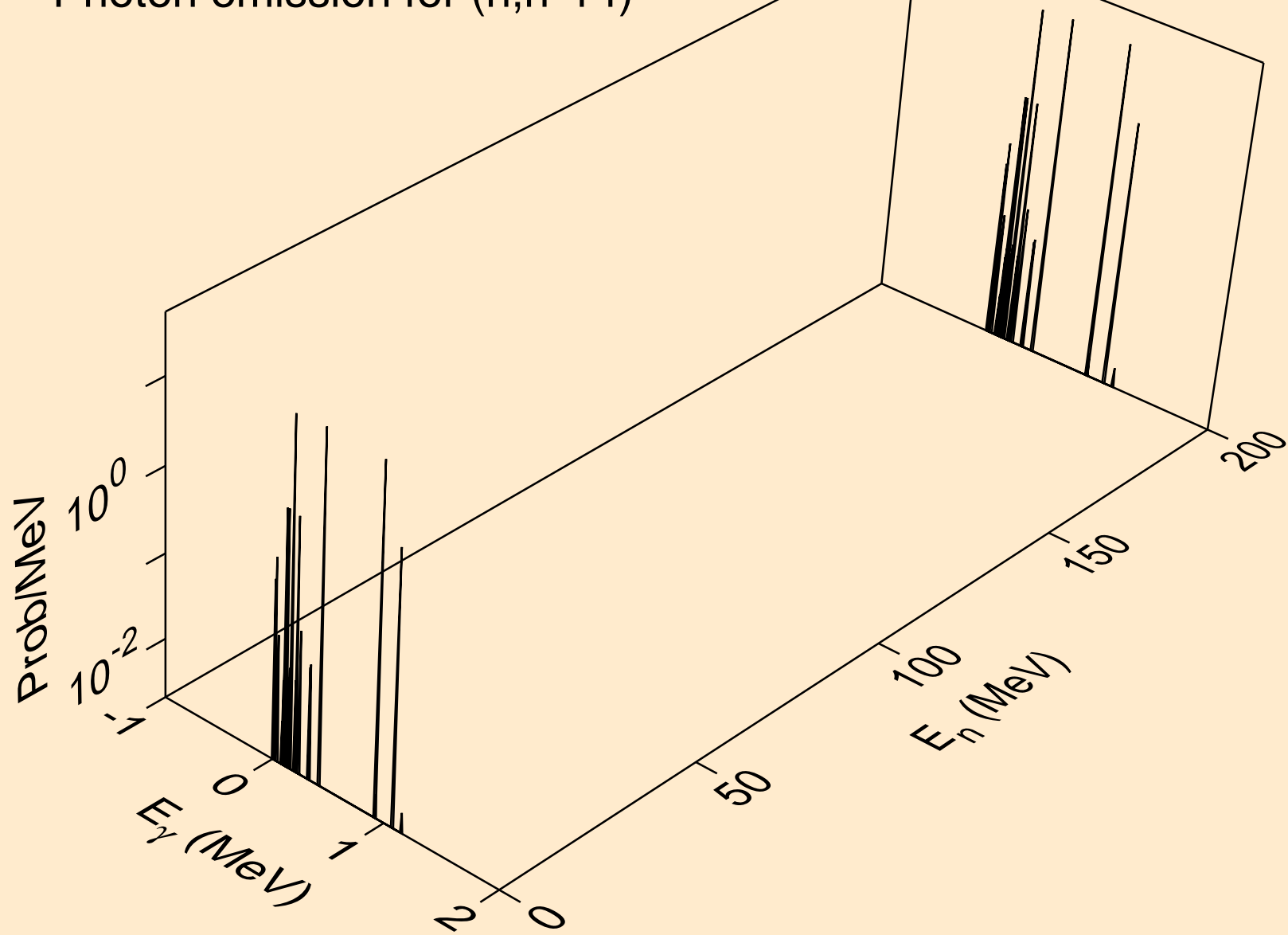

BI212N NEUTRON ACER TENDL-2024 LIBRARY; T=0.K
Photon emission for (n,n*15)

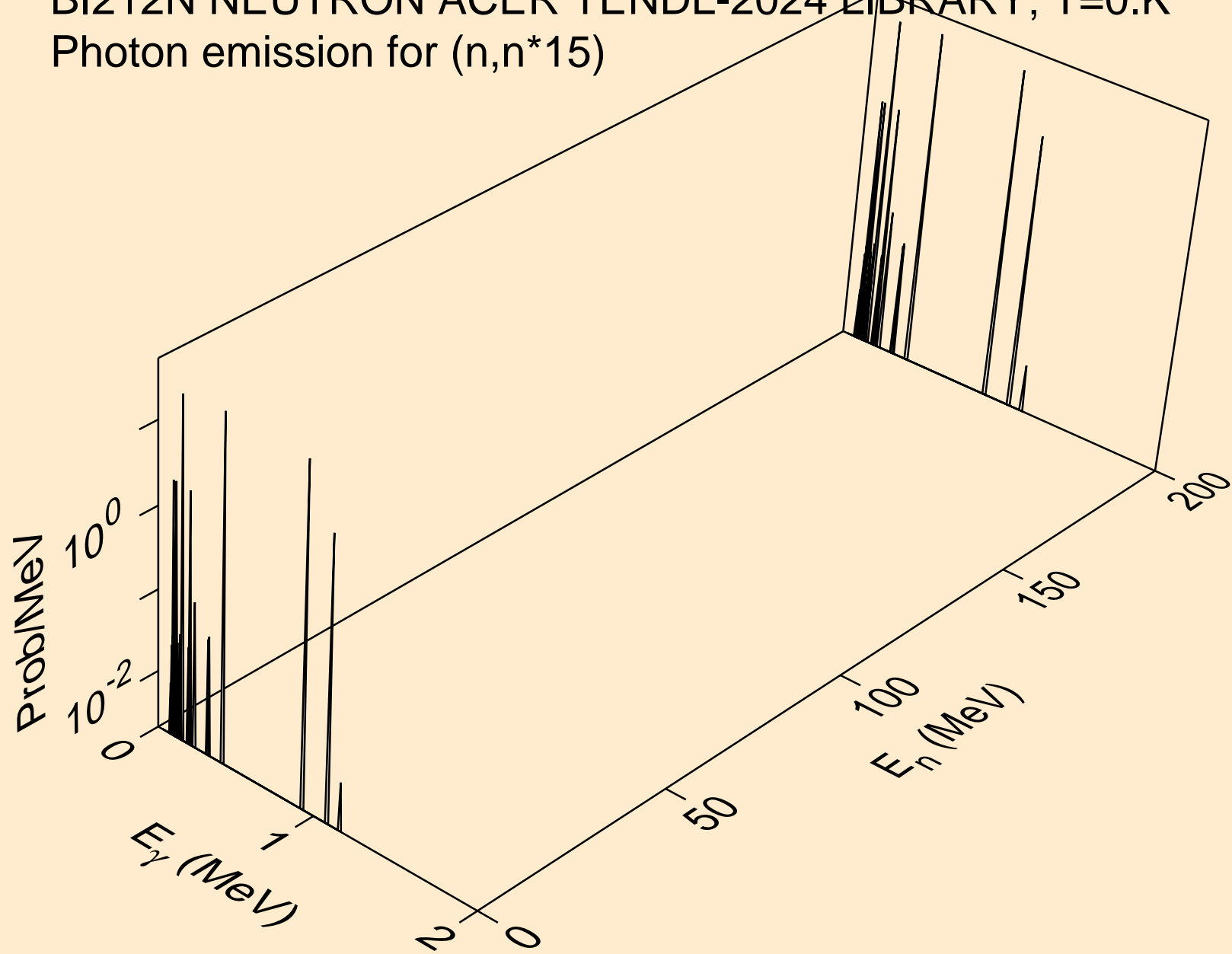

BI212N NEUTRON ACER TENDL-2024 LIBRARY; T=0.K
Photon emission for (n,n*16)

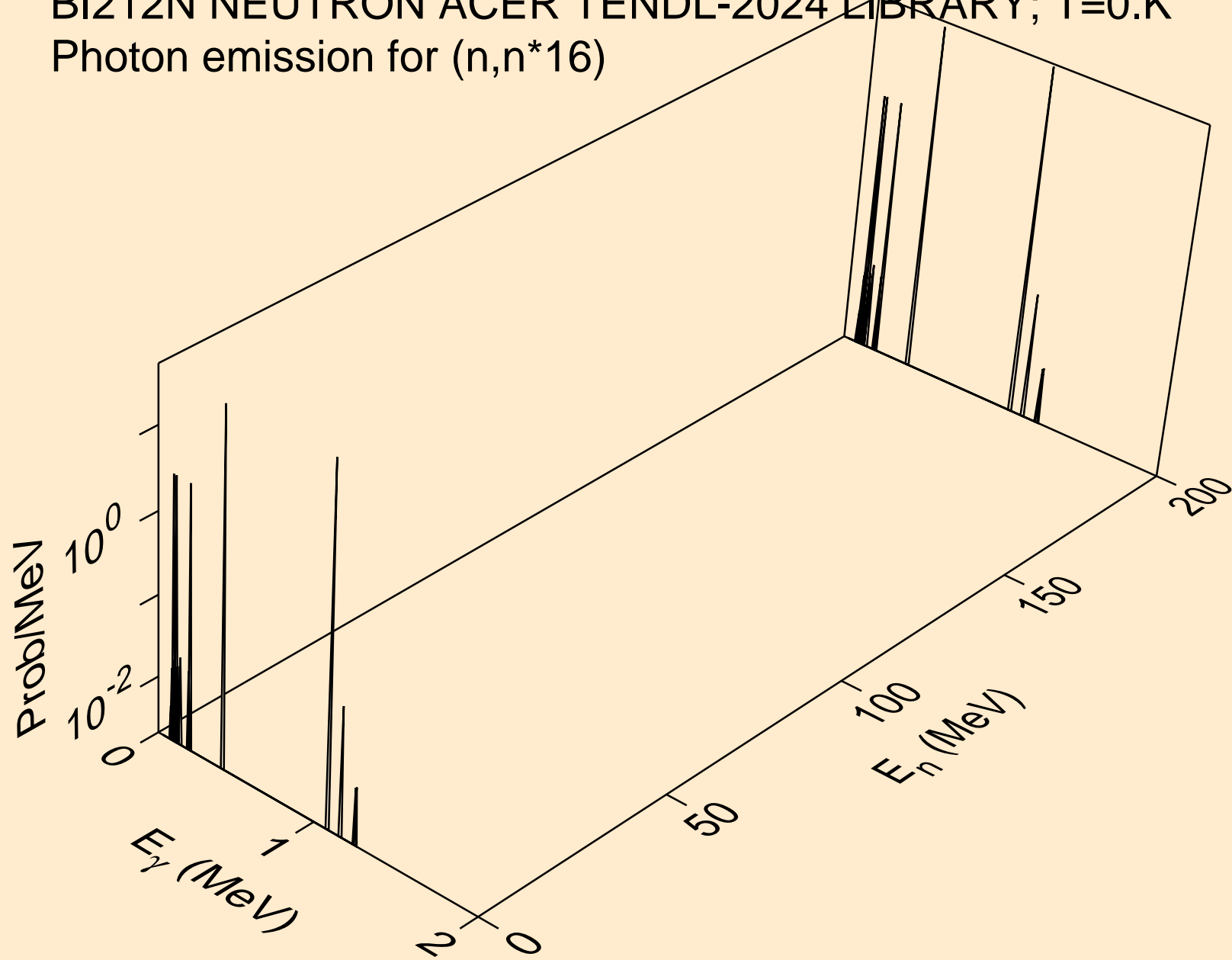

BI212N NEUTRON ACER TENDL-2024 LIBRARY; T=0.K
Photon emission for (n,n*17)

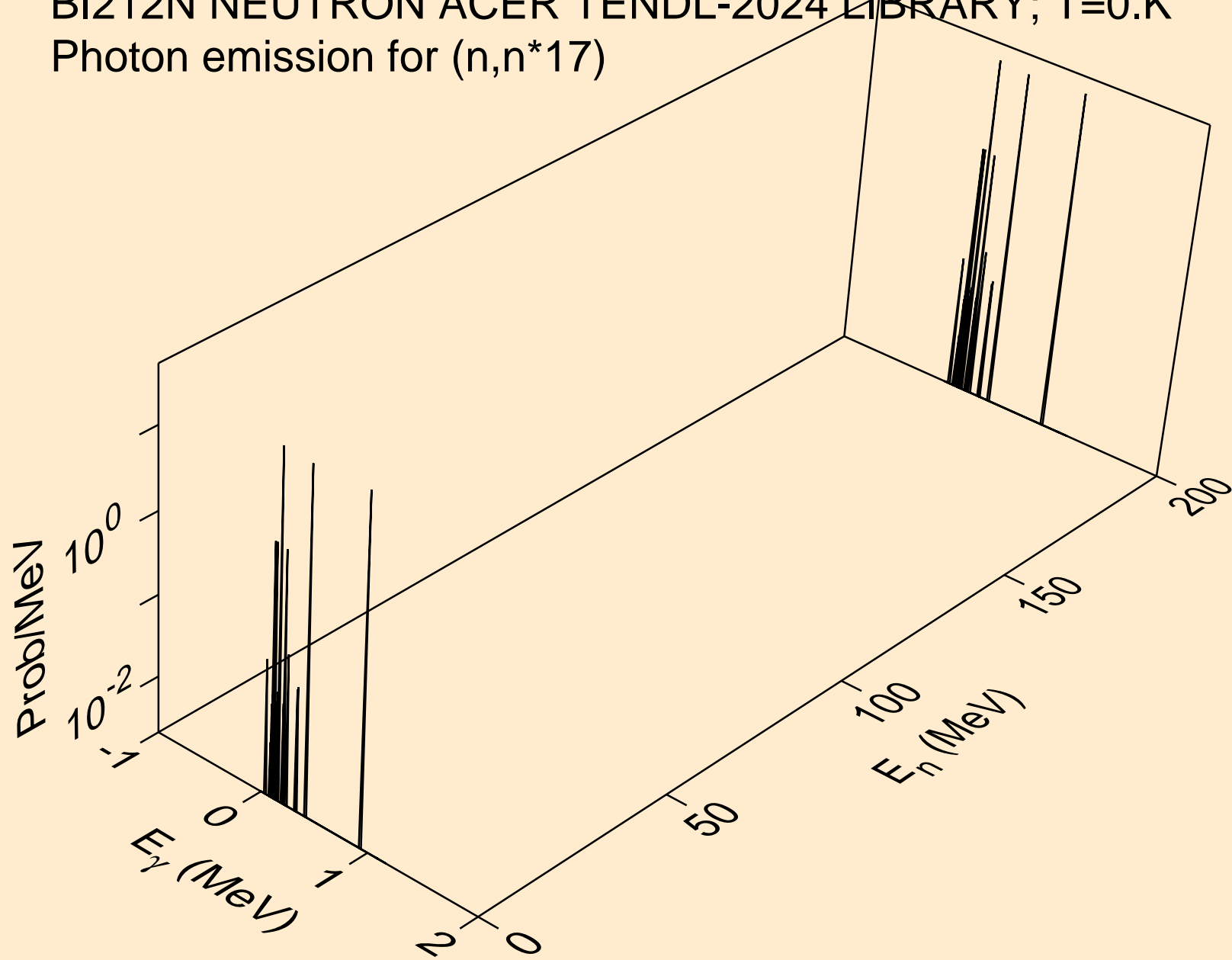

BI212N NEUTRON ACER TENDL-2024 LIBRARY; T=0.K
Photon emission for (n,n*18)

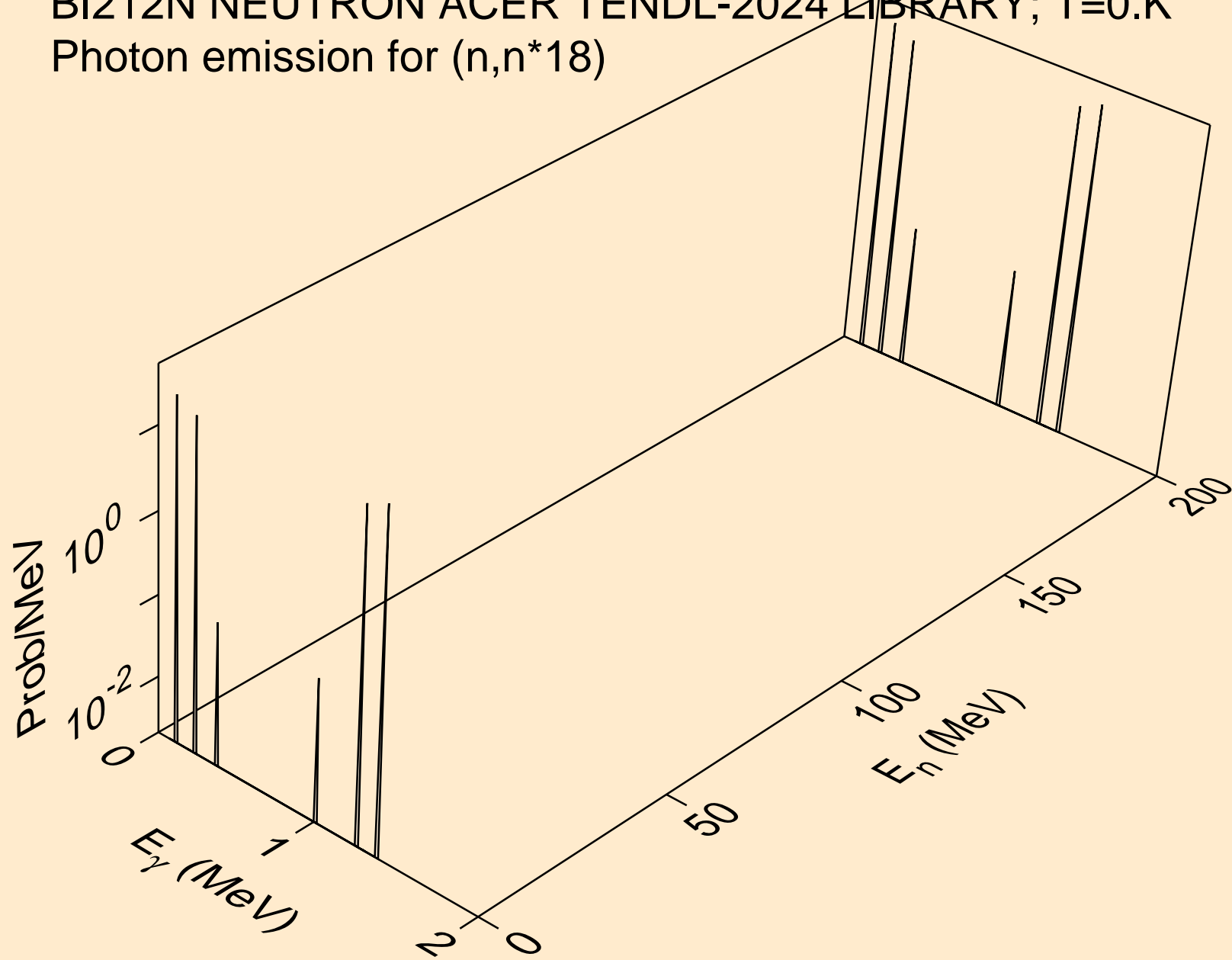

BI212N NEUTRON ACER TENDL-2024 LIBRARY; T=0.K
Photon emission for (n,n*19)

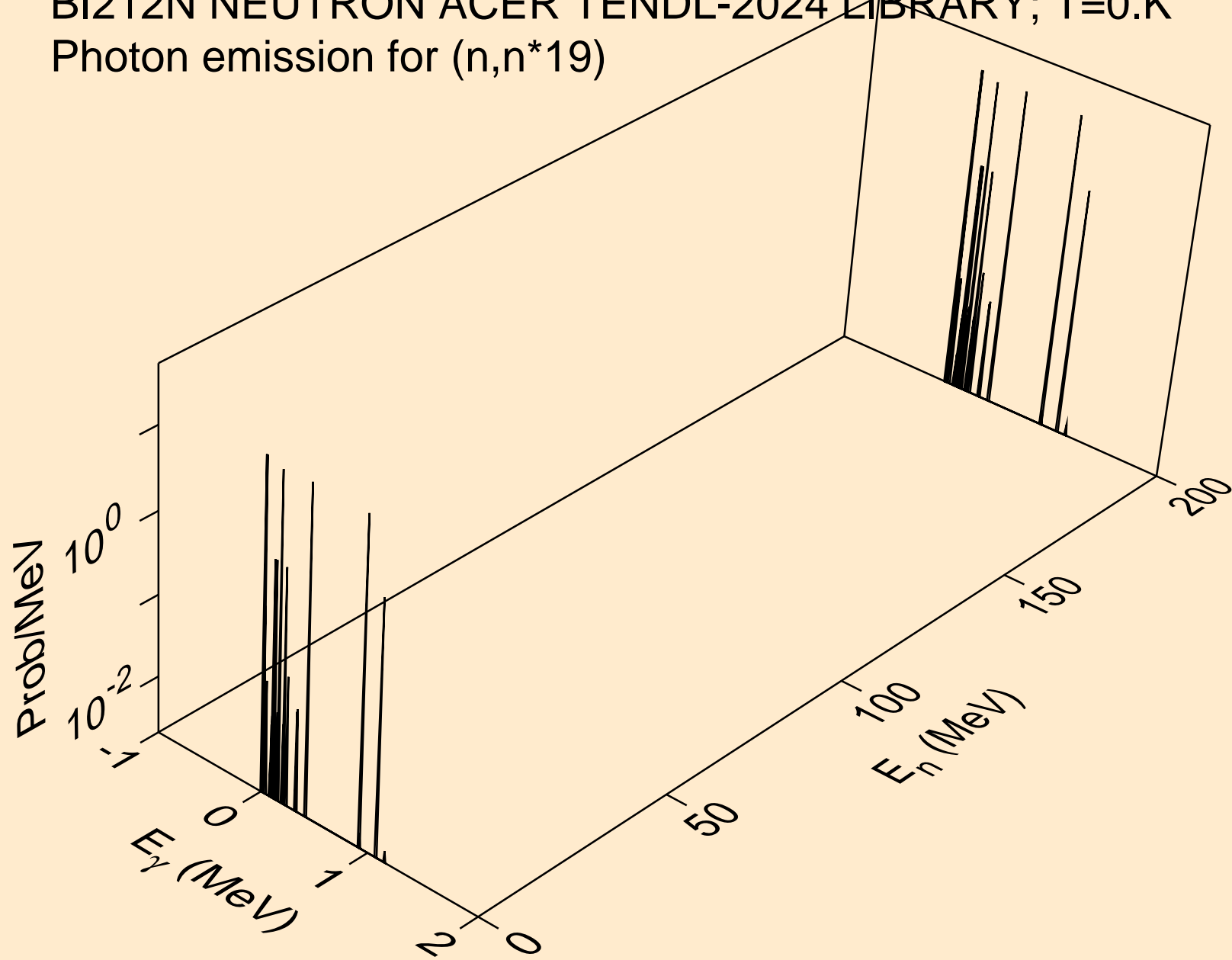

BI212N NEUTRON ACER TENDL-2024 LIBRARY; T=0.K
Photon emission for (n,n*20)

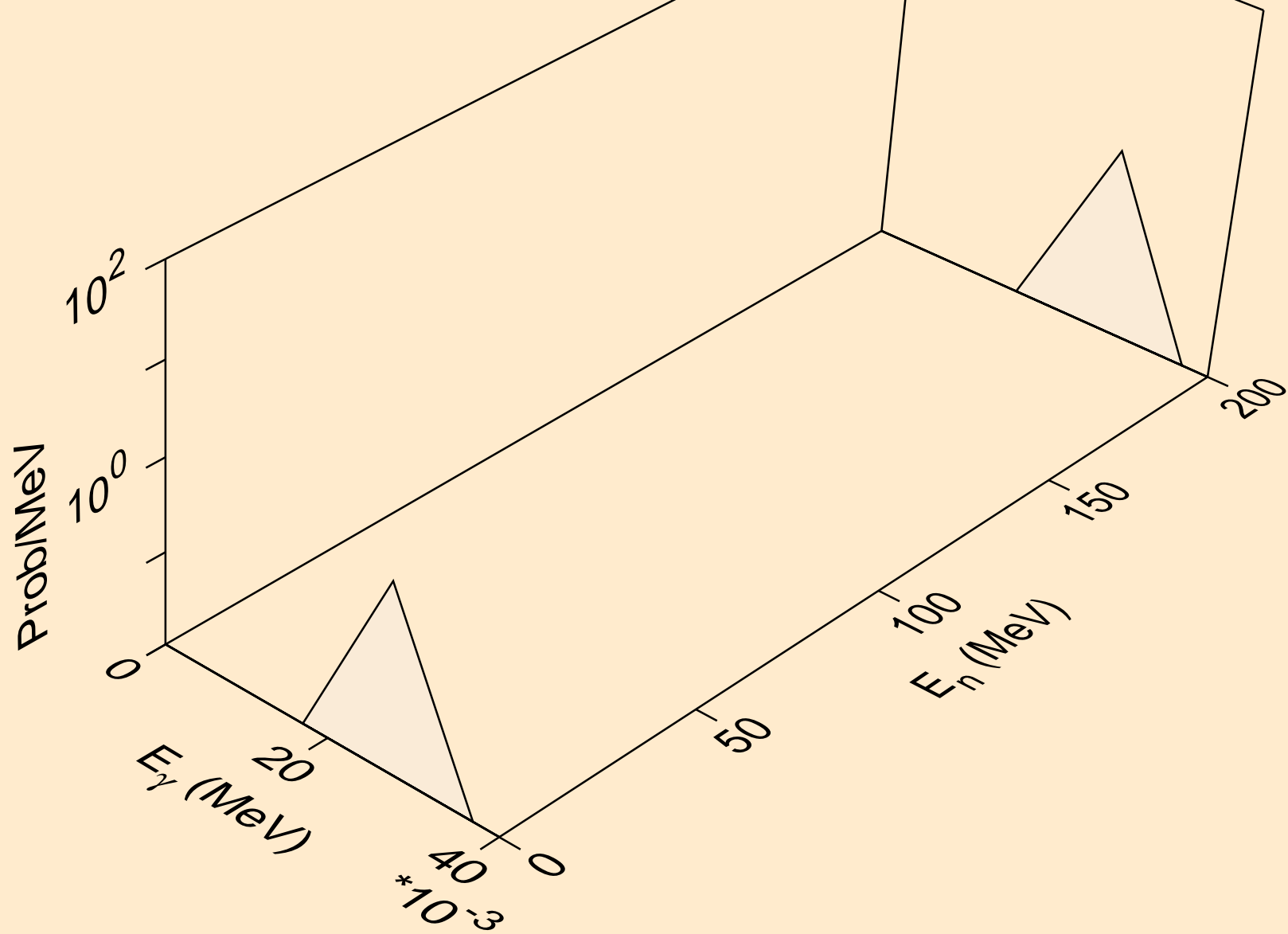

BI212N NEUTRON ACER TENDL-2024 LIBRARY; T=0.K
Photon emission for (n,n*21)

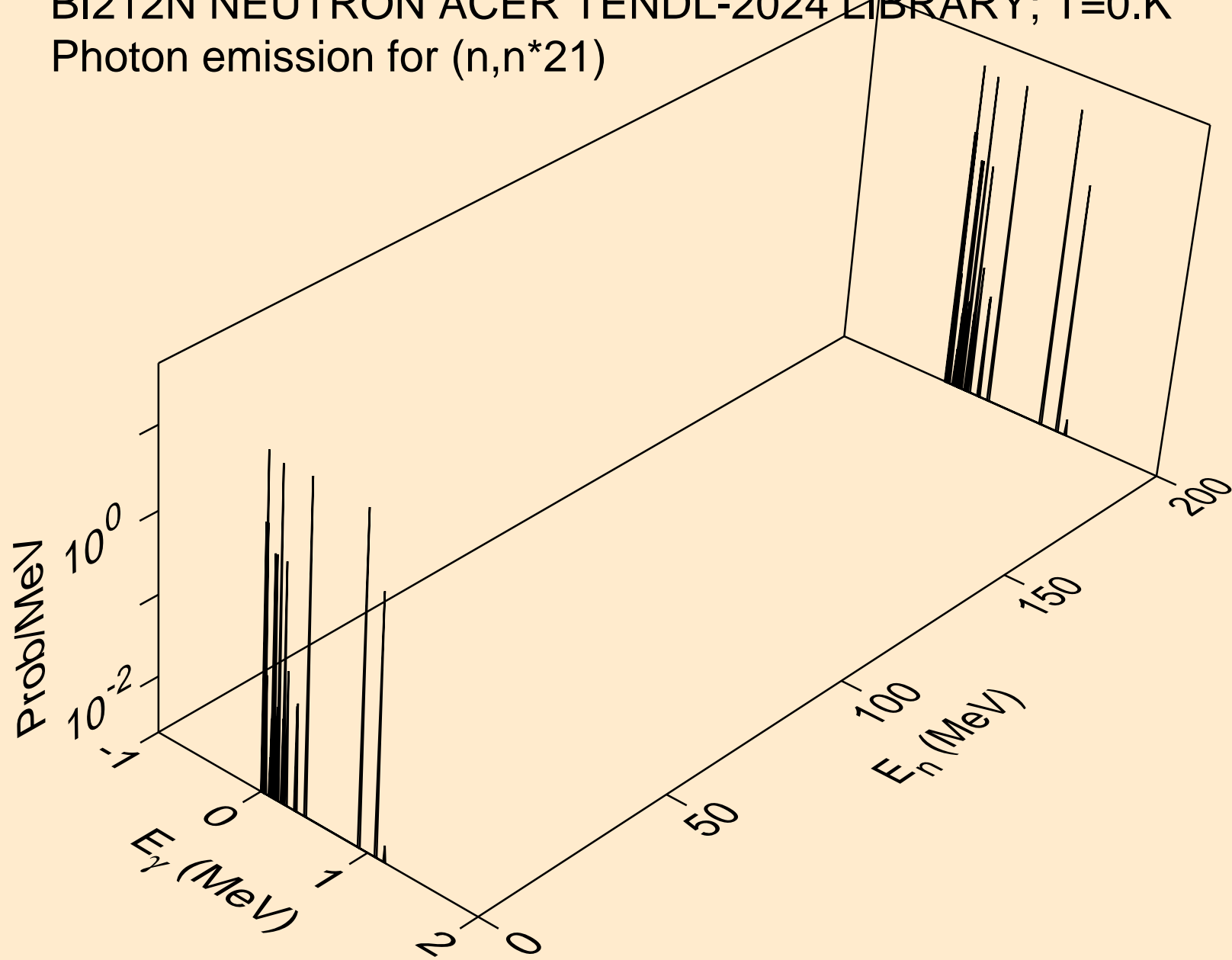

BI212N NEUTRON ACER TENDL-2024 LIBRARY; T=0.K
Photon emission for (n,n*22)

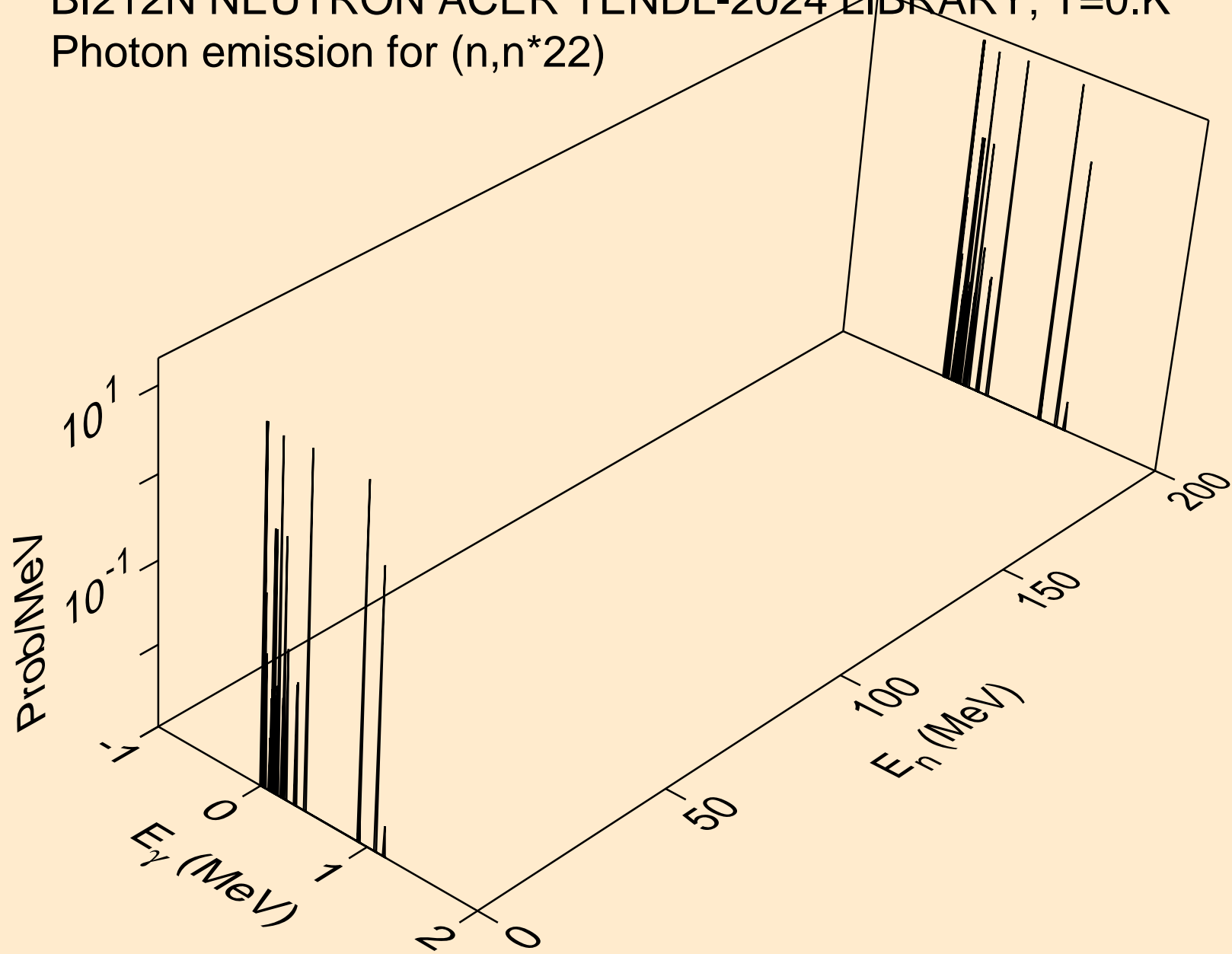

BI212N NEUTRON ACER TENDL-2024 LIBRARY; T=0.K
Photon emission for (n,n*23)

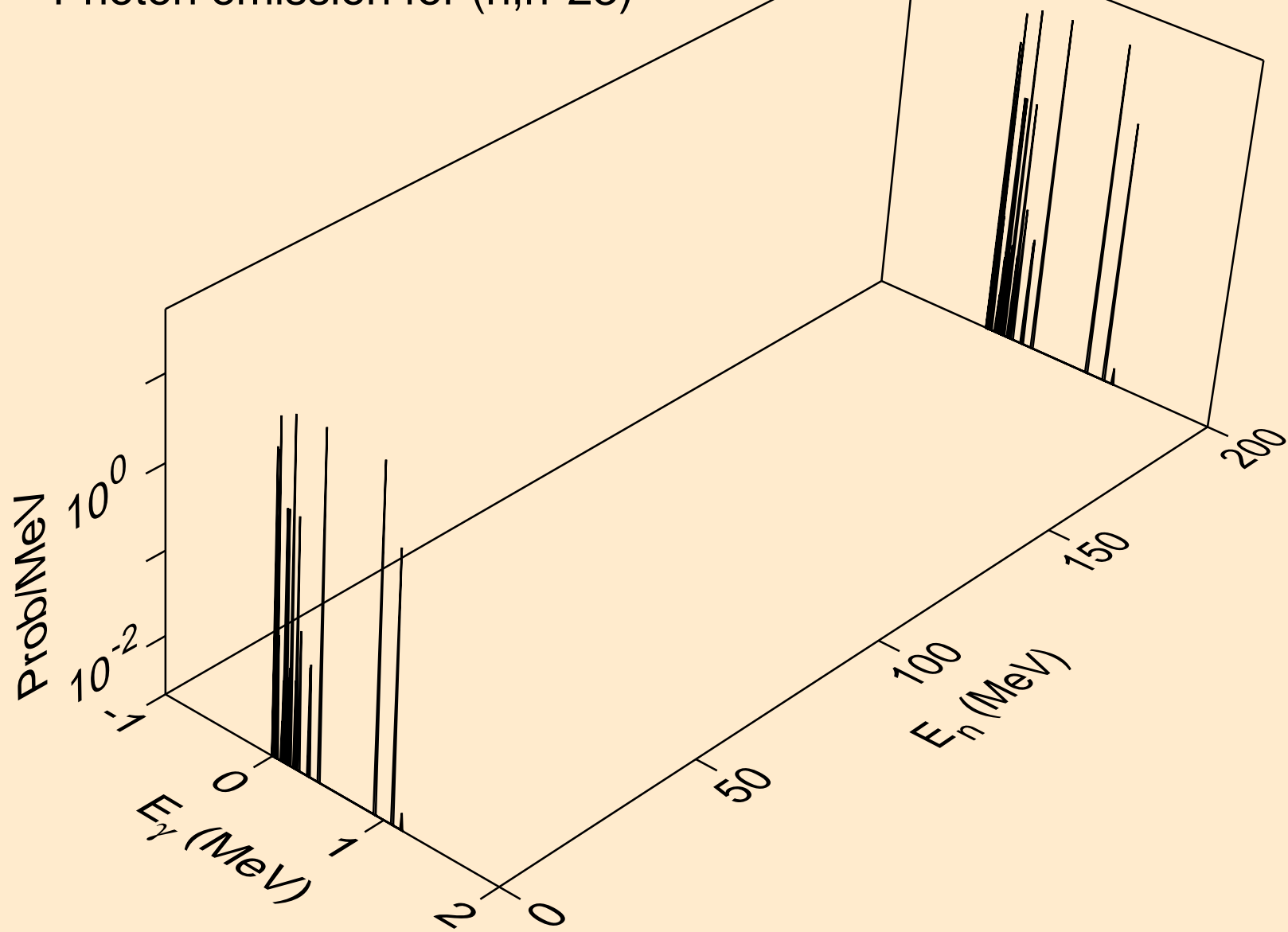

BI212N NEUTRON ACER TENDL-2024 LIBRARY; T=0.K
Photon emission for (n,n*24)

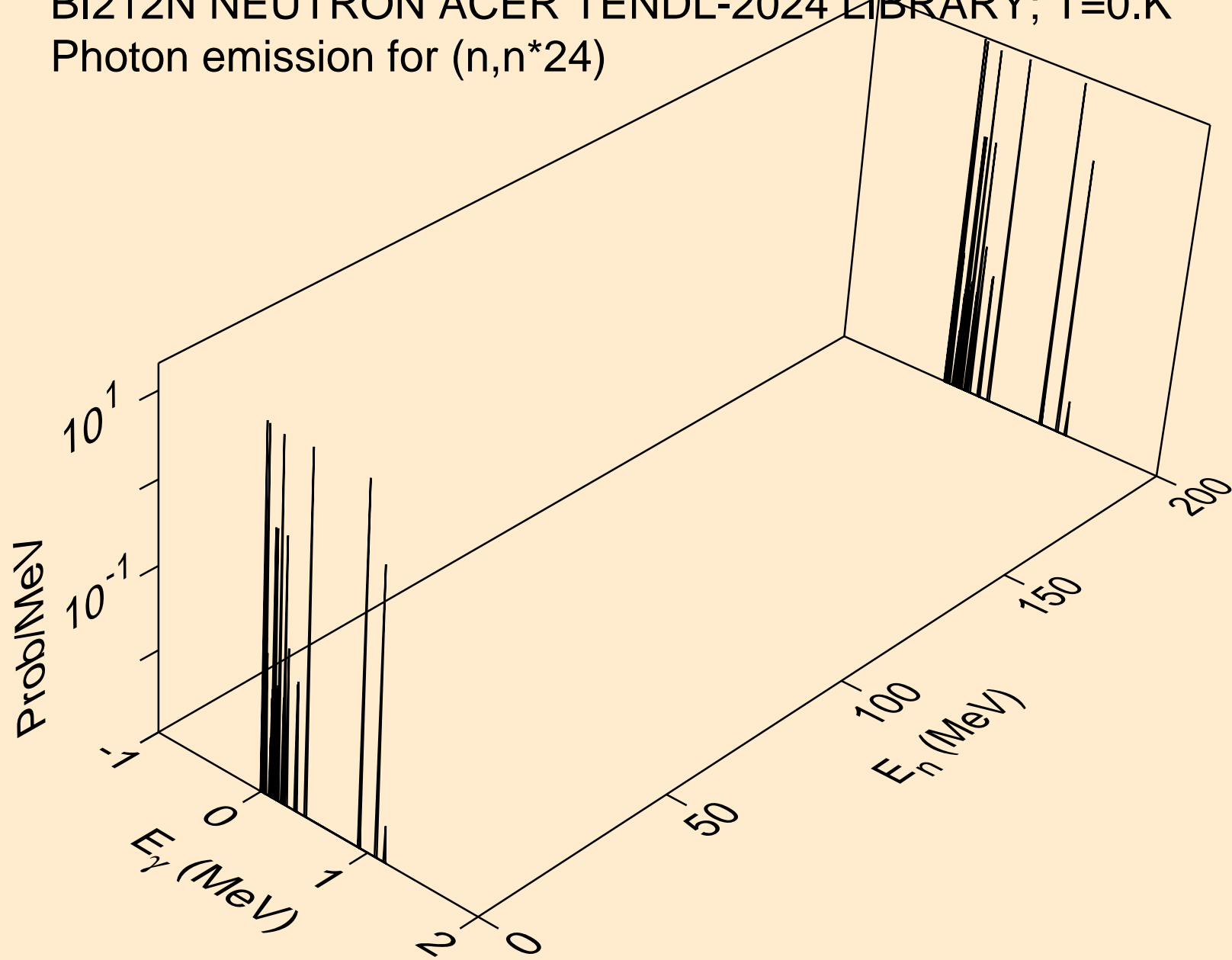

BI212N NEUTRON ACER TENDL-2024 LIBRARY; T=0.K
Photon emission for (n,n*25)

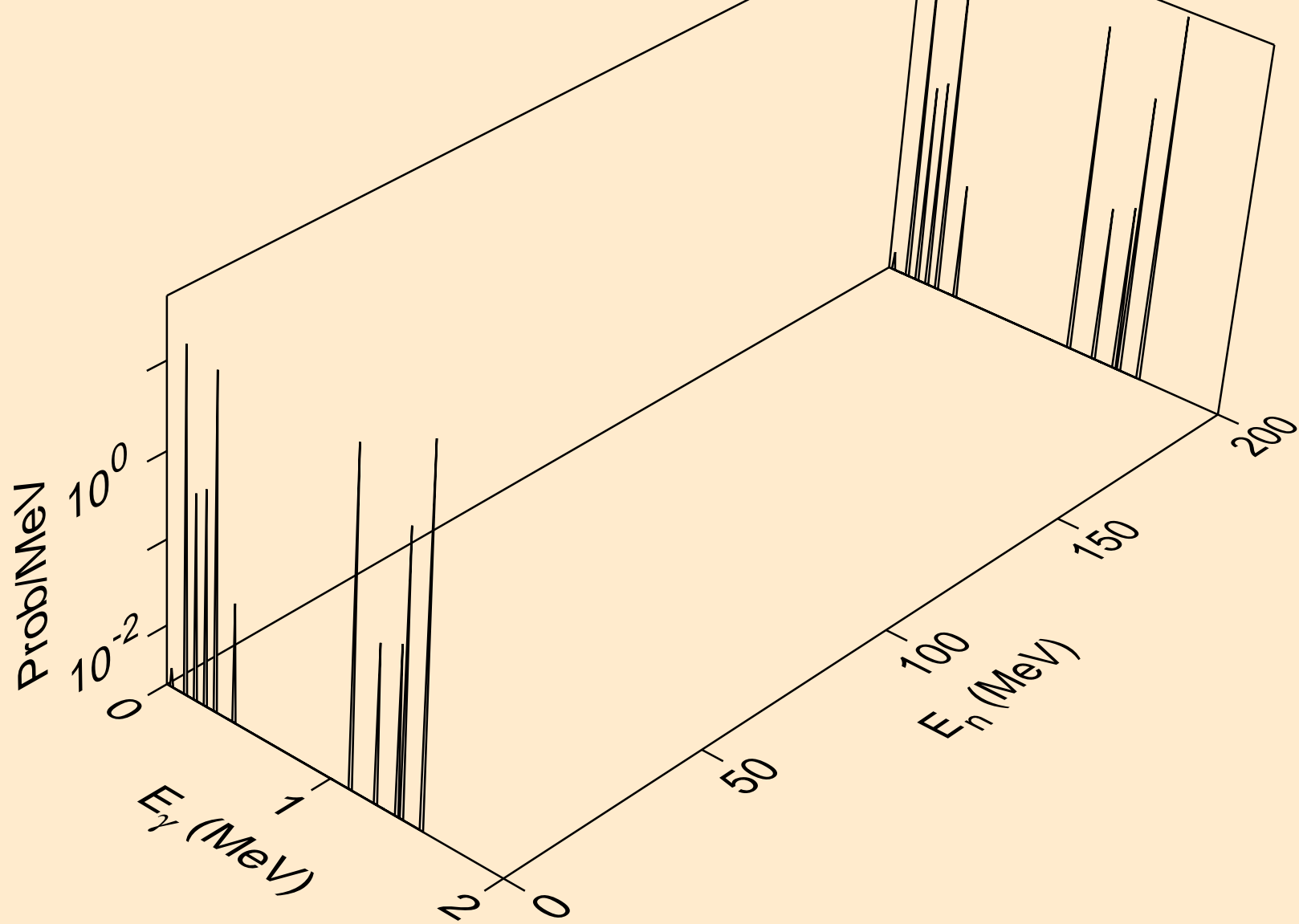

BI212N NEUTRON ACER TENDL-2024 LIBRARY; T=0.K
Photon emission for (n,n*26)

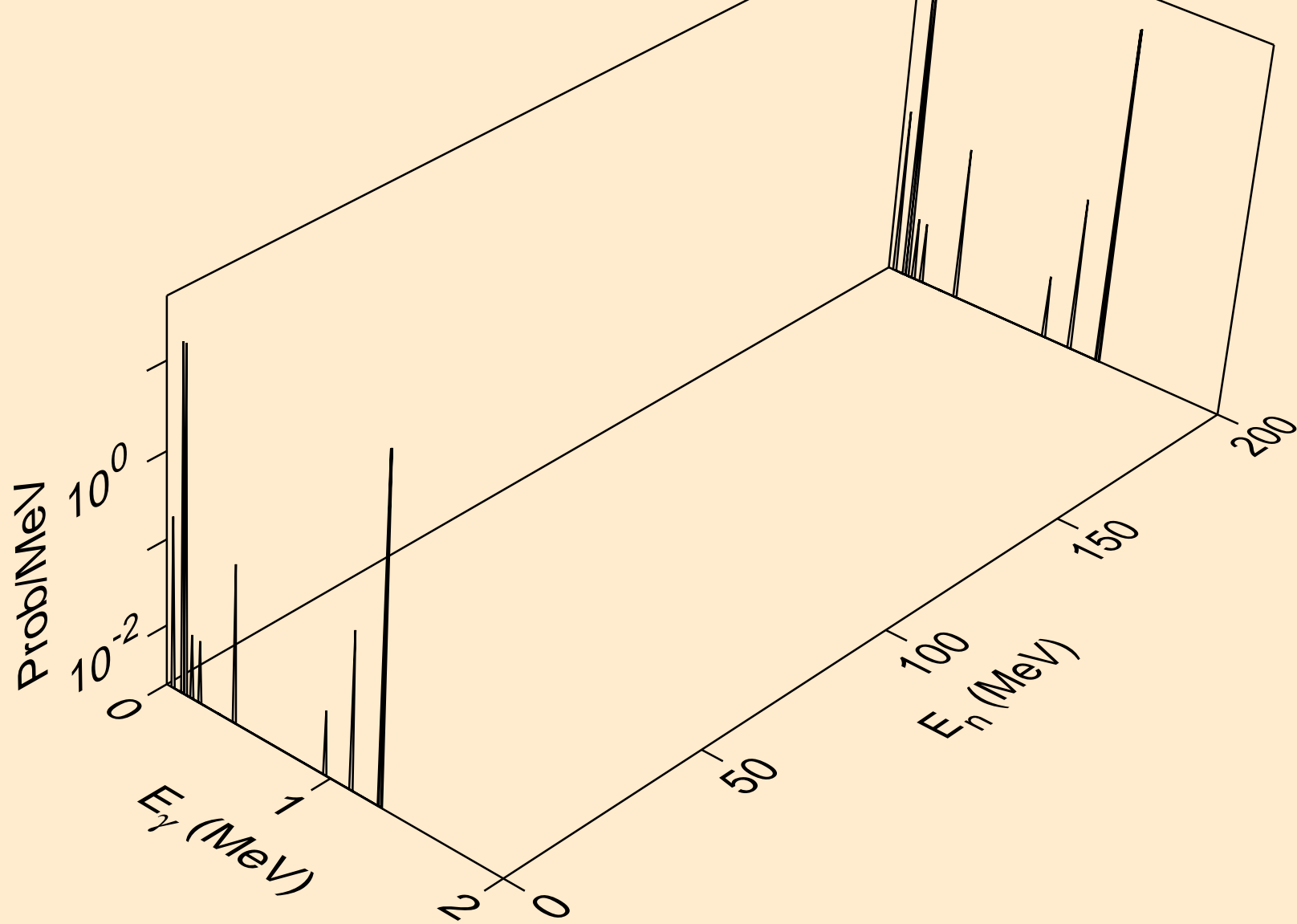

BI212N NEUTRON ACER TENDL-2024 LIBRARY; T=0.K
Photon emission for (n,n*c)

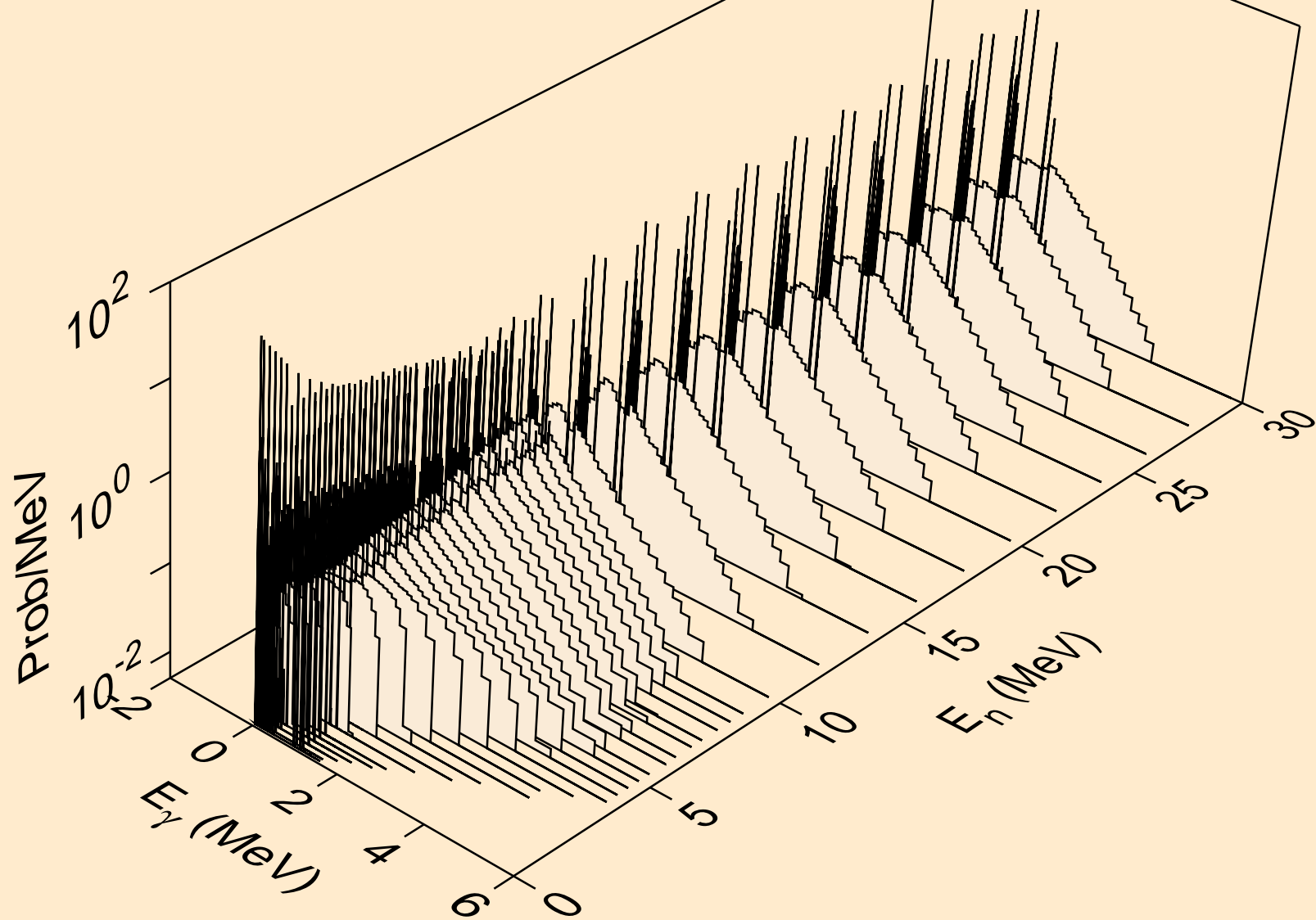

BI212N NEUTRON ACER TENDL-2024 LIBRARY; T=0.K
Photon emission for (n,gma)

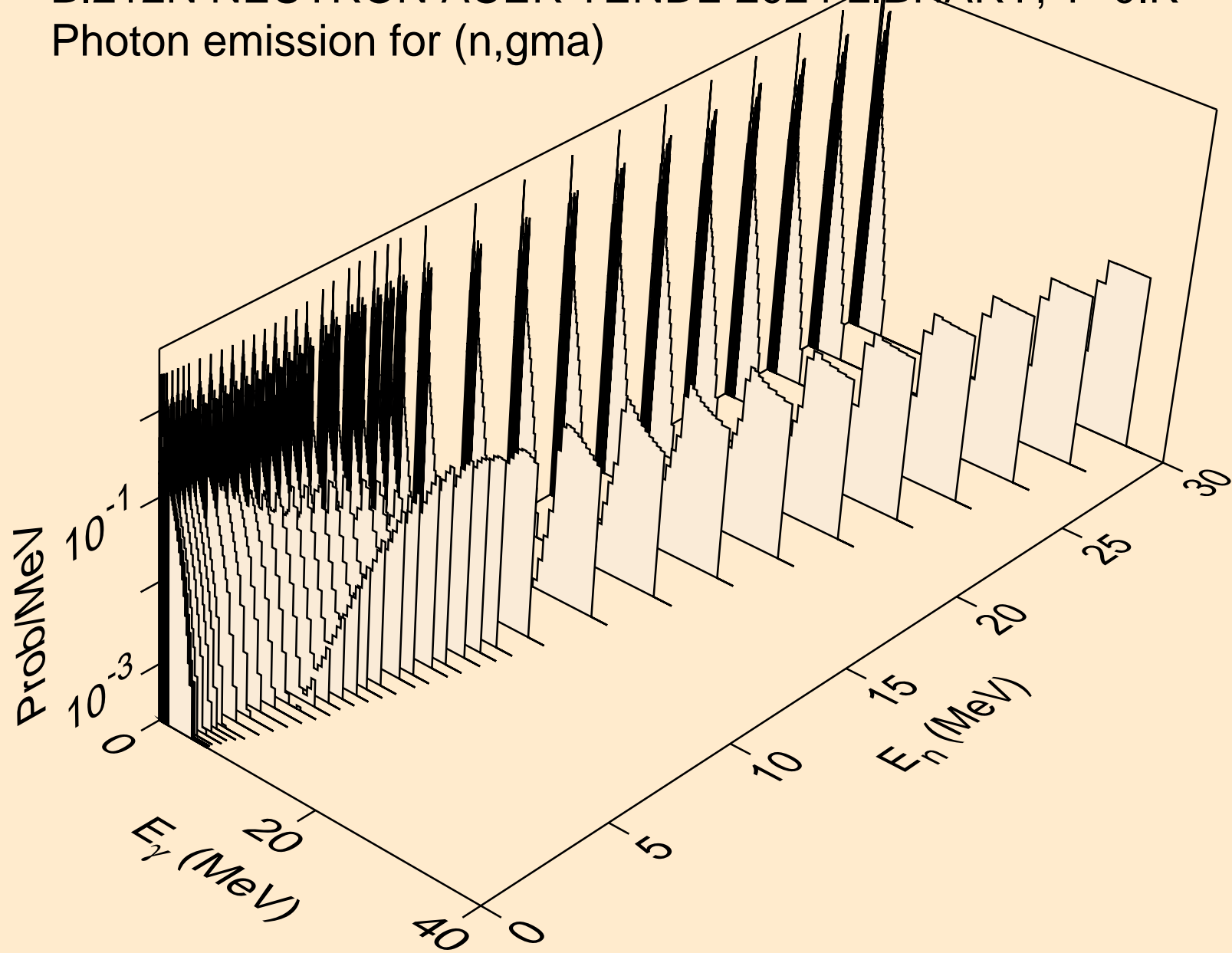

BI212N NEUTRON ACER TENDL-2024 LIBRARY; T=0.K
Photon emission for (n,p)

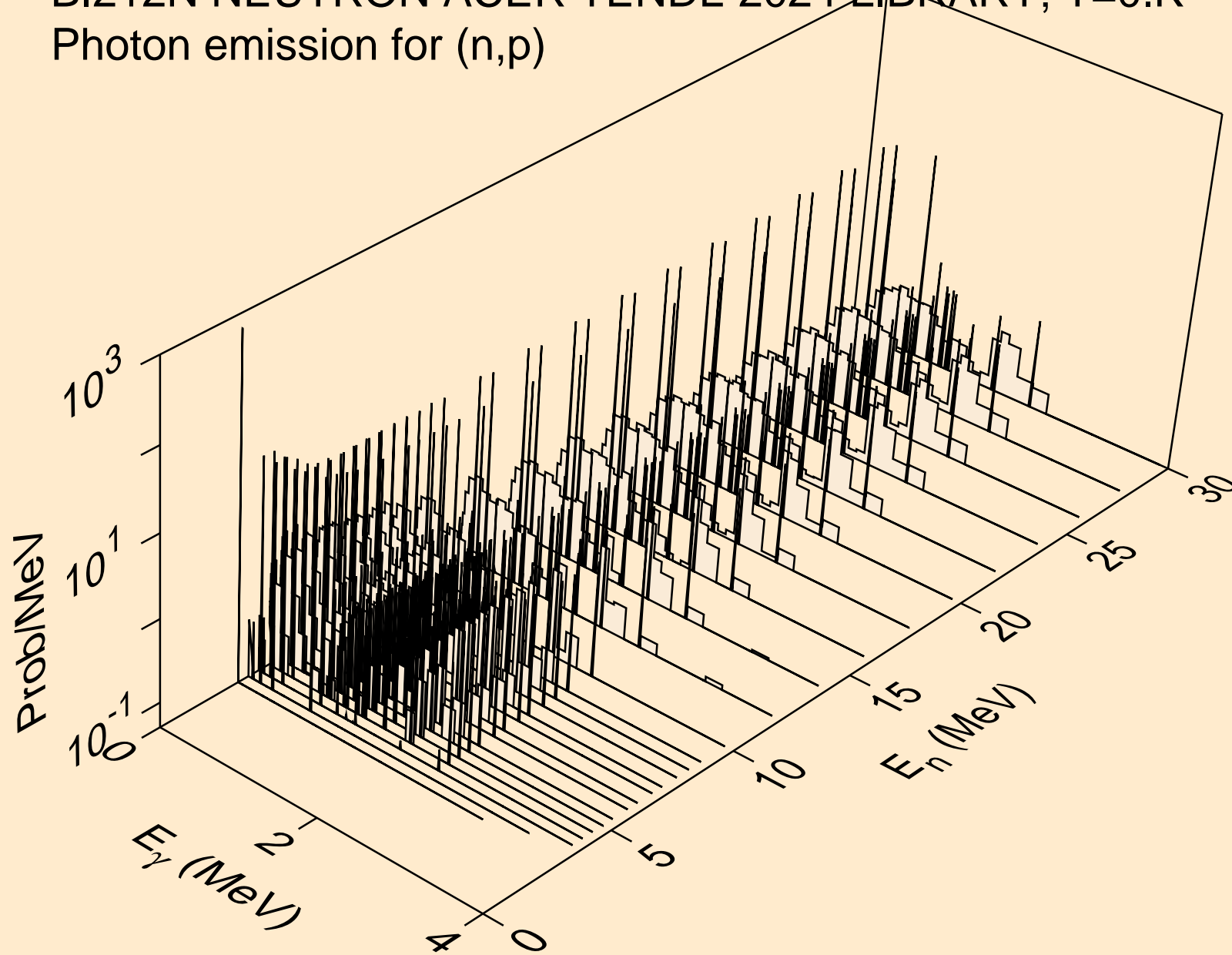

BI212N NEUTRON ACER TENDL-2024 LIBRARY; T=0.K
Photon emission for (n,d)

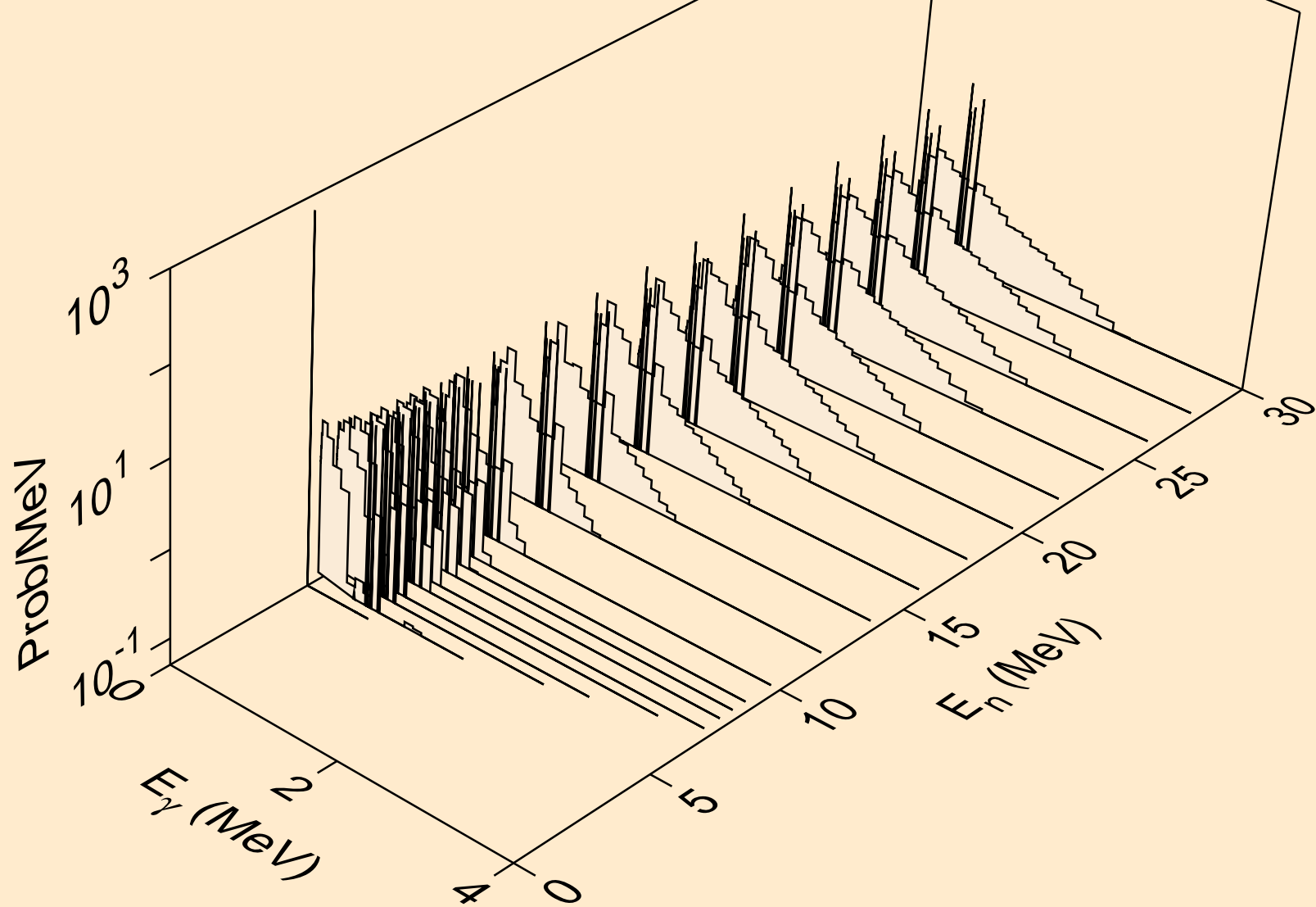

BI212N NEUTRON ACER TENDL-2024 LIBRARY; T=0.K
Photon emission for (n,t)

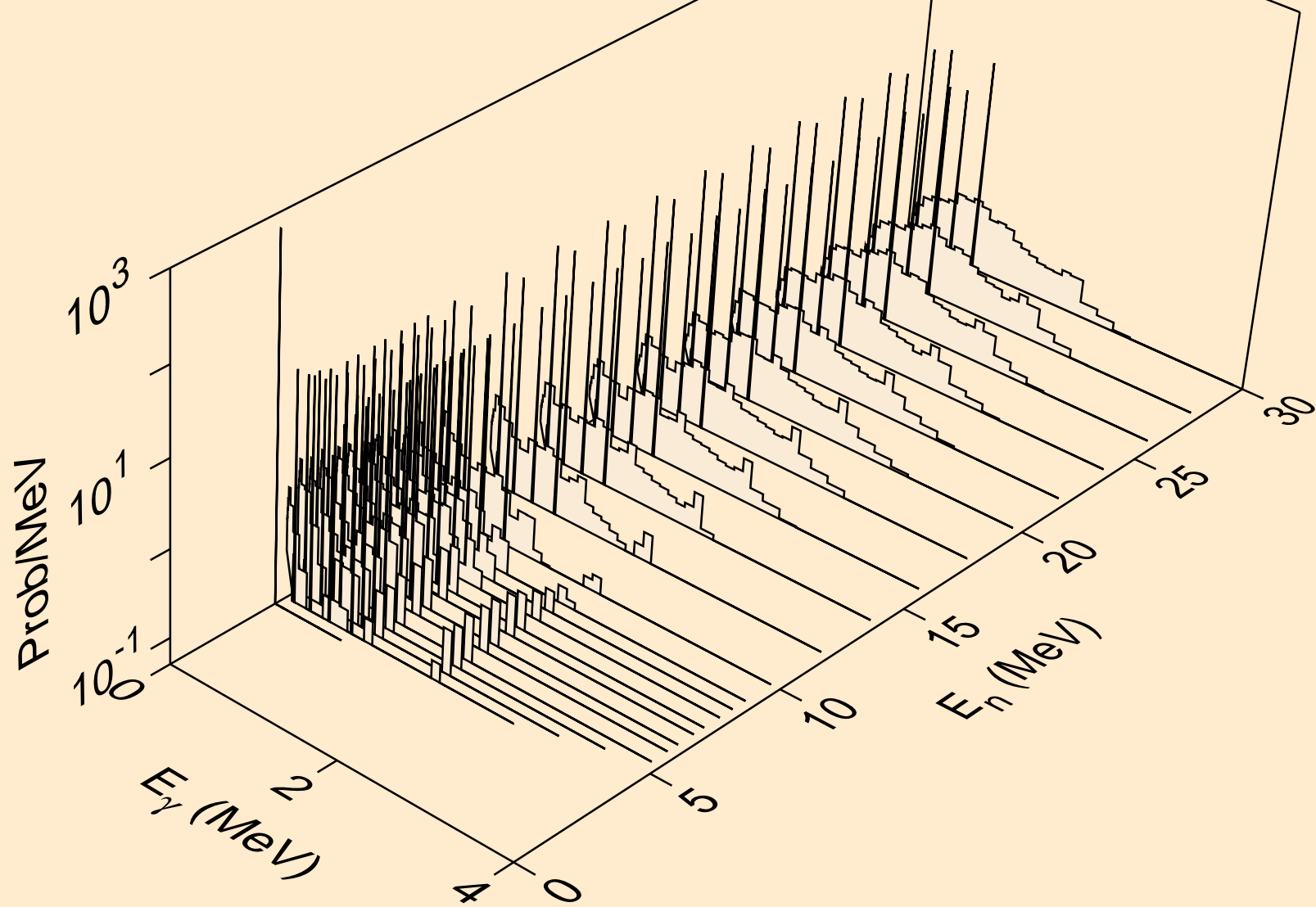

BI212N NEUTRON ACER TENDL-2024 LIBRARY; T=0.K
Photon emission for (n,he3)

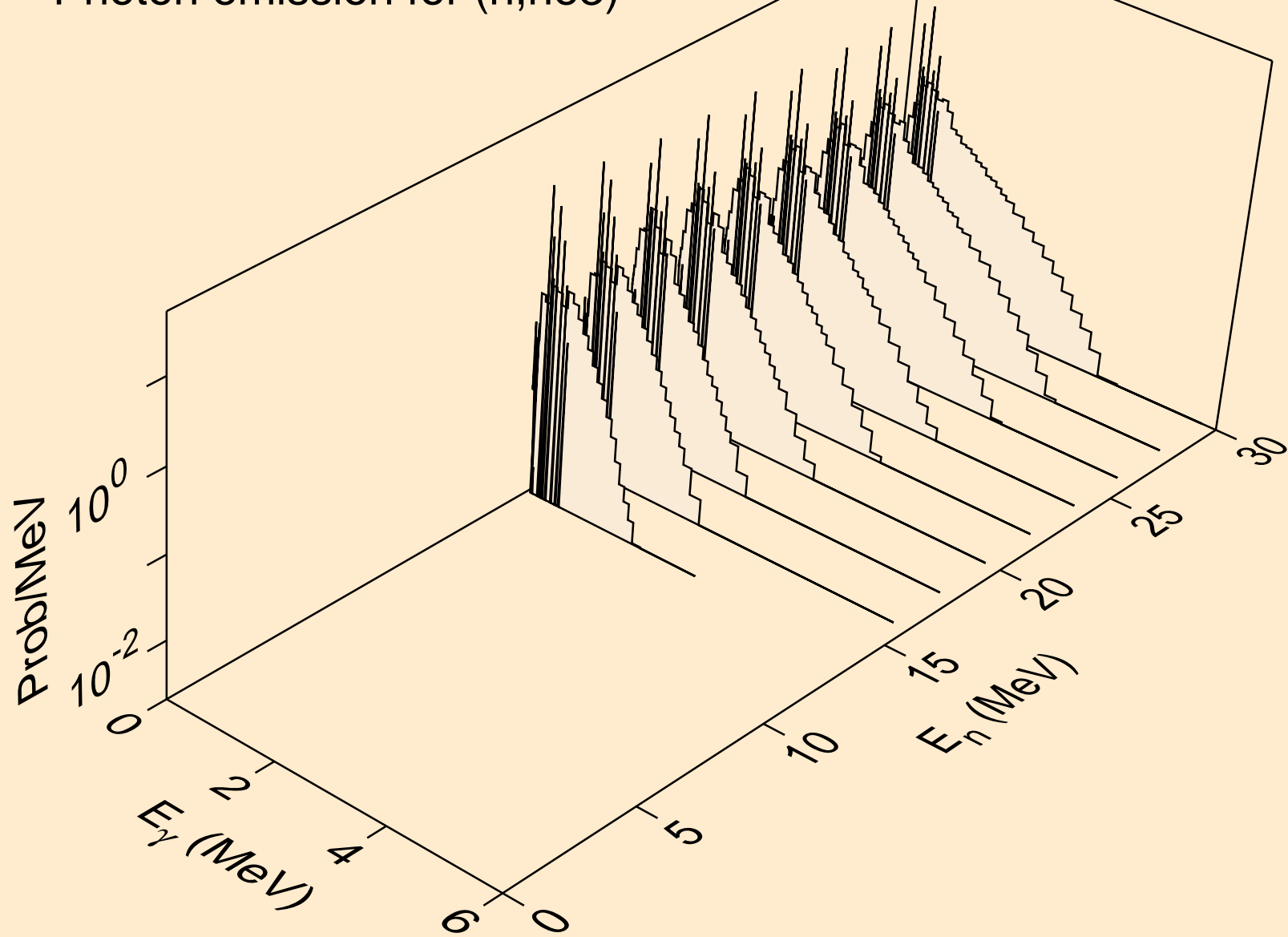

BI212N NEUTRON ACER TENDL-2024 LIBRARY; T=0.K
Photon emission for (n,a)

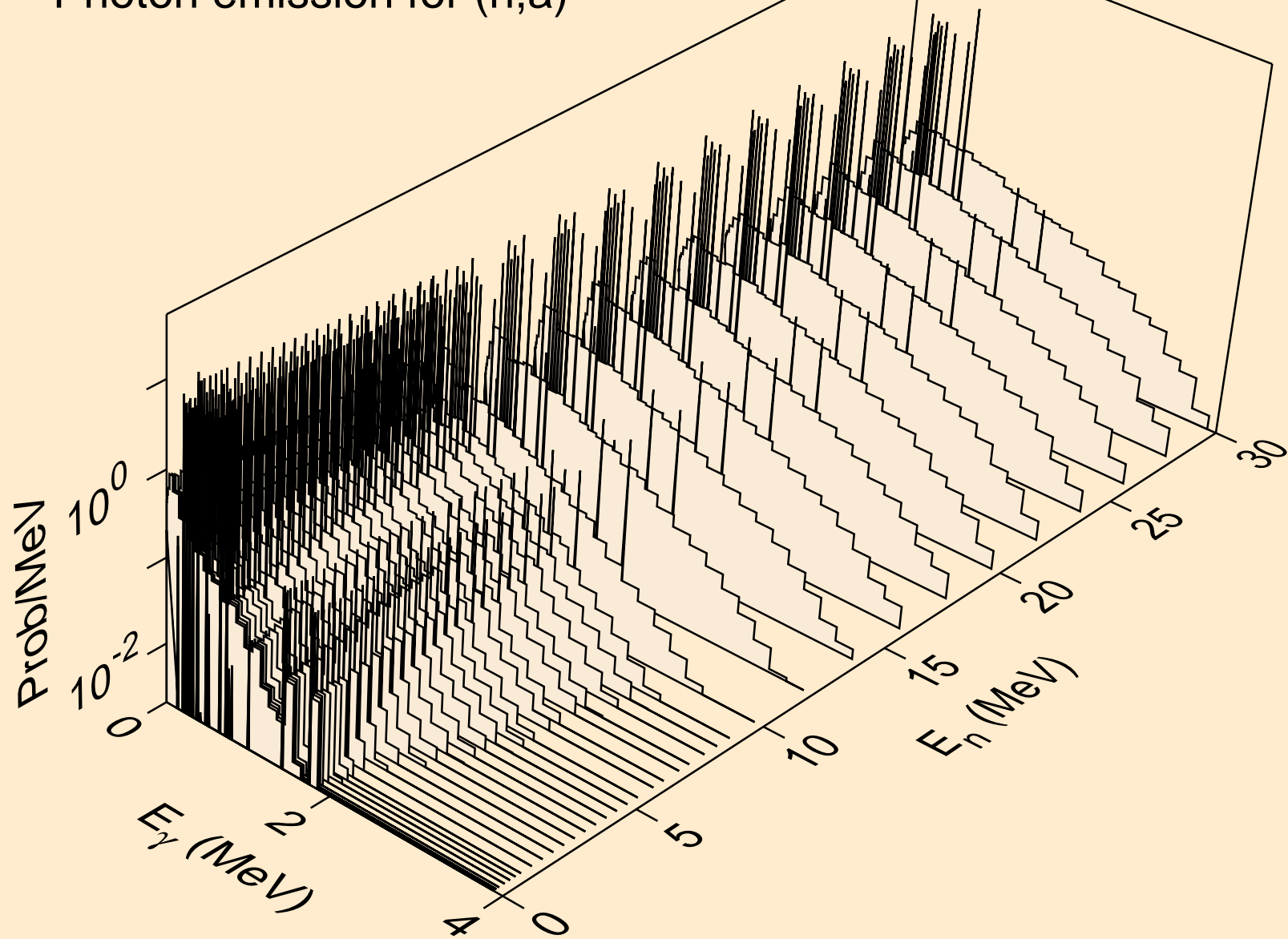

BI212N NEUTRON ACER TENDL-2024 LIBRARY; T=0.K
Photon emission for (n,2a)

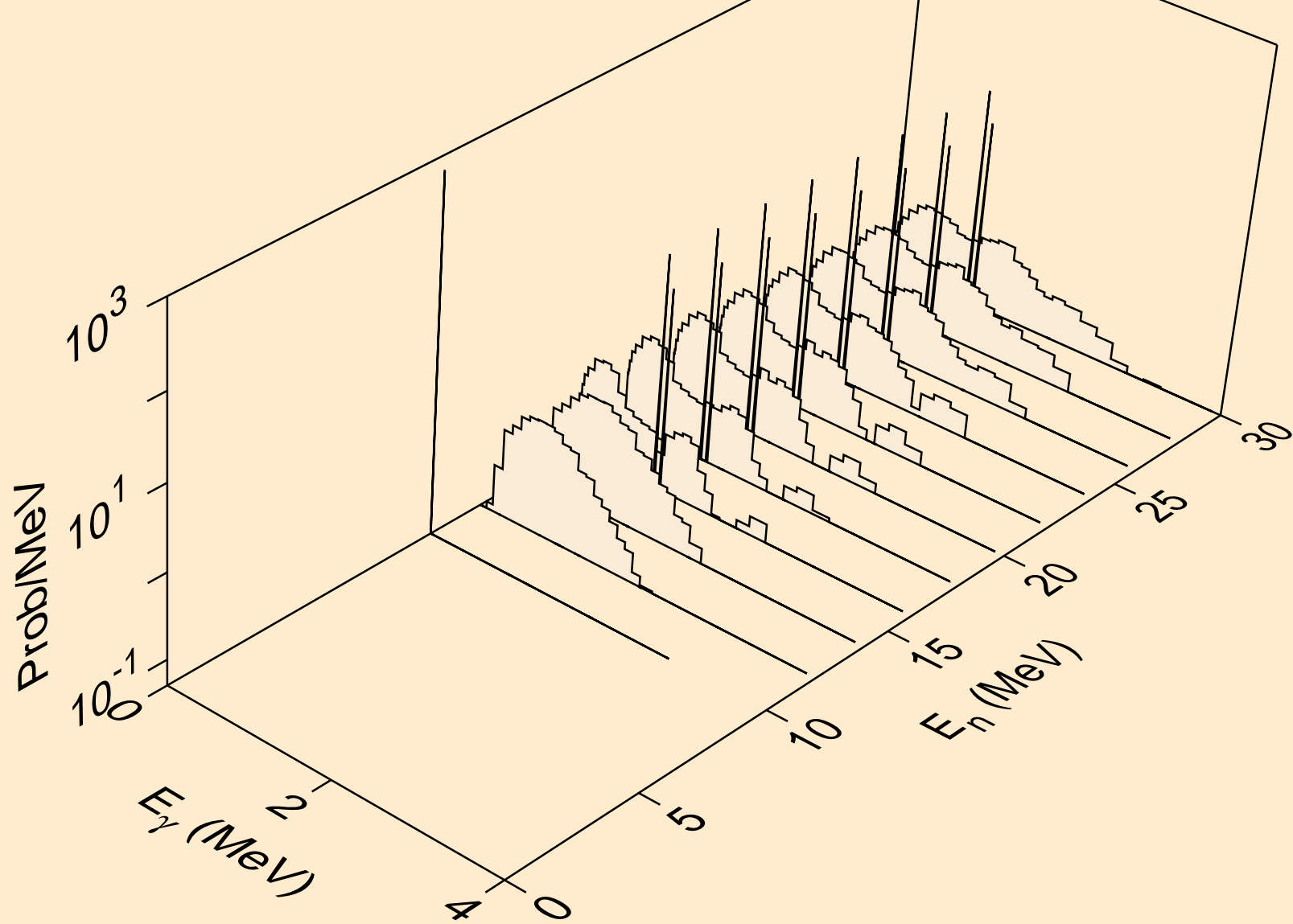

BI212N NEUTRON ACER TENDL-2024 LIBRARY; T=0.K
Photon emission for (n,2p)

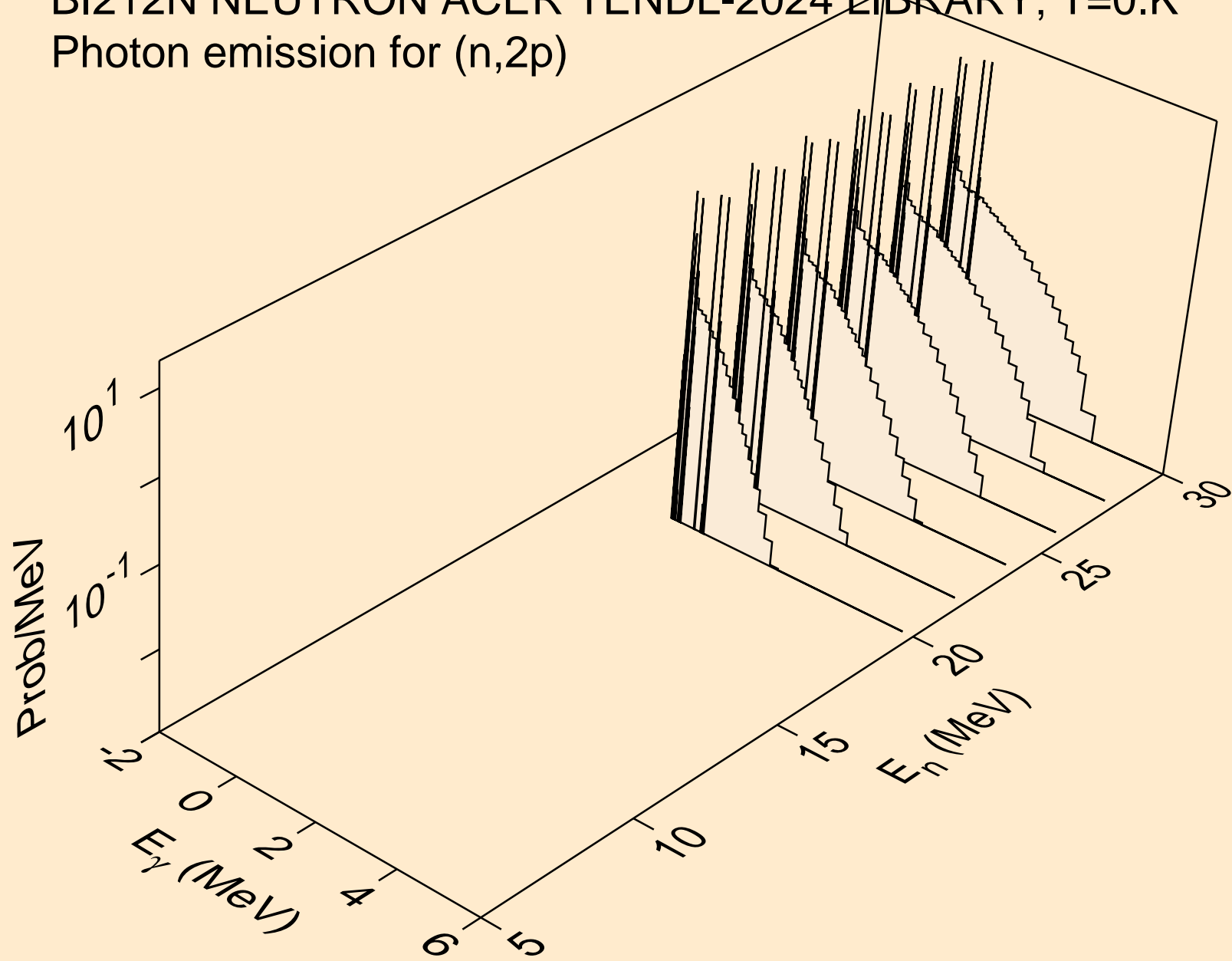

BI212N NEUTRON ACER TENDL-2024 LIBRARY; T=0.K
Photon emission for (n,da)

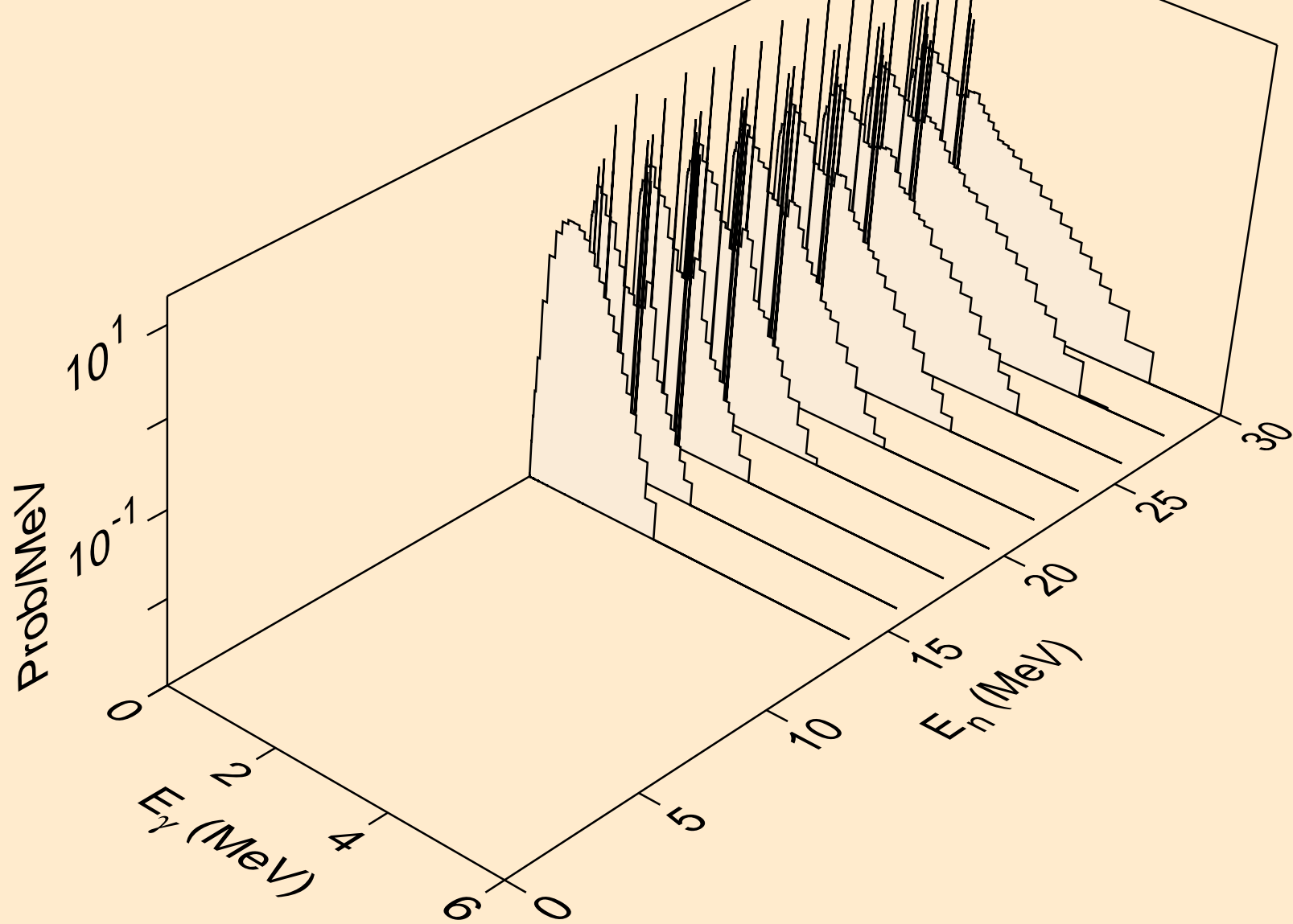

BI212N NEUTRON ACER TENDL-2024 LIBRARY; T=0.K
thermal capture photon spectrum

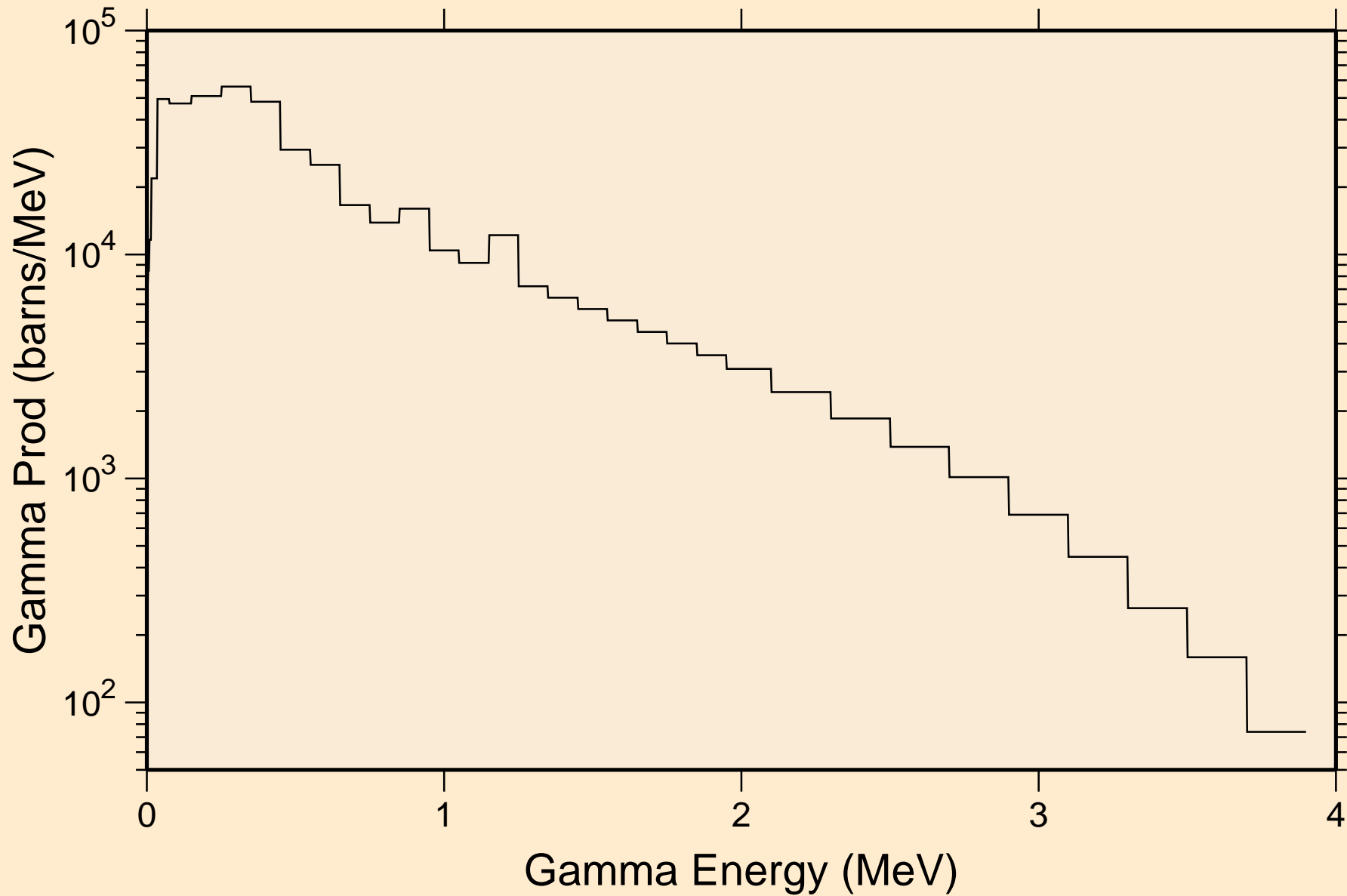

BI212N NEUTRON ACER TENDL-2024 LIBRARY; T=0.K
14 MeV photon spectrum

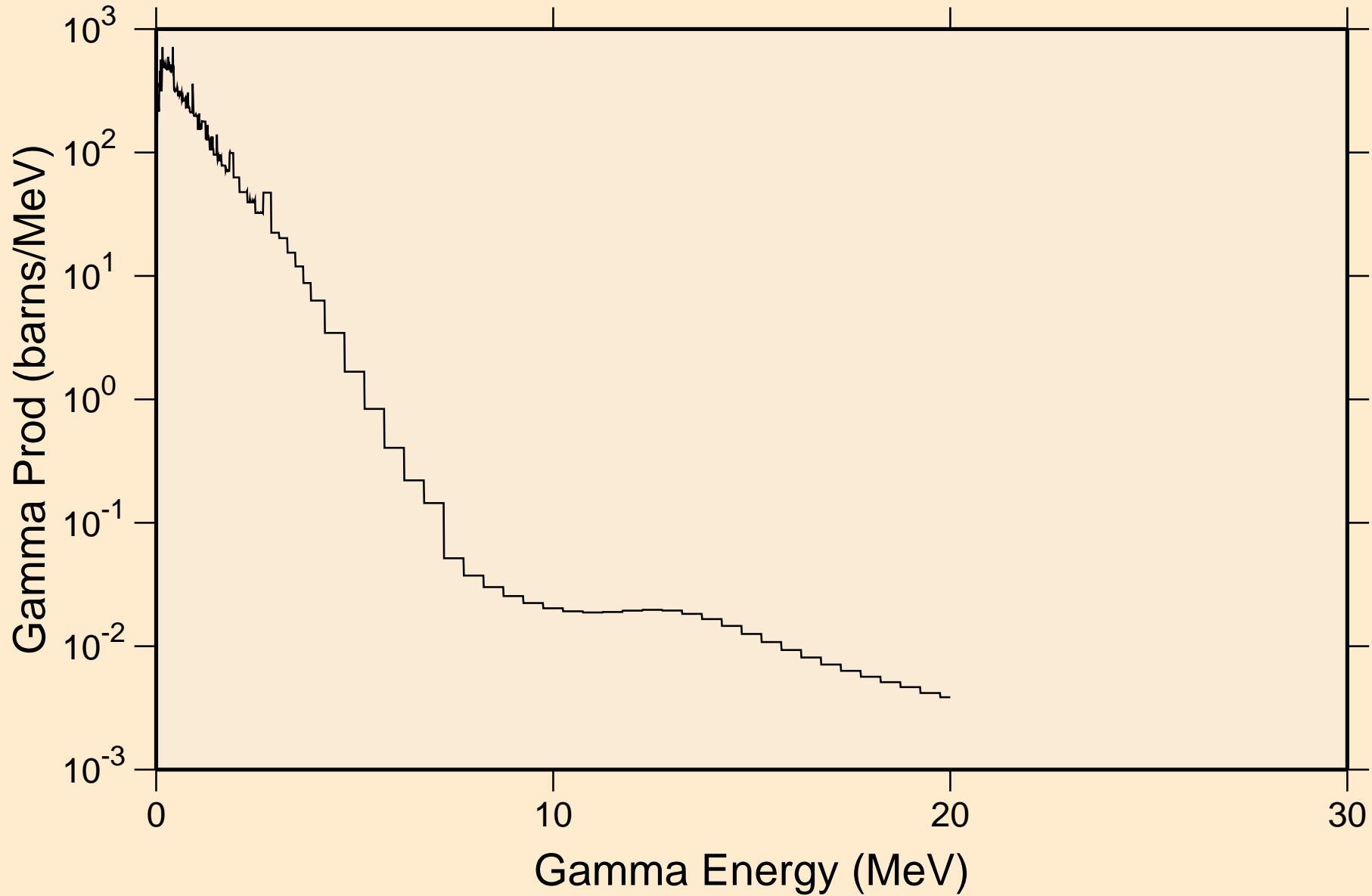

BI212N NEUTRON ACER TENDL-2024 LIBRARY; T=0.K

Particle heating contributions

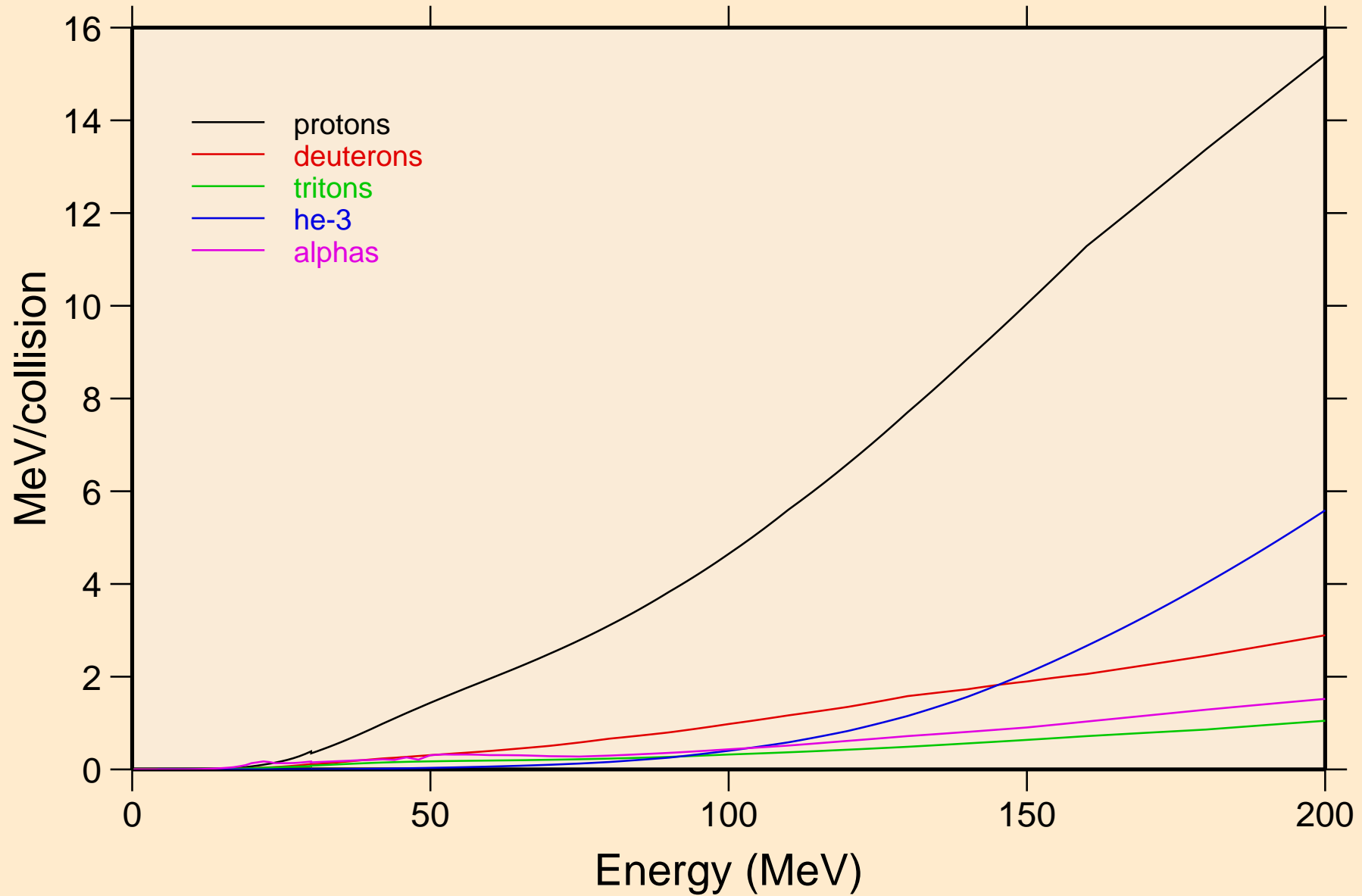

BI212N NEUTRON ACER TENDL-2024 LIBRARY; T=0.K
Recoil Heating

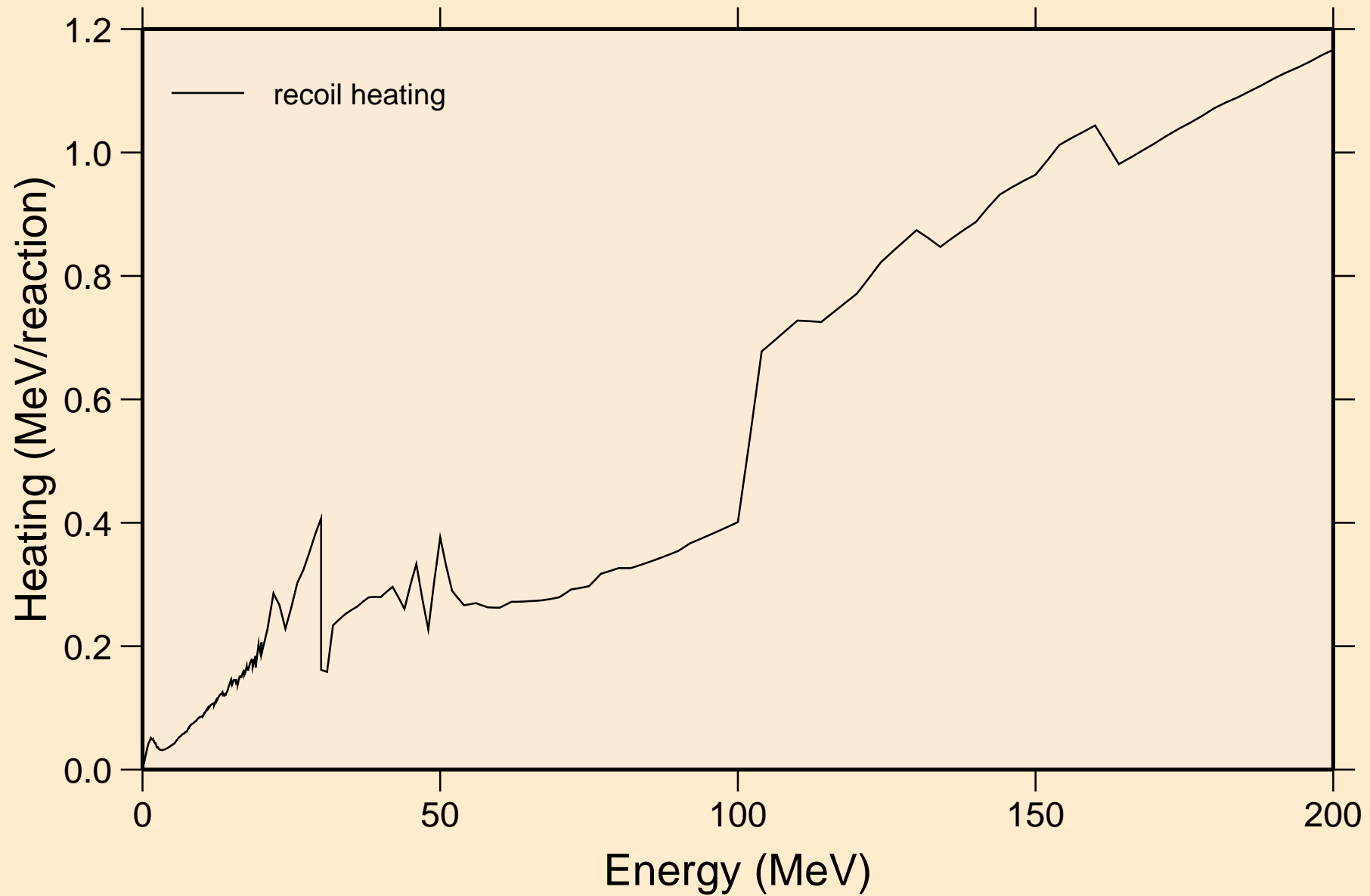

BI212N NEUTRON ACER TENDL-2024 LIBRARY; T=0.K
Particle production cross sections

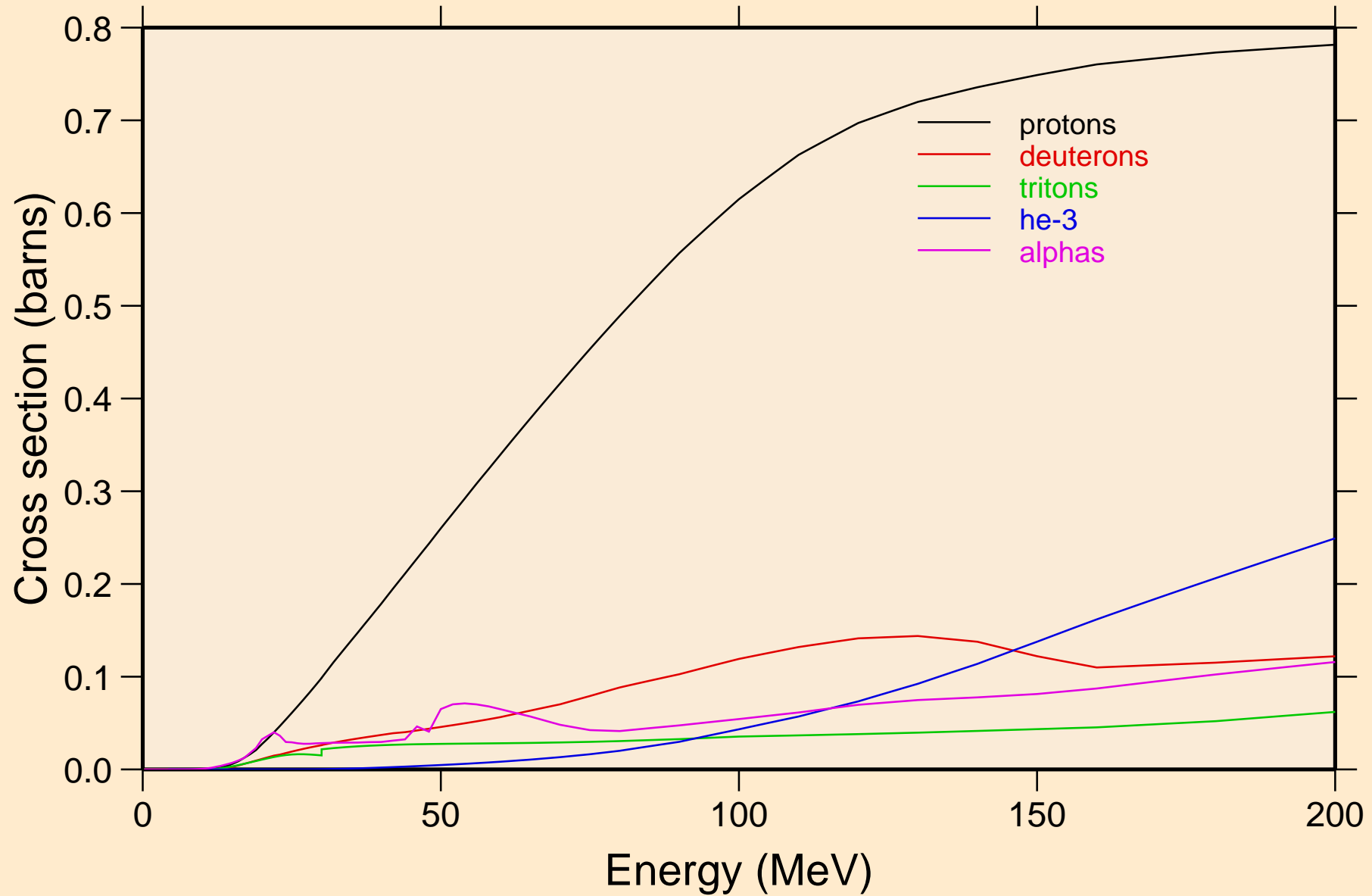

BI212N NEUTRON ACER TENDL-2024 LIBRARY; T=0.K
protons from (n,x)

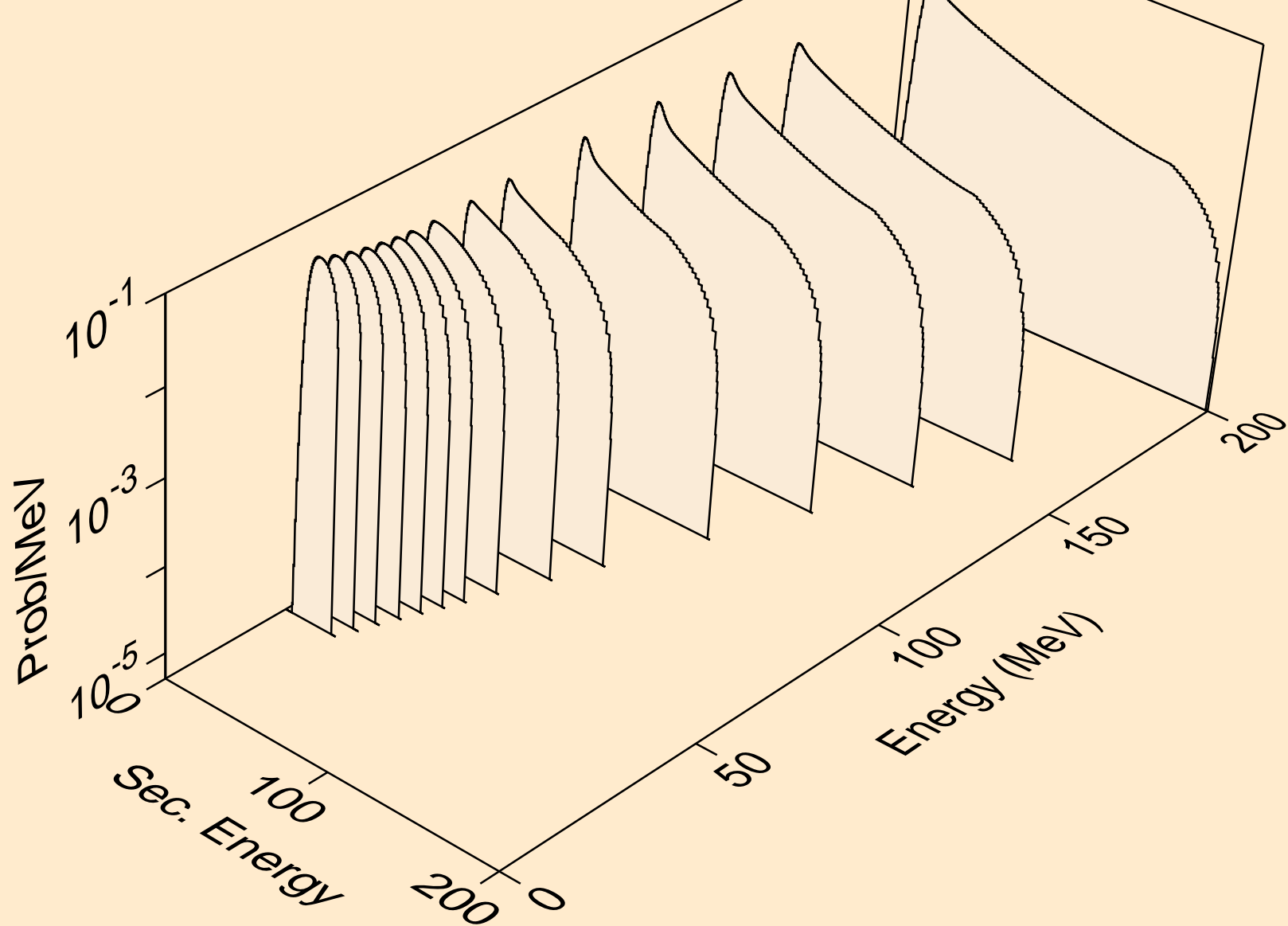

BI212N NEUTRON ACER TENDL-2024 LIBRARY; T=0.K
protons from (n,n*)p



BI212N NEUTRON ACER TENDL-2024 LIBRARY; T=0.K
protons from (n,2np)

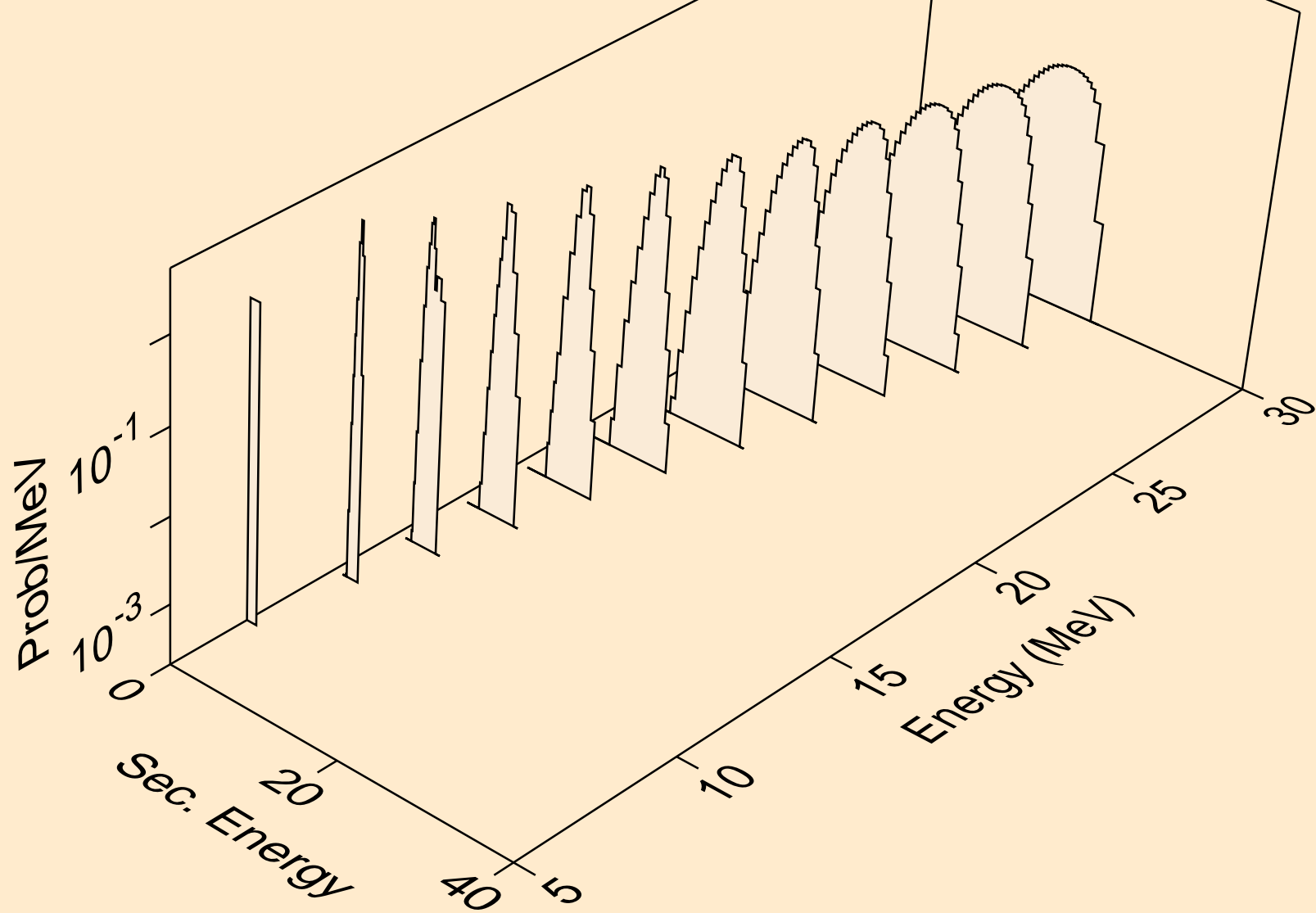

BI212N NEUTRON ACER TENDL-2024 LIBRARY; T=0.K
protons from (n,3np)

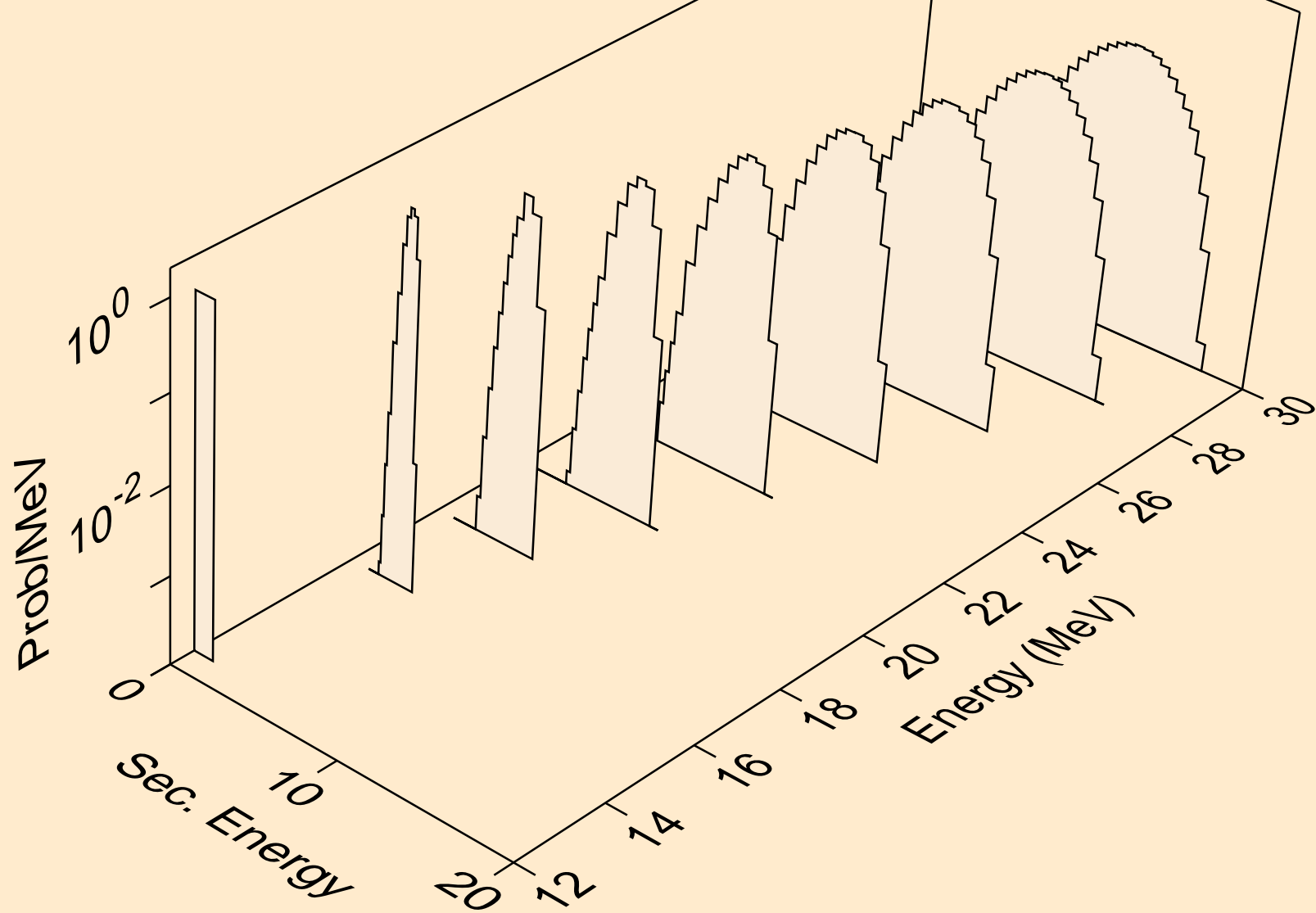

BI212N NEUTRON ACER TENDL-2024 LIBRARY; T=0.K
protons from (n,n2p)

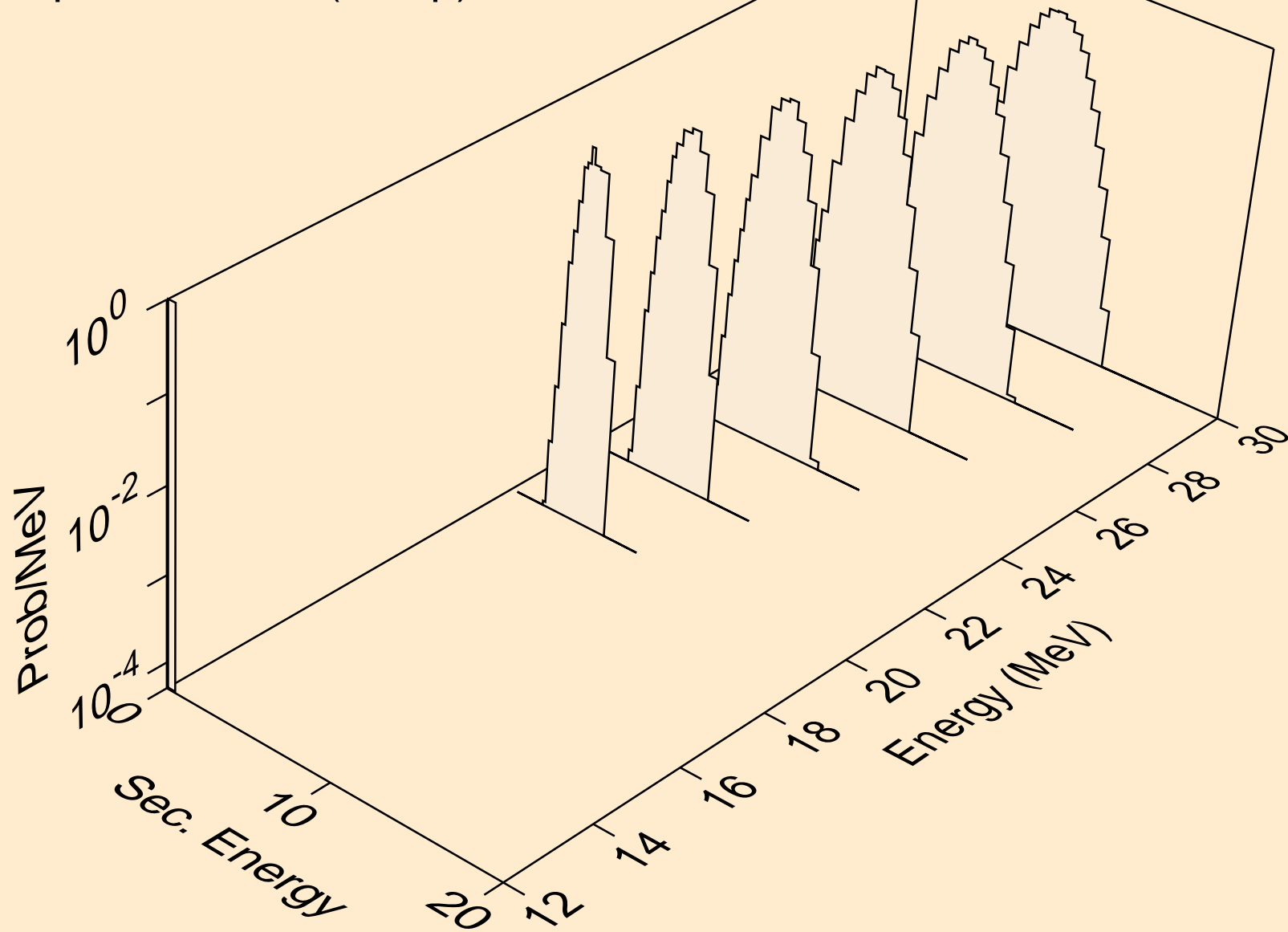

BI212N NEUTRON ACER TENDL-2024 LIBRARY; T=0.K
protons from (n,npa)

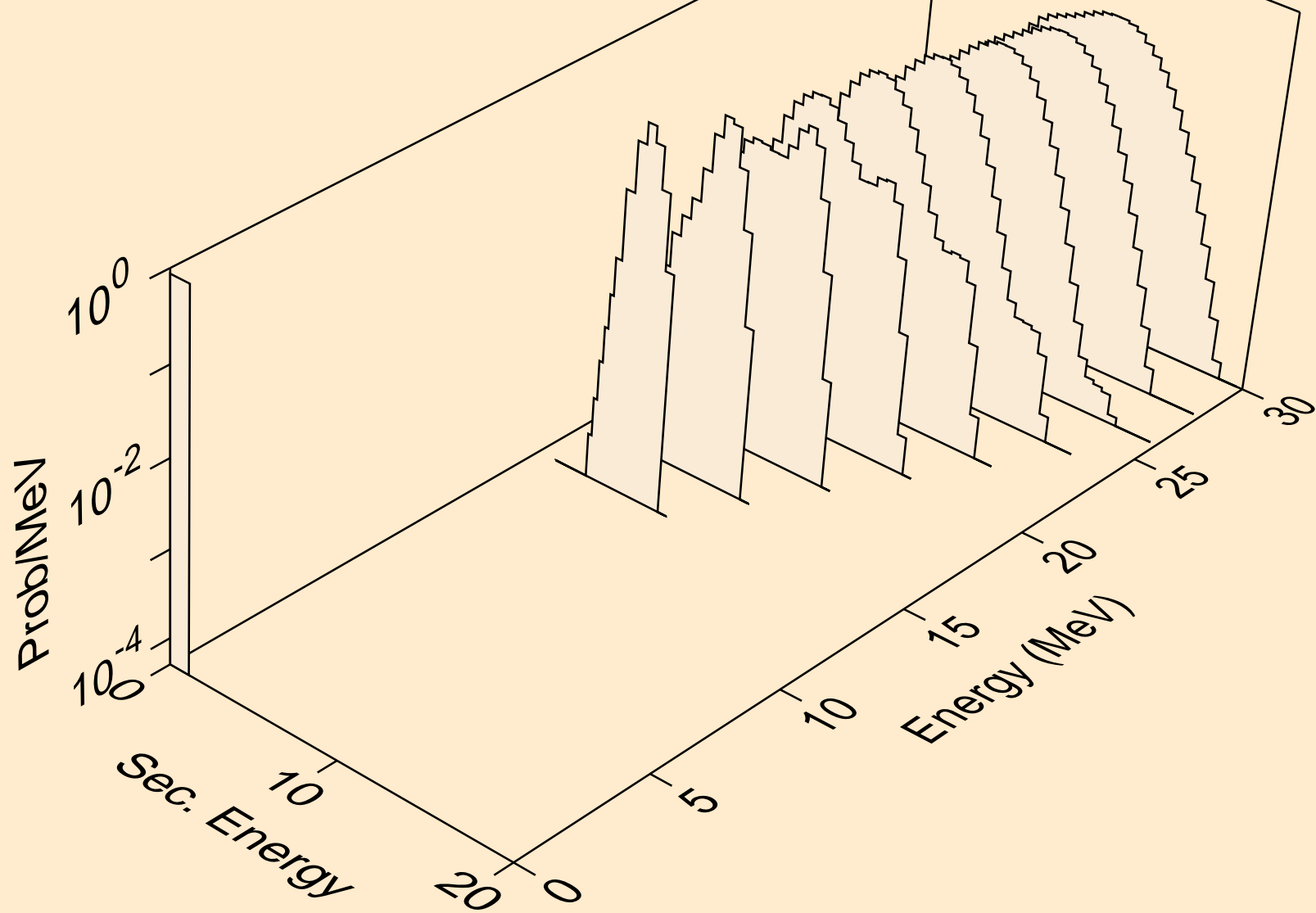

BI212N NEUTRON ACER TENDL-2024 LIBRARY; T=0.K
protons from (n,p)

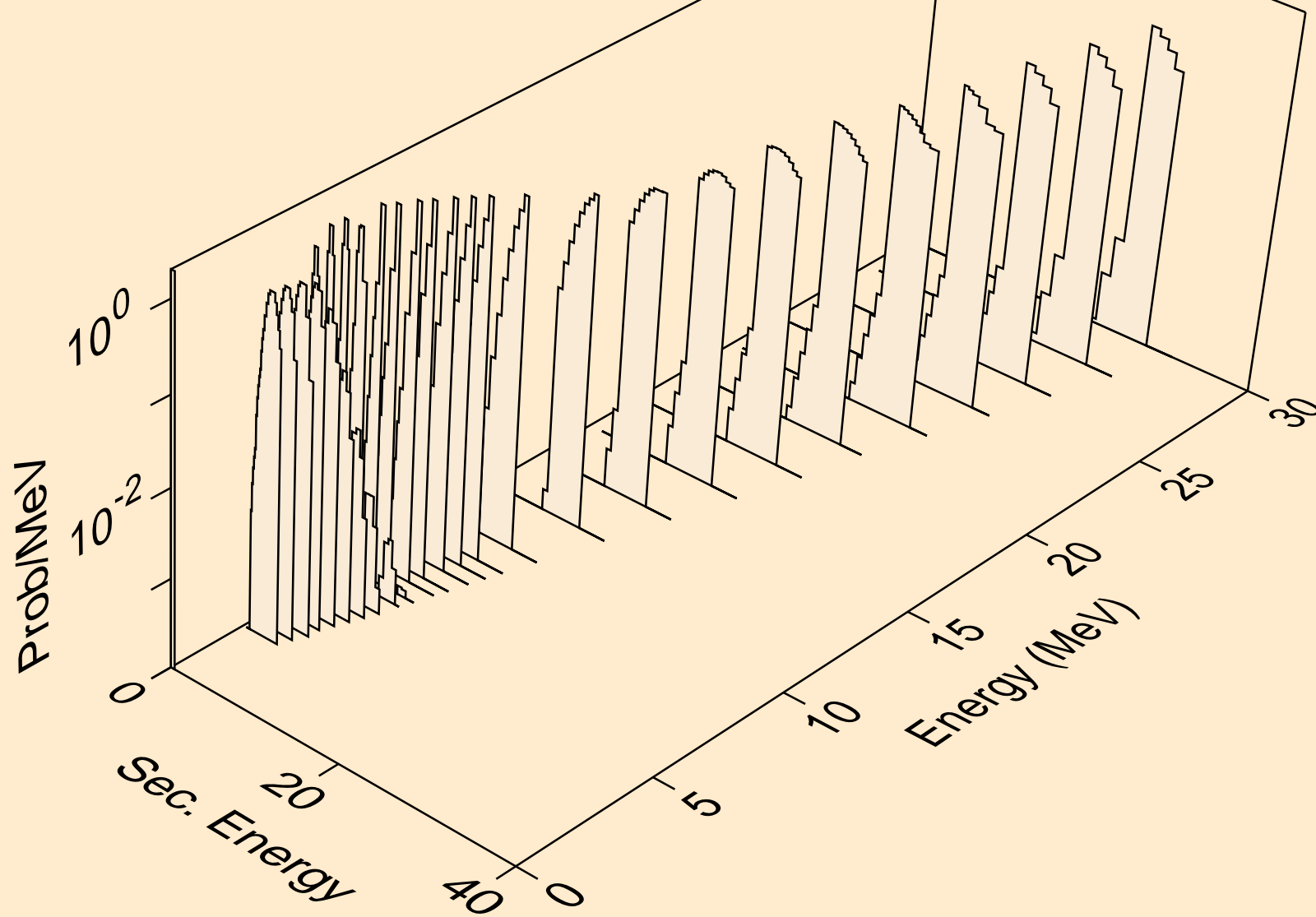

BI212N NEUTRON ACER TENDL-2024 LIBRARY; T=0.K
protons from (n,2p)

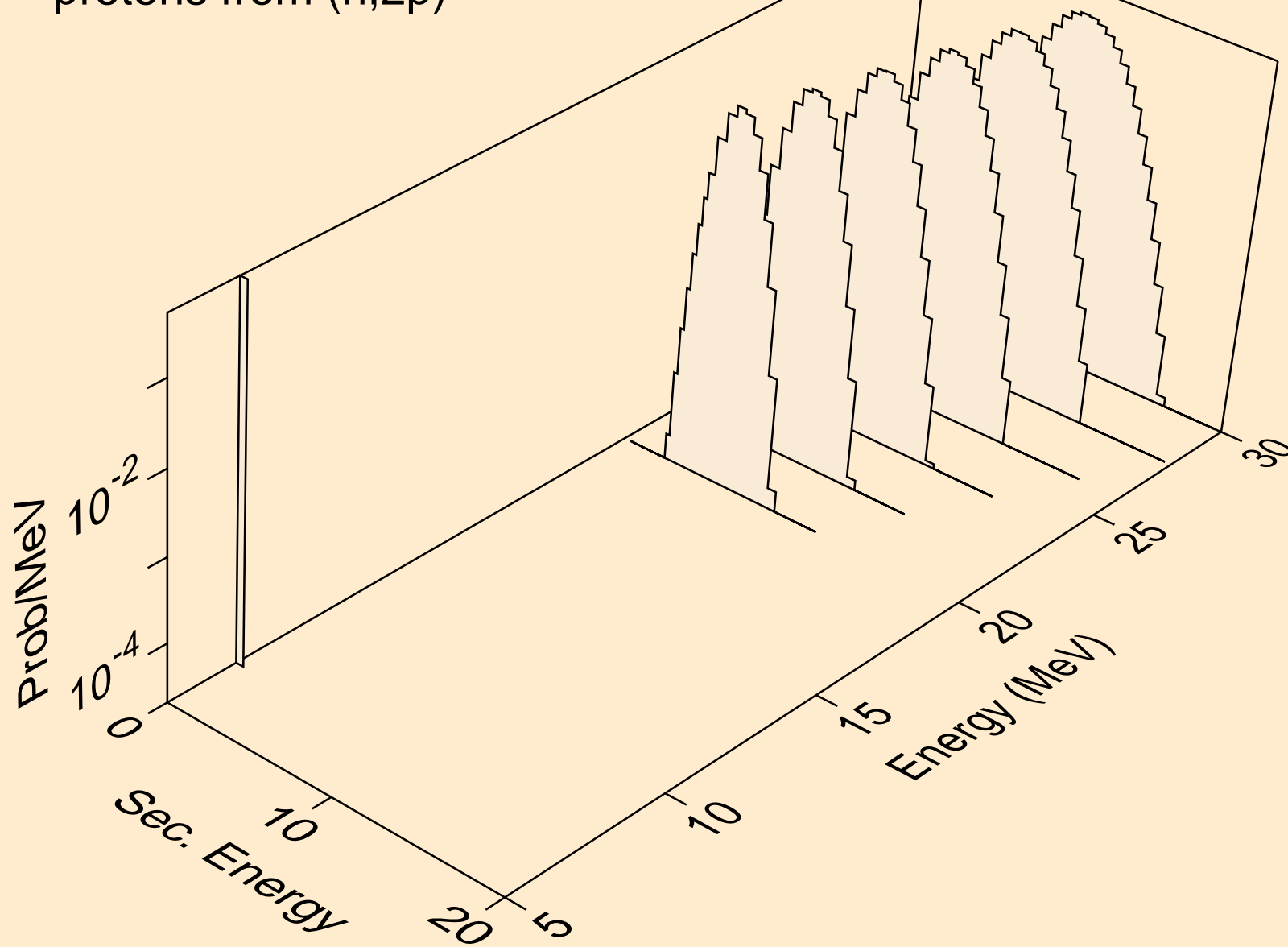

BI212N NEUTRON ACER TENDL-2024 LIBRARY; T=0.K
deuterons from (n,x)

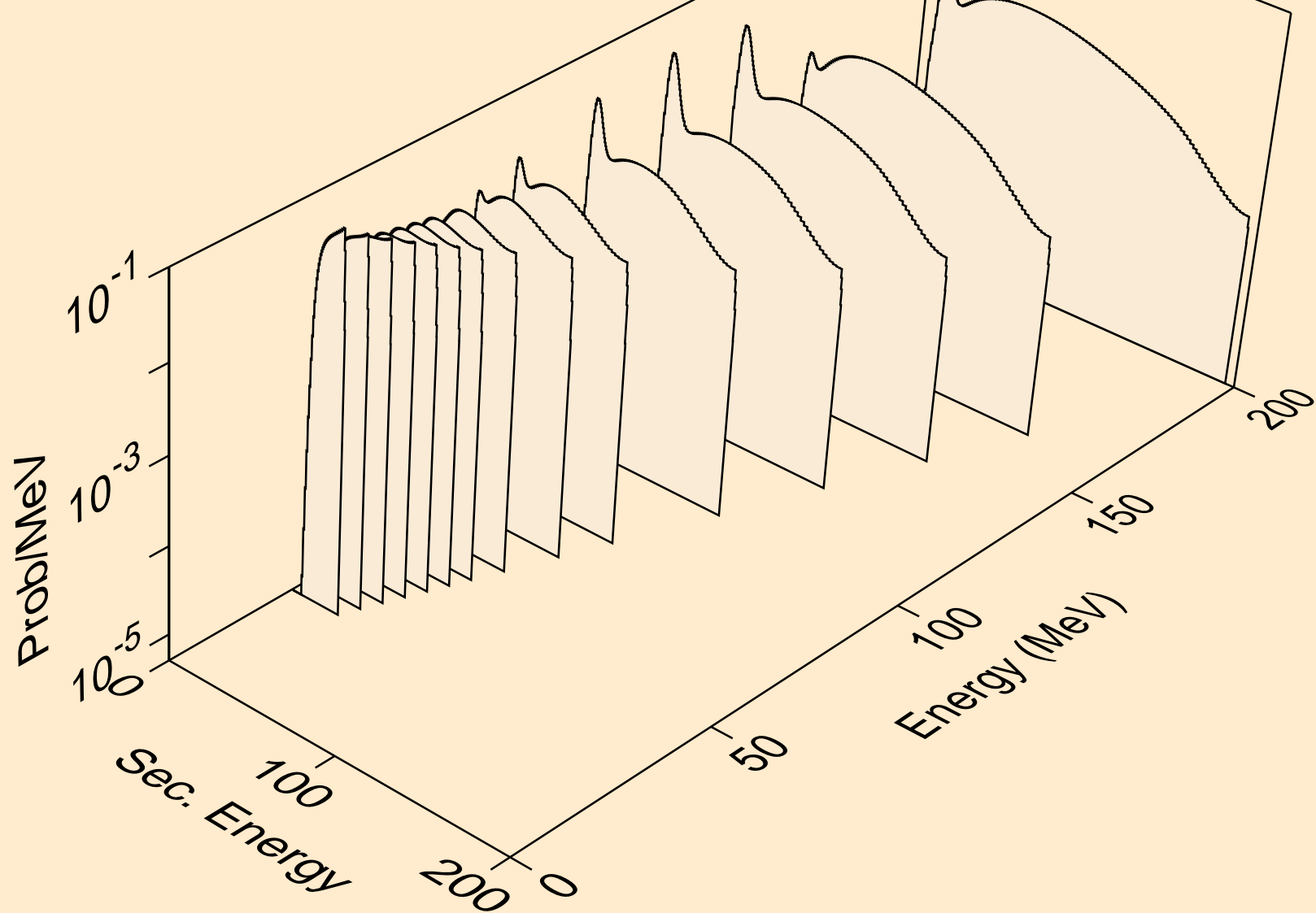

BI212N NEUTRON ACER TENDL-2024 LIBRARY; T=0.K
deuterons from (n,2nd)

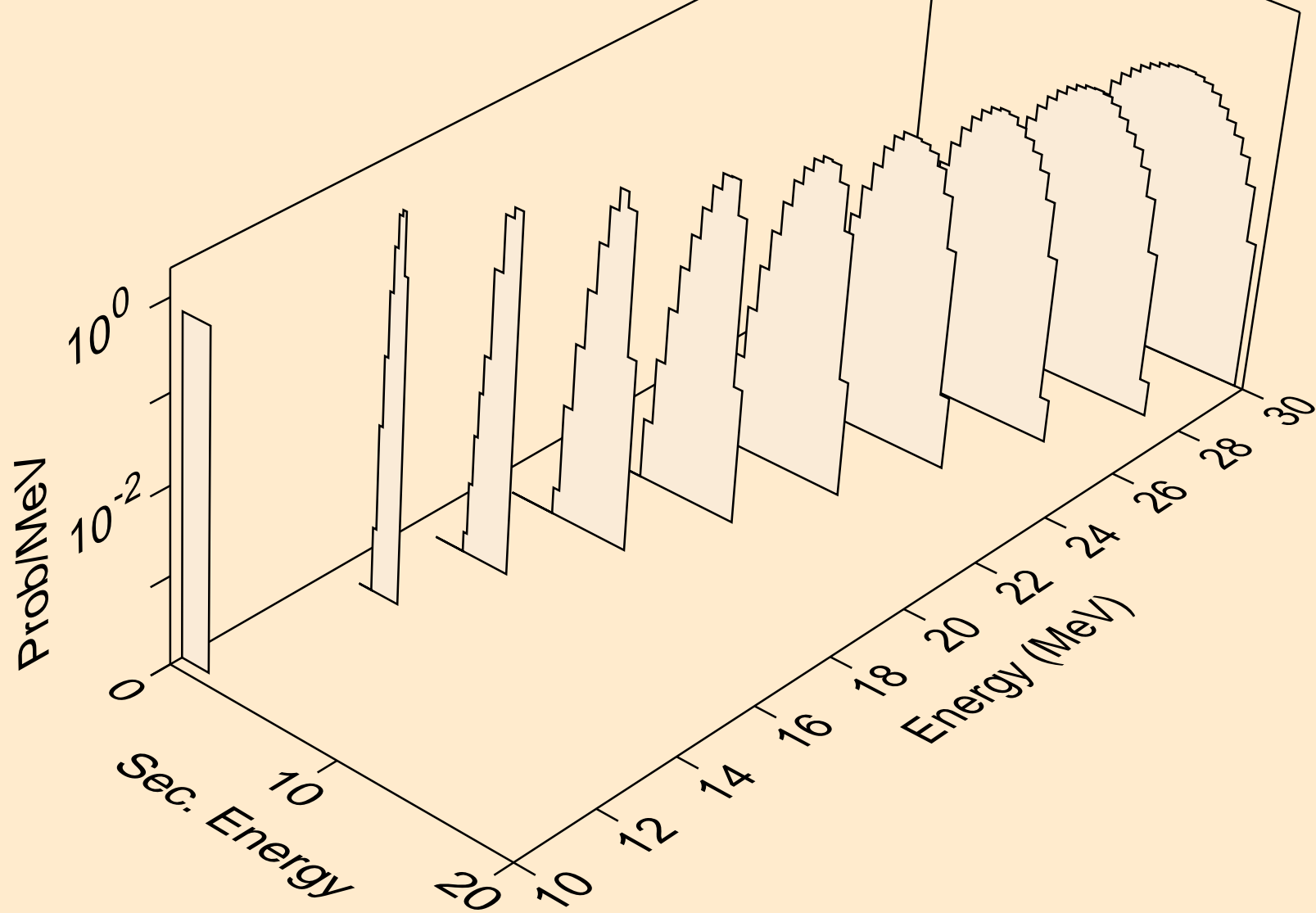

BI212N NEUTRON ACER TENDL-2024 LIBRARY; T=0.K
deuterons from (n,n*)d

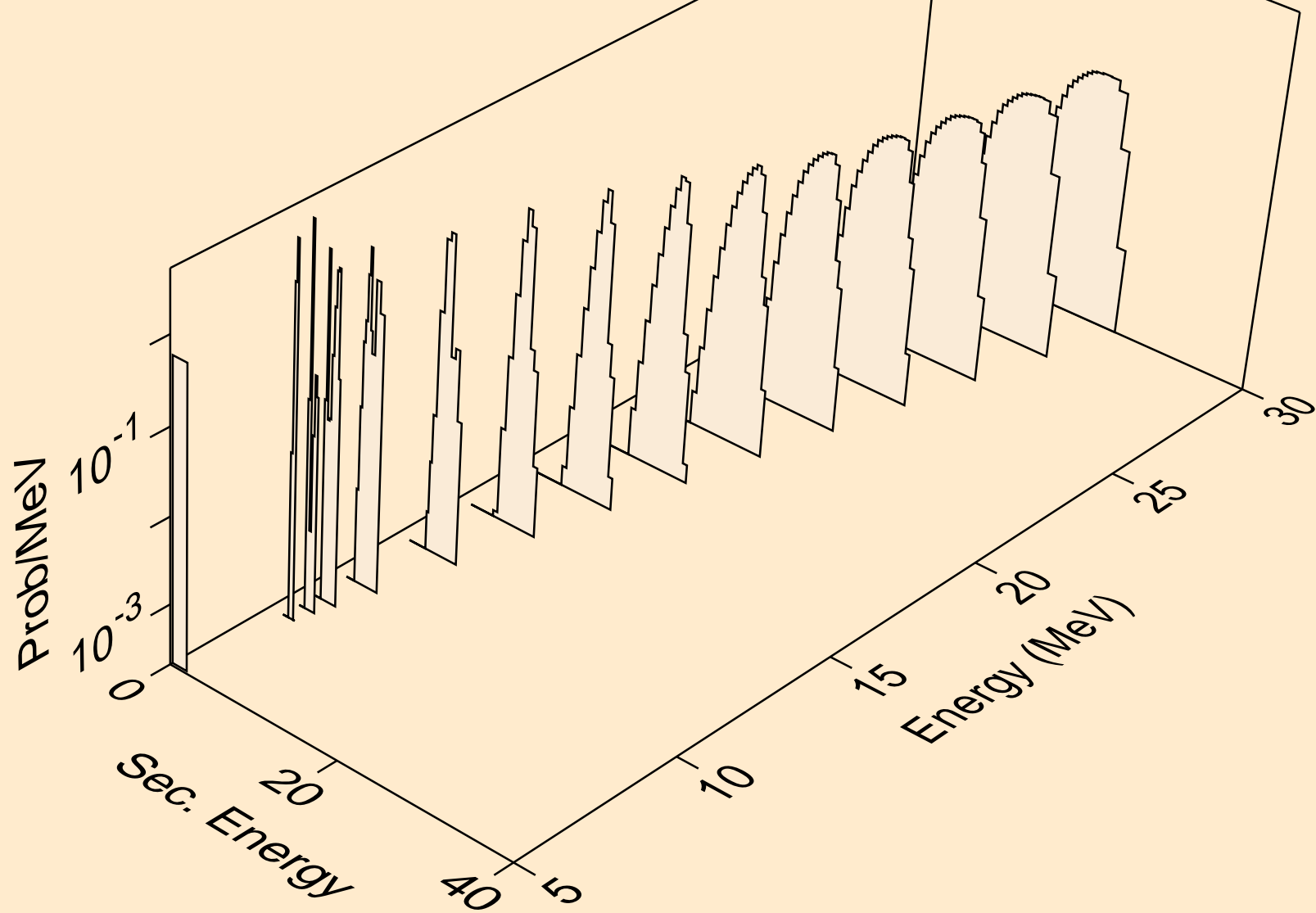

BI212N NEUTRON ACER TENDL-2024 LIBRARY; T=0.K
deuterons from (n,d)

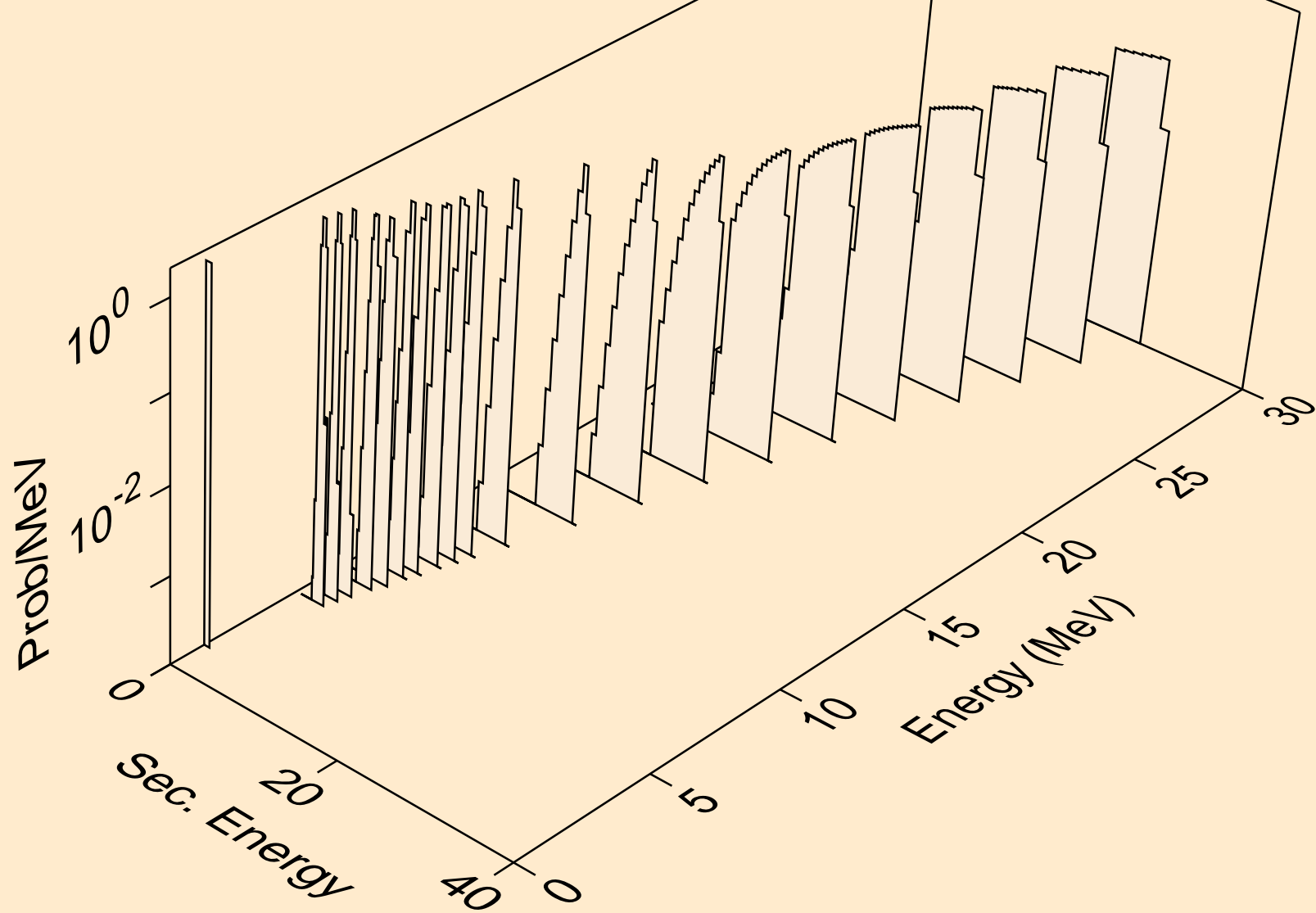

BI212N NEUTRON ACER TENDL-2024 LIBRARY; T=0.K
deuterons from (n,da)

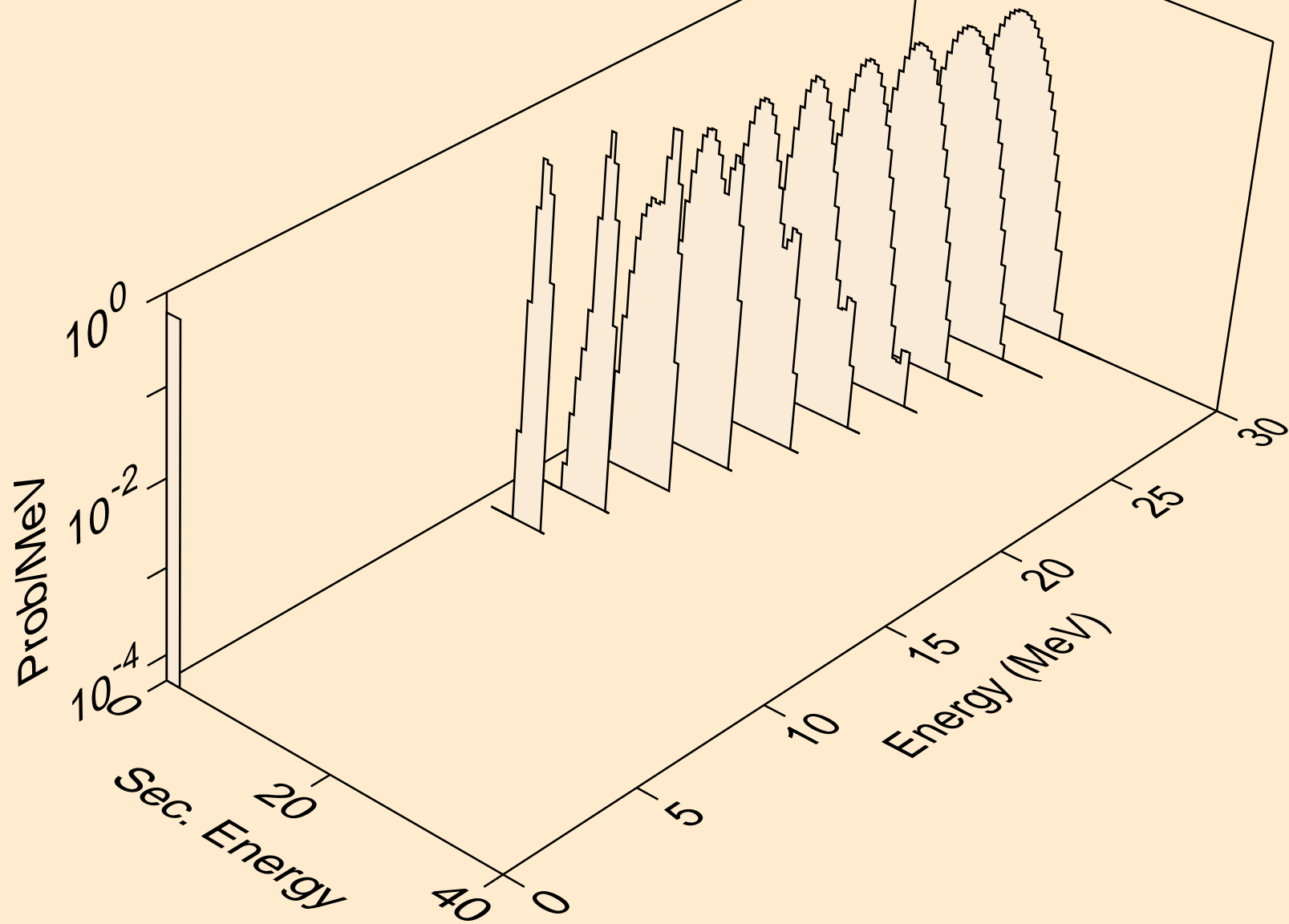

BI212N NEUTRON ACER TENDL-2024 LIBRARY; T=0.K
tritons from (n,x)

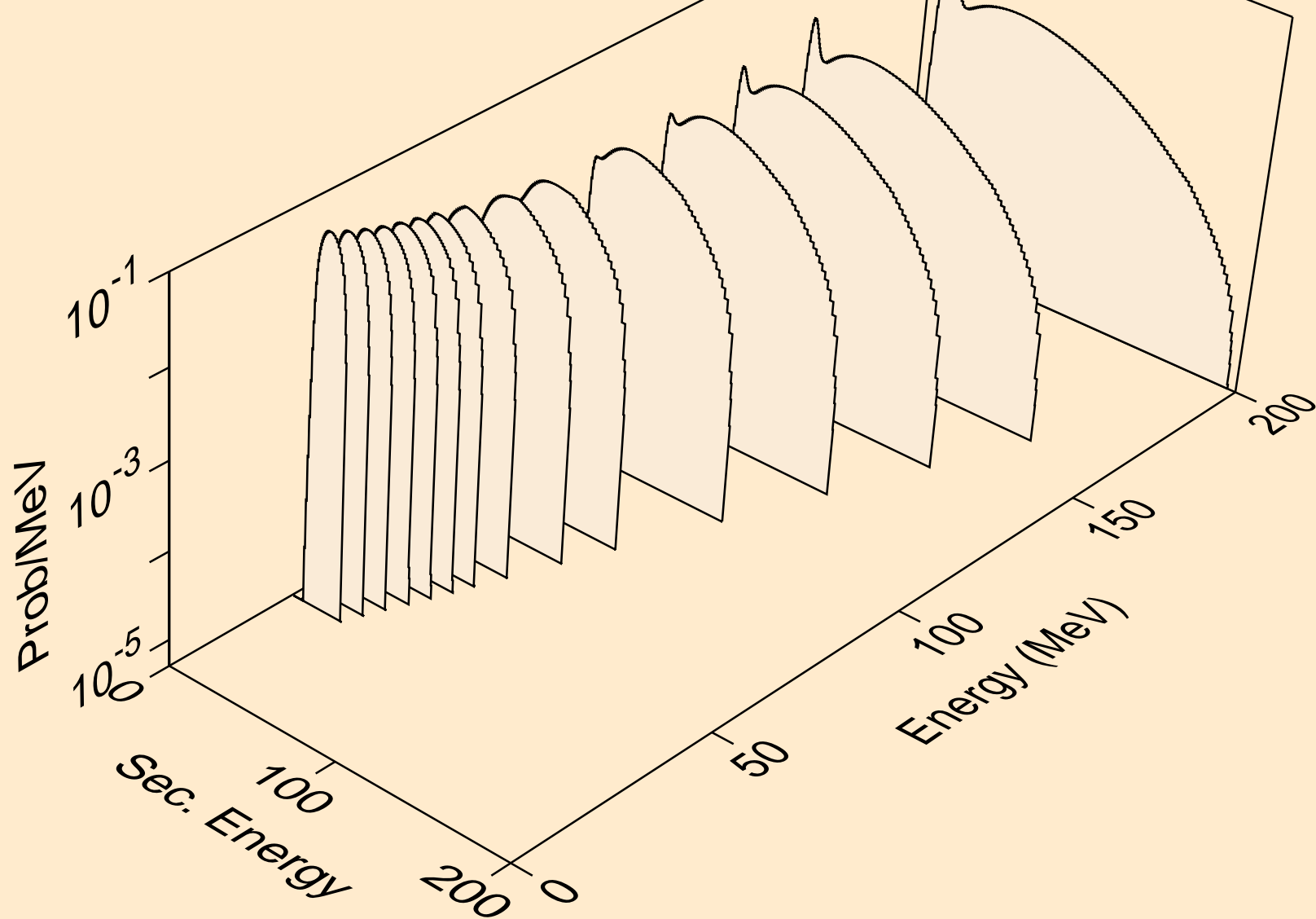

BI212N NEUTRON ACER TENDL-2024 LIBRARY; T=0.K
tritons from (n,n*)t

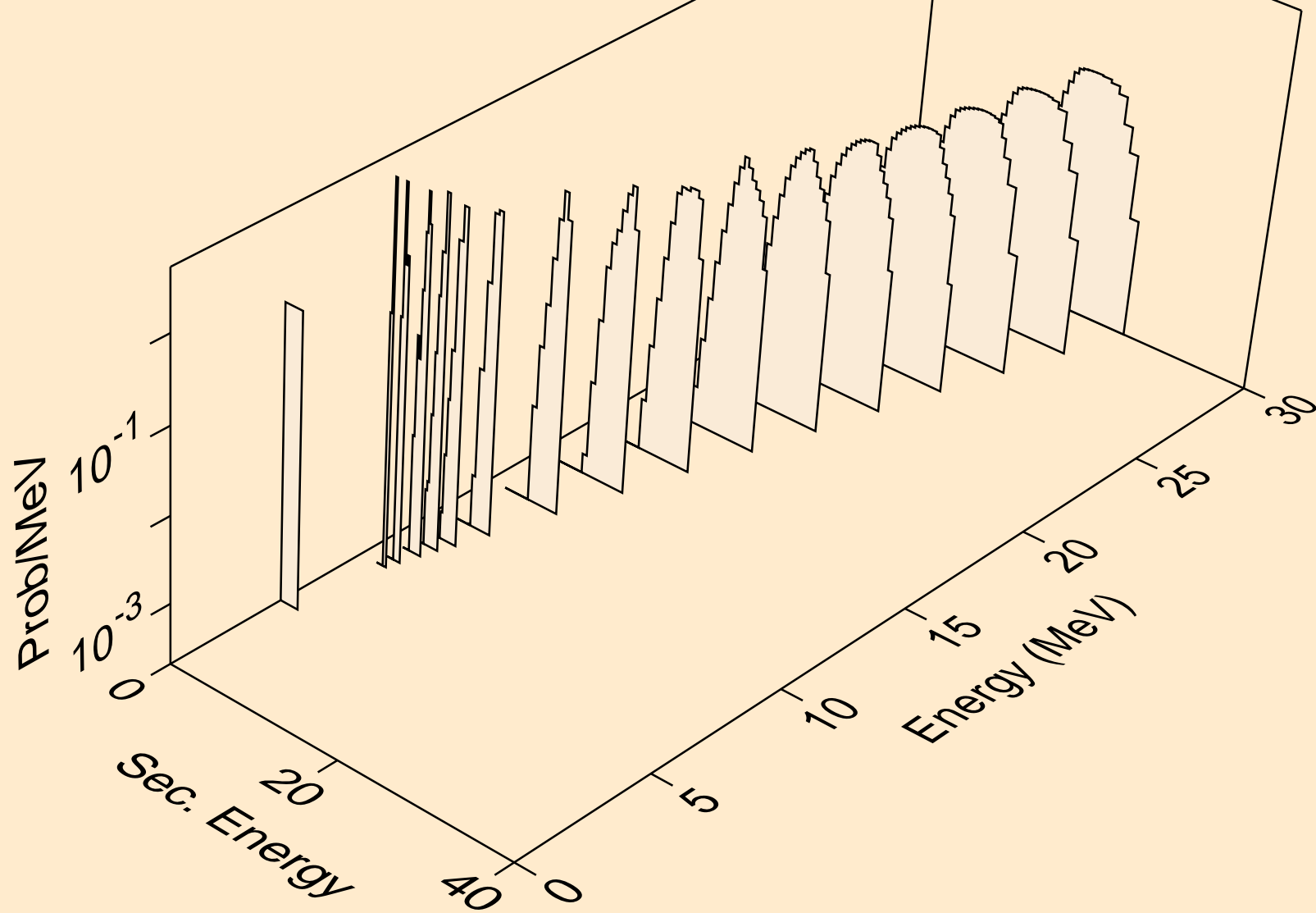

BI212N NEUTRON ACER TENDL-2024 LIBRARY; T=0.K
tritons from (n,t)

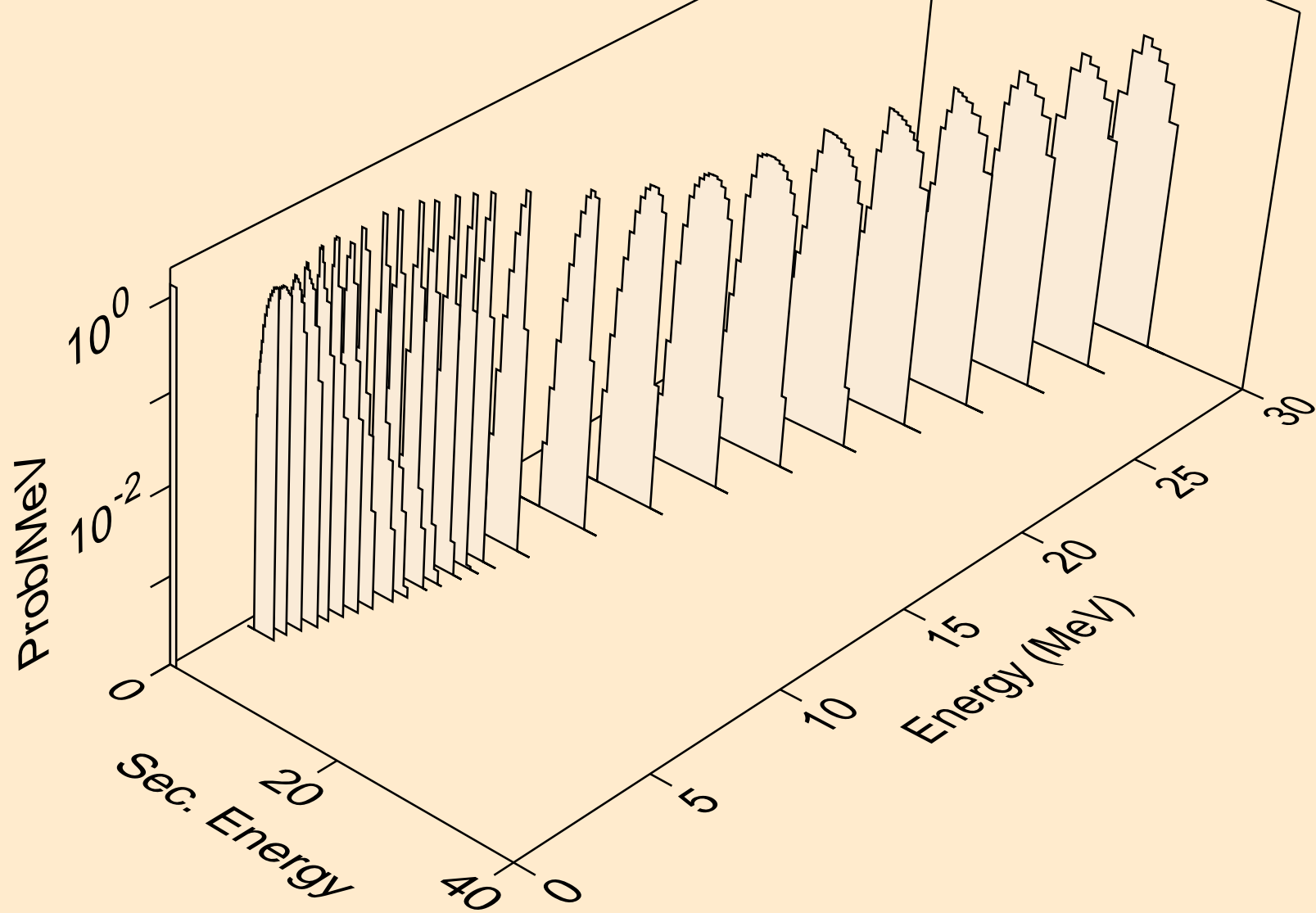

BI212N NEUTRON ACER TENDL-2024 LIBRARY; T=0.K
he3s from (n,x)

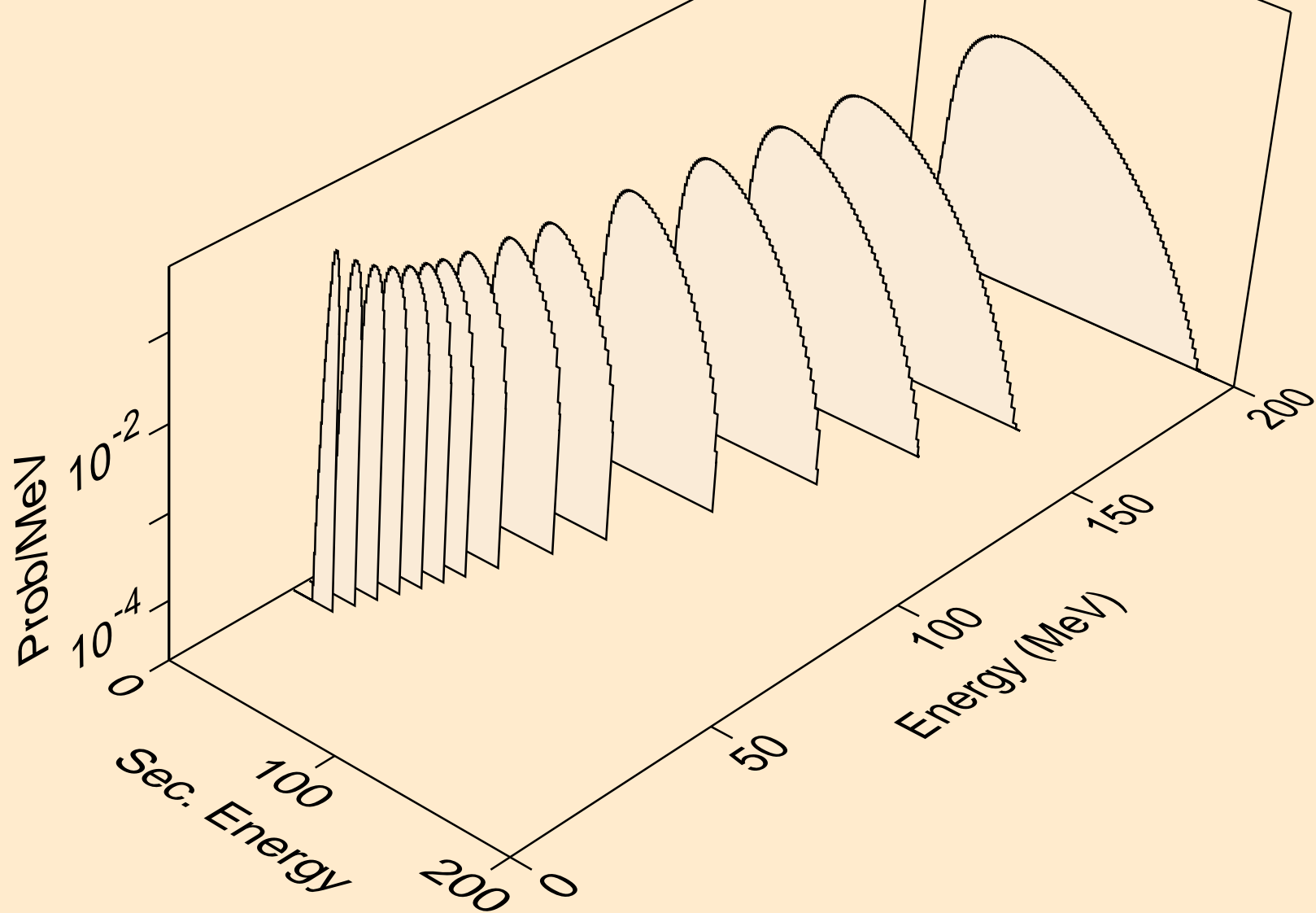

BI212N NEUTRON ACER TENDL-2024 LIBRARY; T=0.K
he3s from (n,n*)he3

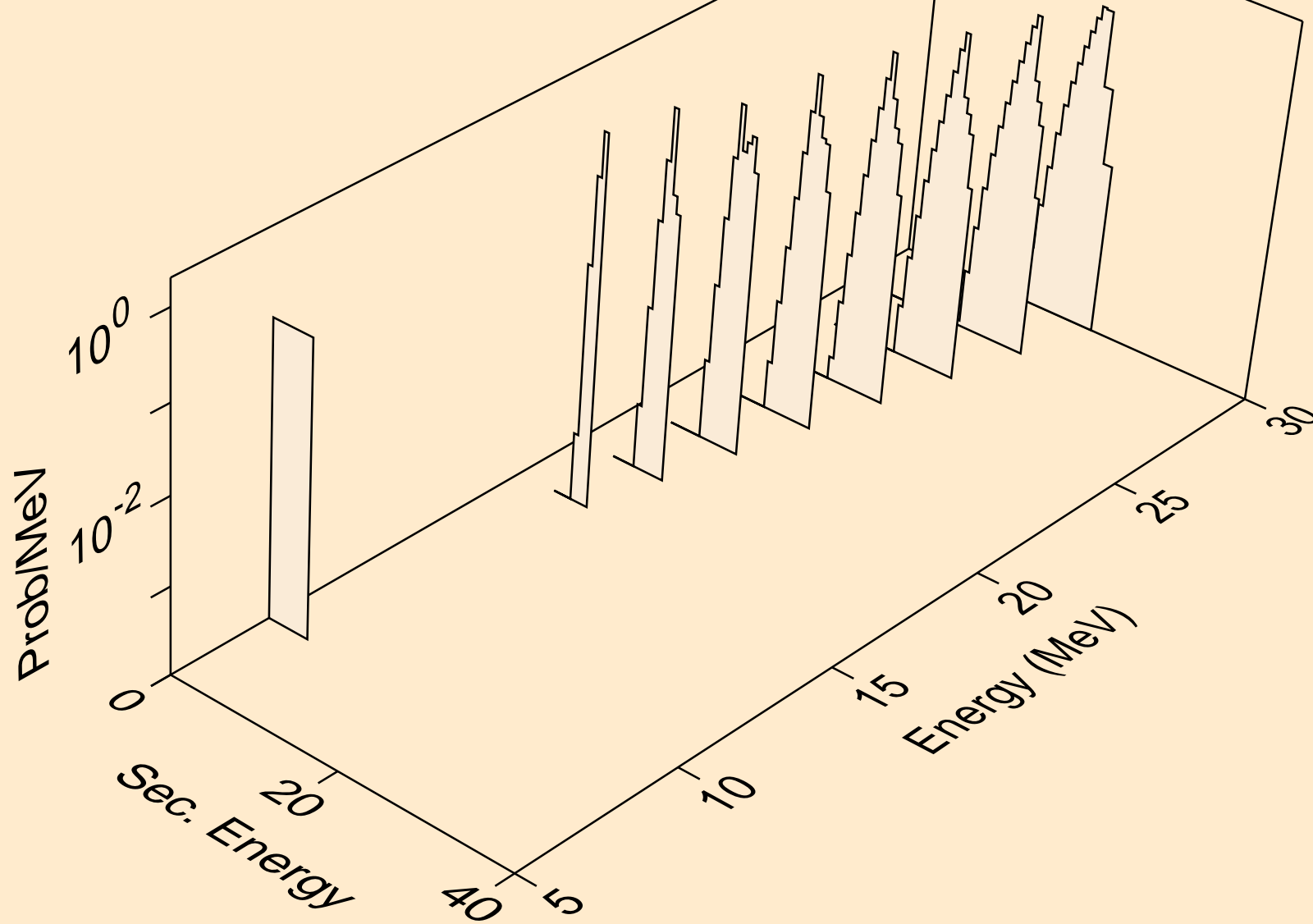

BI212N NEUTRON ACER TENDL-2024 LIBRARY; T=0.K
he3s from (n,he3)

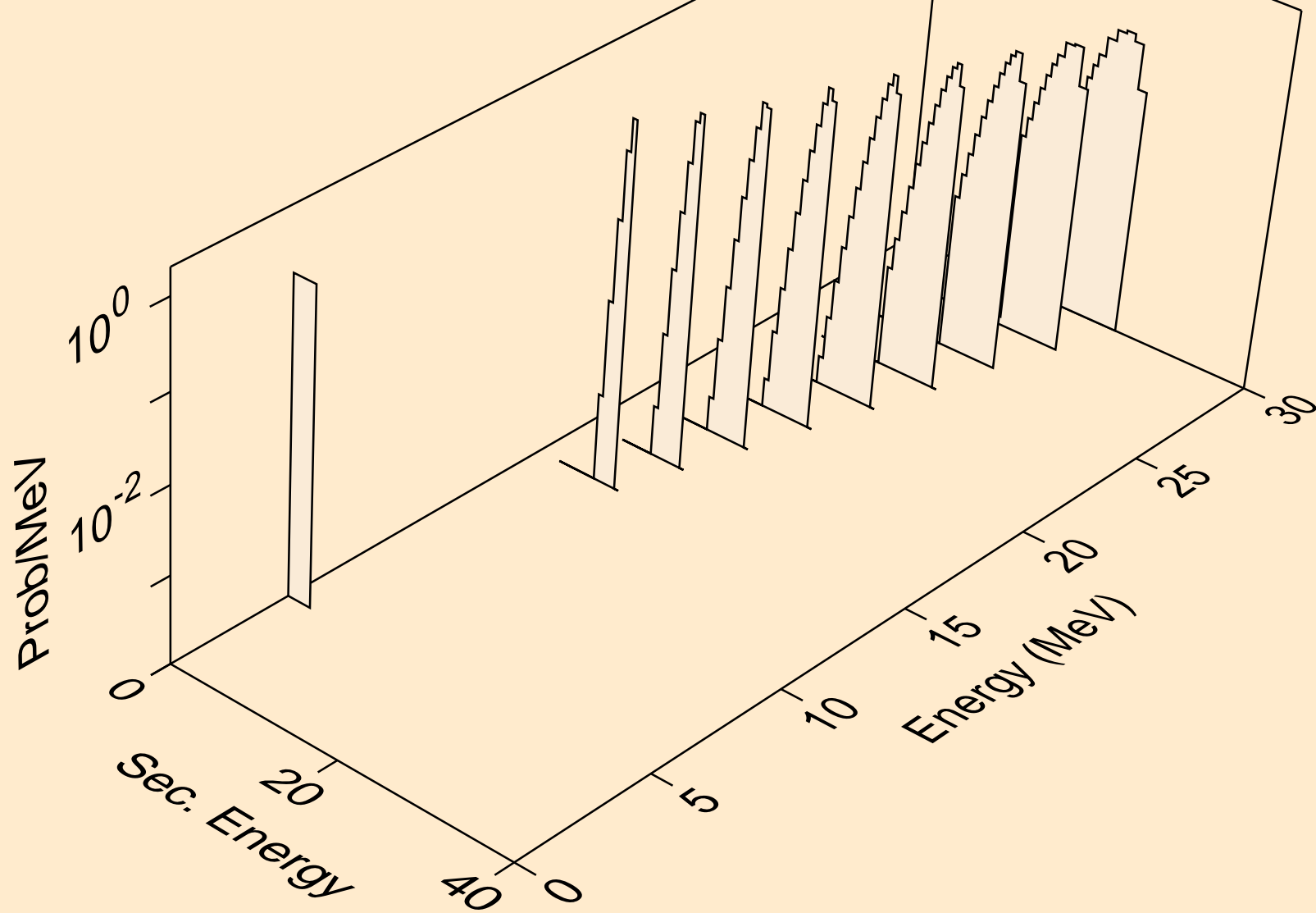

BI212N NEUTRON ACER TENDL-2024 LIBRARY; T=0.K
alphas from (n,x)



BI212N NEUTRON ACER TENDL-2024 LIBRARY; T=0.K
alphas from (n,n*)a

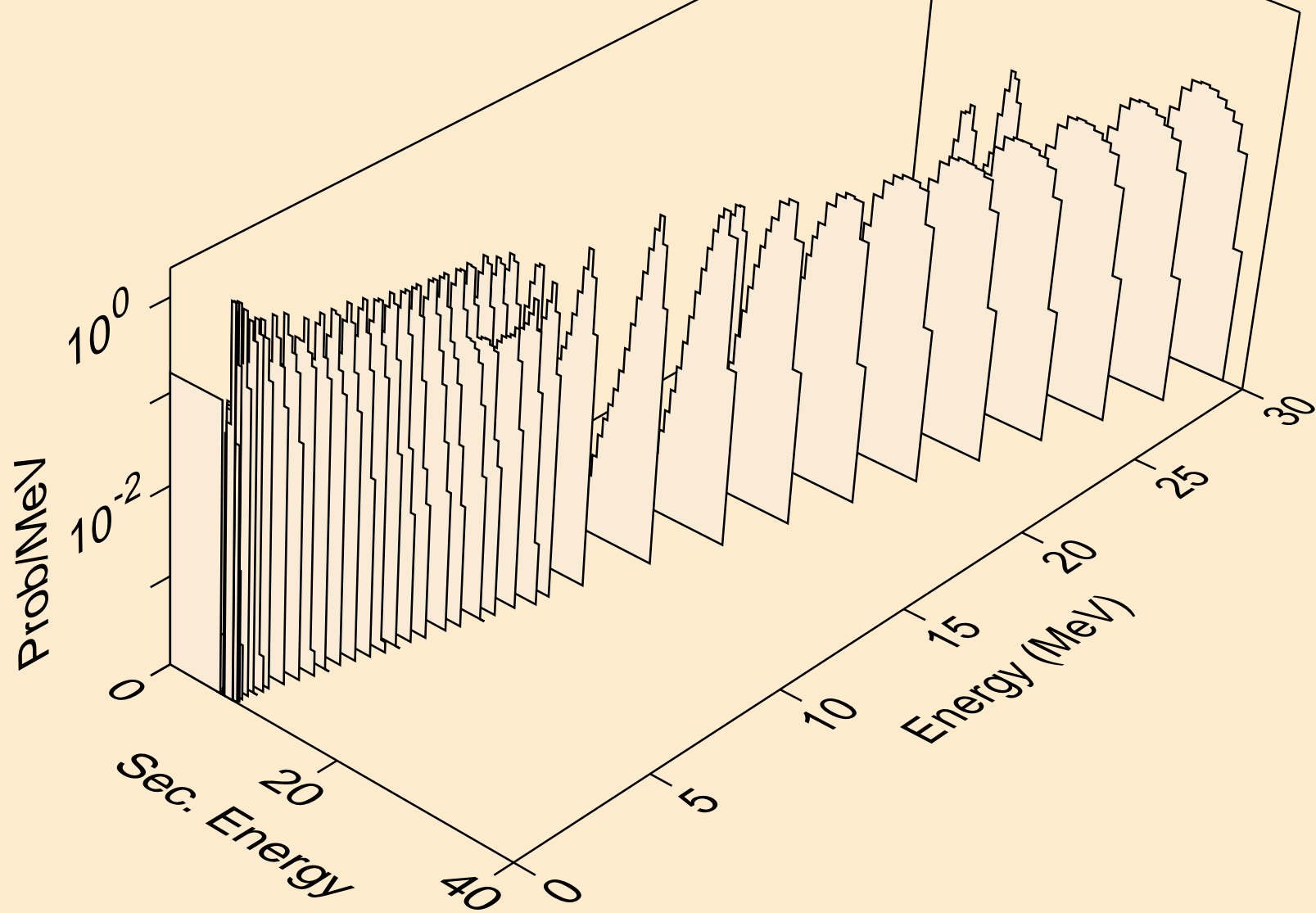

BI212N NEUTRON ACER TENDL-2024 LIBRARY; T=0.K
alphas from (n,2n)a

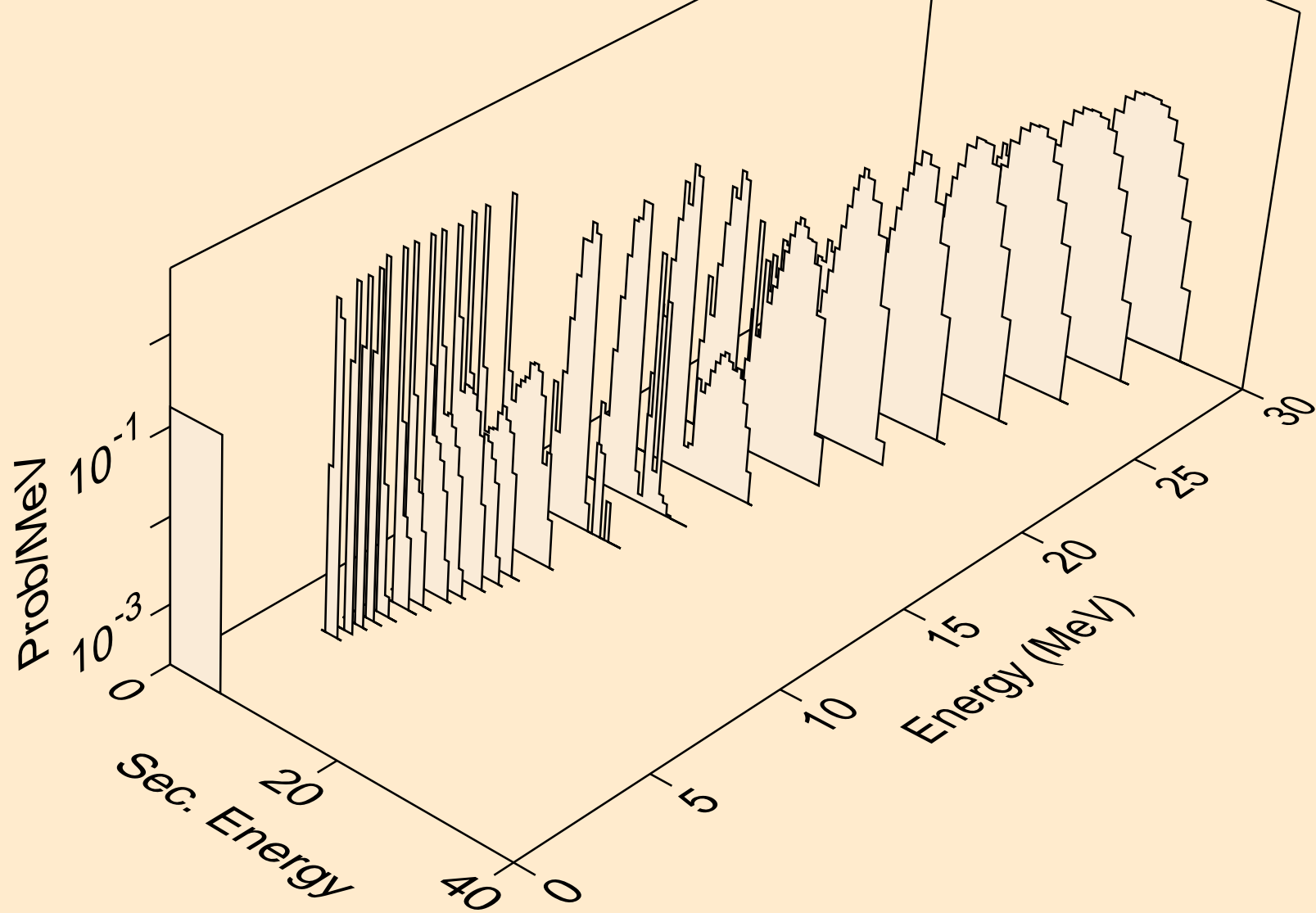

BI212N NEUTRON ACER TENDL-2024 LIBRARY; T=0.K
alphas from (n,3n)a

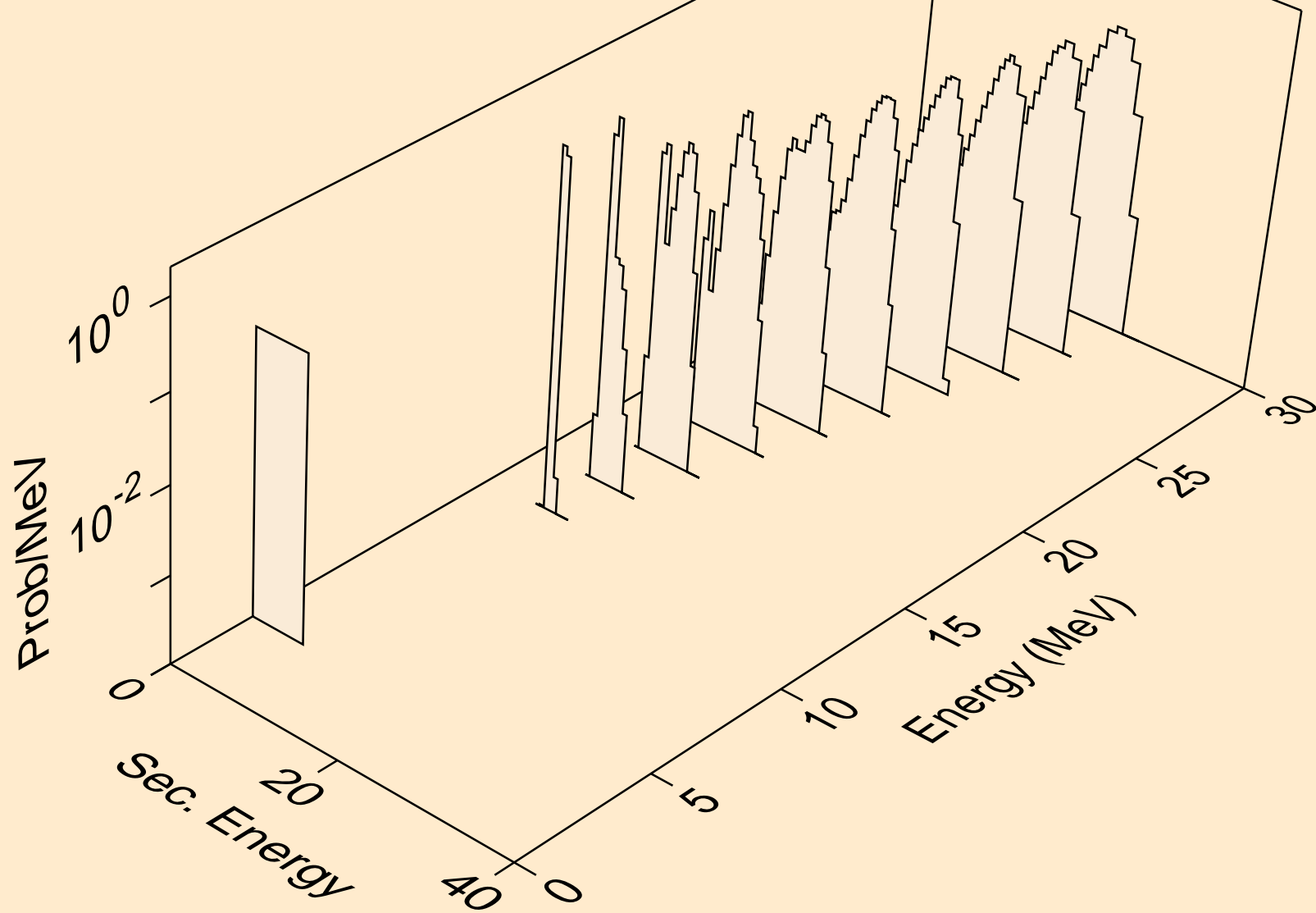

BI212N NEUTRON ACER TENDL-2024 LIBRARY; T=0.K
alphas from (n,npa)

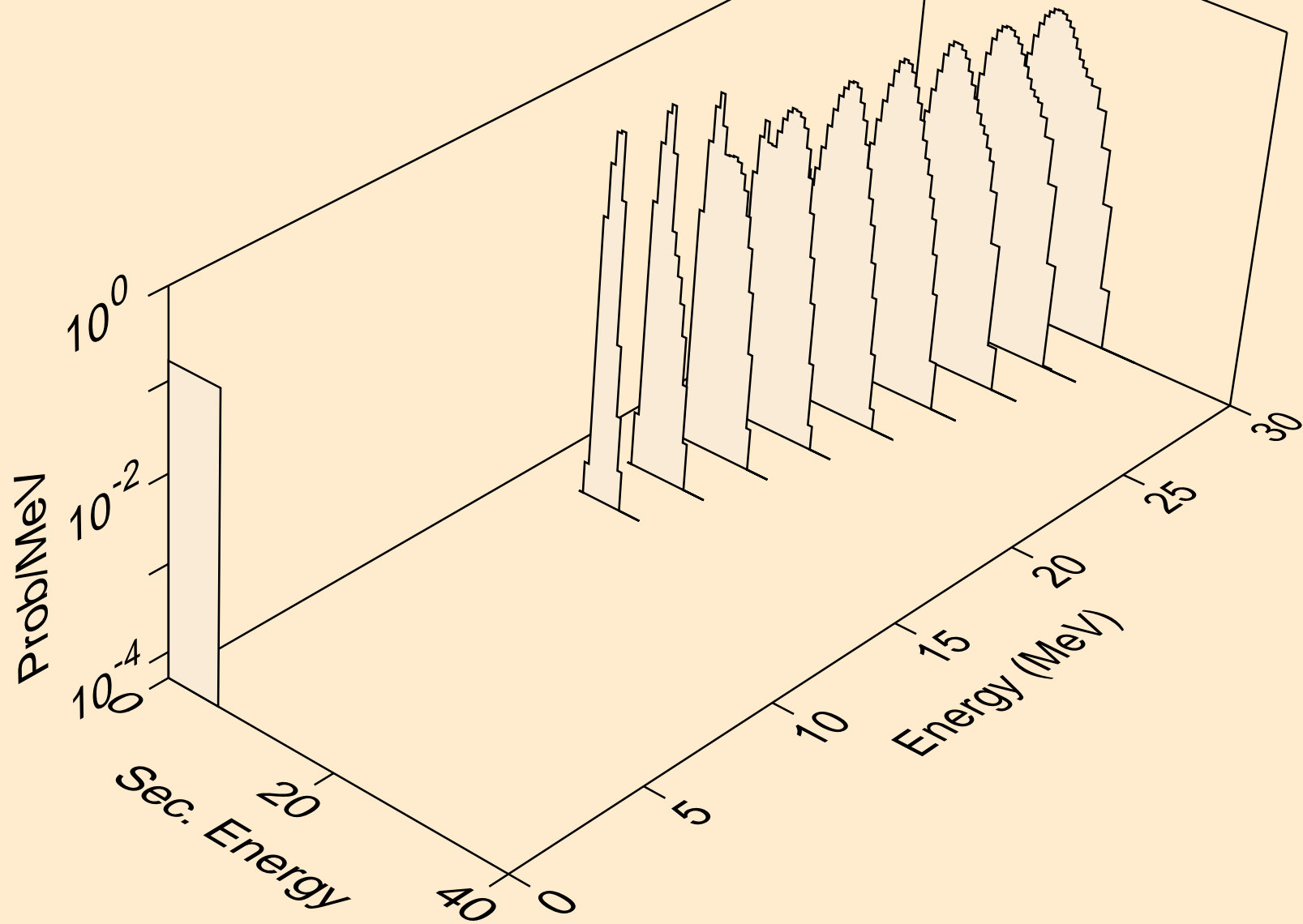

BI212N NEUTRON ACER TENDL-2024 LIBRARY; T=0.K
alphas from (n,a)

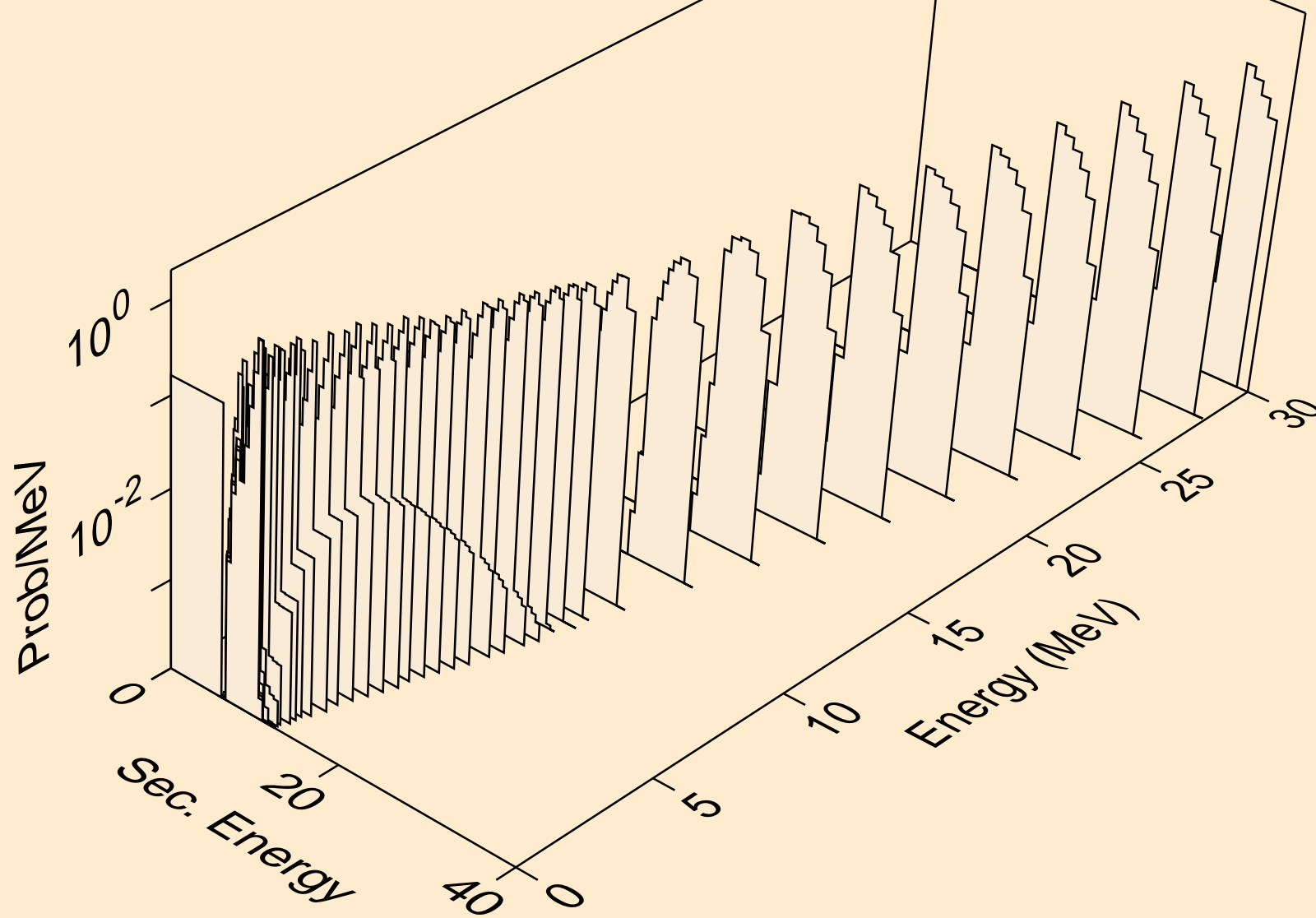

BI212N NEUTRON ACER TENDL-2024 LIBRARY; T=0.K
alphas from (n,2a)

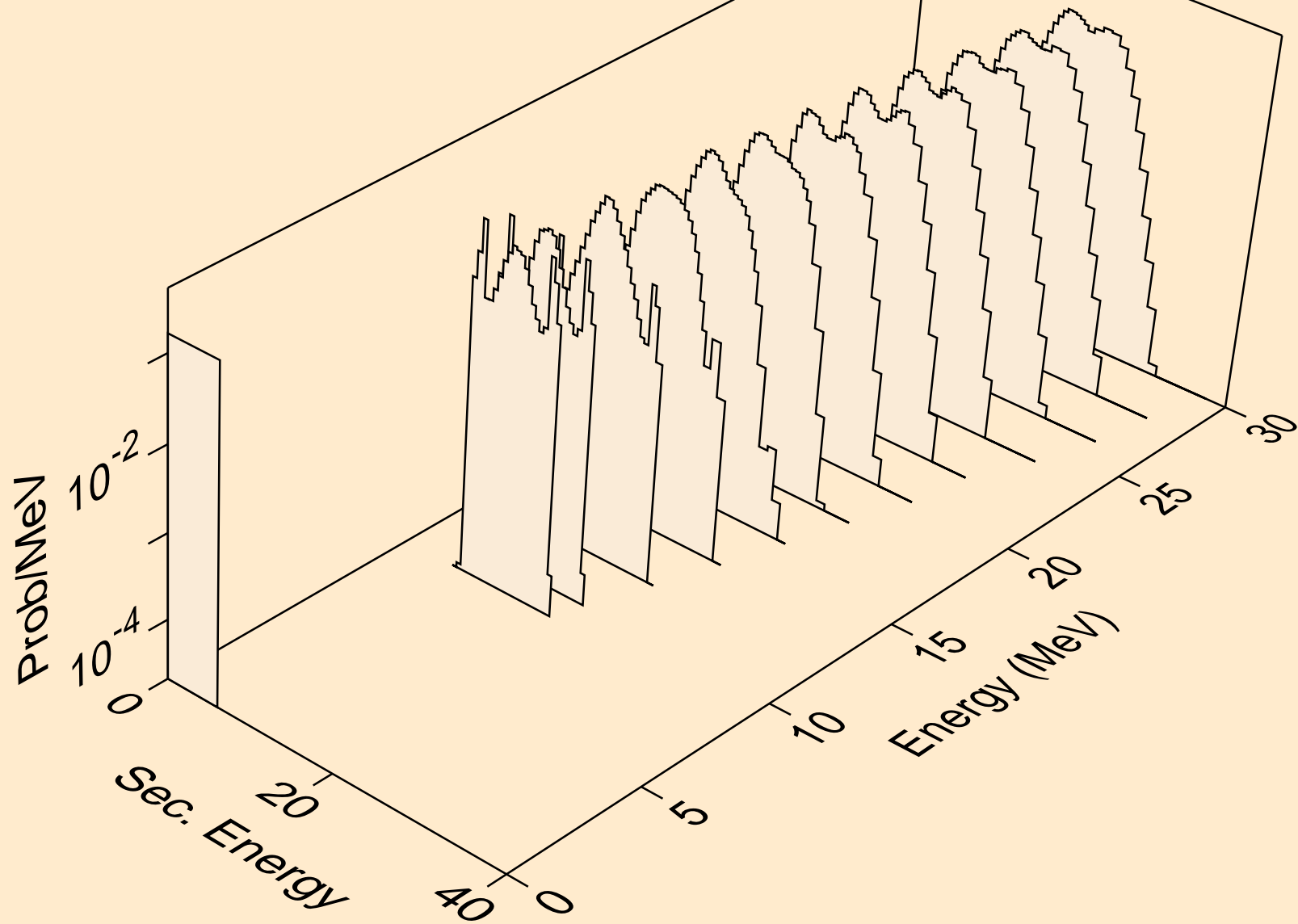

BI212N NEUTRON ACER TENDL-2024 LIBRARY; T=0.K
alphas from (n,da)

