

# CS121M NEUTRON ACER TENDL-2024 LIBRARY; T=0.K

## Principal cross sections

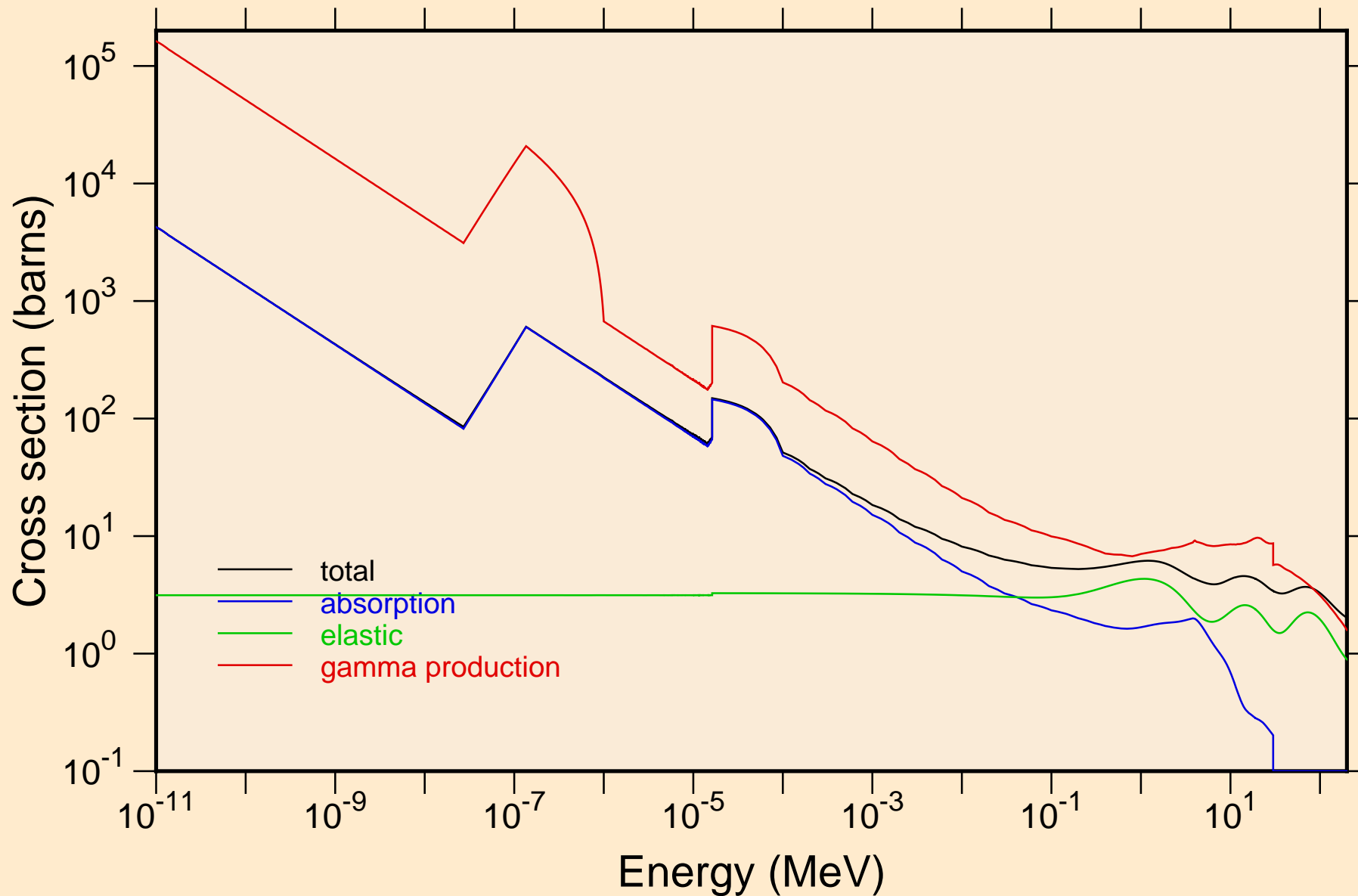

CS121M NEUTRON ACER TENDL-2024 LIBRARY; T=0.K  
resonance total cross section

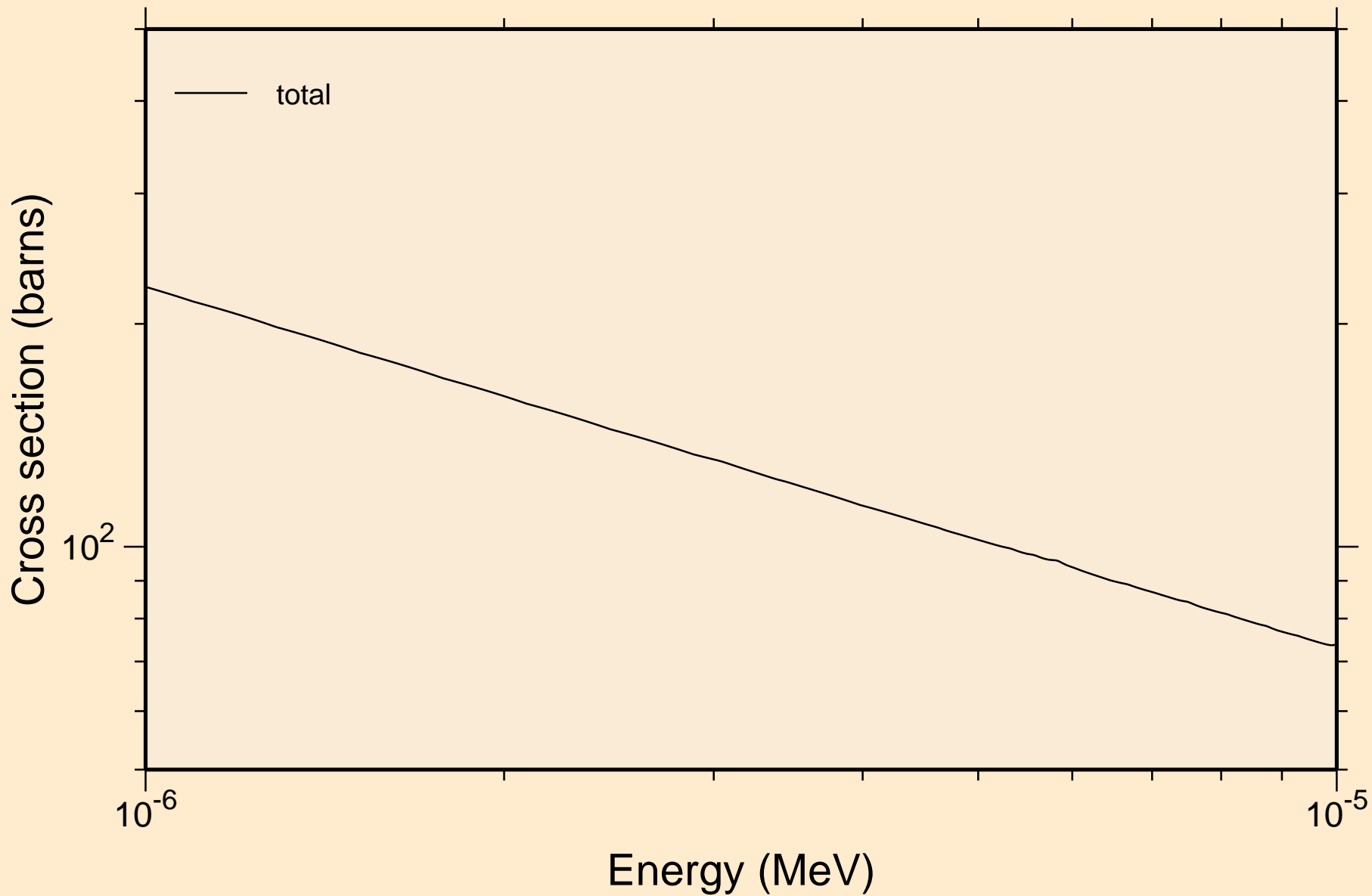

CS121M NEUTRON ACER TENDL-2024 LIBRARY; T=0.K  
resonance total cross section

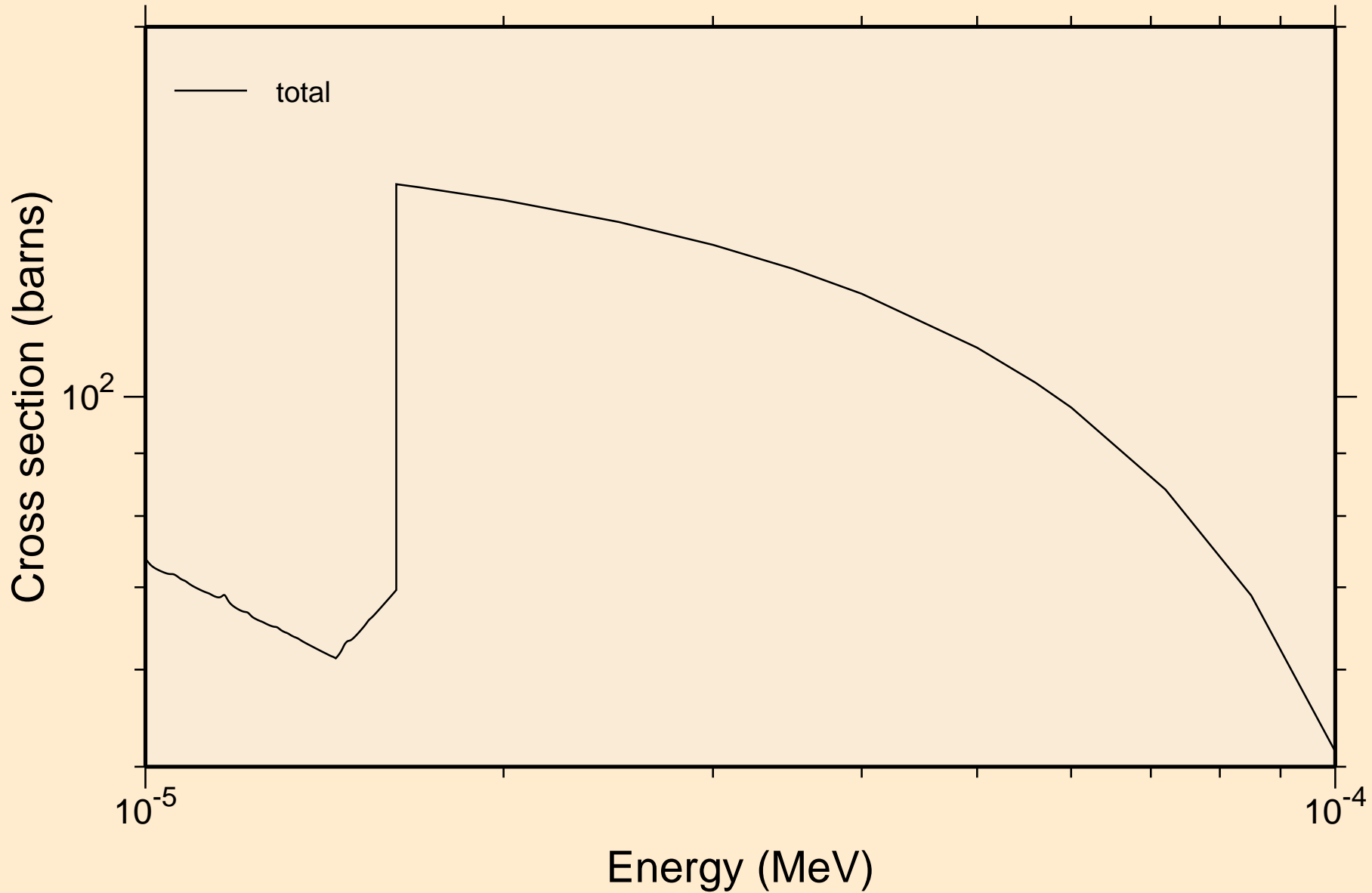

Cs121M NEUTRON ACER TENDL-2024 LIBRARY; T=0.K  
resonance total cross section

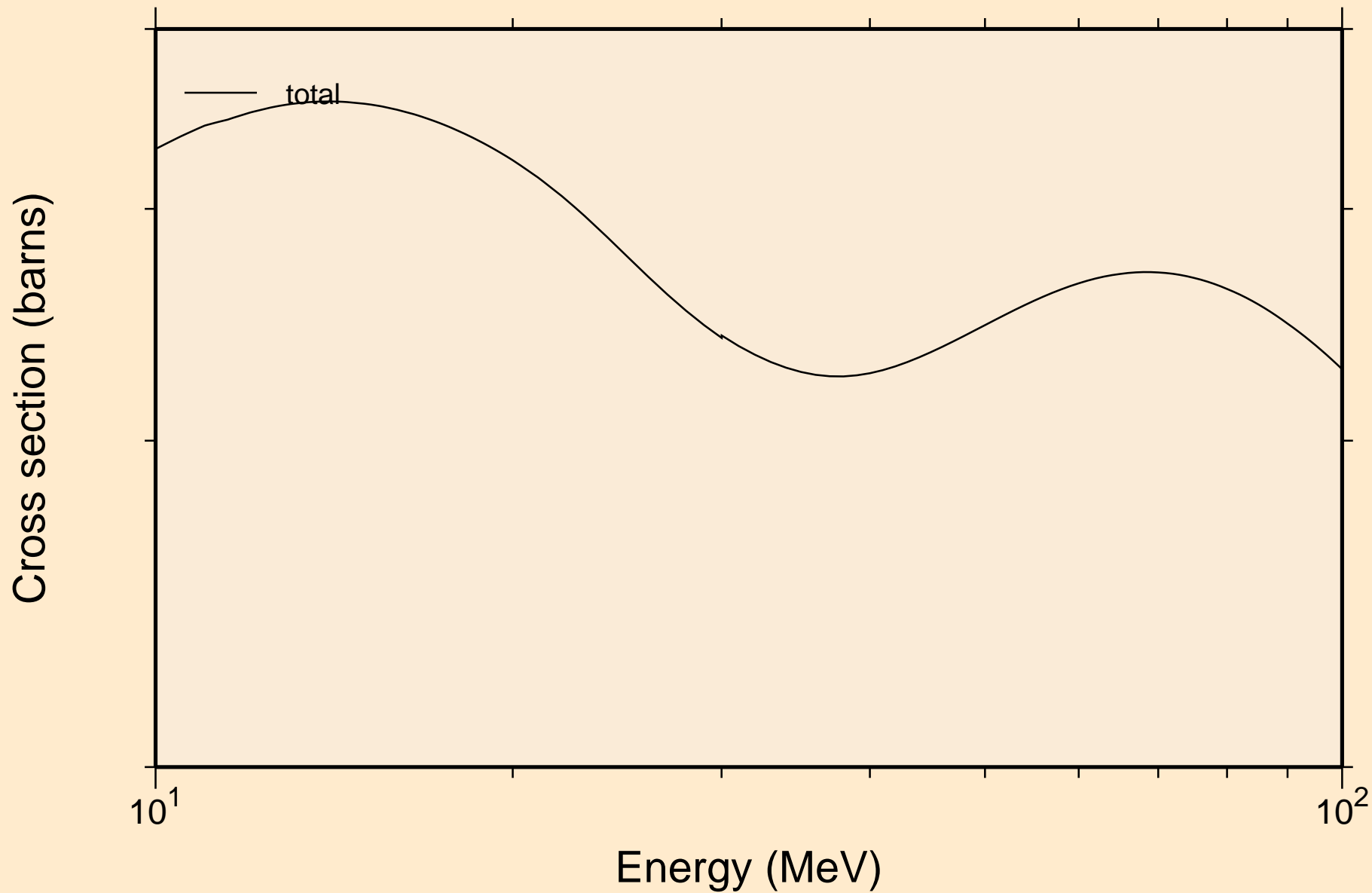

CS121M NEUTRON ACER TENDL-2024 LIBRARY; T=0.K  
resonance absorption cross sections

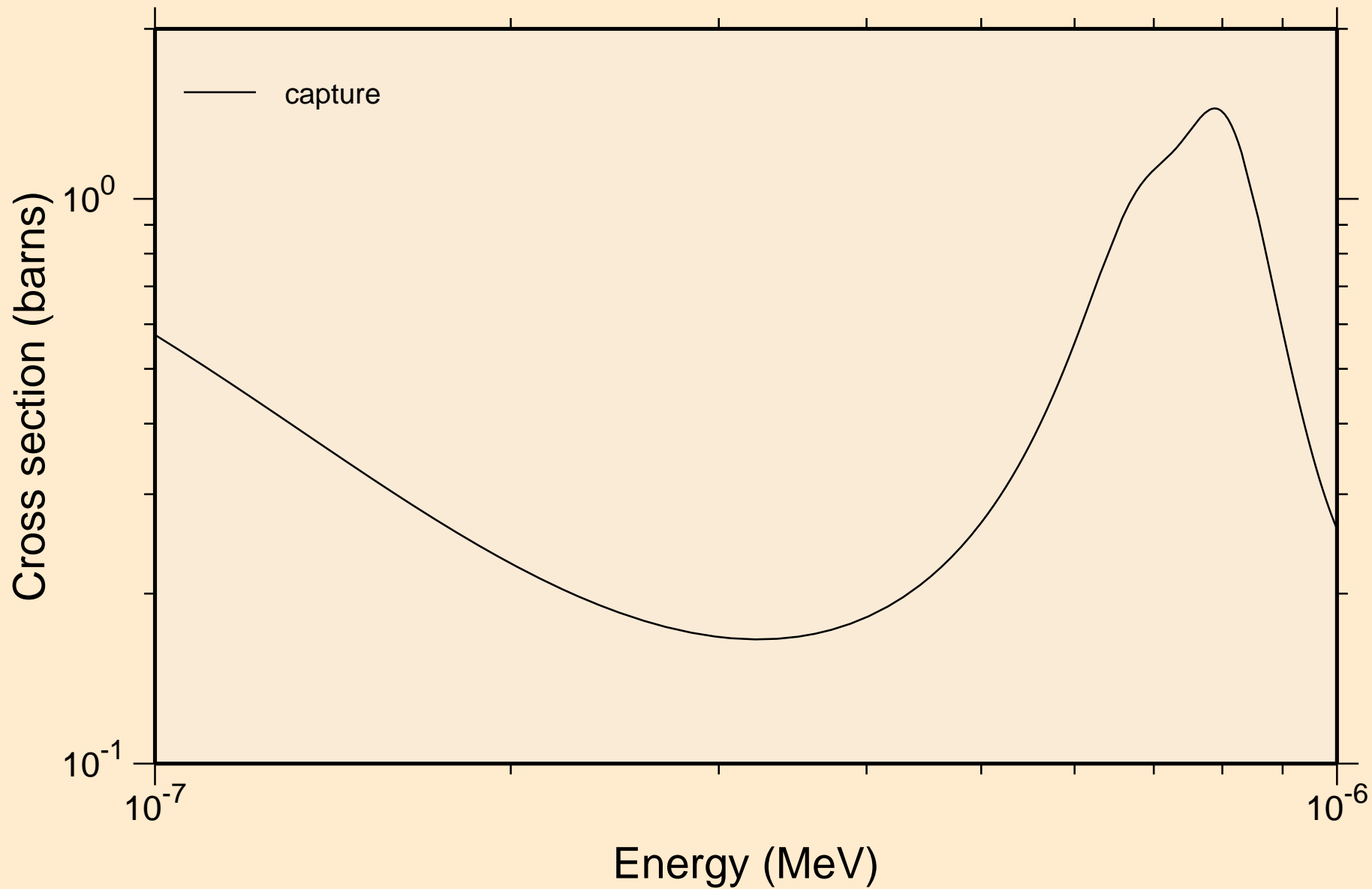

CS121M NEUTRON ACER TENDL-2024 LIBRARY; T=0.K  
resonance absorption cross sections

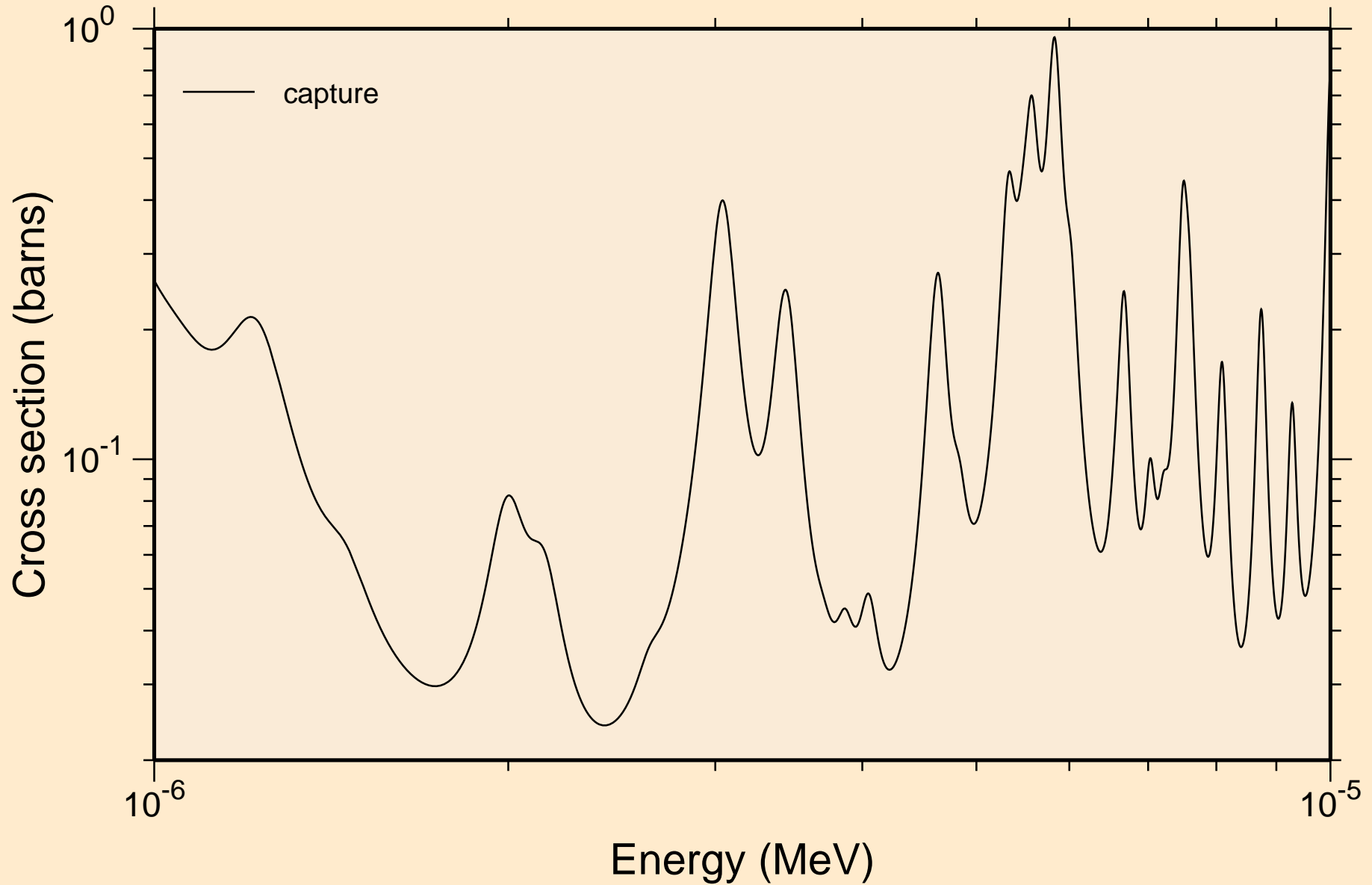

CS121M NEUTRON ACER TENDL-2024 LIBRARY; T=0.K  
resonance absorption cross sections

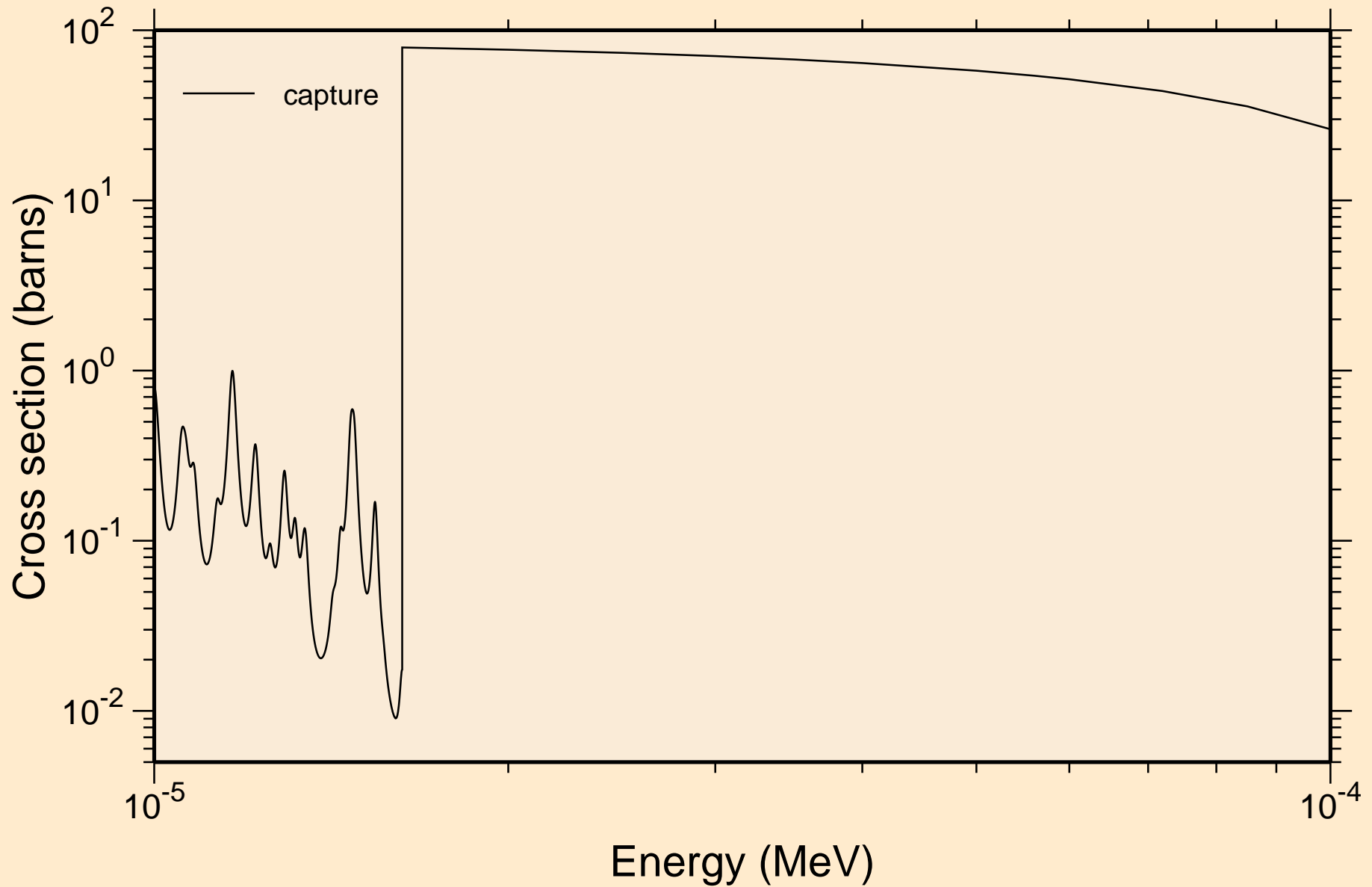

CS121M NEUTRON ACER TENDL-2024 LIBRARY; T=0.K  
resonance absorption cross sections

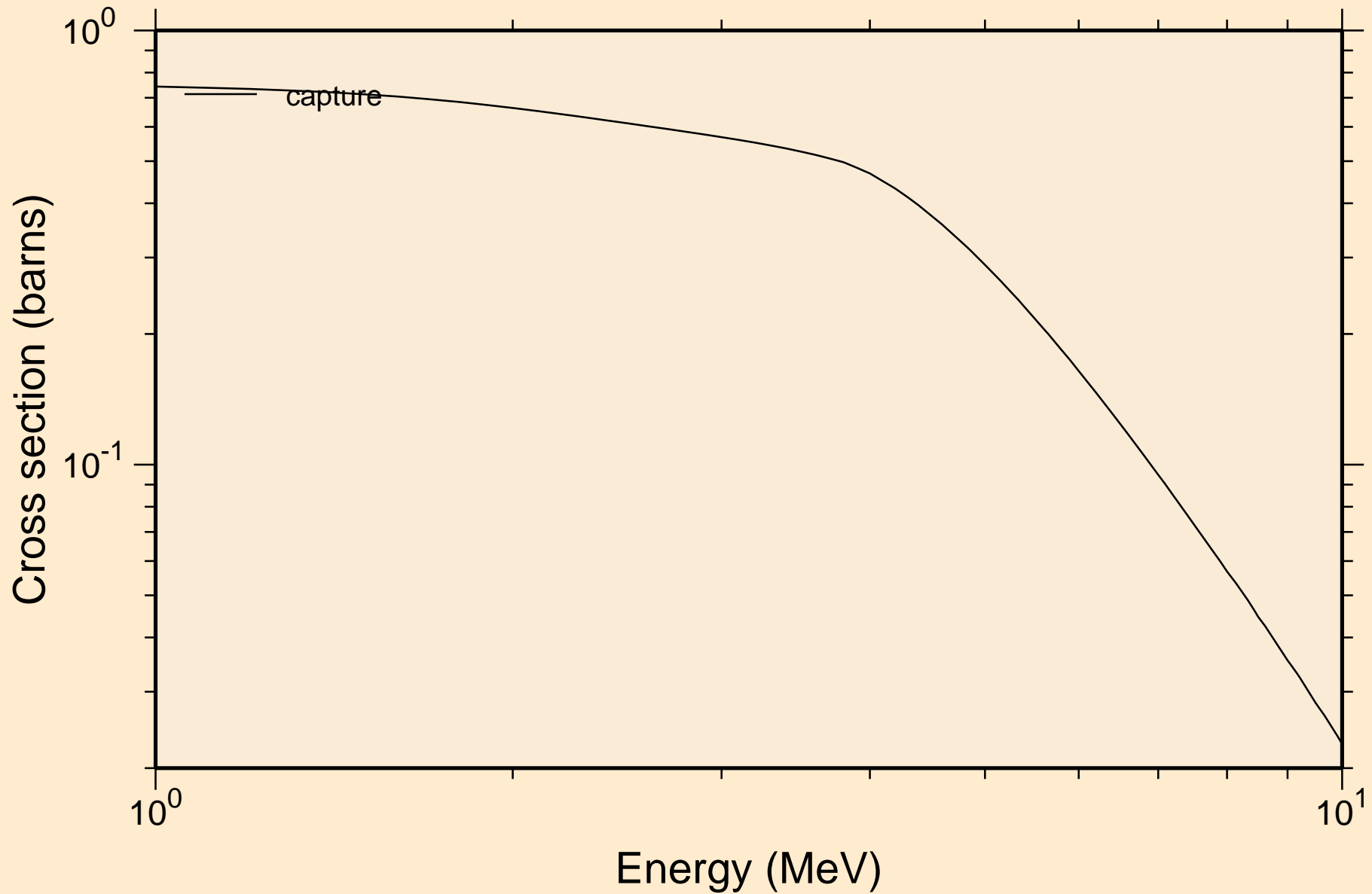

CS121M NEUTRON ACER TENDL-2024 LIBRARY; T=0.K  
Heating

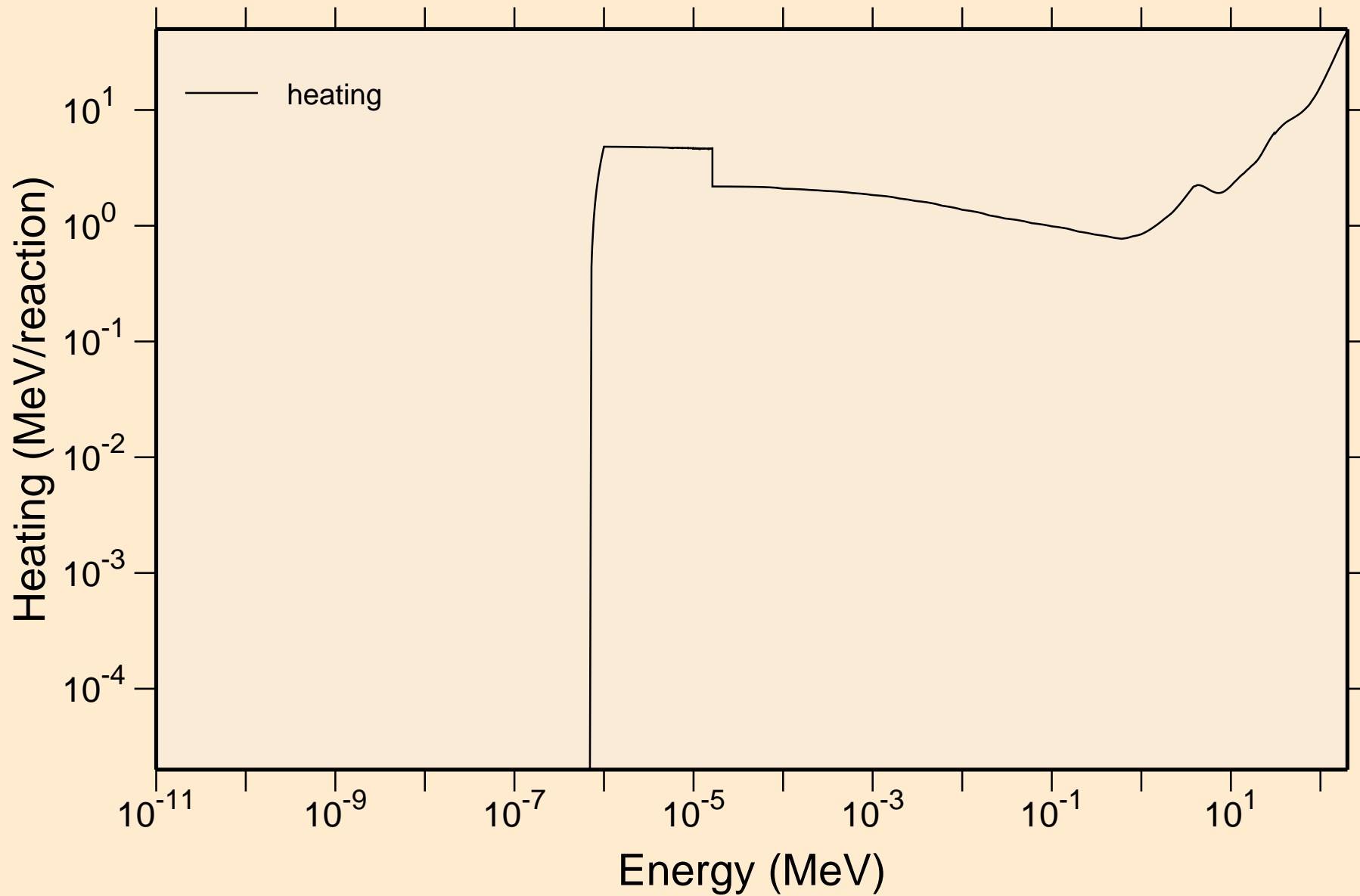

# CS121M NEUTRON ACER TENDL-2024 LIBRARY; T=0.K

## Damage

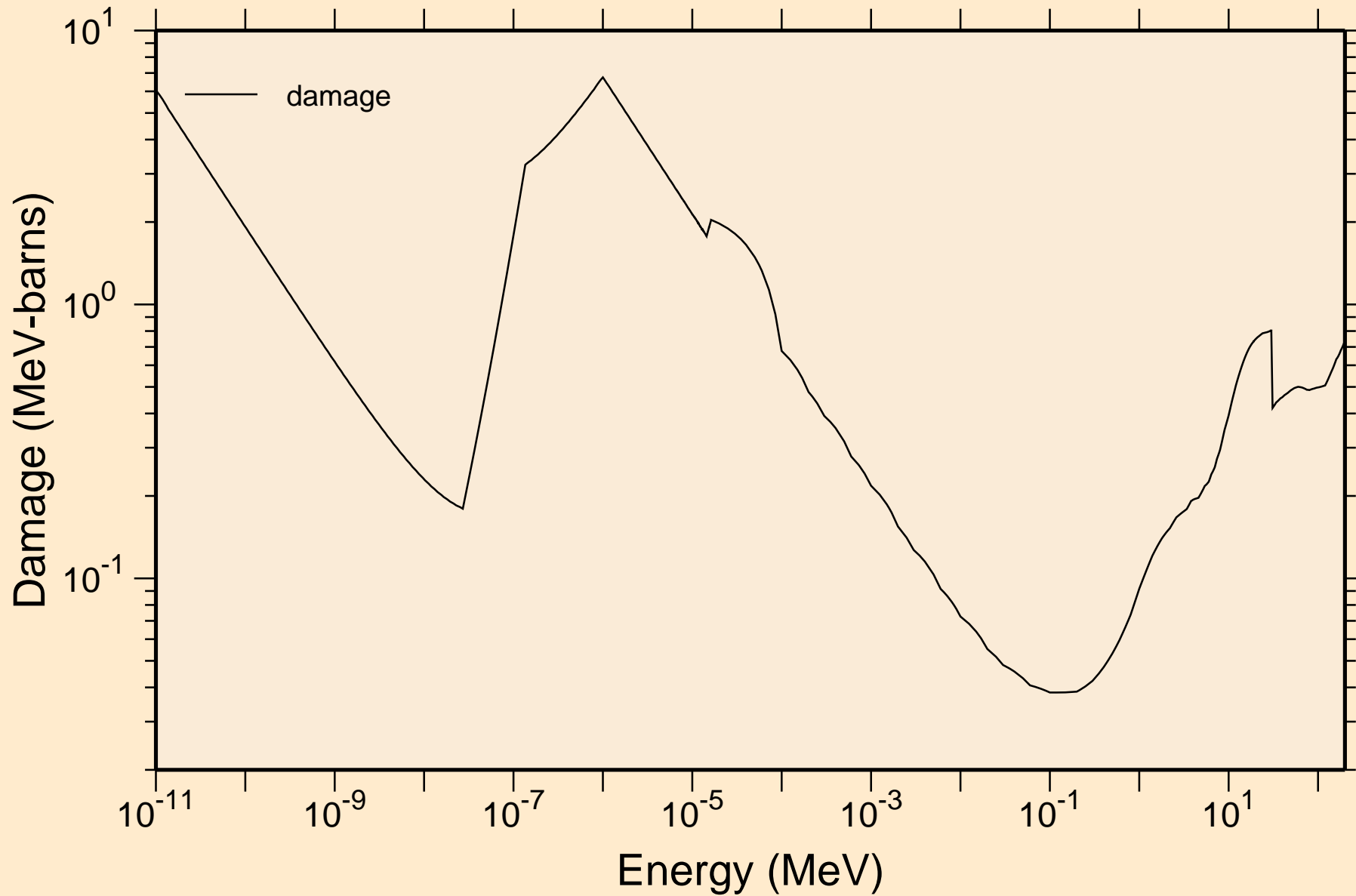

# CS121M NEUTRON ACER TENDL-2024 LIBRARY; T=0.K

## Non-threshold reactions

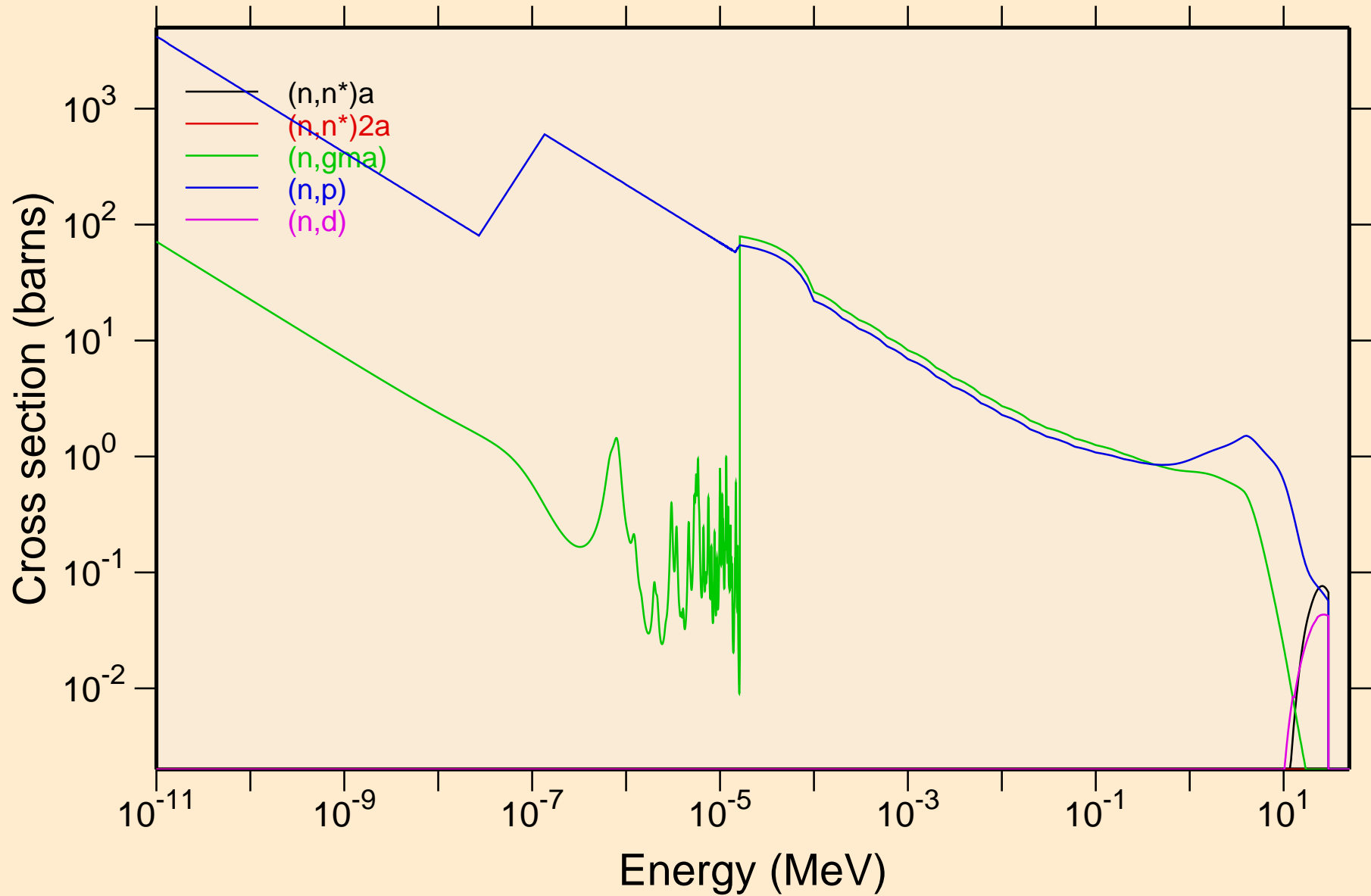

# CS121M NEUTRON ACER TENDL-2024 LIBRARY; T=0.K

## Non-threshold reactions

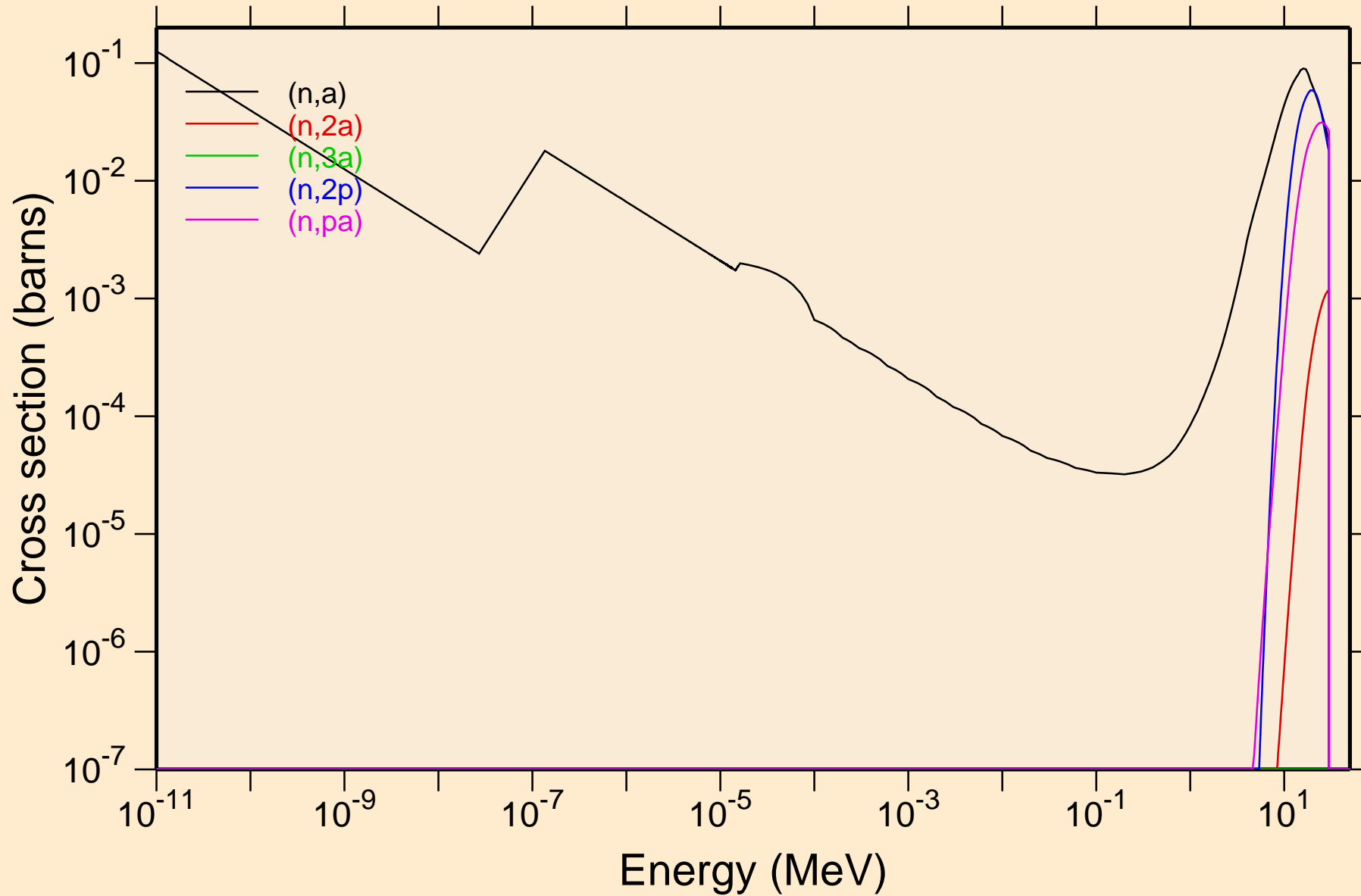

# CS121M NEUTRON ACER TENDL-2024 LIBRARY; T=0.K

## Non-threshold reactions

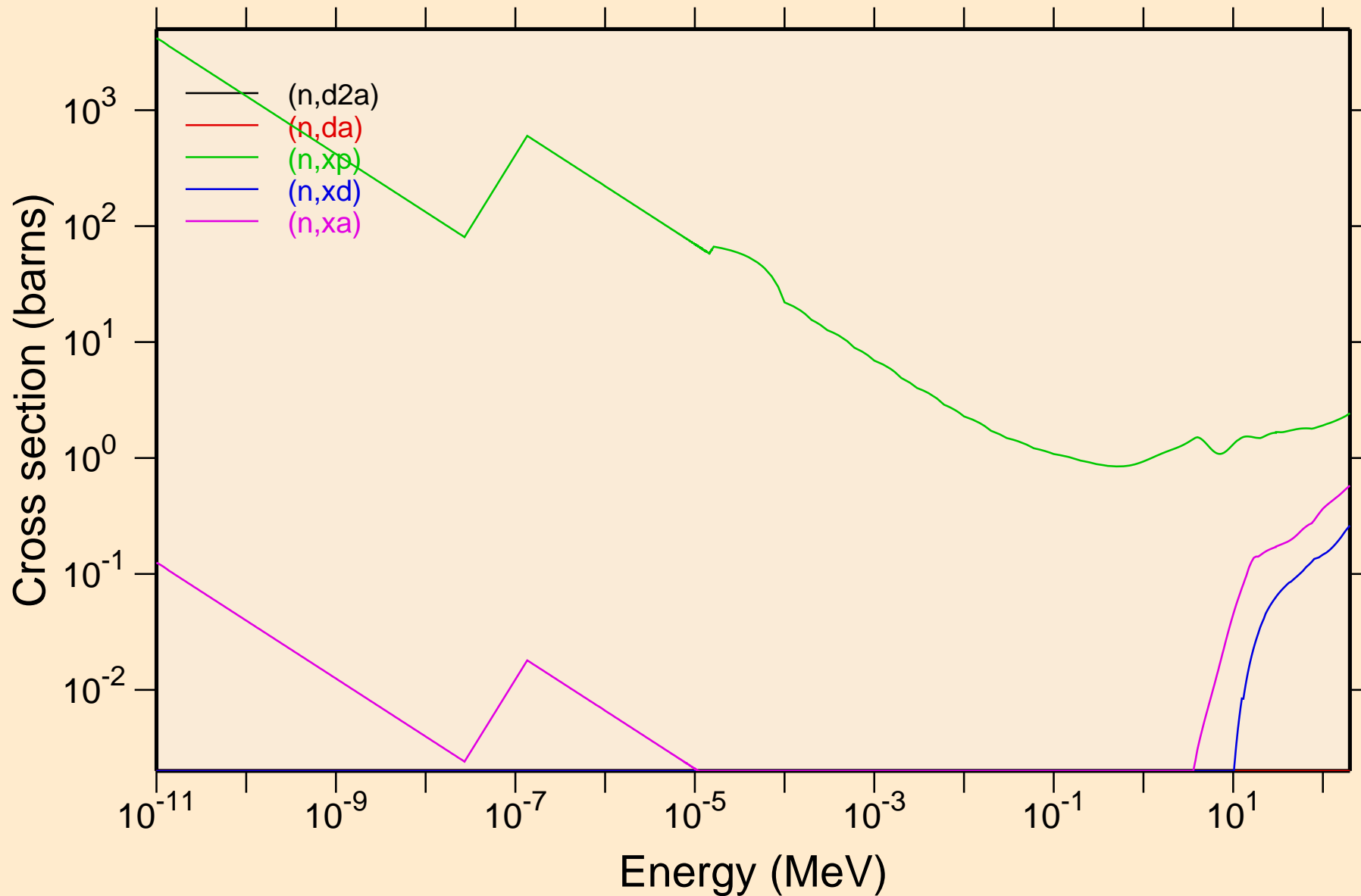

# CS121M NEUTRON ACER TENDL-2024 LIBRARY; T=0.K

## Principal cross sections

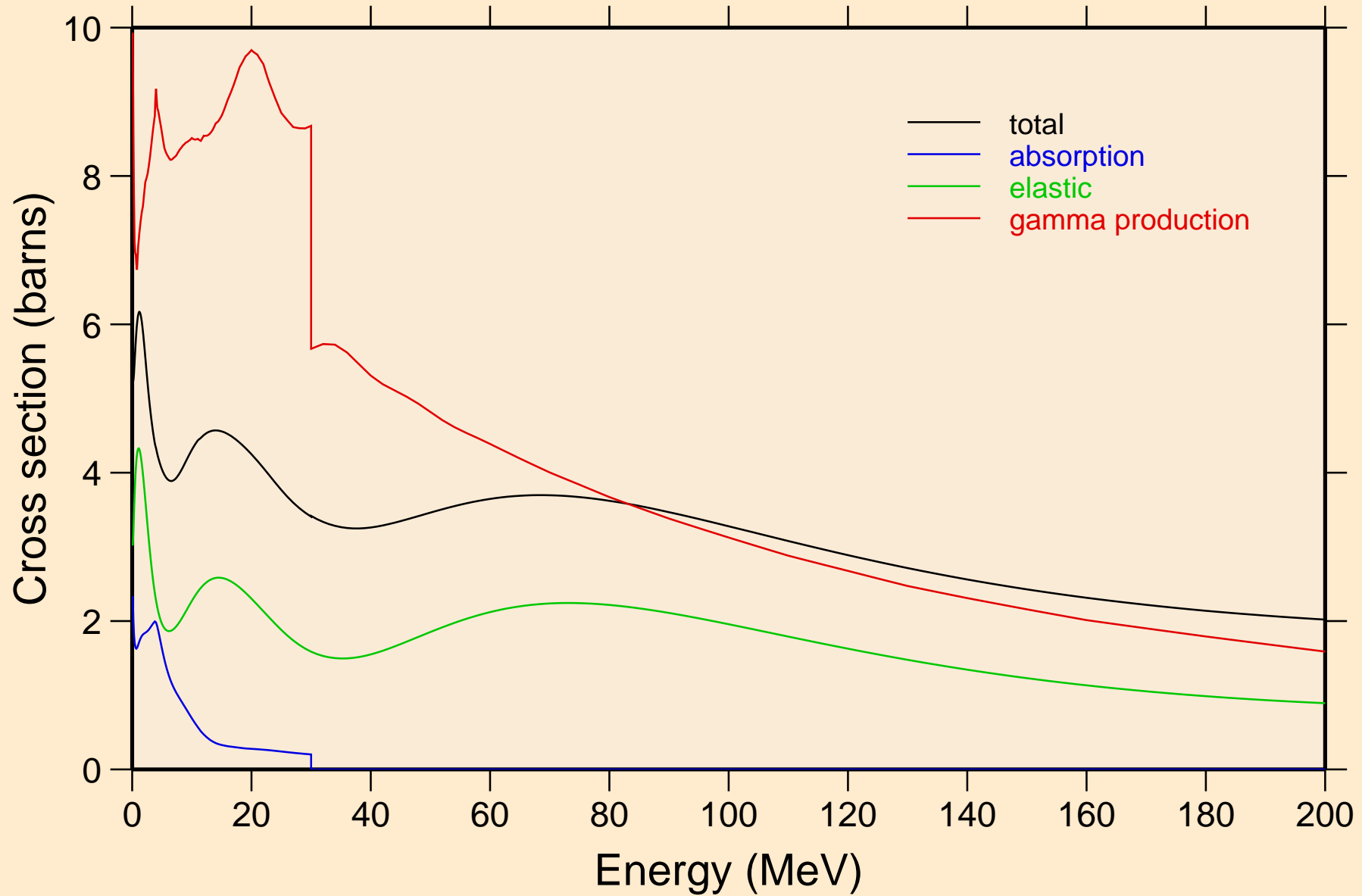

# CS121M NEUTRON ACER TENDL-2024 LIBRARY; T=0.K

## Heating

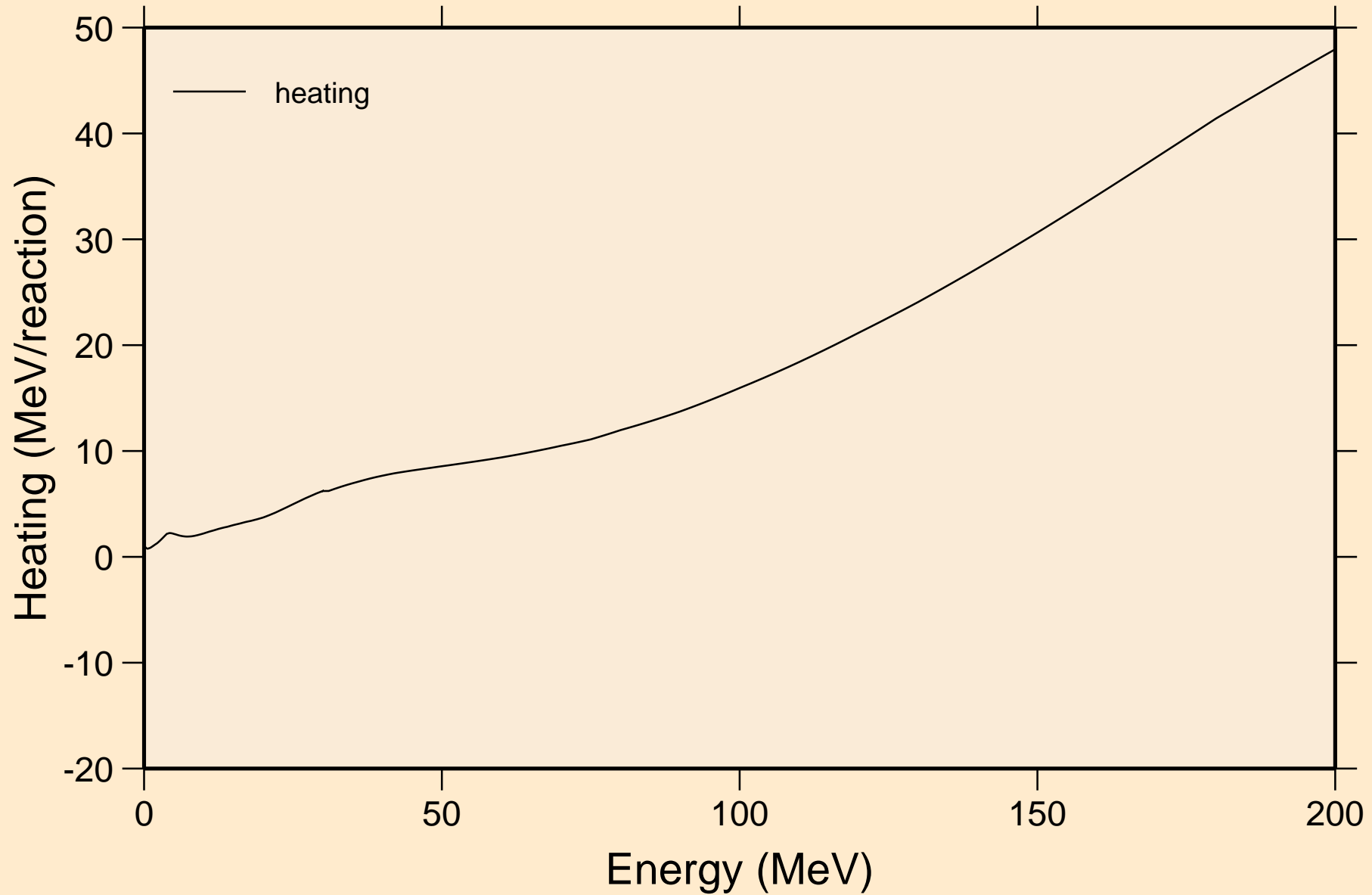

# CS121M NEUTRON ACER TENDL-2024 LIBRARY; T=0.K

## Damage

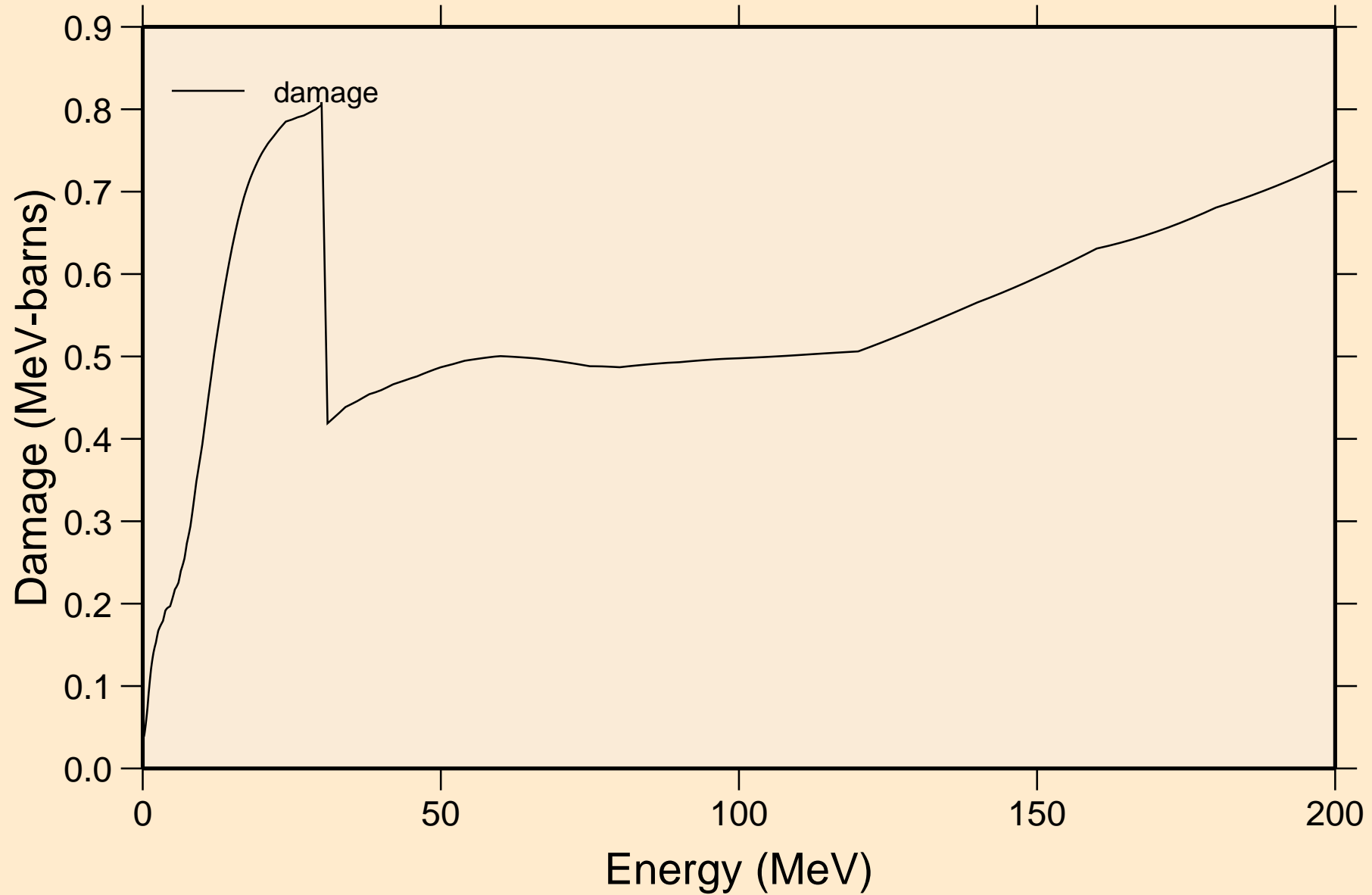

# CS121M NEUTRON ACER TENDL-2024 LIBRARY; T=0.K

## Non-threshold reactions

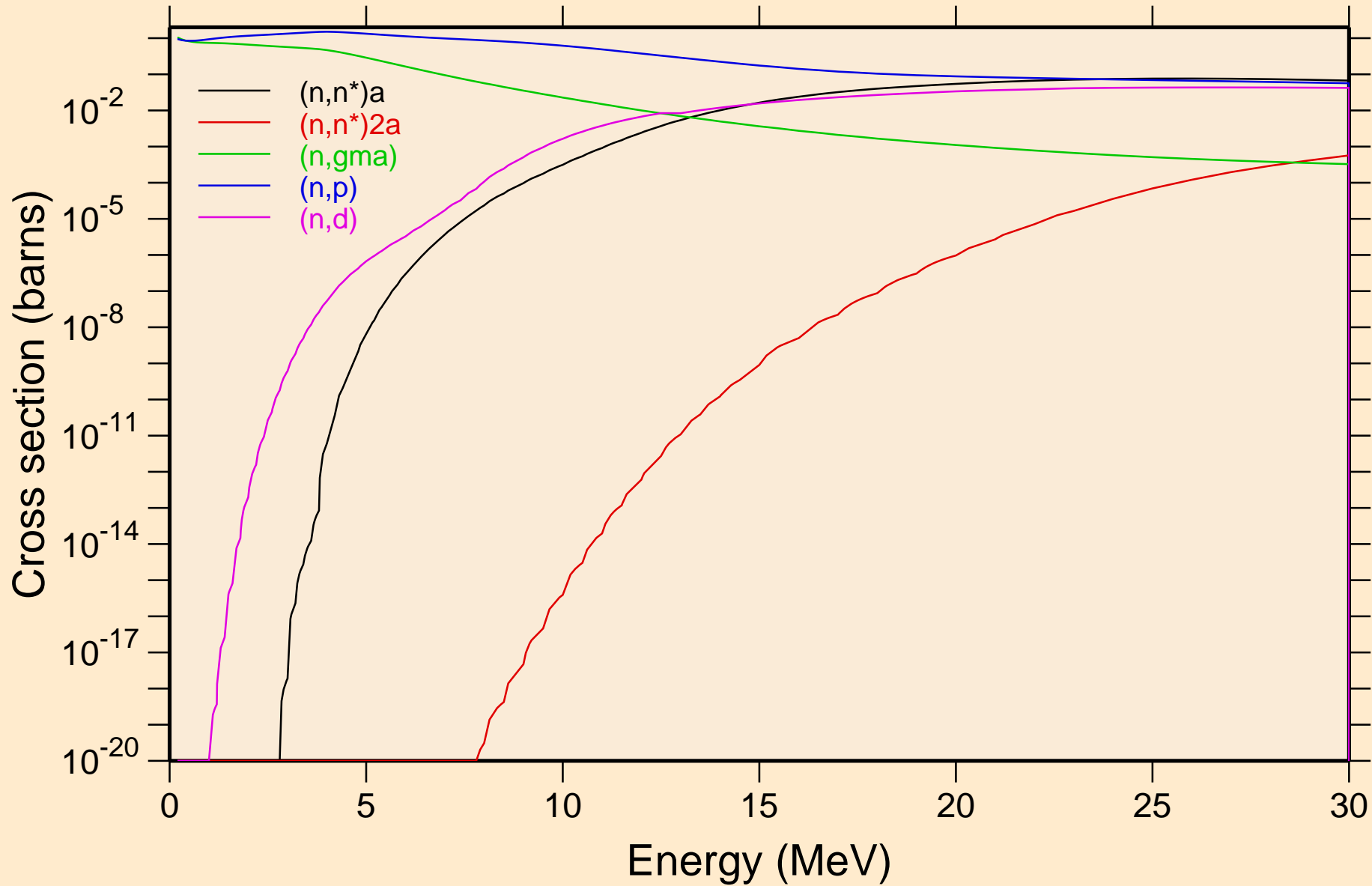

# CS121M NEUTRON ACER TENDL-2024 LIBRARY; T=0.K

## Non-threshold reactions

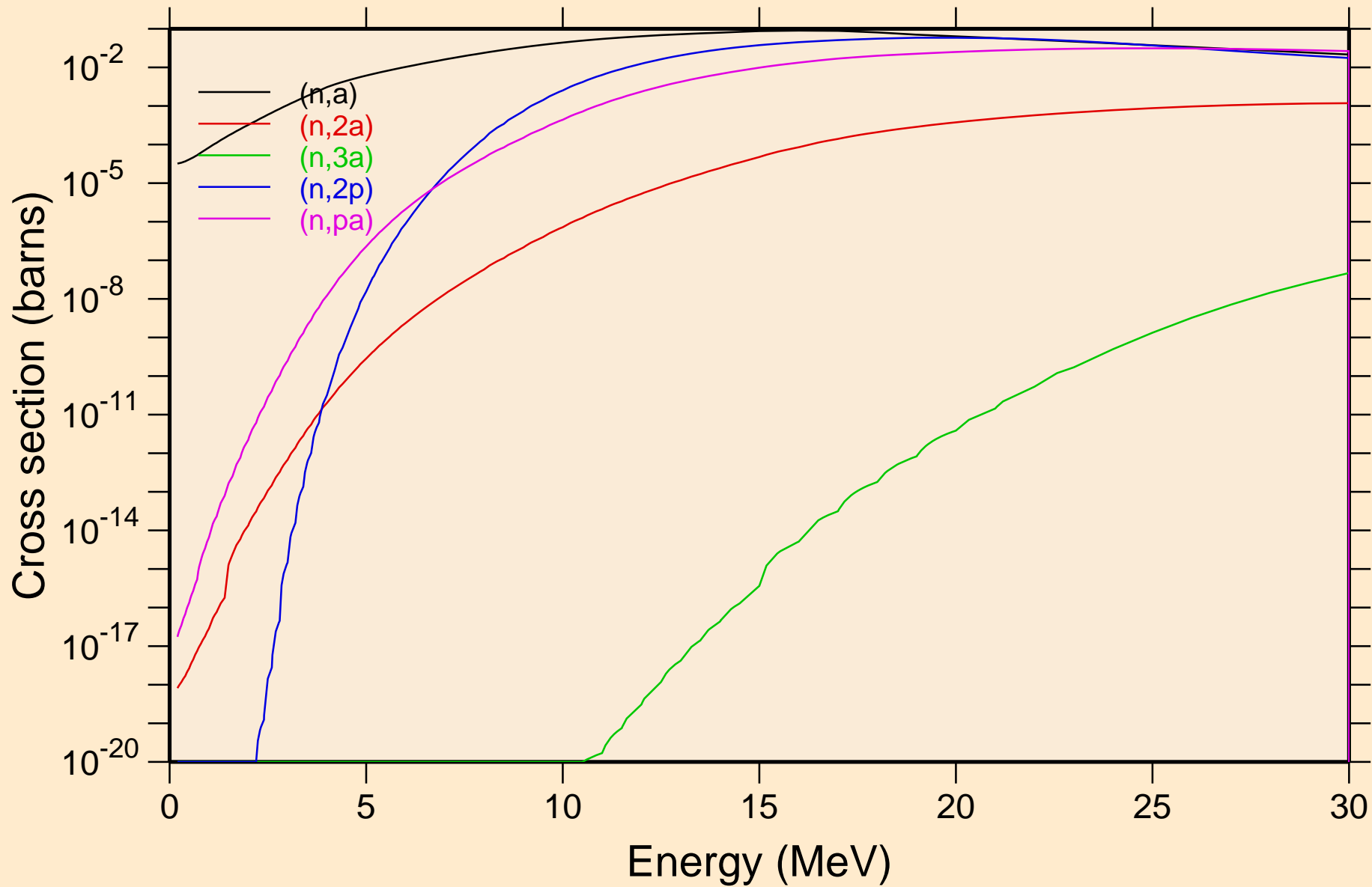

# CS121M NEUTRON ACER TENDL-2024 LIBRARY; T=0.K

## Non-threshold reactions

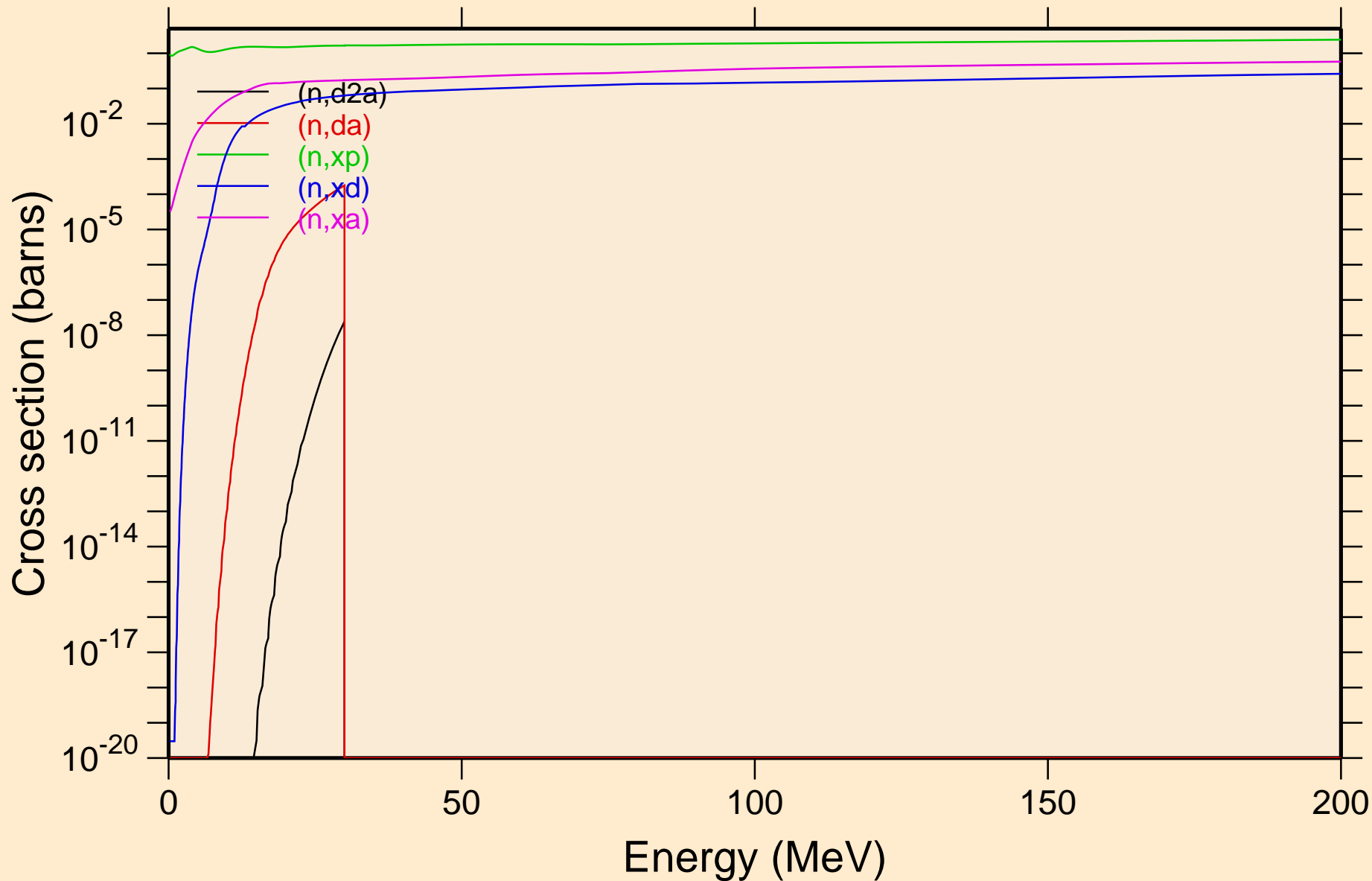

CS121M NEUTRON ACER TENDL-2024 LIBRARY; T=0.K  
Inelastic levels

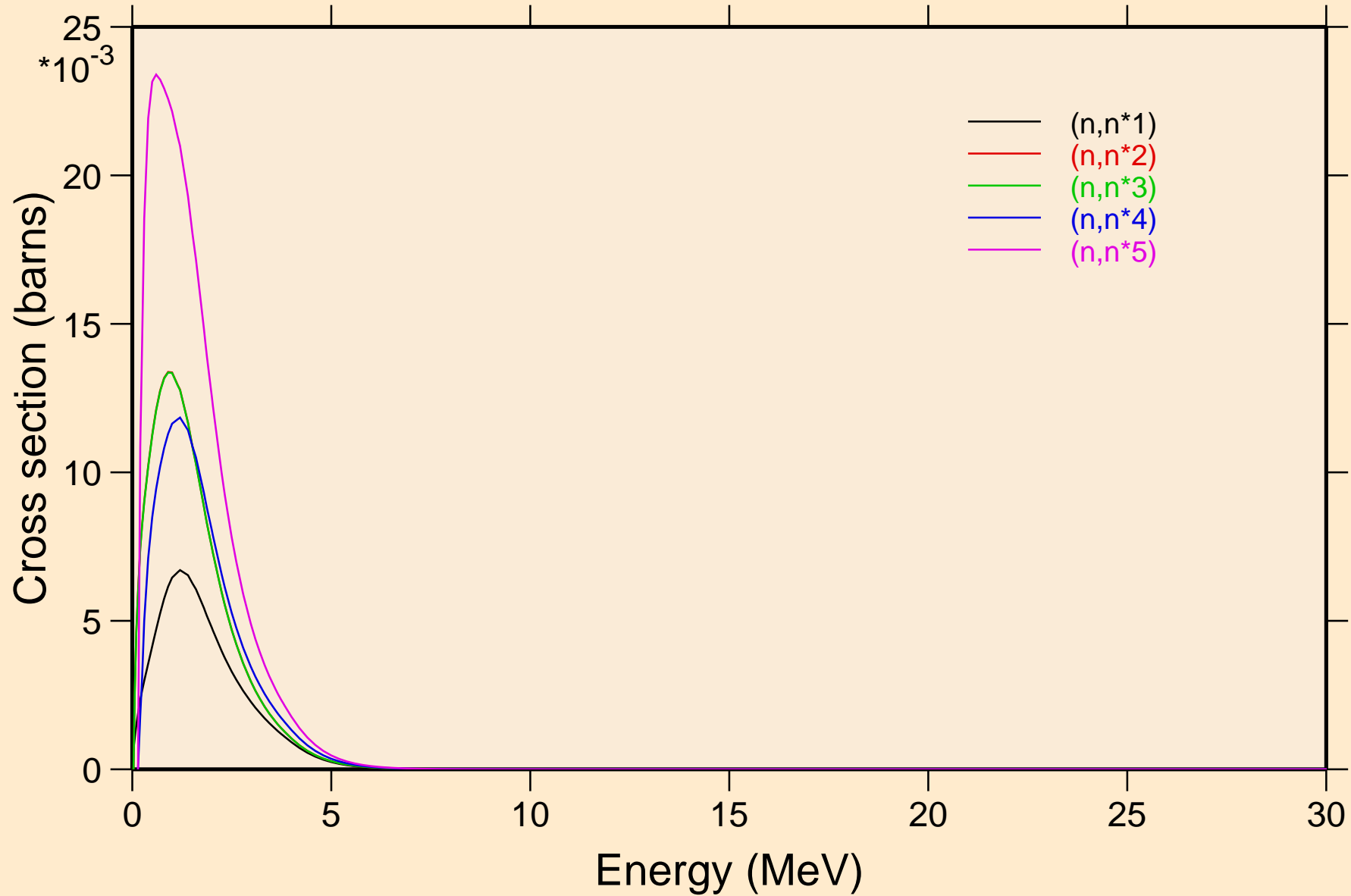

# CS121M NEUTRON ACER TENDL-2024 LIBRARY; T=0.K

## Inelastic levels

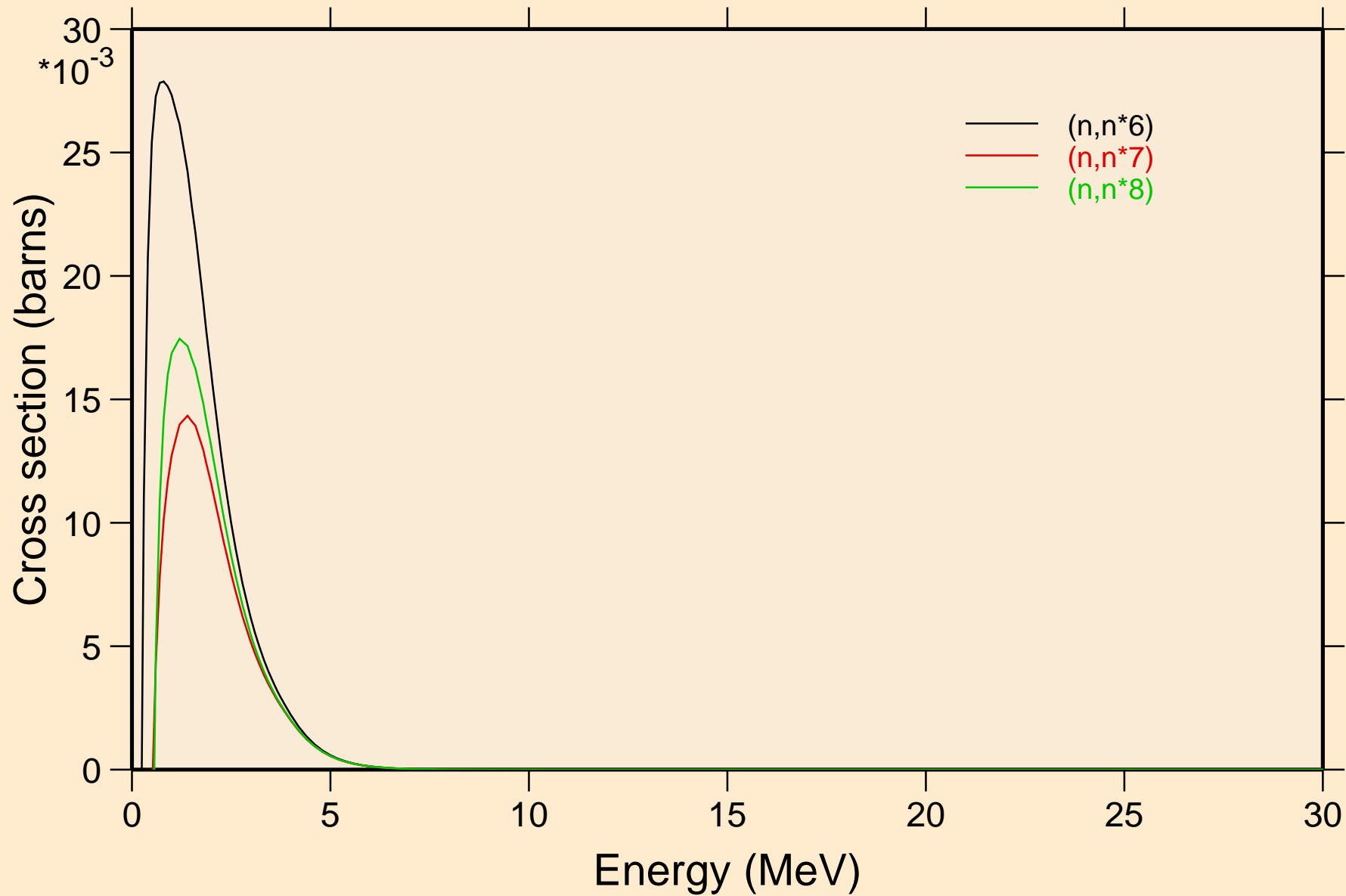

# CS121M NEUTRON ACER TENDL-2024 LIBRARY; T=0.K

## Threshold reactions

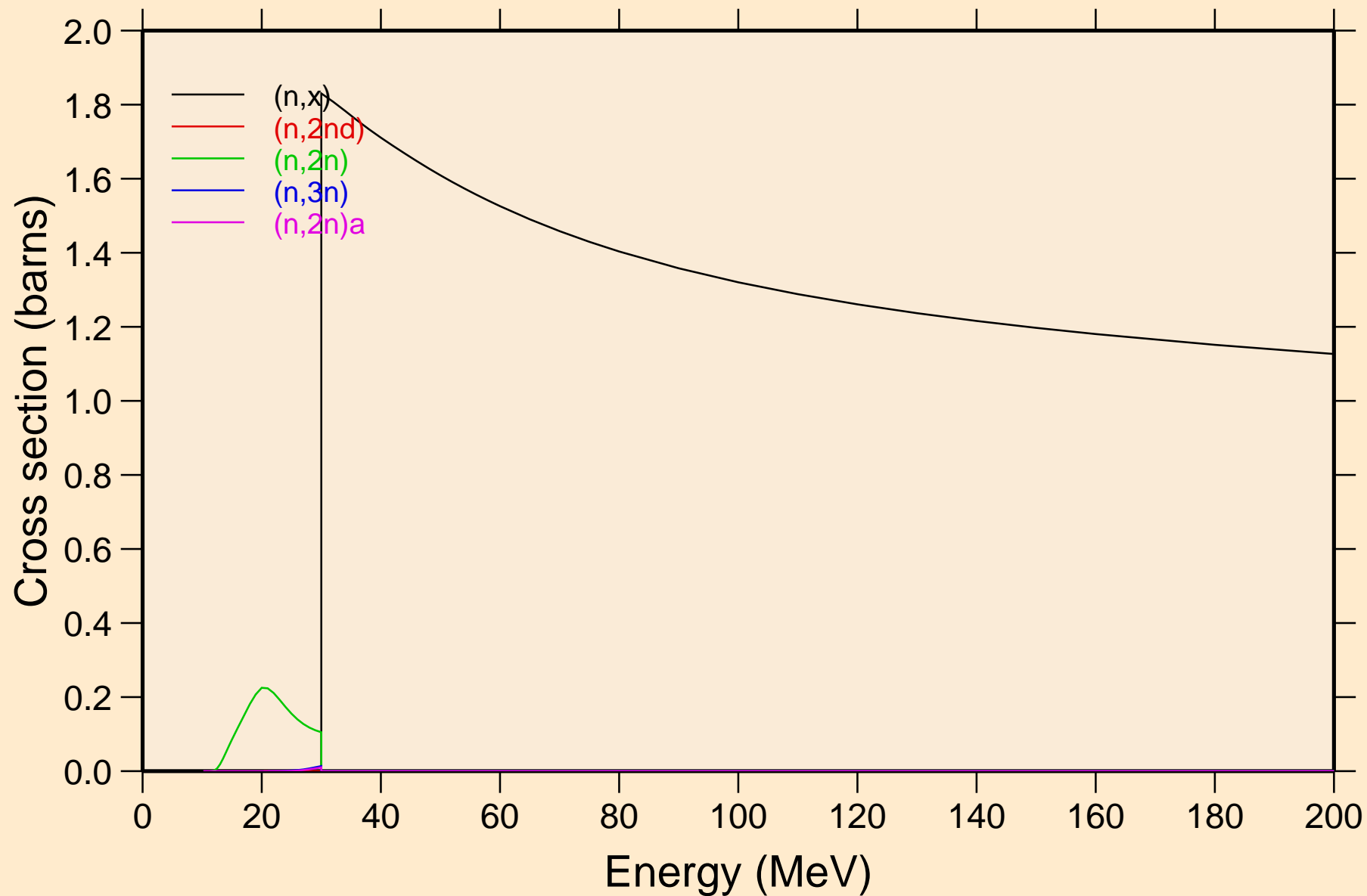

# CS121M NEUTRON ACER TENDL-2024 LIBRARY; T=0.K

## Threshold reactions

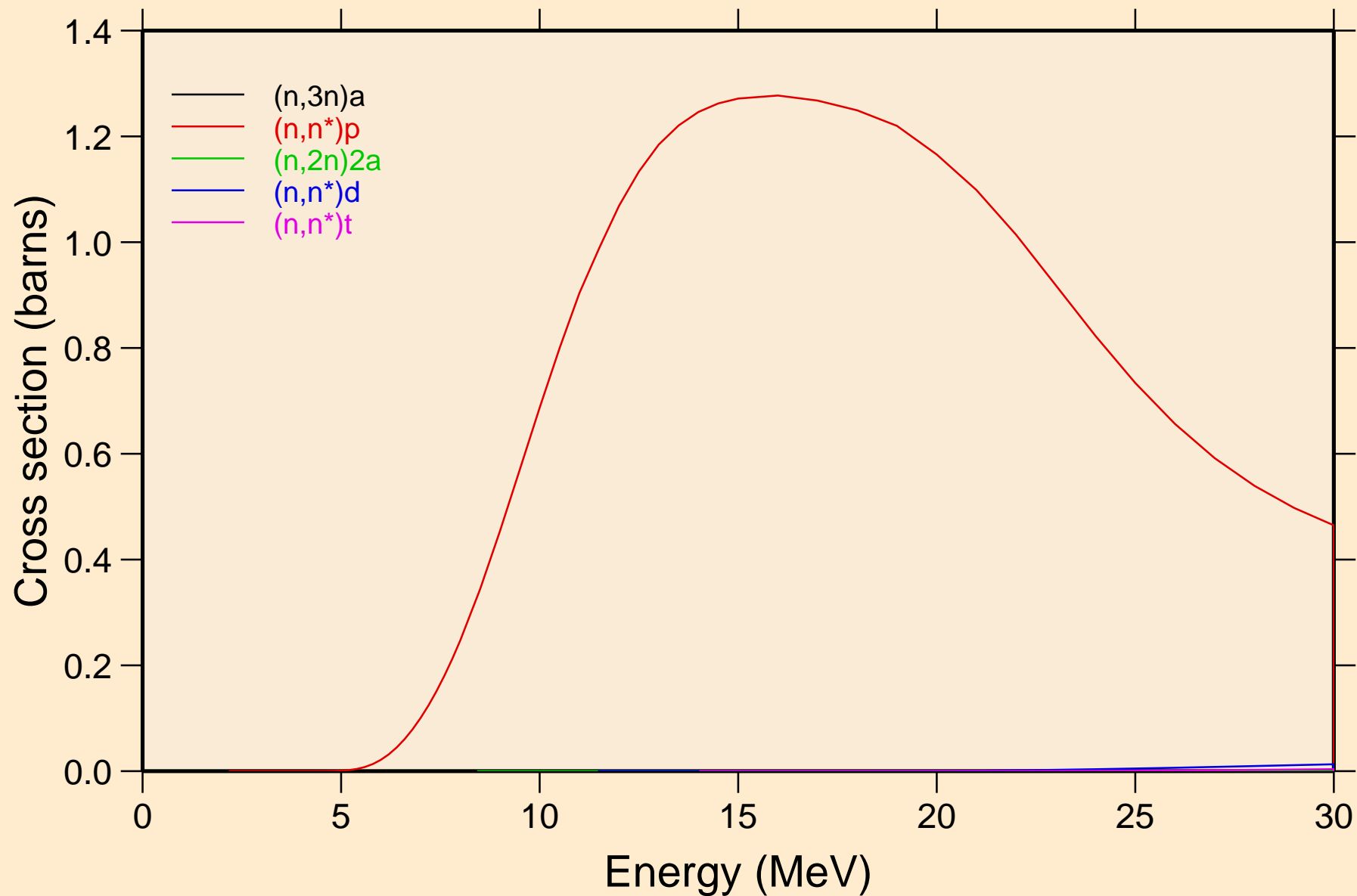

# CS121M NEUTRON ACER TENDL-2024 LIBRARY; T=0.K

## Threshold reactions

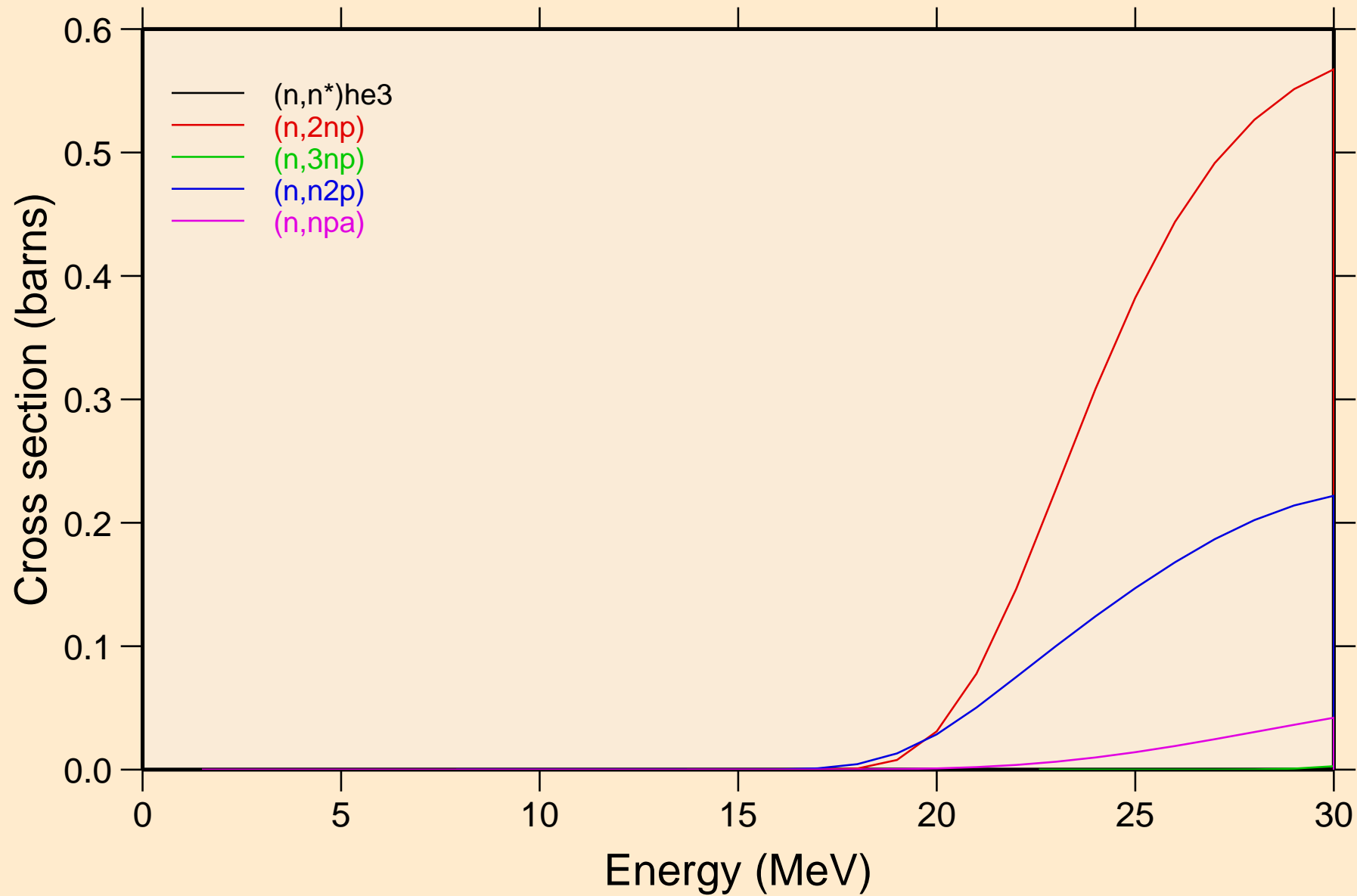

# CS121M NEUTRON ACER TENDL-2024 LIBRARY; T=0.K

## Threshold reactions

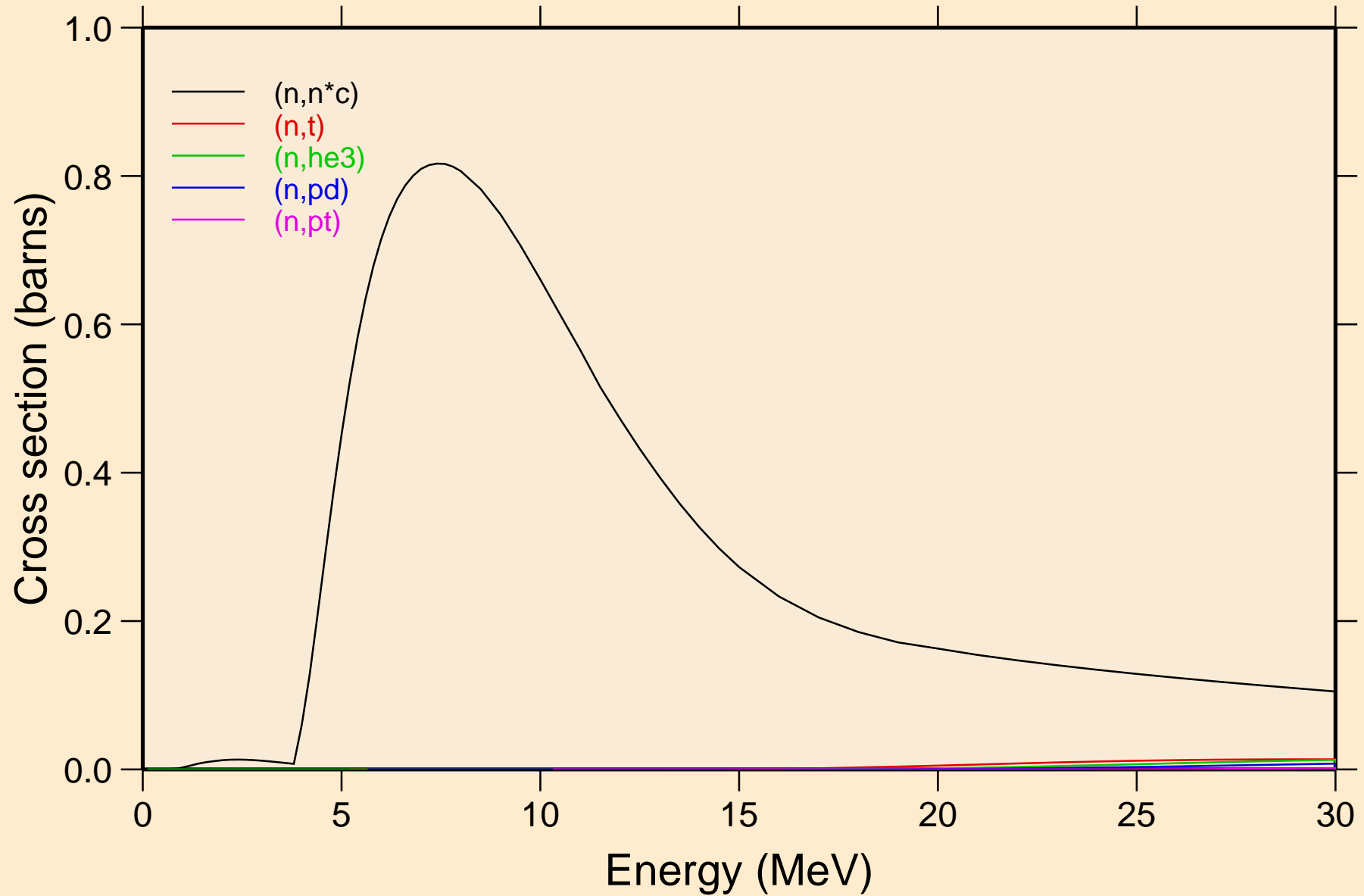

CS121M NEUTRON ACER TENDL-2024 LIBRARY; T=0.K  
Threshold reactions

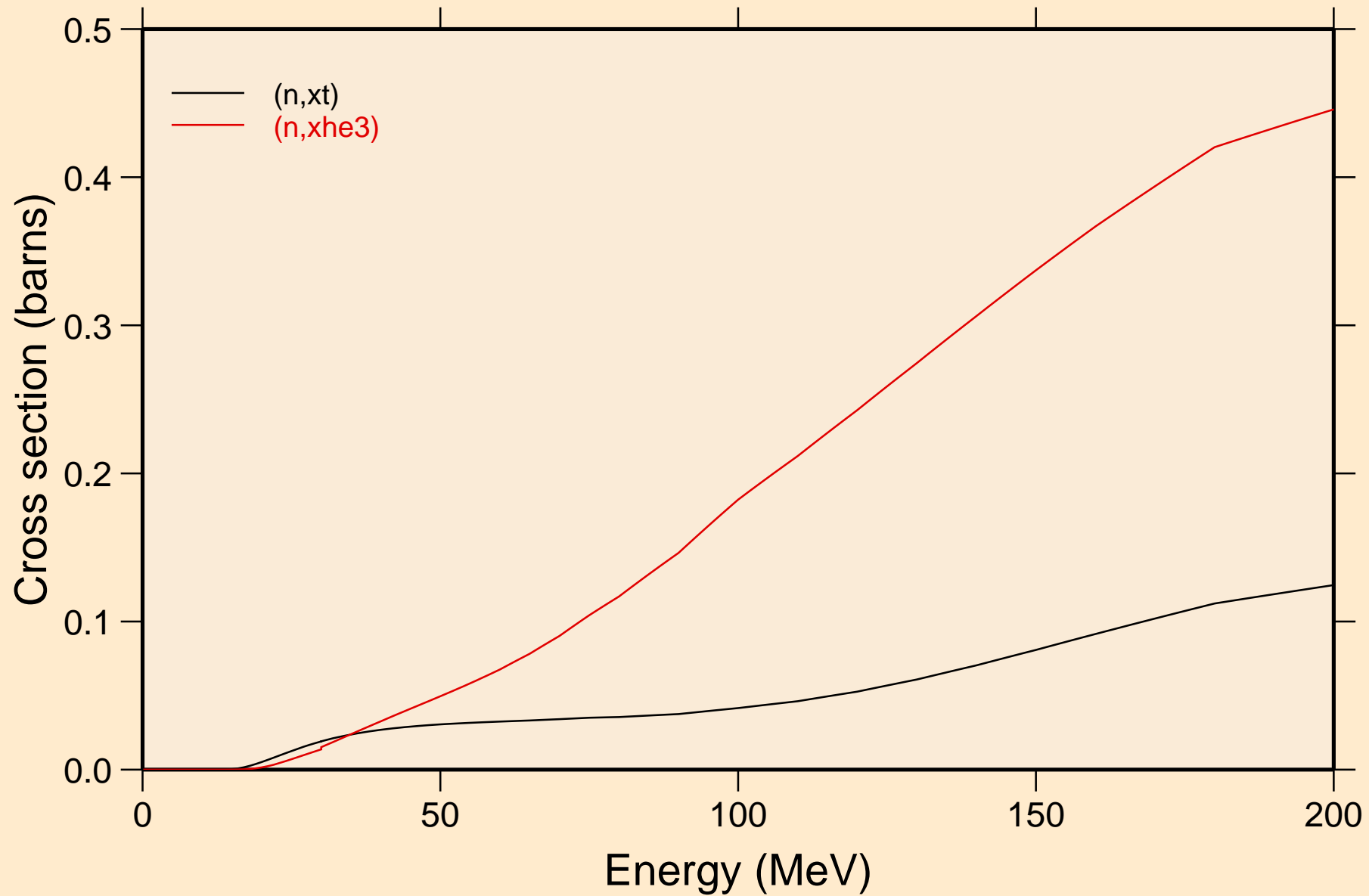

CS121M NEUTRON ACER TENDL-2024 LIBRARY; T=0.K  
angular distribution for elastic

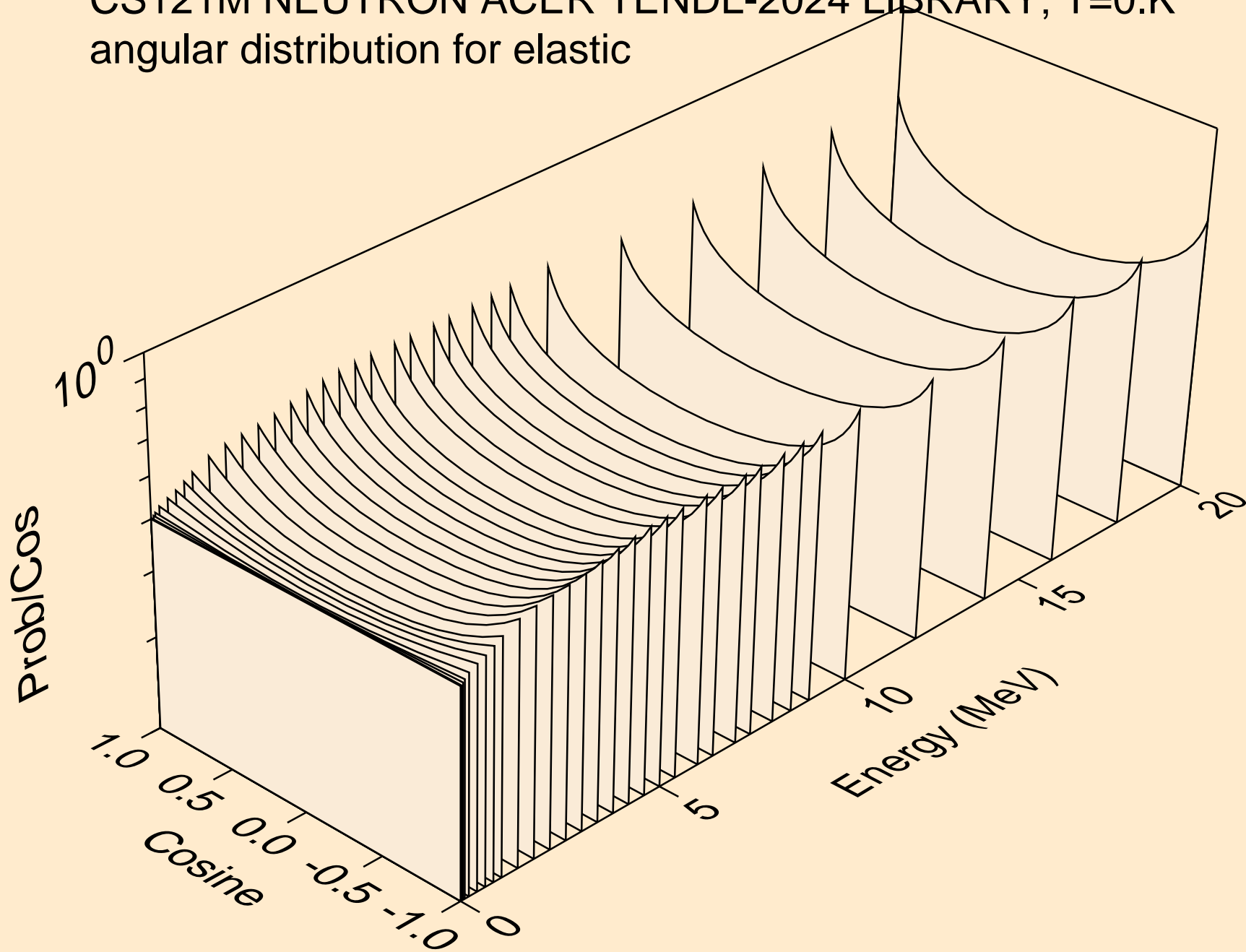

CS121M NEUTRON ACER TENDL-2024 LIBRARY; T=0.K  
angular distribution for elastic

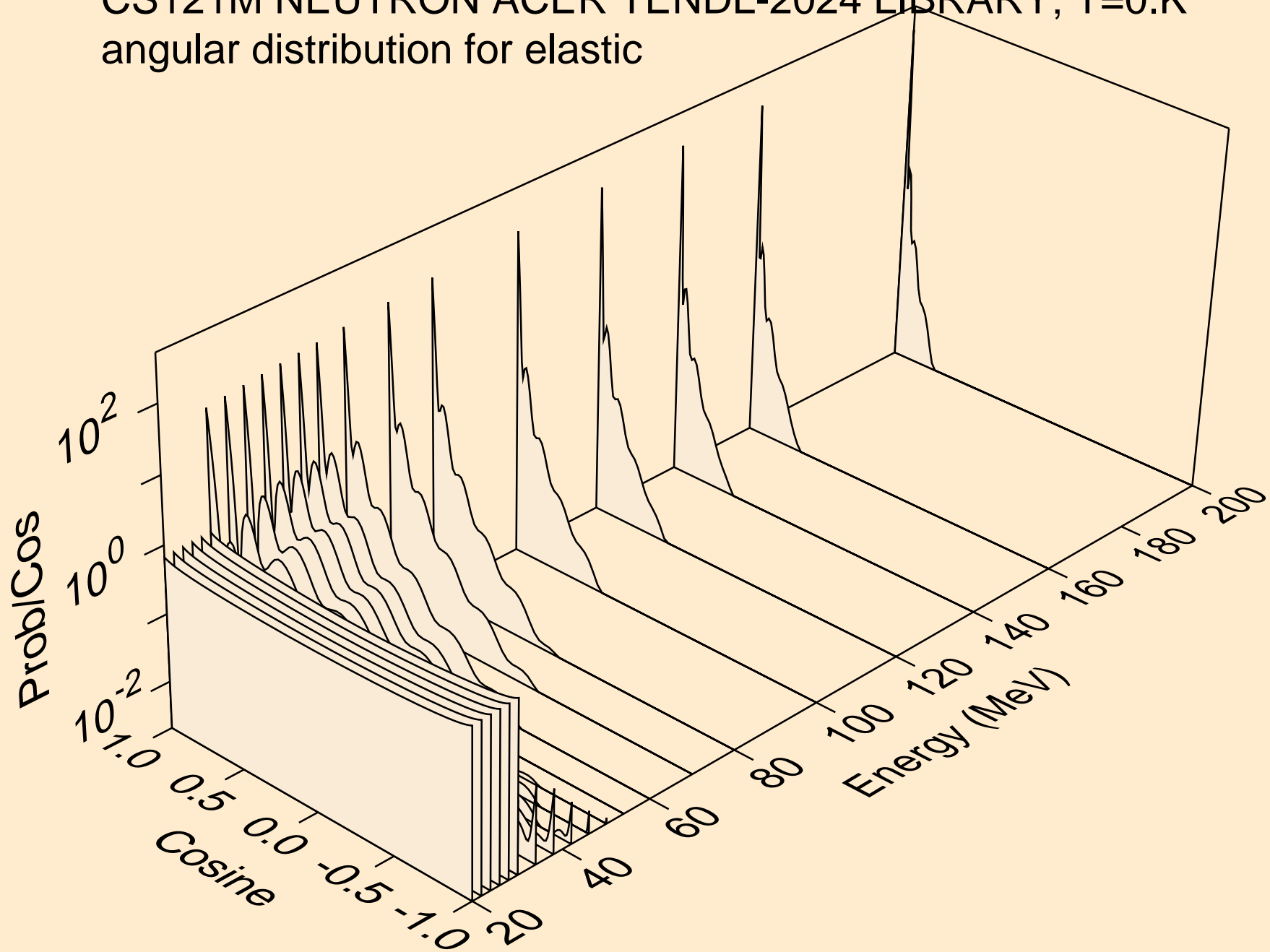

CS121M NEUTRON ACER TENDL-2024 LIBRARY; T=0.K  
angular distribution for (n,n\*1)

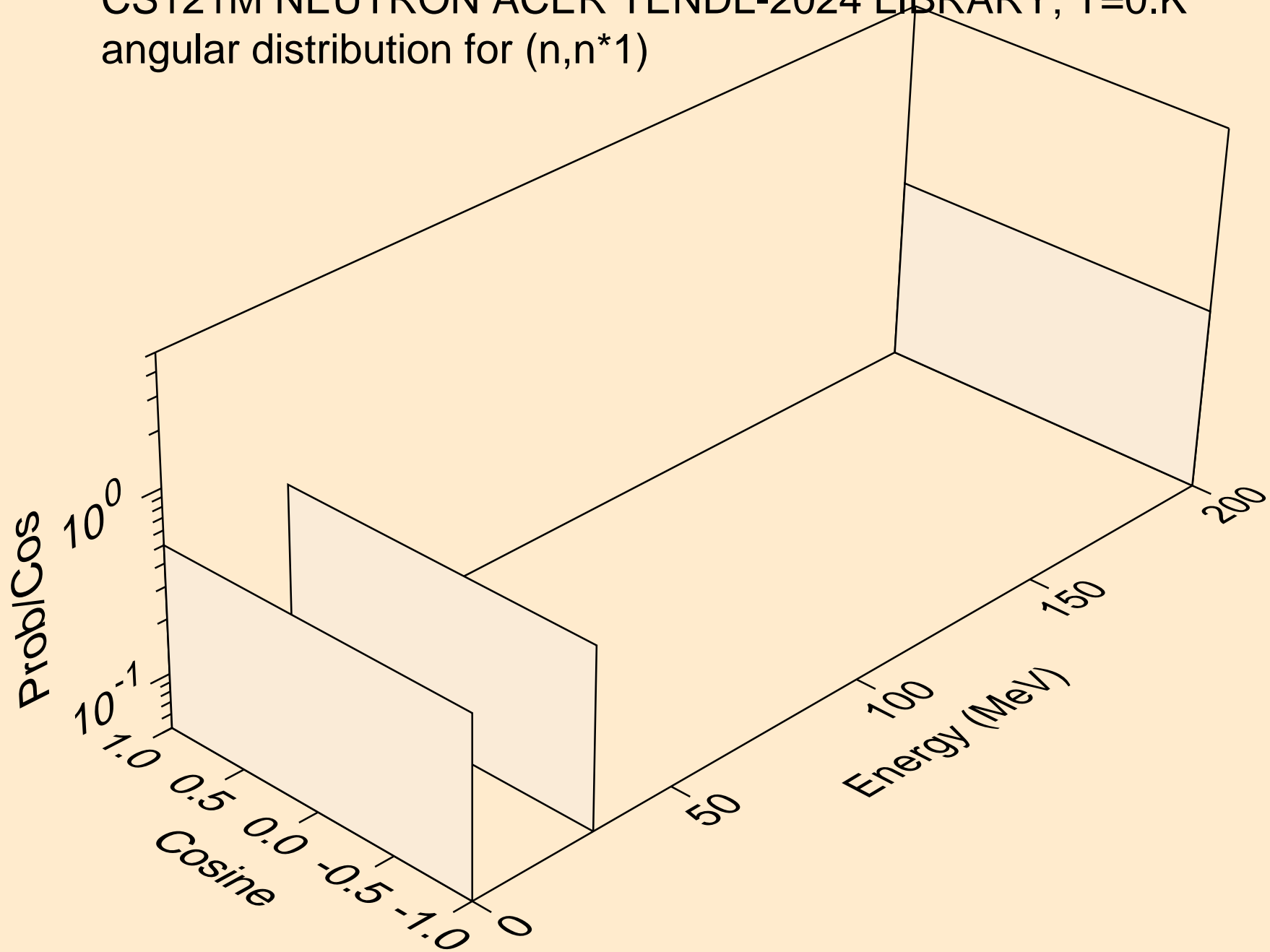

CS121M NEUTRON ACER TENDL-2024 LIBRARY; T=0.K  
angular distribution for (n,n\*2)

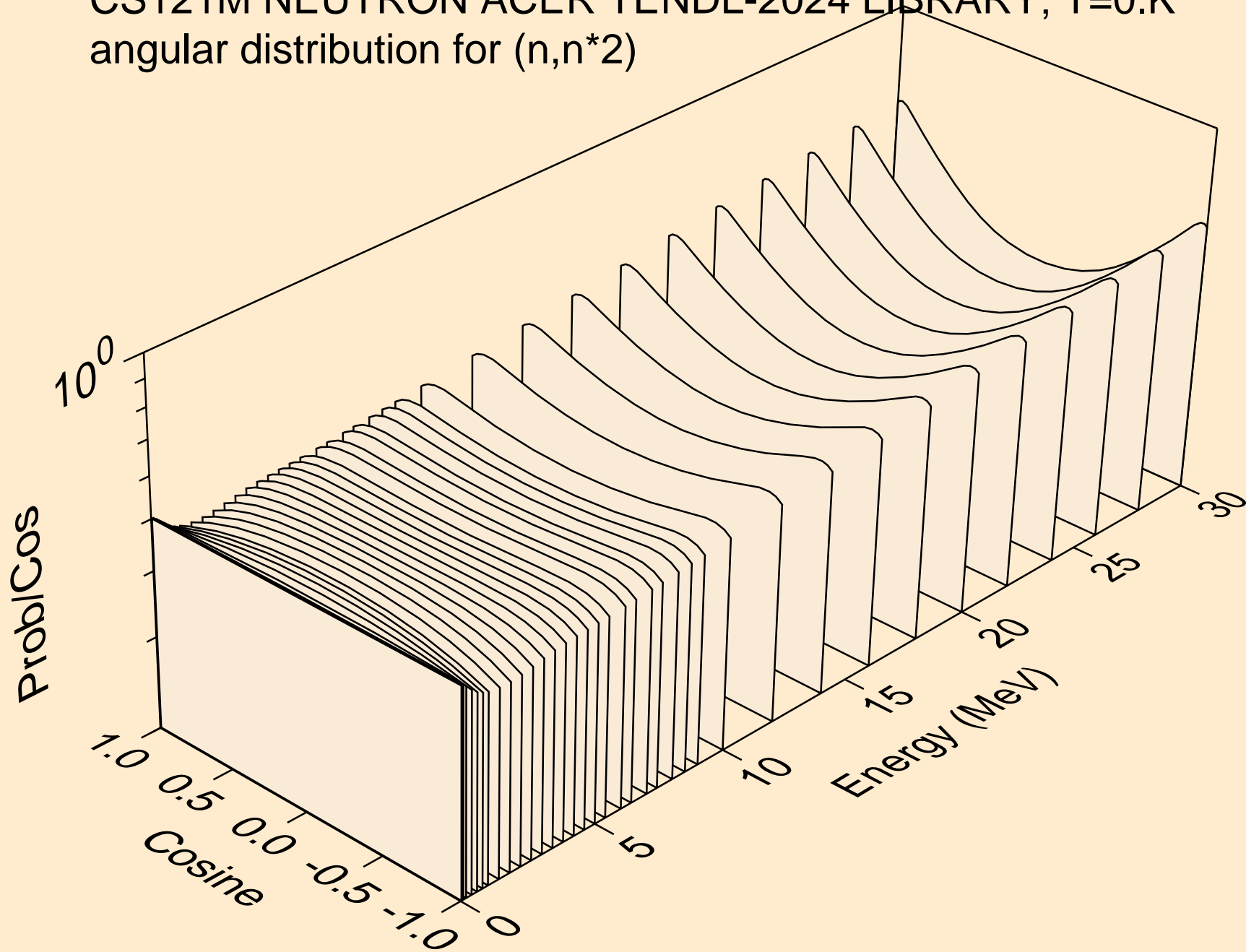

CS121M NEUTRON ACER TENDL-2024 LIBRARY; T=0.K  
angular distribution for (n,n\*3)

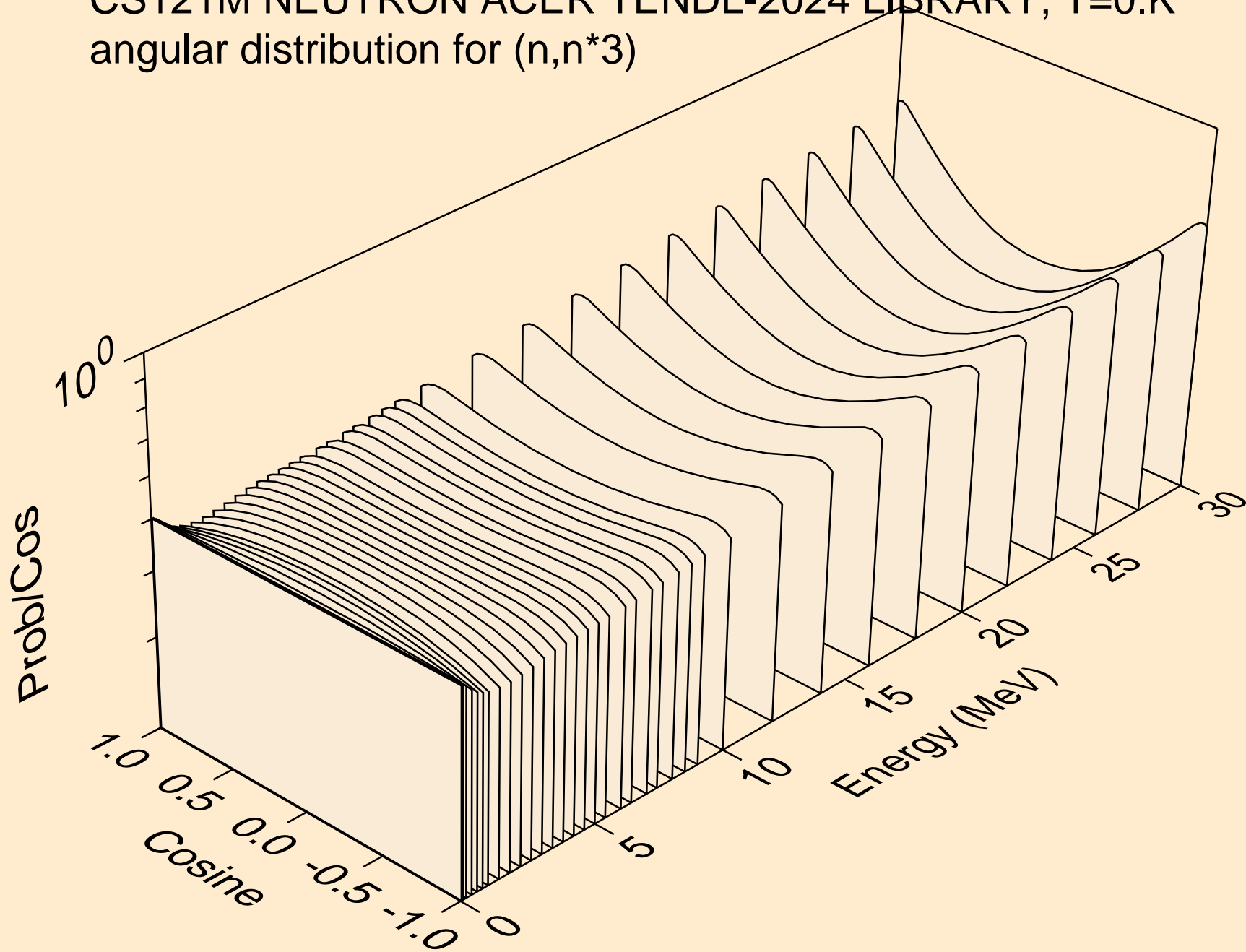

CS121M NEUTRON ACER TENDL-2024 LIBRARY; T=0.K  
angular distribution for (n,n\*4)

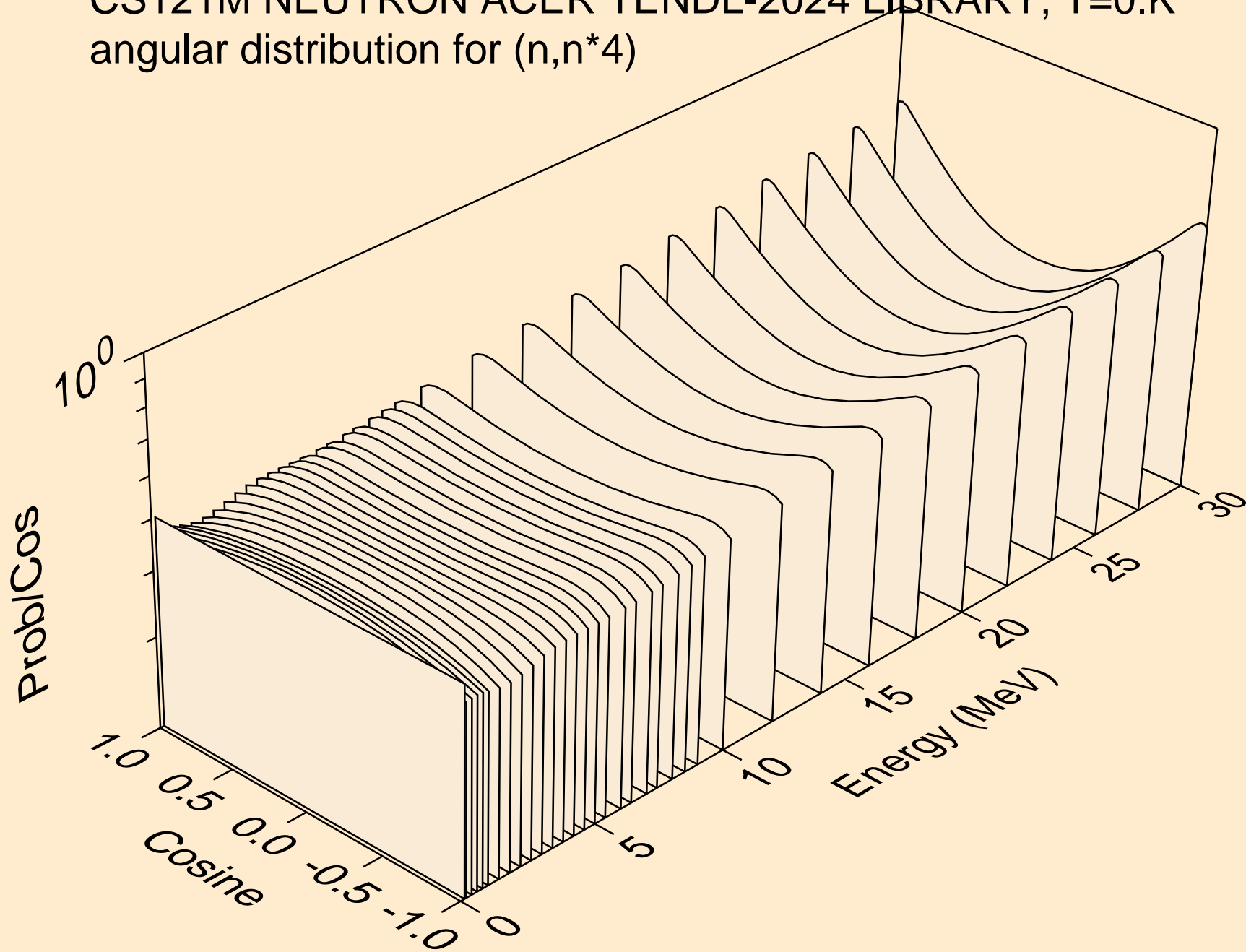

CS121M NEUTRON ACER TENDL-2024 LIBRARY; T=0.K  
angular distribution for (n,n\*5)

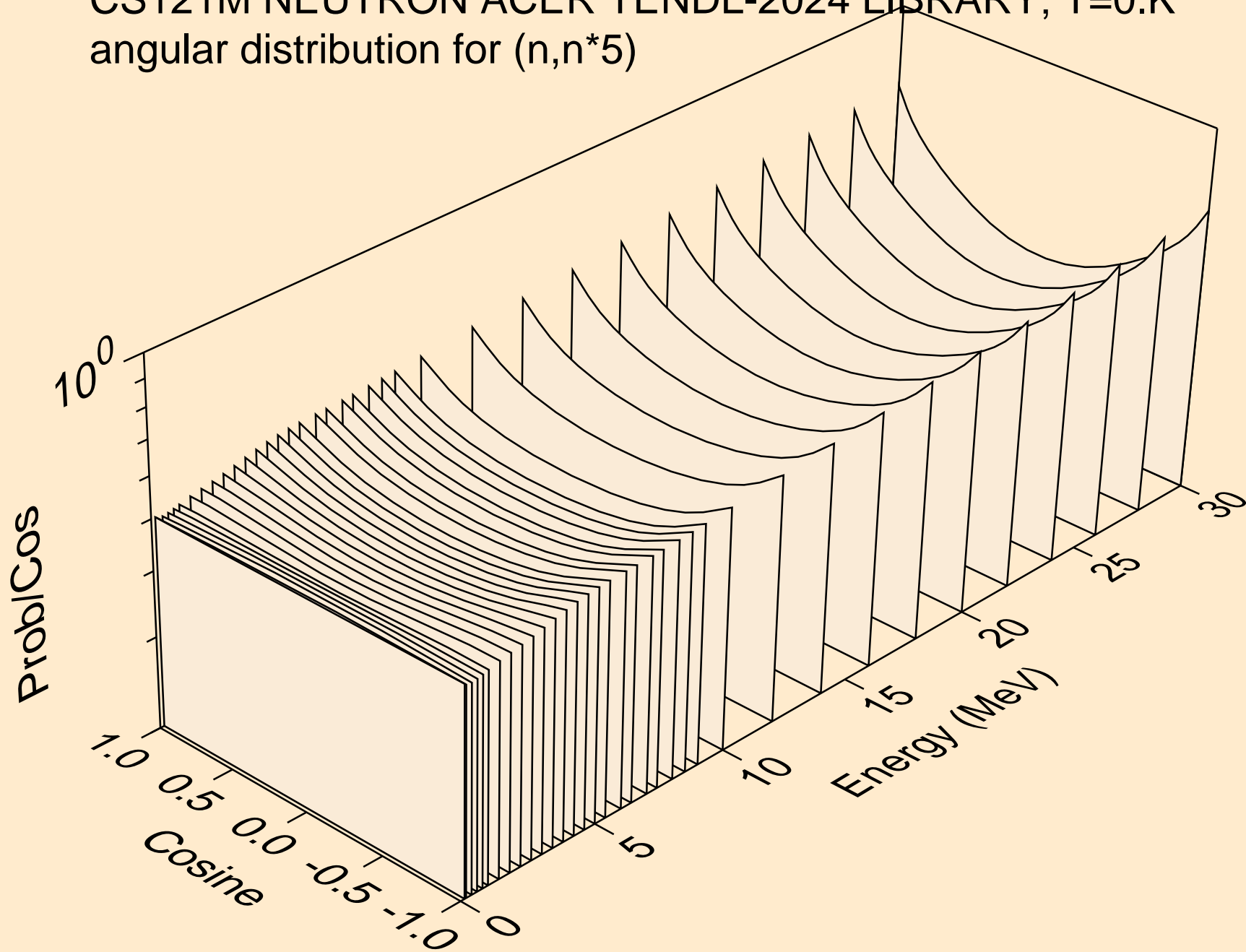

CS121M NEUTRON ACER TENDL-2024 LIBRARY; T=0.K  
angular distribution for (n,n\*6)

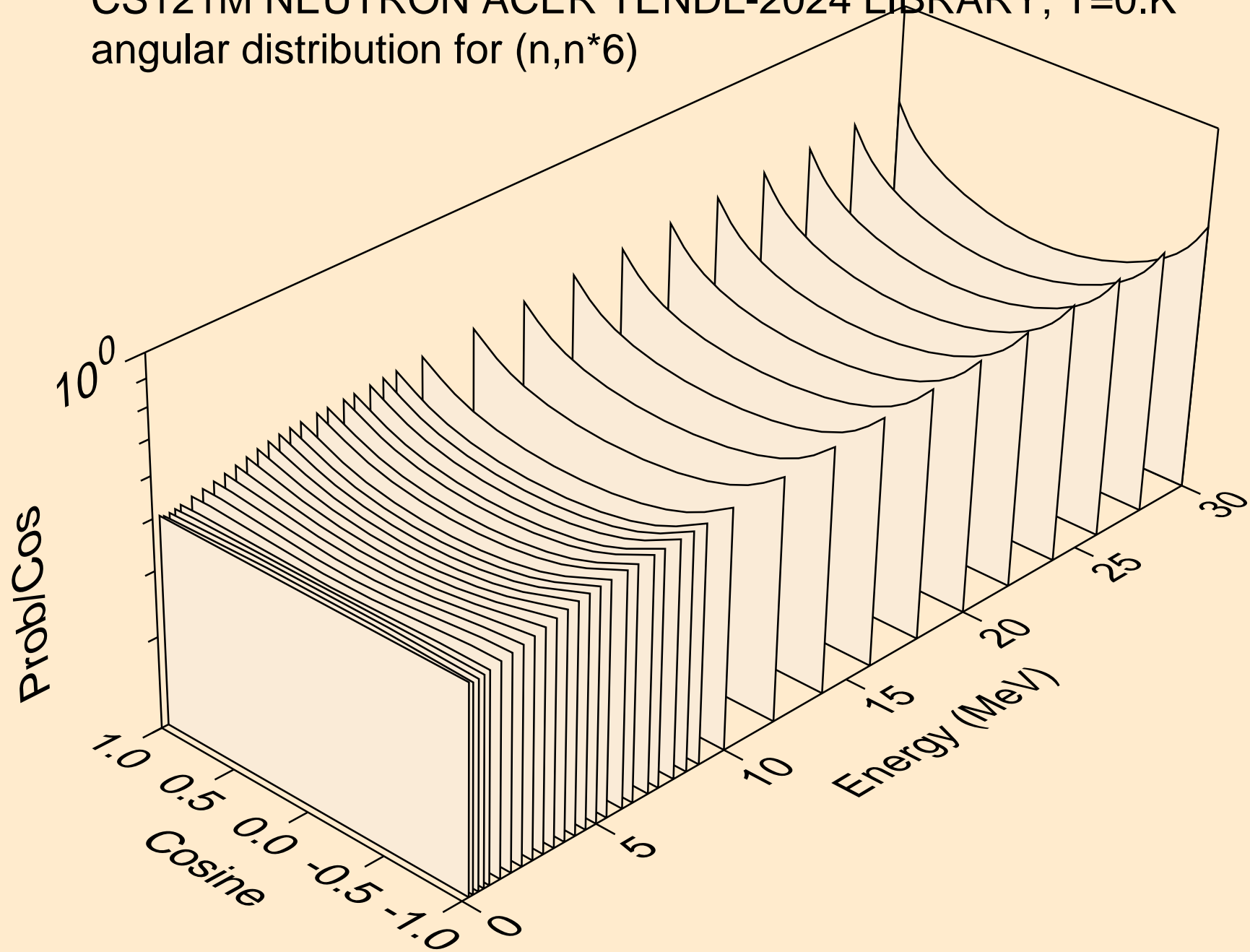

CS121M NEUTRON ACER TENDL-2024 LIBRARY; T=0.K  
angular distribution for (n,n\*7)

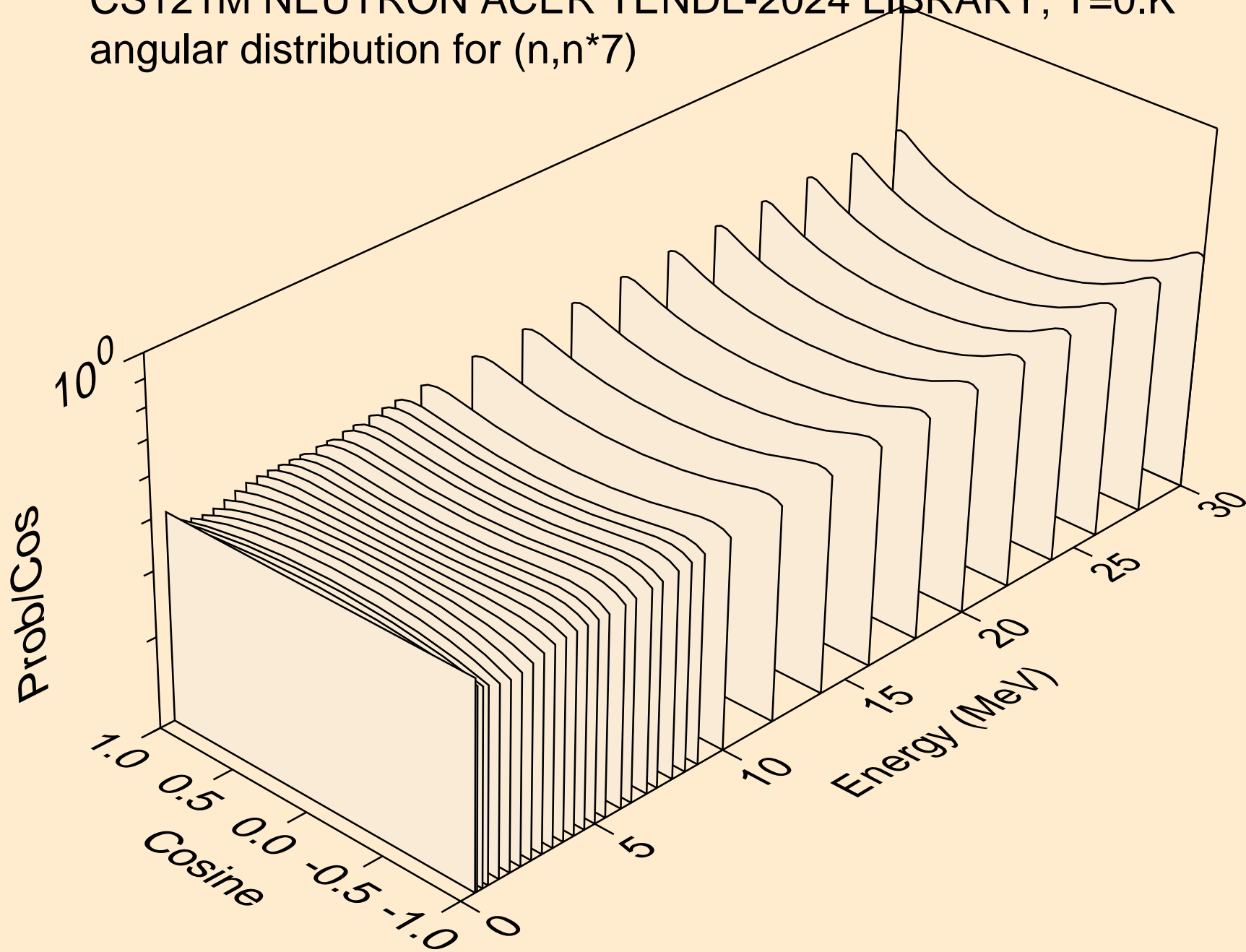

CS121M NEUTRON ACER TENDL-2024 LIBRARY; T=0.K  
angular distribution for (n,n\*8)

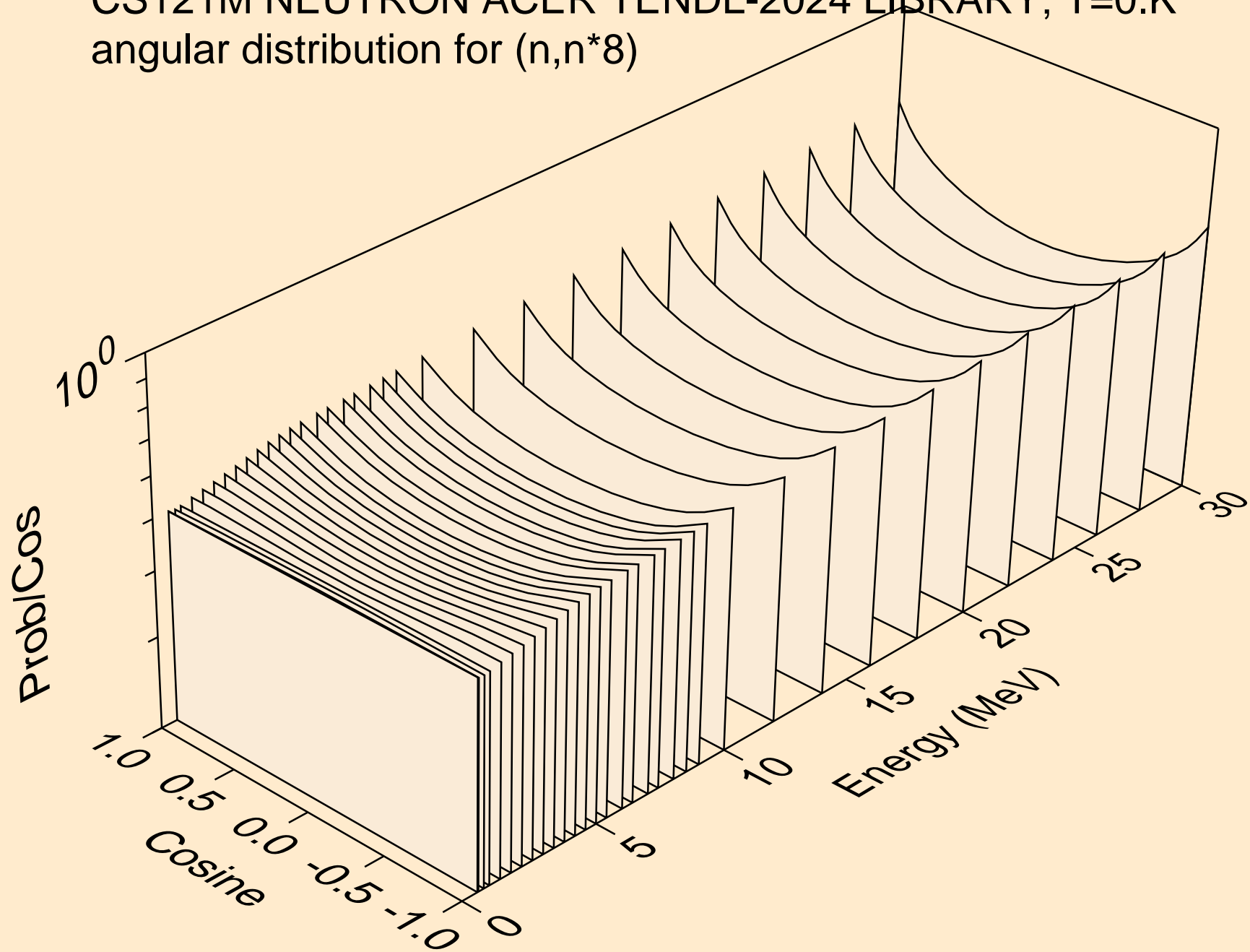

CS121M NEUTRON ACER TENDL-2024 LIBRARY; T=0.K  
Neutron emission for (n,x)

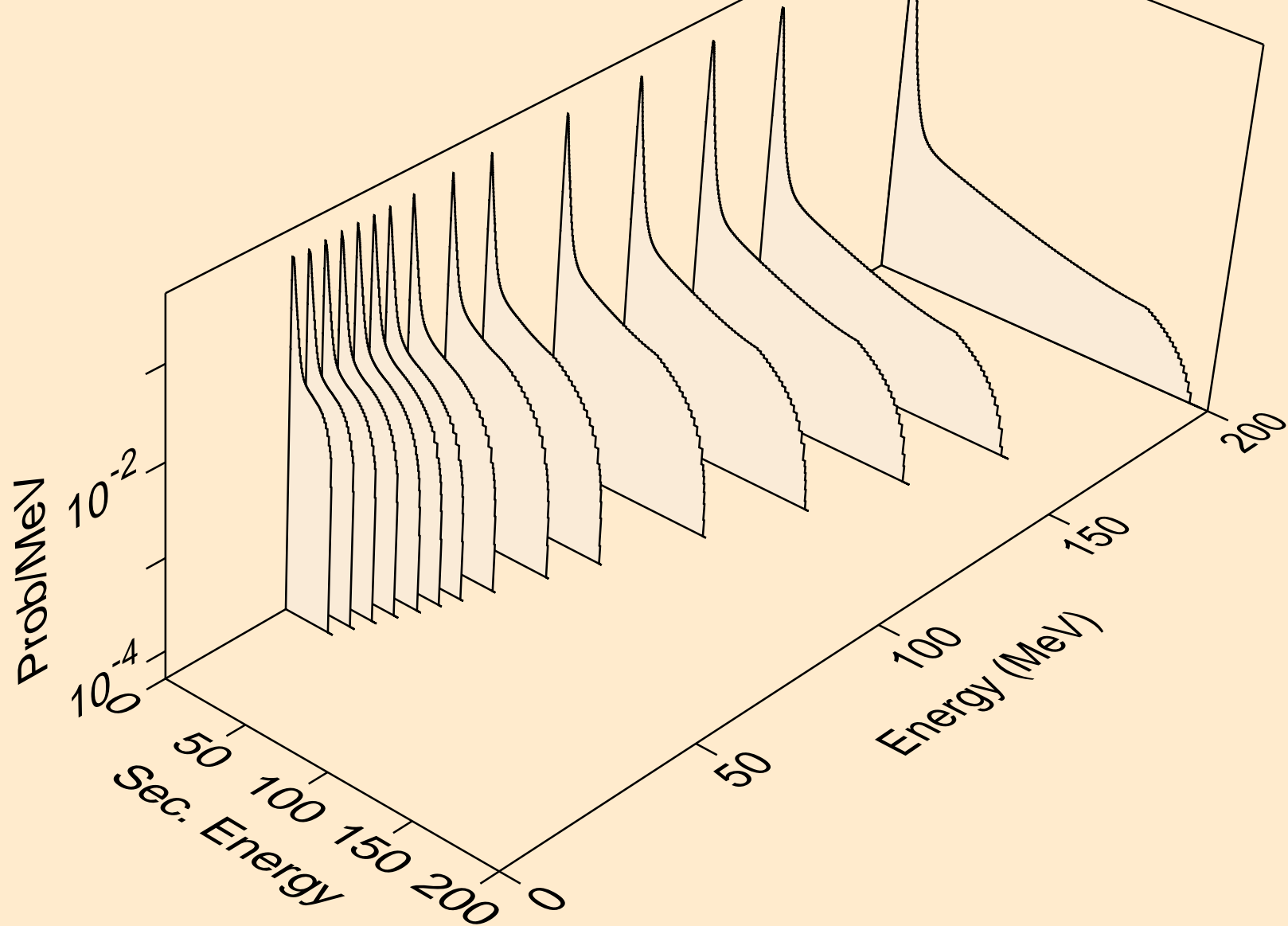

CS121M NEUTRON ACER TENDL-2024 LIBRARY; T=0.K  
Neutron emission for (n,2nd)

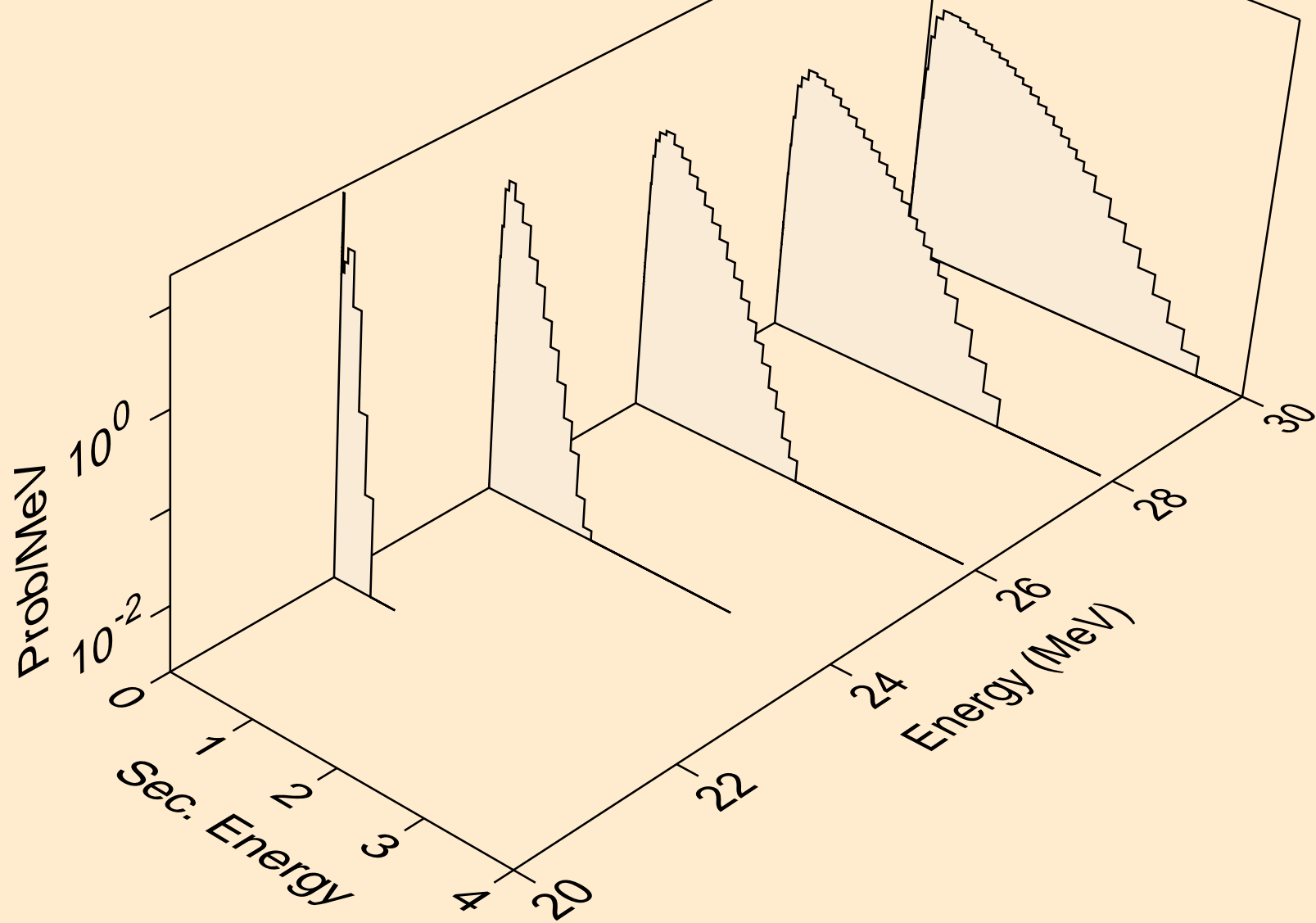

CS121M NEUTRON ACER TENDL-2024 LIBRARY; T=0.K  
Neutron emission for (n,2n)

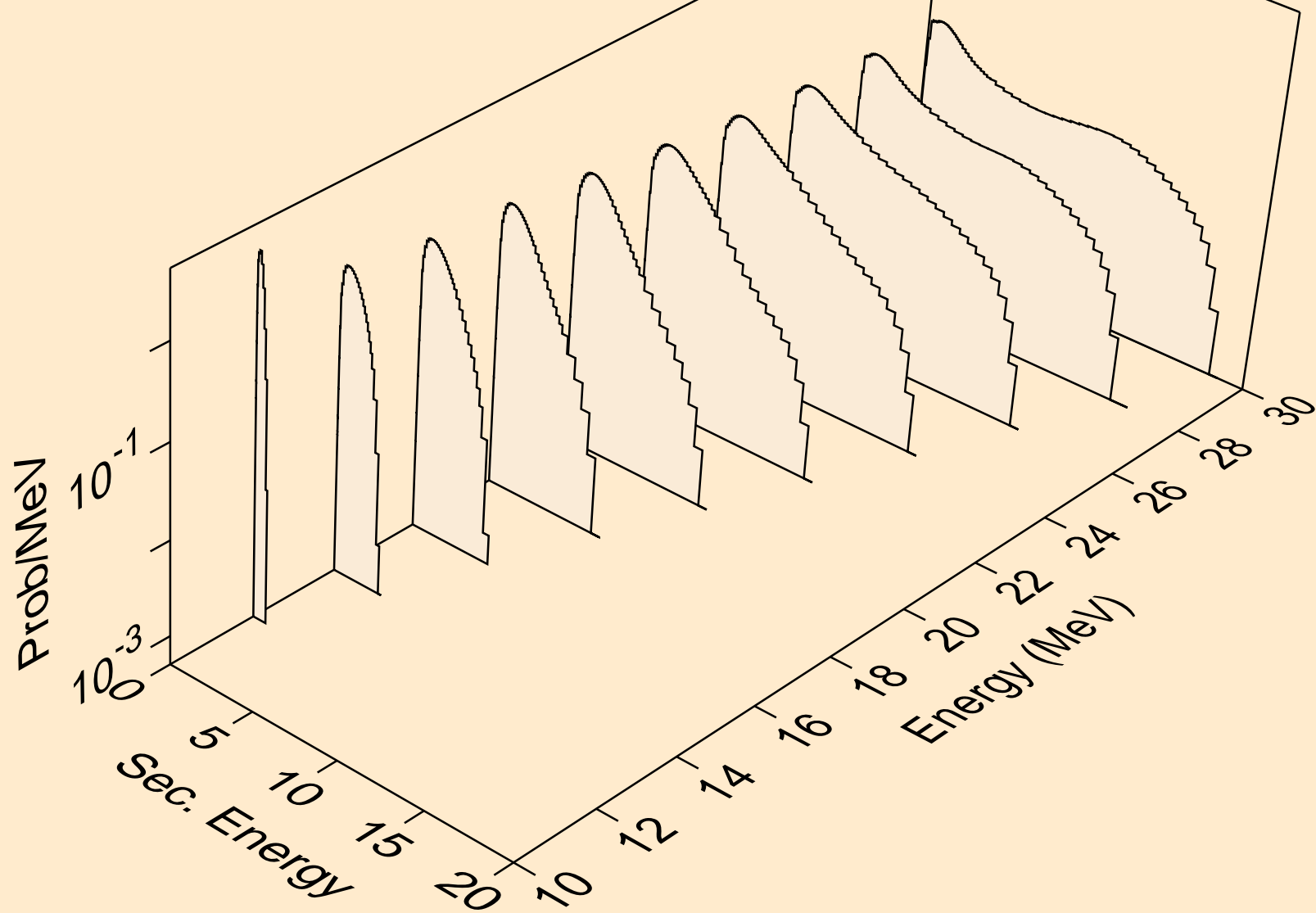

CS121M NEUTRON ACER TENDL-2024 LIBRARY; T=0.K  
Neutron emission for (n,3n)

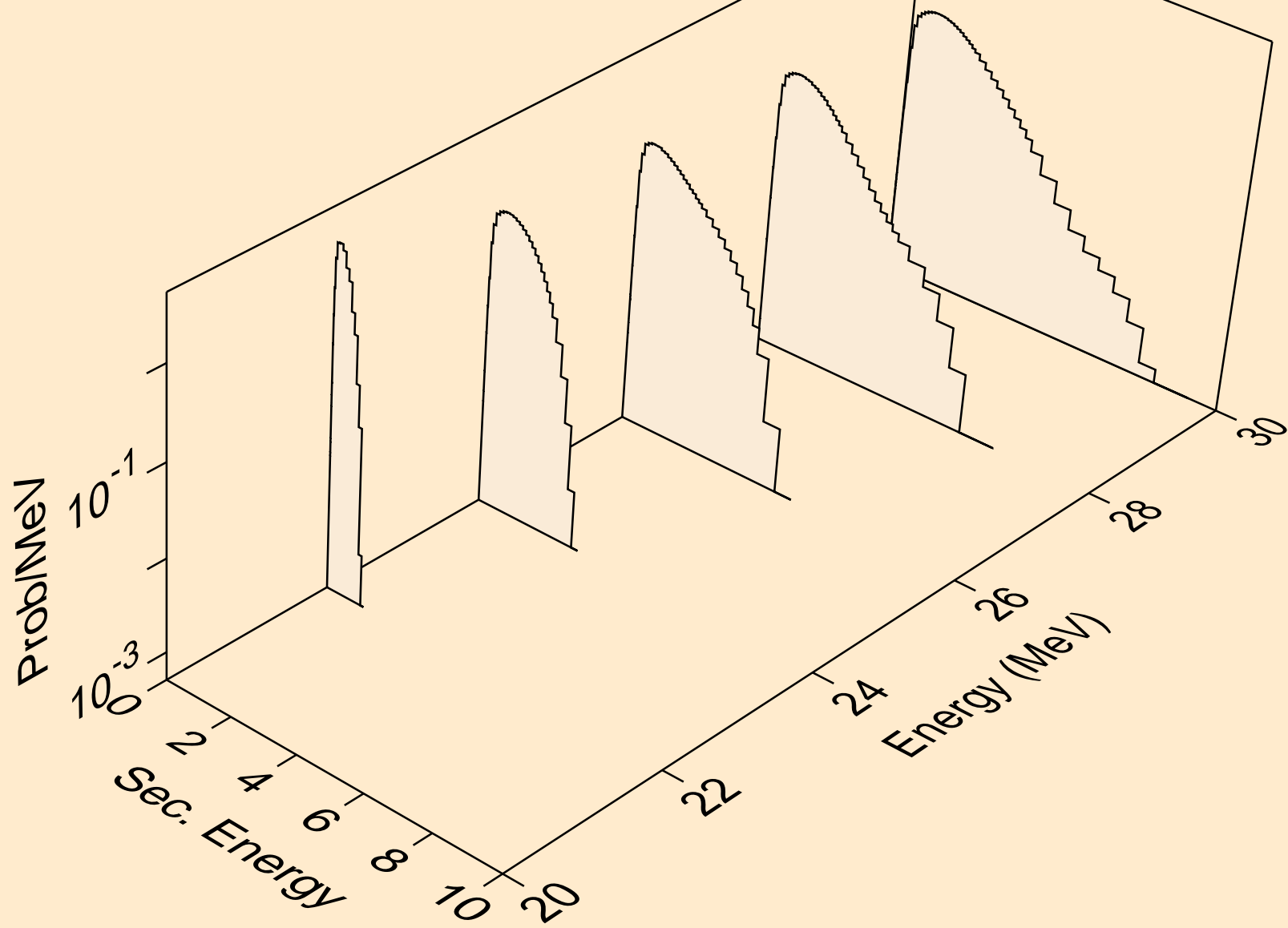

CS121M NEUTRON ACER TENDL-2024 LIBRARY; T=0.K  
Neutron emission for (n,n\*)a

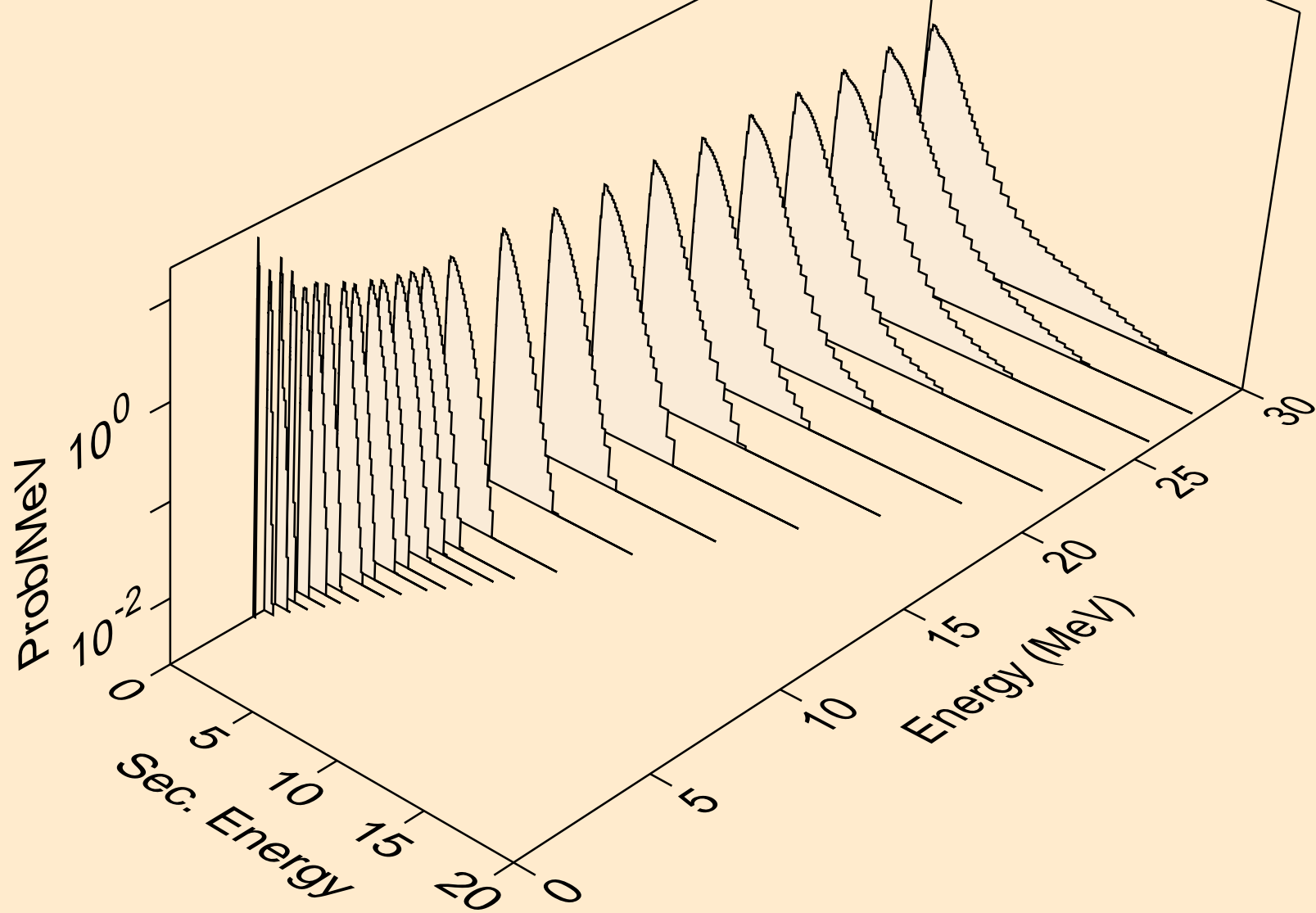

CS121M NEUTRON ACER TENDL-2024 LIBRARY; T=0.K  
Neutron emission for (n,2n)a

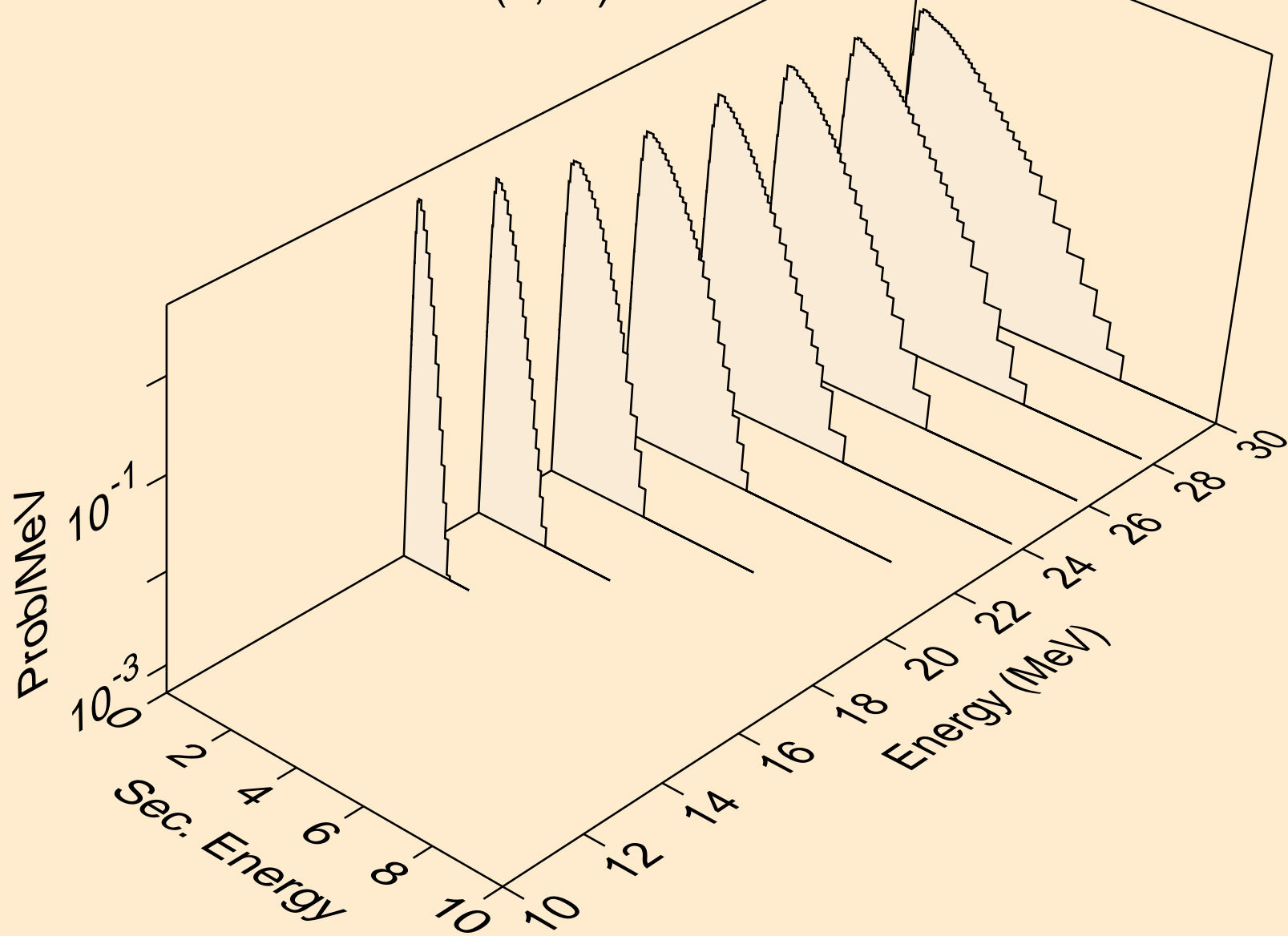

CS121M NEUTRON ACER TENDL-2024 LIBRARY; T=0.K  
Neutron emission for (n,3n)a

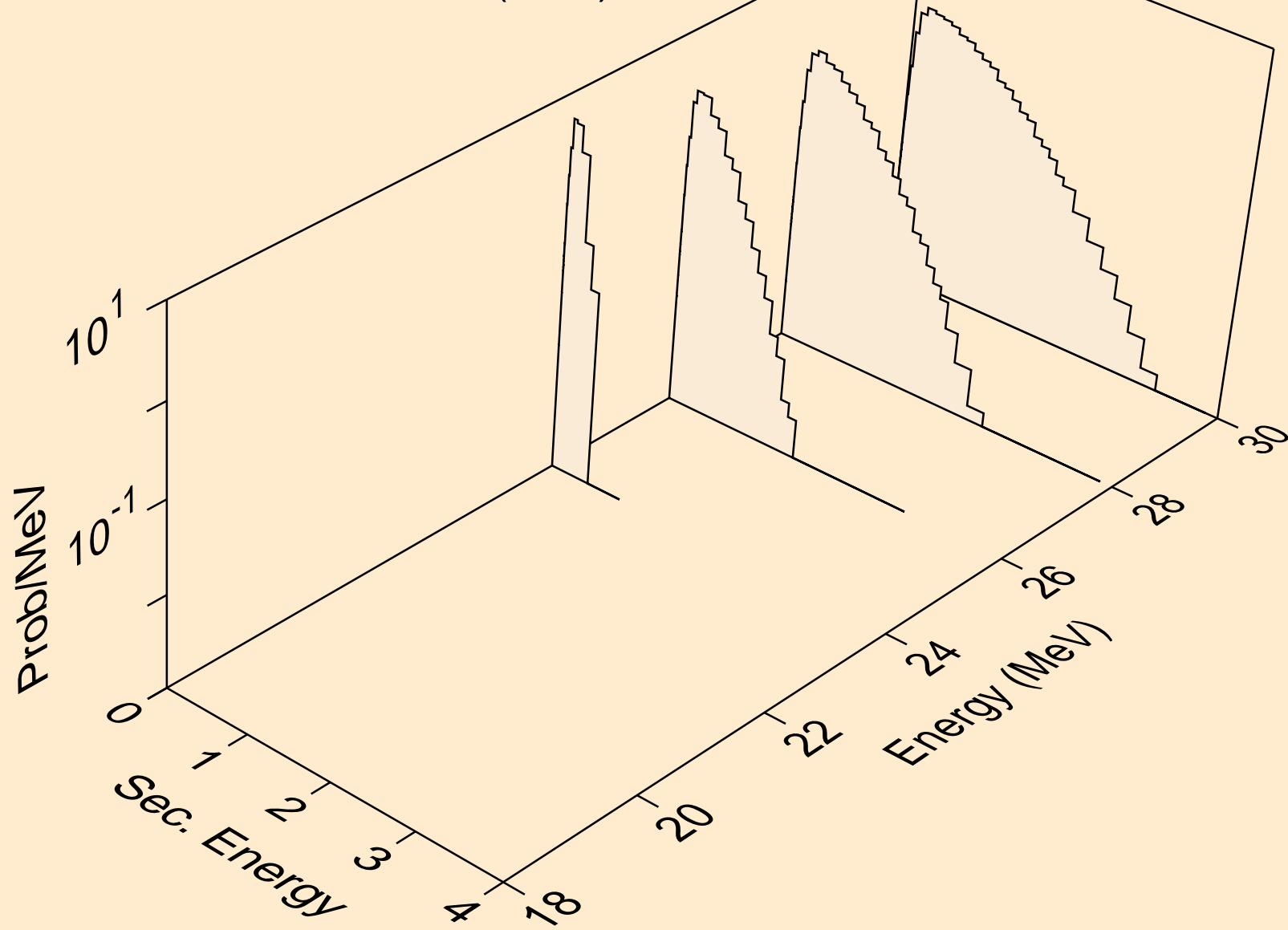

CS121M NEUTRON ACER TENDL-2024 LIBRARY; T=0.K  
Neutron emission for (n,n\*)p

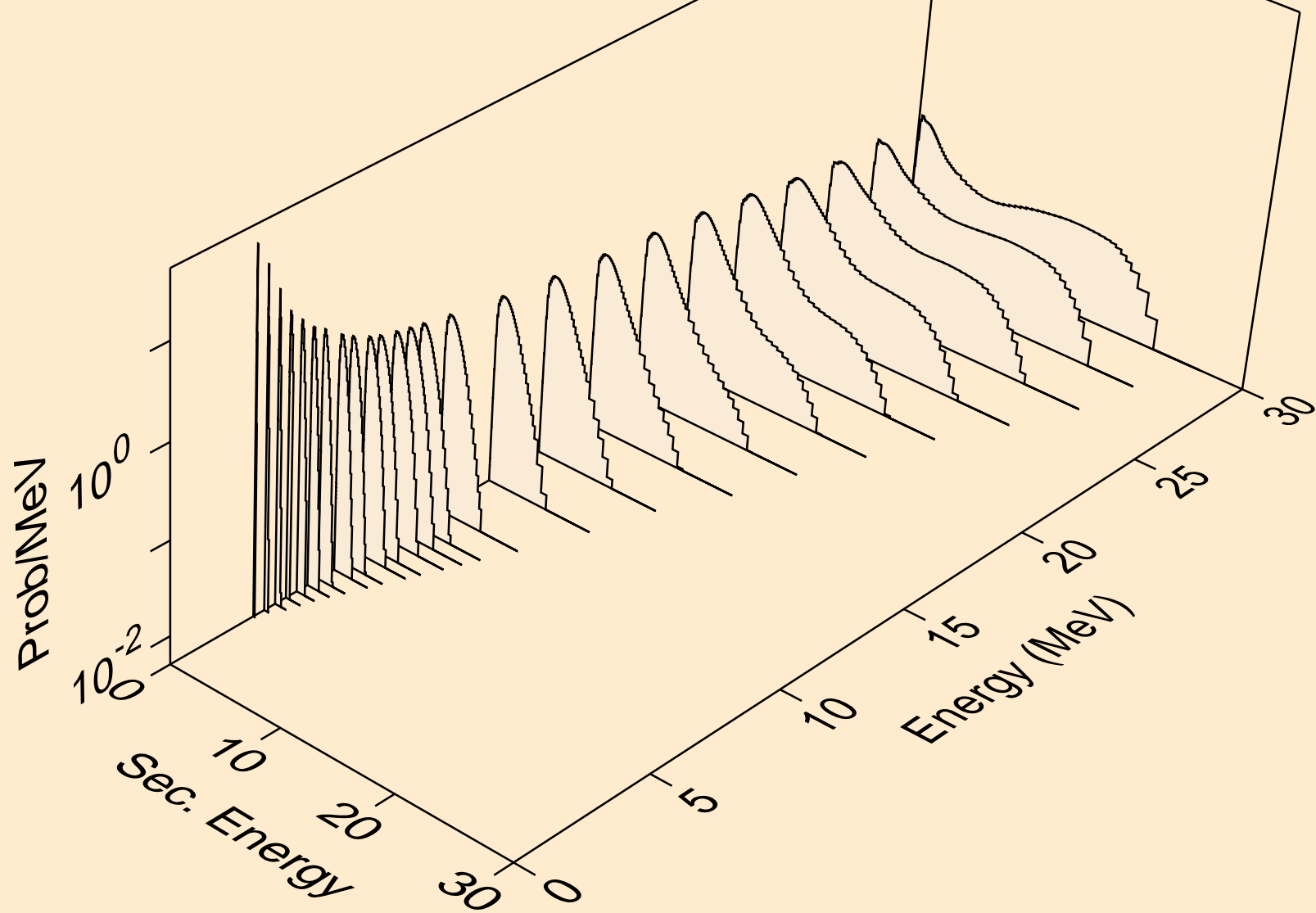

CS121M NEUTRON ACER TENDL-2024 LIBRARY; T=0.K  
Neutron emission for (n,n\*)2a

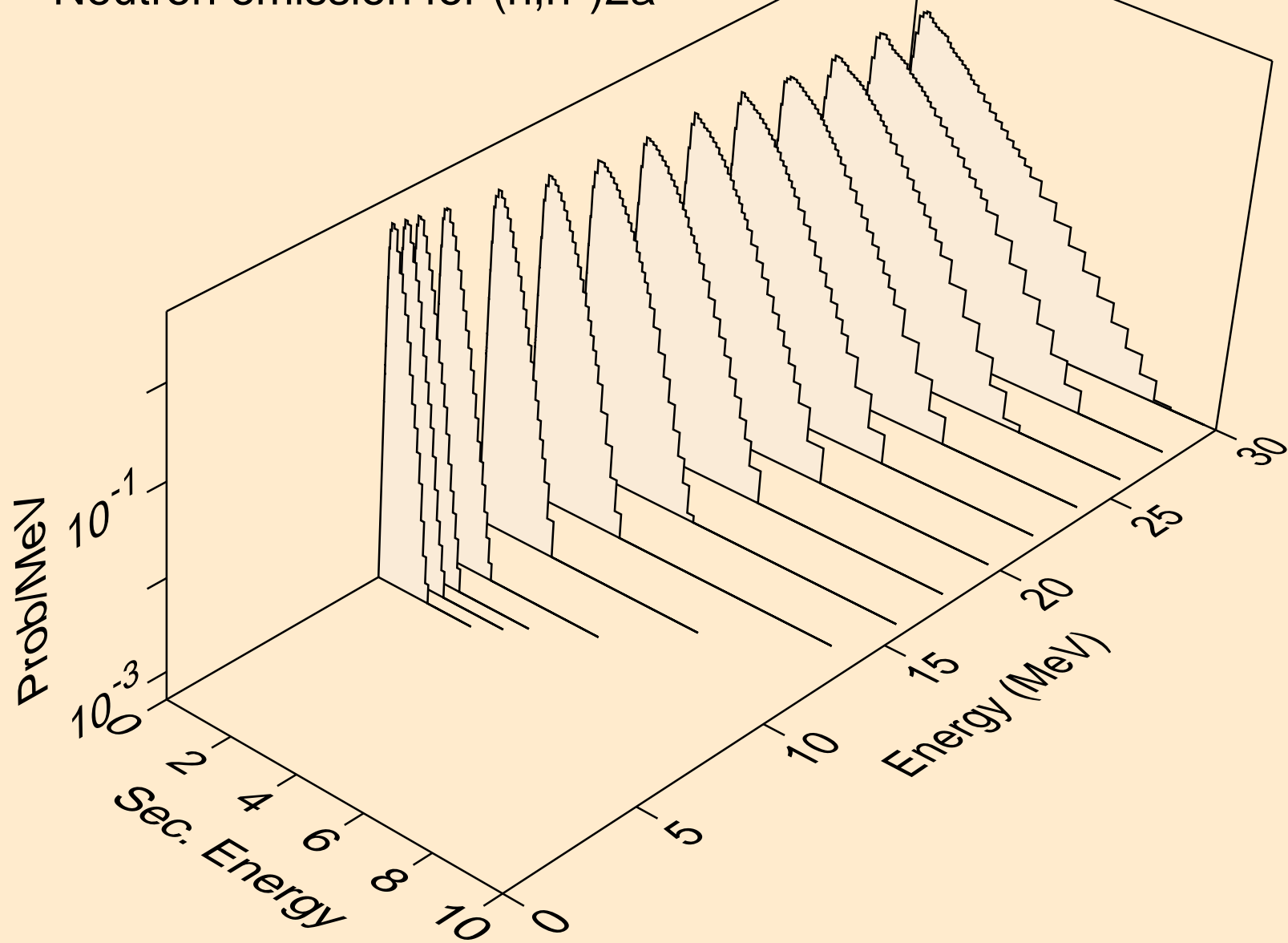

CS121M NEUTRON ACER TENDL-2024 LIBRARY; T=0.K  
Neutron emission for (n,2n)2a

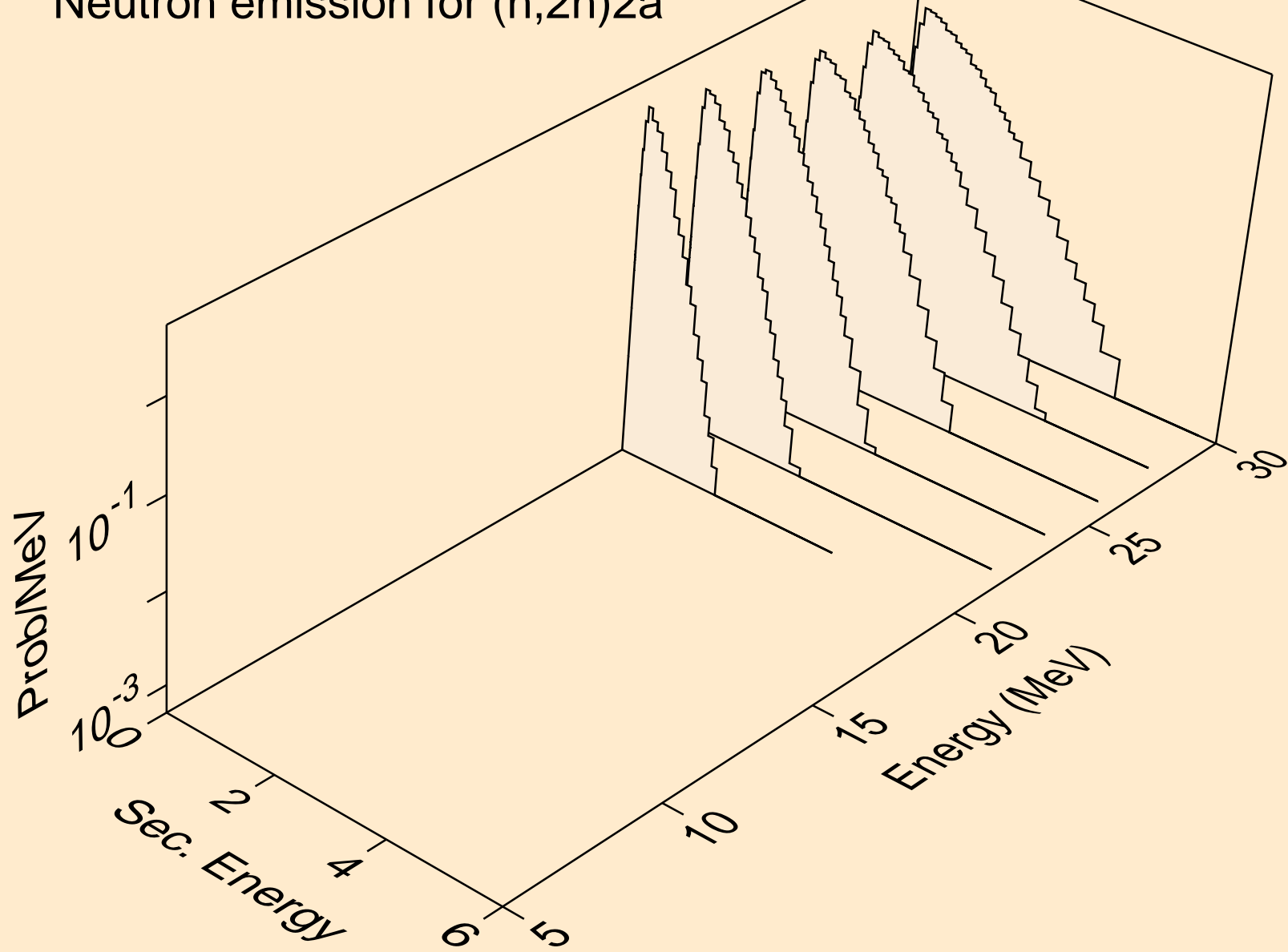

CS121M NEUTRON ACER TENDL-2024 LIBRARY; T=0.K  
Neutron emission for (n,n\*)d

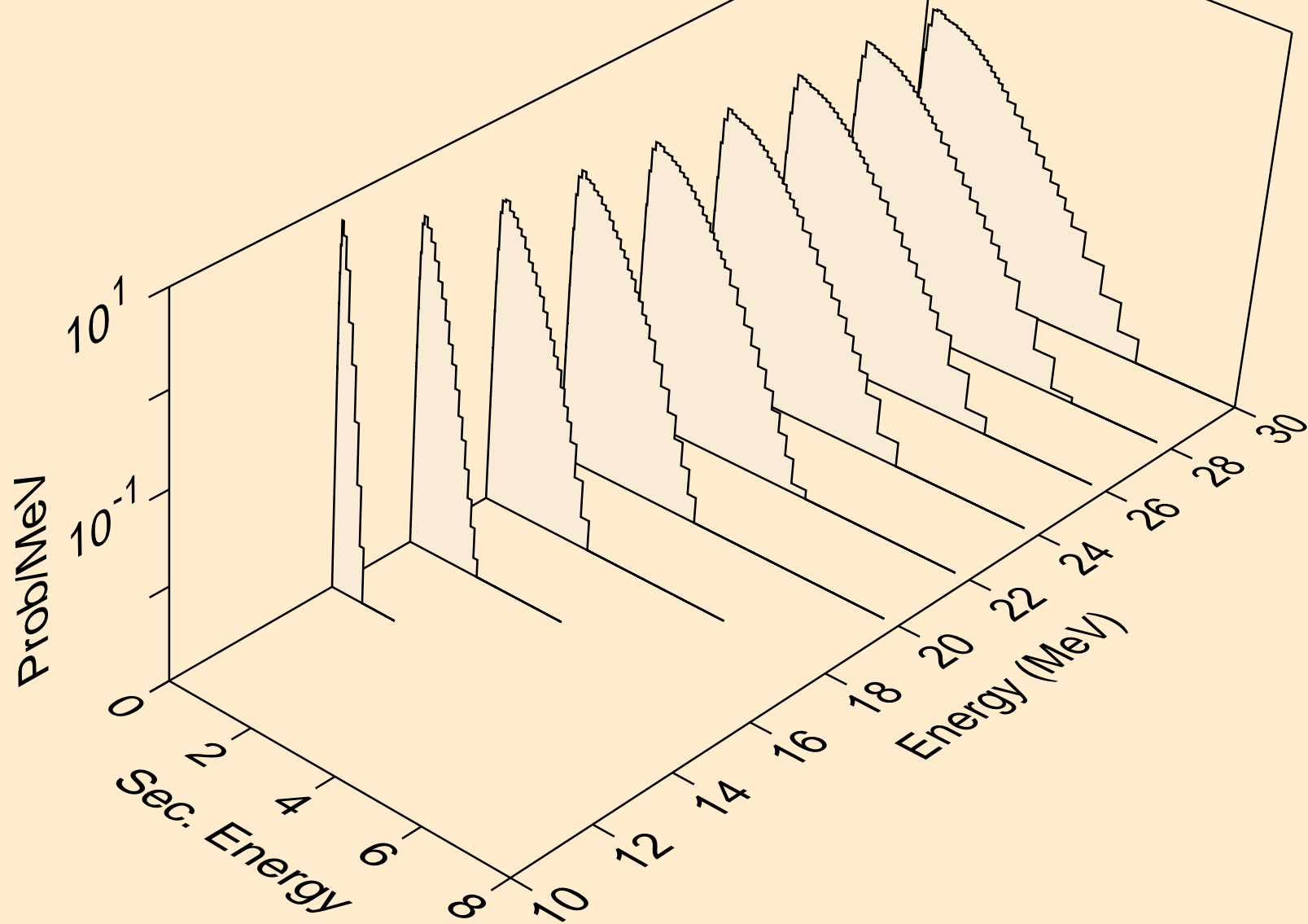

CS121M NEUTRON ACER TENDL-2024 LIBRARY; T=0.K  
Neutron emission for (n,n\*)t

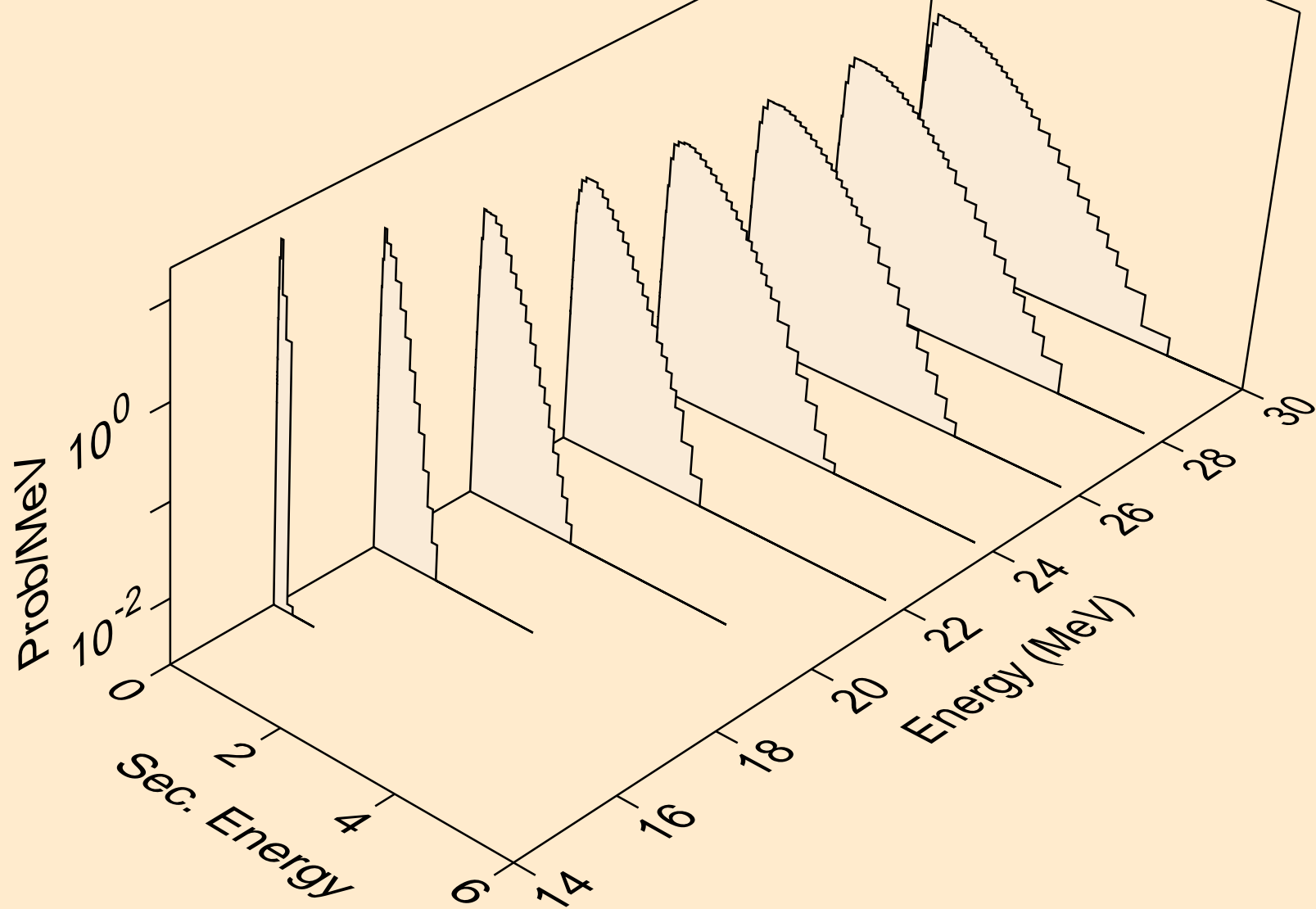

CS121M NEUTRON ACER TENDL-2024 LIBRARY; T=0.K  
Neutron emission for (n,n\*)he3

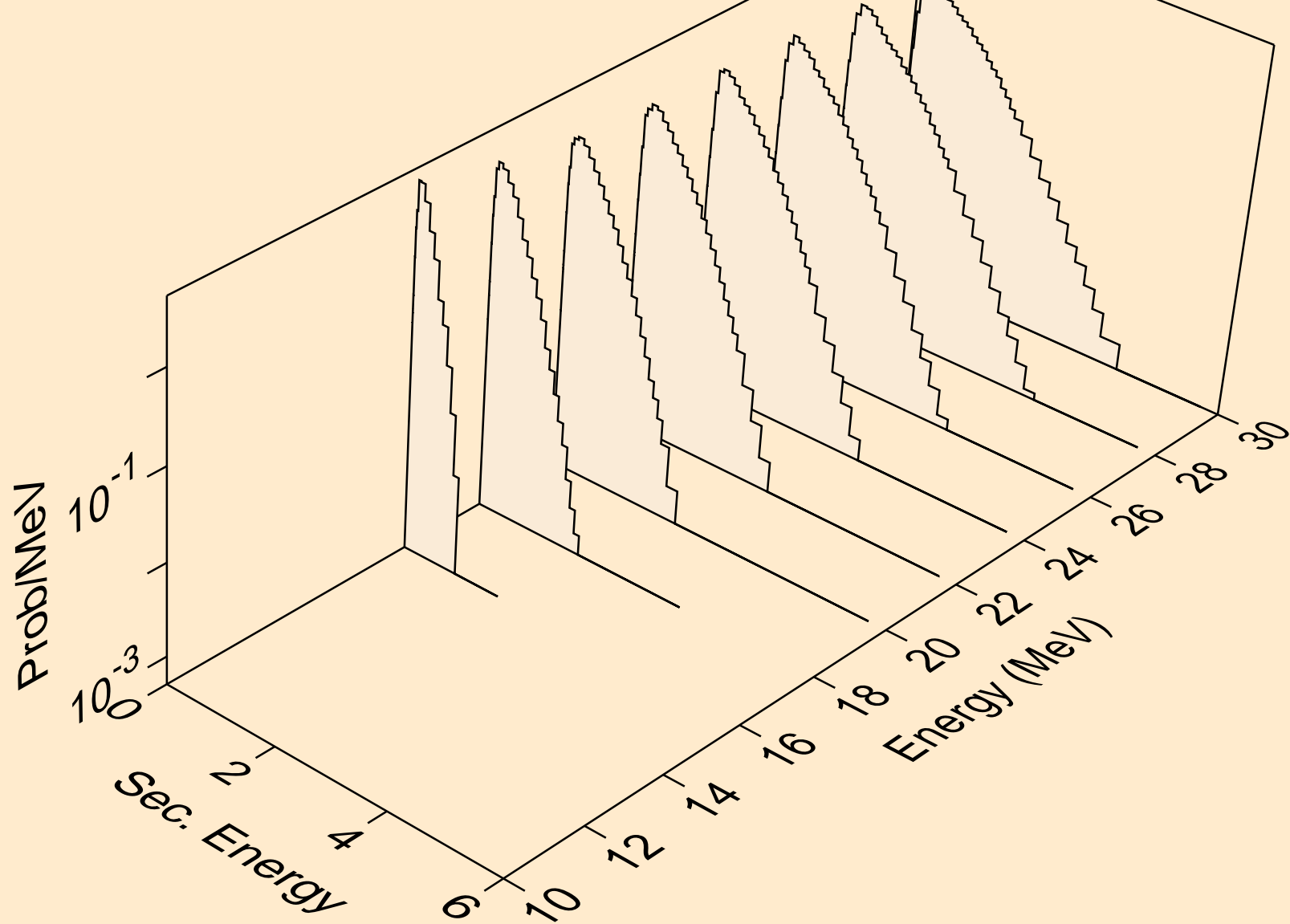

CS121M NEUTRON ACER TENDL-2024 LIBRARY; T=0.K  
Neutron emission for (n,2np)

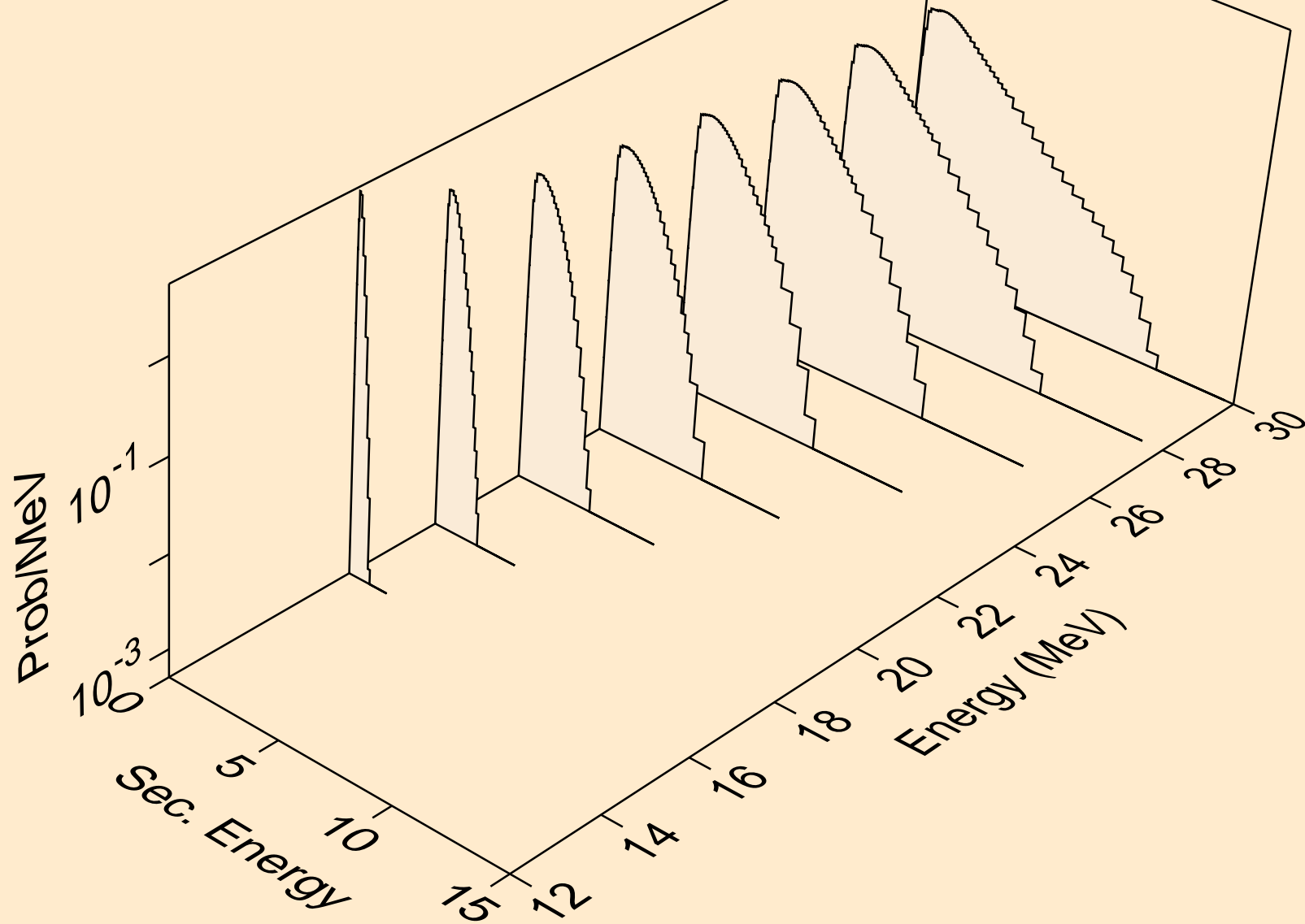

CS121M NEUTRON ACER TENDL-2024 LIBRARY; T=0.K  
Neutron emission for (n,3np)

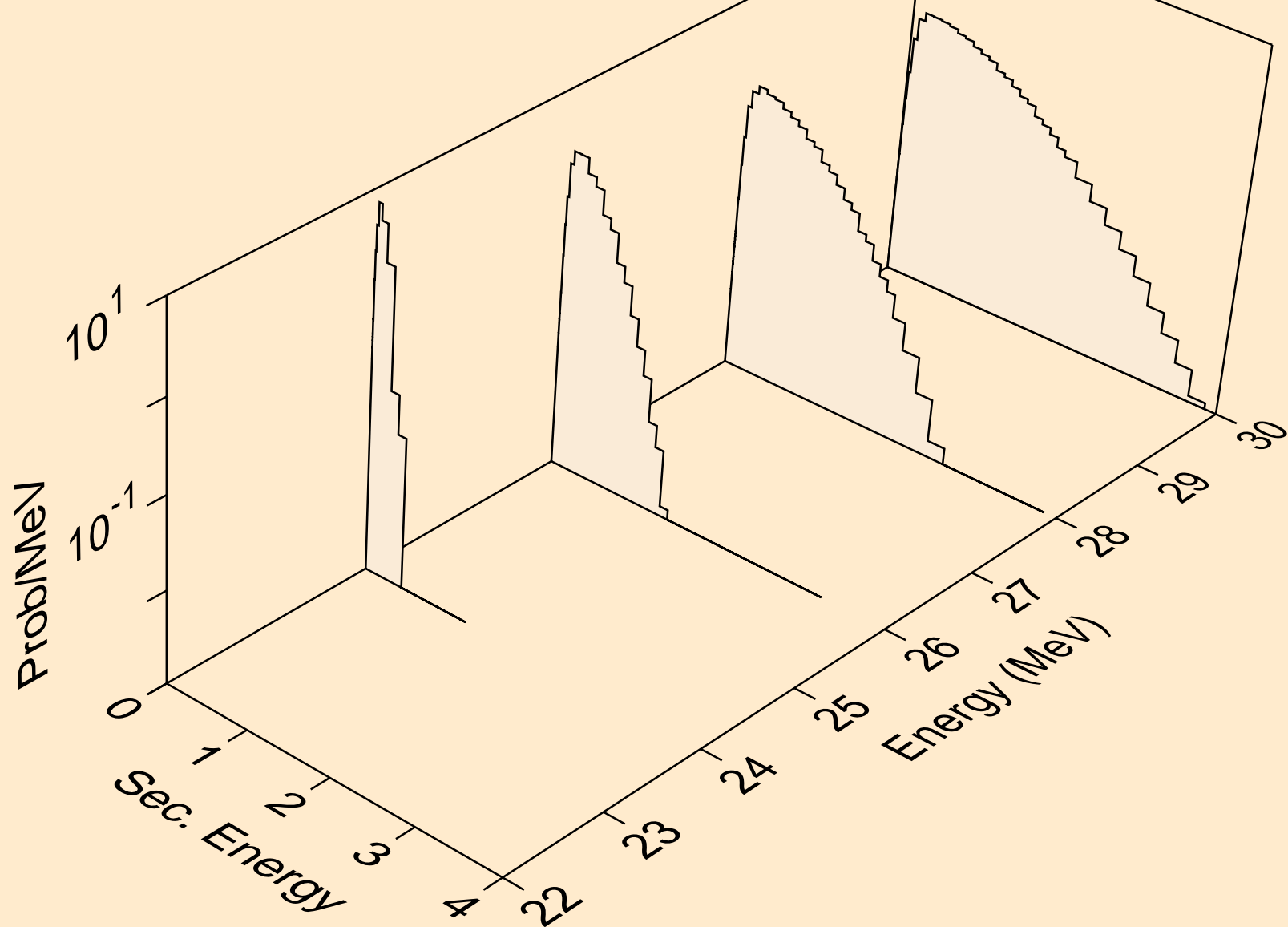

CS121M NEUTRON ACER TENDL-2024 LIBRARY; T=0.K  
Neutron emission for (n,n2p)

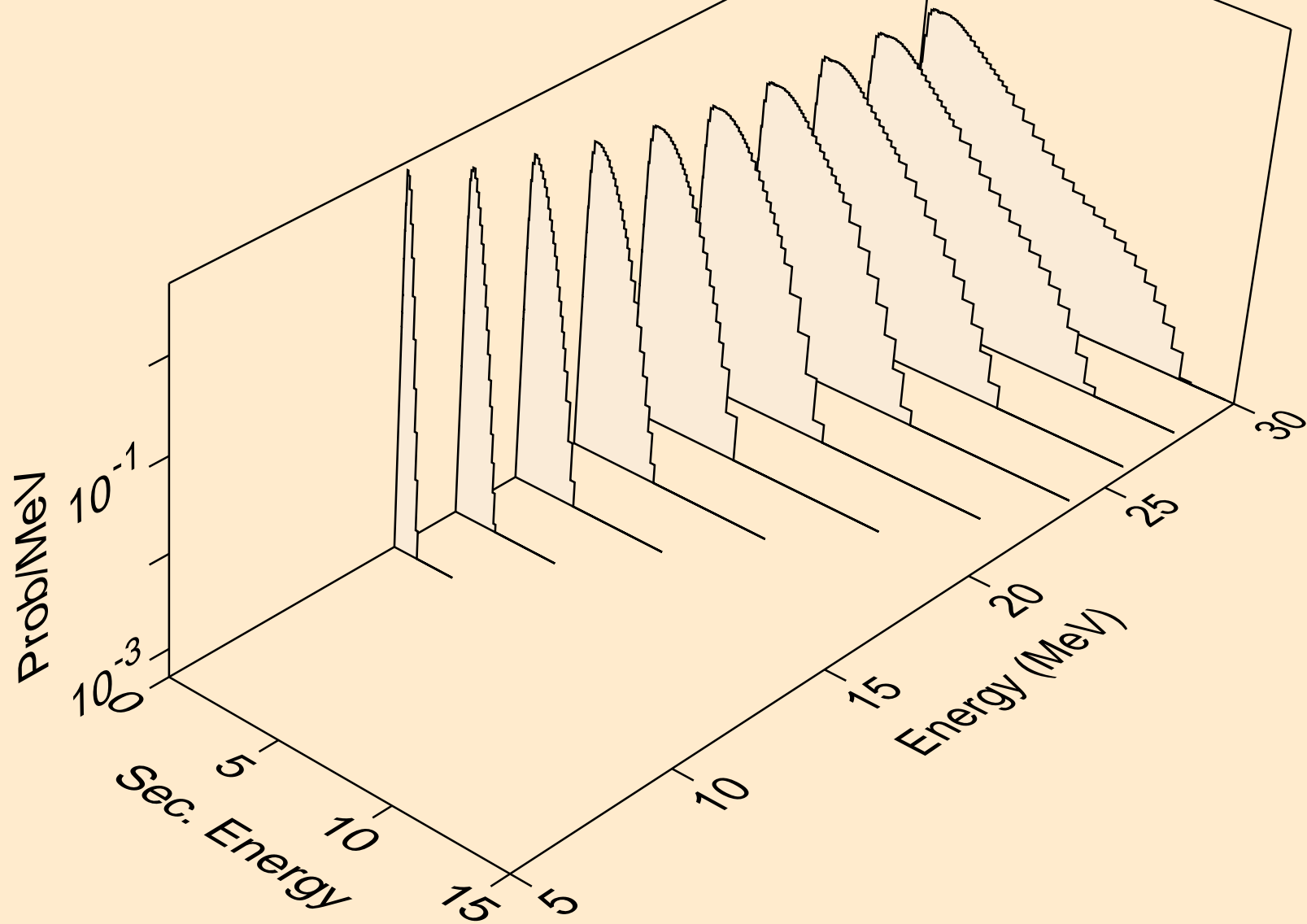

CS121M NEUTRON ACER TENDL-2024 LIBRARY; T=0.K  
Neutron emission for (n,npa)

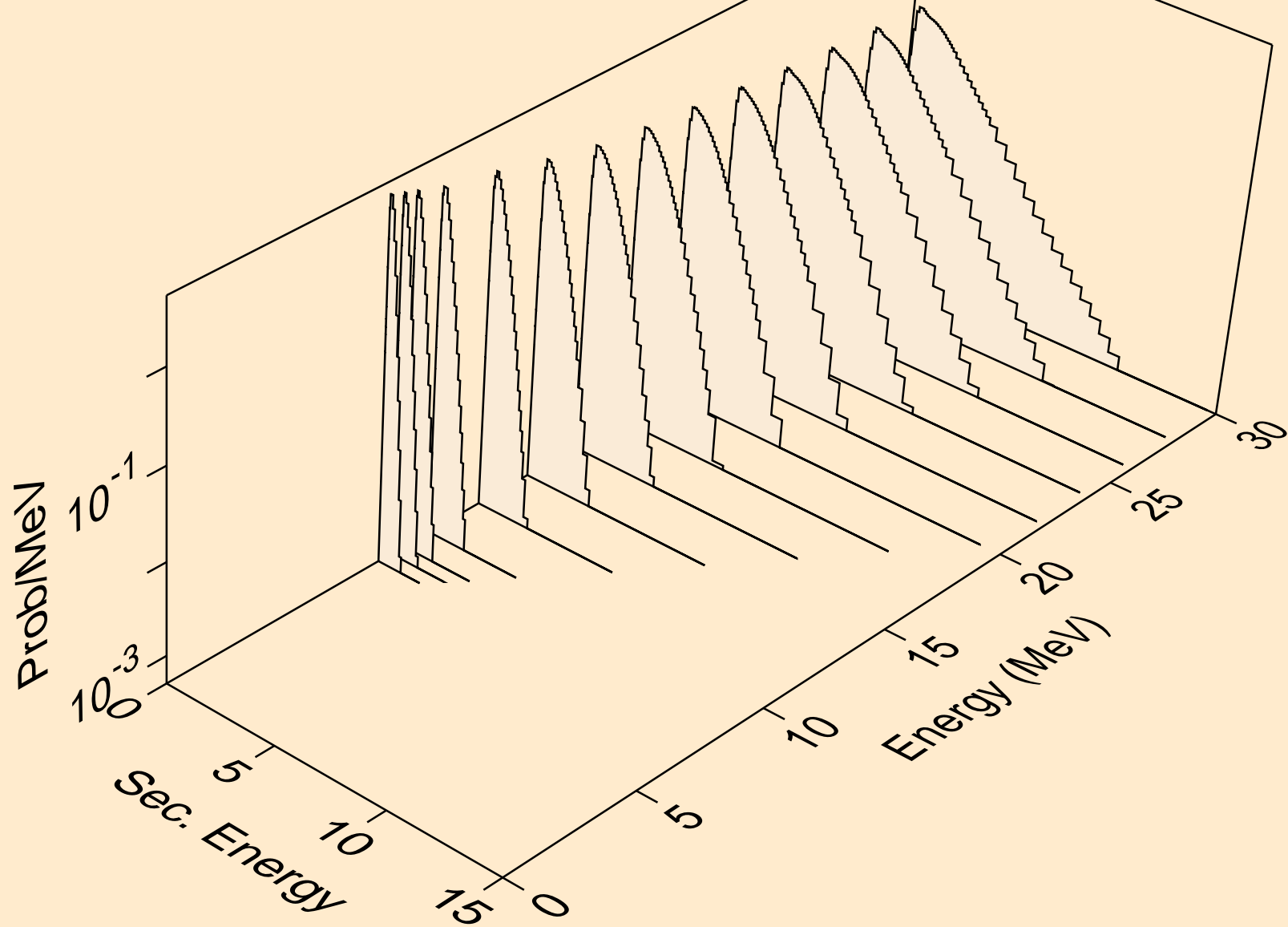

CS121M NEUTRON ACER TENDL-2024 LIBRARY; T=0.K  
Neutron emission for (n,n\*c)

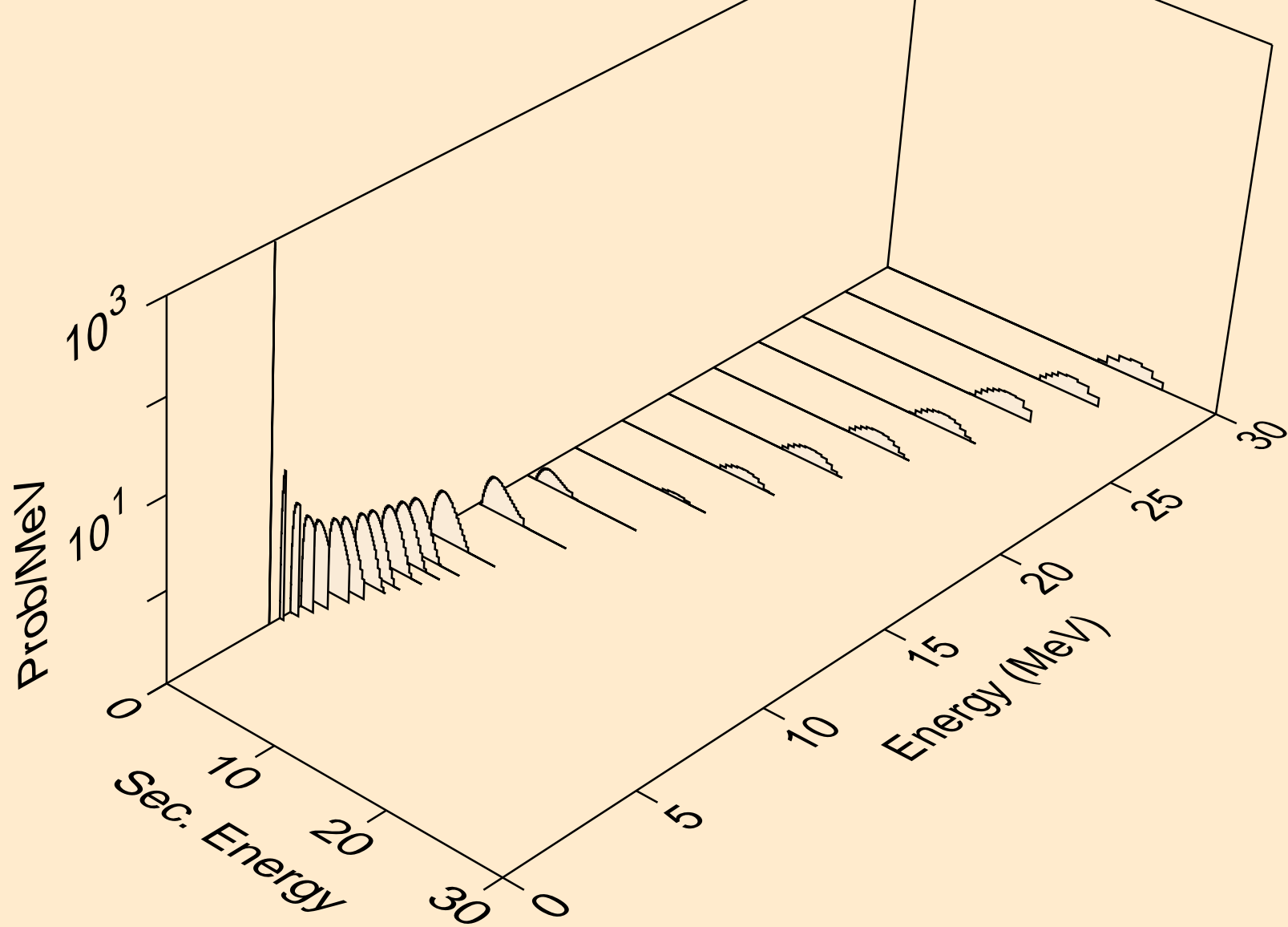

CS121M NEUTRON ACER TENDL-2024 LIBRARY; T=0.K  
Photon emission for (n,x)

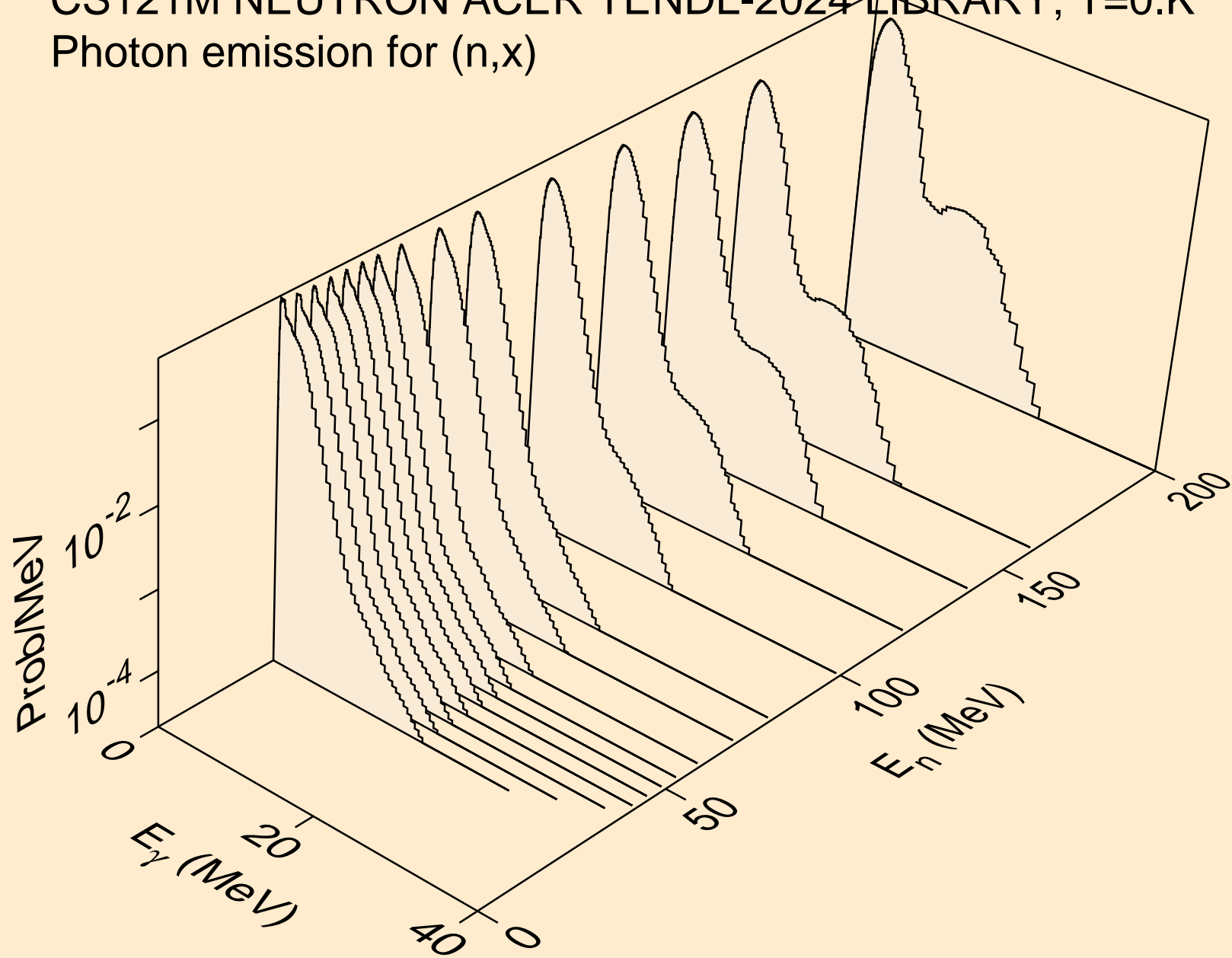

CS121M NEUTRON ACER TENDL-2024 LIBRARY; T=0.K  
Photon emission for (n,2nd)

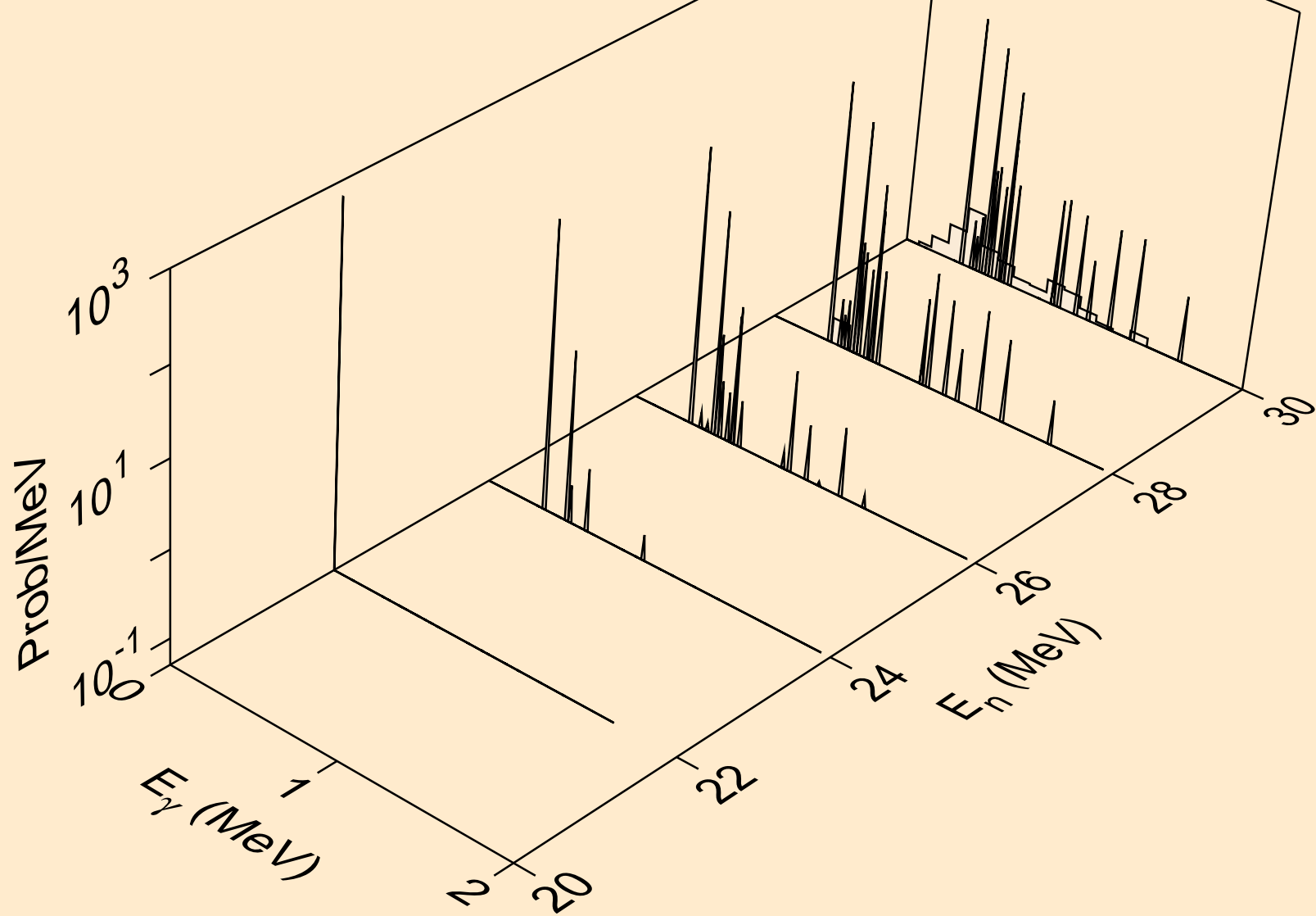

CS121M NEUTRON ACER TENDL-2024 LIBRARY; T=0.K  
Photon emission for (n,2n)

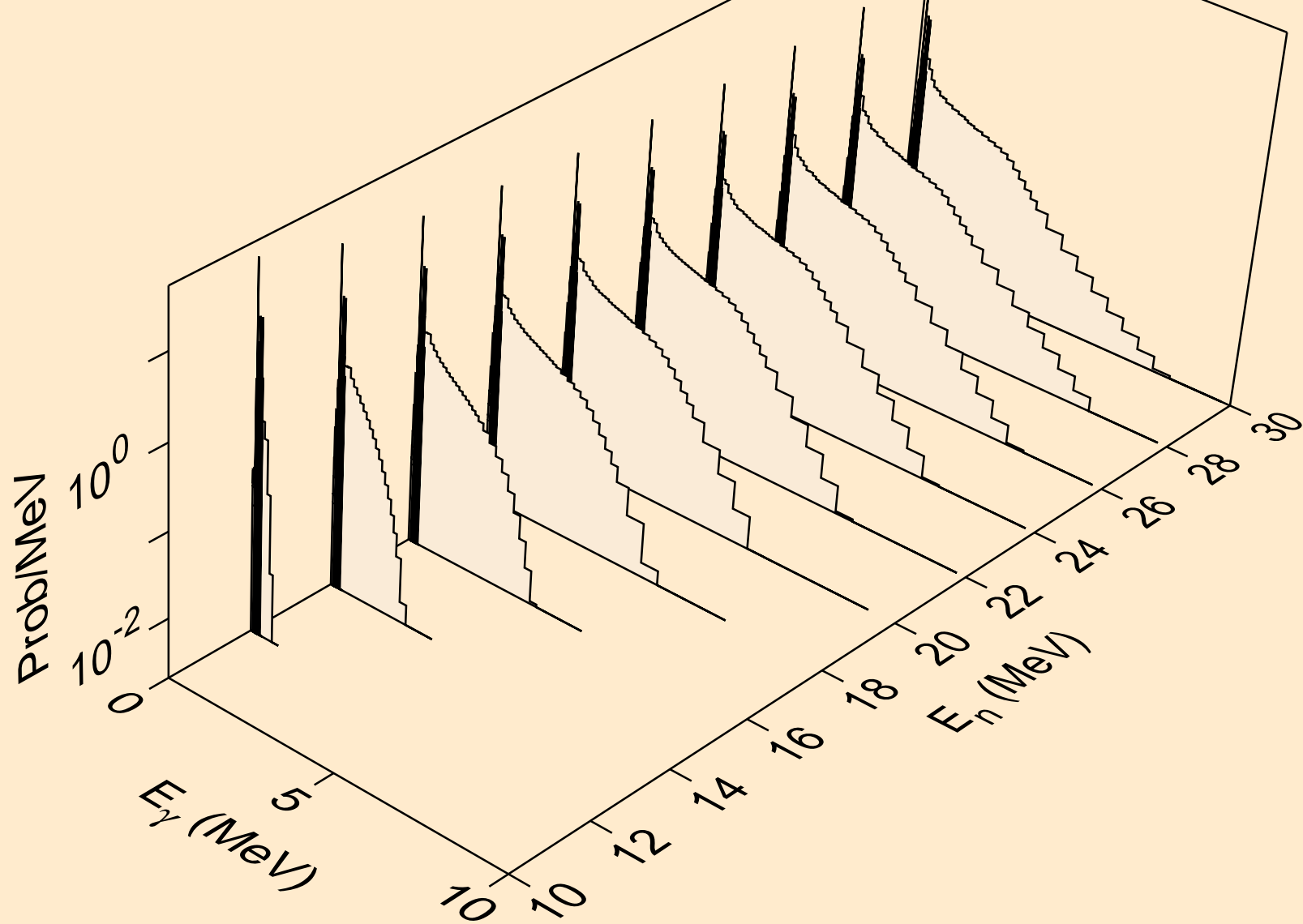

CS121M NEUTRON ACER TENDL-2024 LIBRARY; T=0.K  
Photon emission for (n,3n)

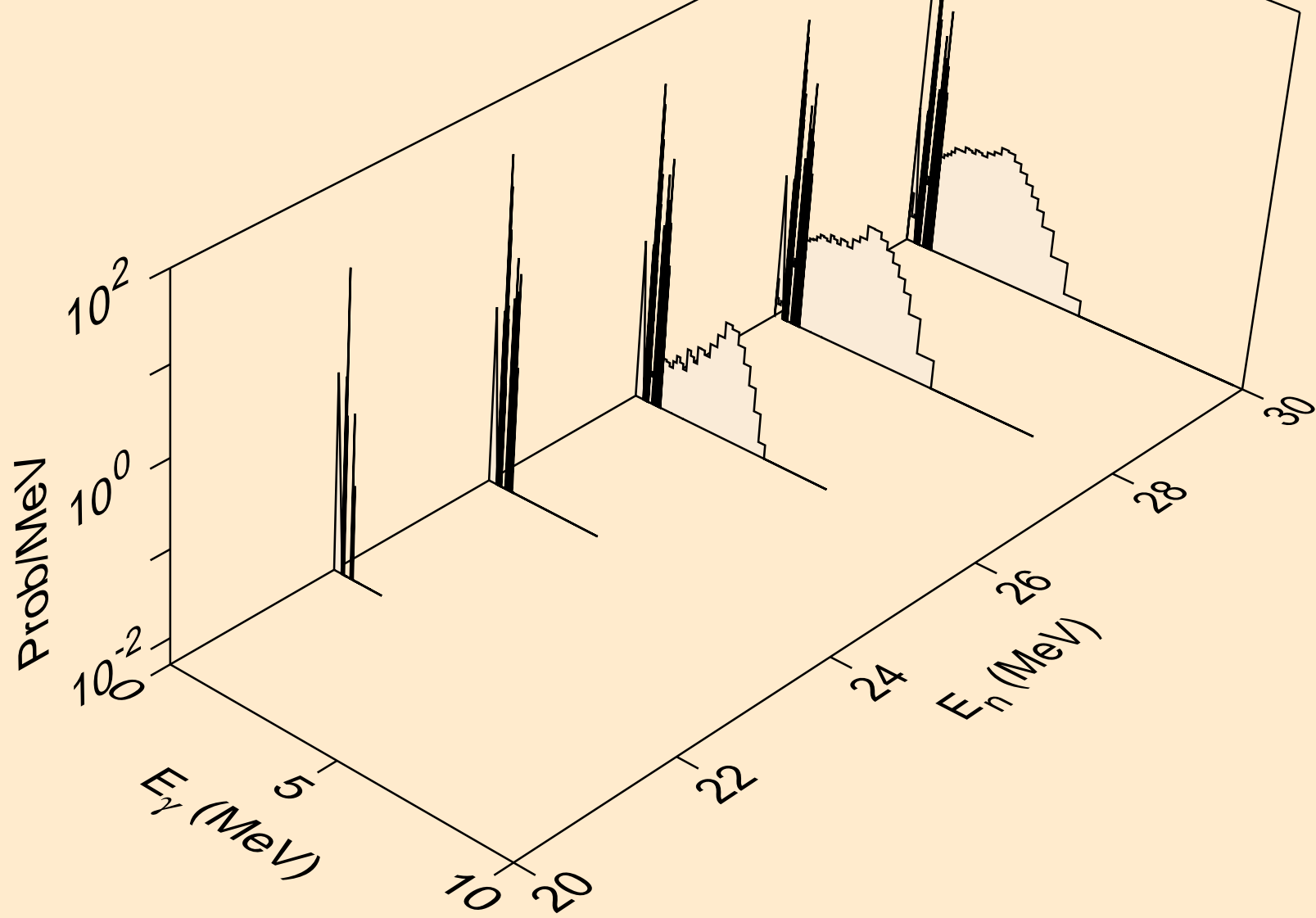

CS121M NEUTRON ACER TENDL-2024 LIBRARY; T=0.K  
Photon emission for (n,n\*)a

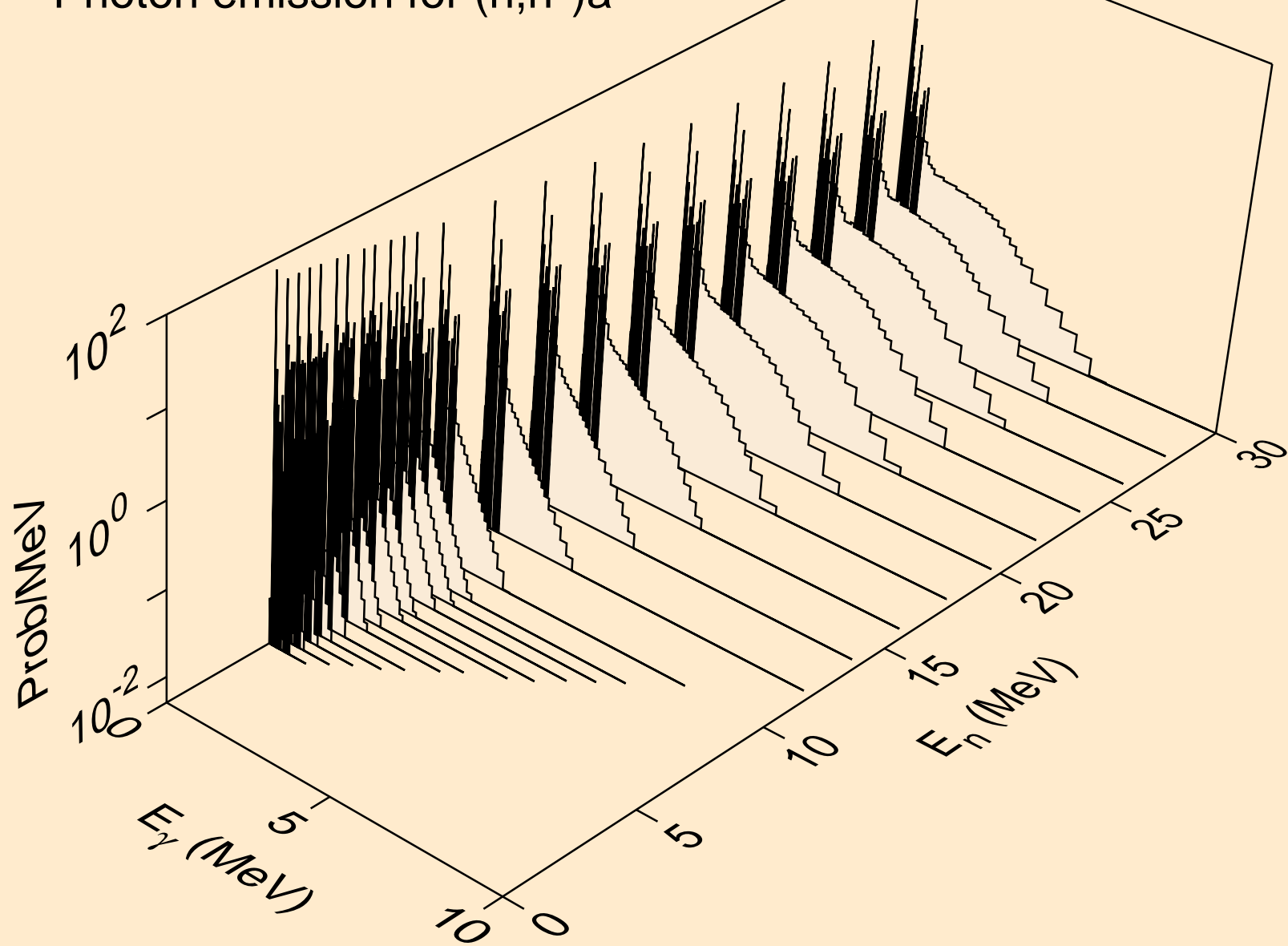

CS121M NEUTRON ACER TENDL-2024 LIBRARY; T=0.K  
Photon emission for (n,2n)a

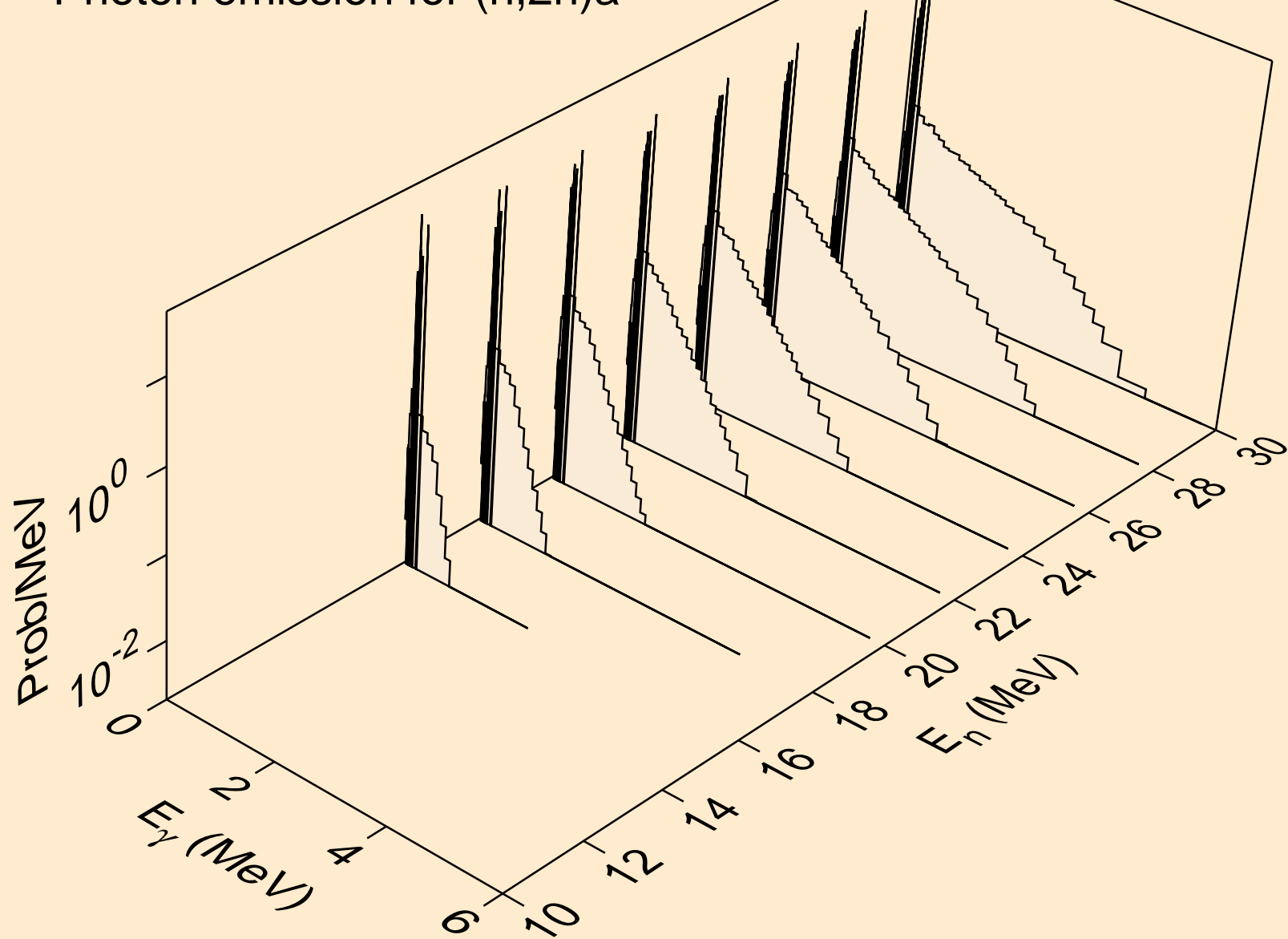

CS121M NEUTRON ACER TENDL-2024 LIBRARY; T=0.K  
Photon emission for (n,3n)a

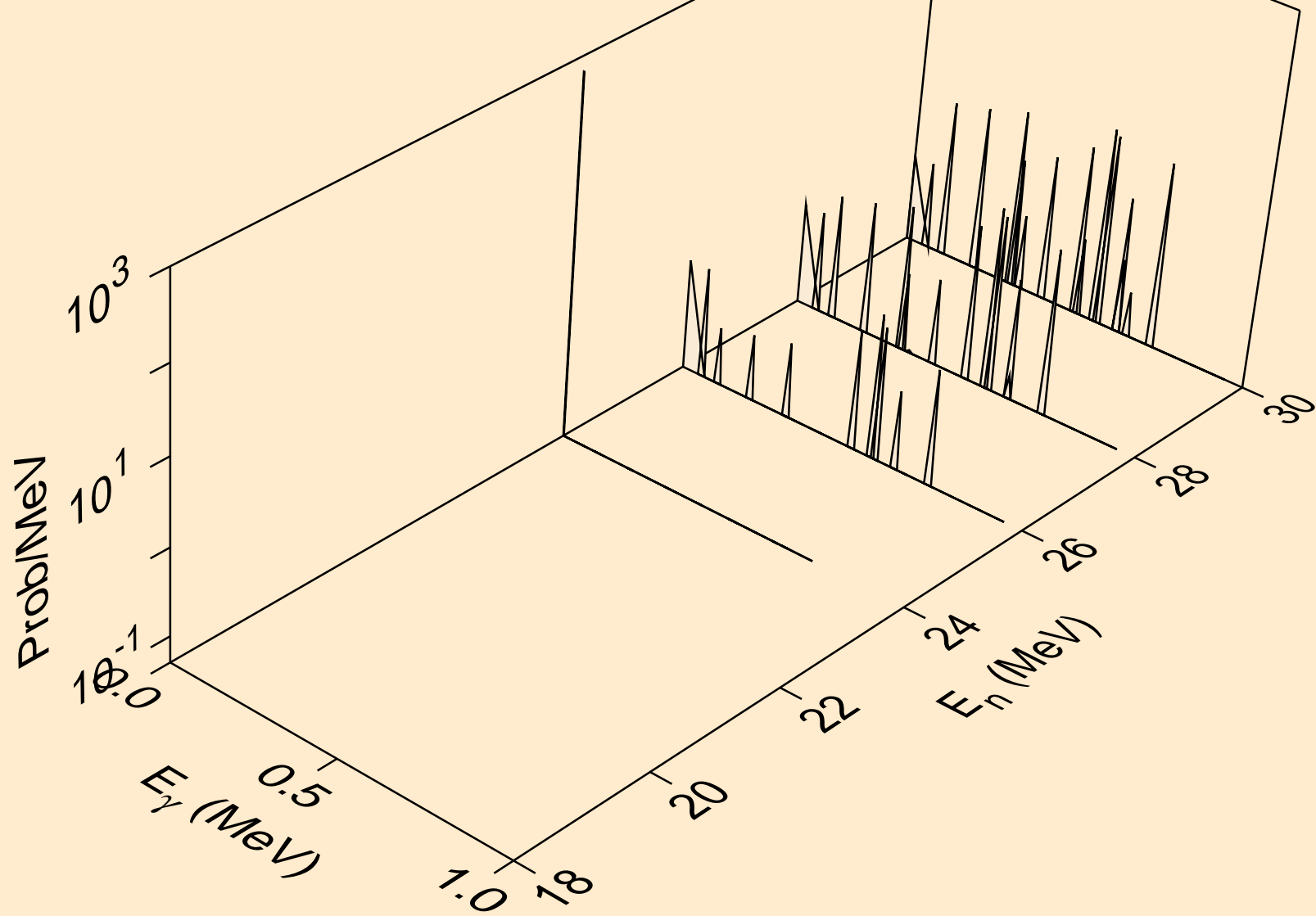

CS121M NEUTRON ACER TENDL-2024 LIBRARY; T=0.K  
Photon emission for (n,n\*)p

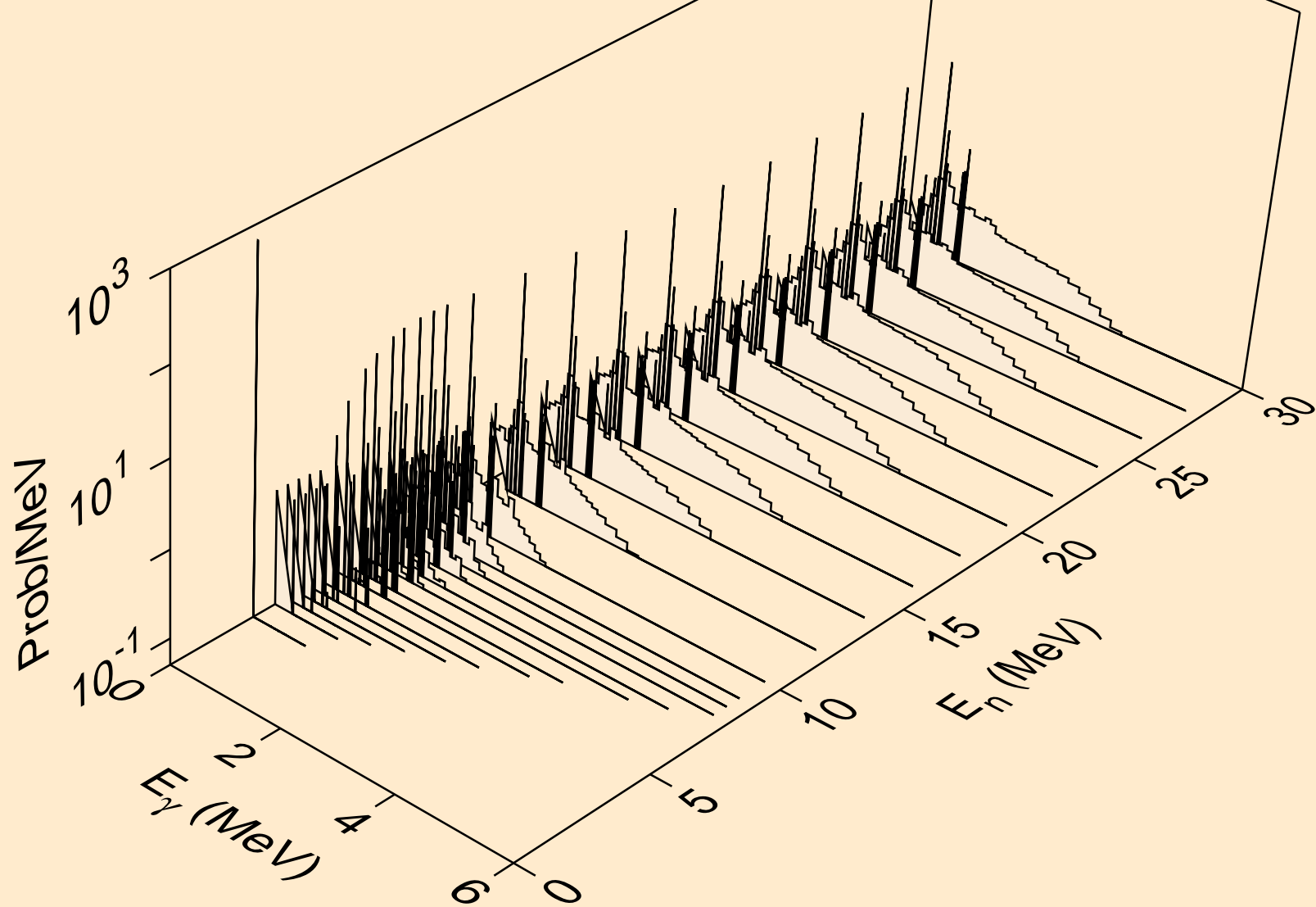

CS121M NEUTRON ACER TENDL-2024 LIBRARY; T=0.K  
Photon emission for (n,n\*)2a

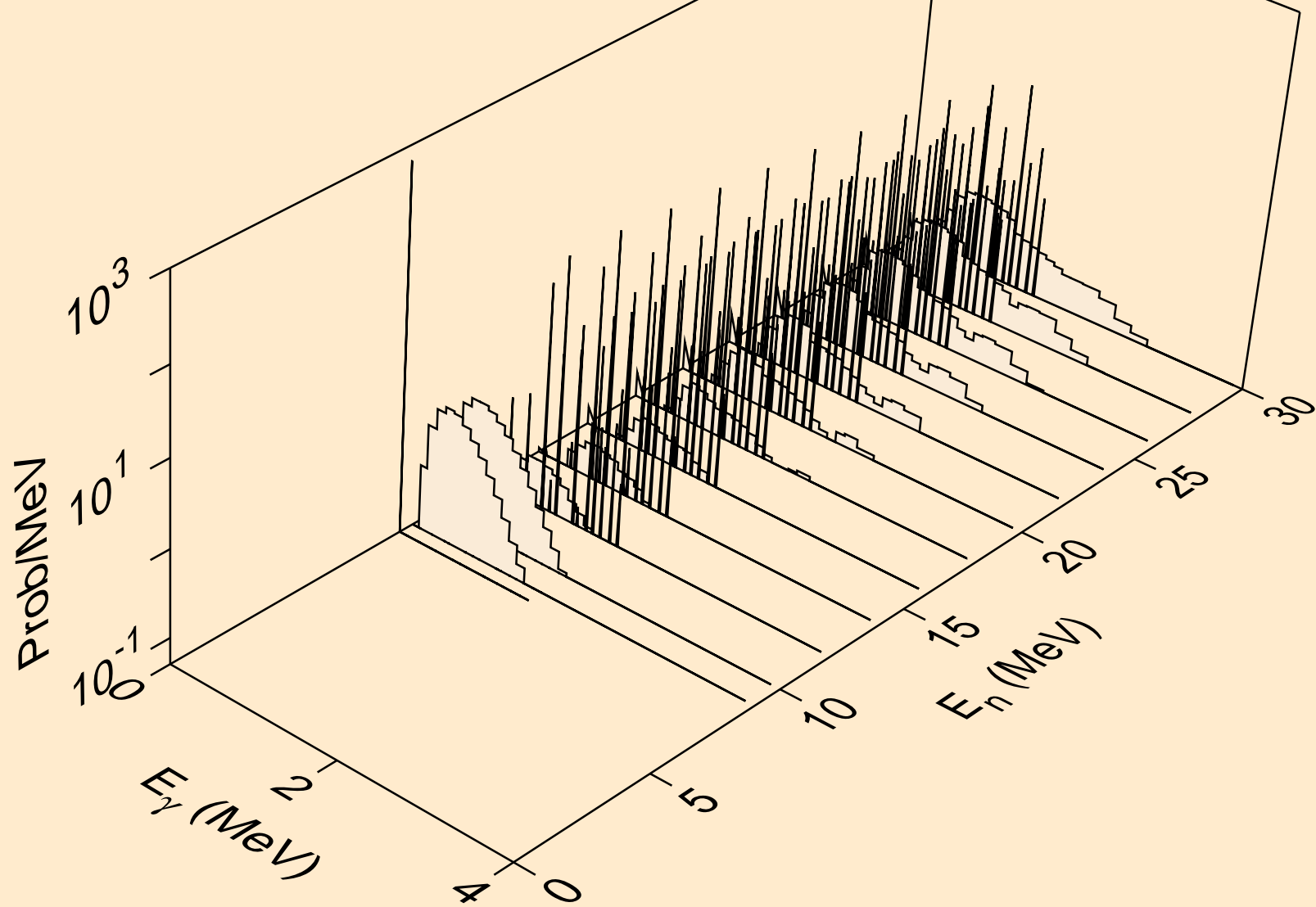

CS121M NEUTRON ACER TENDL-2024 LIBRARY; T=0.K  
Photon emission for (n,2n)2a

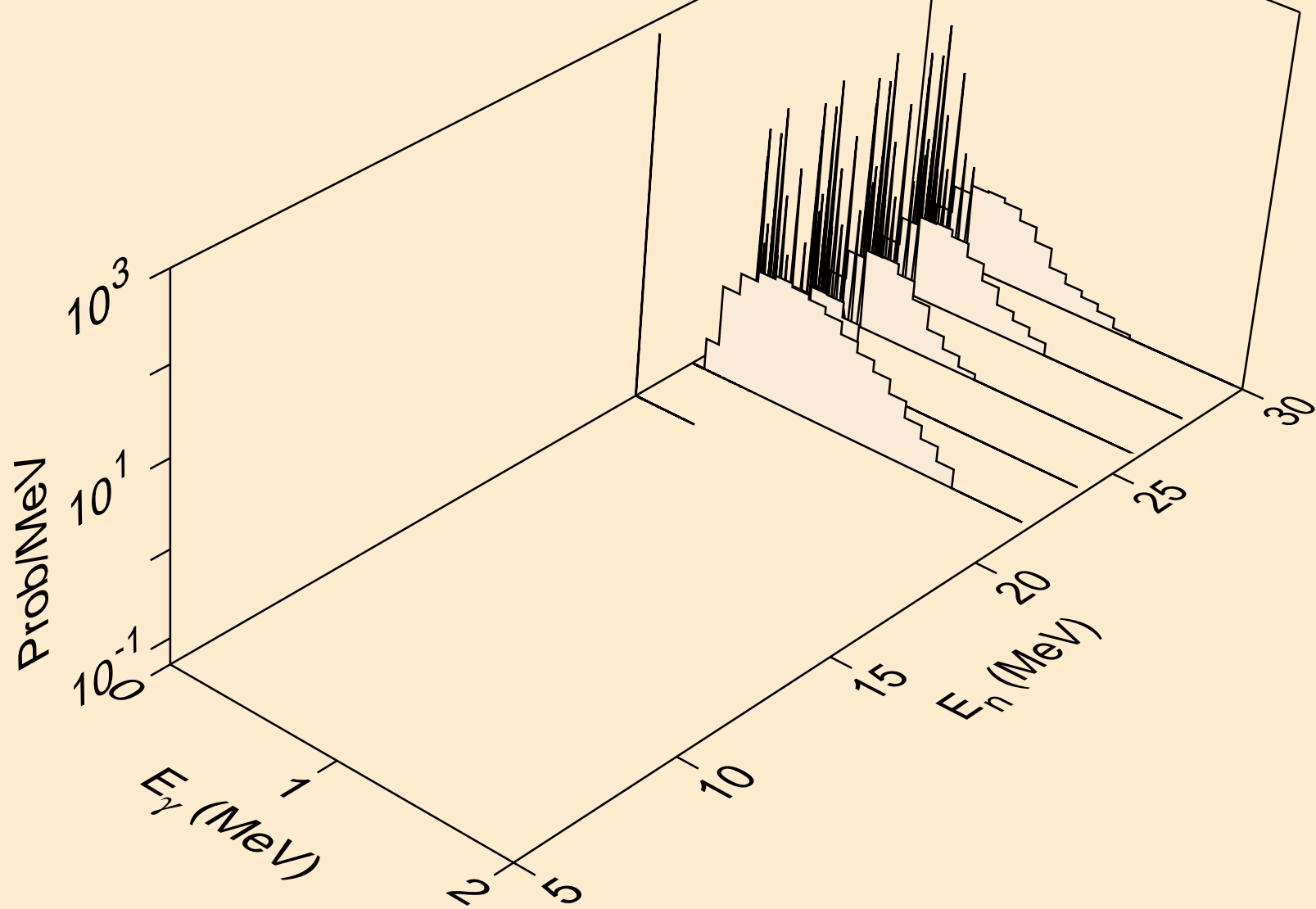

CS121M NEUTRON ACER TENDL-2024 LIBRARY; T=0.K  
Photon emission for (n,n\*)d

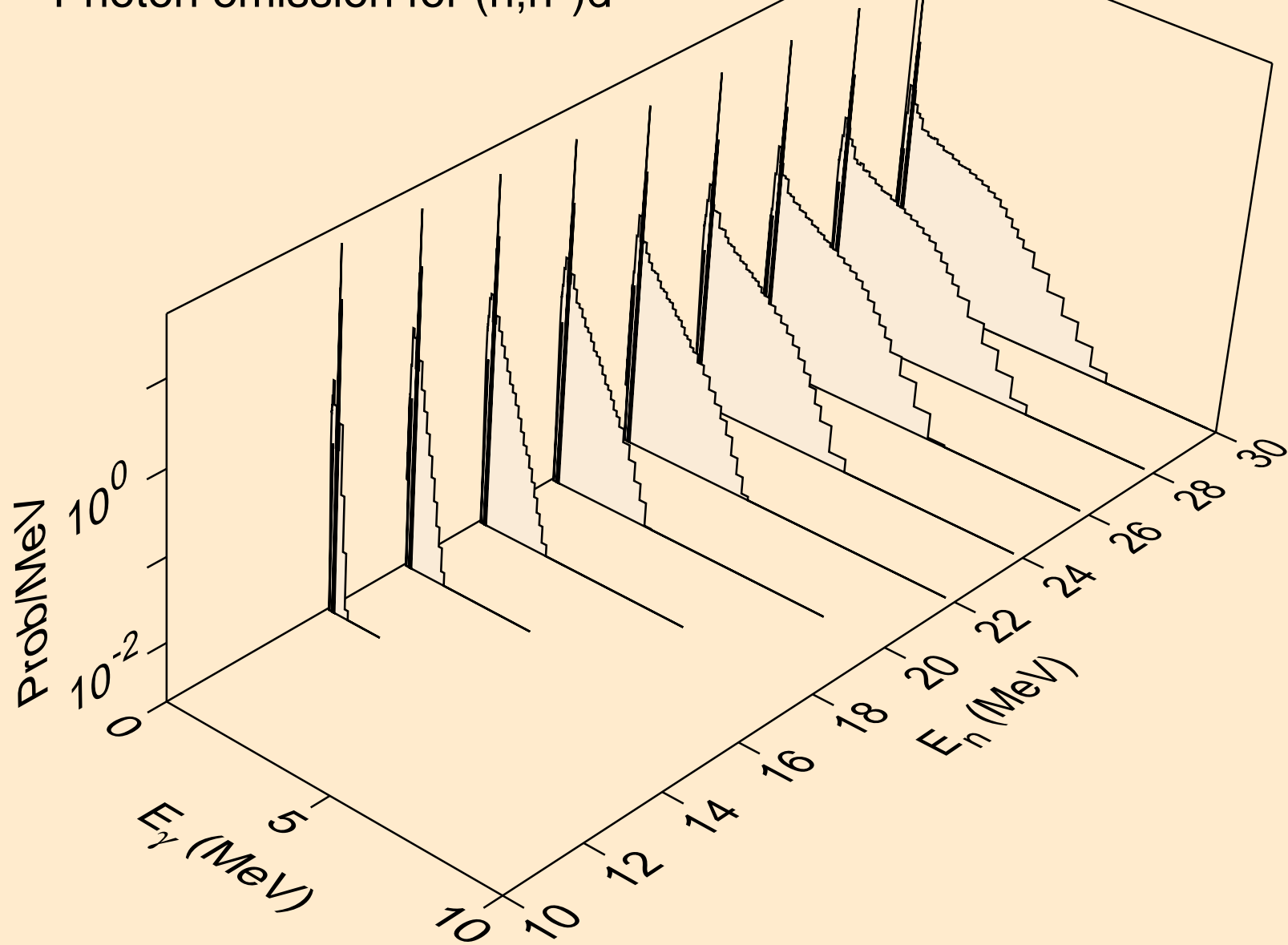

CS121M NEUTRON ACER TENDL-2024 LIBRARY; T=0.K  
Photon emission for (n,n\*)t

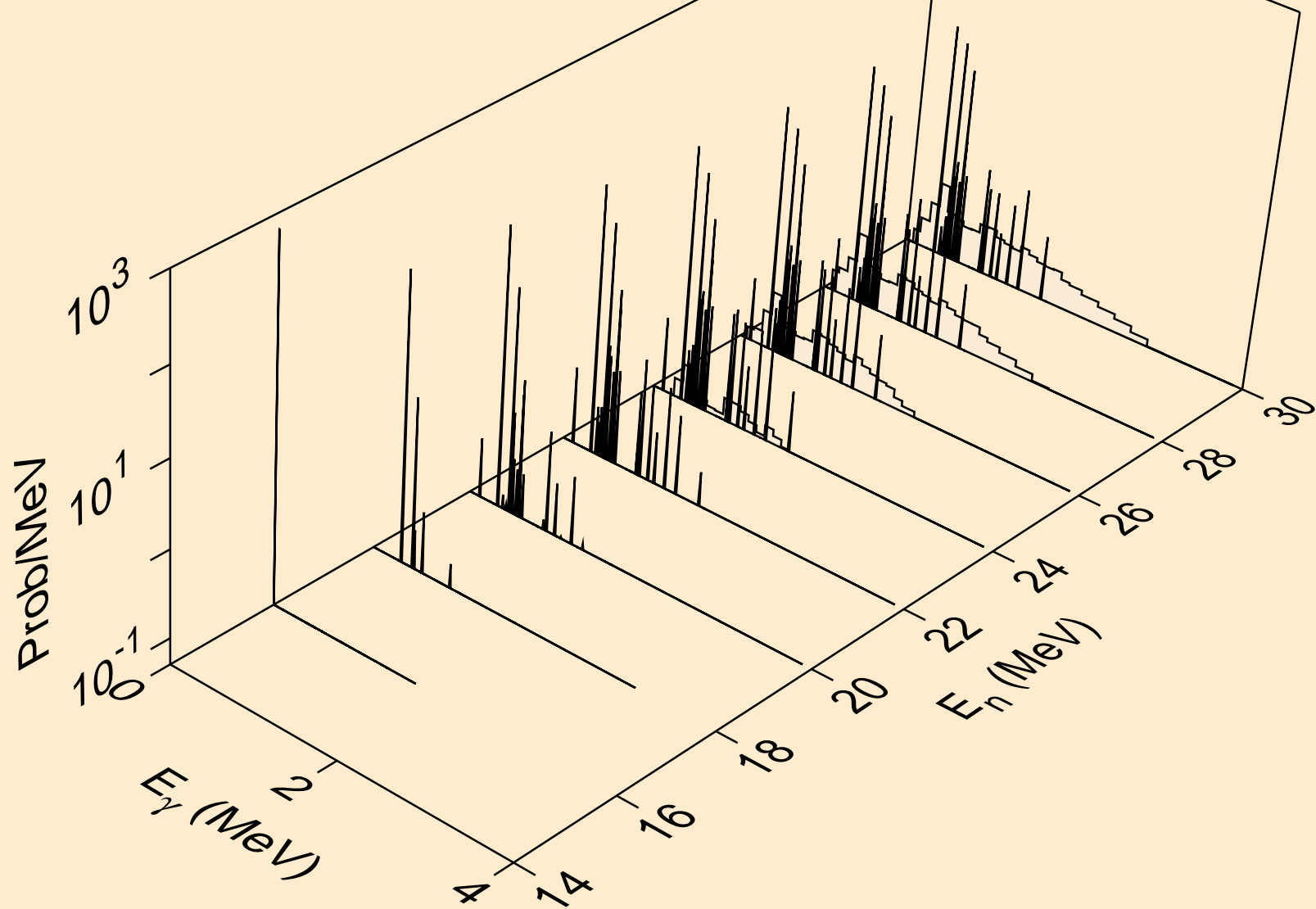

CS121M NEUTRON ACER TENDL-2024 LIBRARY; T=0.K  
Photon emission for (n,n\*)he3

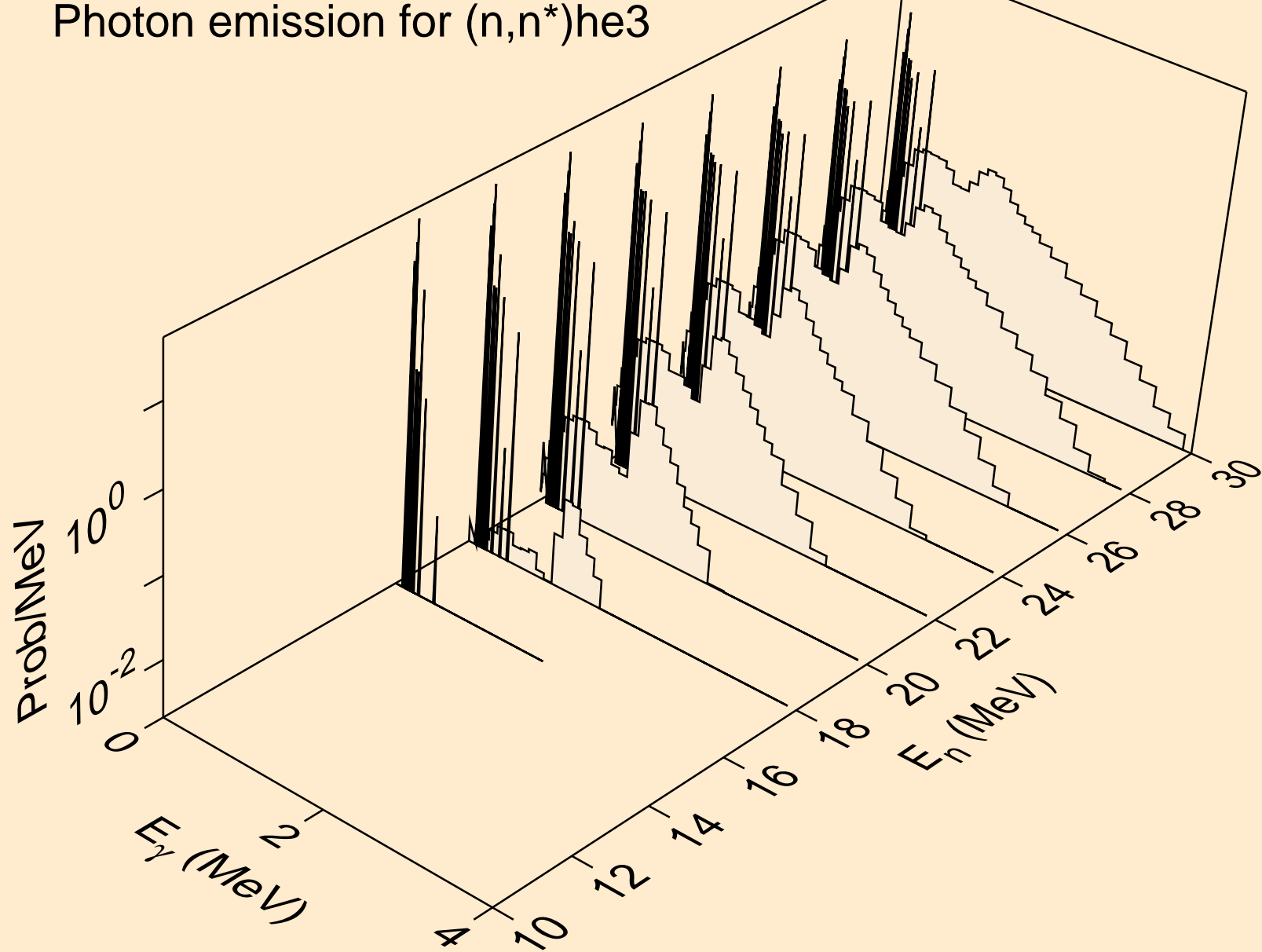

CS121M NEUTRON ACER TENDL-2024 LIBRARY; T=0.K  
Photon emission for (n,2np)

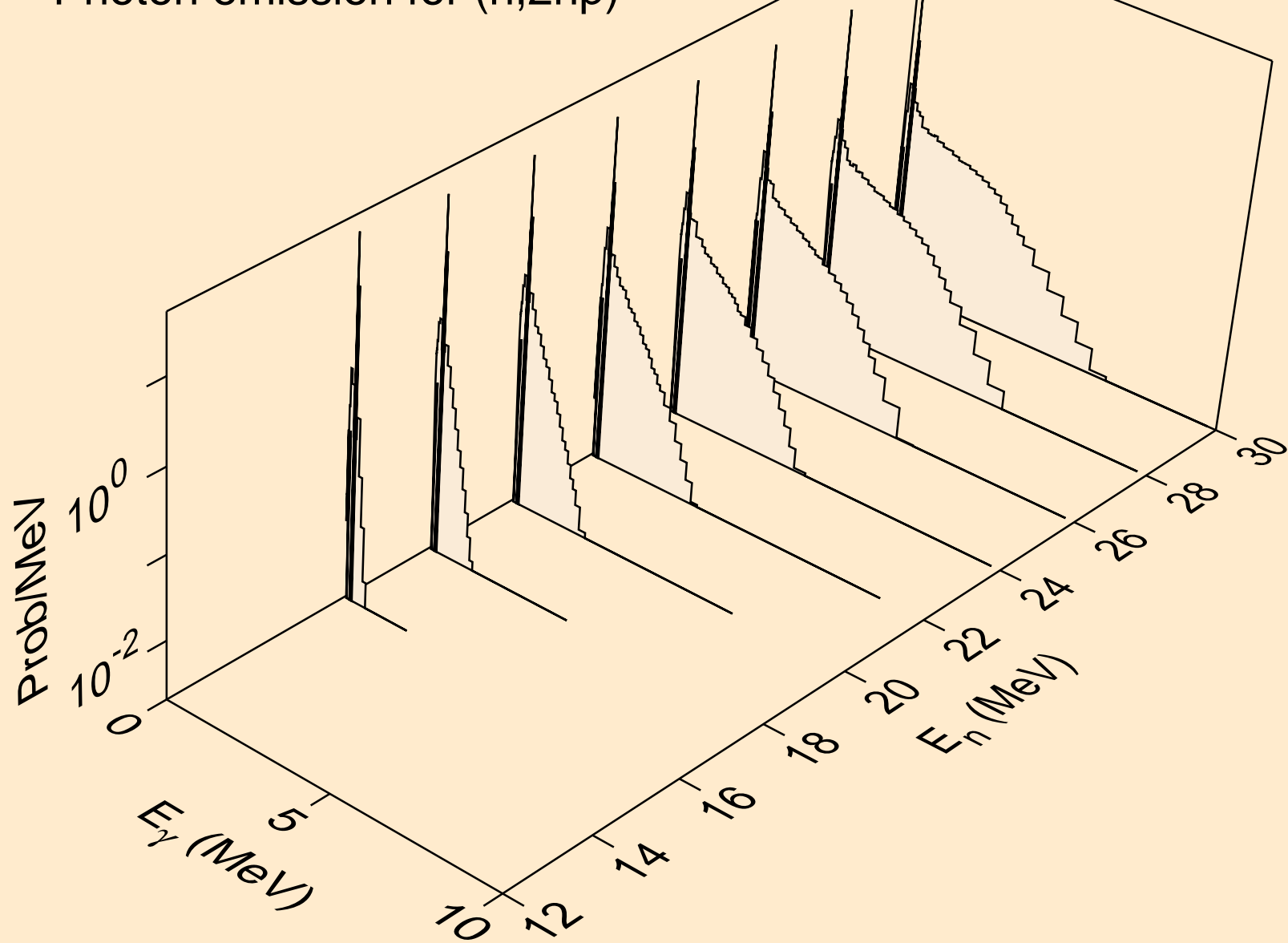

CS121M NEUTRON ACER TENDL-2024 LIBRARY; T=0.K  
Photon emission for (n,3np)

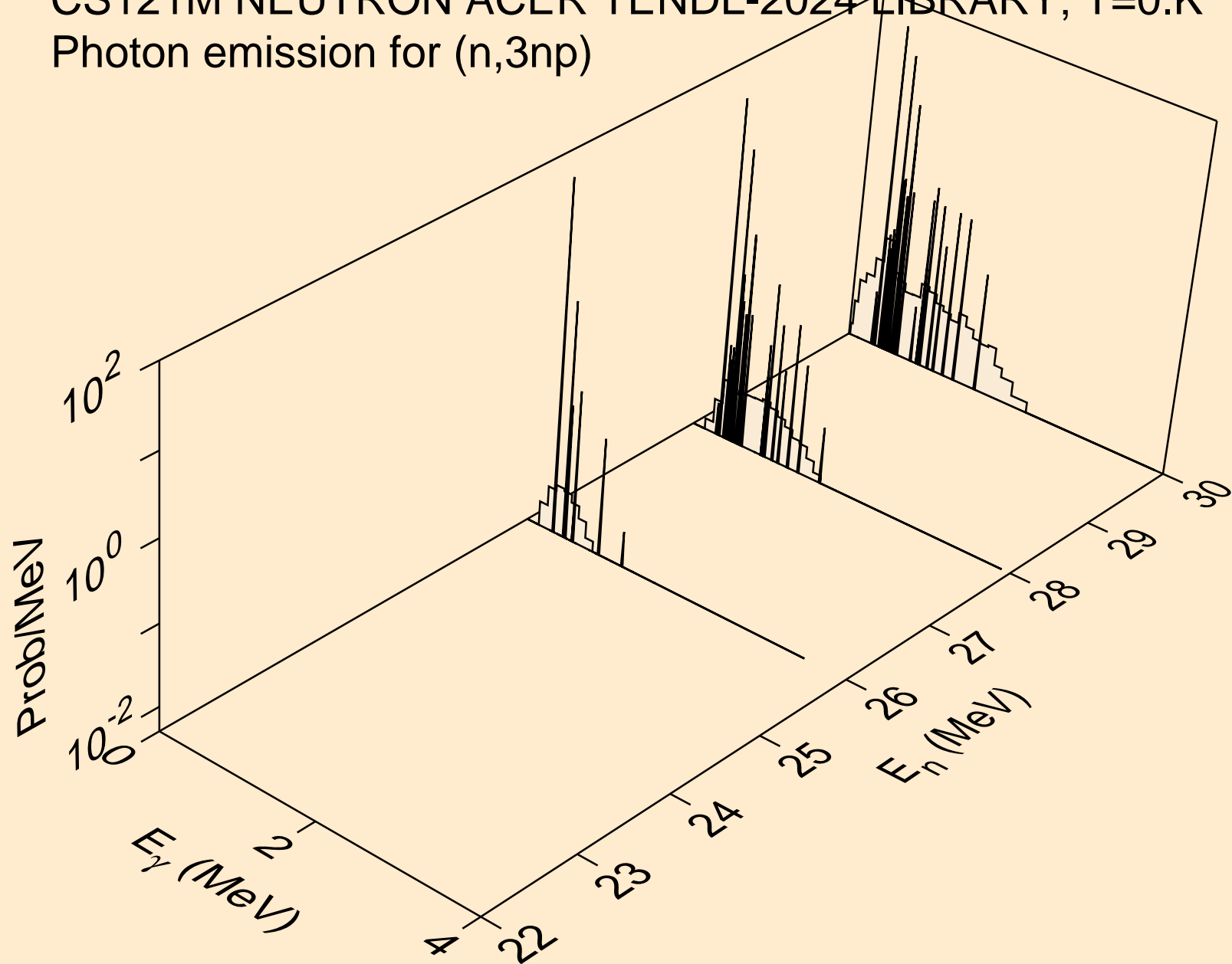

CS121M NEUTRON ACER TENDL-2024 LIBRARY; T=0.K  
Photon emission for (n,n2p)

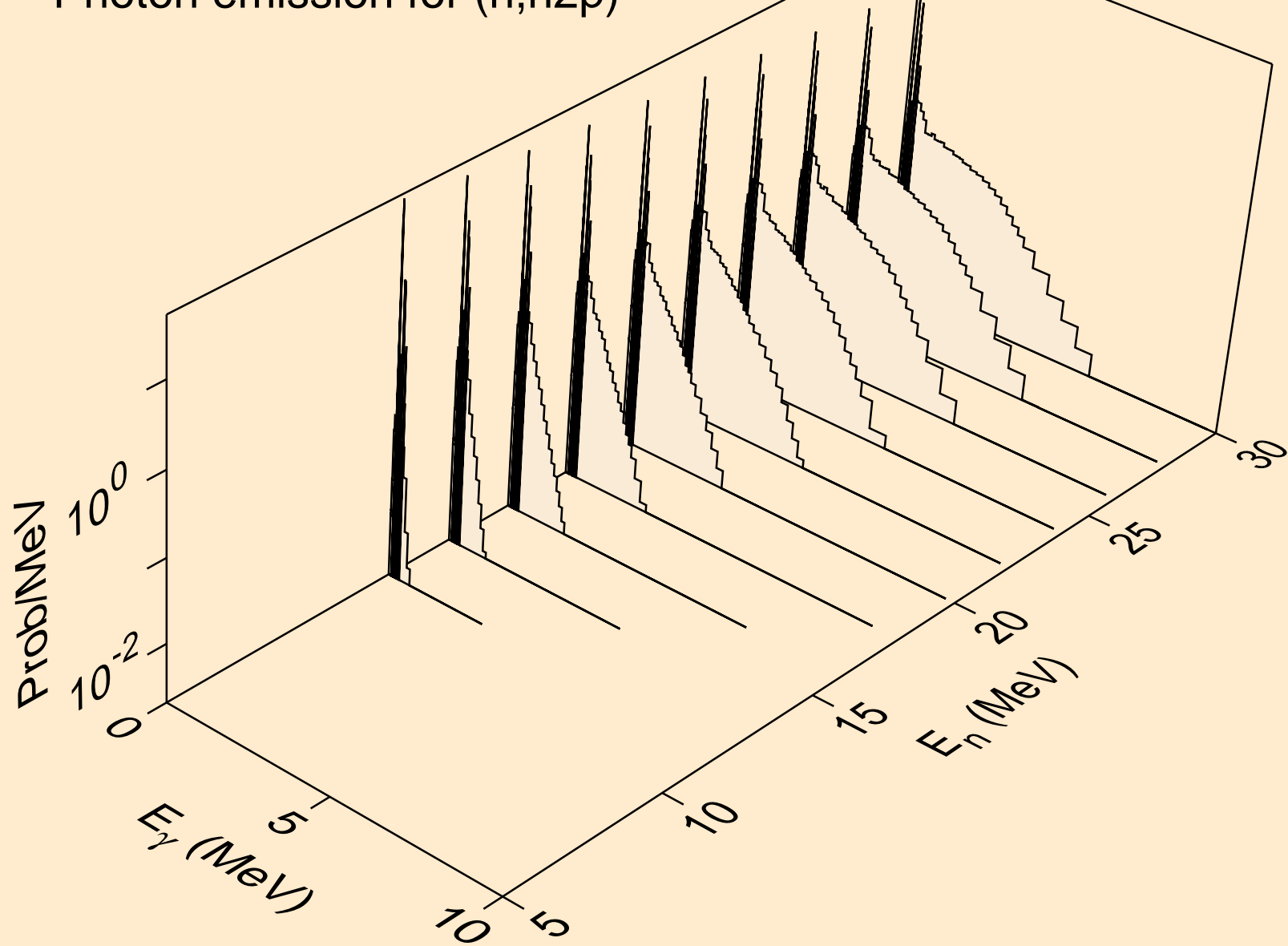

CS121M NEUTRON ACER TENDL-2024 LIBRARY; T=0.K  
Photon emission for (n,npa)

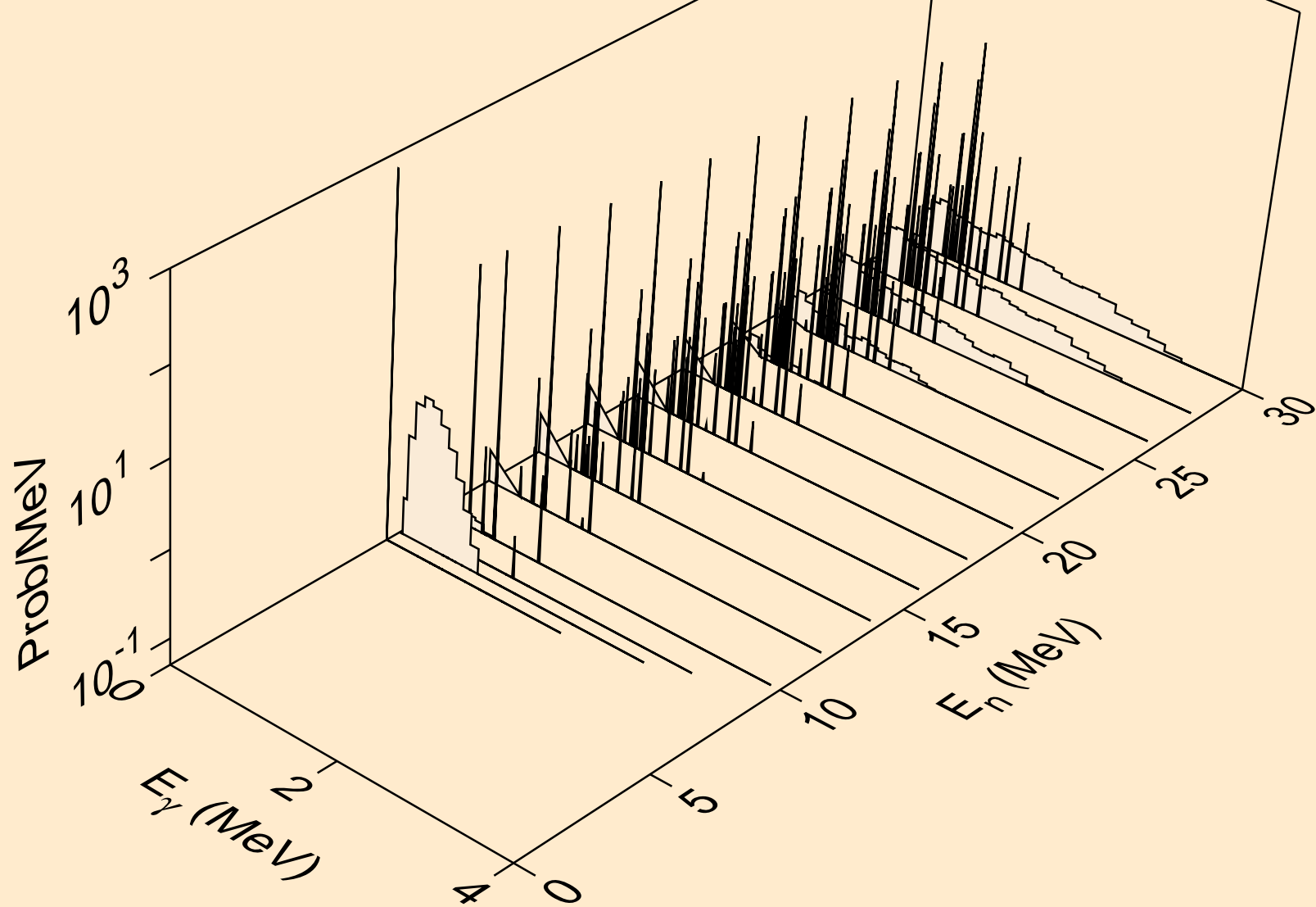

CS121M NEUTRON ACER TENDL-2024 LIBRARY; T=0.K  
Photon emission for (n,n\*2)

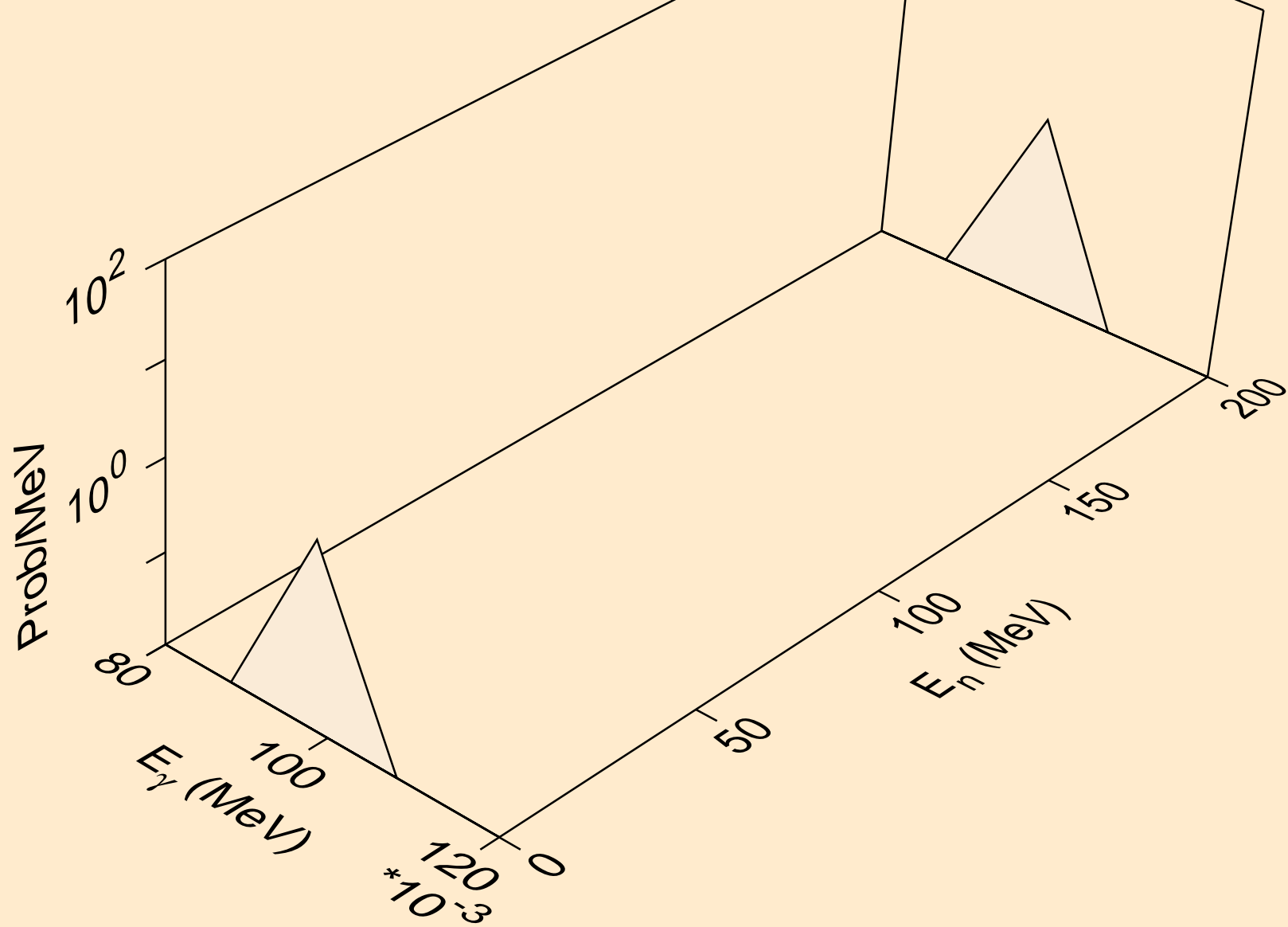

CS121M NEUTRON ACER TENDL-2024 LIBRARY; T=0.K  
Photon emission for (n,n\*3)

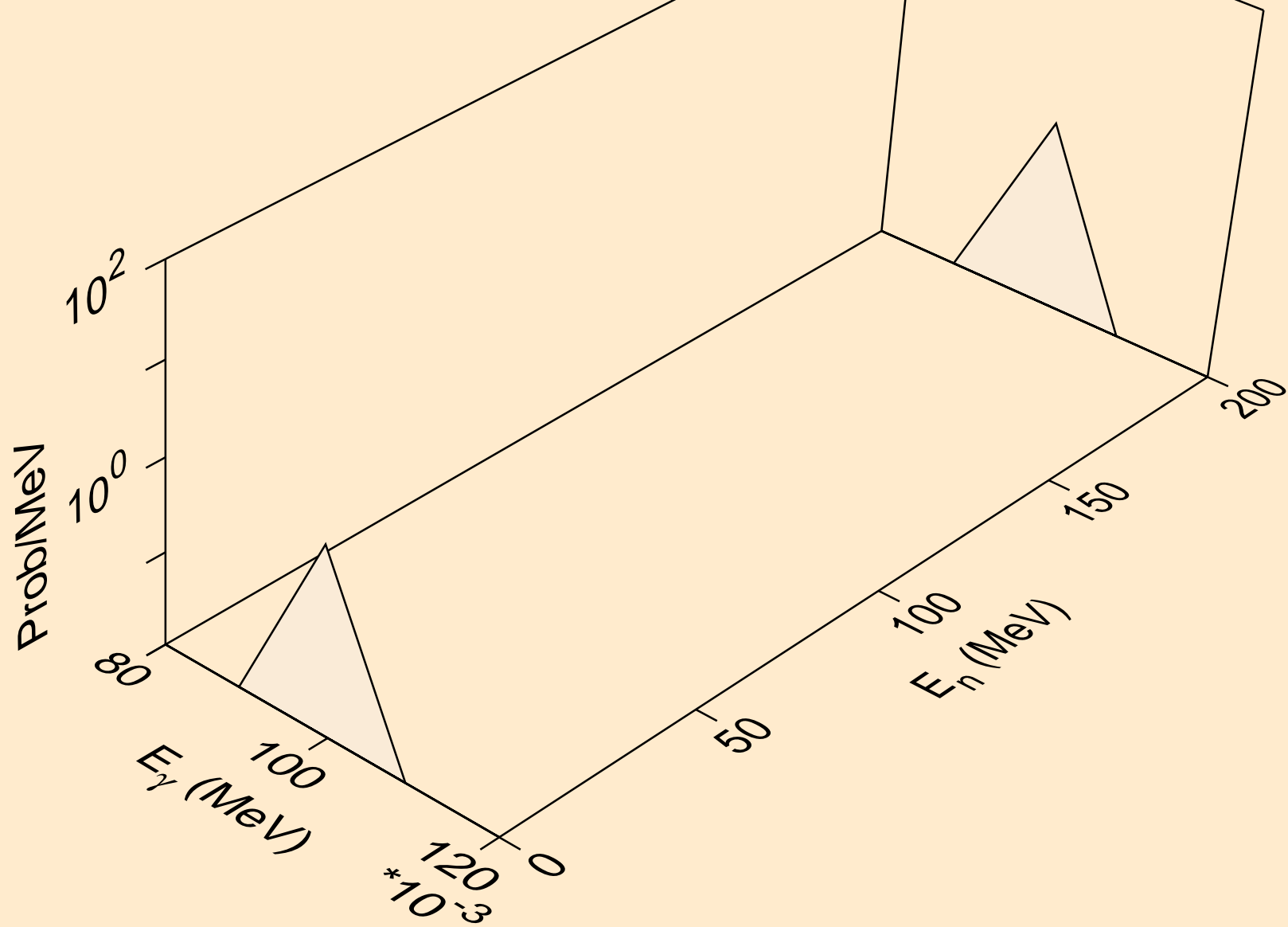

CS121M NEUTRON ACER TENDL-2024 LIBRARY; T=0.K  
Photon emission for (n,n\*4)

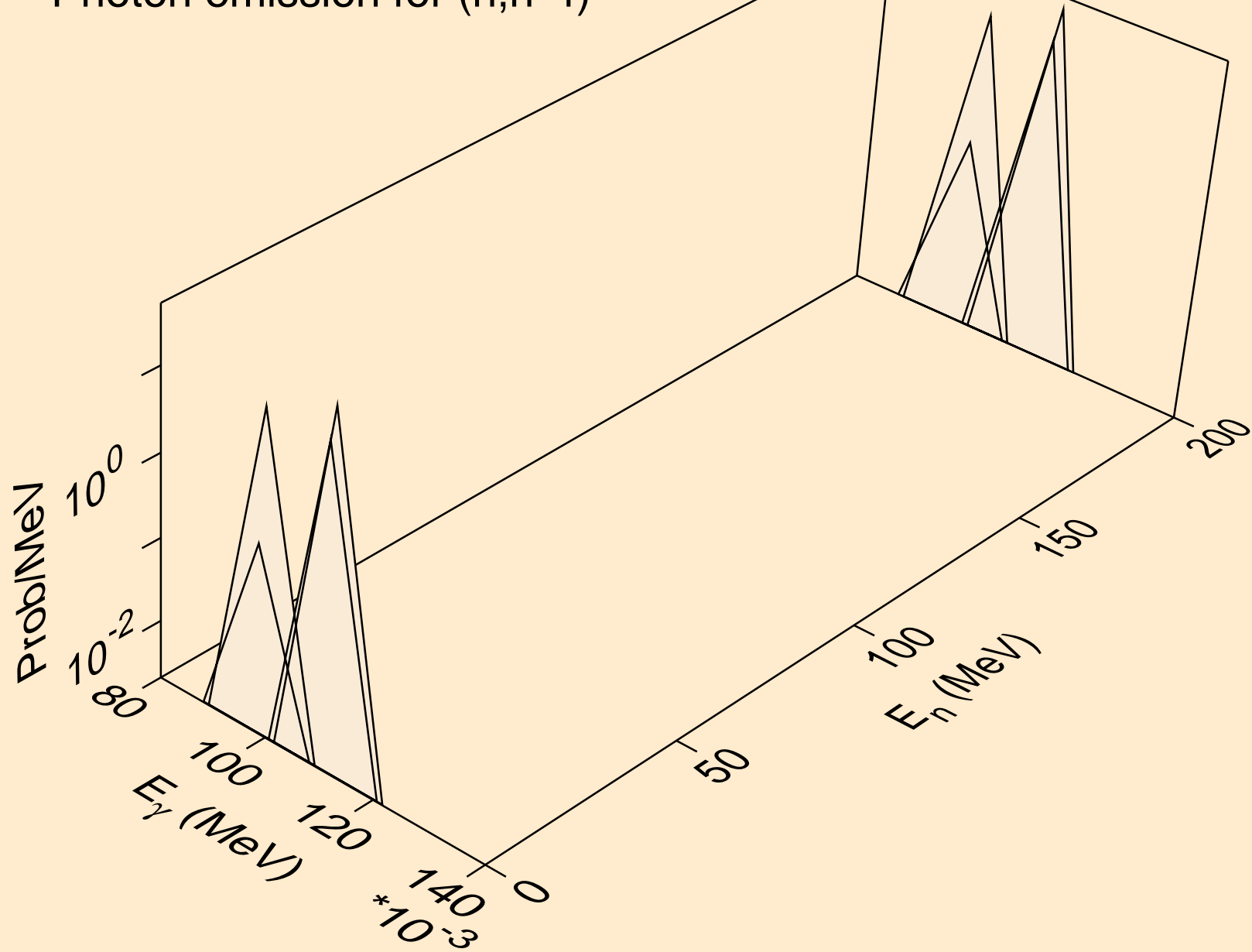

CS121M NEUTRON ACER TENDL-2024 LIBRARY; T=0.K  
Photon emission for (n,n\*5)

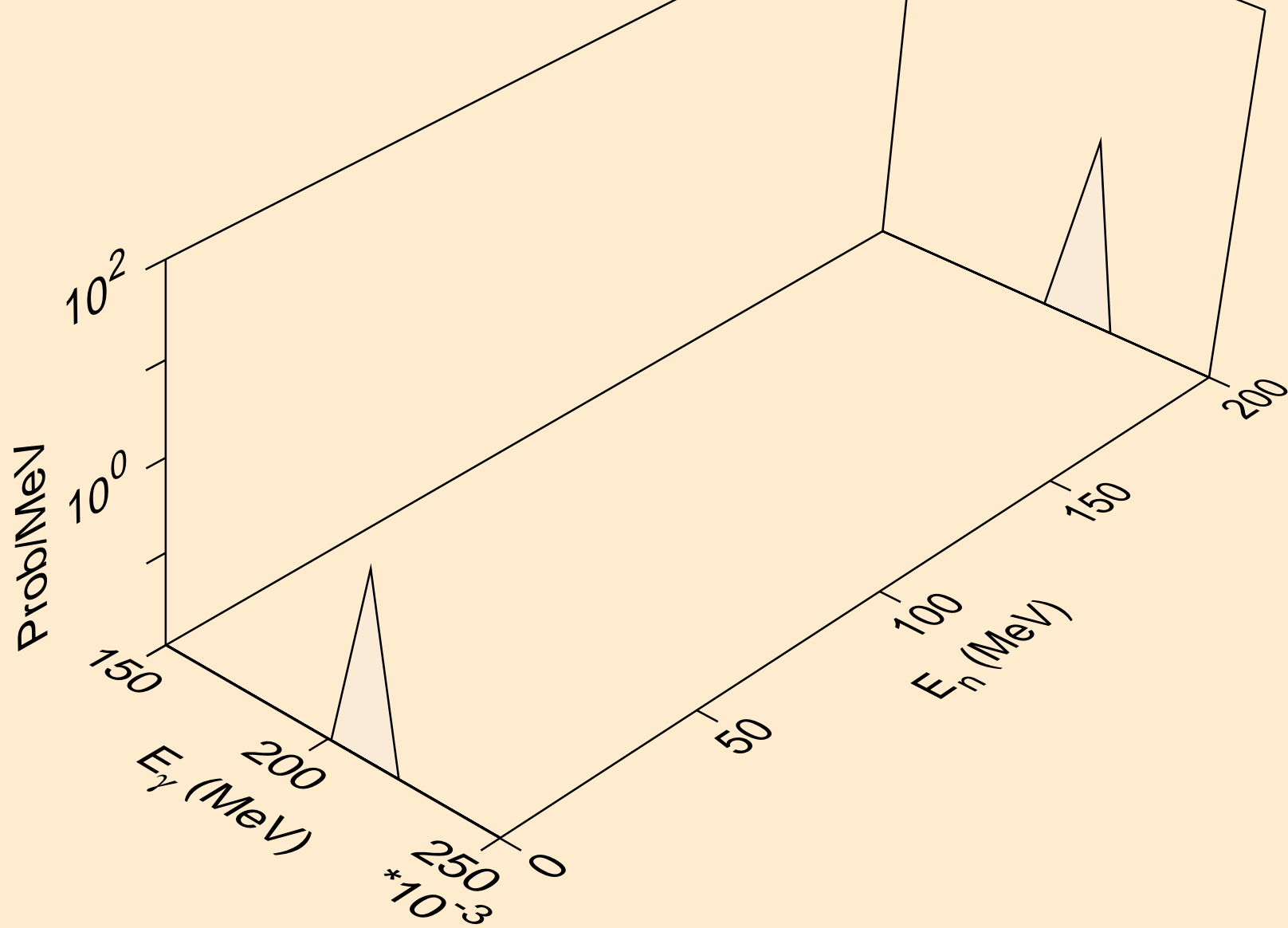

CS121M NEUTRON ACER TENDL-2024 LIBRARY; T=0.K  
Photon emission for (n,n\*6)

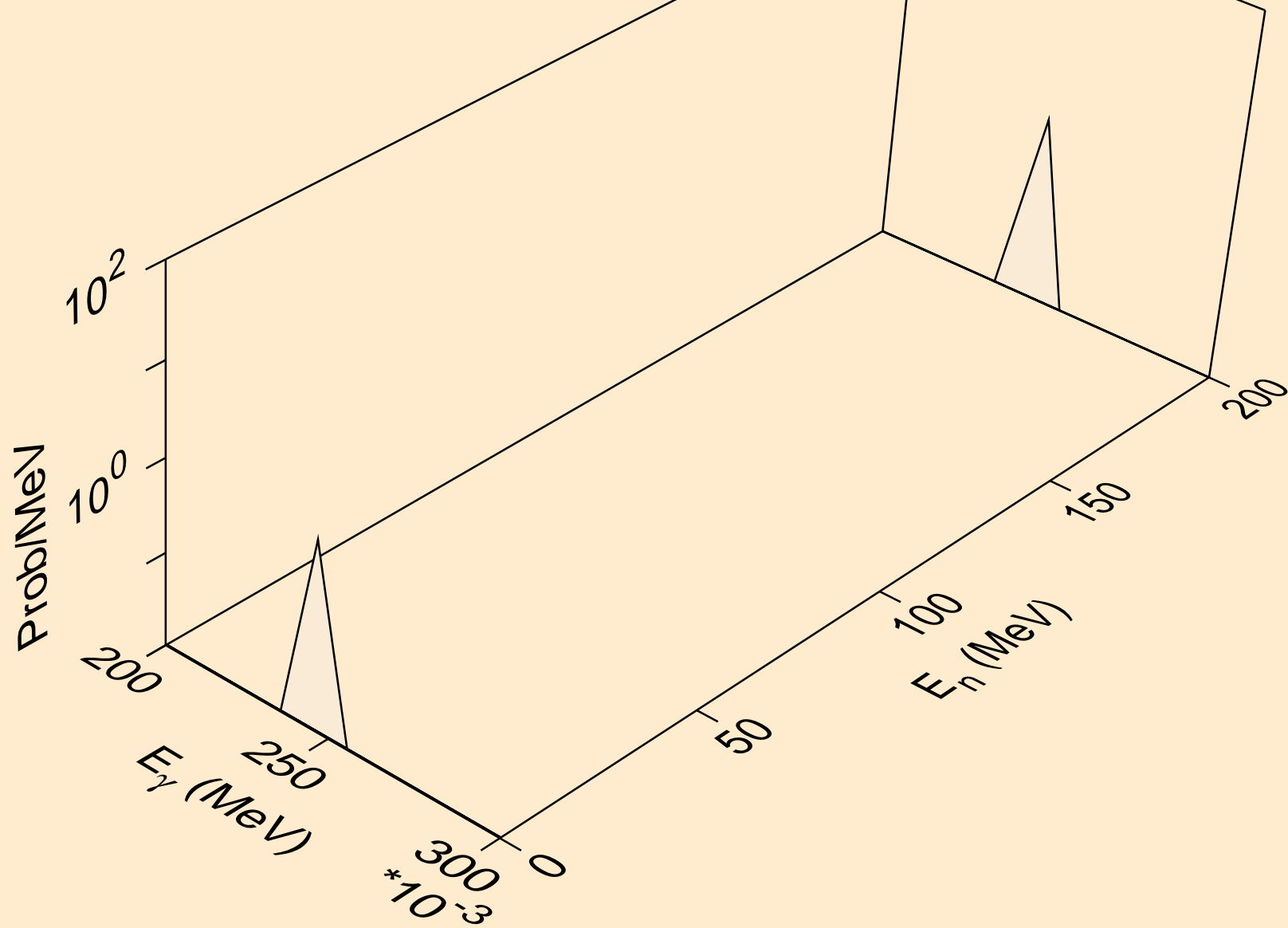

CS121M NEUTRON ACER TENDL-2024 LIBRARY; T=0.K  
Photon emission for (n,n\*7)

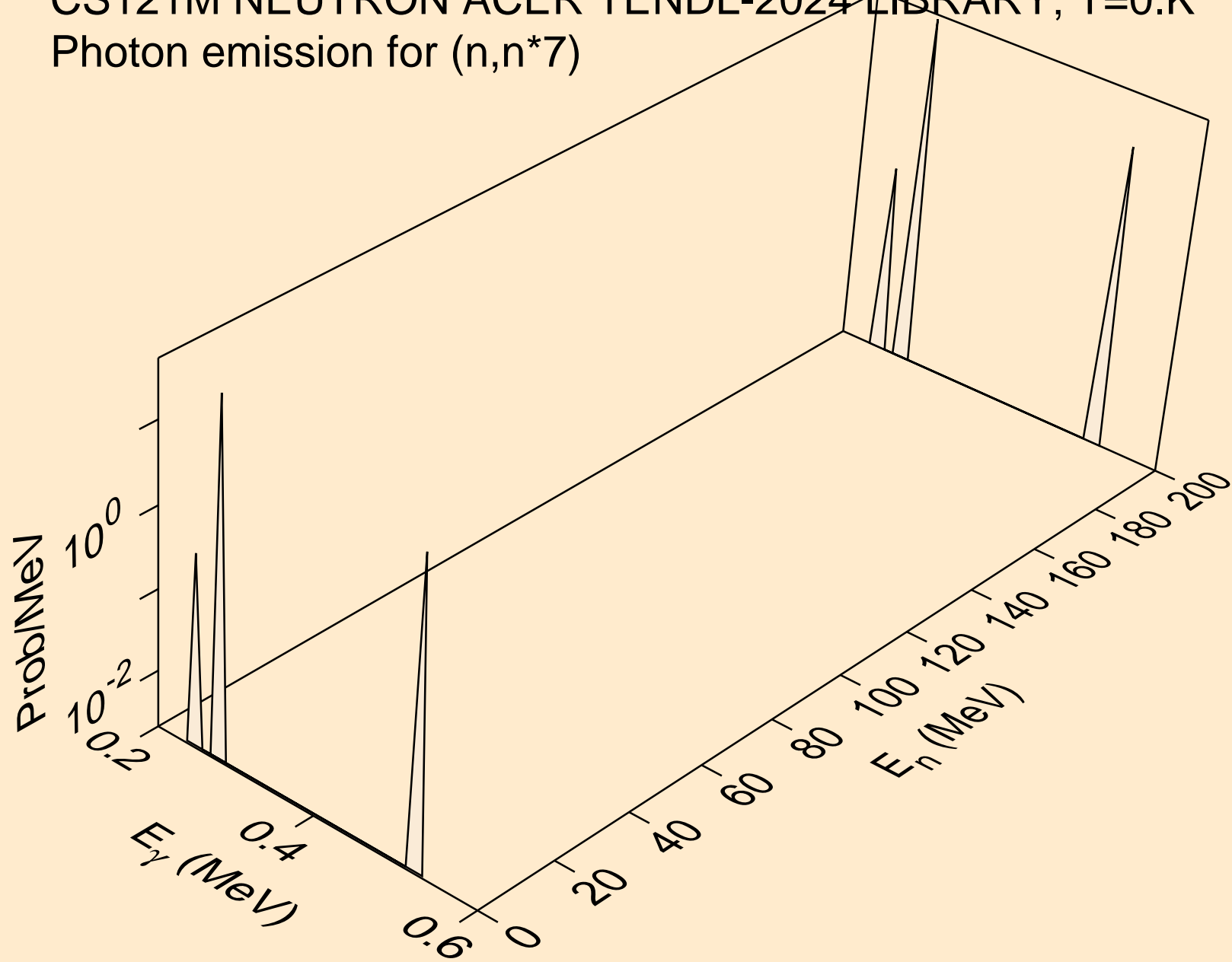

CS121M NEUTRON ACER TENDL-2024 LIBRARY; T=0.K  
Photon emission for (n,n\*8)

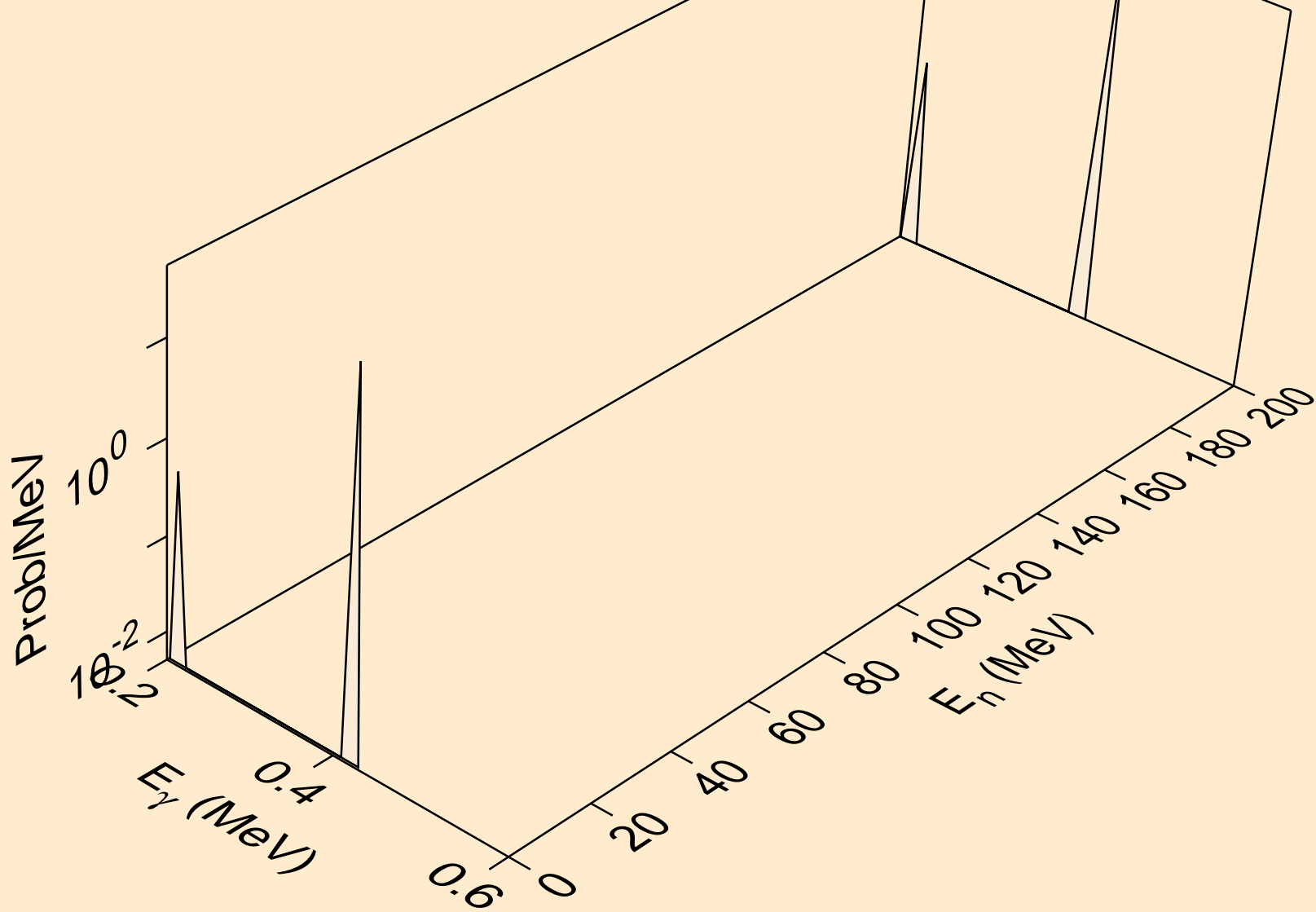

CS121M NEUTRON ACER TENDL-2024 LIBRARY; T=0.K  
Photon emission for (n,n\*c)

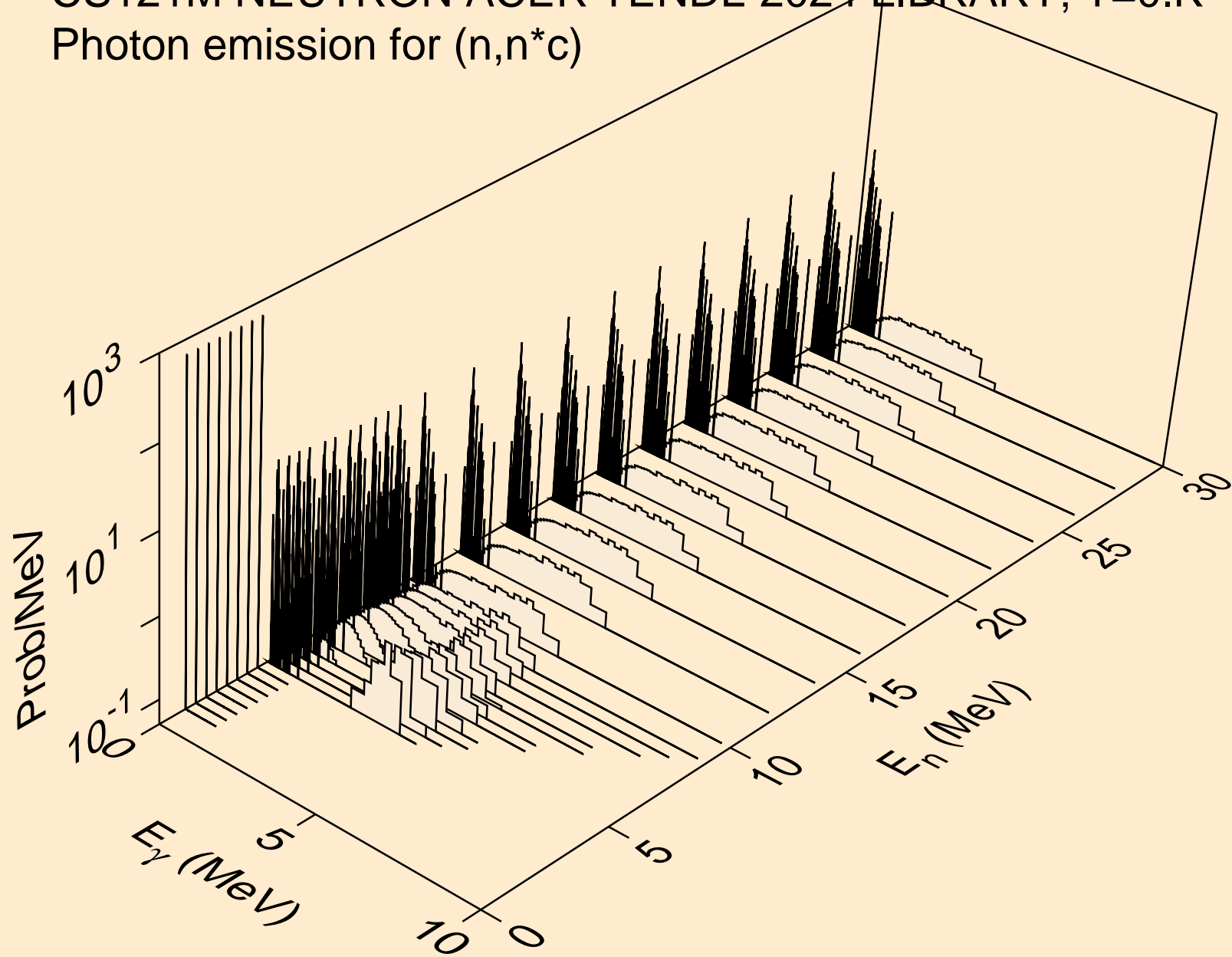

CS121M NEUTRON ACER TENDL-2024 LIBRARY; T=0.K  
Photon emission for (n,gma)

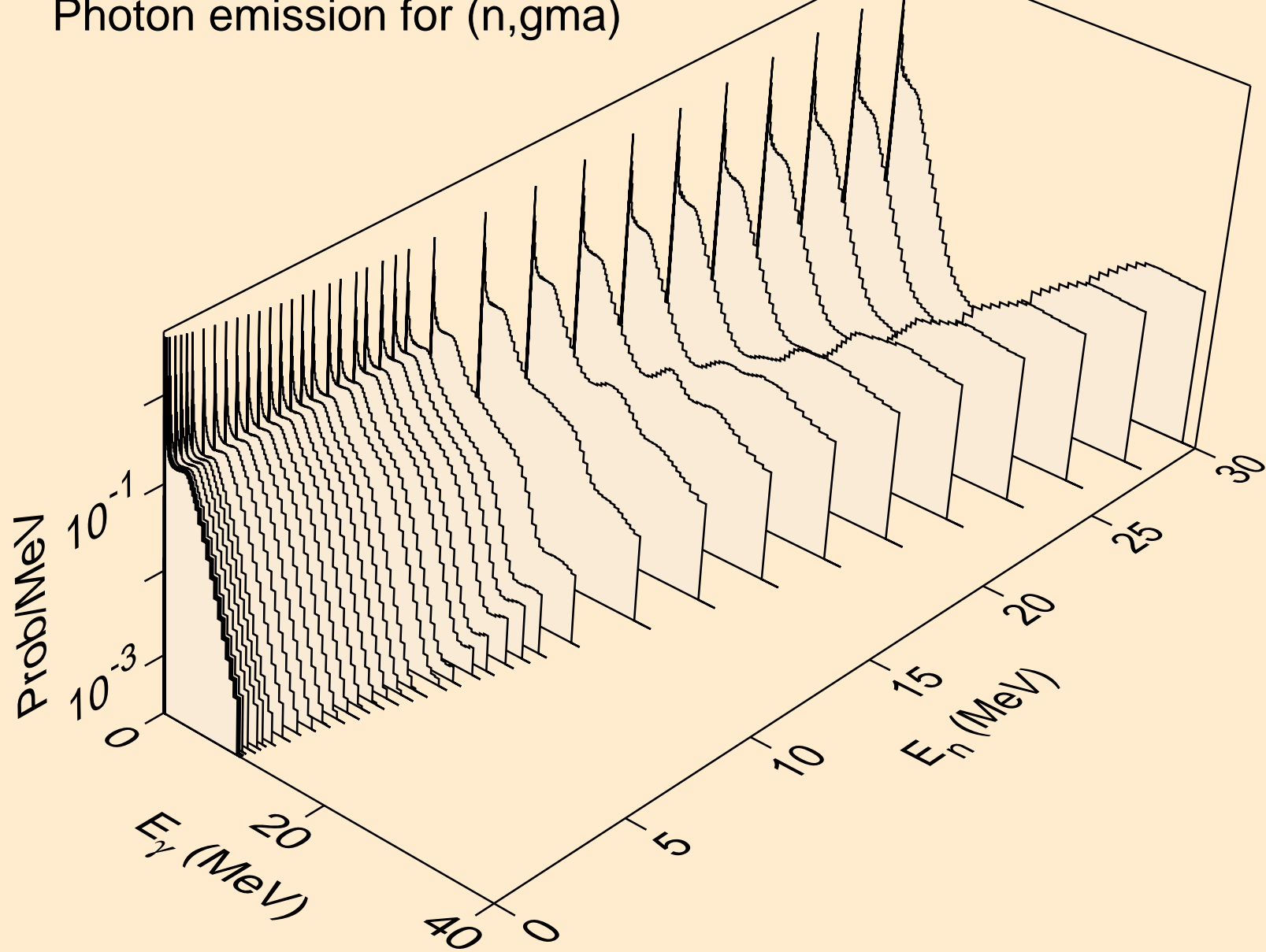

CS121M NEUTRON ACER TENDL-2024 LIBRARY; T=0.K  
Photon emission for (n,p)

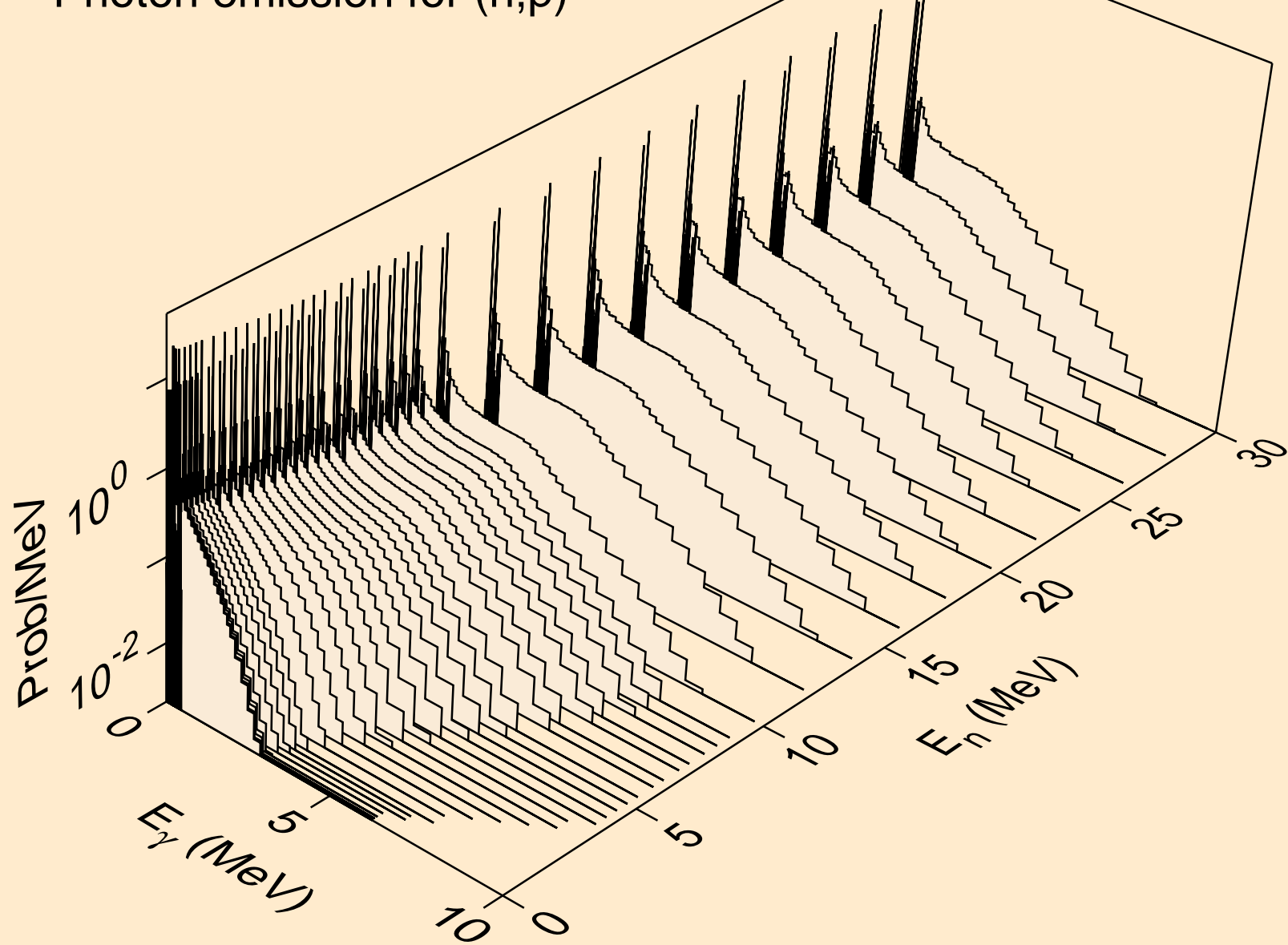

CS121M NEUTRON ACER TENDL-2024 LIBRARY; T=0.K  
Photon emission for (n,d)

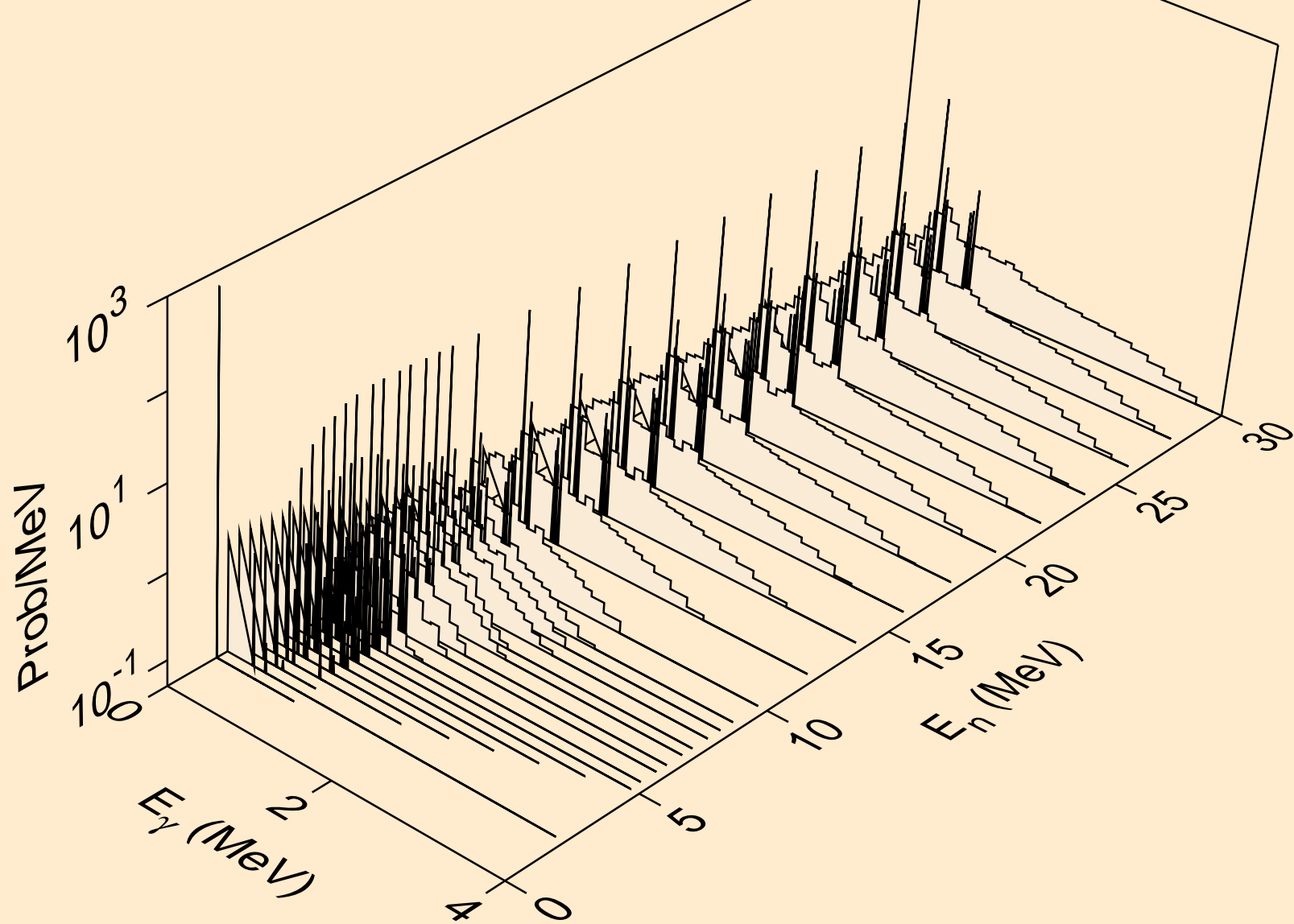

CS121M NEUTRON ACER TENDL-2024 LIBRARY; T=0.K  
Photon emission for (n,t)

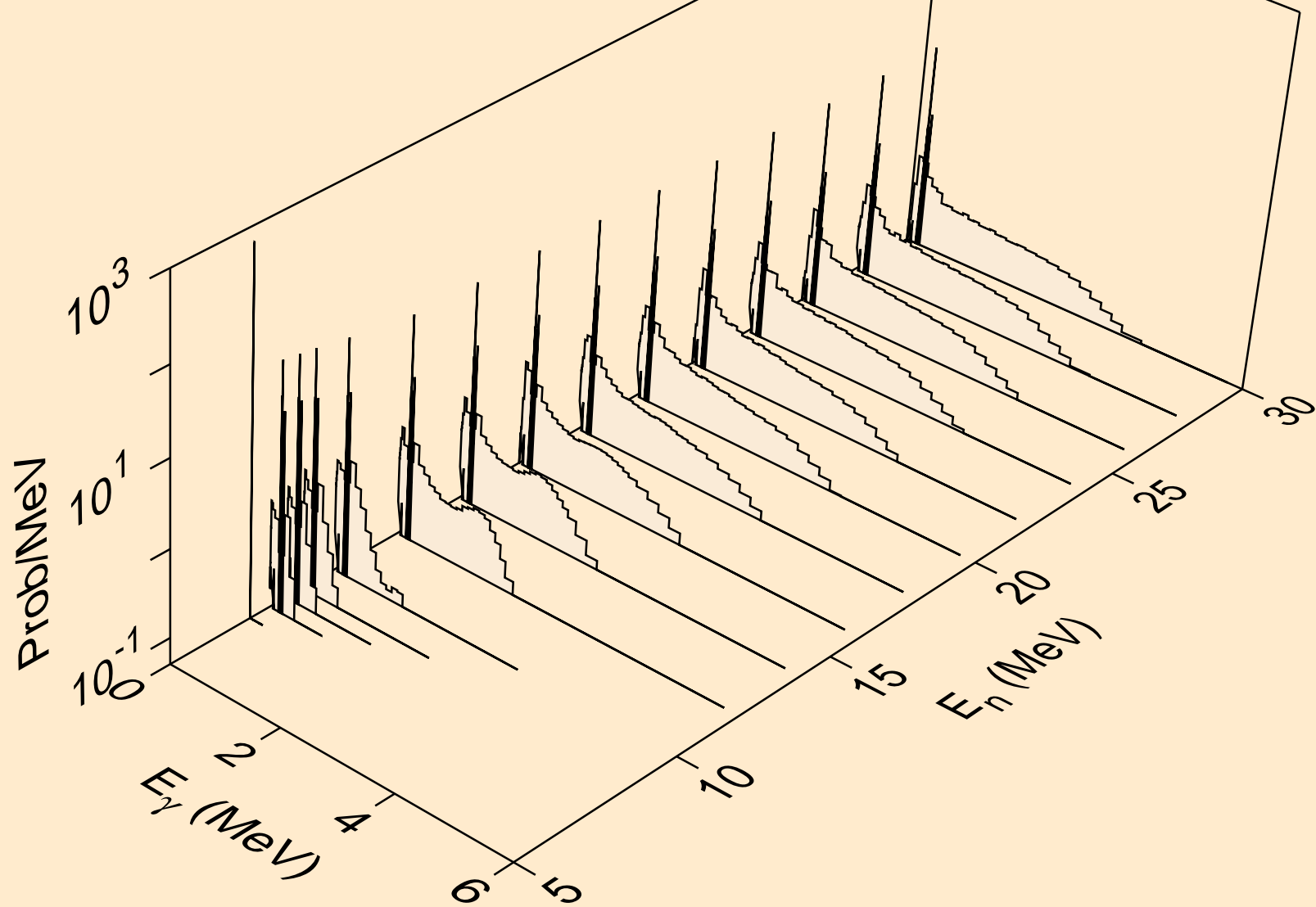

CS121M NEUTRON ACER TENDL-2024 LIBRARY; T=0.K  
Photon emission for (n,he3)

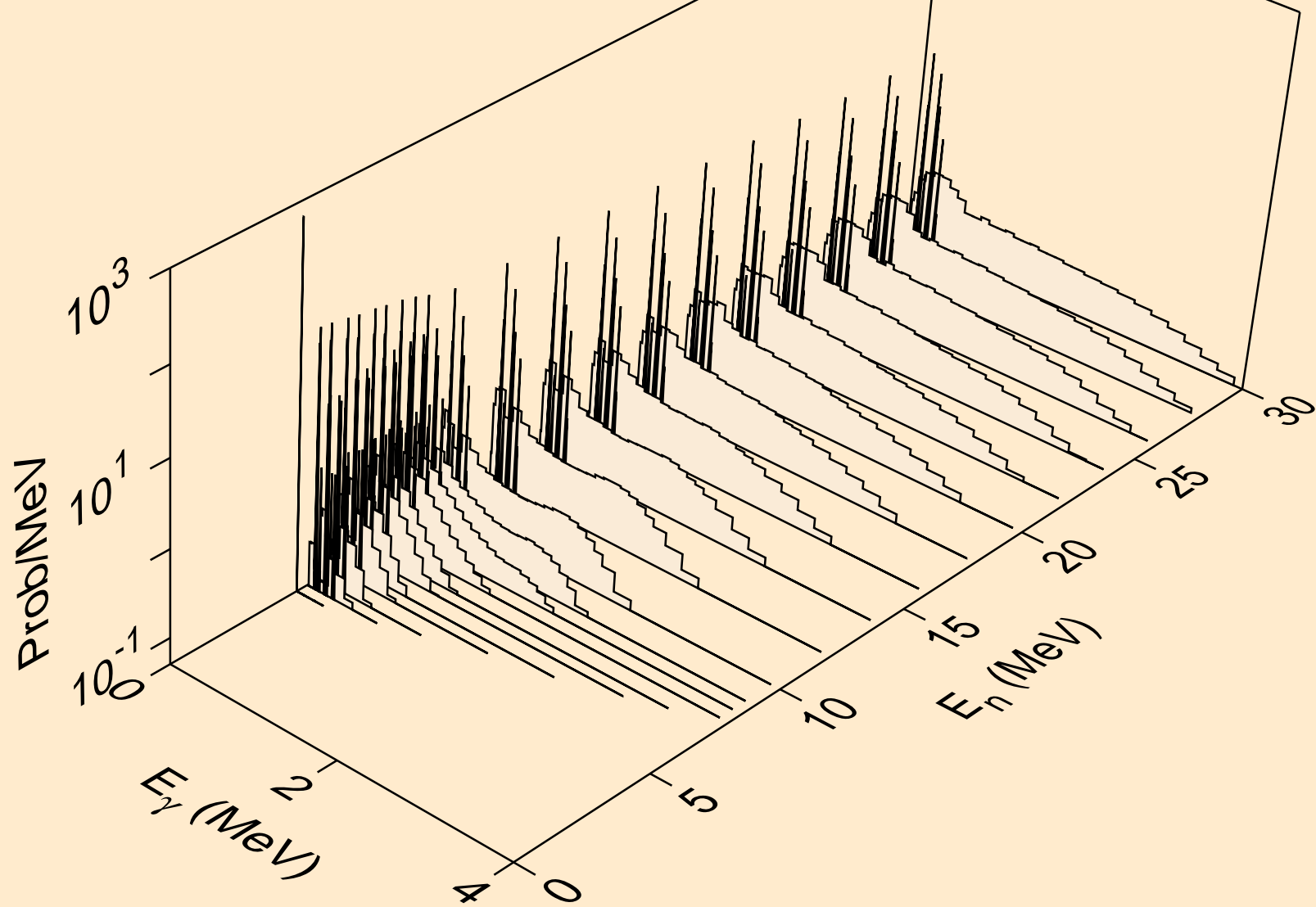

CS121M NEUTRON ACER TENDL-2024 LIBRARY; T=0.K  
Photon emission for (n,a)

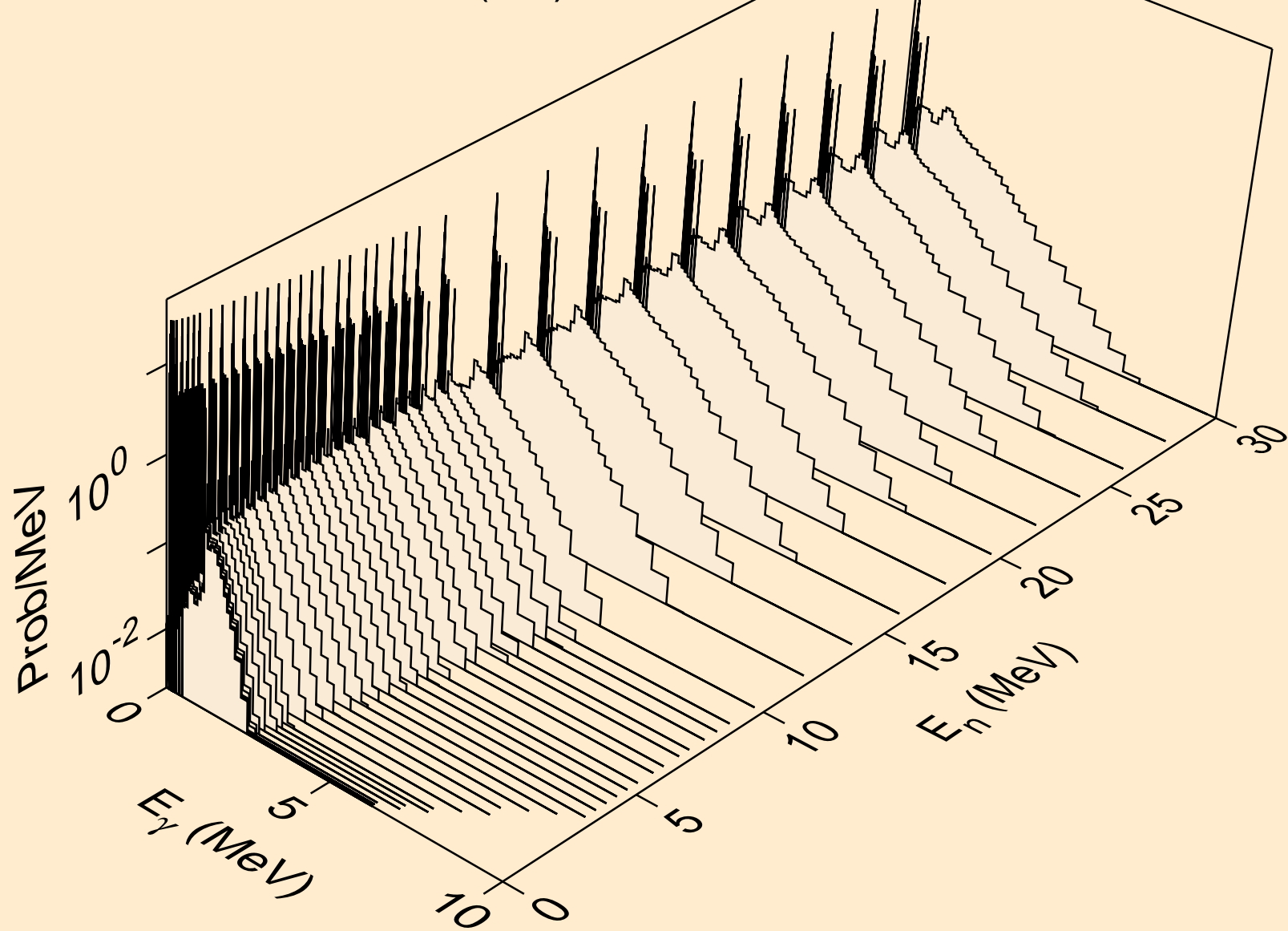

CS121M NEUTRON ACER TENDL-2024 LIBRARY; T=0.K  
Photon emission for (n,2a)

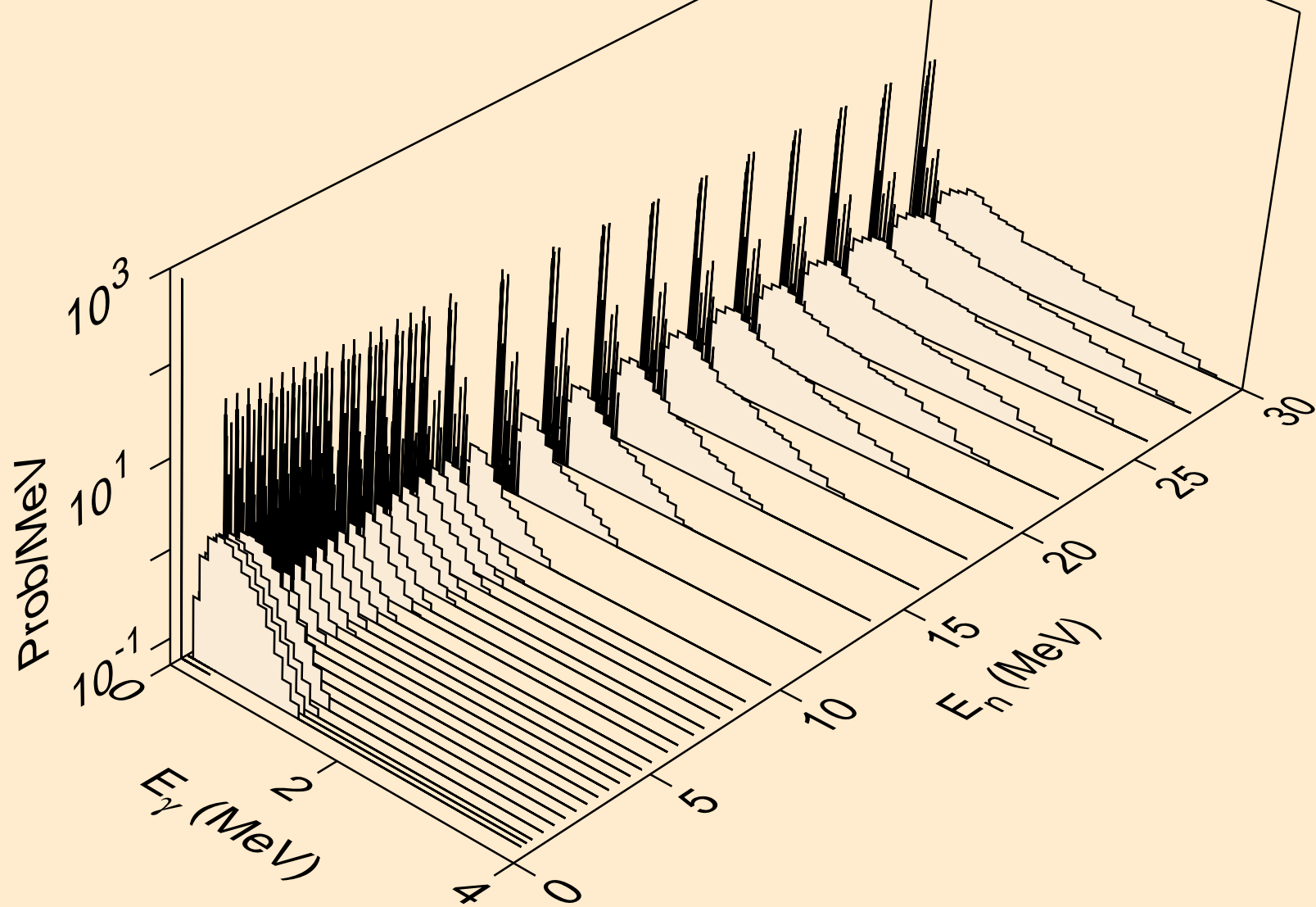

CS121M NEUTRON ACER TENDL-2024 LIBRARY; T=0.K  
Photon emission for (n,3a)

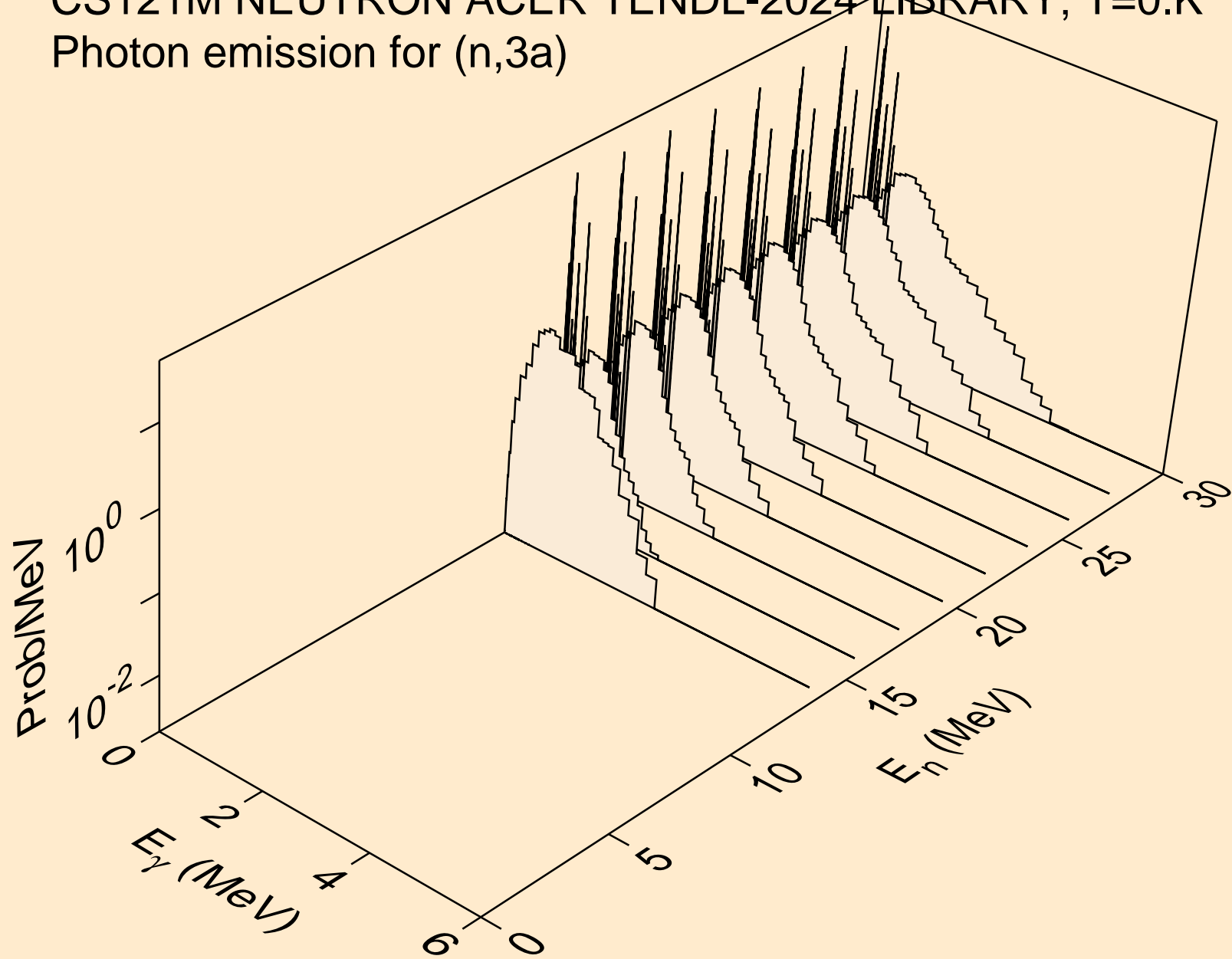

CS121M NEUTRON ACER TENDL-2024 LIBRARY; T=0.K  
Photon emission for (n,2p)

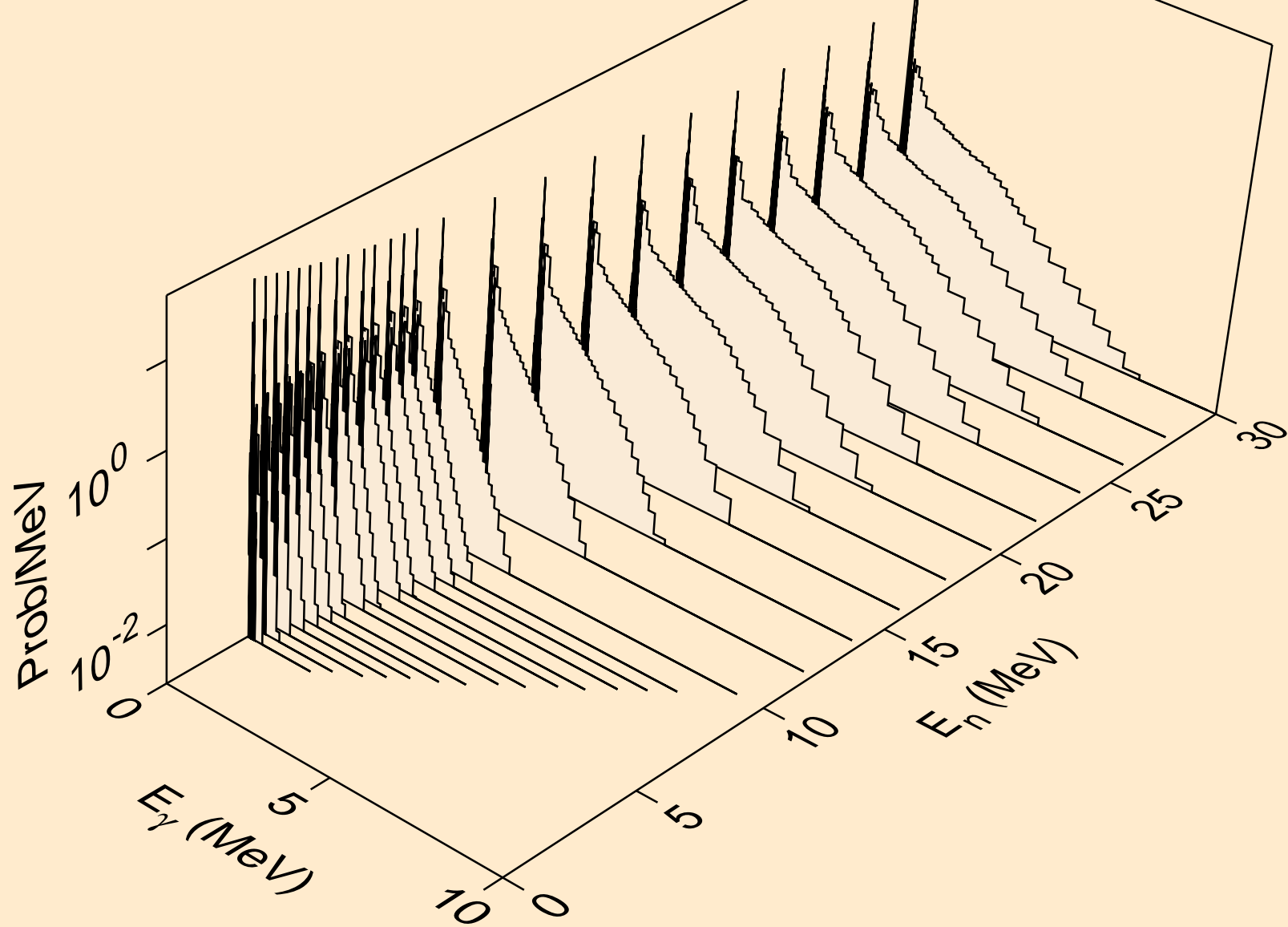

CS121M NEUTRON ACER TENDL-2024 LIBRARY; T=0.K  
Photon emission for (n,p)

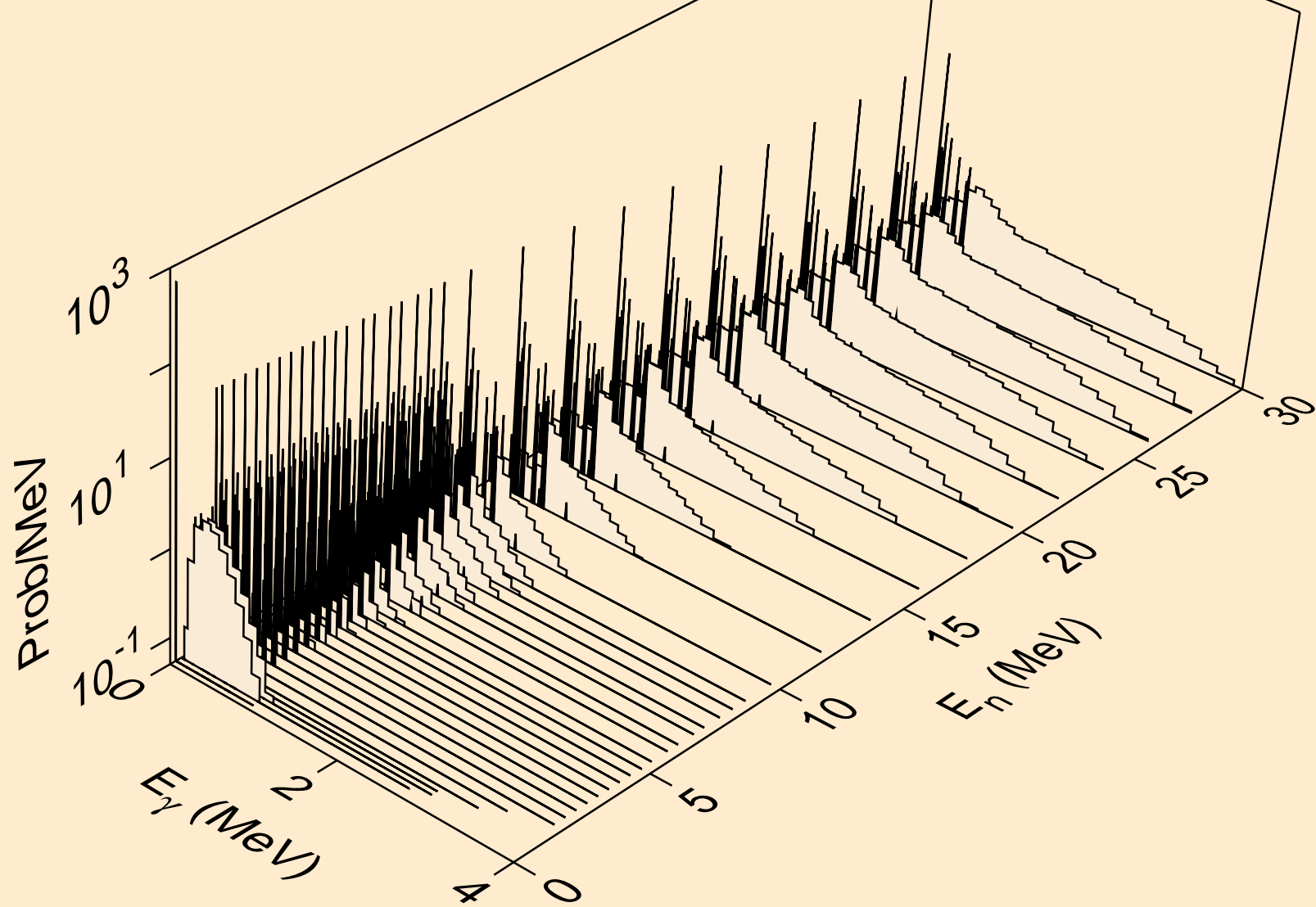

CS121M NEUTRON ACER TENDL-2024 LIBRARY; T=0.K  
Photon emission for (n,d2a)

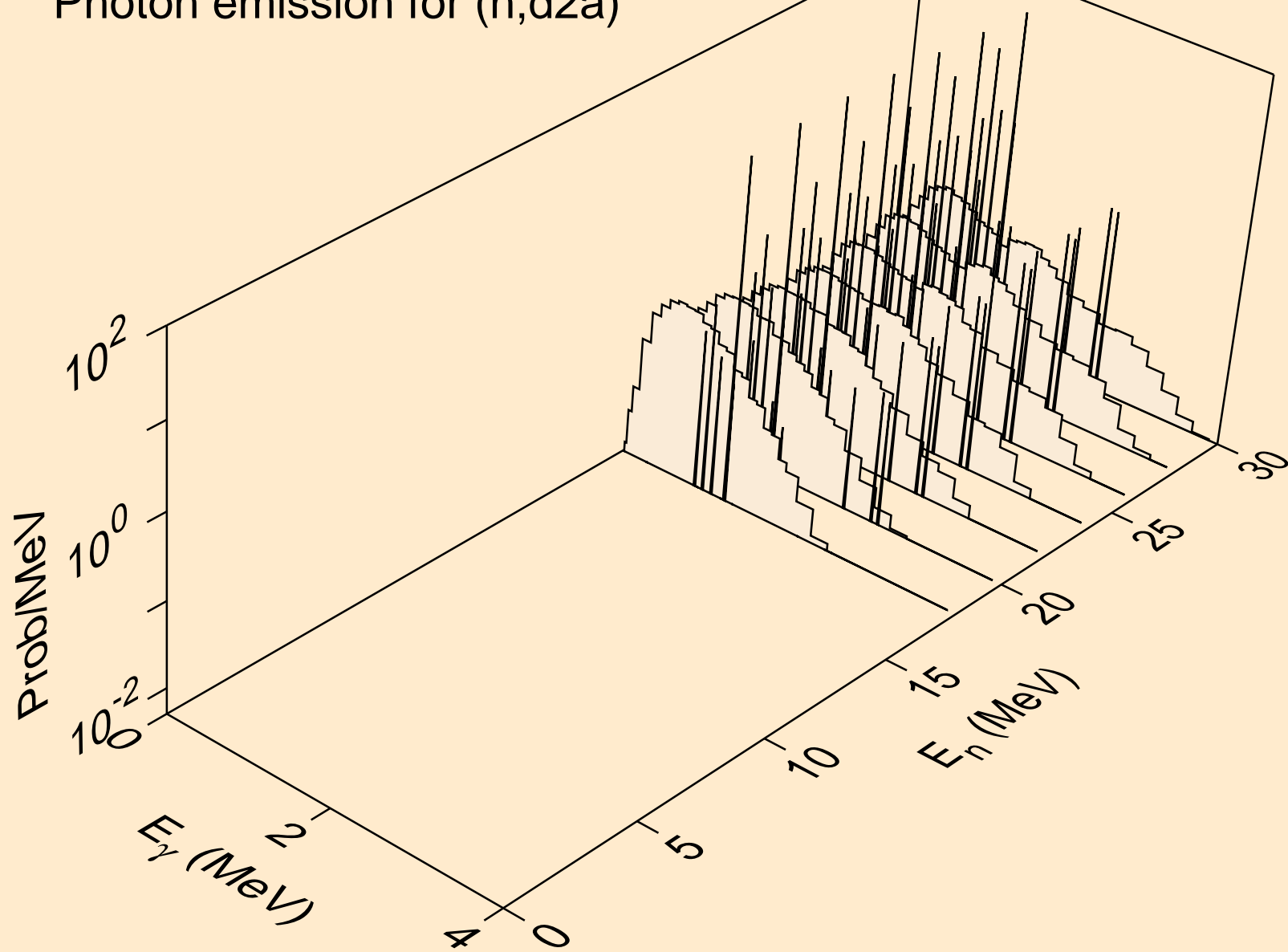

CS121M NEUTRON ACER TENDL-2024 LIBRARY; T=0.K  
Photon emission for (n,pd)

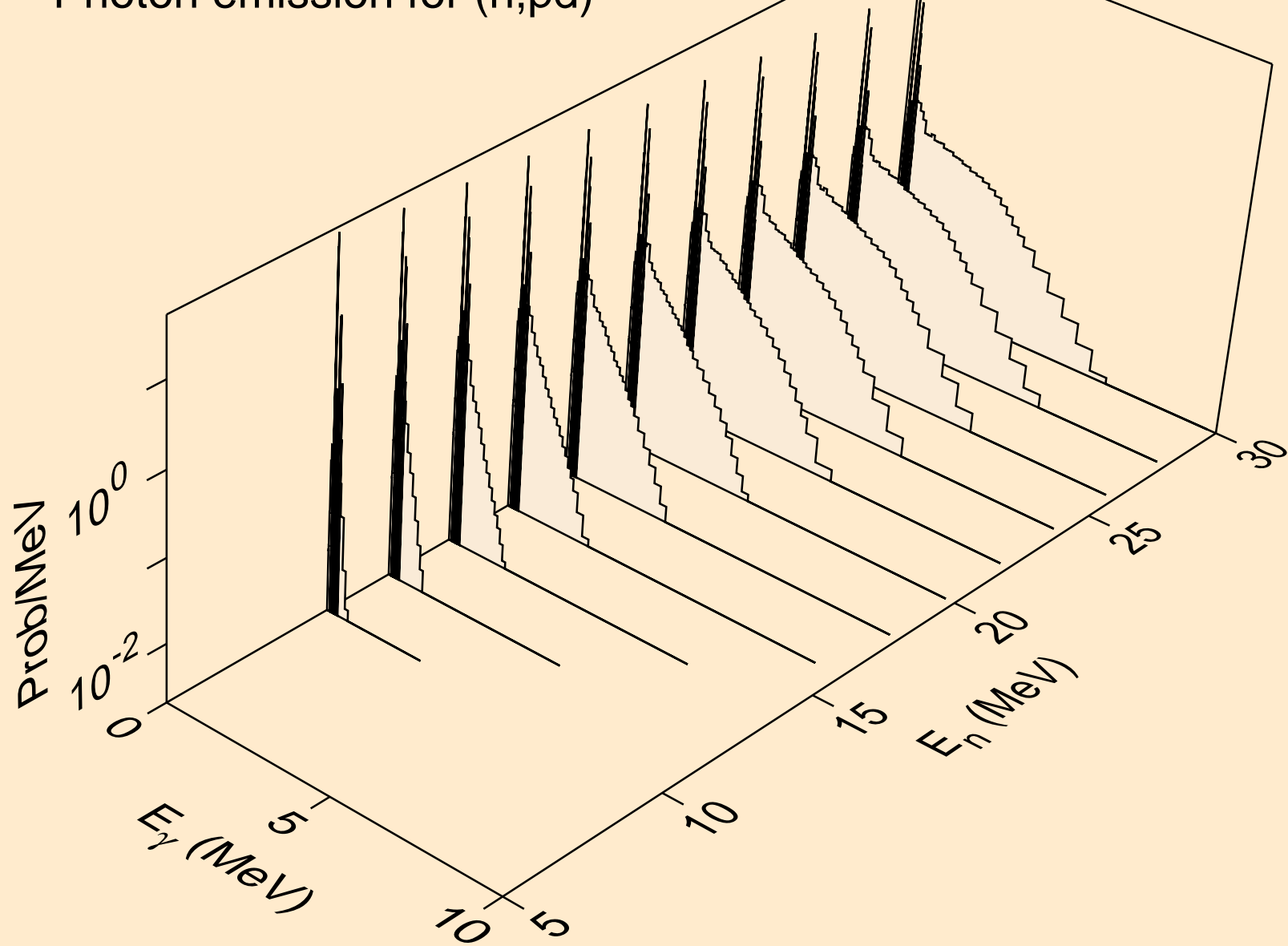

CS121M NEUTRON ACER TENDL-2024 LIBRARY; T=0.K  
Photon emission for (n,pt)

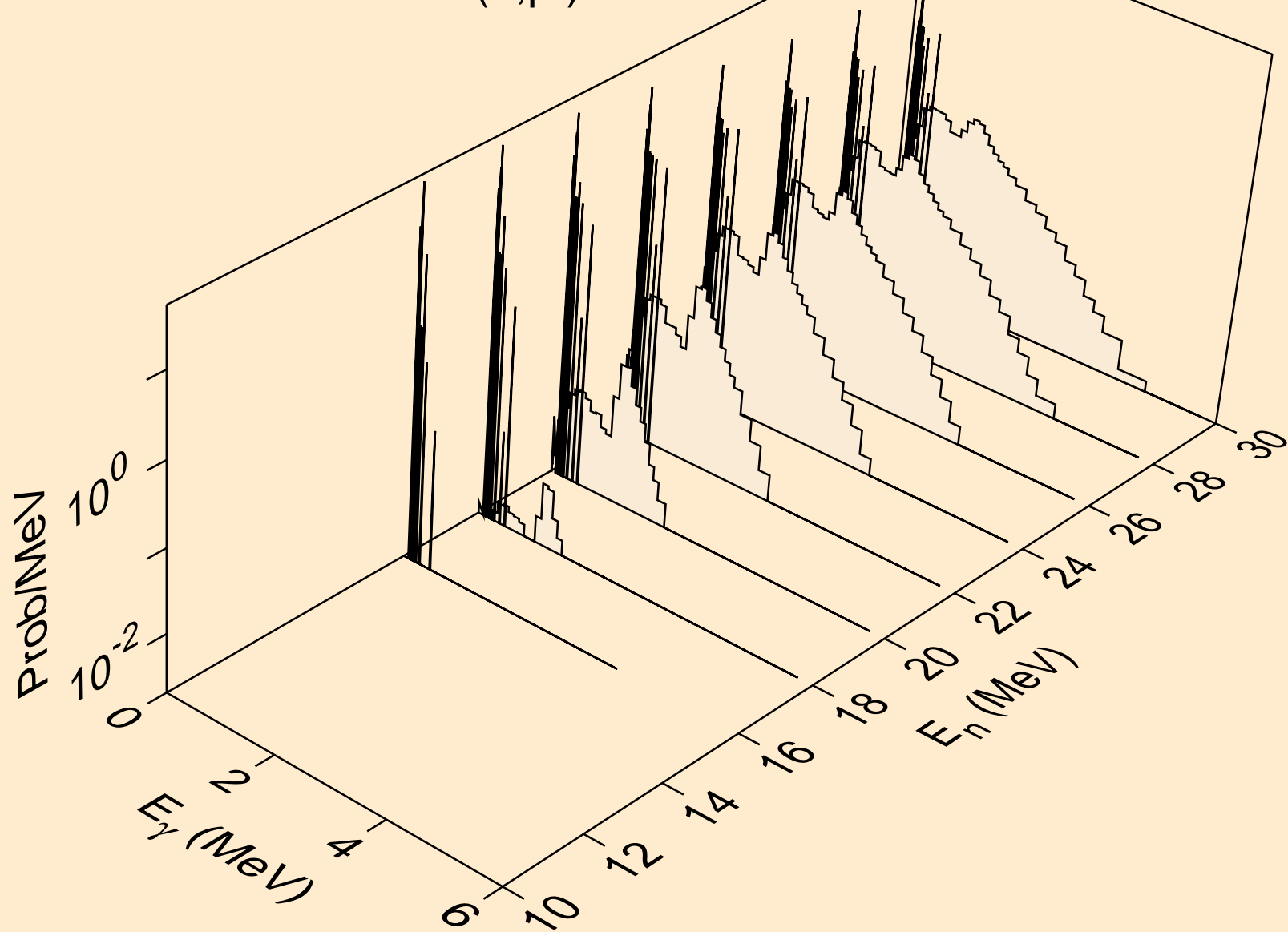

CS121M NEUTRON ACER TENDL-2024 LIBRARY; T=0.K  
Photon emission for (n,da)

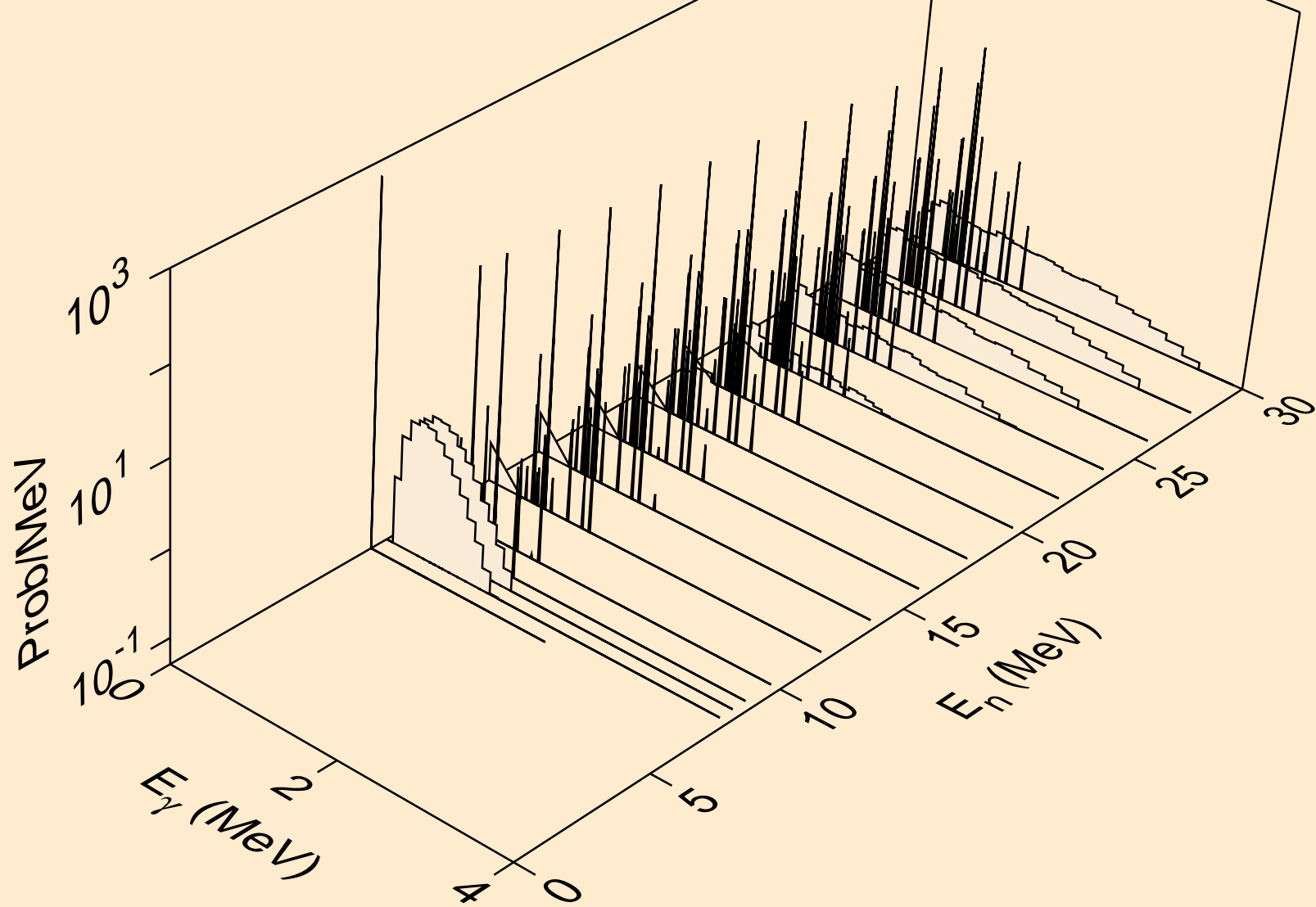

CS121M NEUTRON ACER TENDL-2024 LIBRARY; T=0.K  
thermal capture photon spectrum

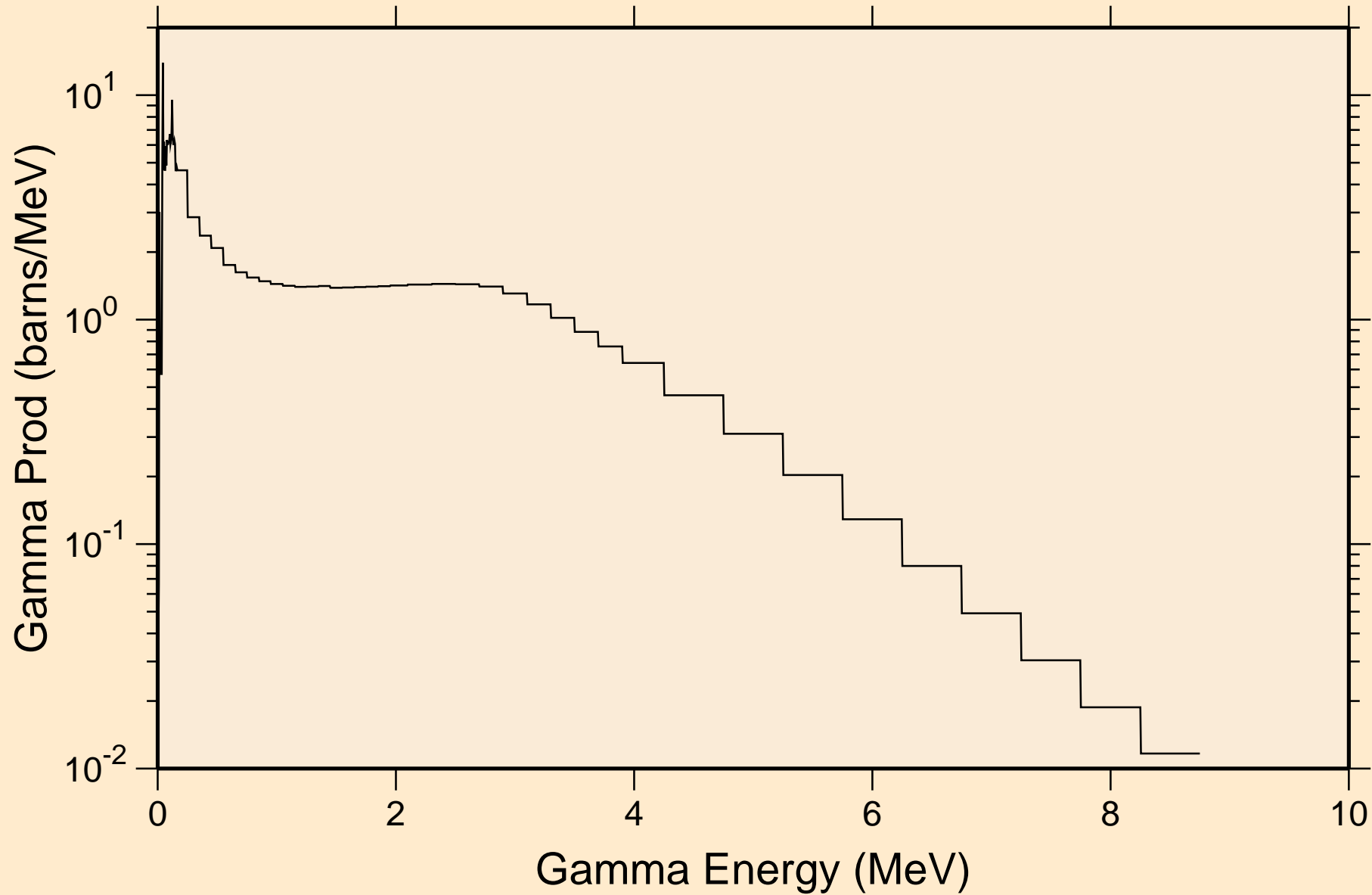

CS121M NEUTRON ACER TENDL-2024 LIBRARY; T=0.K  
14 MeV photon spectrum

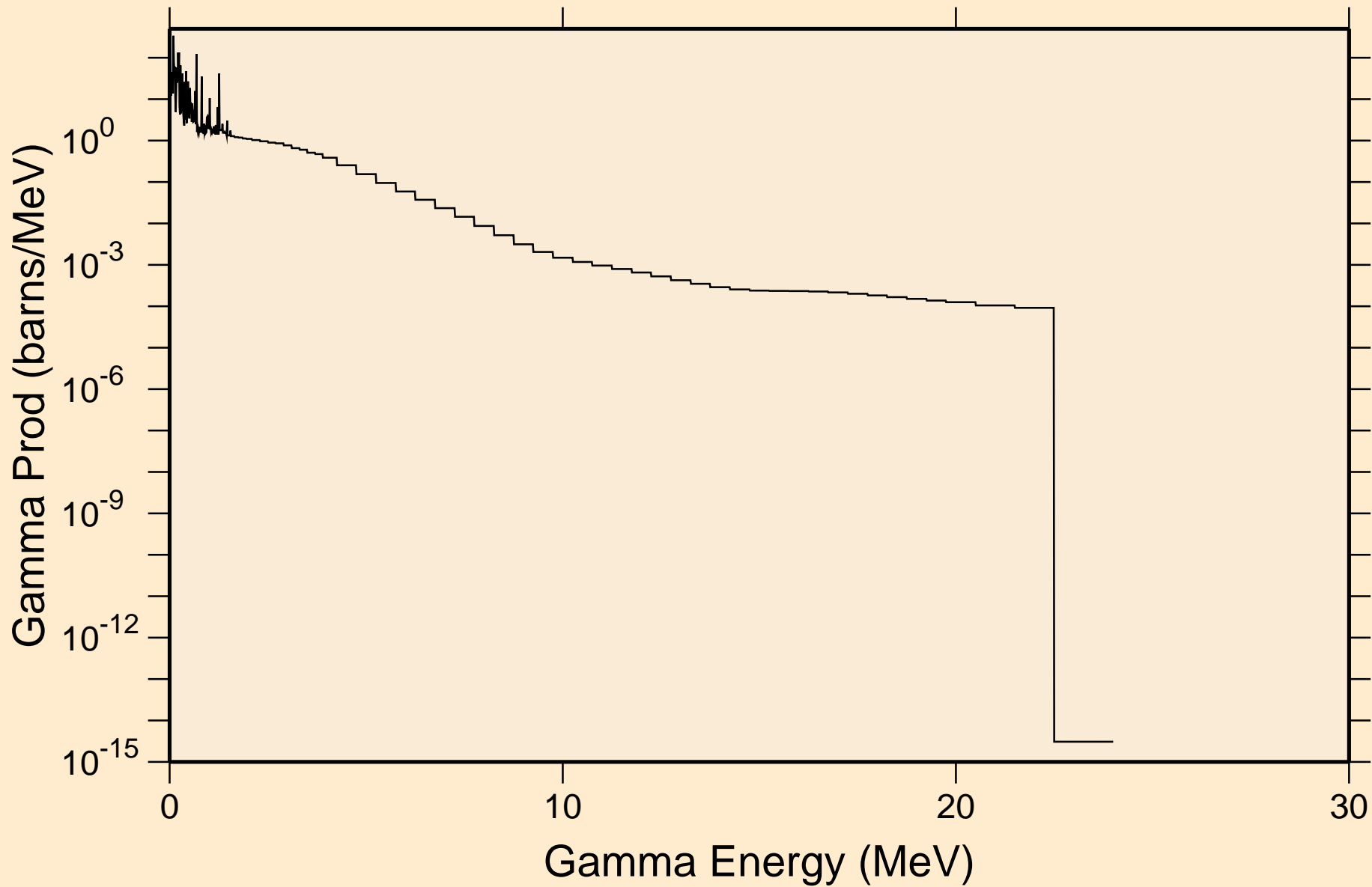

# CS121M NEUTRON ACER TENDL-2024 LIBRARY; T=0.K

## Particle heating contributions

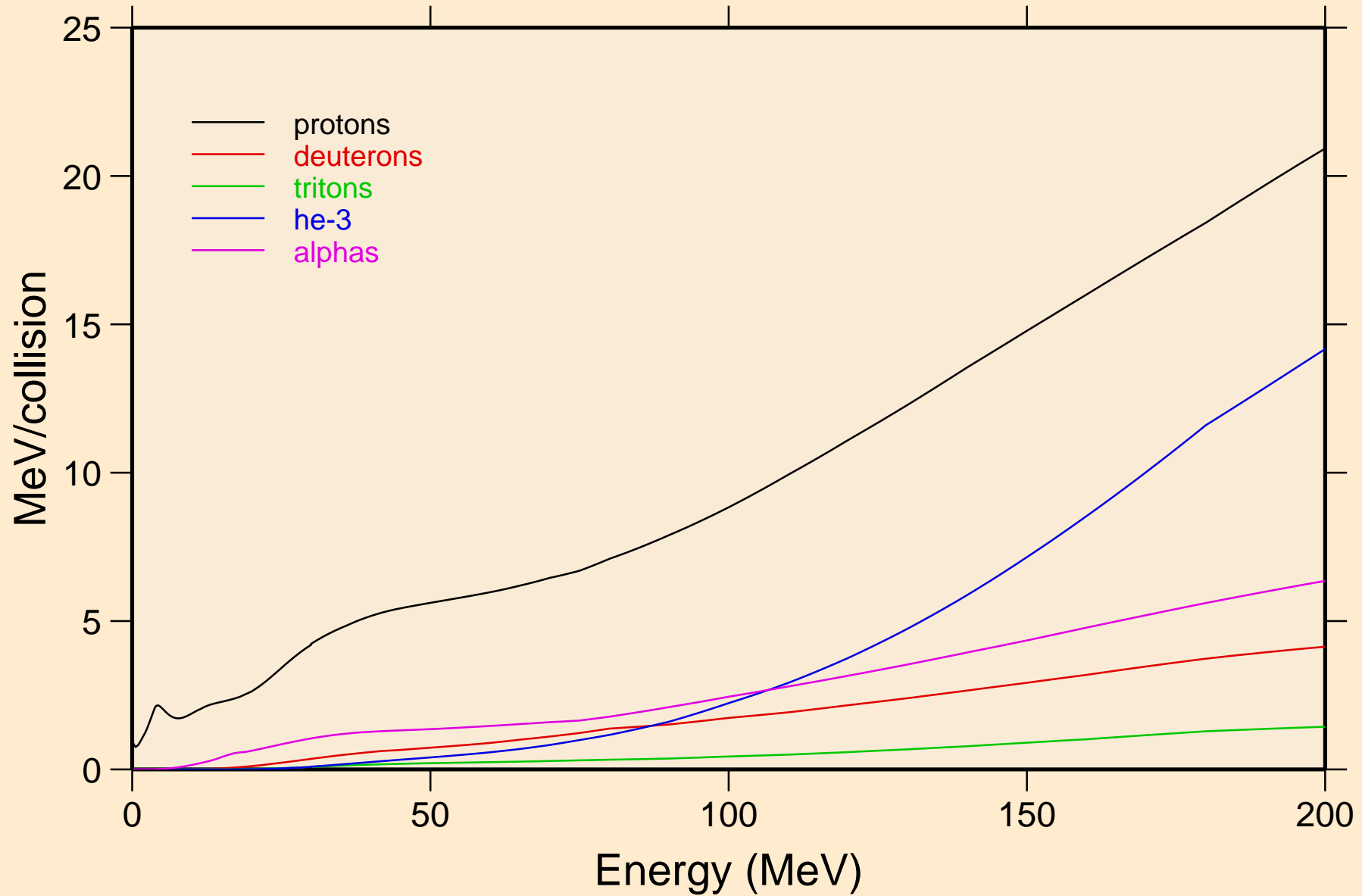

# CS121M NEUTRON ACER TENDL-2024 LIBRARY; T=0.K

## Recoil Heating

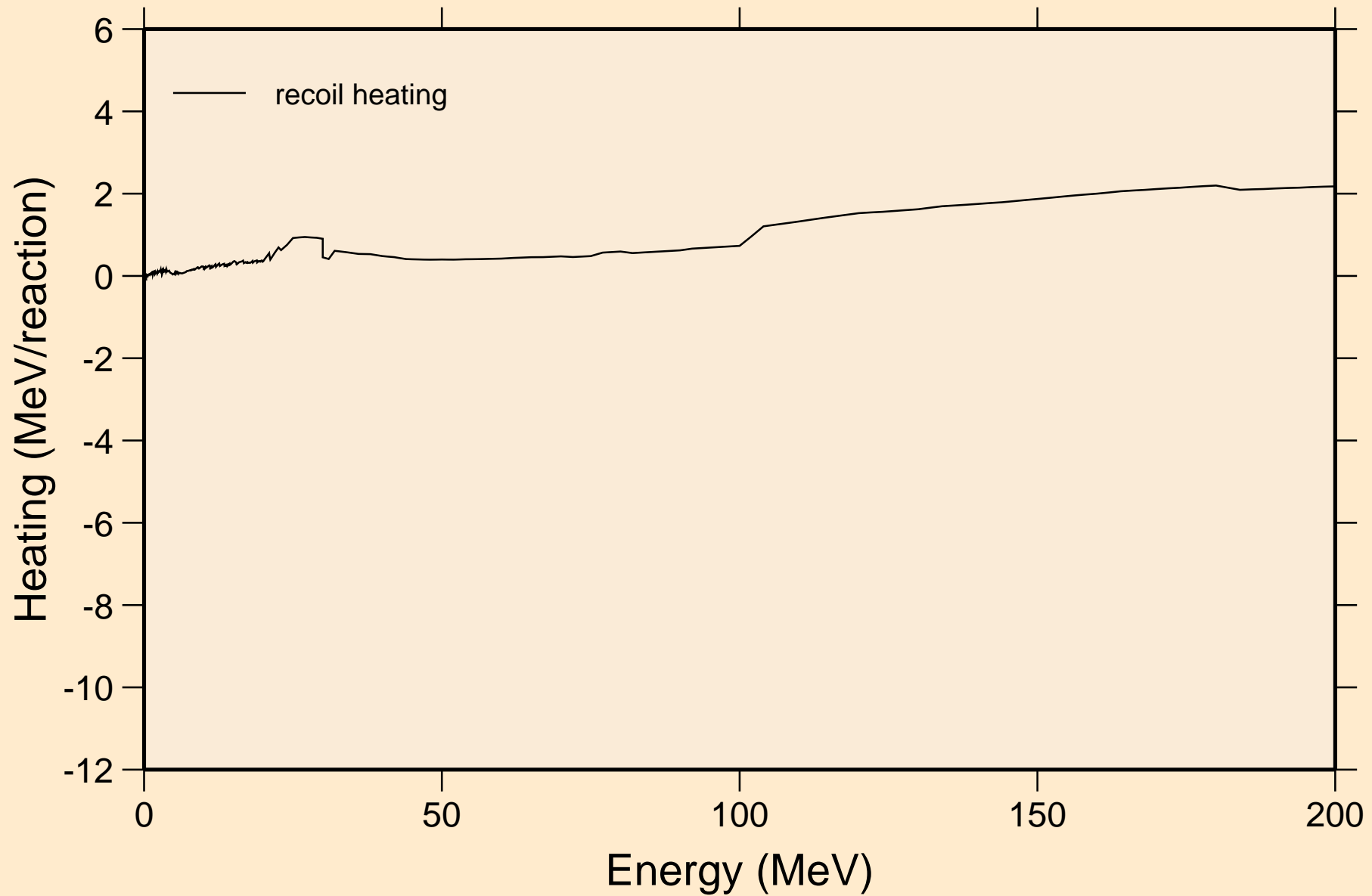

# CS121M NEUTRON ACER TENDL-2024 LIBRARY; T=0.K

## Particle production cross sections

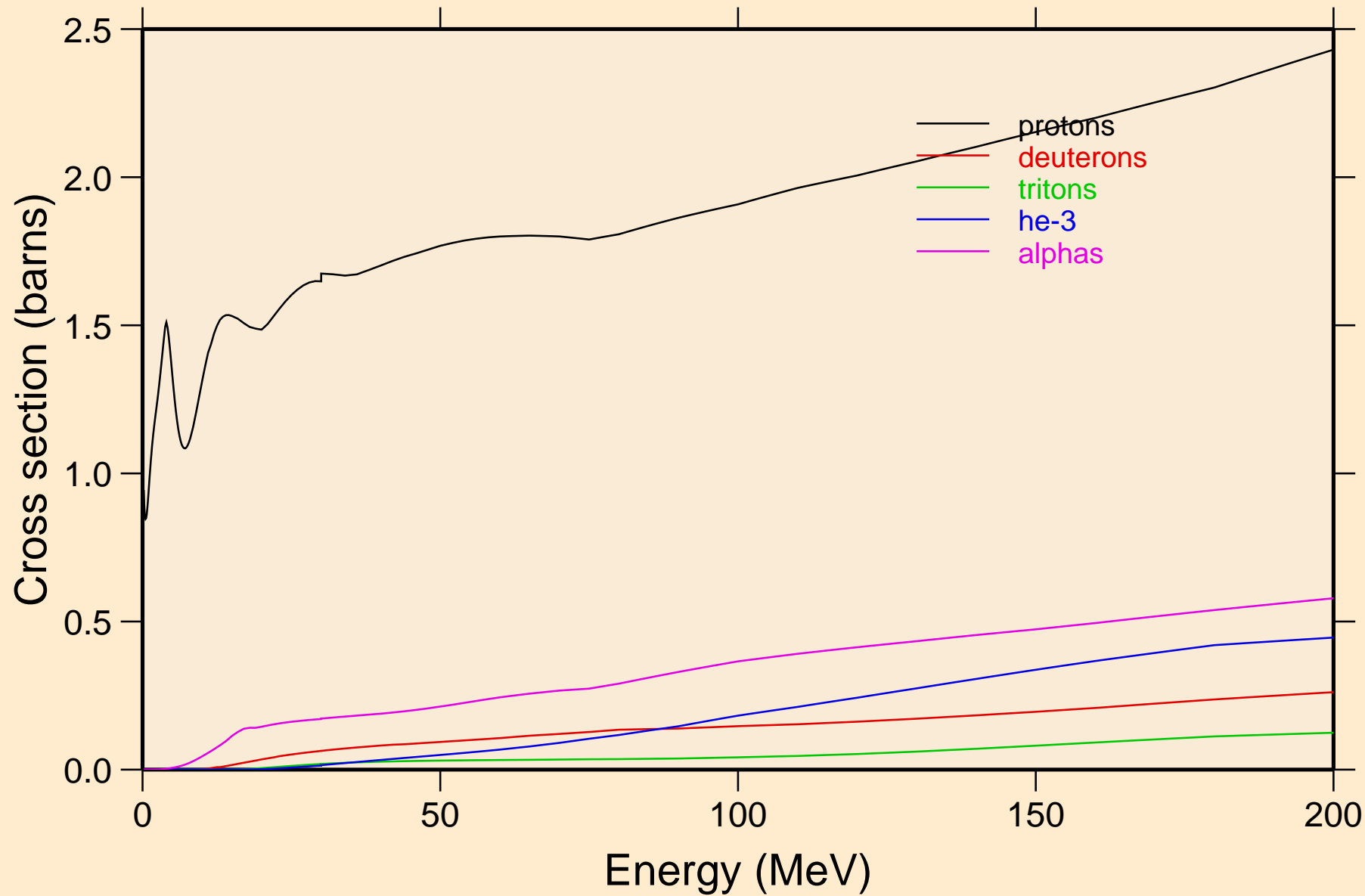

CS121M NEUTRON ACER TENDL-2024 LIBRARY; T=0.K  
protons from (n,x)

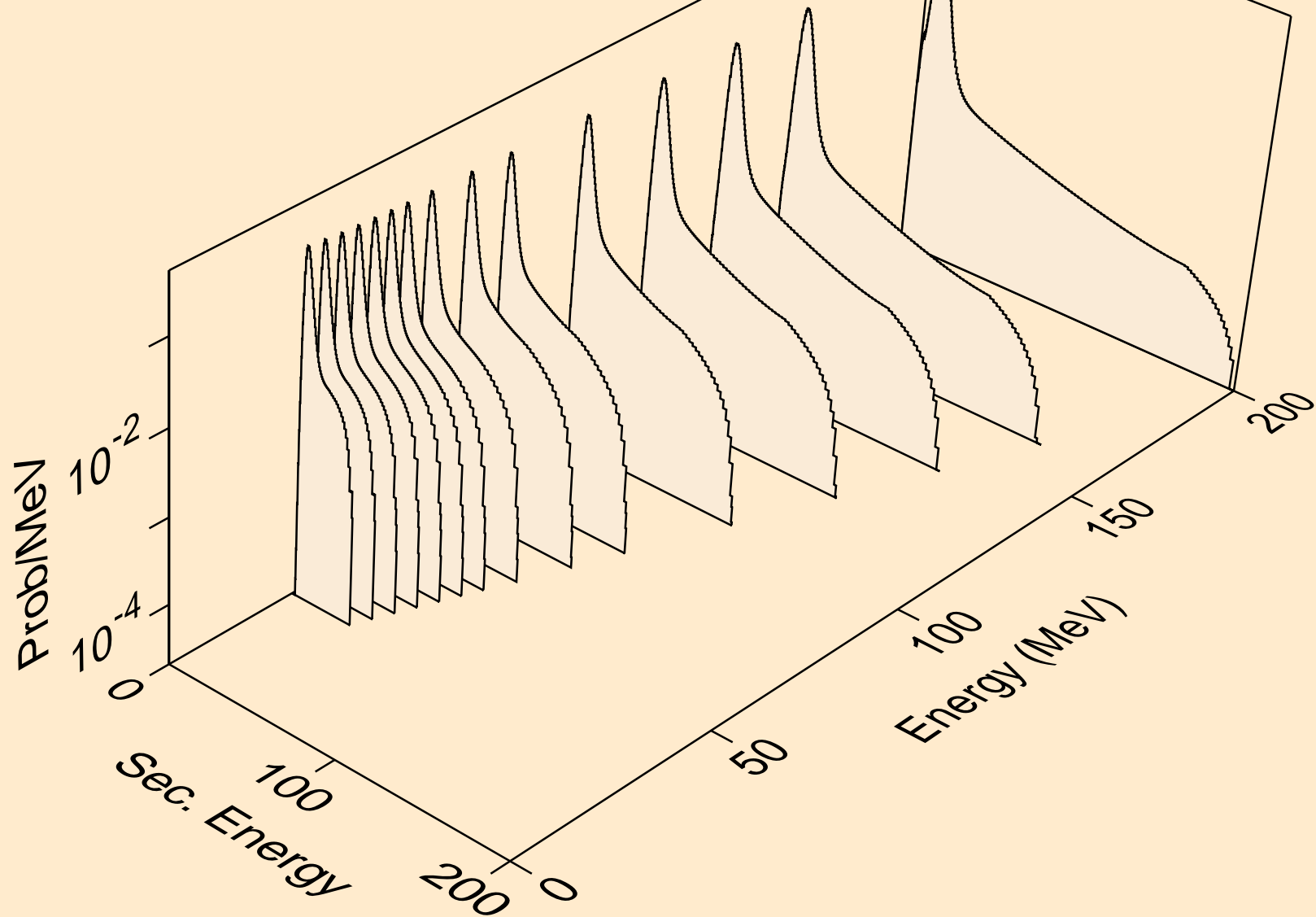

CS121M NEUTRON ACER TENDL-2024 LIBRARY; T=0.K  
protons from (n,n\*)p

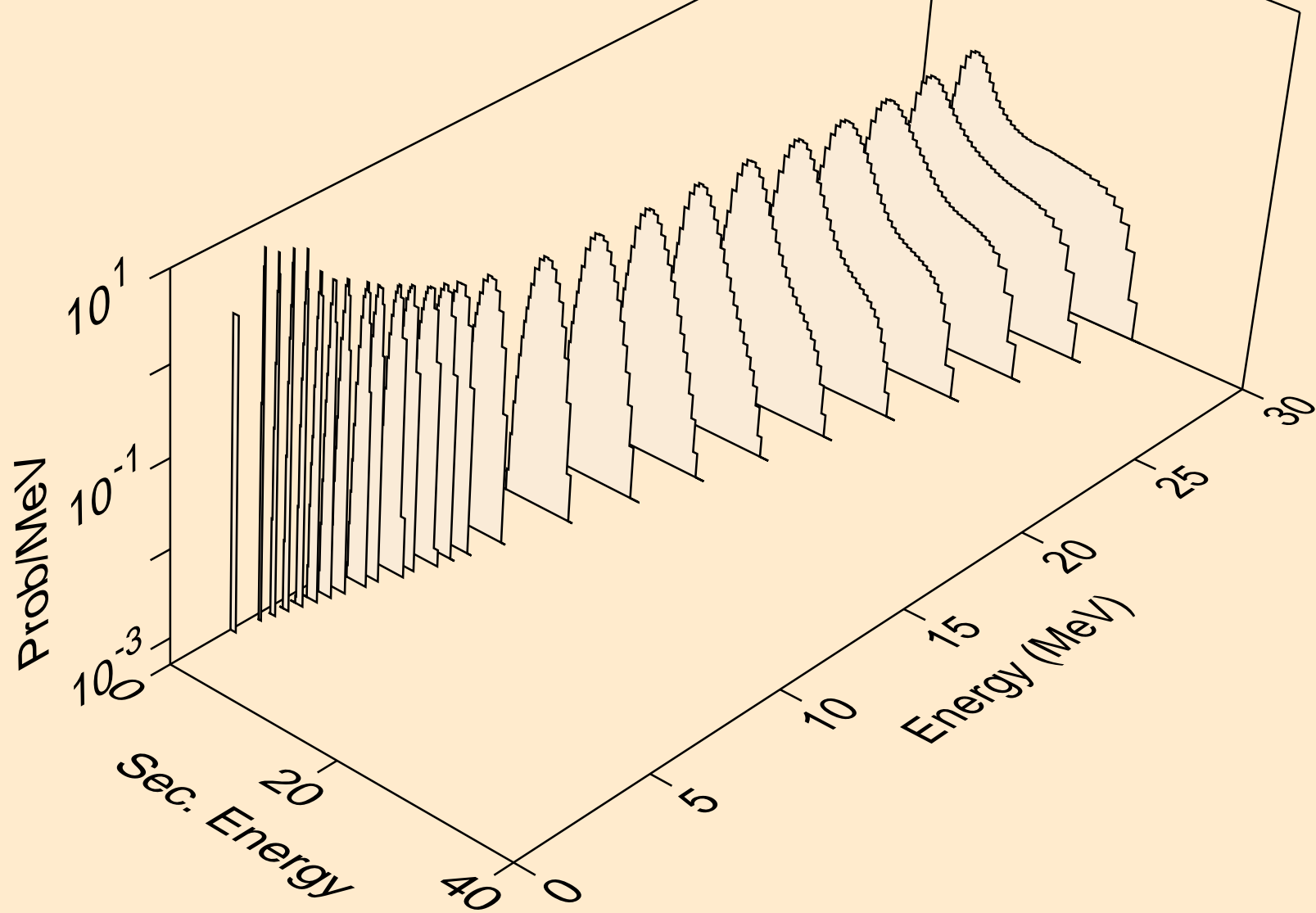

CS121M NEUTRON ACER TENDL-2024 LIBRARY; T=0.K  
protons from (n,2np)

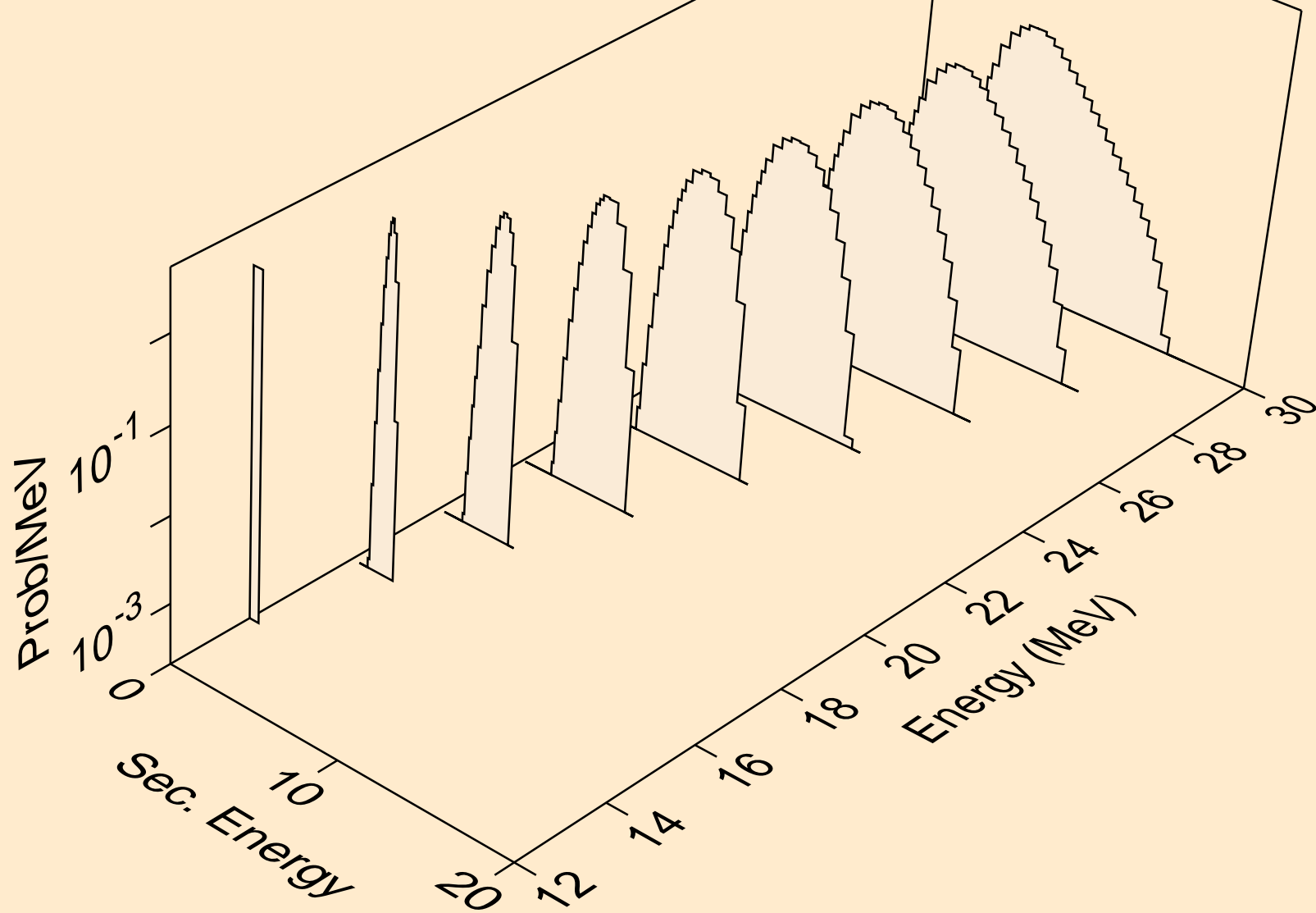

CS121M NEUTRON ACER TENDL-2024 LIBRARY; T=0.K  
protons from (n,3np)

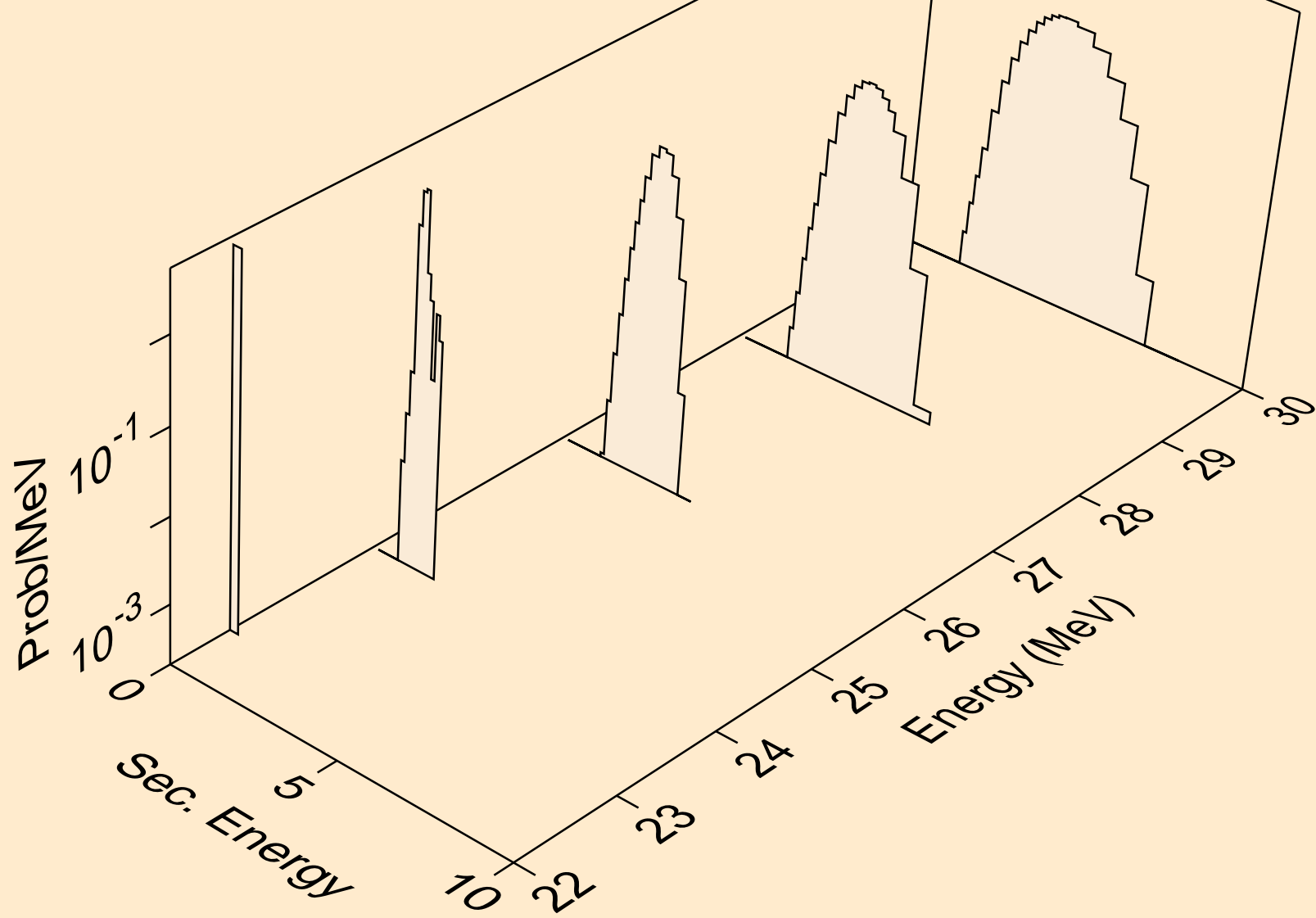

CS121M NEUTRON ACER TENDL-2024 LIBRARY; T=0.K  
protons from (n,n2p)

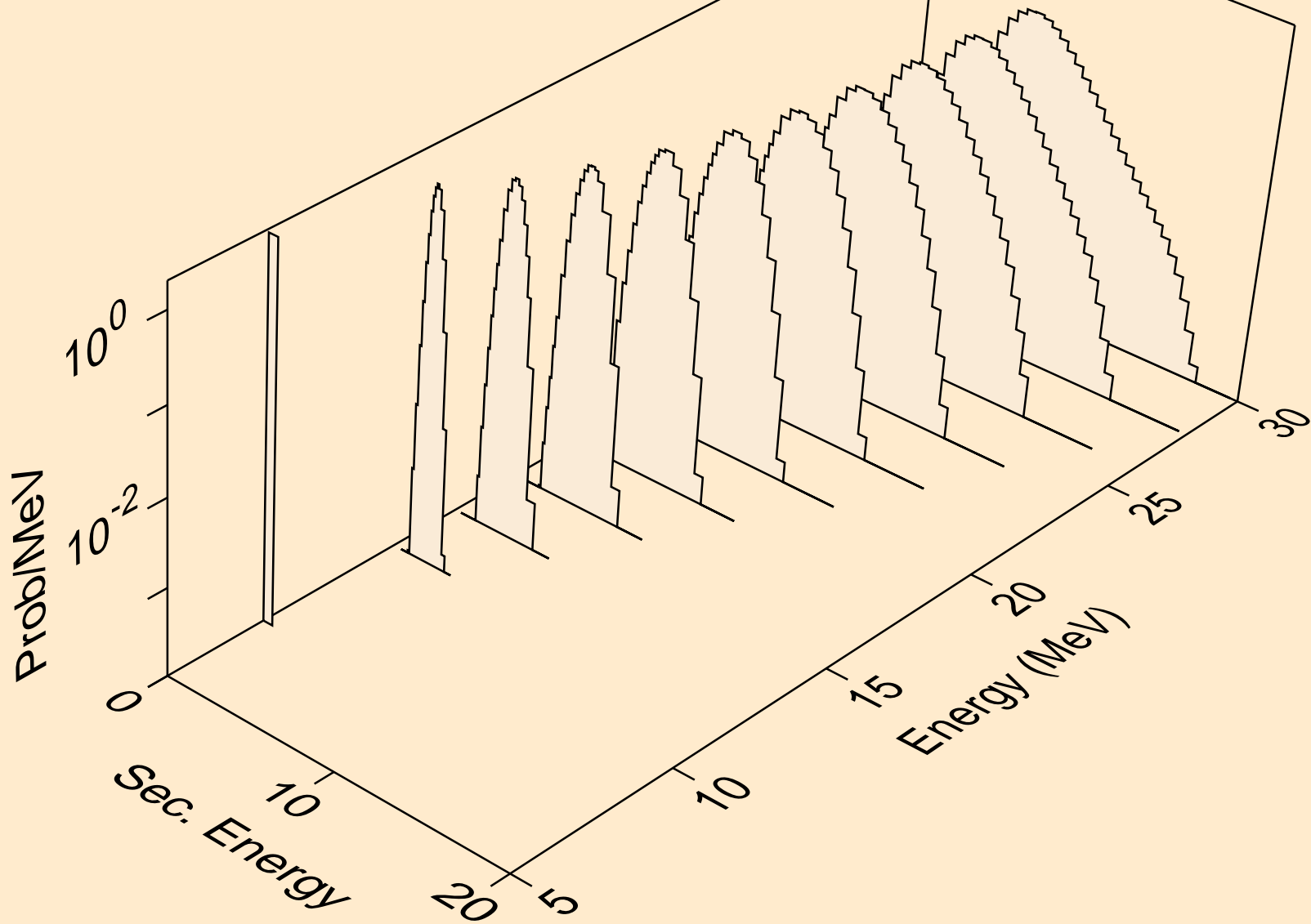

CS121M NEUTRON ACER TENDL-2024 LIBRARY; T=0.K  
protons from (n,npa)

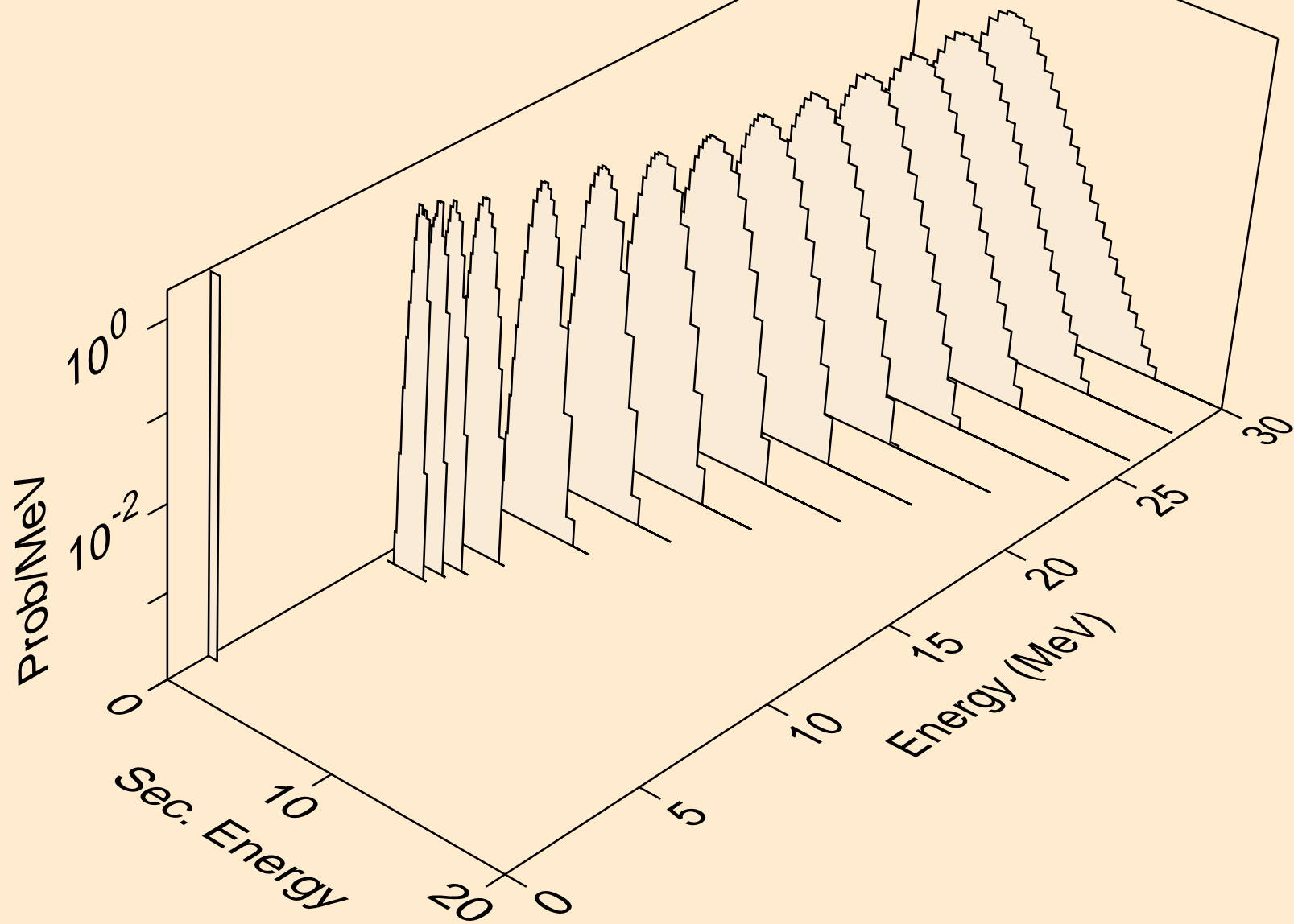

CS121M NEUTRON ACER TENDL-2024 LIBRARY; T=0.K  
protons from (n,p)

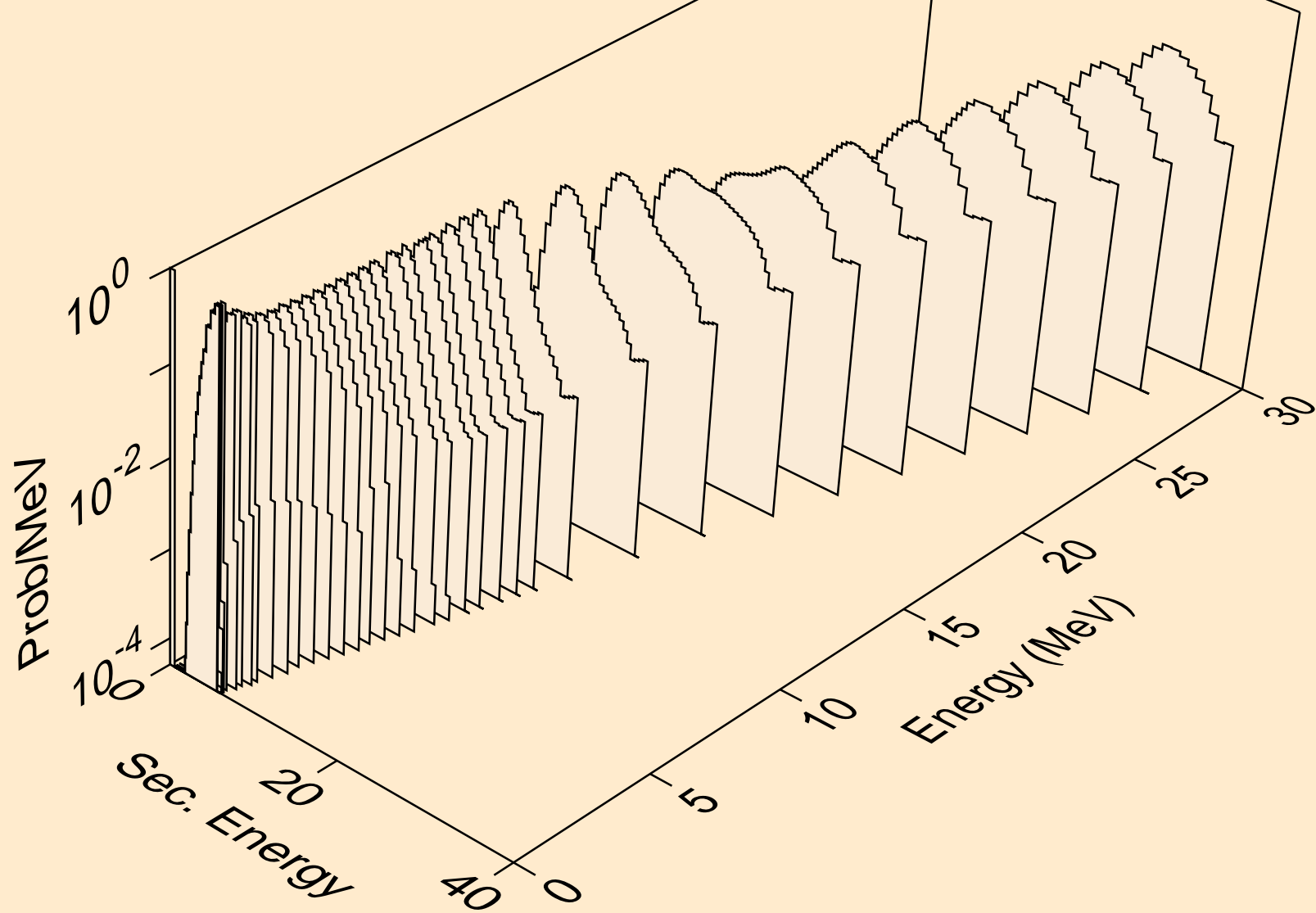

CS121M NEUTRON ACER TENDL-2024 LIBRARY; T=0.K  
protons from (n,2p)

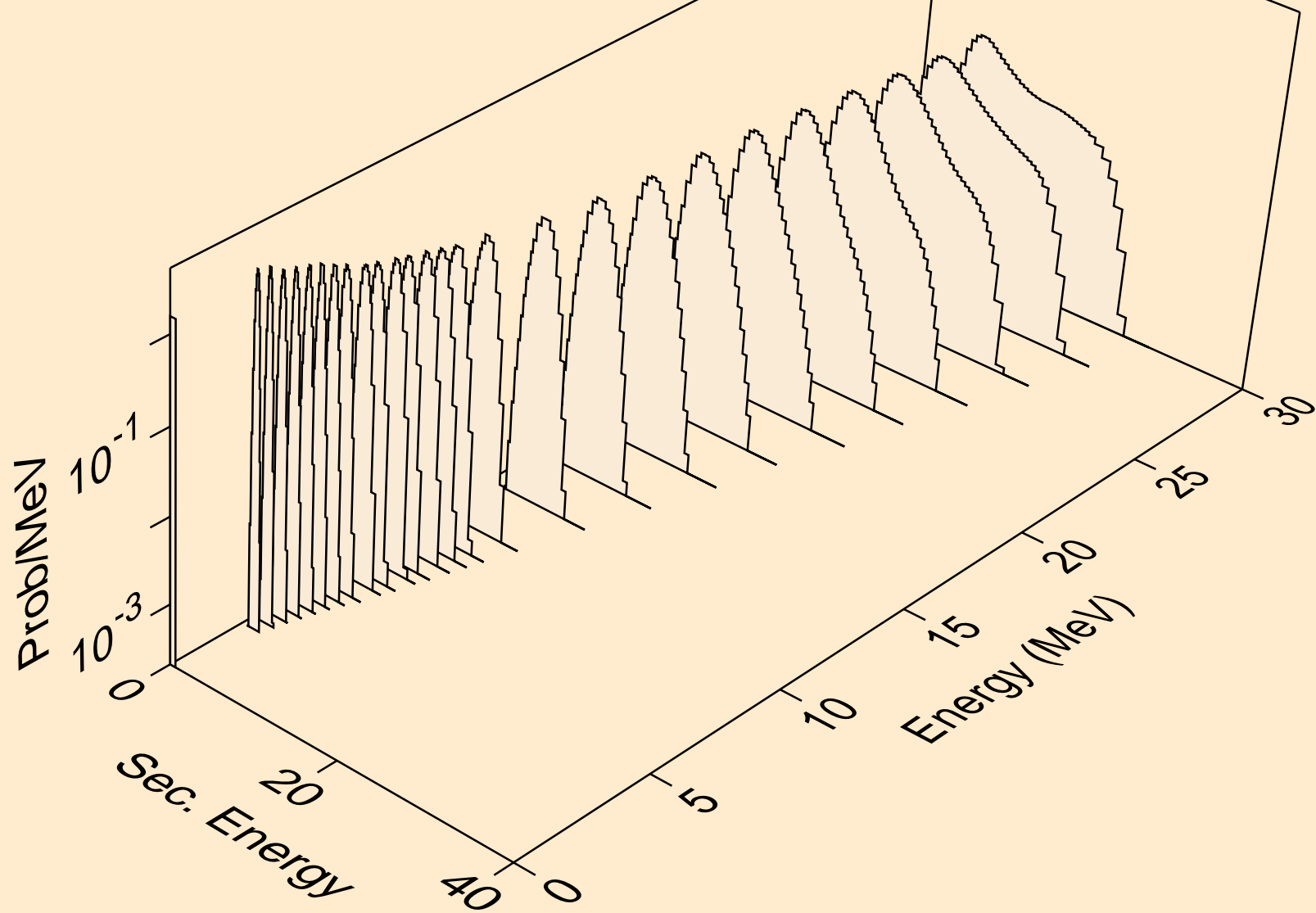

CS121M NEUTRON ACER TENDL-2024 LIBRARY; T=0.K  
protons from (n,p)

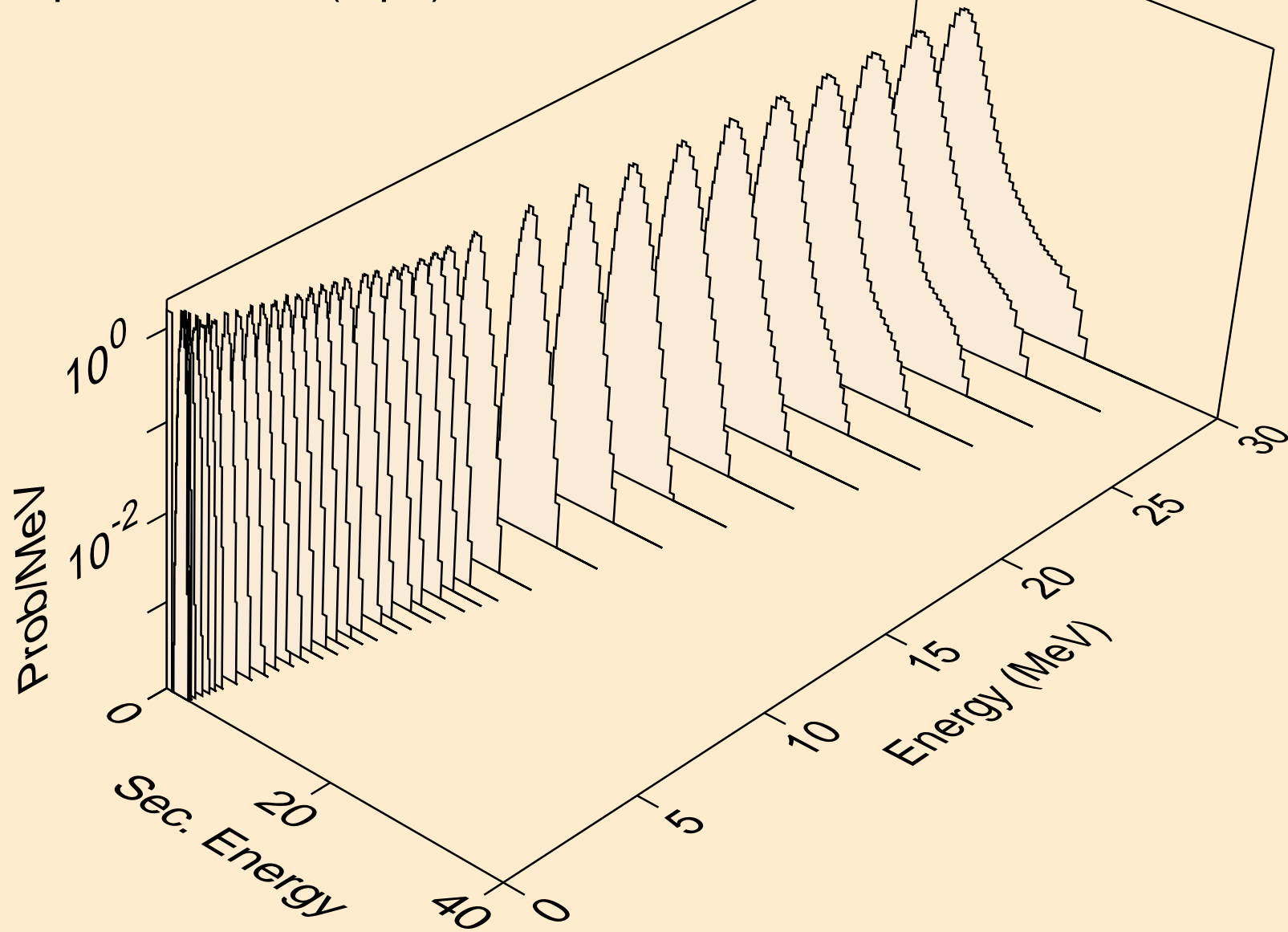

CS121M NEUTRON ACER TENDL-2024 LIBRARY; T=0.K  
protons from (n,pd)

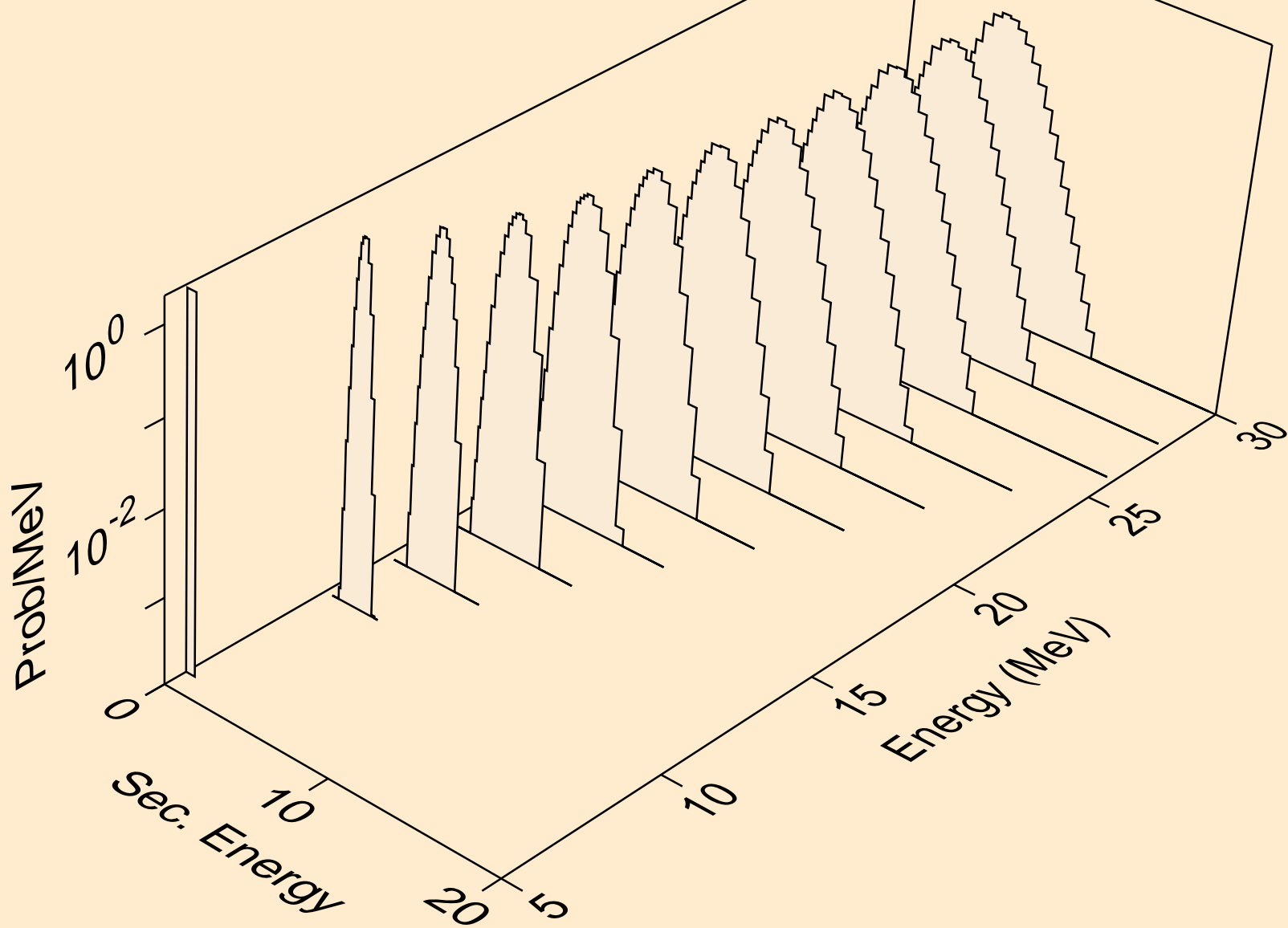

CS121M NEUTRON ACER TENDL-2024 LIBRARY; T=0.K  
protons from (n,pt)

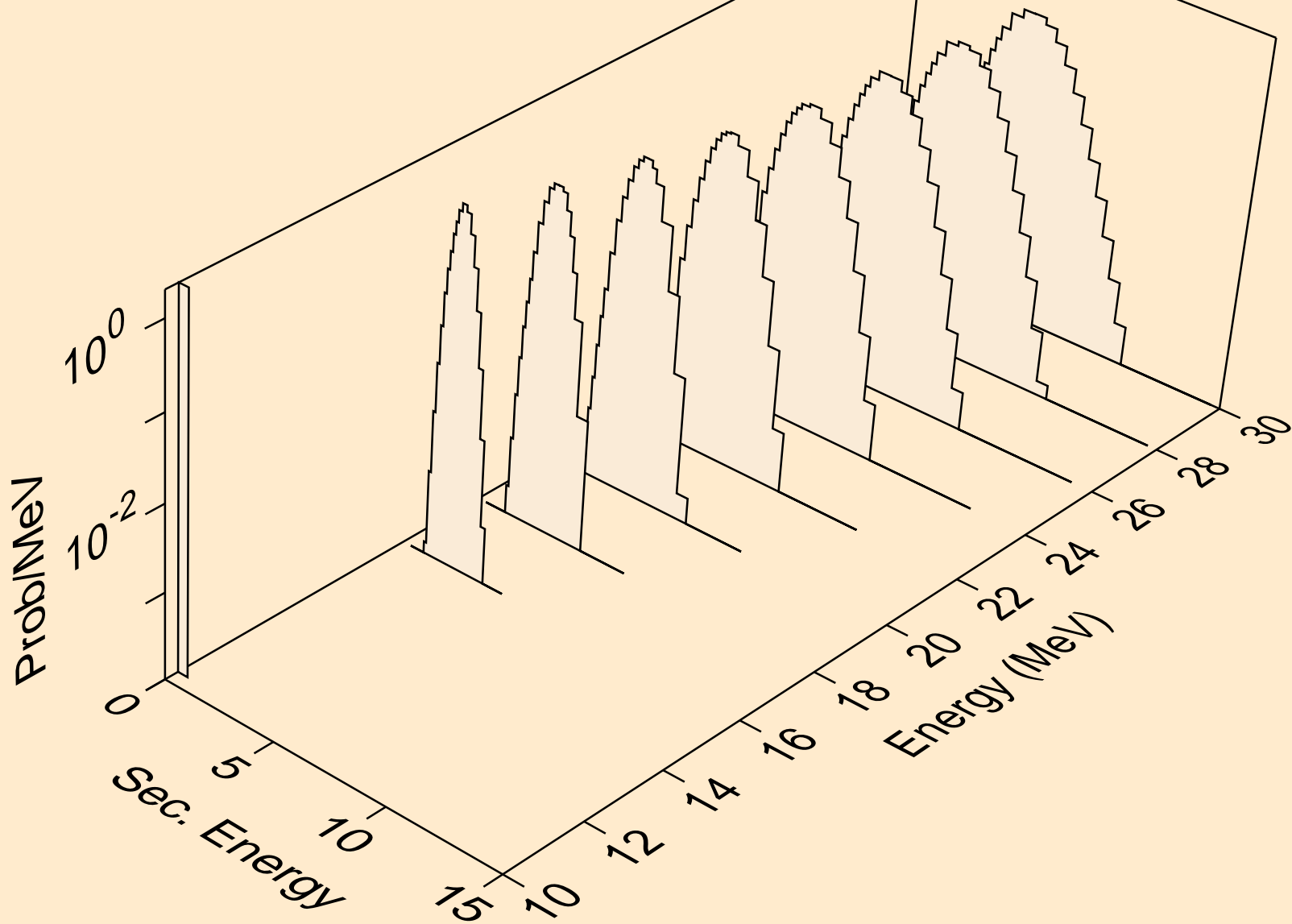

CS121M NEUTRON ACER TENDL-2024 LIBRARY; T=0.K  
deuterons from (n,x)

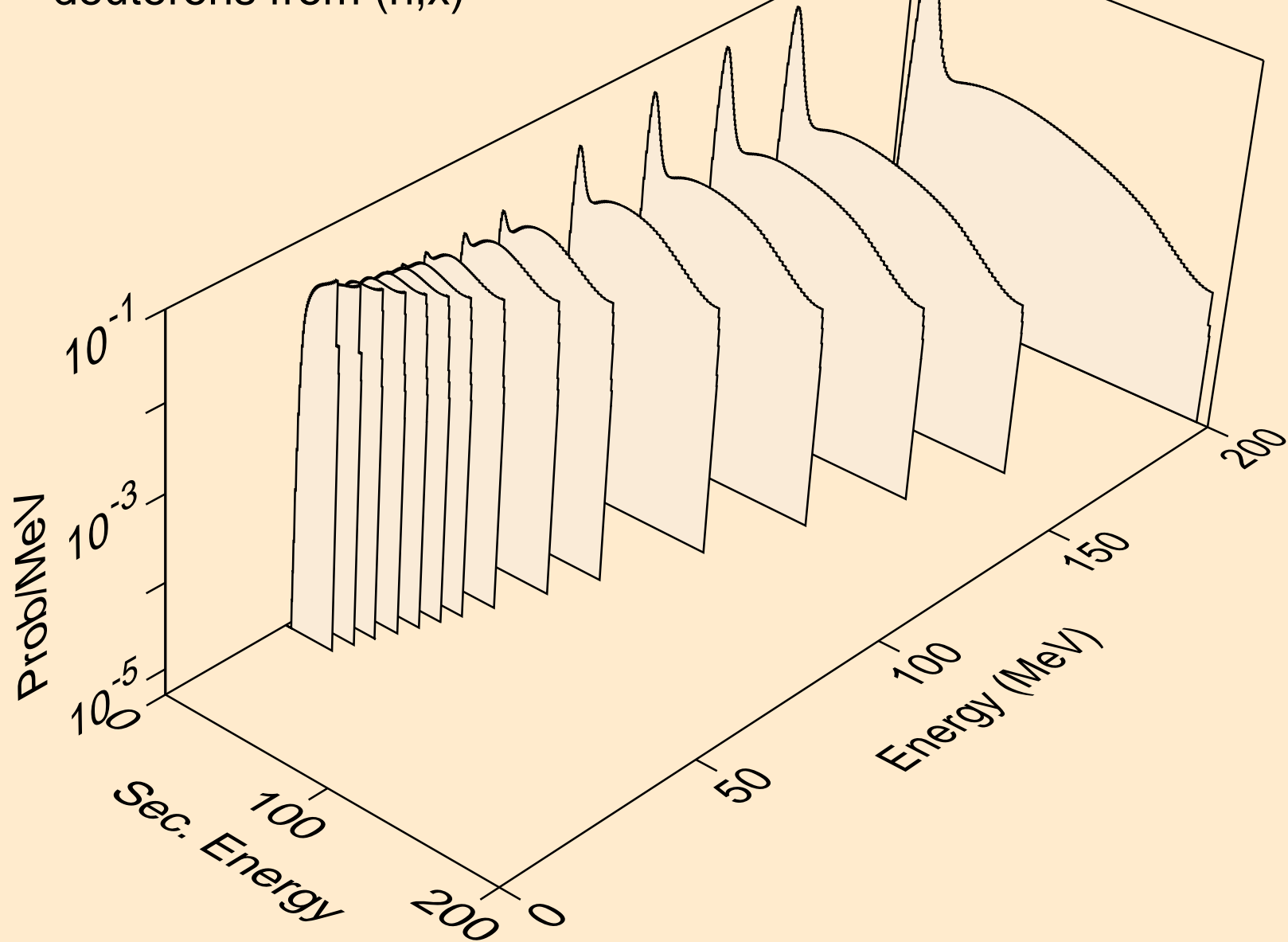

CS121M NEUTRON ACER TENDL-2024 LIBRARY; T=0.K  
deuterons from (n,2nd)

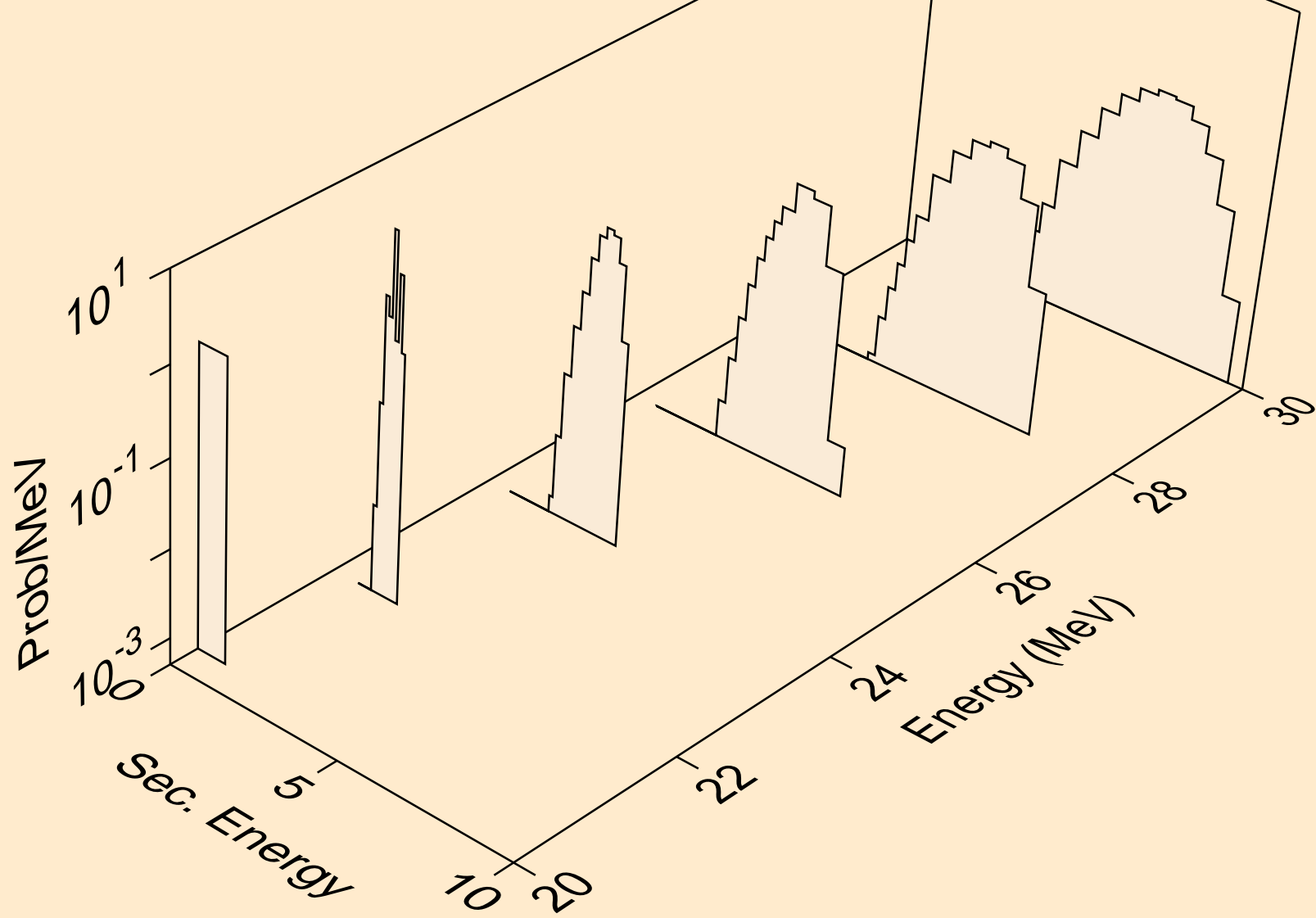

CS121M NEUTRON ACER TENDL-2024 LIBRARY; T=0.K  
deuterons from (n,n\*)d

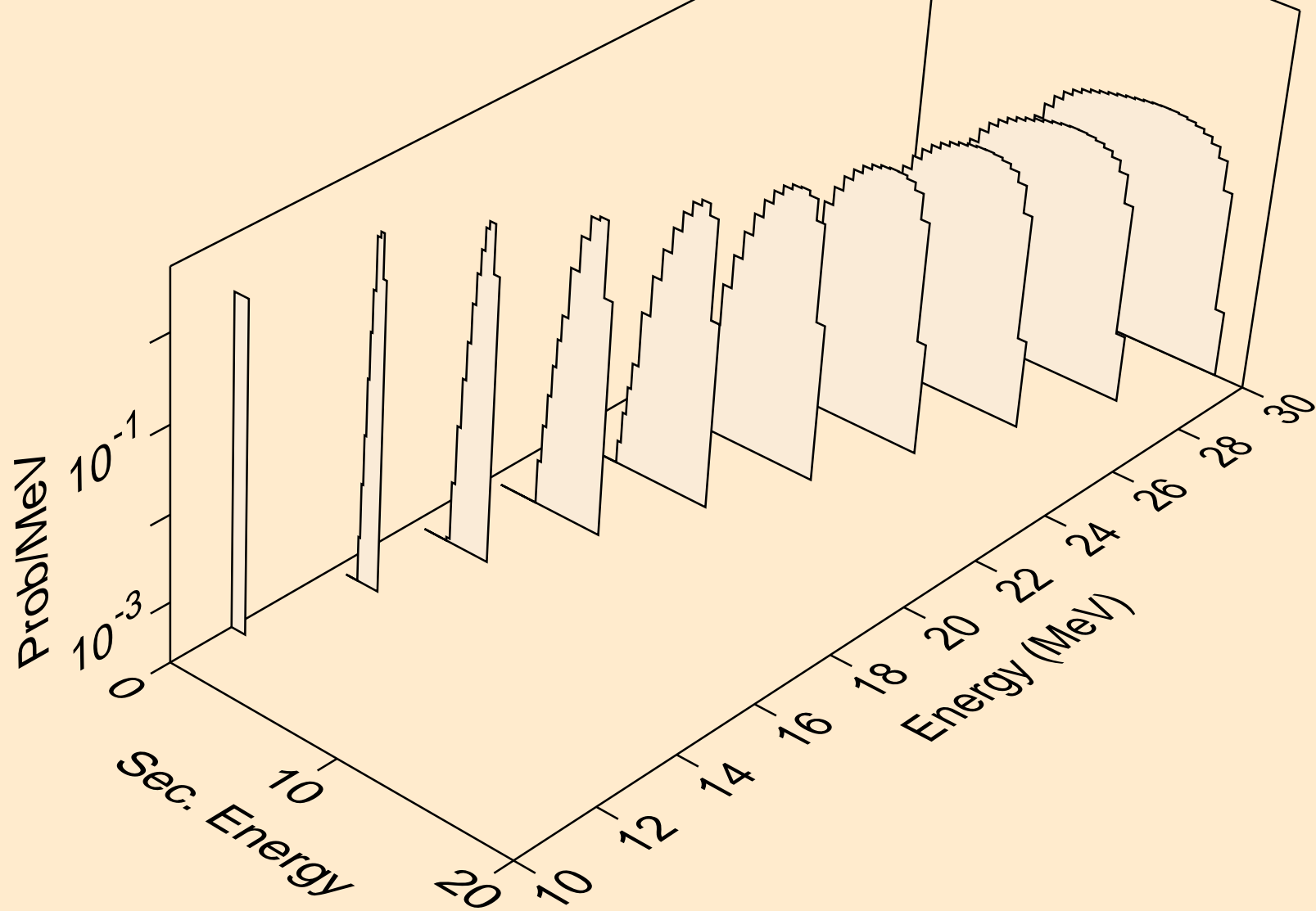

CS121M NEUTRON ACER TENDL-2024 LIBRARY; T=0.K  
deuterons from (n,d)

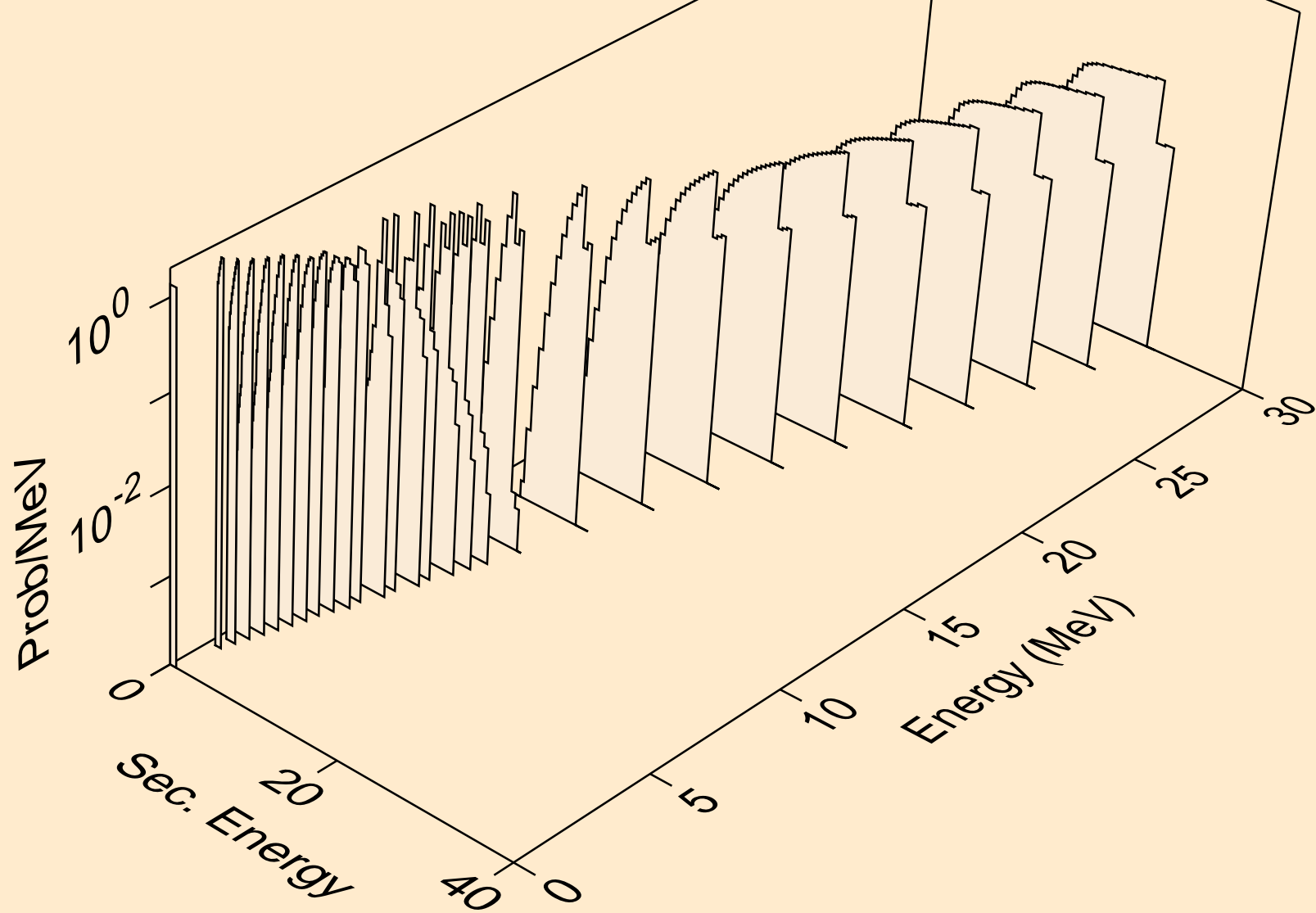

CS121M NEUTRON ACER TENDL-2024 LIBRARY; T=0.K  
deuterons from (n,d2a)

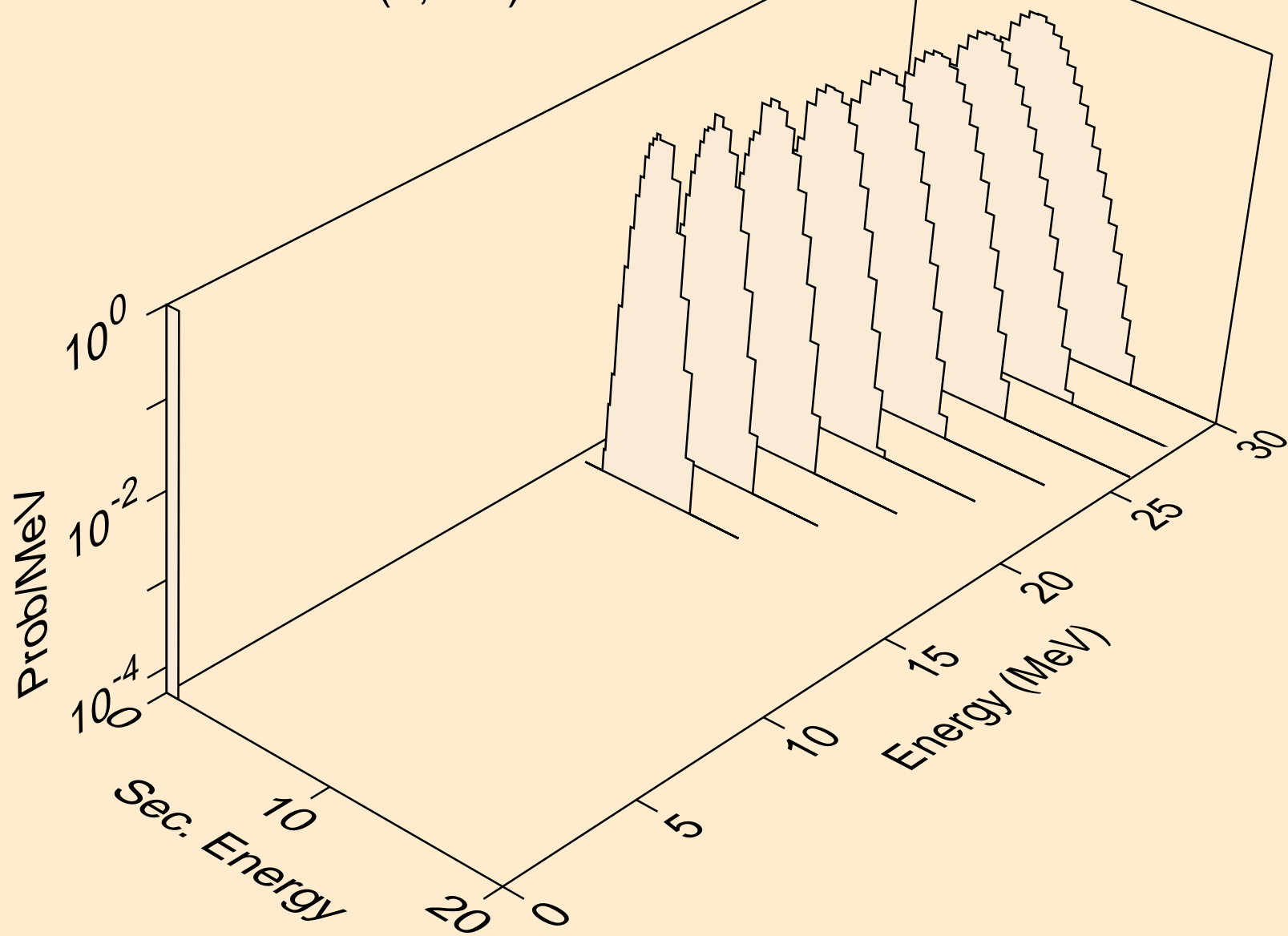

CS121M NEUTRON ACER TENDL-2024 LIBRARY; T=0.K  
deuterons from (n,pd)

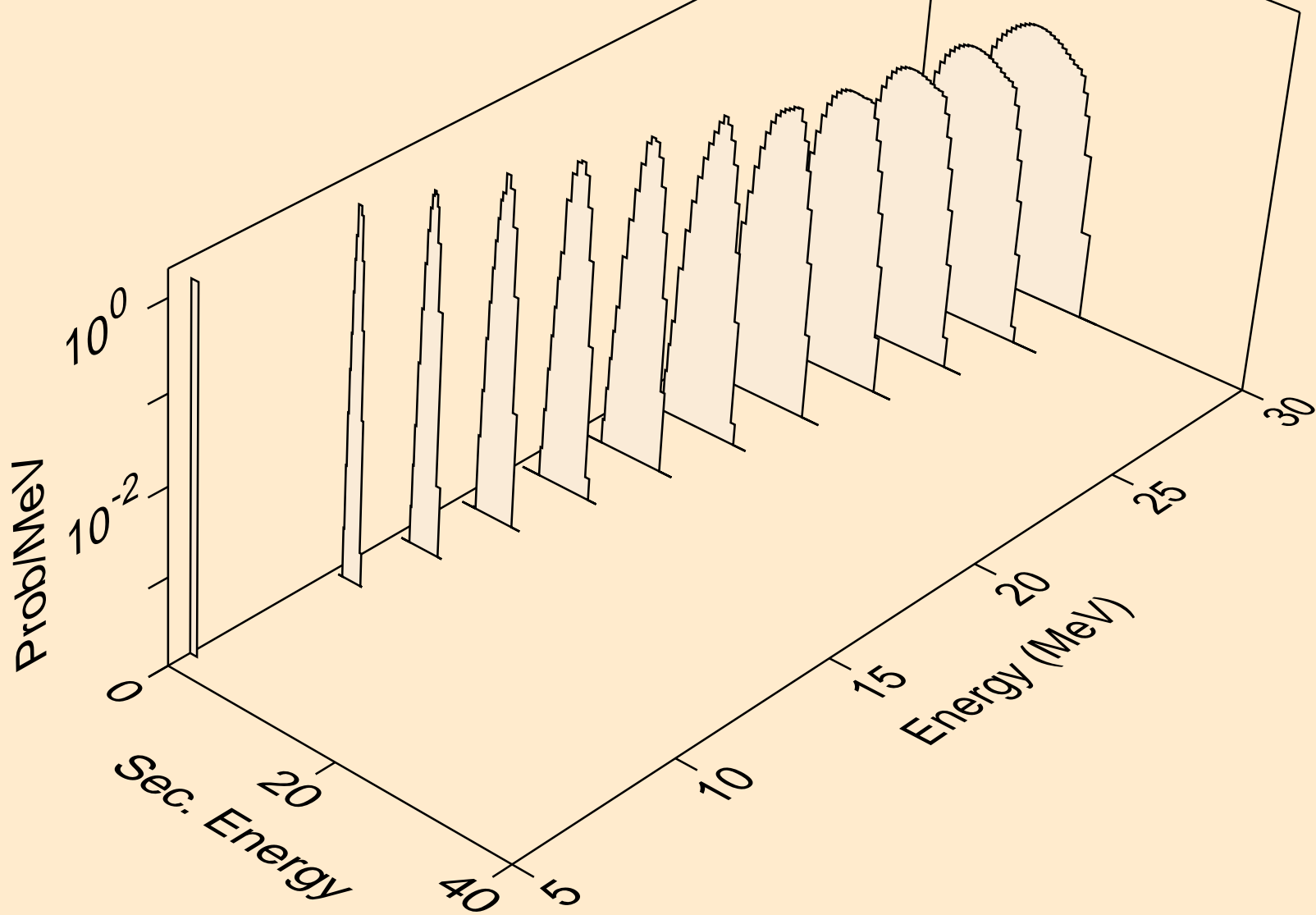

CS121M NEUTRON ACER TENDL-2024 LIBRARY; T=0.K  
deuterons from (n,da)

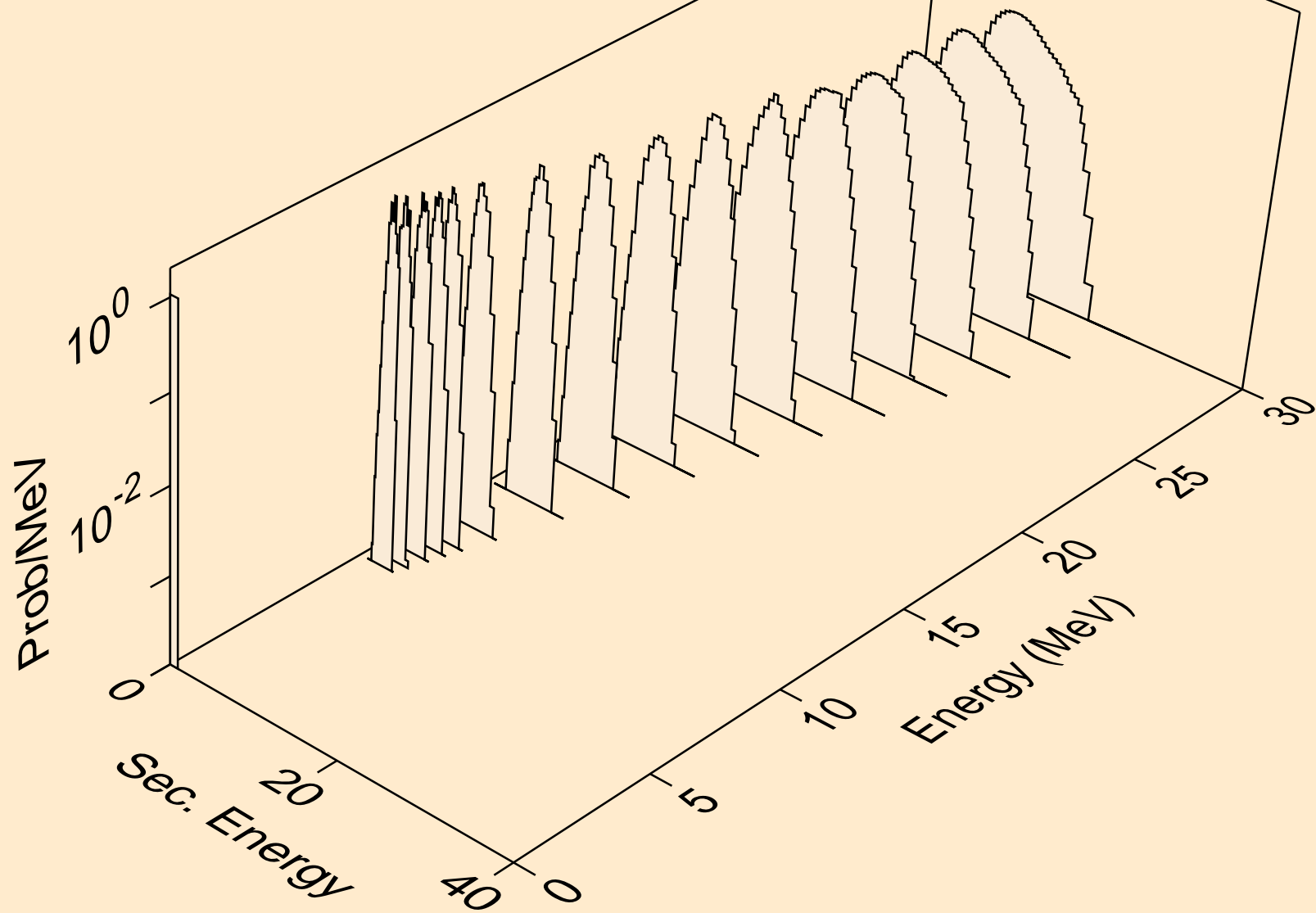

CS121M NEUTRON ACER TENDL-2024 LIBRARY; T=0.K  
tritons from (n,x)

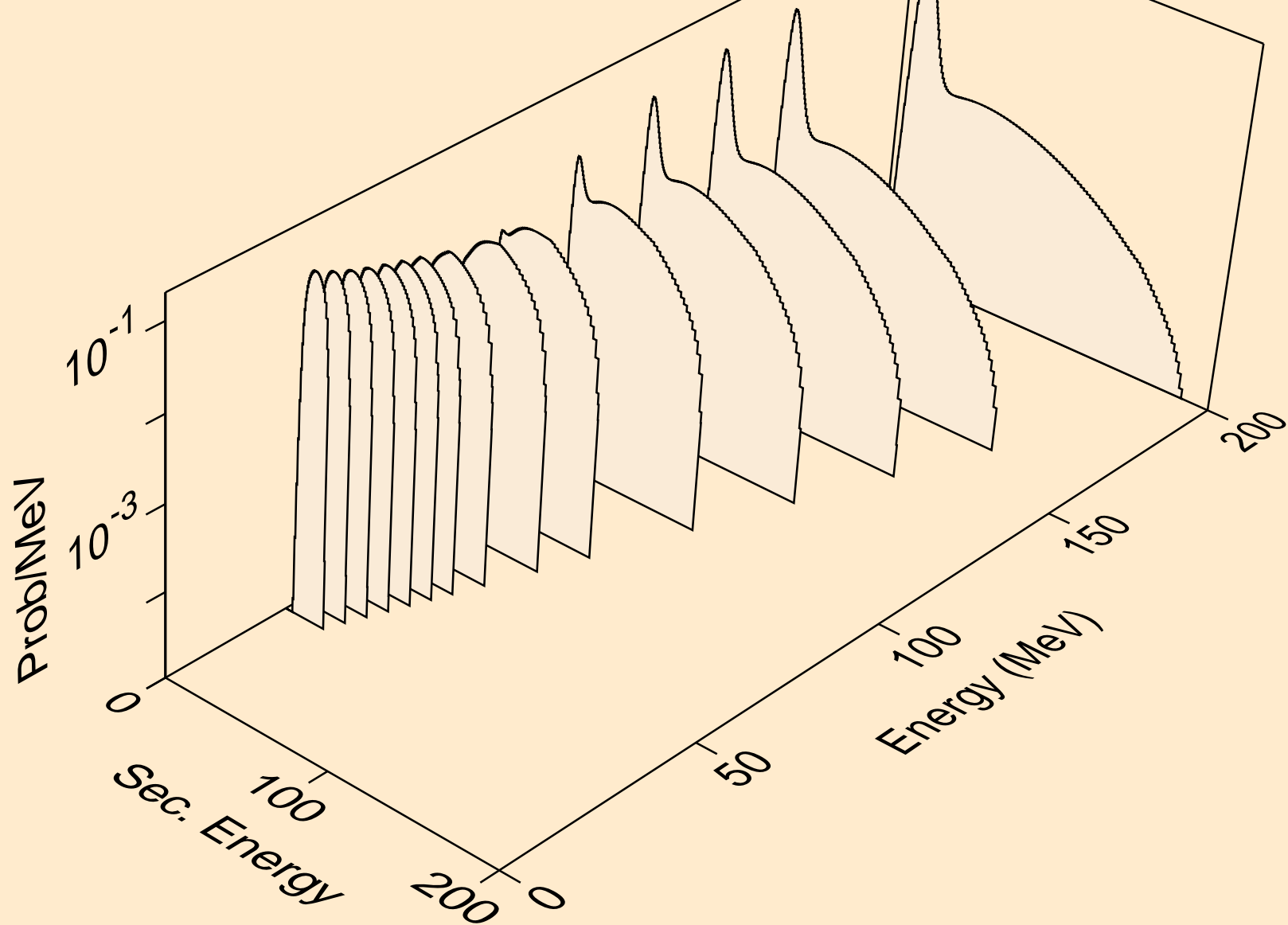

CS121M NEUTRON ACER TENDL-2024 LIBRARY; T=0.K  
tritons from (n,n\*)t

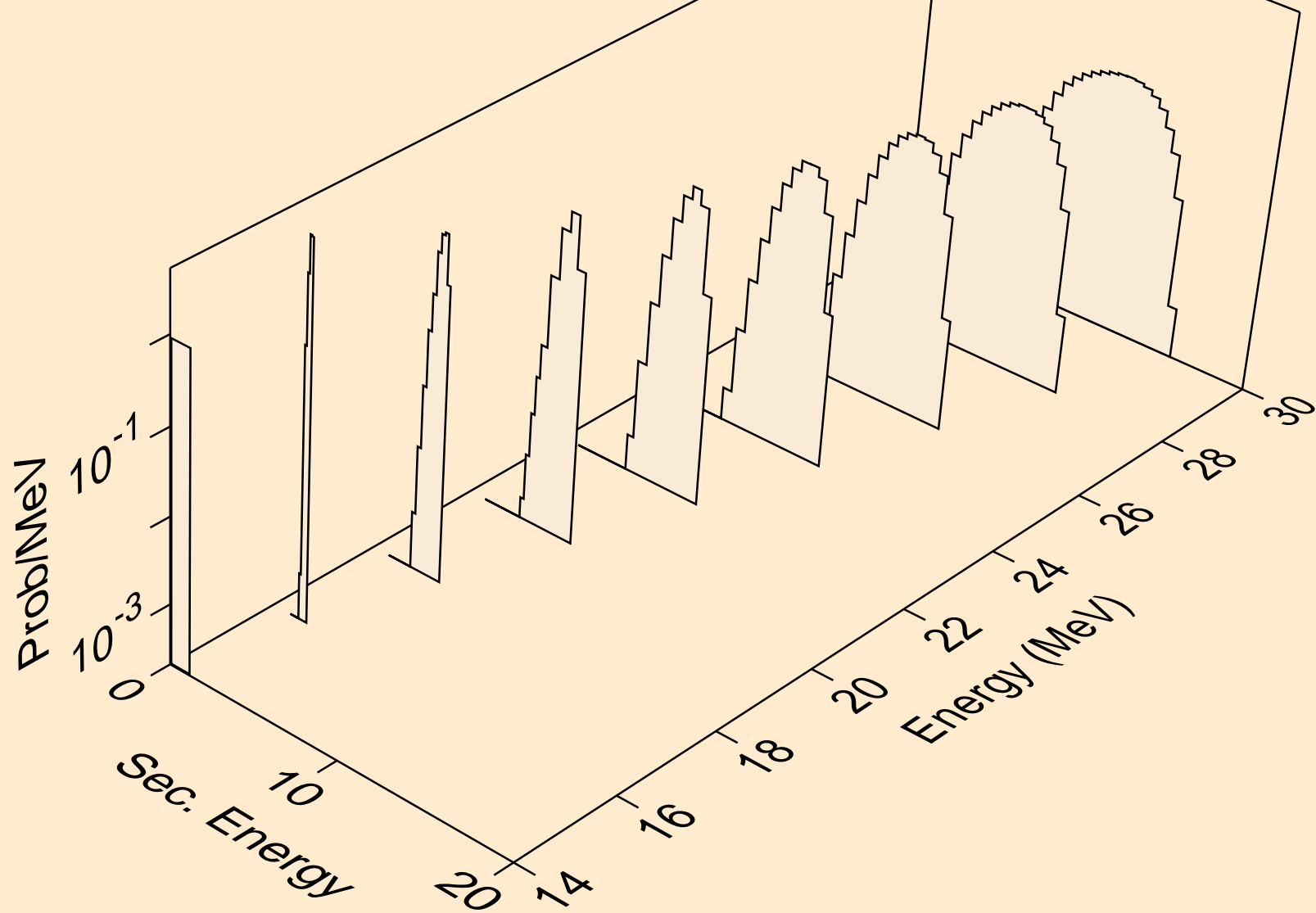

CS121M NEUTRON ACER TENDL-2024 LIBRARY; T=0.K  
tritons from (n,t)

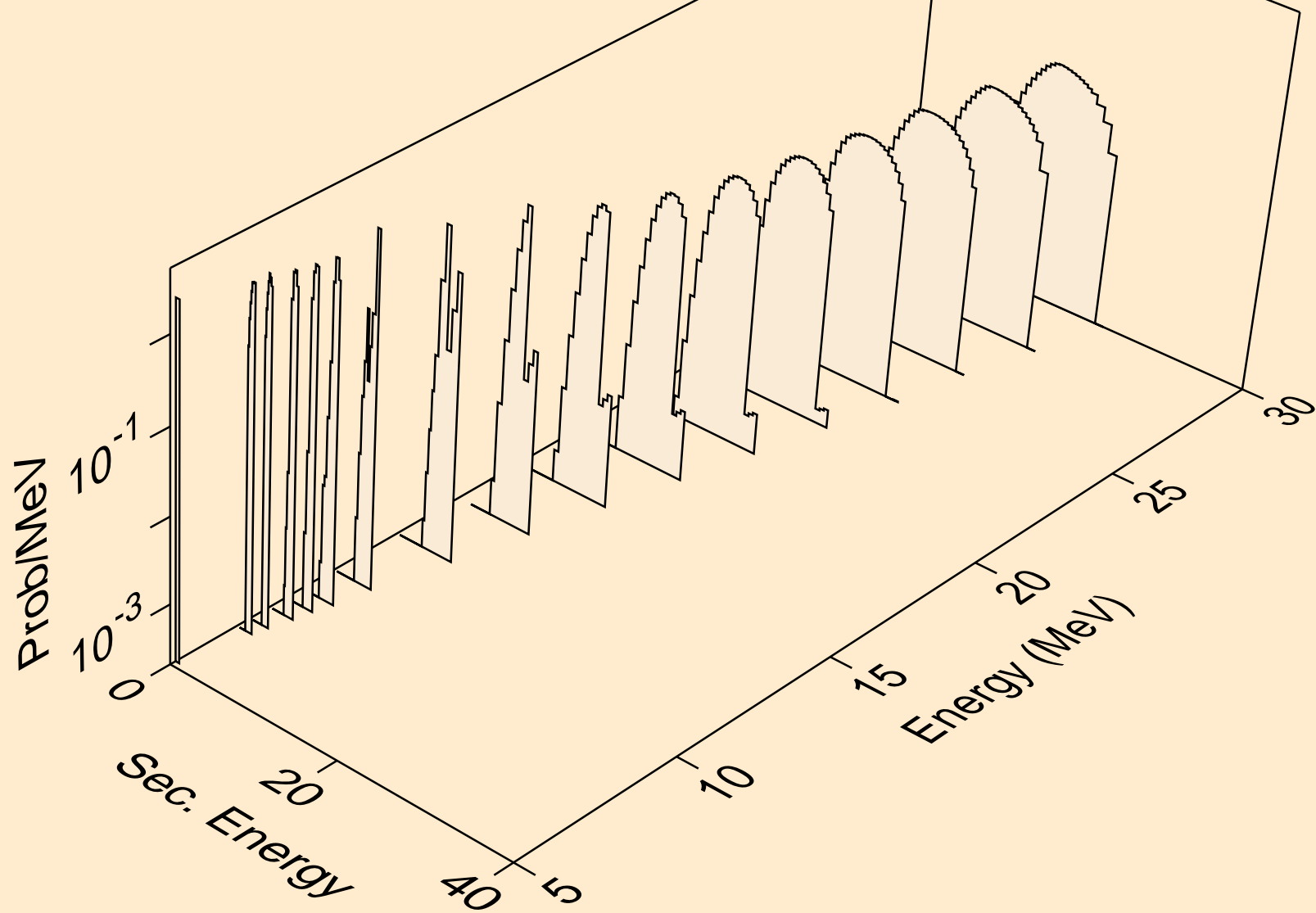

CS121M NEUTRON ACER TENDL-2024 LIBRARY; T=0.K  
tritons from (n,pt)

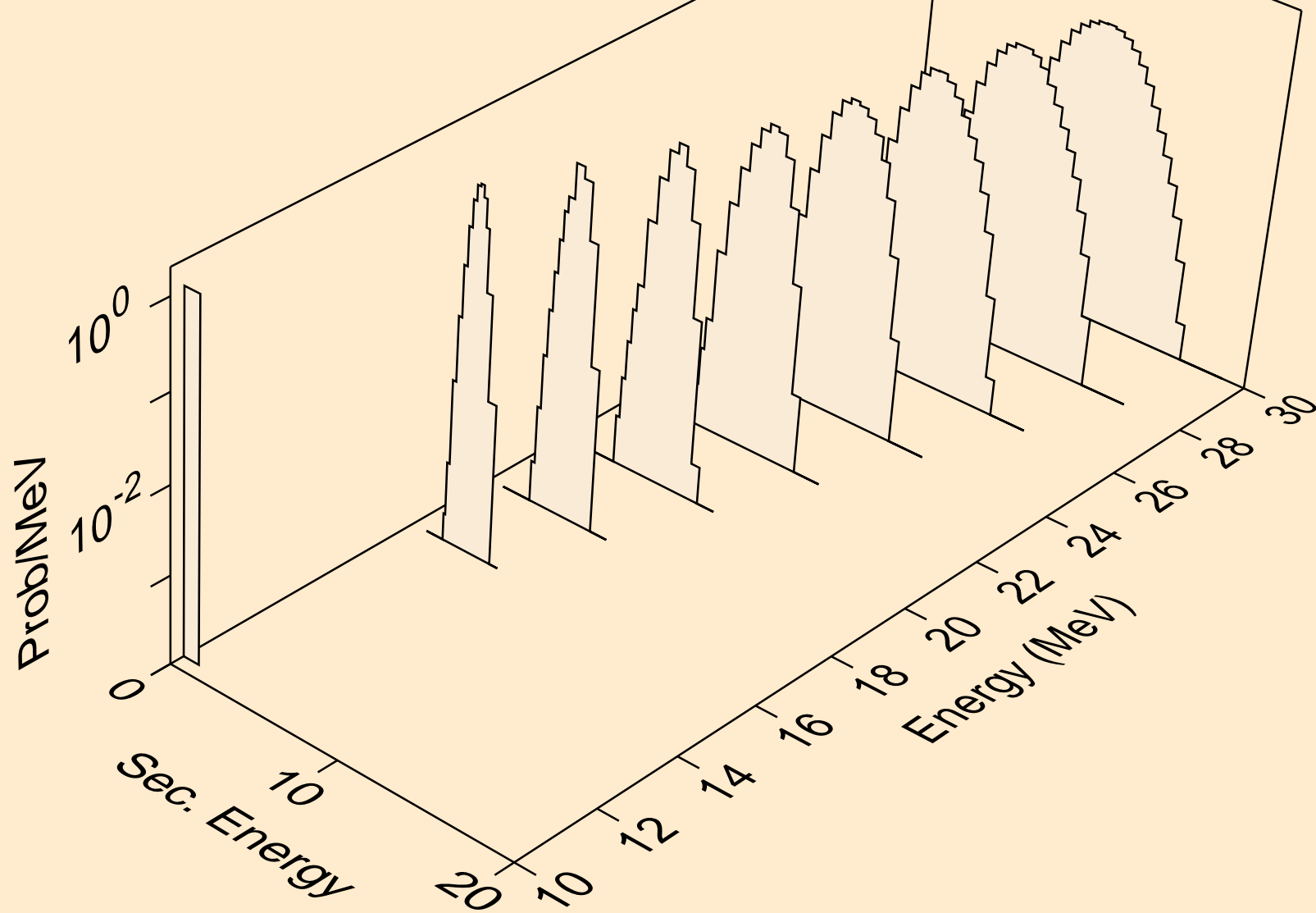

CS121M NEUTRON ACER TENDL-2024 LIBRARY; T=0.K  
he3s from (n,x)

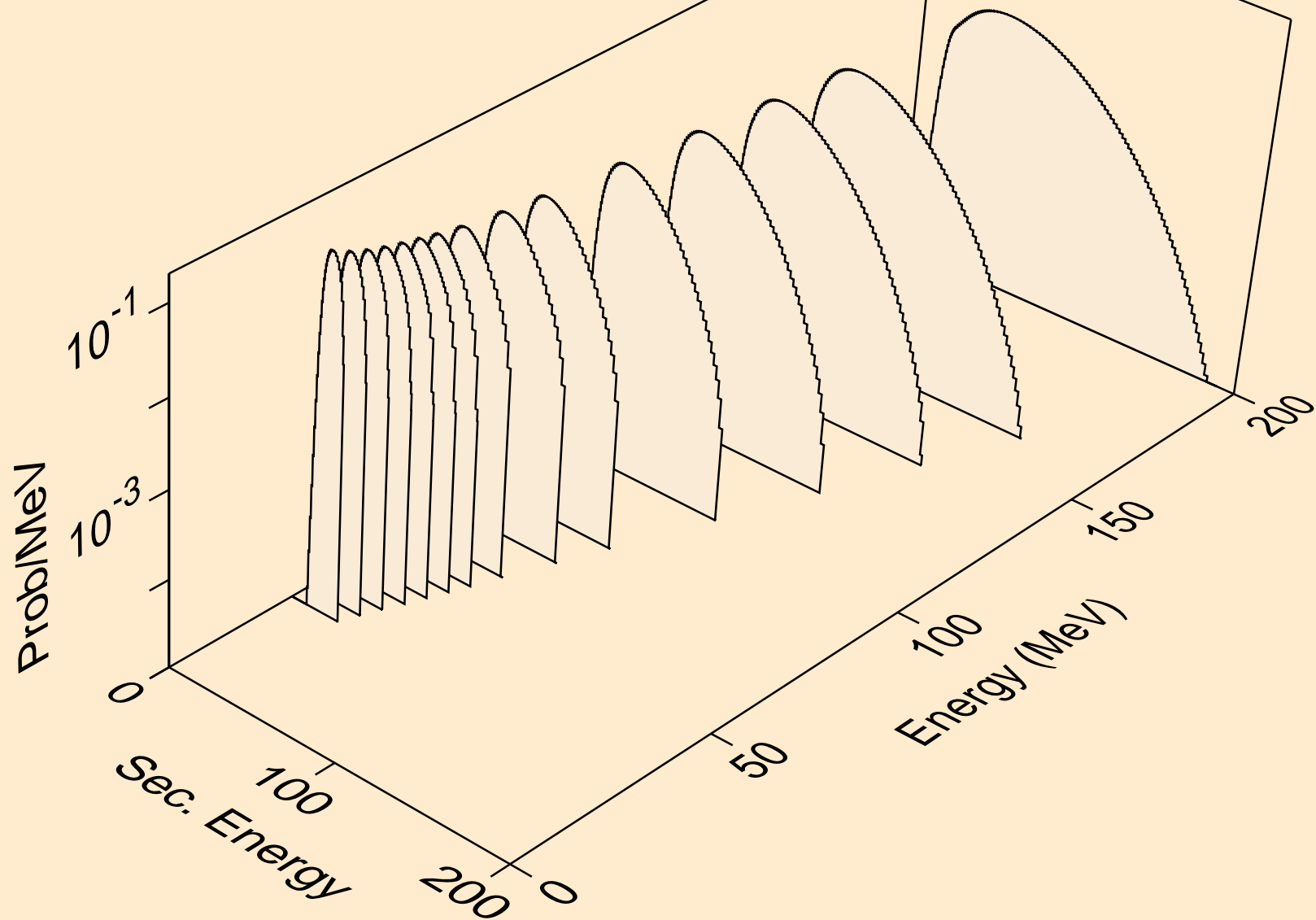

CS121M NEUTRON ACER TENDL-2024 LIBRARY; T=0.K  
he3s from (n,n\*)he3

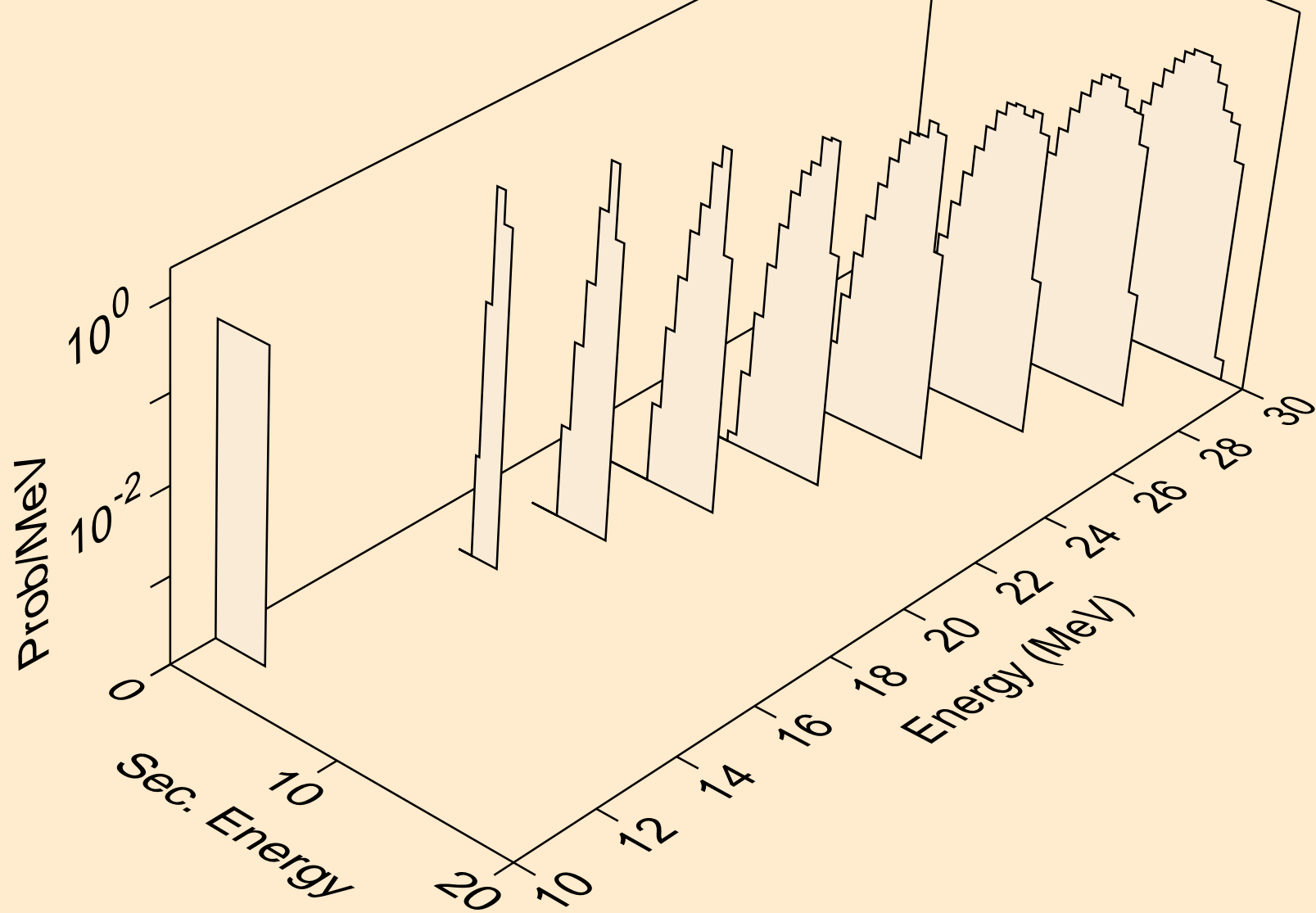

CS121M NEUTRON ACER TENDL-2024 LIBRARY; T=0.K  
he3s from (n,he3)

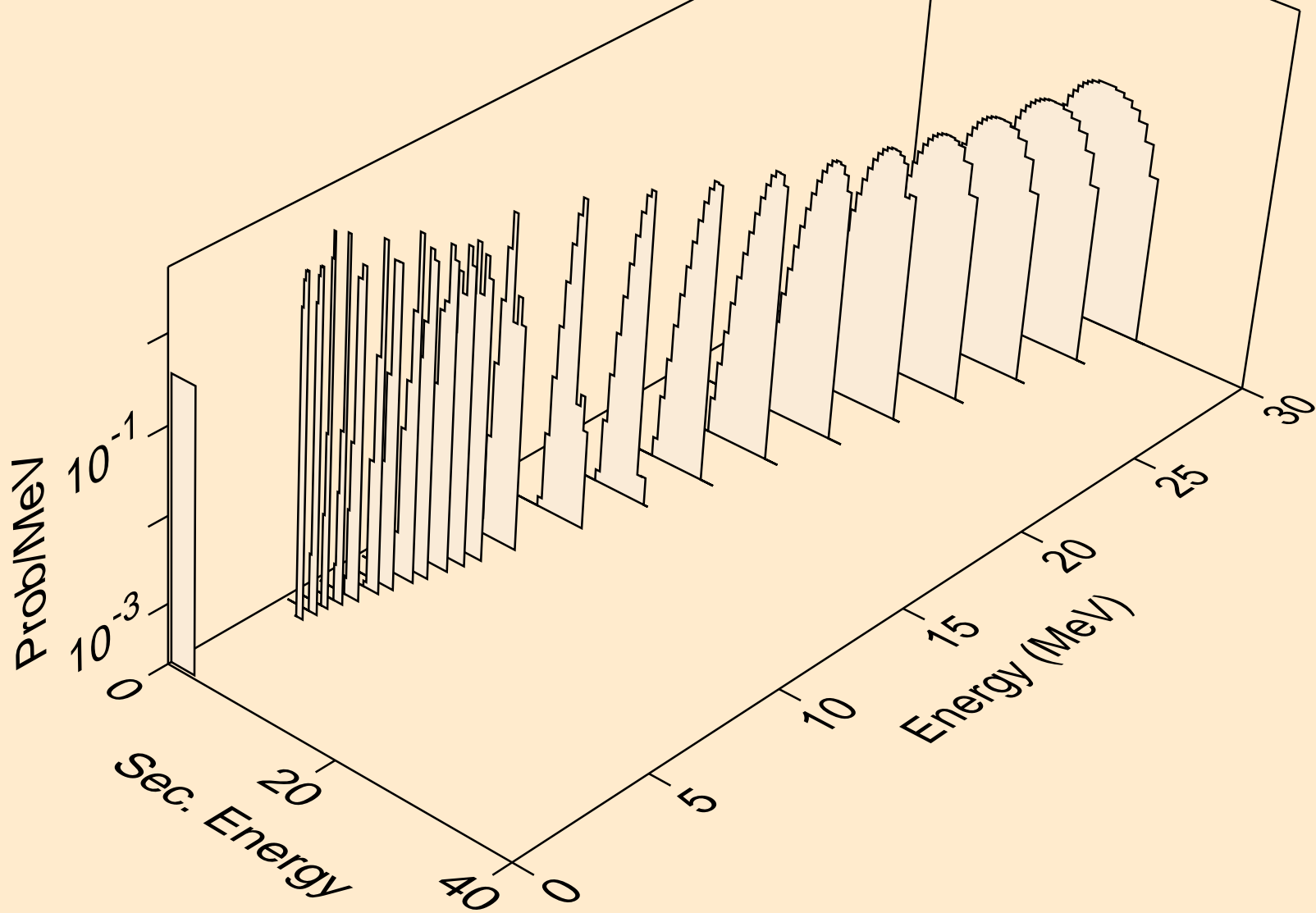

CS121M NEUTRON ACER TENDL-2024 LIBRARY; T=0.K  
alphas from (n,x)

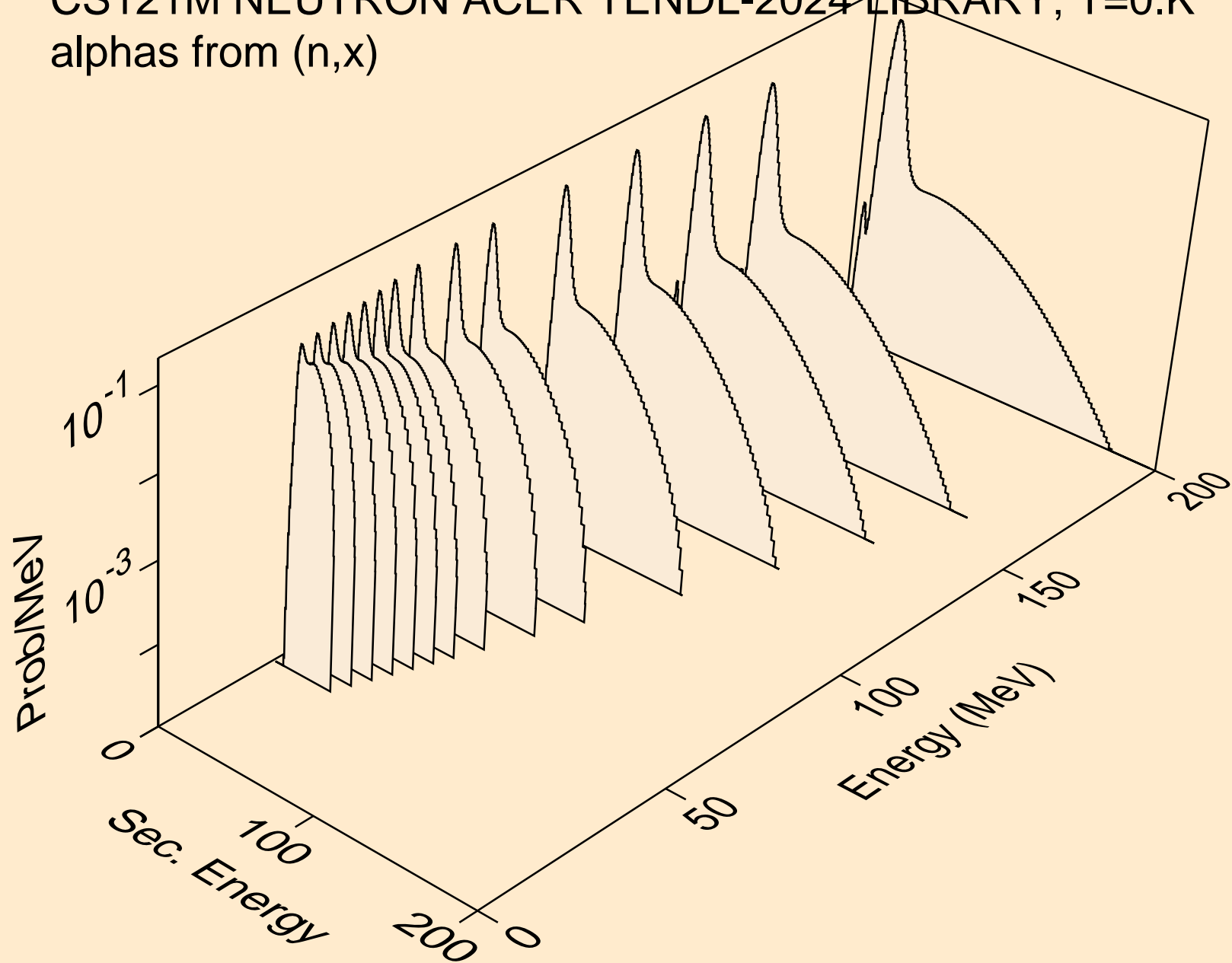

CS121M NEUTRON ACER TENDL-2024 LIBRARY; T=0.K  
alphas from (n,n\*)a

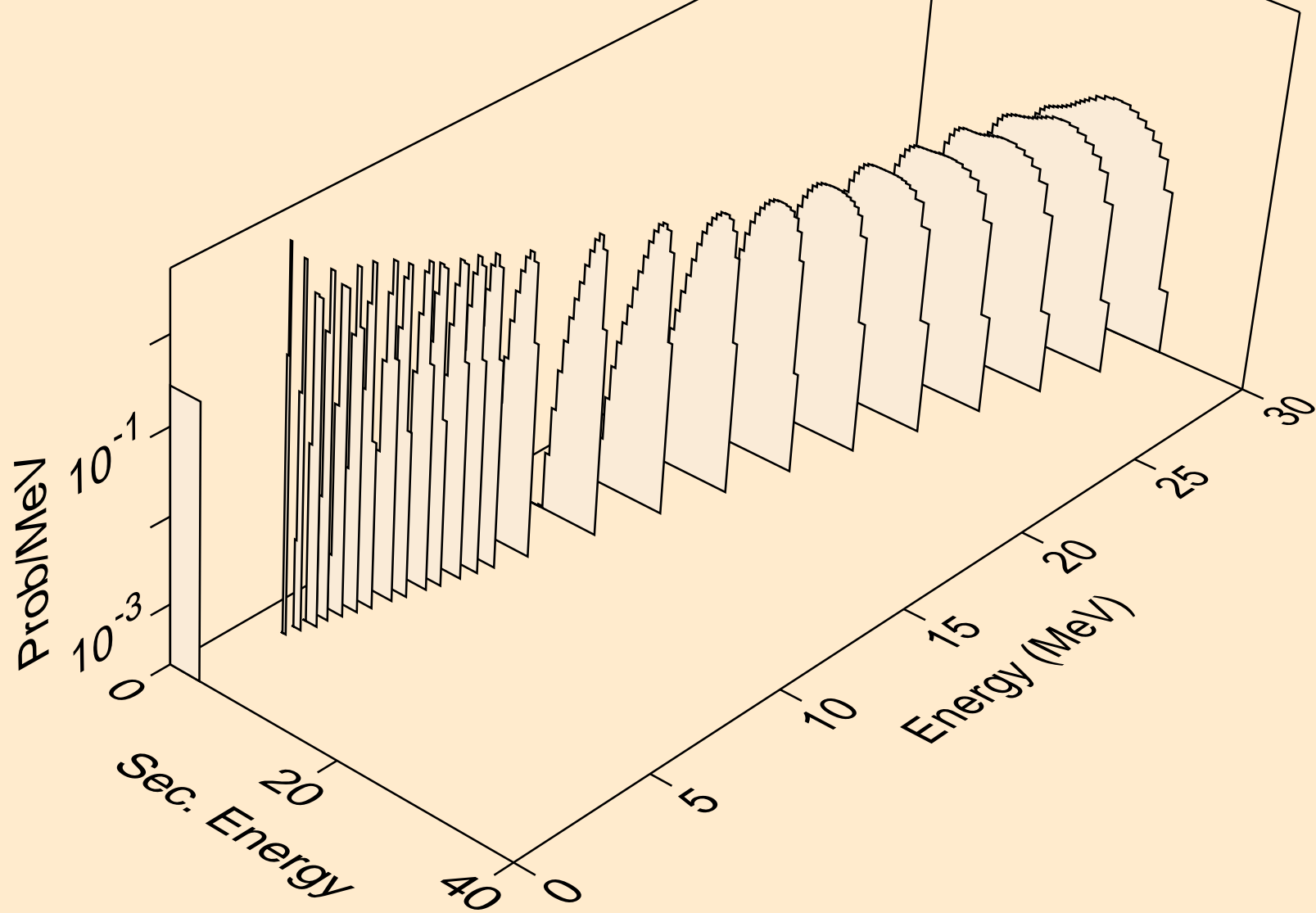

CS121M NEUTRON ACER TENDL-2024 LIBRARY; T=0.K  
alphas from (n,2n)a

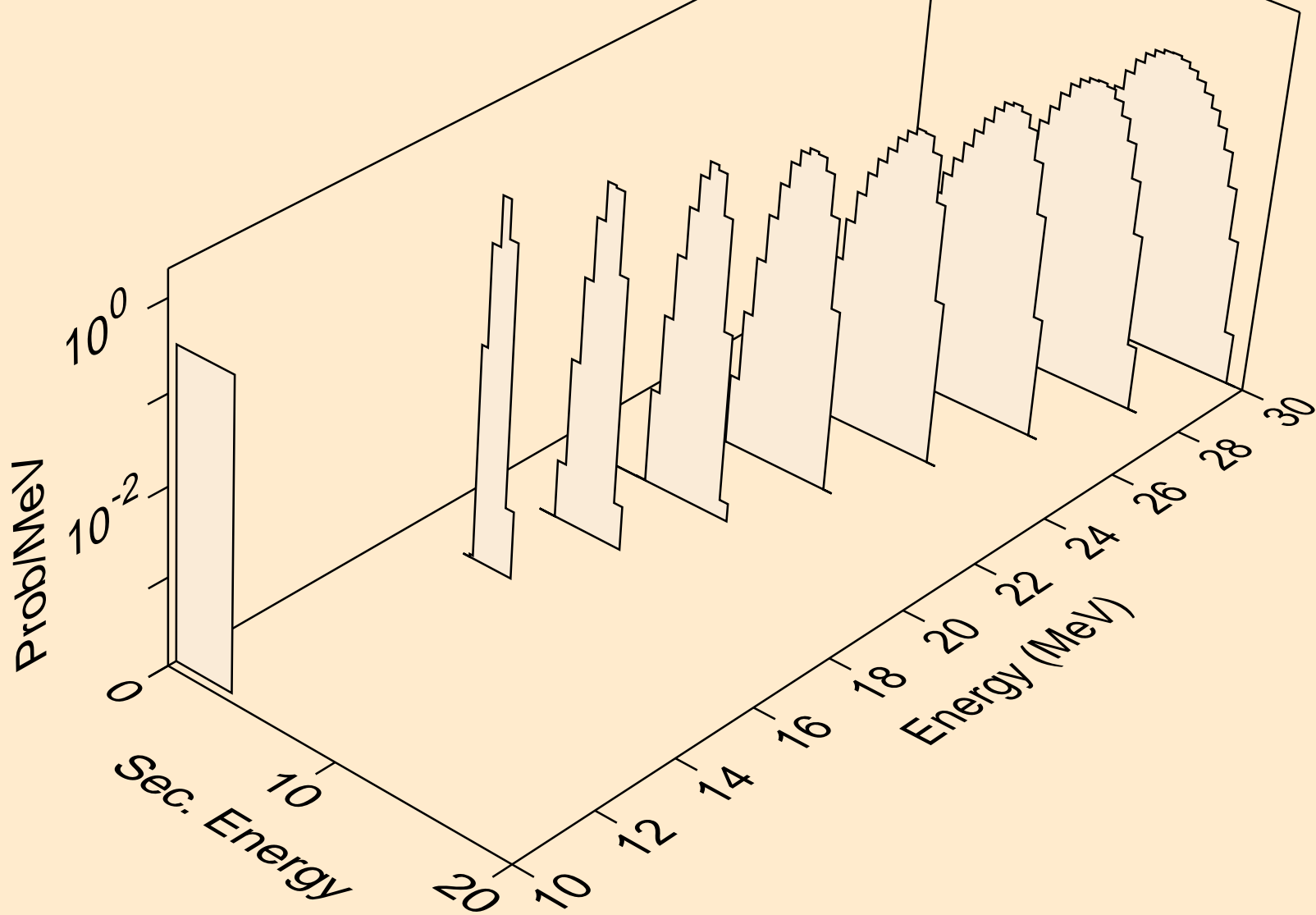

CS121M NEUTRON ACER TENDL-2024 LIBRARY; T=0.K  
alphas from (n,3n)a

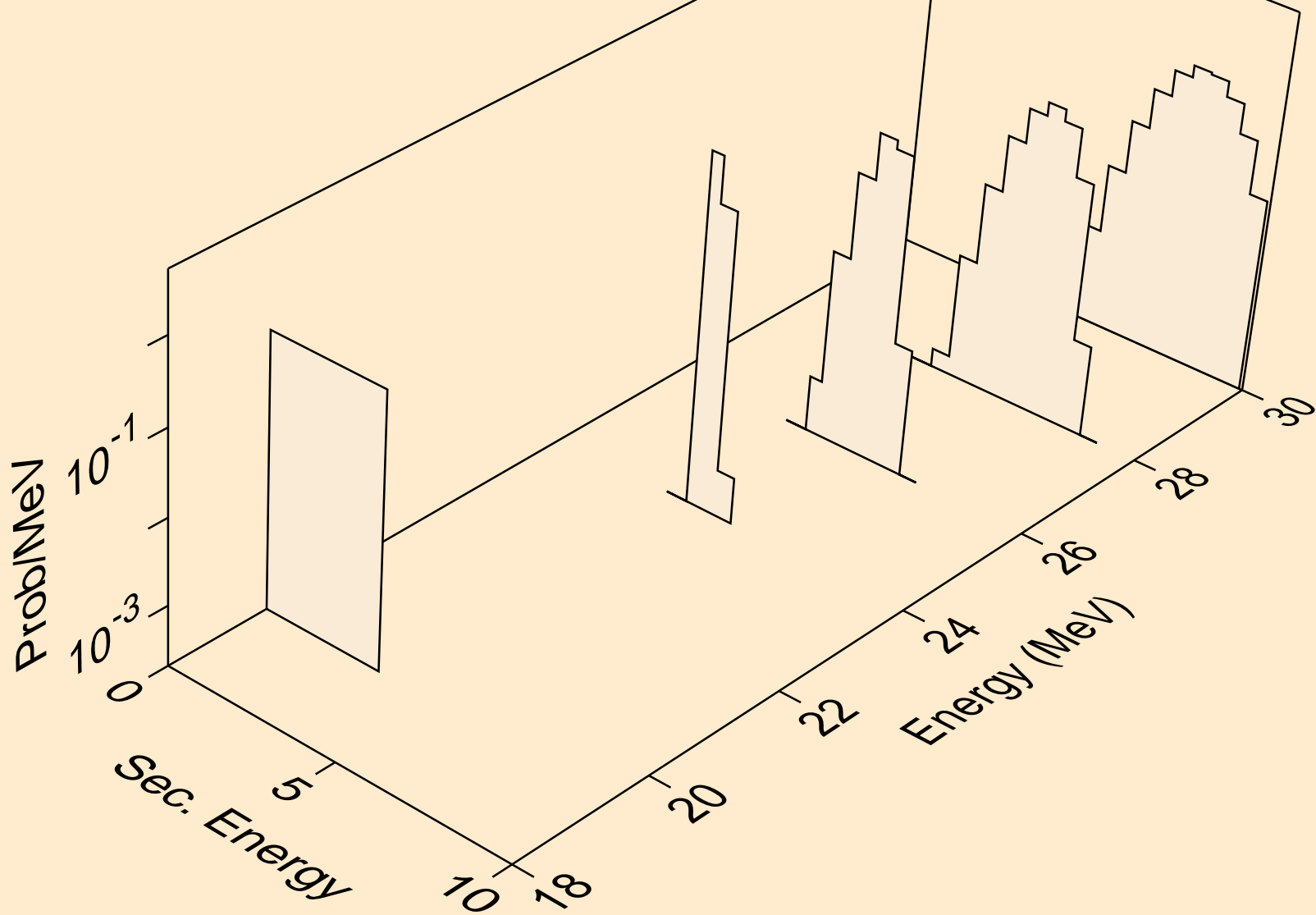

CS121M NEUTRON ACER TENDL-2024 LIBRARY; T=0.K  
alphas from (n,n\*)2a

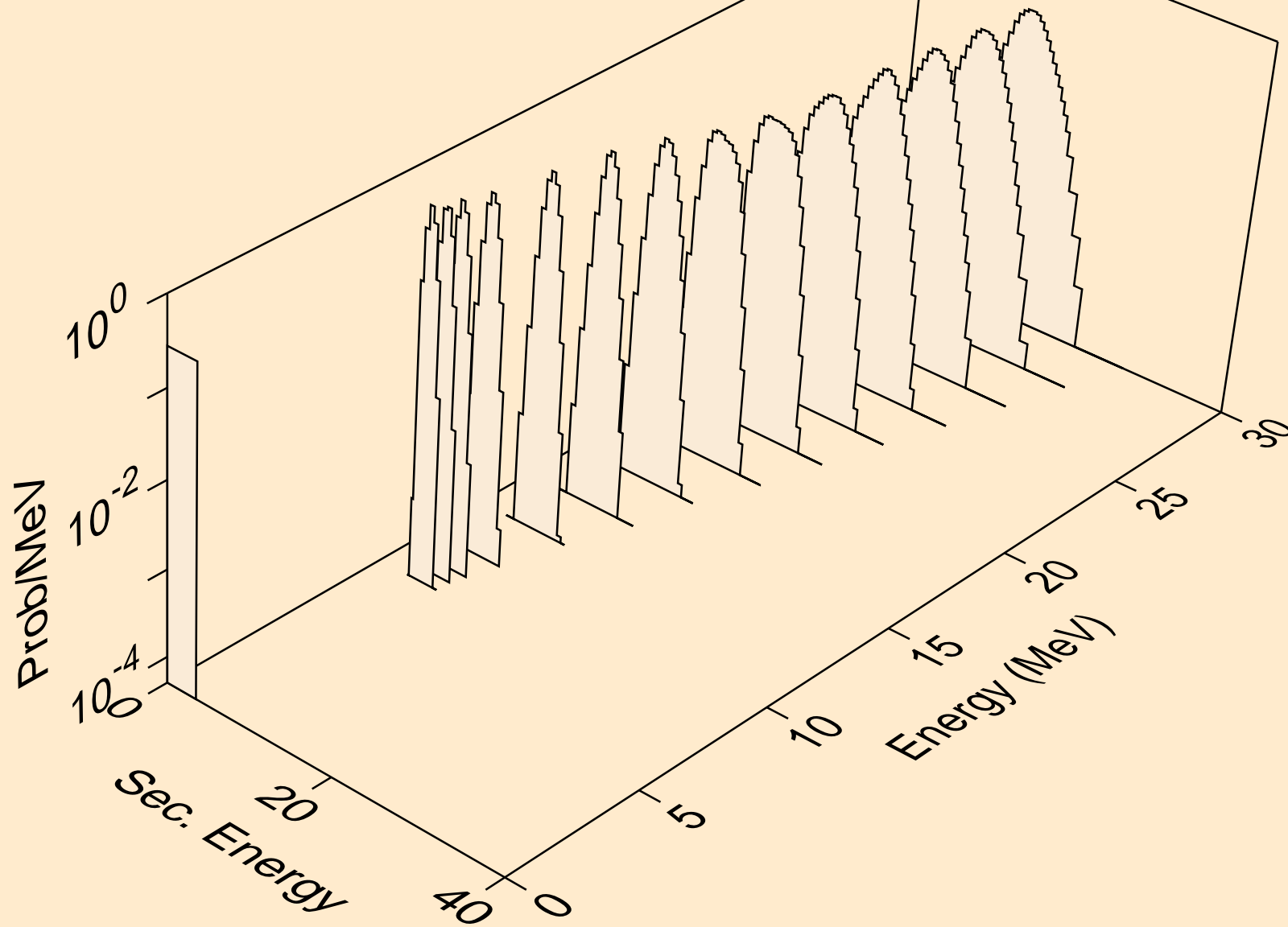

CS121M NEUTRON ACER TENDL-2024 LIBRARY; T=0.K  
alphas from (n,2n)2a

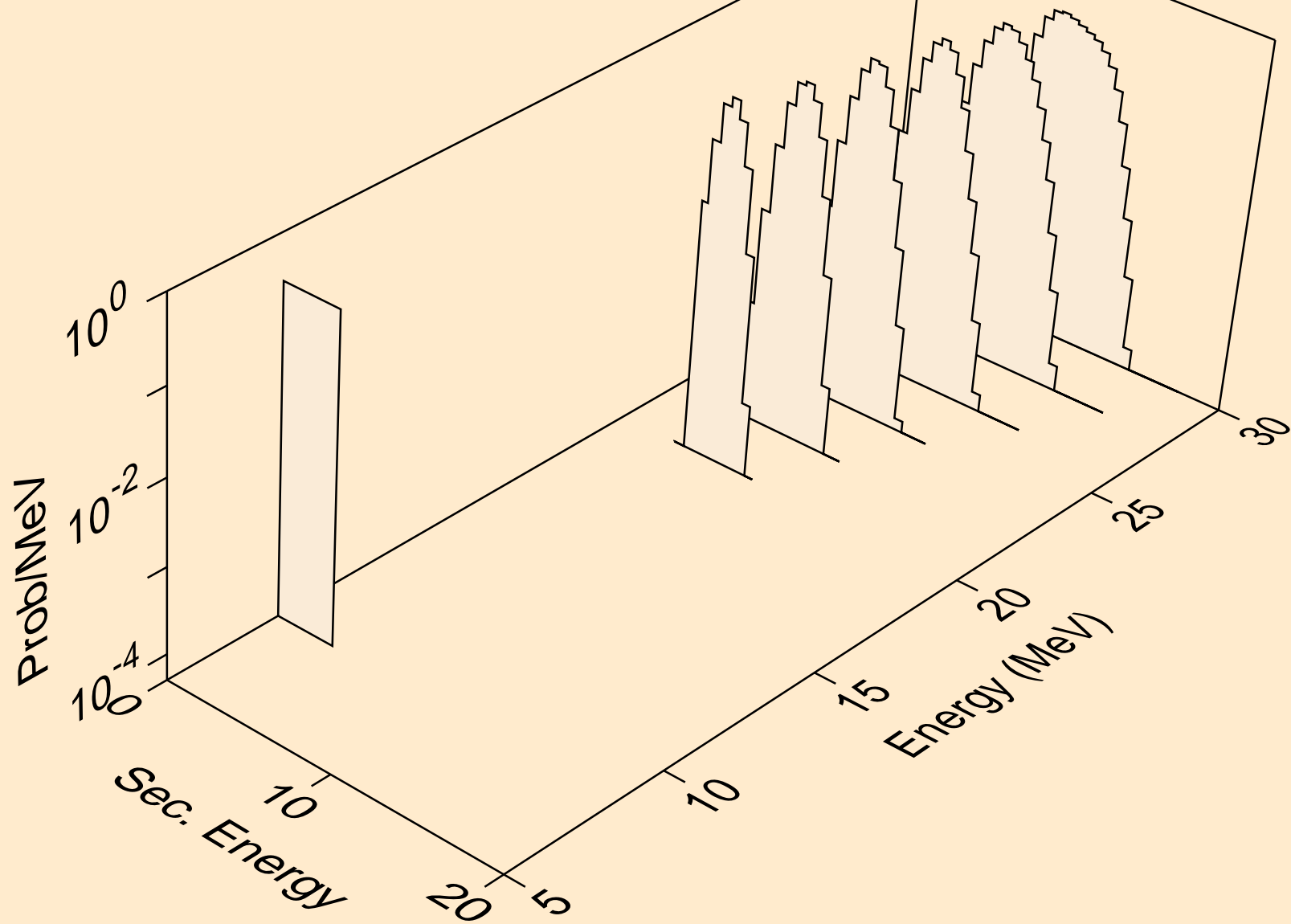

CS121M NEUTRON ACER TENDL-2024 LIBRARY; T=0.K  
alphas from (n,npa)

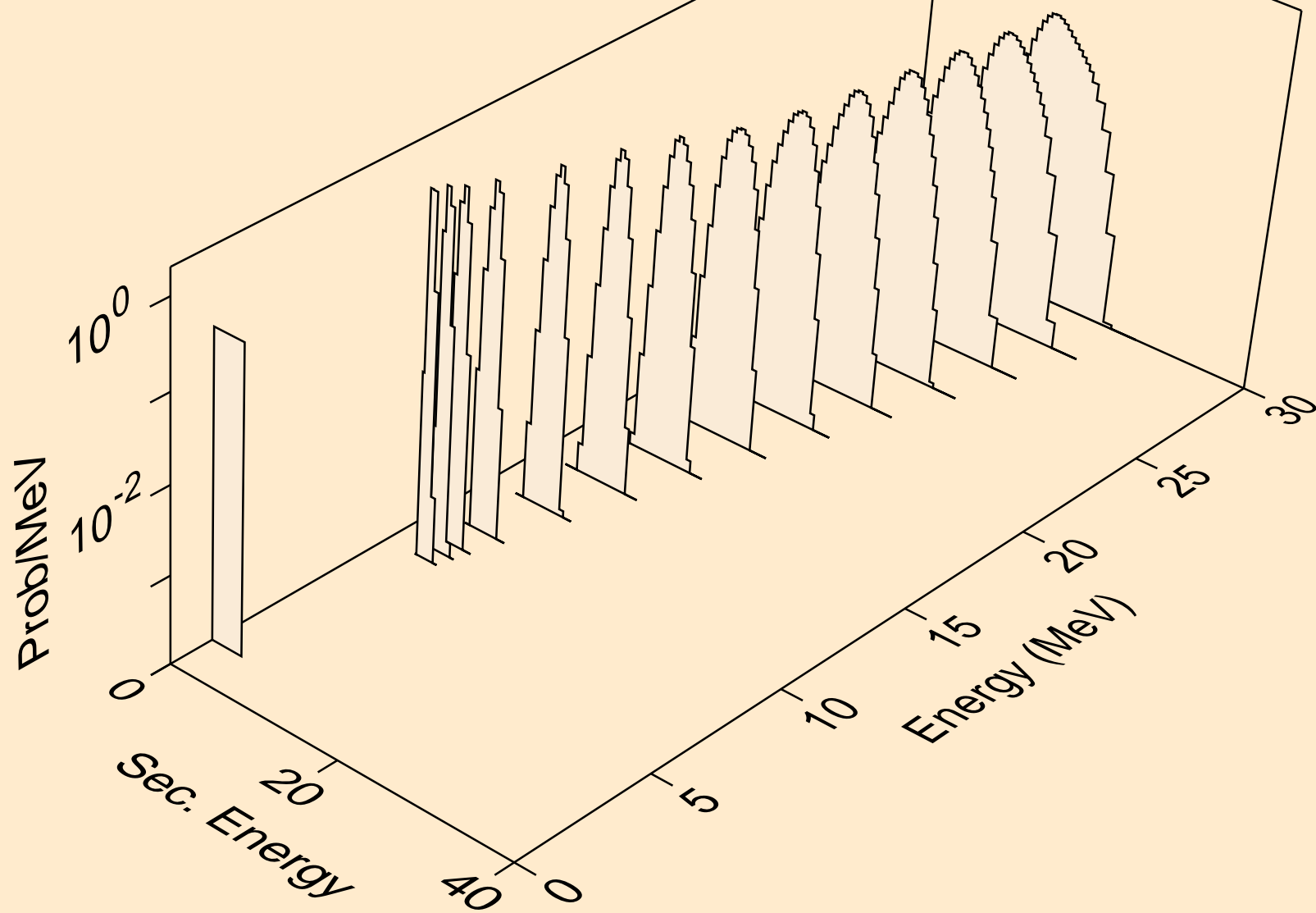

CS121M NEUTRON ACER TENDL-2024 LIBRARY; T=0.K  
alphas from (n,a)

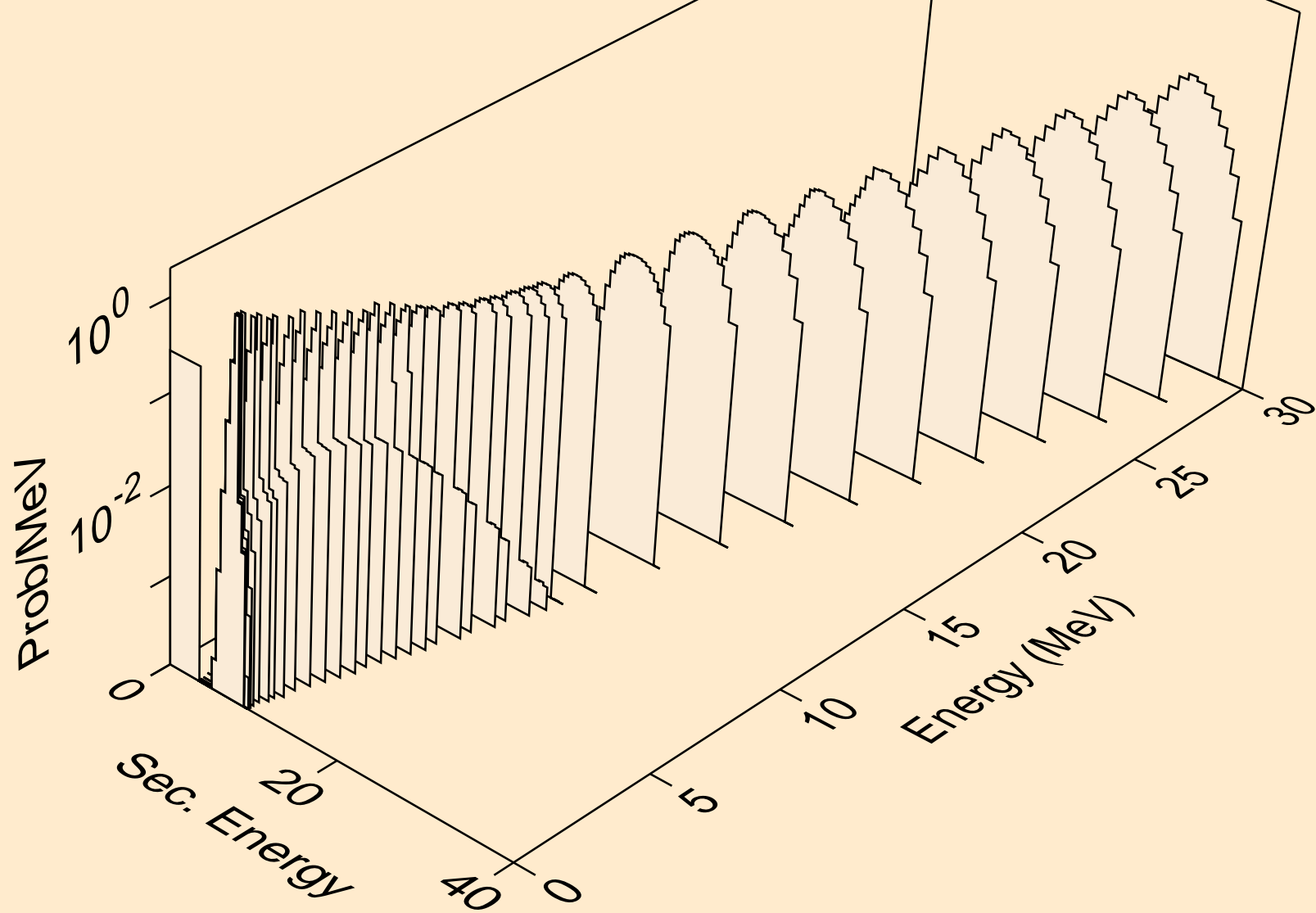

CS121M NEUTRON ACER TENDL-2024 LIBRARY; T=0.K  
alphas from (n,2a)

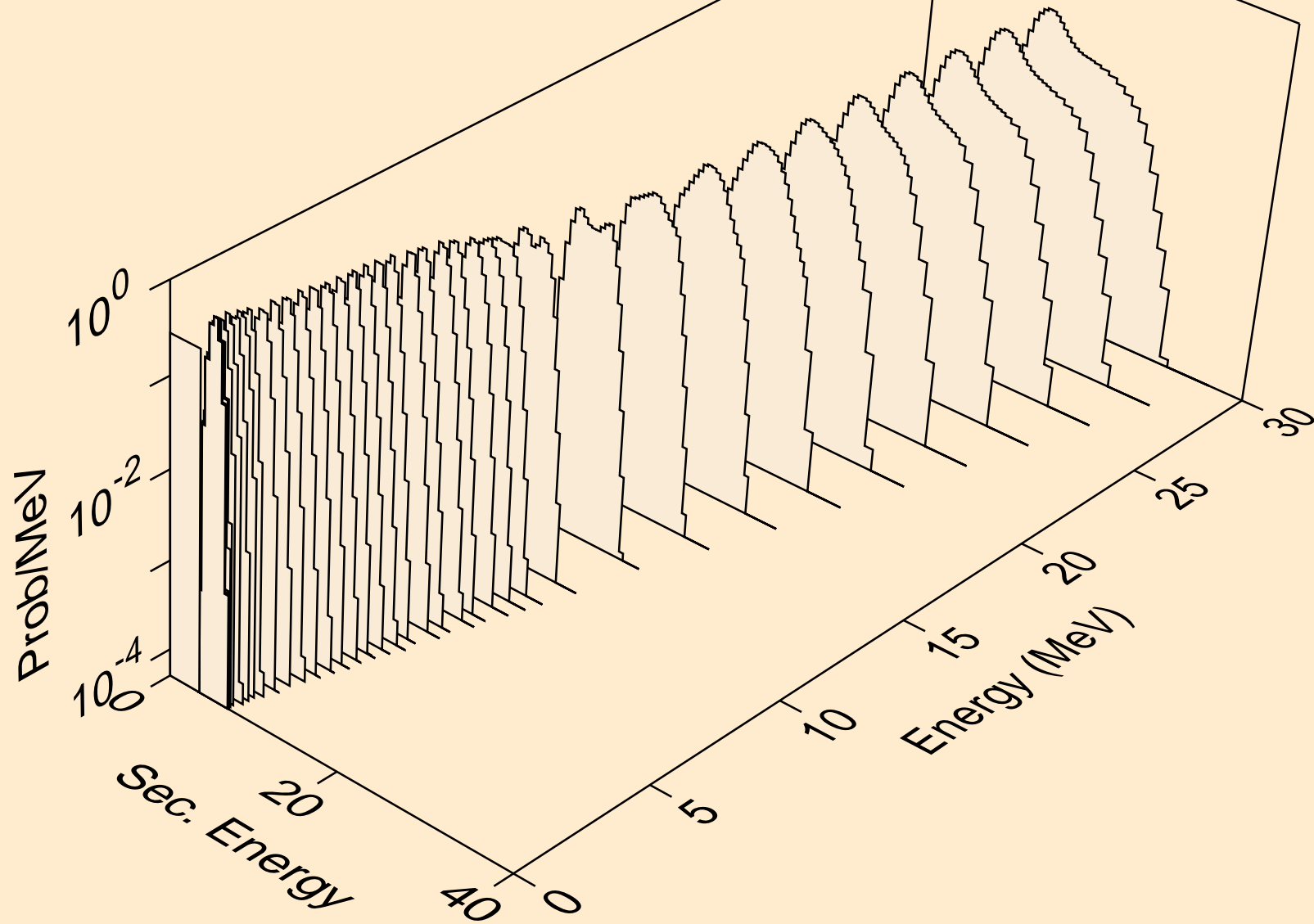

CS121M NEUTRON ACER TENDL-2024 LIBRARY; T=0.K  
alphas from (n,3a)

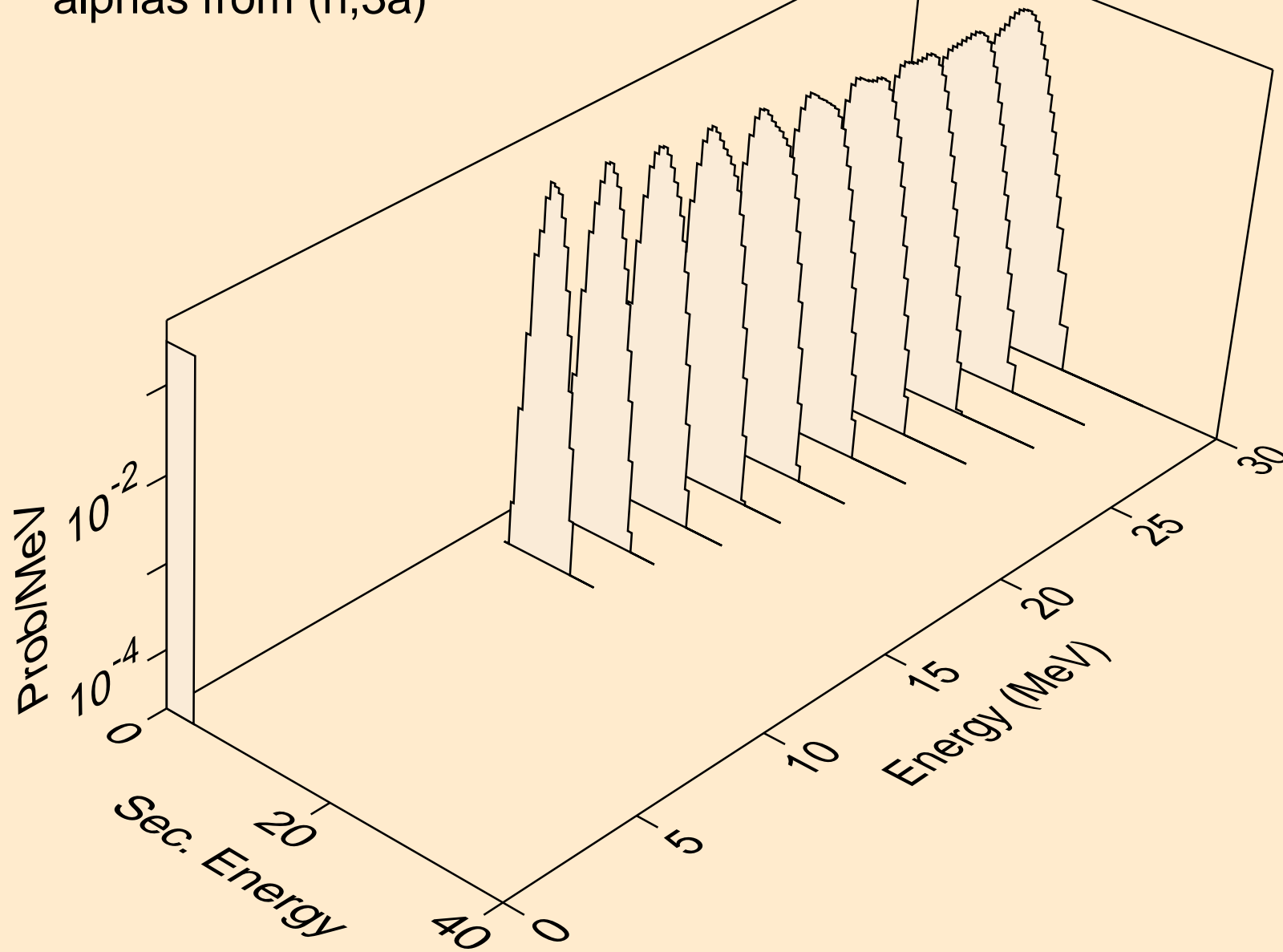

CS121M NEUTRON ACER TENDL-2024 LIBRARY; T=0.K  
alphas from (n,pa)

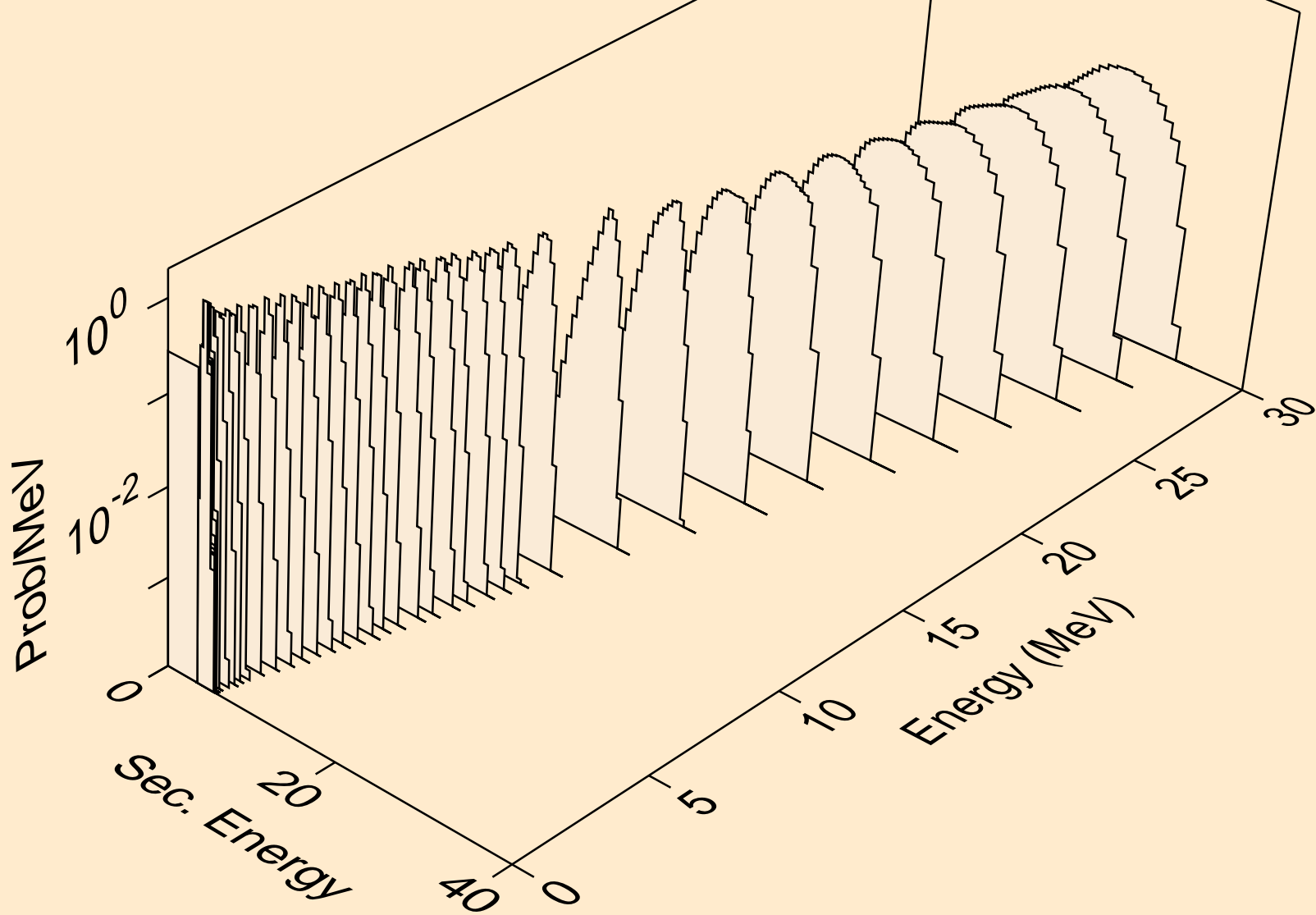

CS121M NEUTRON ACER TENDL-2024 LIBRARY; T=0.K  
alphas from (n,d2a)

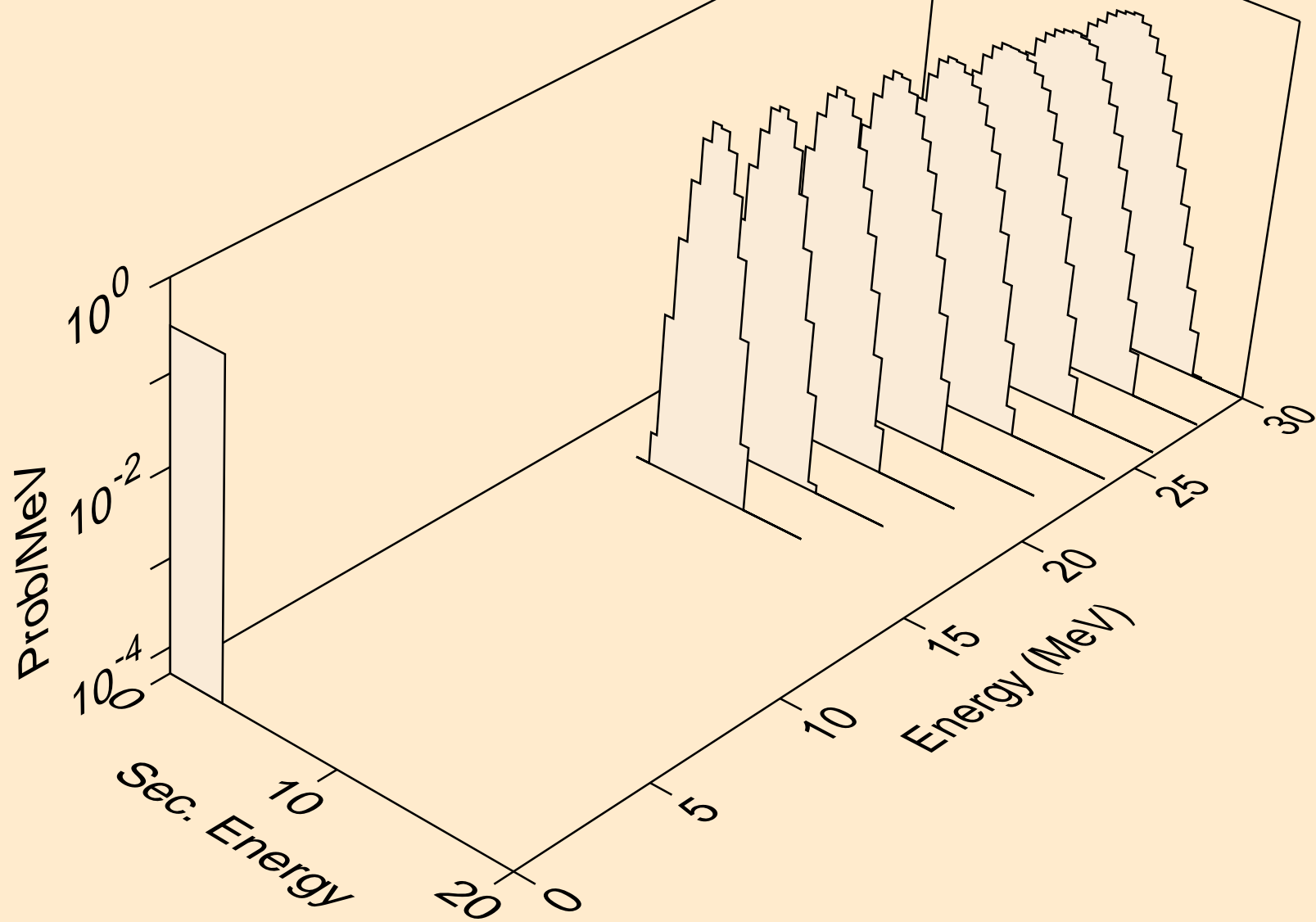

CS121M NEUTRON ACER TENDL-2024 LIBRARY; T=0.K  
alphas from (n,da)

