

# FE064 NEUTRON ACER TENDL-2024 LIBRARY; T=0.K

## Principal cross sections

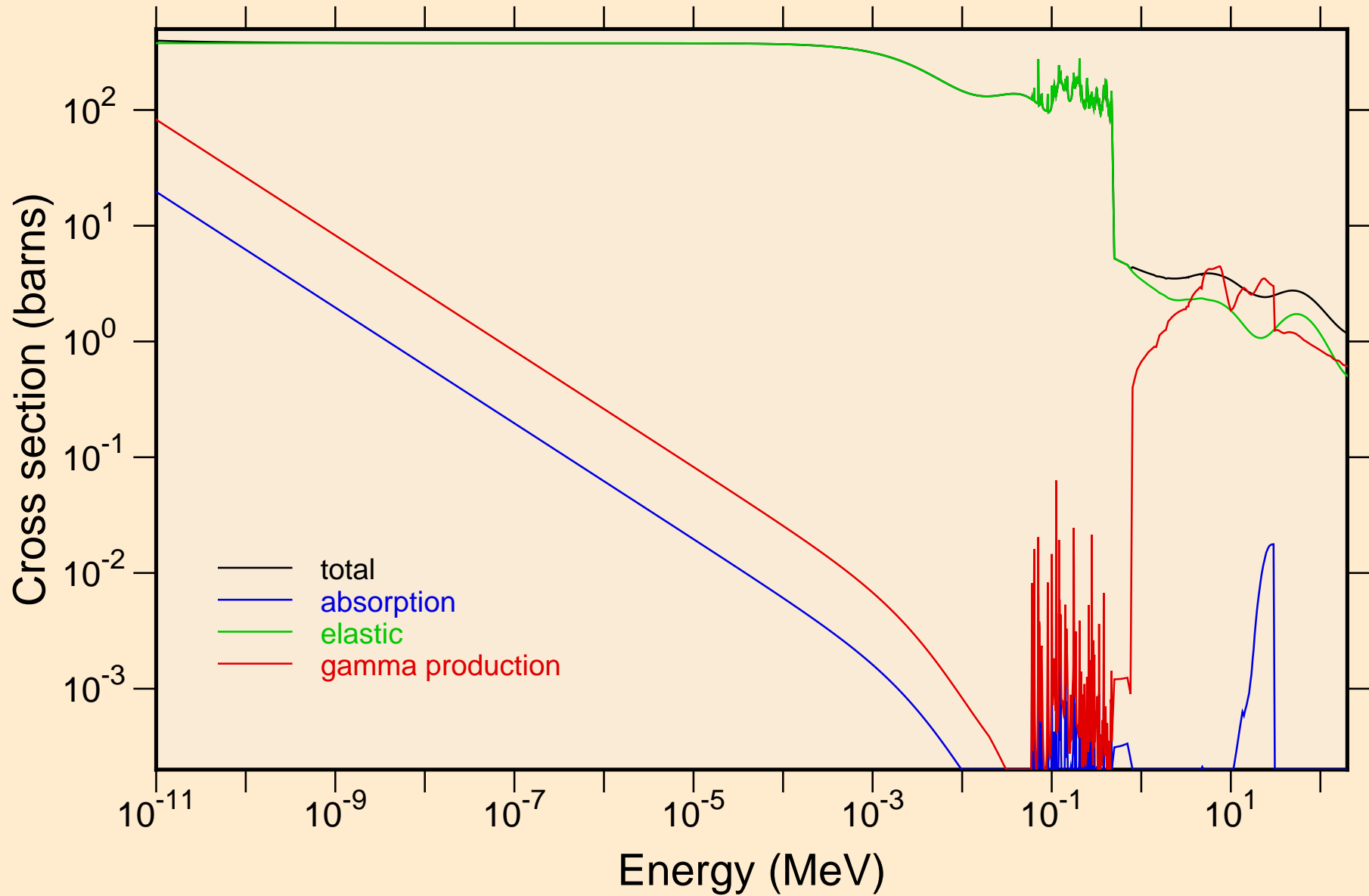

FE064 NEUTRON ACER TENDL-2024 LIBRARY; T=0.K  
resonance total cross section

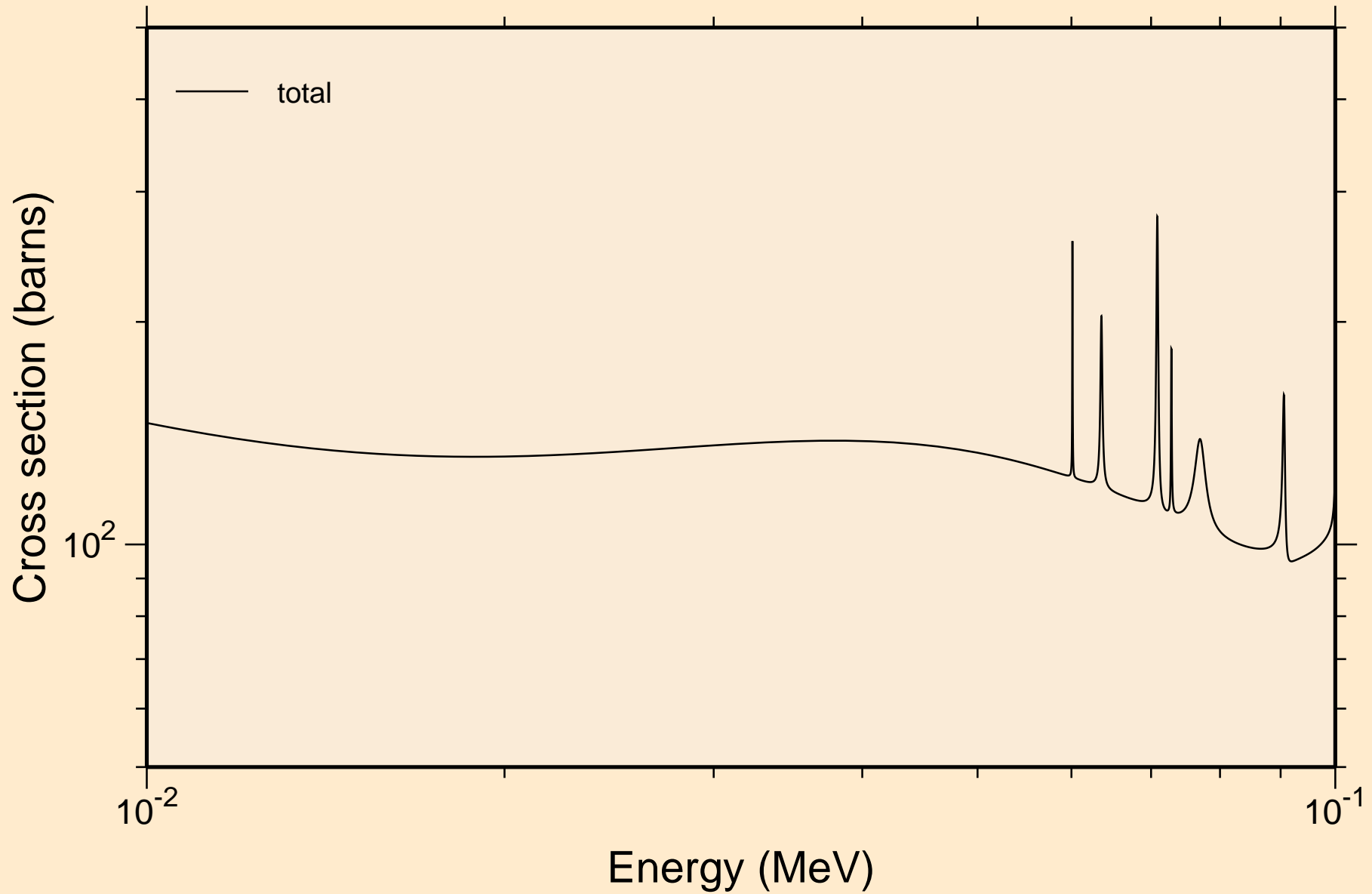

FE064 NEUTRON ACER TENDL-2024 LIBRARY; T=0.K  
resonance total cross section

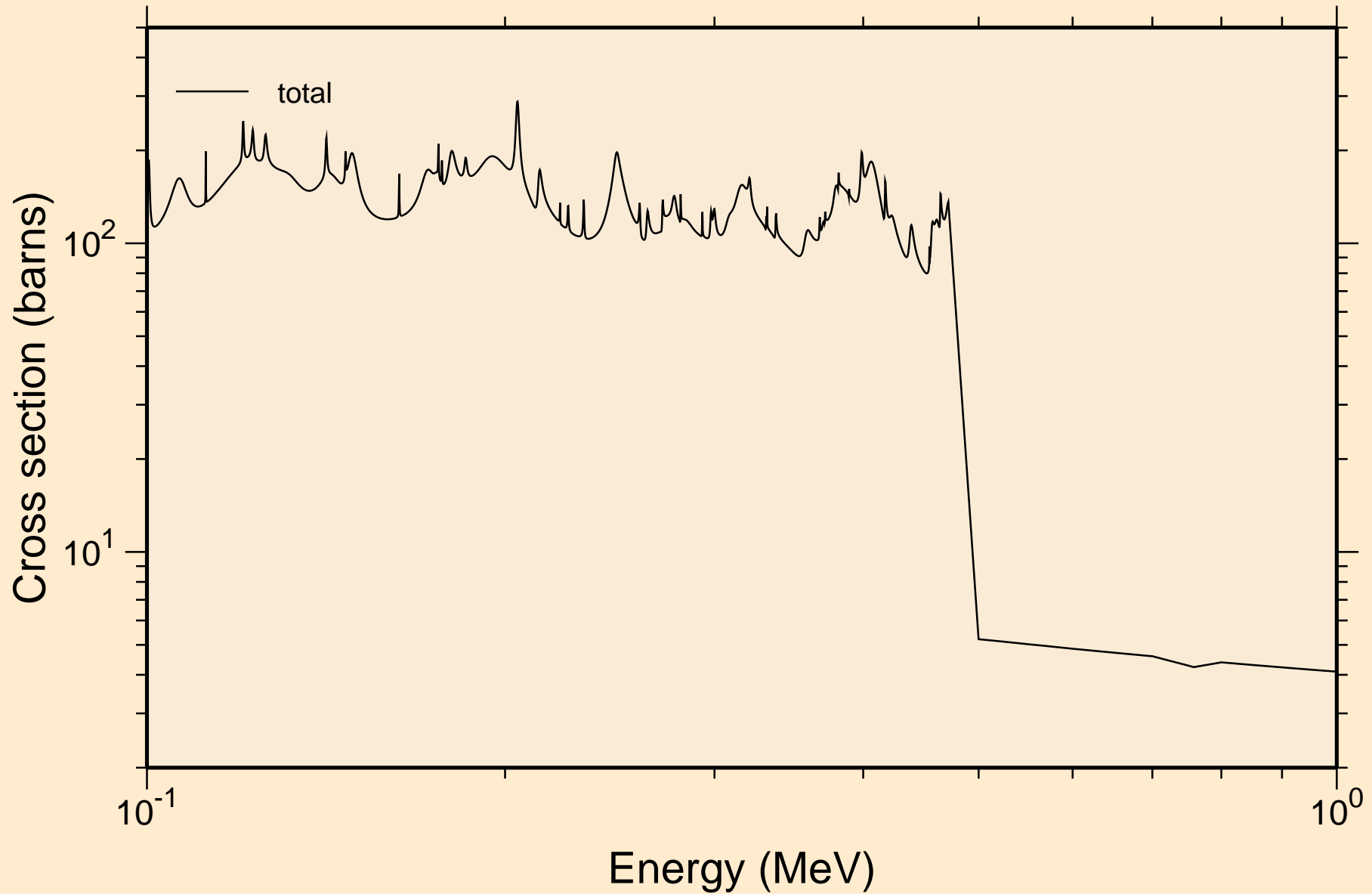

F<sup>54</sup> NEUTRON ACER TENDL-2024 LIBRARY; T=0.K  
resonance total cross section

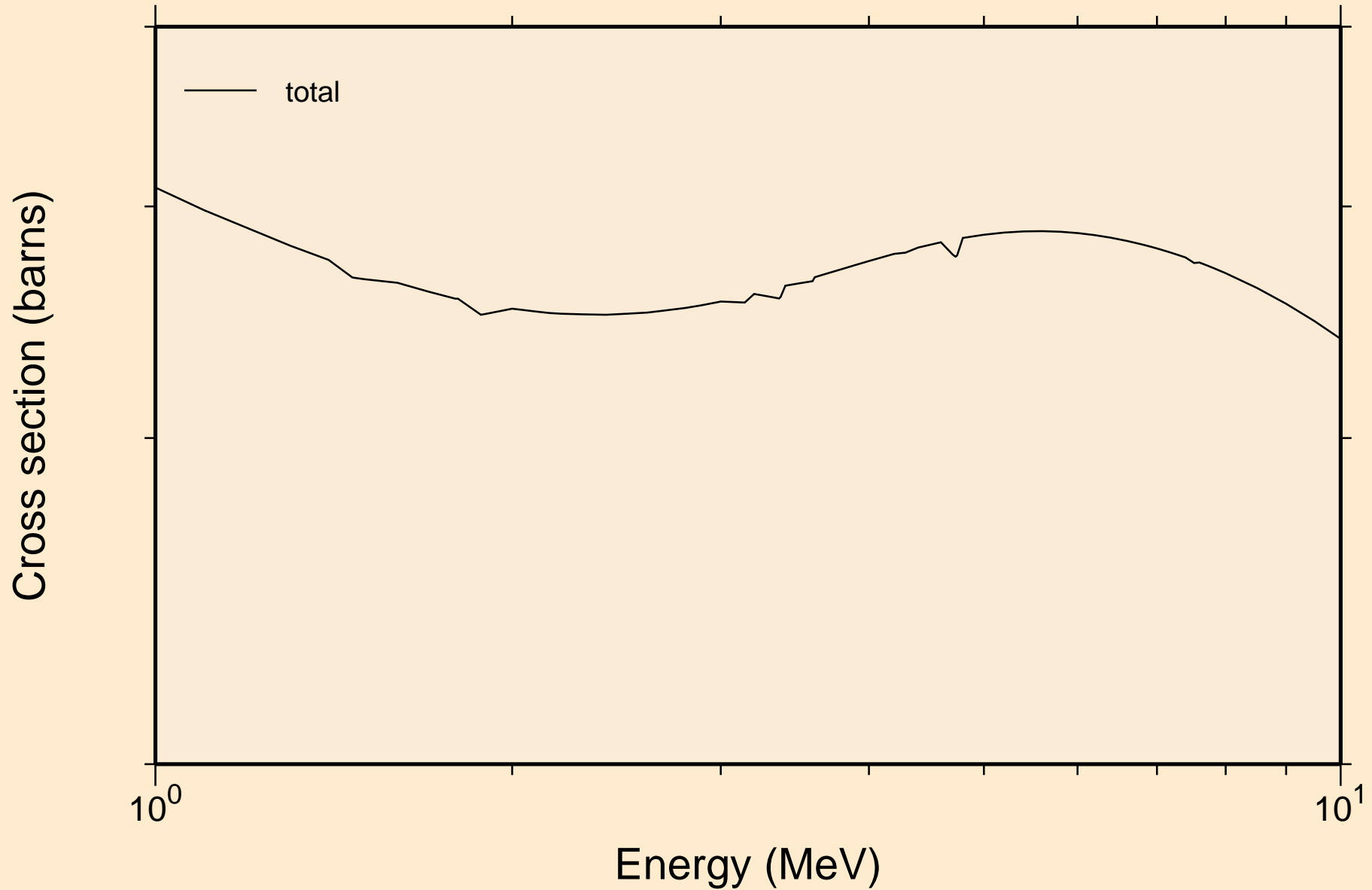

FE064 NEUTRON ACER TENDL-2024 LIBRARY; T=0.K  
resonance absorption cross sections

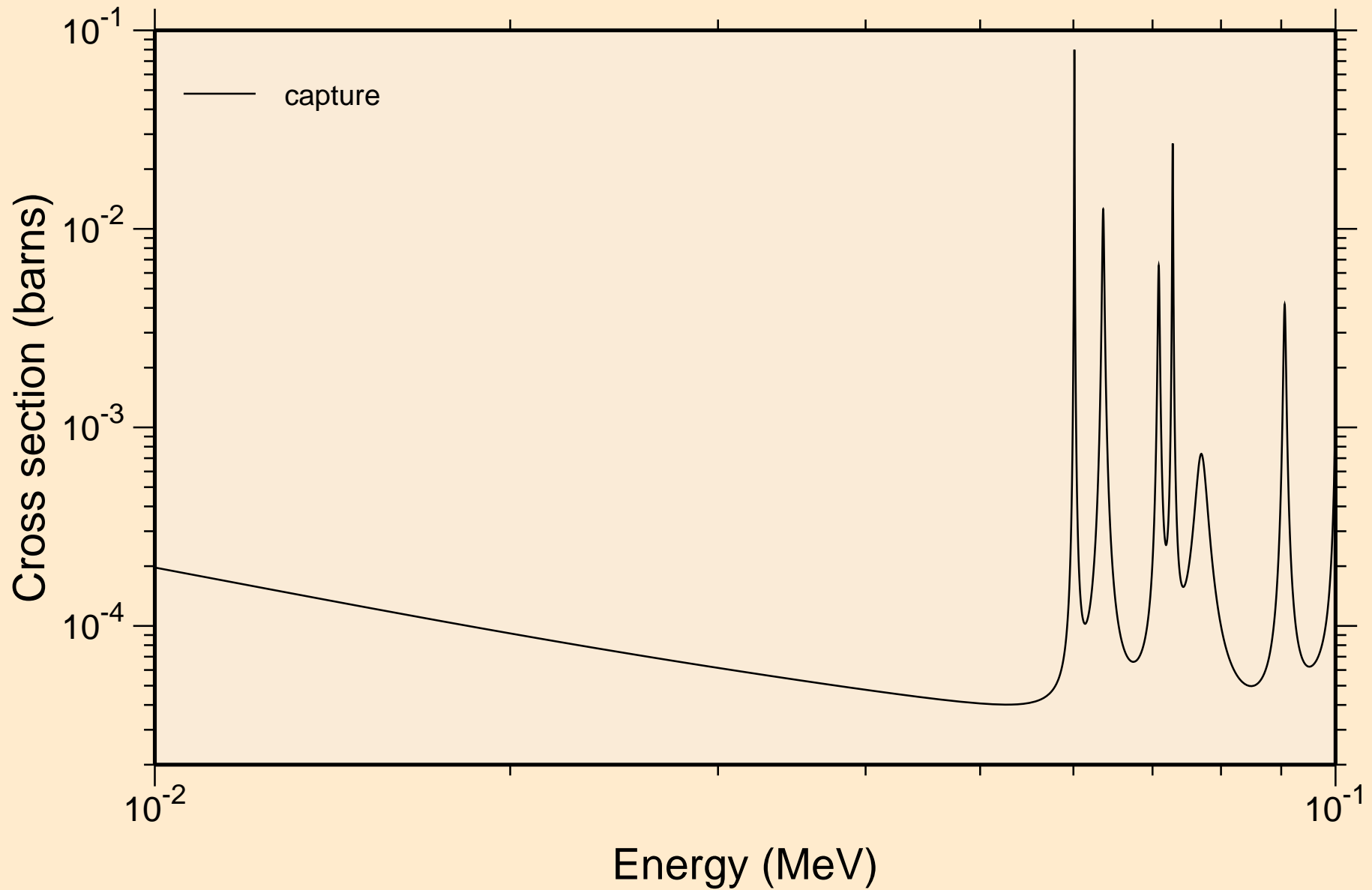

FE064 NEUTRON ACER TENDL-2024 LIBRARY; T=0.K  
resonance absorption cross sections

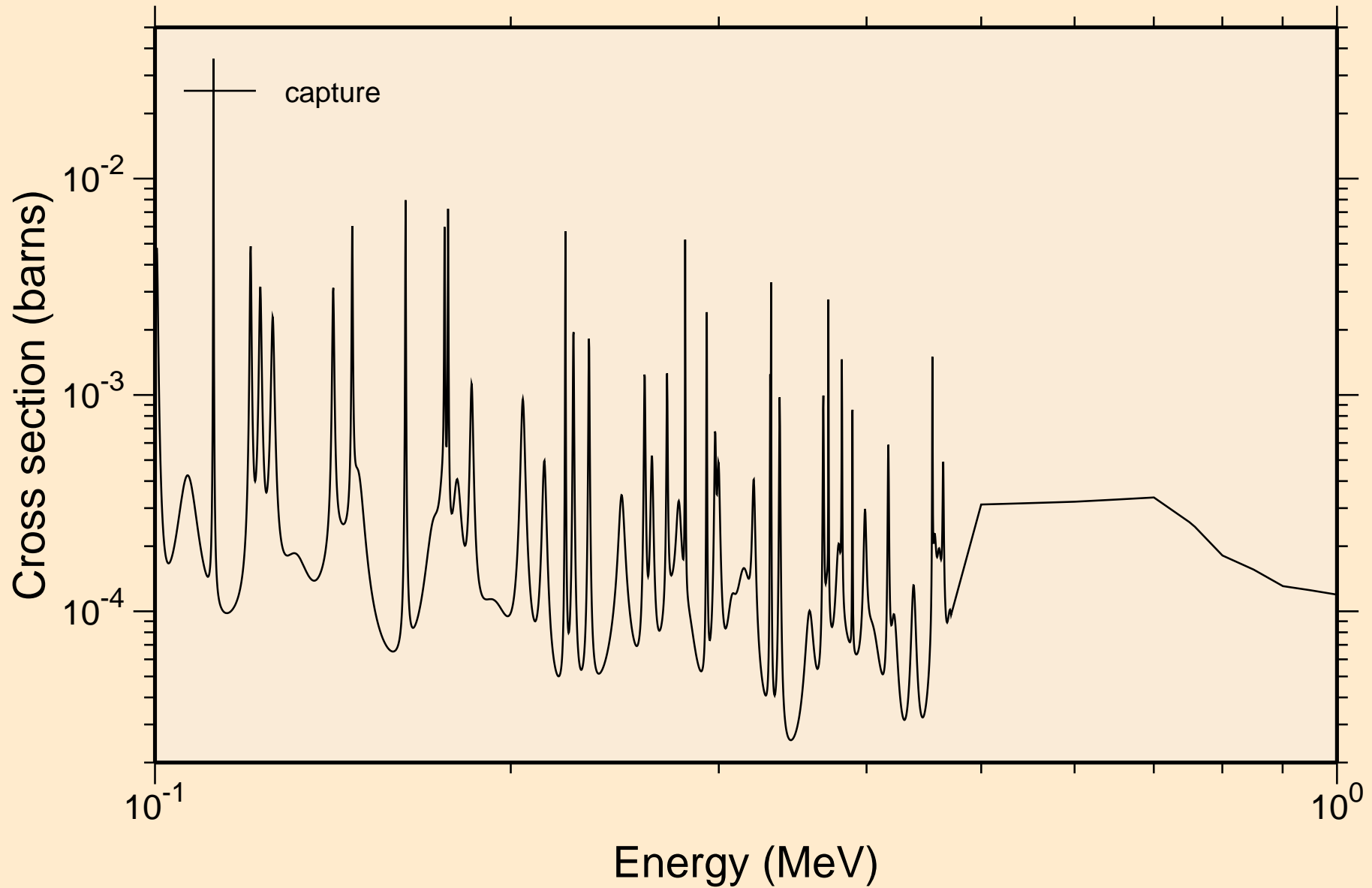

FE064 NEUTRON ACER TENDL-2024 LIBRARY; T=0.K  
resonance absorption cross sections

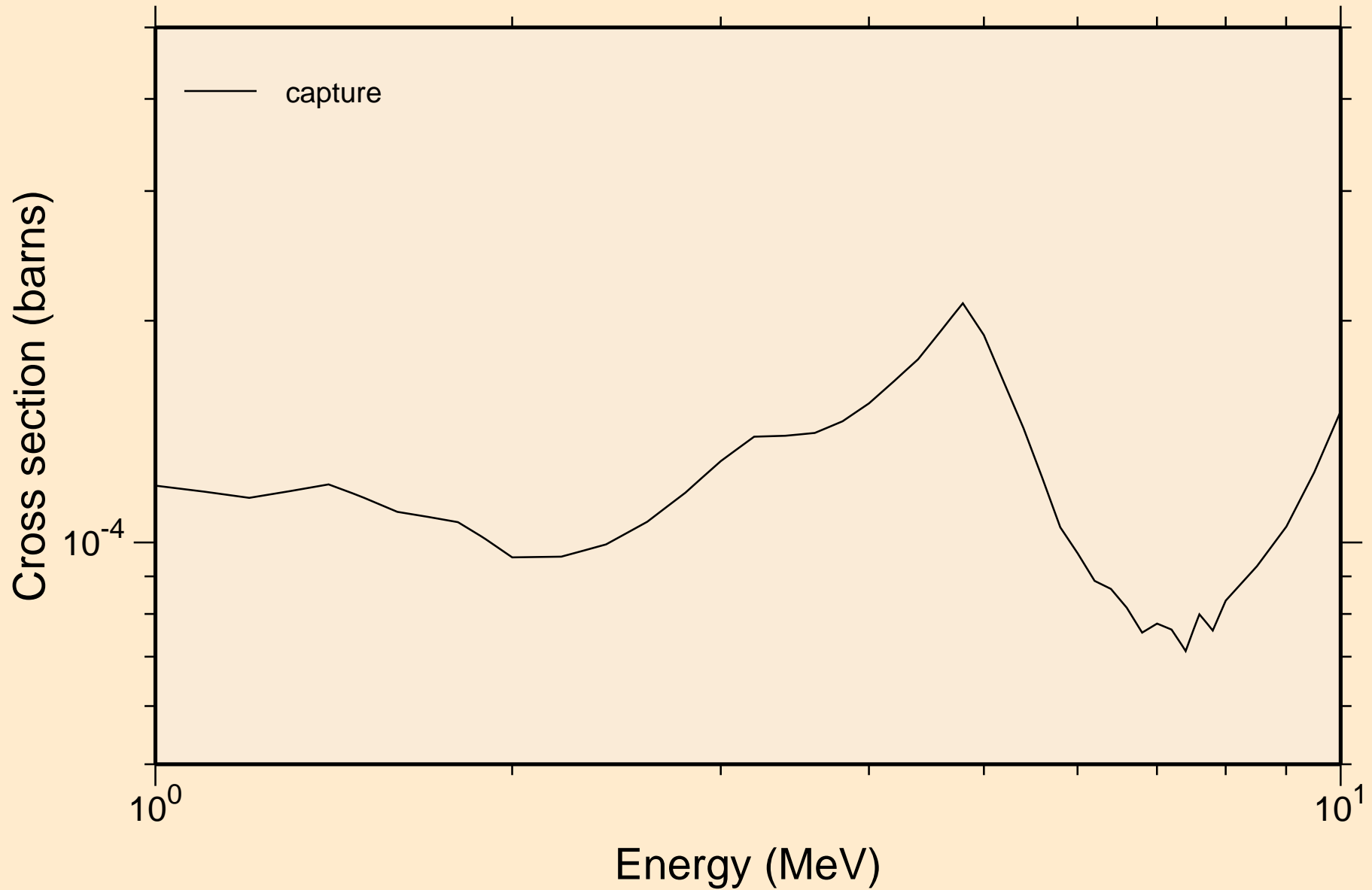

FE064 NEUTRON ACER TENDL-2024 LIBRARY; T=0.K  
Heating

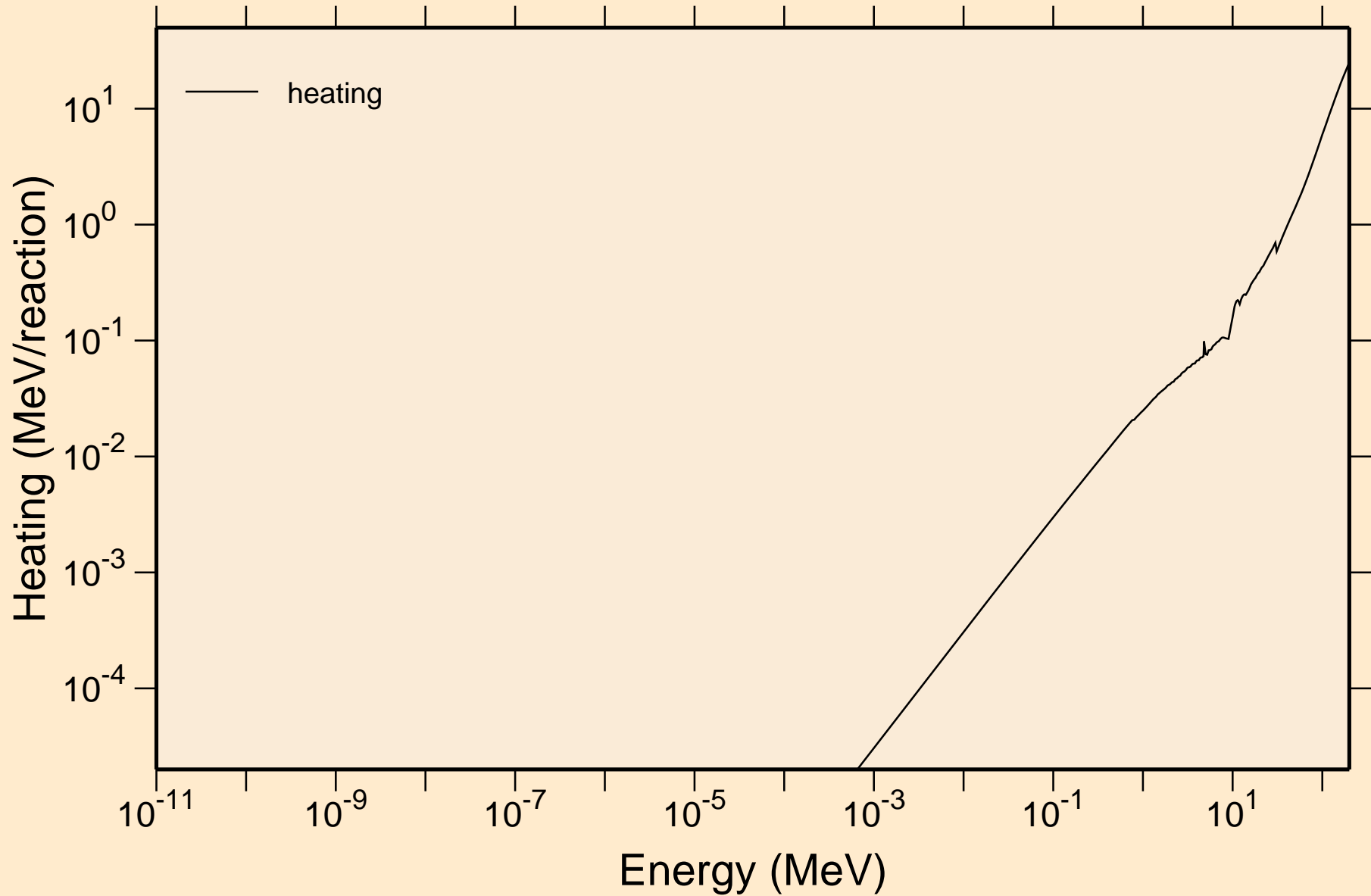

# FE064 NEUTRON ACER TENDL-2024 LIBRARY; T=0.K

## Damage

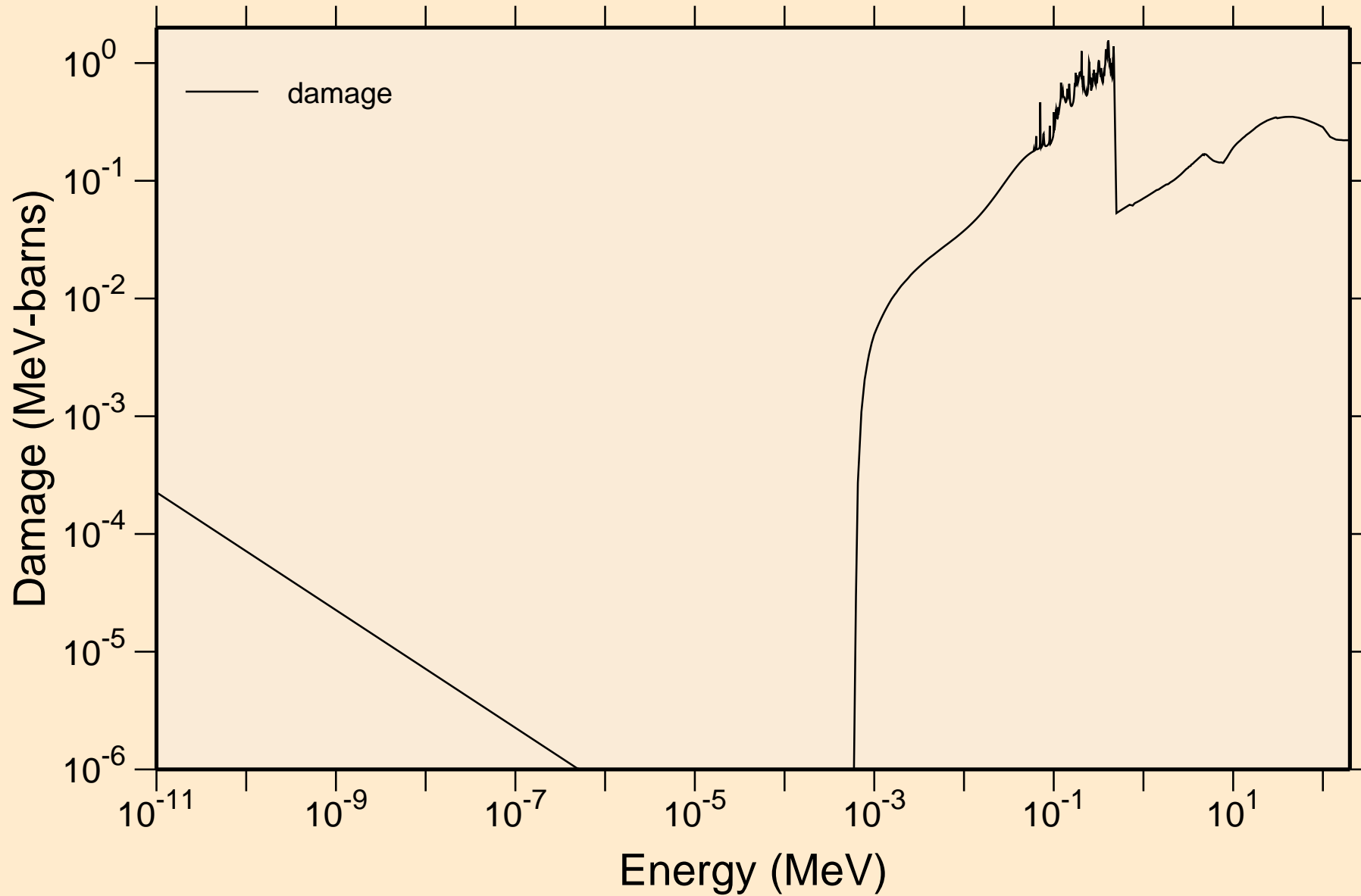

FE064 NEUTRON ACER TENDL-2024 LIBRARY; T=0.K  
Non-threshold reactions

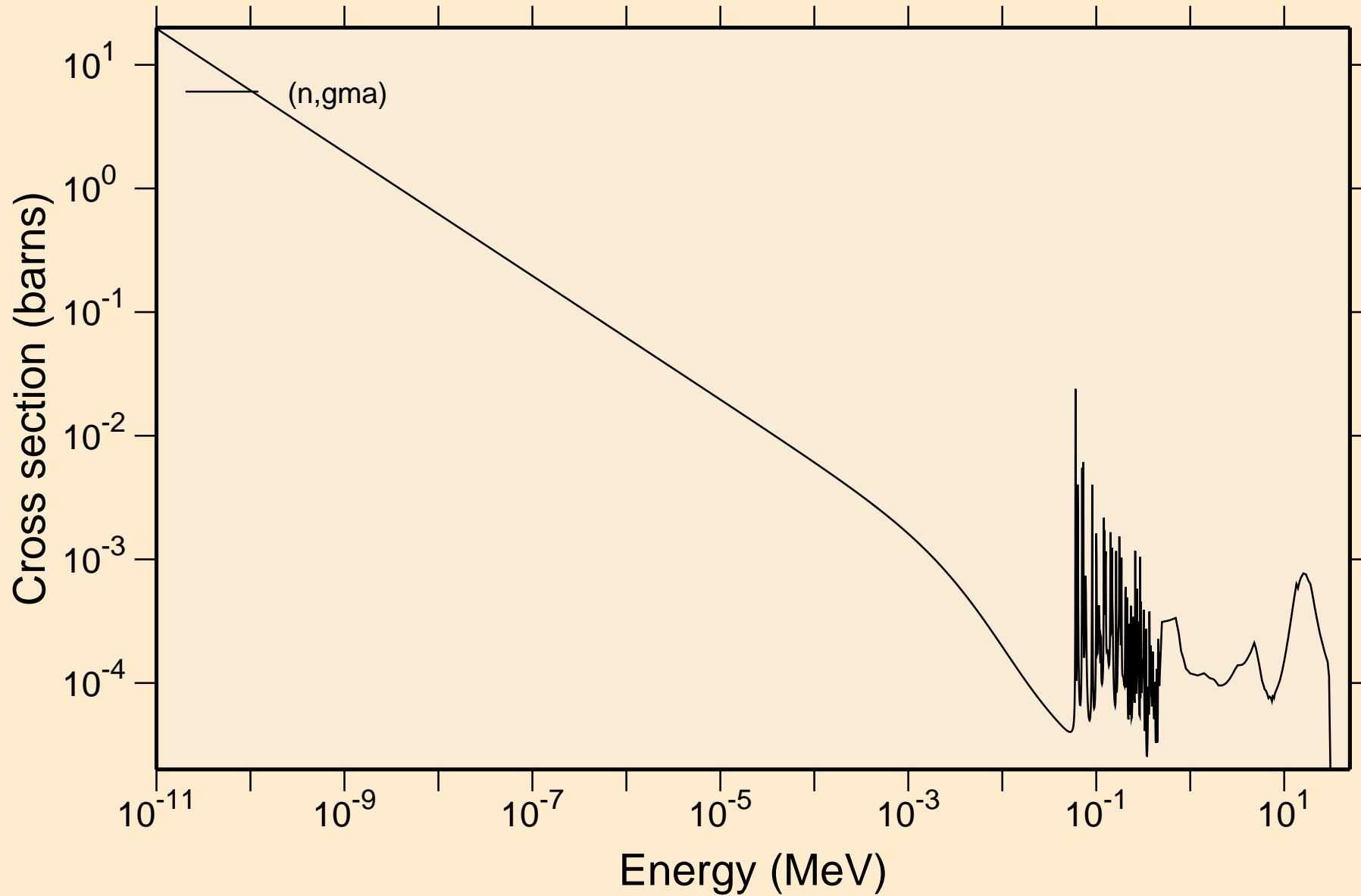

# FE064 NEUTRON ACER TENDL-2024 LIBRARY; T=0.K

## Principal cross sections

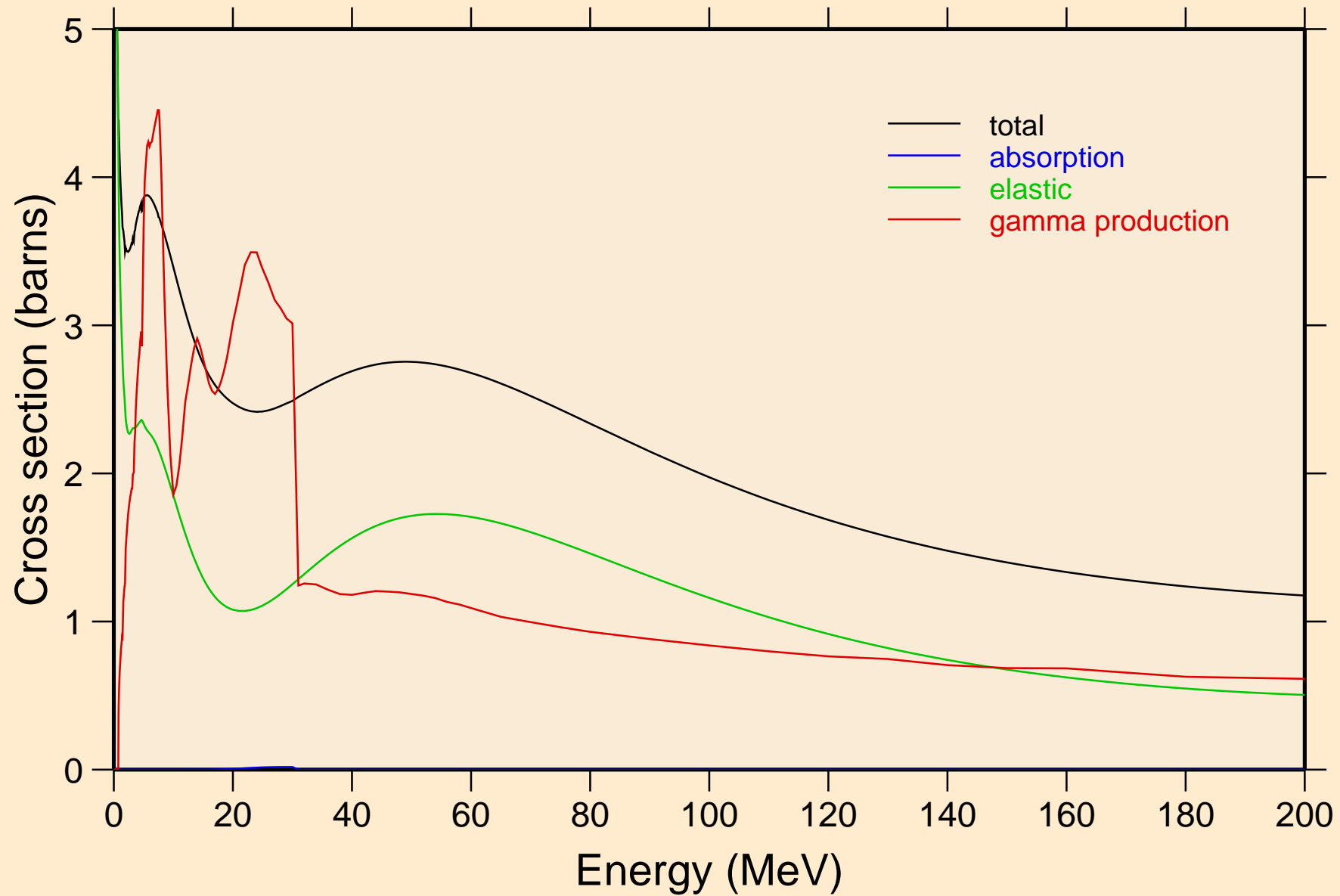

# FE064 NEUTRON ACER TENDL-2024 LIBRARY; T=0.K

## Heating

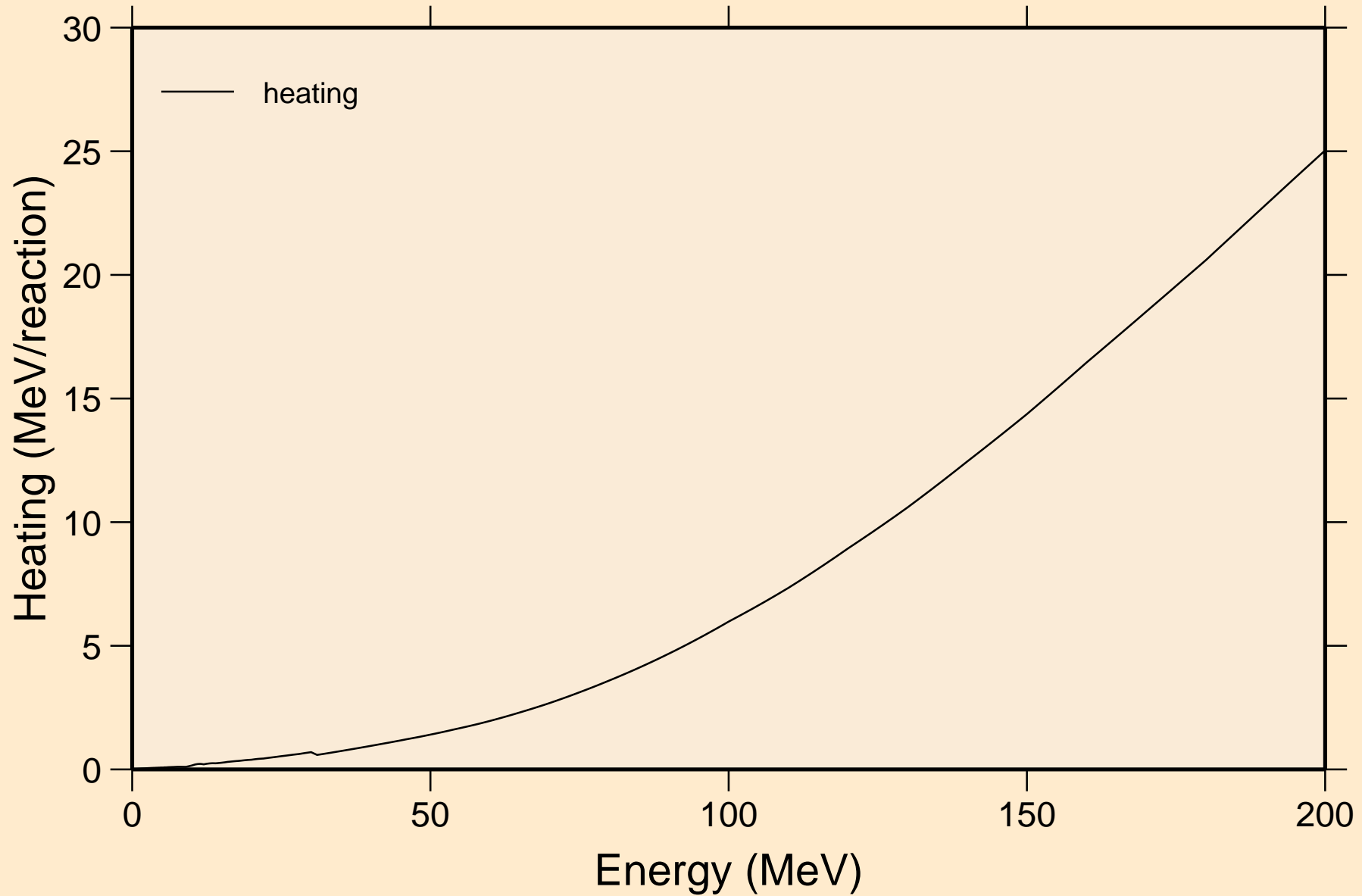

# FE064 NEUTRON ACER TENDL-2024 LIBRARY; T=0.K

## Damage

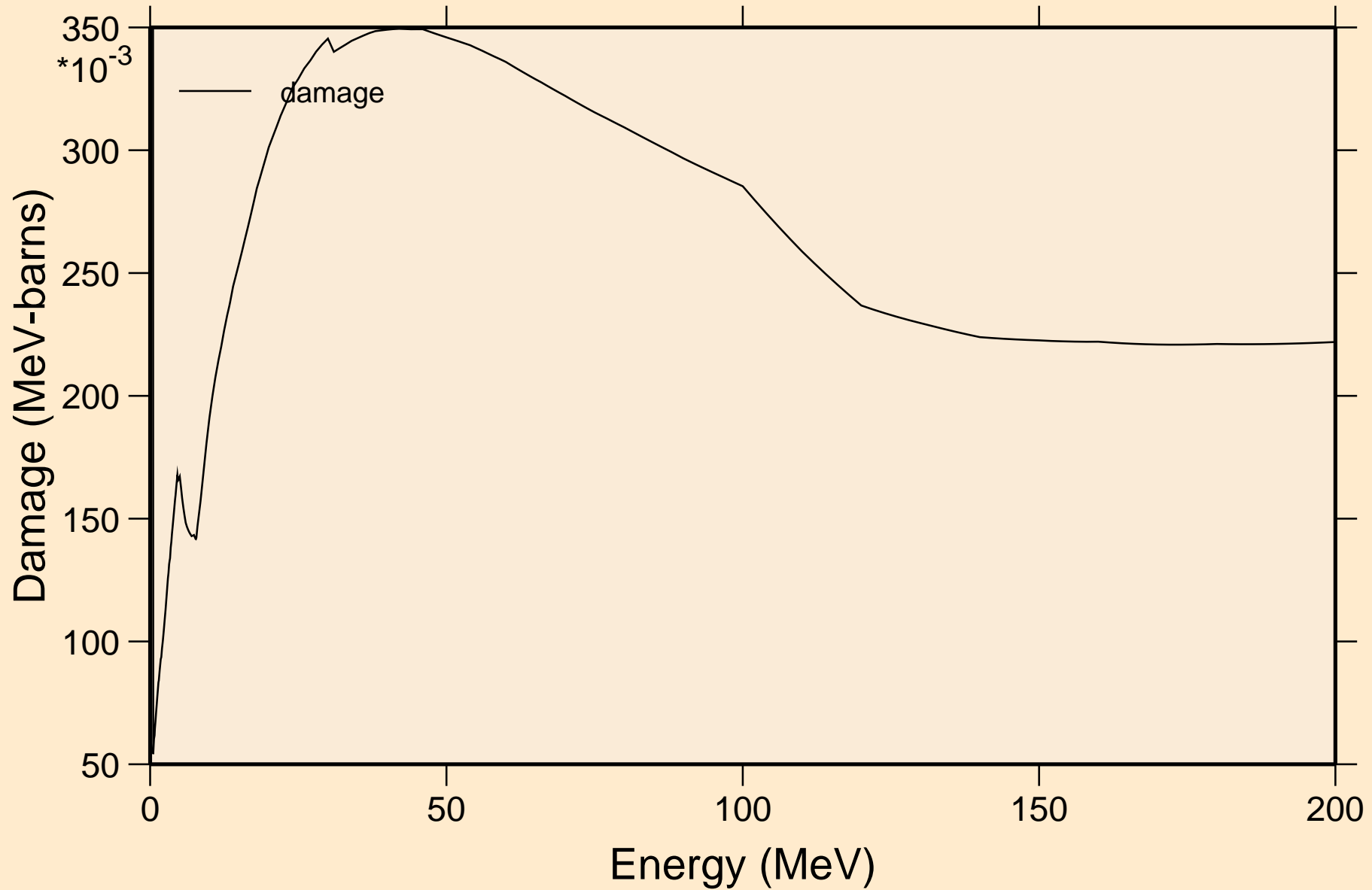

FE064 NEUTRON ACER TENDL-2024 LIBRARY; T=0.K  
Non-threshold reactions

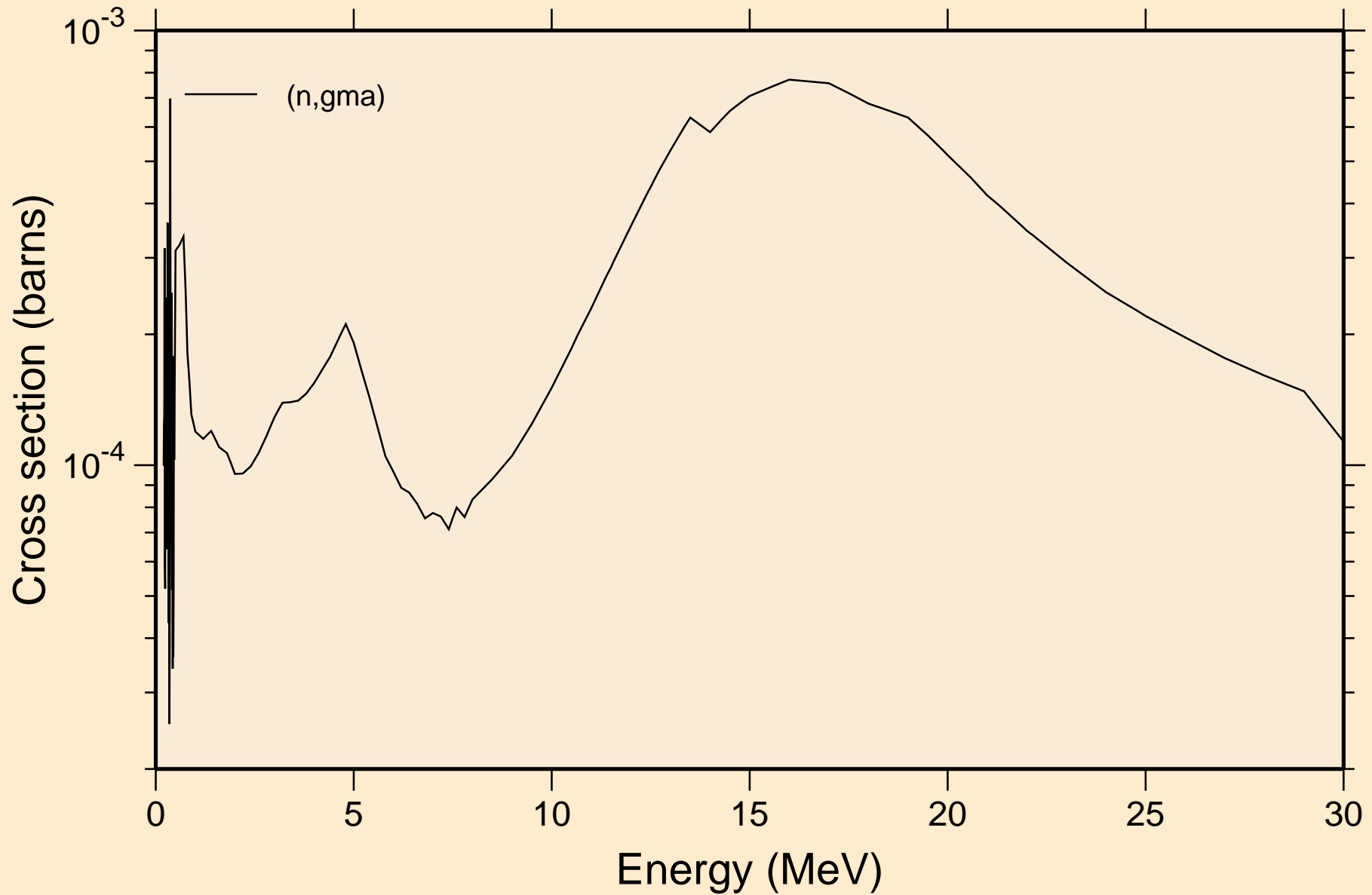

FE064 NEUTRON ACER TENDL-2024 LIBRARY; T=0.K  
Inelastic levels

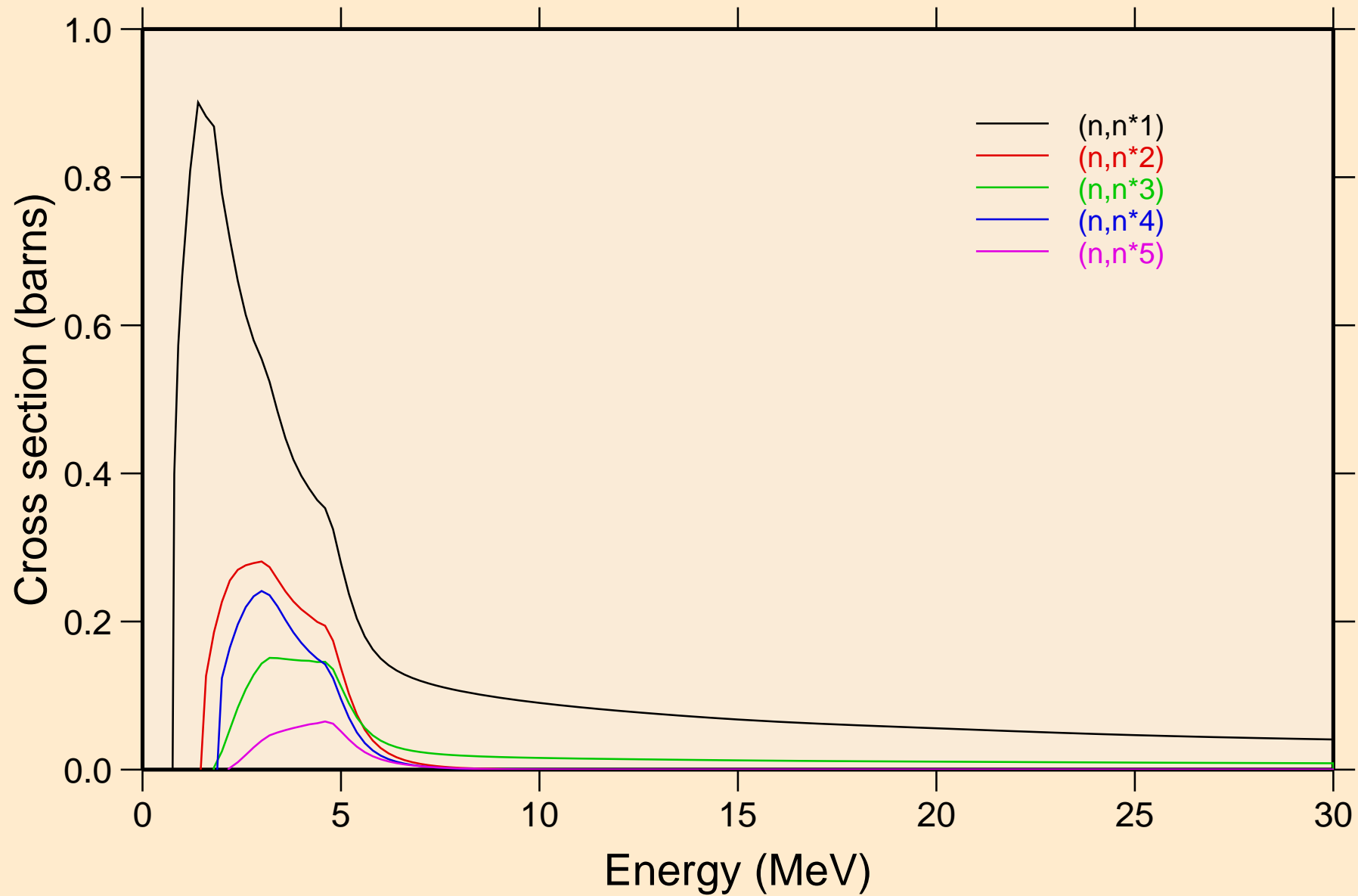

# FE064 NEUTRON ACER TENDL-2024 LIBRARY; T=0.K

## Inelastic levels

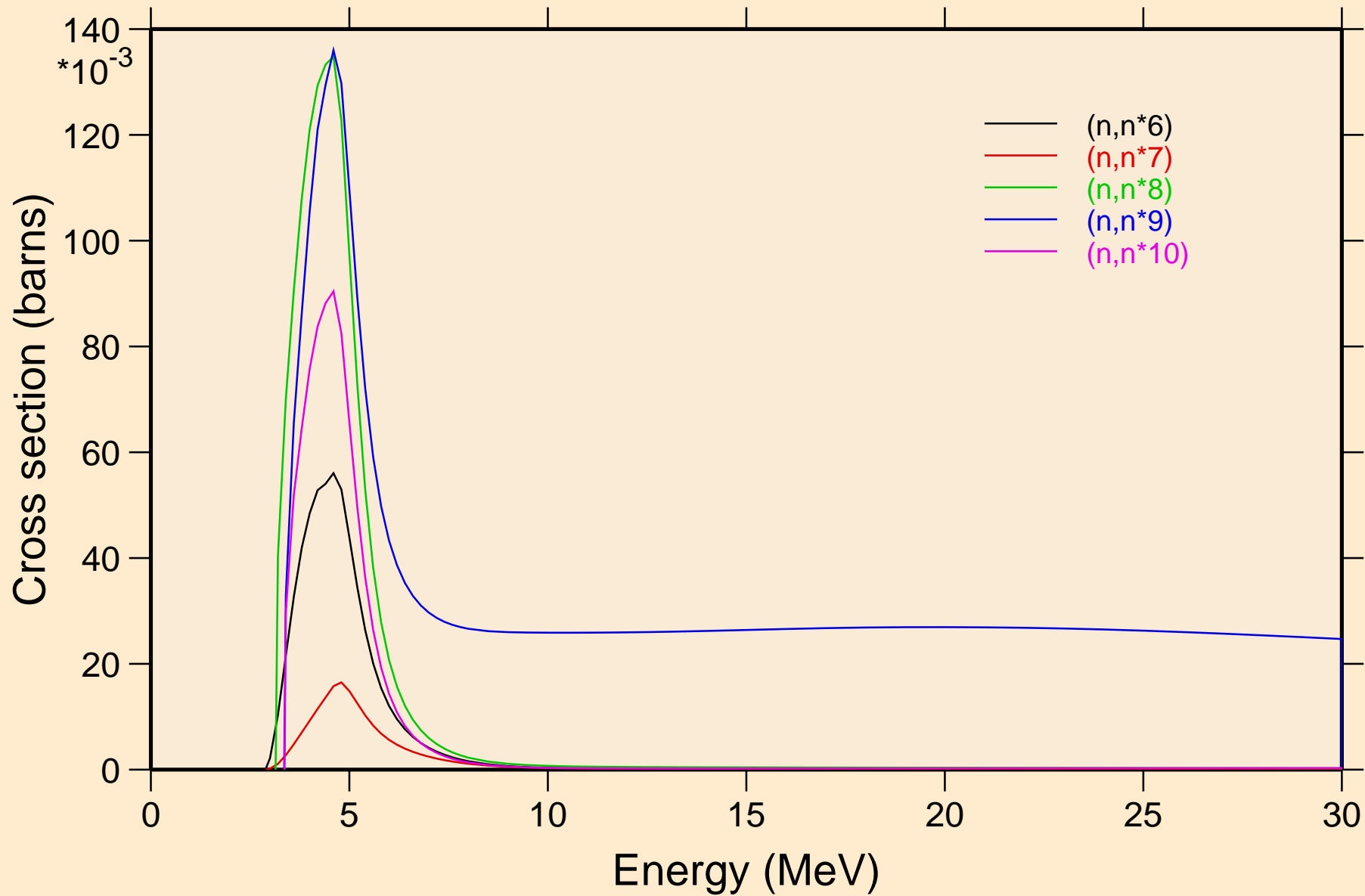

FE064 NEUTRON ACER TENDL-2024 LIBRARY; T=0.K  
Inelastic levels

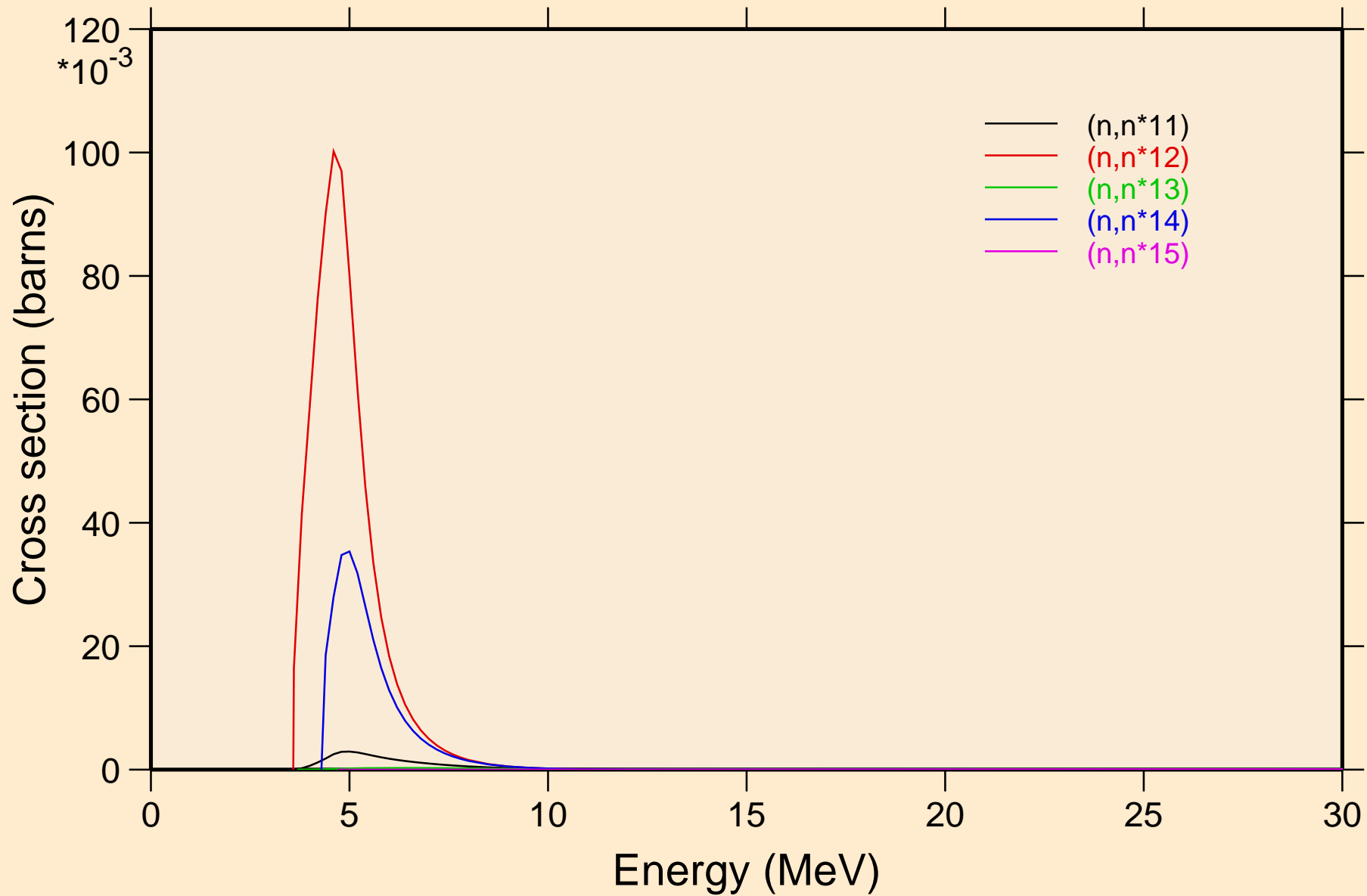

FE064 NEUTRON ACER TENDL-2024 LIBRARY; T=0.K  
Inelastic levels

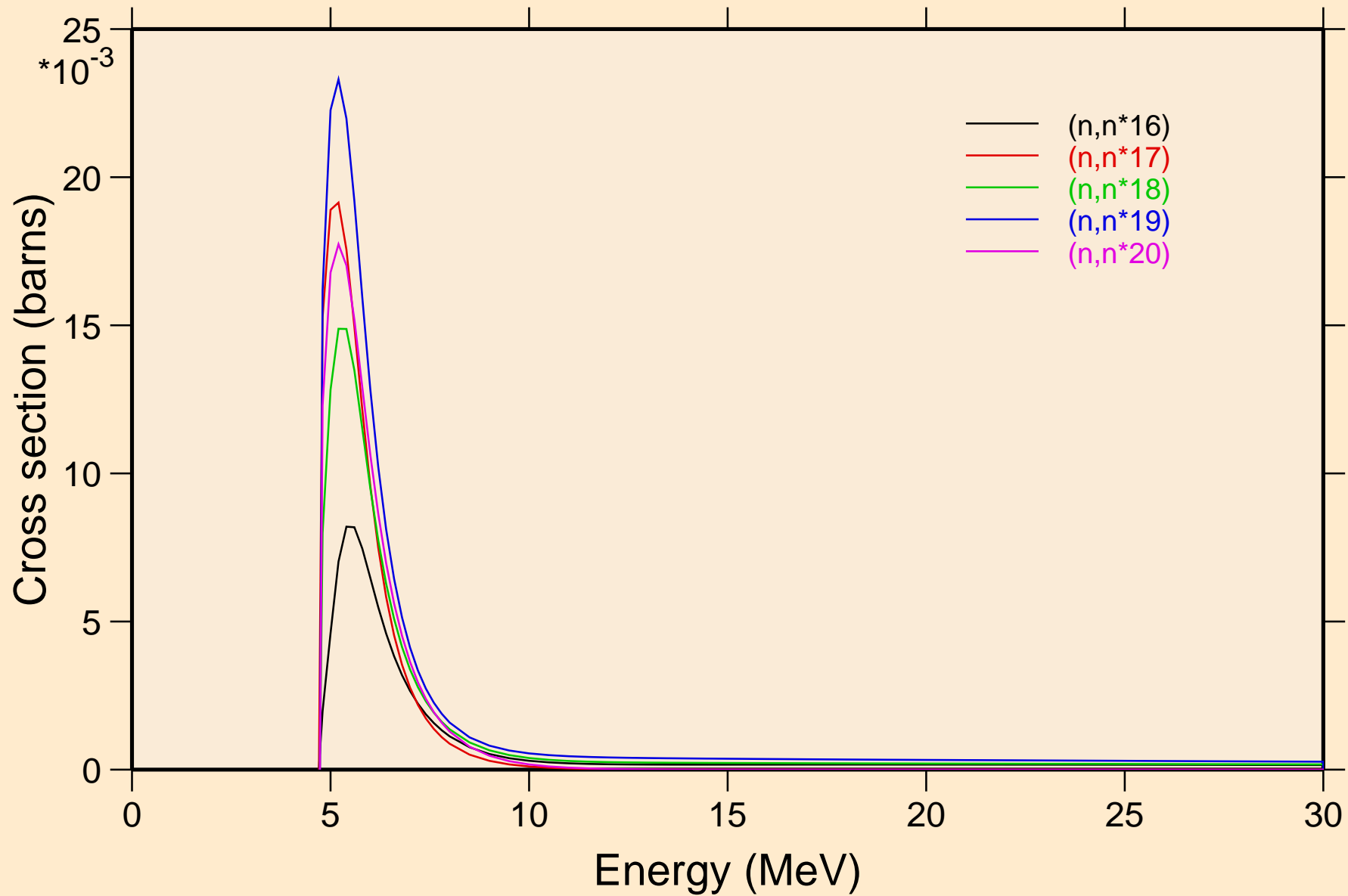

FE064 NEUTRON ACER TENDL-2024 LIBRARY; T=0.K  
Inelastic levels

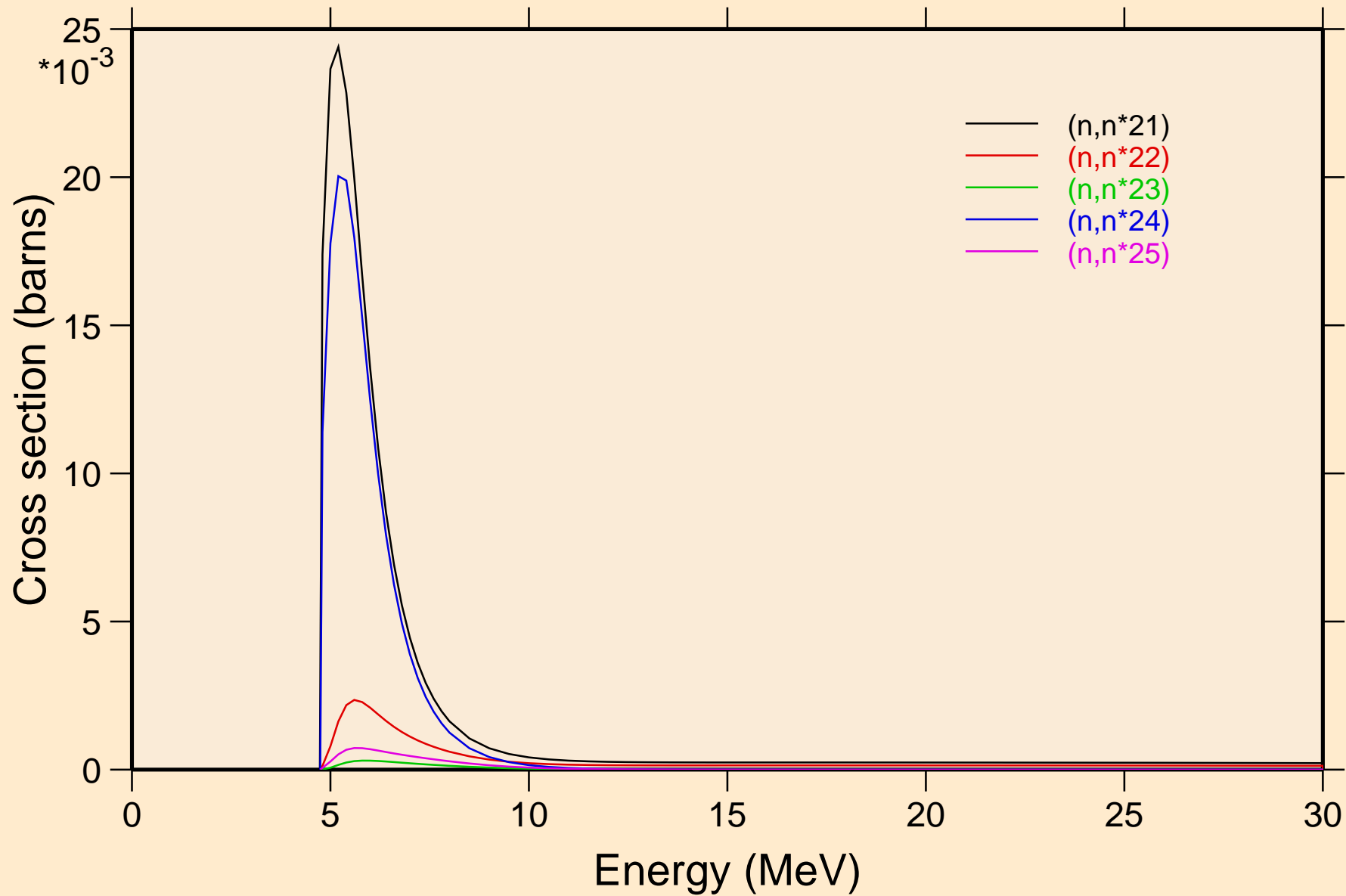

FE064 NEUTRON ACER TENDL-2024 LIBRARY; T=0.K  
Inelastic levels

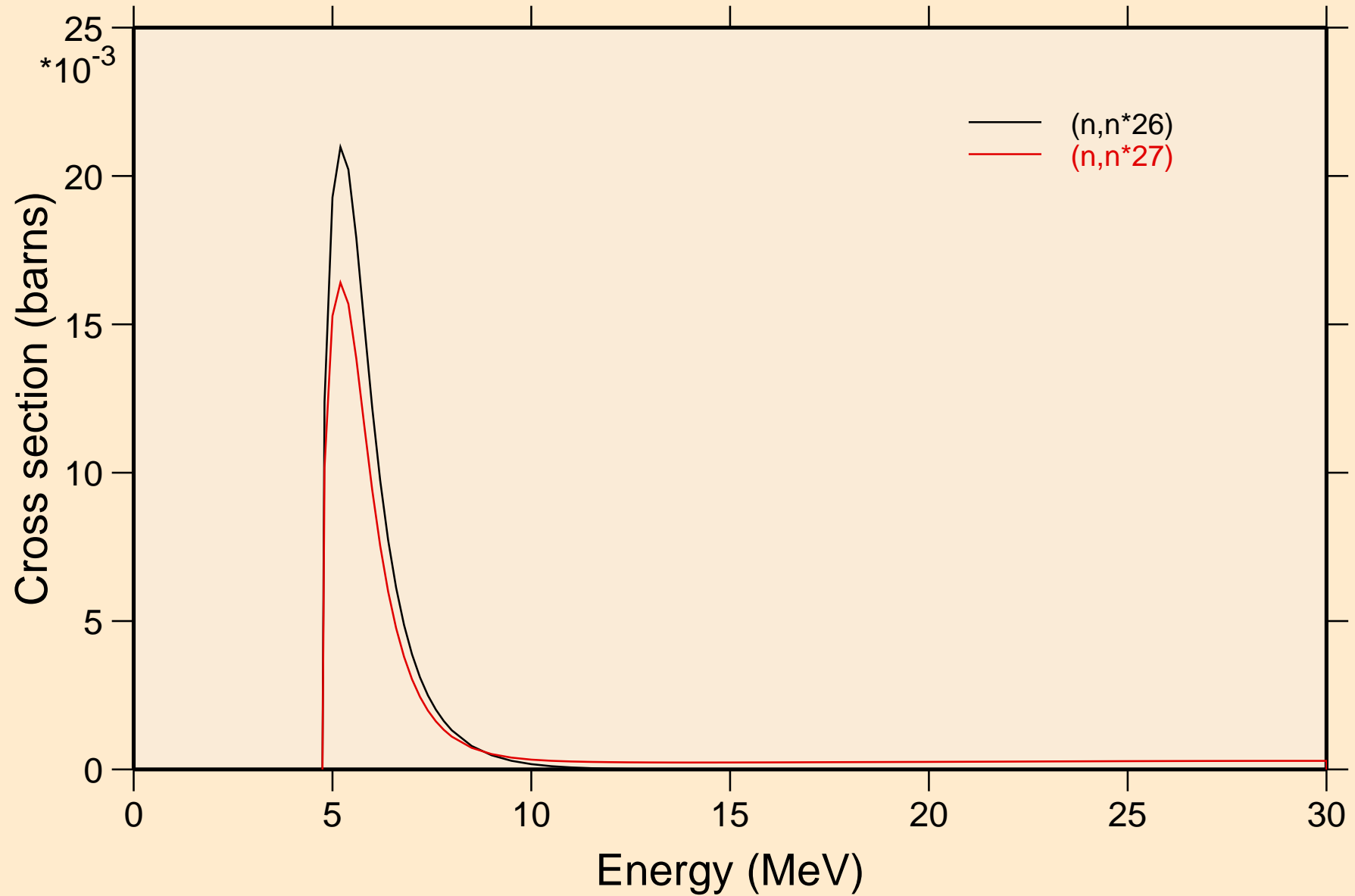

FE064 NEUTRON ACER TENDL-2024 LIBRARY; T=0.K  
Threshold reactions

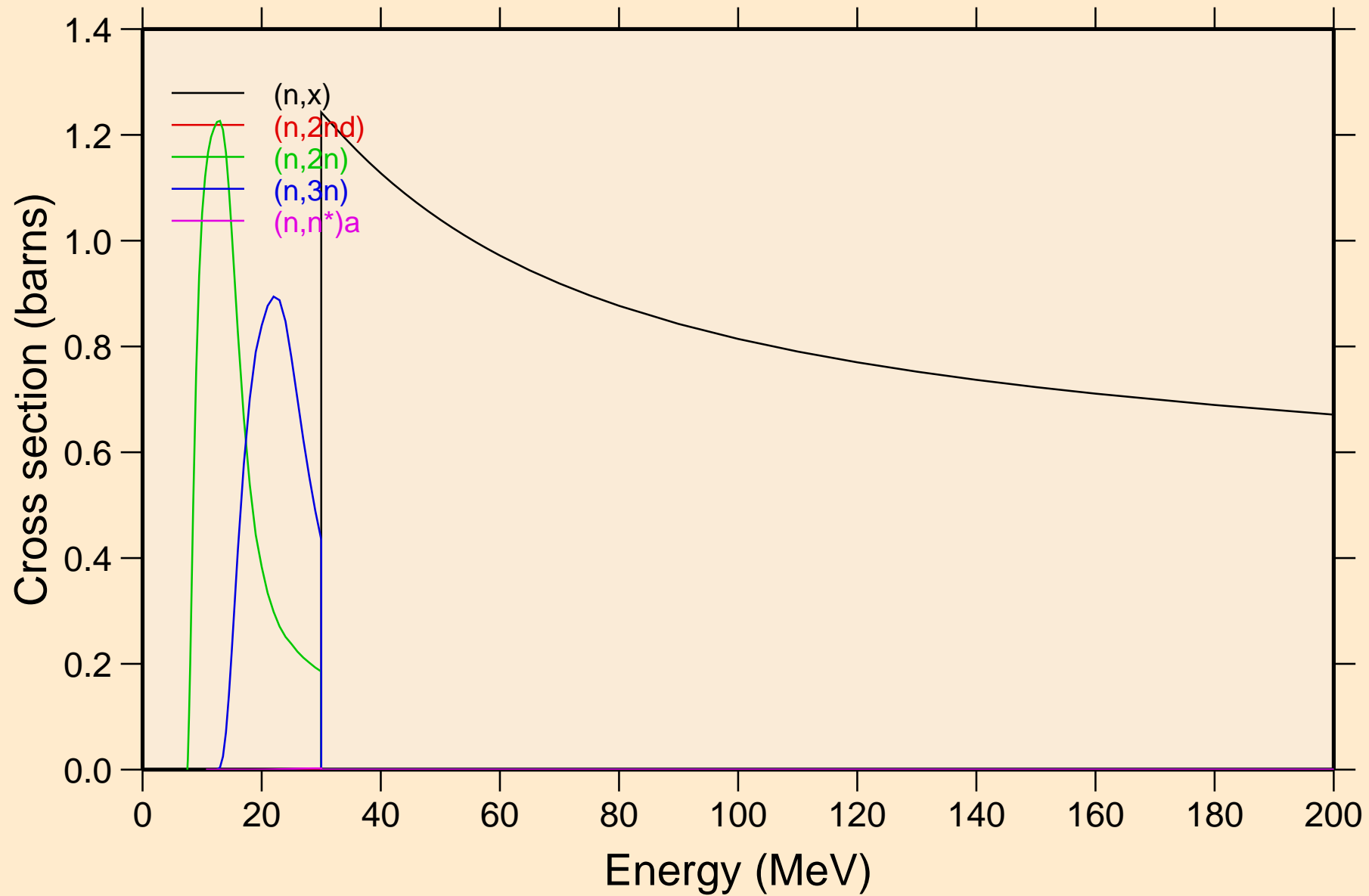

# FE064 NEUTRON ACER TENDL-2024 LIBRARY; T=0.K

## Threshold reactions

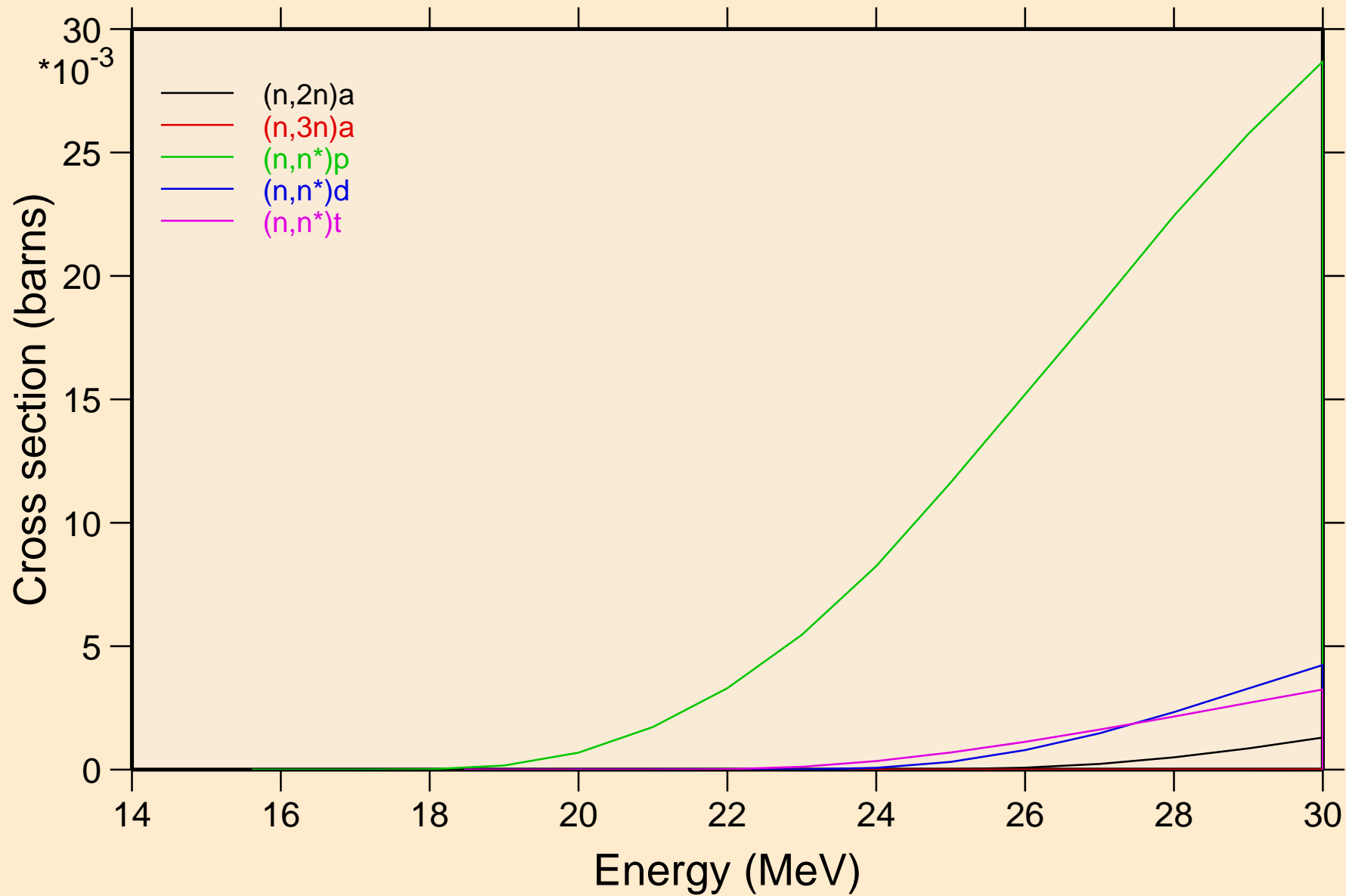

FE064 NEUTRON ACER TENDL-2024 LIBRARY; T=0.K  
Threshold reactions

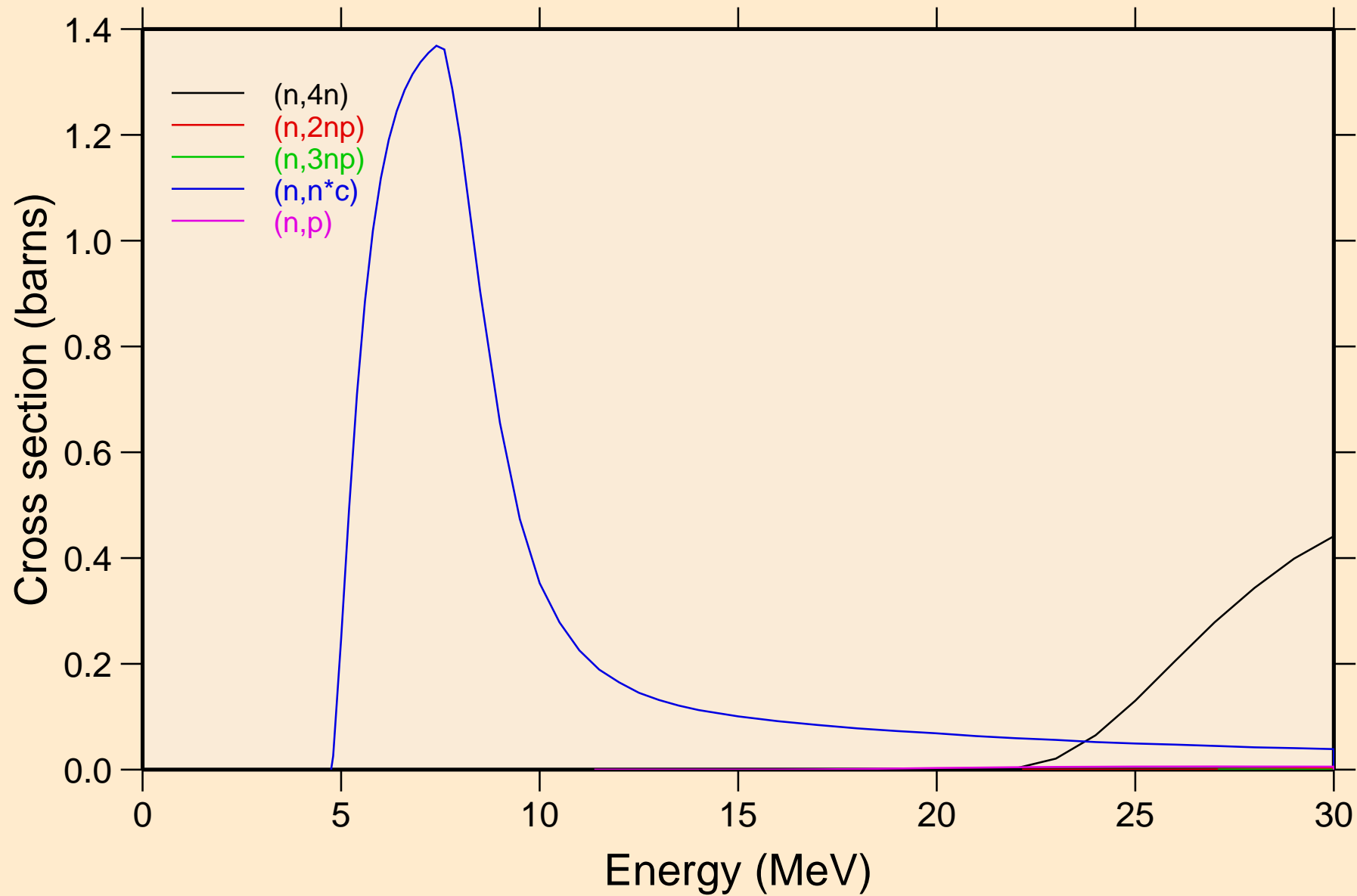

FE064 NEUTRON ACER TENDL-2024 LIBRARY; T=0.K  
Threshold reactions

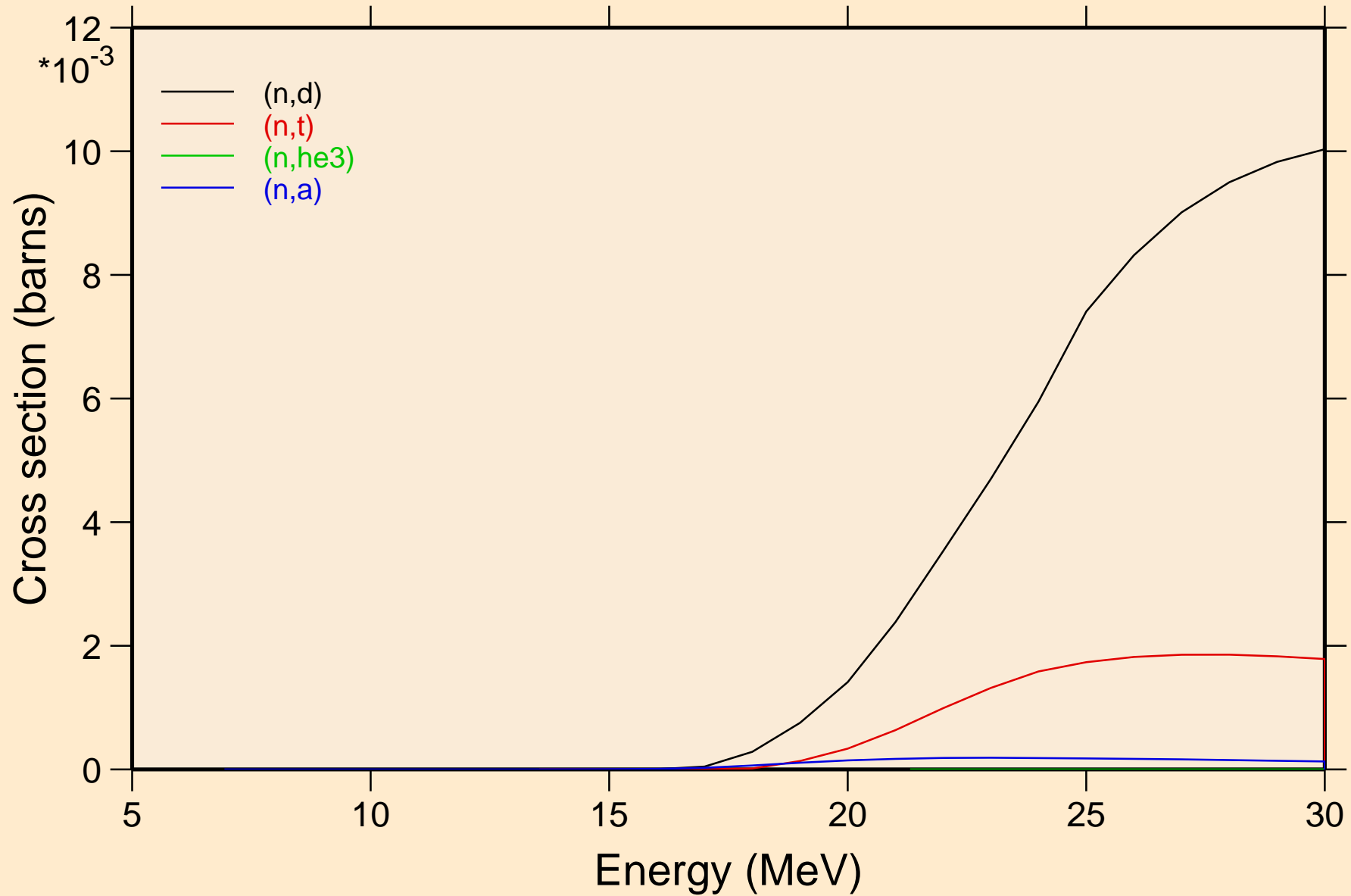

FE064 NEUTRON ACER TENDL-2024 LIBRARY; T=0.K  
Threshold reactions

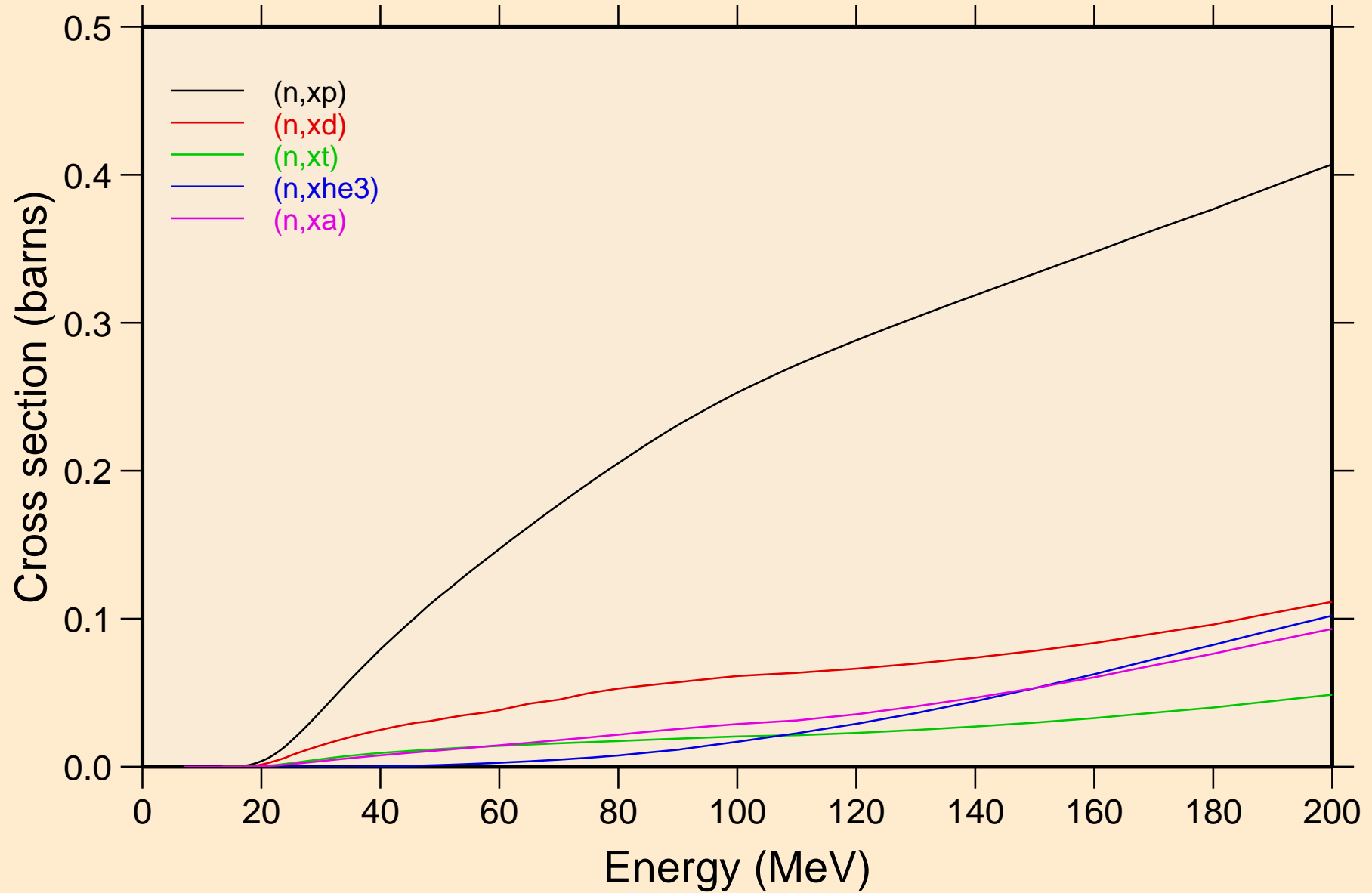

FE064 NEUTRON ACER TENDL-2024 LIBRARY; T=0.K  
angular distribution for elastic

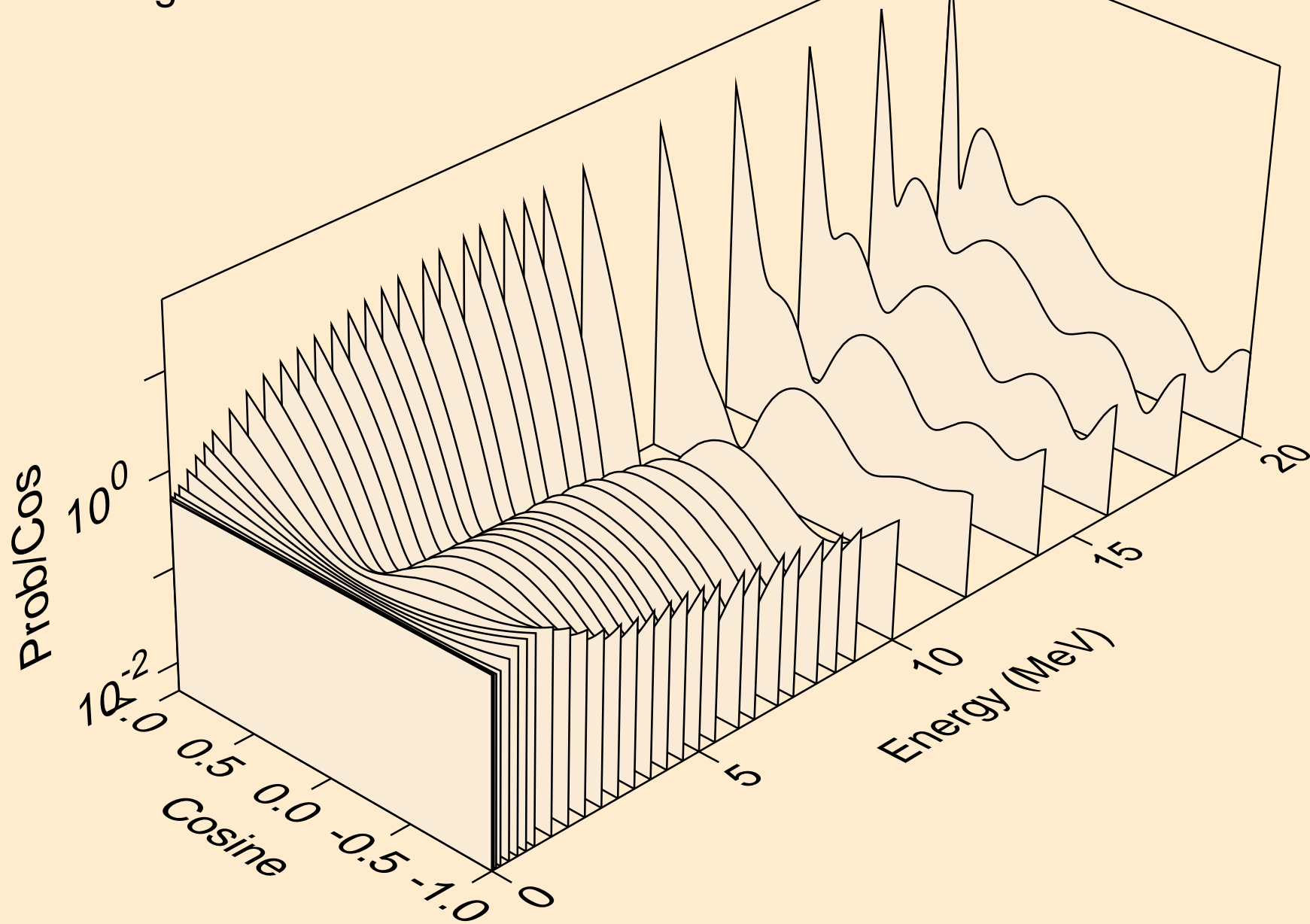

FE064 NEUTRON ACER TENDL-2024 LIBRARY; T=0.K  
angular distribution for elastic

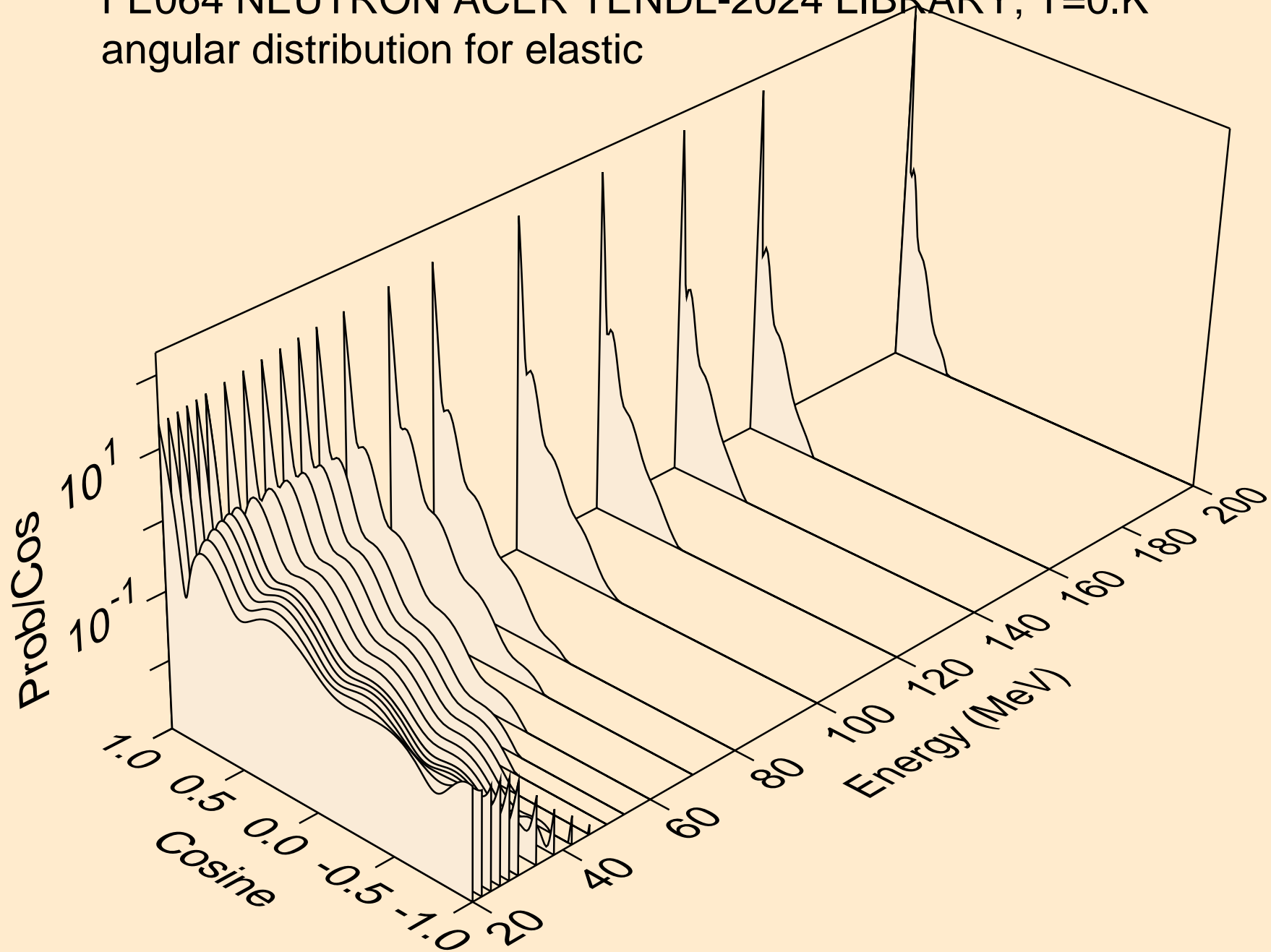

FE064 NEUTRON ACER TENDL-2024 LIBRARY; T=0.K  
angular distribution for (n,n\*1)

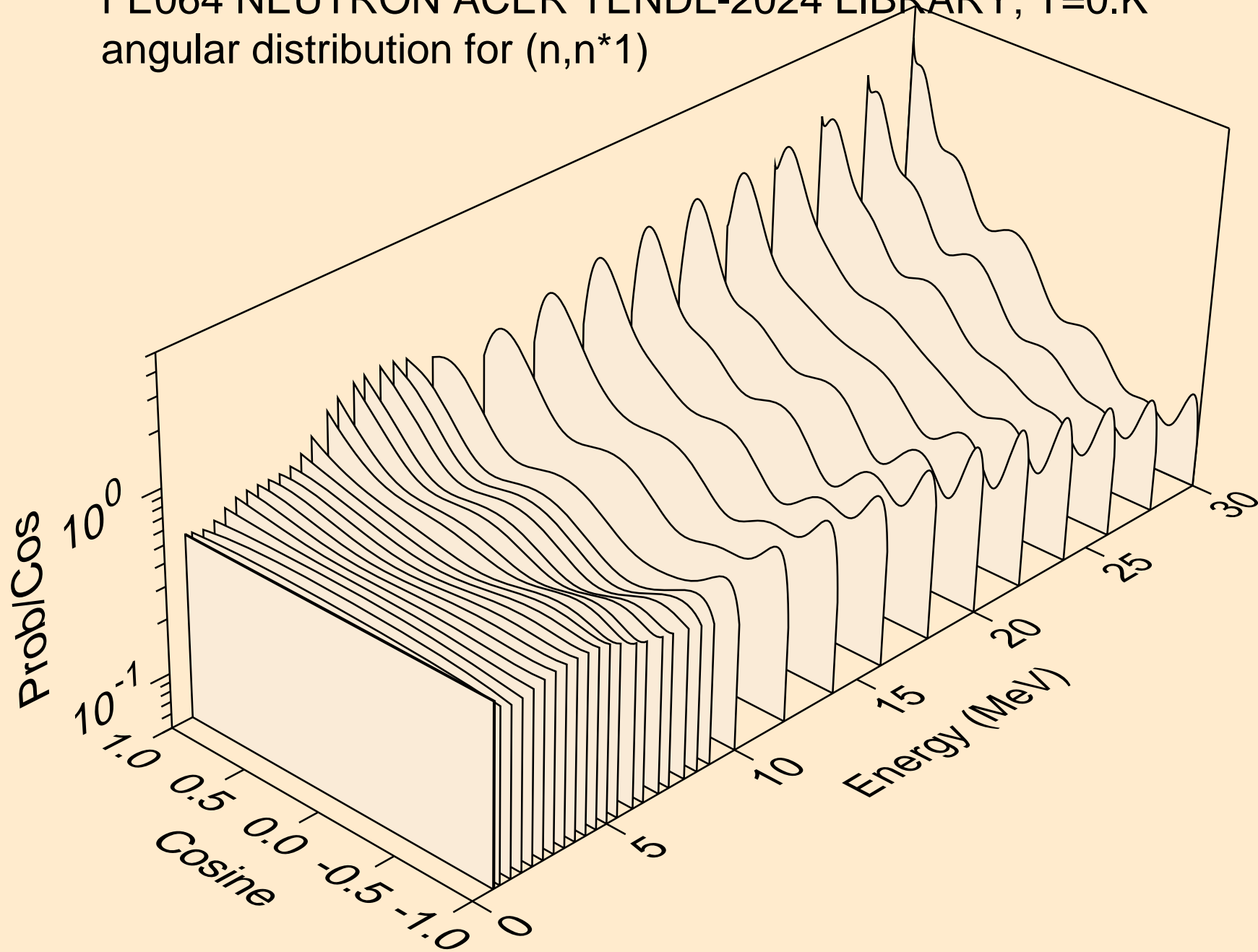

FE064 NEUTRON ACER TENDL-2024 LIBRARY; T=0.K  
angular distribution for (n,n\*2)

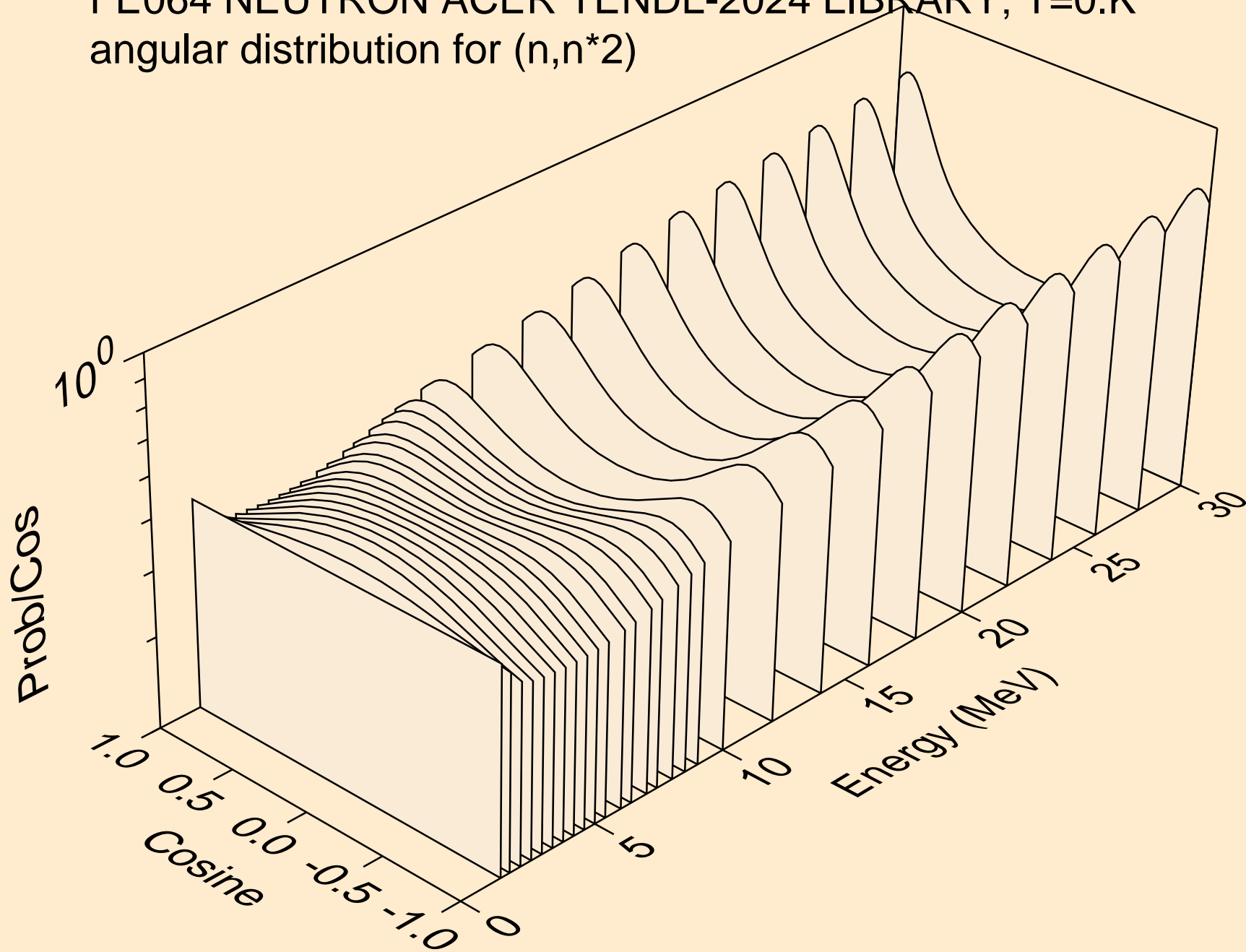

FE064 NEUTRON ACER TENDL-2024 LIBRARY; T=0.K  
angular distribution for (n,n\*3)

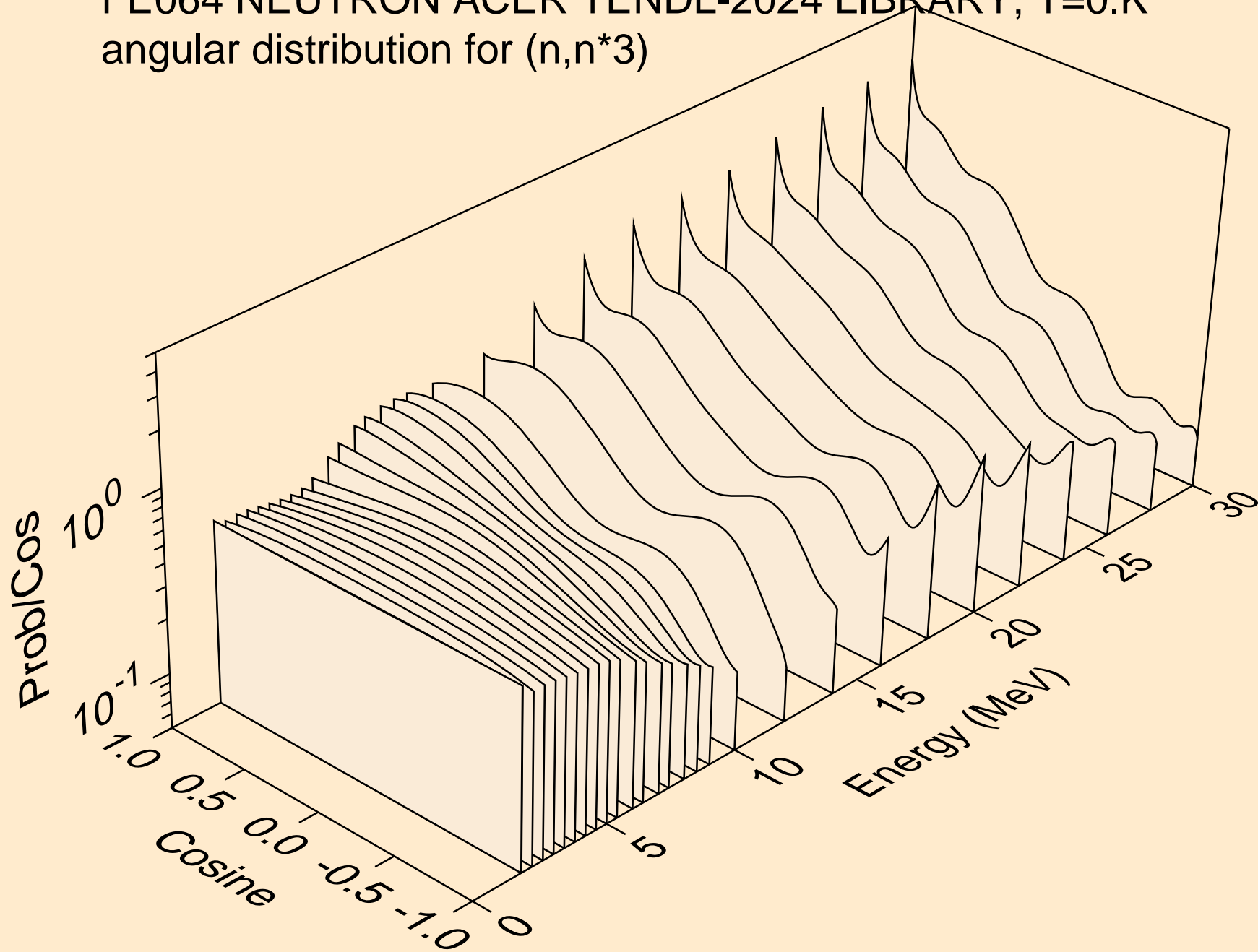

FE064 NEUTRON ACER TENDL-2024 LIBRARY; T=0.K  
angular distribution for (n,n\*4)

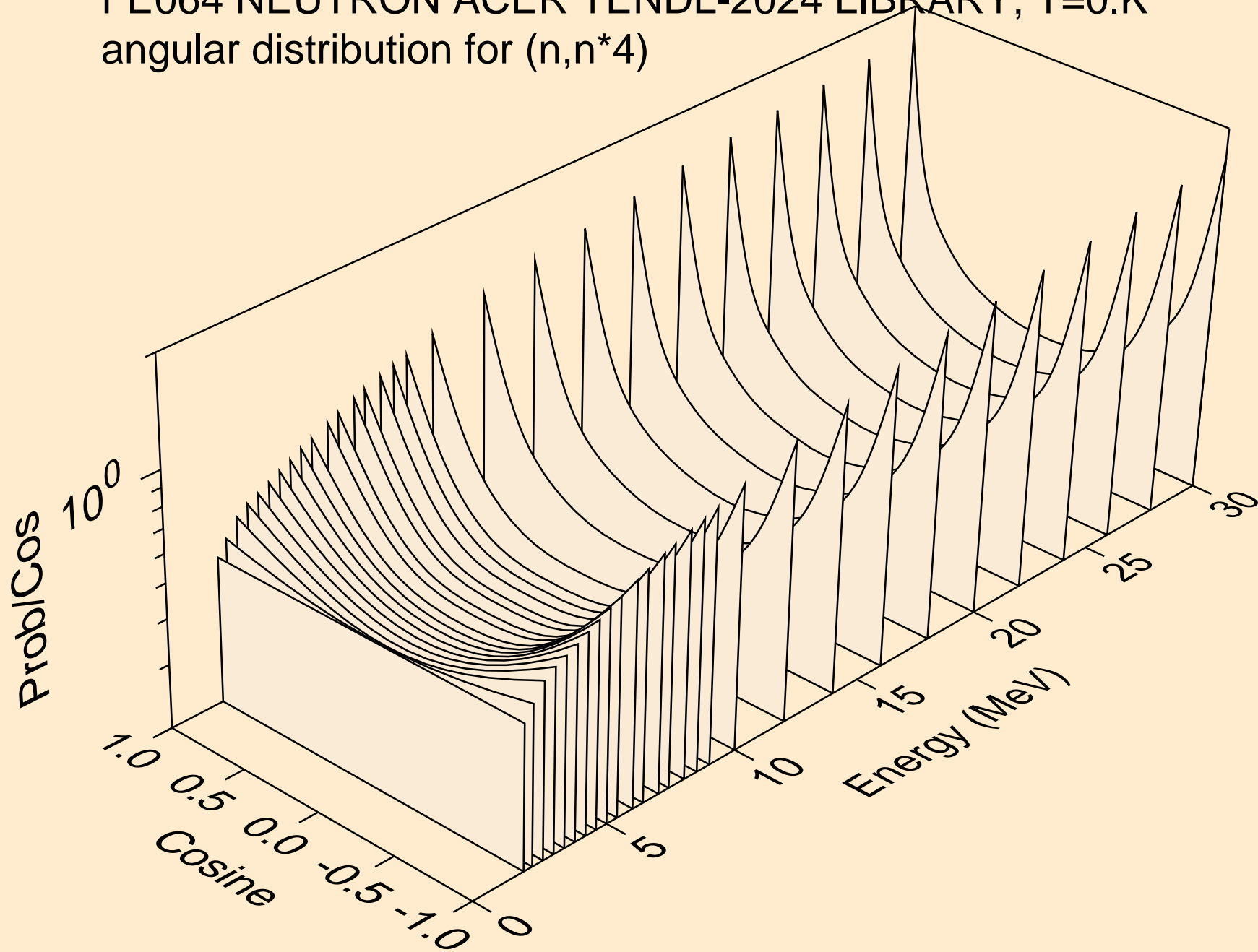

FE064 NEUTRON ACER TENDL-2024 LIBRARY; T=0.K  
angular distribution for (n,n\*5)

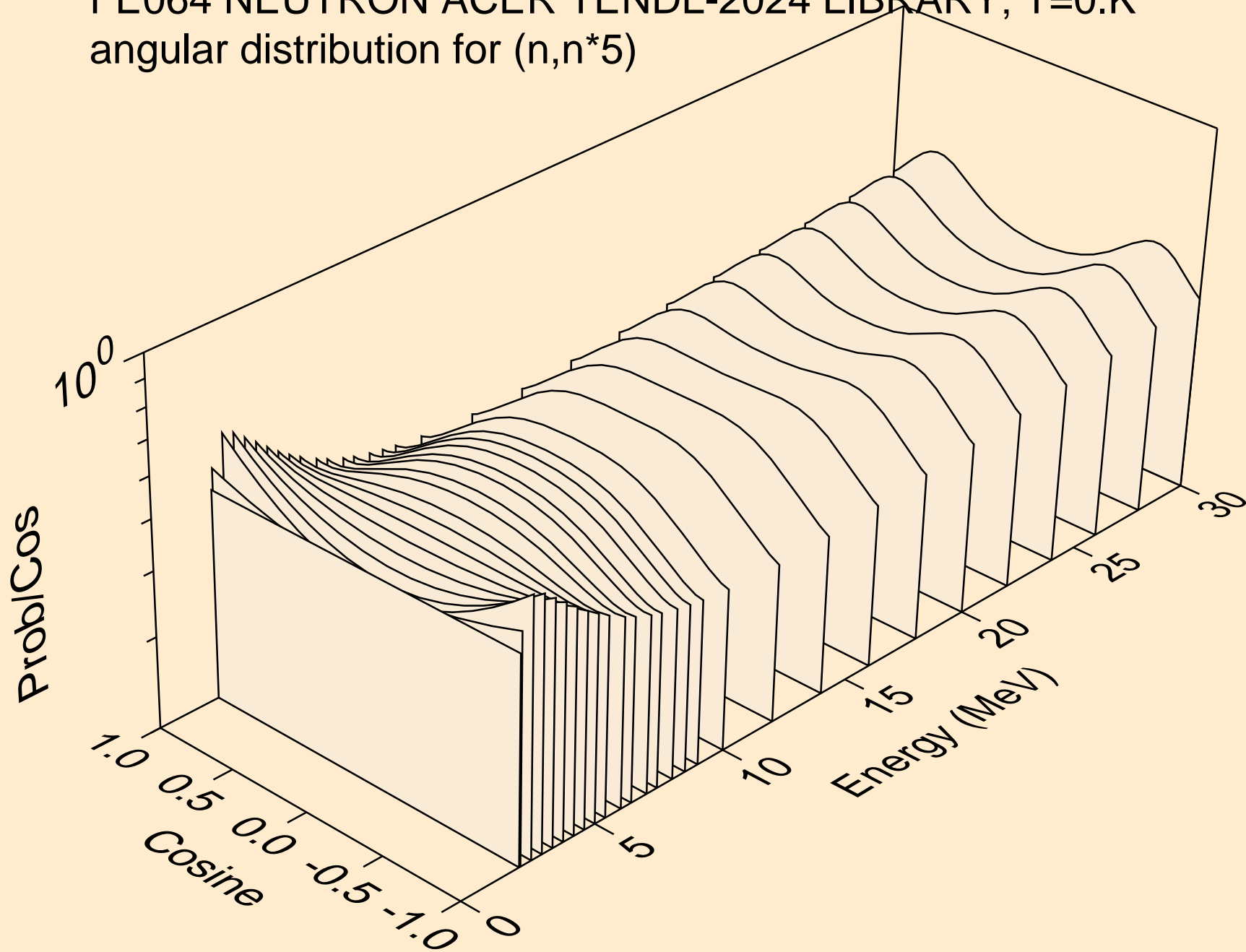

FE064 NEUTRON ACER TENDL-2024 LIBRARY; T=0.K  
angular distribution for (n,n\*6)

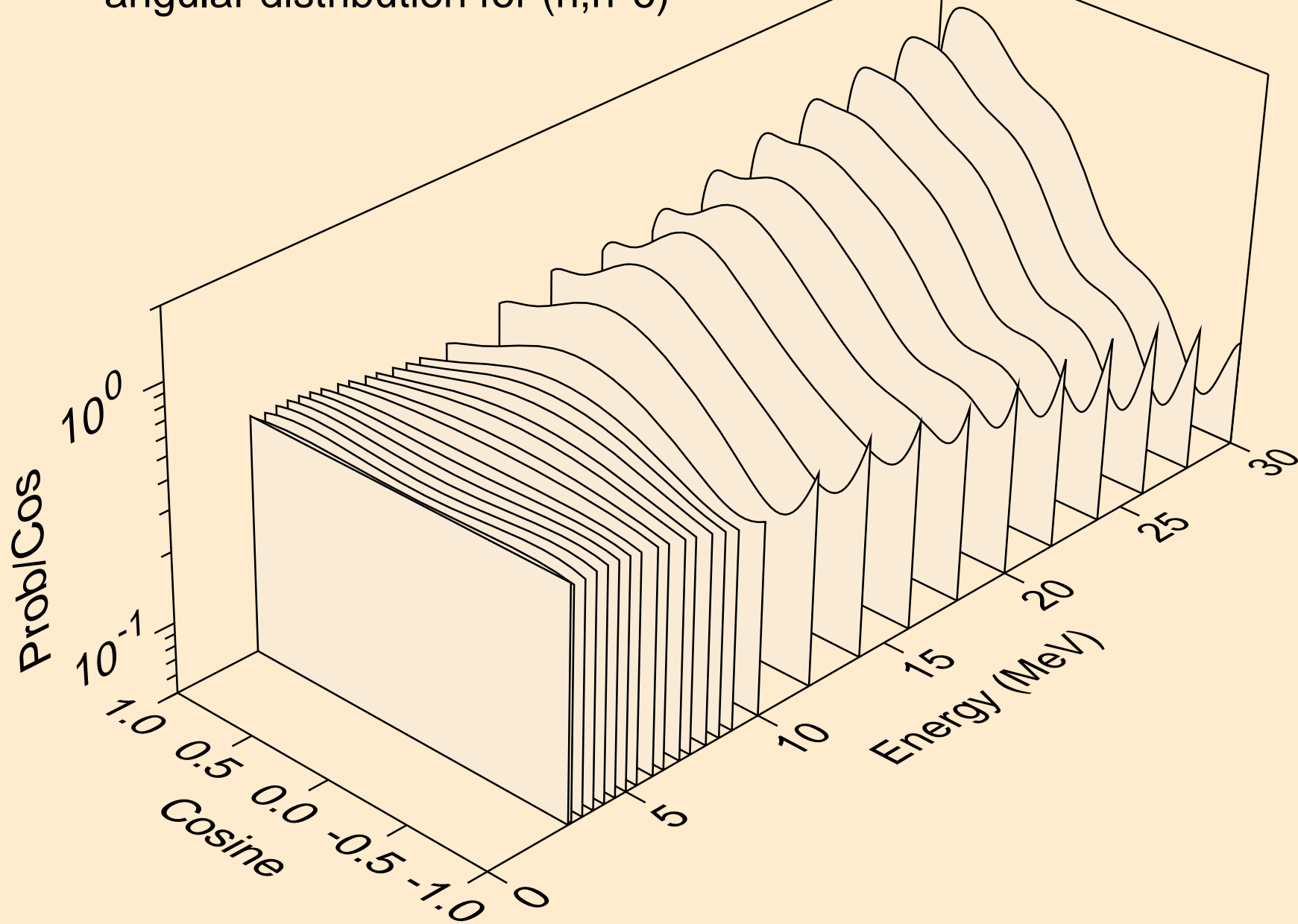

FE064 NEUTRON ACER TENDL-2024 LIBRARY; T=0.K  
angular distribution for (n,n\*7)

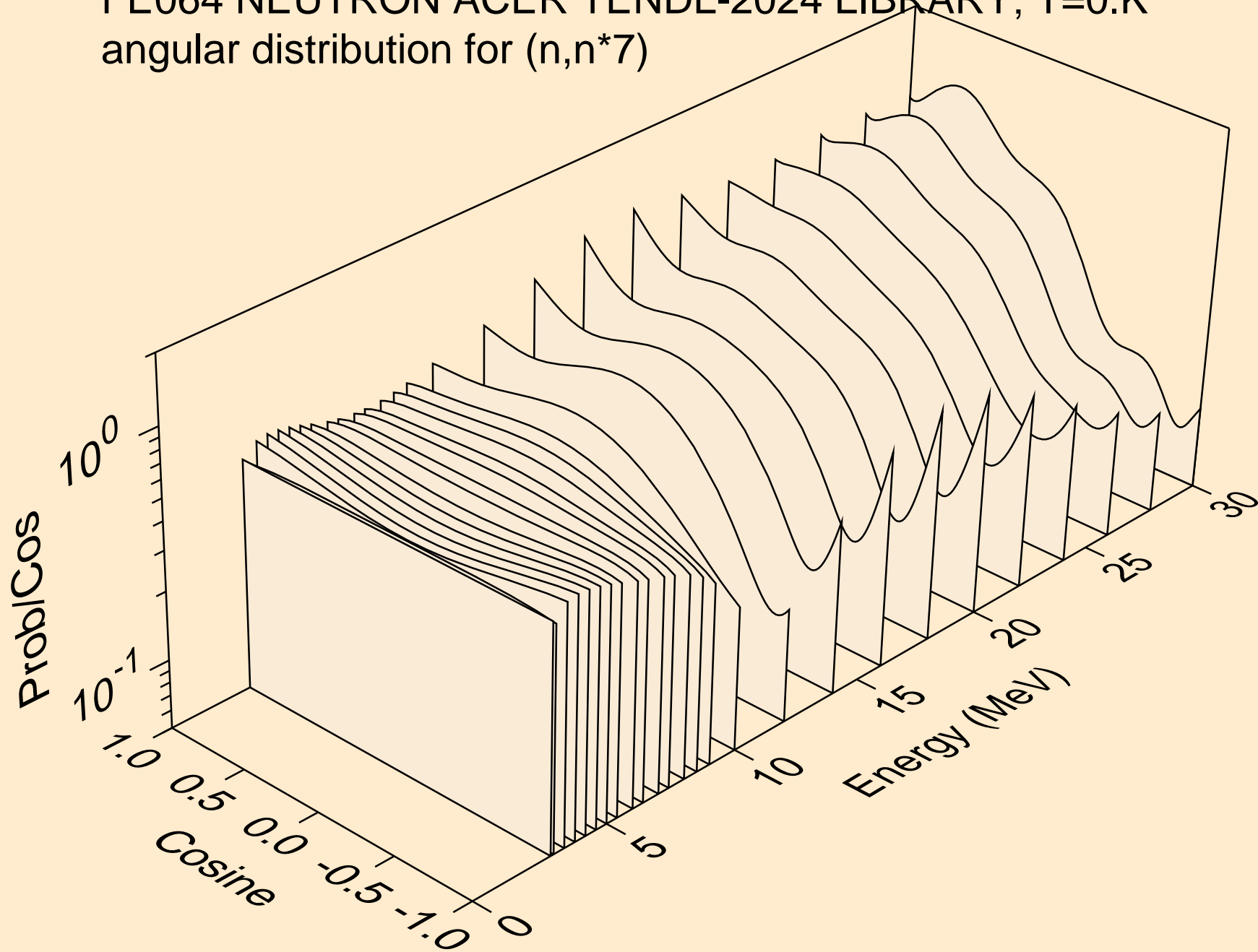

FE064 NEUTRON ACER TENDL-2024 LIBRARY; T=0.K  
angular distribution for (n,n\*8)

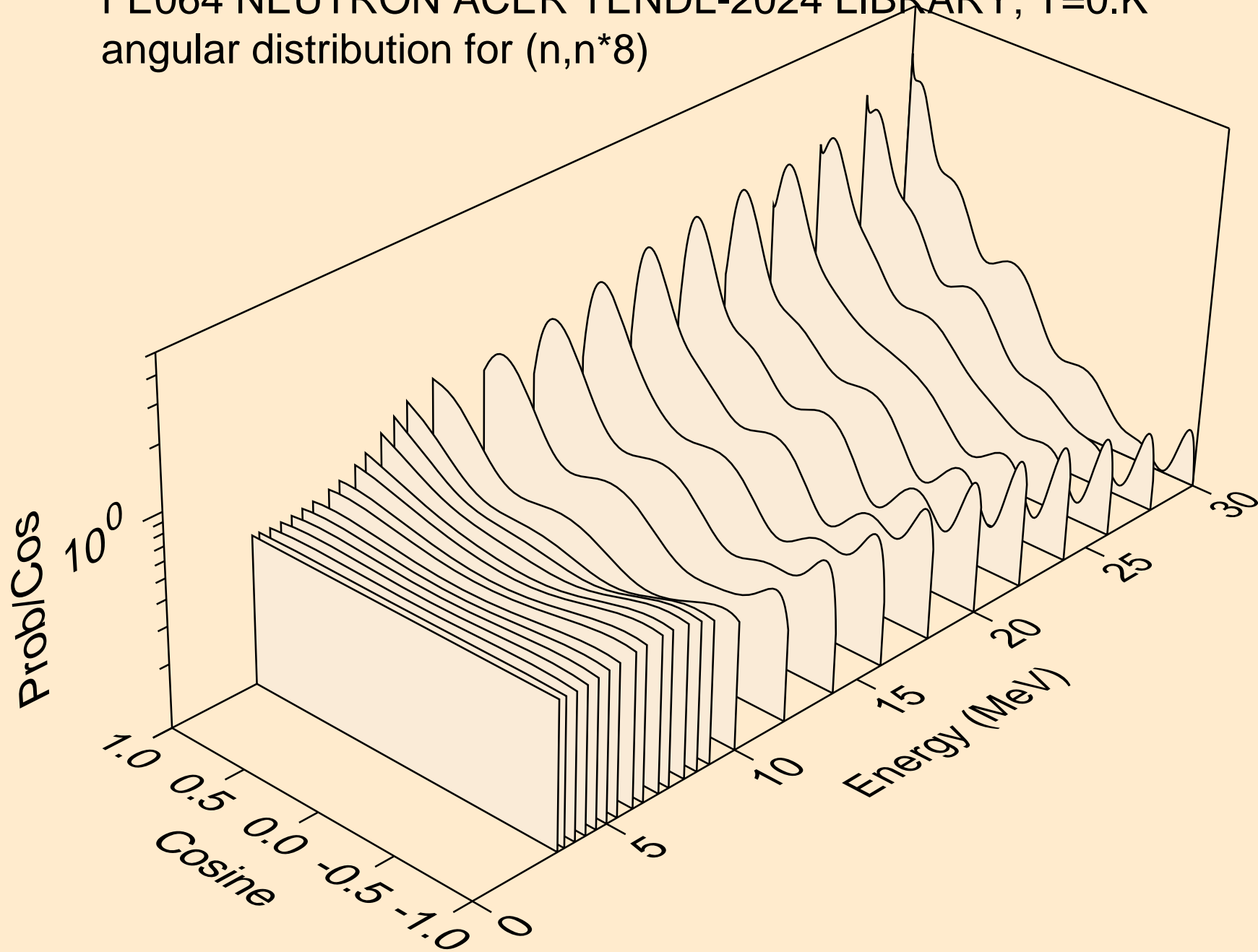

FE064 NEUTRON ACER TENDL-2024 LIBRARY; T=0.K  
angular distribution for (n,n\*9)

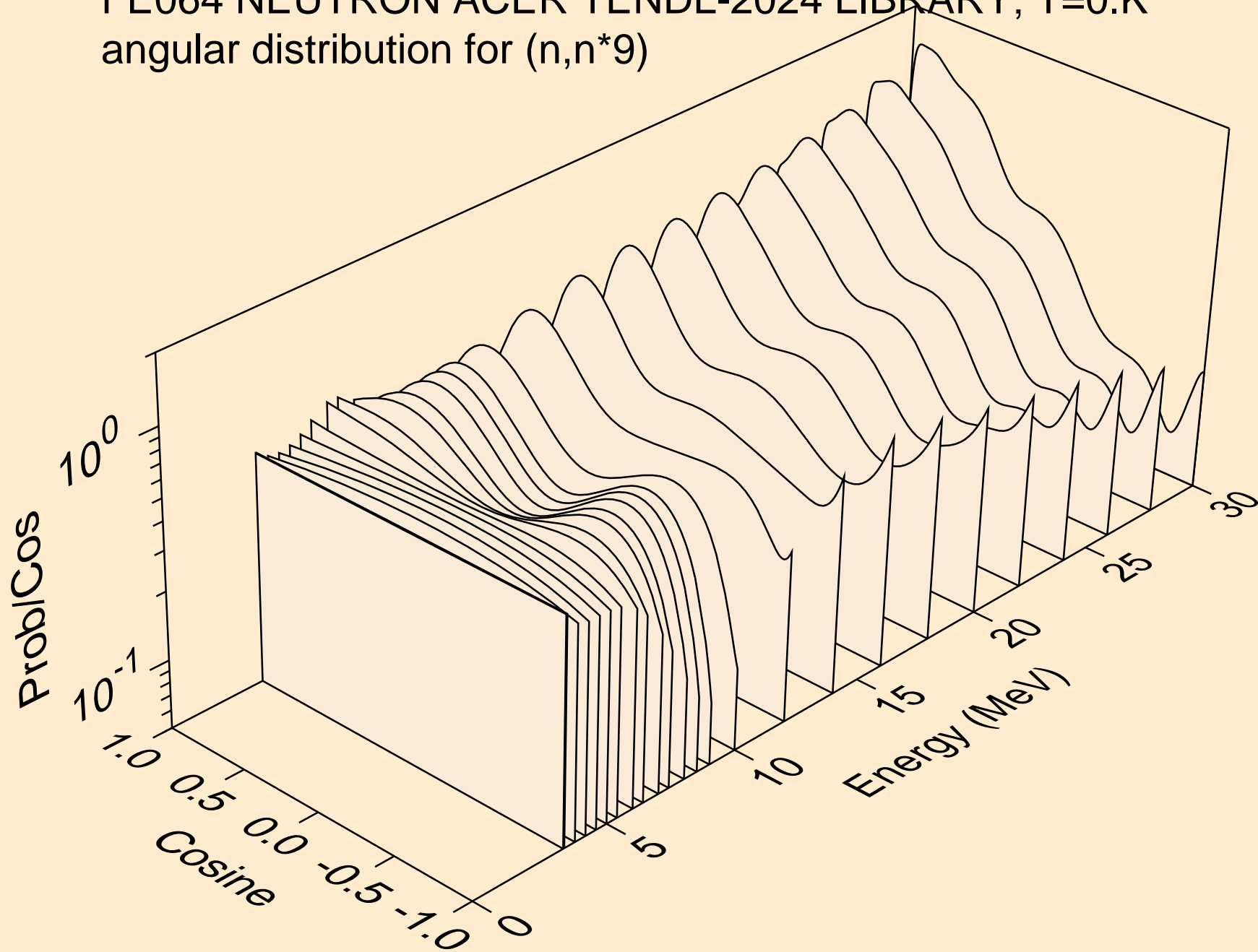

FE064 NEUTRON ACER TENDL-2024 LIBRARY; T=0.K  
angular distribution for (n,n\*10)

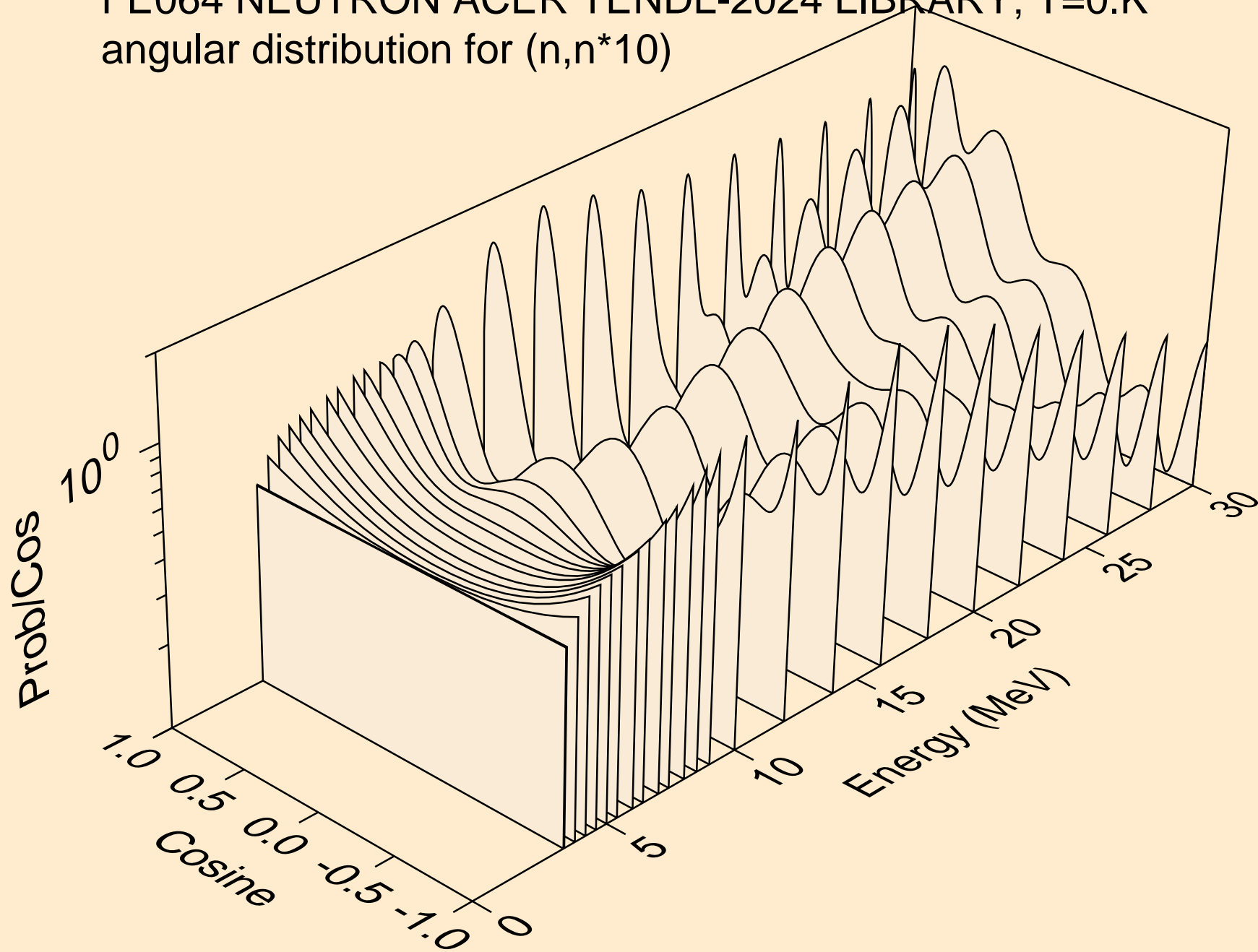

FE064 NEUTRON ACER TENDL-2024 LIBRARY; T=0.K  
angular distribution for (n,n\*11)

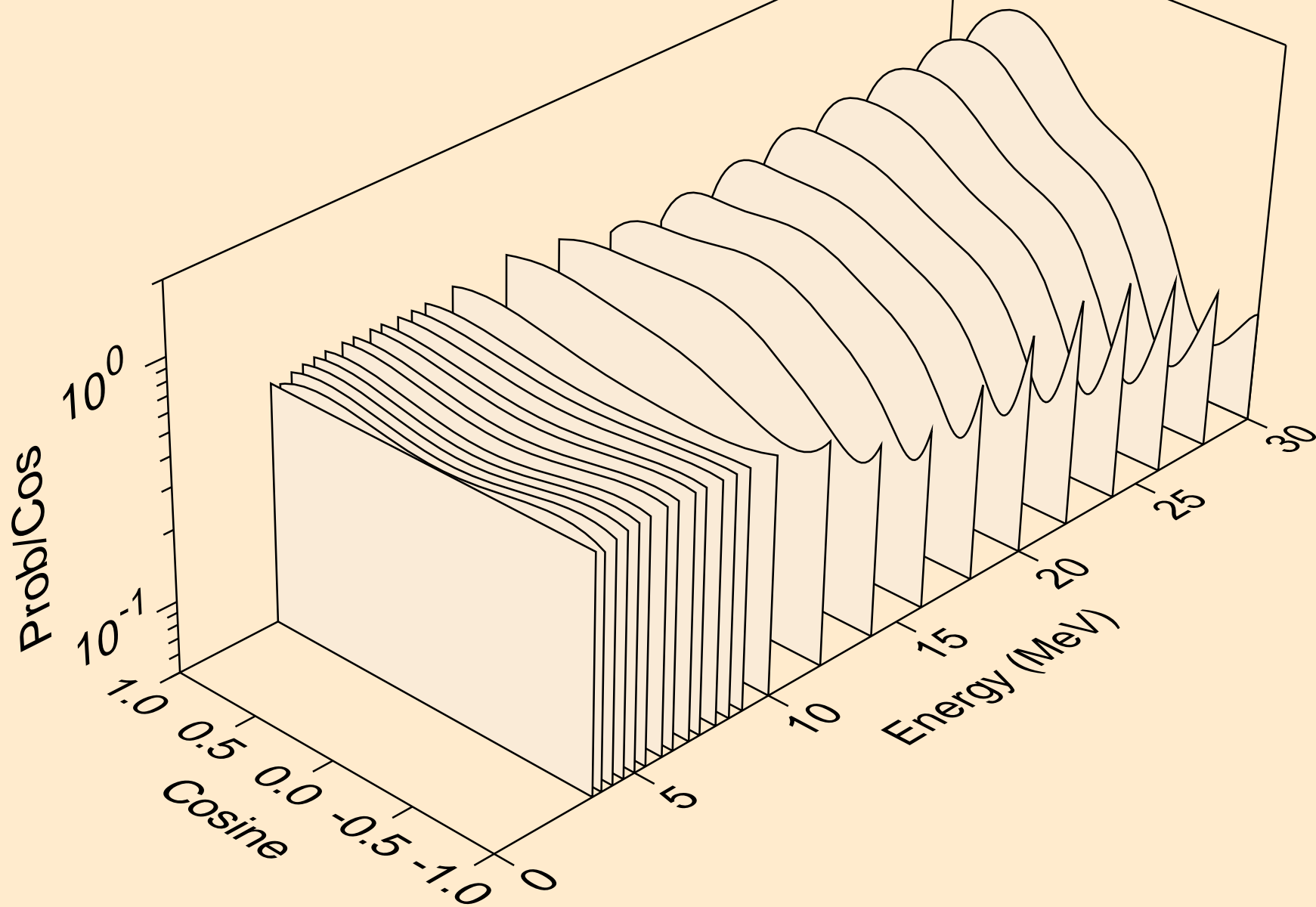

FE064 NEUTRON ACER TENDL-2024 LIBRARY; T=0.K  
angular distribution for (n,n\*12)

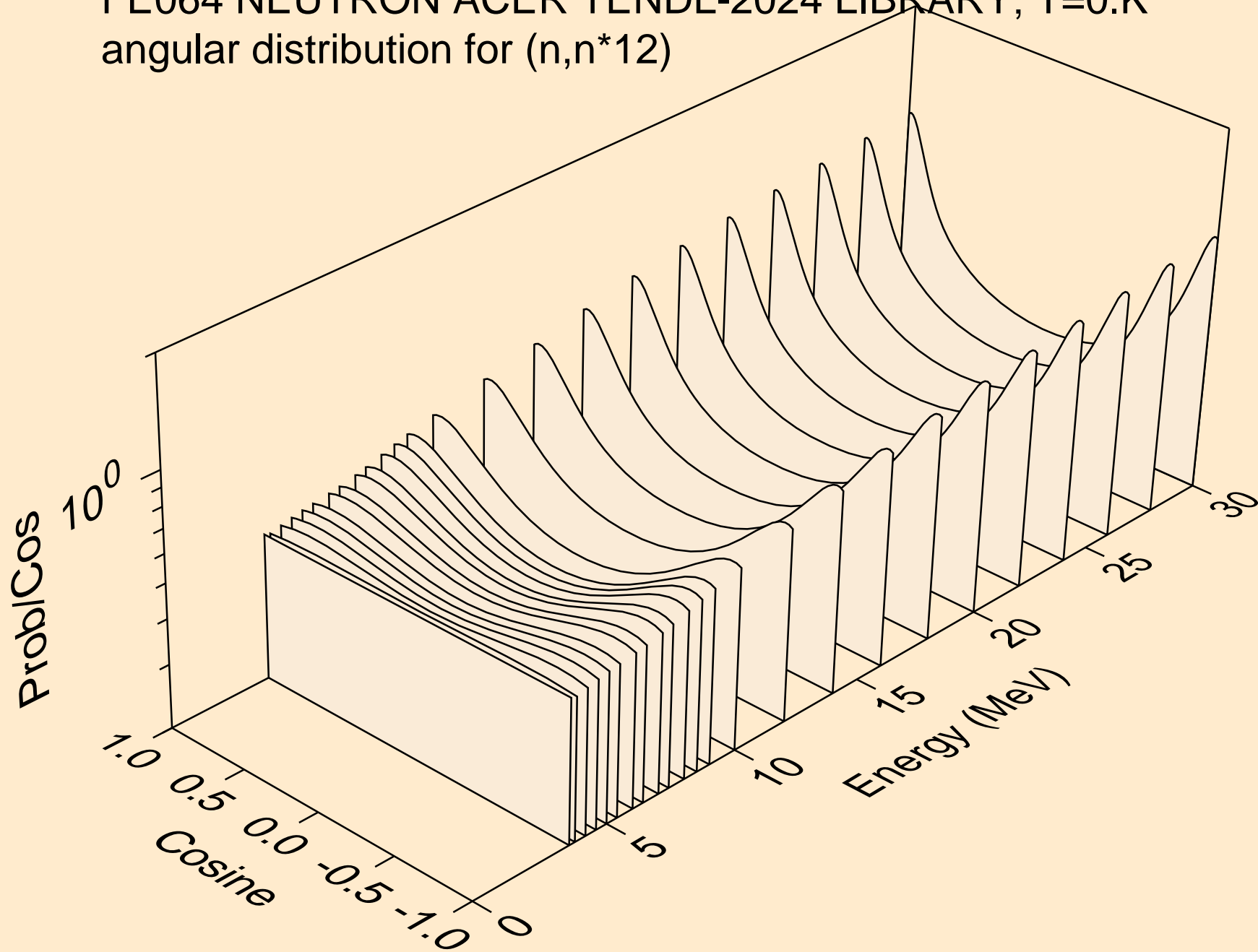

FE064 NEUTRON ACER TENDL-2024 LIBRARY; T=0.K  
angular distribution for (n,n\*13)

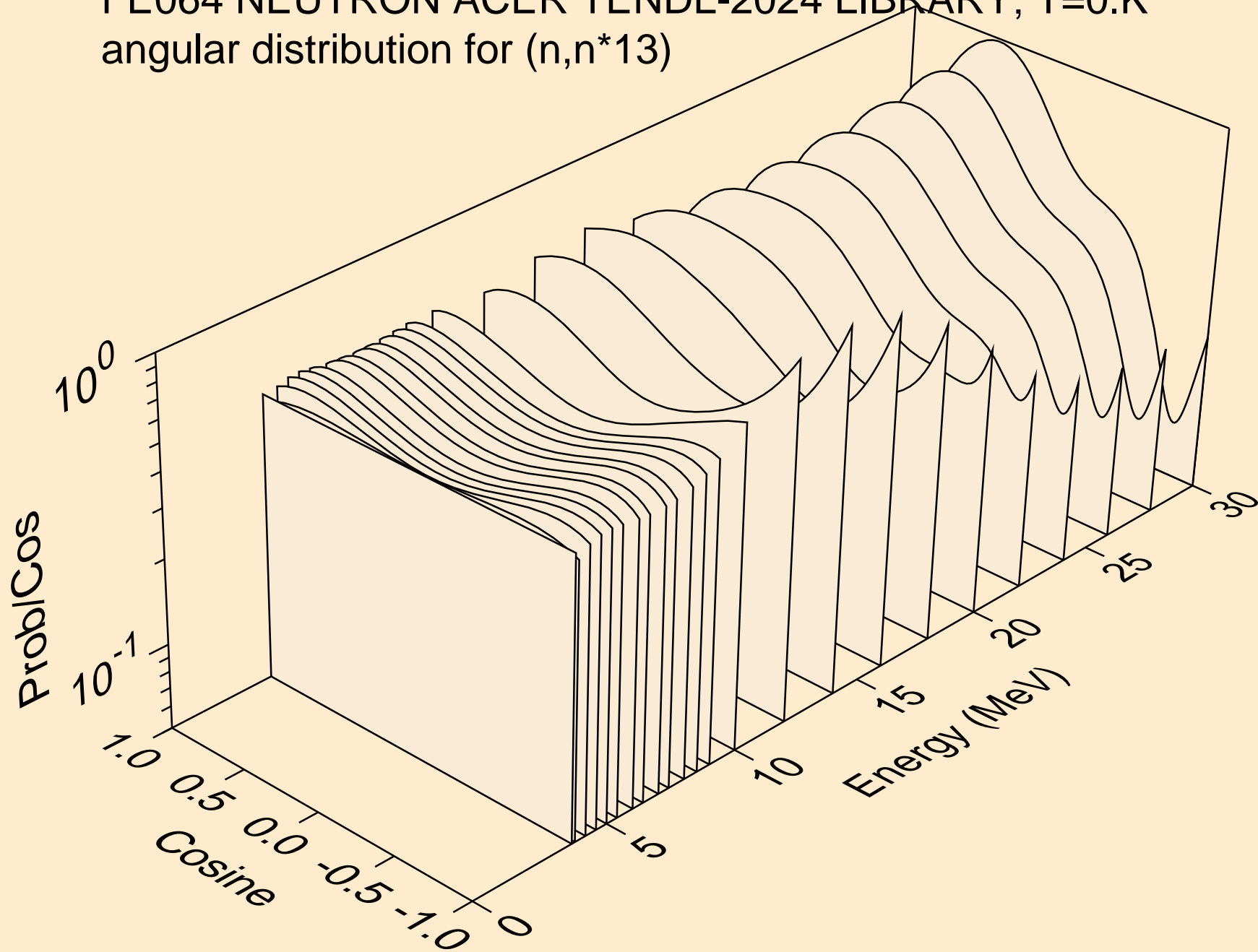

FE064 NEUTRON ACER TENDL-2024 LIBRARY; T=0.K  
angular distribution for (n,n\*14)

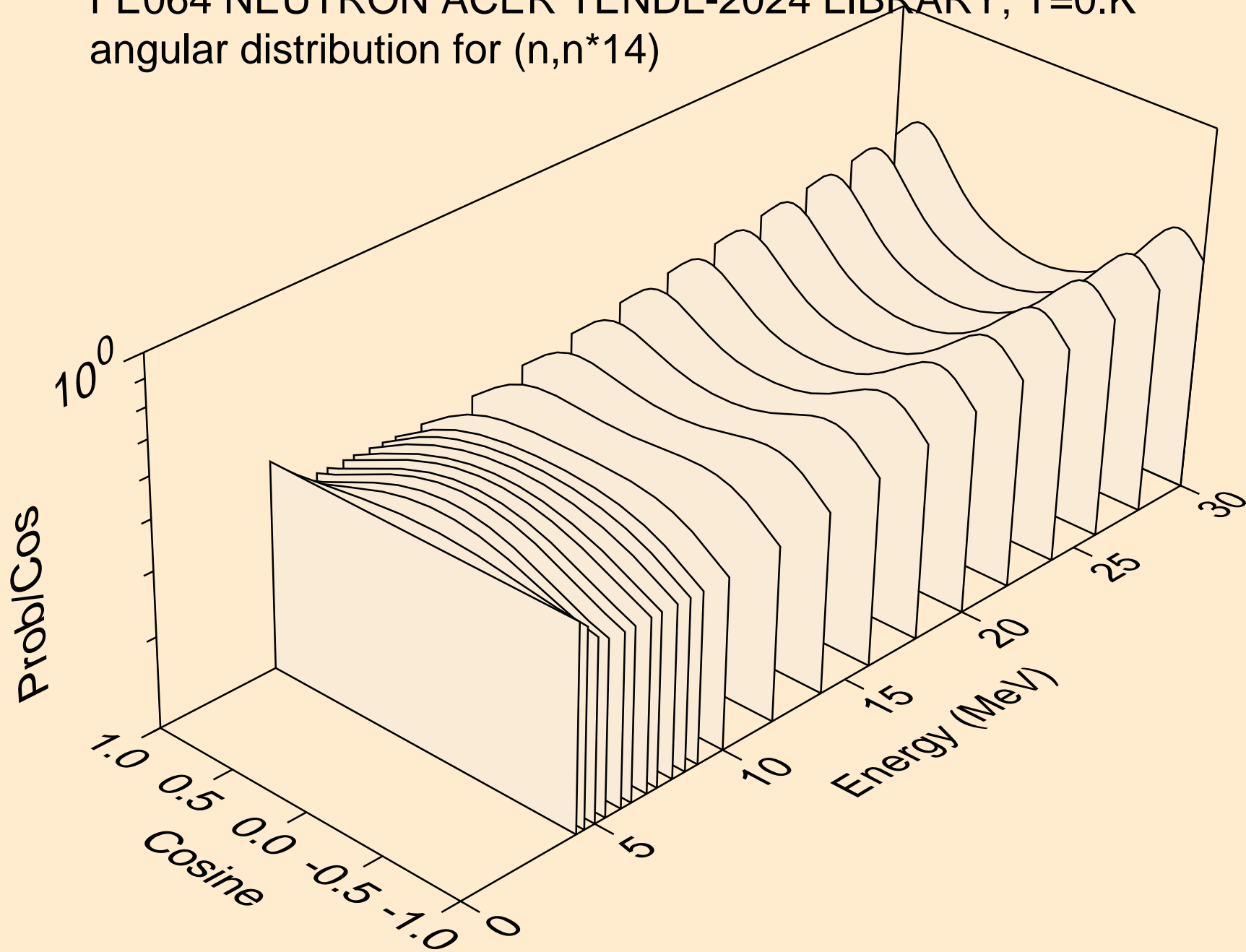

FE064 NEUTRON ACER TENDL-2024 LIBRARY; T=0.K  
angular distribution for (n,n\*15)

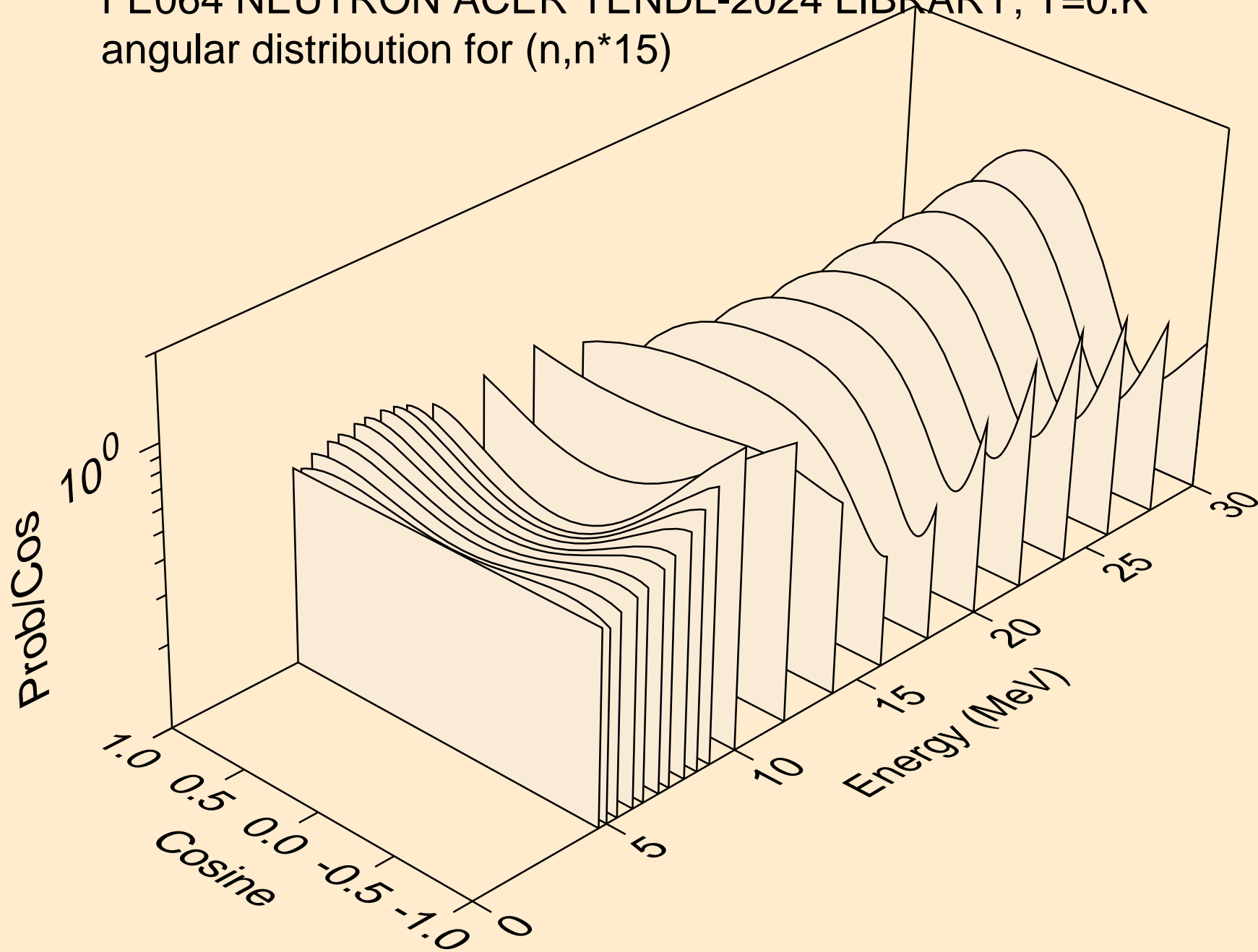

FE064 NEUTRON ACER TENDL-2024 LIBRARY; T=0.K  
angular distribution for (n,n\*16)

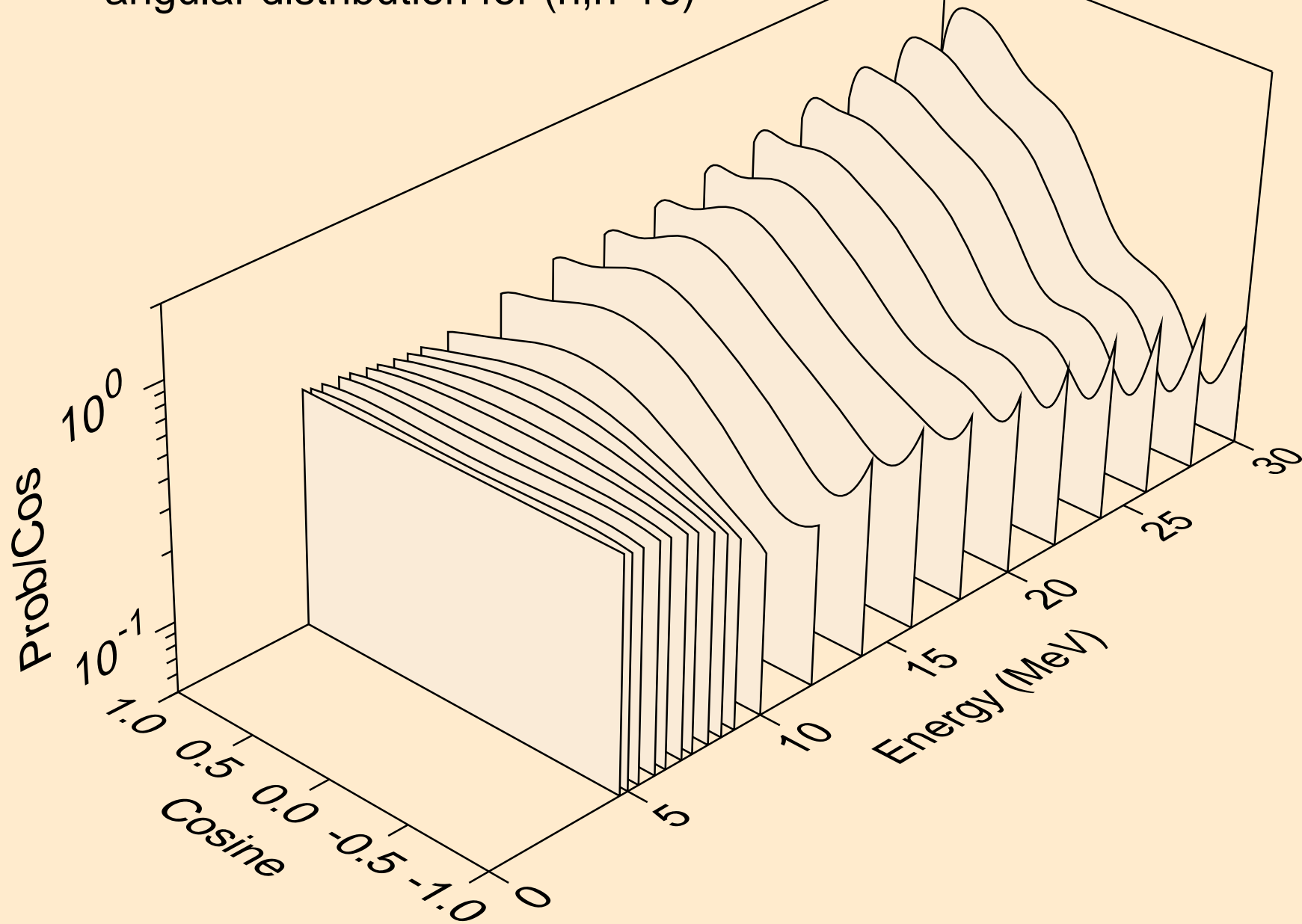

FE064 NEUTRON ACER TENDL-2024 LIBRARY; T=0.K  
angular distribution for (n,n\*17)

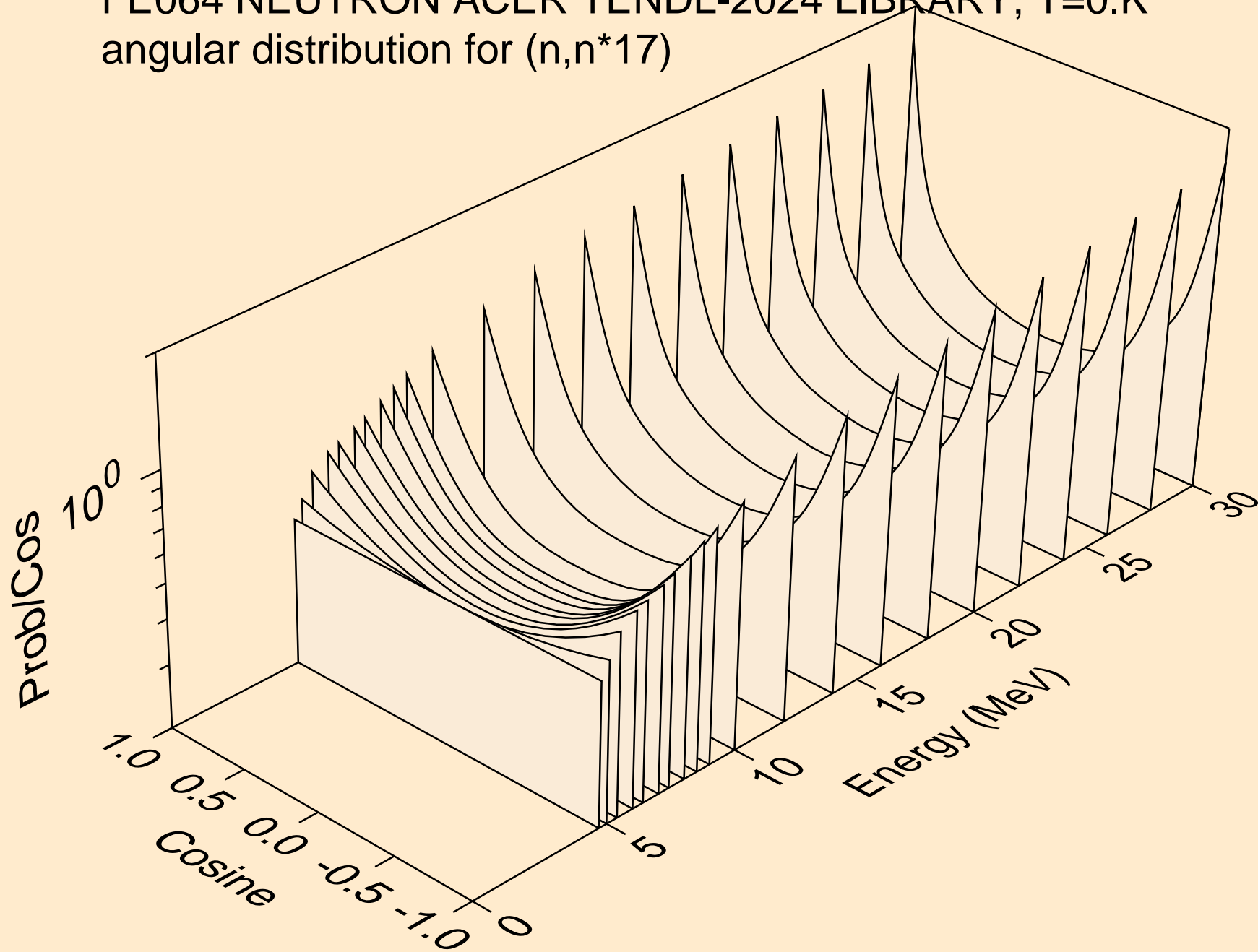

FE064 NEUTRON ACER TENDL-2024 LIBRARY; T=0.K  
angular distribution for (n,n\*18)

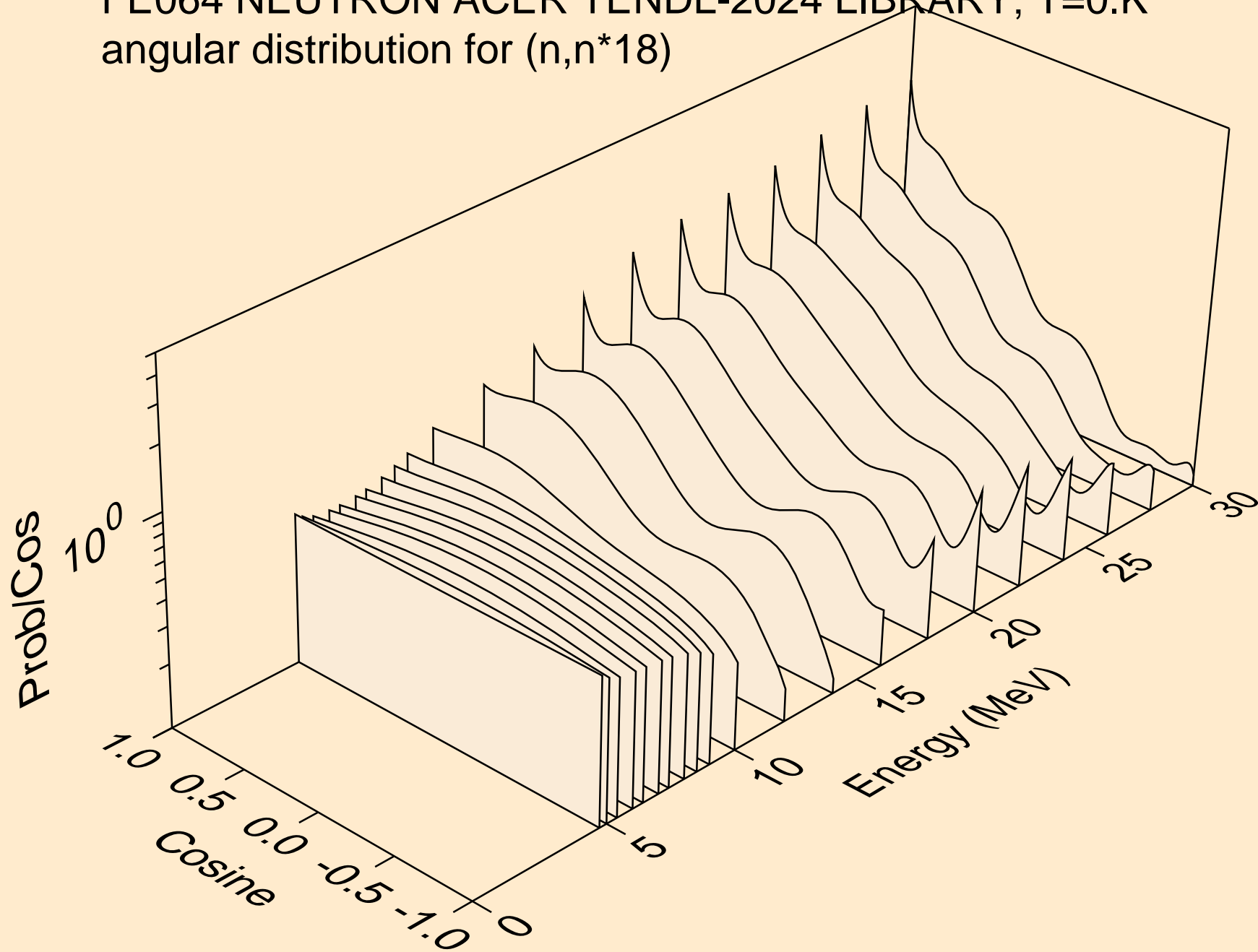

FE064 NEUTRON ACER TENDL-2024 LIBRARY; T=0.K  
angular distribution for (n,n\*19)

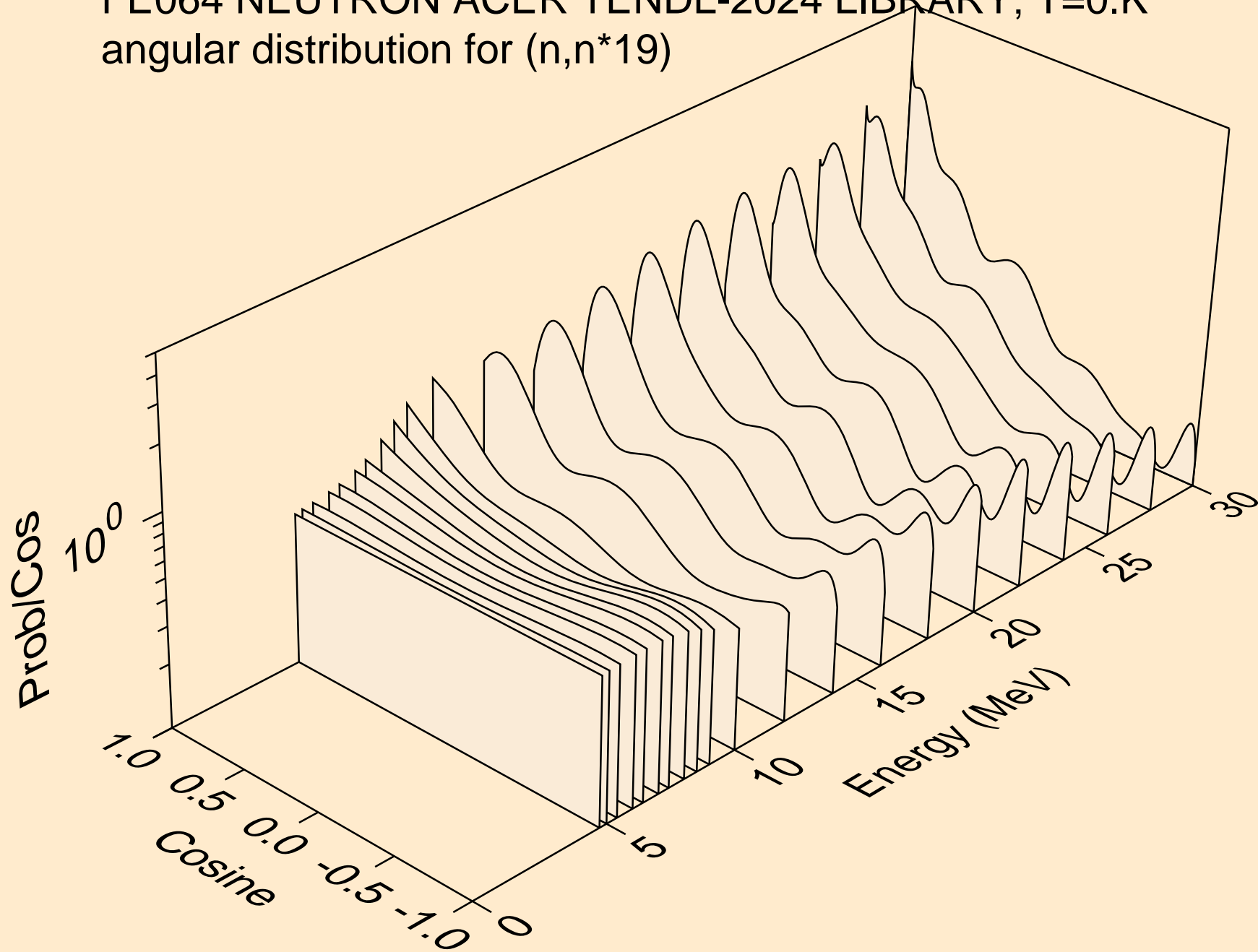

FE064 NEUTRON ACER TENDL-2024 LIBRARY; T=0.K  
angular distribution for (n,n\*20)

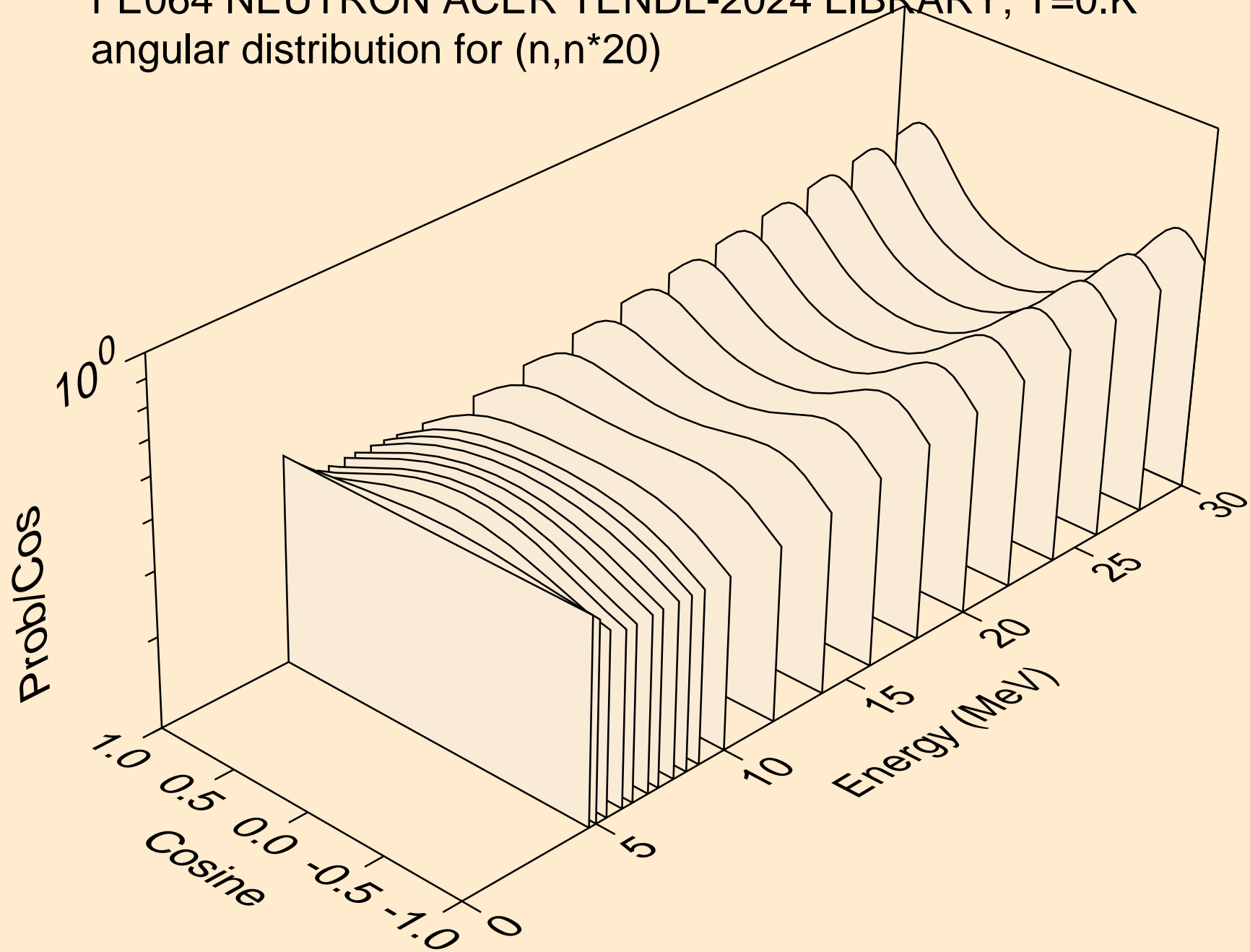

FE064 NEUTRON ACER TENDL-2024 LIBRARY; T=0.K  
angular distribution for (n,n\*21)

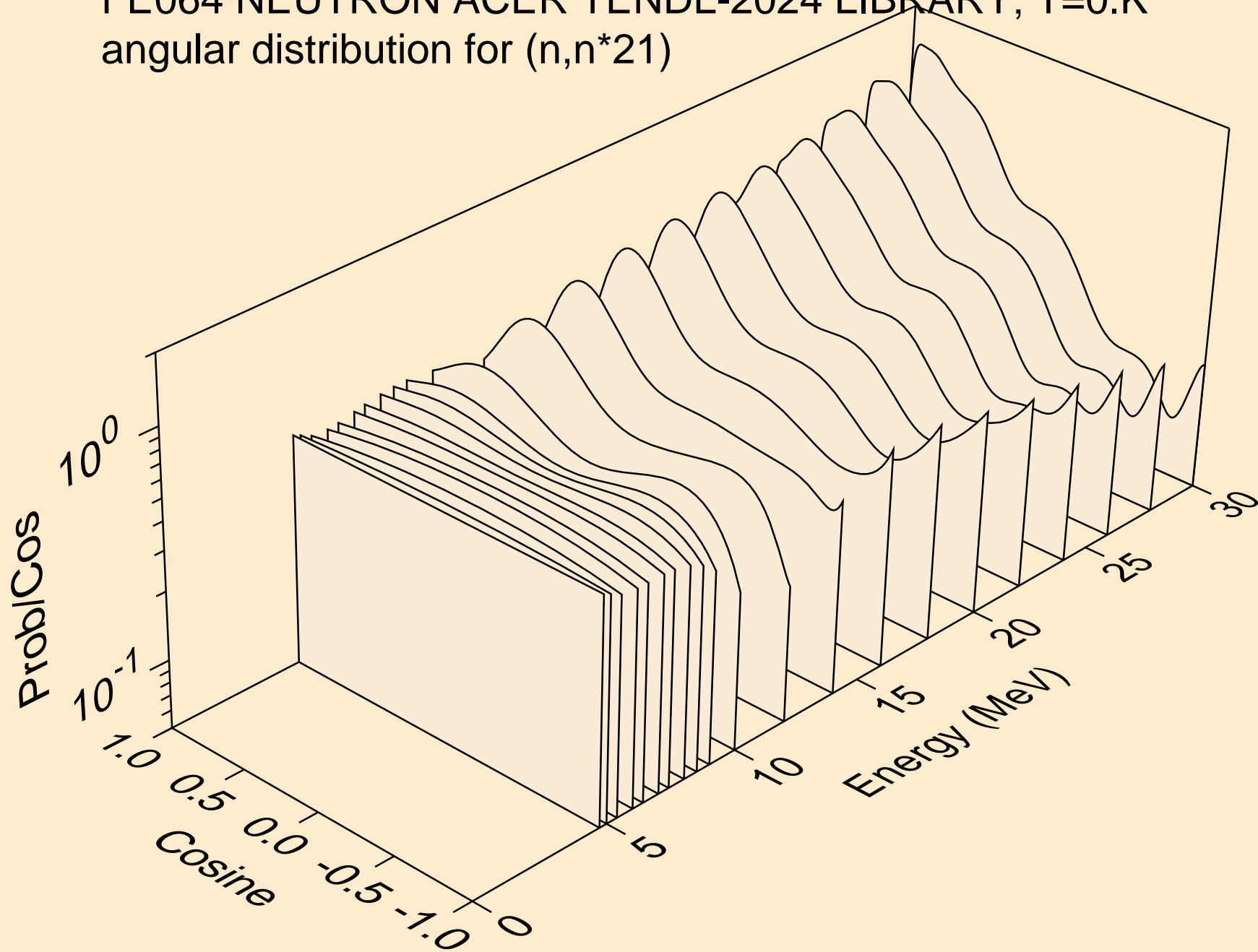

FE064 NEUTRON ACER TENDL-2024 LIBRARY; T=0.K  
angular distribution for (n,n\*22)

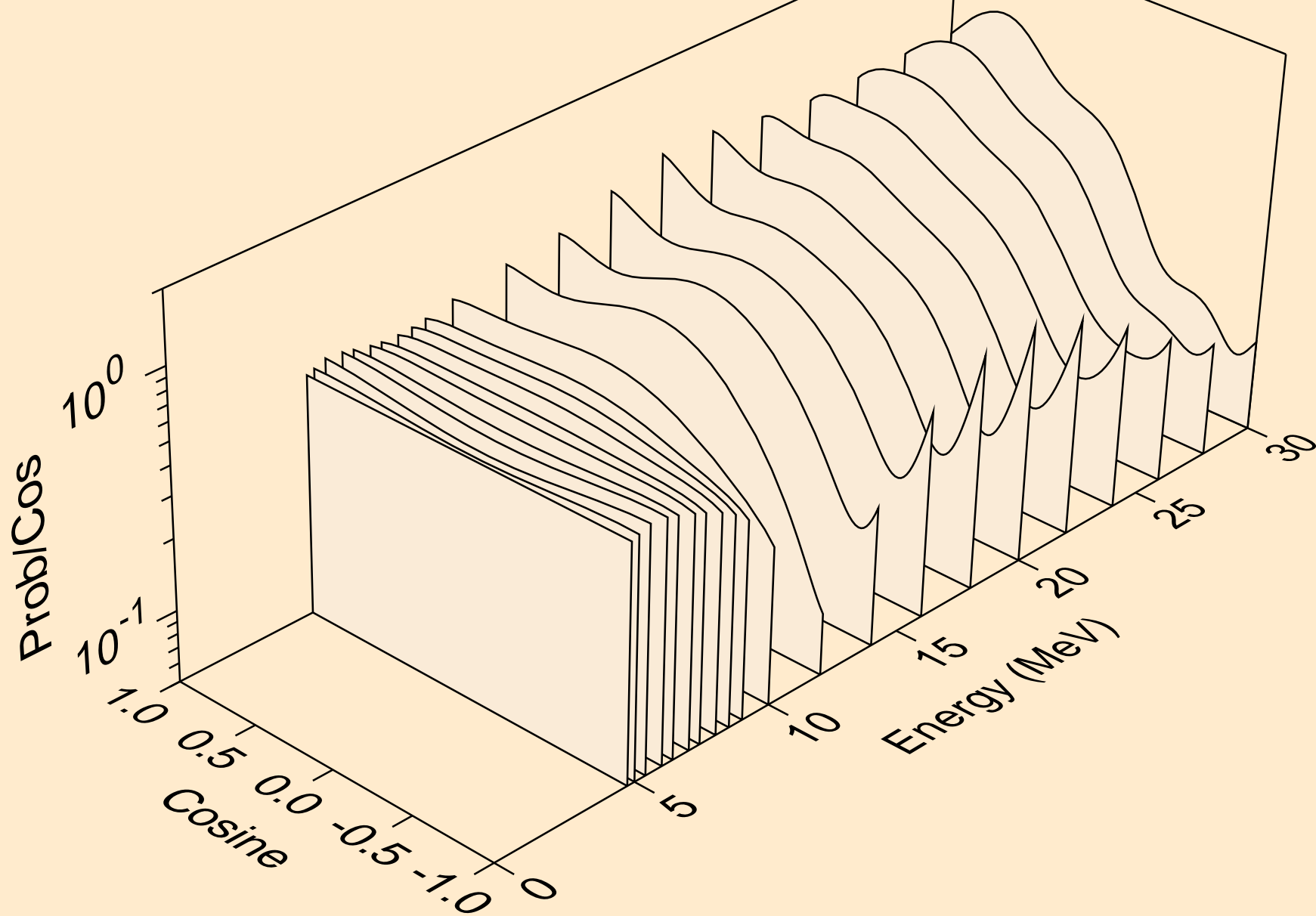

FE064 NEUTRON ACER TENDL-2024 LIBRARY; T=0.K  
angular distribution for (n,n\*23)

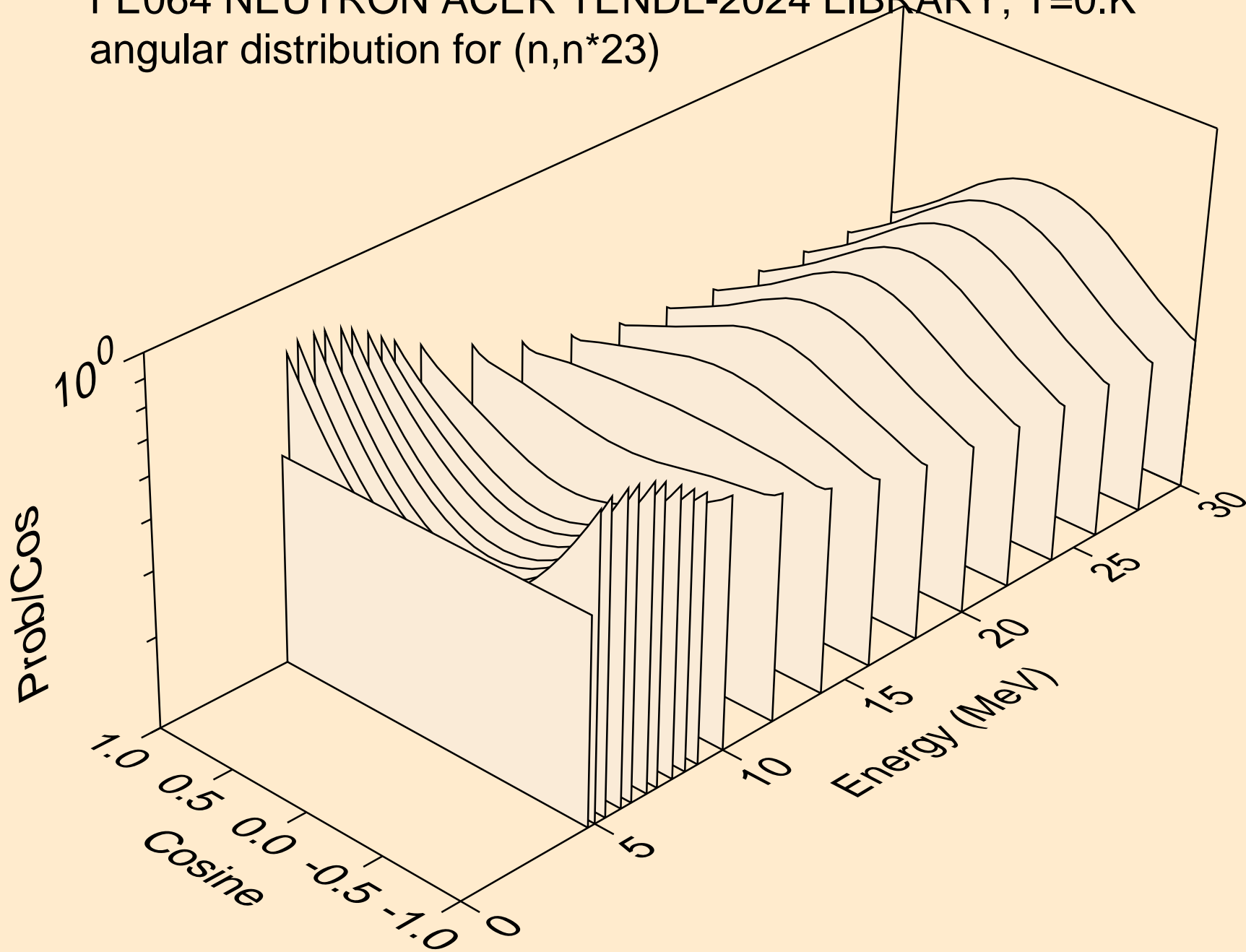

FE064 NEUTRON ACER TENDL-2024 LIBRARY; T=0.K  
angular distribution for (n,n\*24)

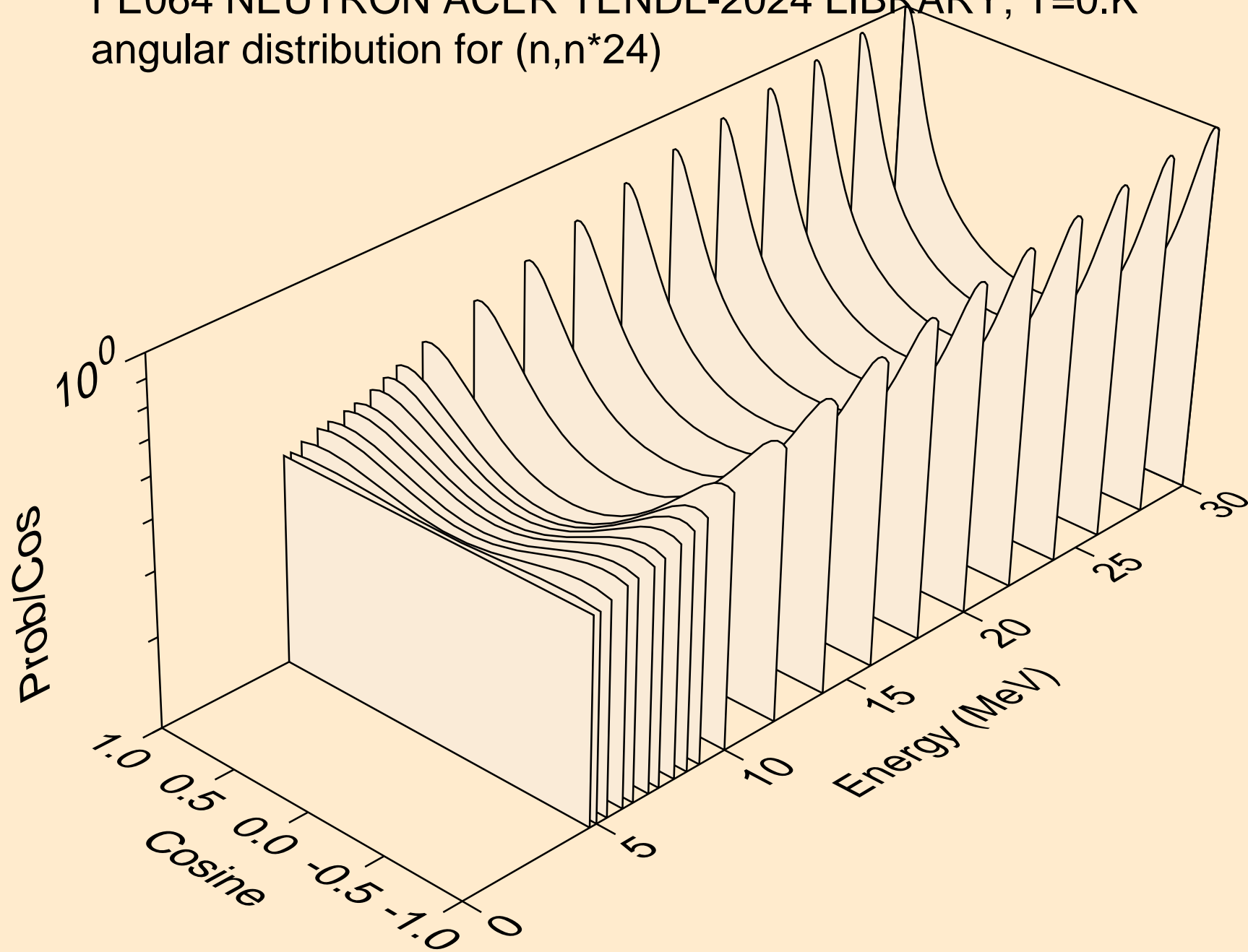

FE064 NEUTRON ACER TENDL-2024 LIBRARY; T=0.K  
angular distribution for (n,n\*25)

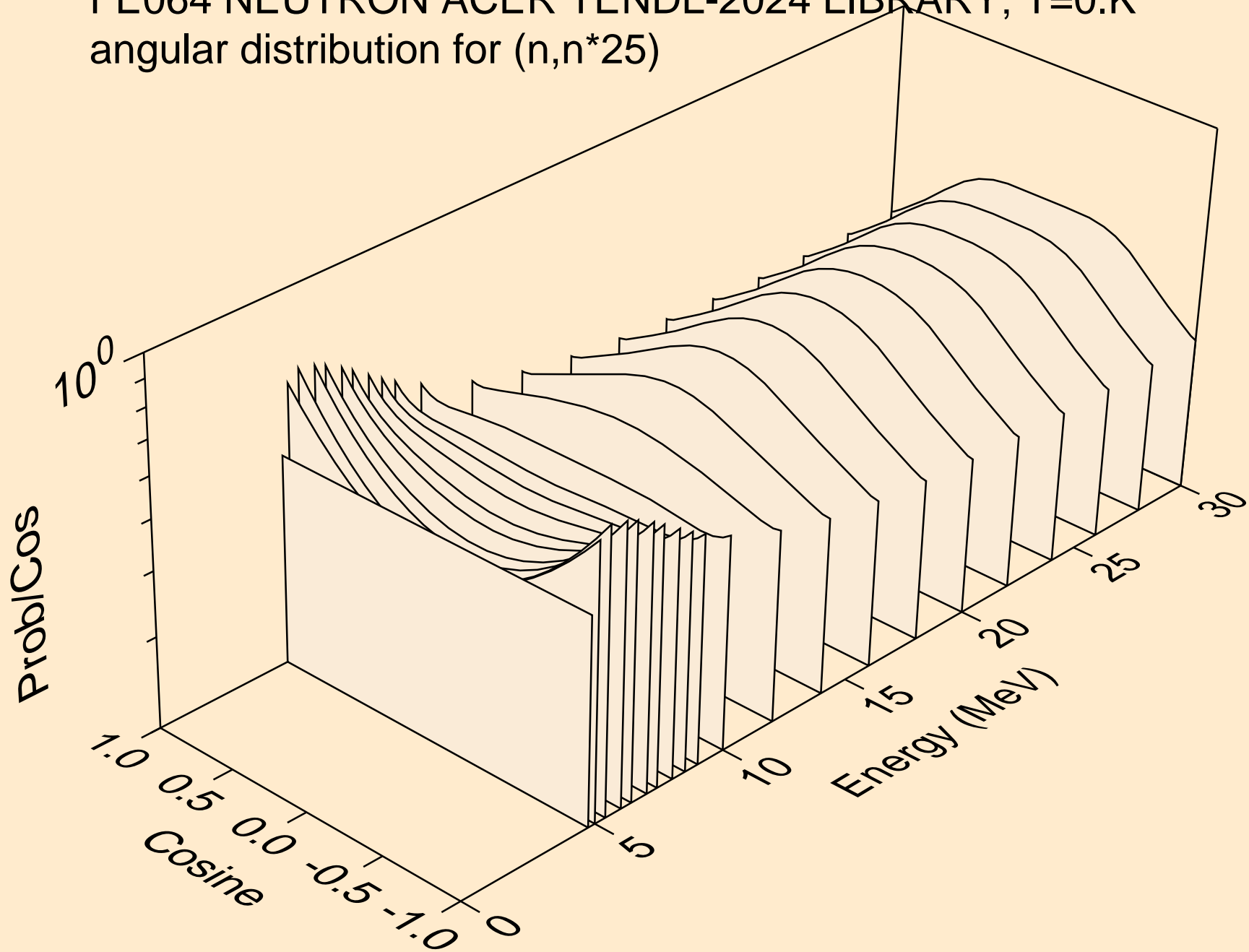

FE064 NEUTRON ACER TENDL-2024 LIBRARY; T=0.K  
angular distribution for (n,n\*26)

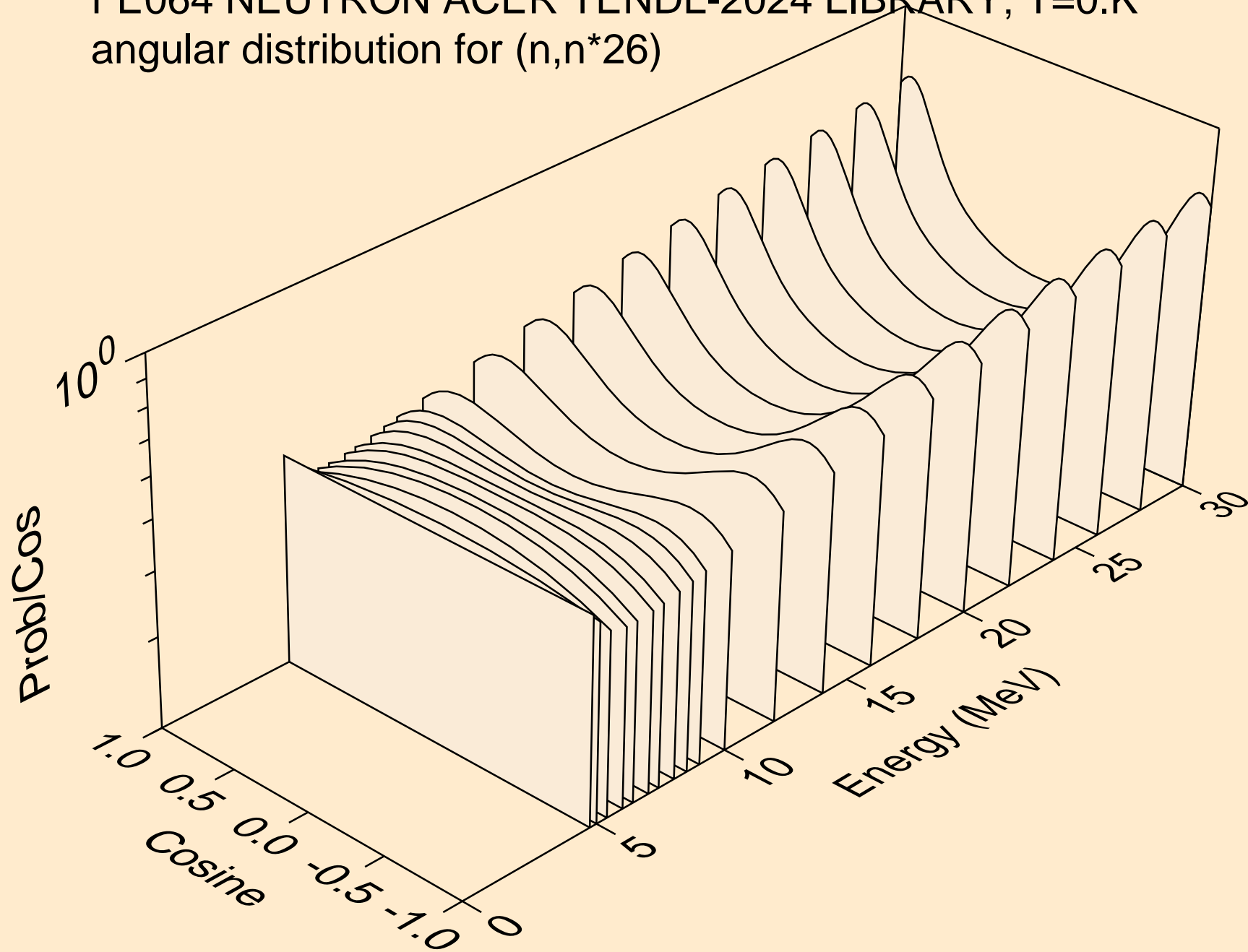

FE064 NEUTRON ACER TENDL-2024 LIBRARY; T=0.K  
angular distribution for (n,n\*27)

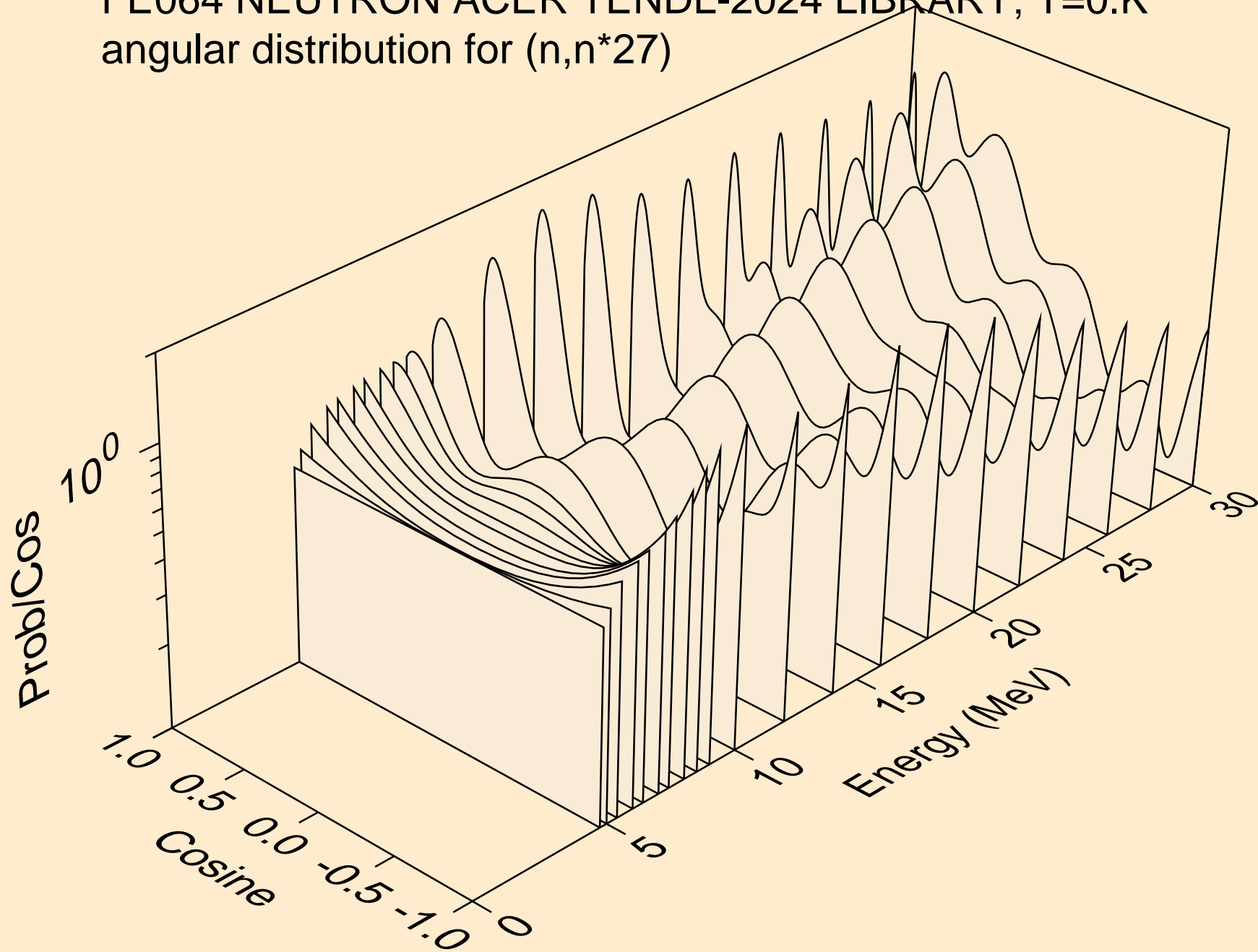

FE064 NEUTRON ACER TENDL-2024 LIBRARY; T=0.K  
Neutron emission for (n,x)

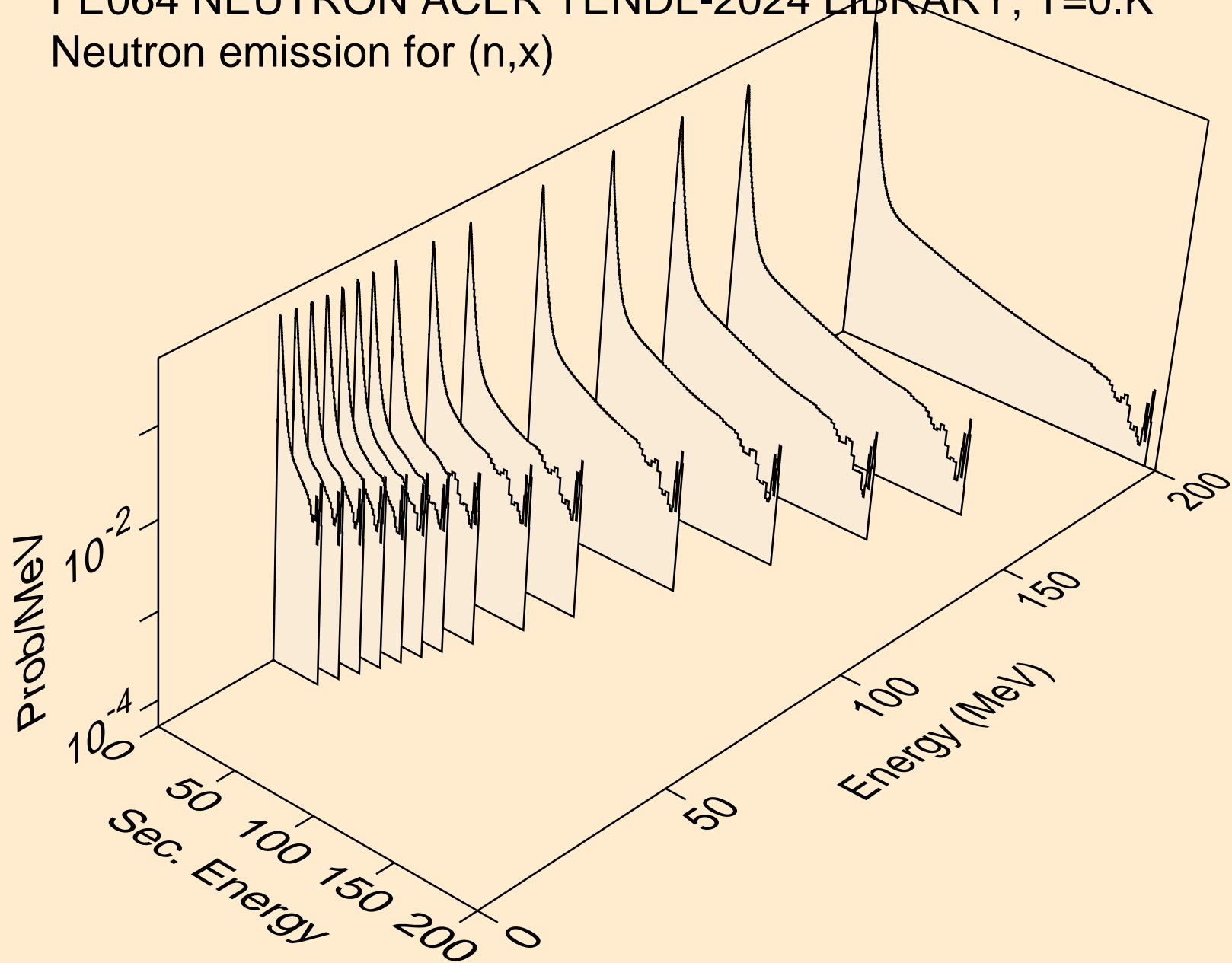

FE064 NEUTRON ACER TENDL-2024 LIBRARY; T=0.K  
Neutron emission for (n,2nd)

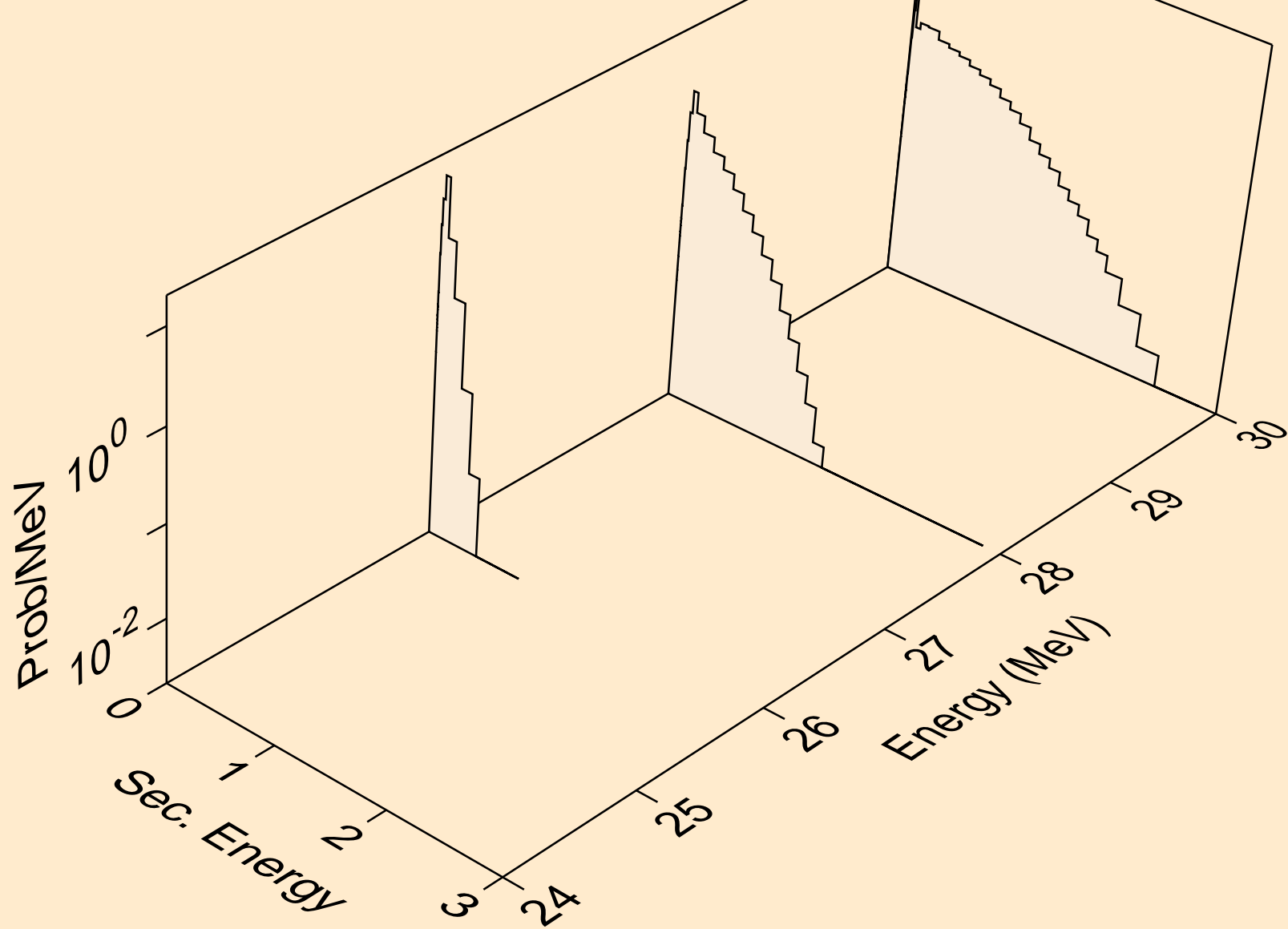

FE064 NEUTRON ACER TENDL-2024 LIBRARY; T=0.K  
Neutron emission for (n,2n)

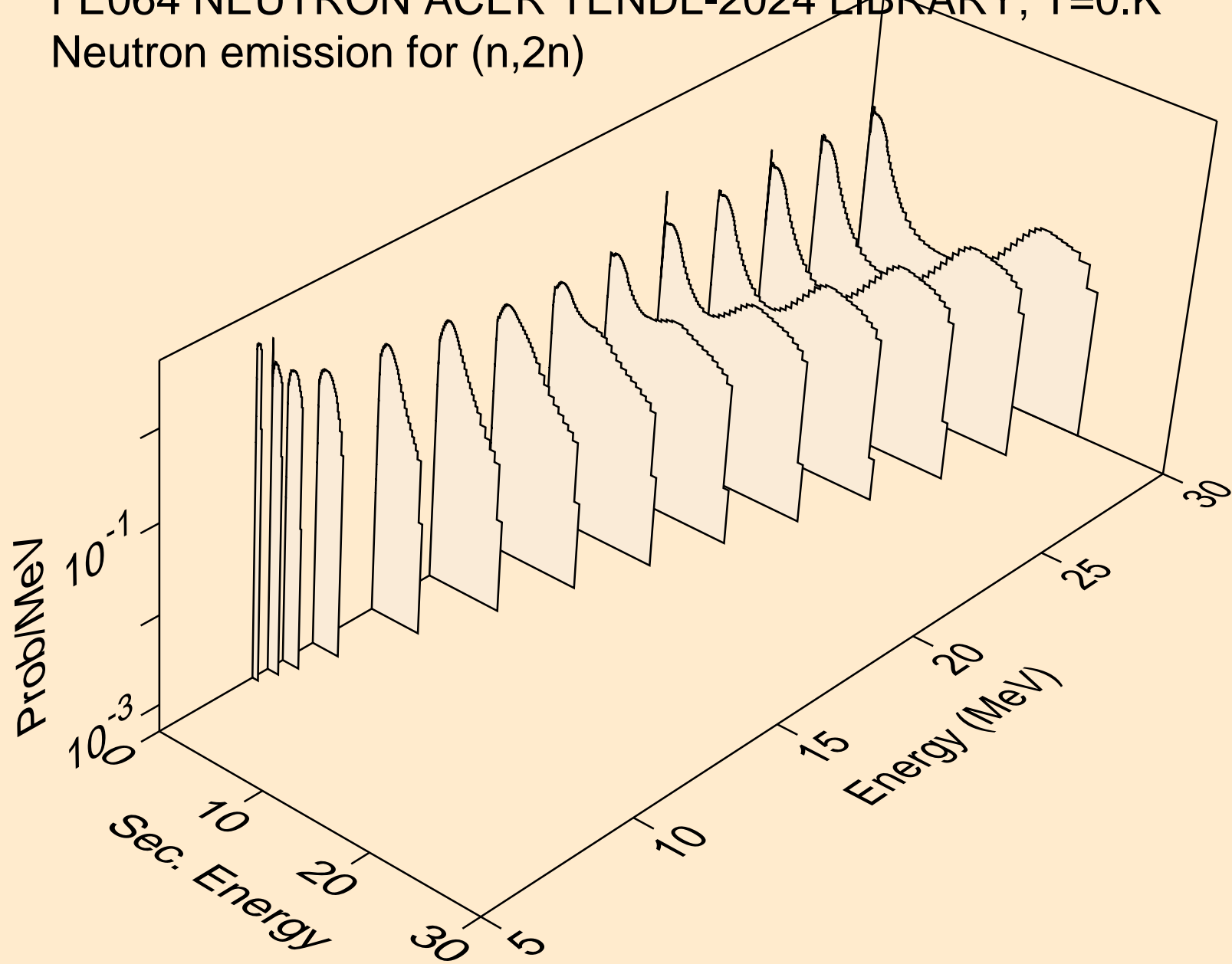

FE064 NEUTRON ACER TENDL-2024 LIBRARY; T=0.K  
Neutron emission for (n,3n)

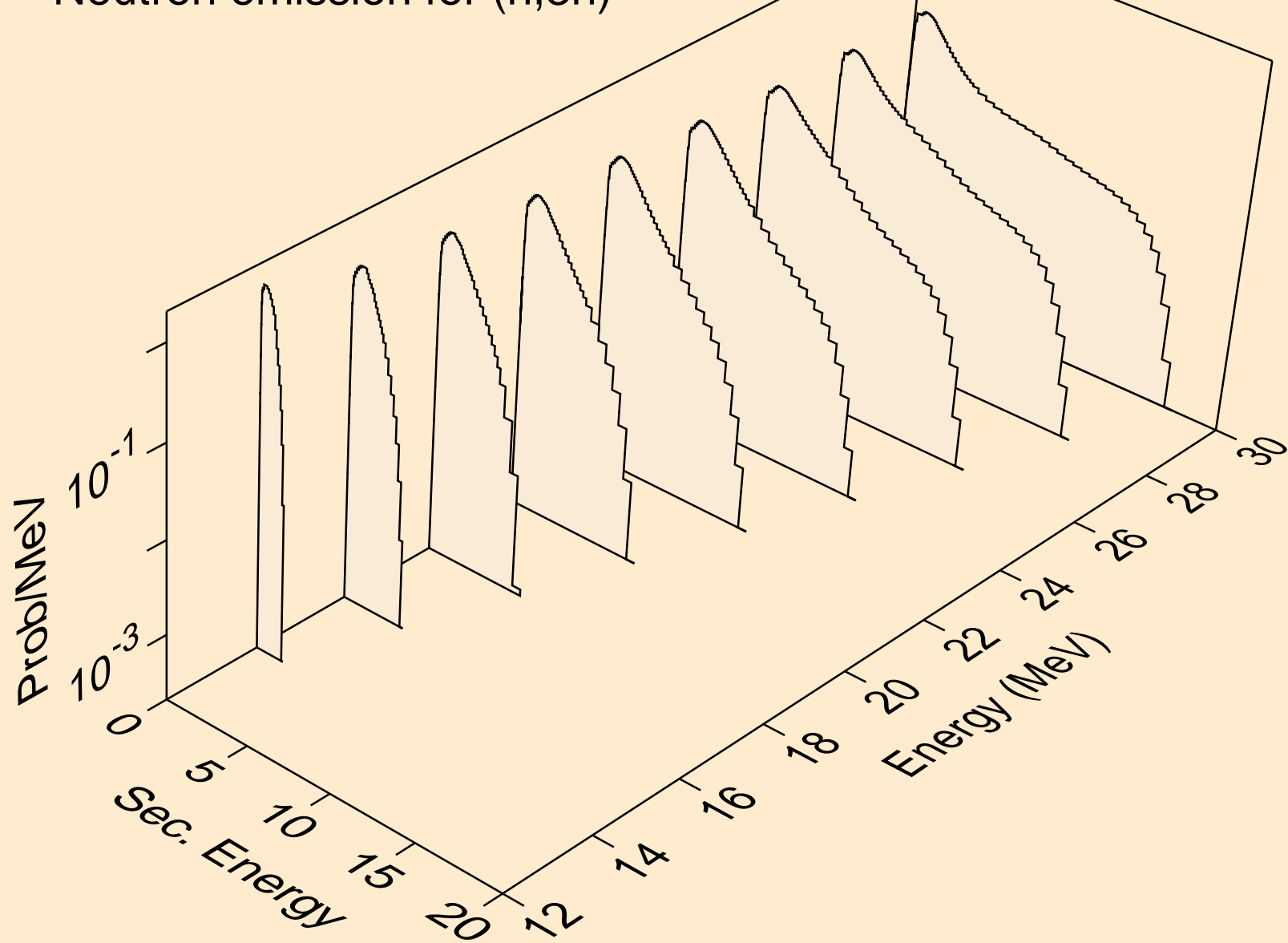

FE064 NEUTRON ACER TENDL-2024 LIBRARY; T=0.K  
Neutron emission for (n,n\*)a

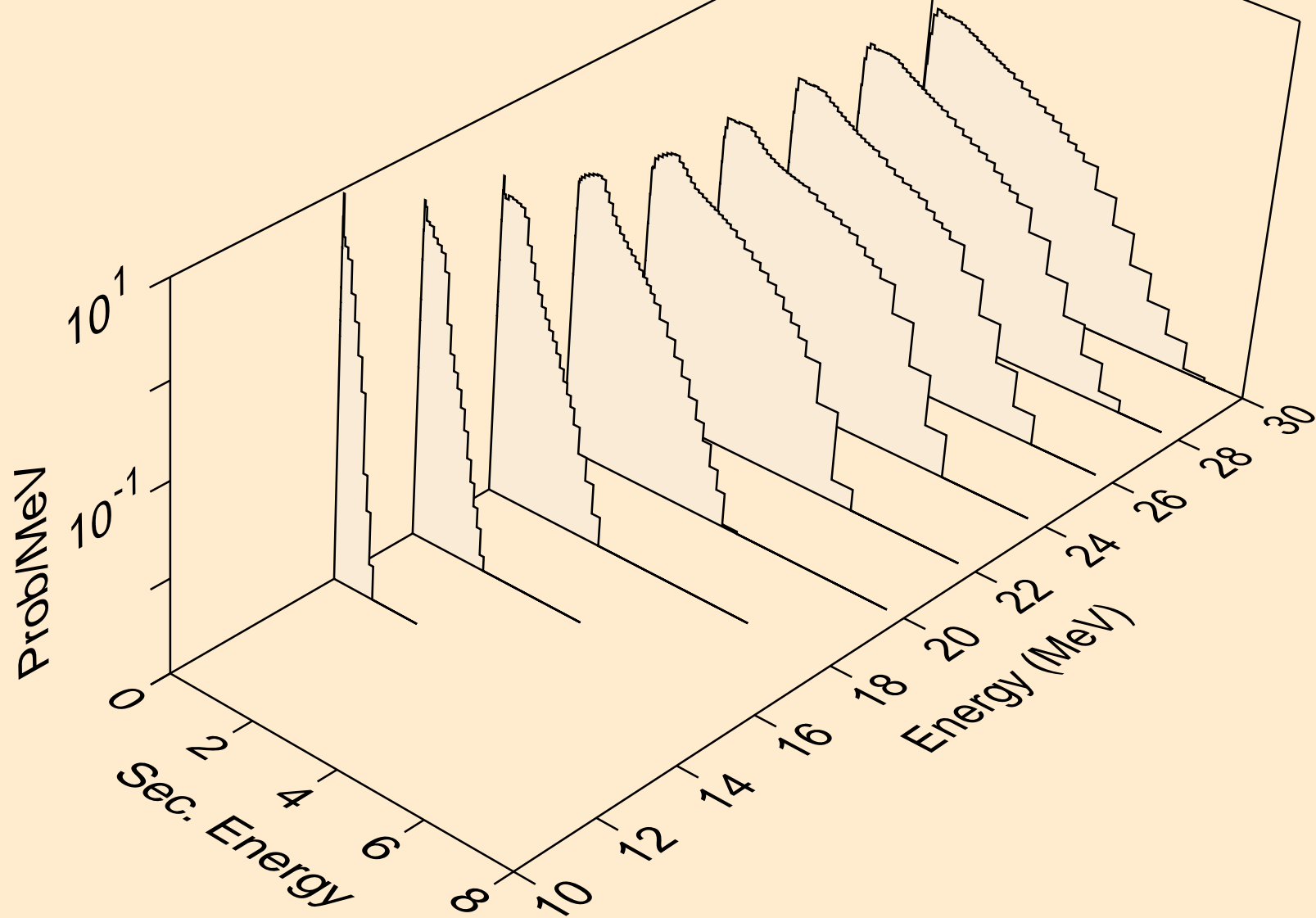

FE064 NEUTRON ACER TENDL-2024 LIBRARY; T=0.K  
Neutron emission for (n,2n)a

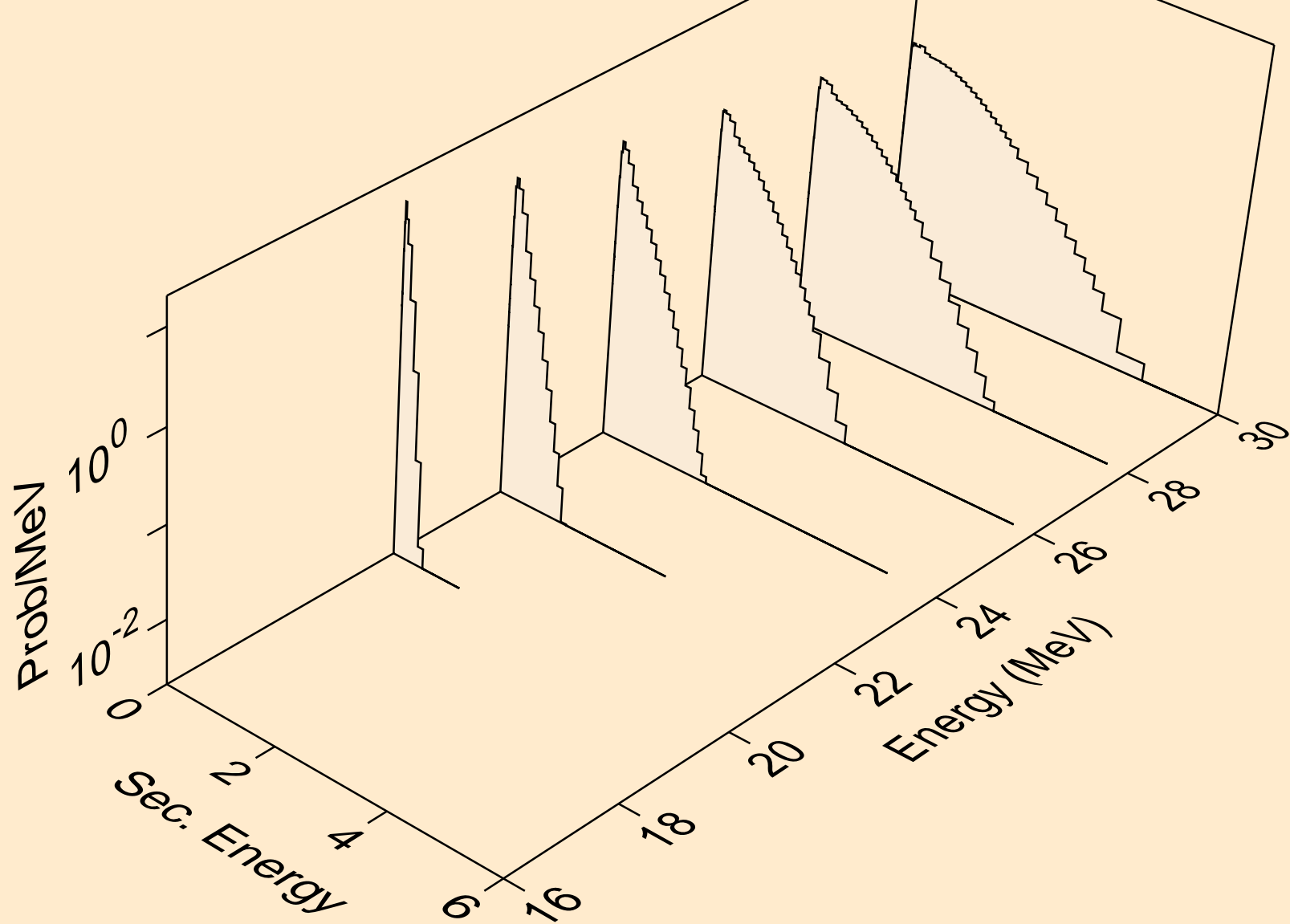

FE064 NEUTRON ACER TENDL-2024 LIBRARY; T=0.K  
Neutron emission for (n,3n)a

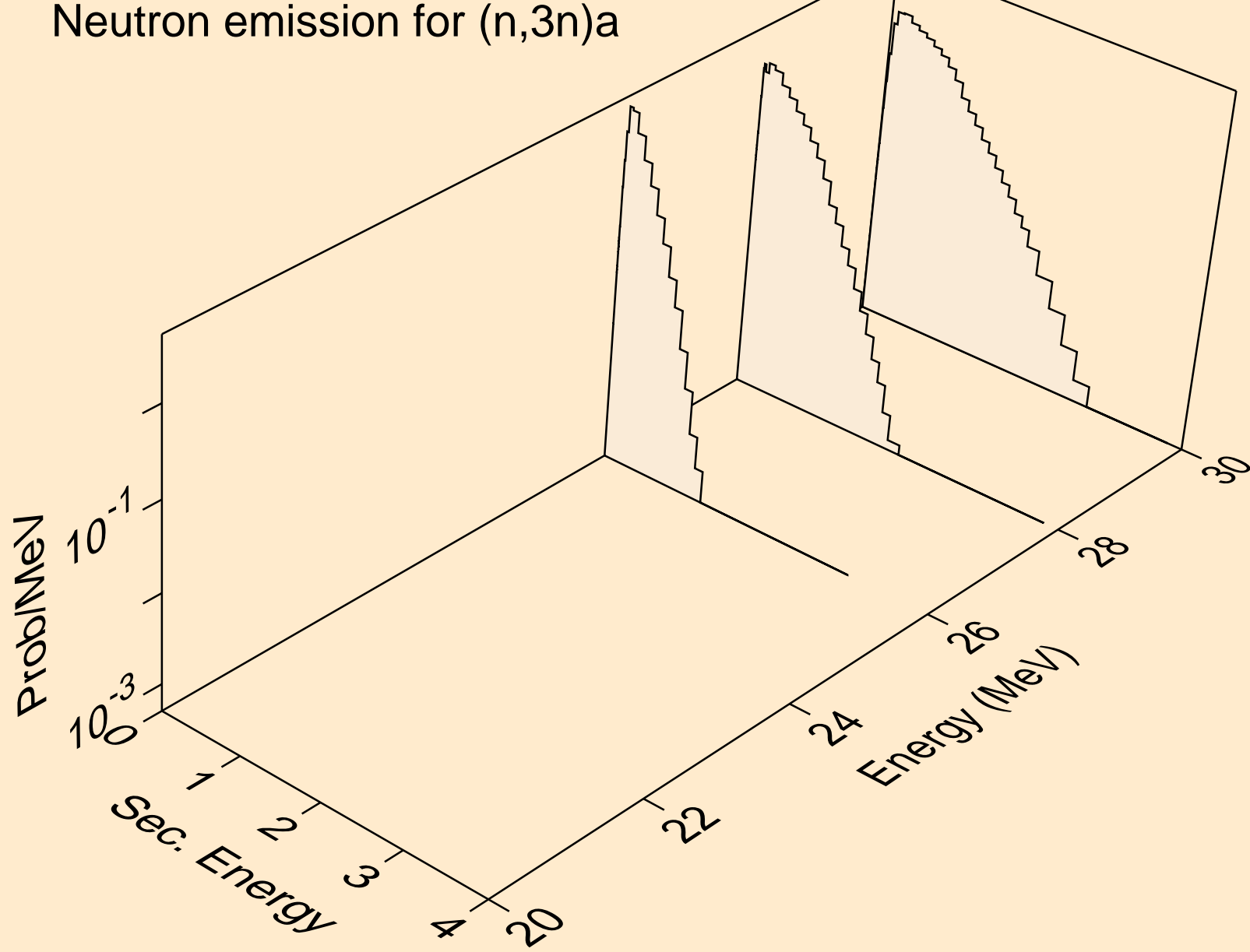

FE064 NEUTRON ACER TENDL-2024 LIBRARY; T=0.K  
Neutron emission for (n,n\*)p

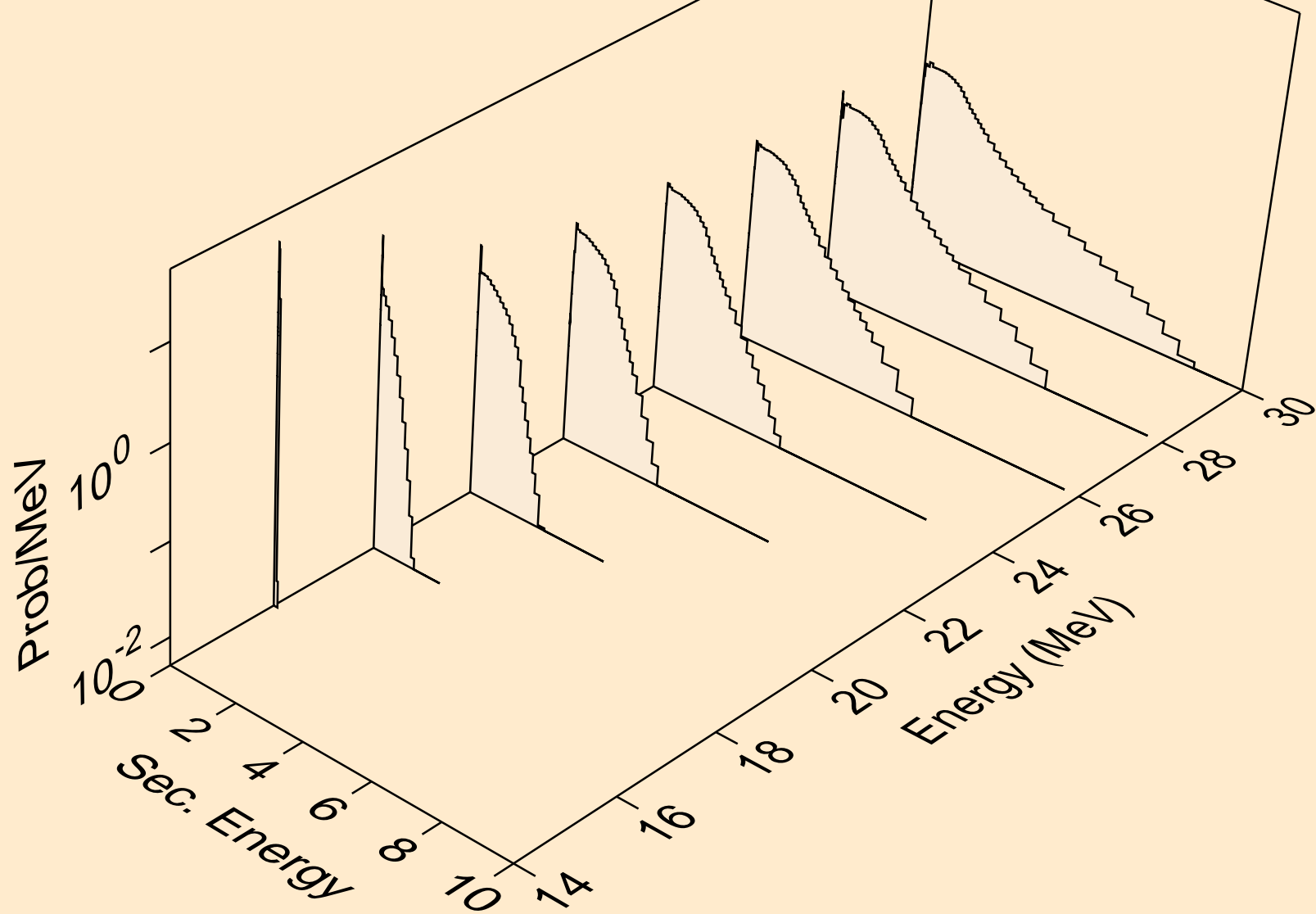

FE064 NEUTRON ACER TENDL-2024 LIBRARY; T=0.K  
Neutron emission for (n,n\*)d

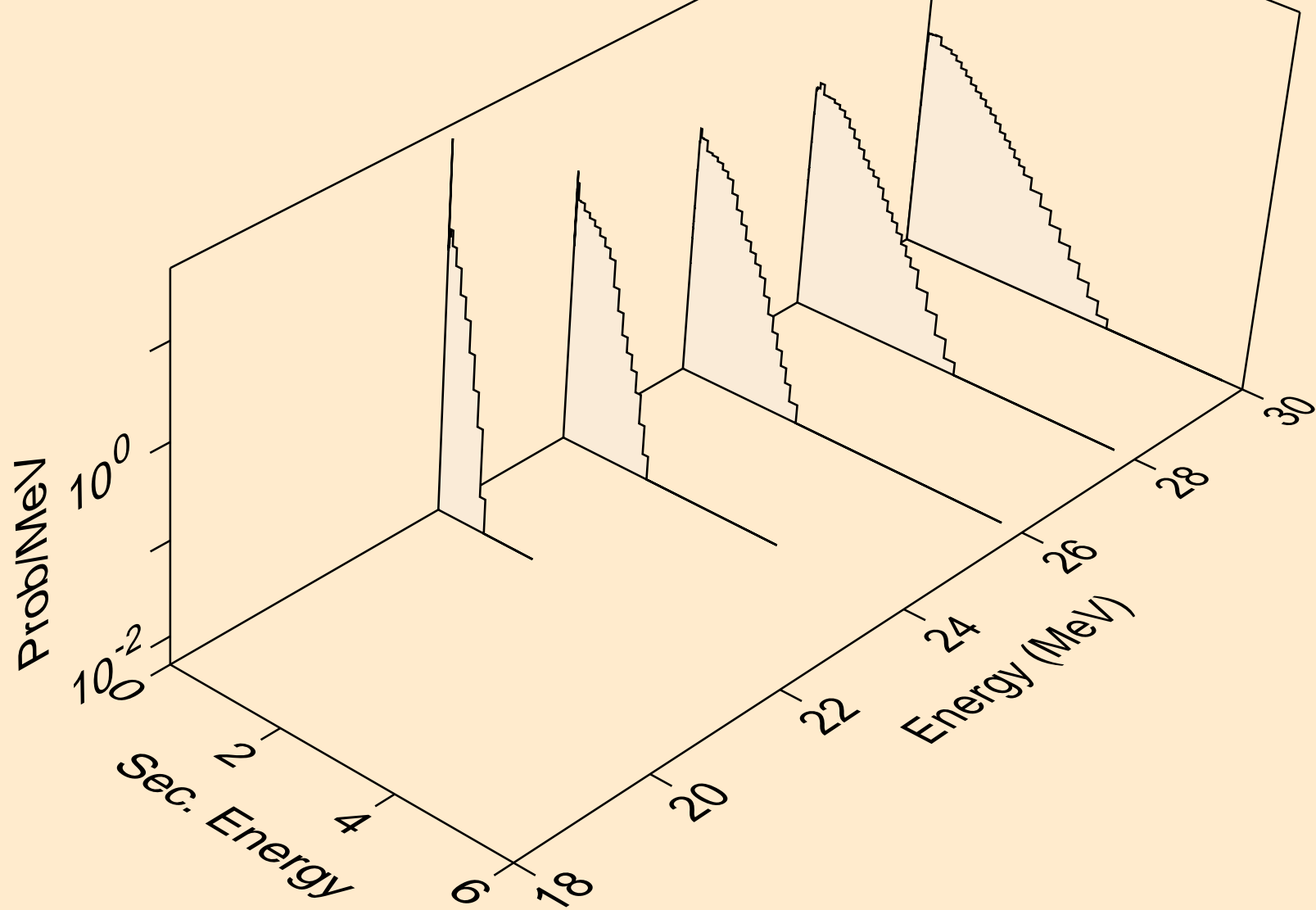

FE064 NEUTRON ACER TENDL-2024 LIBRARY; T=0.K  
Neutron emission for (n,n\*)t

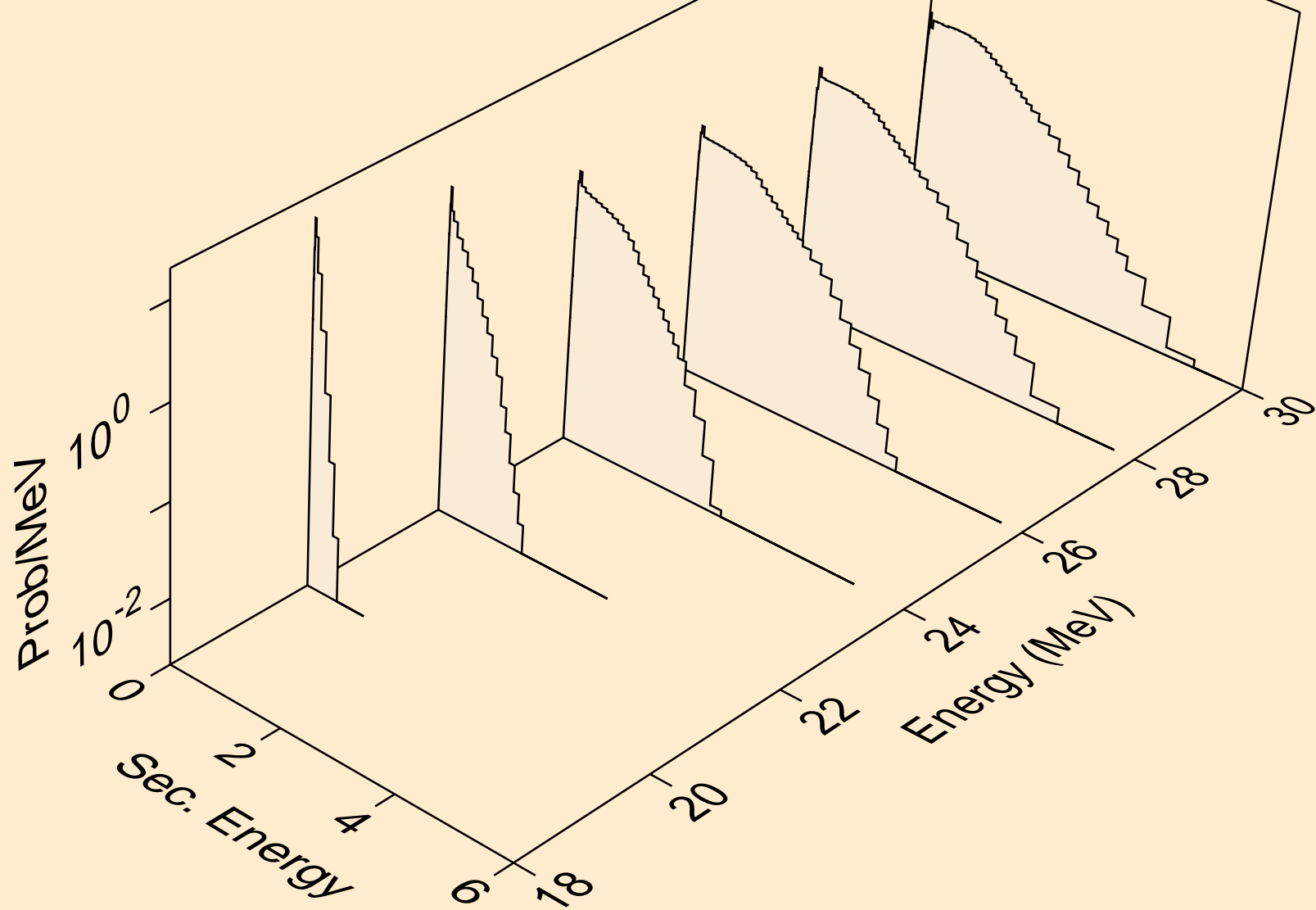

FE064 NEUTRON ACER TENDL-2024 LIBRARY; T=0.K  
Neutron emission for (n,4n)

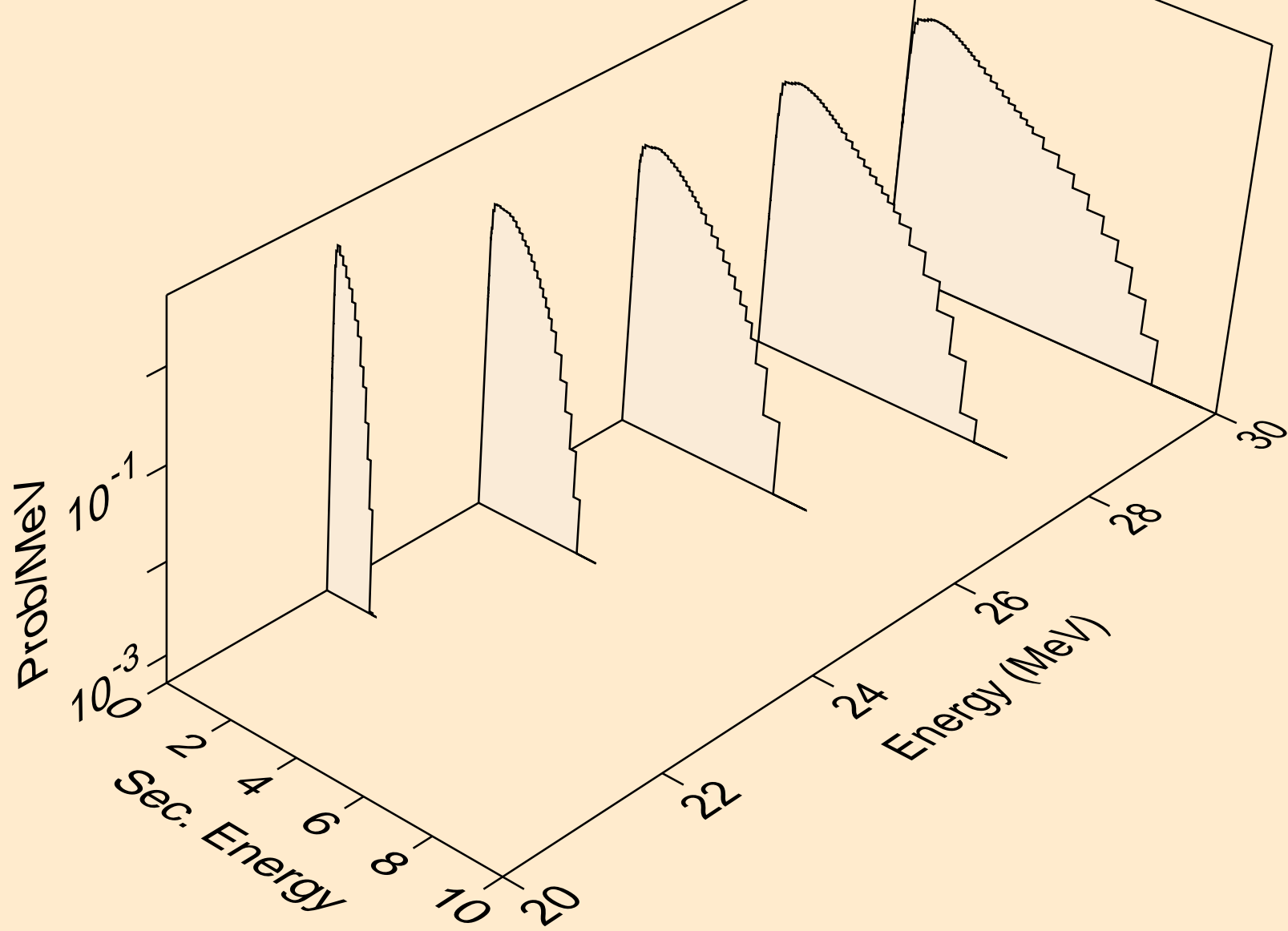

FE064 NEUTRON ACER TENDL-2024 LIBRARY; T=0.K  
Neutron emission for (n,2np)

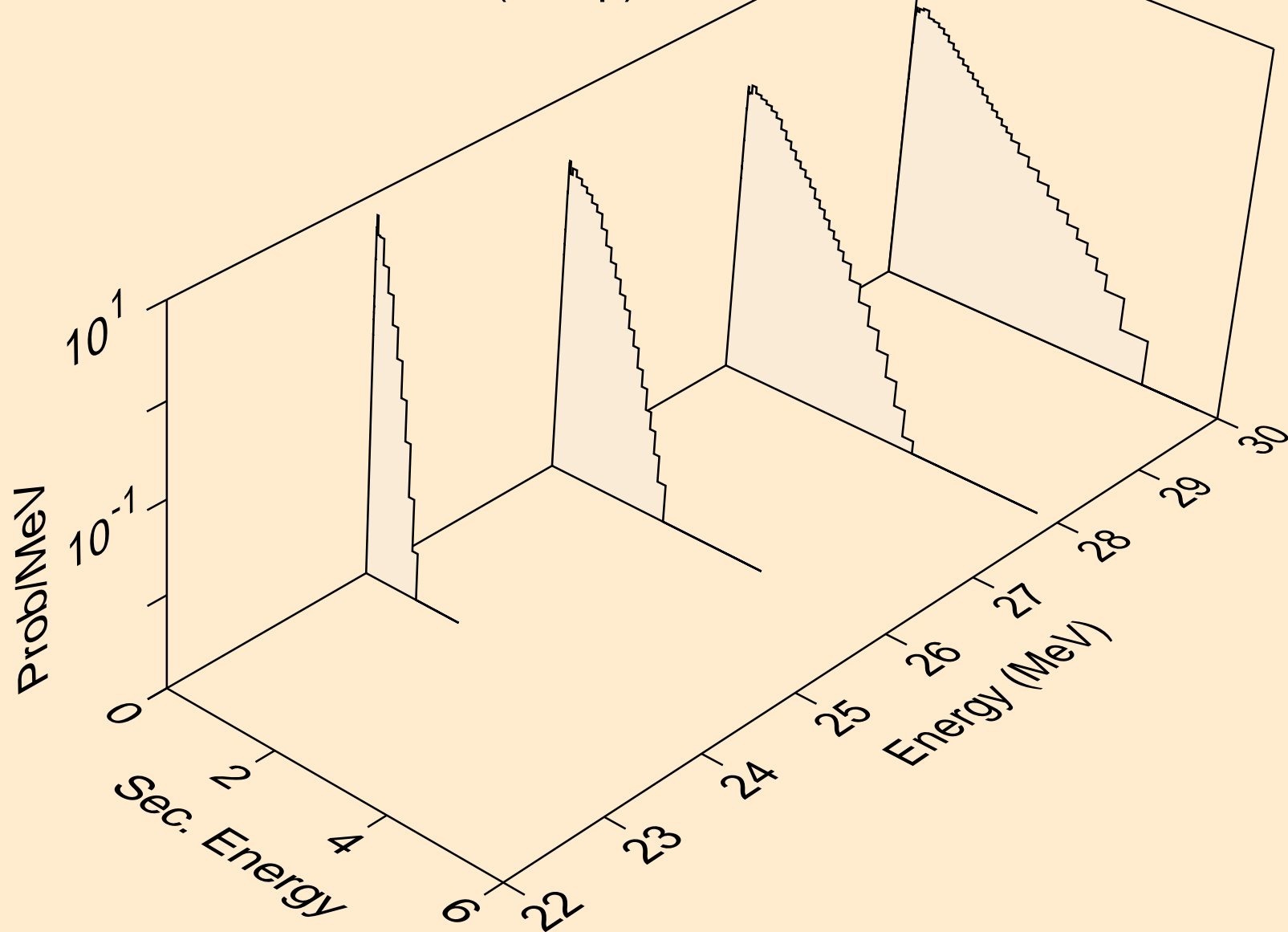

FE064 NEUTRON ACER TENDL-2024 LIBRARY; T=0.K  
Neutron emission for (n,3np)

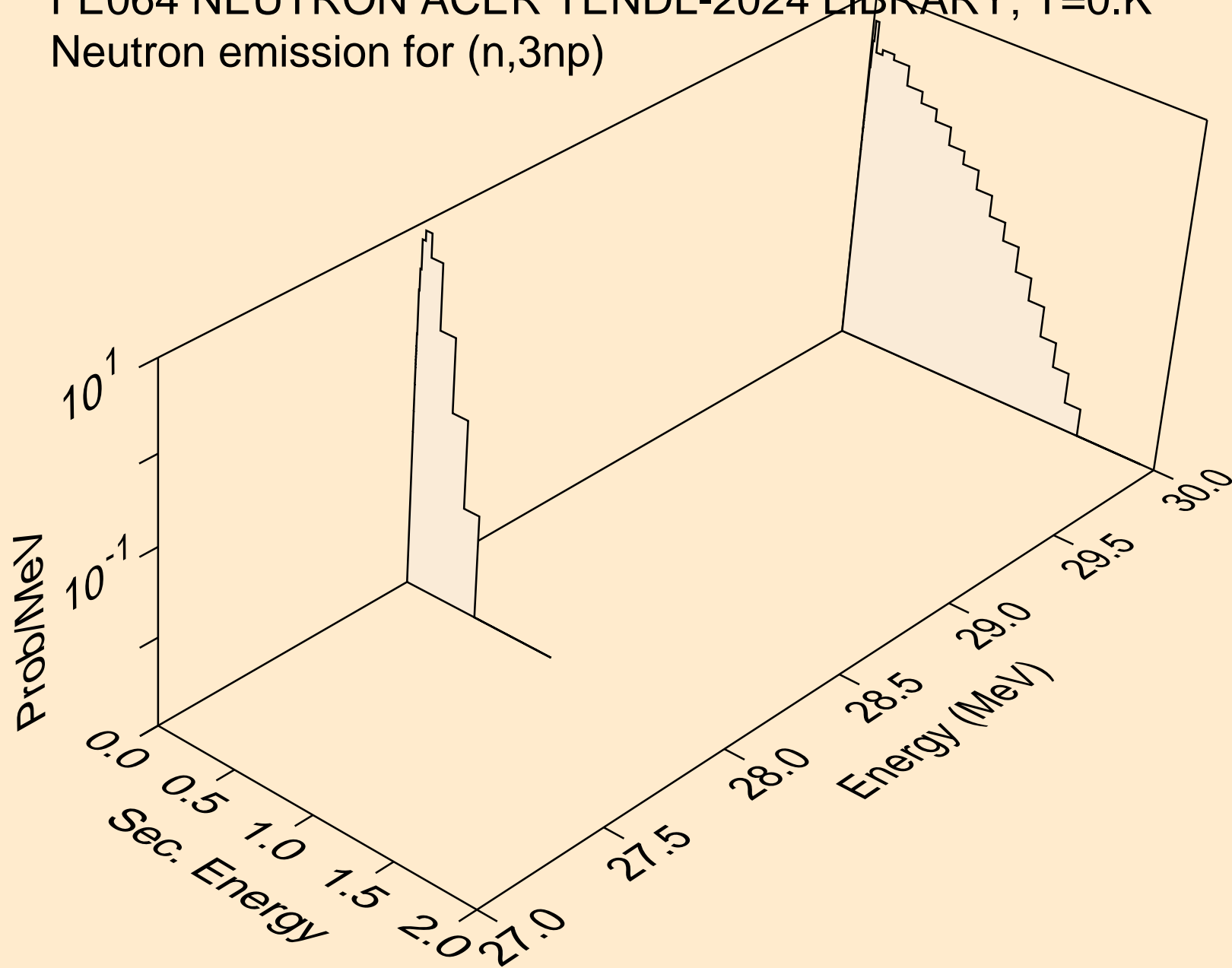

FE064 NEUTRON ACER TENDL-2024 LIBRARY; T=0.K  
Neutron emission for (n,n\*c)

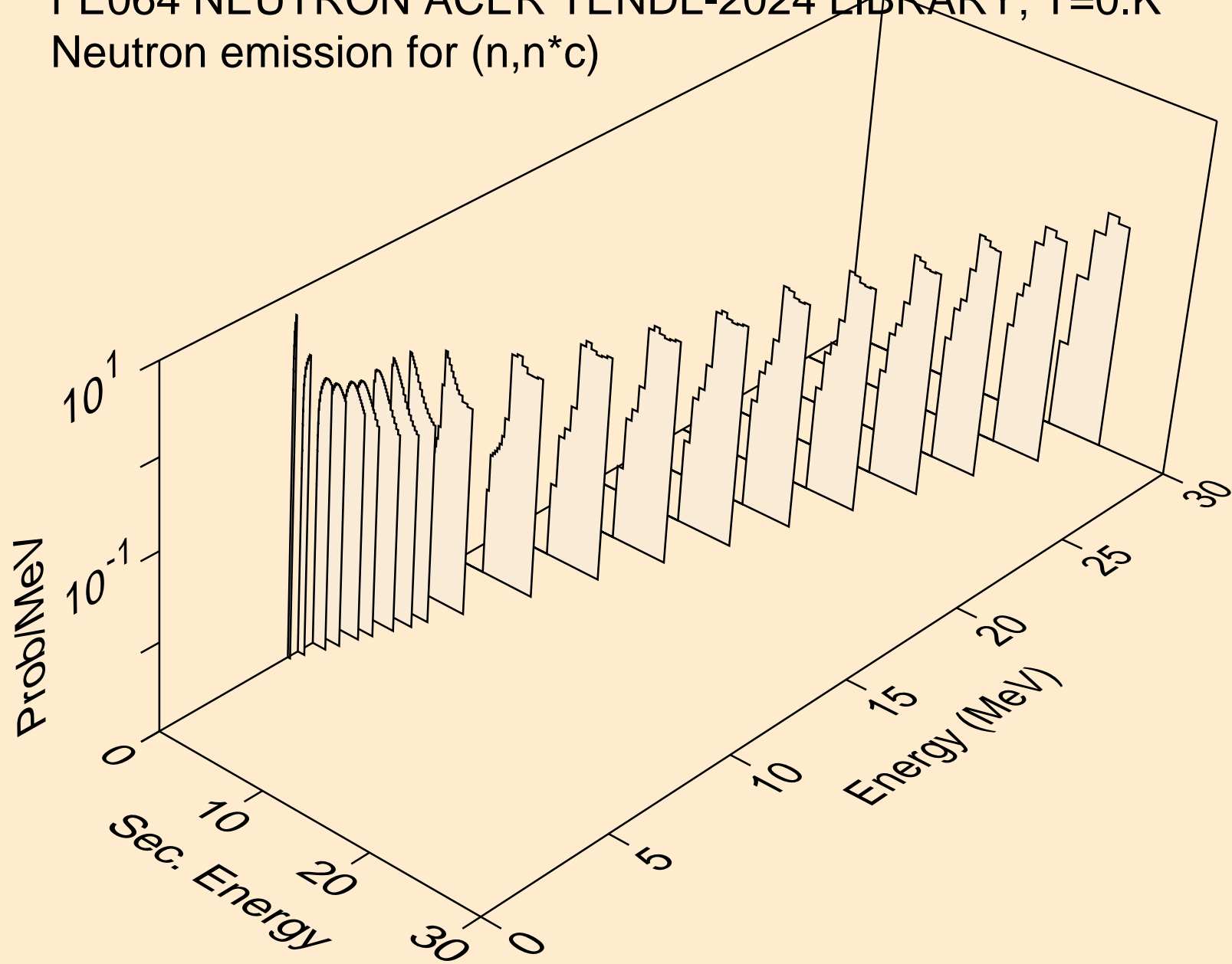

FE064 NEUTRON ACER TENDL-2024 LIBRARY; T=0.K  
Photon emission for (n,x)

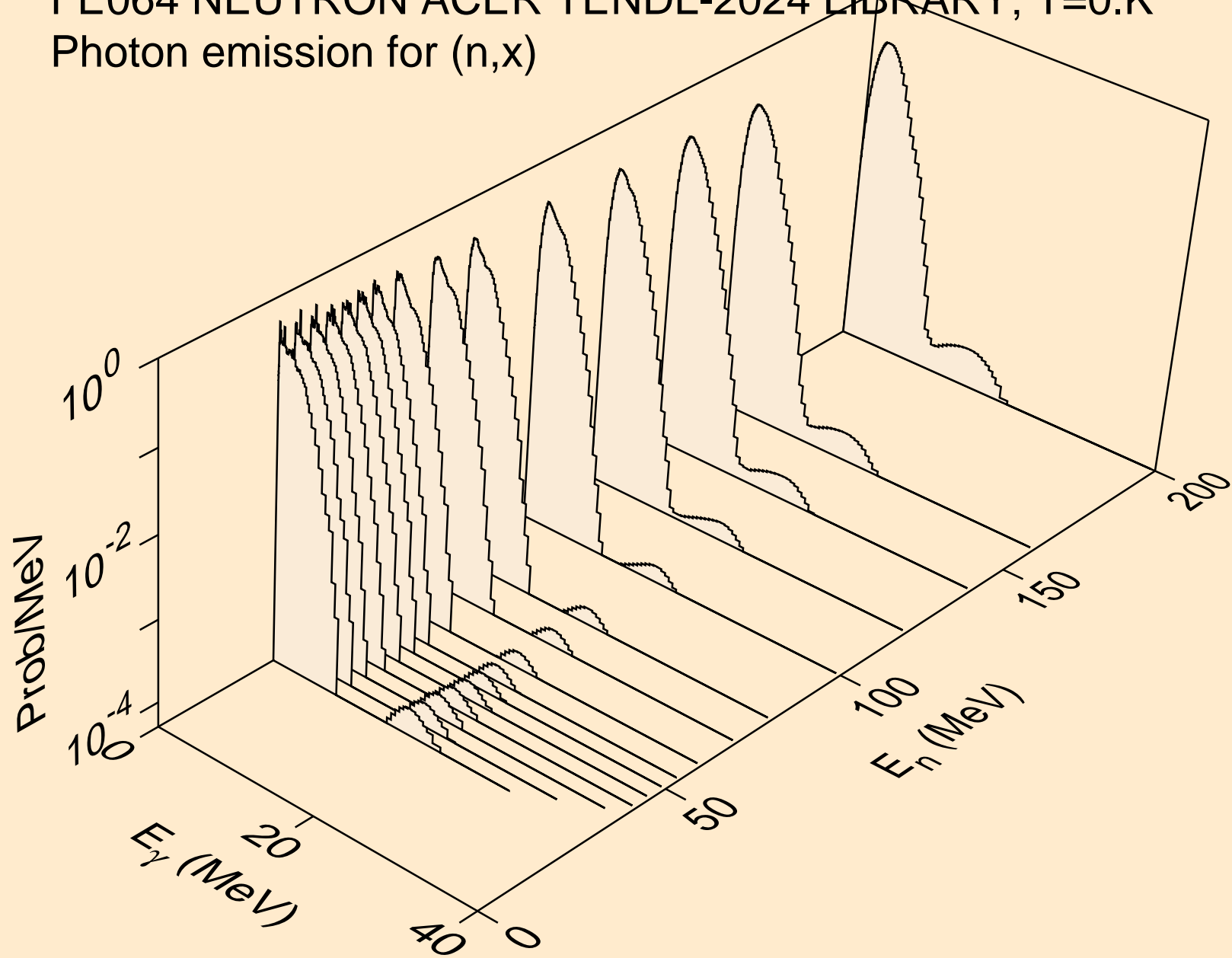

FE064 NEUTRON ACER TENDL-2024 LIBRARY; T=0.K  
Photon emission for (n,2nd)

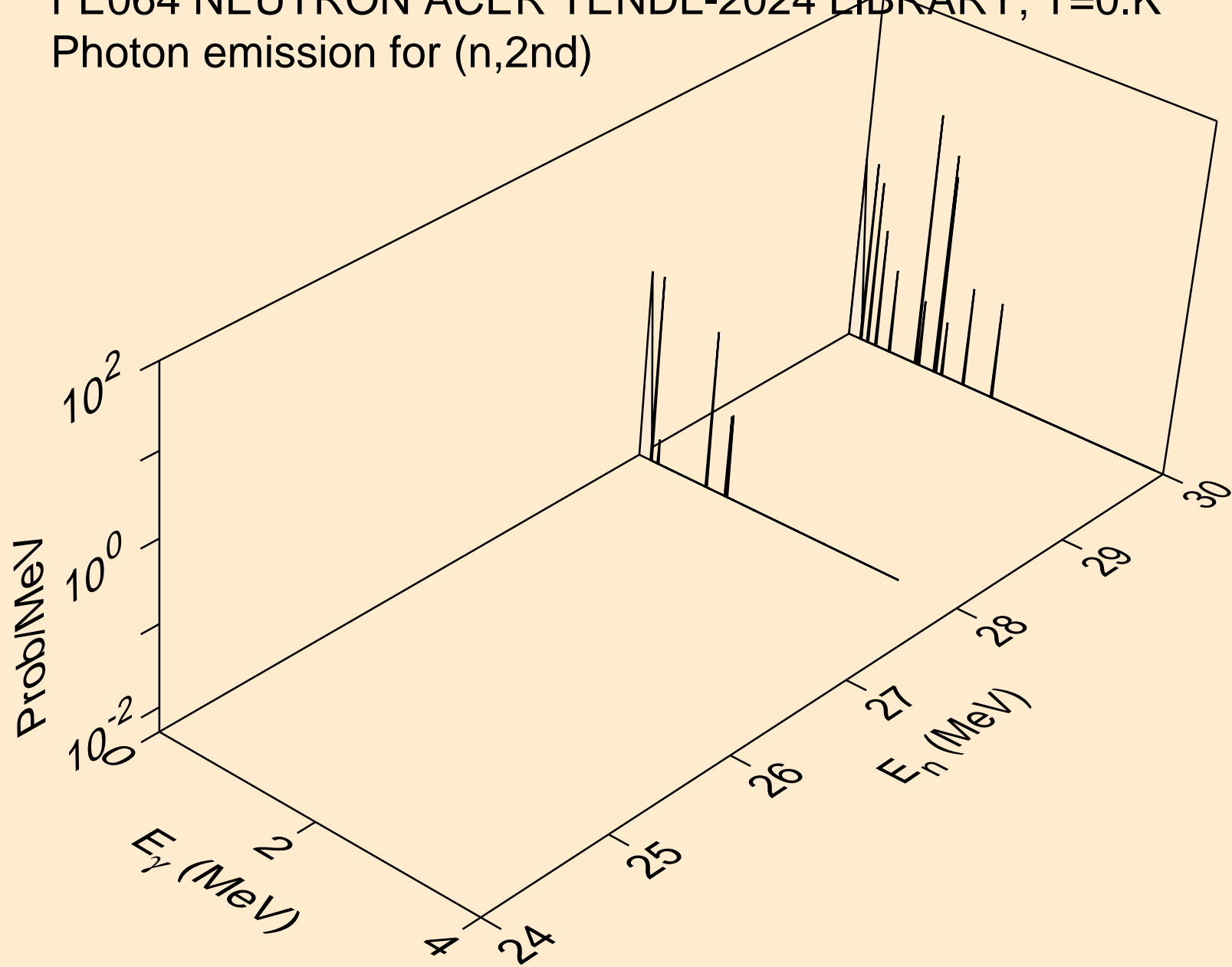

FE064 NEUTRON ACER TENDL-2024 LIBRARY; T=0.K  
Photon emission for (n,2n)

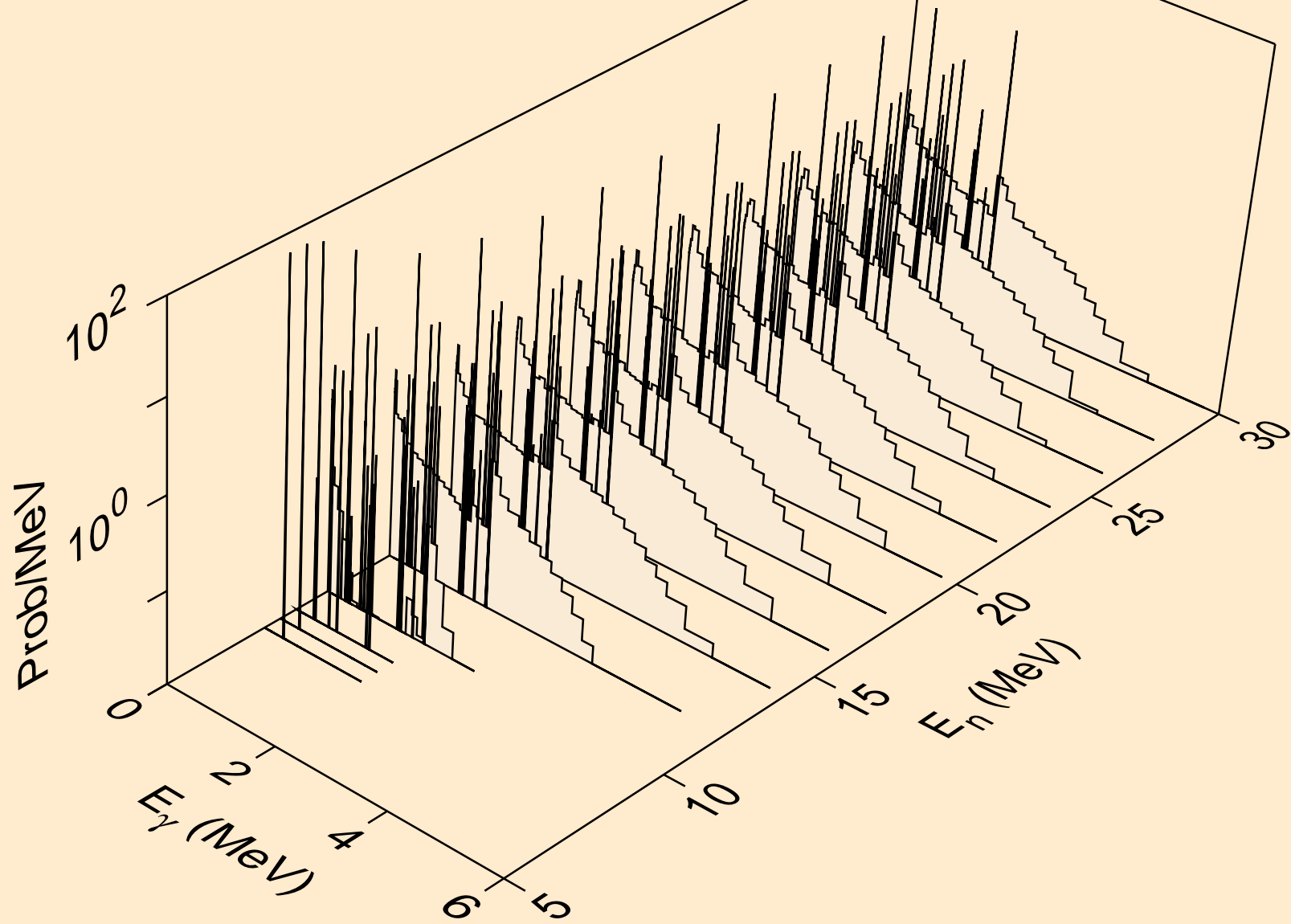

FE064 NEUTRON ACER TENDL-2024 LIBRARY; T=0.K  
Photon emission for (n,3n)

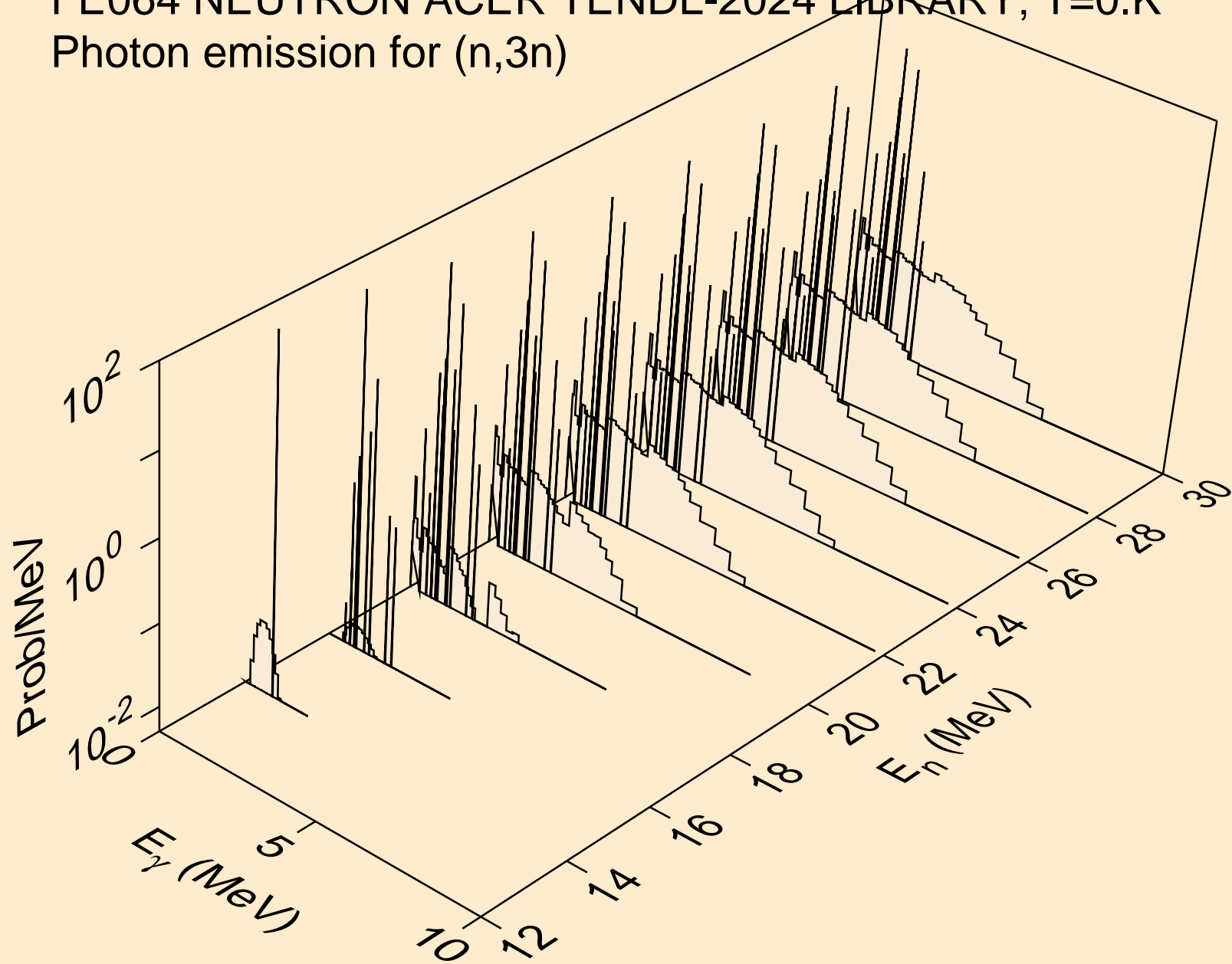

FE064 NEUTRON ACER TENDL-2024 LIBRARY; T=0.K  
Photon emission for (n,n\*)a

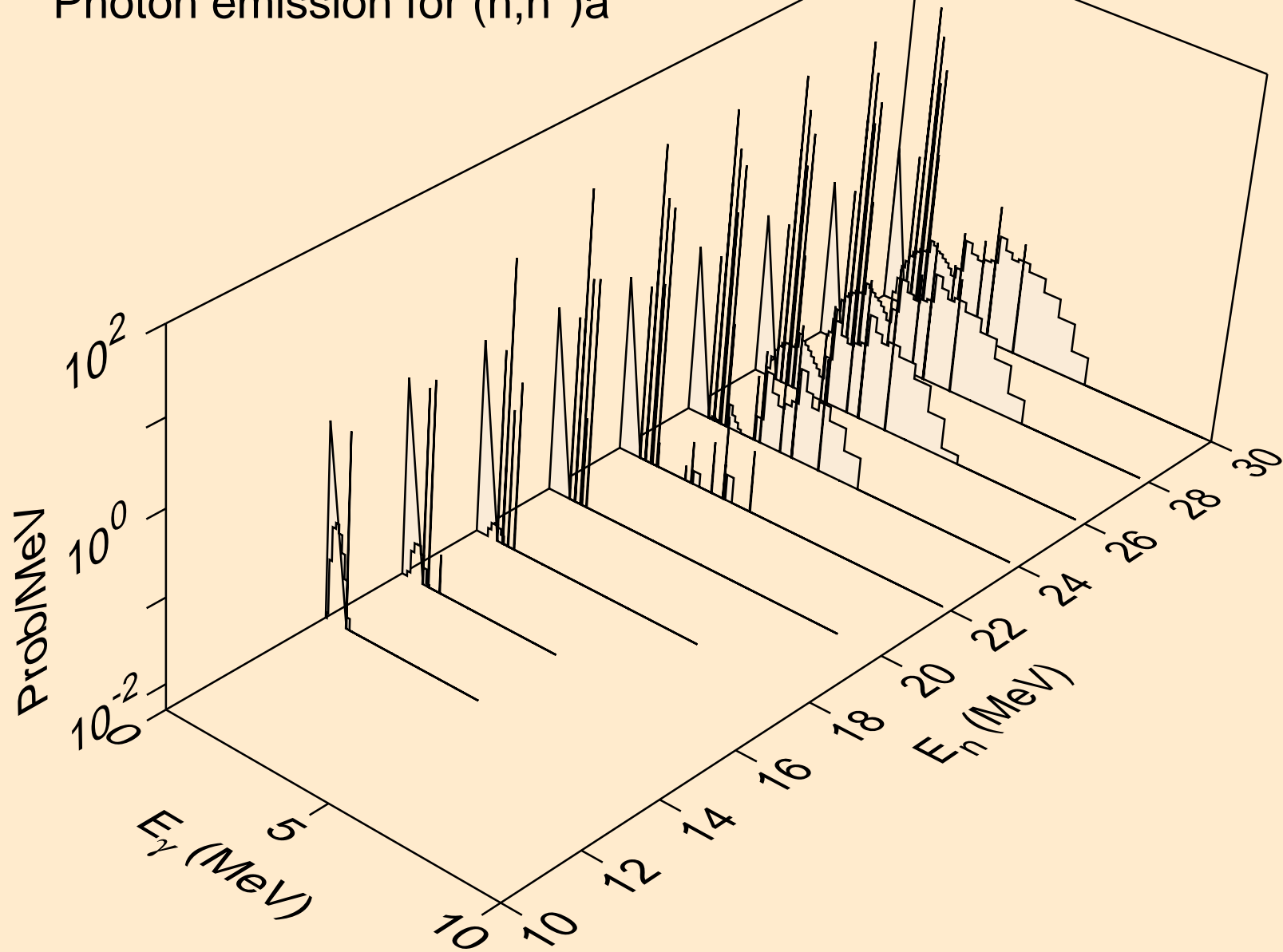

FE064 NEUTRON ACER TENDL-2024 LIBRARY; T=0.K  
Photon emission for (n,2n)a

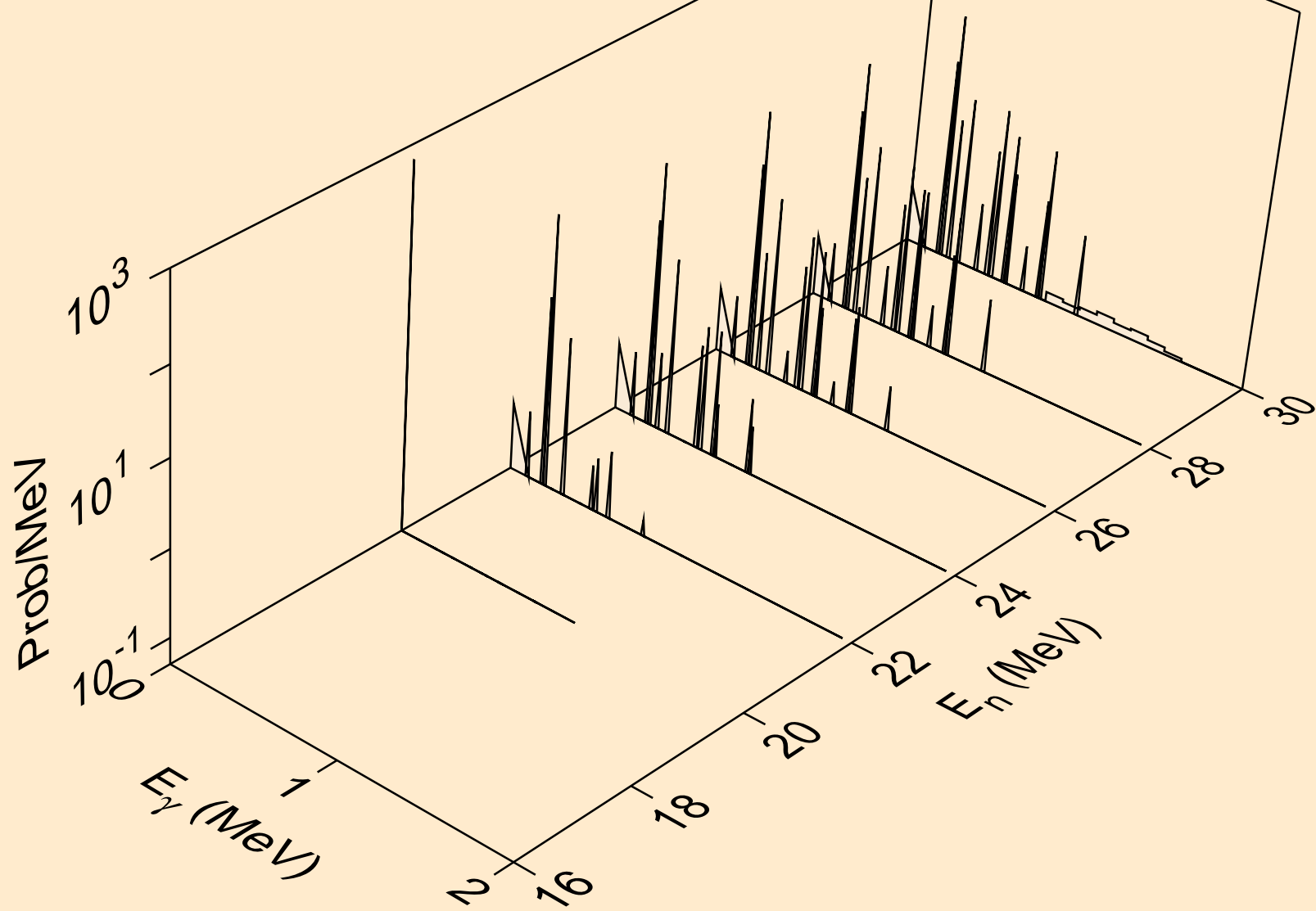

FE064 NEUTRON ACER TENDL-2024 LIBRARY; T=0.K  
Photon emission for (n,3n)a

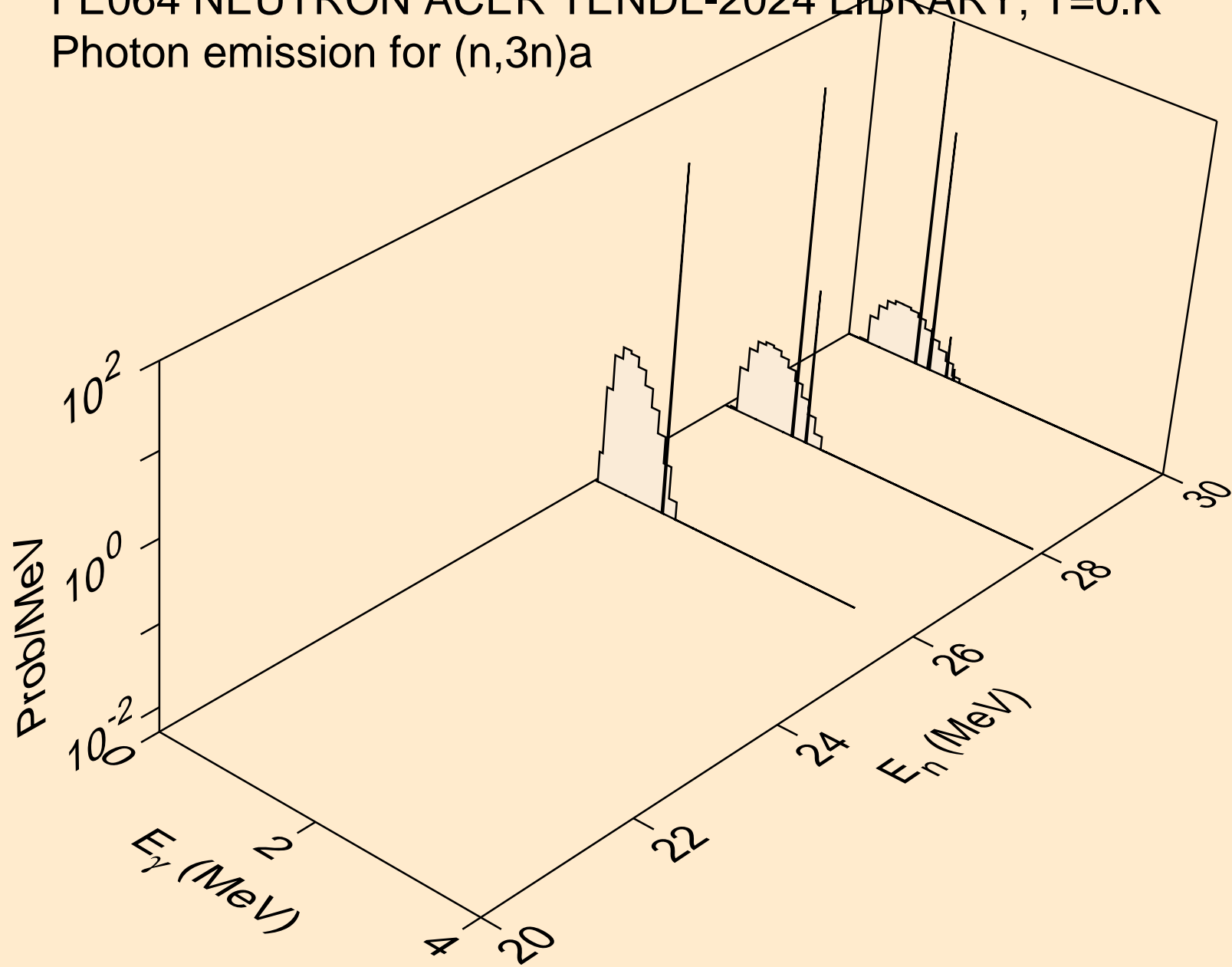

FE064 NEUTRON ACER TENDL-2024 LIBRARY; T=0.K  
Photon emission for (n,n\*)p

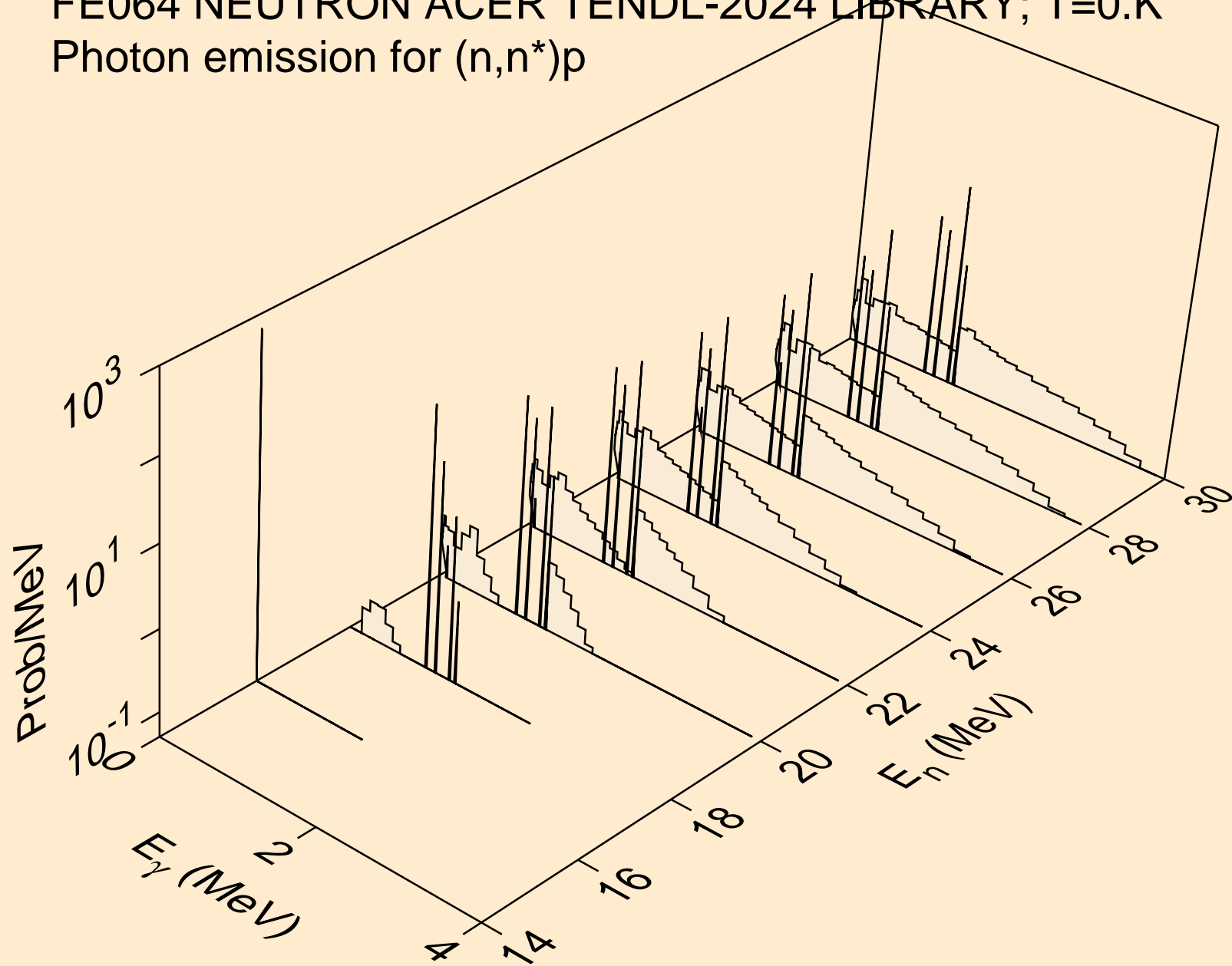

FE064 NEUTRON ACER TENDL-2024 LIBRARY; T=0.K  
Photon emission for (n,n\*)d

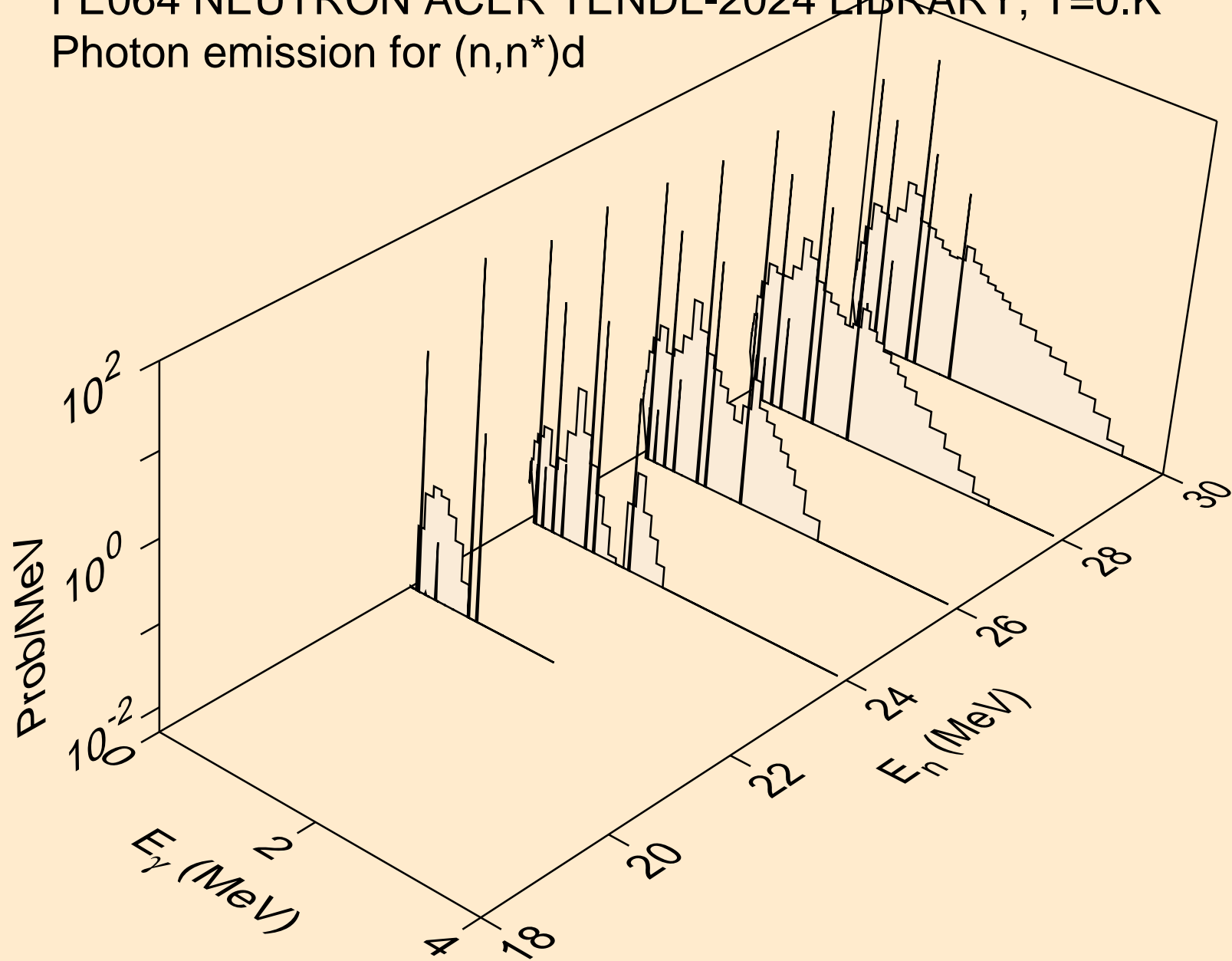

FE064 NEUTRON ACER TENDL-2024 LIBRARY; T=0.K  
Photon emission for (n,n\*)t

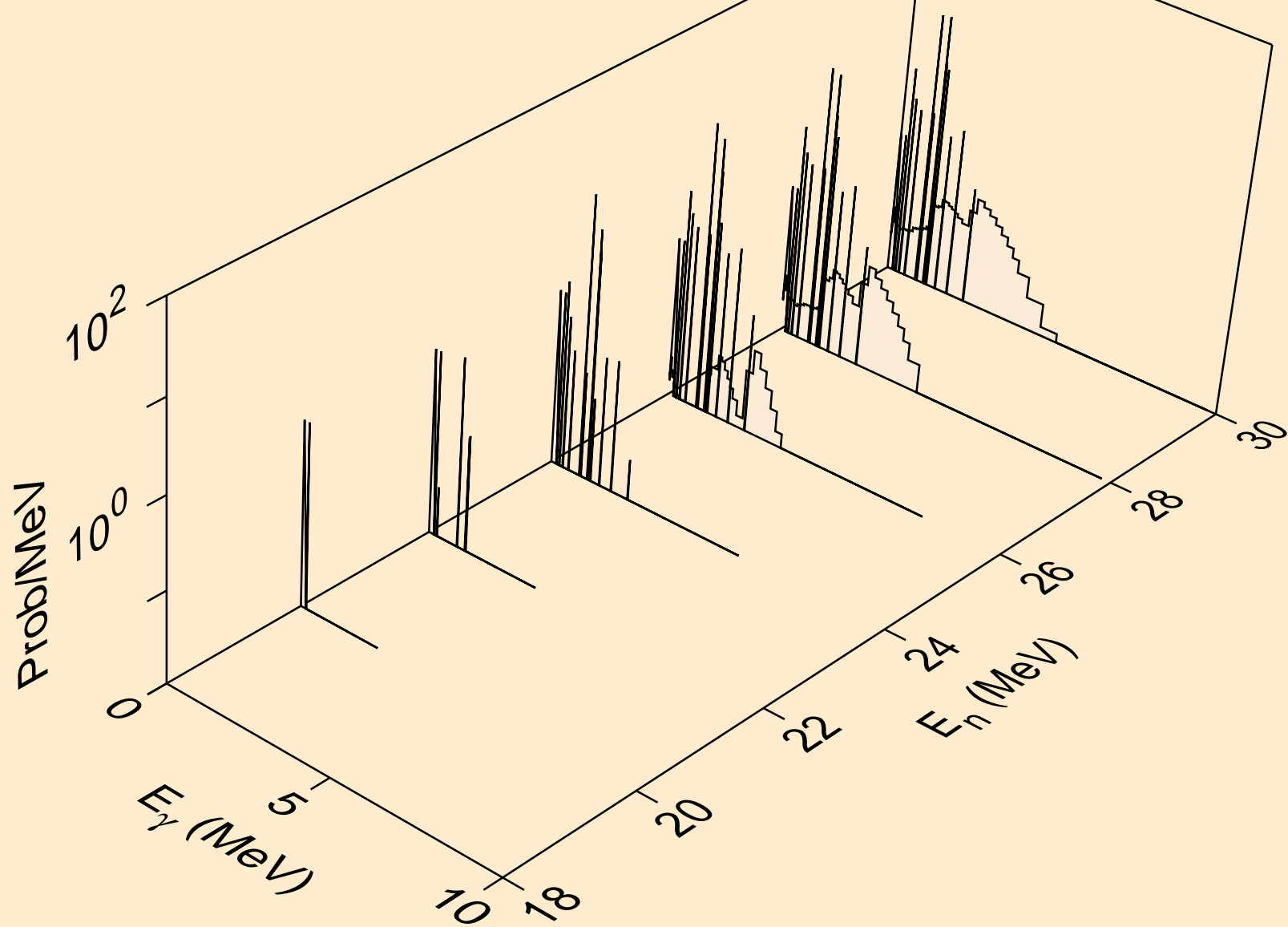

FE064 NEUTRON ACER TENDL-2024 LIBRARY; T=0.K  
Photon emission for (n,4n)

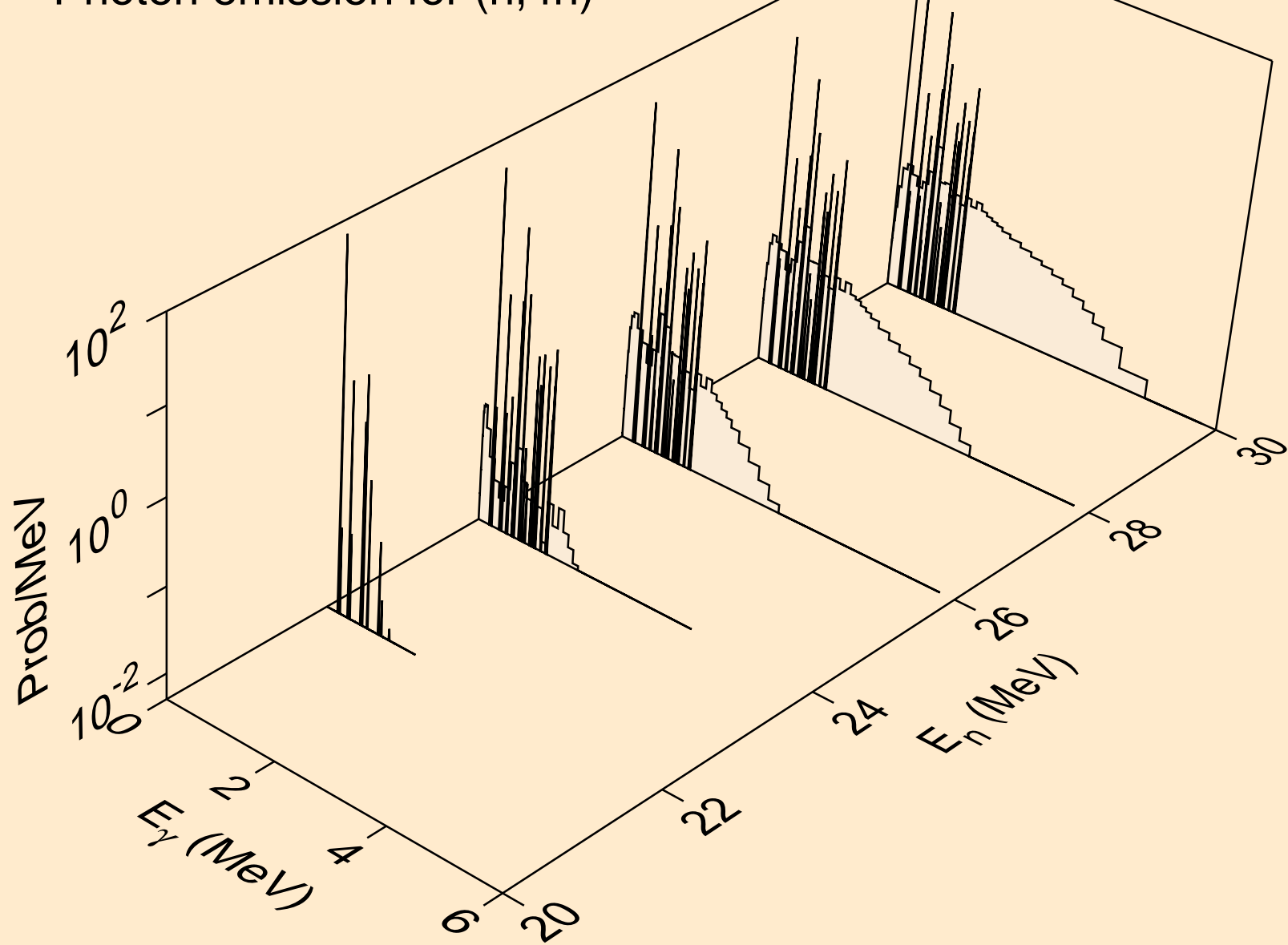

FE064 NEUTRON ACER TENDL-2024 LIBRARY; T=0.K  
Photon emission for (n,2np)

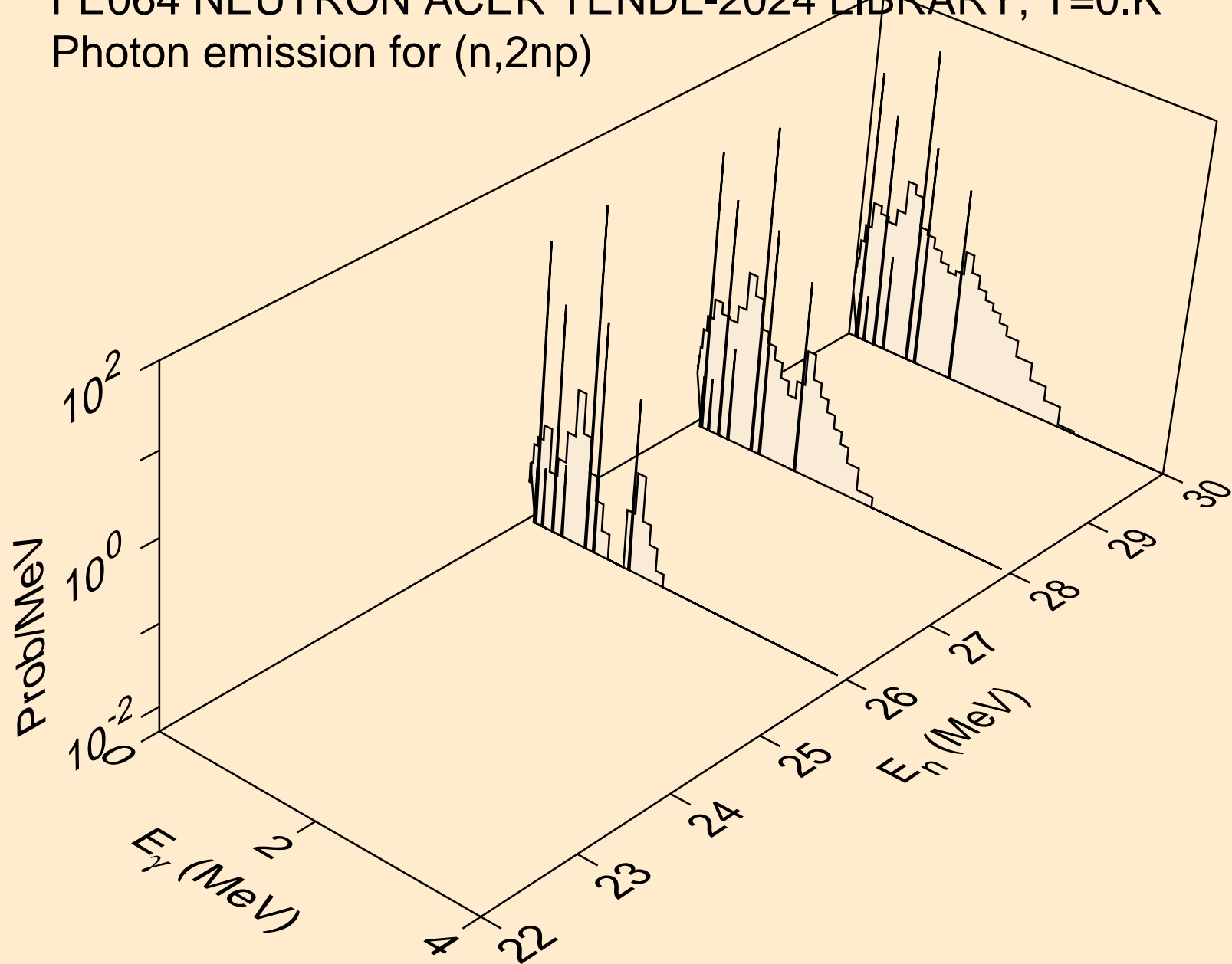

FE064 NEUTRON ACER TENDL-2024 LIBRARY; T=0.K  
Photon emission for (n,3np)

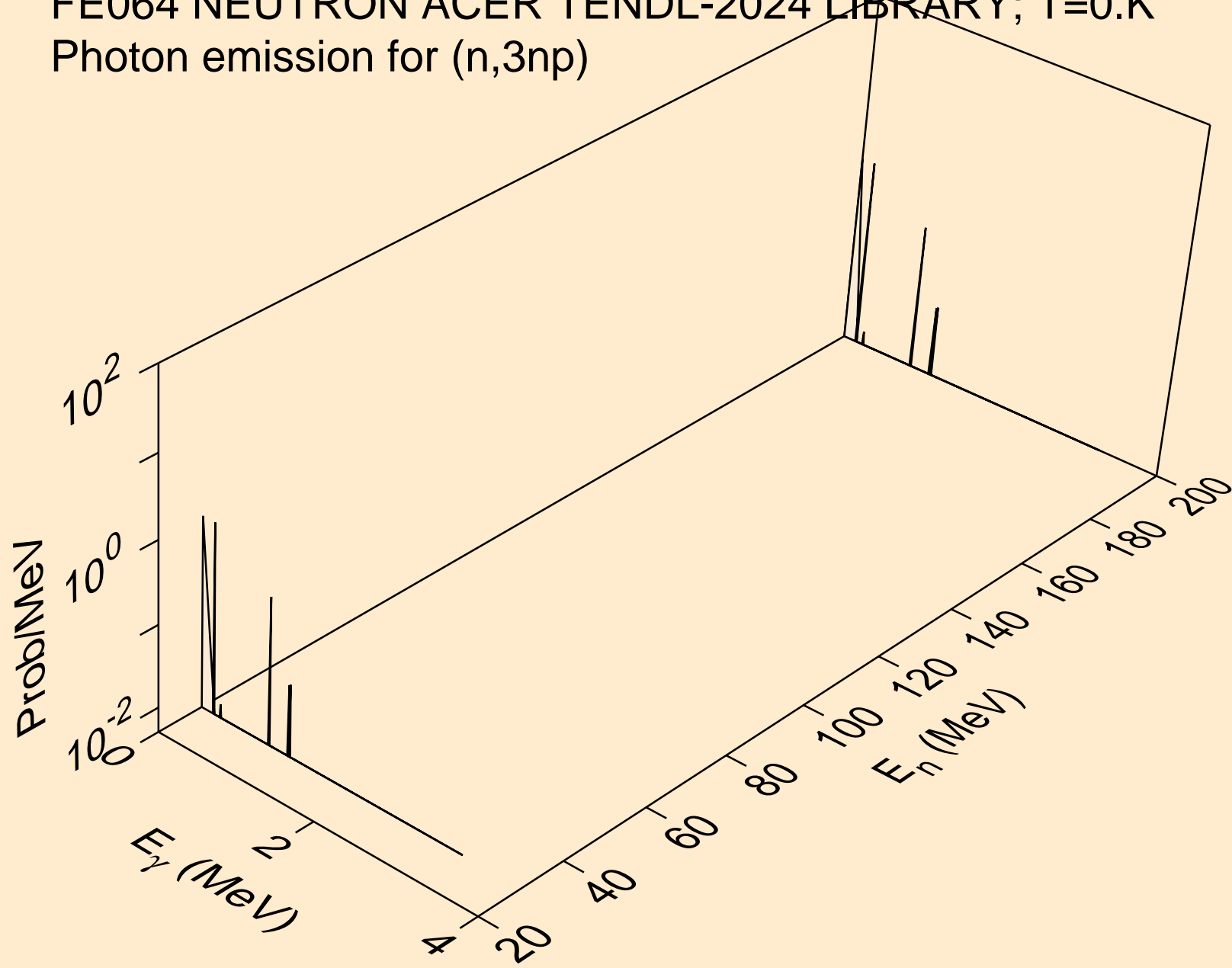

FE064 NEUTRON ACER TENDL-2024 LIBRARY; T=0.K  
Photon emission for (n,n\*c)

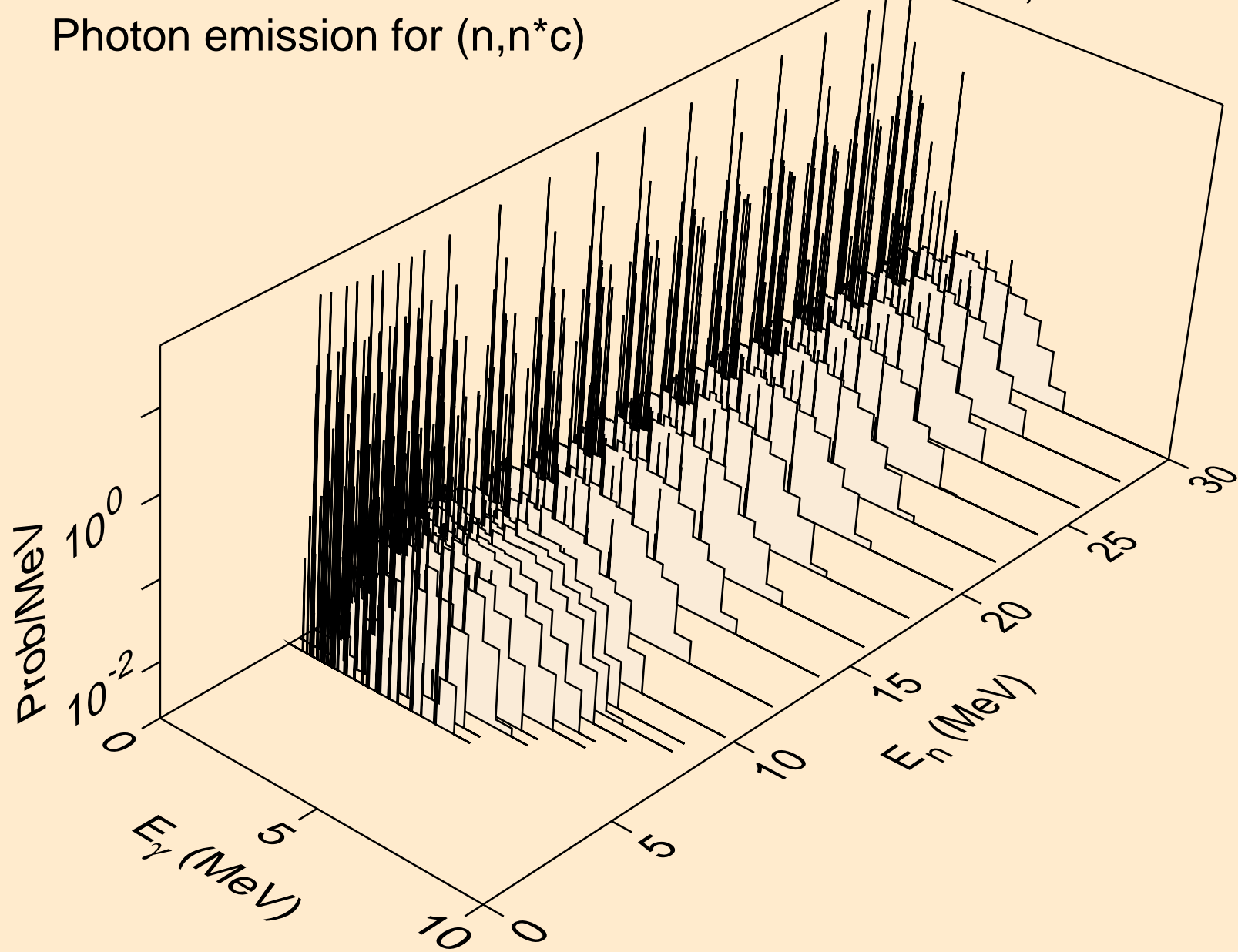

FE064 NEUTRON ACER TENDL-2024 LIBRARY; T=0.K  
Photon emission for (n,gma)

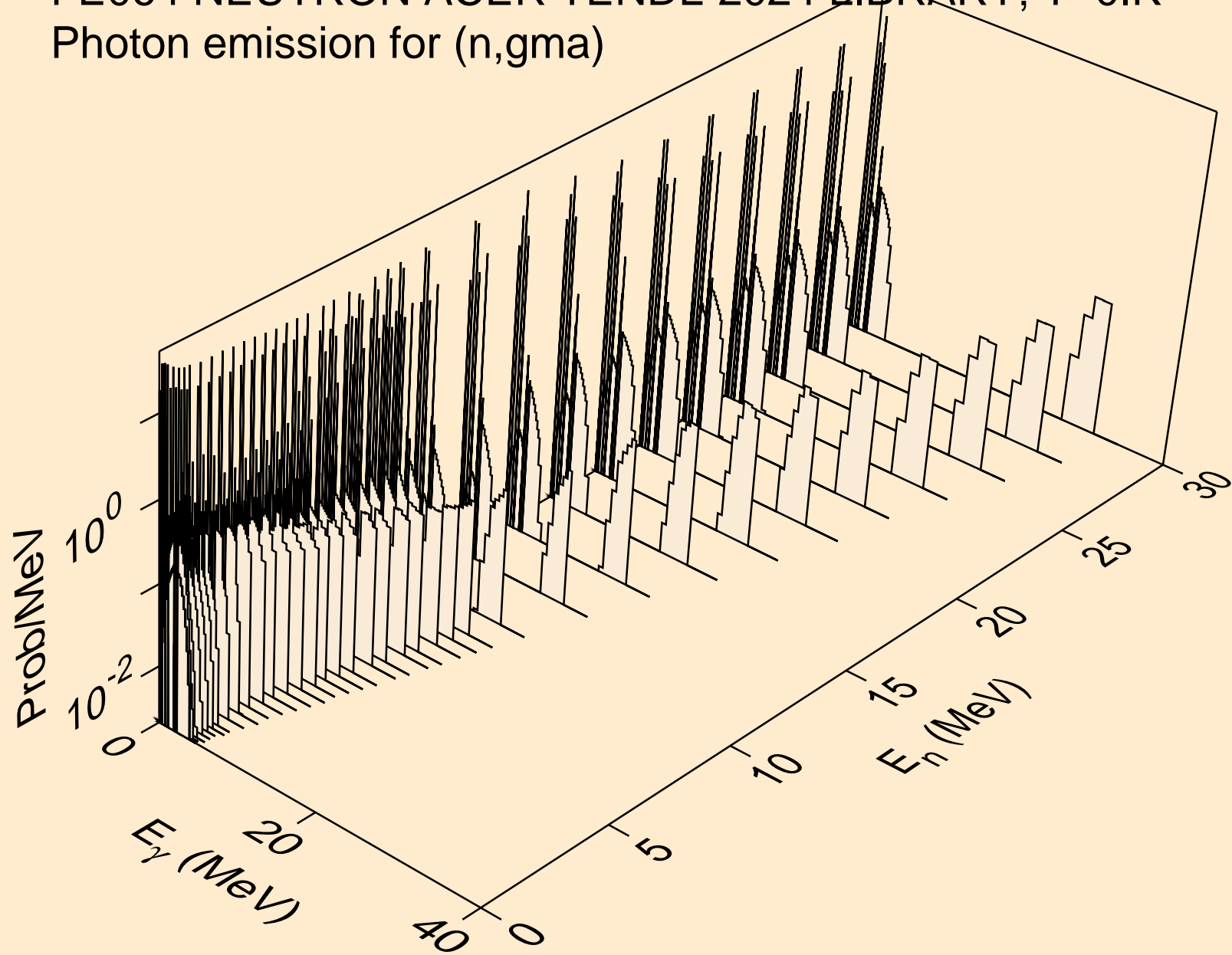

FE064 NEUTRON ACER TENDL-2024 LIBRARY; T=0.K  
Photon emission for (n,p)

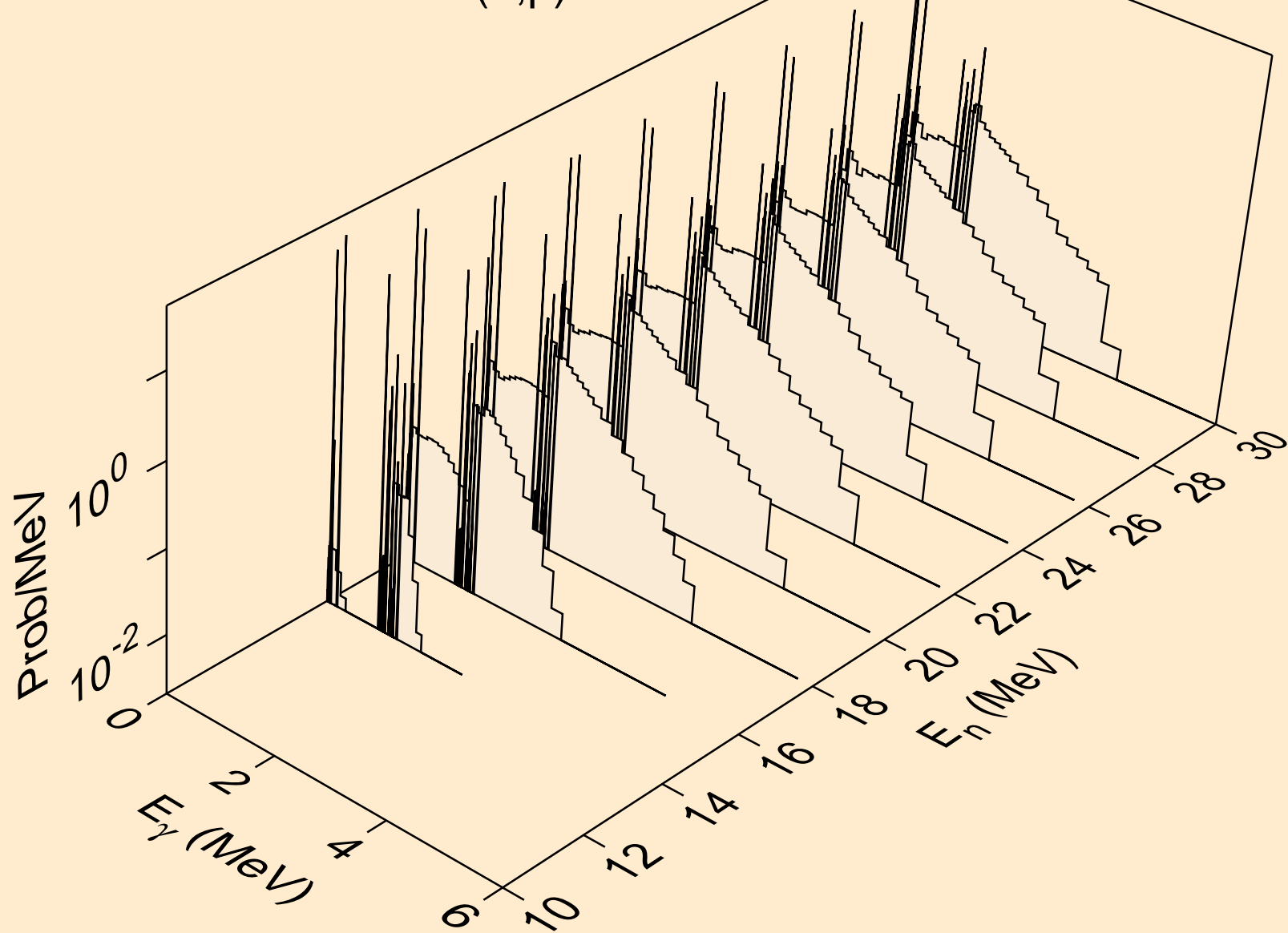

FE064 NEUTRON ACER TENDL-2024 LIBRARY; T=0.K  
Photon emission for (n,d)

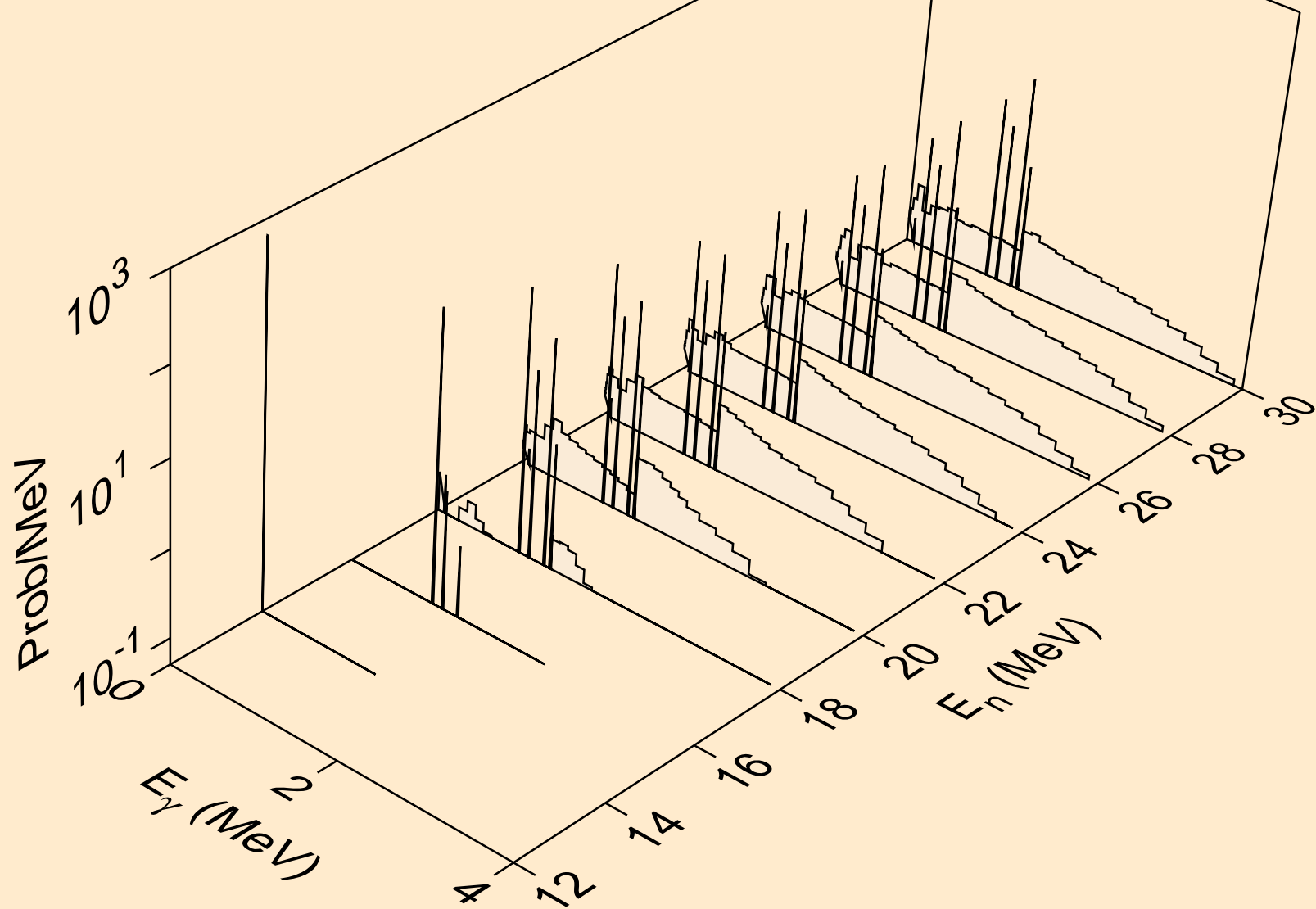

FE064 NEUTRON ACER TENDL-2024 LIBRARY; T=0.K  
Photon emission for (n,t)

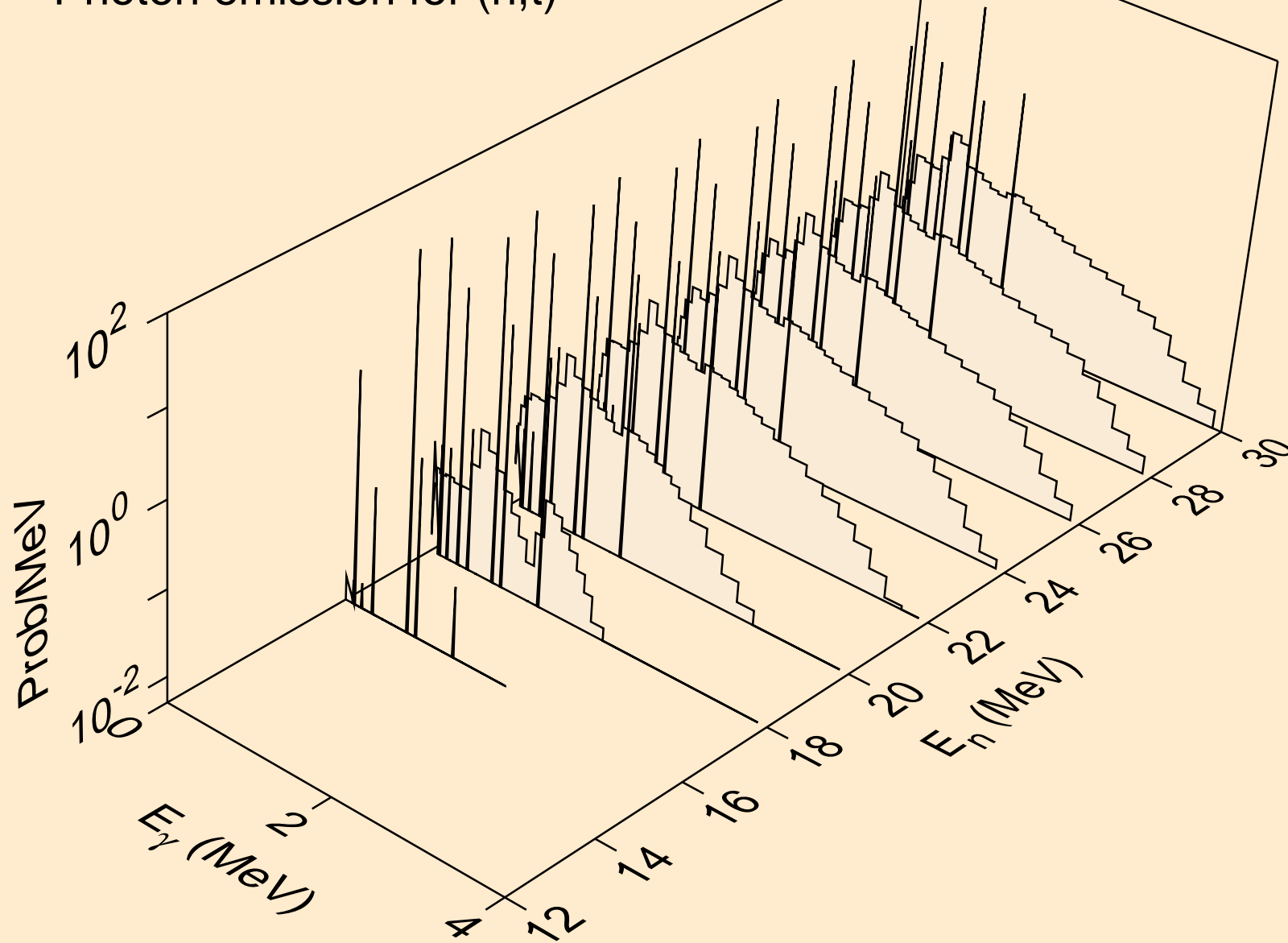

FE064 NEUTRON ACER TENDL-2024 LIBRARY; T=0.K  
Photon emission for (n,he3)

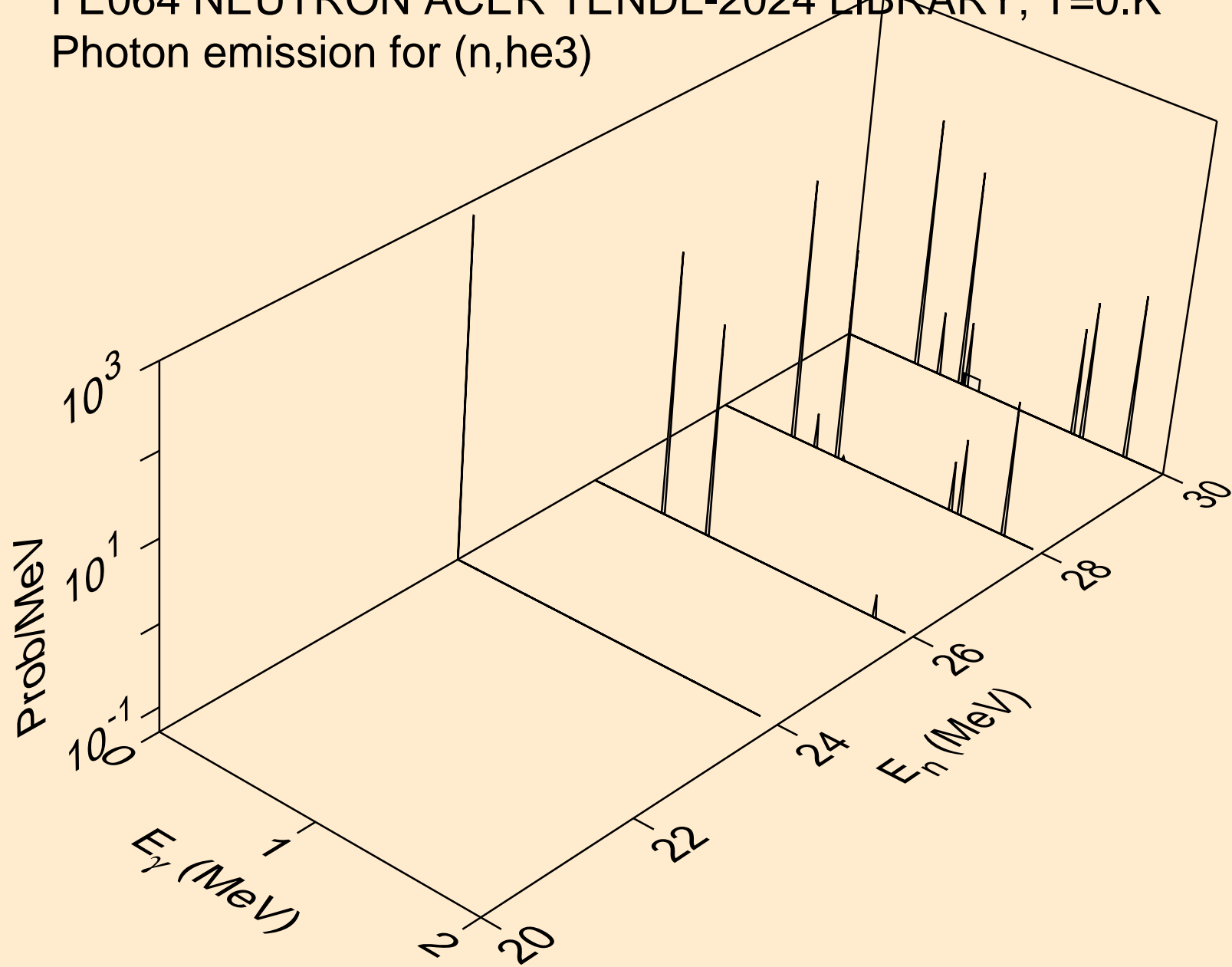

FE064 NEUTRON ACER TENDL-2024 LIBRARY; T=0.K  
Photon emission for (n,a)

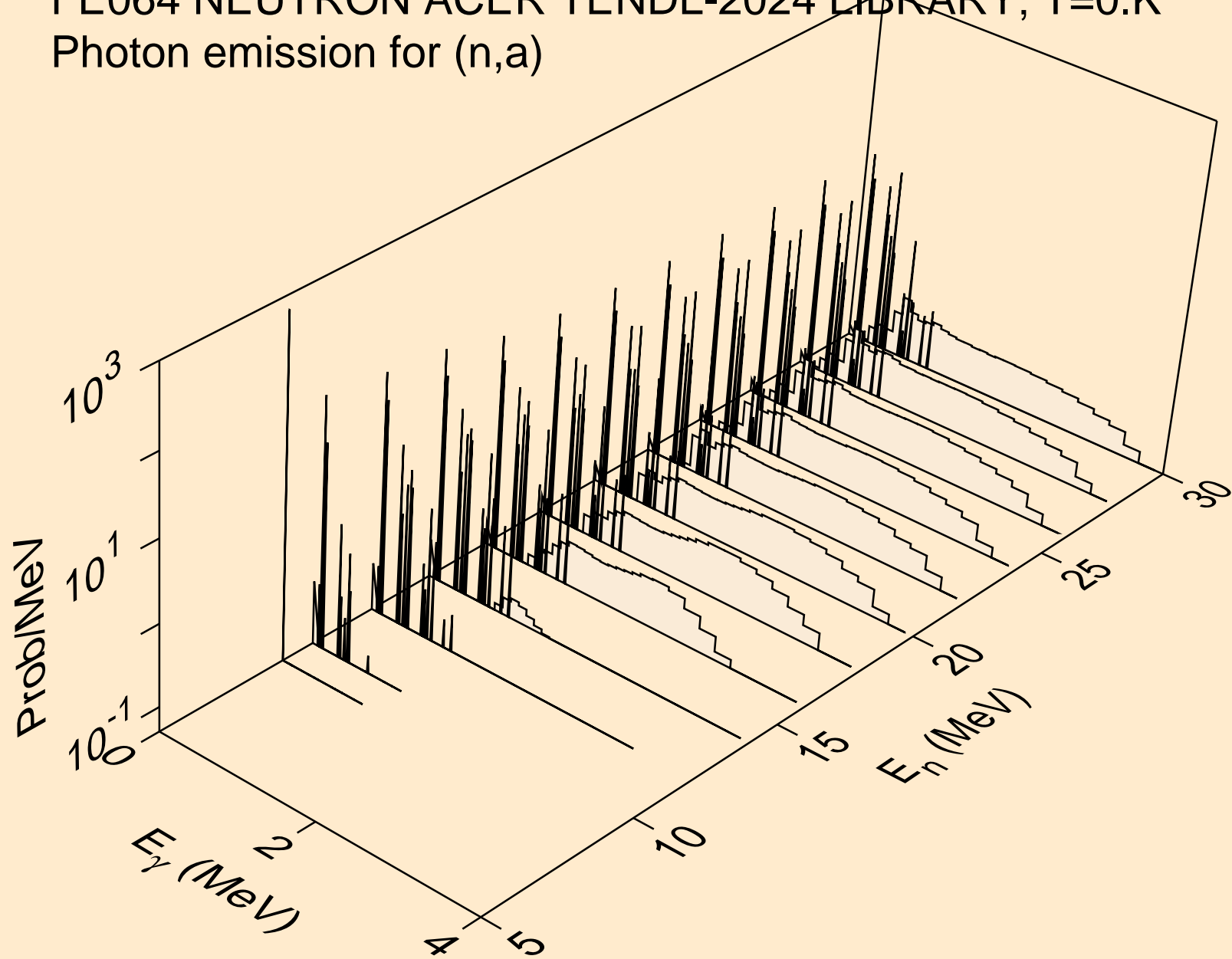

FE064 NEUTRON ACER TENDL-2024 LIBRARY; T=0.K  
thermal capture photon spectrum

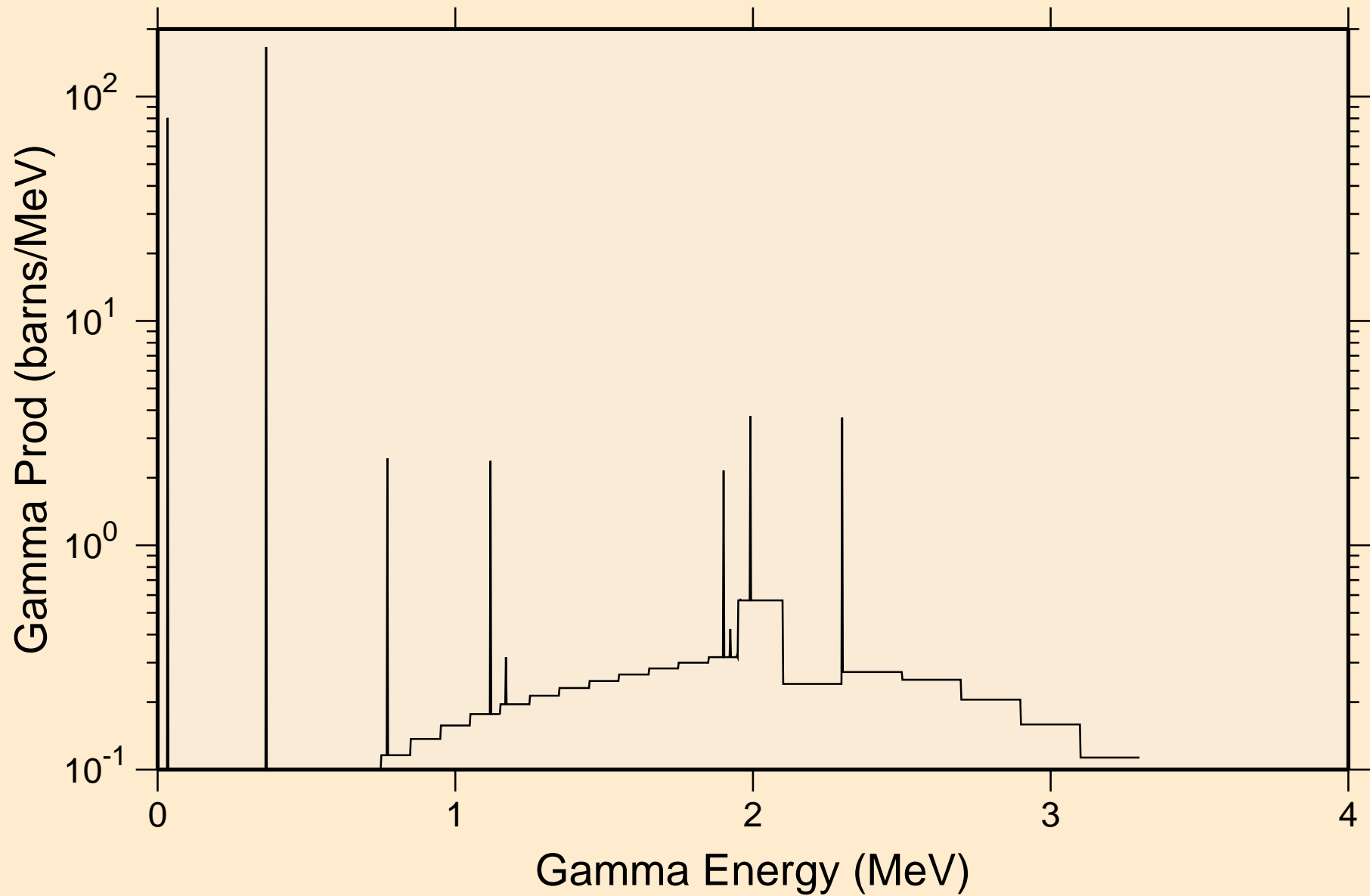

FE064 NEUTRON ACER TENDL-2024 LIBRARY; T=0.K  
14 MeV photon spectrum

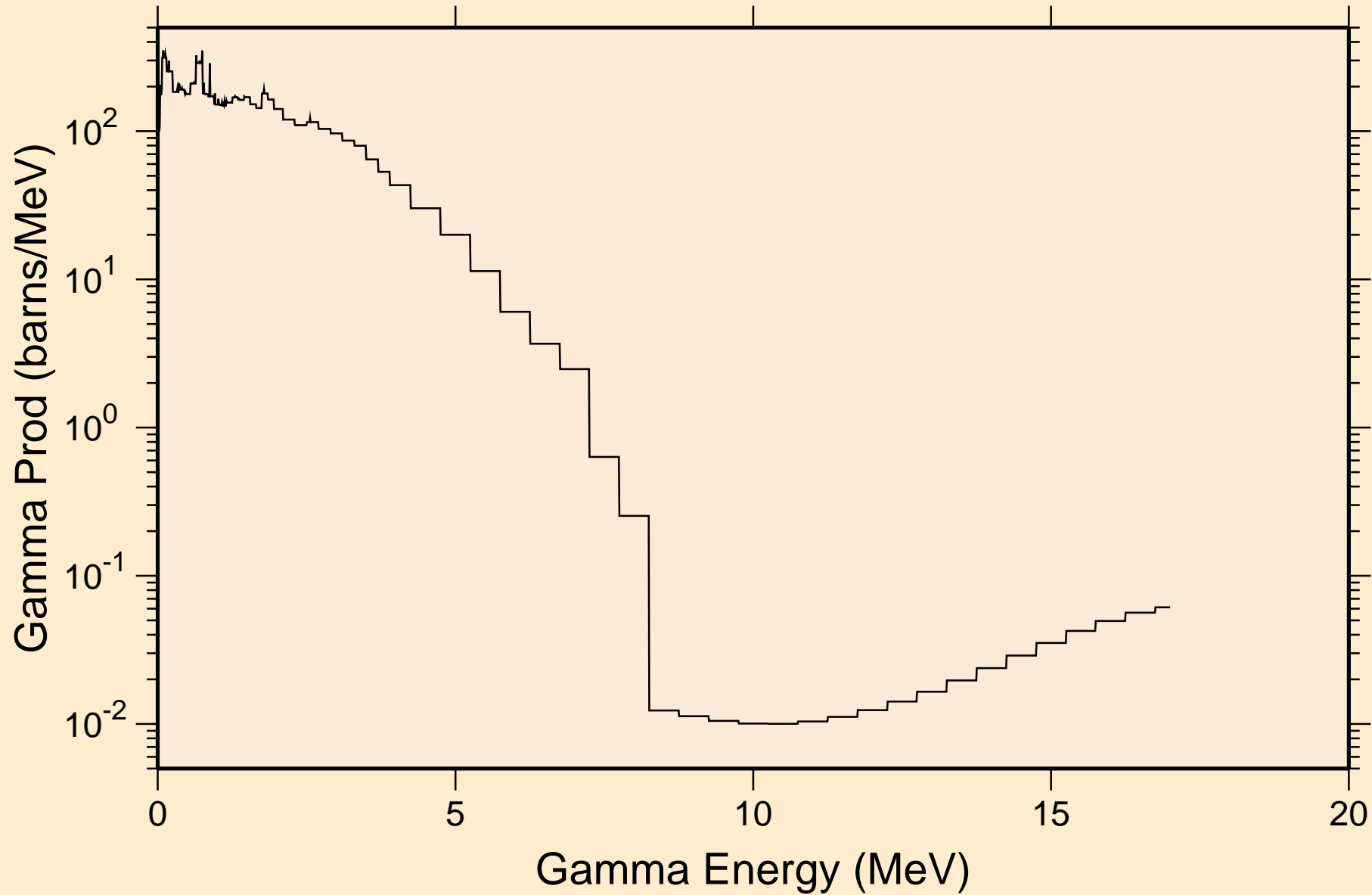

# FE064 NEUTRON ACER TENDL-2024 LIBRARY; T=0.K

## Particle heating contributions

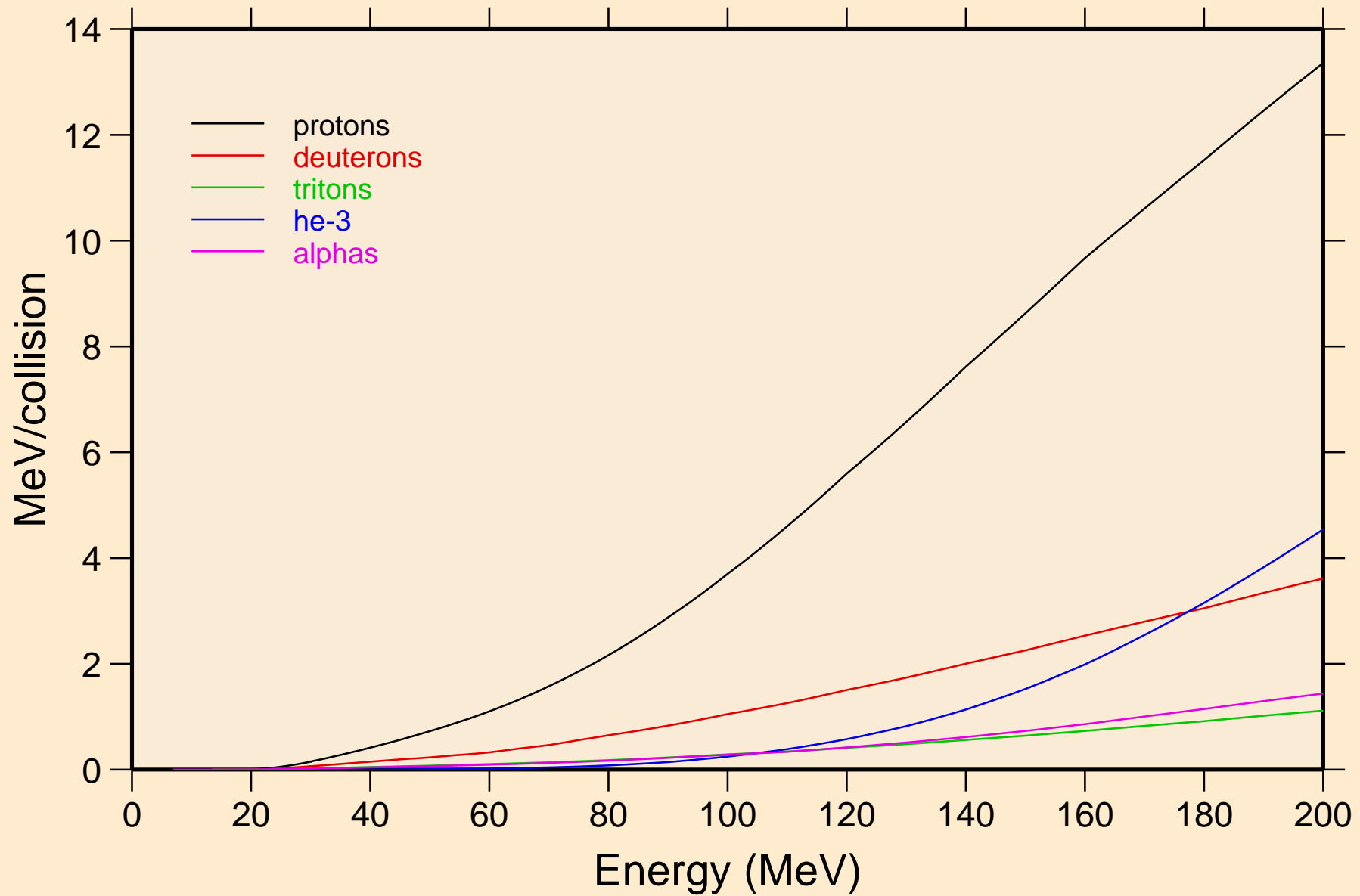

FE064 NEUTRON ACER TENDL-2024 LIBRARY; T=0.K  
Recoil Heating

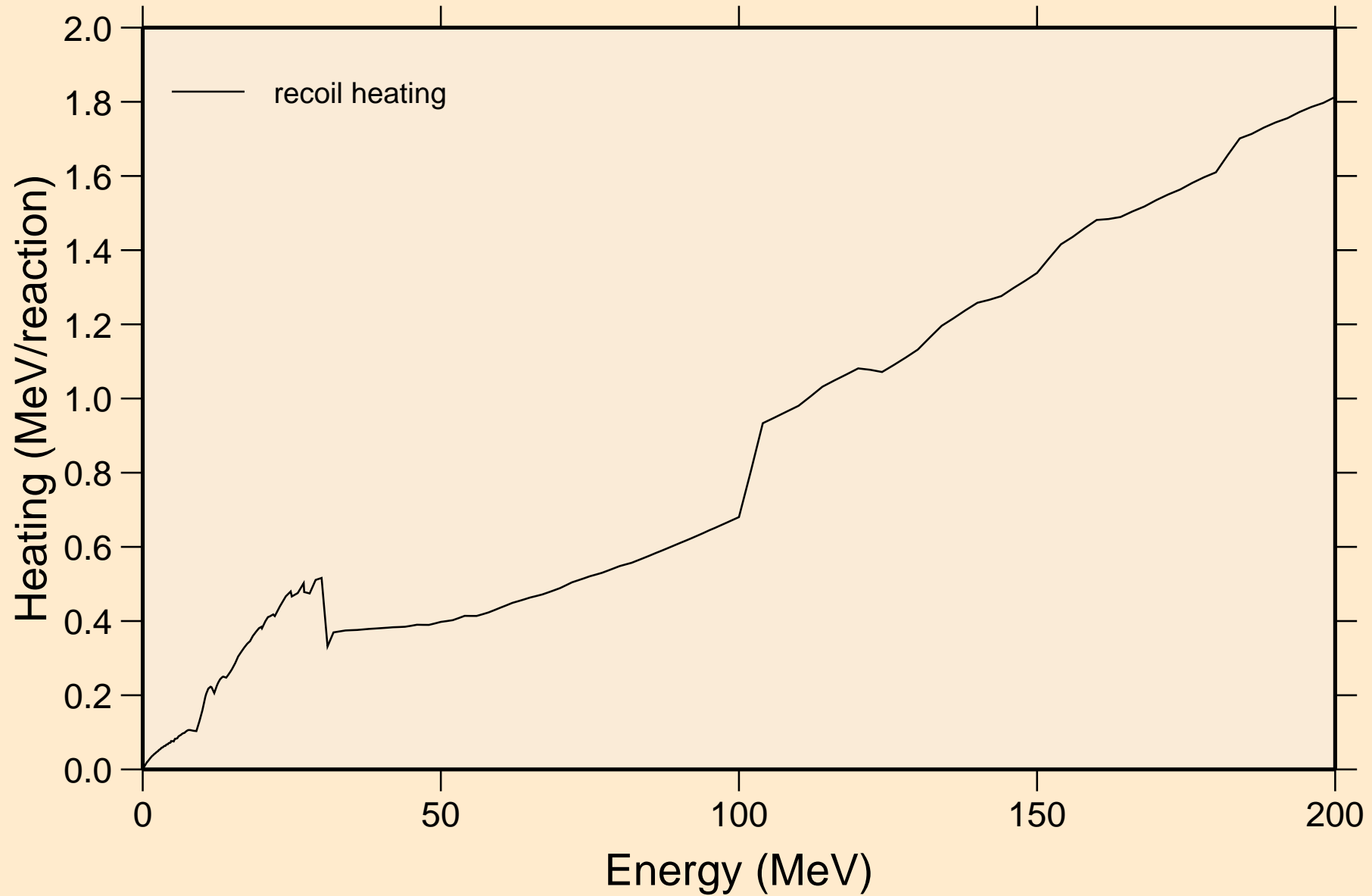

FE064 NEUTRON ACER TENDL-2024 LIBRARY; T=0.K  
Particle production cross sections

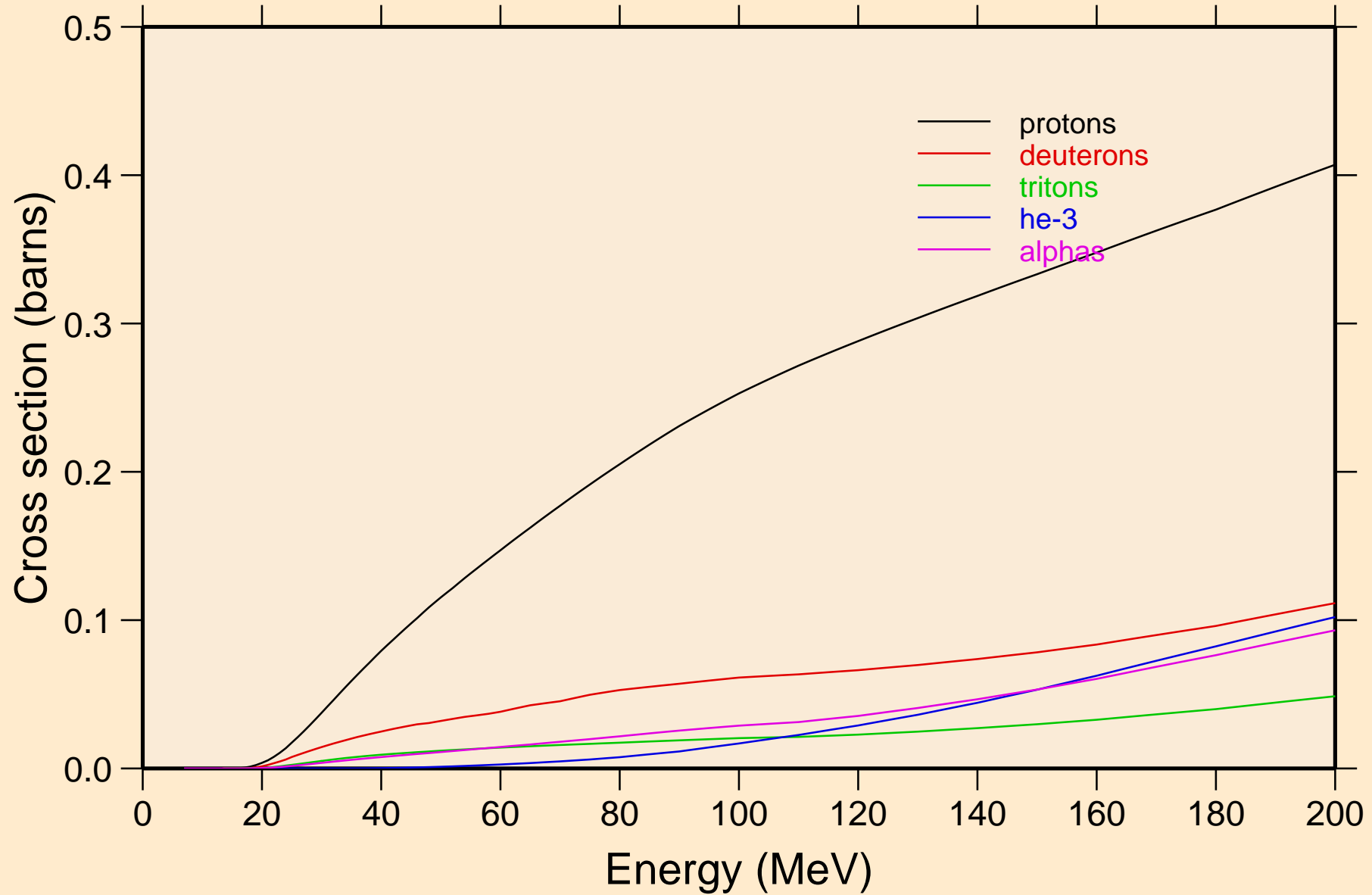

FE064 NEUTRON ACER TENDL-2024 LIBRARY; T=0.K  
protons from (n,x)

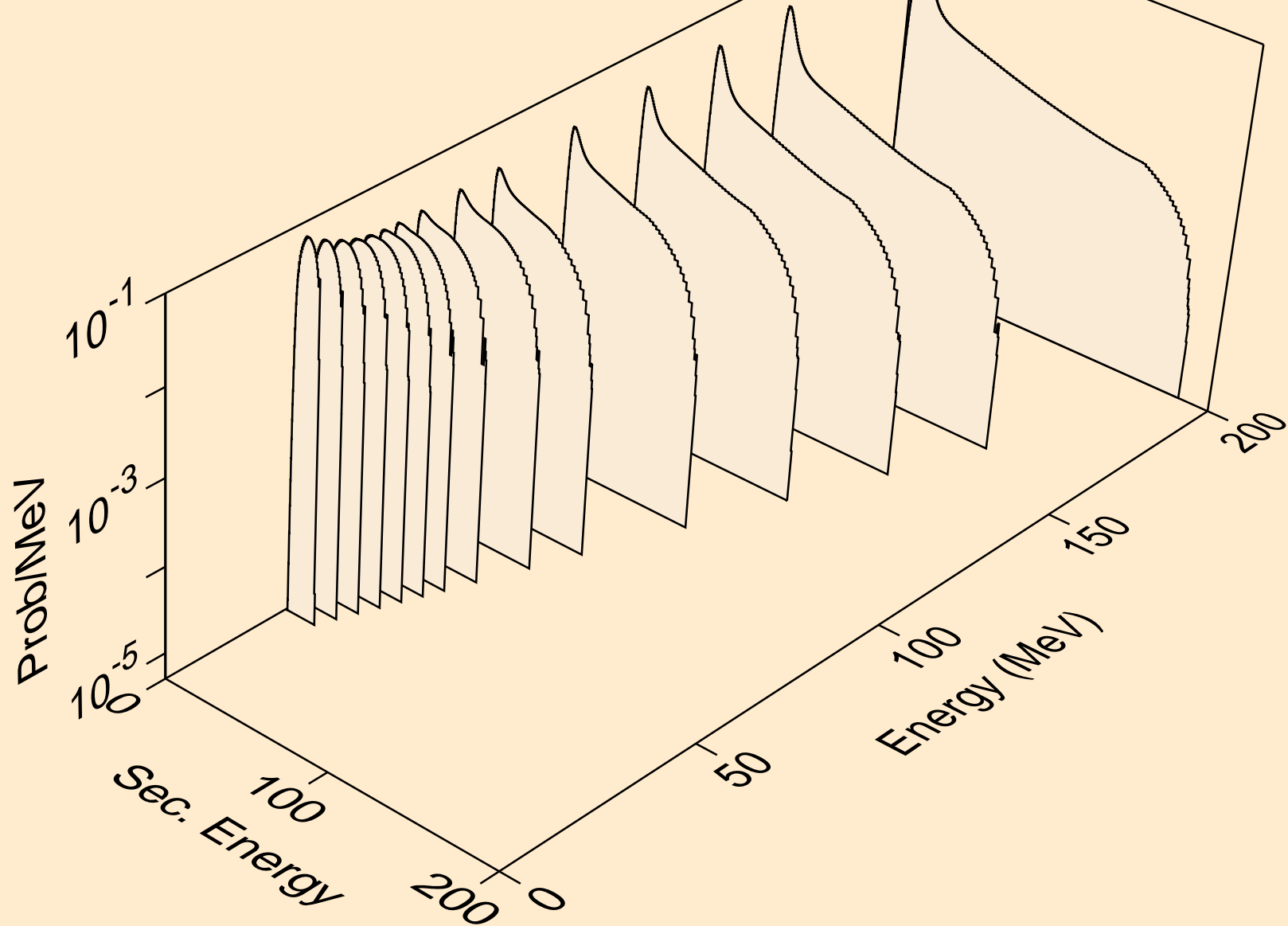

FE064 NEUTRON ACER TENDL-2024 LIBRARY; T=0.K  
protons from (n,n\*)p

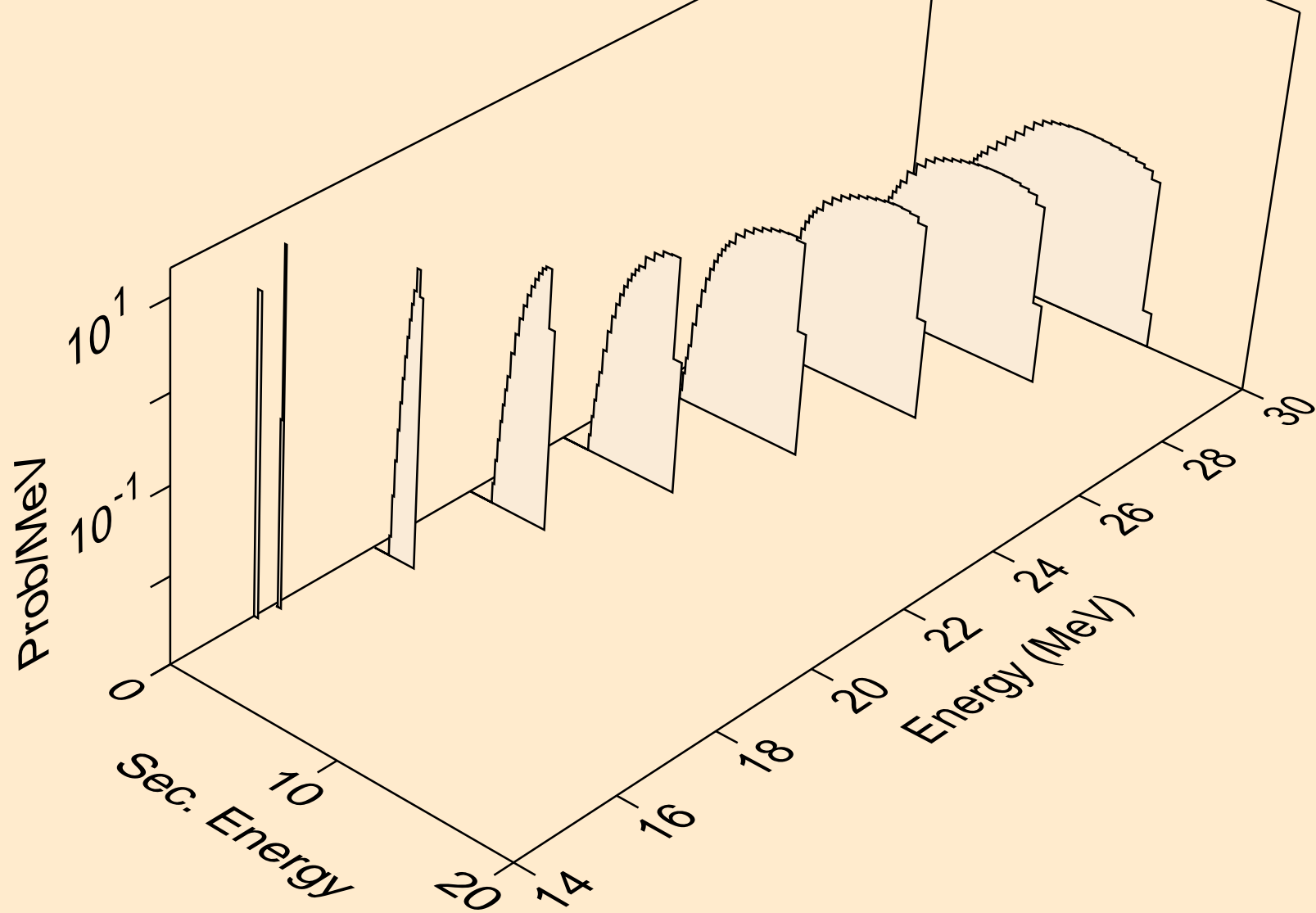

FE064 NEUTRON ACER TENDL-2024 LIBRARY; T=0.K  
protons from (n,2np)

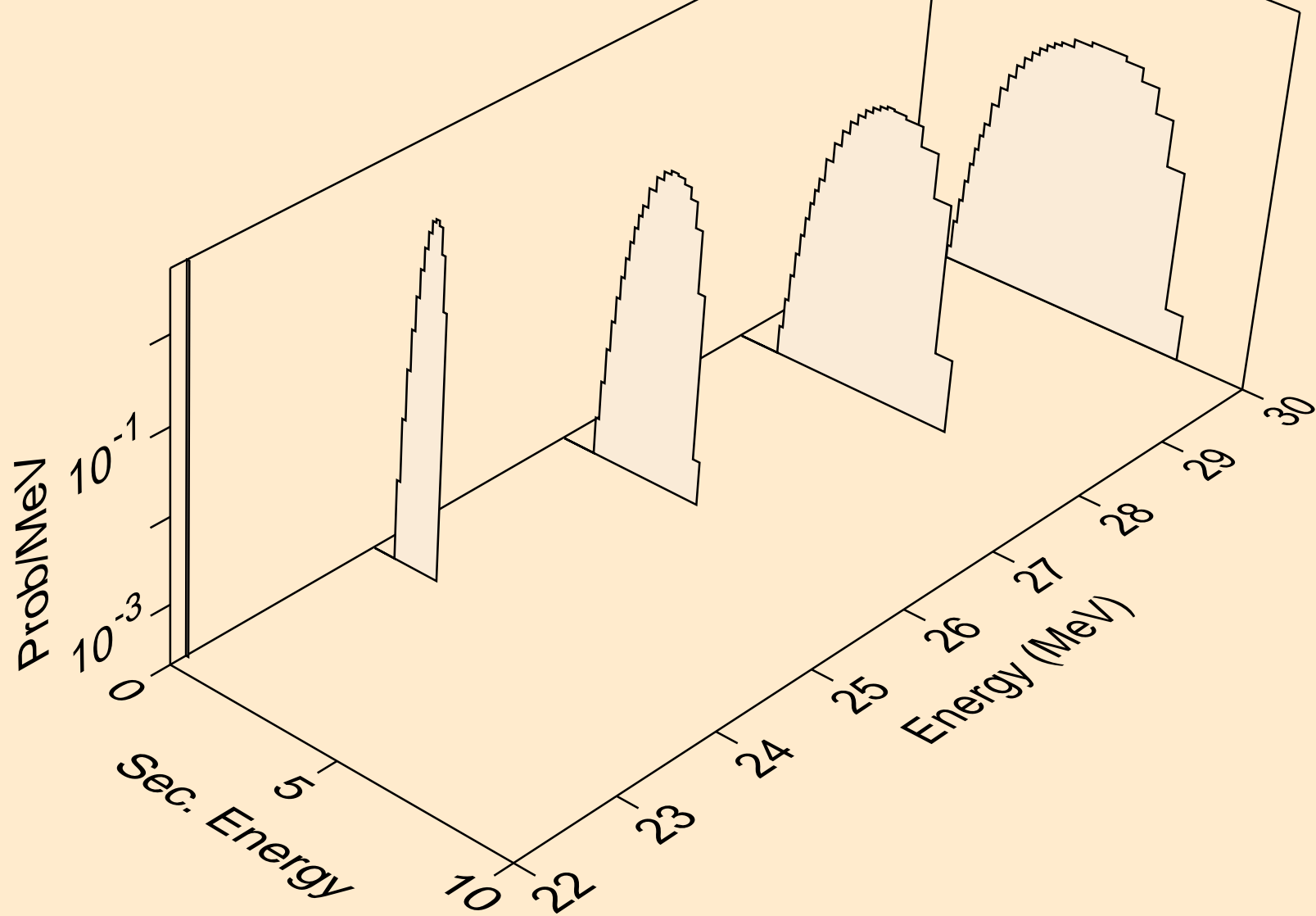

FE064 NEUTRON ACER TENDL-2024 LIBRARY; T=0.K  
protons from (n,3np)

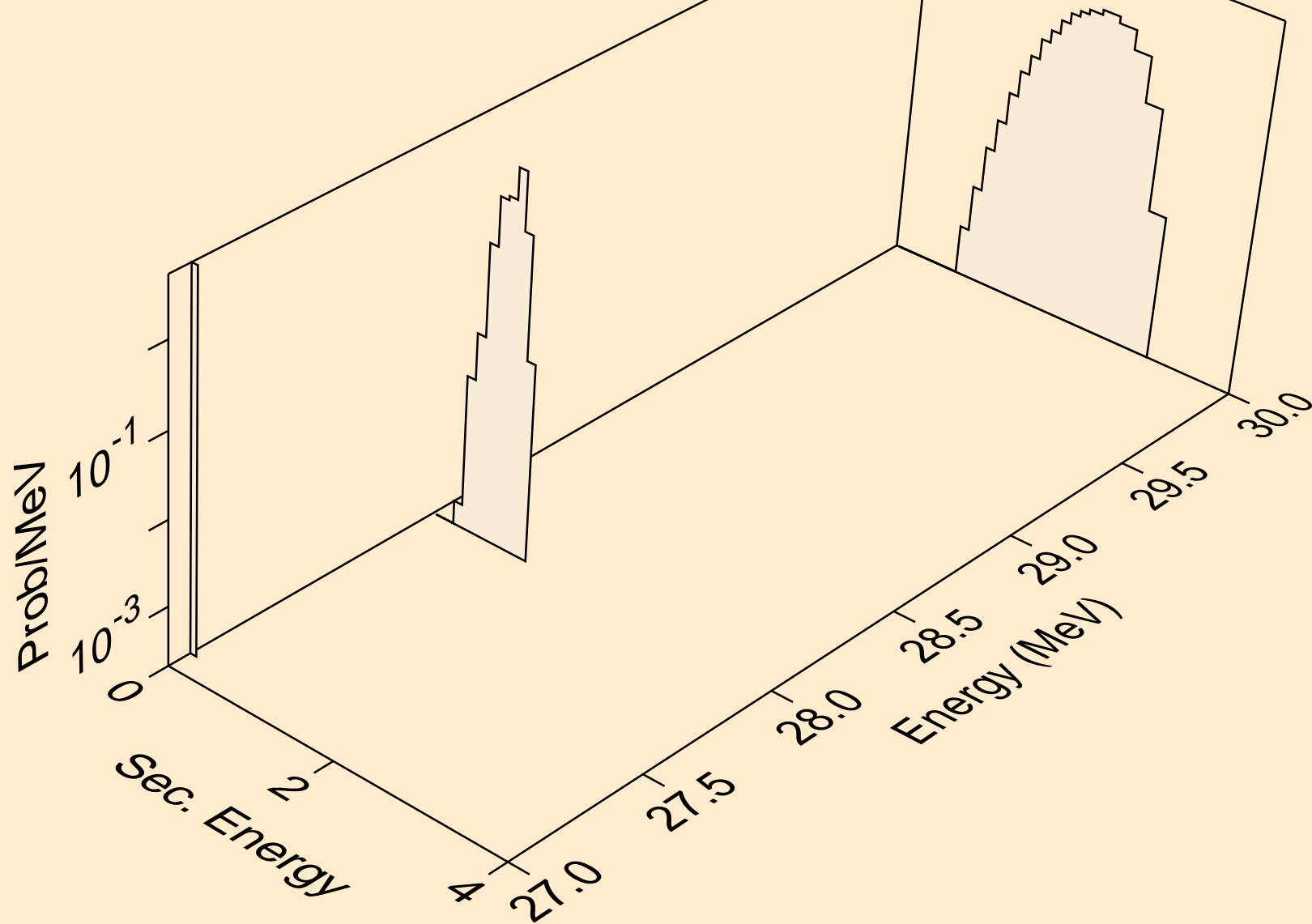

FE064 NEUTRON ACER TENDL-2024 LIBRARY; T=0.K  
protons from (n,p)

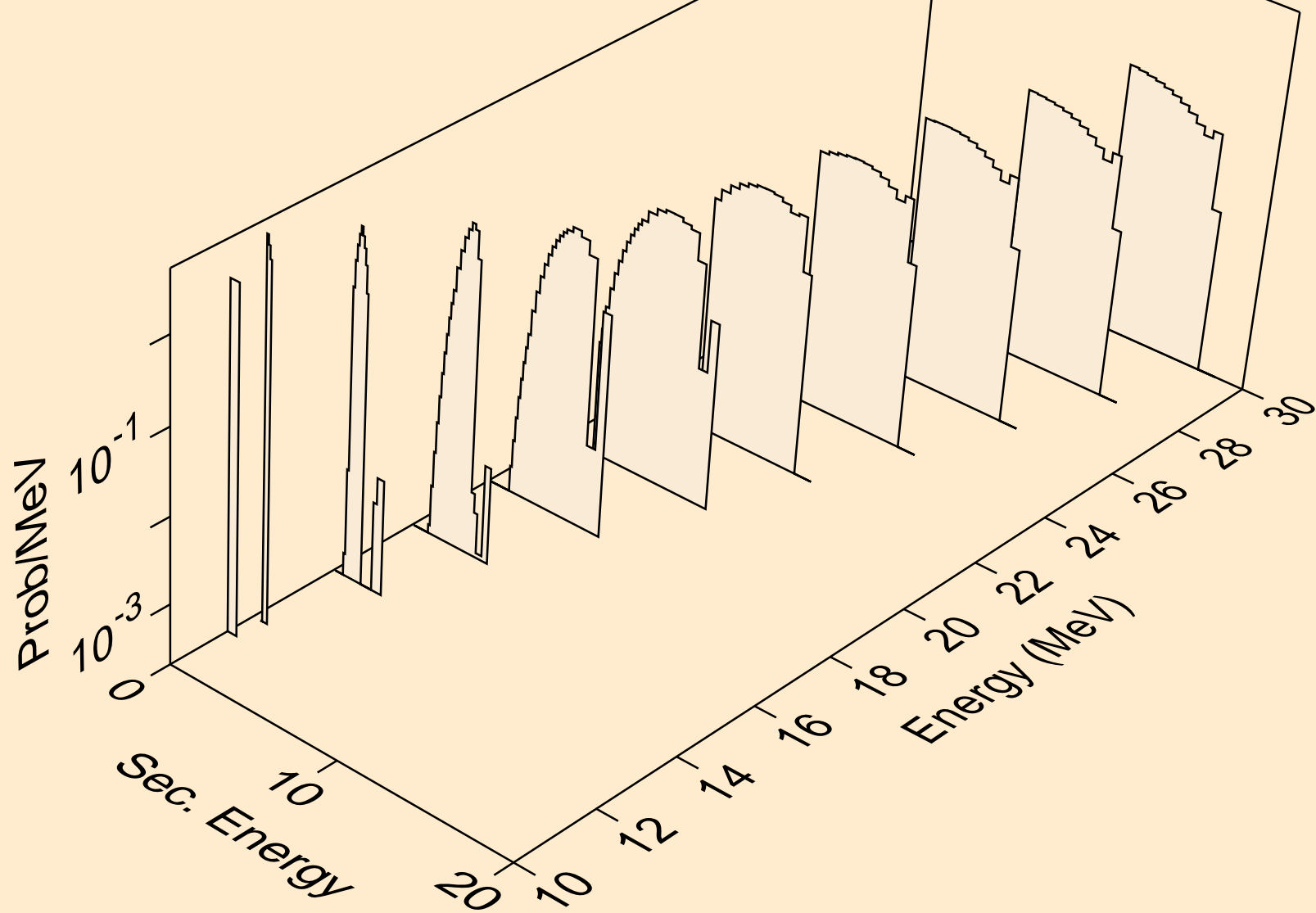

FE064 NEUTRON ACER TENDL-2024 LIBRARY; T=0.K  
deuterons from (n,x)

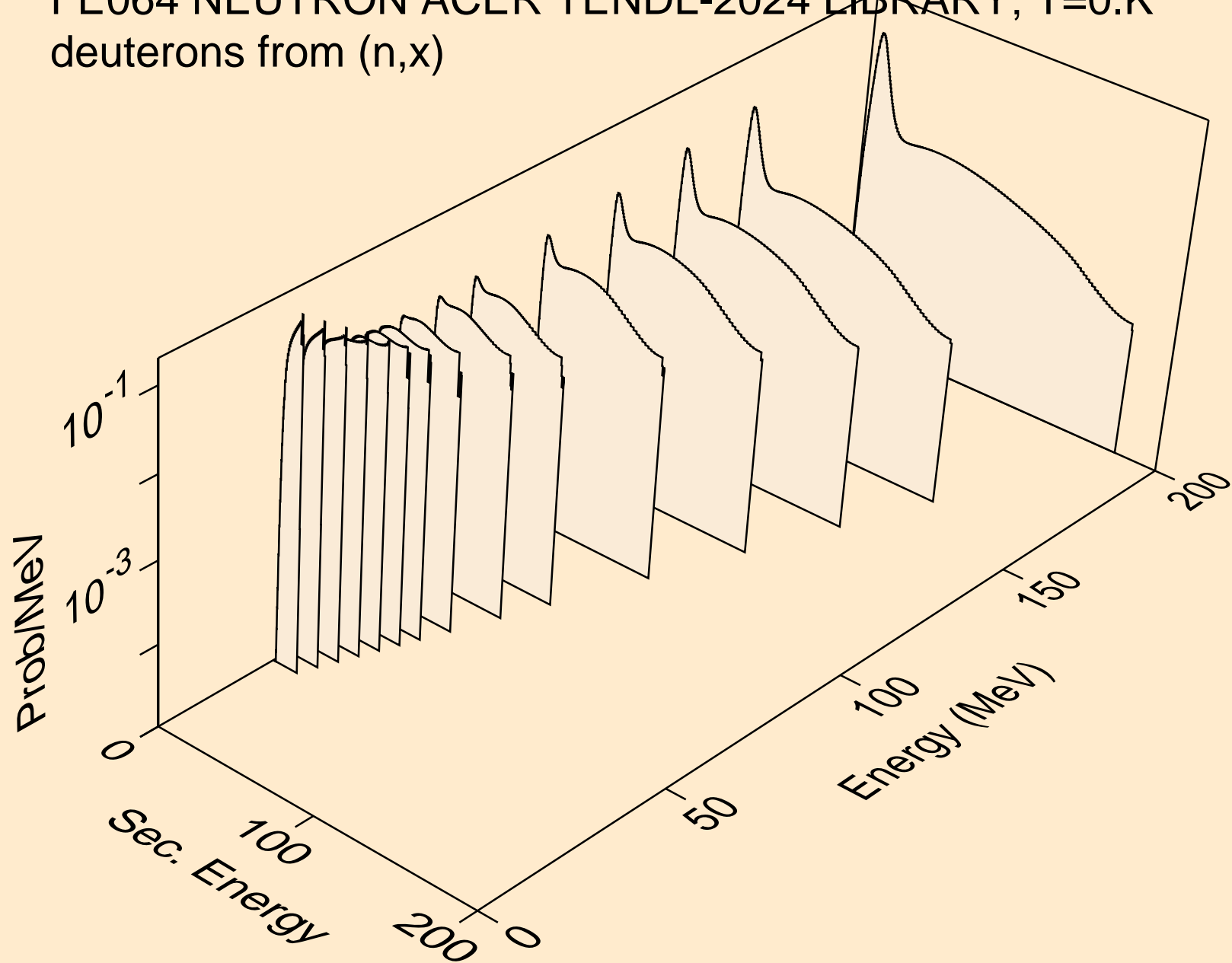

FE064 NEUTRON ACER TENDL-2024 LIBRARY; T=0.K  
deuterons from (n,2nd)

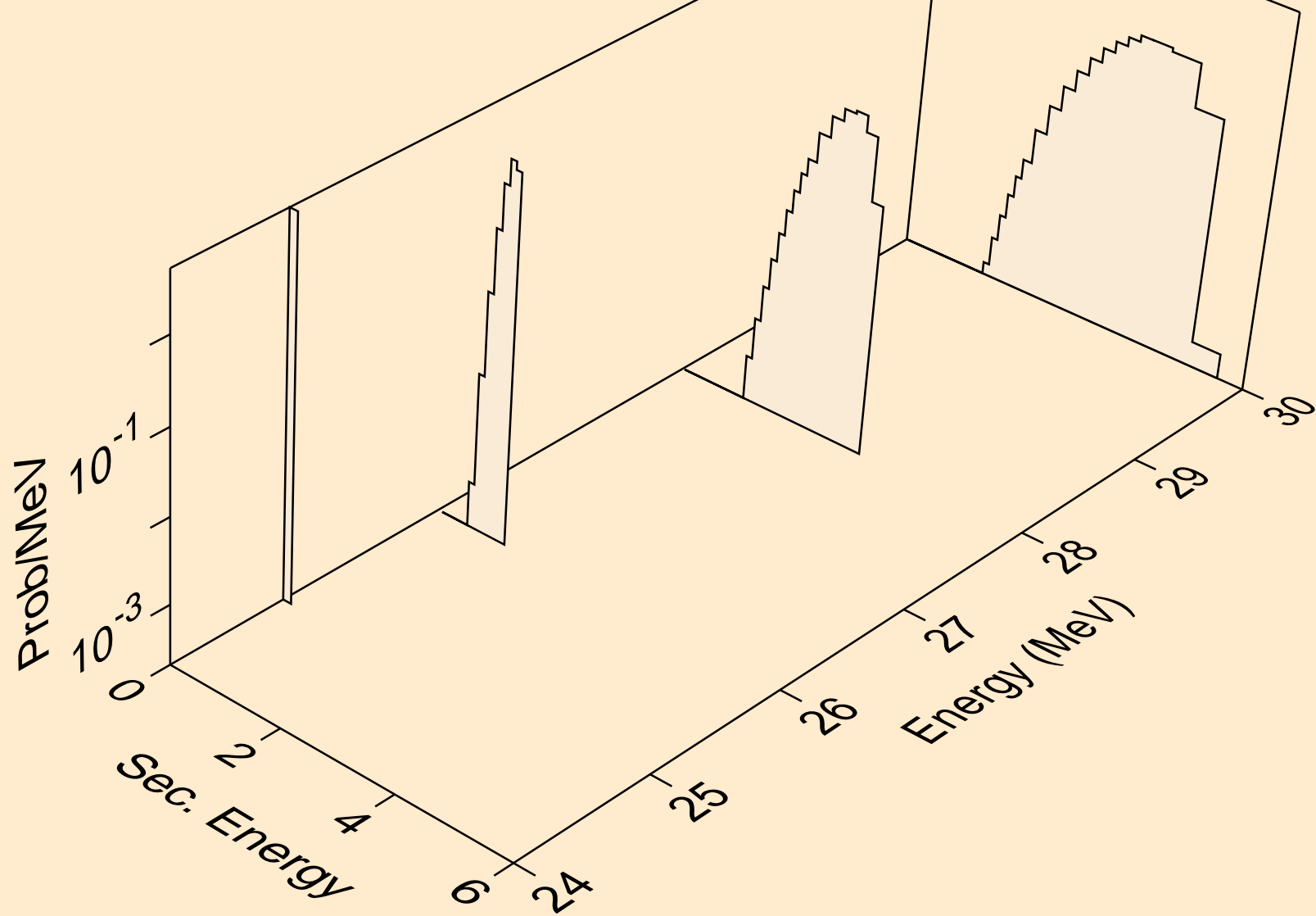

FE064 NEUTRON ACER TENDL-2024 LIBRARY; T=0.K  
deuterons from (n,n\*)d

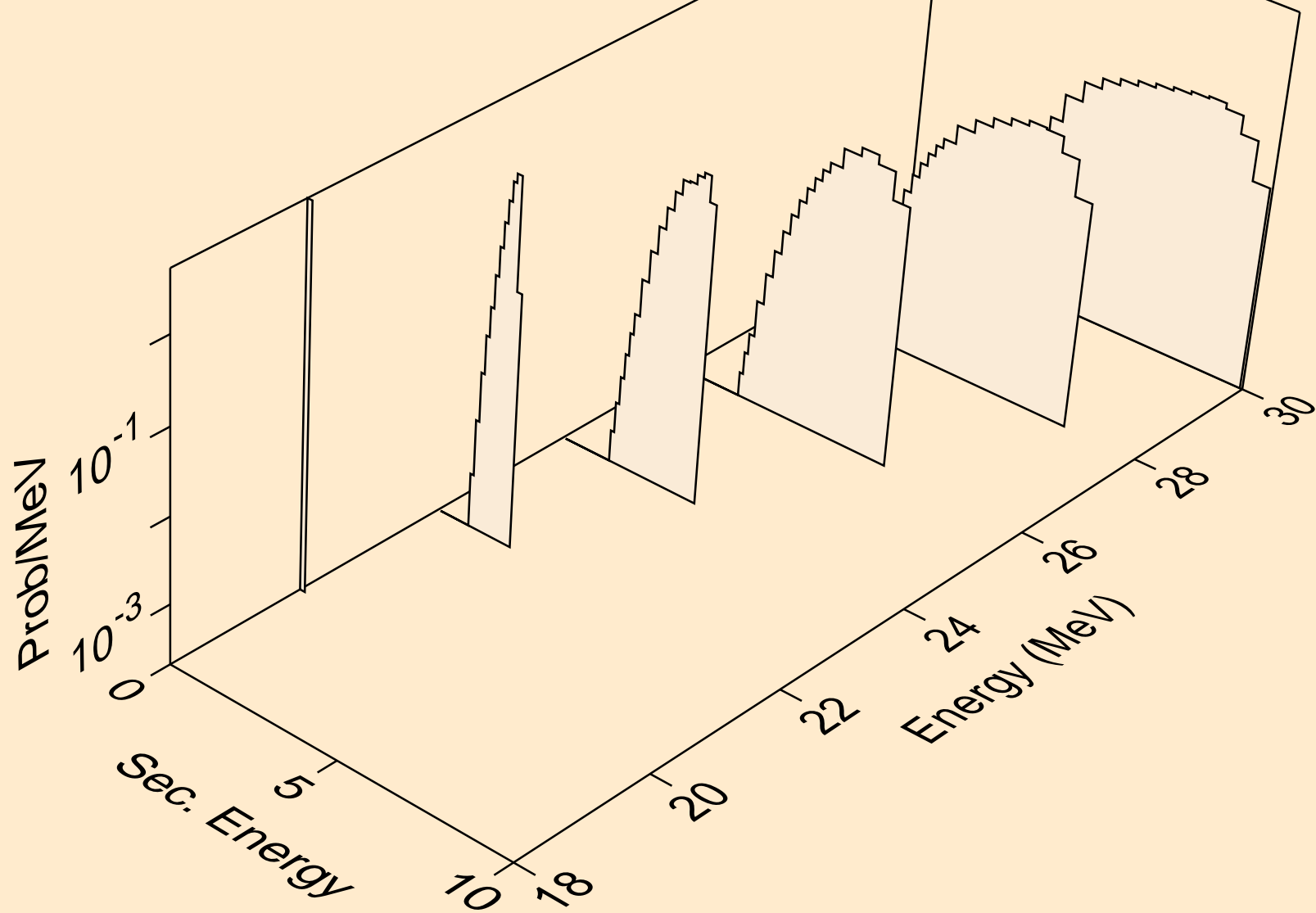

FE064 NEUTRON ACER TENDL-2024 LIBRARY; T=0.K  
deuterons from (n,d)

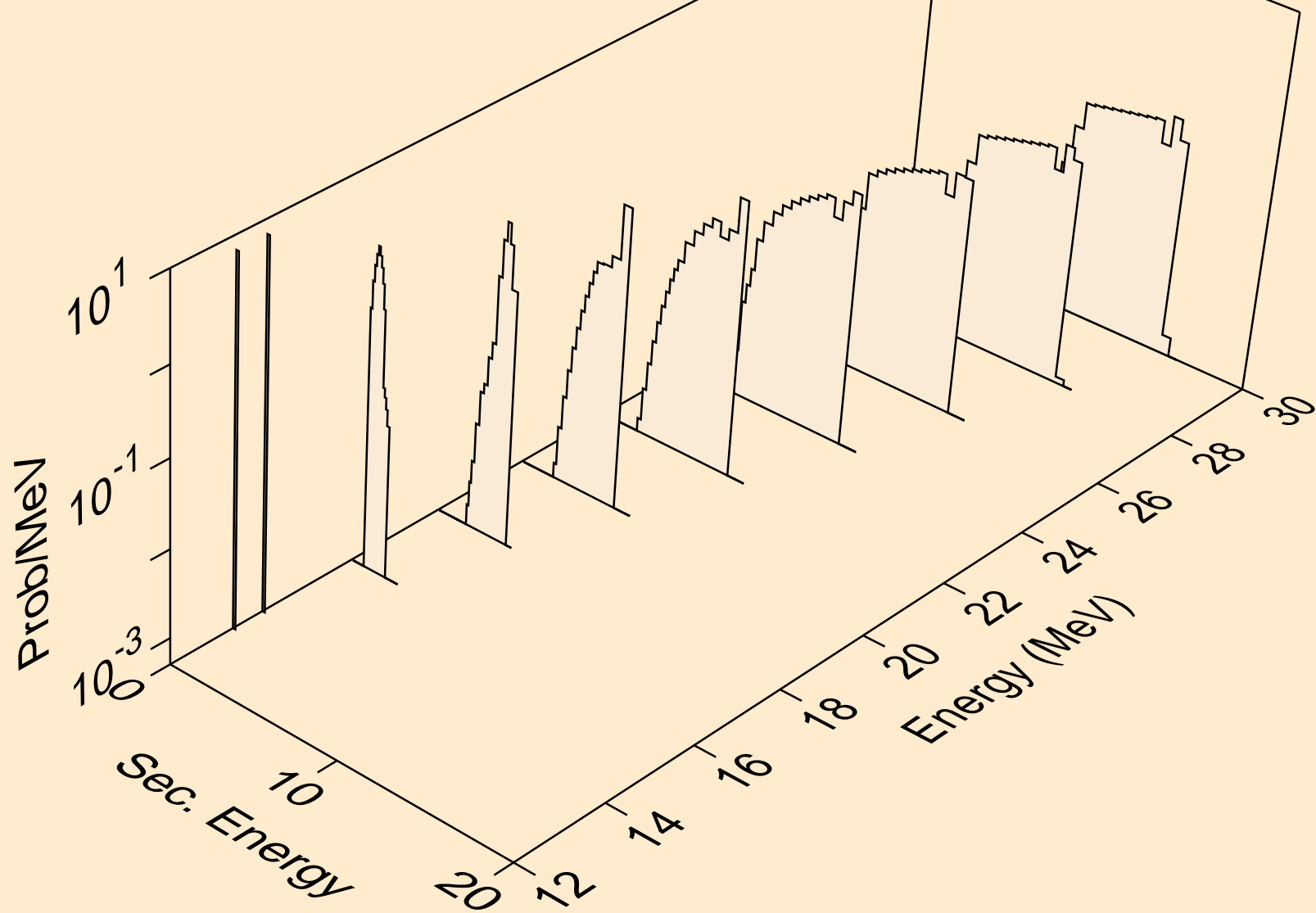

FE064 NEUTRON ACER TENDL-2024 LIBRARY; T=0.K  
tritons from (n,x)

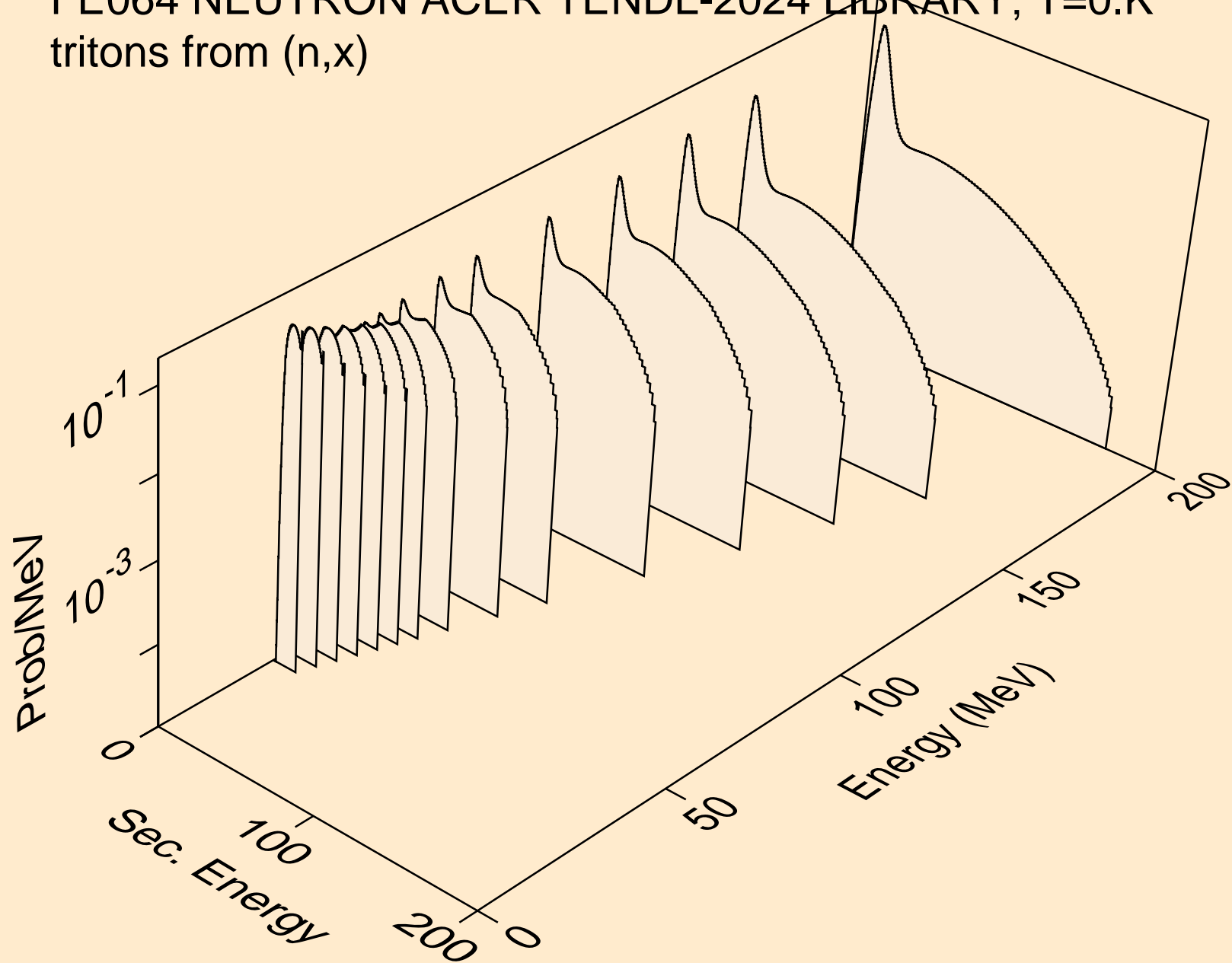

FE064 NEUTRON ACER TENDL-2024 LIBRARY; T=0.K  
tritons from (n,n\*)t

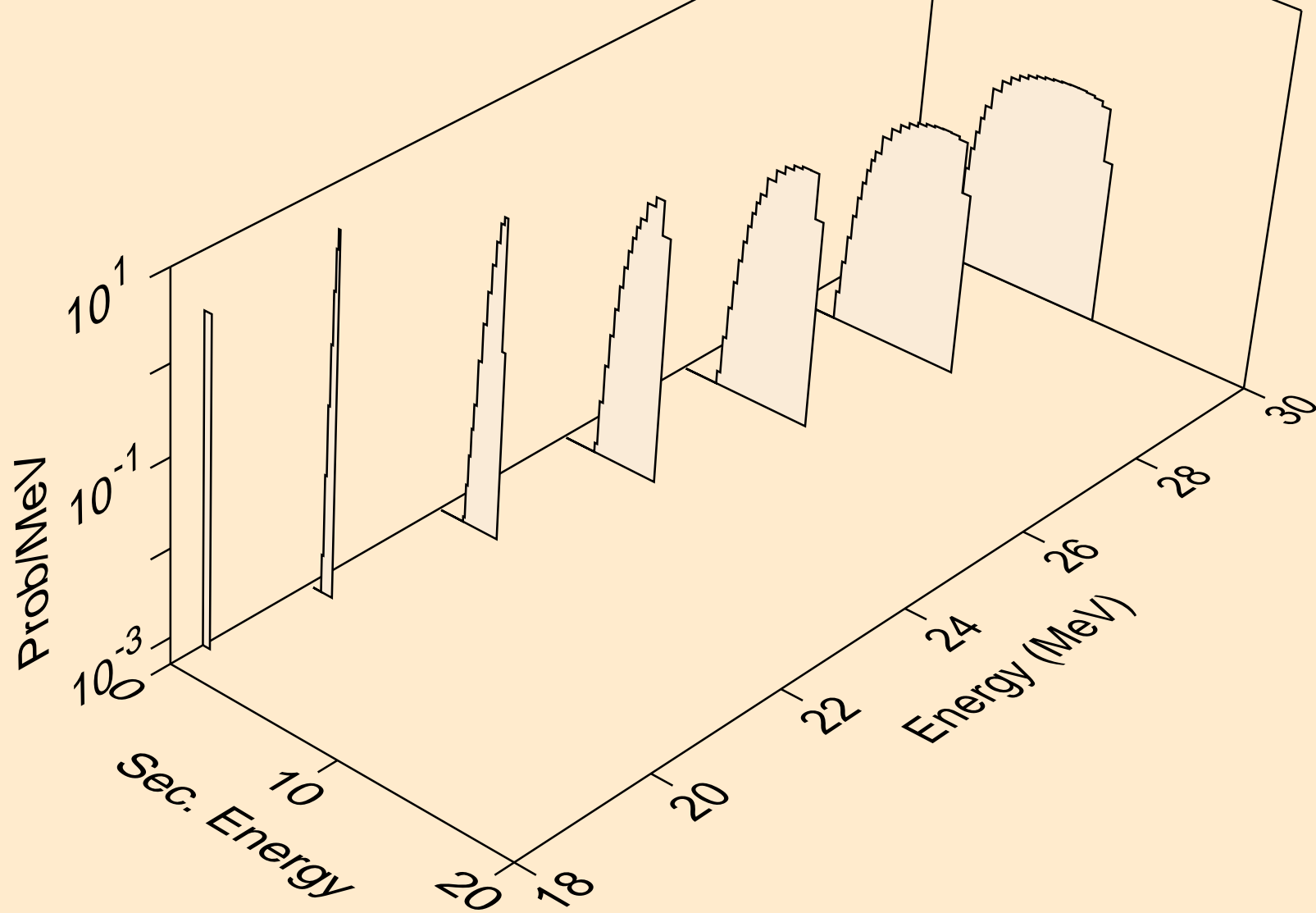

FE064 NEUTRON ACER TENDL-2024 LIBRARY; T=0.K  
tritons from (n,t)

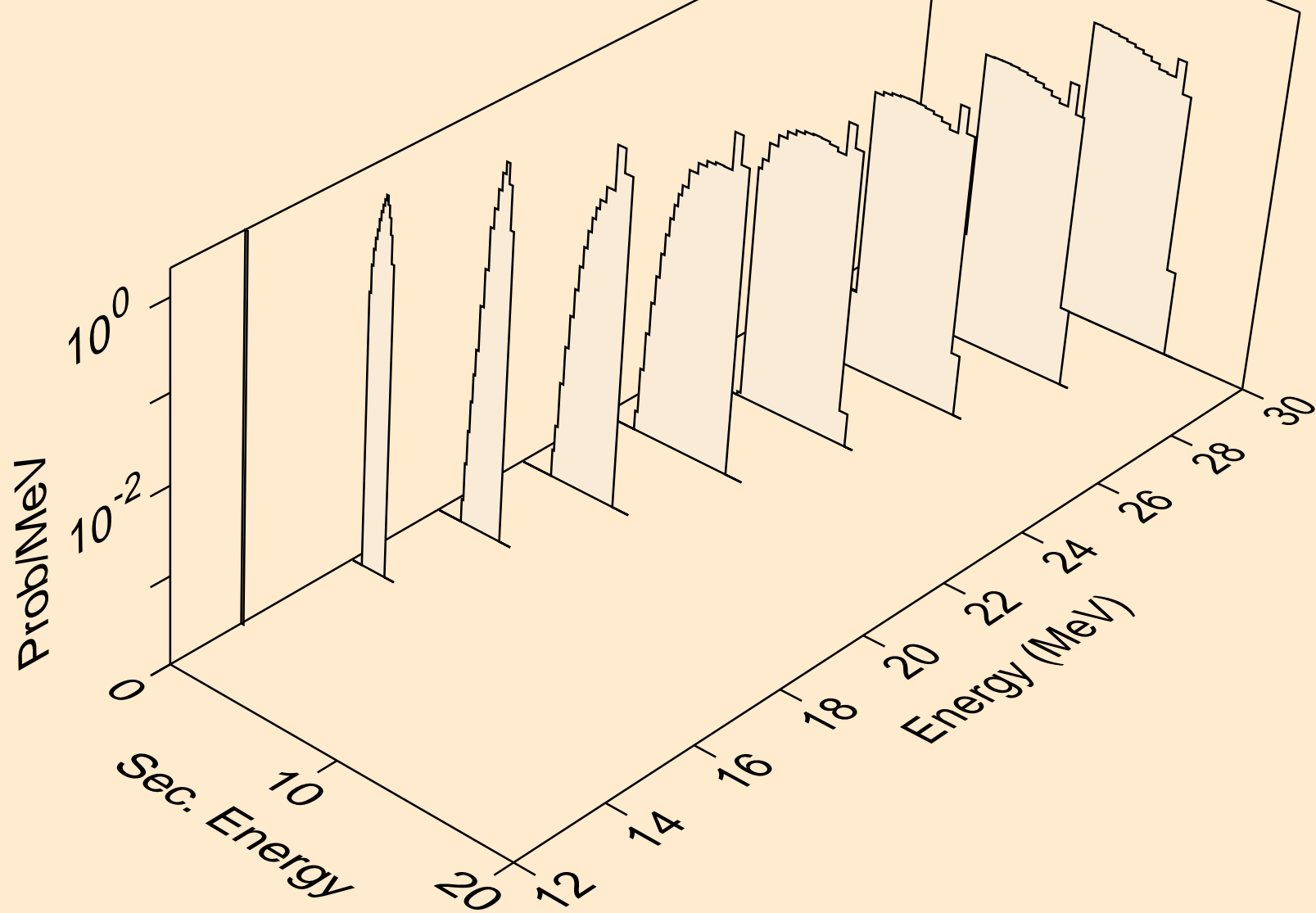

FE064 NEUTRON ACER TENDL-2024 LIBRARY; T=0.K  
he3s from (n,x)

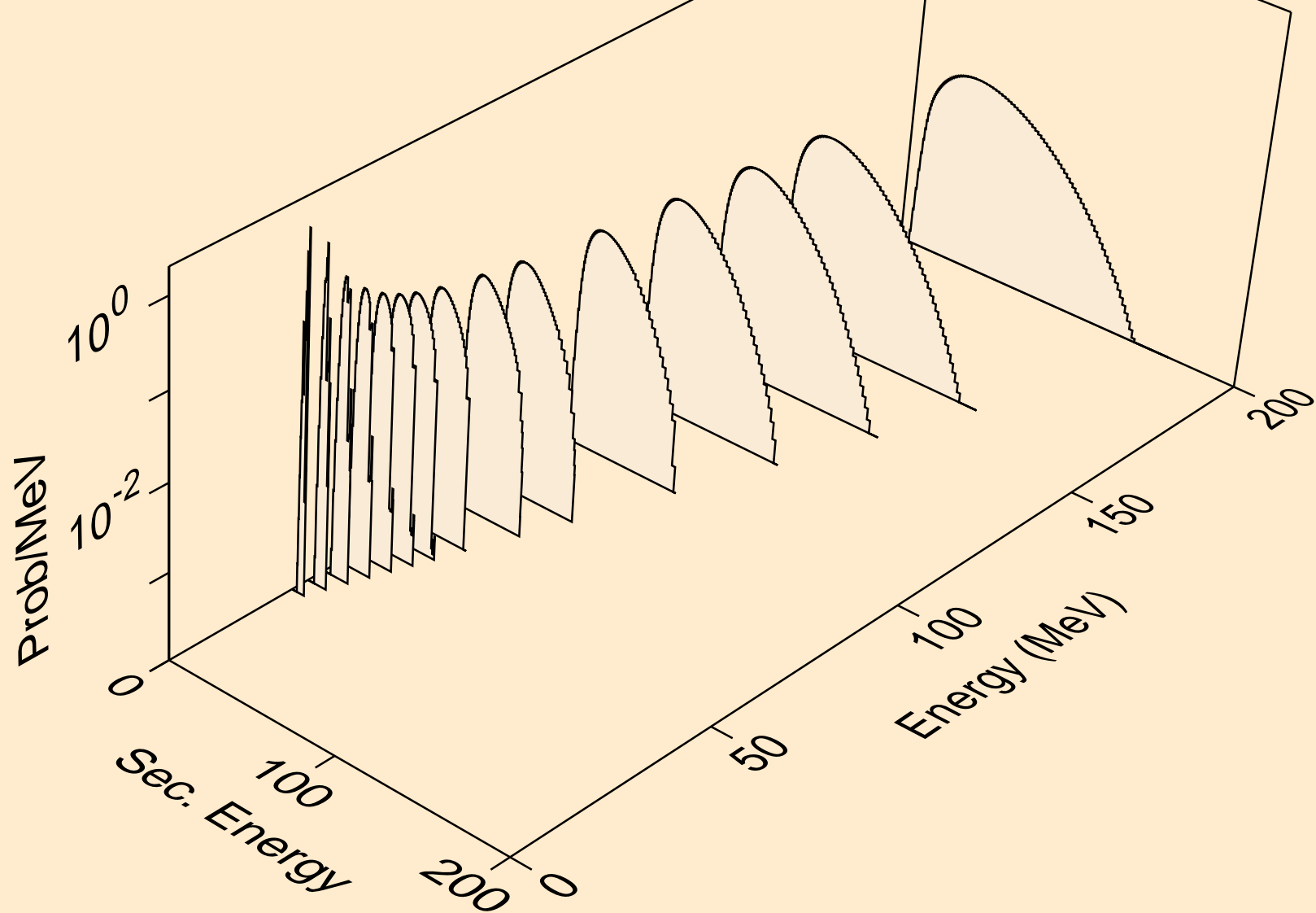

FE064 NEUTRON ACER TENDL-2024 LIBRARY; T=0.K  
he3s from (n,he3)

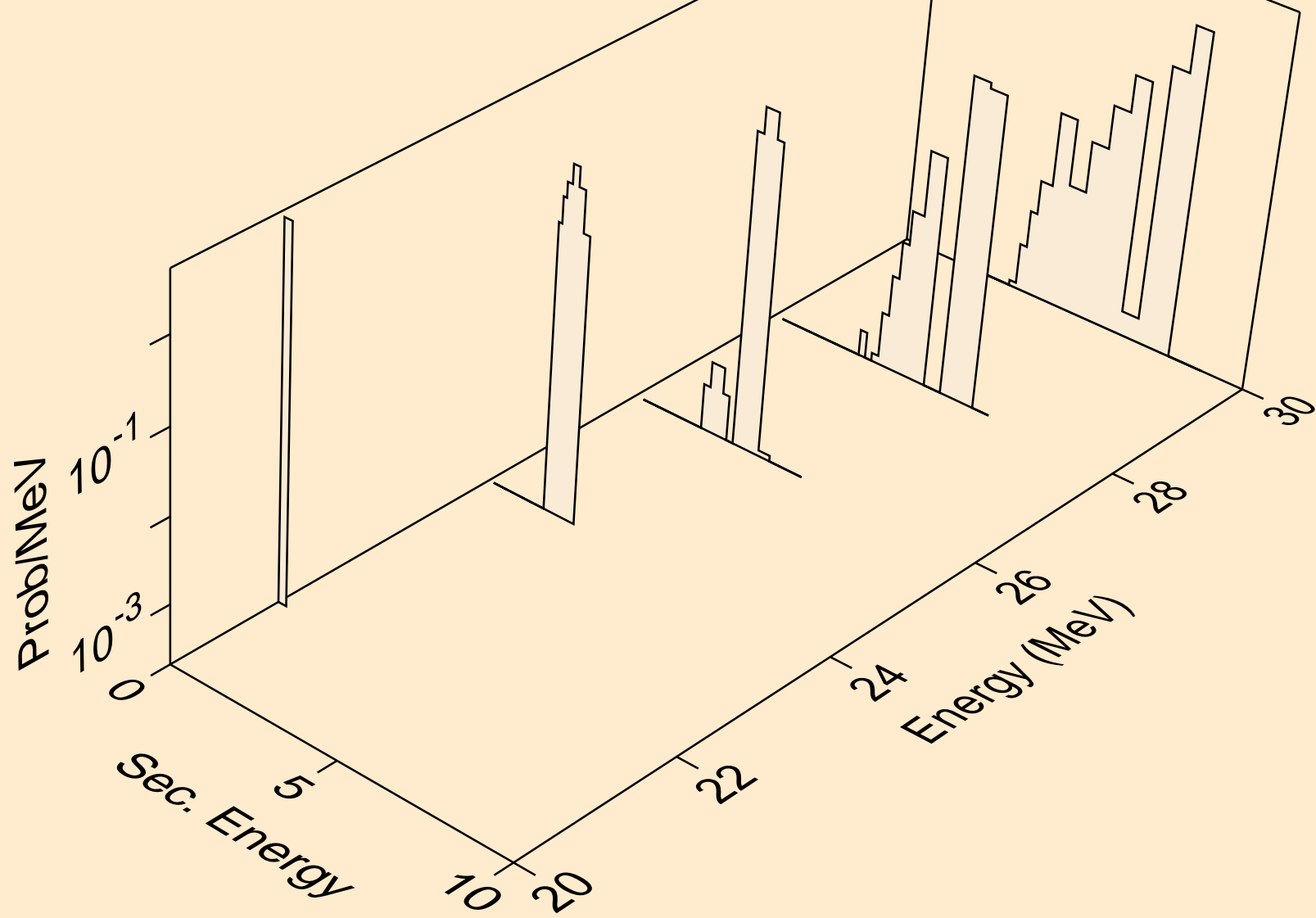

FE064 NEUTRON ACER TENDL-2024 LIBRARY; T=0.K  
alphas from (n,x)

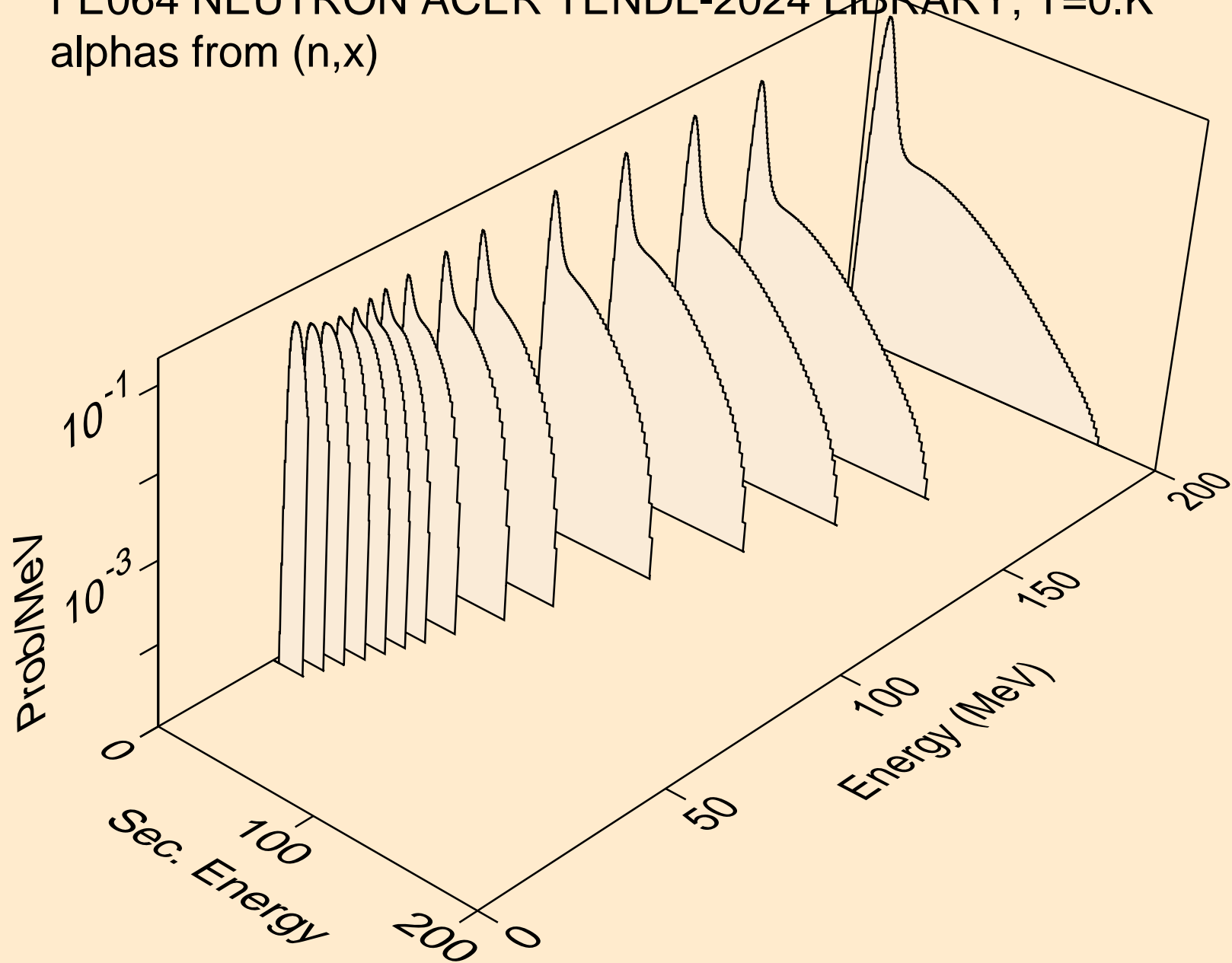

FE064 NEUTRON ACER TENDL-2024 LIBRARY; T=0.K  
alphas from (n,n\*)a

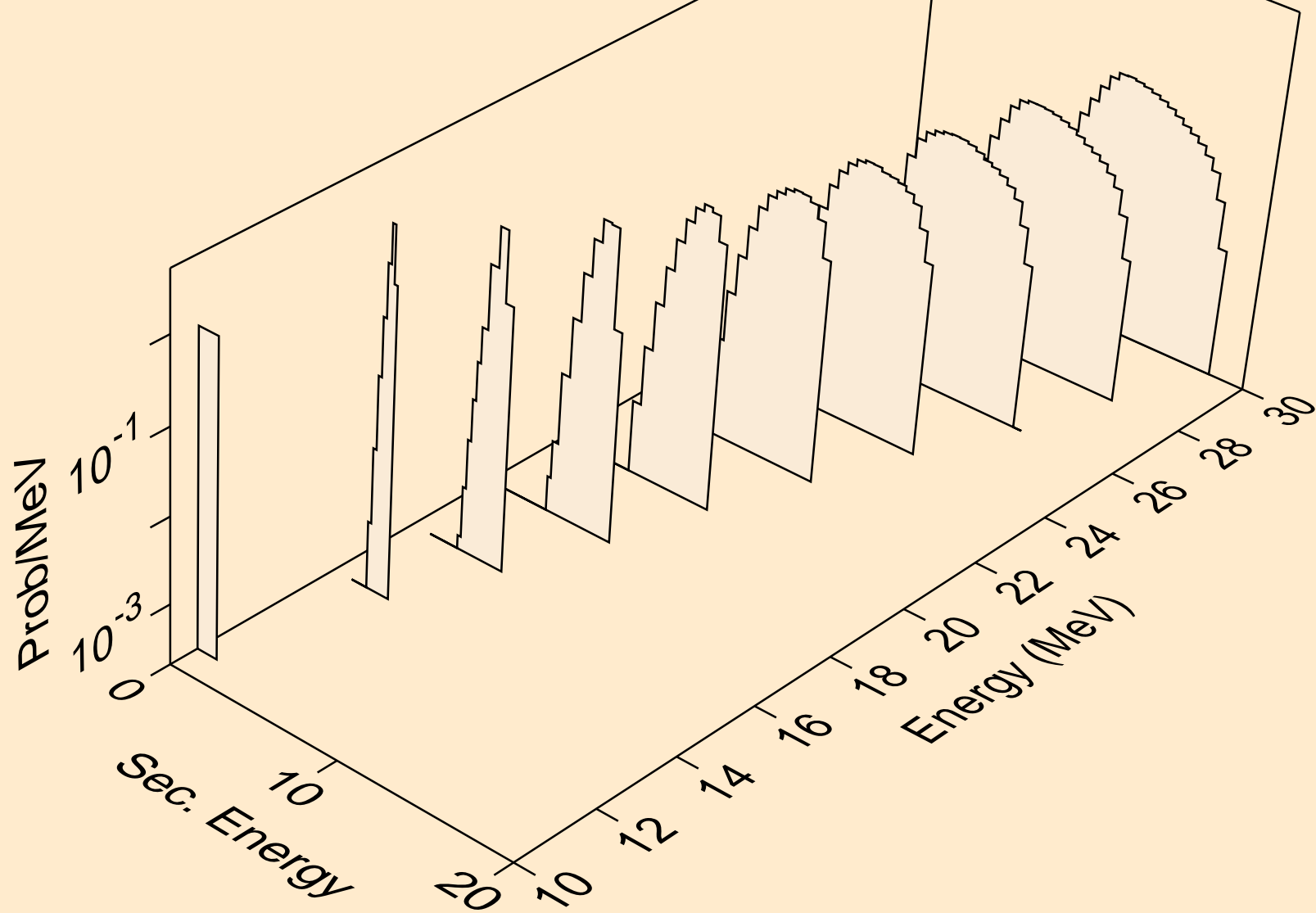

FE064 NEUTRON ACER TENDL-2024 LIBRARY; T=0.K  
alphas from (n,2n)a

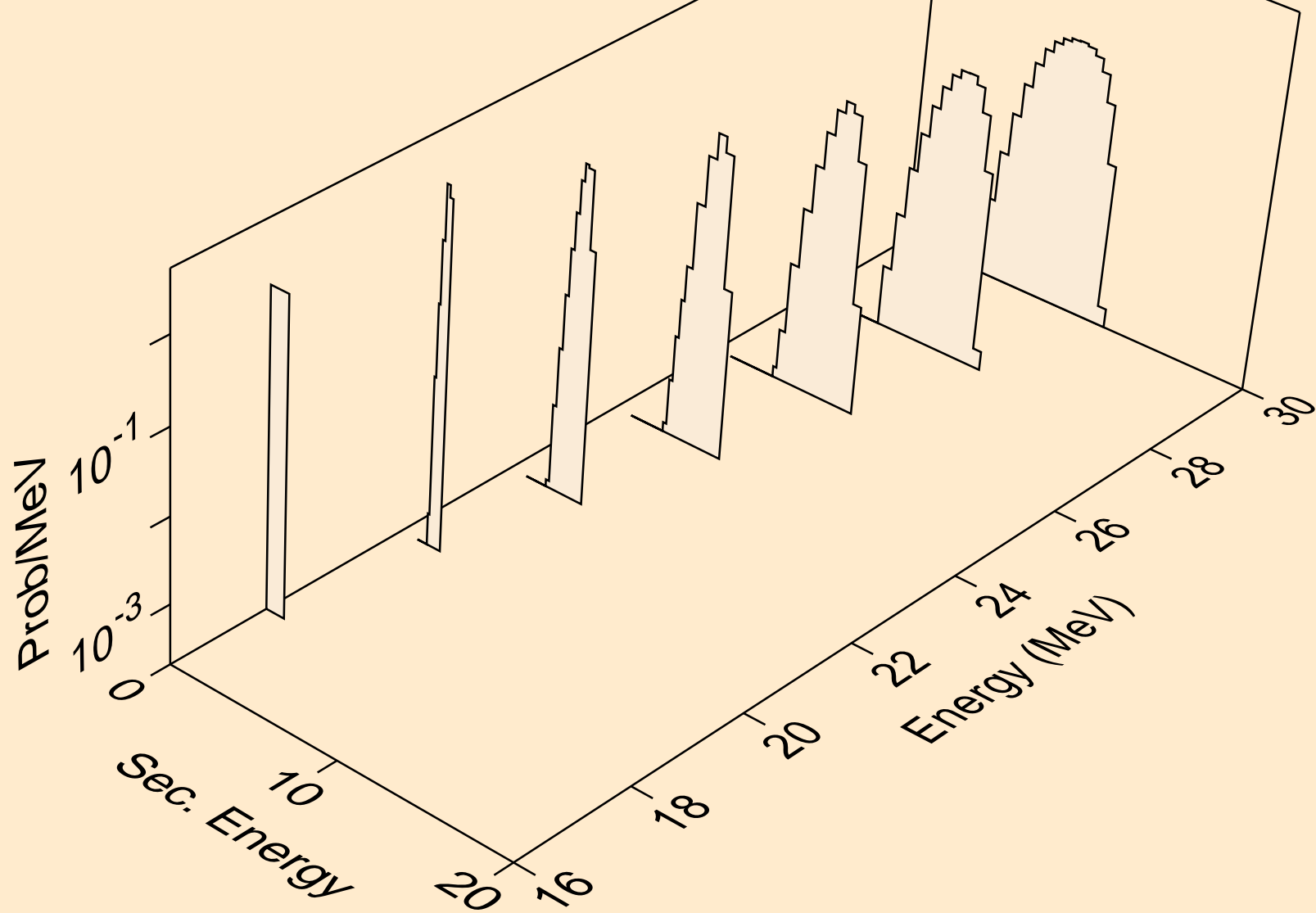

FE064 NEUTRON ACER TENDL-2024 LIBRARY; T=0.K  
alphas from (n,3n)a

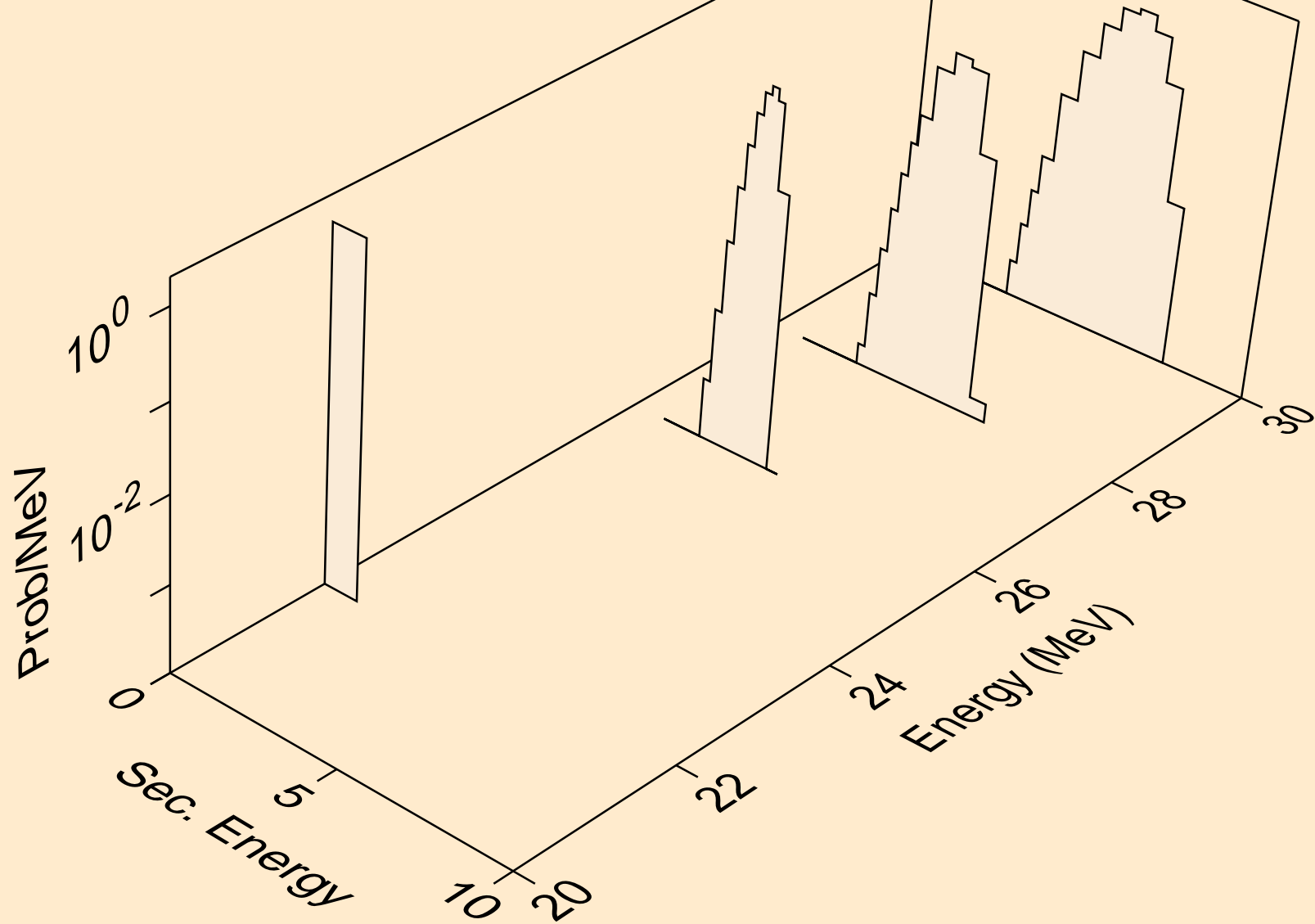

FE064 NEUTRON ACER TENDL-2024 LIBRARY; T=0.K  
alphas from (n,a)

