

GD149 NEUTRON ACER TENDL-2024 LIBRARY; T=0.K

Principal cross sections

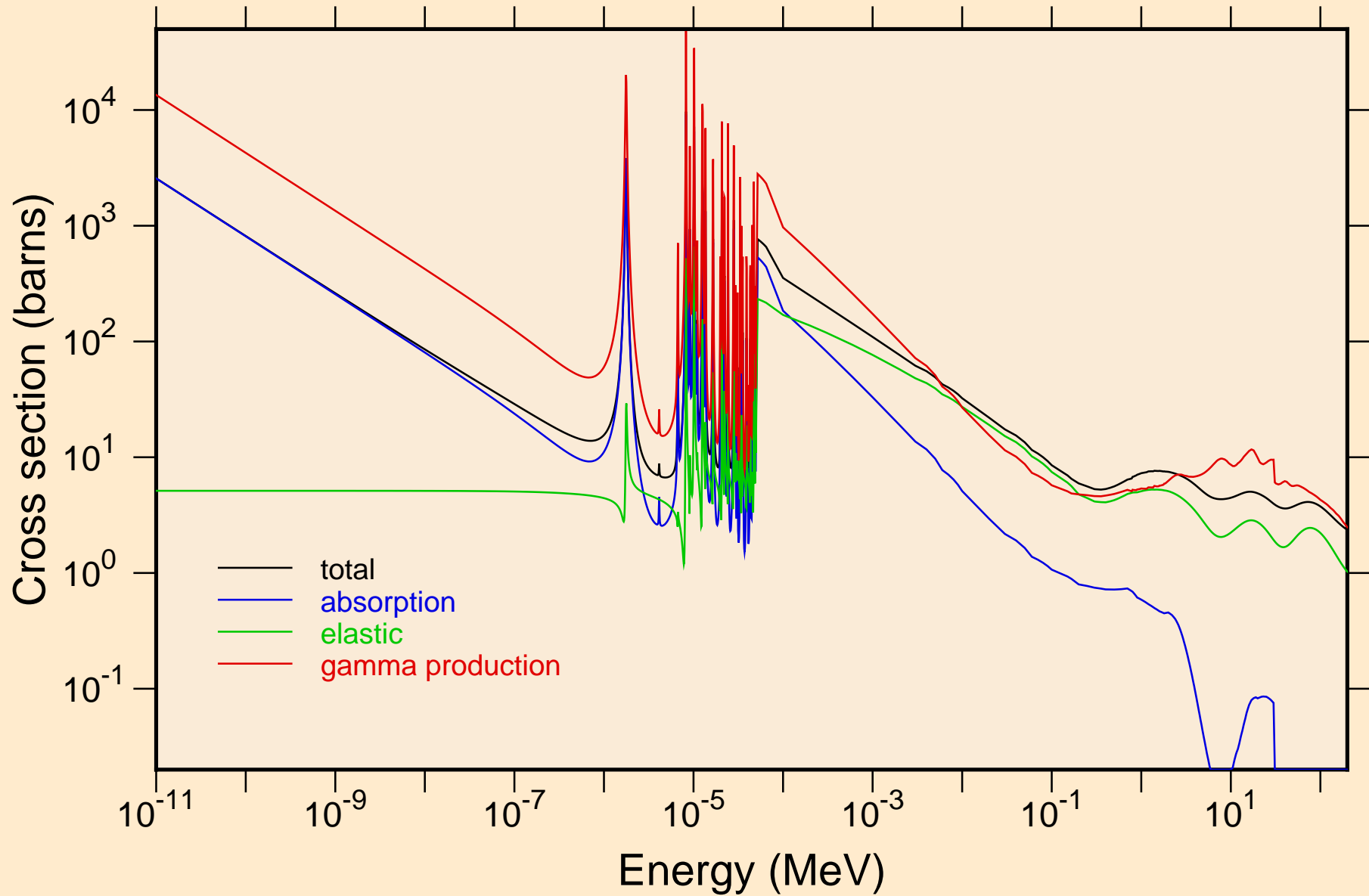

GD149 NEUTRON ACER TENDL-2024 LIBRARY; T=0.K
resonance total cross section

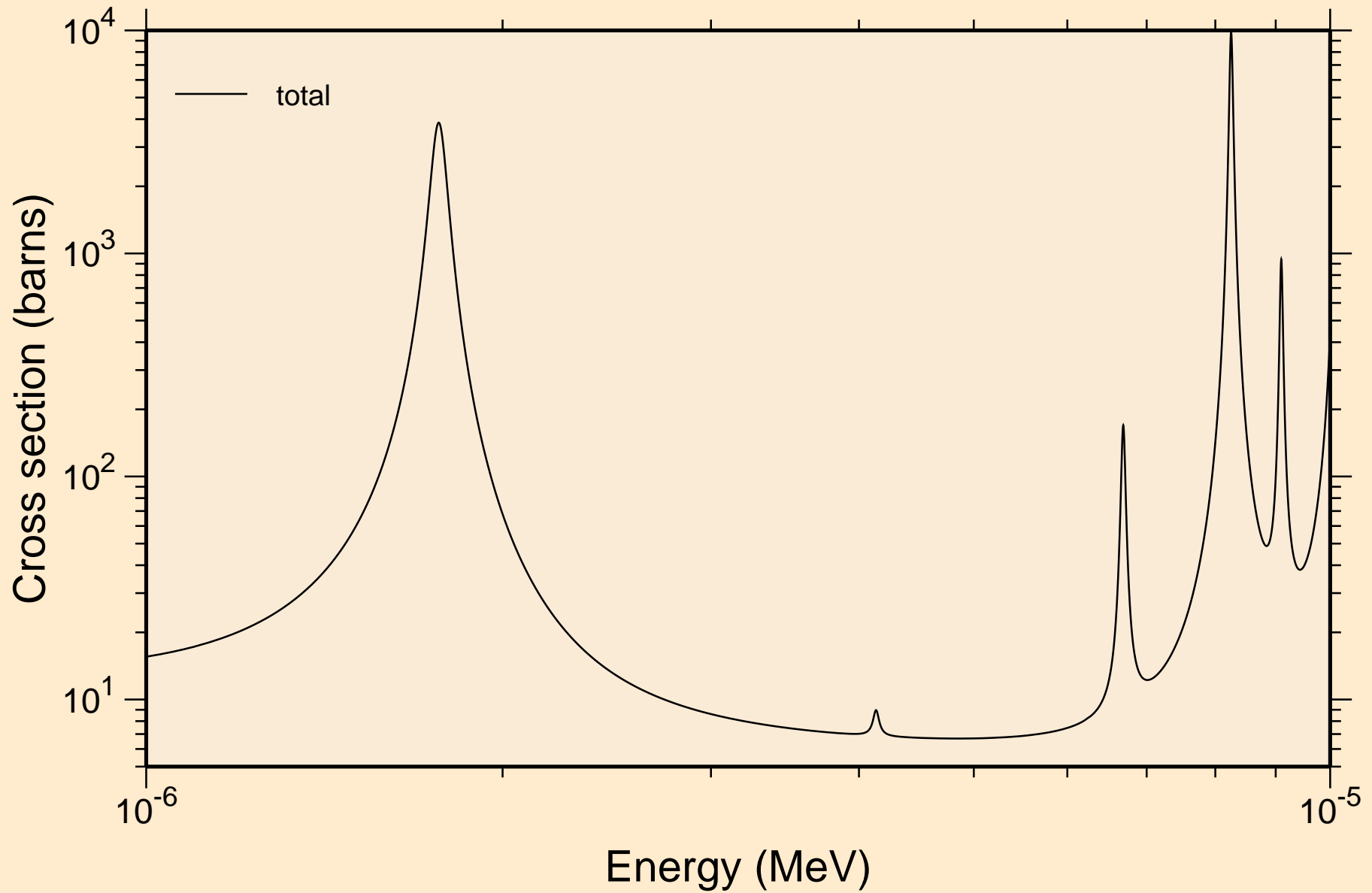

GD149 NEUTRON ACER TENDL-2024 LIBRARY; T=0.K
resonance total cross section

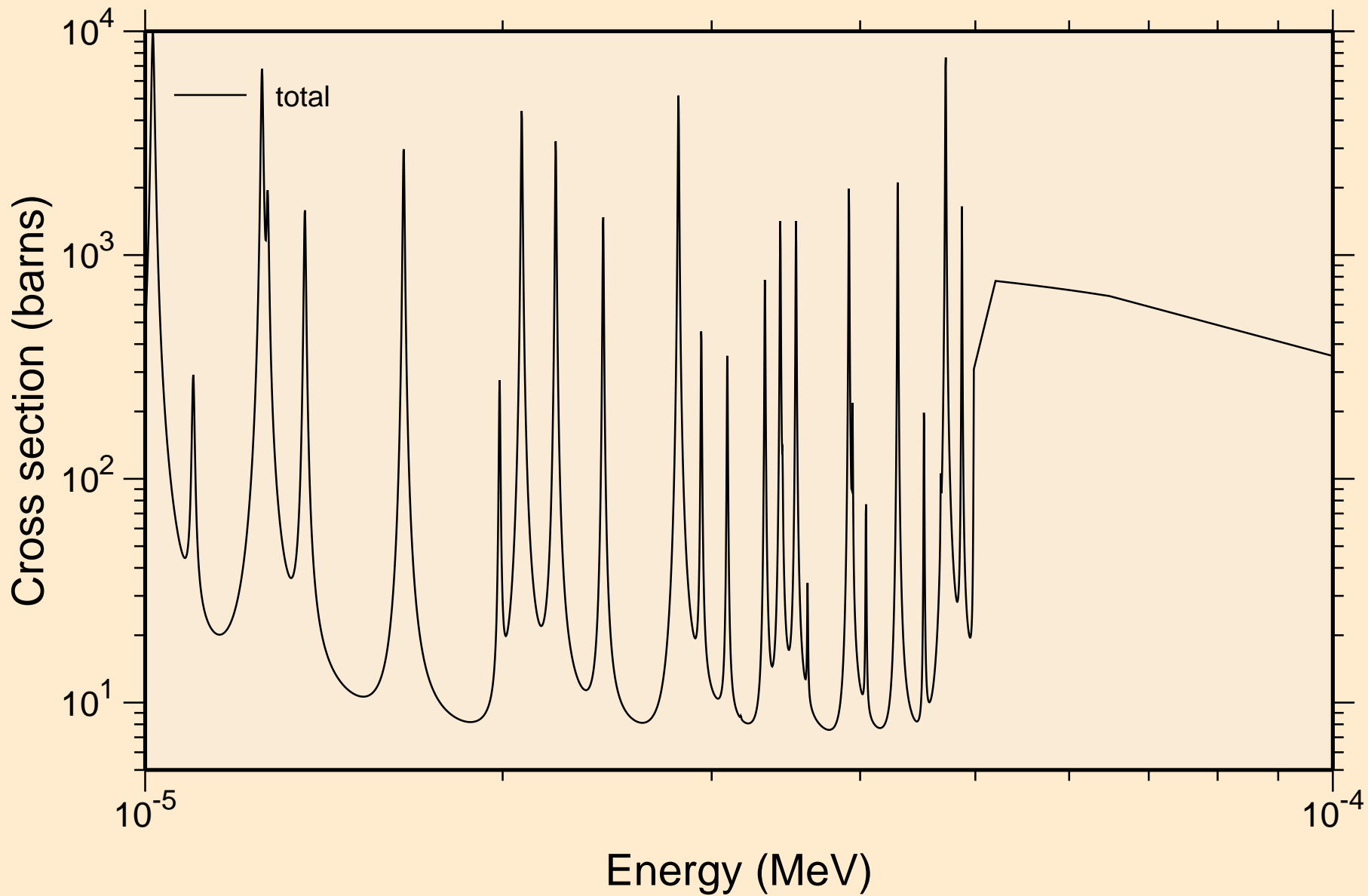

GD149 NEUTRON ACER TENDL-2024 LIBRARY; T=0.K
resonance total cross section

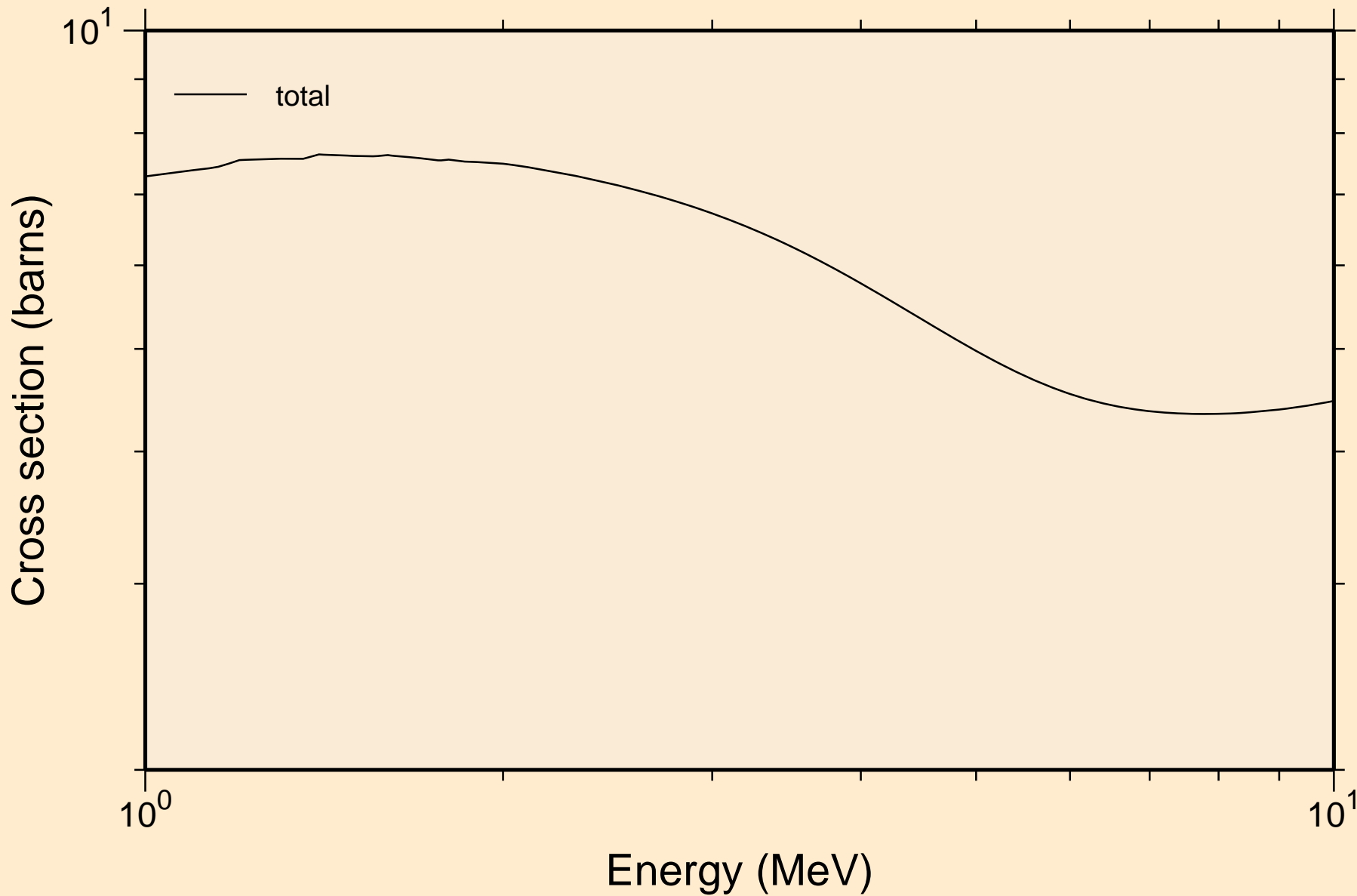

GD149 NEUTRON ACER TENDL-2024 LIBRARY; T=0.K
resonance absorption cross sections

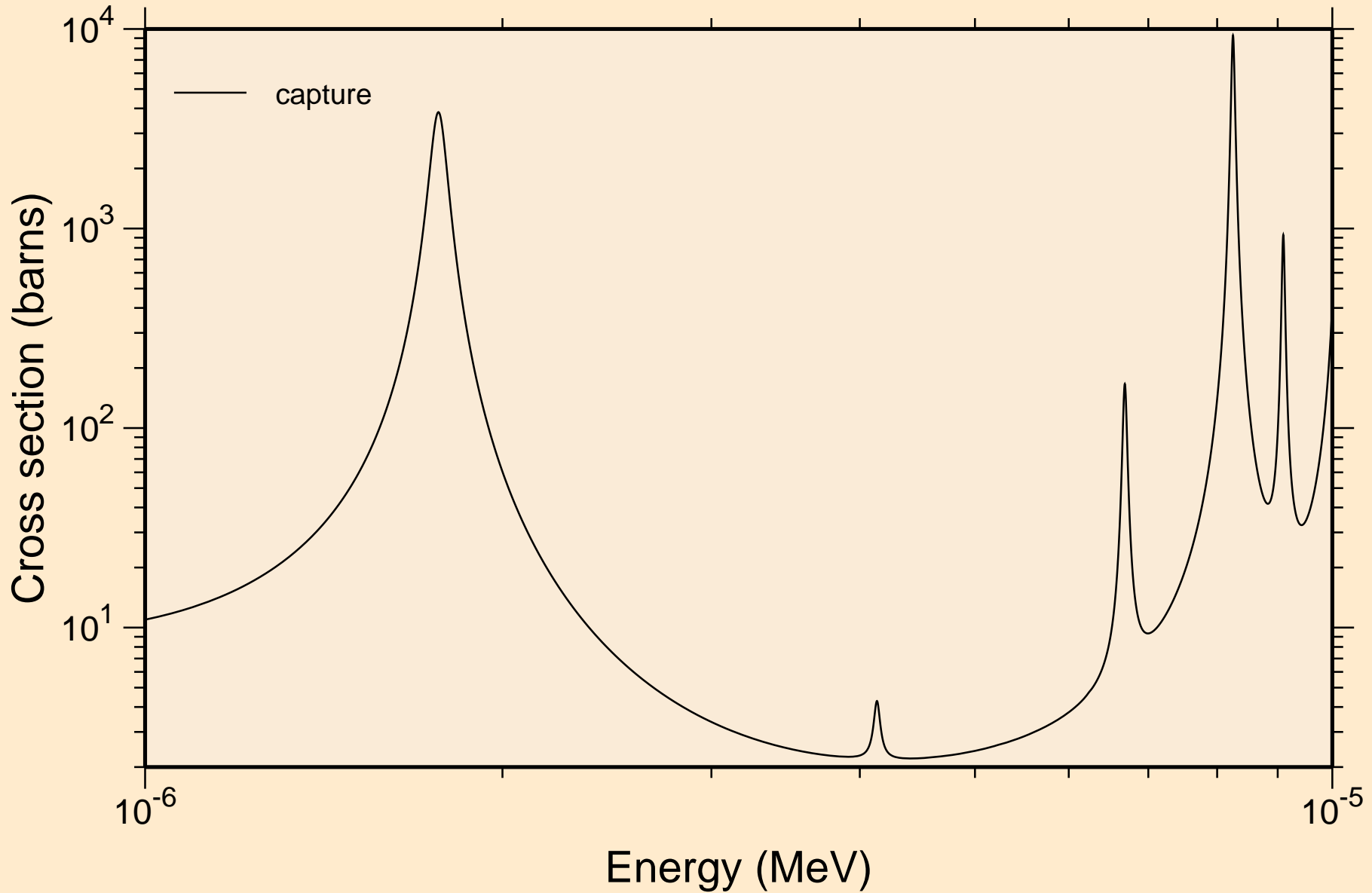

GD149 NEUTRON ACER TENDL-2024 LIBRARY; T=0.K
resonance absorption cross sections

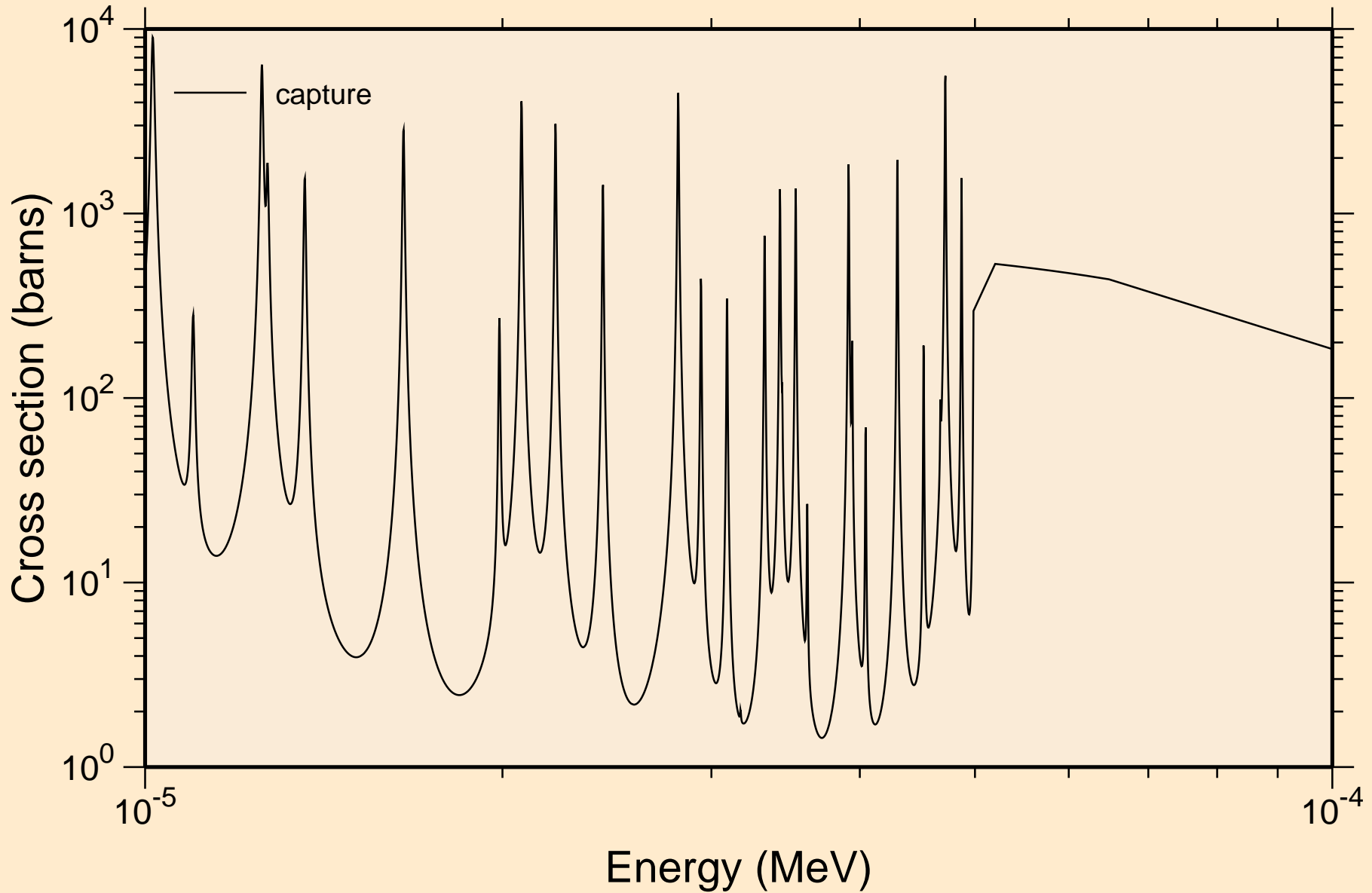

GD149 NEUTRON ACER TENDL-2024 LIBRARY; T=0.K
resonance absorption cross sections

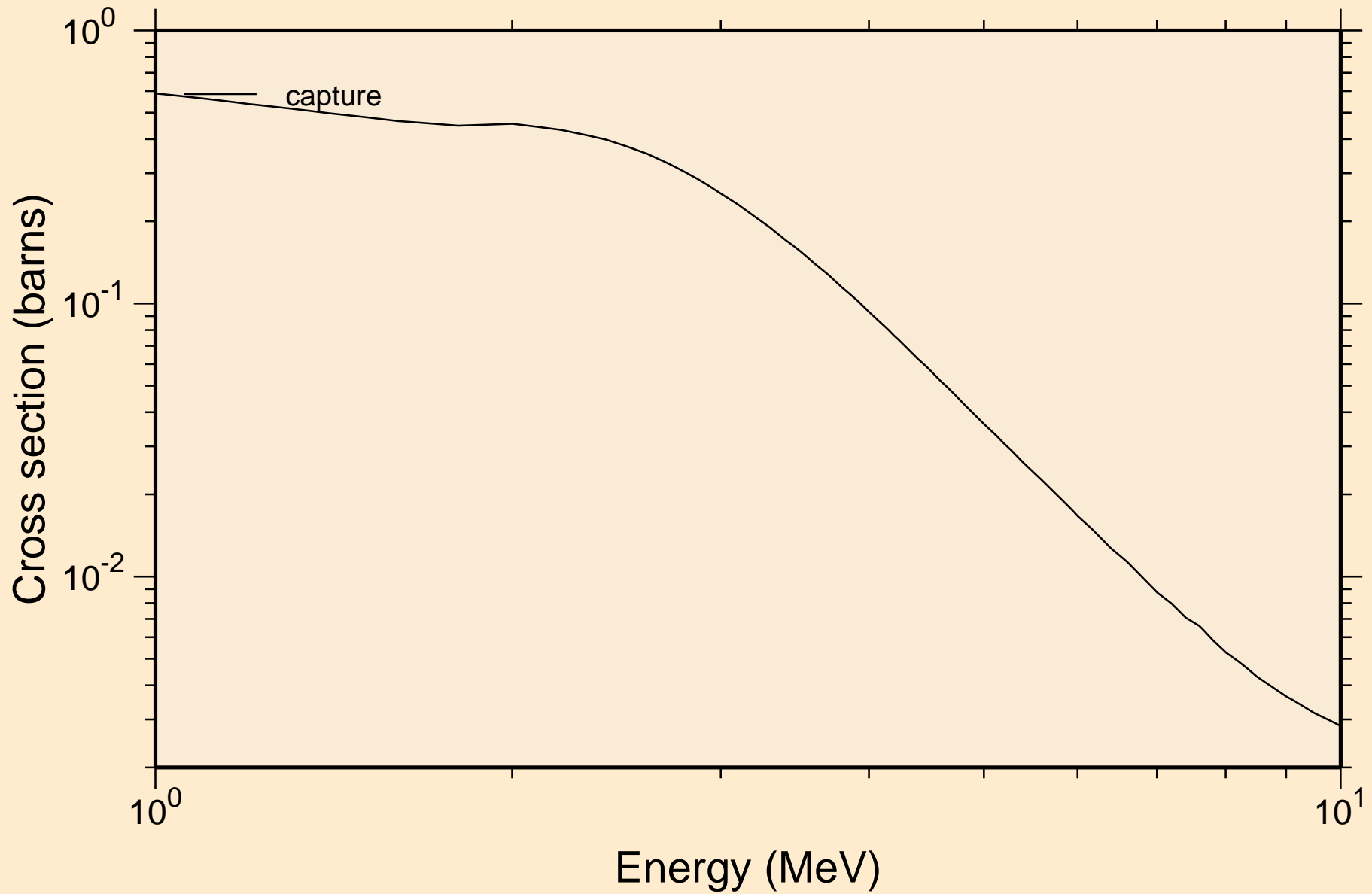

GD149 NEUTRON ACER TENDL-2024 LIBRARY; T=0.K

Heating

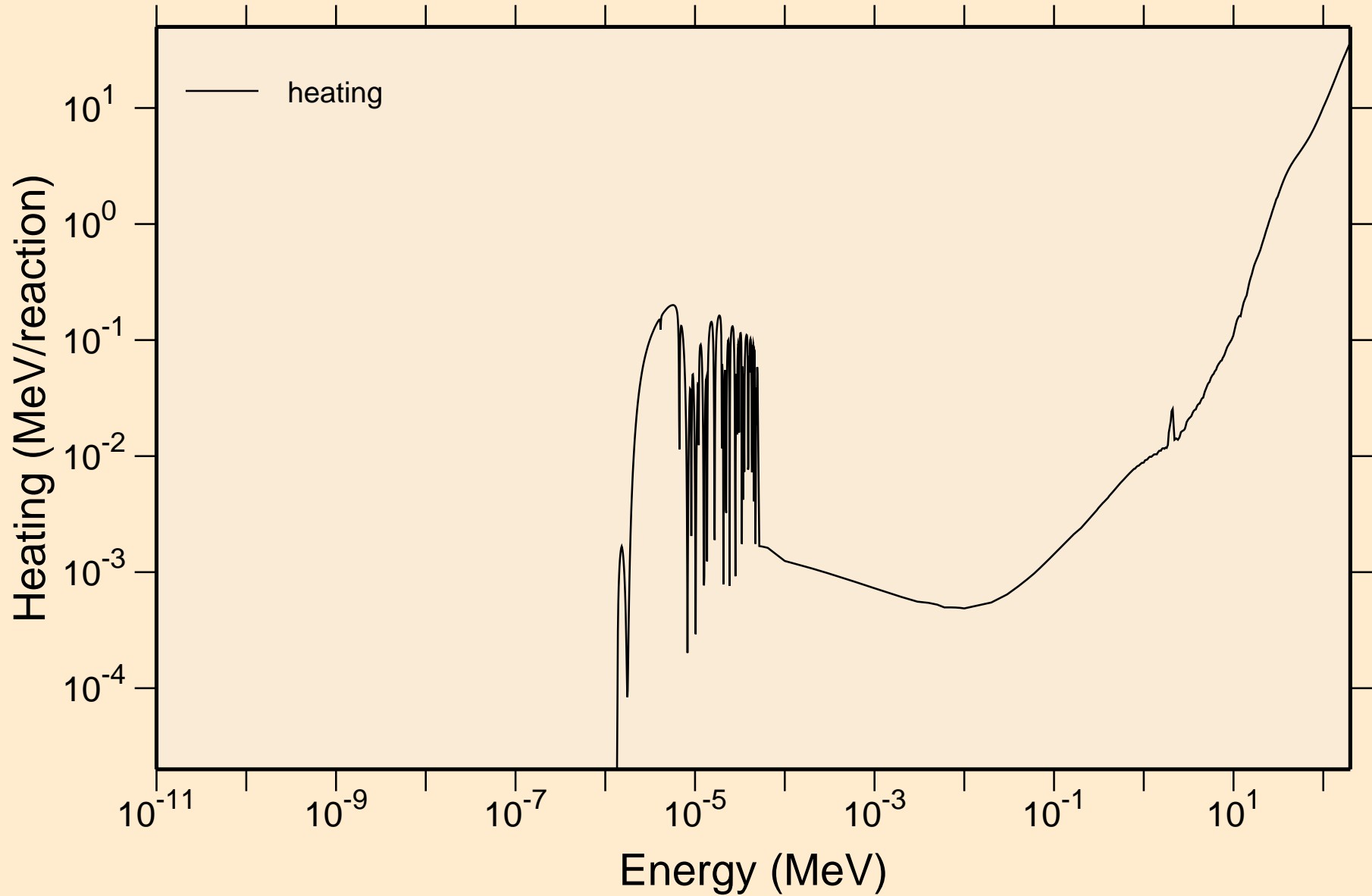

GD149 NEUTRON ACER TENDL-2024 LIBRARY; T=0.K

Damage

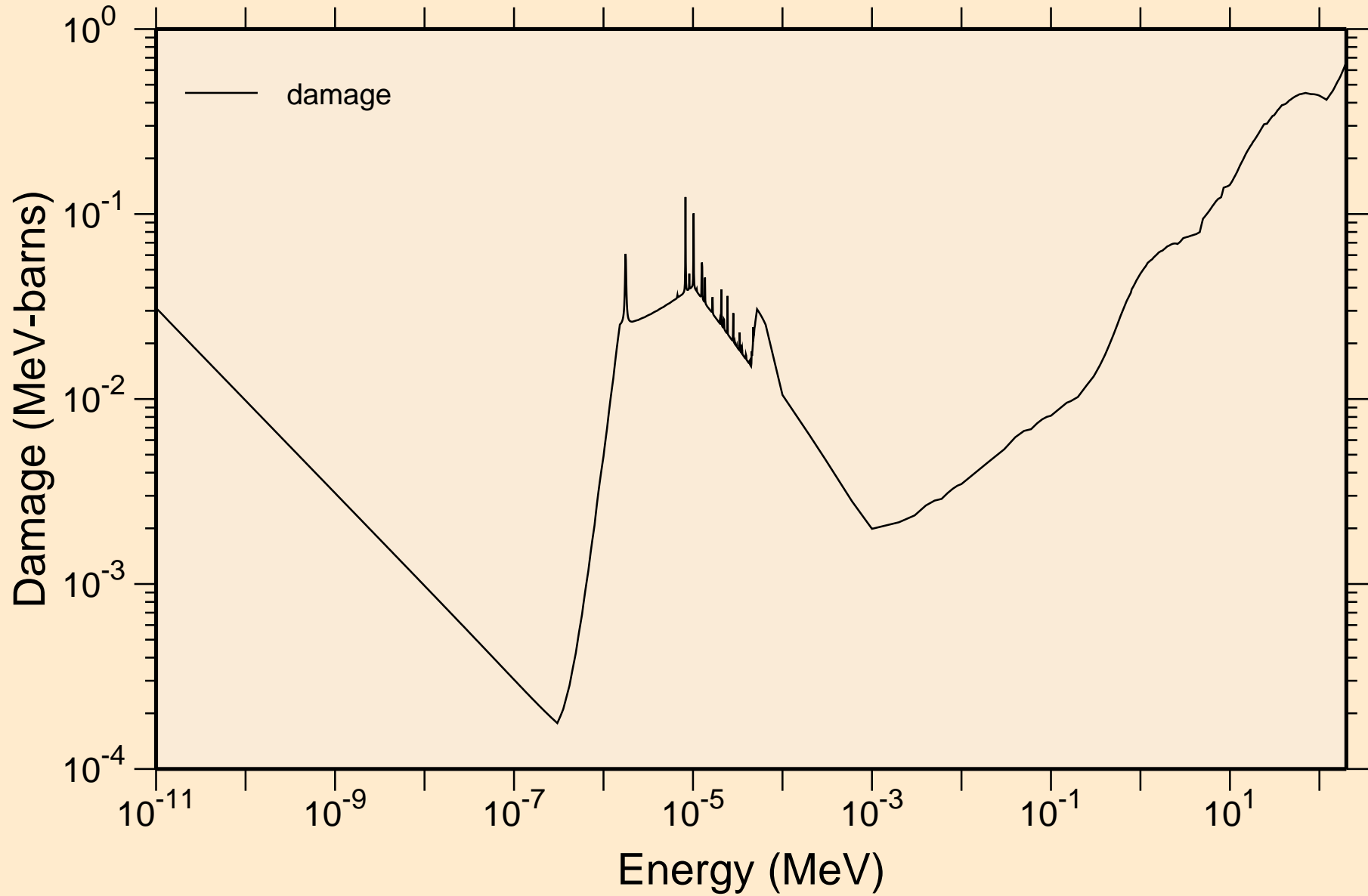

GD149 NEUTRON ACER TENDL-2024 LIBRARY; T=0.K

Non-threshold reactions

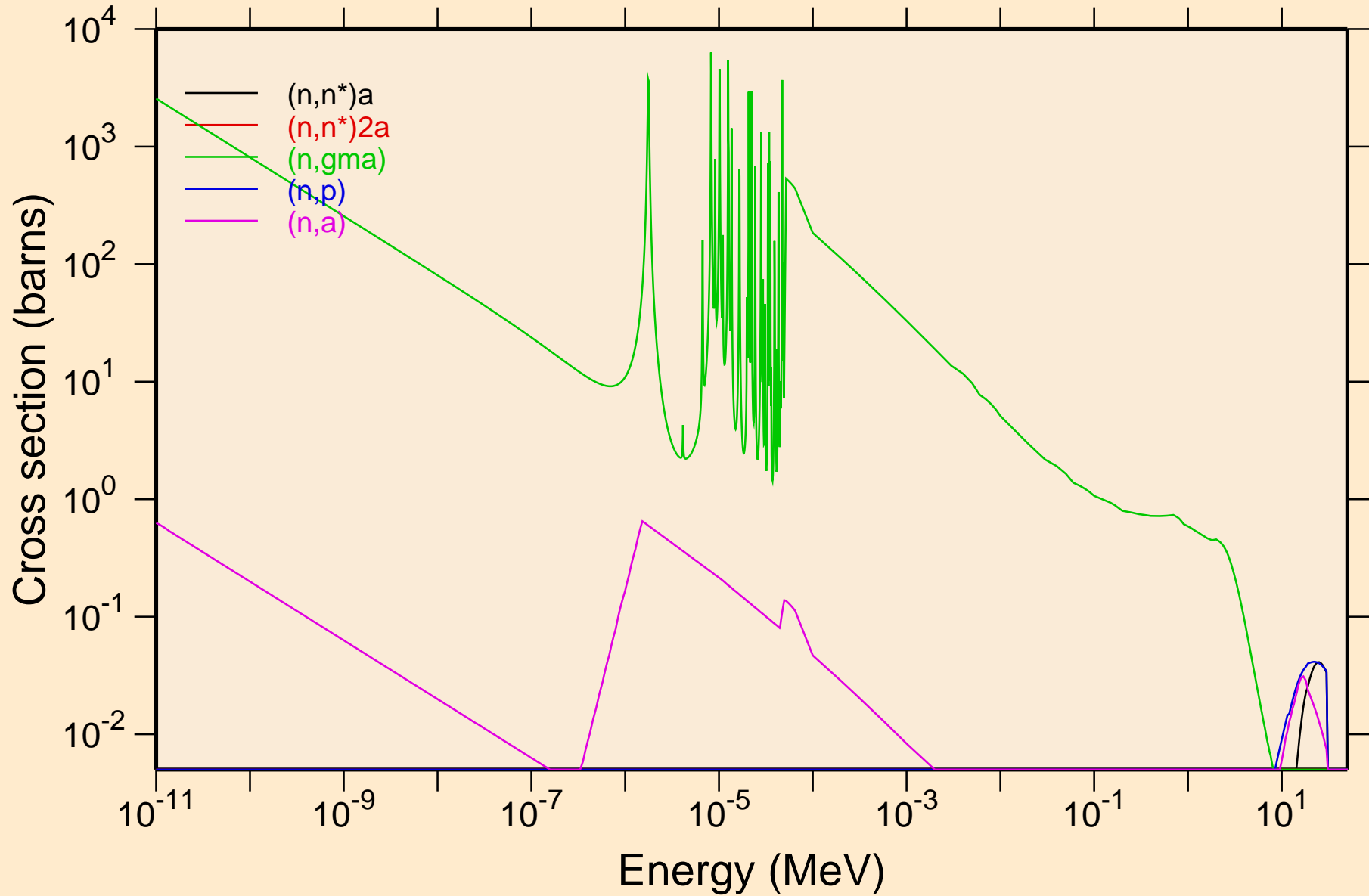

GD149 NEUTRON ACER TENDL-2024 LIBRARY; T=0.K
Non-threshold reactions

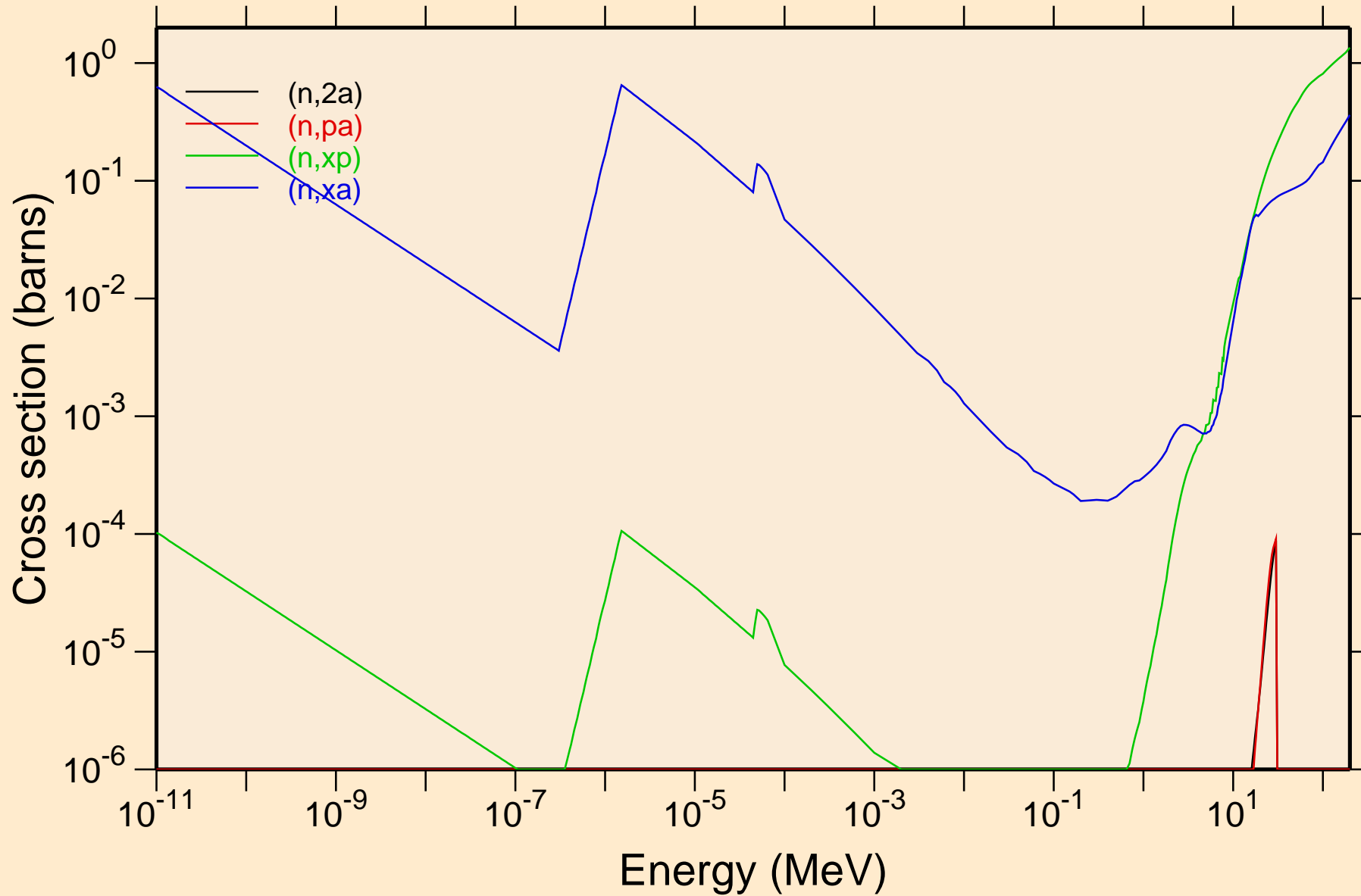

GD149 NEUTRON ACER TENDL-2024 LIBRARY; T=0.K

Principal cross sections

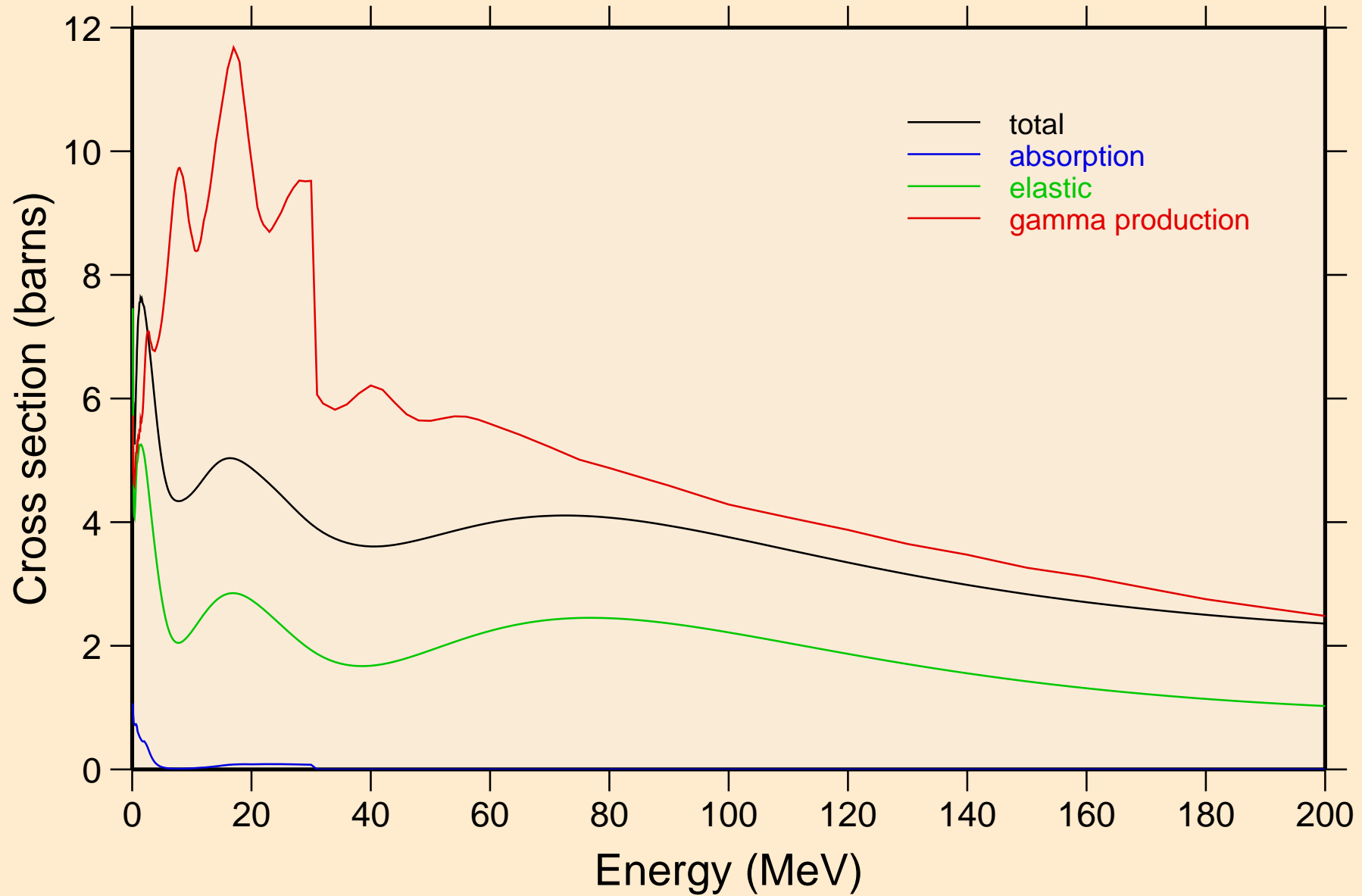

GD149 NEUTRON ACER TENDL-2024 LIBRARY; T=0.K

Heating

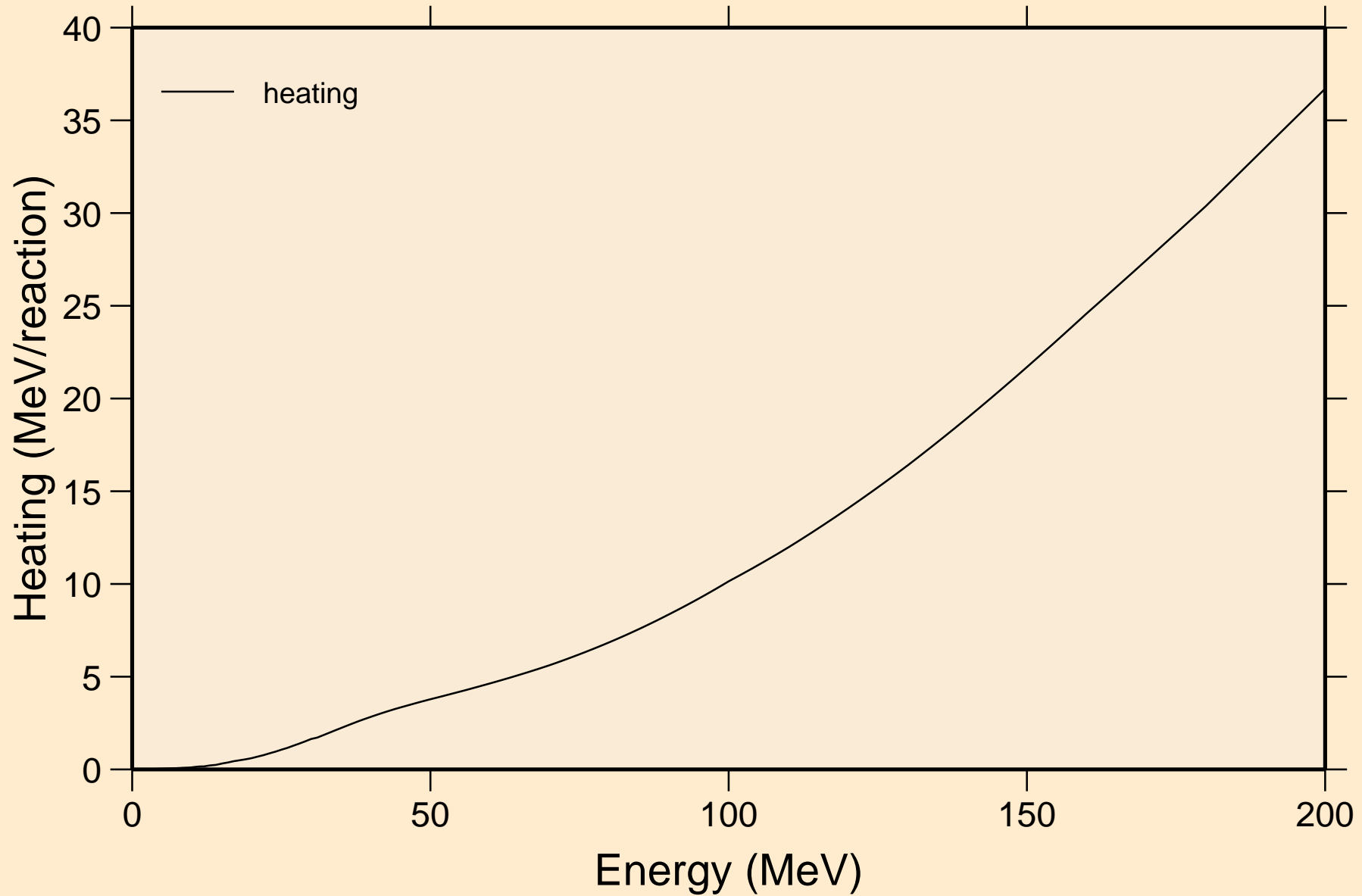

GD149 NEUTRON ACER TENDL-2024 LIBRARY; T=0.K

Damage

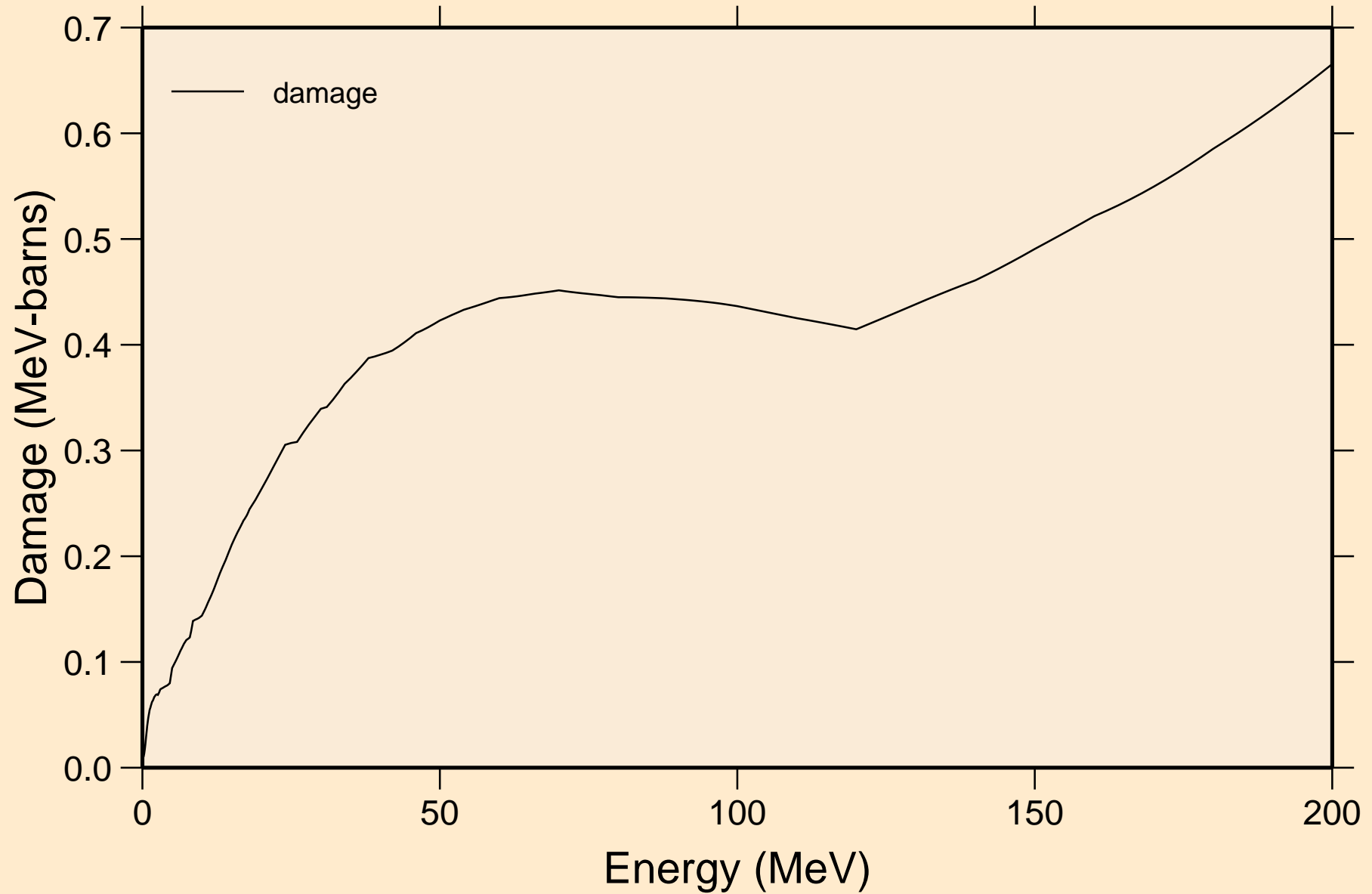

GD149 NEUTRON ACER TENDL-2024 LIBRARY; T=0.K

Non-threshold reactions

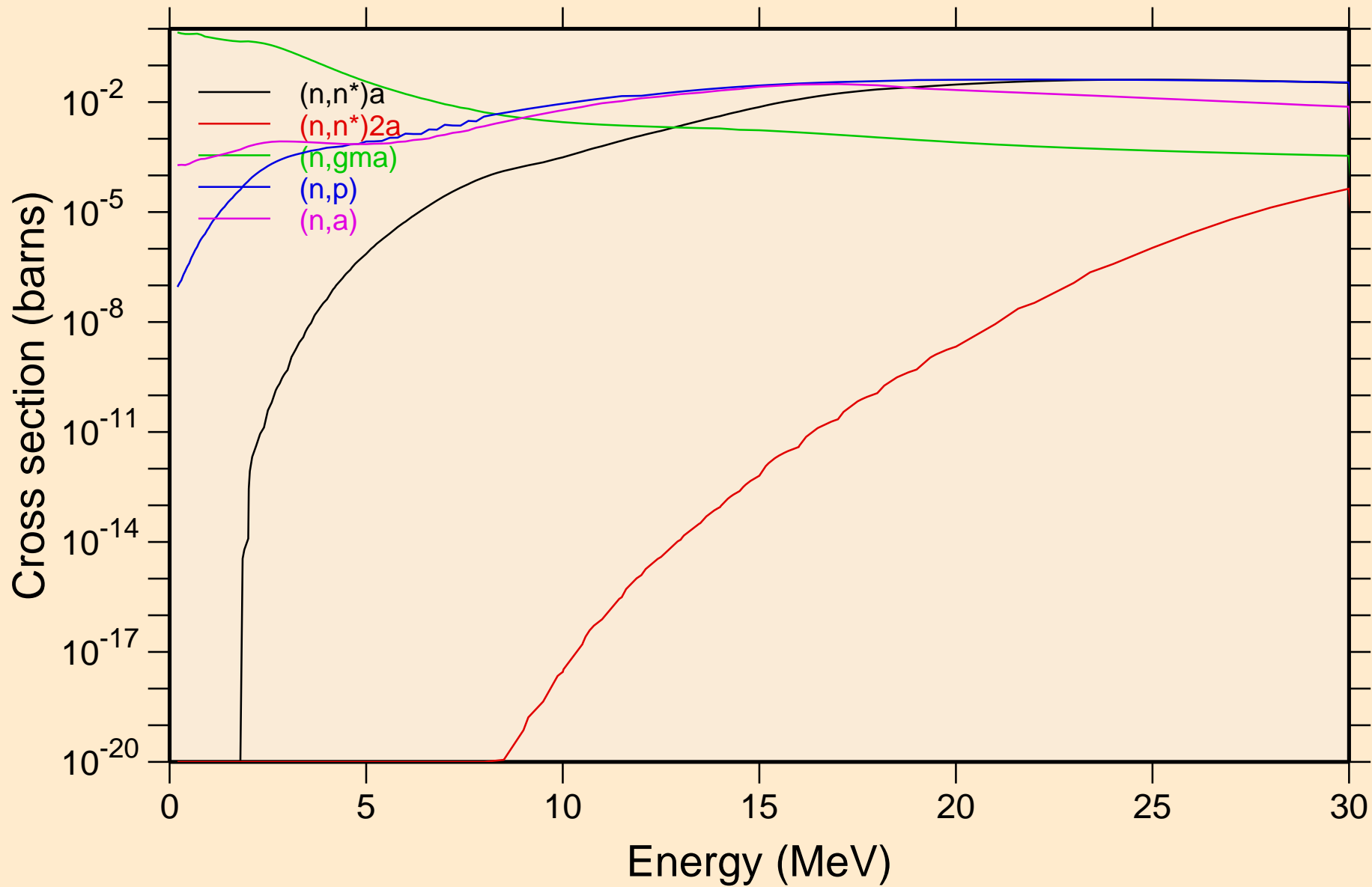

GD149 NEUTRON ACER TENDL-2024 LIBRARY; T=0.K

Non-threshold reactions

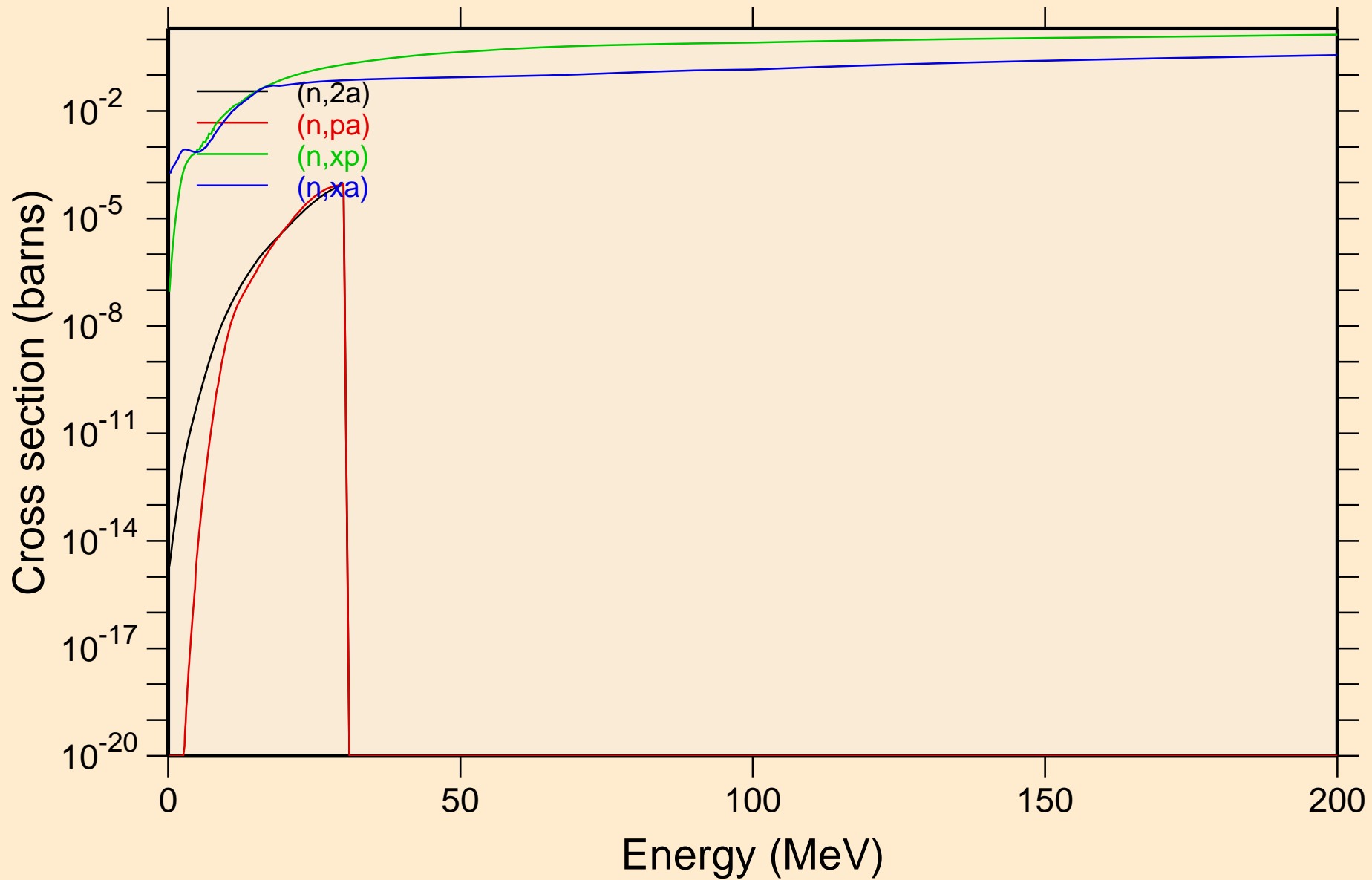

GD149 NEUTRON ACER TENDL-2024 LIBRARY; T=0.K
Inelastic levels

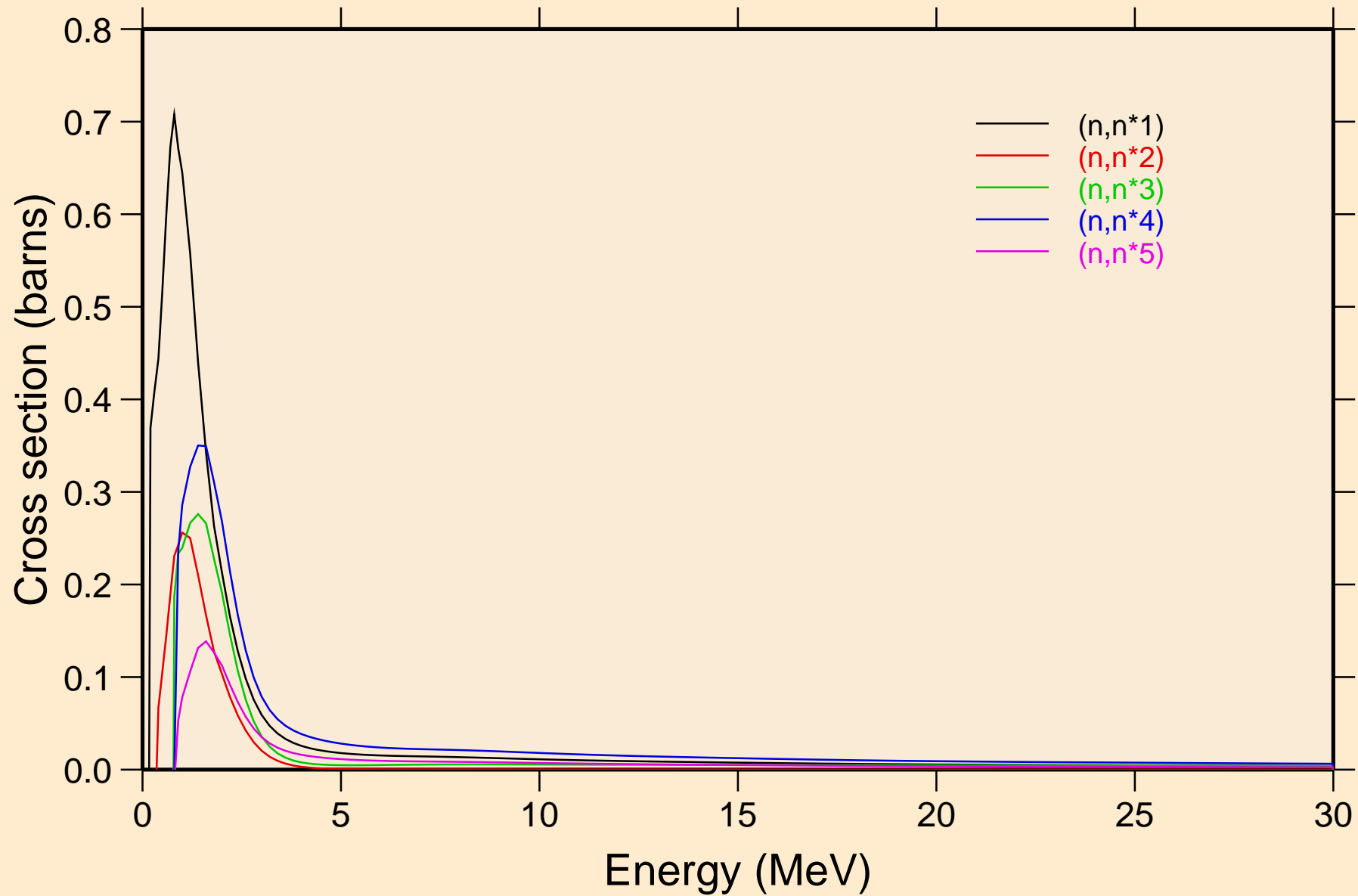

GD149 NEUTRON ACER TENDL-2024 LIBRARY; T=0.K

Inelastic levels

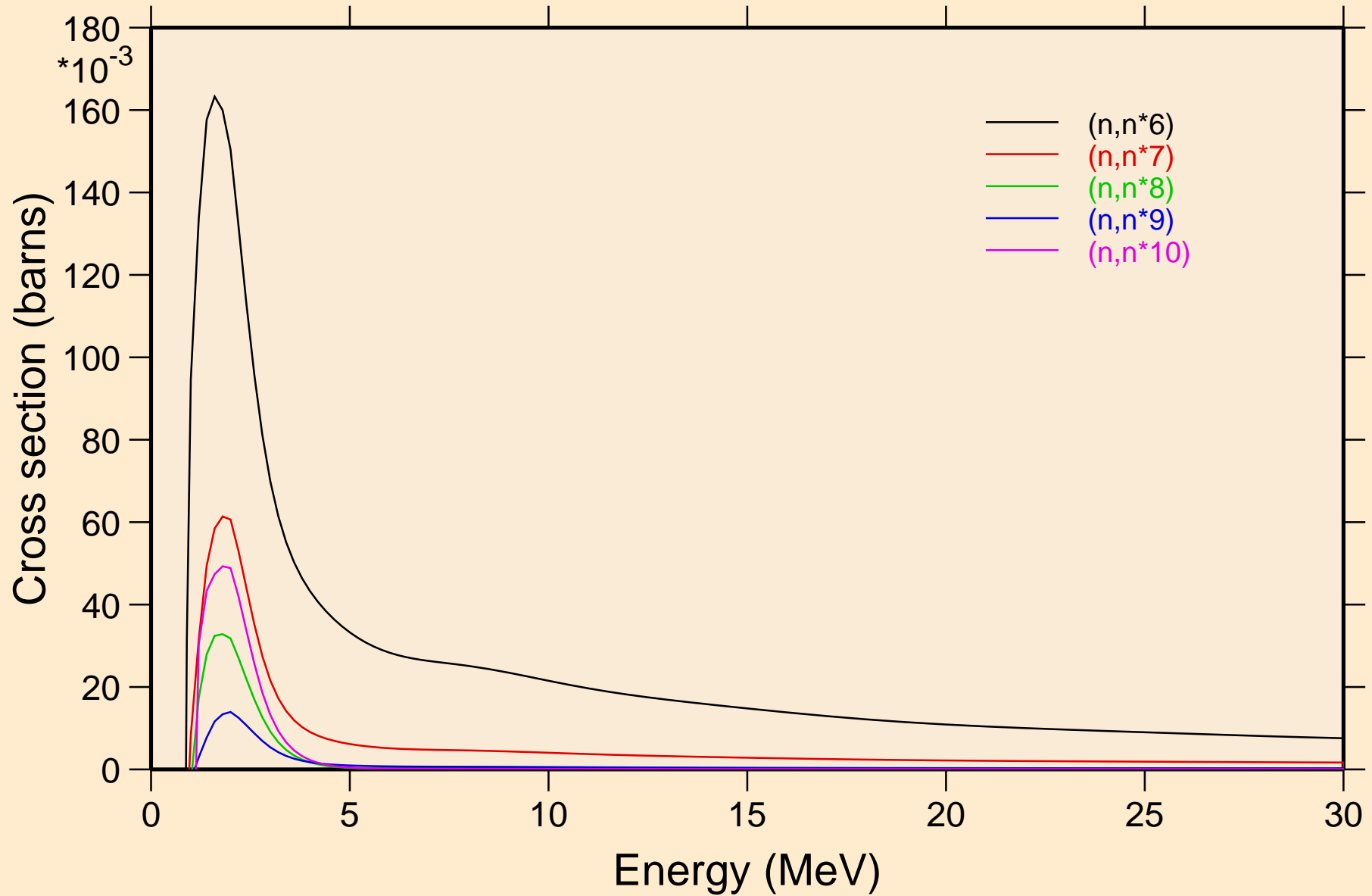

GD149 NEUTRON ACER TENDL-2024 LIBRARY; T=0.K
Inelastic levels

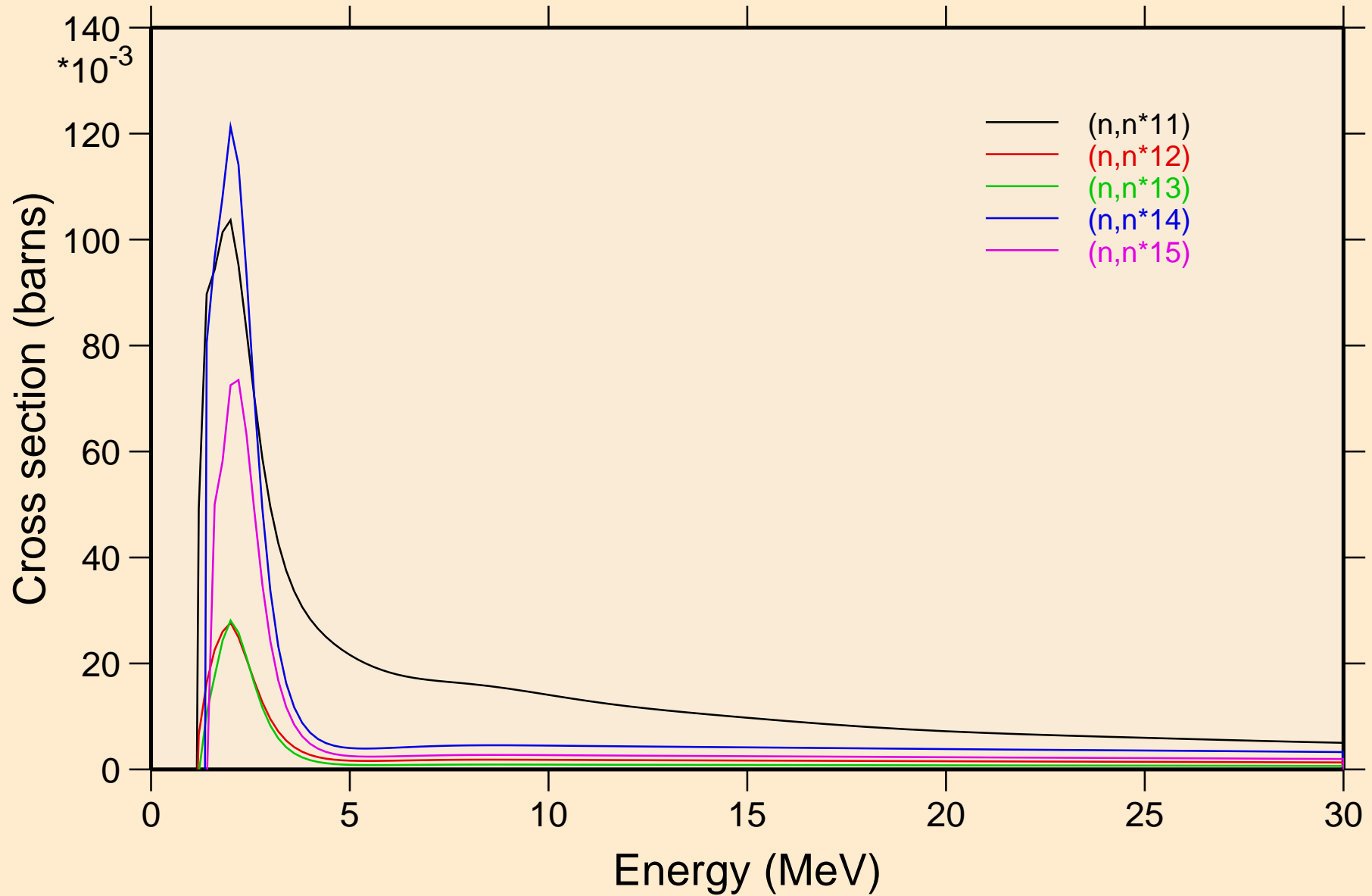

GD149 NEUTRON ACER TENDL-2024 LIBRARY; T=0.K
Inelastic levels

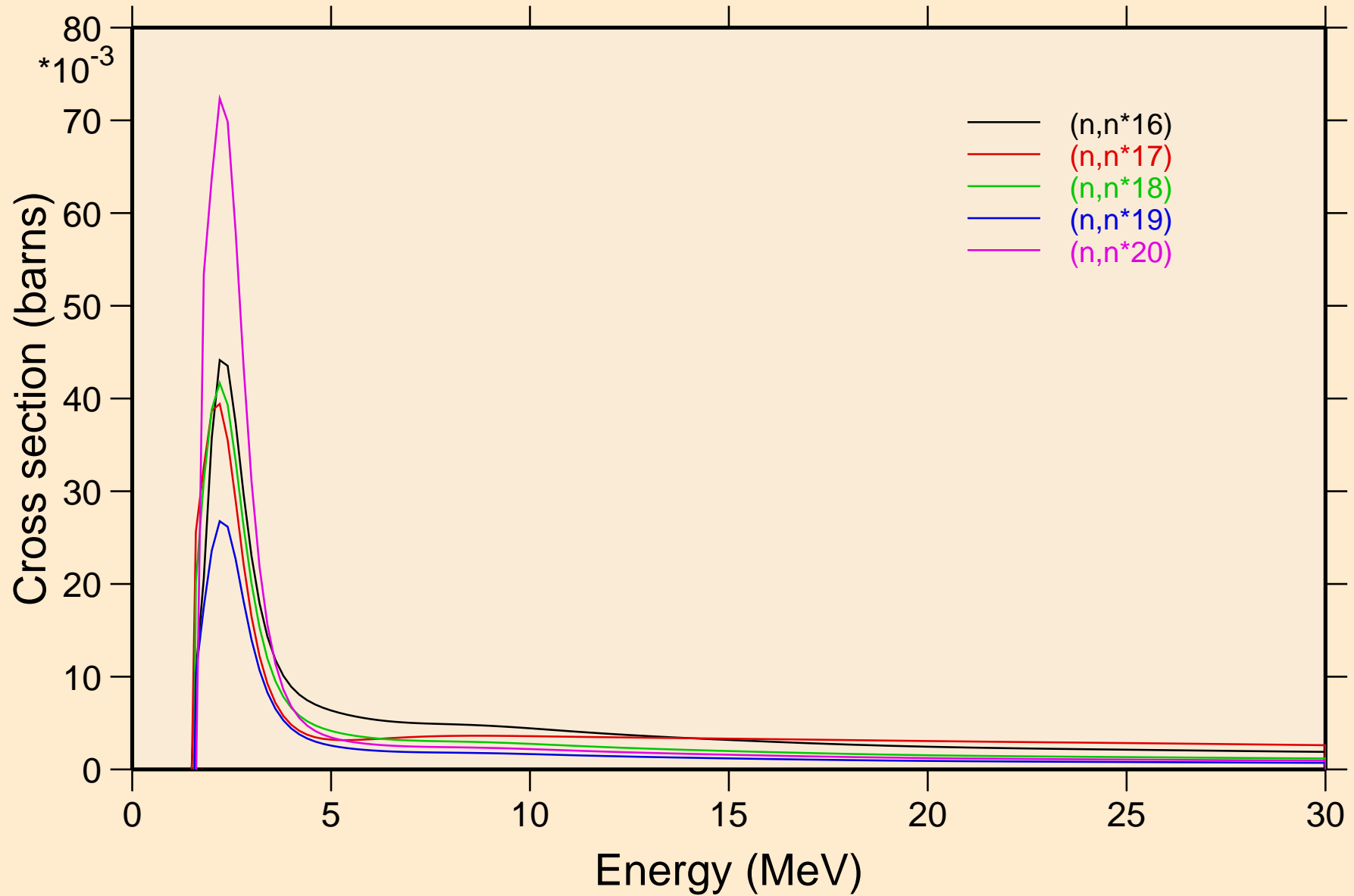

GD149 NEUTRON ACER TENDL-2024 LIBRARY; T=0.K
Inelastic levels

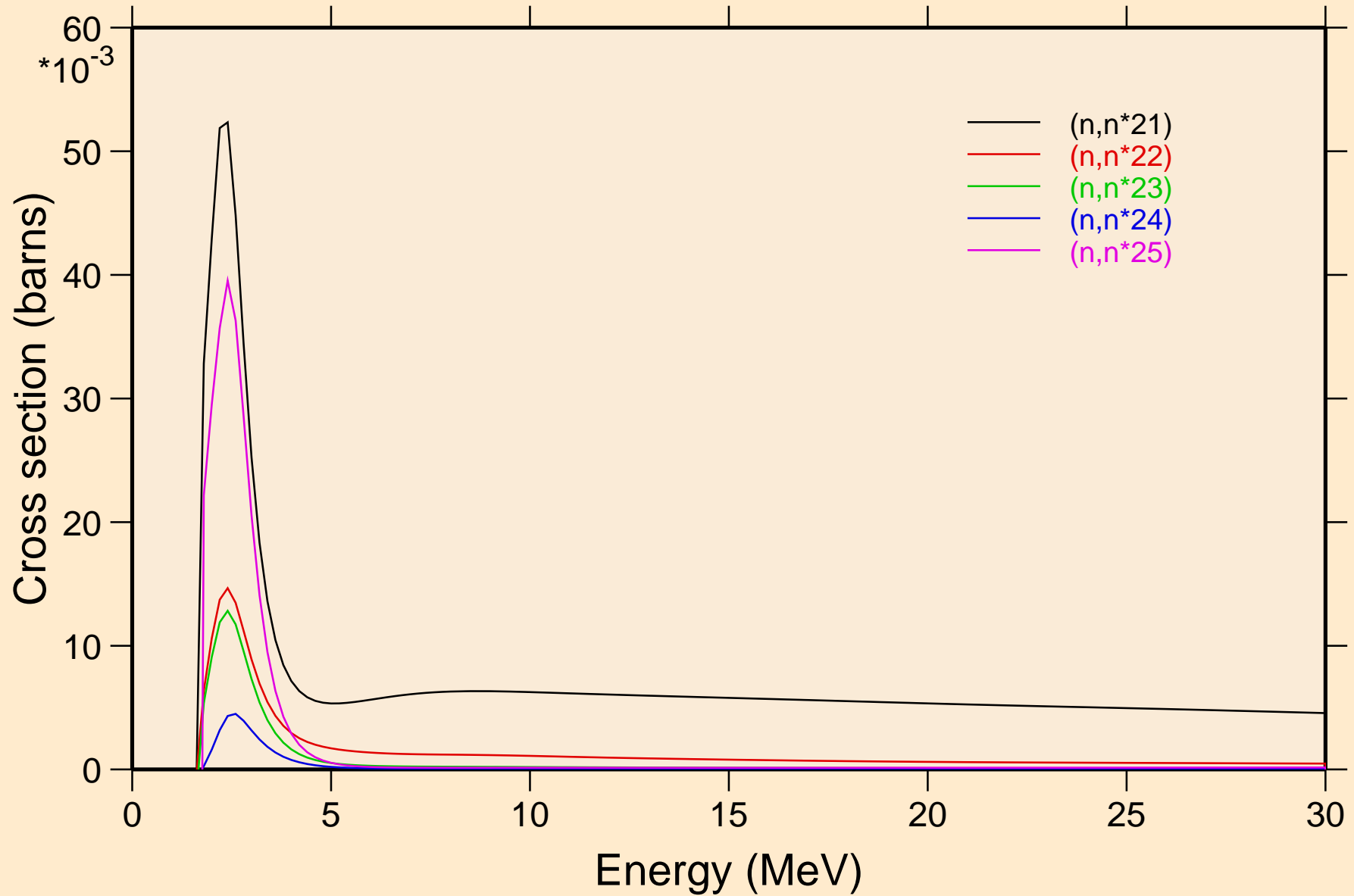

GD149 NEUTRON ACER TENDL-2024 LIBRARY; T=0.K
Inelastic levels

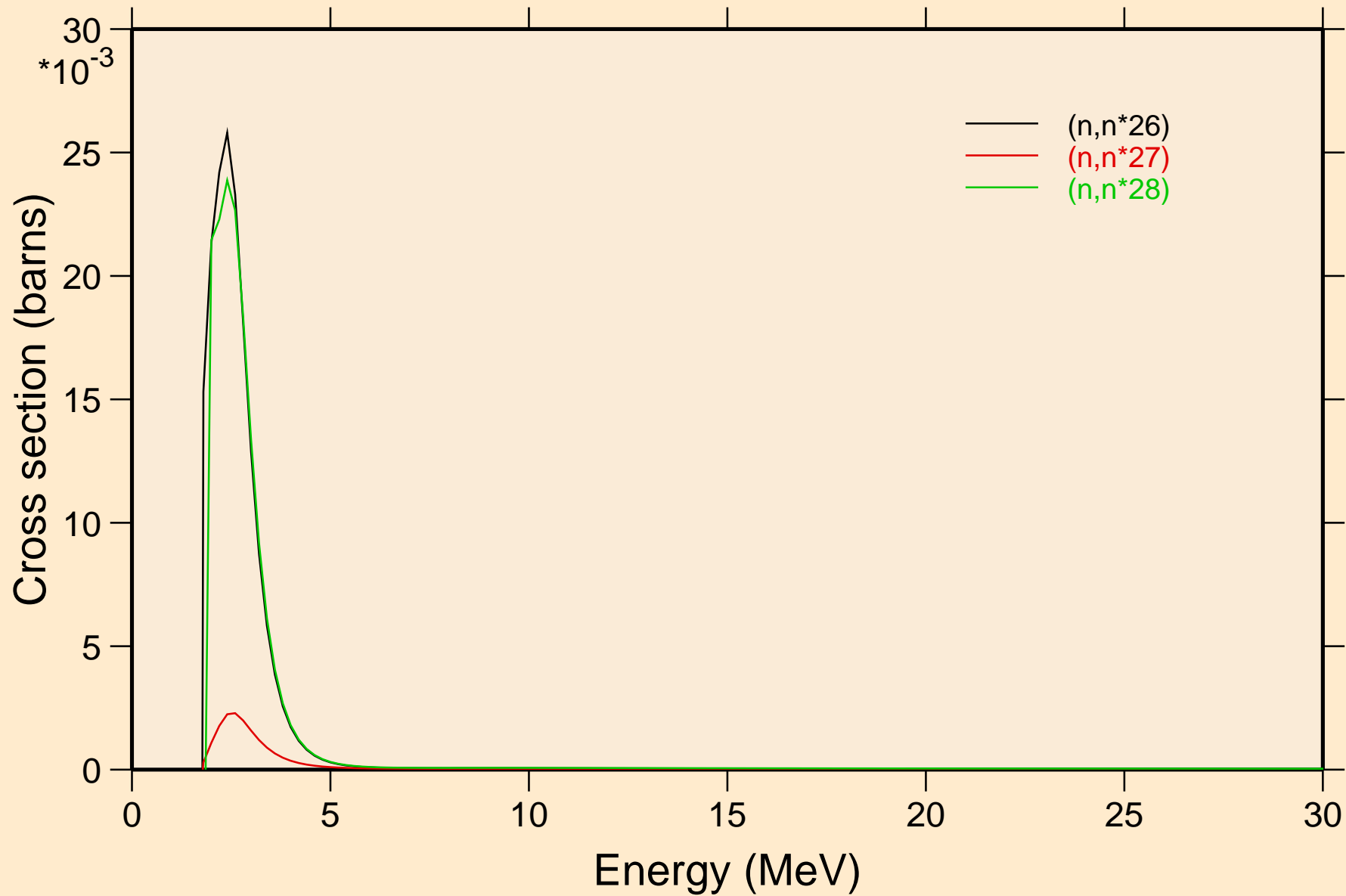

GD149 NEUTRON ACER TENDL-2024 LIBRARY; T=0.K

Threshold reactions

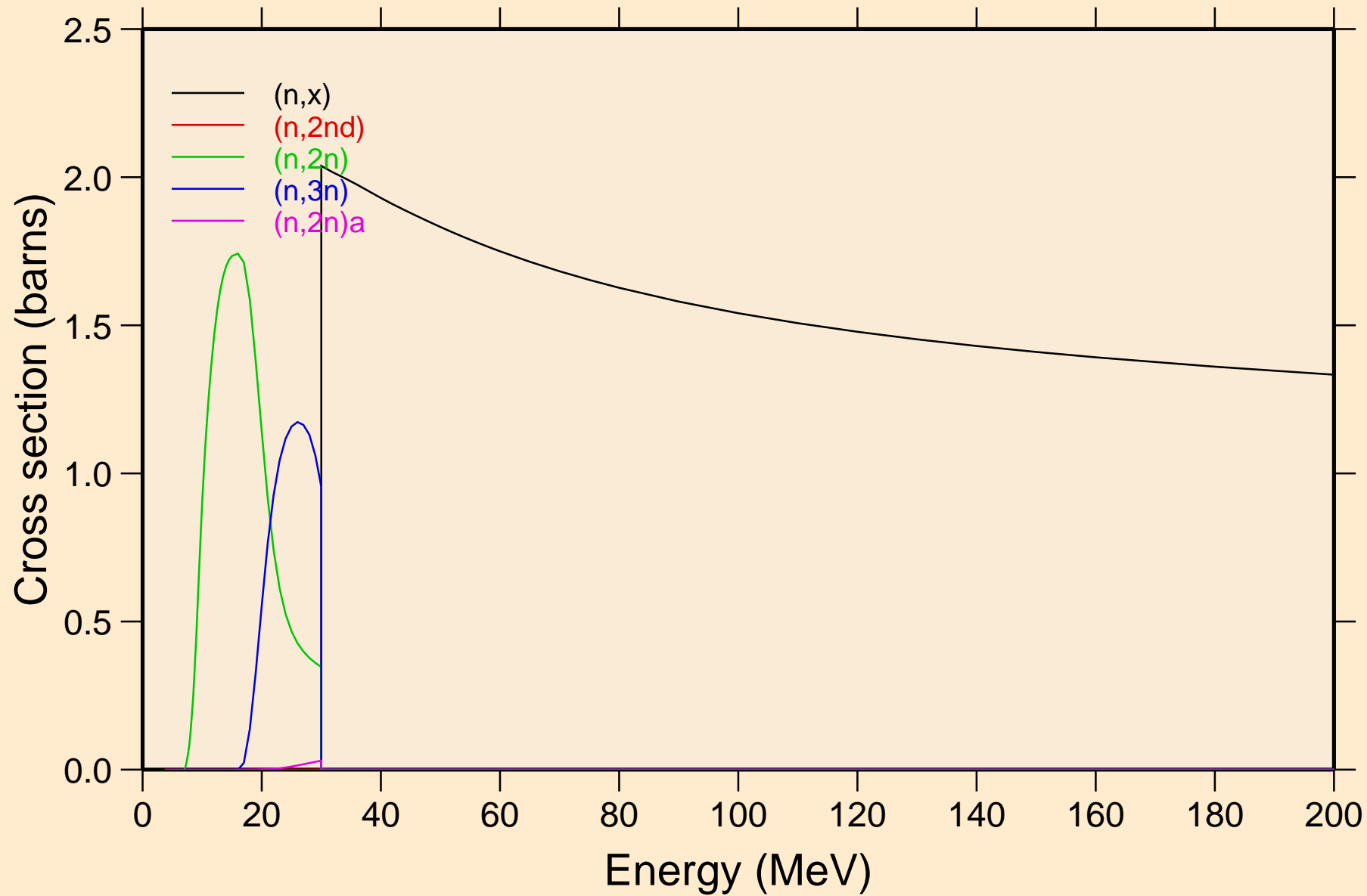

GD149 NEUTRON ACER TENDL-2024 LIBRARY; T=0.K

Threshold reactions

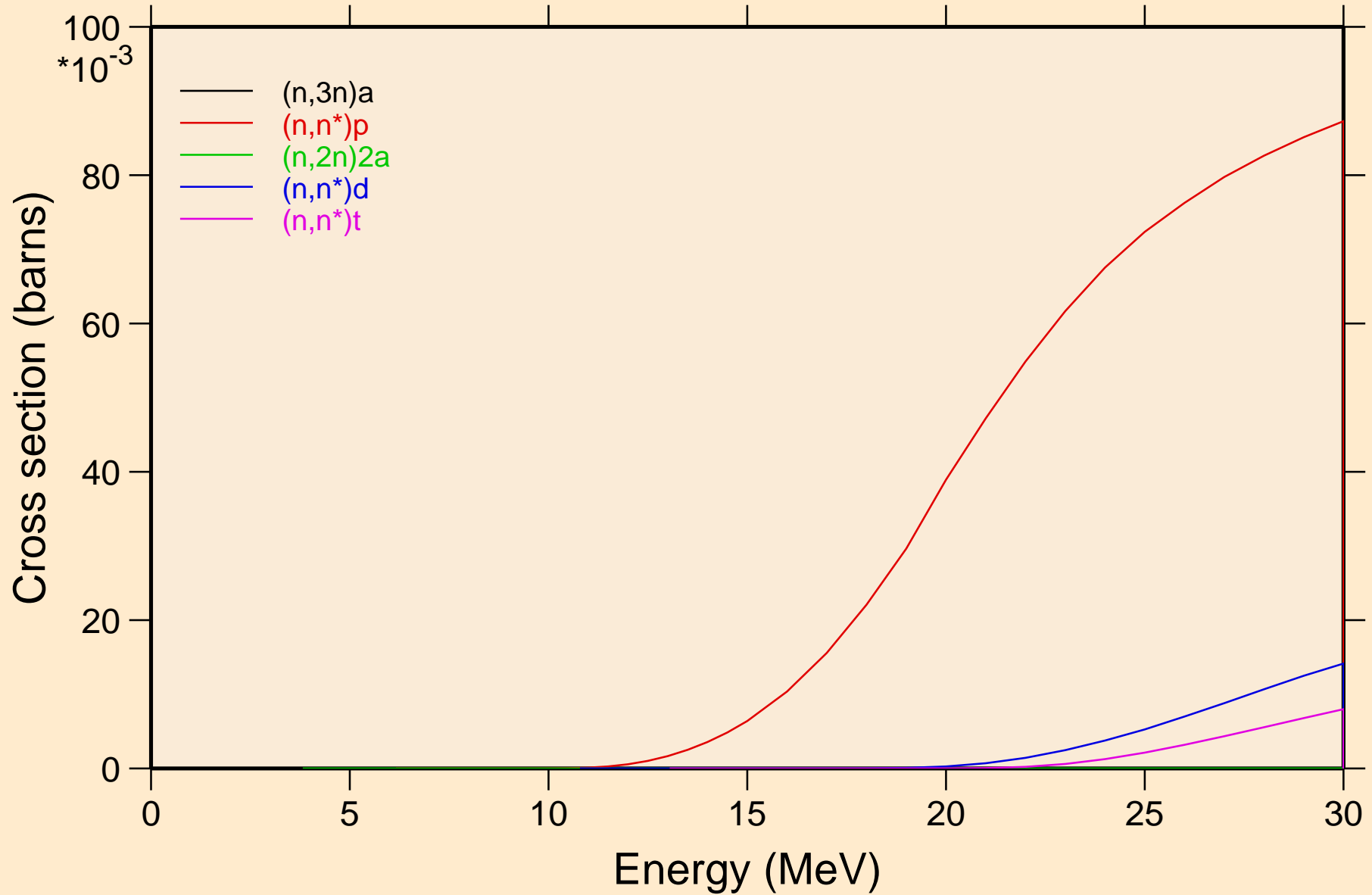

GD149 NEUTRON ACER TENDL-2024 LIBRARY; T=0.K

Threshold reactions

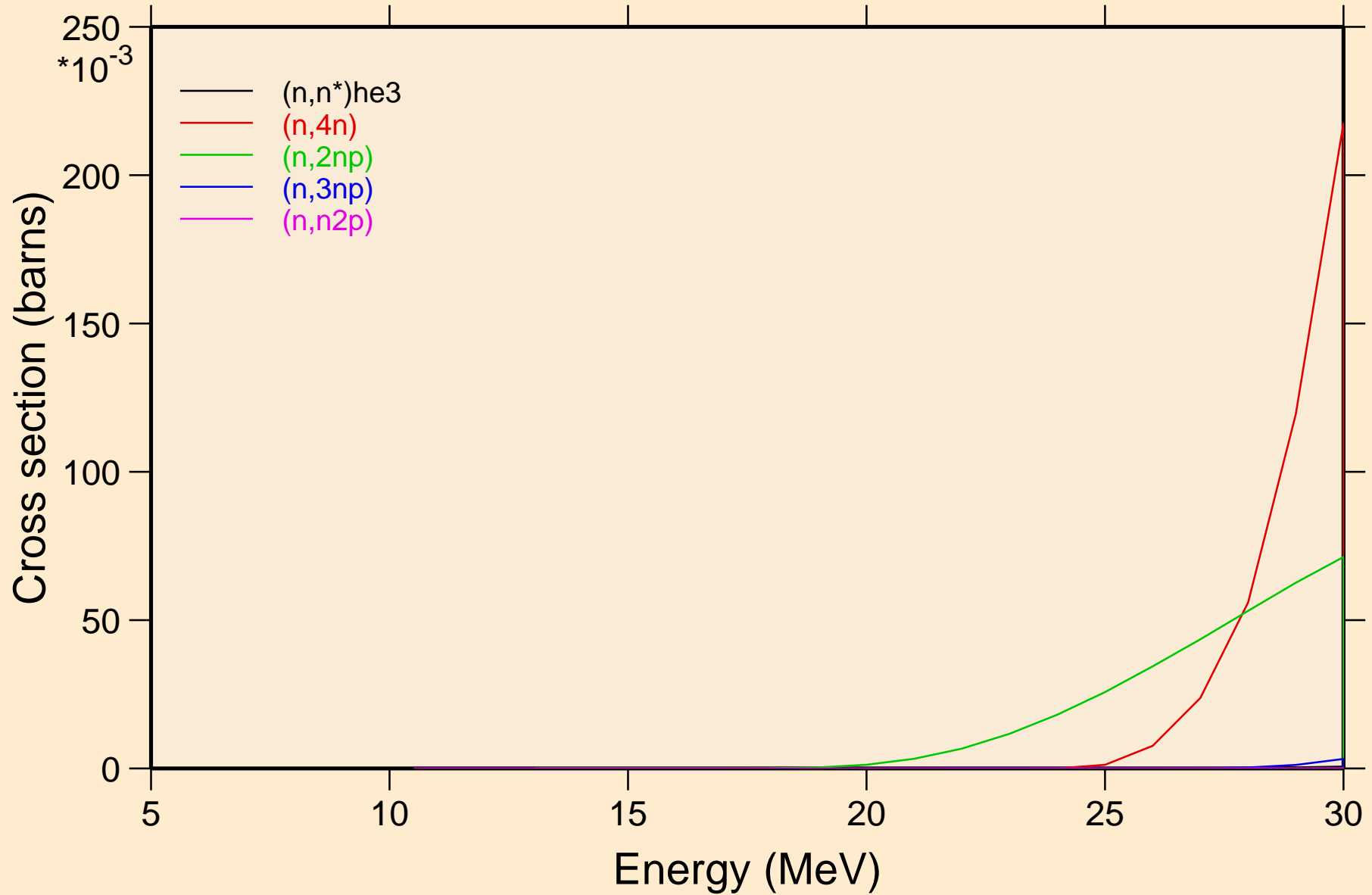

GD149 NEUTRON ACER TENDL-2024 LIBRARY; T=0.K

Threshold reactions

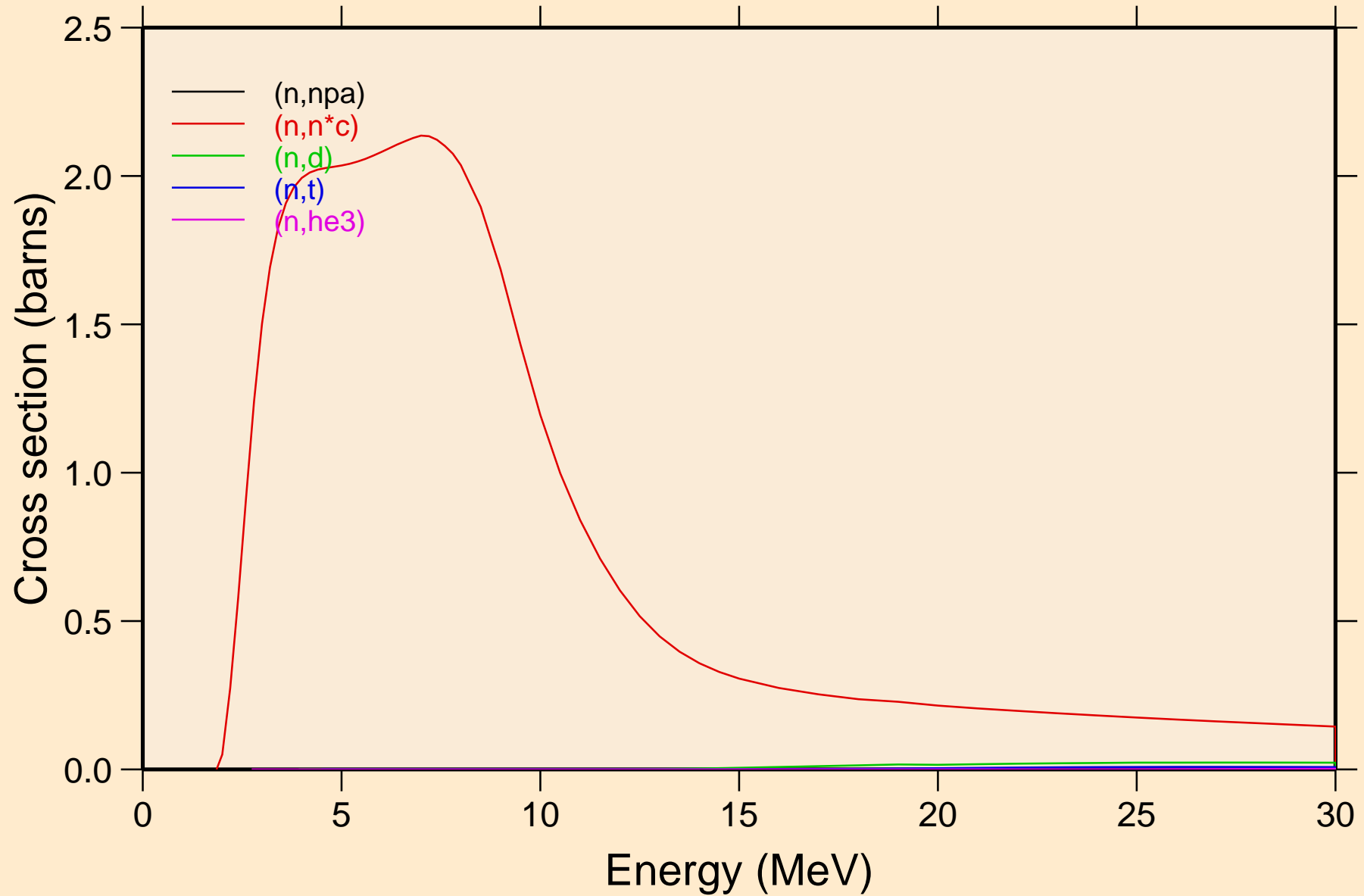

GD149 NEUTRON ACER TENDL-2024 LIBRARY; T=0.K

Threshold reactions

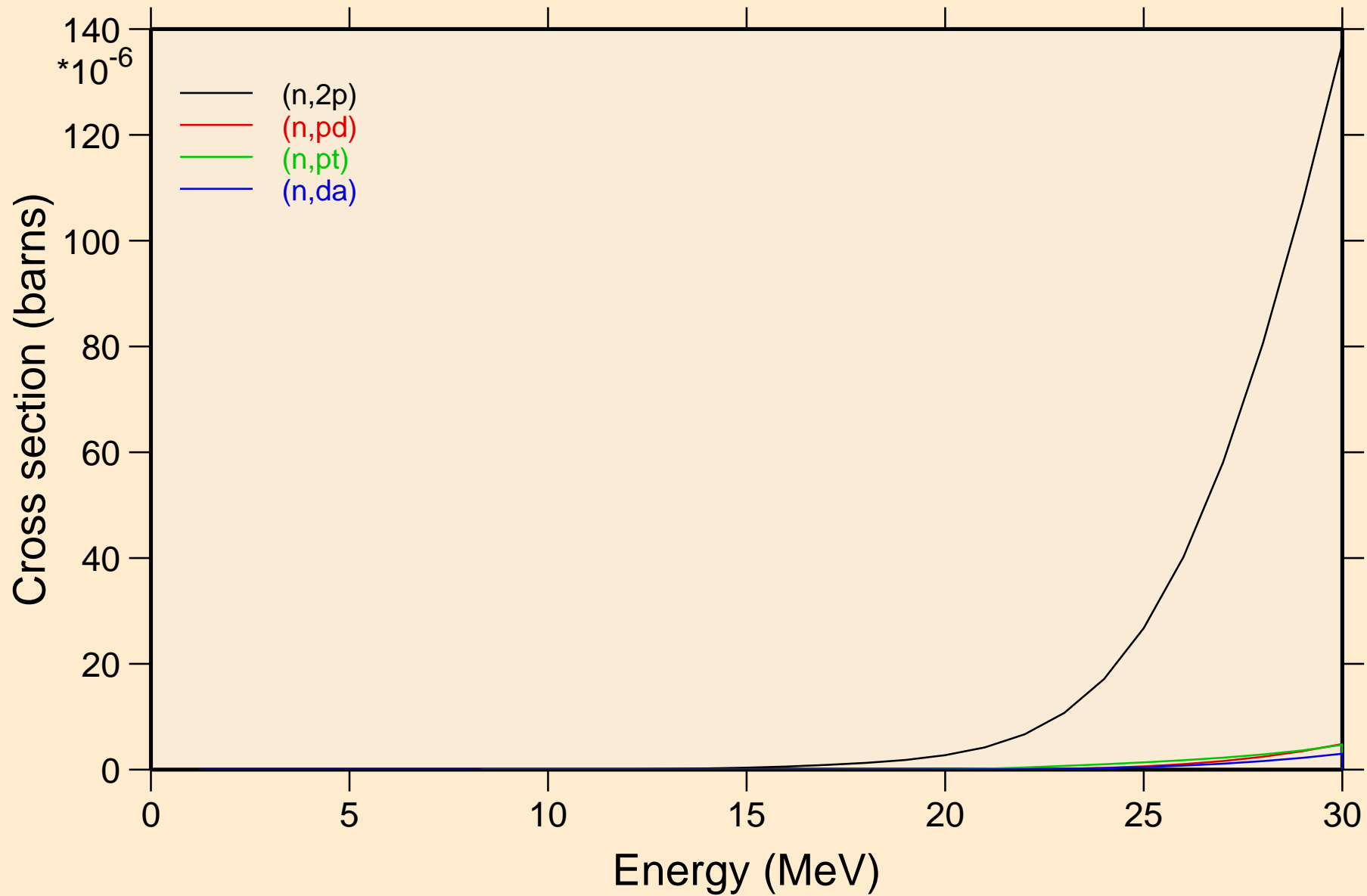

GD149 NEUTRON ACER TENDL-2024 LIBRARY; T=0.K

Threshold reactions

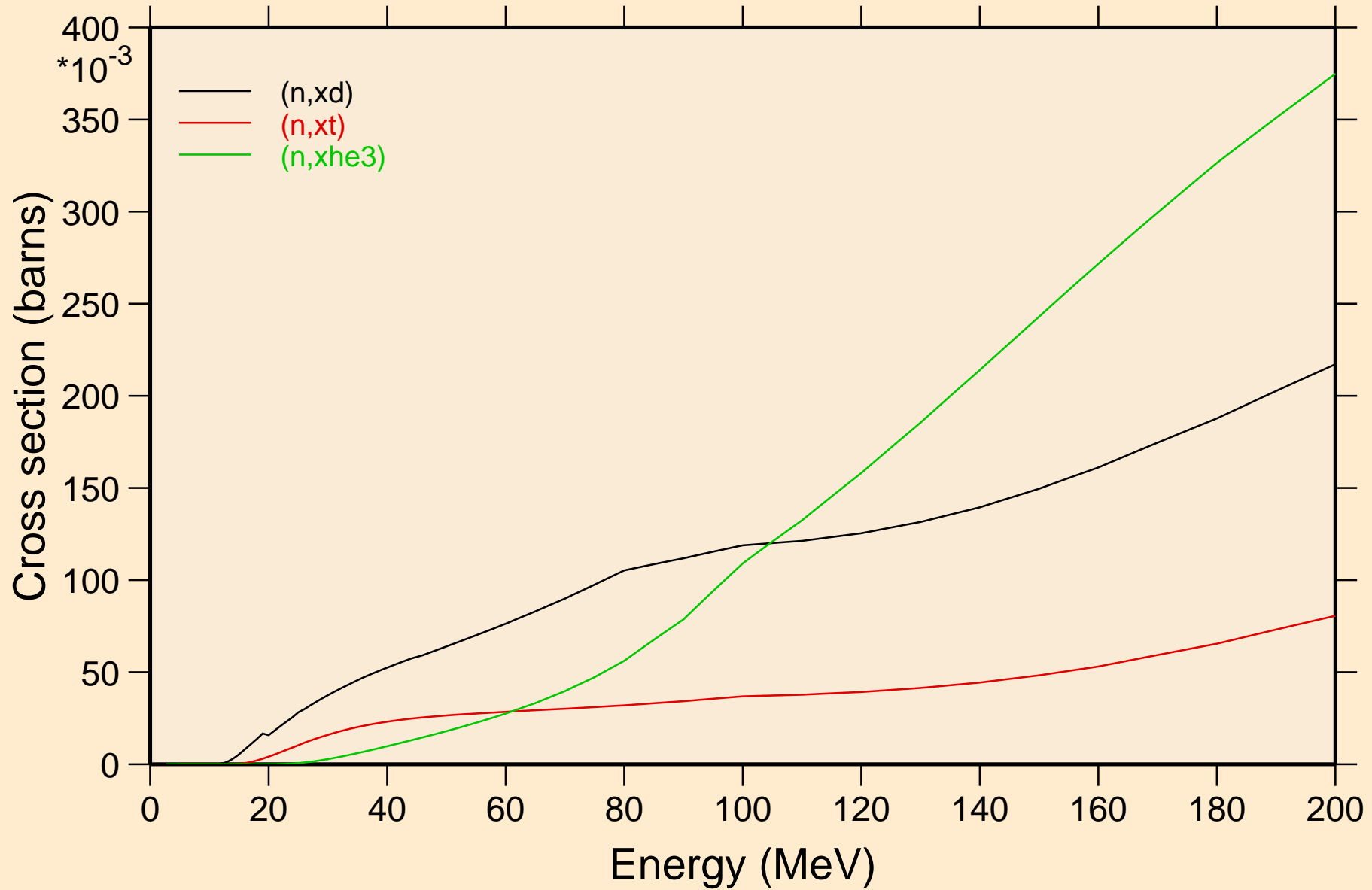

GD149 NEUTRON ACER TENDL-2024 LIBRARY; T=0.K
angular distribution for elastic

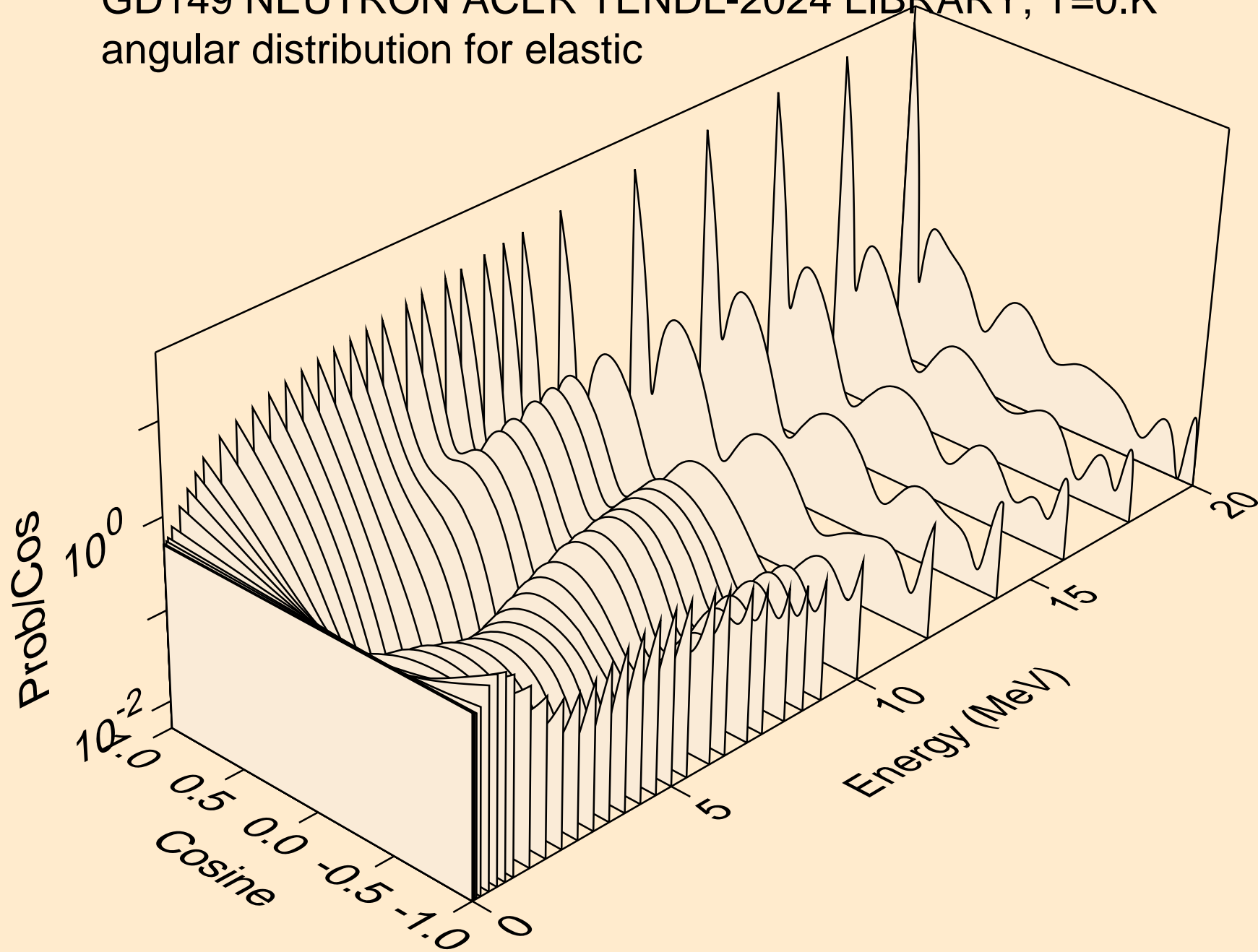

GD149 NEUTRON ACER TENDL-2024 LIBRARY; T=0.K
angular distribution for elastic

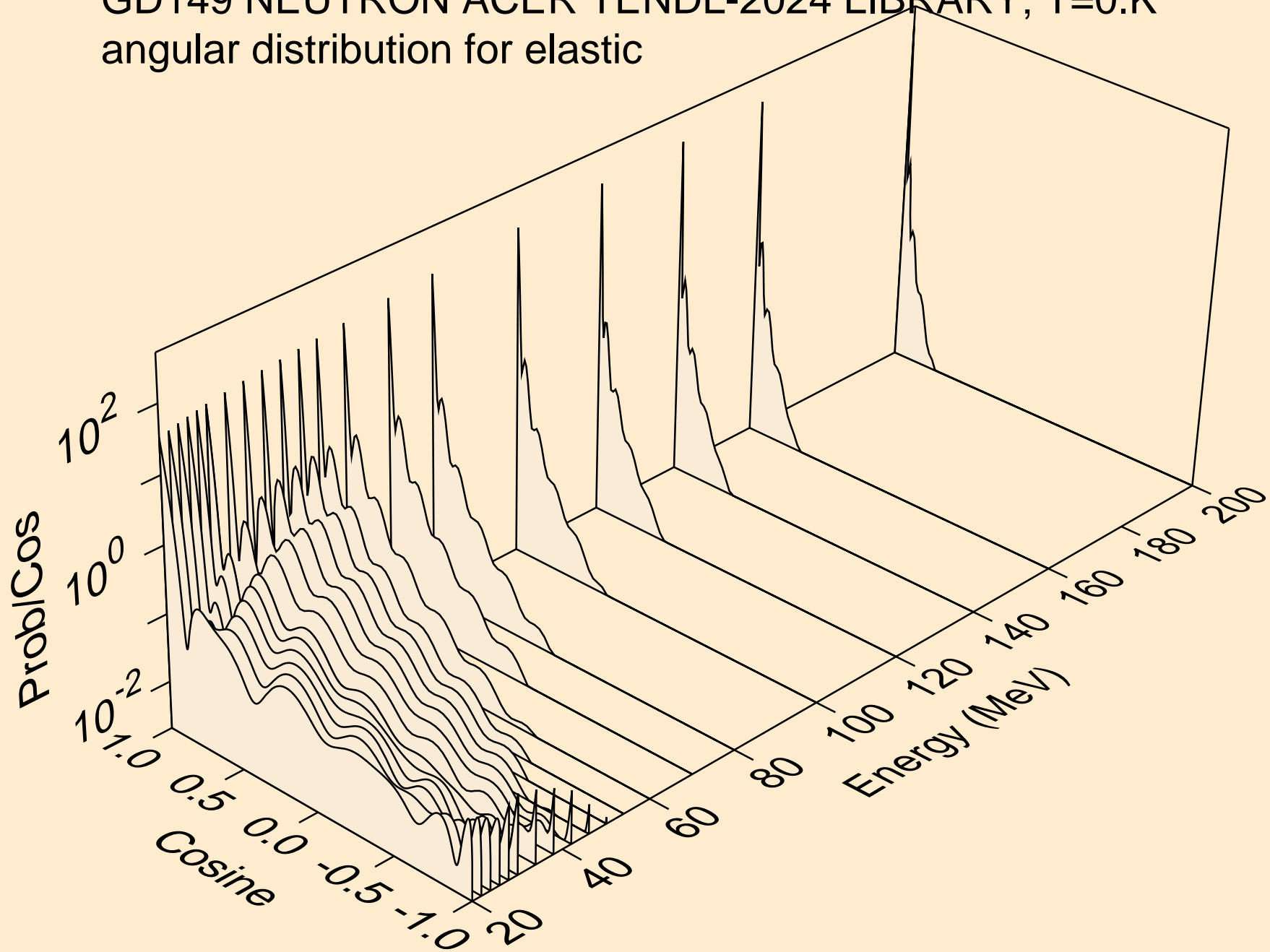

GD149 NEUTRON ACER TENDL-2024 LIBRARY; T=0.K
angular distribution for (n,n*1)

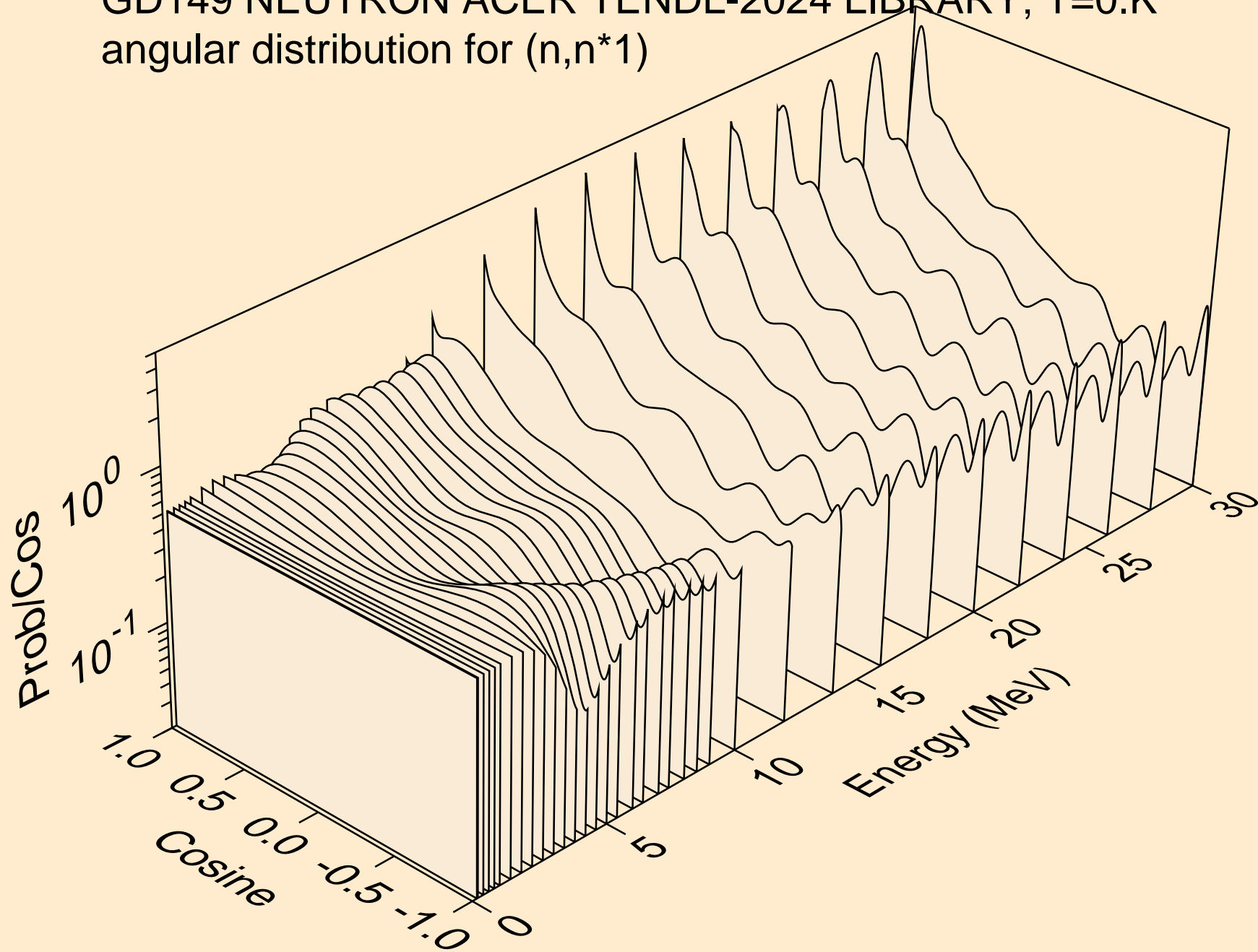

GD149 NEUTRON ACER TENDL-2024 LIBRARY; T=0.K
angular distribution for (n,n*2)

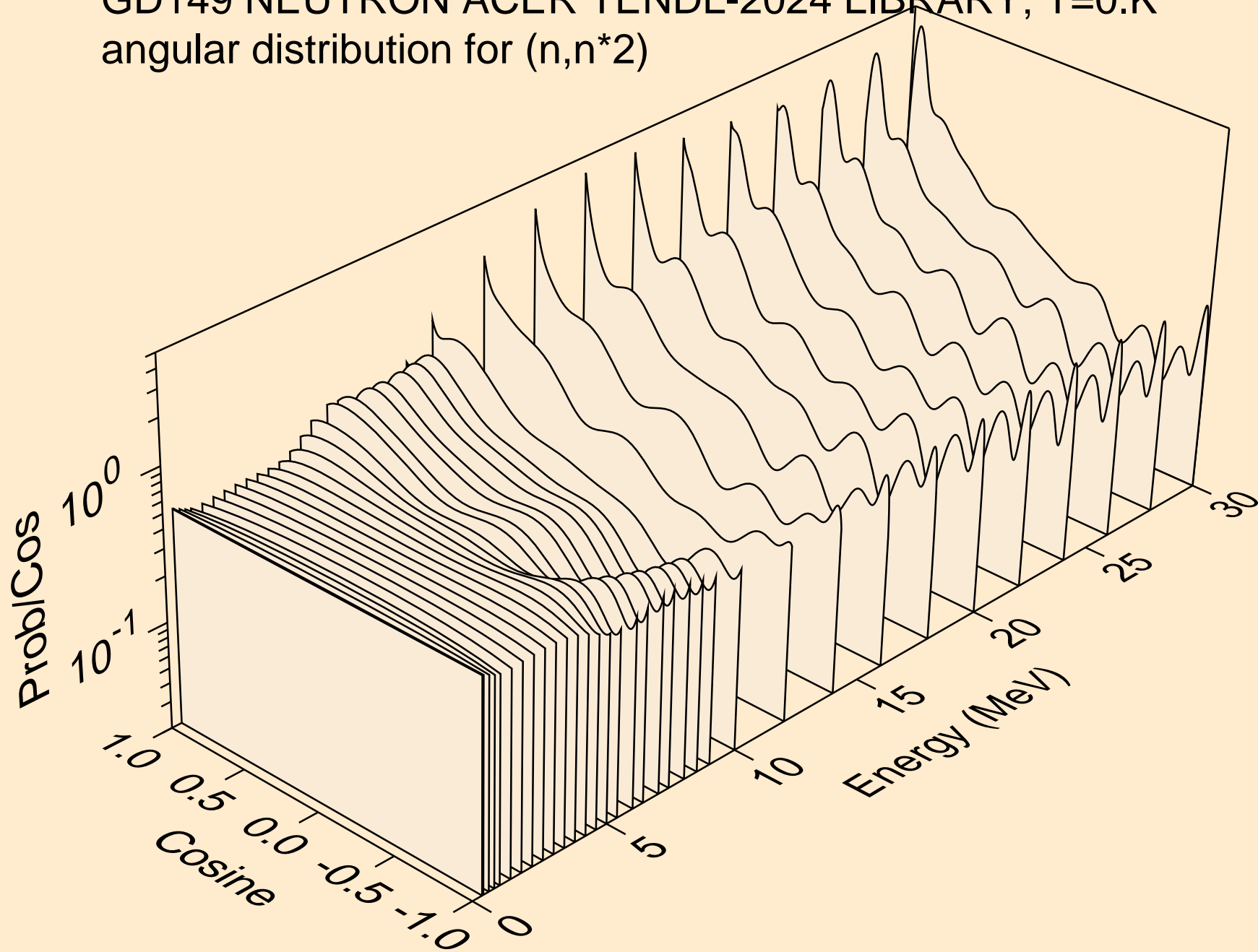

GD149 NEUTRON ACER TENDL-2024 LIBRARY; T=0.K
angular distribution for (n,n*3)

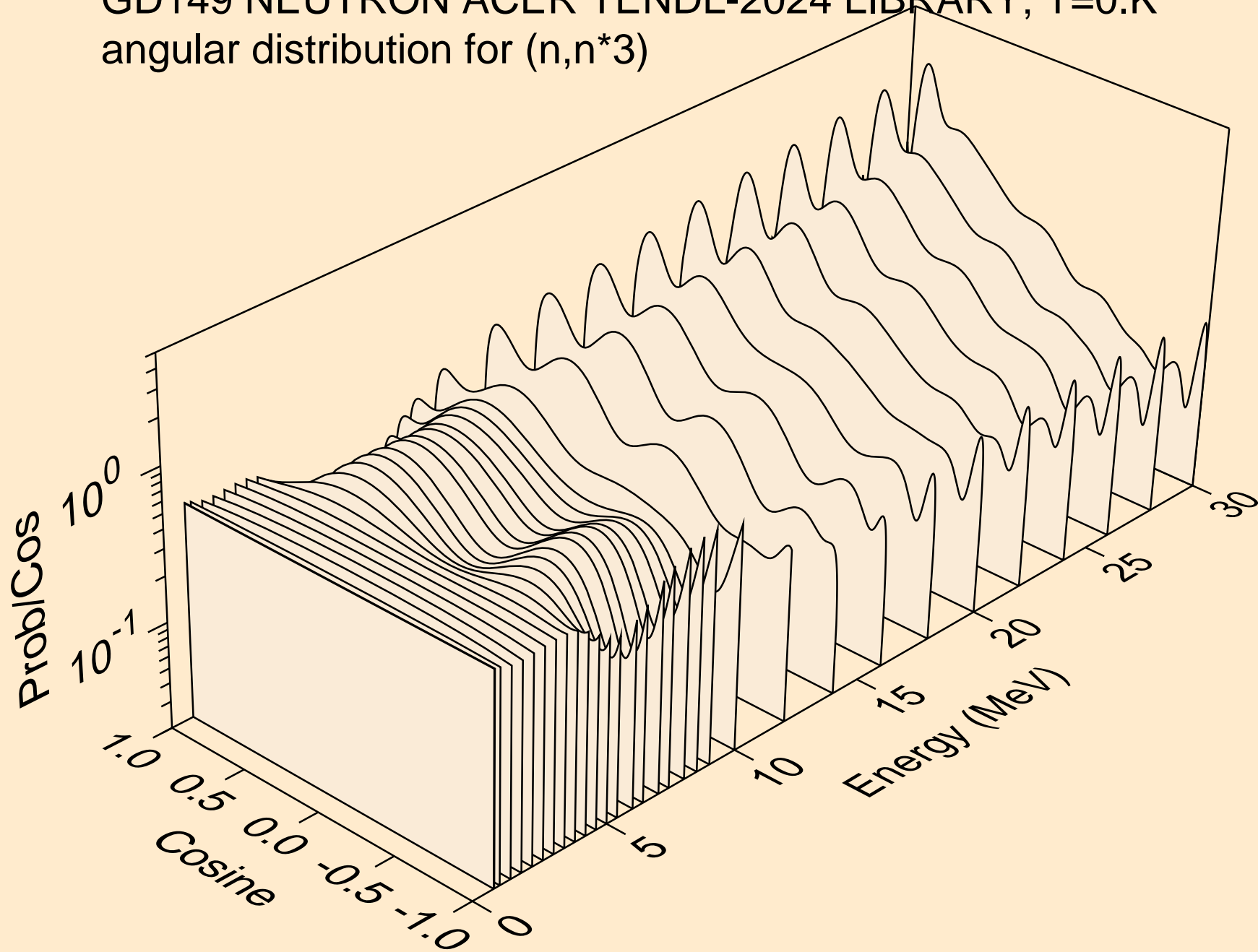

GD149 NEUTRON ACER TENDL-2024 LIBRARY; T=0.K
angular distribution for (n,n*4)

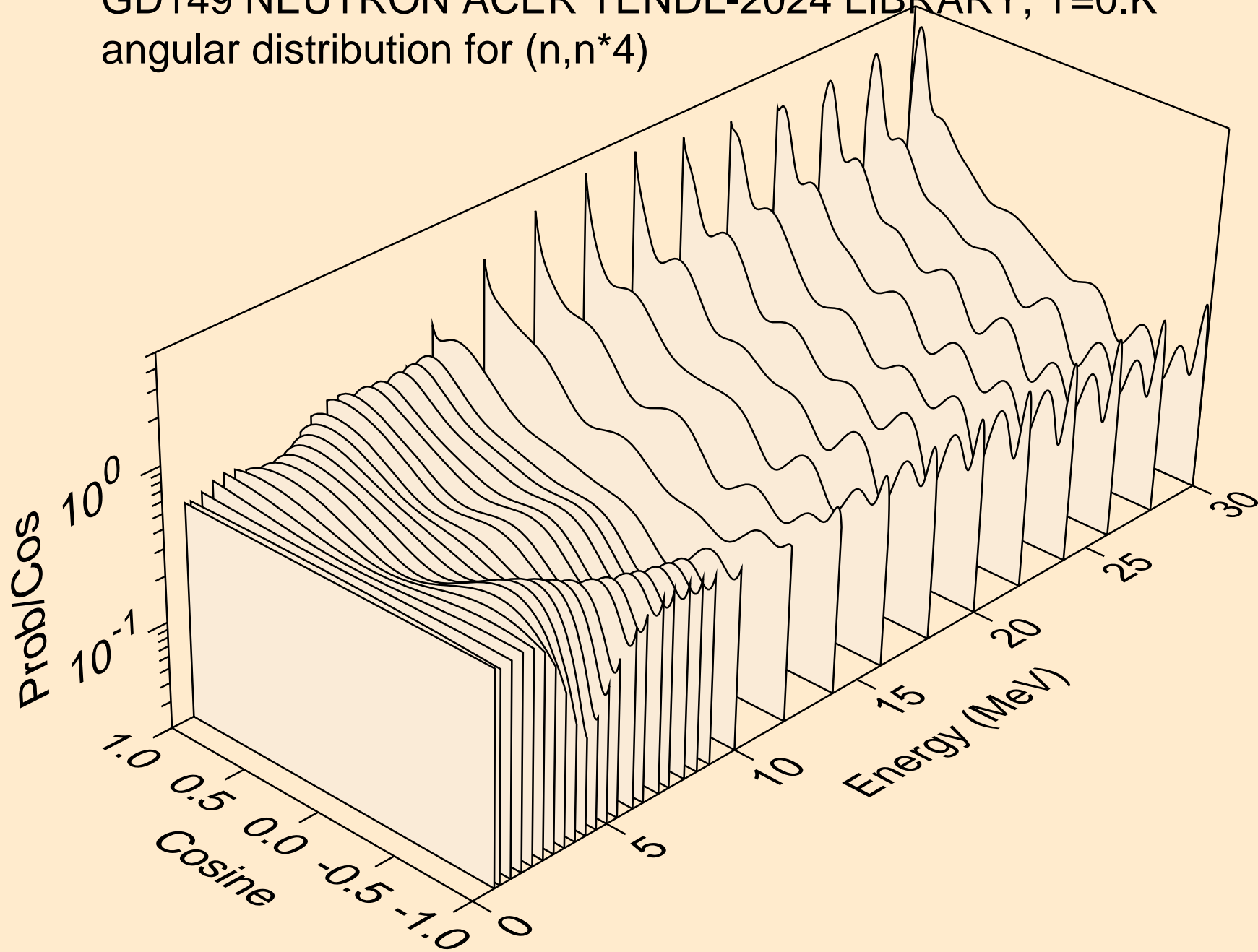

GD149 NEUTRON ACER TENDL-2024 LIBRARY; T=0.K
angular distribution for (n,n*5)

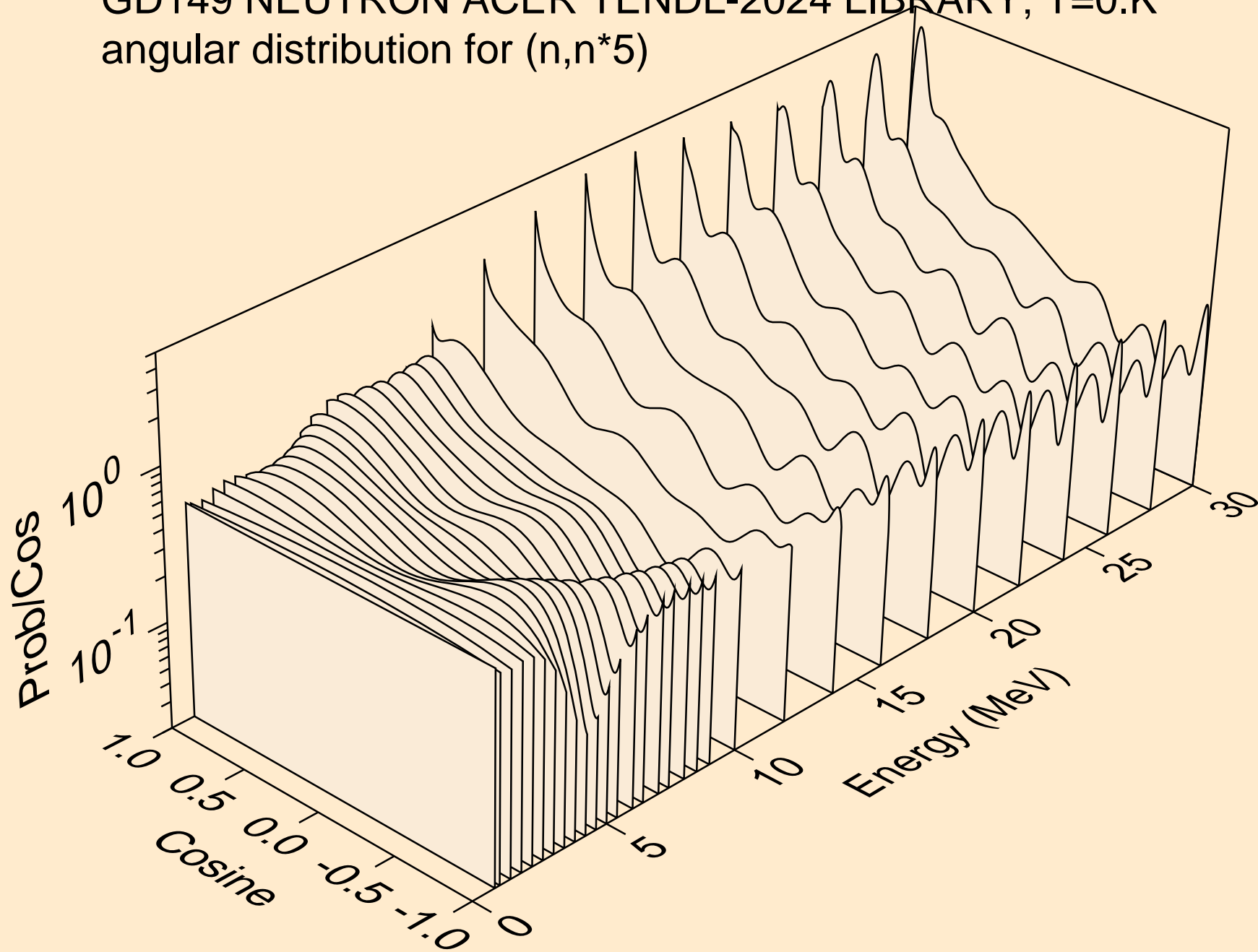

GD149 NEUTRON ACER TENDL-2024 LIBRARY; T=0.K
angular distribution for (n,n*6)

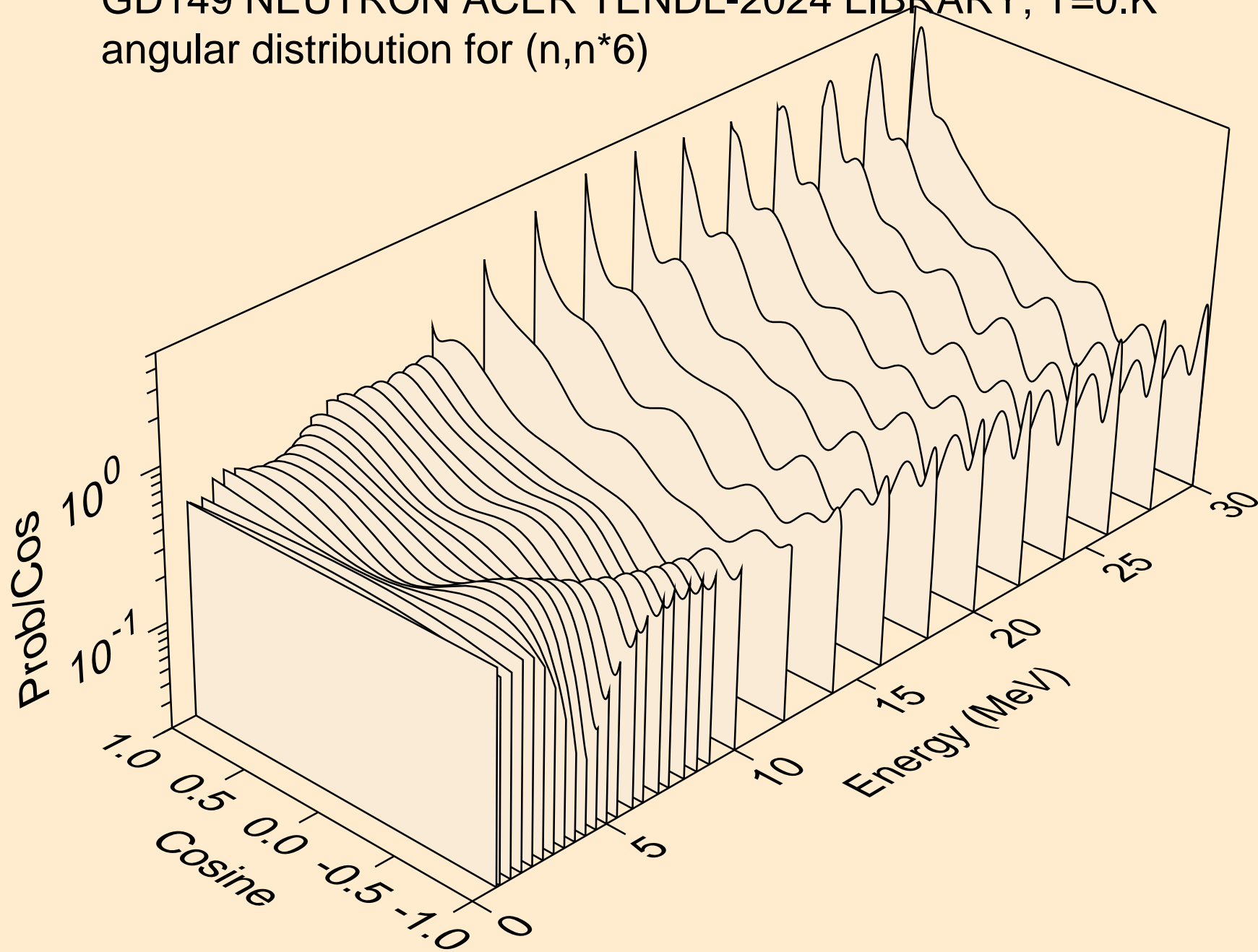

GD149 NEUTRON ACER TENDL-2024 LIBRARY; T=0.K
angular distribution for (n,n*7)

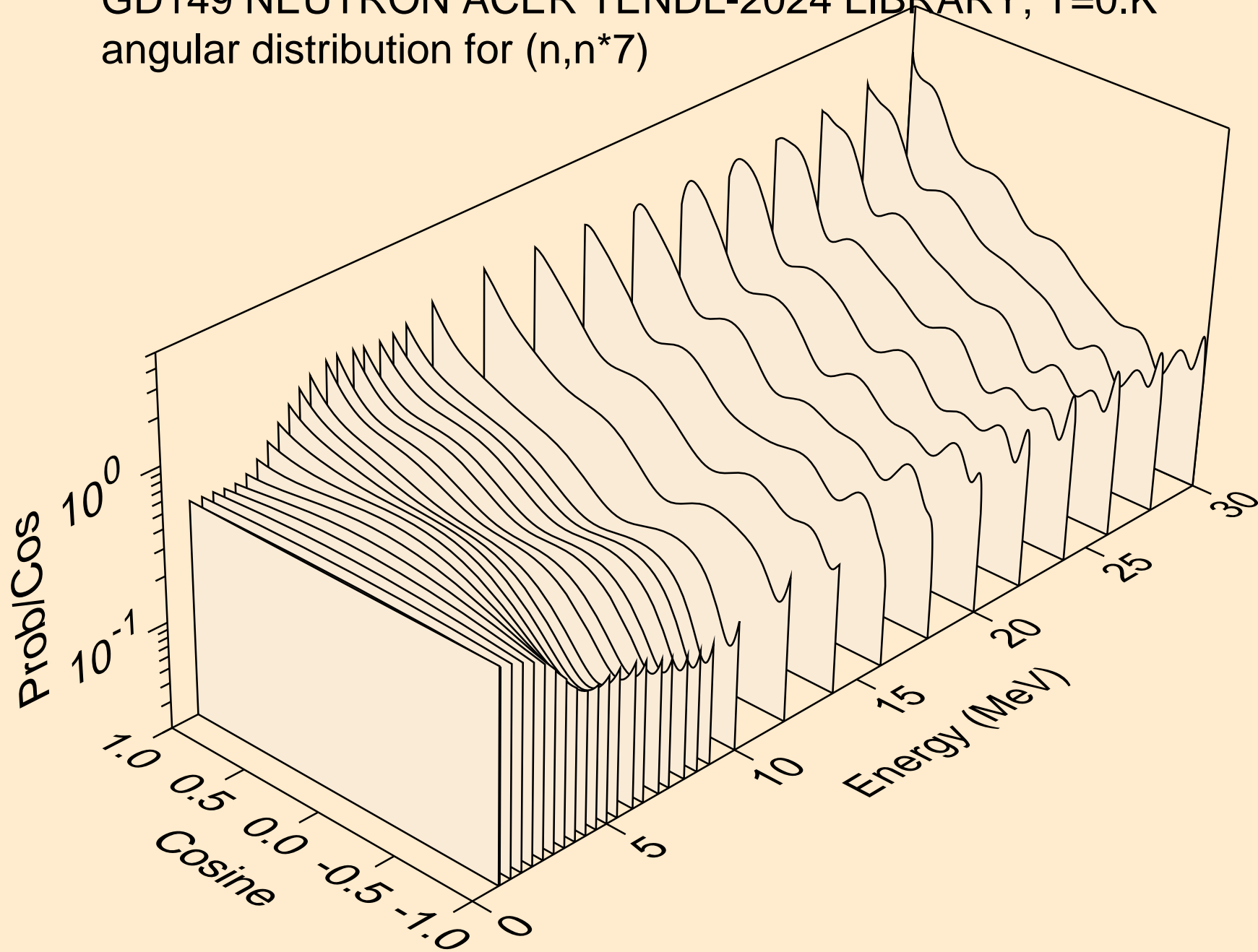

GD149 NEUTRON ACER TENDL-2024 LIBRARY; T=0.K
angular distribution for (n,n*8)

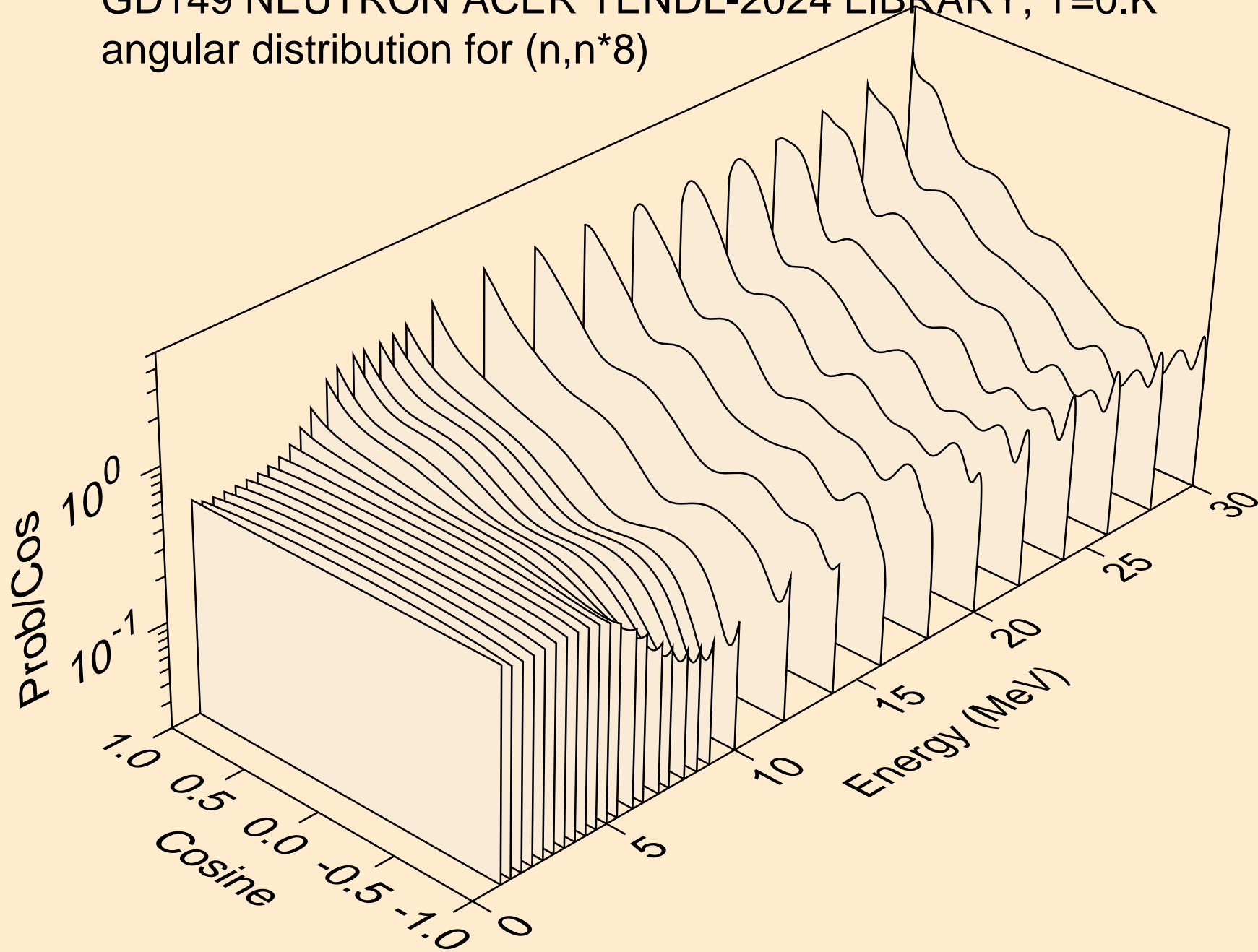

GD149 NEUTRON ACER TENDL-2024 LIBRARY; T=0.K
angular distribution for (n,n*9)

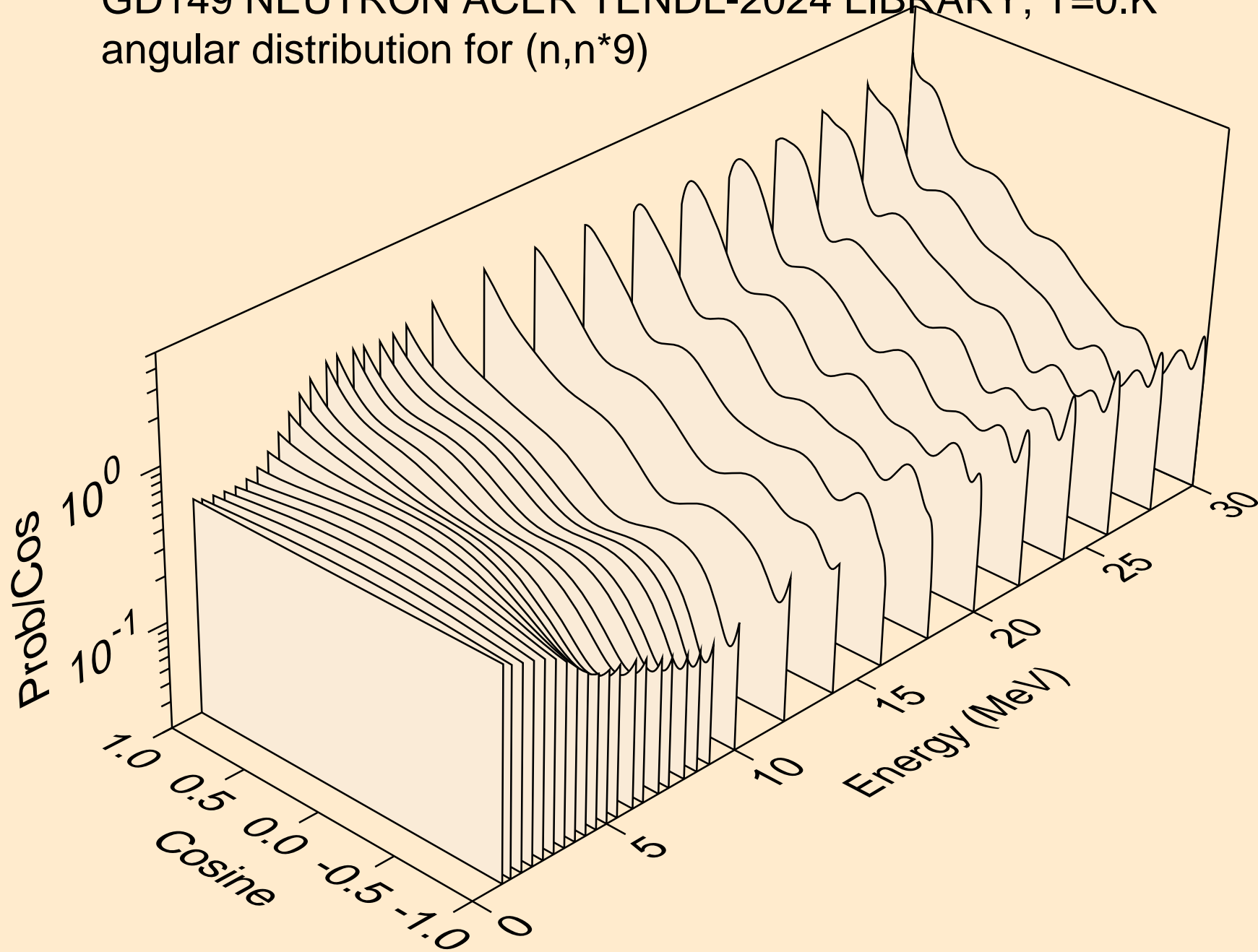

GD149 NEUTRON ACER TENDL-2024 LIBRARY; T=0.K
angular distribution for (n,n*10)

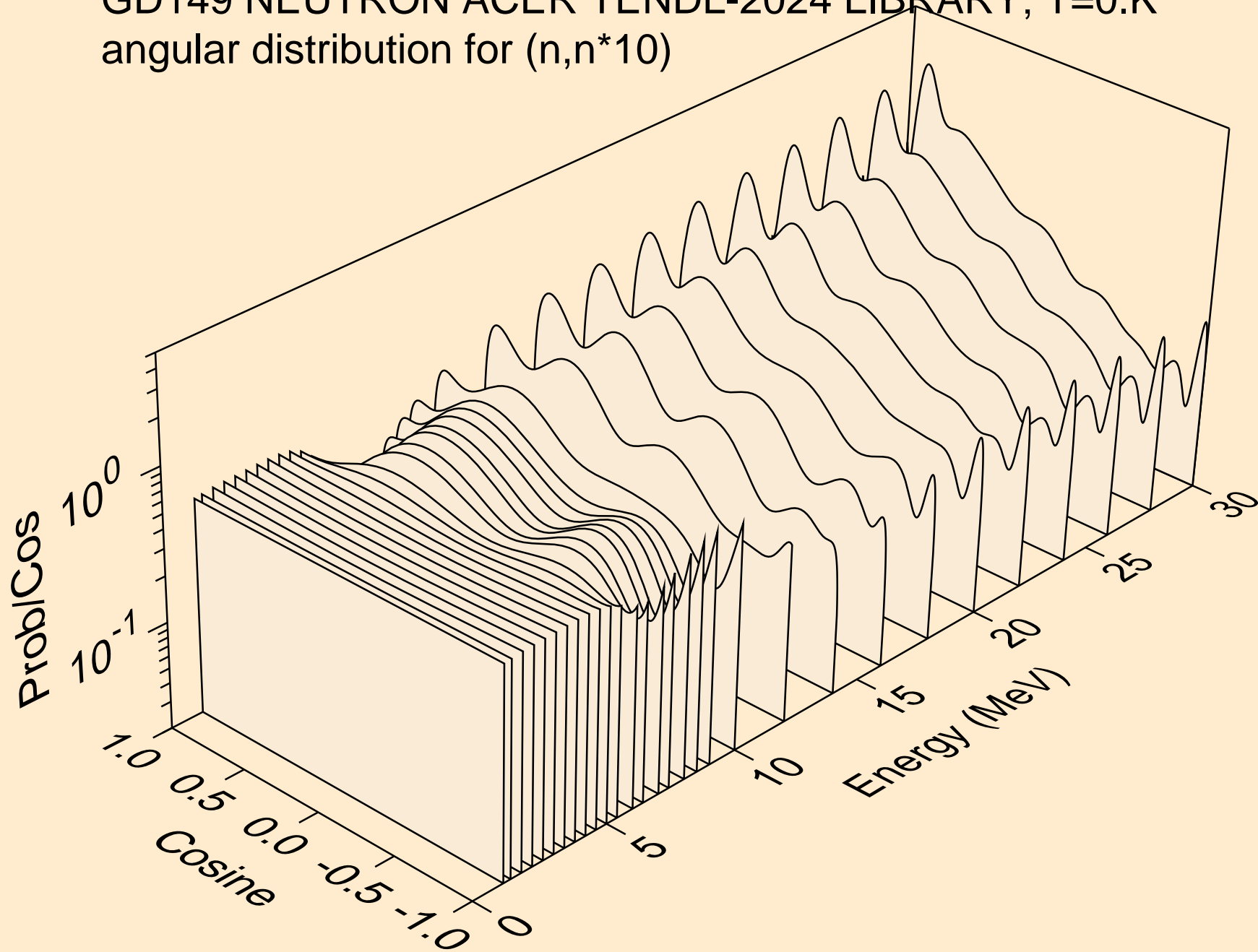

GD149 NEUTRON ACER TENDL-2024 LIBRARY; T=0.K
angular distribution for (n,n*11)

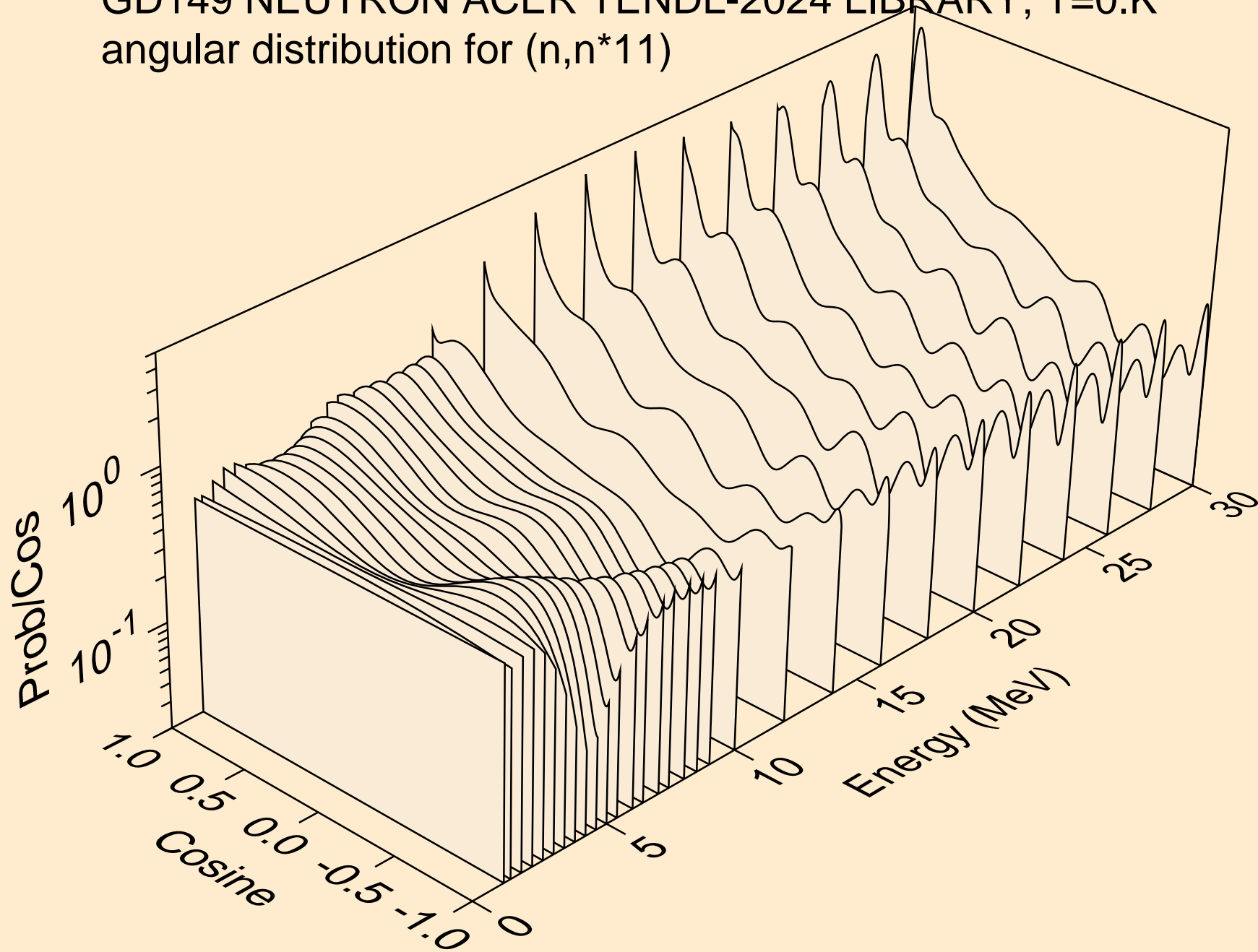

GD149 NEUTRON ACER TENDL-2024 LIBRARY; T=0.K
angular distribution for (n,n*12)

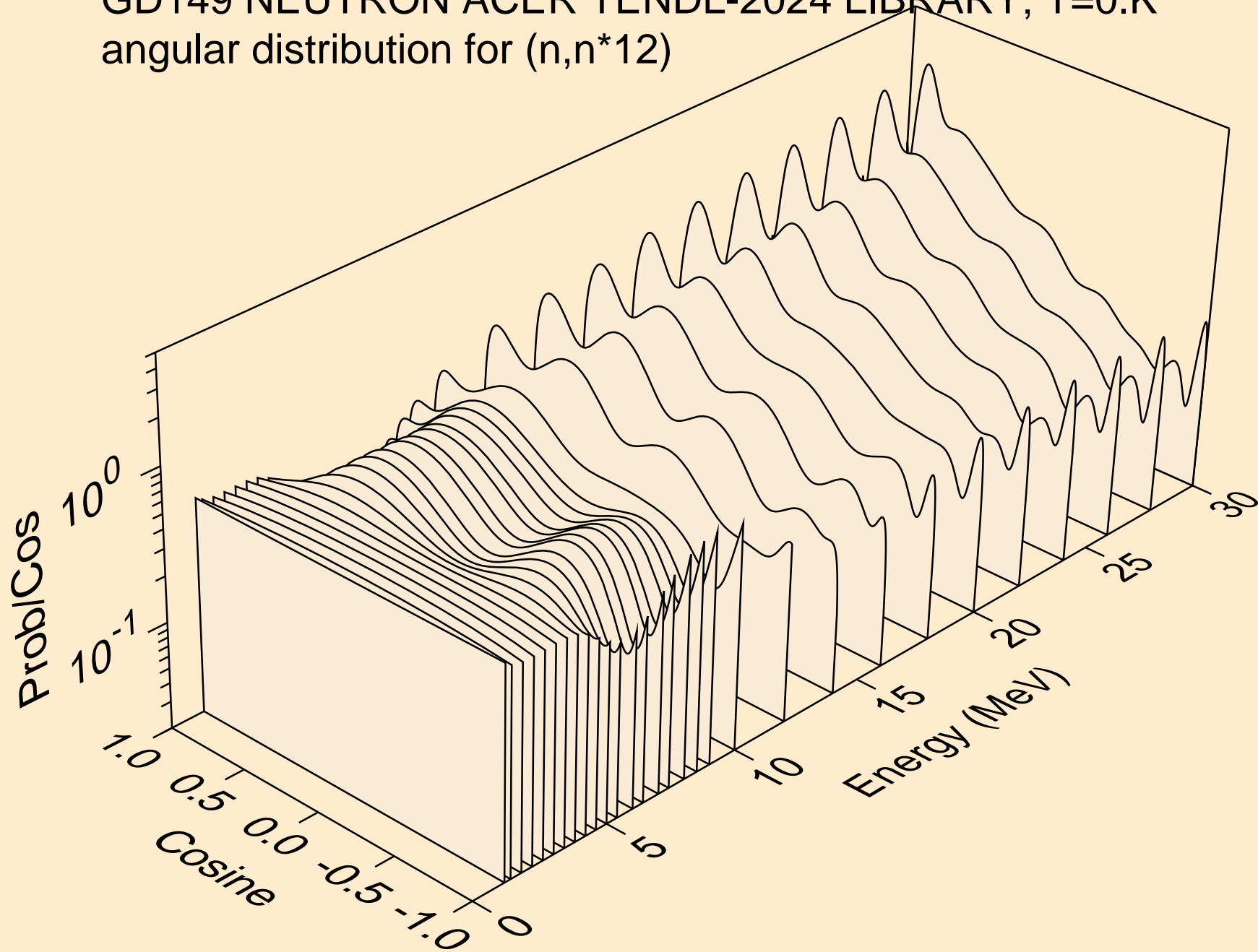

GD149 NEUTRON ACER TENDL-2024 LIBRARY; T=0.K
angular distribution for (n,n*13)

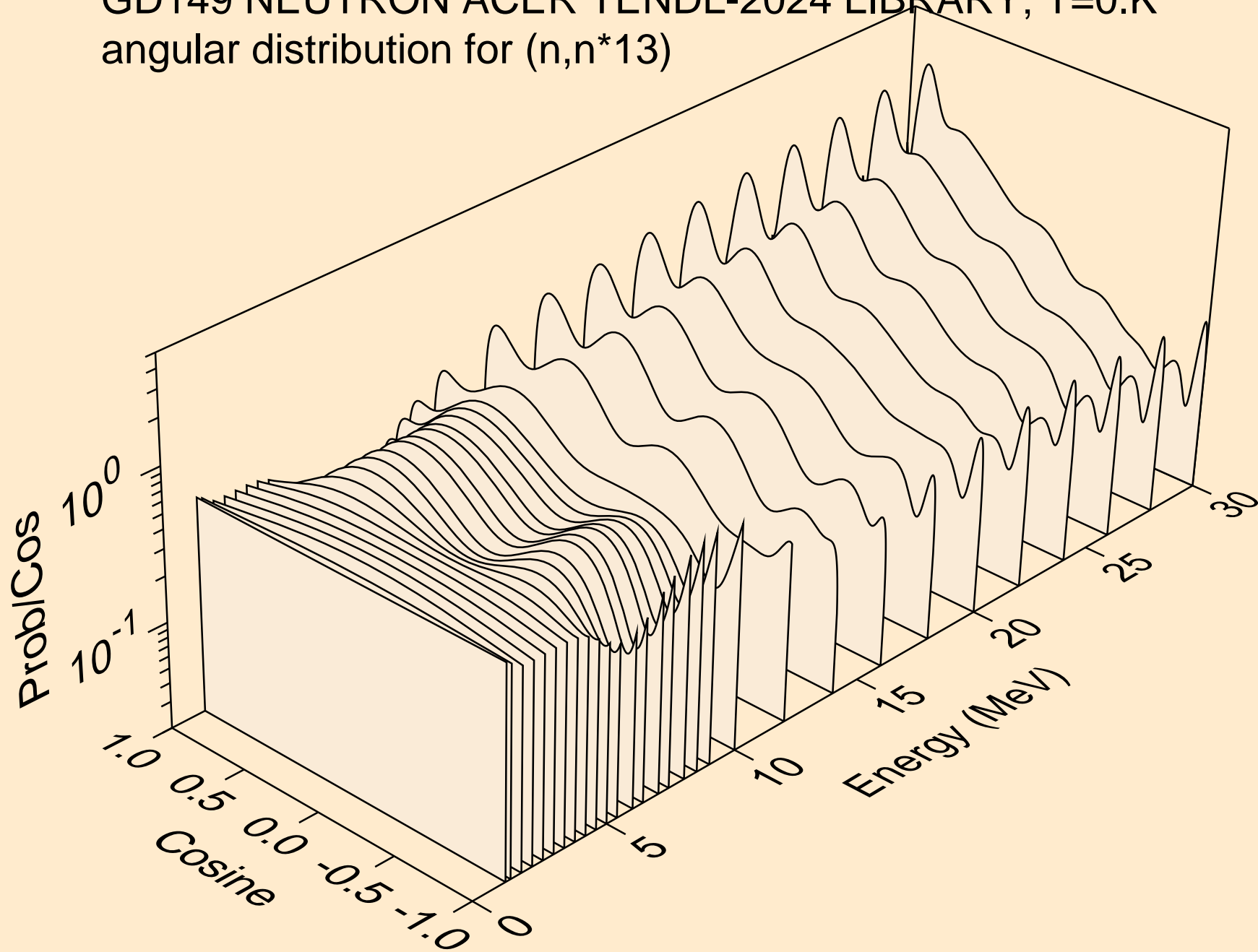

GD149 NEUTRON ACER TENDL-2024 LIBRARY; T=0.K
angular distribution for (n,n*14)

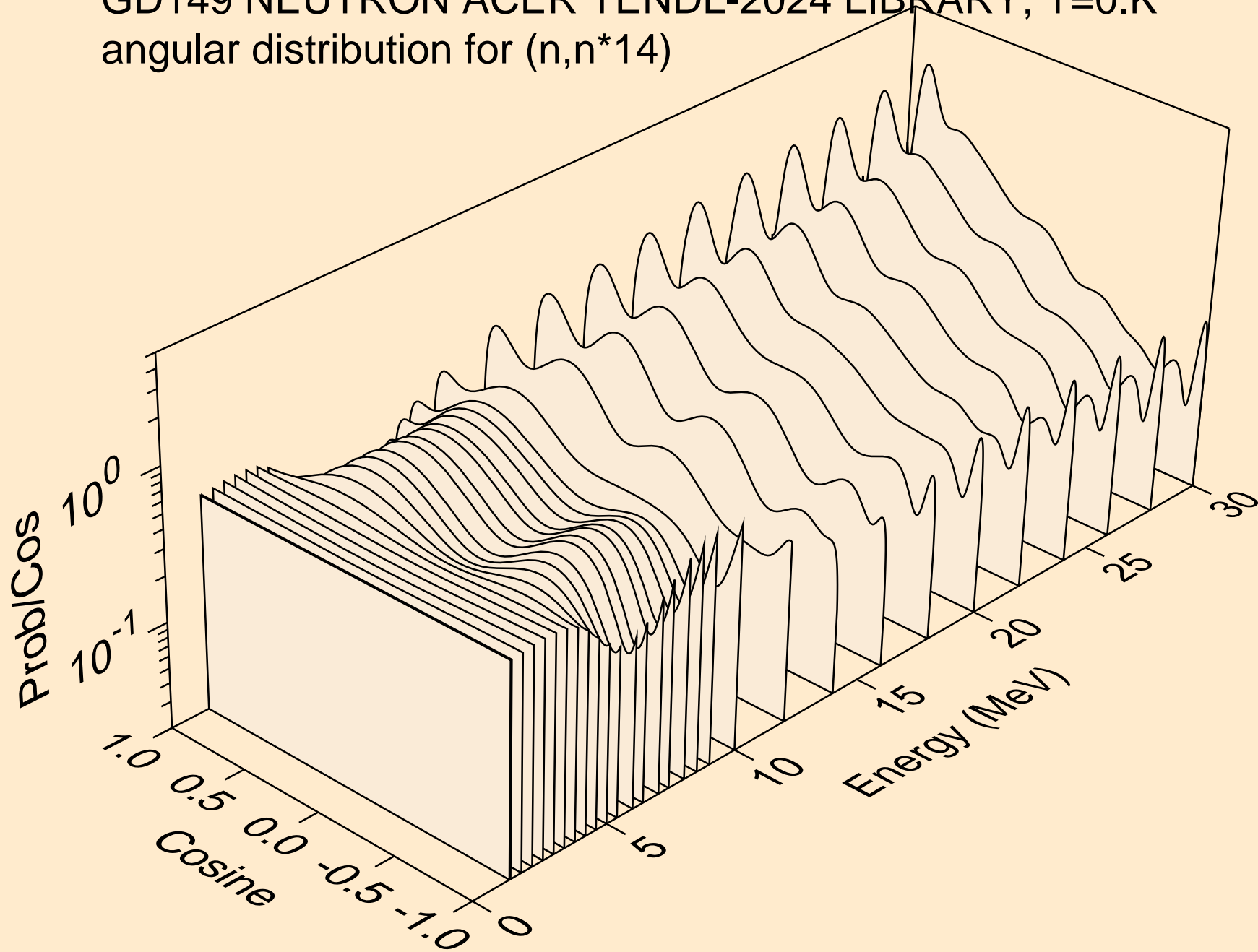

GD149 NEUTRON ACER TENDL-2024 LIBRARY; T=0.K
angular distribution for (n,n*15)

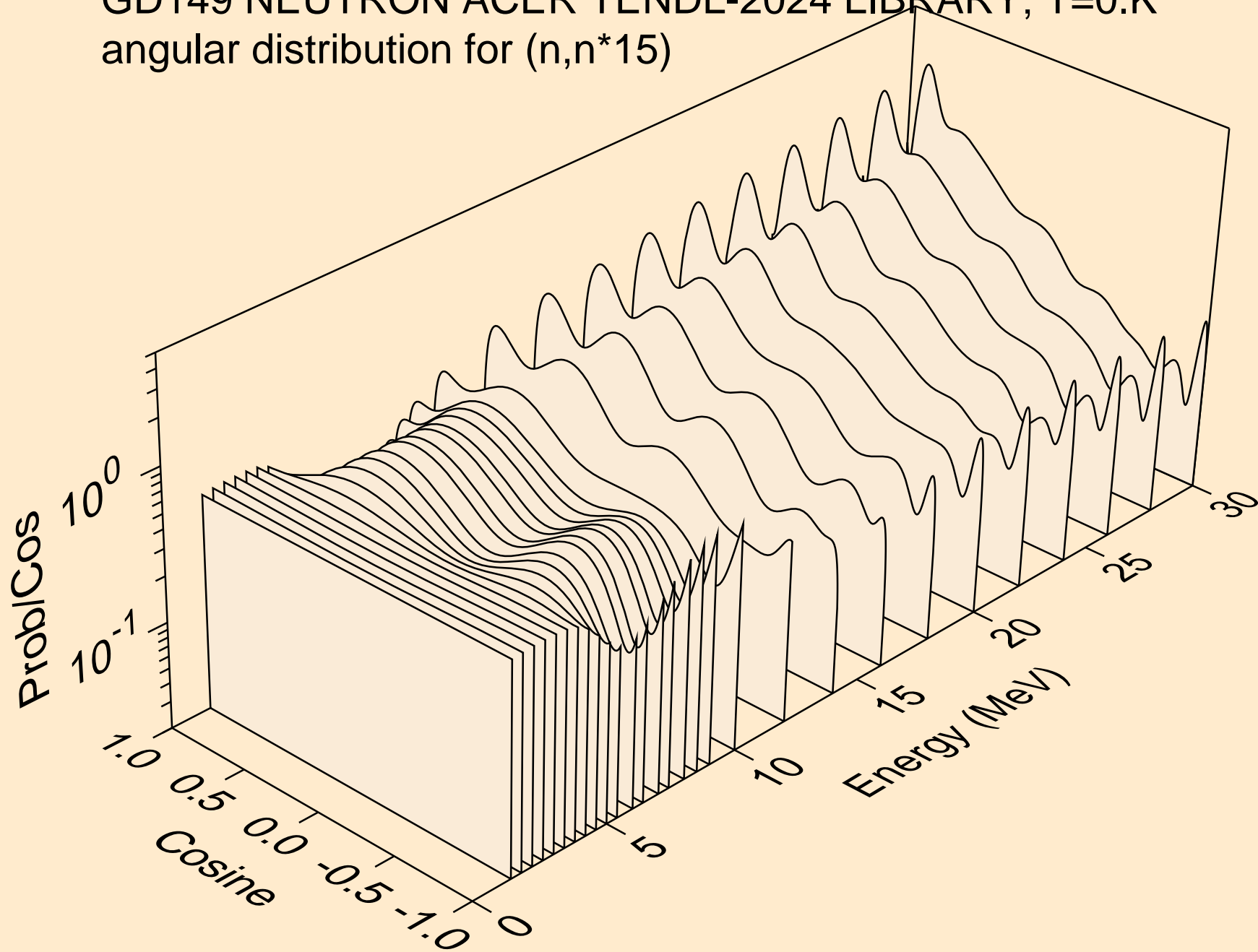

GD149 NEUTRON ACER TENDL-2024 LIBRARY; T=0.K
angular distribution for (n,n*16)

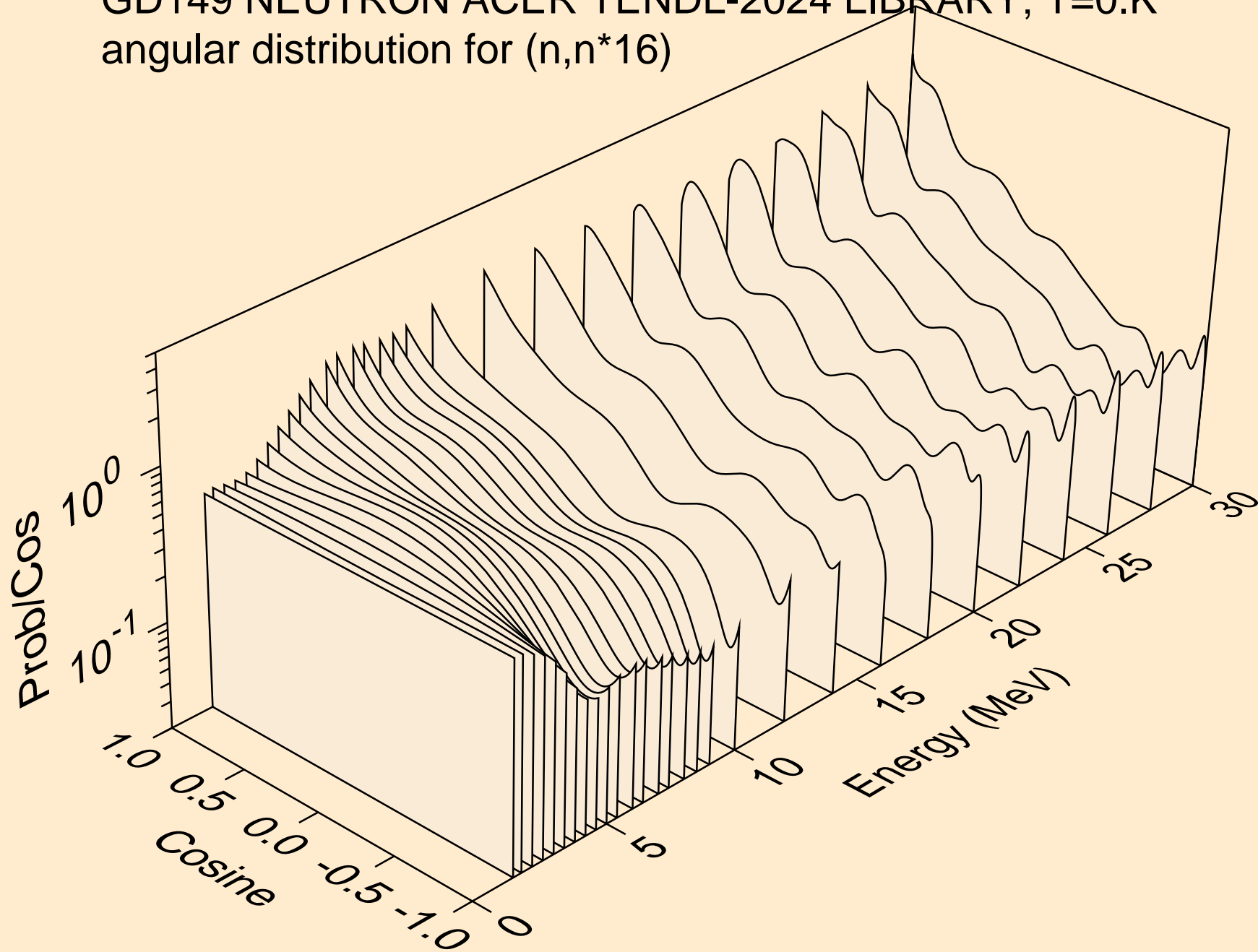

GD149 NEUTRON ACER TENDL-2024 LIBRARY; T=0.K
angular distribution for (n,n*17)

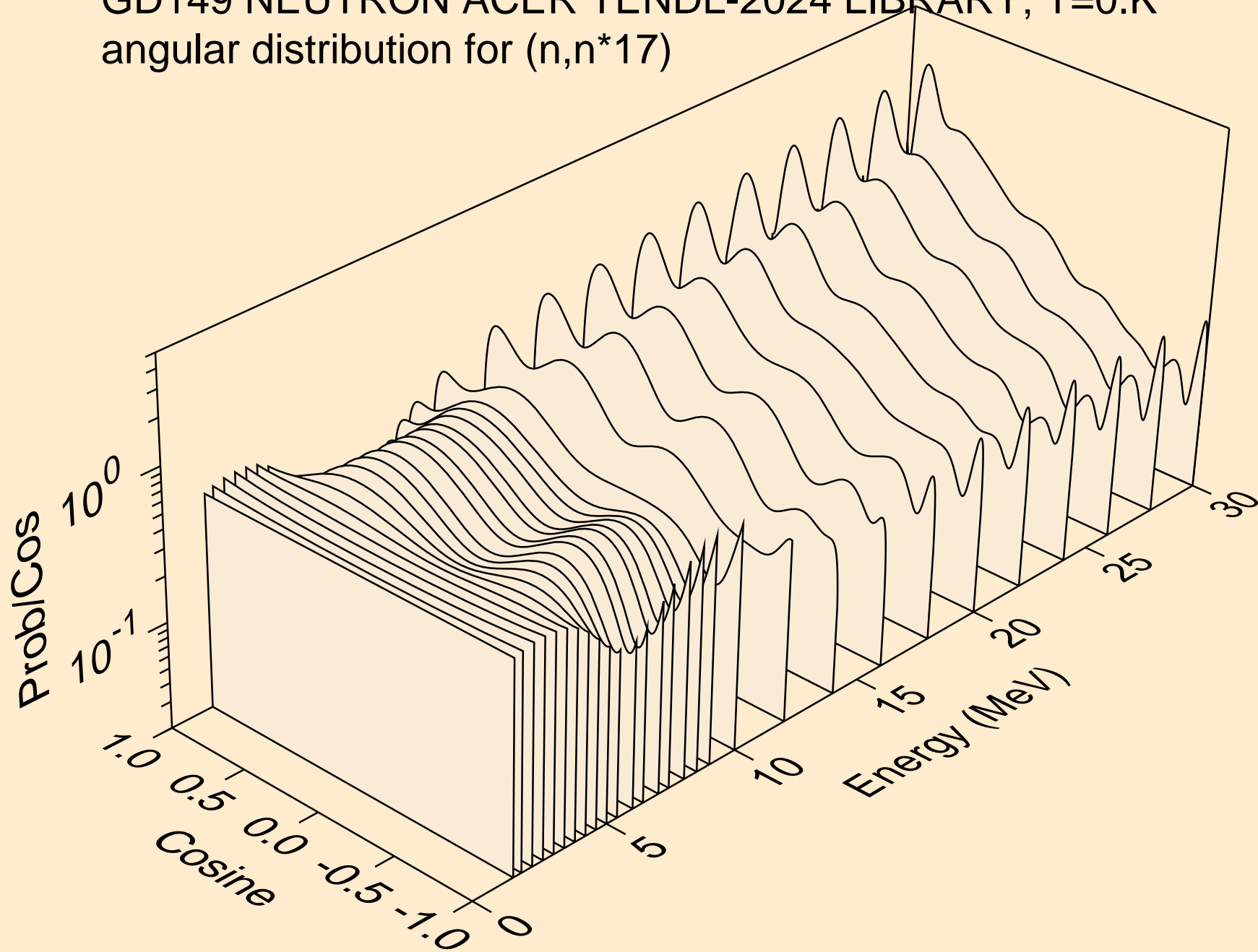

GD149 NEUTRON ACER TENDL-2024 LIBRARY; T=0.K
angular distribution for (n,n*18)

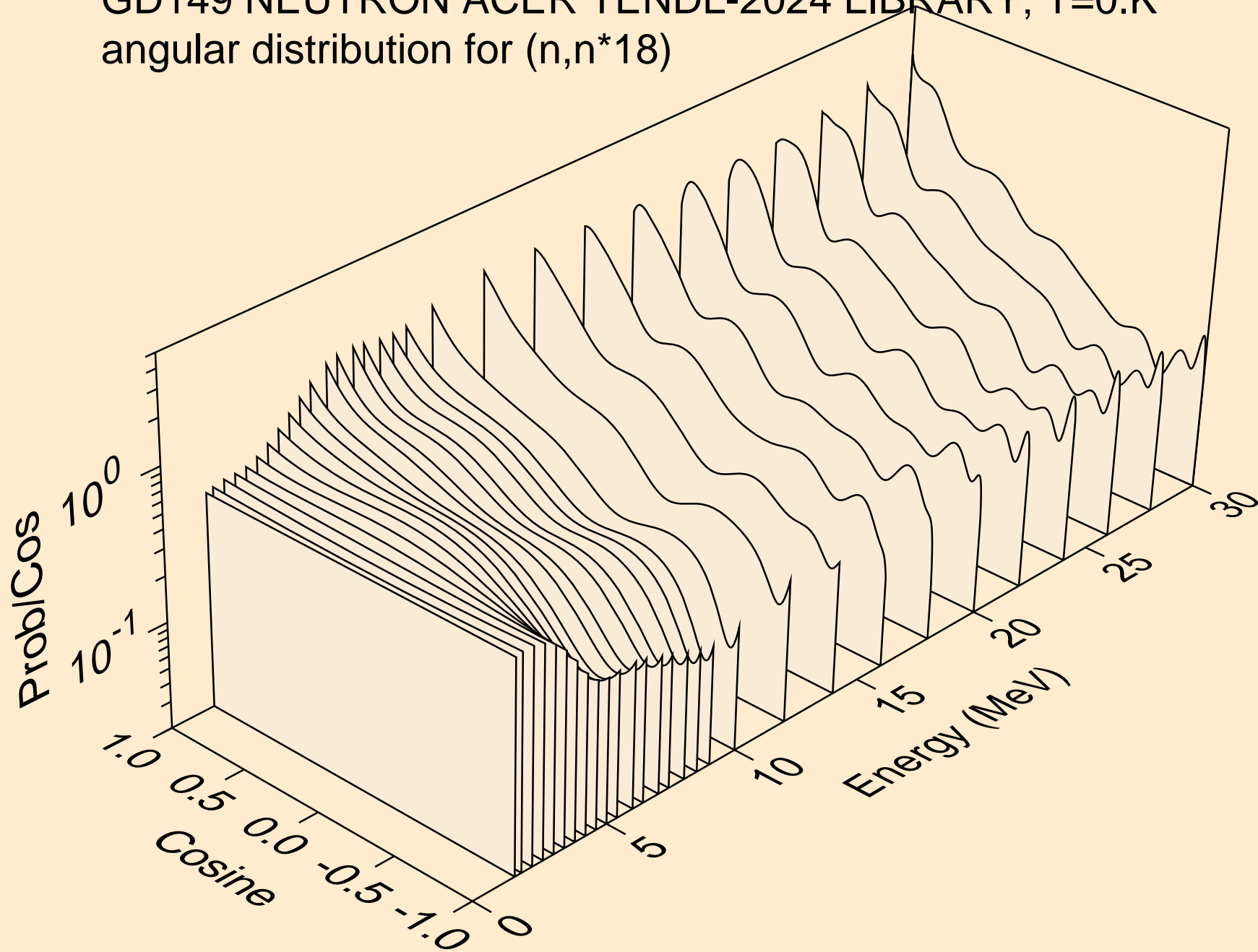

GD149 NEUTRON ACER TENDL-2024 LIBRARY; T=0.K
angular distribution for (n,n*19)

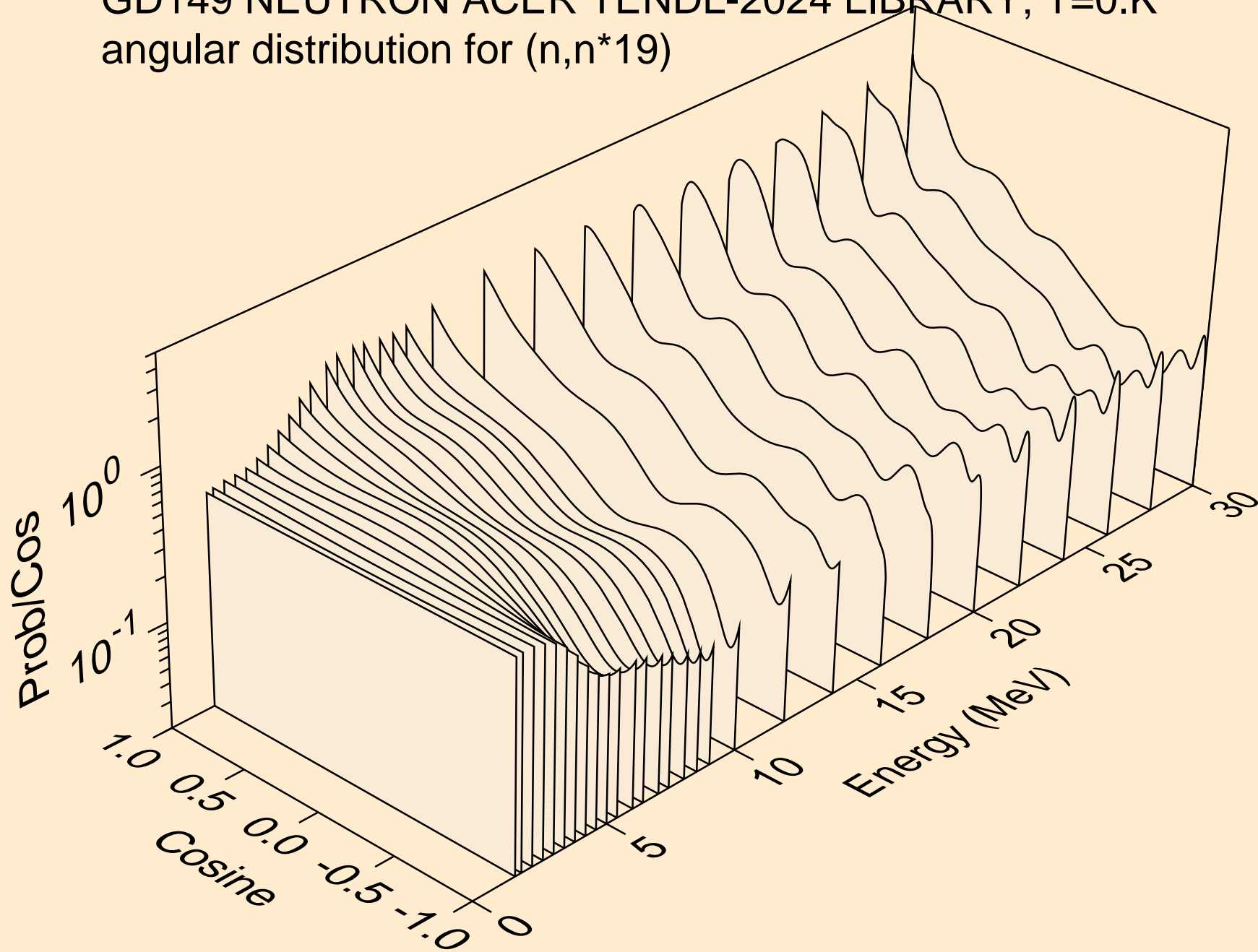

GD149 NEUTRON ACER TENDL-2024 LIBRARY; T=0.K
angular distribution for (n,n*20)

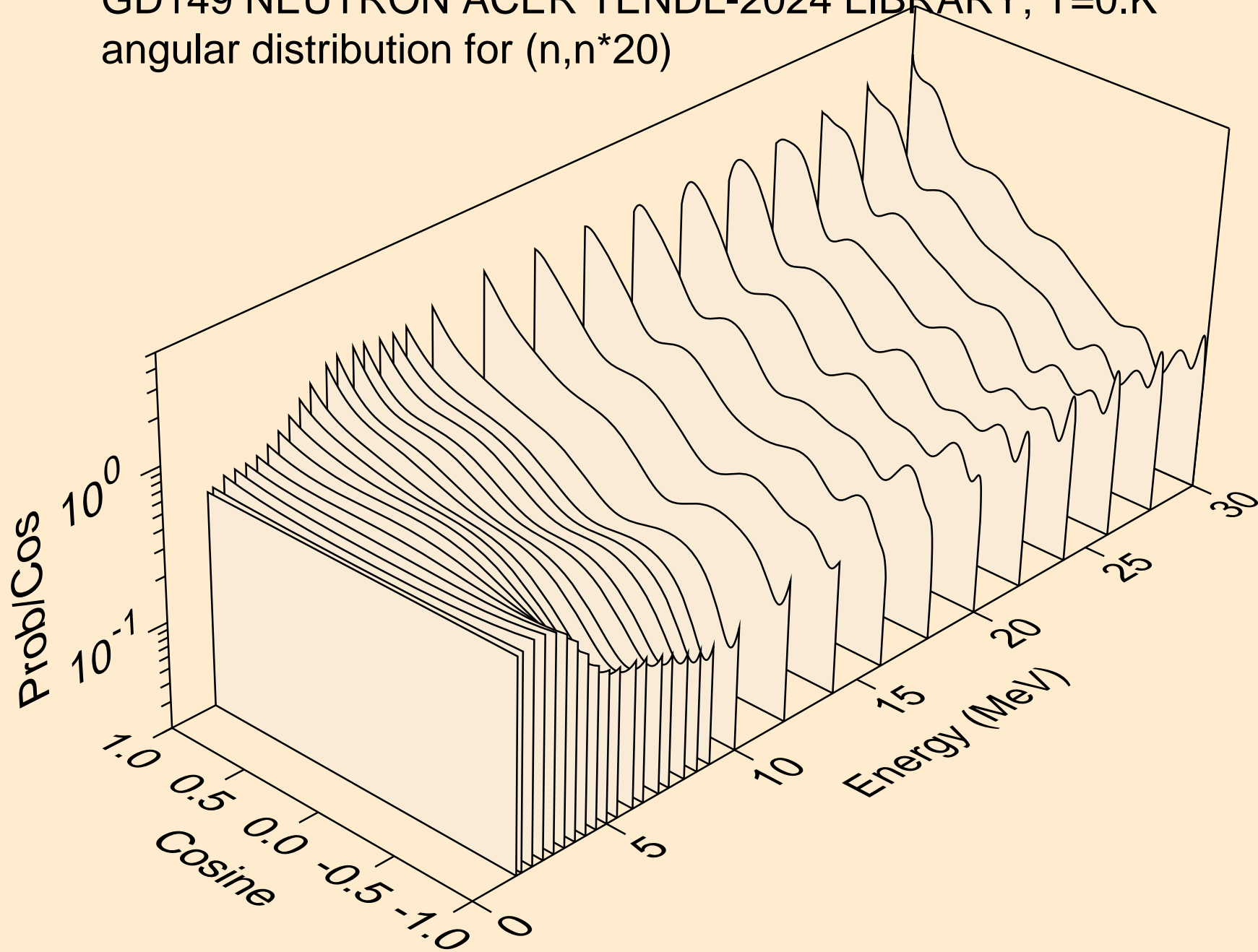

GD149 NEUTRON ACER TENDL-2024 LIBRARY; T=0.K
angular distribution for (n,n*21)

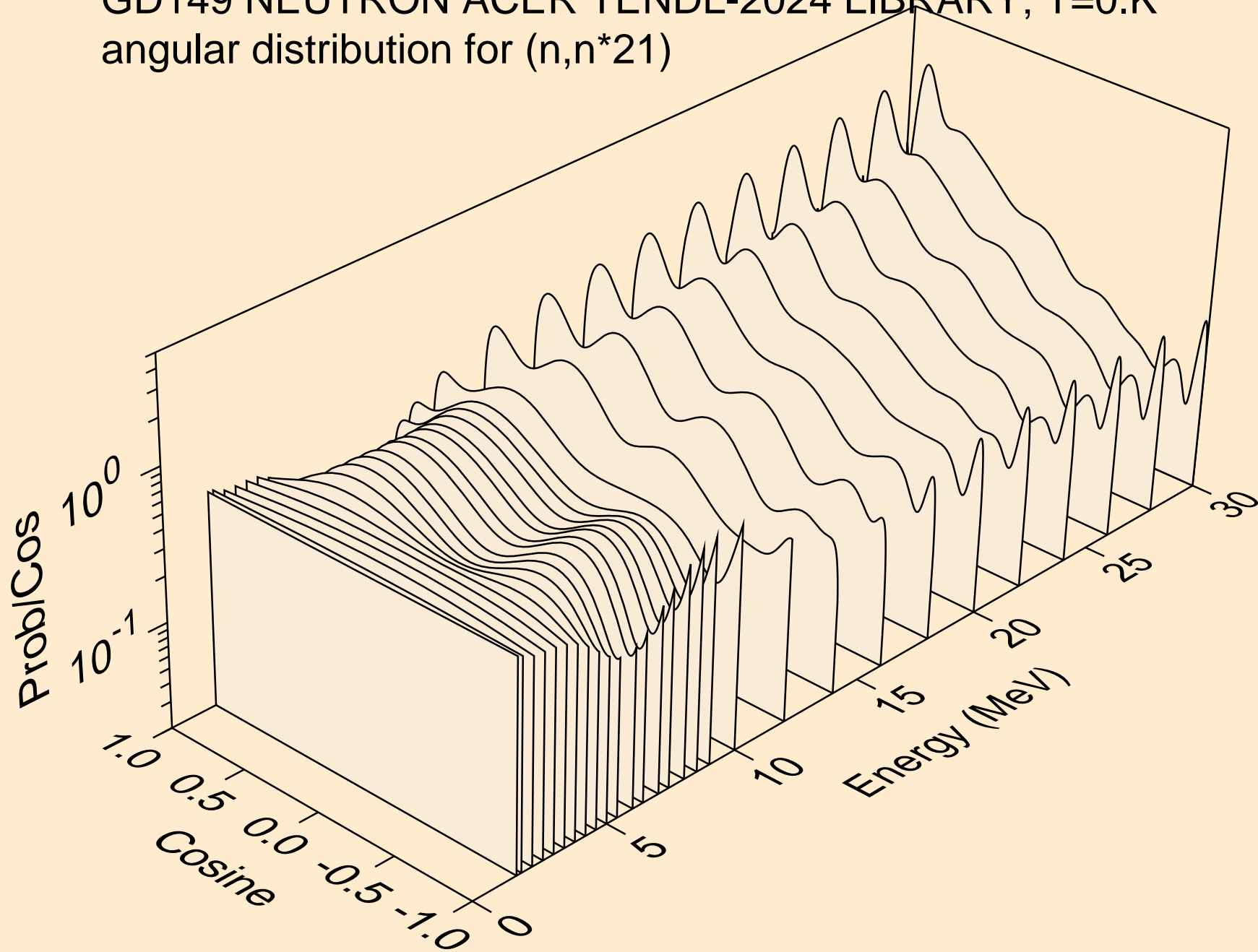

GD149 NEUTRON ACER TENDL-2024 LIBRARY; T=0.K
angular distribution for (n,n*22)

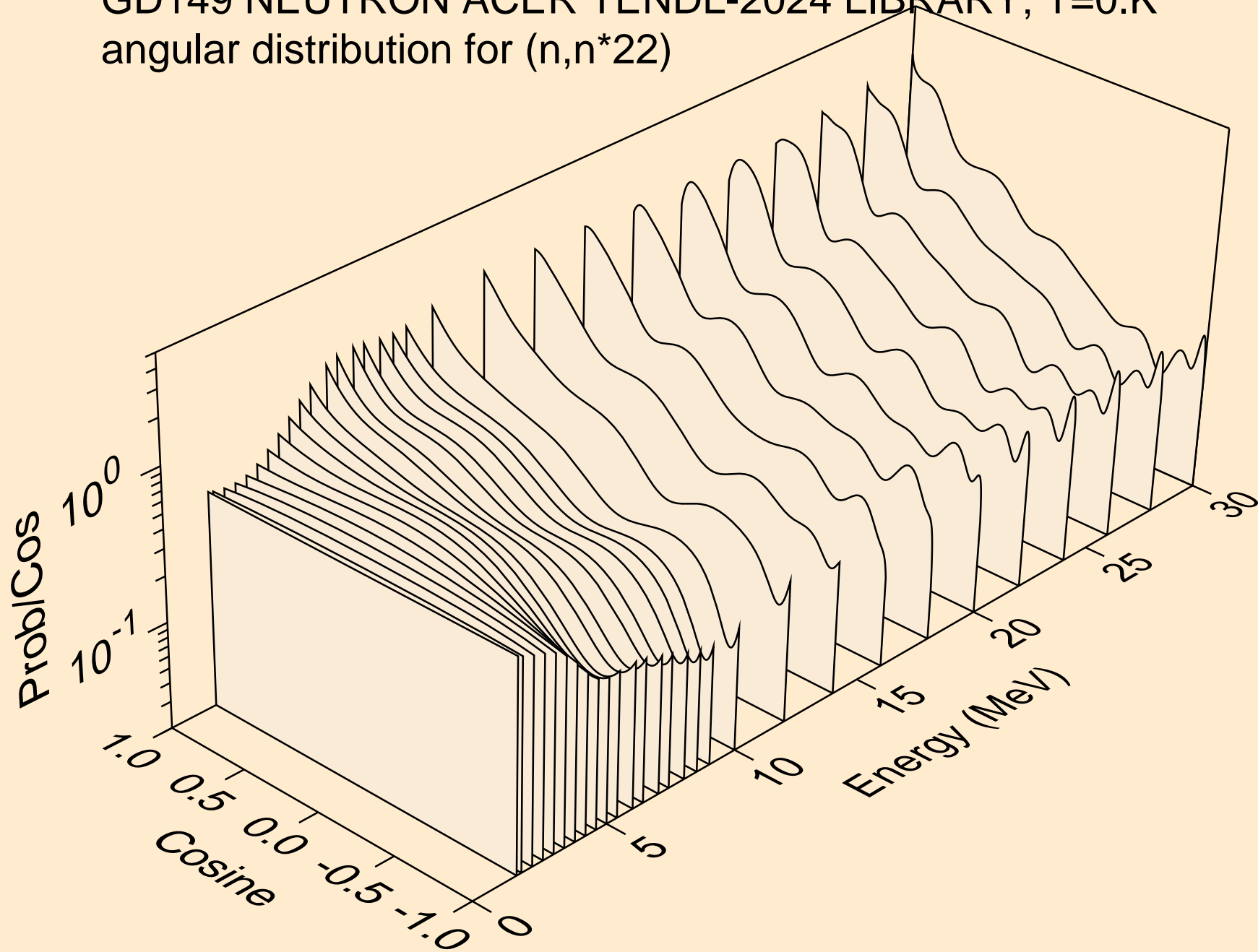

GD149 NEUTRON ACER TENDL-2024 LIBRARY; T=0.K
angular distribution for (n,n*23)

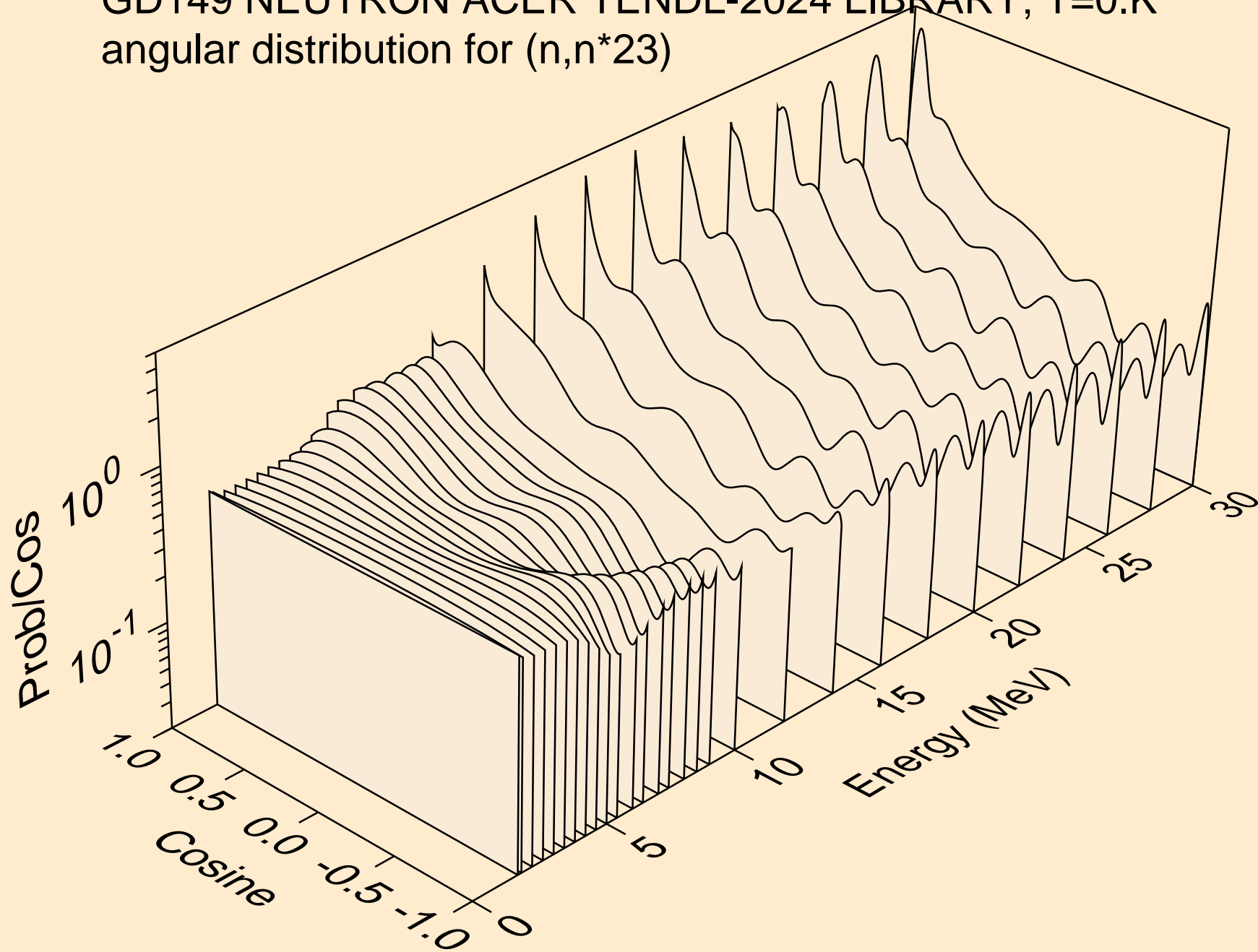

GD149 NEUTRON ACER TENDL-2024 LIBRARY; T=0.K
angular distribution for (n,n*24)

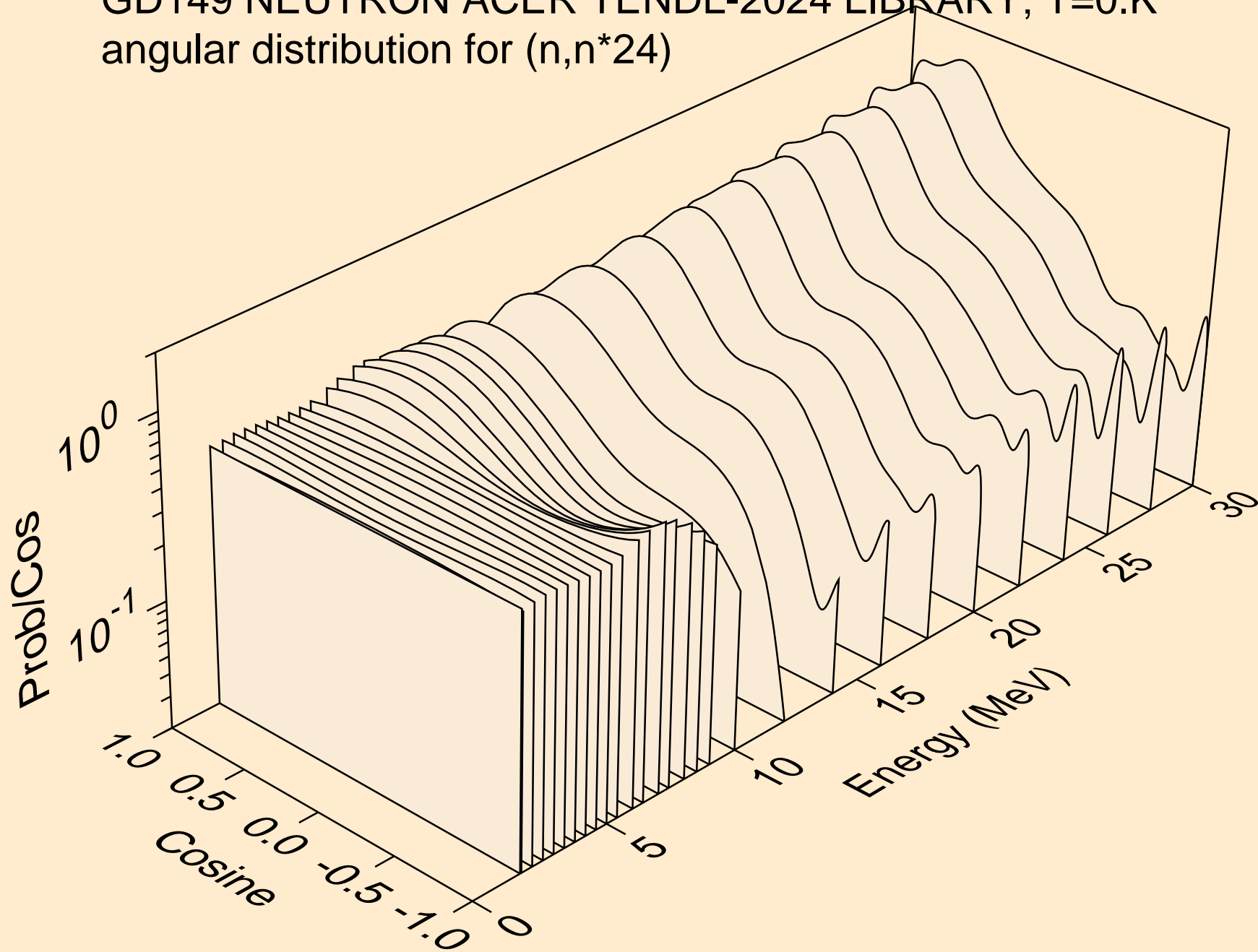

GD149 NEUTRON ACER TENDL-2024 LIBRARY; T=0.K
angular distribution for (n,n*25)

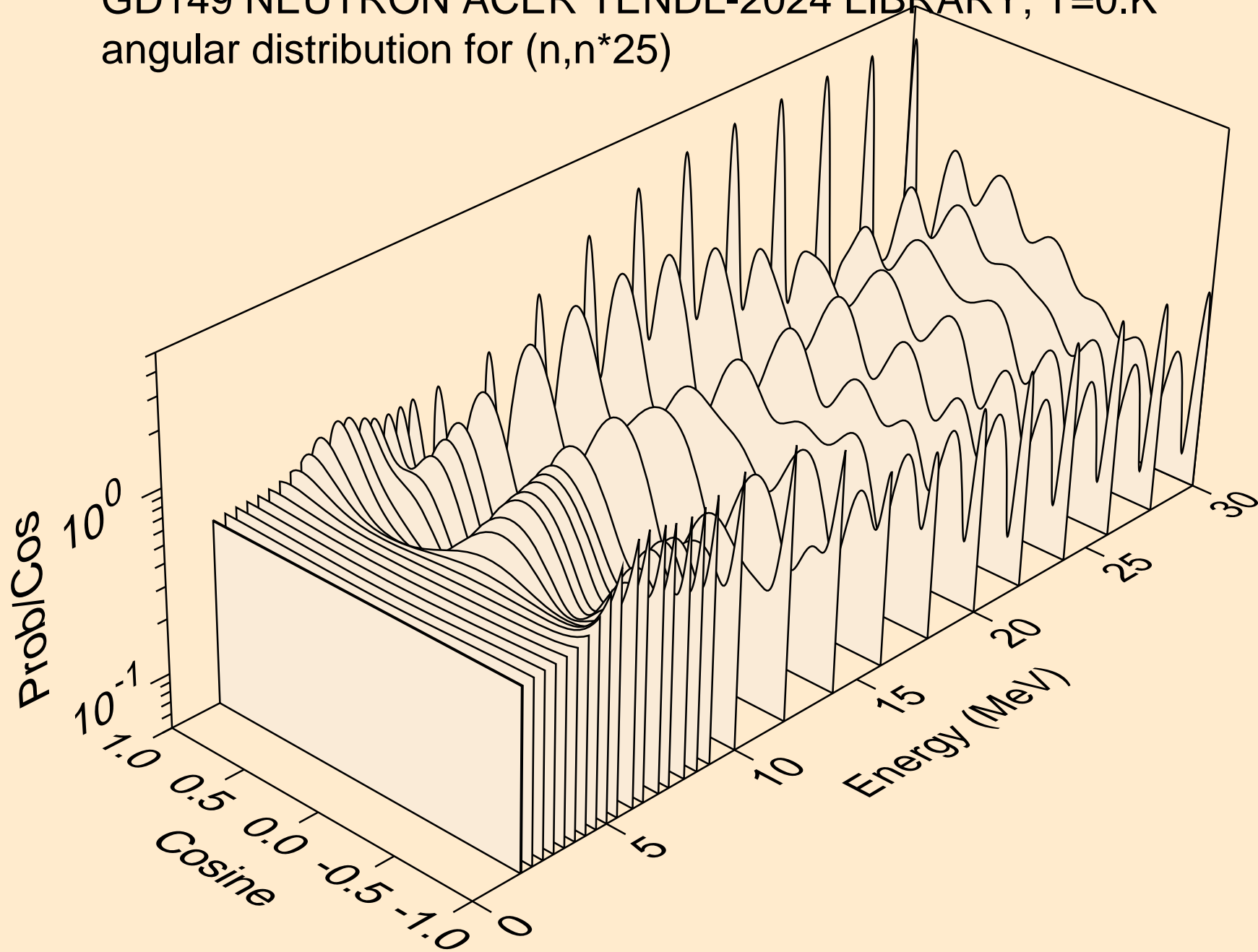

GD149 NEUTRON ACER TENDL-2024 LIBRARY; T=0.K
angular distribution for (n,n*26)

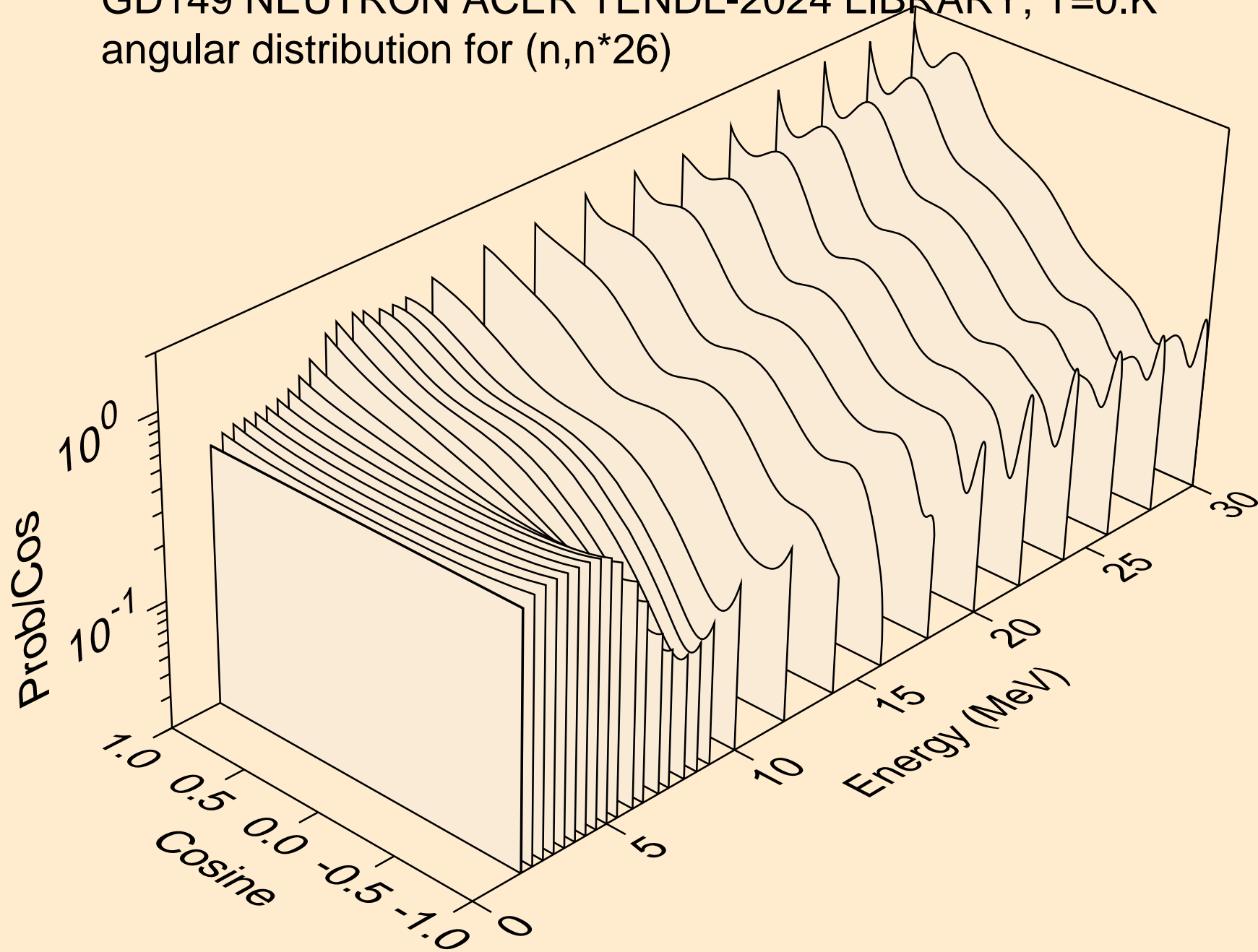

GD149 NEUTRON ACER TENDL-2024 LIBRARY; T=0.K
angular distribution for (n,n*27)

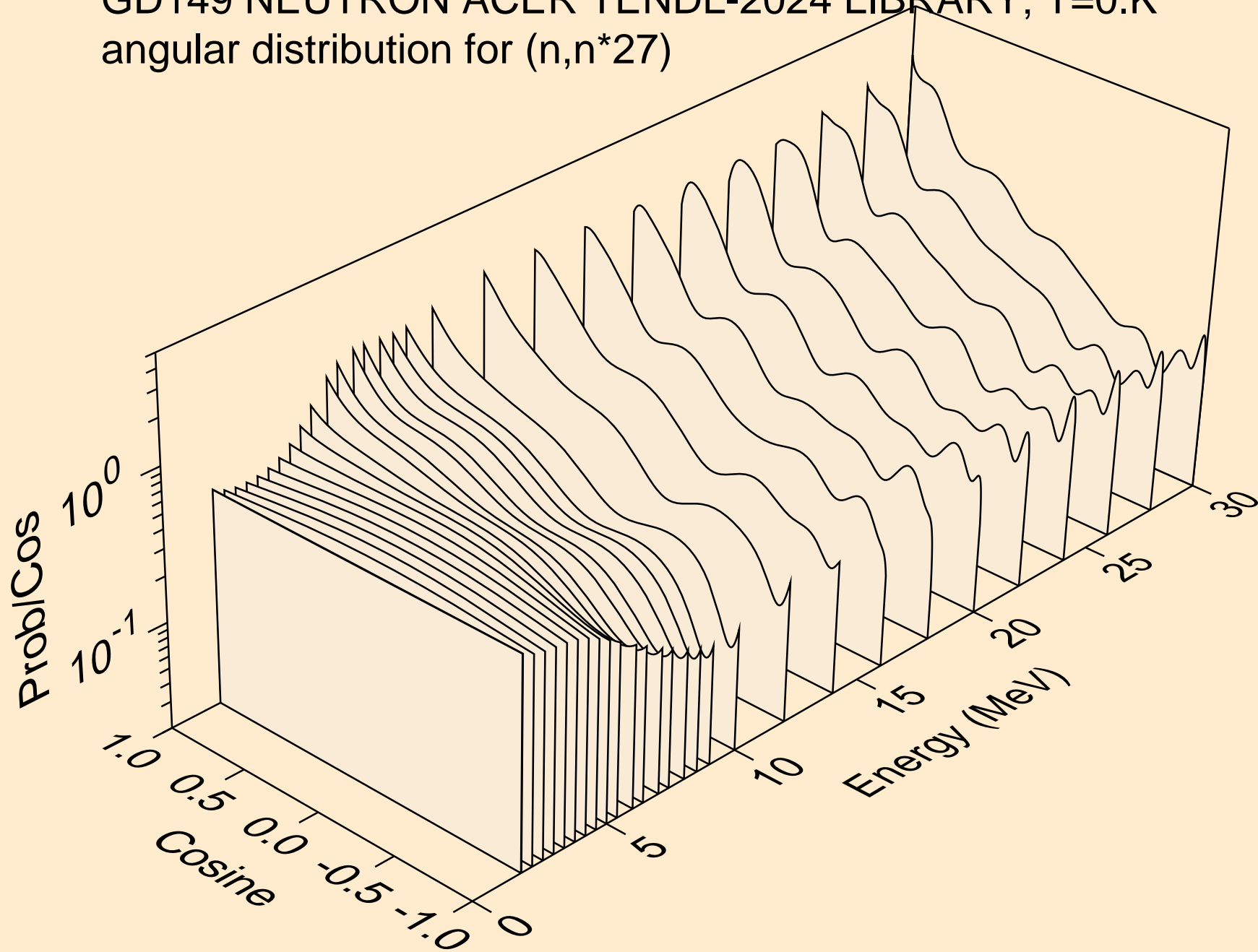

GD149 NEUTRON ACER TENDL-2024 LIBRARY; T=0.K
angular distribution for (n,n*28)

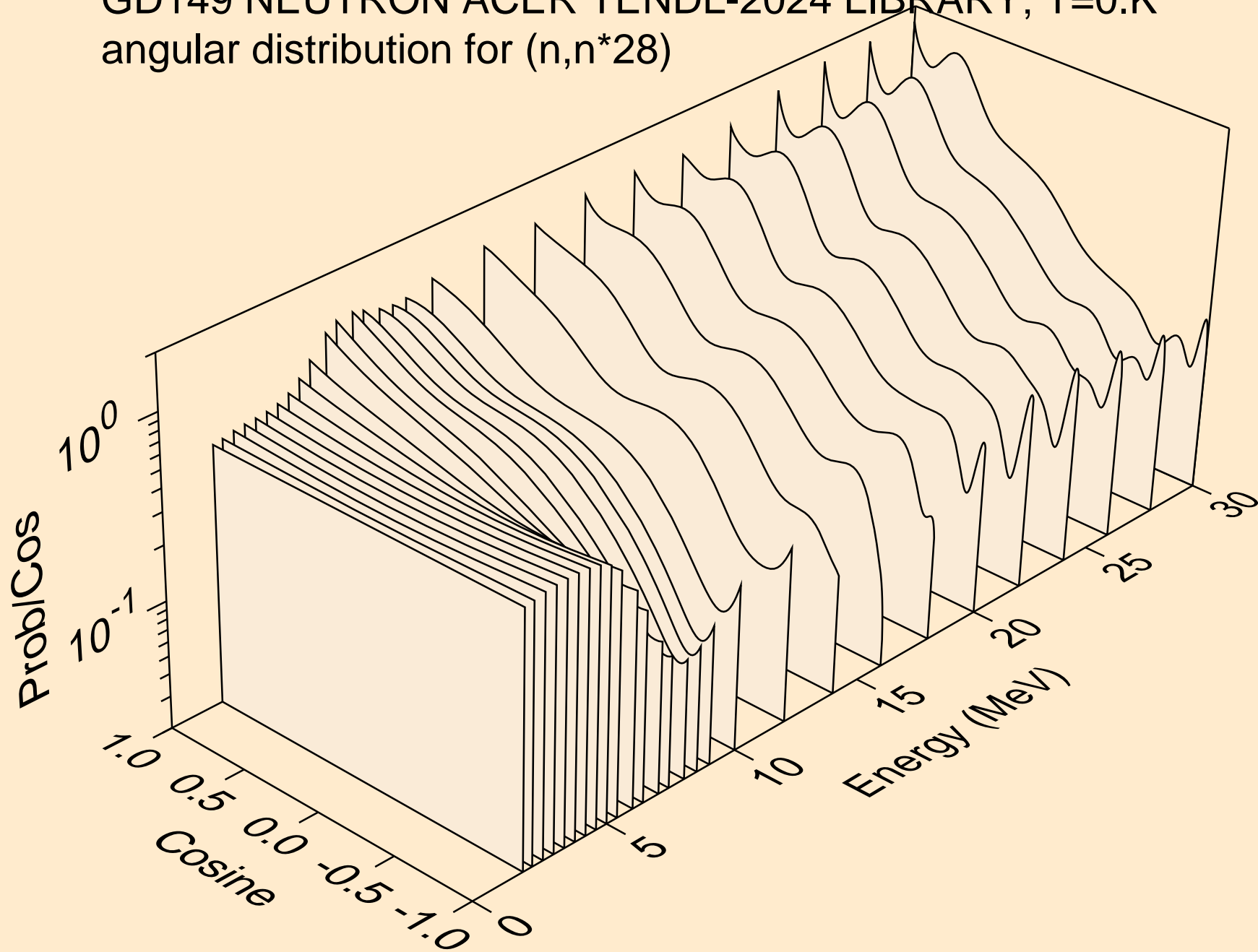

GD149 NEUTRON ACER TENDL-2024 LIBRARY; T=0.K
Neutron emission for (n,x)

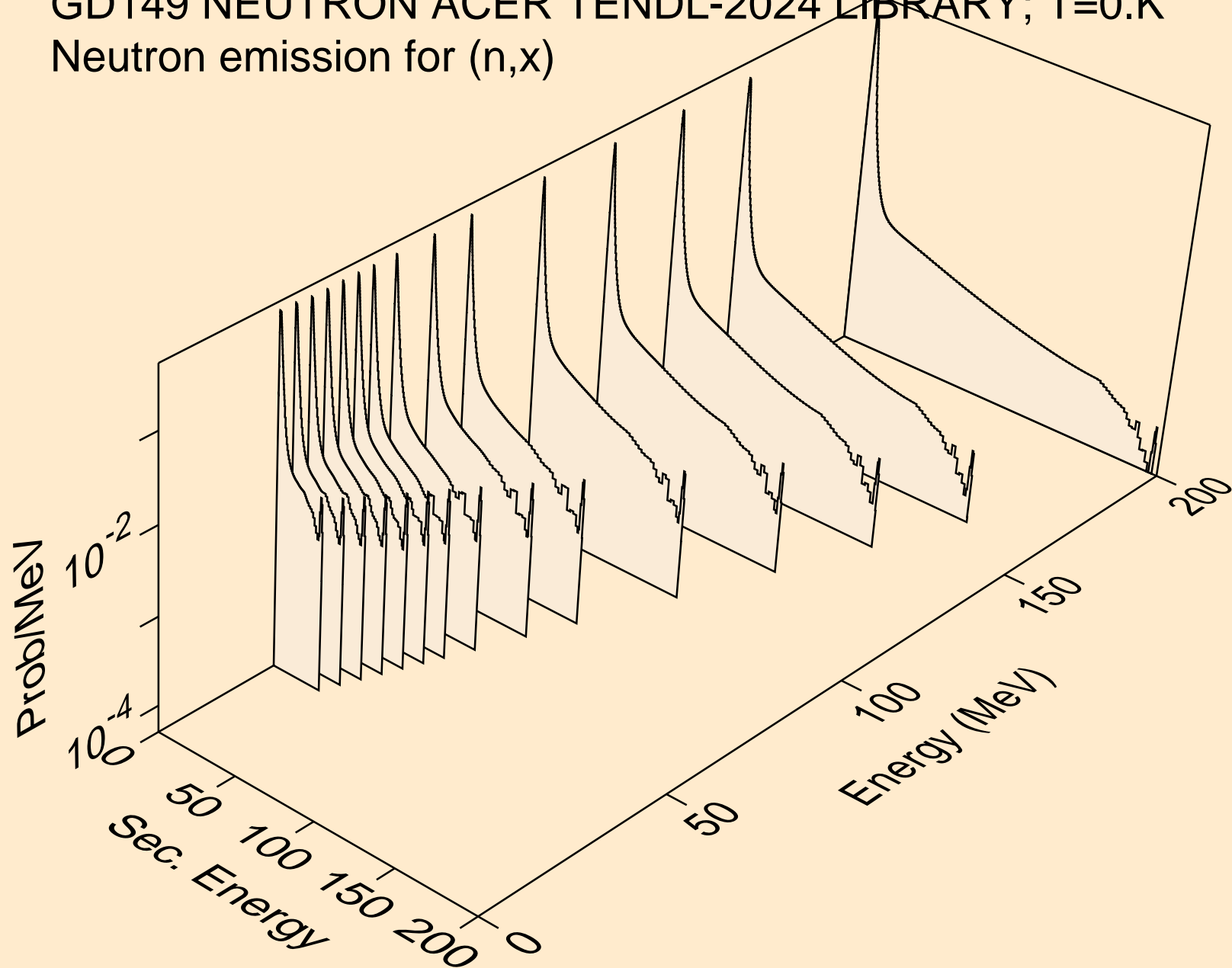

GD149 NEUTRON ACER TENDL-2024 LIBRARY; T=0.K
Neutron emission for (n,2nd)

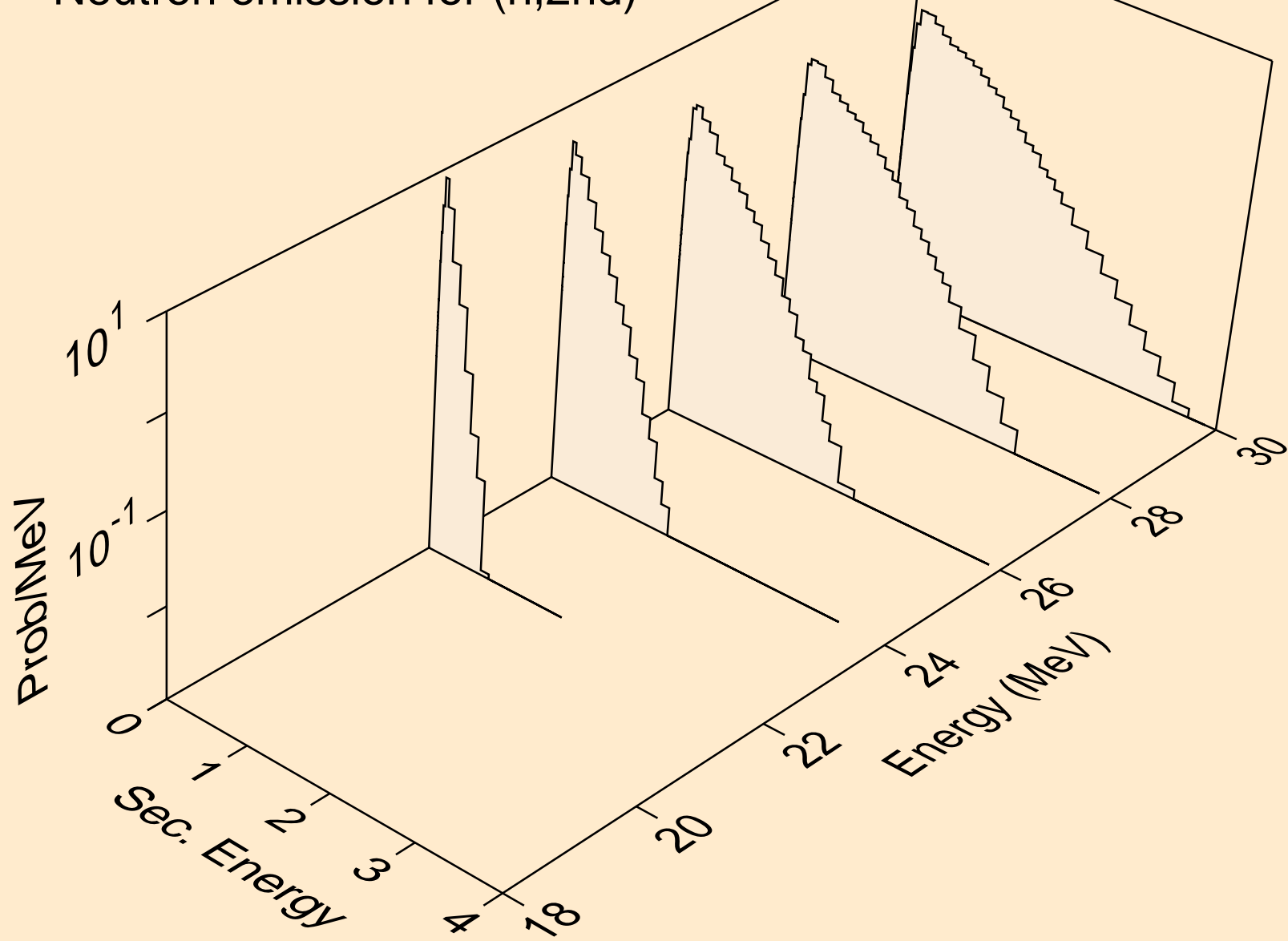

GD149 NEUTRON ACER TENDL-2024 LIBRARY; T=0.K
Neutron emission for (n,2n)

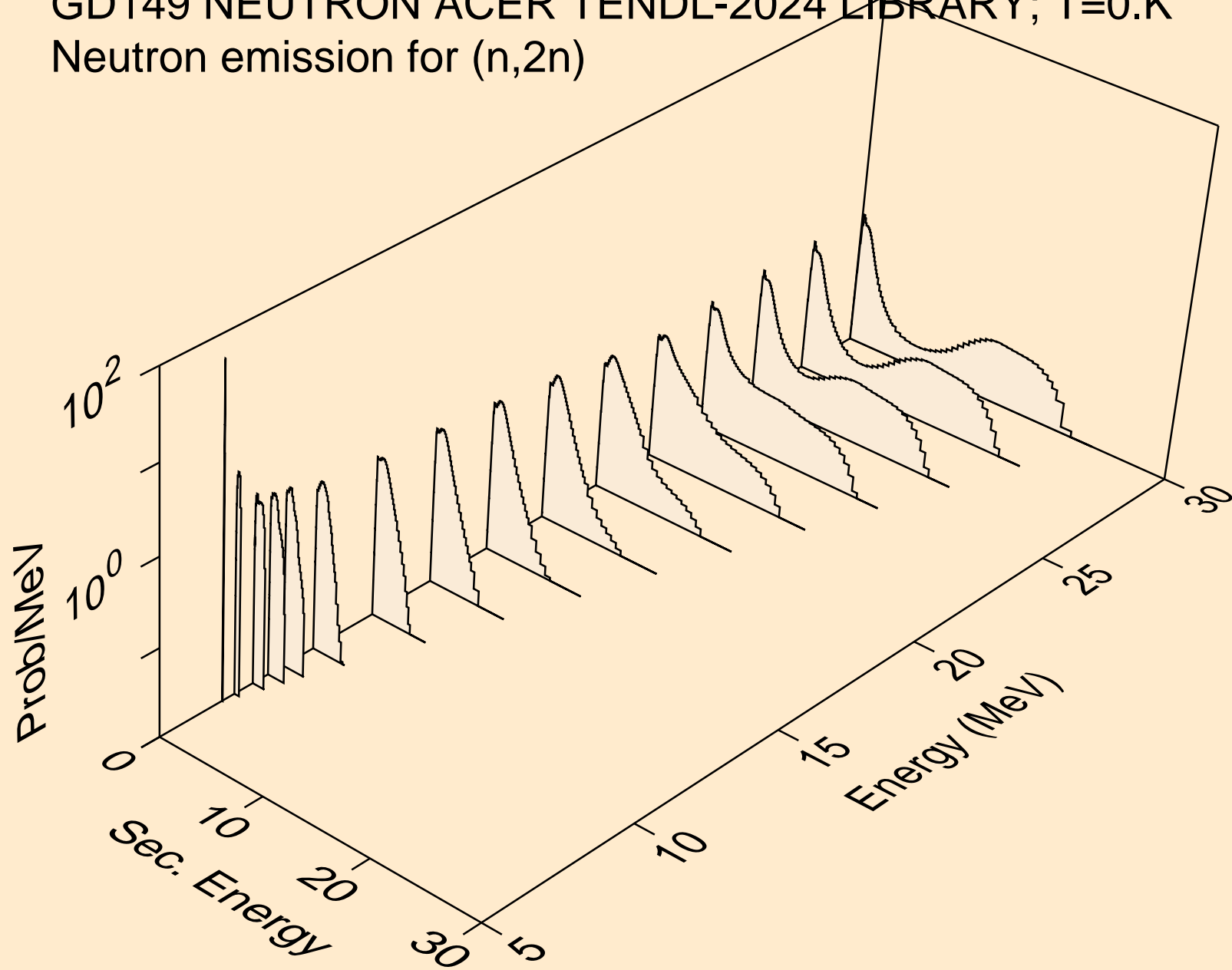

GD149 NEUTRON ACER TENDL-2024 LIBRARY; T=0.K
Neutron emission for (n,3n)

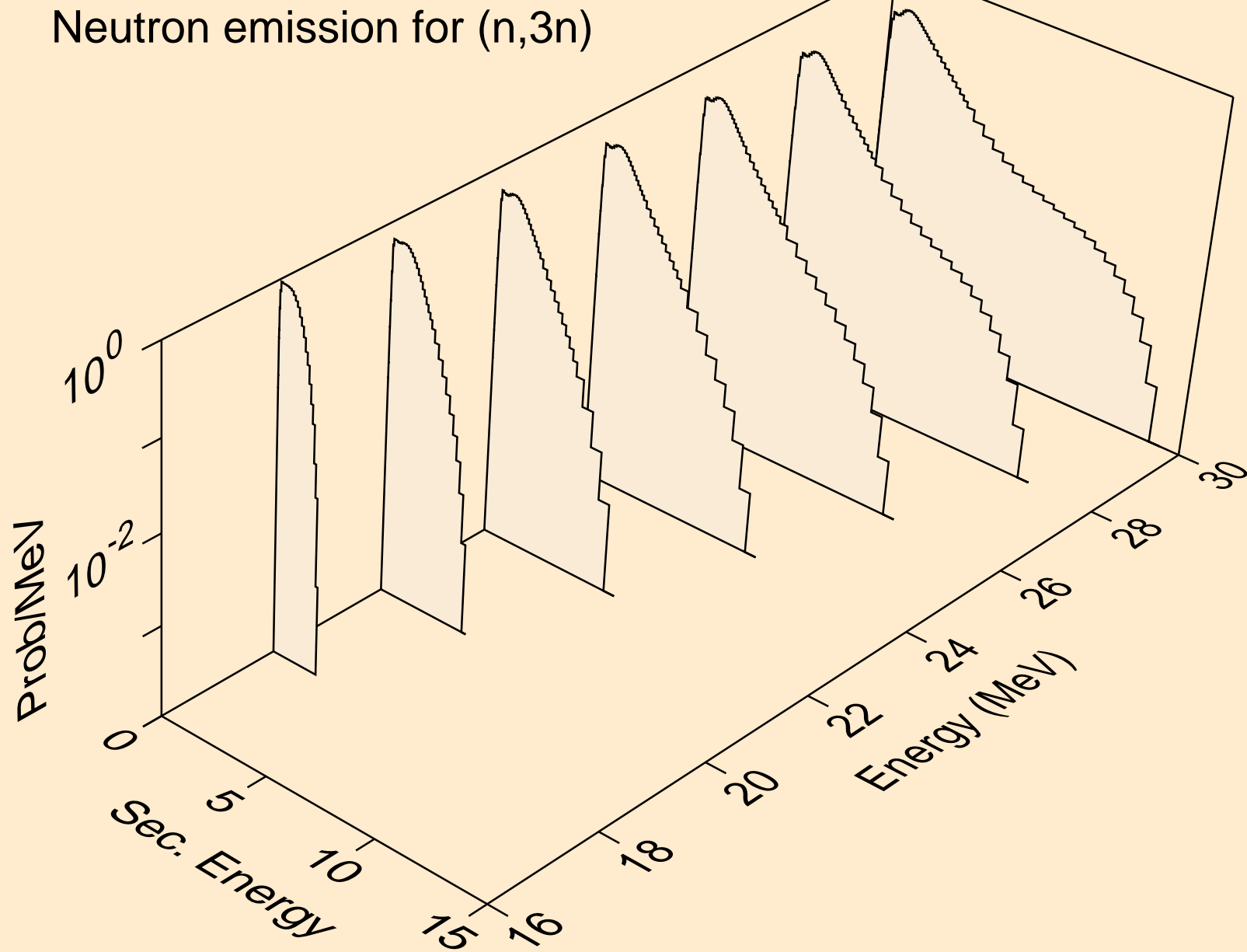

GD149 NEUTRON ACER TENDL-2024 LIBRARY; T=0.K
Neutron emission for (n,n*)a

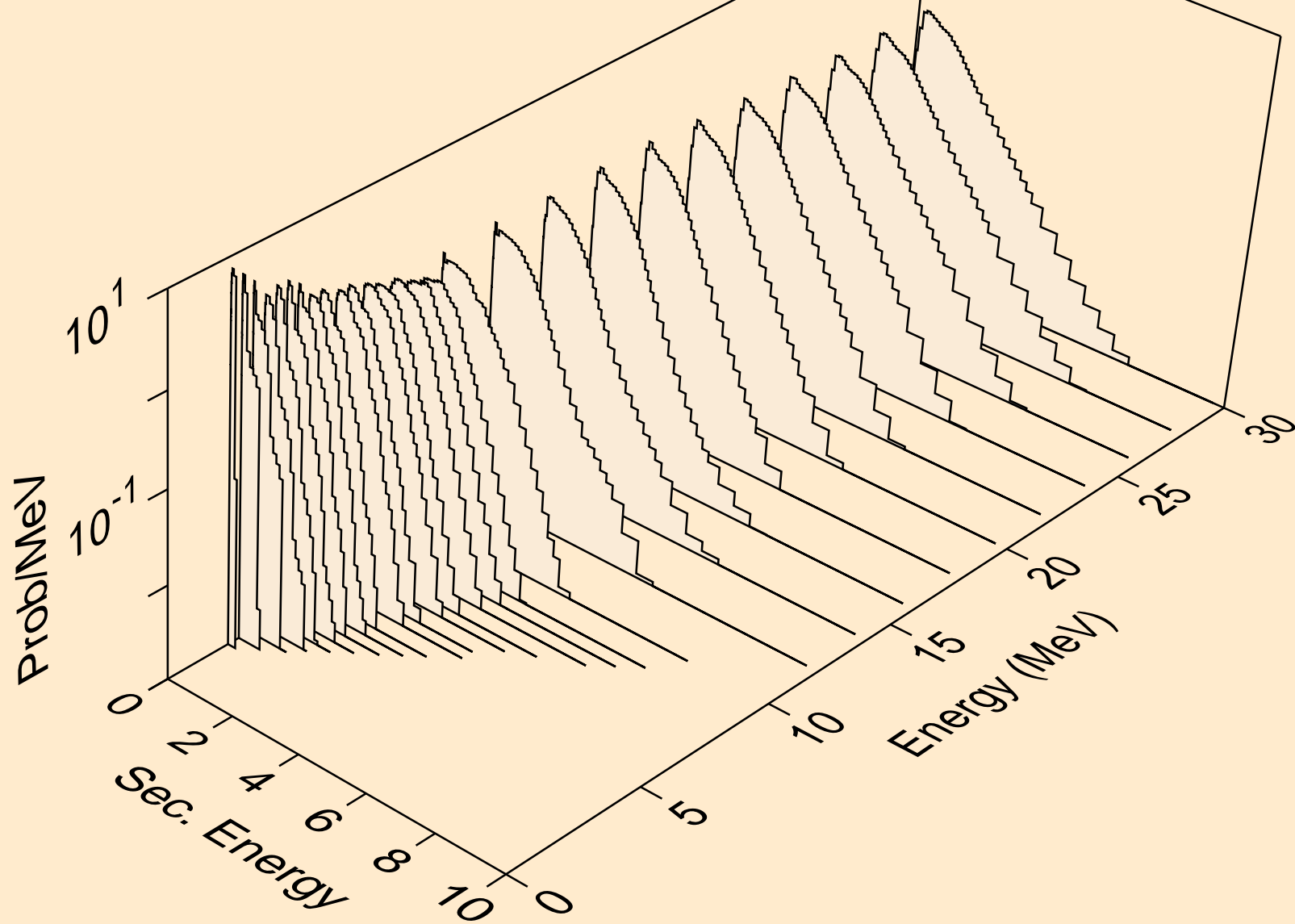

GD149 NEUTRON ACER TENDL-2024 LIBRARY; T=0.K
Neutron emission for (n,2n)a

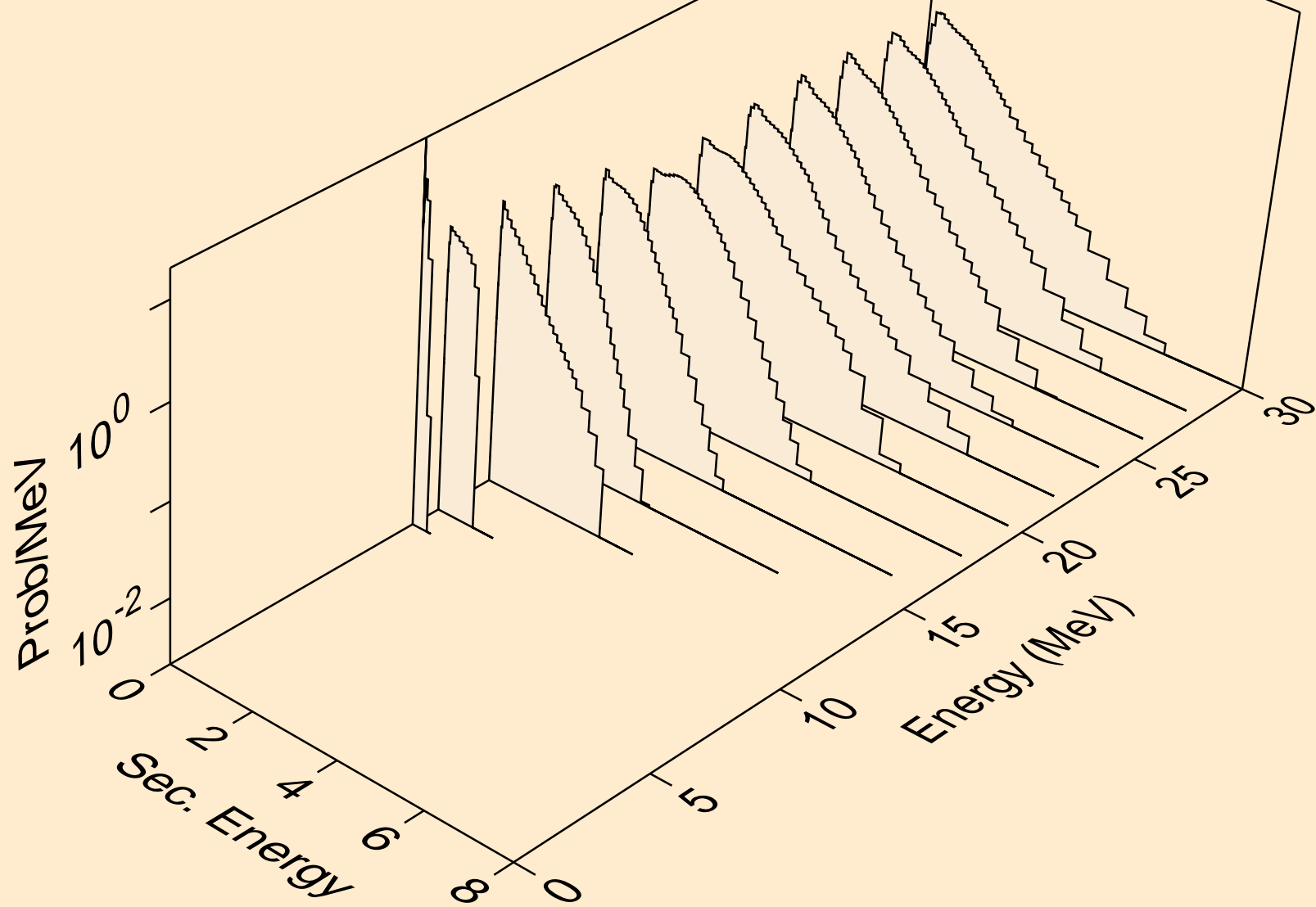

GD149 NEUTRON ACER TENDL-2024 LIBRARY; T=0.K
Neutron emission for (n,3n)a

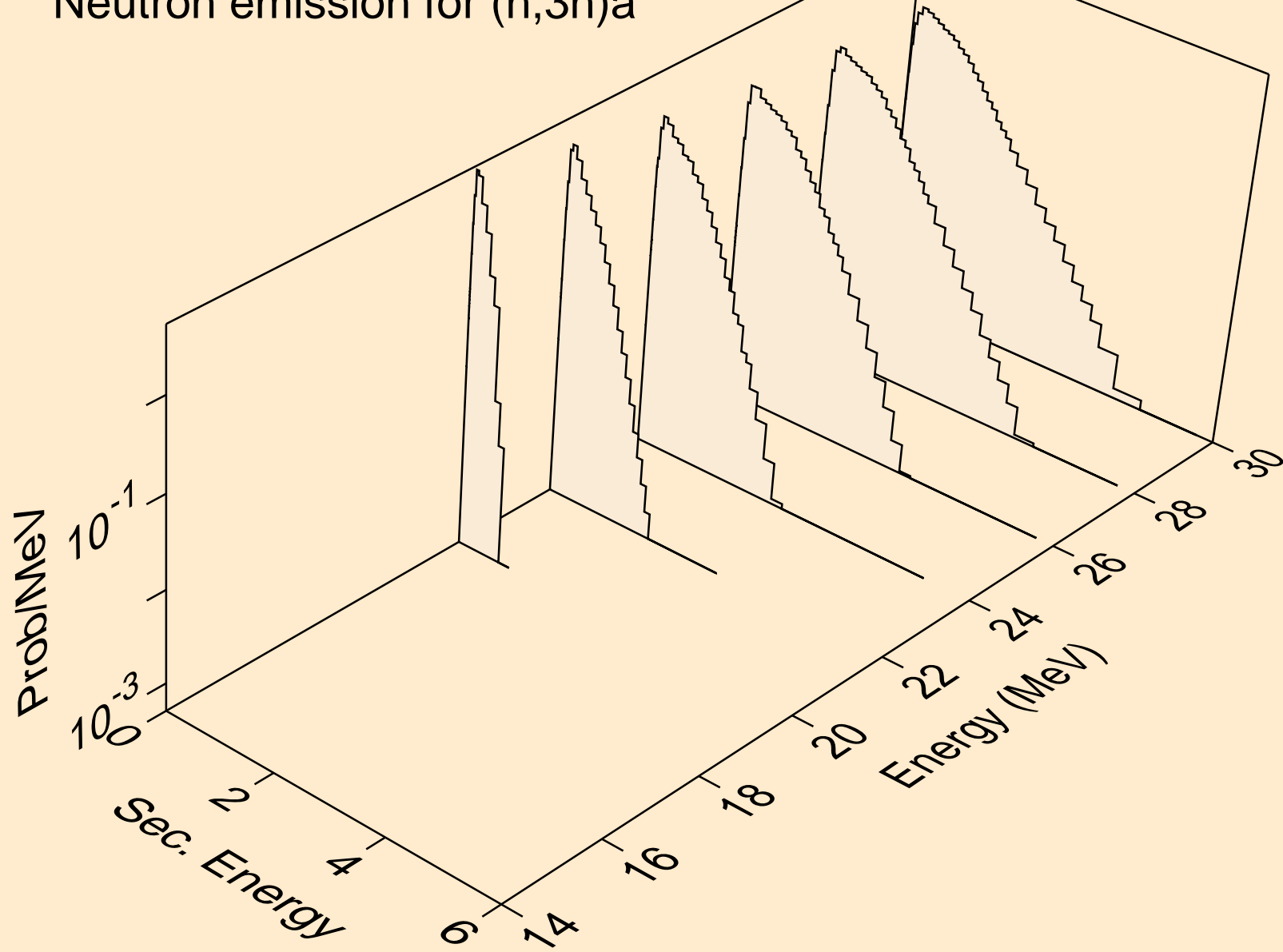

GD149 NEUTRON ACER TENDL-2024 LIBRARY; T=0.K
Neutron emission for (n,n*)p

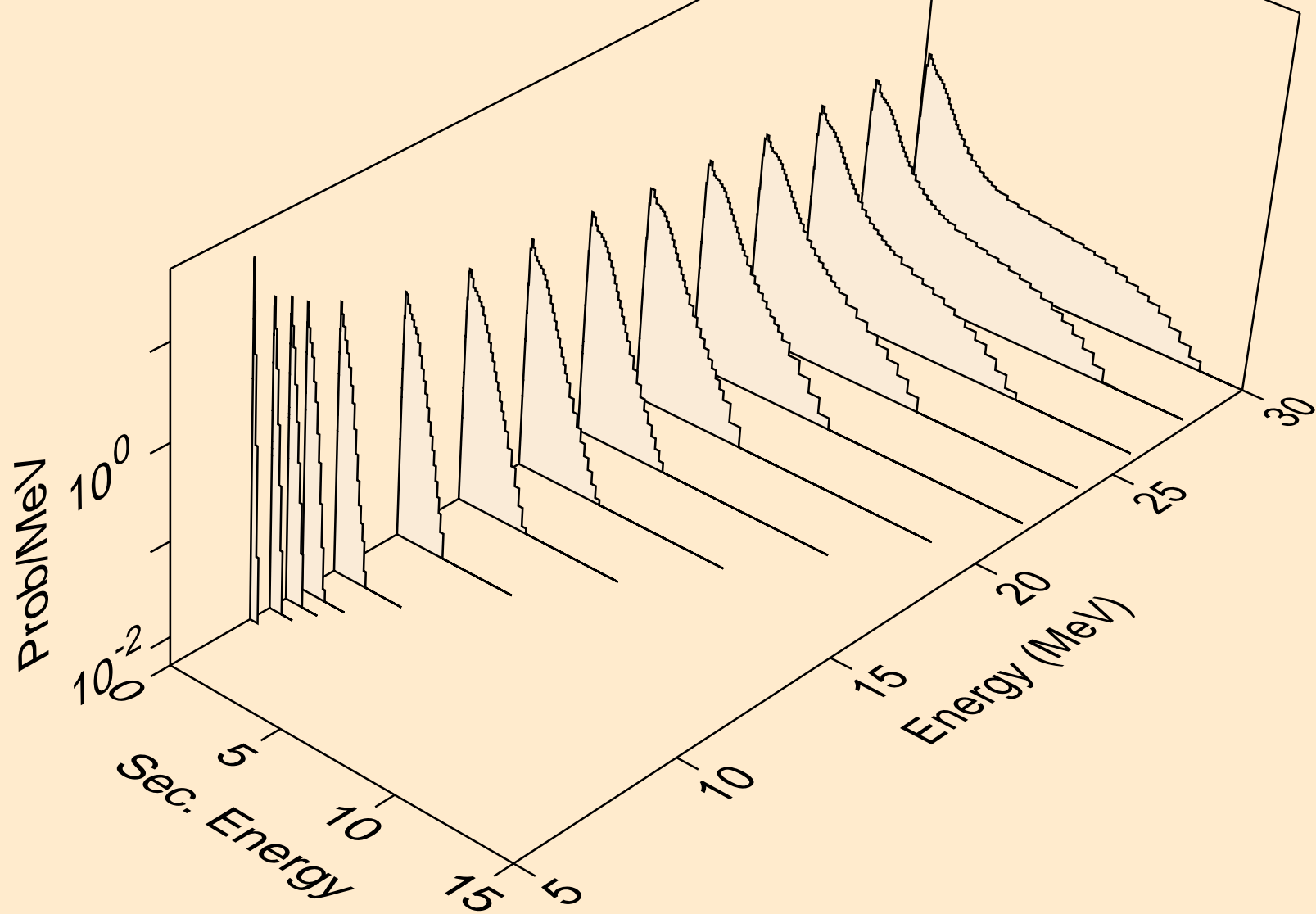

GD149 NEUTRON ACER TENDL-2024 LIBRARY; T=0.K
Neutron emission for (n,n*)2a

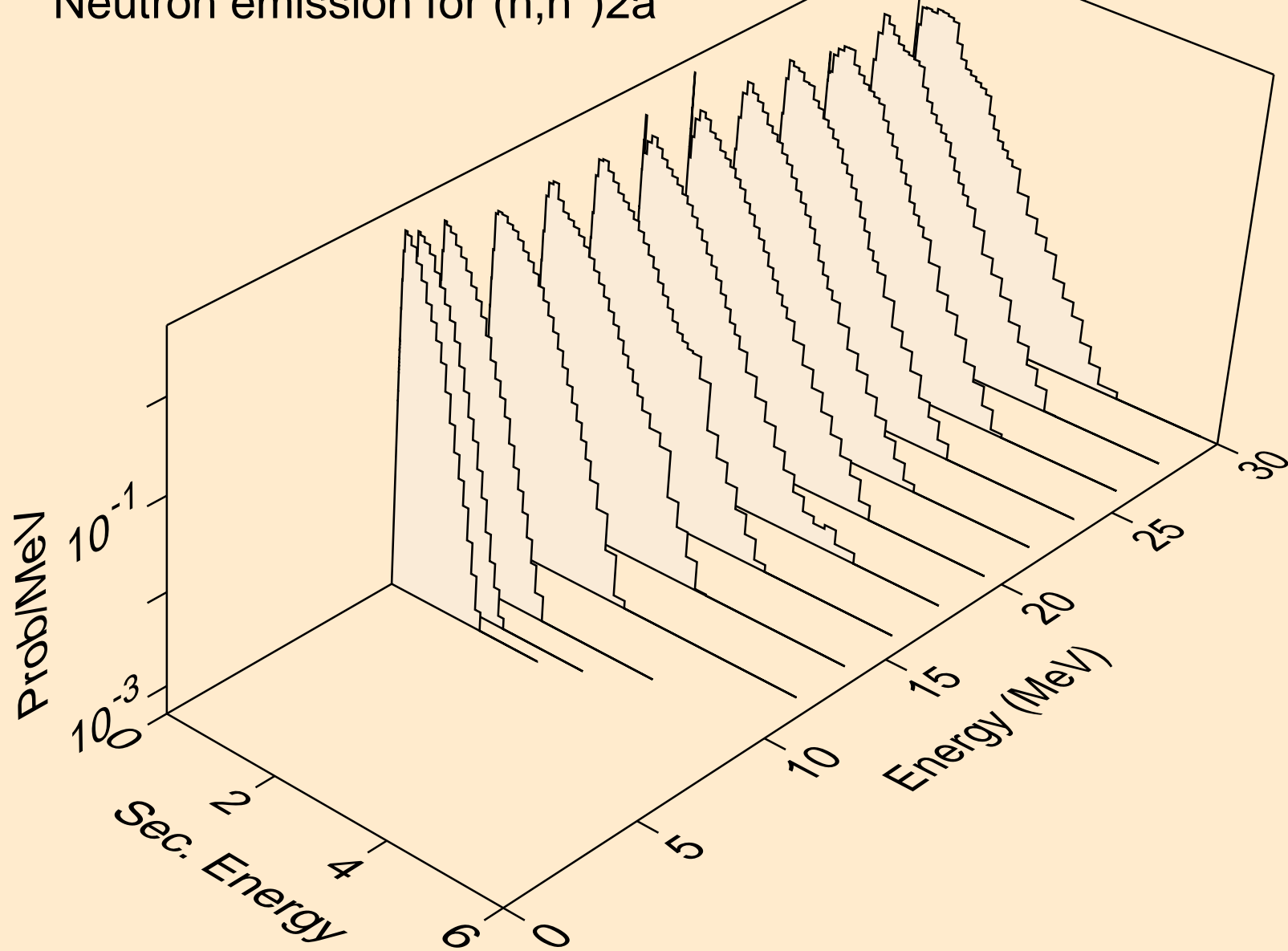

GD149 NEUTRON ACER TENDL-2024 LIBRARY; T=0.K
Neutron emission for (n,2n)2a

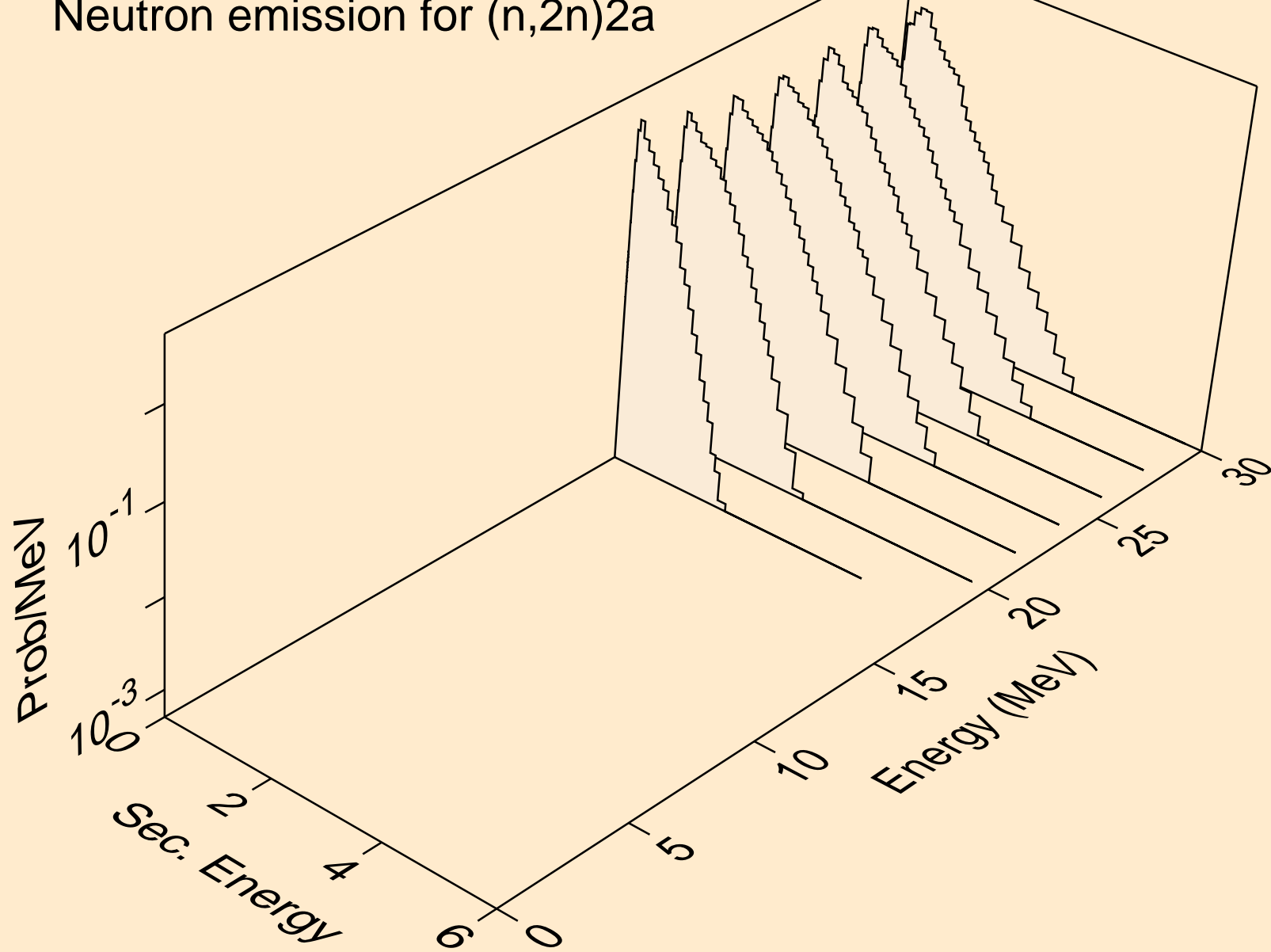

GD149 NEUTRON ACER TENDL-2024 LIBRARY; T=0.K
Neutron emission for (n,n*)d

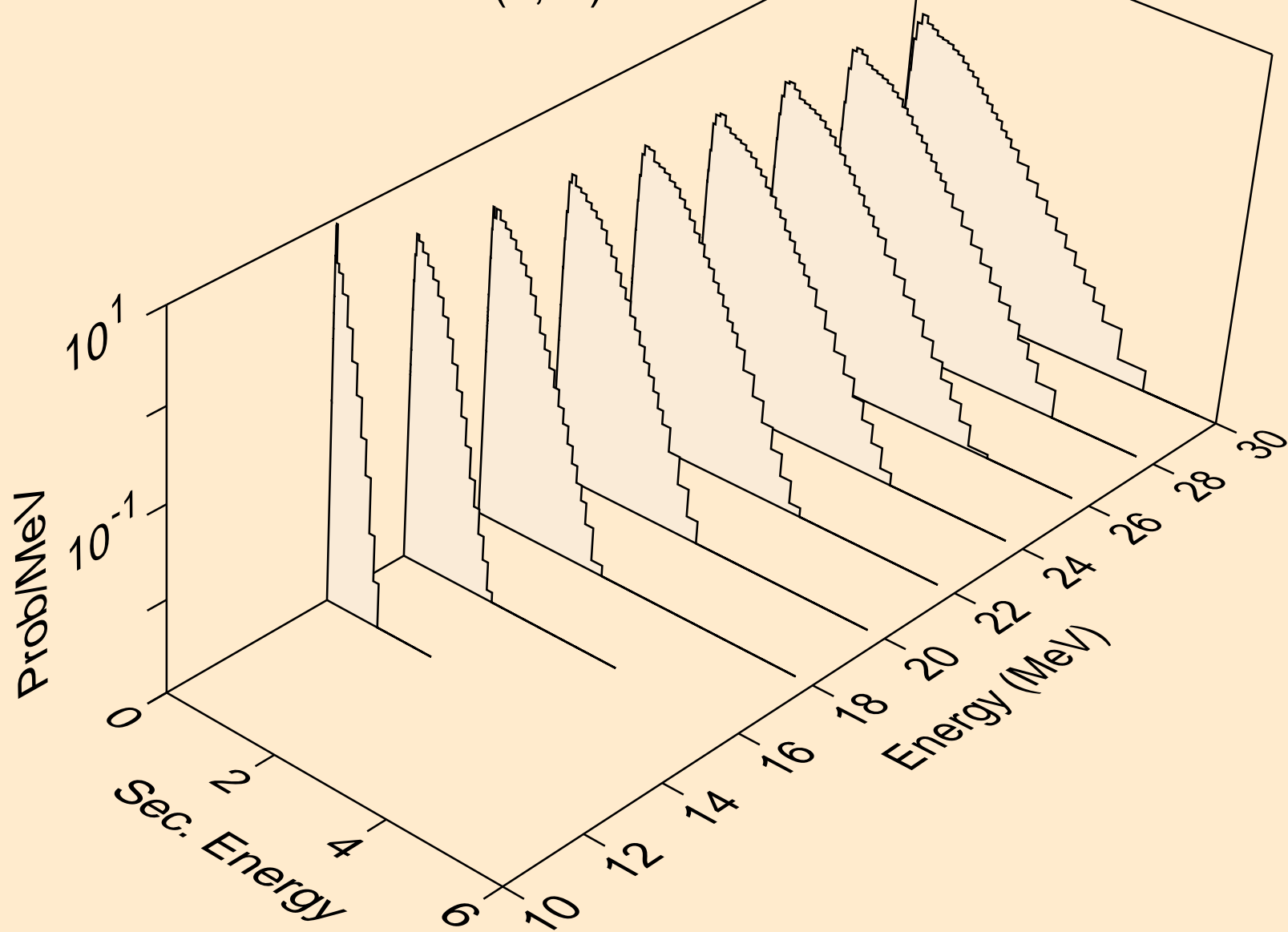

GD149 NEUTRON ACER TENDL-2024 LIBRARY; T=0.K
Neutron emission for (n,n*)t

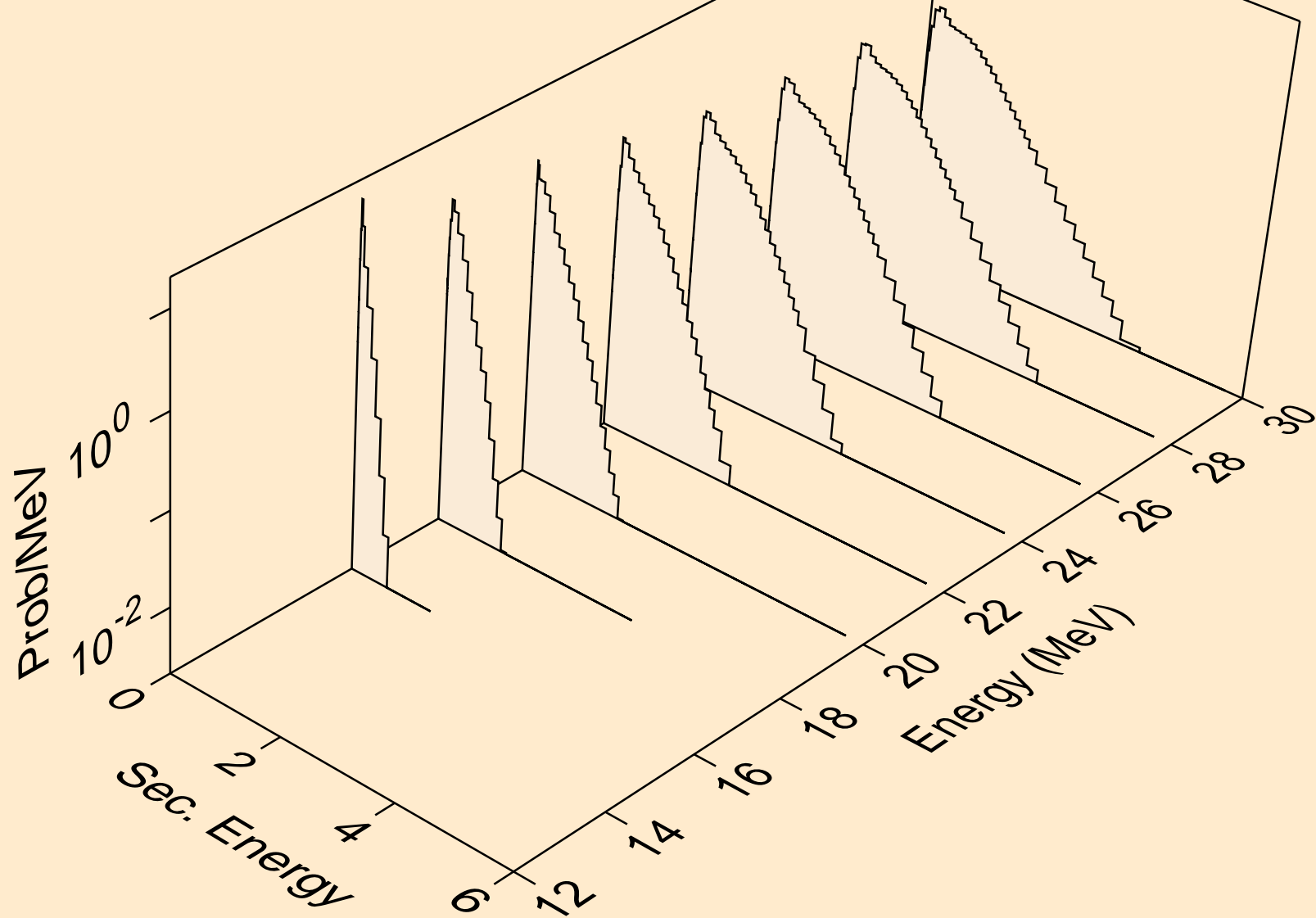

GD149 NEUTRON ACER TENDL-2024 LIBRARY; T=0.K
Neutron emission for (n,n*)he3

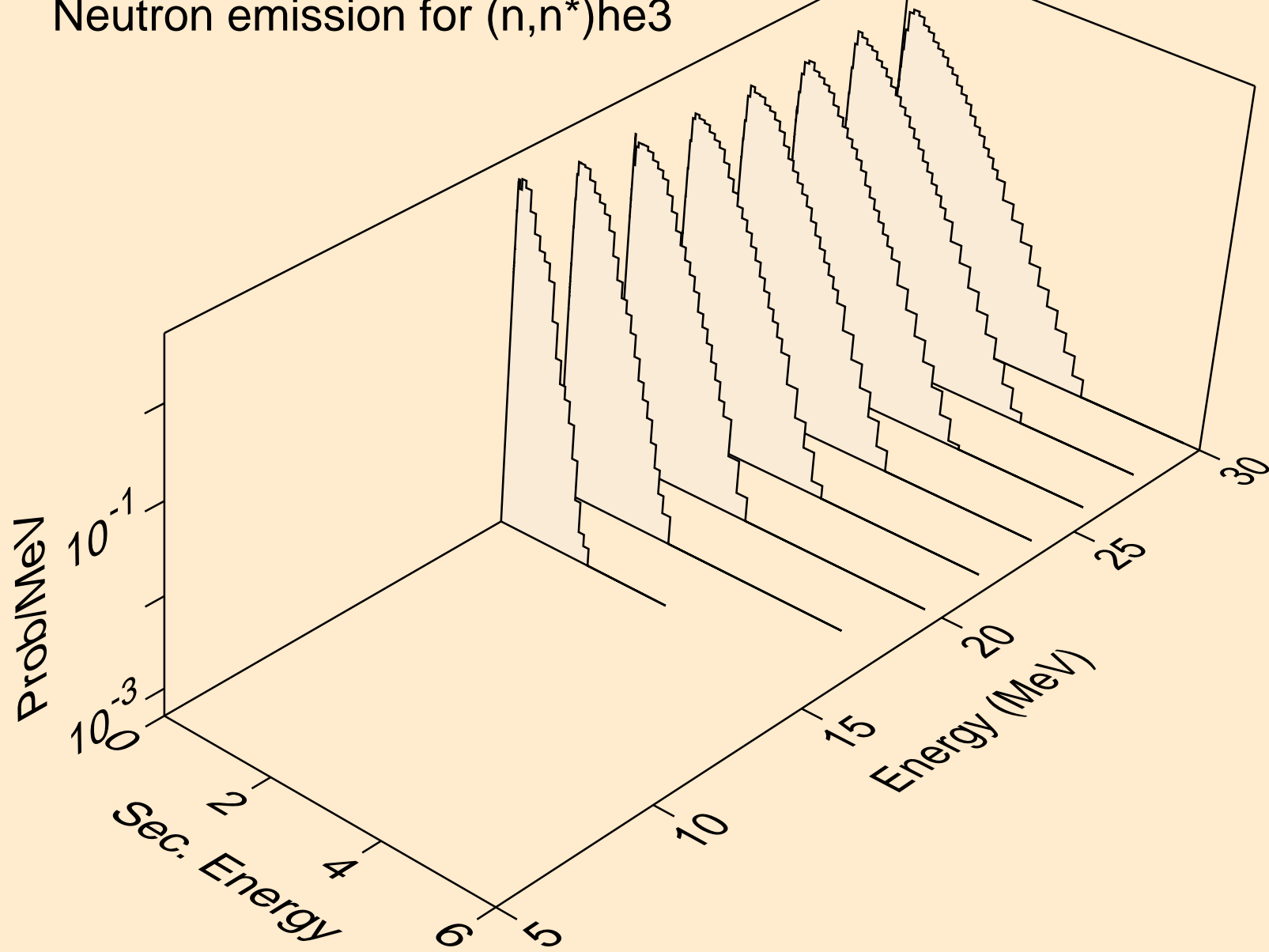

GD149 NEUTRON ACER TENDL-2024 LIBRARY; T=0.K
Neutron emission for (n,4n)

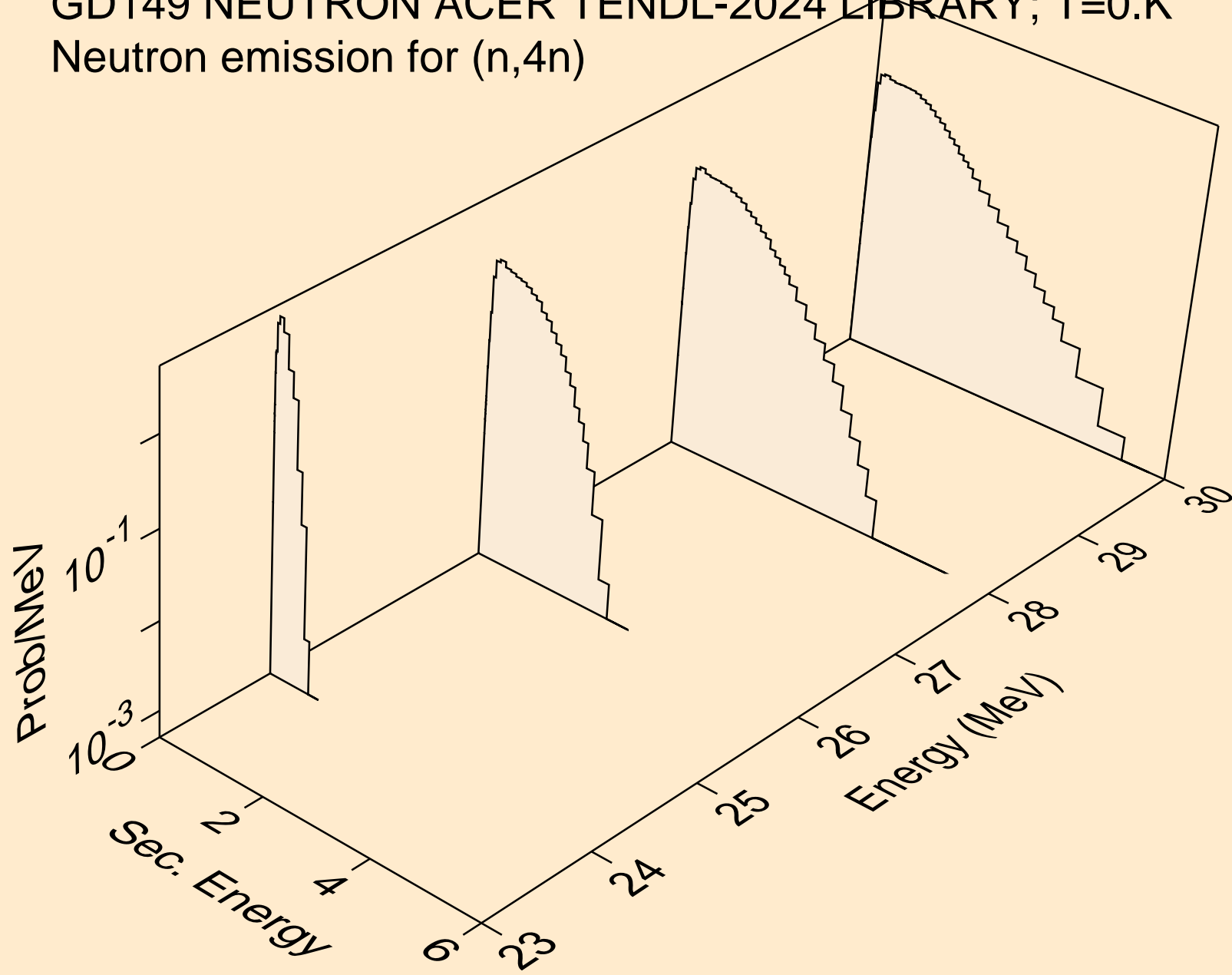

GD149 NEUTRON ACER TENDL-2024 LIBRARY; T=0.K
Neutron emission for (n,2np)

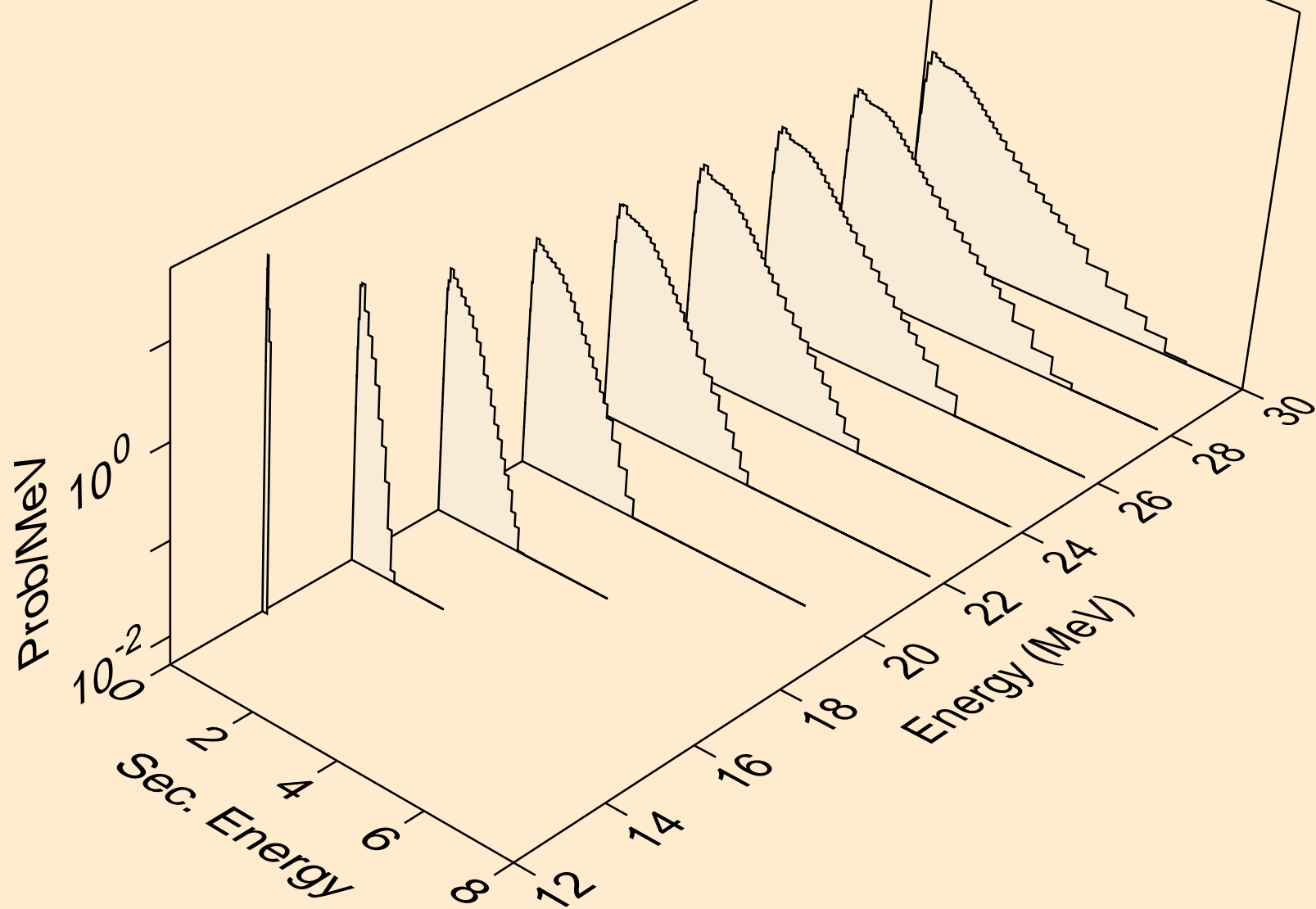

GD149 NEUTRON ACER TENDL-2024 LIBRARY; T=0.K
Neutron emission for (n,3np)

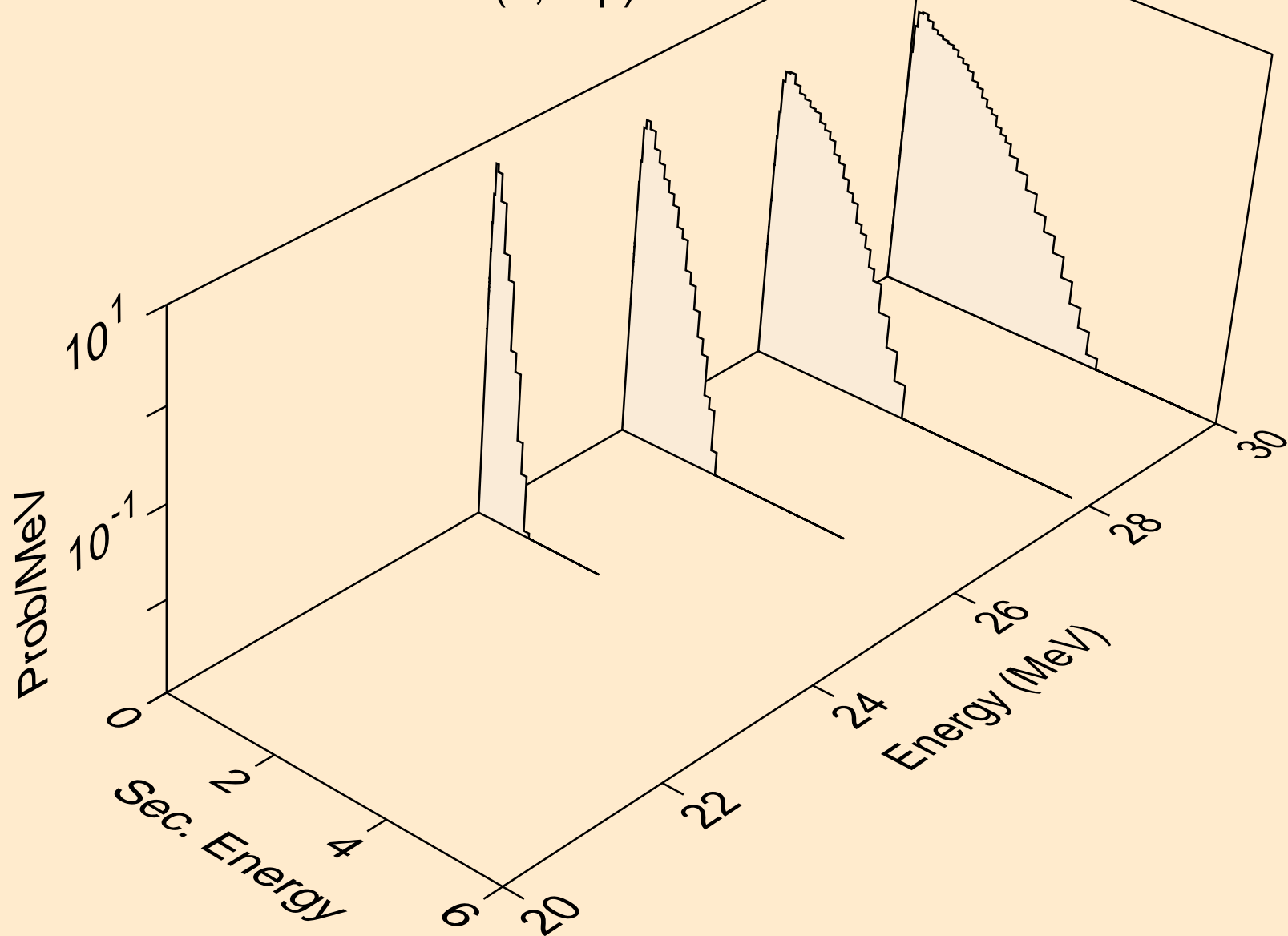

GD149 NEUTRON ACER TENDL-2024 LIBRARY; T=0.K
Neutron emission for (n,n2p)

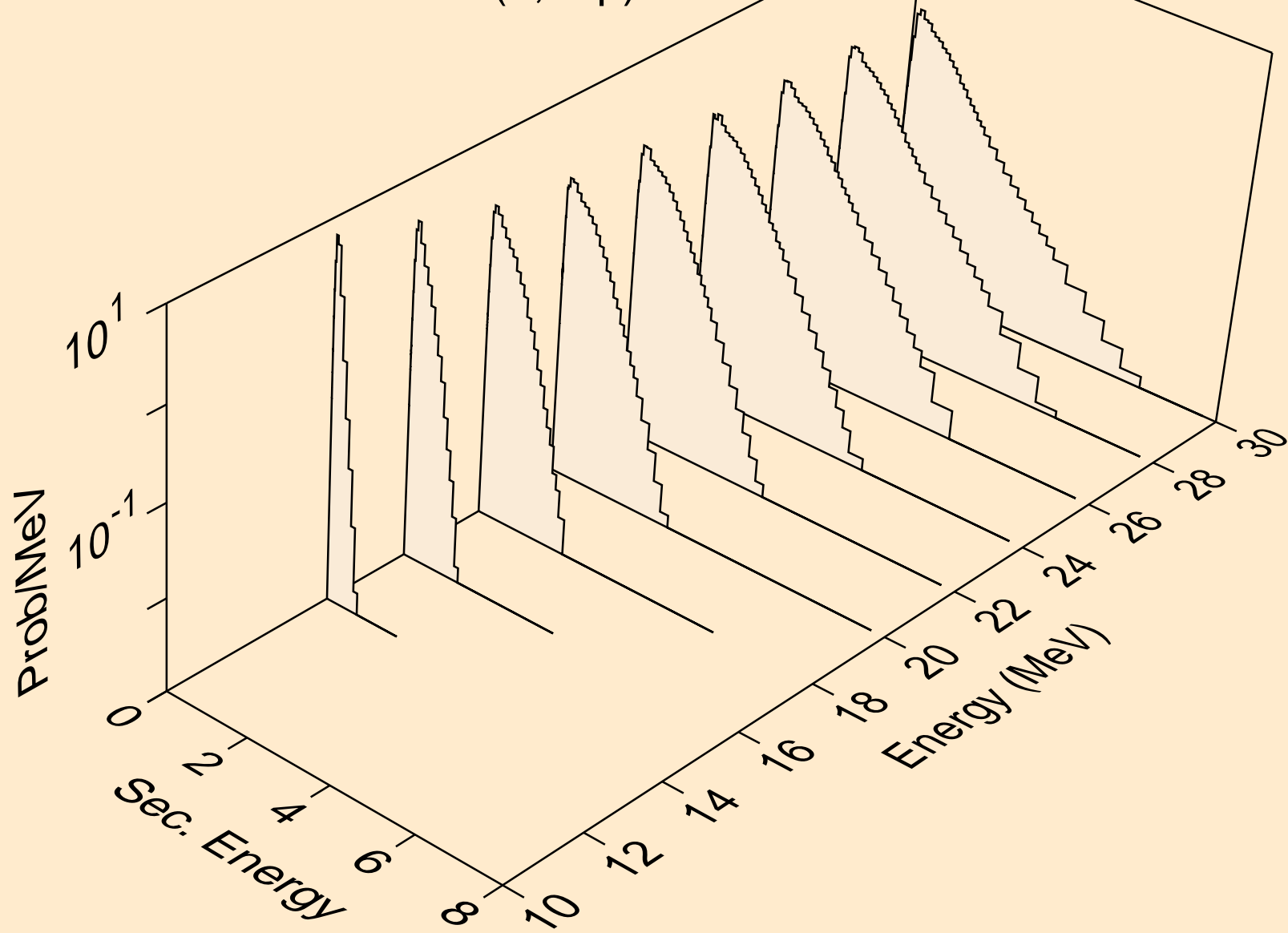

GD149 NEUTRON ACER TENDL-2024 LIBRARY; T=0.K
Neutron emission for (n,npa)

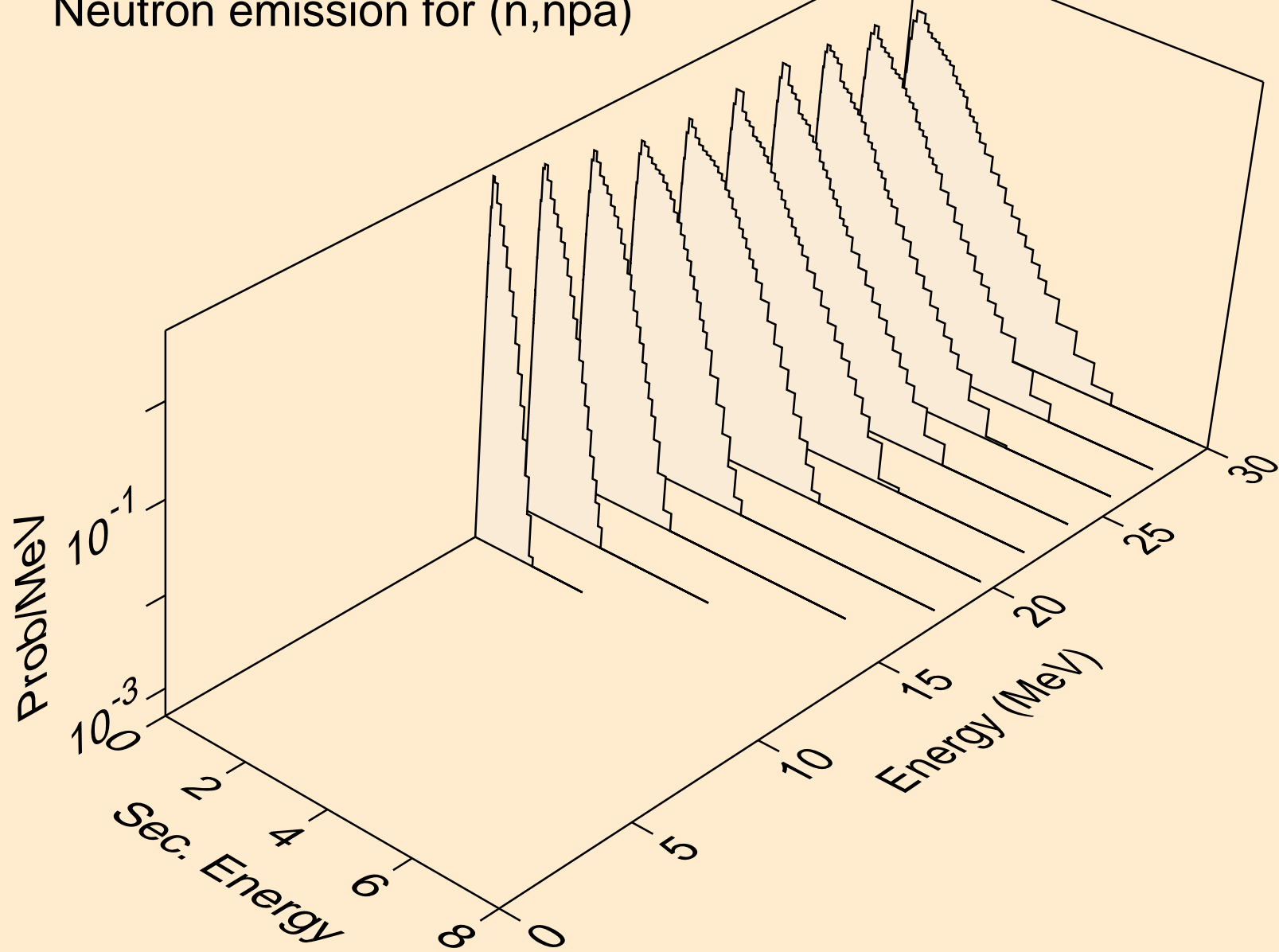

GD149 NEUTRON ACER TENDL-2024 LIBRARY; T=0.K
Neutron emission for (n,n*c)

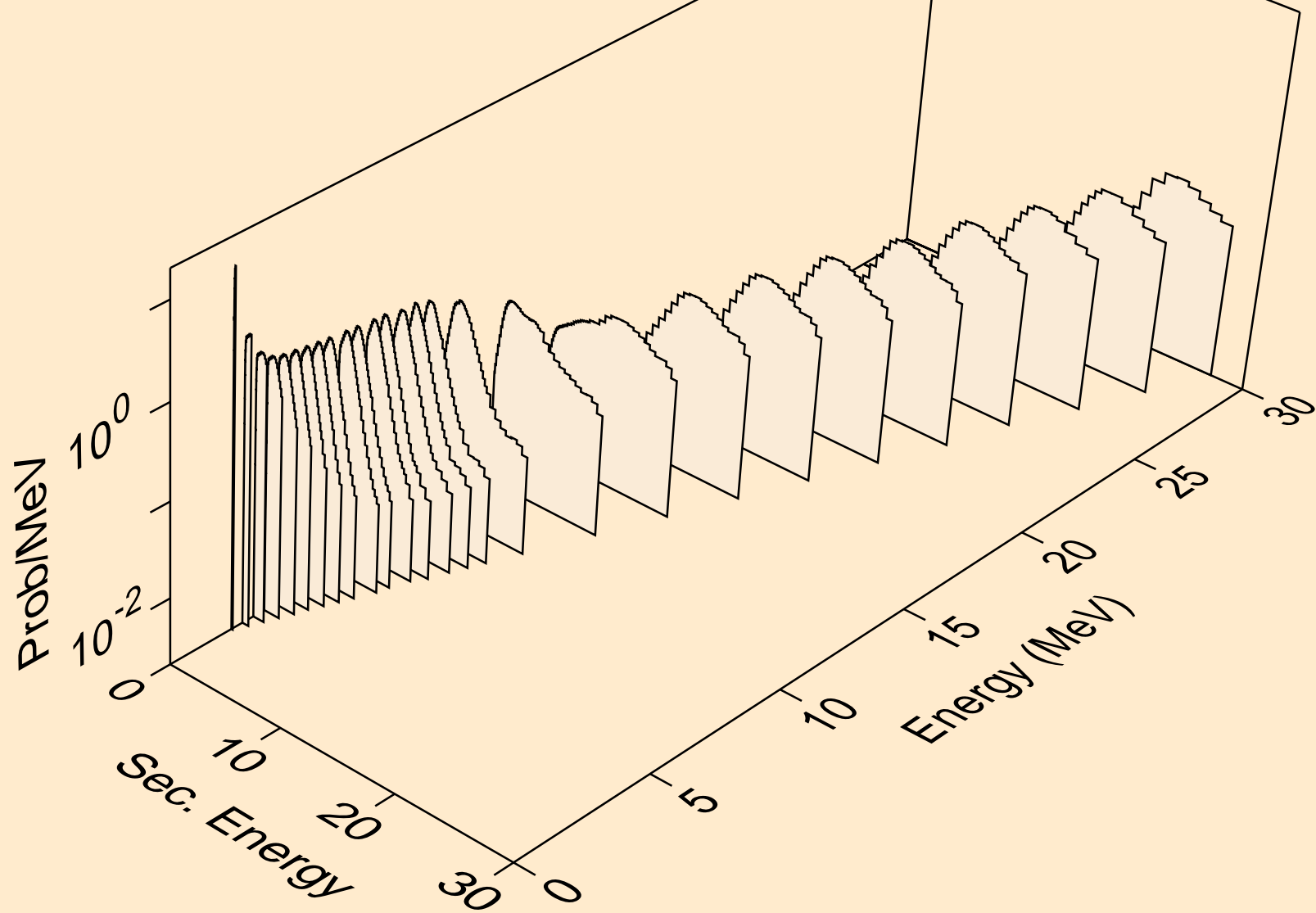

GD149 NEUTRON ACER TENDL-2024 LIBRARY; T=0.K
Photon emission for (n,x)

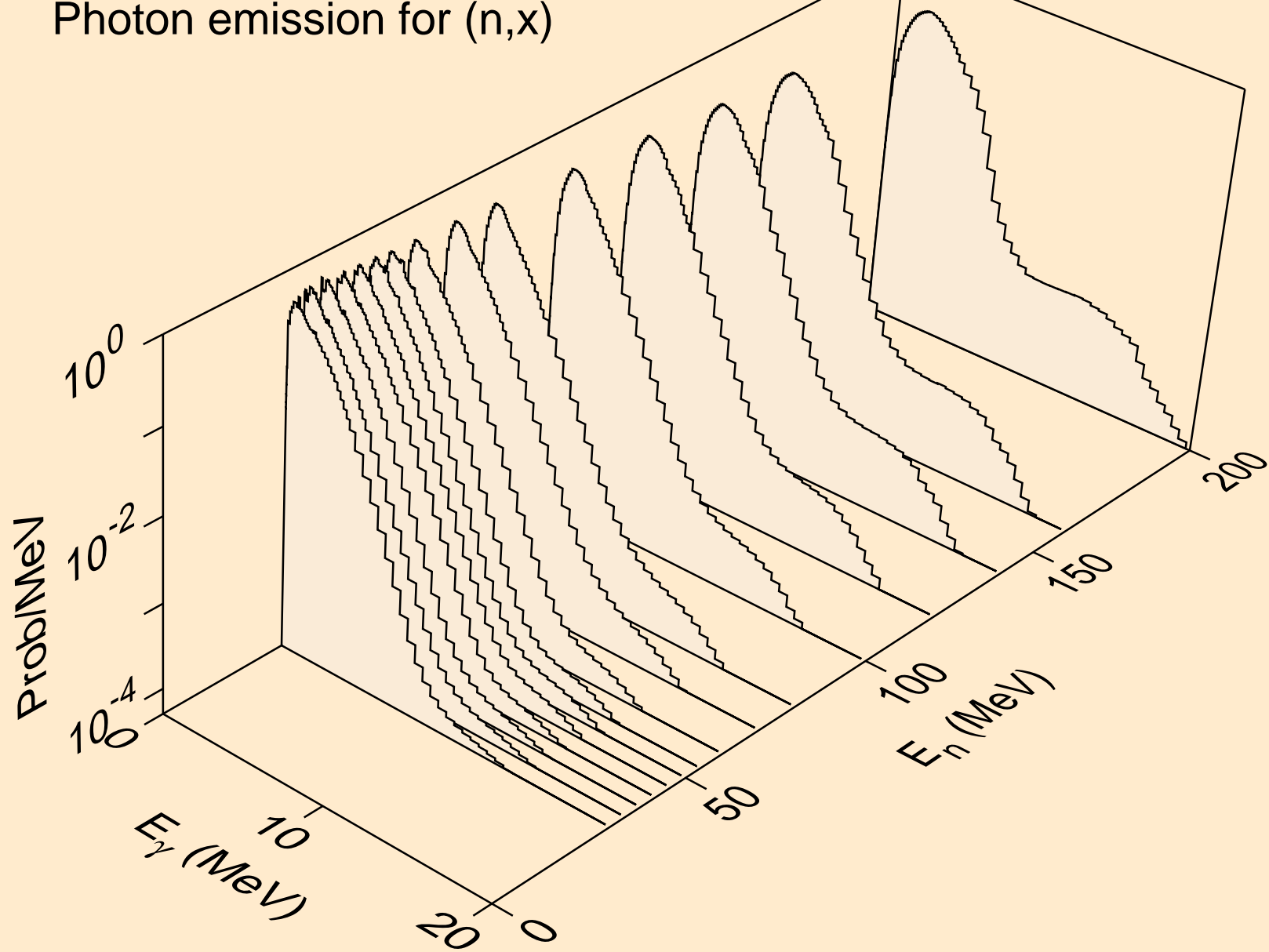

GD149 NEUTRON ACER TENDL-2024 LIBRARY; T=0.K
Photon emission for (n,2nd)

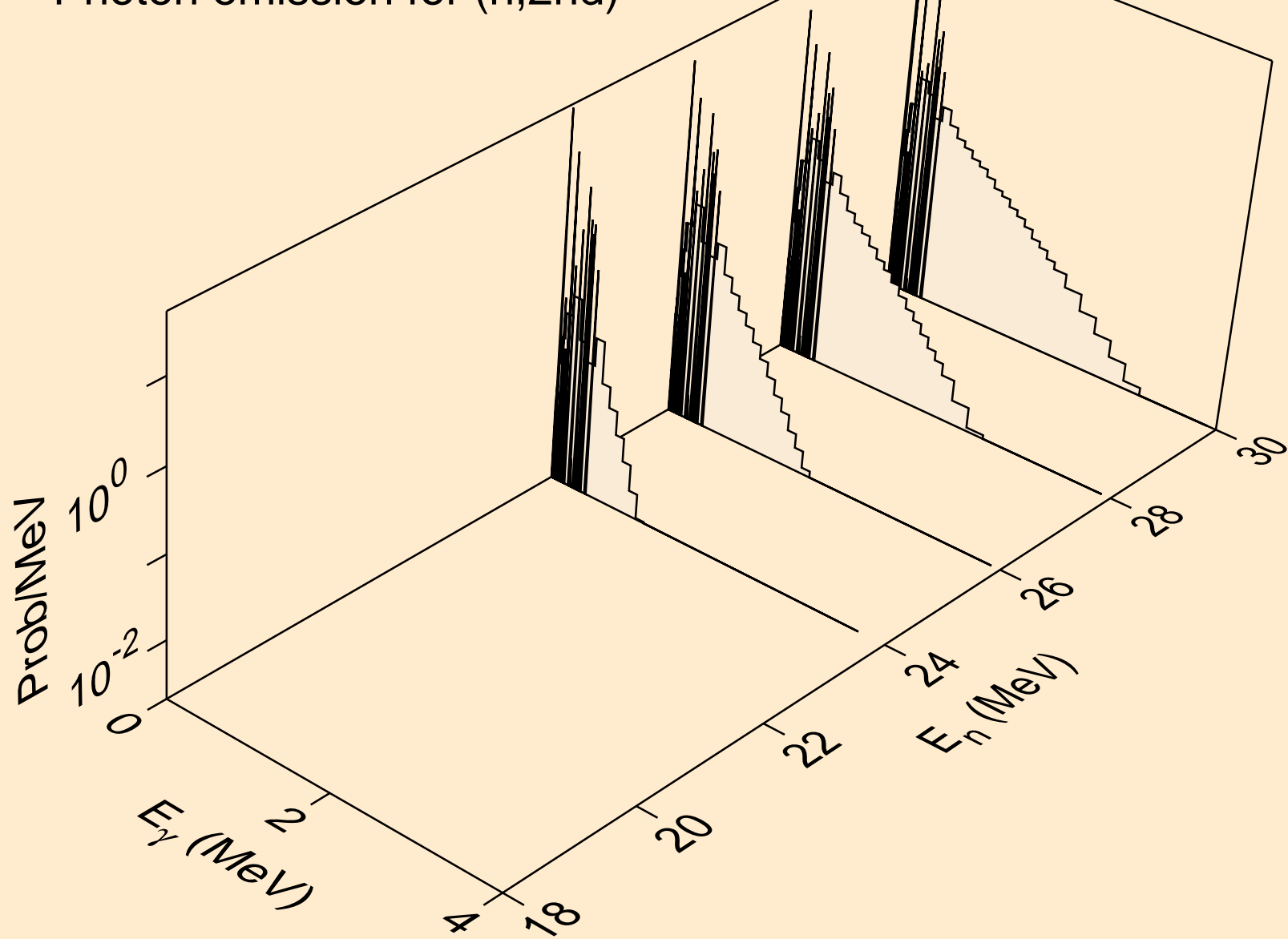

GD149 NEUTRON ACER TENDL-2024 LIBRARY; T=0.K
Photon emission for (n,2n)

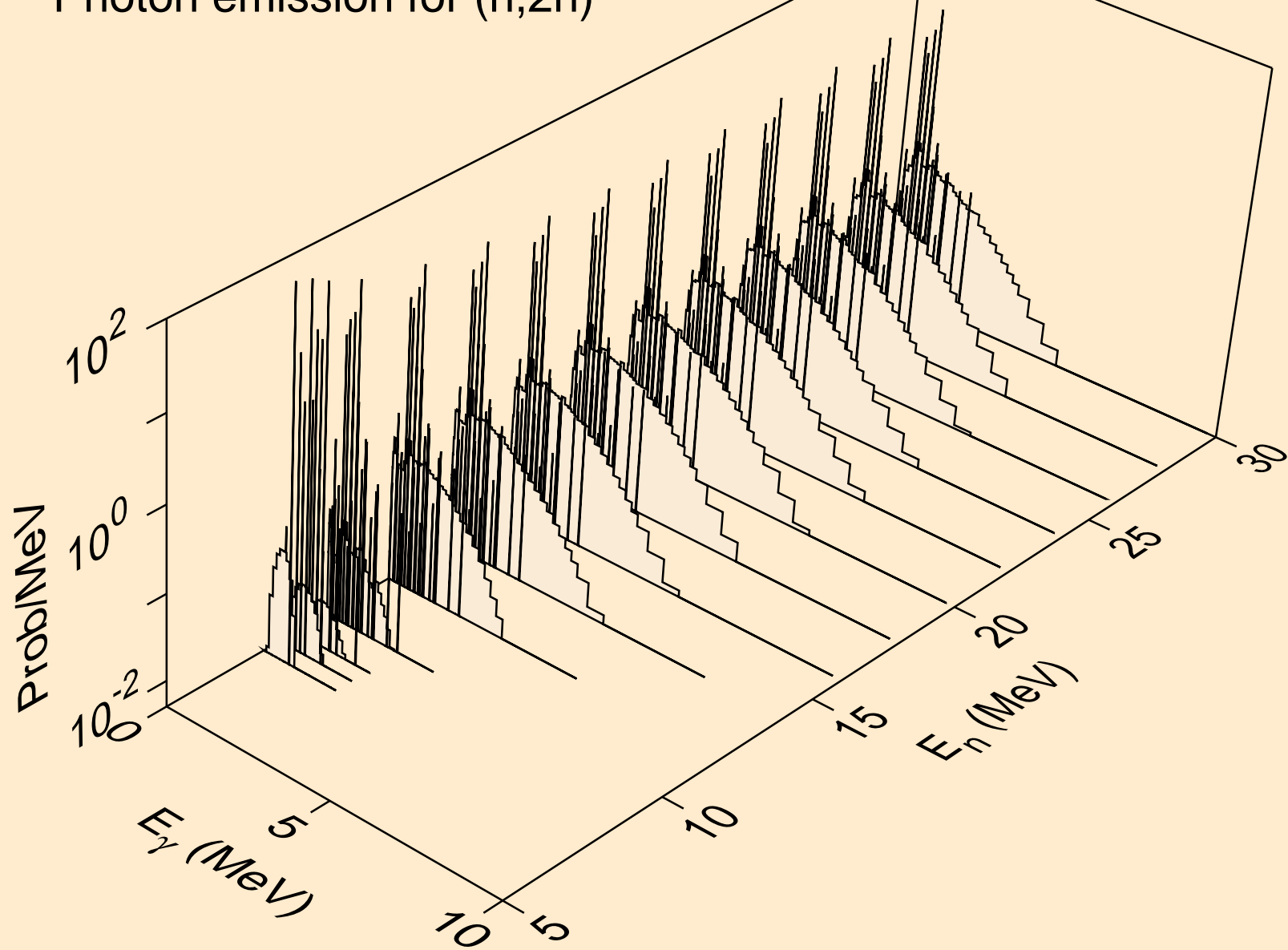

GD149 NEUTRON ACER TENDL-2024 LIBRARY; T=0.K
Photon emission for (n,3n)

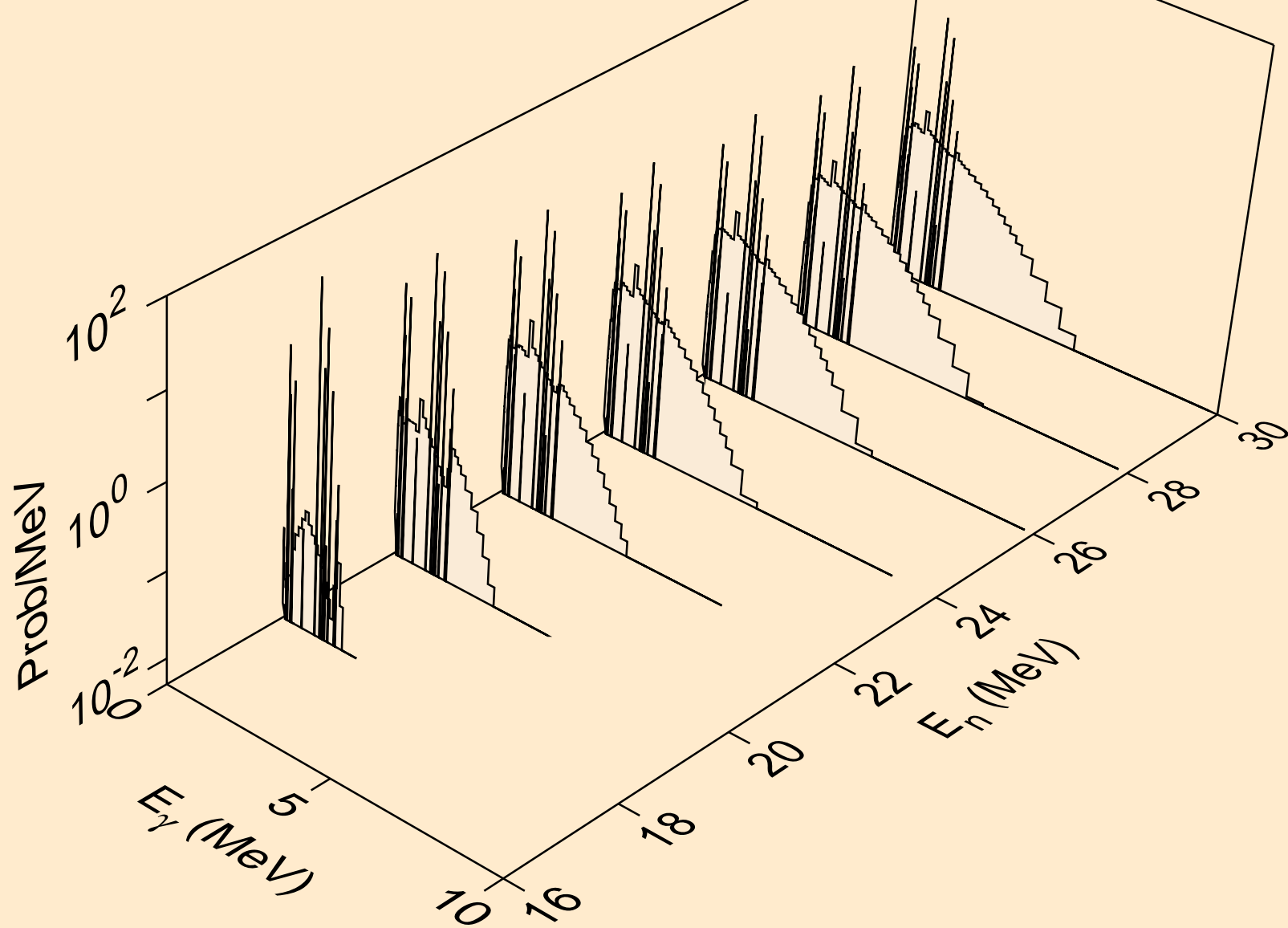

GD149 NEUTRON ACER TENDL-2024 LIBRARY; T=0.K
Photon emission for (n,n*)a

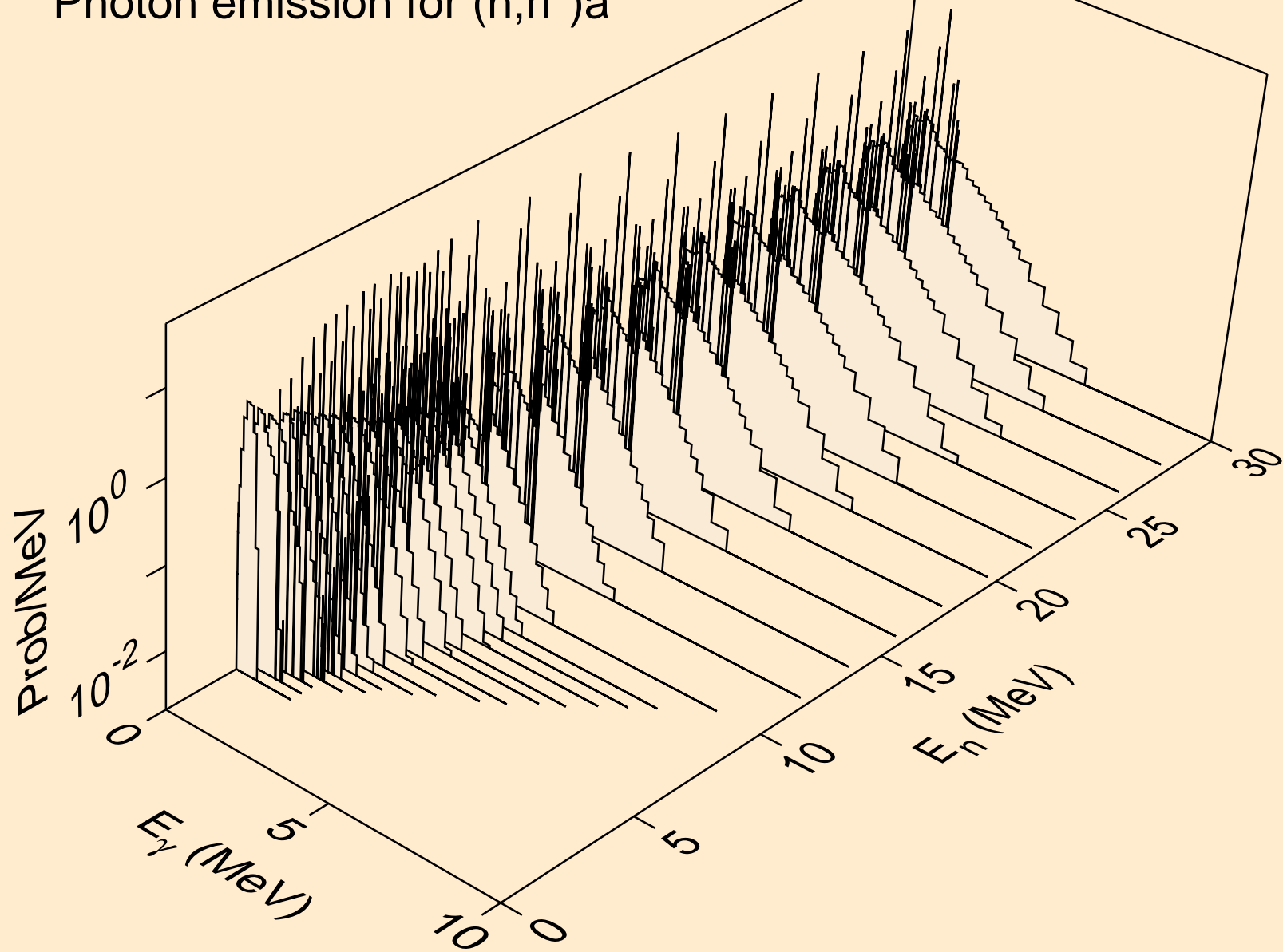

GD149 NEUTRON ACER TENDL-2024 LIBRARY; T=0.K
Photon emission for (n,2n)a

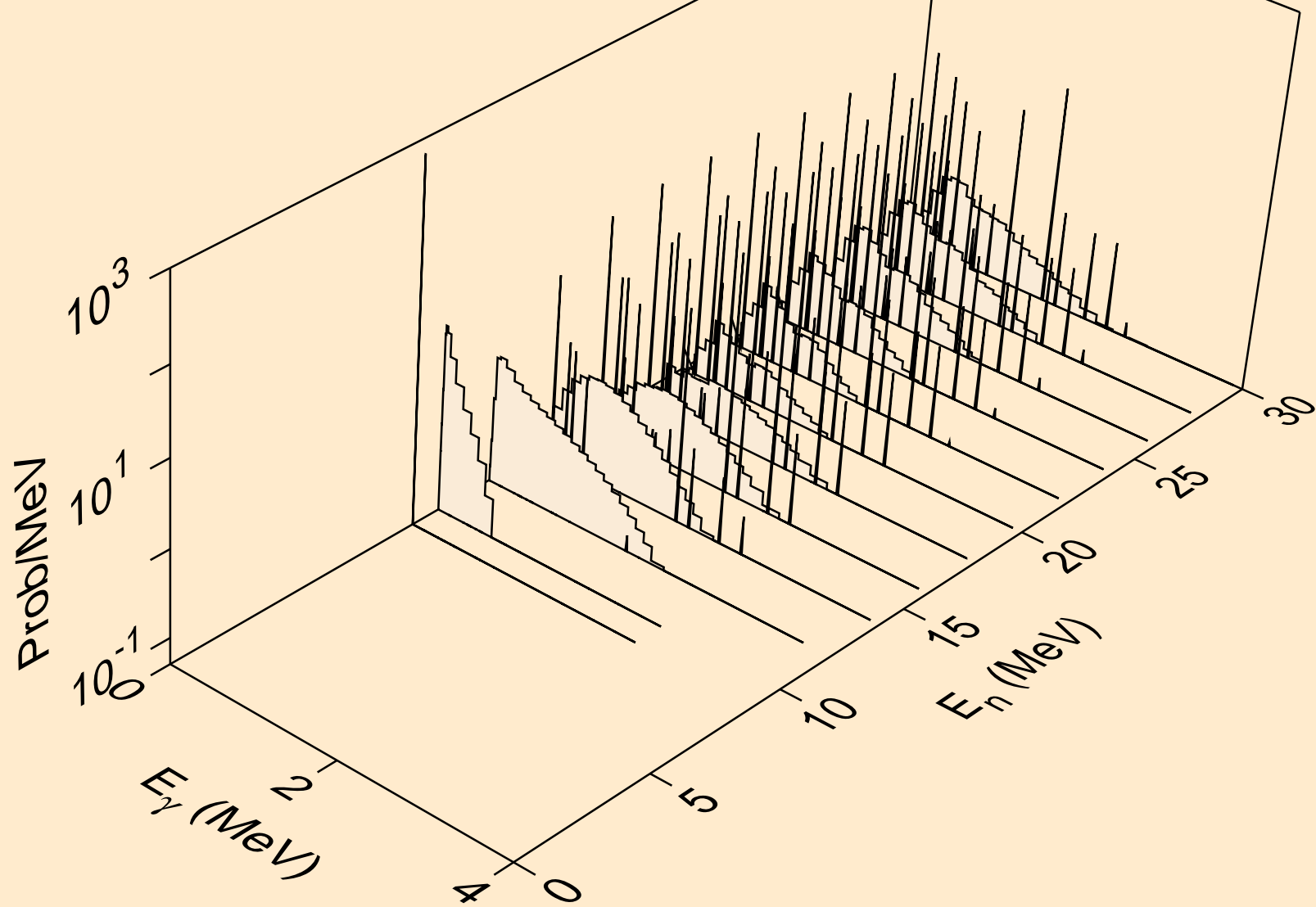

GD149 NEUTRON ACER TENDL-2024 LIBRARY; T=0.K
Photon emission for (n,3n)a

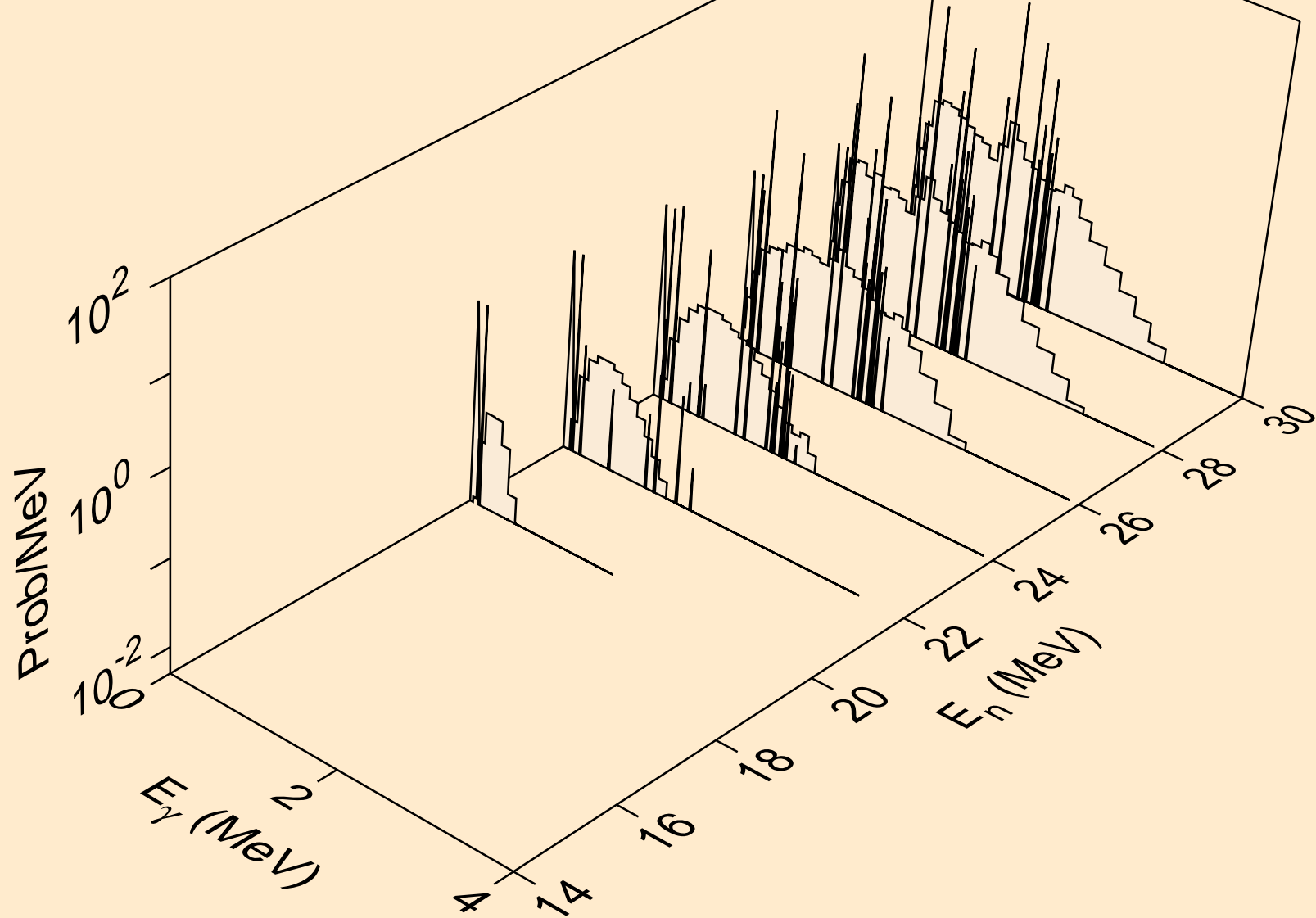

GD149 NEUTRON ACER TENDL-2024 LIBRARY; T=0.K
Photon emission for (n,n*)p

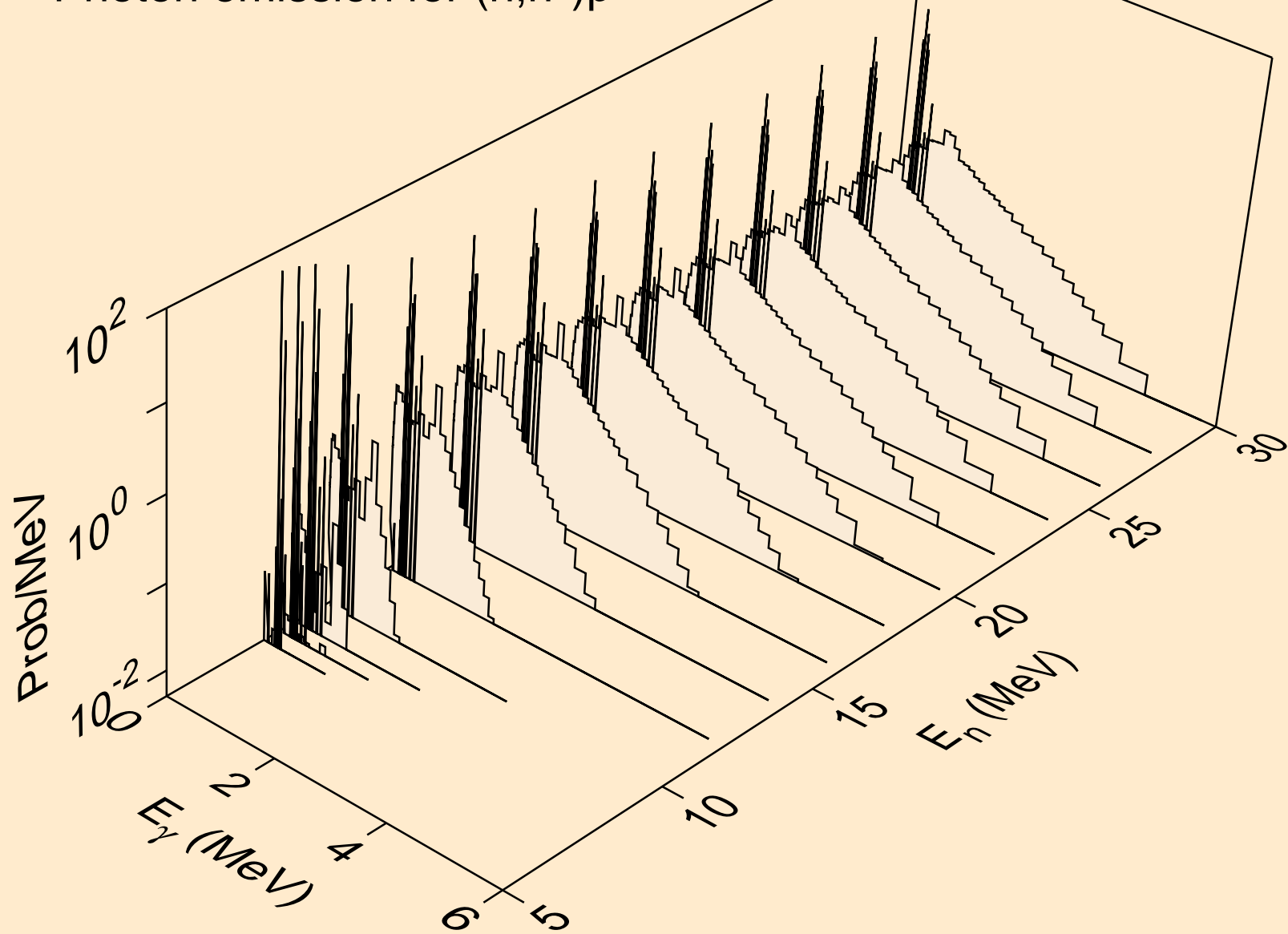

GD149 NEUTRON ACER TENDL-2024 LIBRARY; T=0.K
Photon emission for (n,n*)2a

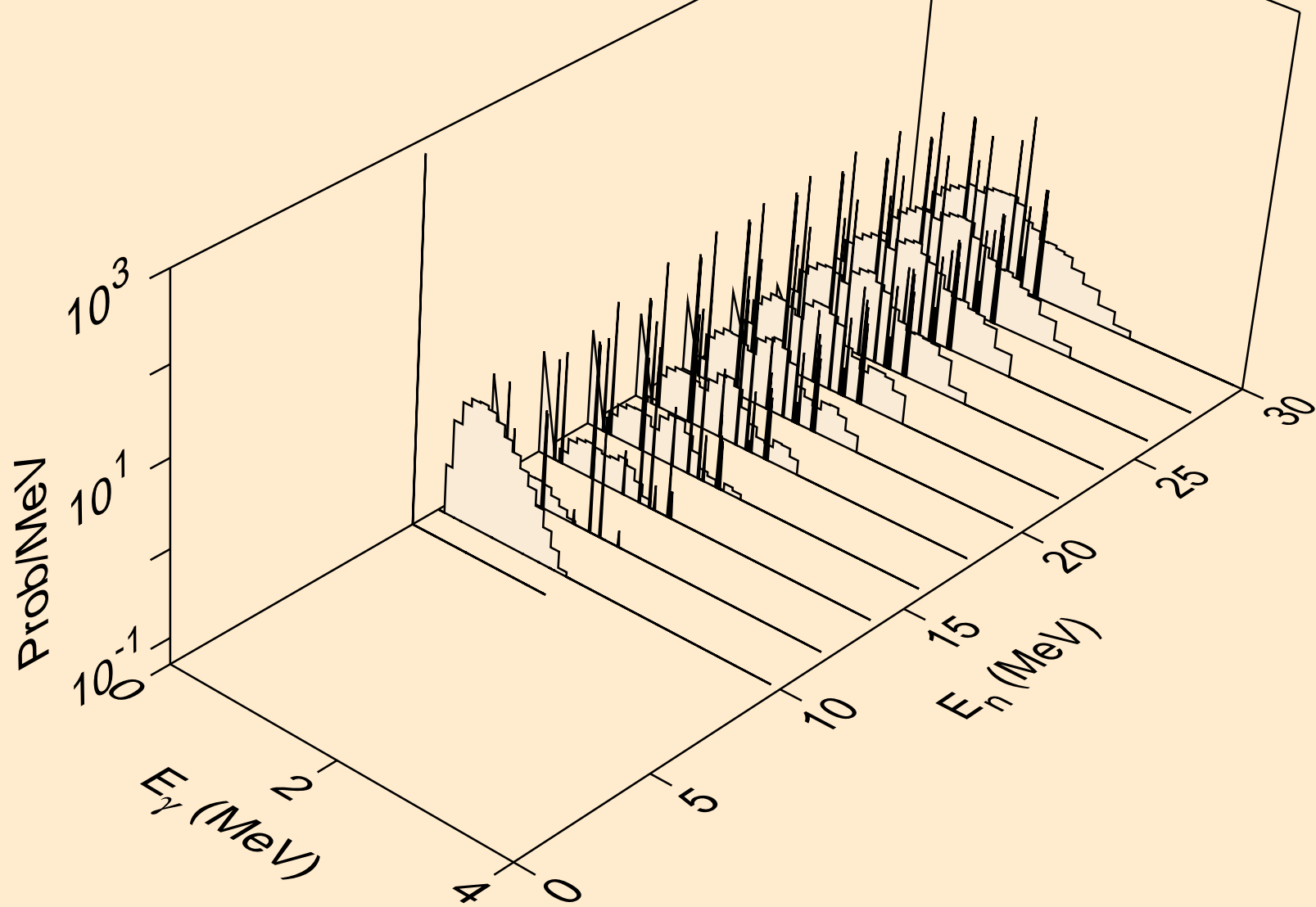

GD149 NEUTRON ACER TENDL-2024 LIBRARY; T=0.K
Photon emission for (n,2n)2a

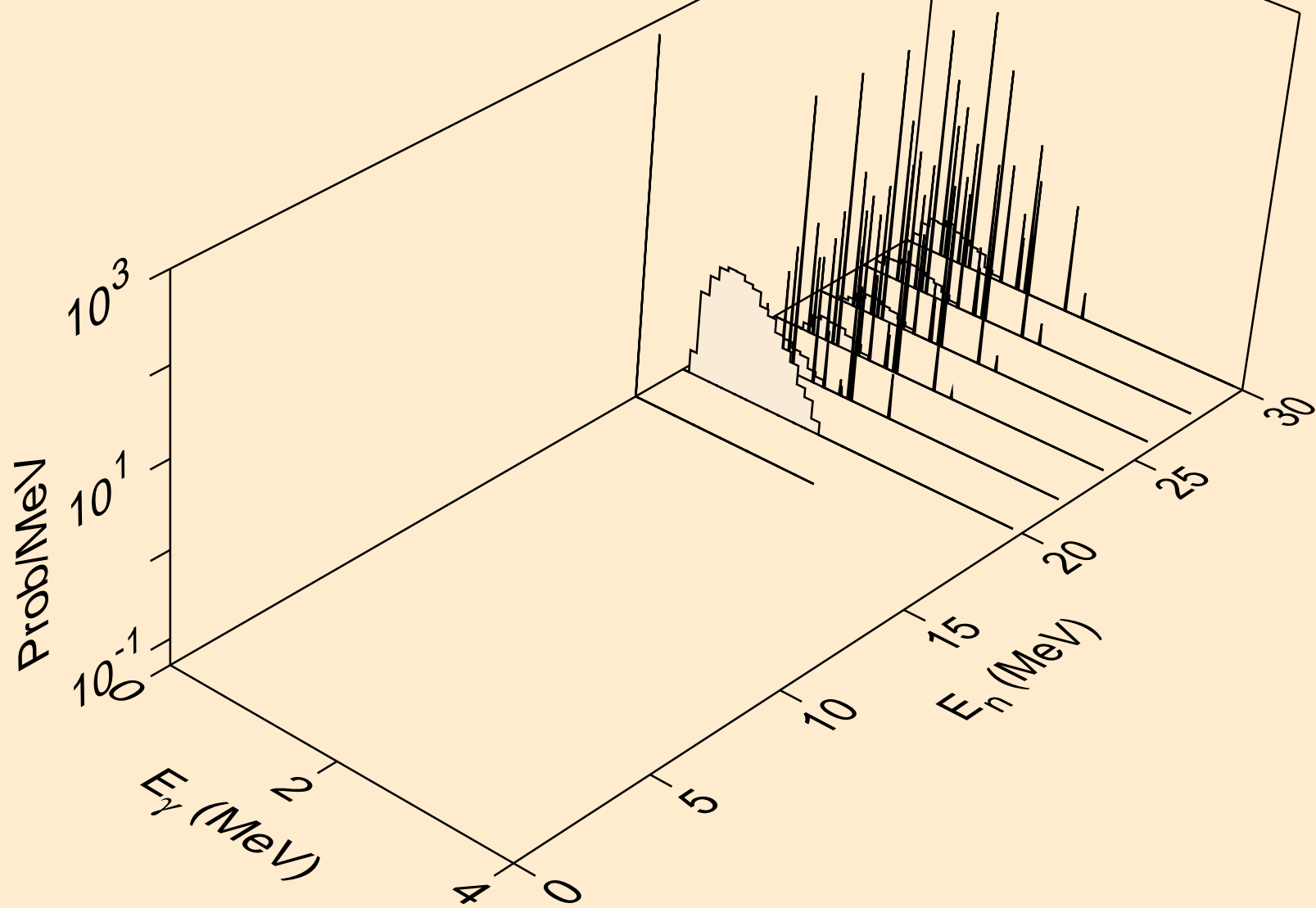

GD149 NEUTRON ACER TENDL-2024 LIBRARY; T=0.K
Photon emission for (n,n*)d

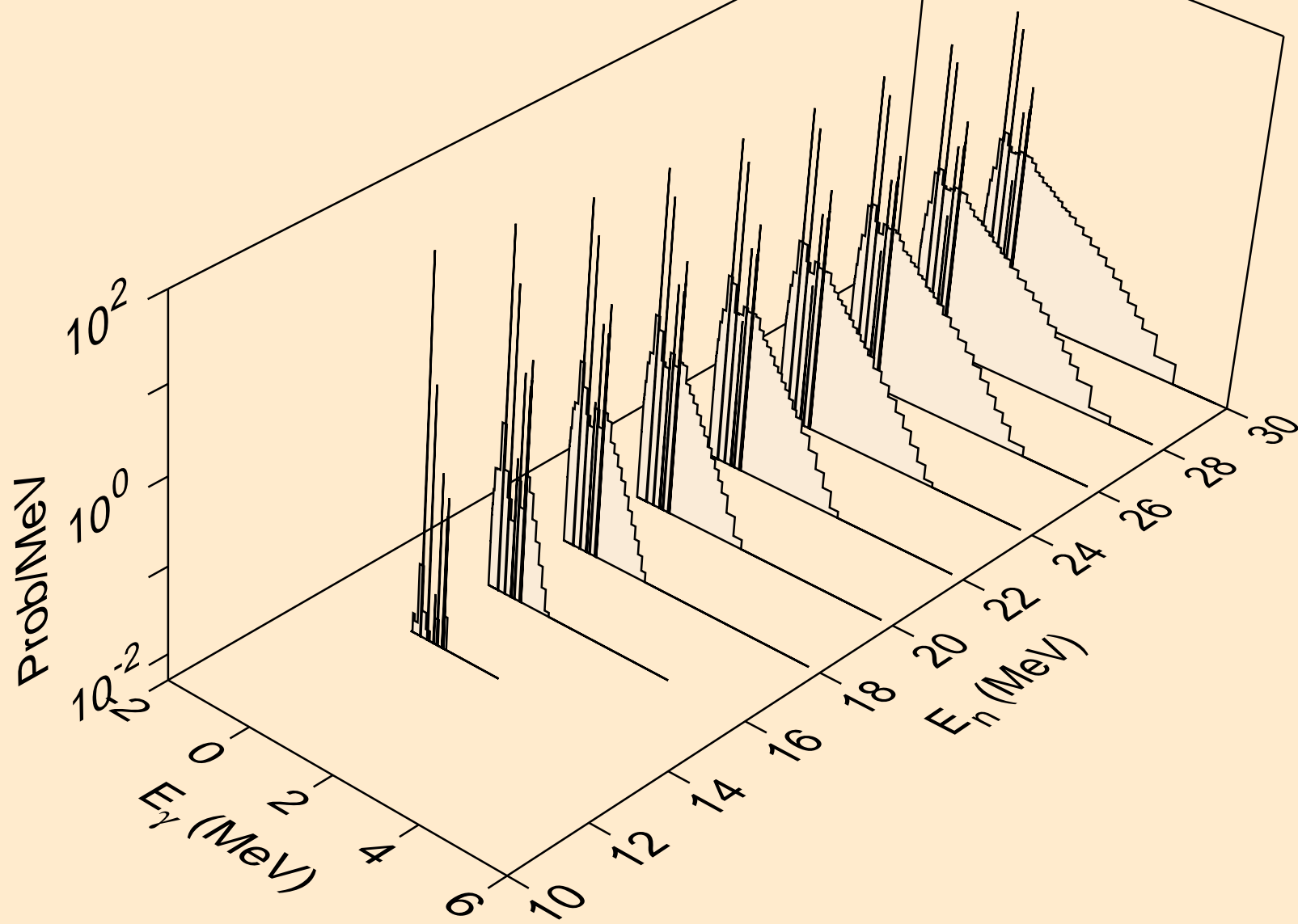

GD149 NEUTRON ACER TENDL-2024 LIBRARY; T=0.K
Photon emission for (n,n*)t

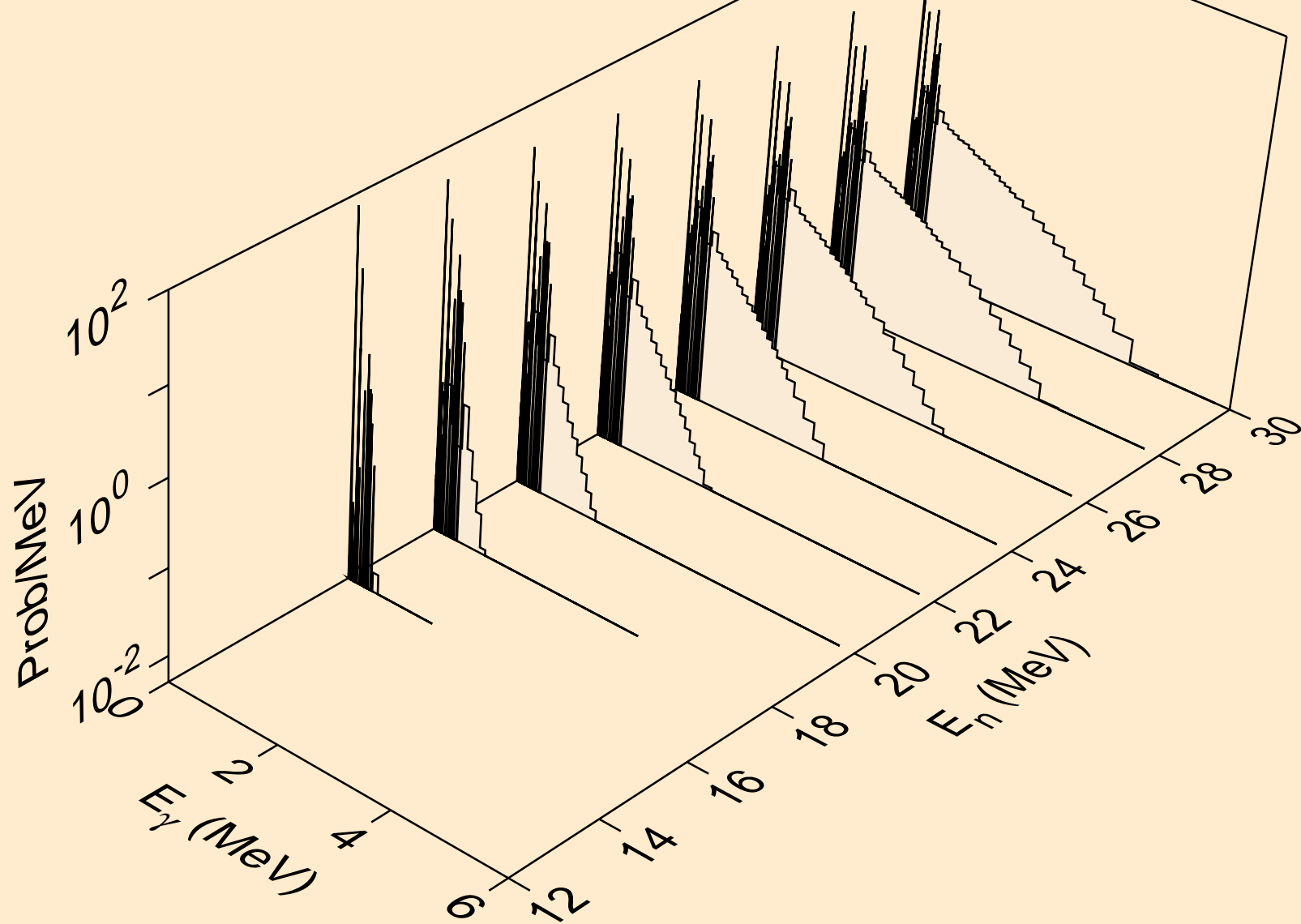

GD149 NEUTRON ACER TENDL-2024 LIBRARY; T=0.K
Photon emission for (n,n*)he3

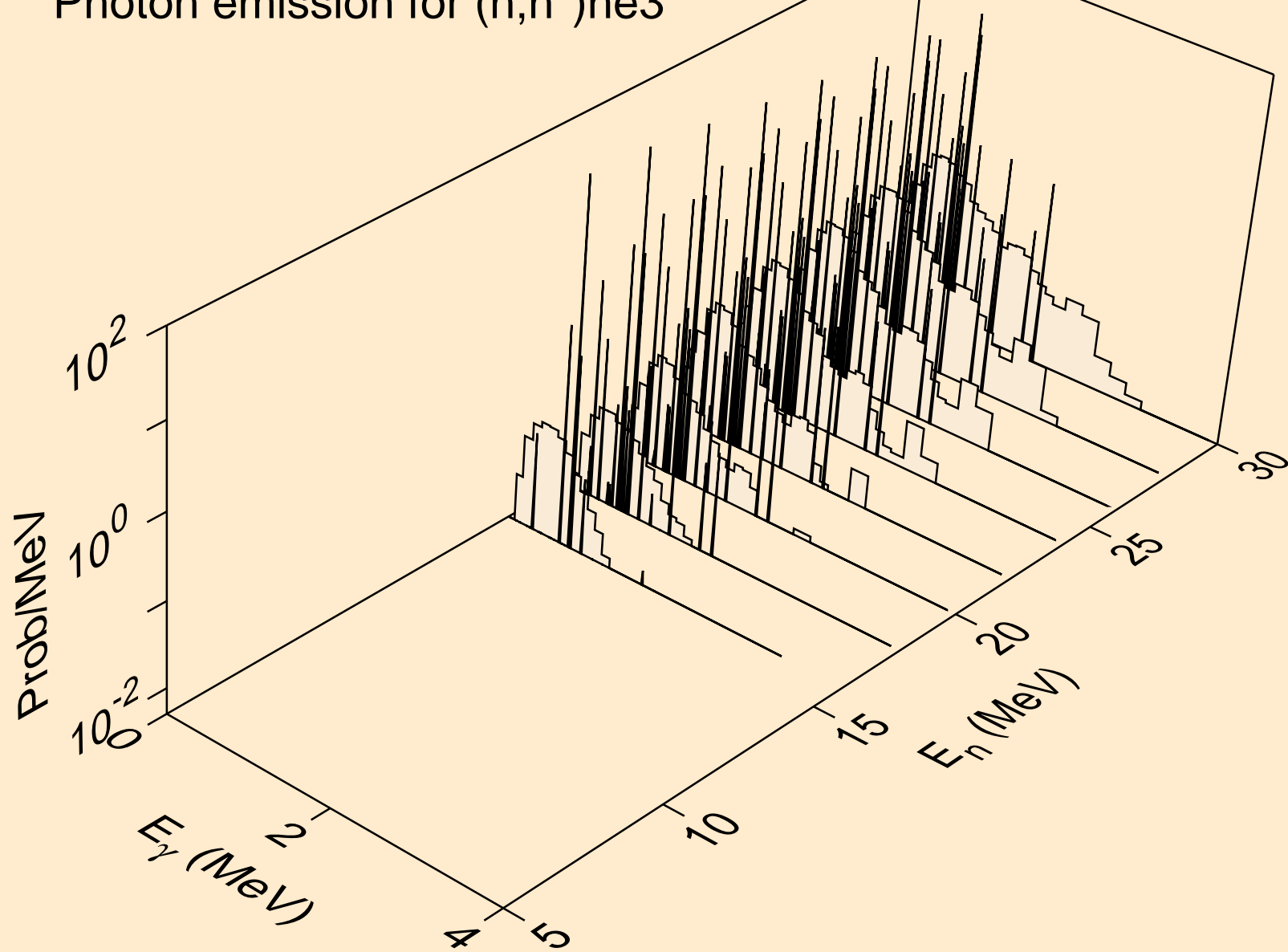

GD149 NEUTRON ACER TENDL-2024 LIBRARY; T=0.K
Photon emission for (n,4n)

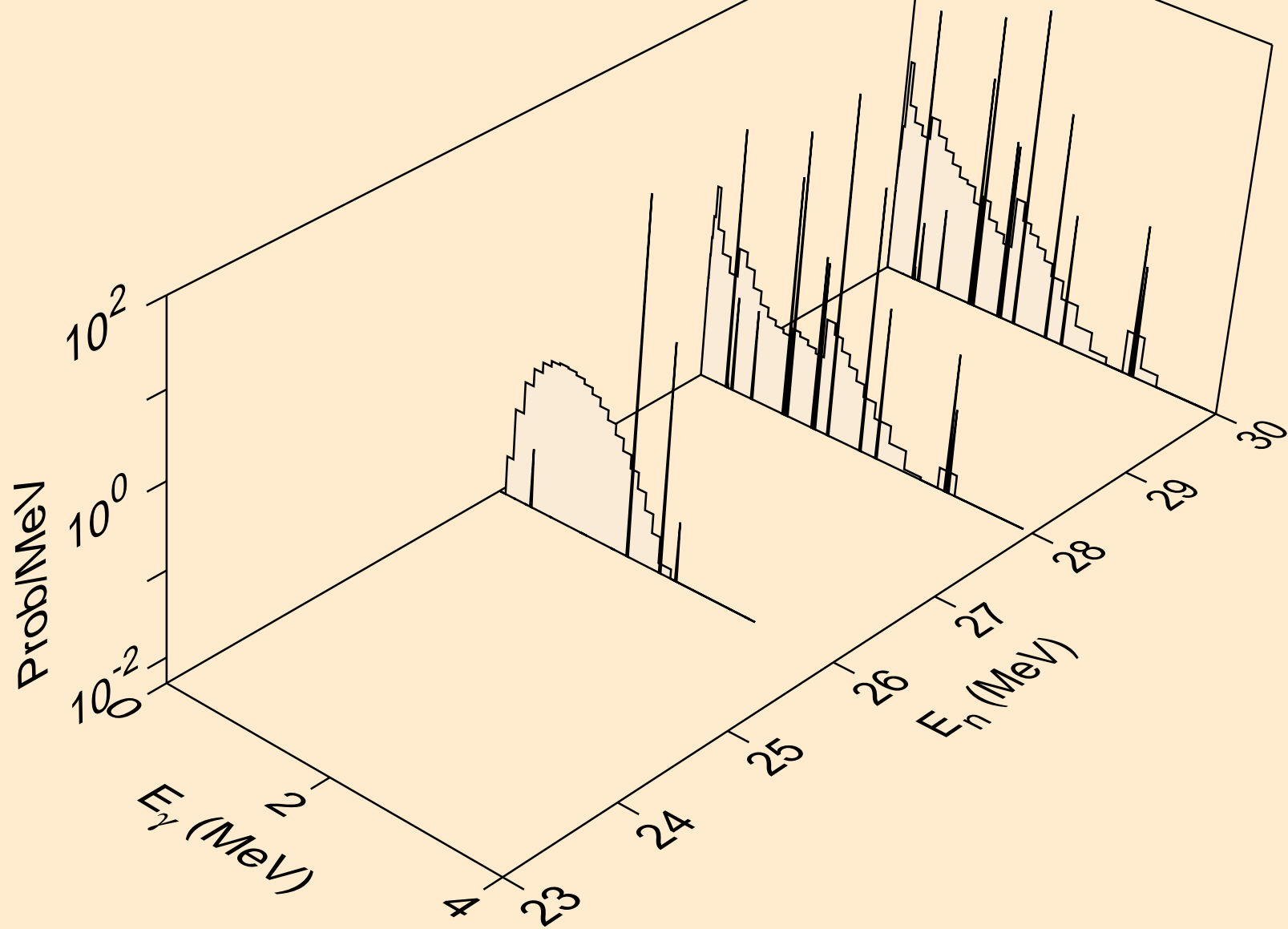

GD149 NEUTRON ACER TENDL-2024 LIBRARY; T=0.K
Photon emission for (n,2np)

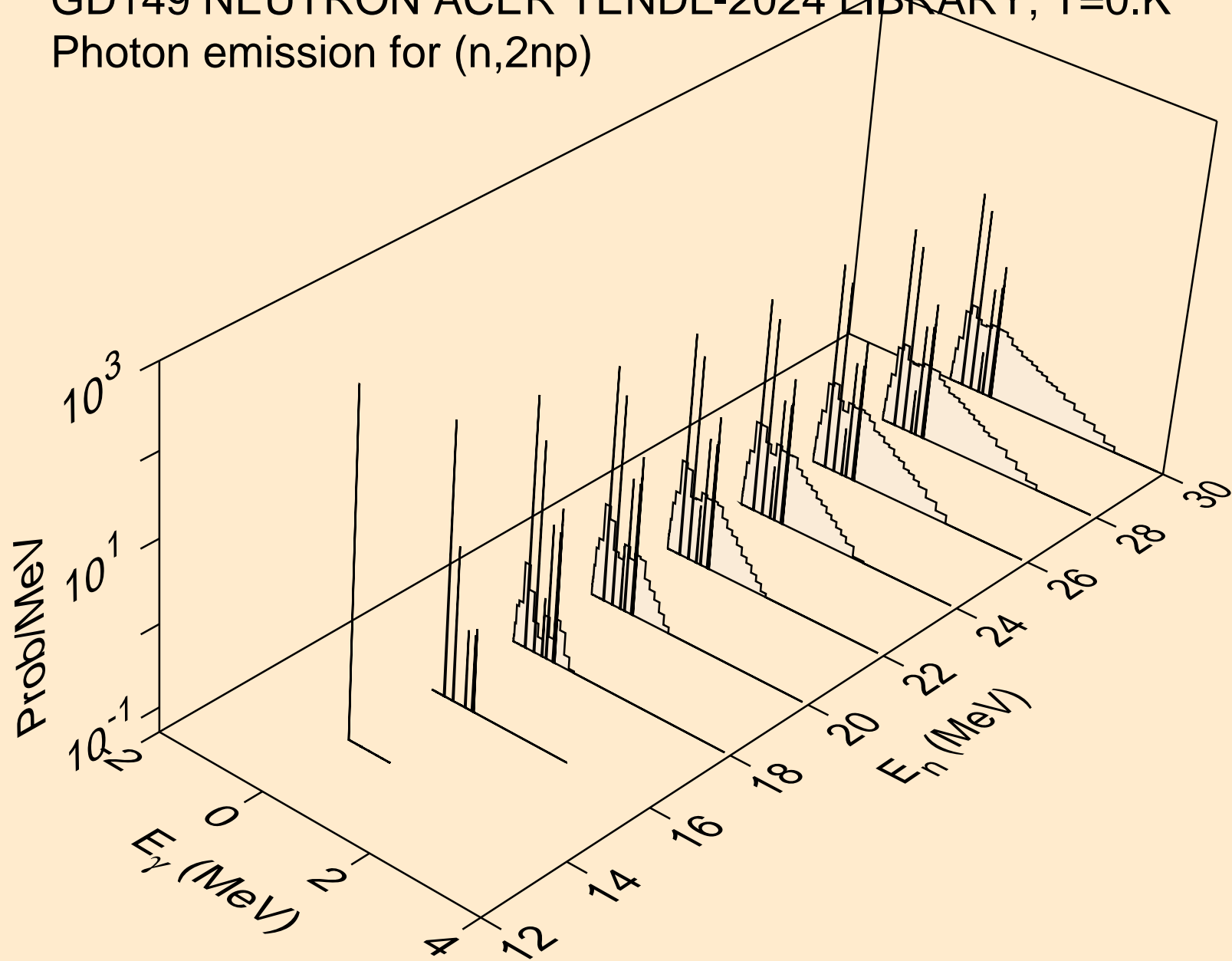

GD149 NEUTRON ACER TENDL-2024 LIBRARY; T=0.K
Photon emission for (n,3np)

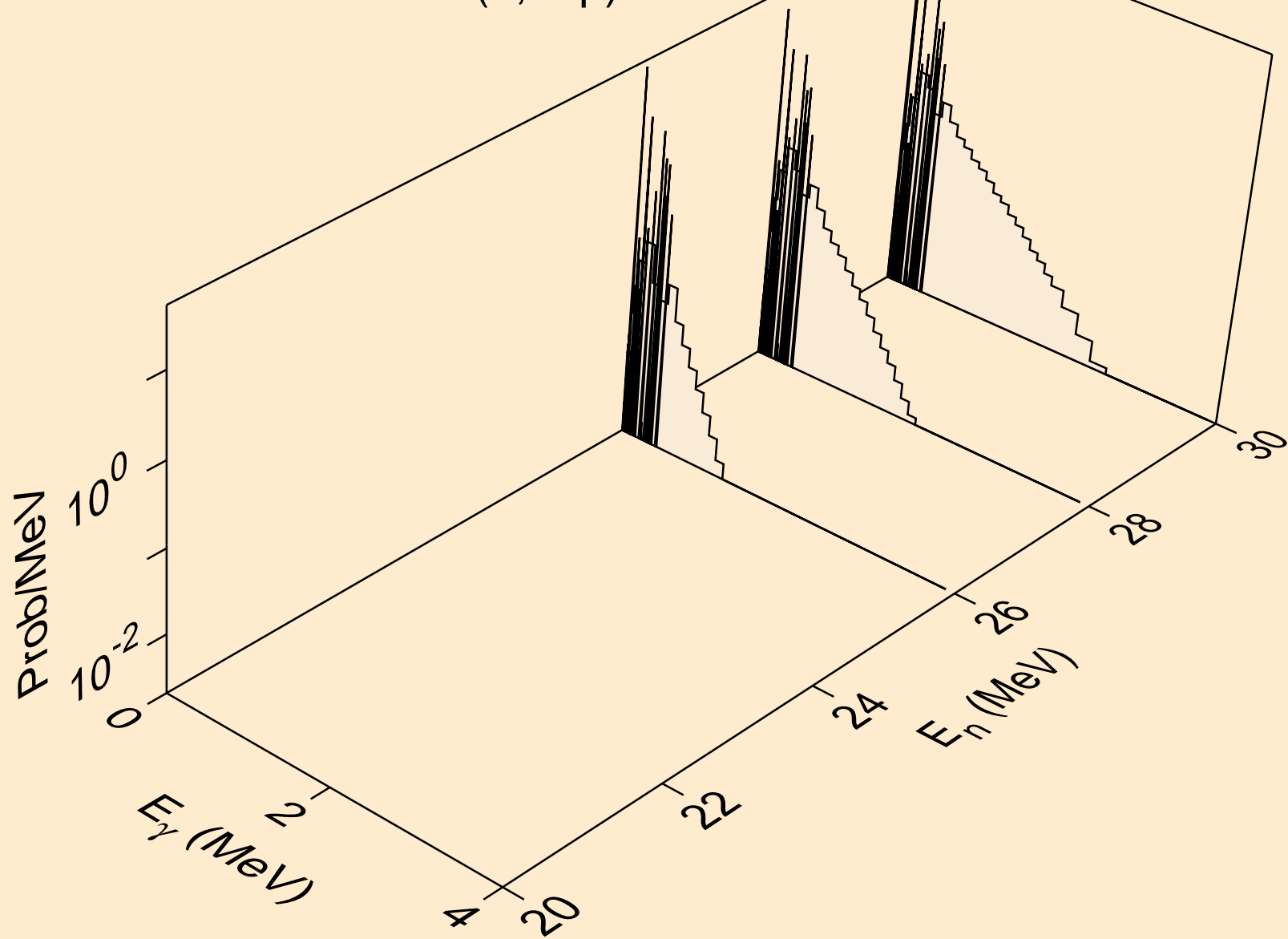

GD149 NEUTRON ACER TENDL-2024 LIBRARY; T=0.K
Photon emission for (n,n2p)

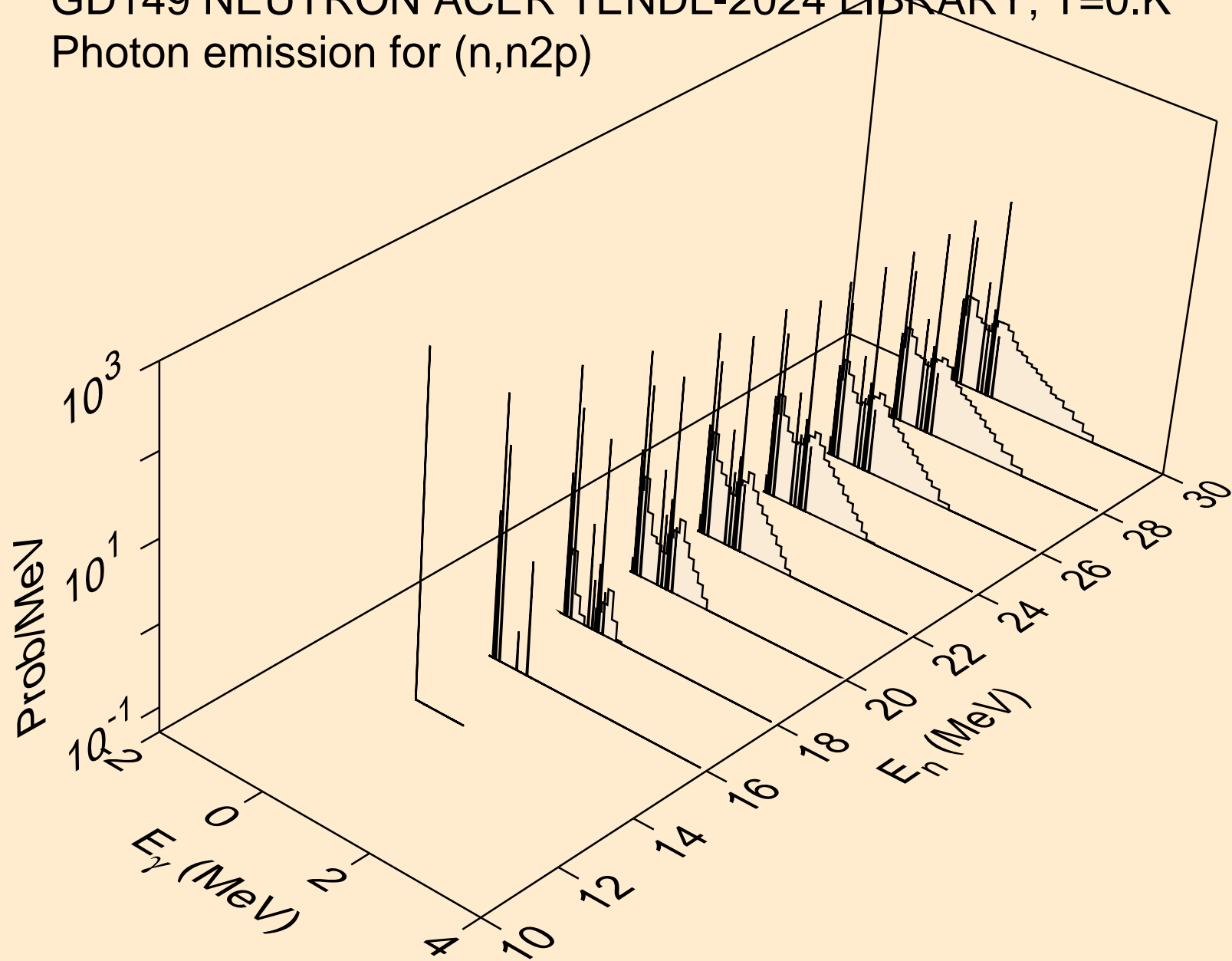

GD149 NEUTRON ACER TENDL-2024 LIBRARY; T=0.K
Photon emission for (n,npa)

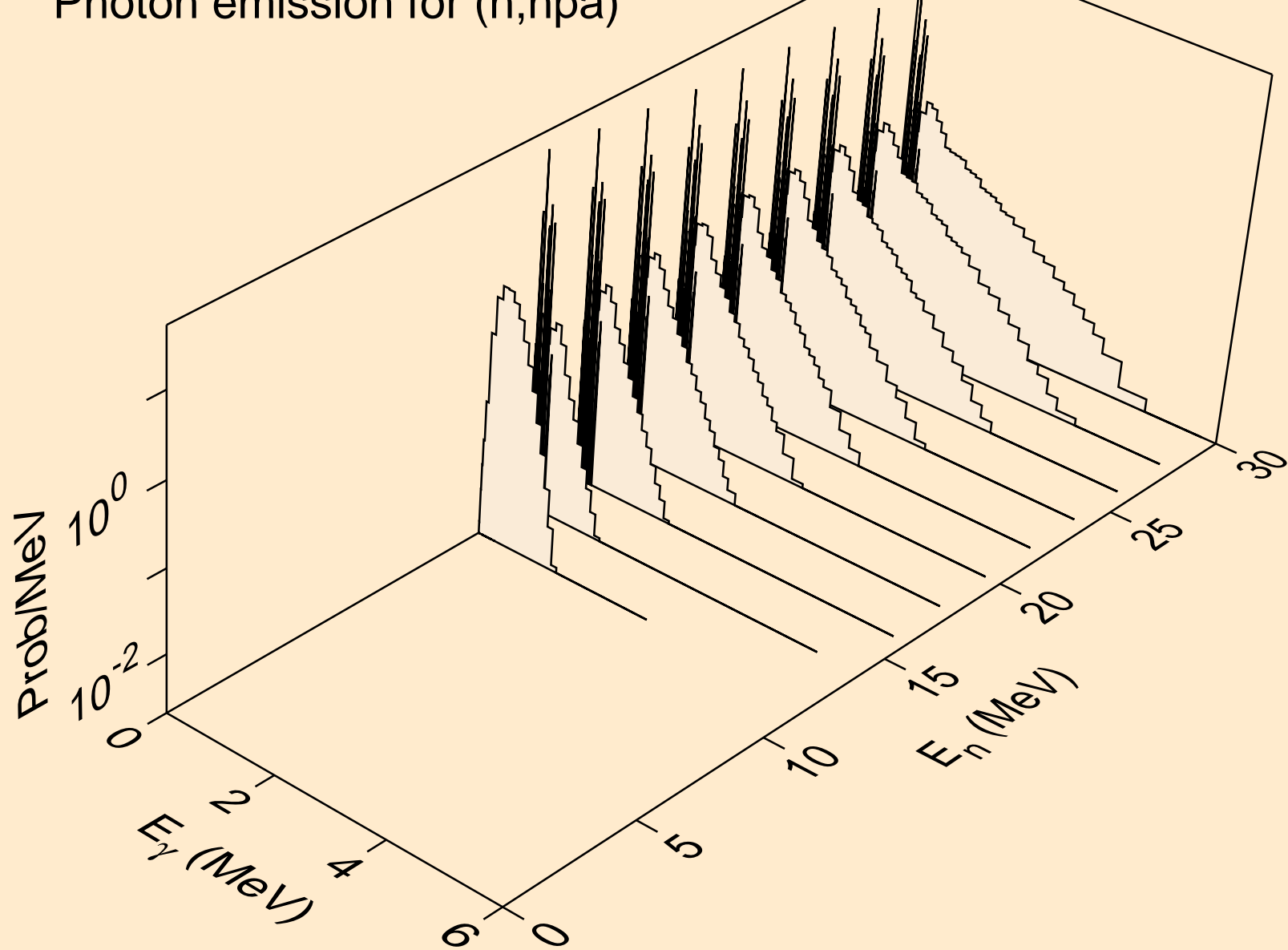

GD149 NEUTRON ACER TENDL-2024 LIBRARY; T=0.K
Photon emission for (n,n*c)

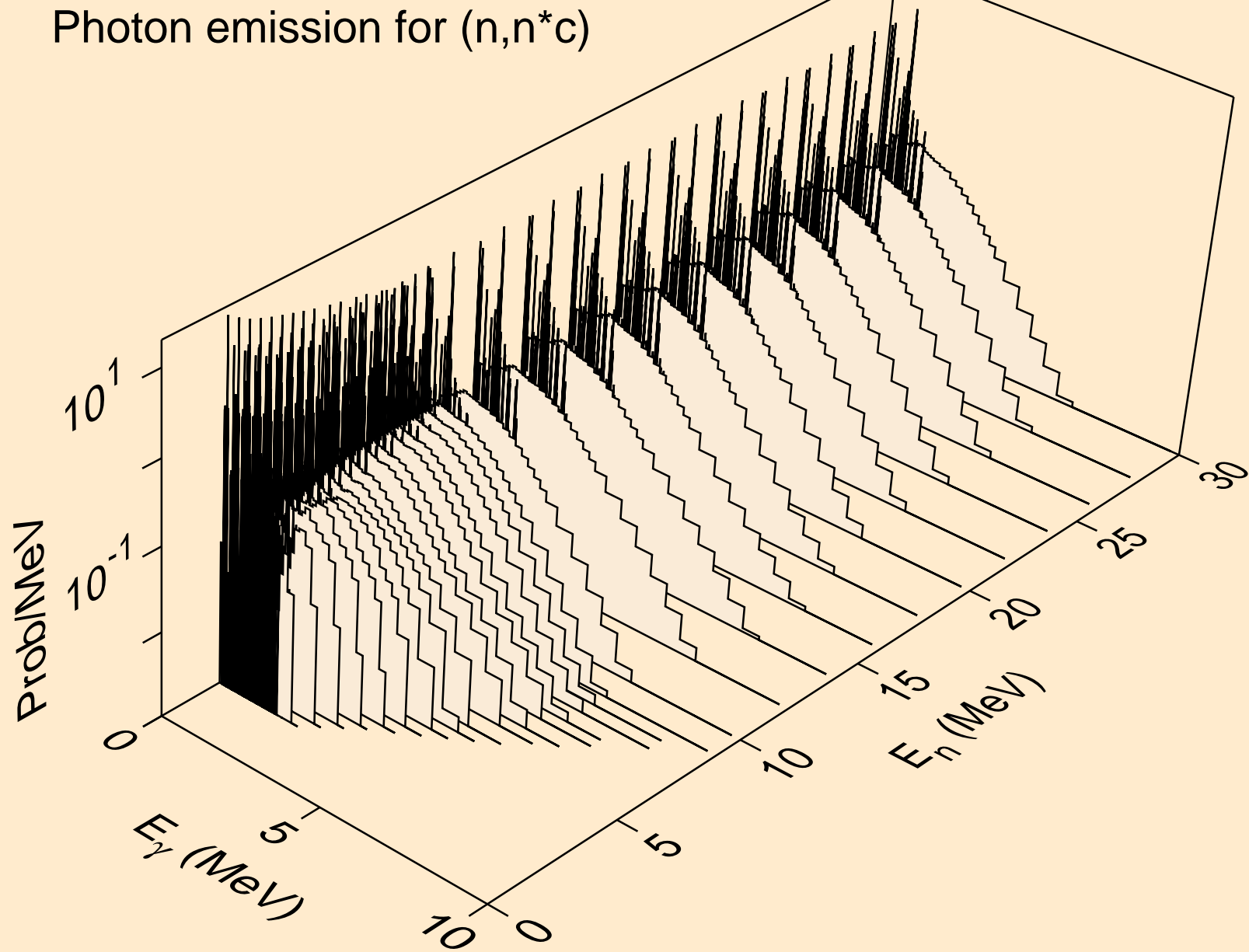

GD149 NEUTRON ACER TENDL-2024 LIBRARY; T=0.K
Photon emission for (n,gma)

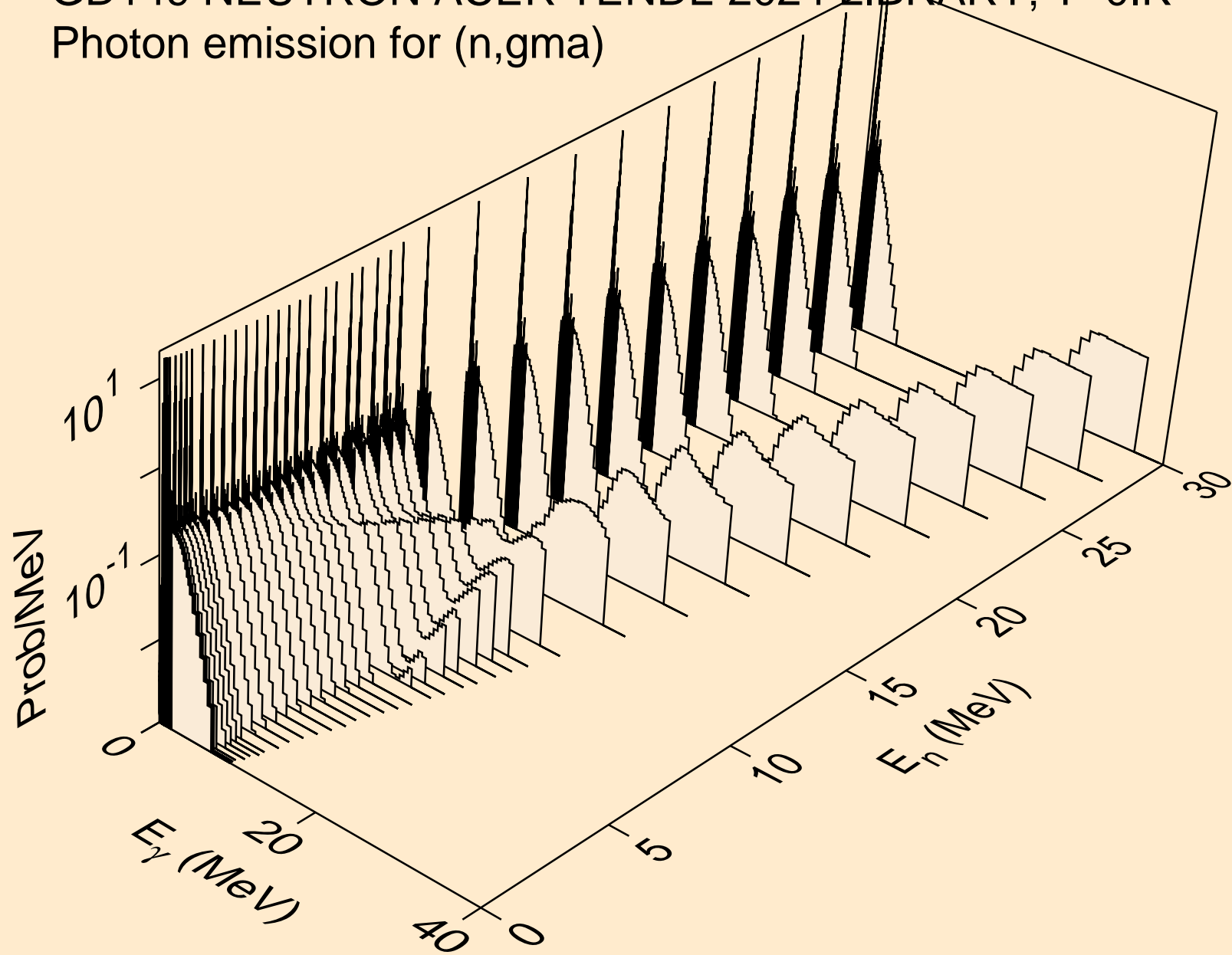

GD149 NEUTRON ACER TENDL-2024 LIBRARY; T=0.K
Photon emission for (n,p)

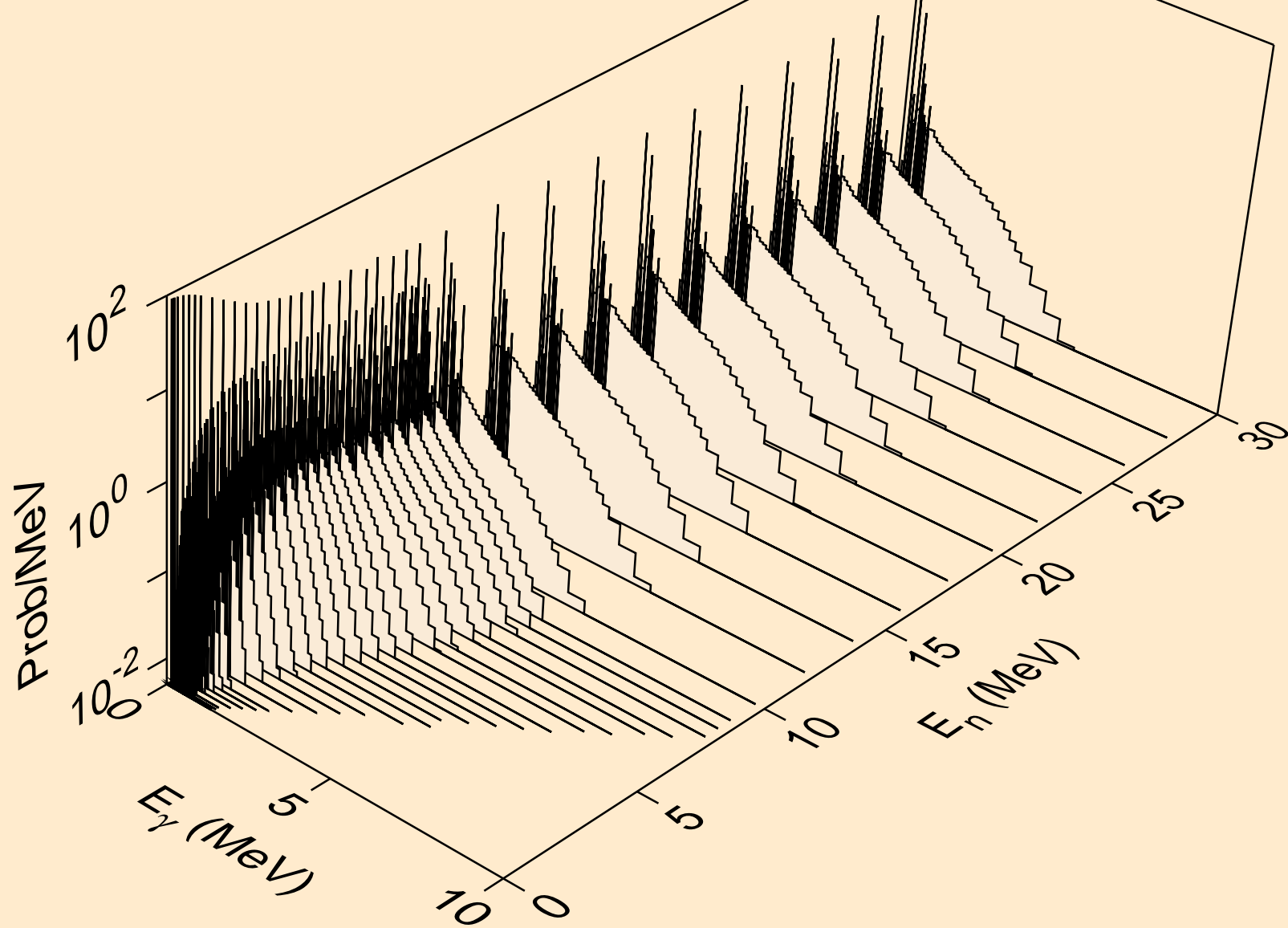

GD149 NEUTRON ACER TENDL-2024 LIBRARY; T=0.K
Photon emission for (n,d)

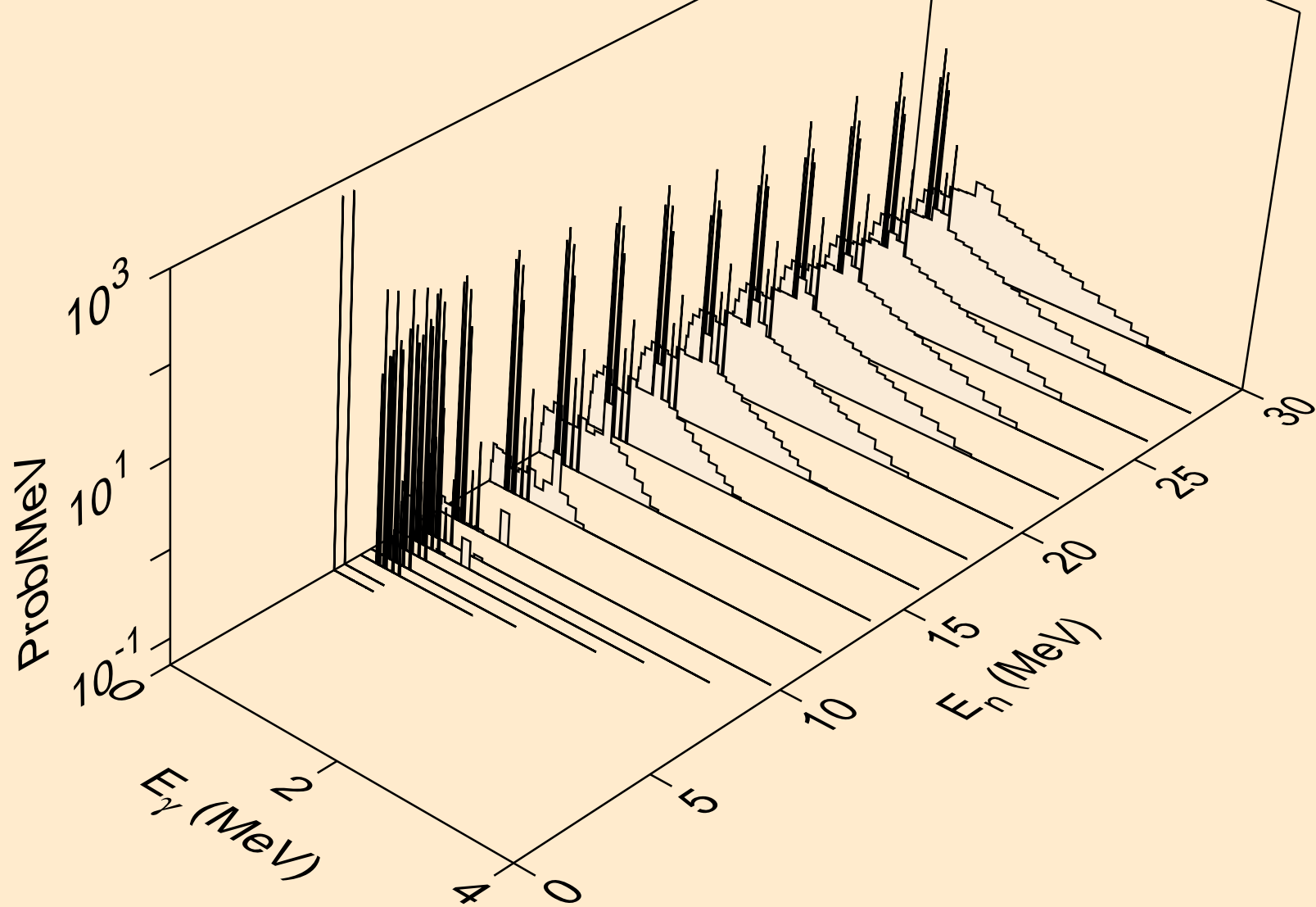

GD149 NEUTRON ACER TENDL-2024 LIBRARY; T=0.K
Photon emission for (n,t)

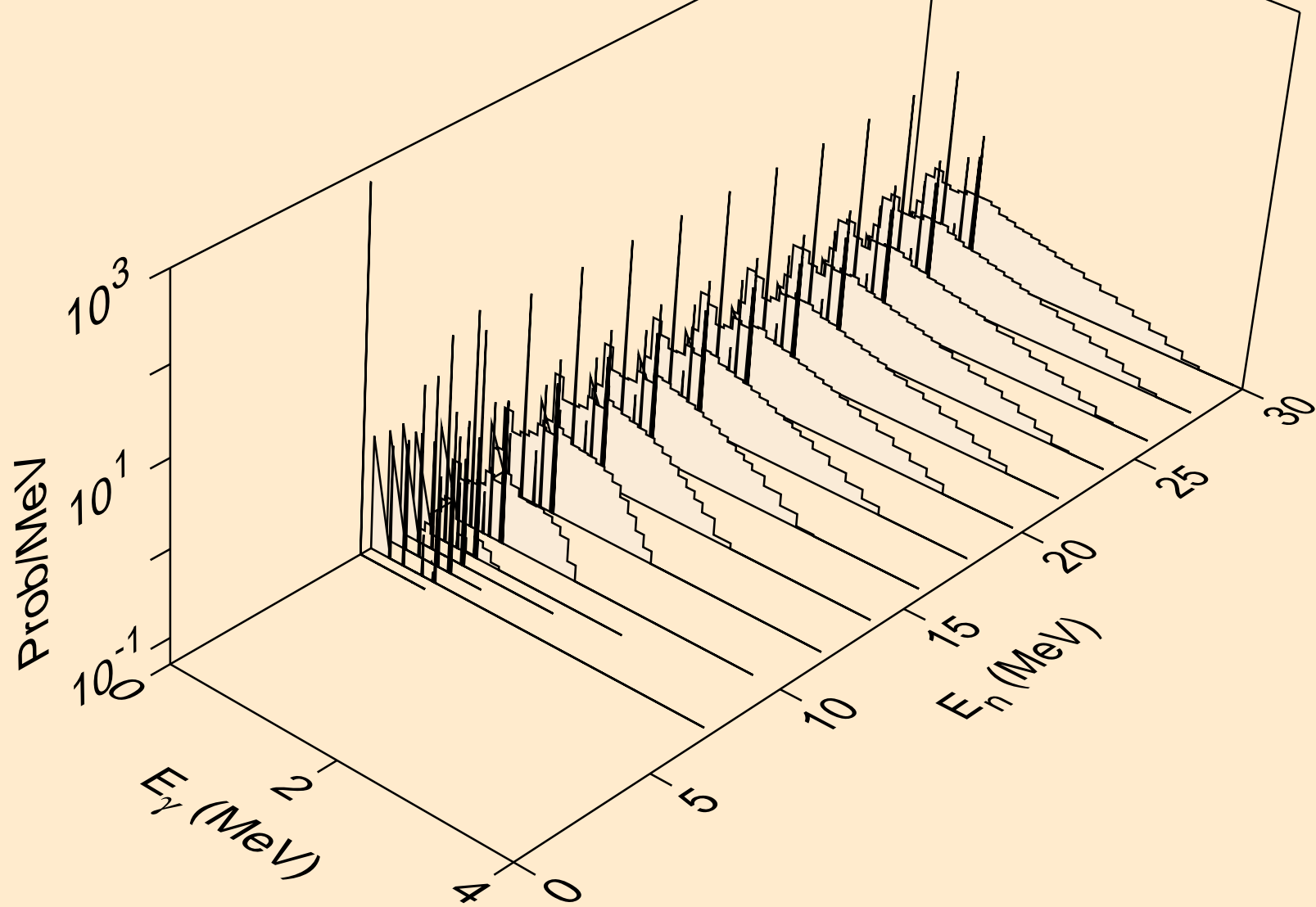

GD149 NEUTRON ACER TENDL-2024 LIBRARY; T=0.K
Photon emission for (n,he3)

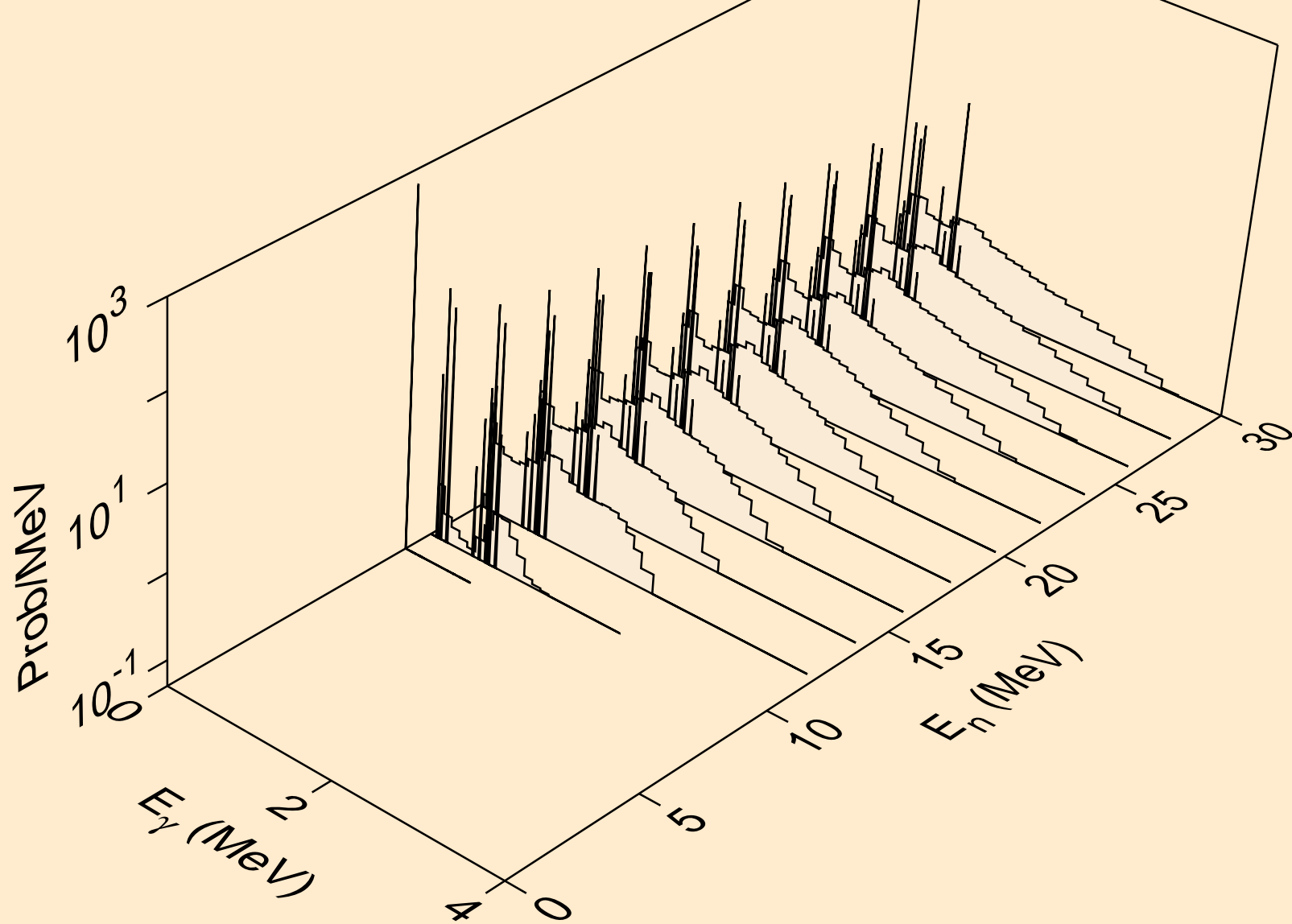

GD149 NEUTRON ACER TENDL-2024 LIBRARY; T=0.K
Photon emission for (n,a)

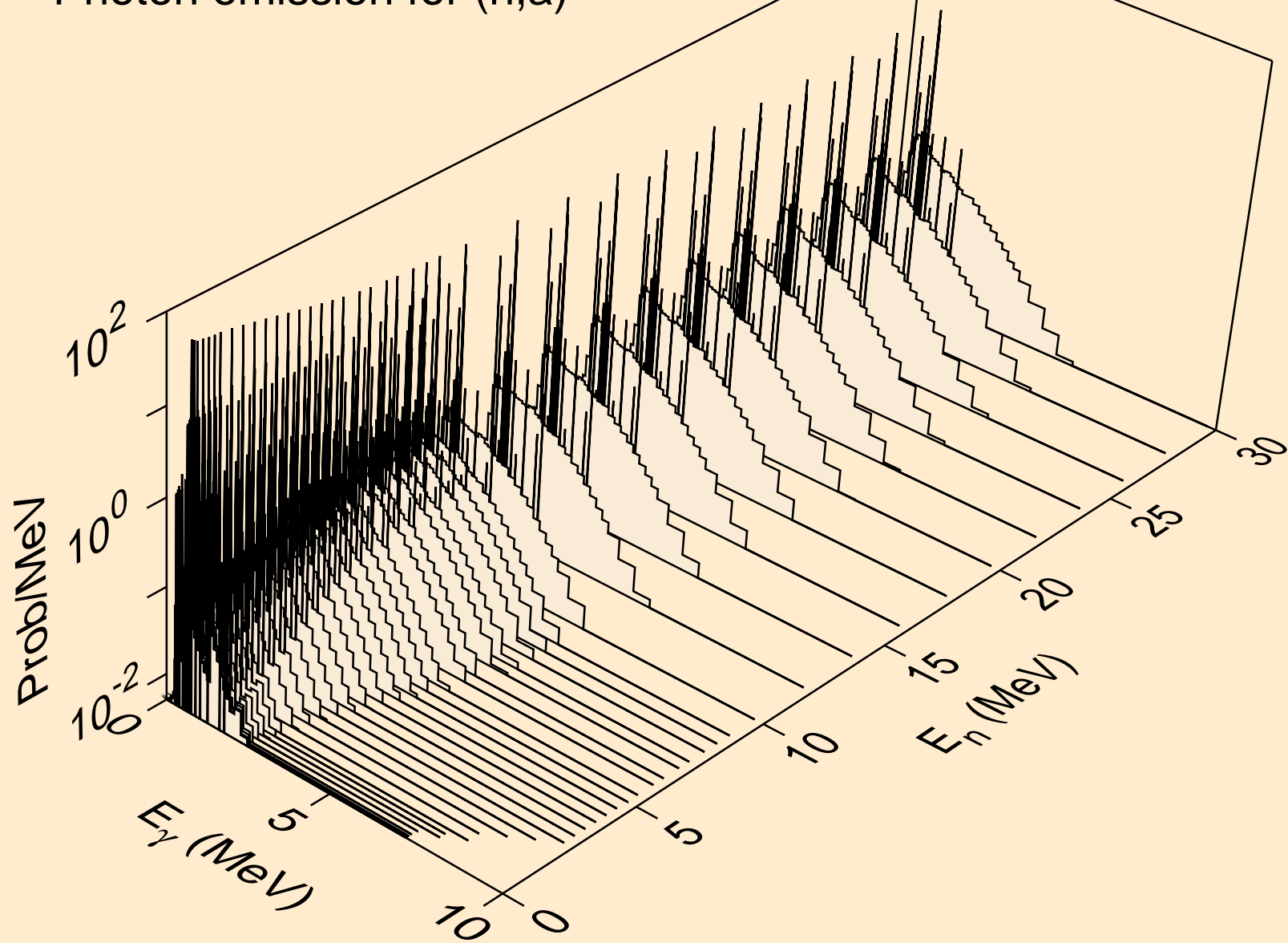

GD149 NEUTRON ACER TENDL-2024 LIBRARY; T=0.K
Photon emission for (n,2a)

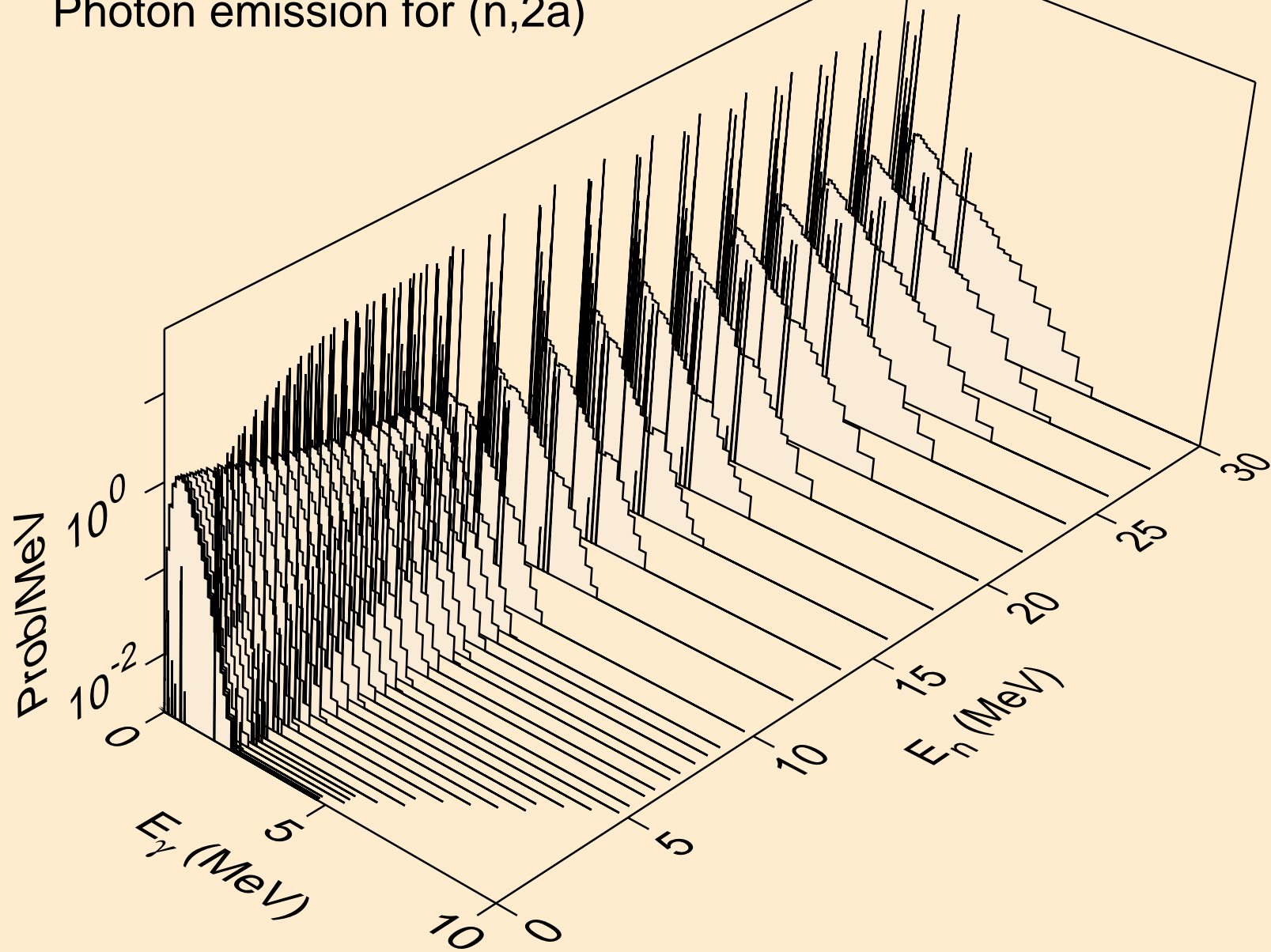

GD149 NEUTRON ACER TENDL-2024 LIBRARY; T=0.K
Photon emission for (n,2p)

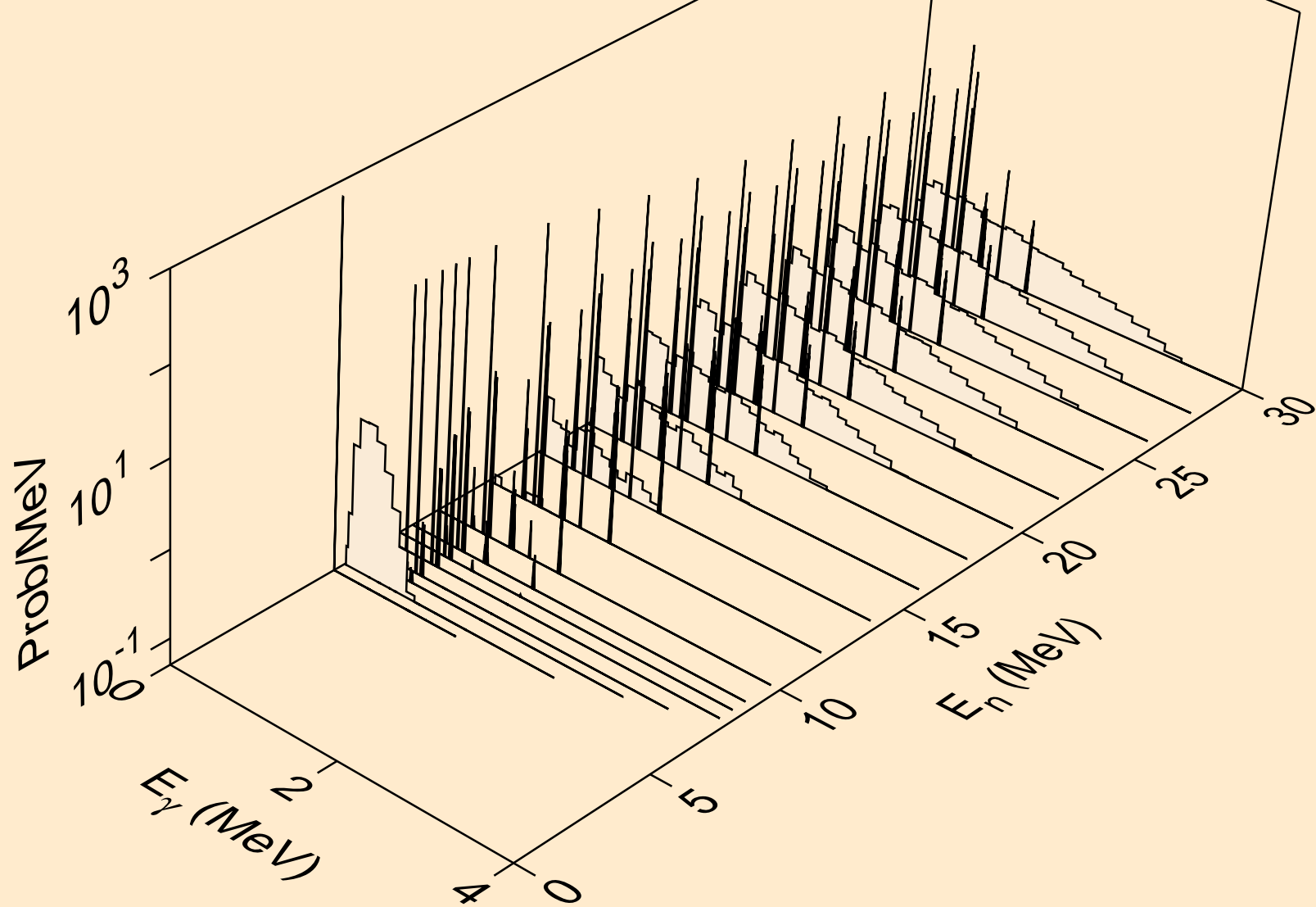

GD149 NEUTRON ACER TENDL-2024 LIBRARY; T=0.K
Photon emission for (n,p)

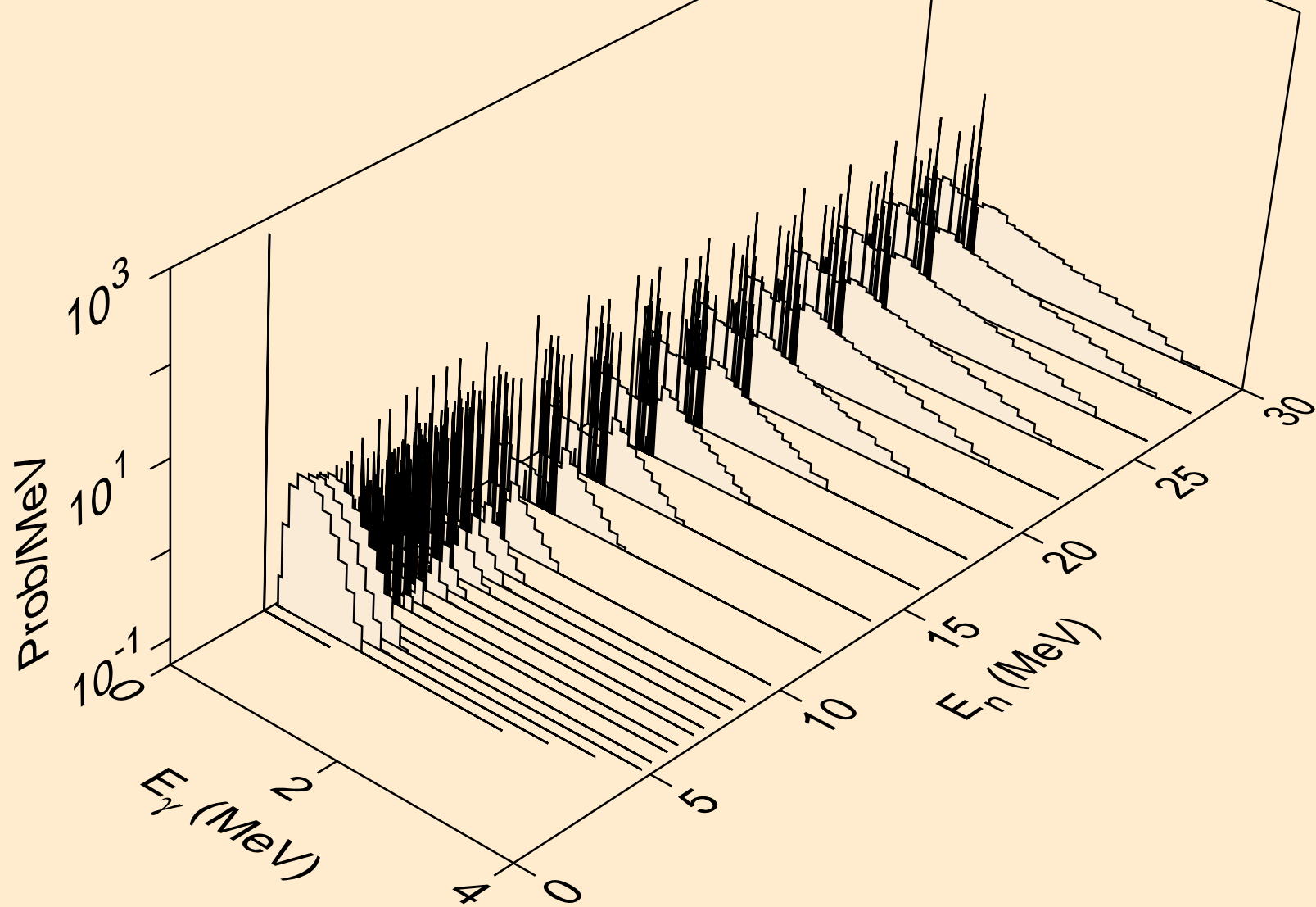

GD149 NEUTRON ACER TENDL-2024 LIBRARY; T=0.K
Photon emission for (n,pd)

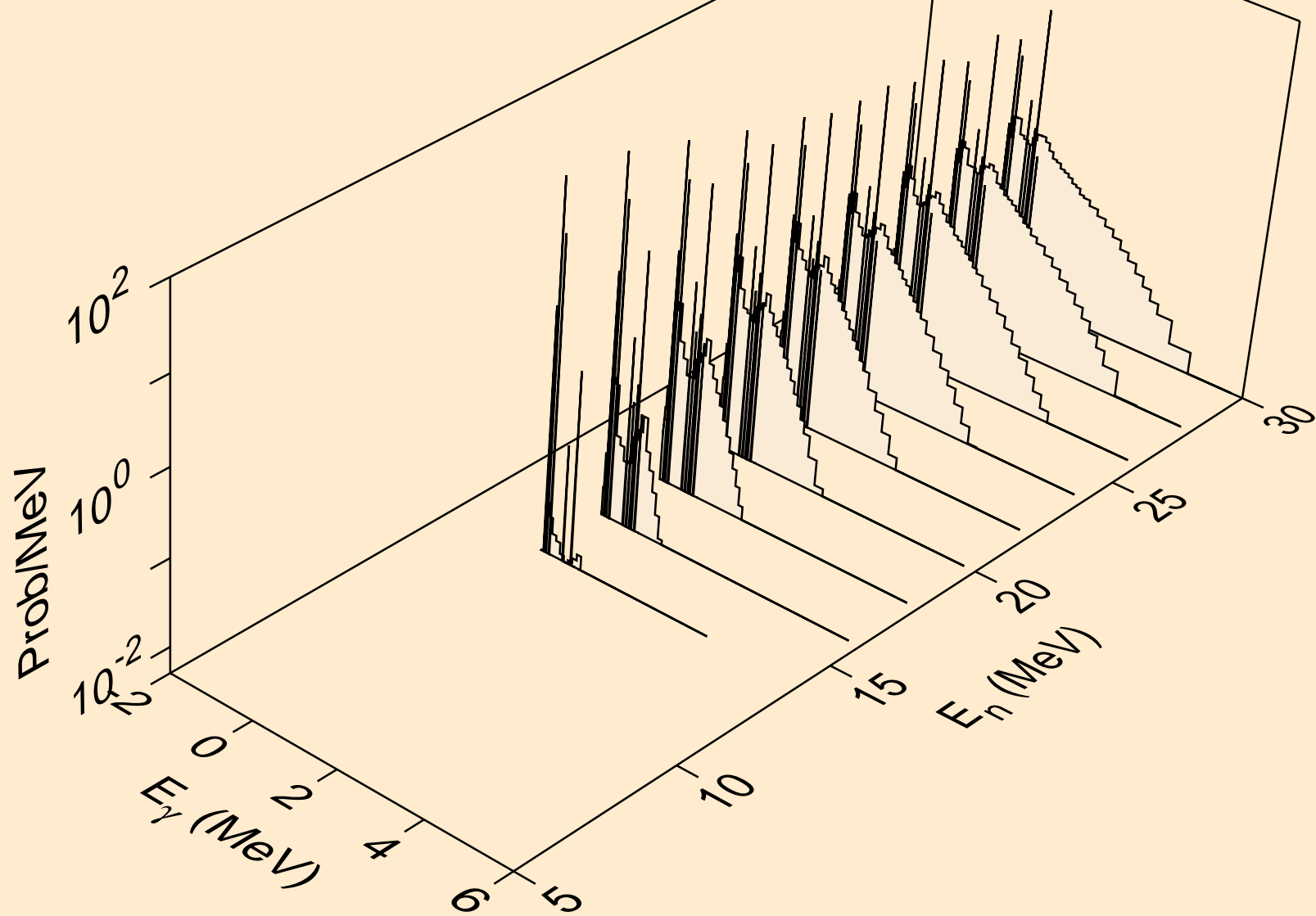

GD149 NEUTRON ACER TENDL-2024 LIBRARY; T=0.K
Photon emission for (n,pt)

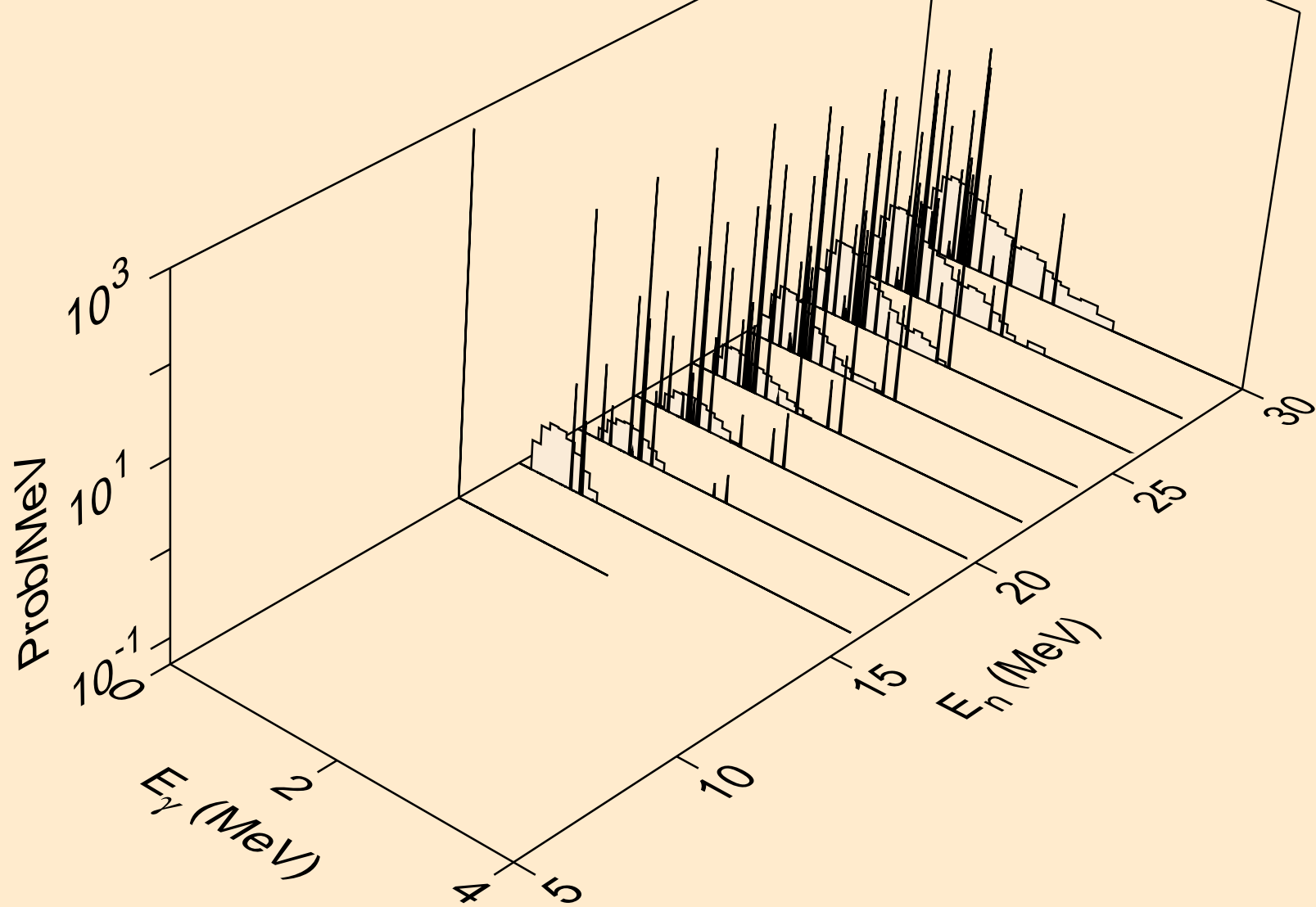

GD149 NEUTRON ACER TENDL-2024 LIBRARY; T=0.K
Photon emission for (n,da)

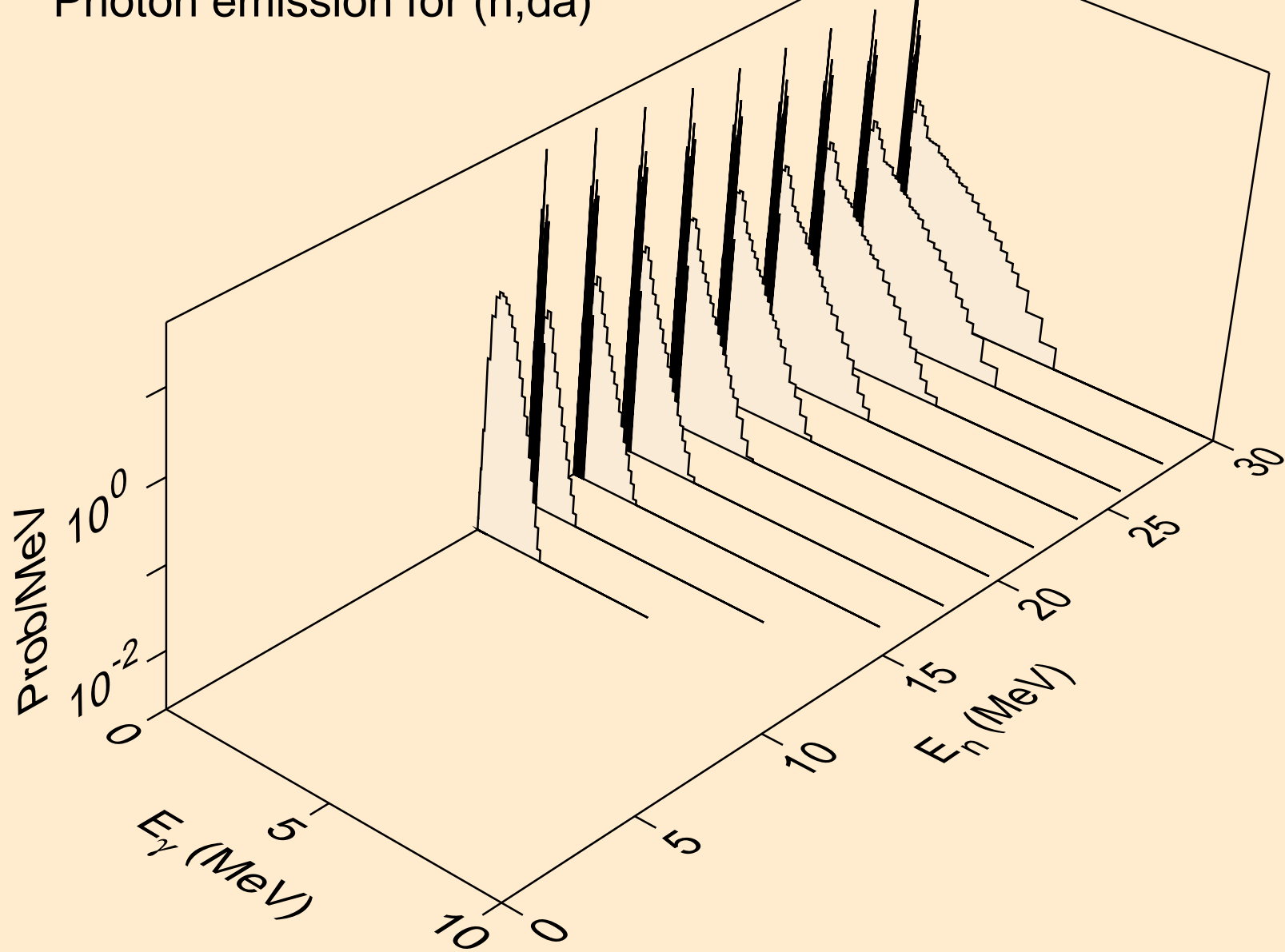

GD149 NEUTRON ACER TENDL-2024 LIBRARY; T=0.K
thermal capture photon spectrum

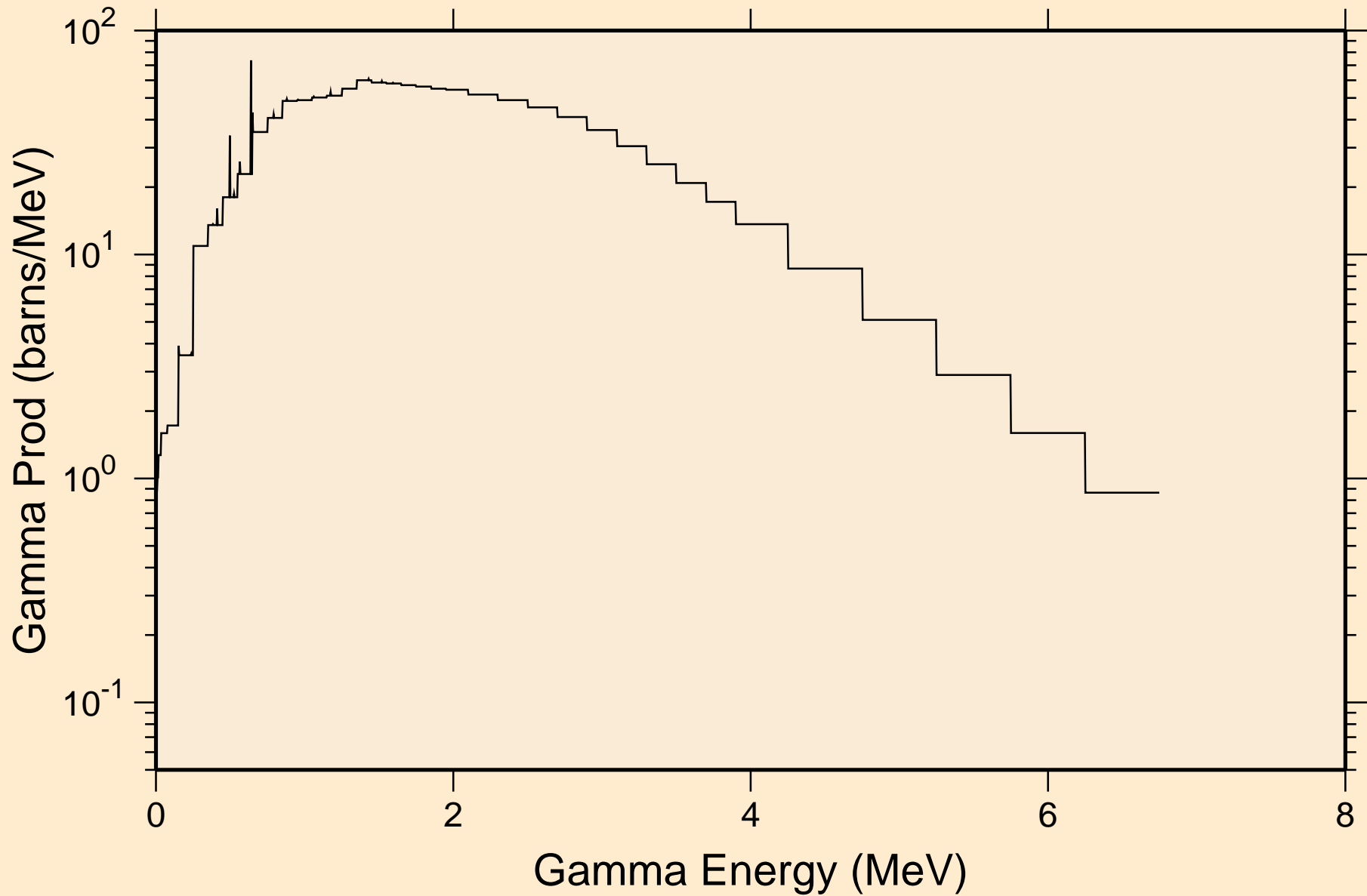

GD149 NEUTRON ACER TENDL-2024 LIBRARY; T=0.K
14 MeV photon spectrum

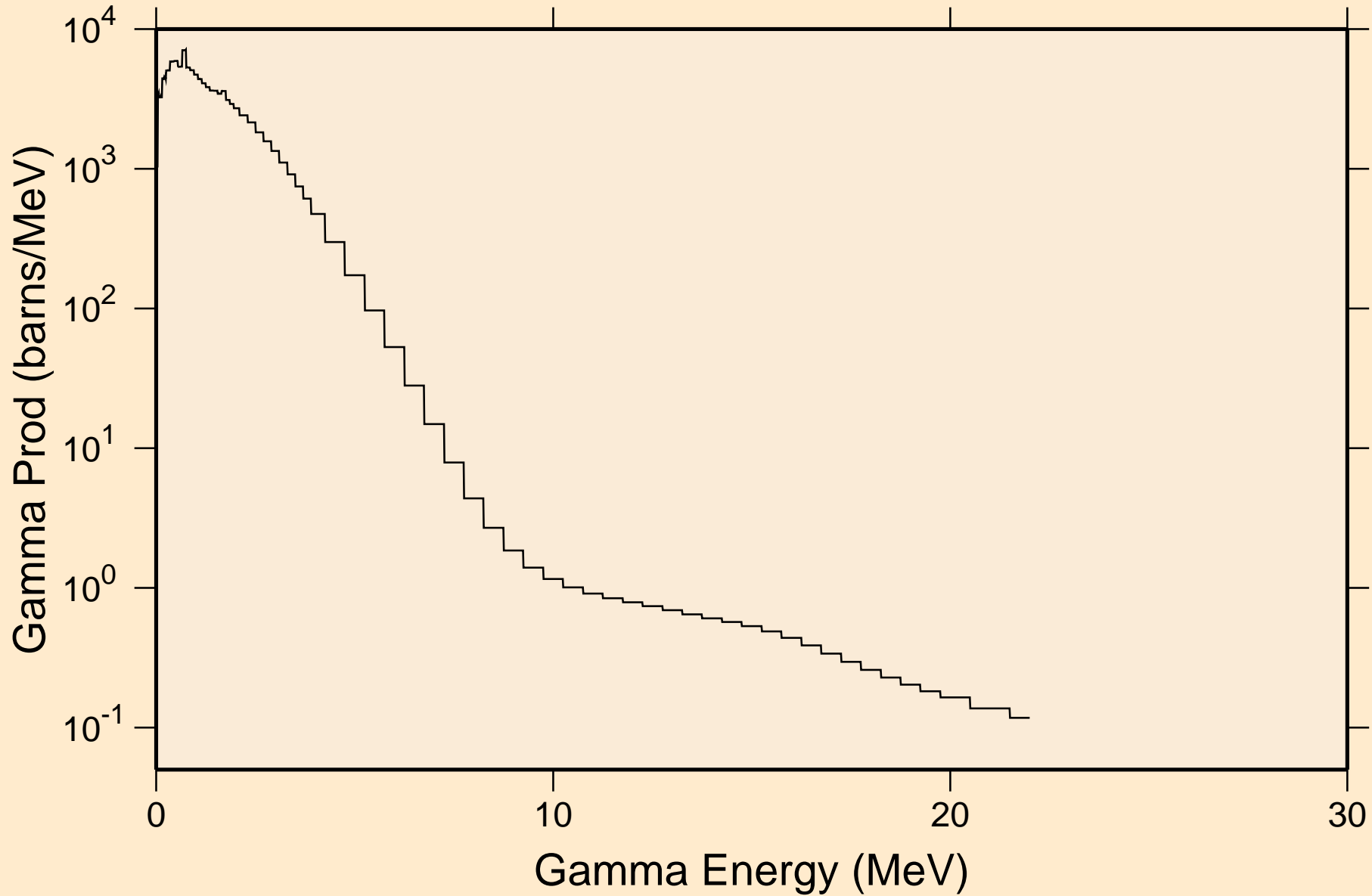

GD149 NEUTRON ACER TENDL-2024 LIBRARY; T=0.K

Particle heating contributions

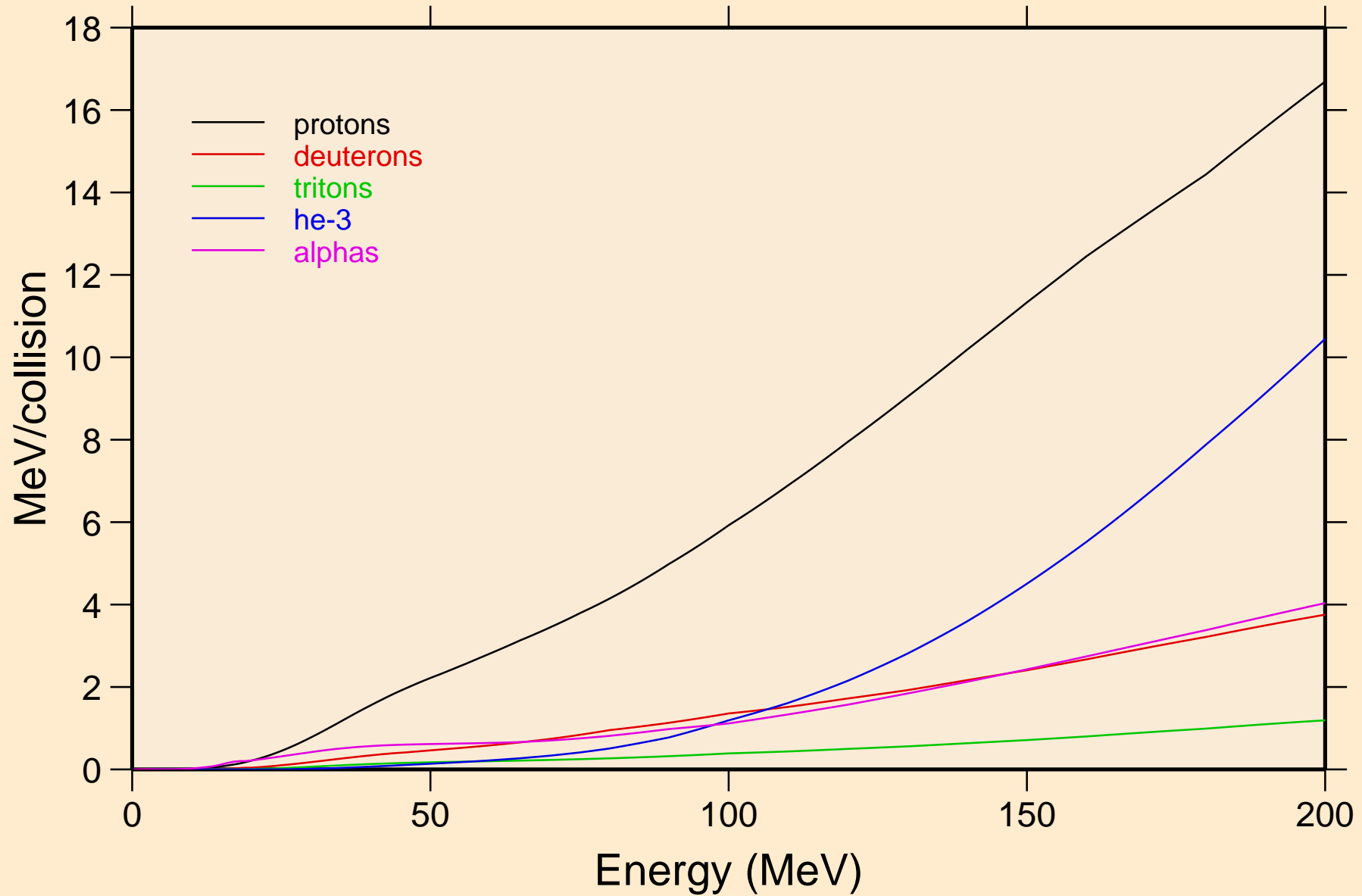

GD149 NEUTRON ACER TENDL-2024 LIBRARY; T=0.K

Recoil Heating

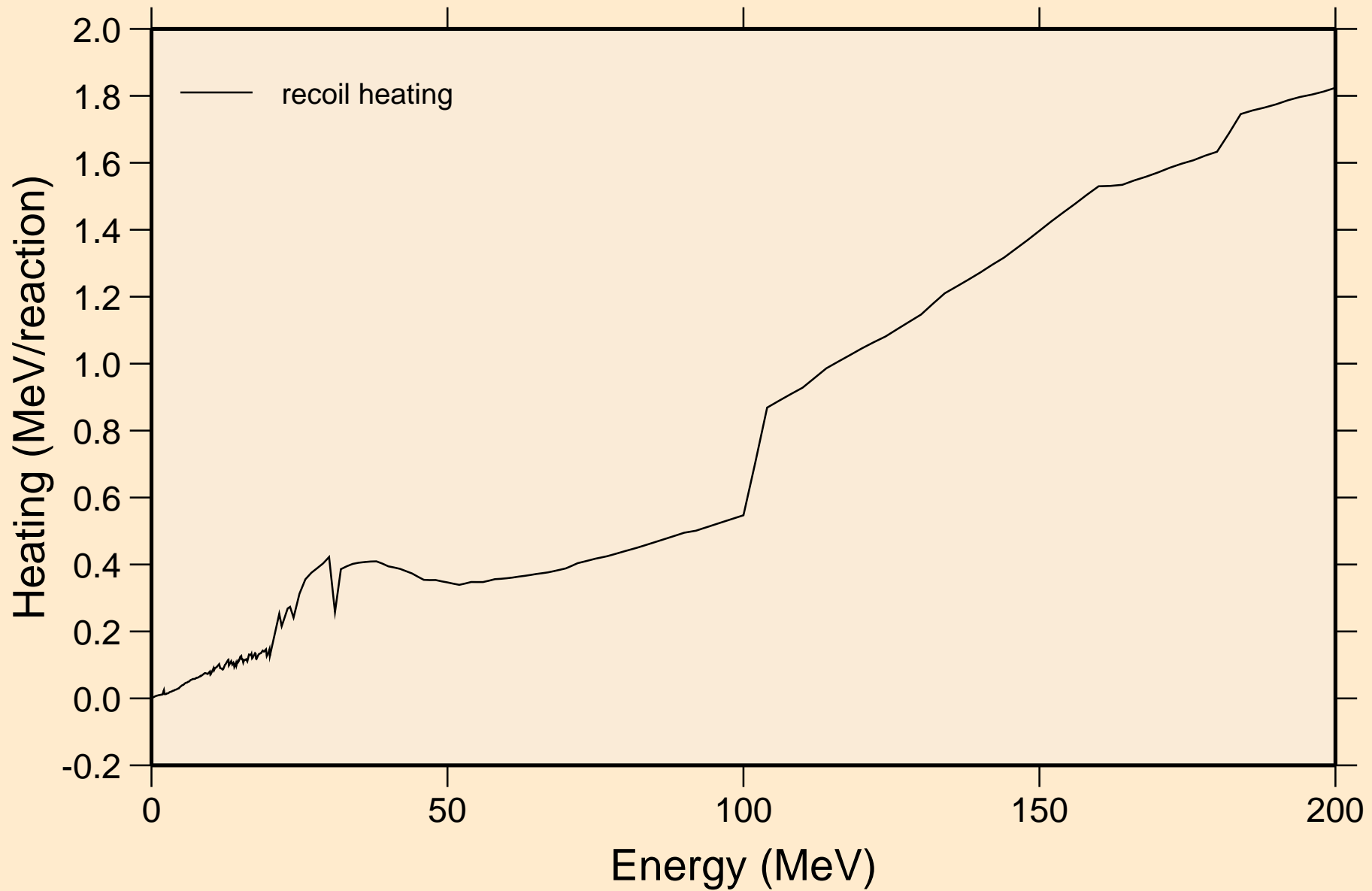

GD149 NEUTRON ACER TENDL-2024 LIBRARY; T=0.K
Particle production cross sections

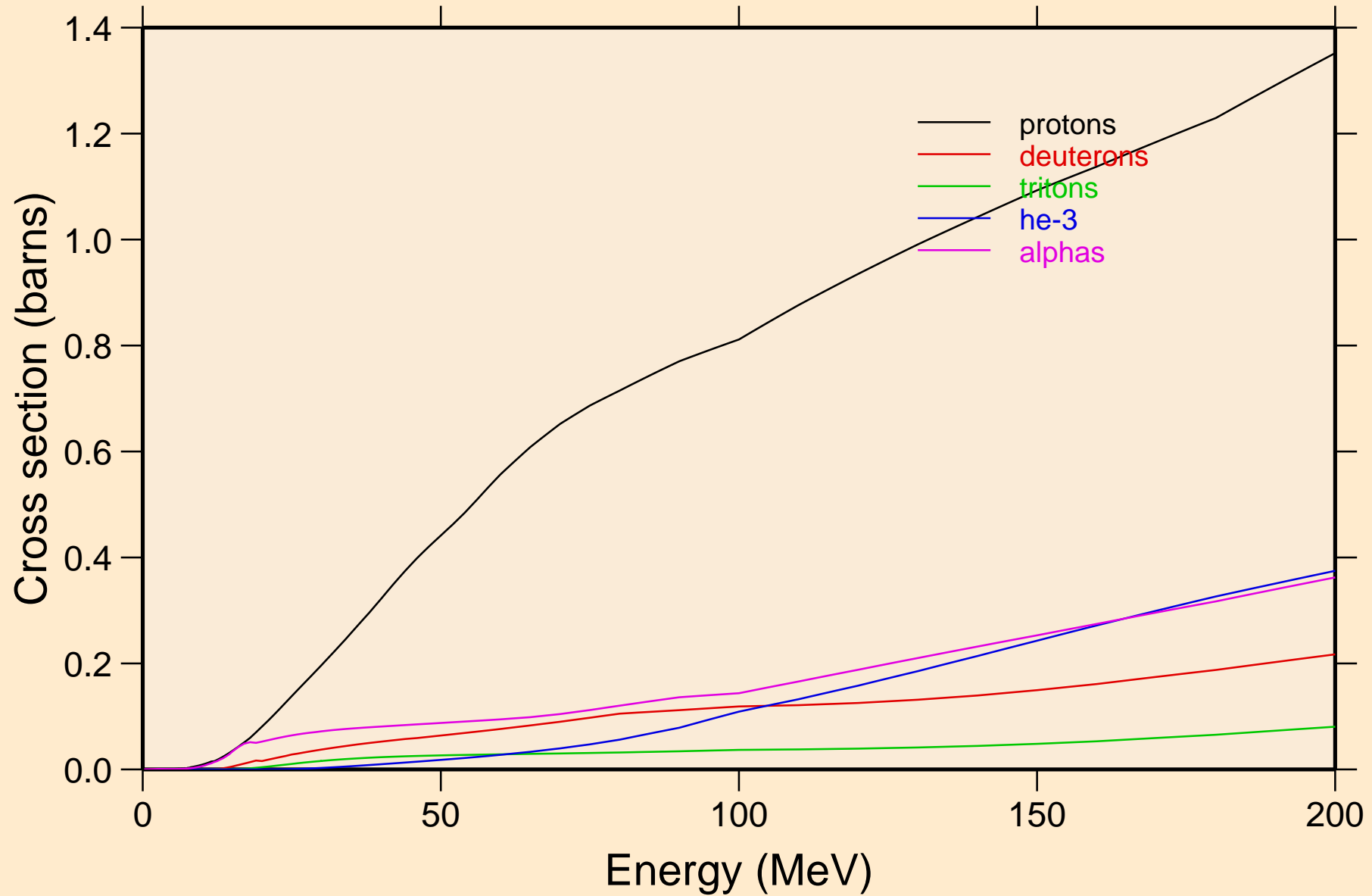

GD149 NEUTRON ACER TENDL-2024 LIBRARY; T=0.K
protons from (n,x)

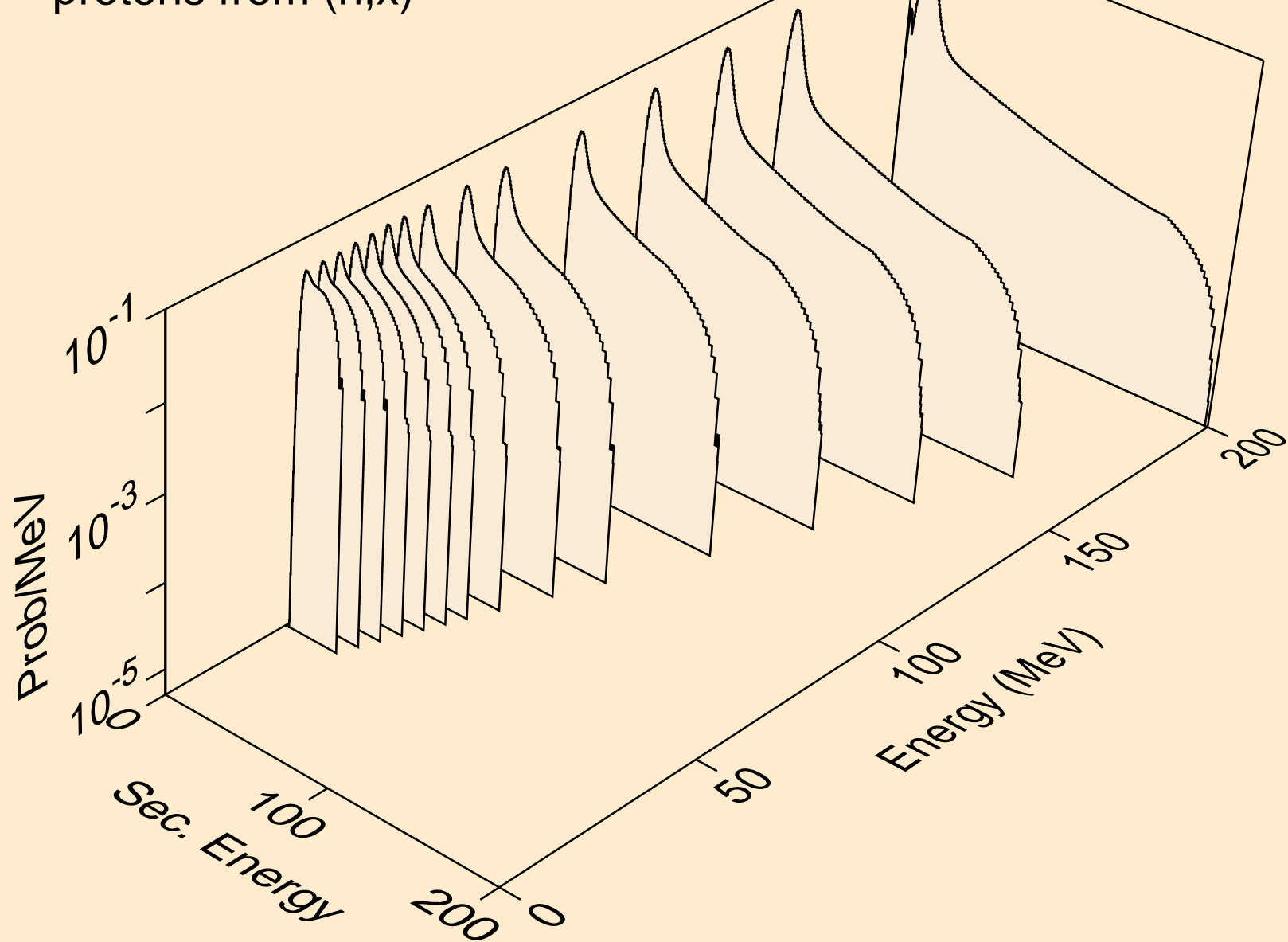

GD149 NEUTRON ACER TENDL-2024 LIBRARY; T=0.K
protons from (n,n*)p

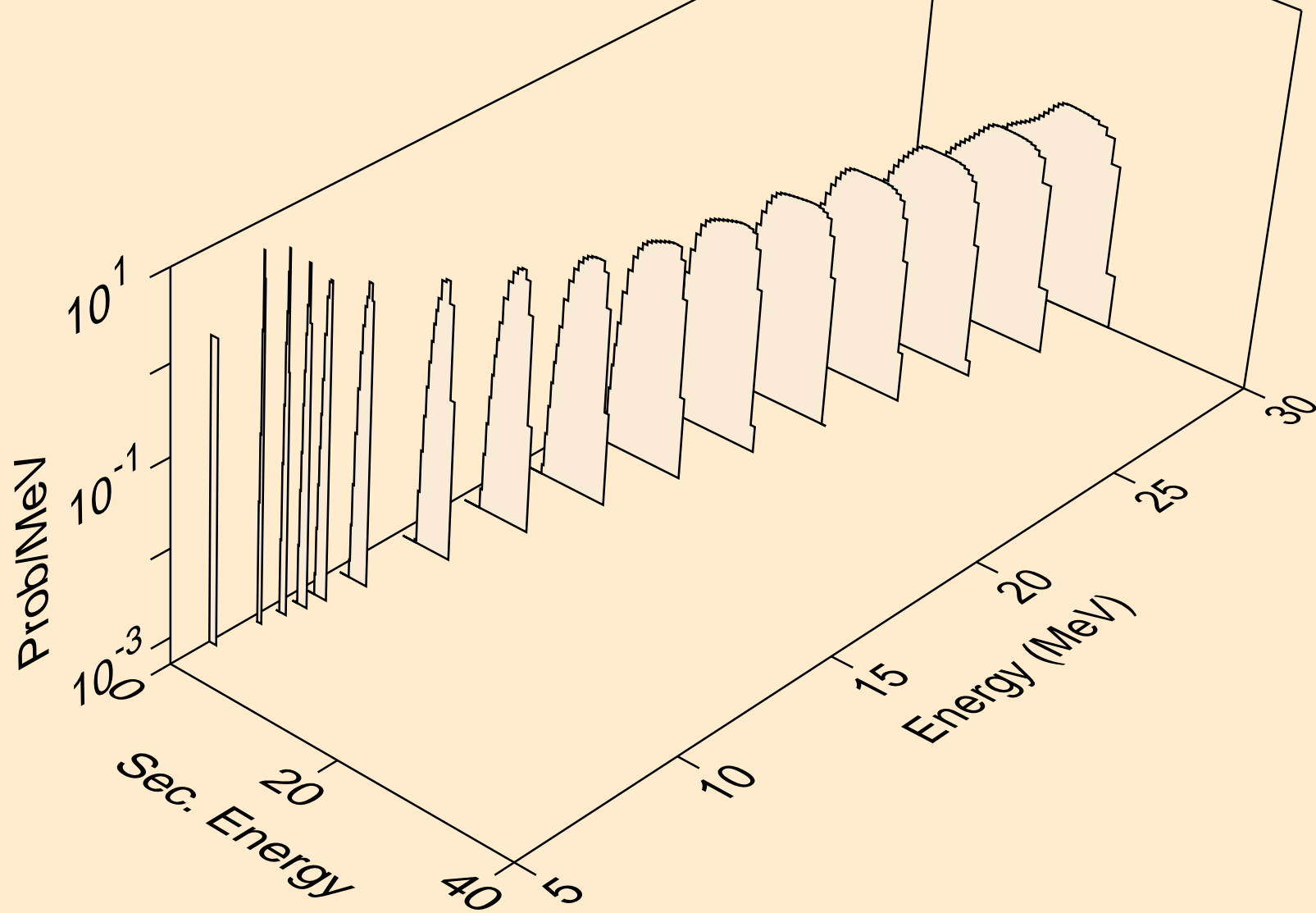

GD149 NEUTRON ACER TENDL-2024 LIBRARY; T=0.K
protons from (n,2np)

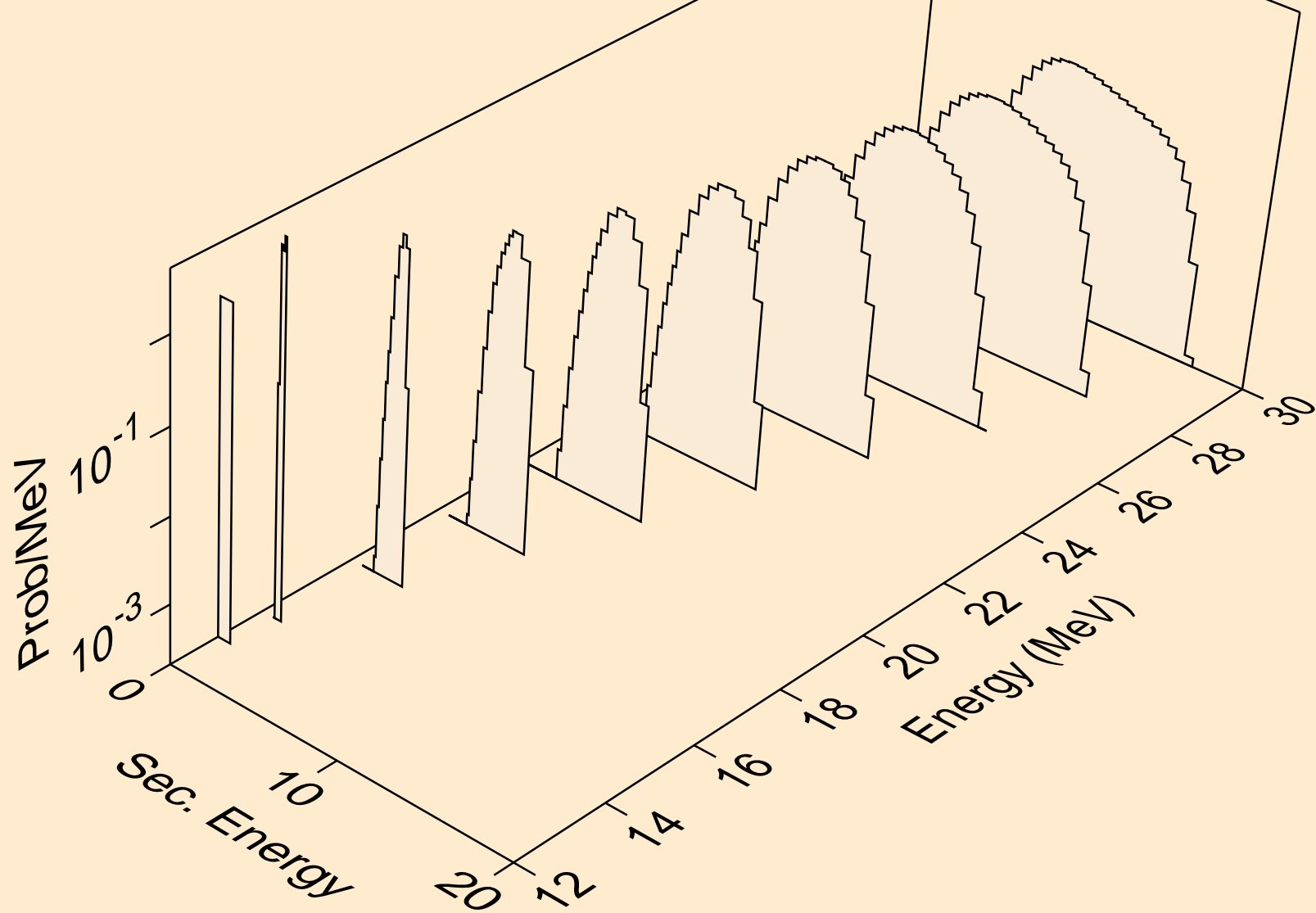

GD149 NEUTRON ACER TENDL-2024 LIBRARY; T=0.K
protons from (n,3np)

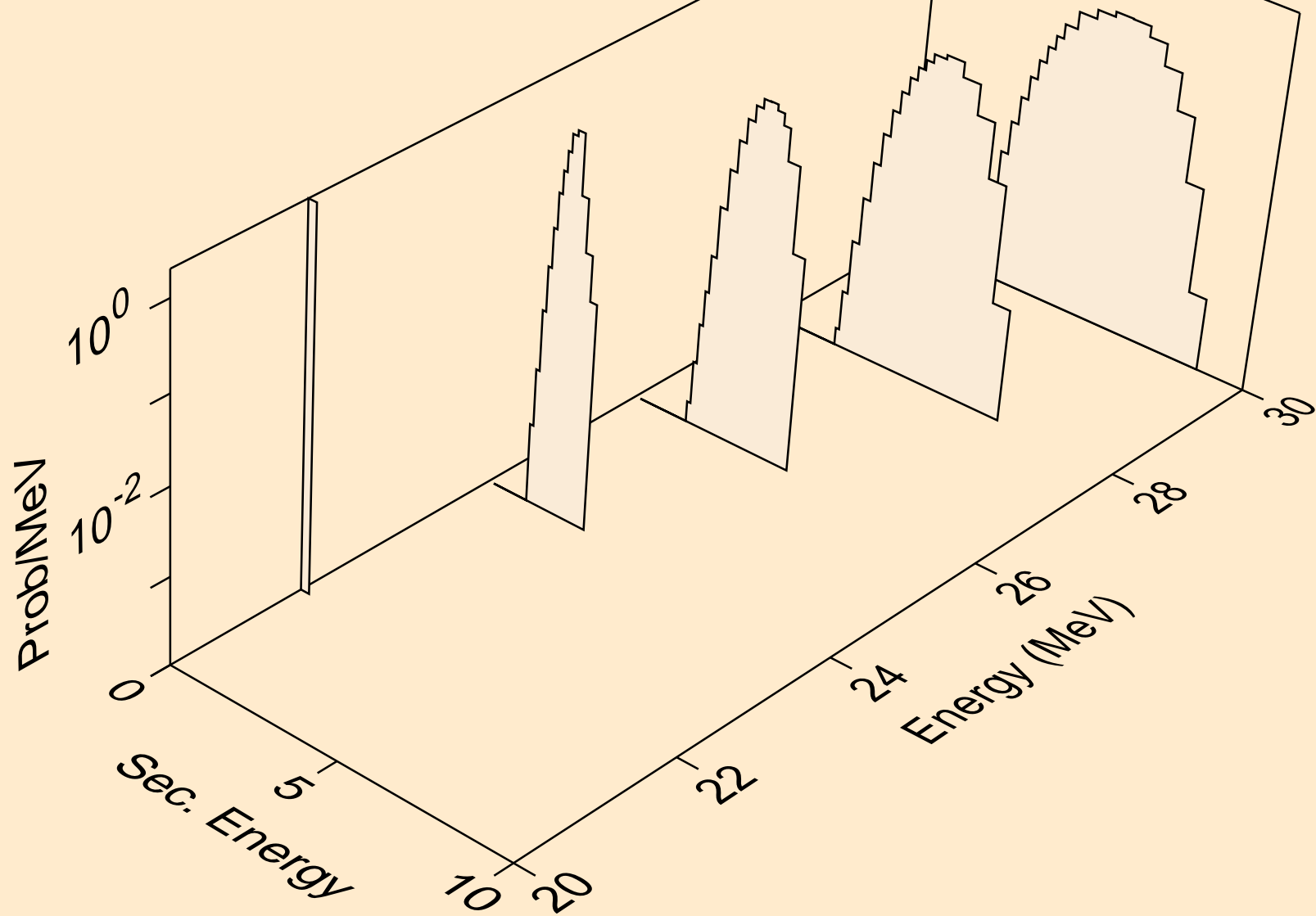

GD149 NEUTRON ACER TENDL-2024 LIBRARY; T=0.K
protons from (n,n2p)

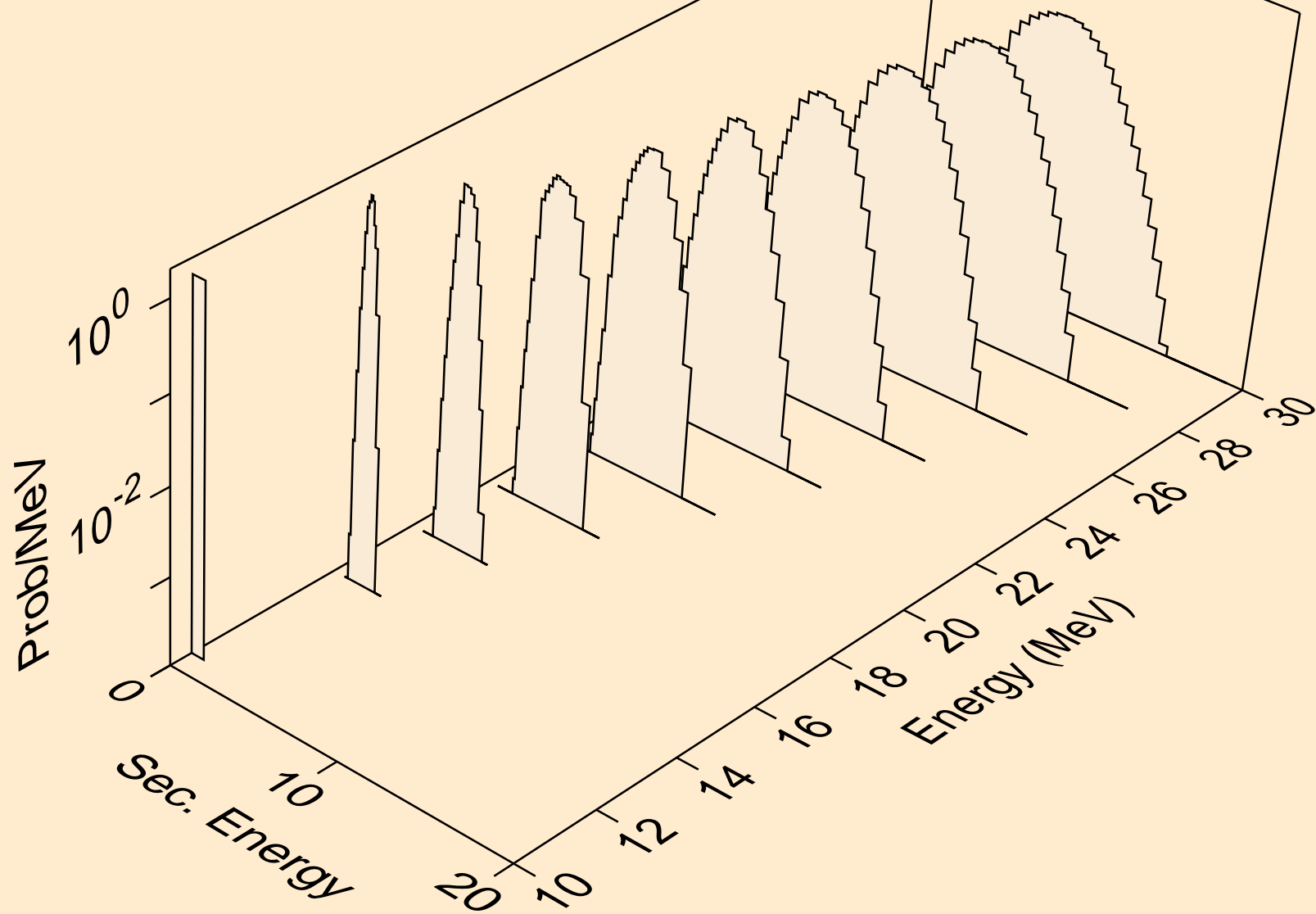

GD149 NEUTRON ACER TENDL-2024 LIBRARY; T=0.K
protons from (n,npa)

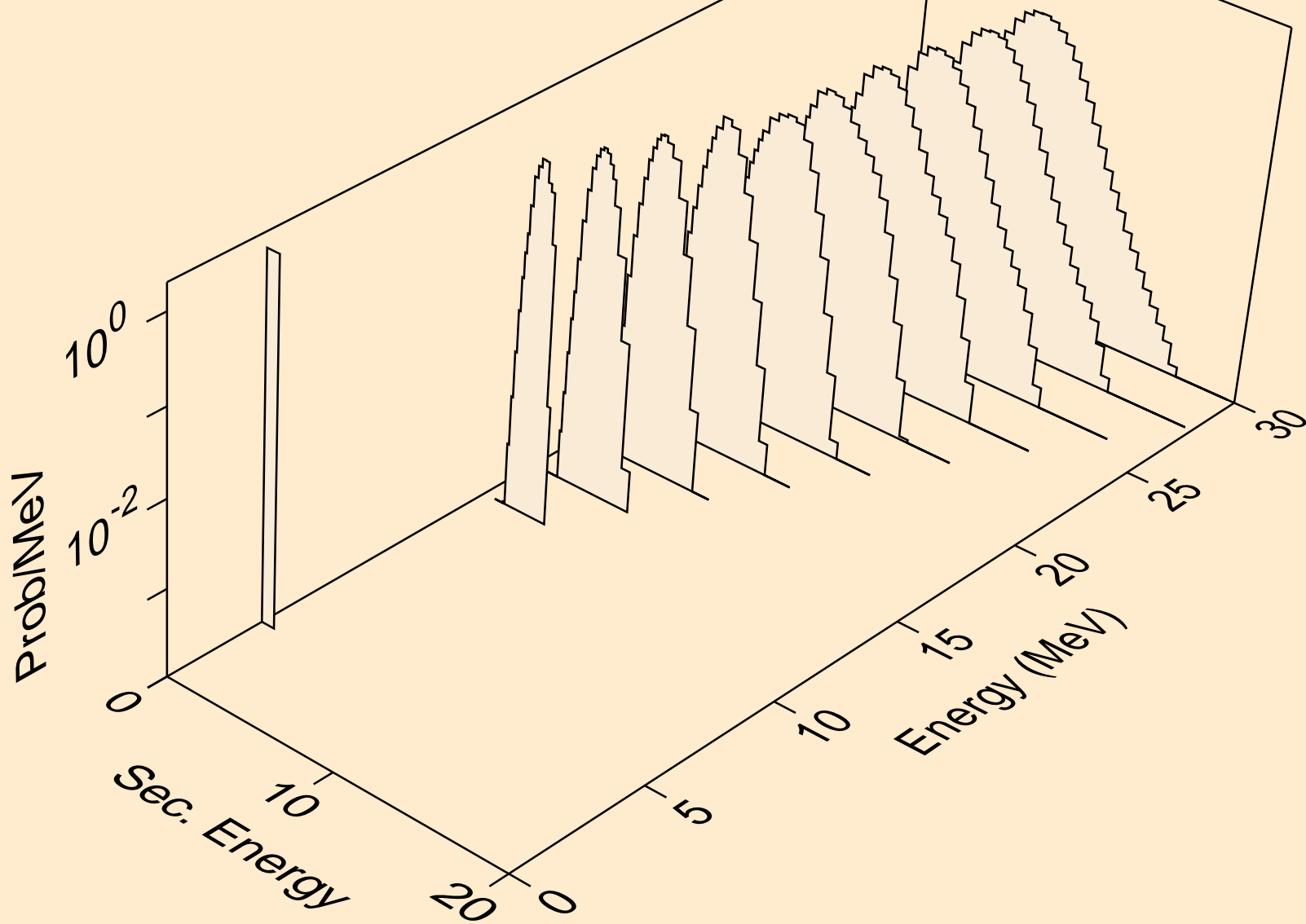

GD149 NEUTRON ACER TENDL-2024 LIBRARY; T=0.K
protons from (n,p)

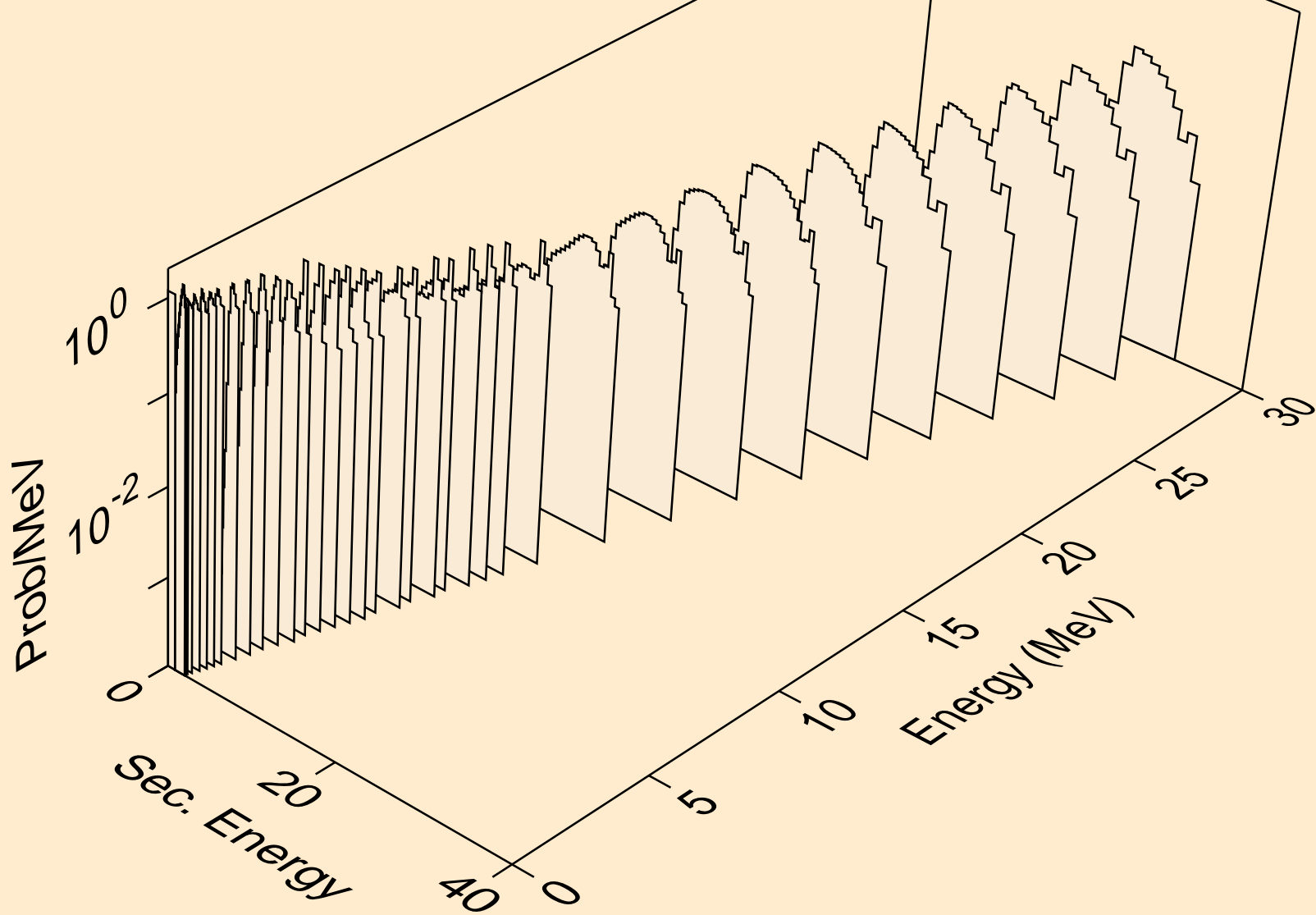

GD149 NEUTRON ACER TENDL-2024 LIBRARY; T=0.K
protons from (n,2p)

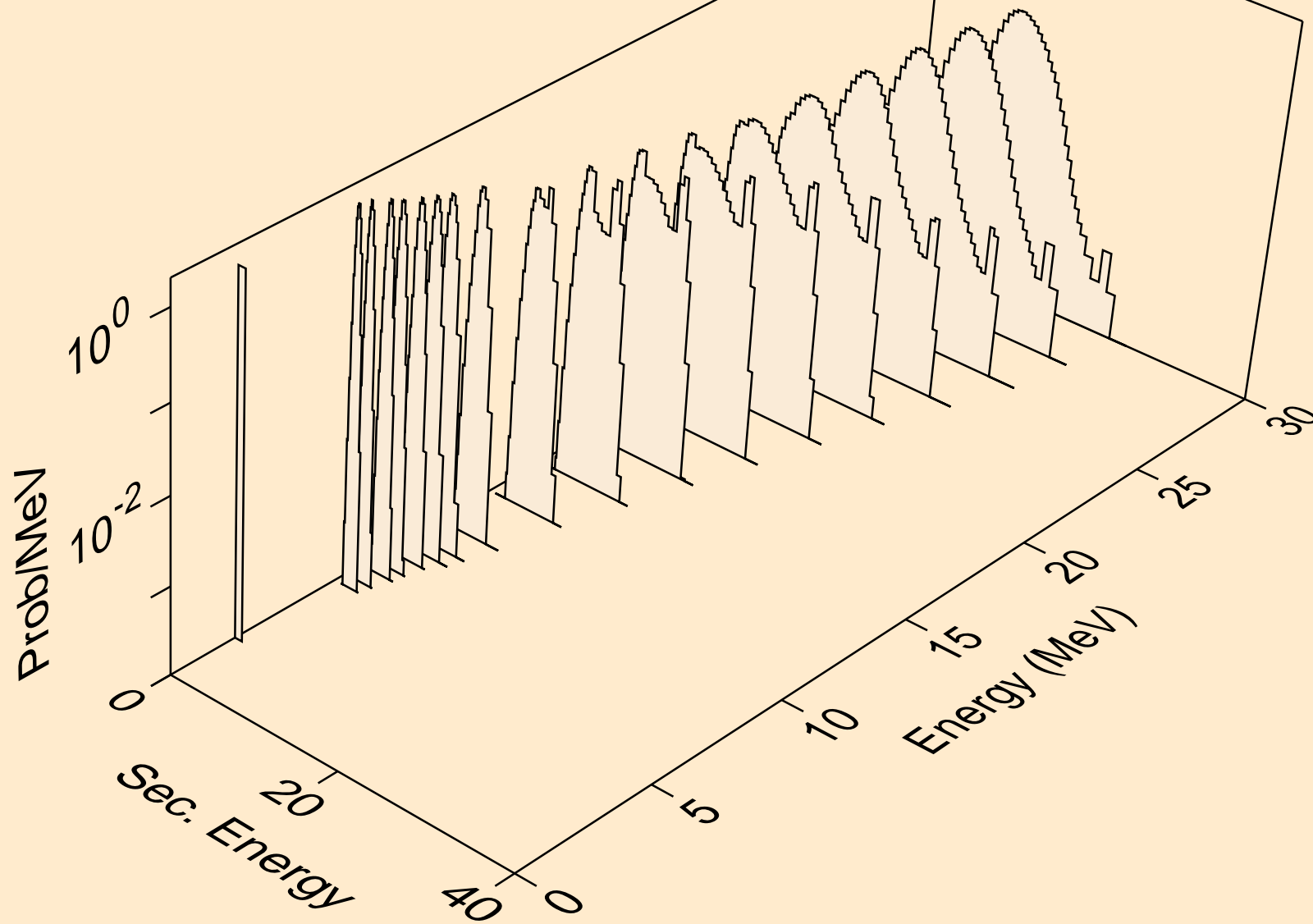

GD149 NEUTRON ACER TENDL-2024 LIBRARY; T=0.K
protons from (n,p)

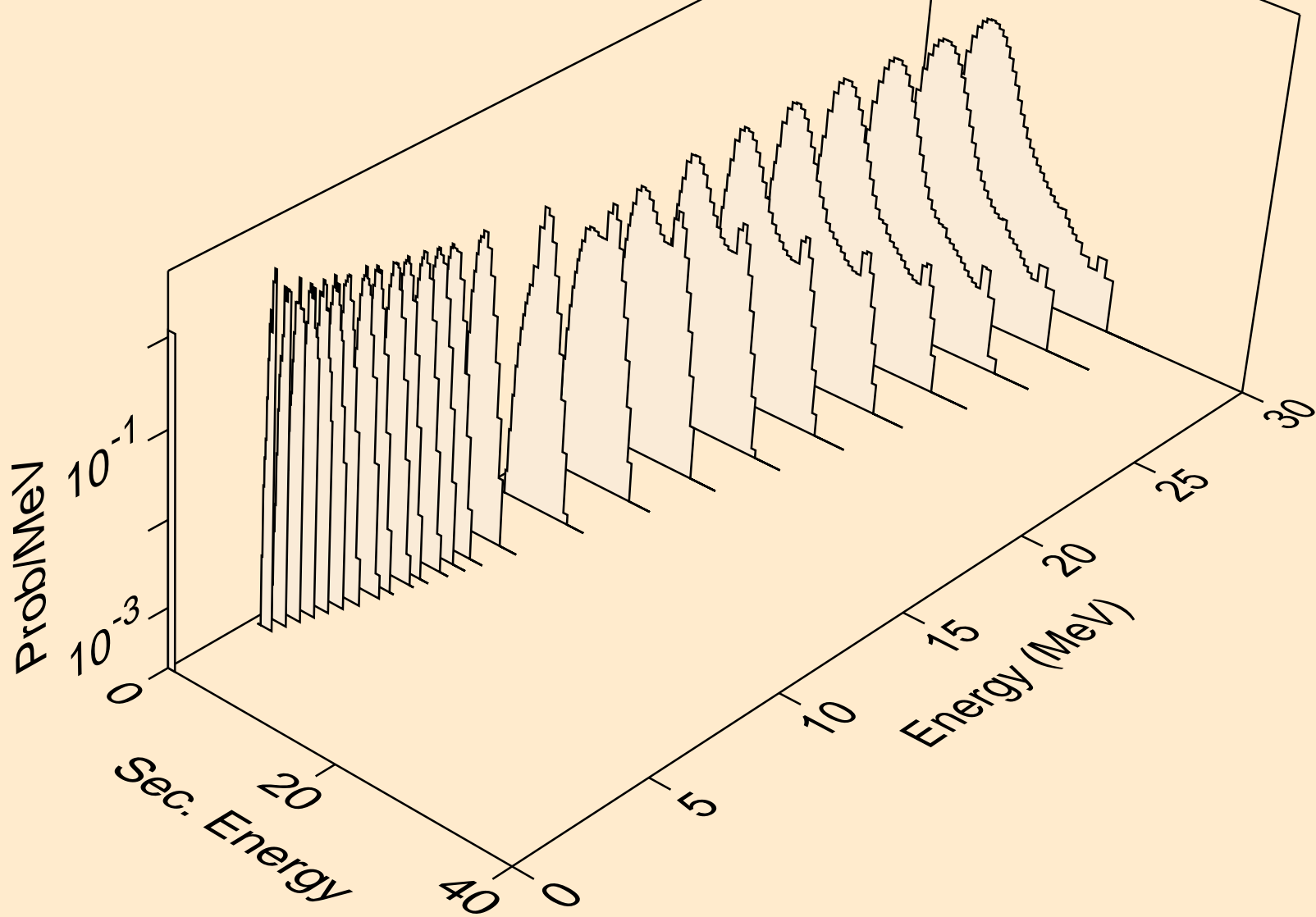

GD149 NEUTRON ACER TENDL-2024 LIBRARY; T=0.K
protons from (n,pd)

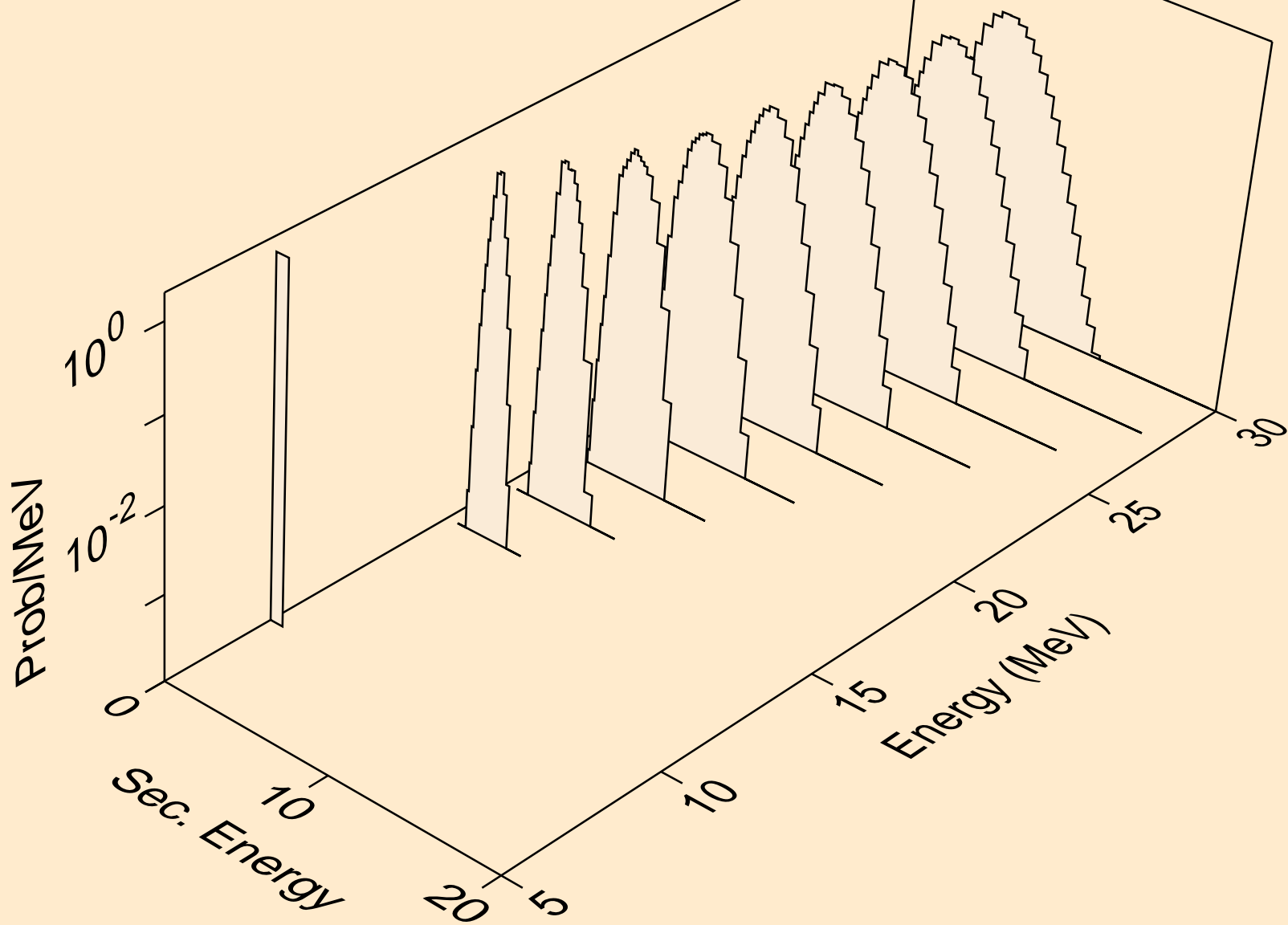

GD149 NEUTRON ACER TENDL-2024 LIBRARY; T=0.K
protons from (n,pt)

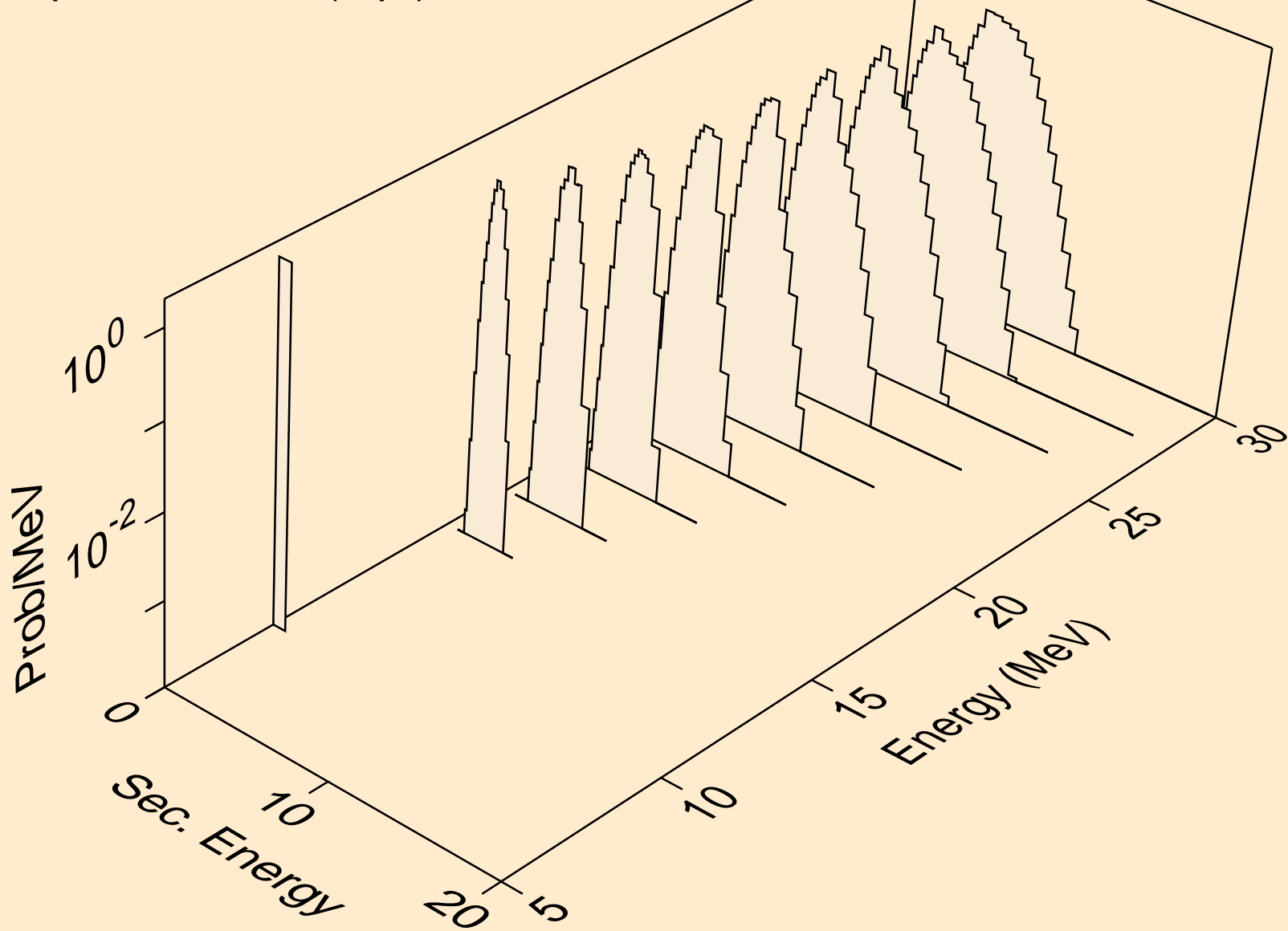

GD149 NEUTRON ACER TENDL-2024 LIBRARY; T=0.K
deuterons from (n,x)

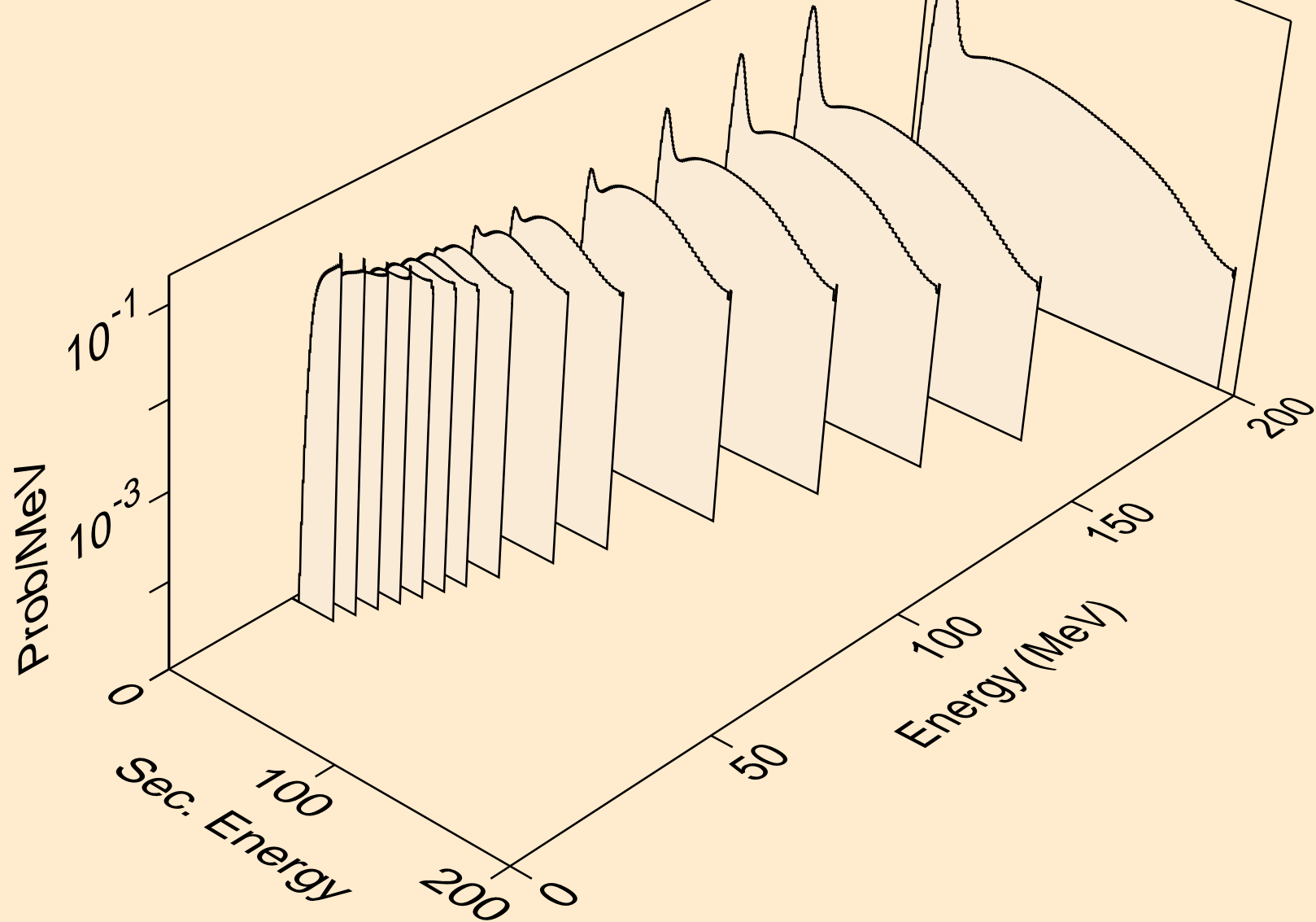

GD149 NEUTRON ACER TENDL-2024 LIBRARY; T=0.K
deuterons from (n,2nd)

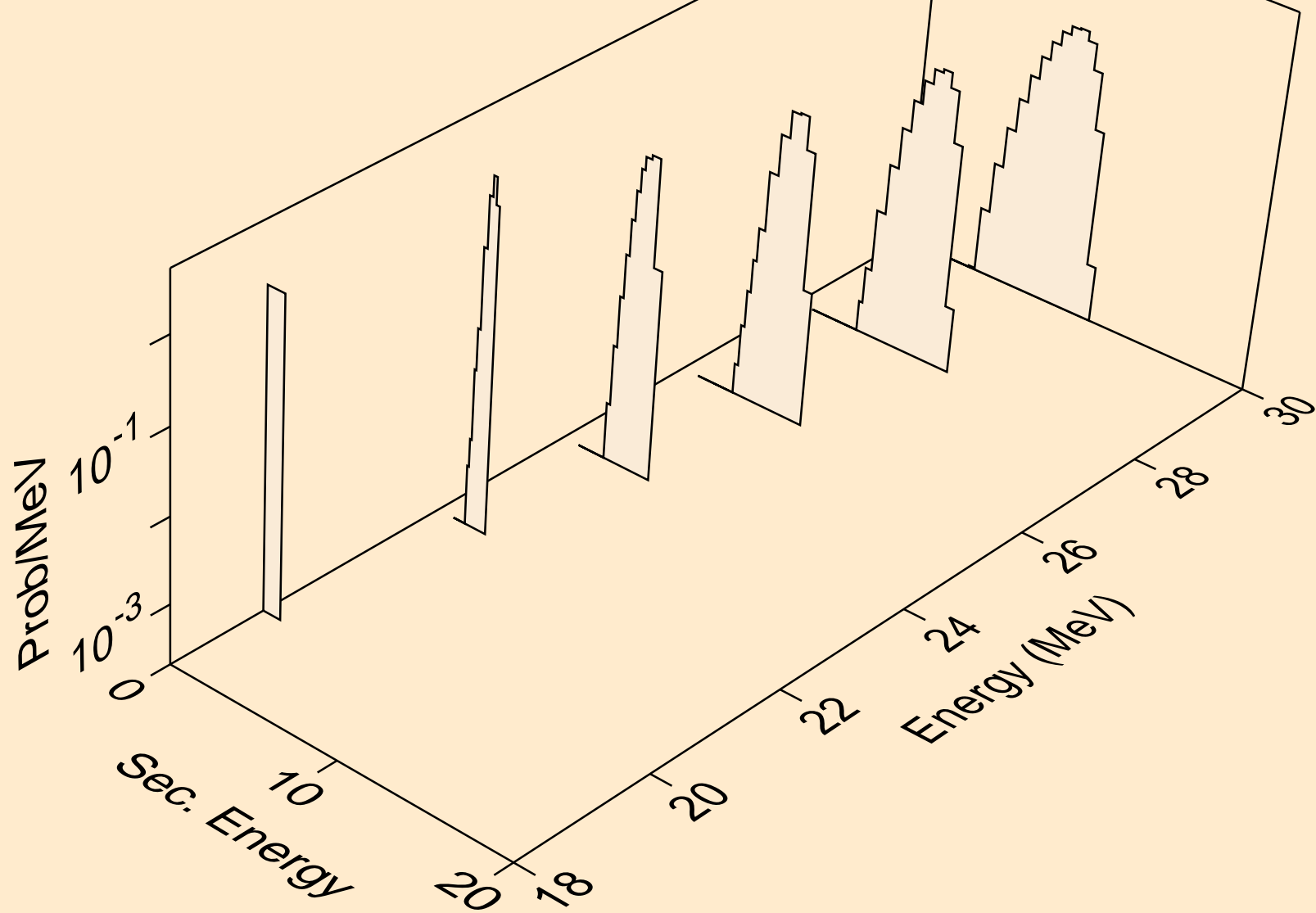

GD149 NEUTRON ACER TENDL-2024 LIBRARY; T=0.K
deuterons from (n,n*)d

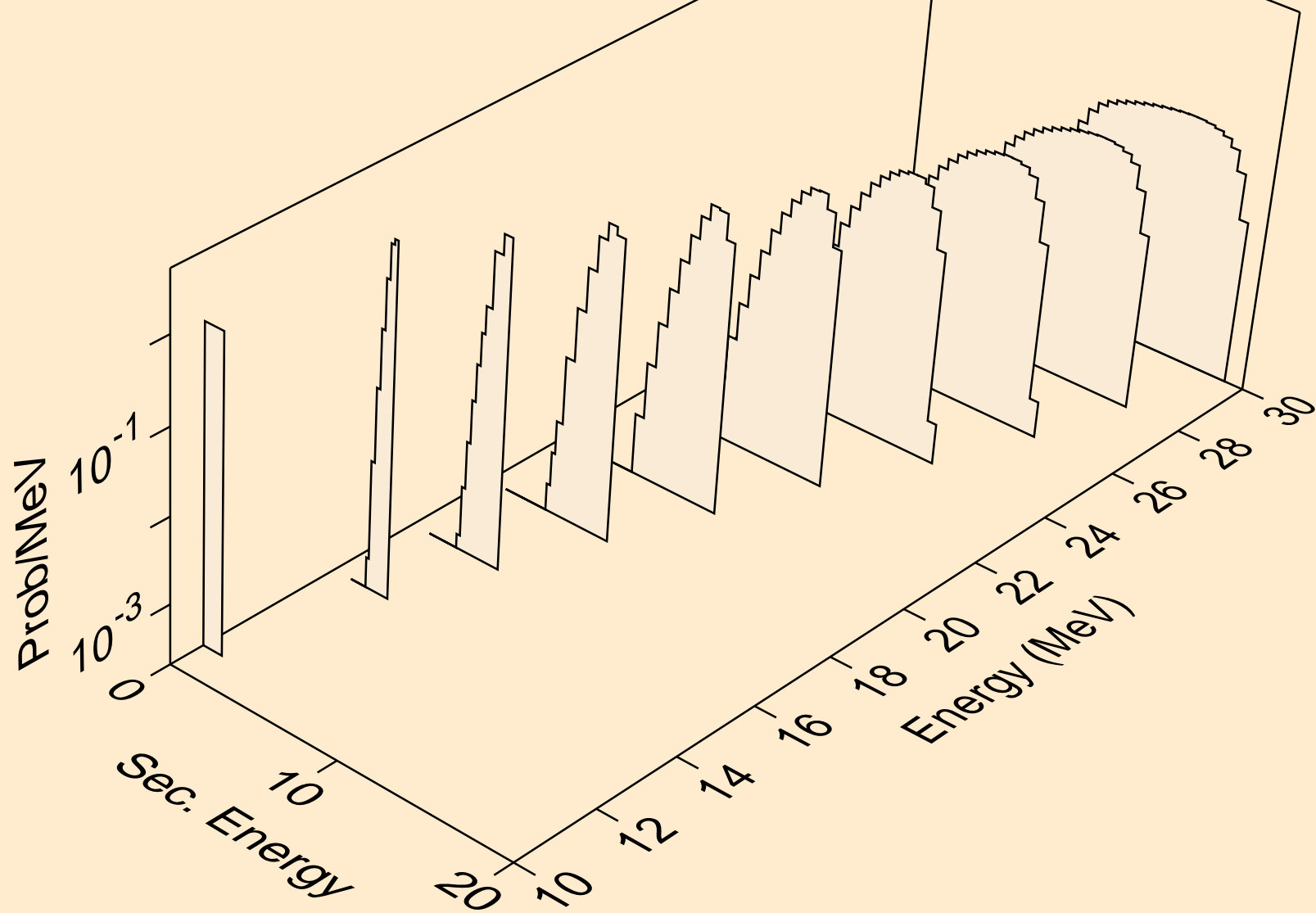

GD149 NEUTRON ACER TENDL-2024 LIBRARY; T=0.K
deuterons from (n,d)

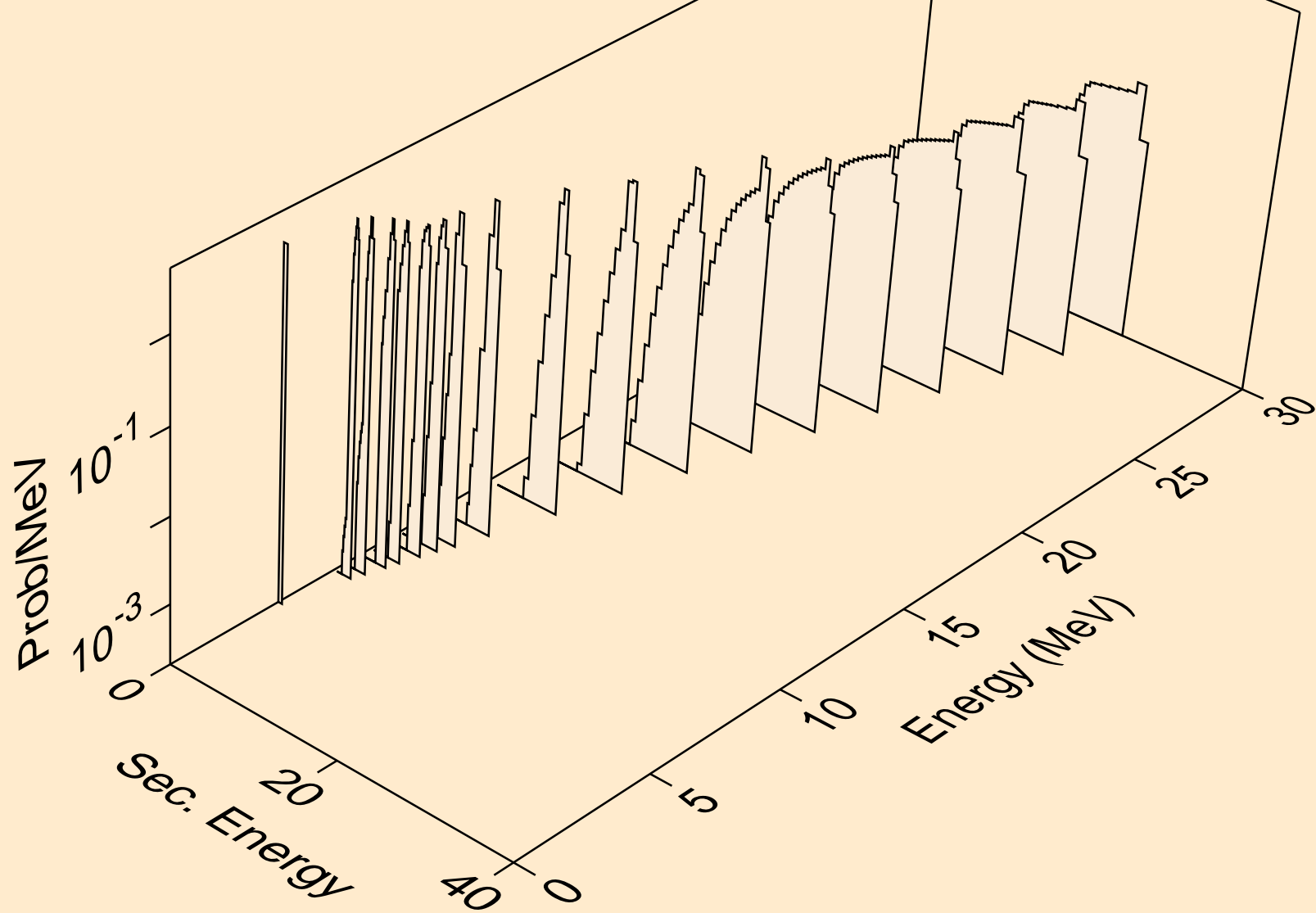

GD149 NEUTRON ACER TENDL-2024 LIBRARY; T=0.K
deuterons from (n,pd)

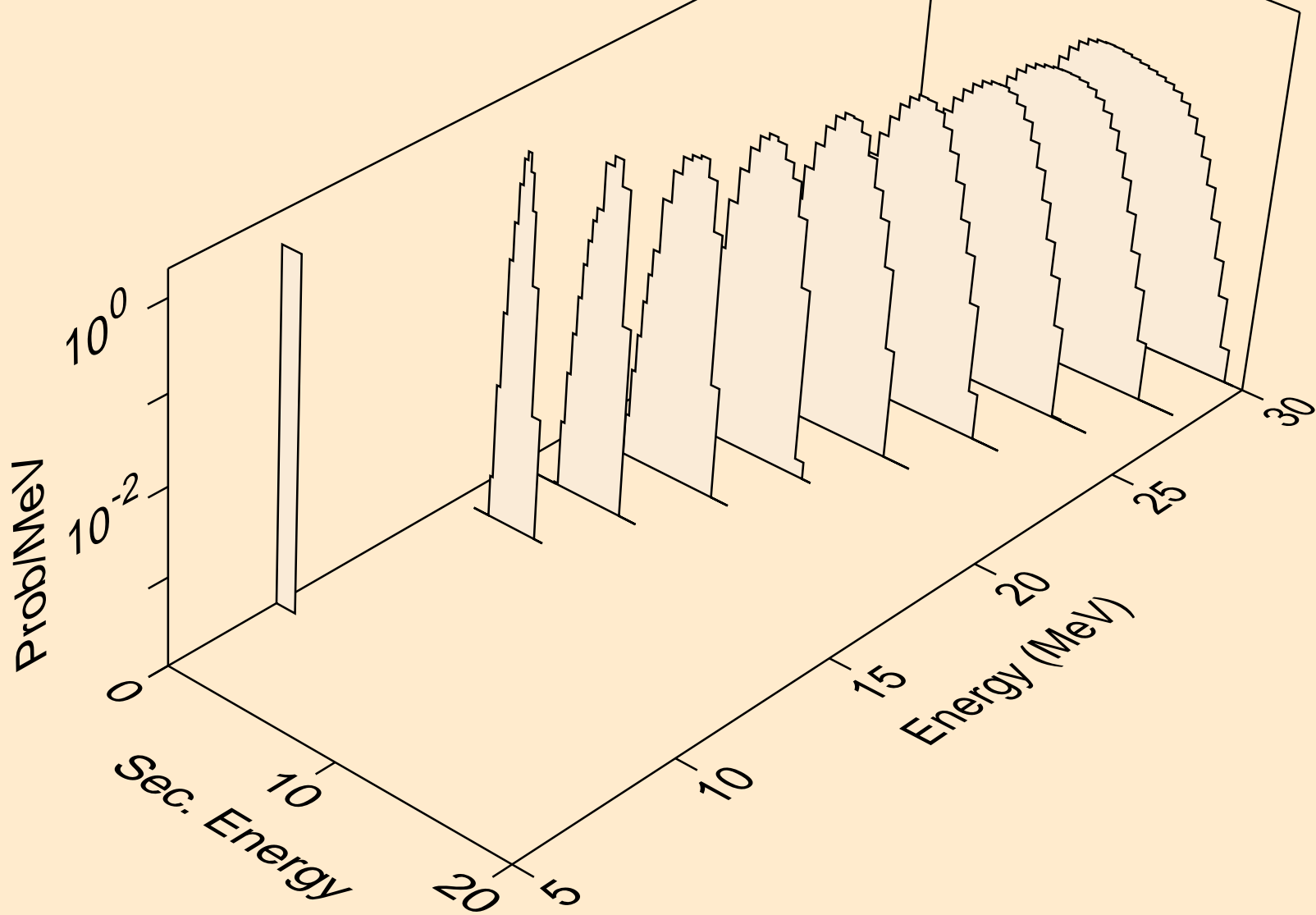

GD149 NEUTRON ACER TENDL-2024 LIBRARY; T=0.K
deuterons from (n,da)

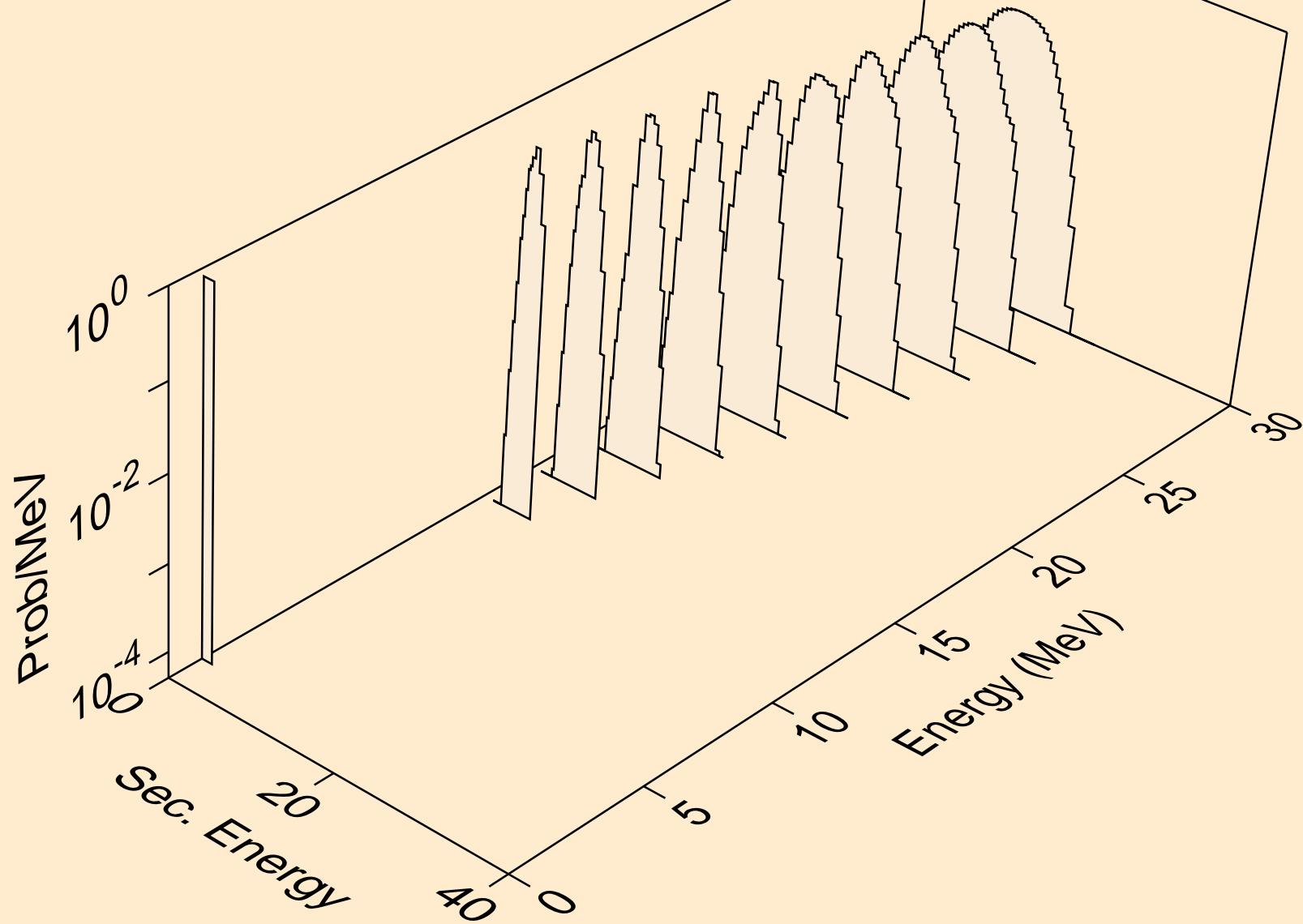

GD149 NEUTRON ACER TENDL-2024 LIBRARY; T=0.K
tritons from (n,x)

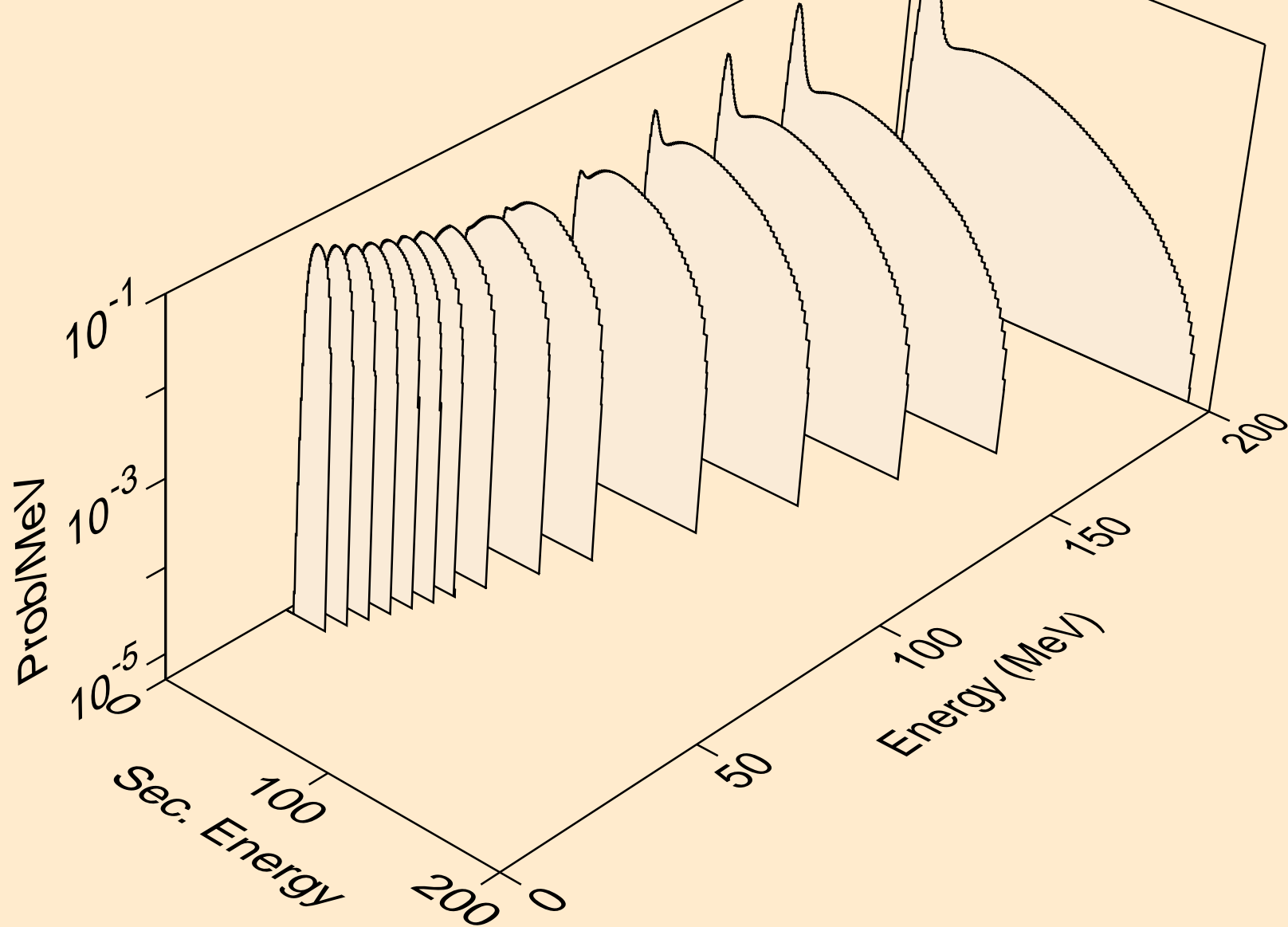

GD149 NEUTRON ACER TENDL-2024 LIBRARY; T=0.K
tritons from (n,n*)t

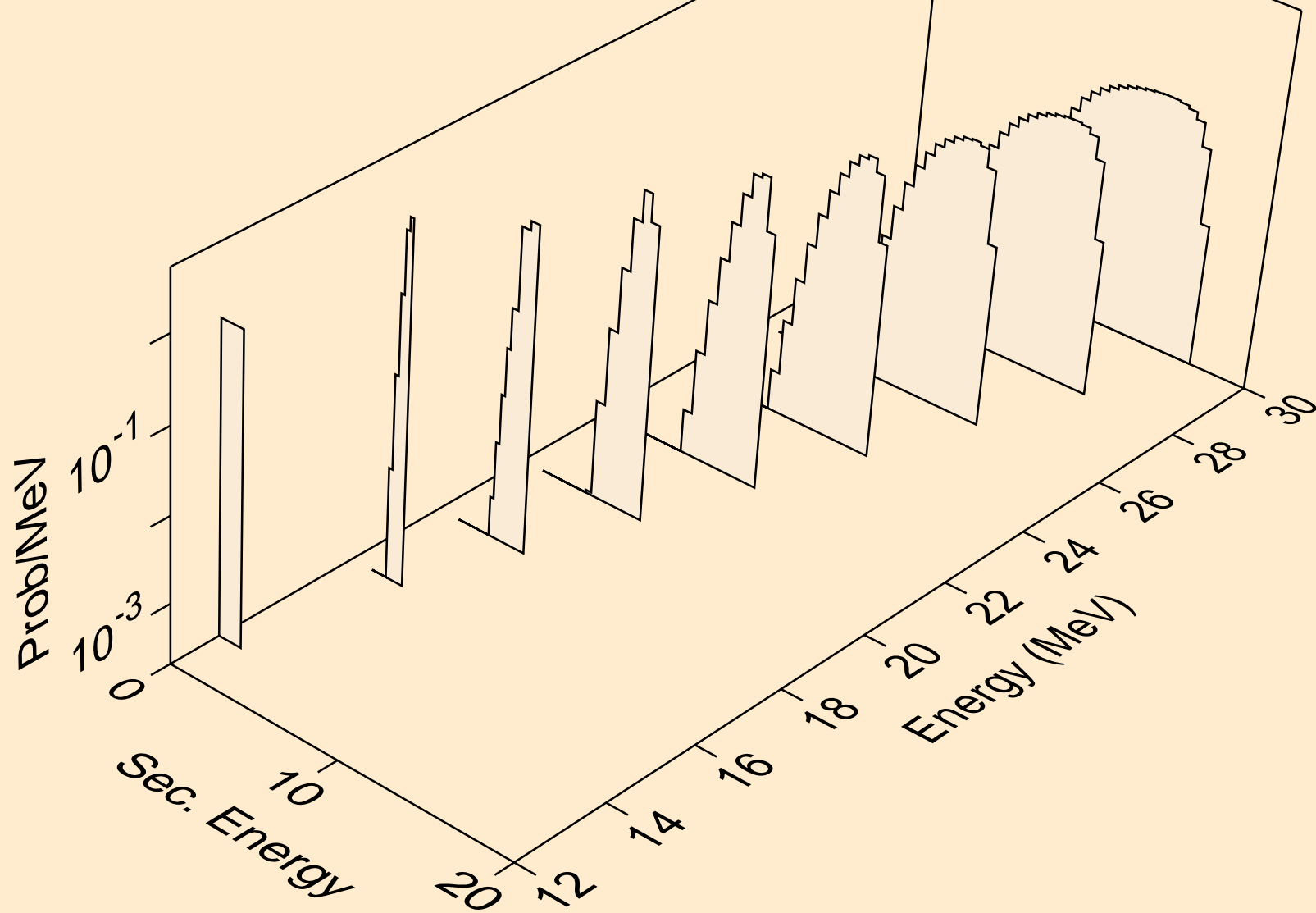

GD149 NEUTRON ACER TENDL-2024 LIBRARY; T=0.K
tritons from (n,t)

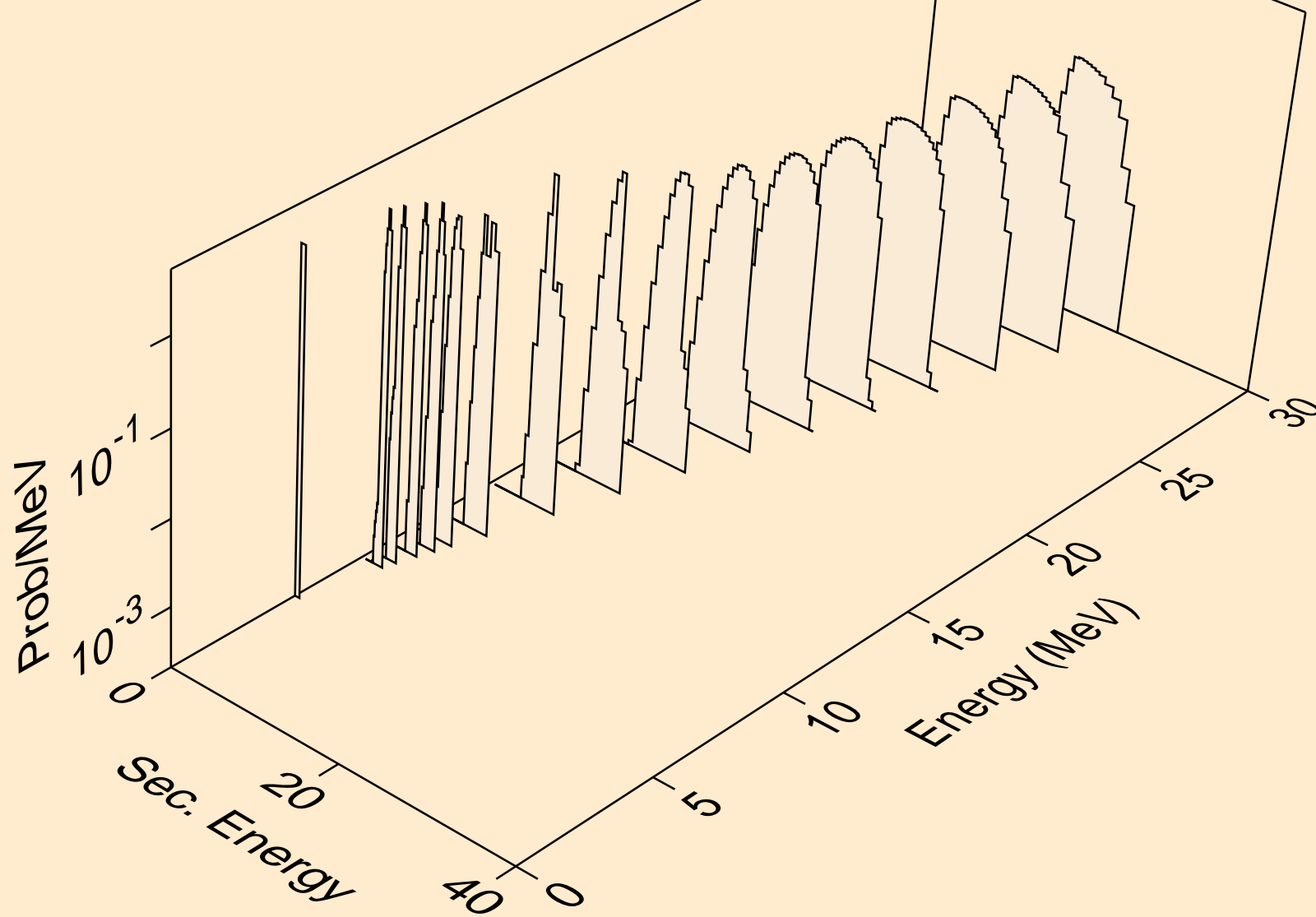

GD149 NEUTRON ACER TENDL-2024 LIBRARY; T=0.K
tritons from (n,pt)

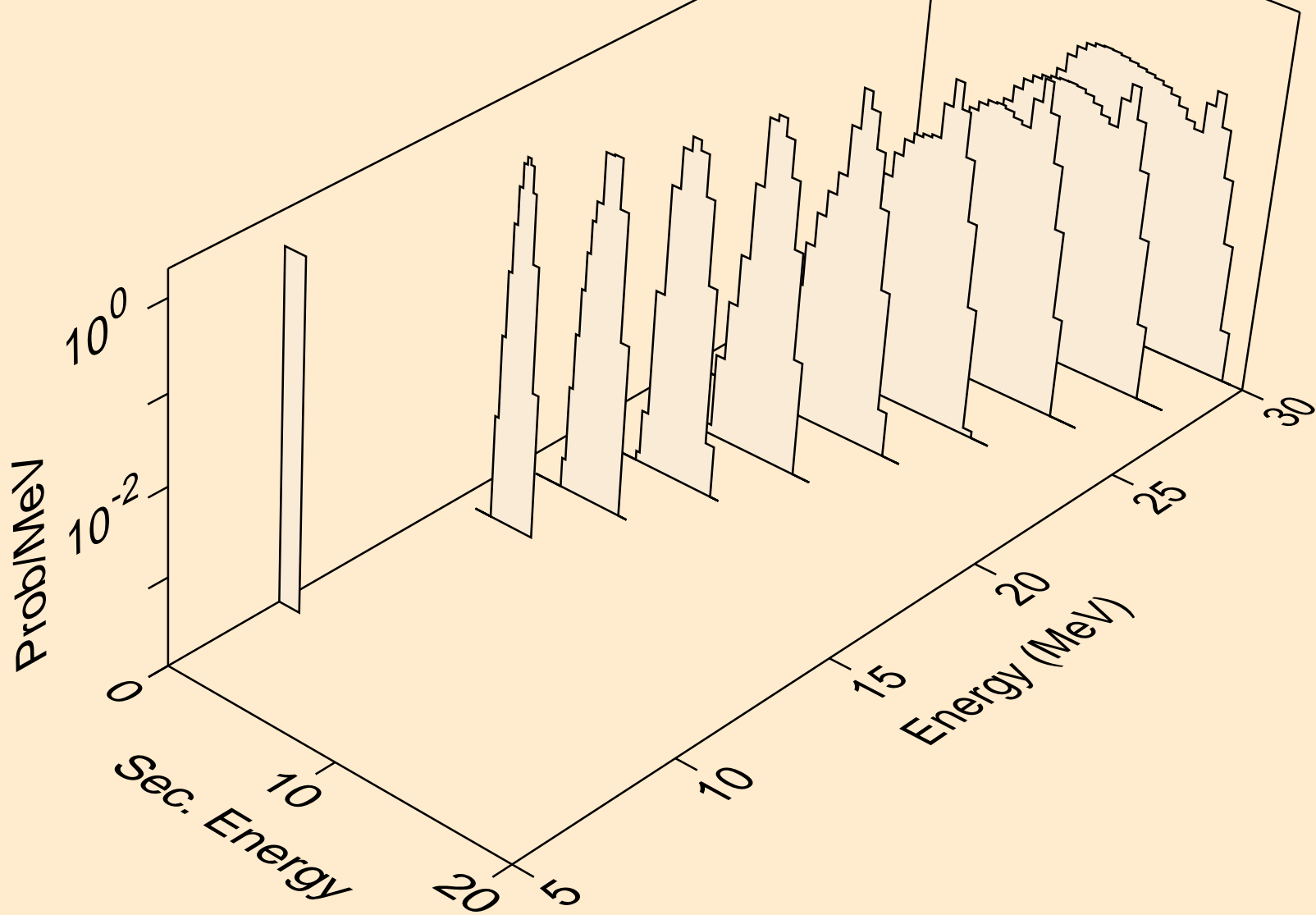

GD149 NEUTRON ACER TENDL-2024 LIBRARY; T=0.K
he3s from (n,x)

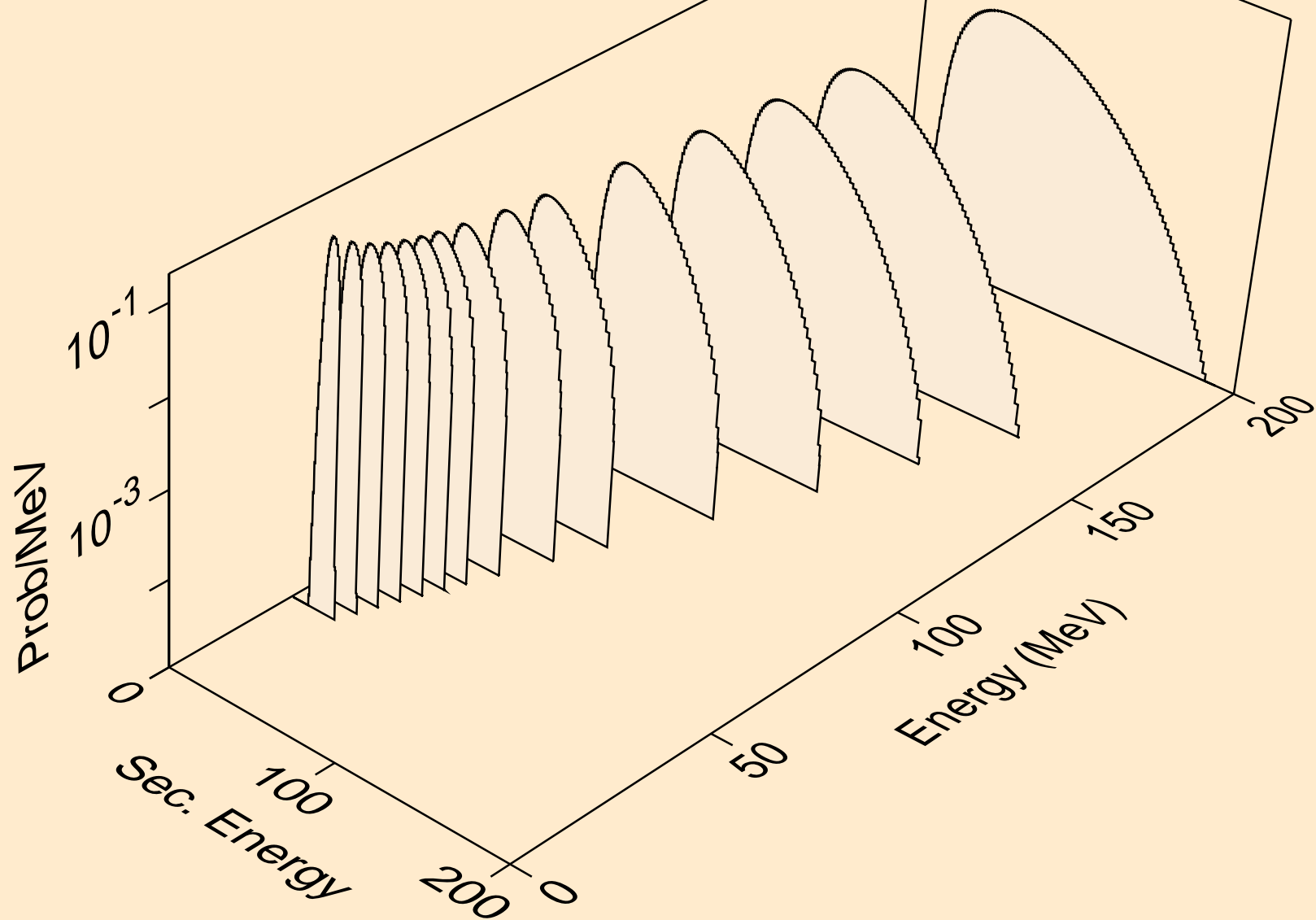

GD149 NEUTRON ACER TENDL-2024 LIBRARY; T=0.K
he3s from (n,n*)he3

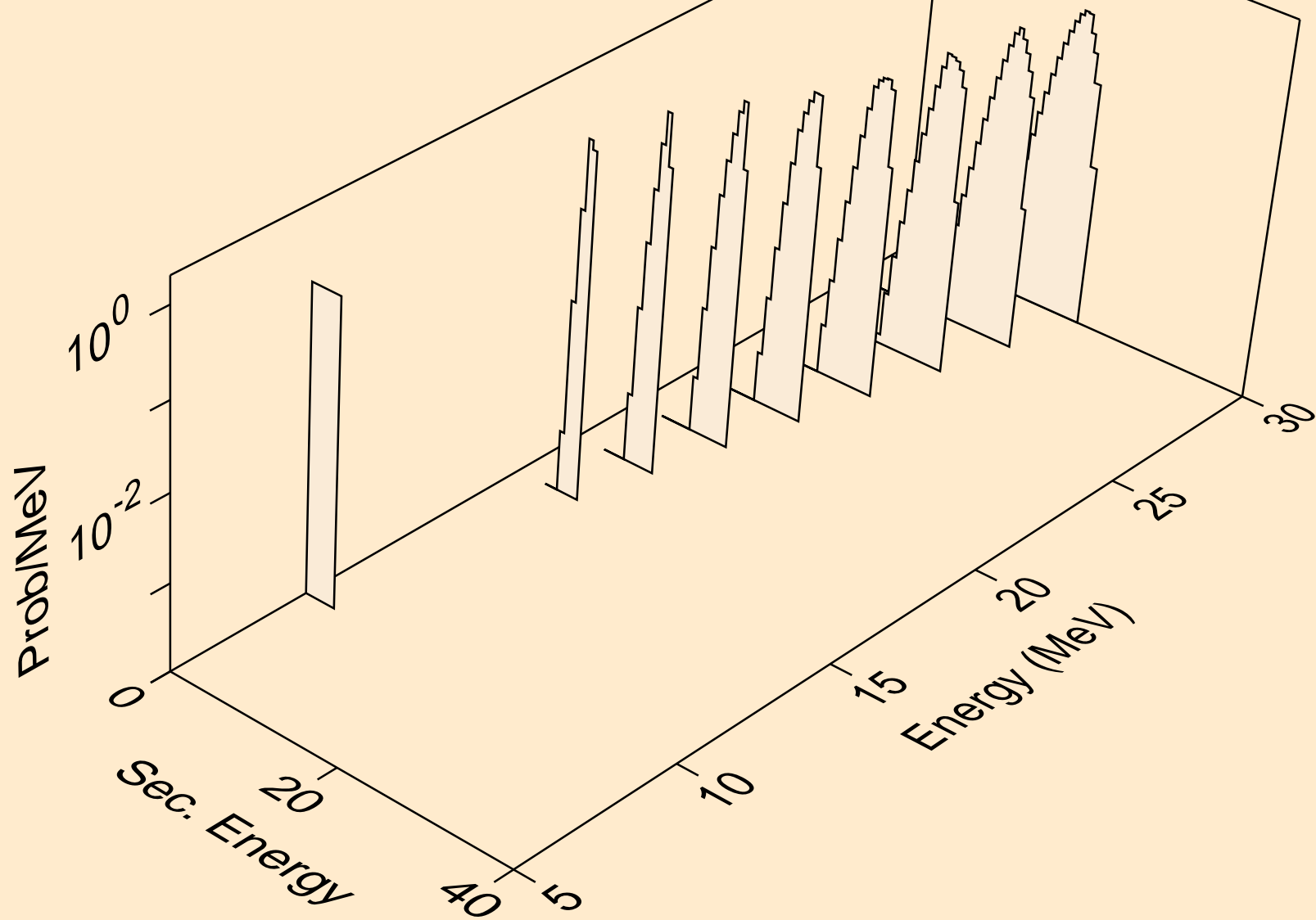

GD149 NEUTRON ACER TENDL-2024 LIBRARY; T=0.K
he3s from (n,he3)

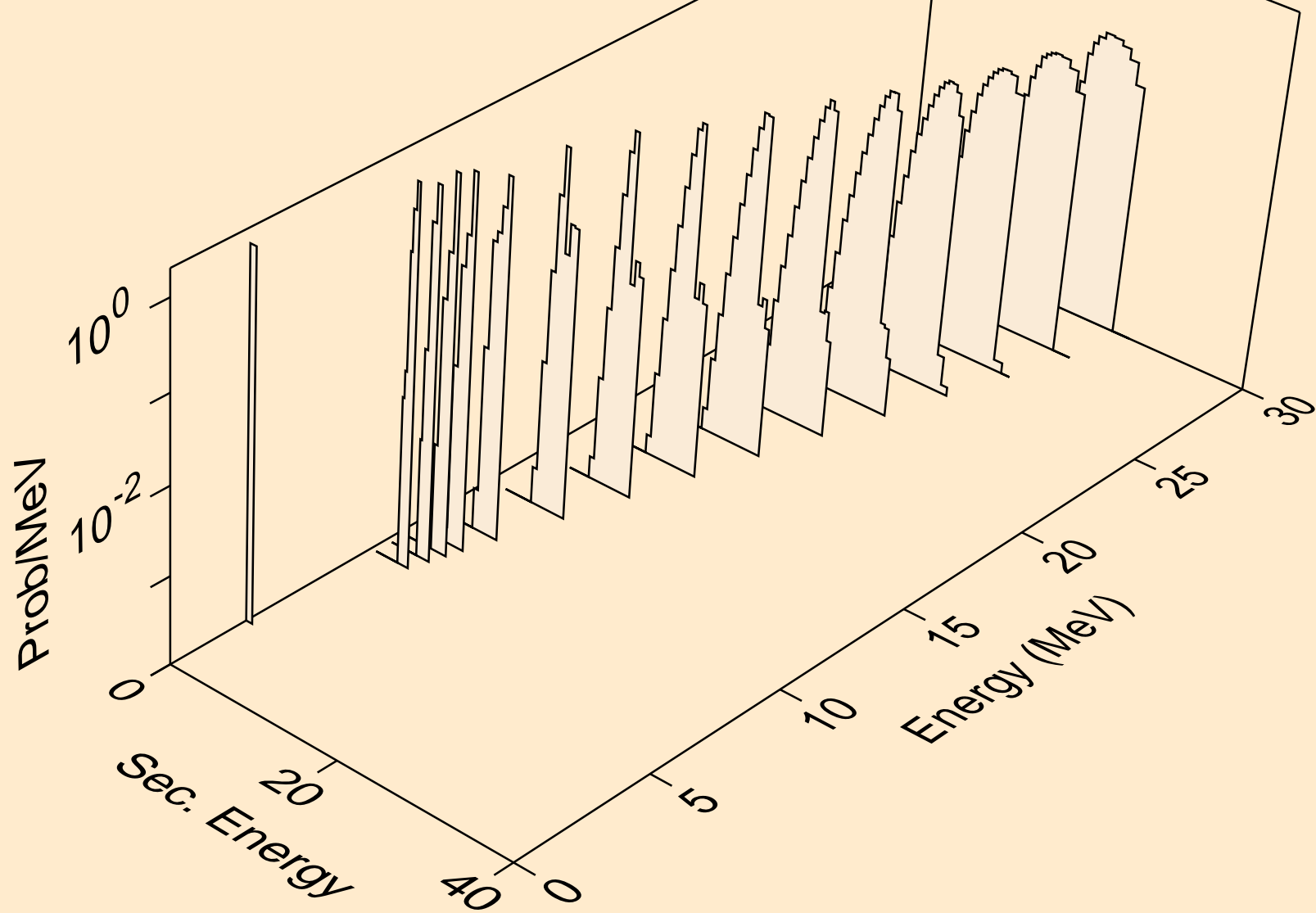

GD149 NEUTRON ACER TENDL-2024 LIBRARY; T=0.K
alphas from (n,x)

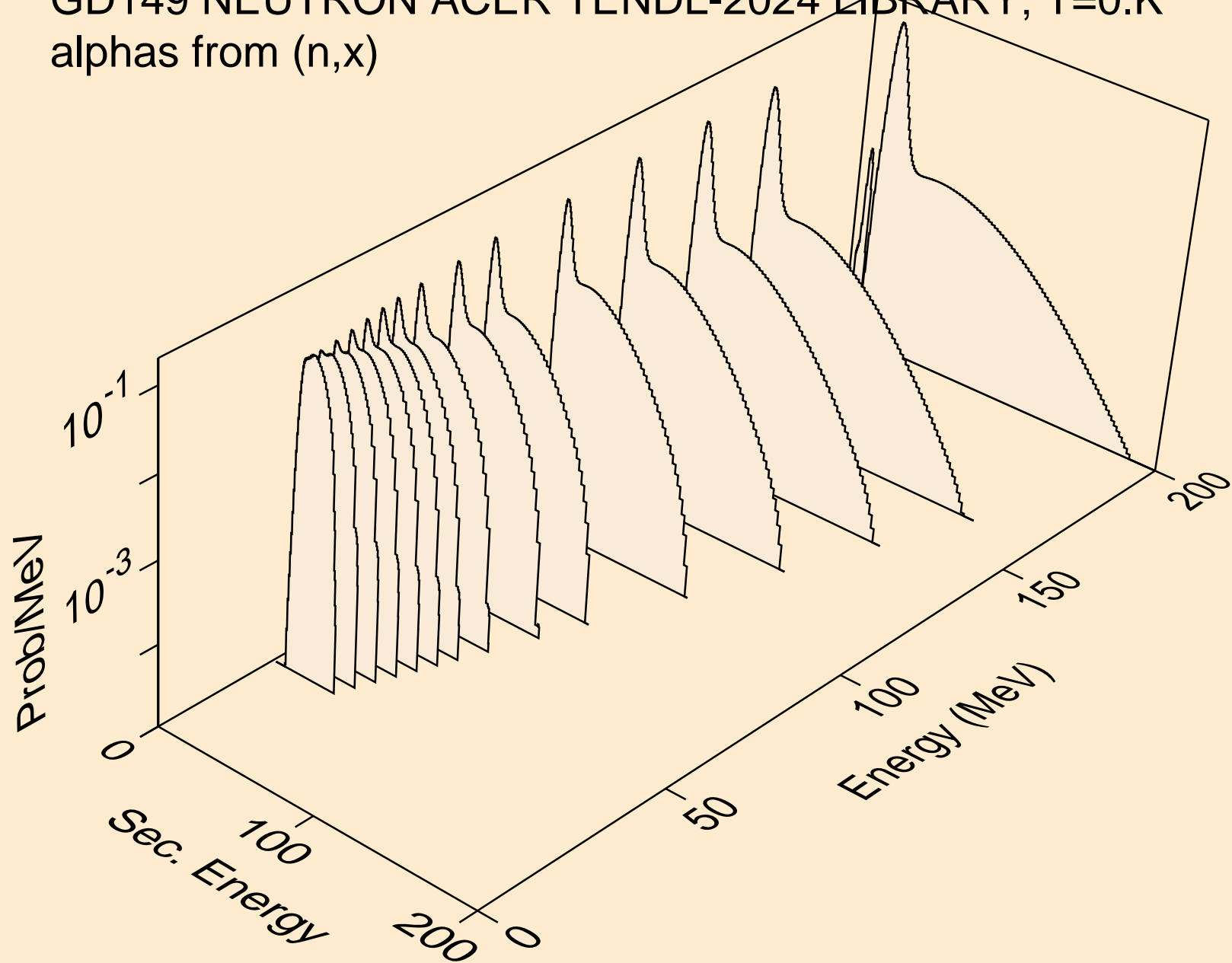

GD149 NEUTRON ACER TENDL-2024 LIBRARY; T=0.K
alphas from (n,n*)a

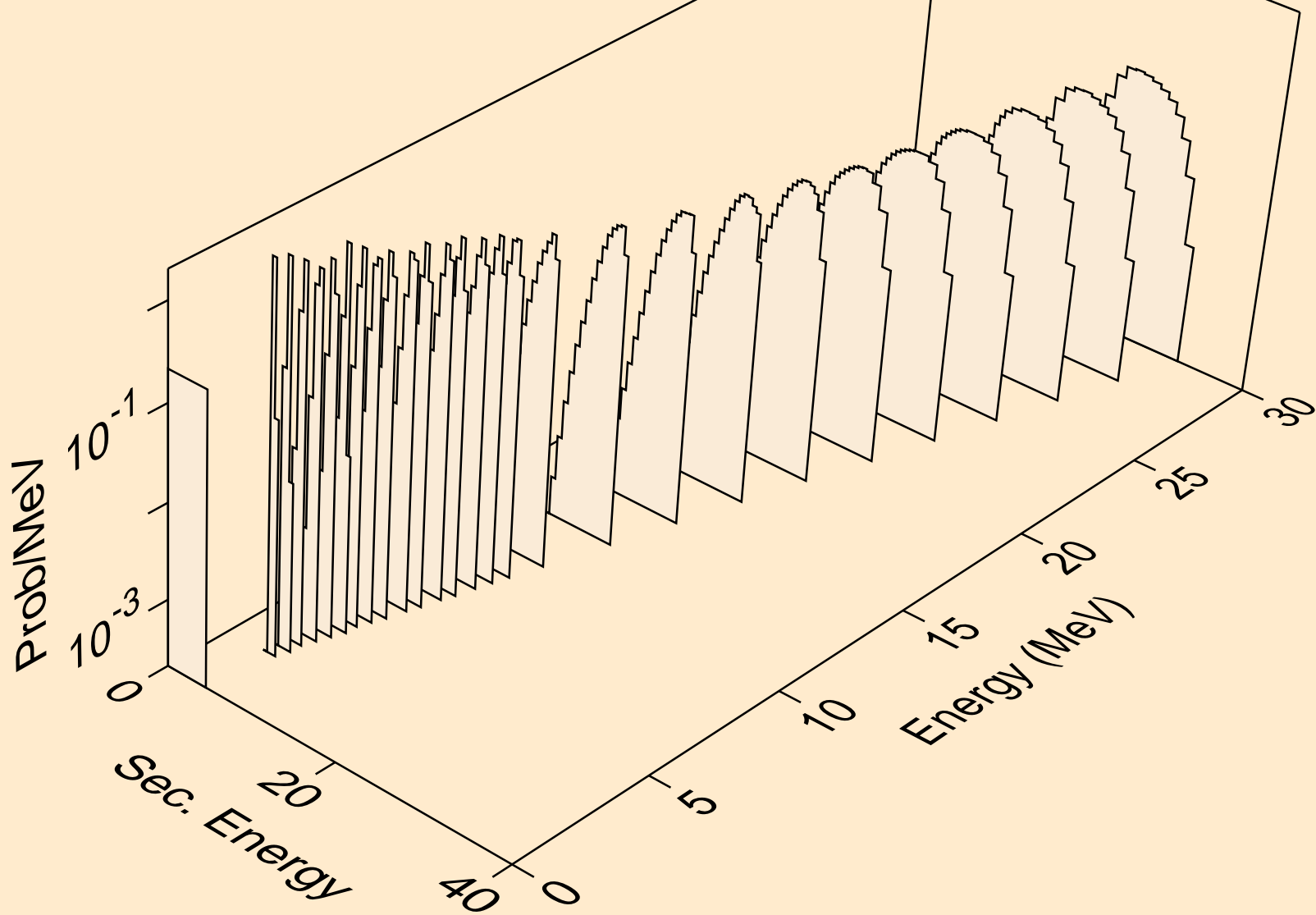

GD149 NEUTRON ACER TENDL-2024 LIBRARY; T=0.K
alphas from (n,2n)a

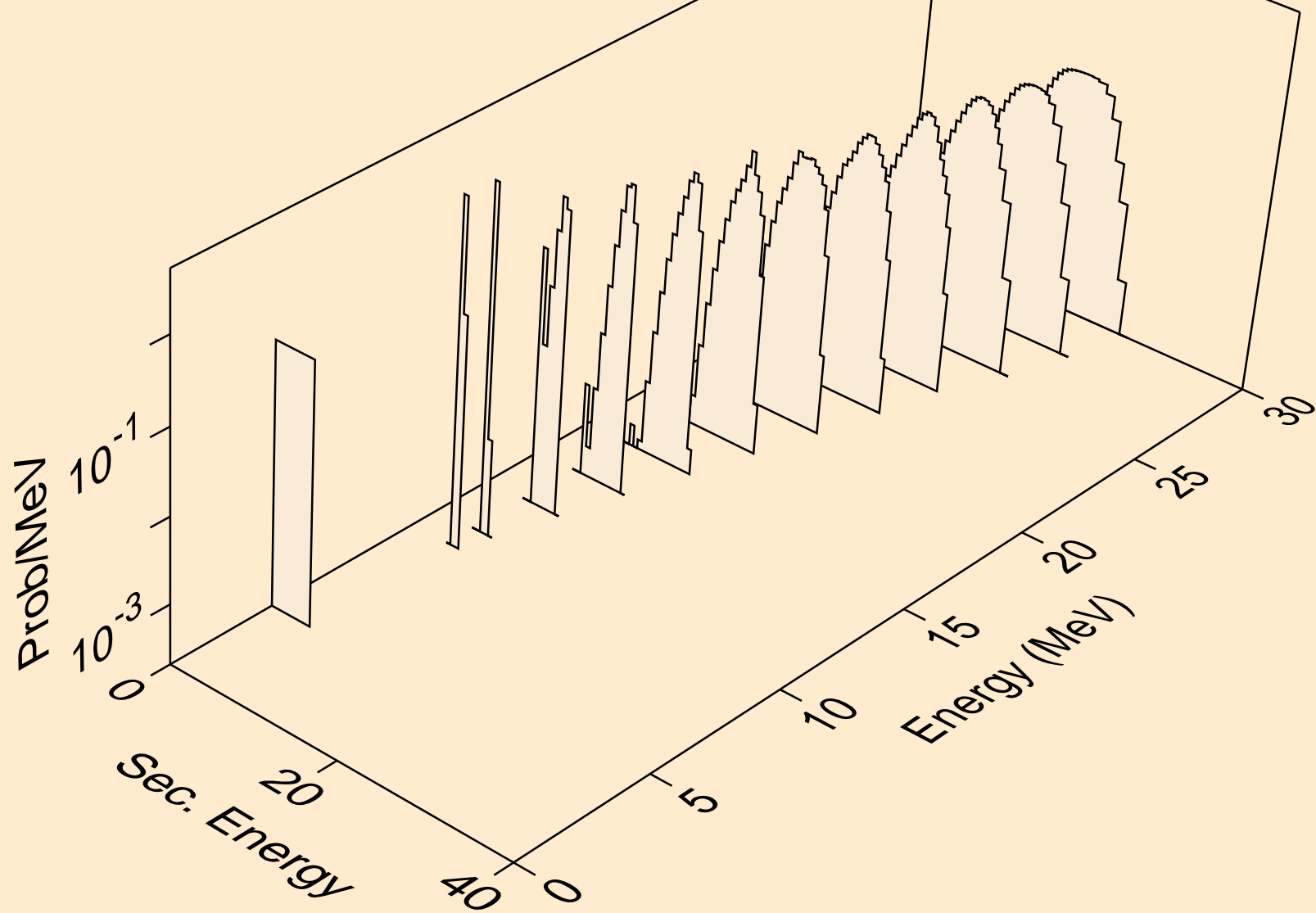

GD149 NEUTRON ACER TENDL-2024 LIBRARY; T=0.K
alphas from (n,3n)a

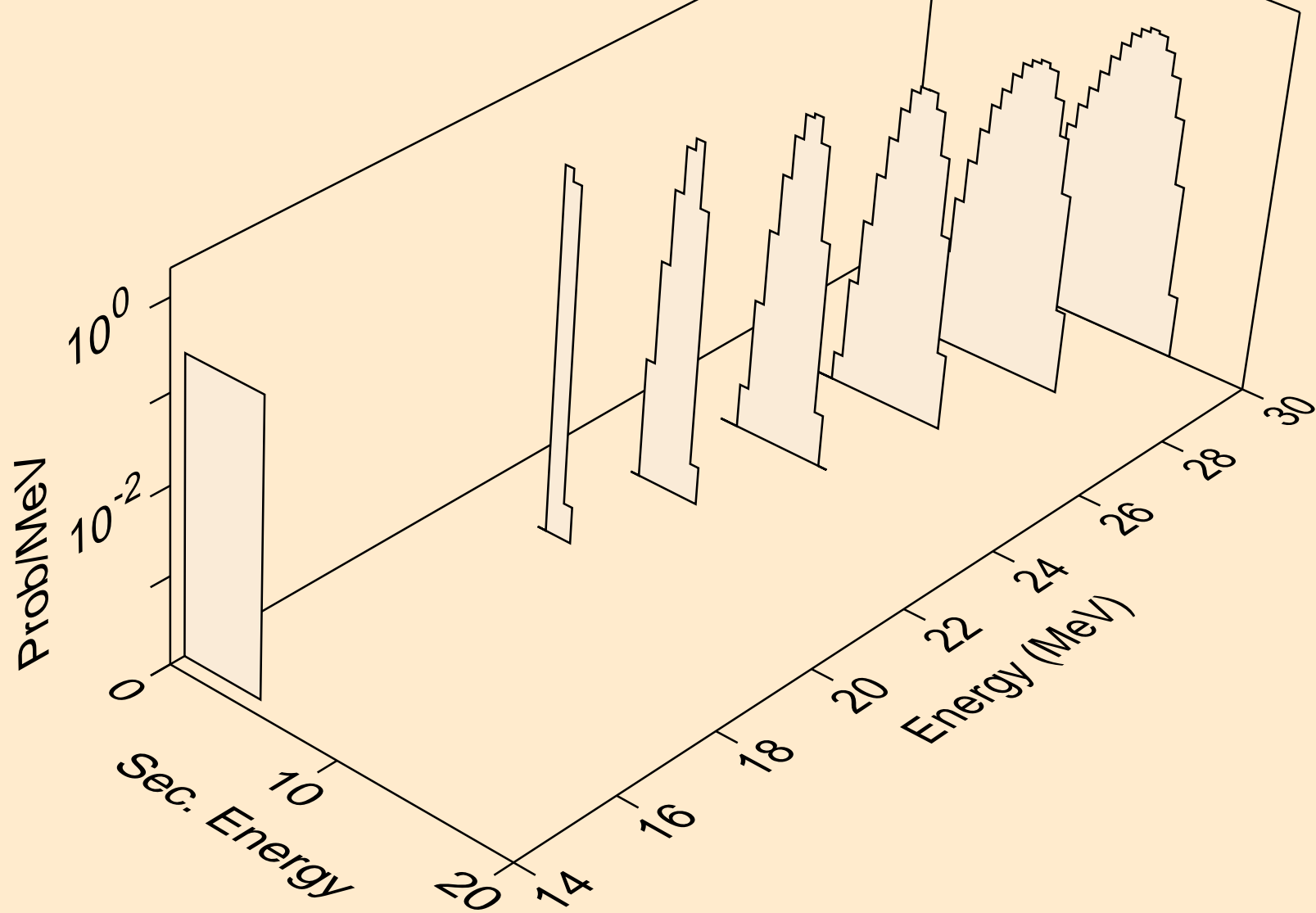

GD149 NEUTRON ACER TENDL-2024 LIBRARY; T=0.K
alphas from (n,n*)2a

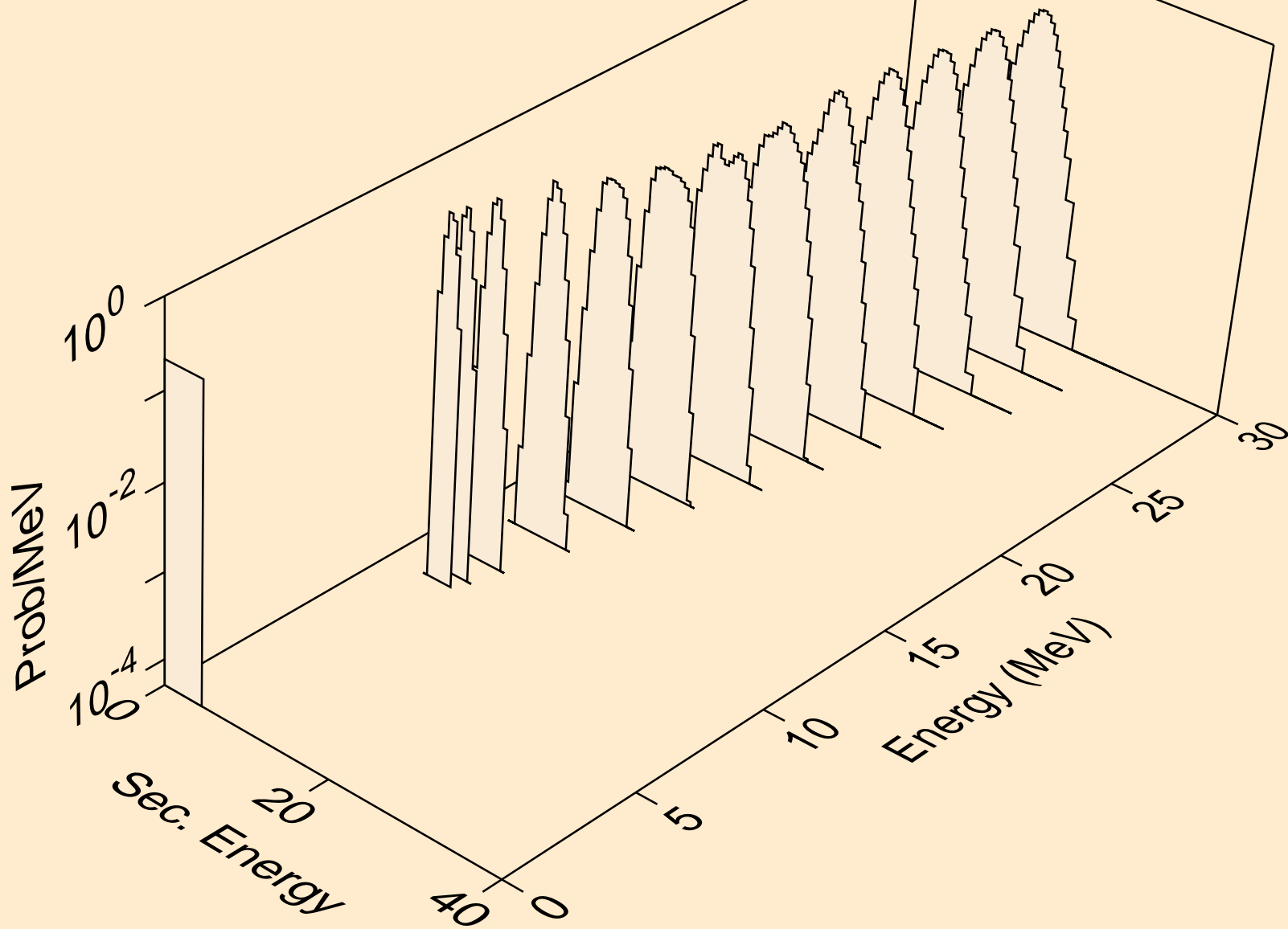

GD149 NEUTRON ACER TENDL-2024 LIBRARY; T=0.K
alphas from (n,2n)2a

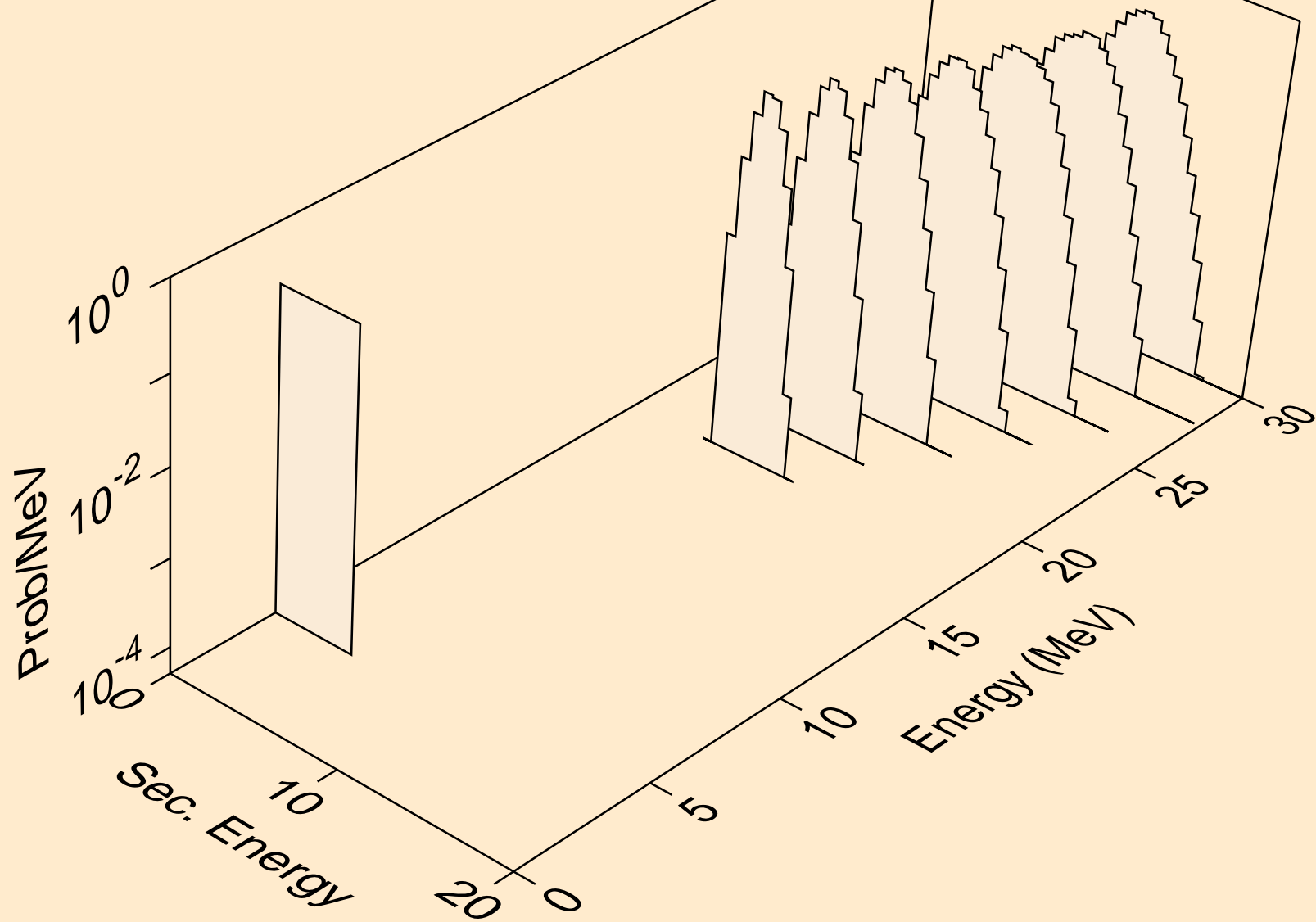

GD149 NEUTRON ACER TENDL-2024 LIBRARY; T=0.K
alphas from (n,npa)

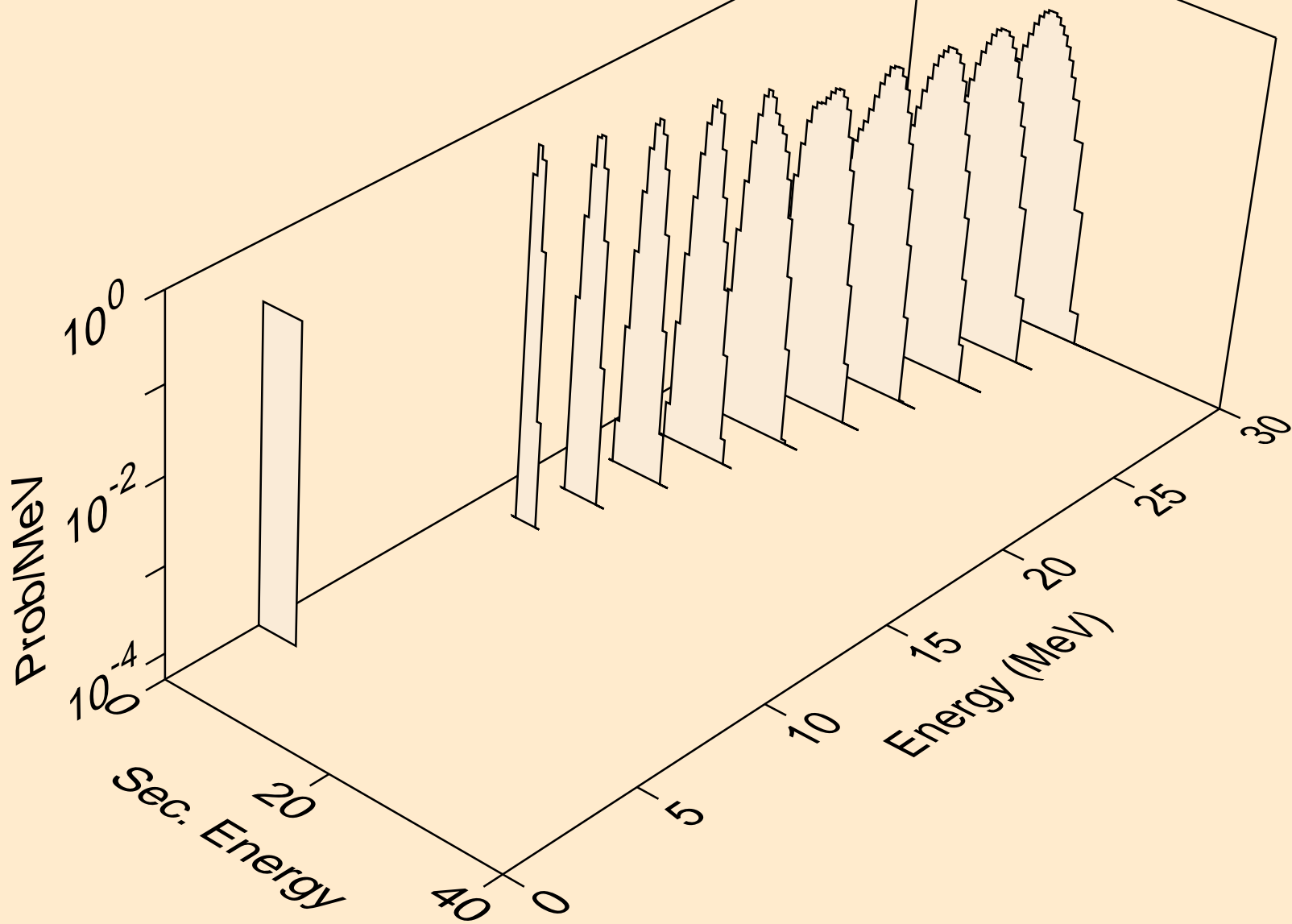

GD149 NEUTRON ACER TENDL-2024 LIBRARY; T=0.K
alphas from (n,a)

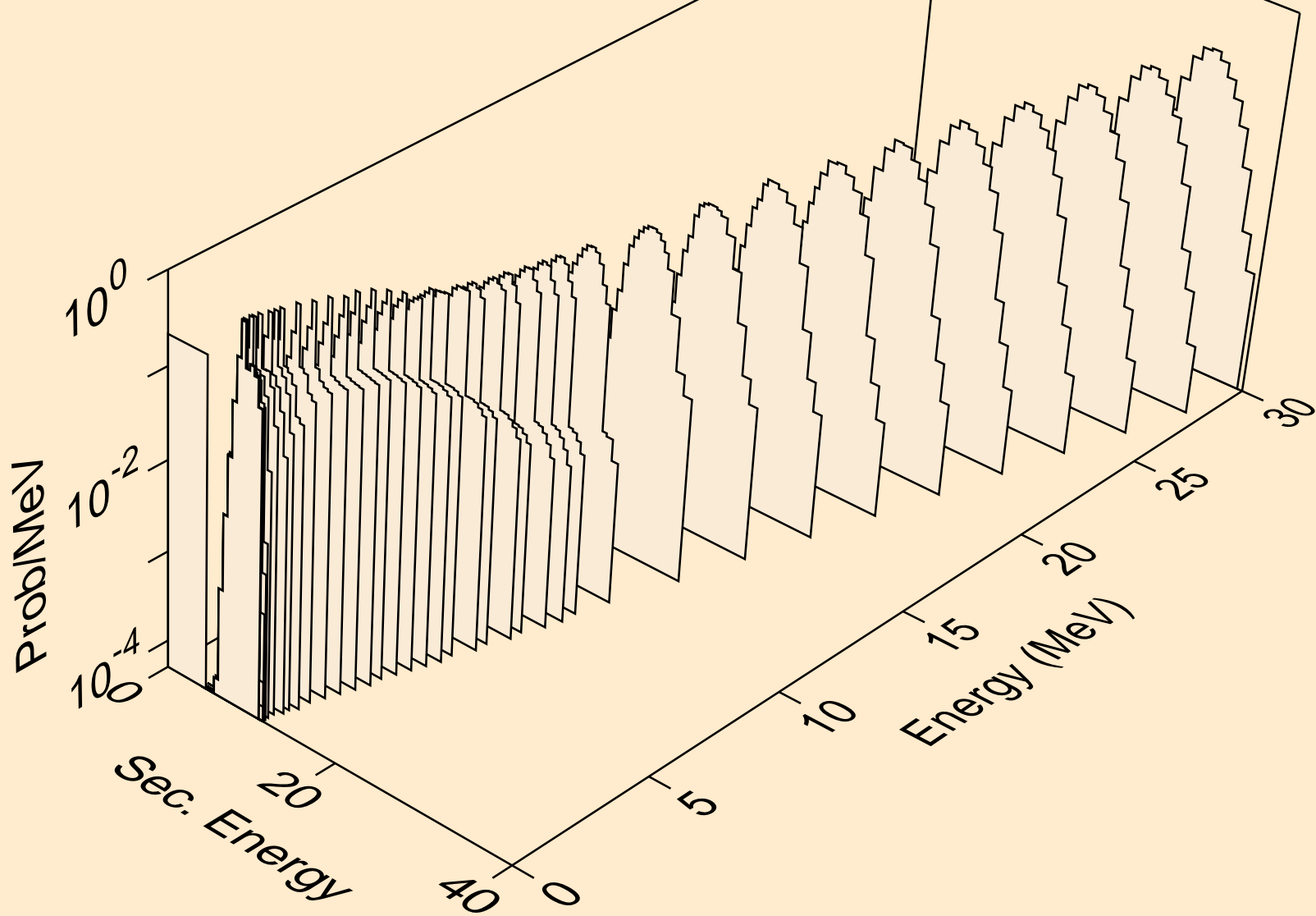

GD149 NEUTRON ACER TENDL-2024 LIBRARY; T=0.K
alphas from (n,2a)

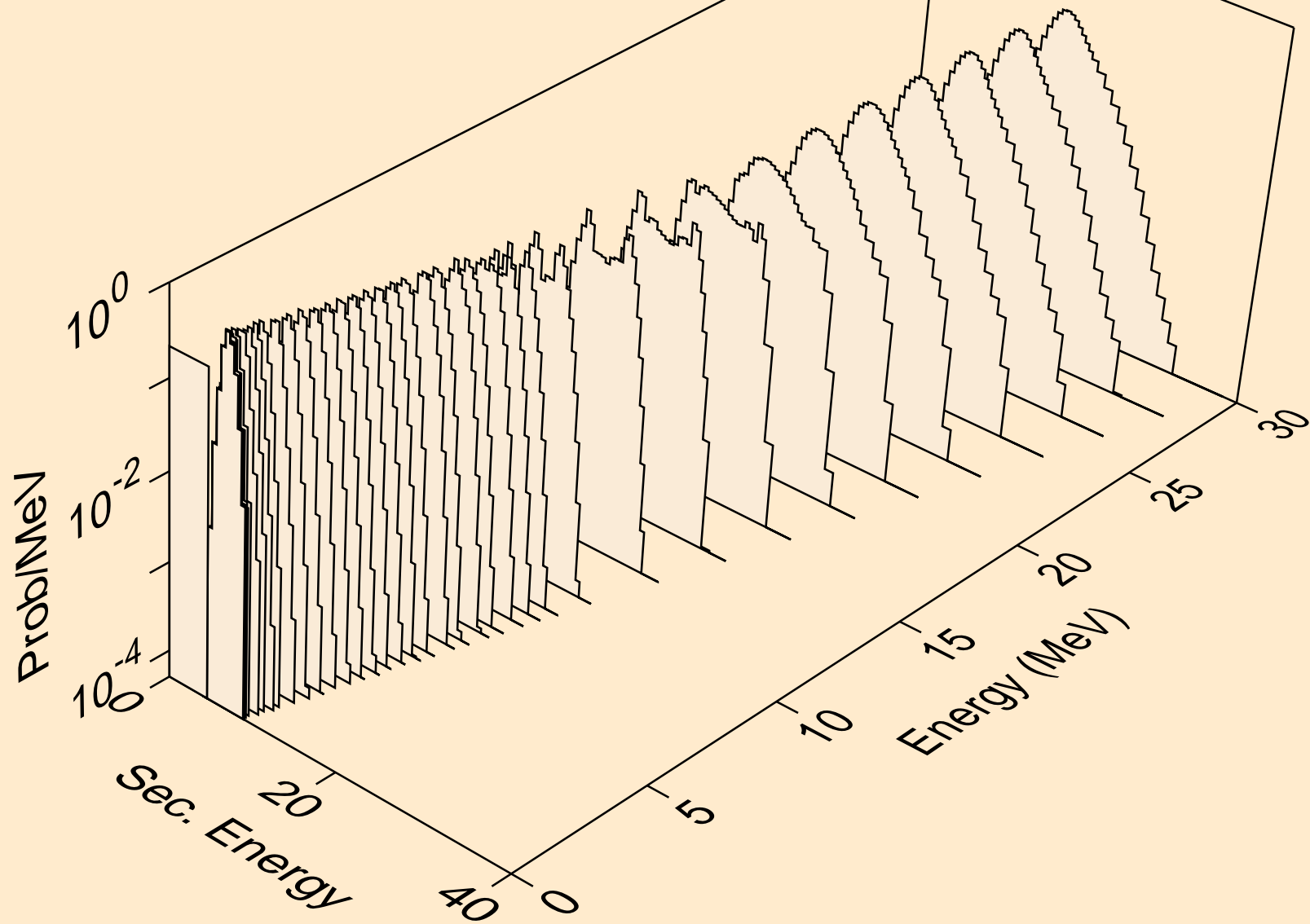

GD149 NEUTRON ACER TENDL-2024 LIBRARY; T=0.K
alphas from (n,pa)

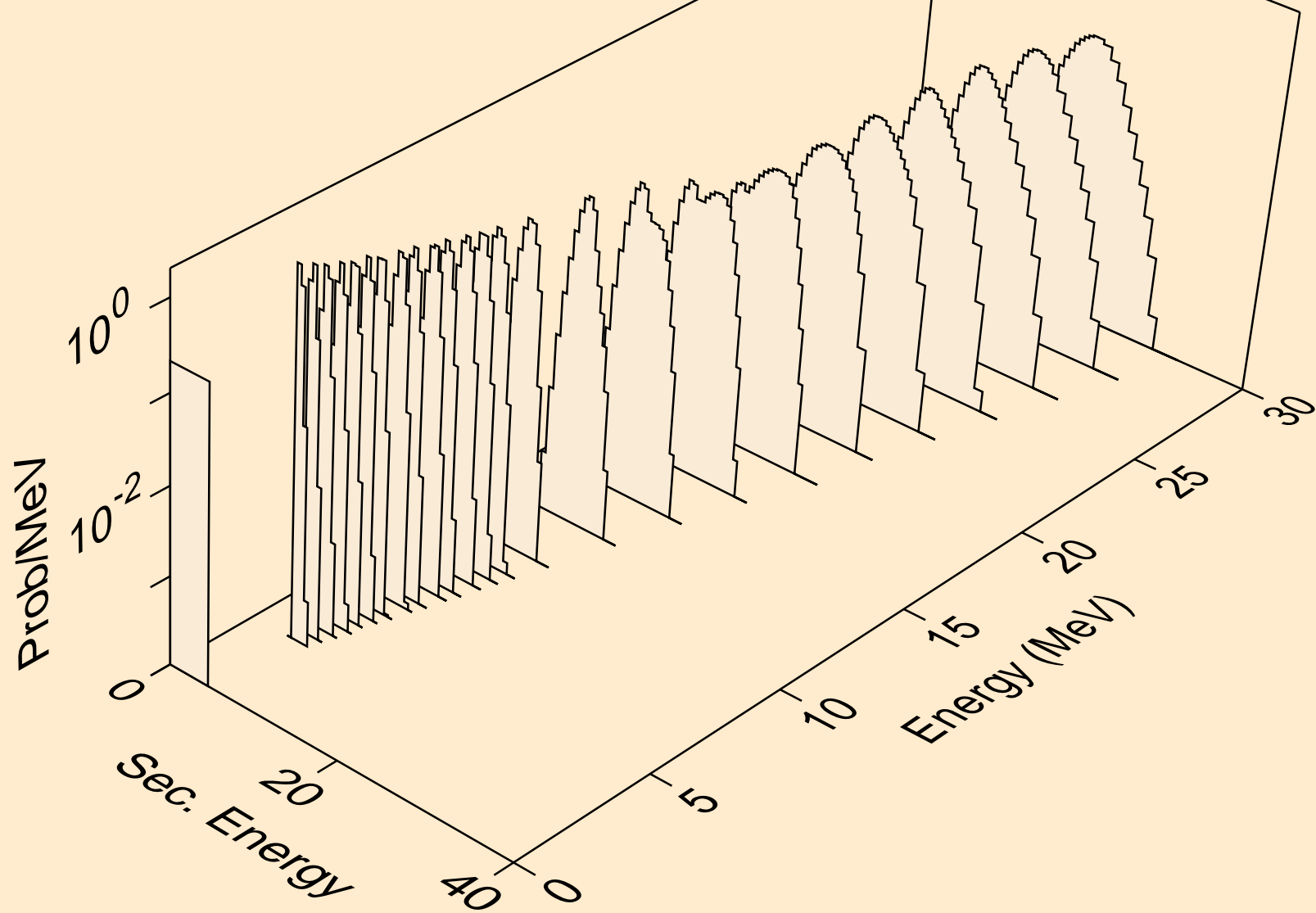

GD149 NEUTRON ACER TENDL-2024 LIBRARY; T=0.K
alphas from (n,da)

