

# HF182 NEUTRON ACER TENDL-2024 LIBRARY; T=0.K

## Principal cross sections

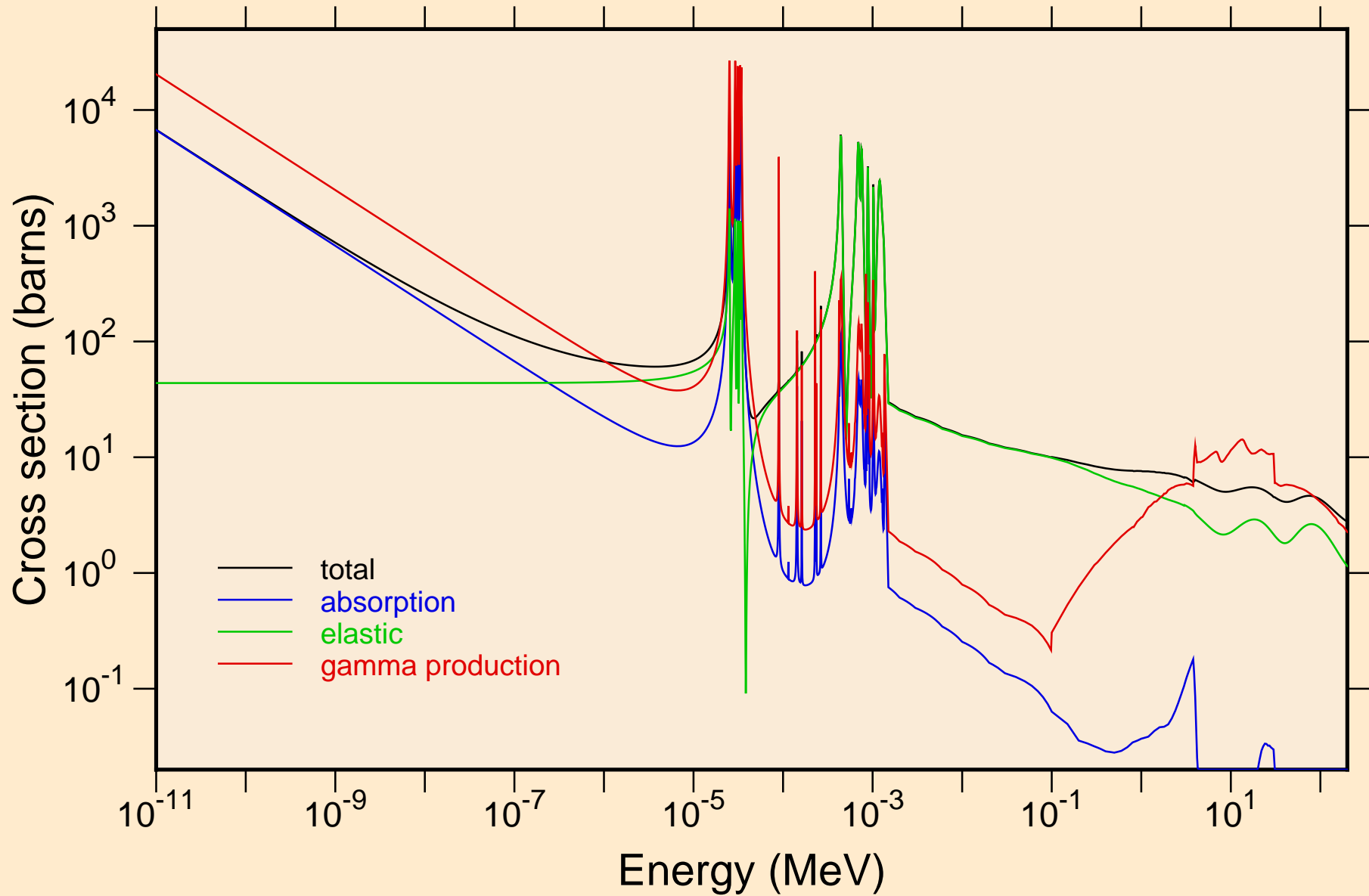

HF182 NEUTRON ACER TENDL-2024 LIBRARY; T=0.K  
resonance total cross section

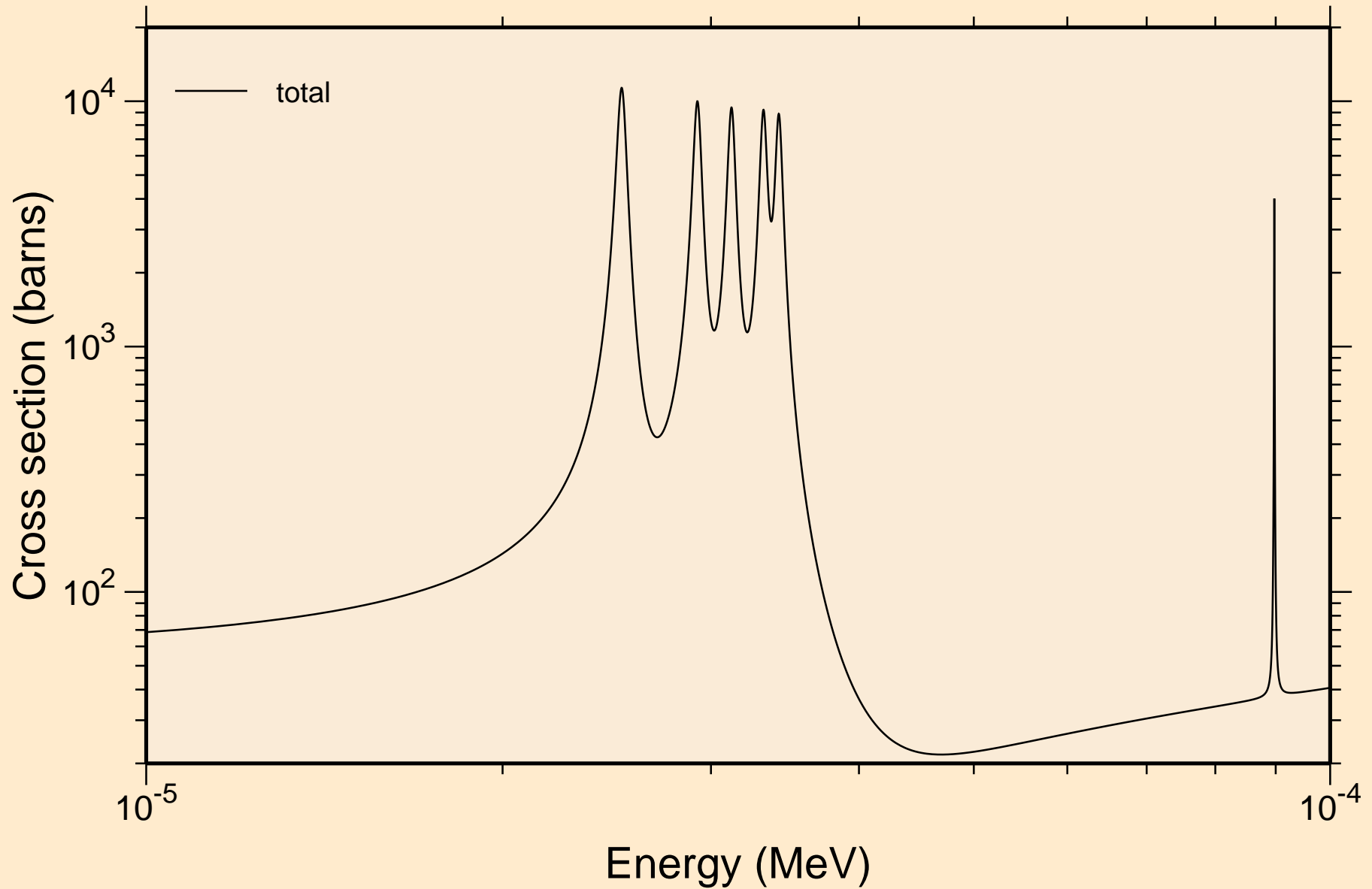

HF182 NEUTRON ACER TENDL-2024 LIBRARY; T=0.K  
resonance total cross section

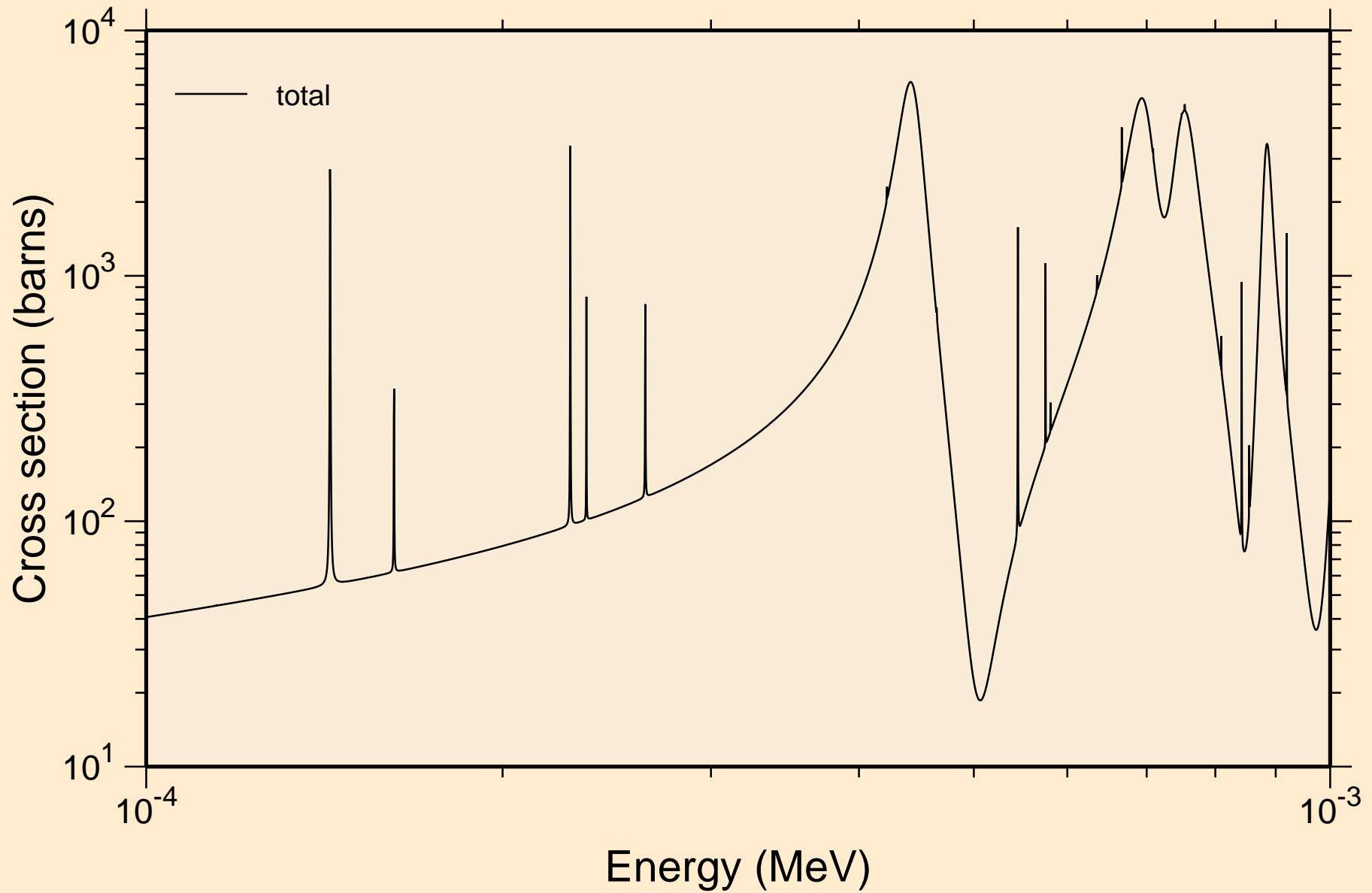

HF182 NEUTRON ACER TENDL-2024 LIBRARY; T=0.K  
resonance total cross section

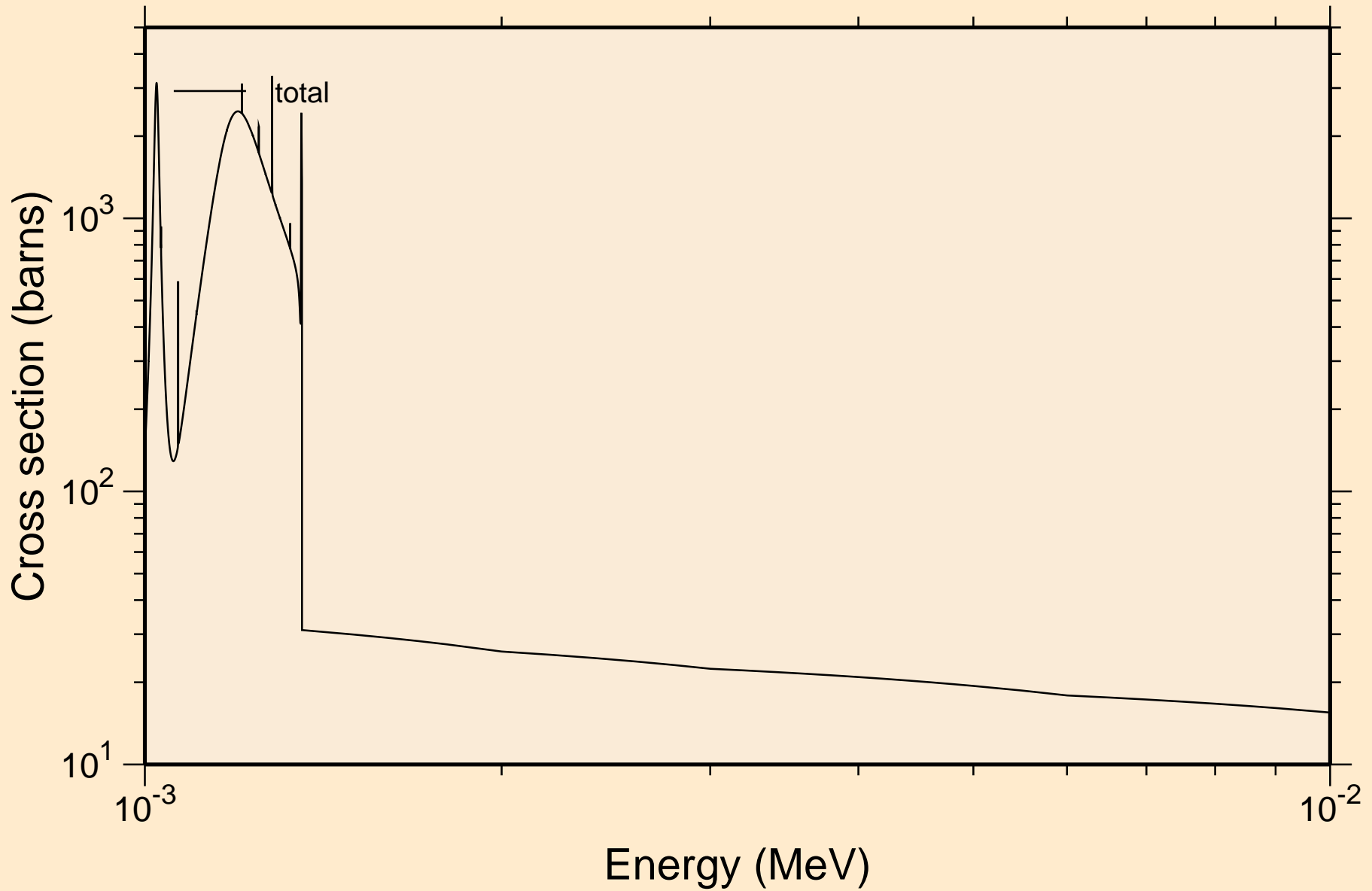

HF182 NEUTRON ACER TENDL-2024 LIBRARY; T=0.K  
resonance total cross section

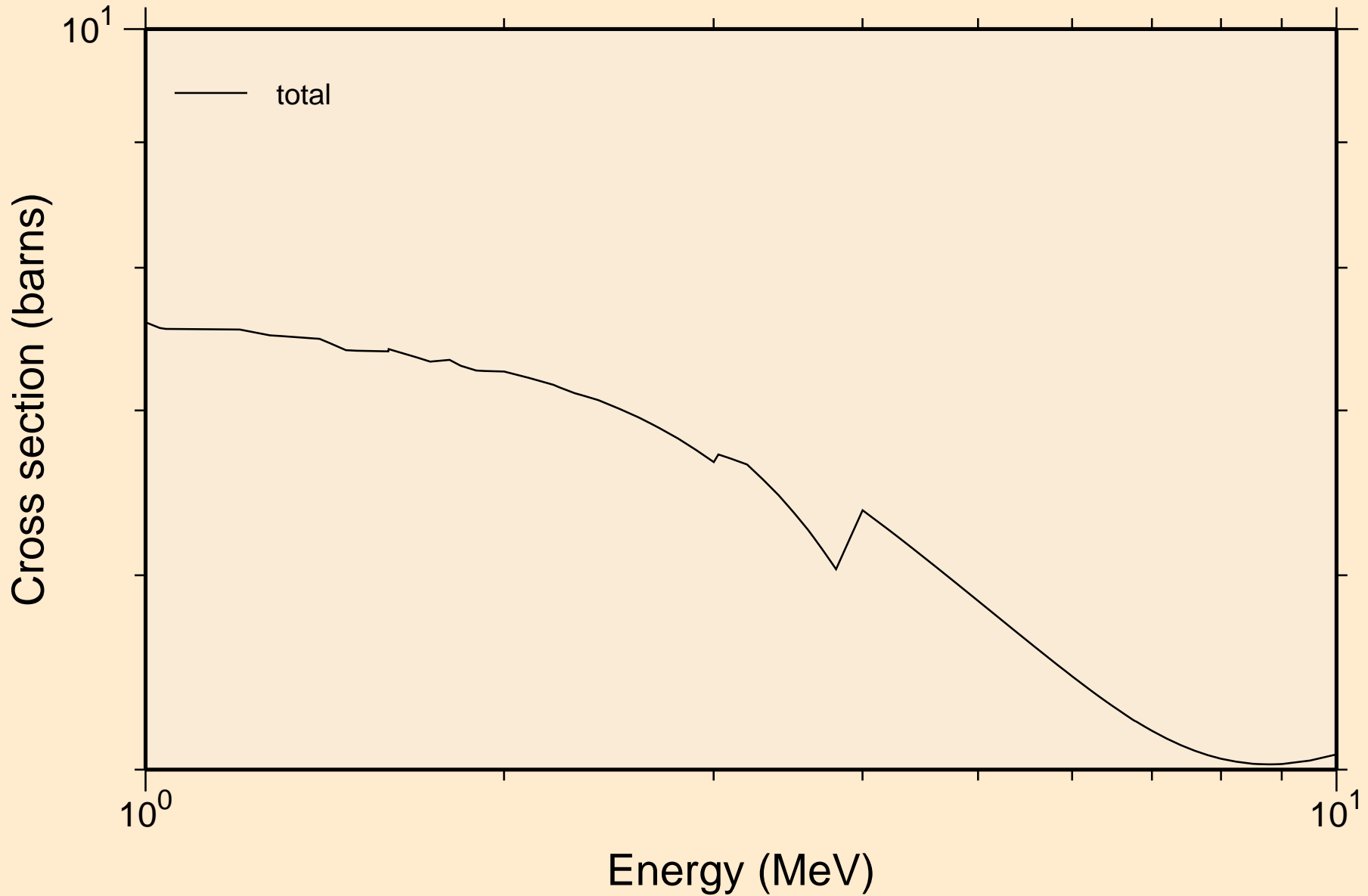

HF182 NEUTRON ACER TENDL-2024 LIBRARY; T=0.K  
resonance absorption cross sections

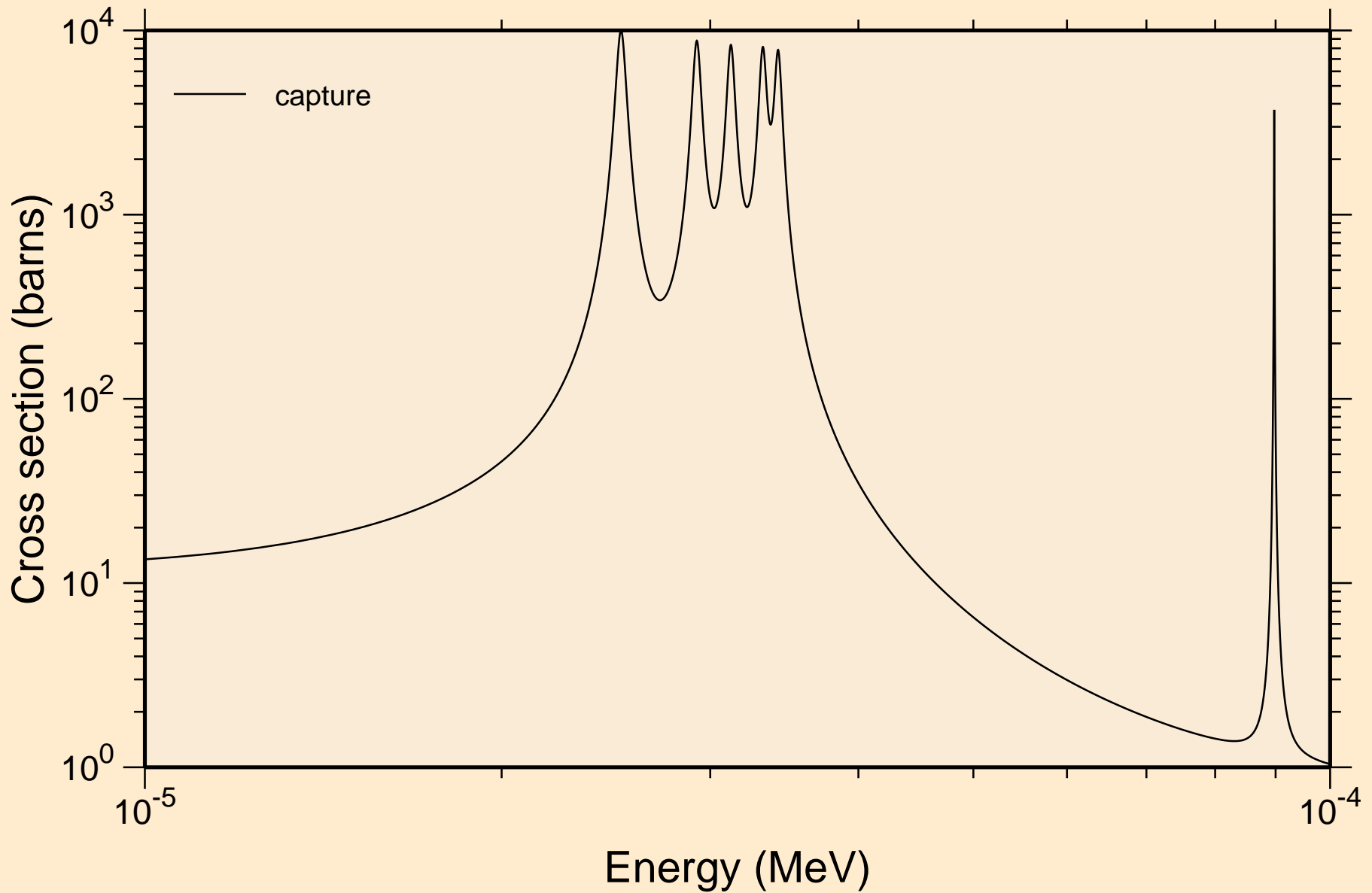

HF182 NEUTRON ACER TENDL-2024 LIBRARY; T=0.K  
resonance absorption cross sections

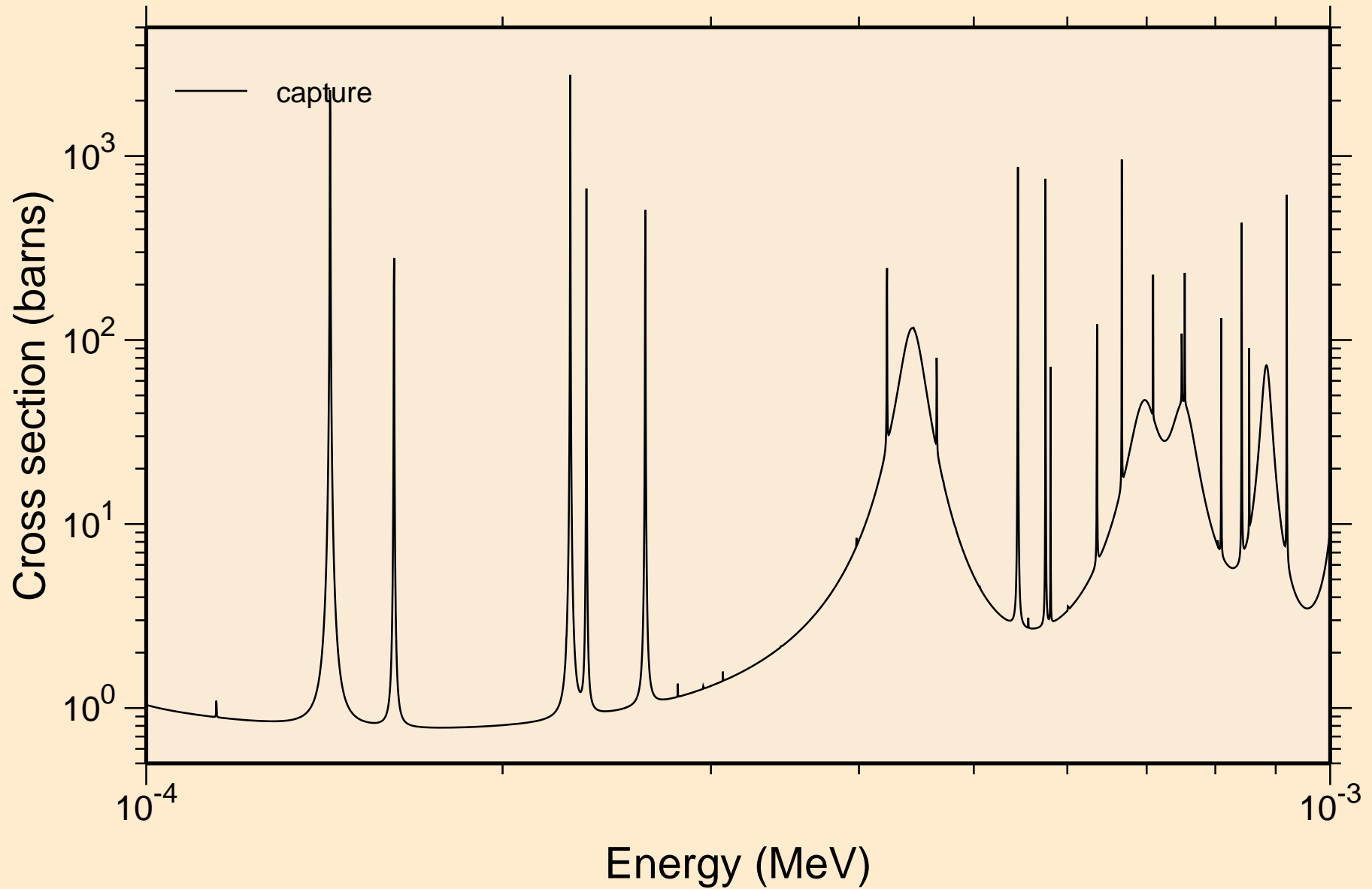

HF182 NEUTRON ACER TENDL-2024 LIBRARY; T=0.K  
resonance absorption cross sections

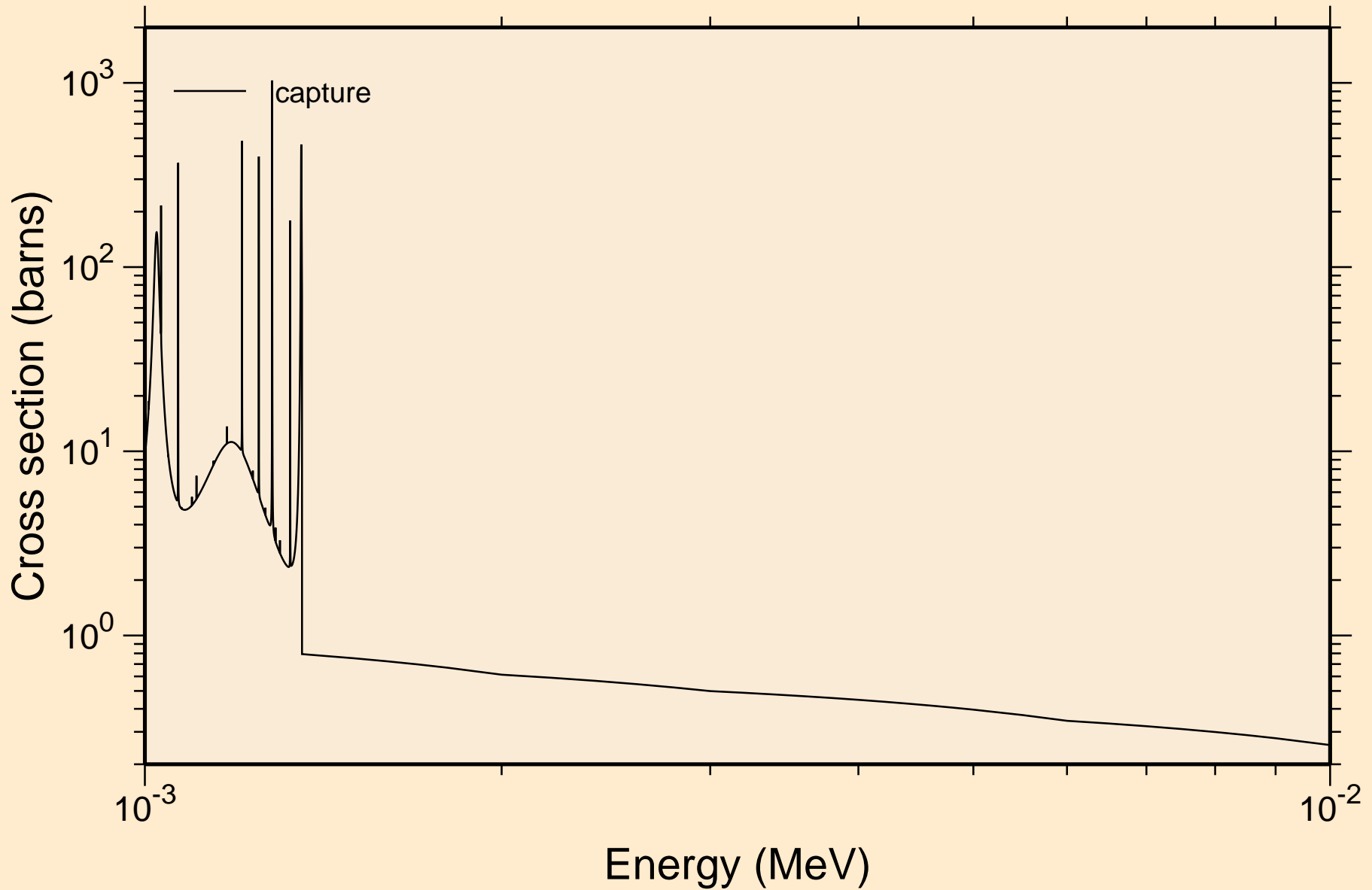

HF182 NEUTRON ACER TENDL-2024 LIBRARY; T=0.K  
resonance absorption cross sections

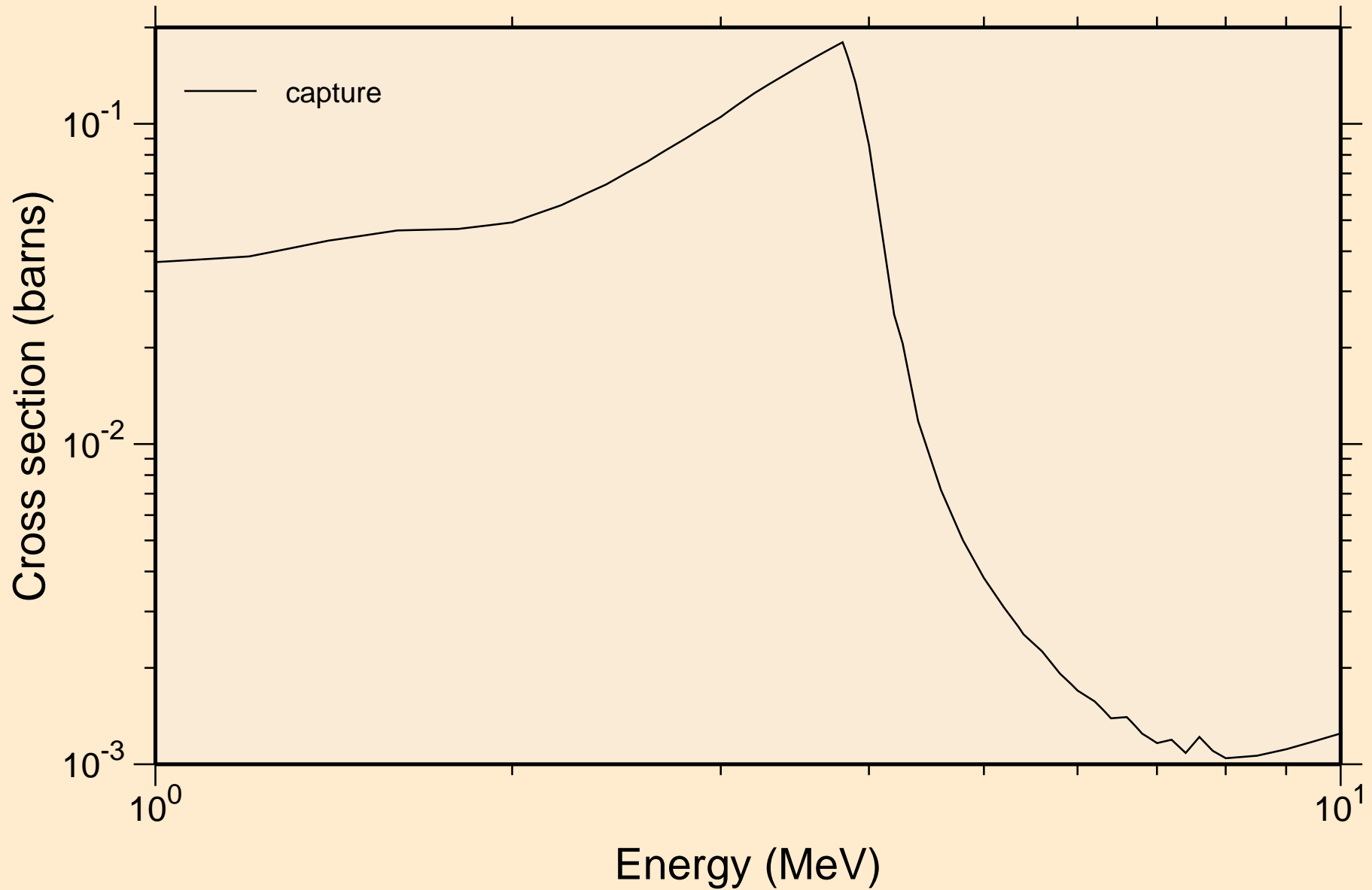

HF182 NEUTRON ACER TENDL-2024 LIBRARY; T=0.K  
Heating

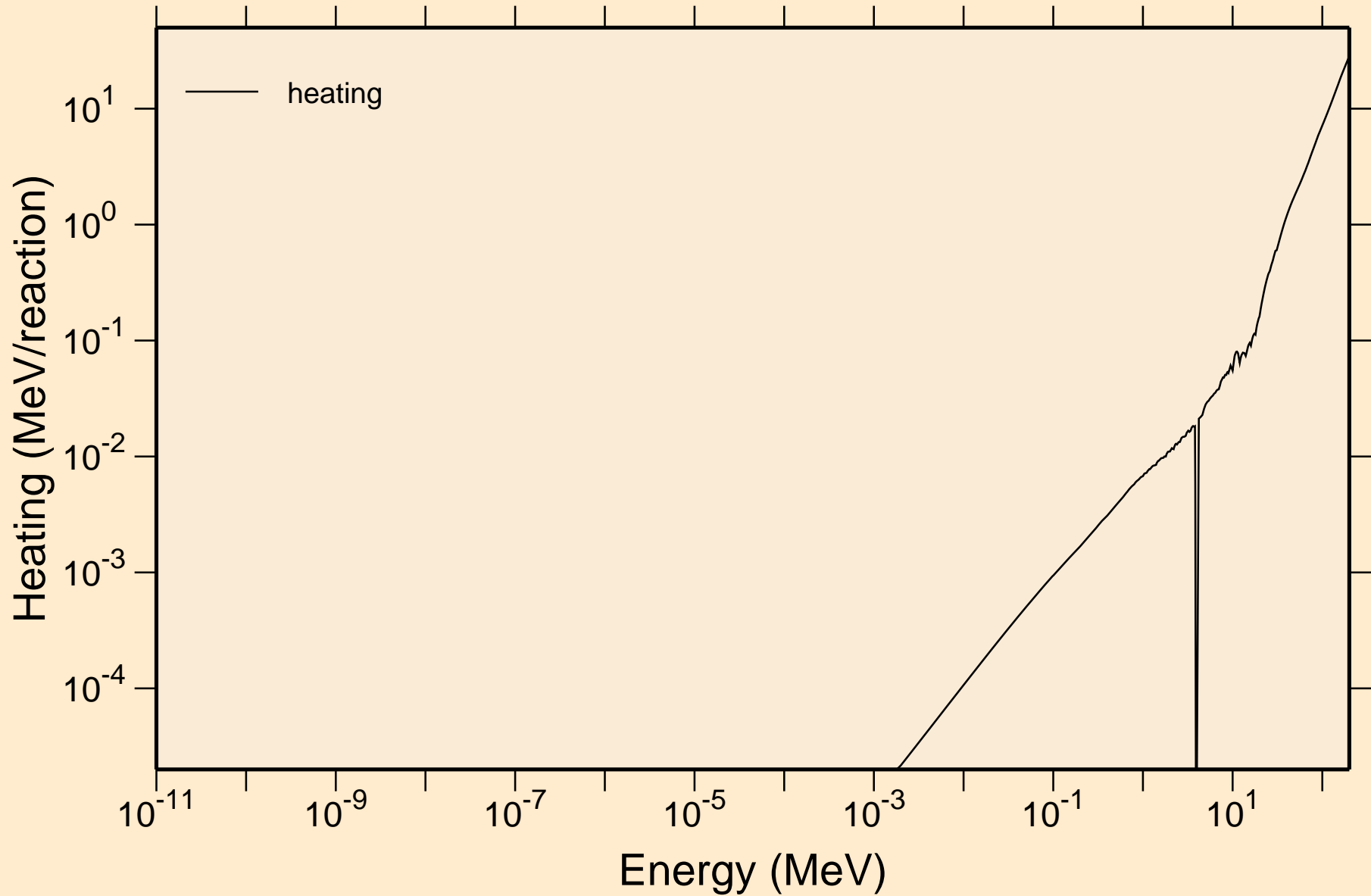

# HF182 NEUTRON ACER TENDL-2024 LIBRARY; T=0.K

## Damage

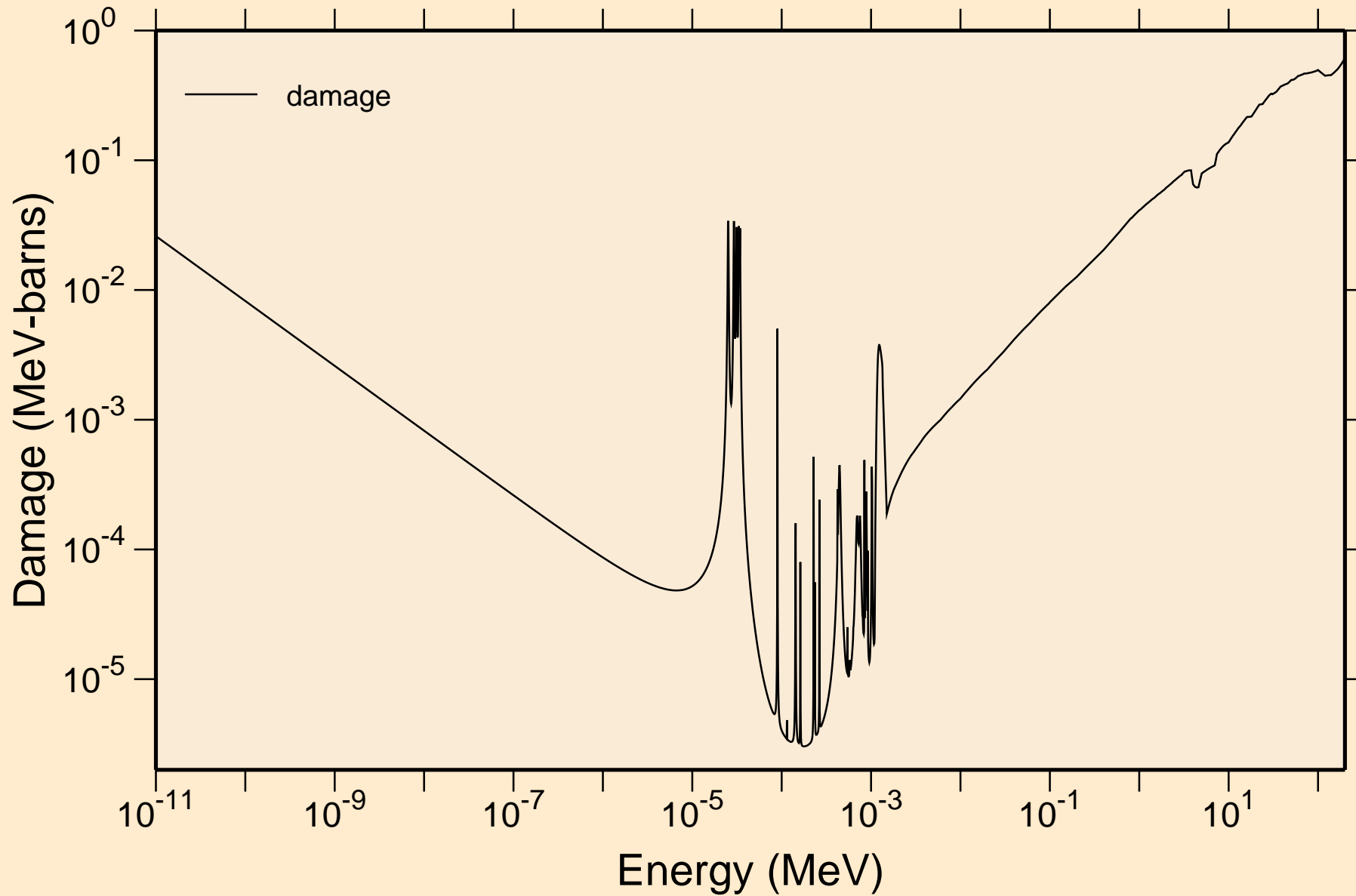

# HF182 NEUTRON ACER TENDL-2024 LIBRARY; T=0.K

## Non-threshold reactions

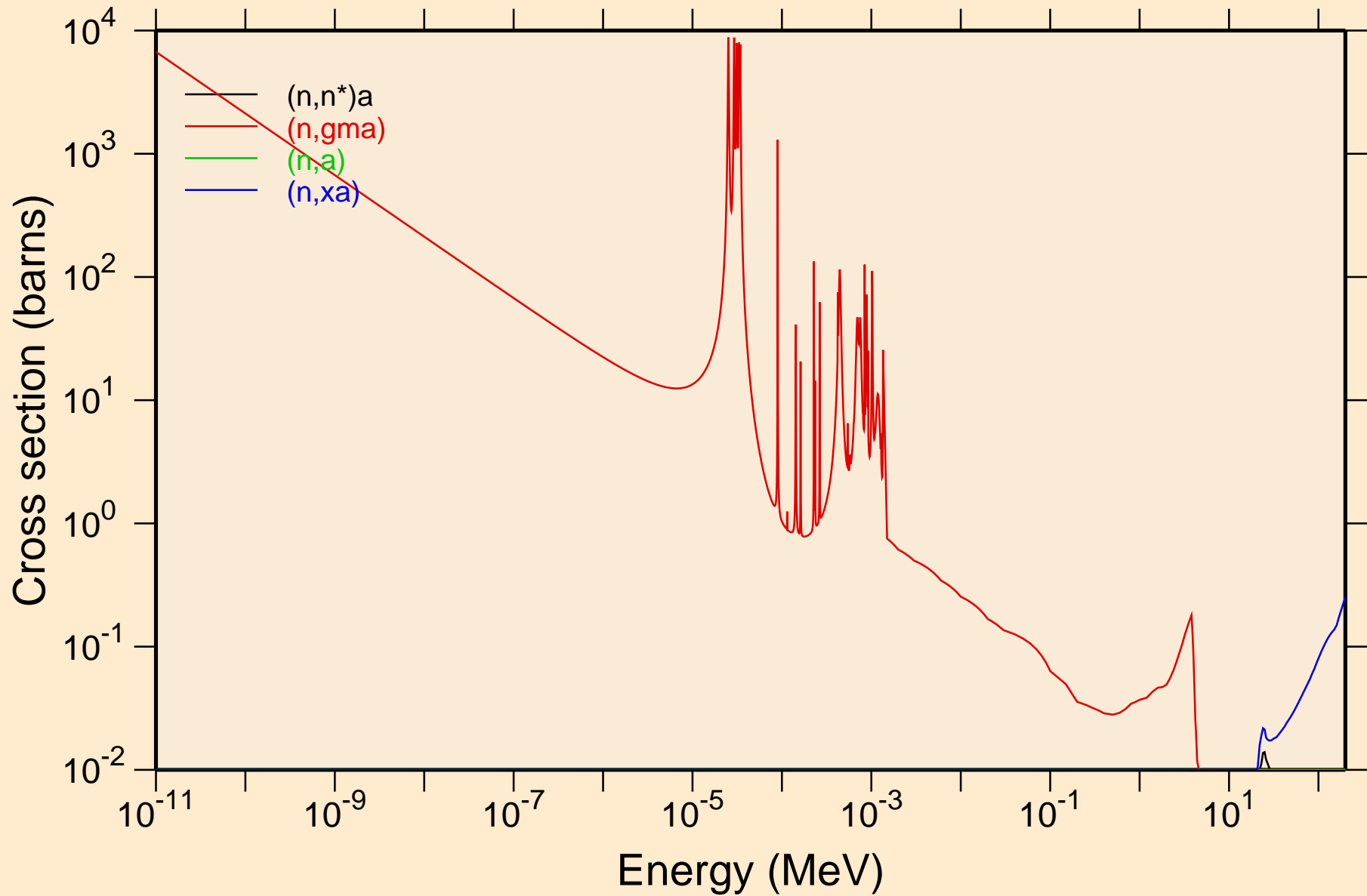

# HF182 NEUTRON ACER TENDL-2024 LIBRARY; T=0.K

## Principal cross sections

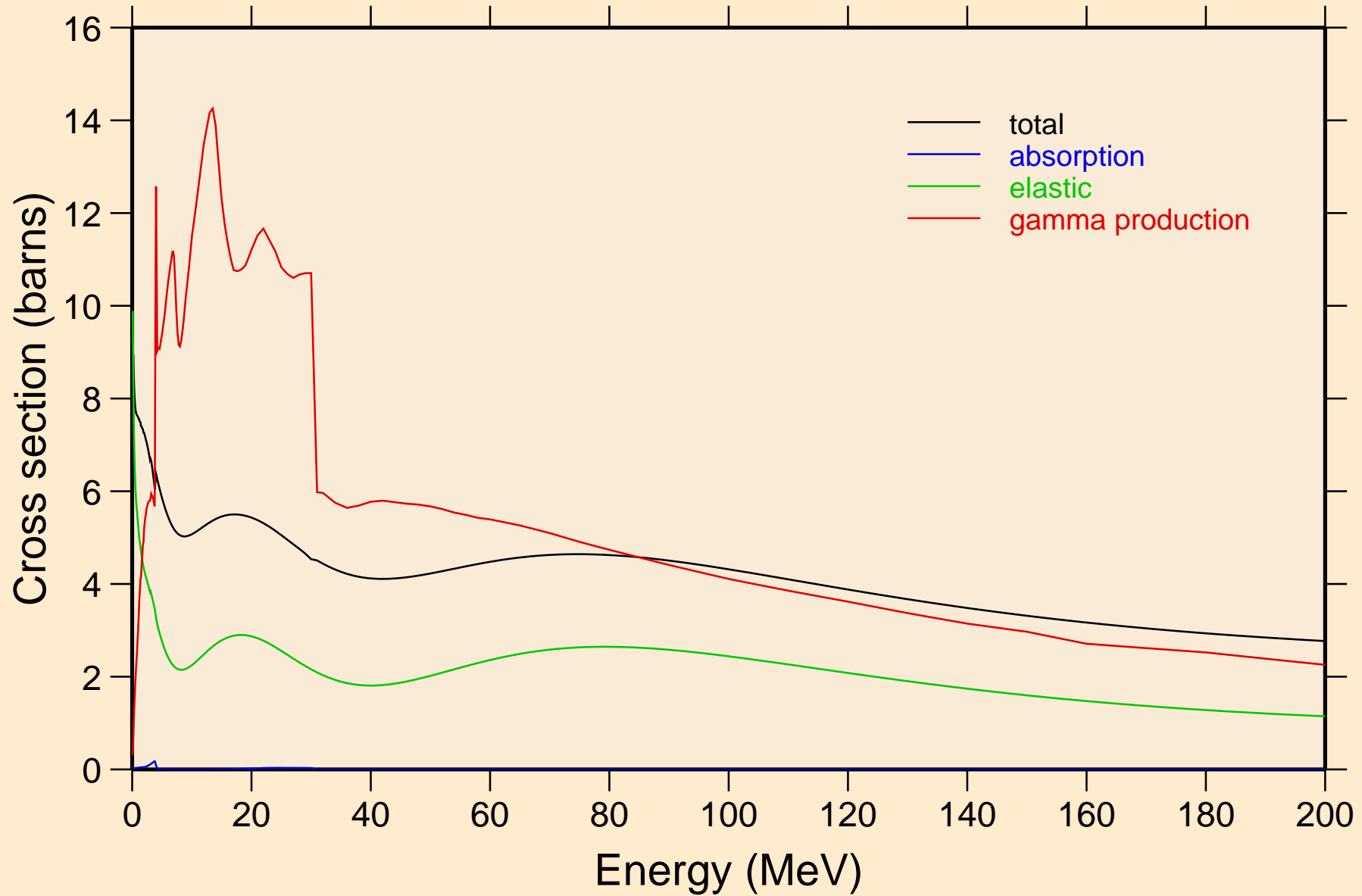

# HF182 NEUTRON ACER TENDL-2024 LIBRARY; T=0.K

## Heating

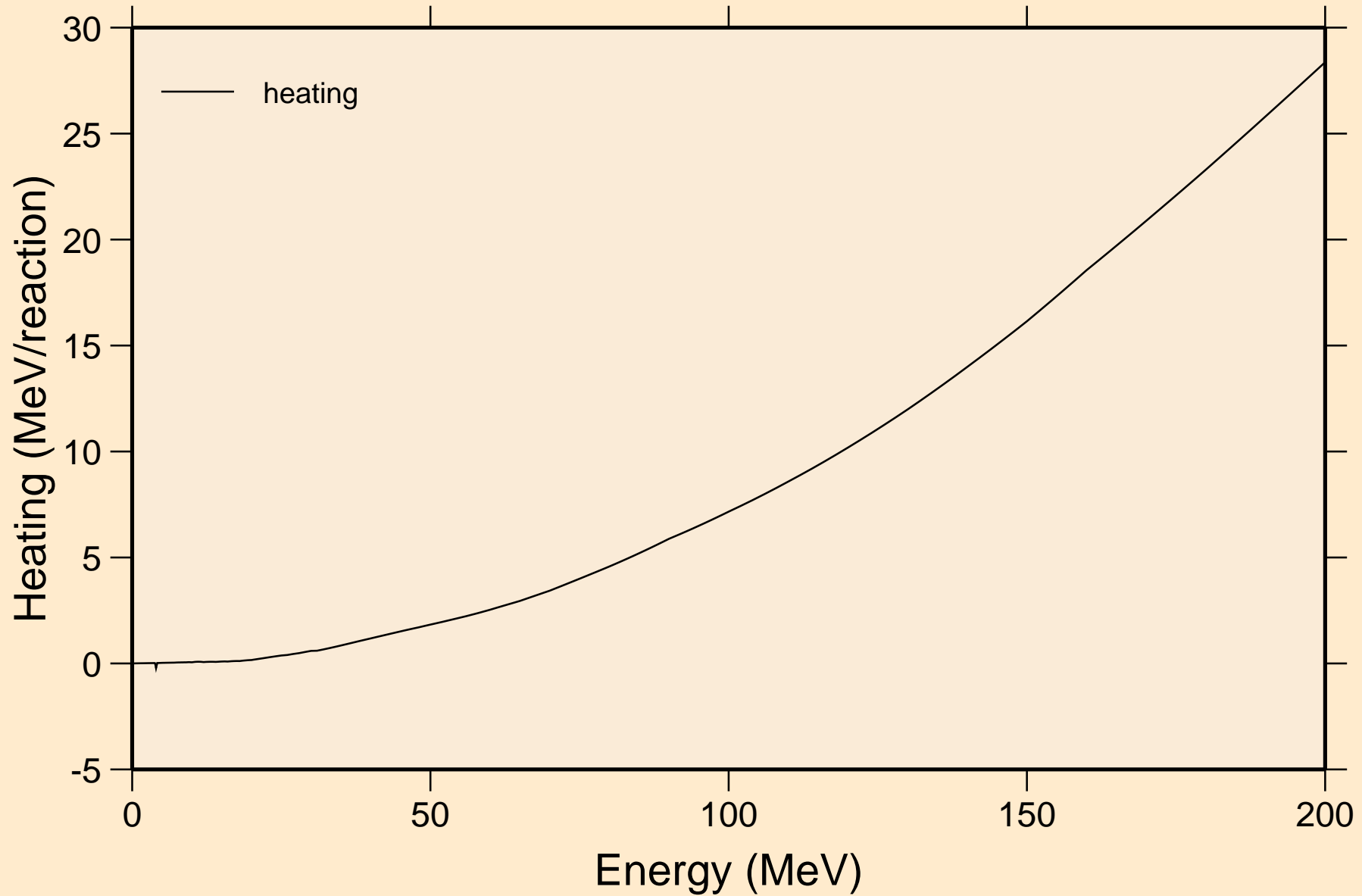

# HF182 NEUTRON ACER TENDL-2024 LIBRARY; T=0.K

## Damage

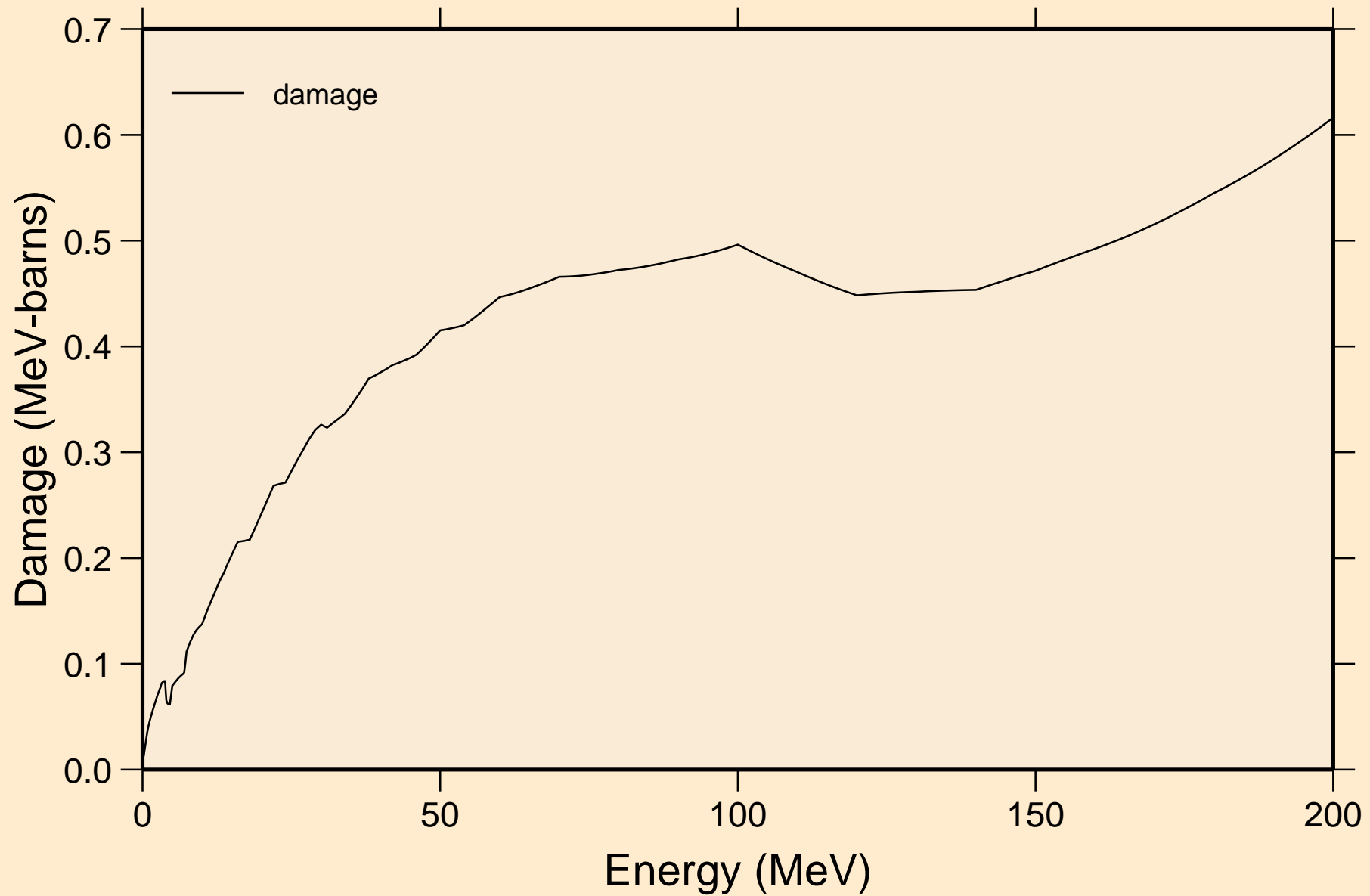

# HF182 NEUTRON ACER TENDL-2024 LIBRARY; T=0.K

## Non-threshold reactions

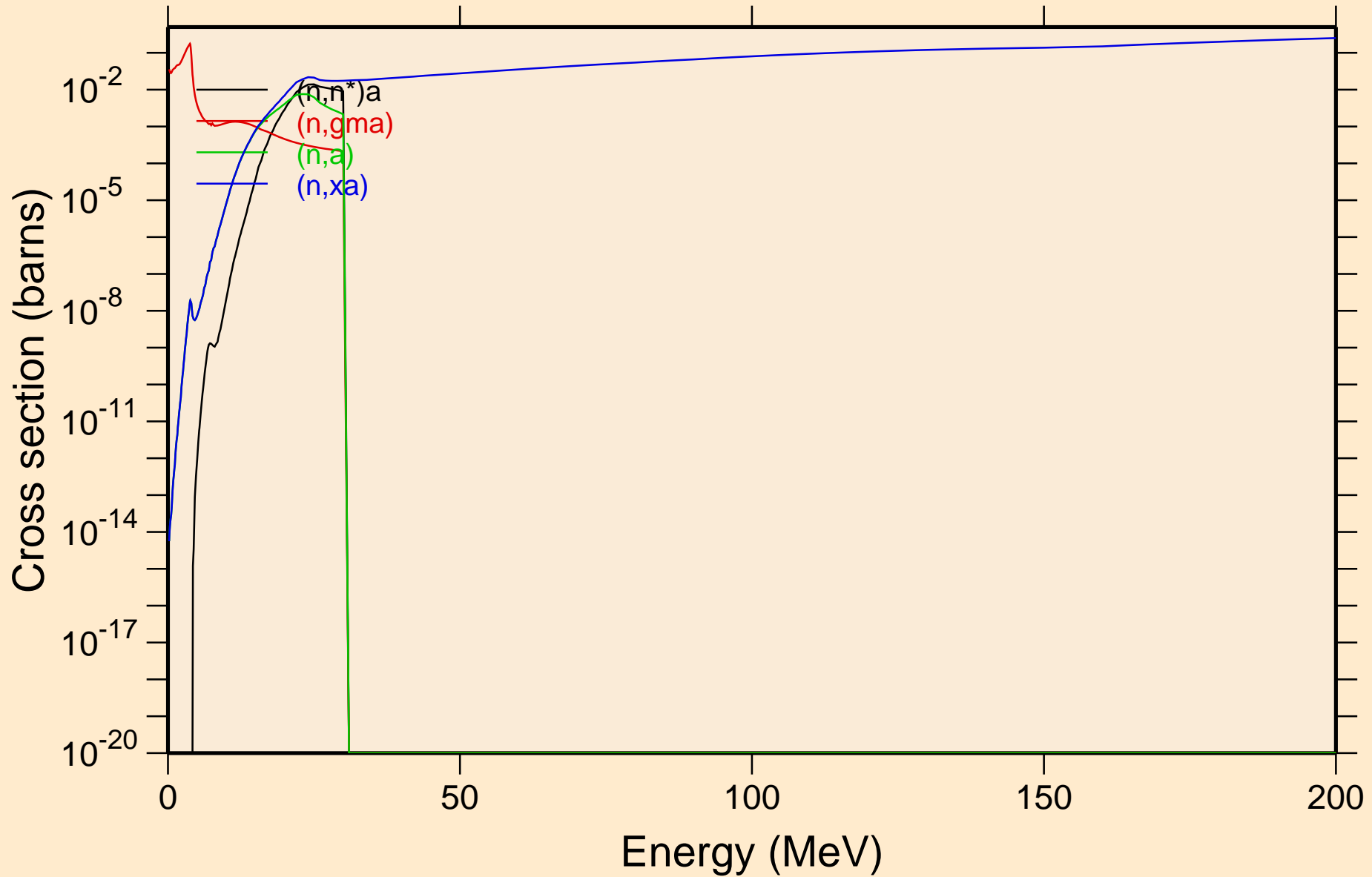

# HF182 NEUTRON ACER TENDL-2024 LIBRARY; T=0.K

## Inelastic levels

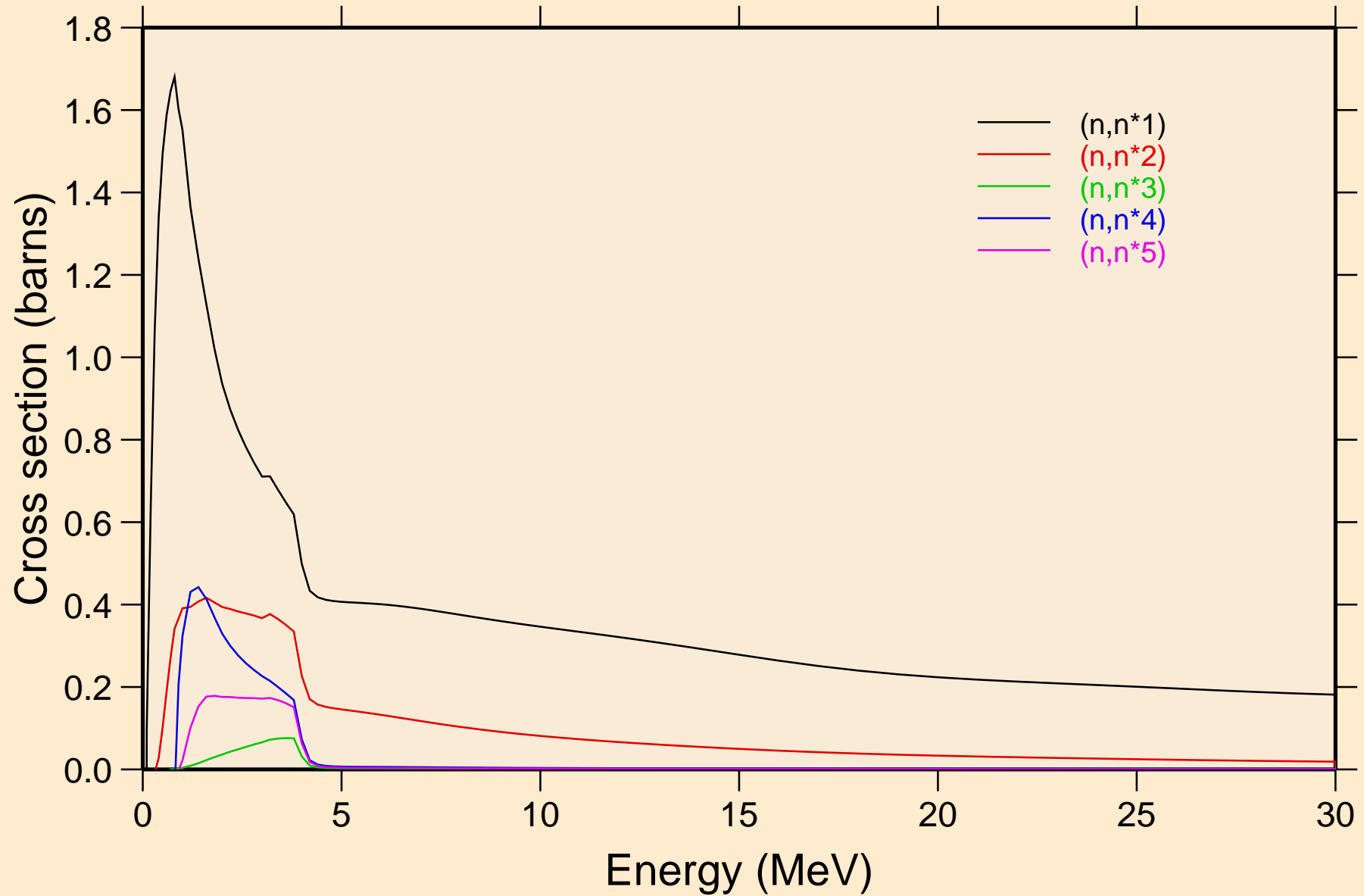

# HF182 NEUTRON ACER TENDL-2024 LIBRARY; T=0.K

## Inelastic levels

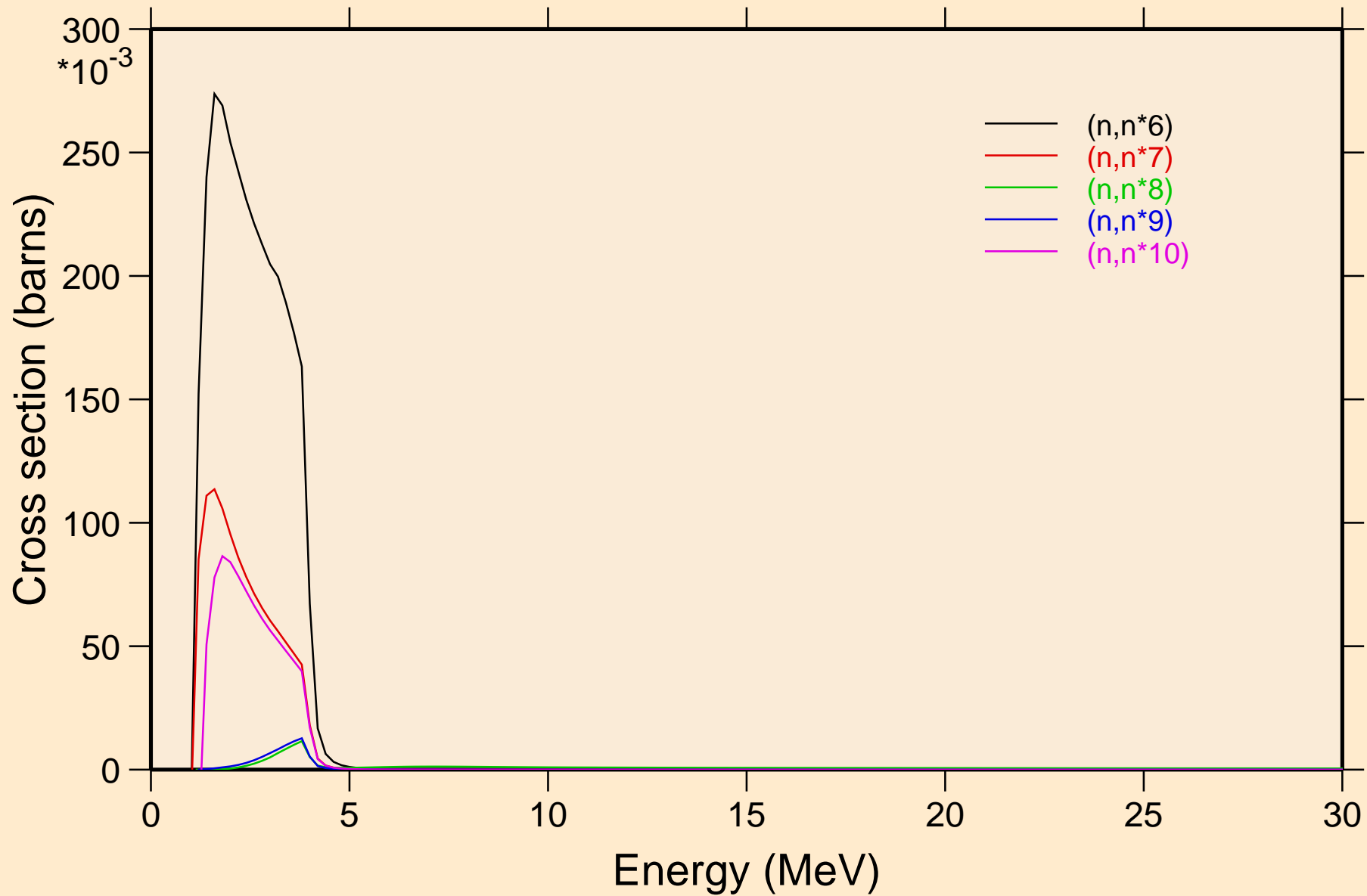

# HF182 NEUTRON ACER TENDL-2024 LIBRARY; T=0.K

## Inelastic levels

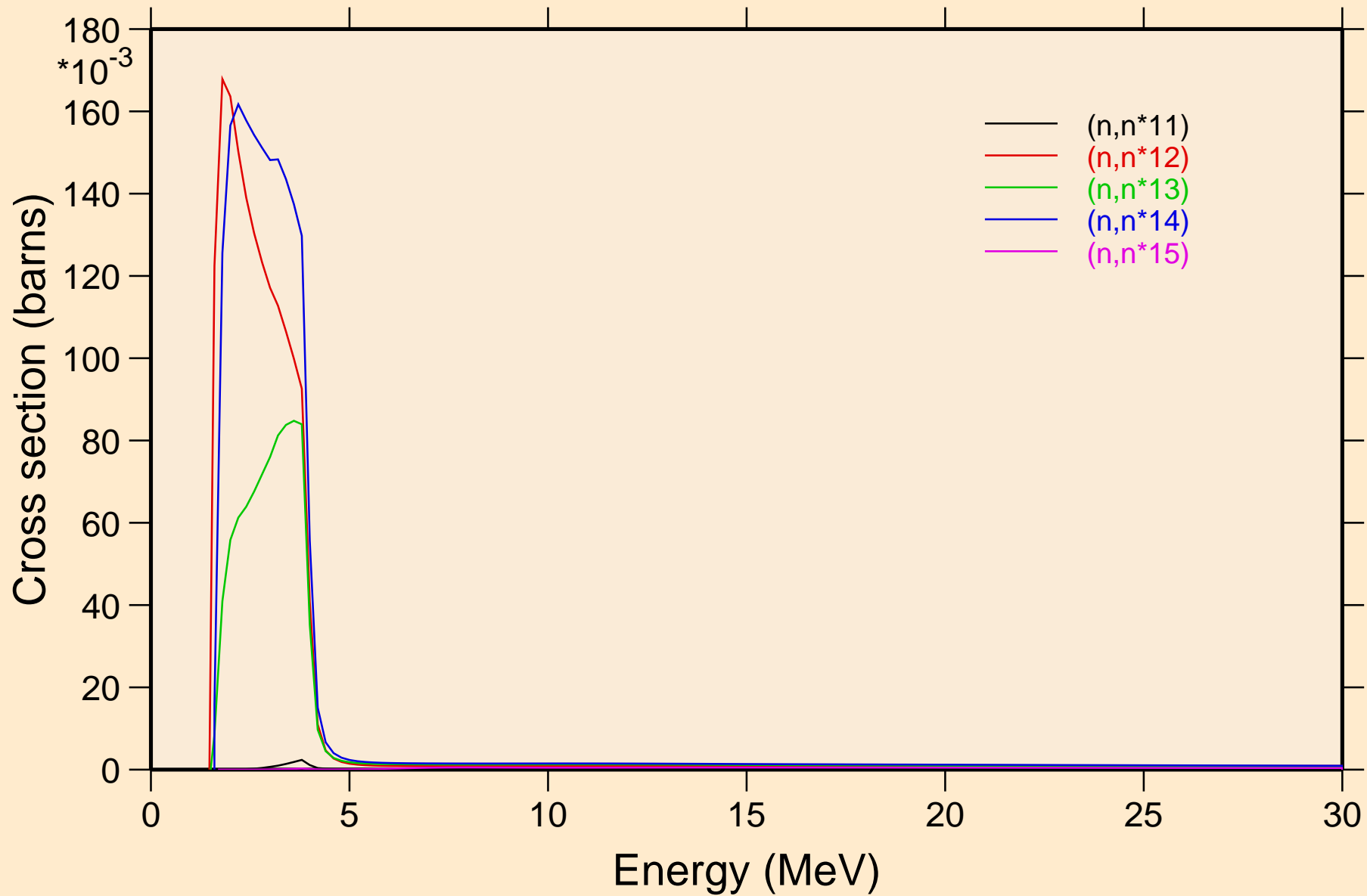

# HF182 NEUTRON ACER TENDL-2024 LIBRARY; T=0.K

## Inelastic levels

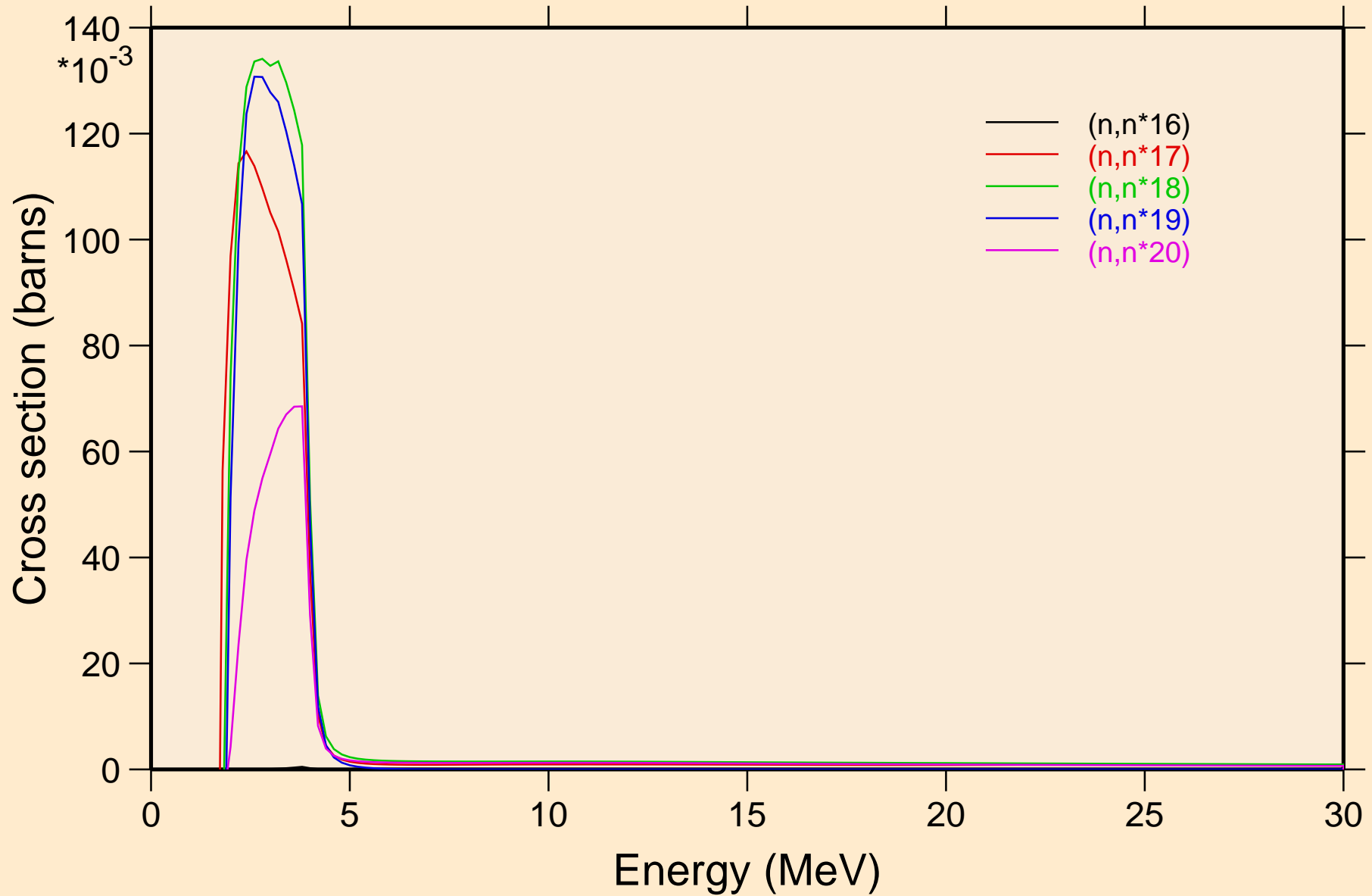

HF182 NEUTRON ACER TENDL-2024 LIBRARY; T=0.K  
Inelastic levels

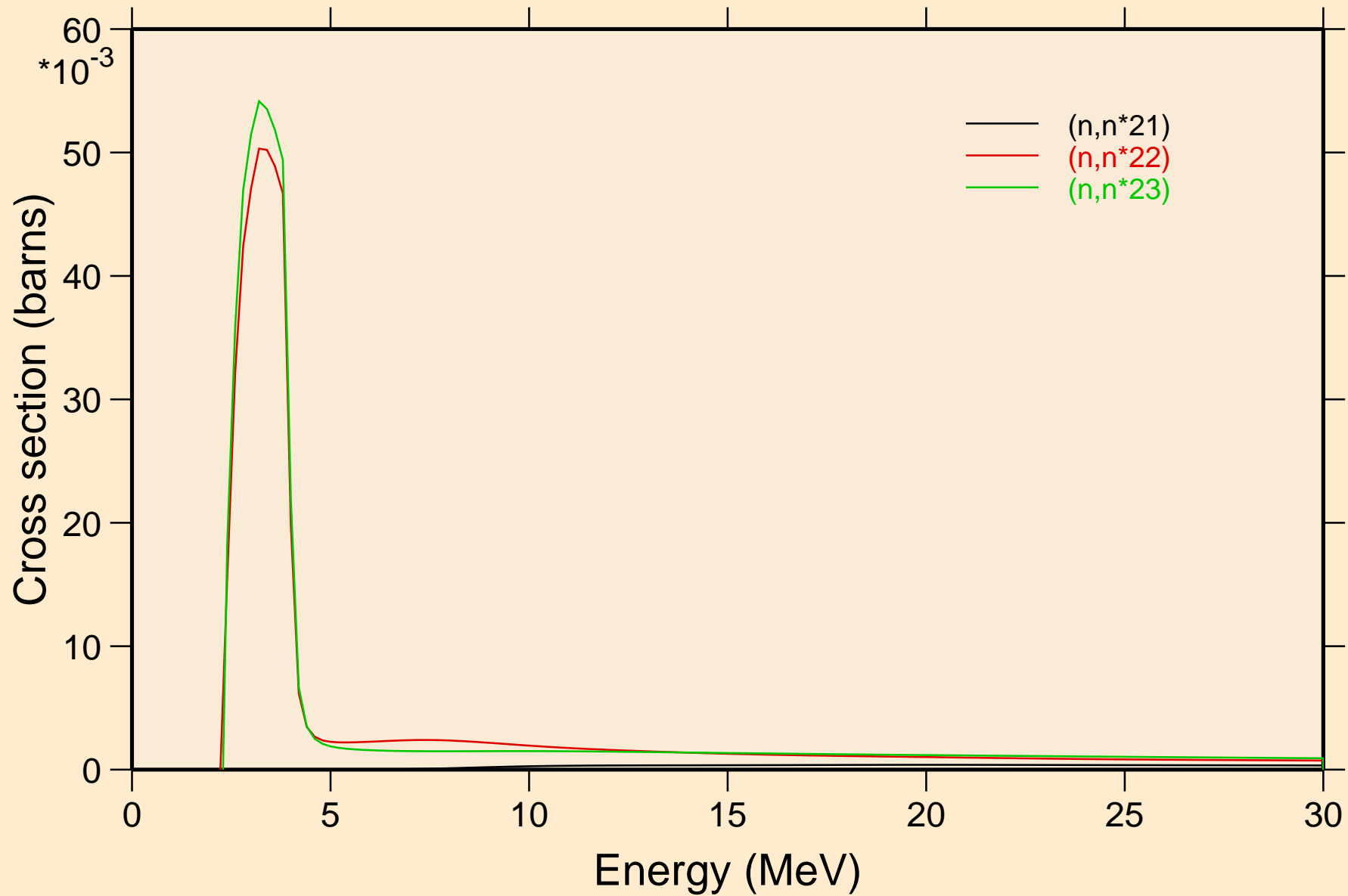

# HF182 NEUTRON ACER TENDL-2024 LIBRARY; T=0.K

## Threshold reactions

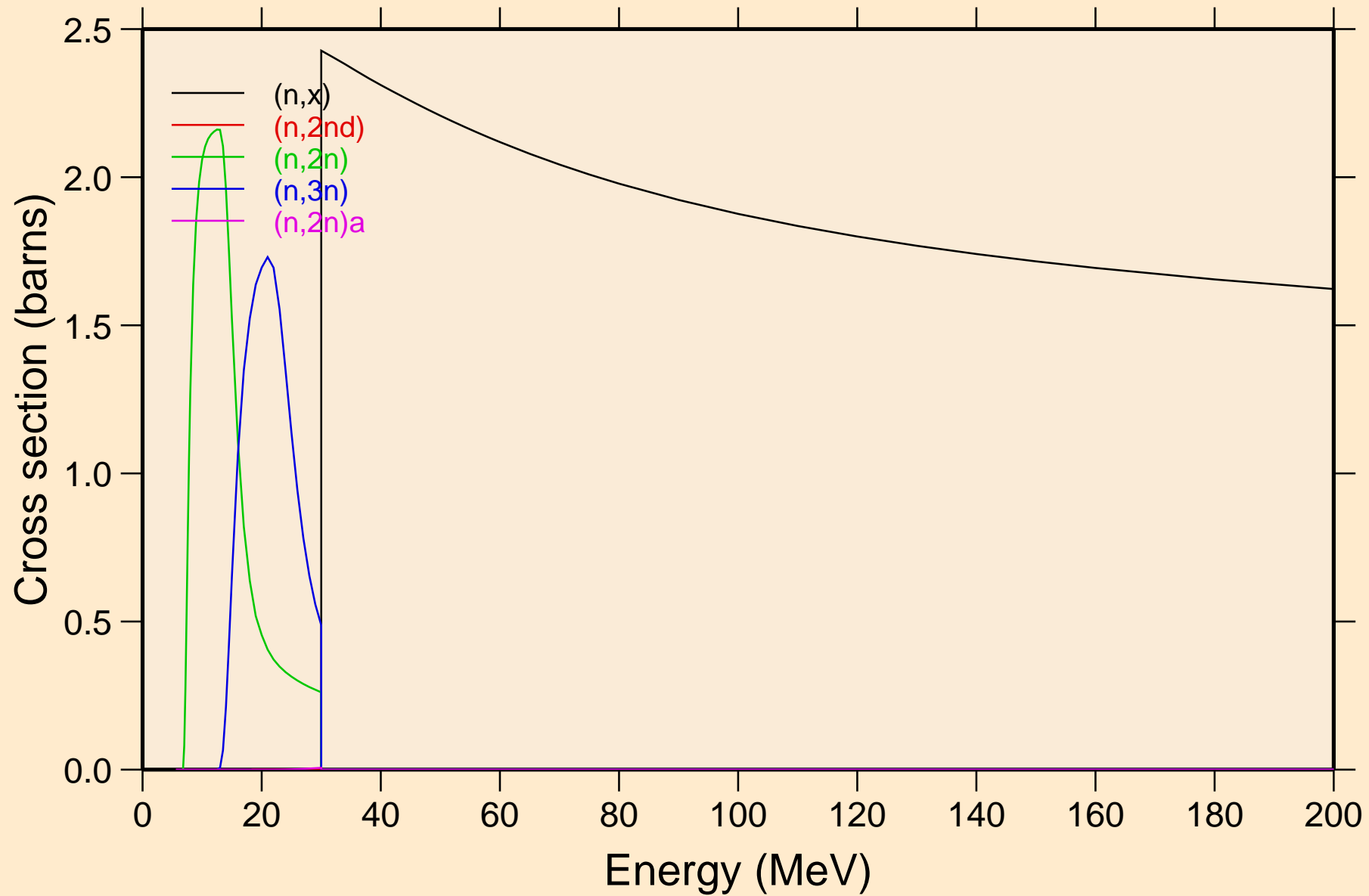

# HF182 NEUTRON ACER TENDL-2024 LIBRARY; T=0.K

## Threshold reactions

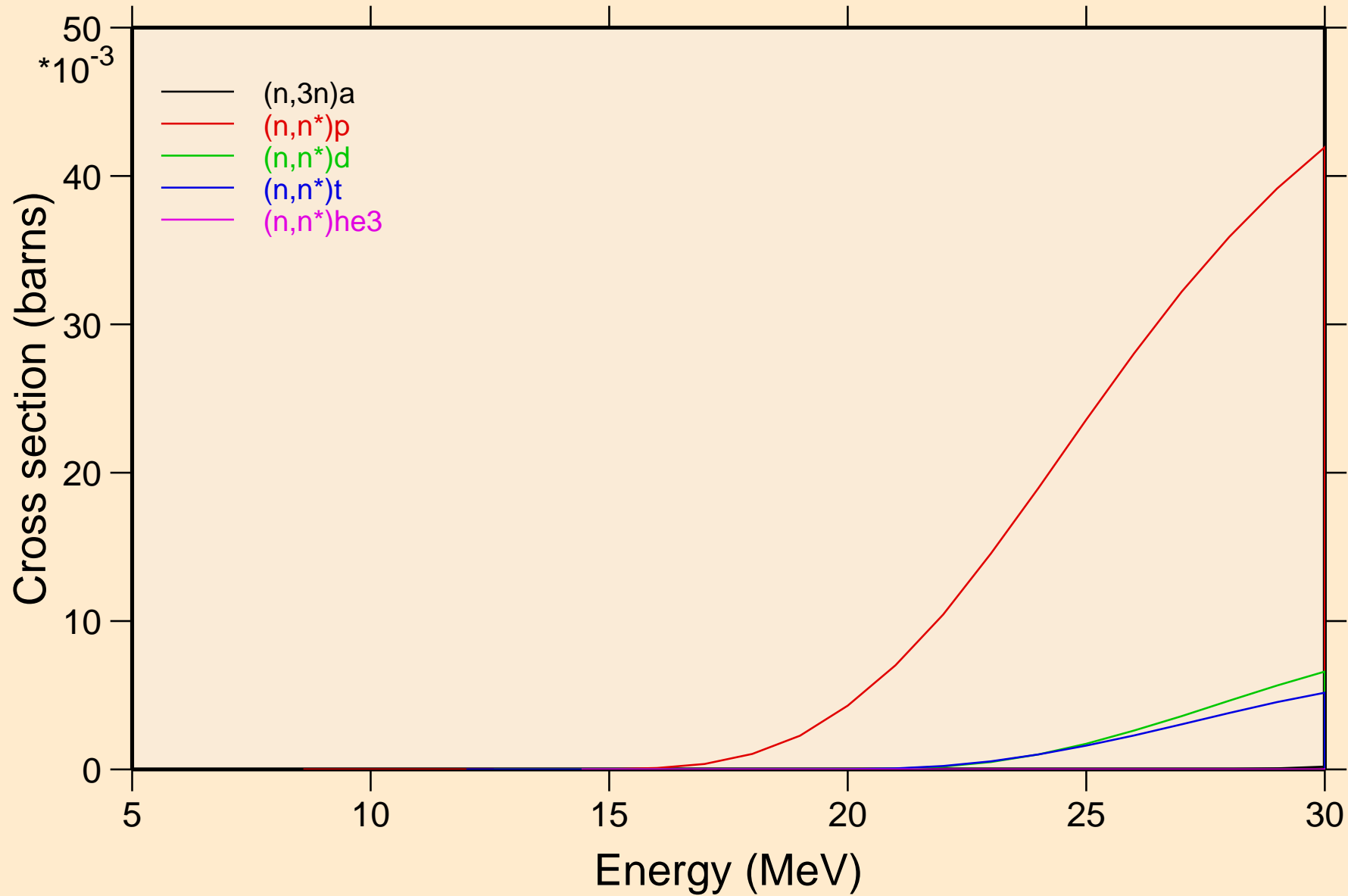

# HF182 NEUTRON ACER TENDL-2024 LIBRARY; T=0.K

## Threshold reactions

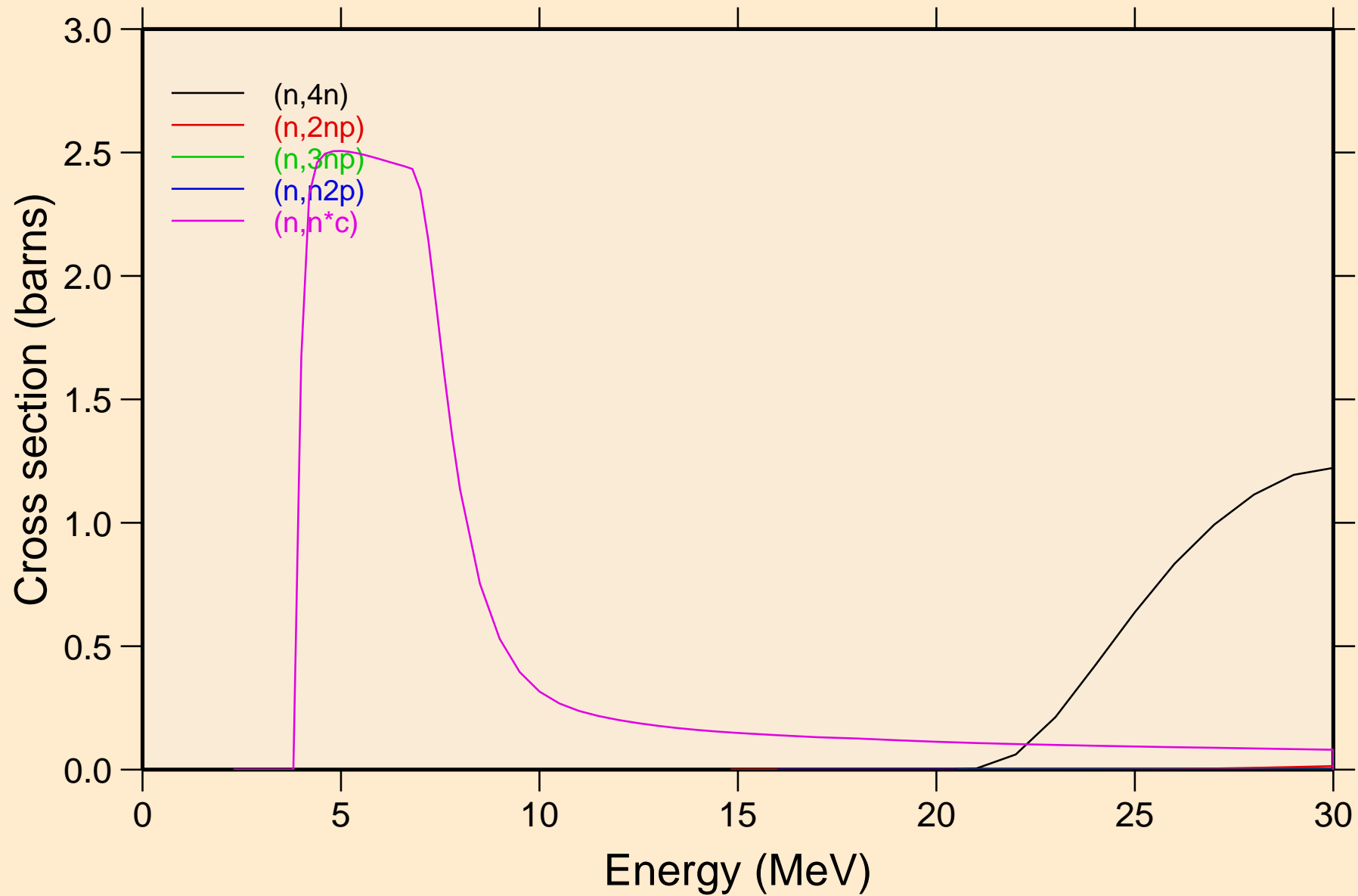

# HF182 NEUTRON ACER TENDL-2024 LIBRARY; T=0.K

## Threshold reactions

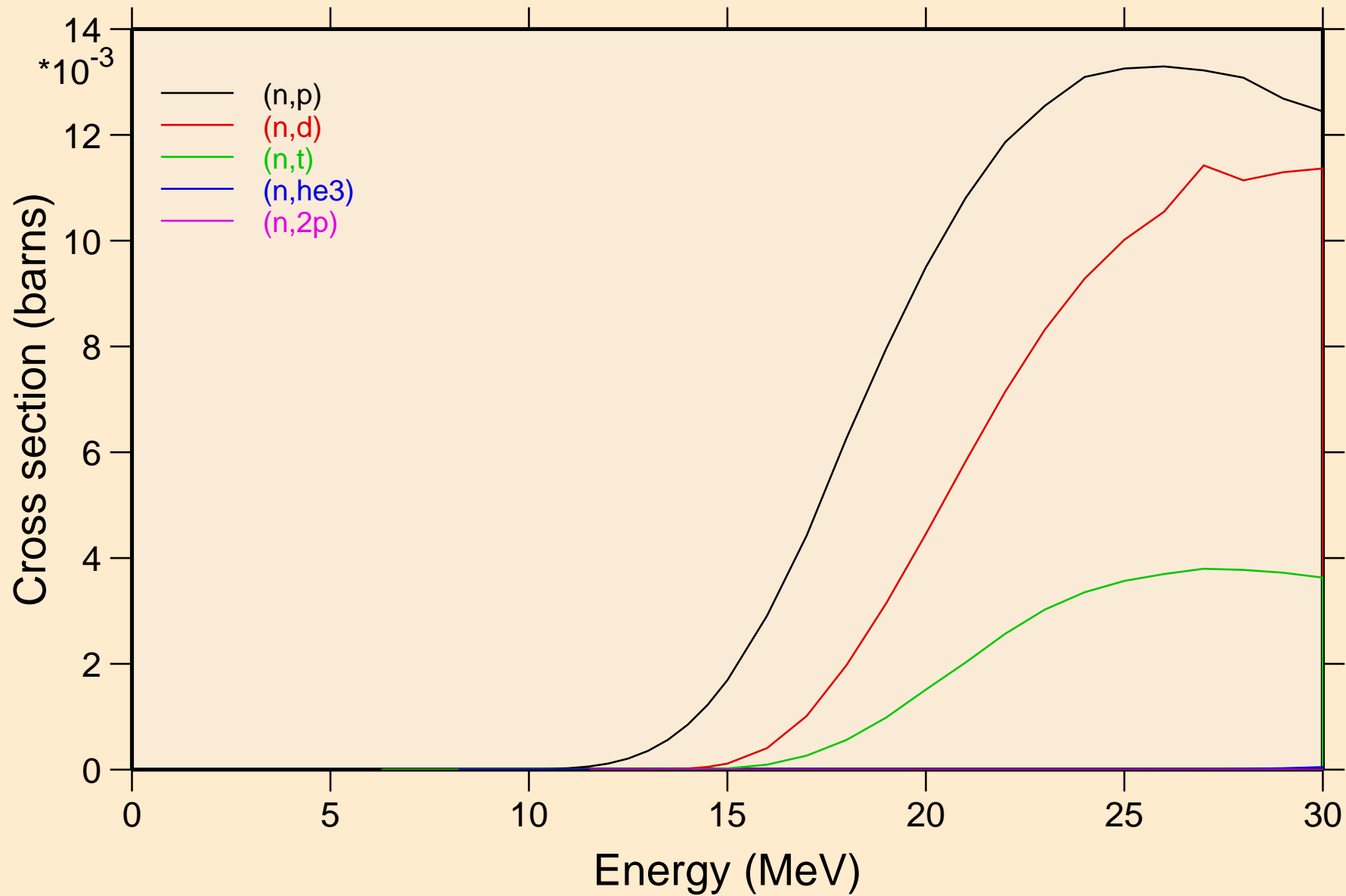

# HF182 NEUTRON ACER TENDL-2024 LIBRARY; T=0.K

## Threshold reactions

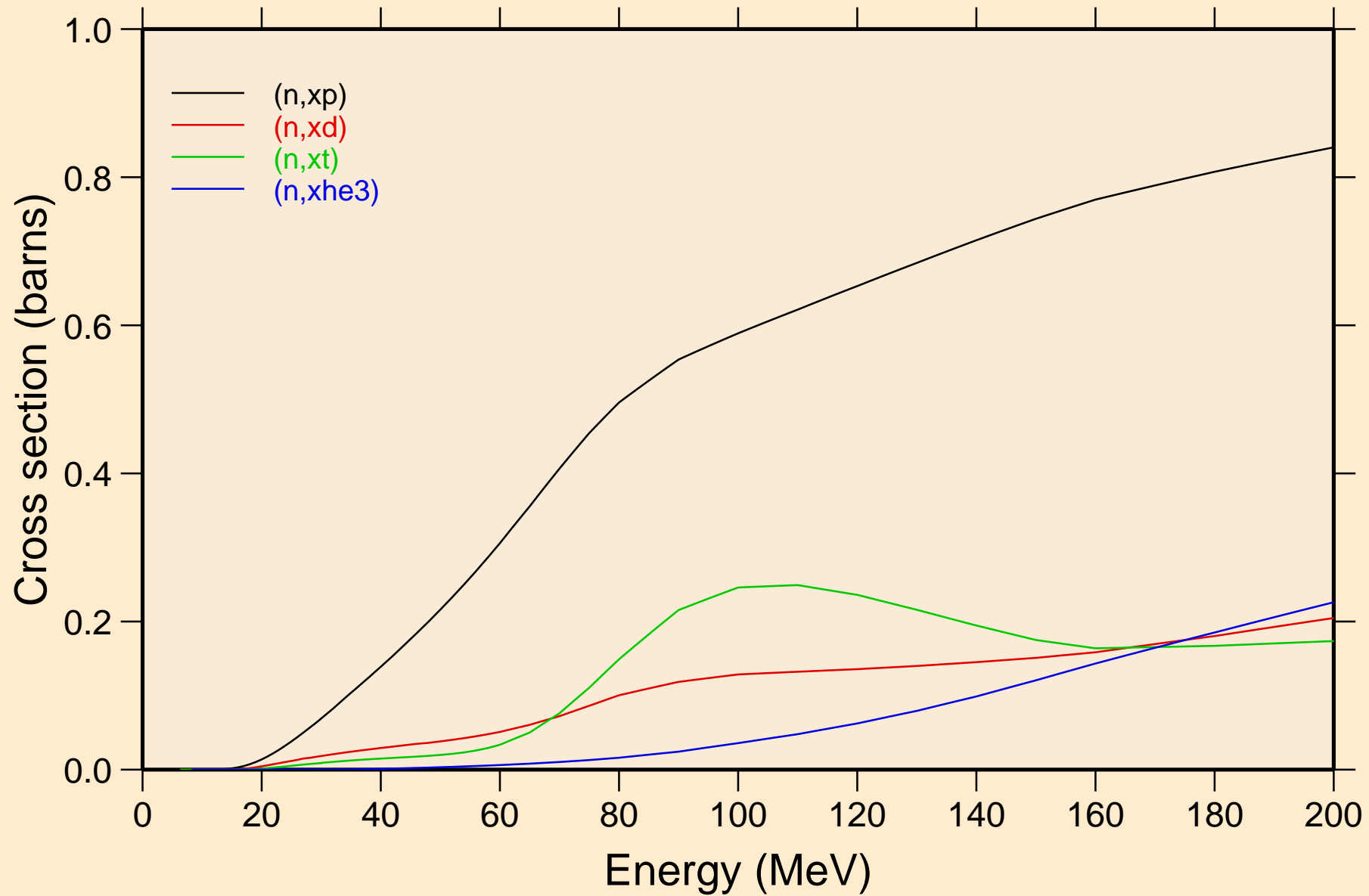

HF182 NEUTRON ACER TENDL-2024 LIBRARY; T=0.K  
angular distribution for elastic

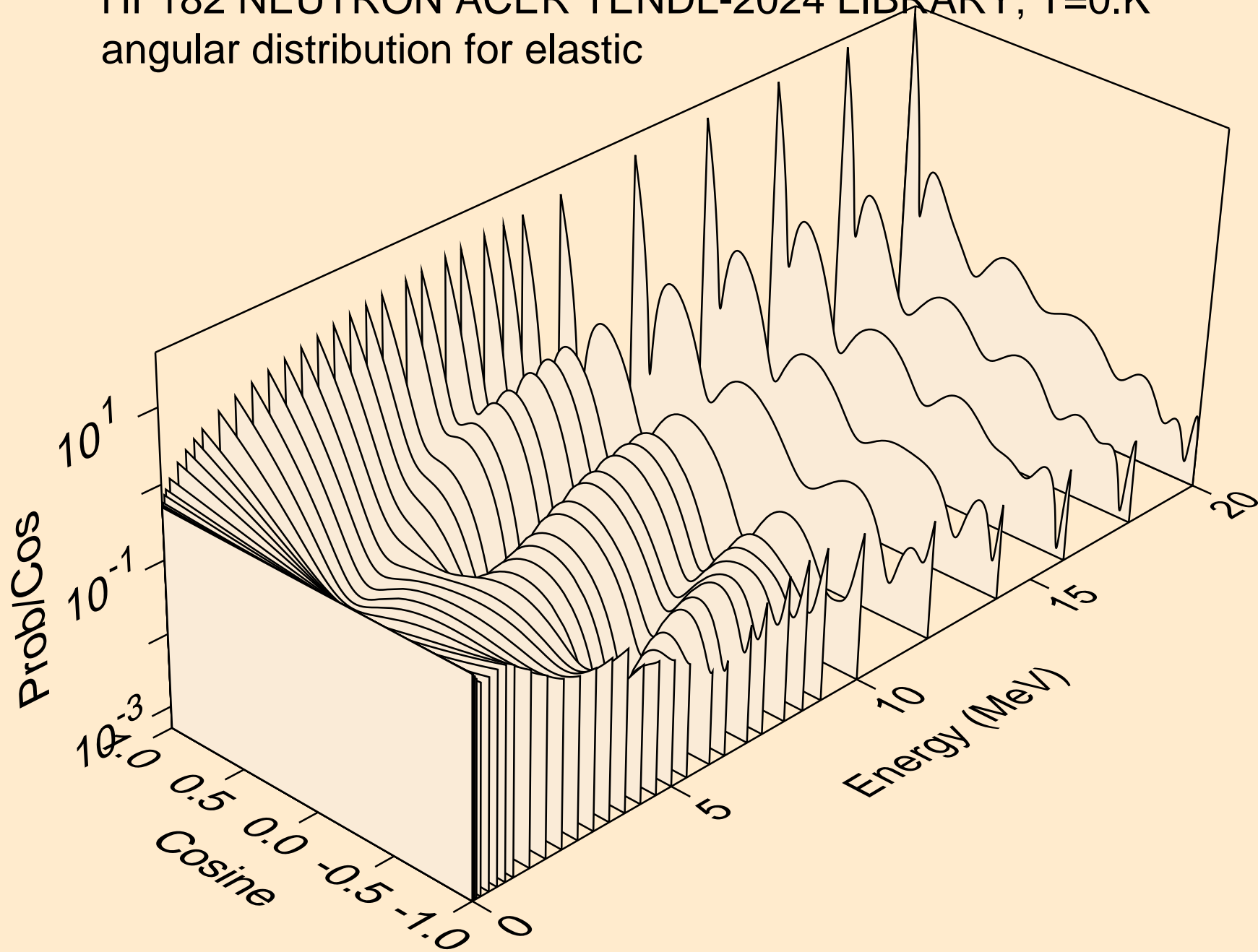

HF182 NEUTRON ACER TENDL-2024 LIBRARY; T=0.K  
angular distribution for elastic

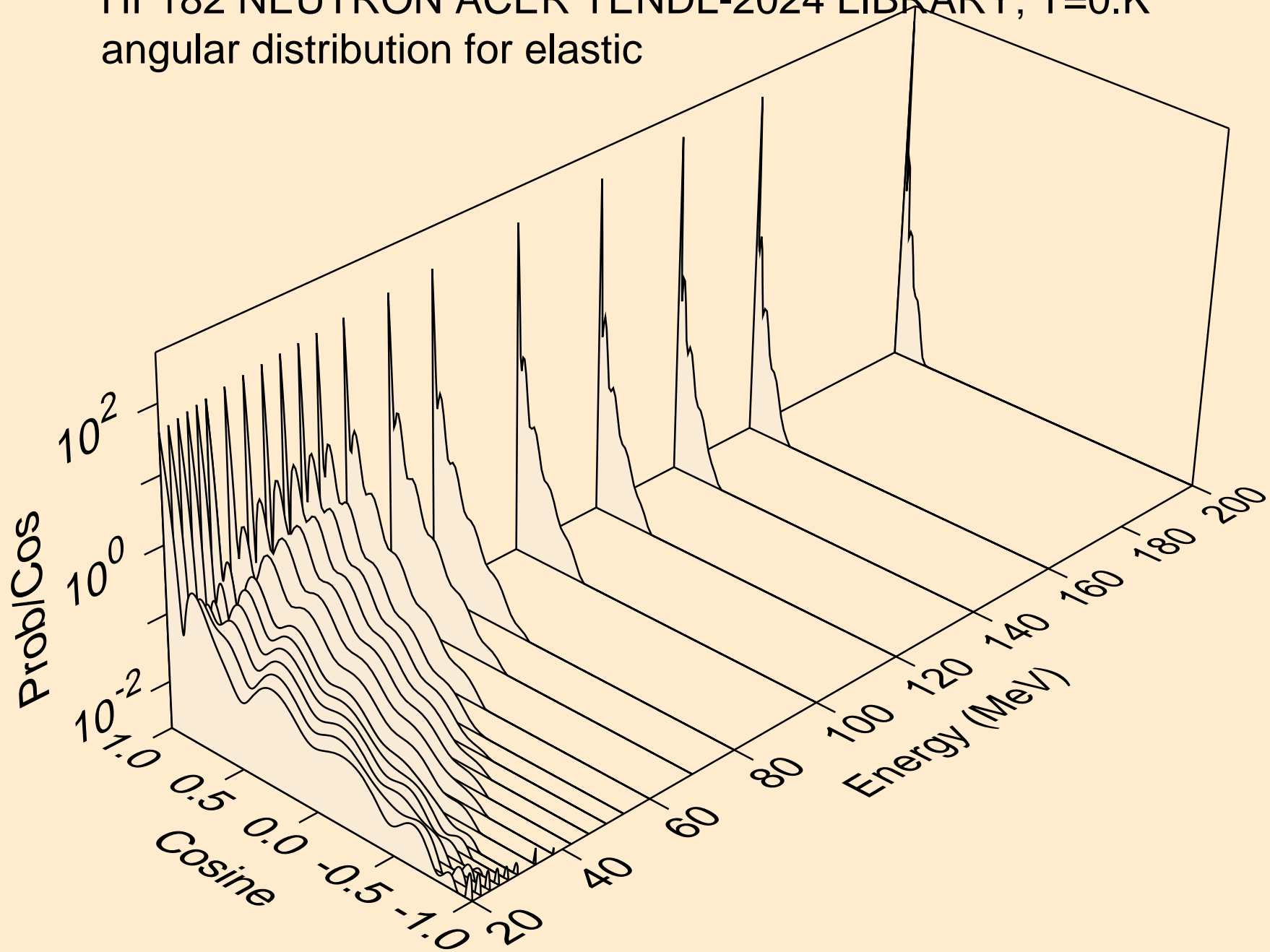

HF182 NEUTRON ACER TENDL-2024 LIBRARY; T=0.K  
angular distribution for (n,n\*1)

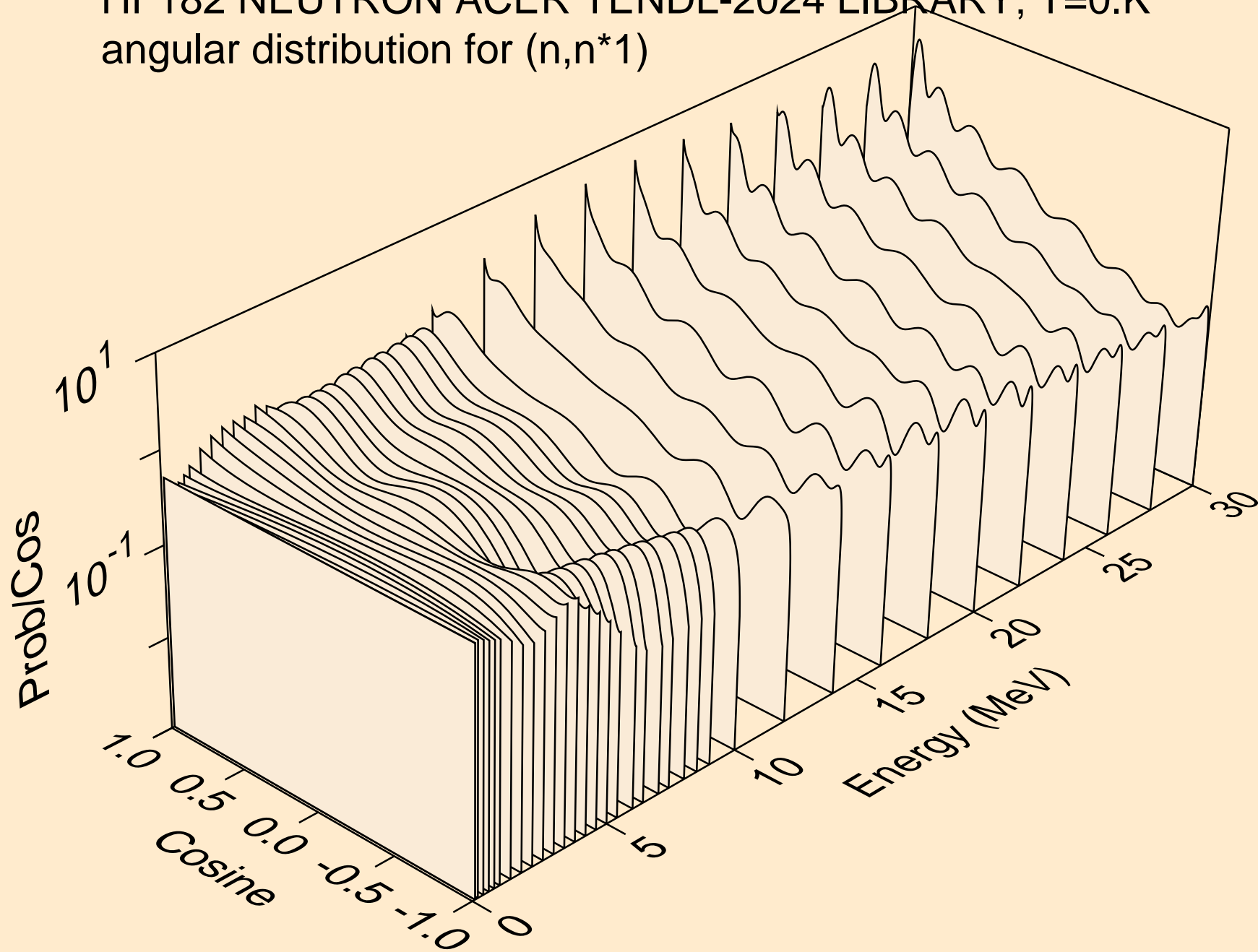

HF182 NEUTRON ACER TENDL-2024 LIBRARY; T=0.K  
angular distribution for (n,n\*2)

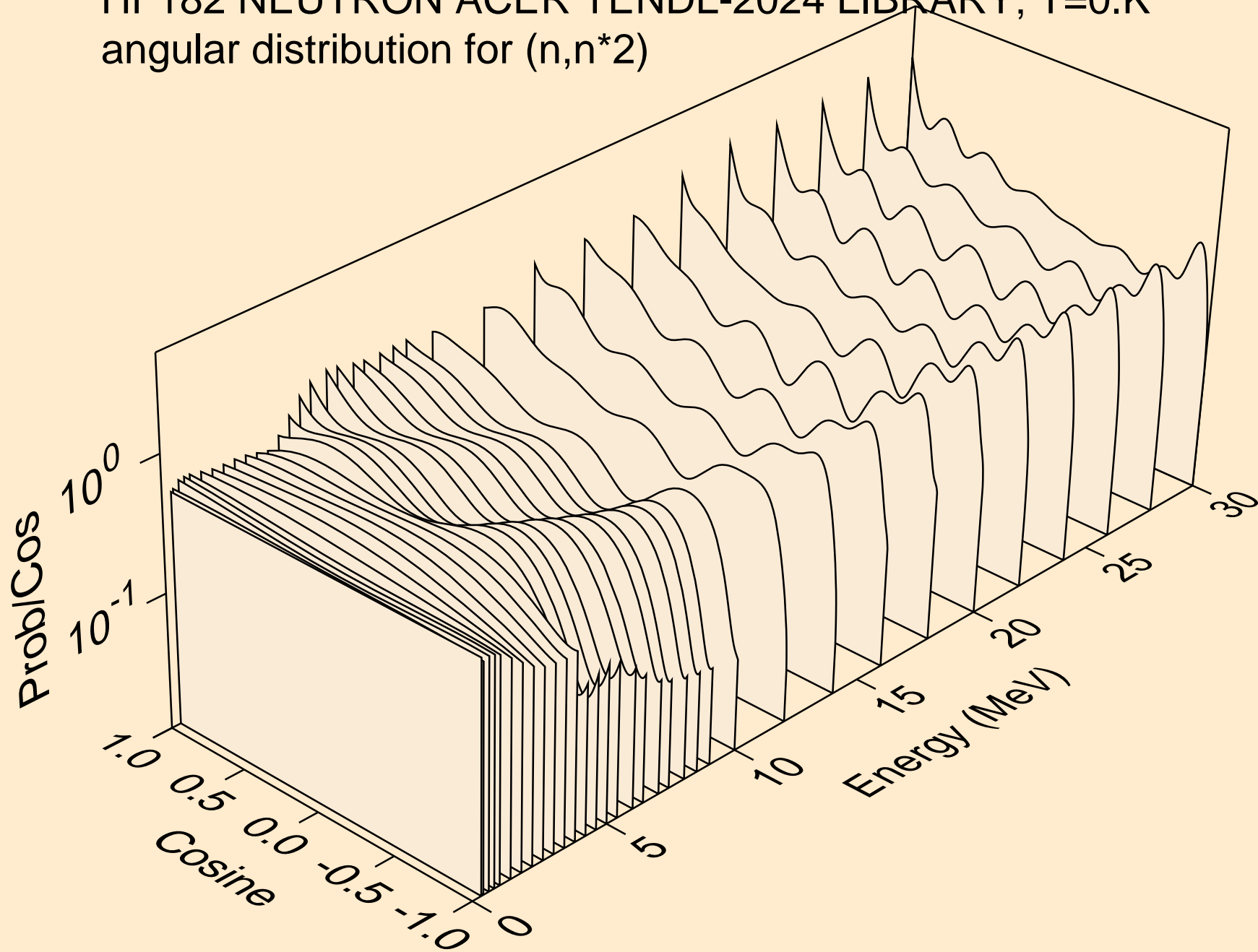

HF182 NEUTRON ACER TENDL-2024 LIBRARY; T=0.K  
angular distribution for (n,n\*3)

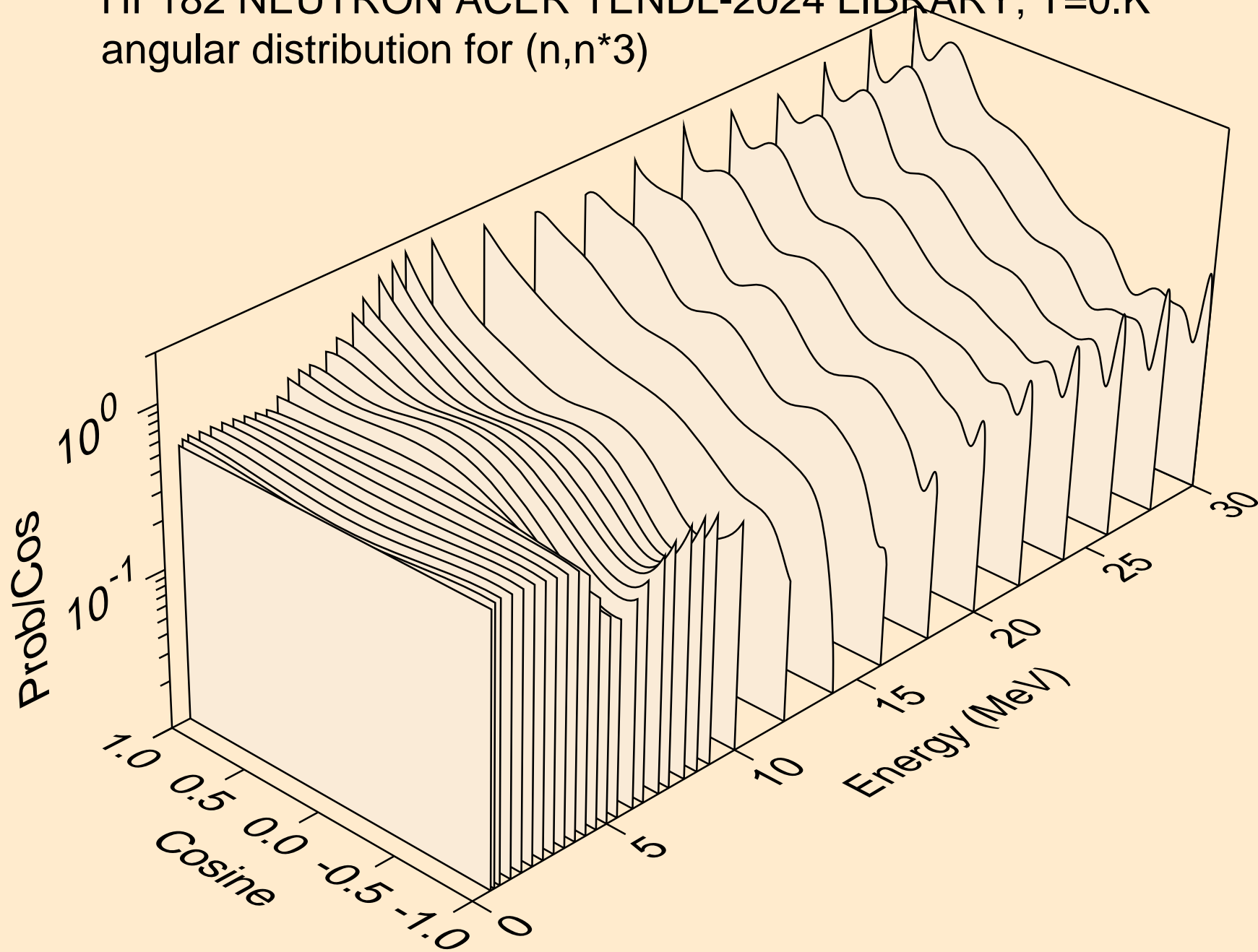

HF182 NEUTRON ACER TENDL-2024 LIBRARY; T=0.K  
angular distribution for (n,n\*4)

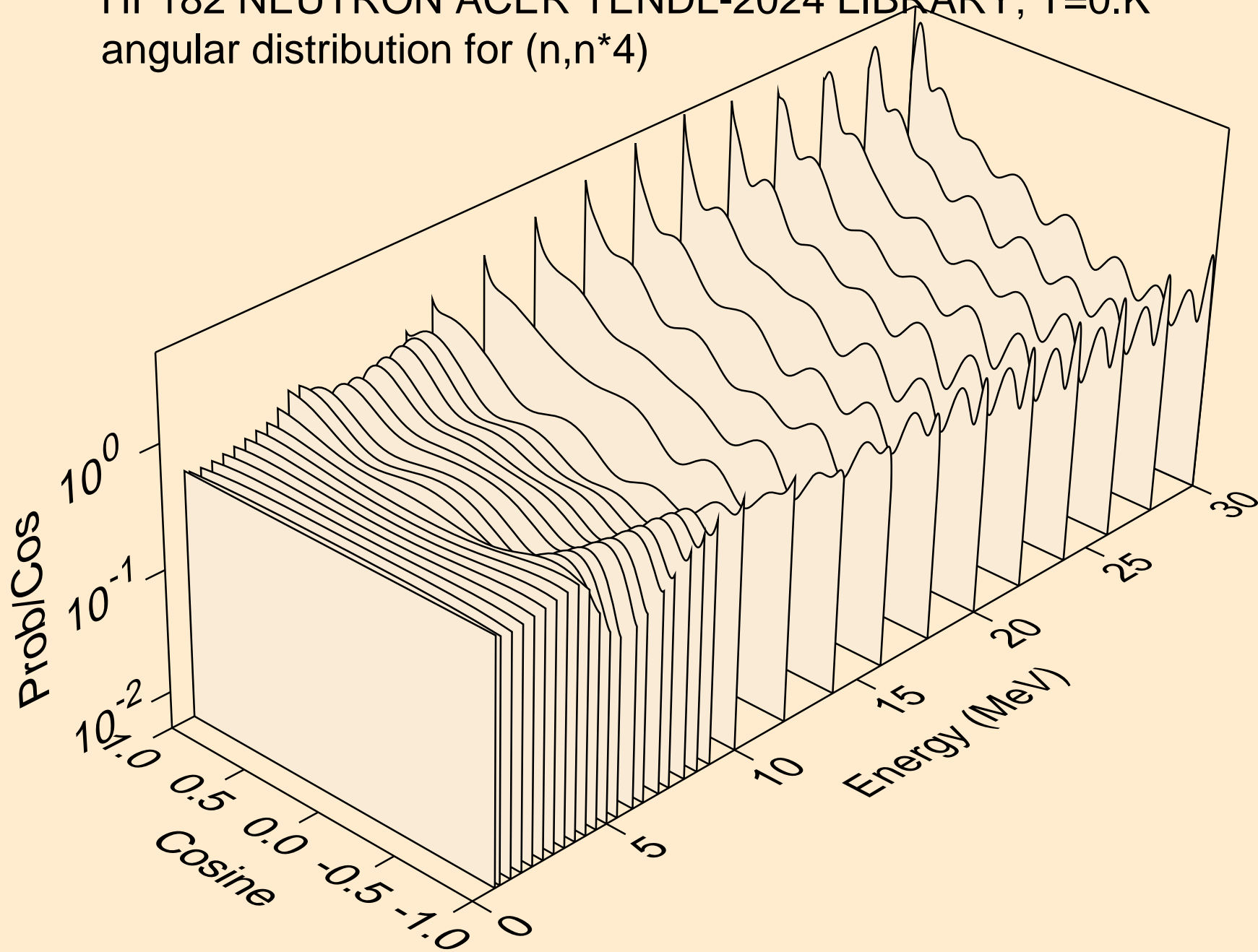

HF182 NEUTRON ACER TENDL-2024 LIBRARY; T=0.K  
angular distribution for (n,n\*5)

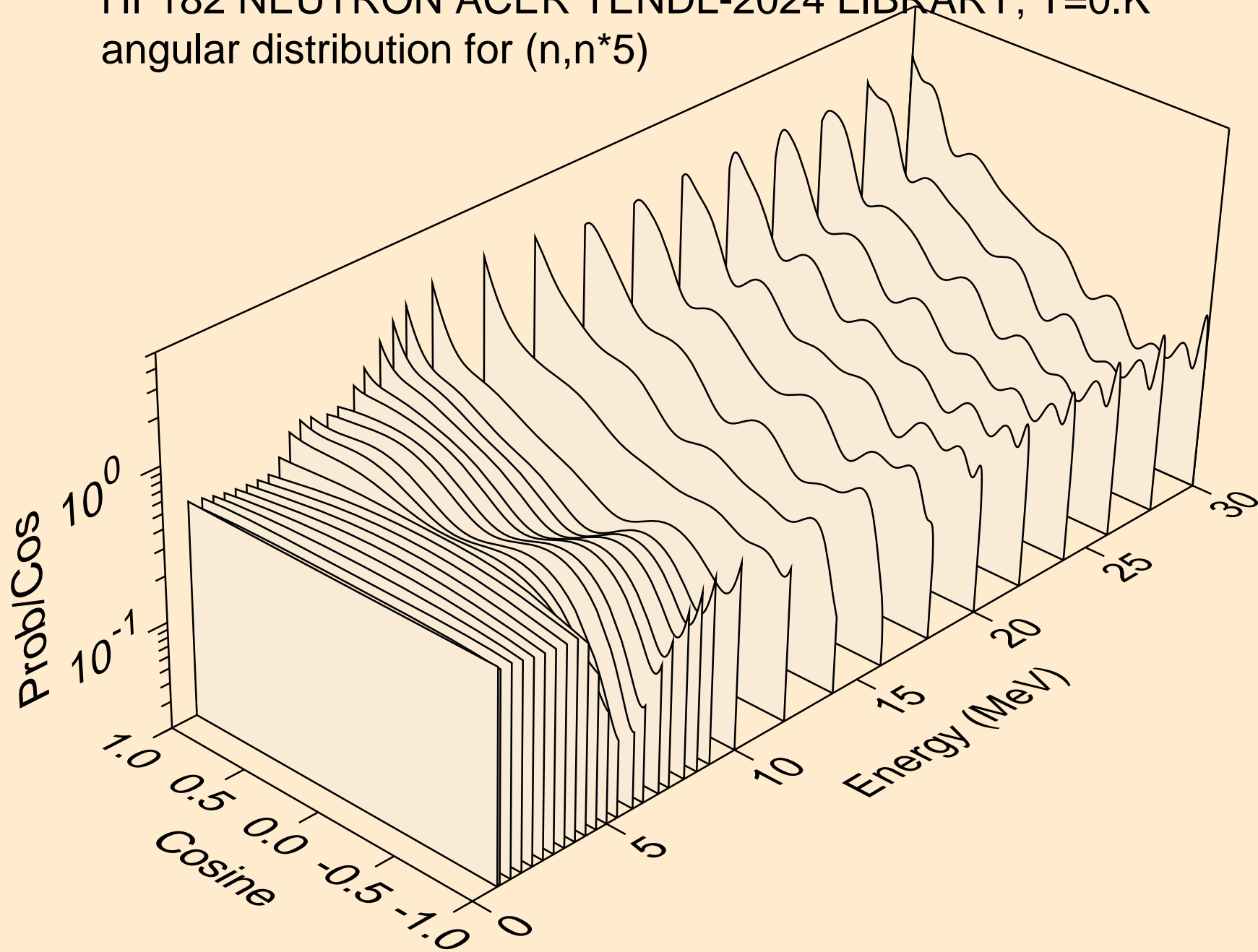

HF182 NEUTRON ACER TENDL-2024 LIBRARY; T=0.K  
angular distribution for (n,n\*6)

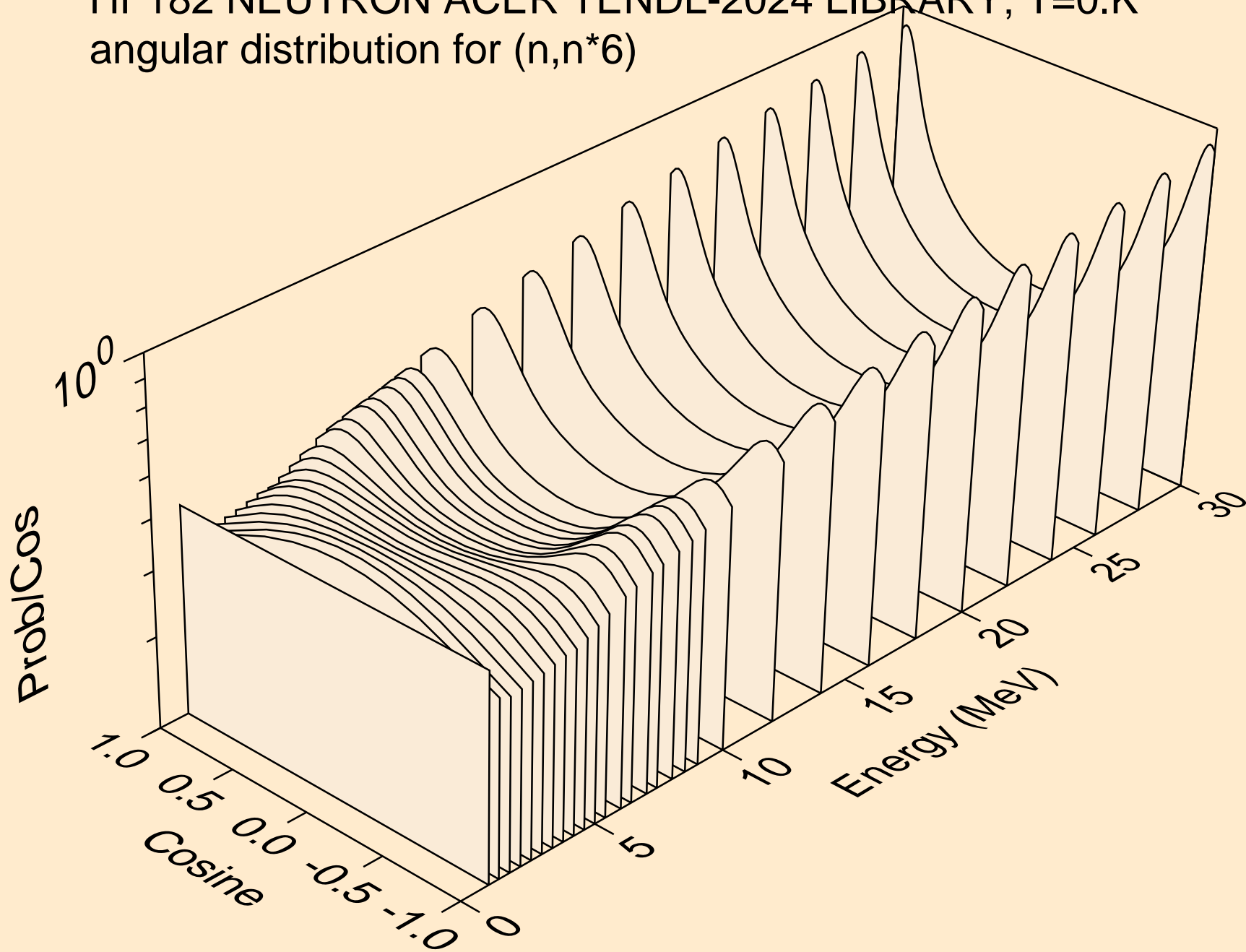

HF182 NEUTRON ACER TENDL-2024 LIBRARY; T=0.K  
angular distribution for (n,n\*7)

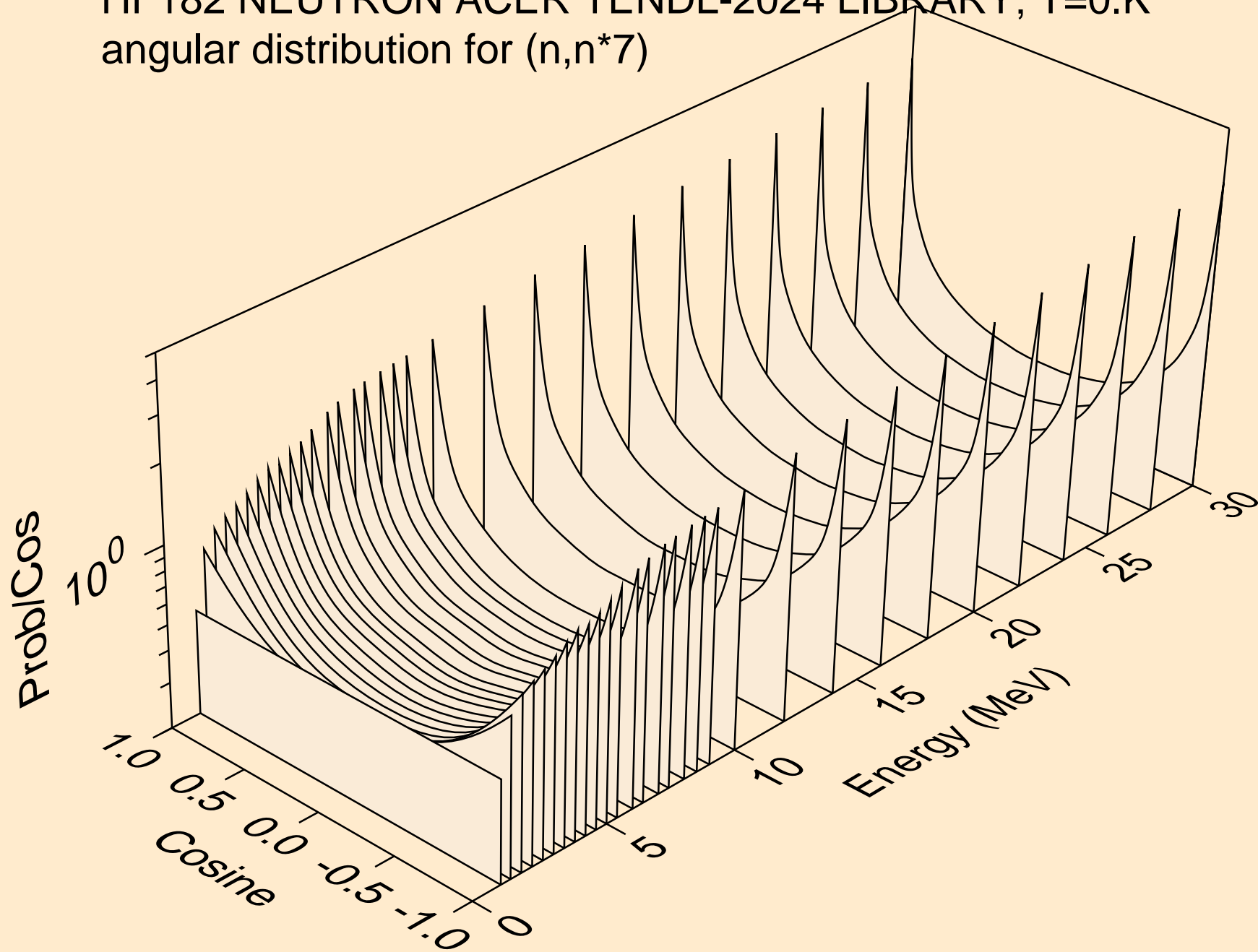

HF182 NEUTRON ACER TENDL-2024 LIBRARY; T=0.K  
angular distribution for (n,n\*8)

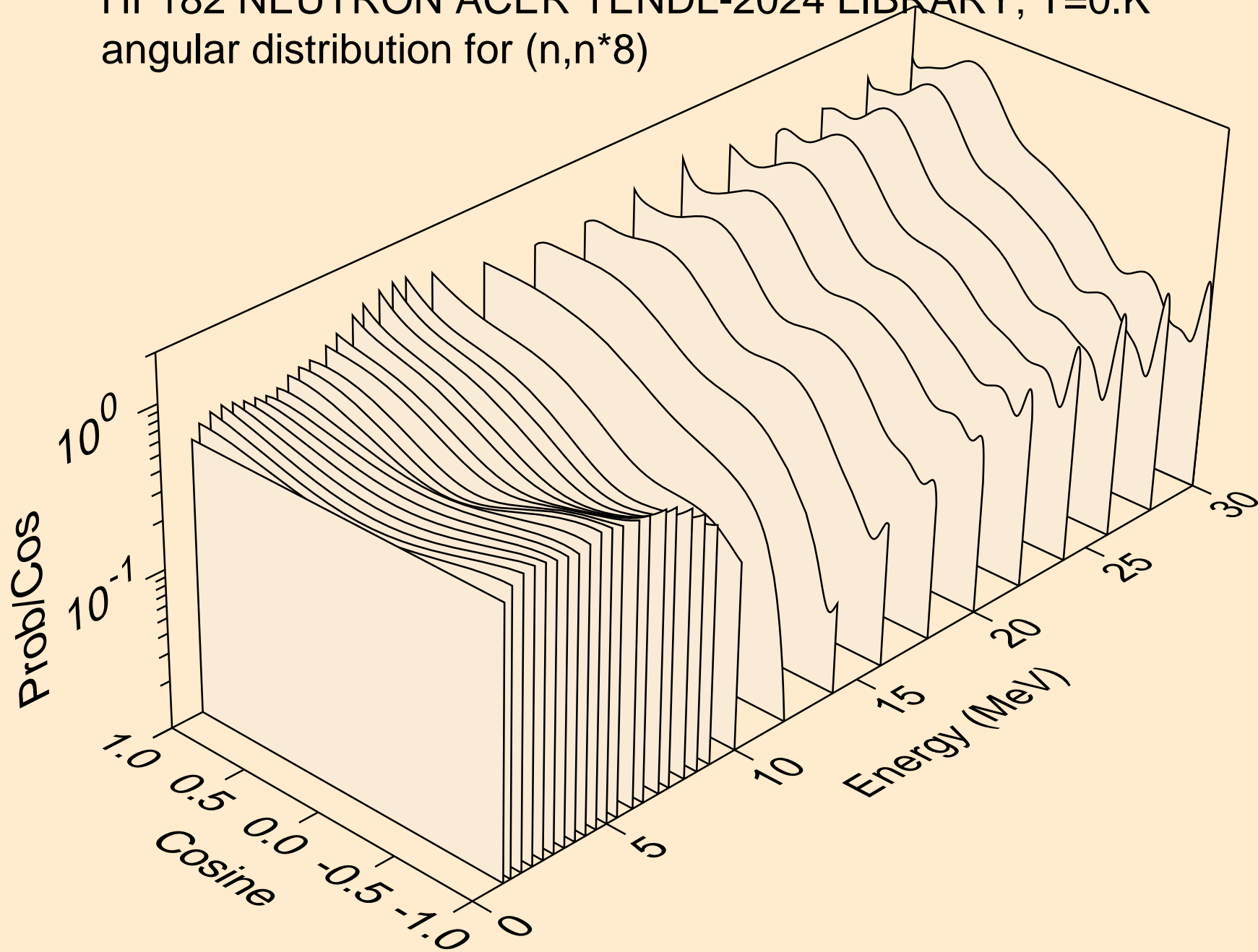

HF182 NEUTRON ACER TENDL-2024 LIBRARY; T=0.K  
angular distribution for (n,n\*9)

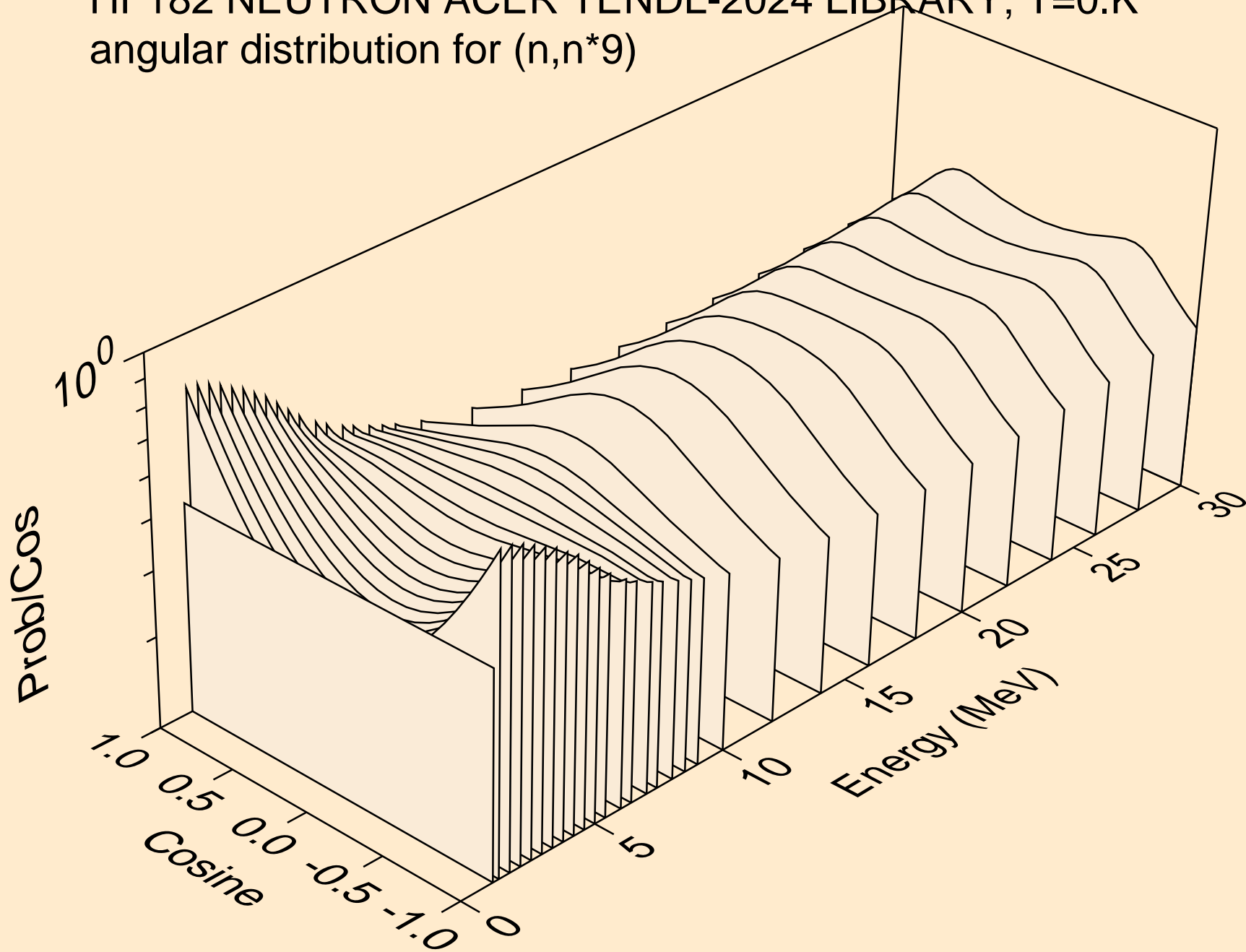

HF182 NEUTRON ACER TENDL-2024 LIBRARY; T=0.K  
angular distribution for (n,n\*10)

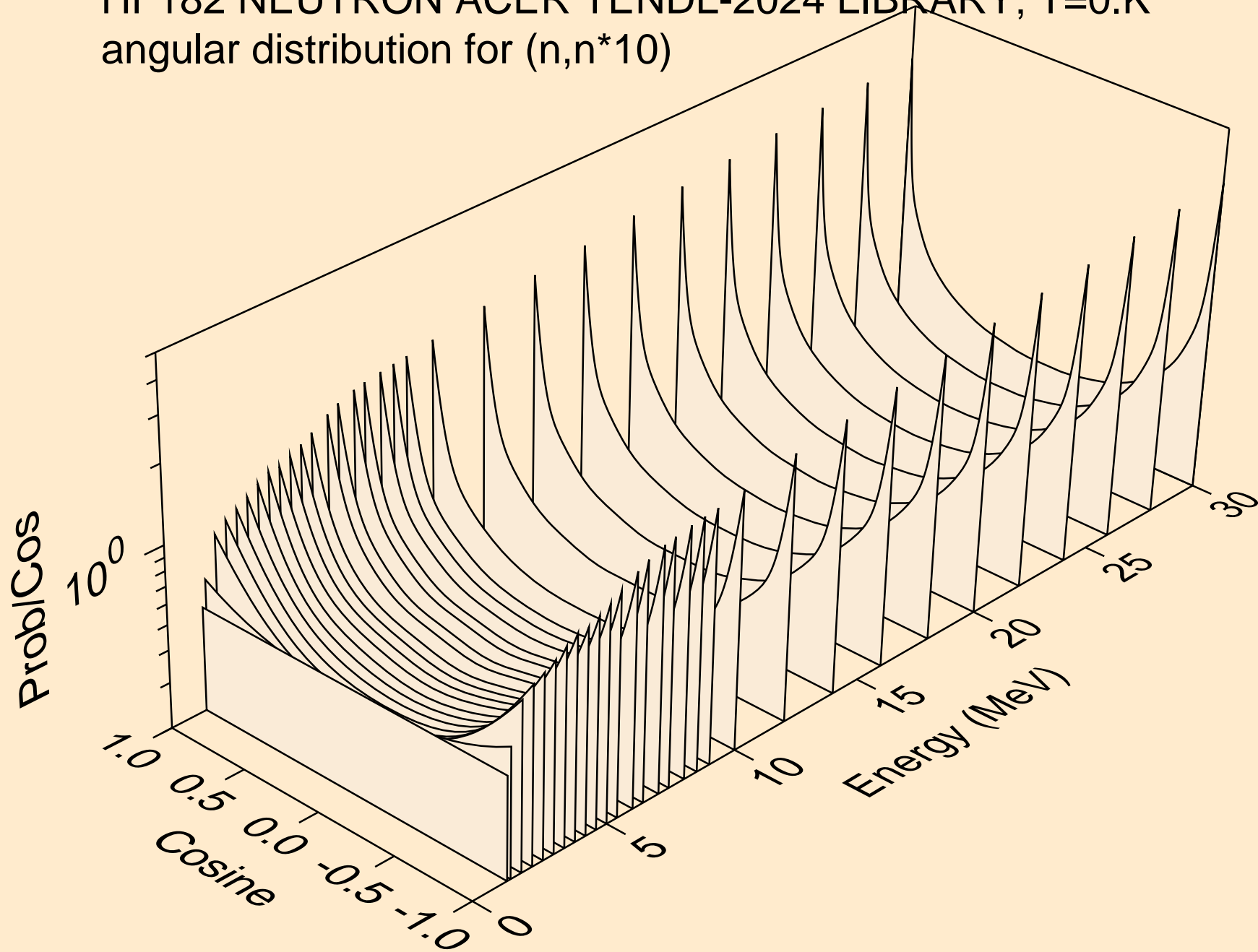

HF182 NEUTRON ACER TENDL-2024 LIBRARY; T=0.K  
angular distribution for (n,n\*11)

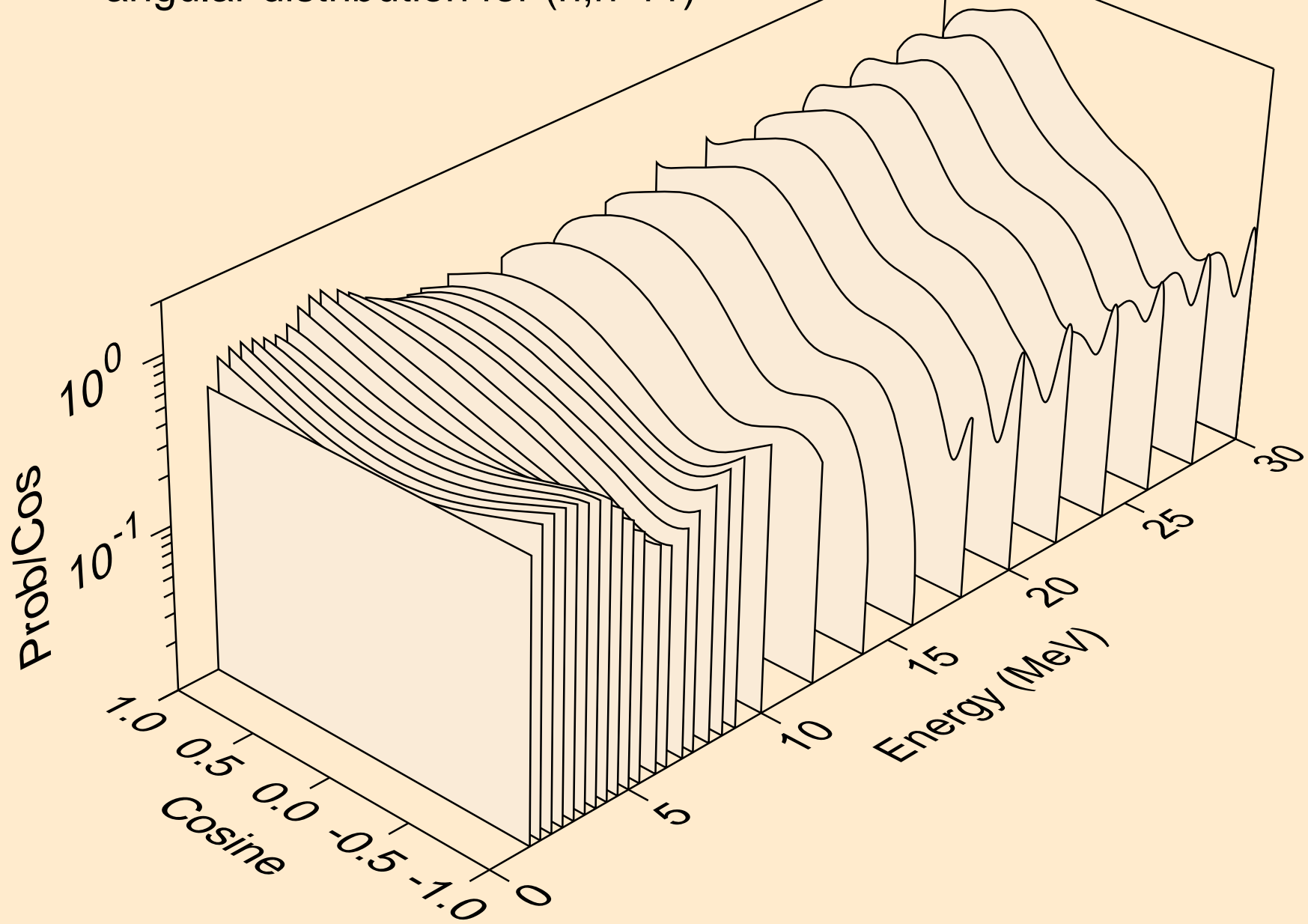

HF182 NEUTRON ACER TENDL-2024 LIBRARY; T=0.K  
angular distribution for (n,n\*12)

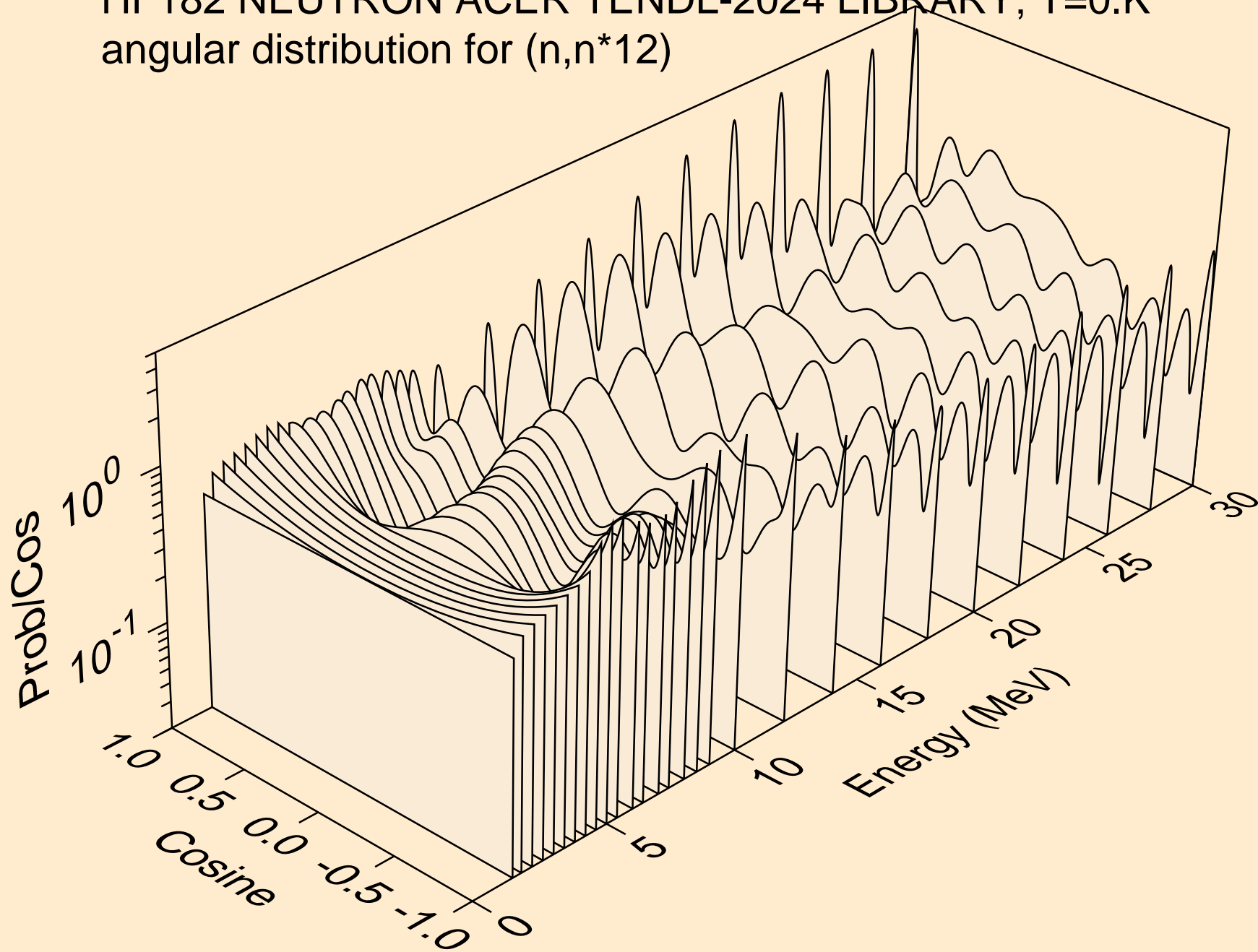

HF182 NEUTRON ACER TENDL-2024 LIBRARY; T=0.K  
angular distribution for (n,n\*13)

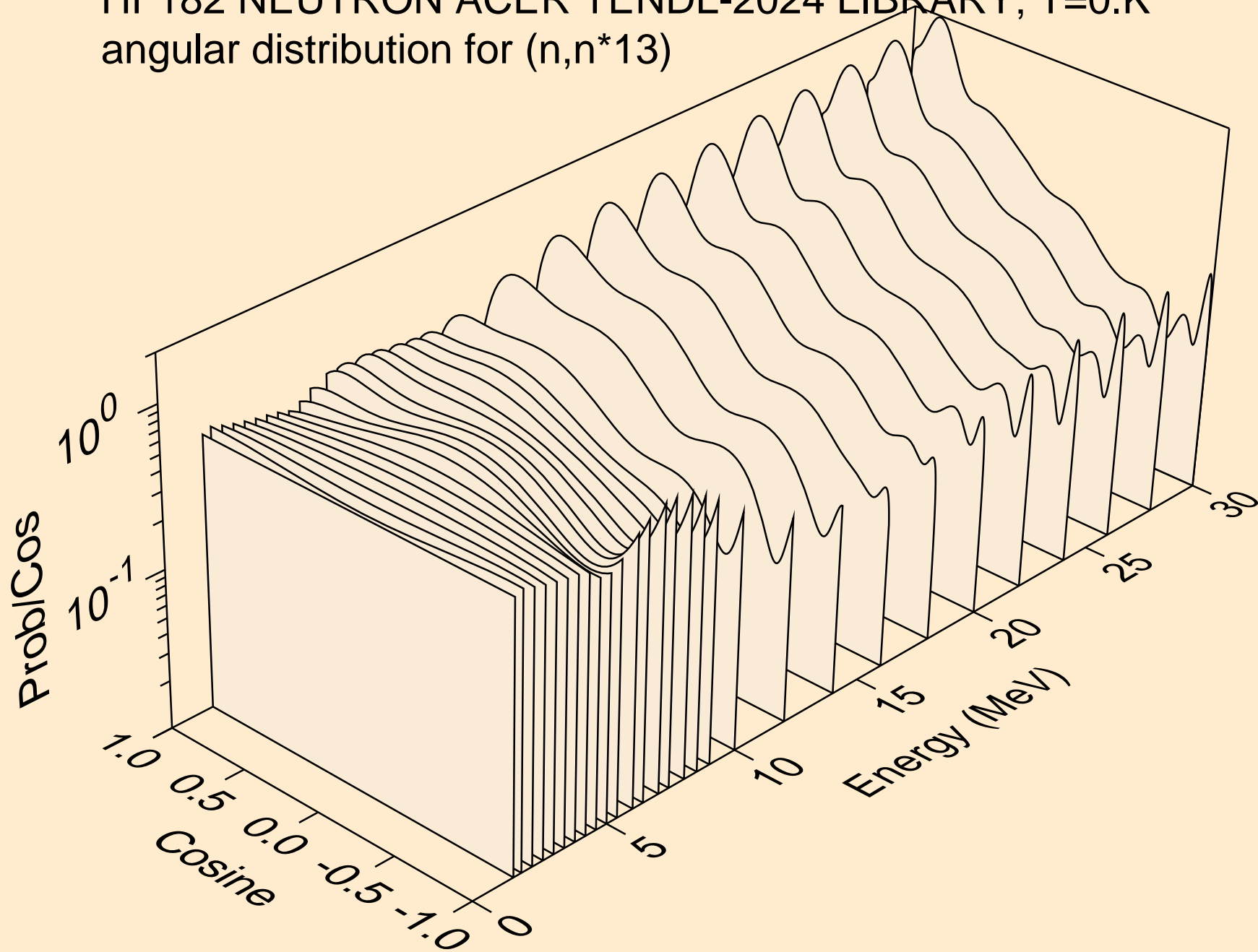

HF182 NEUTRON ACER TENDL-2024 LIBRARY; T=0.K  
angular distribution for (n,n\*14)

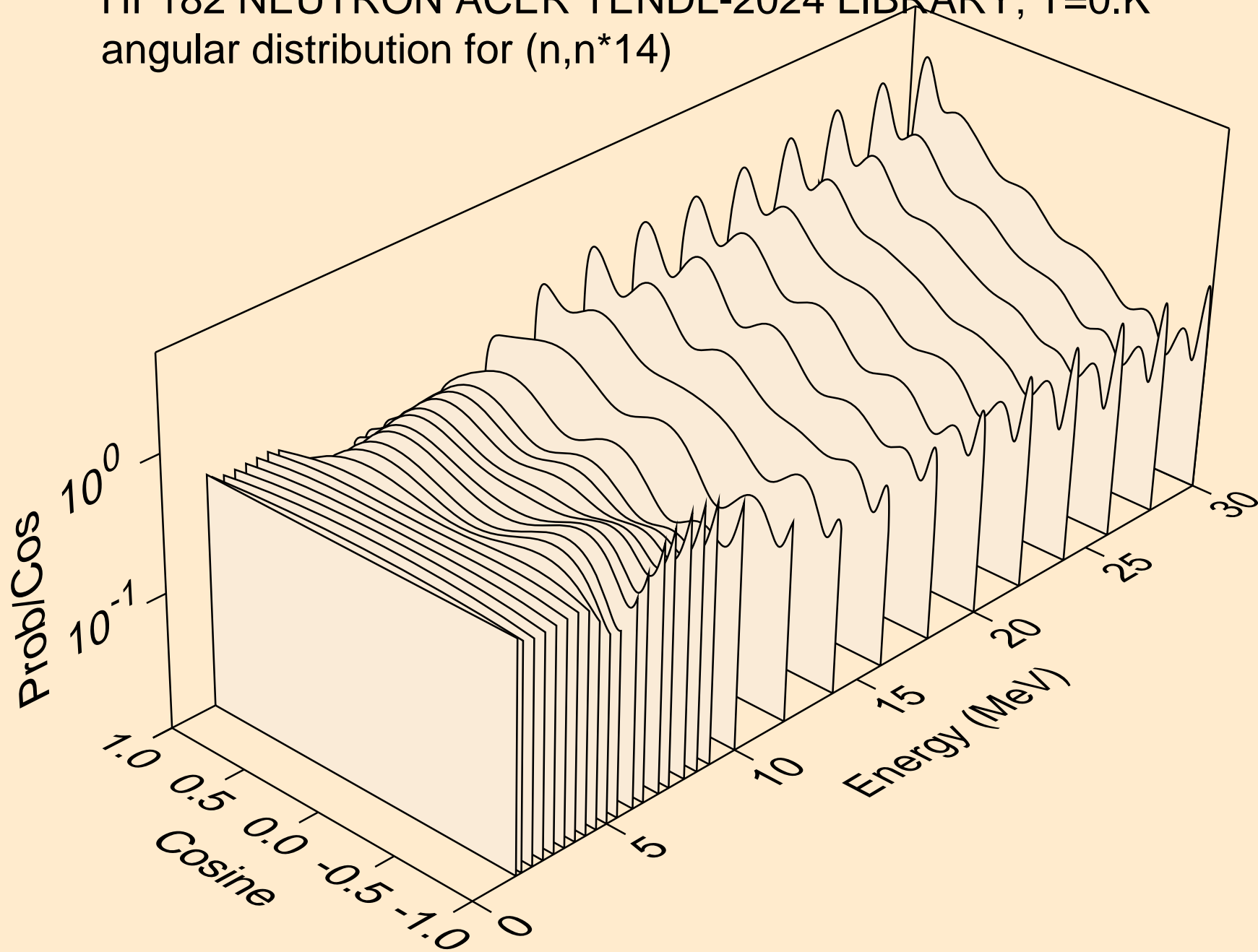

HF182 NEUTRON ACER TENDL-2024 LIBRARY; T=0.K  
angular distribution for (n,n\*15)

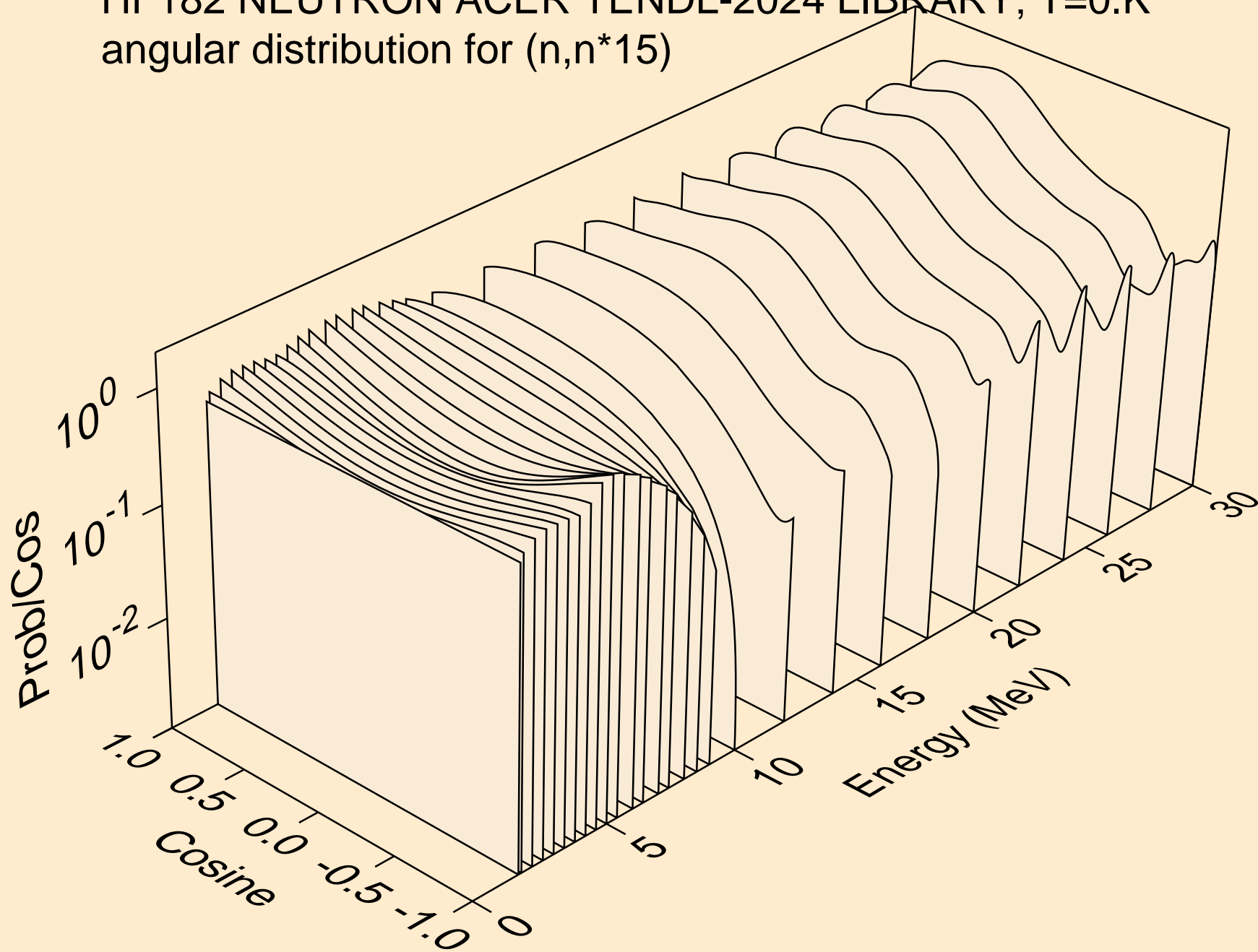

HF182 NEUTRON ACER TENDL-2024 LIBRARY; T=0.K  
angular distribution for (n,n\*16)

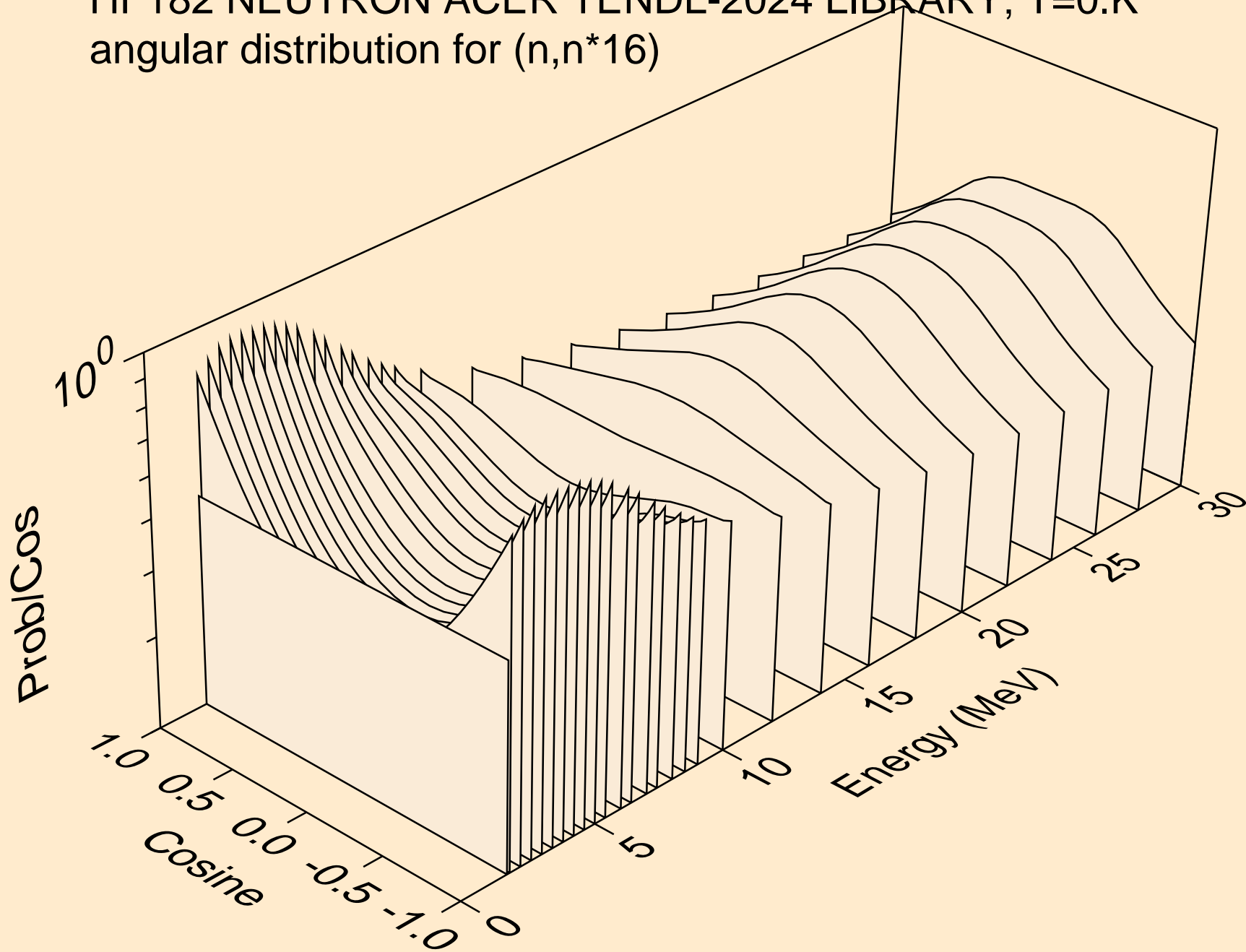

HF182 NEUTRON ACER TENDL-2024 LIBRARY; T=0.K  
angular distribution for (n,n\*17)

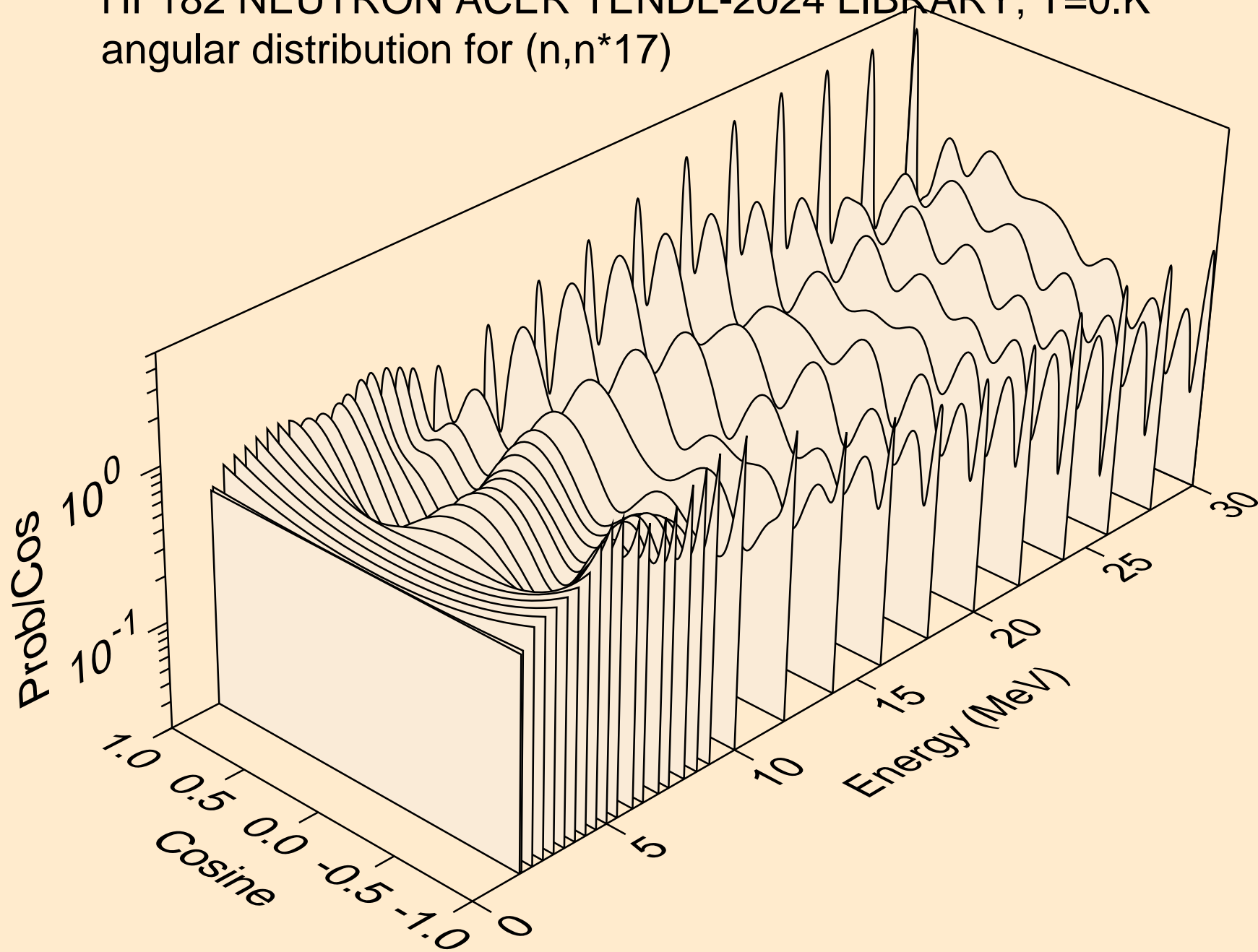

HF182 NEUTRON ACER TENDL-2024 LIBRARY; T=0.K  
angular distribution for (n,n\*18)

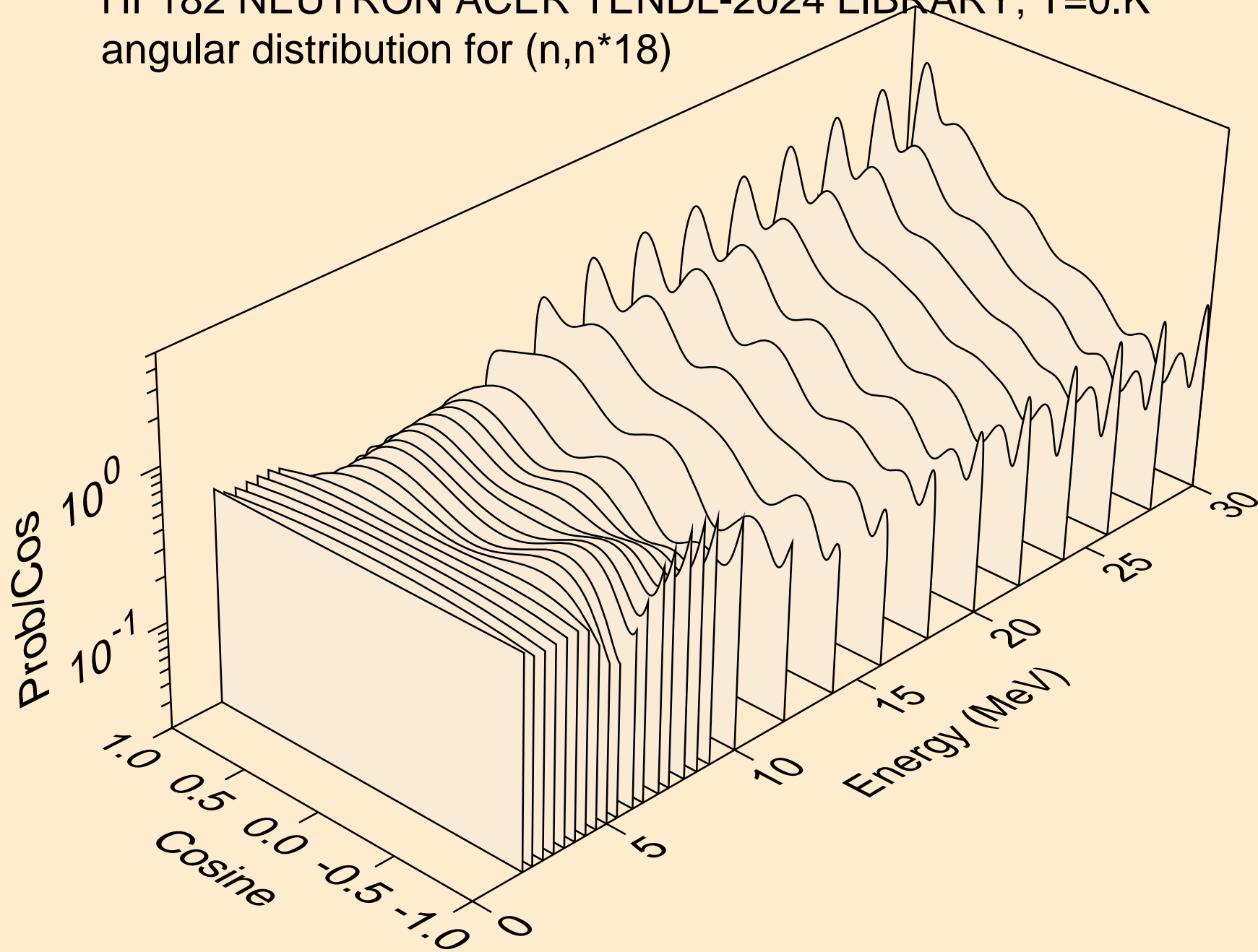

HF182 NEUTRON ACER TENDL-2024 LIBRARY; T=0.K  
angular distribution for (n,n\*19)

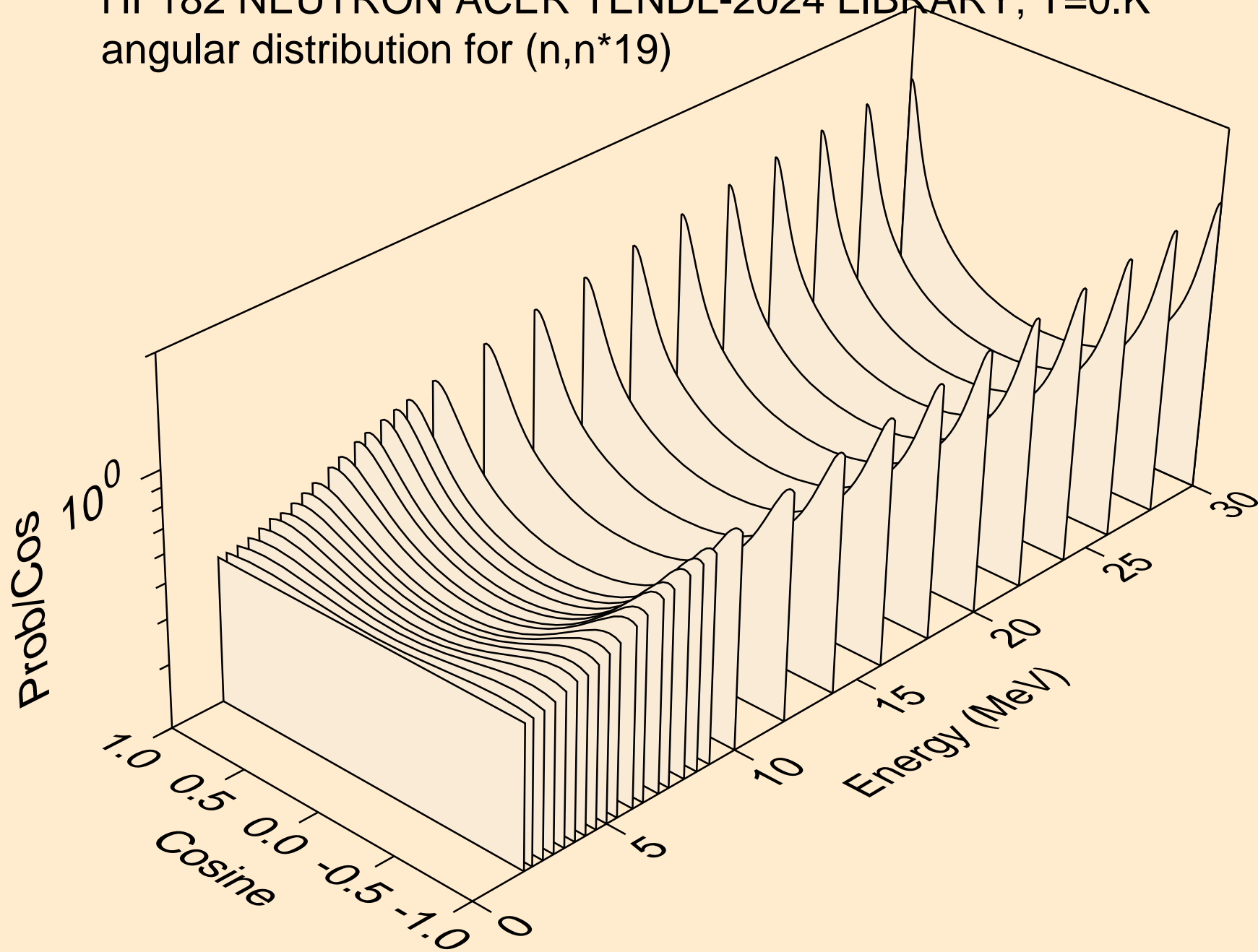

HF182 NEUTRON ACER TENDL-2024 LIBRARY; T=0.K  
angular distribution for (n,n\*20)

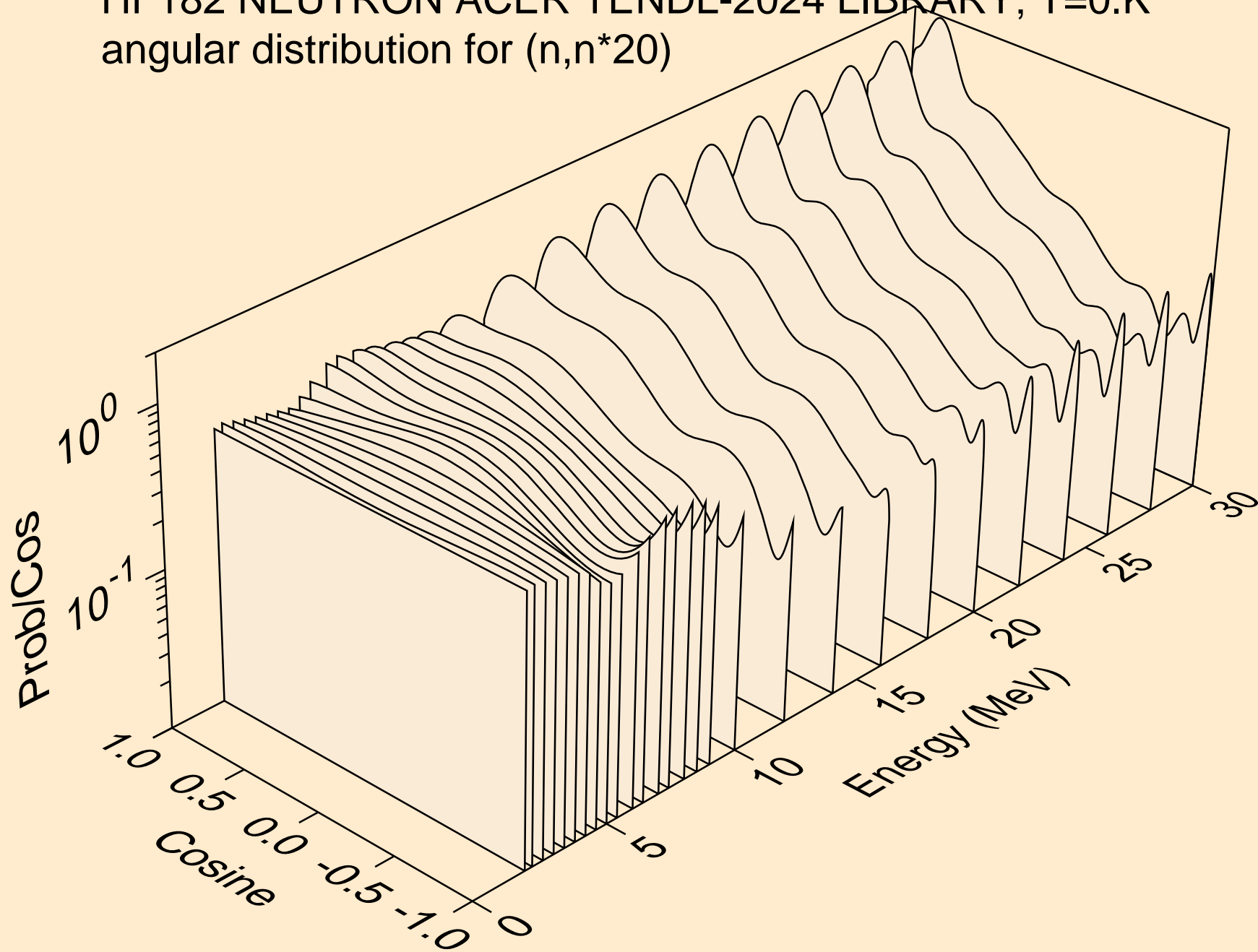

HF182 NEUTRON ACER TENDL-2024 LIBRARY; T=0.K  
angular distribution for (n,n\*21)

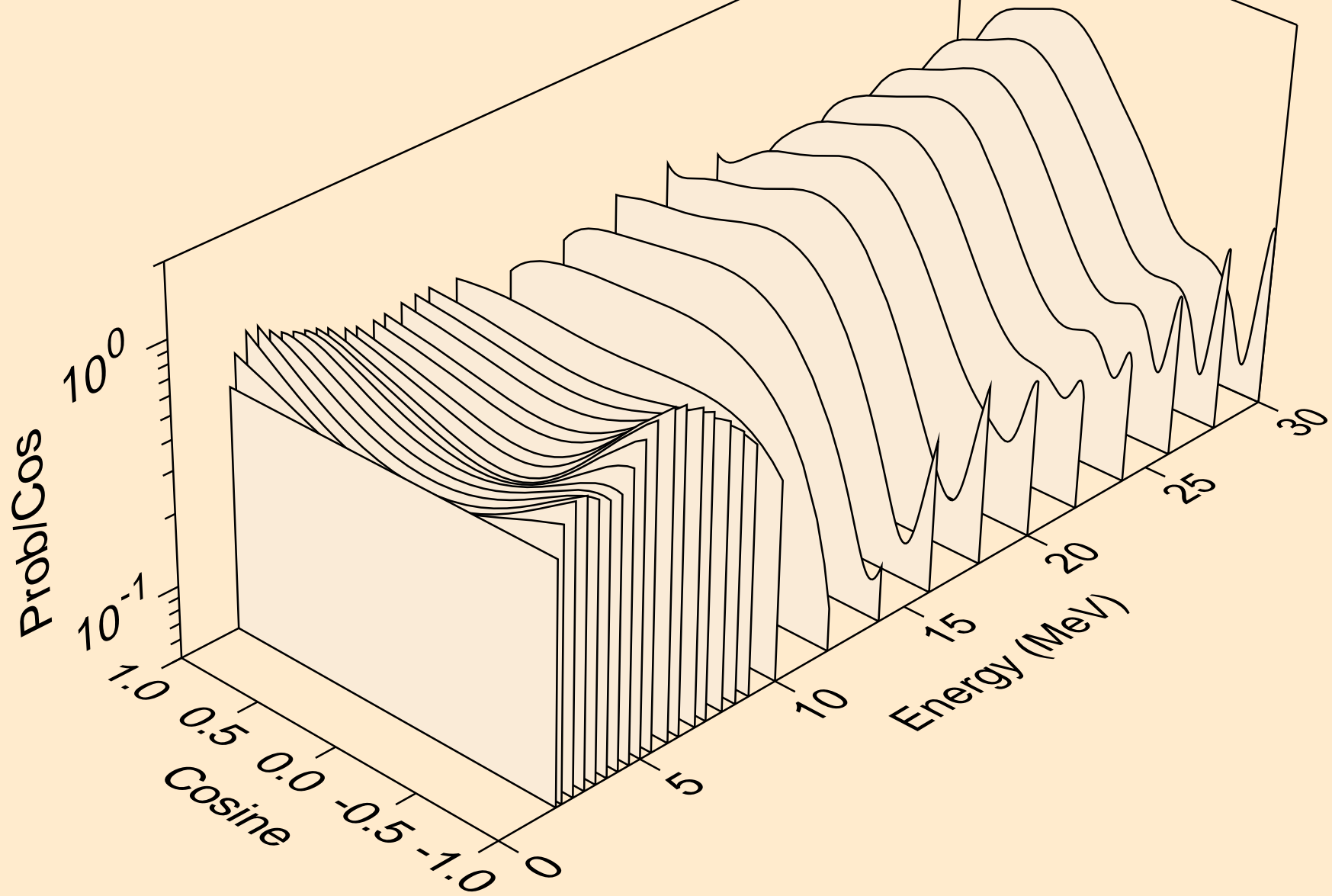

HF182 NEUTRON ACER TENDL-2024 LIBRARY; T=0.K  
angular distribution for (n,n\*22)

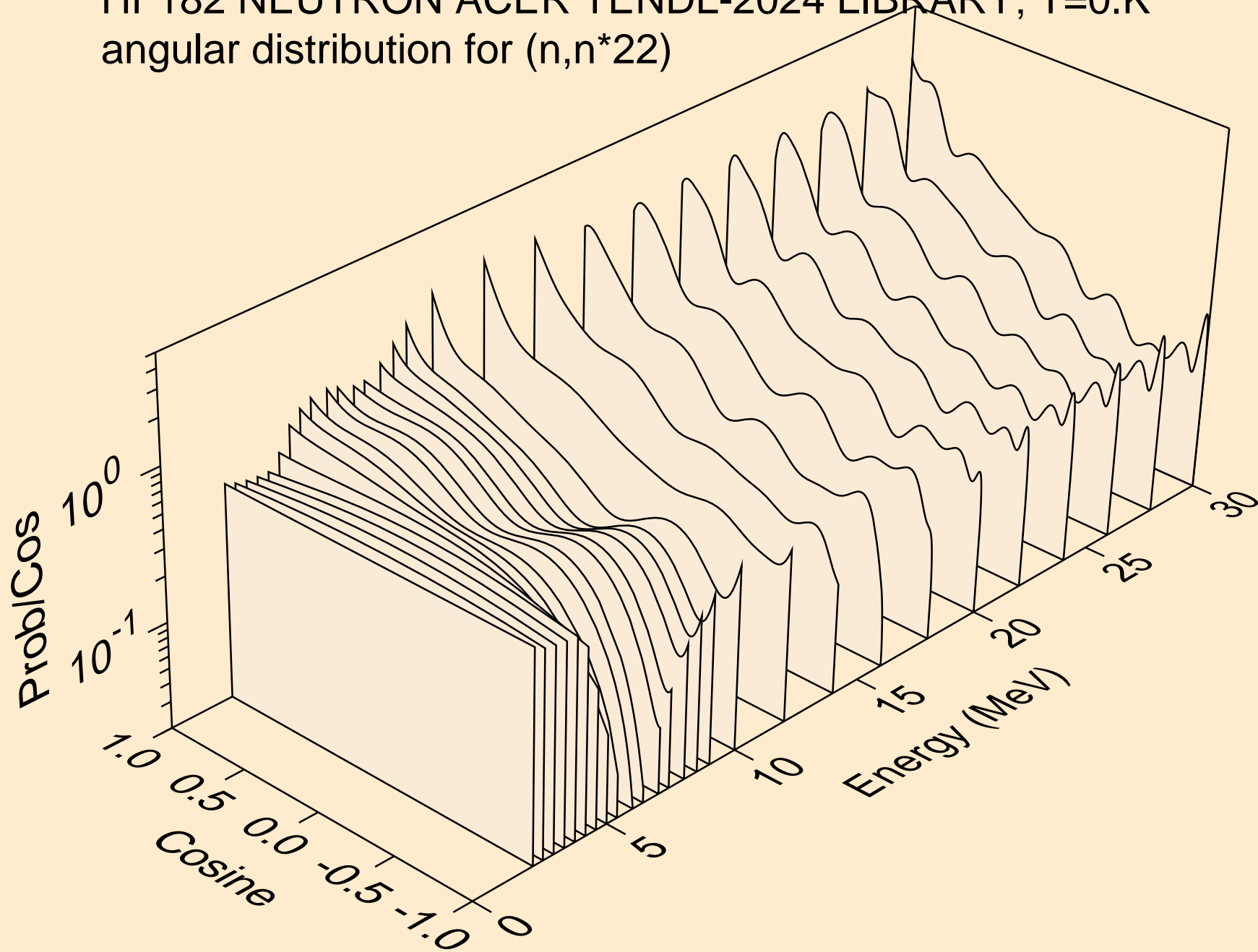

HF182 NEUTRON ACER TENDL-2024 LIBRARY; T=0.K  
angular distribution for (n,n\*23)

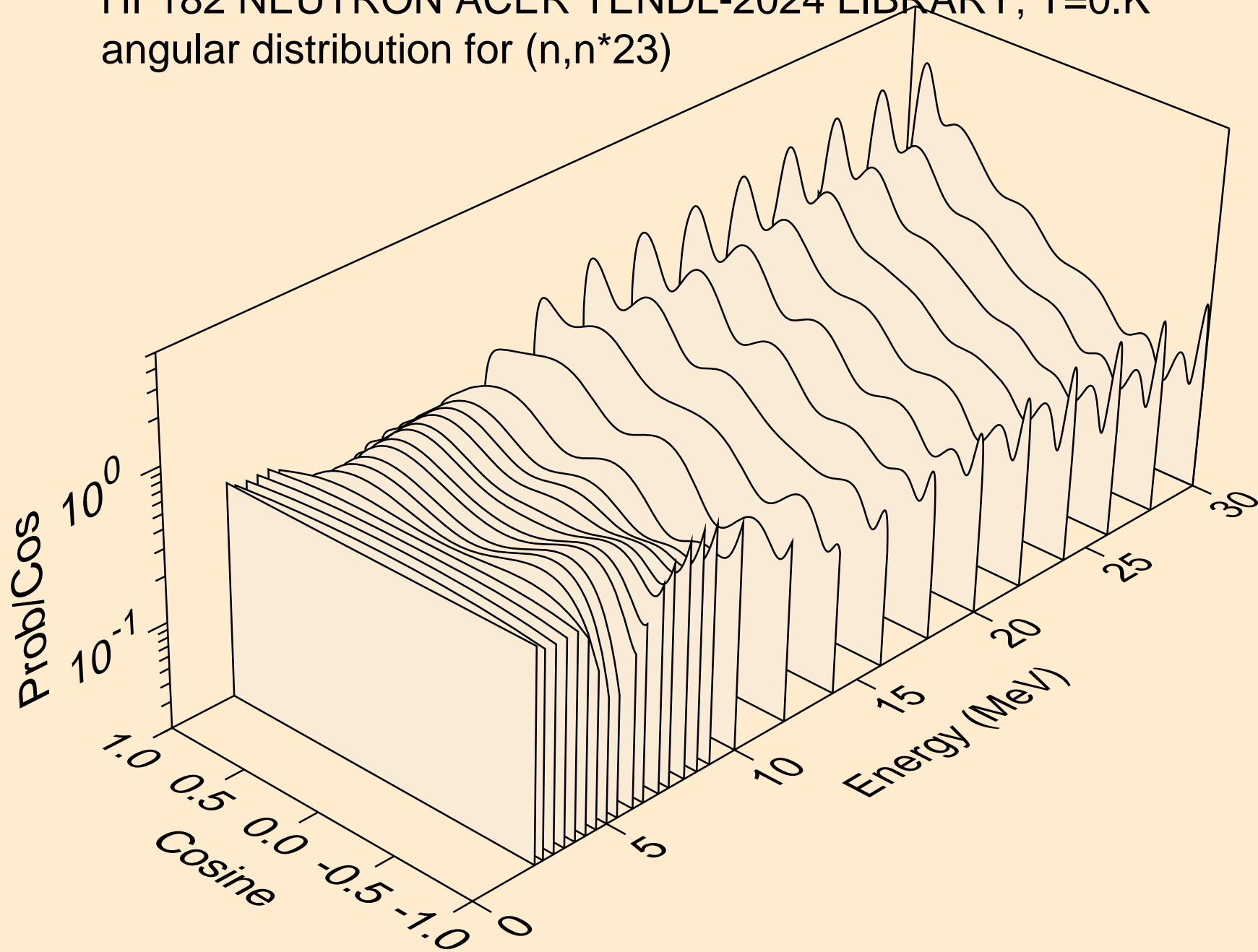

HF182 NEUTRON ACER TENDL-2024 LIBRARY; T=0.K  
Neutron emission for (n,x)

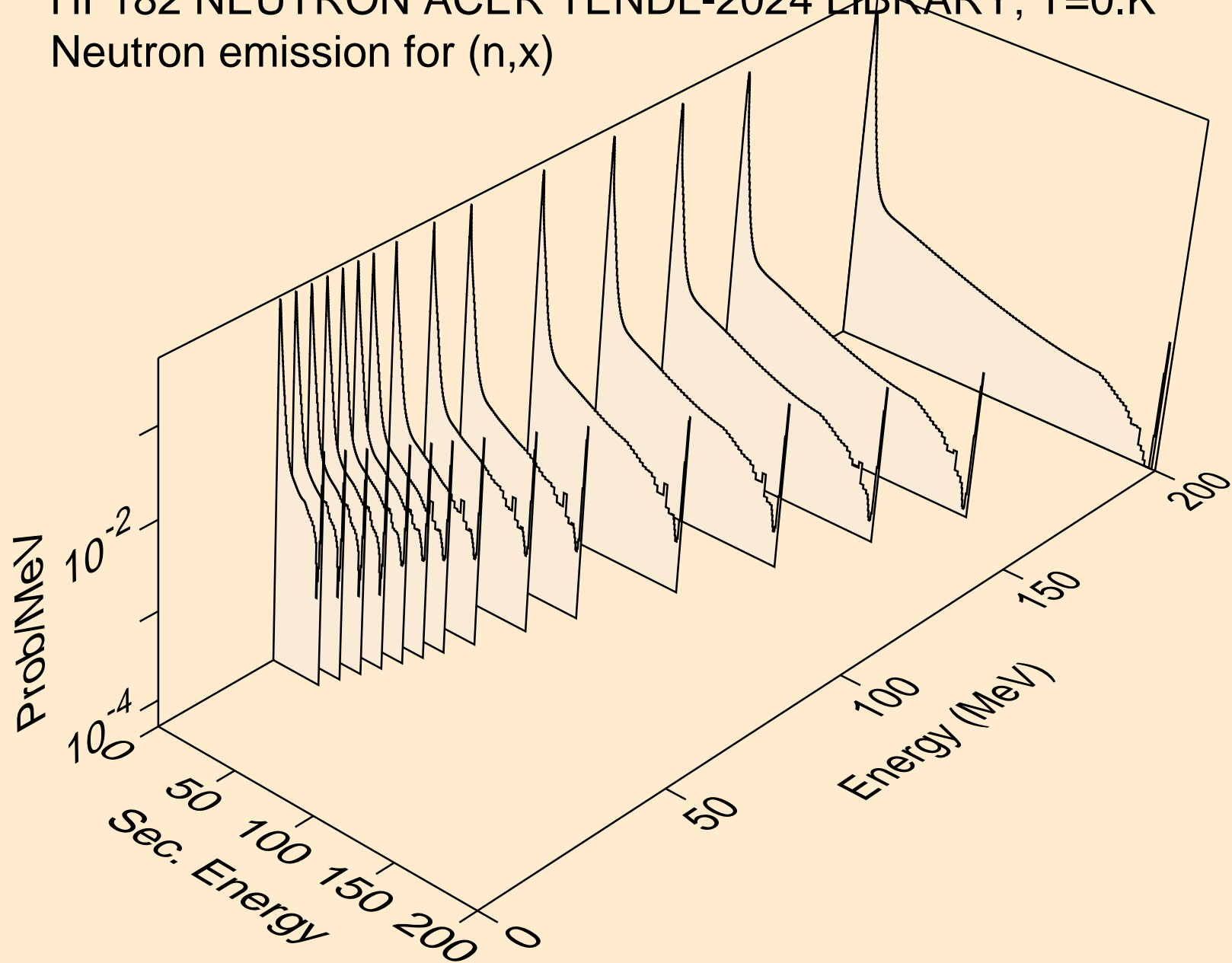

HF182 NEUTRON ACER TENDL-2024 LIBRARY; T=0.K  
Neutron emission for (n,2nd)

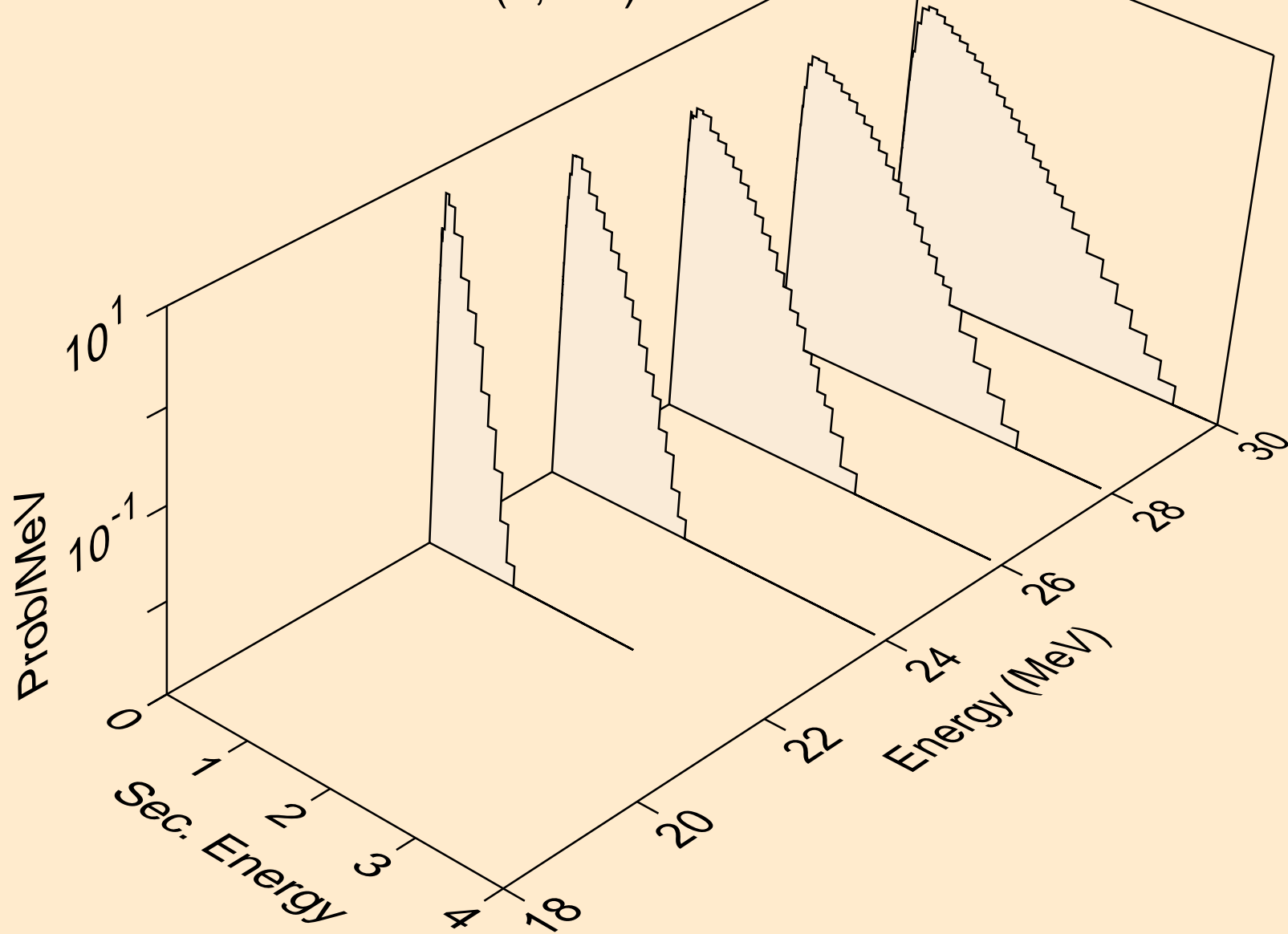

HF182 NEUTRON ACER TENDL-2024 LIBRARY; T=0.K  
Neutron emission for (n,2n)

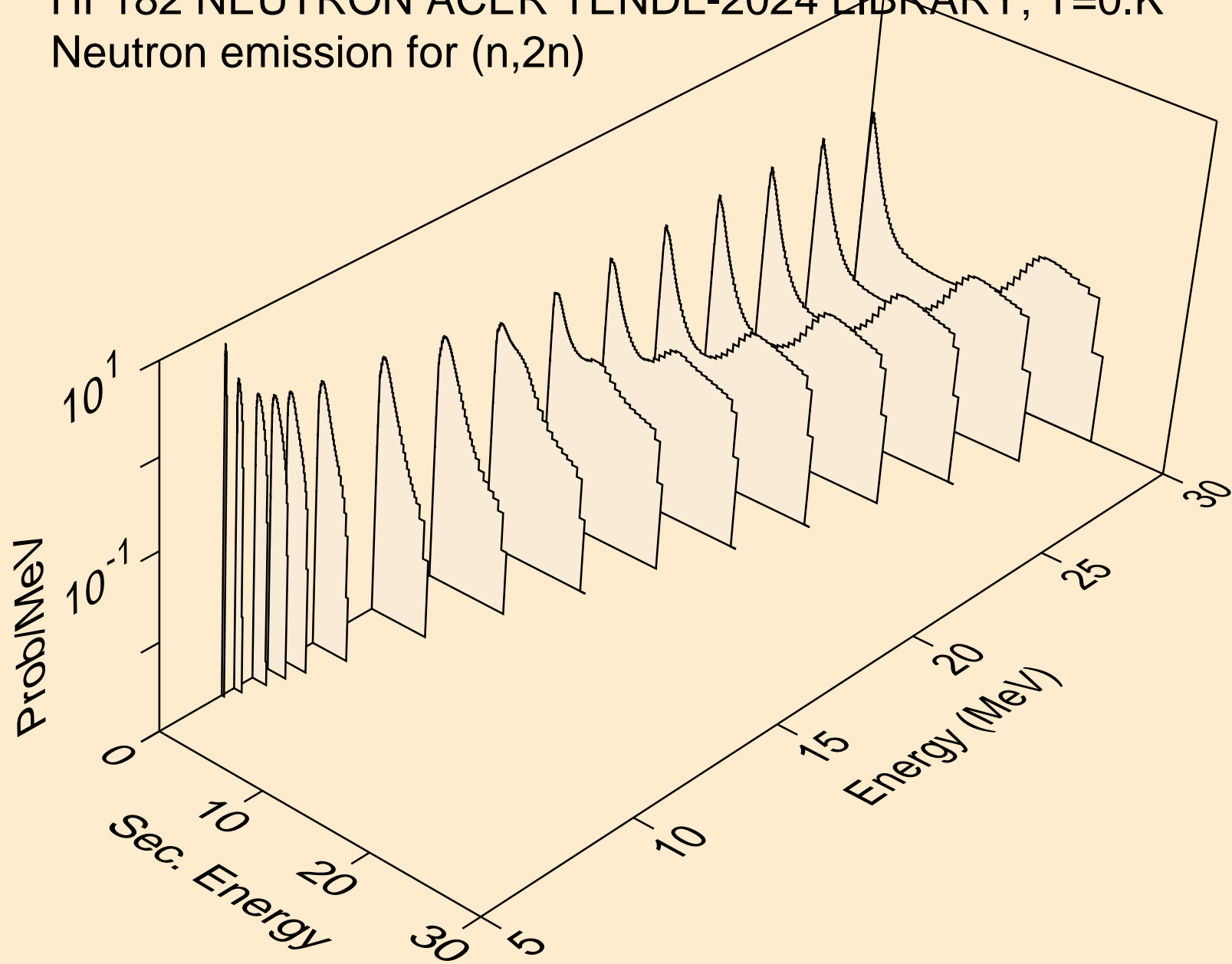

HF182 NEUTRON ACER TENDL-2024 LIBRARY; T=0.K  
Neutron emission for (n,3n)

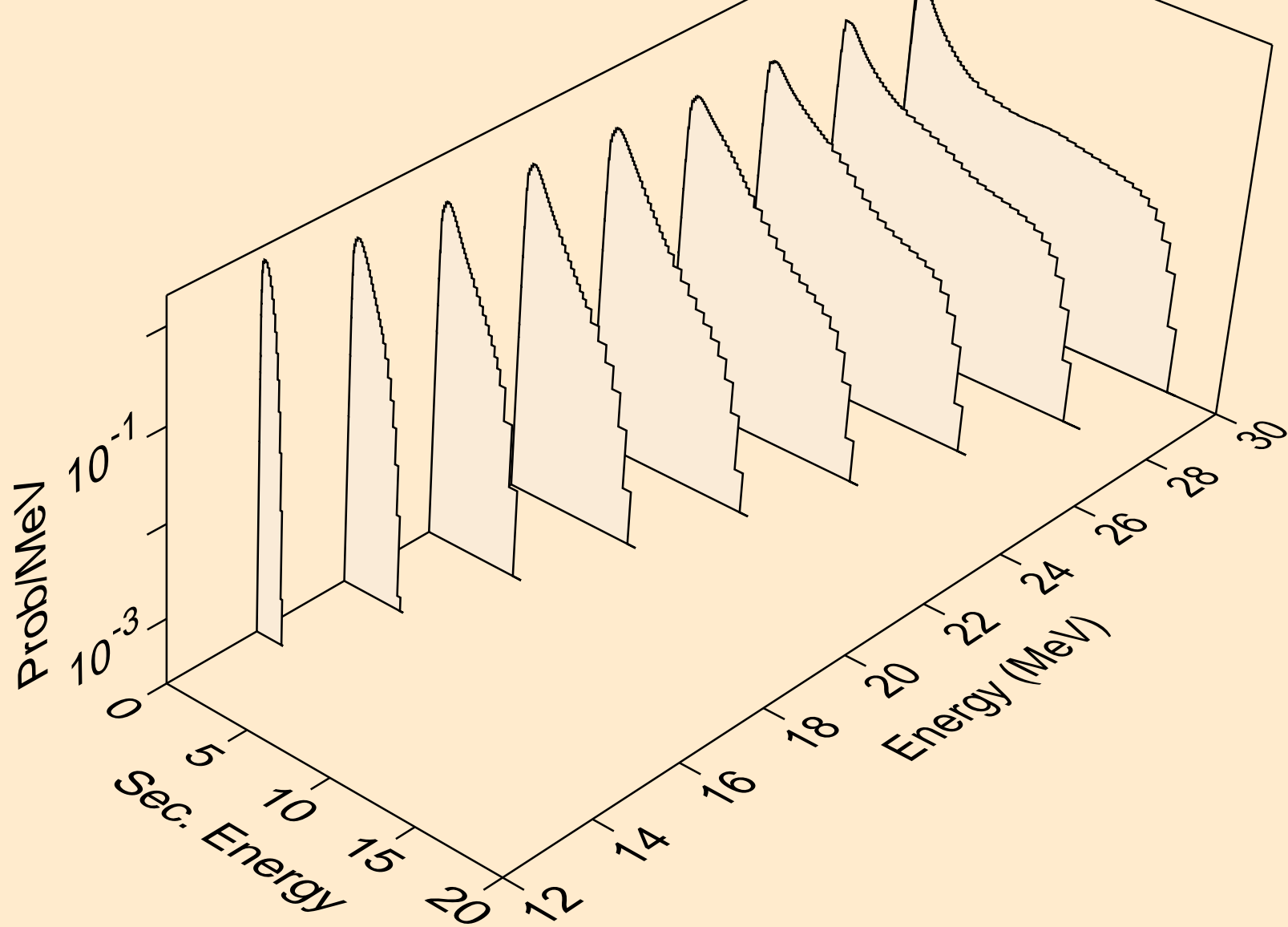

HF182 NEUTRON ACER TENDL-2024 LIBRARY; T=0.K  
Neutron emission for (n,n\*)a

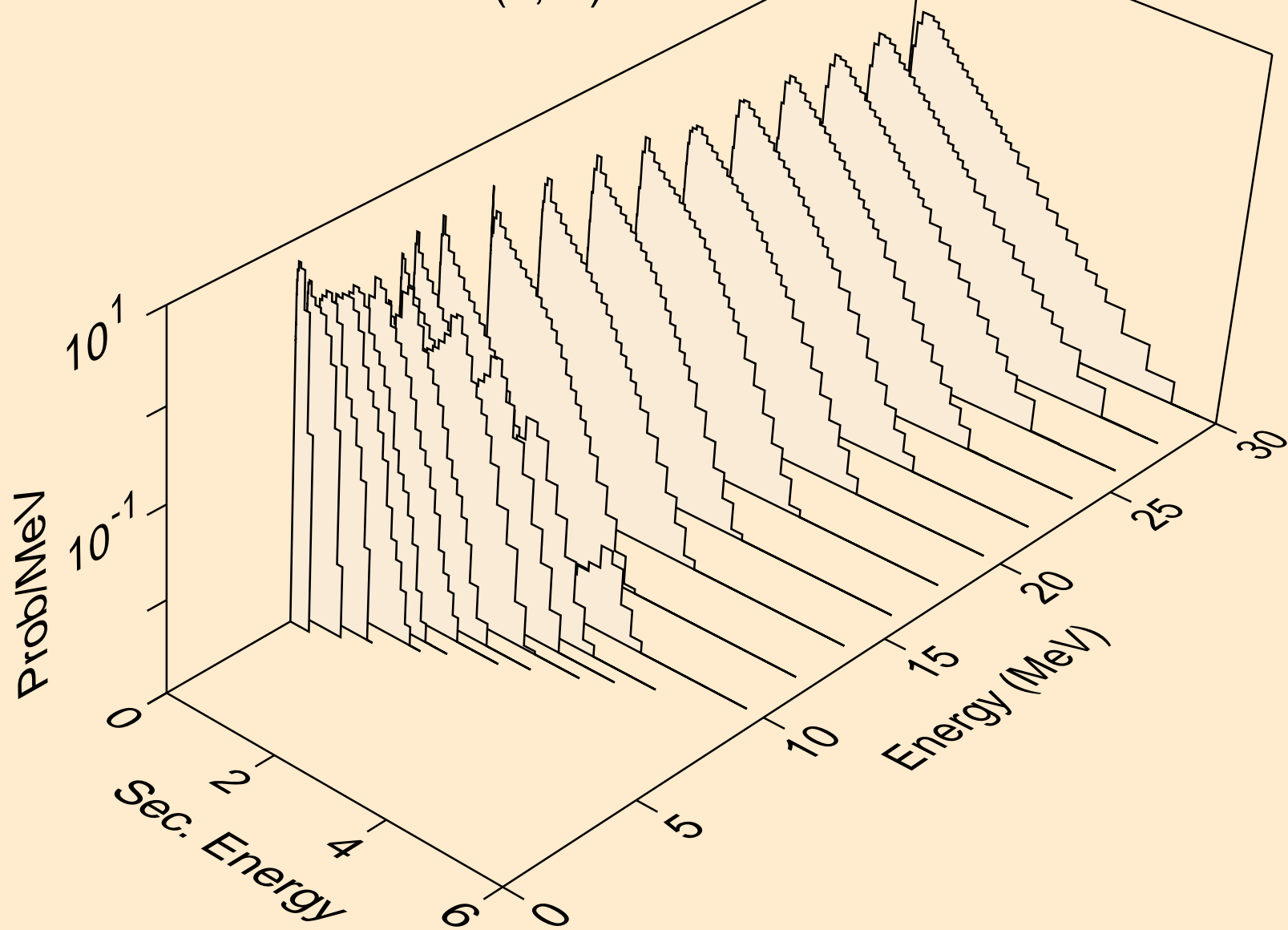

HF182 NEUTRON ACER TENDL-2024 LIBRARY; T=0.K  
Neutron emission for (n,2n)a

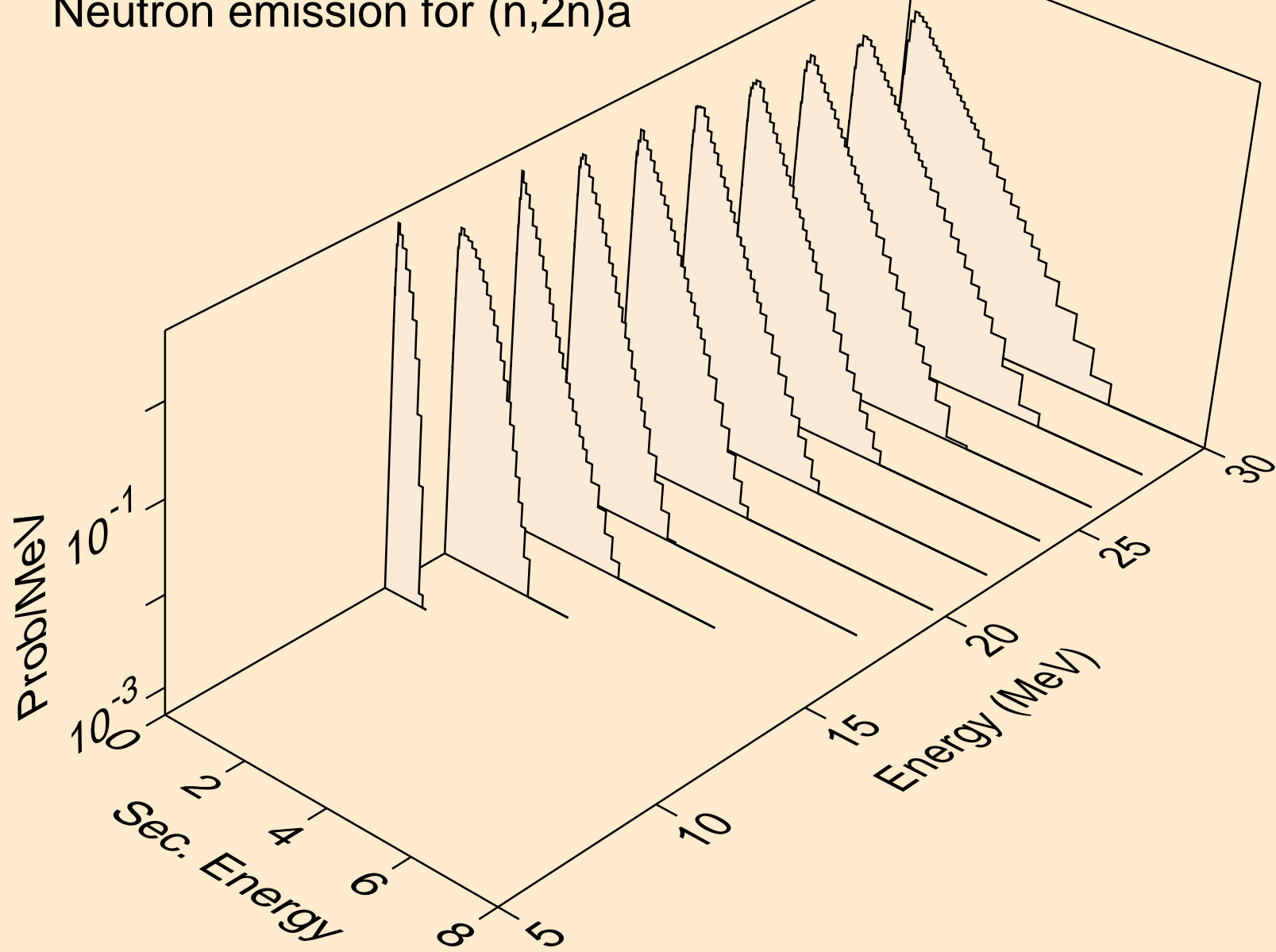

HF182 NEUTRON ACER TENDL-2024 LIBRARY; T=0.K  
Neutron emission for (n,3n)a

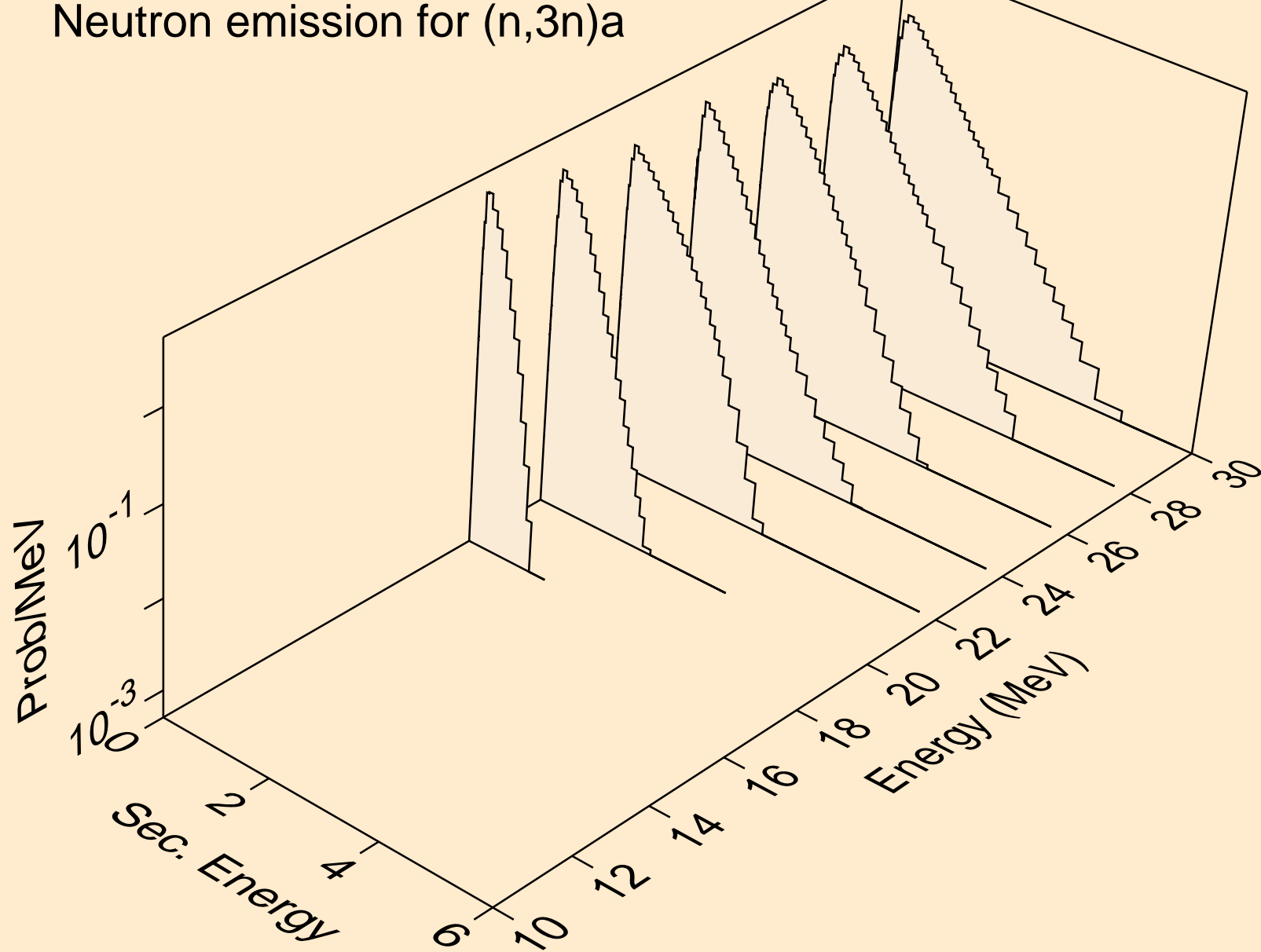

HF182 NEUTRON ACER TENDL-2024 LIBRARY; T=0.K  
Neutron emission for (n,n\*)p

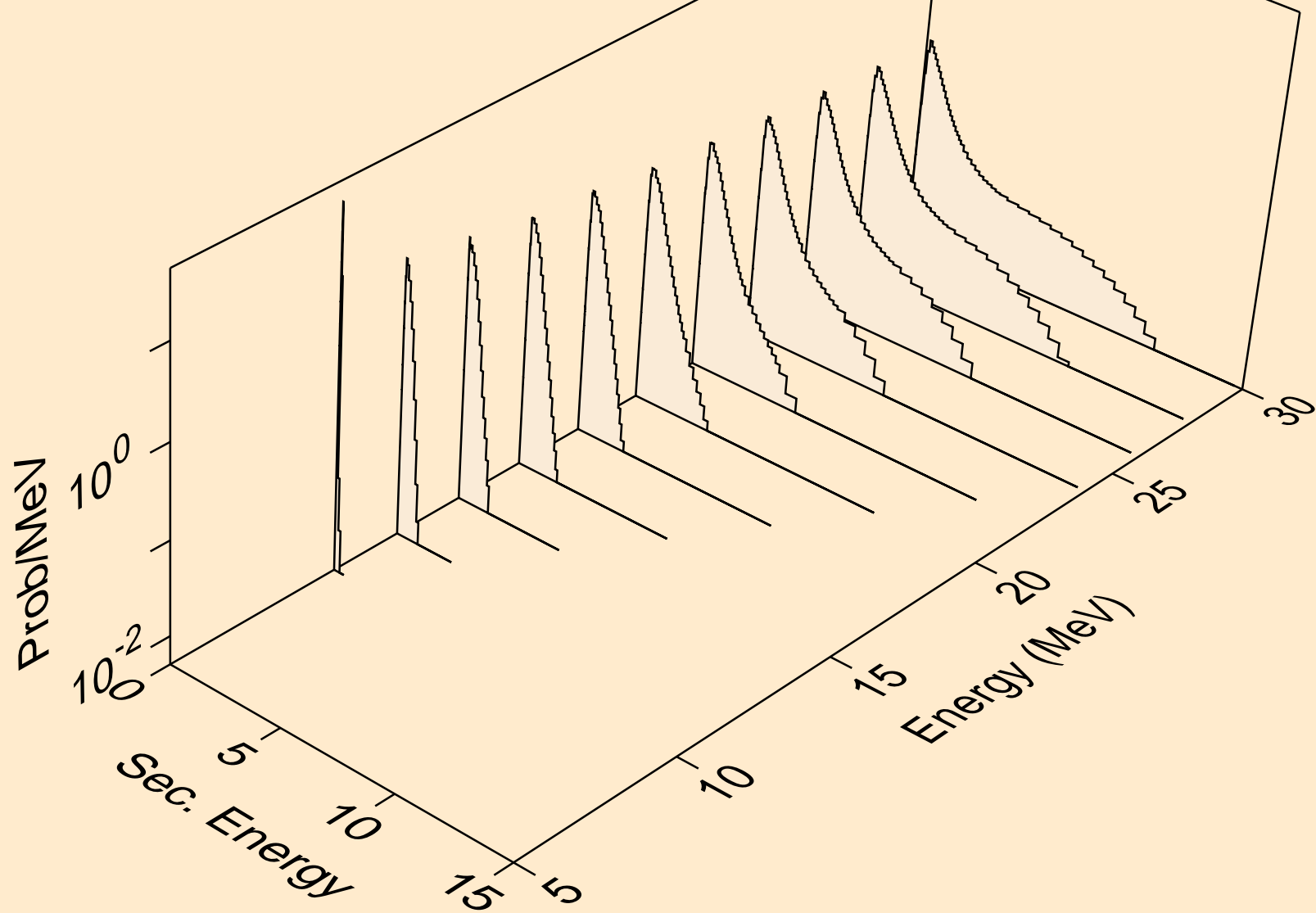

HF182 NEUTRON ACER TENDL-2024 LIBRARY; T=0.K  
Neutron emission for (n,n\*)d

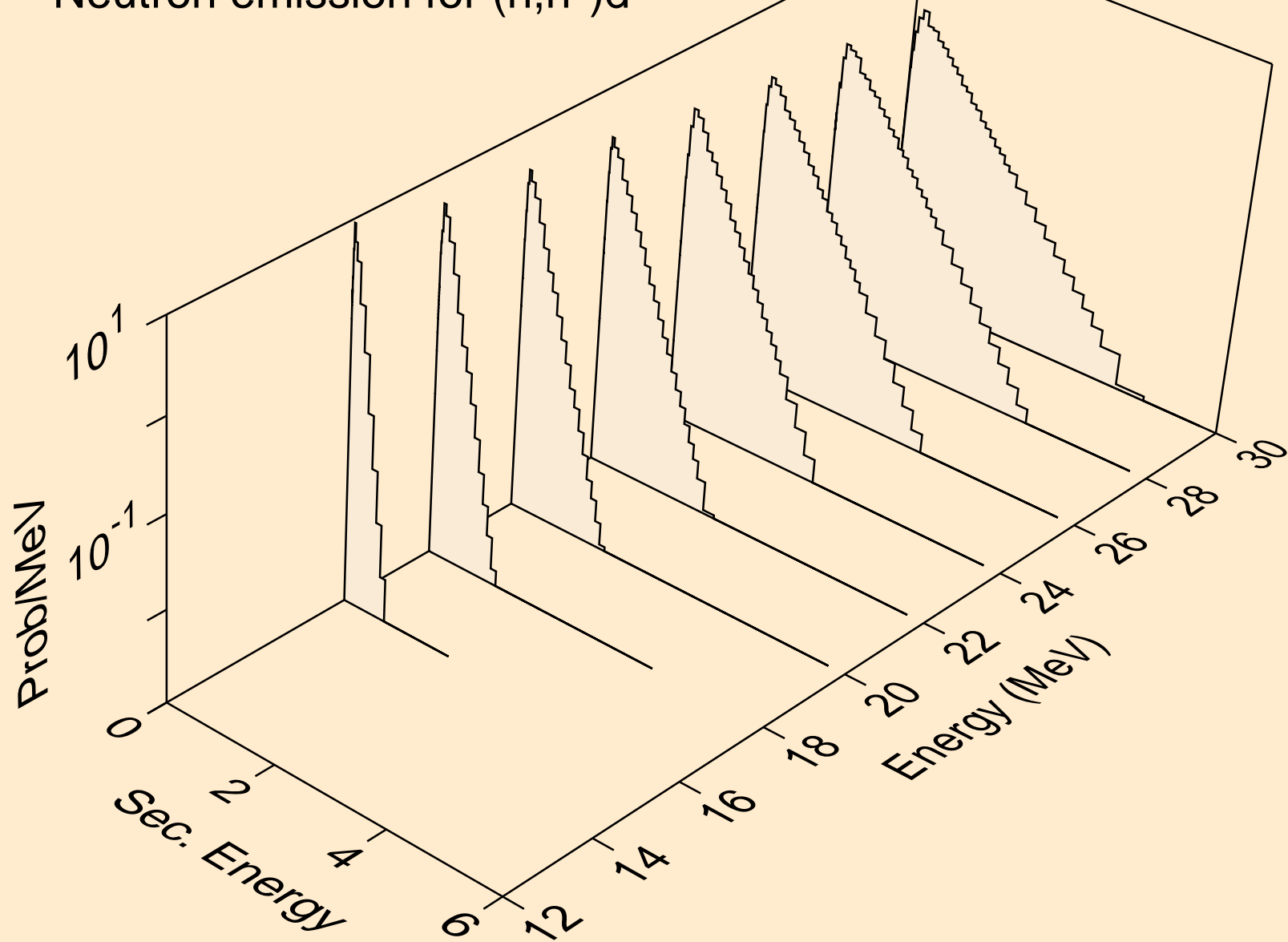

HF182 NEUTRON ACER TENDL-2024 LIBRARY; T=0.K  
Neutron emission for (n,n\*)t

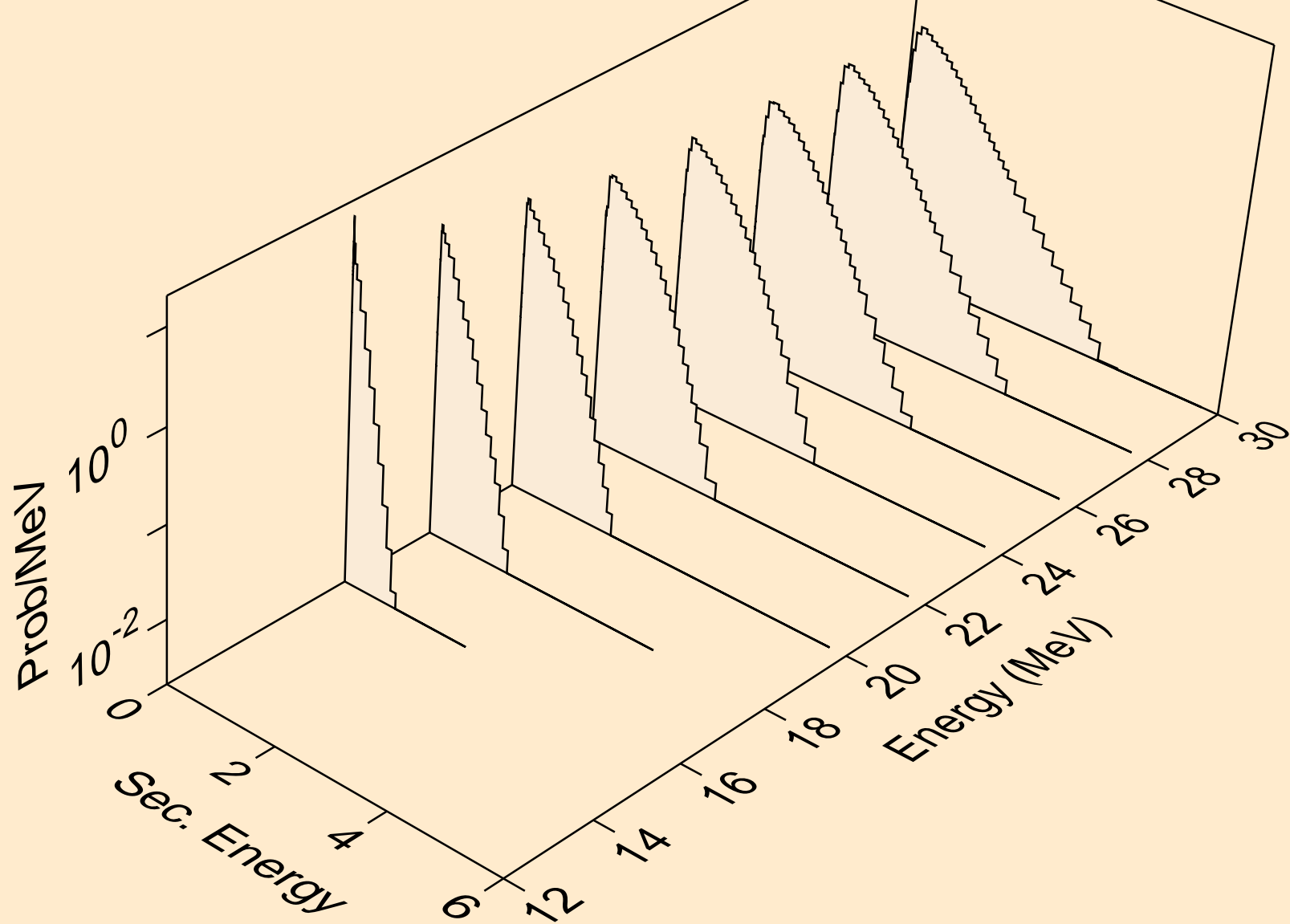

HF182 NEUTRON ACER TENDL-2024 LIBRARY; T=0.K  
Neutron emission for (n,n\*)he3

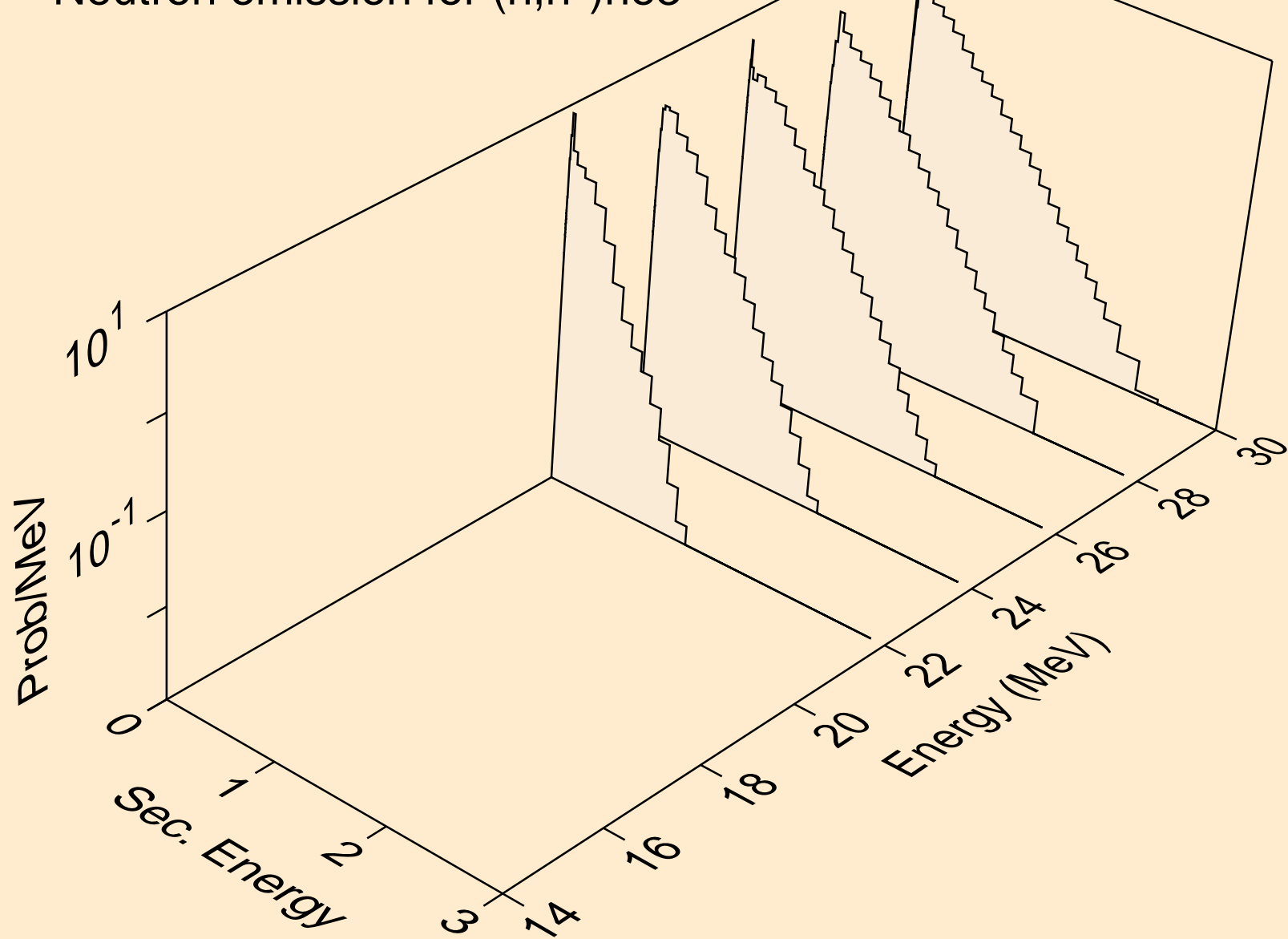

HF182 NEUTRON ACER TENDL-2024 LIBRARY; T=0.K  
Neutron emission for (n,4n)

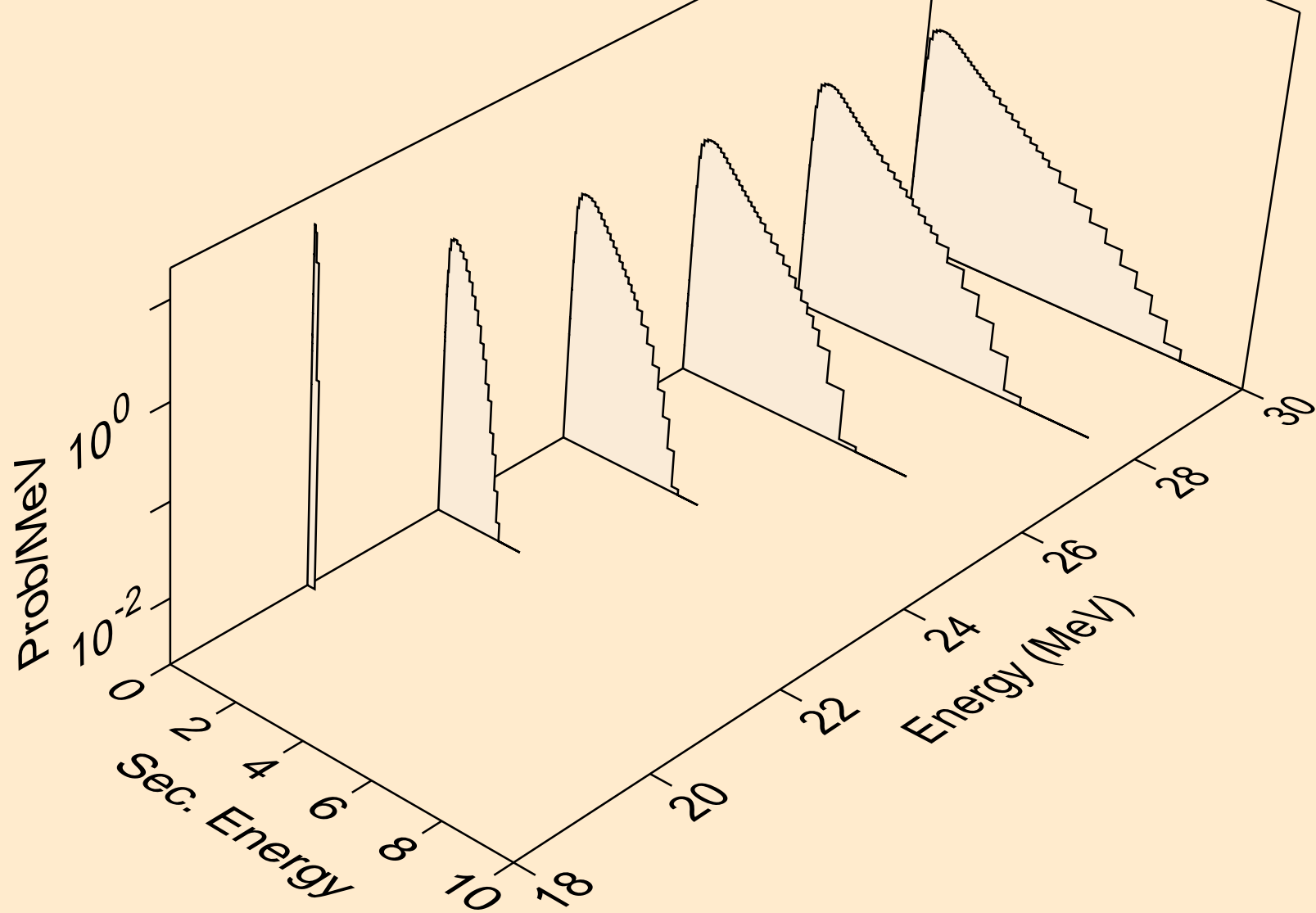

HF182 NEUTRON ACER TENDL-2024 LIBRARY; T=0.K  
Neutron emission for (n,2np)

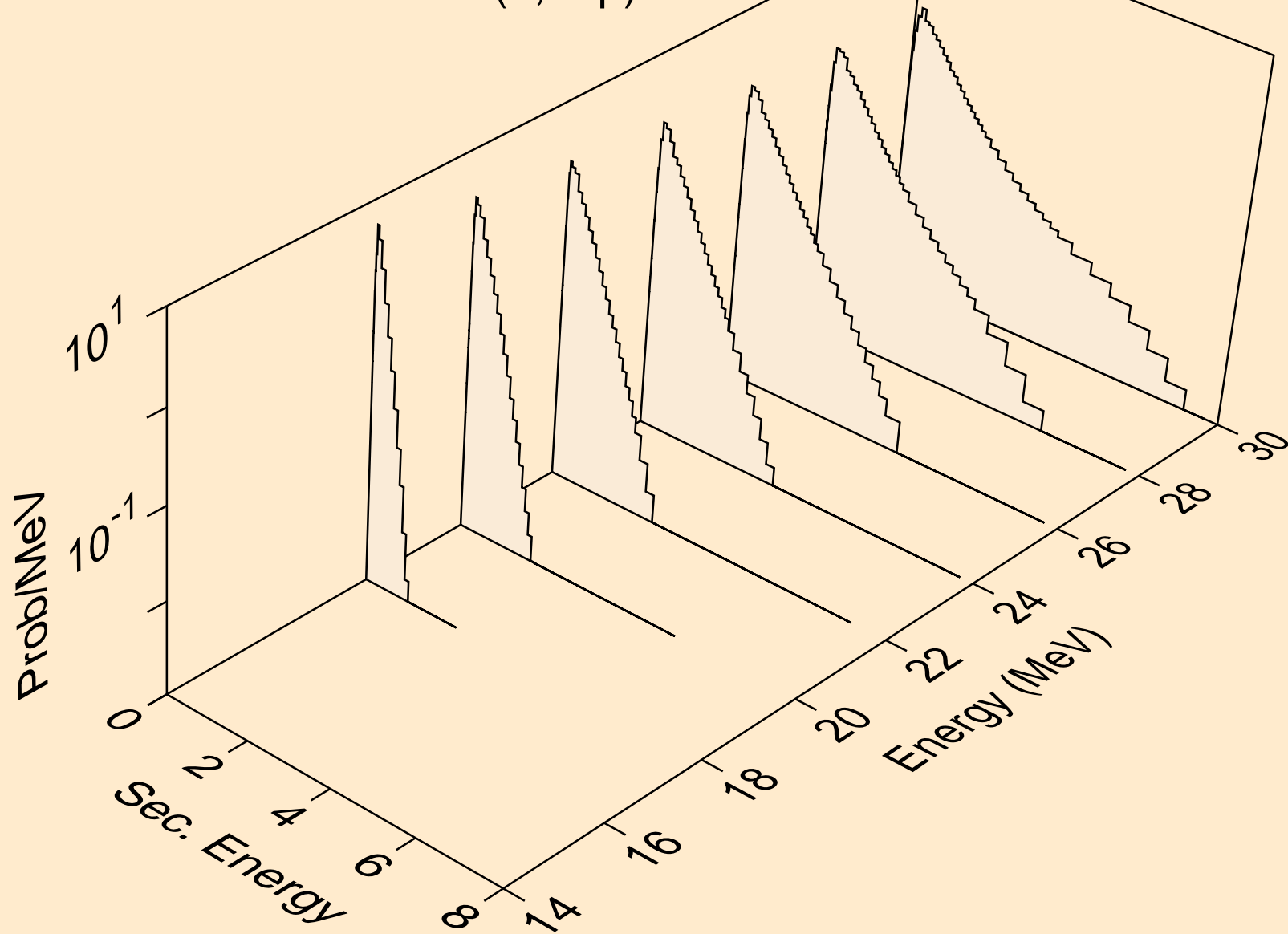

HF182 NEUTRON ACER TENDL-2024 LIBRARY; T=0.K  
Neutron emission for (n,3np)

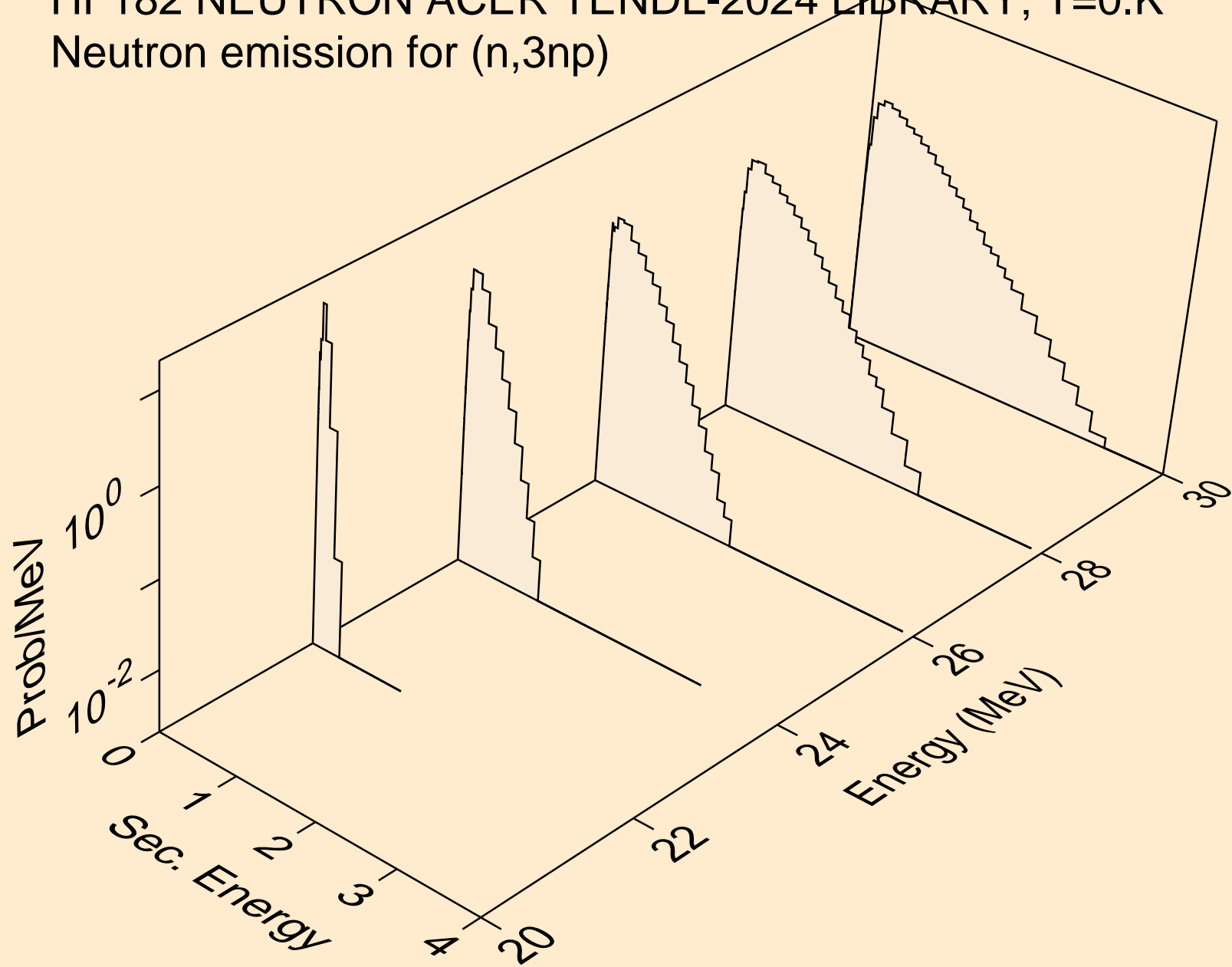

HF182 NEUTRON ACER TENDL-2024 LIBRARY; T=0.K  
Neutron emission for (n,n2p)

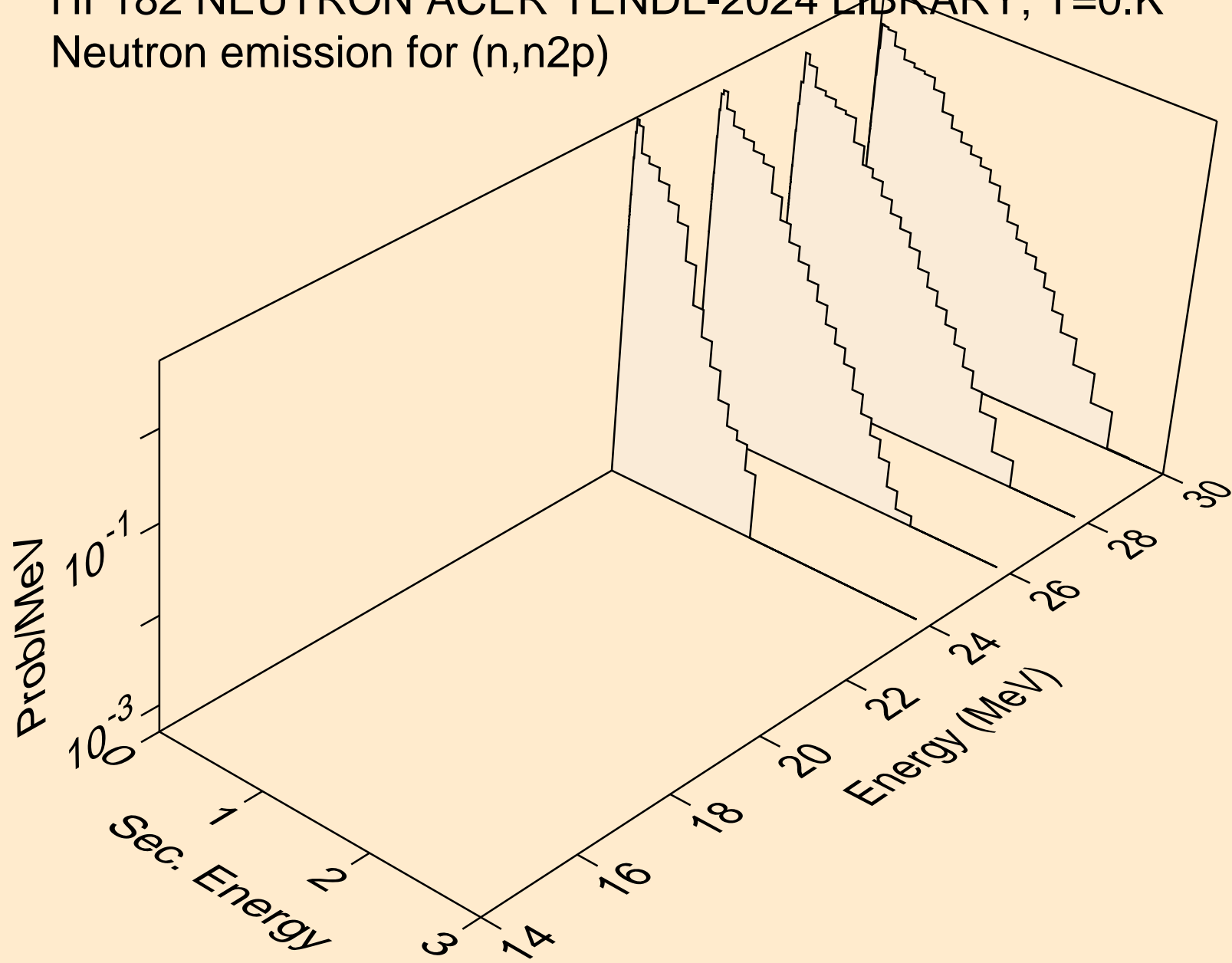

HF182 NEUTRON ACER TENDL-2024 LIBRARY; T=0.K  
Neutron emission for (n,n\*c)

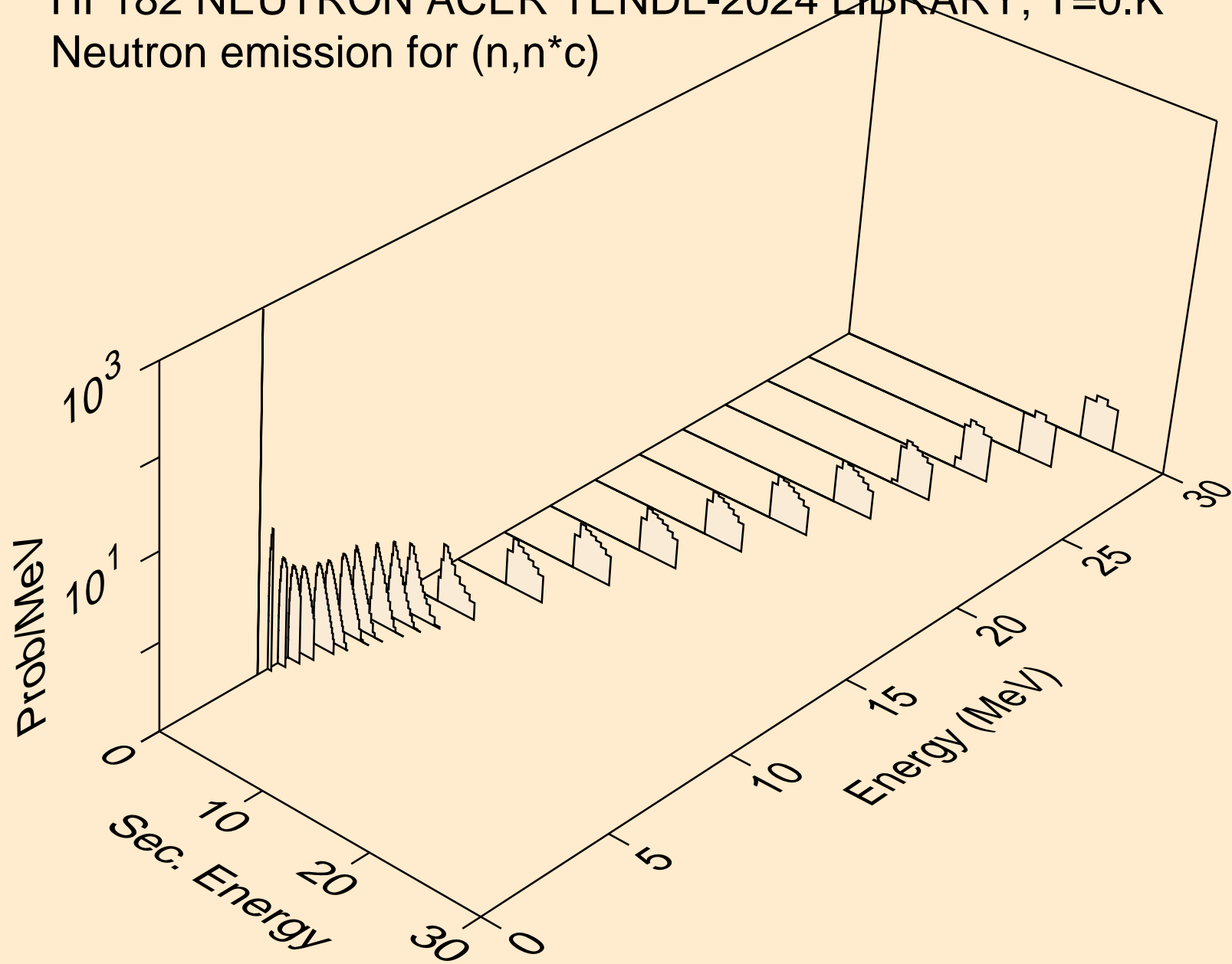

HF182 NEUTRON ACER TENDL-2024 LIBRARY; T=0.K  
Photon emission for (n,x)

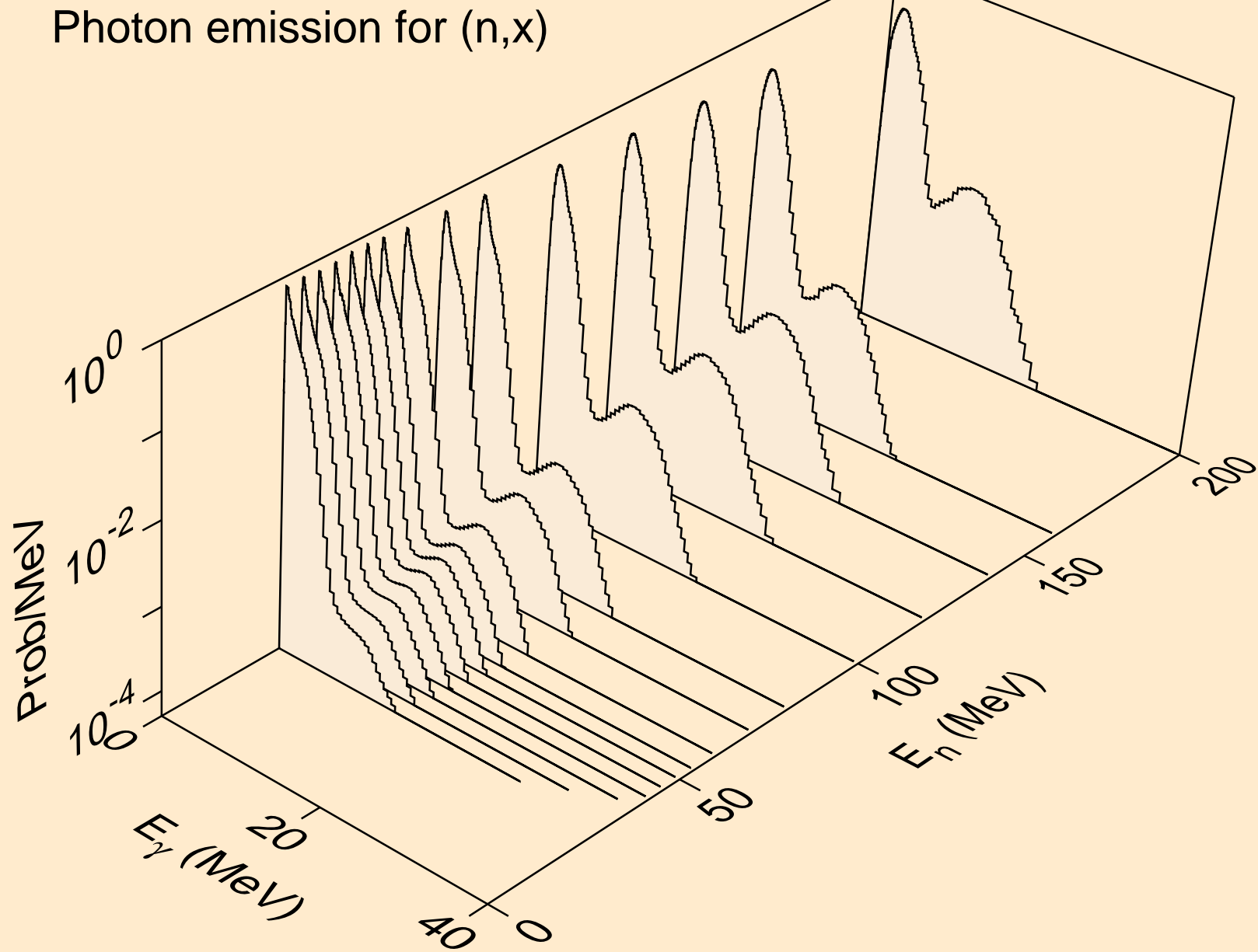

HF182 NEUTRON ACER TENDL-2024 LIBRARY; T=0.K  
Photon emission for (n,2nd)

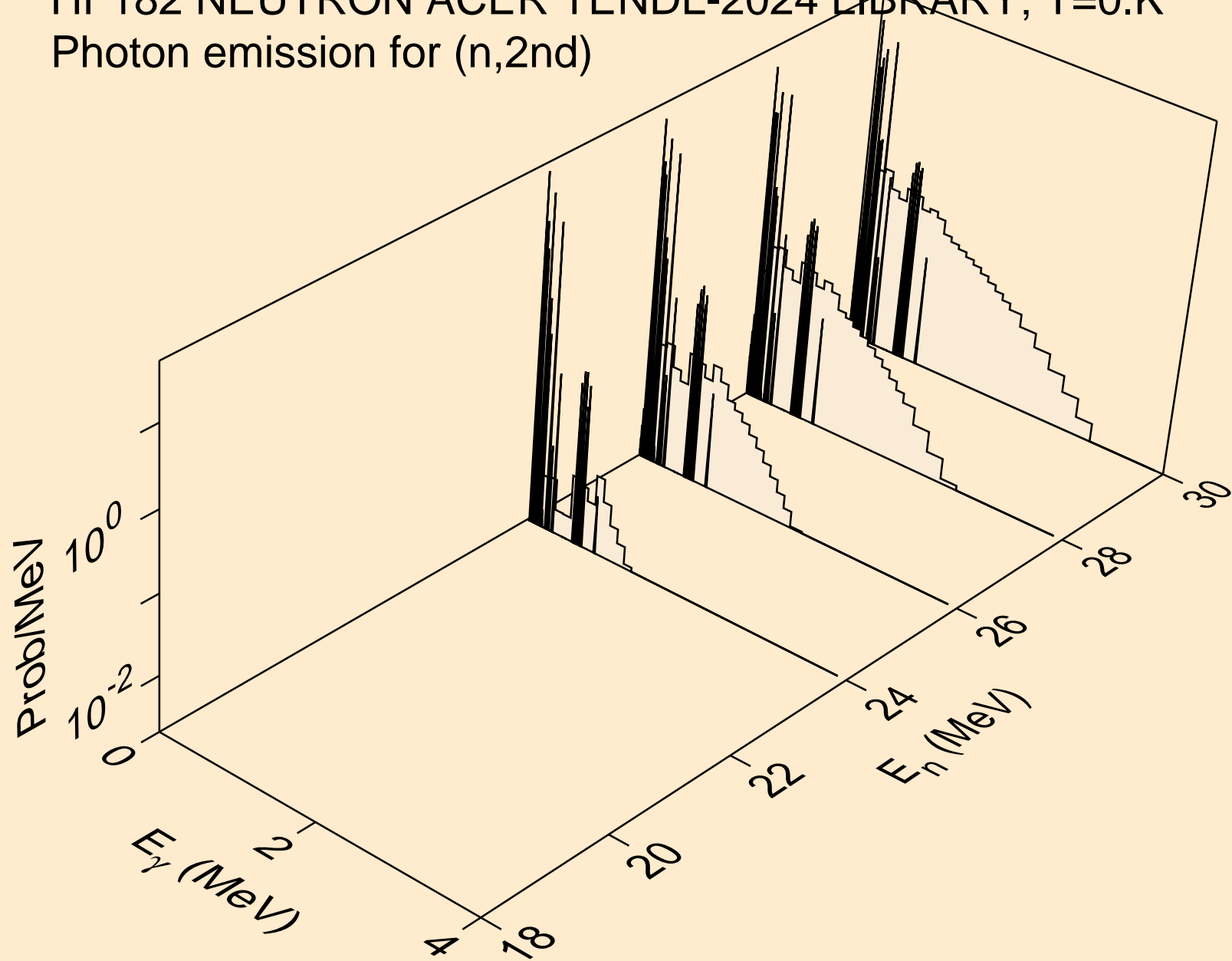

HF182 NEUTRON ACER TENDL-2024 LIBRARY; T=0.K  
Photon emission for (n,2n)

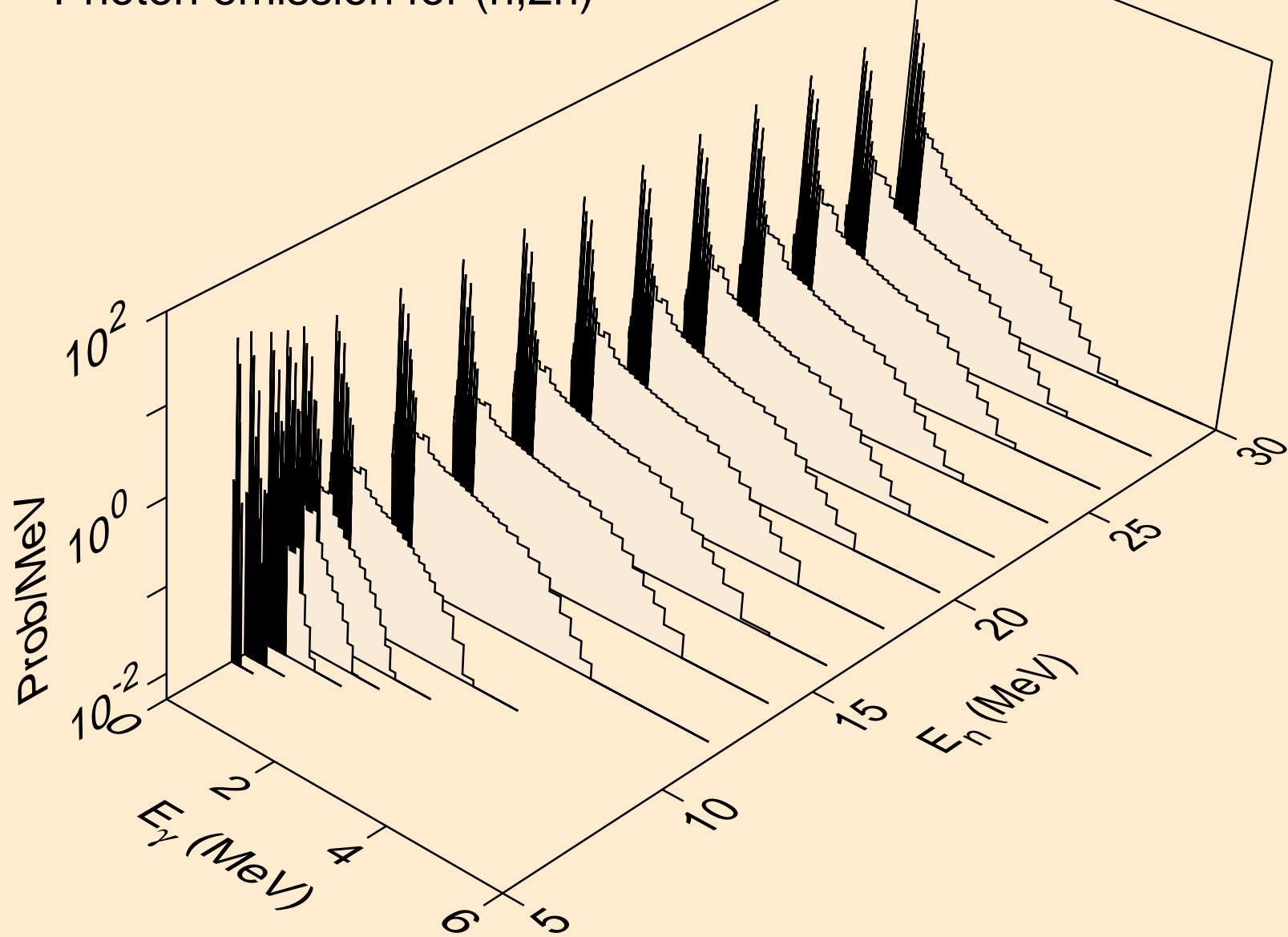

HF182 NEUTRON ACER TENDL-2024 LIBRARY; T=0.K  
Photon emission for (n,3n)

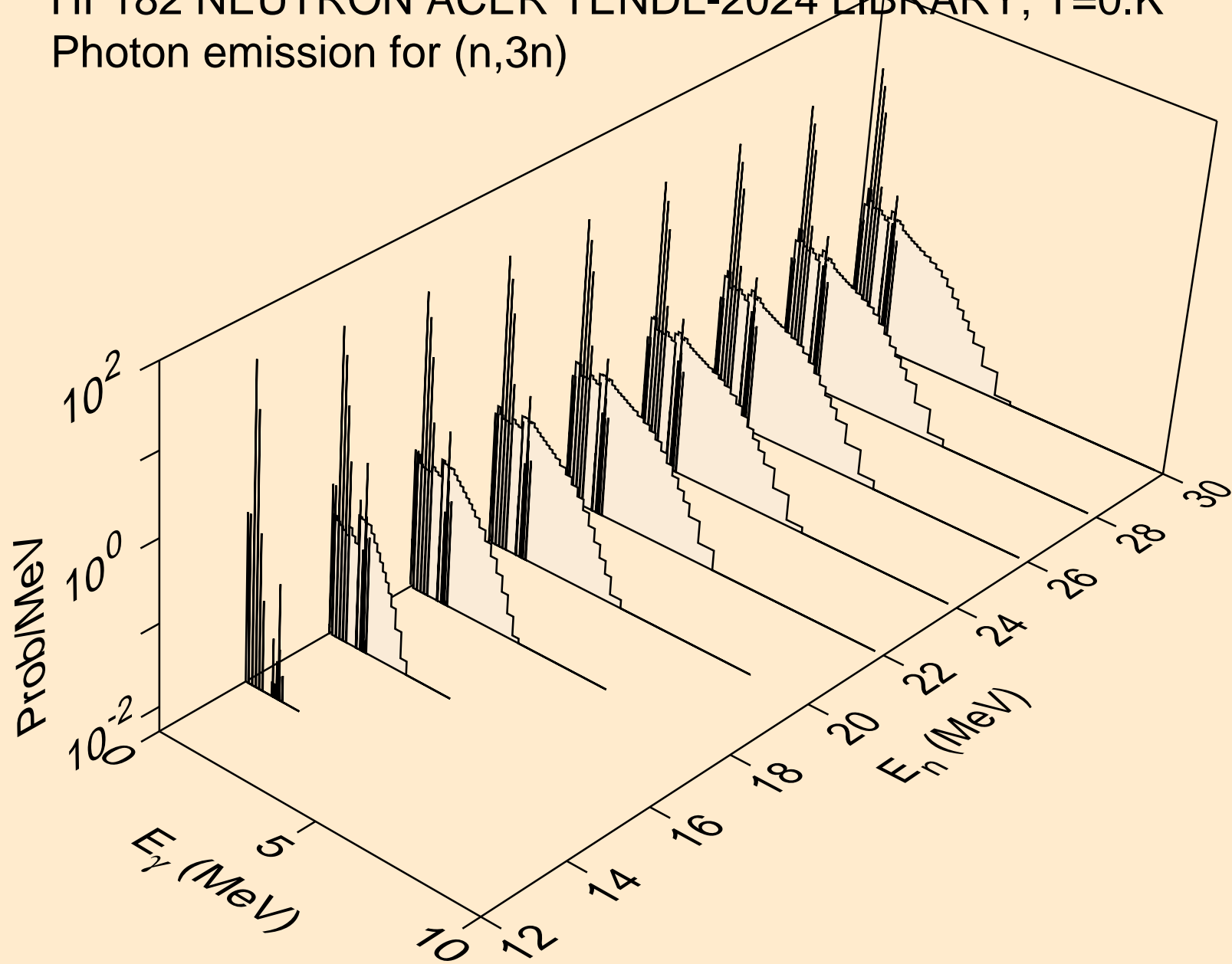

HF182 NEUTRON ACER TENDL-2024 LIBRARY; T=0.K  
Photon emission for (n,n\*)a

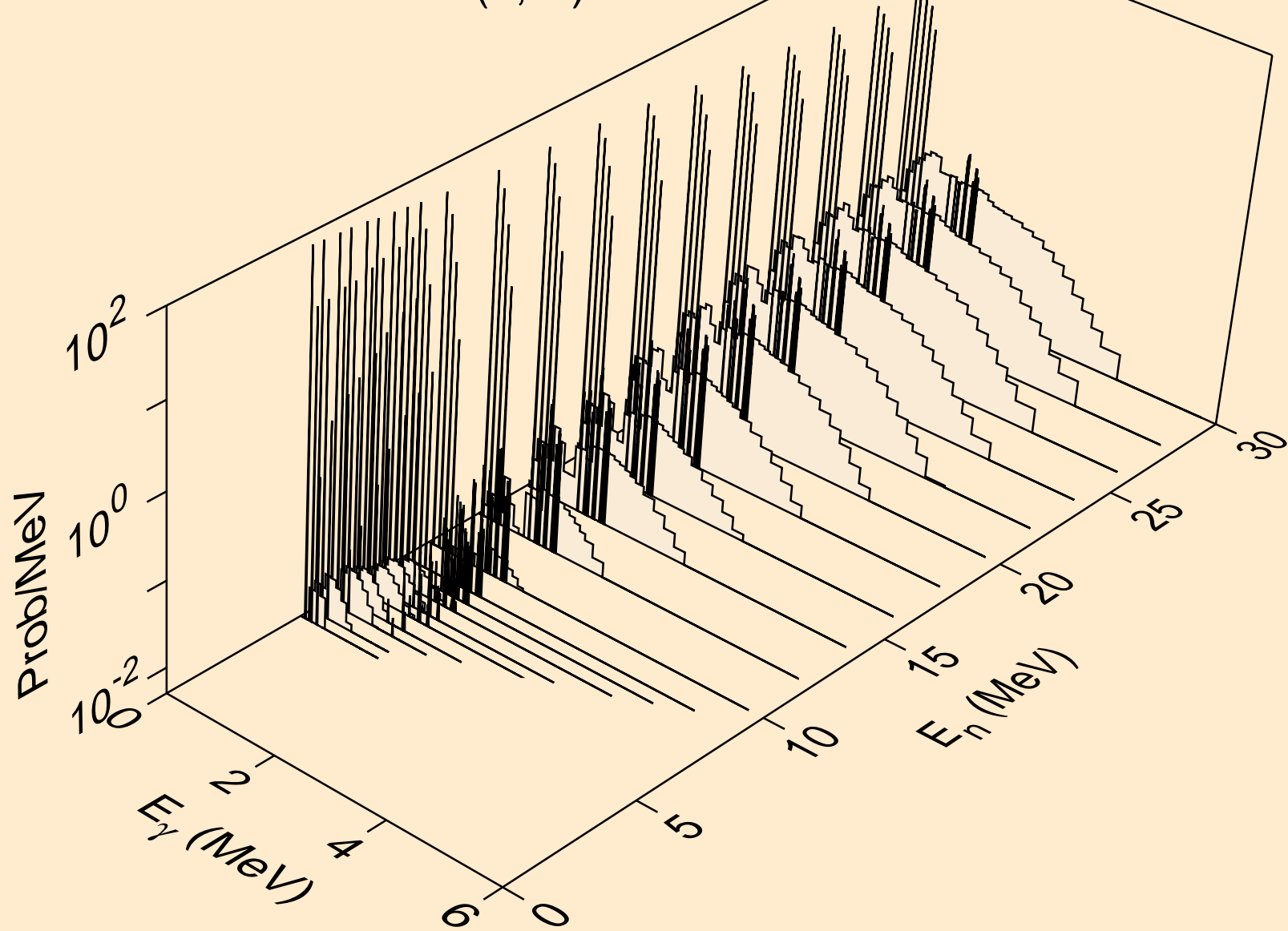

HF182 NEUTRON ACER TENDL-2024 LIBRARY; T=0.K  
Photon emission for (n,2n)a

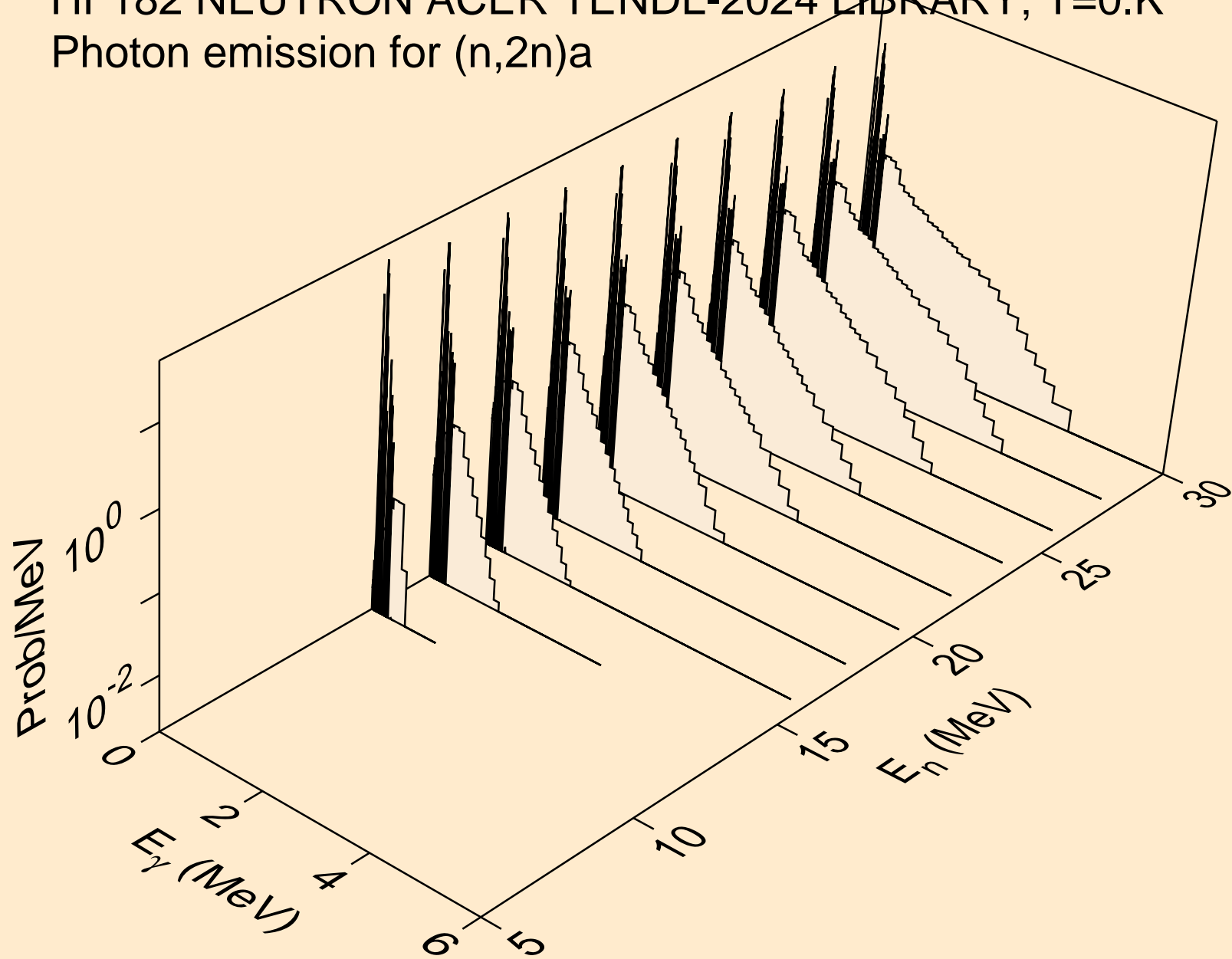

HF182 NEUTRON ACER TENDL-2024 LIBRARY; T=0.K  
Photon emission for (n,3n)a

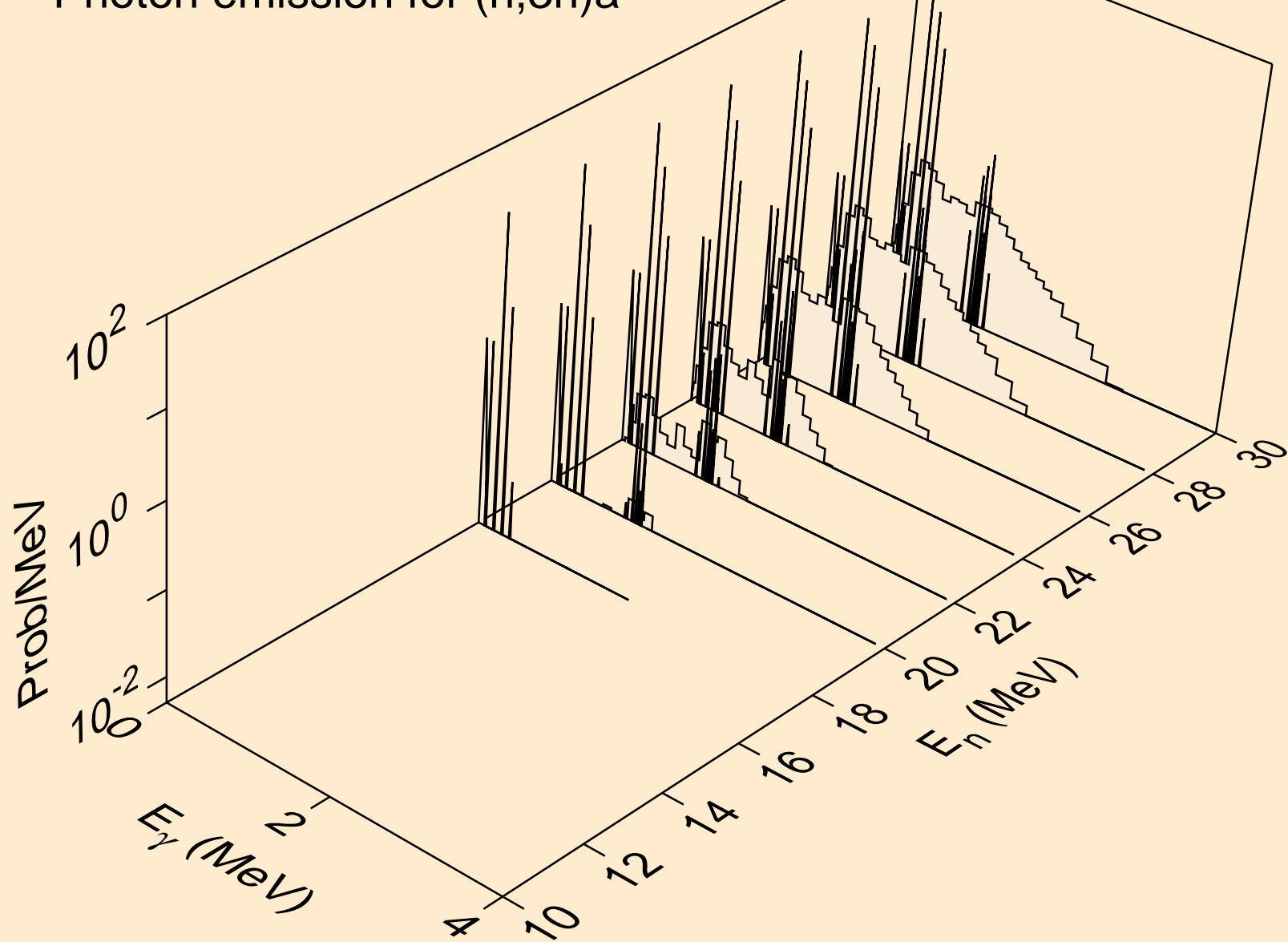

HF182 NEUTRON ACER TENDL-2024 LIBRARY; T=0.K  
Photon emission for (n,n\*)p

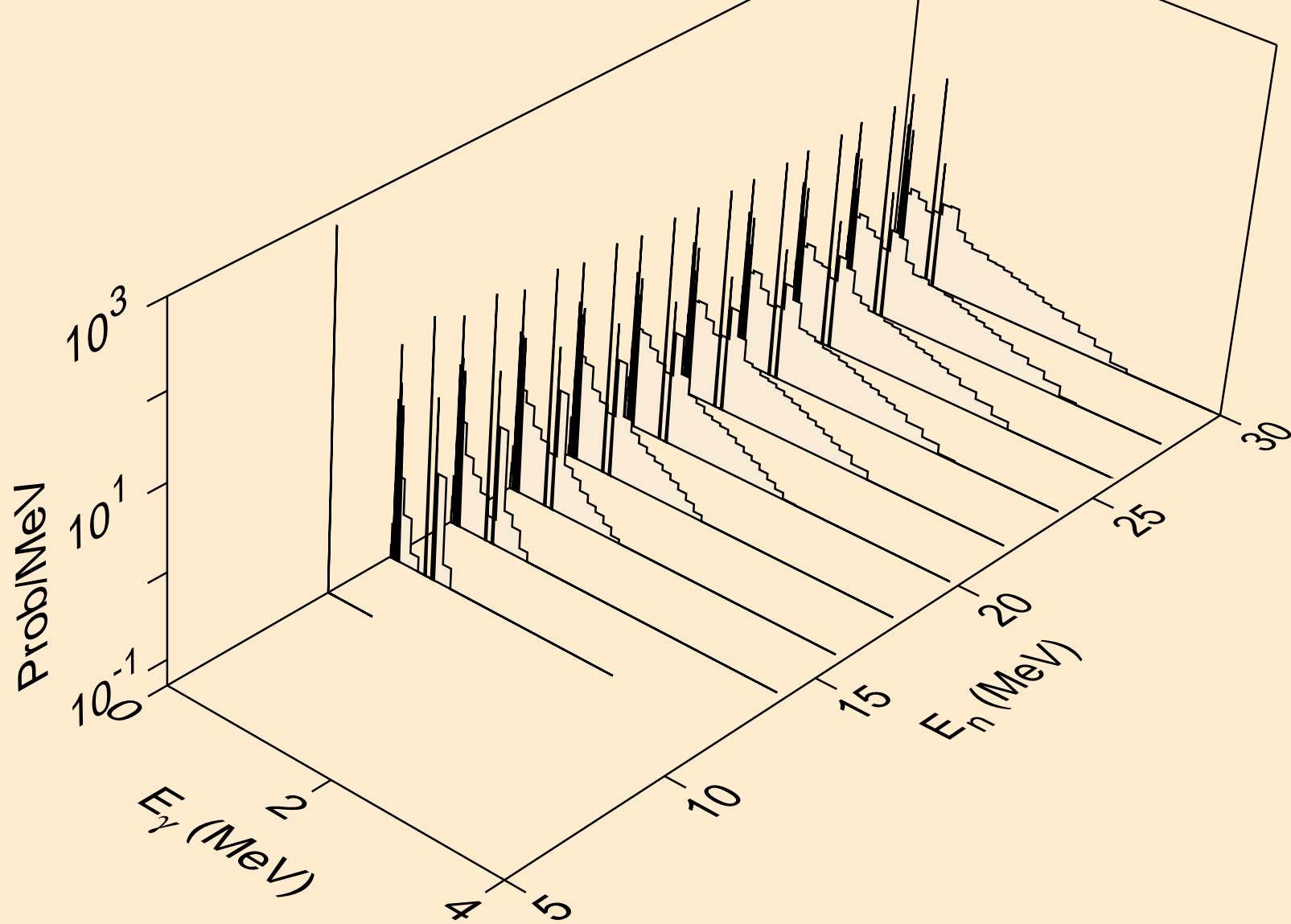

HF182 NEUTRON ACER TENDL-2024 LIBRARY; T=0.K  
Photon emission for (n,n\*)d

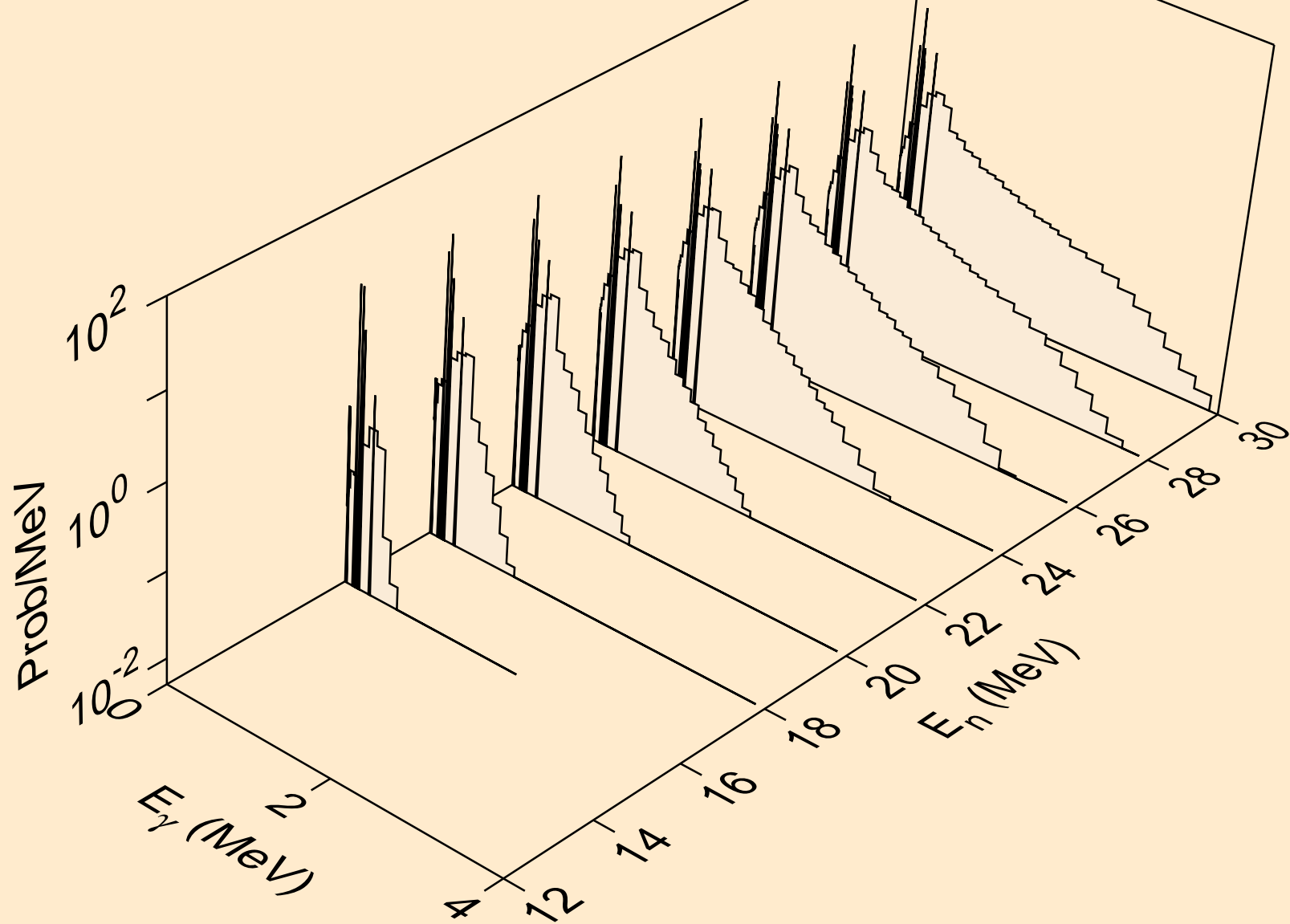

HF182 NEUTRON ACER TENDL-2024 LIBRARY; T=0.K  
Photon emission for (n,n\*)t

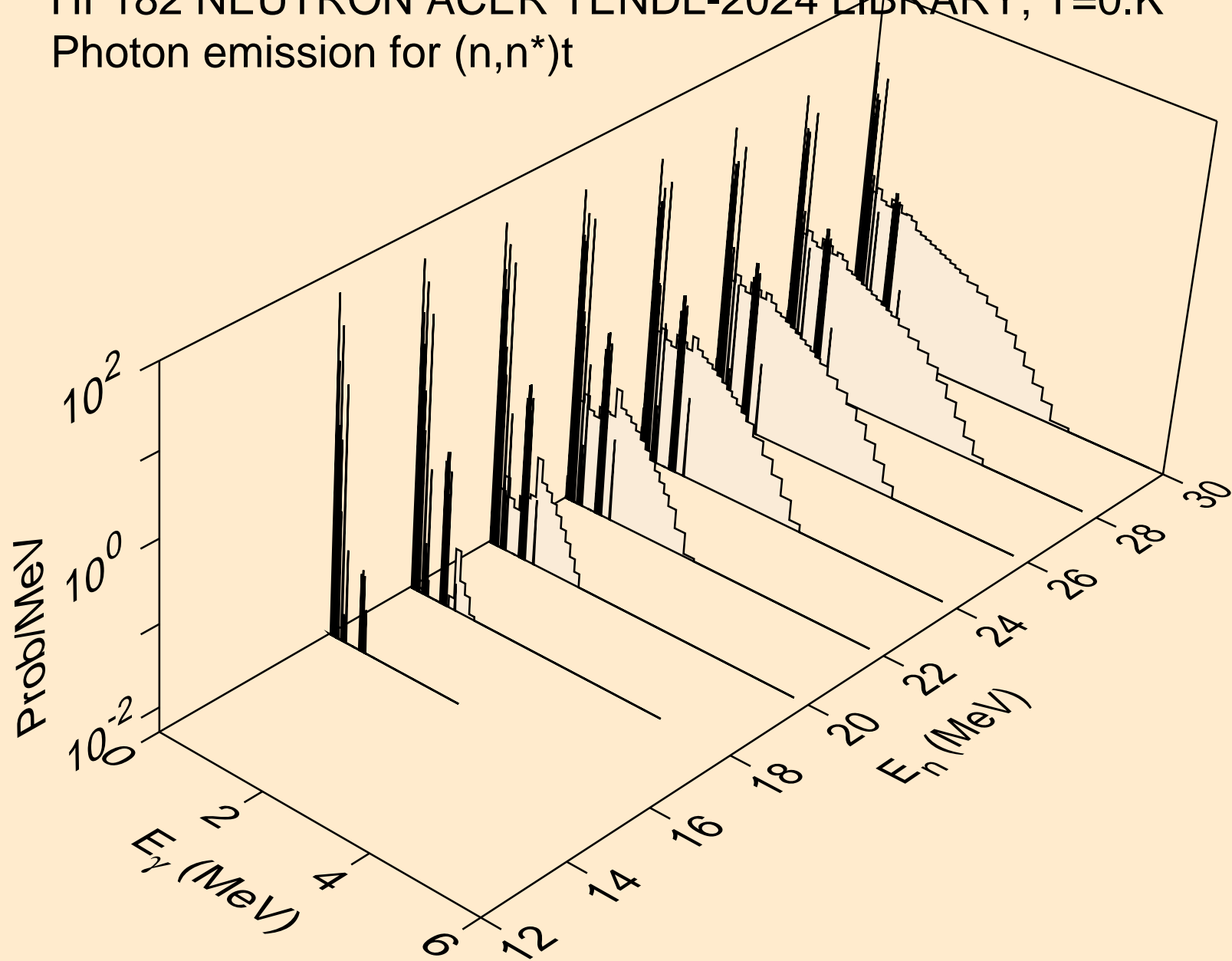

HF182 NEUTRON ACER TENDL-2024 LIBRARY; T=0.K  
Photon emission for (n,n\*)he3

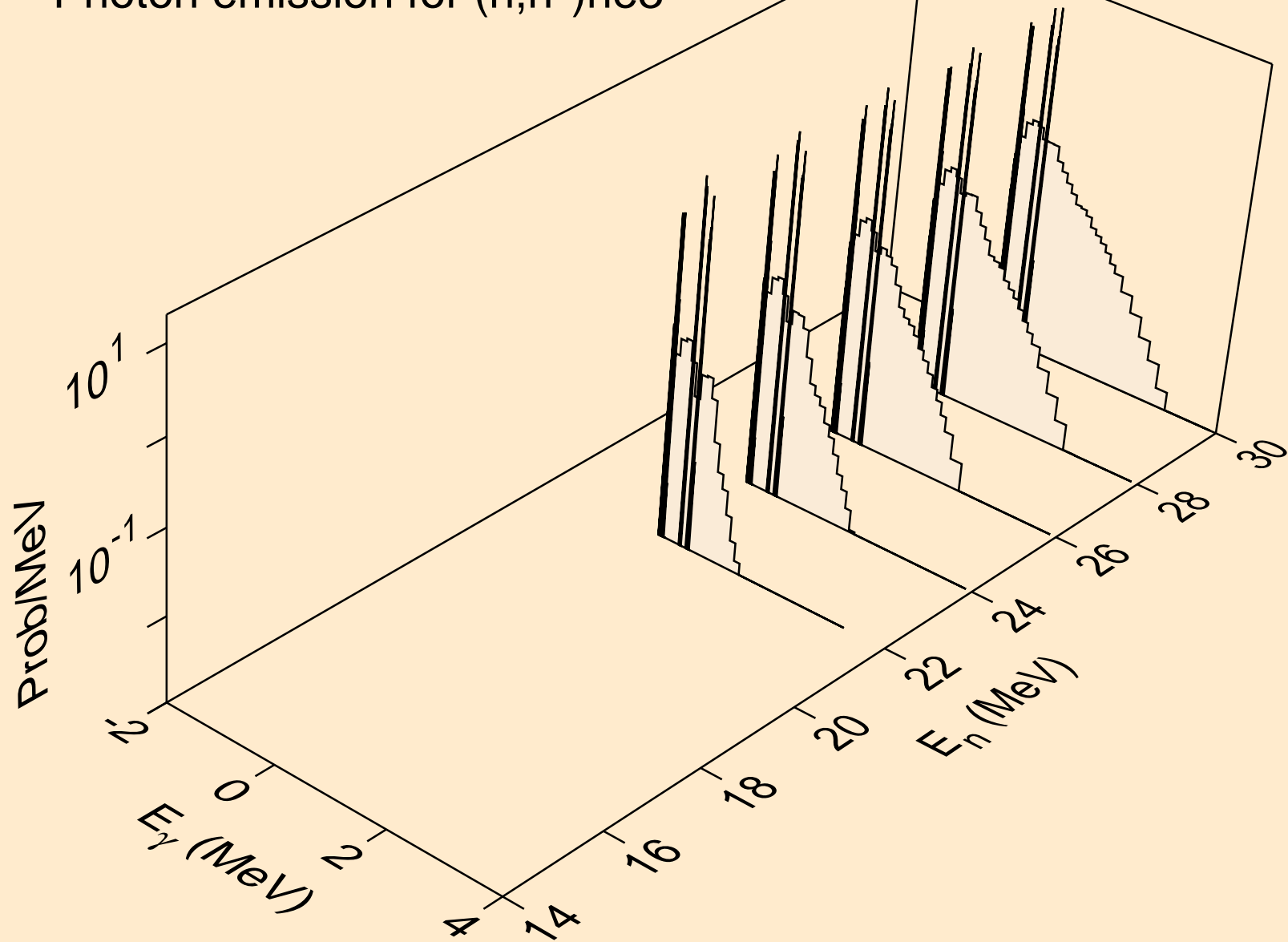

HF182 NEUTRON ACER TENDL-2024 LIBRARY; T=0.K  
Photon emission for (n,4n)

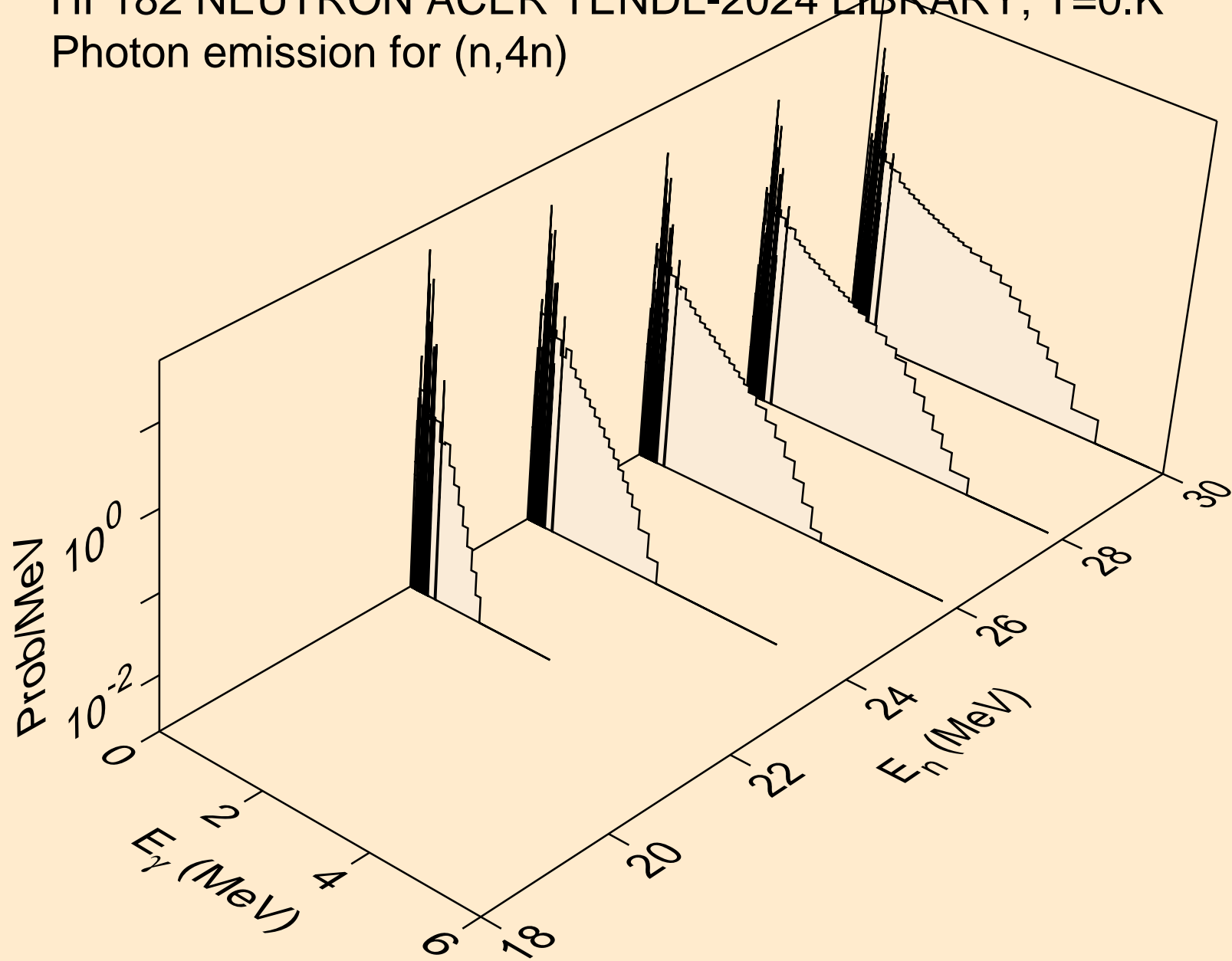

HF182 NEUTRON ACER TENDL-2024 LIBRARY; T=0.K  
Photon emission for (n,2np)

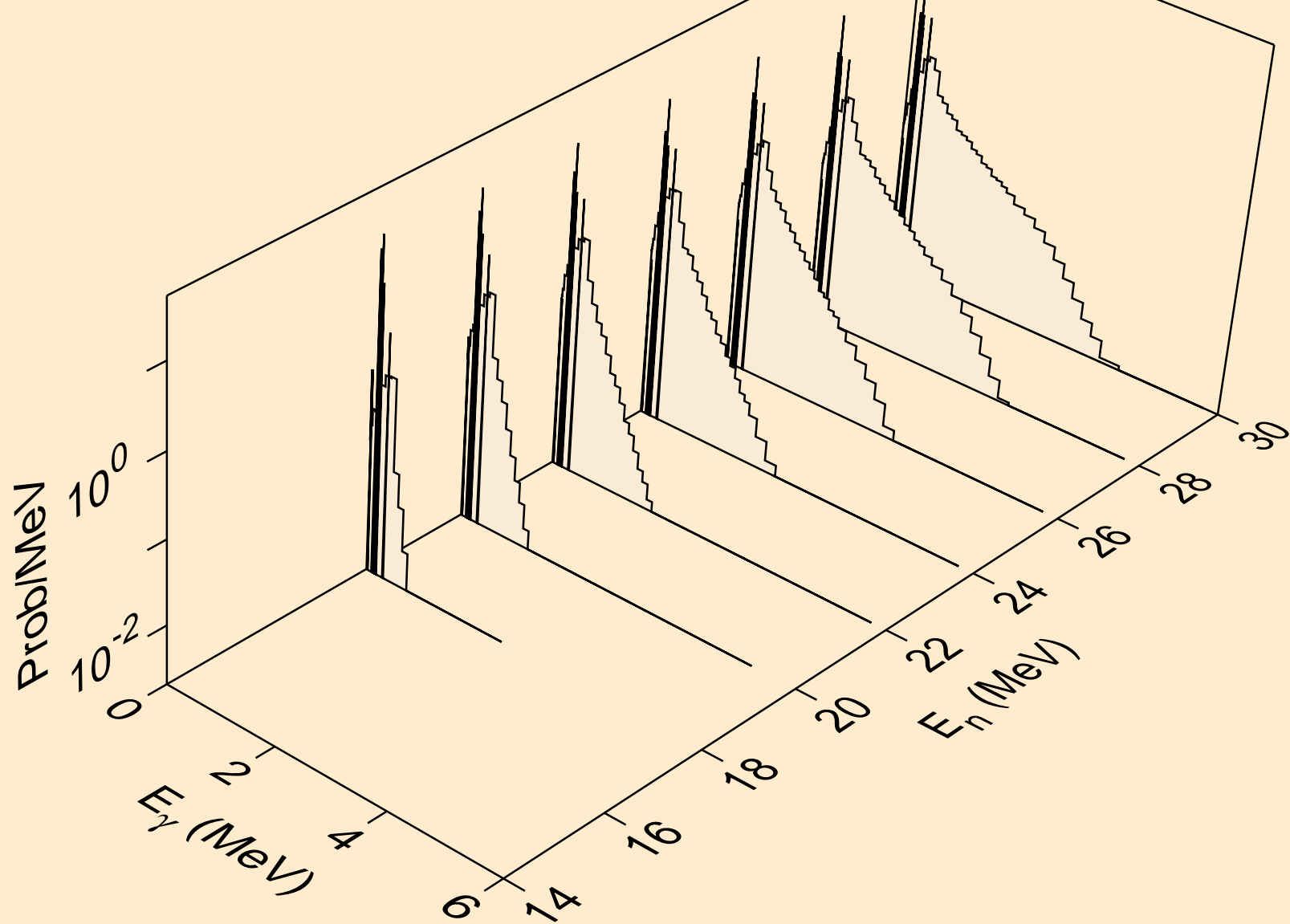

HF182 NEUTRON ACER TENDL-2024 LIBRARY; T=0.K  
Photon emission for (n,3np)

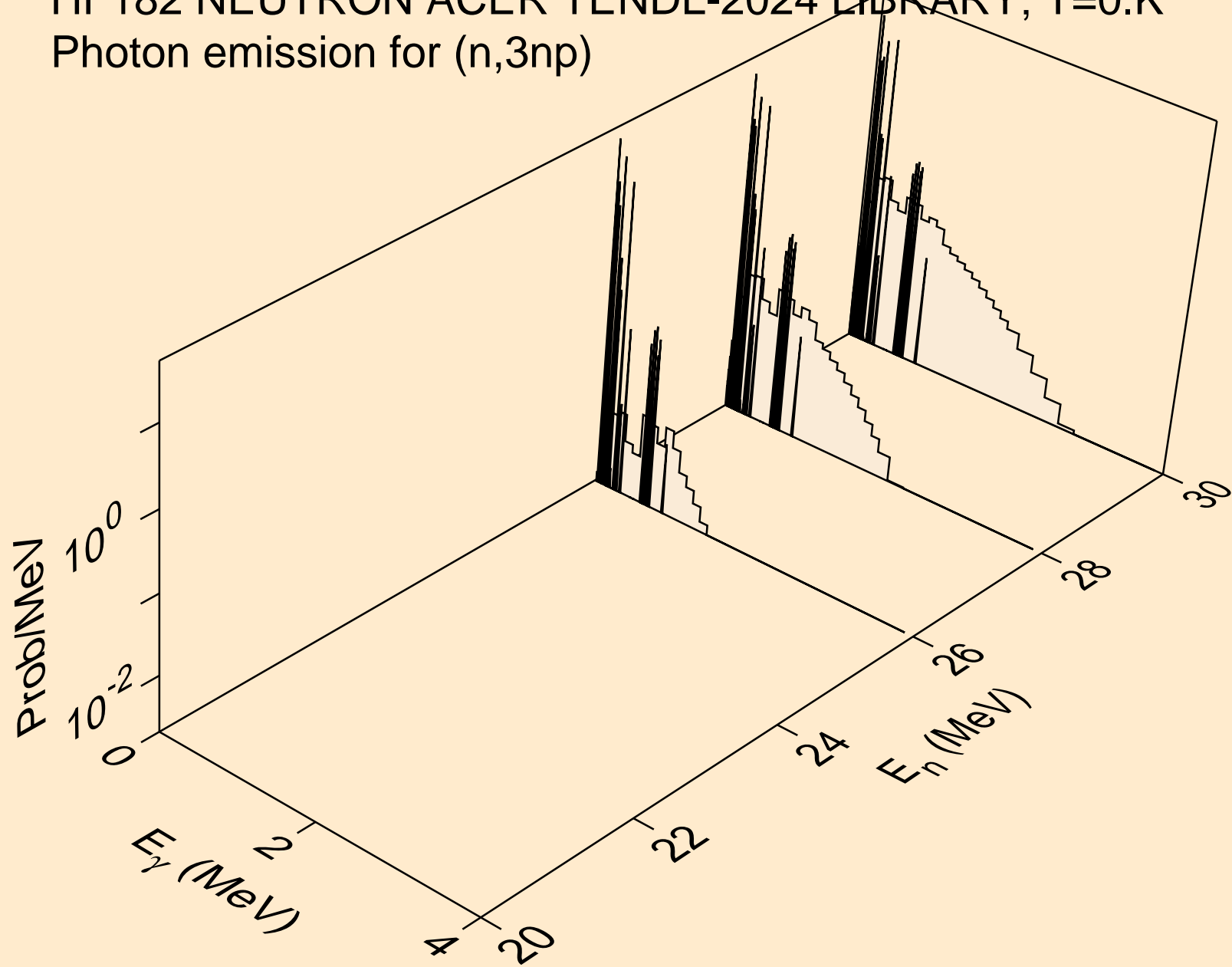

HF182 NEUTRON ACER TENDL-2024 LIBRARY; T=0.K  
Photon emission for (n,n2p)

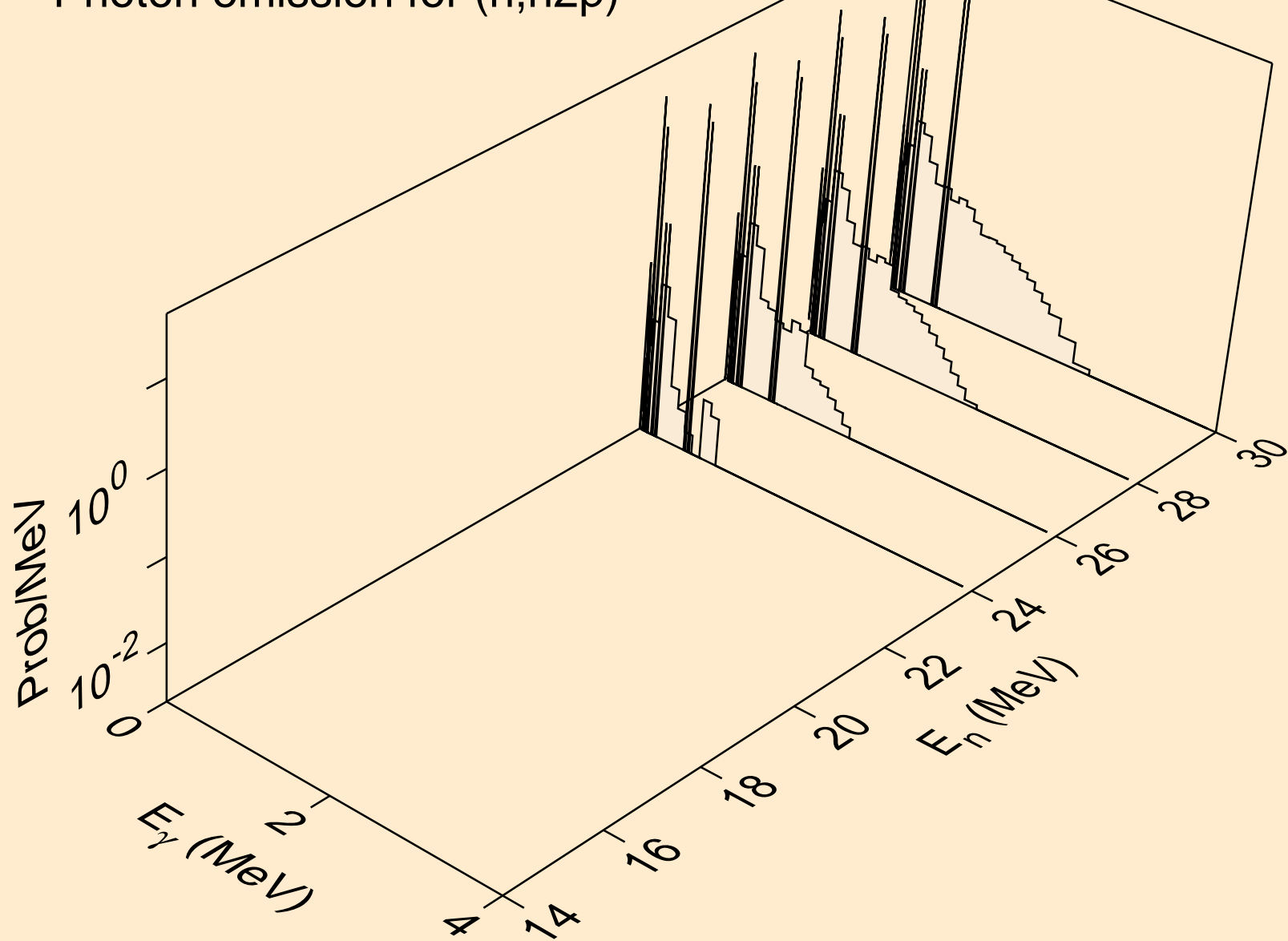

HF182 NEUTRON ACER TENDL-2024 LIBRARY; T=0.K  
Photon emission for (n,n\*c)

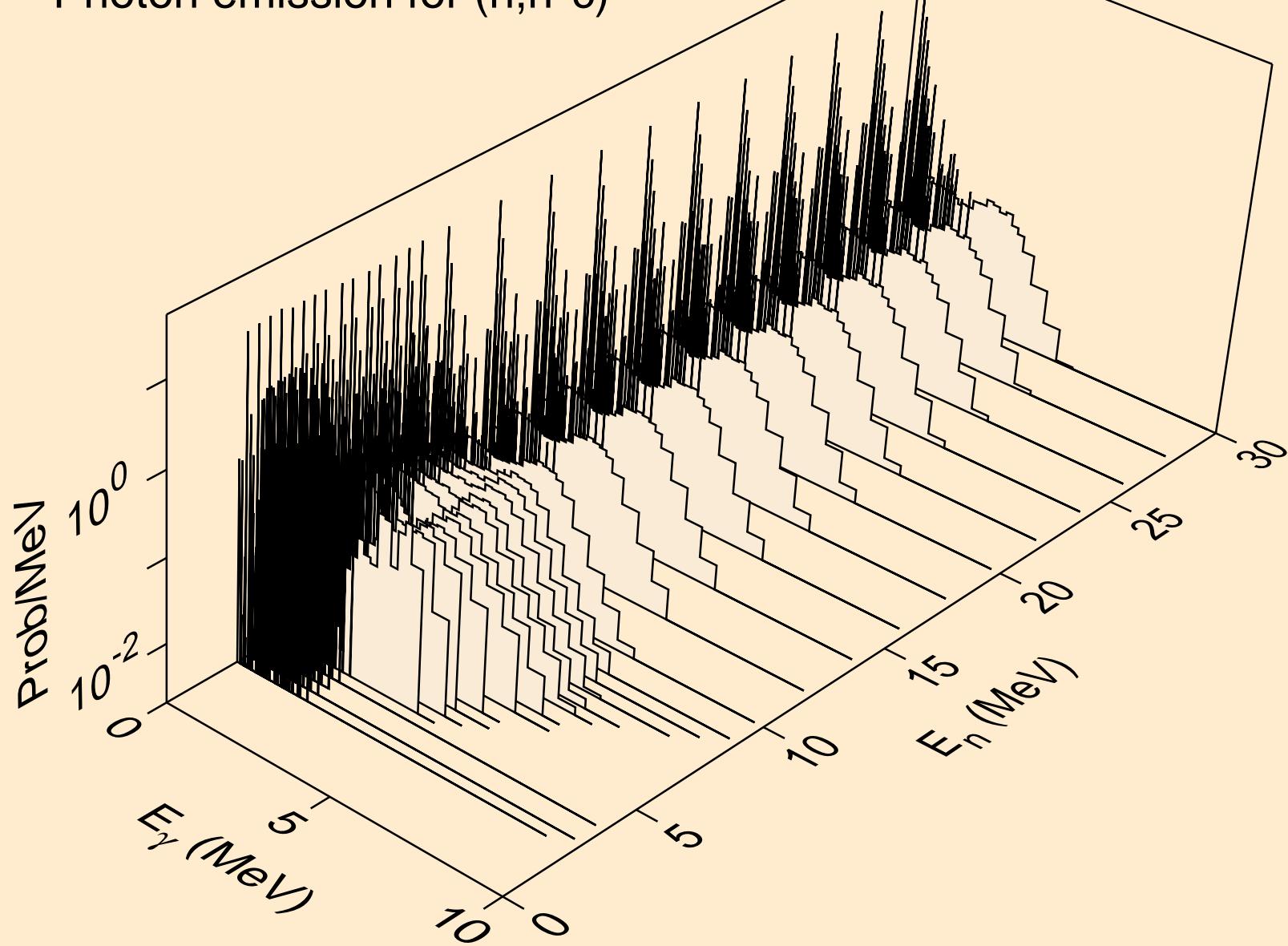

HF182 NEUTRON ACER TENDL-2024 LIBRARY; T=0.K  
Photon emission for (n,gma)

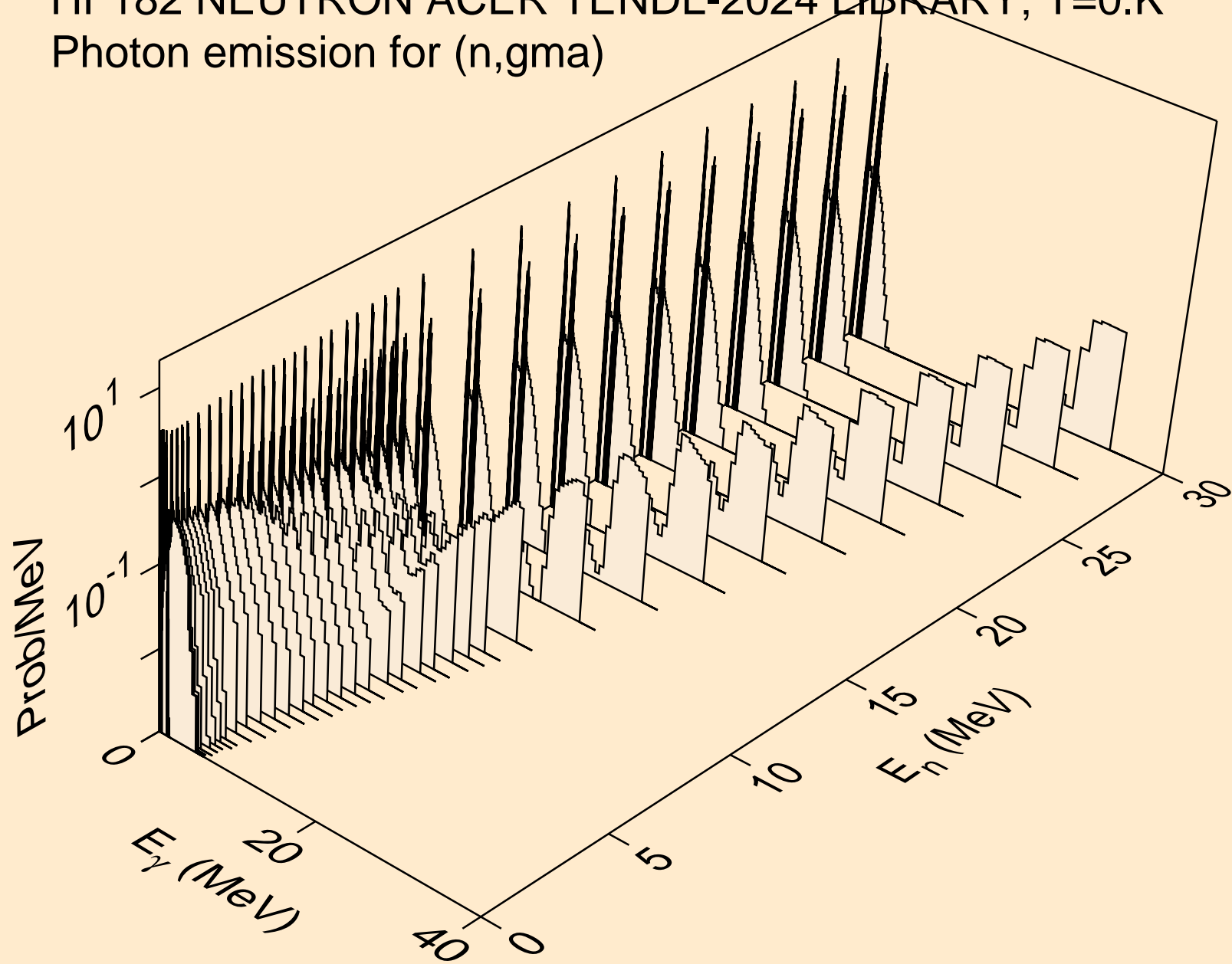

HF182 NEUTRON ACER TENDL-2024 LIBRARY; T=0.K  
Photon emission for (n,p)

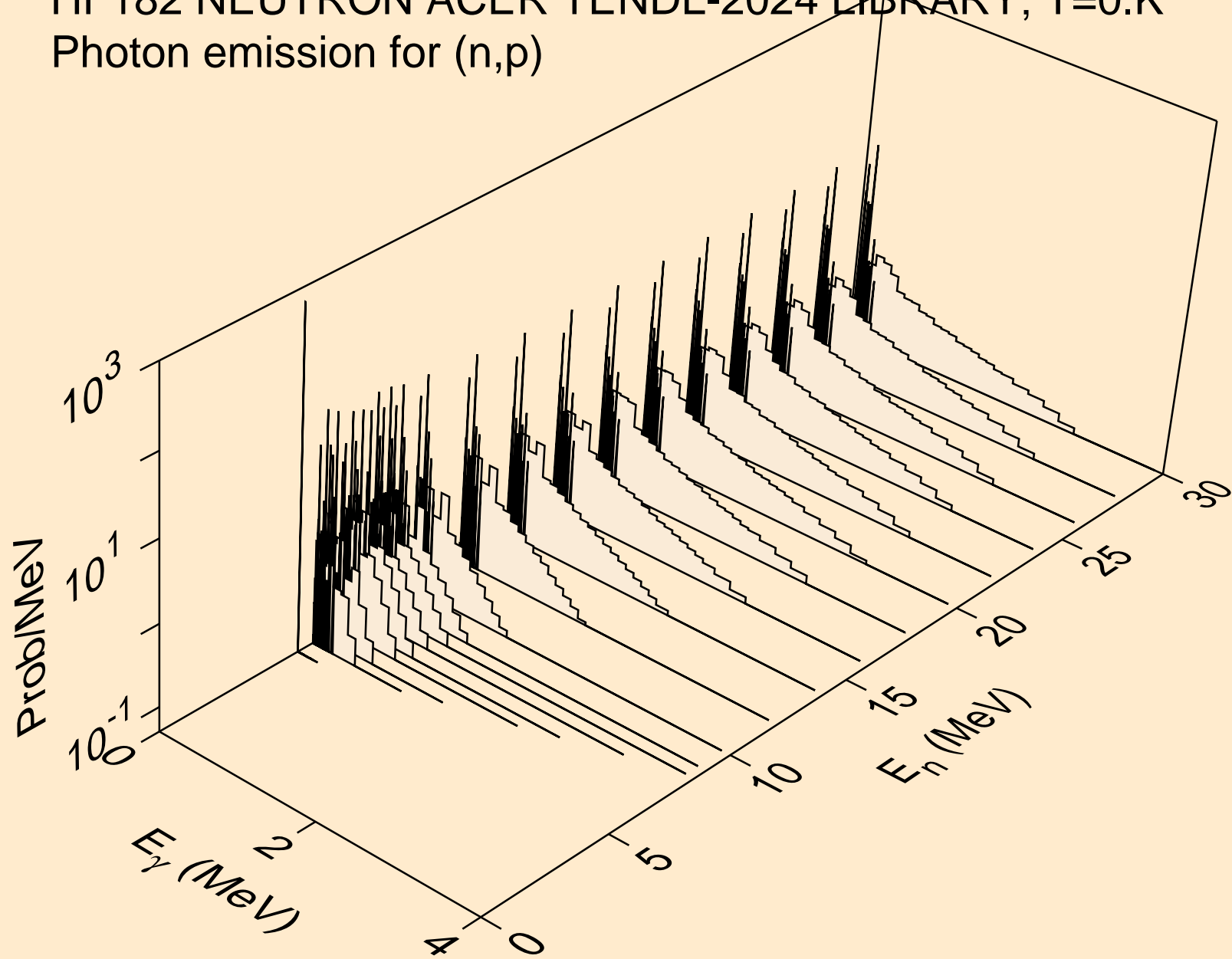

HF182 NEUTRON ACER TENDL-2024 LIBRARY; T=0.K  
Photon emission for (n,d)

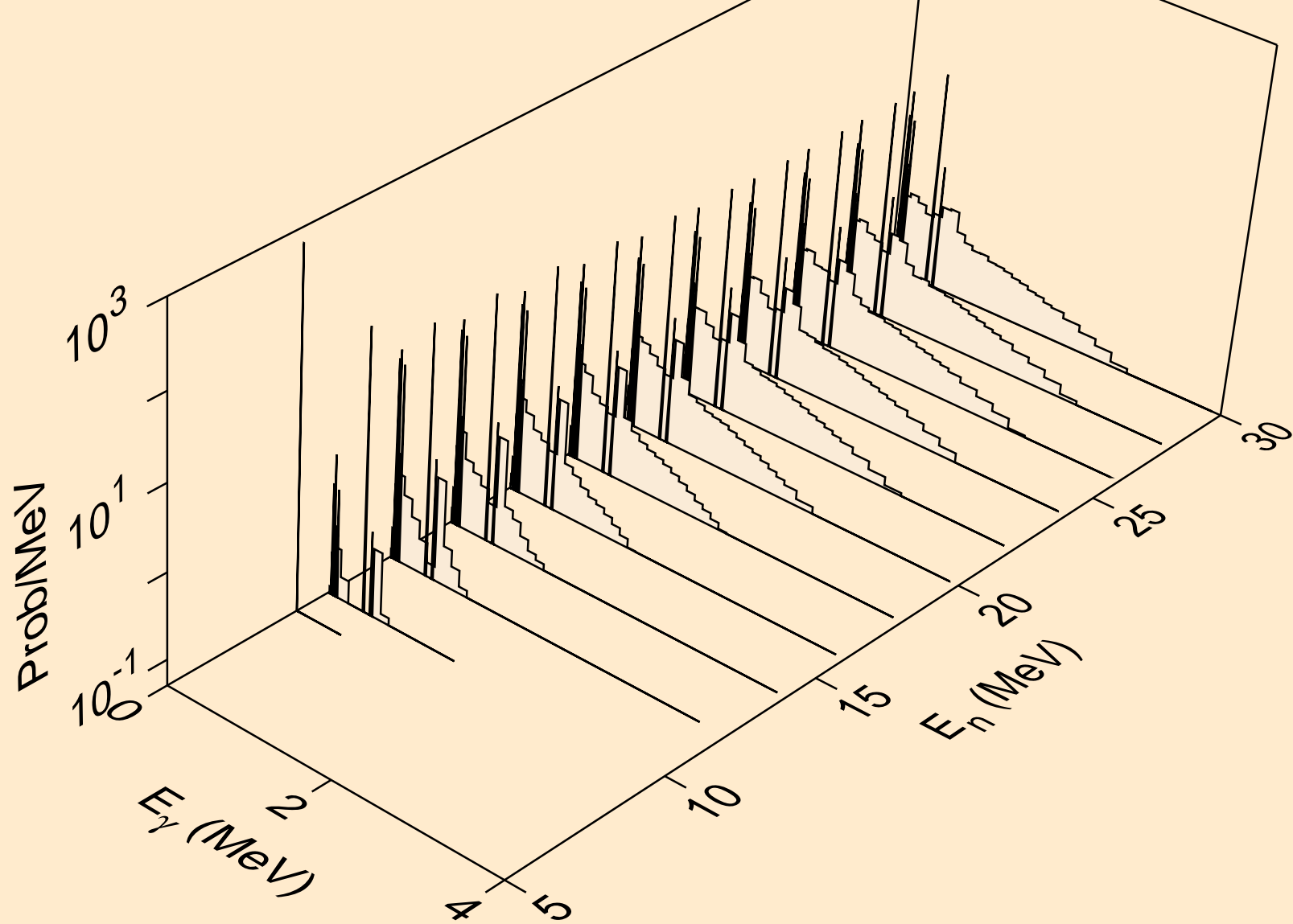

HF182 NEUTRON ACER TENDL-2024 LIBRARY; T=0.K  
Photon emission for (n,t)

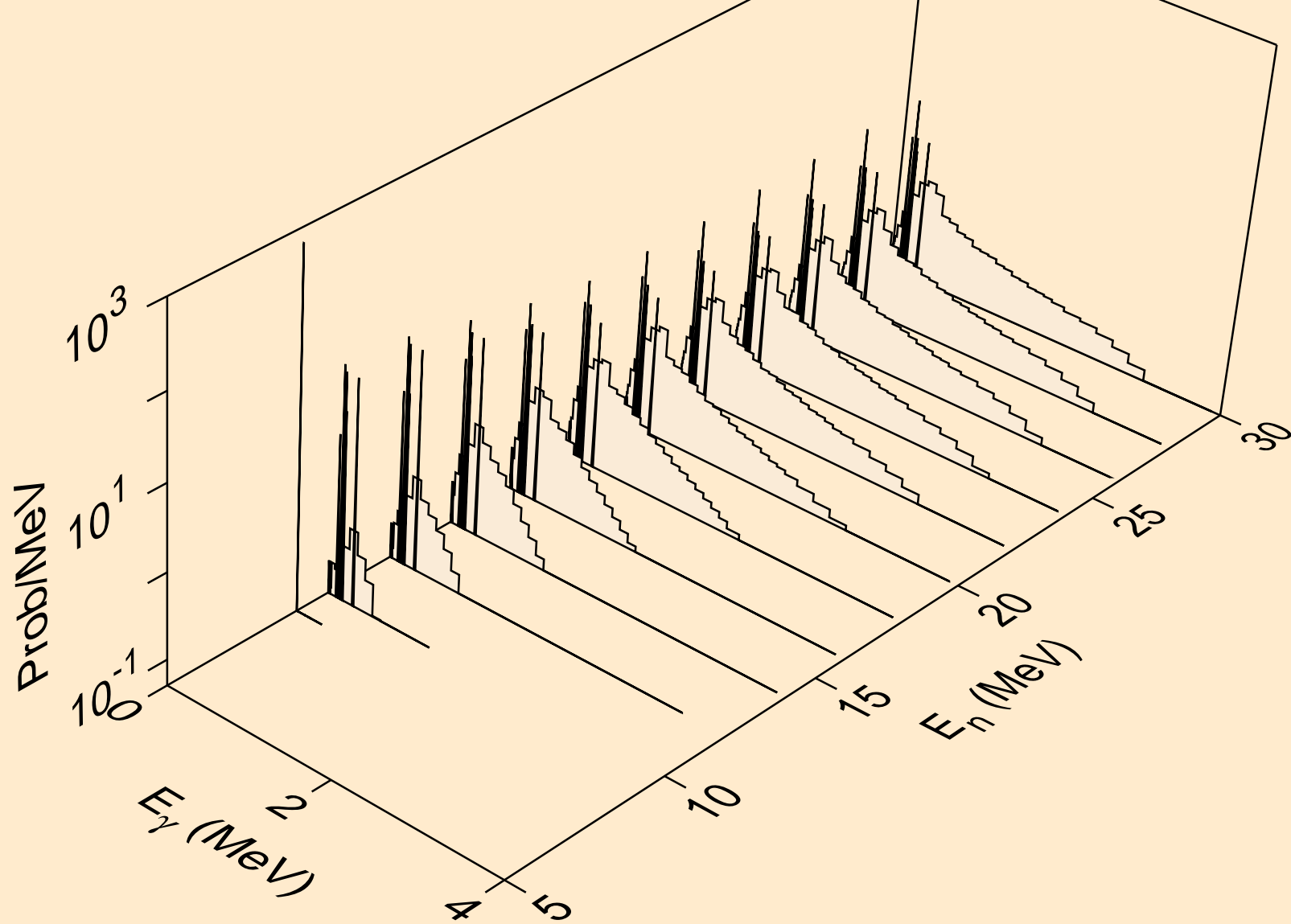

HF182 NEUTRON ACER TENDL-2024 LIBRARY; T=0.K  
Photon emission for (n,he3)

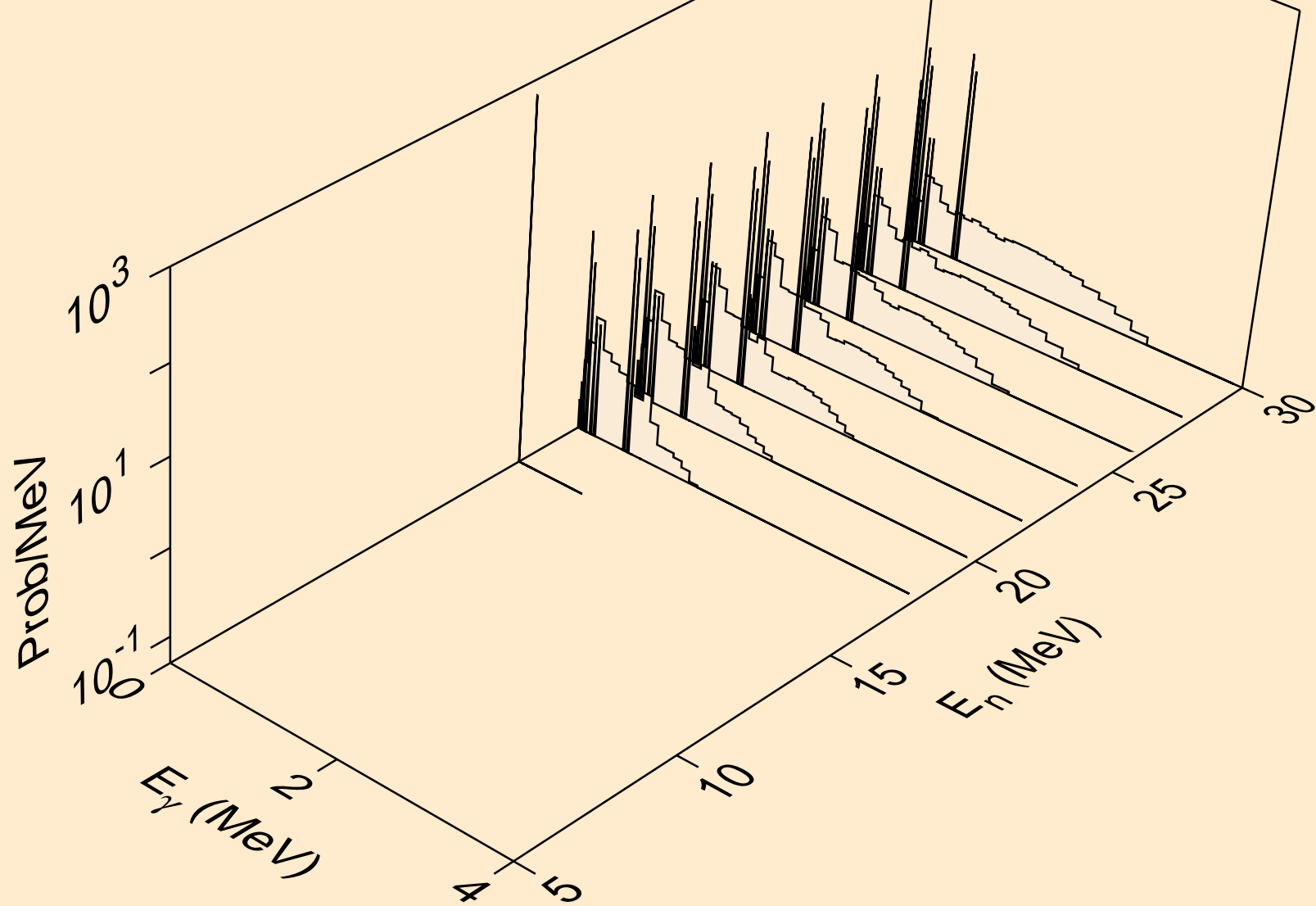

HF182 NEUTRON ACER TENDL-2024 LIBRARY; T=0.K  
Photon emission for (n,a)

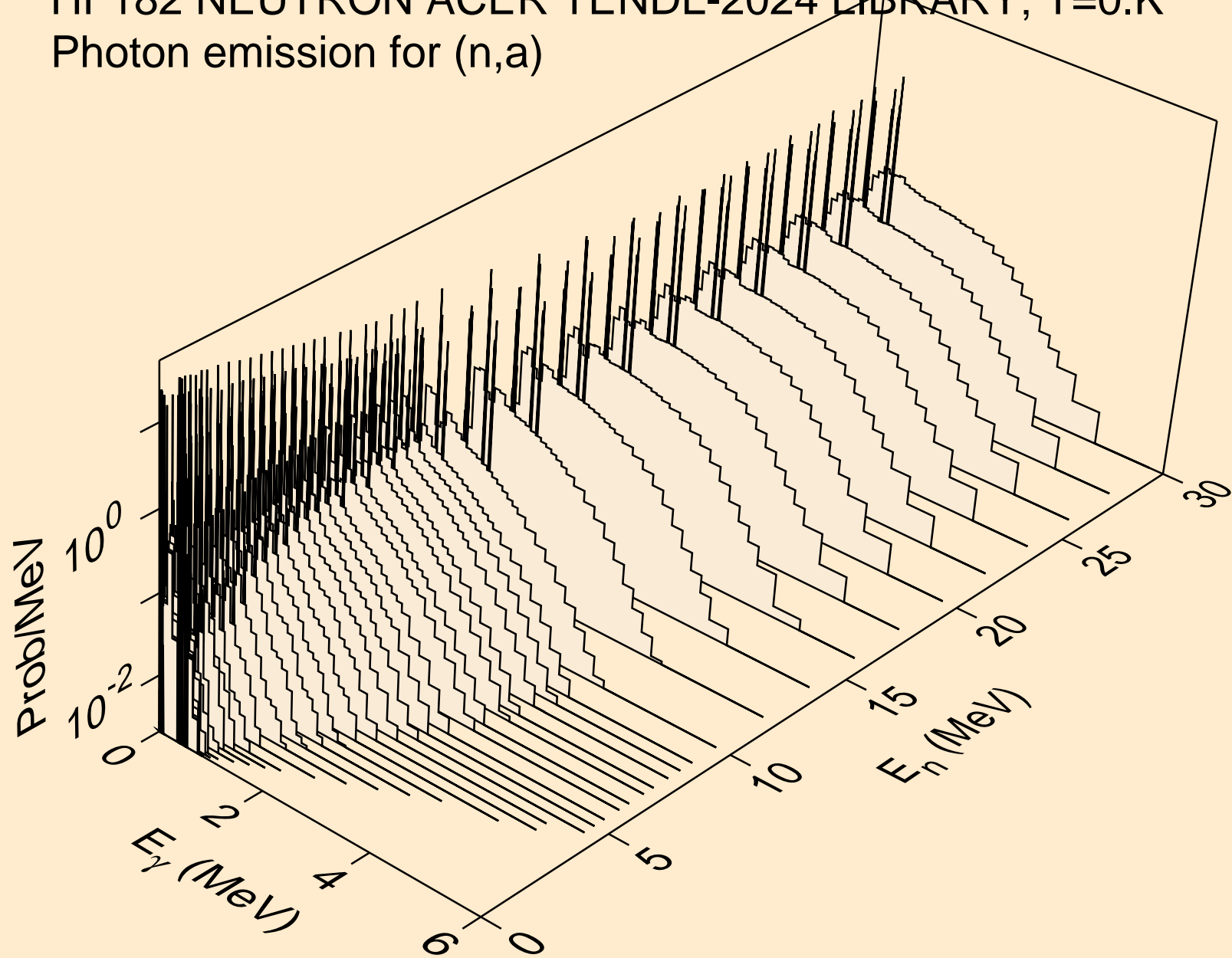

HF182 NEUTRON ACER TENDL-2024 LIBRARY; T=0.K  
Photon emission for (n,2p)

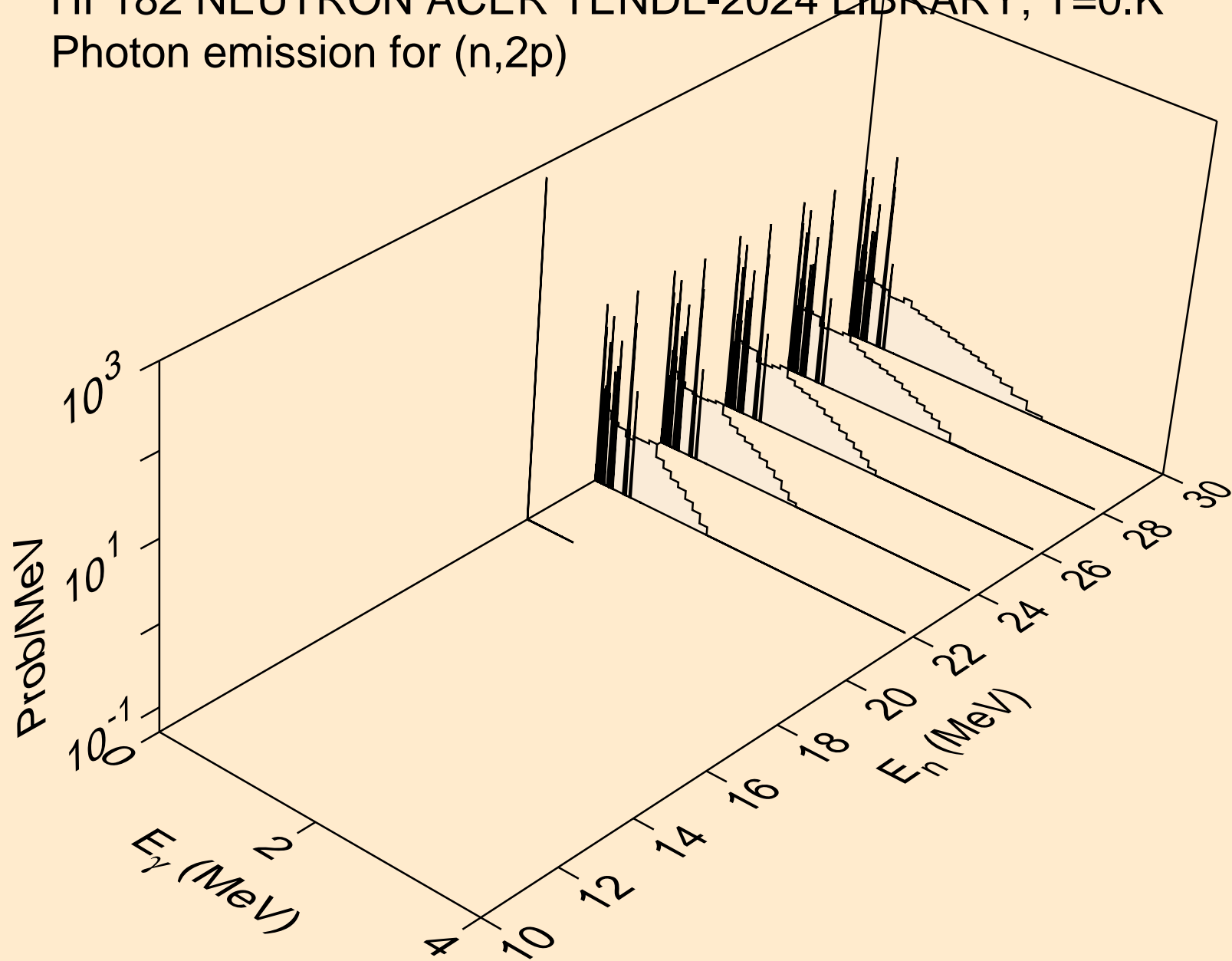

HF182 NEUTRON ACER TENDL-2024 LIBRARY; T=0.K  
thermal capture photon spectrum

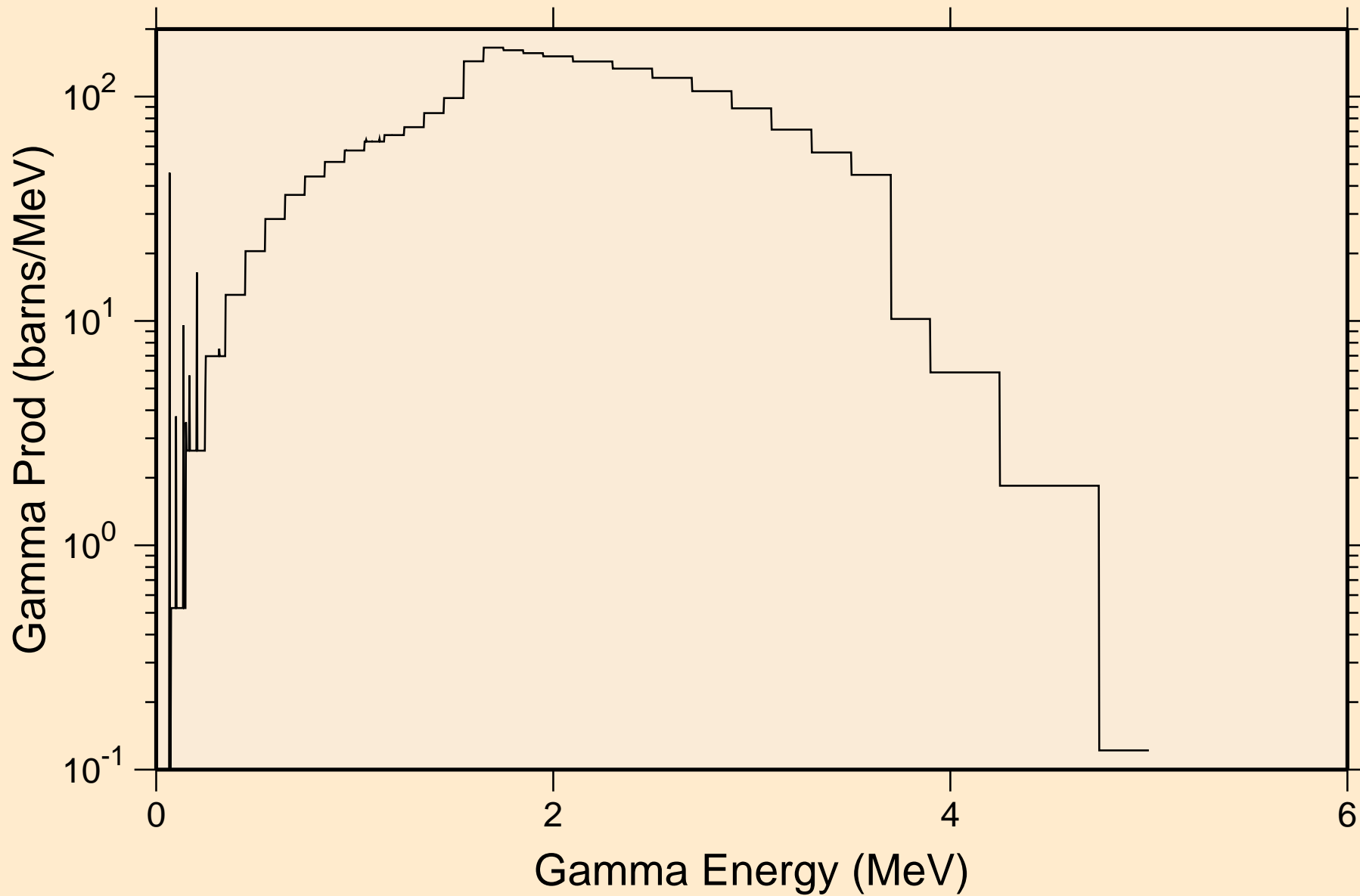

HF182 NEUTRON ACER TENDL-2024 LIBRARY; T=0.K  
14 MeV photon spectrum

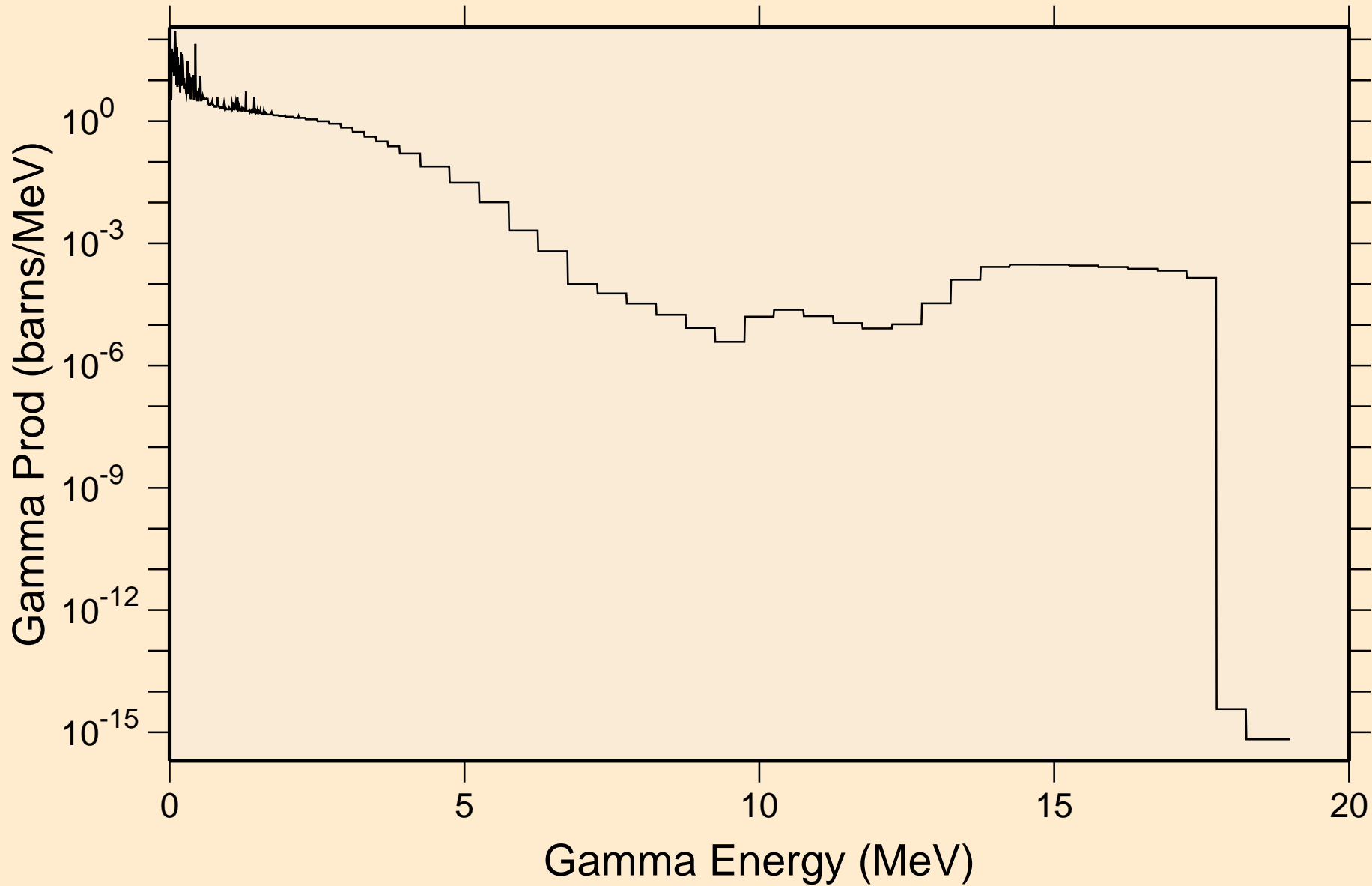

# HF182 NEUTRON ACER TENDL-2024 LIBRARY; T=0.K

## Particle heating contributions

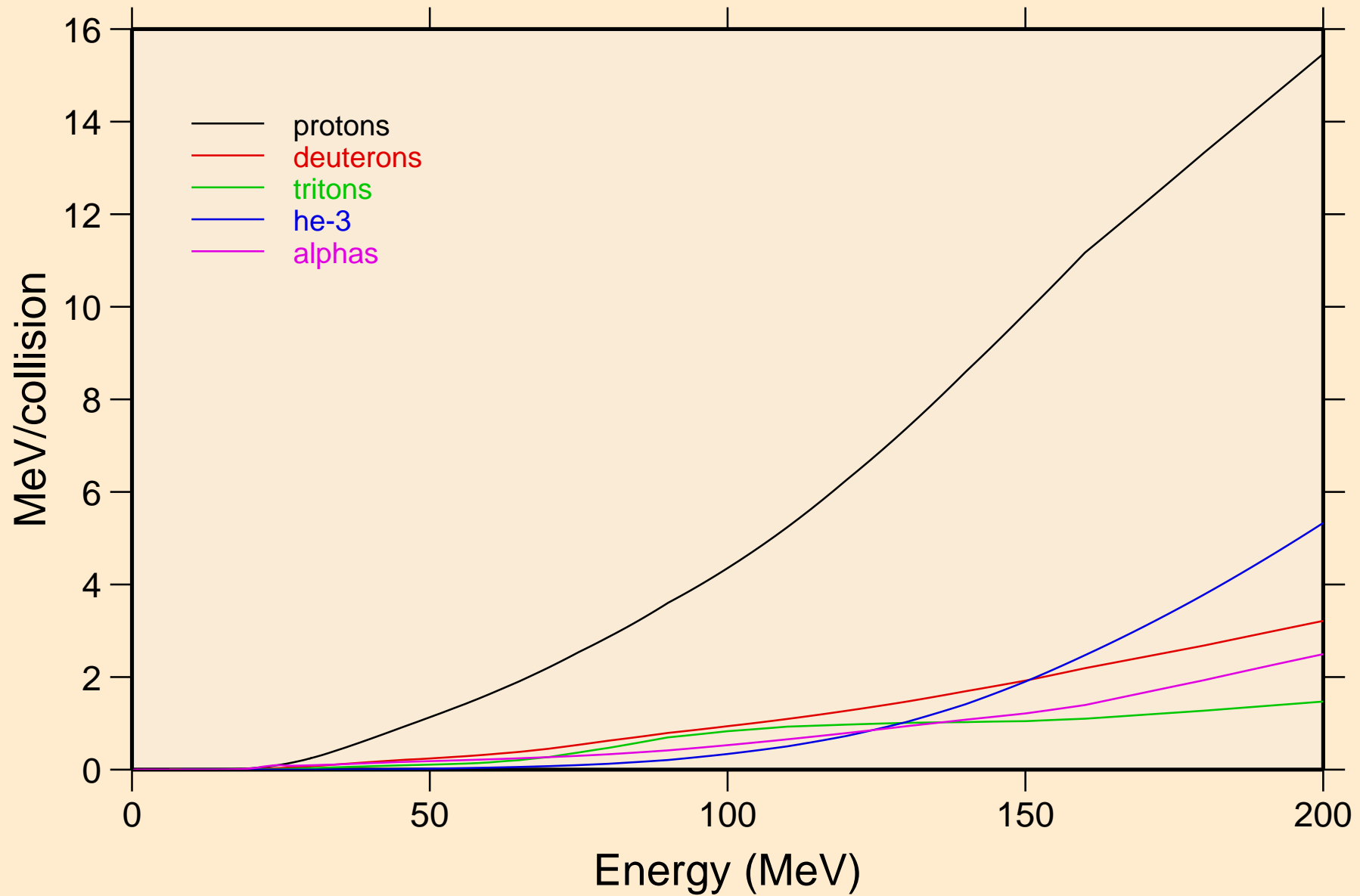

# HF182 NEUTRON ACER TENDL-2024 LIBRARY; T=0.K

## Recoil Heating

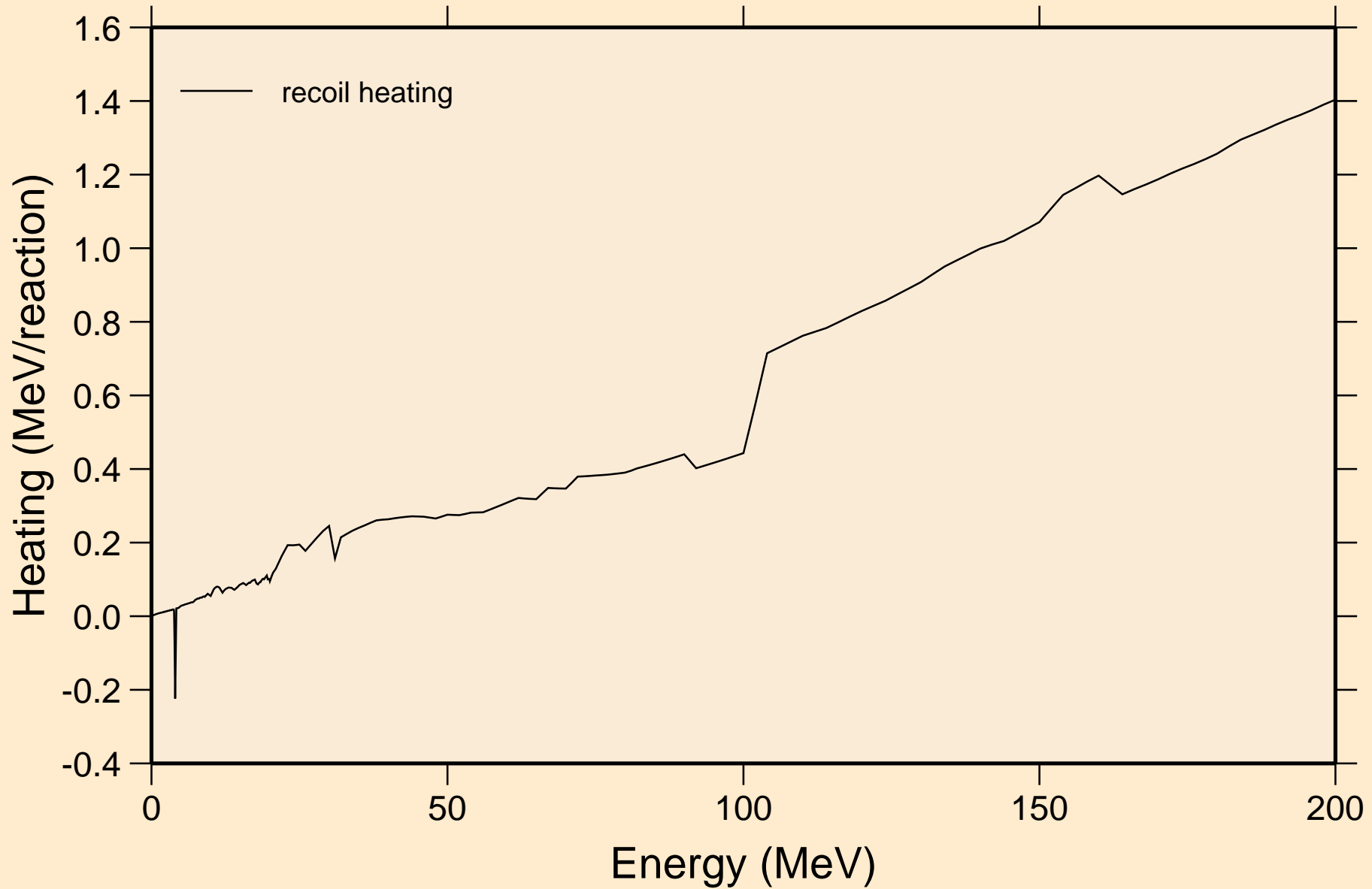

# HF182 NEUTRON ACER TENDL-2024 LIBRARY; T=0.K

## Particle production cross sections

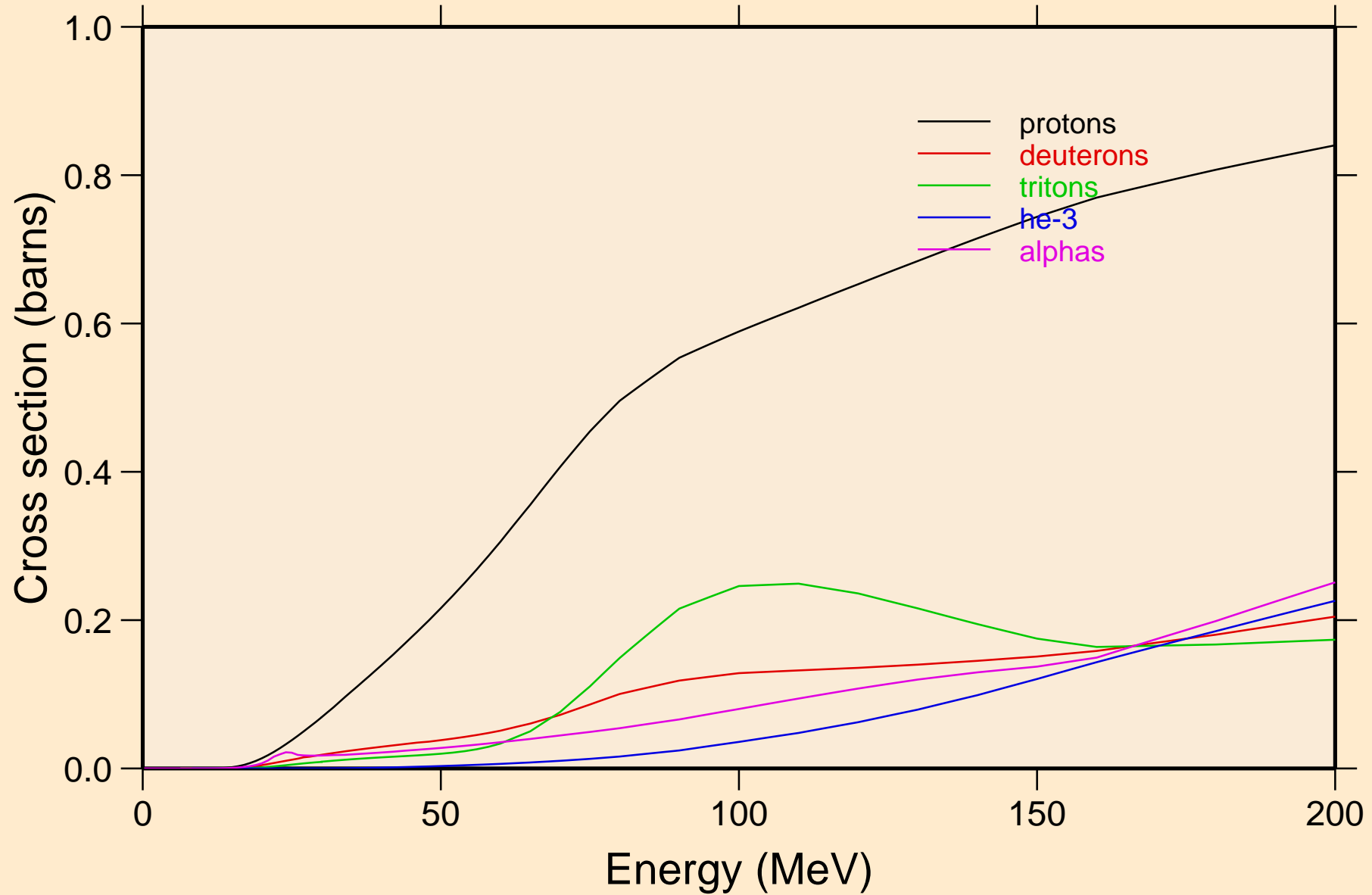

HF182 NEUTRON ACER TENDL-2024 LIBRARY; T=0.K  
protons from (n,x)

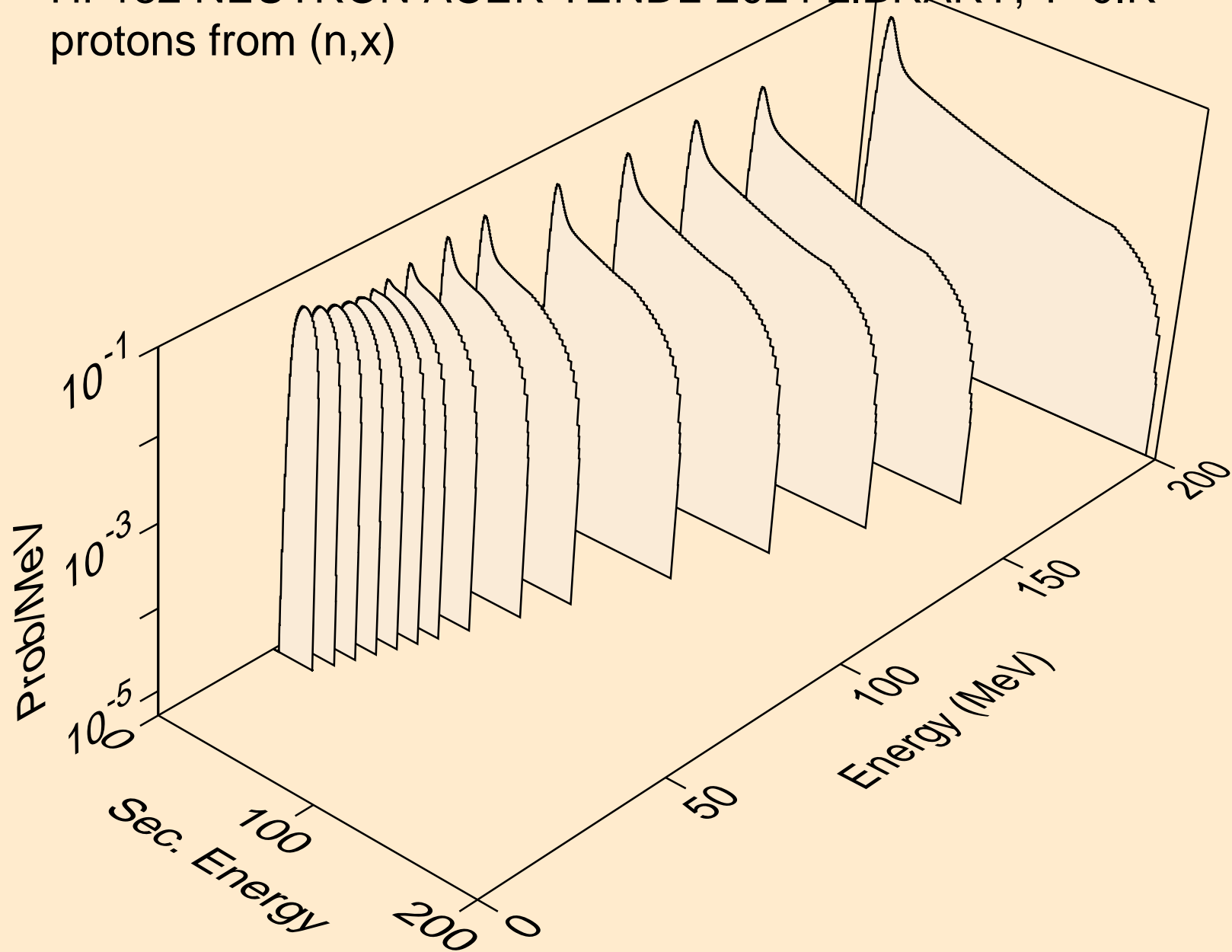

HF182 NEUTRON ACER TENDL-2024 LIBRARY; T=0.K  
protons from (n,n\*)p

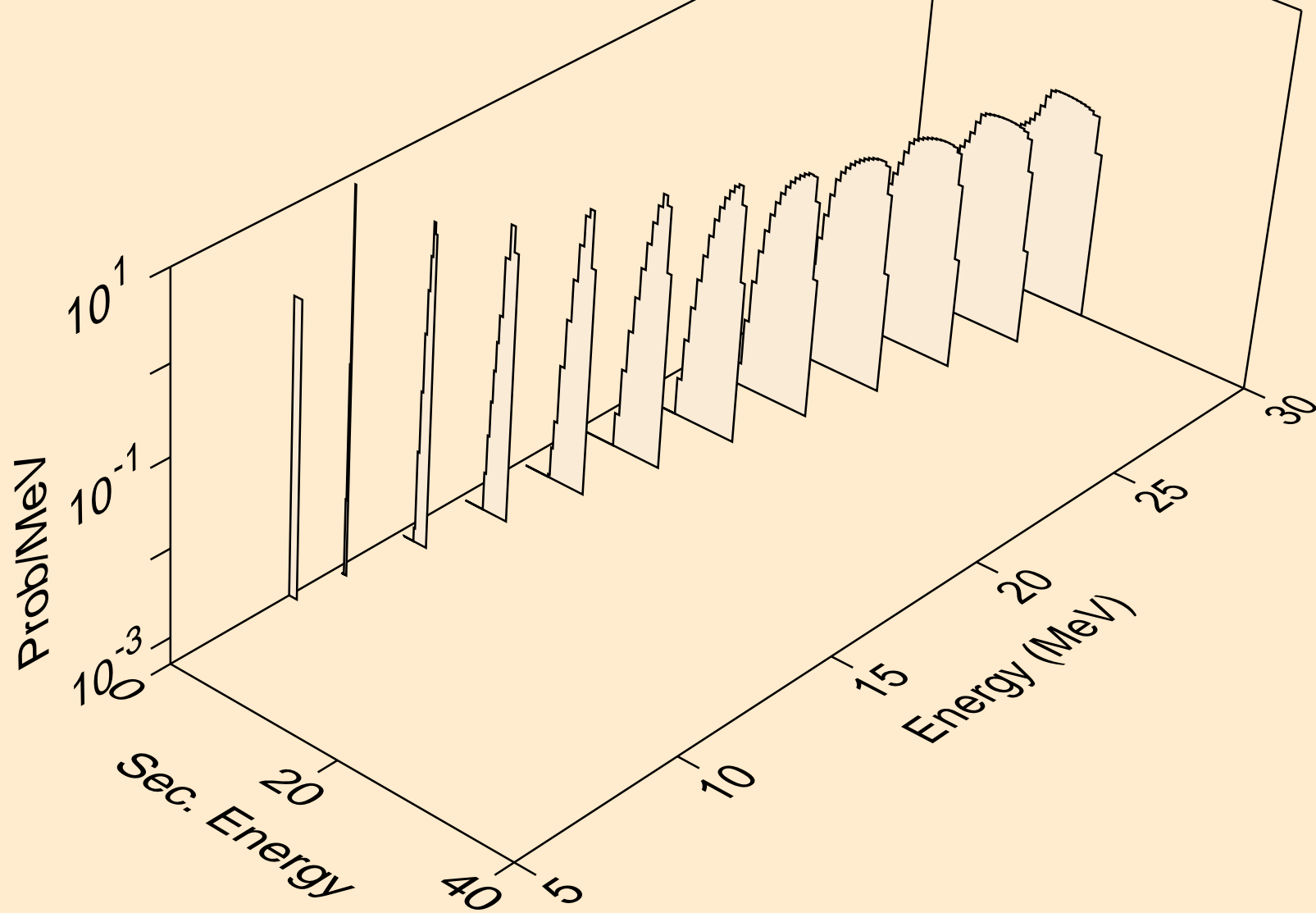

HF182 NEUTRON ACER TENDL-2024 LIBRARY; T=0.K  
protons from (n,2np)

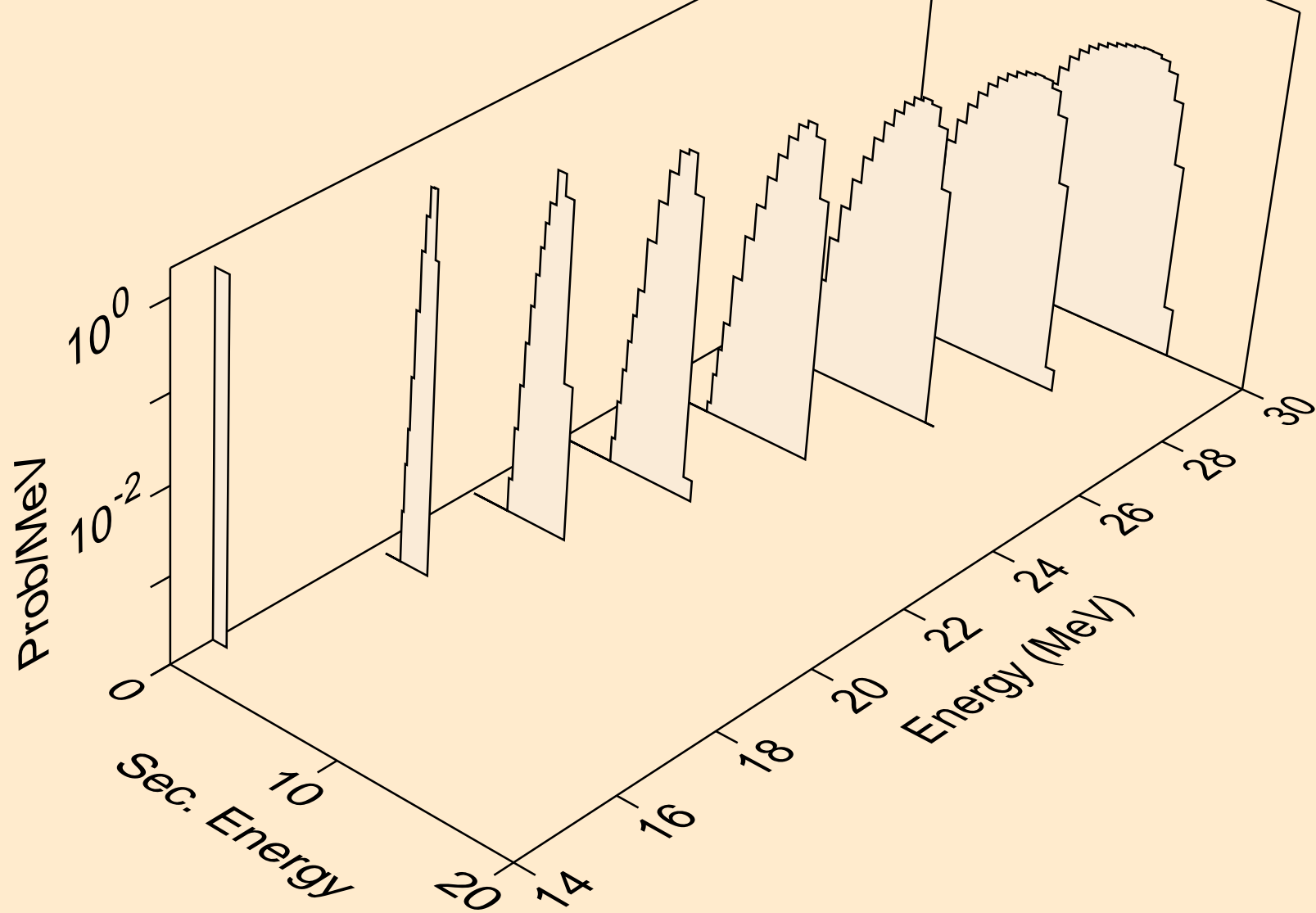

HF182 NEUTRON ACER TENDL-2024 LIBRARY; T=0.K  
protons from (n,3np)

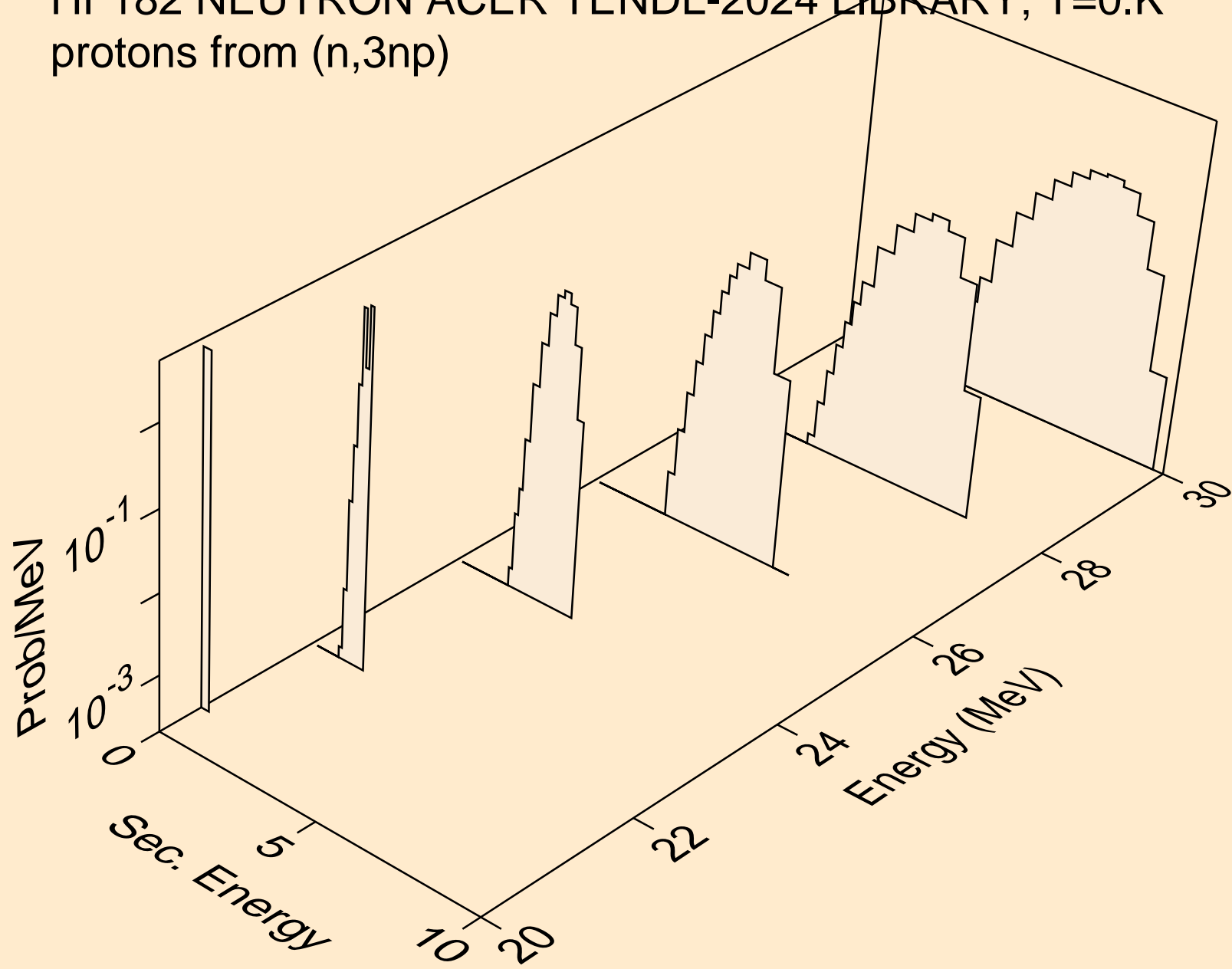

HF182 NEUTRON ACER TENDL-2024 LIBRARY; T=0.K  
protons from (n,n2p)

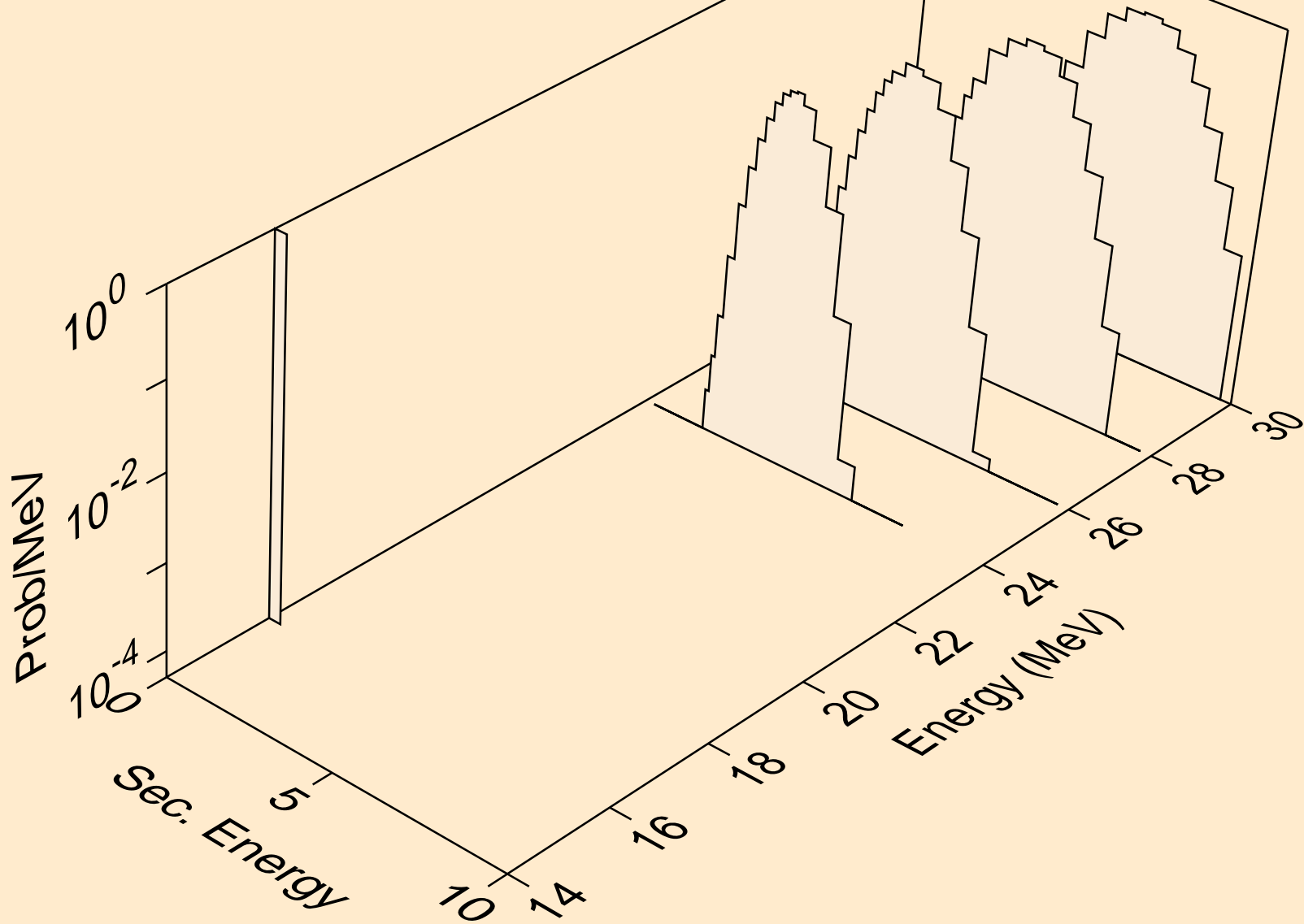

HF182 NEUTRON ACER TENDL-2024 LIBRARY; T=0.K  
protons from (n,p)

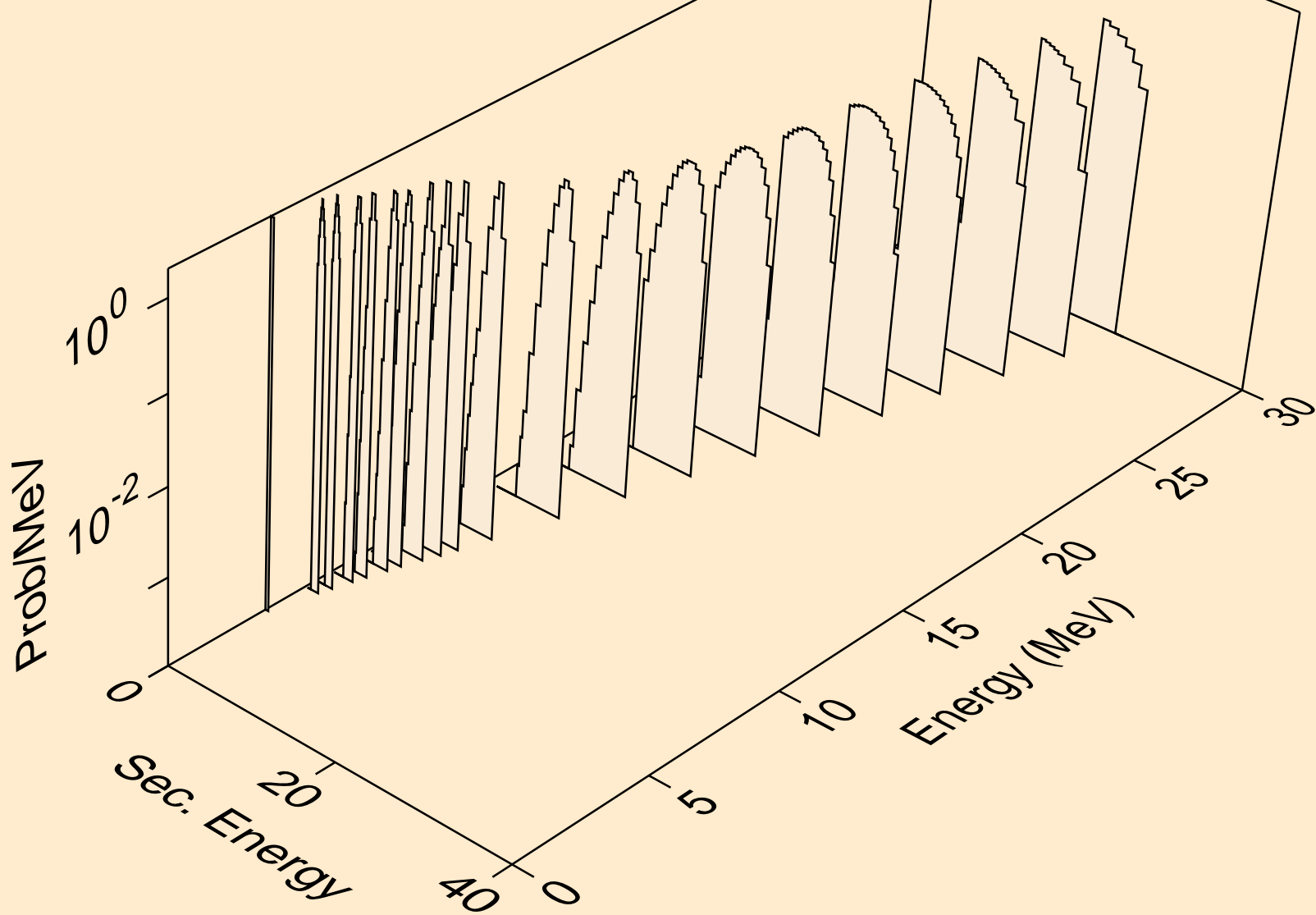

HF182 NEUTRON ACER TENDL-2024 LIBRARY; T=0.K  
protons from (n,2p)

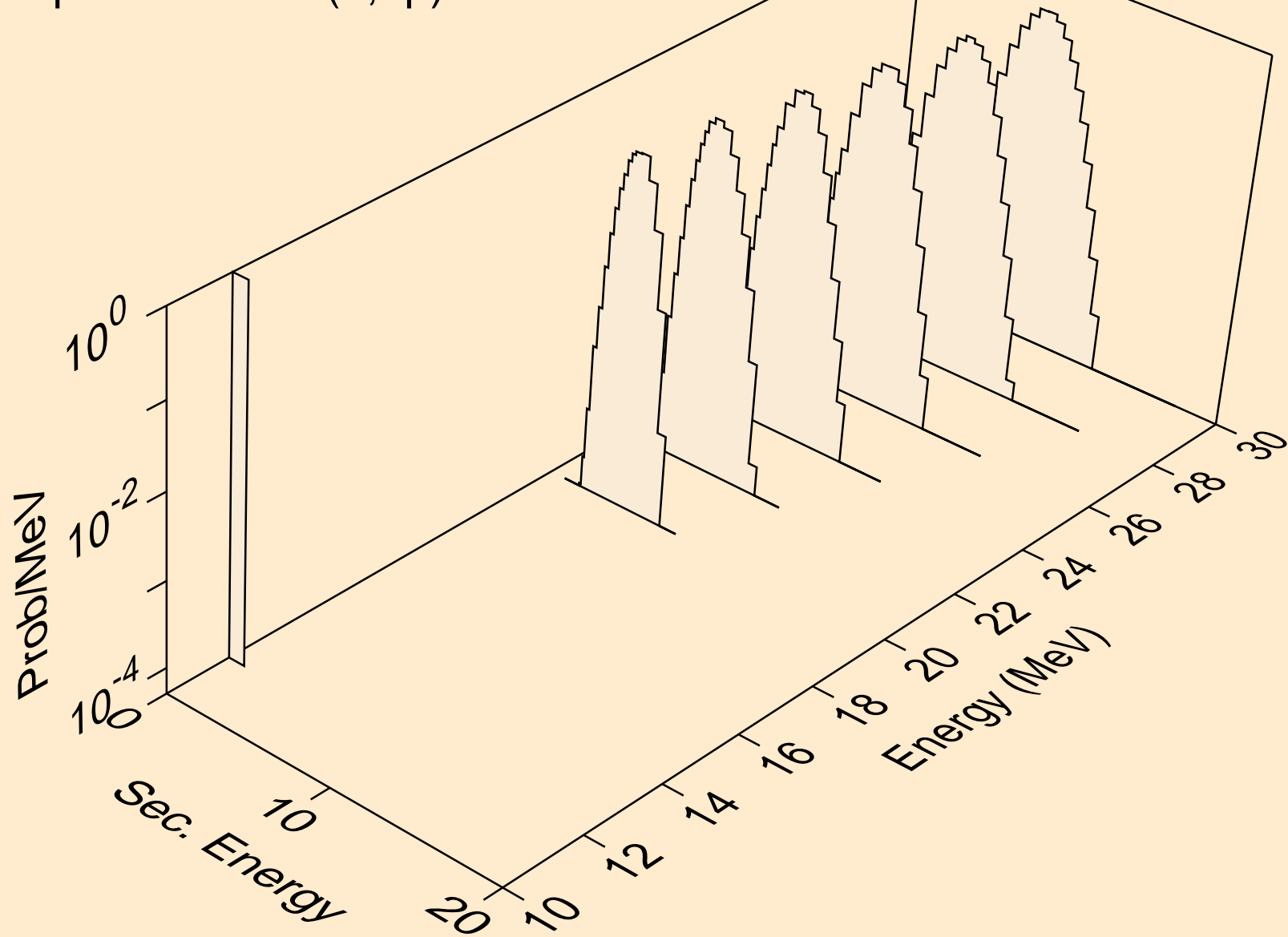

HF182 NEUTRON ACER TENDL-2024 LIBRARY; T=0.K  
deuterons from (n,x)

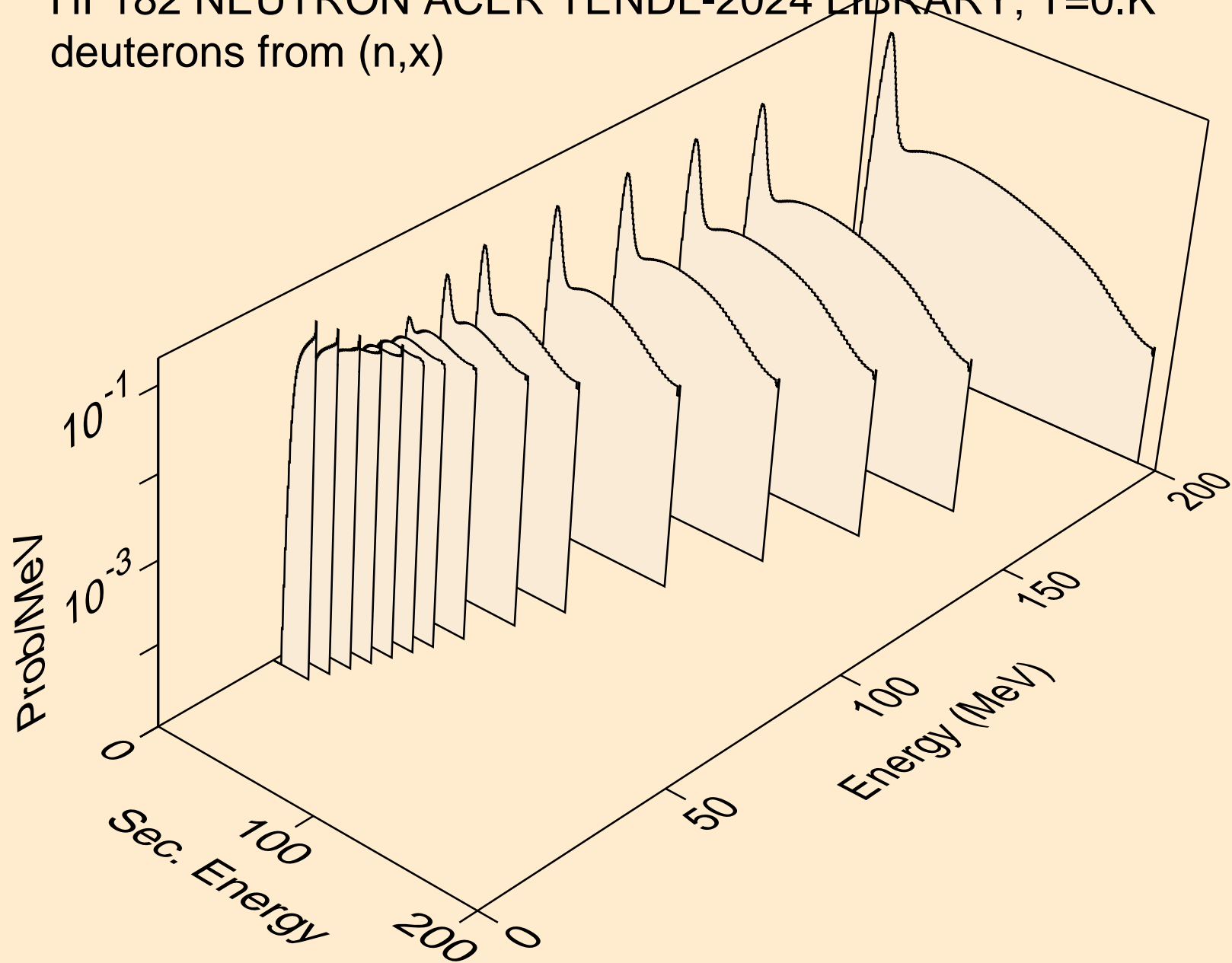

HF182 NEUTRON ACER TENDL-2024 LIBRARY; T=0.K  
deuterons from (n,2nd)

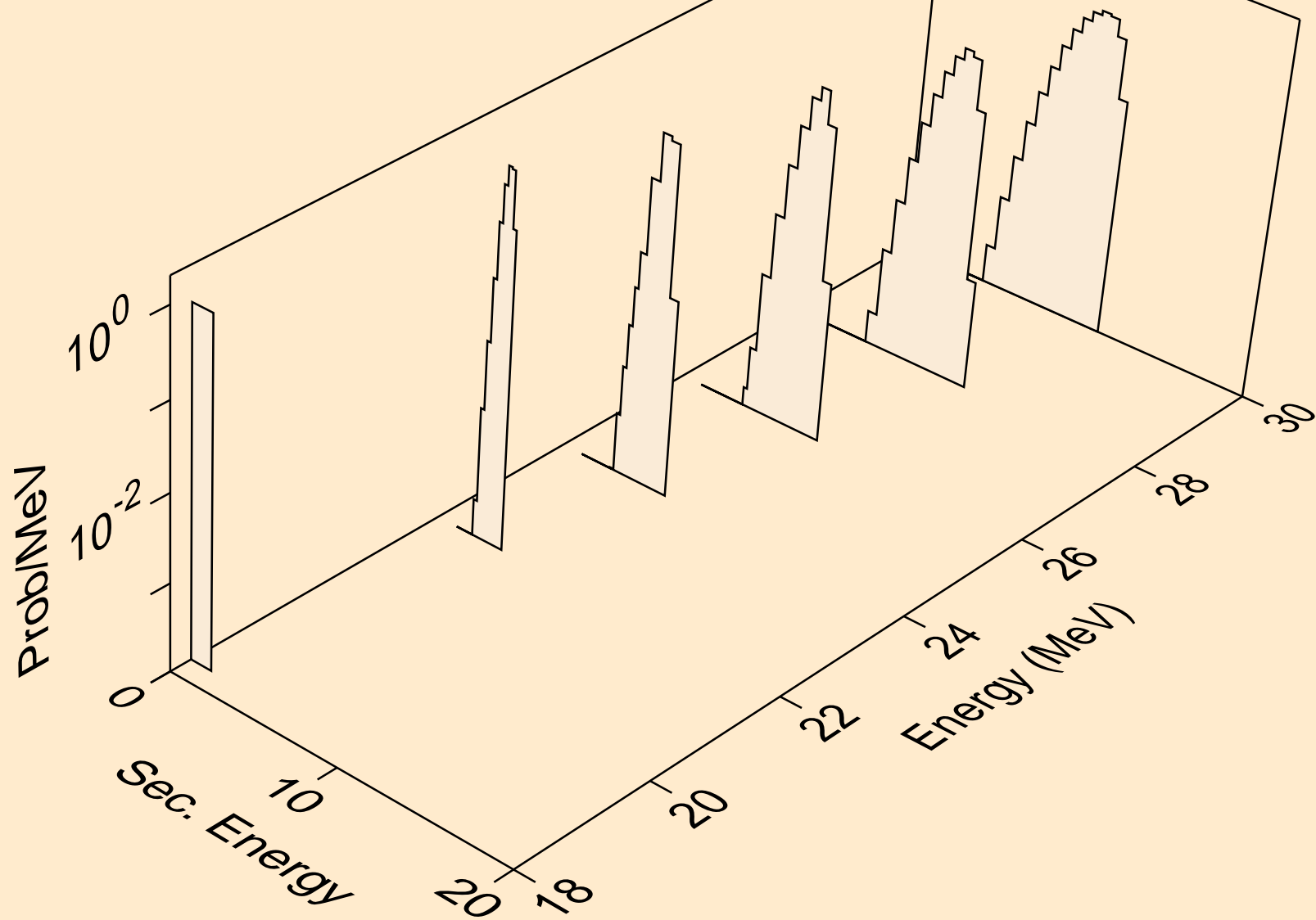

HF182 NEUTRON ACER TENDL-2024 LIBRARY; T=0.K  
deuterons from (n,n\*)d

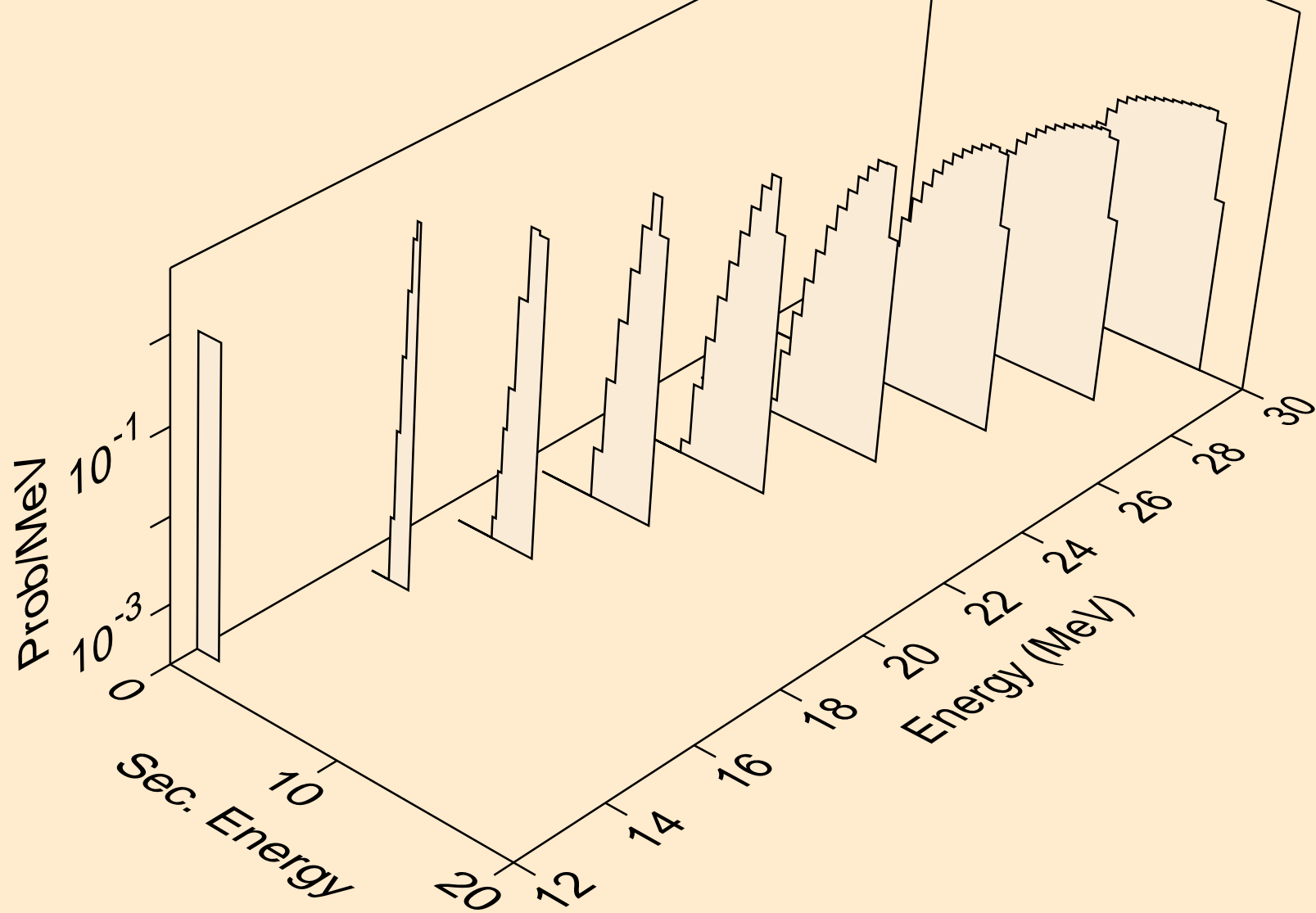

HF182 NEUTRON ACER TENDL-2024 LIBRARY; T=0.K  
deuterons from (n,d)

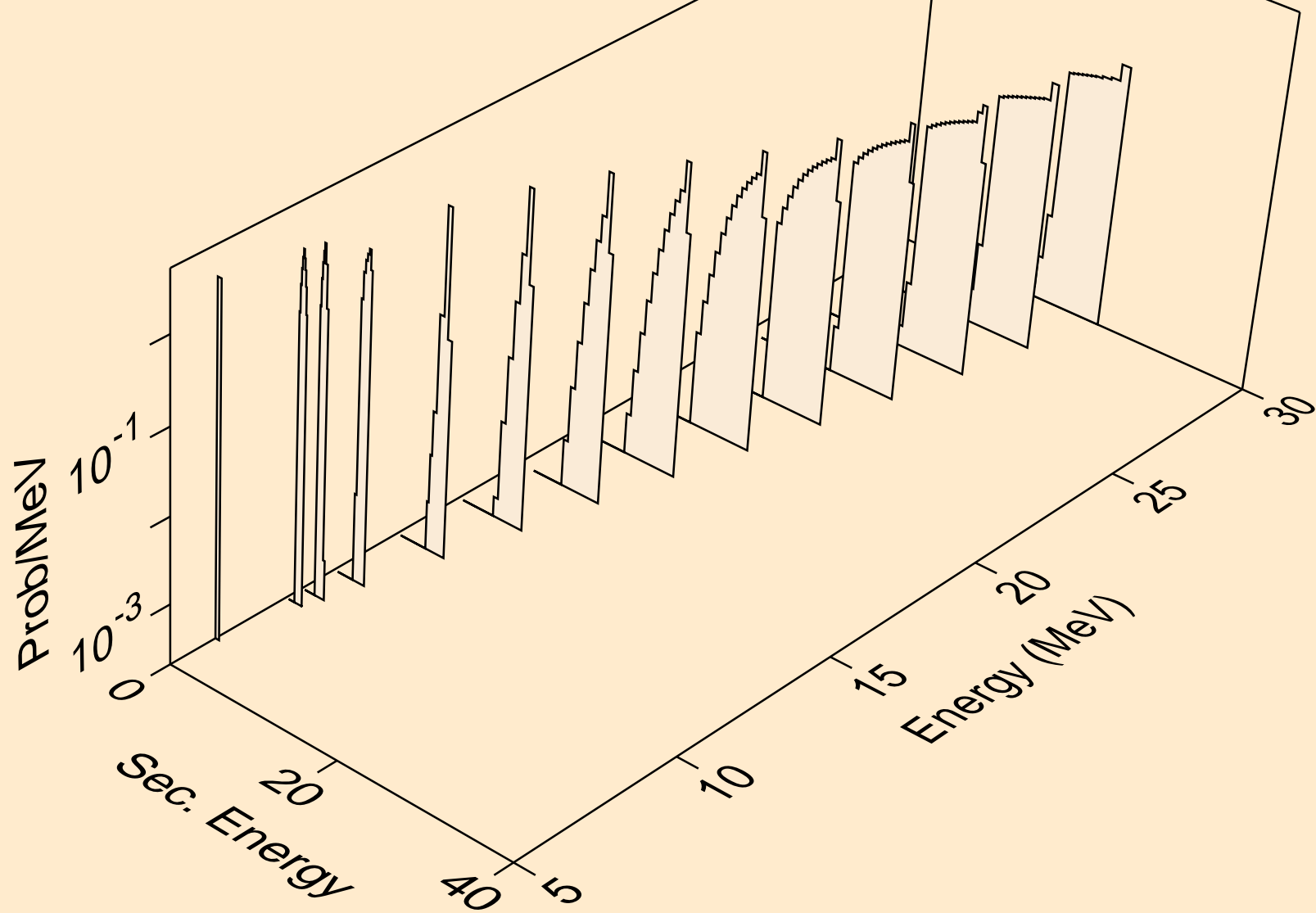

HF182 NEUTRON ACER TENDL-2024 LIBRARY; T=0.K  
tritons from (n,x)

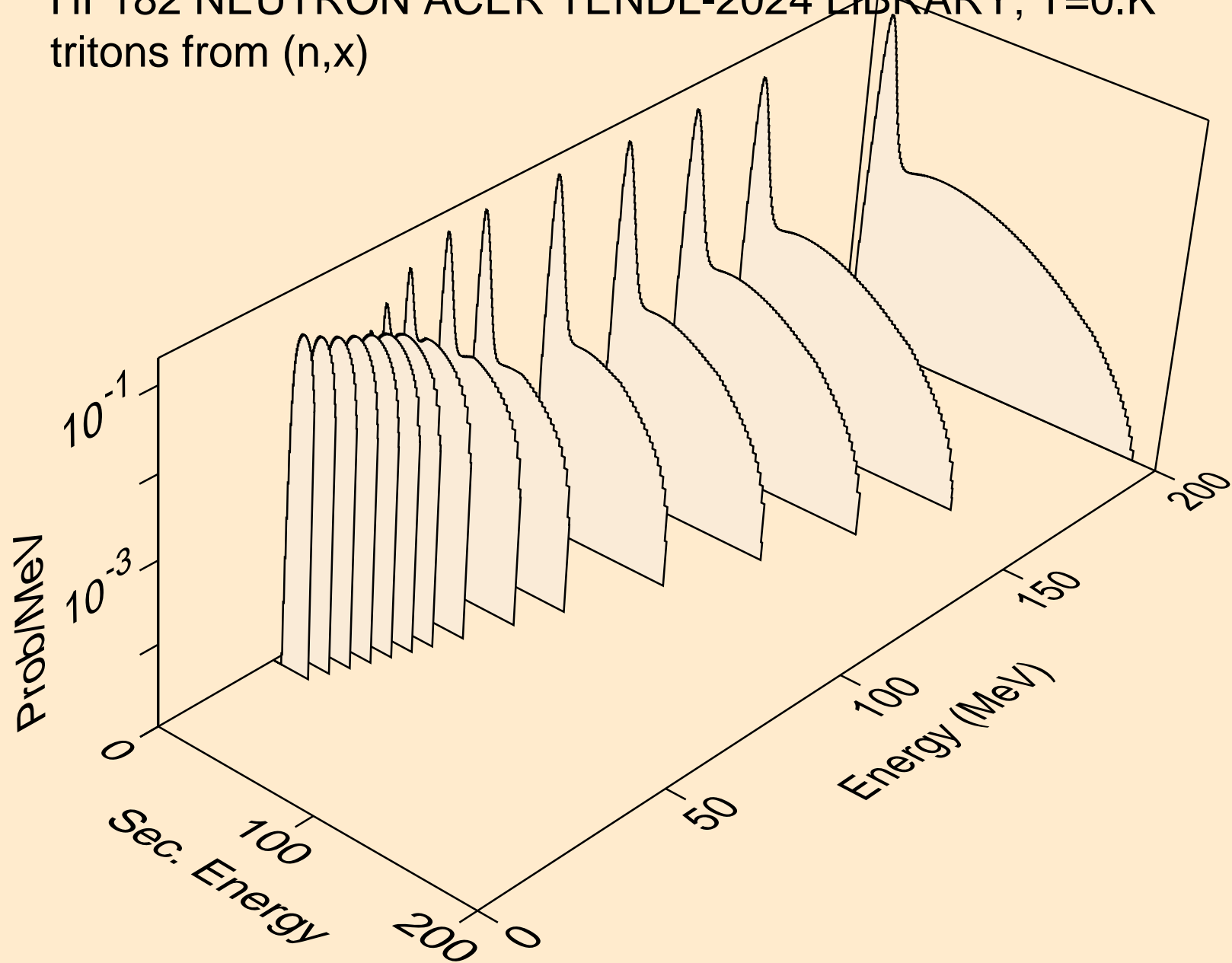

HF182 NEUTRON ACER TENDL-2024 LIBRARY; T=0.K  
tritons from (n,n\*)t

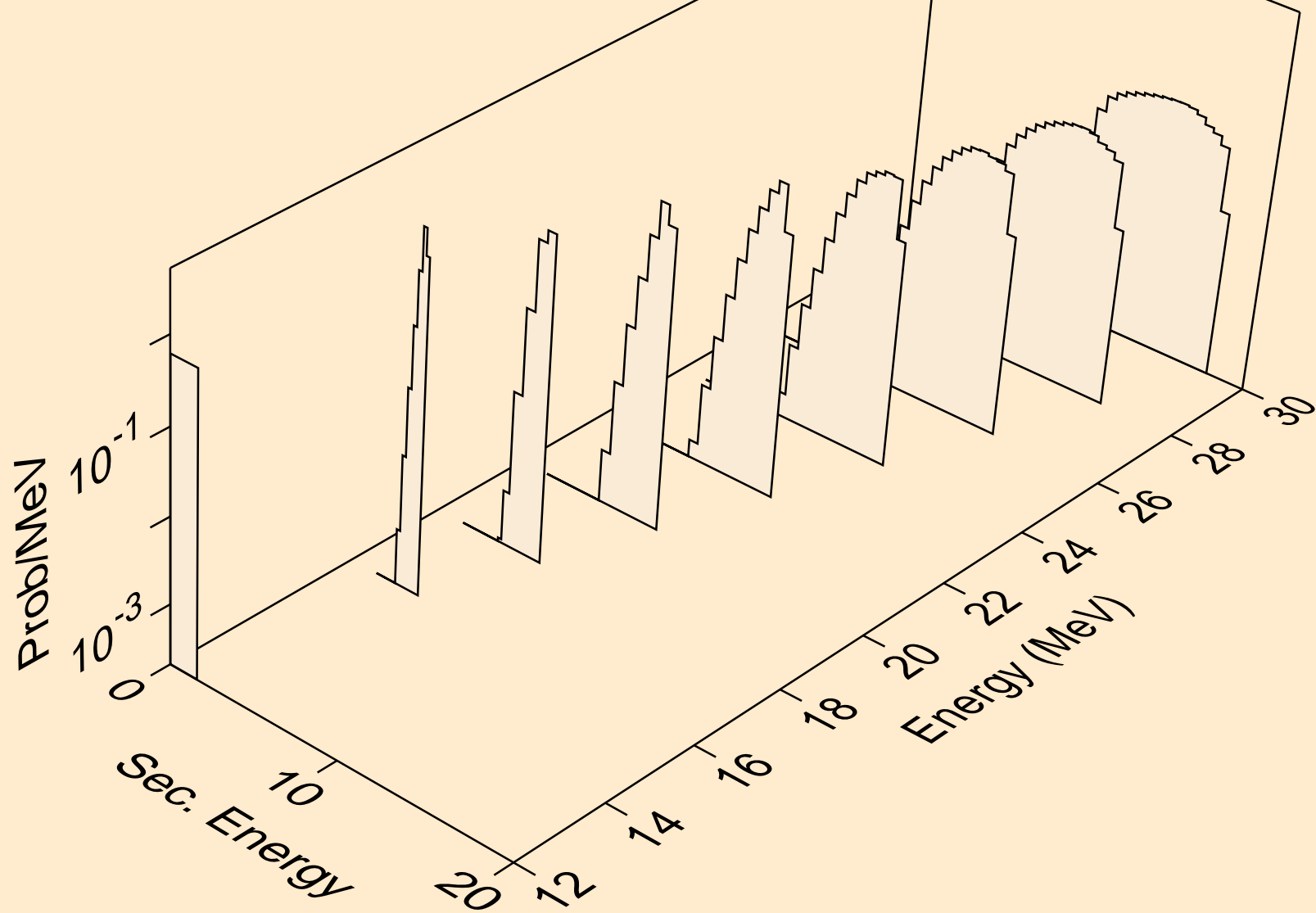

HF182 NEUTRON ACER TENDL-2024 LIBRARY; T=0.K  
tritons from (n,t)

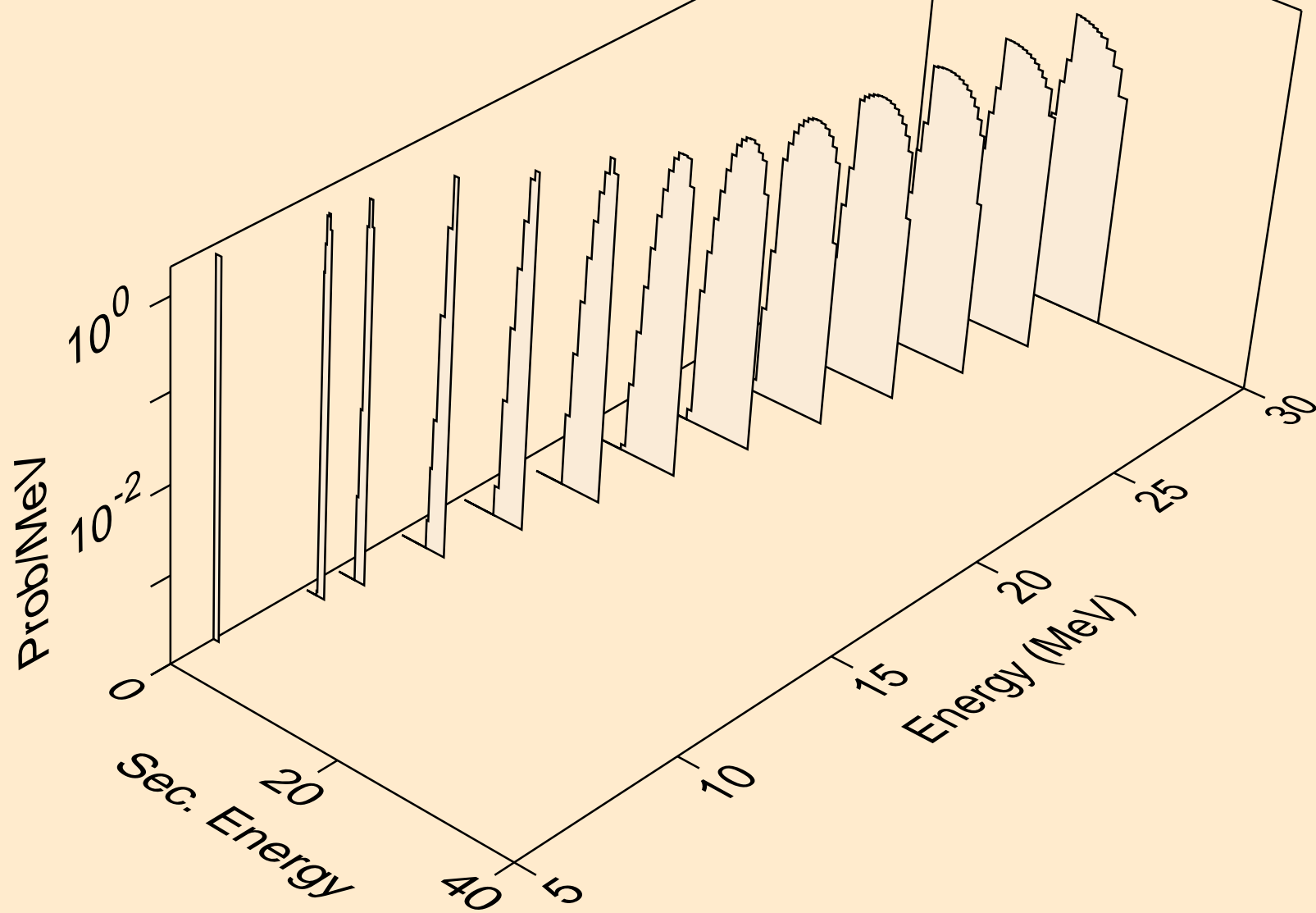

HF182 NEUTRON ACER TENDL-2024 LIBRARY; T=0.K  
he3s from (n,x)

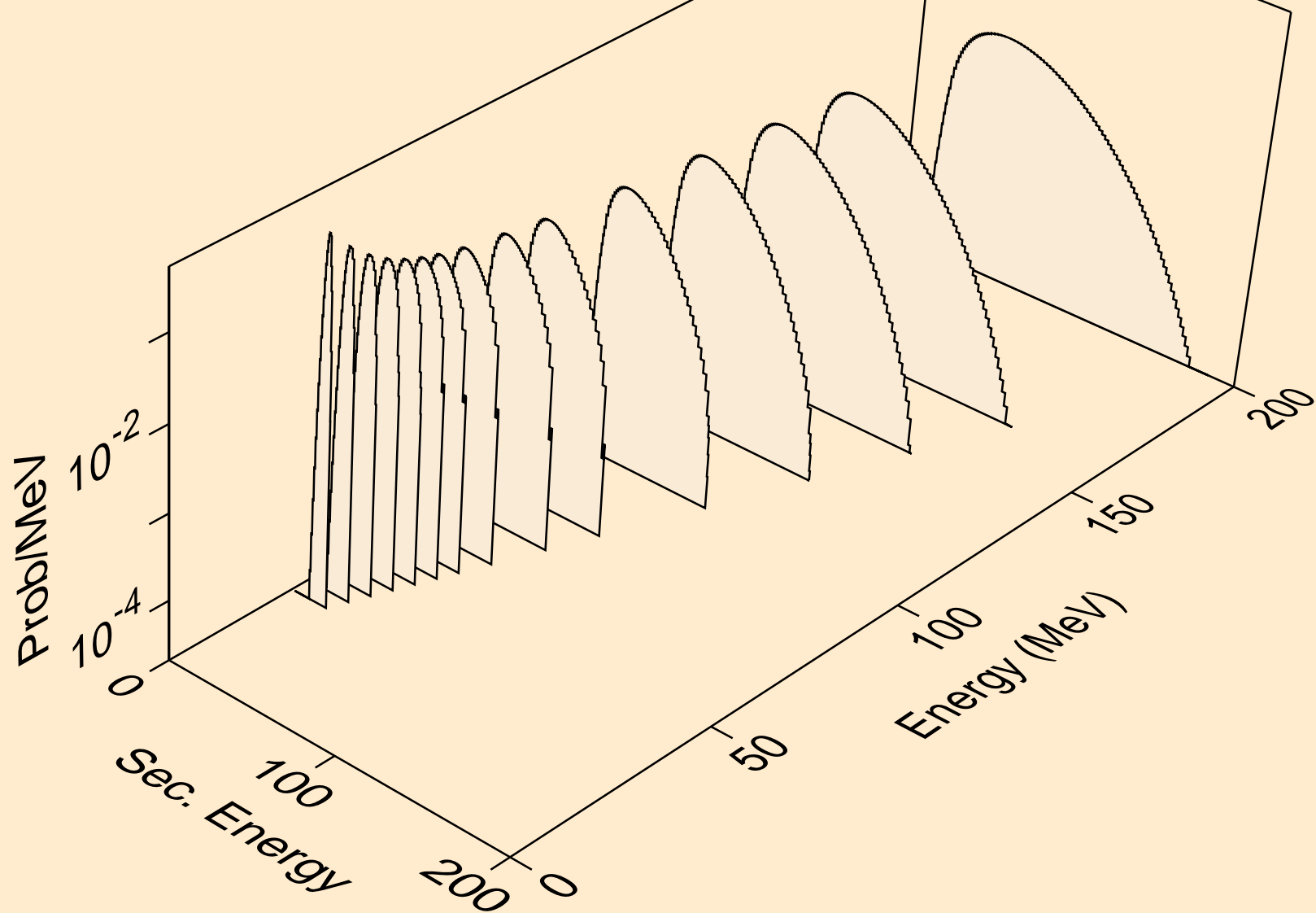

HF182 NEUTRON ACER TENDL-2024 LIBRARY; T=0.K  
he3s from (n,n\*)he3

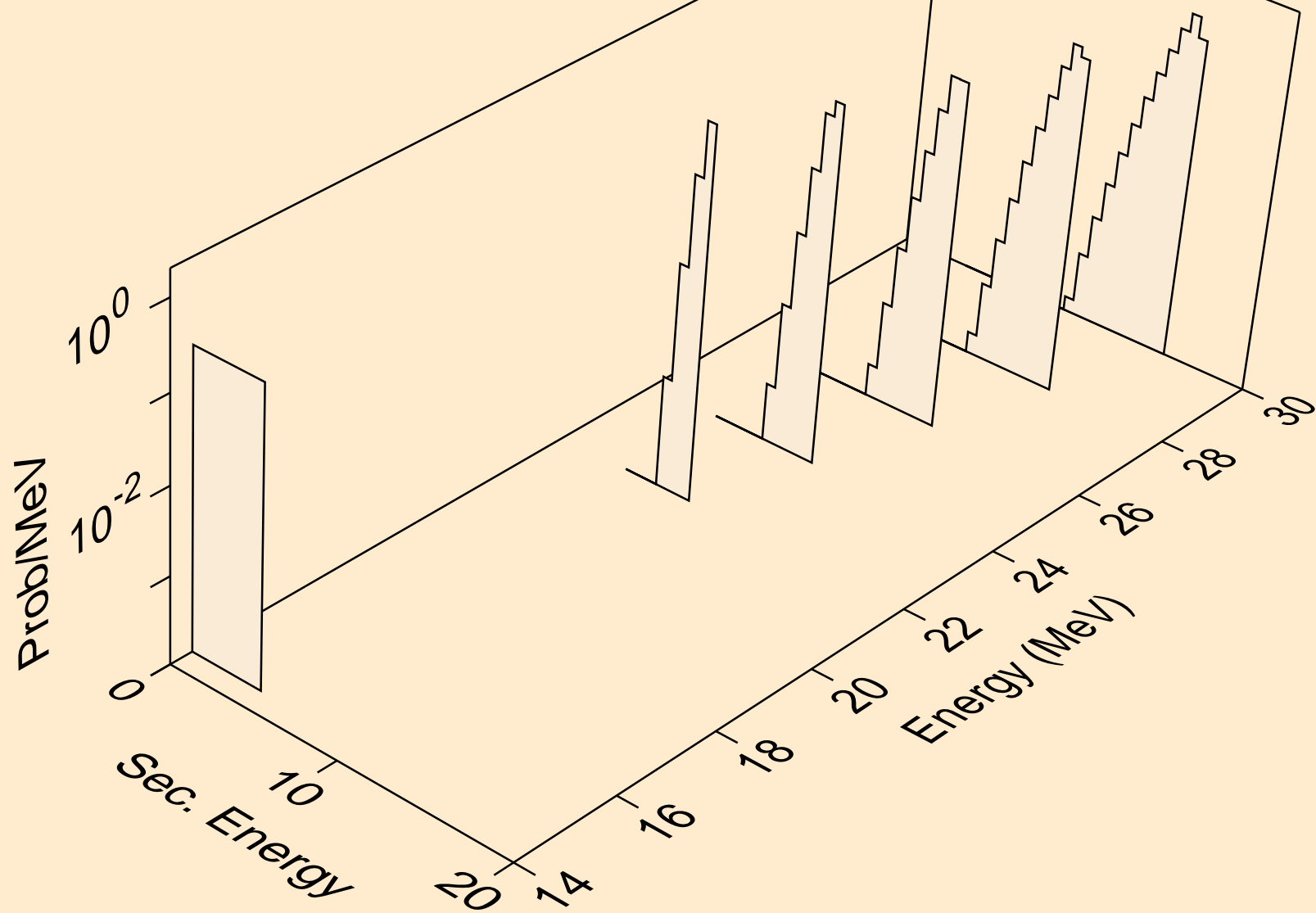

HF182 NEUTRON ACER TENDL-2024 LIBRARY; T=0.K  
he3s from (n,he3)

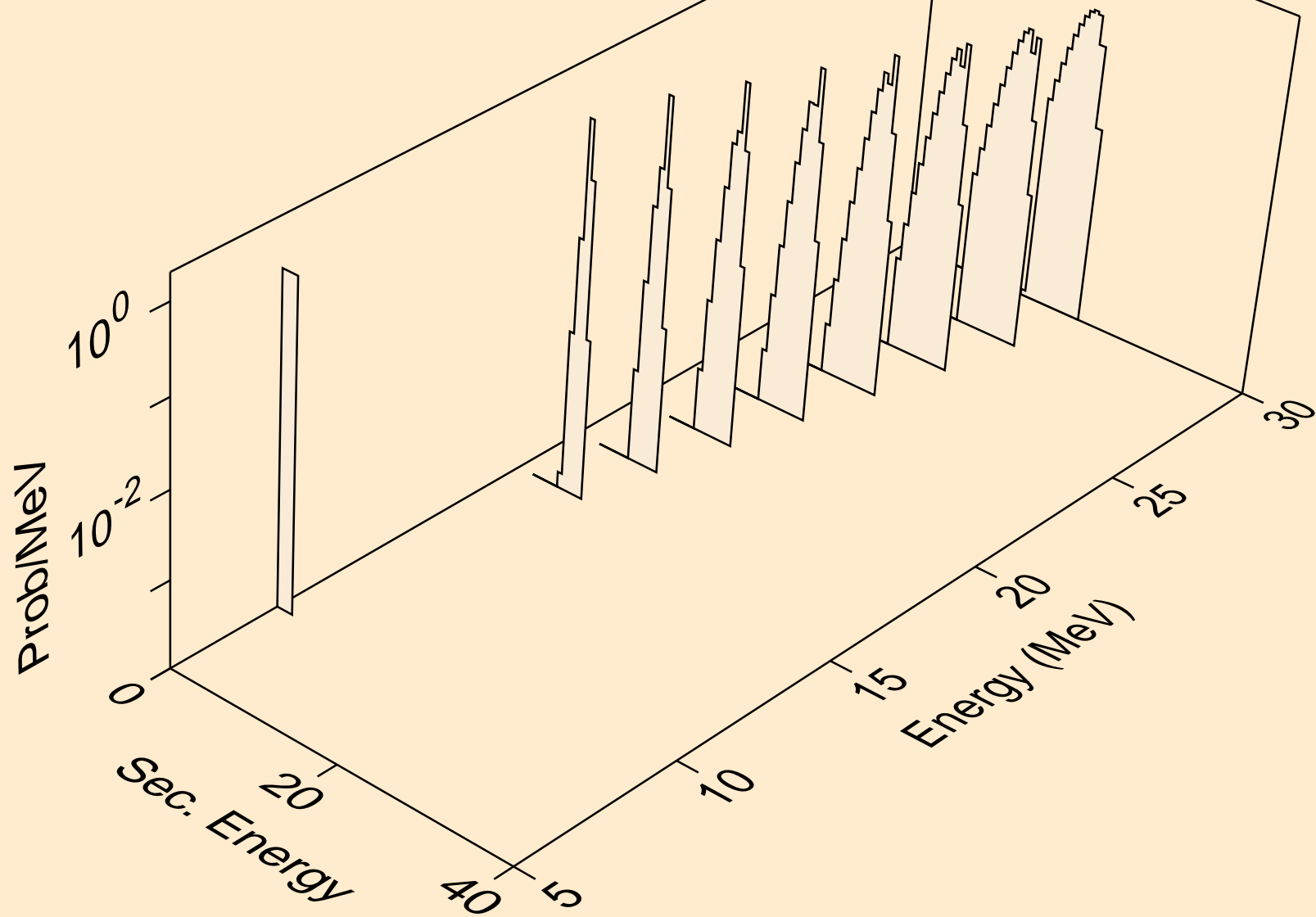

HF182 NEUTRON ACER TENDL-2024 LIBRARY; T=0.K  
alphas from (n,x)

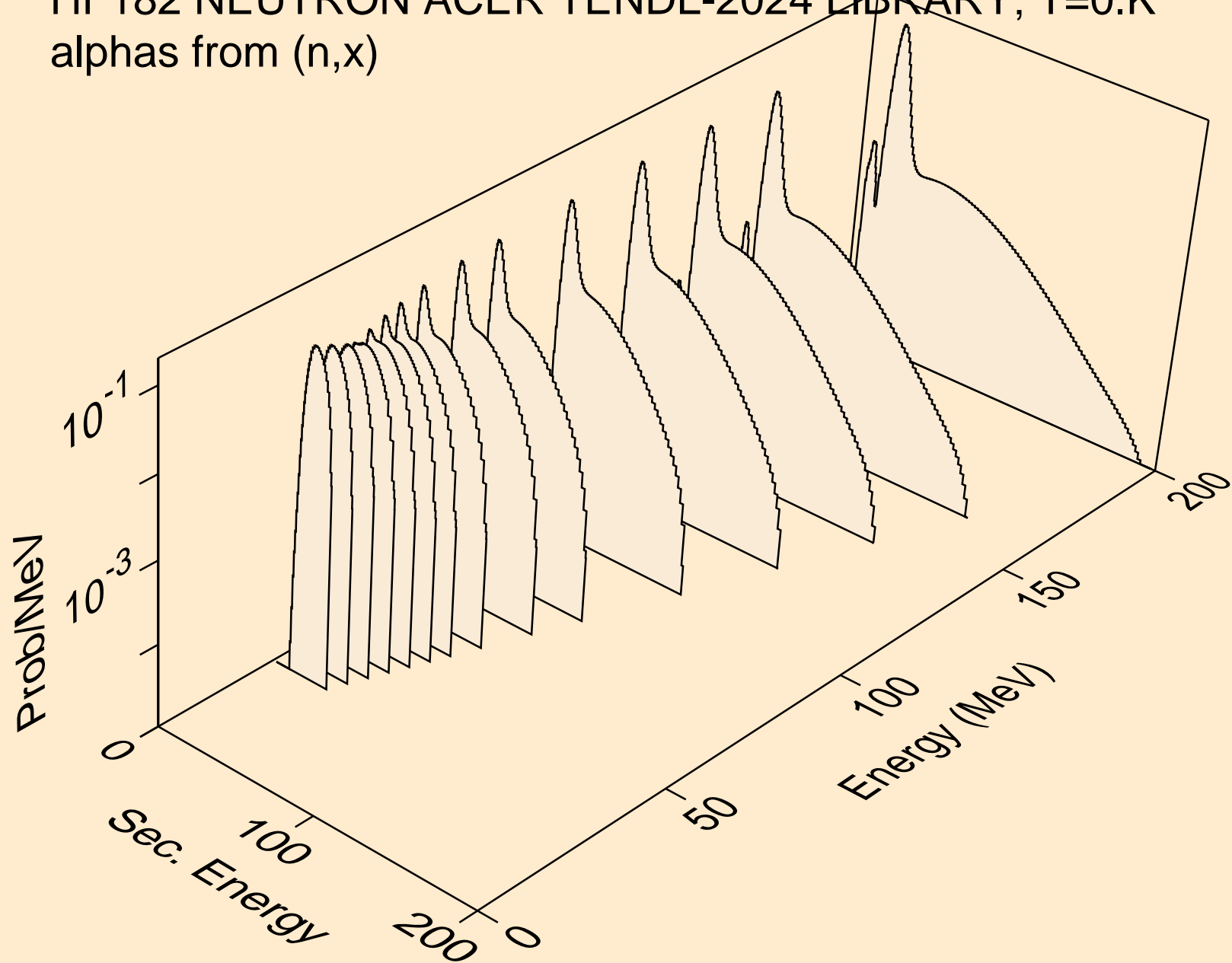

HF182 NEUTRON ACER TENDL-2024 LIBRARY; T=0.K  
alphas from (n,n\*)a

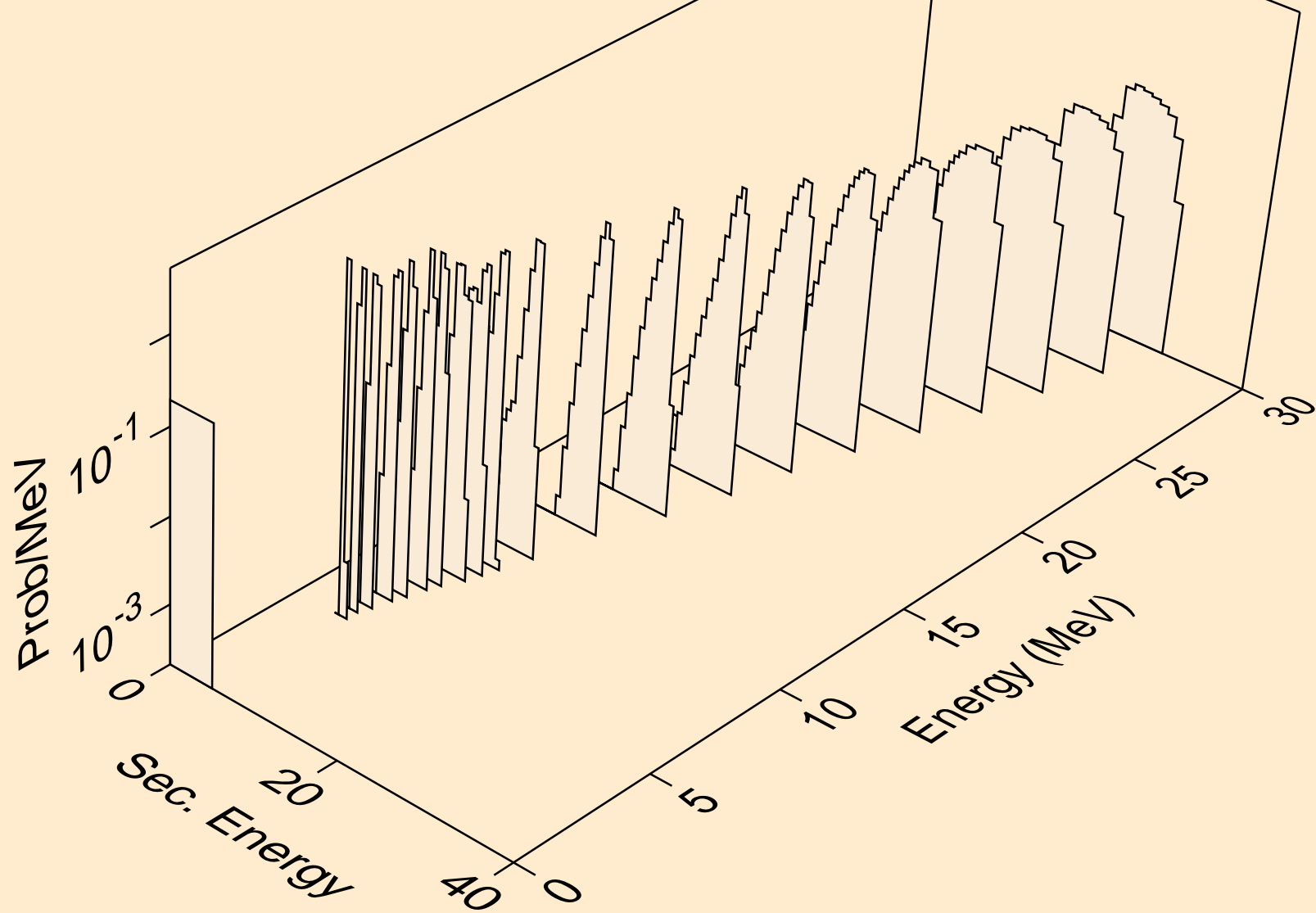

HF182 NEUTRON ACER TENDL-2024 LIBRARY; T=0.K  
alphas from (n,2n)a

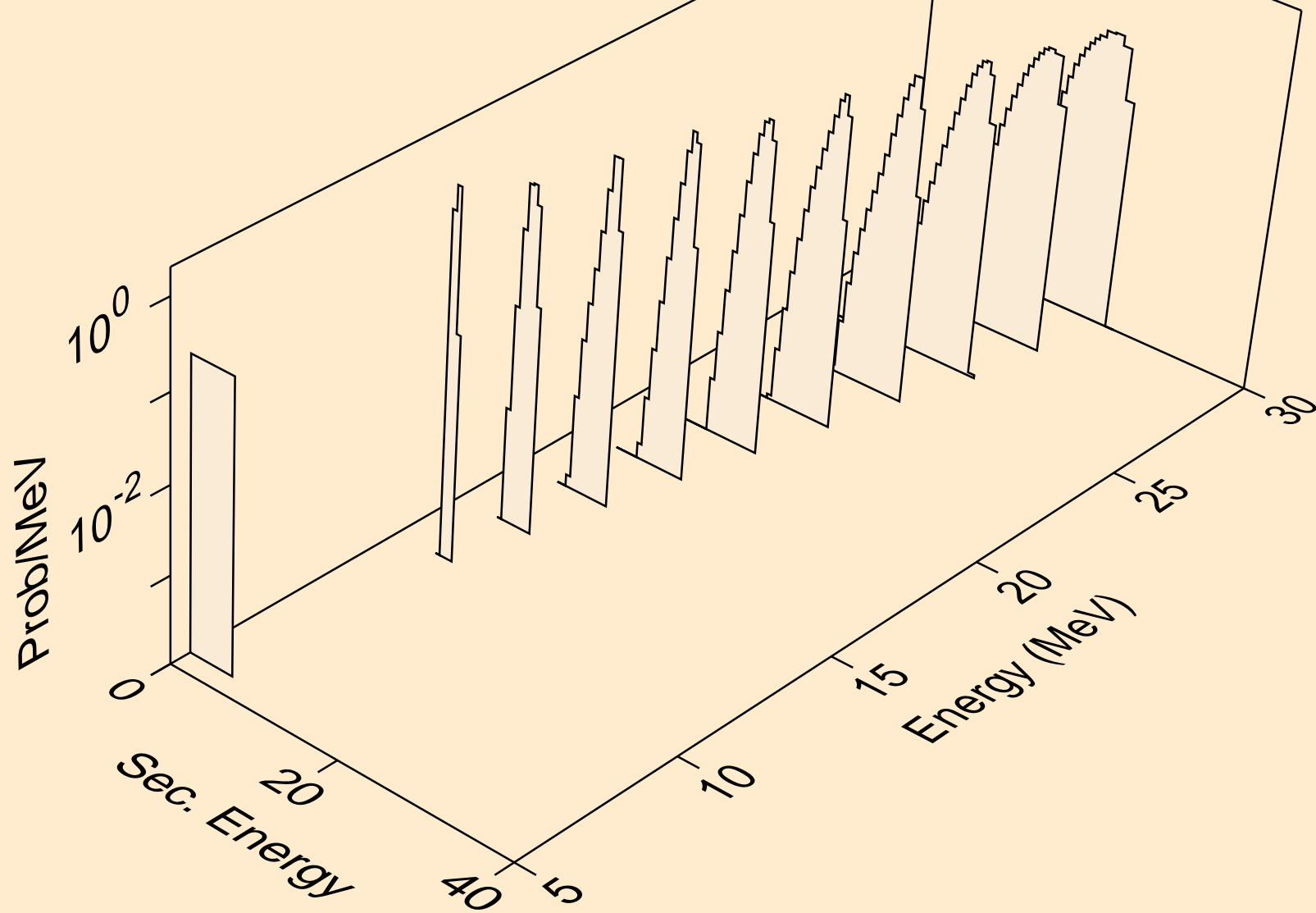

HF182 NEUTRON ACER TENDL-2024 LIBRARY; T=0.K  
alphas from (n,3n)a

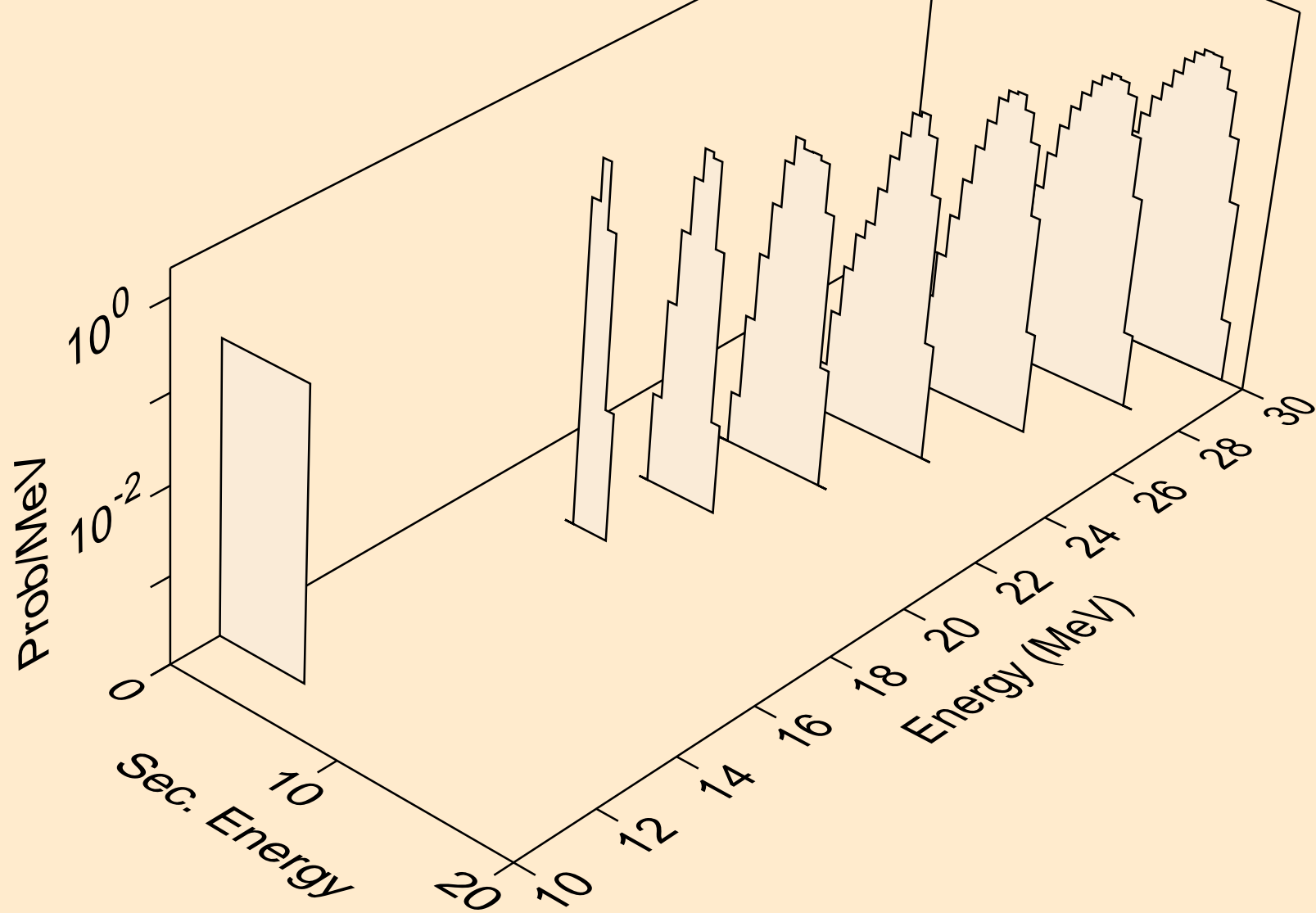

HF182 NEUTRON ACER TENDL-2024 LIBRARY; T=0.K  
alphas from (n,a)

