

HO147 NEUTRON ACER TENDL-2024 LIBRARY; T=0.K

Principal cross sections

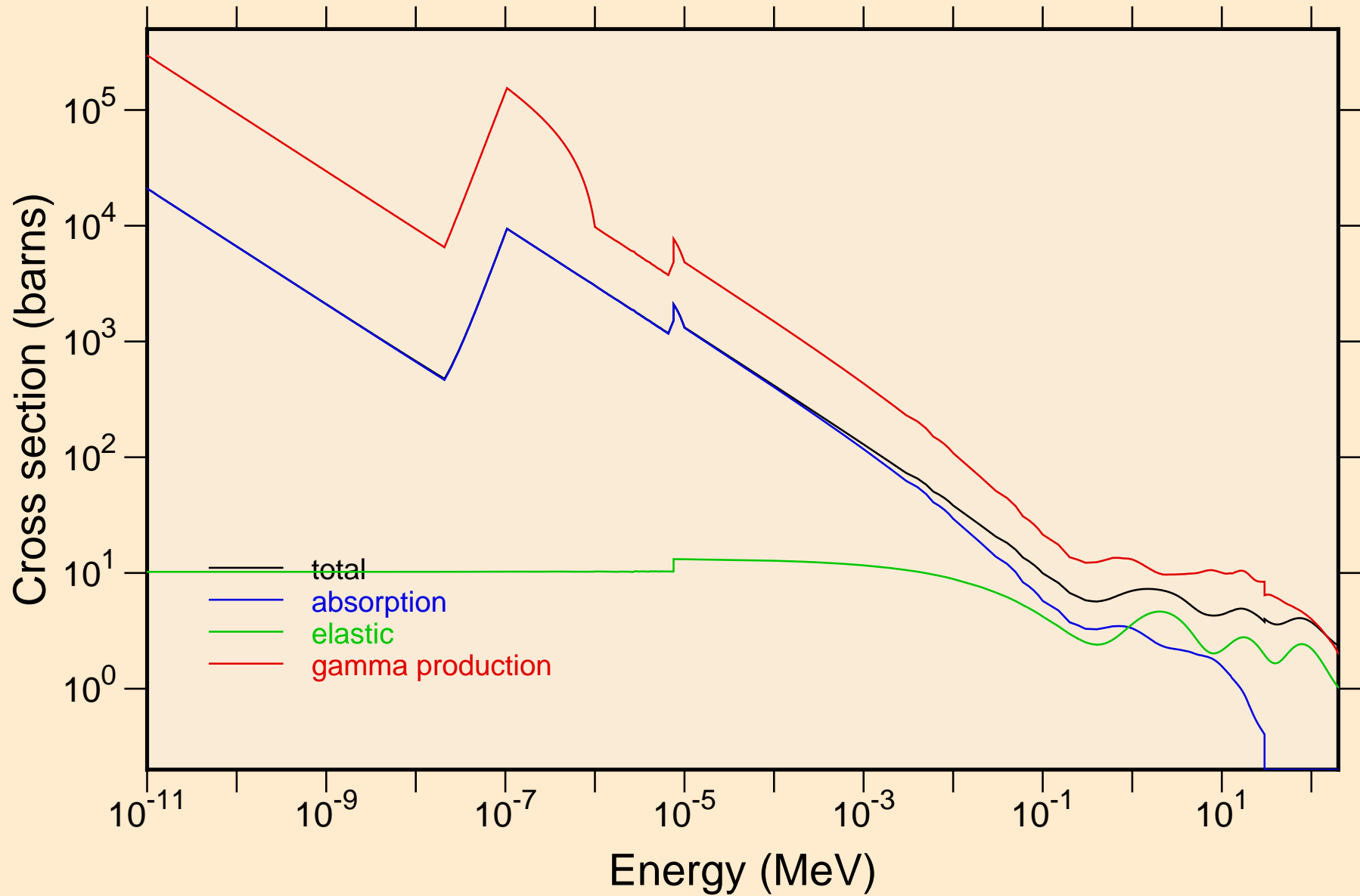

HO147 NEUTRON ACER TENDL-2024 LIBRARY; T=0.K

Heating

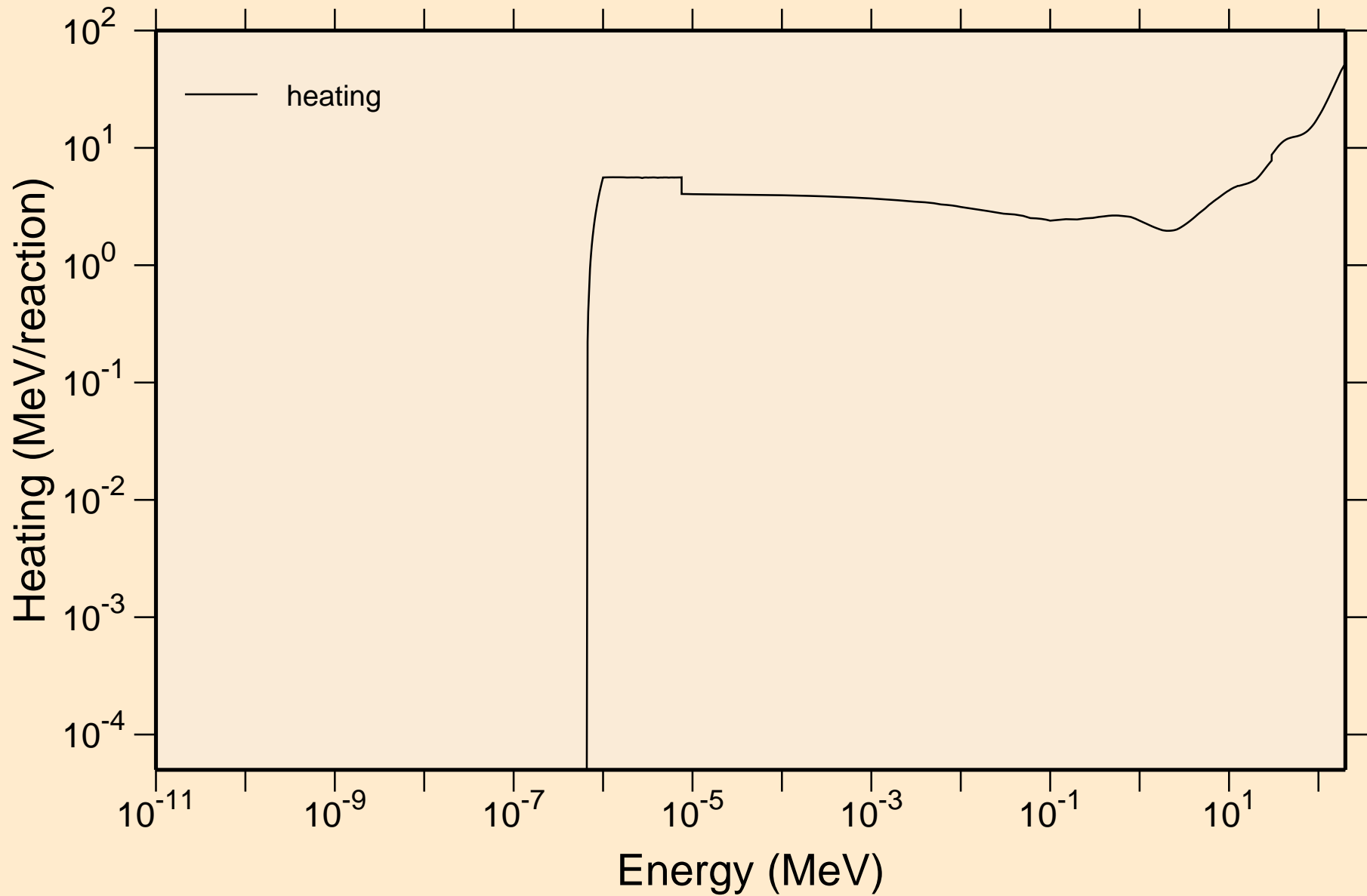

HO147 NEUTRON ACER TENDL-2024 LIBRARY; T=0.K

Damage

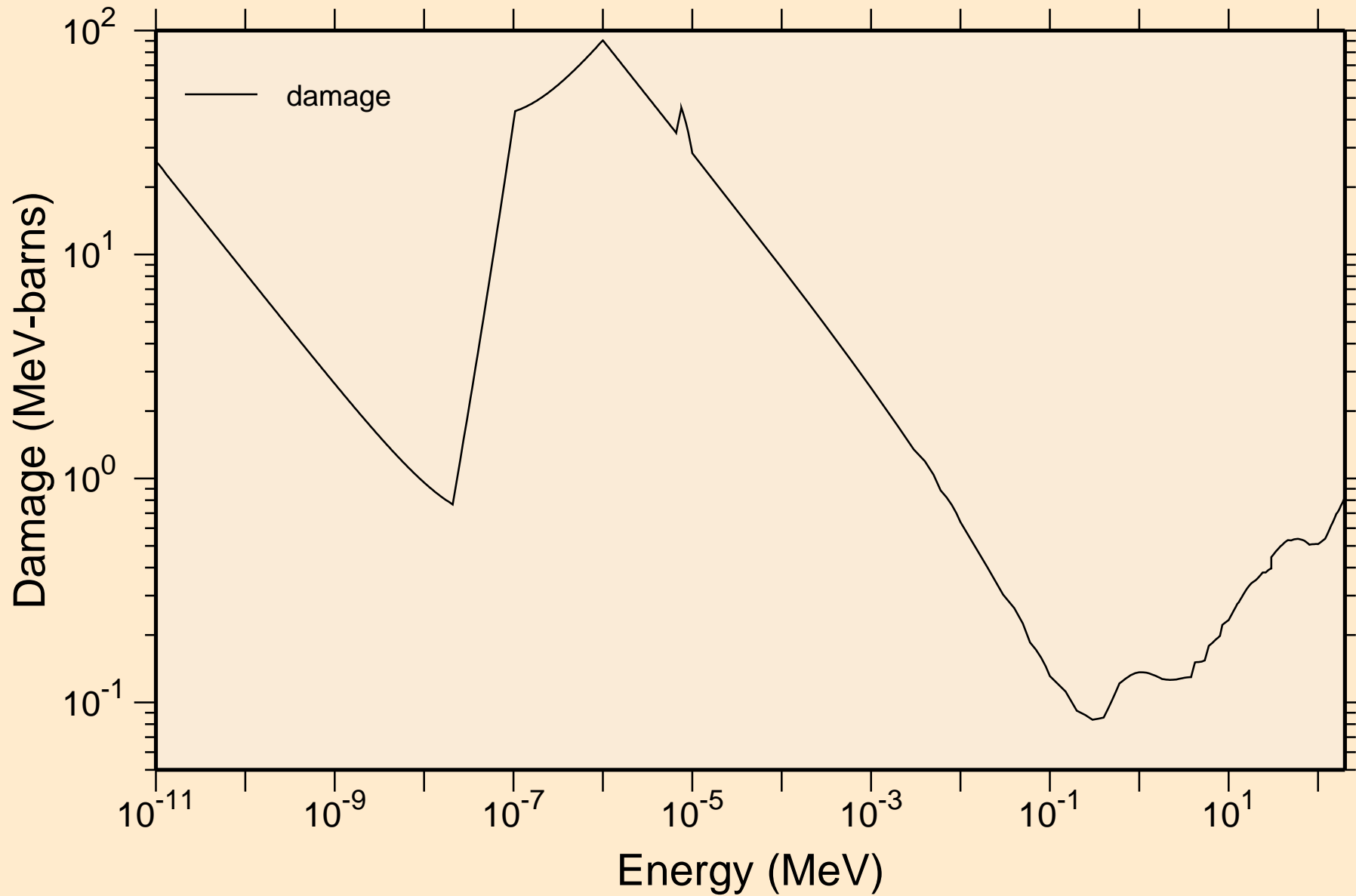

HO147 NEUTRON ACER TENDL-2024 LIBRARY; T=0.K

Non-threshold reactions

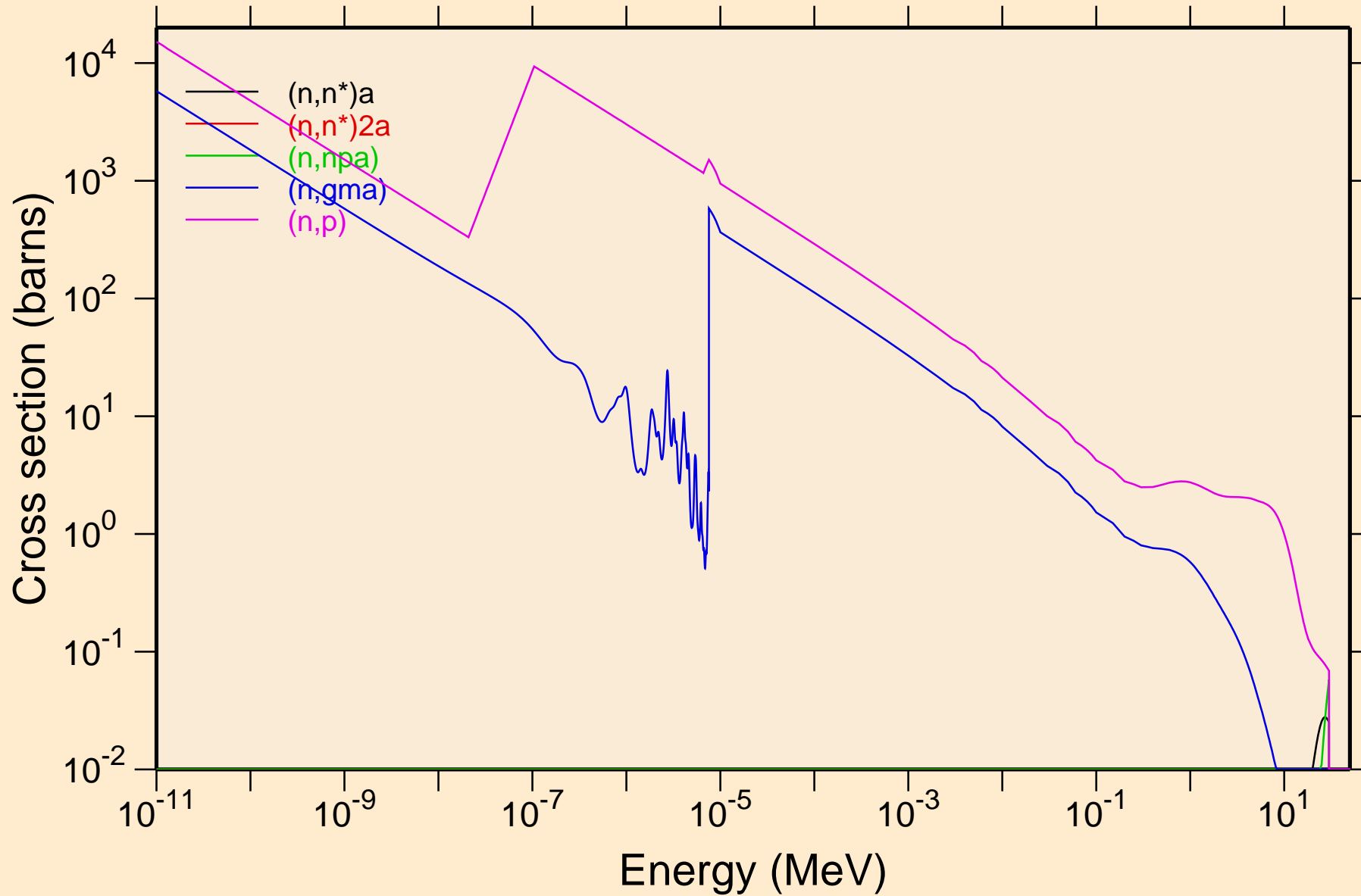

HO147 NEUTRON ACER TENDL-2024 LIBRARY; T=0.K

Non-threshold reactions

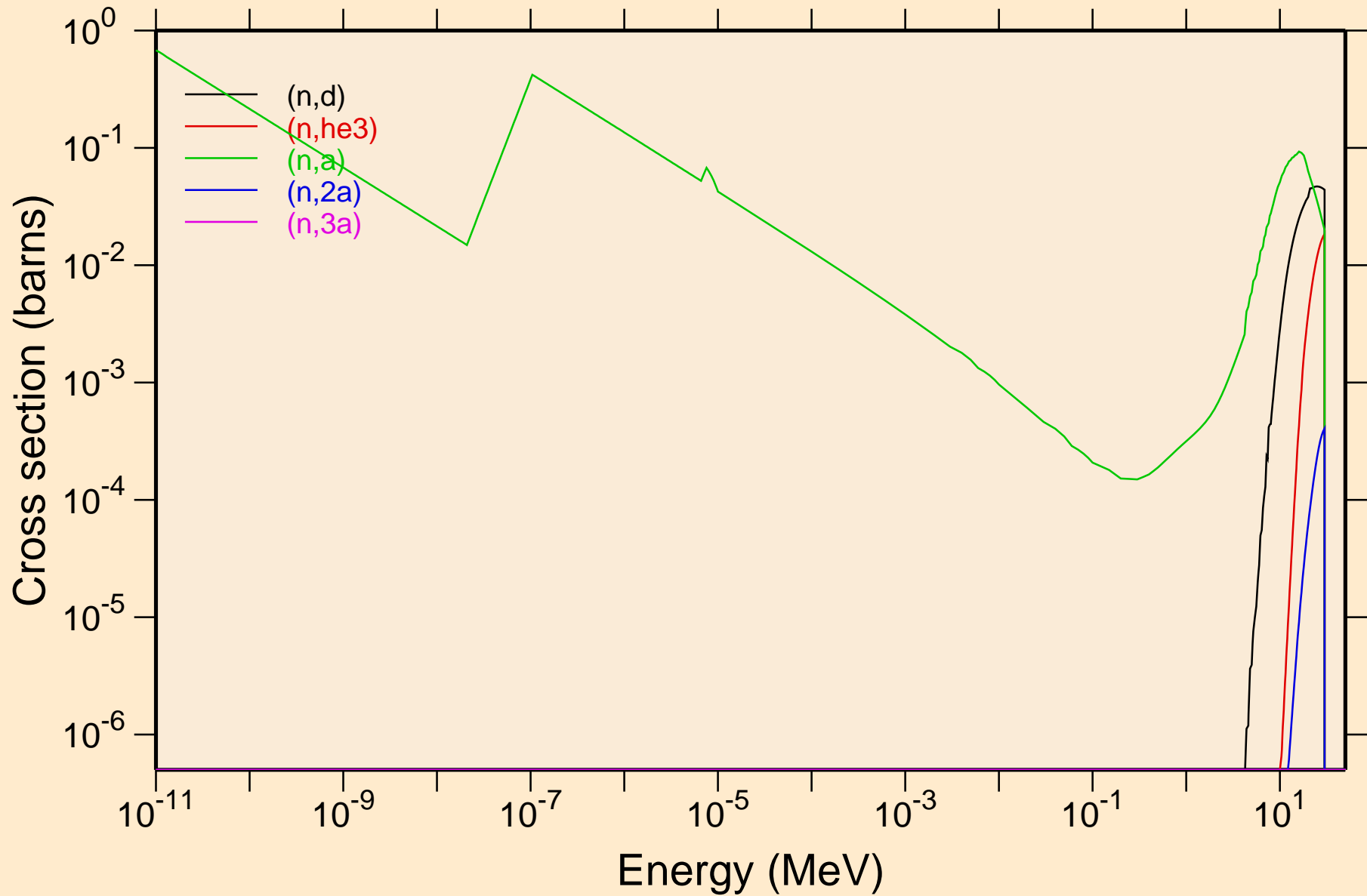

HO147 NEUTRON ACER TENDL-2024 LIBRARY; T=0.K

Non-threshold reactions

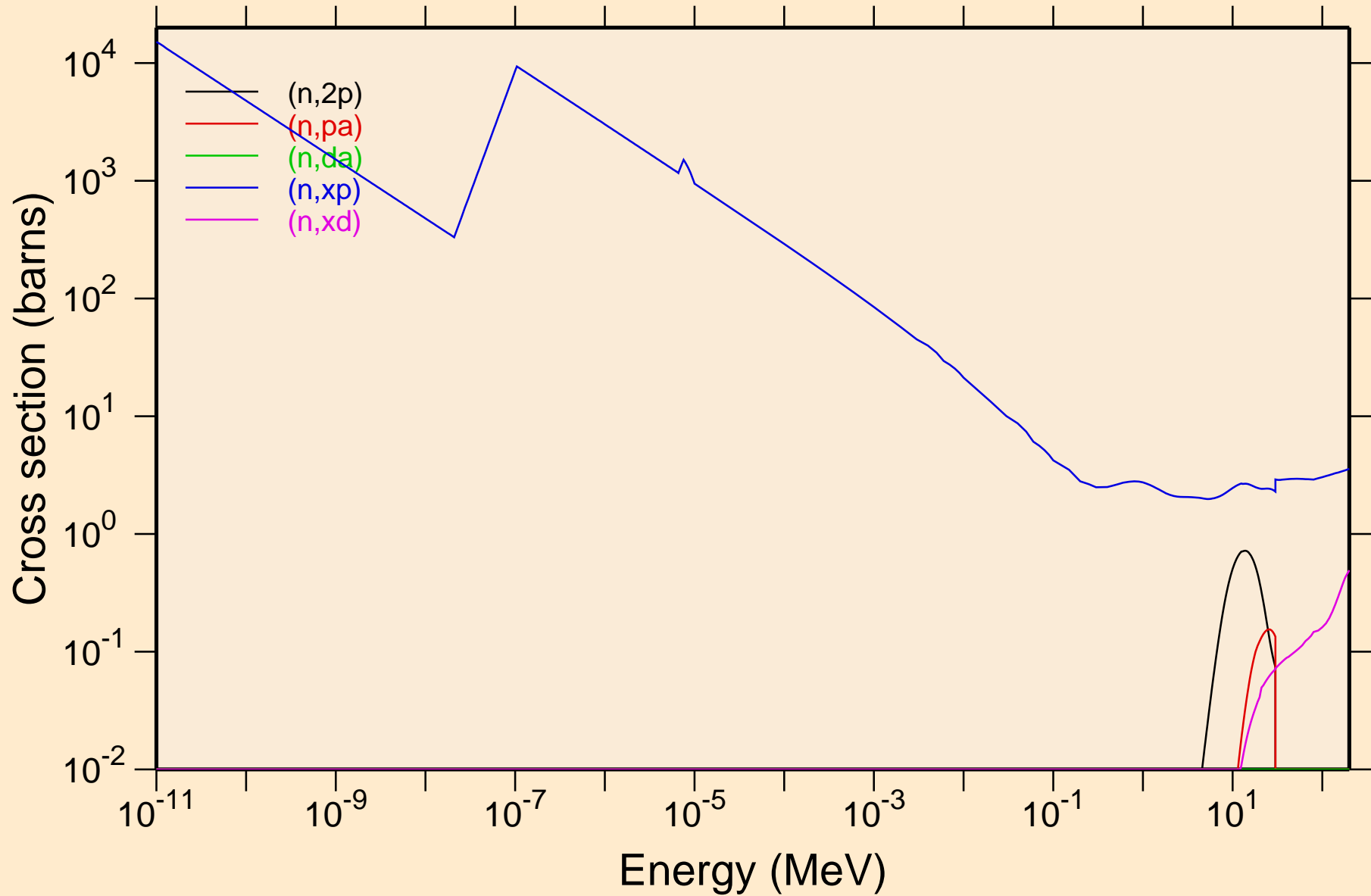

HO147 NEUTRON ACER TENDL-2024 LIBRARY; T=0.K
Non-threshold reactions

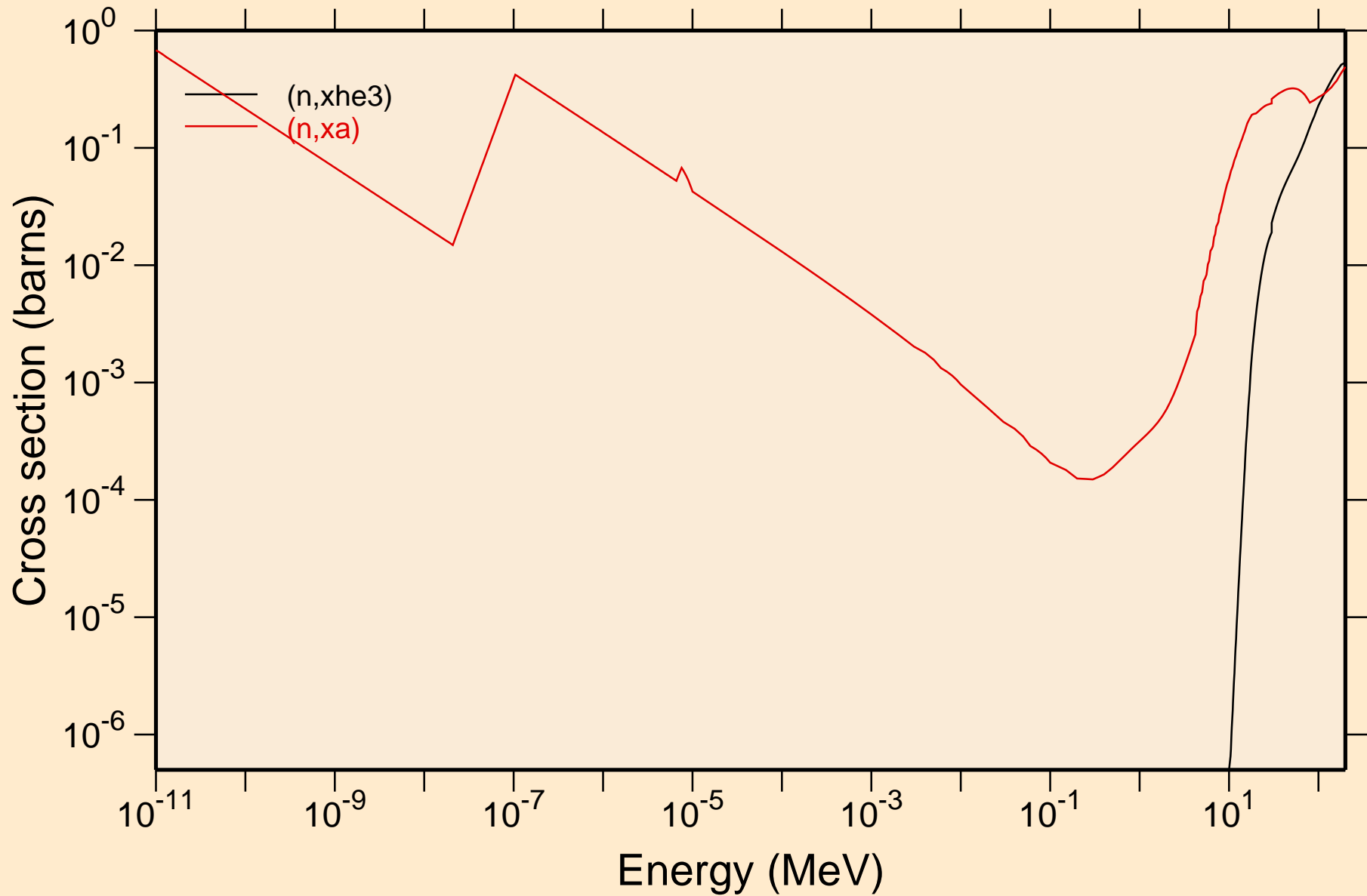

HO147 NEUTRON ACER TENDL-2024 LIBRARY; T=0.K

Principal cross sections

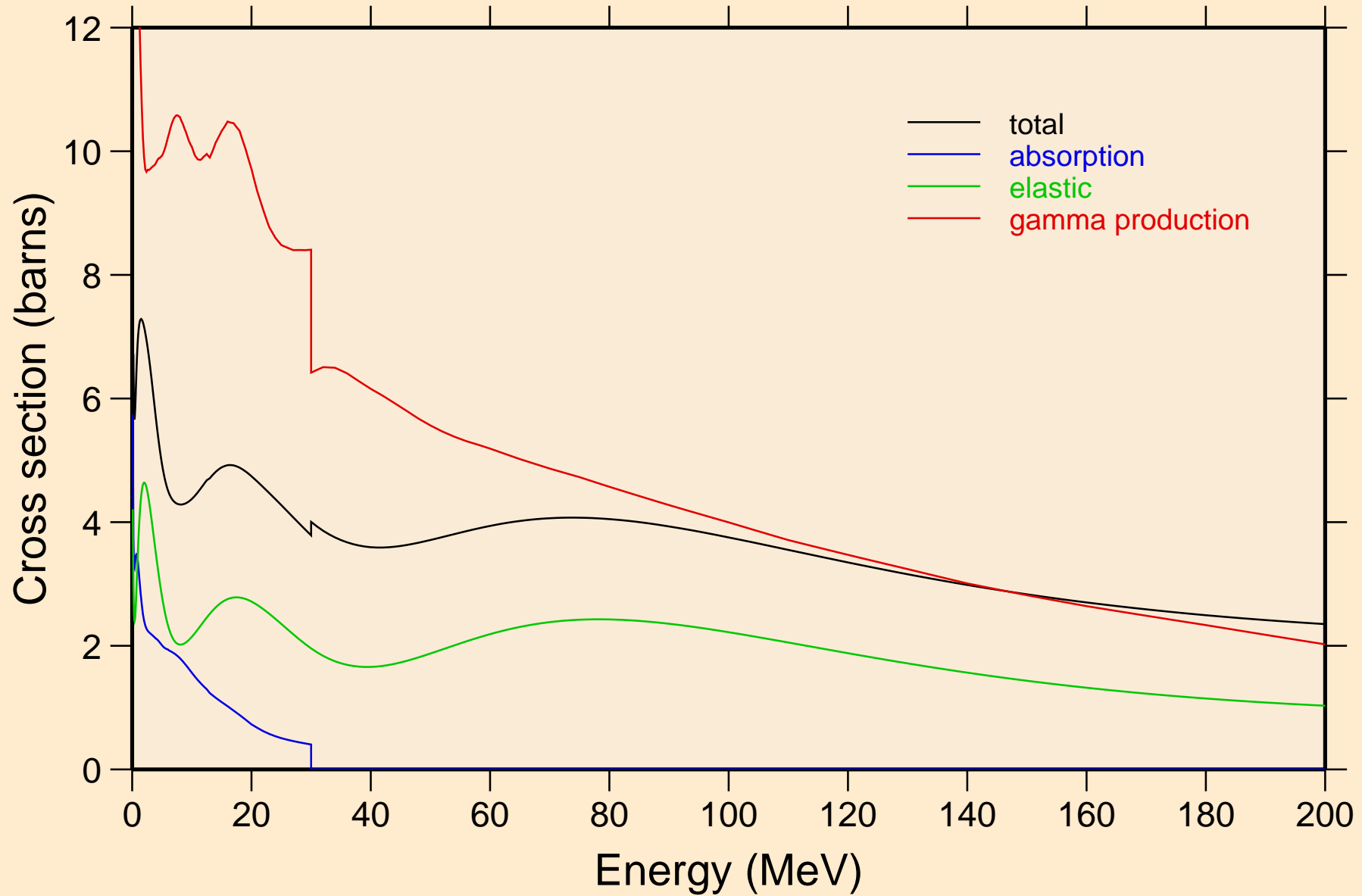

HO147 NEUTRON ACER TENDL-2024 LIBRARY; T=0.K

Heating

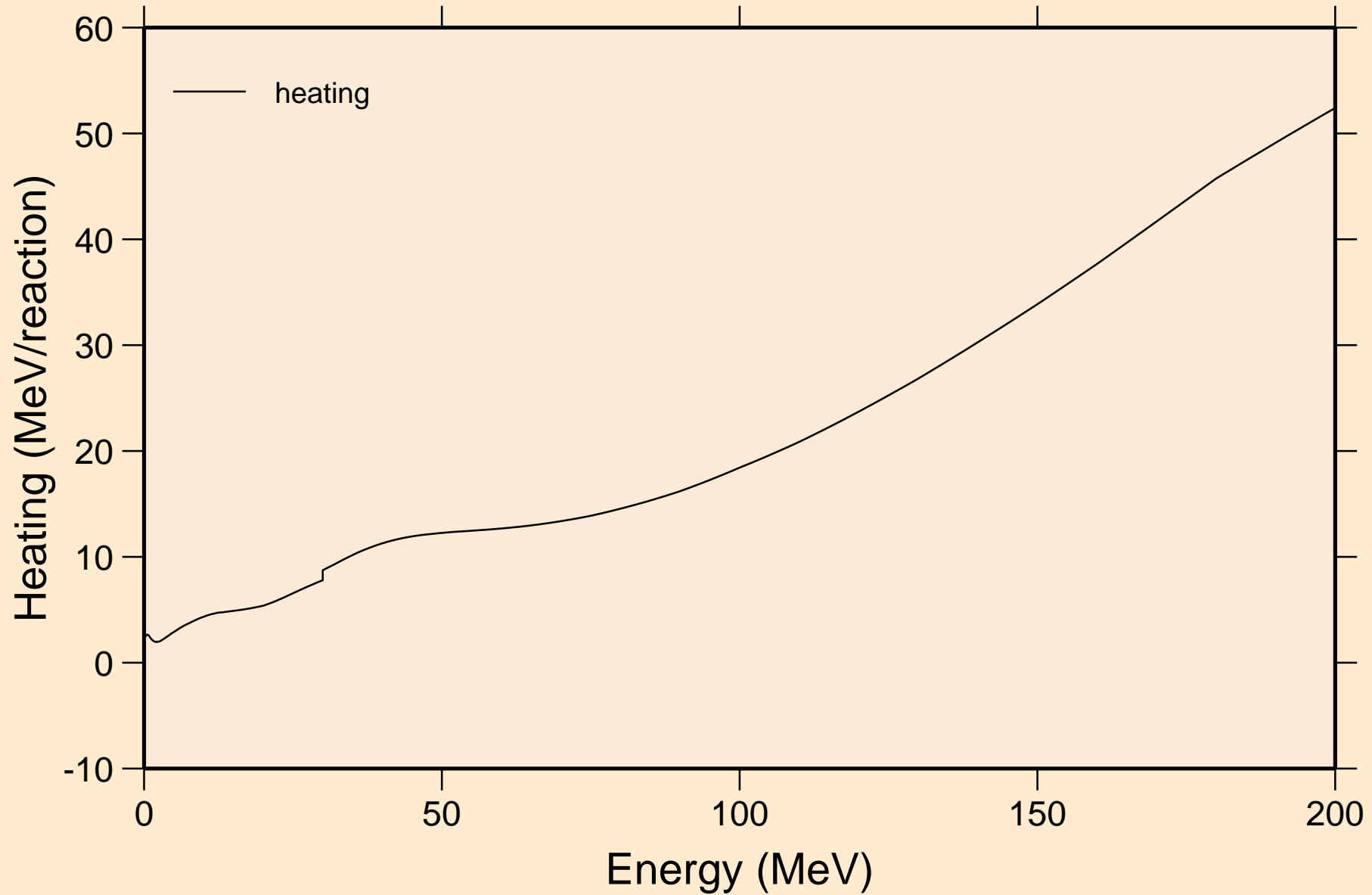

HO147 NEUTRON ACER TENDL-2024 LIBRARY; T=0.K

Damage

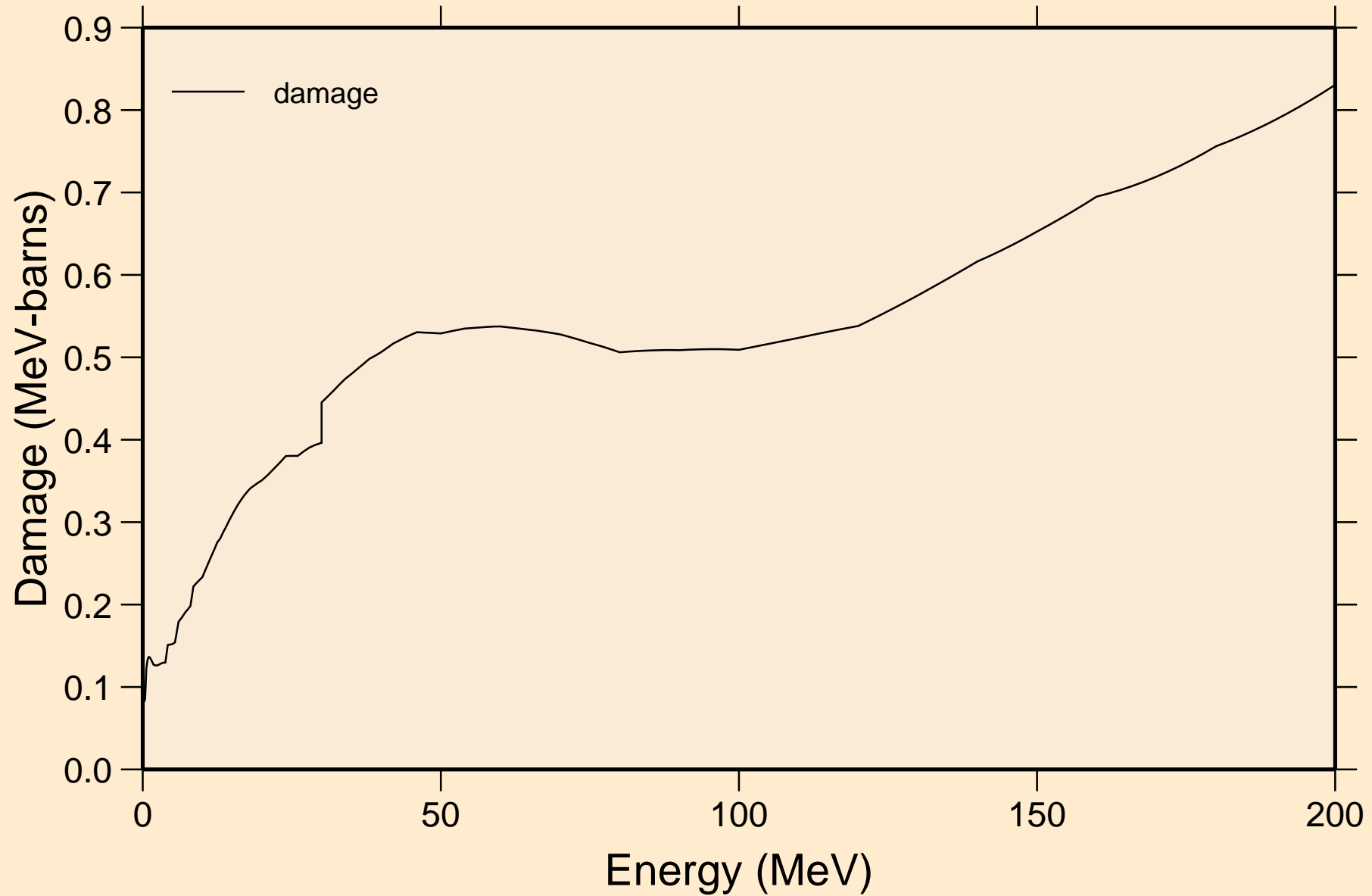

HO147 NEUTRON ACER TENDL-2024 LIBRARY; T=0.K

Non-threshold reactions

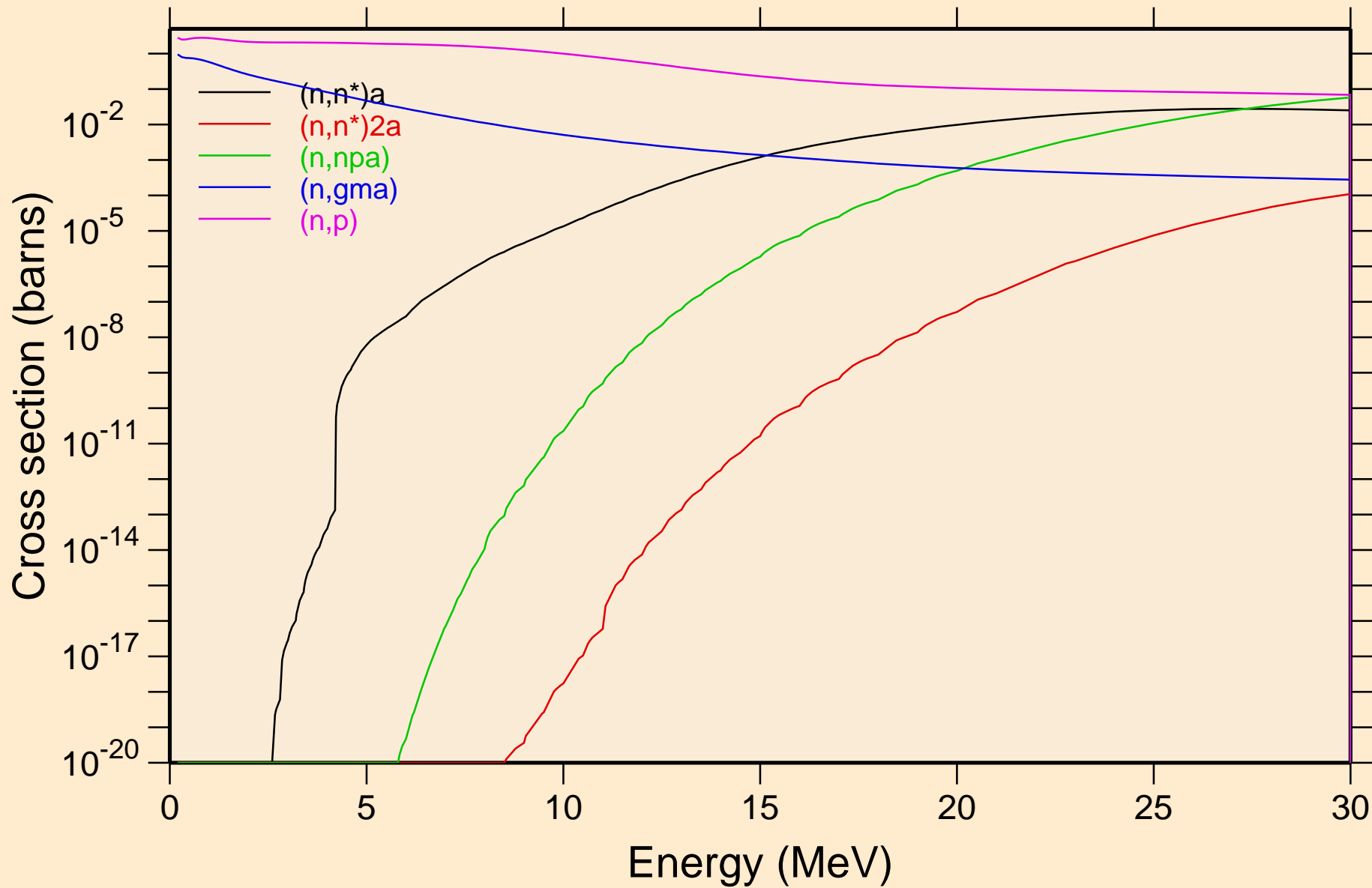

HO147 NEUTRON ACER TENDL-2024 LIBRARY; T=0.K

Non-threshold reactions

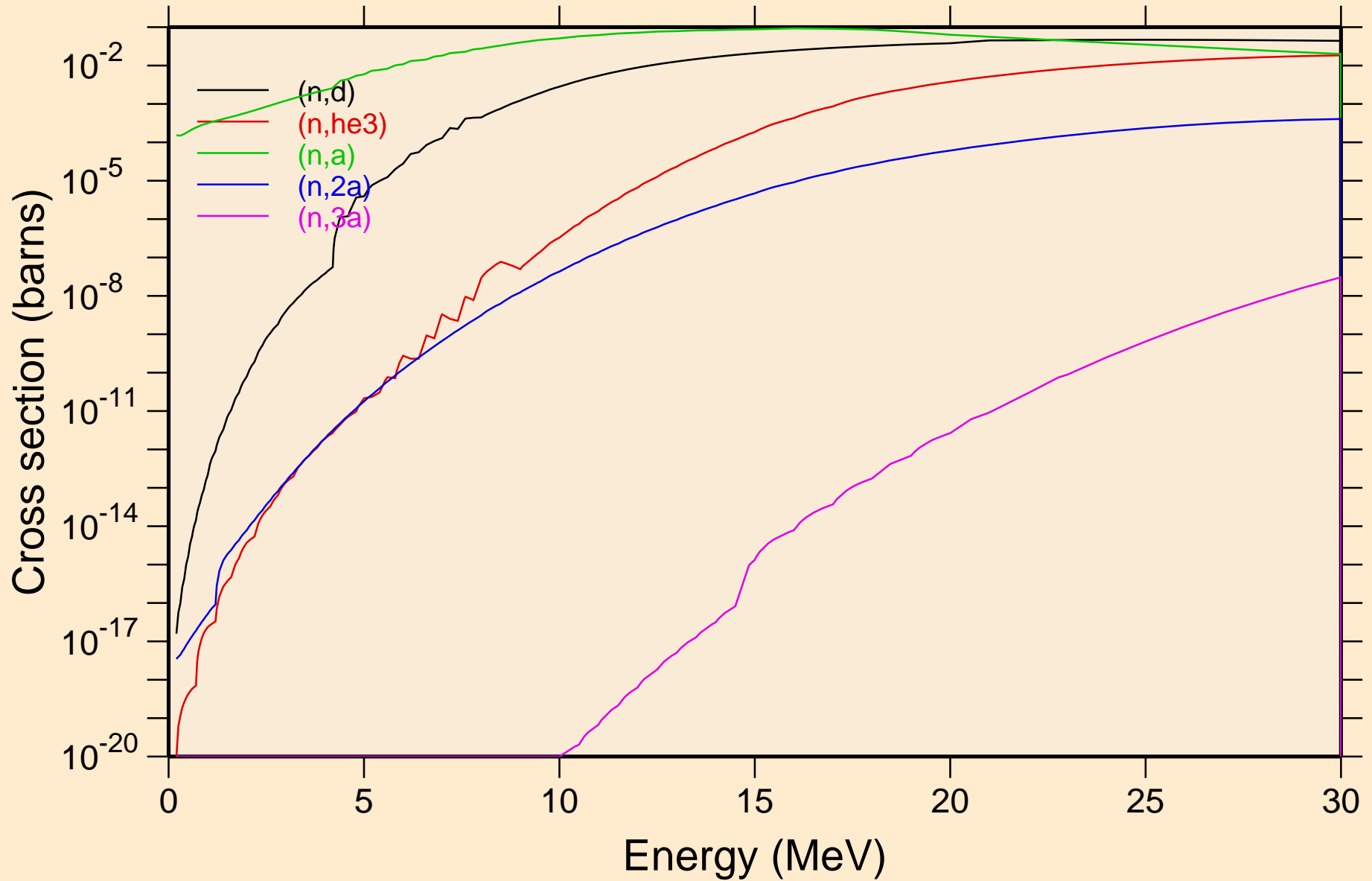

HO147 NEUTRON ACER TENDL-2024 LIBRARY; T=0.K

Non-threshold reactions

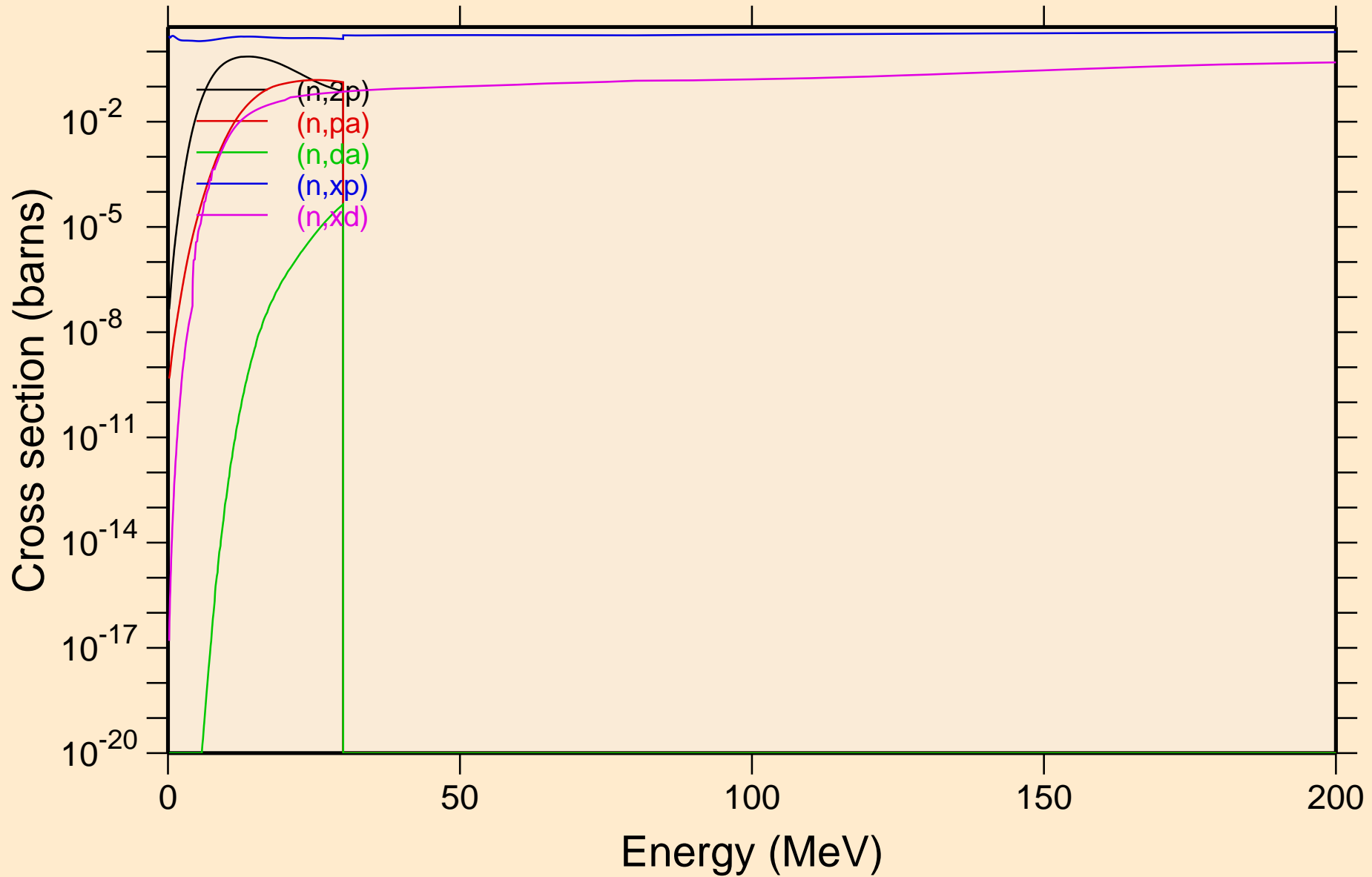

HO147 NEUTRON ACER TENDL-2024 LIBRARY; T=0.K
Non-threshold reactions

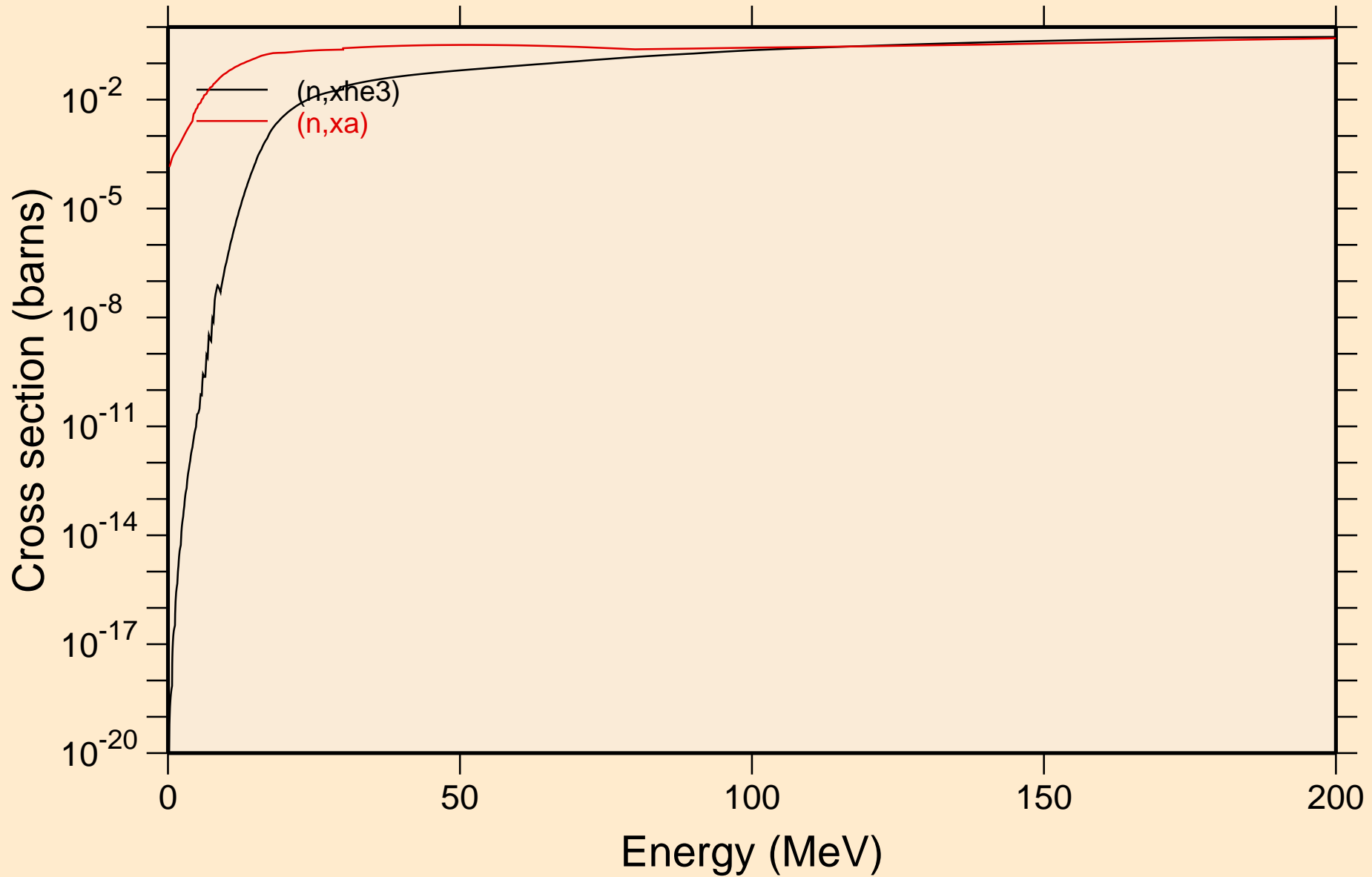

HO147 NEUTRON ACER TENDL-2024 LIBRARY; T=0.K

Inelastic levels

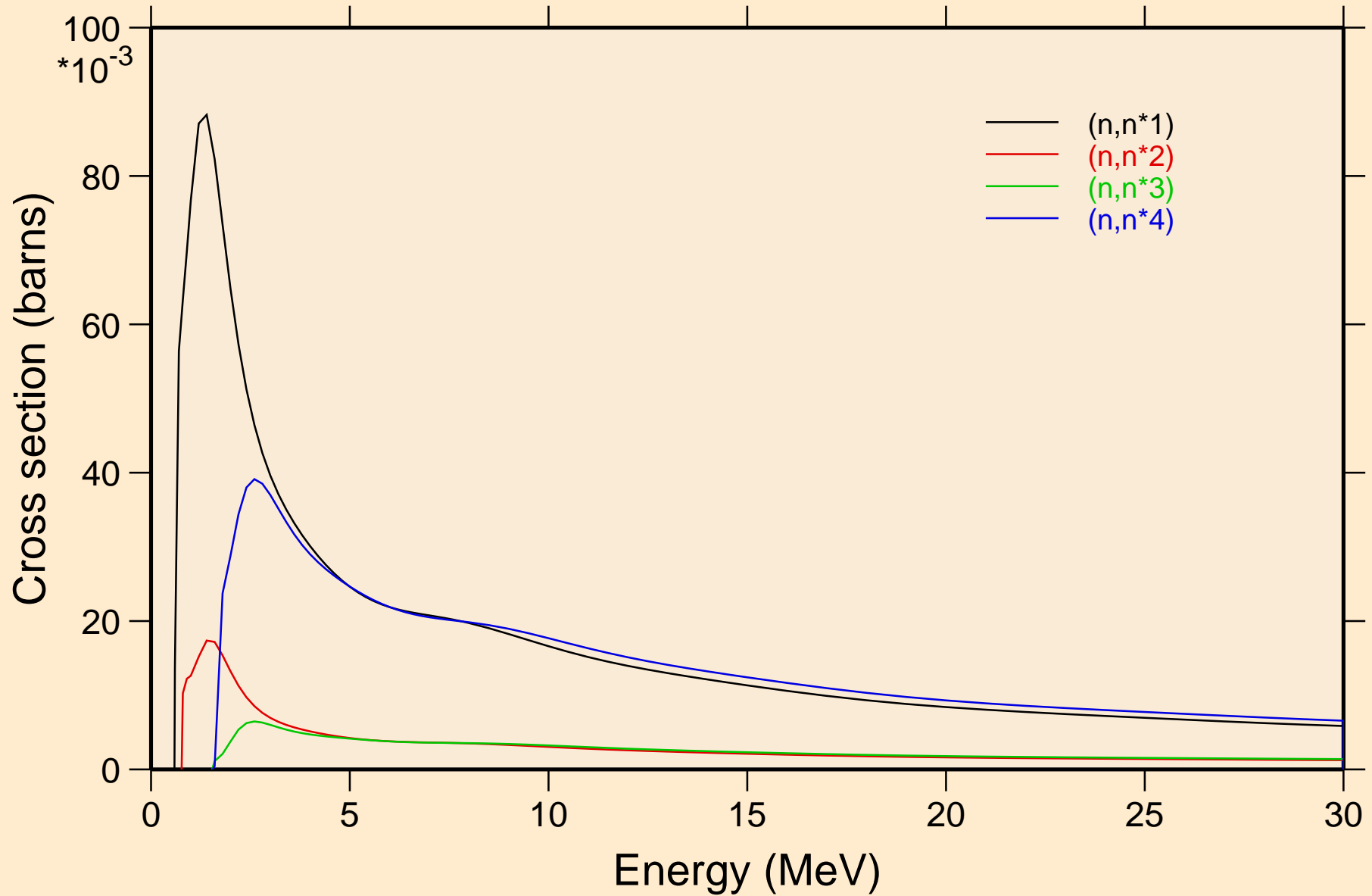

HO147 NEUTRON ACER TENDL-2024 LIBRARY; T=0.K

Threshold reactions

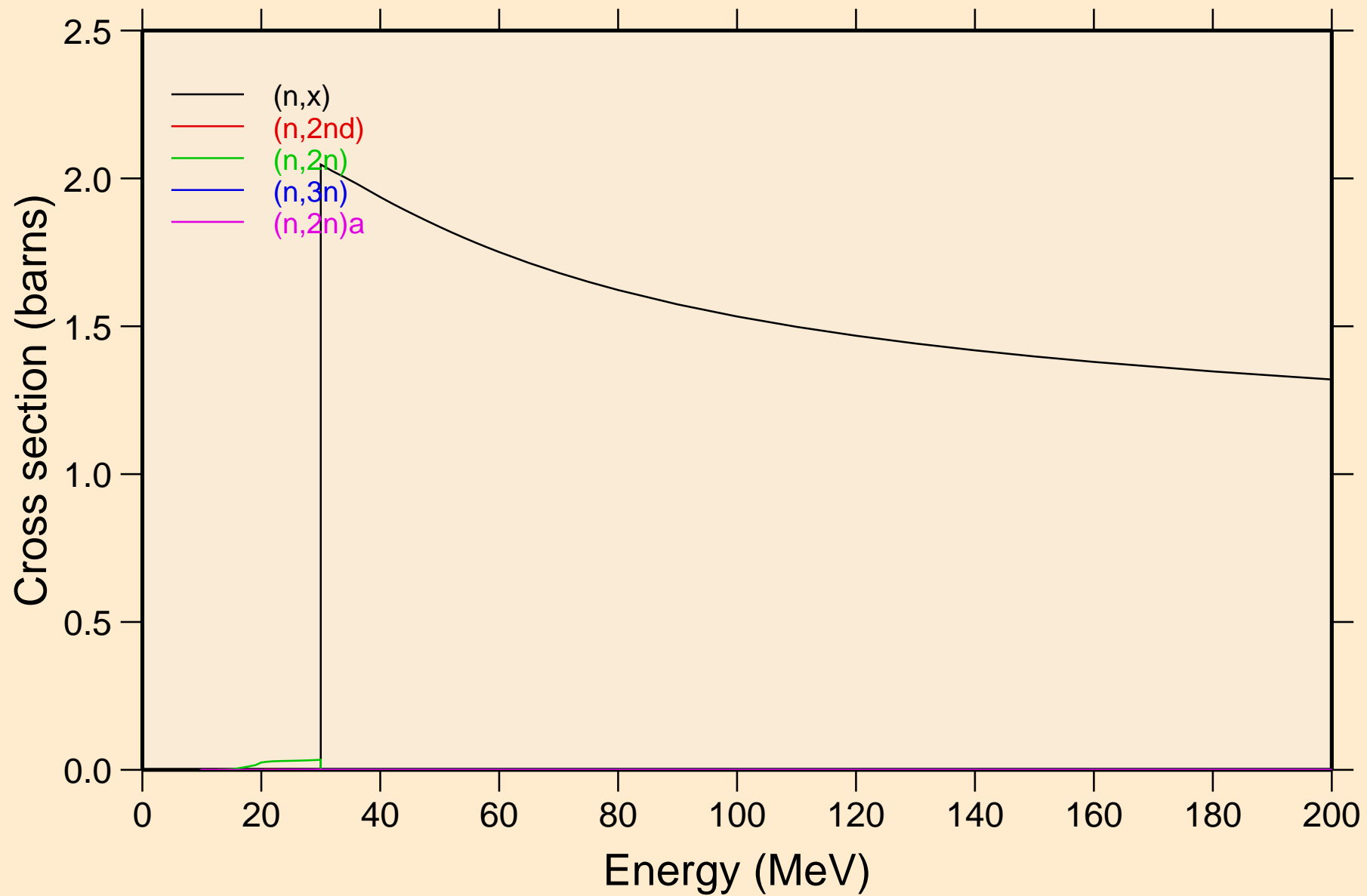

HO147 NEUTRON ACER TENDL-2024 LIBRARY; T=0.K

Threshold reactions

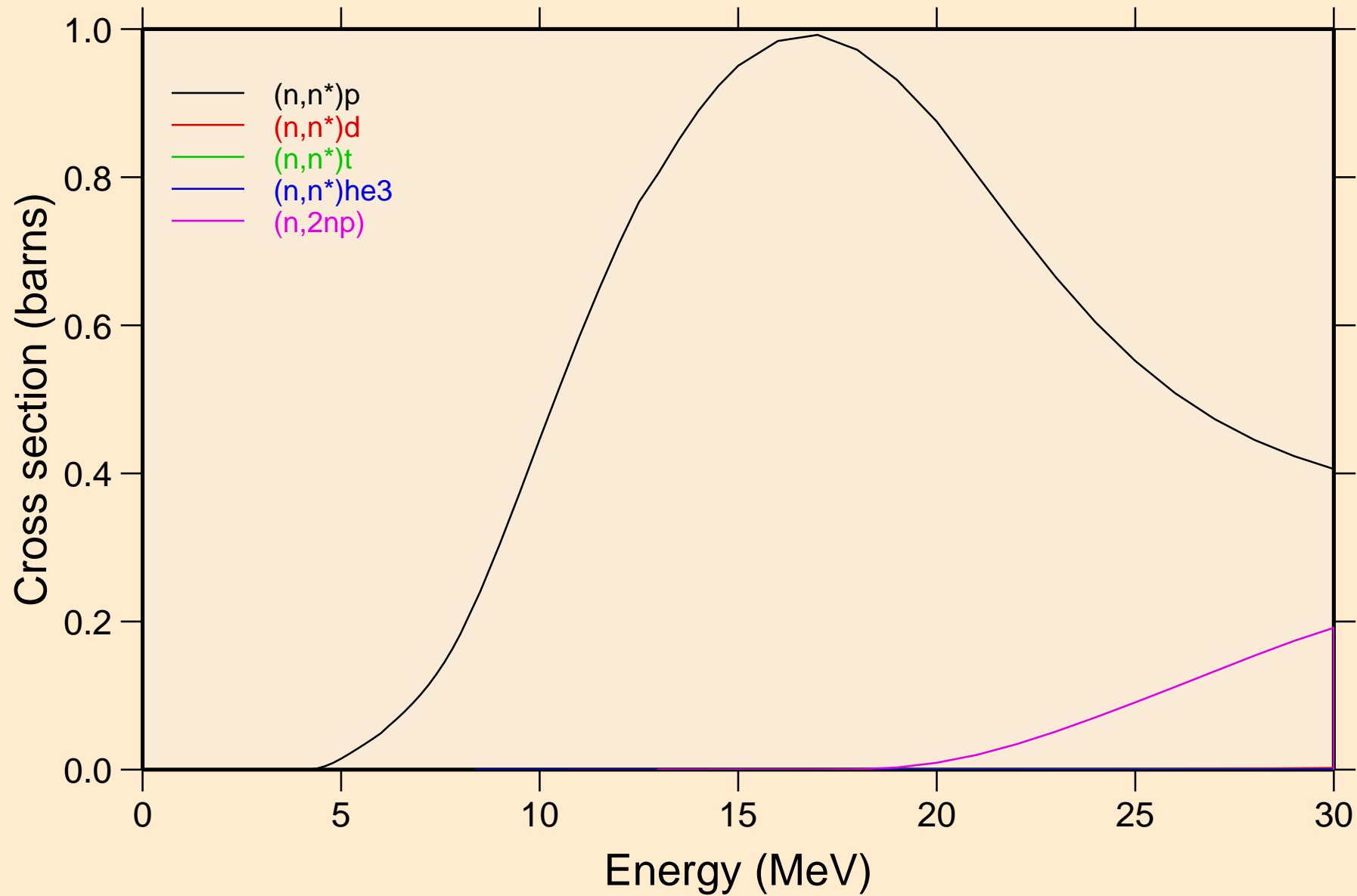

HO147 NEUTRON ACER TENDL-2024 LIBRARY; T=0.K

Threshold reactions

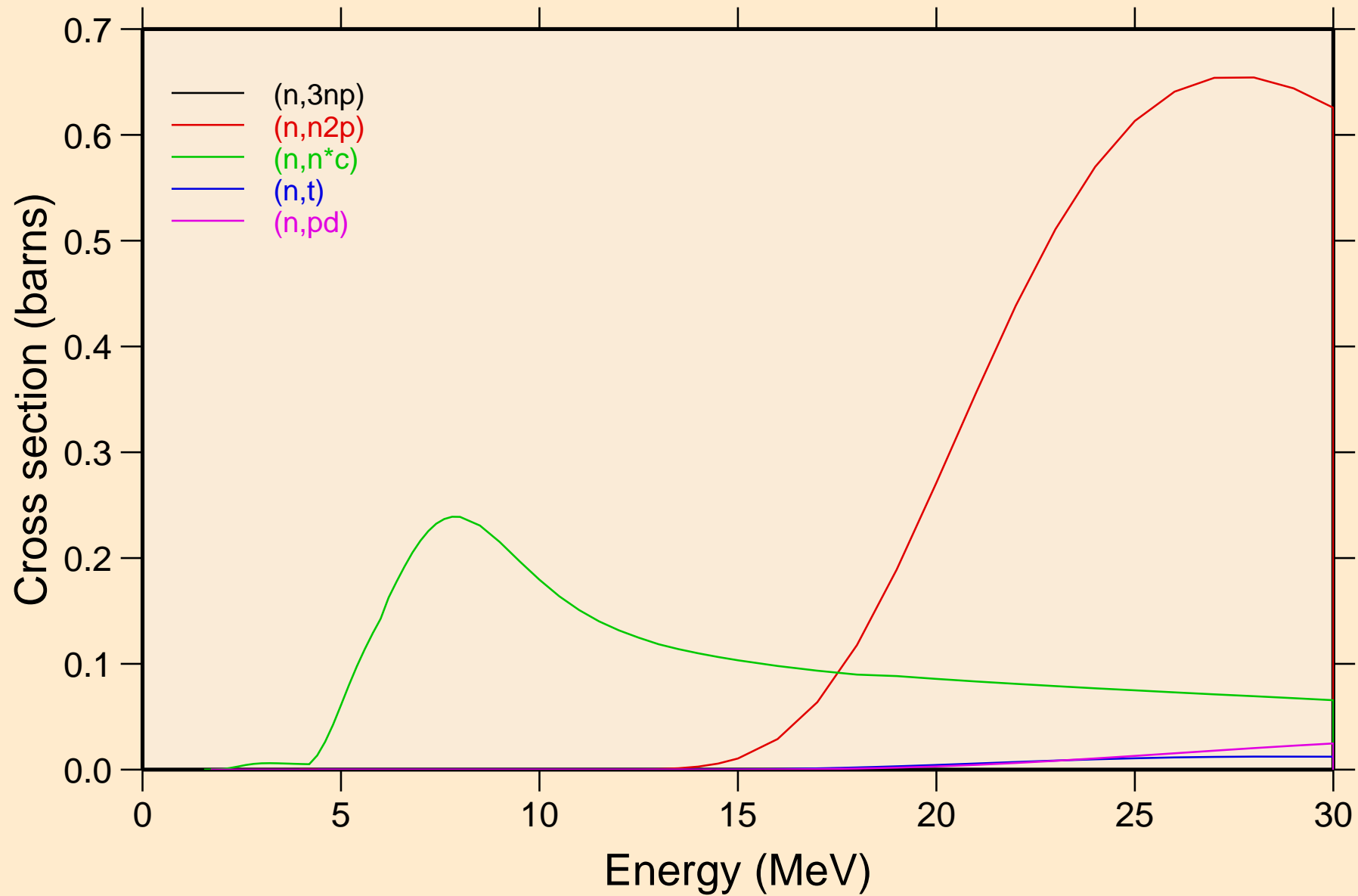

HO147 NEUTRON ACER TENDL-2024 LIBRARY; T=0.K

Threshold reactions

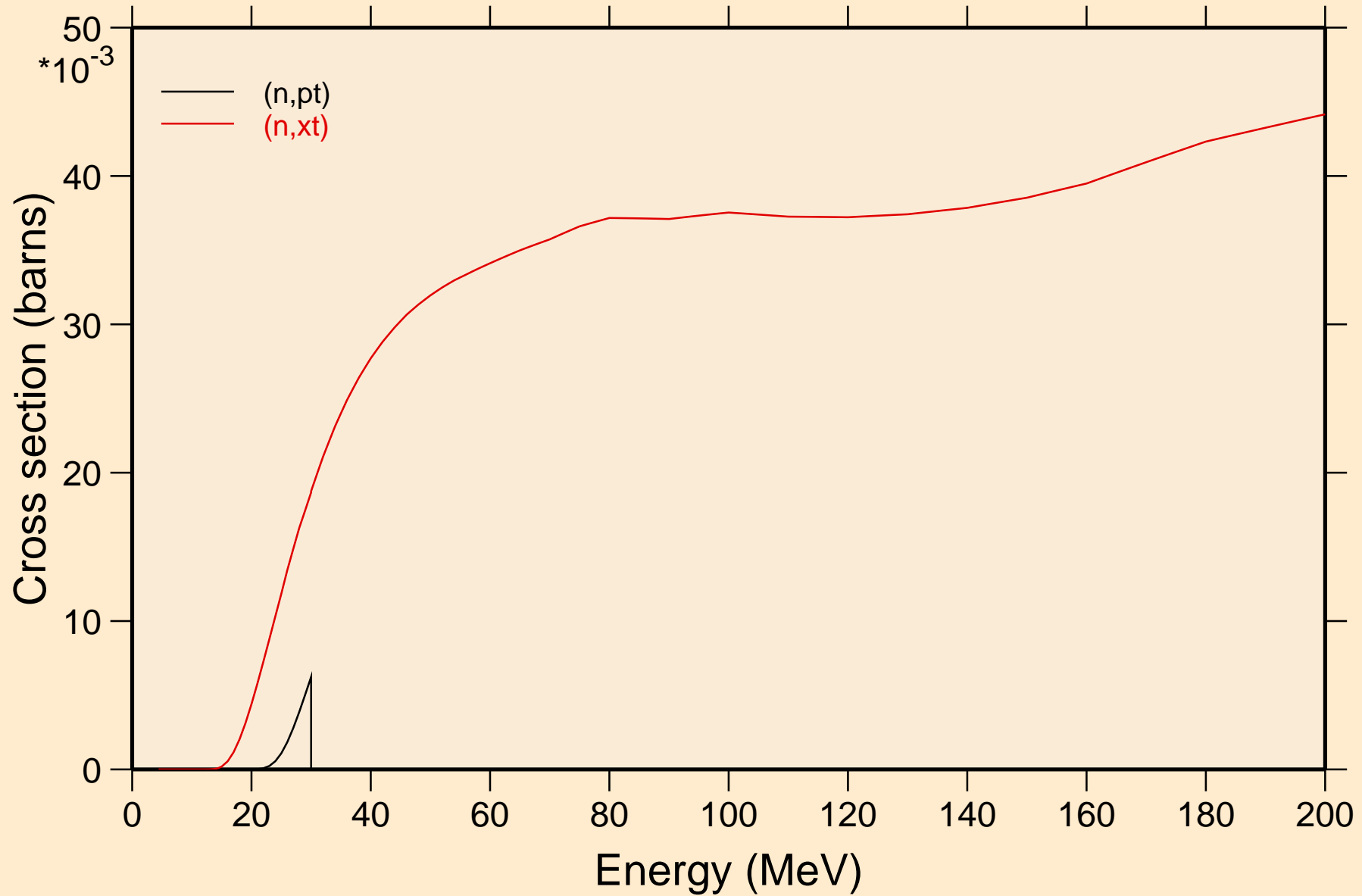

HO147 NEUTRON ACER TENDL-2024 LIBRARY; T=0.K
angular distribution for elastic

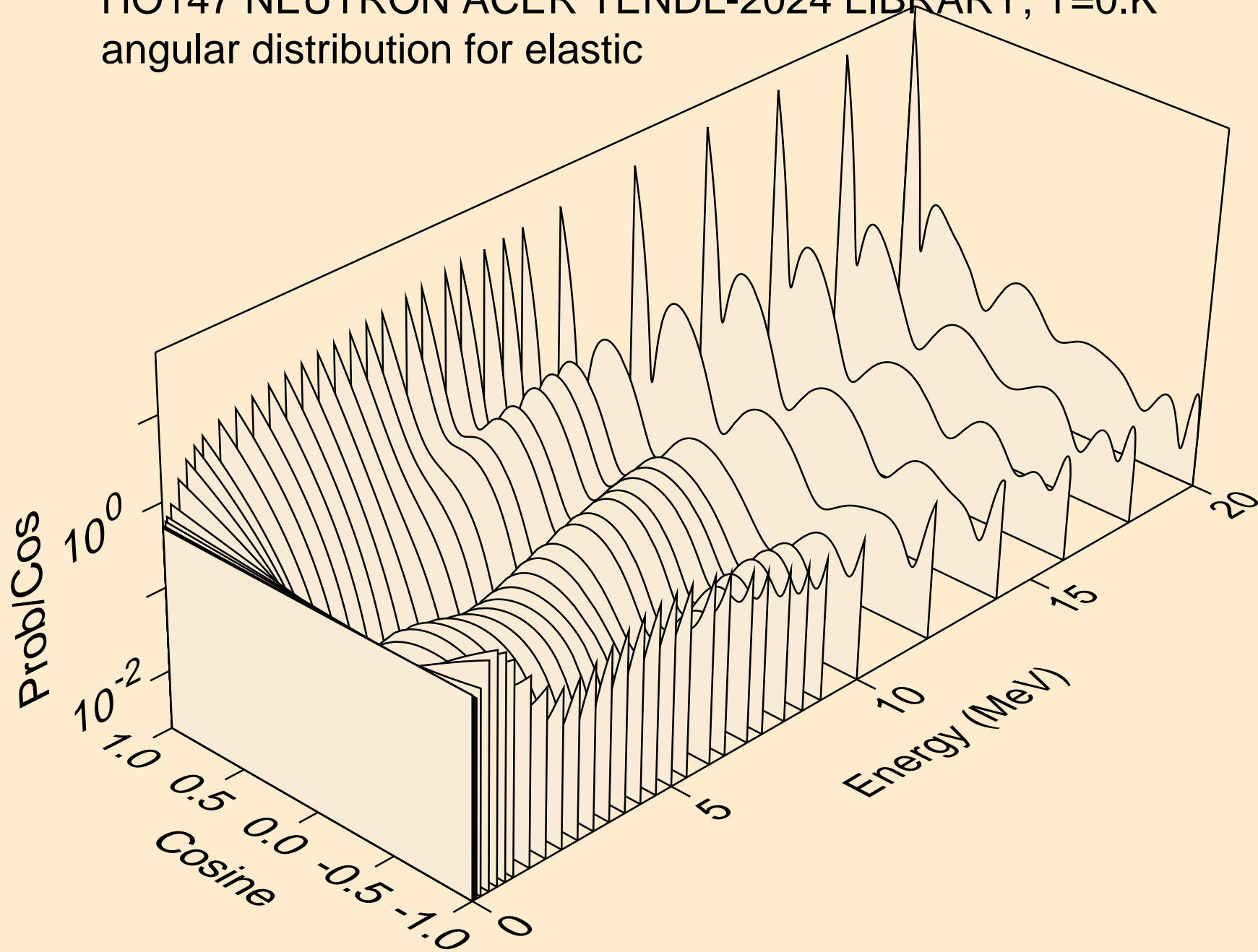

HO147 NEUTRON ACER TENDL-2024 LIBRARY; T=0.K
angular distribution for elastic

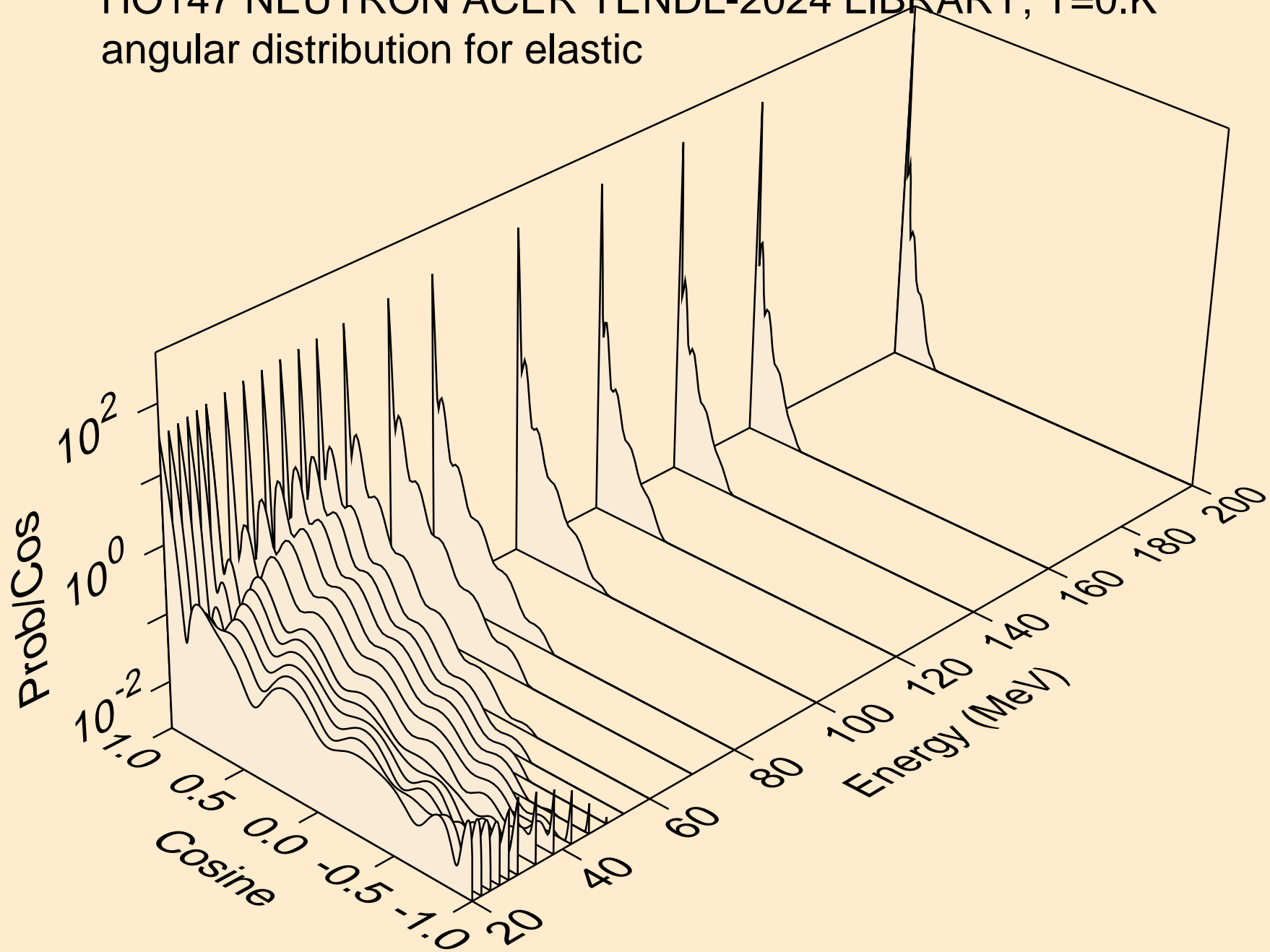

HO147 NEUTRON ACER TENDL-2024 LIBRARY; T=0.K
angular distribution for (n,n*1)

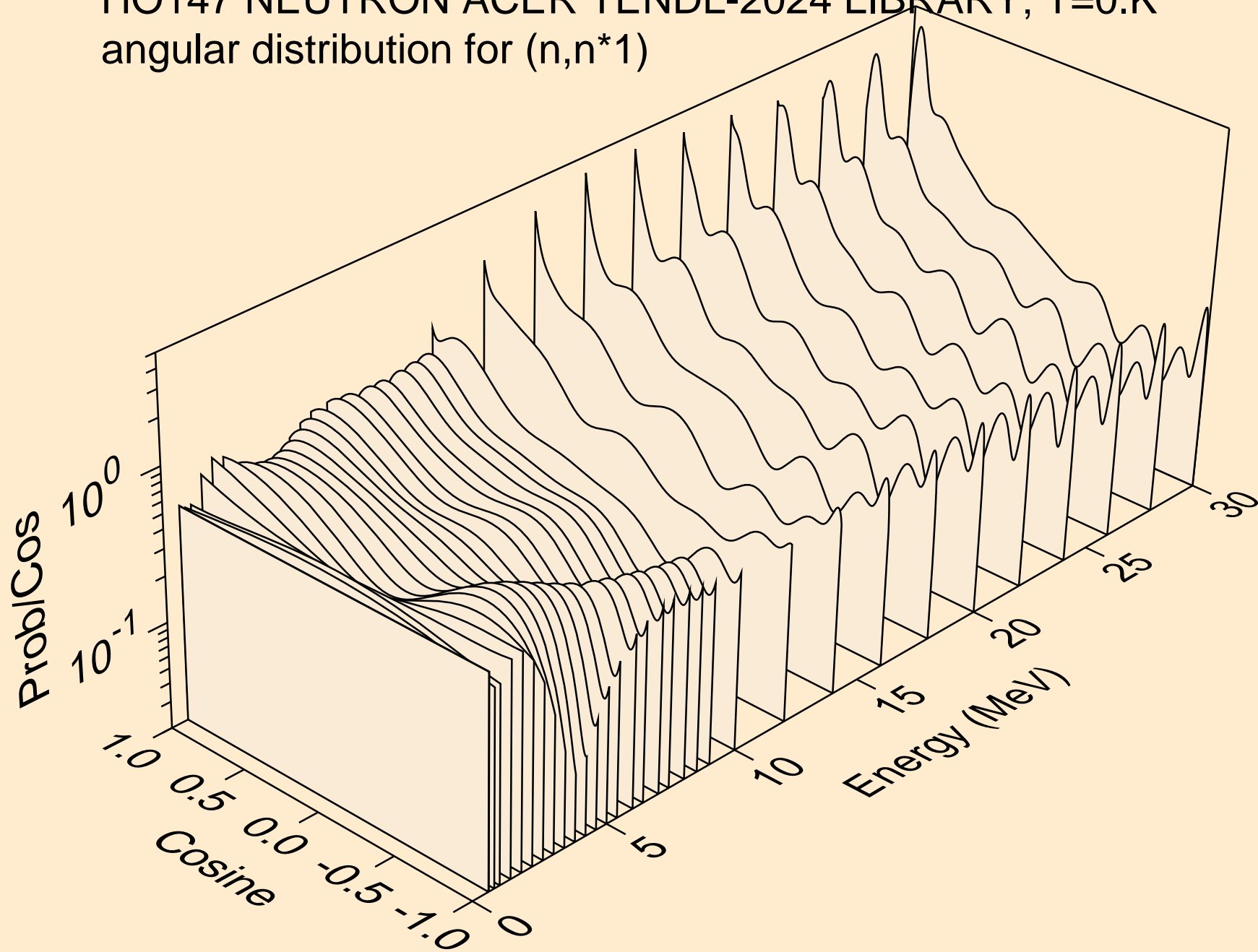

HO147 NEUTRON ACER TENDL-2024 LIBRARY; T=0.K
angular distribution for (n,n*2)

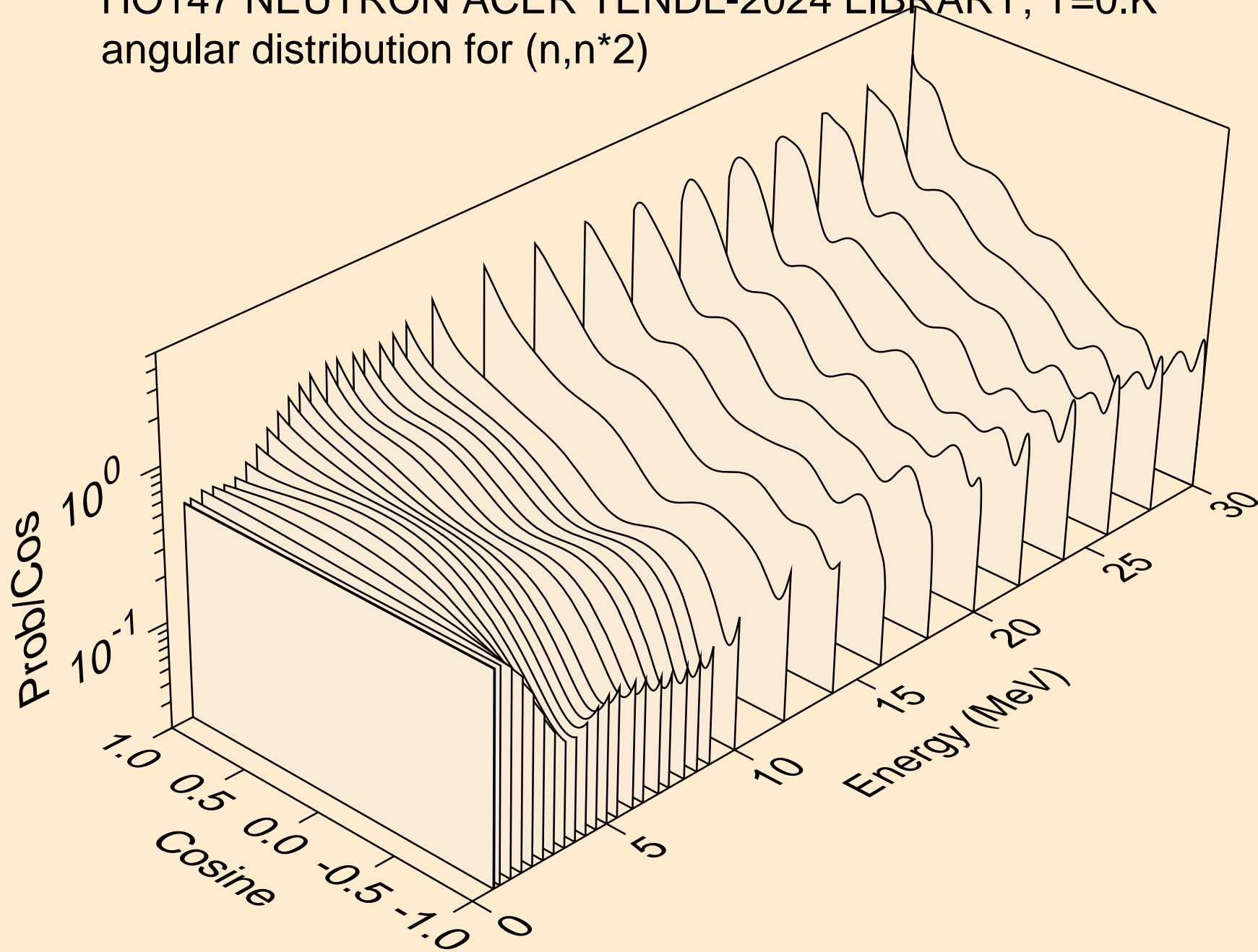

HO147 NEUTRON ACER TENDL-2024 LIBRARY; T=0.K
angular distribution for (n,n*3)

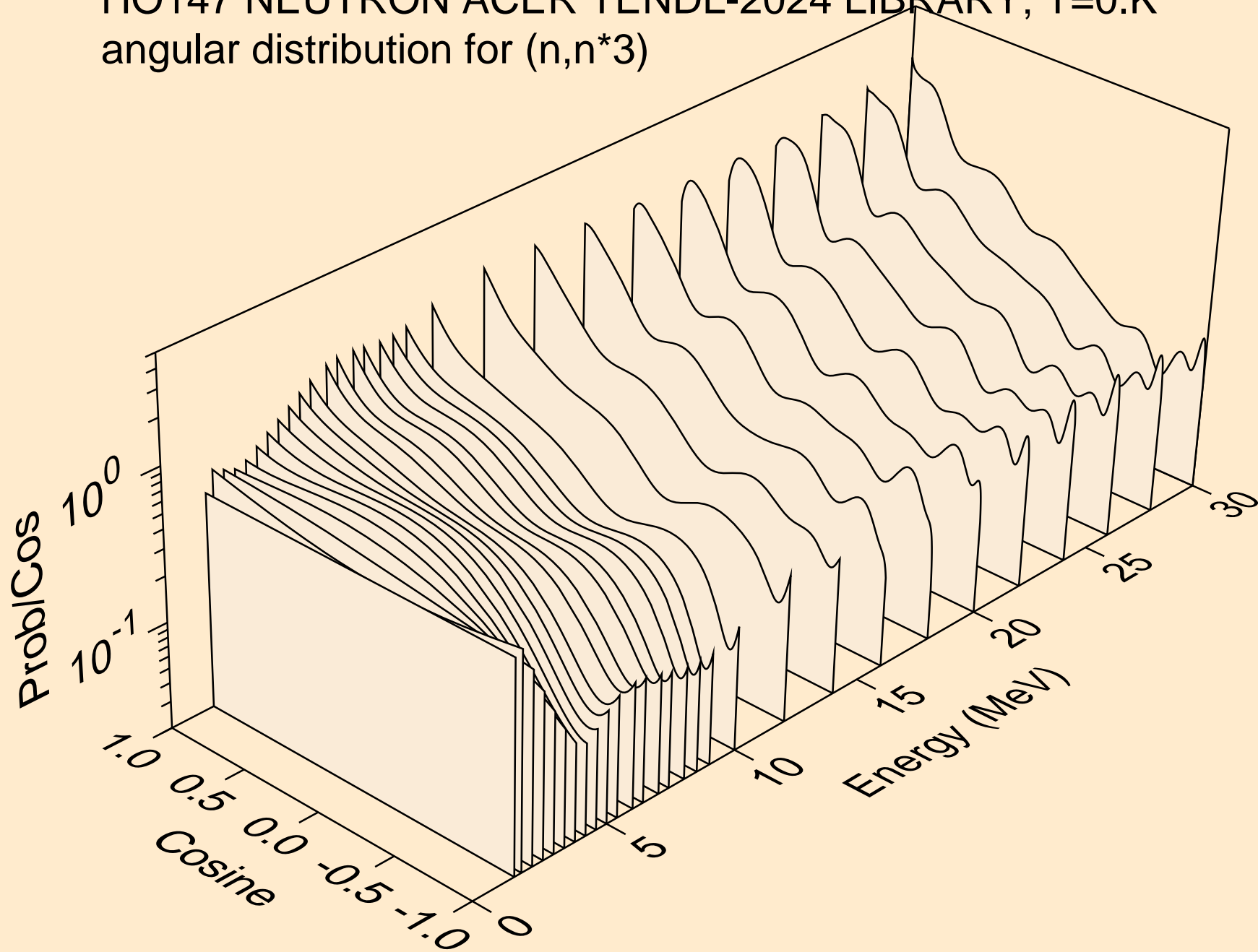

HO147 NEUTRON ACER TENDL-2024 LIBRARY; T=0.K
angular distribution for (n,n*4)

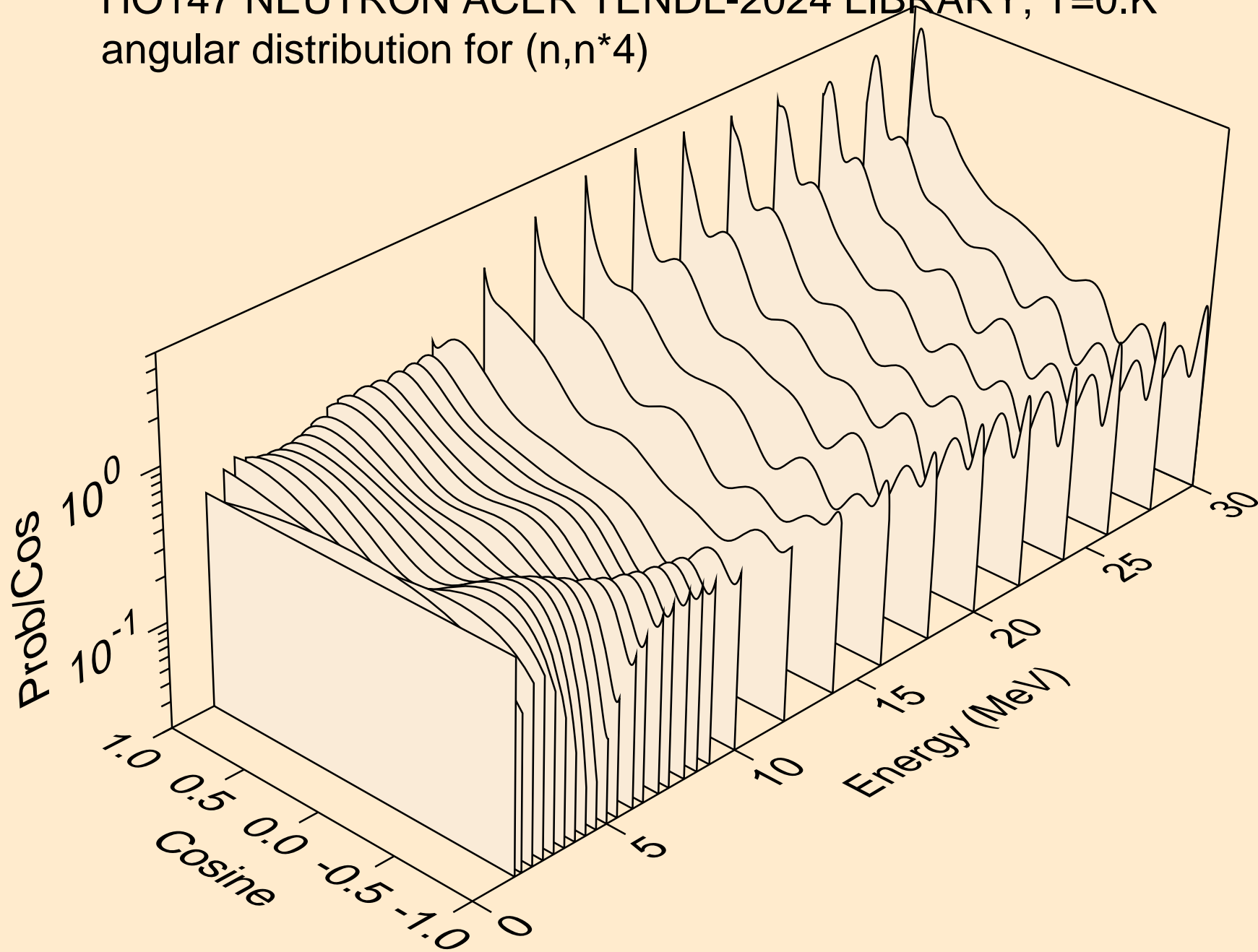

HO147 NEUTRON ACER TENDL-2024 LIBRARY; T=0.K
Neutron emission for (n,x)

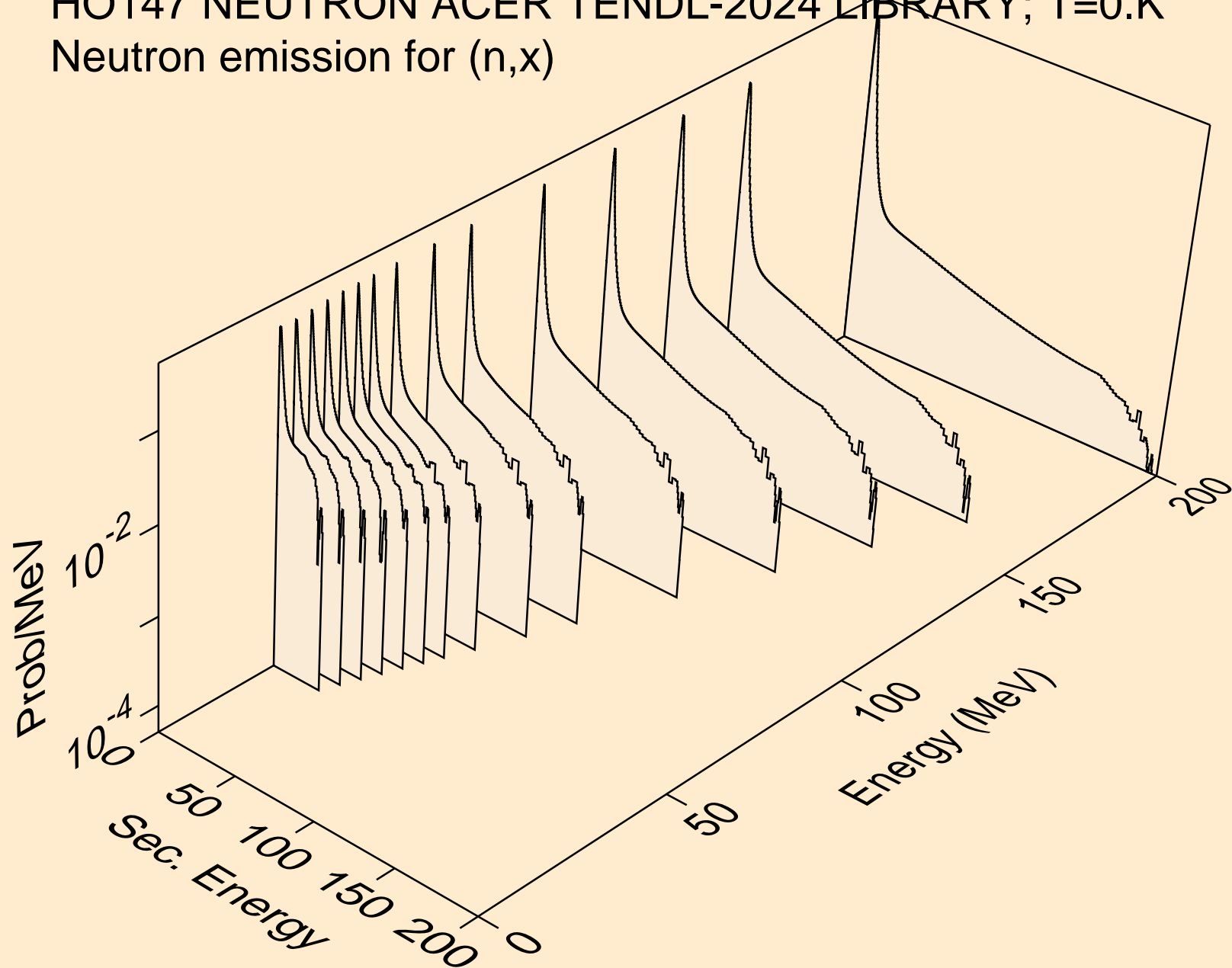

HO147 NEUTRON ACER TENDL-2024 LIBRARY; T=0.K
Neutron emission for (n,2nd)

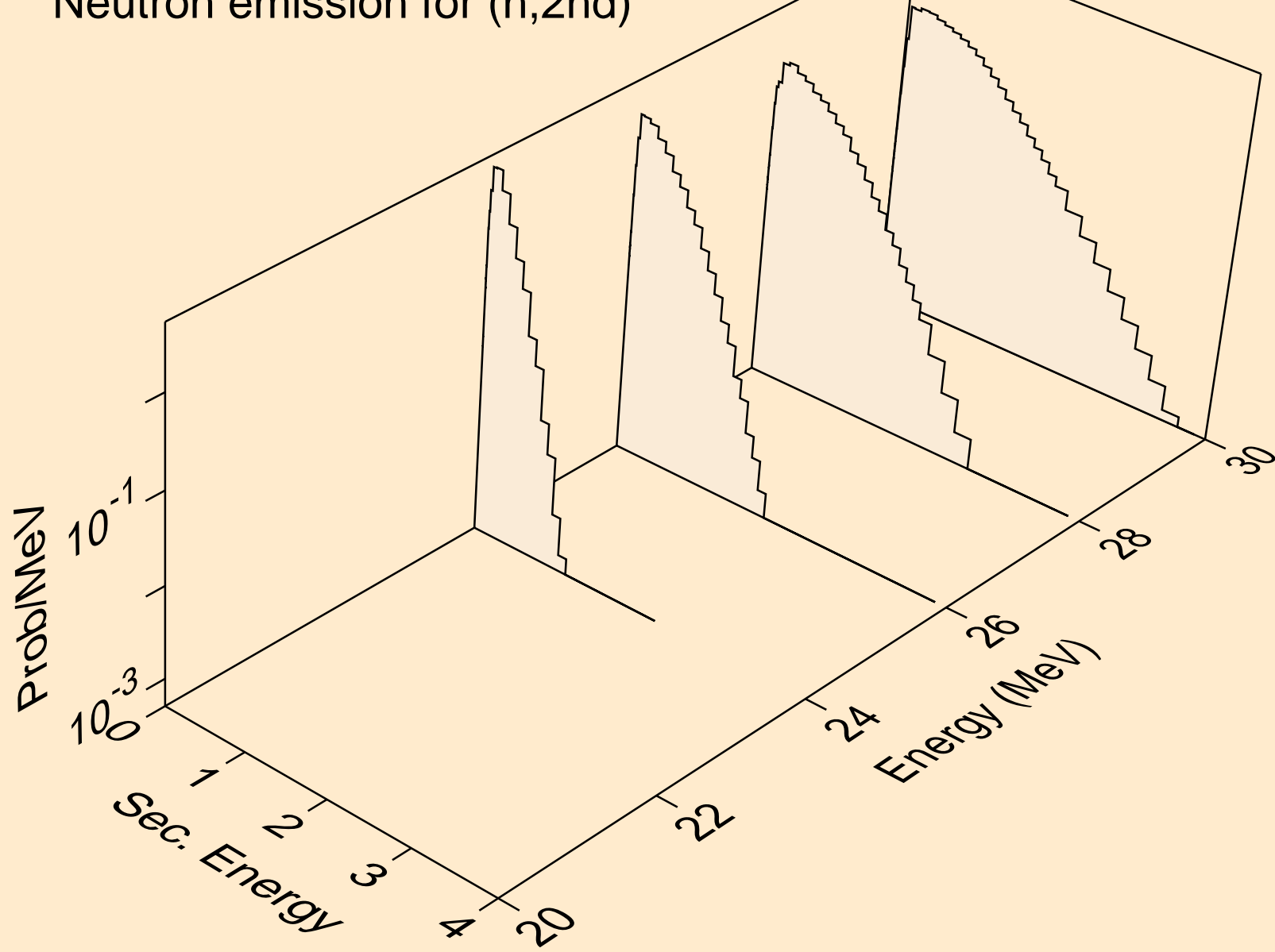

HO147 NEUTRON ACER TENDL-2024 LIBRARY; T=0.K
Neutron emission for (n,2n)

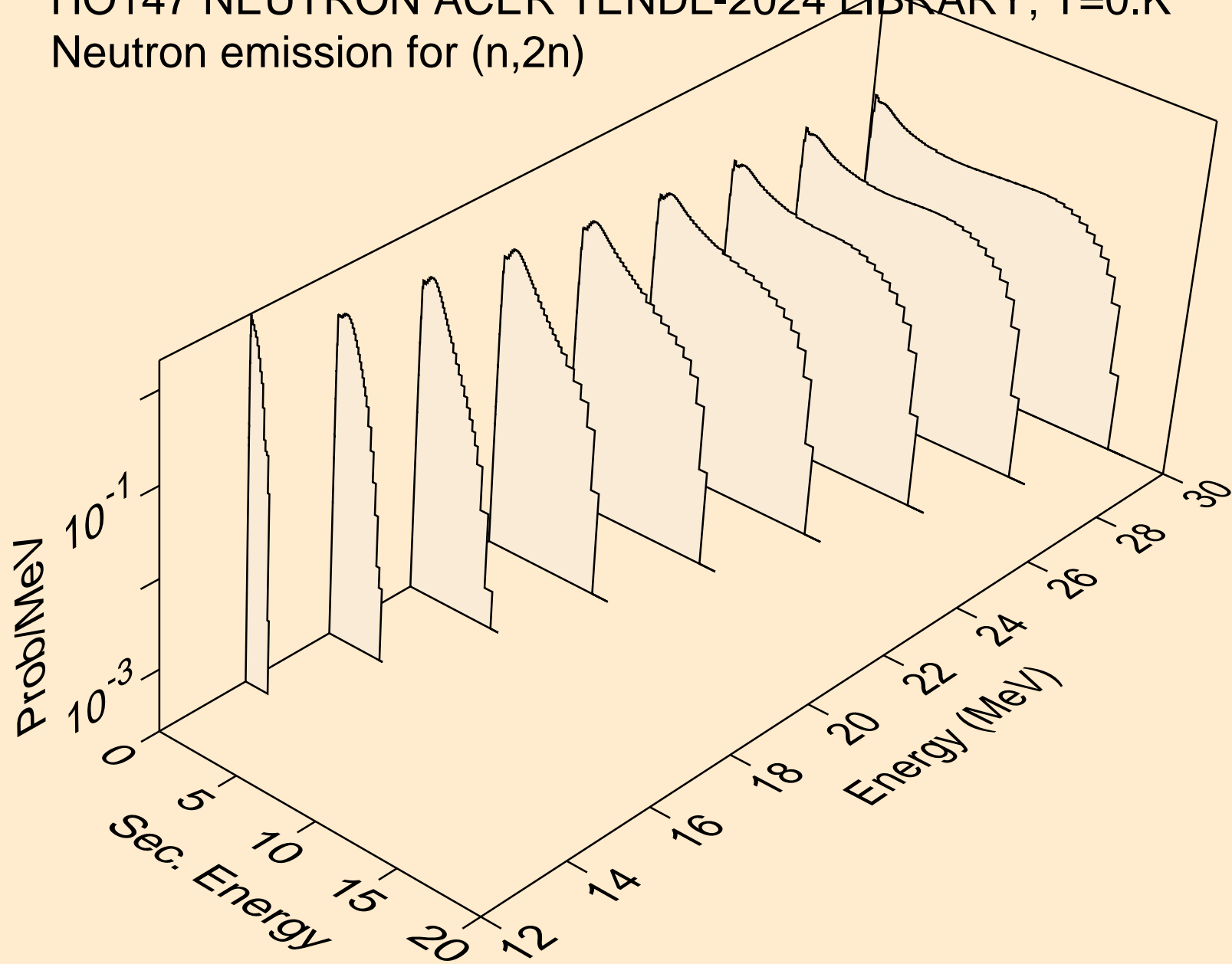

HO147 NEUTRON ACER TENDL-2024 LIBRARY; T=0.K
Neutron emission for (n,3n)

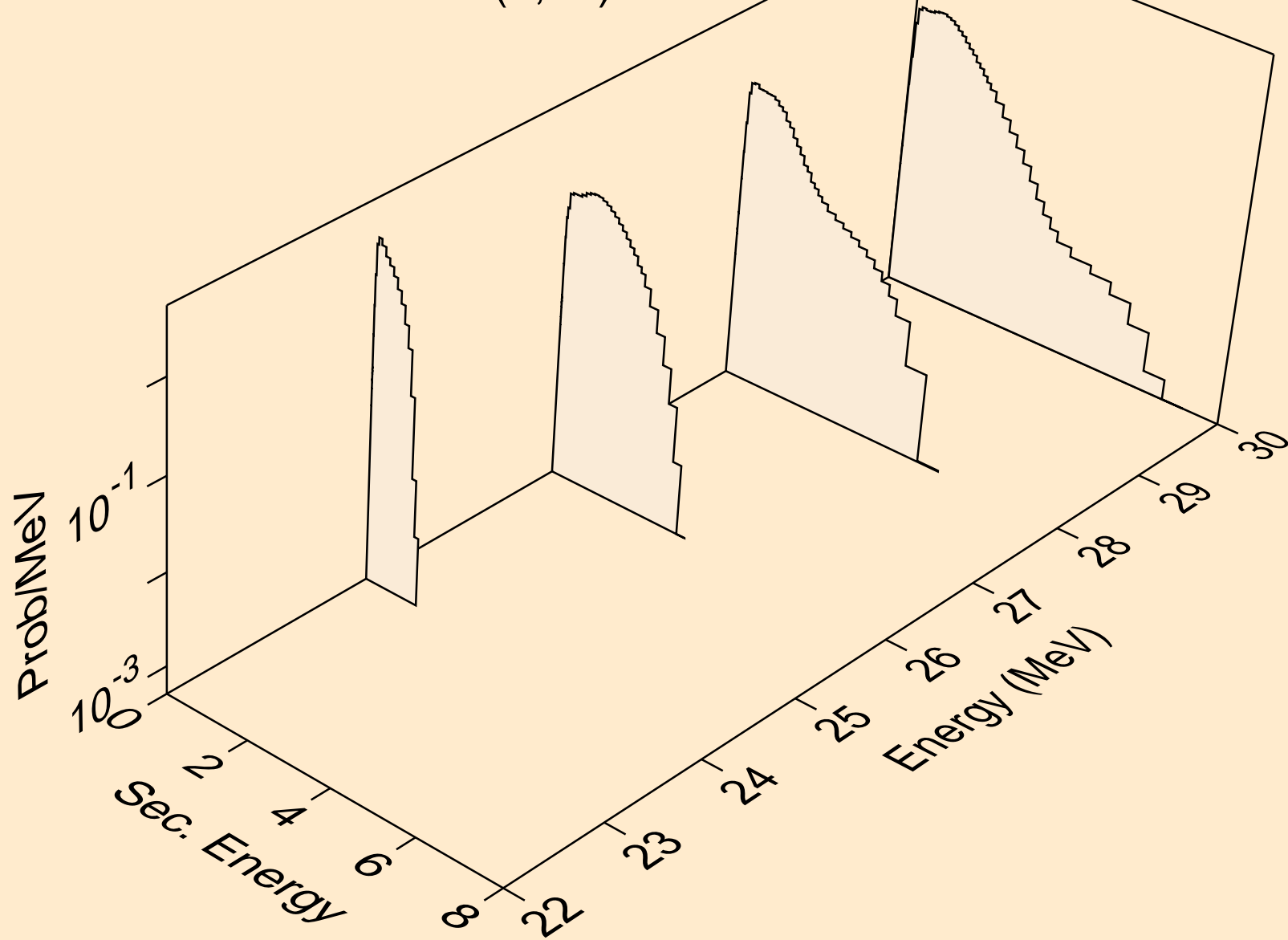

HO147 NEUTRON ACER TENDL-2024 LIBRARY; T=0.K
Neutron emission for (n,n*)a

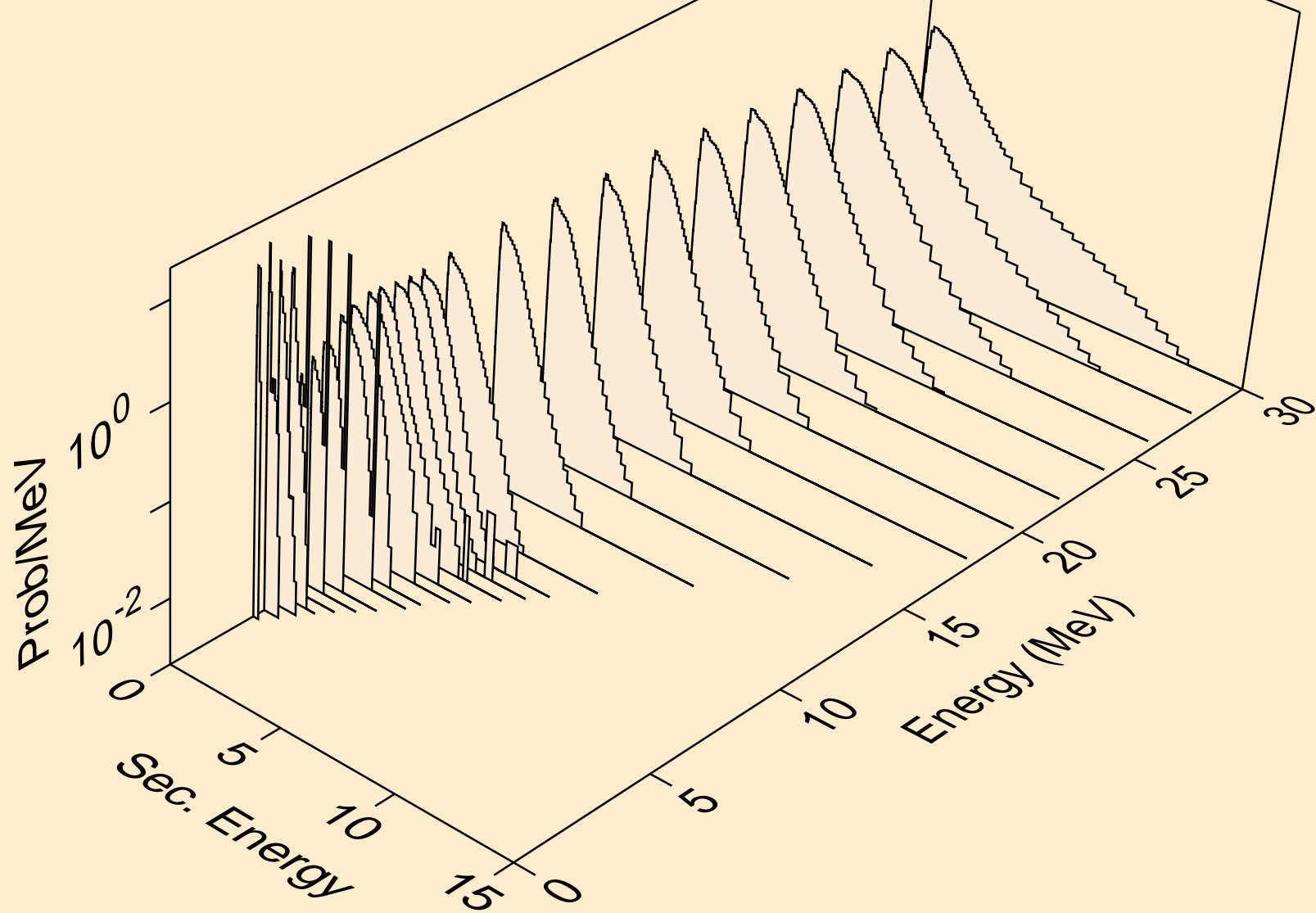

HO147 NEUTRON ACER TENDL-2024 LIBRARY; T=0.K
Neutron emission for (n,2n)a

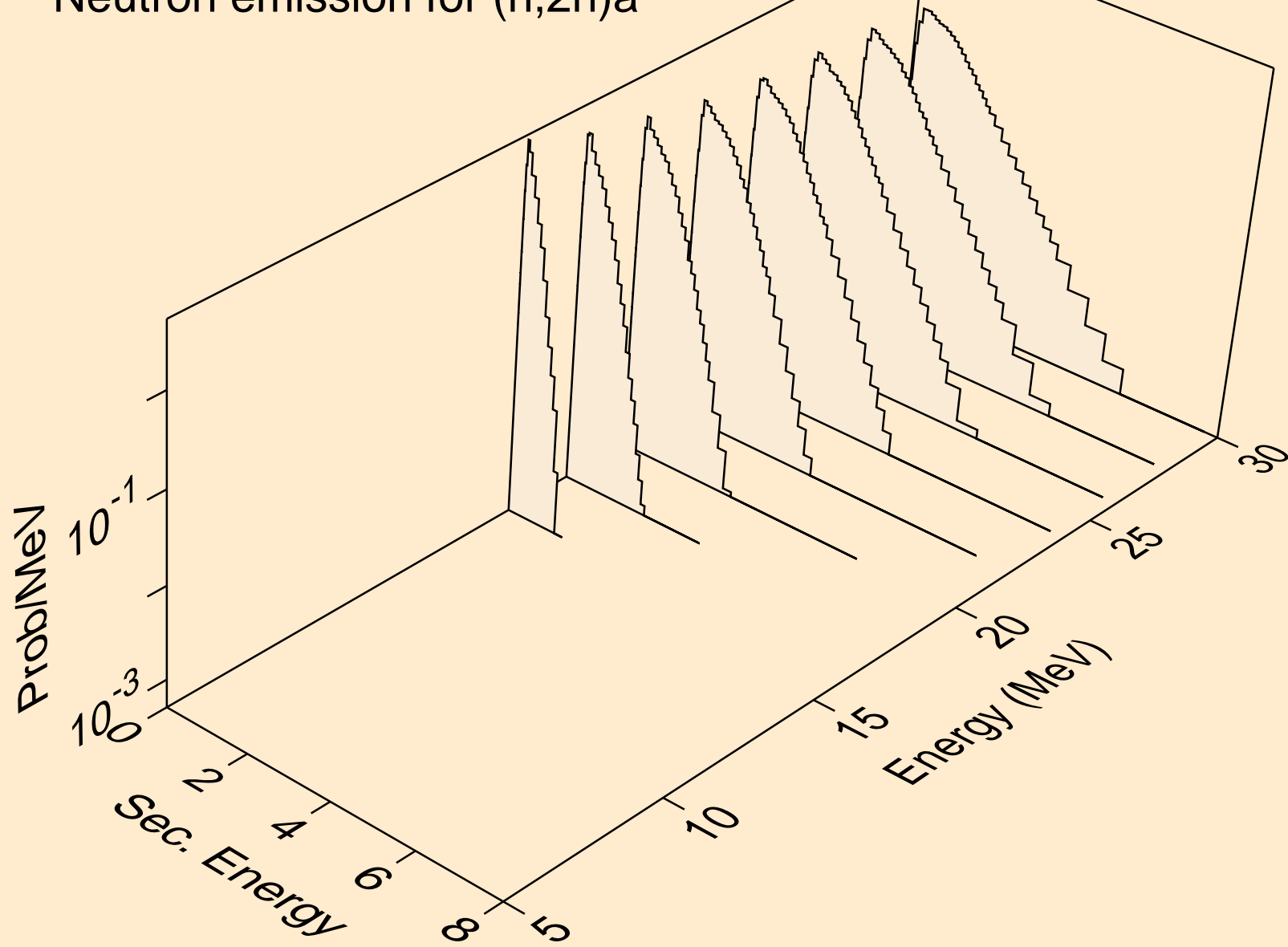

HO147 NEUTRON ACER TENDL-2024 LIBRARY; T=0.K
Neutron emission for (n,n*)p

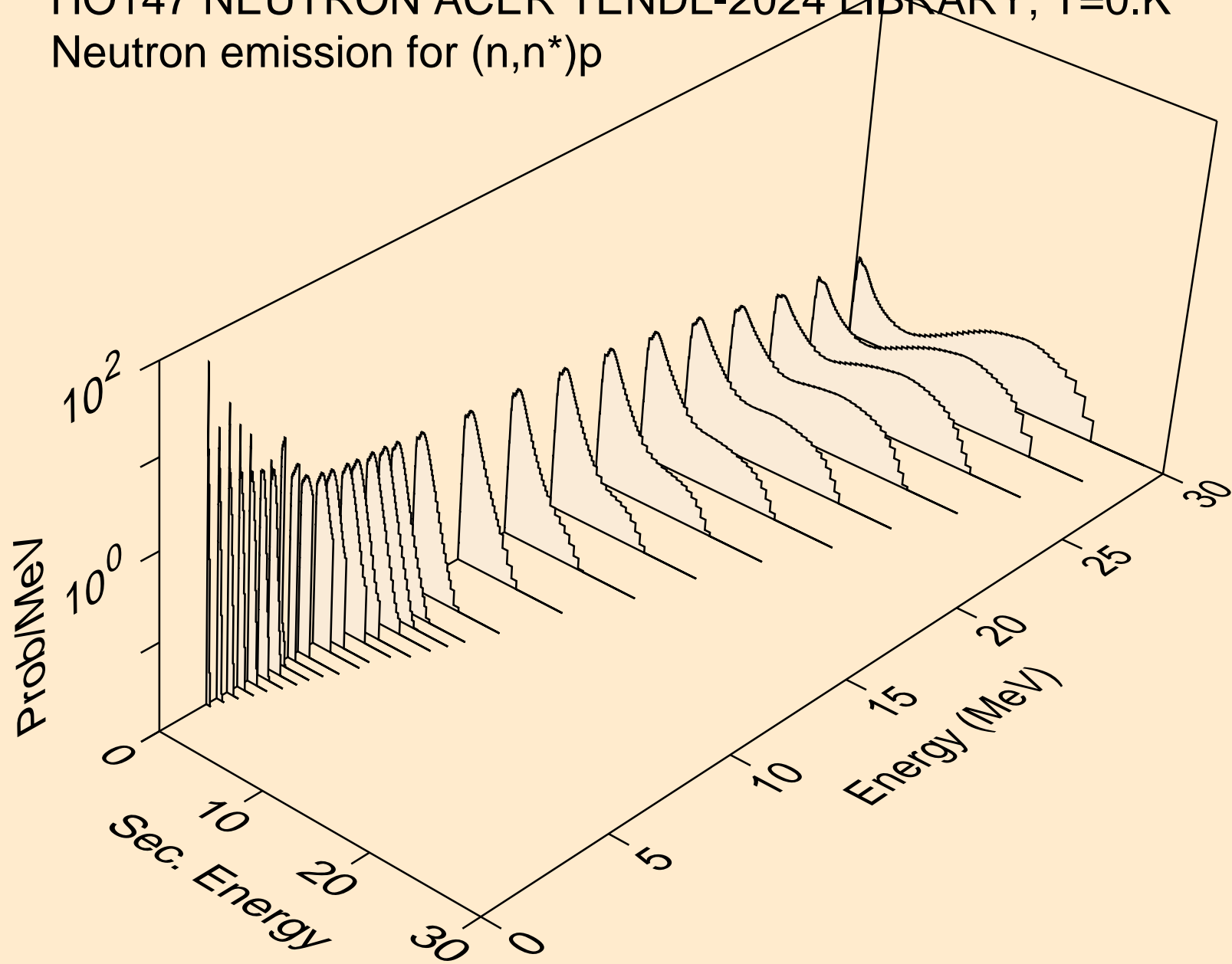

HO147 NEUTRON ACER TENDL-2024 LIBRARY; T=0.K
Neutron emission for (n,n*)2a

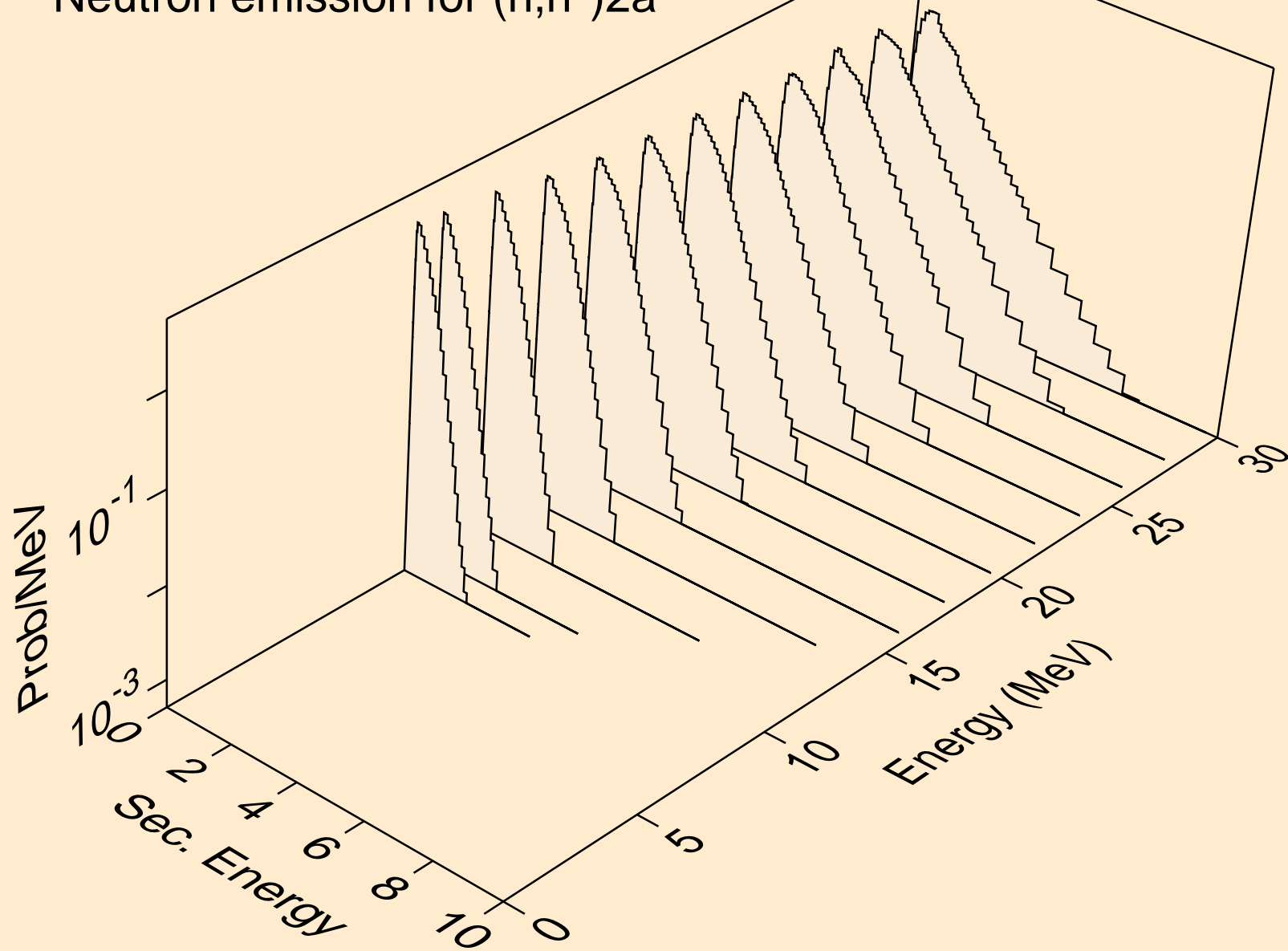

HO147 NEUTRON ACER TENDL-2024 LIBRARY; T=0.K
Neutron emission for (n,n*)d

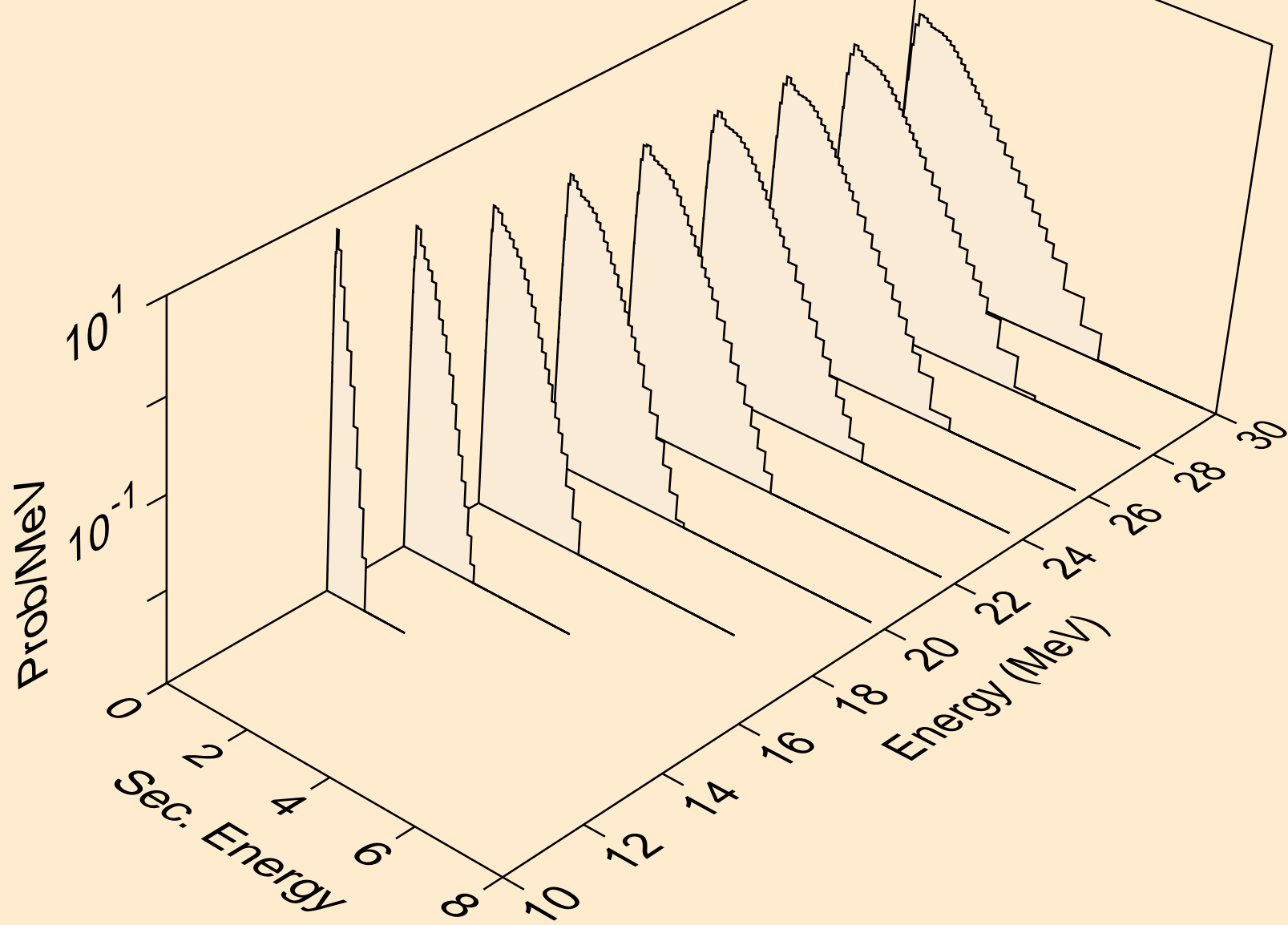

HO147 NEUTRON ACER TENDL-2024 LIBRARY; T=0.K
Neutron emission for (n,n*)t

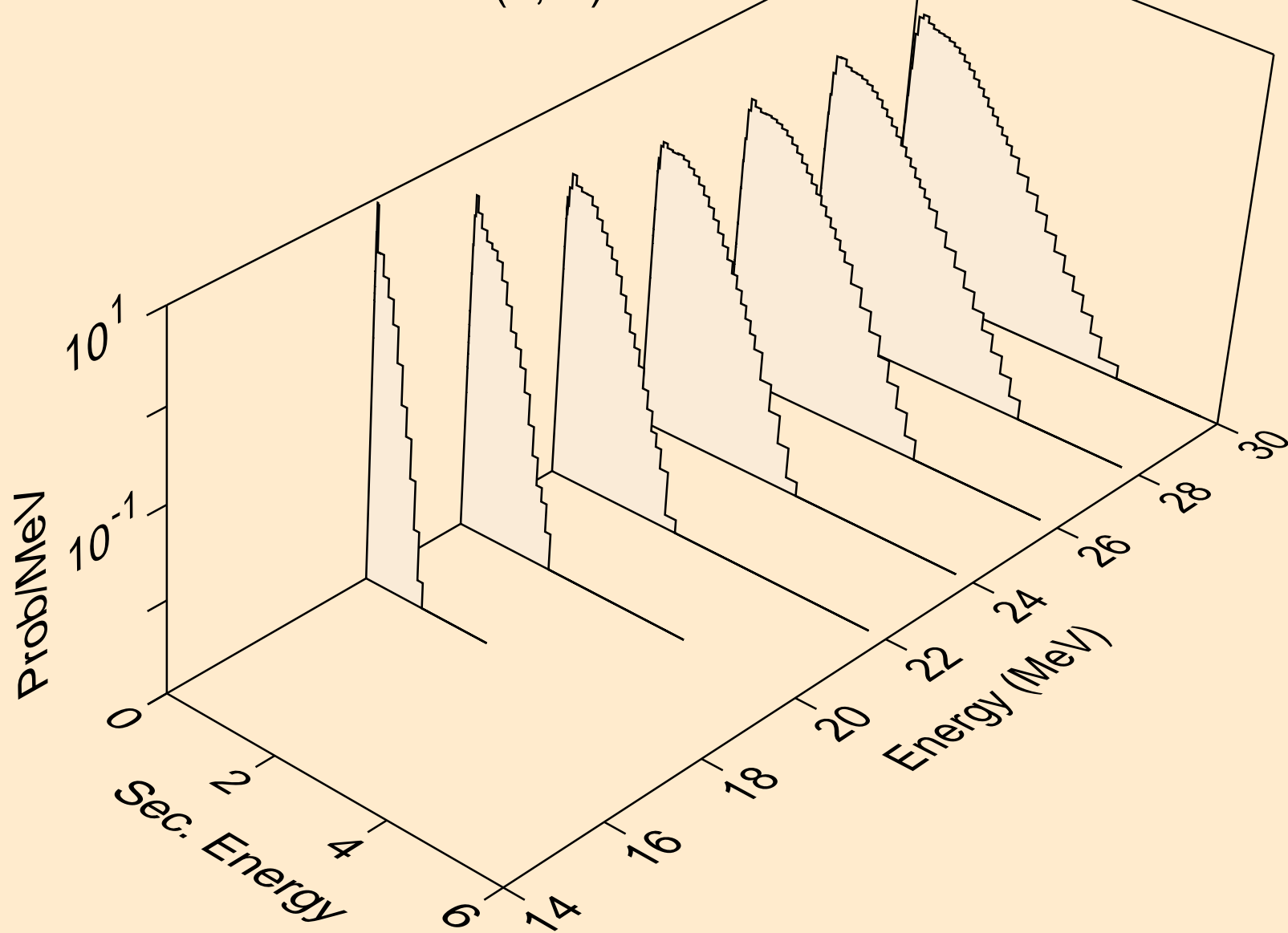

HO147 NEUTRON ACER TENDL-2024 LIBRARY; T=0.K
Neutron emission for (n,n*)he3

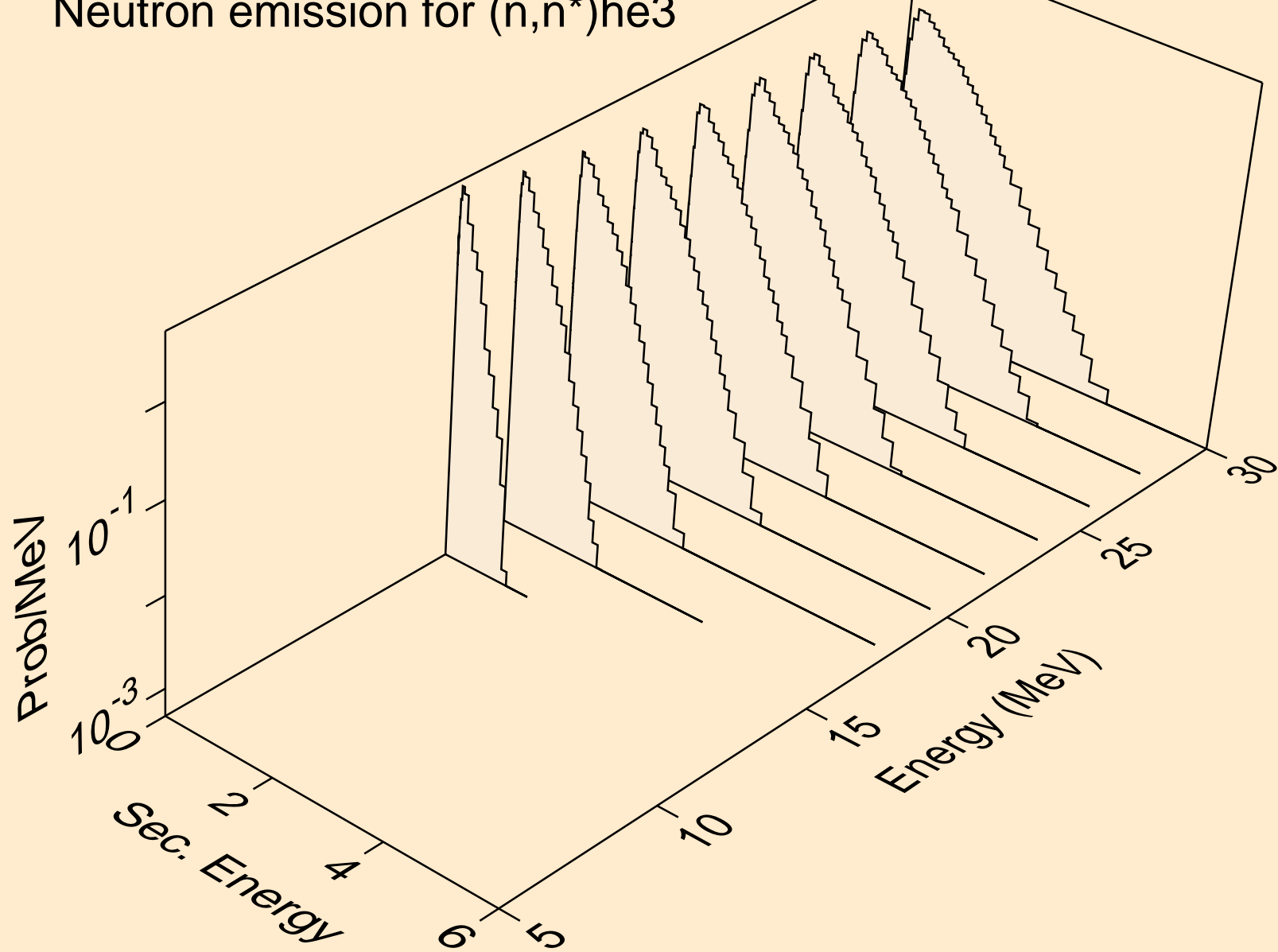

HO147 NEUTRON ACER TENDL-2024 LIBRARY; T=0.K
Neutron emission for (n,2np)

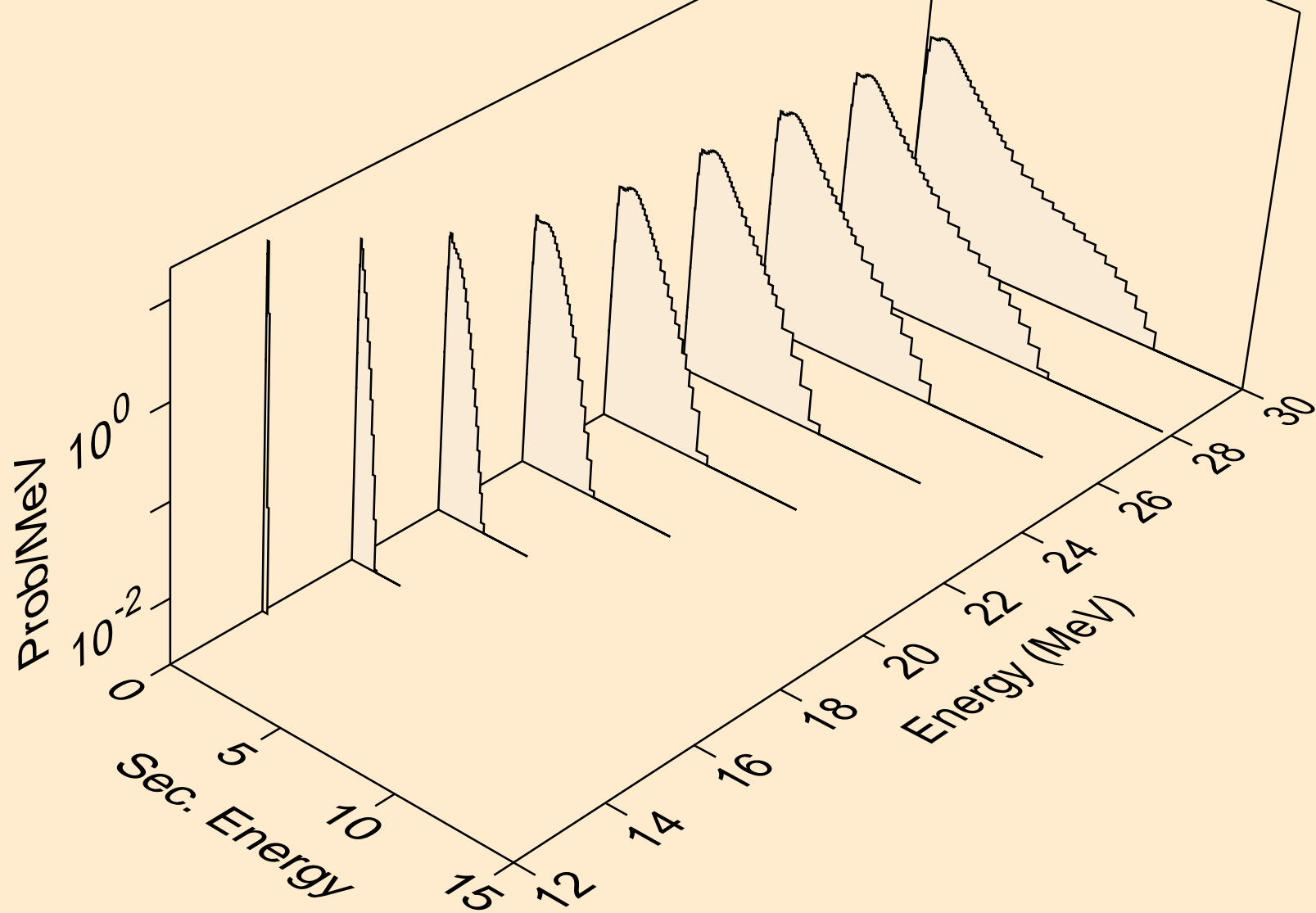

HO147 NEUTRON ACER TENDL-2024 LIBRARY; T=0.K
Neutron emission for (n,3np)

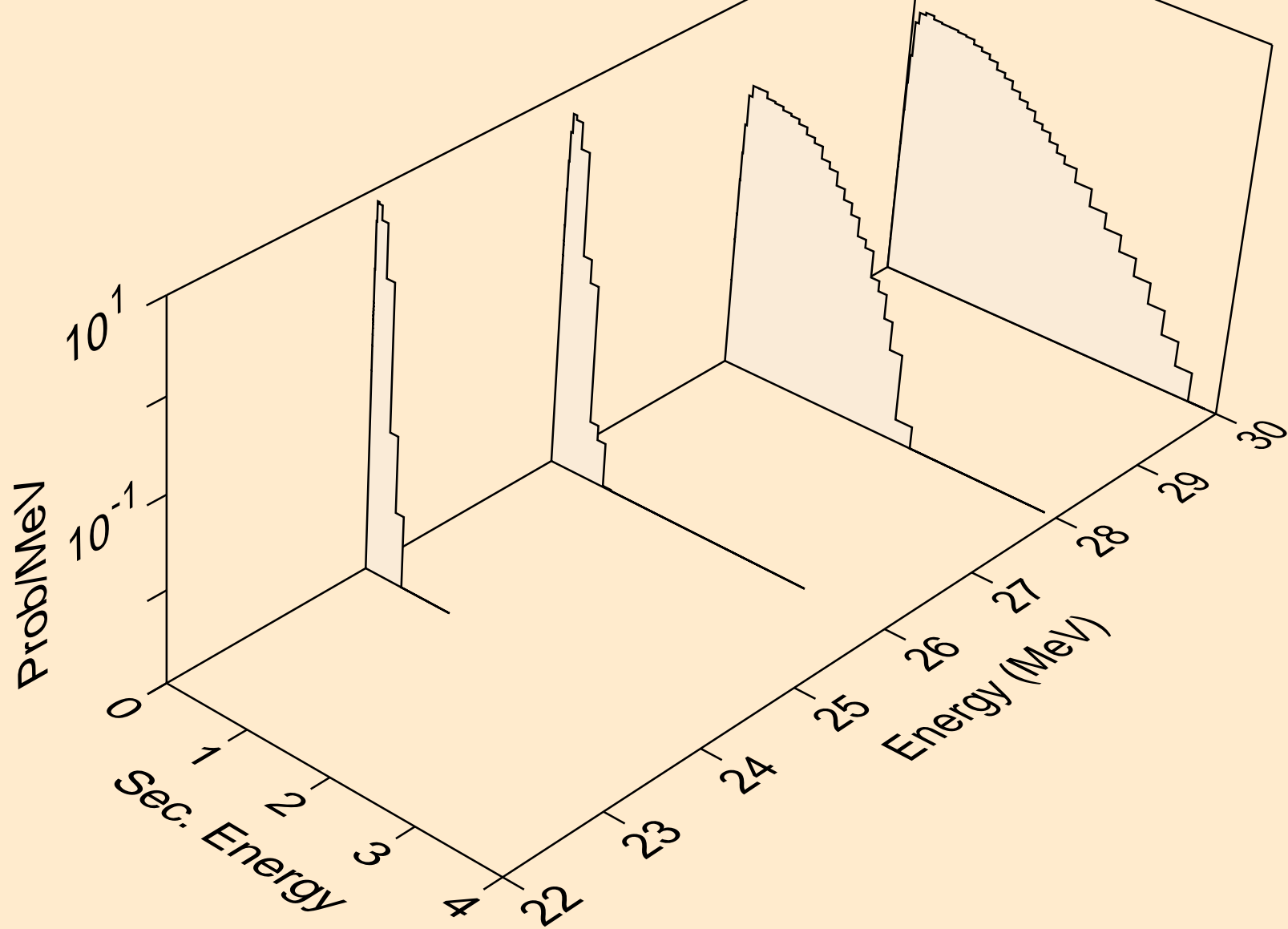

HO147 NEUTRON ACER TENDL-2024 LIBRARY; T=0.K
Neutron emission for (n,n2p)

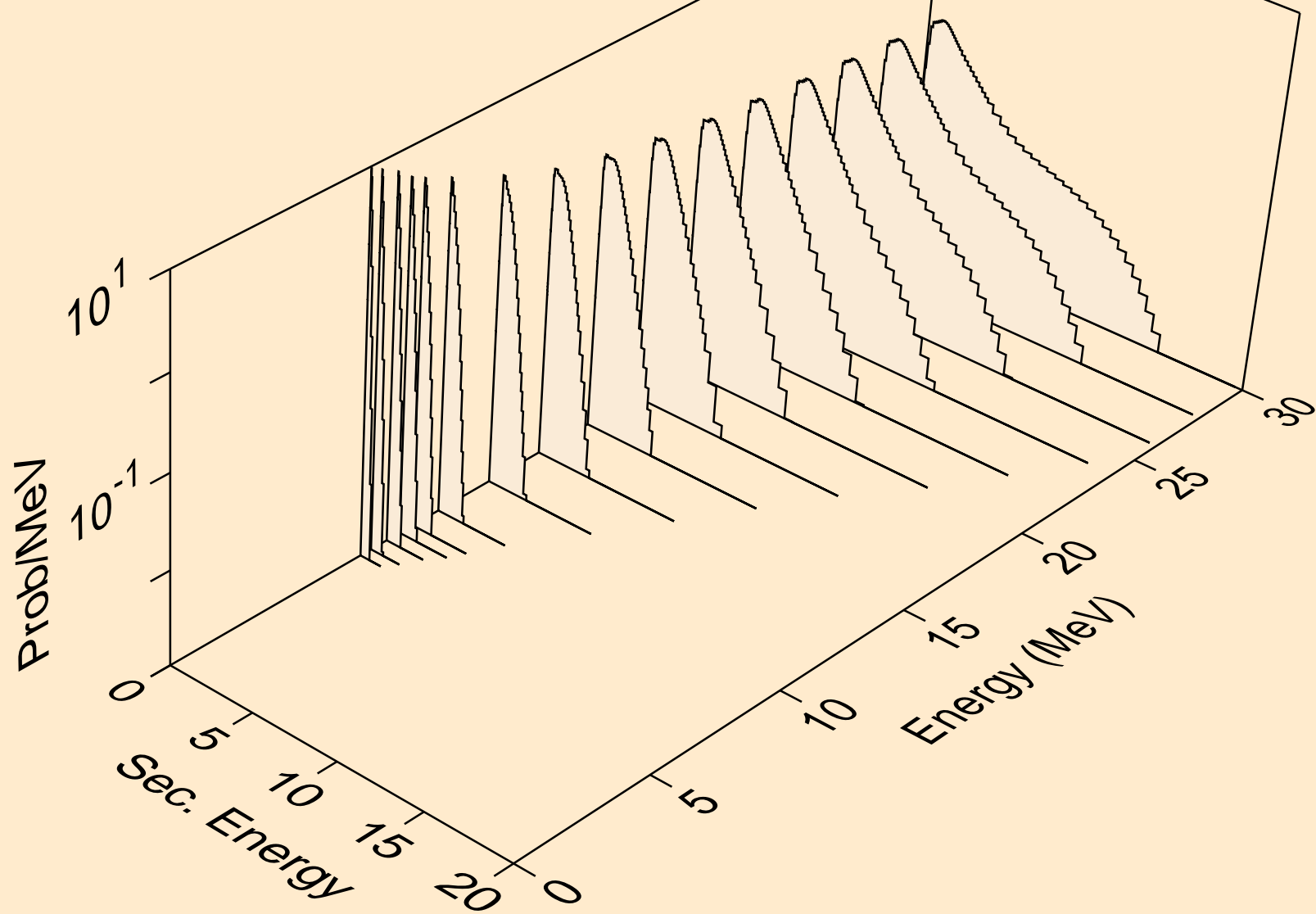

HO147 NEUTRON ACER TENDL-2024 LIBRARY; T=0.K
Neutron emission for (n,npa)

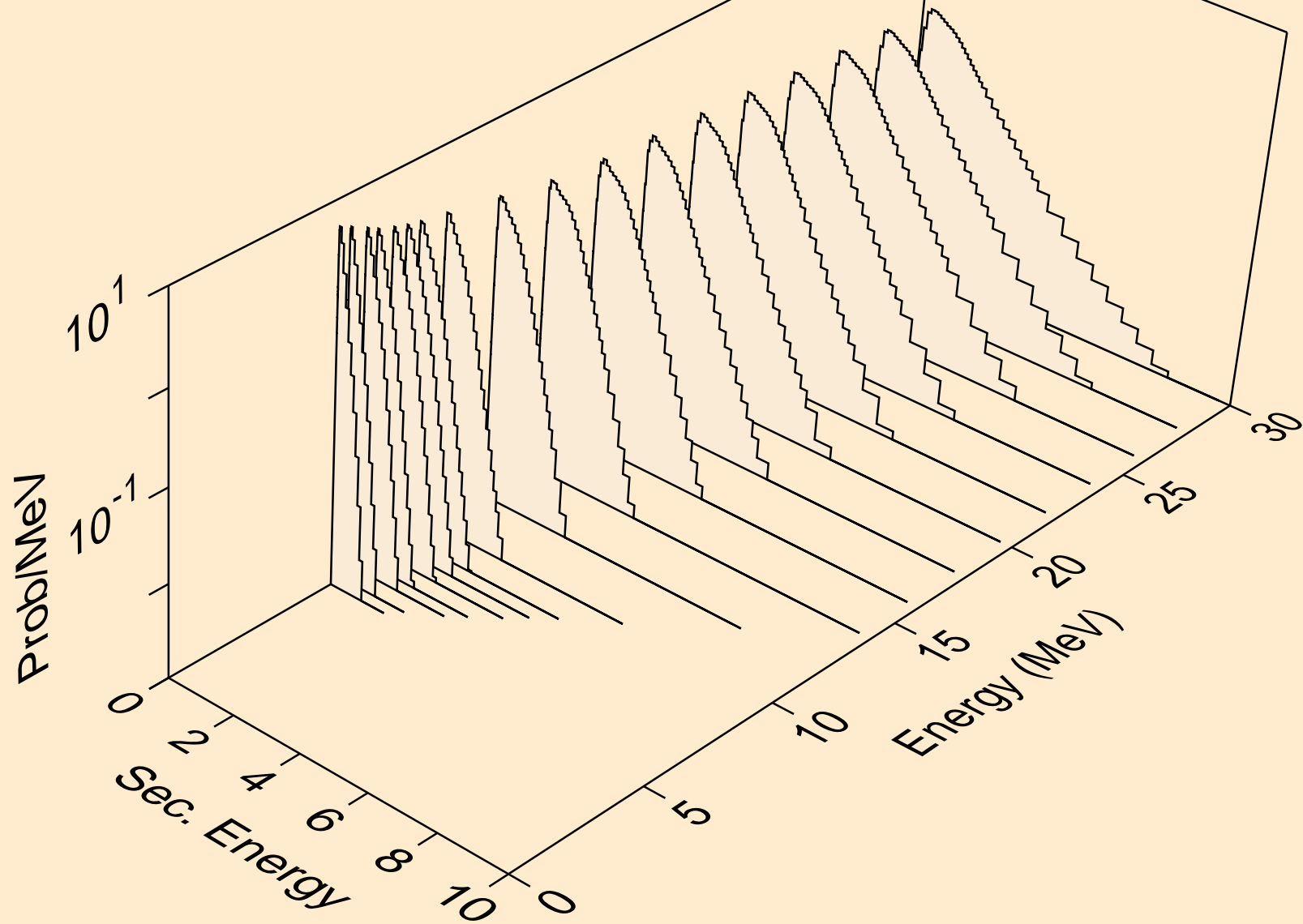

HO147 NEUTRON ACER TENDL-2024 LIBRARY; T=0.K
Neutron emission for (n,n*c)

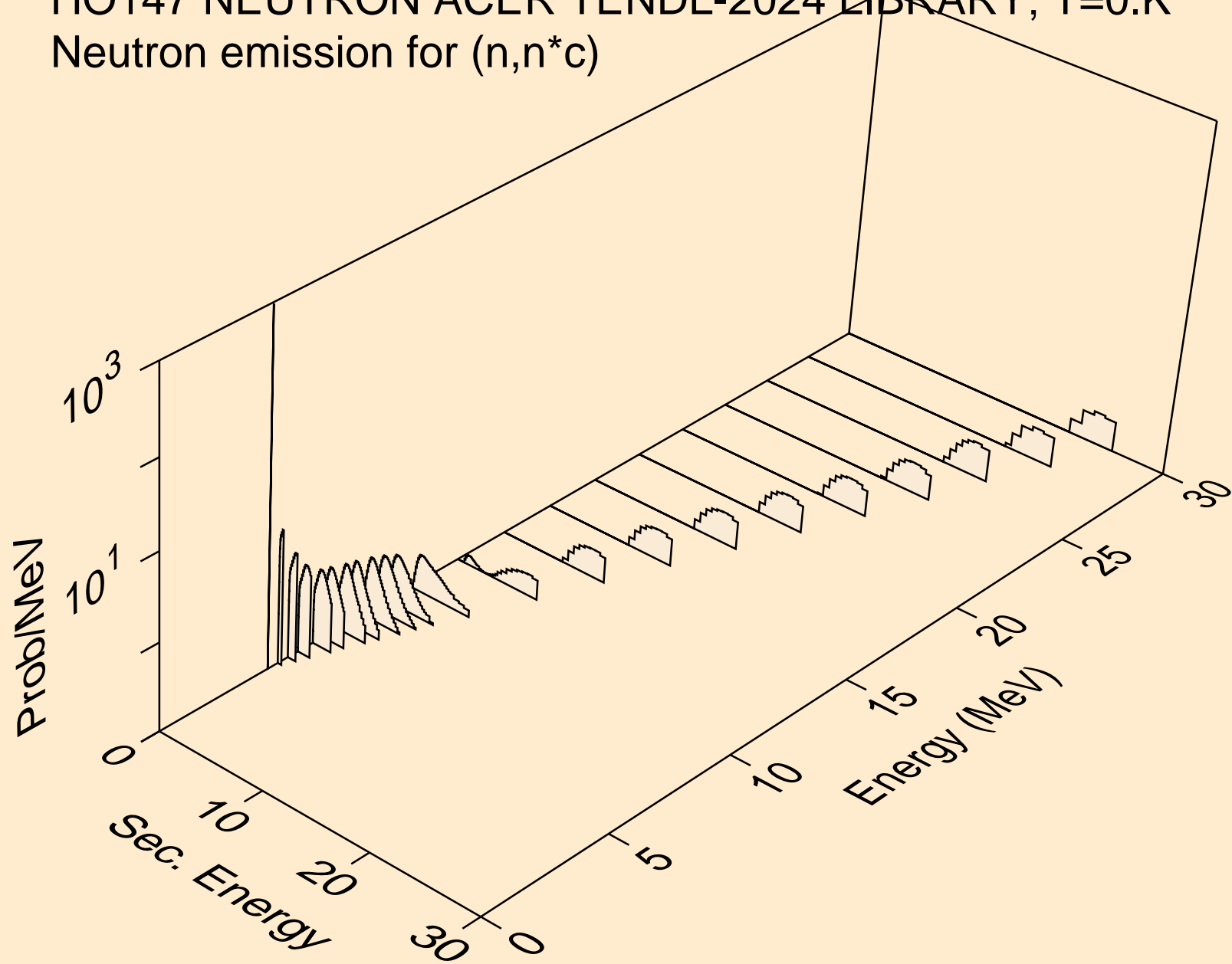

HO147 NEUTRON ACER TENDL-2024 LIBRARY; T=0.K
Photon emission for (n,x)

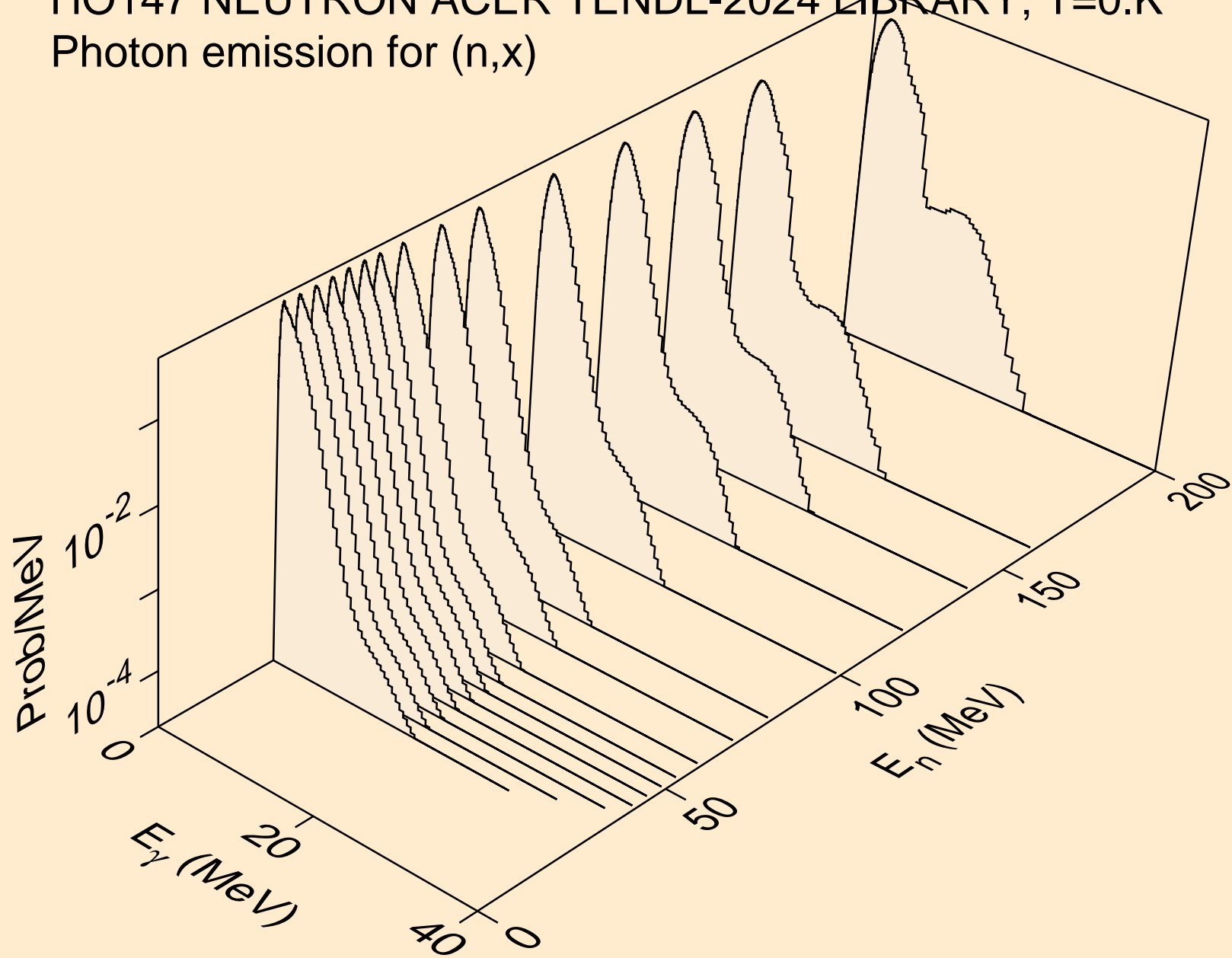

HO147 NEUTRON ACER TENDL-2024 LIBRARY; T=0.K
Photon emission for (n,2nd)

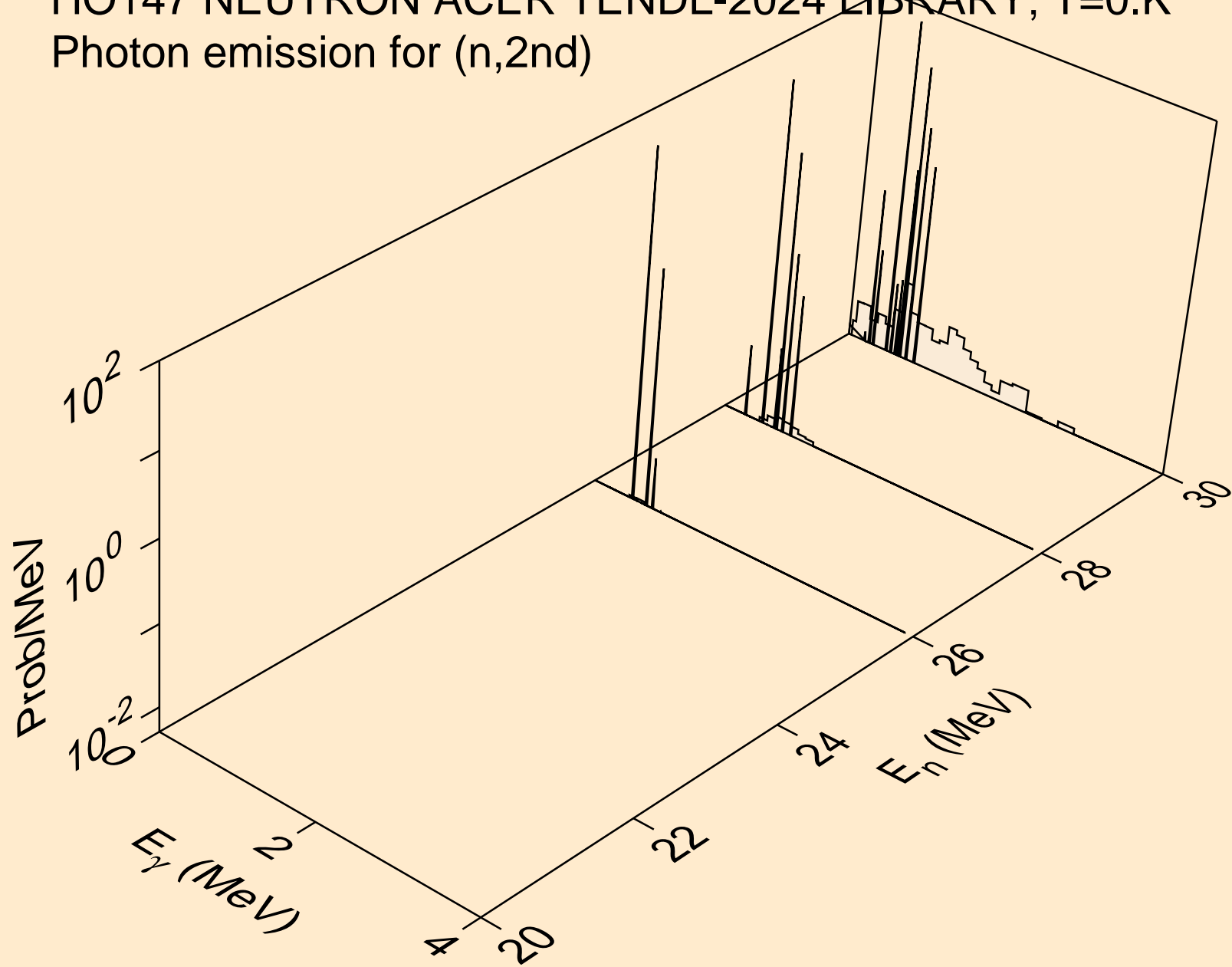

HO147 NEUTRON ACER TENDL-2024 LIBRARY; T=0.K
Photon emission for (n,2n)

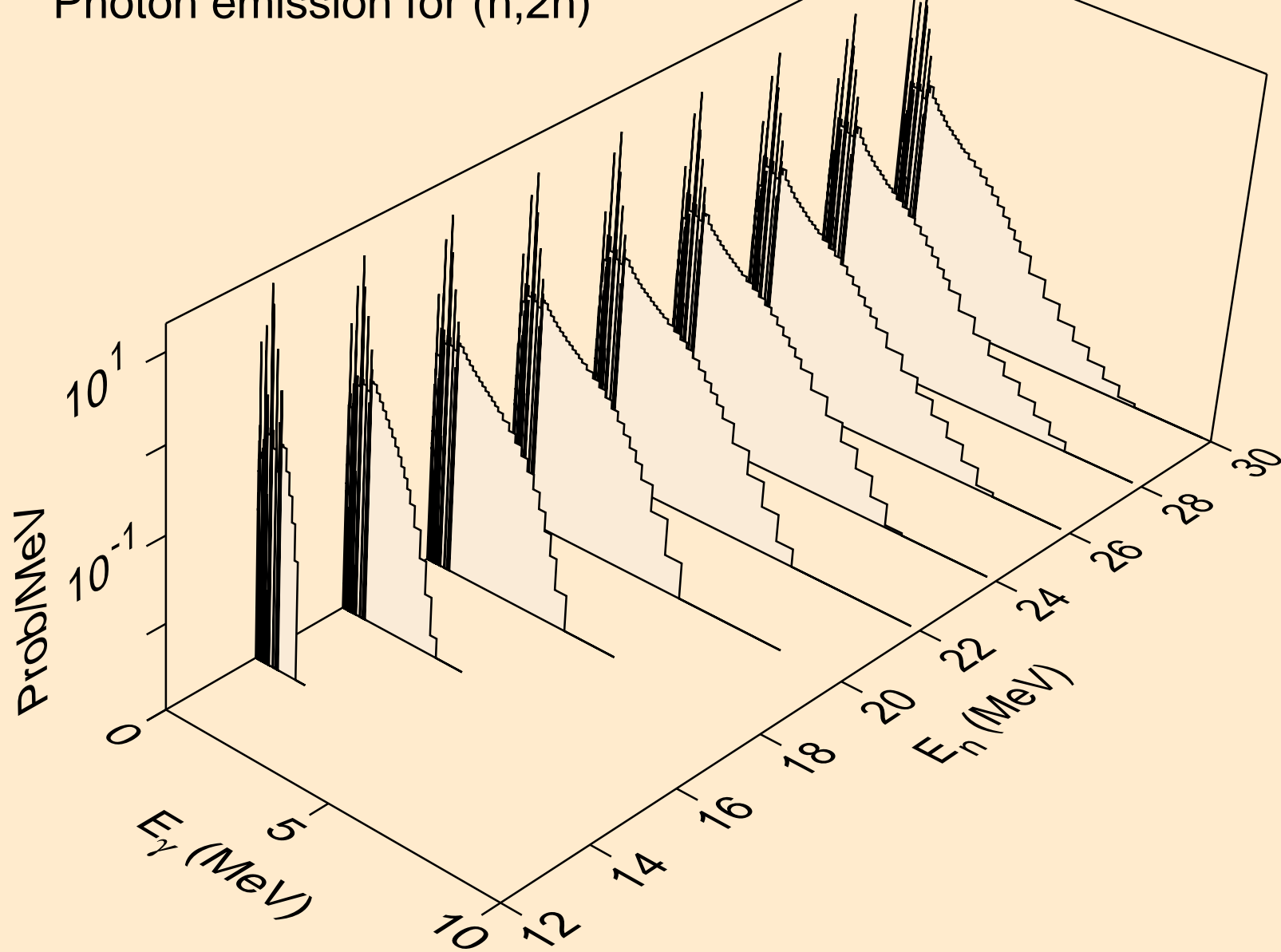

HO147 NEUTRON ACER TENDL-2024 LIBRARY; T=0.K
Photon emission for (n,3n)

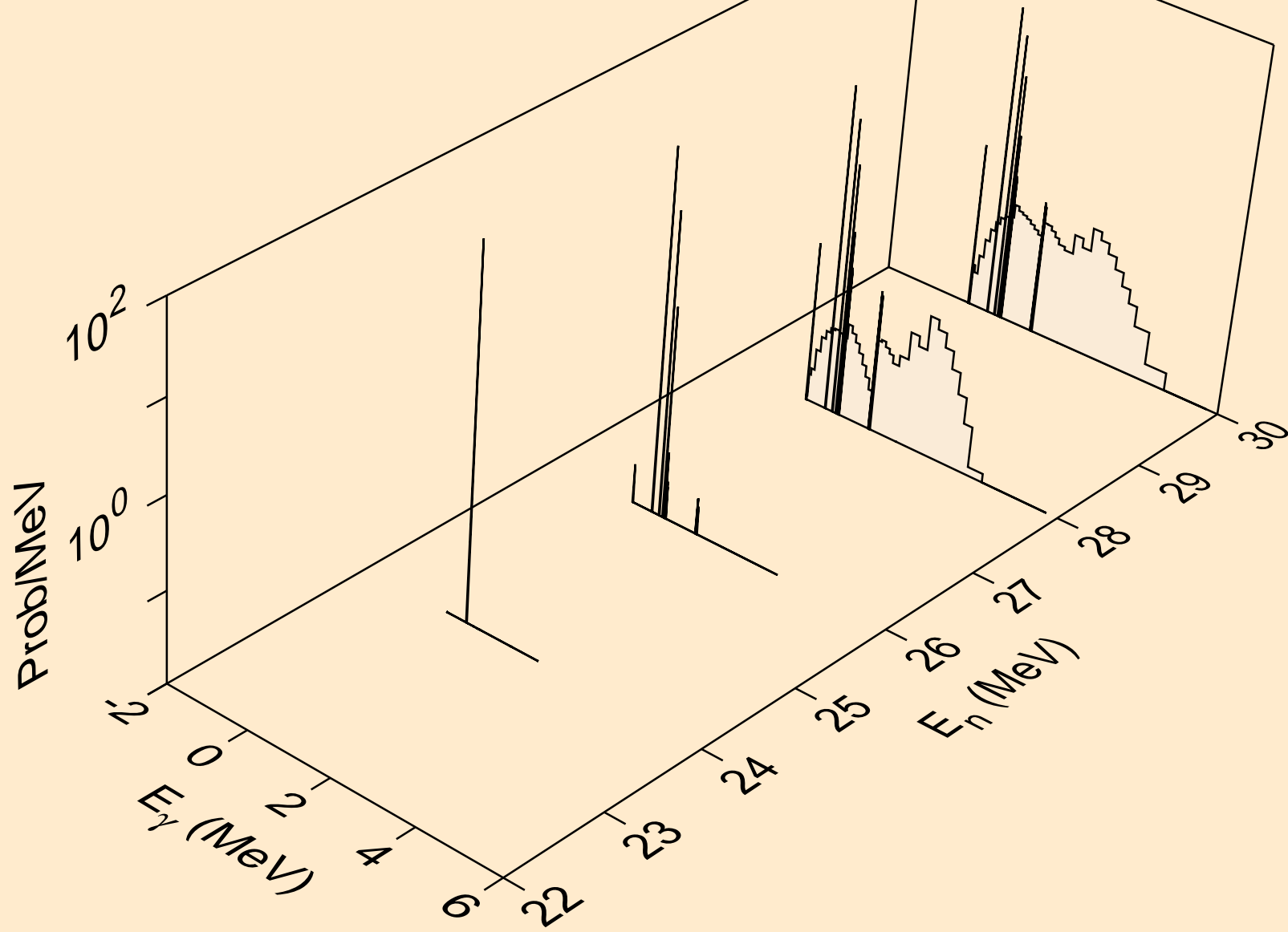

HO147 NEUTRON ACER TENDL-2024 LIBRARY; T=0.K
Photon emission for (n,n*)a

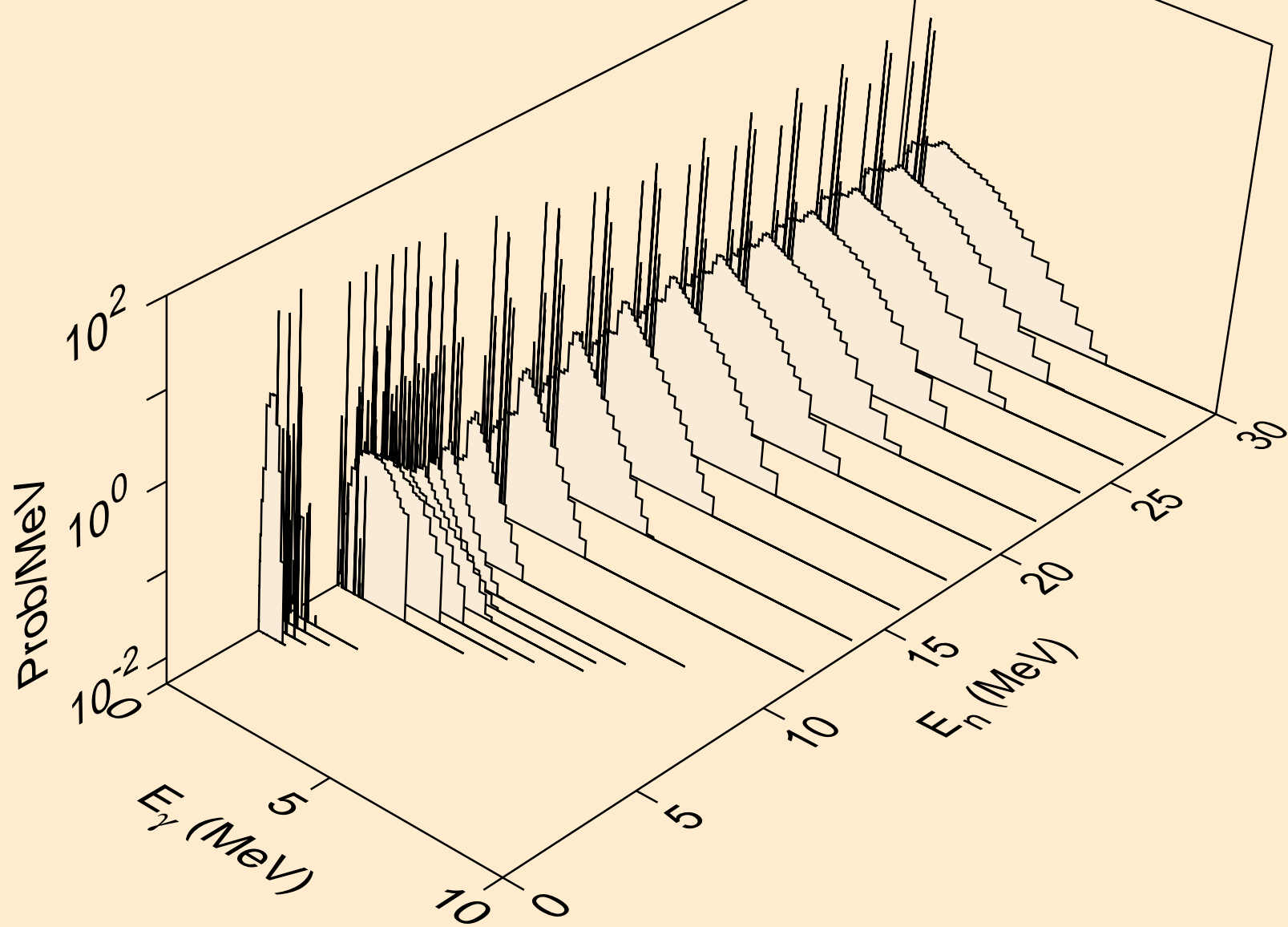

HO147 NEUTRON ACER TENDL-2024 LIBRARY; T=0.K
Photon emission for (n,2n)a

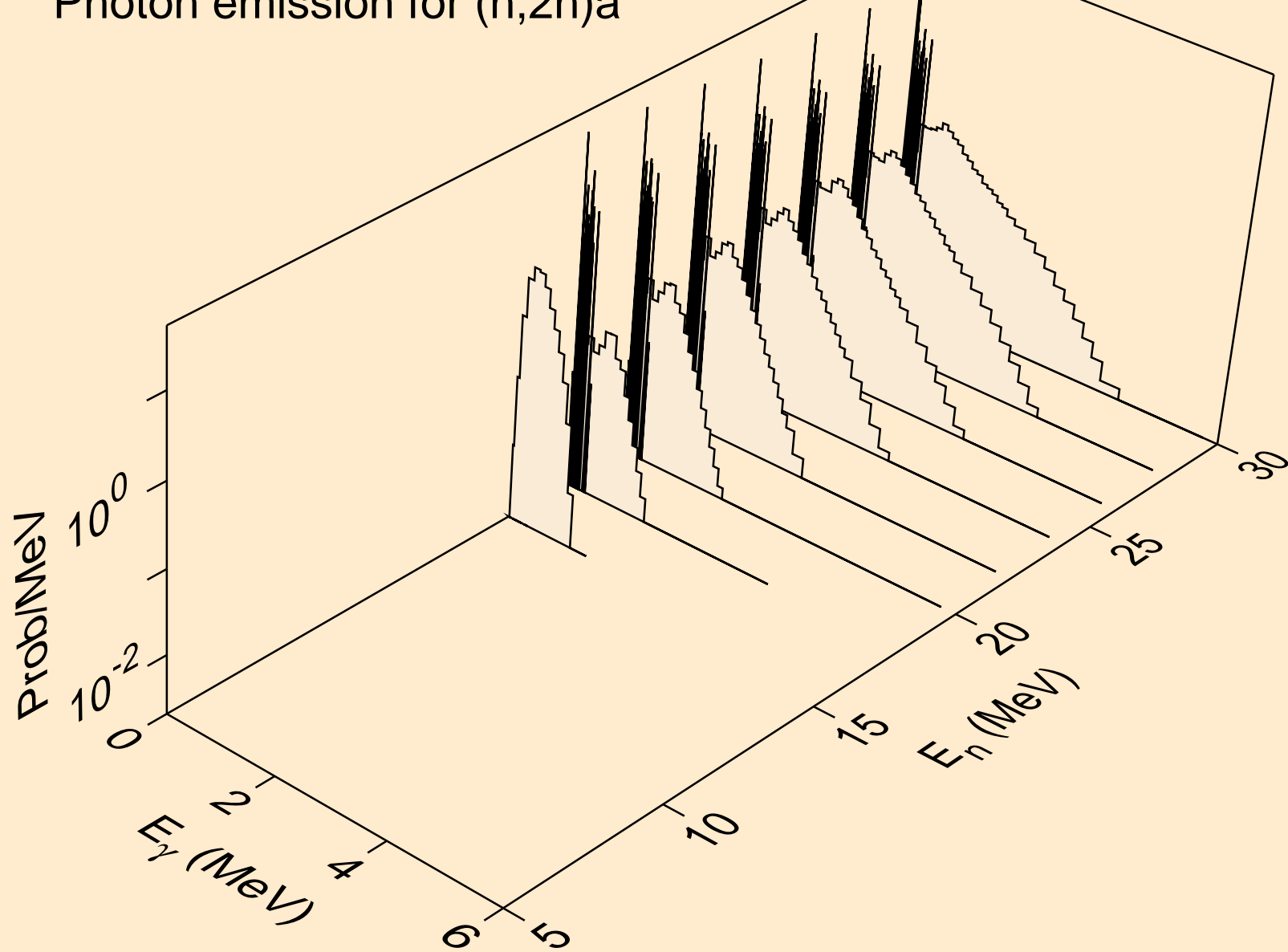

HO147 NEUTRON ACER TENDL-2024 LIBRARY; T=0.K
Photon emission for (n,n*)p

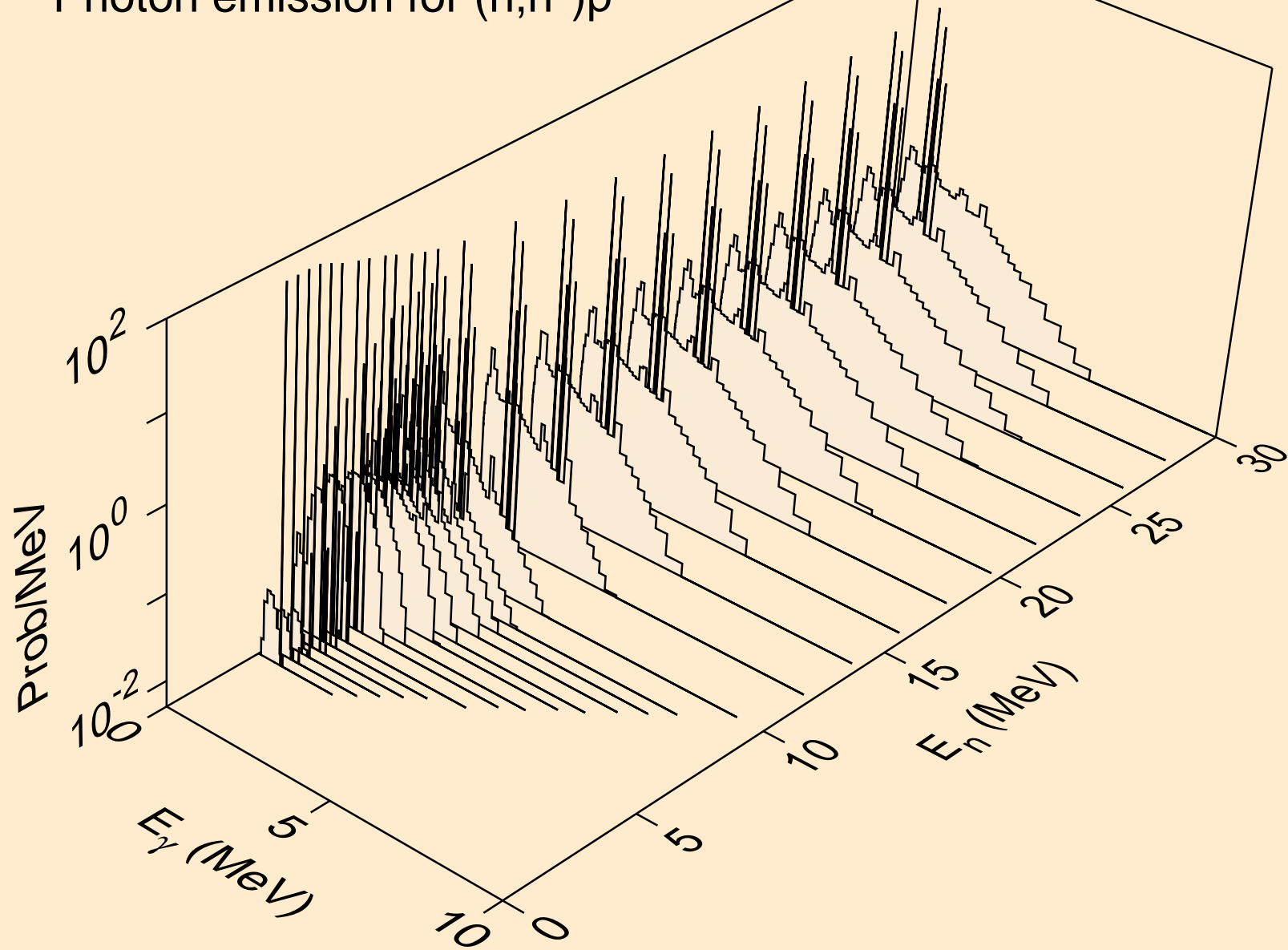

HO147 NEUTRON ACER TENDL-2024 LIBRARY; T=0.K
Photon emission for (n,n*)2a

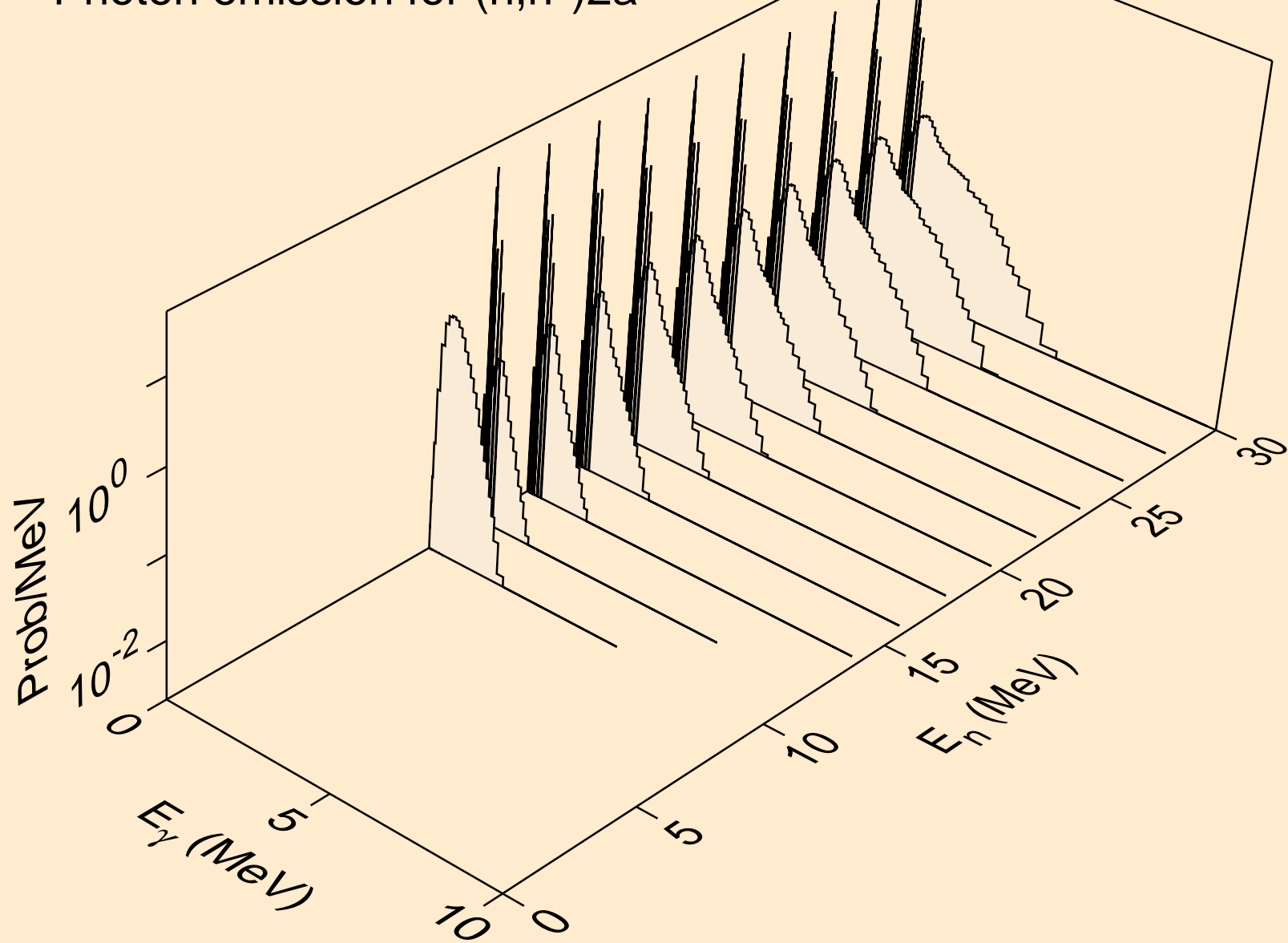

HO147 NEUTRON ACER TENDL-2024 LIBRARY; T=0.K
Photon emission for (n,n*)d

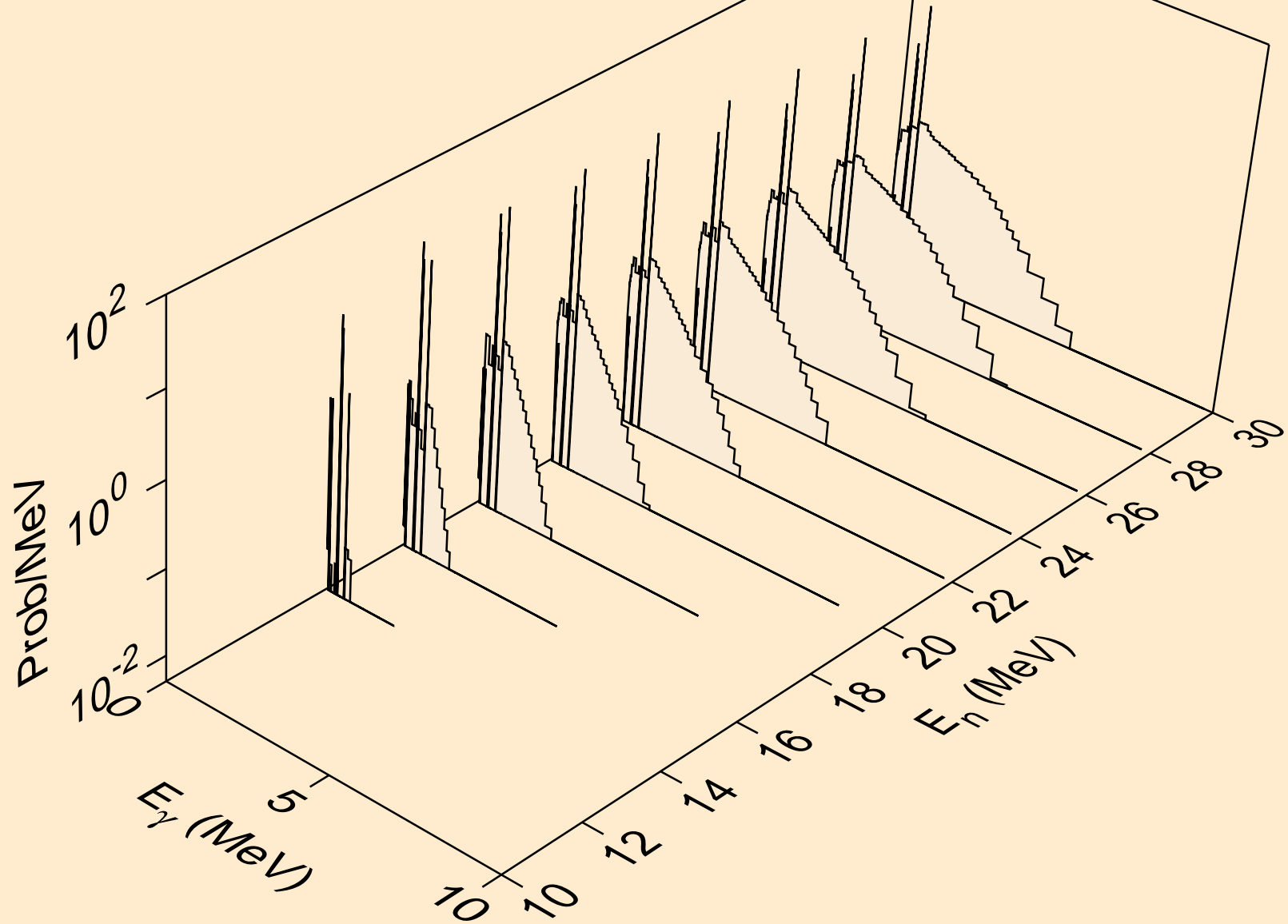

HO147 NEUTRON ACER TENDL-2024 LIBRARY; T=0.K
Photon emission for (n,n*)t

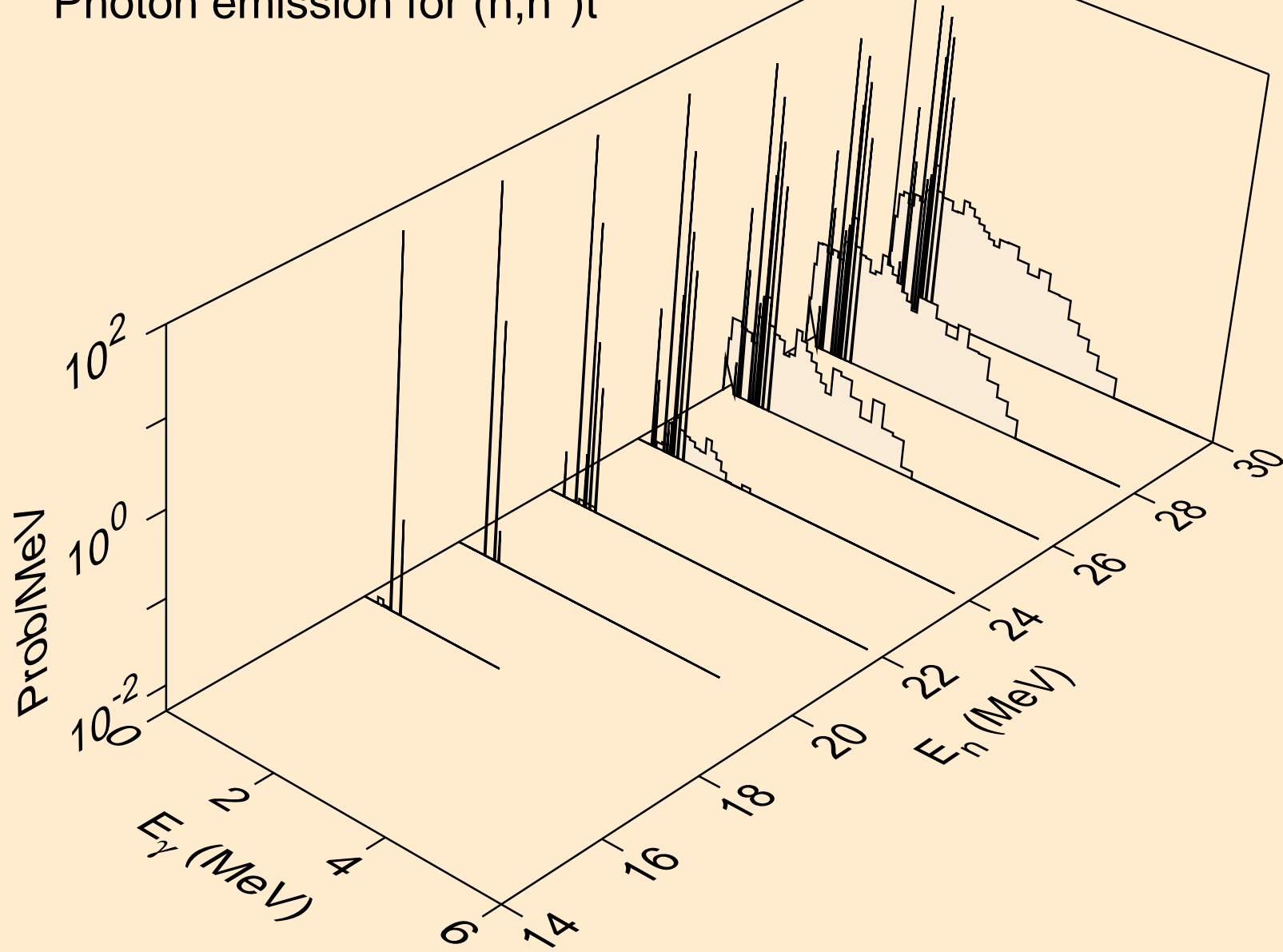

HO147 NEUTRON ACER TENDL-2024 LIBRARY; T=0.K
Photon emission for (n,n*)he3

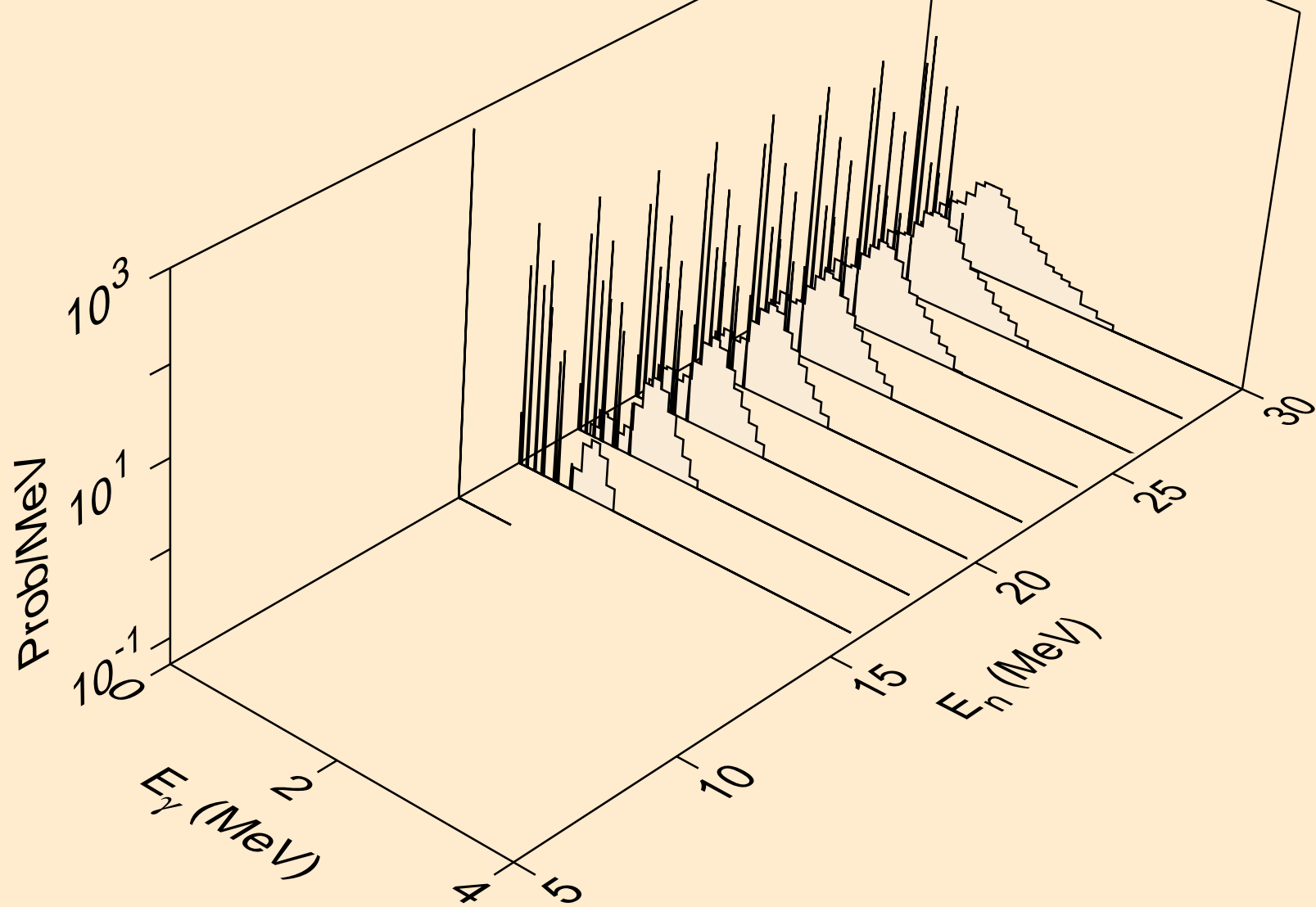

HO147 NEUTRON ACER TENDL-2024 LIBRARY; T=0.K
Photon emission for (n,2np)

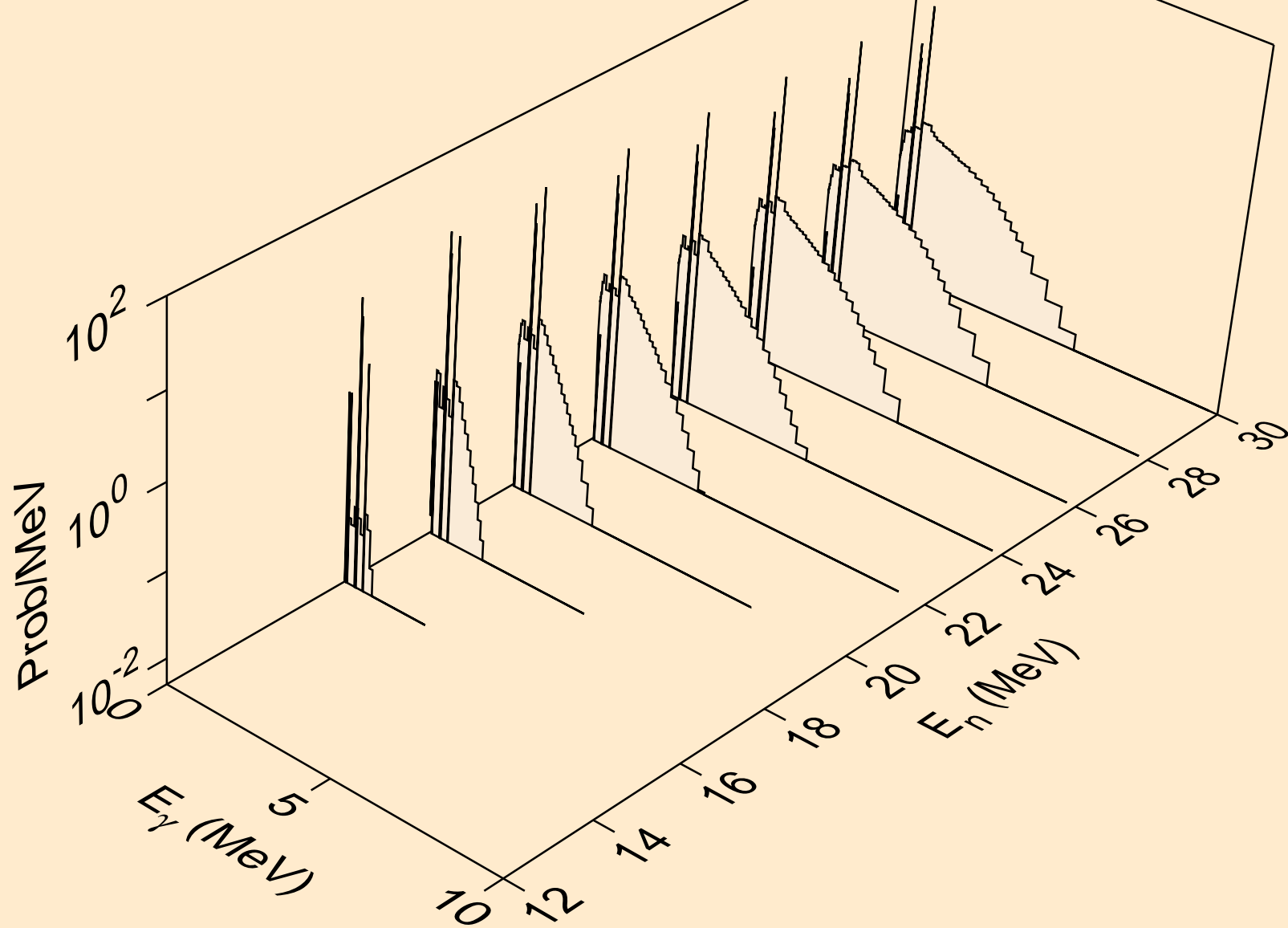

HO147 NEUTRON ACER TENDL-2024 LIBRARY; T=0.K
Photon emission for (n,3np)

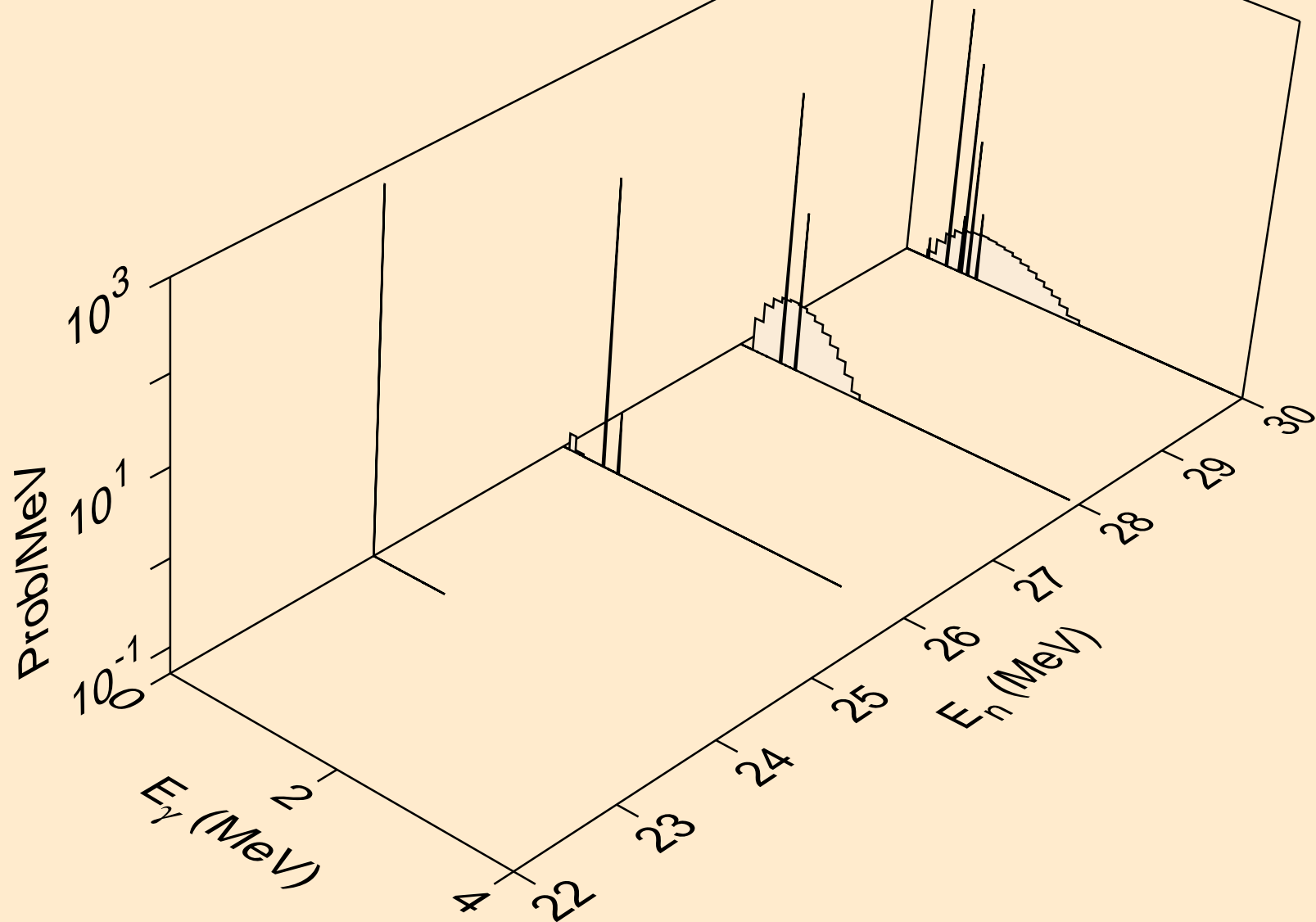

HO147 NEUTRON ACER TENDL-2024 LIBRARY; T=0.K
Photon emission for (n,n2p)

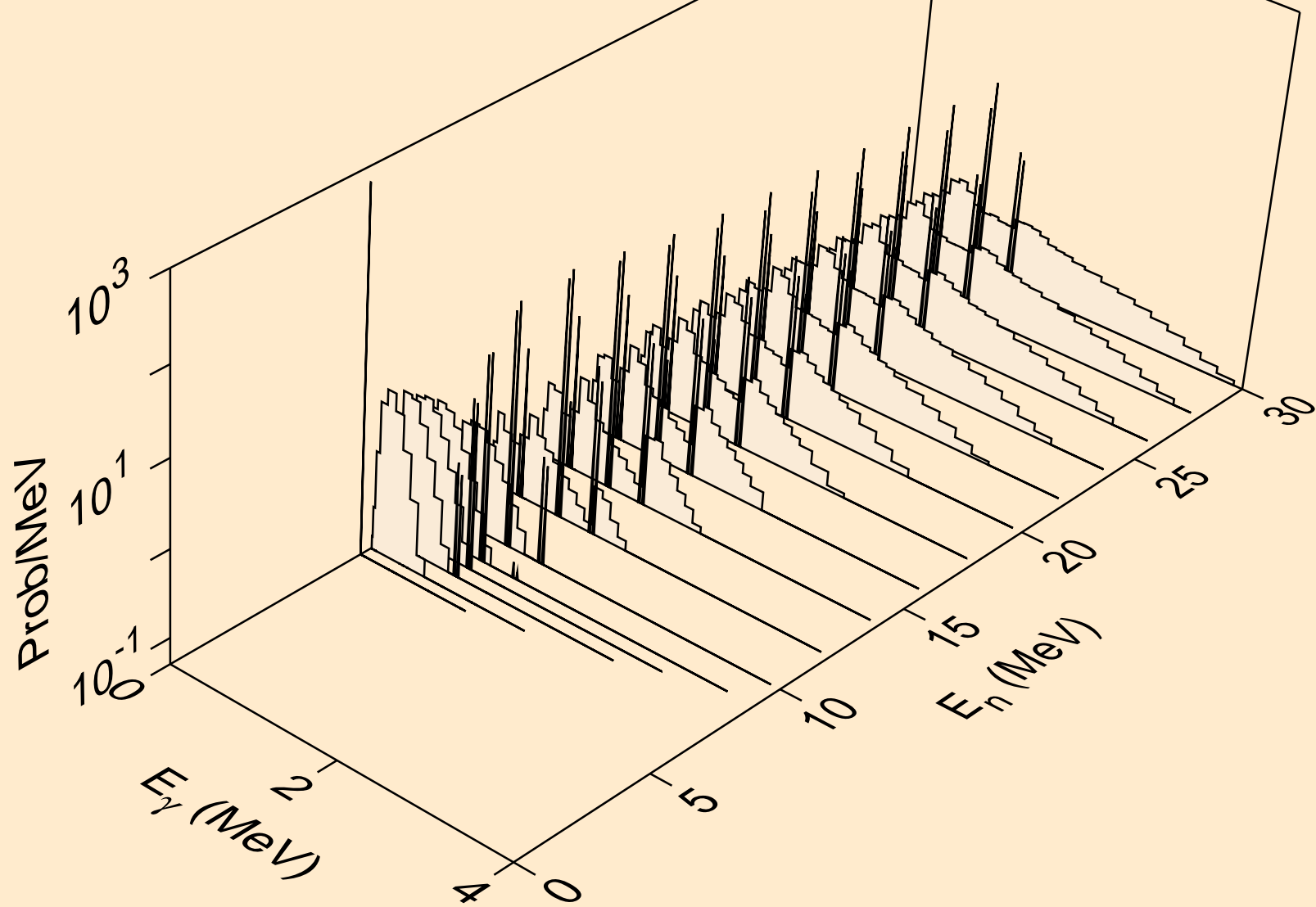

HO147 NEUTRON ACER TENDL-2024 LIBRARY; T=0.K
Photon emission for (n,npa)

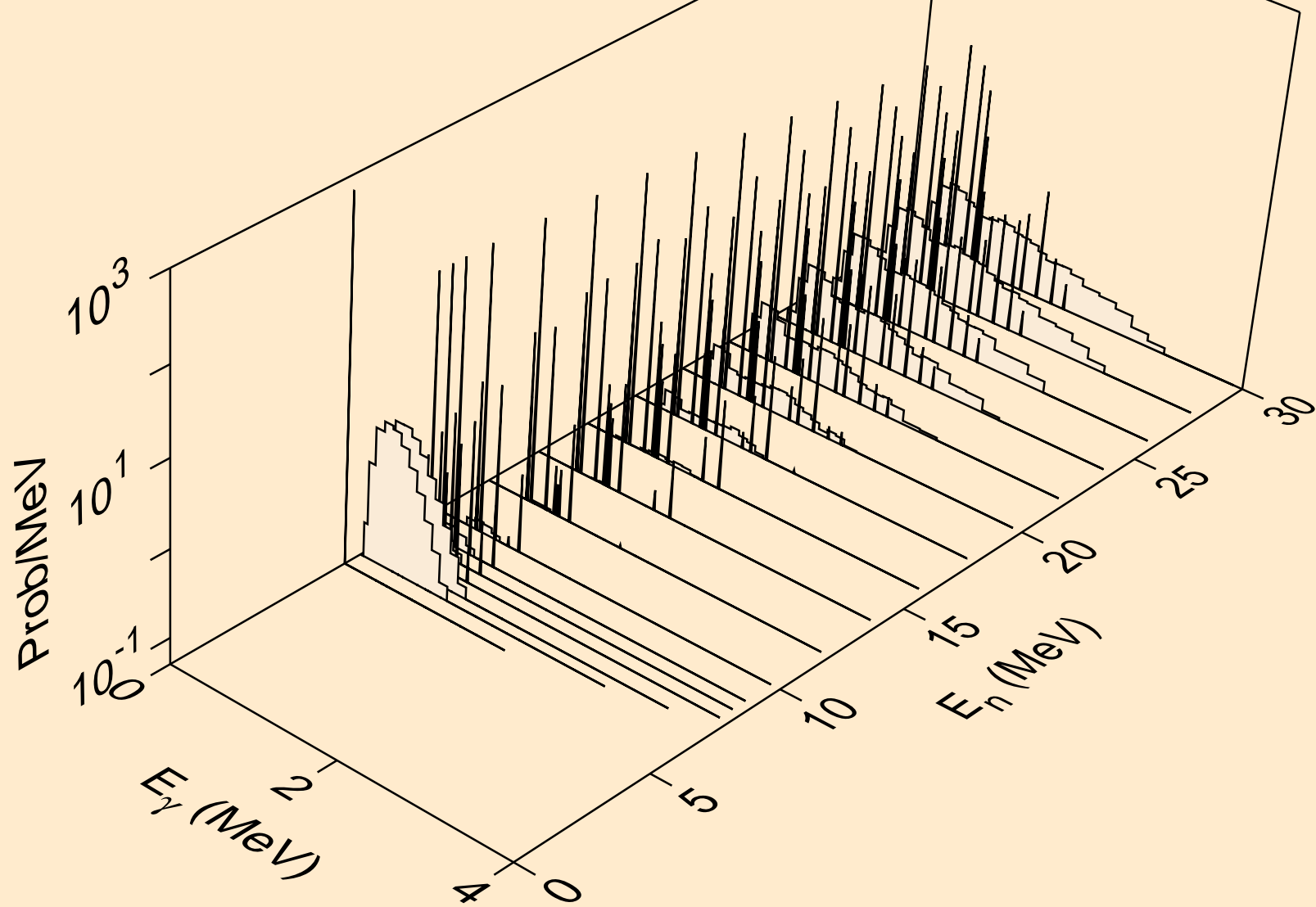

HO147 NEUTRON ACER TENDL-2024 LIBRARY; T=0.K
Photon emission for (n,n*c)

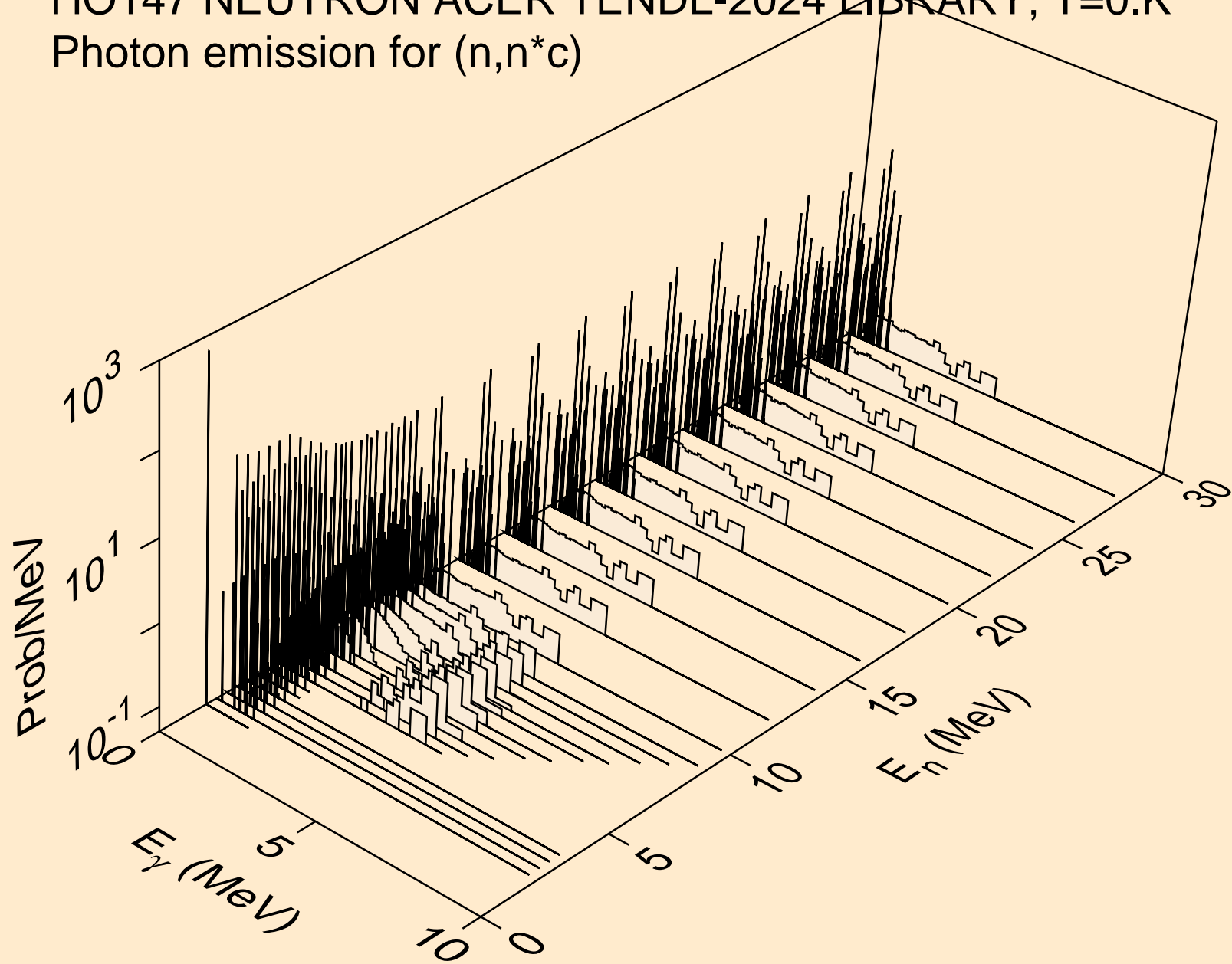

HO147 NEUTRON ACER TENDL-2024 LIBRARY; T=0.K
Photon emission for (n,gma)

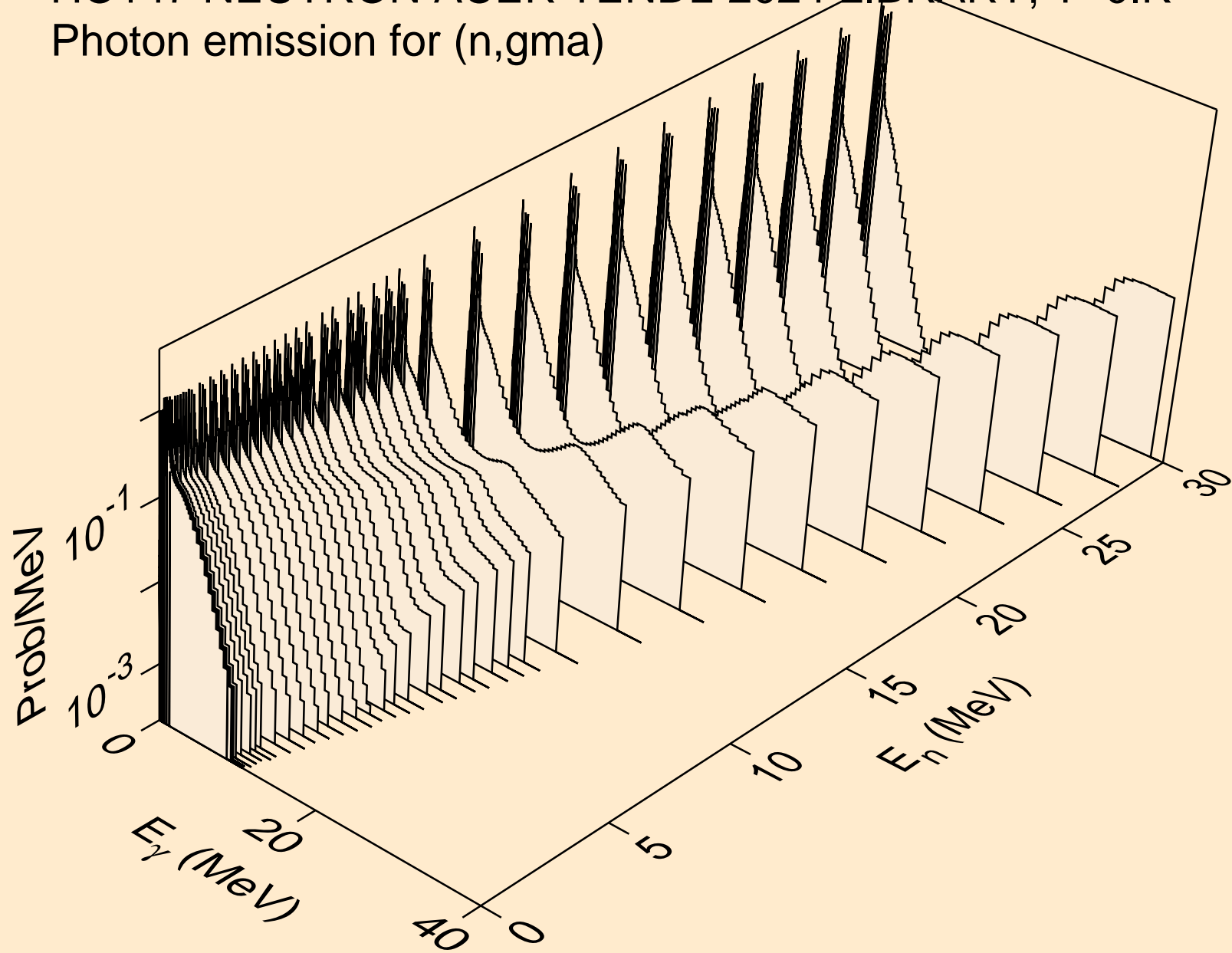

HO147 NEUTRON ACER TENDL-2024 LIBRARY; T=0.K
Photon emission for (n,p)

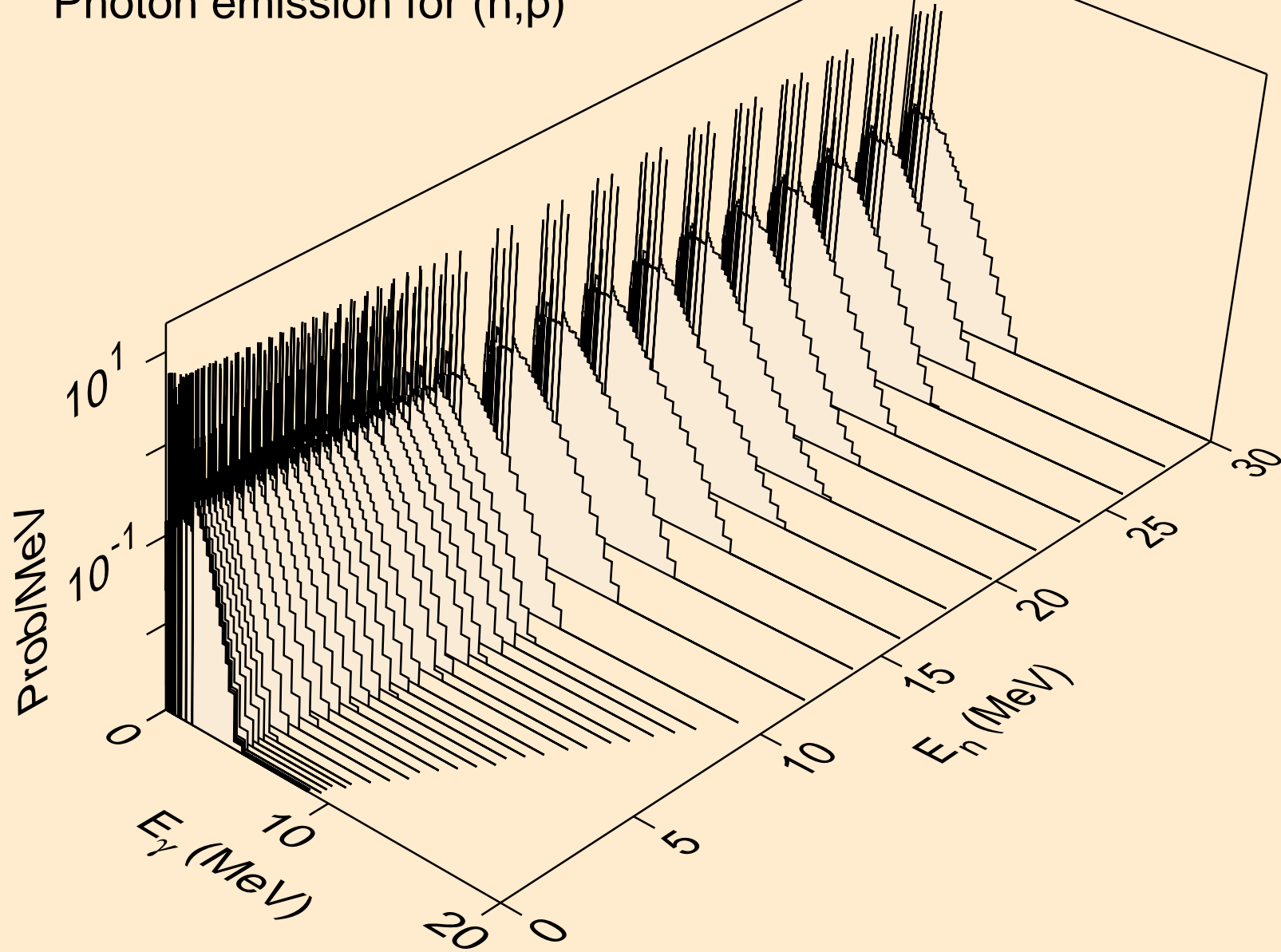

HO147 NEUTRON ACER TENDL-2024 LIBRARY; T=0.K
Photon emission for (n,d)

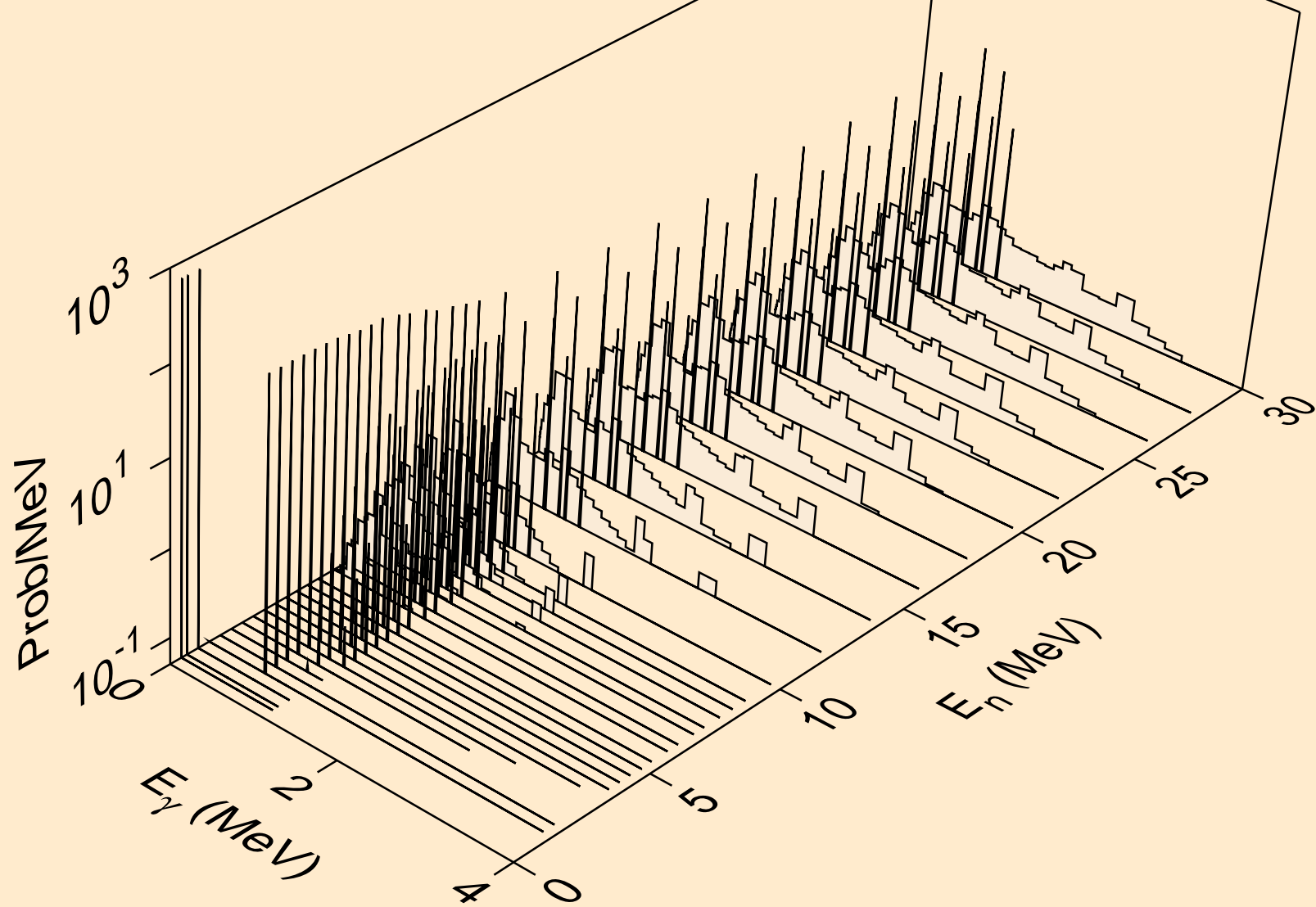

HO147 NEUTRON ACER TENDL-2024 LIBRARY; T=0.K
Photon emission for (n,t)

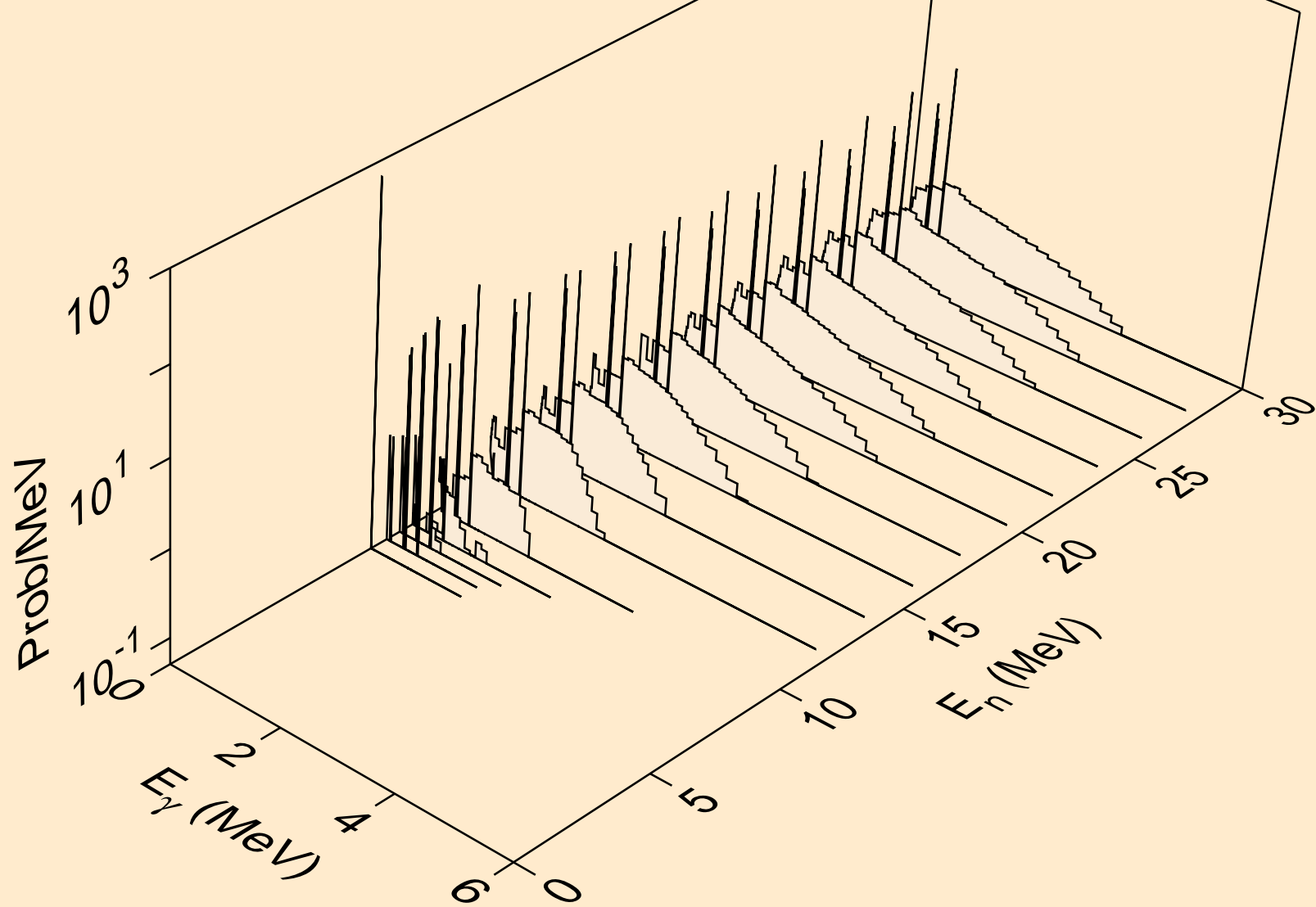

HO147 NEUTRON ACER TENDL-2024 LIBRARY; T=0.K
Photon emission for (n,he3)

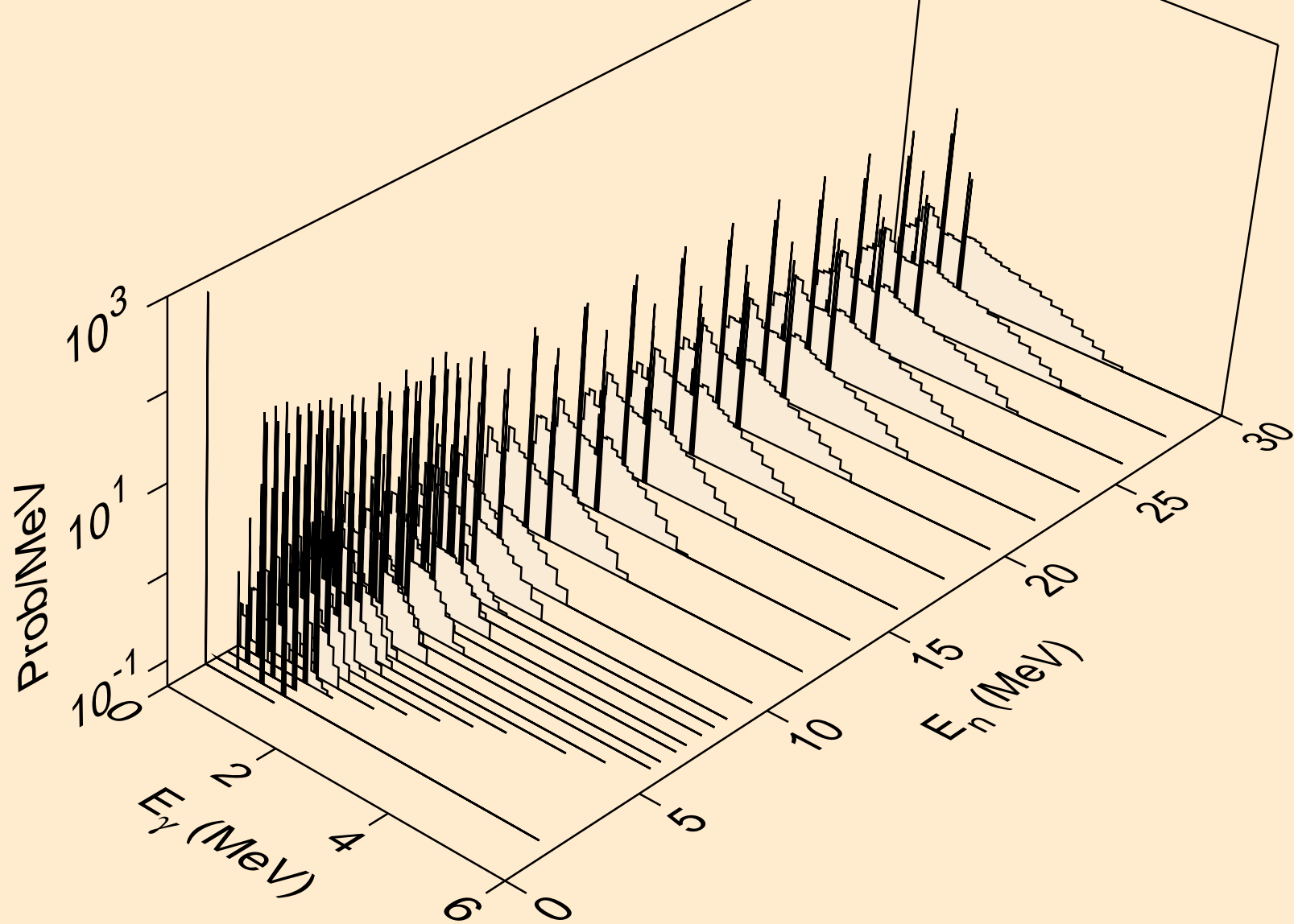

HO147 NEUTRON ACER TENDL-2024 LIBRARY; T=0.K
Photon emission for (n,a)

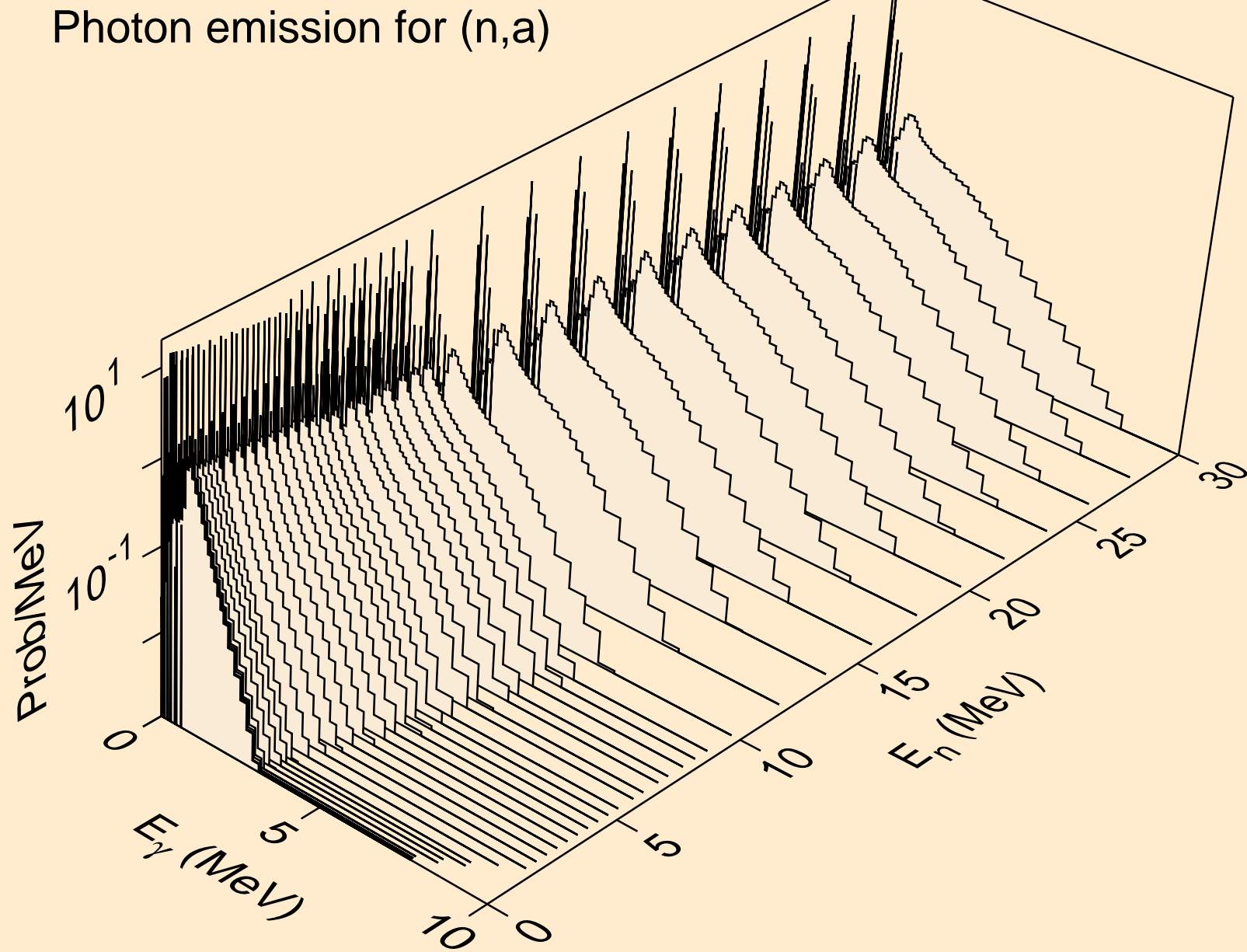

HO147 NEUTRON ACER TENDL-2024 LIBRARY; T=0.K
Photon emission for (n,2a)

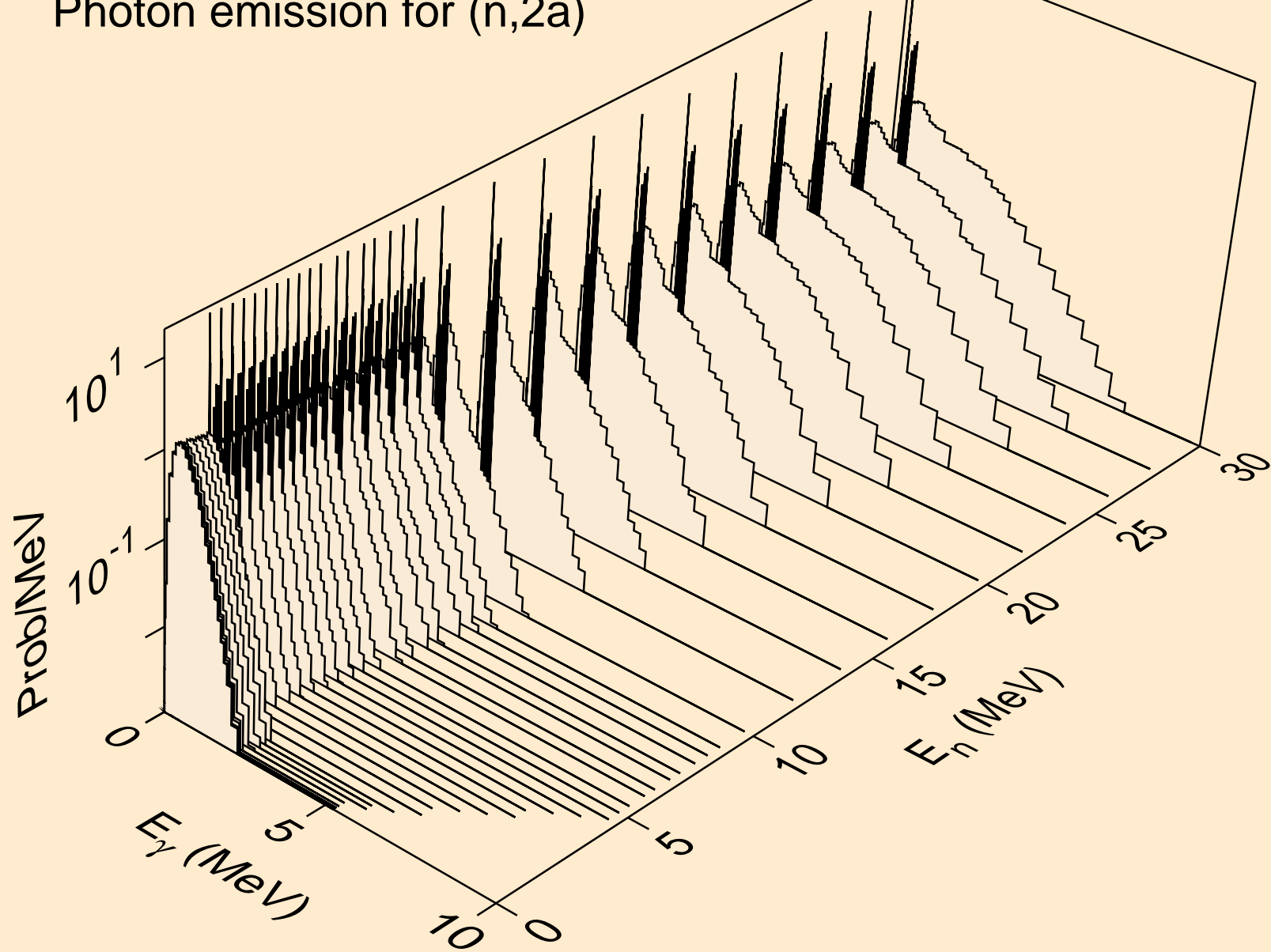

HO147 NEUTRON ACER TENDL-2024 LIBRARY; T=0.K
Photon emission for (n,3a)

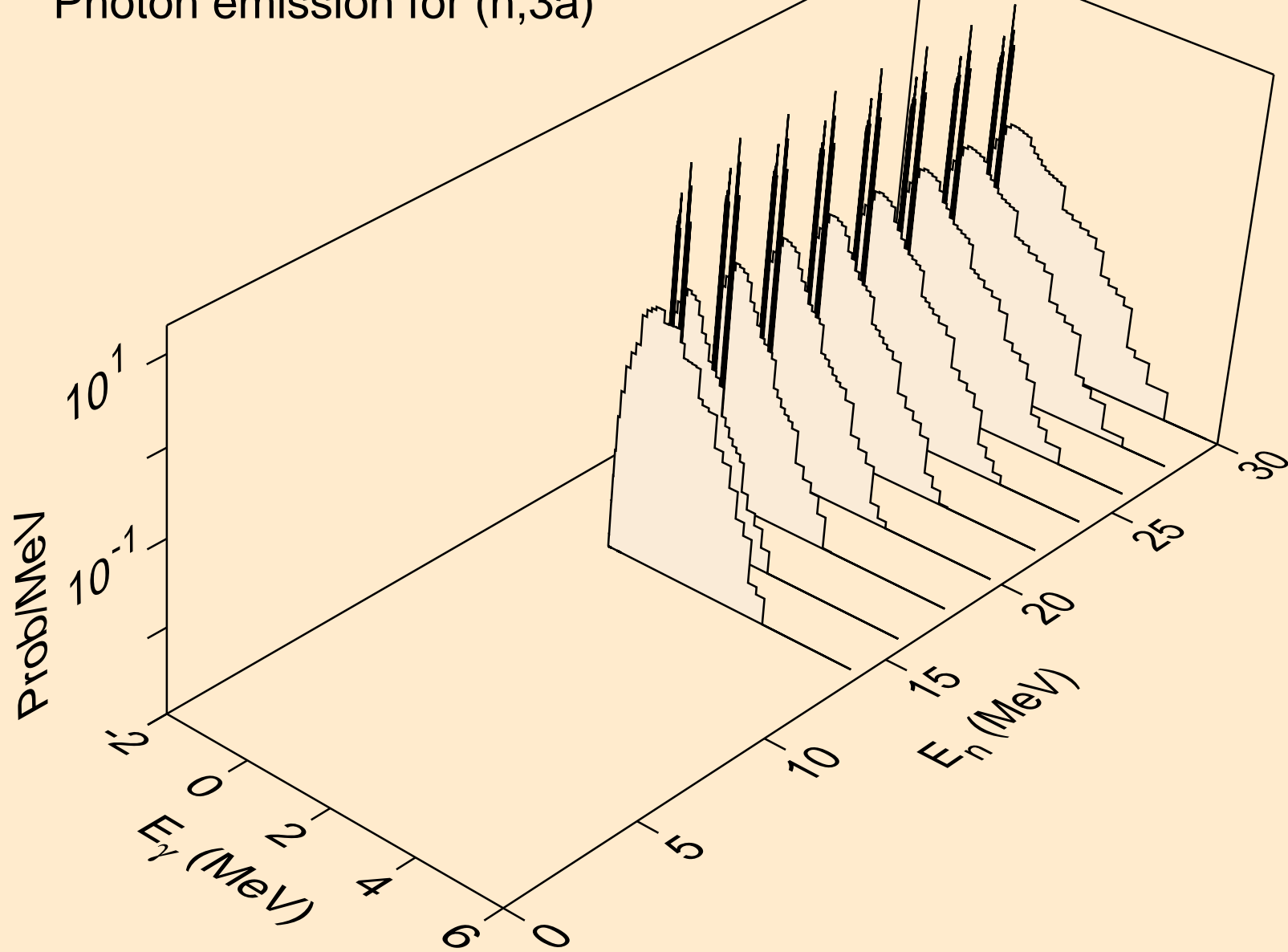

HO147 NEUTRON ACER TENDL-2024 LIBRARY; T=0.K
Photon emission for (n,2p)

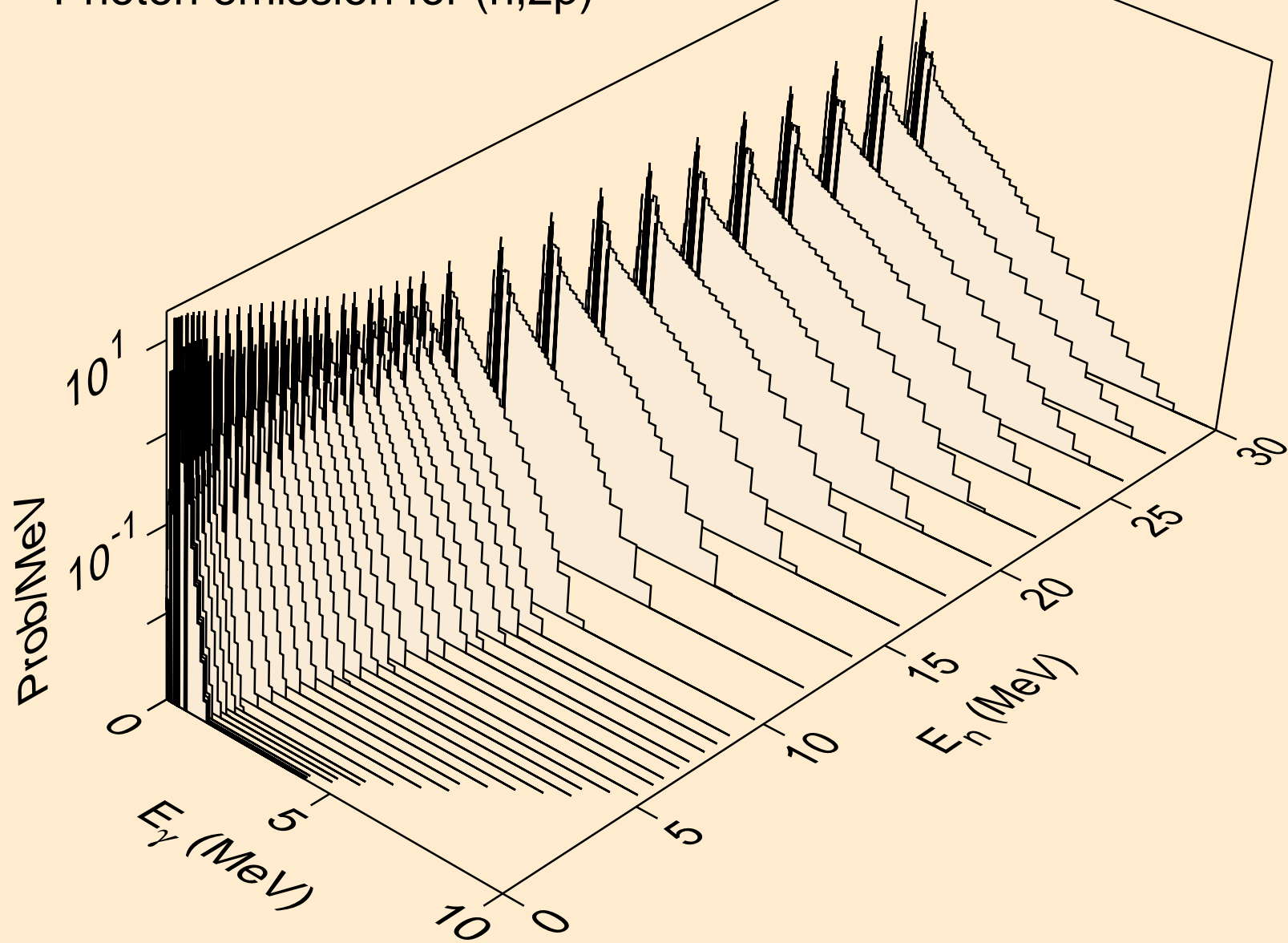

HO147 NEUTRON ACER TENDL-2024 LIBRARY; T=0.K
Photon emission for (n,p α)

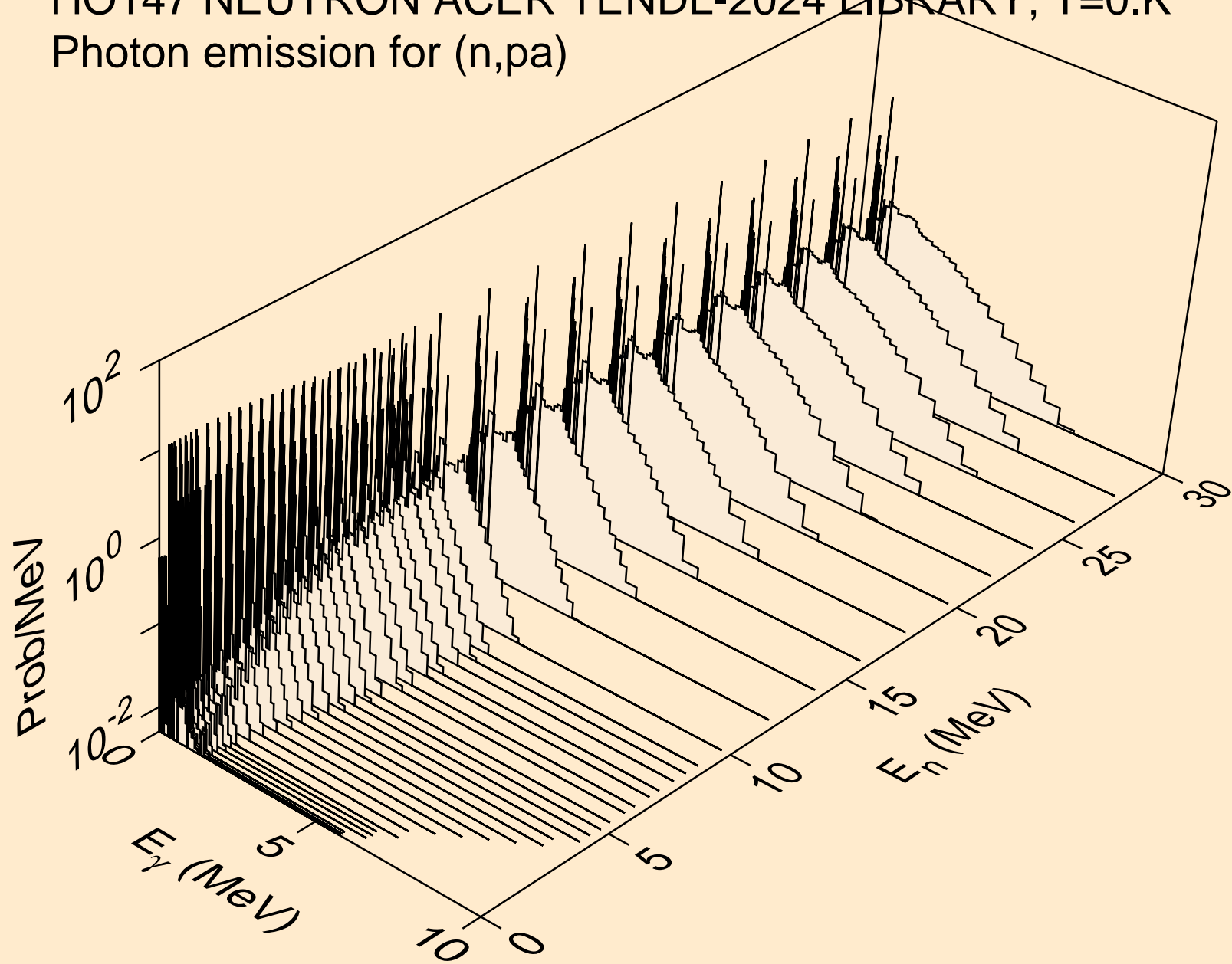

HO147 NEUTRON ACER TENDL-2024 LIBRARY; T=0.K
Photon emission for (n,pd)

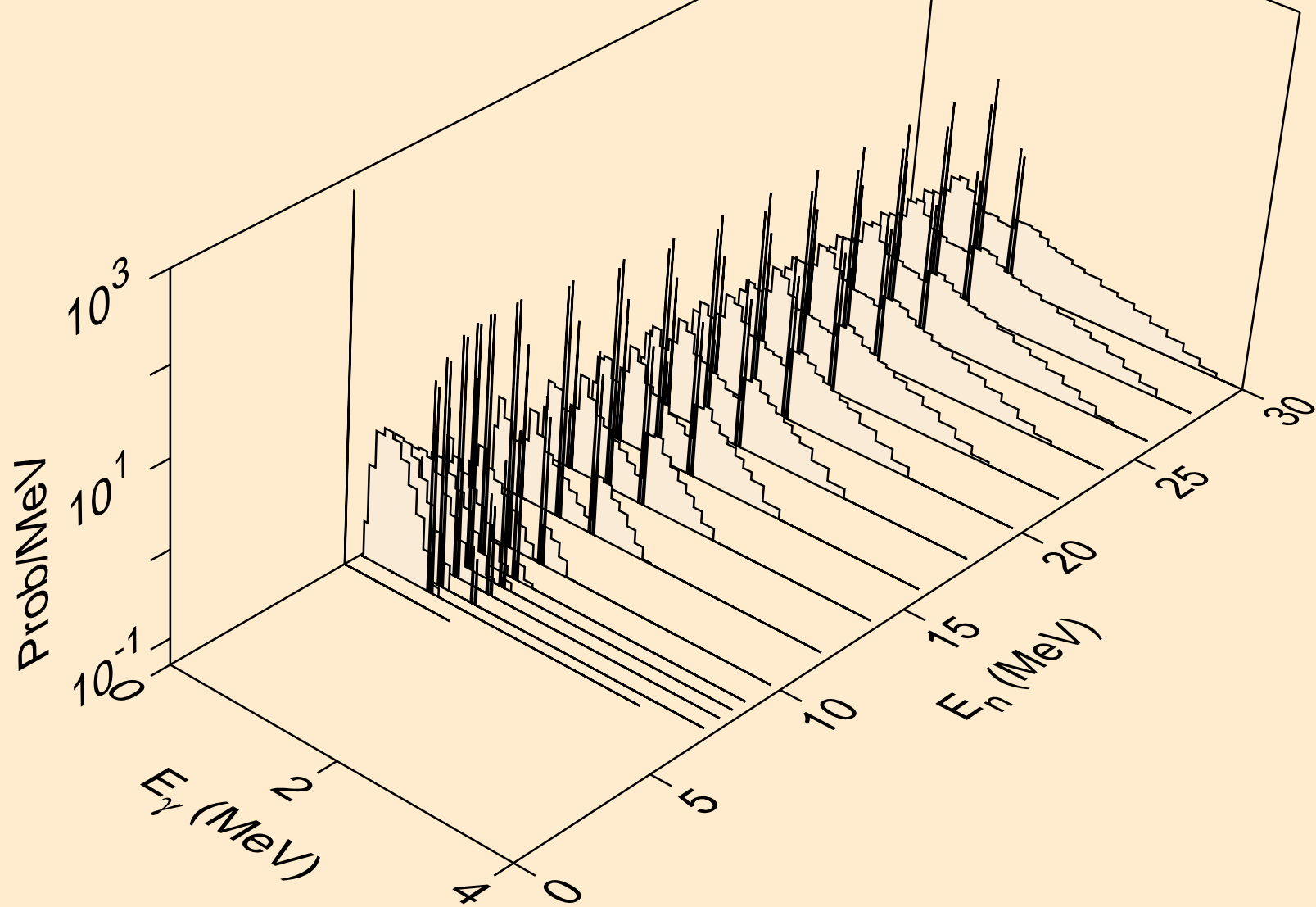

HO147 NEUTRON ACER TENDL-2024 LIBRARY; T=0.K
Photon emission for (n,pt)

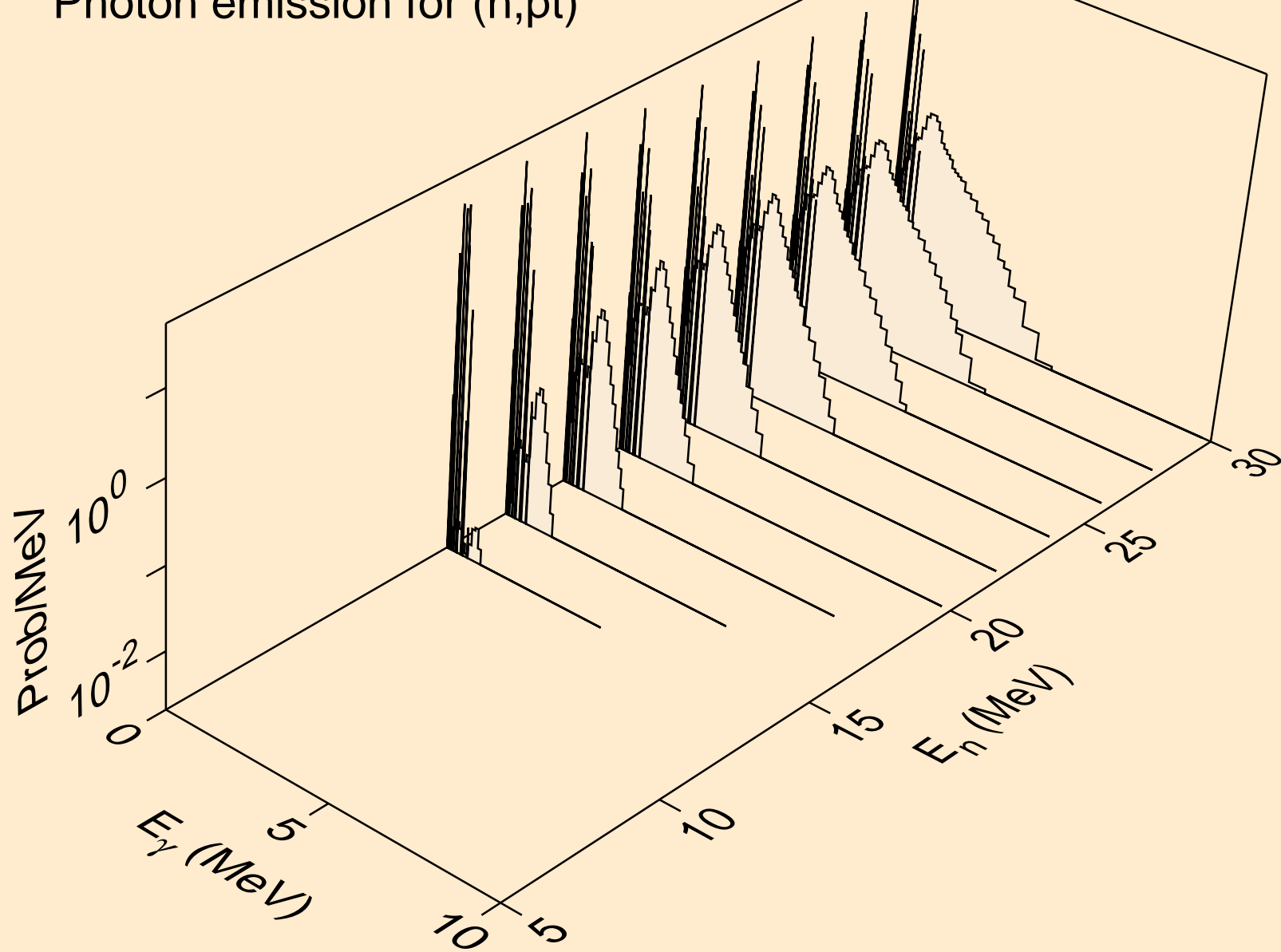

HO147 NEUTRON ACER TENDL-2024 LIBRARY; T=0.K
Photon emission for (n,da)

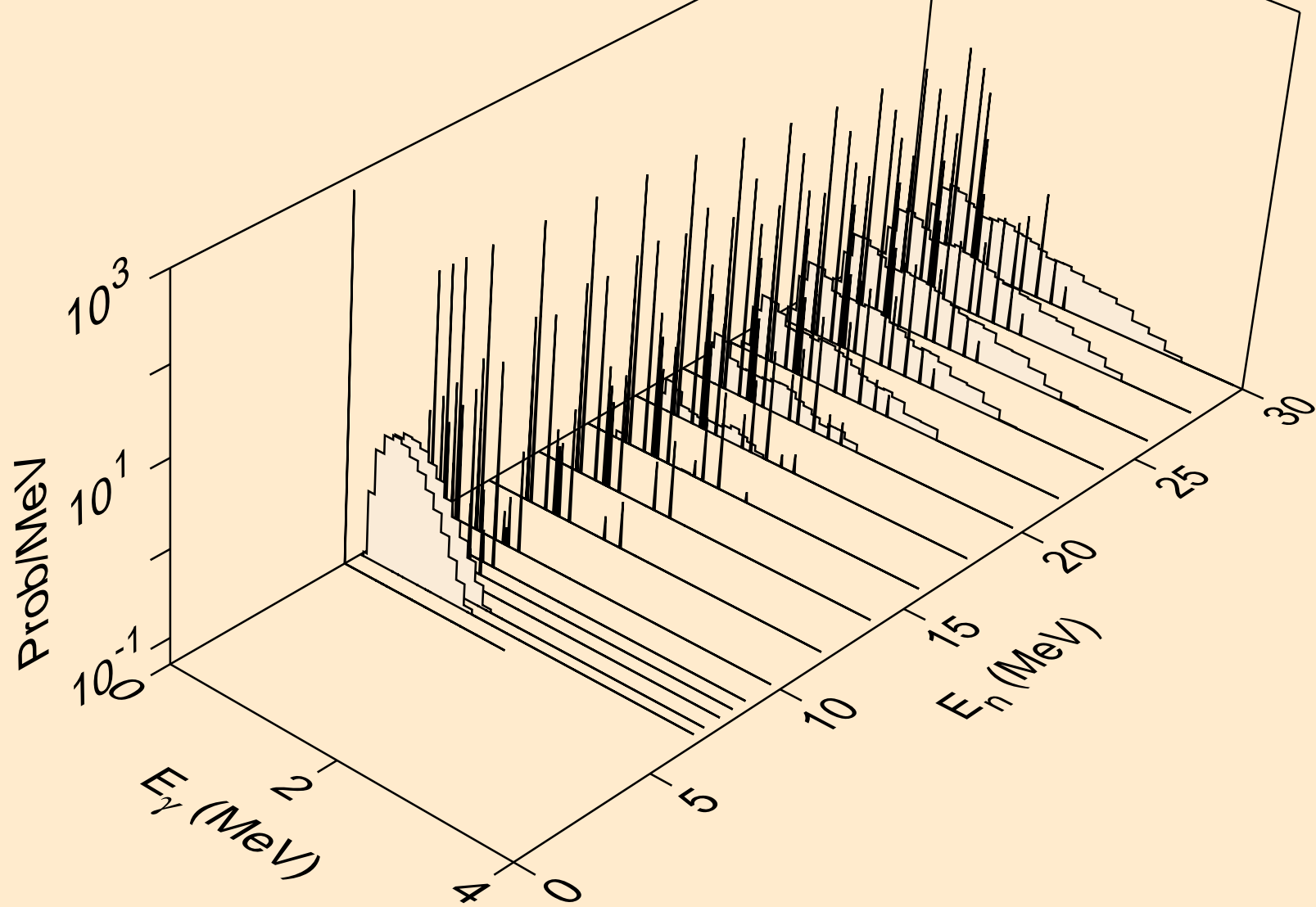

HO147 NEUTRON ACER TENDL-2024 LIBRARY; T=0.K
thermal capture photon spectrum

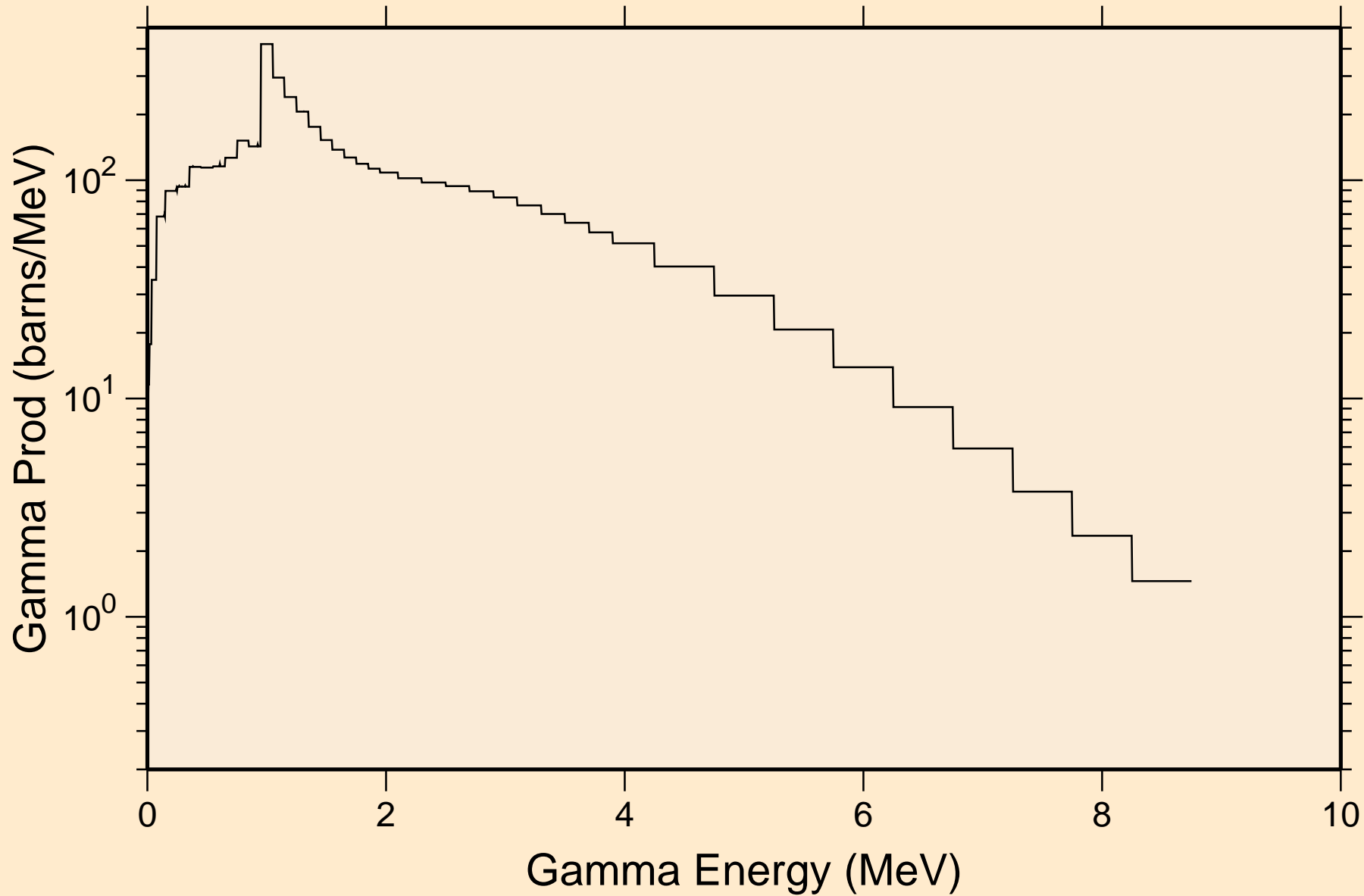

HO147 NEUTRON ACER TENDL-2024 LIBRARY; T=0.K
14 MeV photon spectrum

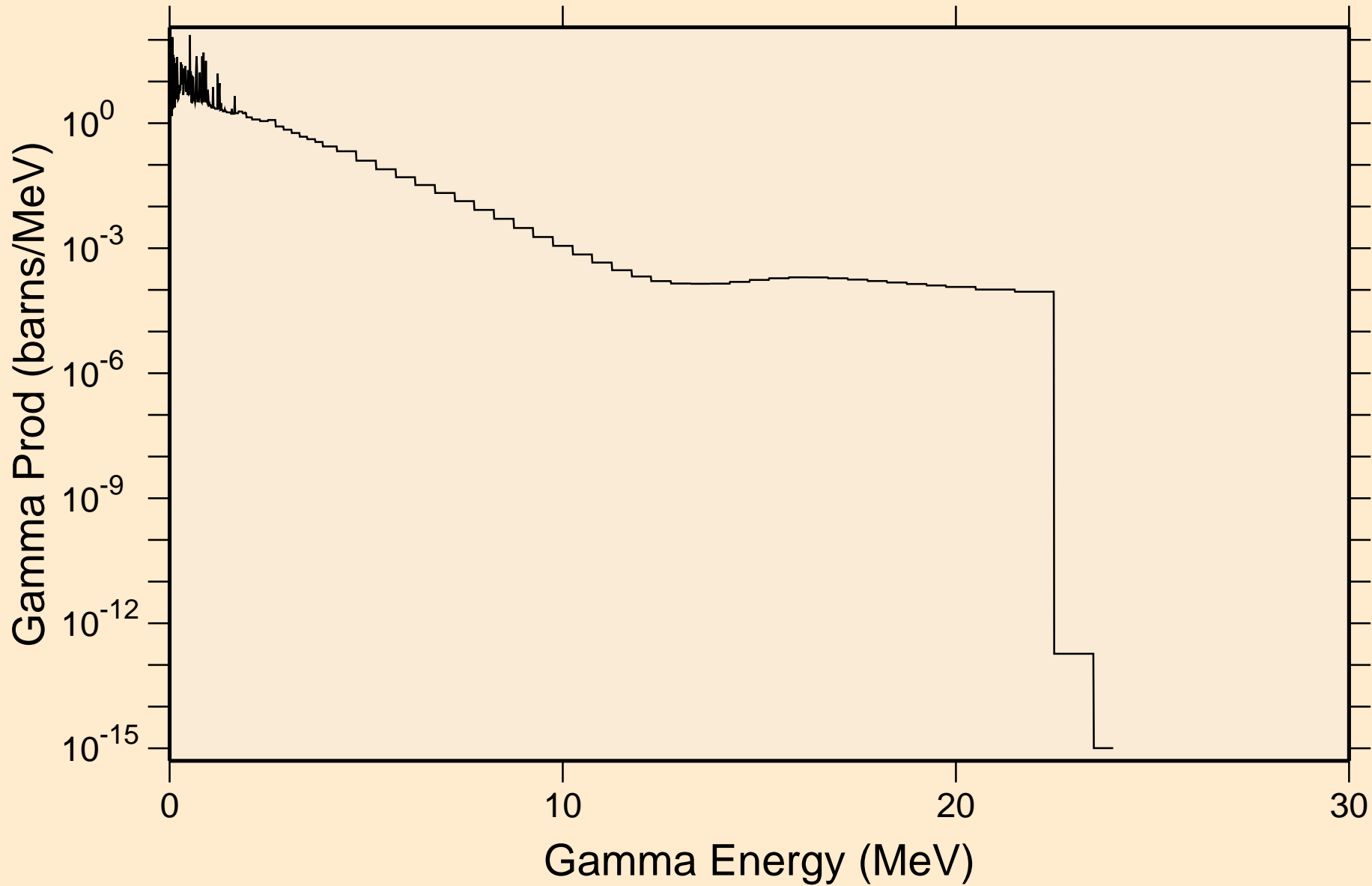

HO147 NEUTRON ACER TENDL-2024 LIBRARY; T=0.K

Particle heating contributions

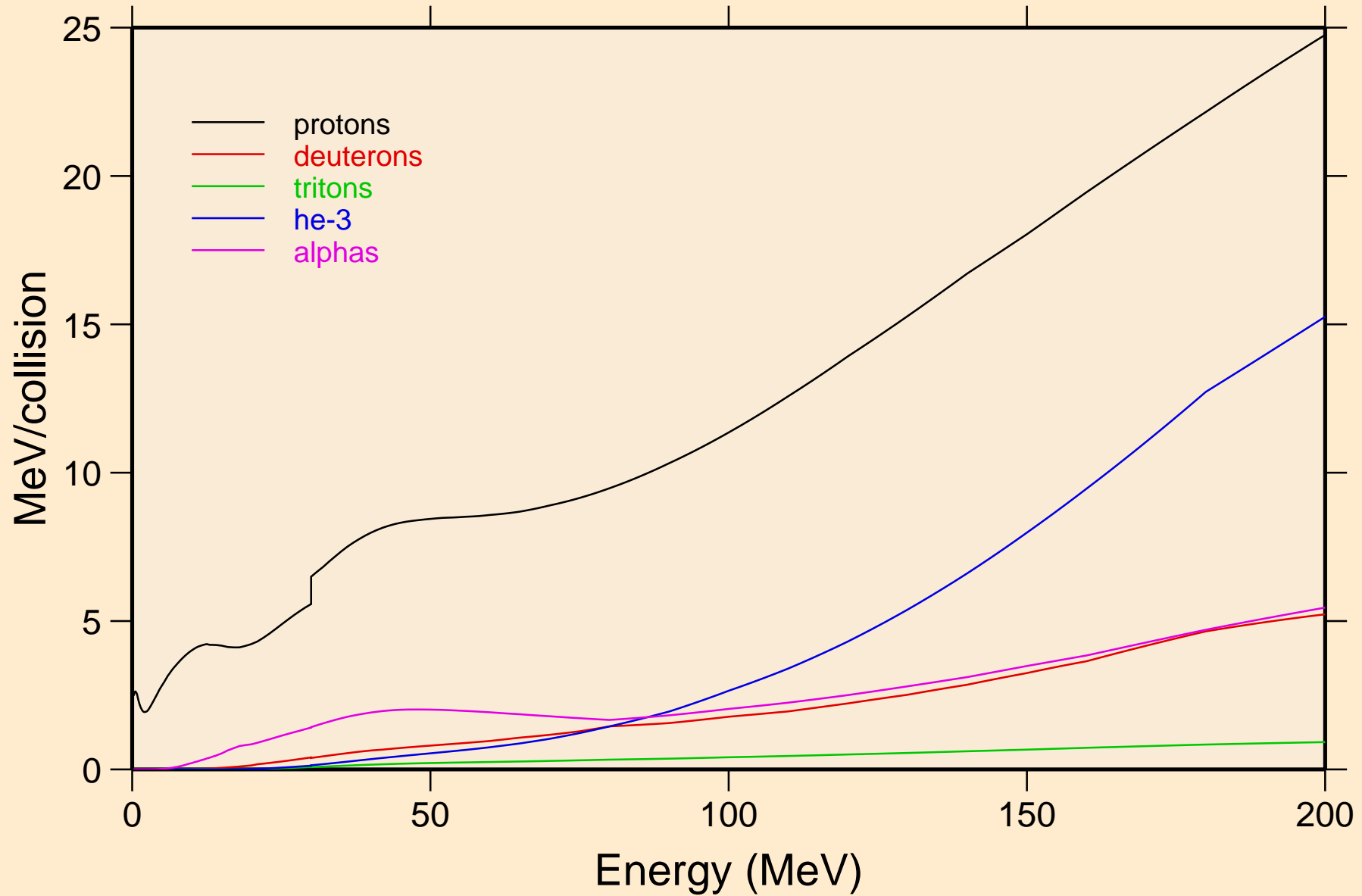

HO147 NEUTRON ACER TENDL-2024 LIBRARY; T=0.K

Recoil Heating

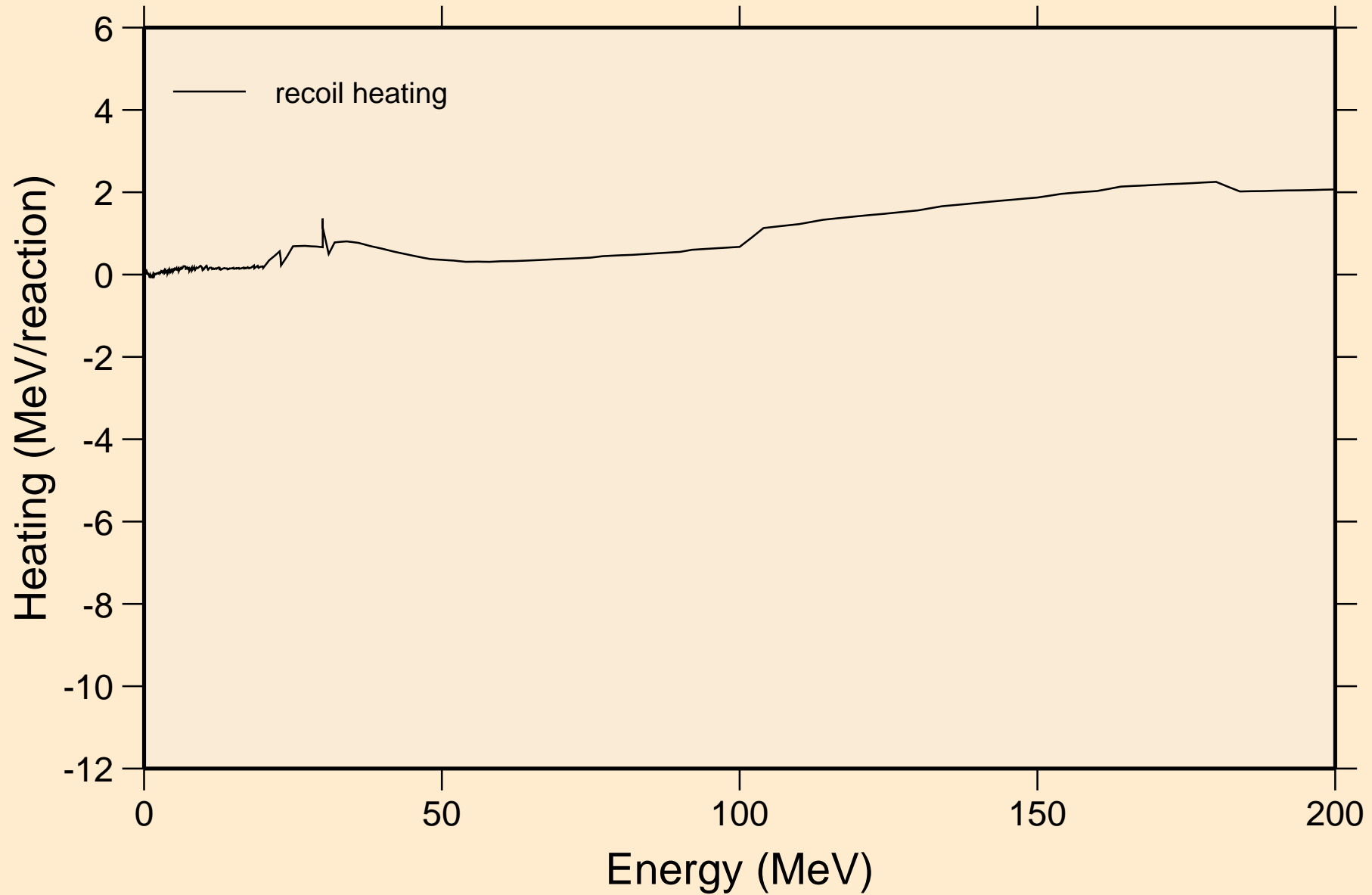

HO147 NEUTRON ACER TENDL-2024 LIBRARY; T=0.K

Particle production cross sections

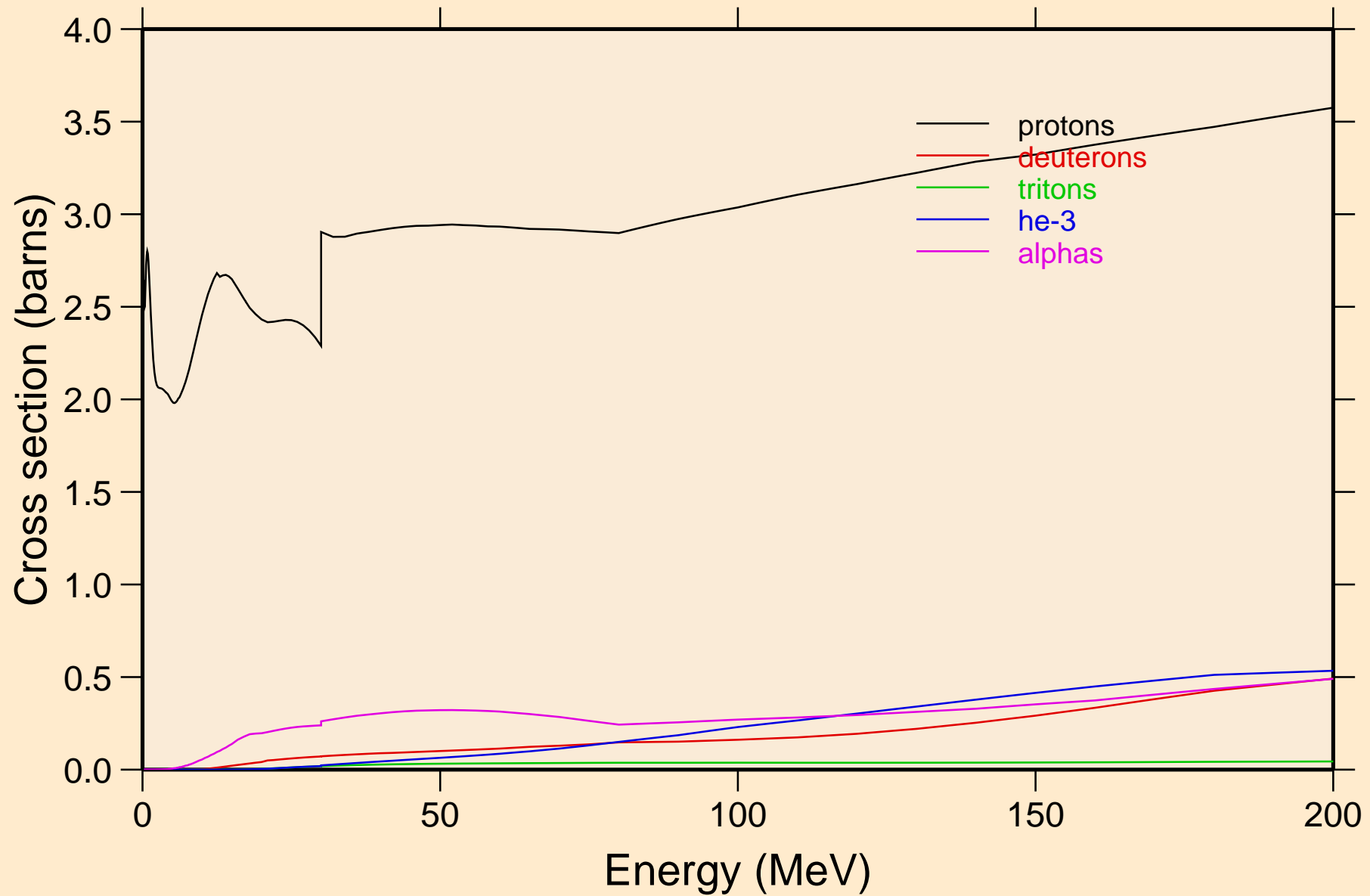

HO147 NEUTRON ACER TENDL-2024 LIBRARY; T=0.K
protons from (n,x)

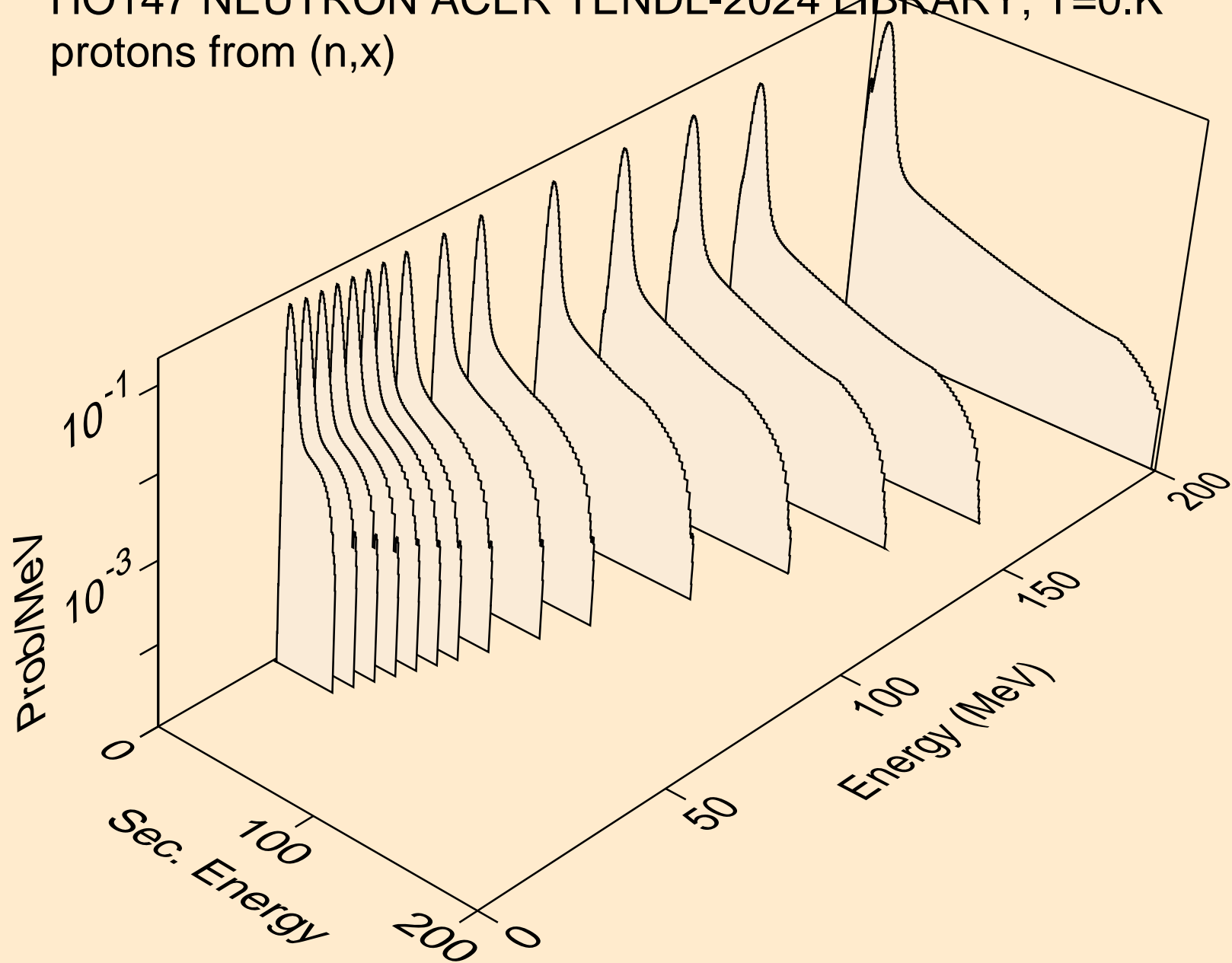

HO147 NEUTRON ACER TENDL-2024 LIBRARY; T=0.K
protons from (n,n*)p

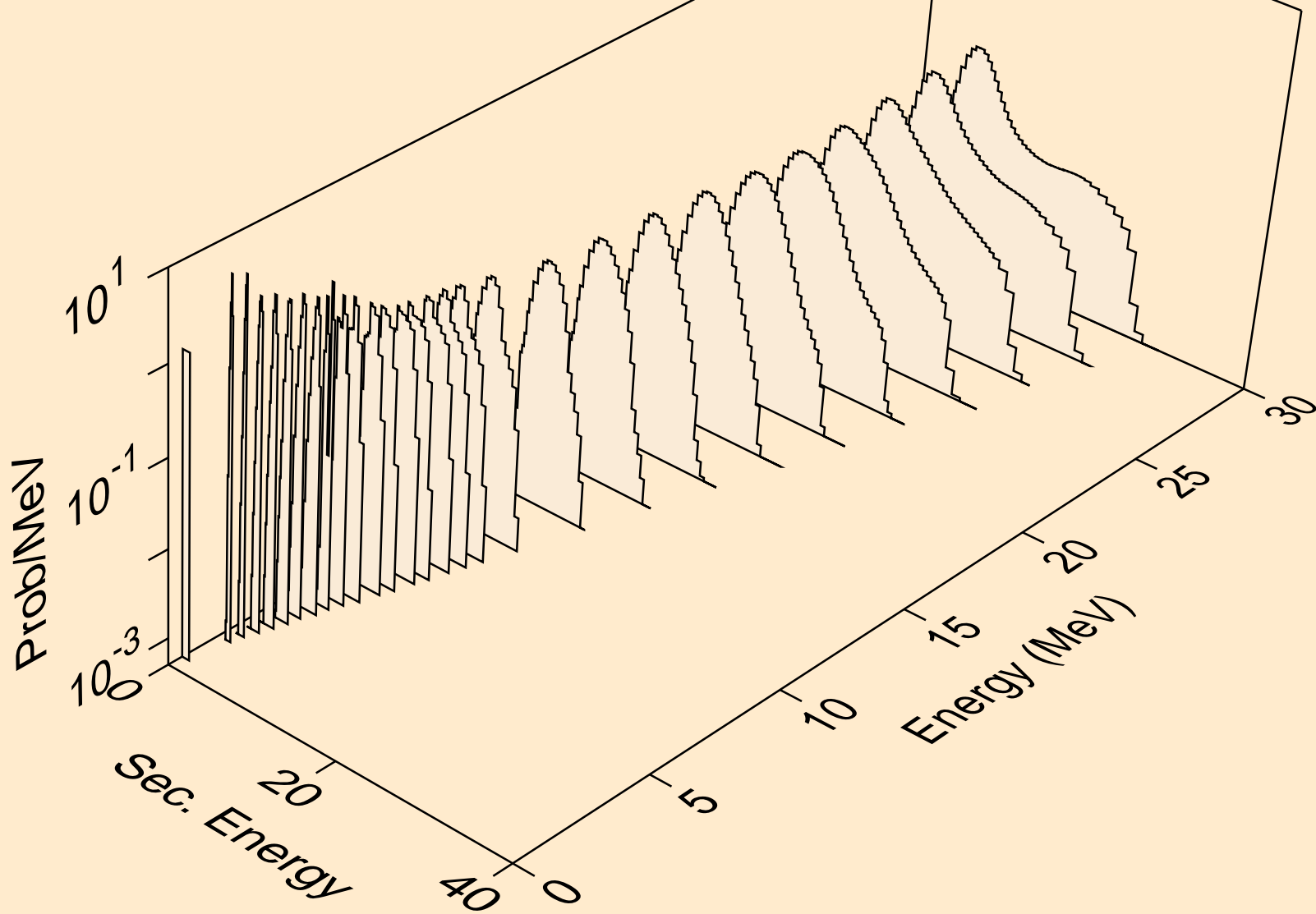

HO147 NEUTRON ACER TENDL-2024 LIBRARY; T=0.K
protons from (n,2np)

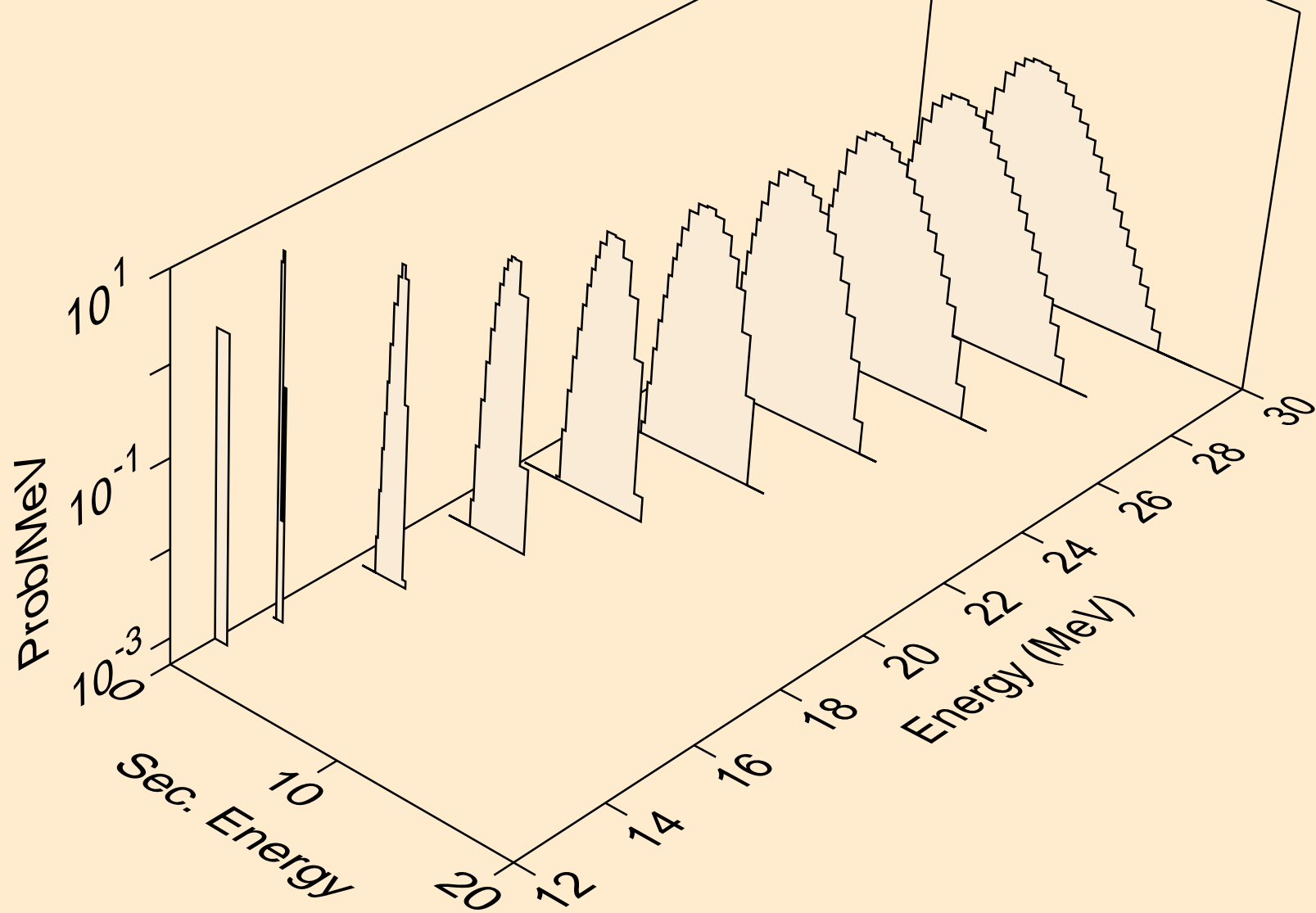

HO147 NEUTRON ACER TENDL-2024 LIBRARY; T=0.K
protons from (n,3np)

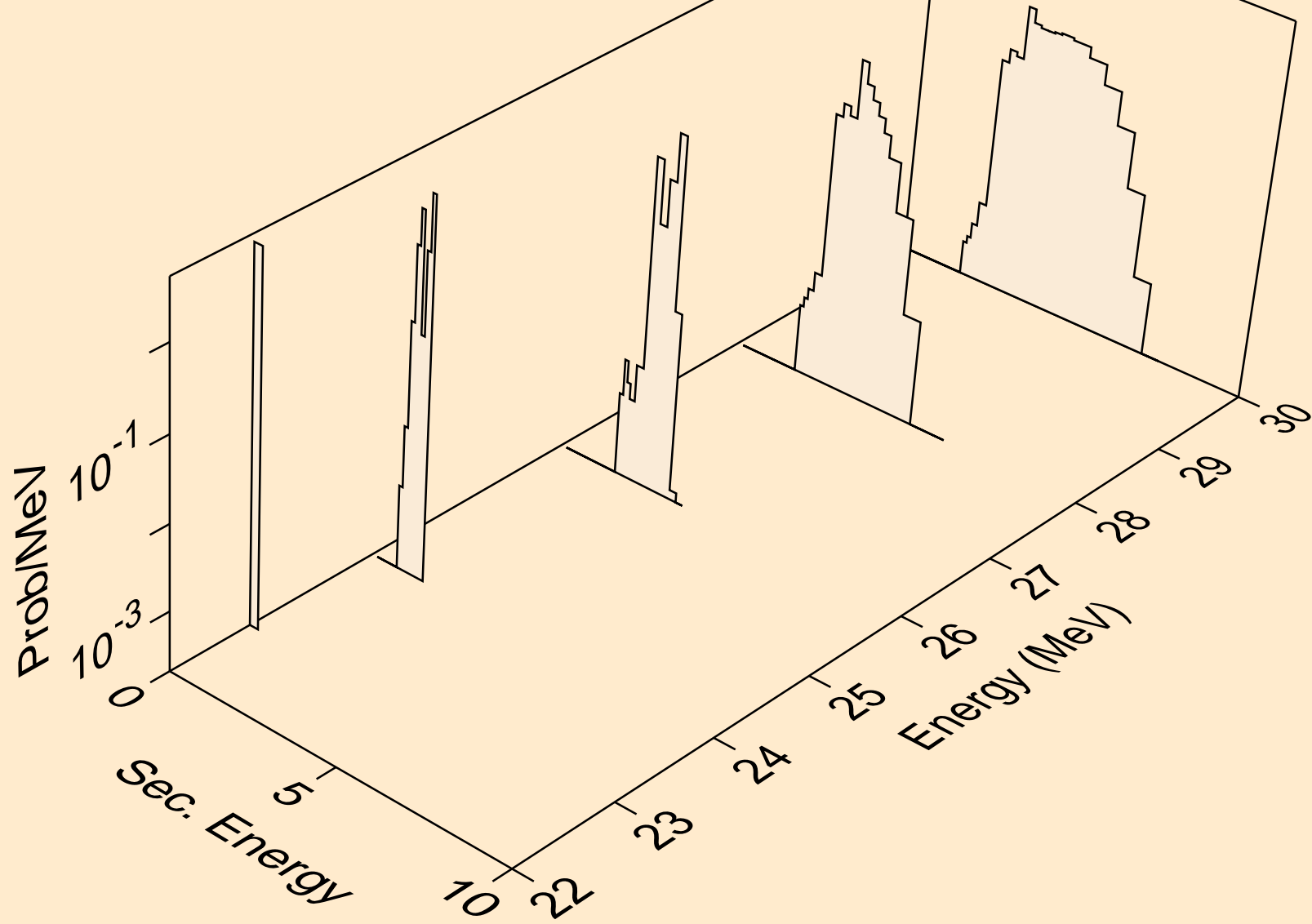

HO147 NEUTRON ACER TENDL-2024 LIBRARY; T=0.K
protons from (n,n2p)

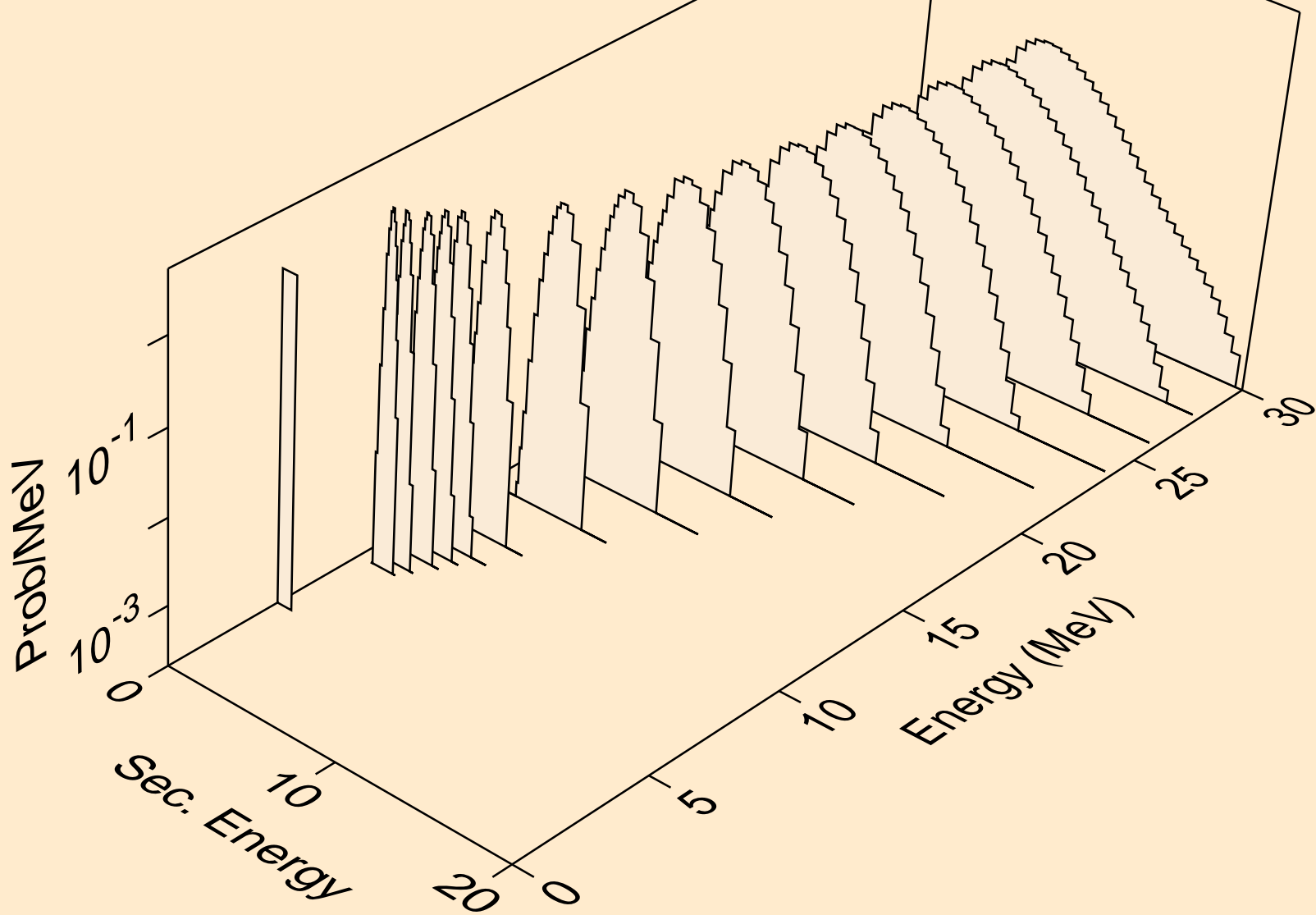

HO147 NEUTRON ACER TENDL-2024 LIBRARY; T=0.K
protons from (n,npa)

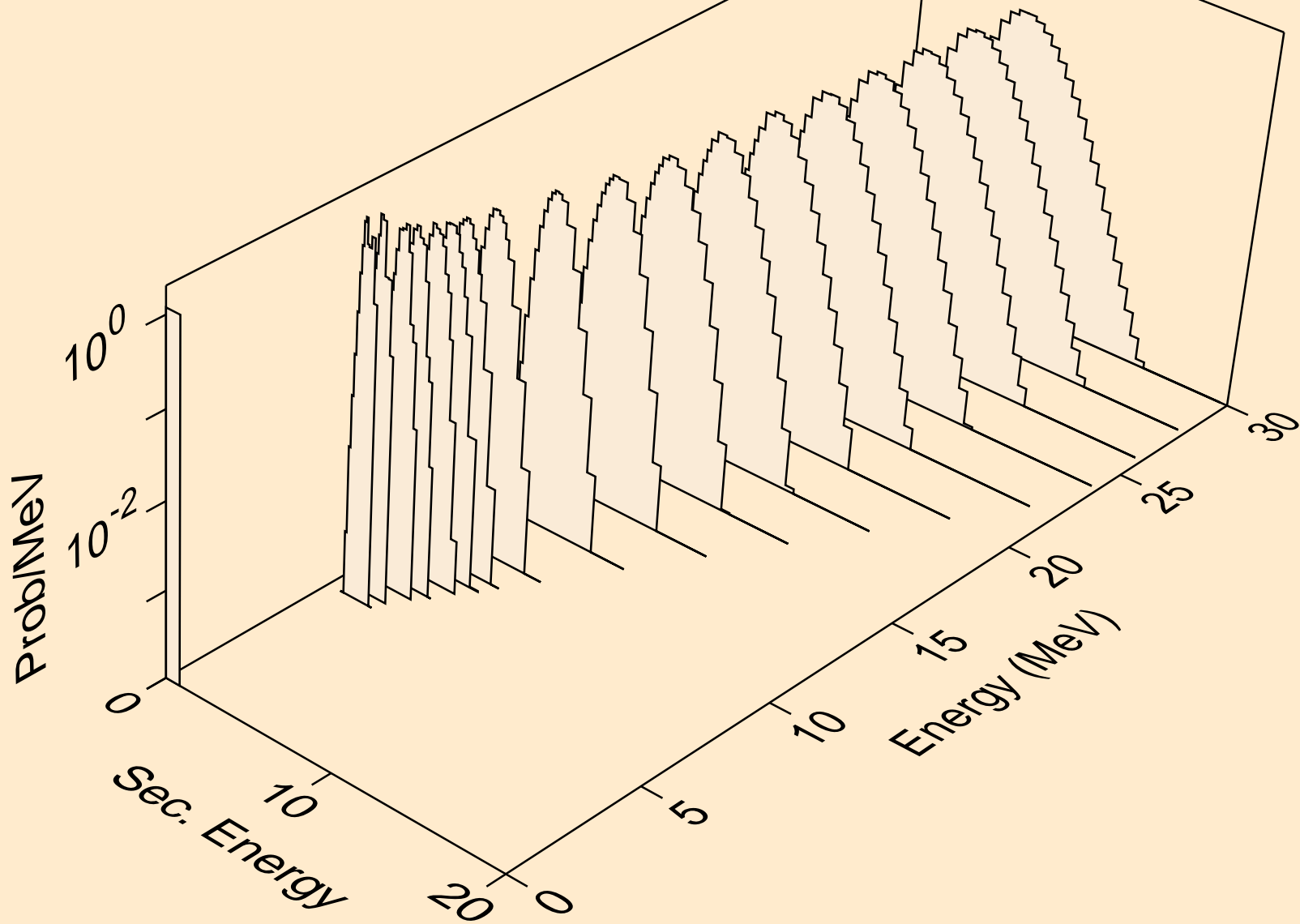

HO147 NEUTRON ACER TENDL-2024 LIBRARY; T=0.K
protons from (n,p)

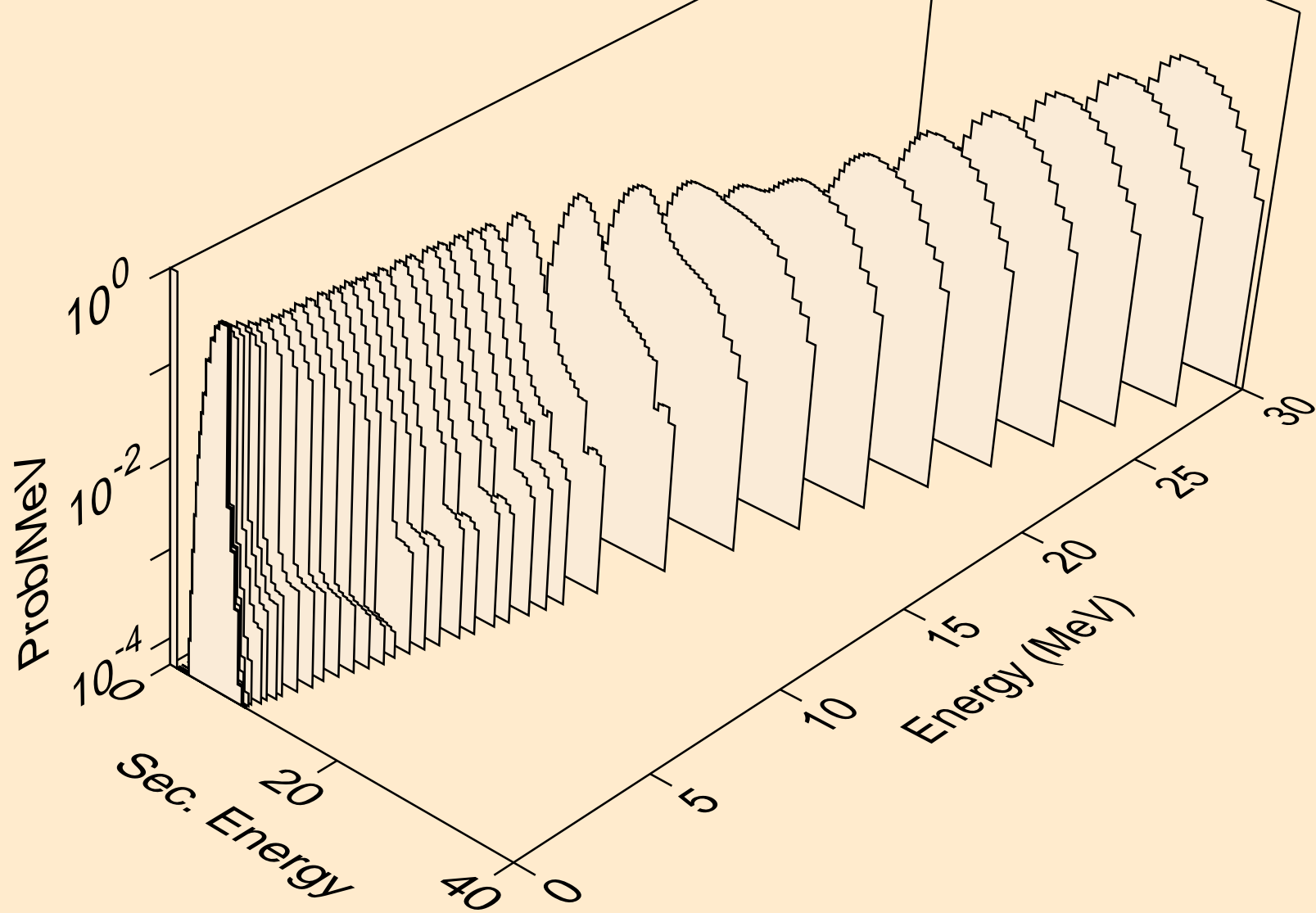

HO147 NEUTRON ACER TENDL-2024 LIBRARY; T=0.K
protons from (n,2p)

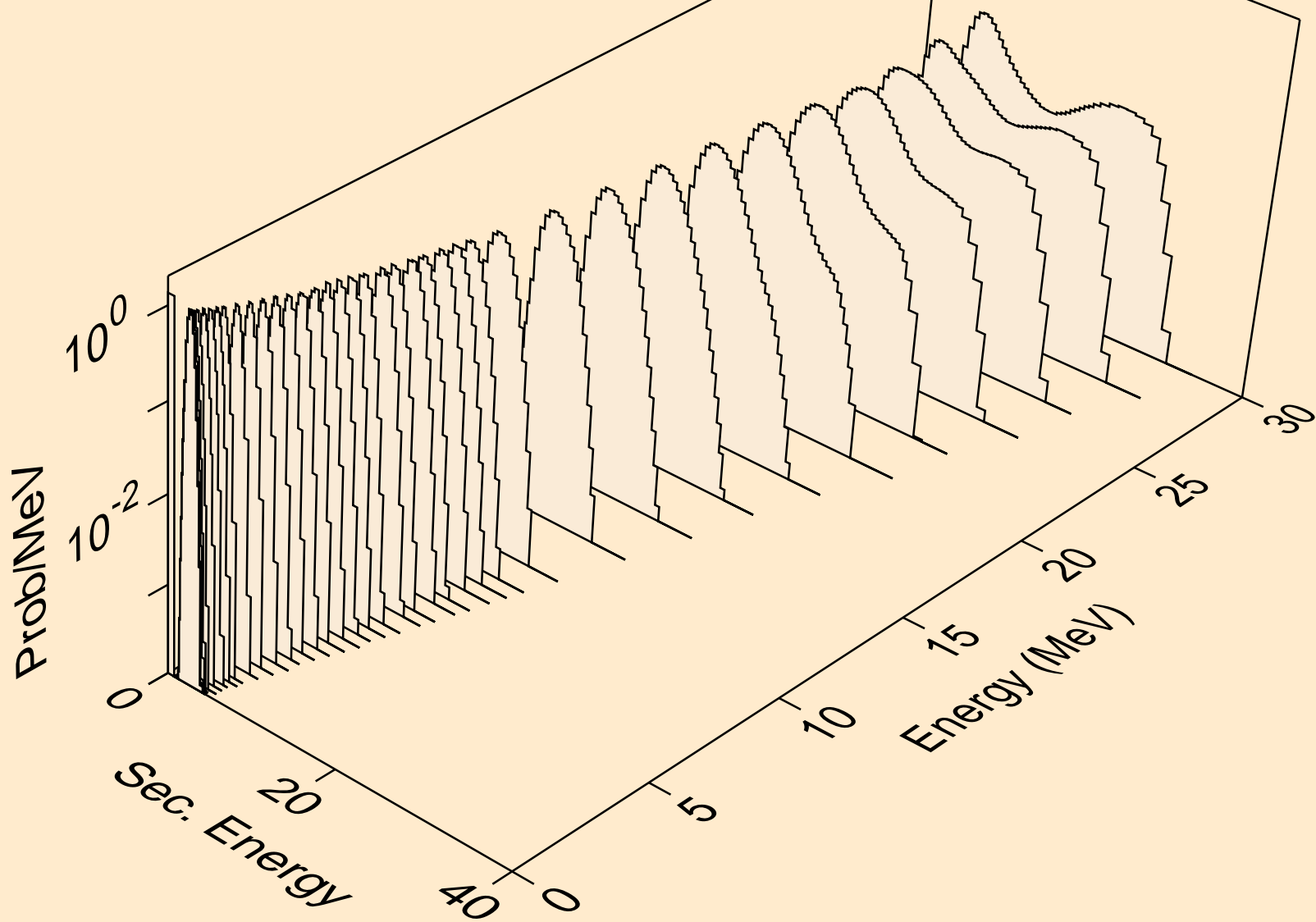

HO147 NEUTRON ACER TENDL-2024 LIBRARY; T=0.K
protons from (n,p)

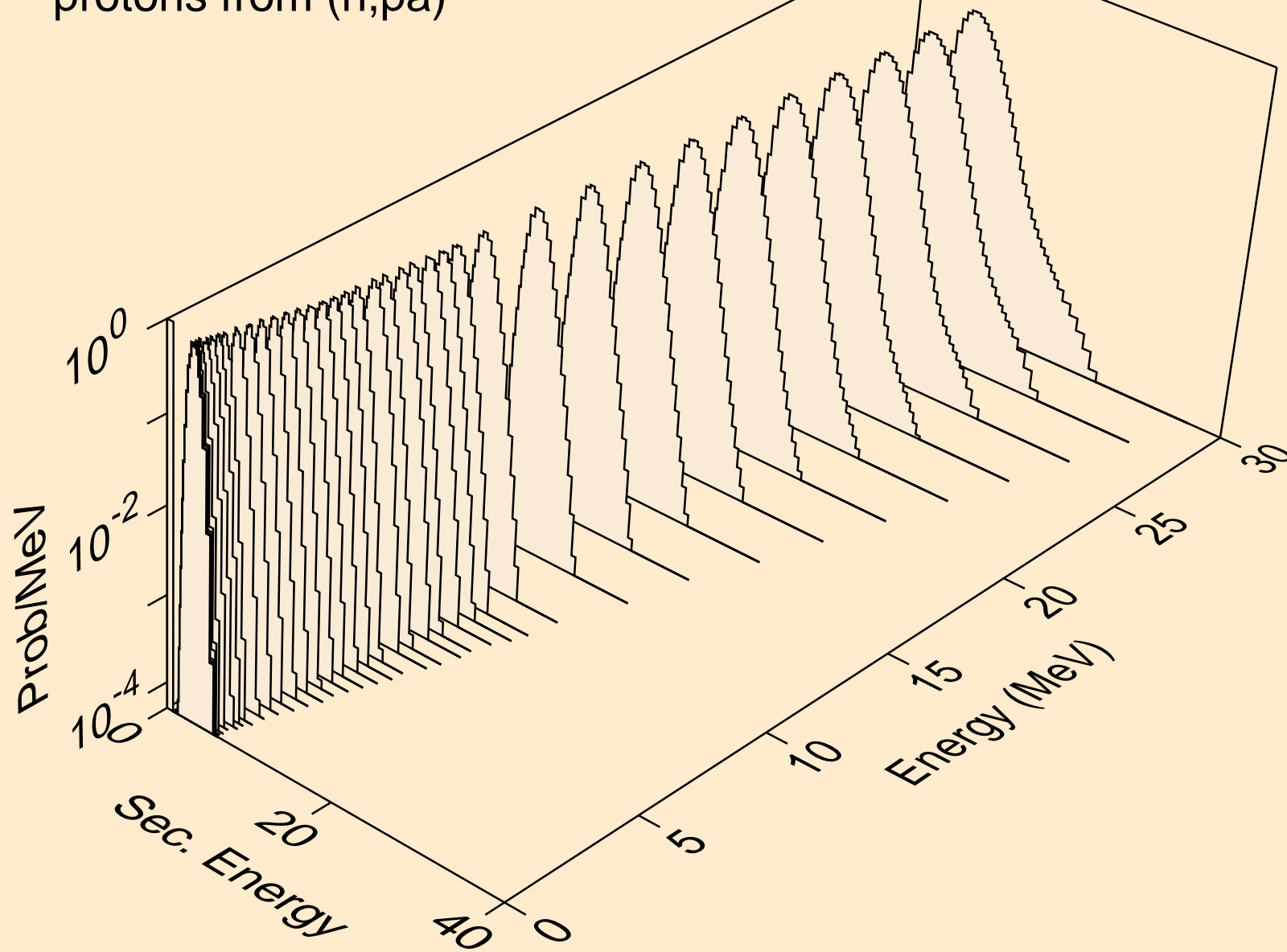

HO147 NEUTRON ACER TENDL-2024 LIBRARY; T=0.K
protons from (n,pd)

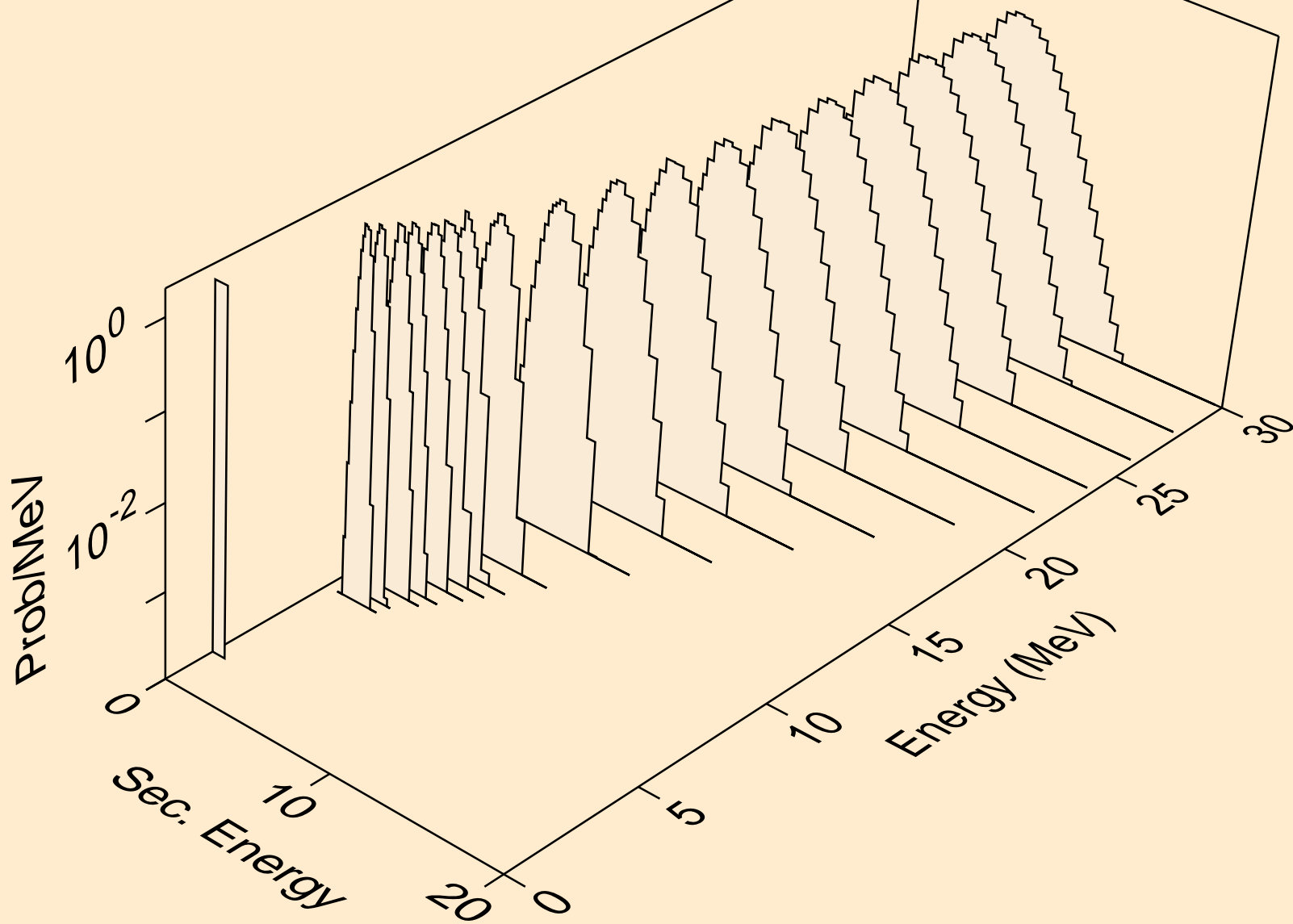

HO147 NEUTRON ACER TENDL-2024 LIBRARY; T=0.K
protons from (n,pt)

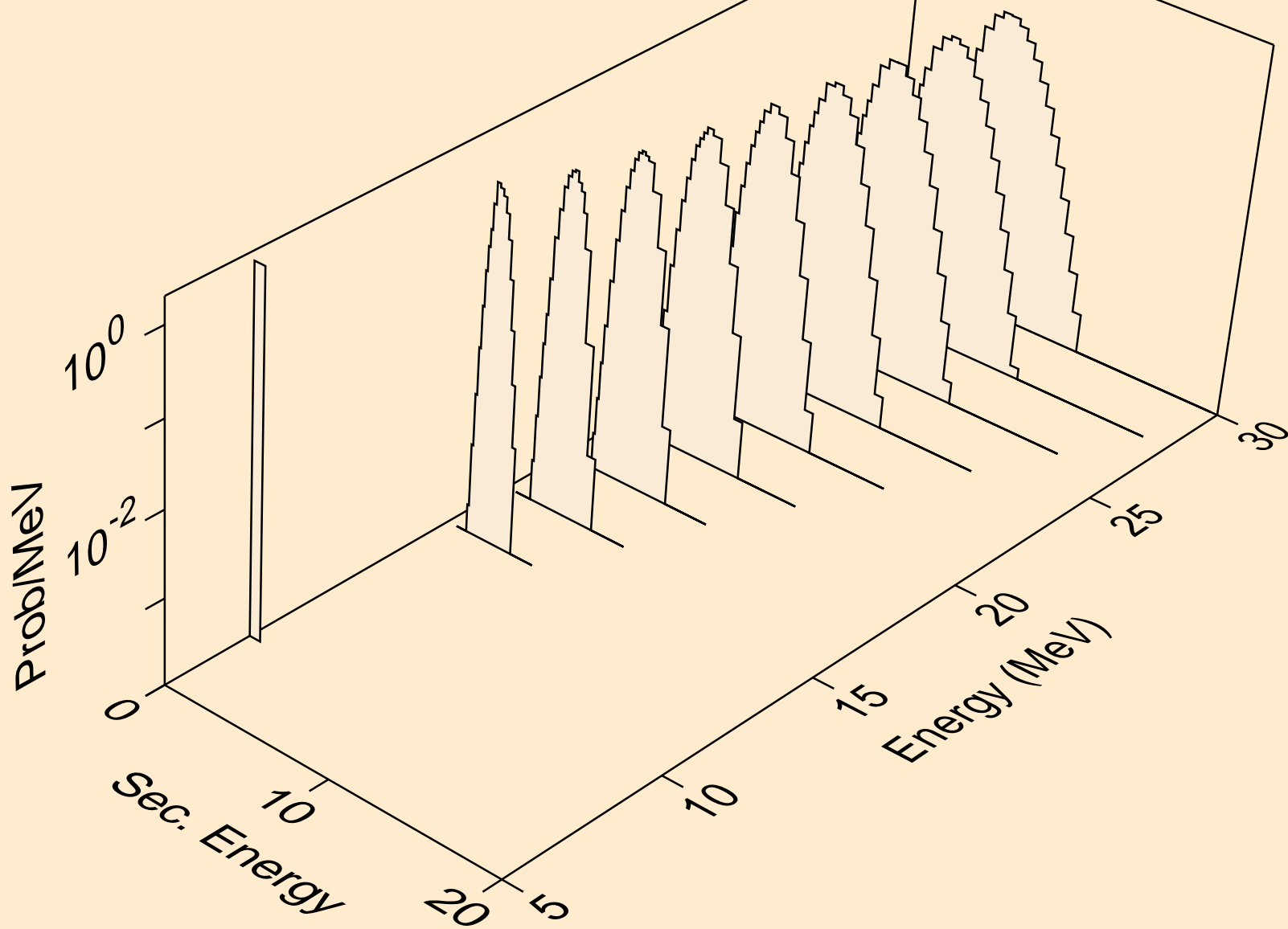

HO147 NEUTRON ACER TENDL-2024 LIBRARY; T=0.K
deuterons from (n,x)

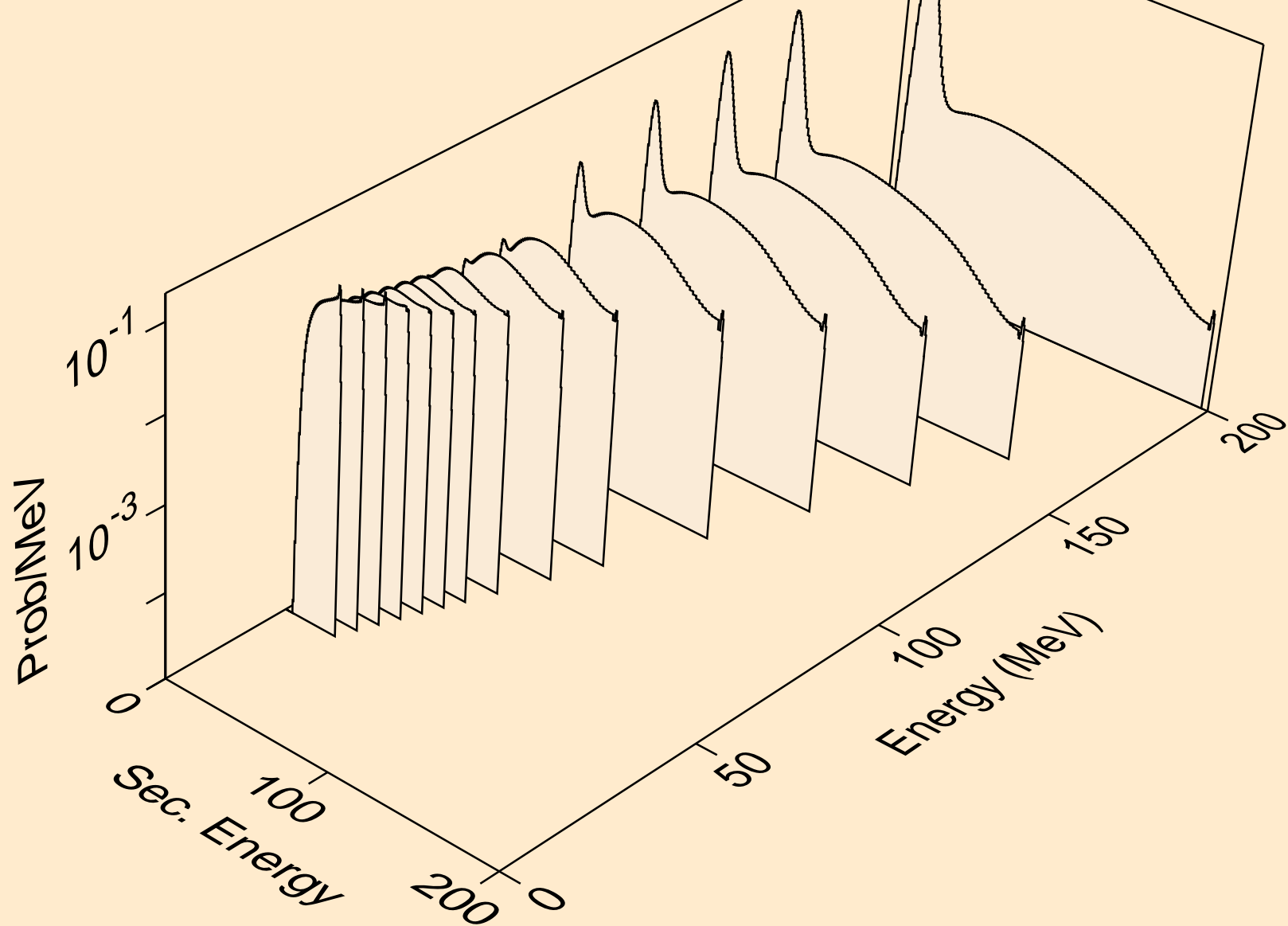

HO147 NEUTRON ACER TENDL-2024 LIBRARY; T=0.K
deuterons from (n,2nd)

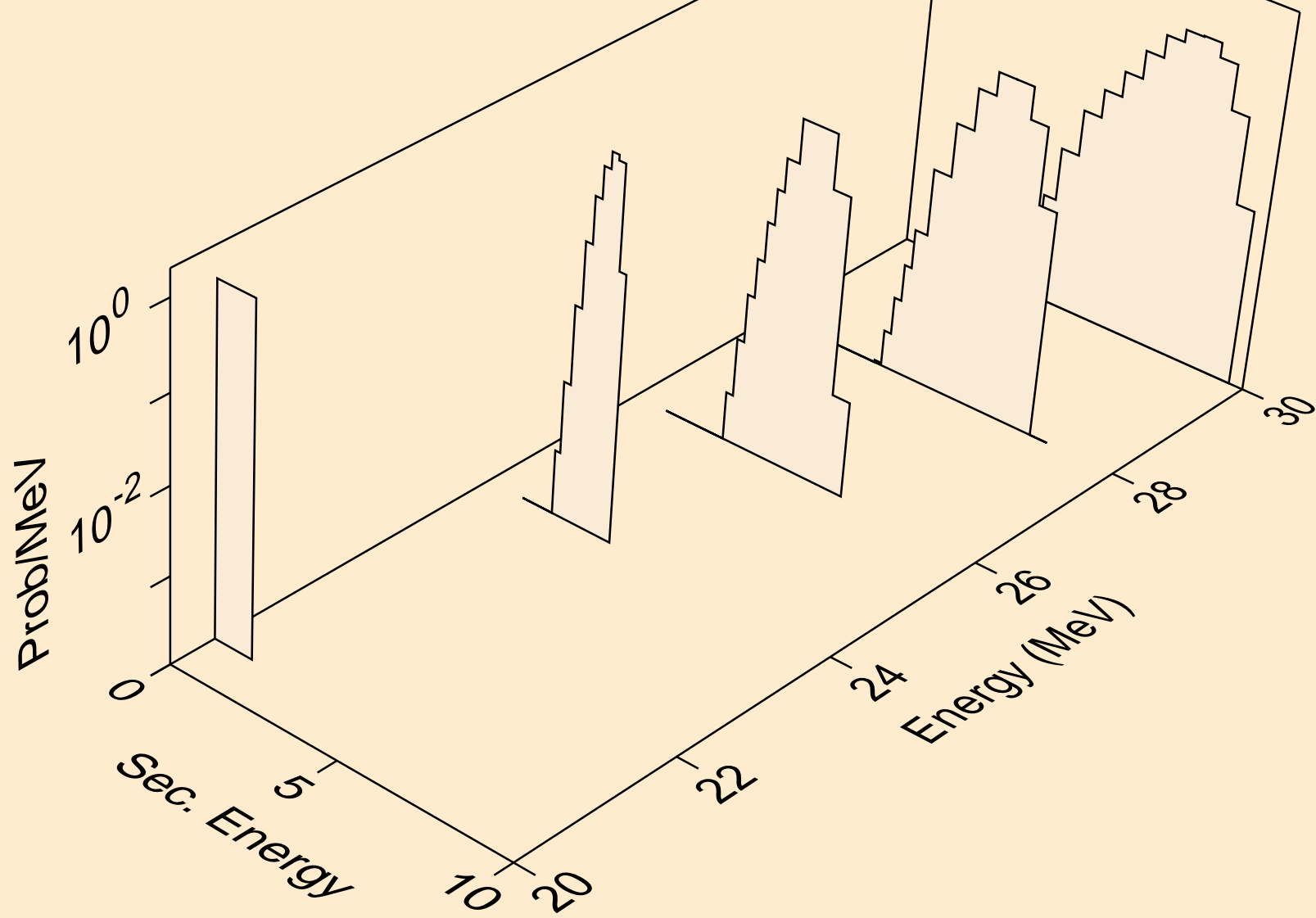

HO147 NEUTRON ACER TENDL-2024 LIBRARY; T=0.K
deuterons from (n,n*)d

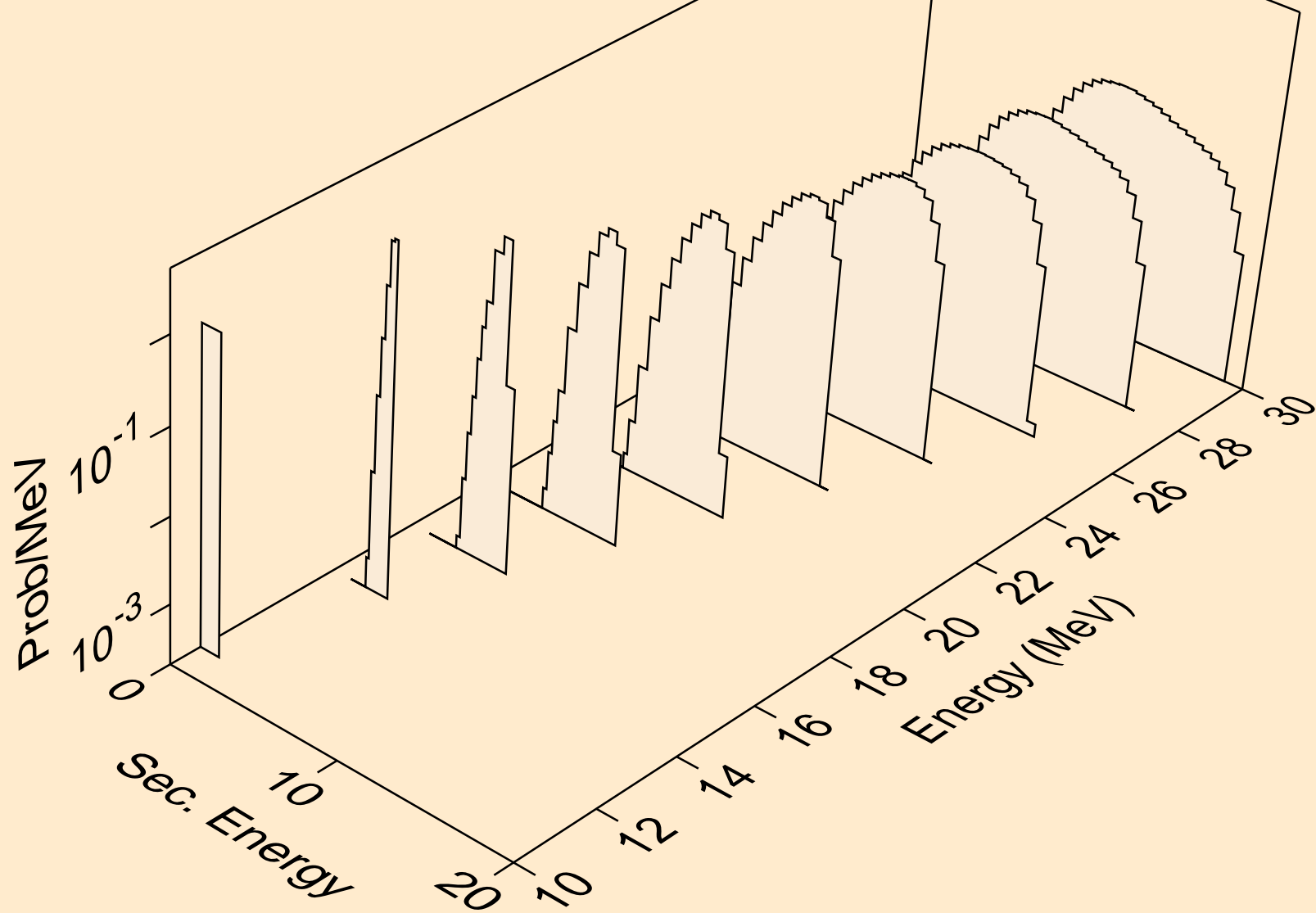

HO147 NEUTRON ACER TENDL-2024 LIBRARY; T=0.K
deuterons from (n,d)

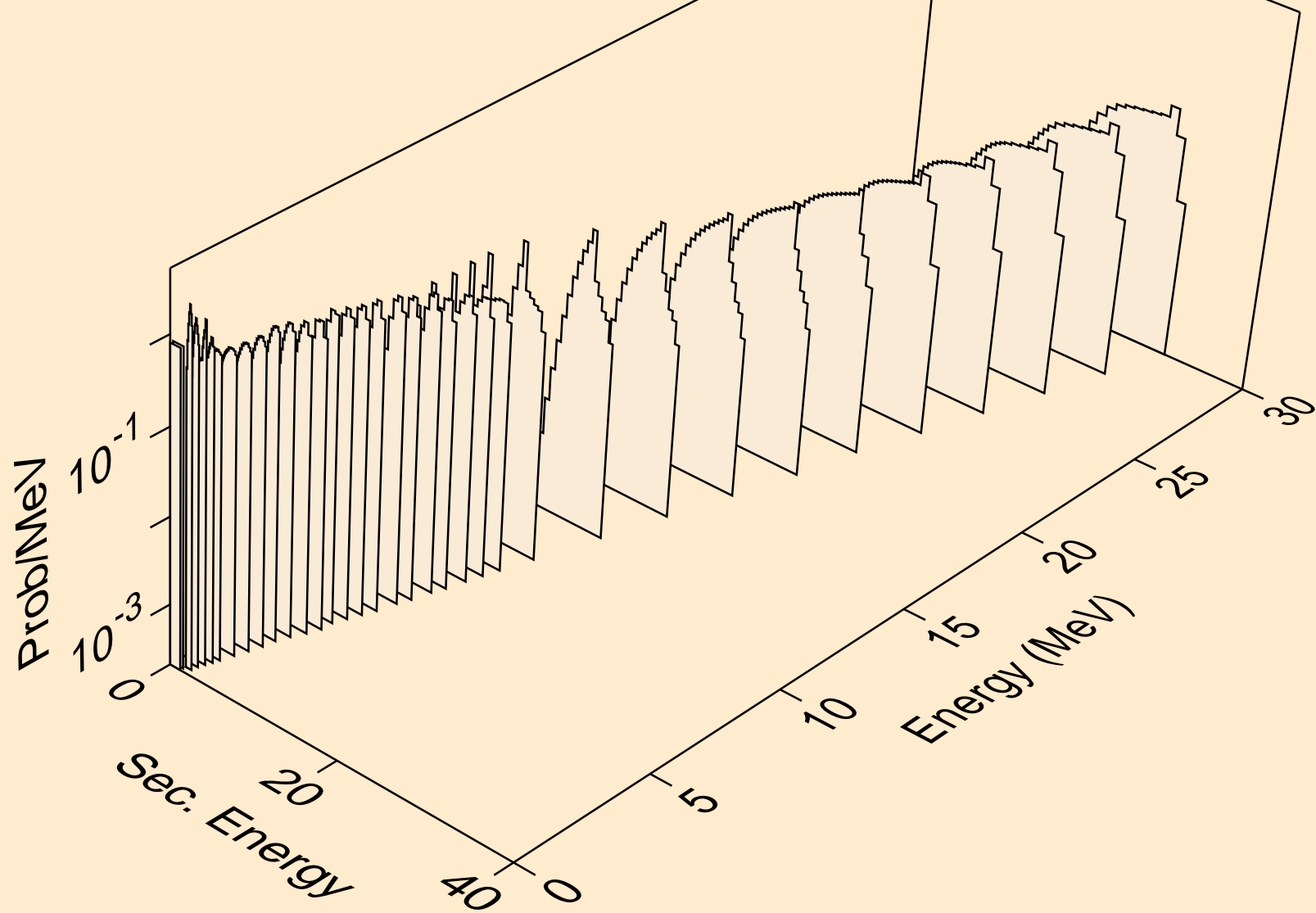

HO147 NEUTRON ACER TENDL-2024 LIBRARY; T=0.K
deuterons from (n,pd)

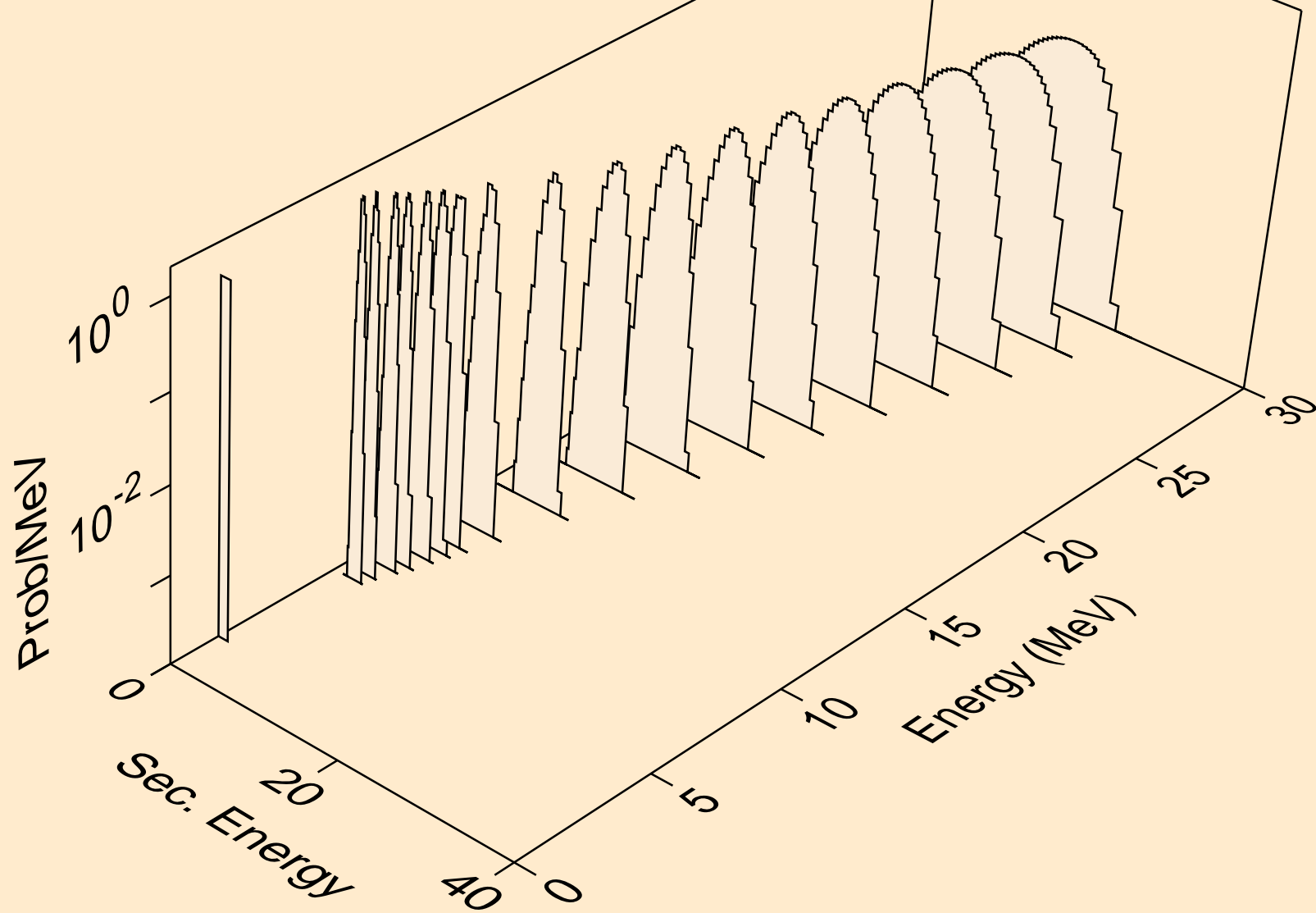

HO147 NEUTRON ACER TENDL-2024 LIBRARY; T=0.K
deuterons from (n,da)

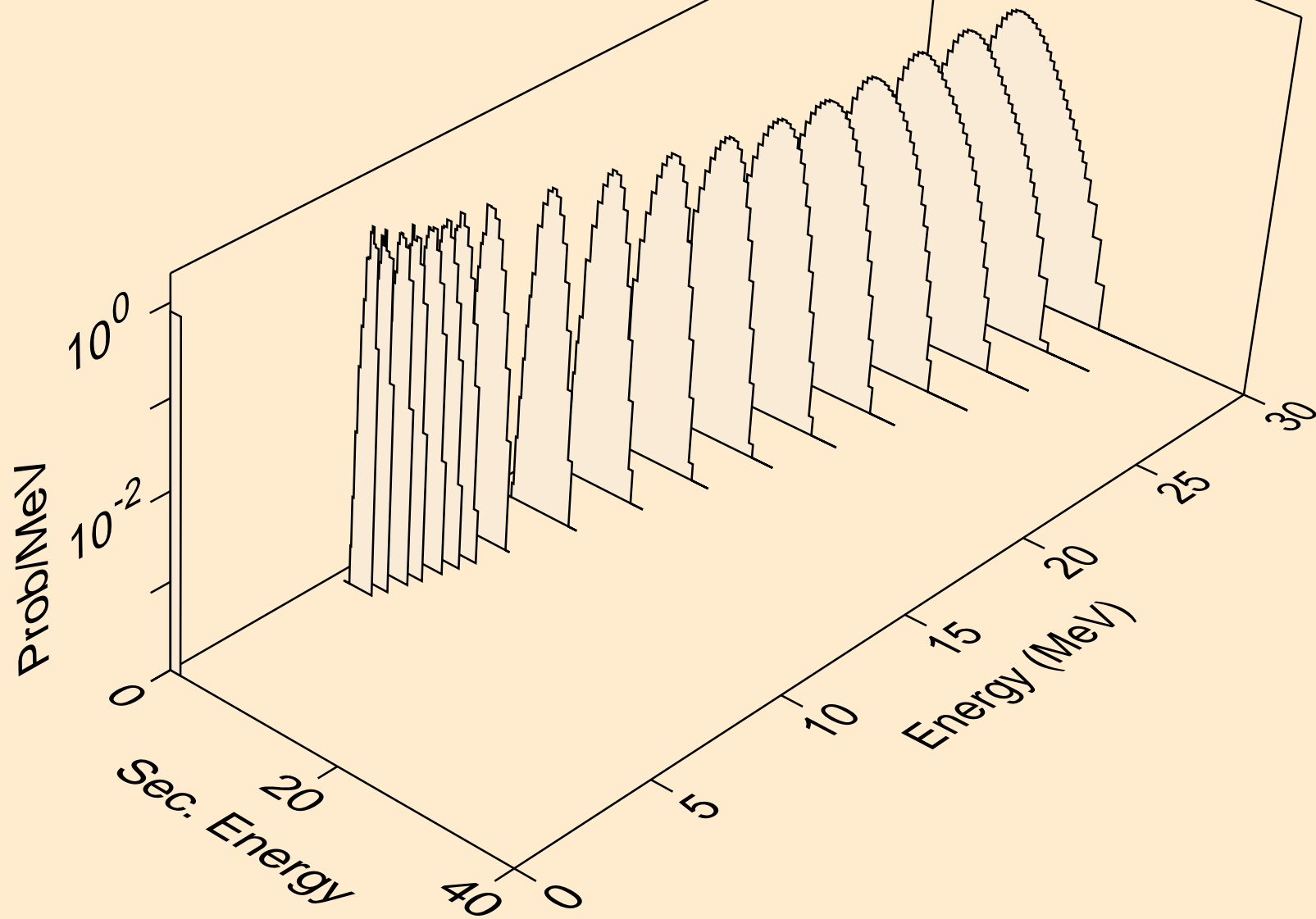

HO147 NEUTRON ACER TENDL-2024 LIBRARY; T=0.K
tritons from (n,x)

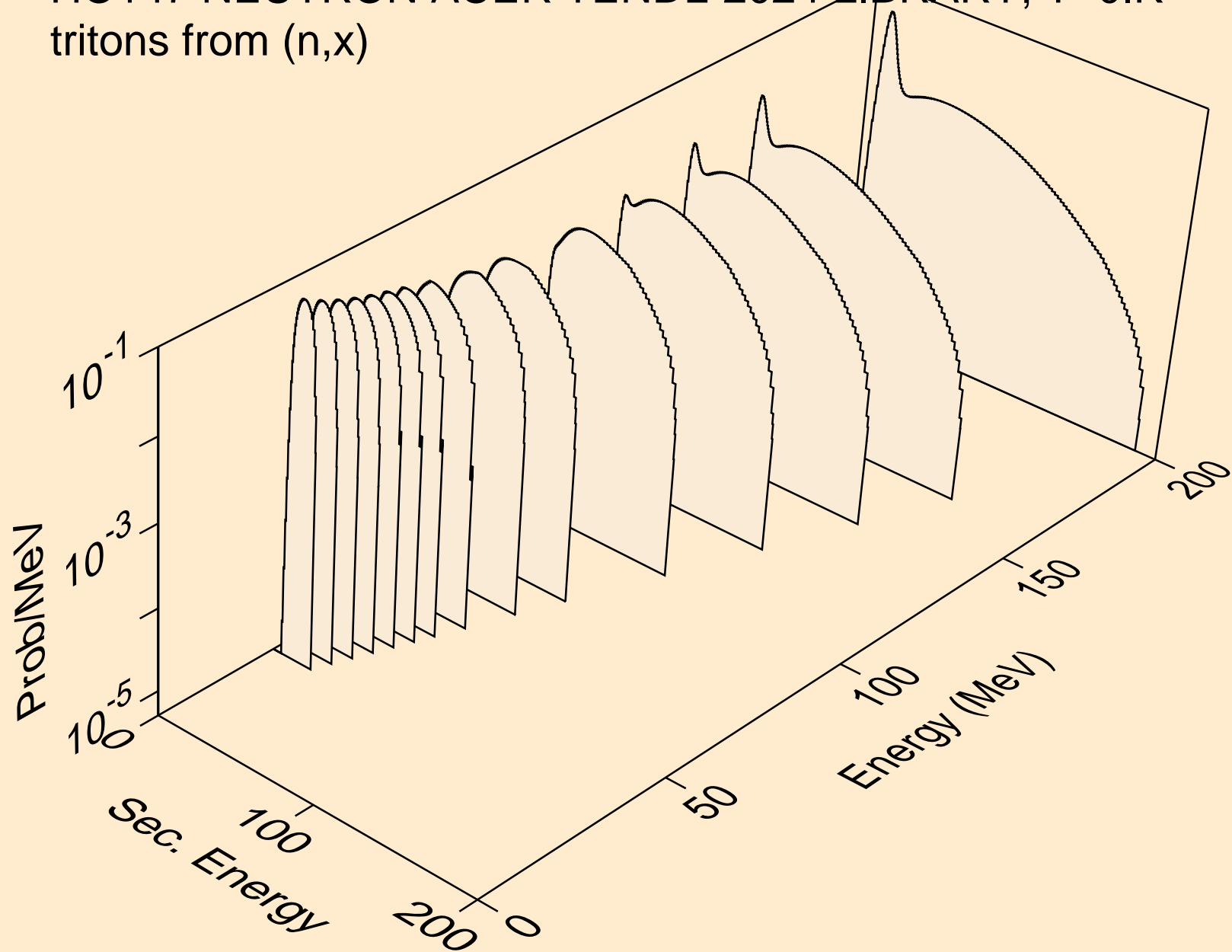

HO147 NEUTRON ACER TENDL-2024 LIBRARY; T=0.K
tritons from (n,n*)t

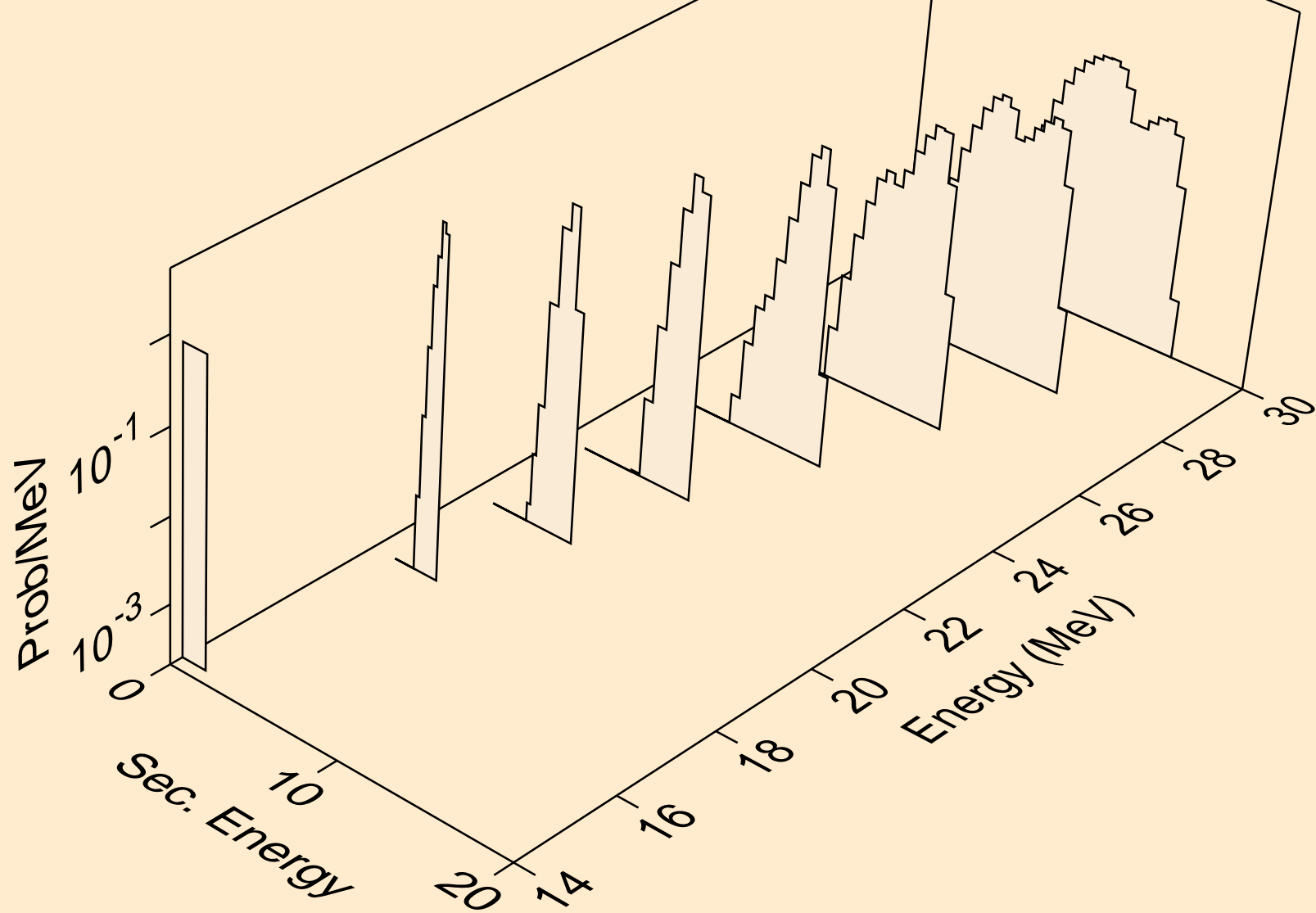

HO147 NEUTRON ACER TENDL-2024 LIBRARY; T=0.K
tritons from (n,t)

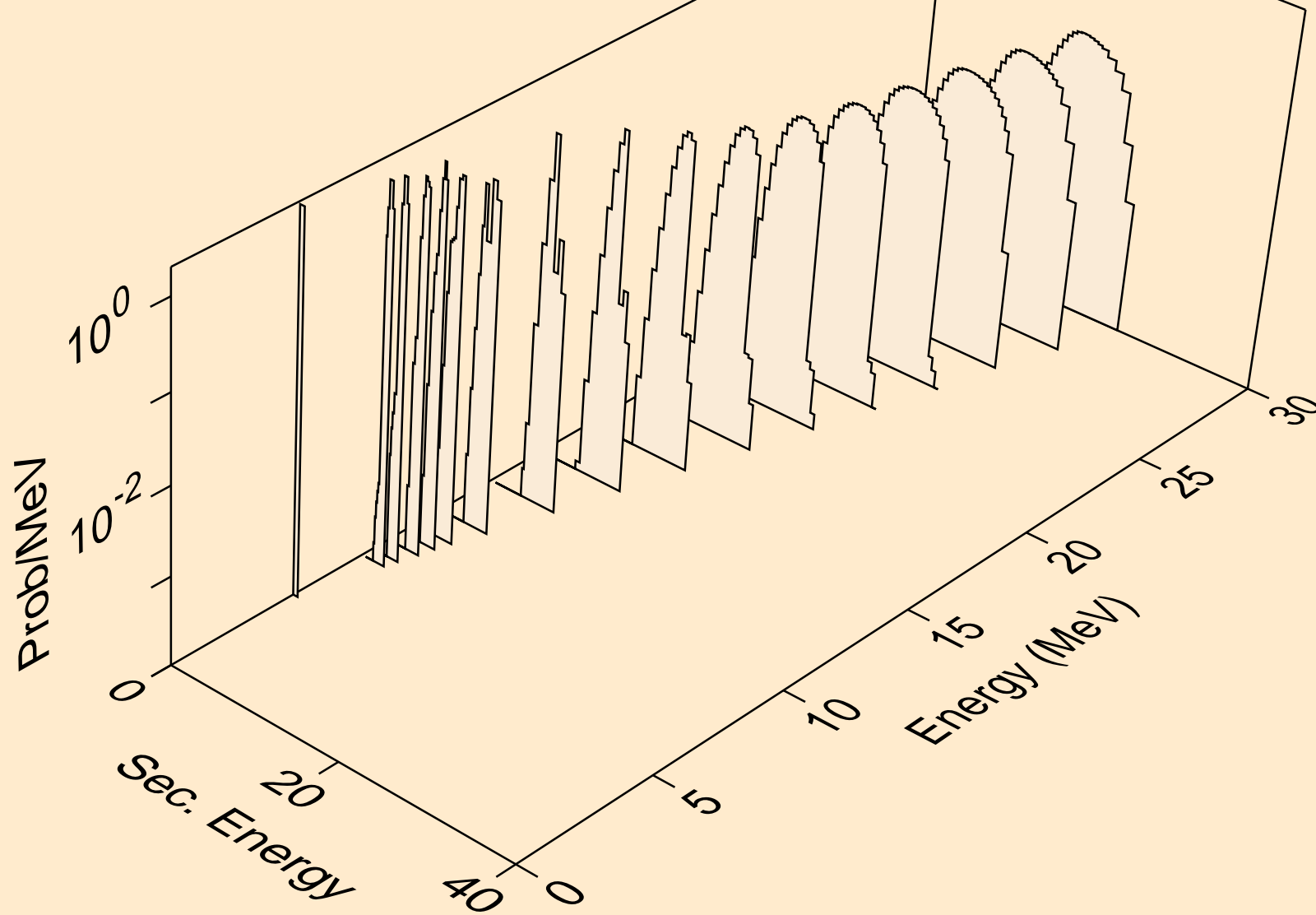

HO147 NEUTRON ACER TENDL-2024 LIBRARY; T=0.K
tritons from (n,pt)

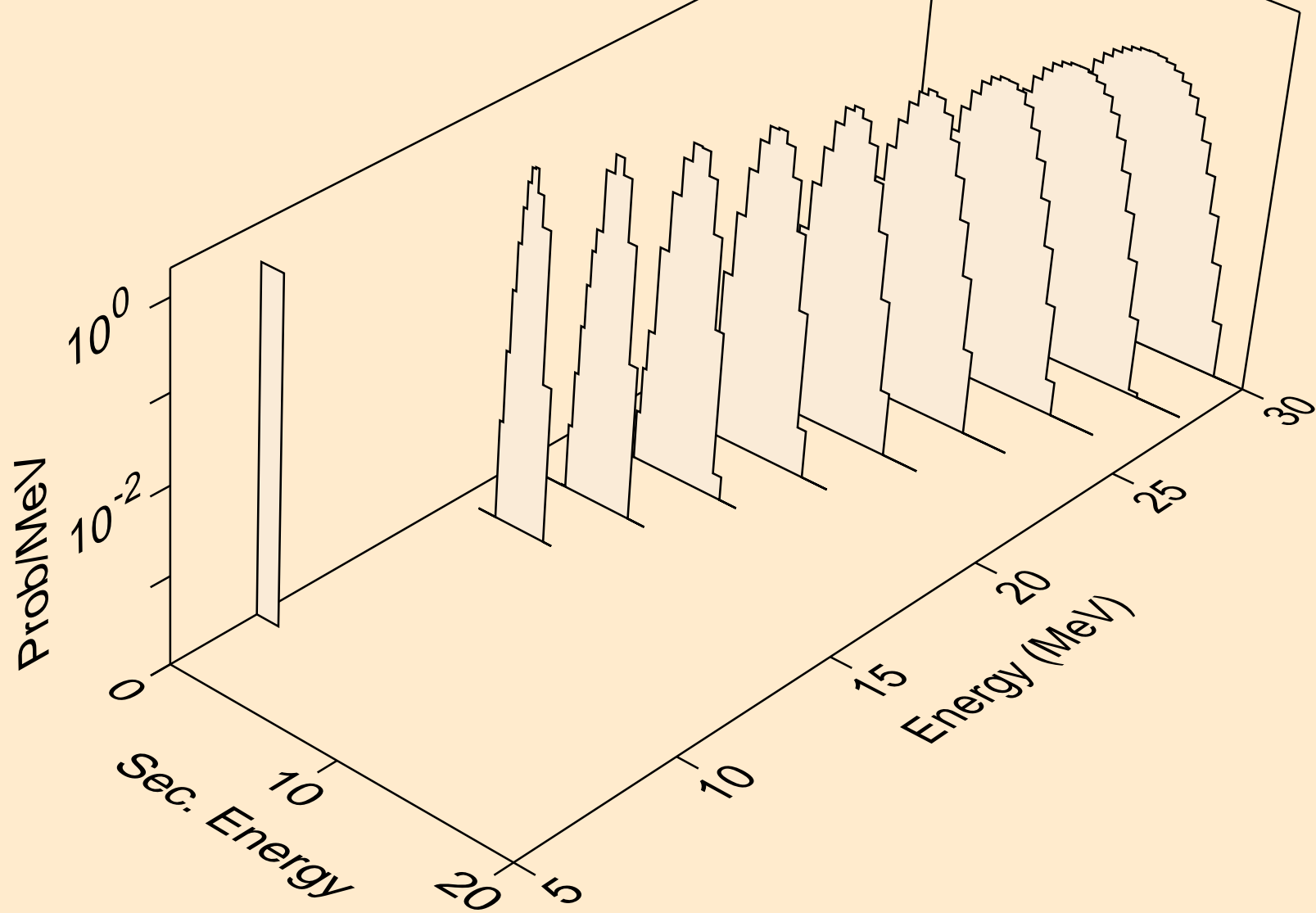

HO147 NEUTRON ACER TENDL-2024 LIBRARY; T=0.K
he3s from (n,x)

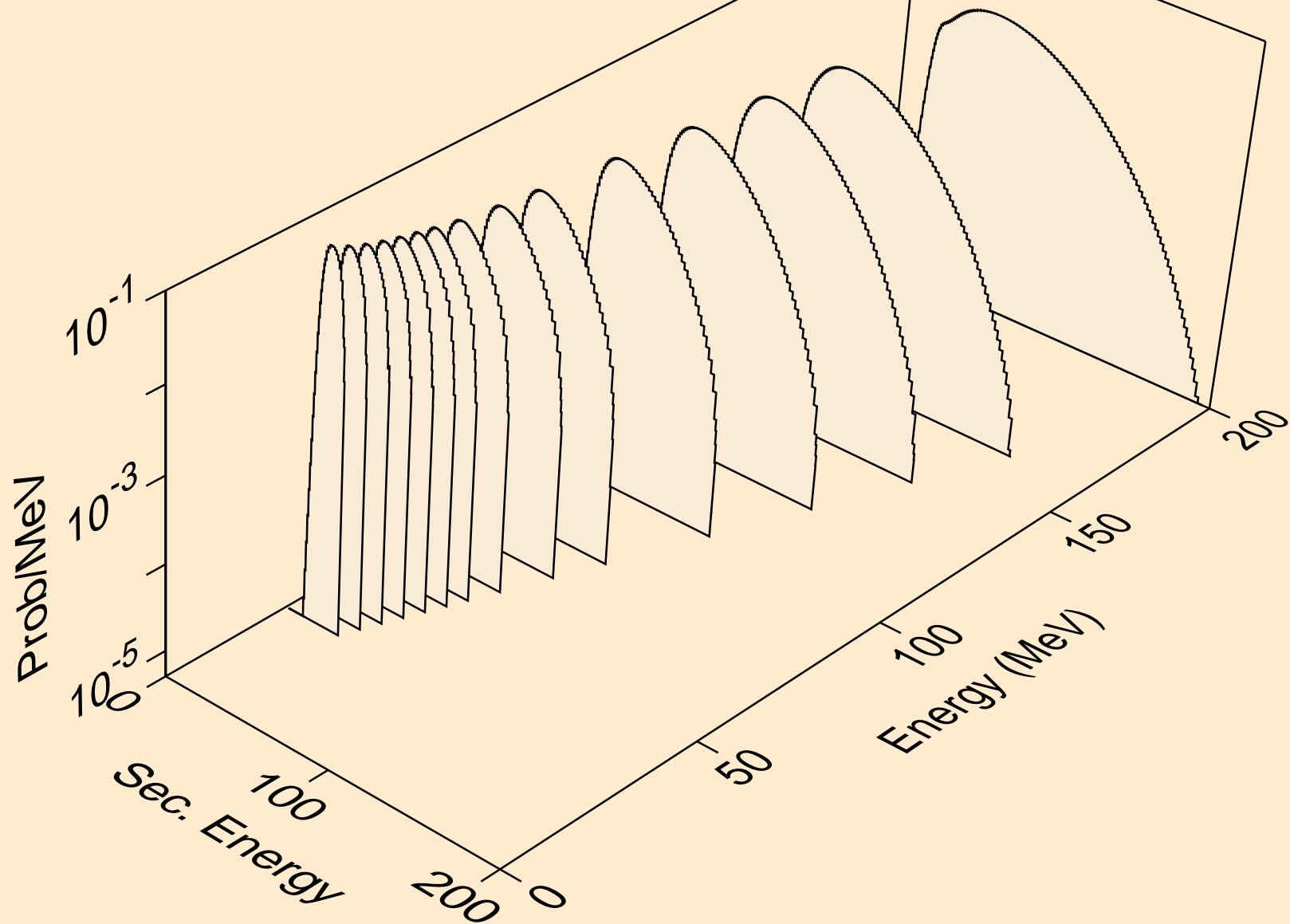

HO147 NEUTRON ACER TENDL-2024 LIBRARY; T=0.K
he3s from (n,n*)he3

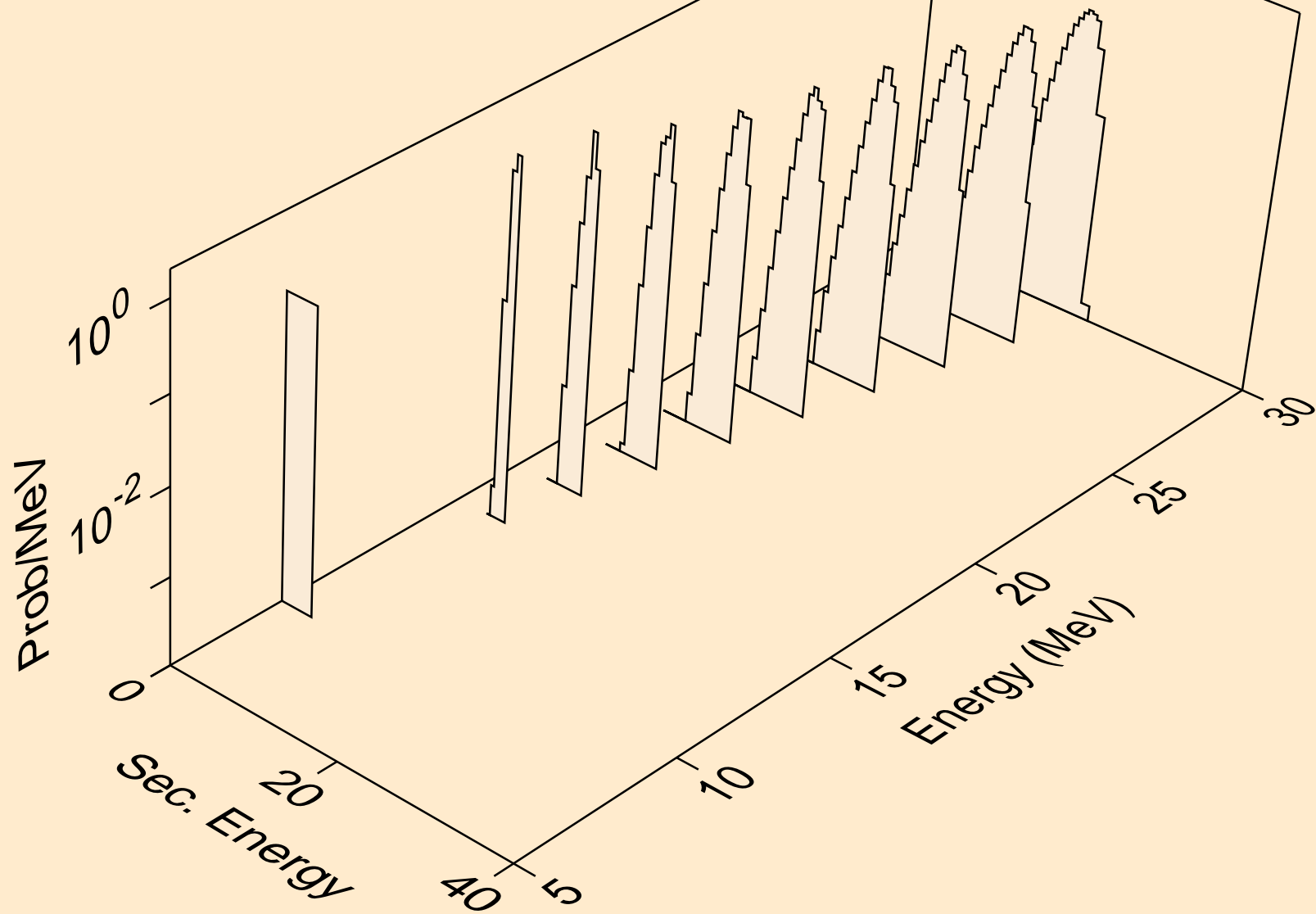

HO147 NEUTRON ACER TENDL-2024 LIBRARY; T=0.K
he3s from (n,he3)

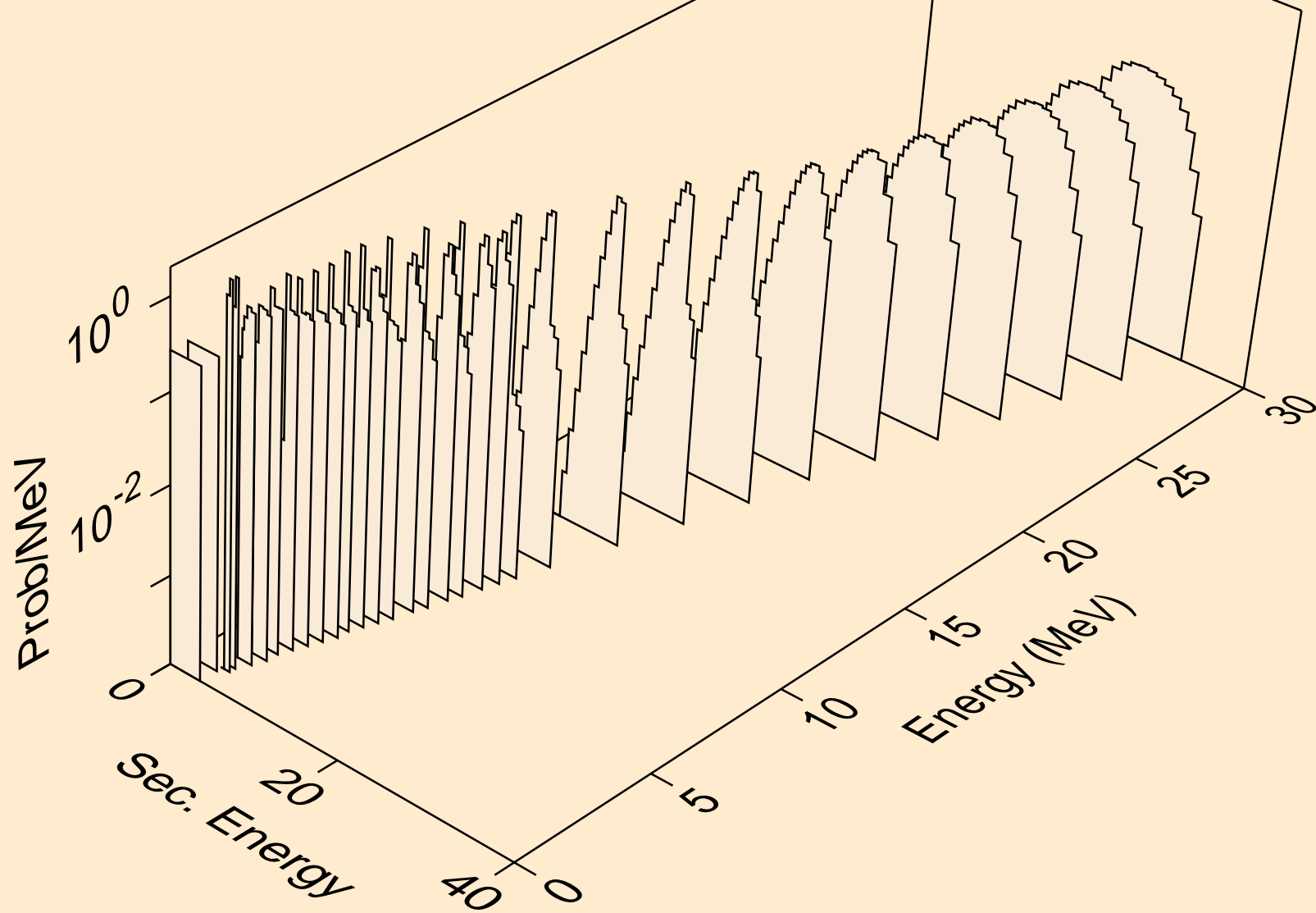

HO147 NEUTRON ACER TENDL-2024 LIBRARY; T=0.K
alphas from (n,x)

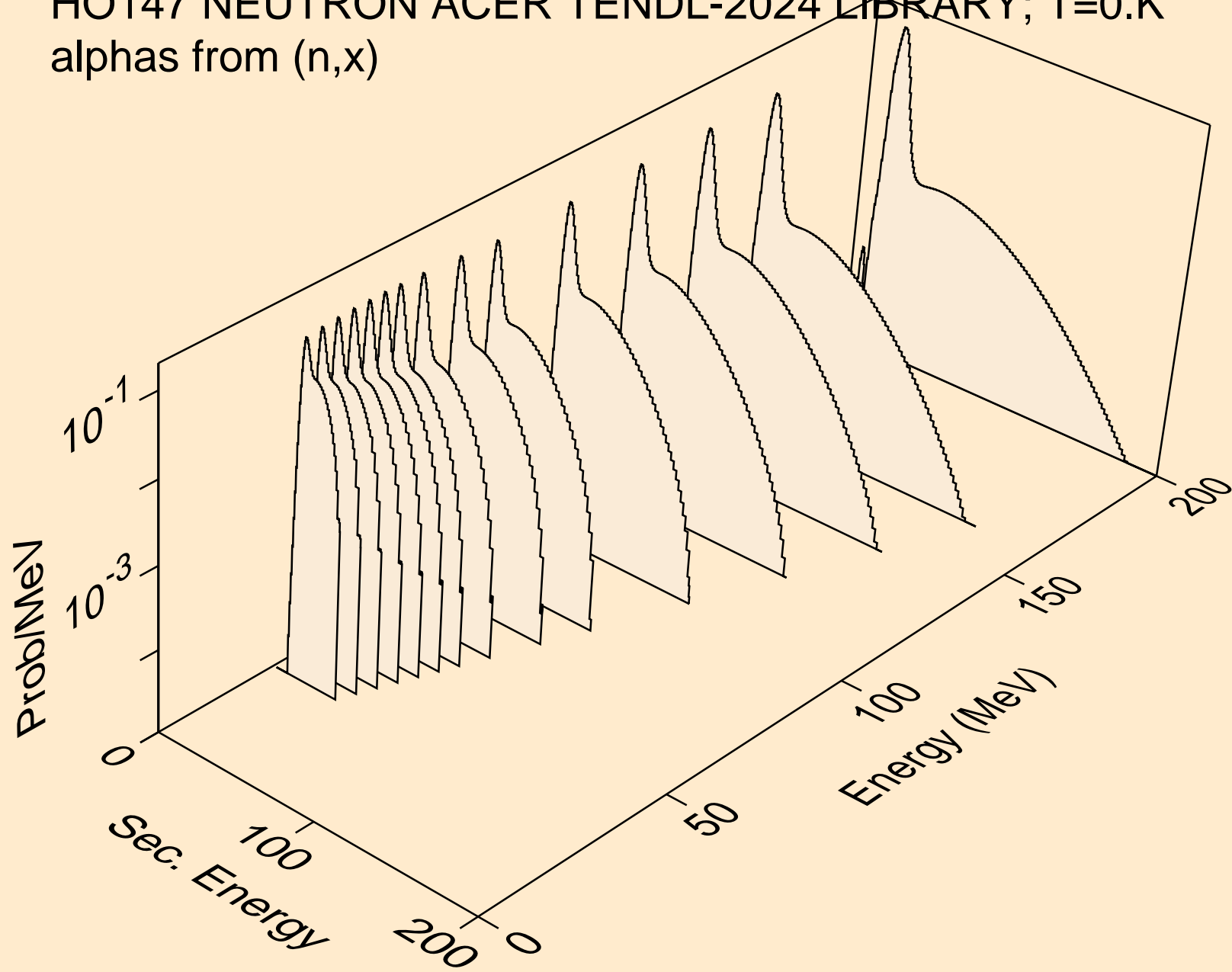

HO147 NEUTRON ACER TENDL-2024 LIBRARY; T=0.K
alphas from (n,n*)a

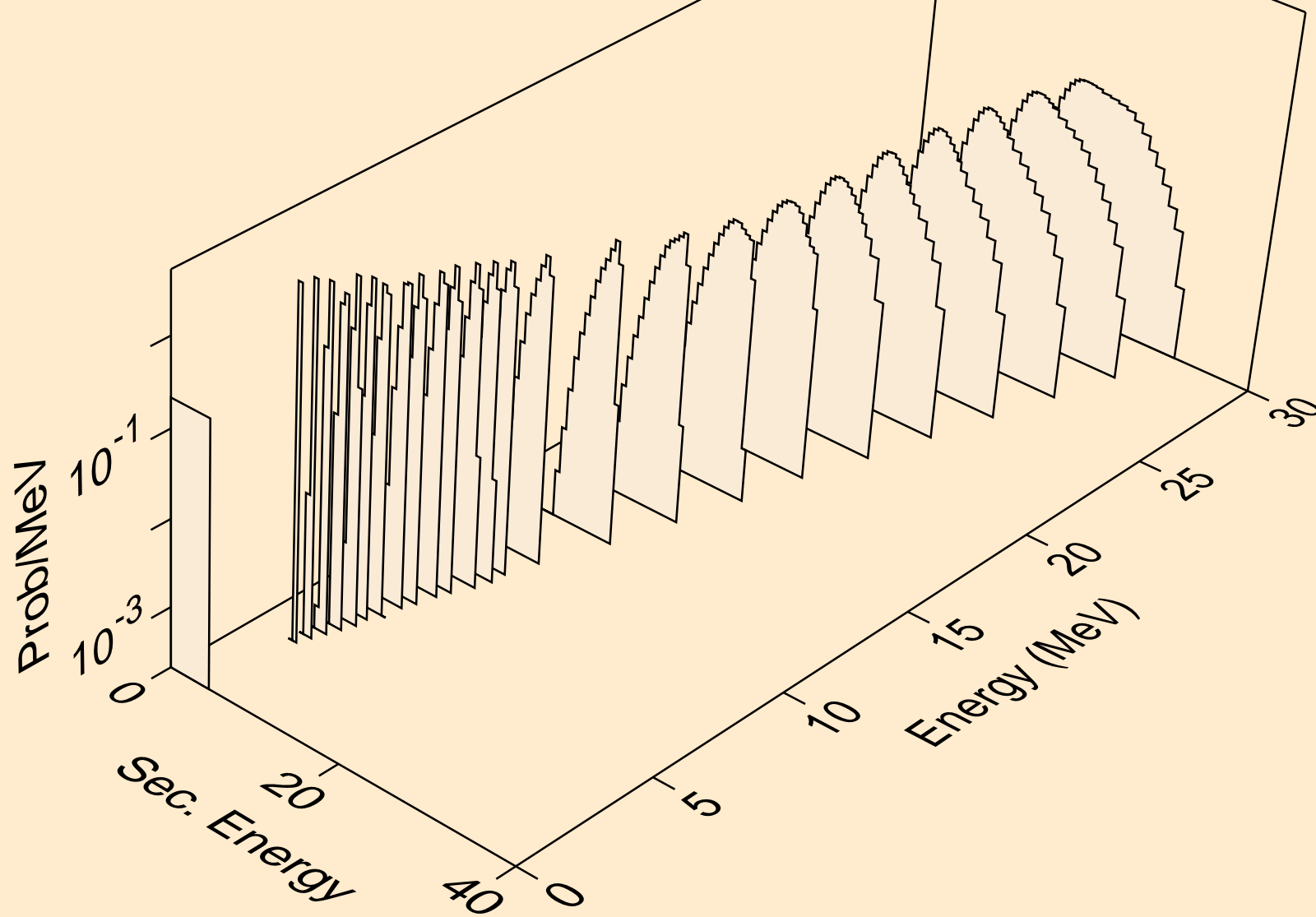

HO147 NEUTRON ACER TENDL-2024 LIBRARY; T=0.K
alphas from (n,2n)a

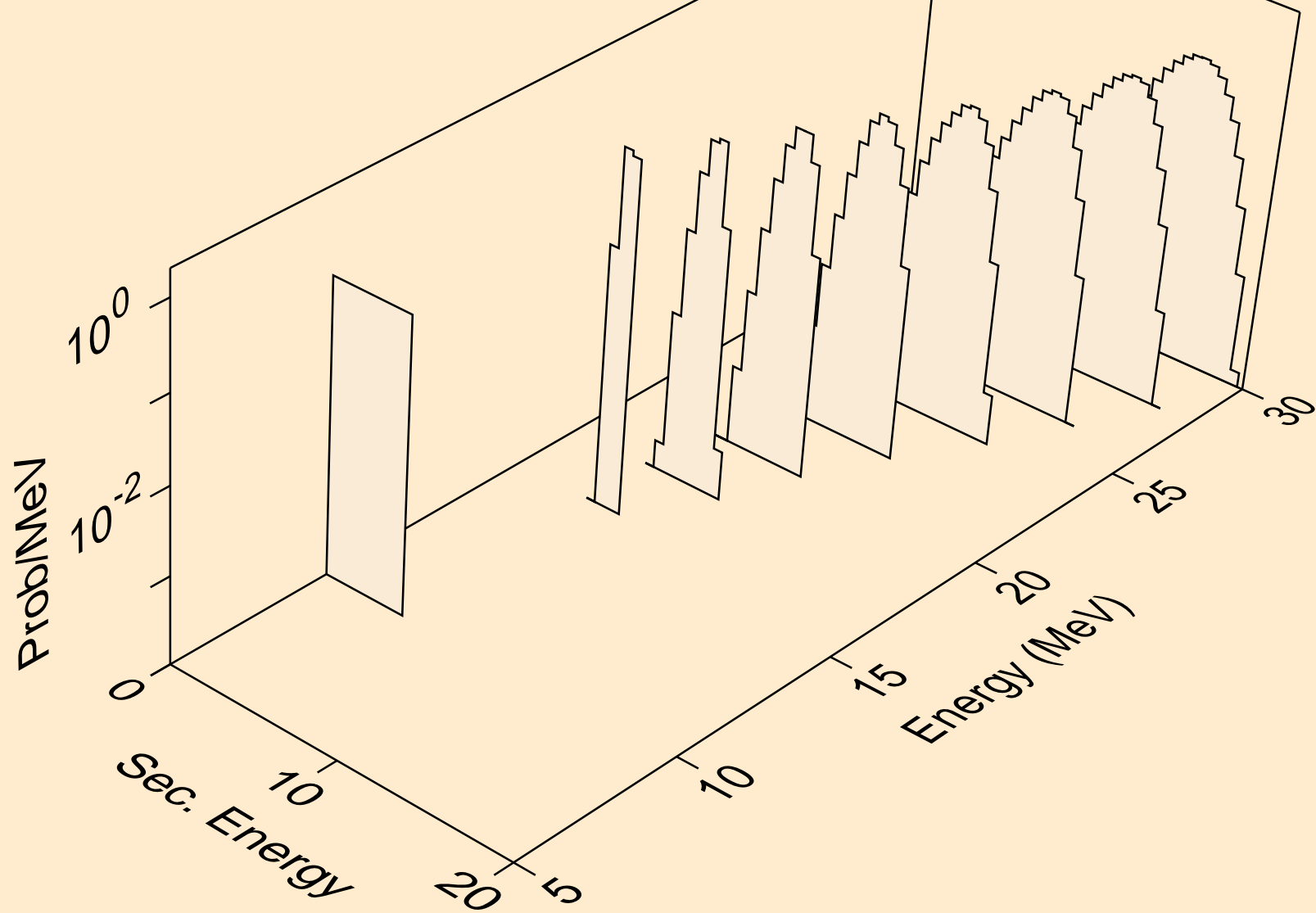

HO147 NEUTRON ACER TENDL-2024 LIBRARY; T=0.K
alphas from (n,n*)2a

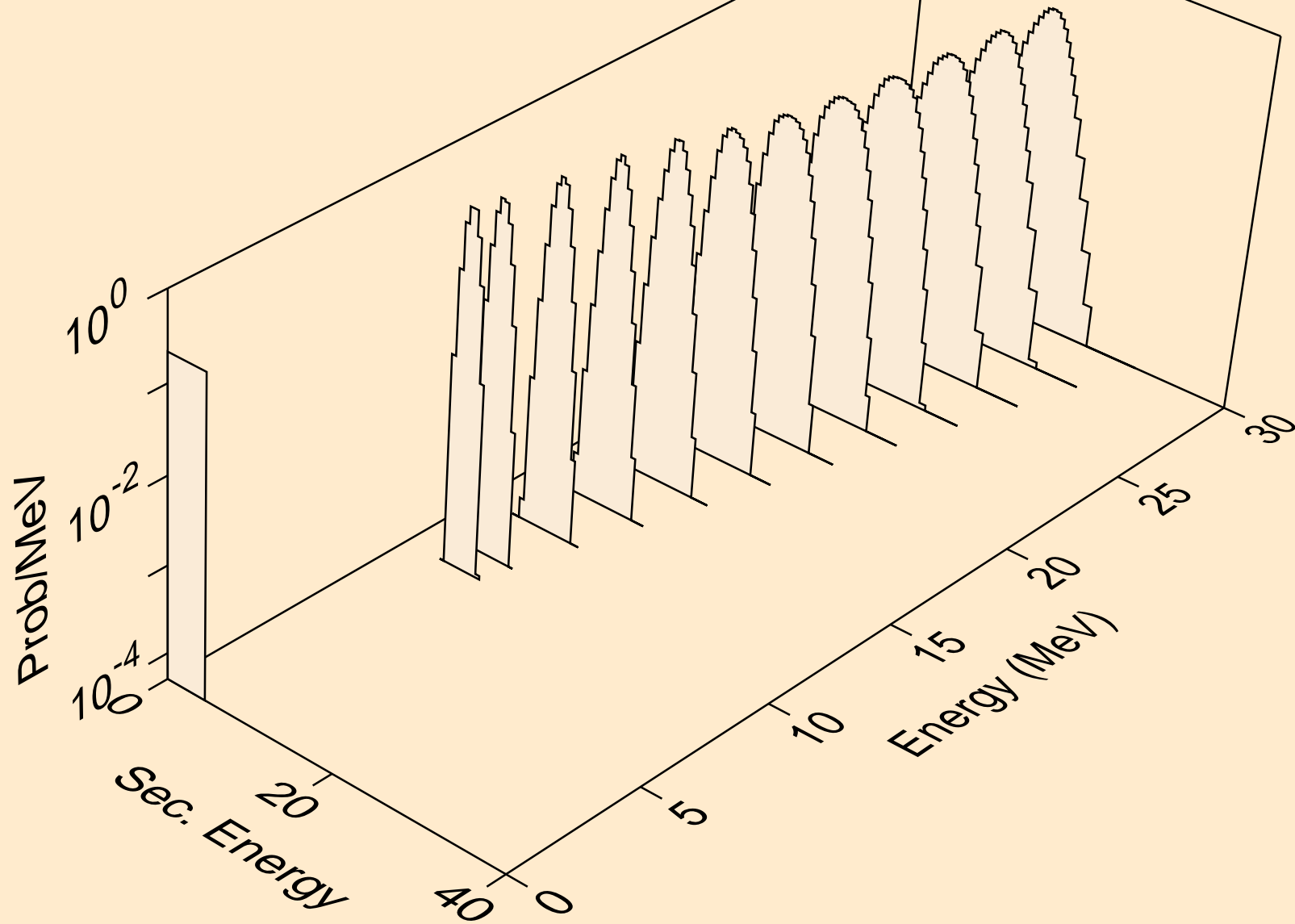

HO147 NEUTRON ACER TENDL-2024 LIBRARY; T=0.K
alphas from (n,npa)

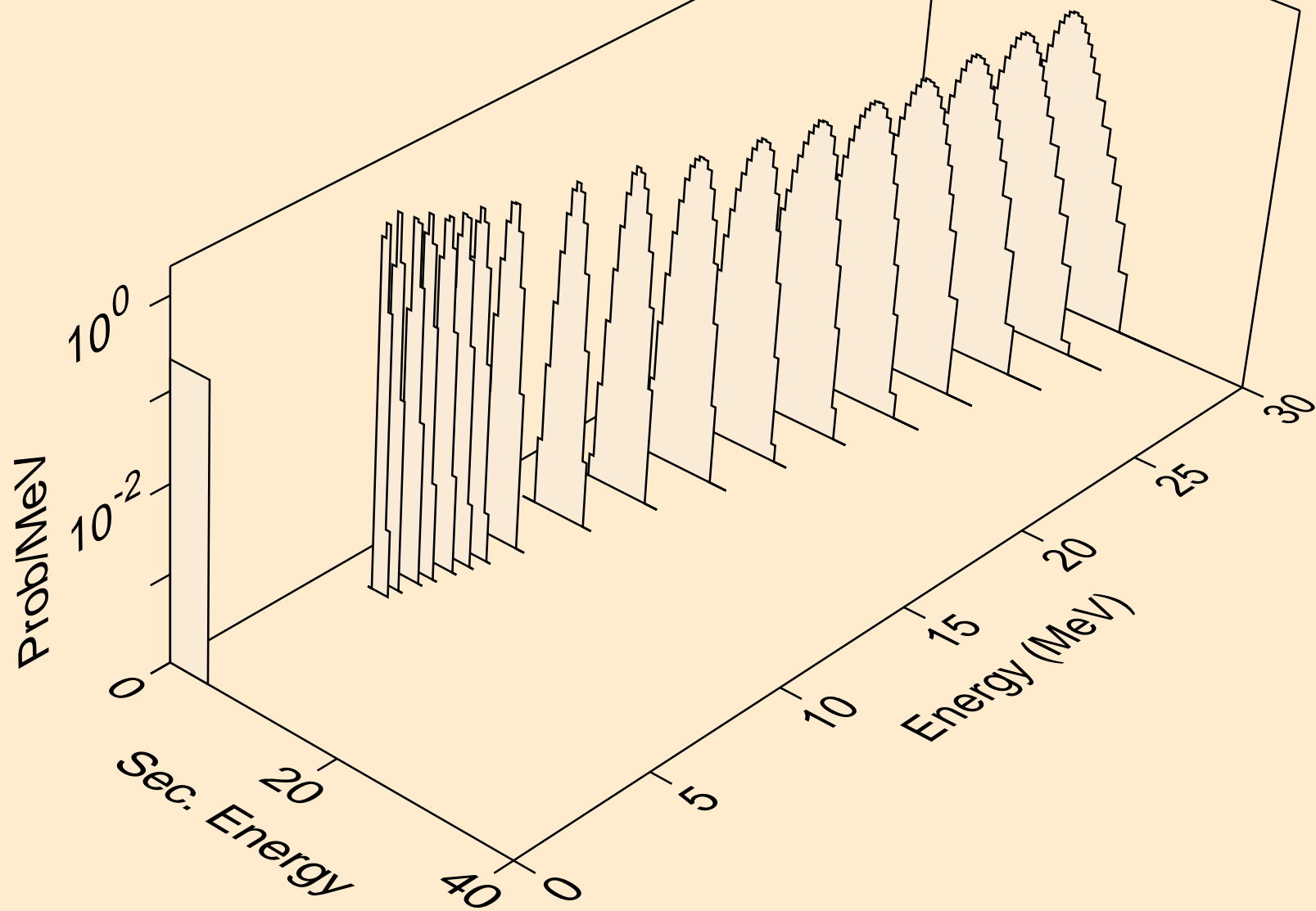

HO147 NEUTRON ACER TENDL-2024 LIBRARY; T=0.K
alphas from (n,a)

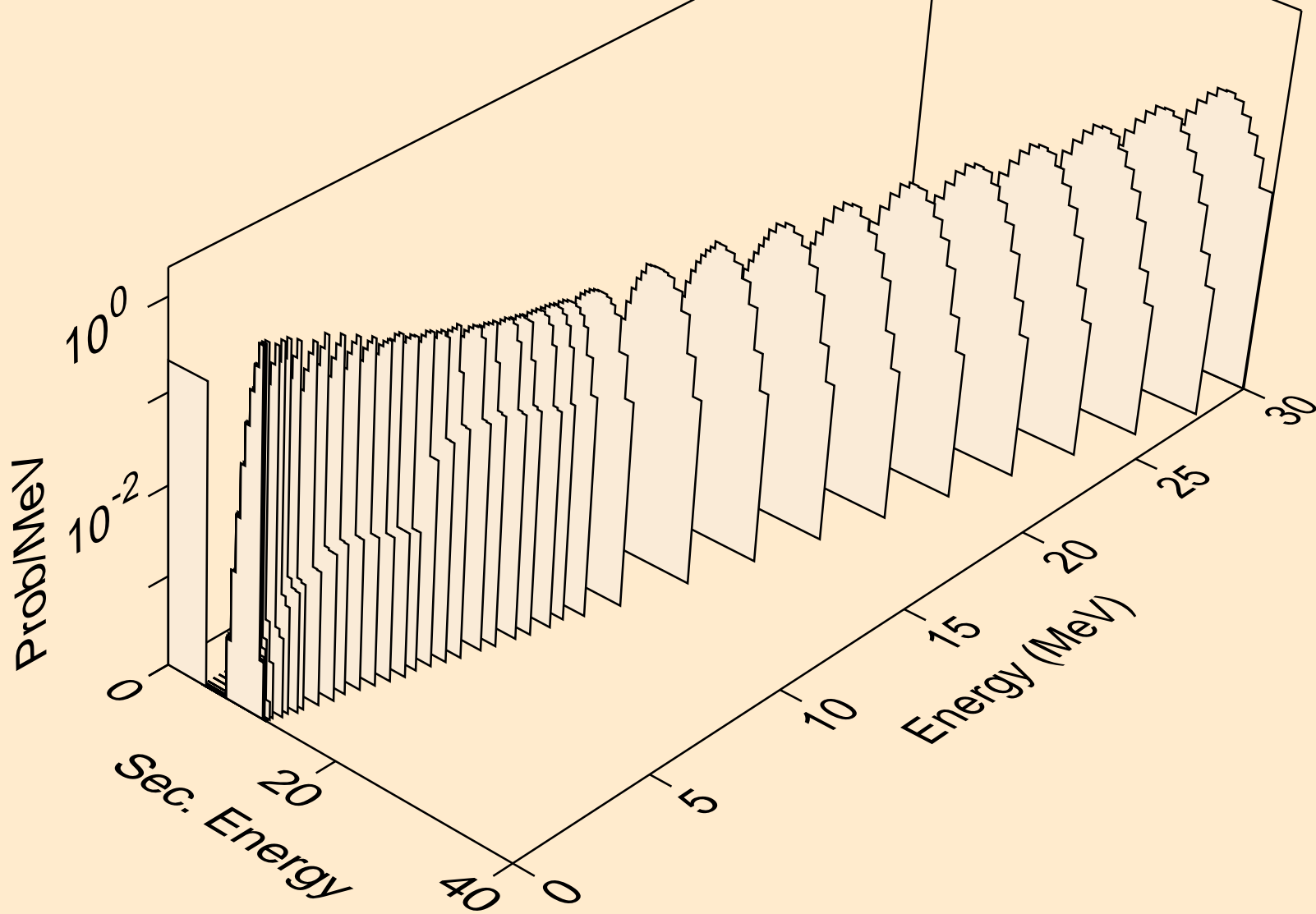

HO147 NEUTRON ACER TENDL-2024 LIBRARY; T=0.K
alphas from (n,2a)

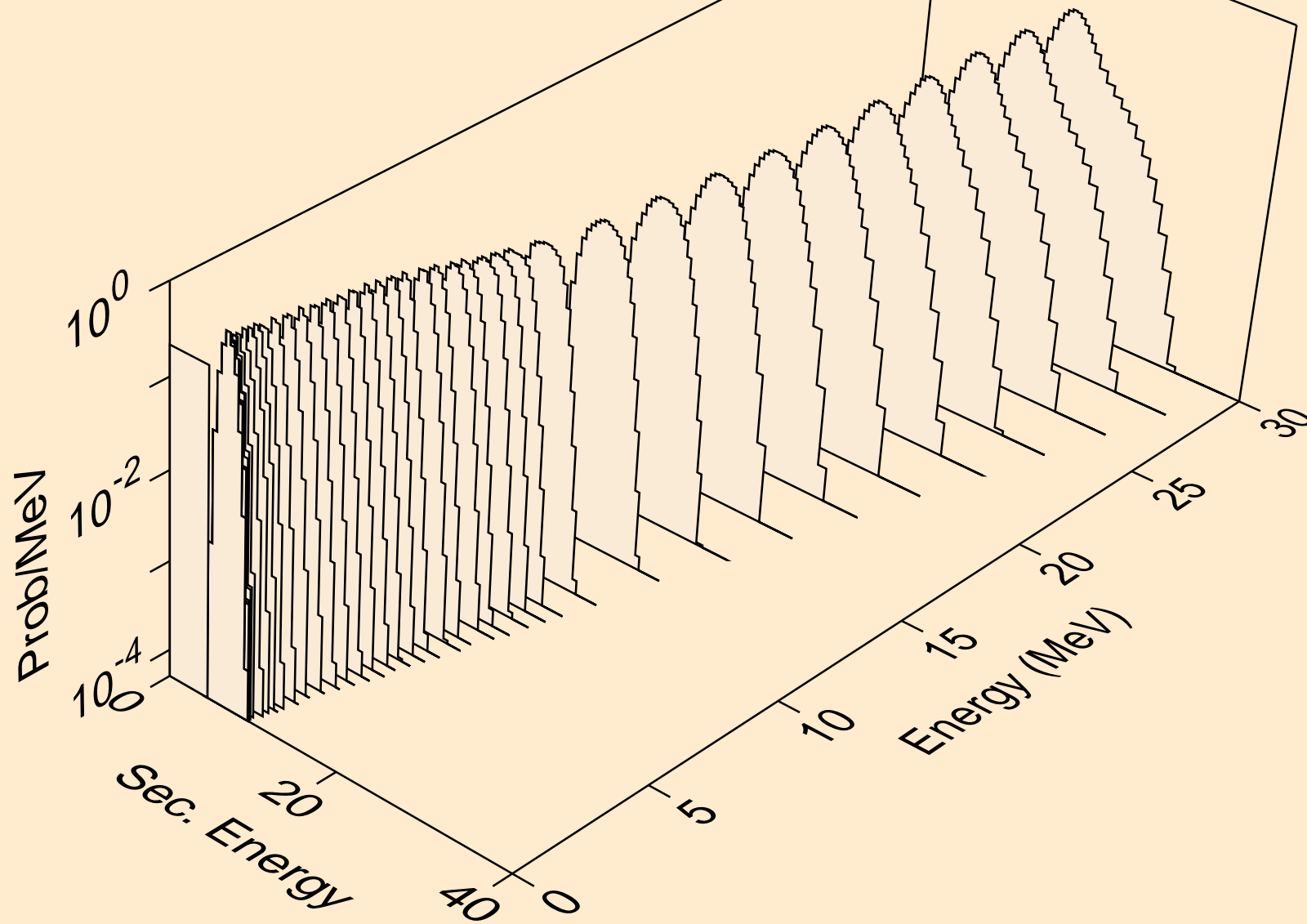

HO147 NEUTRON ACER TENDL-2024 LIBRARY; T=0.K
alphas from (n,3a)

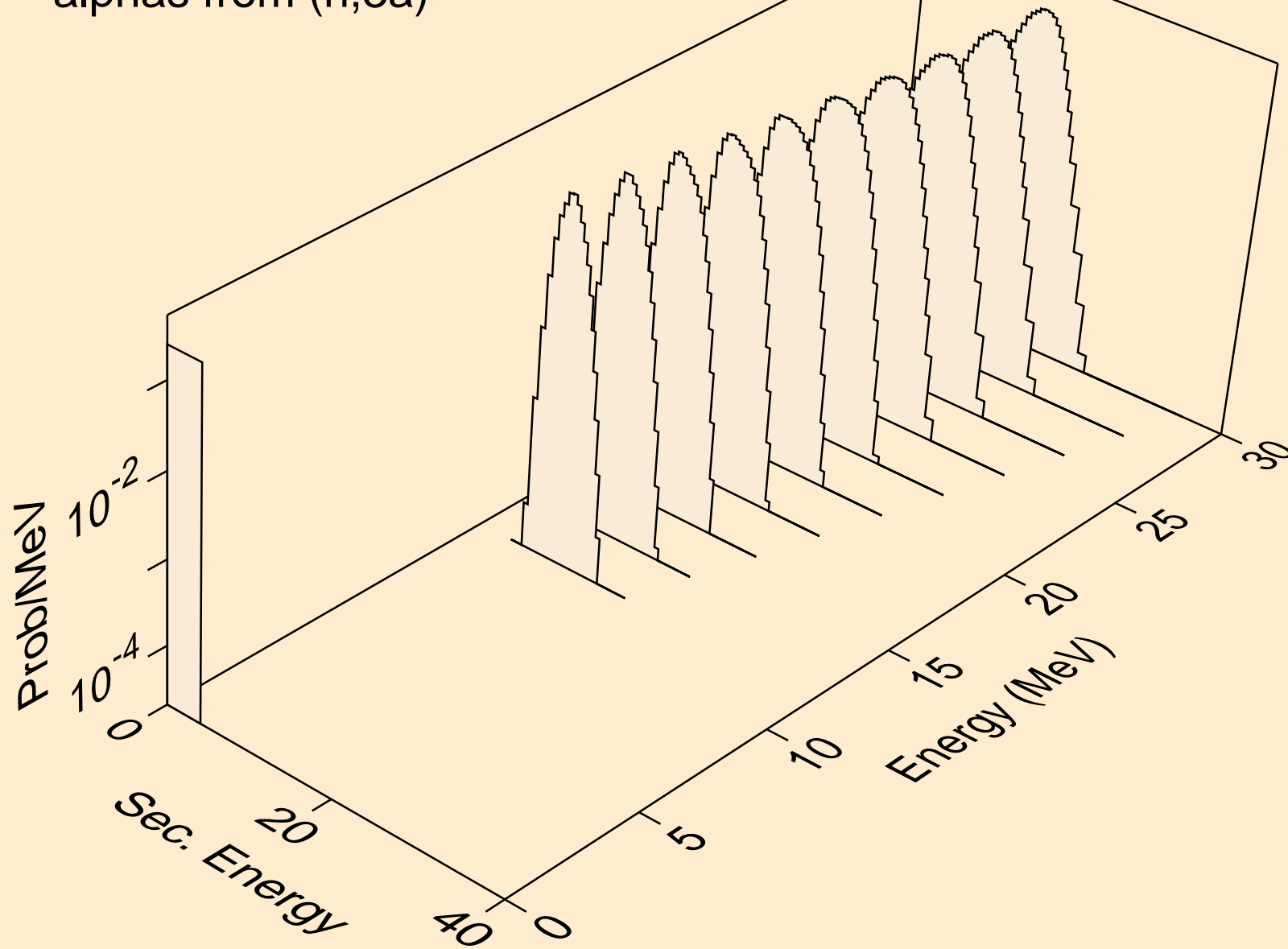

HO147 NEUTRON ACER TENDL-2024 LIBRARY; T=0.K
alphas from (n,pa)

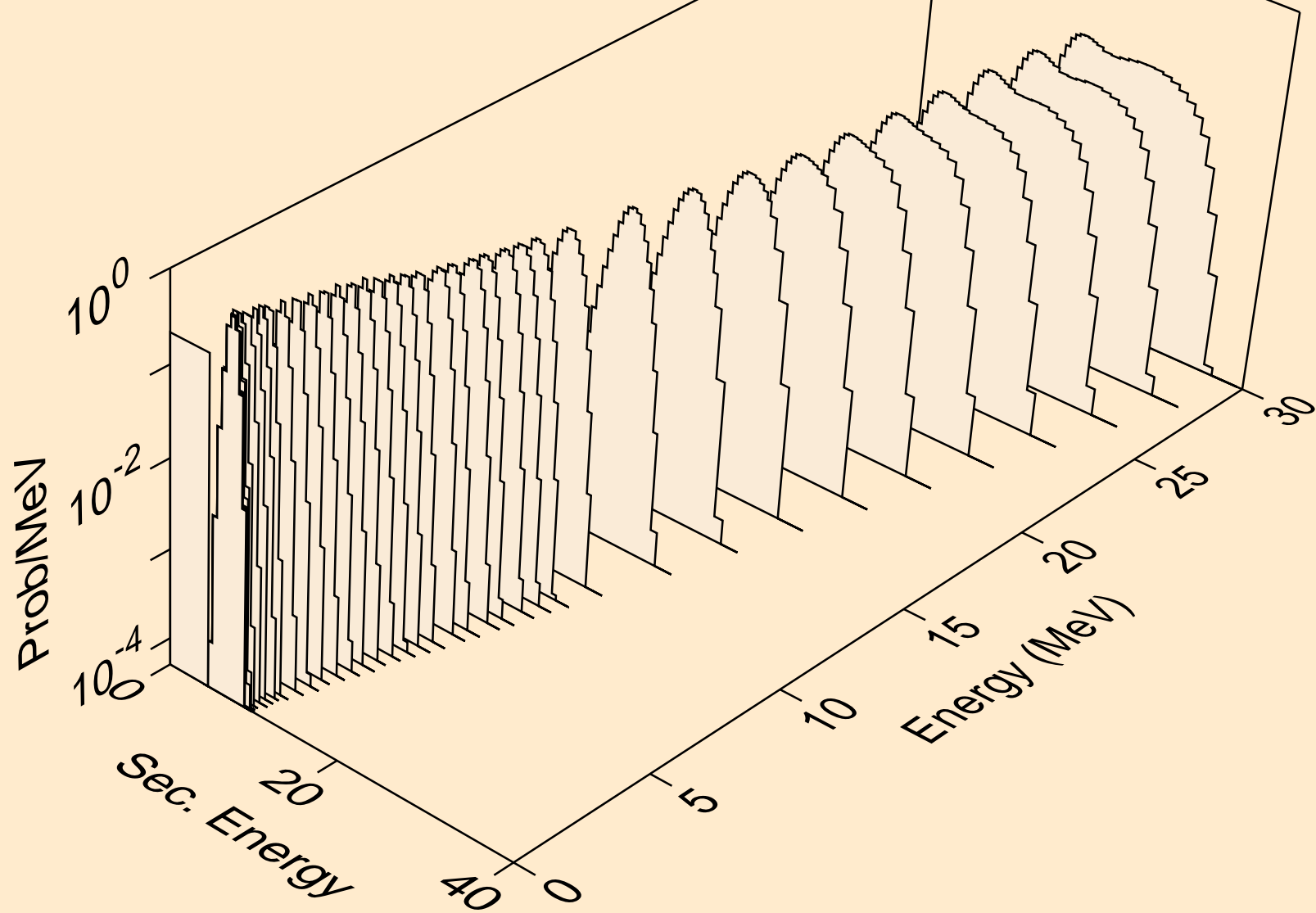

HO147 NEUTRON ACER TENDL-2024 LIBRARY; T=0.K
alphas from (n,da)

