

# HO164M NEUTRON ACER TENDL-2024 LIBRARY; T=0.K

## Principal cross sections

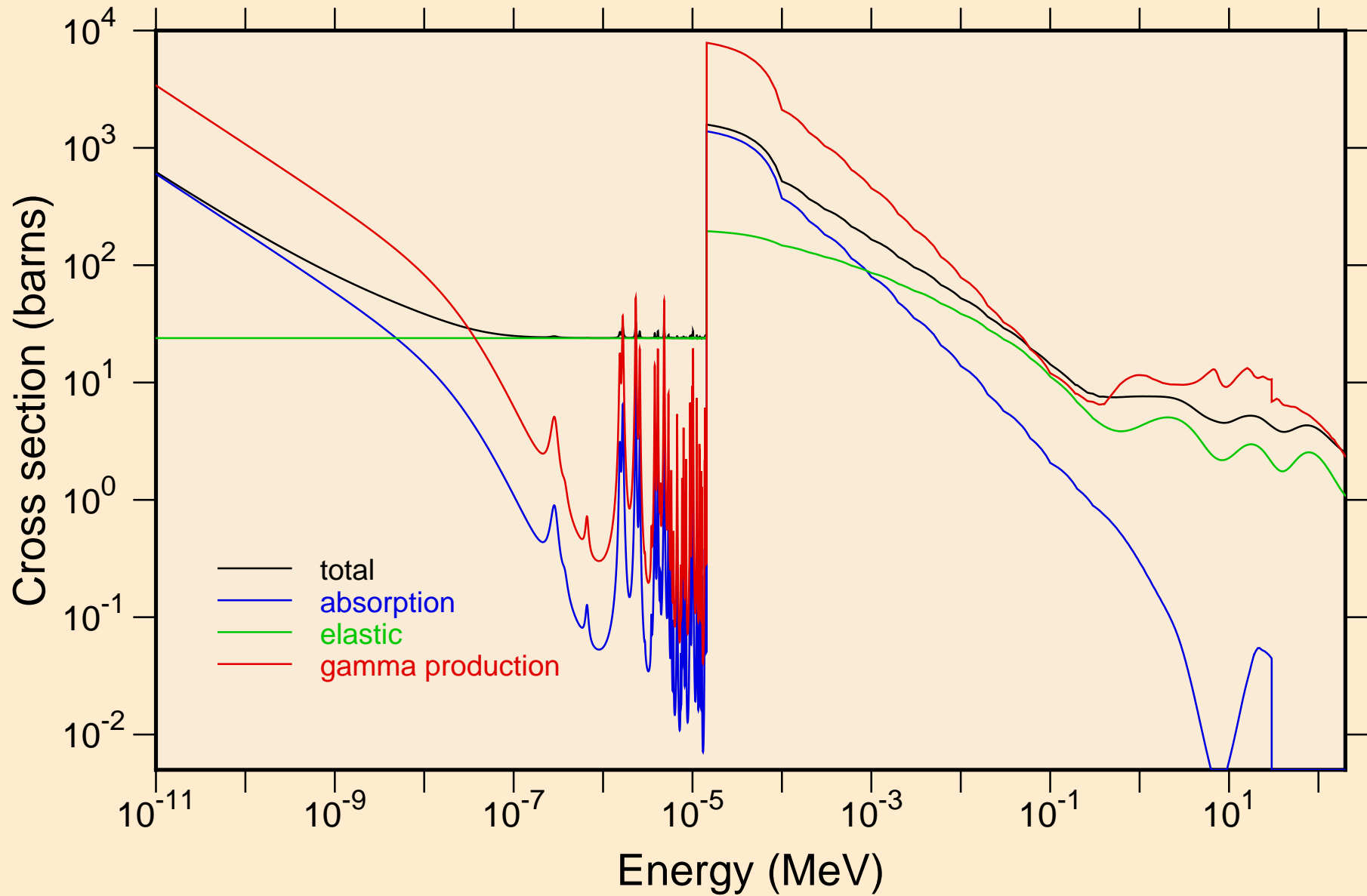

H<sup>164</sup>M NEUTRON ACER TENDL-2024 LIBRARY; T=0.K  
resonance total cross section

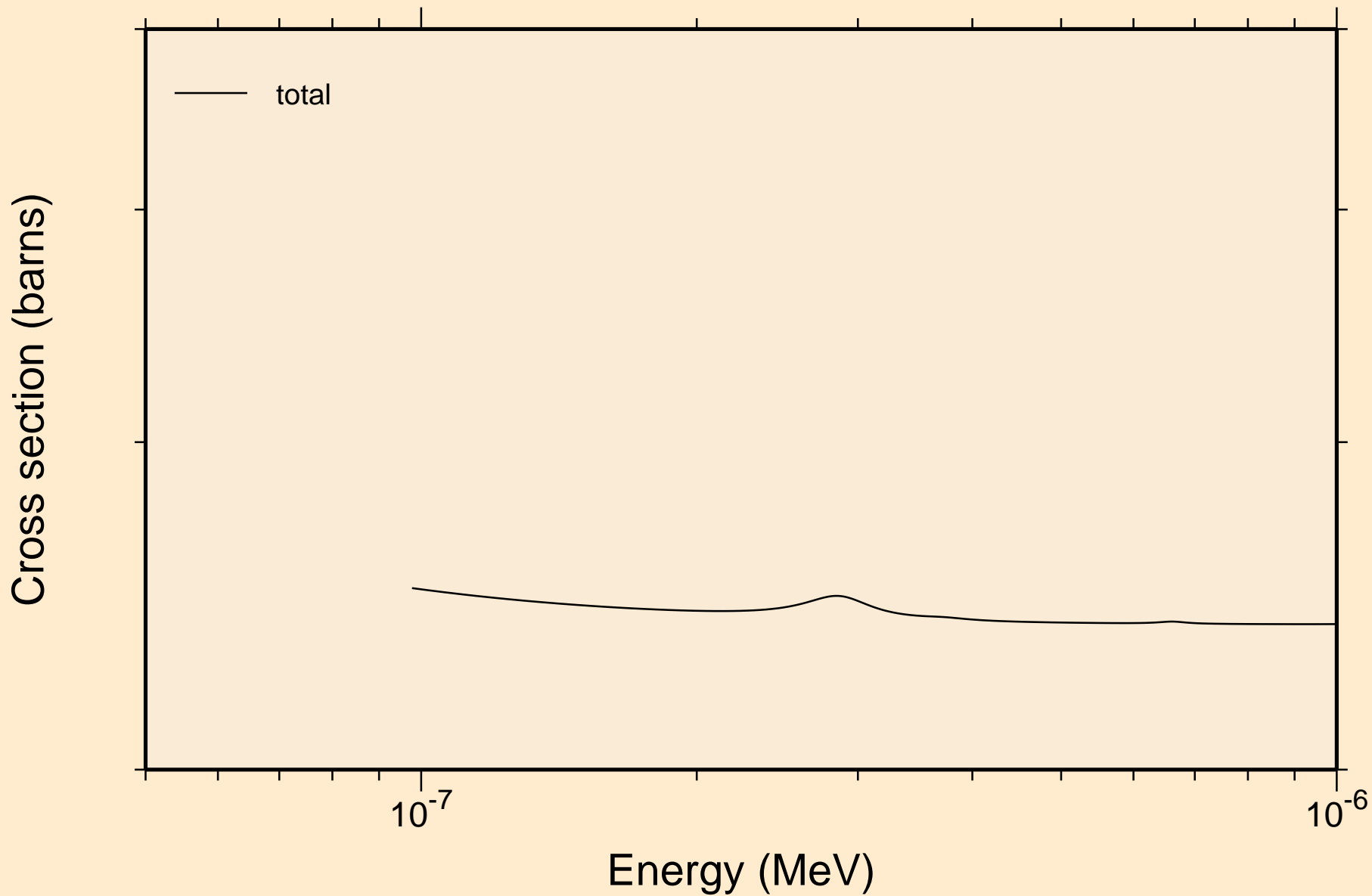

H<sup>164m</sup>O NEUTRON ACER TENDL-2024 LIBRARY; T=0.K  
resonance total cross section

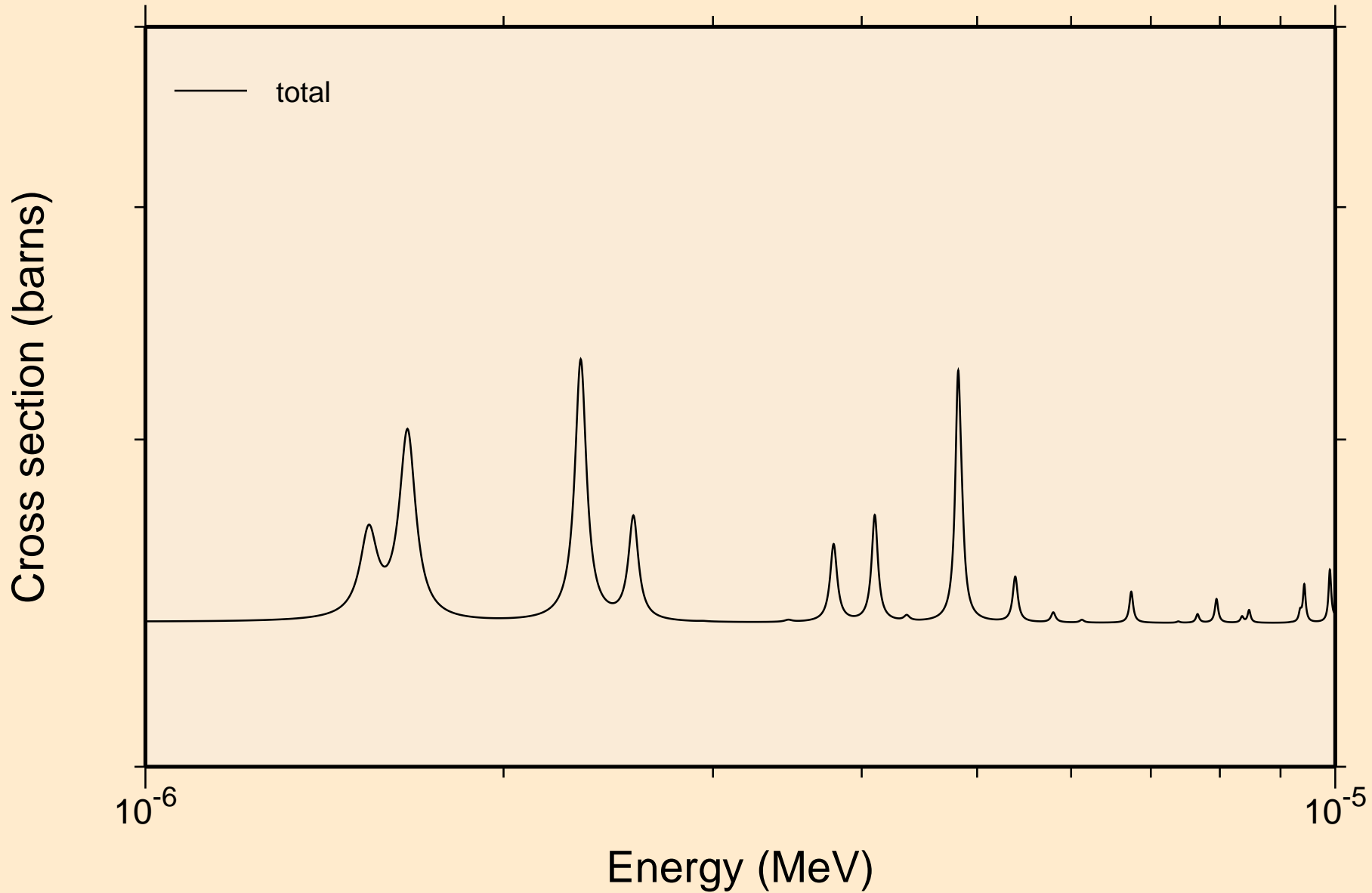

HO164M NEUTRON ACER TENDL-2024 LIBRARY; T=0.K  
resonance total cross section

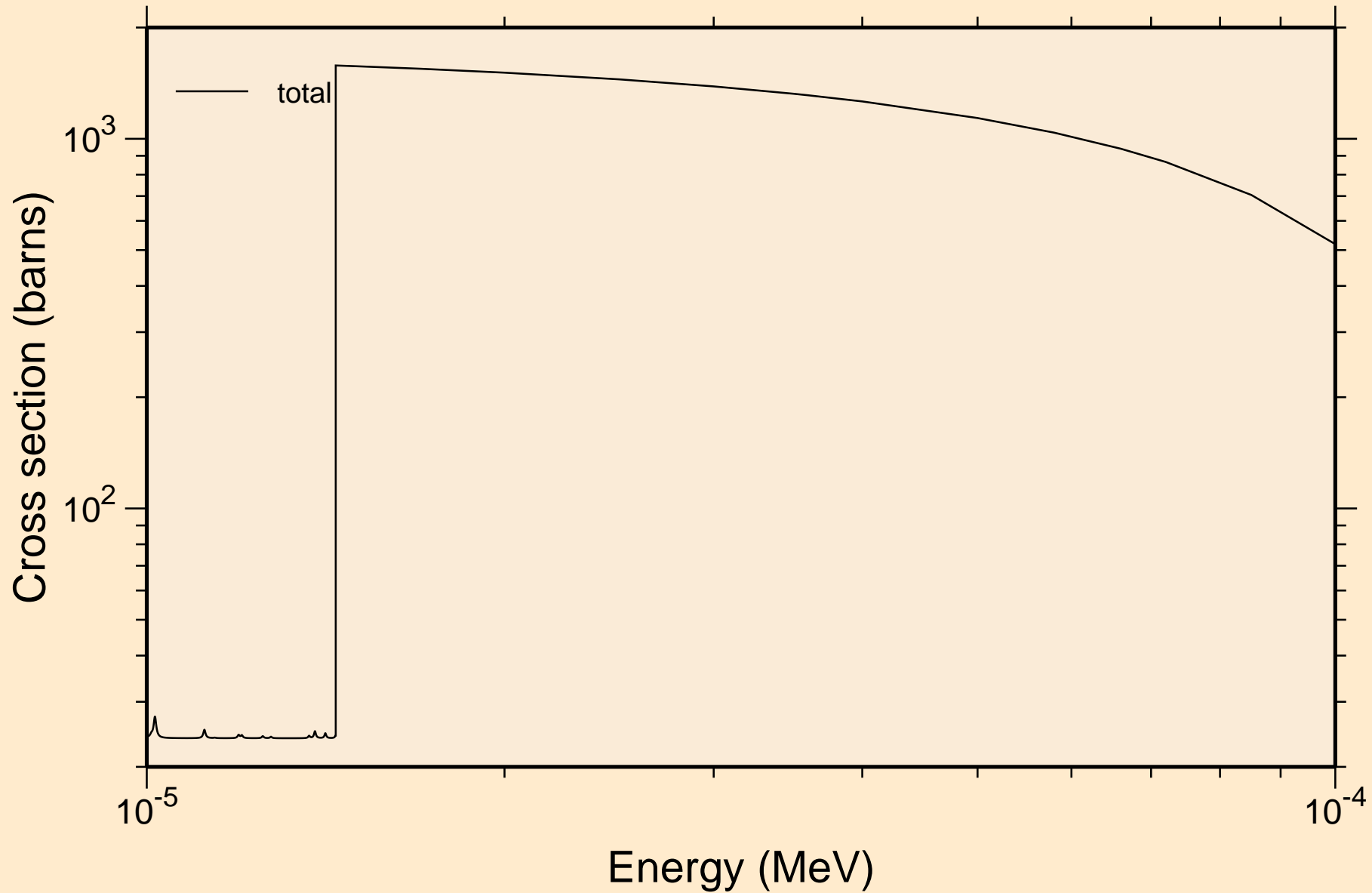

HO164M NEUTRON ACER TENDL-2024 LIBRARY; T=0.K  
resonance total cross section

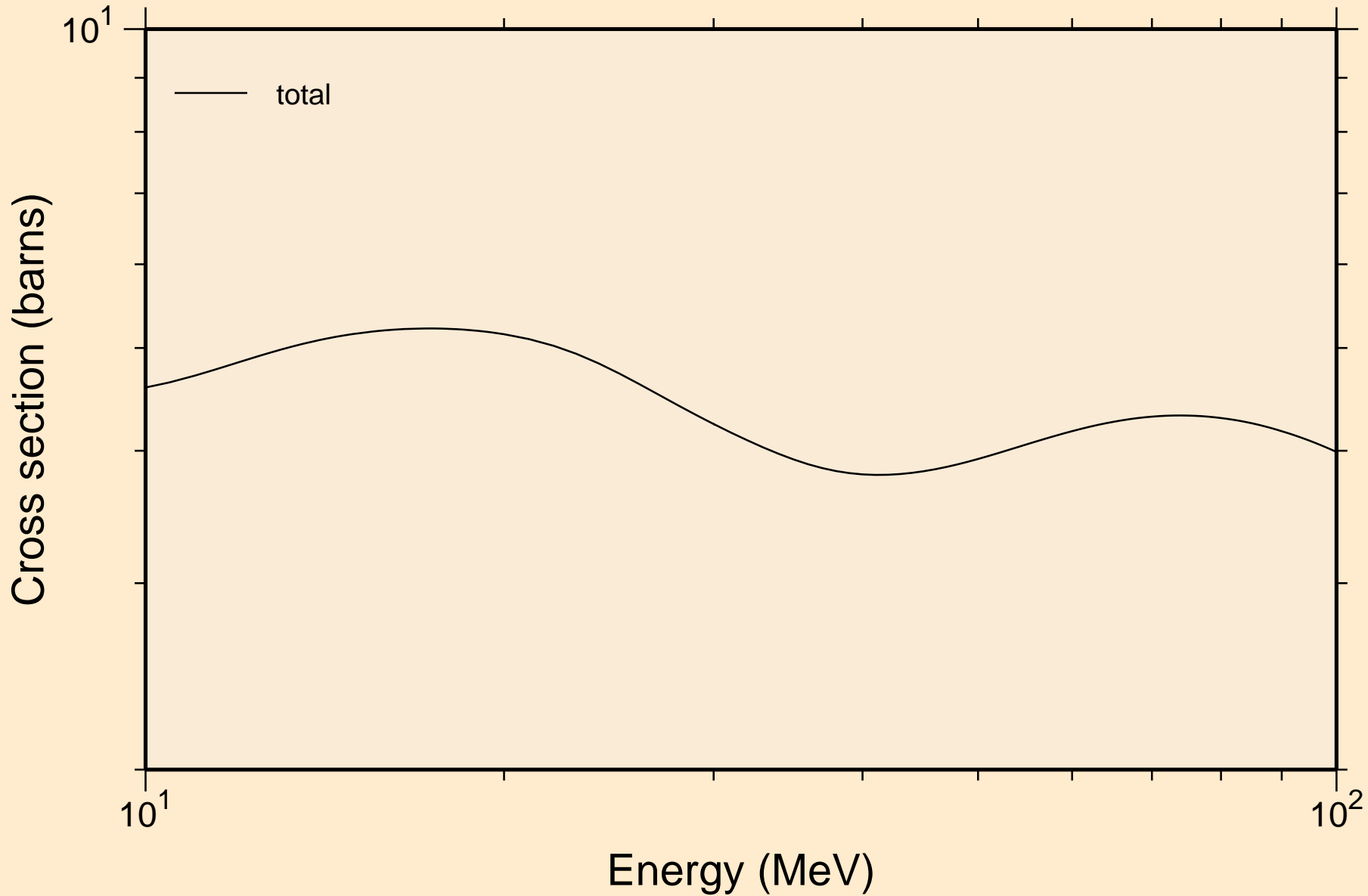

HO164M NEUTRON ACER TENDL-2024 LIBRARY; T=0.K  
resonance absorption cross sections

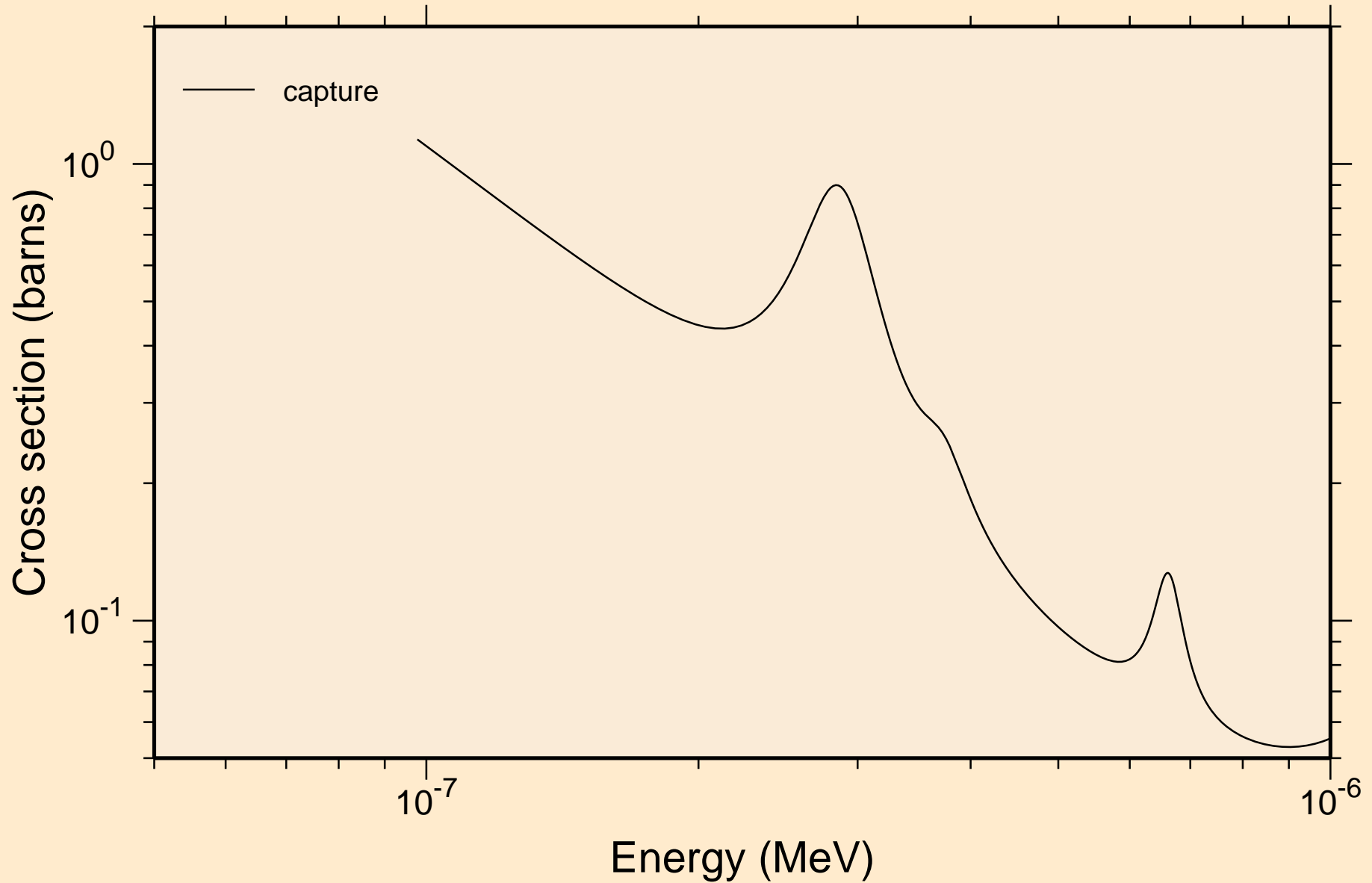

HO164M NEUTRON ACER TENDL-2024 LIBRARY; T=0.K  
resonance absorption cross sections

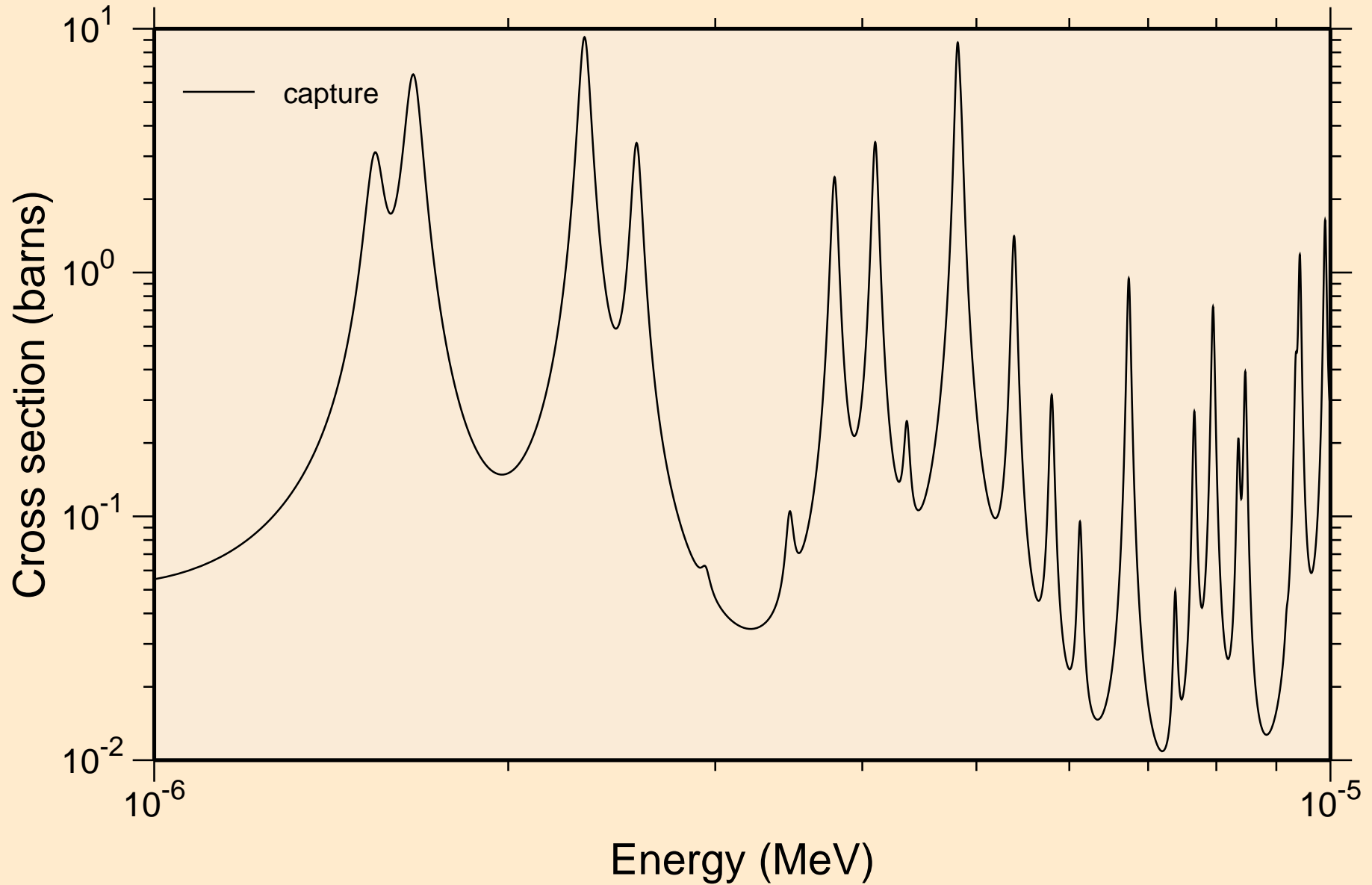

HO164M NEUTRON ACER TENDL-2024 LIBRARY; T=0.K  
resonance absorption cross sections

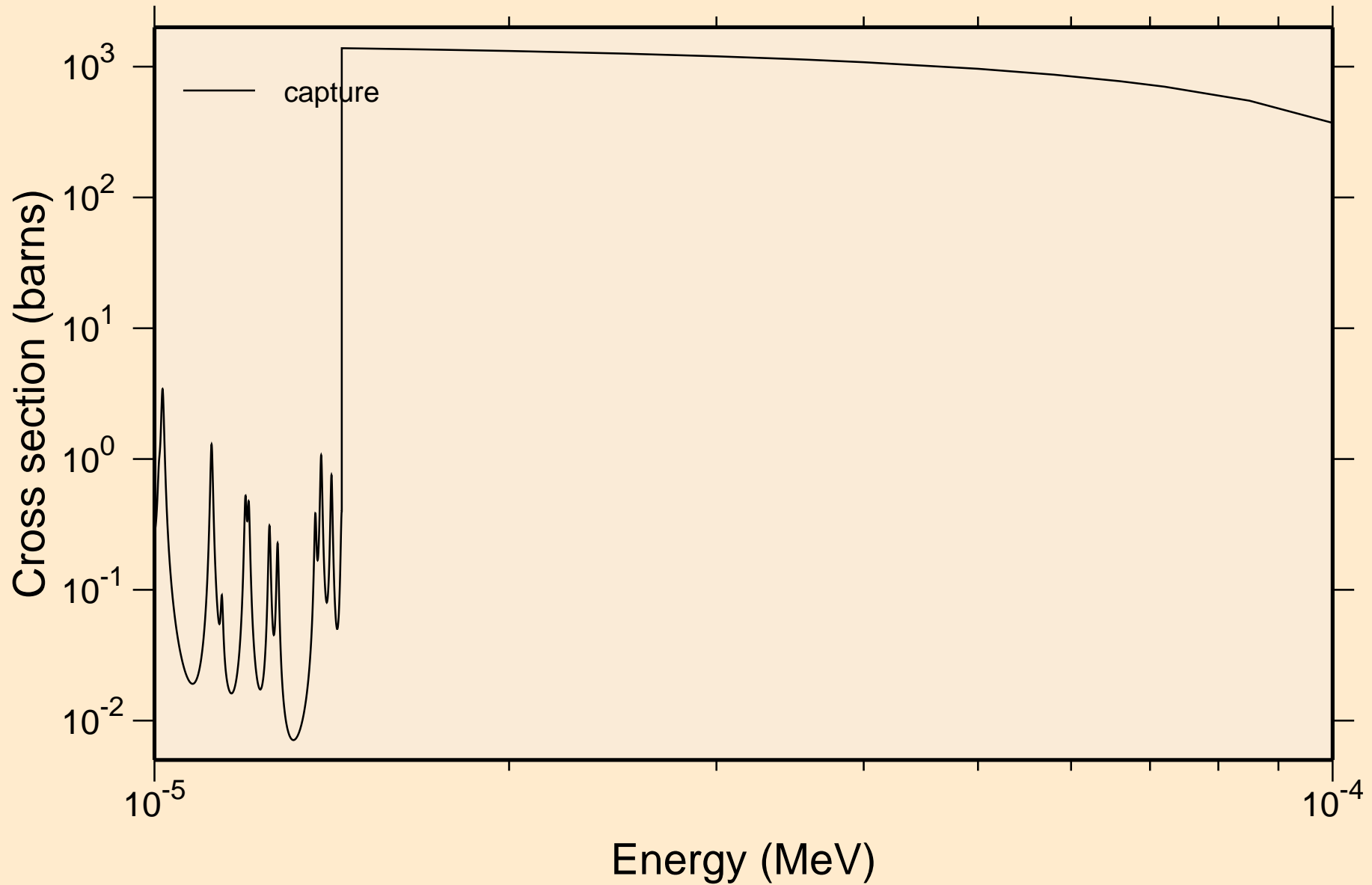

HO164M NEUTRON ACER TENDL-2024 LIBRARY; T=0.K  
resonance absorption cross sections

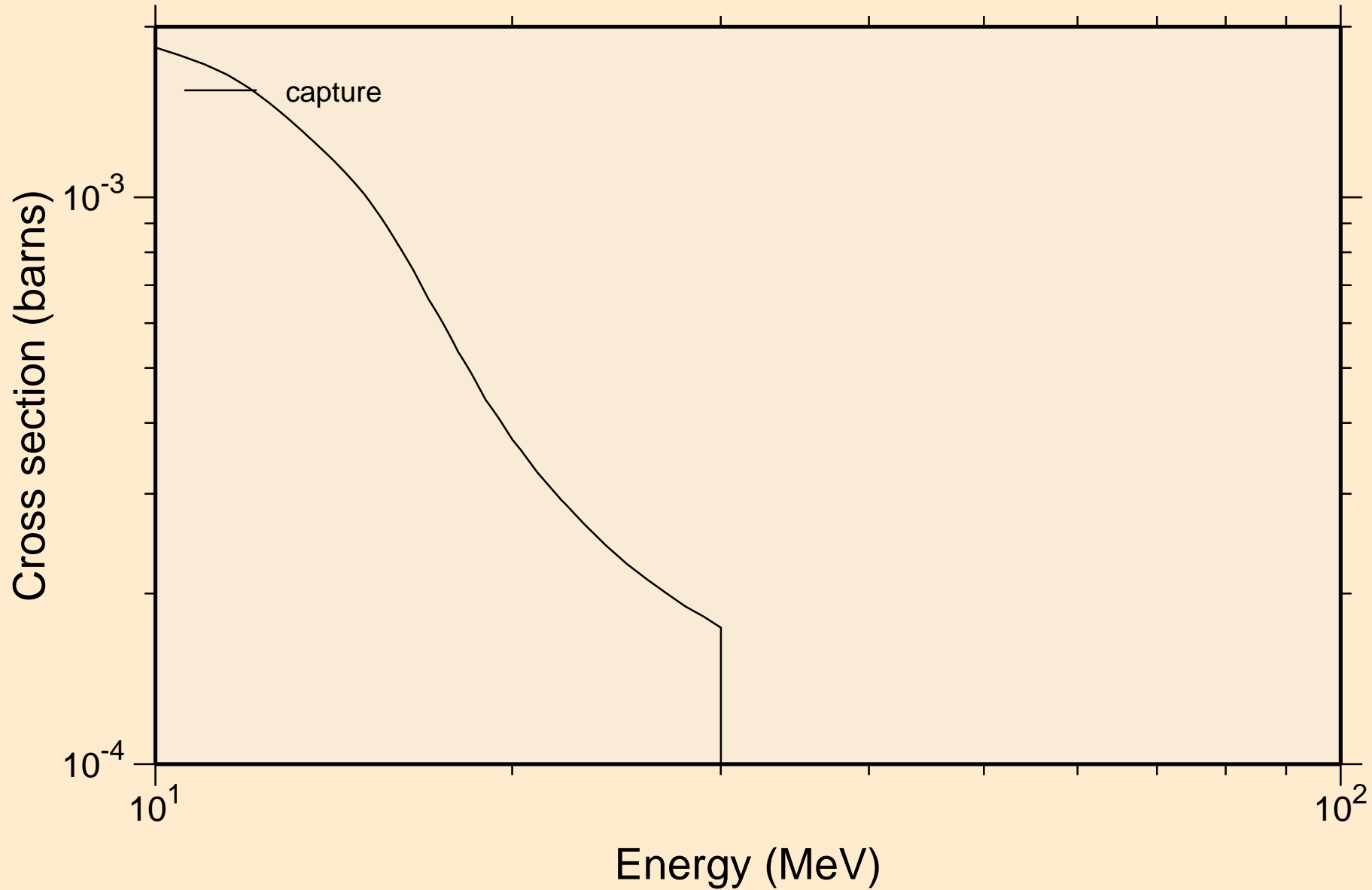

HO164M NEUTRON ACER TENDL-2024 LIBRARY; T=0.K  
Heating

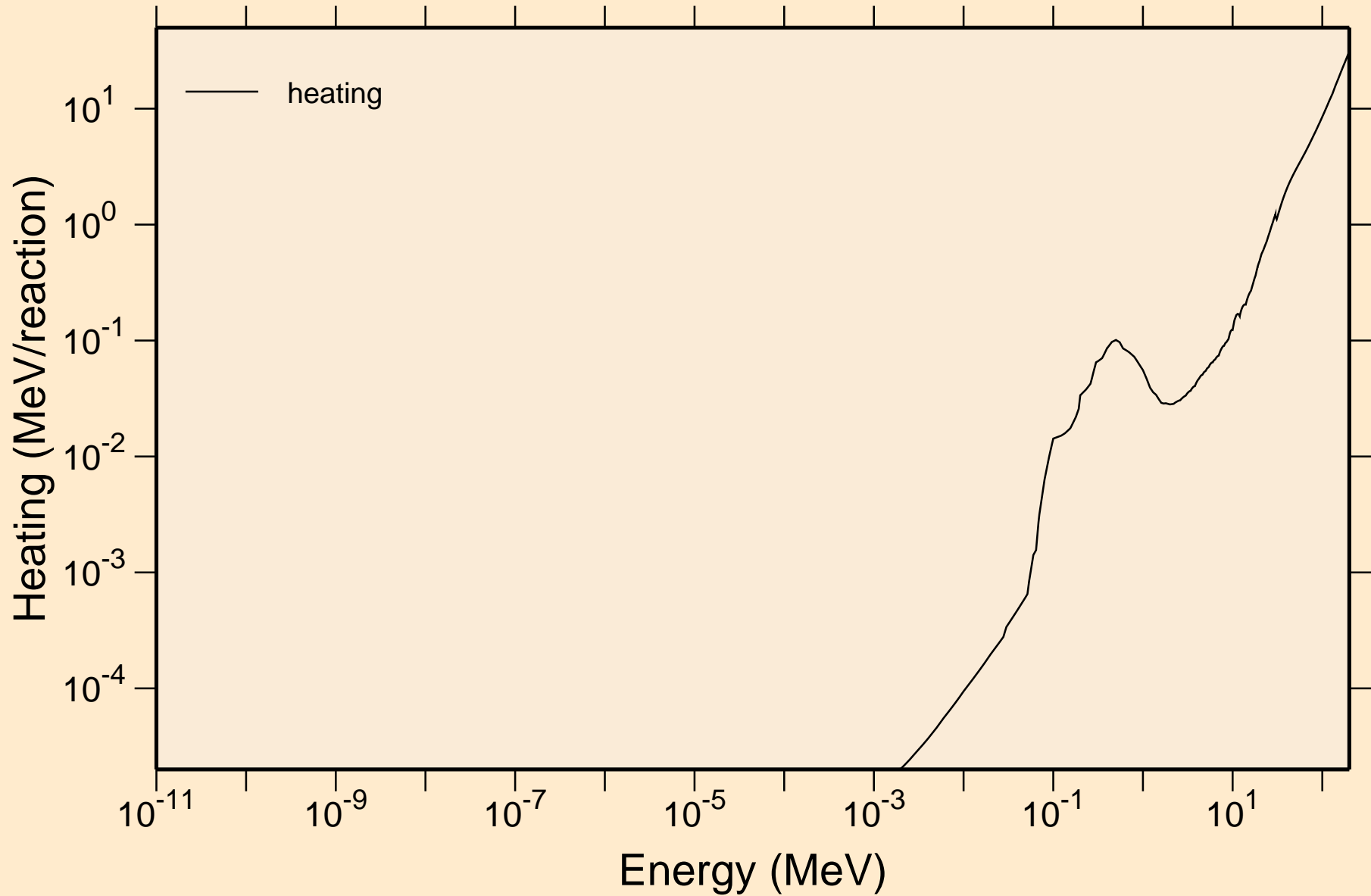

# HO164M NEUTRON ACER TENDL-2024 LIBRARY; T=0.K

## Damage

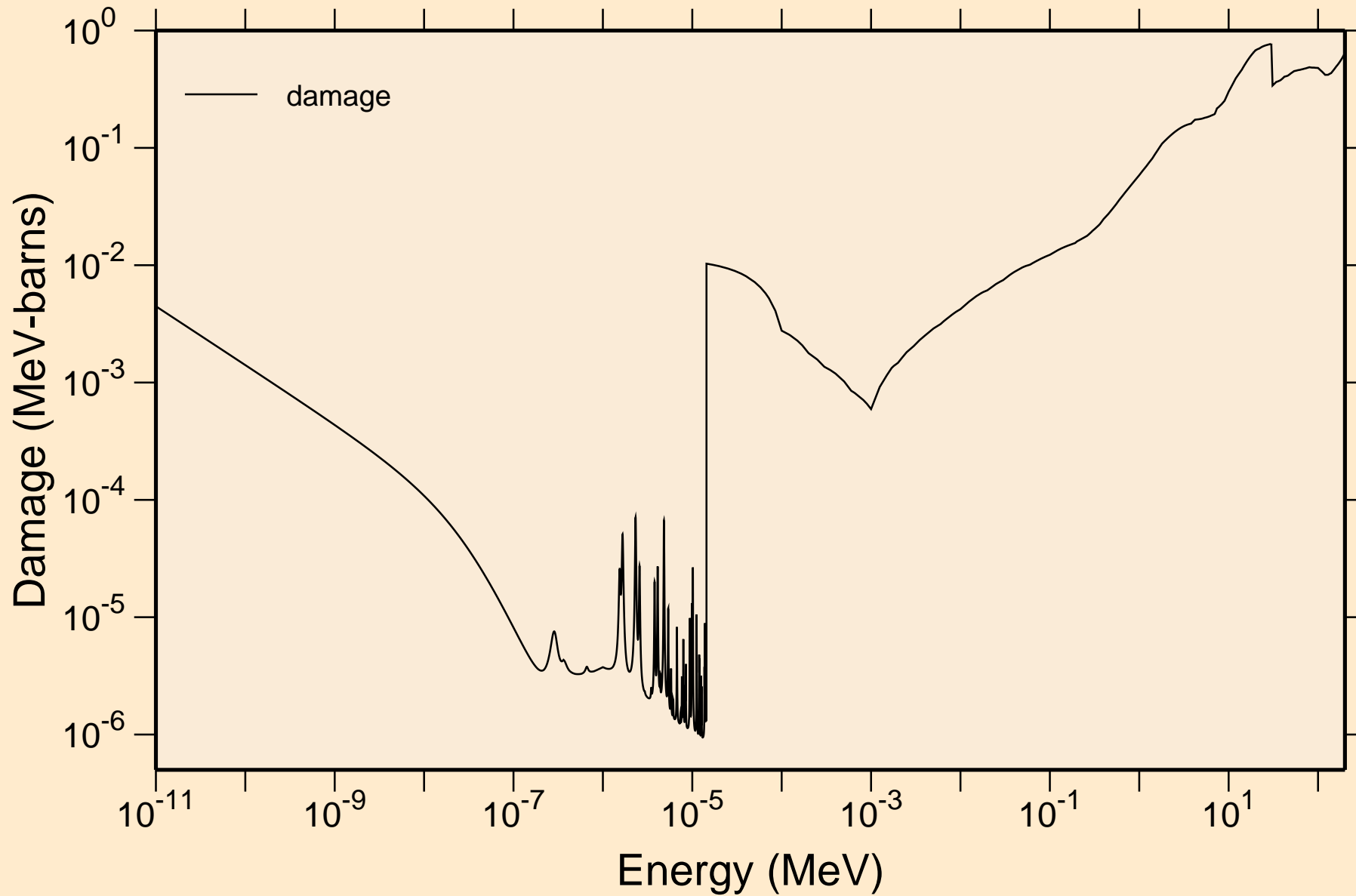

# HO164M NEUTRON ACER TENDL-2024 LIBRARY; T=0.K

## Non-threshold reactions

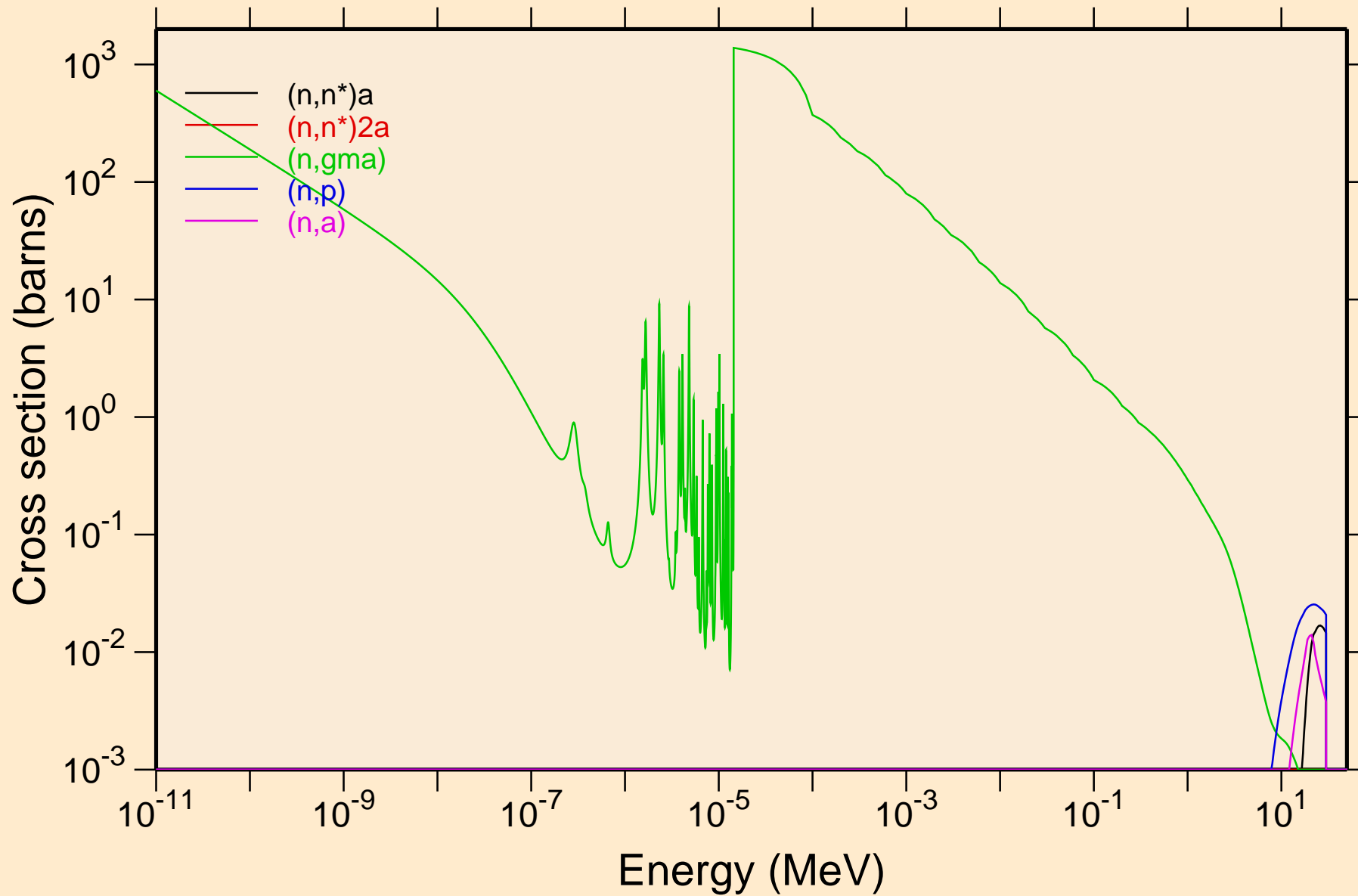

# HO164M NEUTRON ACER TENDL-2024 LIBRARY; T=0.K

## Non-threshold reactions

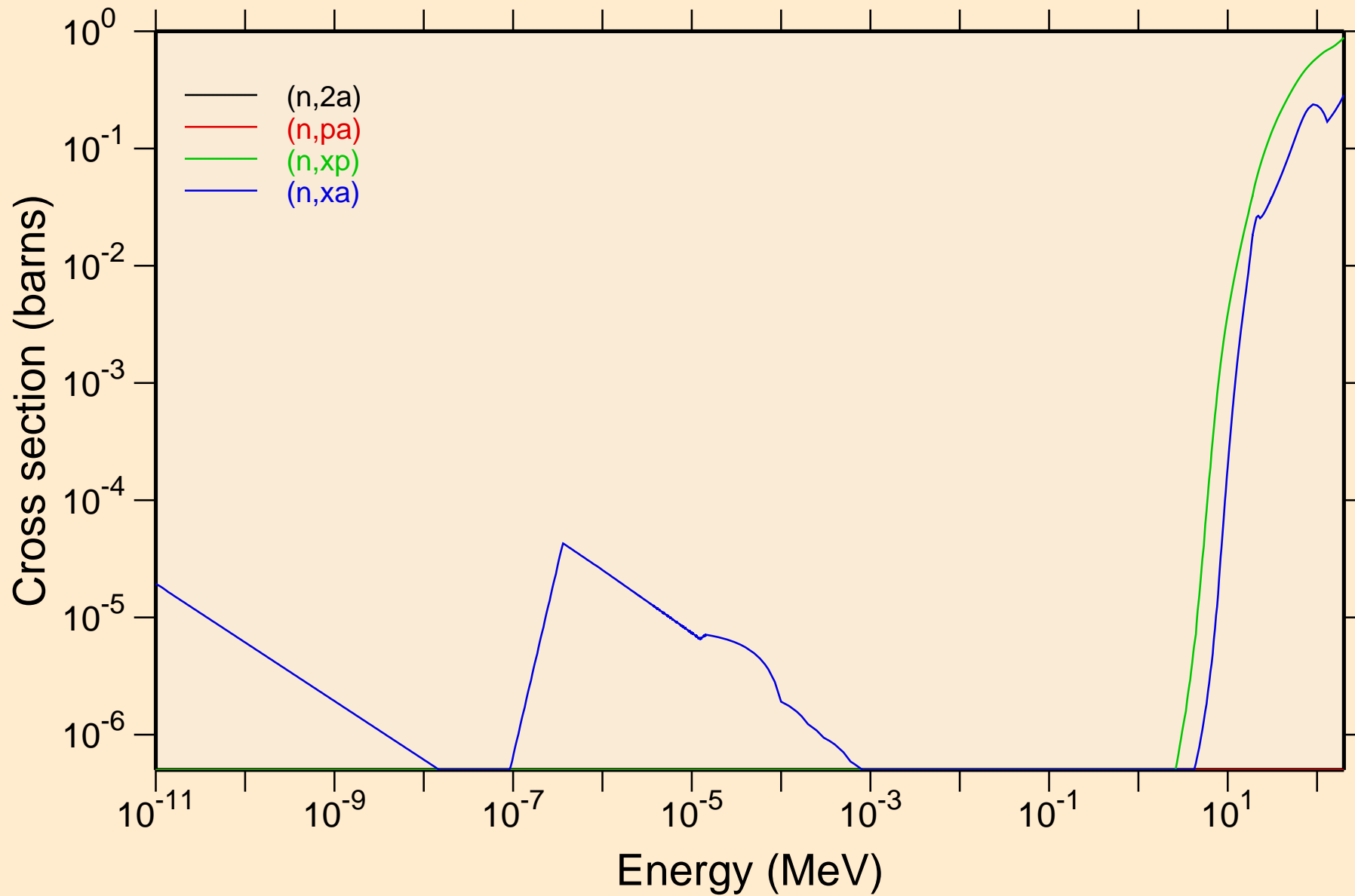

# HO164M NEUTRON ACER TENDL-2024 LIBRARY; T=0.K

## Principal cross sections

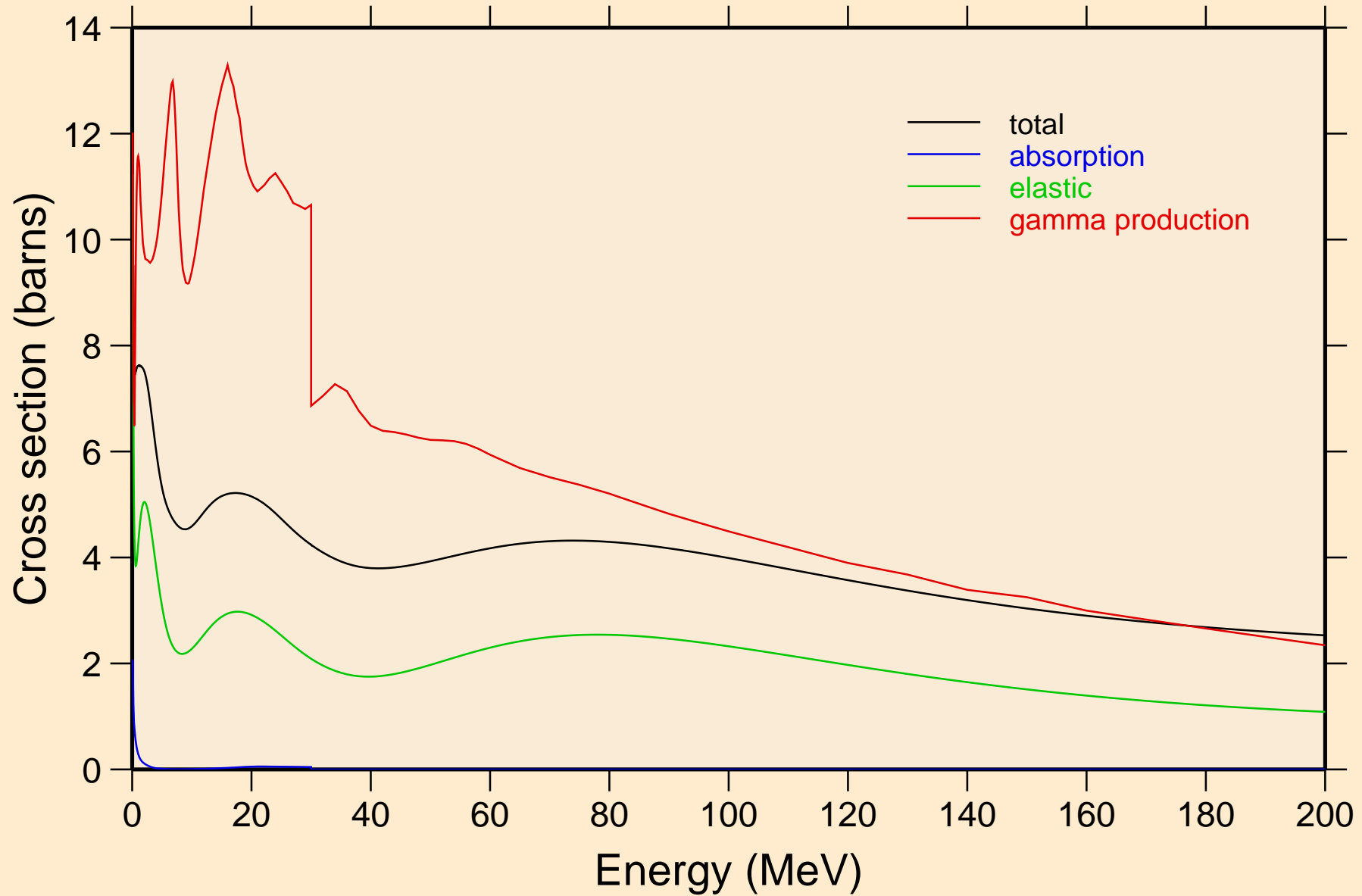

# HO164M NEUTRON ACER TENDL-2024 LIBRARY; T=0.K

## Heating

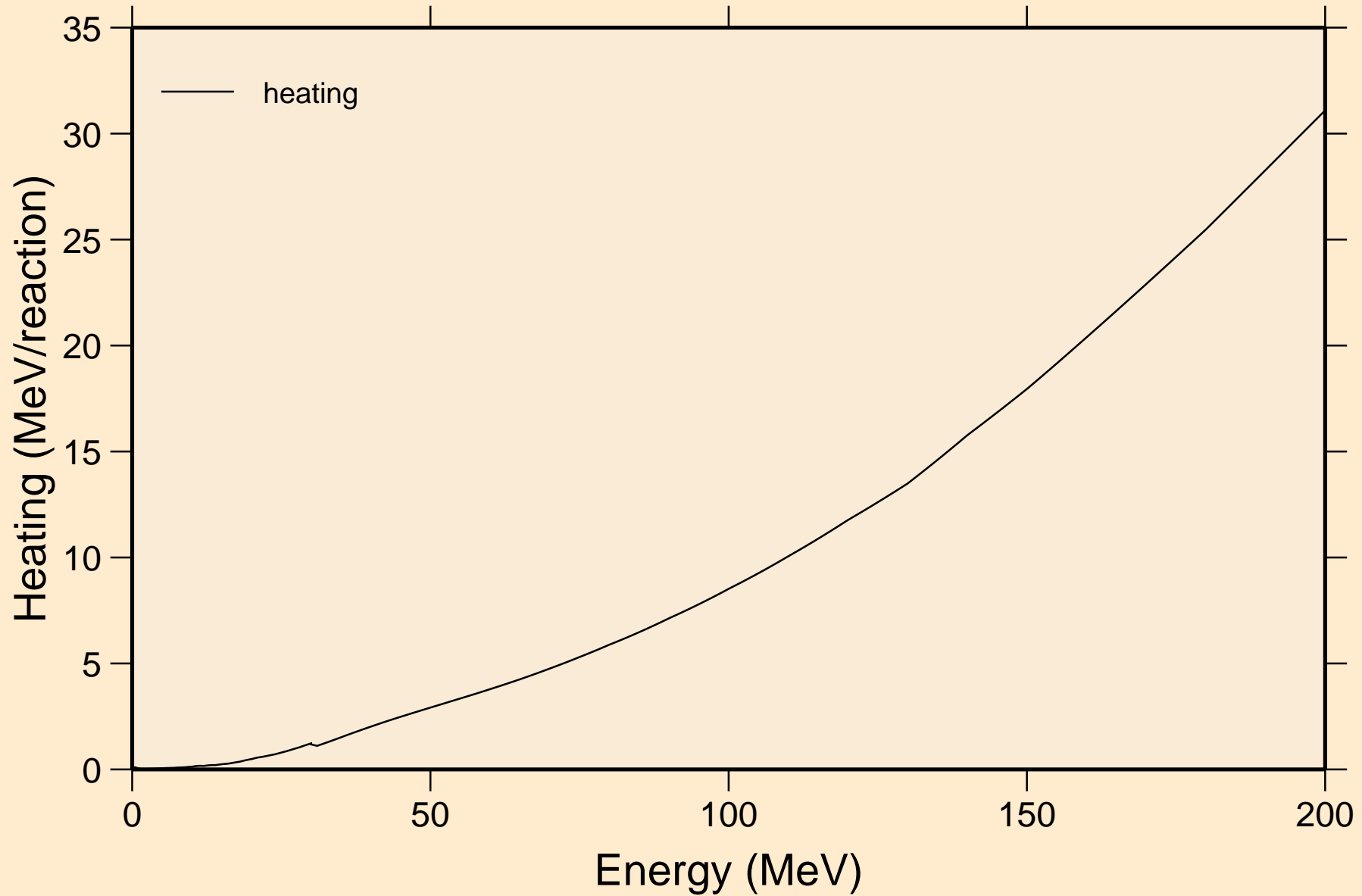

HO164M NEUTRON ACER TENDL-2024 LIBRARY; T=0.K  
Damage

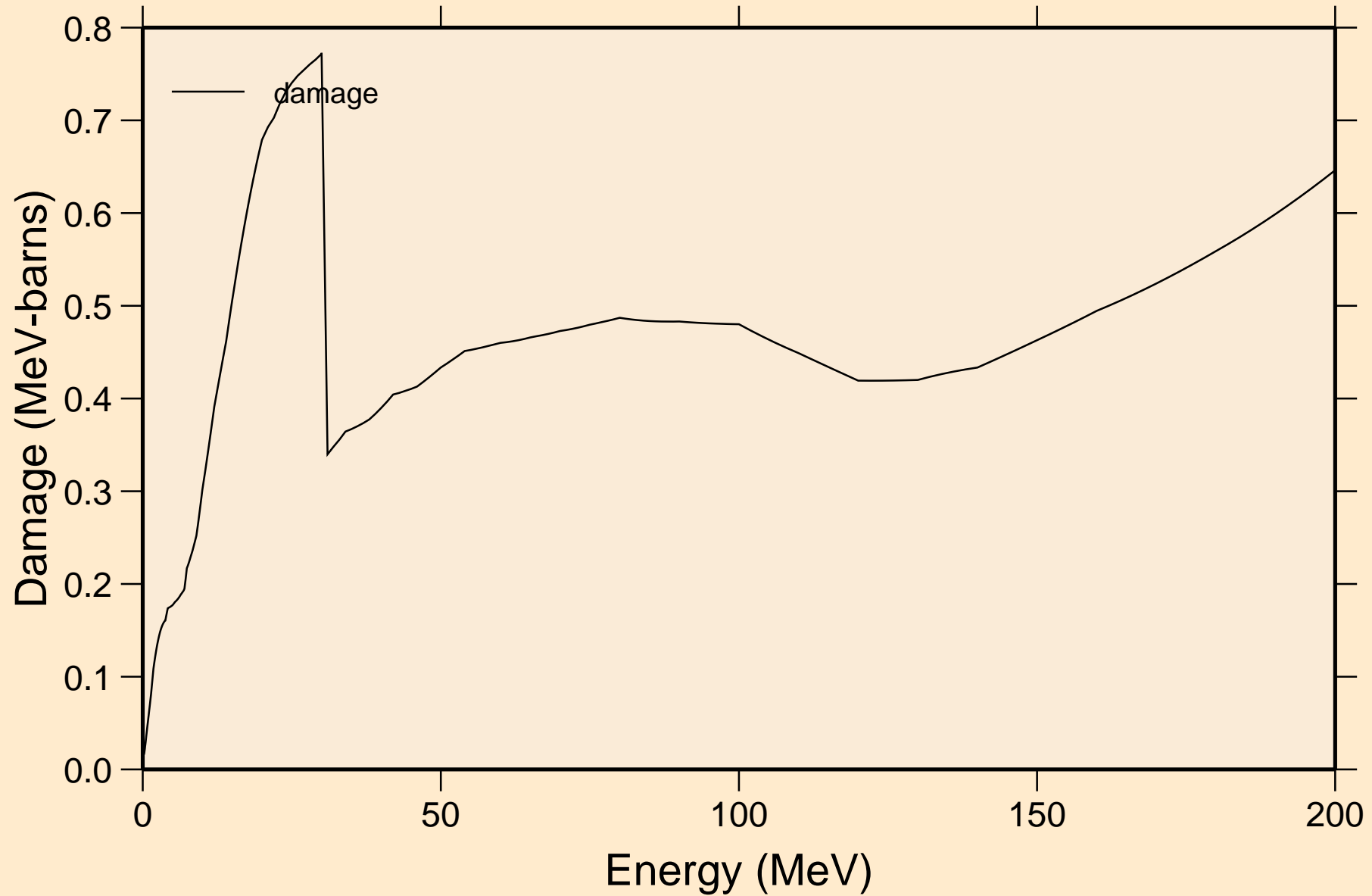

# HO164M NEUTRON ACER TENDL-2024 LIBRARY; T=0.K

## Non-threshold reactions

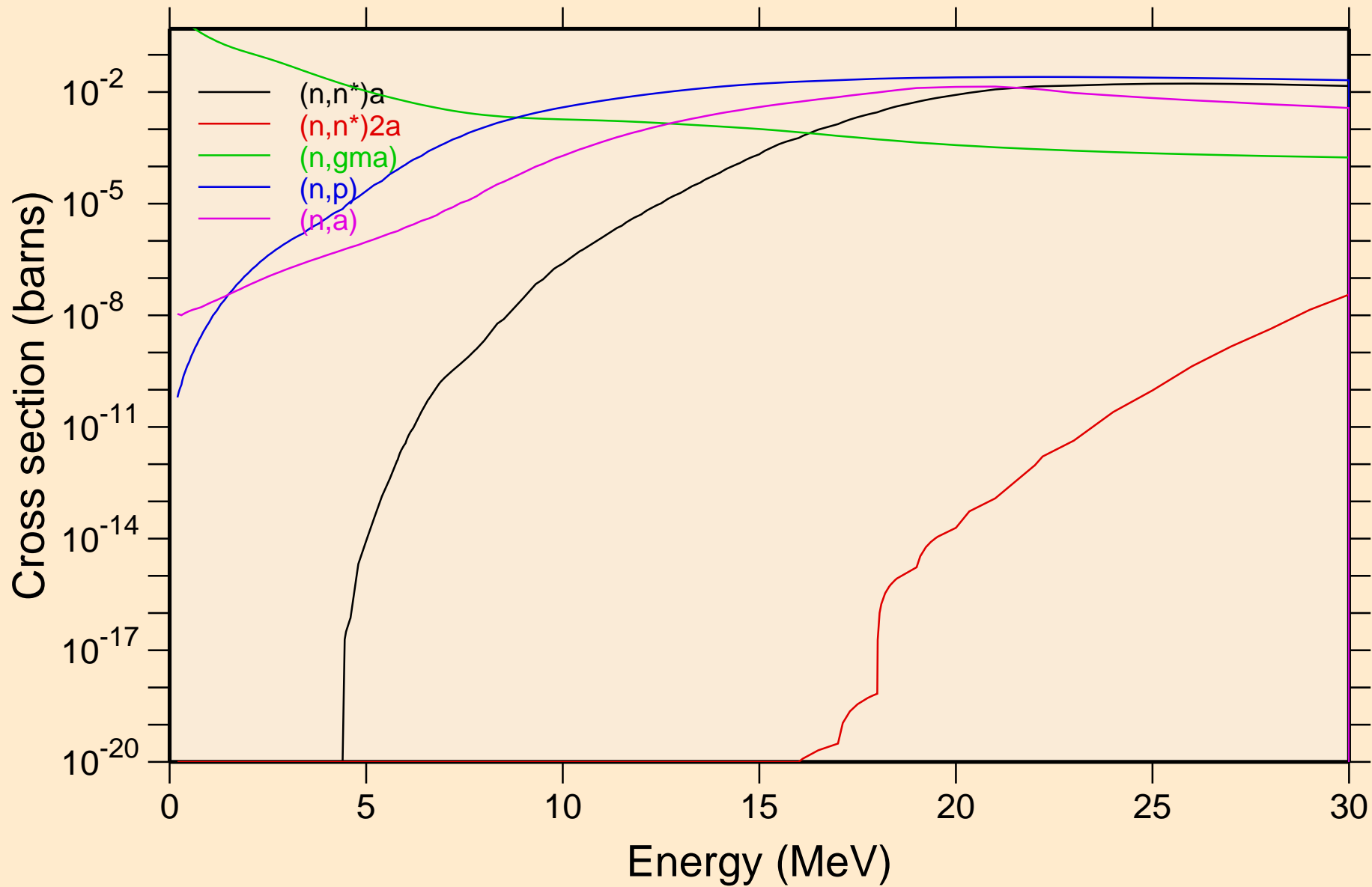

# HO164M NEUTRON ACER TENDL-2024 LIBRARY; T=0.K

## Non-threshold reactions

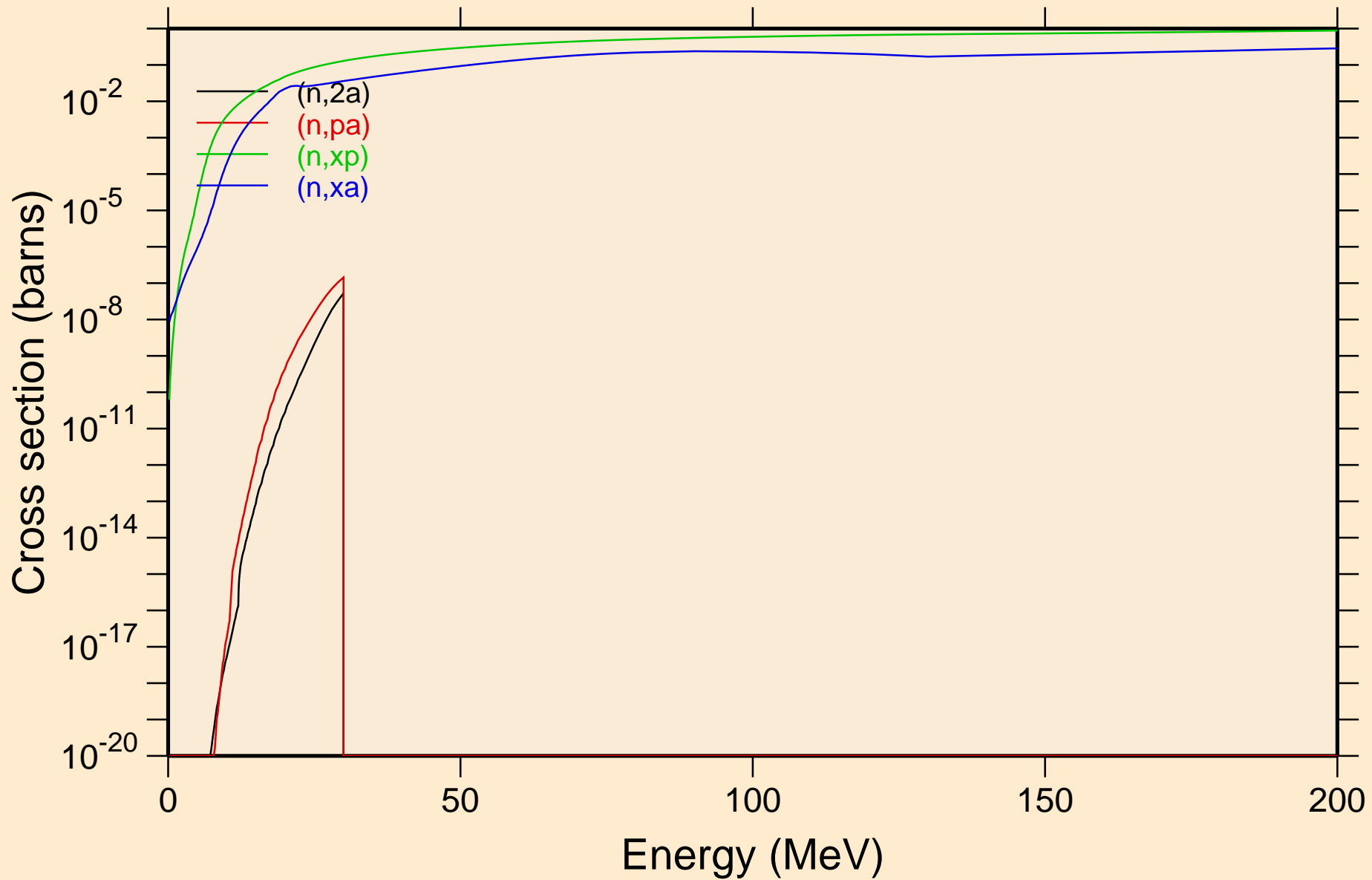

HO164M NEUTRON ACER TENDL-2024 LIBRARY; T=0.K  
Inelastic levels

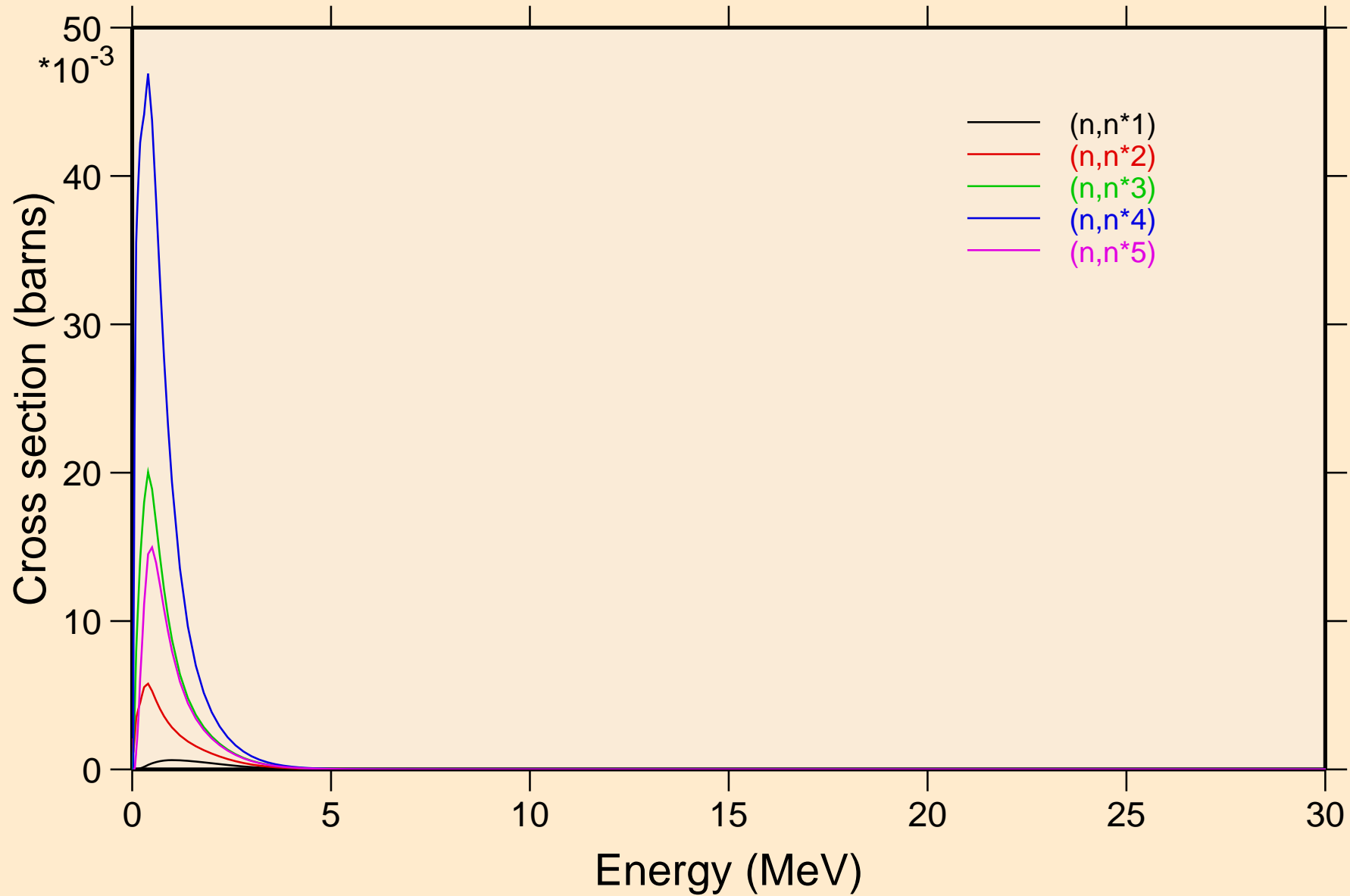

HO164M NEUTRON ACER TENDL-2024 LIBRARY; T=0.K  
Inelastic levels

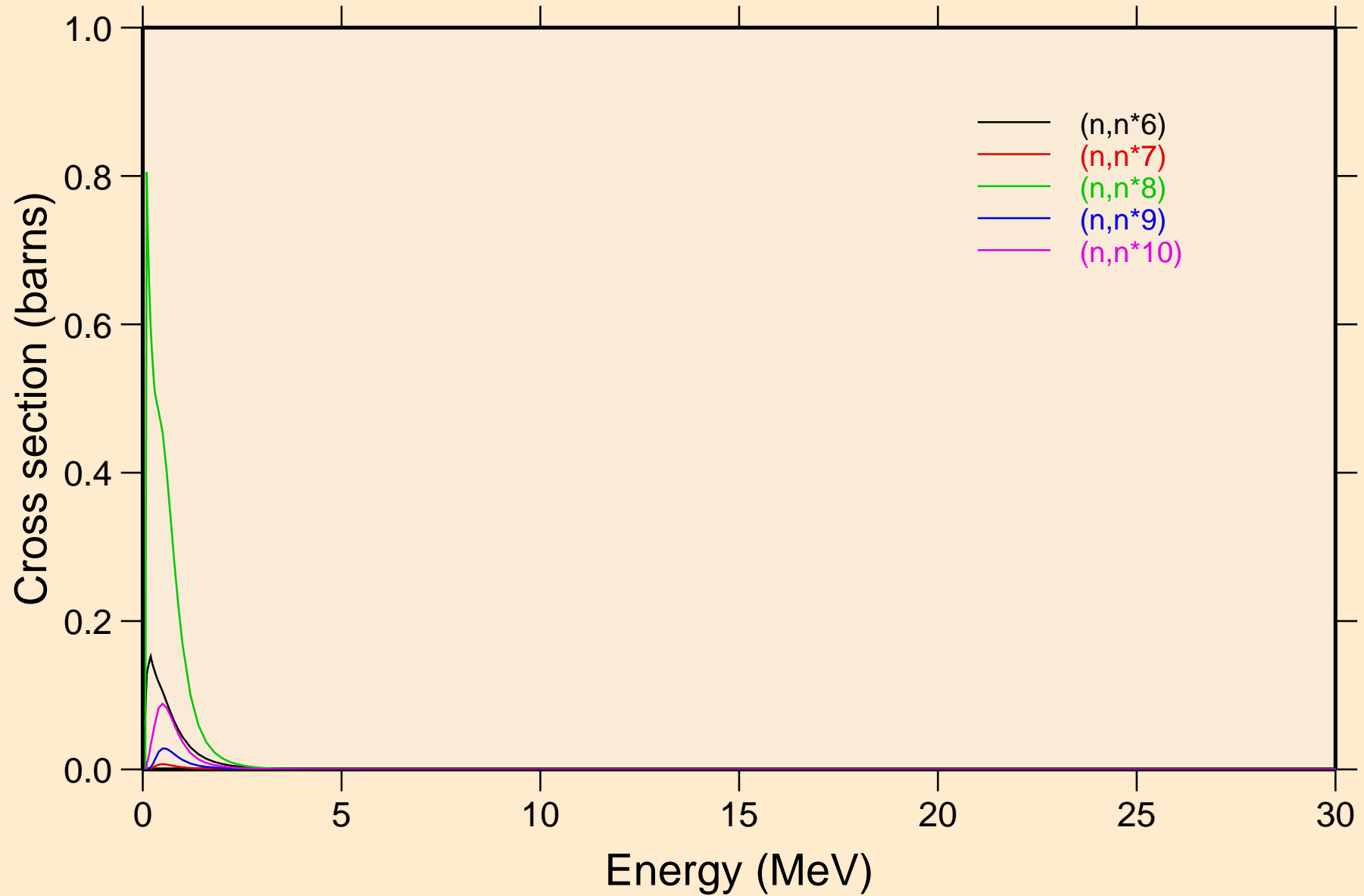

# HO164M NEUTRON ACER TENDL-2024 LIBRARY; T=0.K

## Inelastic levels

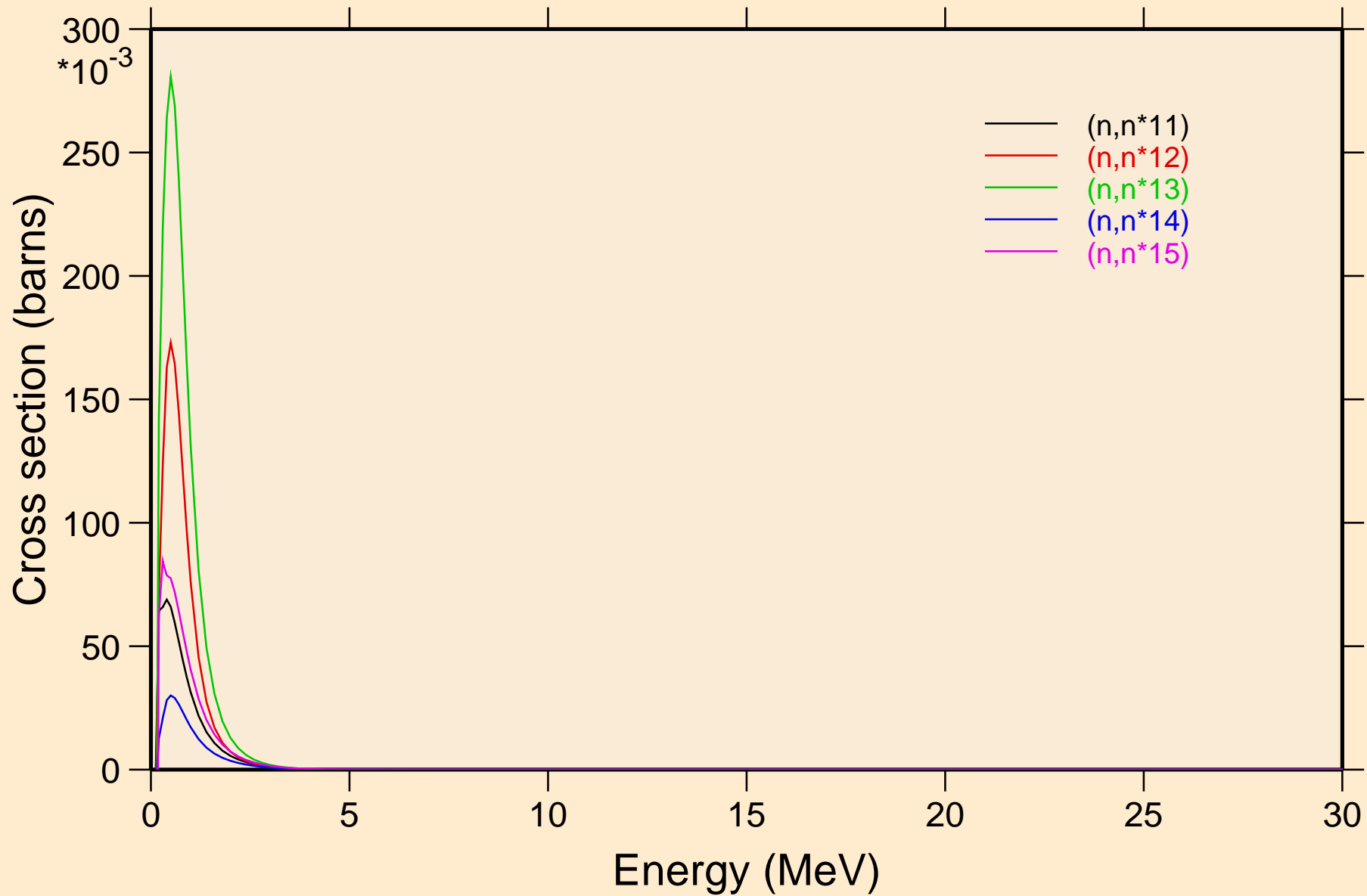

HO164M NEUTRON ACER TENDL-2024 LIBRARY; T=0.K  
Inelastic levels

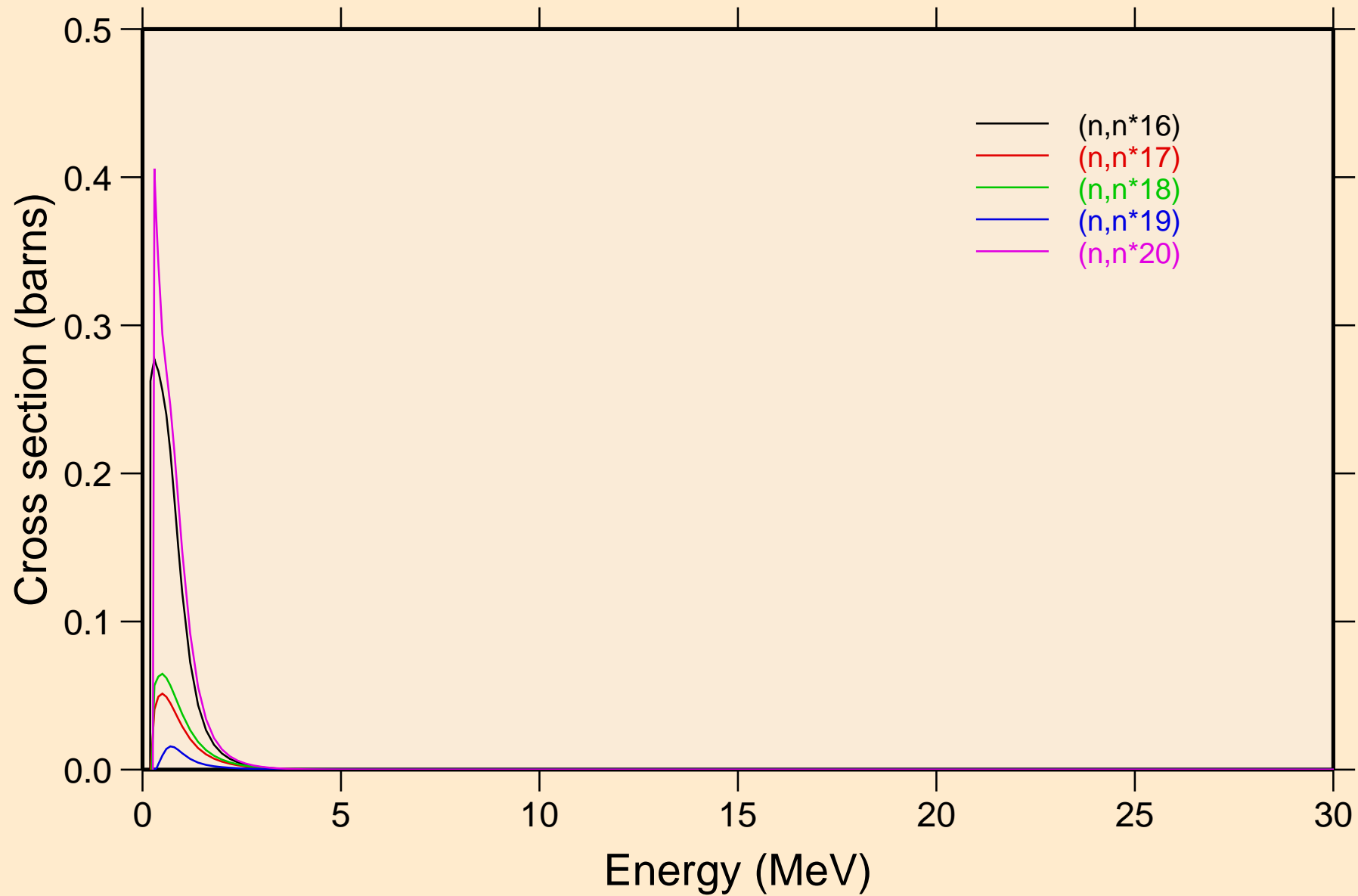

HO164M NEUTRON ACER TENDL-2024 LIBRARY; T=0.K  
Inelastic levels

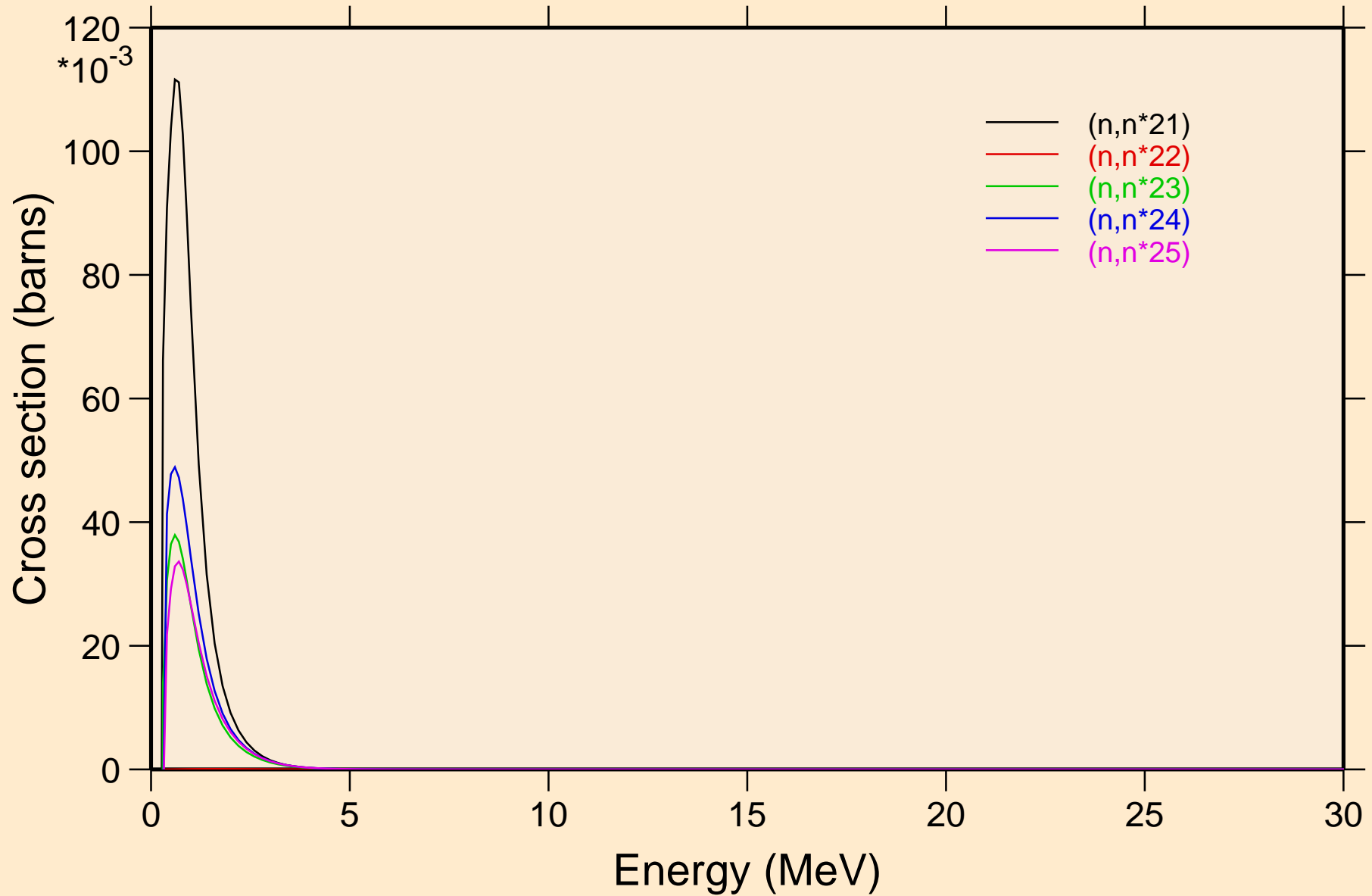

HO164M NEUTRON ACER TENDL-2024 LIBRARY; T=0.K  
Inelastic levels

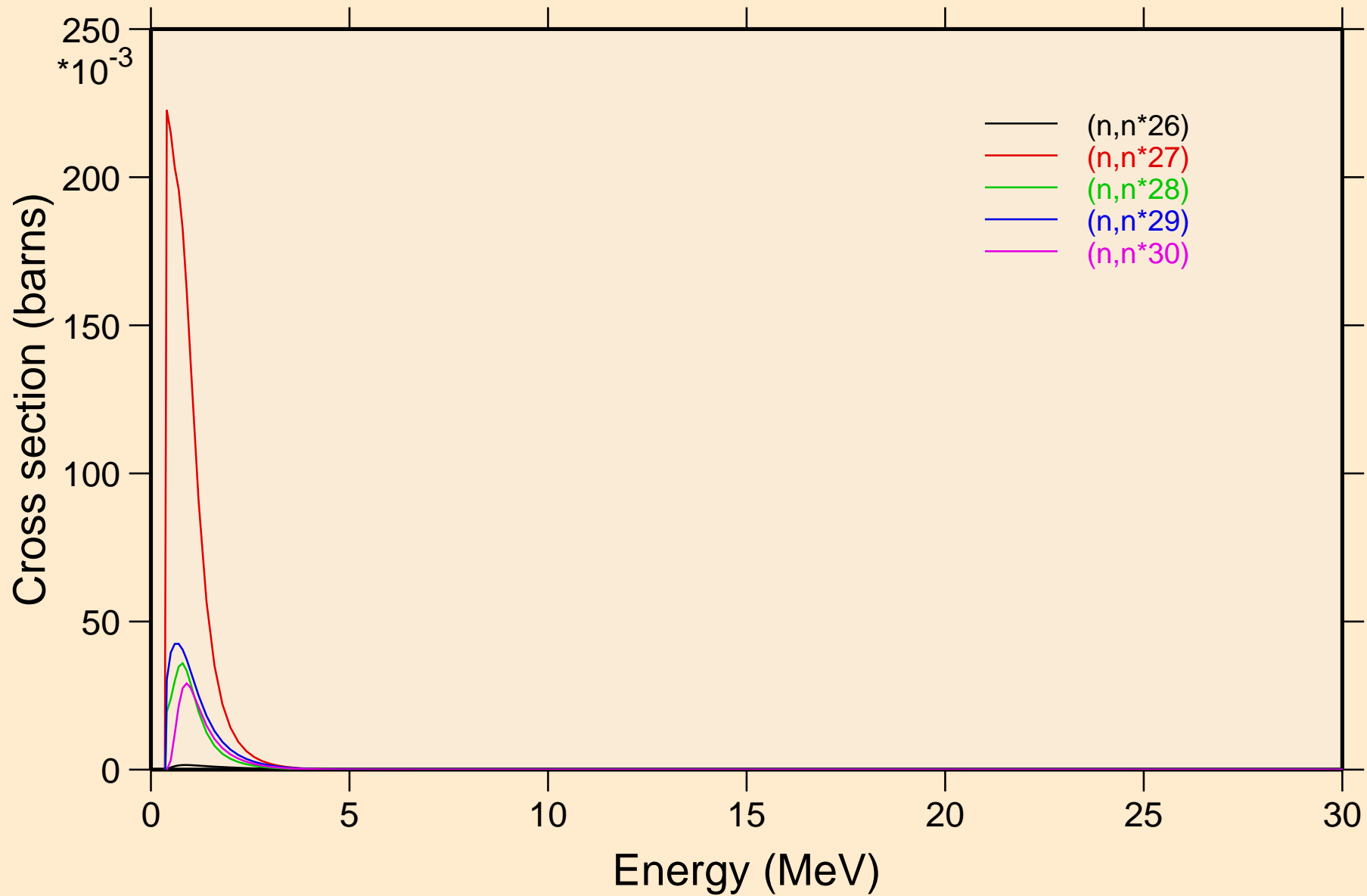

# HO164M NEUTRON ACER TENDL-2024 LIBRARY; T=0.K

## Threshold reactions

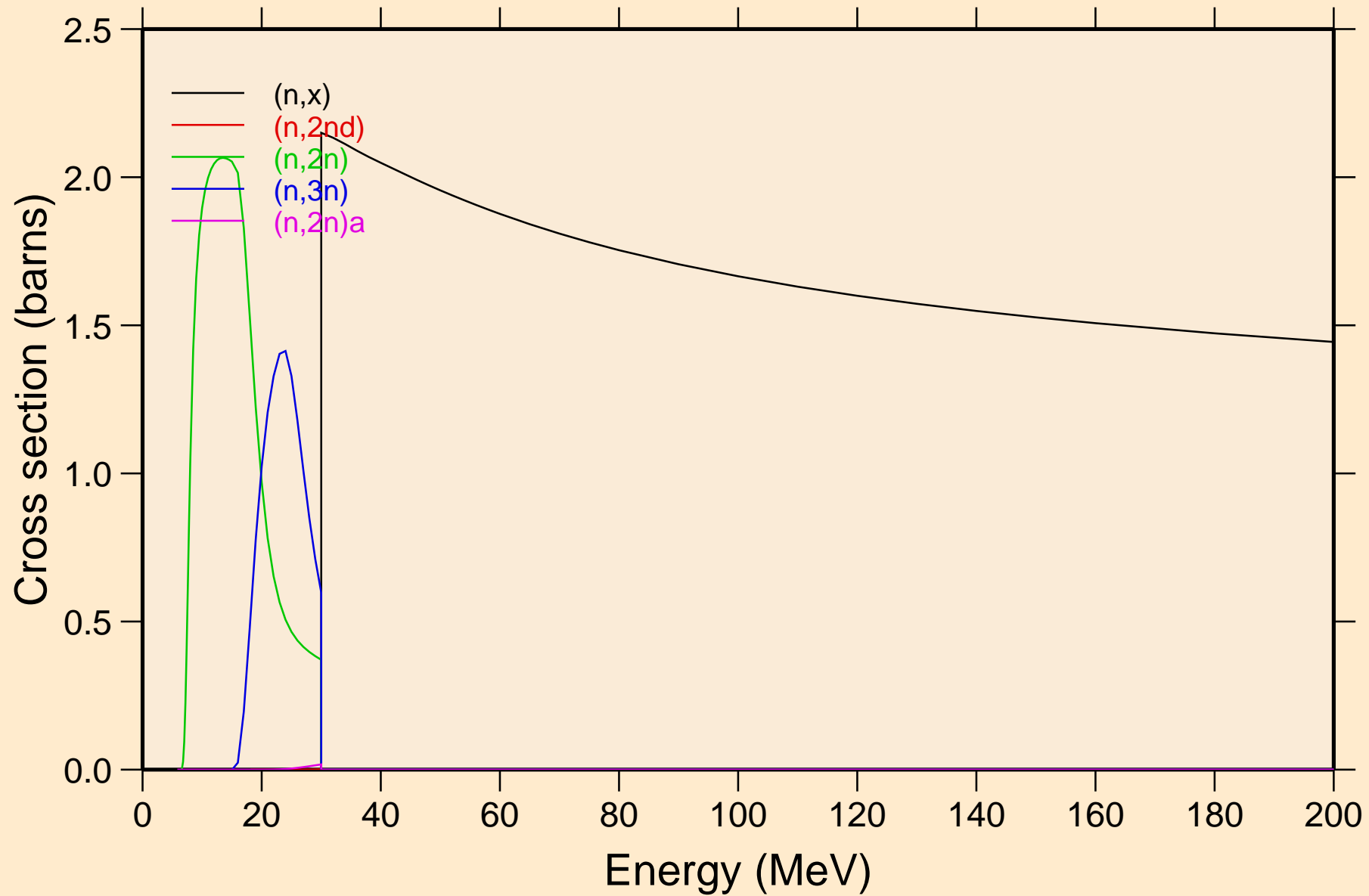

# HO164M NEUTRON ACER TENDL-2024 LIBRARY; T=0.K

## Threshold reactions

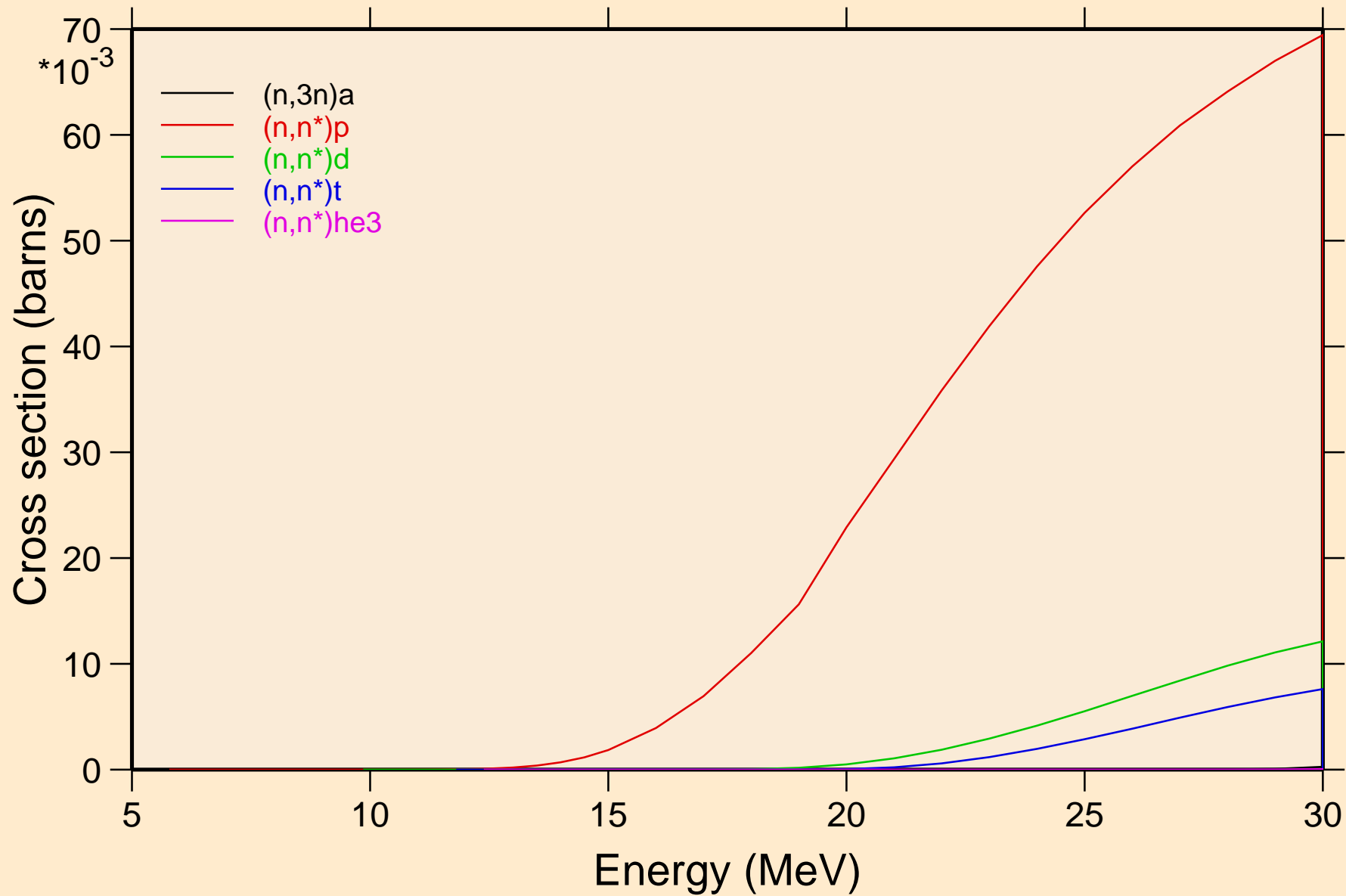

HO164M NEUTRON ACER TENDL-2024 LIBRARY; T=0.K  
Threshold reactions

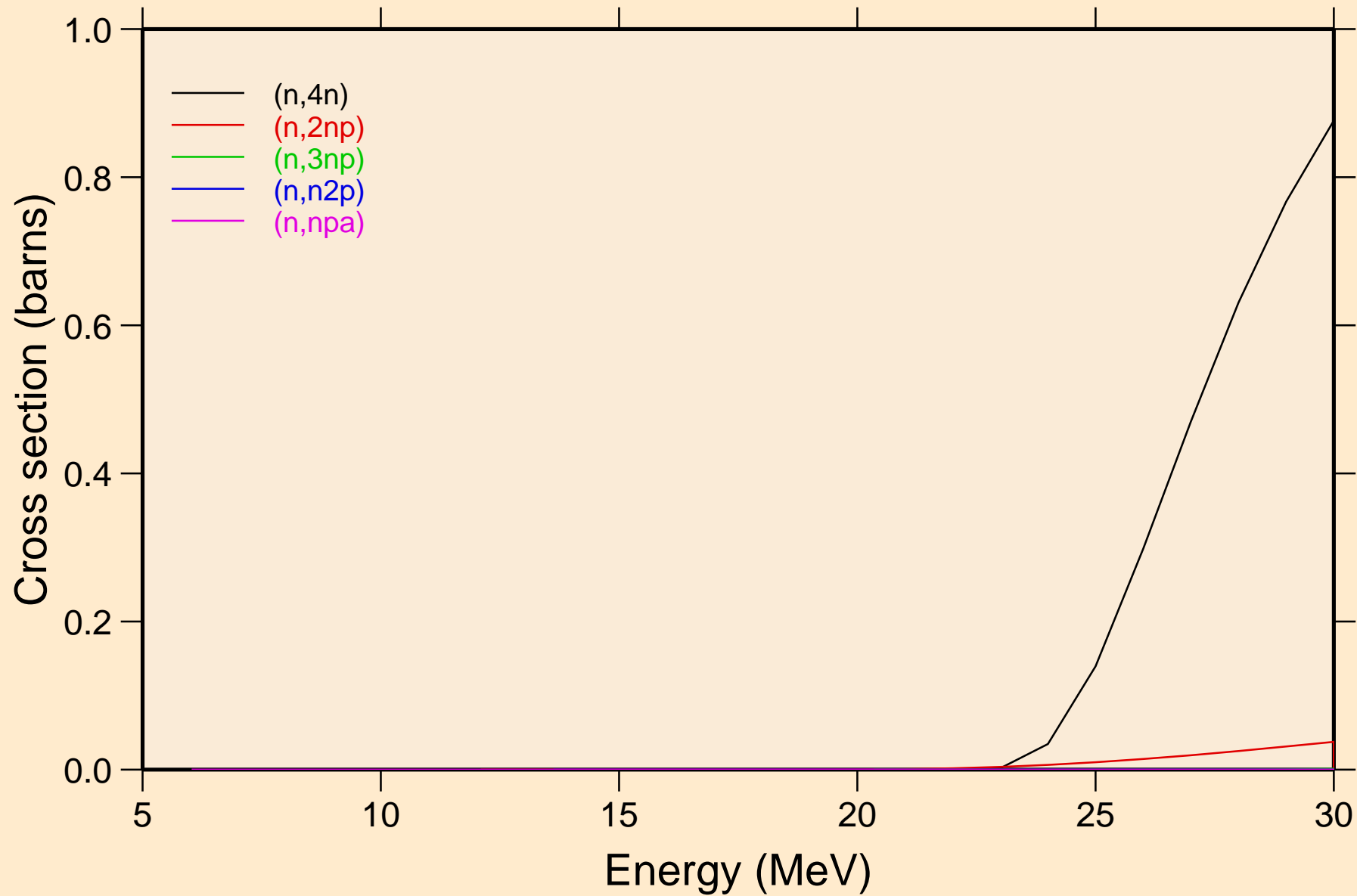

# HO164M NEUTRON ACER TENDL-2024 LIBRARY; T=0.K

## Threshold reactions

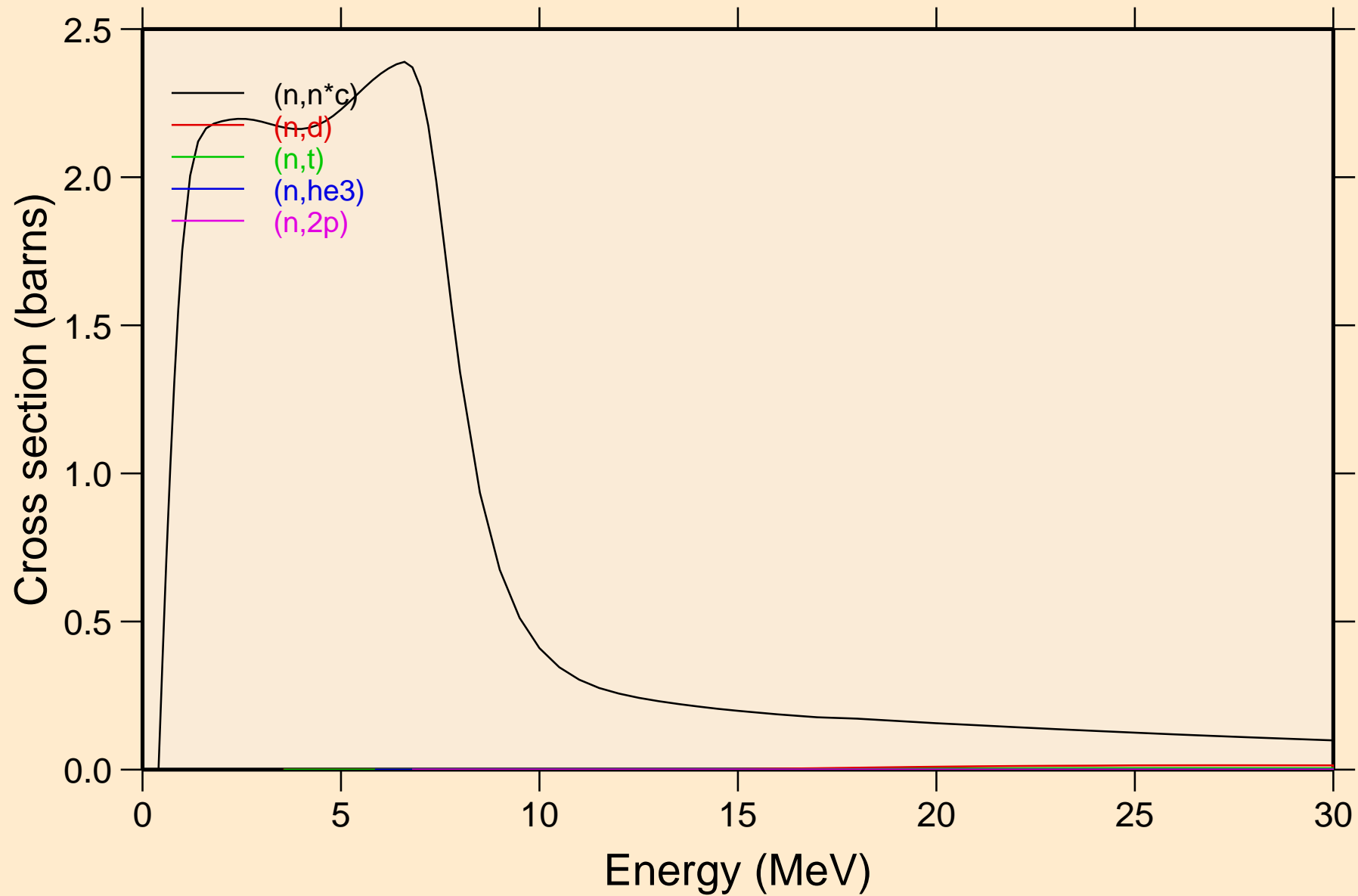

# HO164M NEUTRON ACER TENDL-2024 LIBRARY; T=0.K

## Threshold reactions

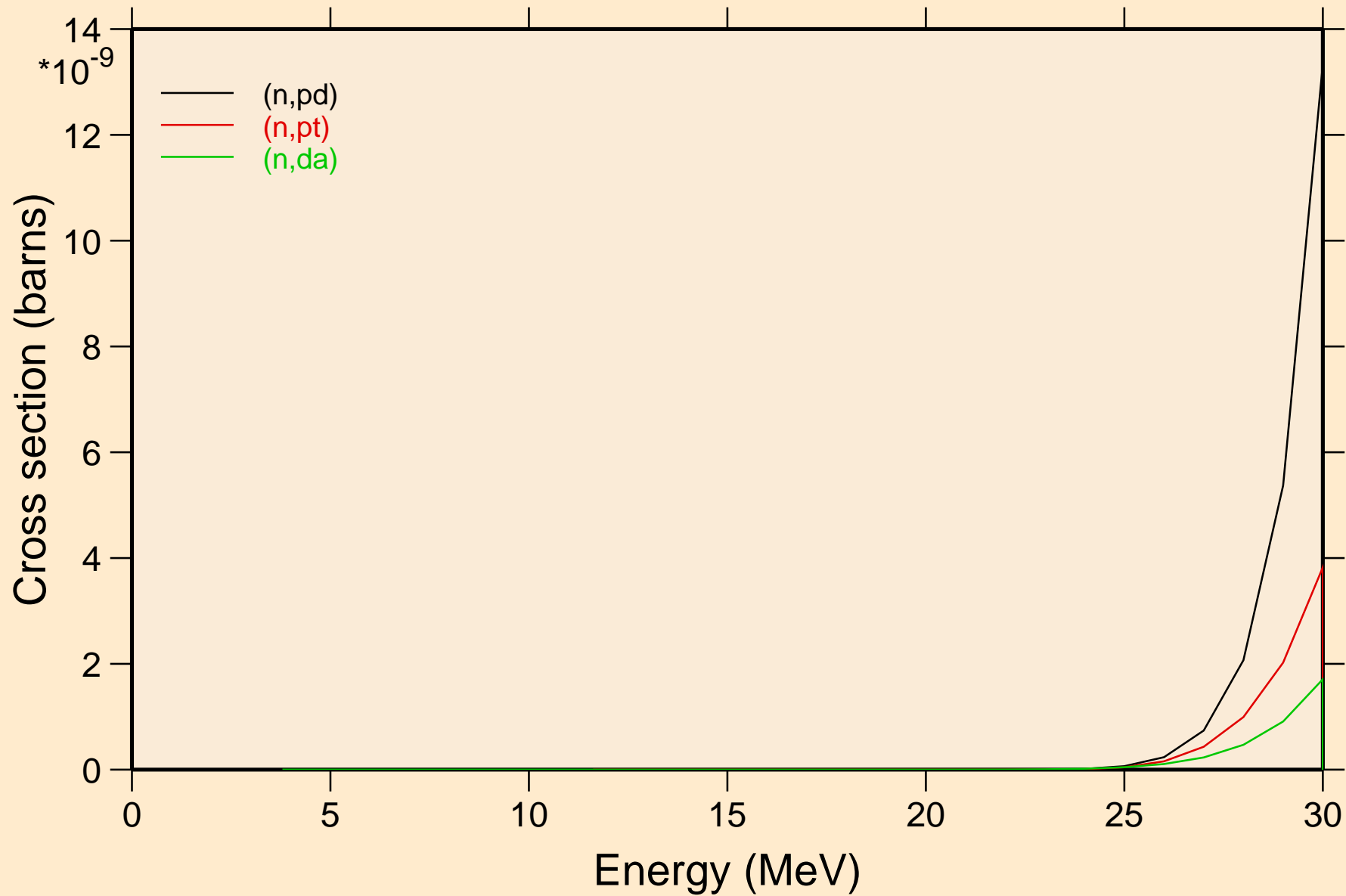

# HO164M NEUTRON ACER TENDL-2024 LIBRARY; T=0.K

## Threshold reactions

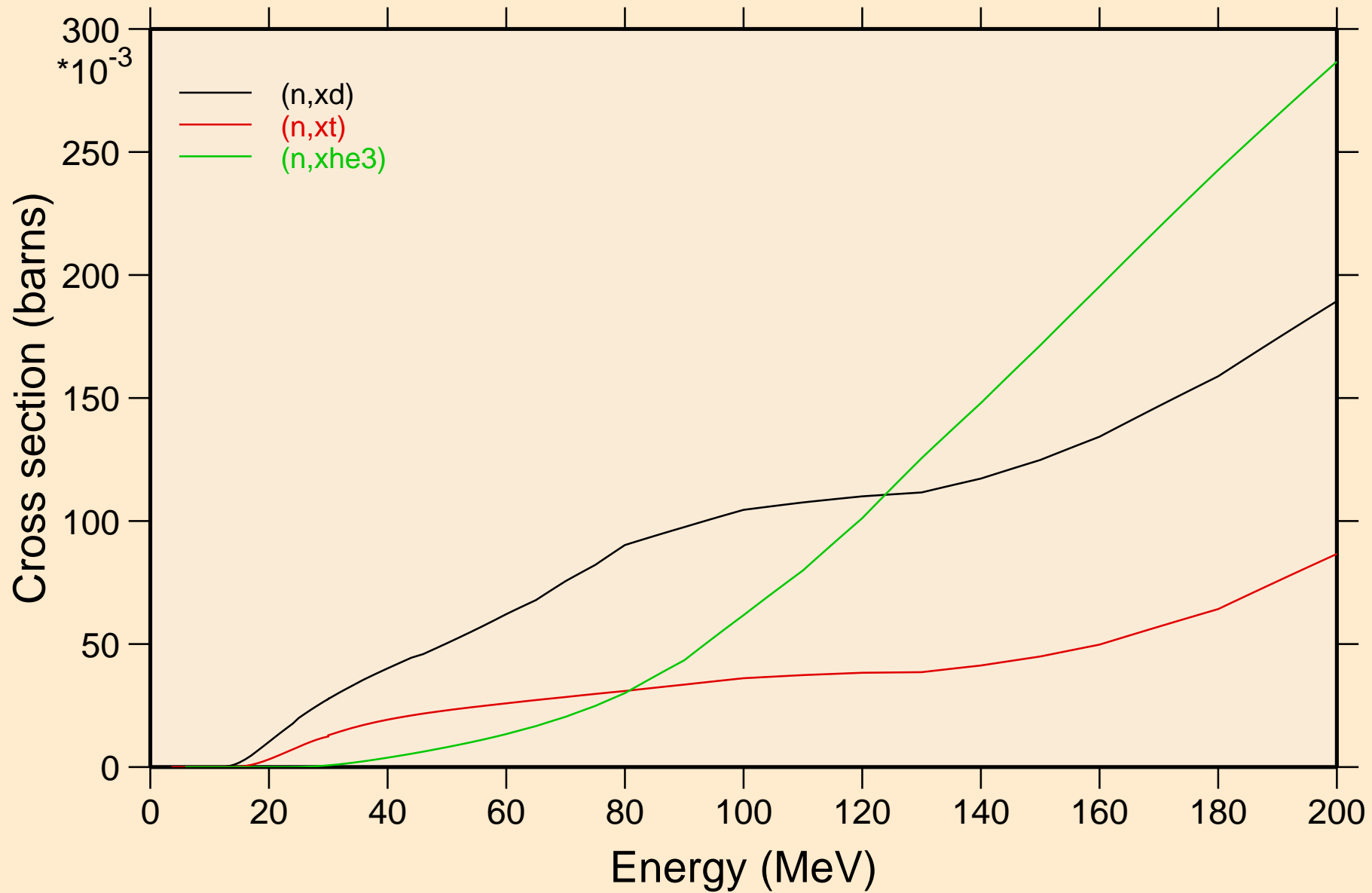

HO164M NEUTRON ACER TENDL-2024 LIBRARY; T=0.K  
angular distribution for elastic

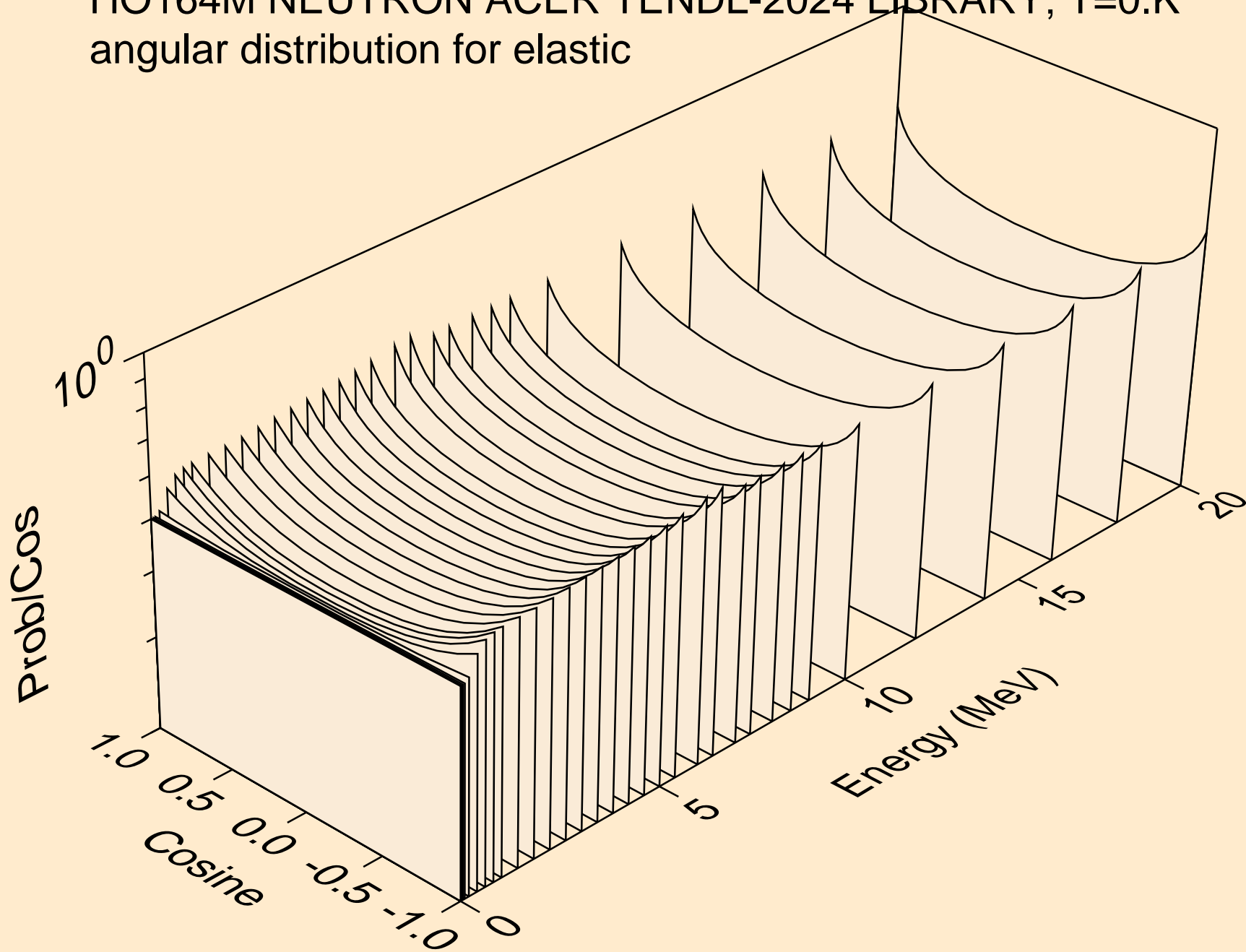

HO164M NEUTRON ACER TENDL-2024 LIBRARY; T=0.K  
angular distribution for elastic

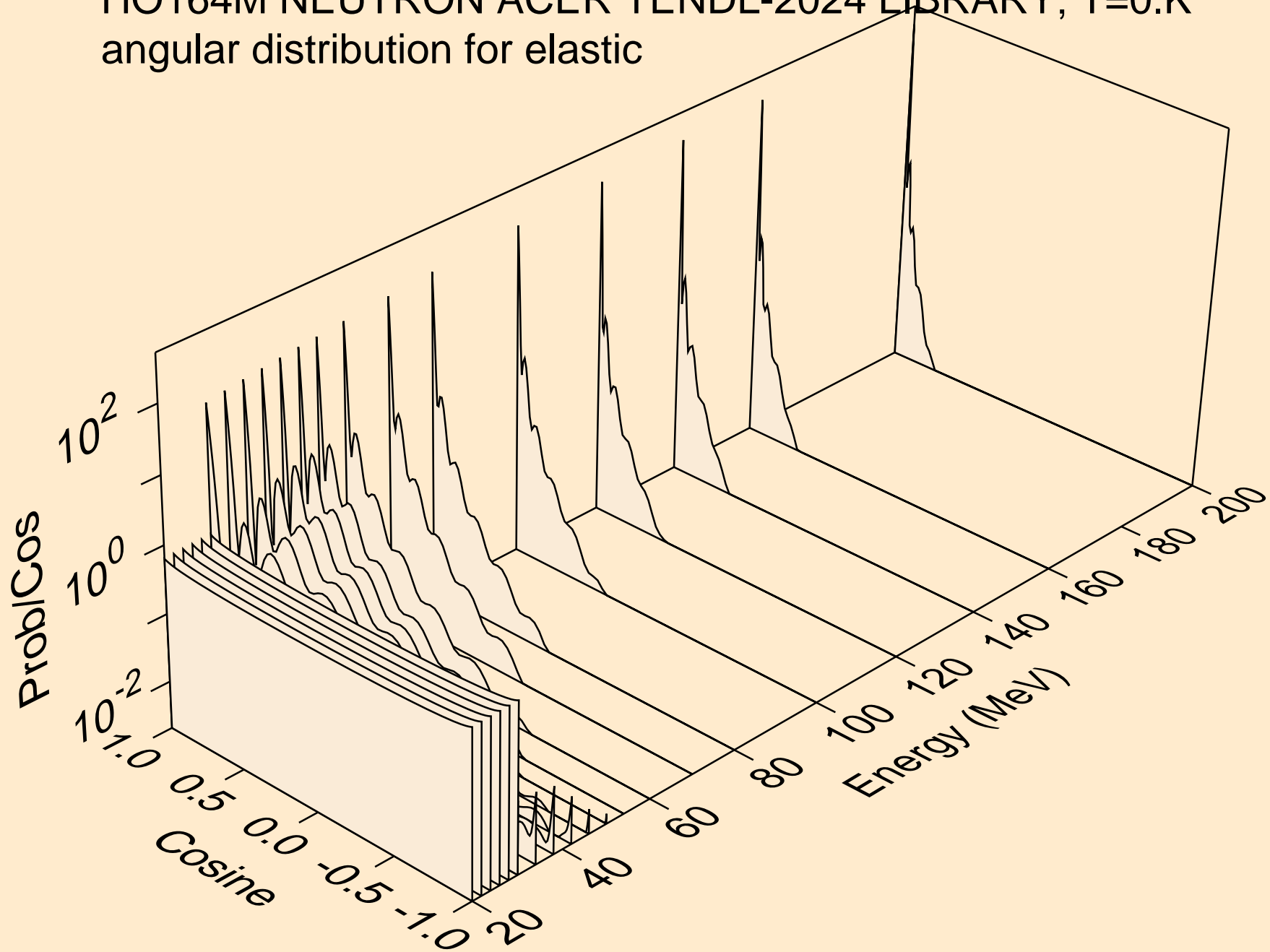

HO164M NEUTRON ACER TENDL-2024 LIBRARY; T=0.K  
angular distribution for (n,n\*1)

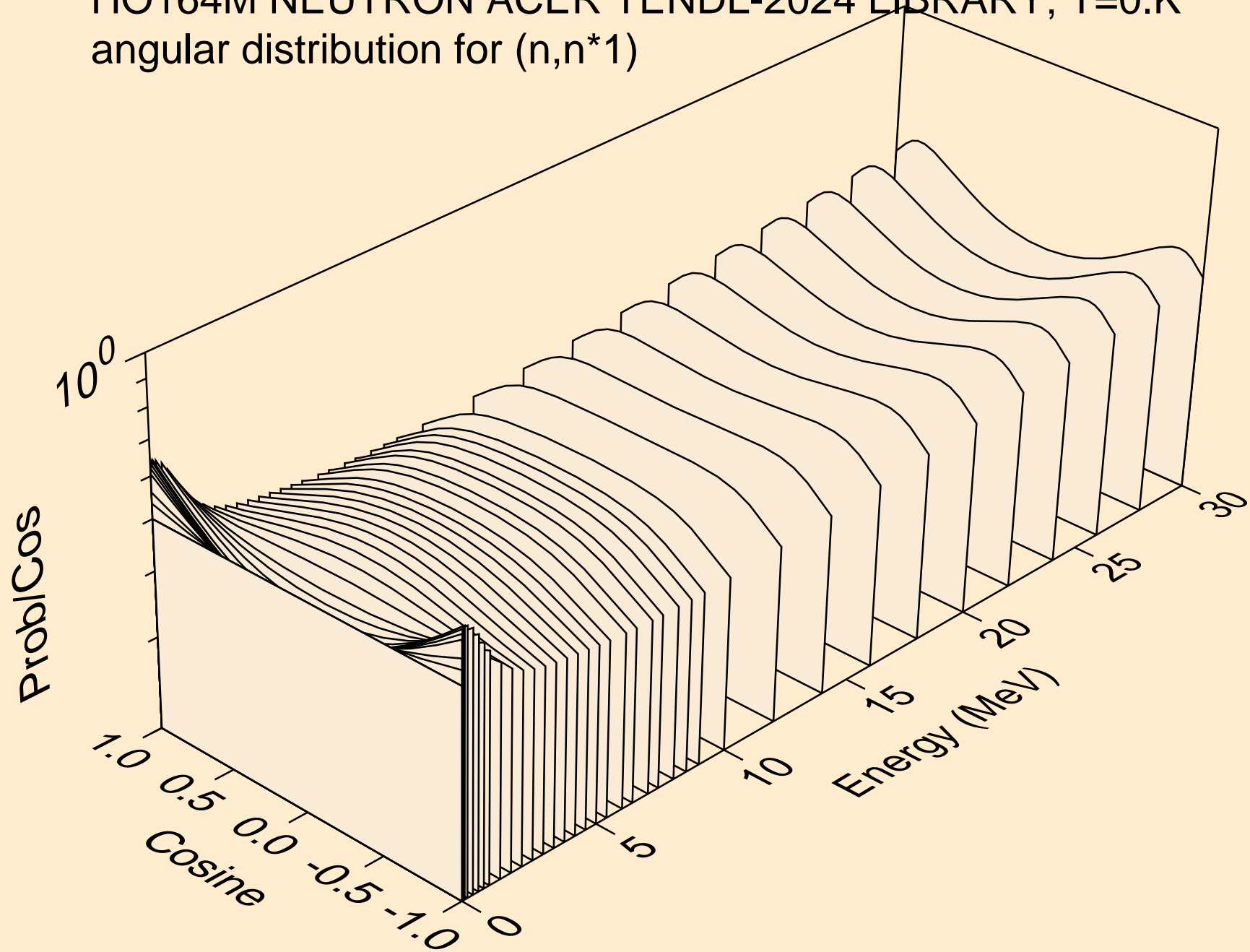

HO164M NEUTRON ACER TENDL-2024 LIBRARY; T=0.K  
angular distribution for (n,n\*2)

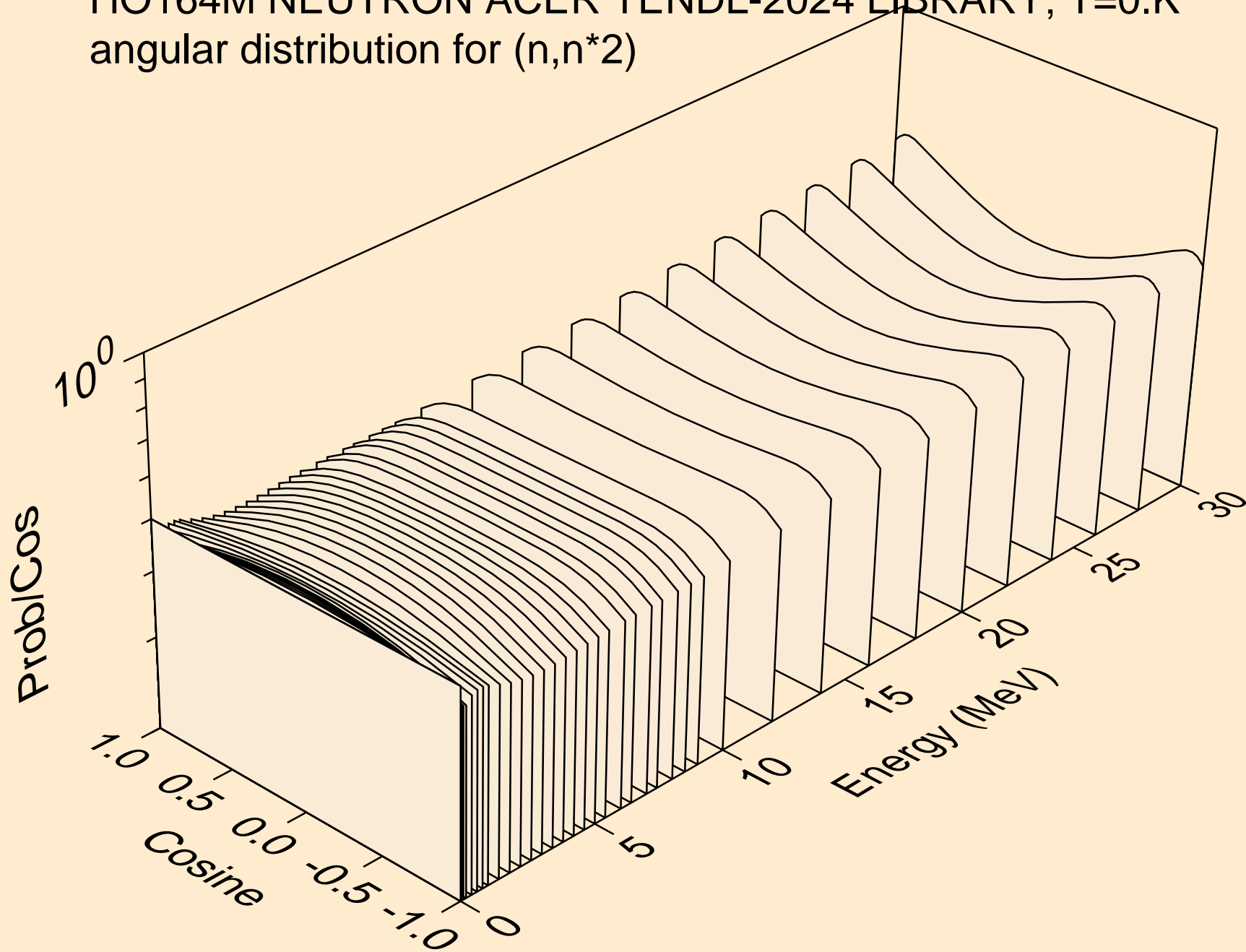

HO164M NEUTRON ACER TENDL-2024 LIBRARY; T=0.K  
angular distribution for (n,n\*3)

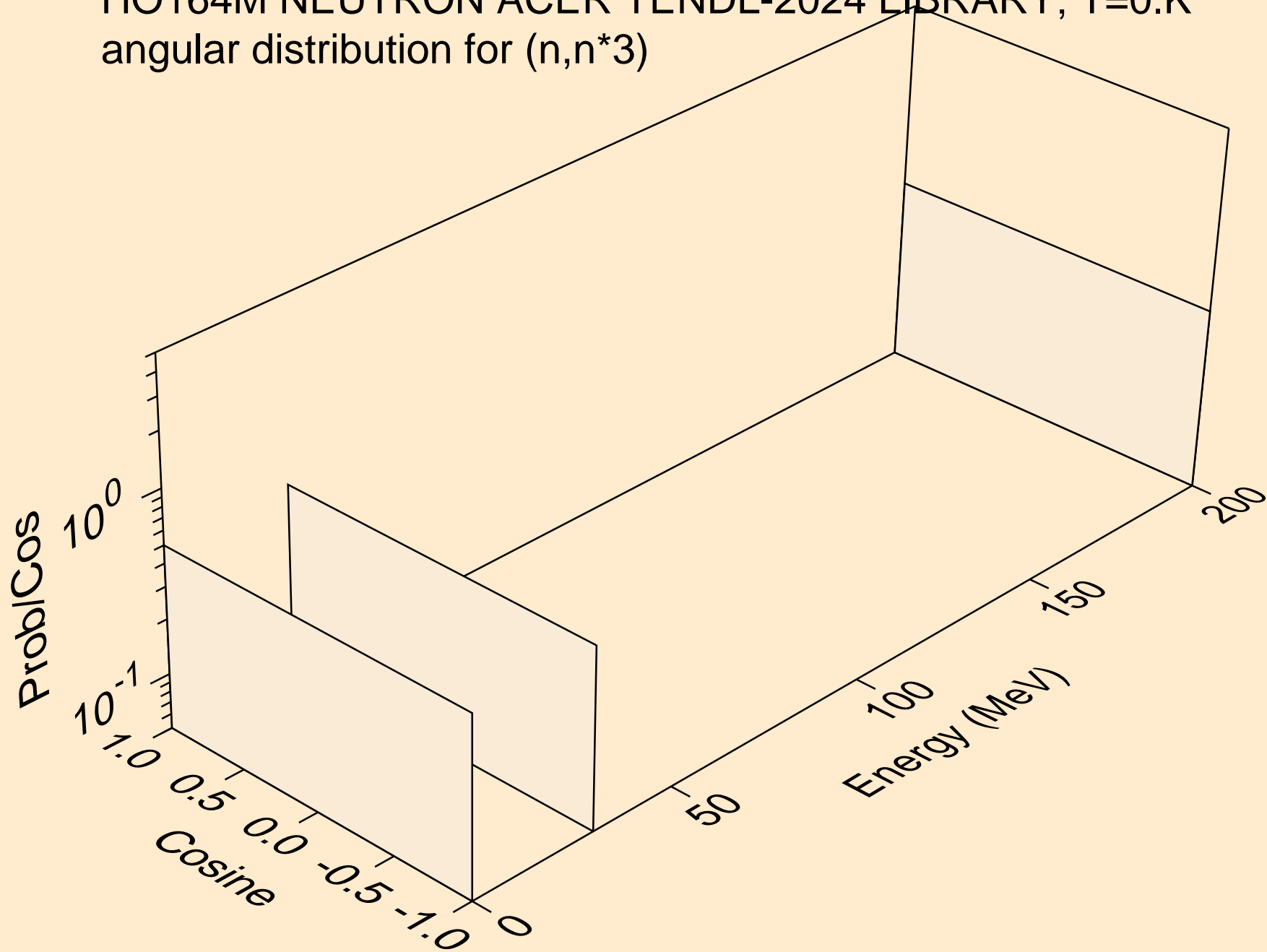

HO164M NEUTRON ACER TENDL-2024 LIBRARY; T=0.K  
angular distribution for (n,n\*4)

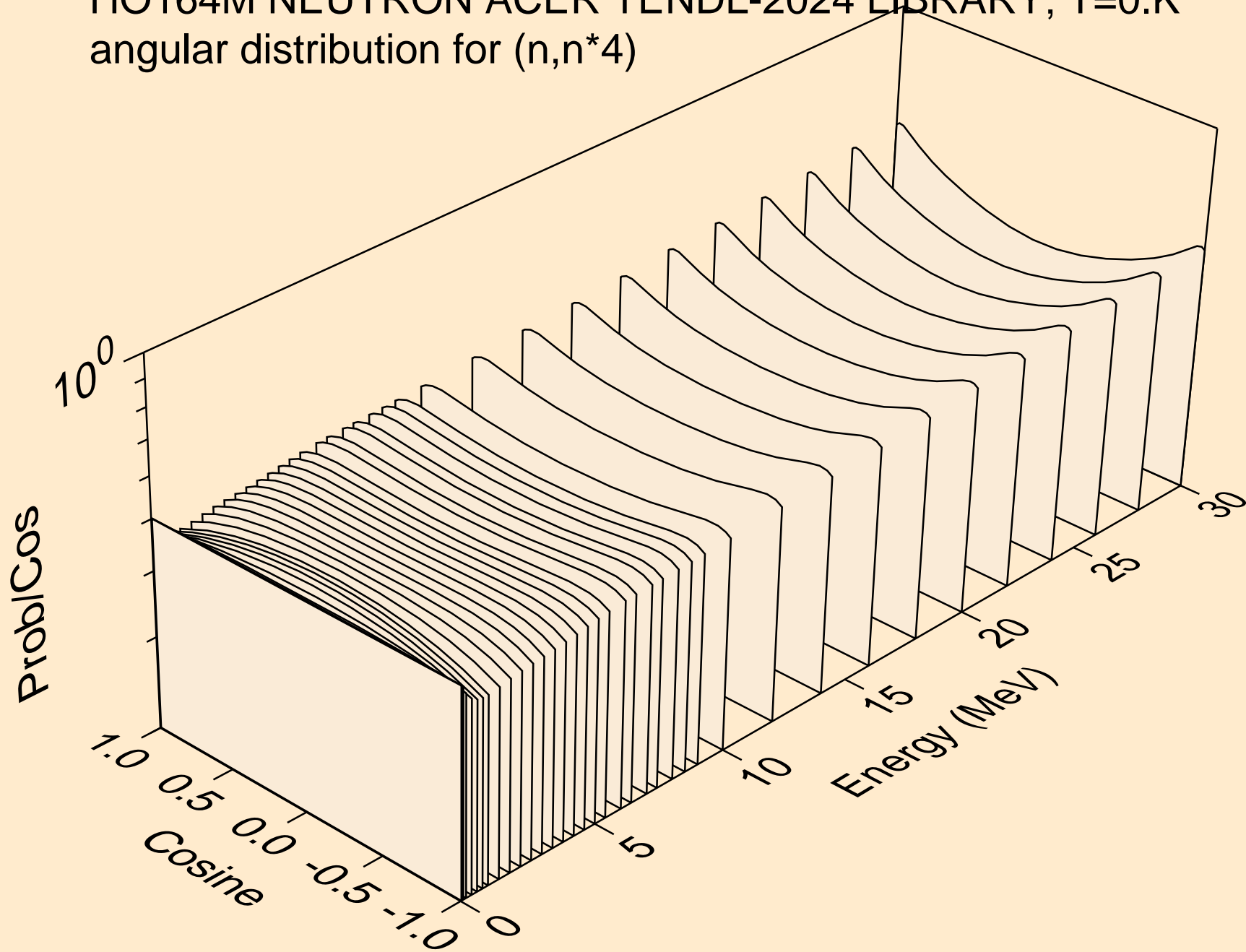

HO164M NEUTRON ACER TENDL-2024 LIBRARY; T=0.K  
angular distribution for (n,n\*5)

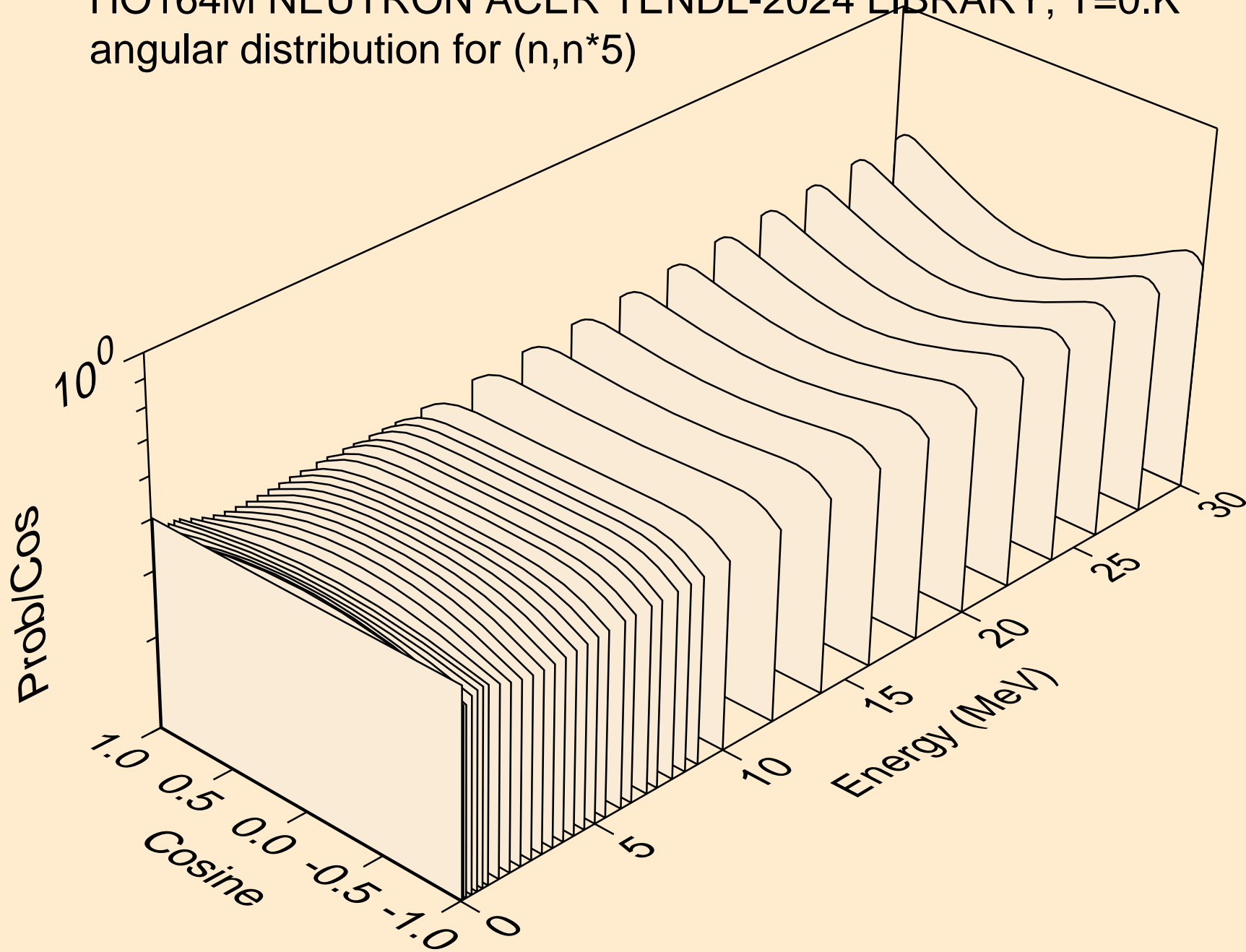

HO164M NEUTRON ACER TENDL-2024 LIBRARY; T=0.K  
angular distribution for (n,n\*6)

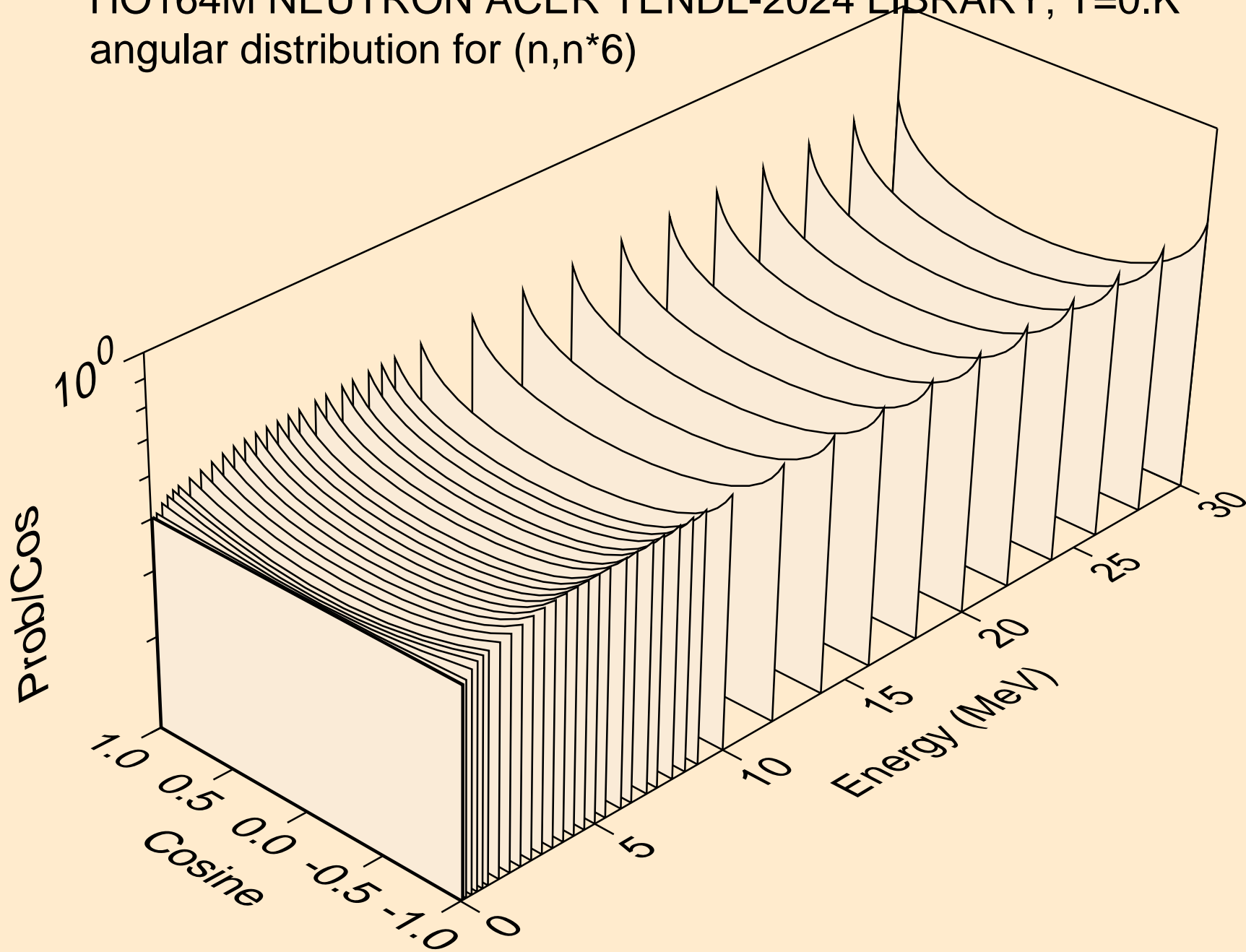

HO164M NEUTRON ACER TENDL-2024 LIBRARY; T=0.K  
angular distribution for (n,n\*7)

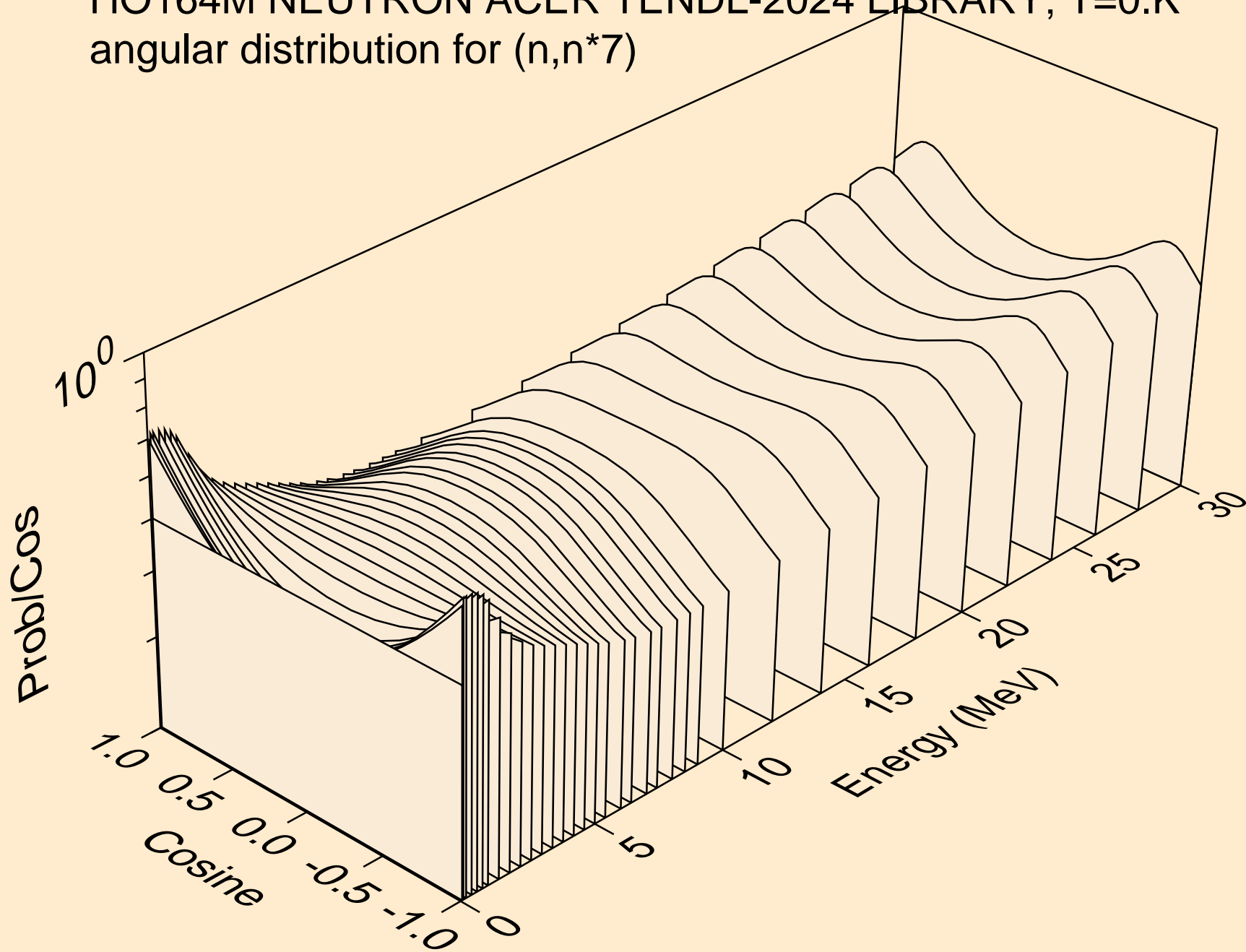

HO164M NEUTRON ACER TENDL-2024 LIBRARY; T=0.K  
angular distribution for (n,n\*8)

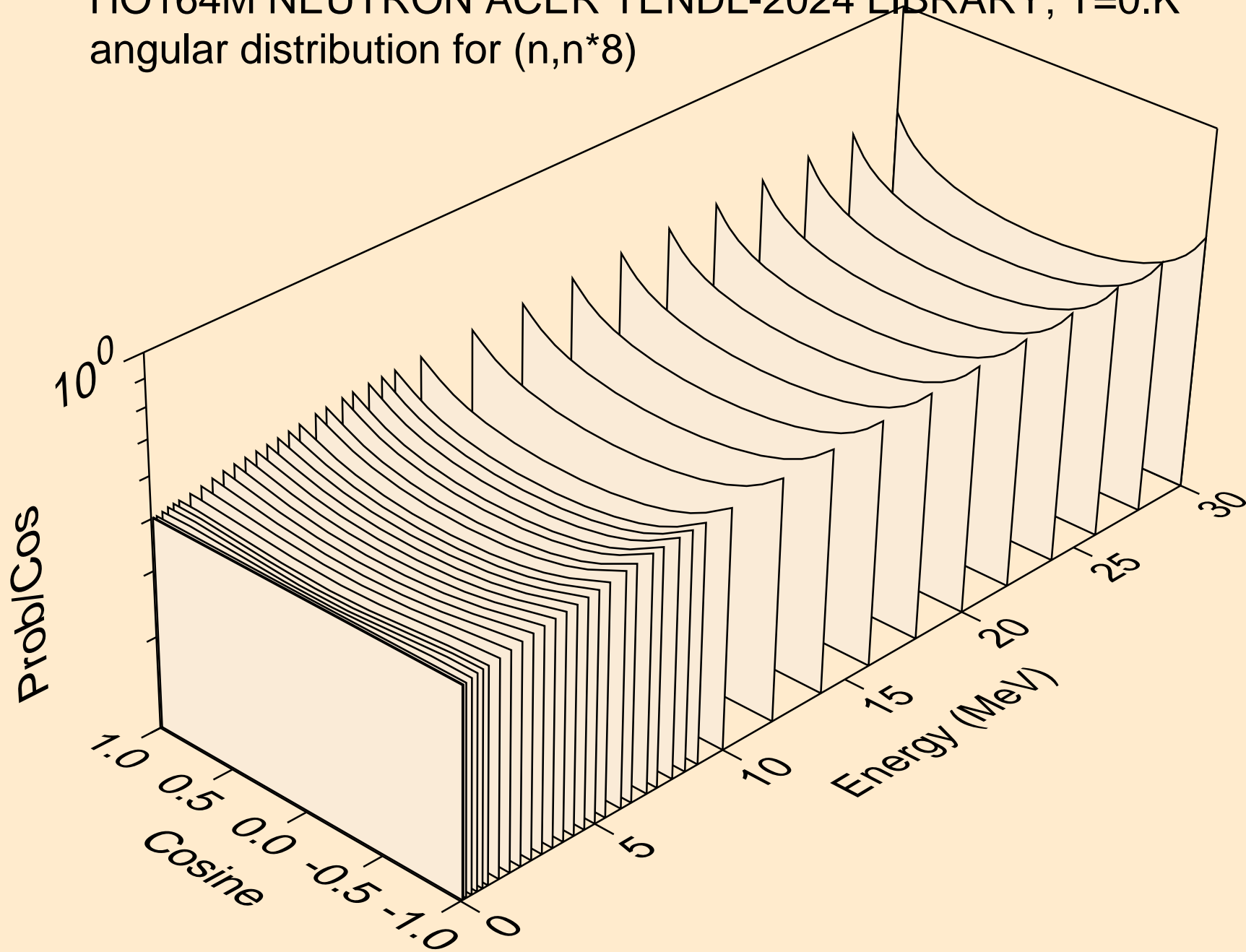

HO164M NEUTRON ACER TENDL-2024 LIBRARY; T=0.K  
angular distribution for (n,n\*9)

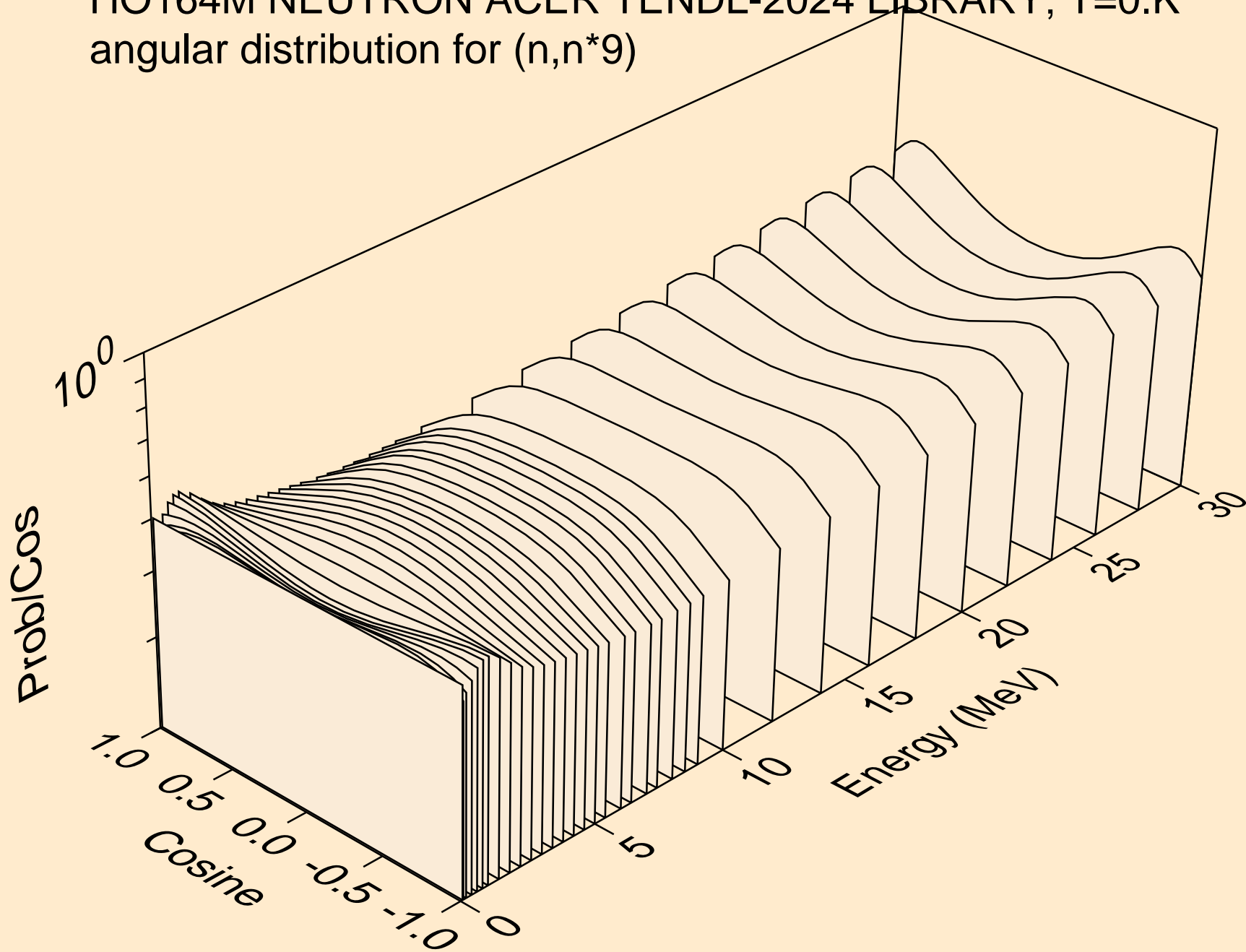

HO164M NEUTRON ACER TENDL-2024 LIBRARY; T=0.K  
angular distribution for (n,n\*10)

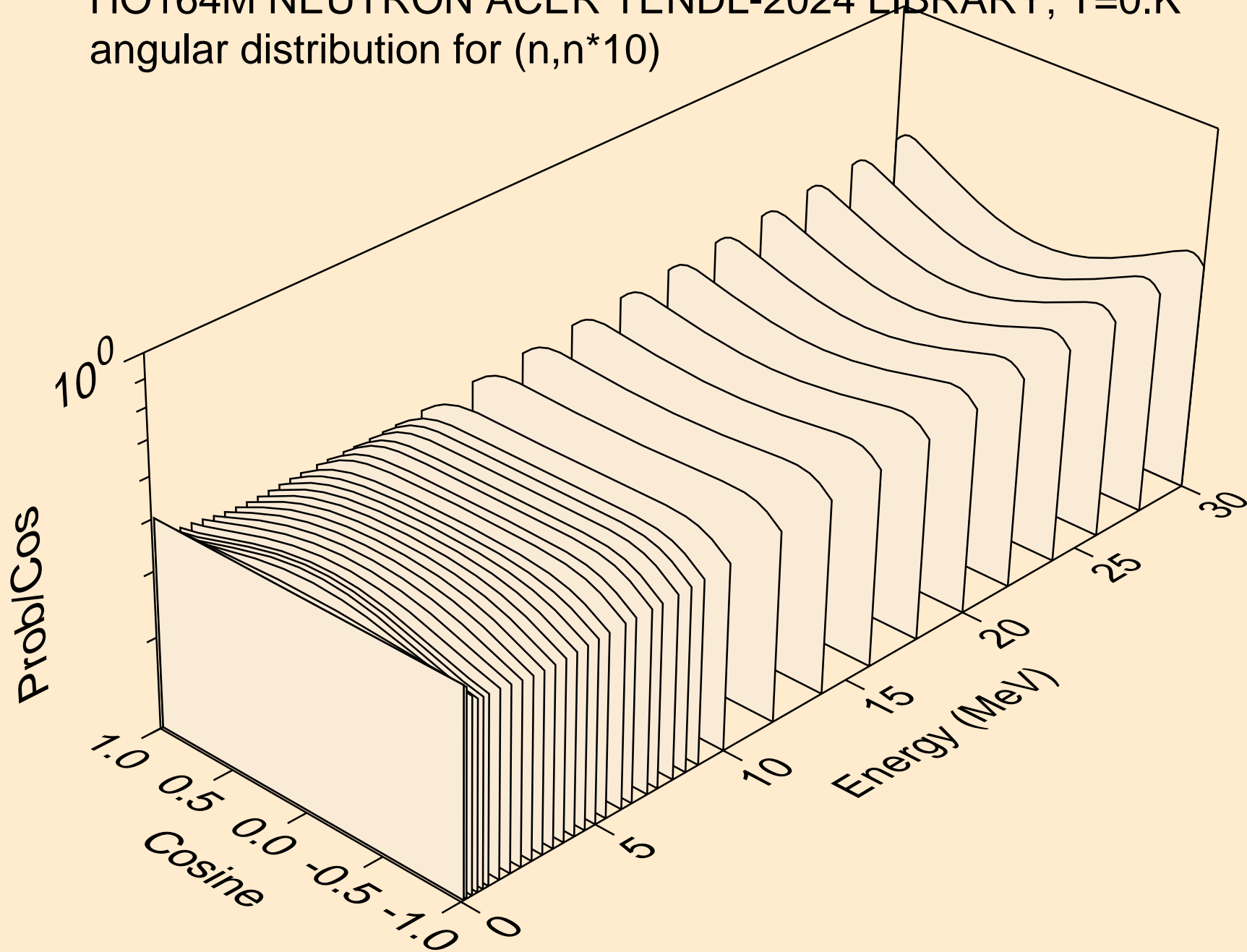

HO164M NEUTRON ACER TENDL-2024 LIBRARY; T=0.K  
angular distribution for (n,n\*11)

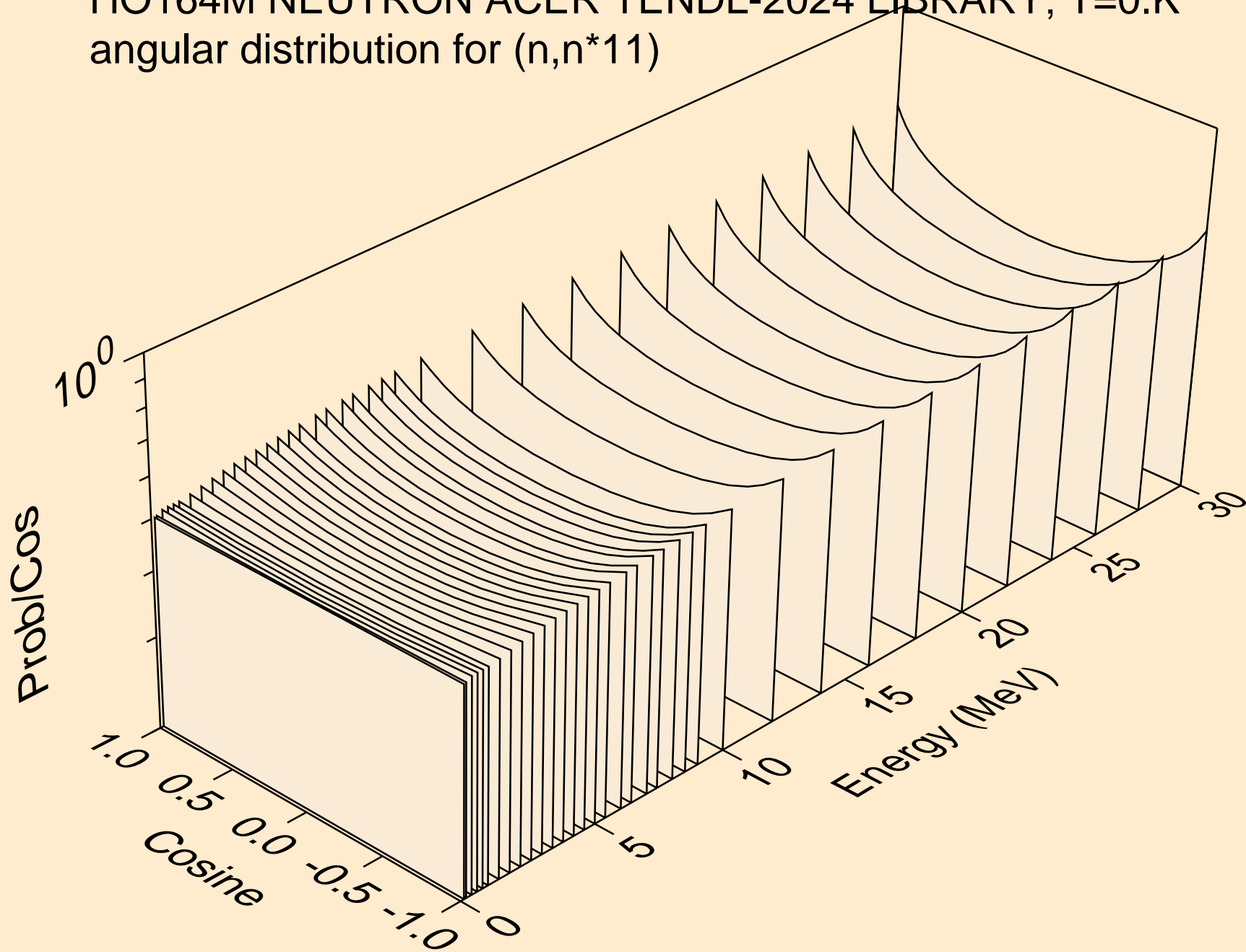

HO164M NEUTRON ACER TENDL-2024 LIBRARY; T=0.K  
angular distribution for (n,n\*12)

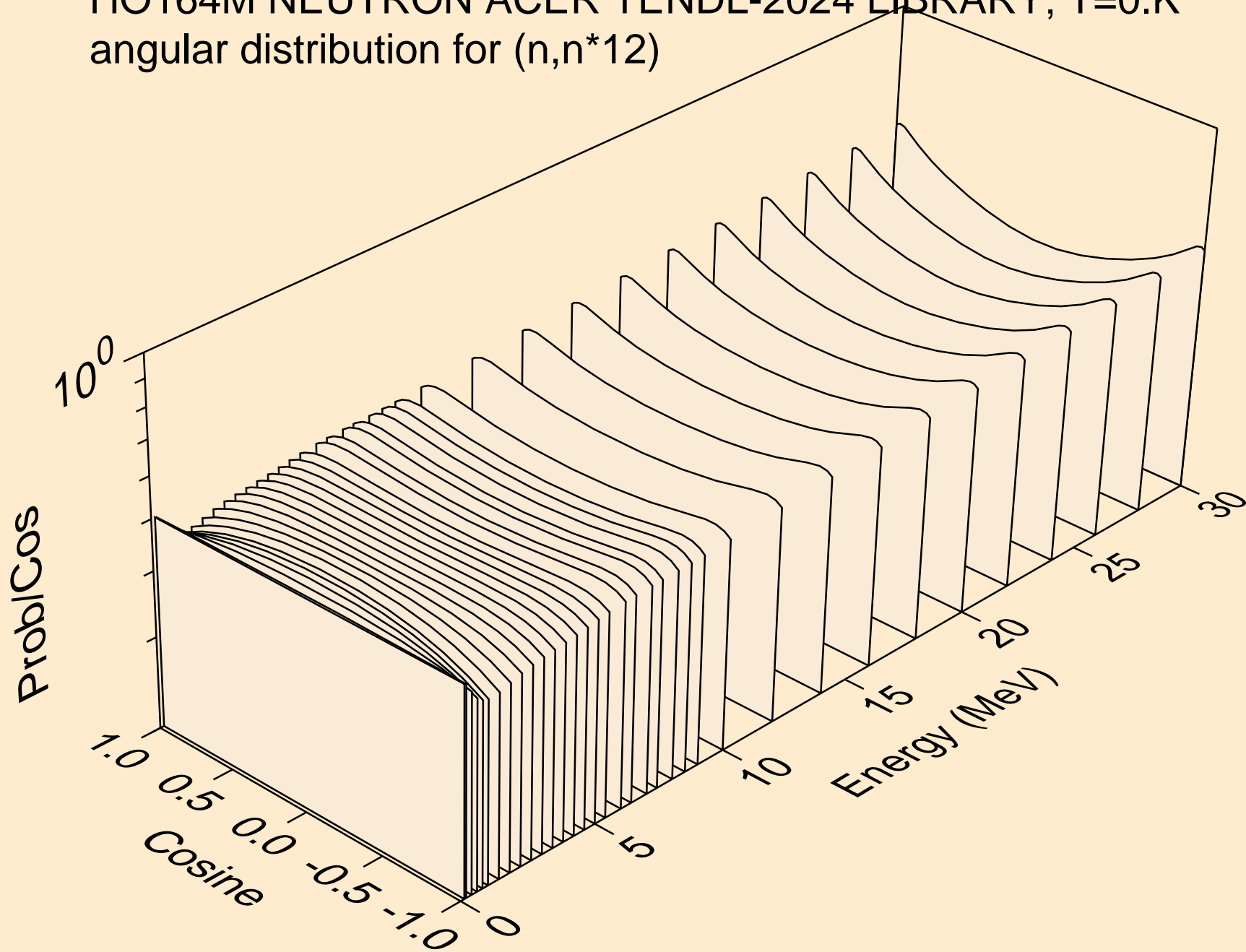

HO164M NEUTRON ACER TENDL-2024 LIBRARY; T=0.K  
angular distribution for (n,n\*13)

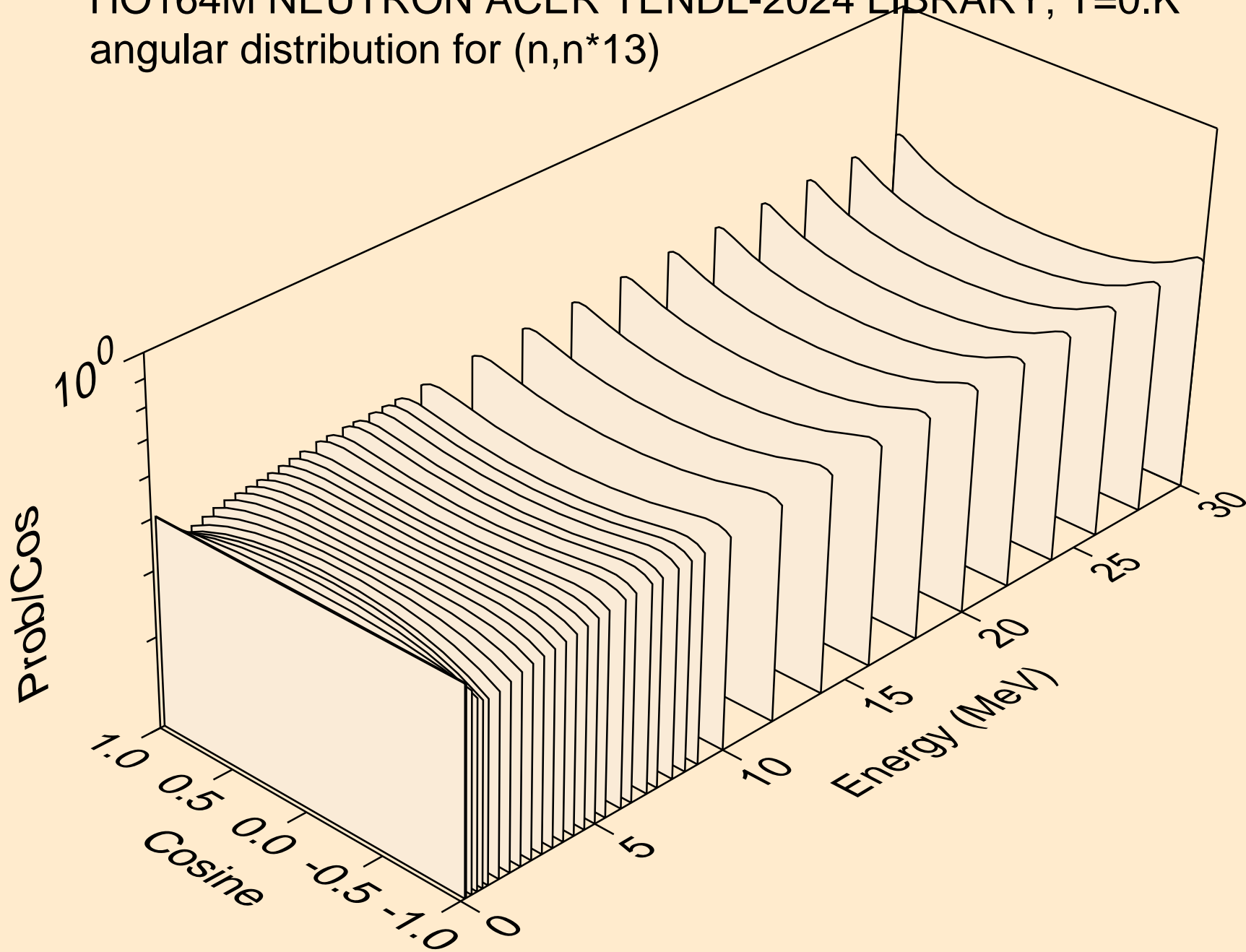

HO164M NEUTRON ACER TENDL-2024 LIBRARY; T=0.K  
angular distribution for (n,n\*14)

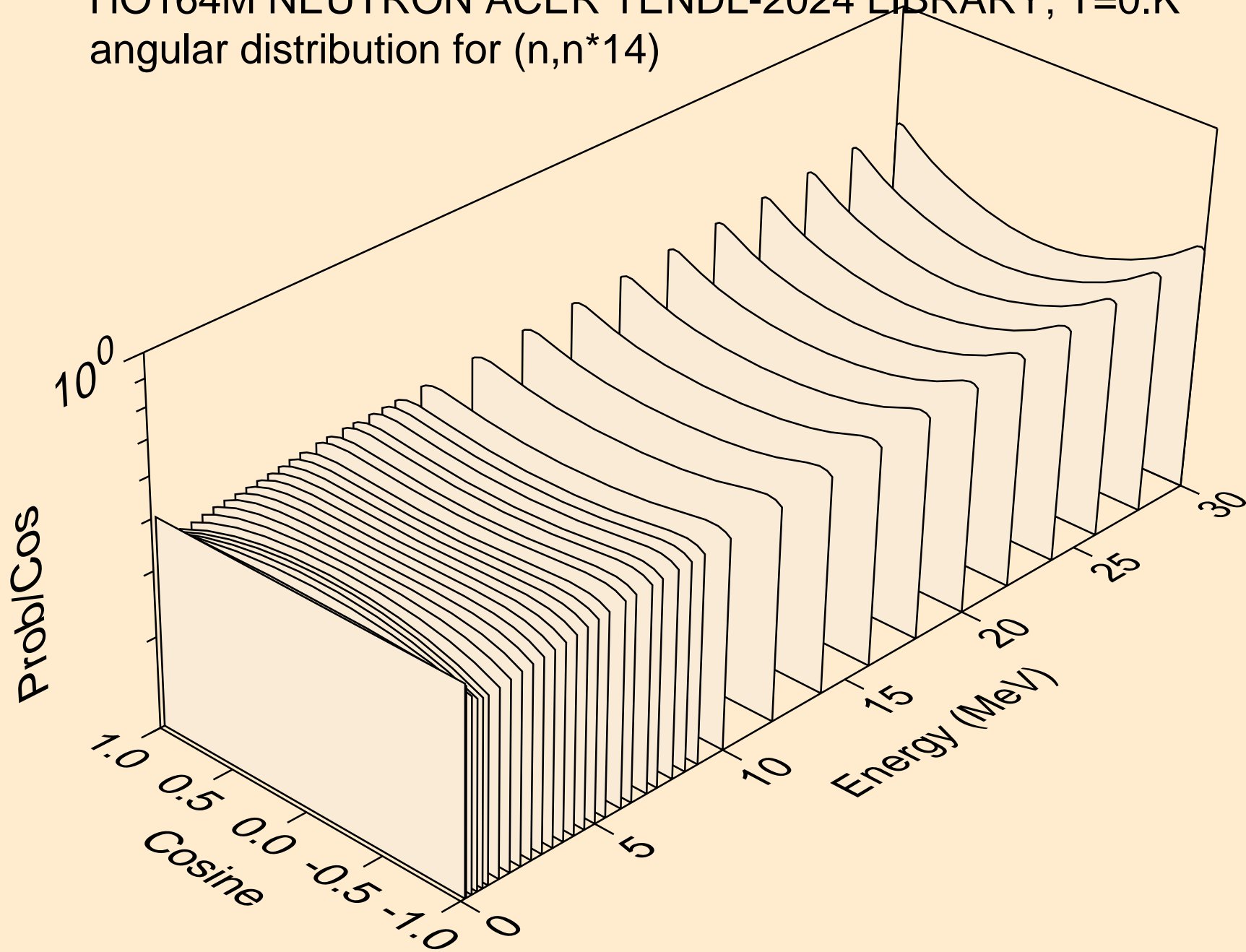

HO164M NEUTRON ACER TENDL-2024 LIBRARY; T=0.K  
angular distribution for (n,n\*15)

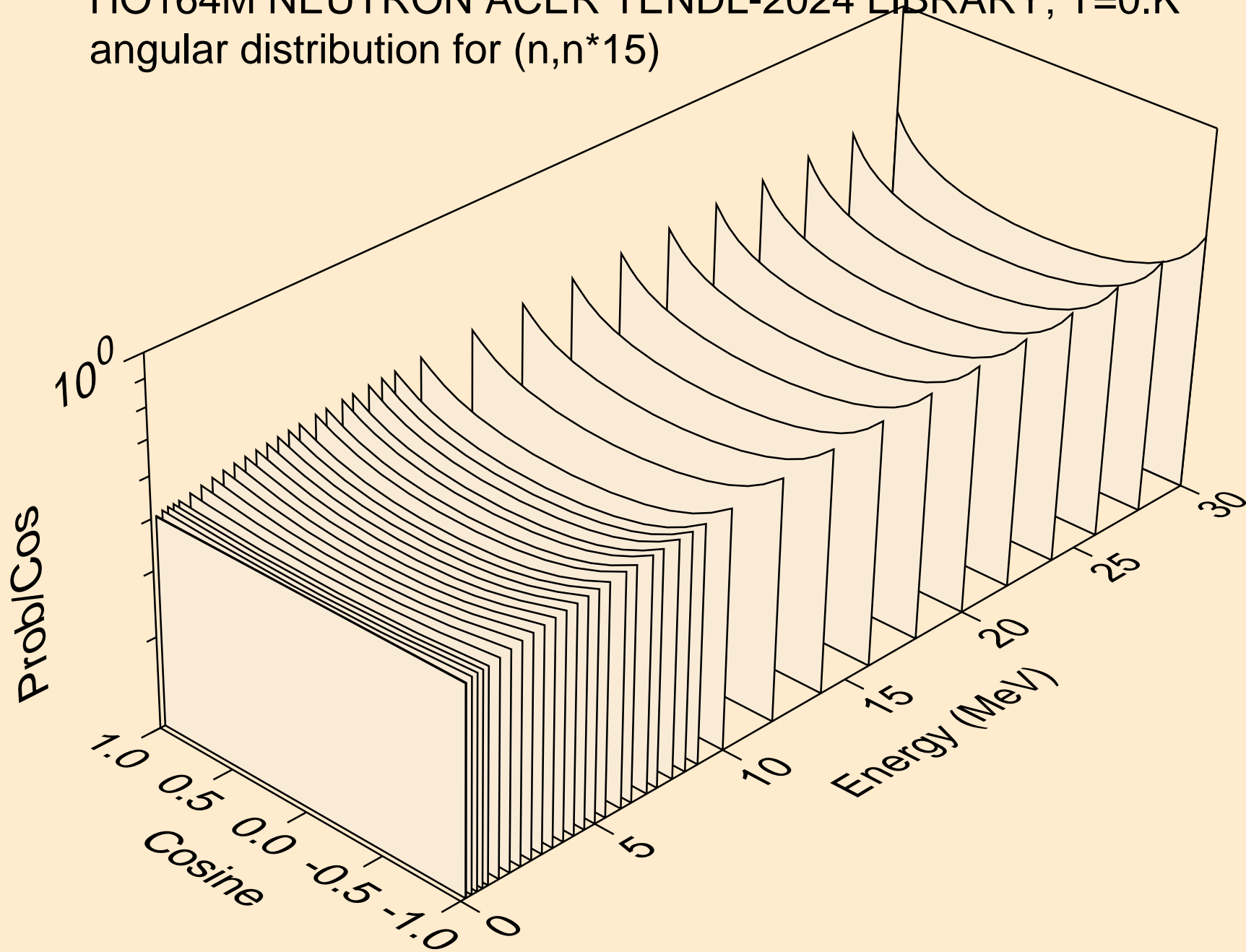

HO164M NEUTRON ACER TENDL-2024 LIBRARY; T=0.K  
angular distribution for (n,n\*16)

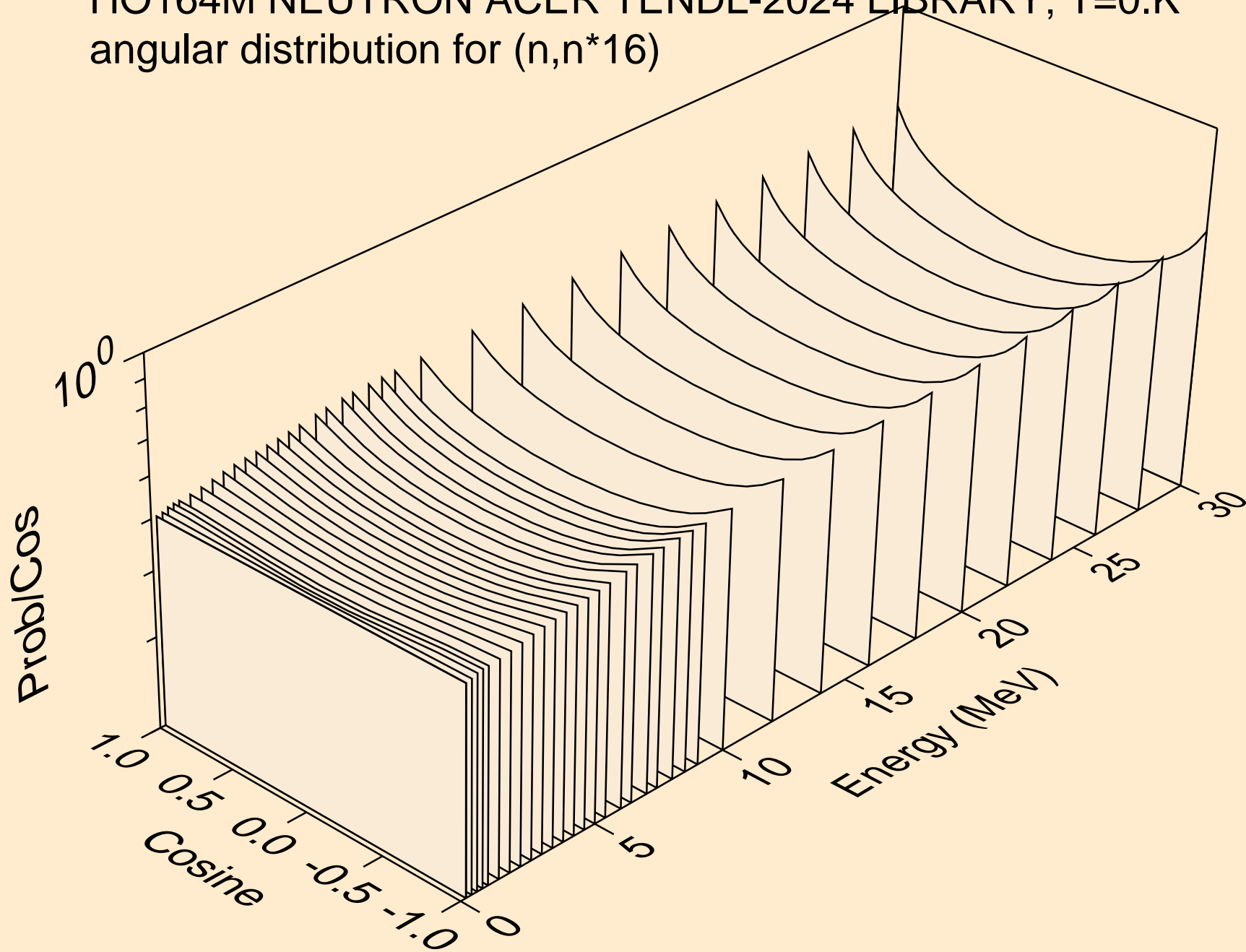

HO164M NEUTRON ACER TENDL-2024 LIBRARY; T=0.K  
angular distribution for (n,n\*17)

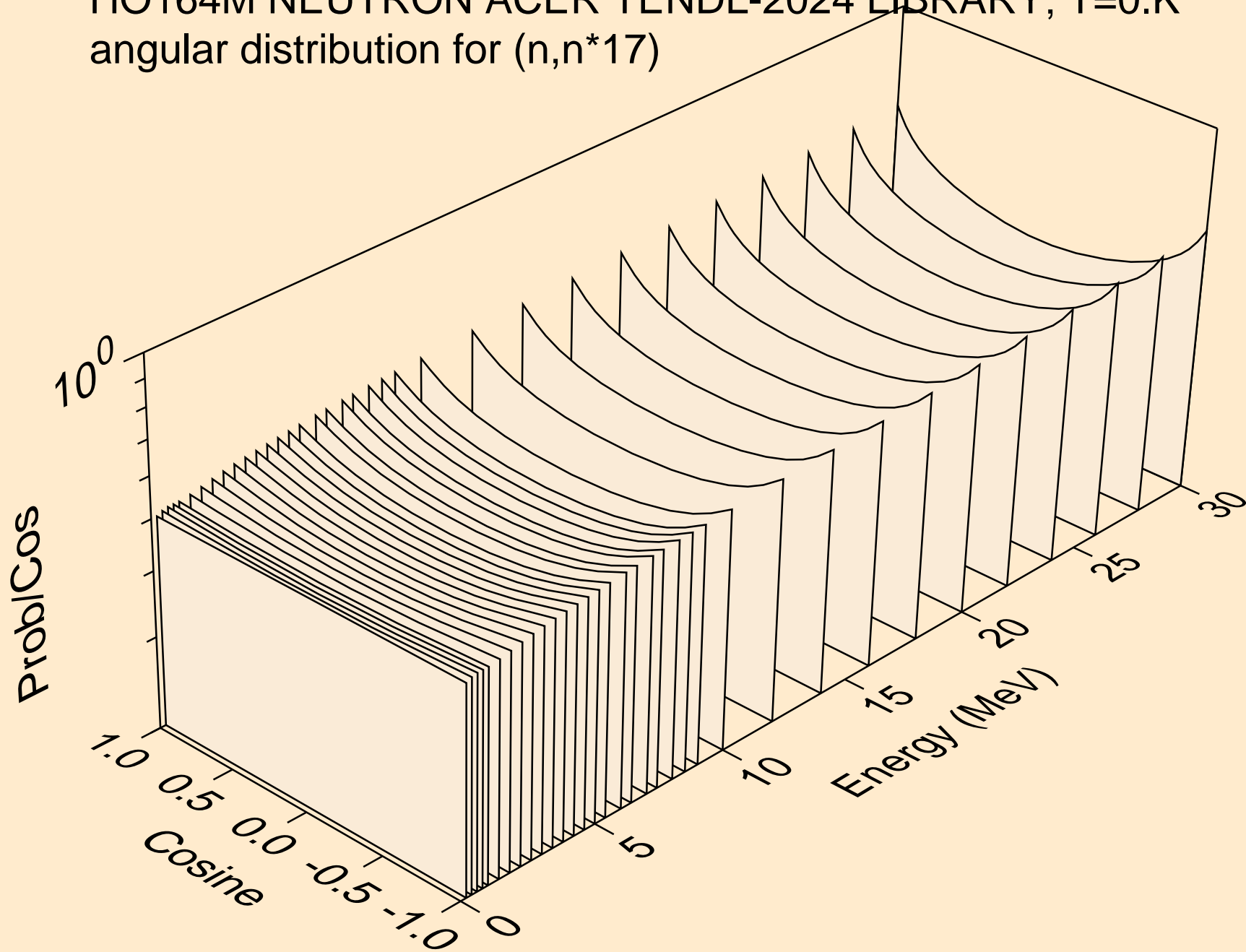

HO164M NEUTRON ACER TENDL-2024 LIBRARY; T=0.K  
angular distribution for (n,n\*18)

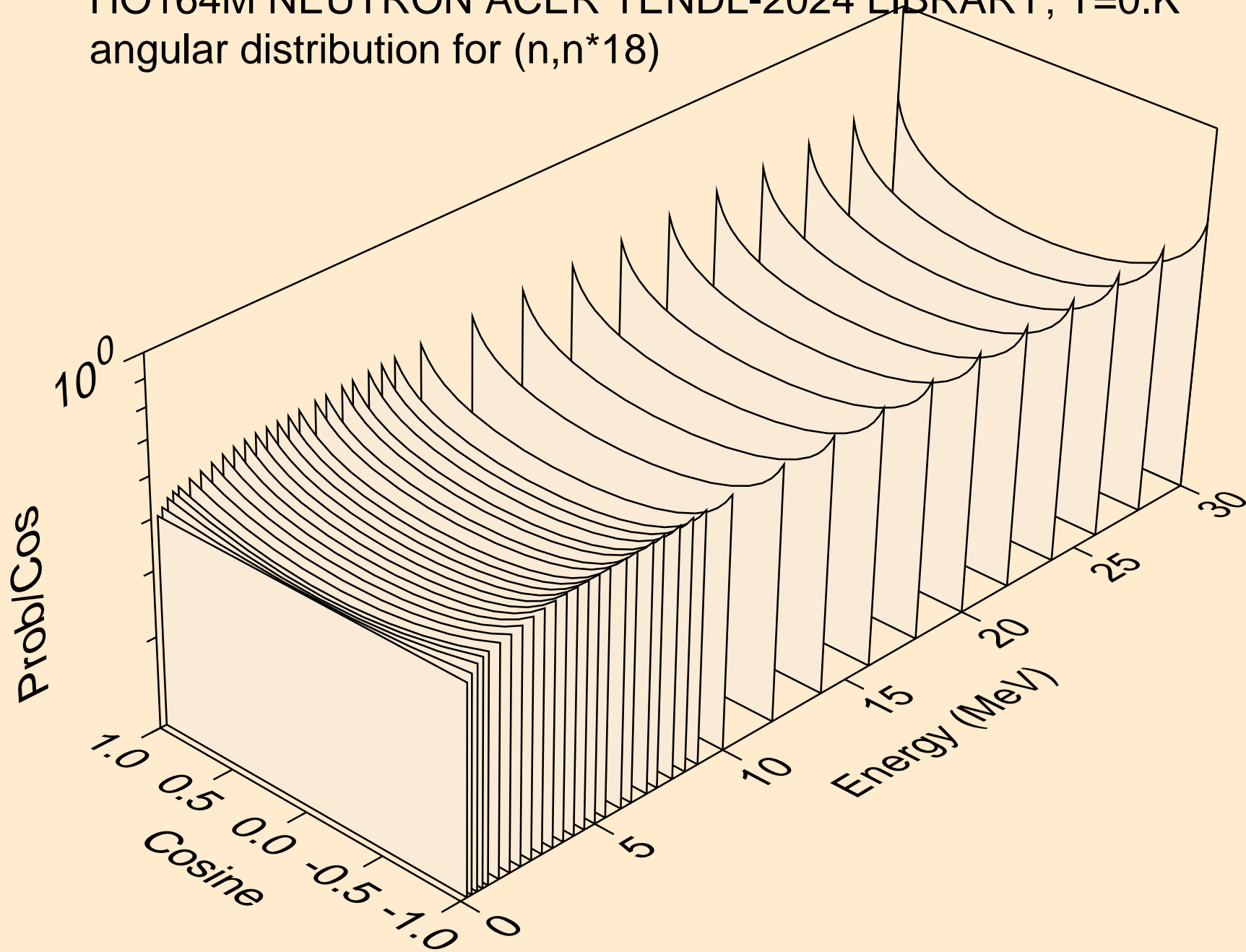

HO164M NEUTRON ACER TENDL-2024 LIBRARY; T=0.K  
angular distribution for (n,n\*19)

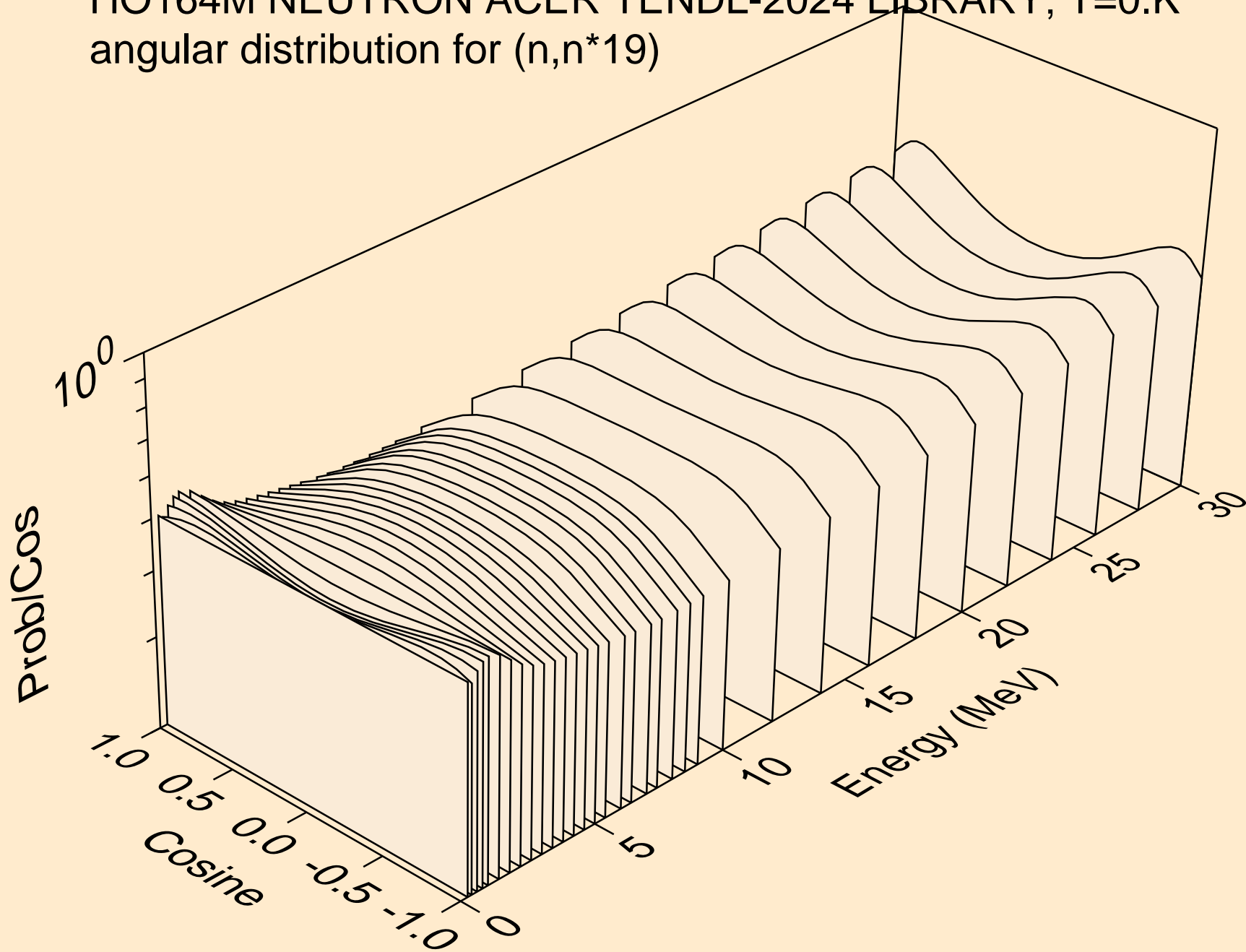

HO164M NEUTRON ACER TENDL-2024 LIBRARY; T=0.K  
angular distribution for (n,n\*20)

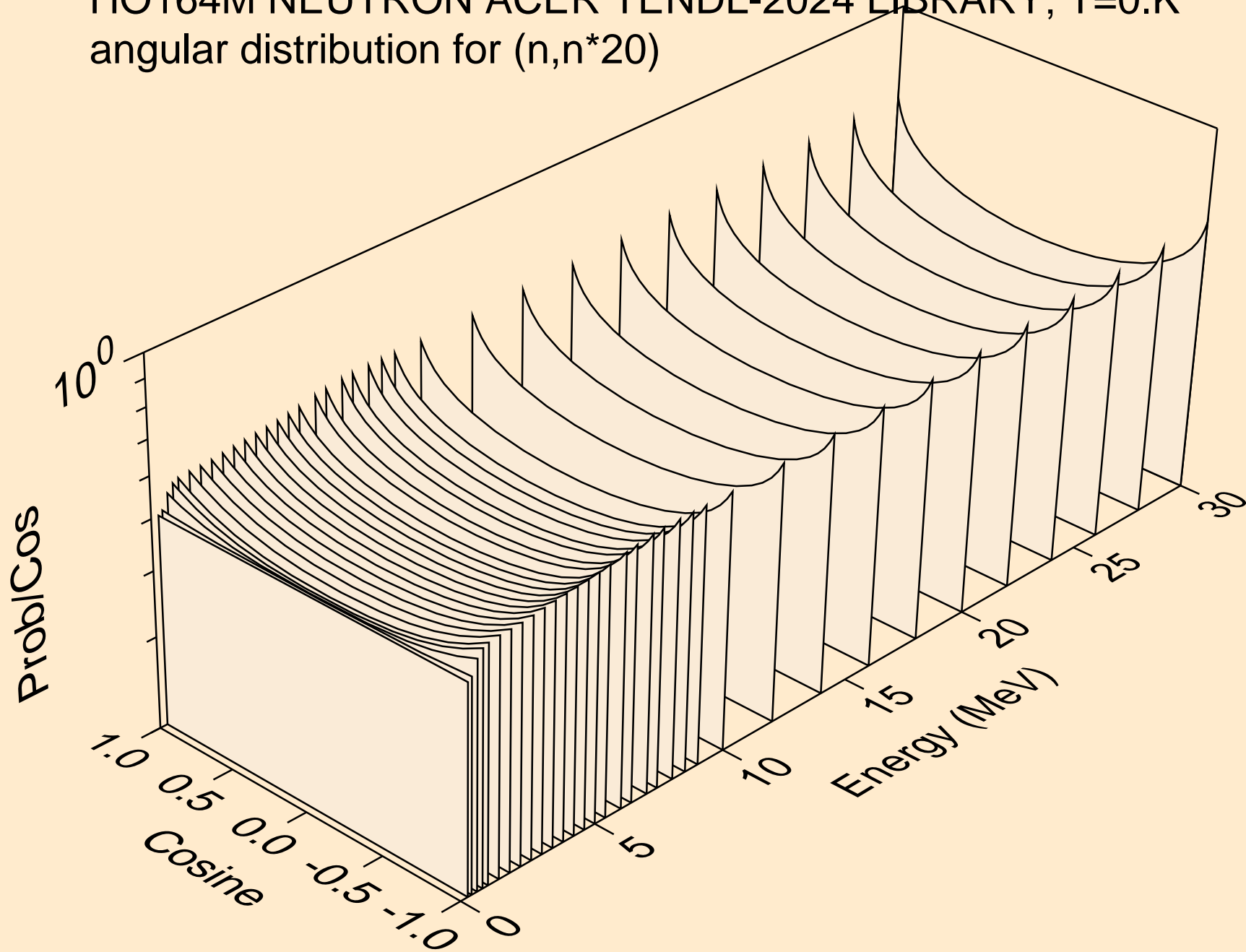

HO164M NEUTRON ACER TENDL-2024 LIBRARY; T=0.K  
angular distribution for (n,n\*21)

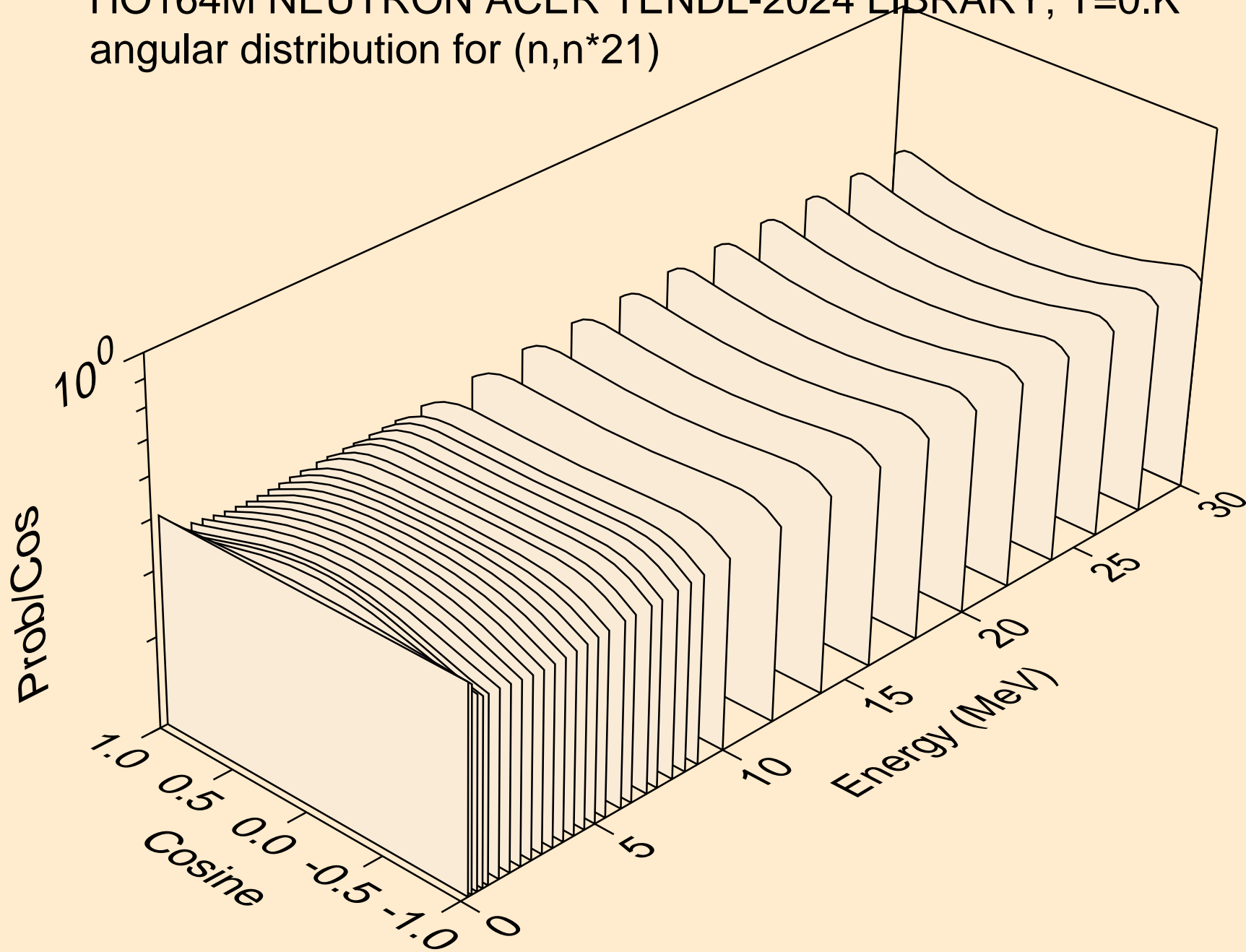

HO164M NEUTRON ACER TENDL-2024 LIBRARY; T=0.K  
angular distribution for (n,n\*22)

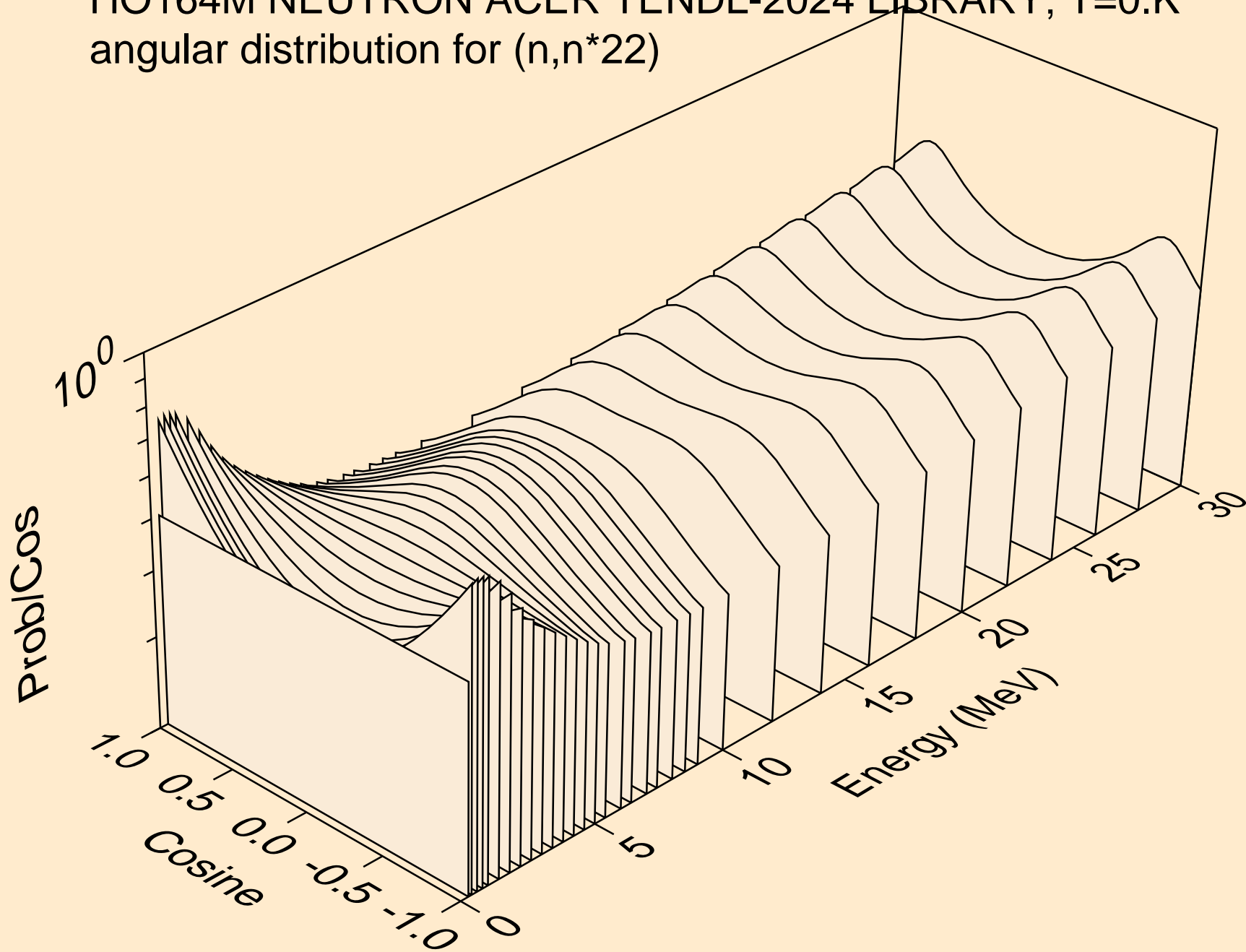

HO164M NEUTRON ACER TENDL-2024 LIBRARY; T=0.K  
angular distribution for (n,n\*23)

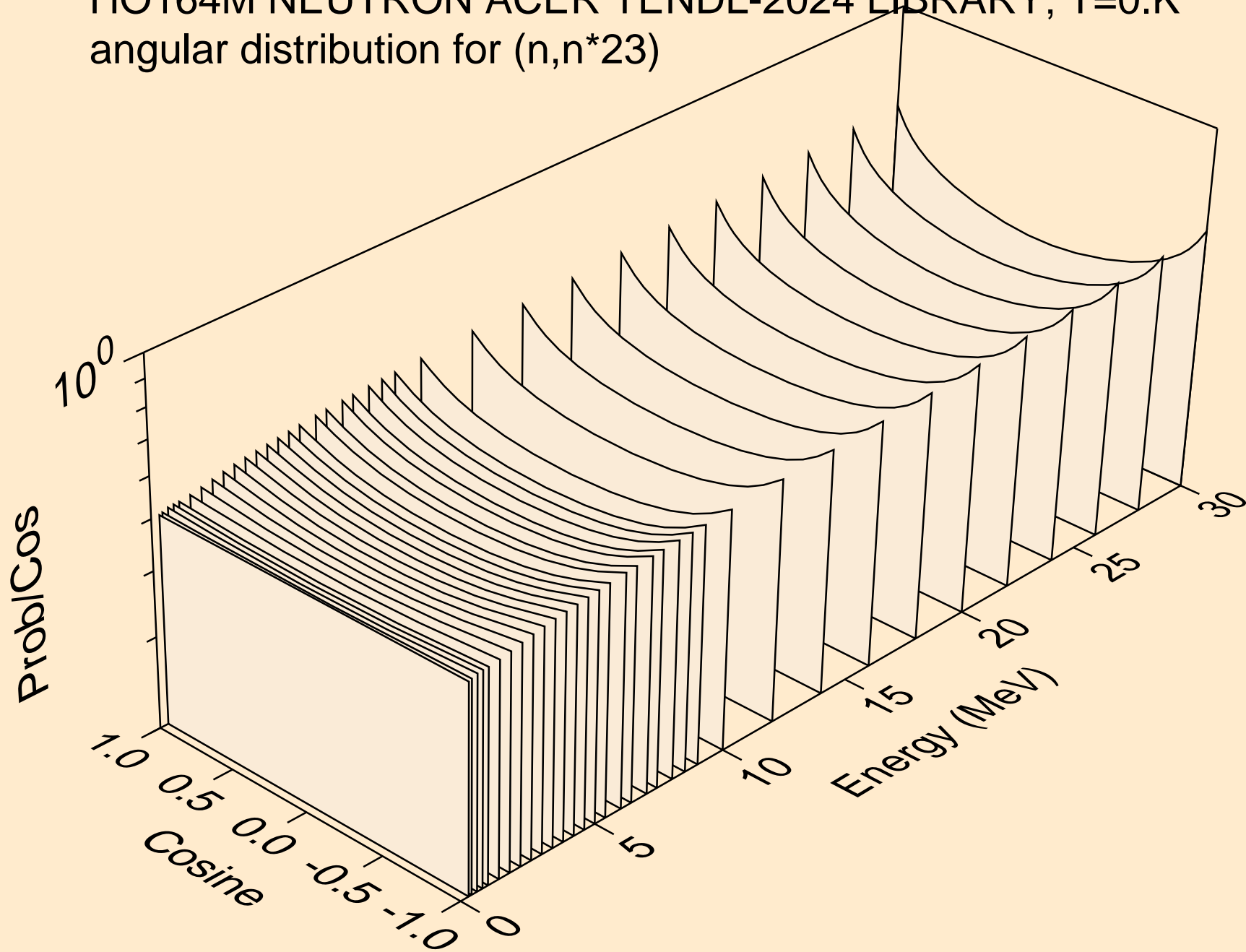

HO164M NEUTRON ACER TENDL-2024 LIBRARY; T=0.K  
angular distribution for (n,n\*24)

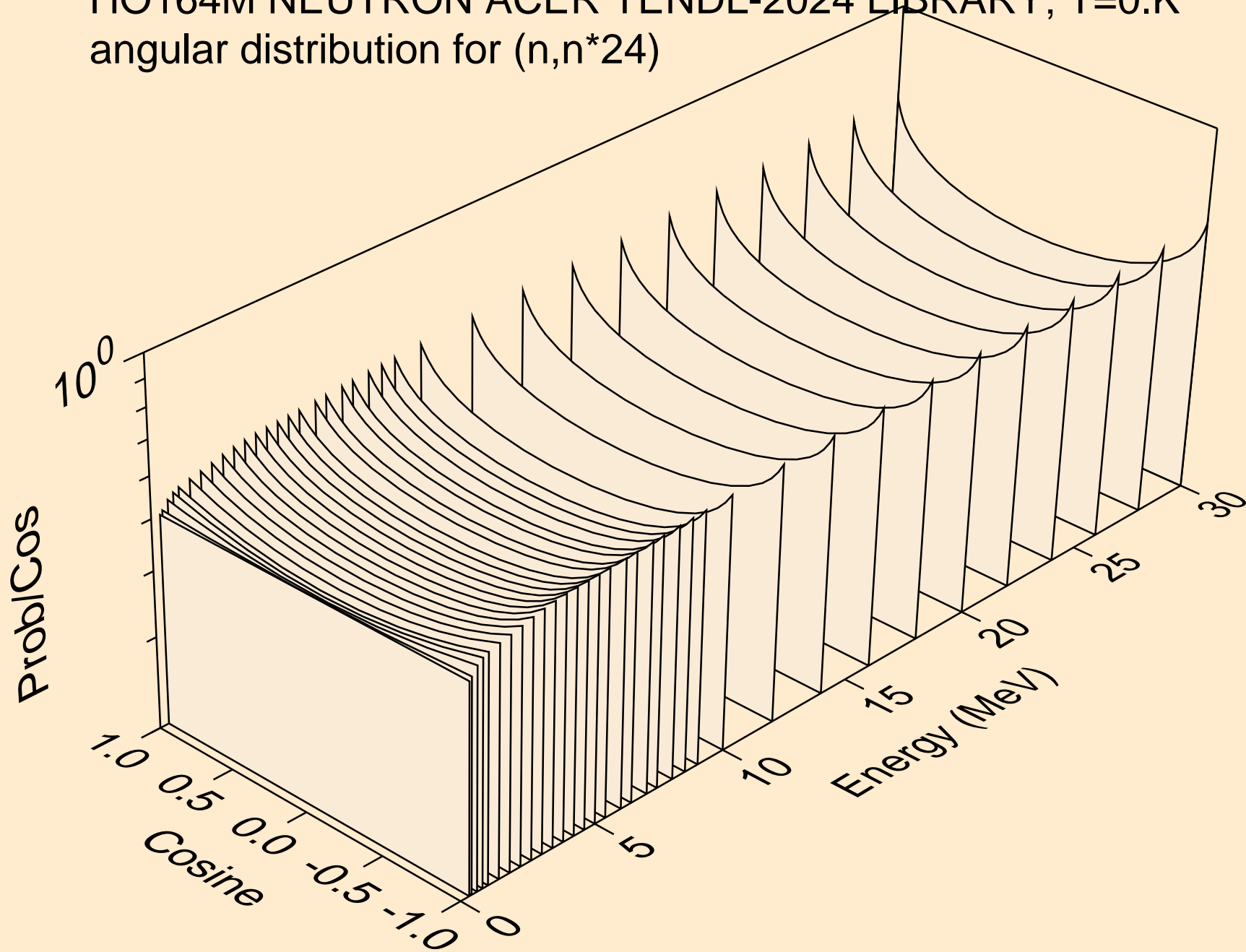

HO164M NEUTRON ACER TENDL-2024 LIBRARY; T=0.K  
angular distribution for (n,n\*25)

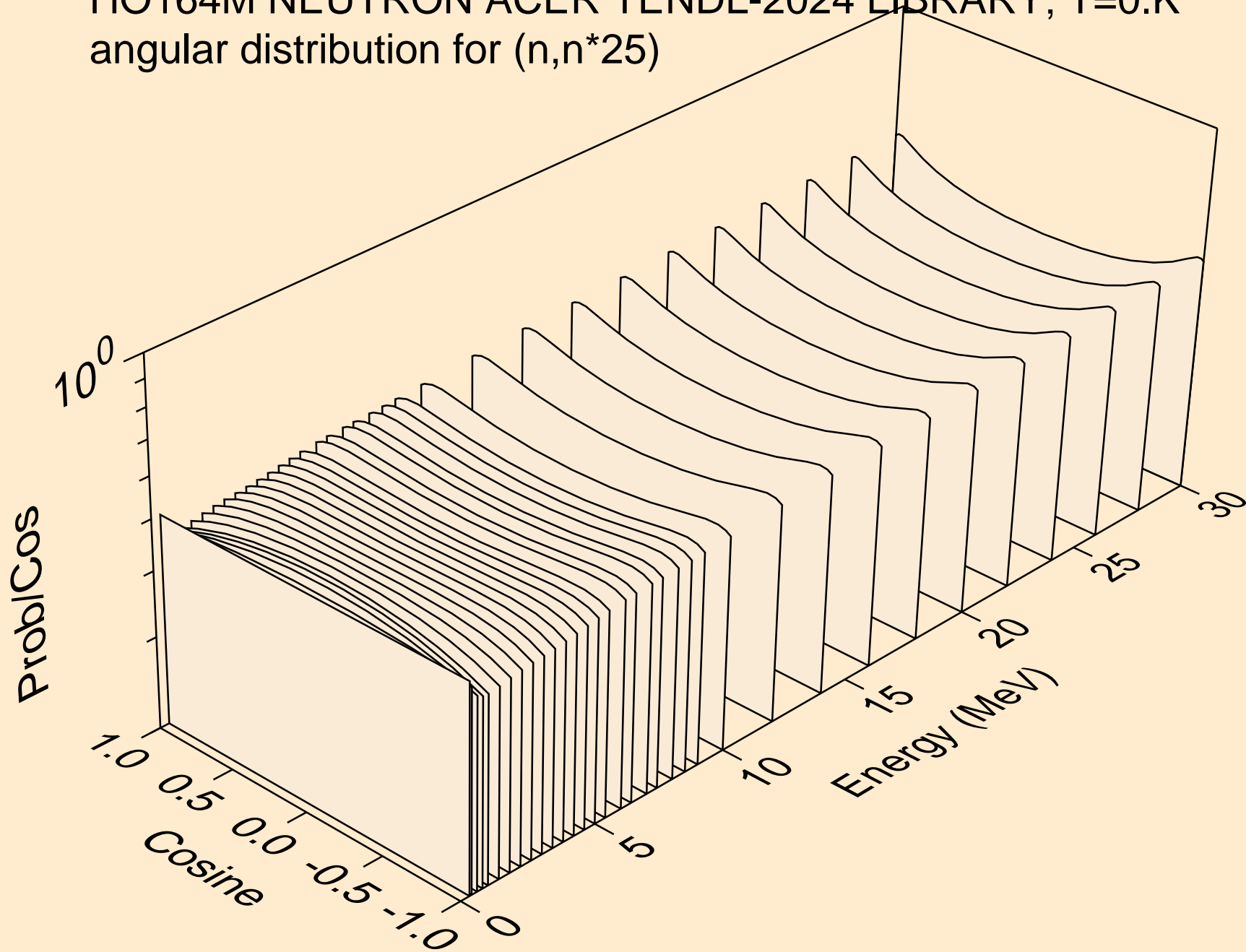

HO164M NEUTRON ACER TENDL-2024 LIBRARY; T=0.K  
angular distribution for (n,n\*26)

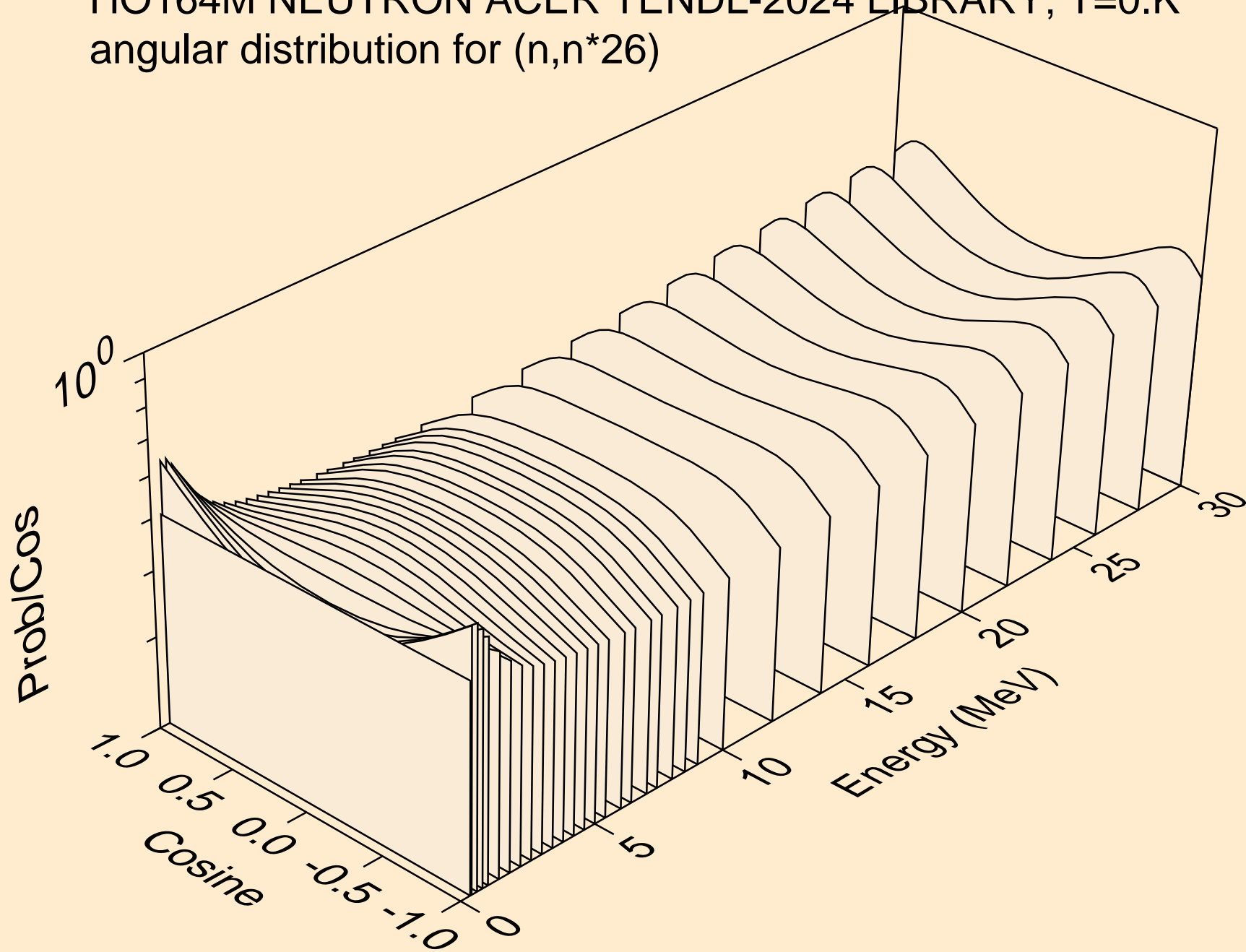

HO164M NEUTRON ACER TENDL-2024 LIBRARY; T=0.K  
angular distribution for (n,n\*27)

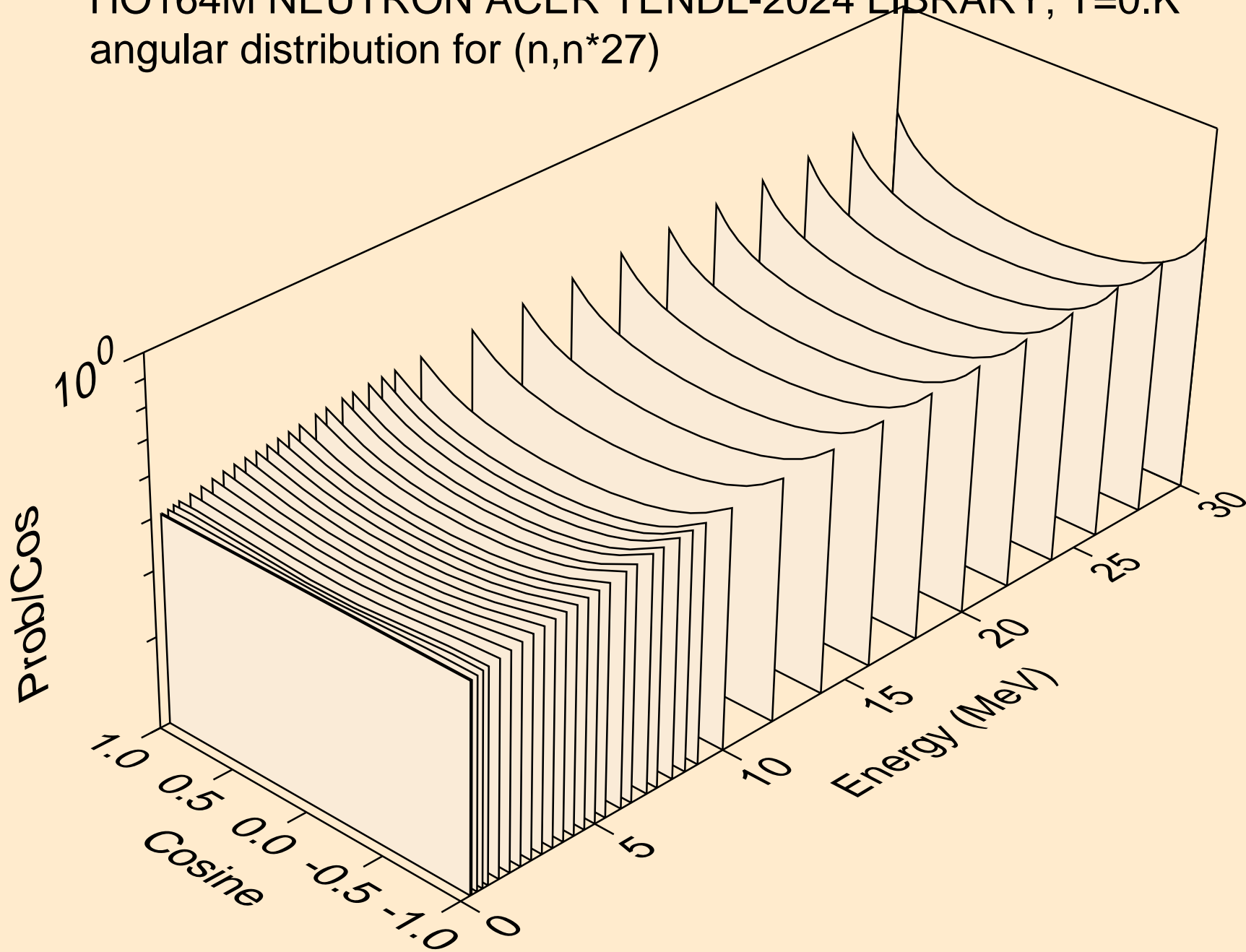

HO164M NEUTRON ACER TENDL-2024 LIBRARY; T=0.K  
angular distribution for (n,n\*28)

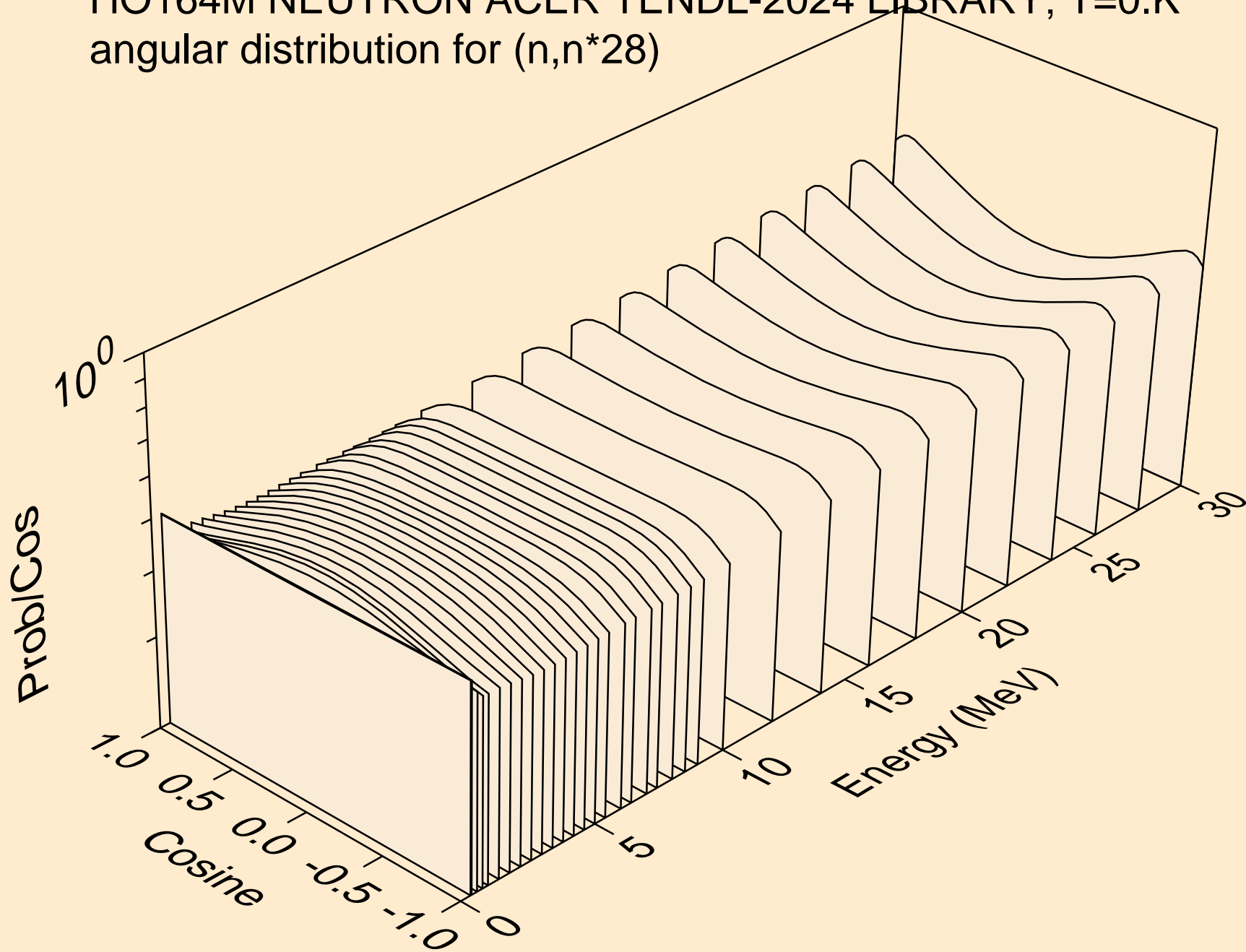

HO164M NEUTRON ACER TENDL-2024 LIBRARY; T=0.K  
angular distribution for (n,n\*29)

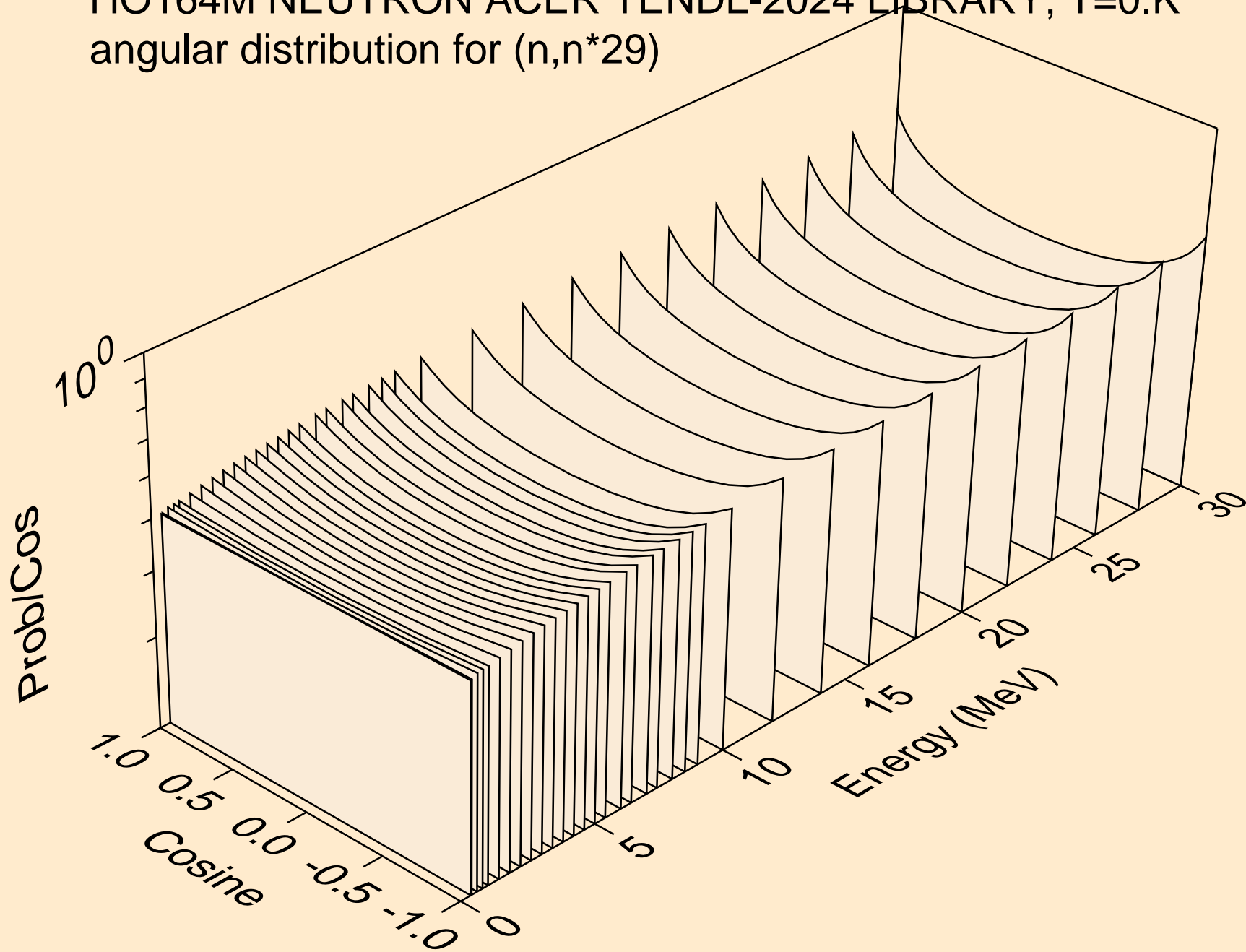

HO164M NEUTRON ACER TENDL-2024 LIBRARY; T=0.K  
angular distribution for (n,n\*30)

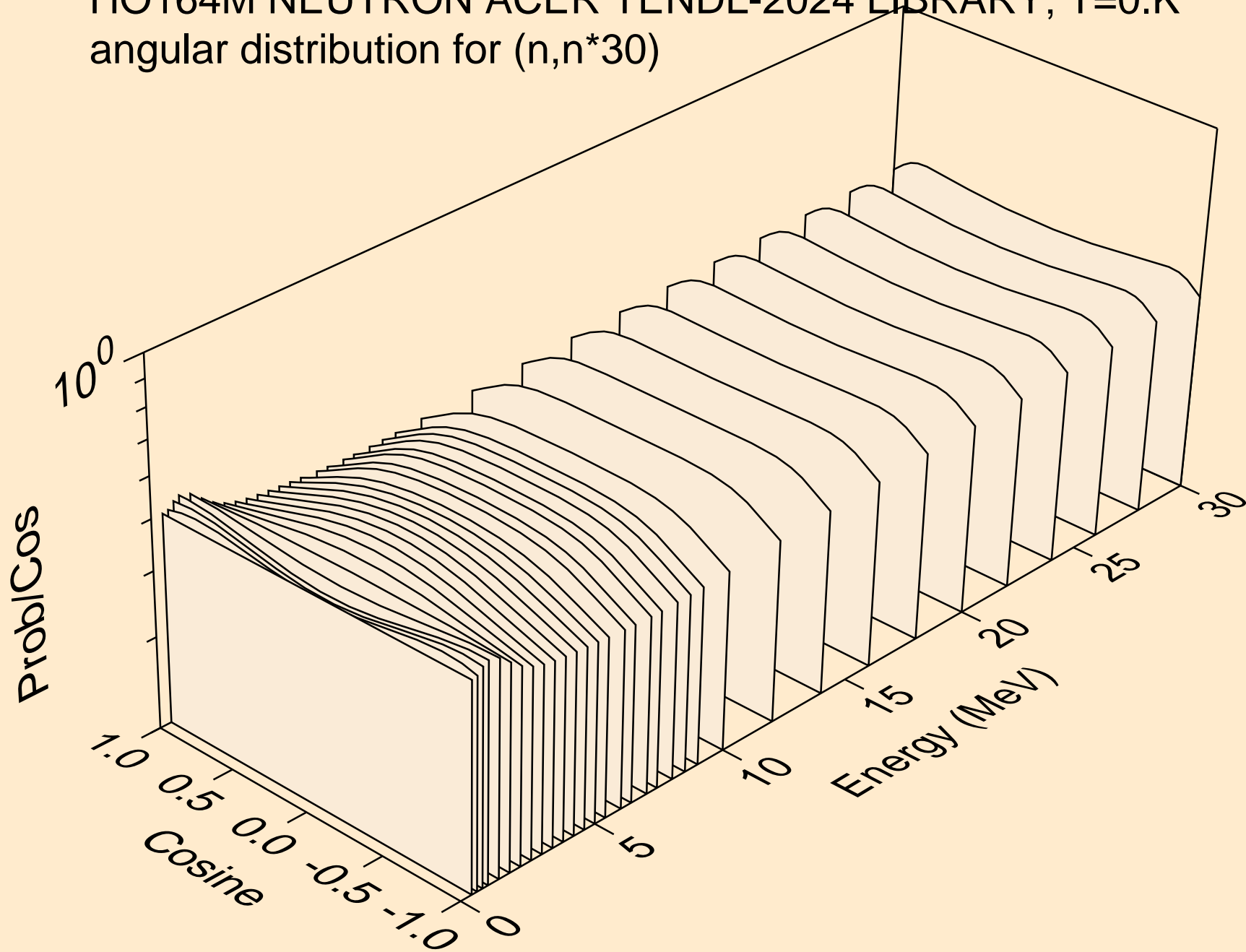

HO164M NEUTRON ACER TENDL-2024 LIBRARY; T=0.K  
Neutron emission for (n,x)

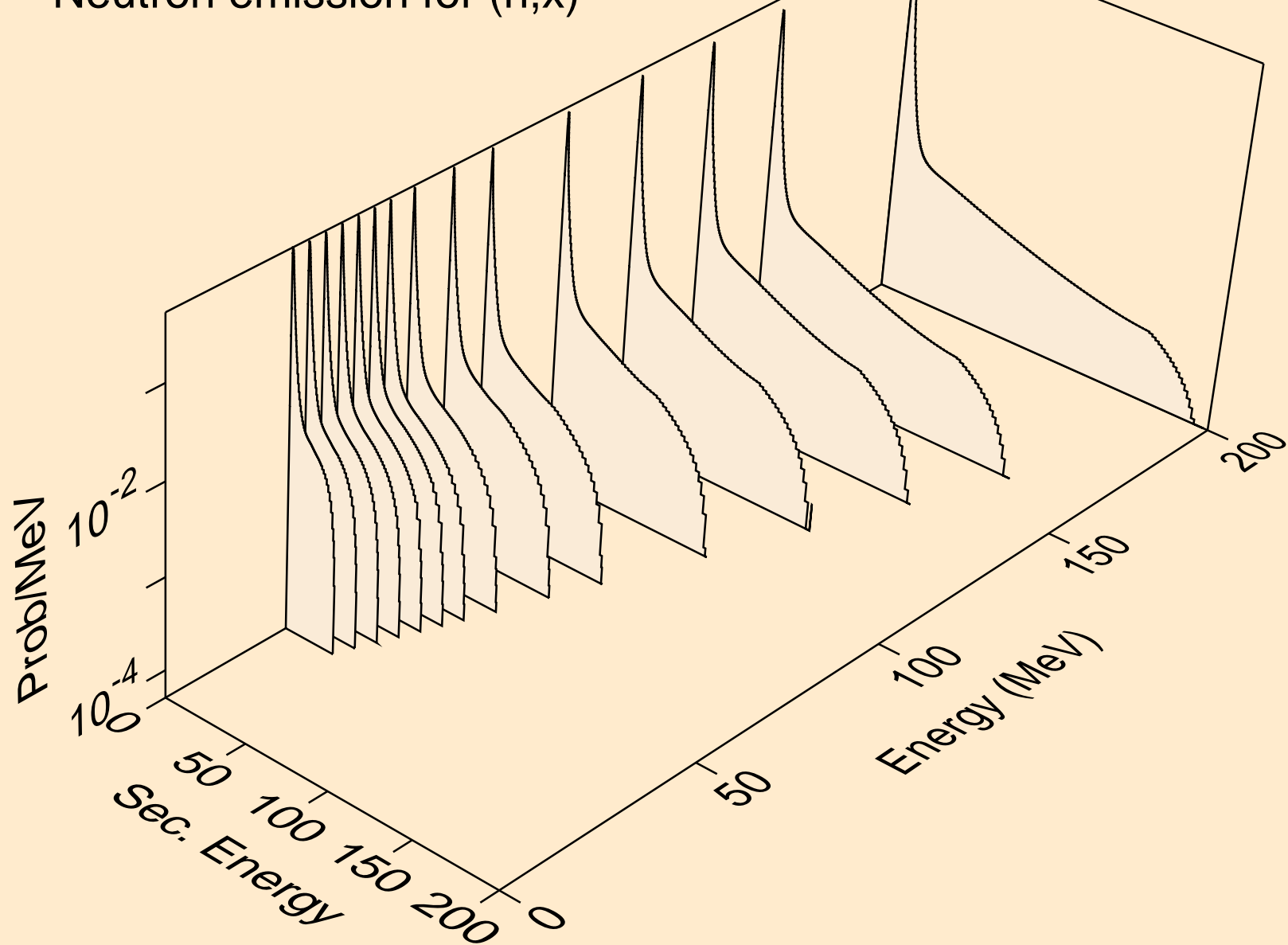

HO164M NEUTRON ACER TENDL-2024 LIBRARY; T=0.K  
Neutron emission for (n,2nd)

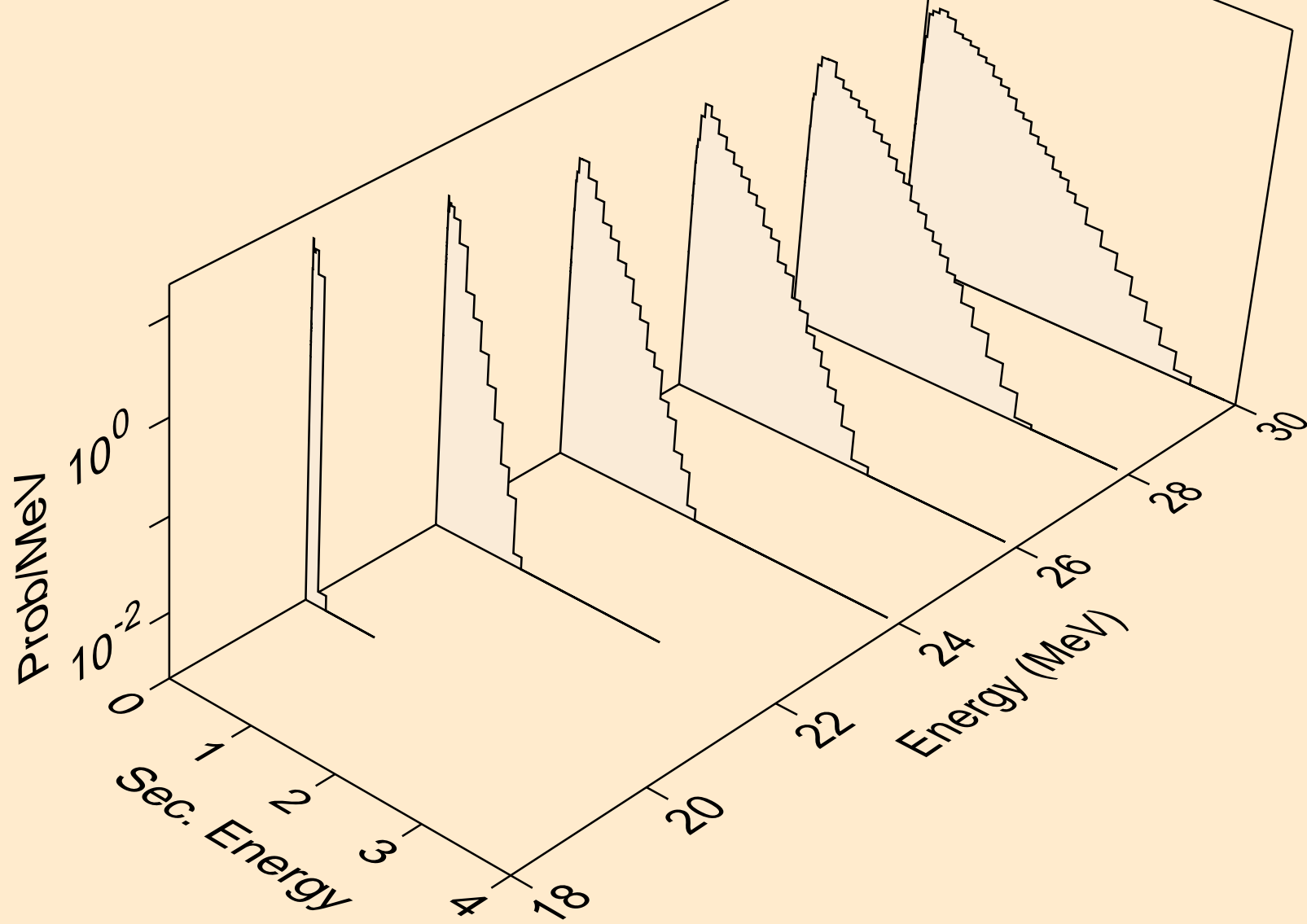

HO164M NEUTRON ACER TENDL-2024 LIBRARY; T=0.K  
Neutron emission for (n,2n)

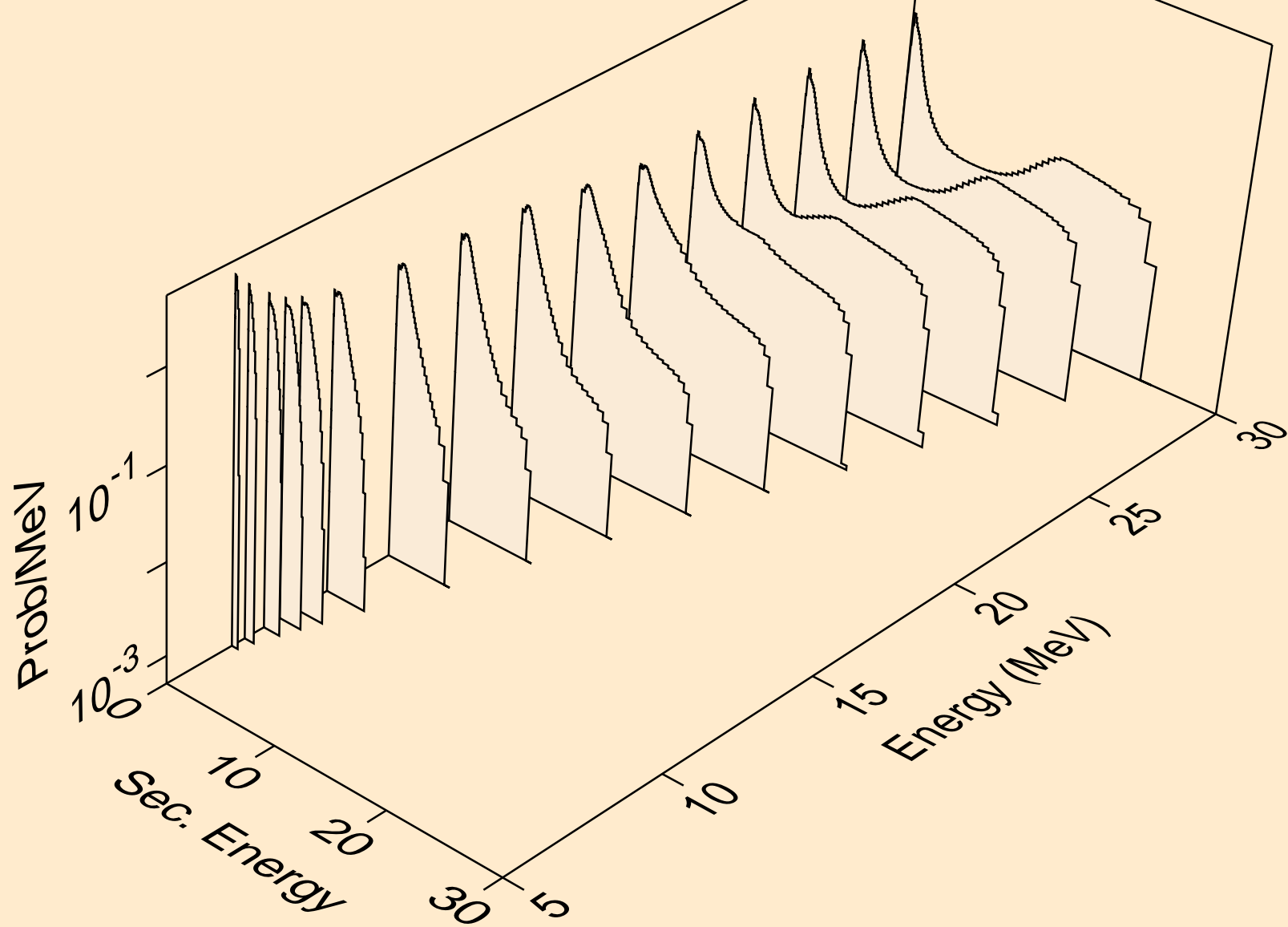

HO164M NEUTRON ACER TENDL-2024 LIBRARY; T=0.K  
Neutron emission for (n,3n)

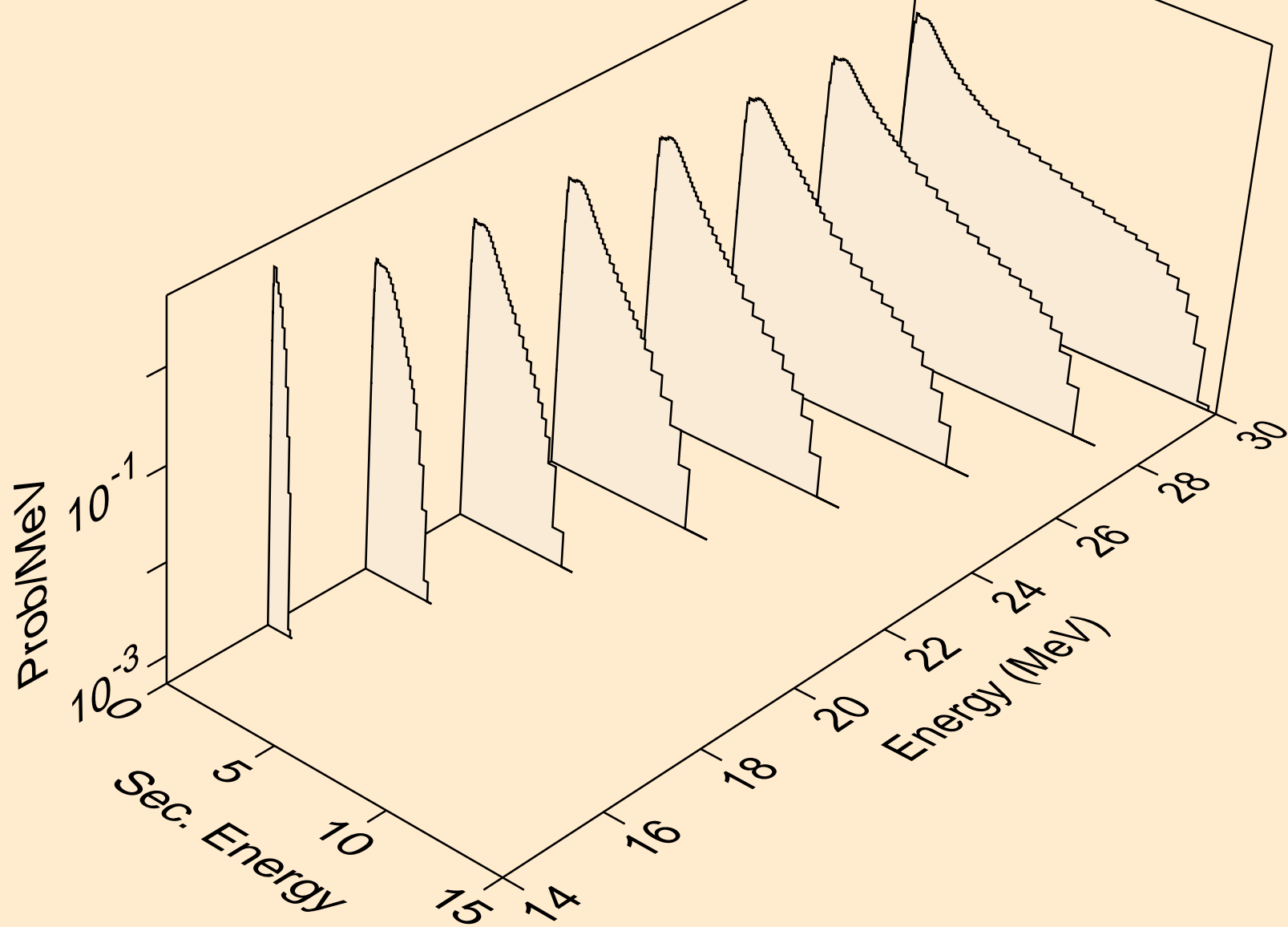

HO164M NEUTRON ACER TENDL-2024 LIBRARY; T=0.K  
Neutron emission for (n,n\*)a

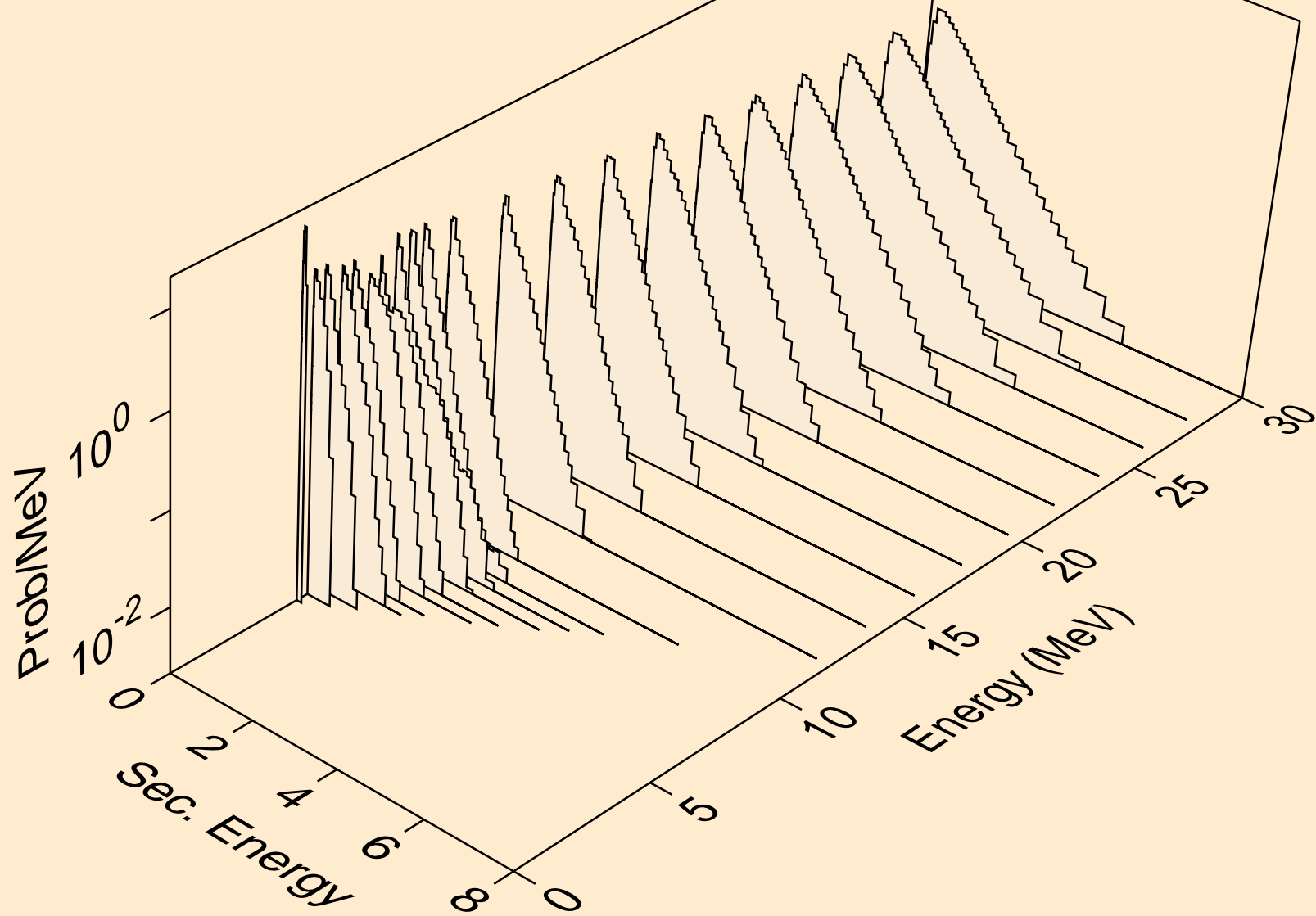

HO164M NEUTRON ACER TENDL-2024 LIBRARY; T=0.K  
Neutron emission for (n,2n)a

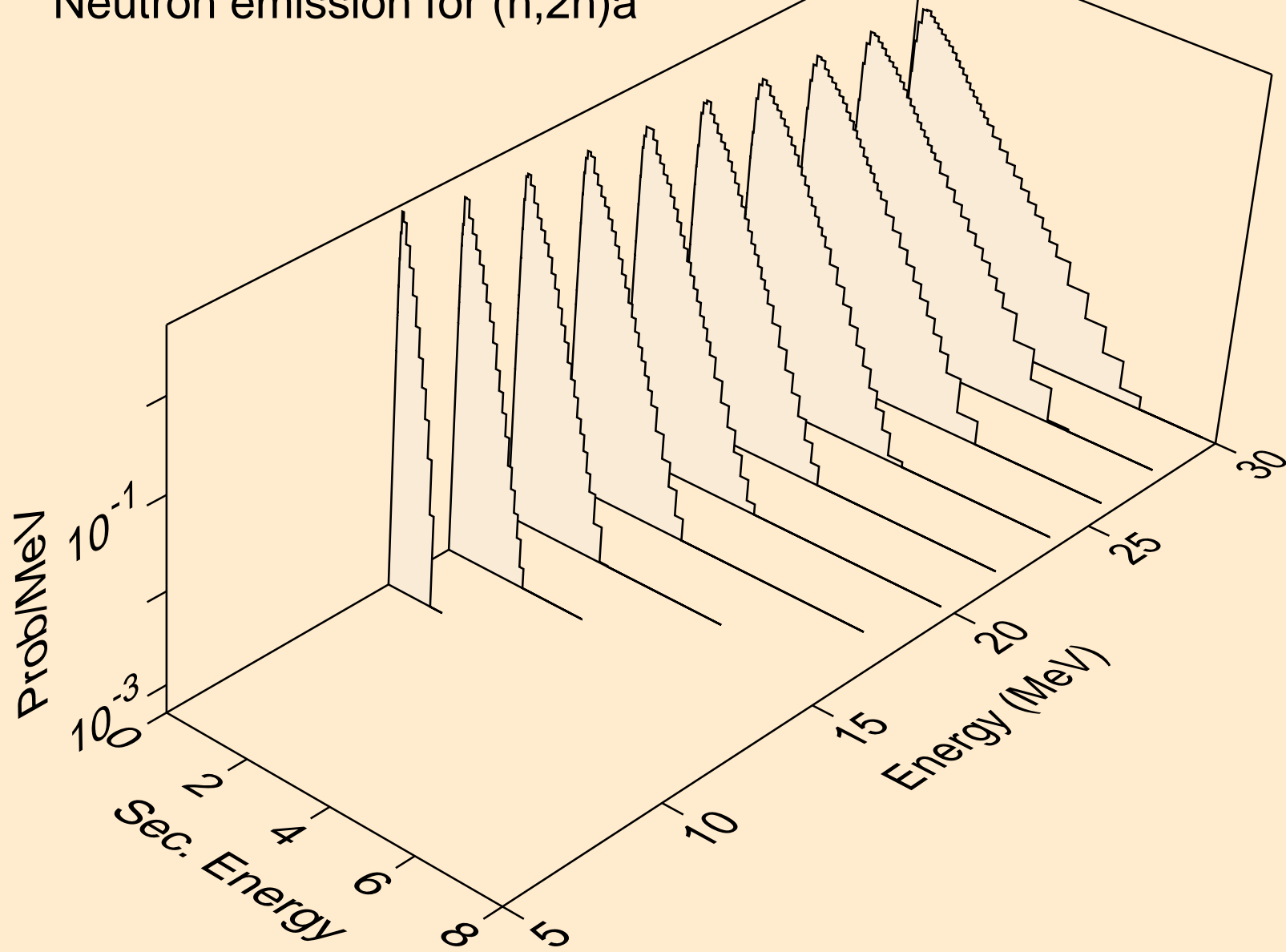

HO164M NEUTRON ACER TENDL-2024 LIBRARY; T=0.K  
Neutron emission for (n,3n)a

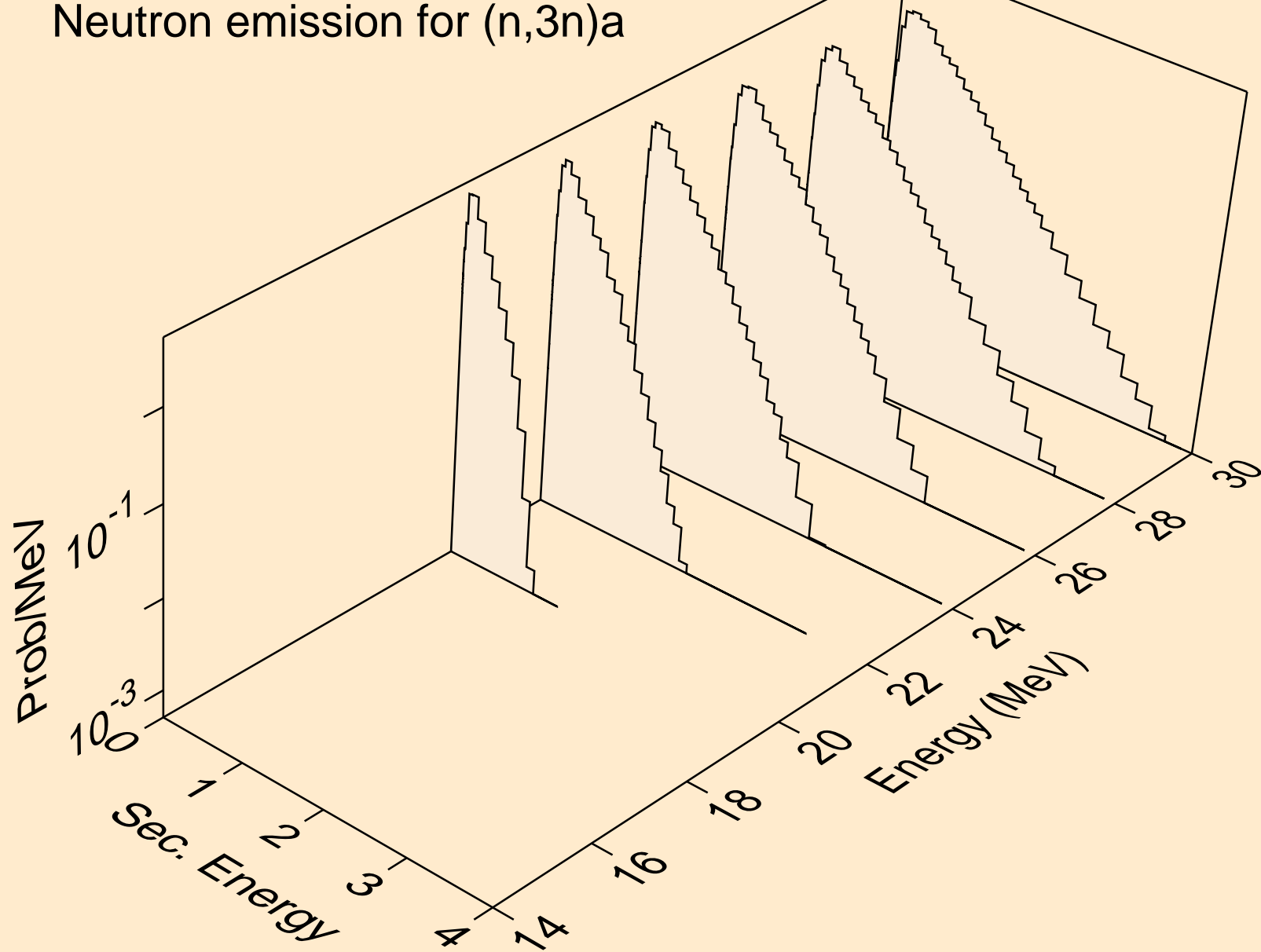

HO164M NEUTRON ACER TENDL-2024 LIBRARY; T=0.K  
Neutron emission for (n,n\*)p

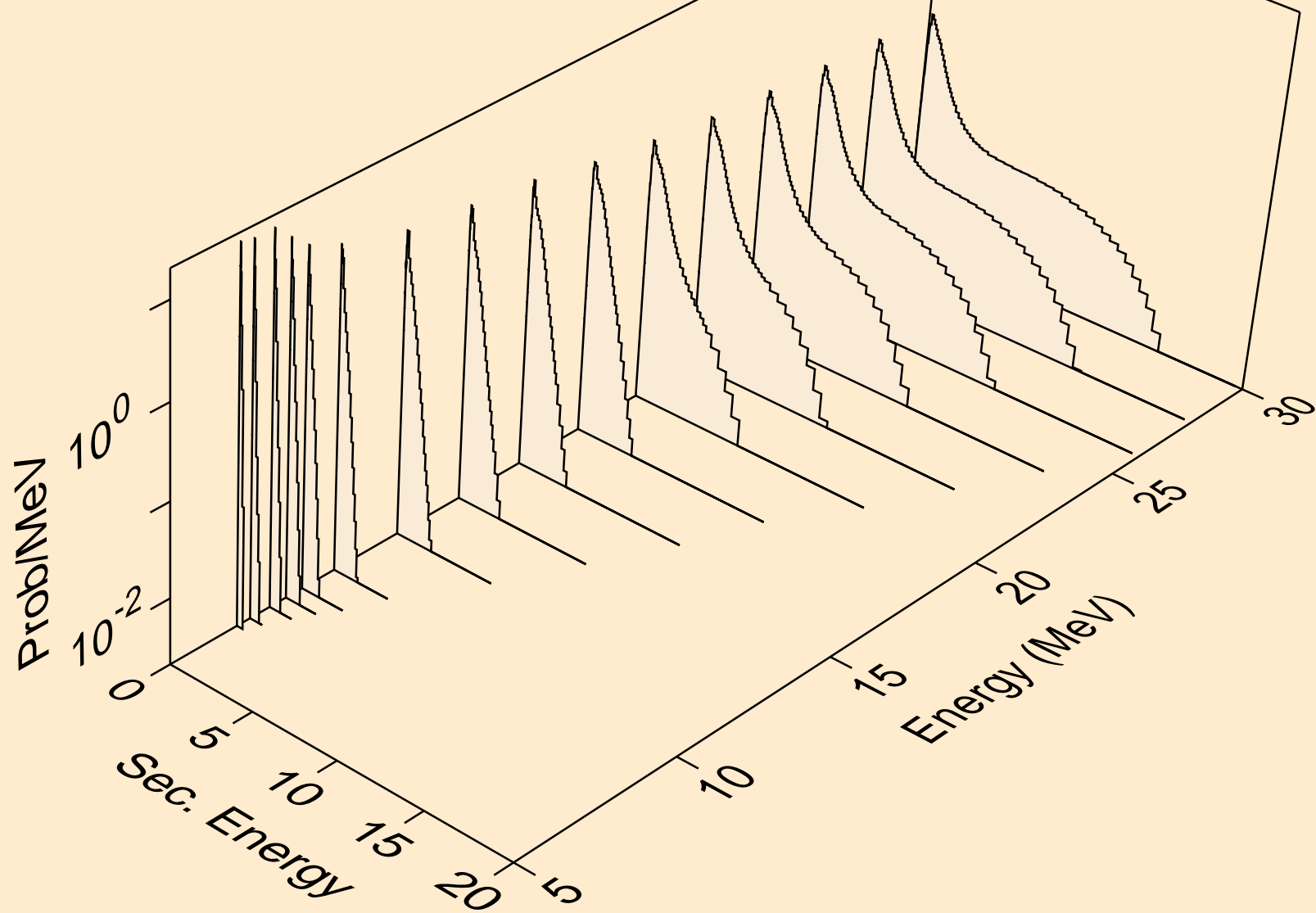

HO164M NEUTRON ACER TENDL-2024 LIBRARY; T=0.K  
Neutron emission for (n,n\*)2a

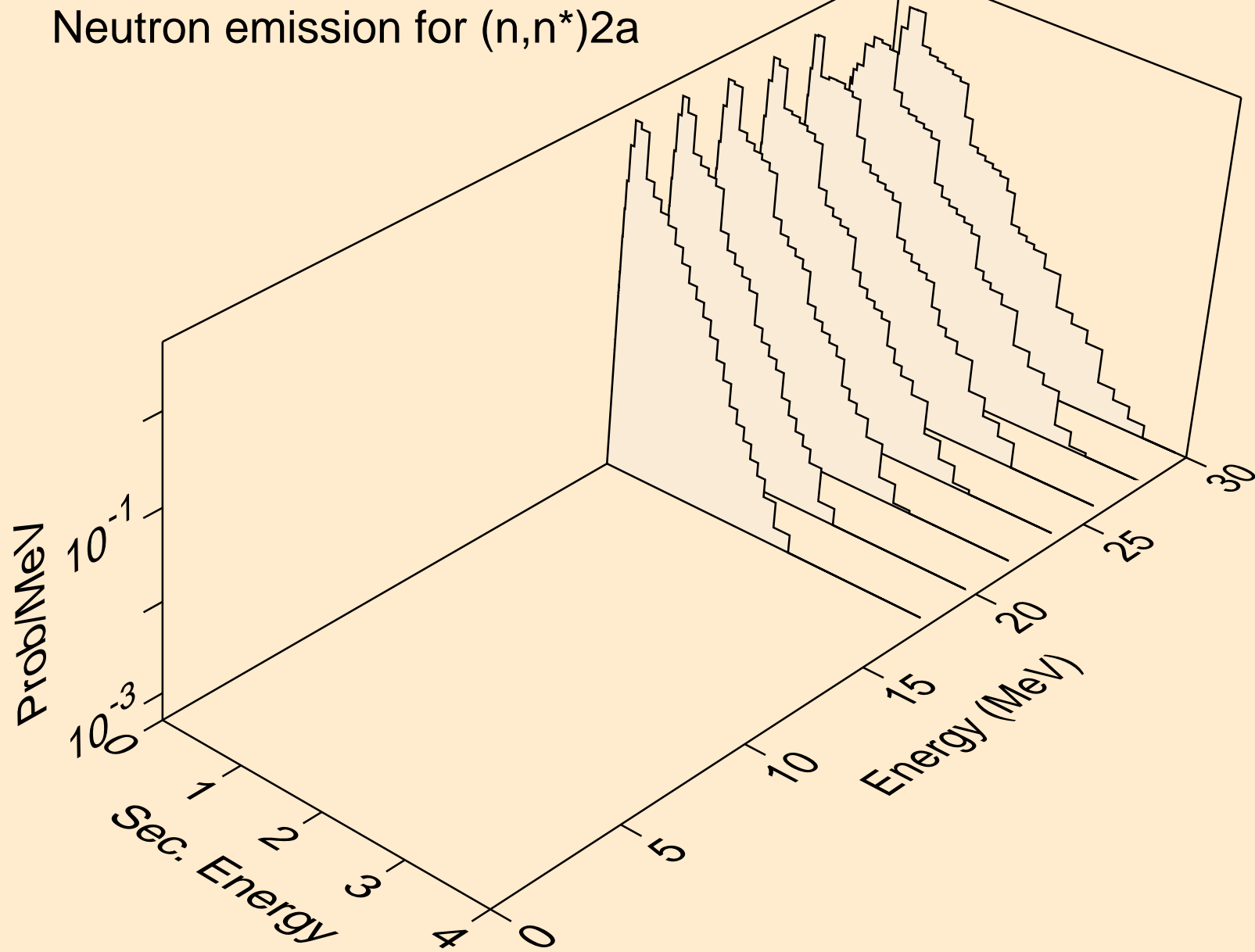

HO164M NEUTRON ACER TENDL-2024 LIBRARY; T=0.K  
Neutron emission for (n,n\*)d

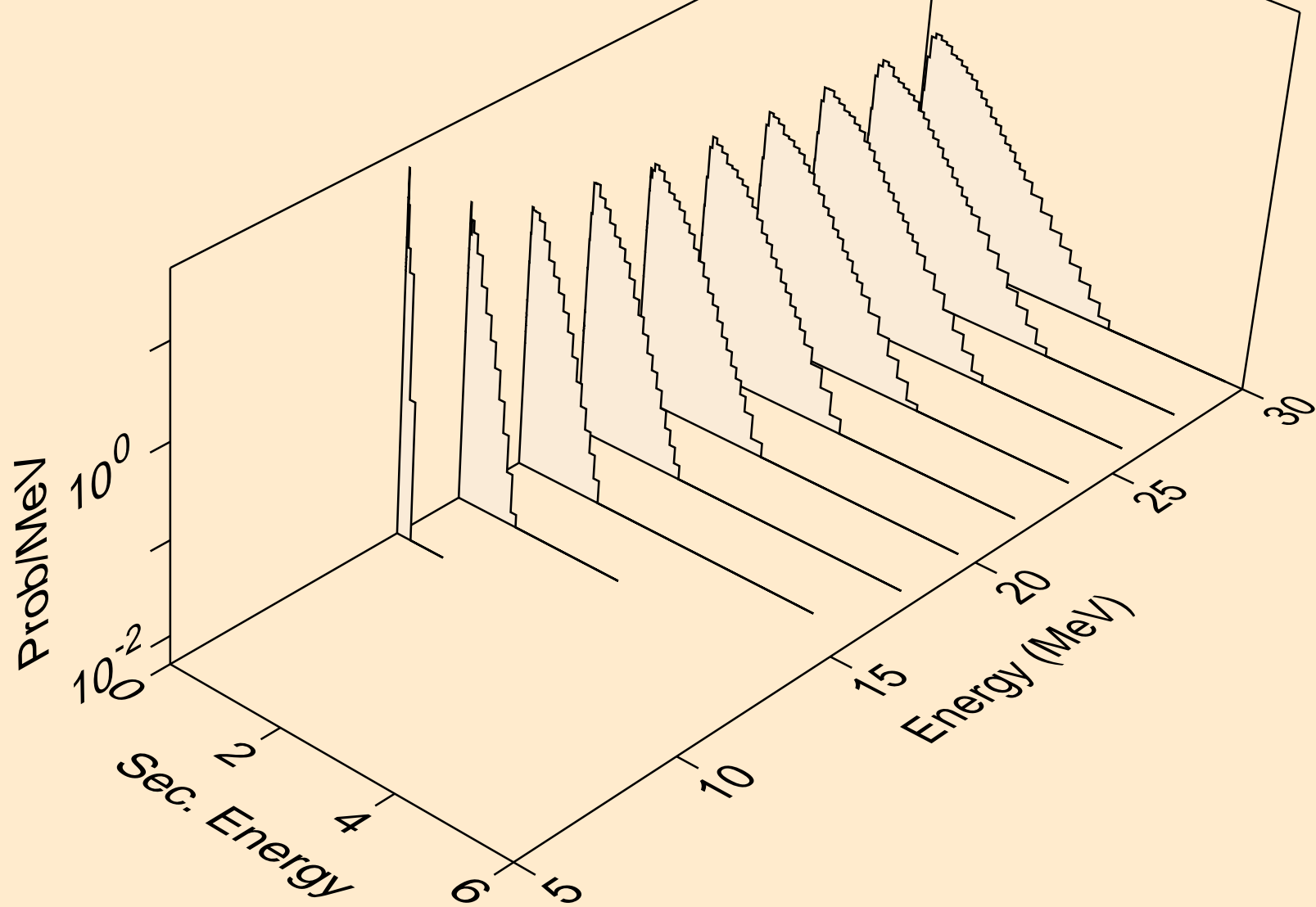

HO164M NEUTRON ACER TENDL-2024 LIBRARY; T=0.K  
Neutron emission for (n,n\*)t

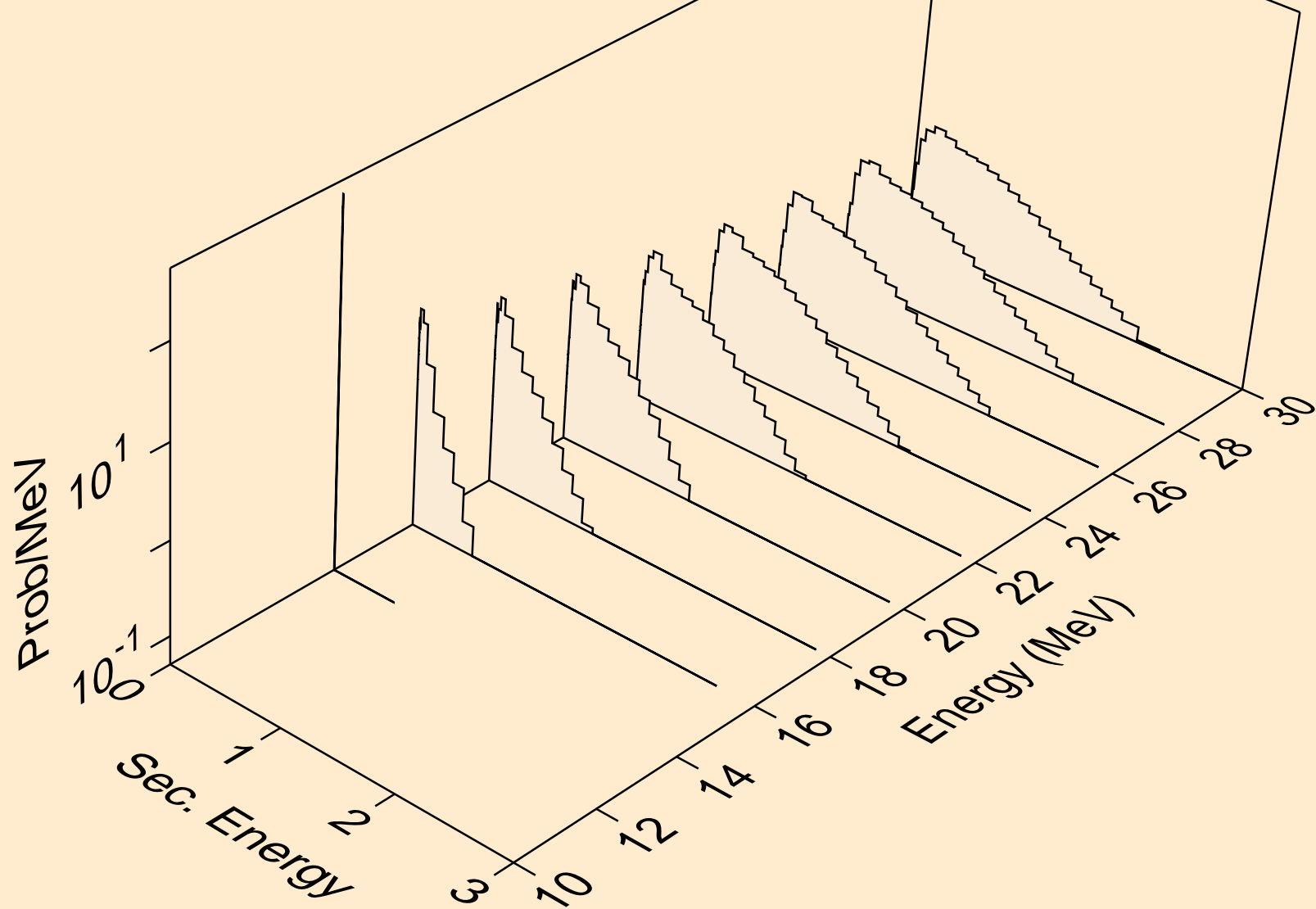

HO164M NEUTRON ACER TENDL-2024 LIBRARY; T=0.K  
Neutron emission for (n,n\*)he3

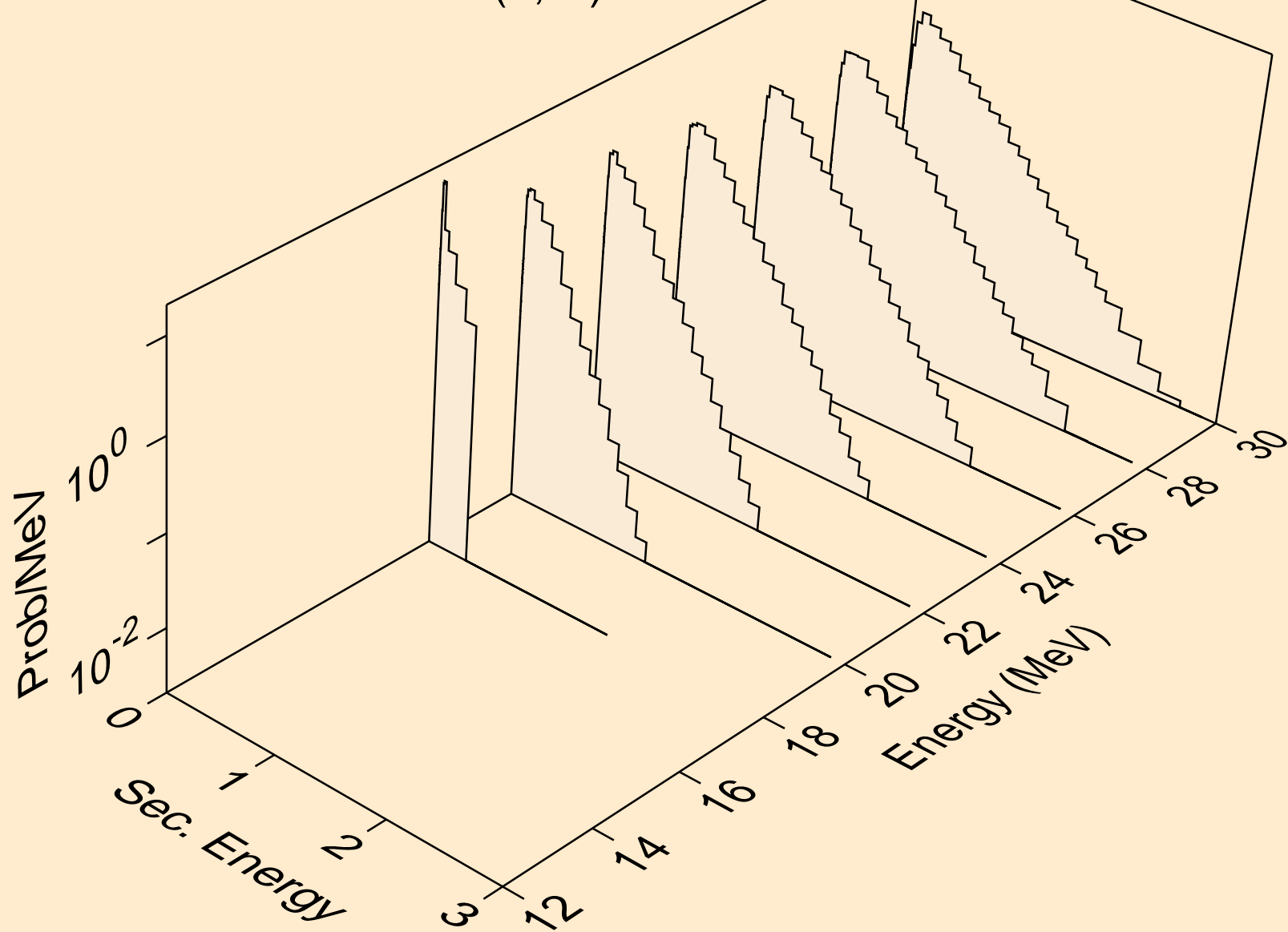

HO164M NEUTRON ACER TENDL-2024 LIBRARY; T=0.K  
Neutron emission for (n,4n)

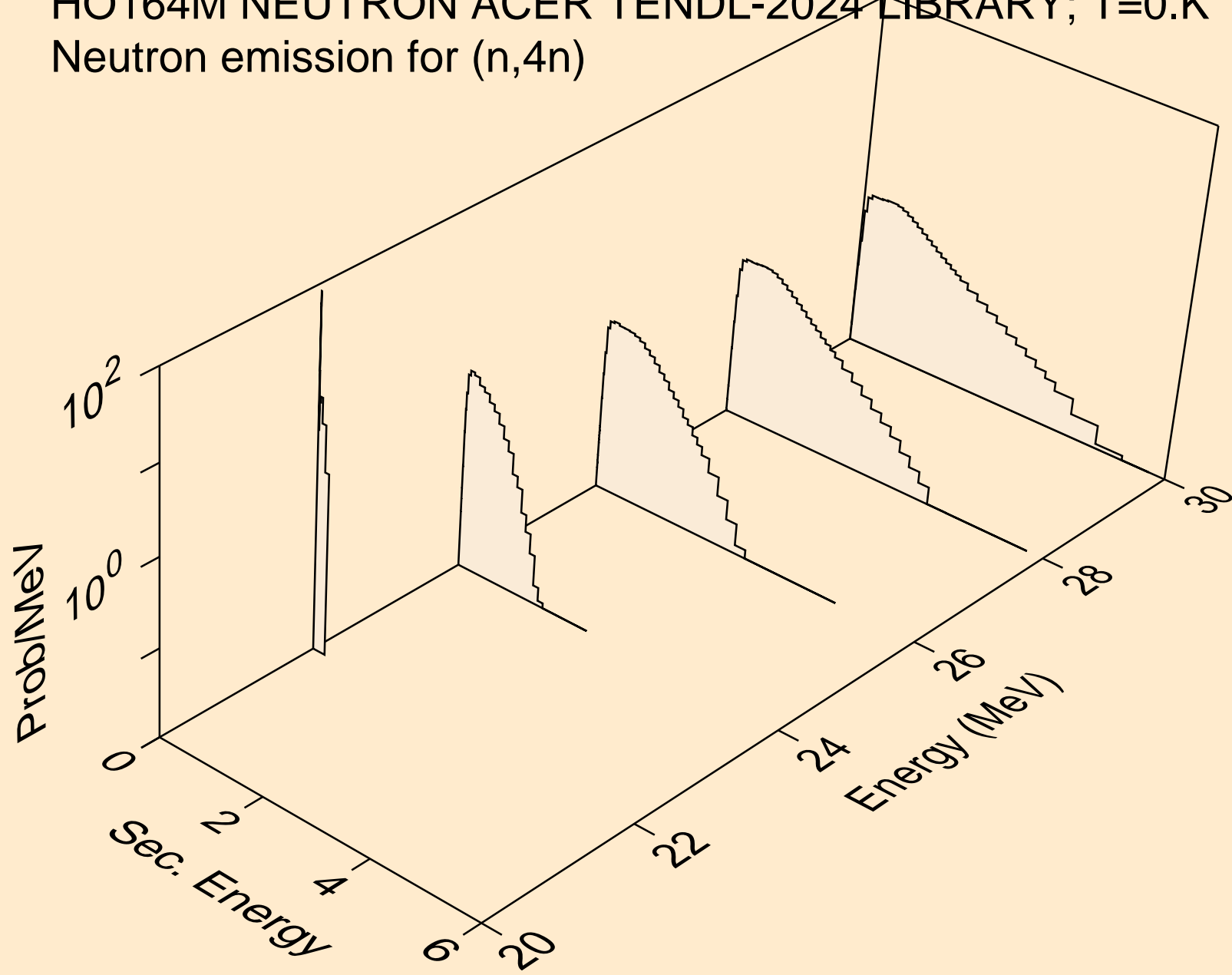

HO164M NEUTRON ACER TENDL-2024 LIBRARY; T=0.K  
Neutron emission for (n,2np)

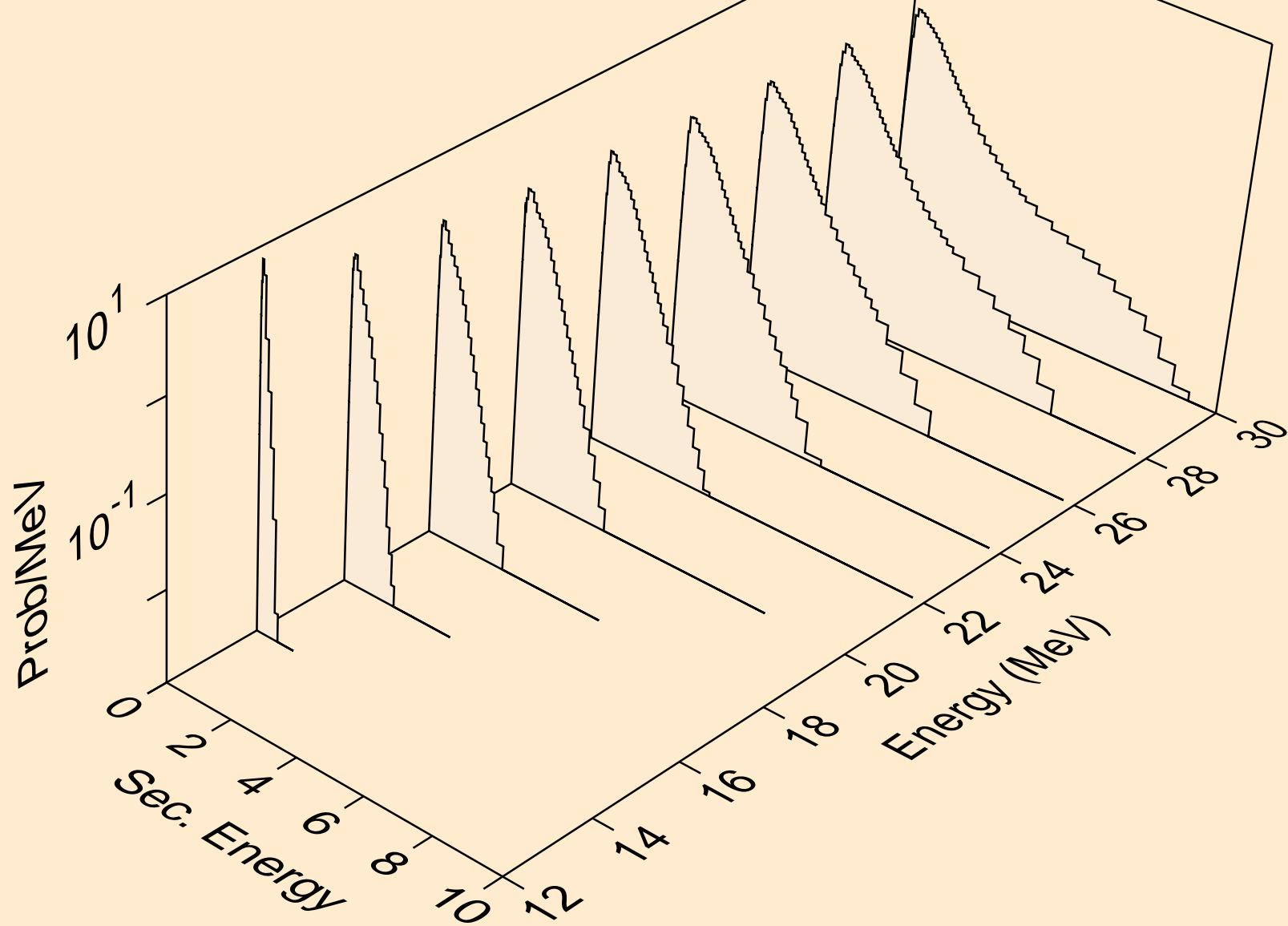

HO164M NEUTRON ACER TENDL-2024 LIBRARY; T=0.K  
Neutron emission for (n,3np)

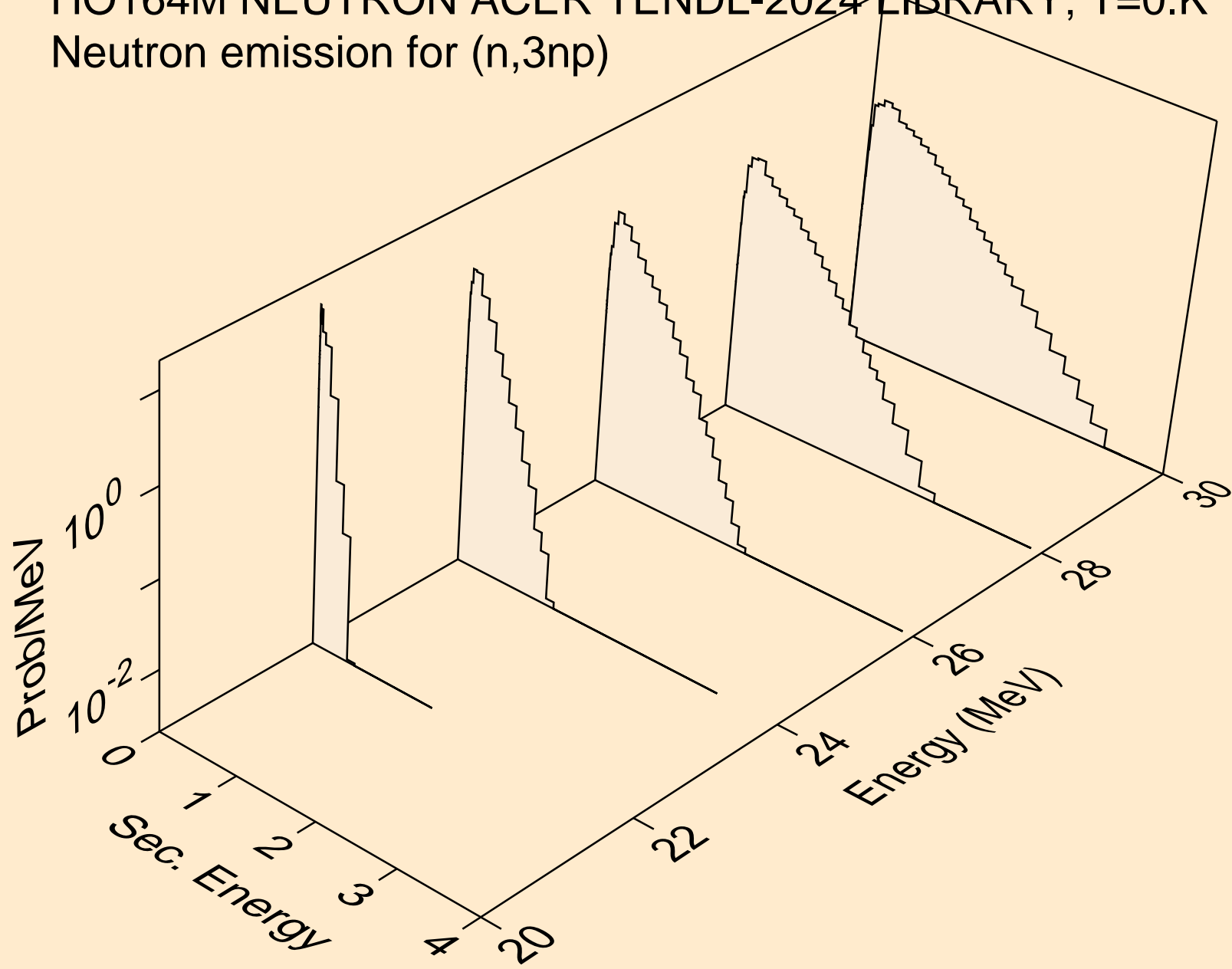

HO164M NEUTRON ACER TENDL-2024 LIBRARY; T=0.K  
Neutron emission for (n,n2p)

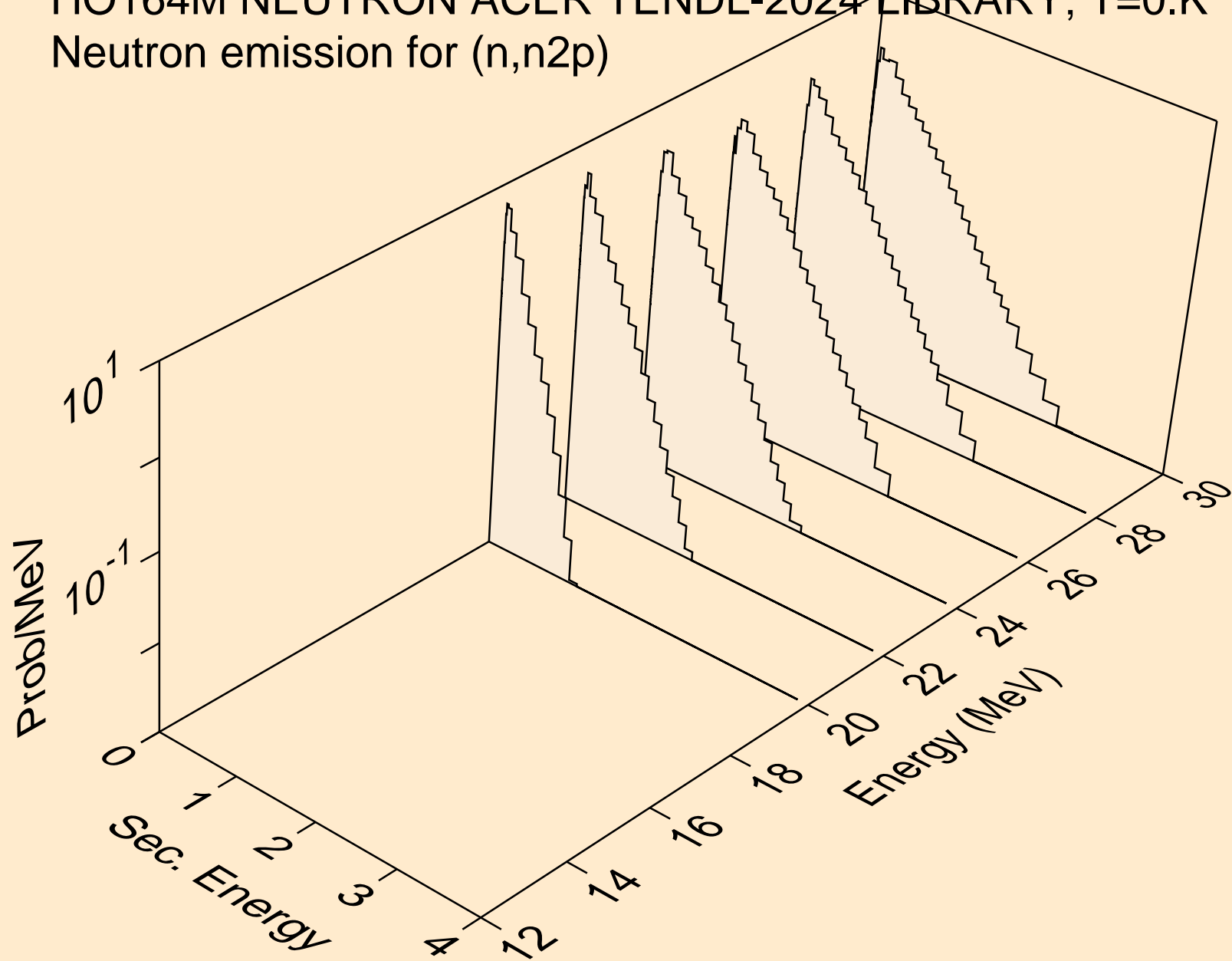

HO164M NEUTRON ACER TENDL-2024 LIBRARY; T=0.K  
Neutron emission for (n,npa)

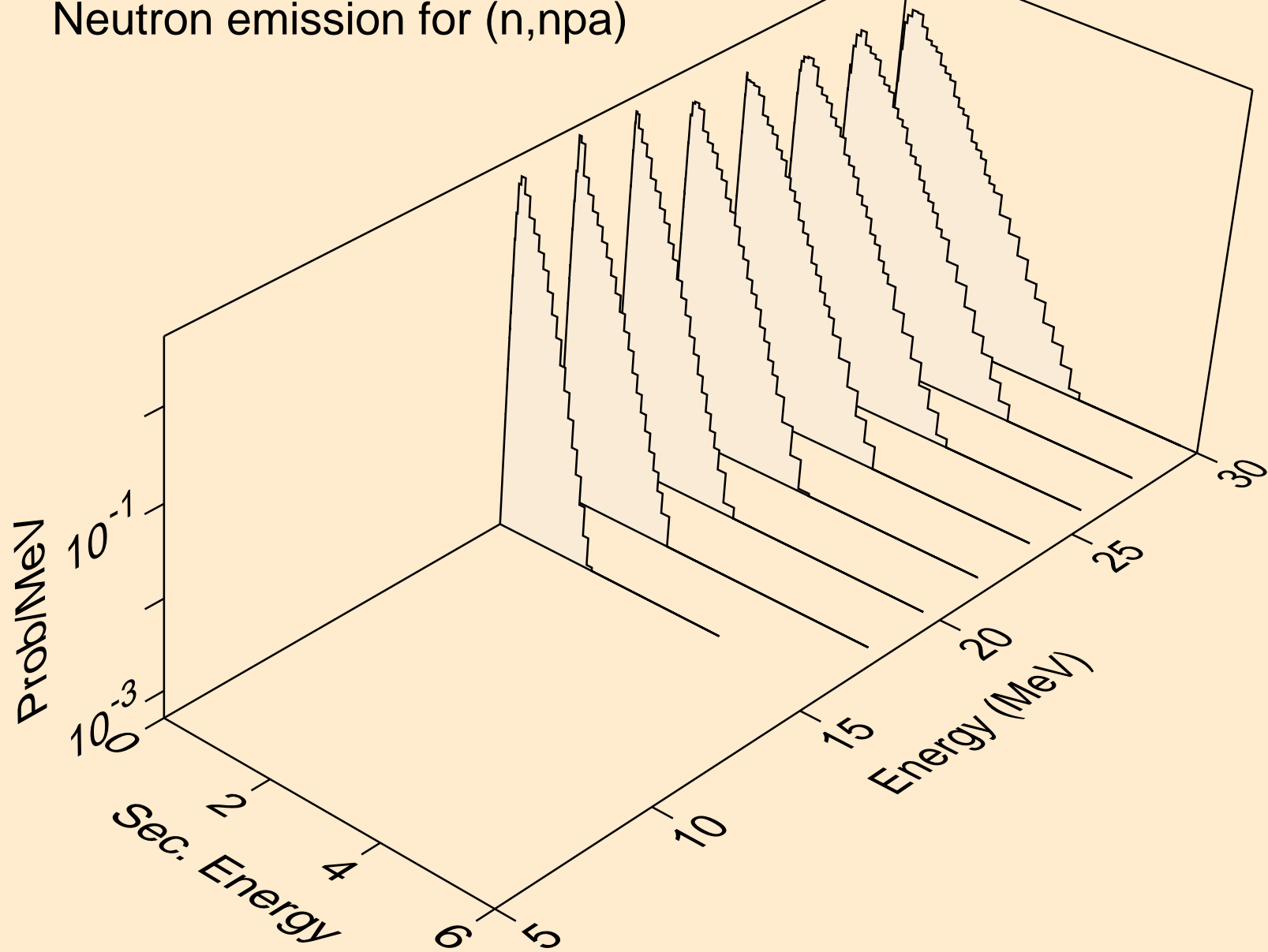

HO164M NEUTRON ACER TENDL-2024 LIBRARY; T=0.K  
Neutron emission for (n,n\*c)

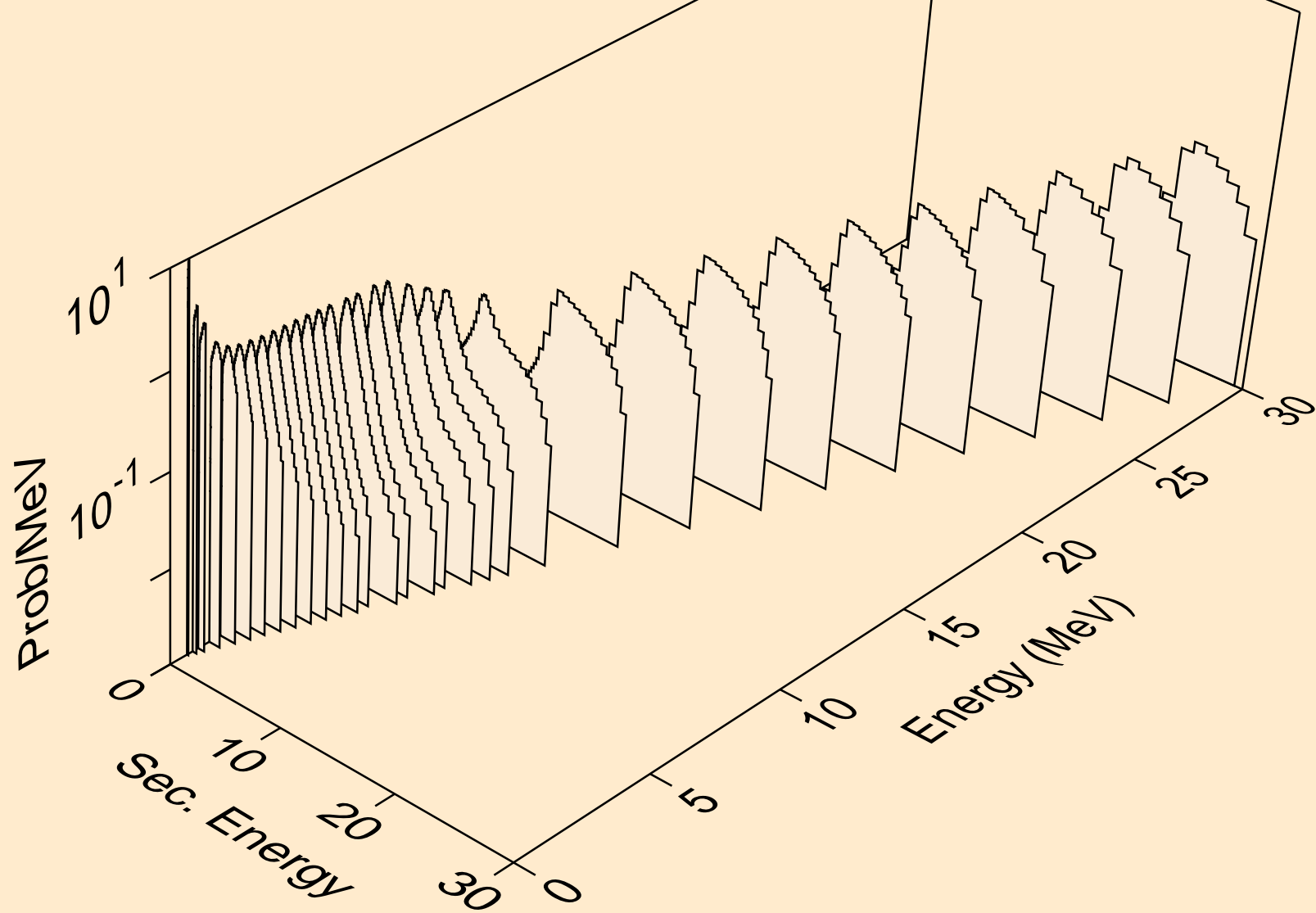

HO164M NEUTRON ACER TENDL-2024 LIBRARY; T=0.K  
Photon emission for (n,x)

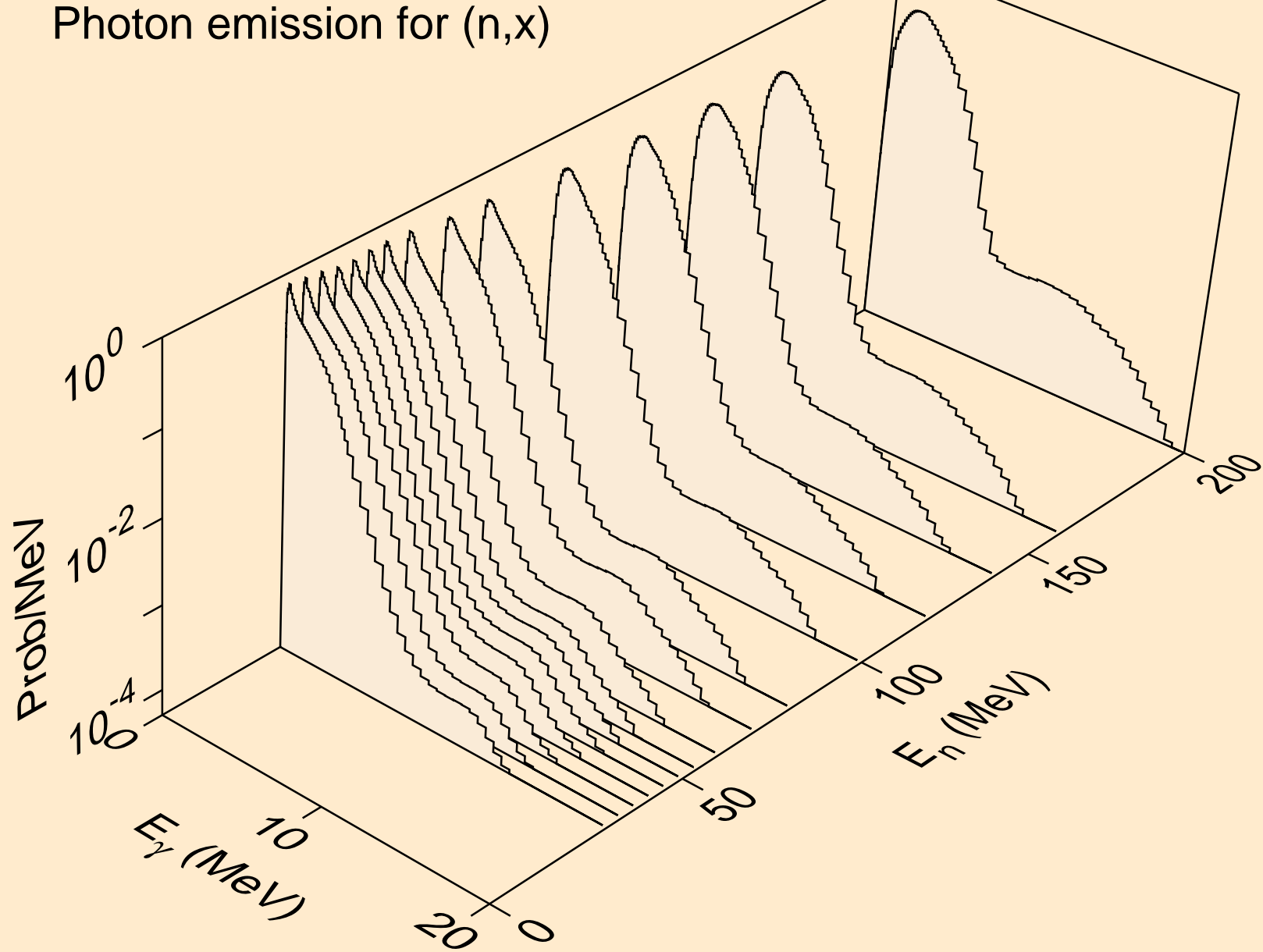

HO164M NEUTRON ACER TENDL-2024 LIBRARY; T=0.K  
Photon emission for (n,2nd)

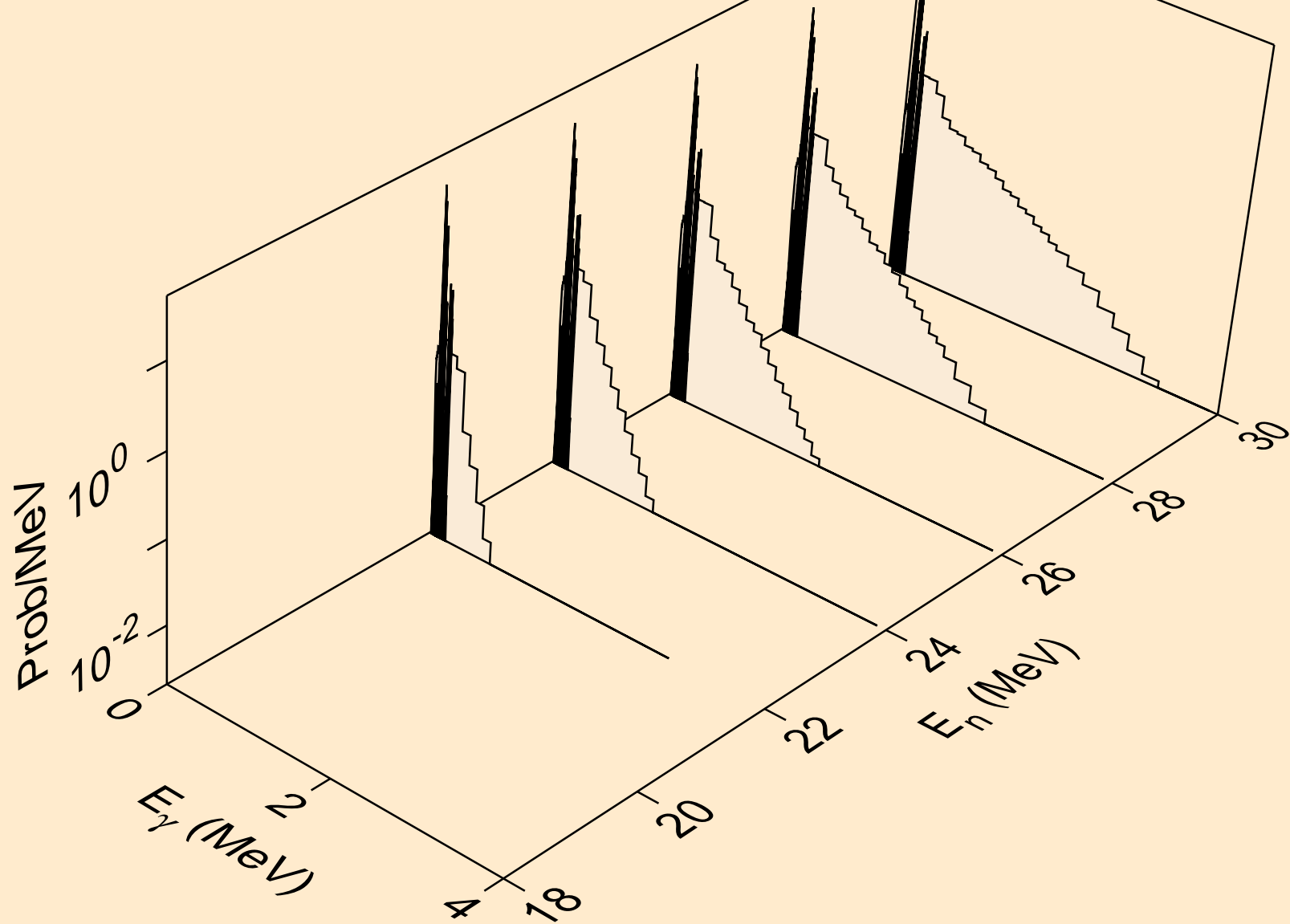

HO164M NEUTRON ACER TENDL-2024 LIBRARY; T=0.K  
Photon emission for (n,2n)

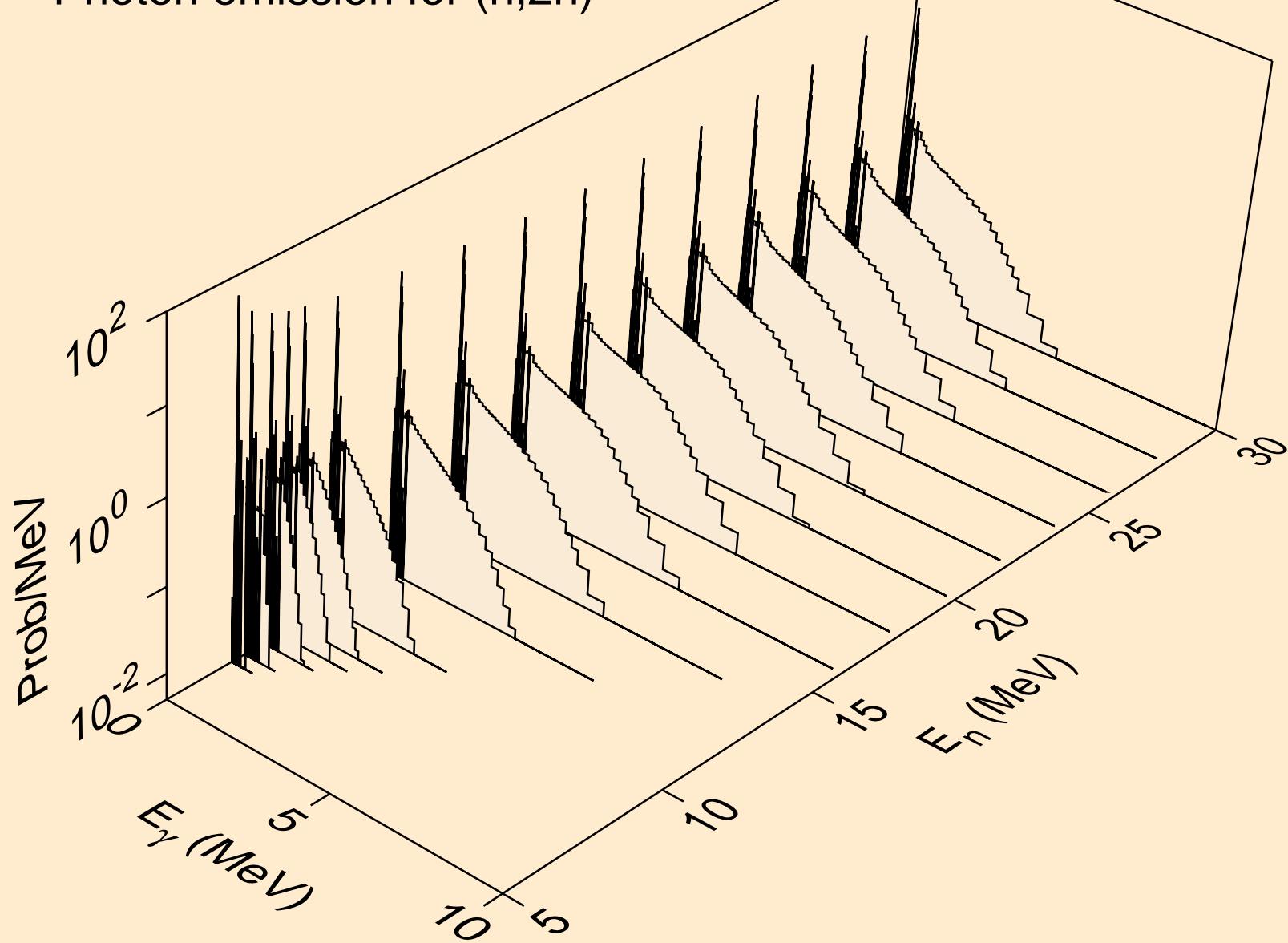

HO164M NEUTRON ACER TENDL-2024 LIBRARY; T=0.K  
Photon emission for (n,3n)

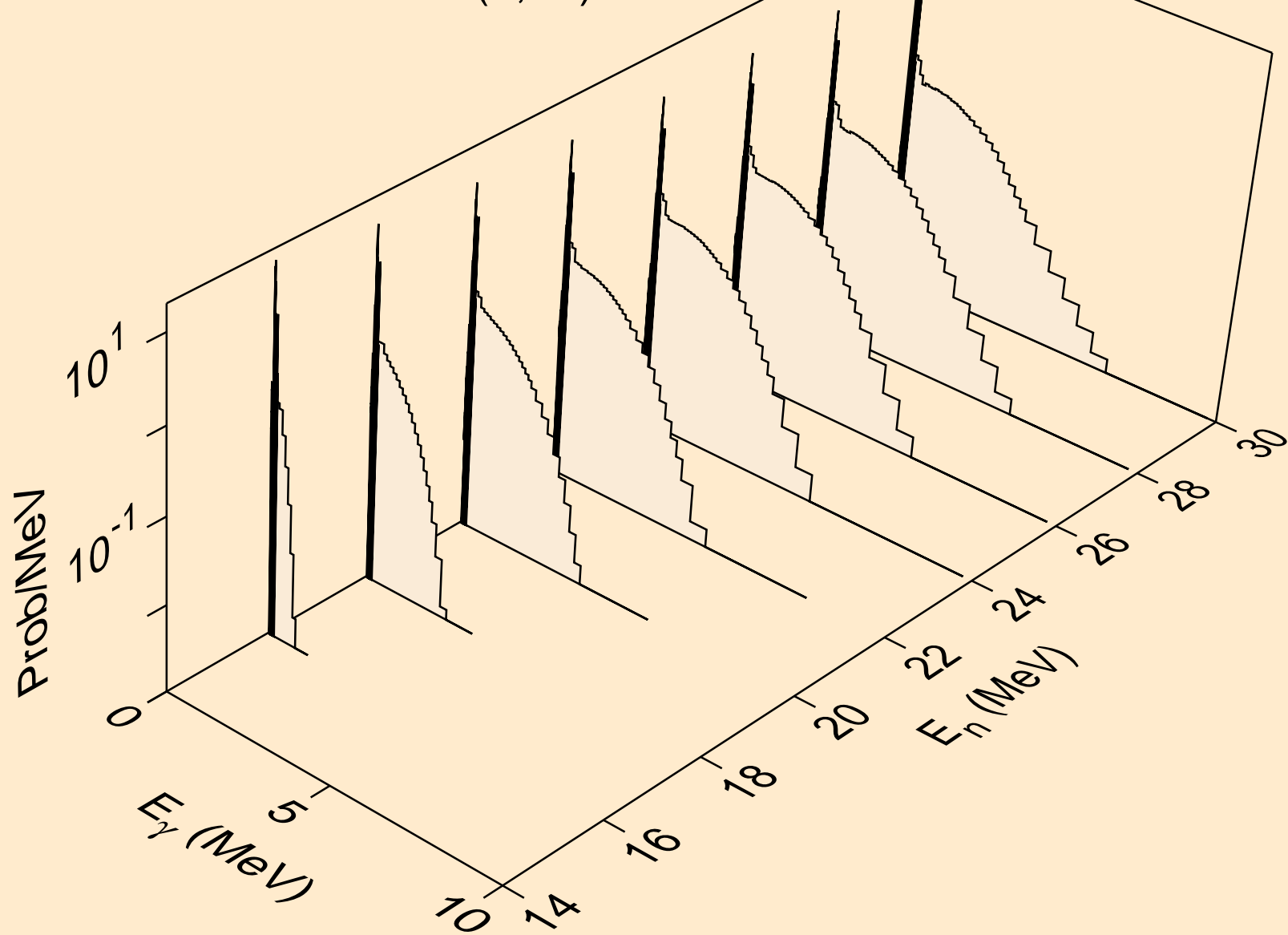

HO164M NEUTRON ACER TENDL-2024 LIBRARY; T=0.K  
Photon emission for (n,n\*)a

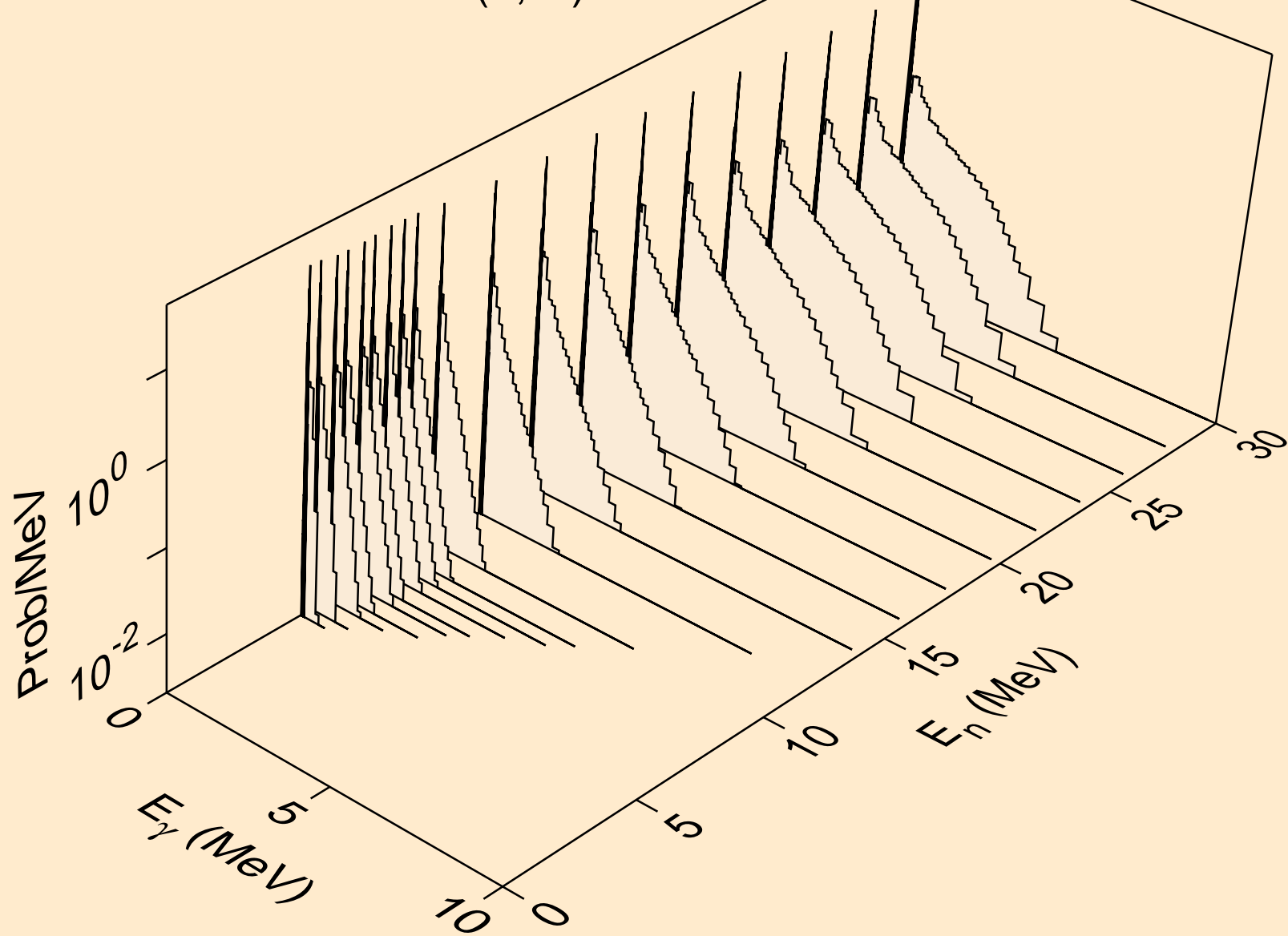

HO164M NEUTRON ACER TENDL-2024 LIBRARY; T=0.K  
Photon emission for (n,2n)a

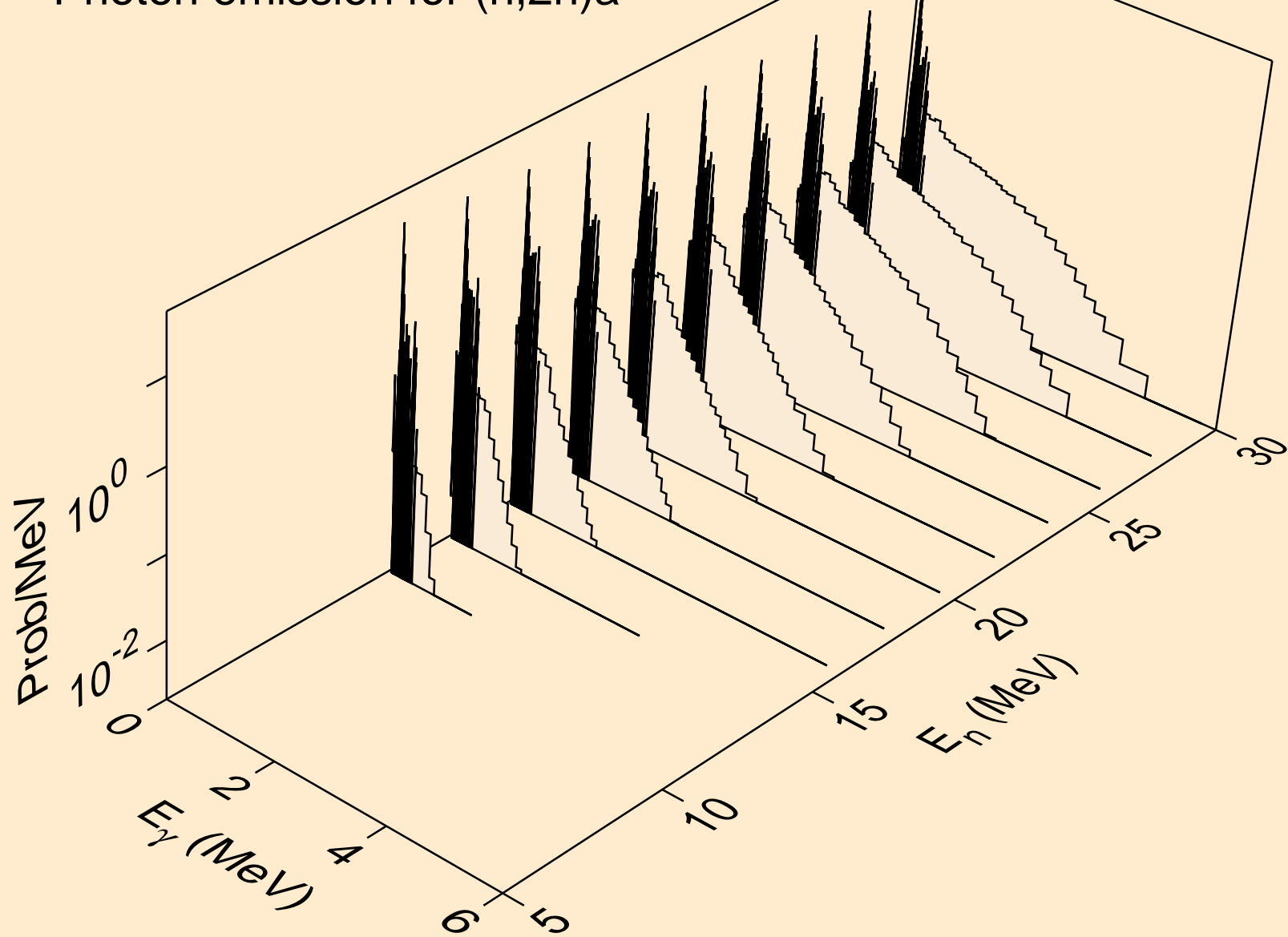

HO164M NEUTRON ACER TENDL-2024 LIBRARY; T=0.K  
Photon emission for (n,3n)a

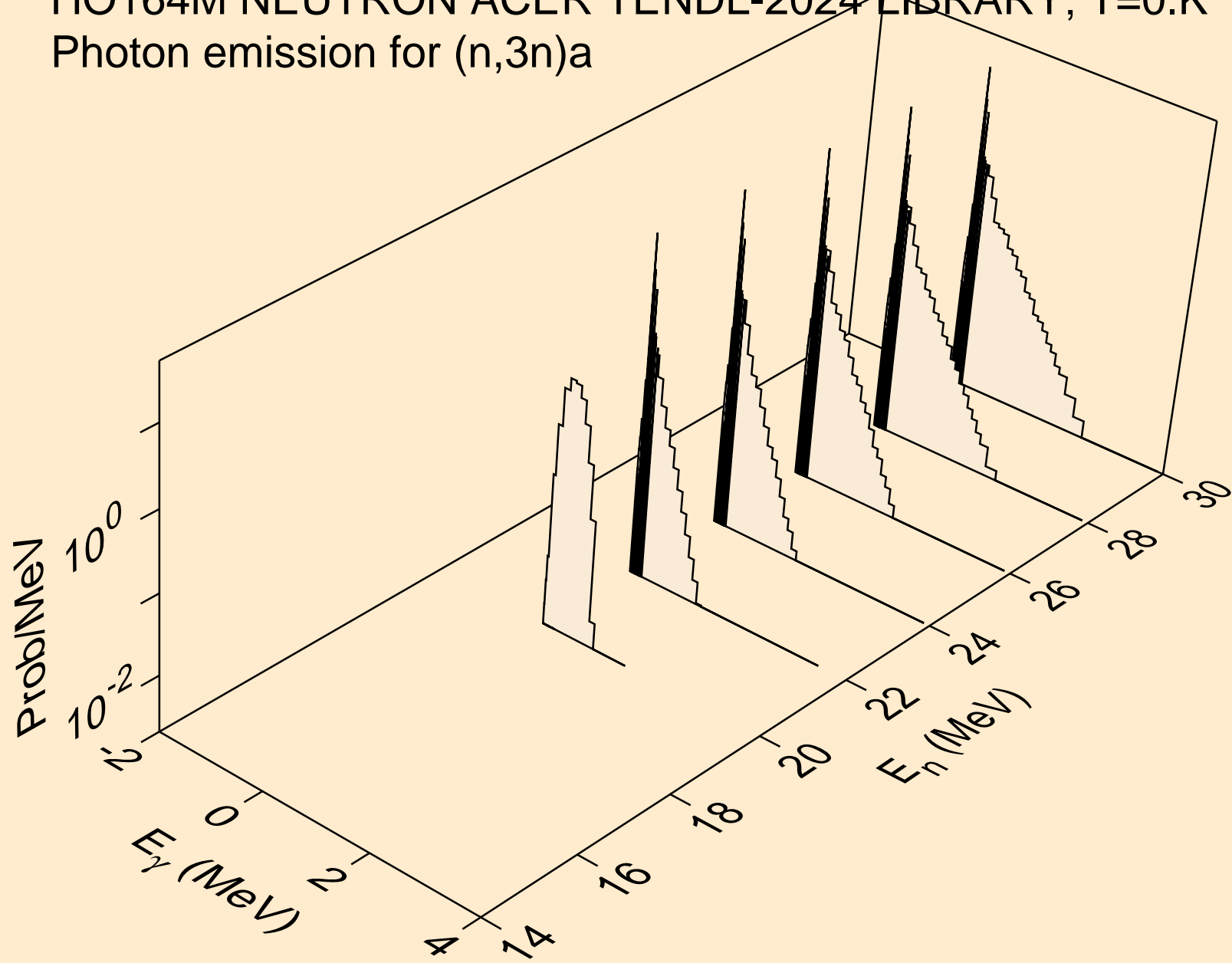

HO164M NEUTRON ACER TENDL-2024 LIBRARY; T=0.K  
Photon emission for (n,n\*)p

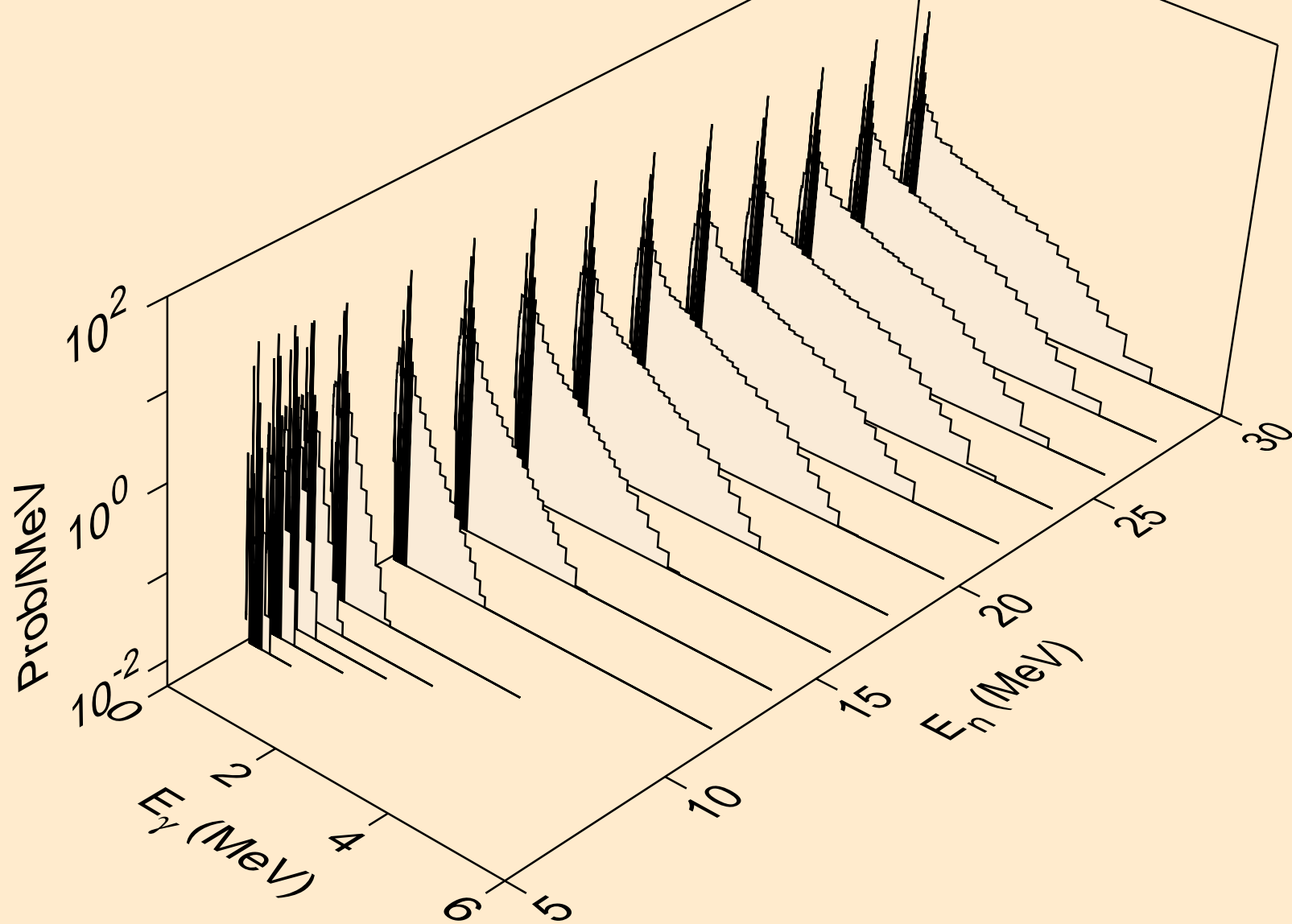

HO164M NEUTRON ACER TENDL-2024 LIBRARY; T=0.K  
Photon emission for (n,n\*)2a

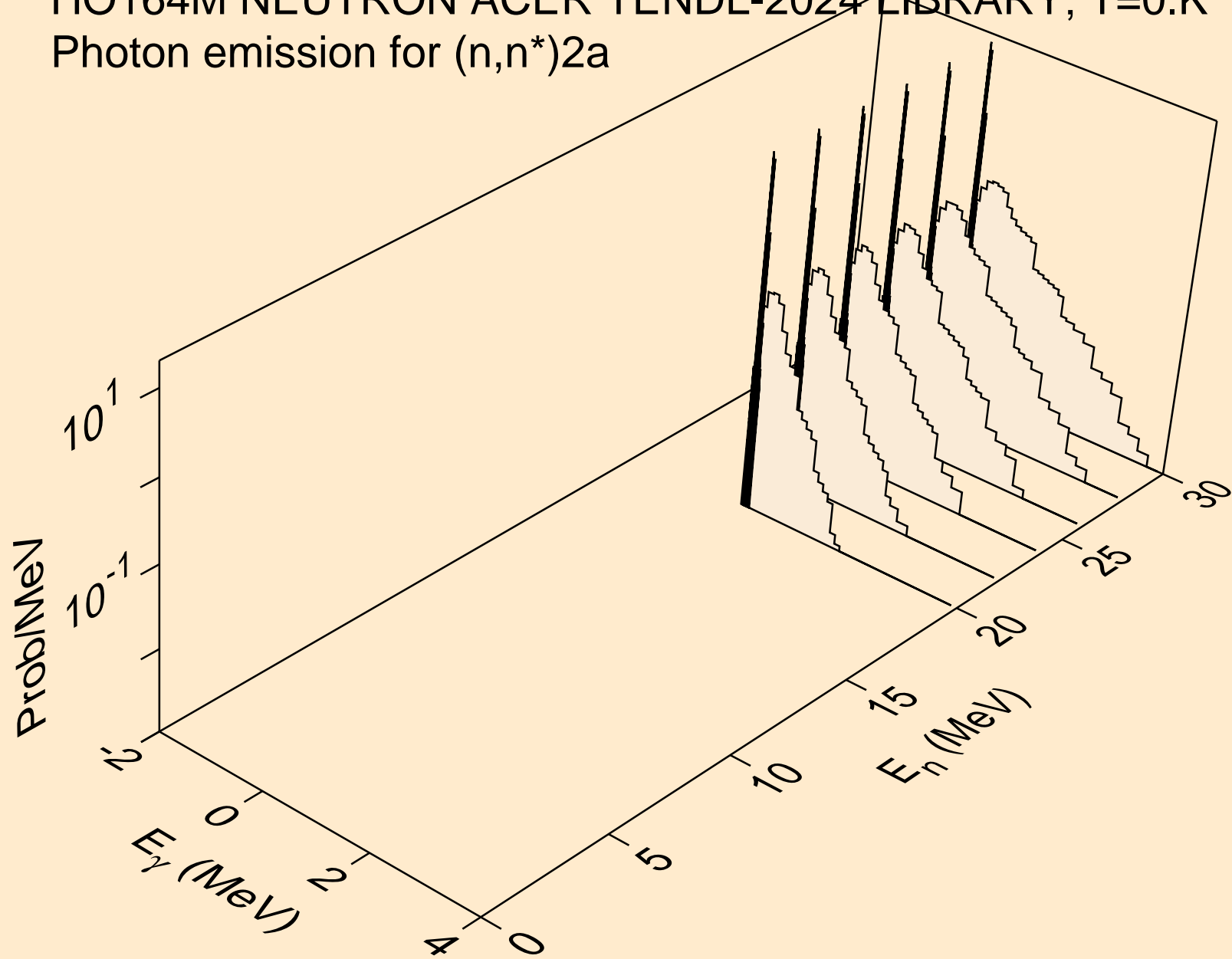

HO164M NEUTRON ACER TENDL-2024 LIBRARY; T=0.K  
Photon emission for (n,n\*)d

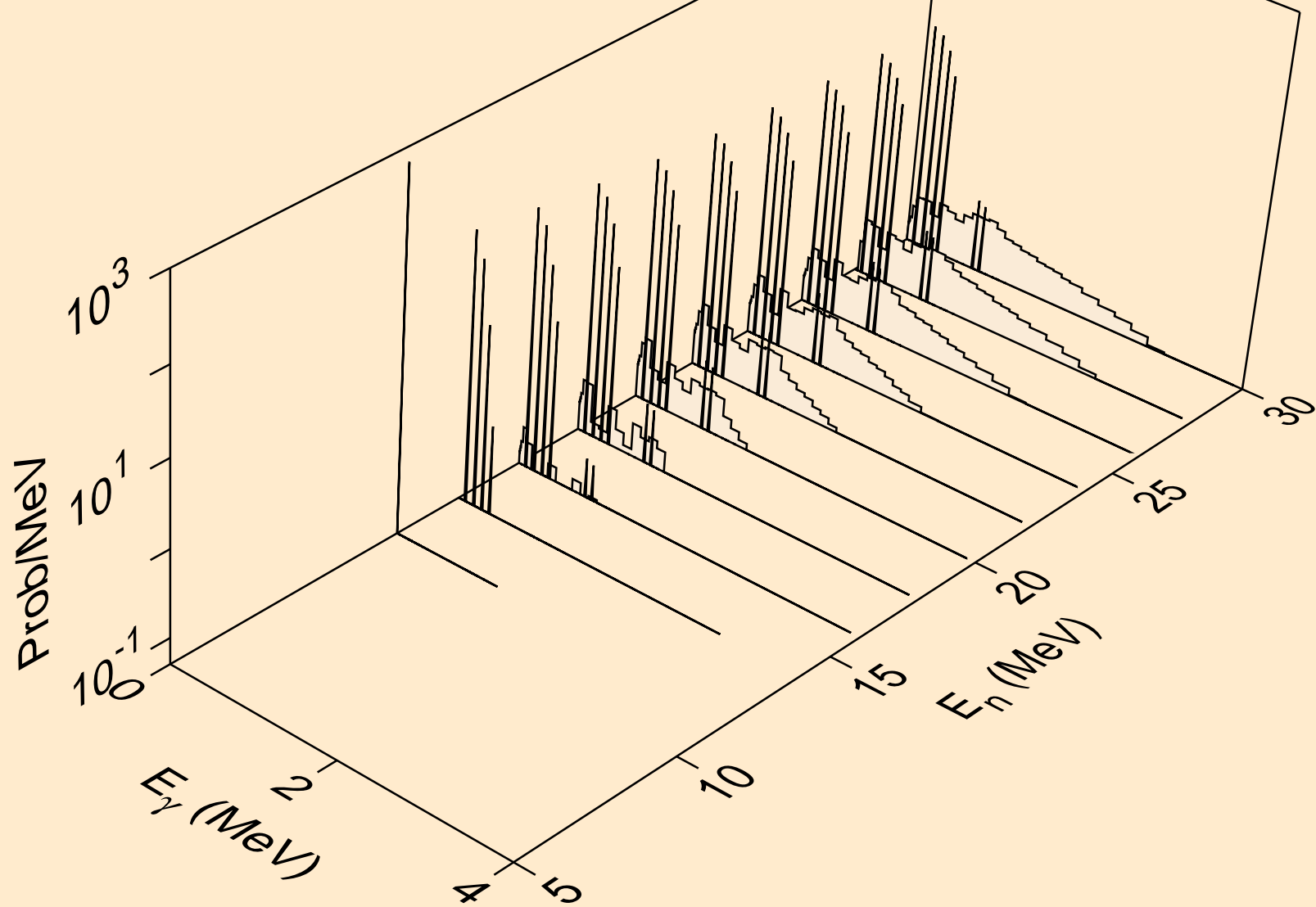

HO164M NEUTRON ACER TENDL-2024 LIBRARY; T=0.K  
Photon emission for (n,n\*)t

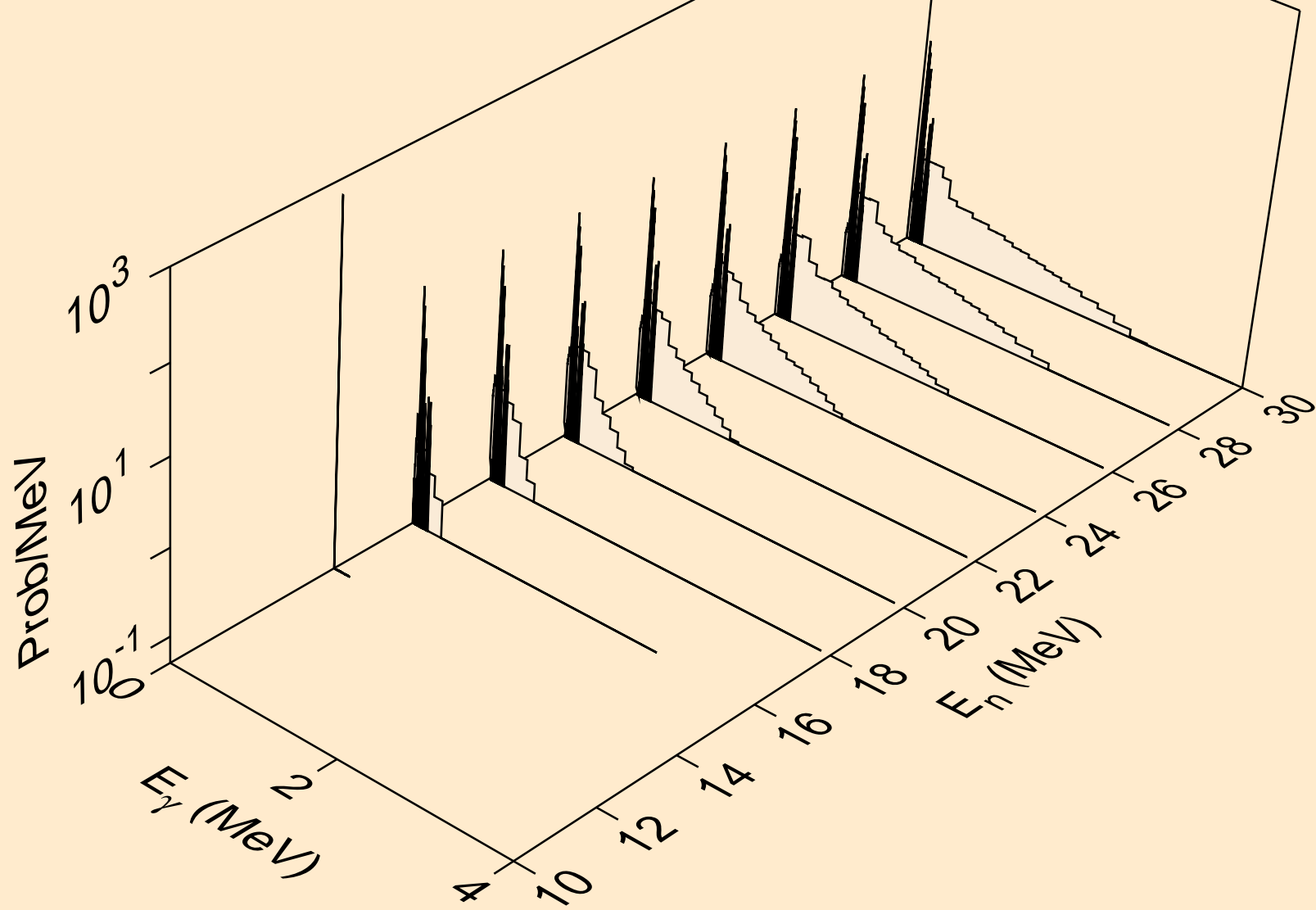

HO164M NEUTRON ACER TENDL-2024 LIBRARY; T=0.K  
Photon emission for (n,n\*)he3

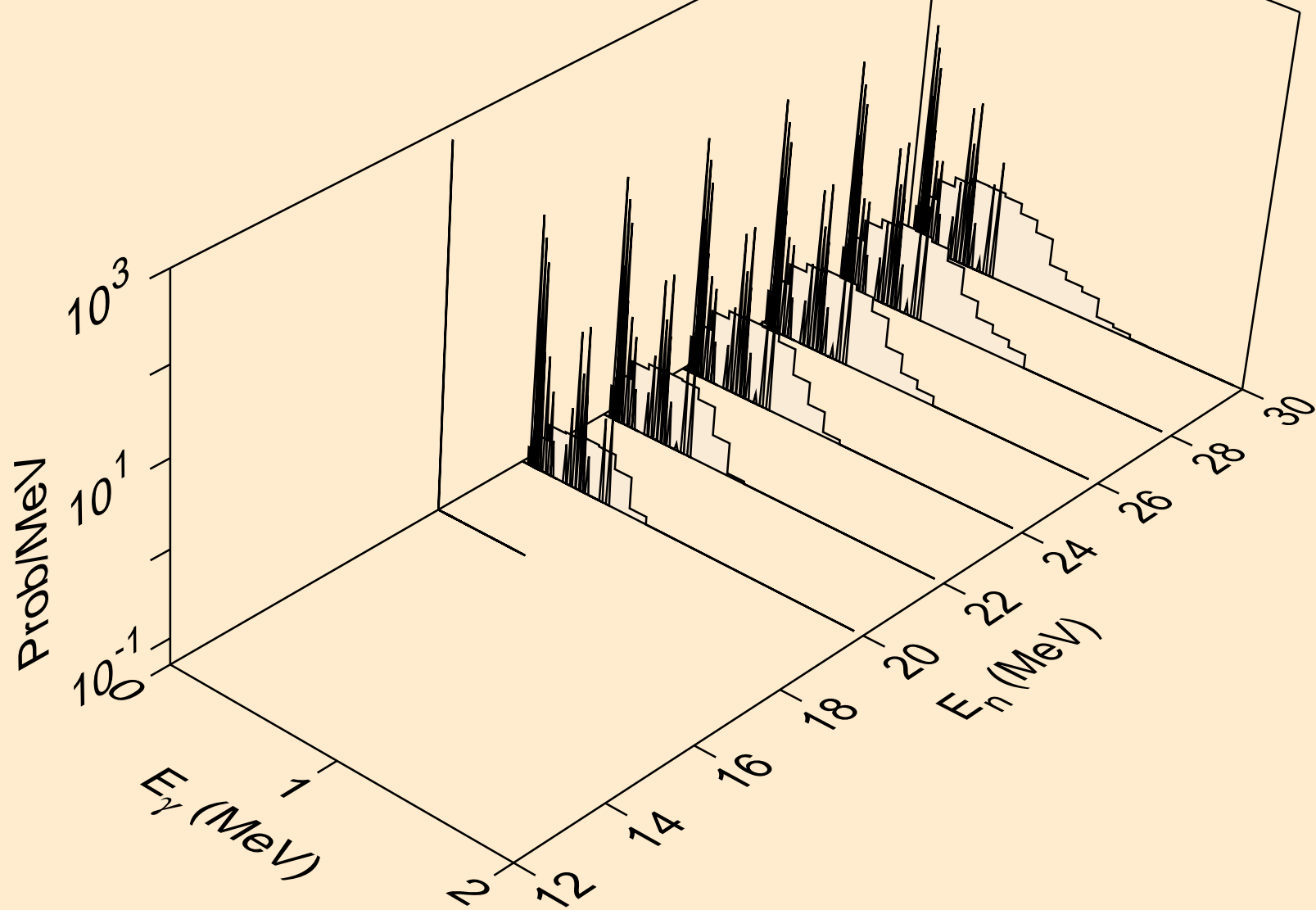

HO164M NEUTRON ACER TENDL-2024 LIBRARY; T=0.K  
Photon emission for (n,4n)

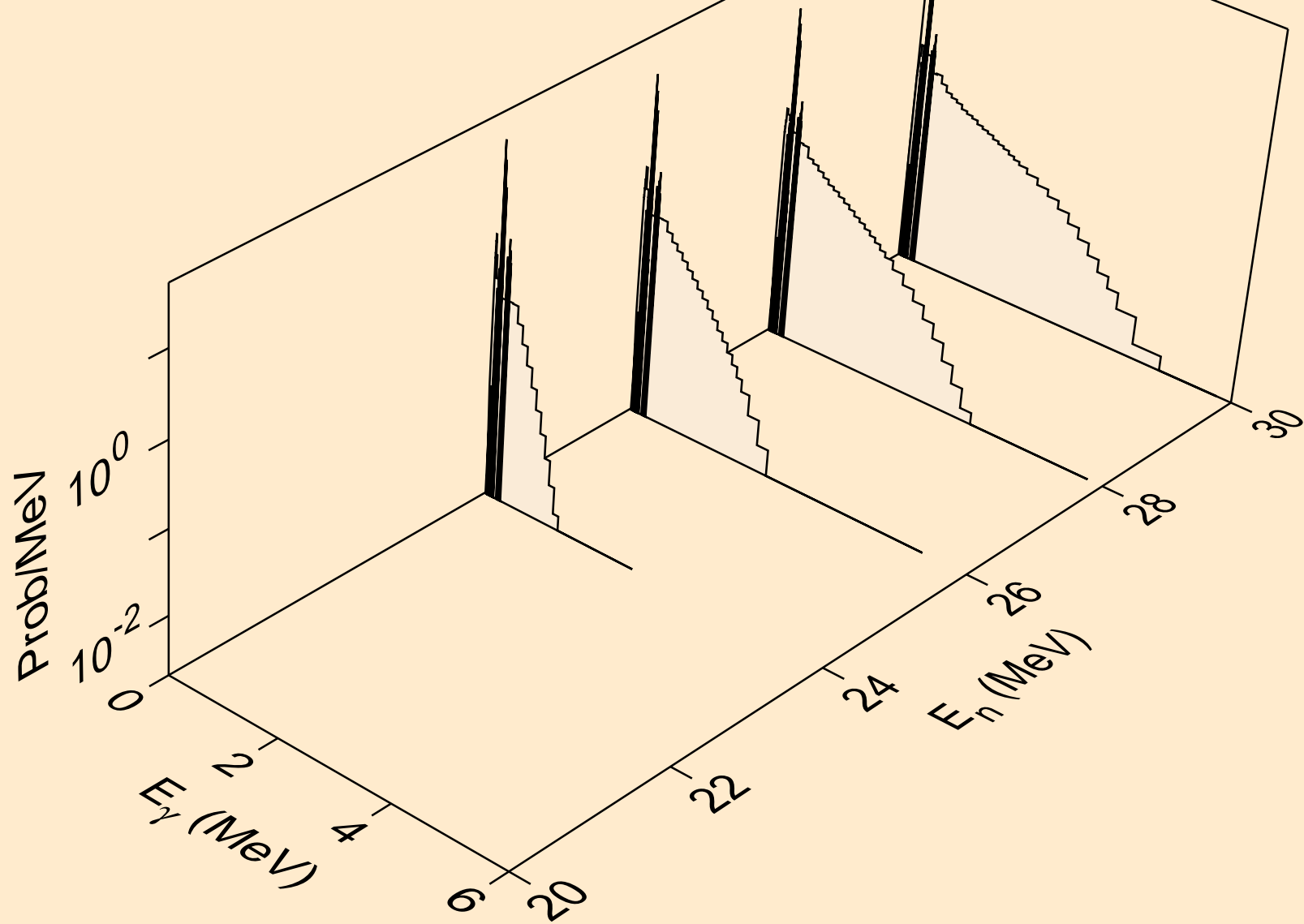

HO164M NEUTRON ACER TENDL-2024 LIBRARY; T=0.K  
Photon emission for (n,2np)

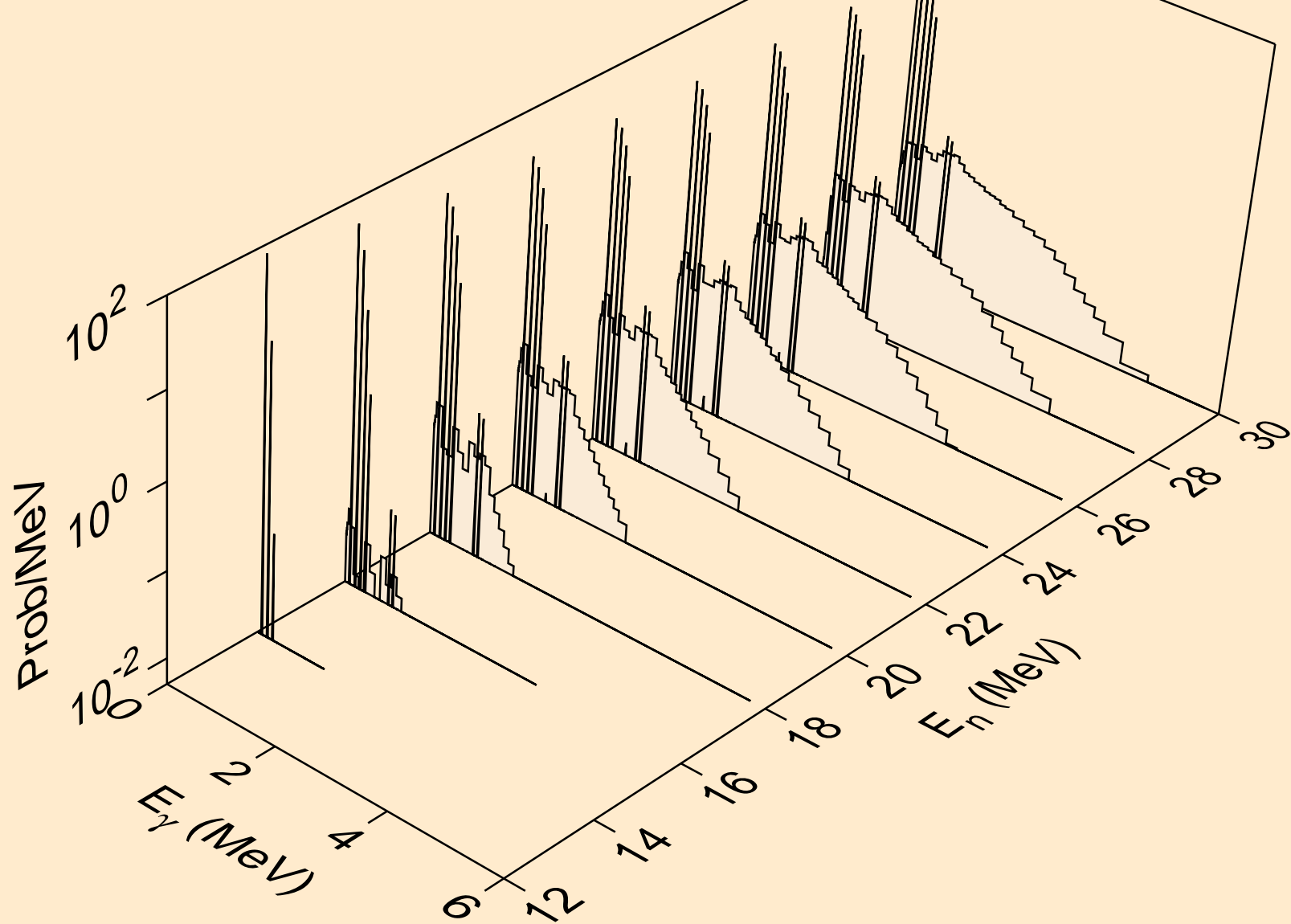

HO164M NEUTRON ACER TENDL-2024 LIBRARY; T=0.K  
Photon emission for (n,3np)

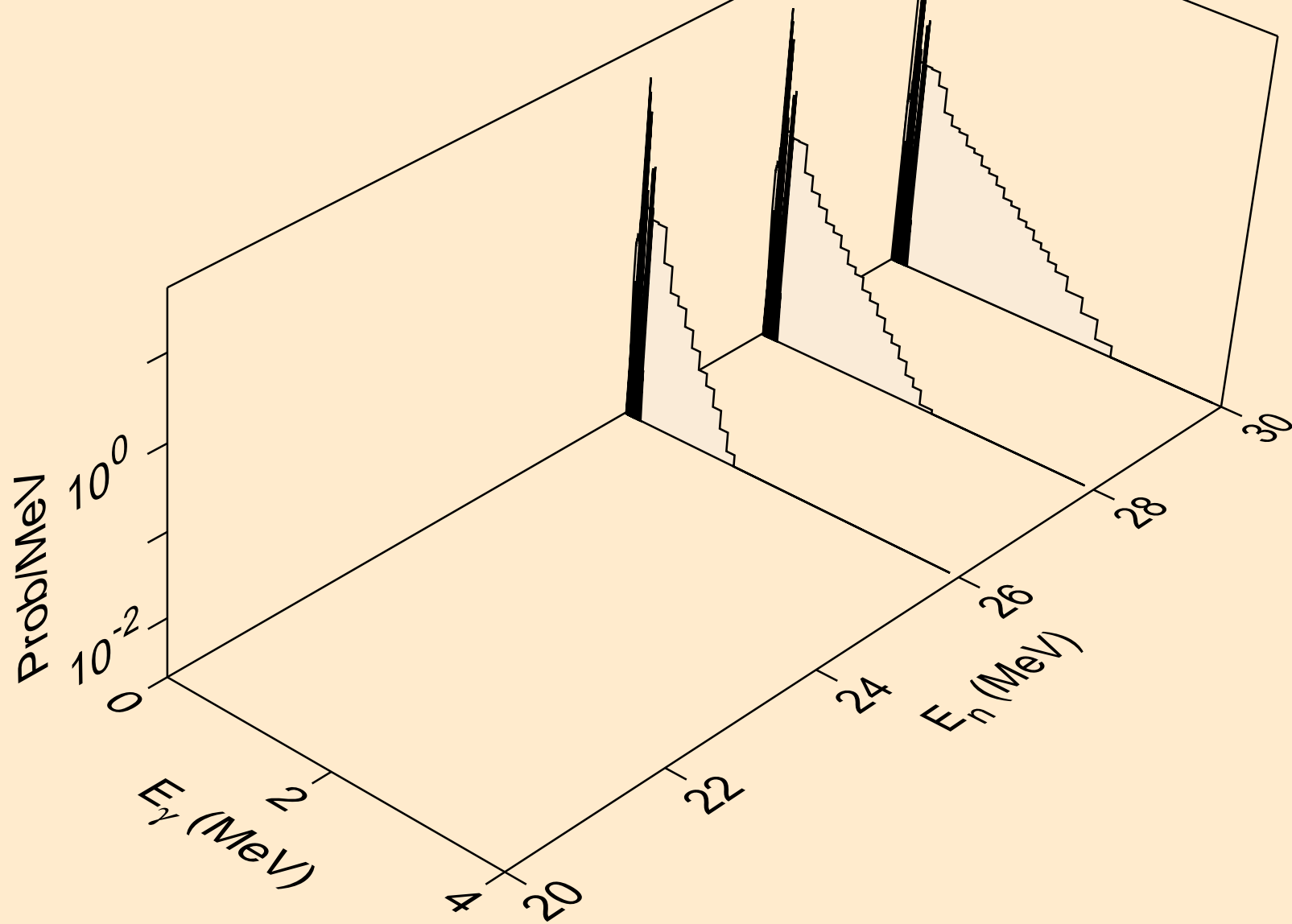

HO164M NEUTRON ACER TENDL-2024 LIBRARY; T=0.K  
Photon emission for (n,n2p)

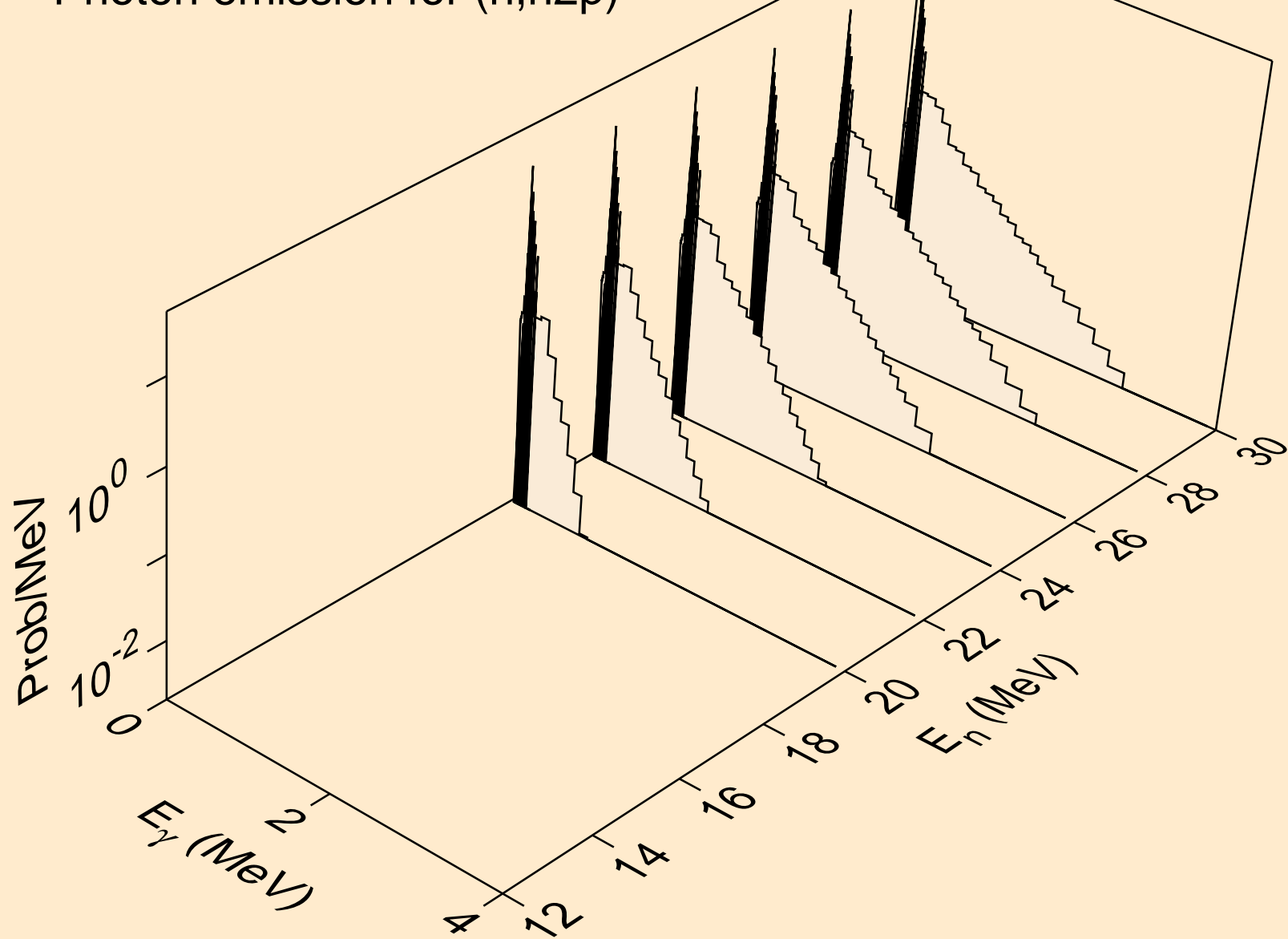

HO164M NEUTRON ACER TENDL-2024 LIBRARY; T=0.K  
Photon emission for (n,npa)

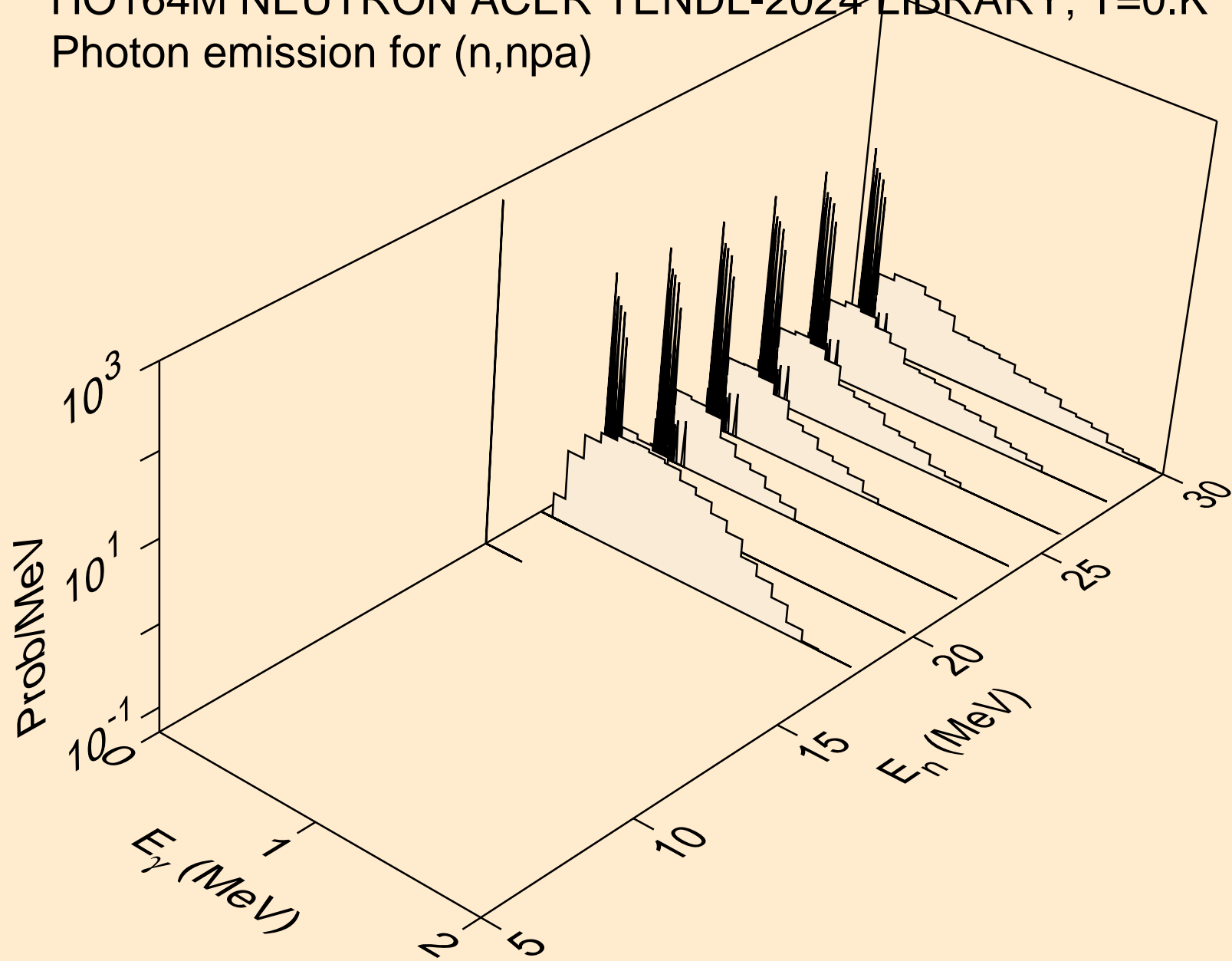

HO164M NEUTRON ACER TENDL-2024 LIBRARY; T=0.K  
Photon emission for (n,n\*1)

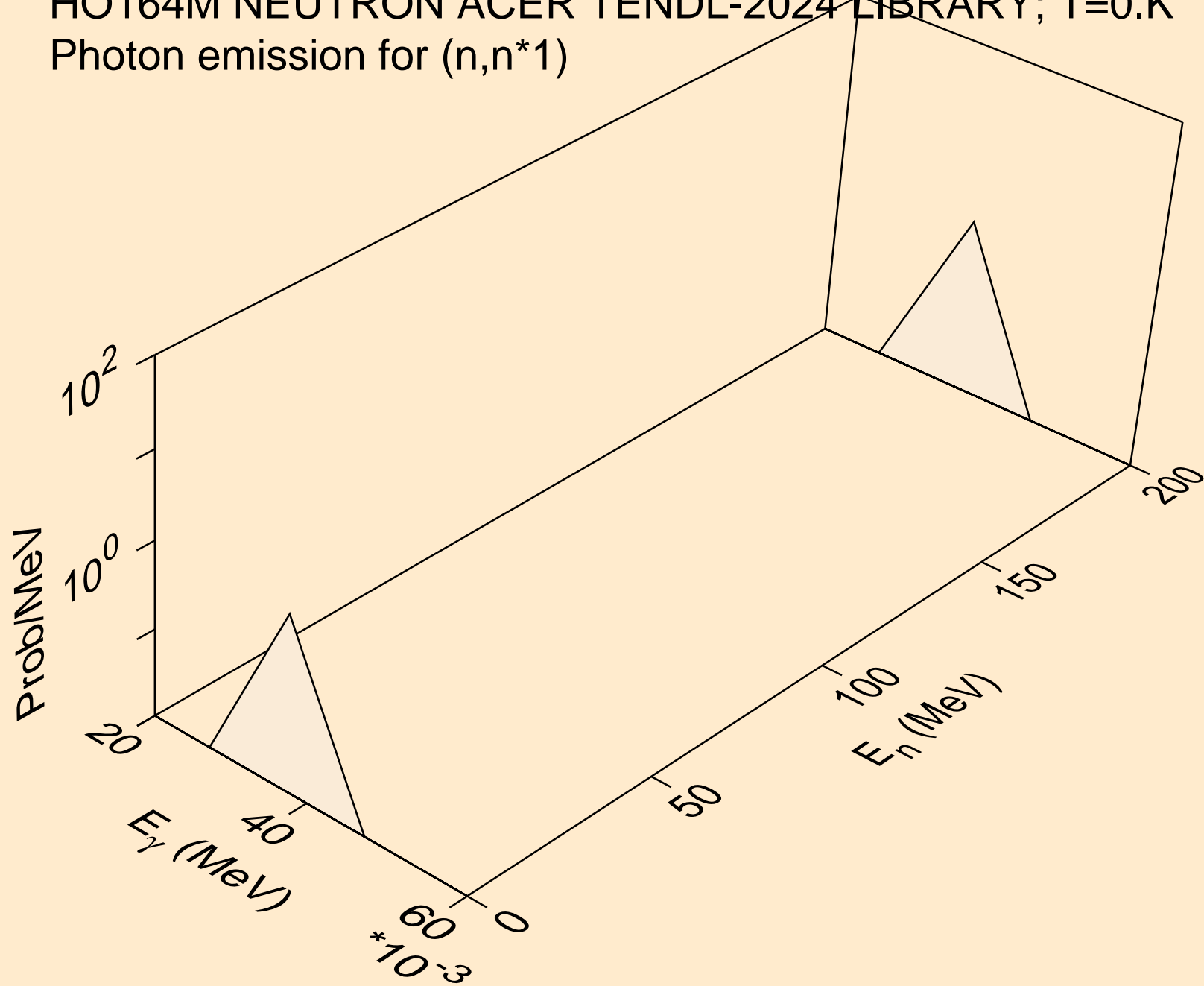

HO164M NEUTRON ACER TENDL-2024 LIBRARY; T=0.K  
Photon emission for (n,n\*2)

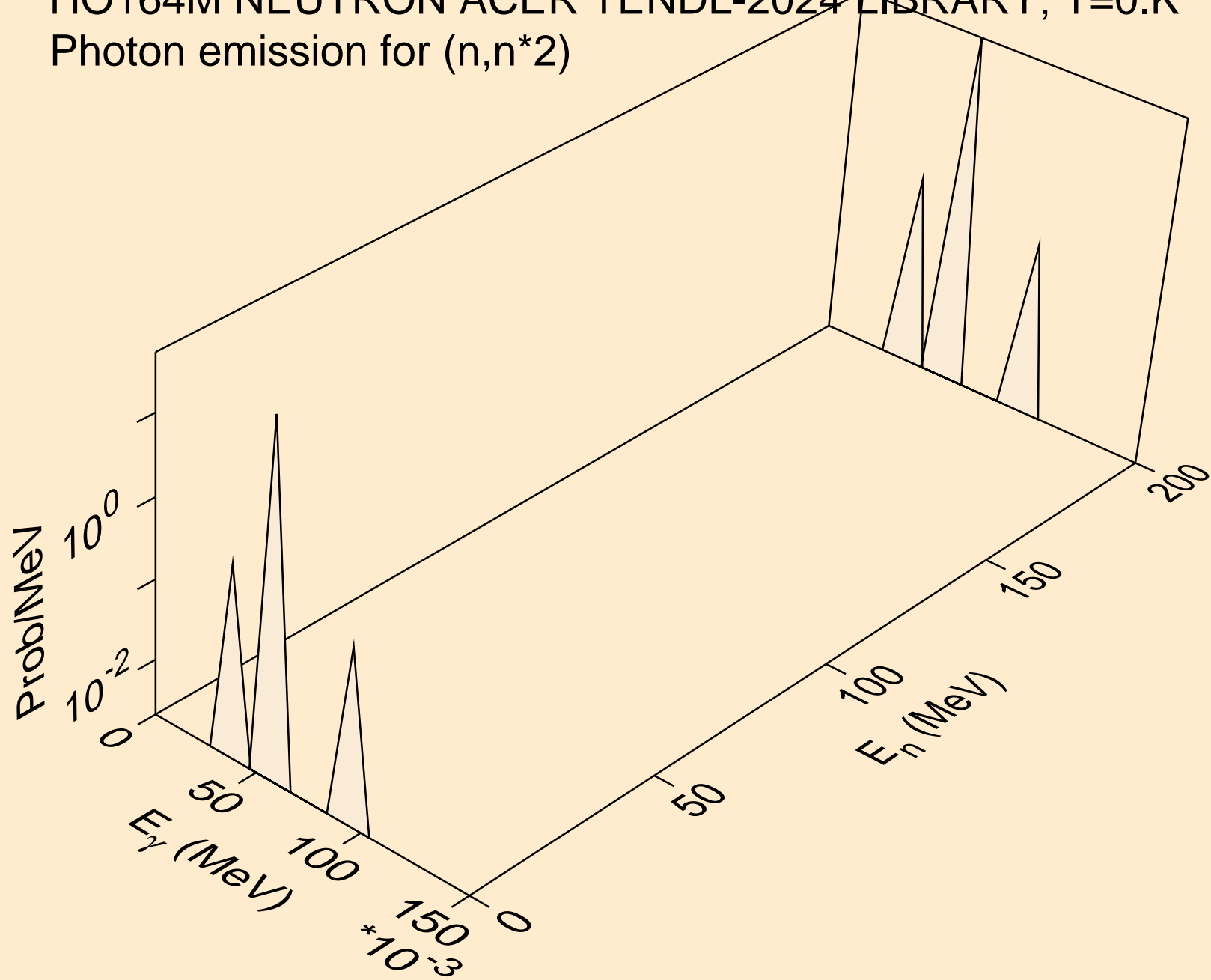

HO164M NEUTRON ACER TENDL-2024 LIBRARY; T=0.K  
Photon emission for (n,n\*4)

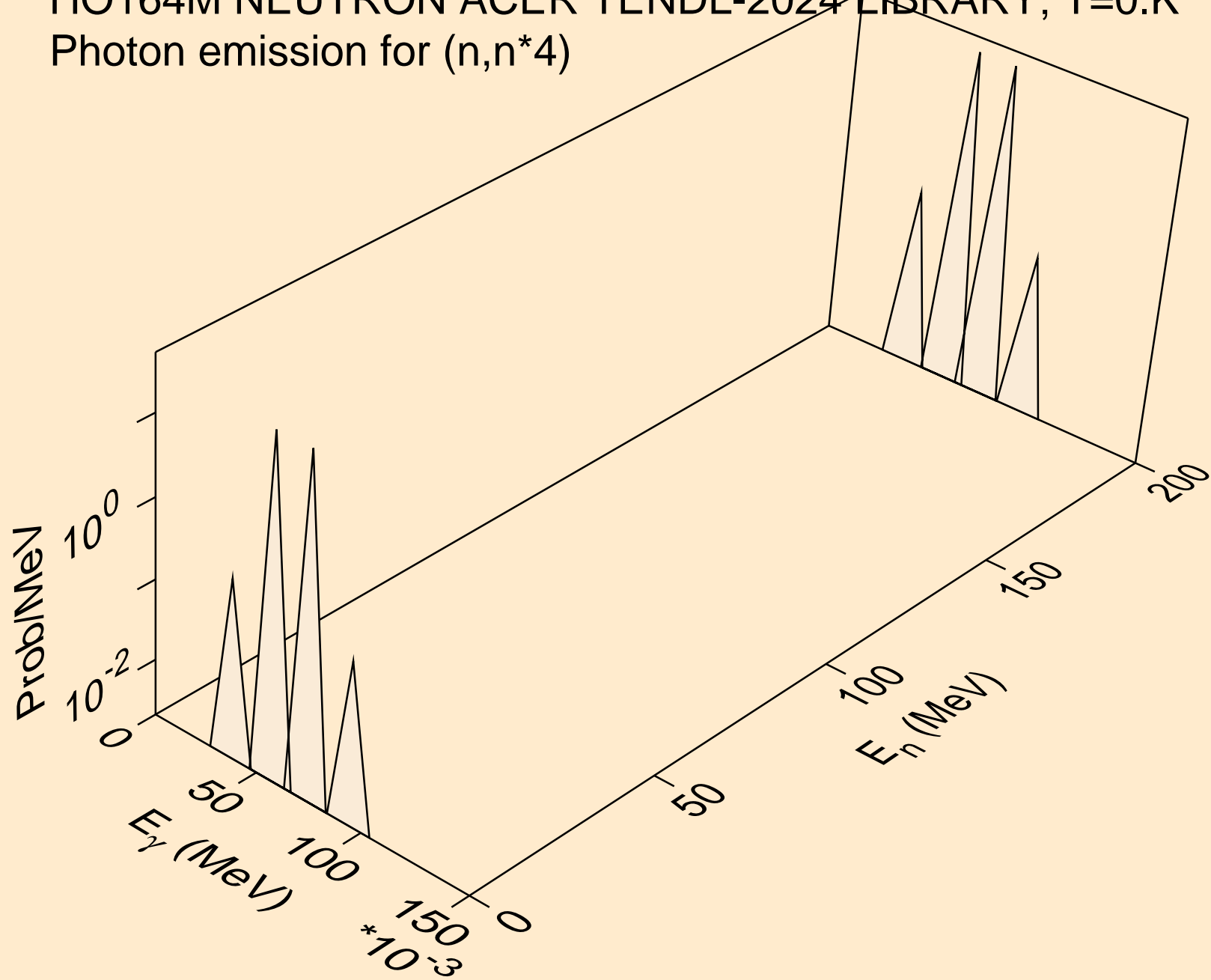

HO164M NEUTRON ACER TENDL-2024 LIBRARY; T=0.K  
Photon emission for (n,n\*5)

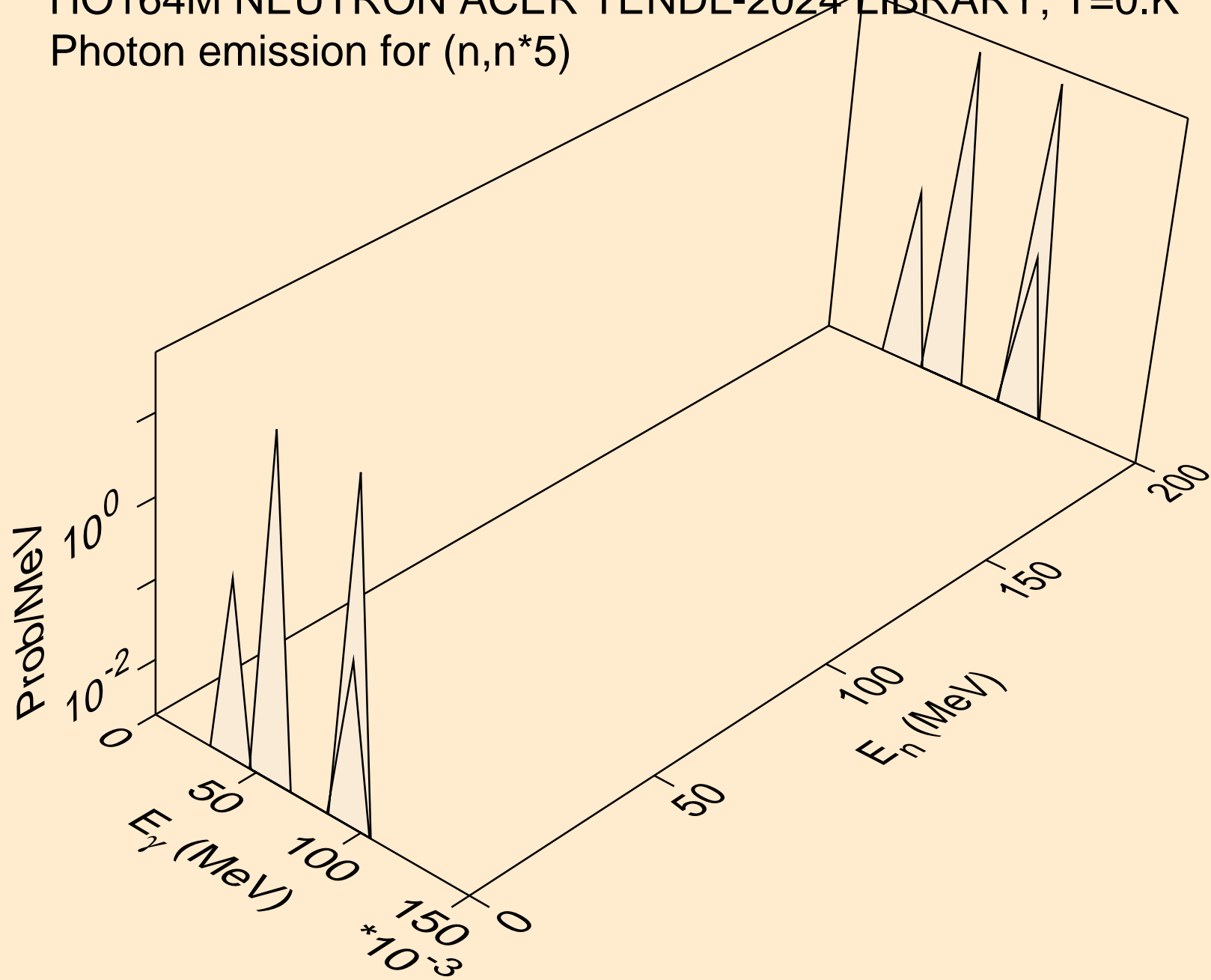

HO164M NEUTRON ACER TENDL-2024 LIBRARY; T=0.K  
Photon emission for (n,n\*6)

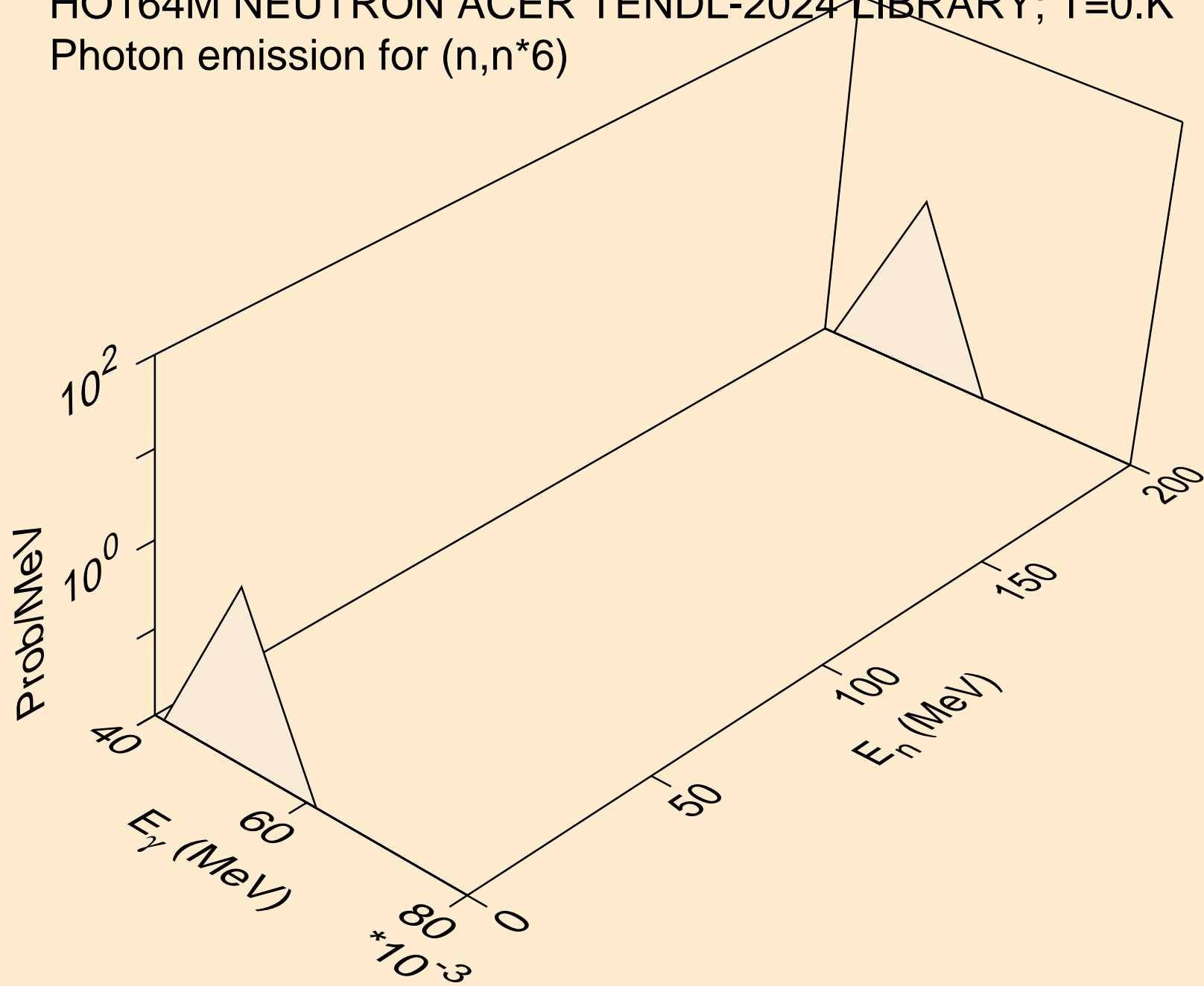

HO164M NEUTRON ACER TENDL-2024 LIBRARY; T=0.K  
Photon emission for (n,n\*7)

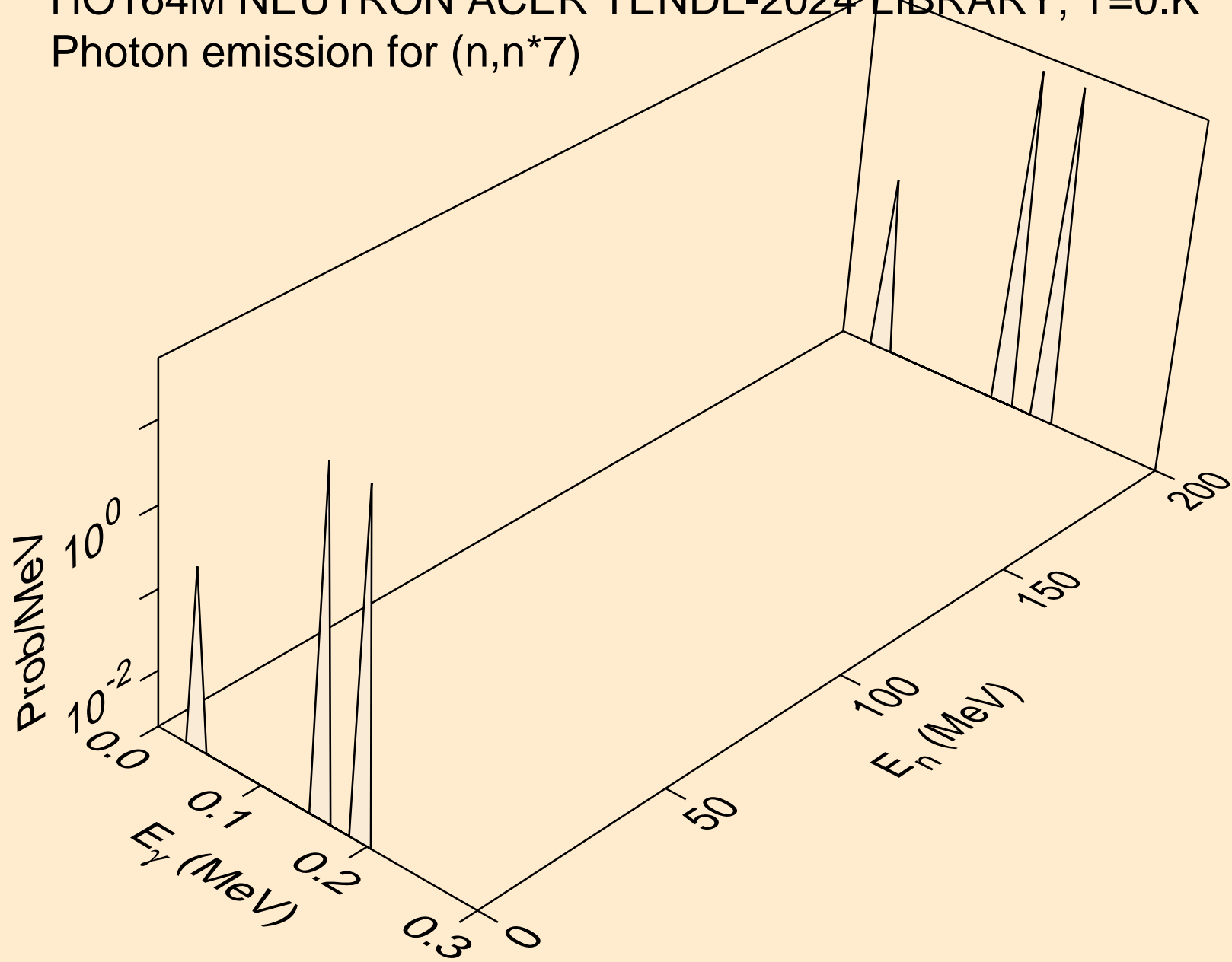

HO164M NEUTRON ACER TENDL-2024 LIBRARY; T=0.K  
Photon emission for (n,n\*8)

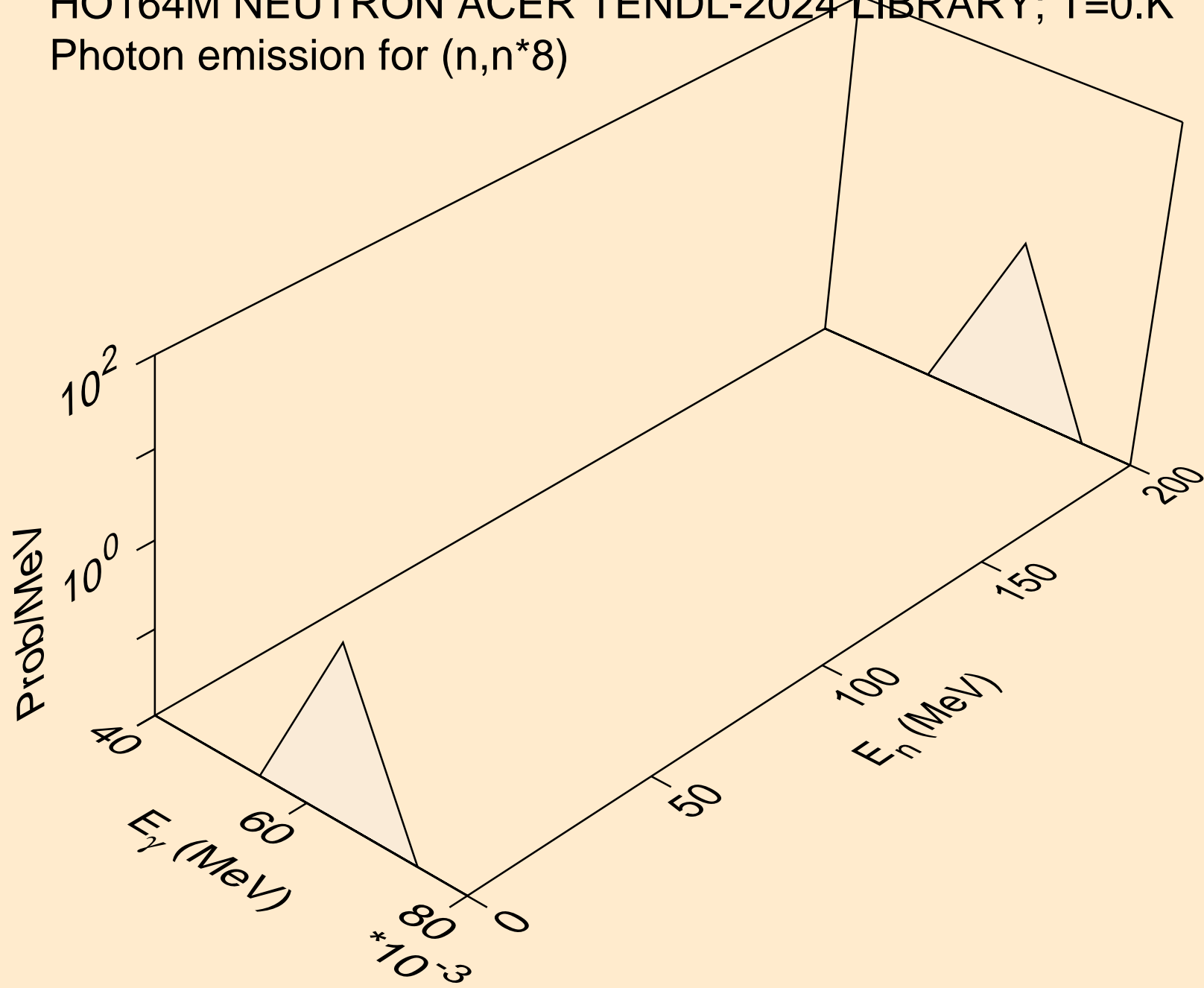

HO164M NEUTRON ACER TENDL-2024 LIBRARY; T=0.K  
Photon emission for (n,n\*9)

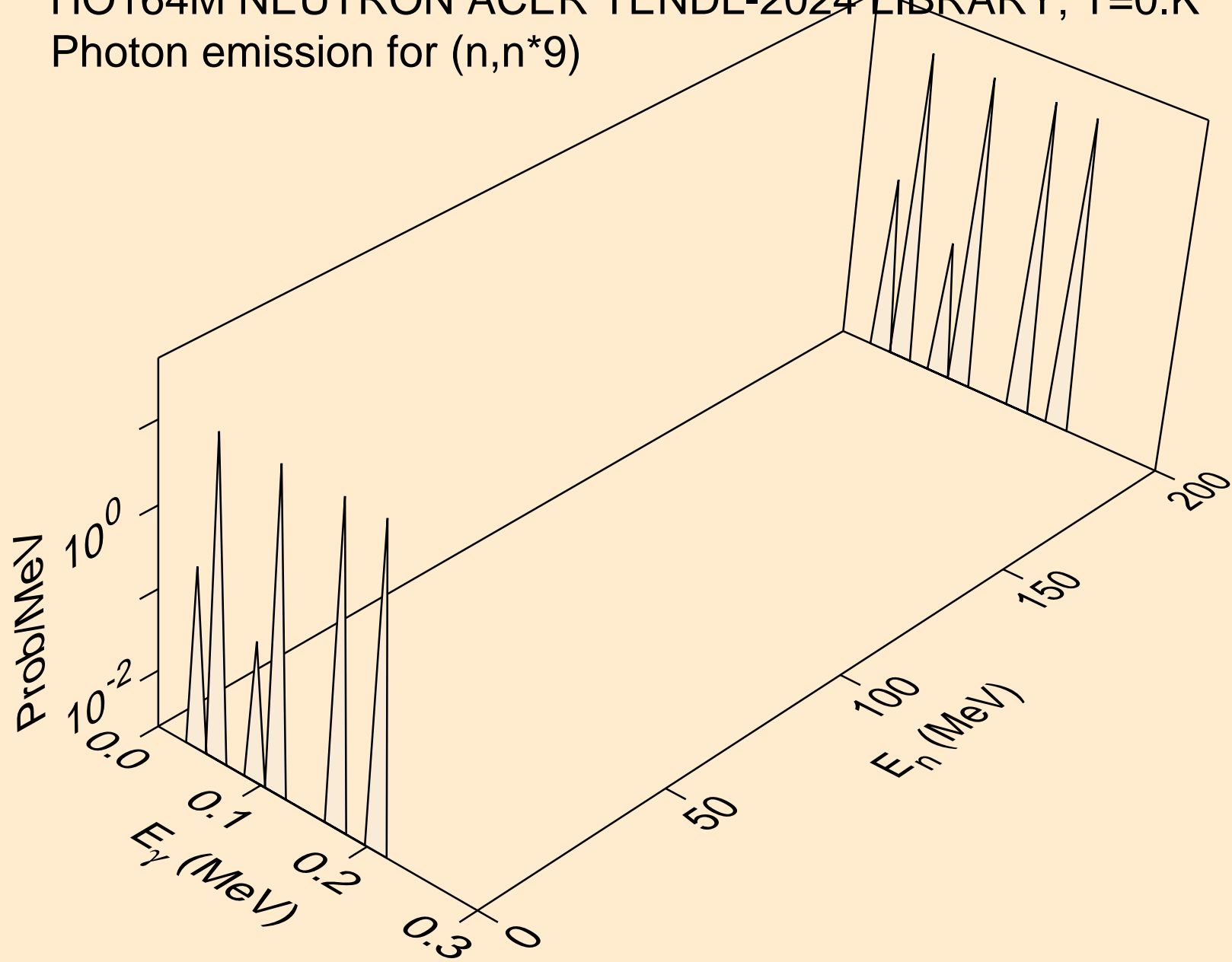

HO164M NEUTRON ACER TENDL-2024 LIBRARY; T=0.K  
Photon emission for (n,n\*10)

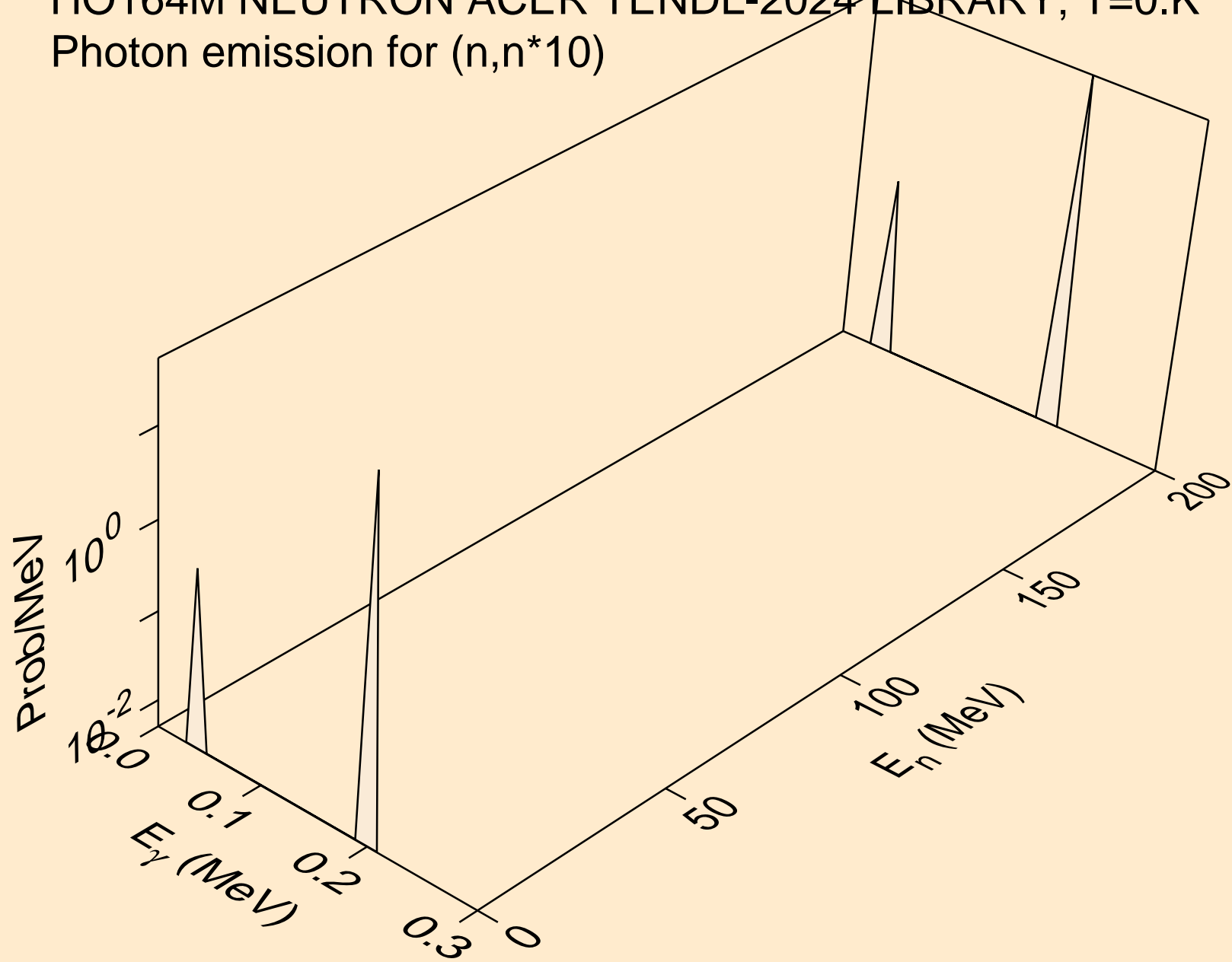

HO164M NEUTRON ACER TENDL-2024 LIBRARY; T=0.K  
Photon emission for (n,n\*11)

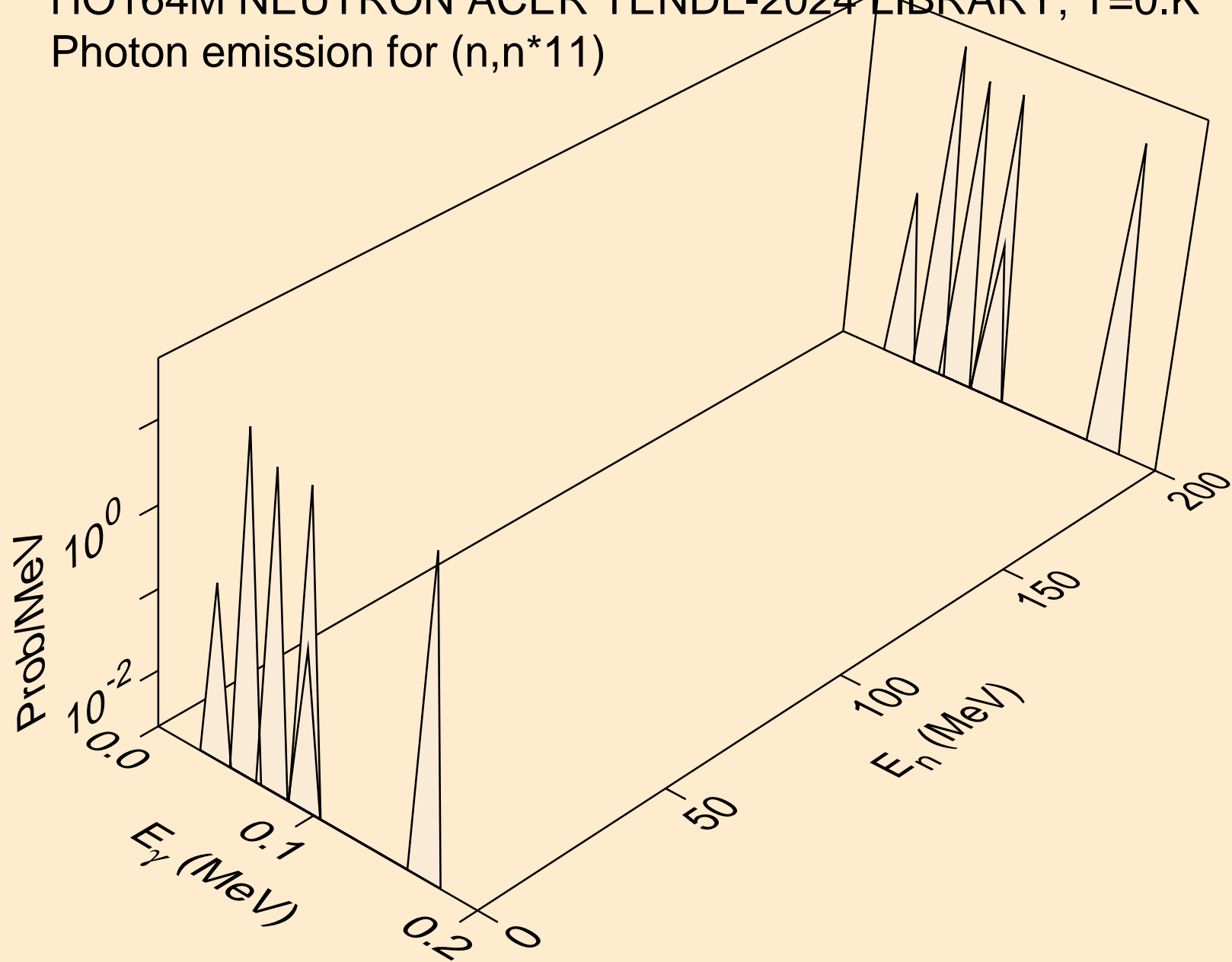

HO164M NEUTRON ACER TENDL-2024 LIBRARY; T=0.K  
Photon emission for (n,n\*12)

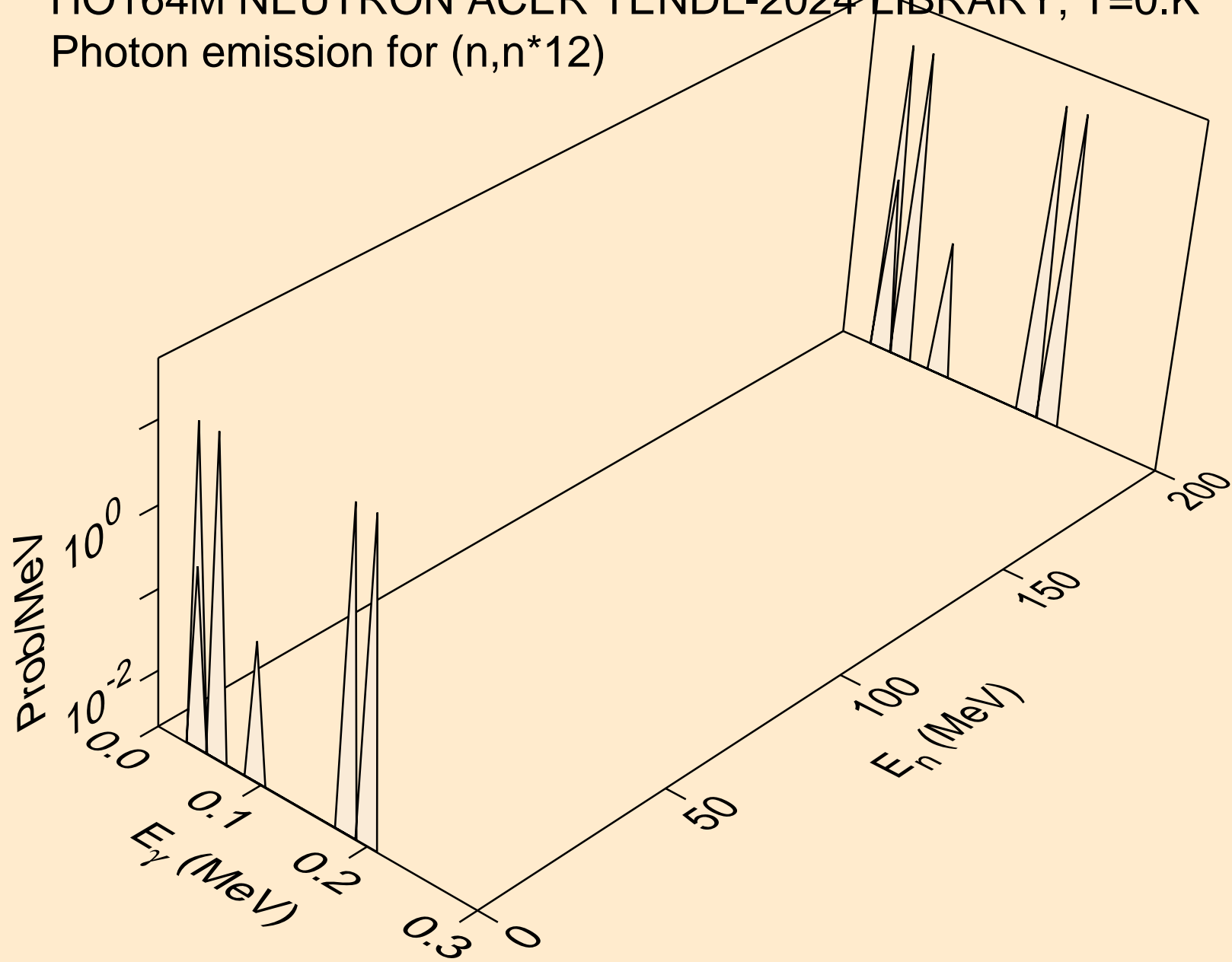

HO164M NEUTRON ACER TENDL-2024 LIBRARY; T=0.K  
Photon emission for (n,n\*13)

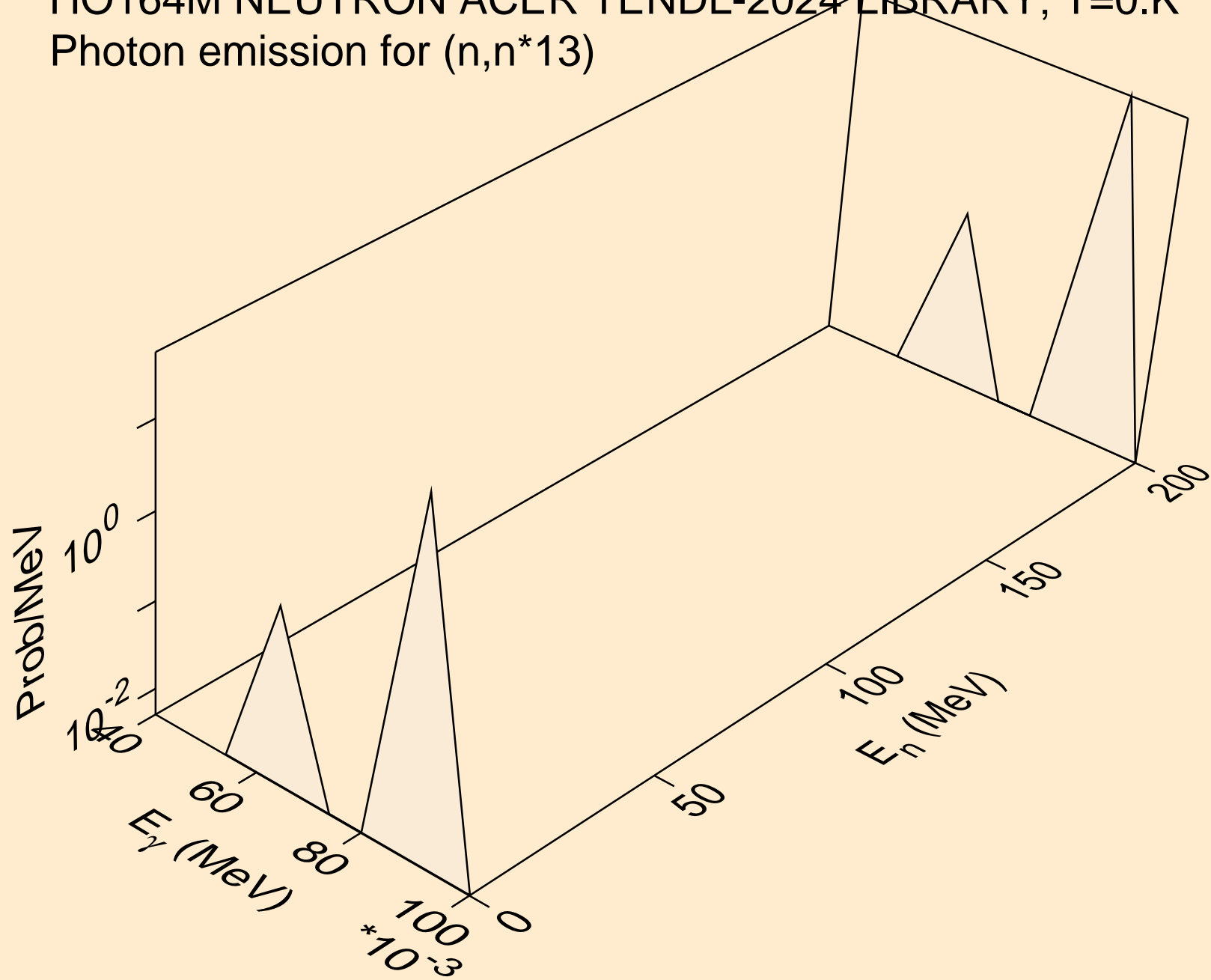

HO164M NEUTRON ACER TENDL-2024 LIBRARY; T=0.K  
Photon emission for (n,n\*14)

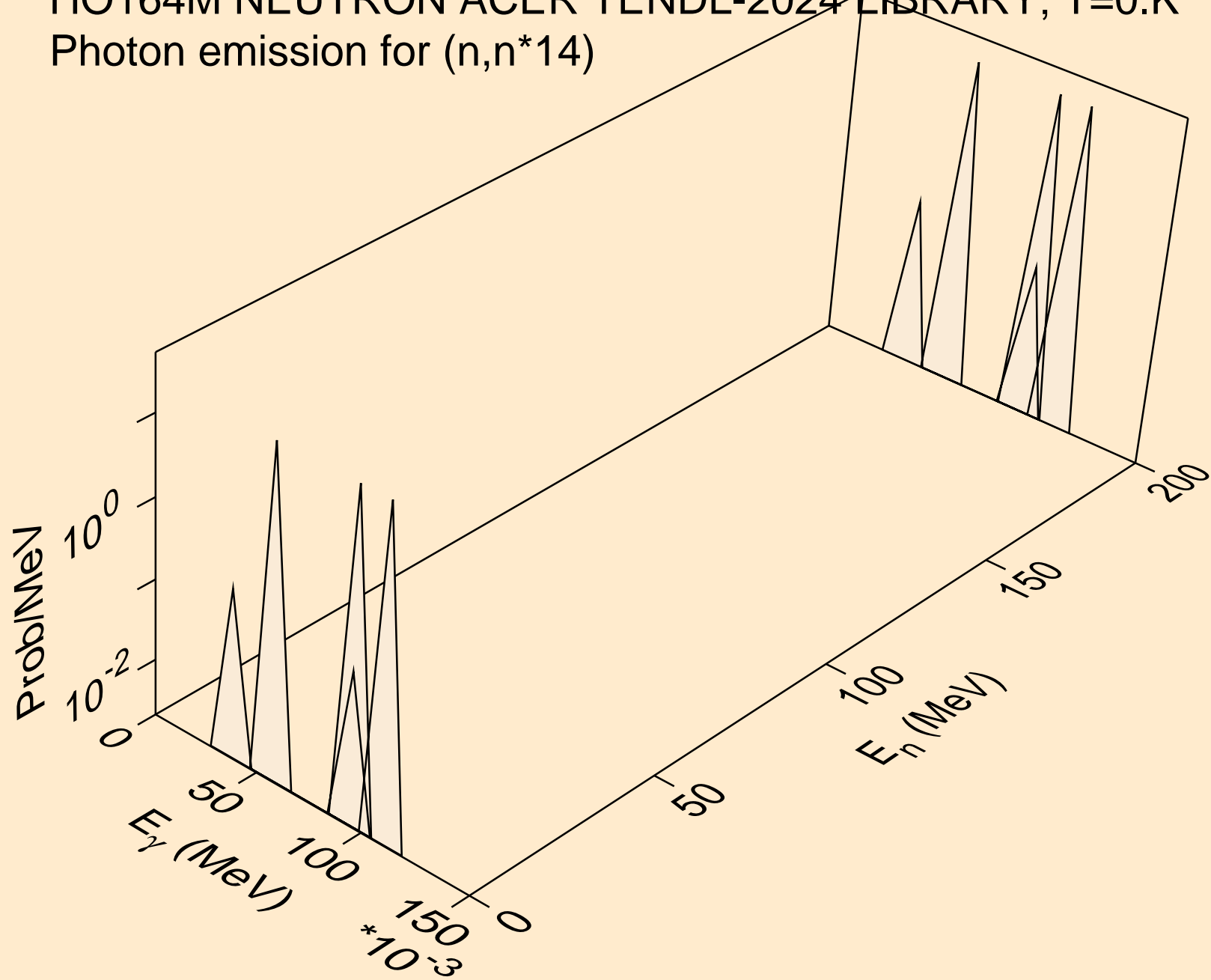

HO164M NEUTRON ACER TENDL-2024 LIBRARY; T=0.K  
Photon emission for (n,n\*15)

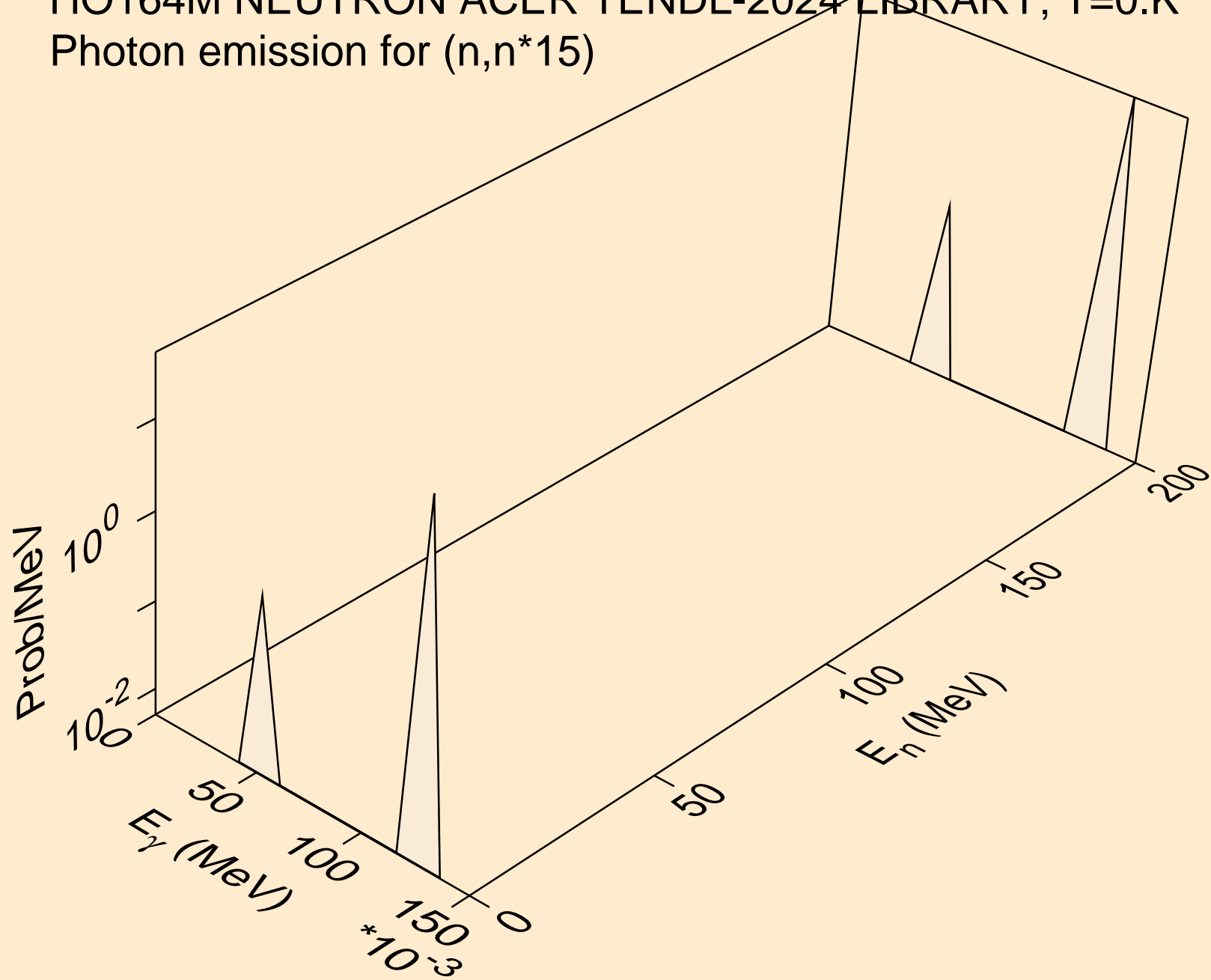

HO164M NEUTRON ACER TENDL-2024 LIBRARY; T=0.K  
Photon emission for (n,n\*16)

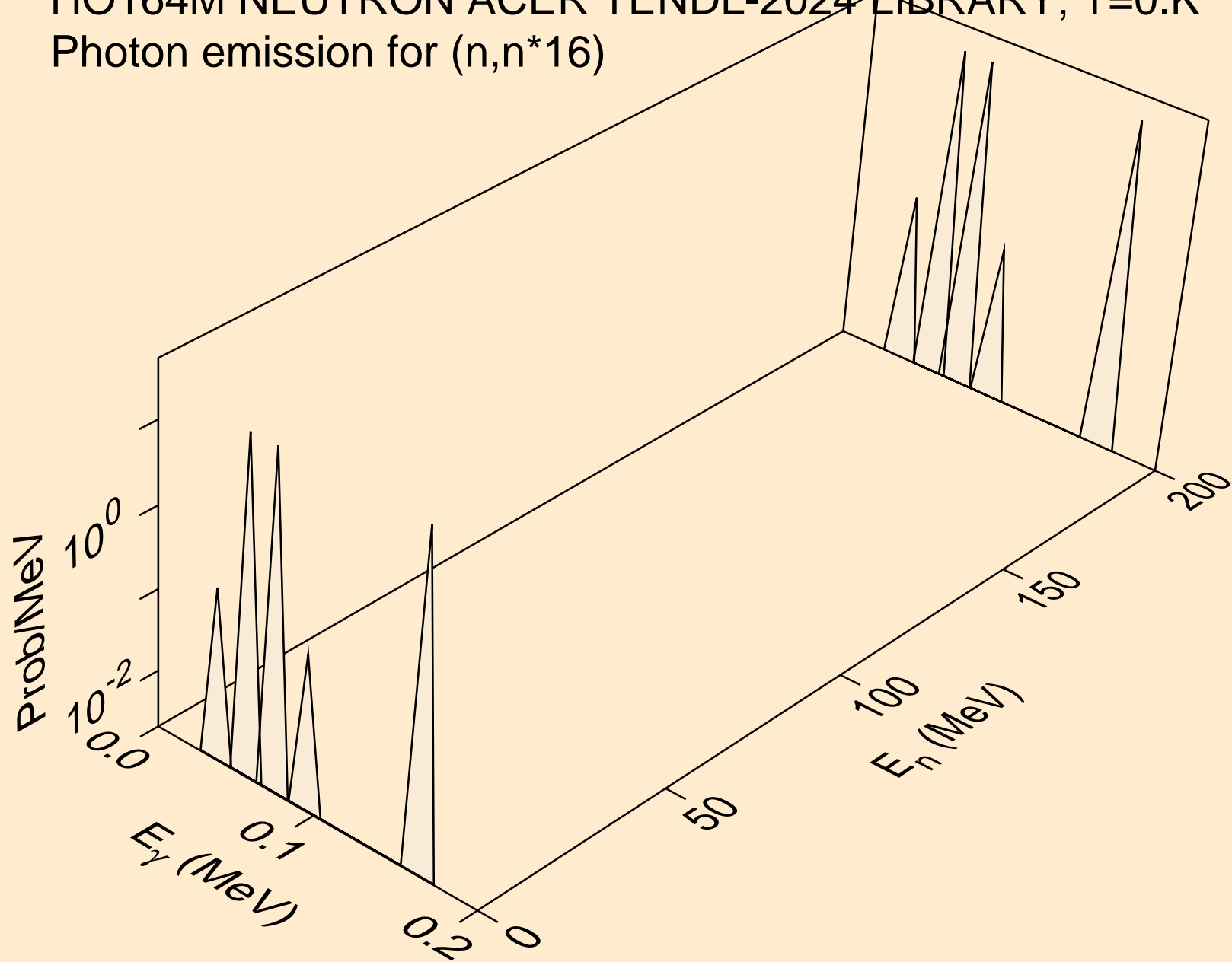

HO164M NEUTRON ACER TENDL-2024 LIBRARY; T=0.K  
Photon emission for (n,n\*17)

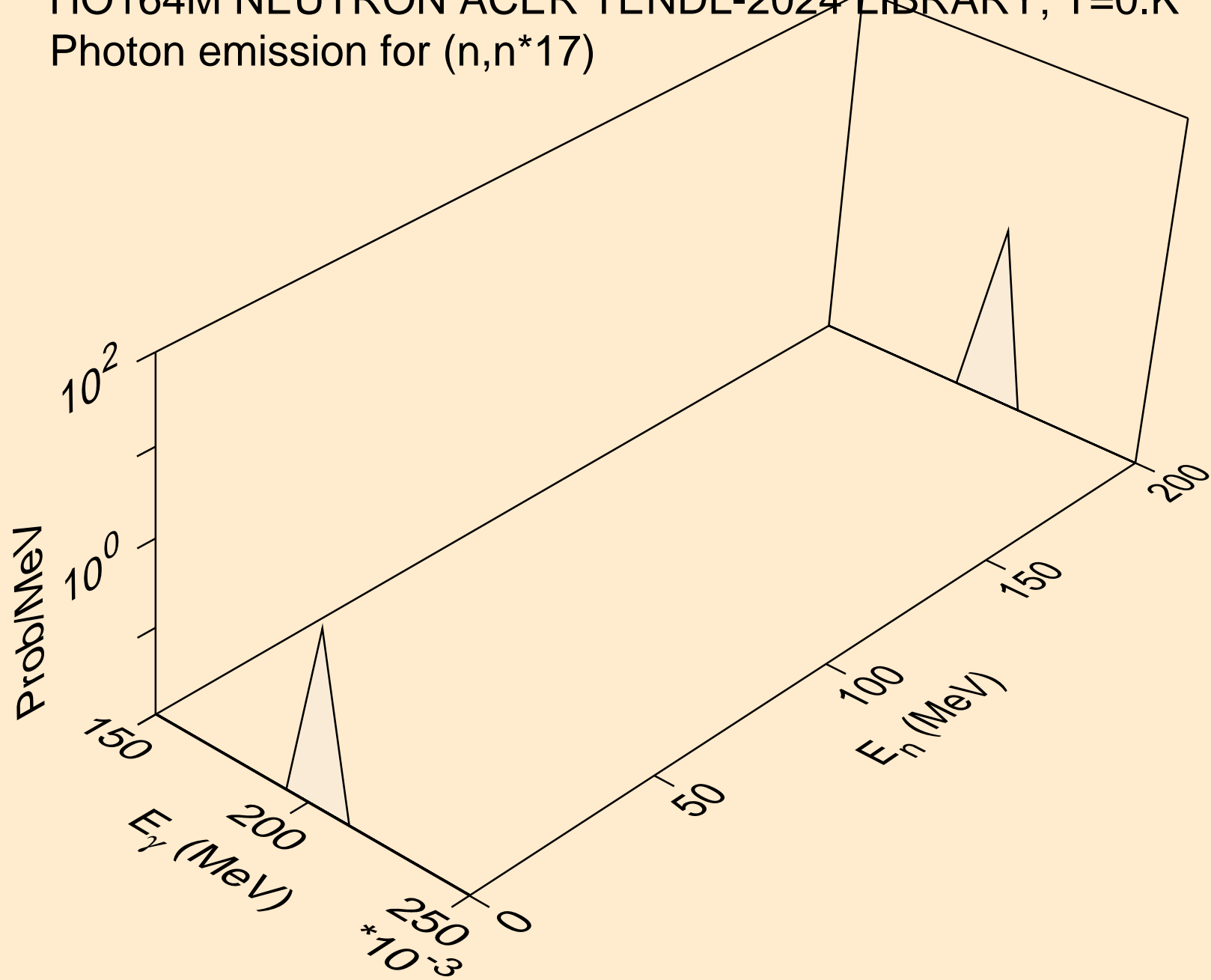

HO164M NEUTRON ACER TENDL-2024 LIBRARY; T=0.K  
Photon emission for (n,n\*18)

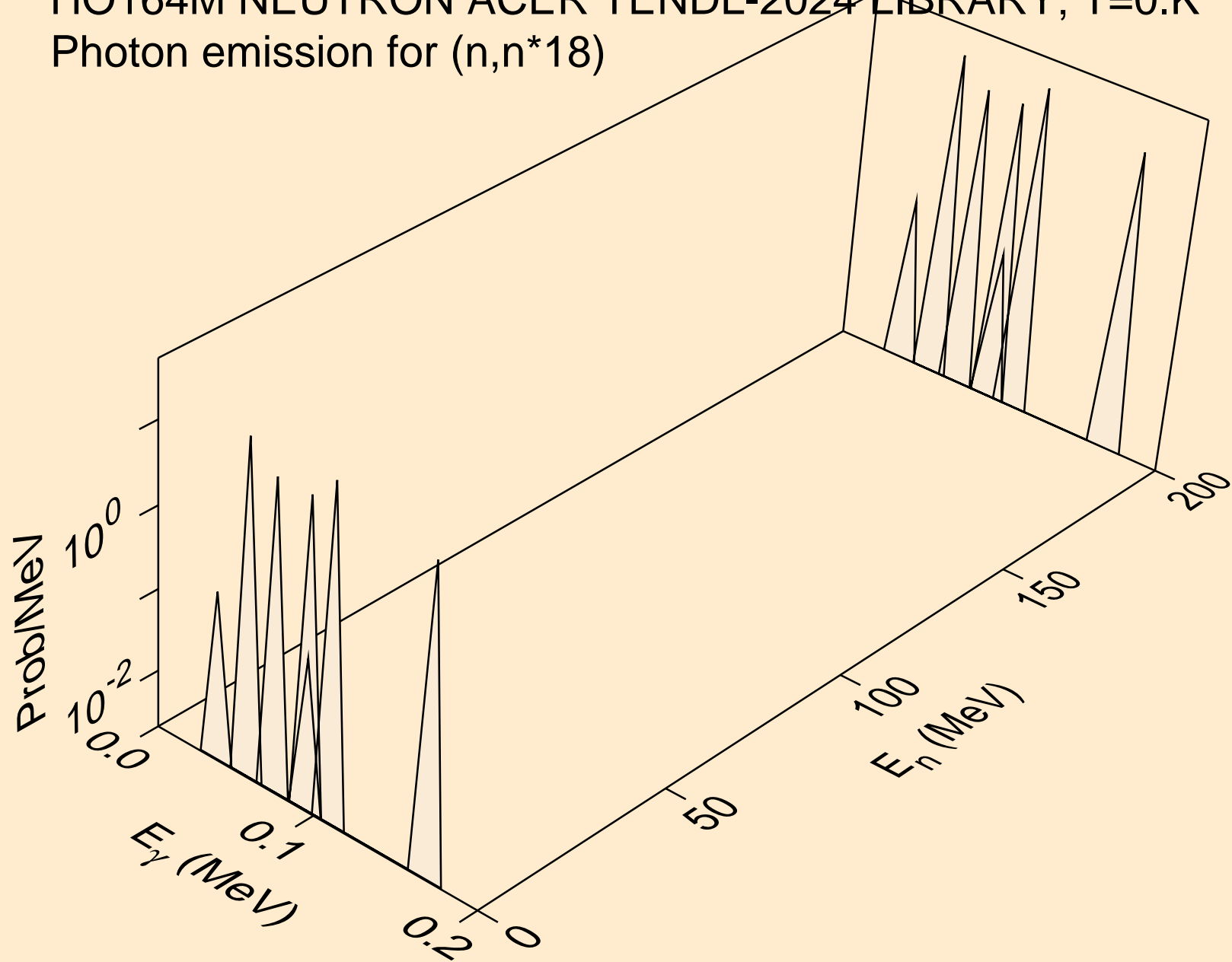

HO164M NEUTRON ACER TENDL-2024 LIBRARY; T=0.K  
Photon emission for (n,n\*19)

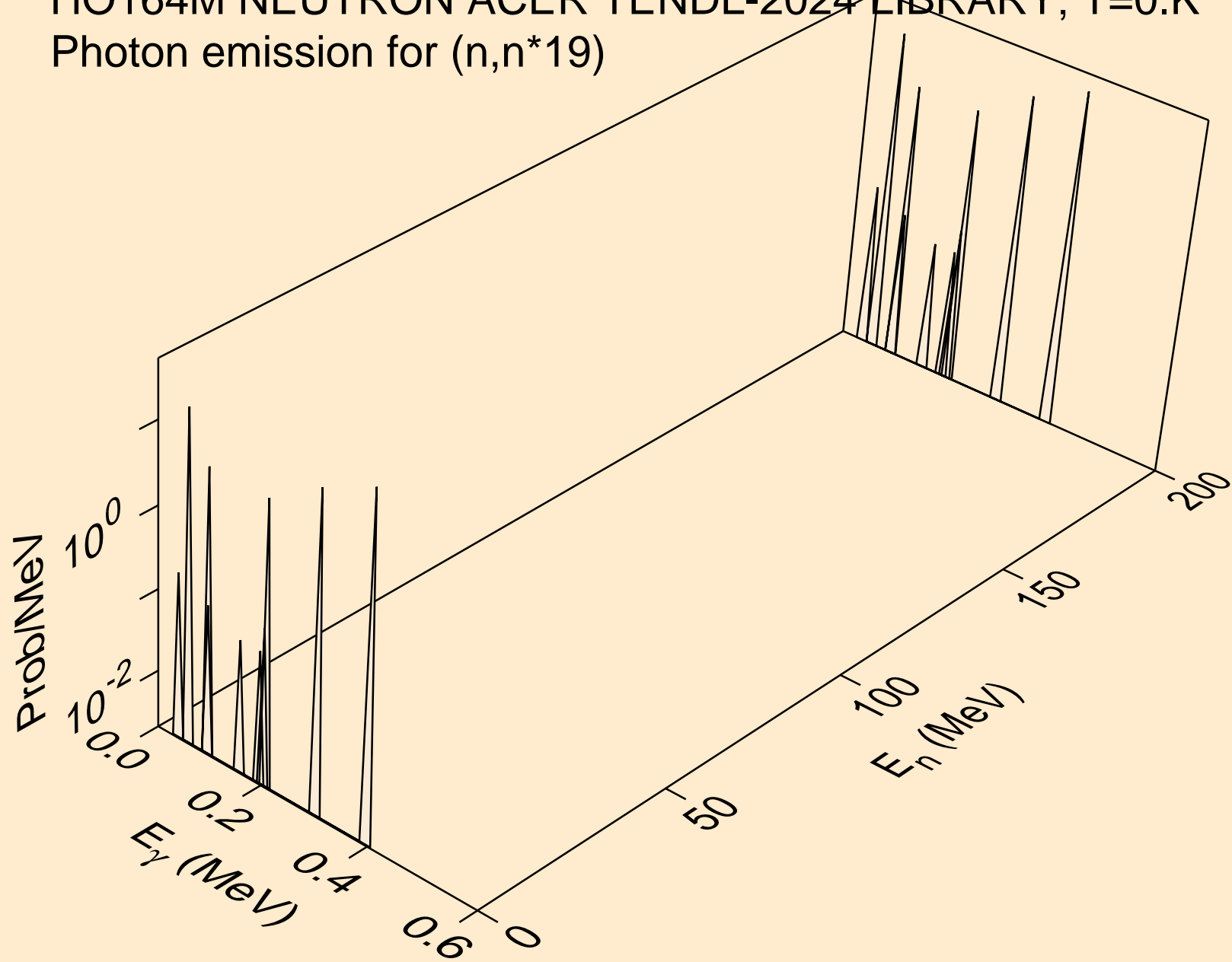

HO164M NEUTRON ACER TENDL-2024 LIBRARY; T=0.K  
Photon emission for (n,n\*20)

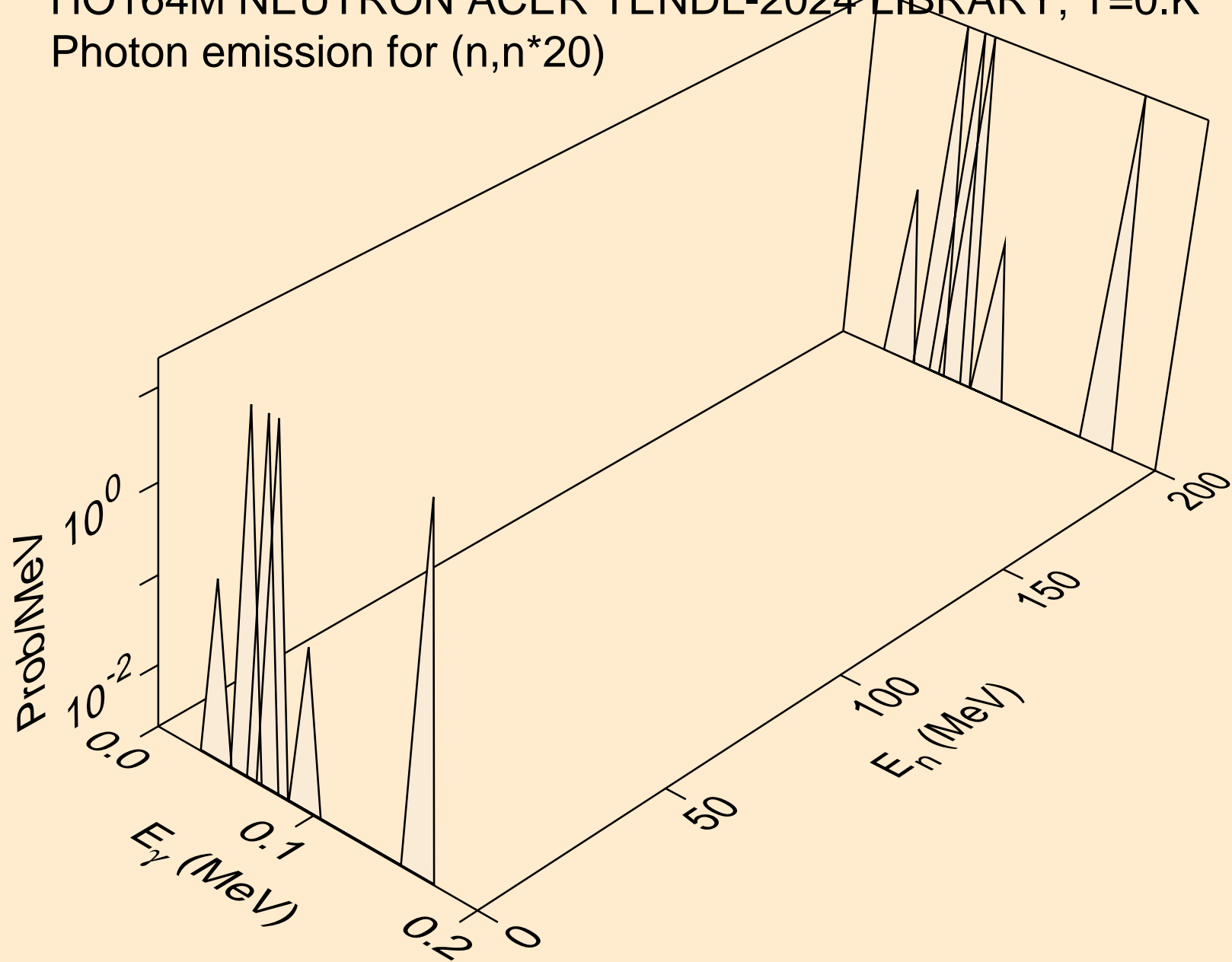

HO164M NEUTRON ACER TENDL-2024 LIBRARY; T=0.K  
Photon emission for (n,n\*21)

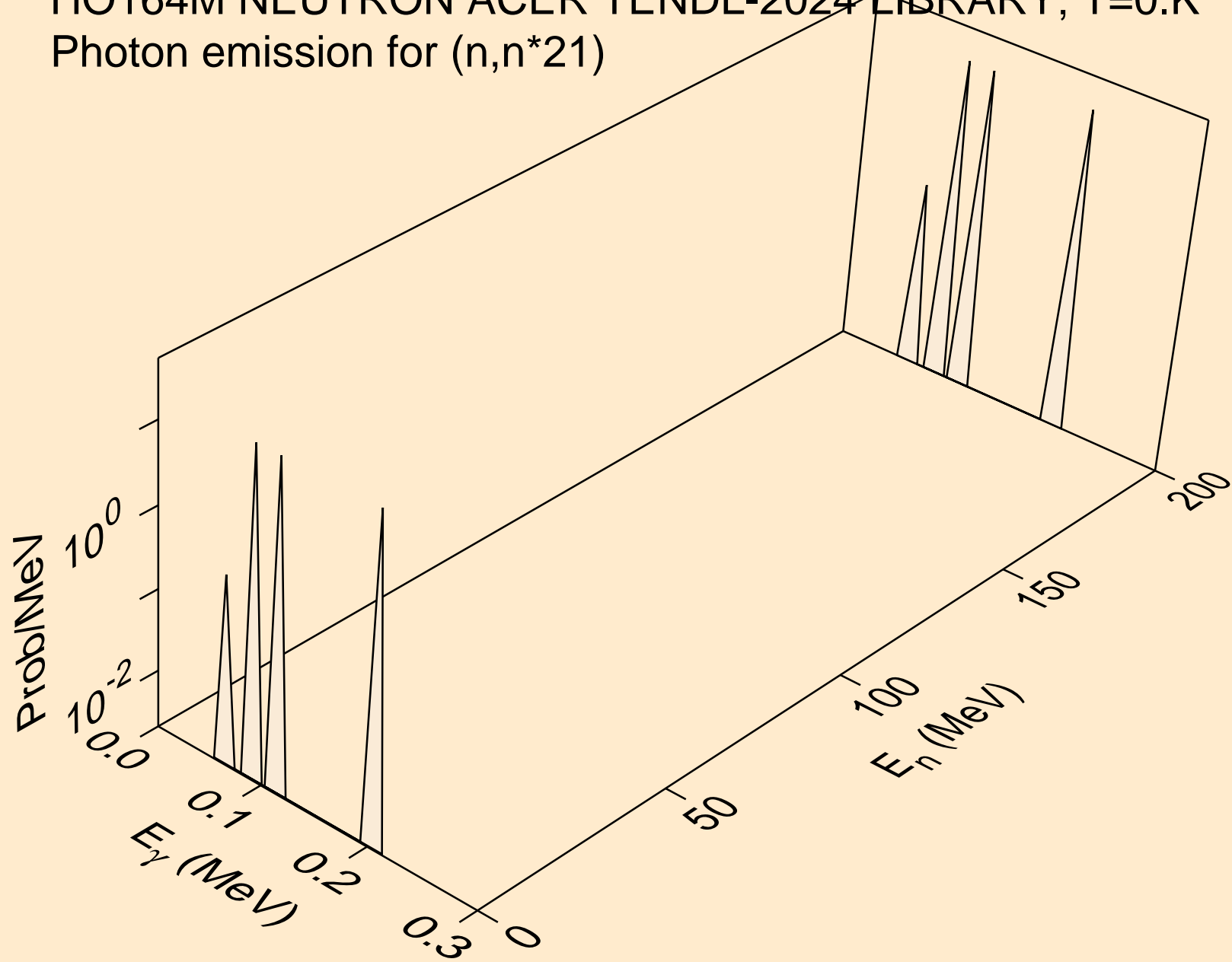

HO164M NEUTRON ACER TENDL-2024 LIBRARY; T=0.K  
Photon emission for (n,n\*22)

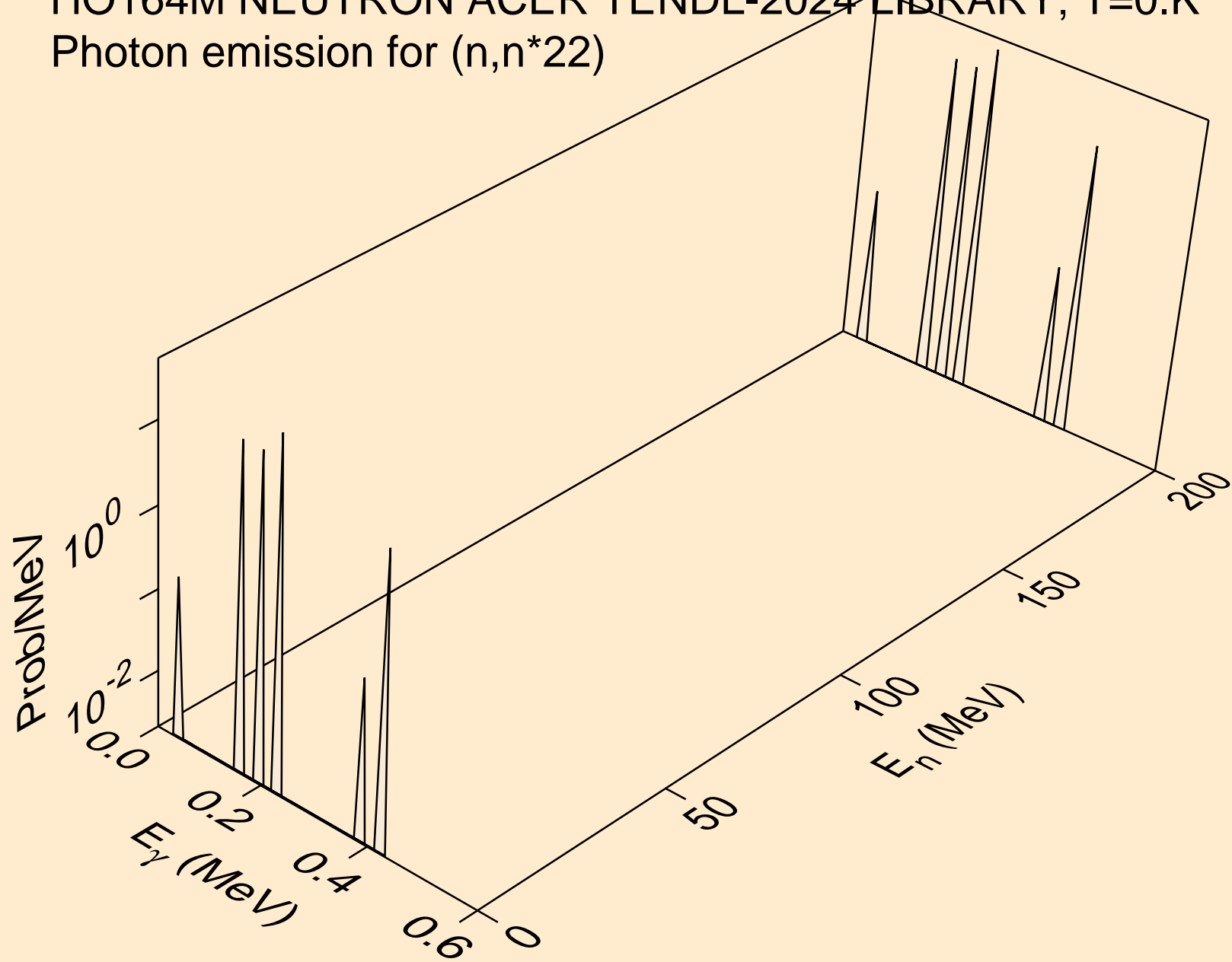

HO164M NEUTRON ACER TENDL-2024 LIBRARY; T=0.K  
Photon emission for (n,n\*23)

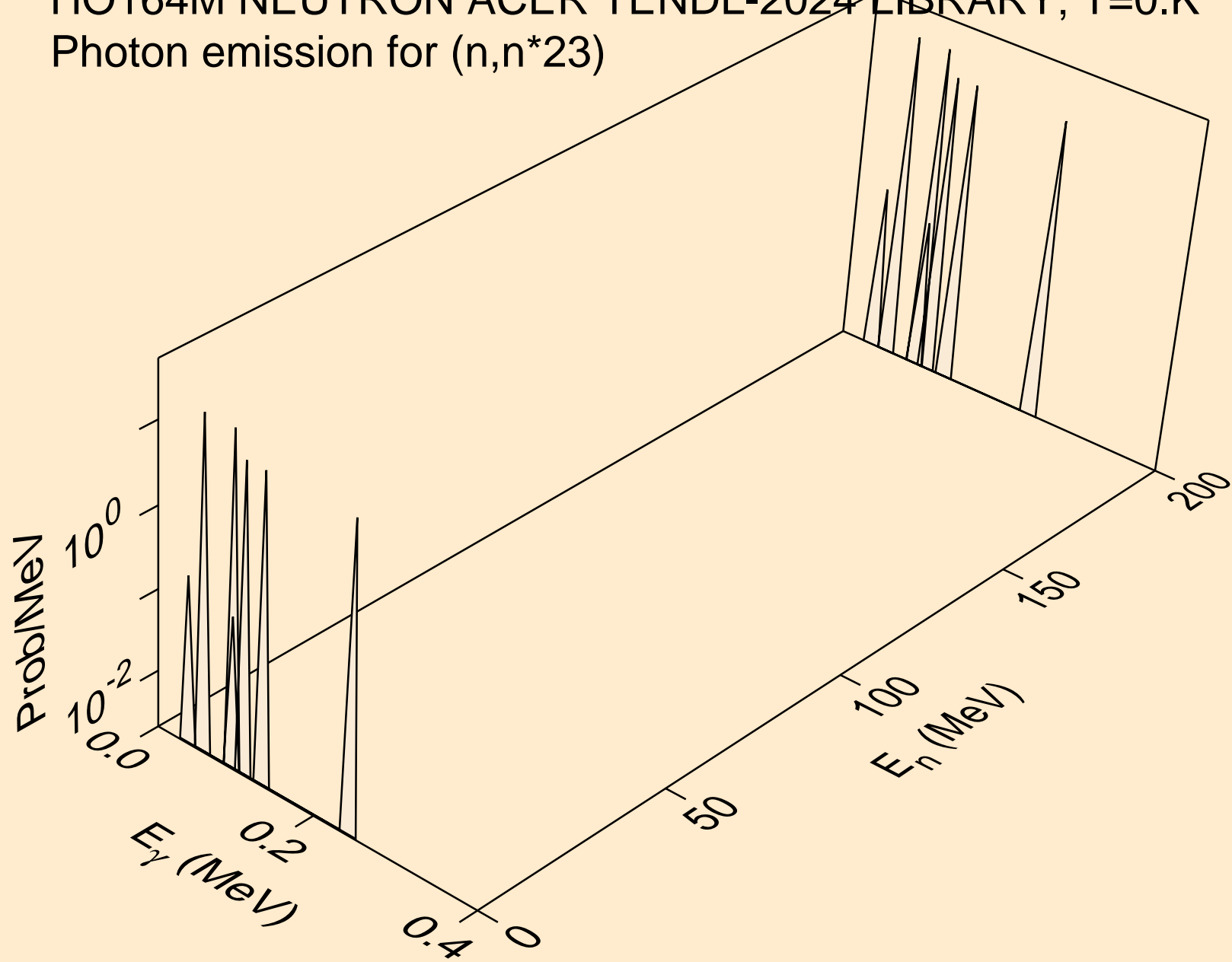

HO164M NEUTRON ACER TENDL-2024 LIBRARY; T=0.K  
Photon emission for (n,n\*24)

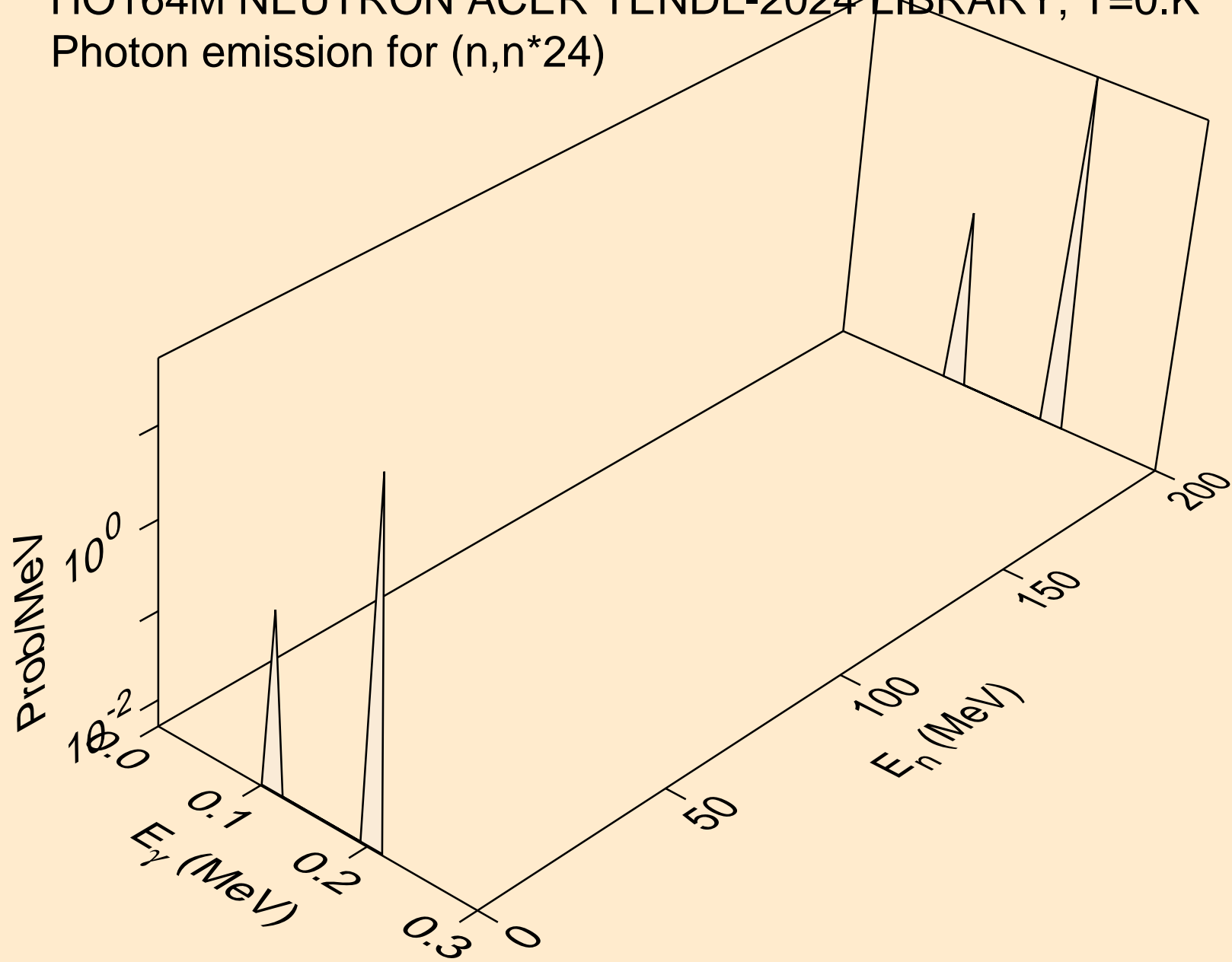

HO164M NEUTRON ACER TENDL-2024 LIBRARY; T=0.K  
Photon emission for (n,n\*25)

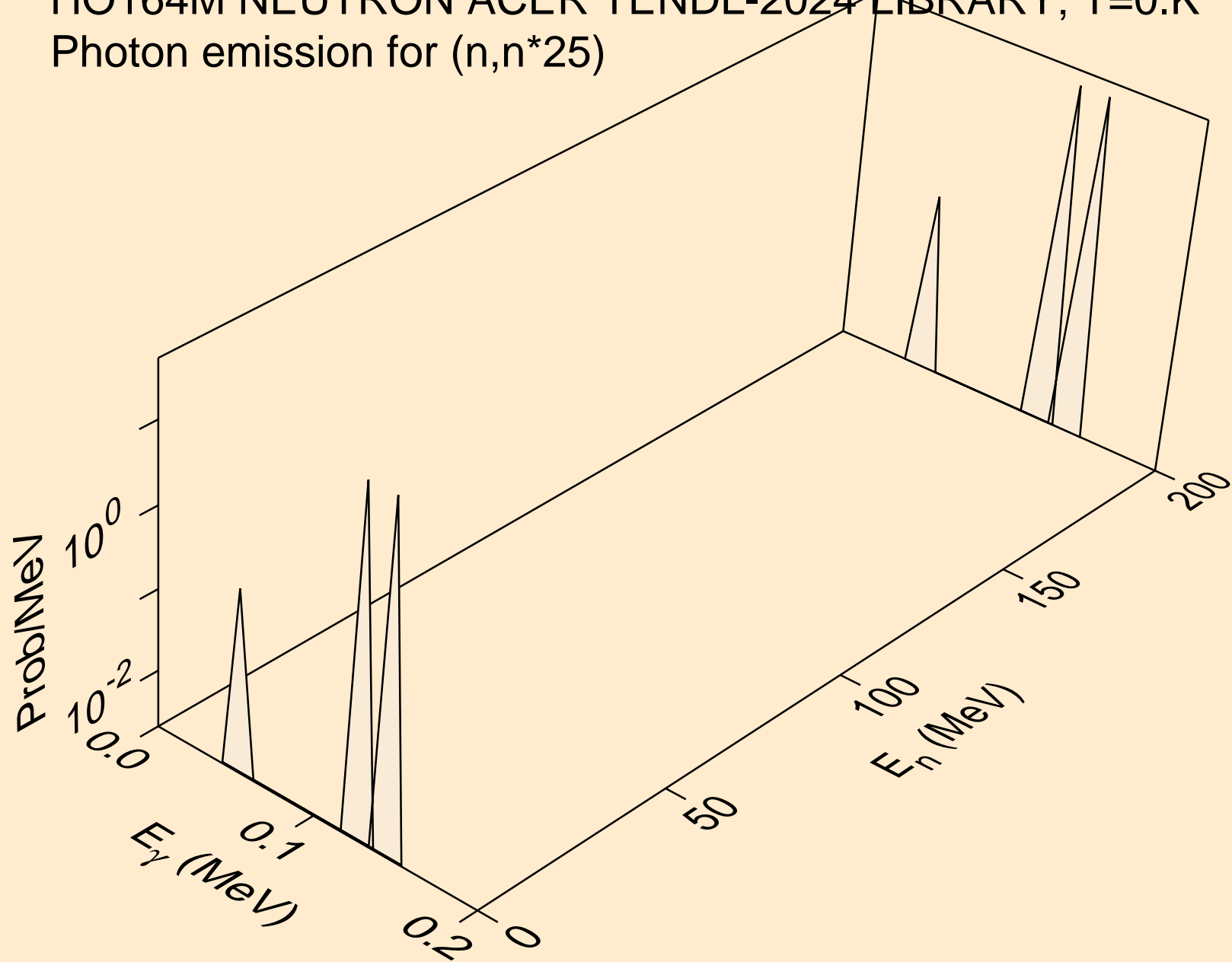

HO164M NEUTRON ACER TENDL-2024 LIBRARY; T=0.K  
Photon emission for (n,n\*26)

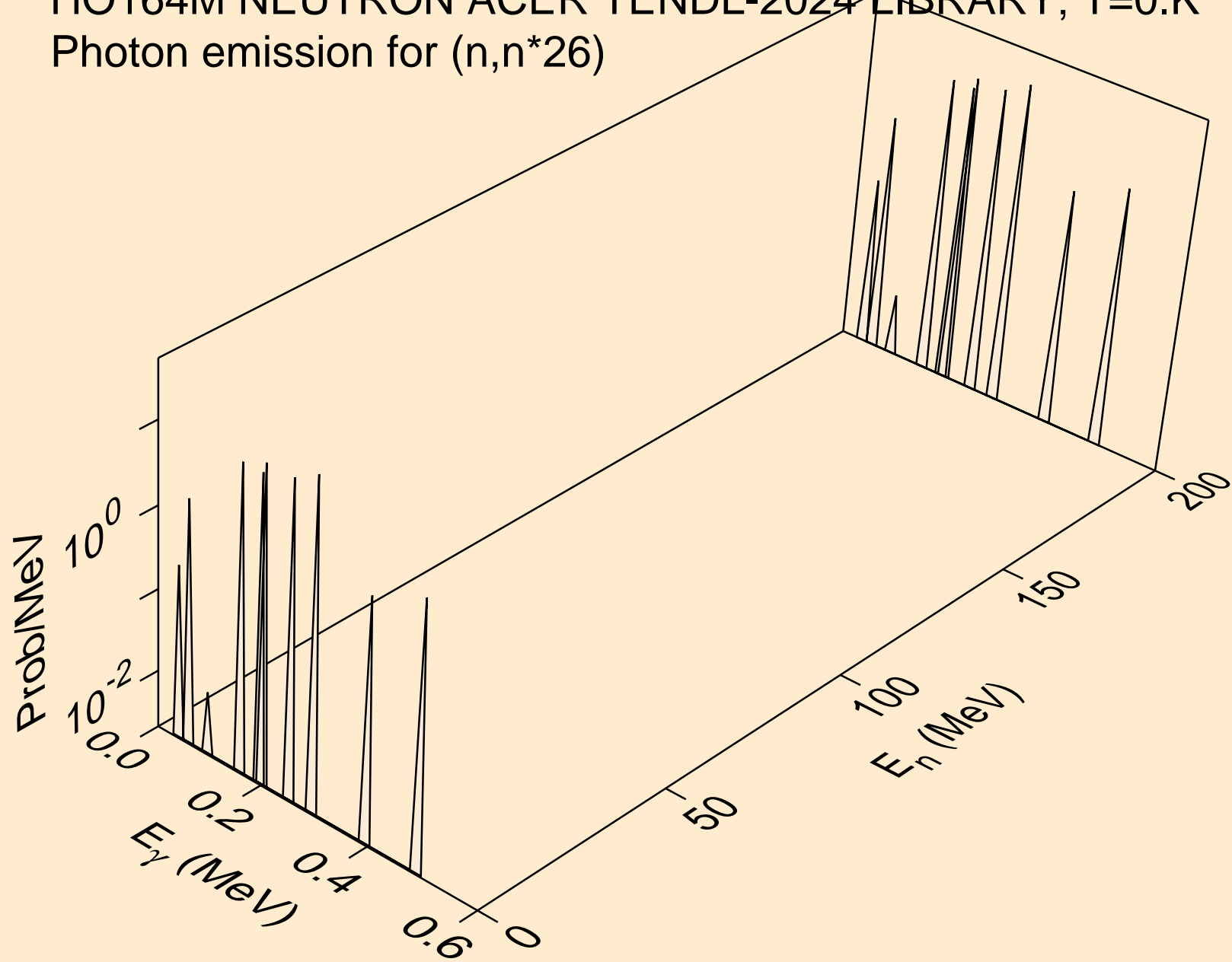

HO164M NEUTRON ACER TENDL-2024 LIBRARY; T=0.K  
Photon emission for (n,n\*27)

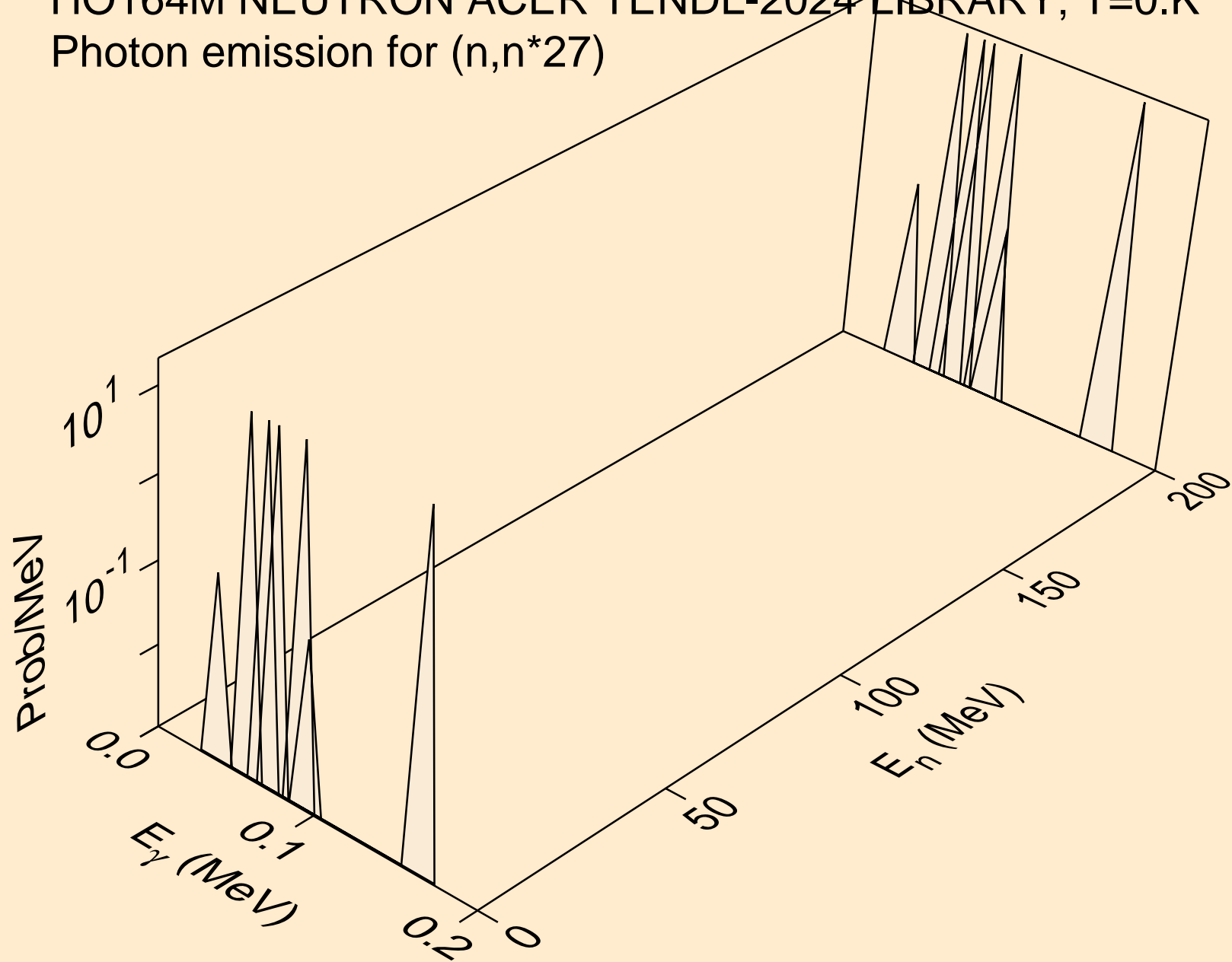

HO164M NEUTRON ACER TENDL-2024 LIBRARY; T=0.K  
Photon emission for (n,n\*28)

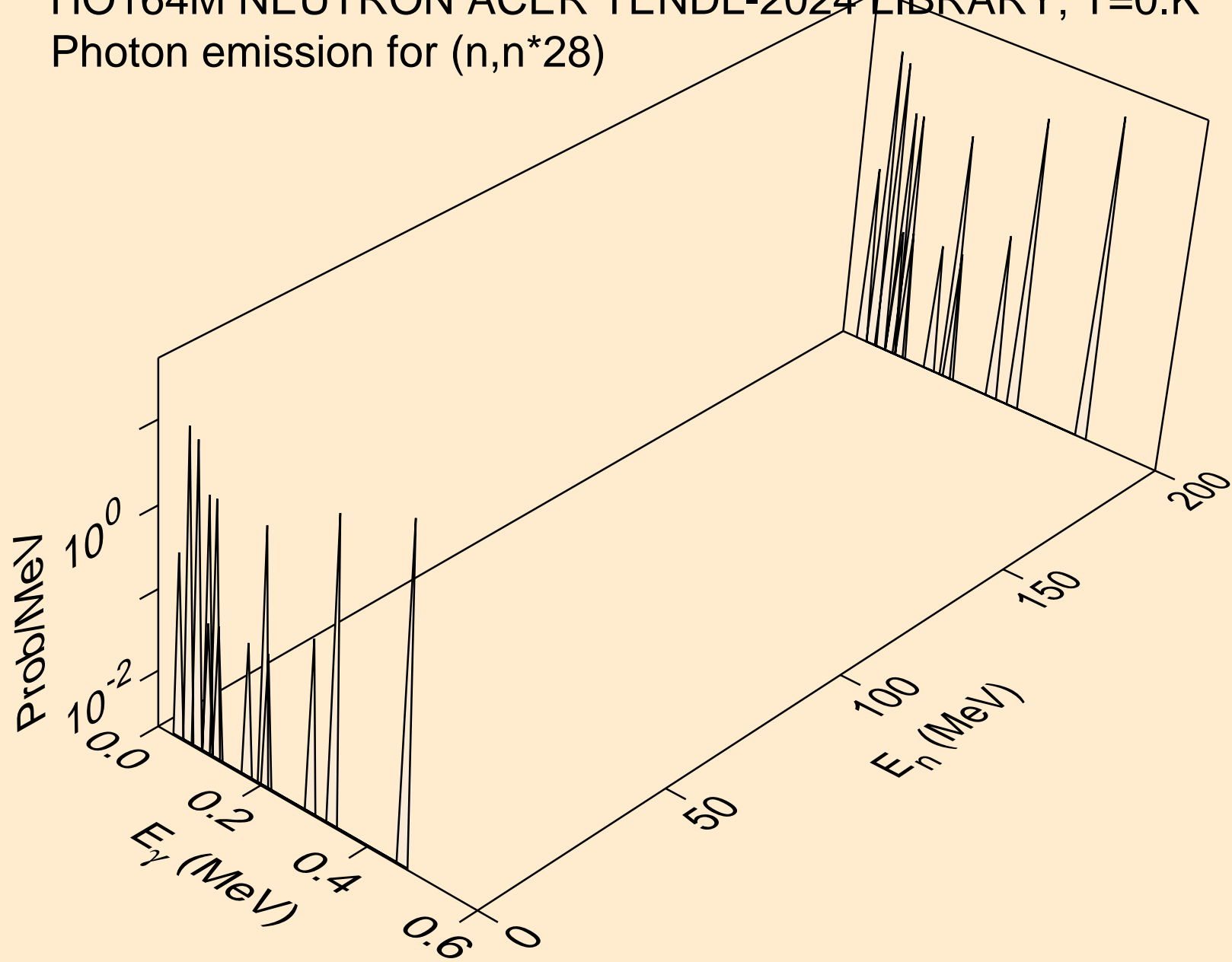

HO164M NEUTRON ACER TENDL-2024 LIBRARY; T=0.K  
Photon emission for (n,n\*29)

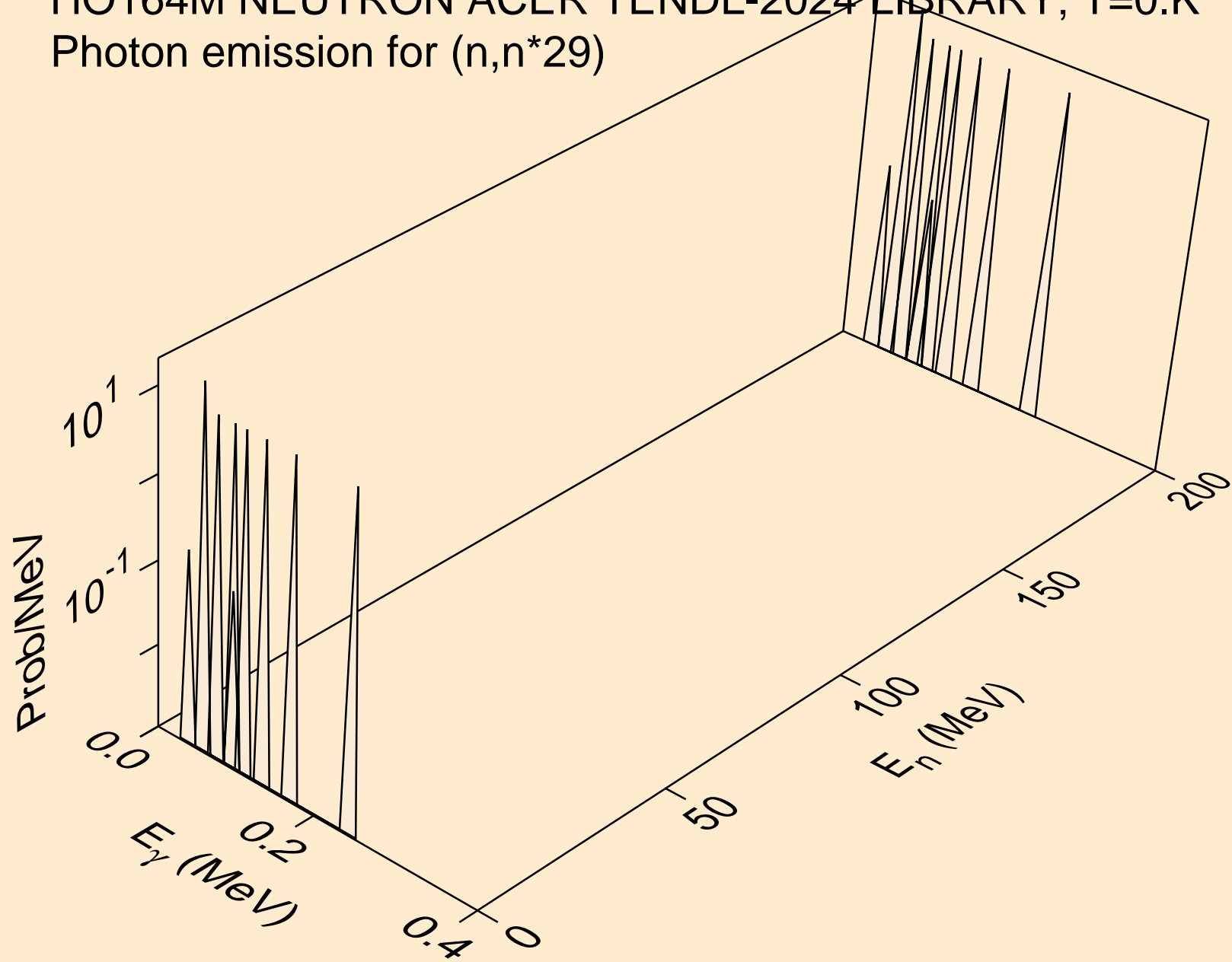

HO164M NEUTRON ACER TENDL-2024 LIBRARY; T=0.K  
Photon emission for (n,n\*30)

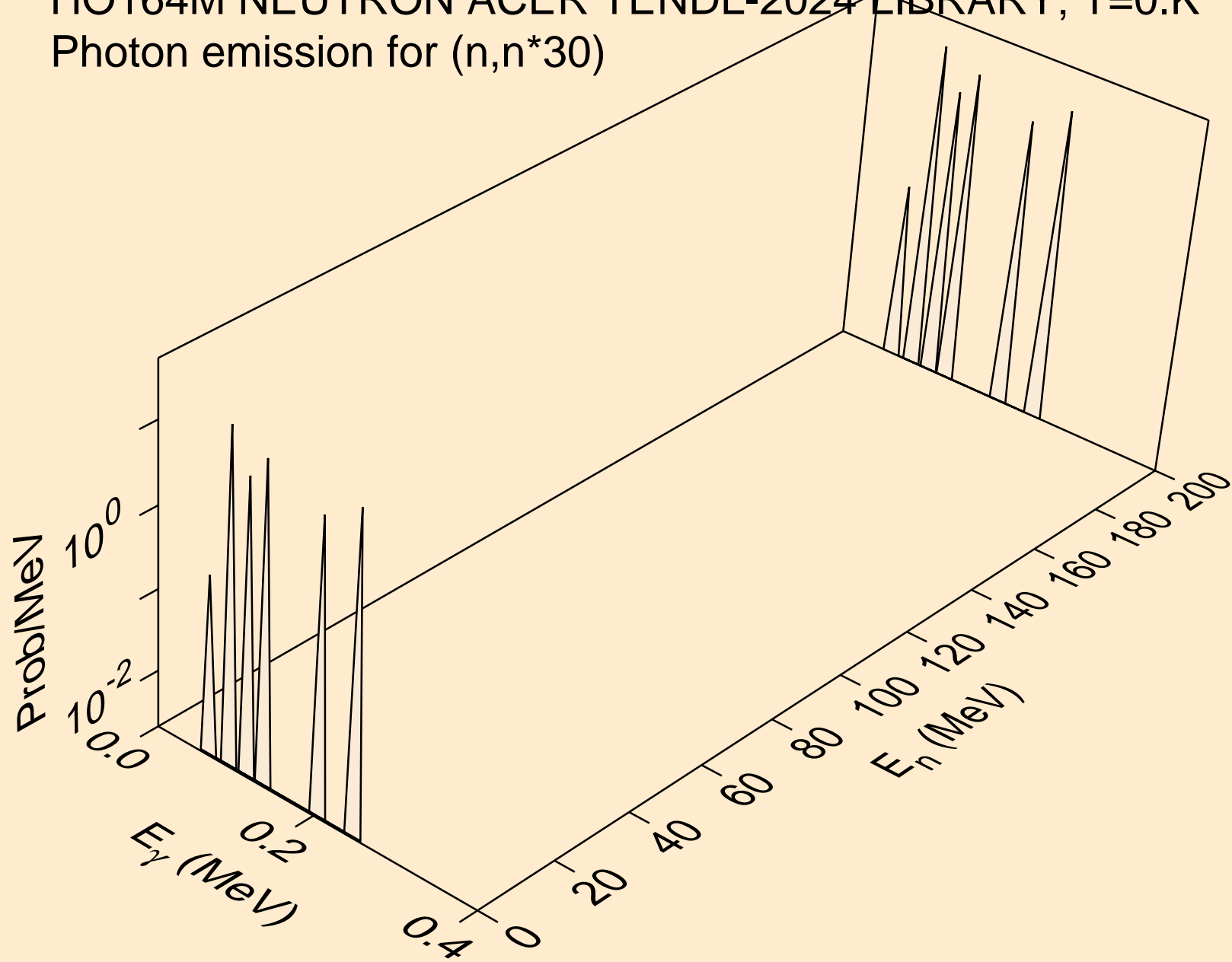

HO164M NEUTRON ACER TENDL-2024 LIBRARY; T=0.K  
Photon emission for (n,n\*c)

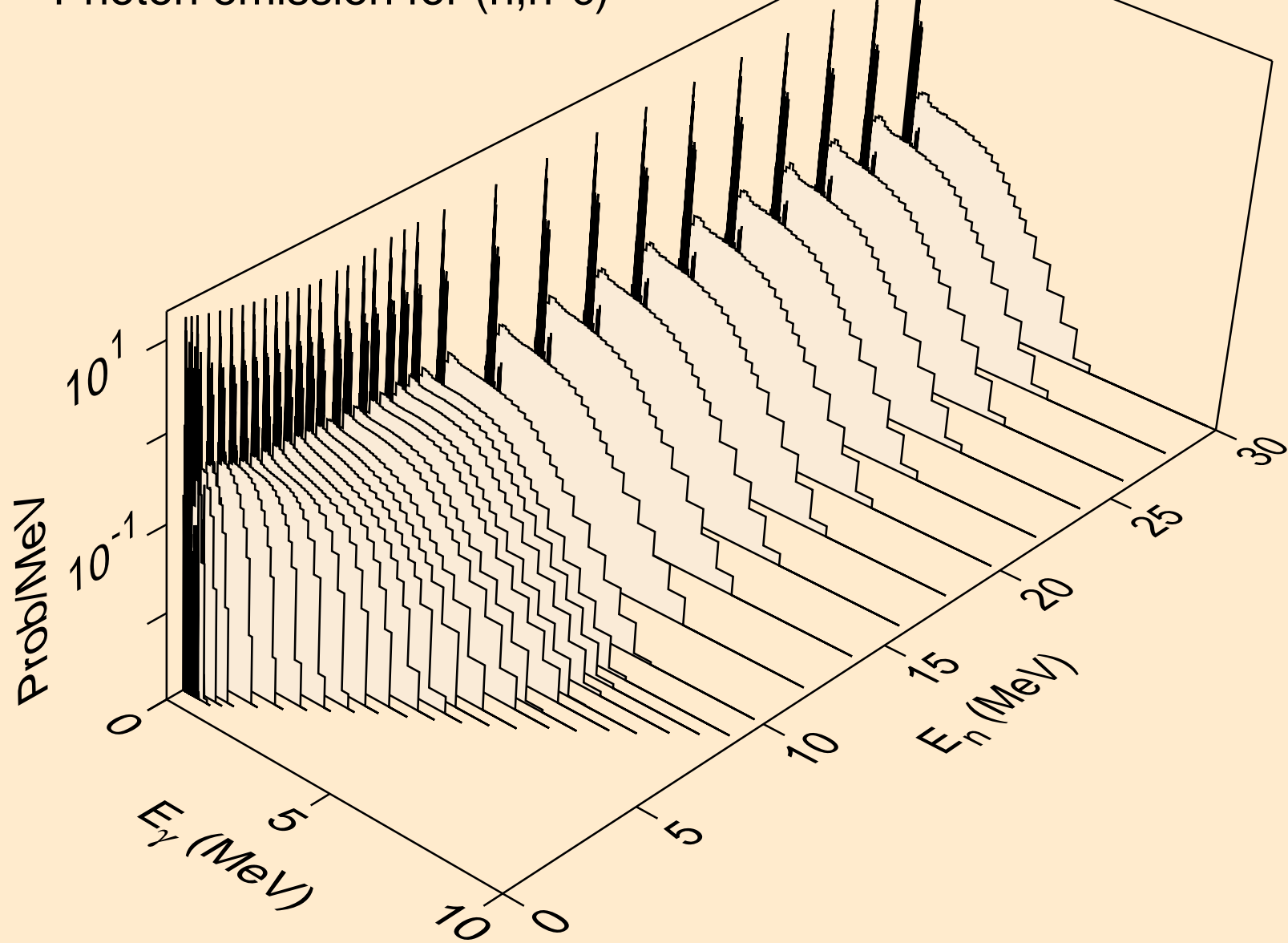

HO164M NEUTRON ACER TENDL-2024 LIBRARY; T=0.K  
Photon emission for (n,gma)

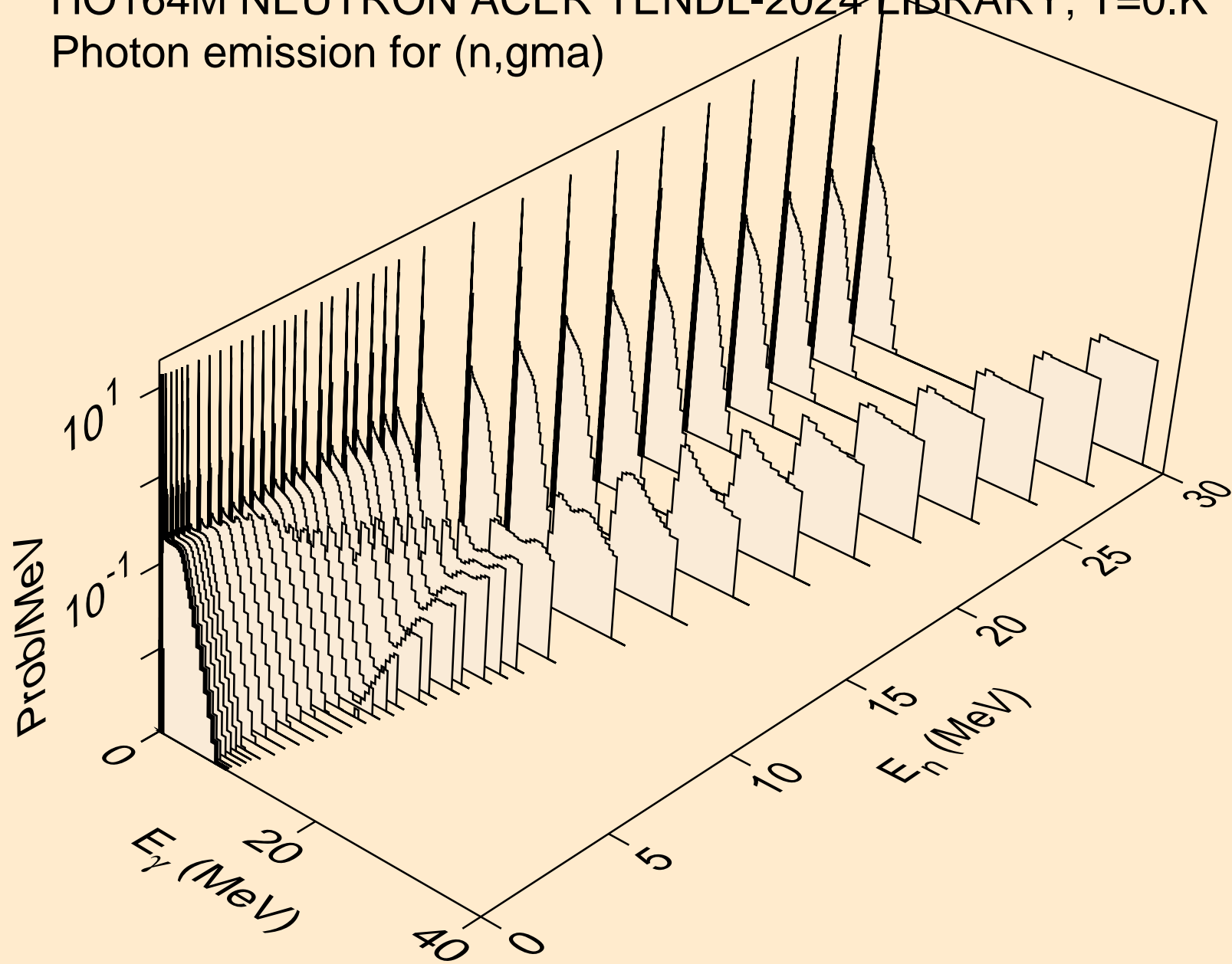

HO164M NEUTRON ACER TENDL-2024 LIBRARY; T=0.K  
Photon emission for (n,p)

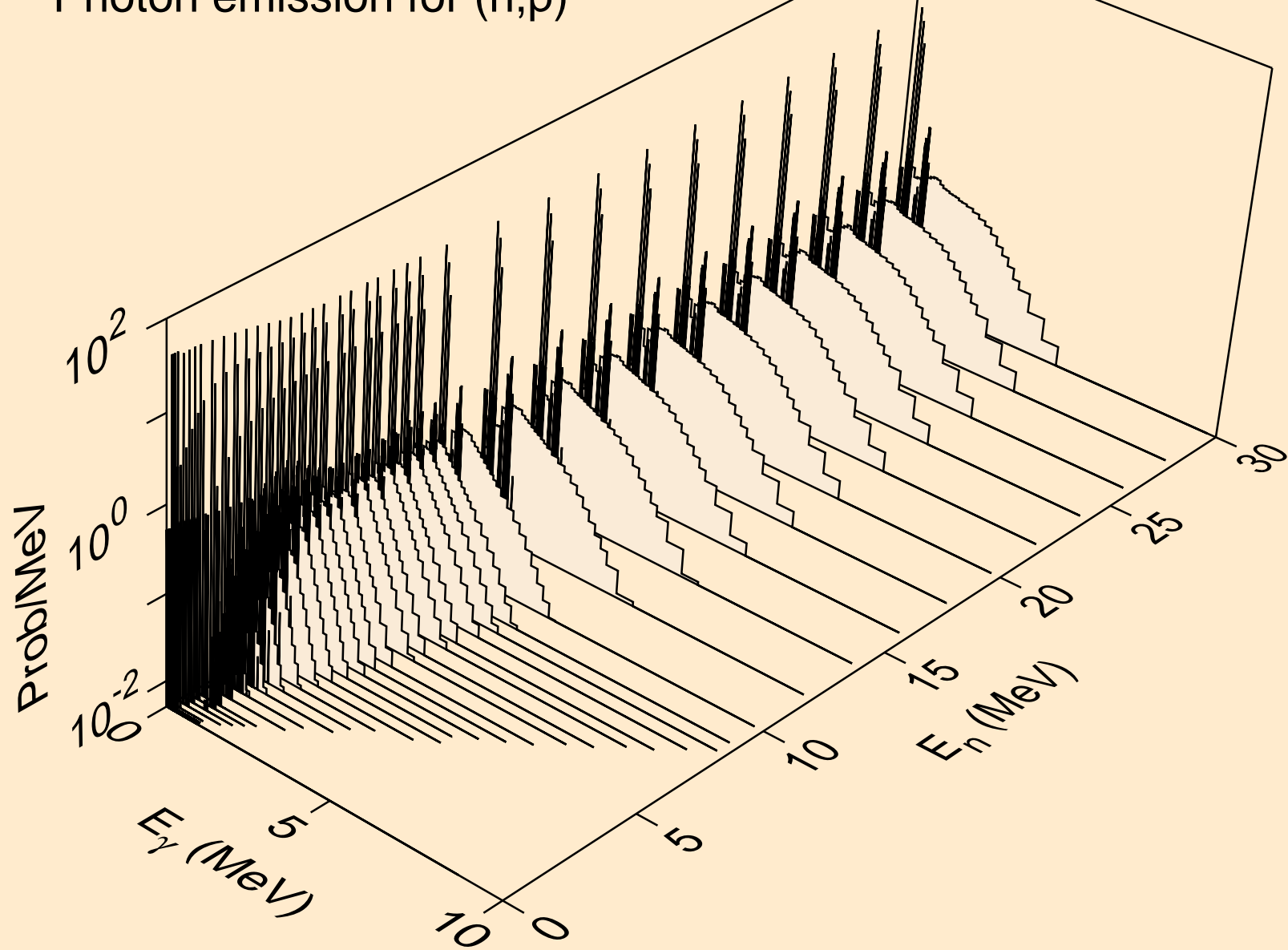

HO164M NEUTRON ACER TENDL-2024 LIBRARY; T=0.K  
Photon emission for (n,d)

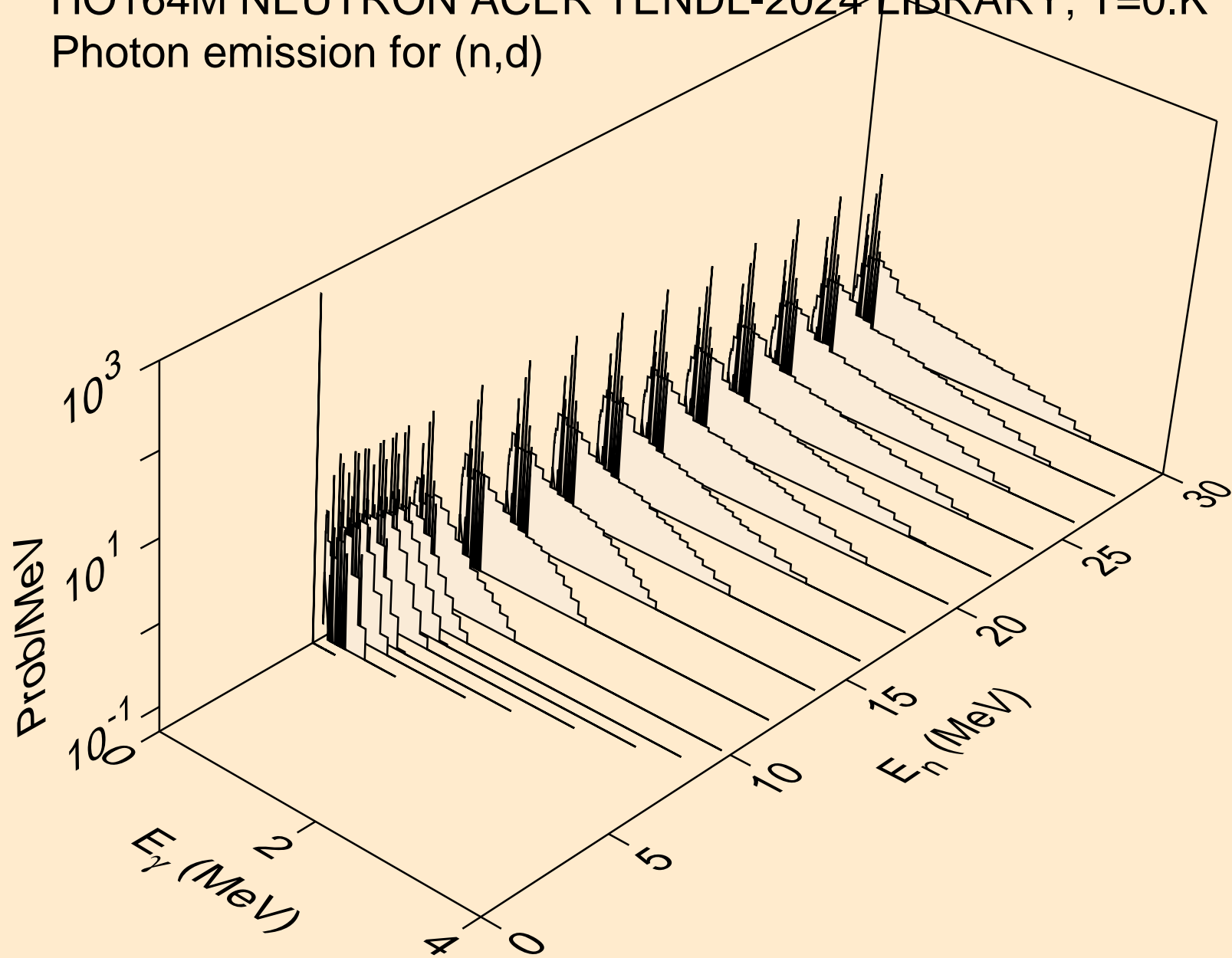

HO164M NEUTRON ACER TENDL-2024 LIBRARY; T=0.K  
Photon emission for (n,t)

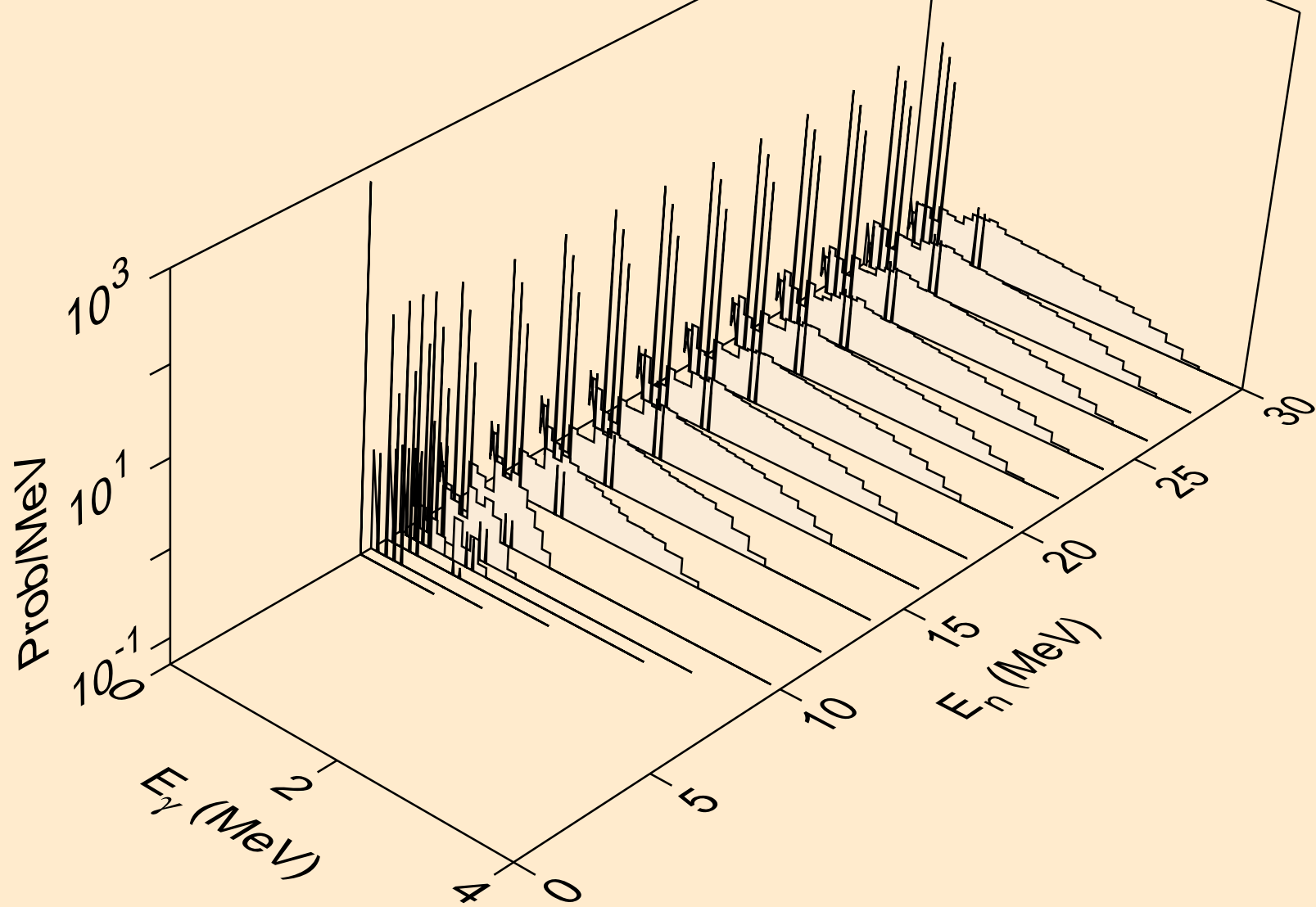

HO164M NEUTRON ACER TENDL-2024 LIBRARY; T=0.K  
Photon emission for (n,he3)

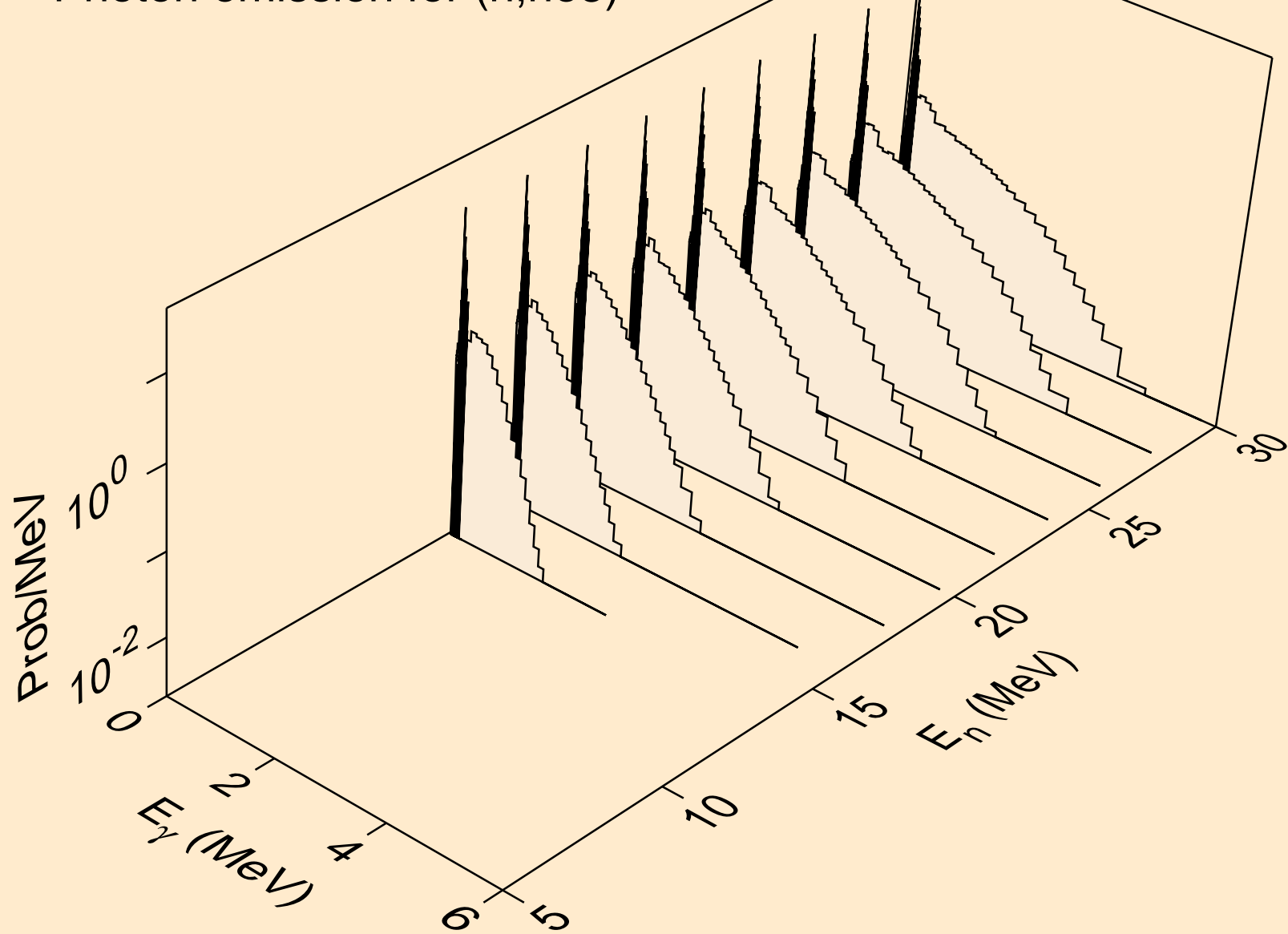

HO164M NEUTRON ACER TENDL-2024 LIBRARY; T=0.K  
Photon emission for (n,a)

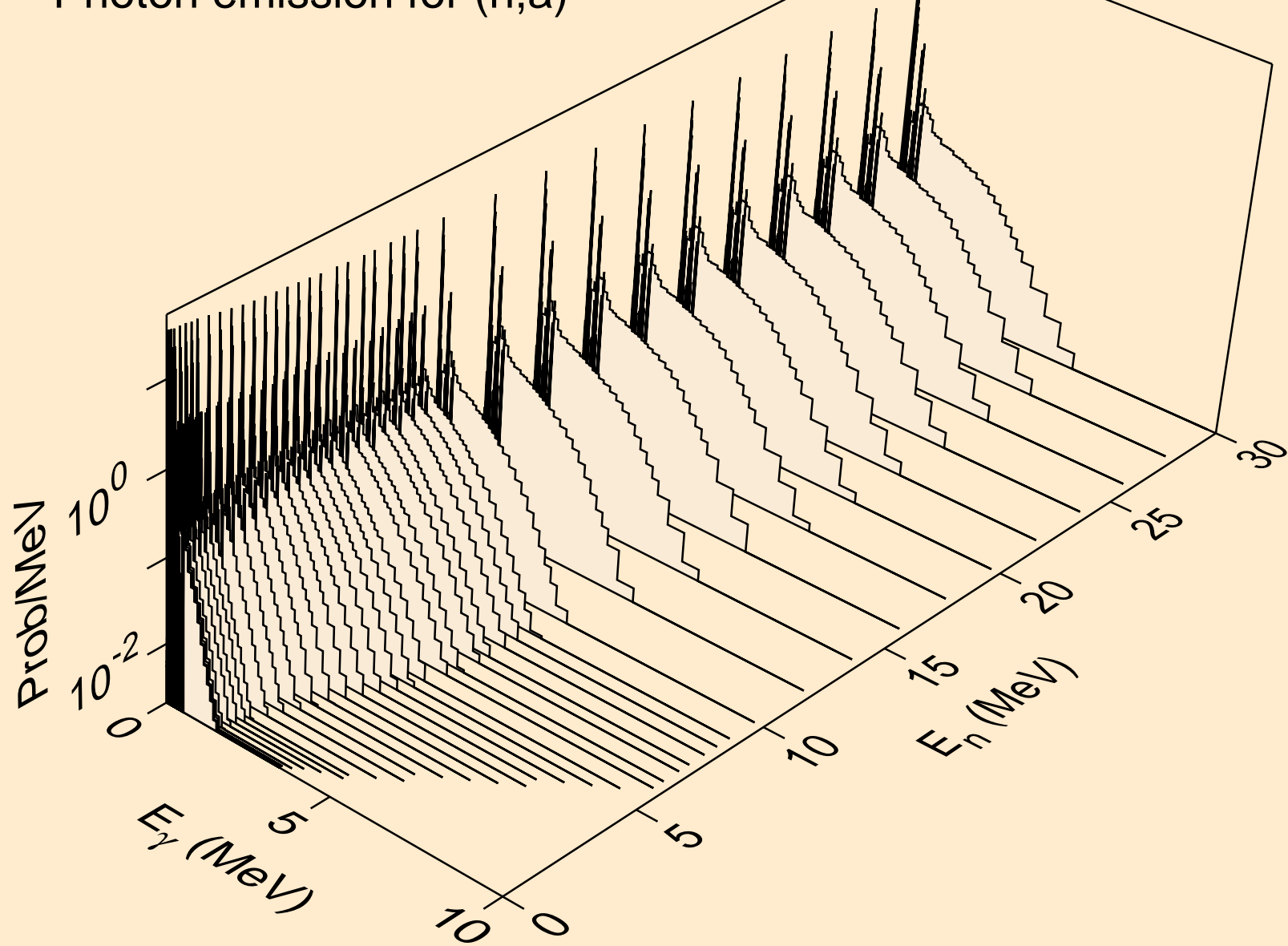

HO164M NEUTRON ACER TENDL-2024 LIBRARY; T=0.K  
Photon emission for (n,2a)

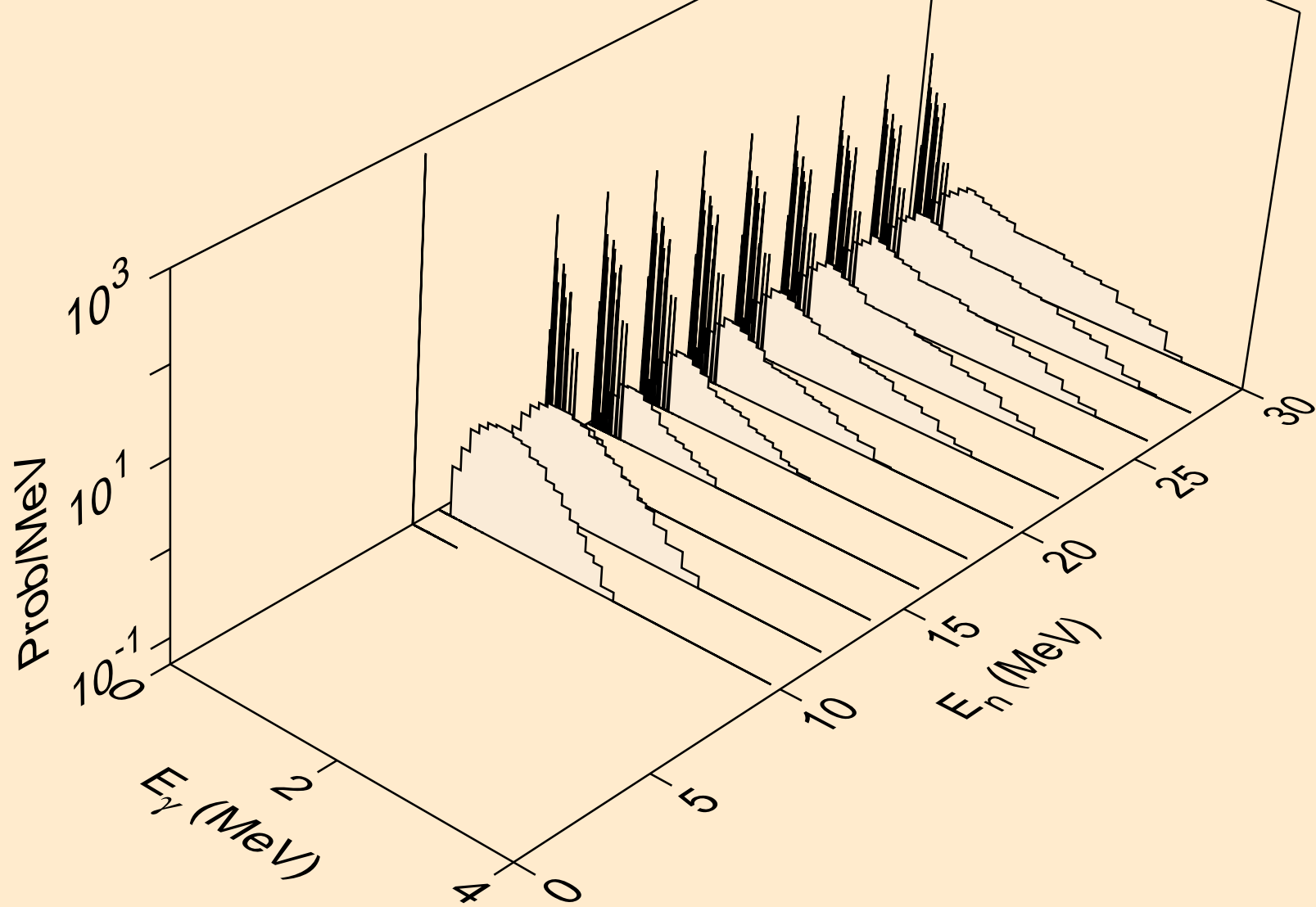

HO164M NEUTRON ACER TENDL-2024 LIBRARY; T=0.K  
Photon emission for (n,2p)

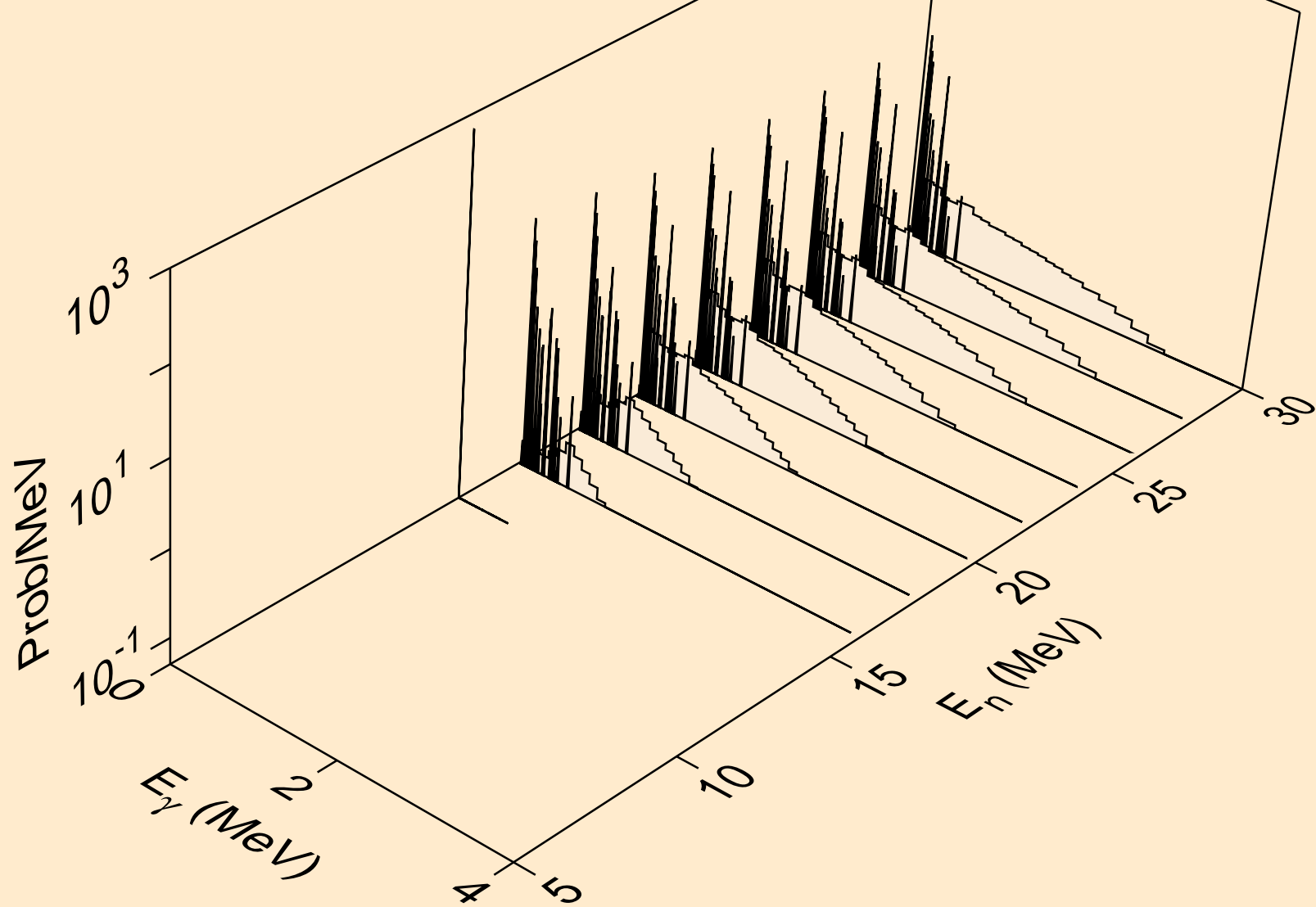

HO164M NEUTRON ACER TENDL-2024 LIBRARY; T=0.K  
Photon emission for (n,p)

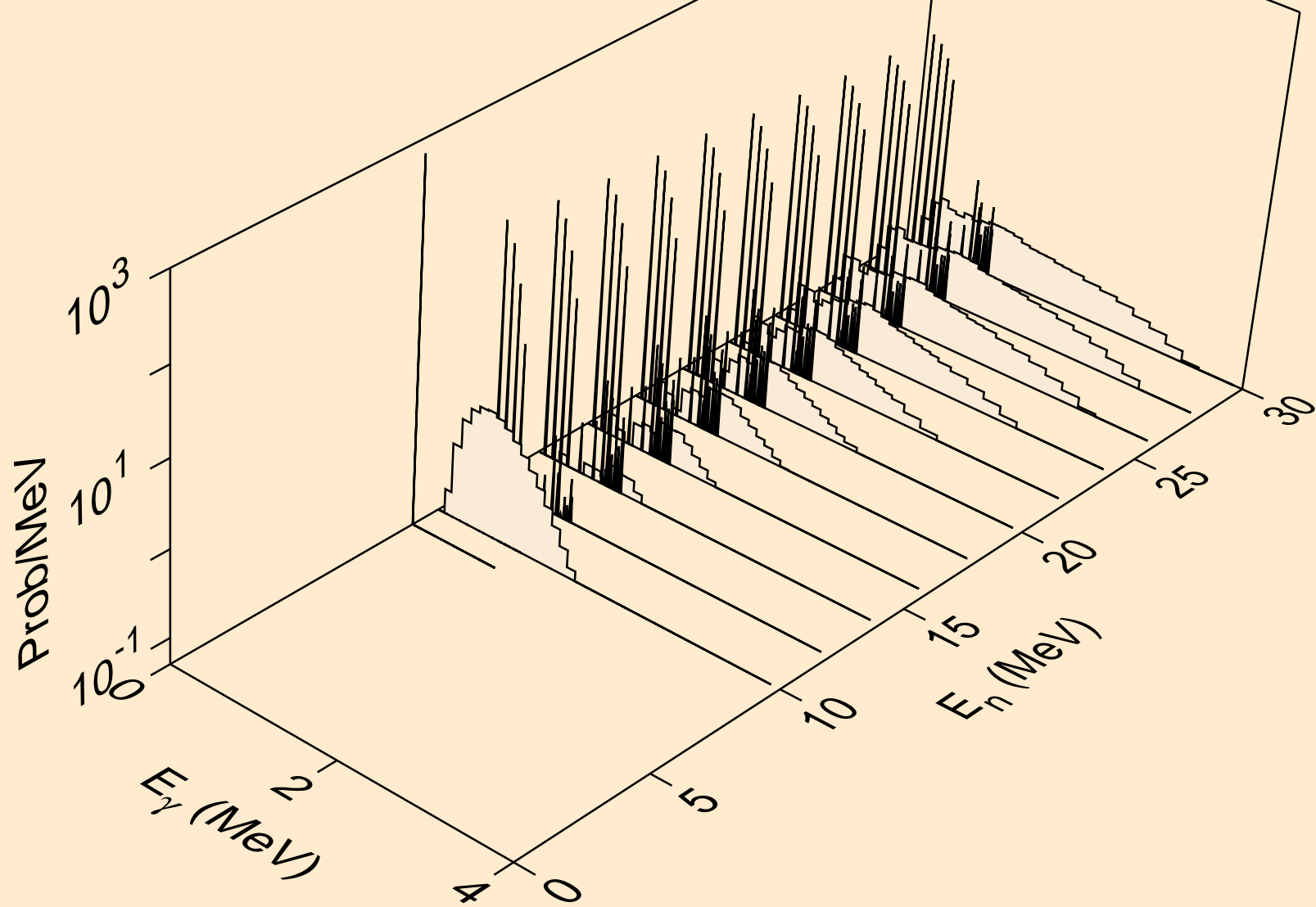

HO164M NEUTRON ACER TENDL-2024 LIBRARY; T=0.K  
Photon emission for (n,pd)

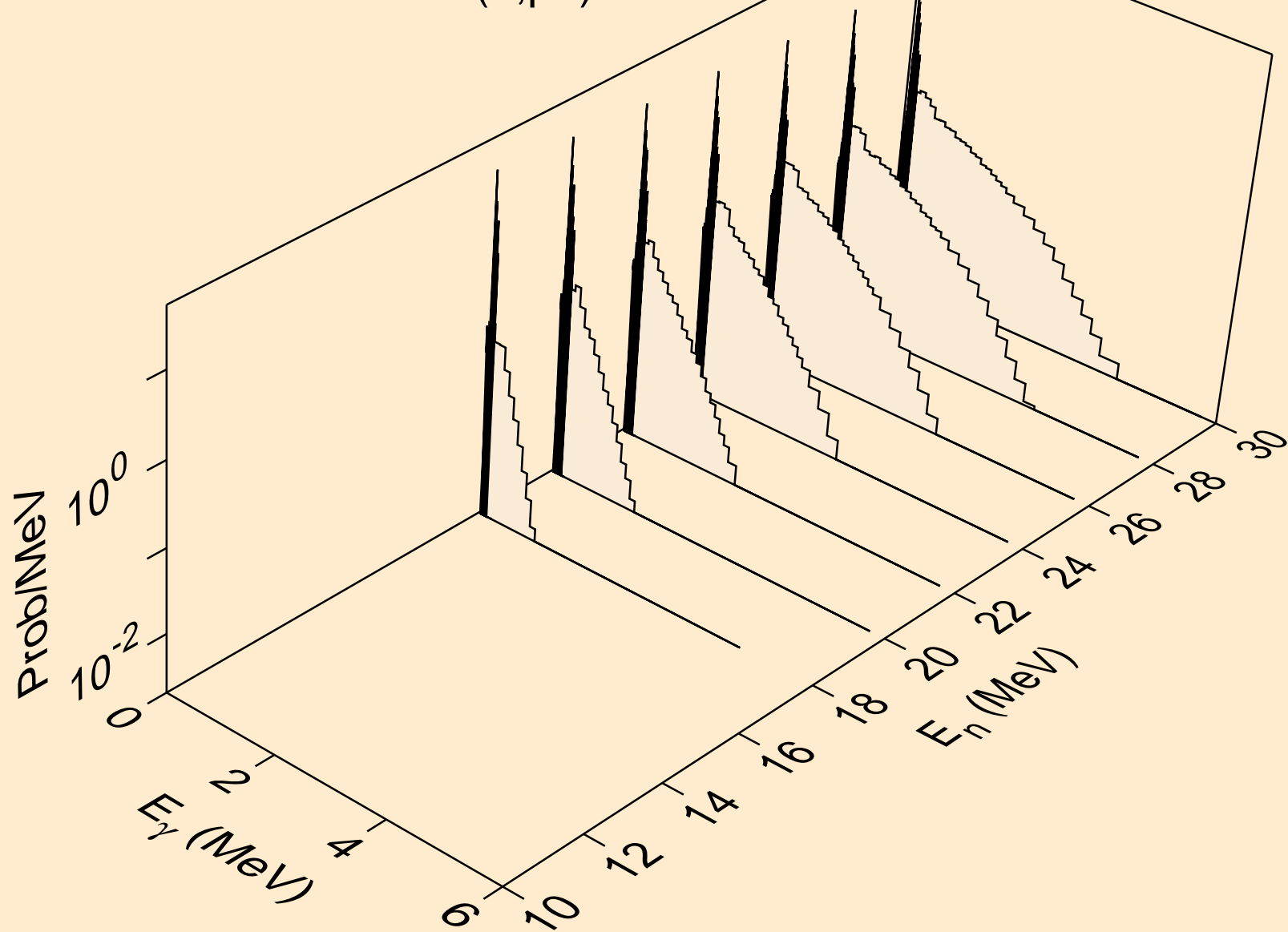

HO164M NEUTRON ACER TENDL-2024 LIBRARY; T=0.K  
Photon emission for (n,pt)

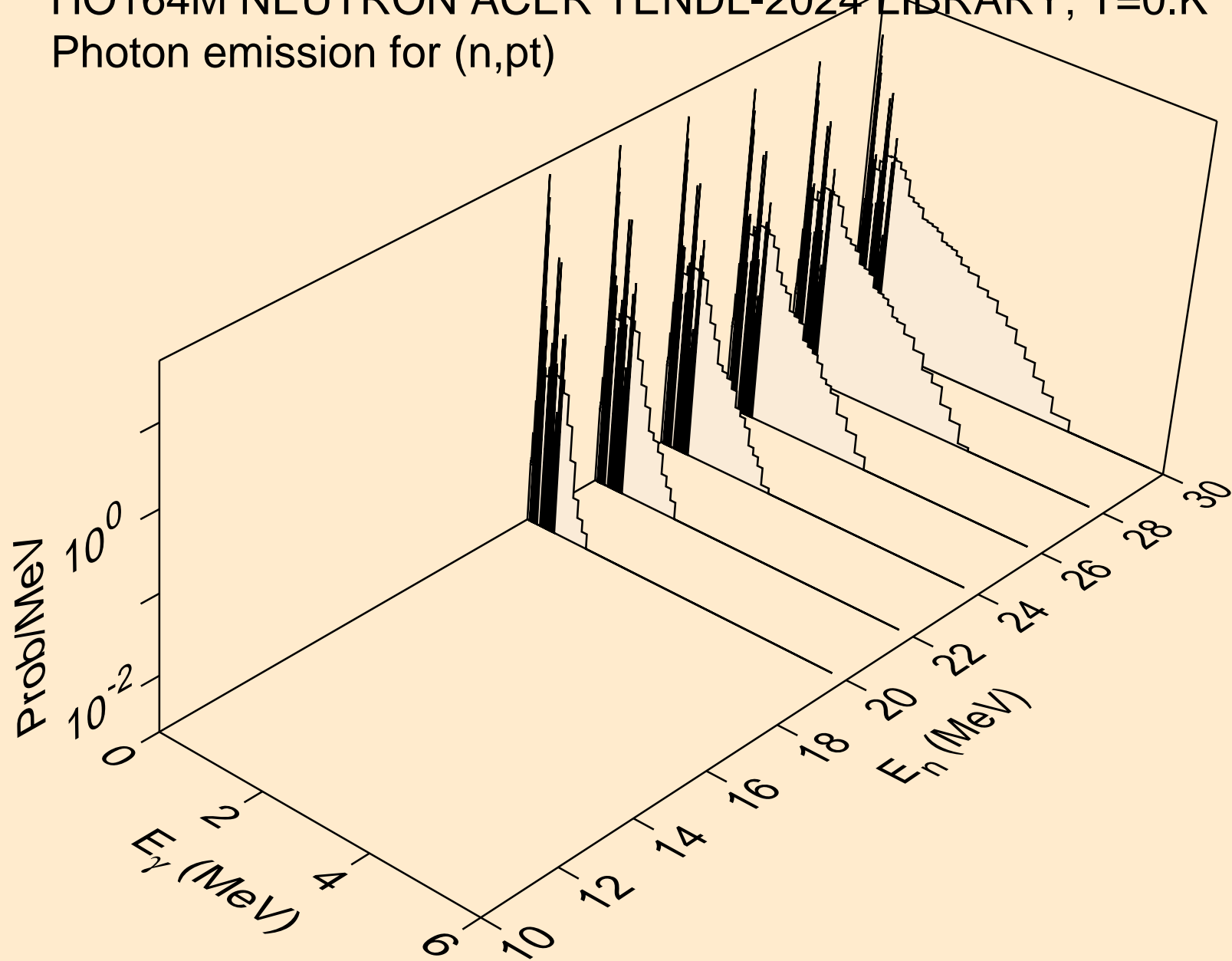

HO164M NEUTRON ACER TENDL-2024 LIBRARY; T=0.K  
Photon emission for (n,da)

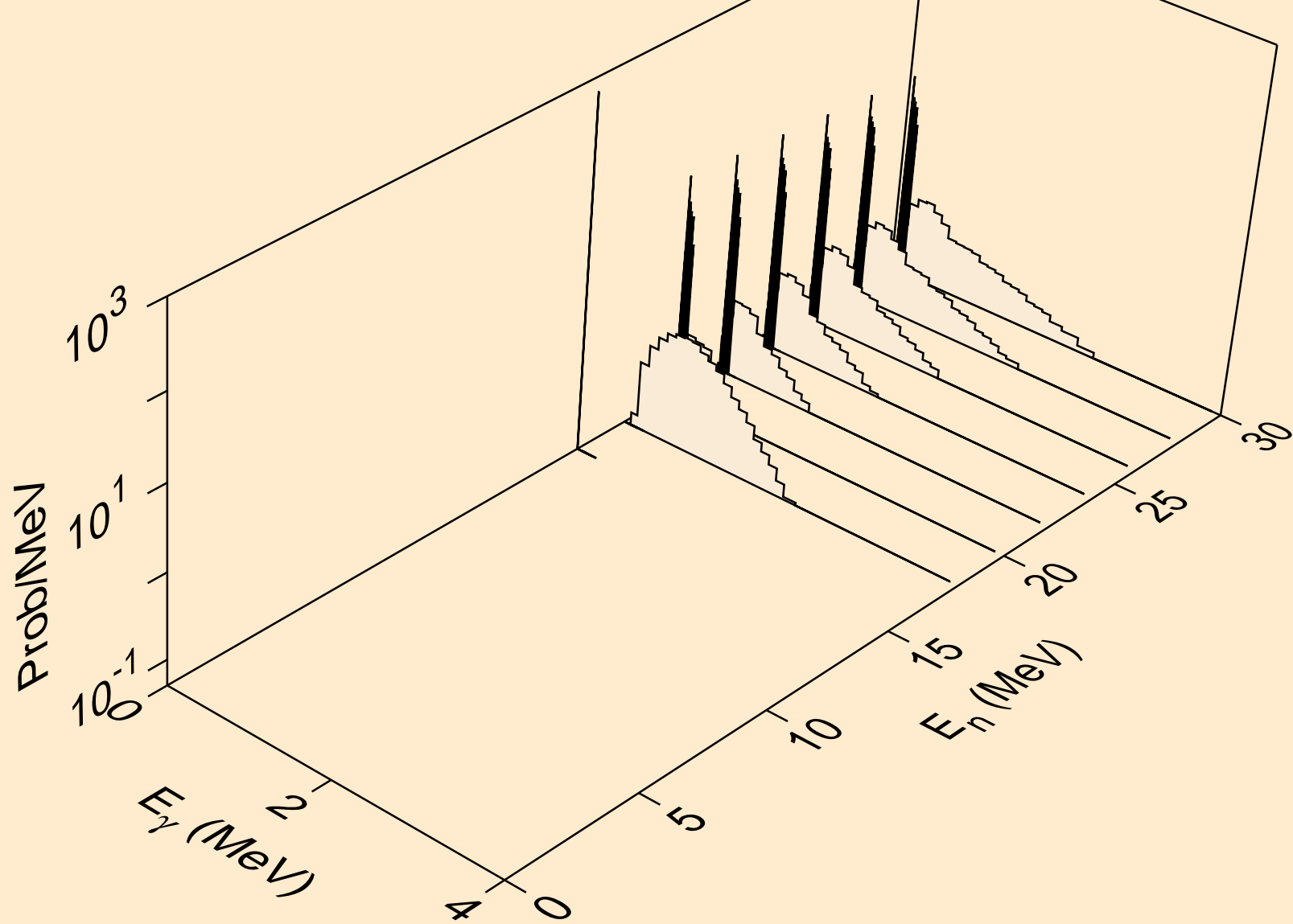

HO164M NEUTRON ACER TENDL-2024 LIBRARY; T=0.K  
thermal capture photon spectrum

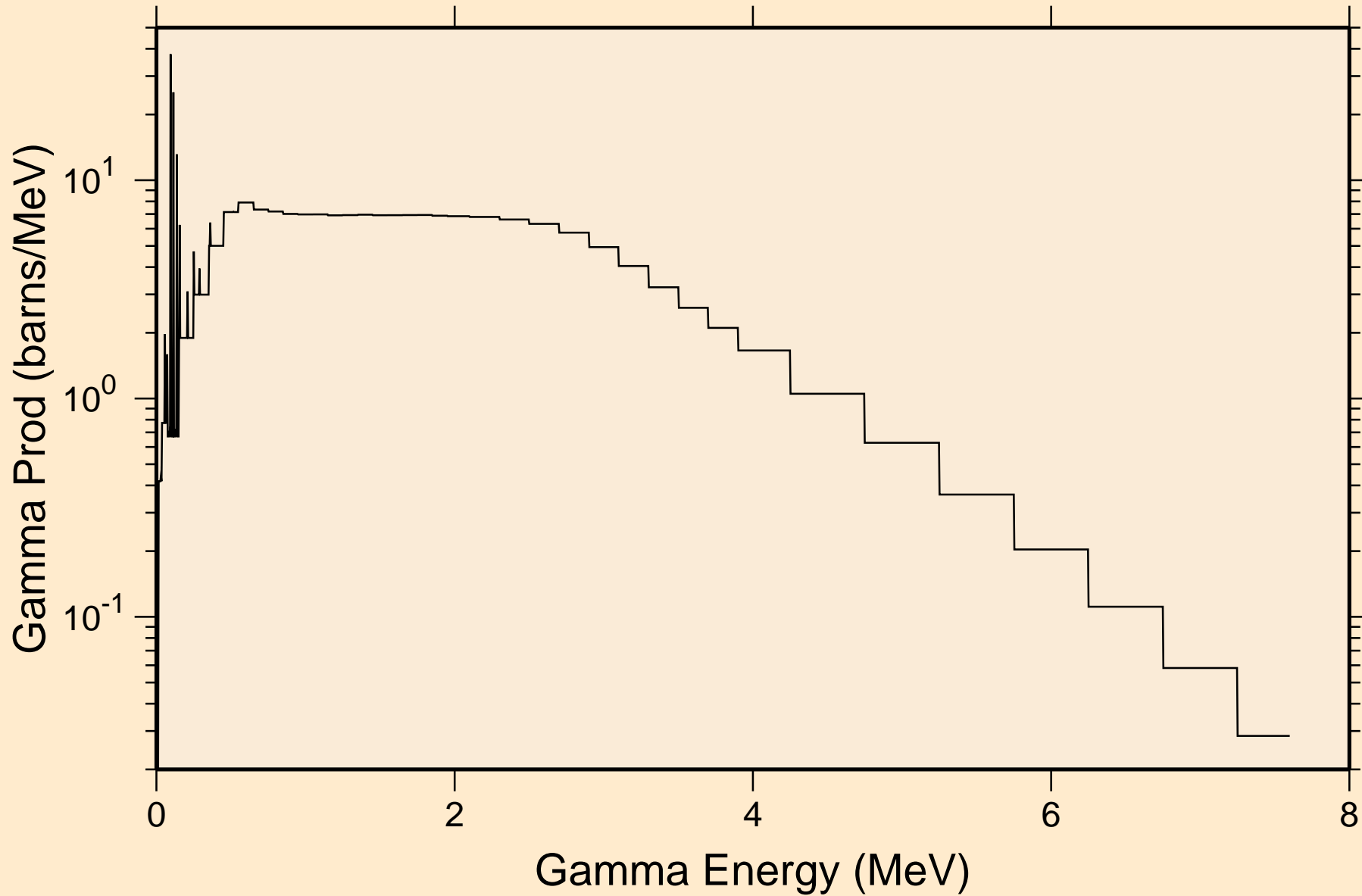

HO164M NEUTRON ACER TENDL-2024 LIBRARY; T=0.K  
14 MeV photon spectrum

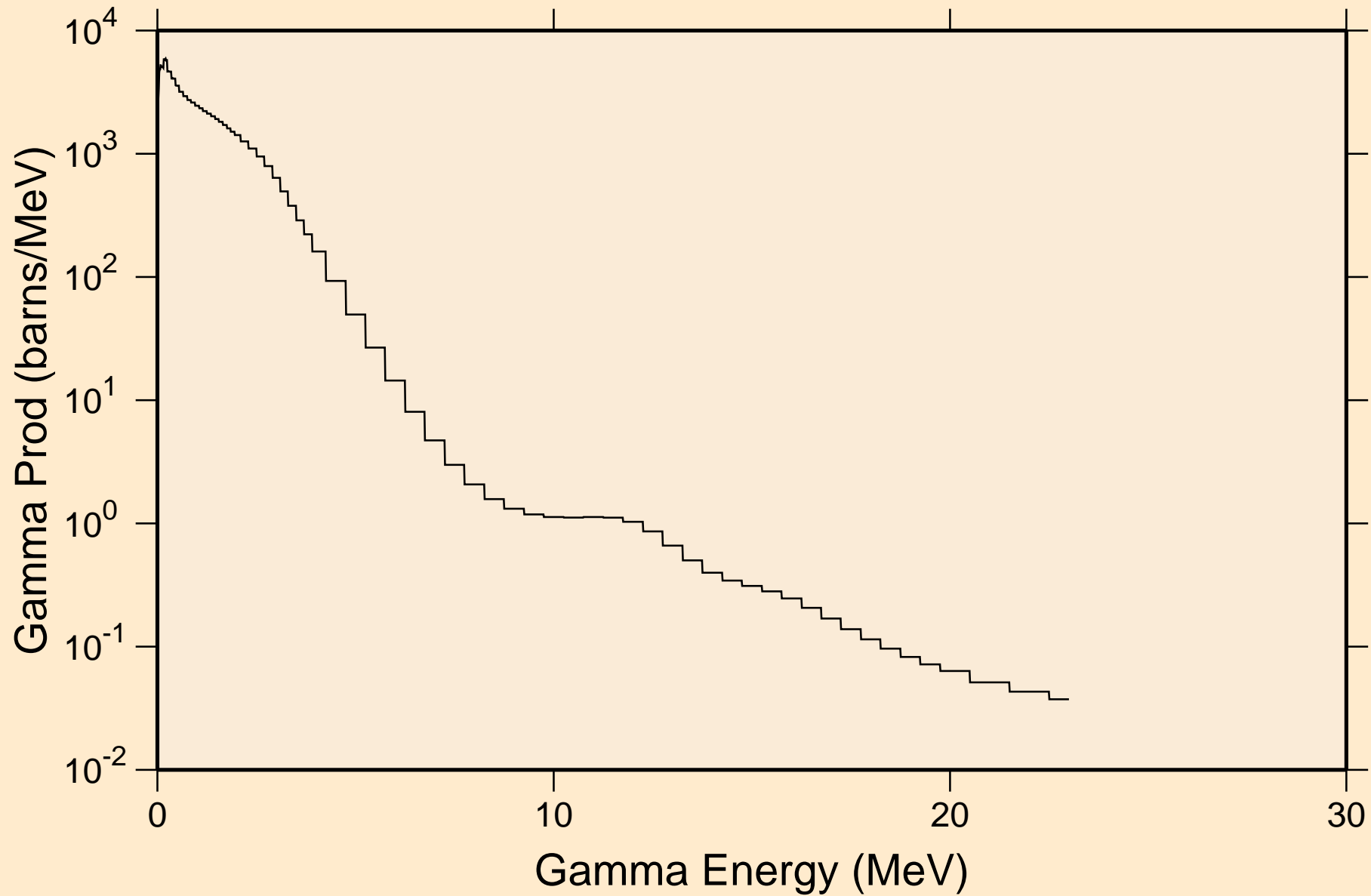

# HO164M NEUTRON ACER TENDL-2024 LIBRARY; T=0.K

## Particle heating contributions

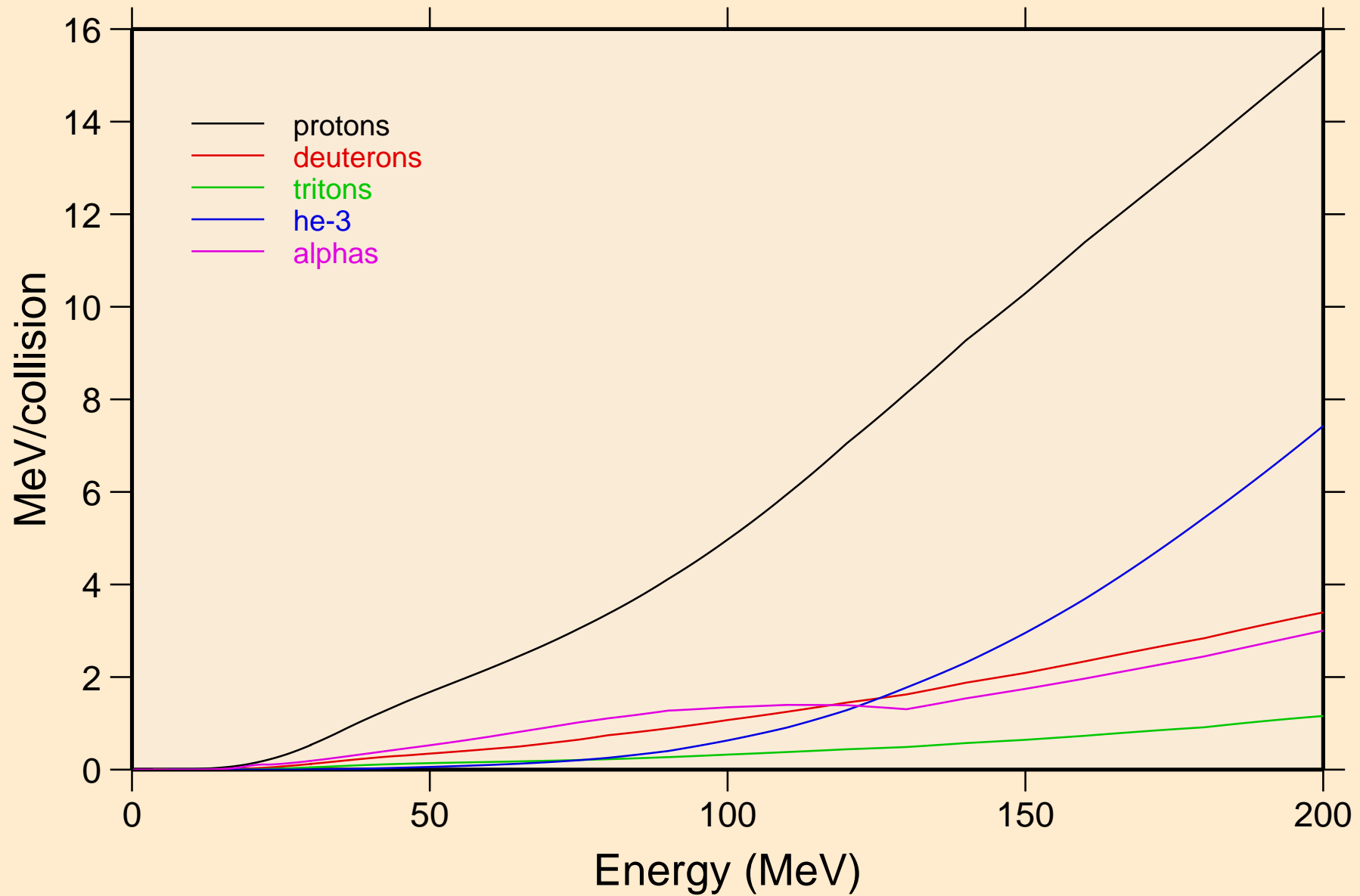

HO164M NEUTRON ACER TENDL-2024 LIBRARY; T=0.K  
Recoil Heating

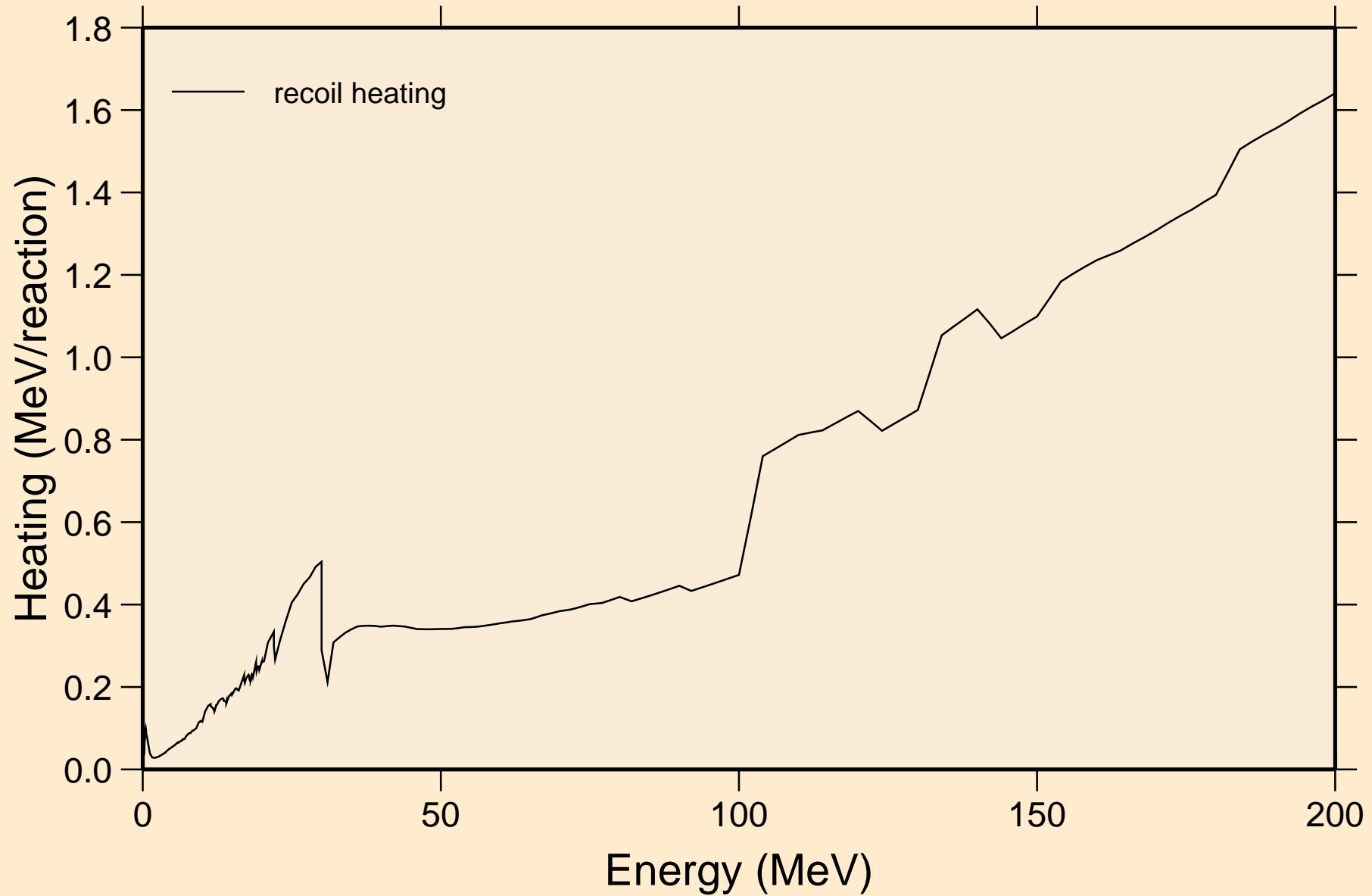

HO164M NEUTRON ACER TENDL-2024 LIBRARY; T=0.K  
Particle production cross sections

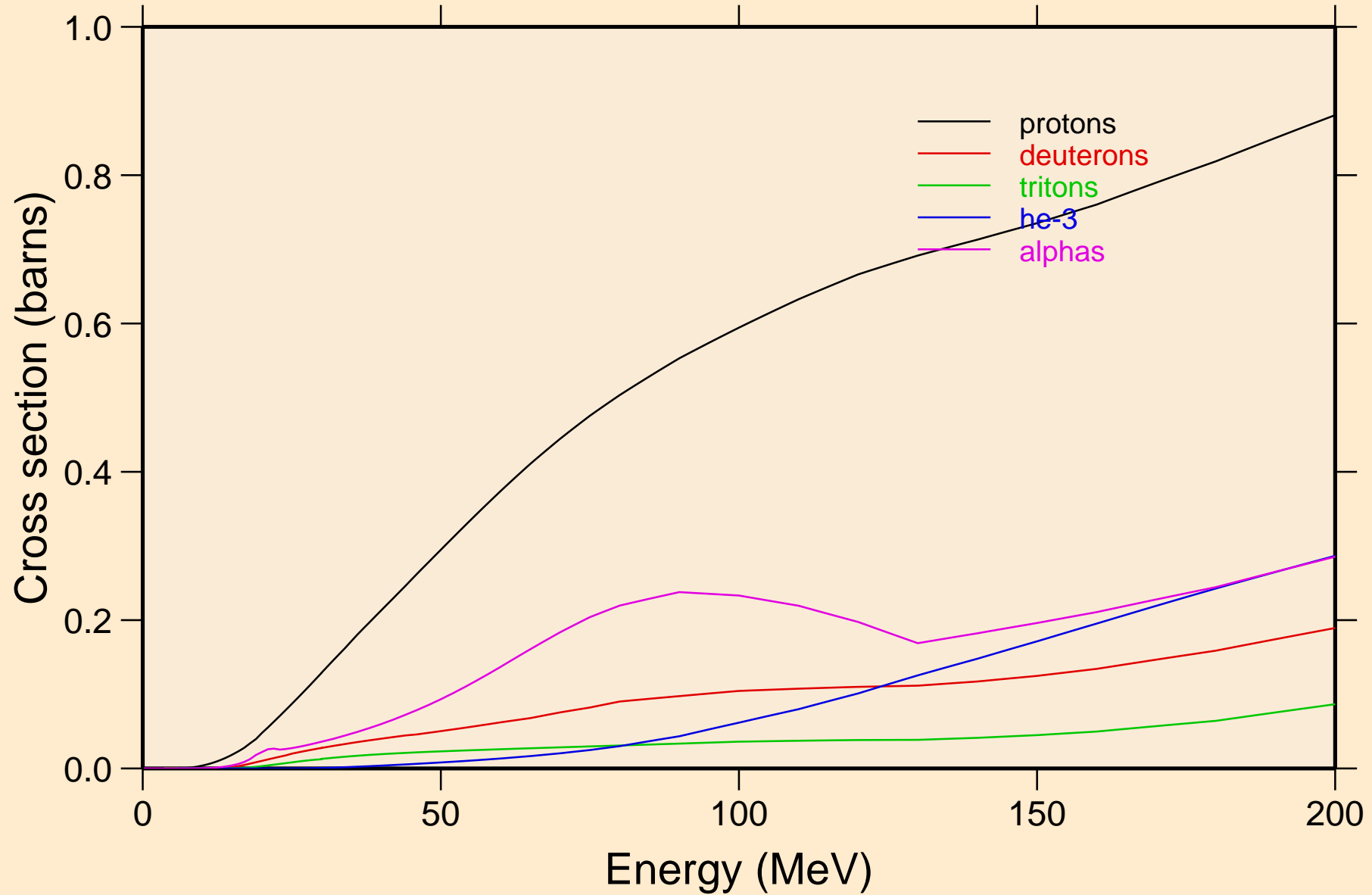

HO164M NEUTRON ACER TENDL-2024 LIBRARY; T=0.K  
protons from (n,x)

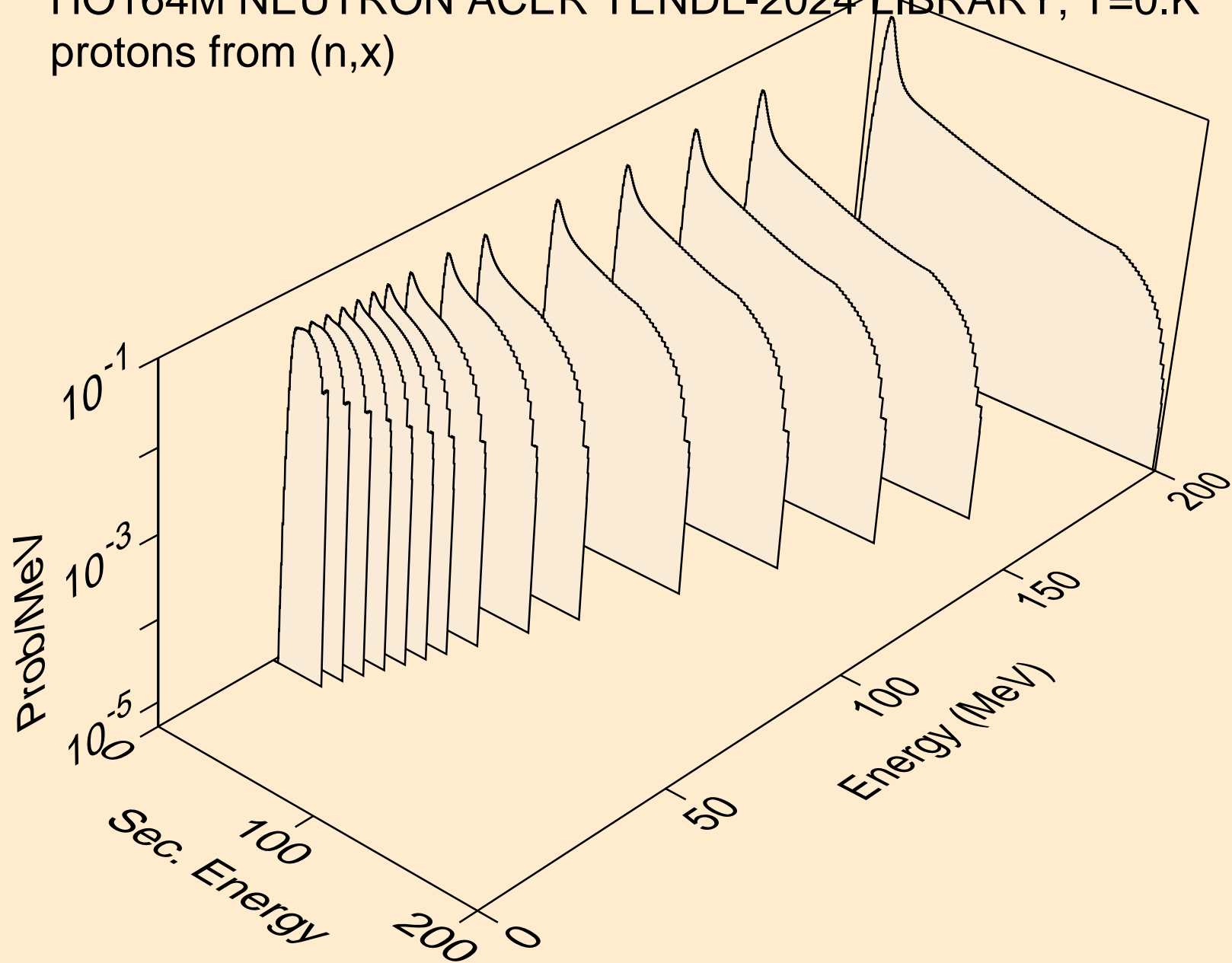

HO164M NEUTRON ACER TENDL-2024 LIBRARY; T=0.K  
protons from (n,n\*)p

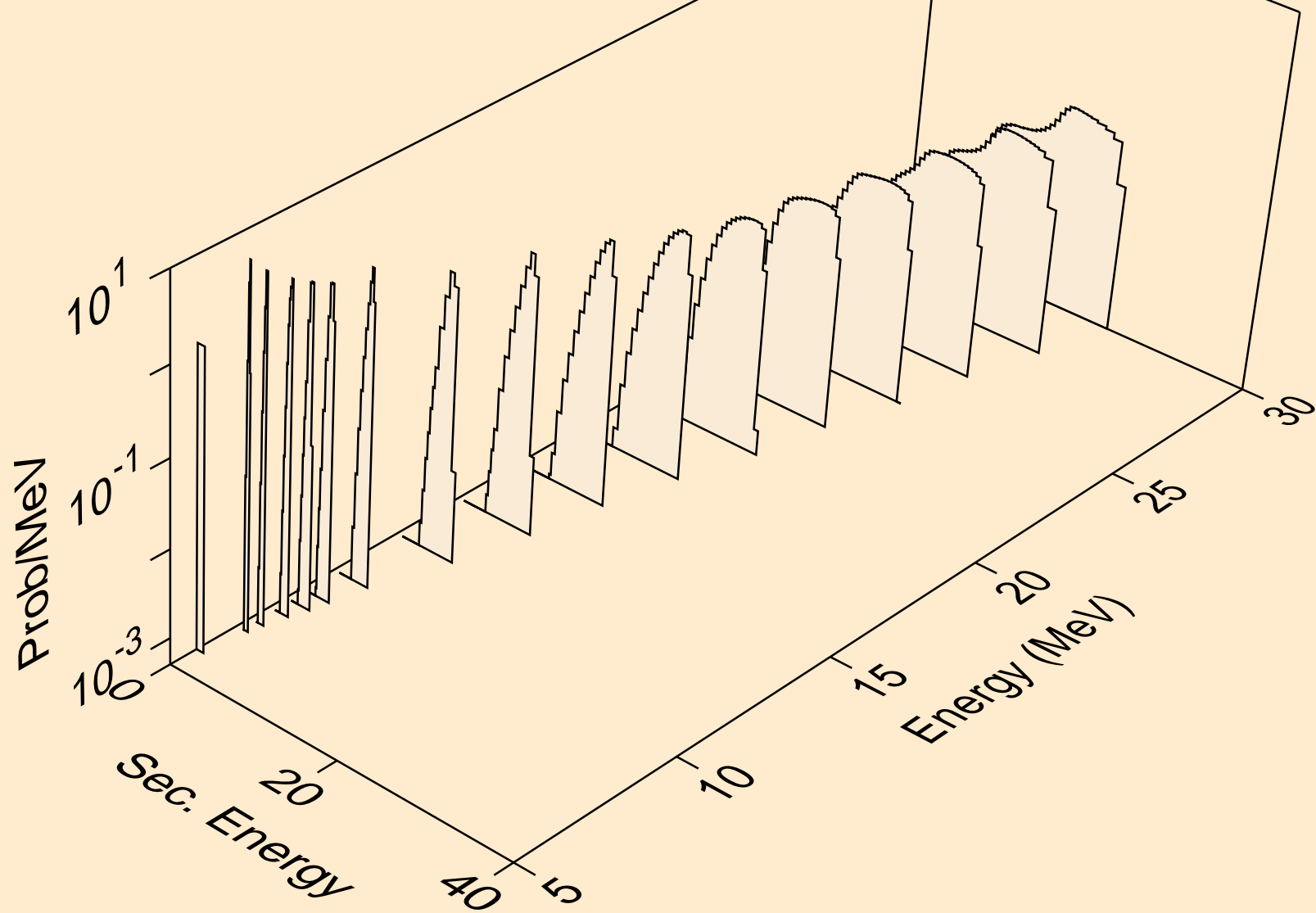

HO164M NEUTRON ACER TENDL-2024 LIBRARY; T=0.K  
protons from (n,2np)

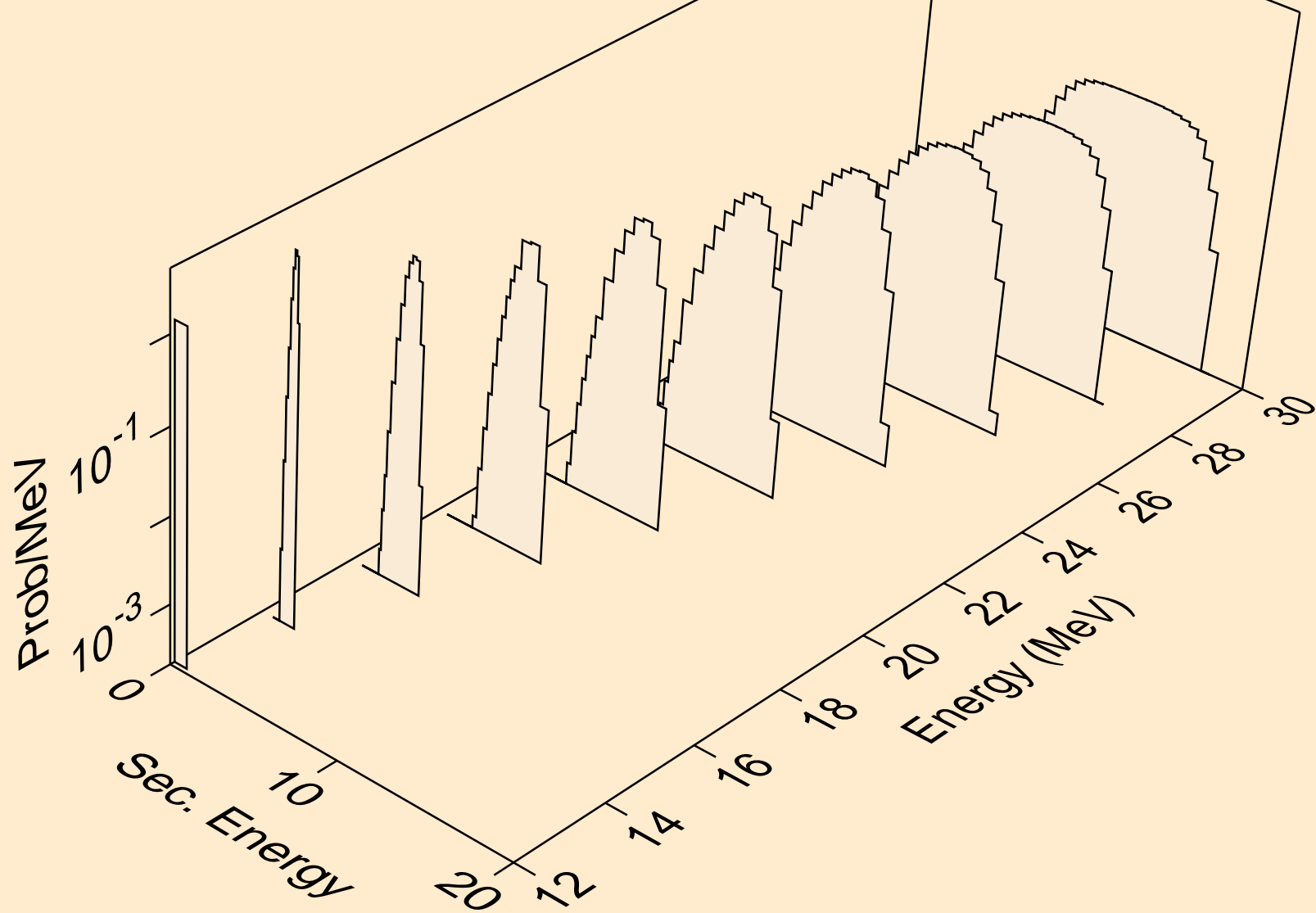

HO164M NEUTRON ACER TENDL-2024 LIBRARY; T=0.K  
protons from (n,3np)

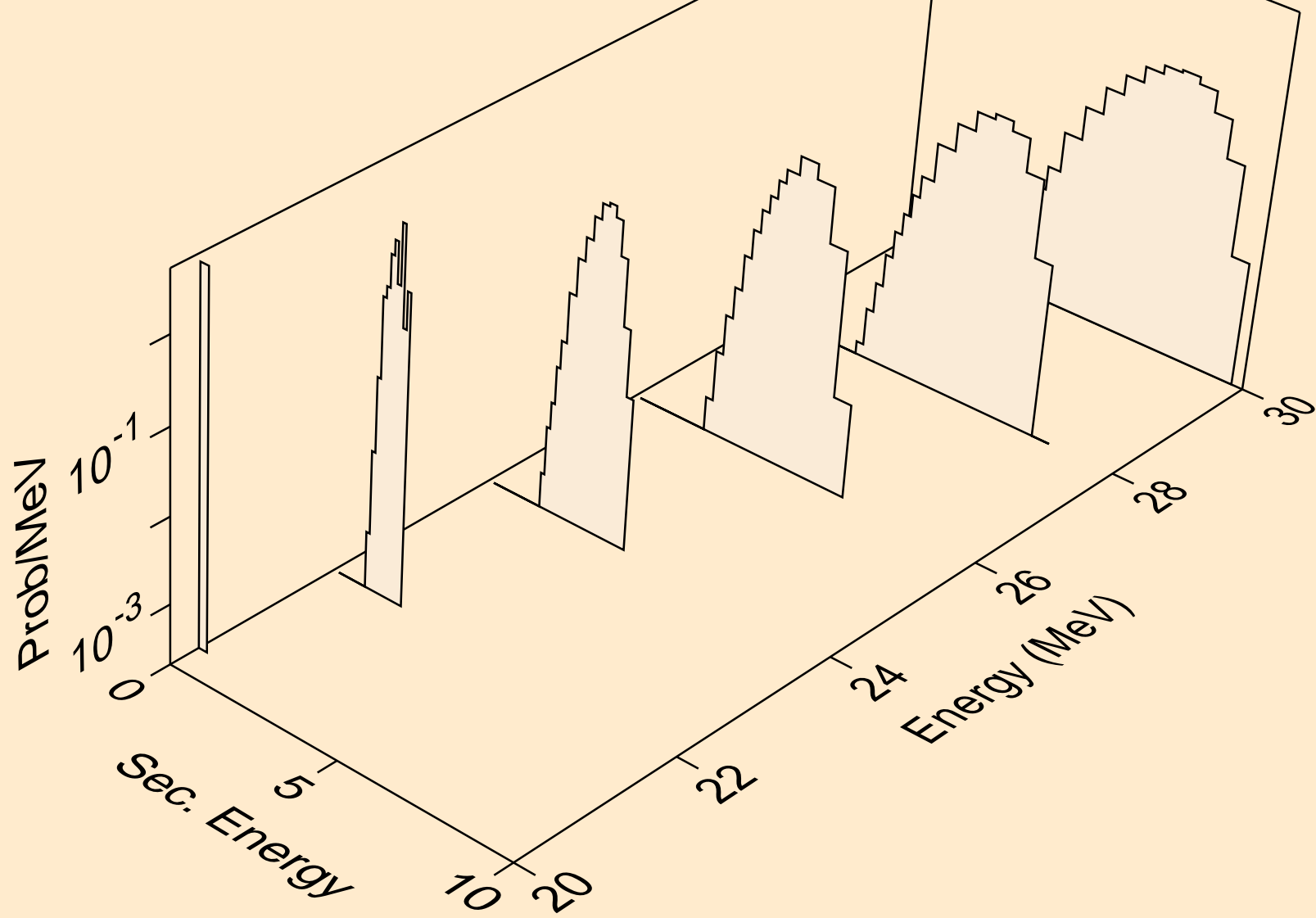

HO164M NEUTRON ACER TENDL-2024 LIBRARY; T=0.K  
protons from (n,n2p)

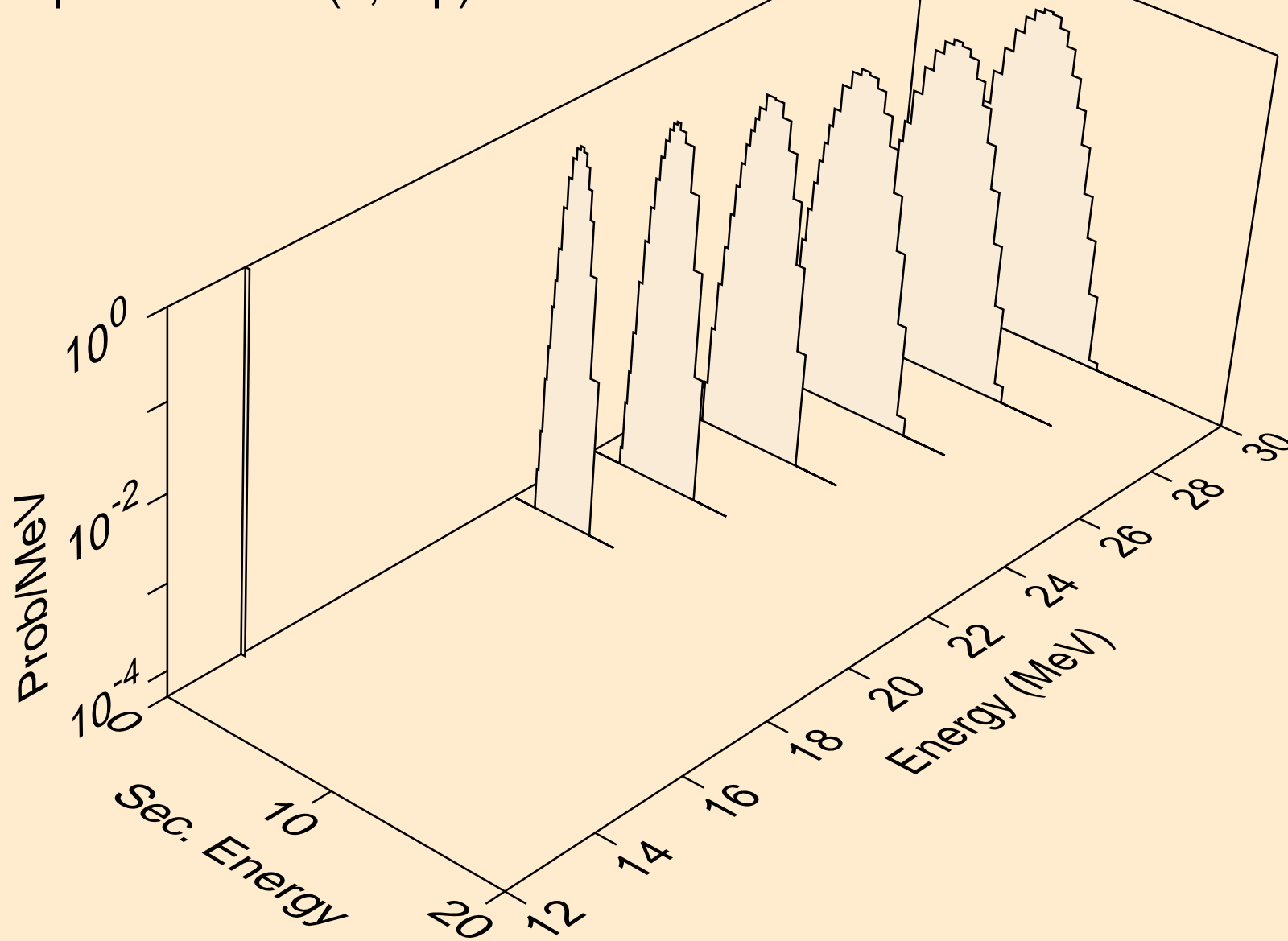

HO164M NEUTRON ACER TENDL-2024 LIBRARY; T=0.K  
protons from (n,npa)

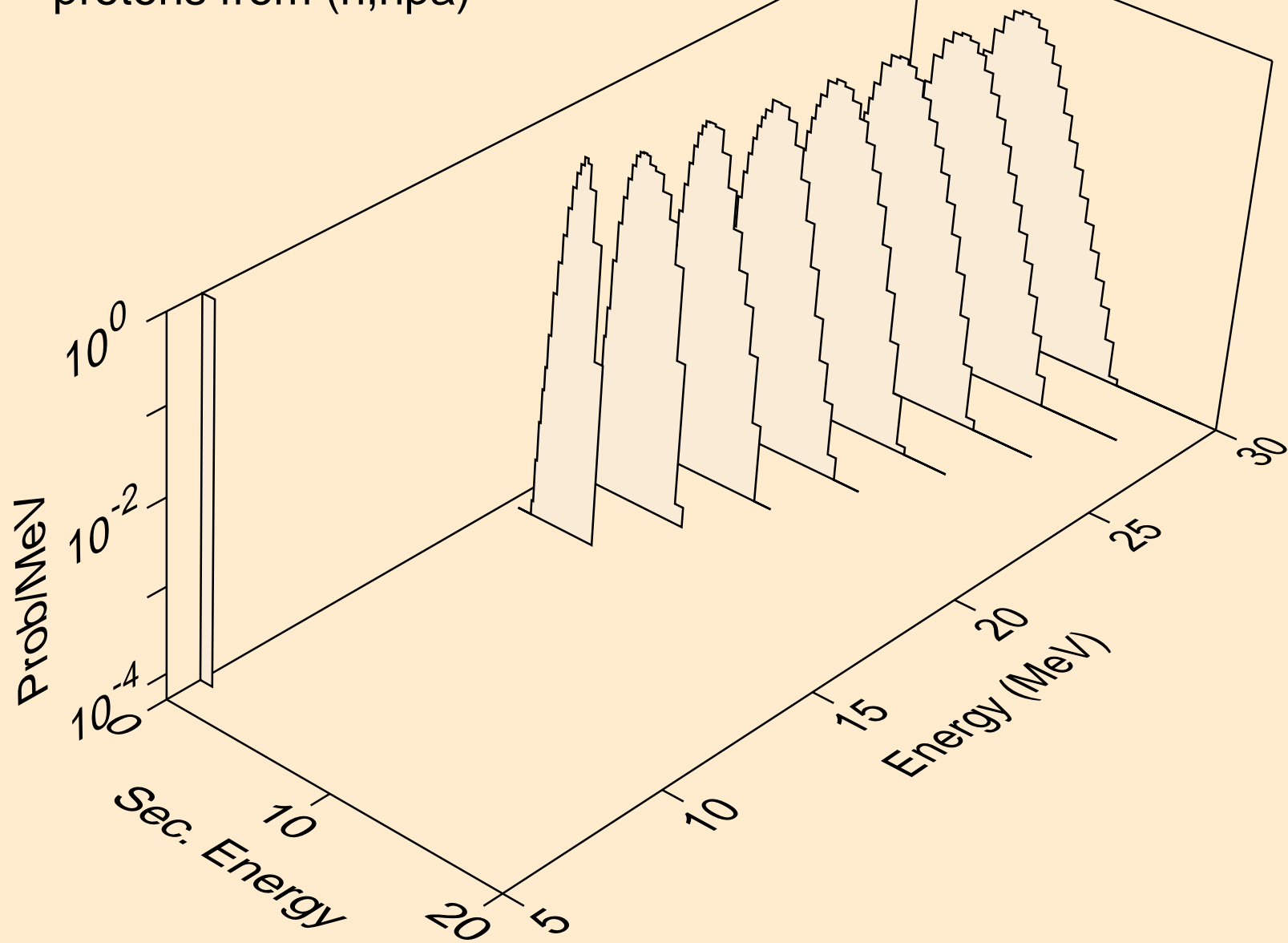

HO164M NEUTRON ACER TENDL-2024 LIBRARY; T=0.K  
protons from (n,p)

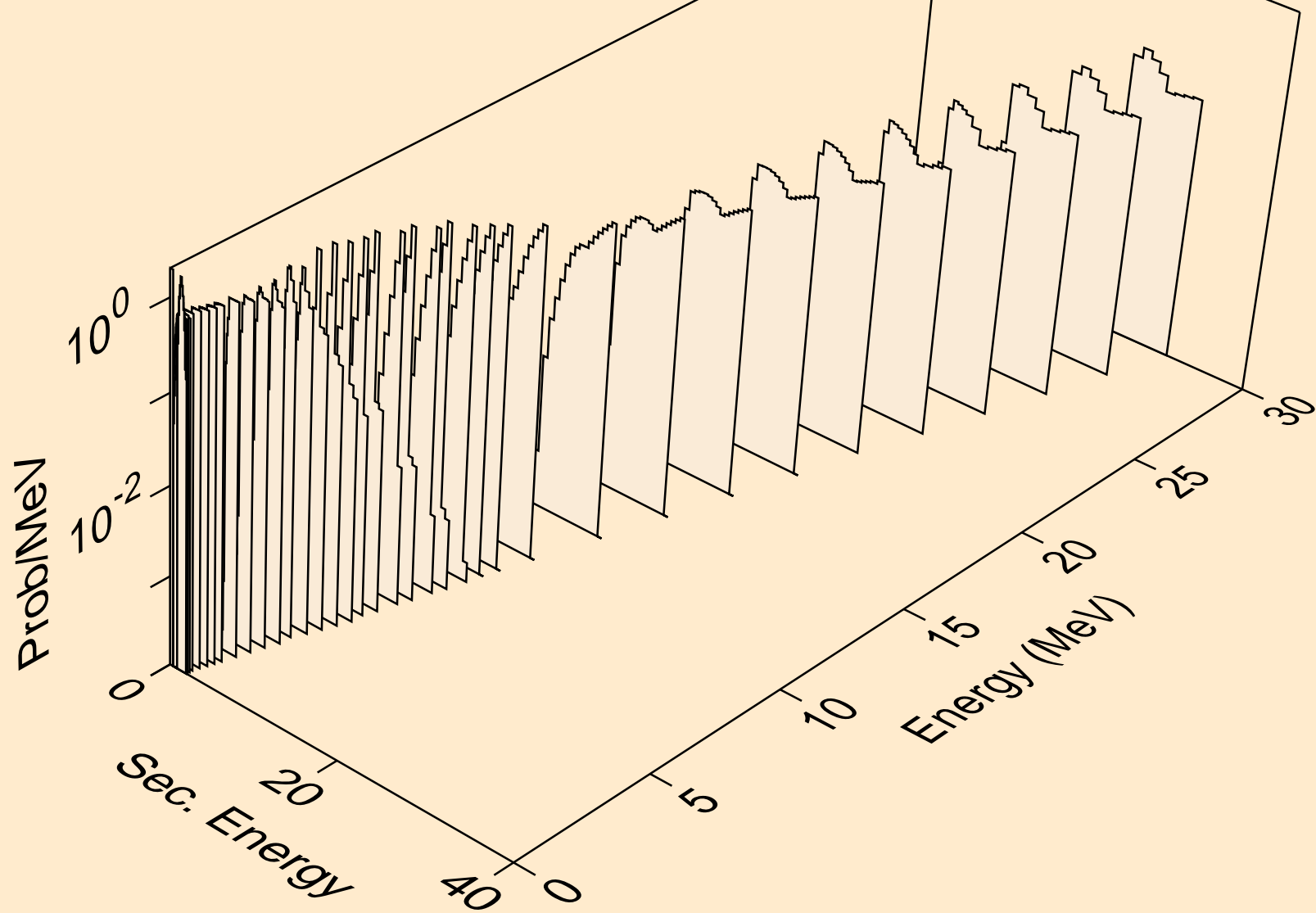

HO164M NEUTRON ACER TENDL-2024 LIBRARY; T=0.K  
protons from (n,2p)

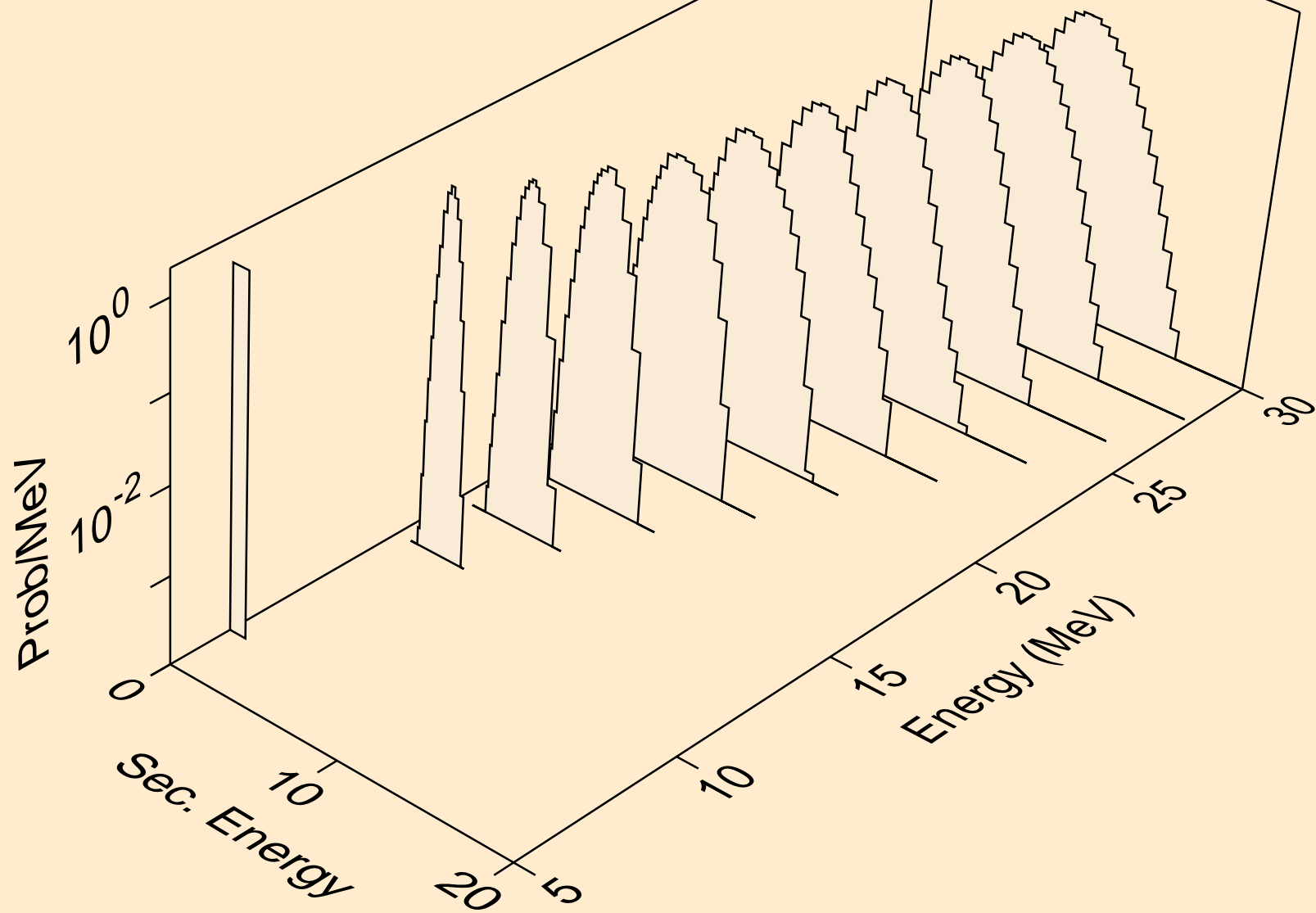

HO164M NEUTRON ACER TENDL-2024 LIBRARY; T=0.K  
protons from (n,p)

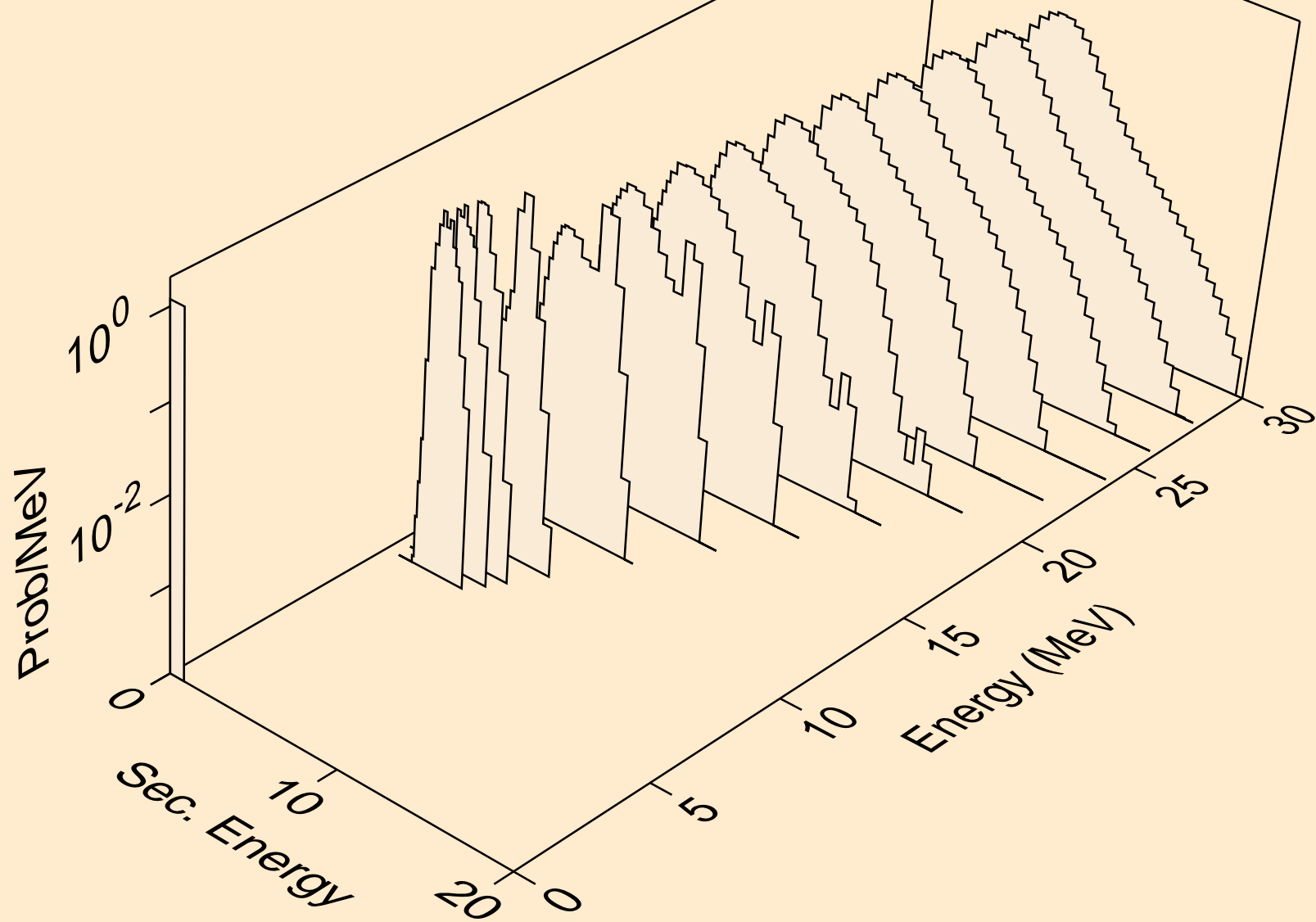

HO164M NEUTRON ACER TENDL-2024 LIBRARY; T=0.K  
protons from (n,pd)

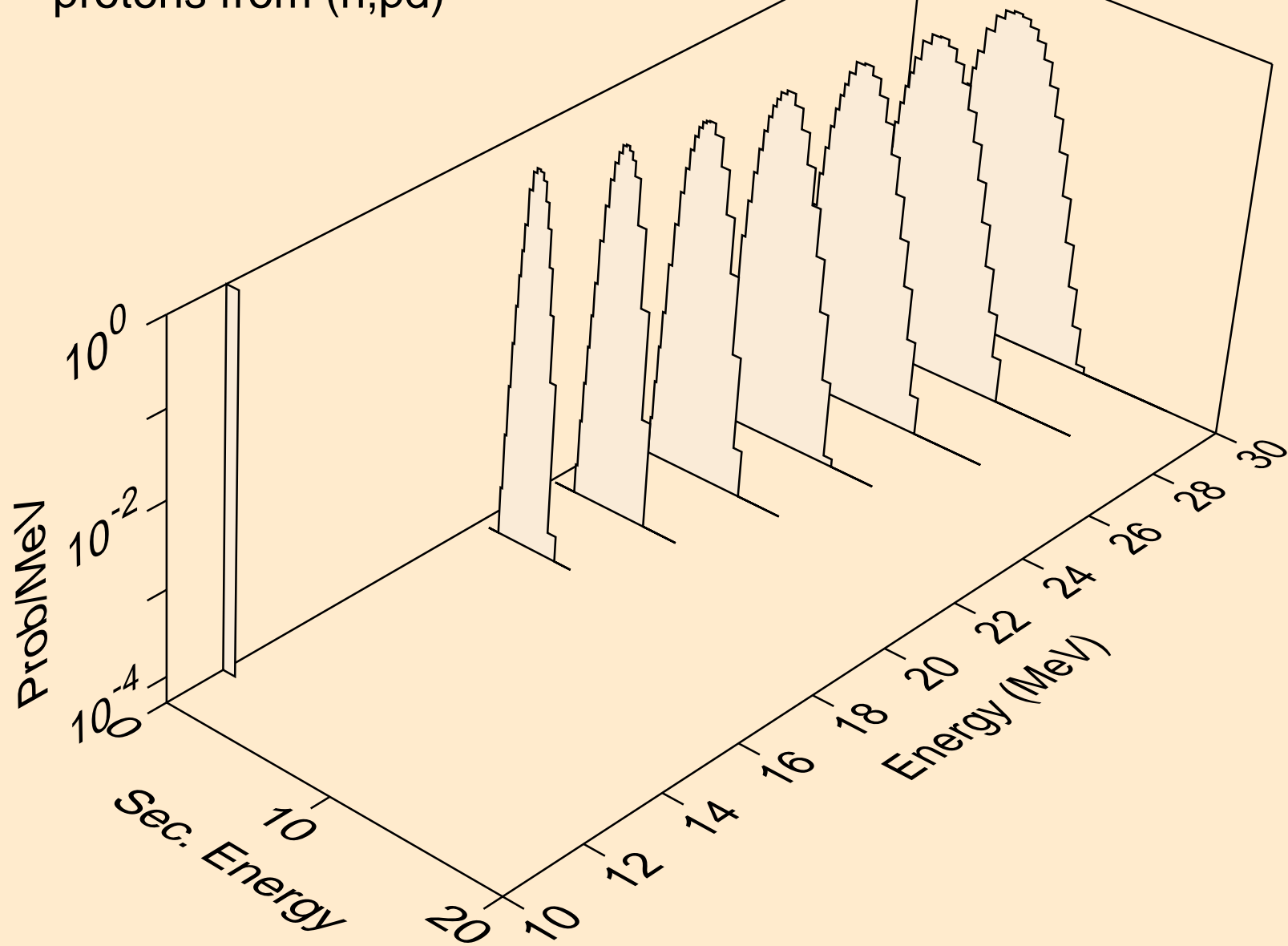

HO164M NEUTRON ACER TENDL-2024 LIBRARY; T=0.K  
protons from (n,pt)

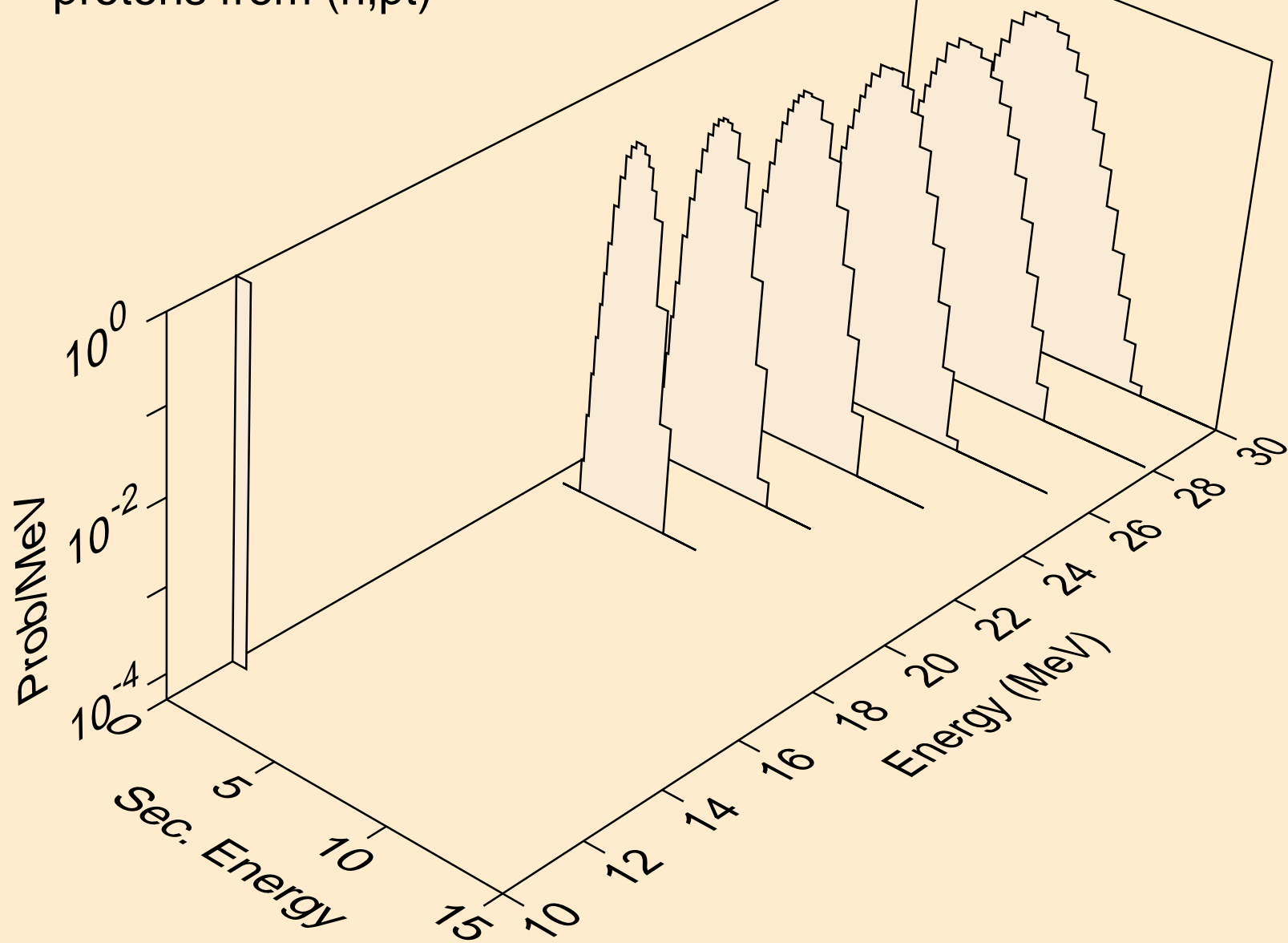

HO164M NEUTRON ACER TENDL-2024 LIBRARY; T=0.K  
deuterons from (n,x)

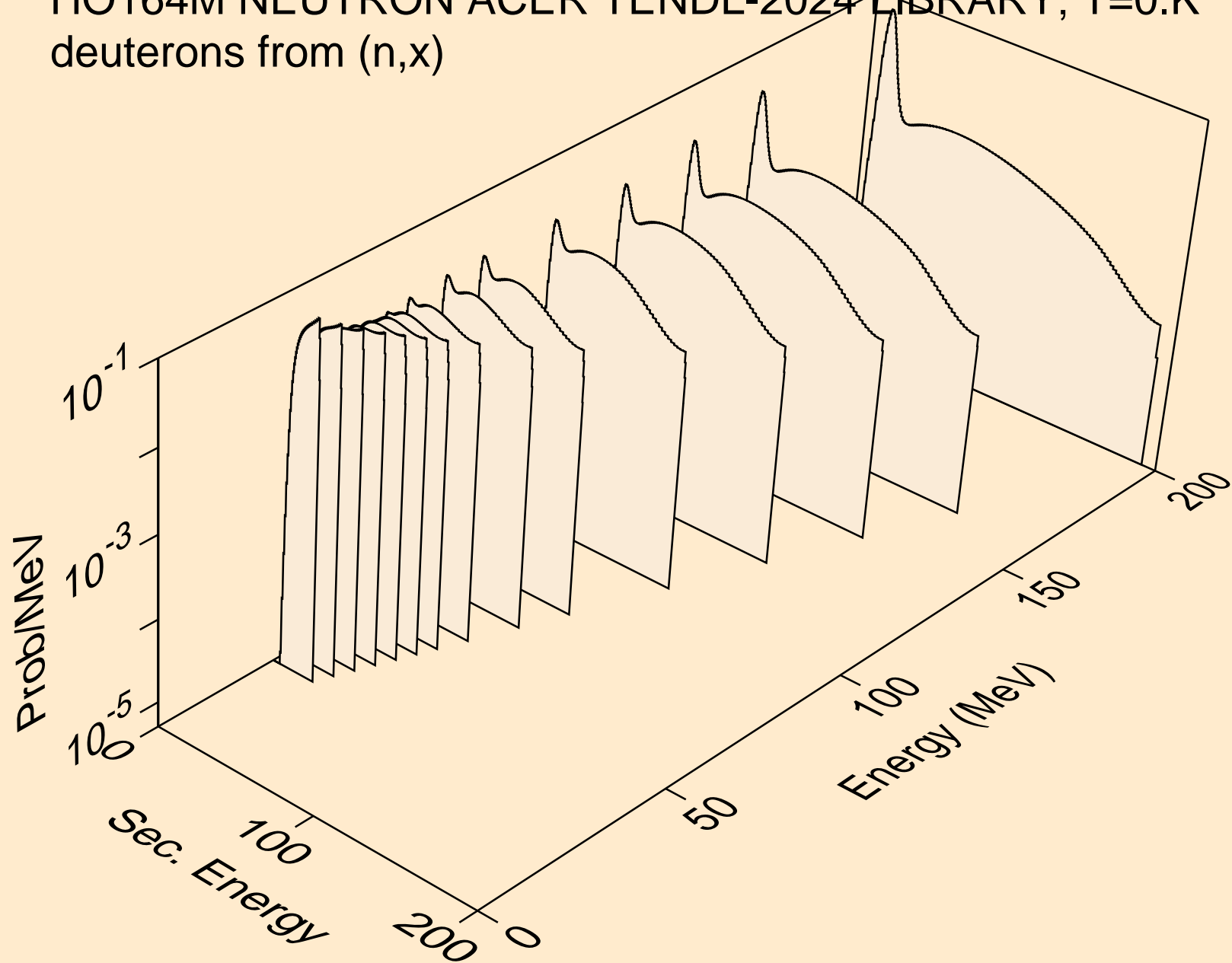

HO164M NEUTRON ACER TENDL-2024 LIBRARY; T=0.K  
deuterons from (n,2nd)

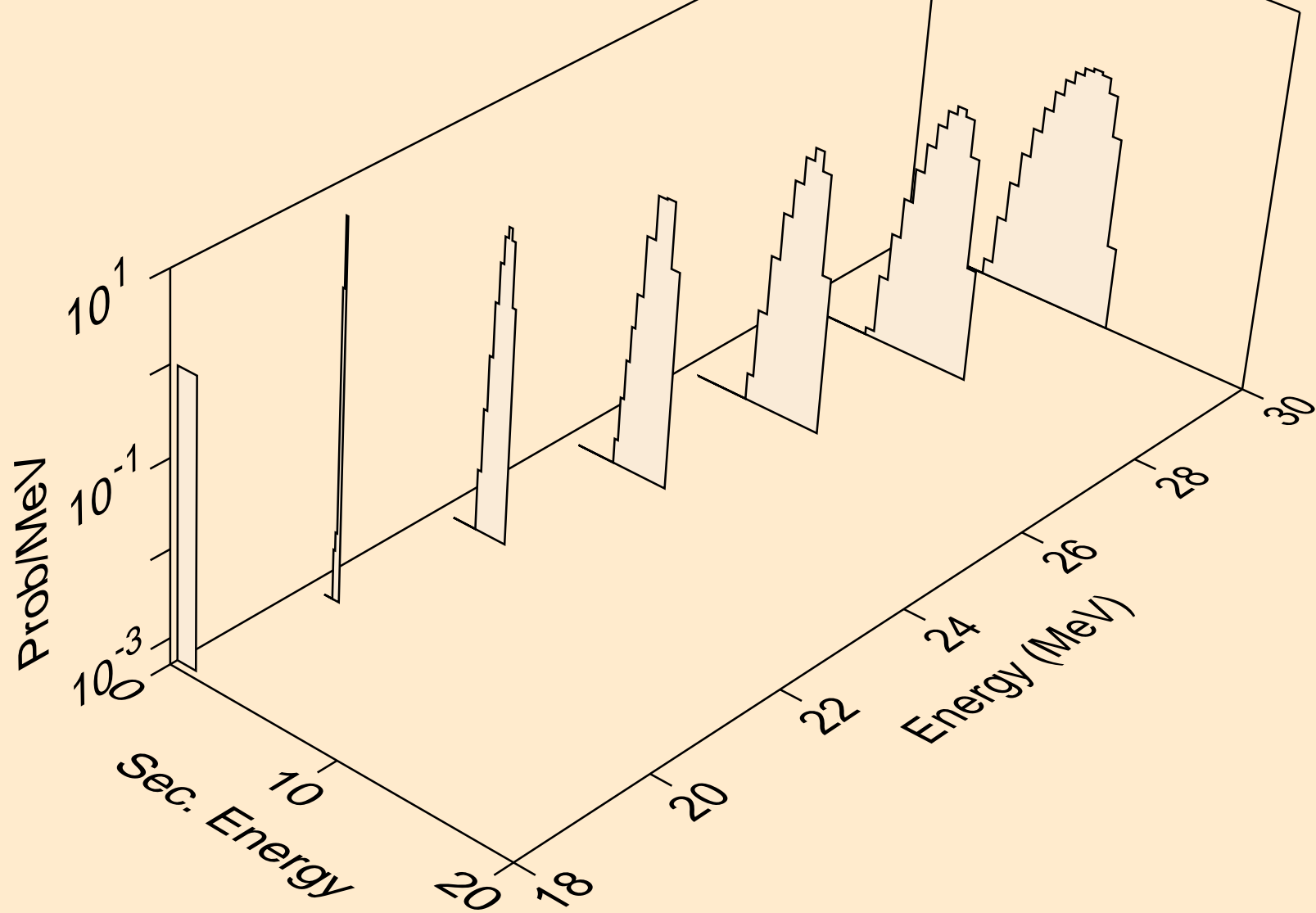

HO164M NEUTRON ACER TENDL-2024 LIBRARY; T=0.K  
deuterons from (n,n\*)d

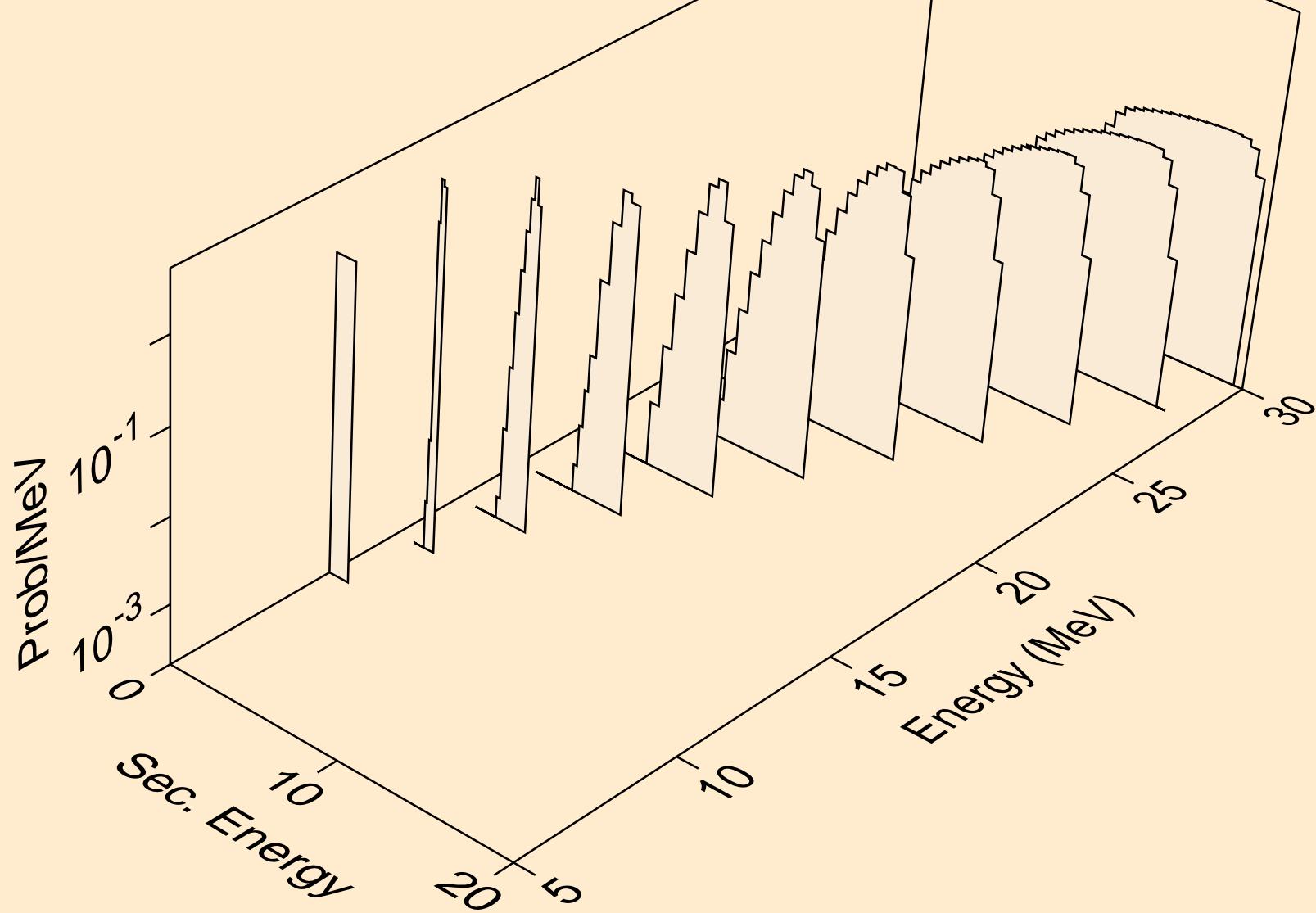

HO164M NEUTRON ACER TENDL-2024 LIBRARY; T=0.K  
deuterons from (n,d)

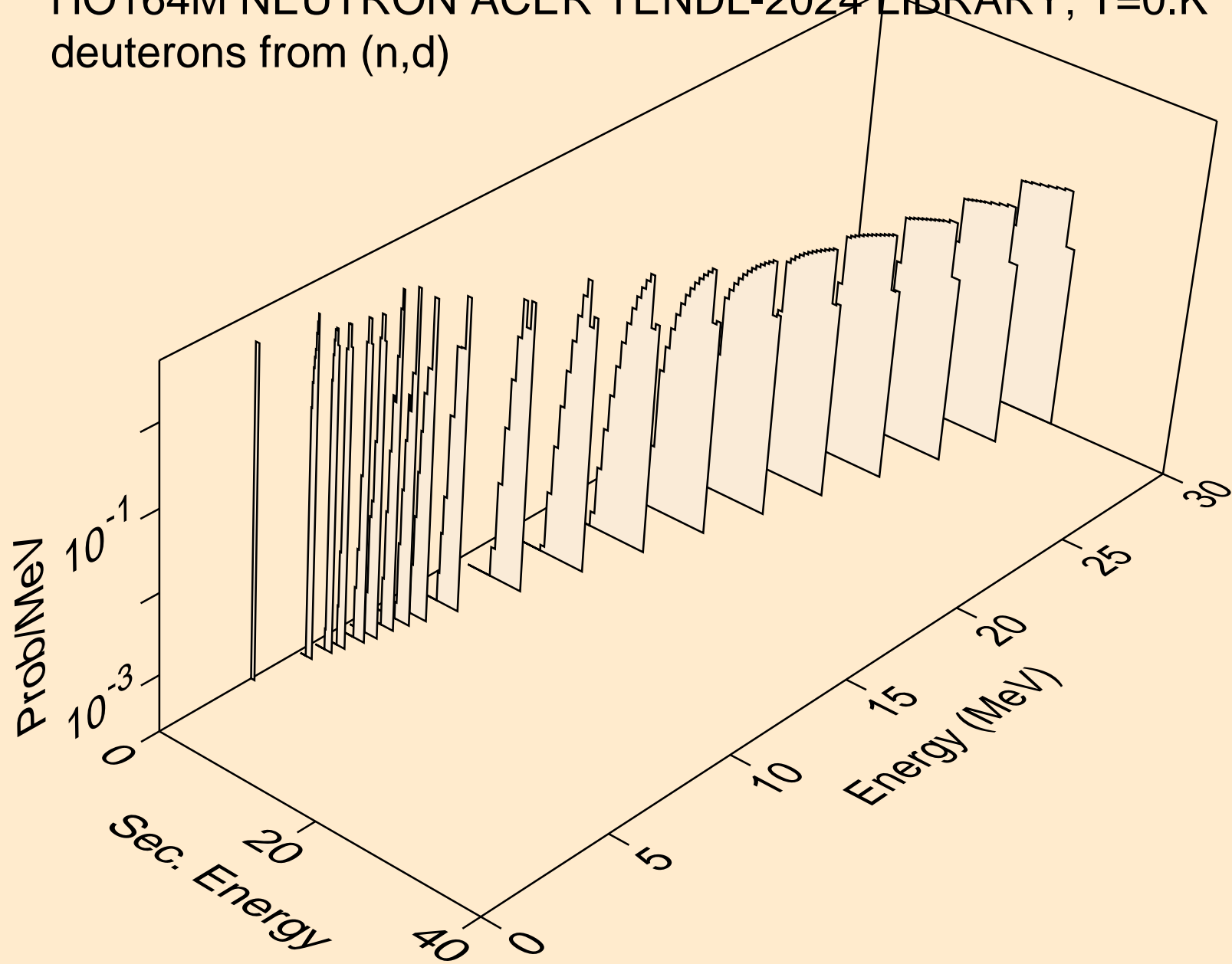

HO164M NEUTRON ACER TENDL-2024 LIBRARY; T=0.K  
deuterons from (n,pd)

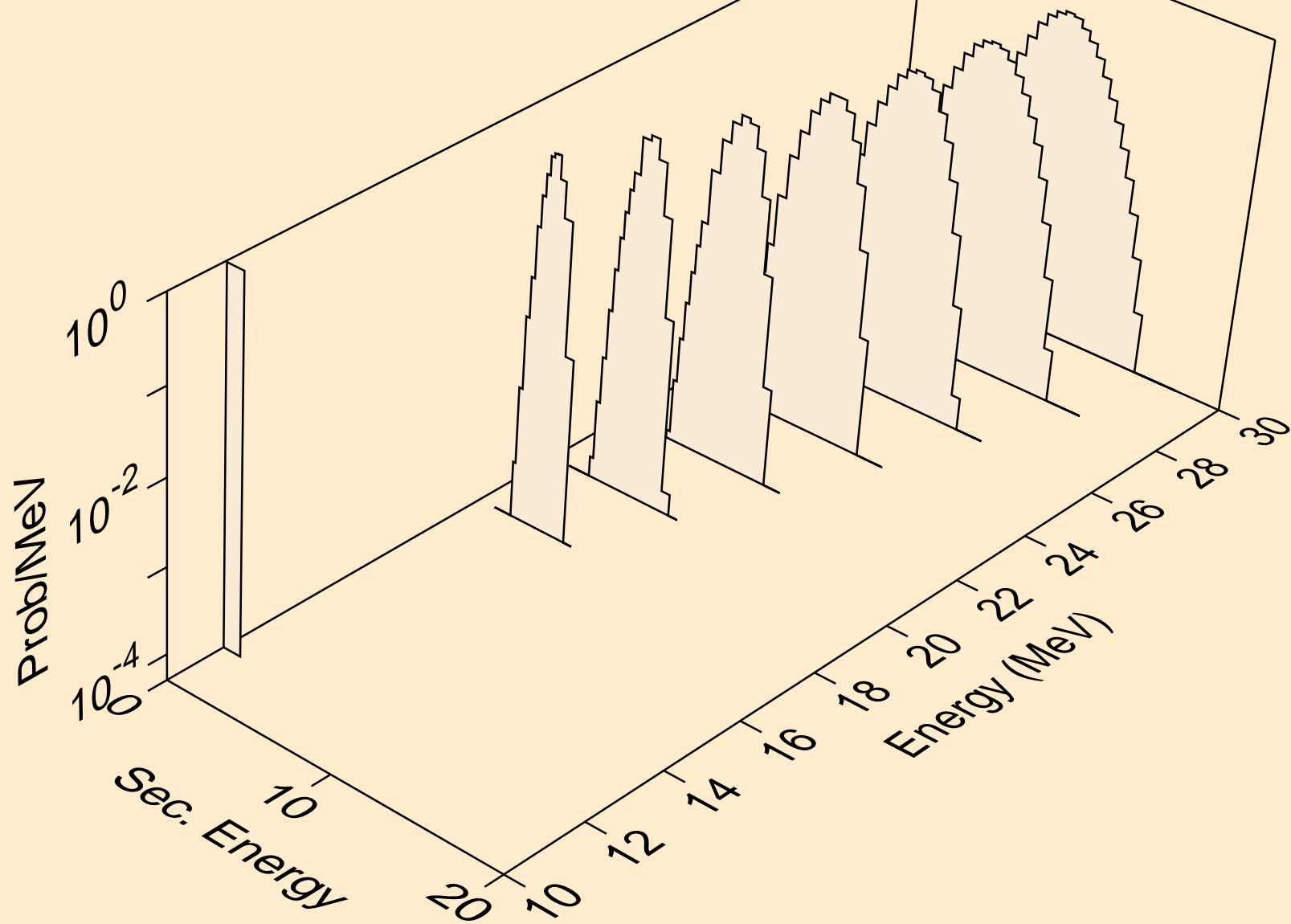

HO164M NEUTRON ACER TENDL-2024 LIBRARY; T=0.K  
deuterons from (n,da)

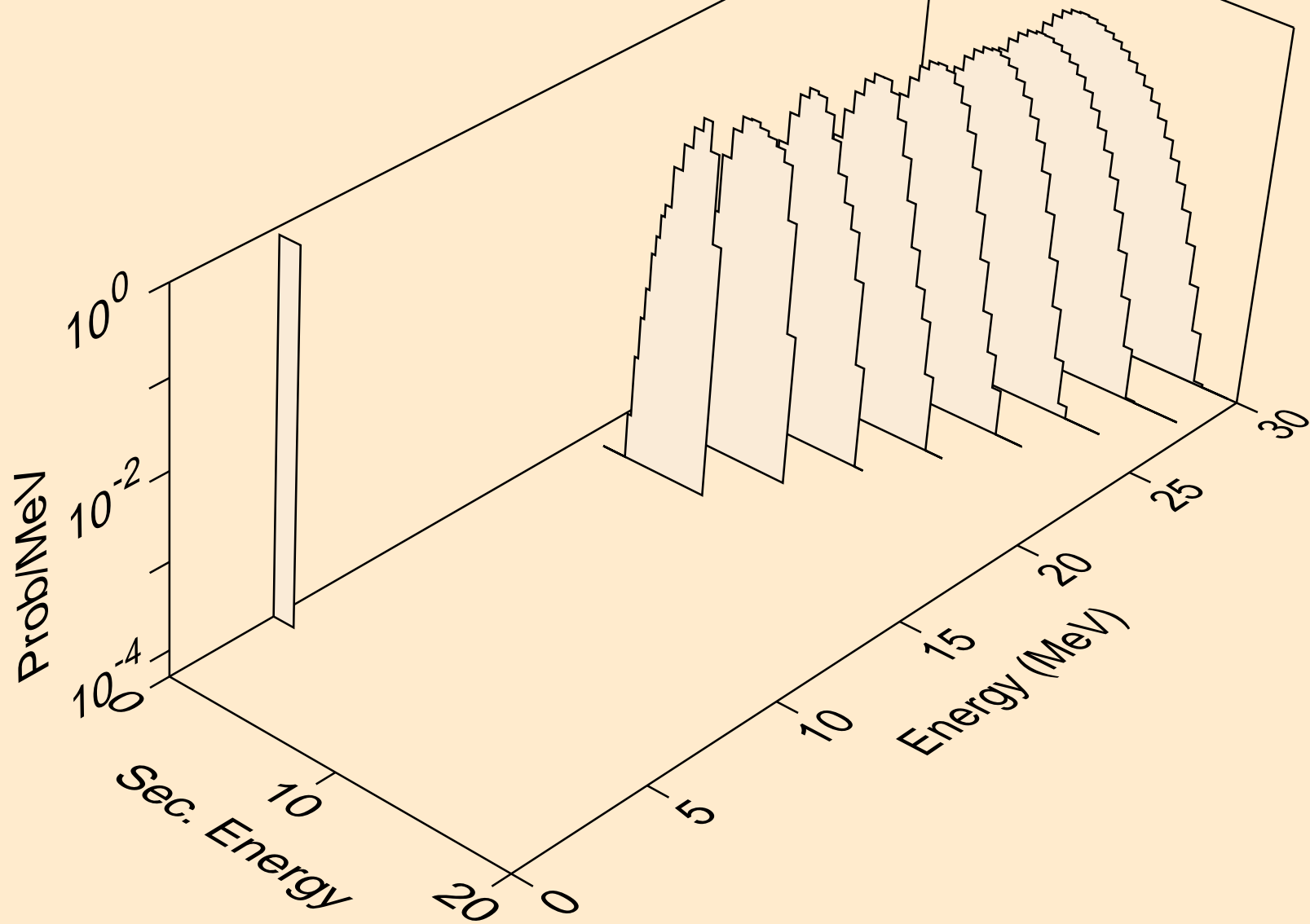

HO164M NEUTRON ACER TENDL-2024 LIBRARY; T=0.K  
tritons from (n,x)

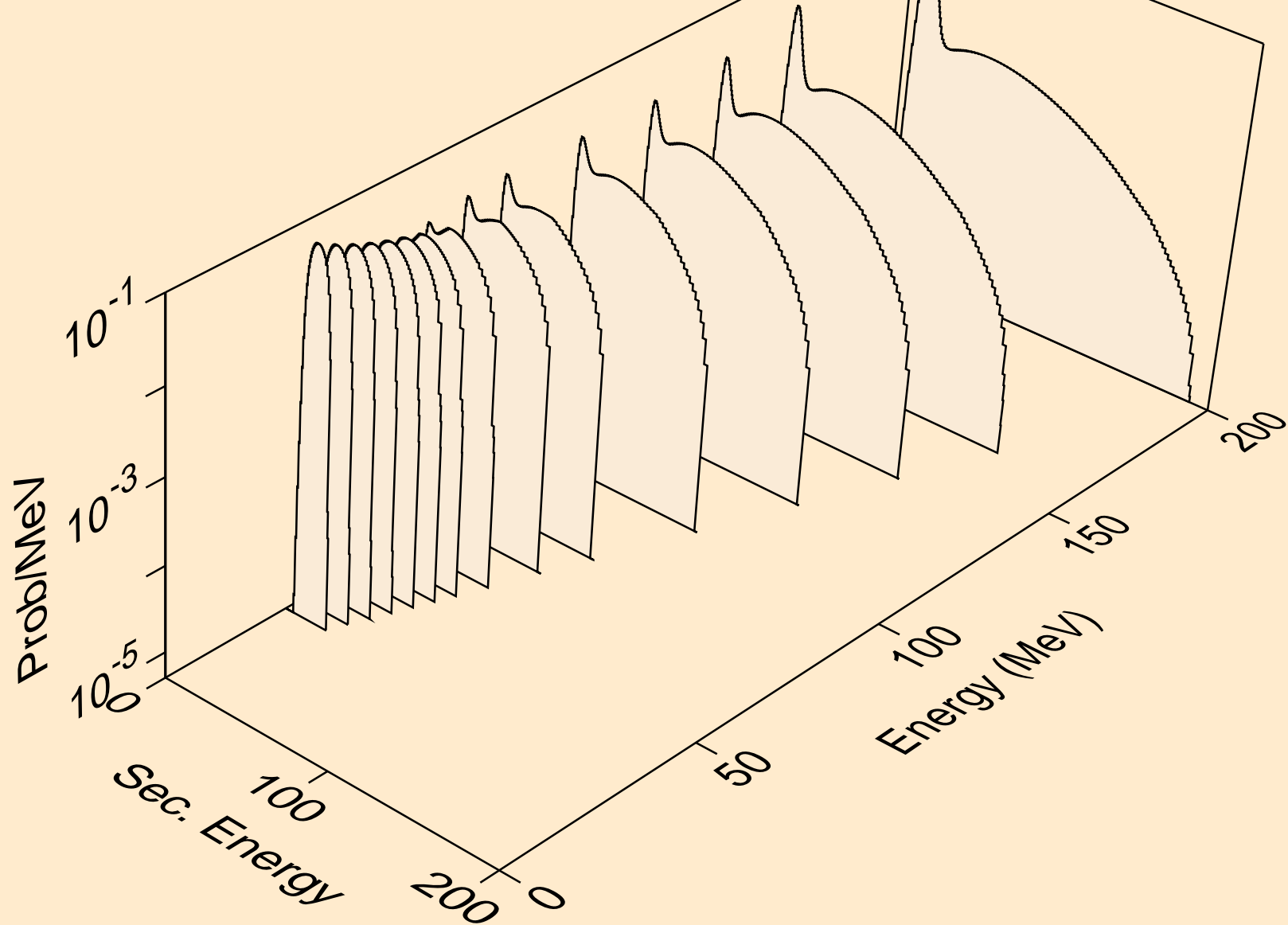



HO164M NEUTRON ACER TENDL-2024 LIBRARY; T=0.K  
tritons from (n,t)

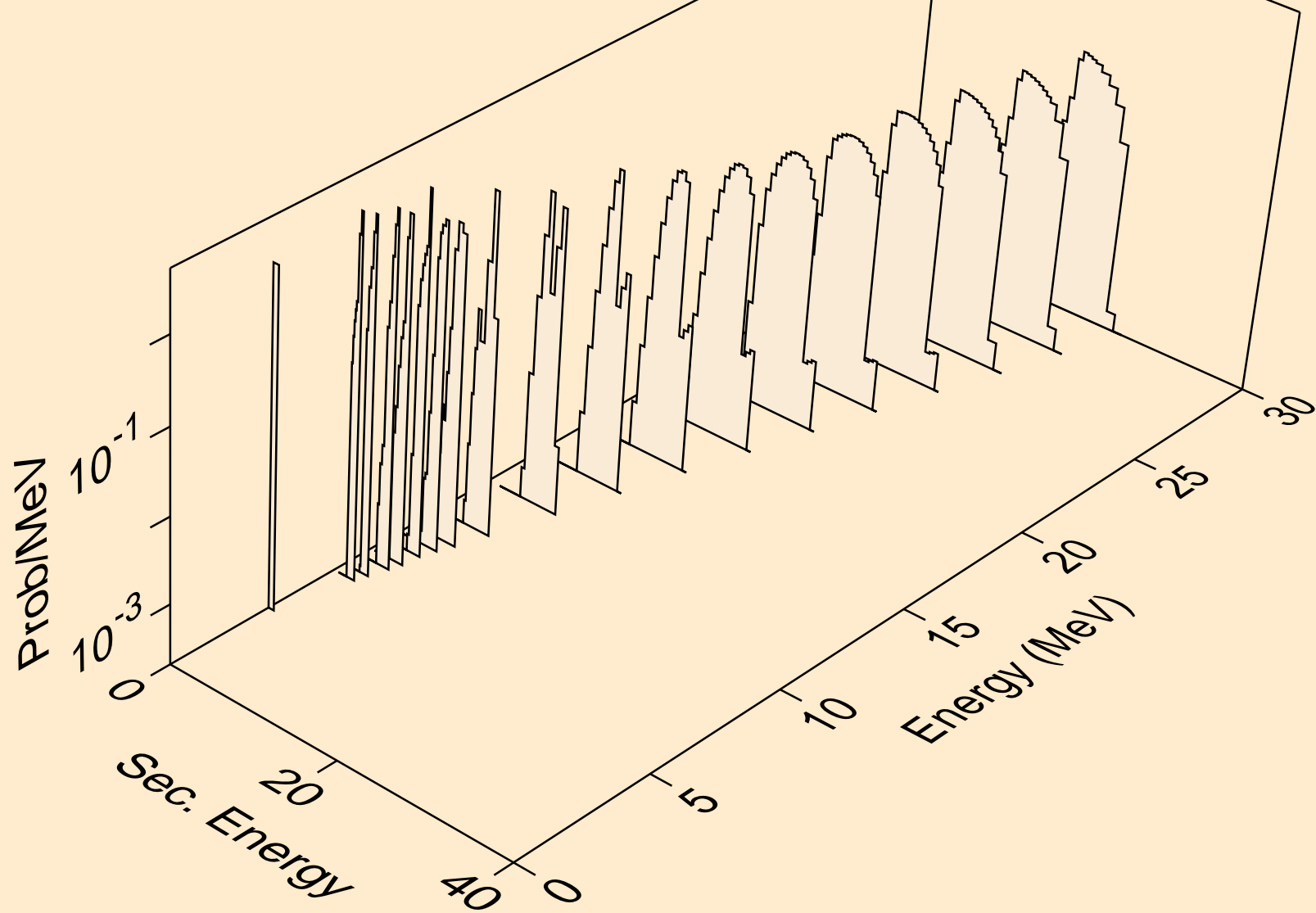

HO164M NEUTRON ACER TENDL-2024 LIBRARY; T=0.K  
tritons from (n,pt)

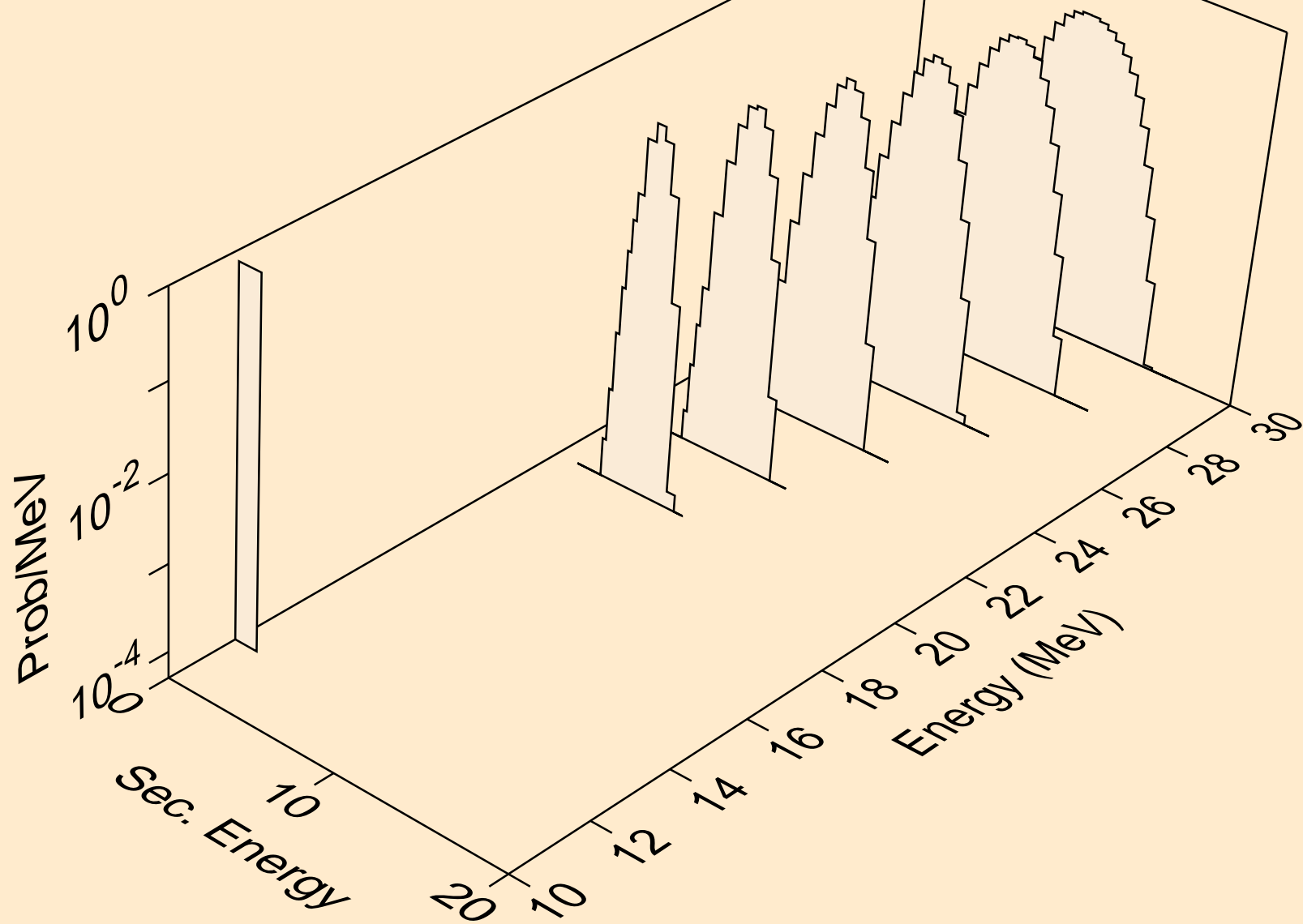

HO164M NEUTRON ACER TENDL-2024 LIBRARY; T=0.K  
he3s from (n,x)

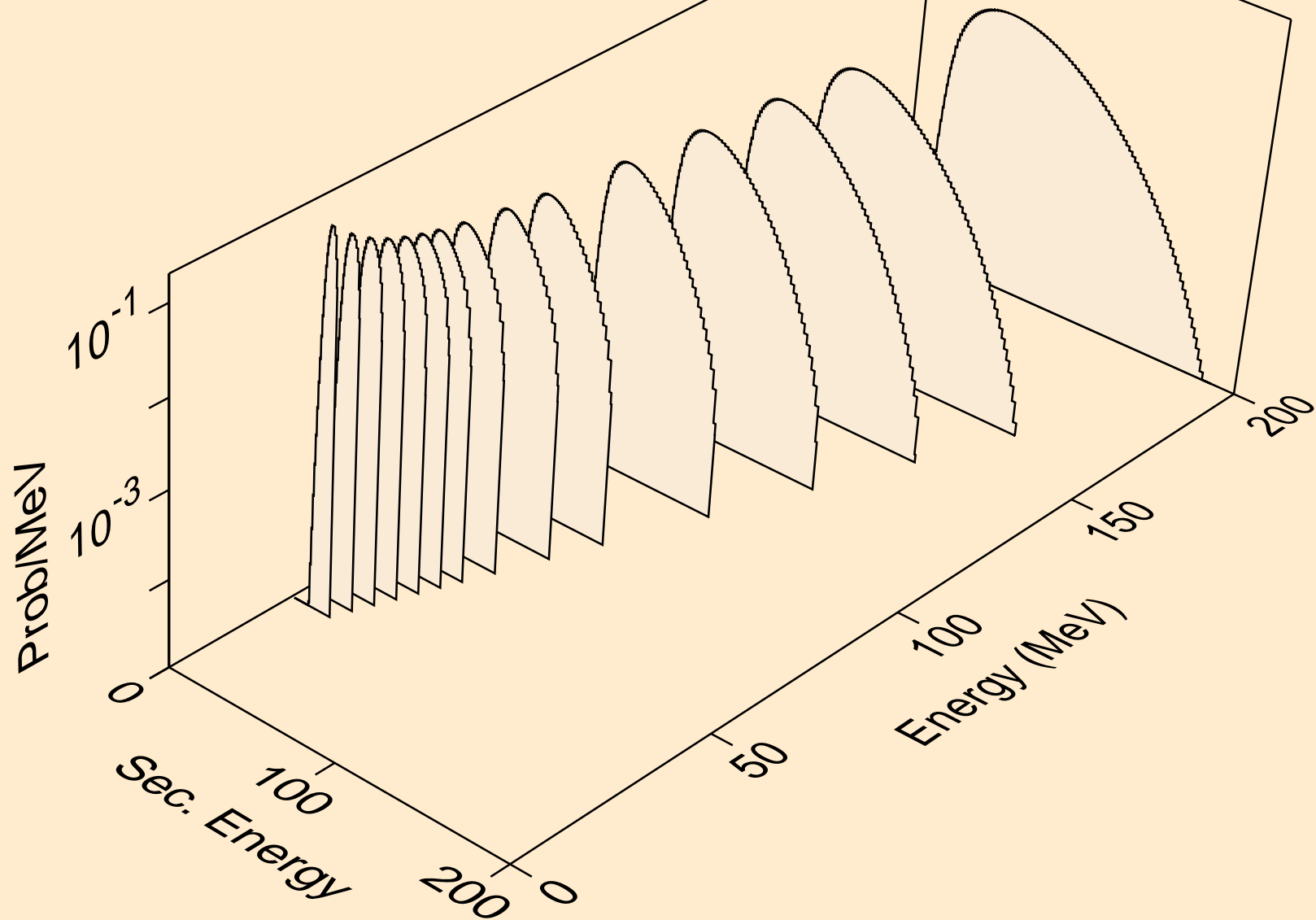

HO164M NEUTRON ACER TENDL-2024 LIBRARY; T=0.K  
he3s from (n,n\*)he3

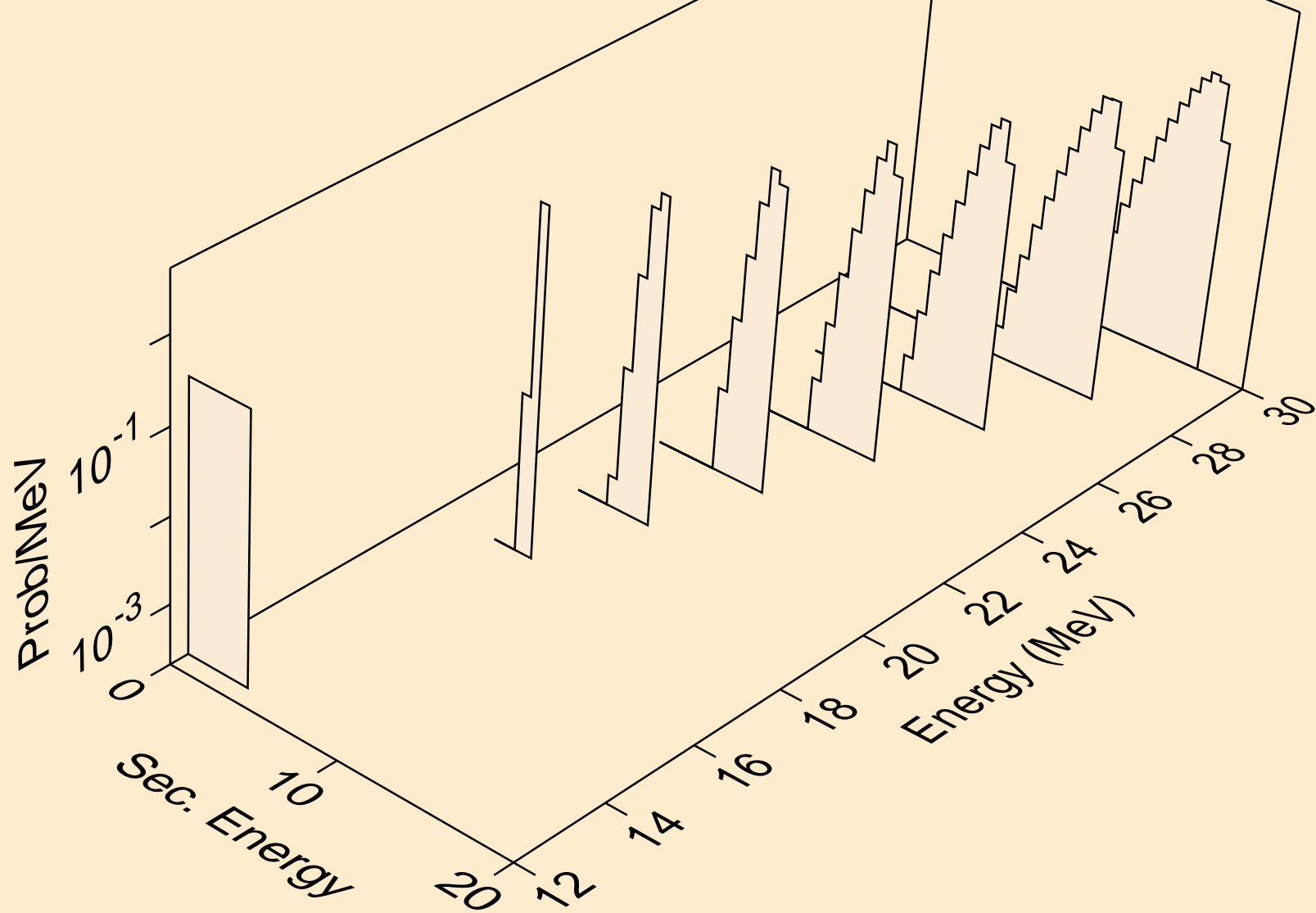

HO164M NEUTRON ACER TENDL-2024 LIBRARY; T=0.K  
he3s from (n,he3)

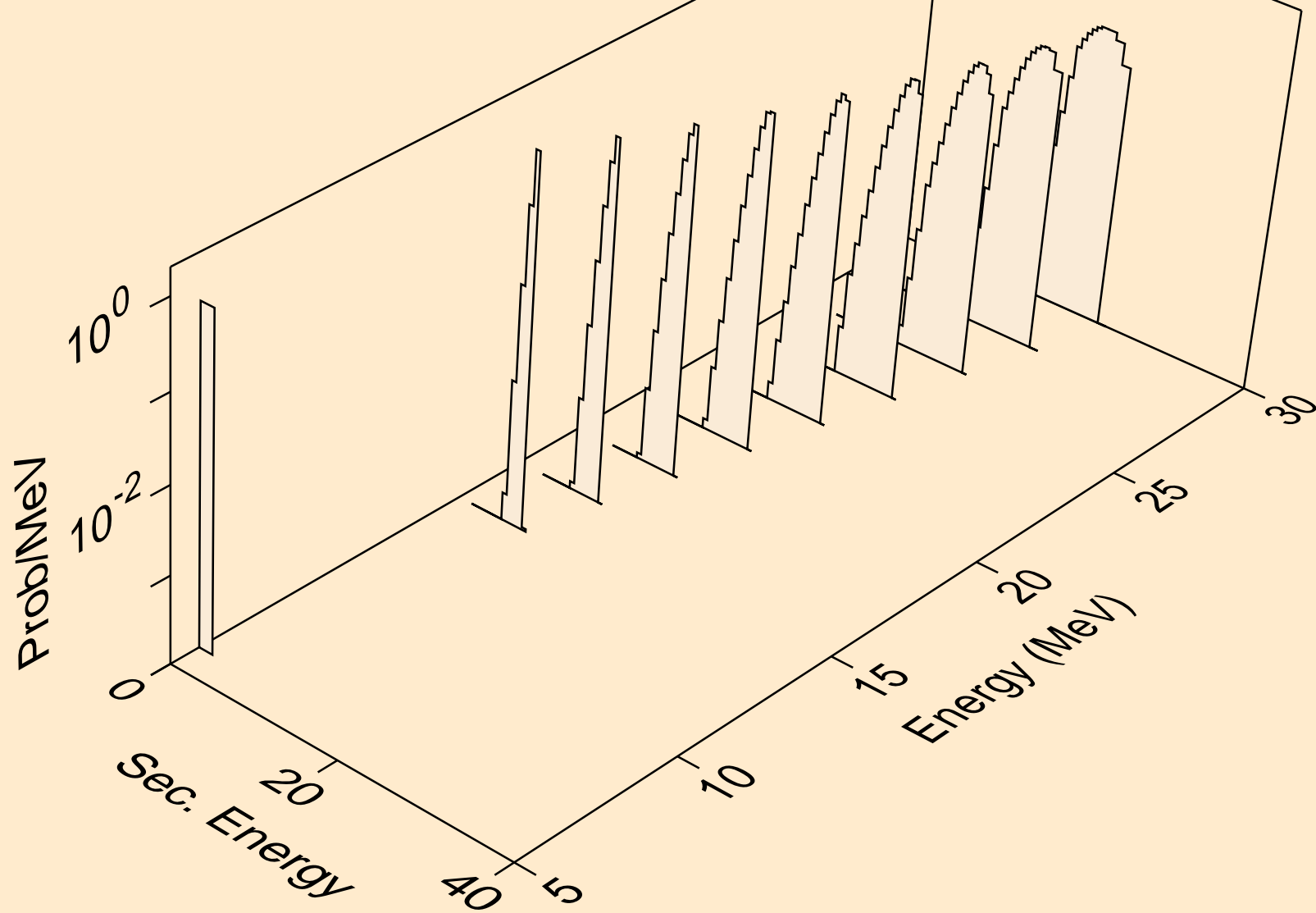

HO164M NEUTRON ACER TENDL-2024 LIBRARY; T=0.K  
alphas from (n,x)

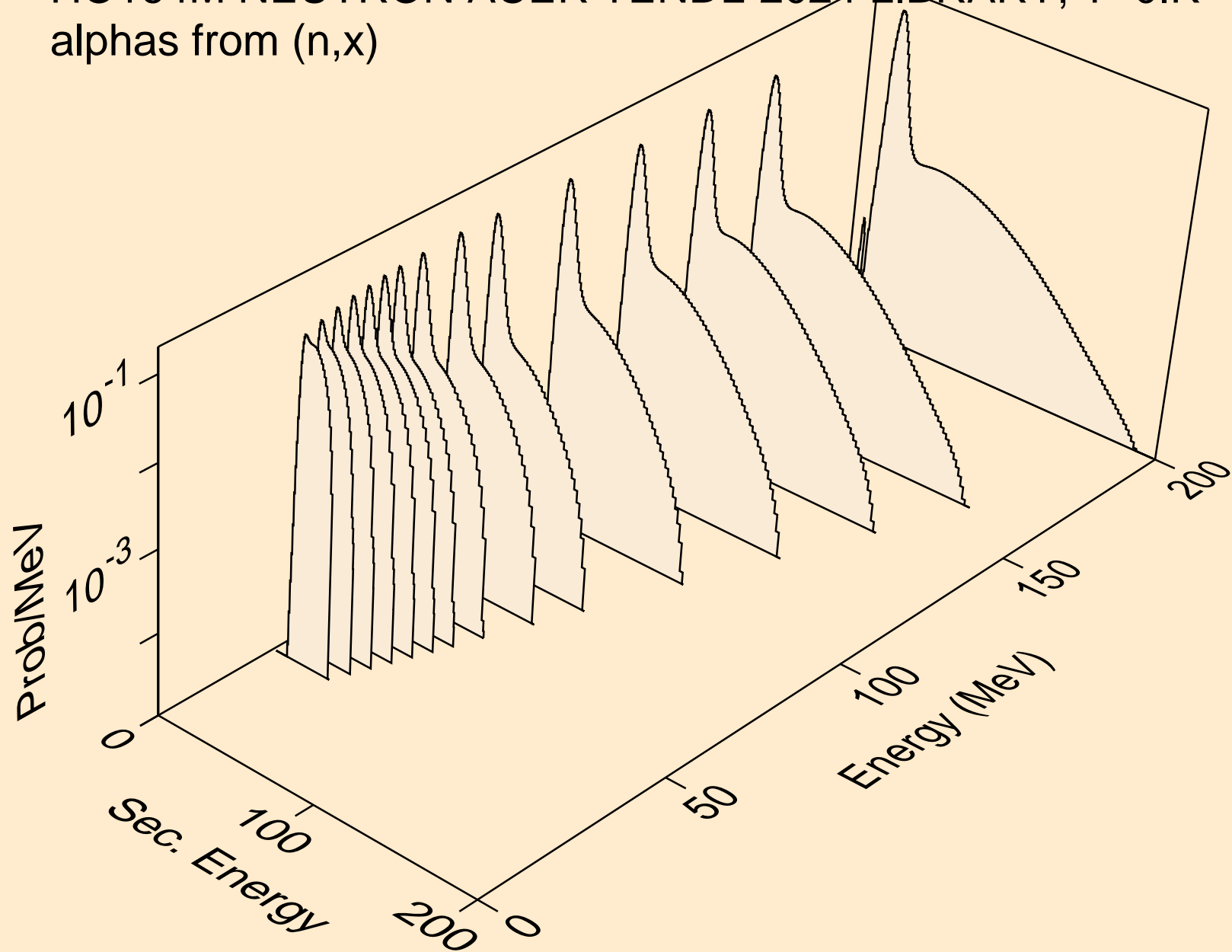

HO164M NEUTRON ACER TENDL-2024 LIBRARY; T=0.K  
alphas from (n,n\*)a

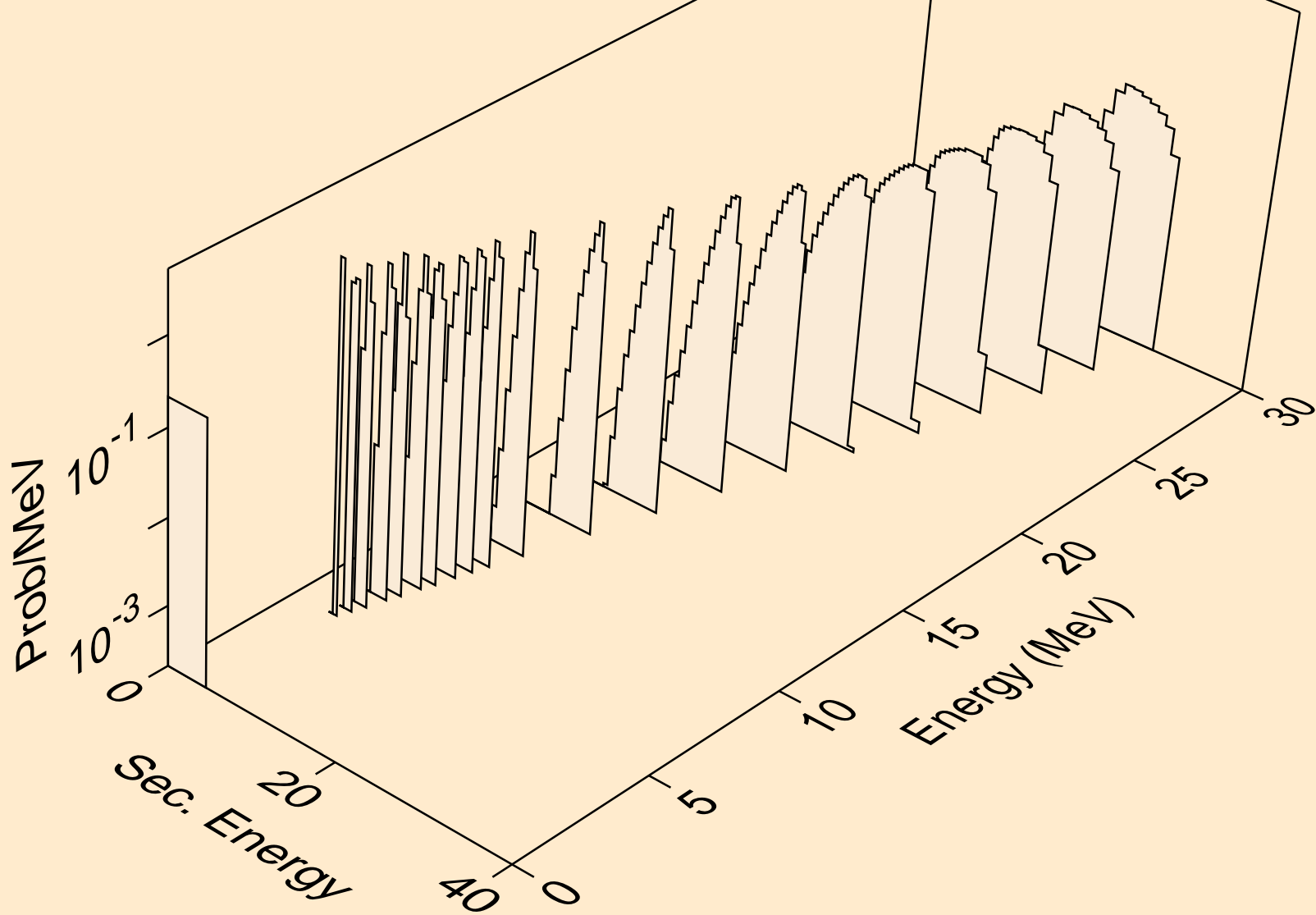

HO164M NEUTRON ACER TENDL-2024 LIBRARY; T=0.K  
alphas from (n,2n)a

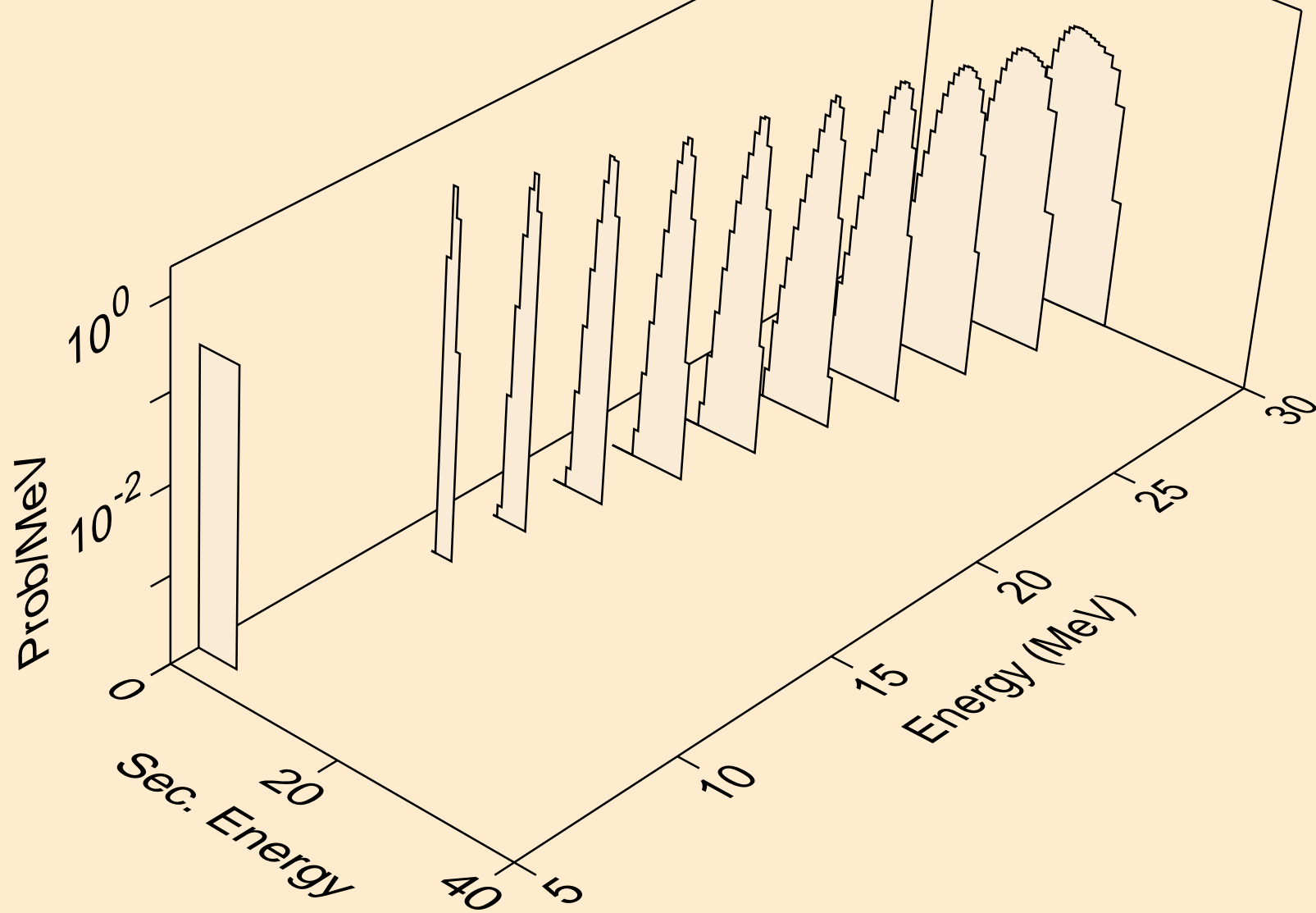

HO164M NEUTRON ACER TENDL-2024 LIBRARY; T=0.K  
alphas from (n,3n)a

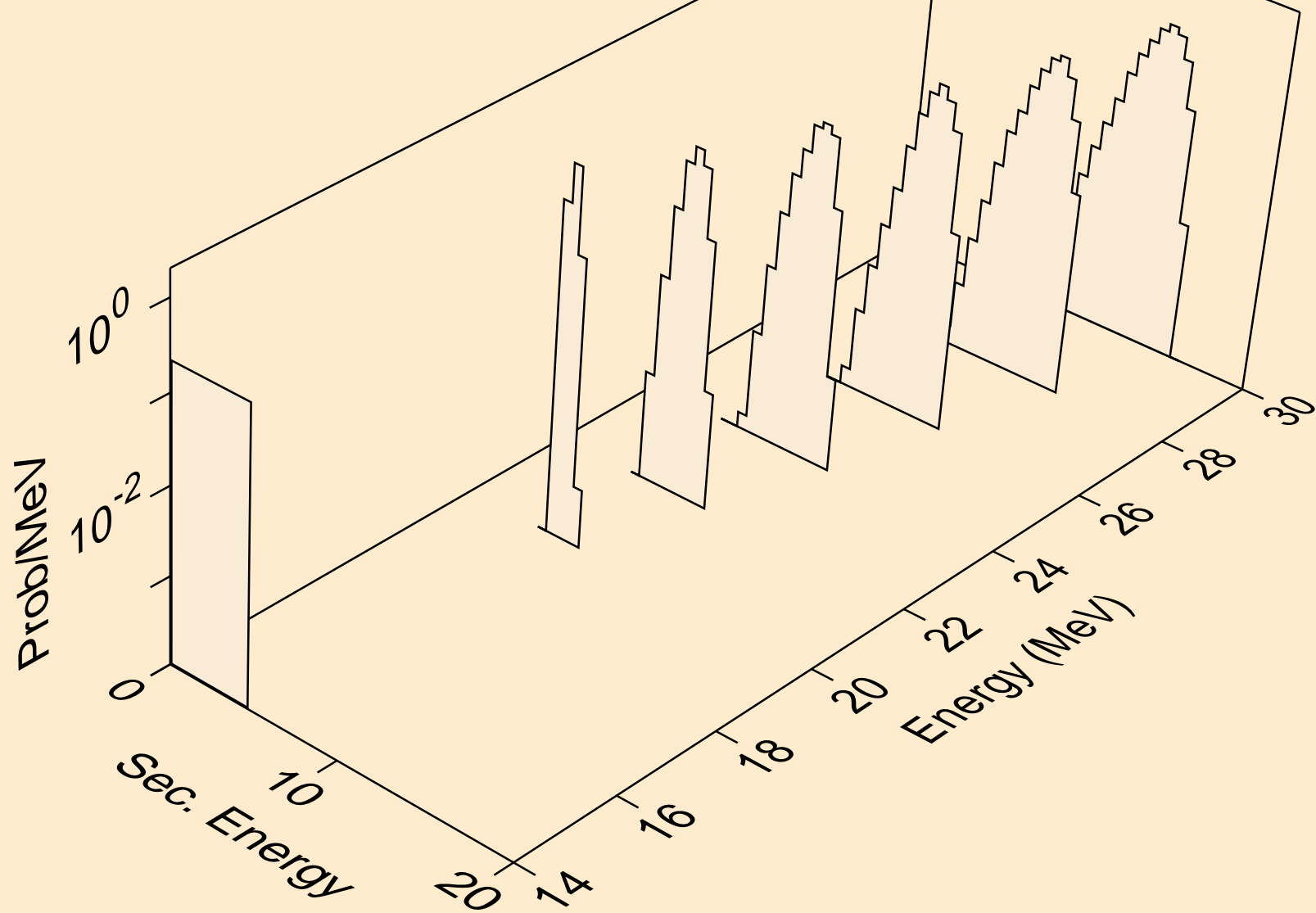

HO164M NEUTRON ACER TENDL-2024 LIBRARY; T=0.K  
alphas from (n,n\*)2a

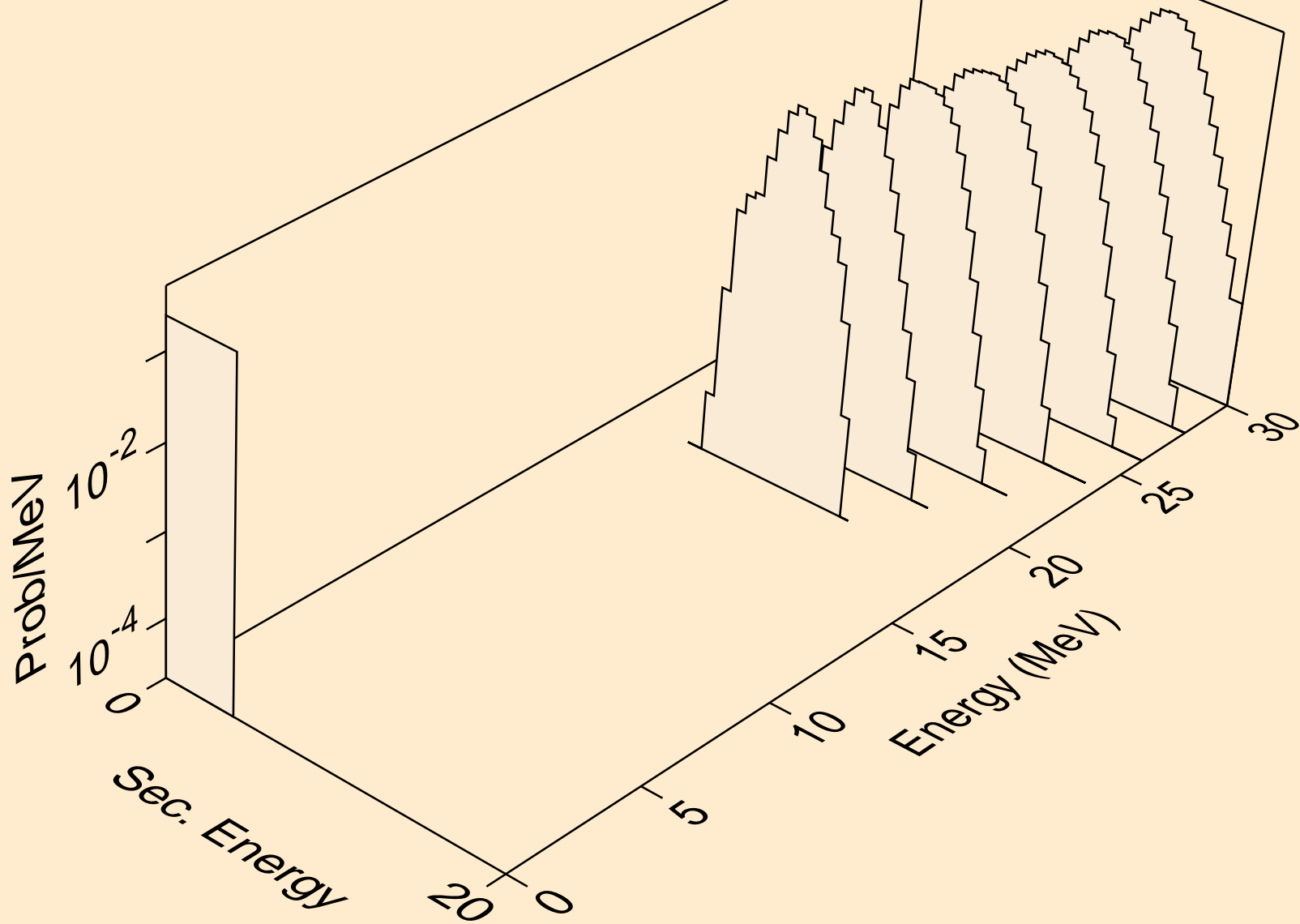

HO164M NEUTRON ACER TENDL-2024 LIBRARY; T=0.K  
alphas from (n,npa)

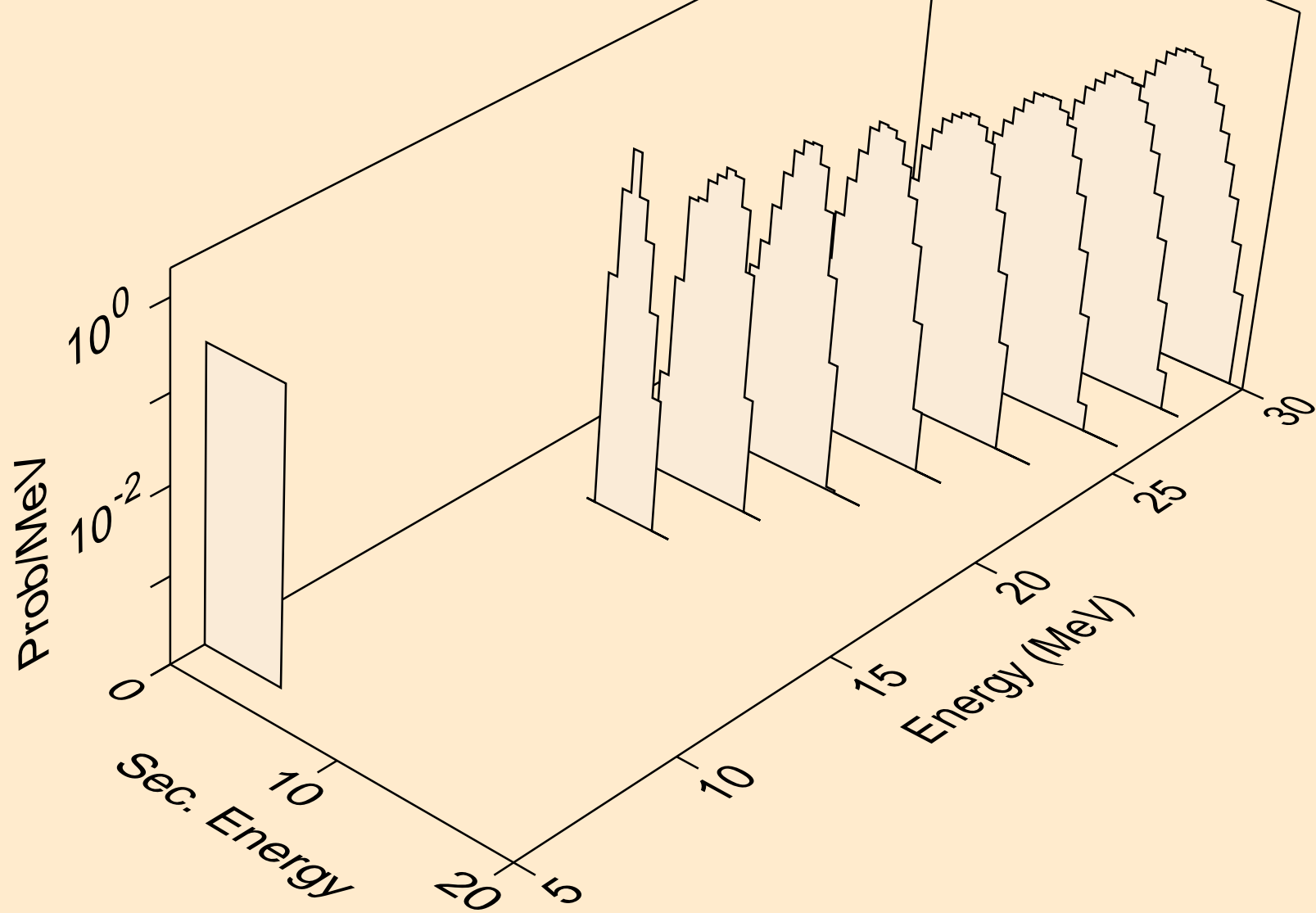

HO164M NEUTRON ACER TENDL-2024 LIBRARY; T=0.K  
alphas from (n,a)

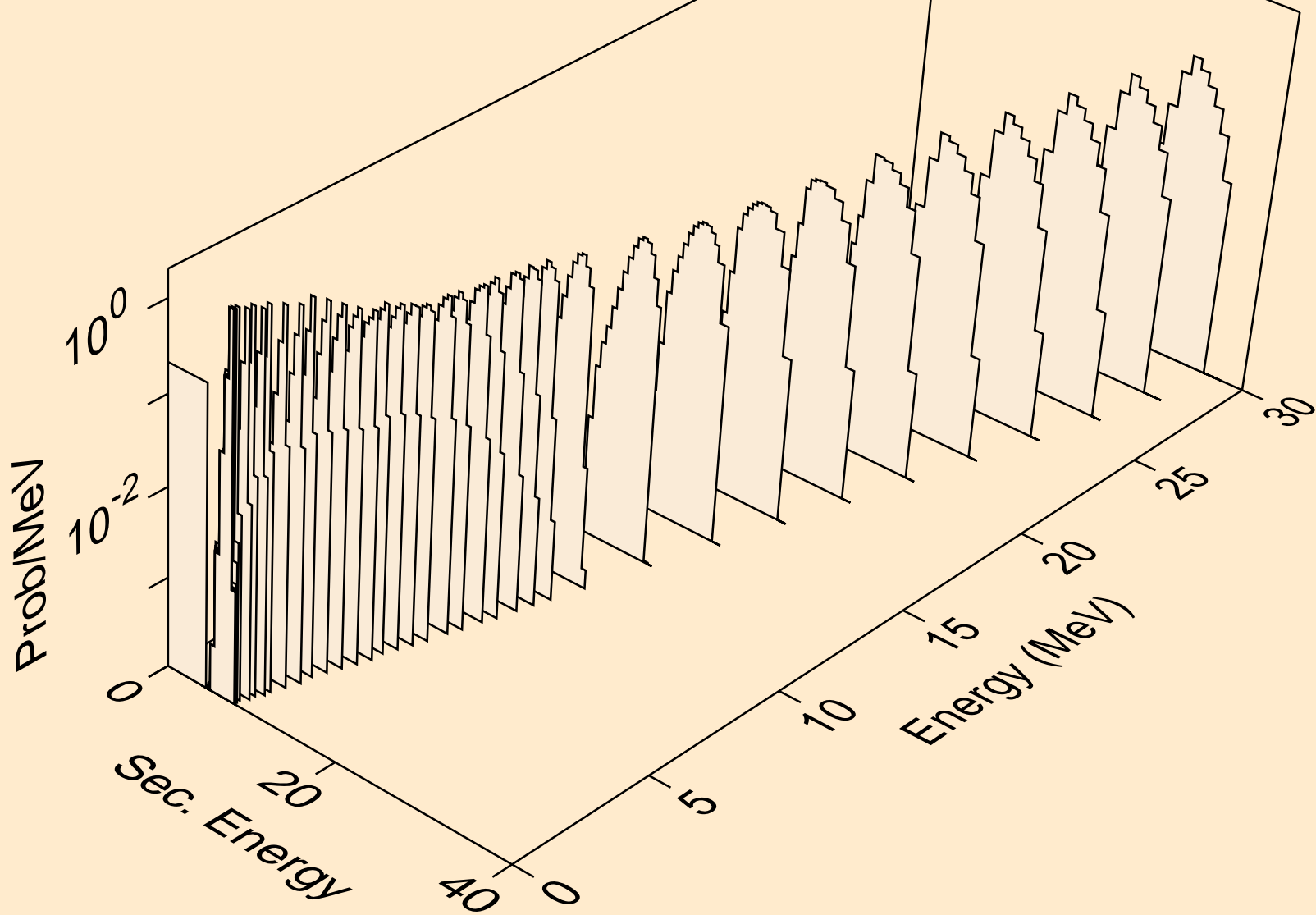

HO164M NEUTRON ACER TENDL-2024 LIBRARY; T=0.K  
alphas from (n,2a)

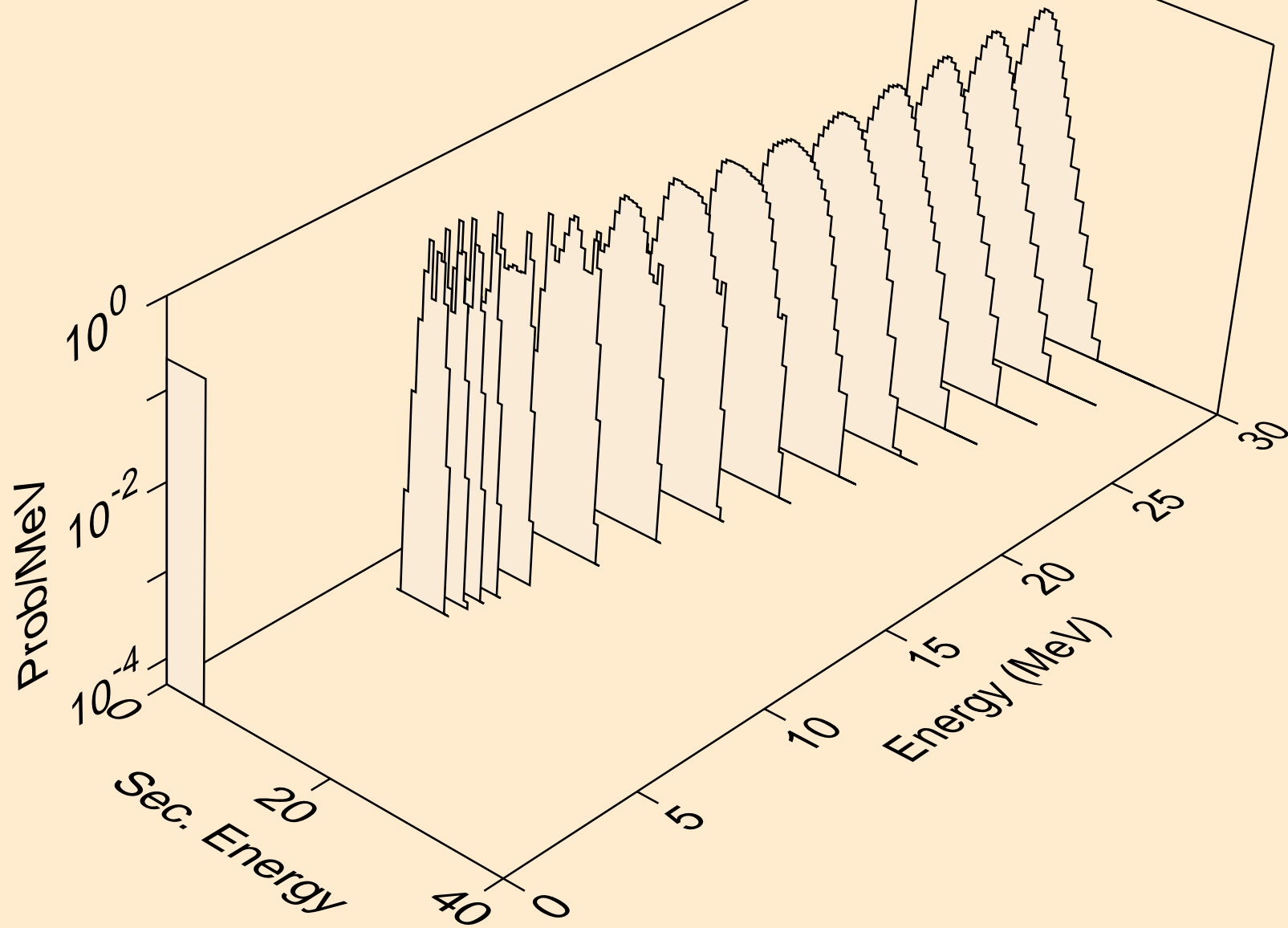

HO164M NEUTRON ACER TENDL-2024 LIBRARY; T=0.K  
alphas from (n,pa)

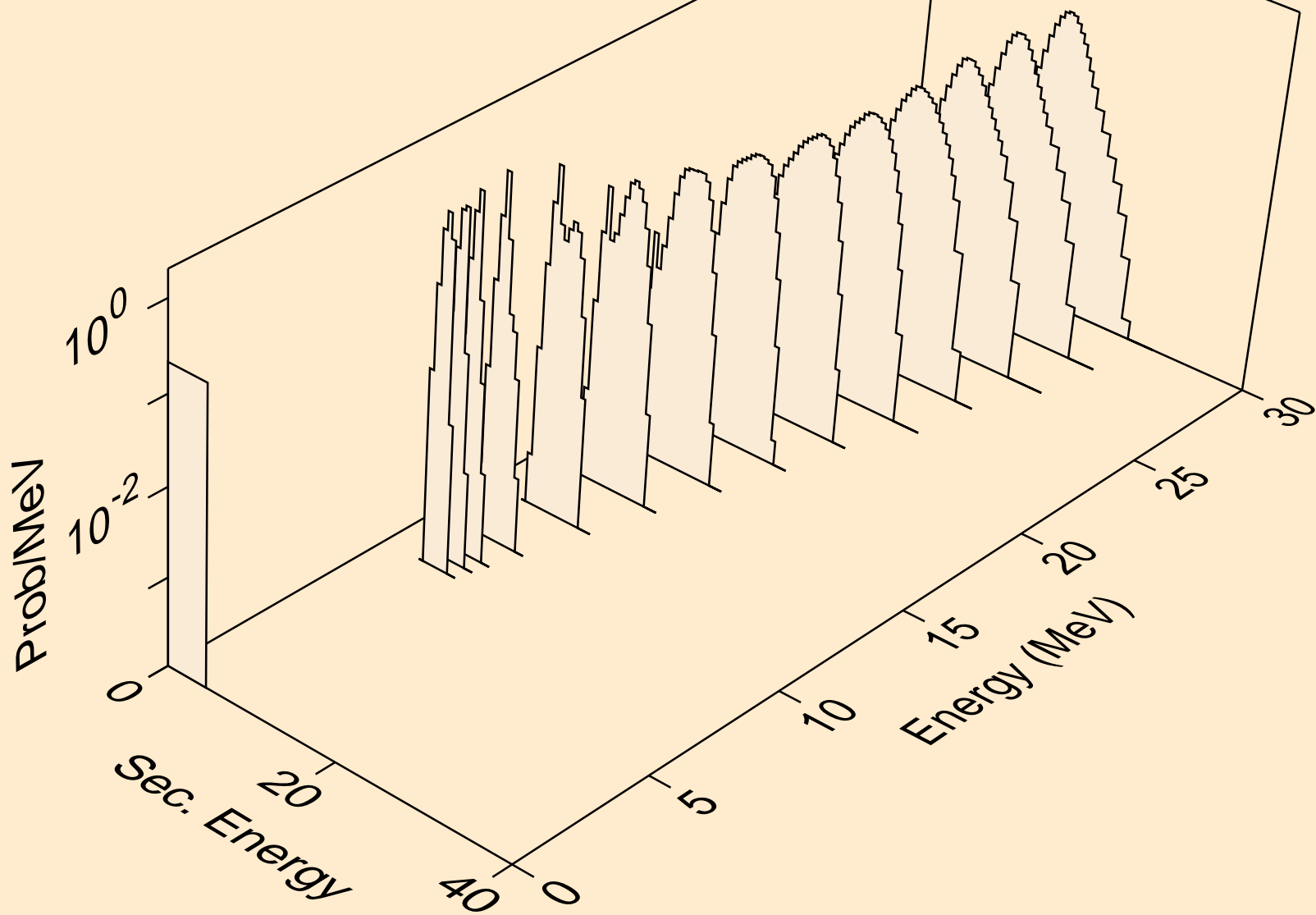

HO164M NEUTRON ACER TENDL-2024 LIBRARY; T=0.K  
alphas from (n,da)

