

# I132 NEUTRON ACER TENDL-2024 LIBRARY; T=0.K

## Principal cross sections

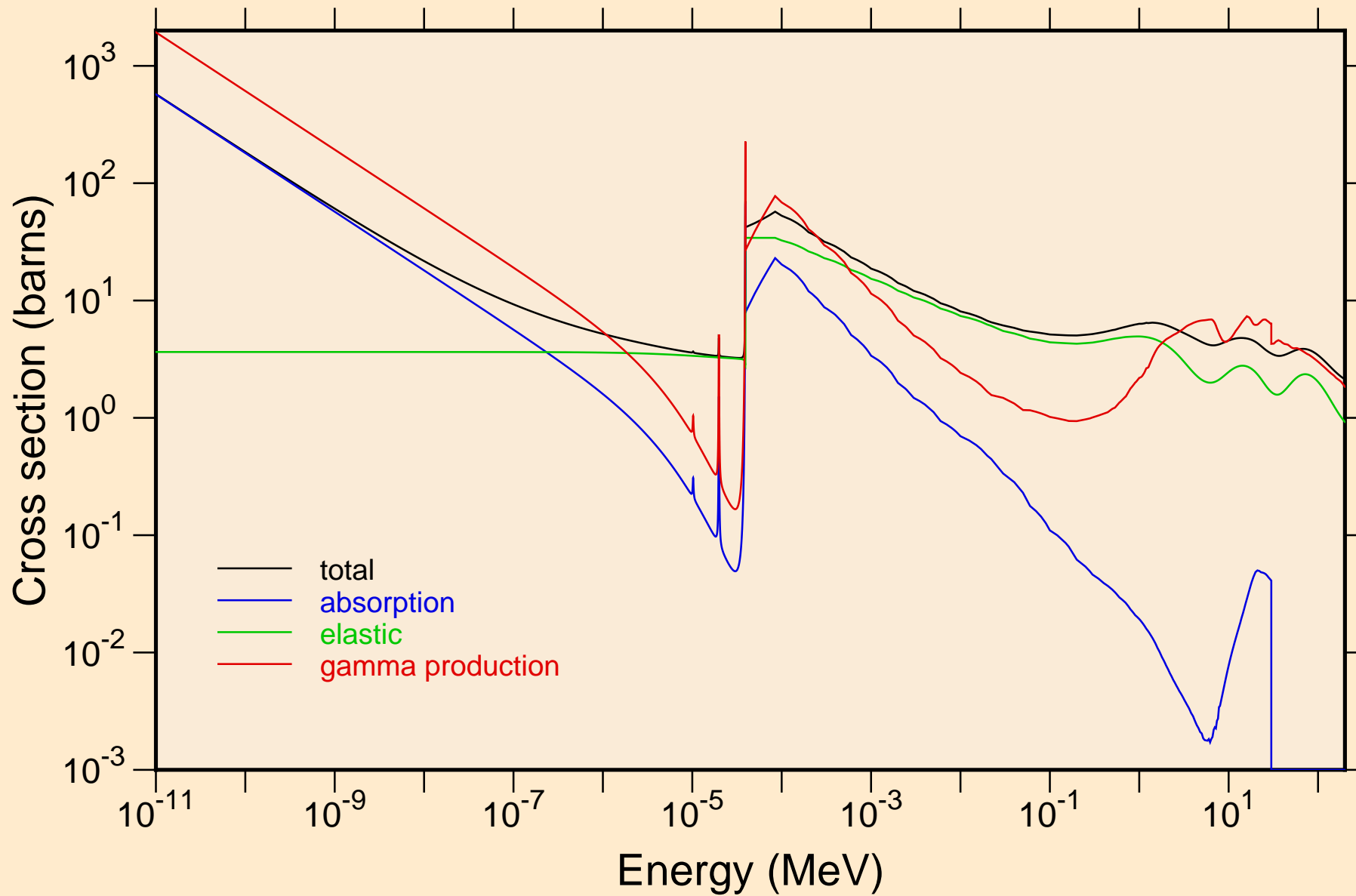

# I132 NEUTRON ACER TENDL-2024 LIBRARY; T=0.K

## Heating

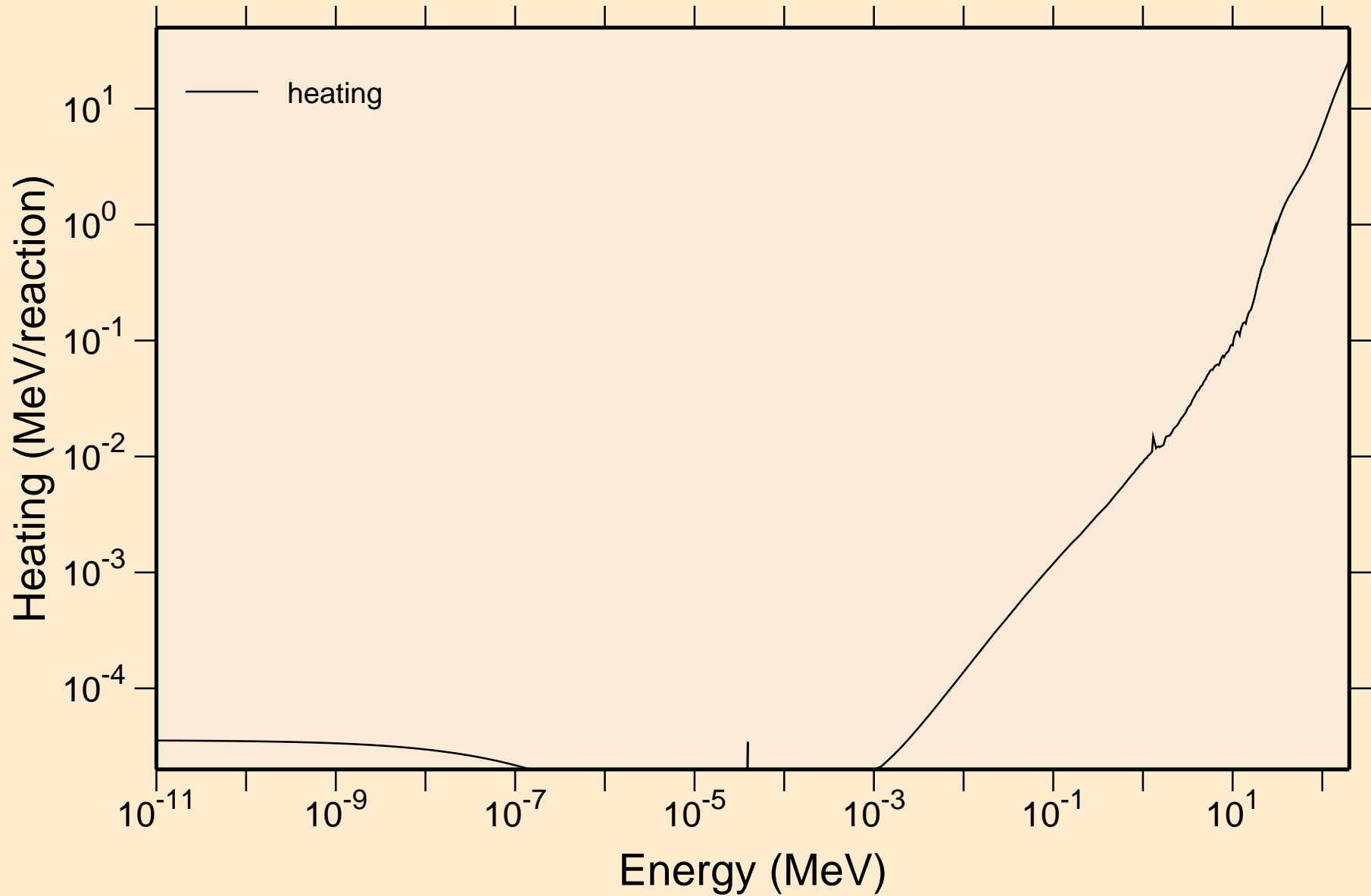

# I132 NEUTRON ACER TENDL-2024 LIBRARY; T=0.K

## Damage

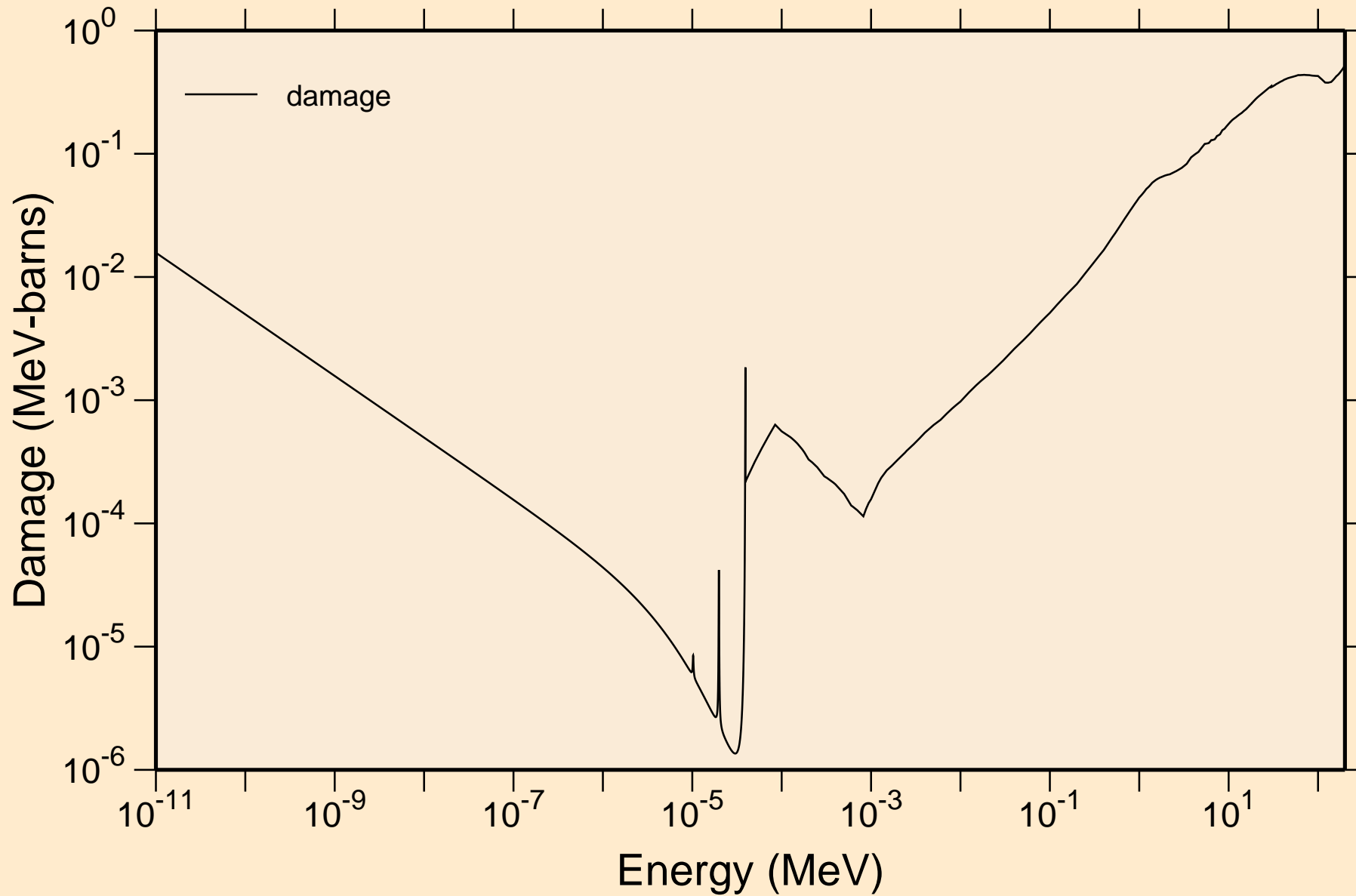

# I132 NEUTRON ACER TENDL-2024 LIBRARY; T=0.K

## Non-threshold reactions

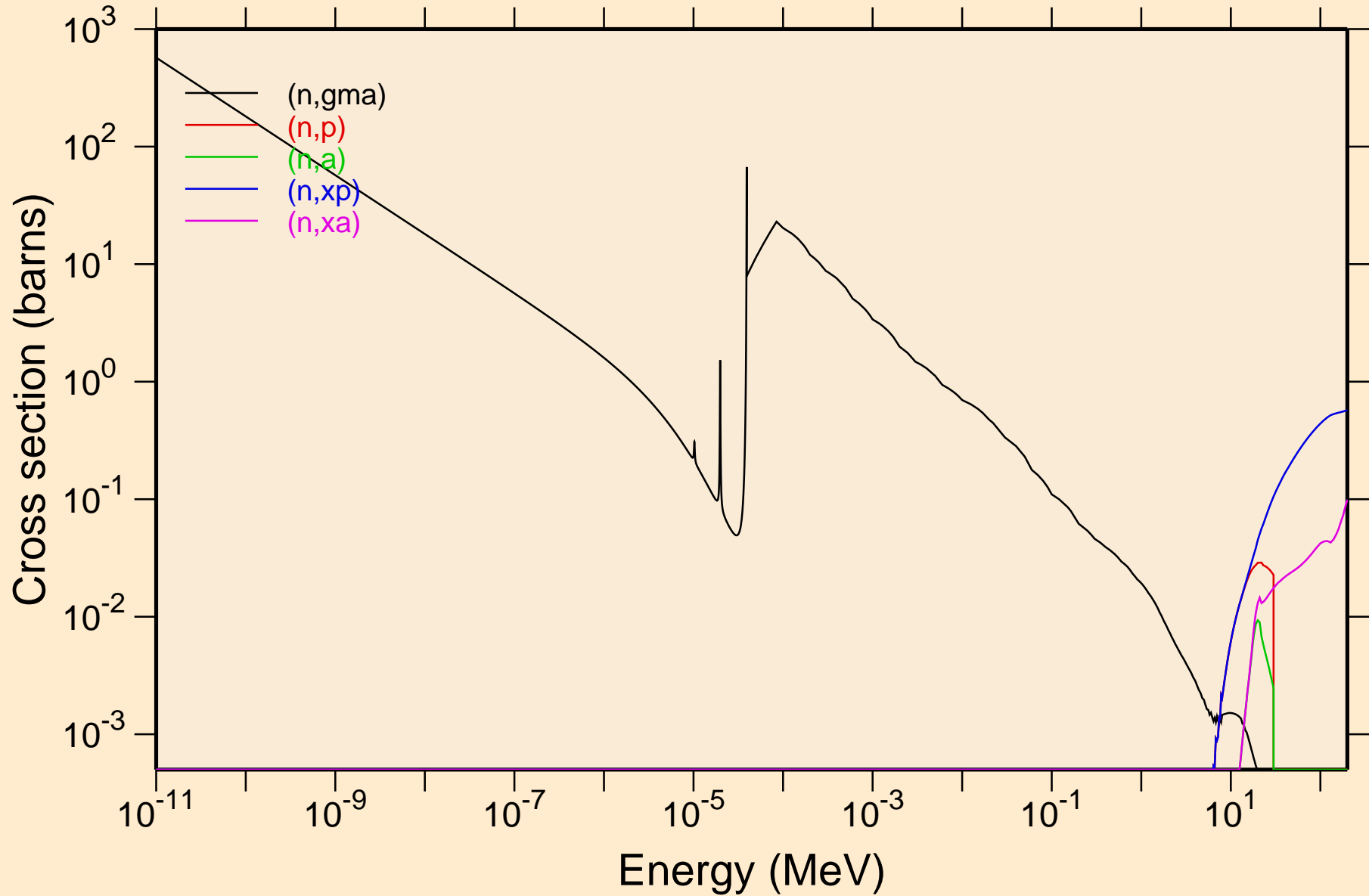

# I132 NEUTRON ACER TENDL-2024 LIBRARY; T=0.K

## Principal cross sections

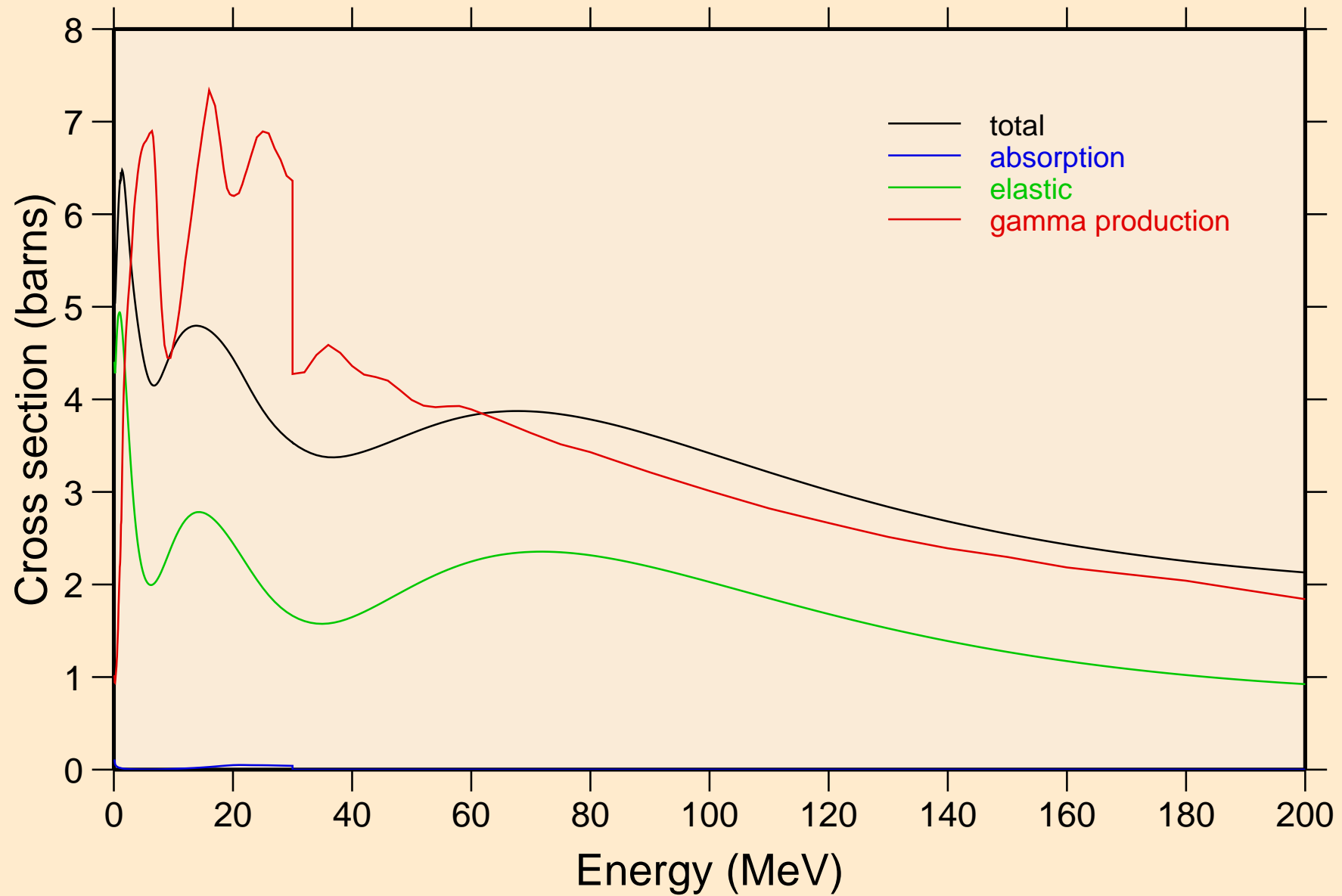

# I132 NEUTRON ACER TENDL-2024 LIBRARY; T=0.K

## Heating

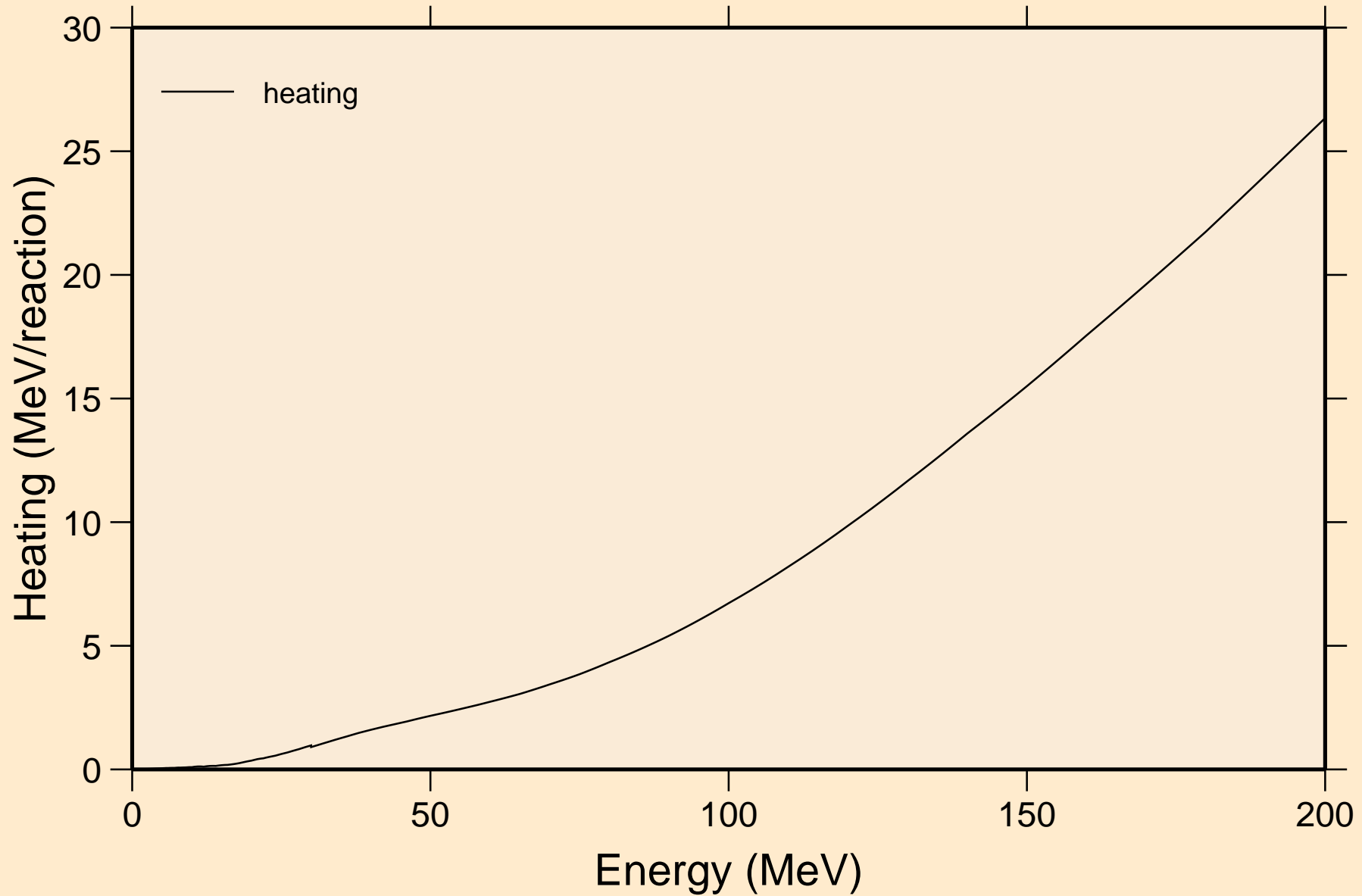

# I132 NEUTRON ACER TENDL-2024 LIBRARY; T=0.K

## Damage

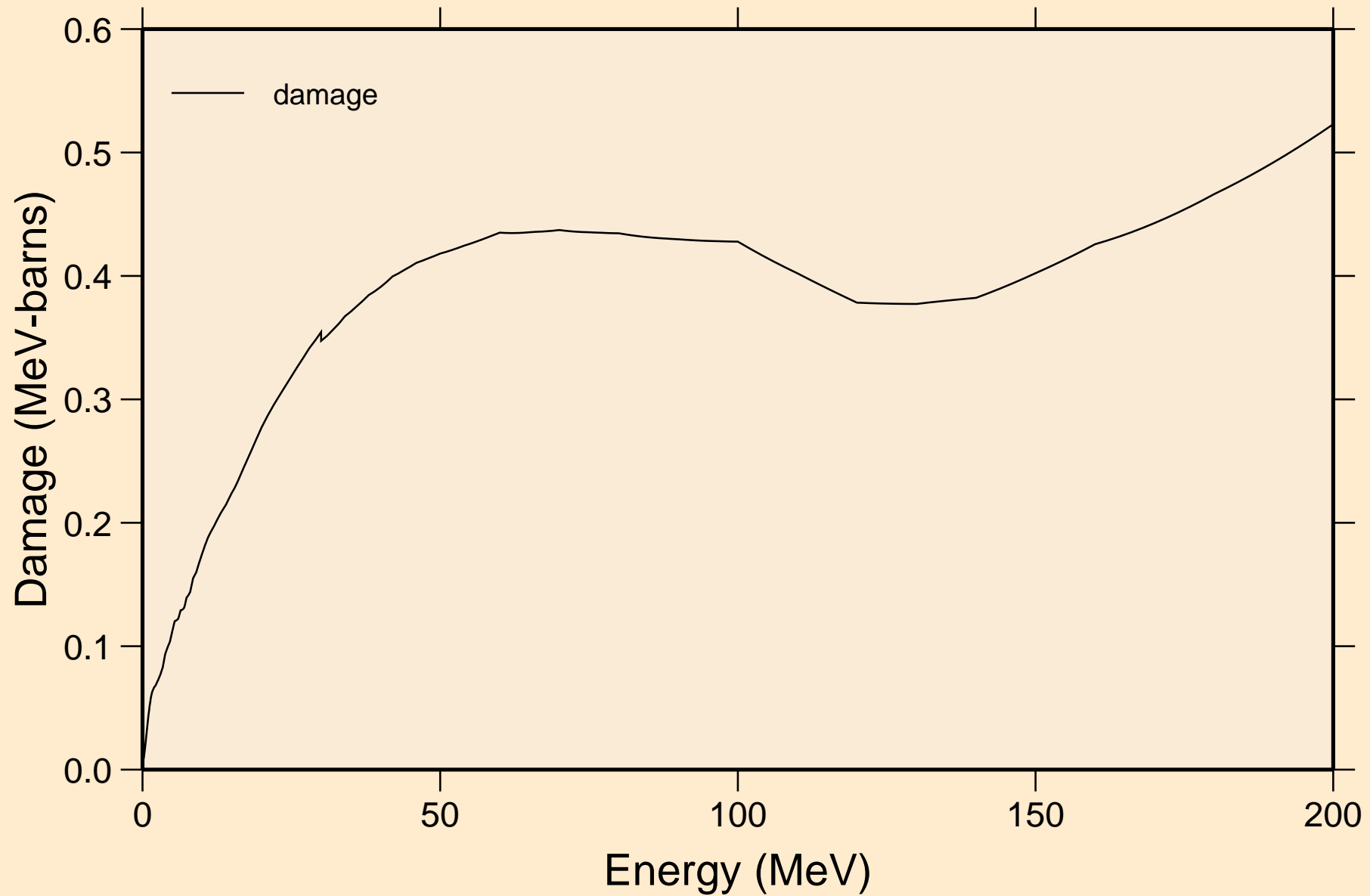

# I132 NEUTRON ACER TENDL-2024 LIBRARY; T=0.K

## Non-threshold reactions

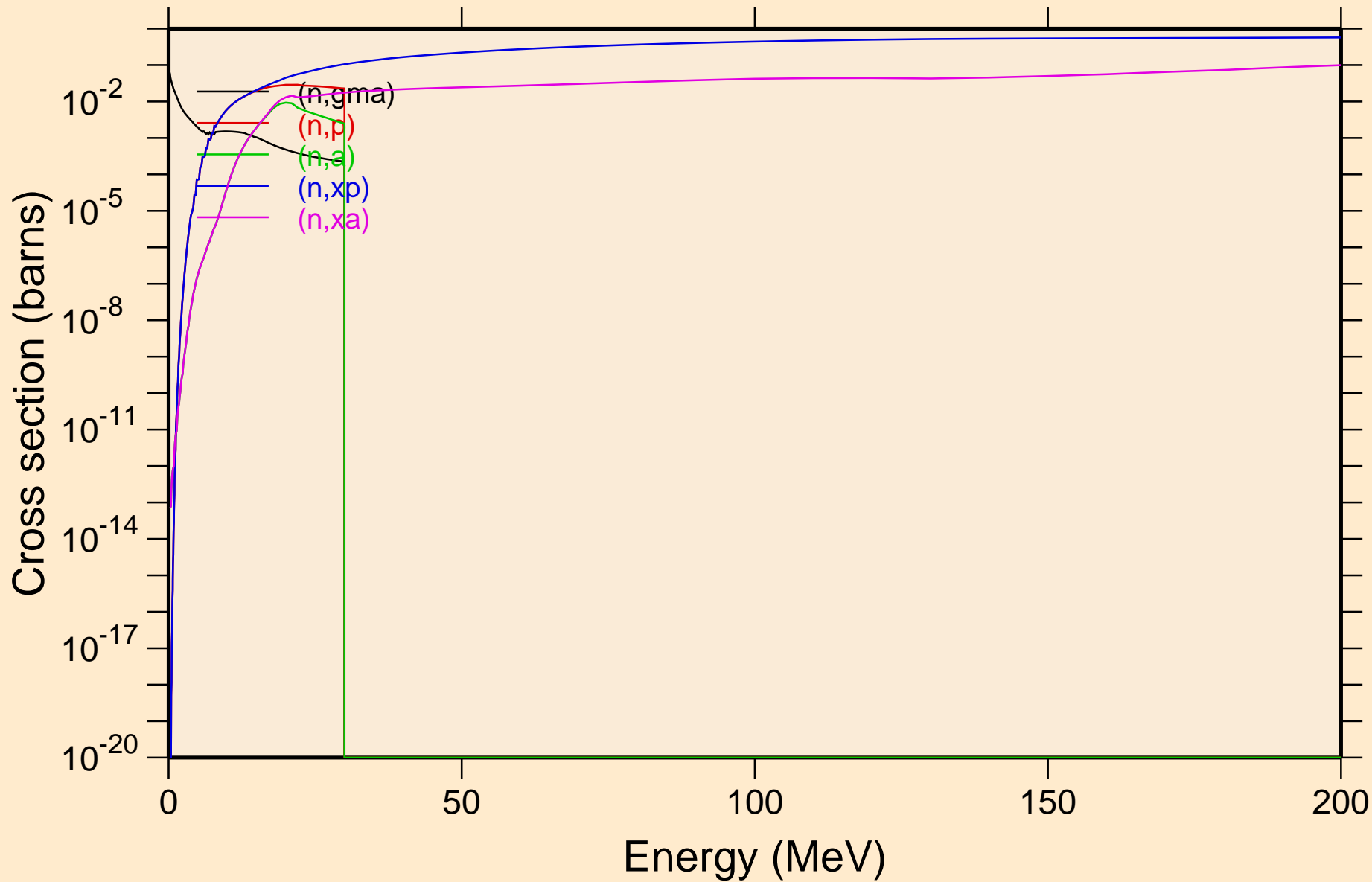

# I132 NEUTRON ACER TENDL-2024 LIBRARY; T=0.K

## Inelastic levels

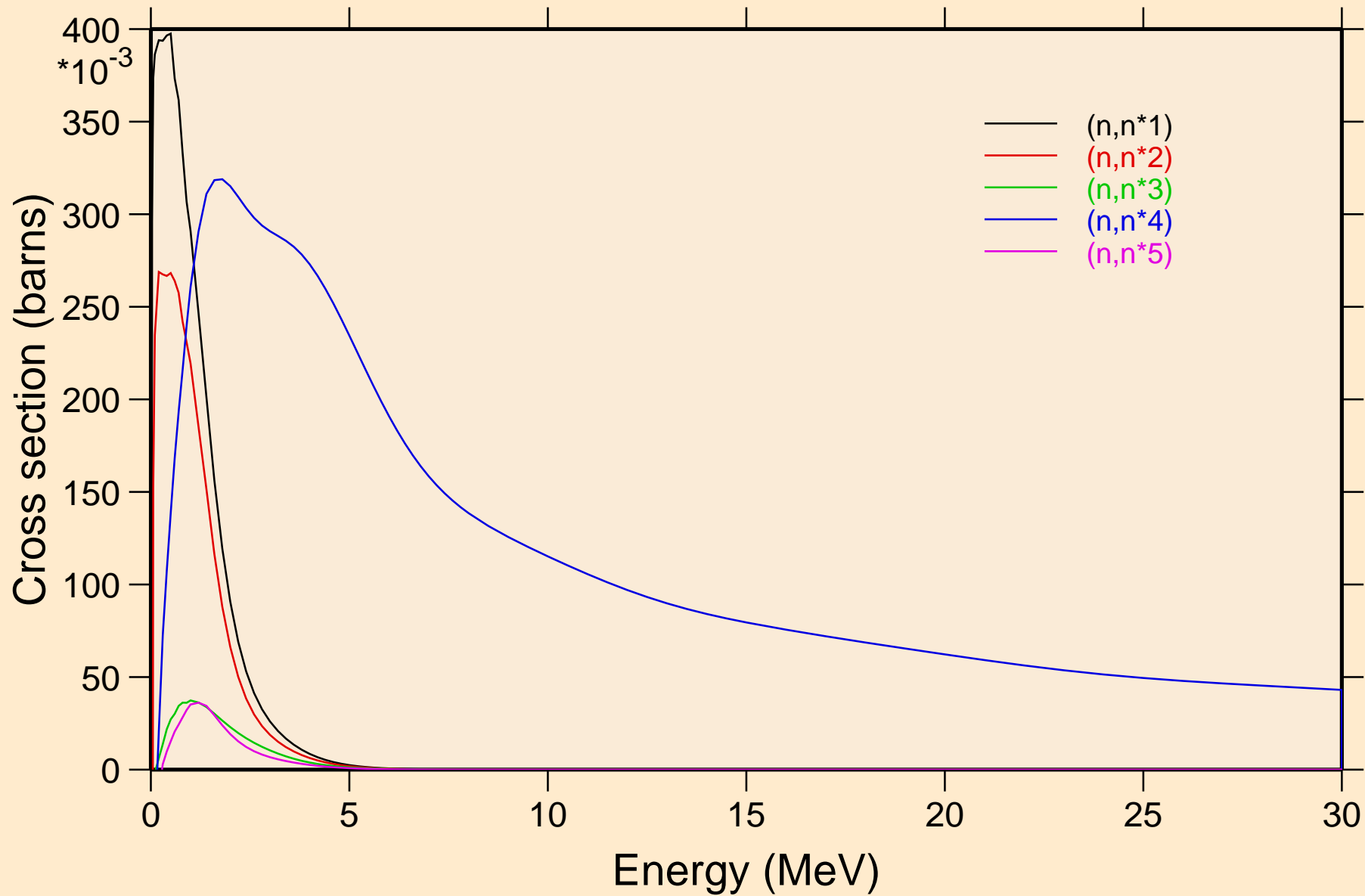

I132 NEUTRON ACER TENDL-2024 LIBRARY; T=0.K  
Inelastic levels

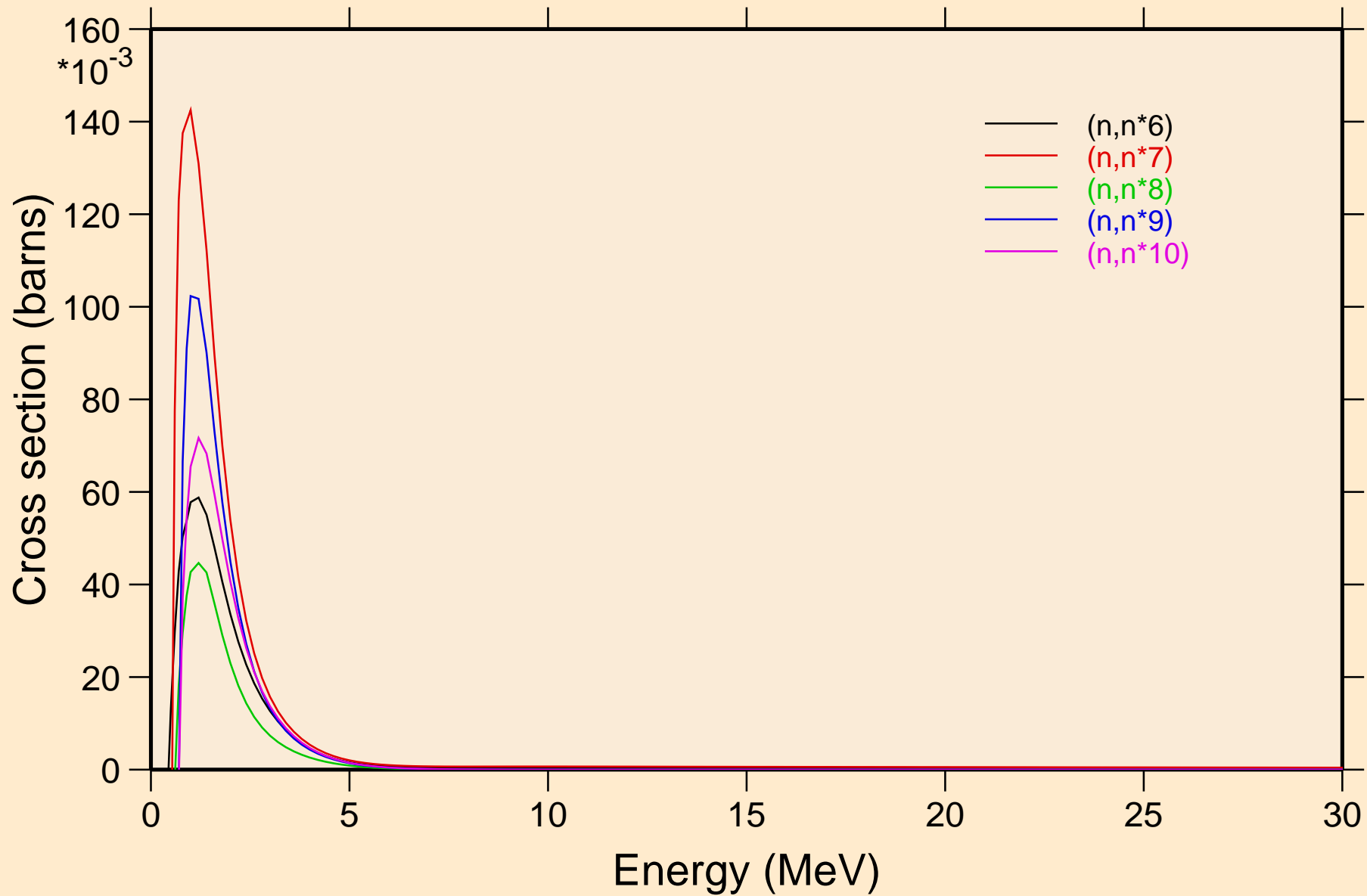

I132 NEUTRON ACER TENDL-2024 LIBRARY; T=0.K  
Inelastic levels

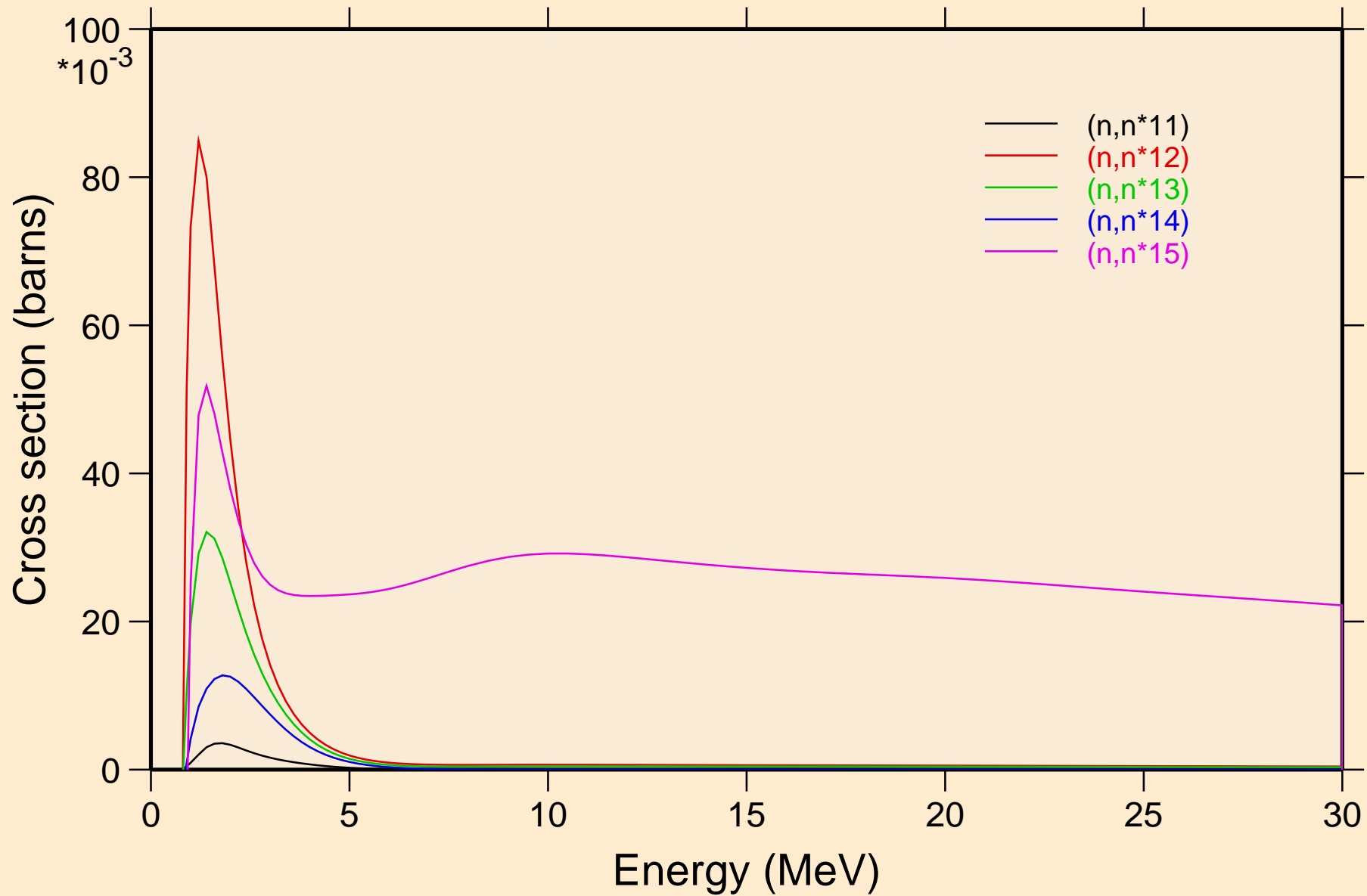

# I132 NEUTRON ACER TENDL-2024 LIBRARY; T=0.K

## Inelastic levels

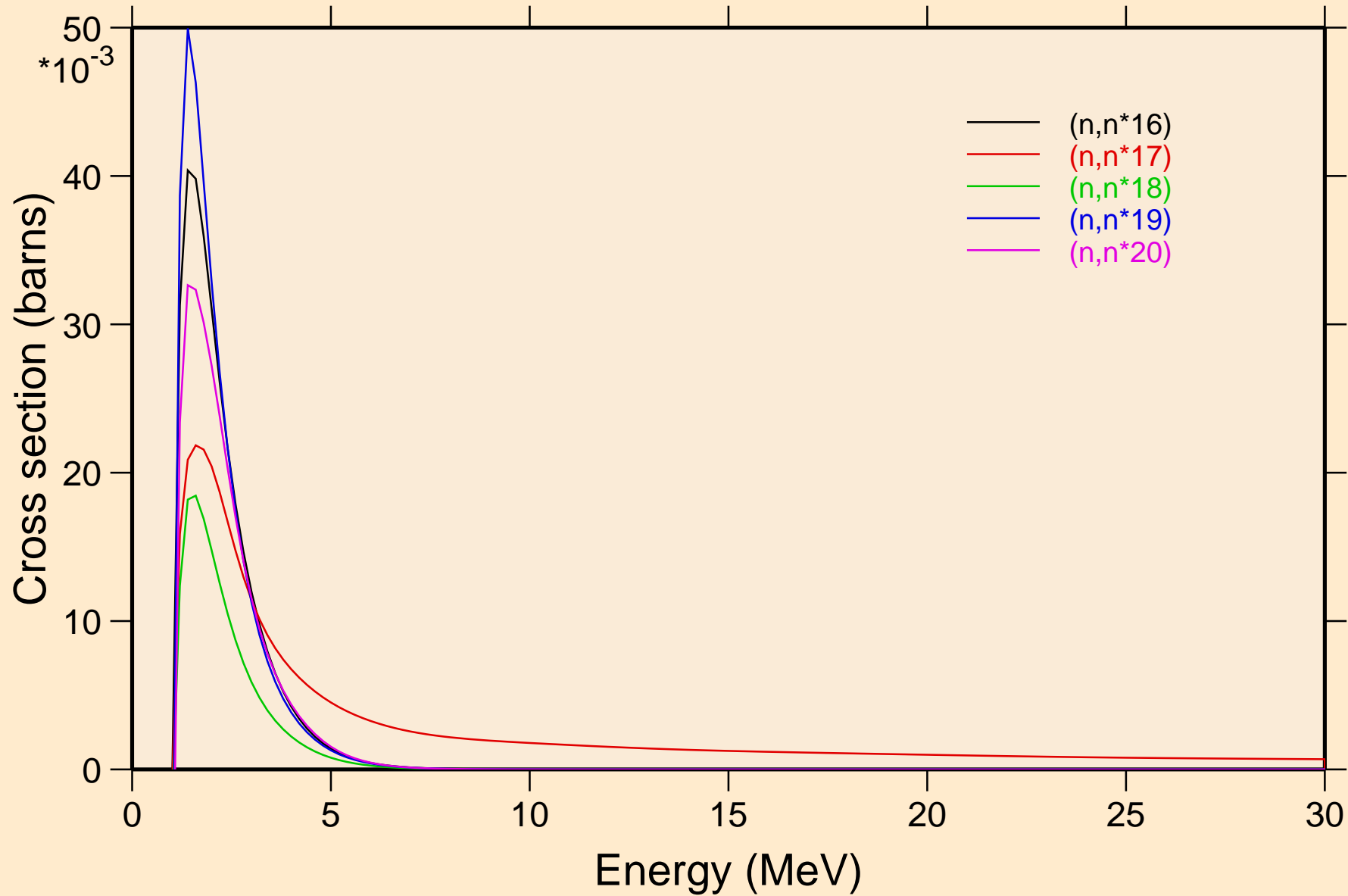

# I132 NEUTRON ACER TENDL-2024 LIBRARY; T=0.K

## Inelastic levels

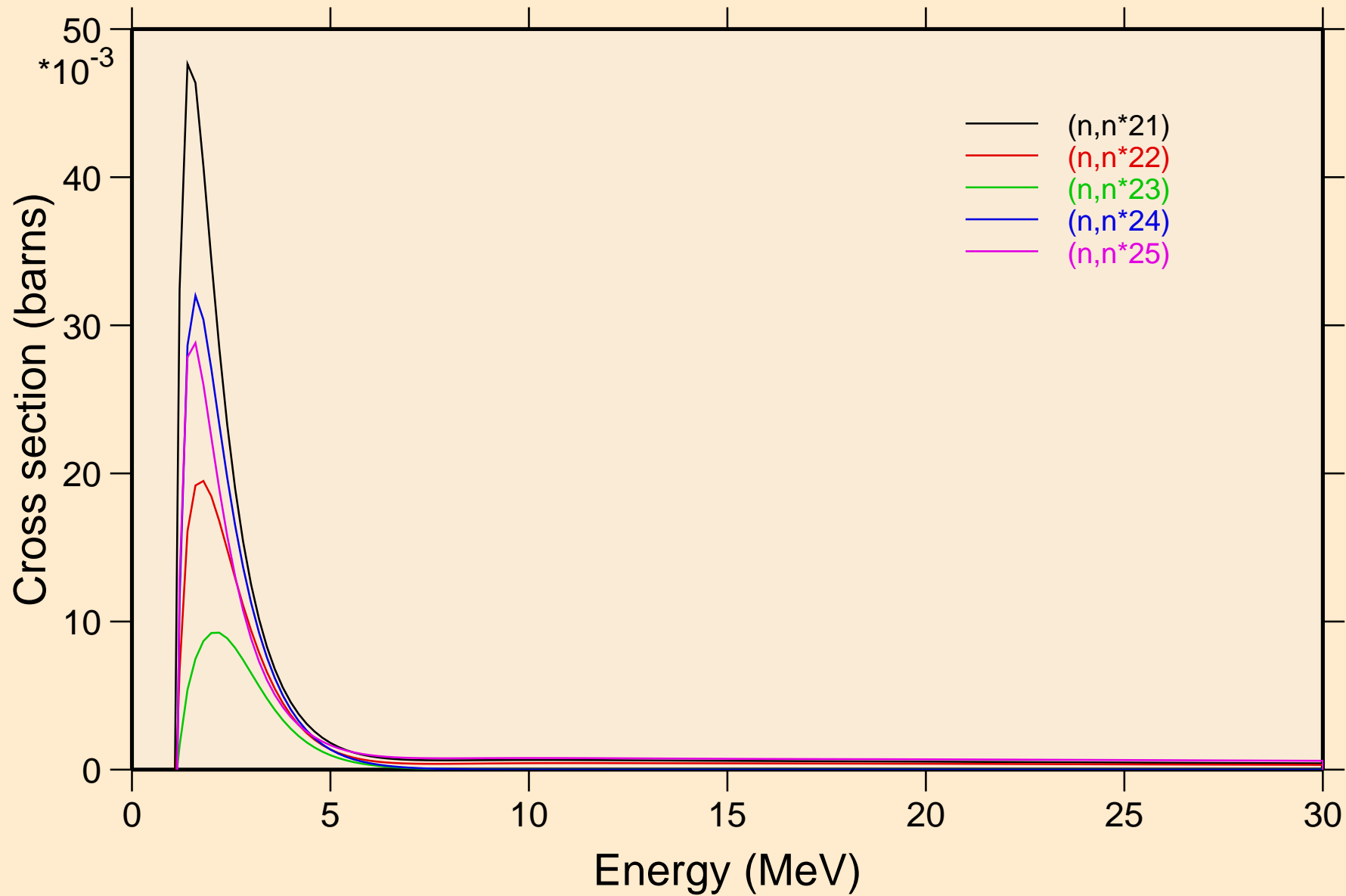

I132 NEUTRON ACER TENDL-2024 LIBRARY; T=0.K  
Inelastic levels

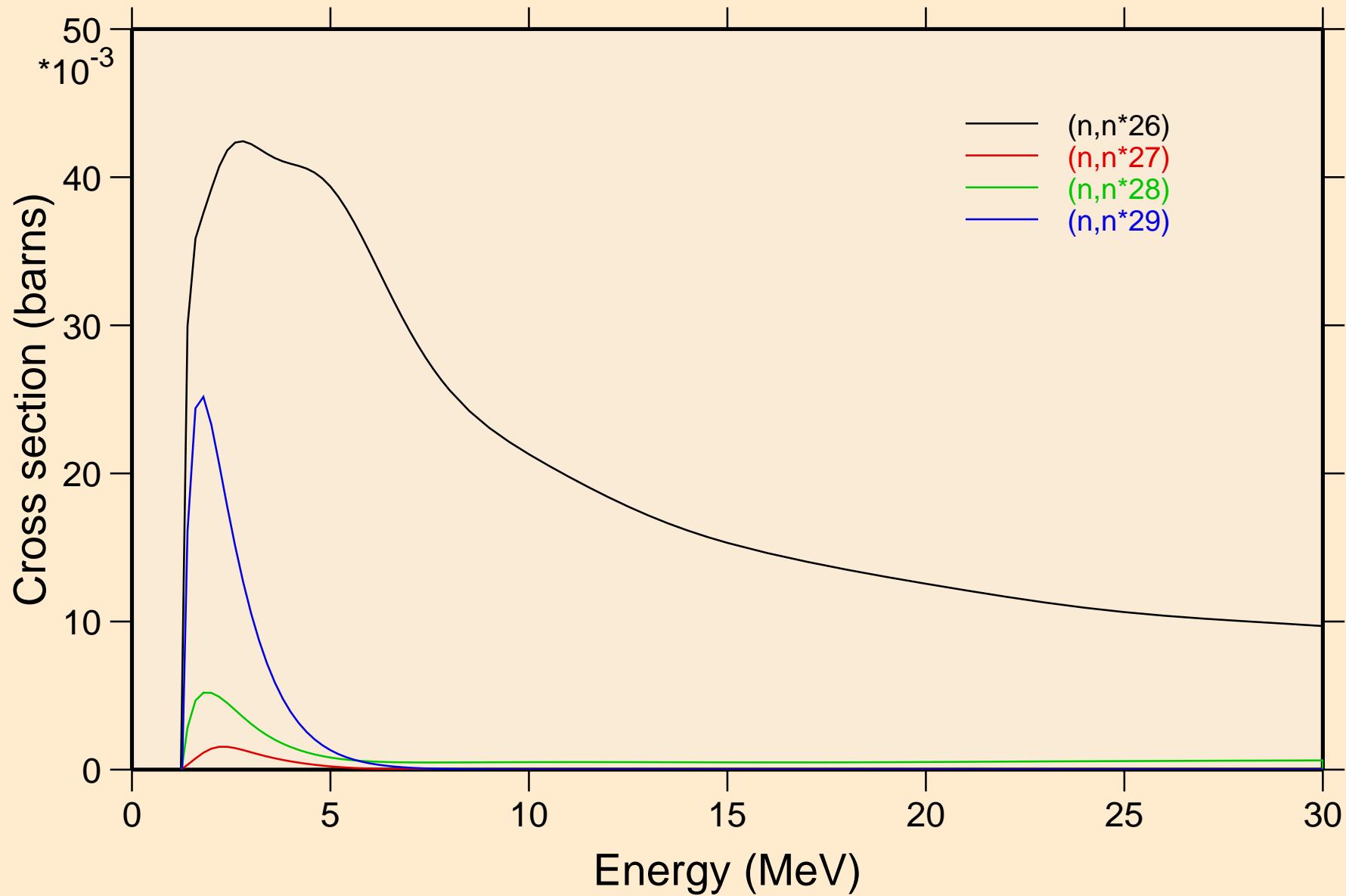

# I132 NEUTRON ACER TENDL-2024 LIBRARY; T=0.K

## Threshold reactions

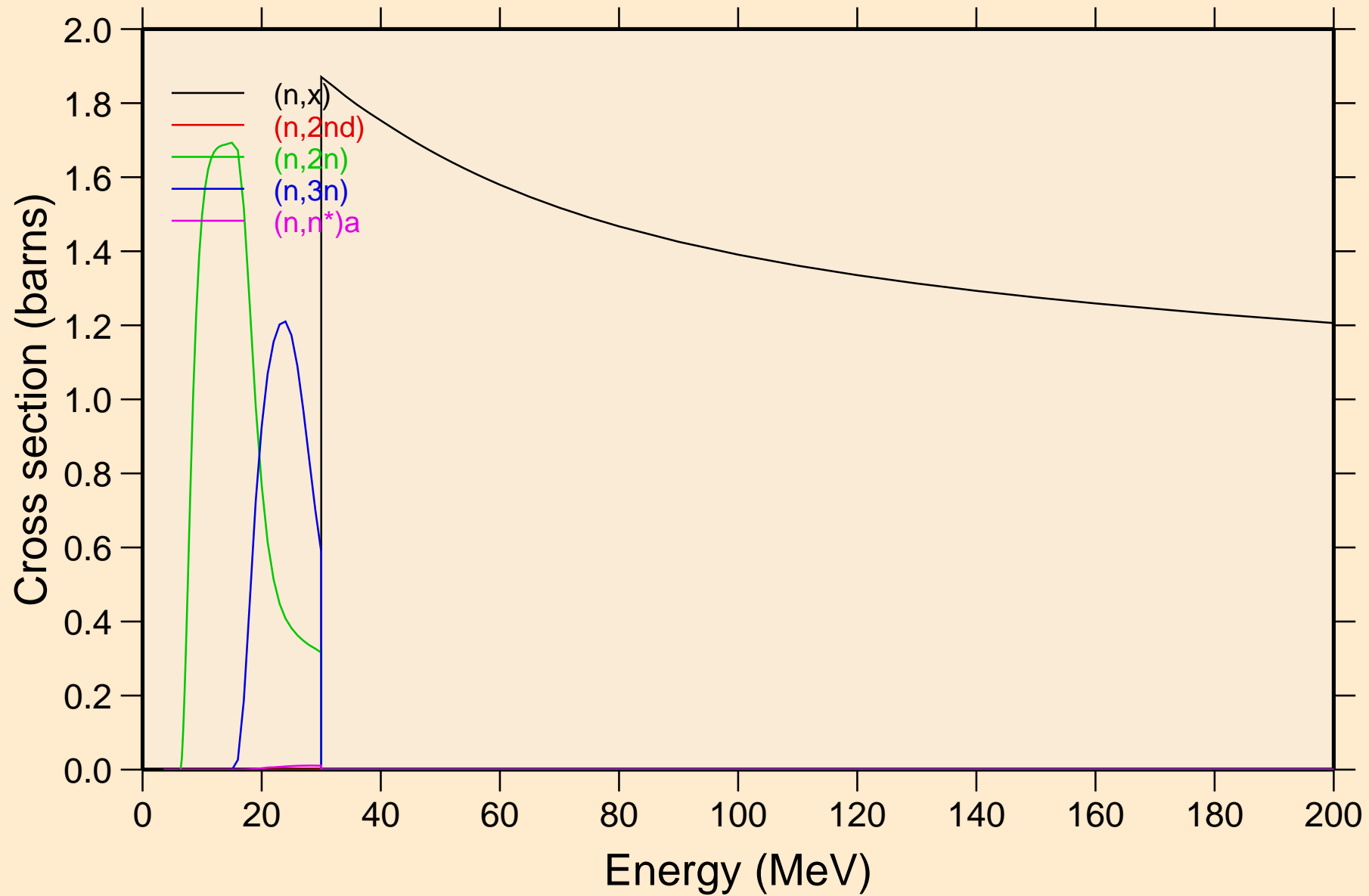

# I132 NEUTRON ACER TENDL-2024 LIBRARY; T=0.K

## Threshold reactions

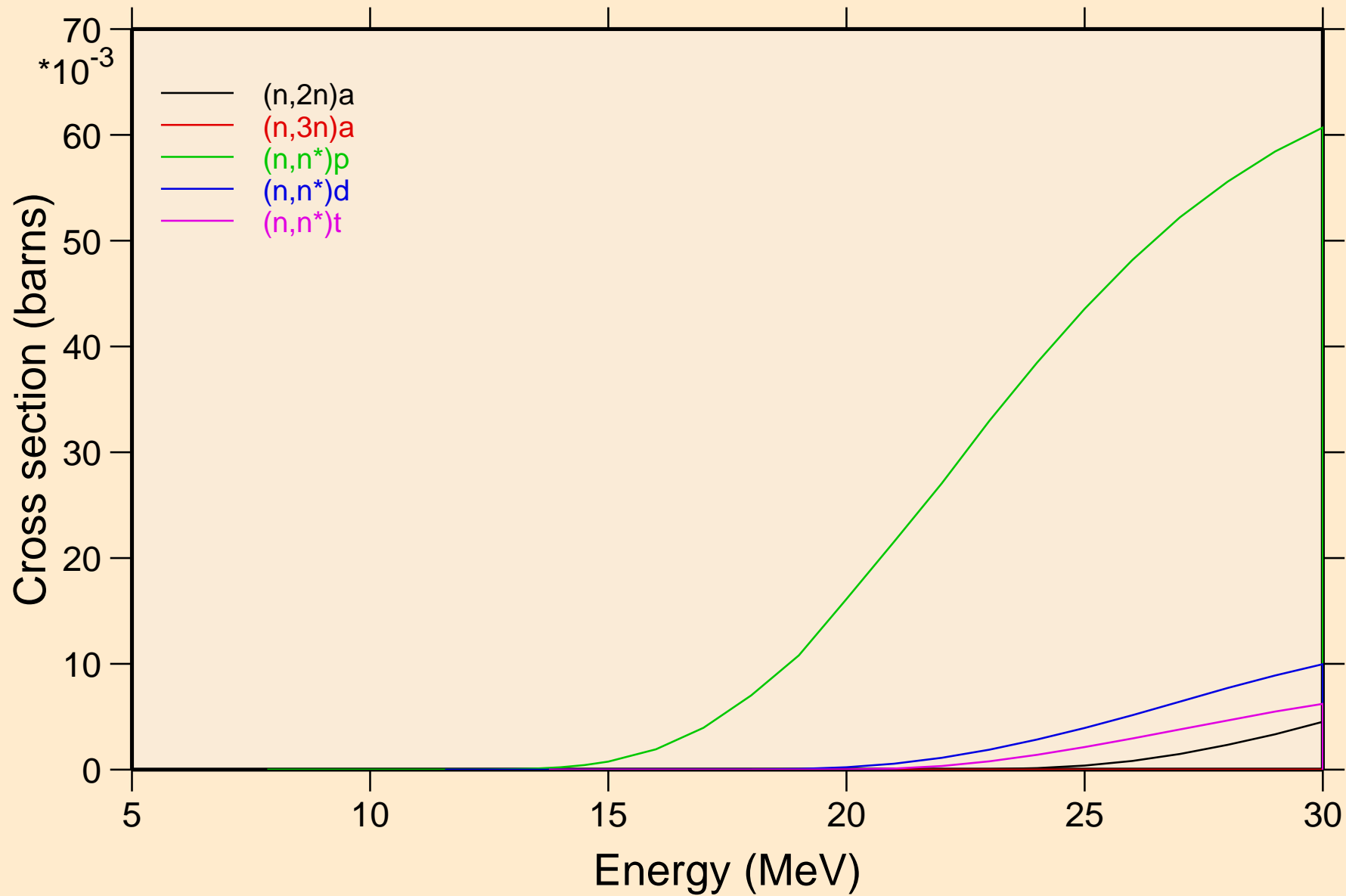

# I132 NEUTRON ACER TENDL-2024 LIBRARY; T=0.K

## Threshold reactions

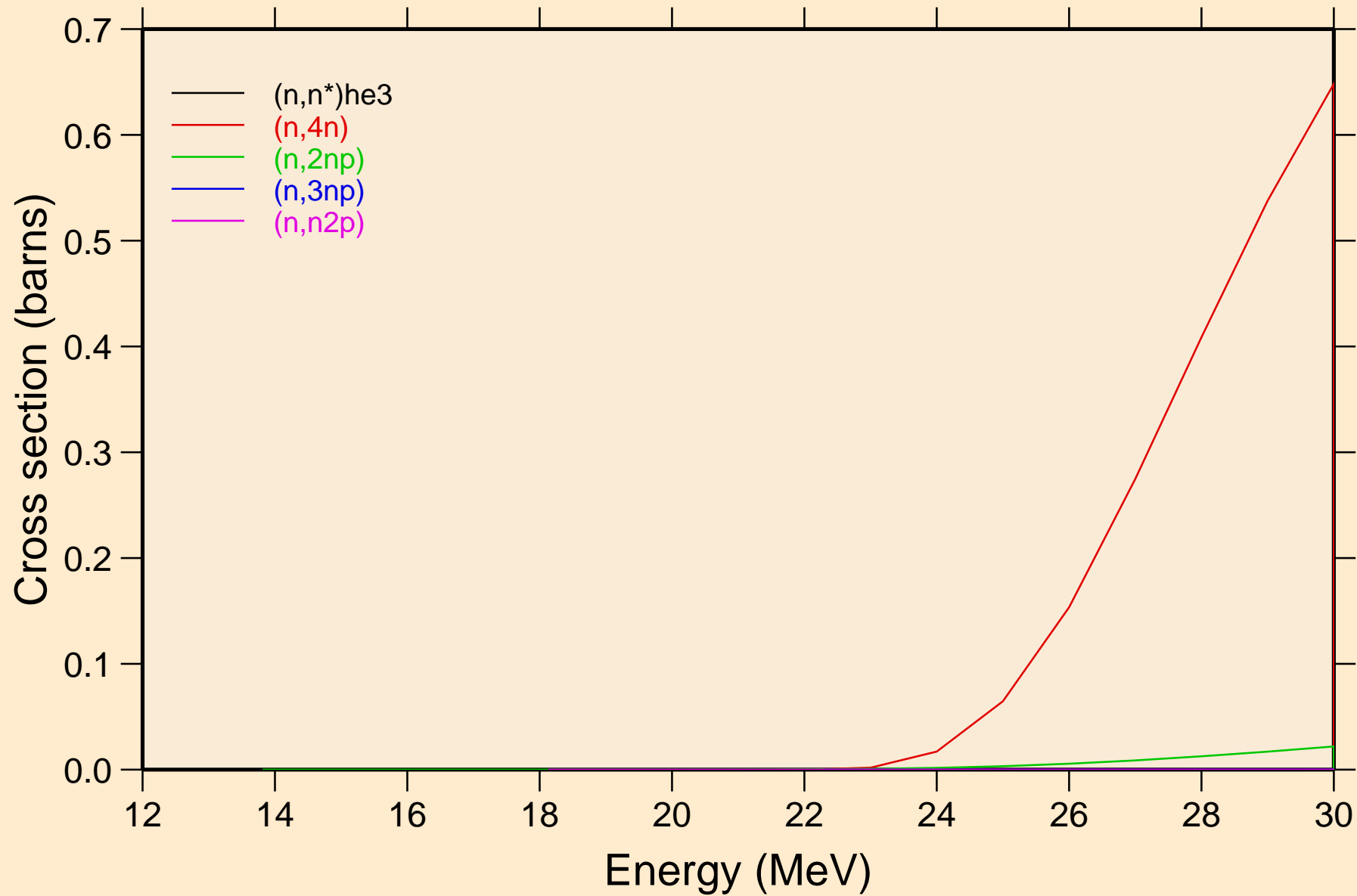

# I132 NEUTRON ACER TENDL-2024 LIBRARY; T=0.K

## Threshold reactions

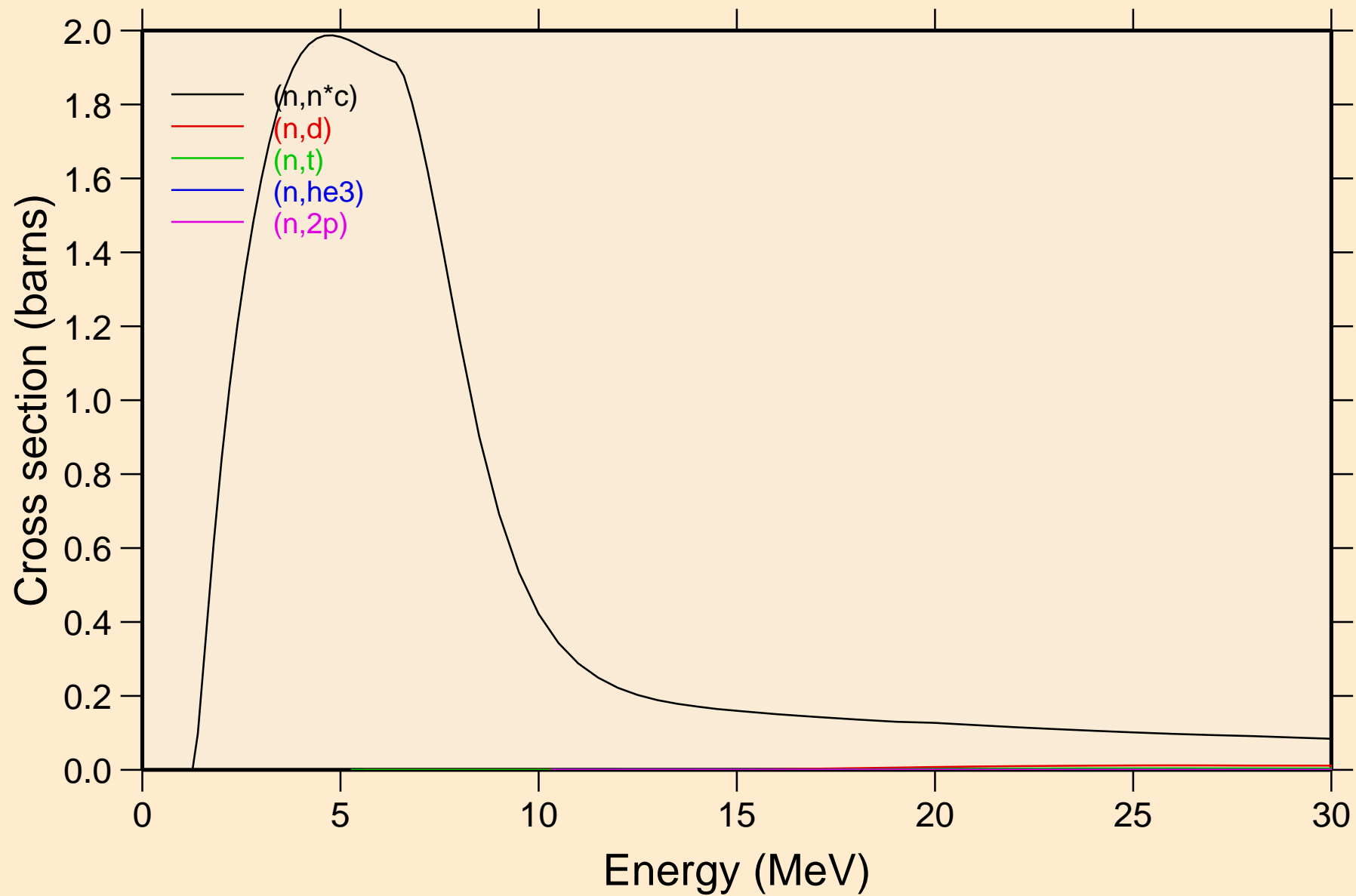

# I132 NEUTRON ACER TENDL-2024 LIBRARY; T=0.K

## Threshold reactions

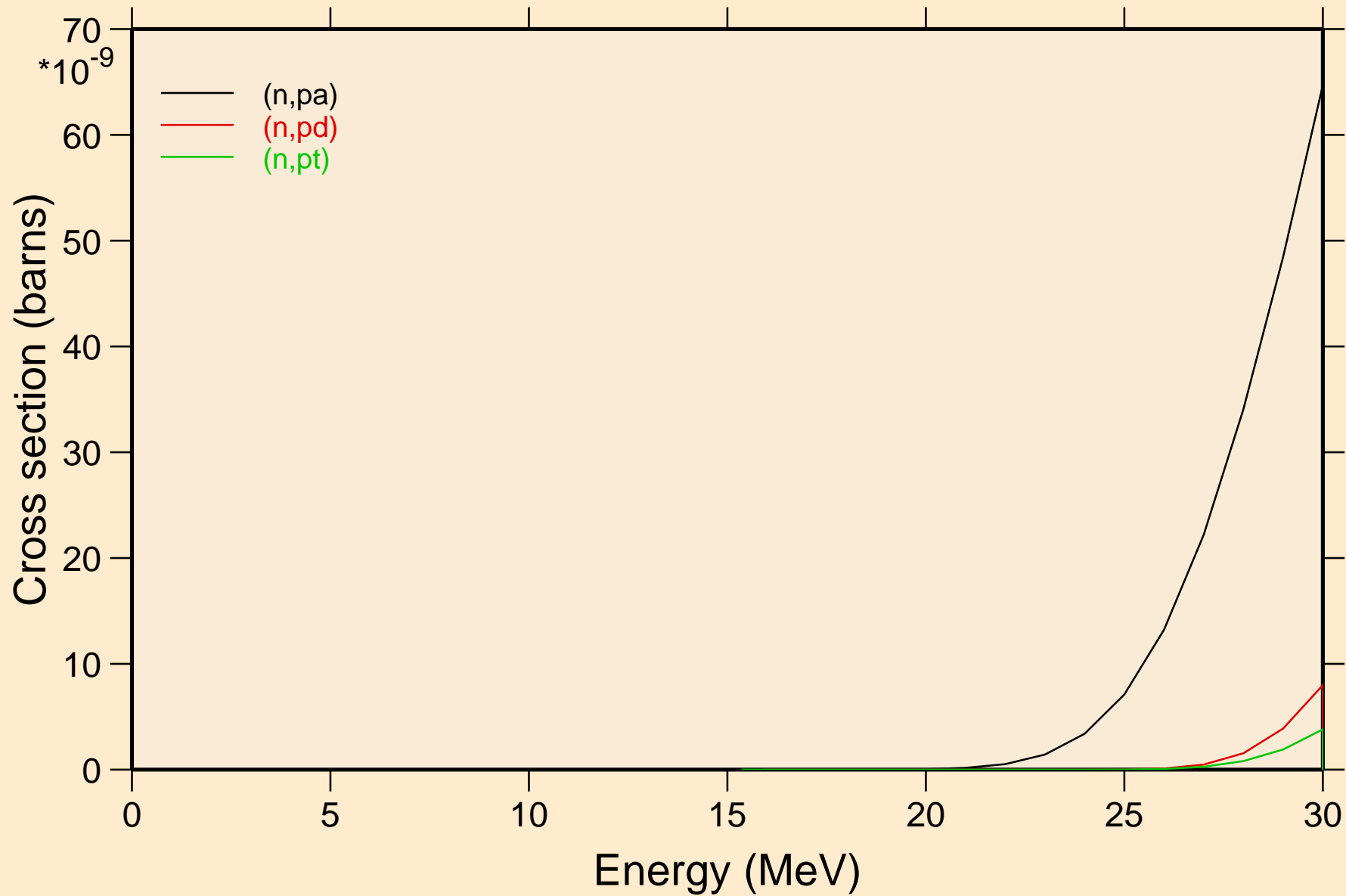

# I132 NEUTRON ACER TENDL-2024 LIBRARY; T=0.K

## Threshold reactions

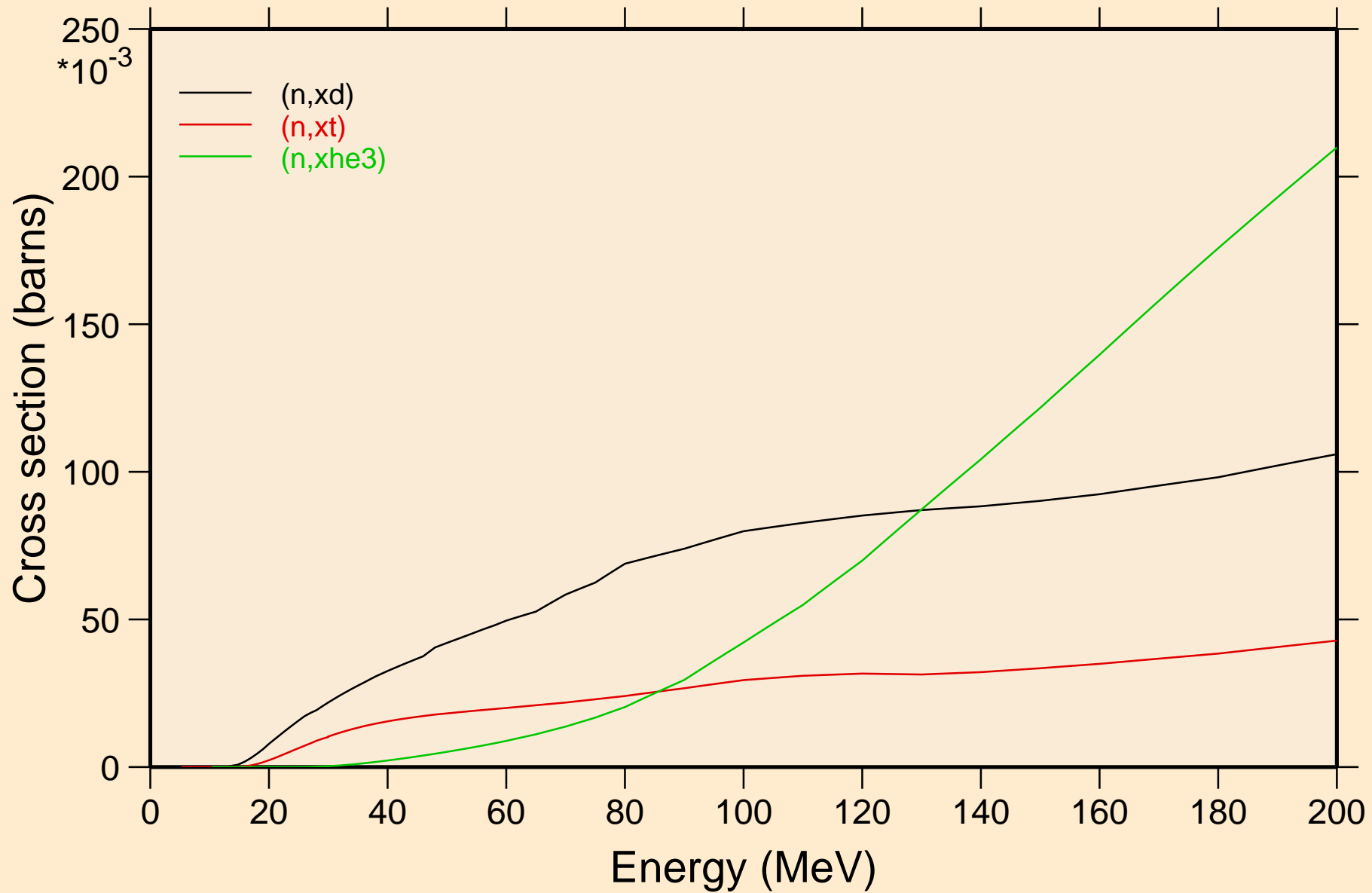

I132 NEUTRON ACER TENDL-2024 LIBRARY; T=0.K  
angular distribution for elastic

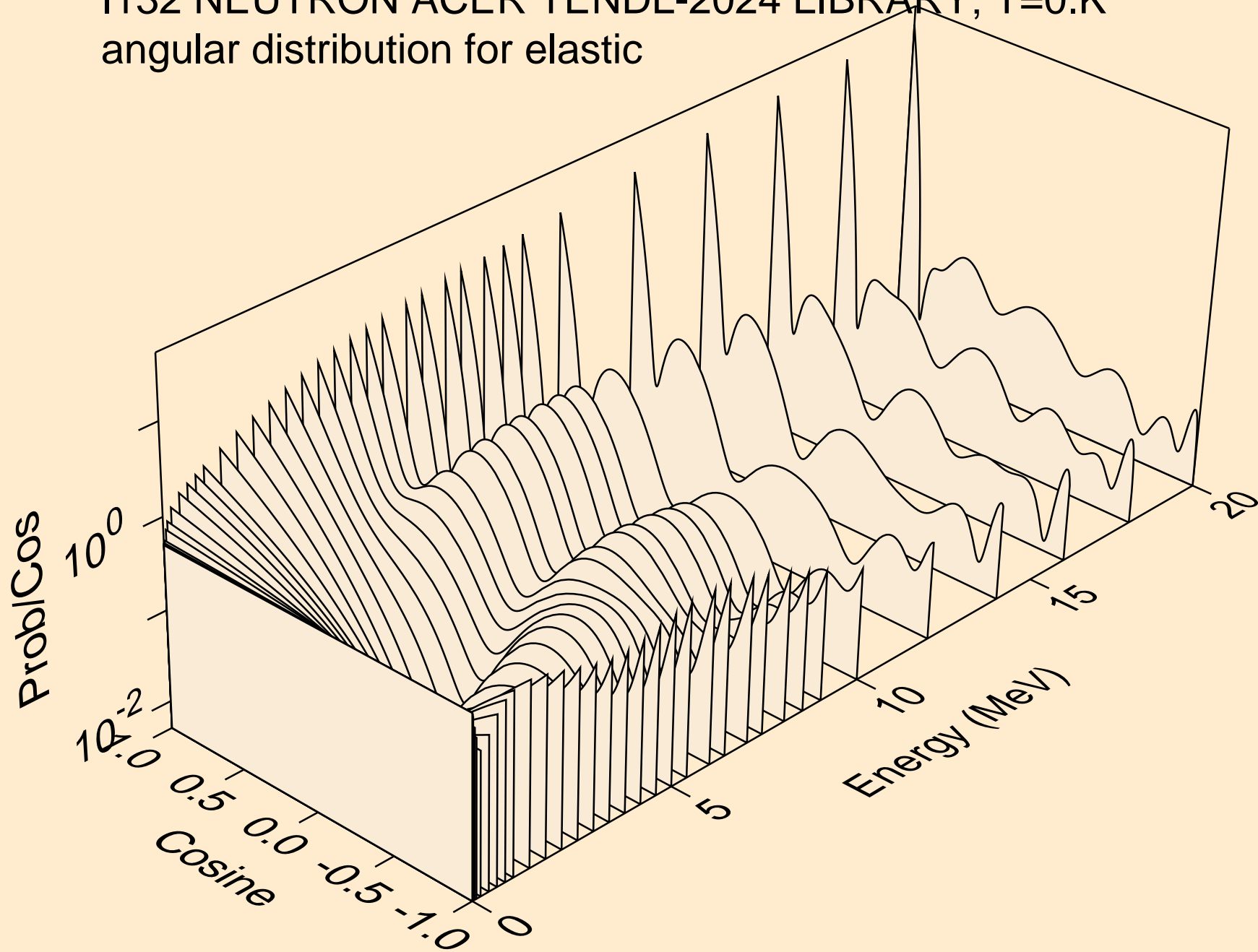

I132 NEUTRON ACER TENDL-2024 LIBRARY; T=0.K  
angular distribution for elastic

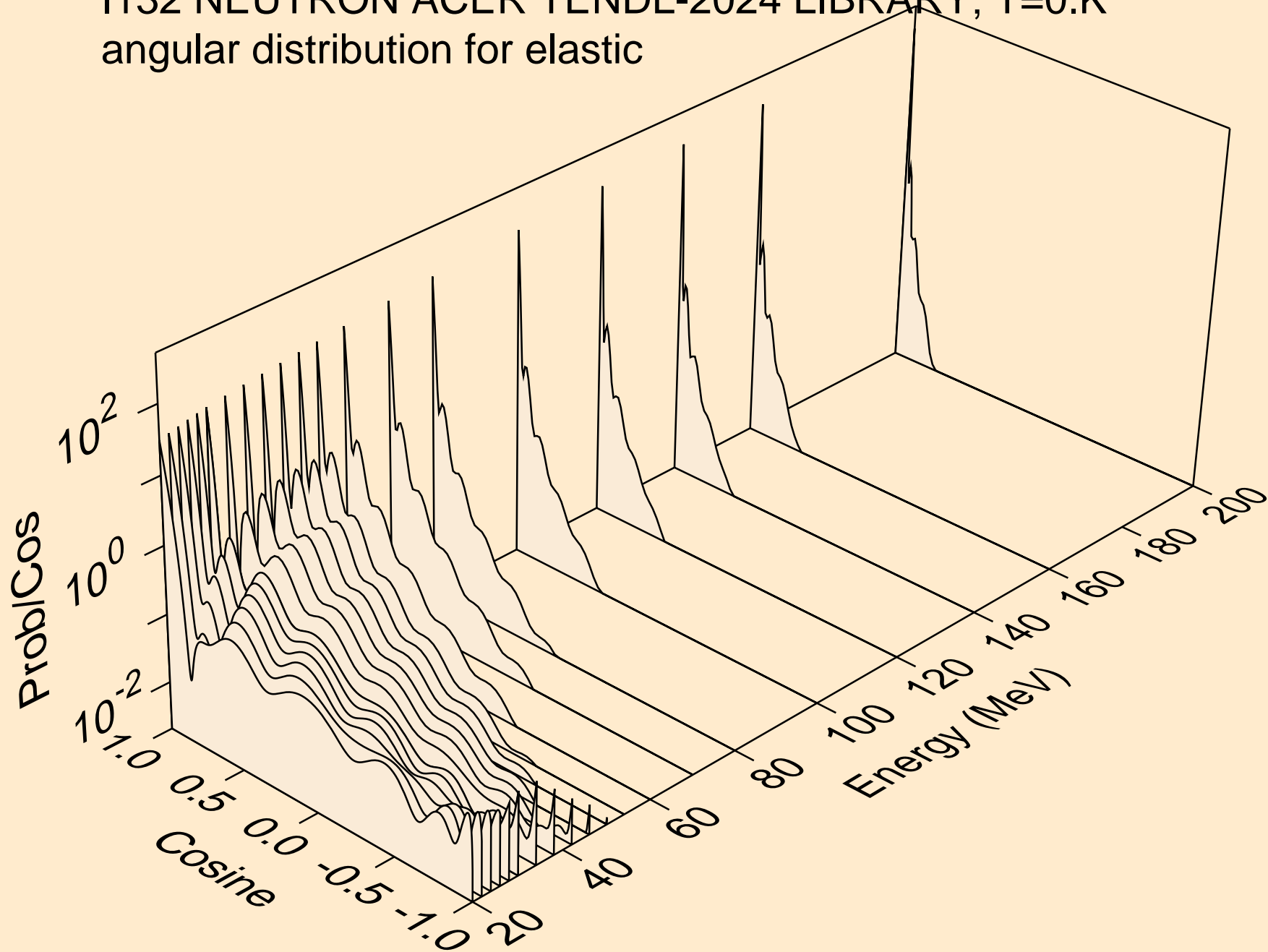

I132 NEUTRON ACER TENDL-2024 LIBRARY; T=0.K  
angular distribution for (n,n\*1)

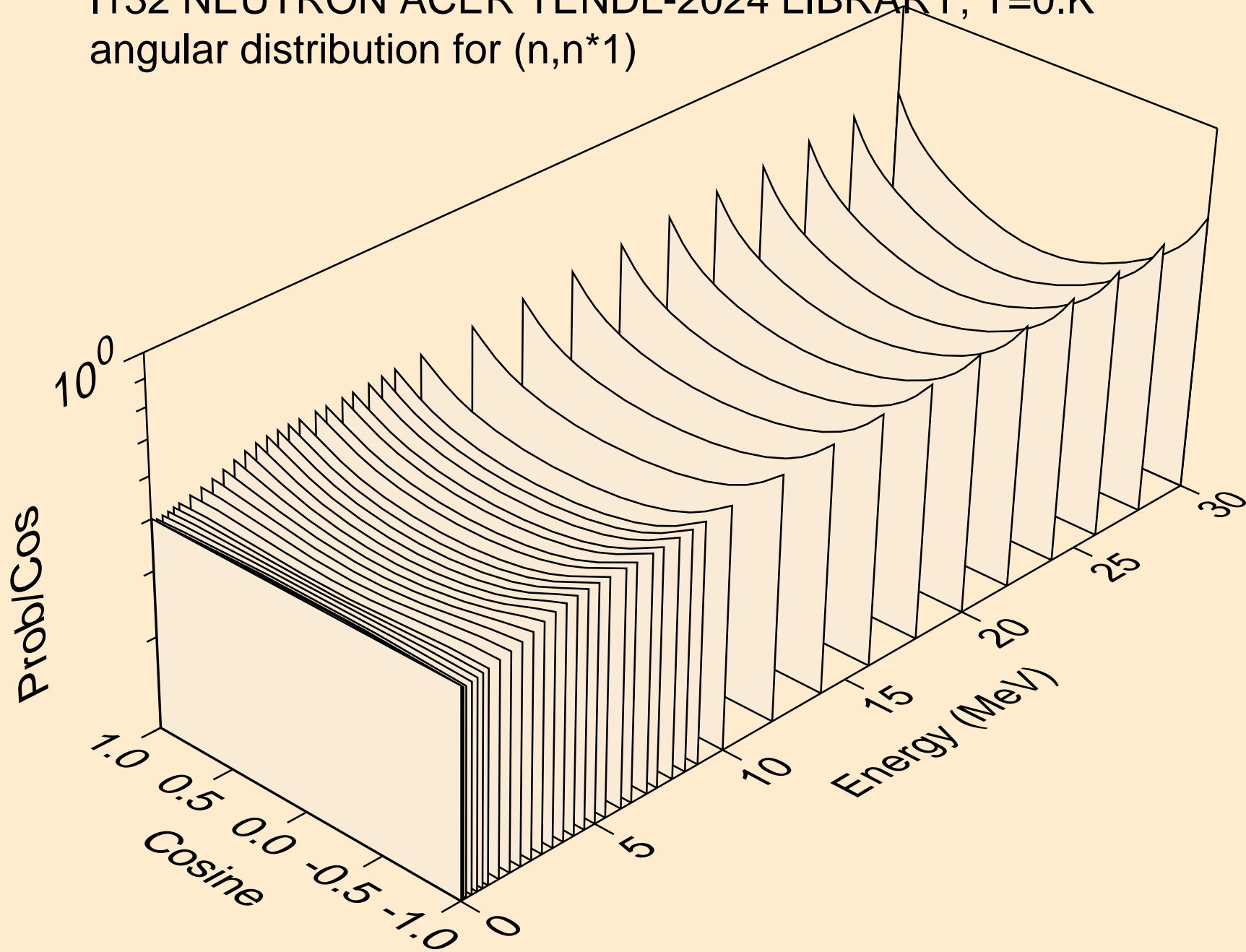

I132 NEUTRON ACER TENDL-2024 LIBRARY; T=0.K  
angular distribution for (n,n\*2)

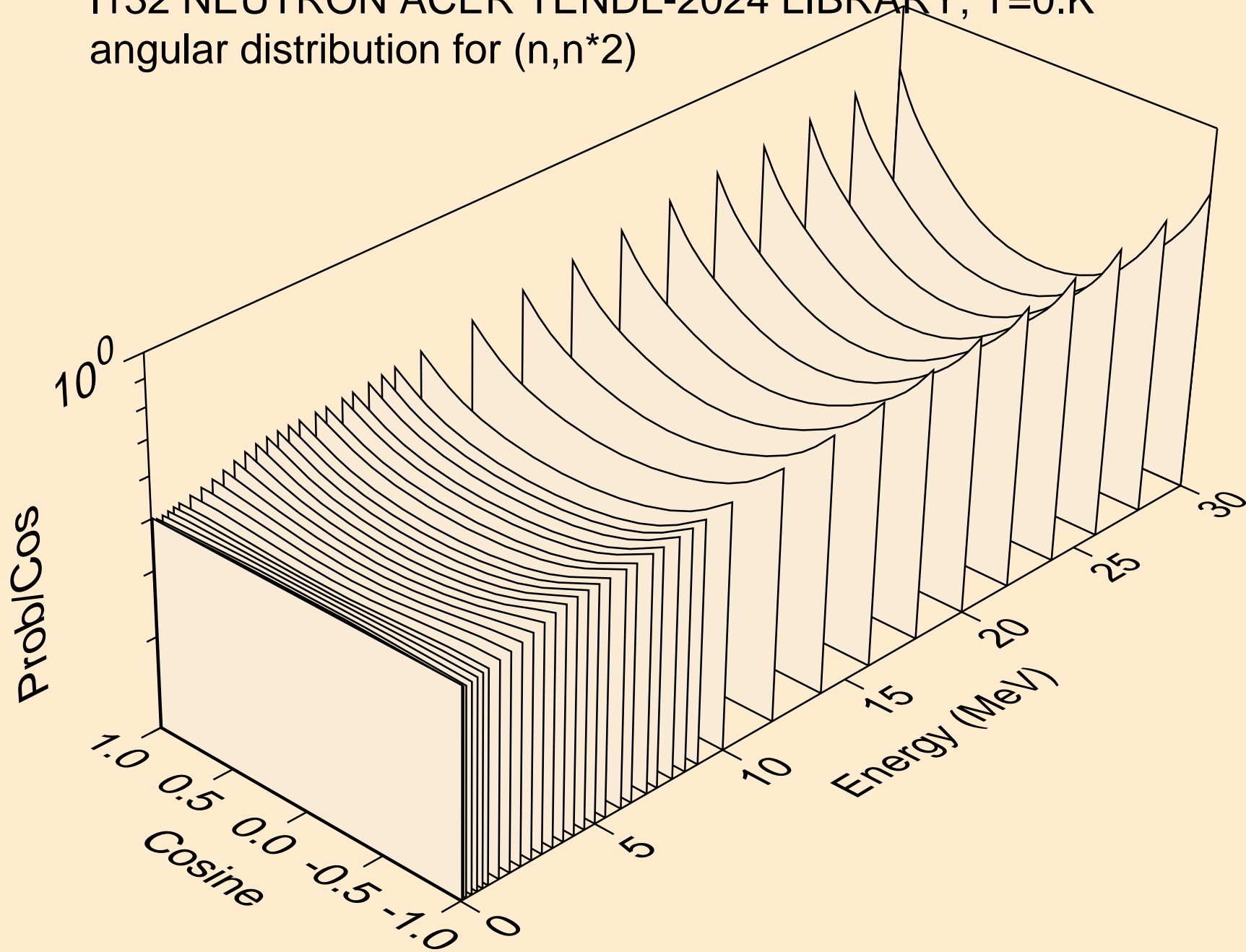

I132 NEUTRON ACER TENDL-2024 LIBRARY; T=0.K  
angular distribution for (n,n\*3)

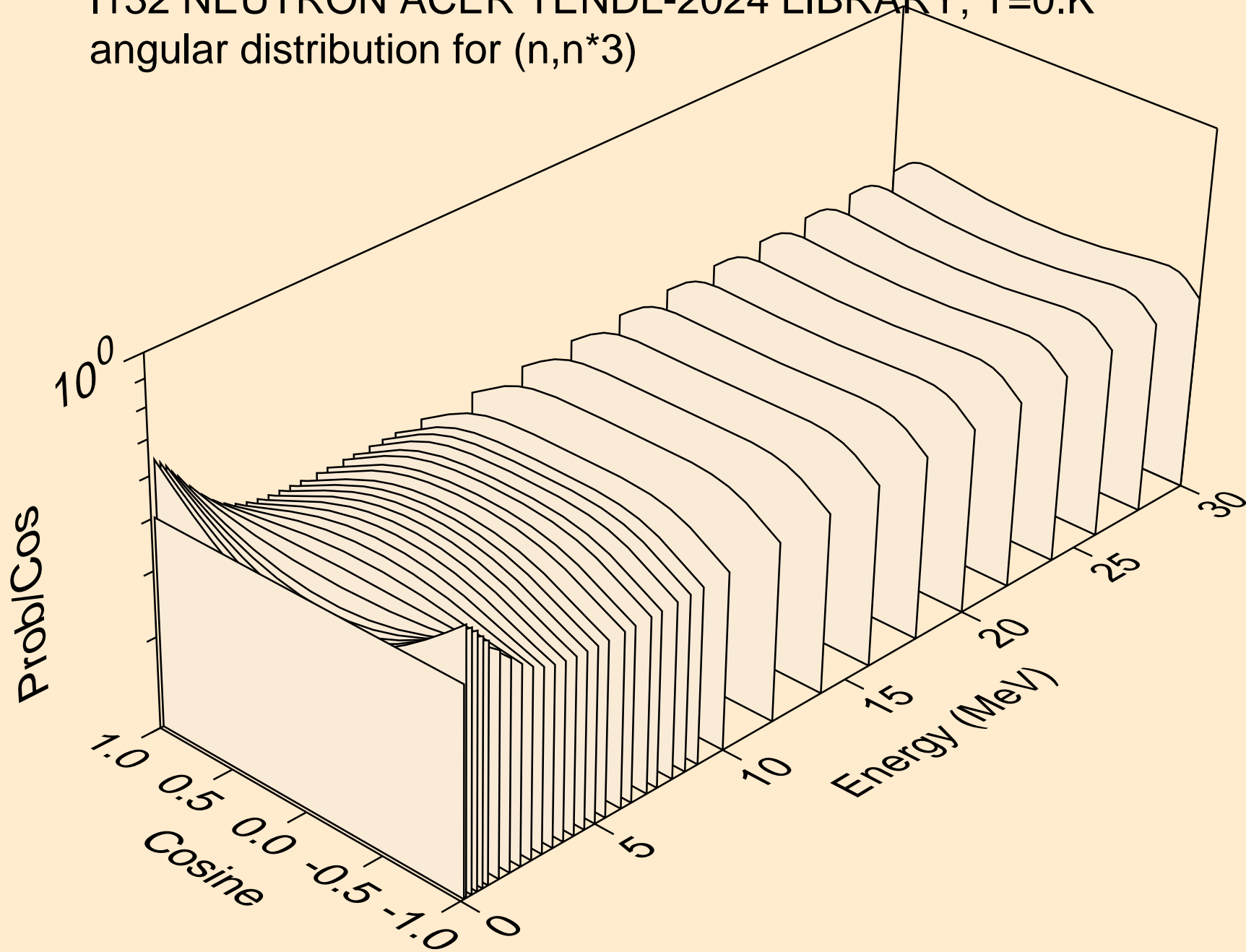

I132 NEUTRON ACER TENDL-2024 LIBRARY; T=0.K  
angular distribution for (n,n\*4)

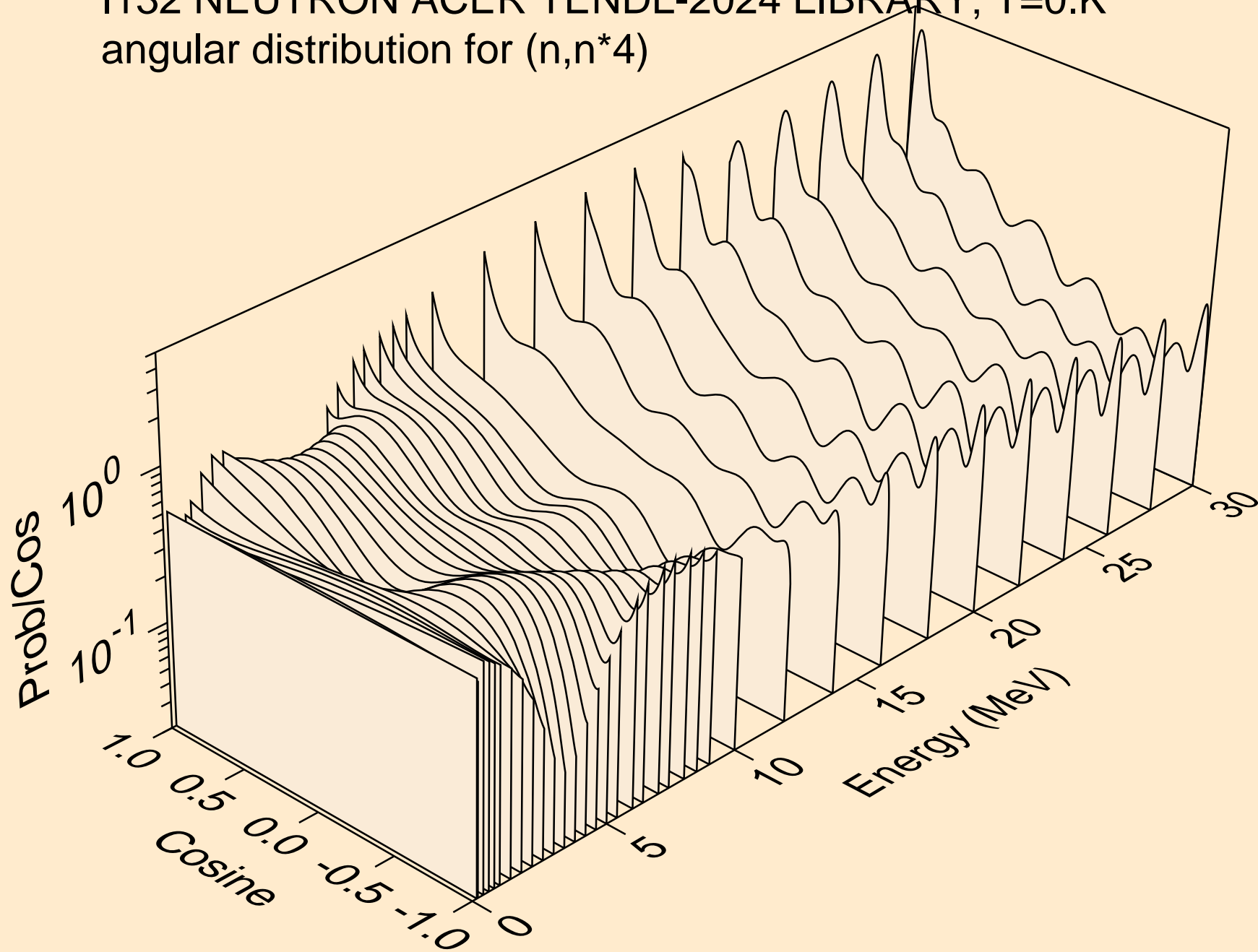

I132 NEUTRON ACER TENDL-2024 LIBRARY; T=0.K  
angular distribution for (n,n\*5)

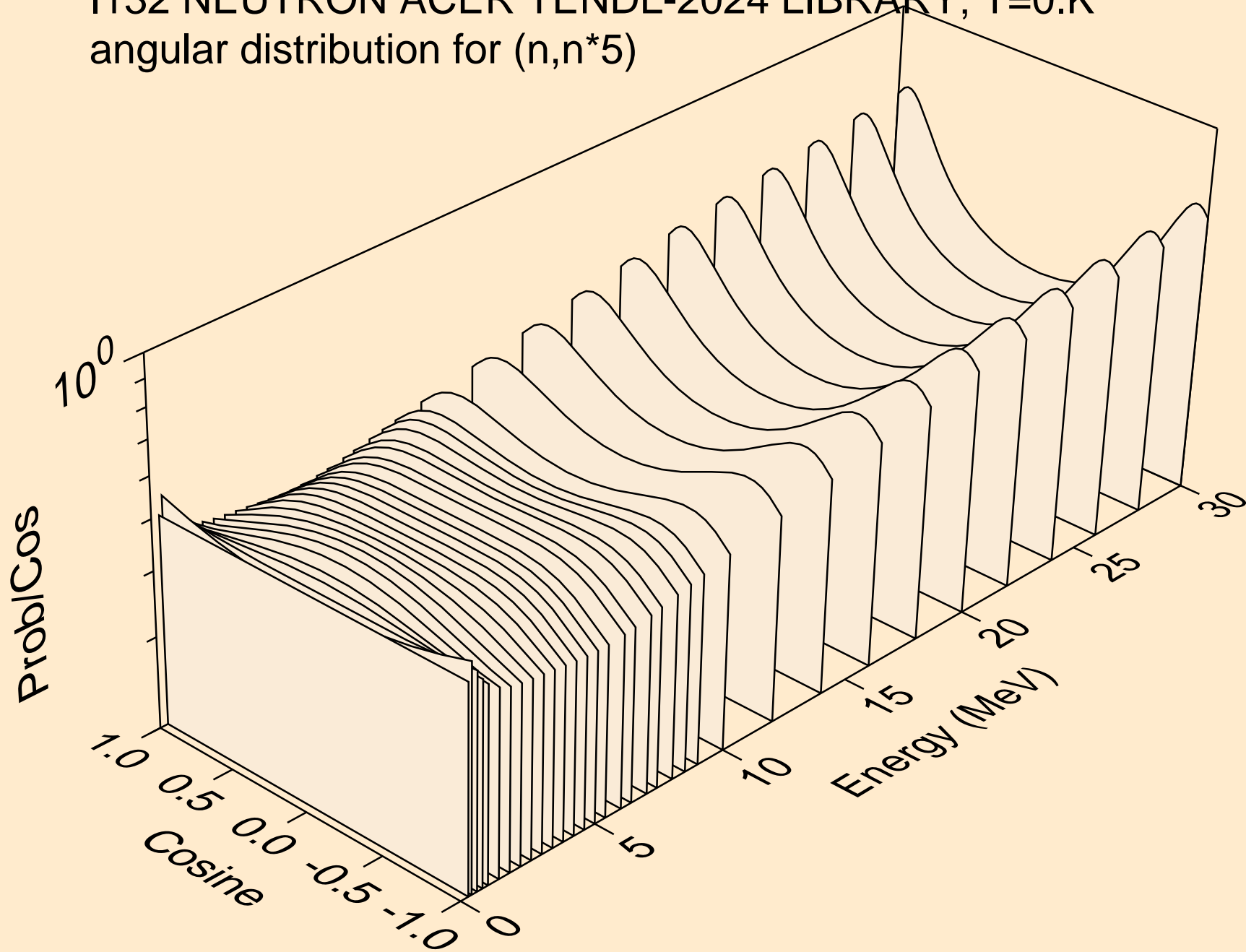

I132 NEUTRON ACER TENDL-2024 LIBRARY; T=0.K  
angular distribution for (n,n\*6)

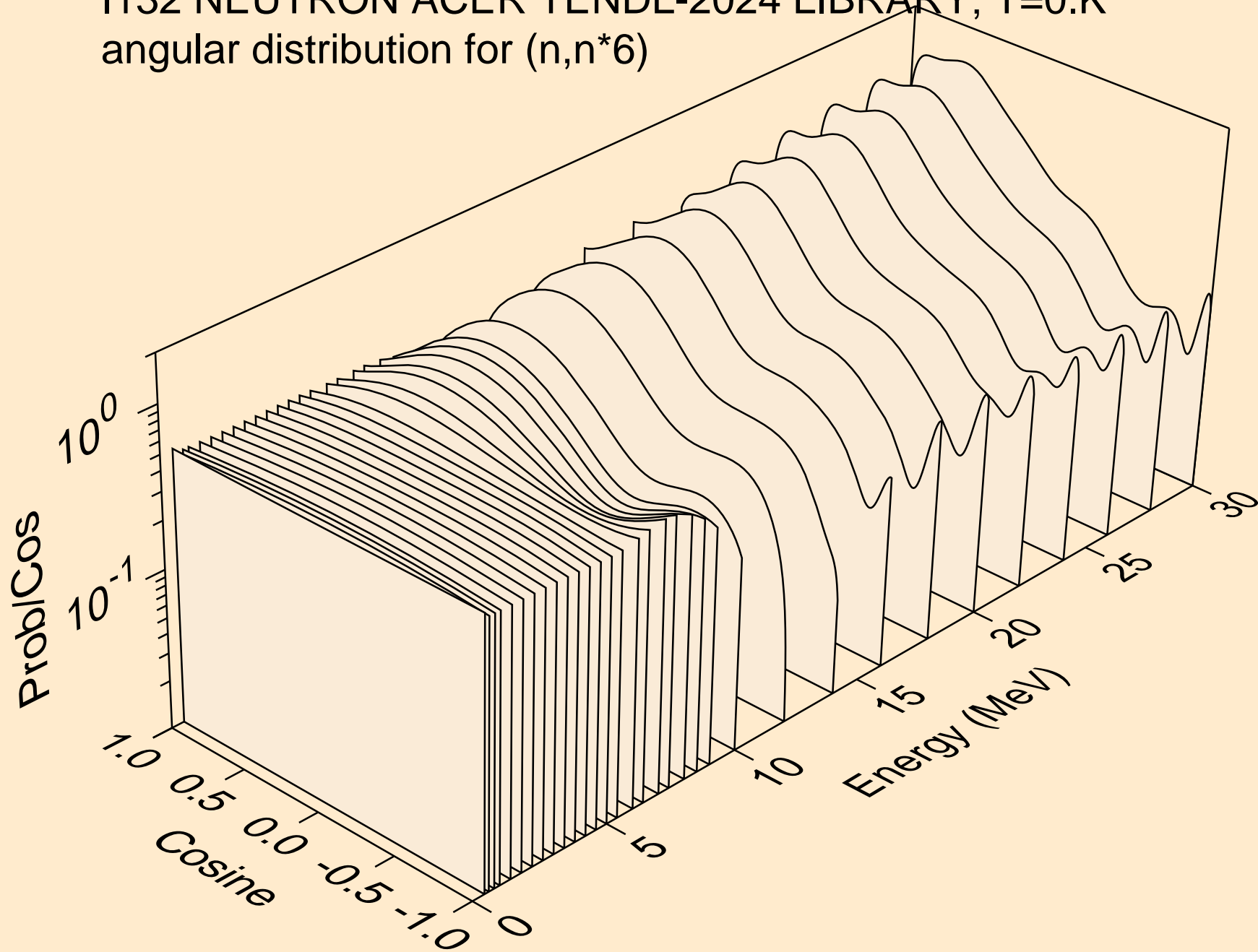

I132 NEUTRON ACER TENDL-2024 LIBRARY; T=0.K  
angular distribution for (n,n\*7)

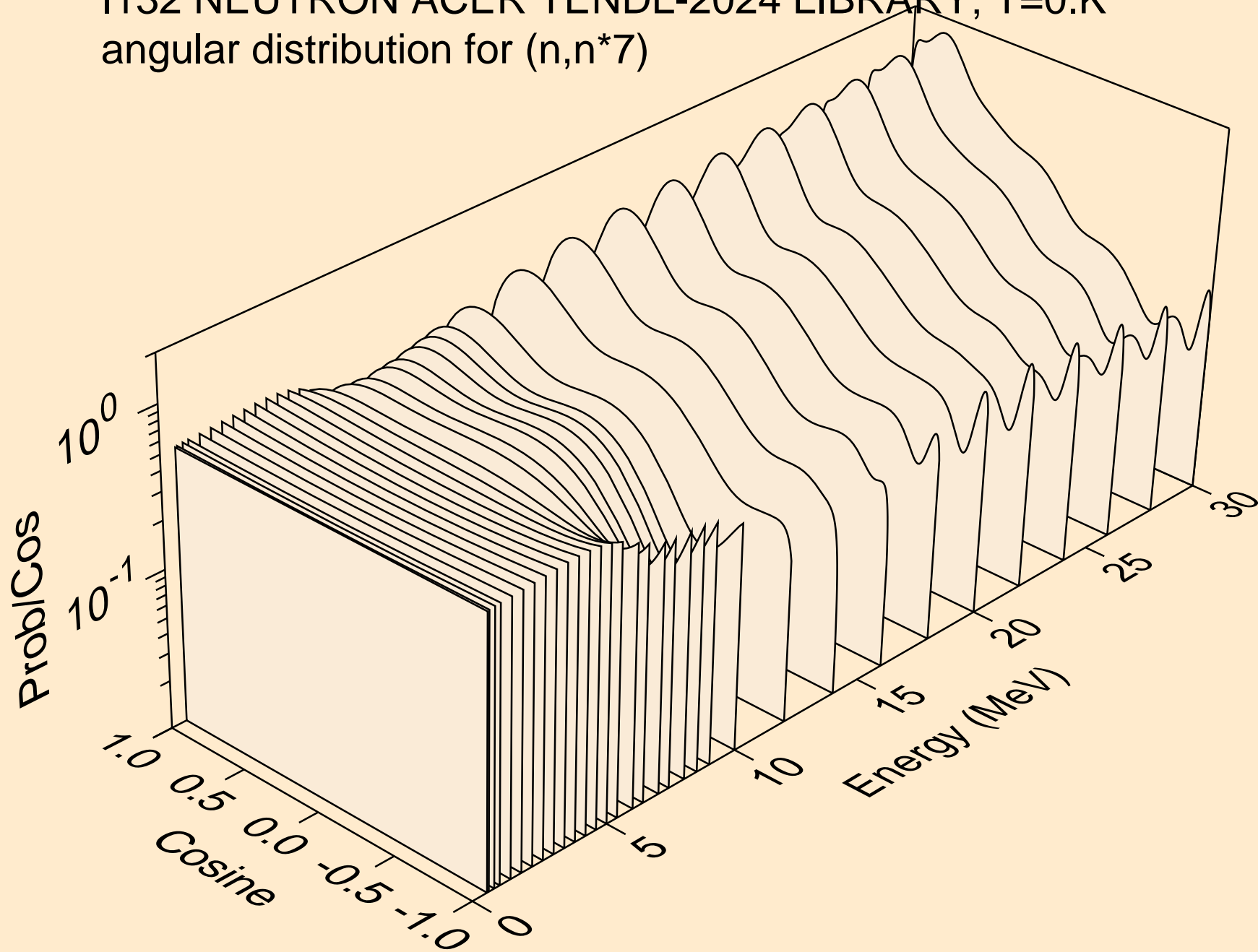

I132 NEUTRON ACER TENDL-2024 LIBRARY; T=0.K  
angular distribution for (n,n\*8)

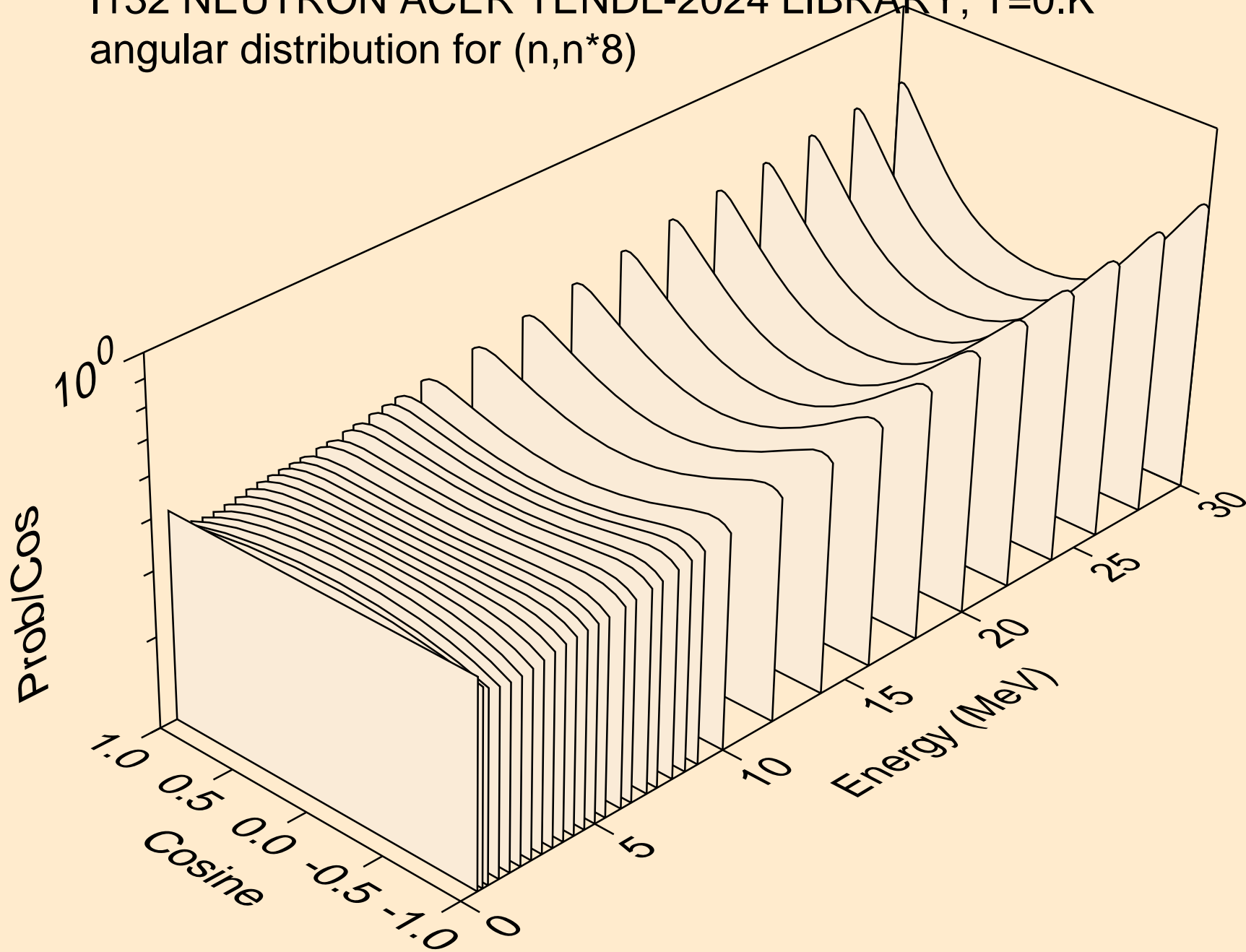

I132 NEUTRON ACER TENDL-2024 LIBRARY; T=0.K  
angular distribution for (n,n\*9)

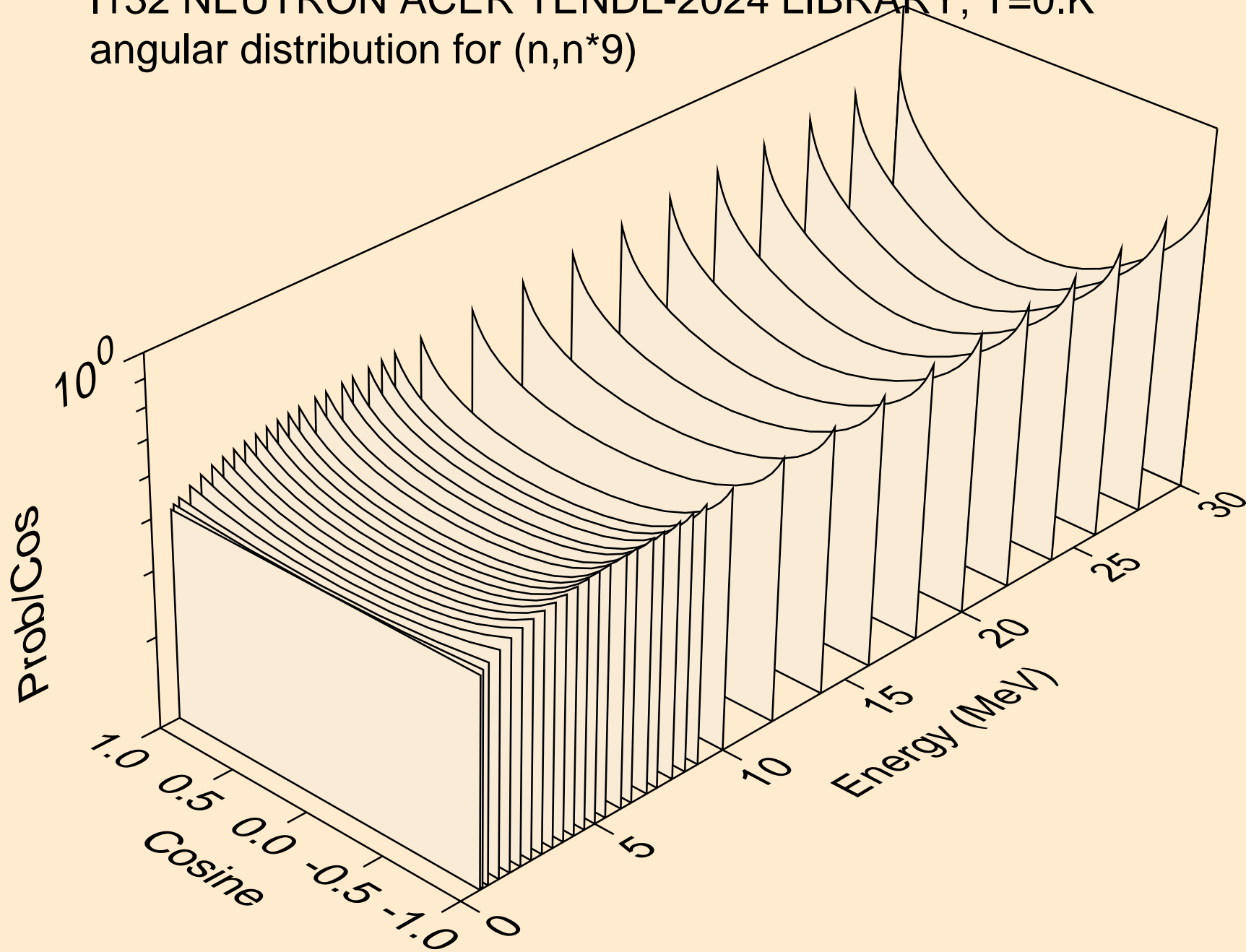

I132 NEUTRON ACER TENDL-2024 LIBRARY; T=0.K  
angular distribution for (n,n\*10)

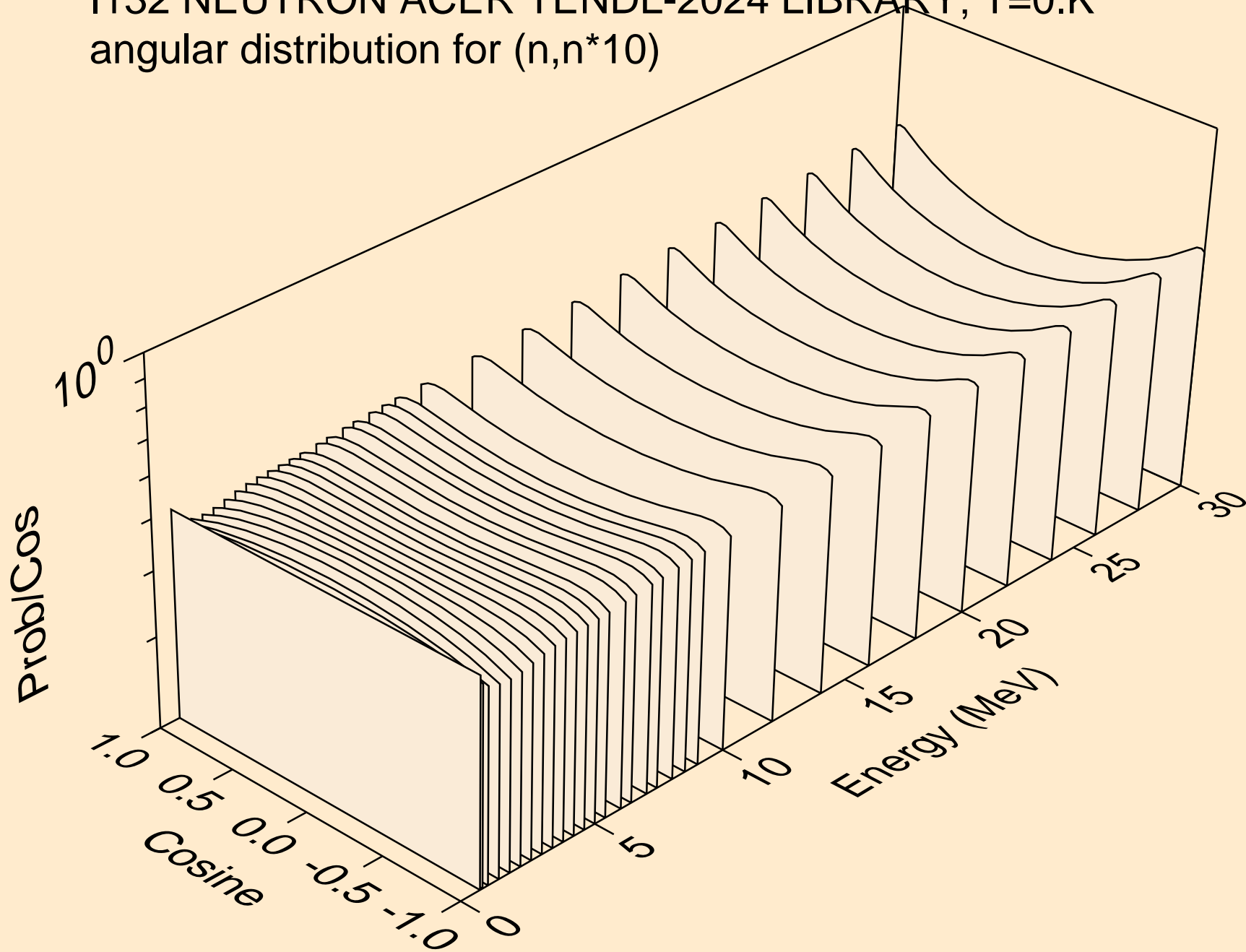

I132 NEUTRON ACER TENDL-2024 LIBRARY; T=0.K  
angular distribution for (n,n\*11)

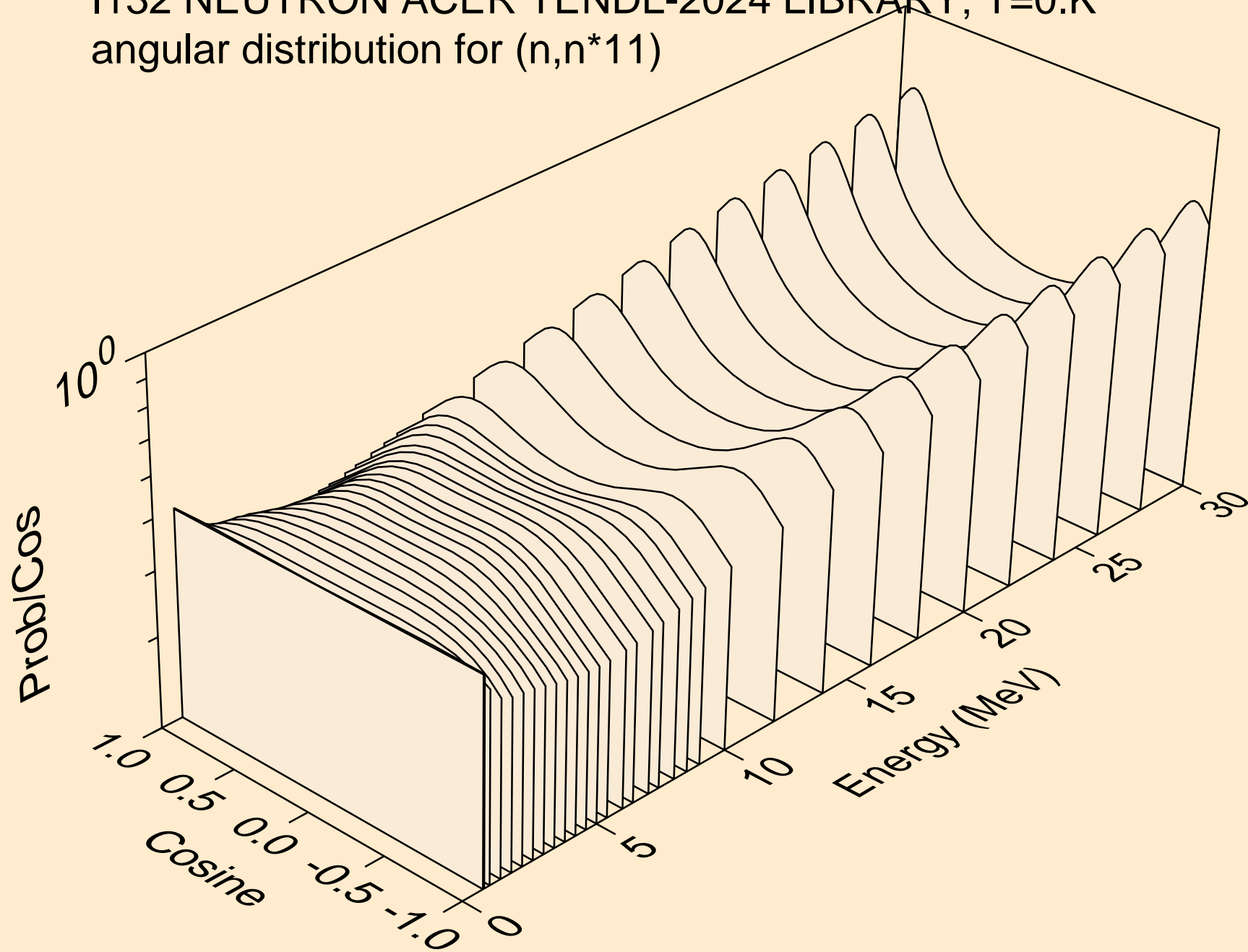

I132 NEUTRON ACER TENDL-2024 LIBRARY; T=0.K  
angular distribution for (n,n\*12)

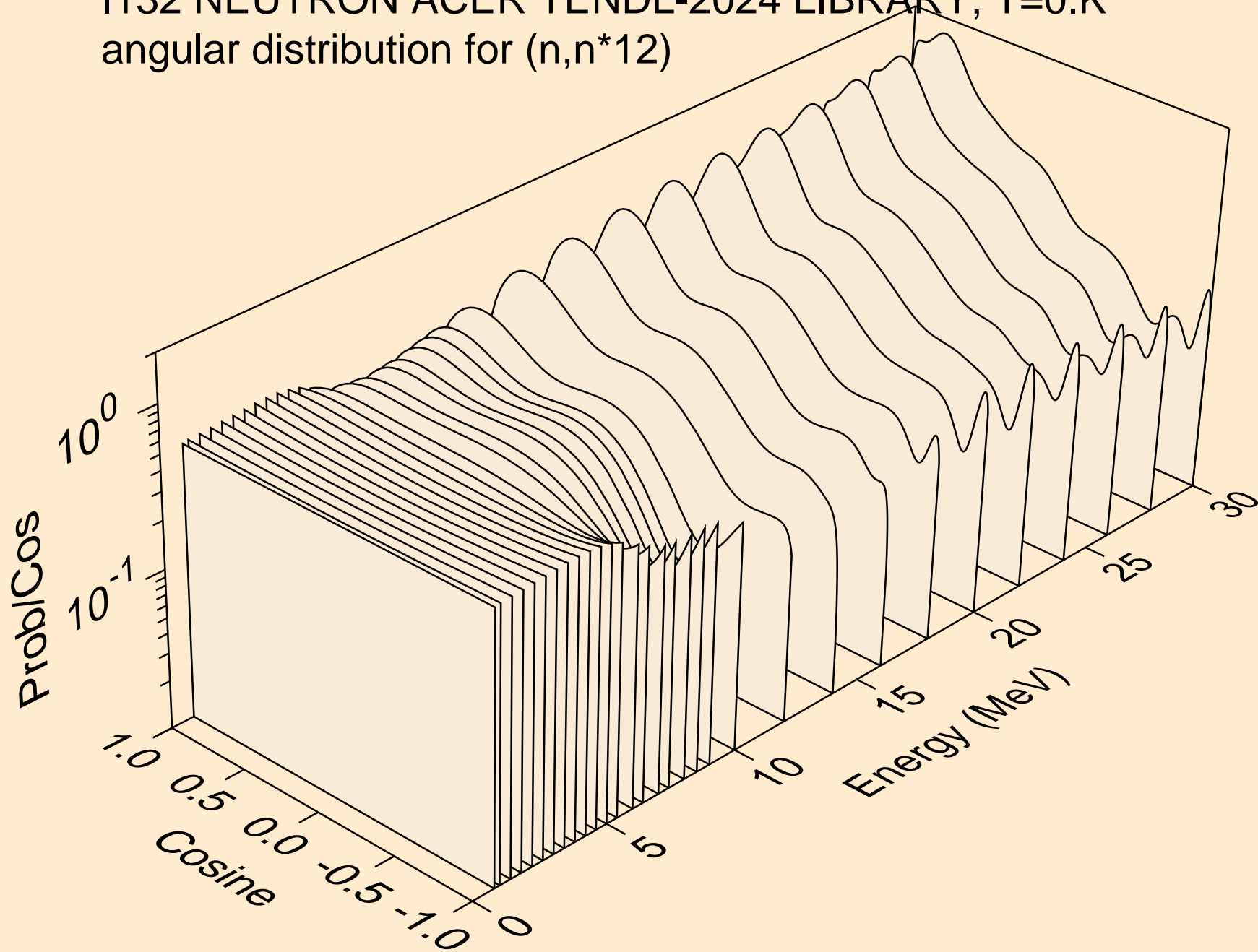

I132 NEUTRON ACER TENDL-2024 LIBRARY; T=0.K  
angular distribution for (n,n\*13)

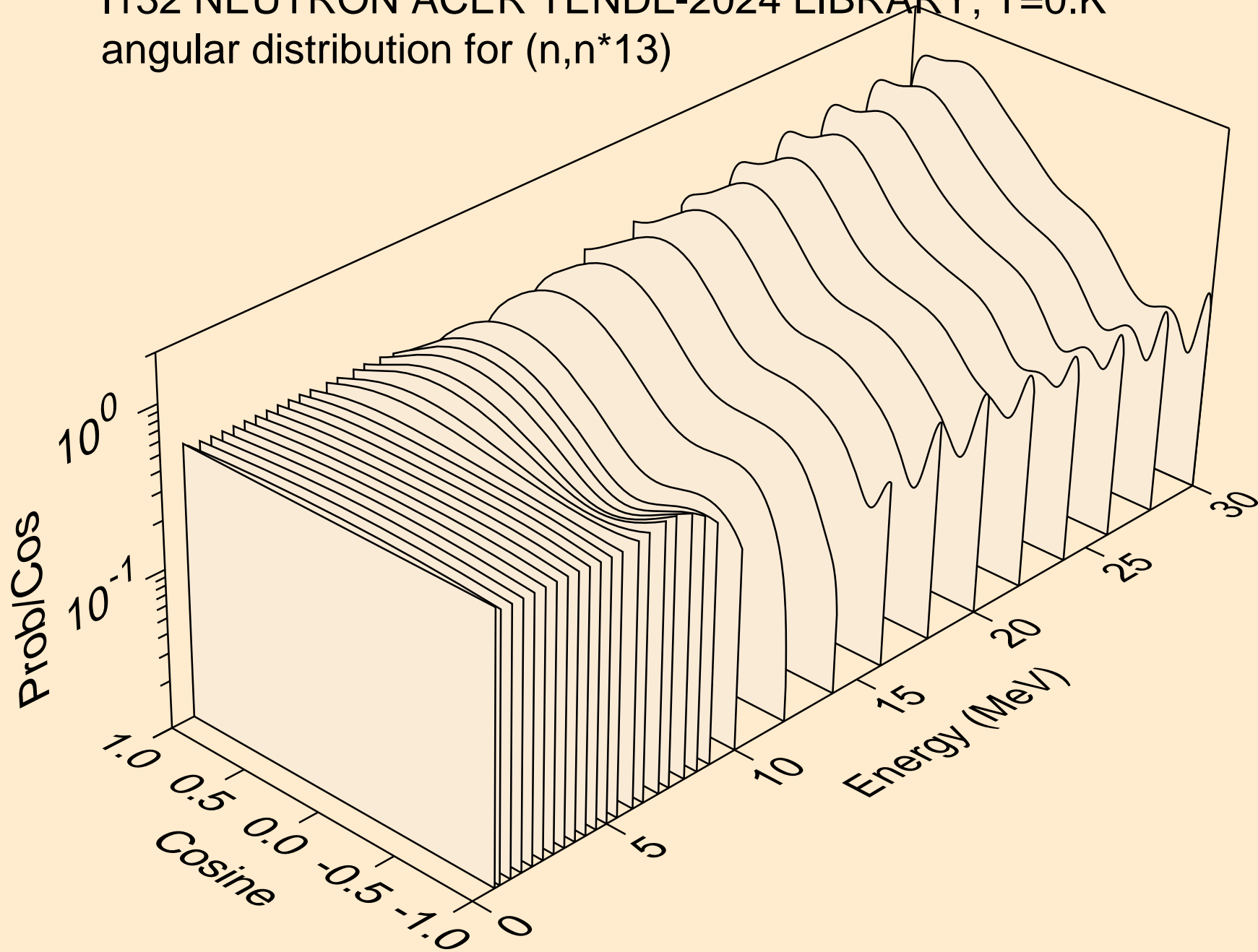

I132 NEUTRON ACER TENDL-2024 LIBRARY; T=0.K  
angular distribution for (n,n\*14)

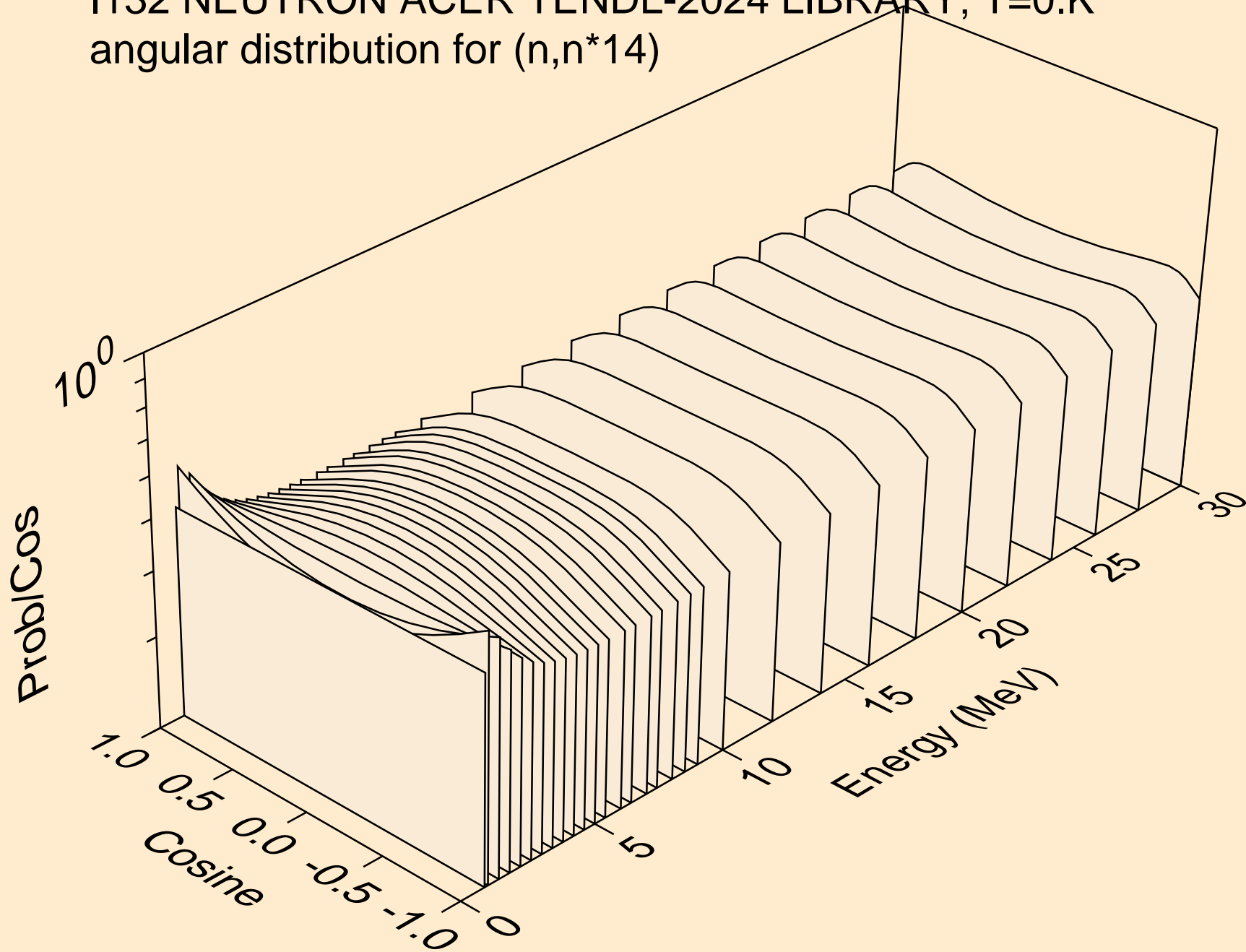

I132 NEUTRON ACER TENDL-2024 LIBRARY; T=0.K  
angular distribution for (n,n\*15)

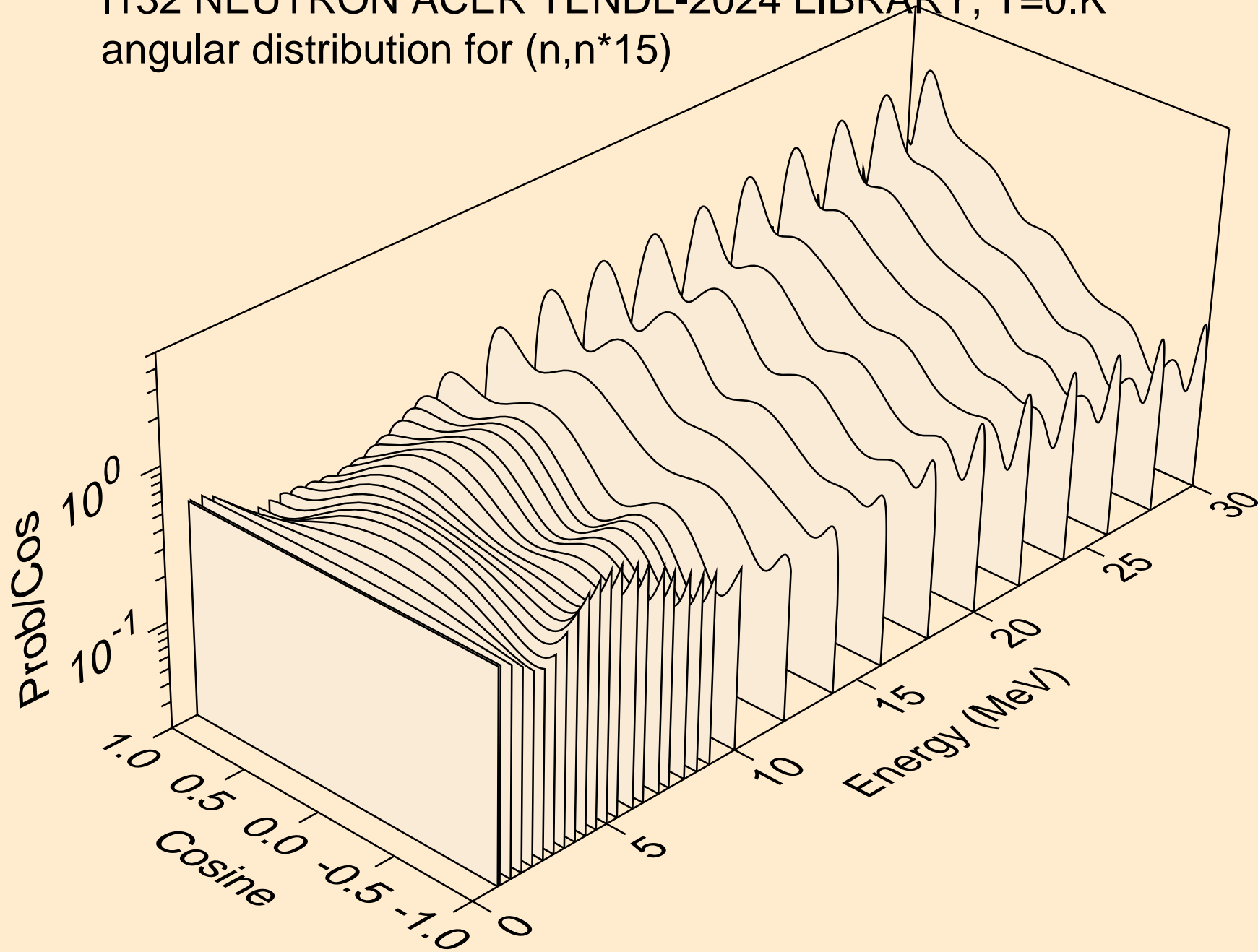

I132 NEUTRON ACER TENDL-2024 LIBRARY; T=0.K  
angular distribution for (n,n\*16)

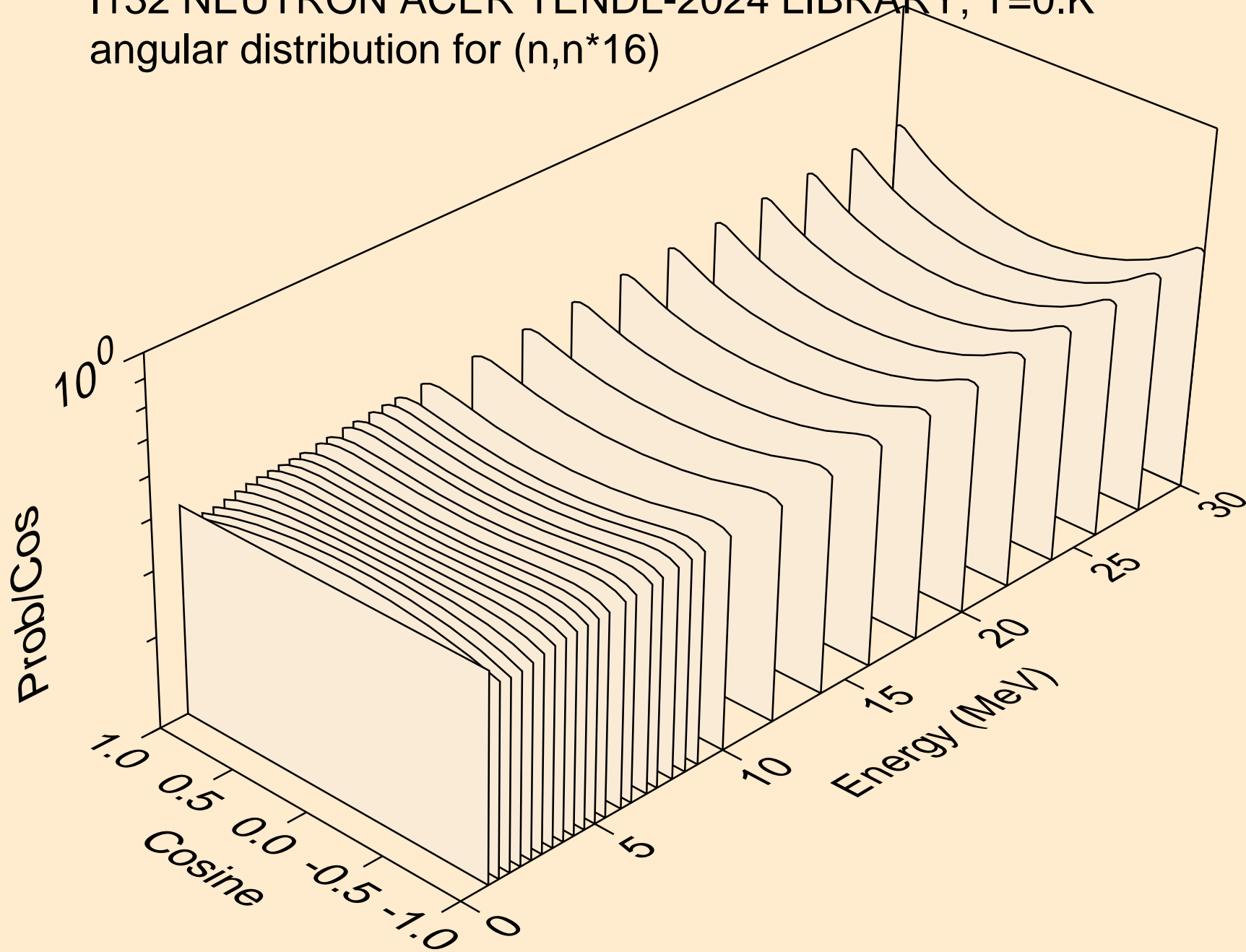

I132 NEUTRON ACER TENDL-2024 LIBRARY; T=0.K  
angular distribution for (n,n\*17)

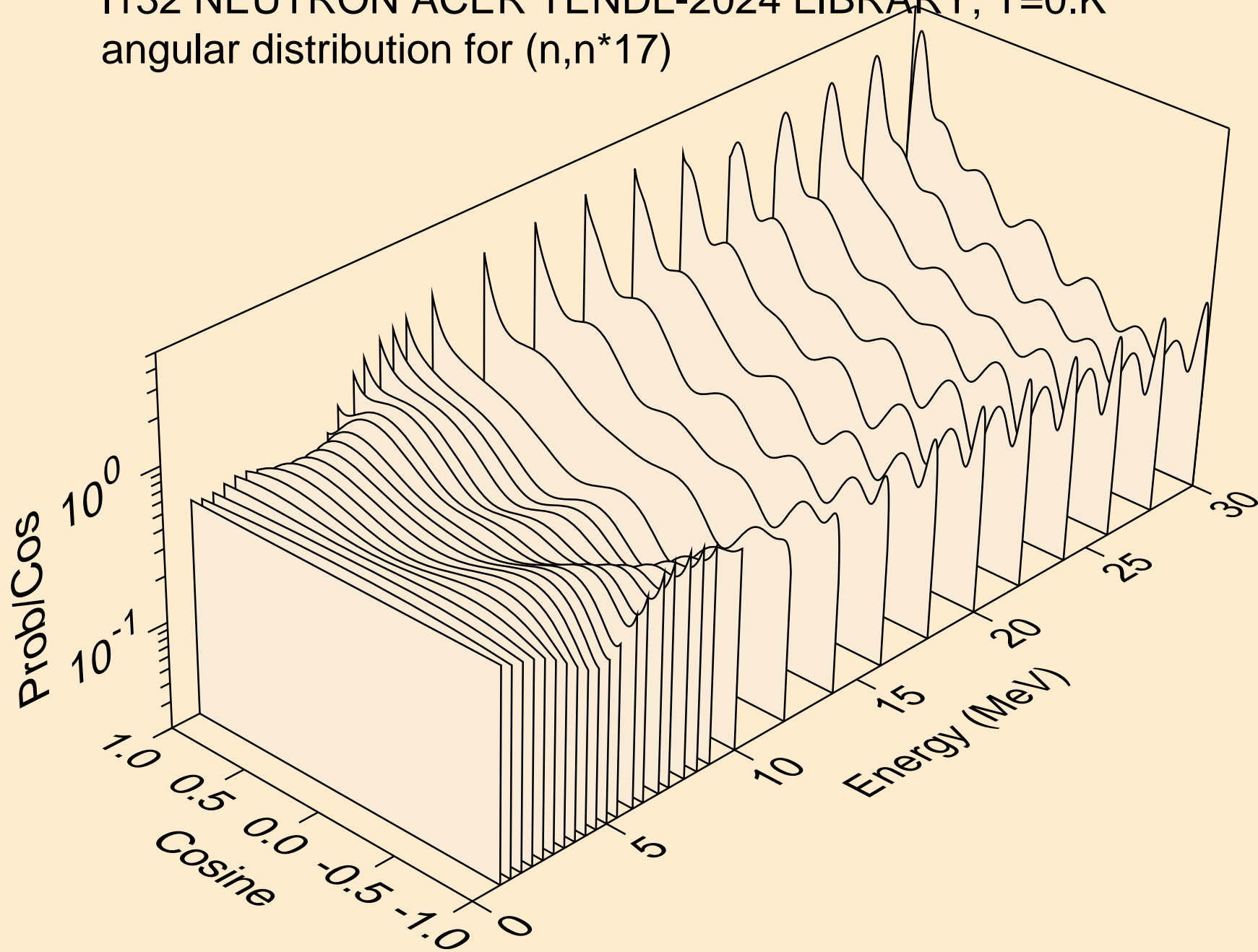

I132 NEUTRON ACER TENDL-2024 LIBRARY; T=0.K  
angular distribution for (n,n\*18)

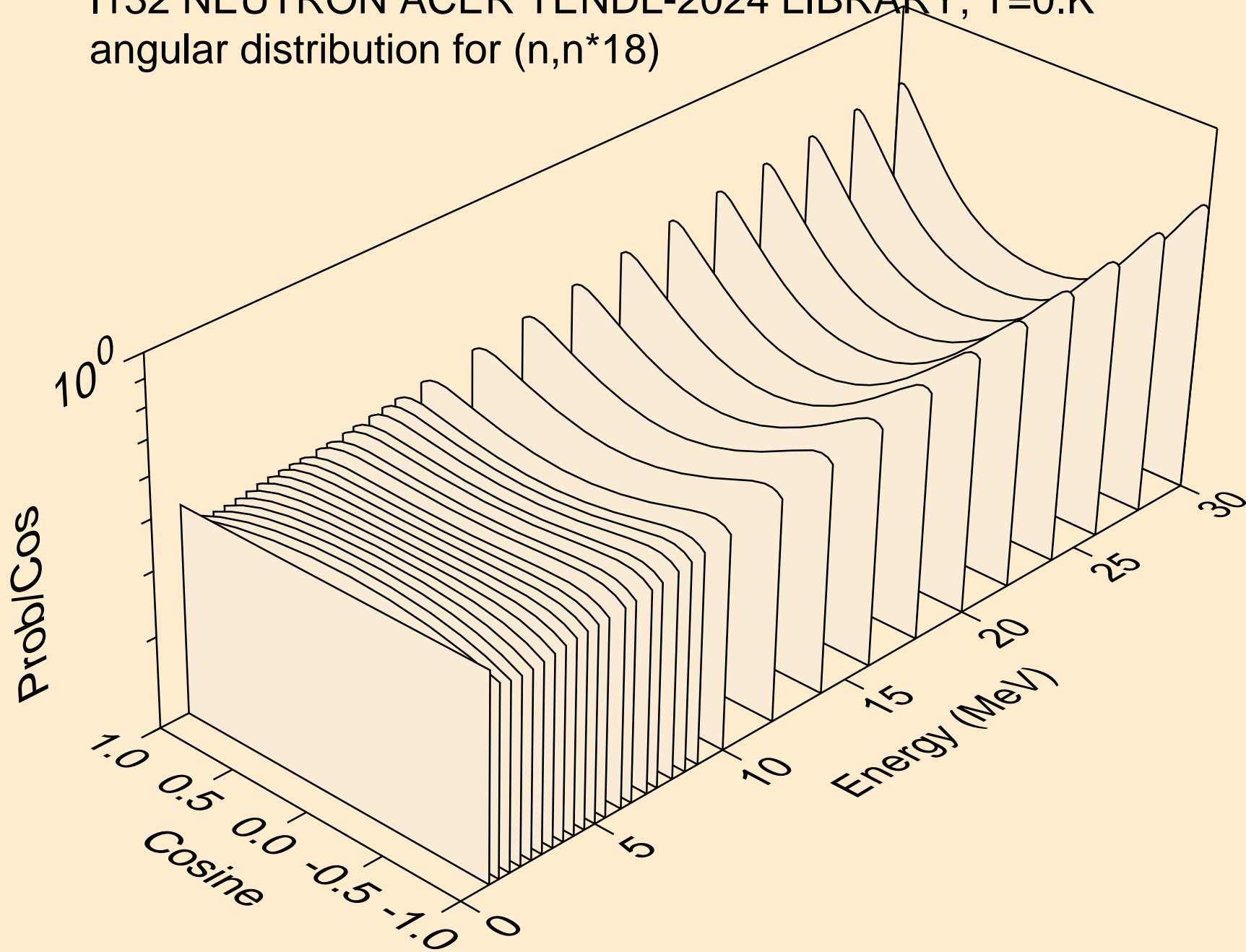

I132 NEUTRON ACER TENDL-2024 LIBRARY; T=0.K  
angular distribution for (n,n\*19)

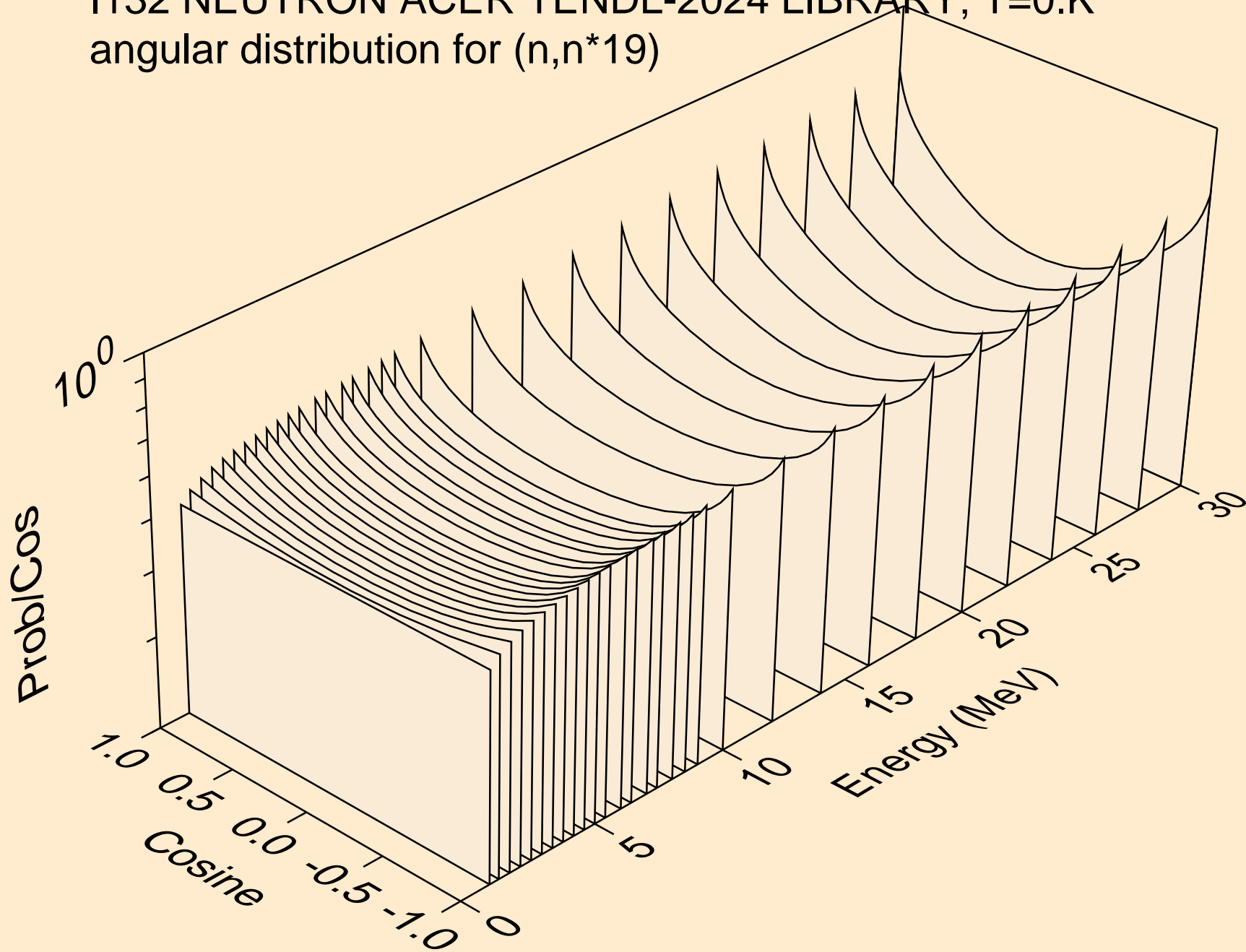

I132 NEUTRON ACER TENDL-2024 LIBRARY; T=0.K  
angular distribution for (n,n\*20)

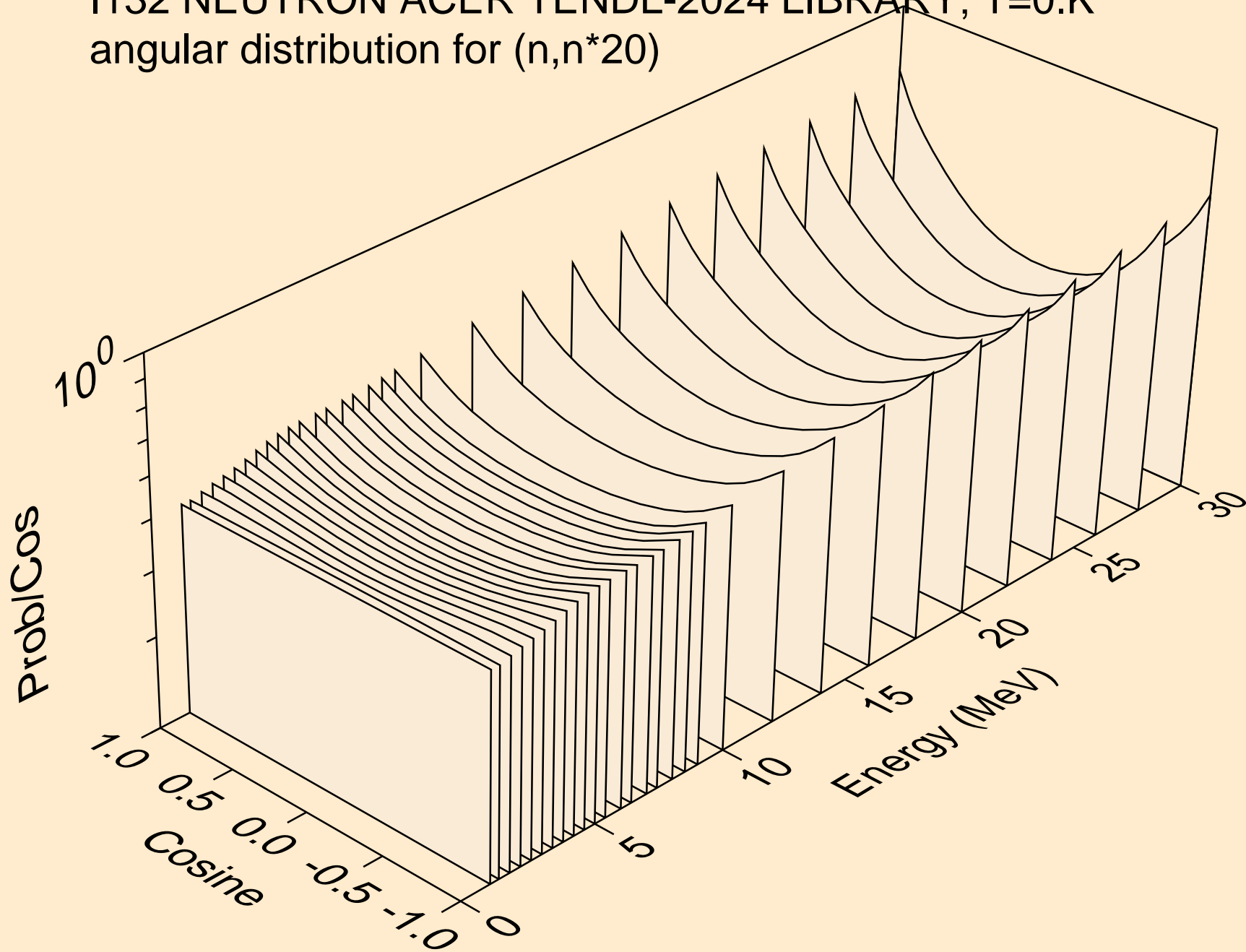

I132 NEUTRON ACER TENDL-2024 LIBRARY; T=0.K  
angular distribution for (n,n\*21)

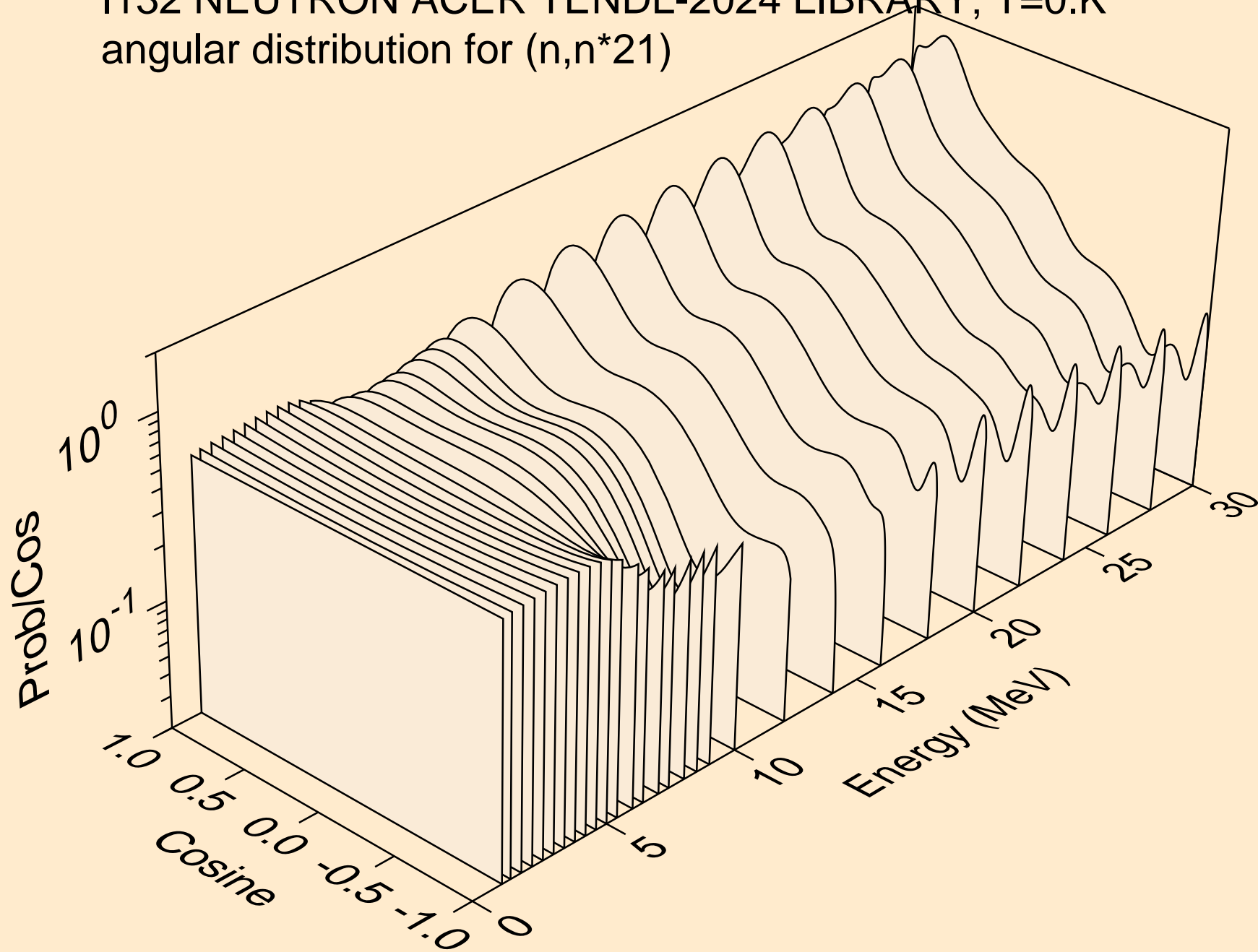

I132 NEUTRON ACER TENDL-2024 LIBRARY; T=0.K  
angular distribution for (n,n\*22)

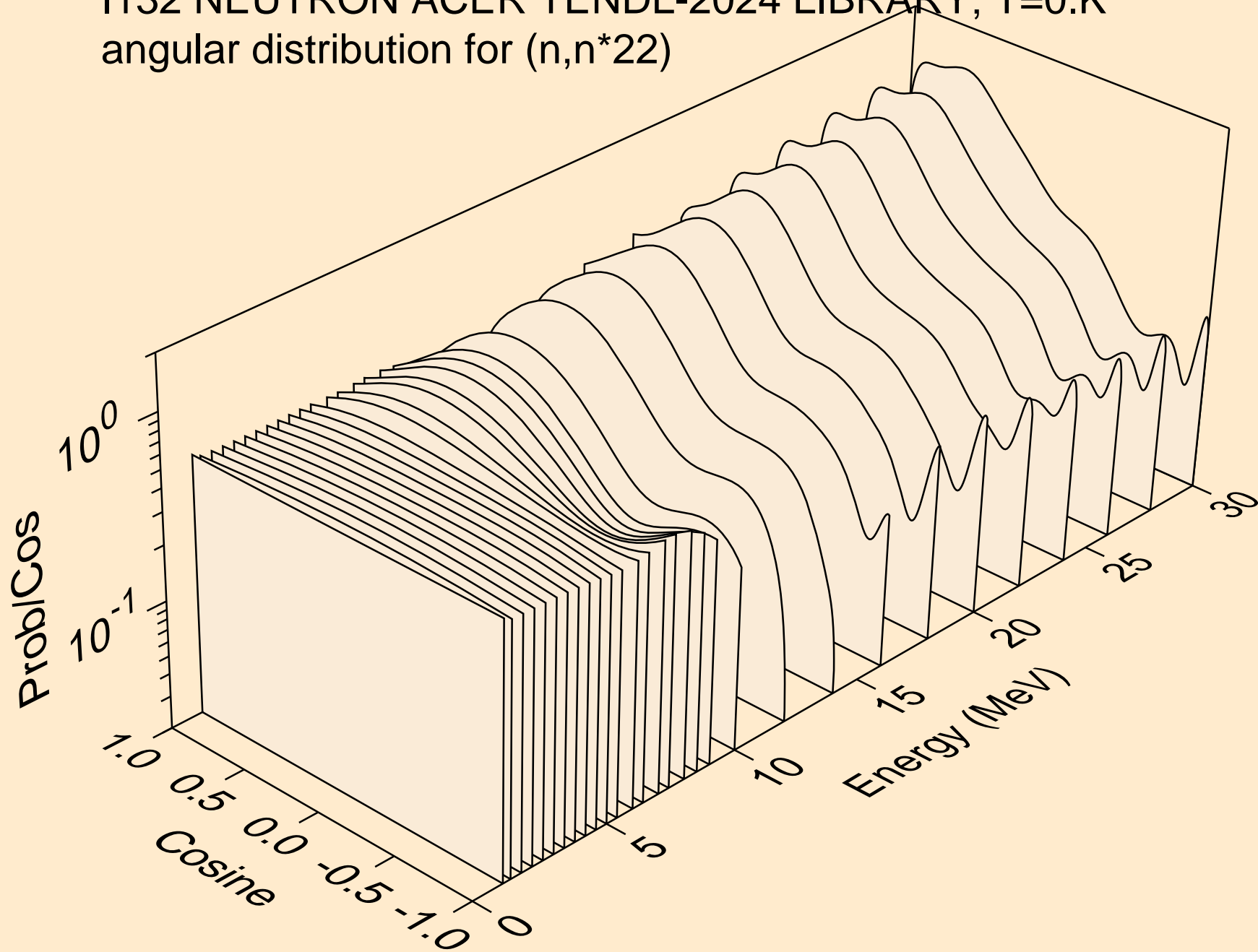

I132 NEUTRON ACER TENDL-2024 LIBRARY; T=0.K  
angular distribution for (n,n\*23)

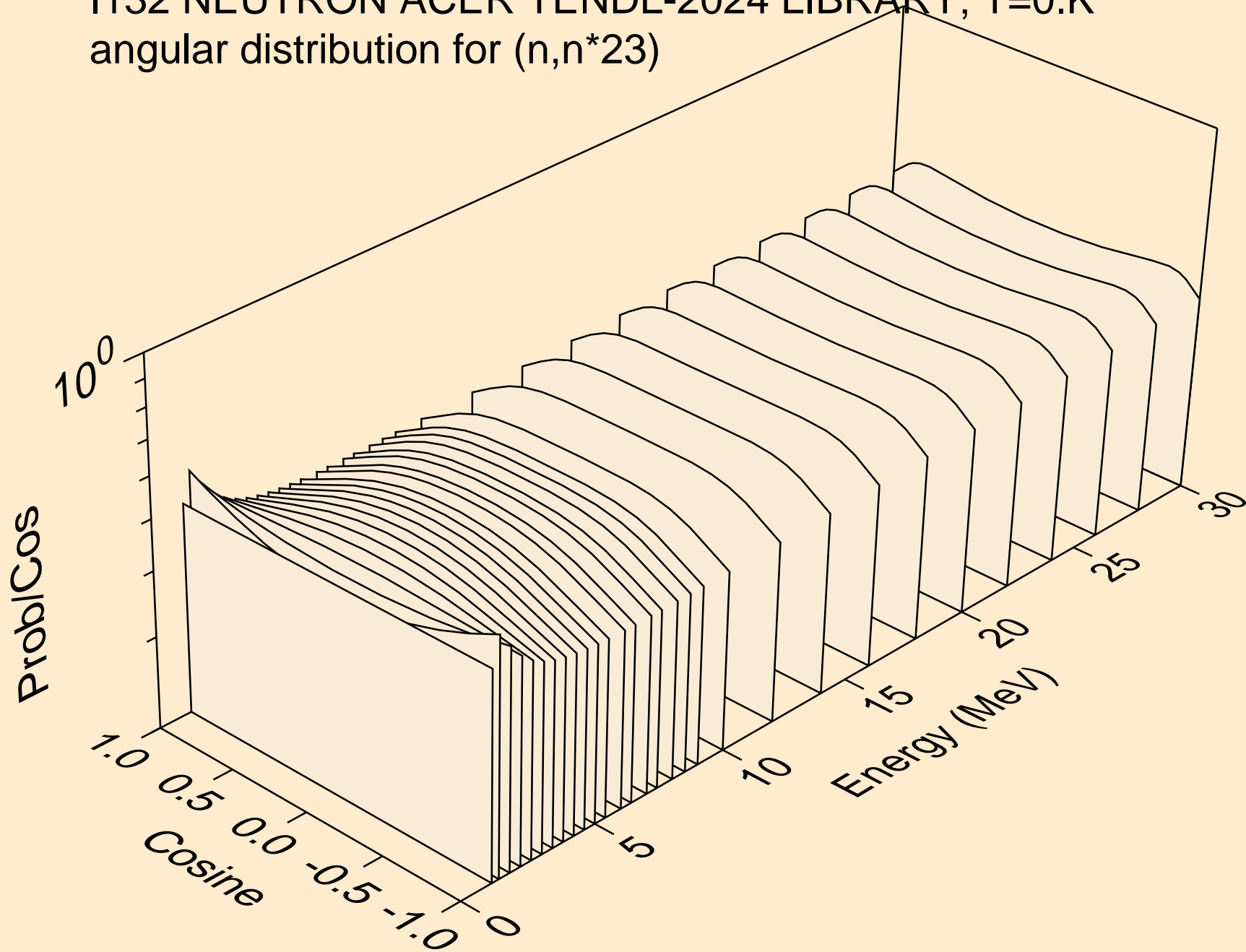

I132 NEUTRON ACER TENDL-2024 LIBRARY; T=0.K  
angular distribution for (n,n\*24)

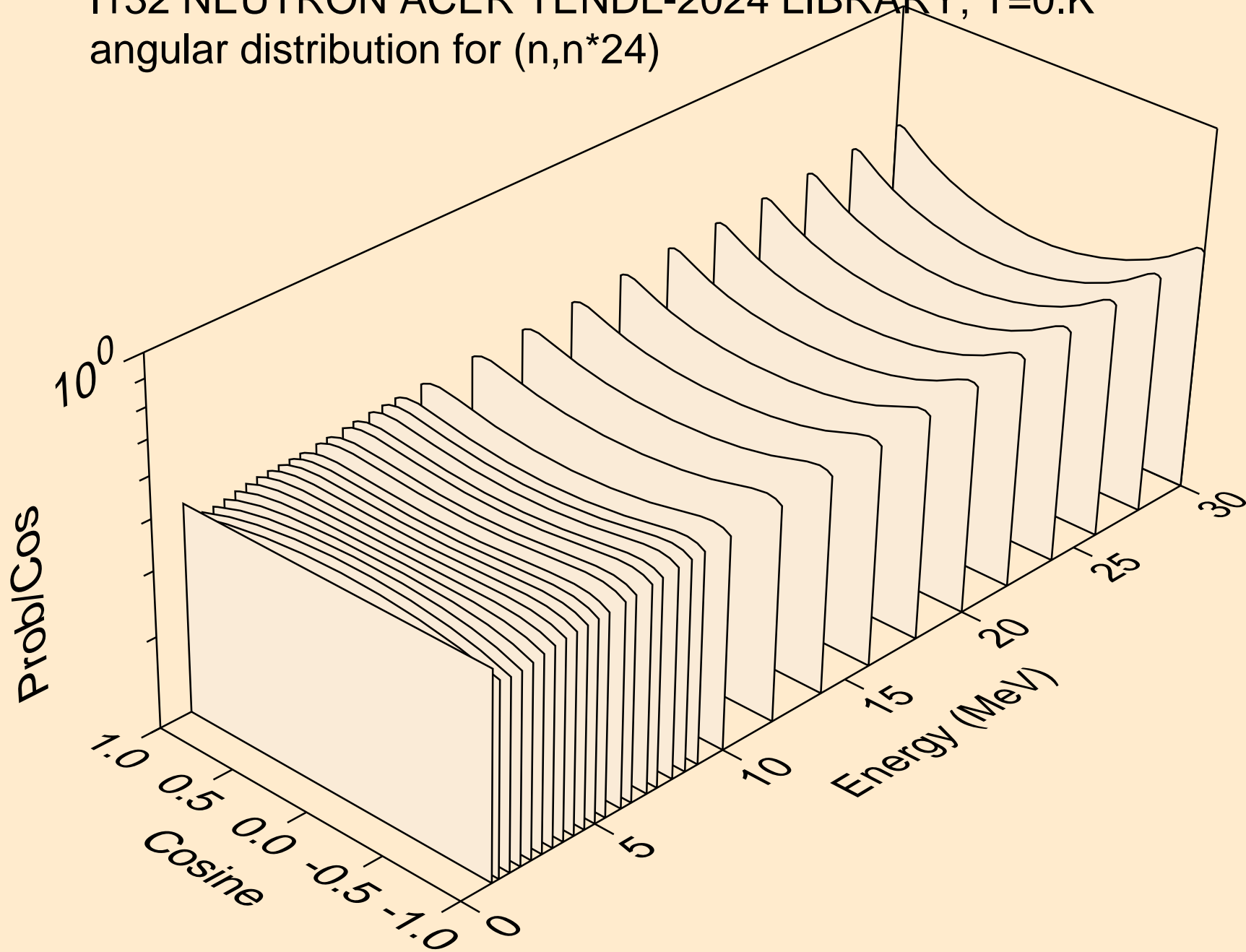

I132 NEUTRON ACER TENDL-2024 LIBRARY; T=0.K  
angular distribution for (n,n\*25)

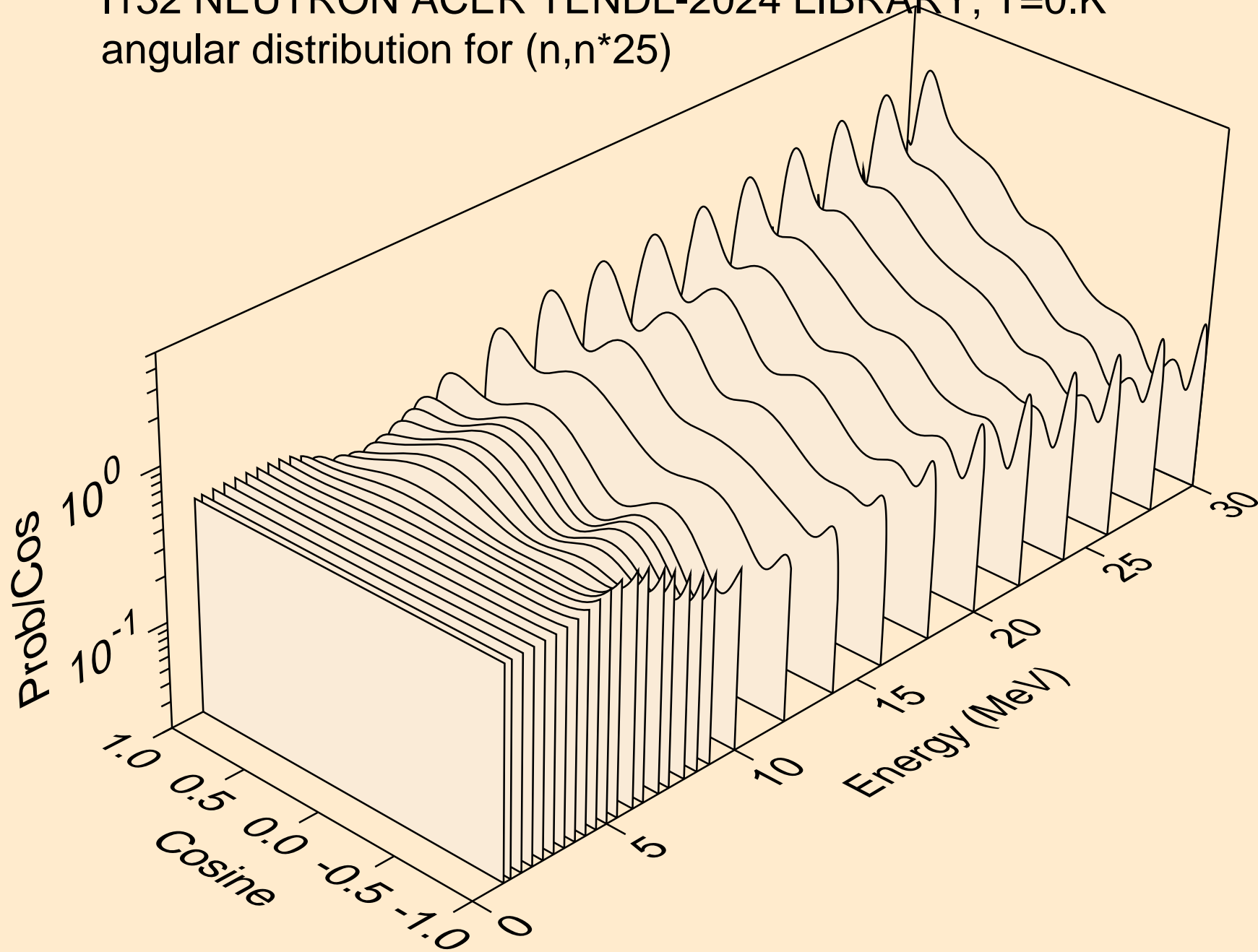

I132 NEUTRON ACER TENDL-2024 LIBRARY; T=0.K  
angular distribution for (n,n\*26)

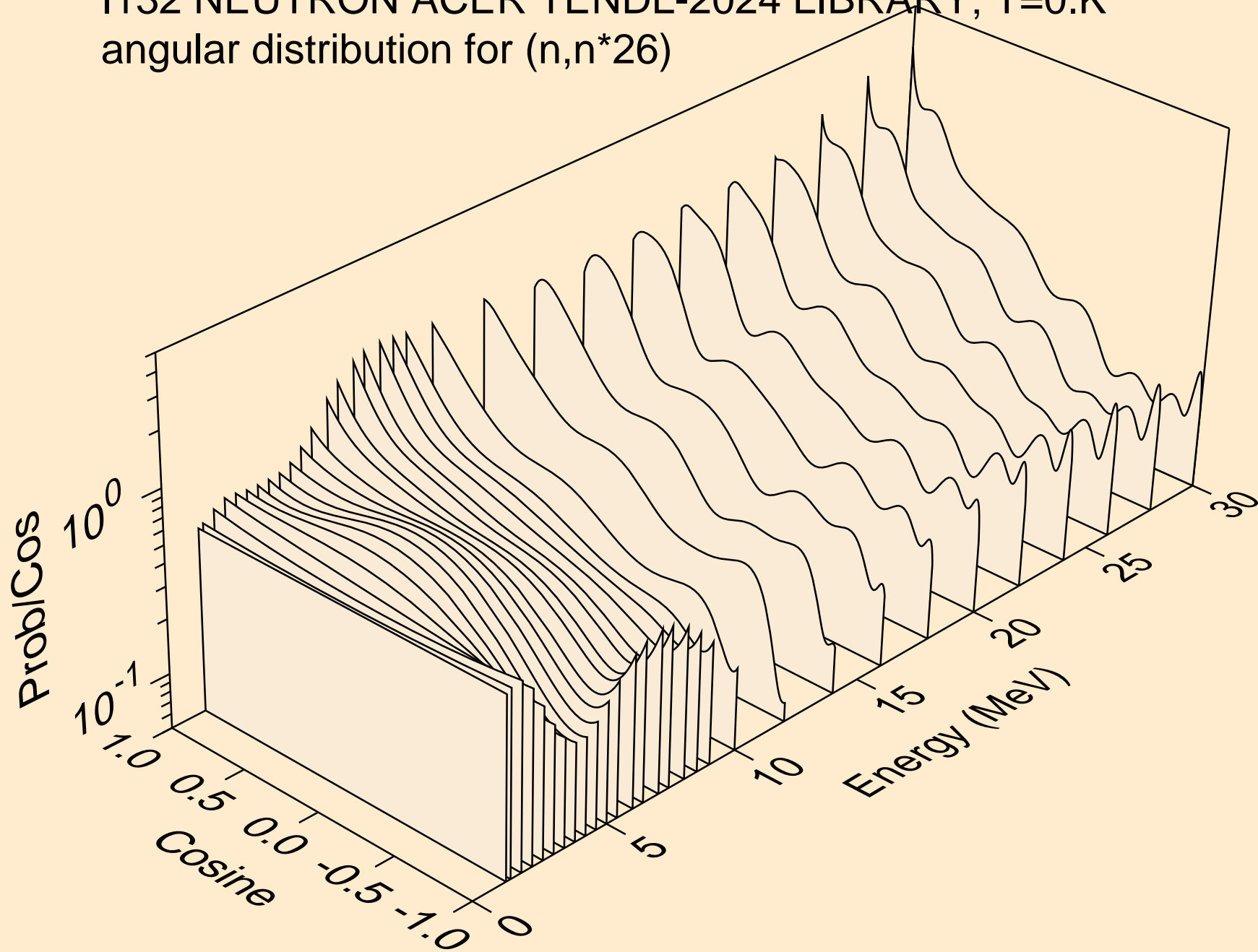

I132 NEUTRON ACER TENDL-2024 LIBRARY; T=0.K  
angular distribution for (n,n\*27)

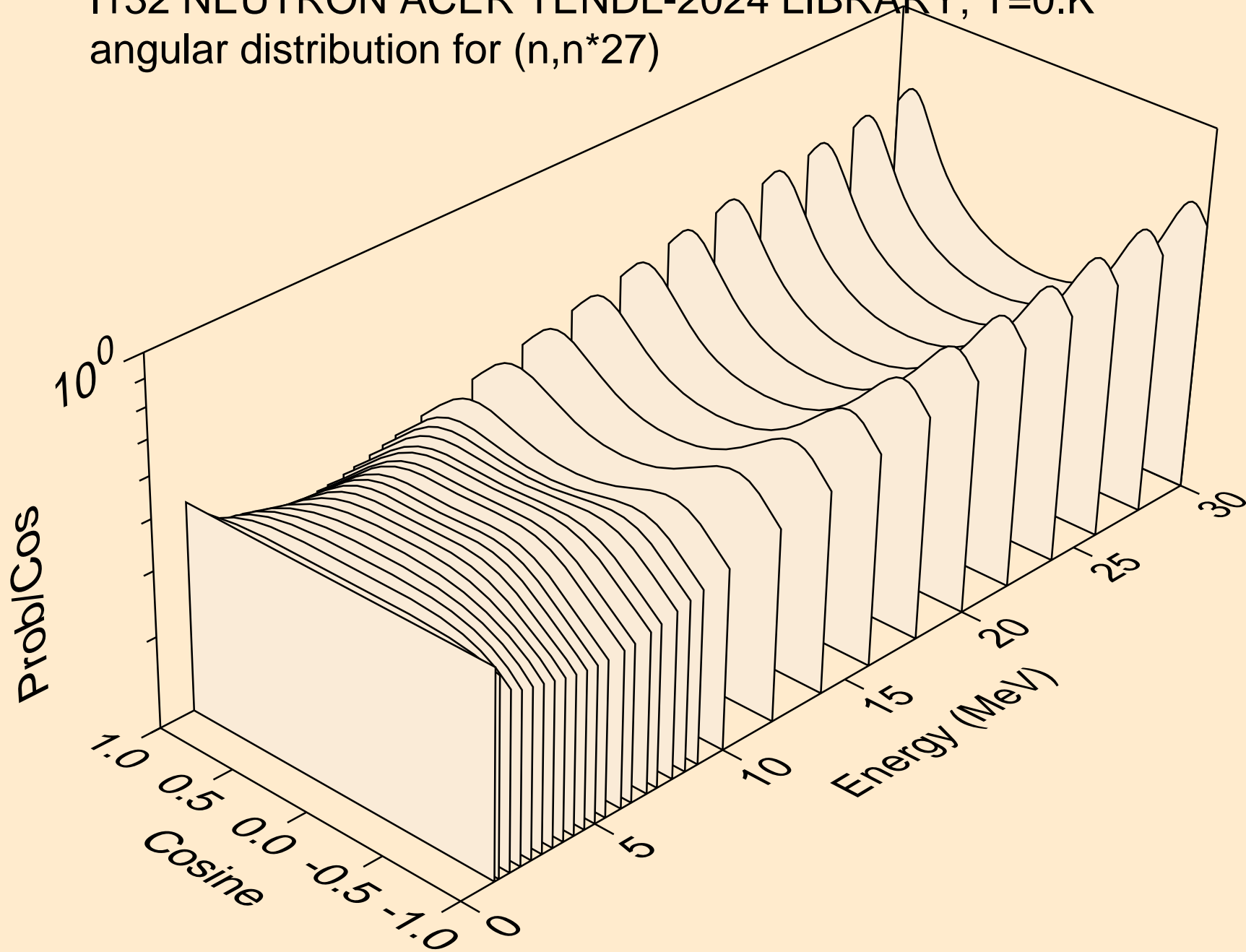

I132 NEUTRON ACER TENDL-2024 LIBRARY; T=0.K  
angular distribution for (n,n\*28)

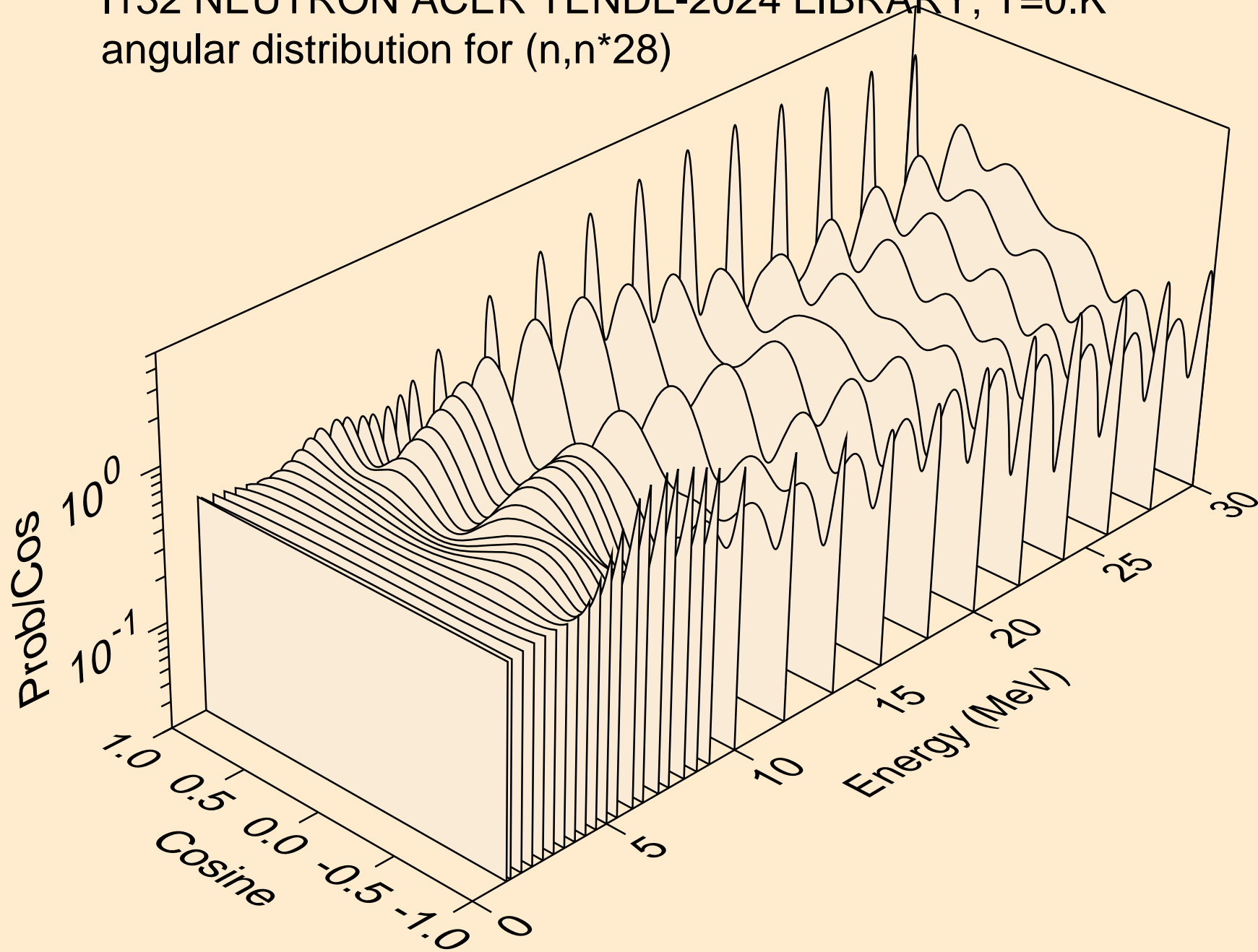

I132 NEUTRON ACER TENDL-2024 LIBRARY; T=0.K  
angular distribution for (n,n\*29)

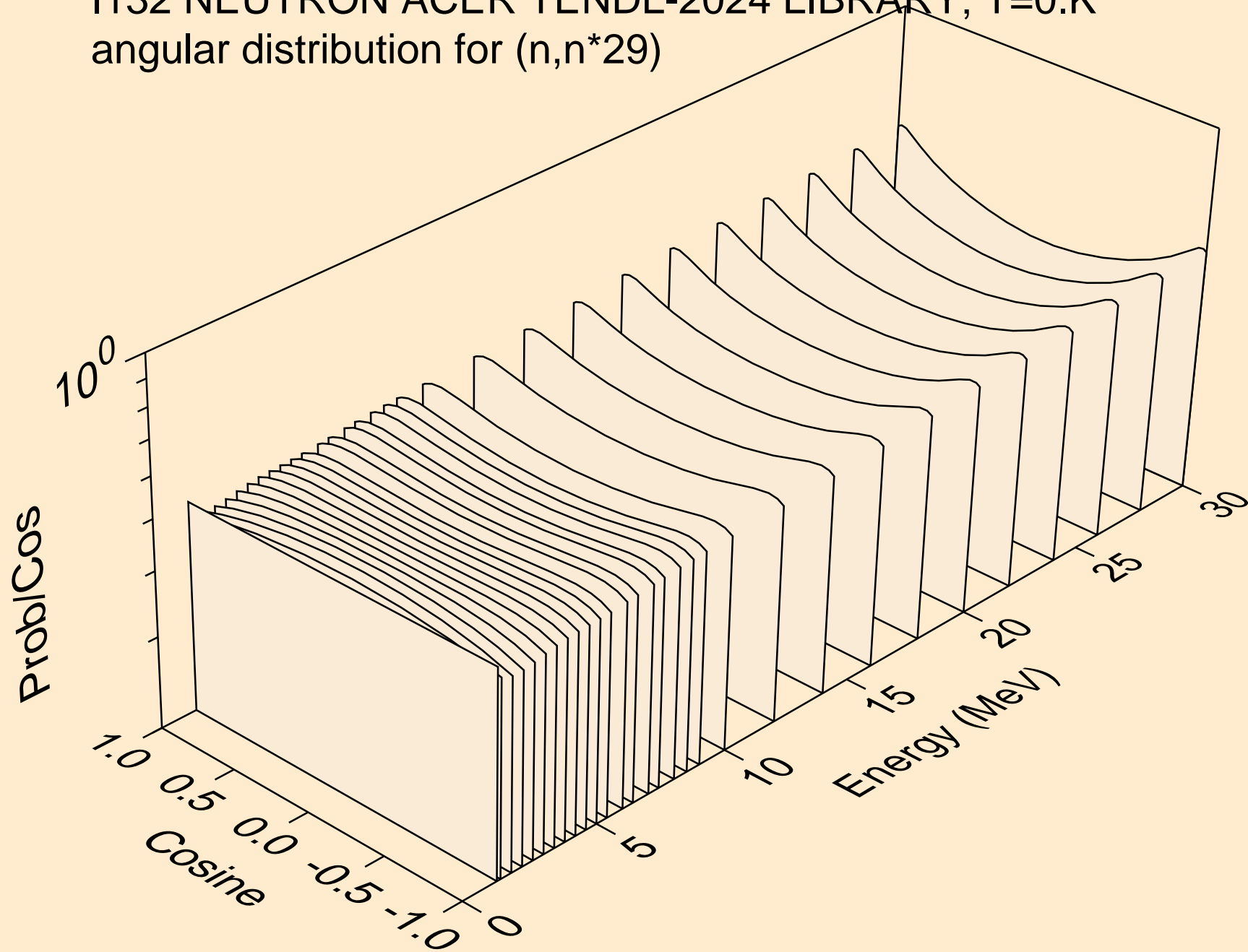

I132 NEUTRON ACER TENDL-2024 LIBRARY; T=0.K  
Neutron emission for (n,x)

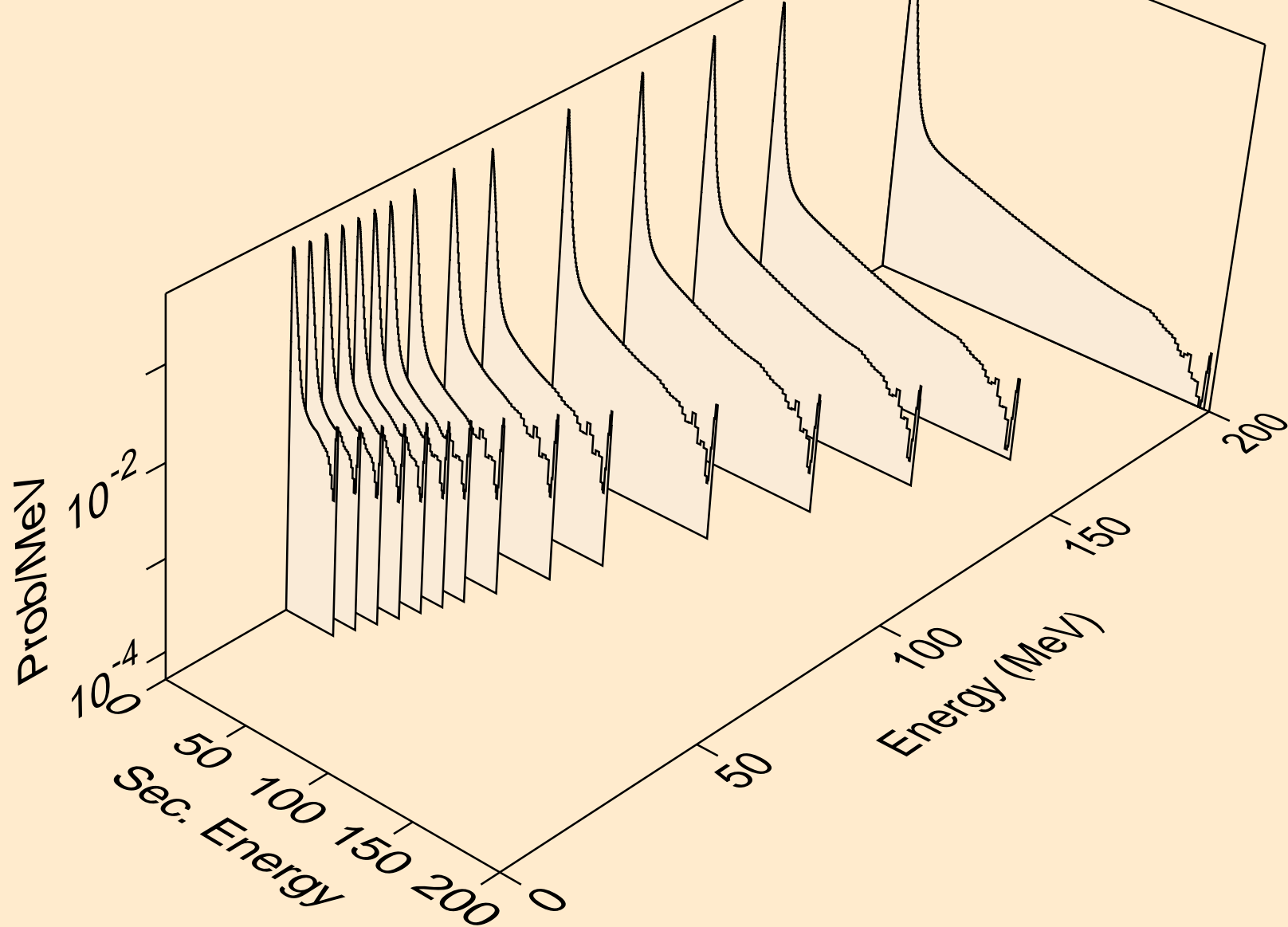

I132 NEUTRON ACER TENDL-2024 LIBRARY; T=0.K  
Neutron emission for (n,2nd)

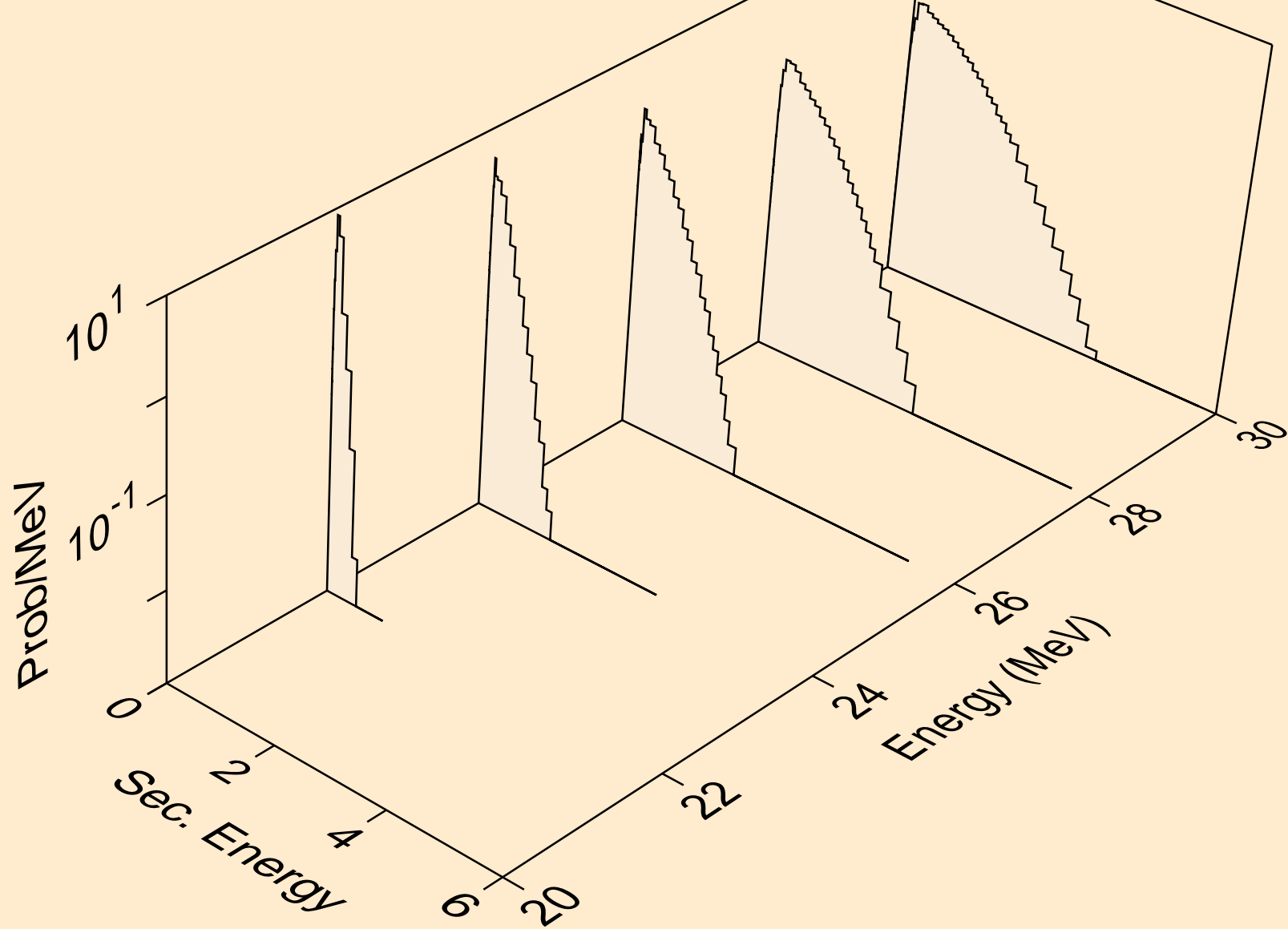

I132 NEUTRON ACER TENDL-2024 LIBRARY; T=0.K  
Neutron emission for (n,2n)

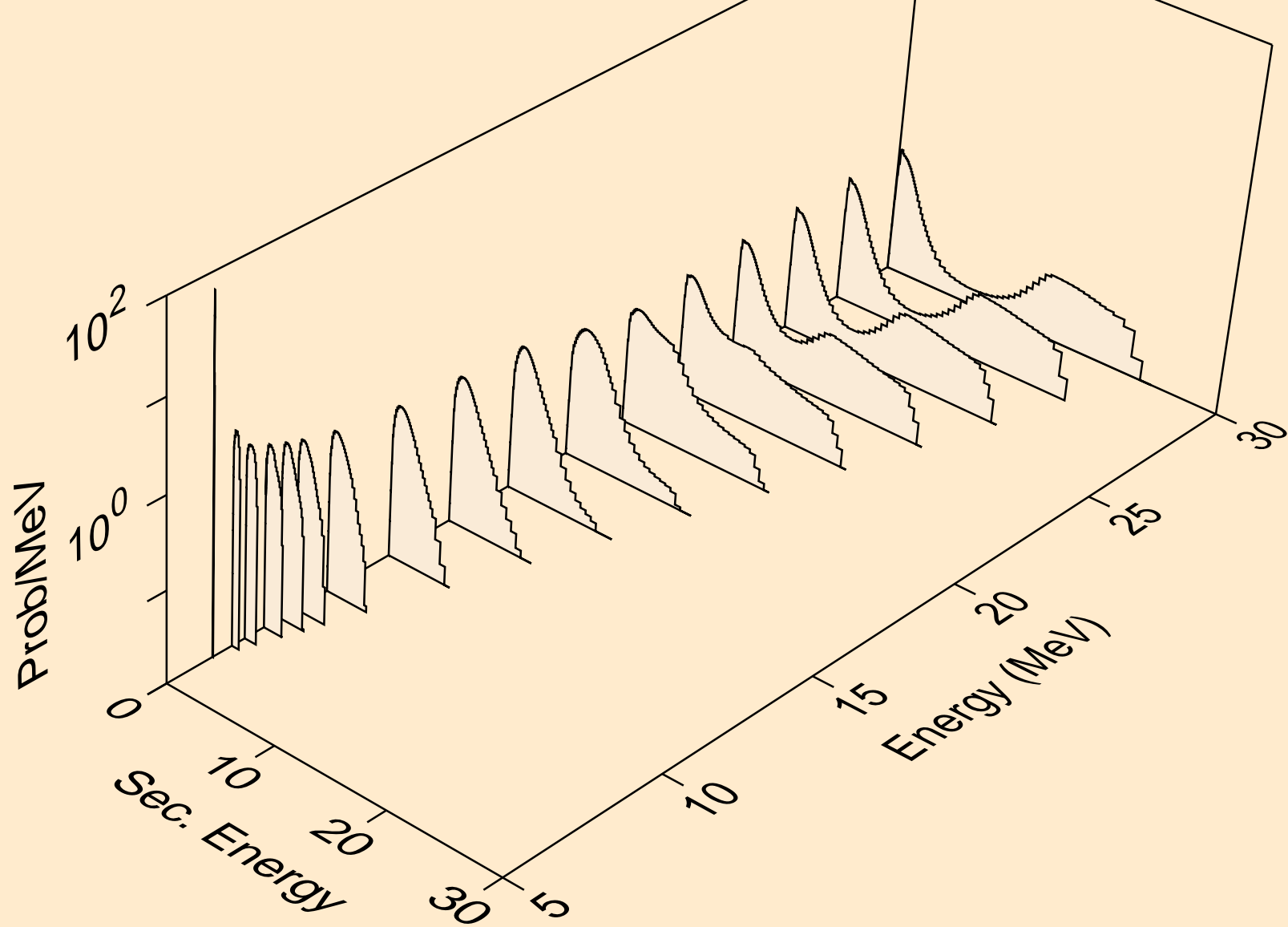

I132 NEUTRON ACER TENDL-2024 LIBRARY; T=0.K  
Neutron emission for (n,3n)

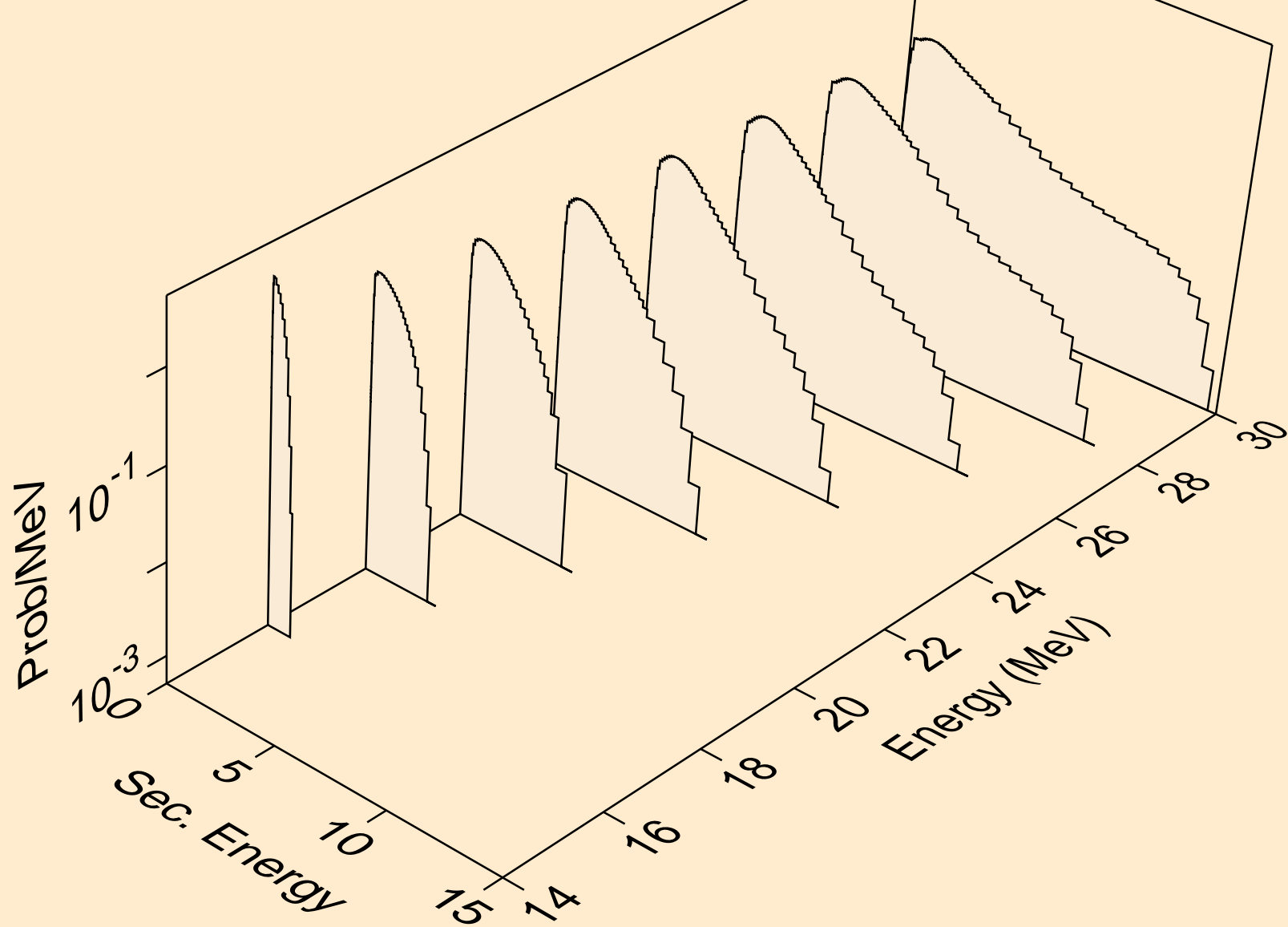

I132 NEUTRON ACER TENDL-2024 LIBRARY; T=0.K  
Neutron emission for (n,n\*)a

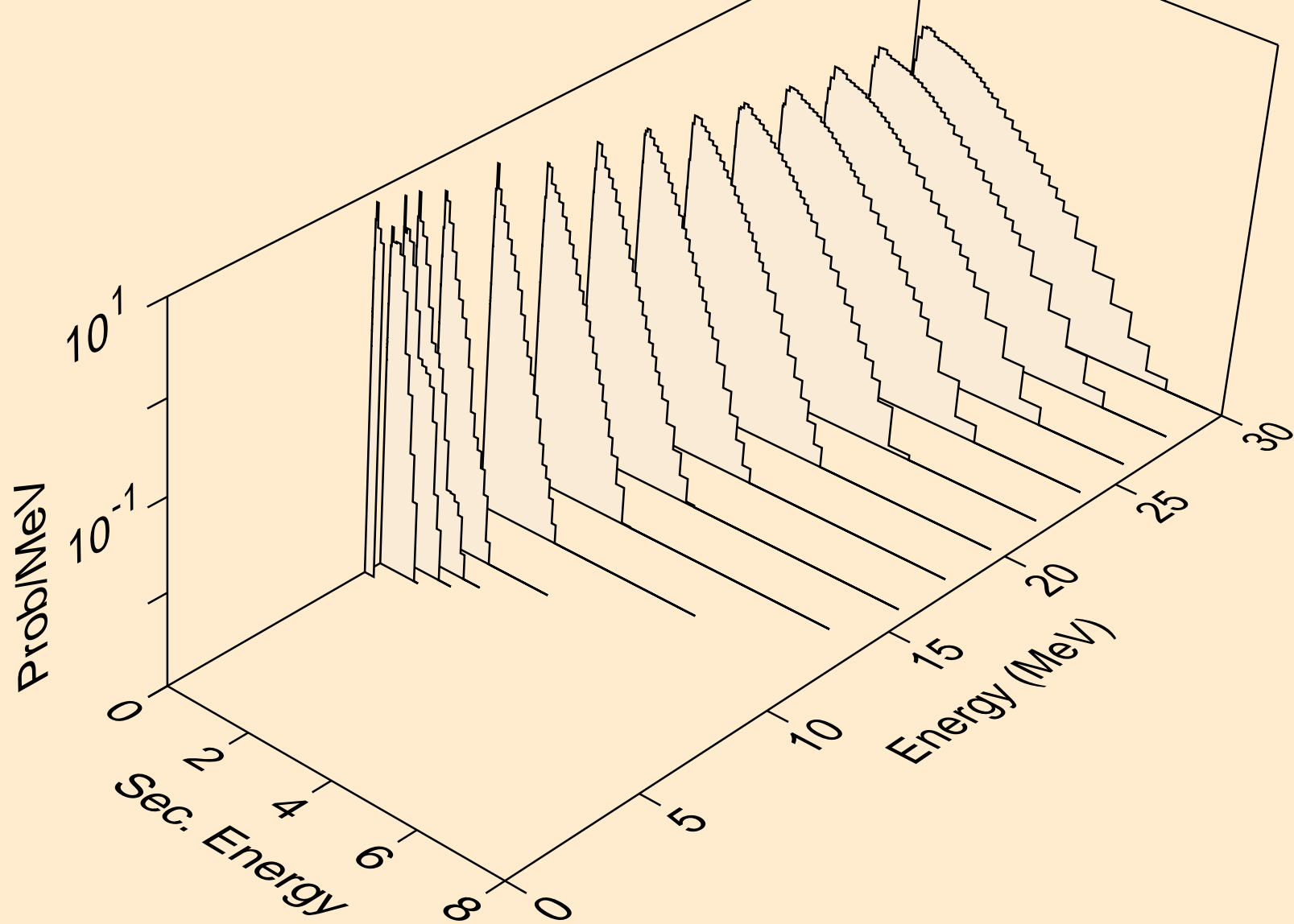

I132 NEUTRON ACER TENDL-2024 LIBRARY; T=0.K  
Neutron emission for (n,2n)a

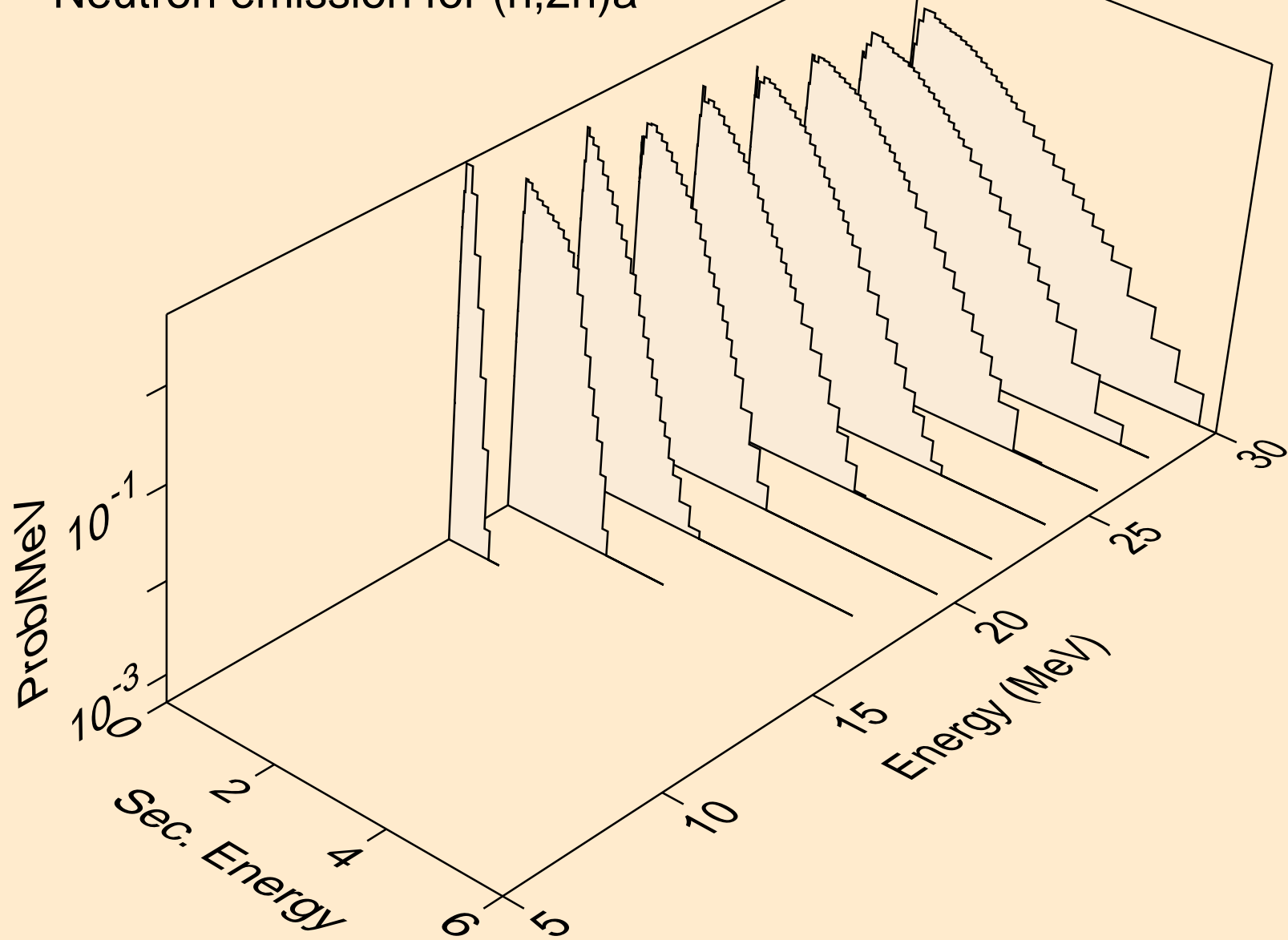

I132 NEUTRON ACER TENDL-2024 LIBRARY; T=0.K  
Neutron emission for (n,3n)a

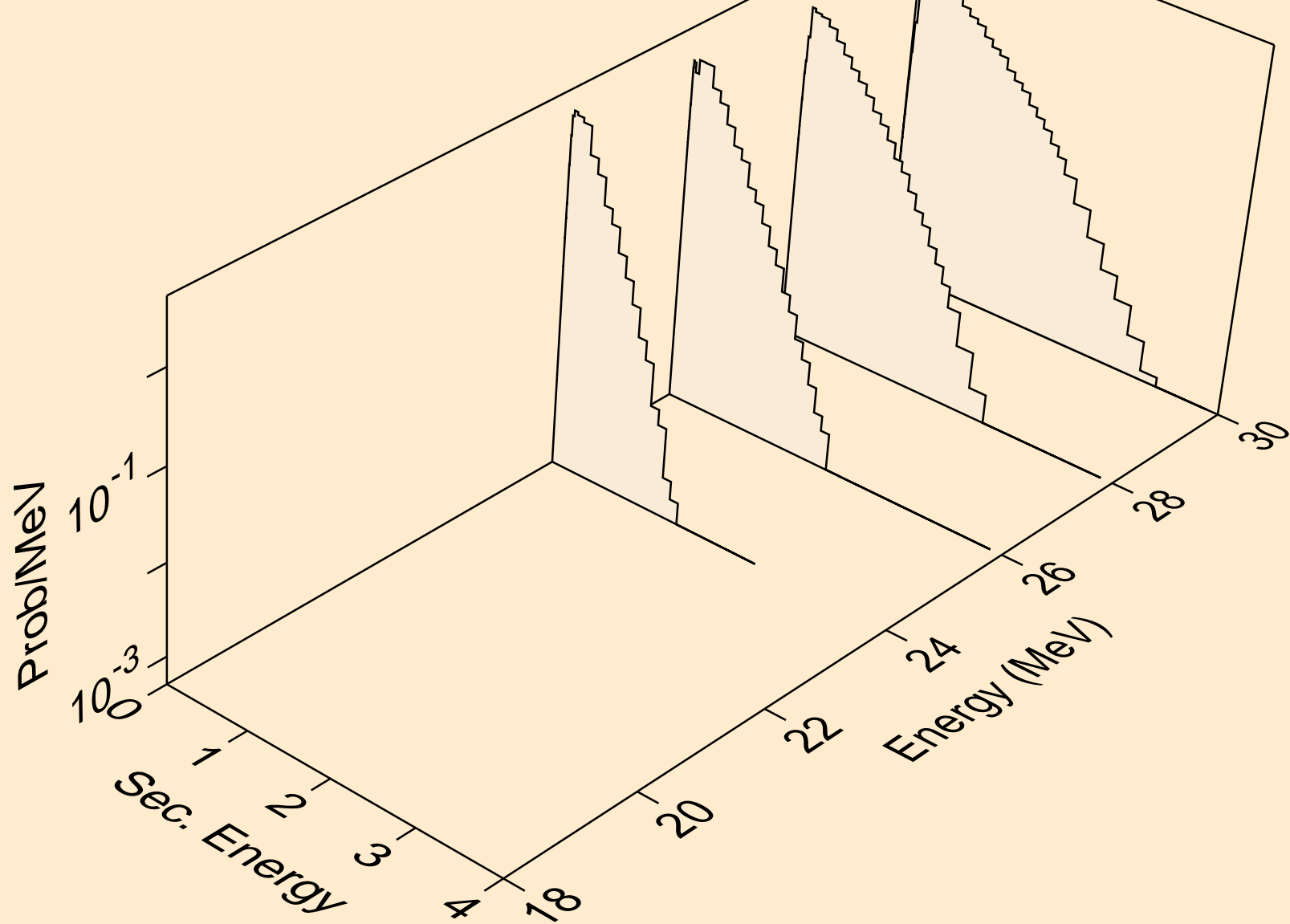

I132 NEUTRON ACER TENDL-2024 LIBRARY; T=0.K  
Neutron emission for (n,n\*)p

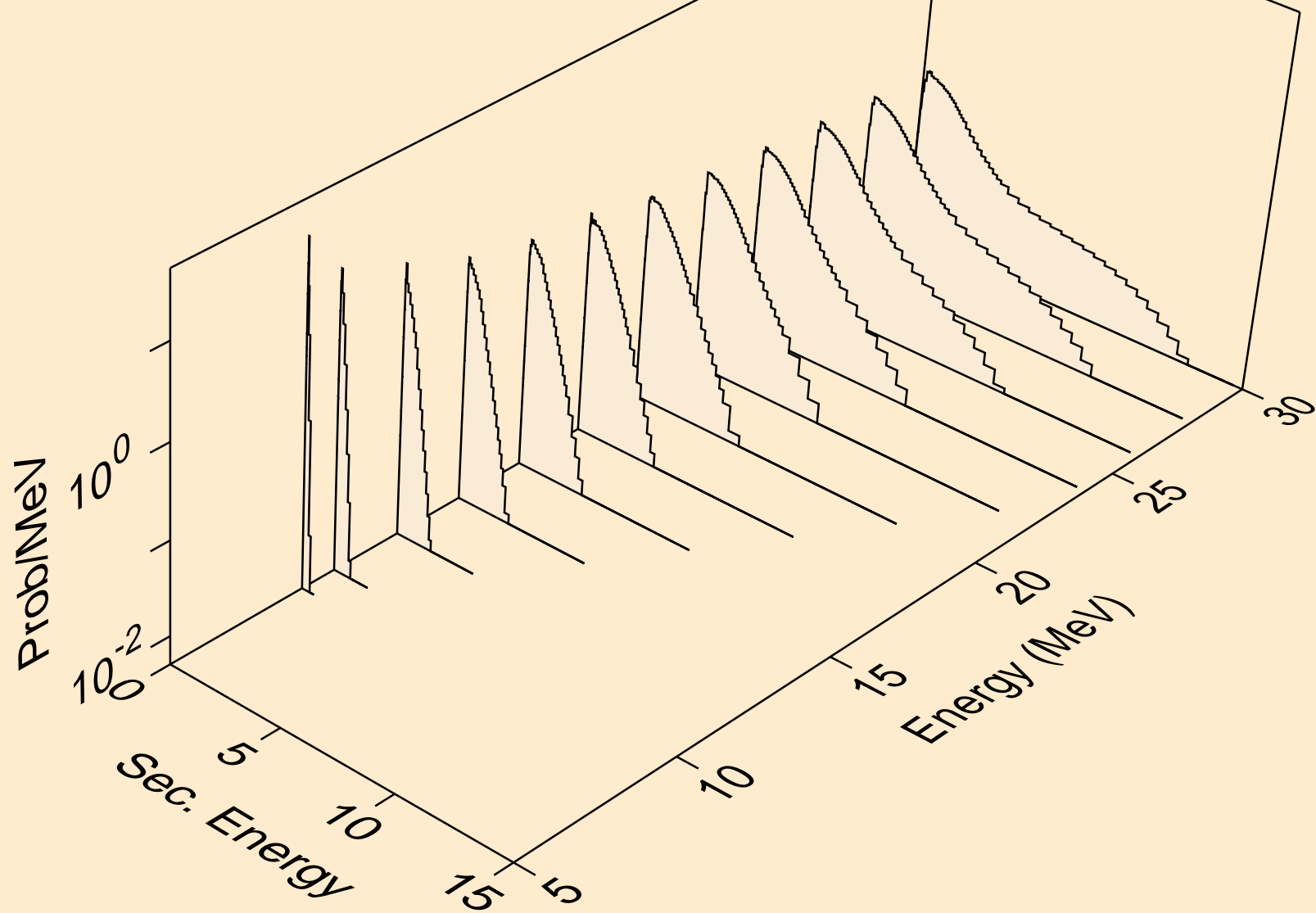

I132 NEUTRON ACER TENDL-2024 LIBRARY; T=0.K  
Neutron emission for (n,n\*)d

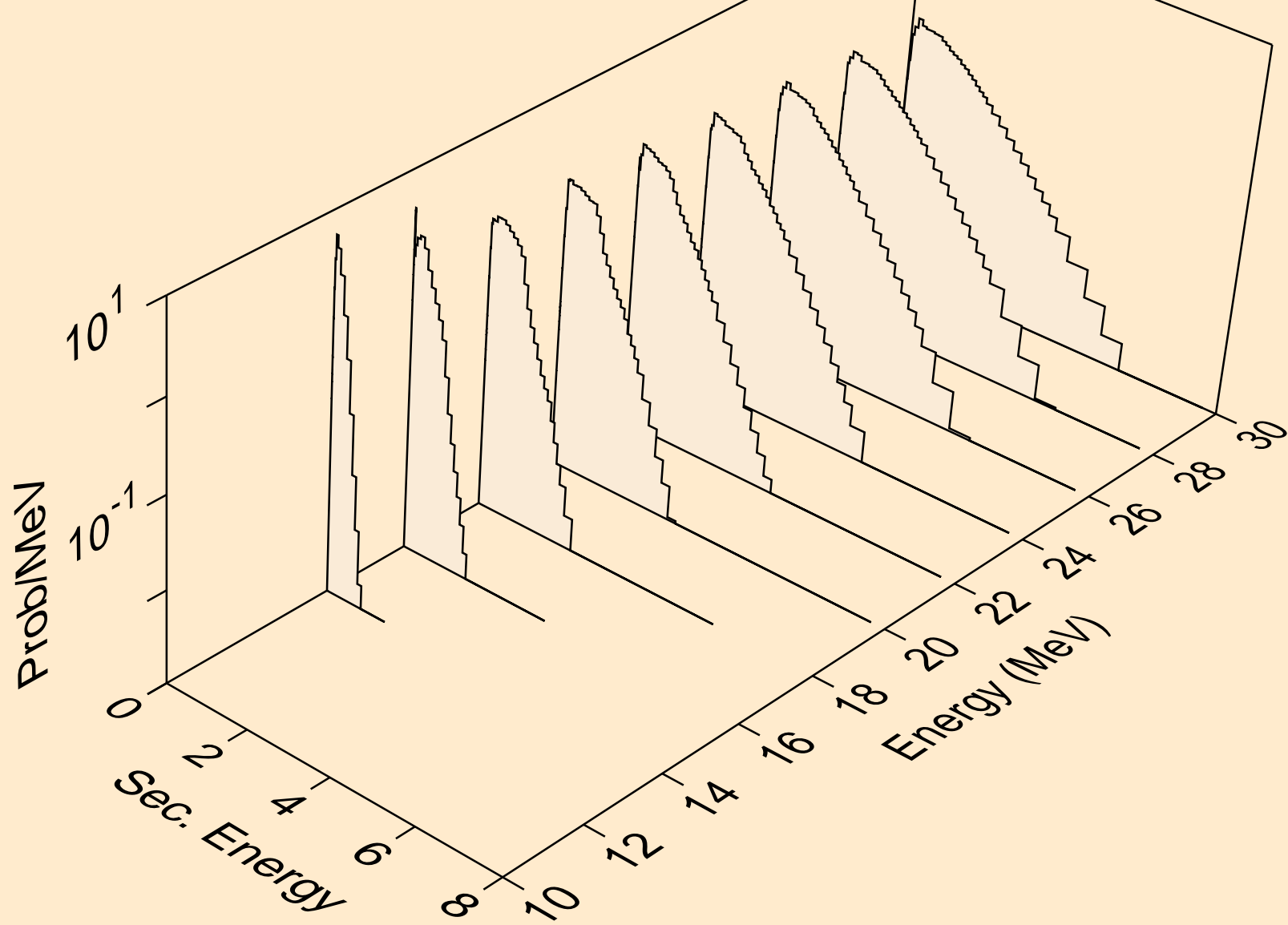

I132 NEUTRON ACER TENDL-2024 LIBRARY; T=0.K  
Neutron emission for (n,n\*)t

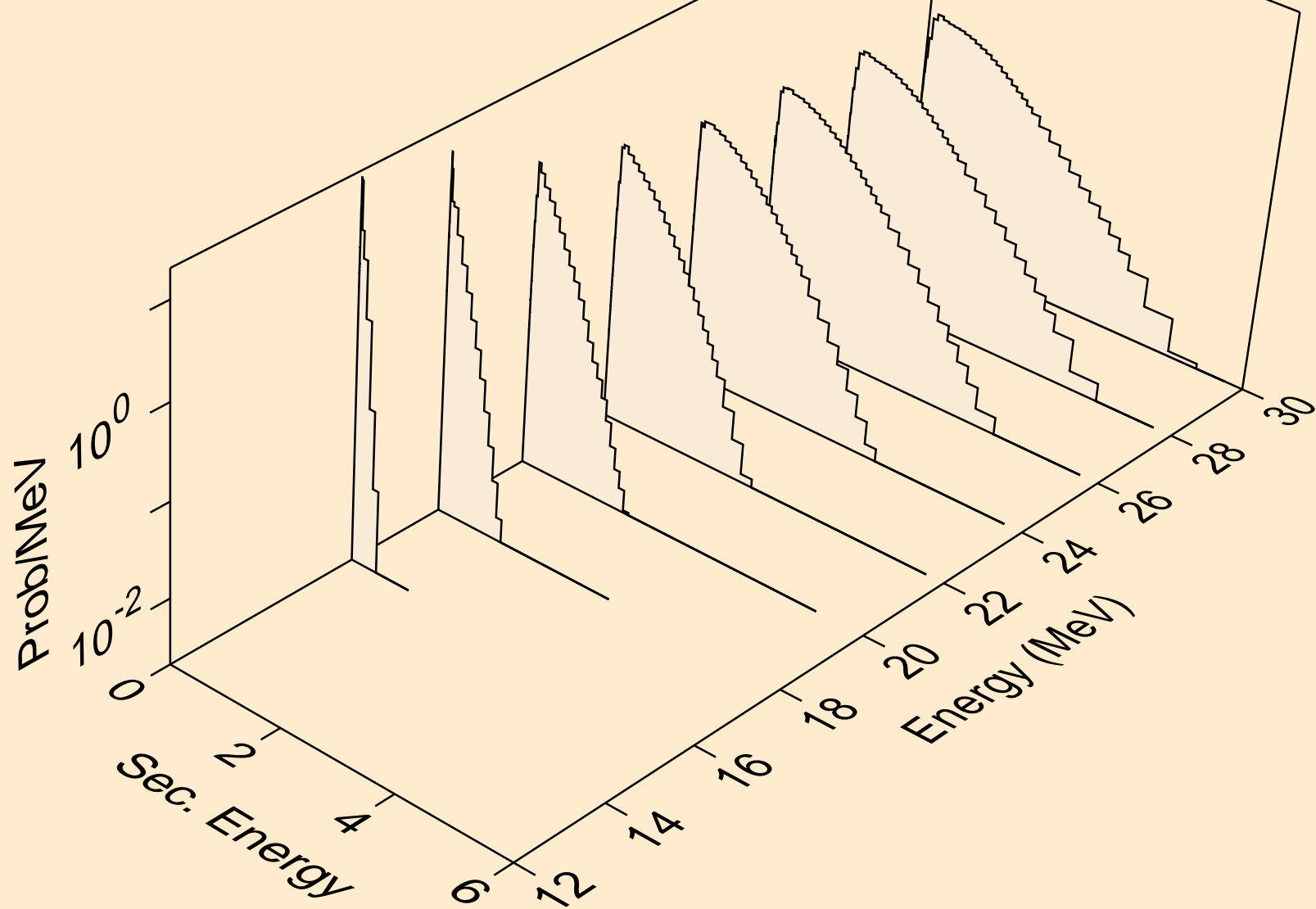

I132 NEUTRON ACER TENDL-2024 LIBRARY; T=0.K  
Neutron emission for (n,n\*)he3

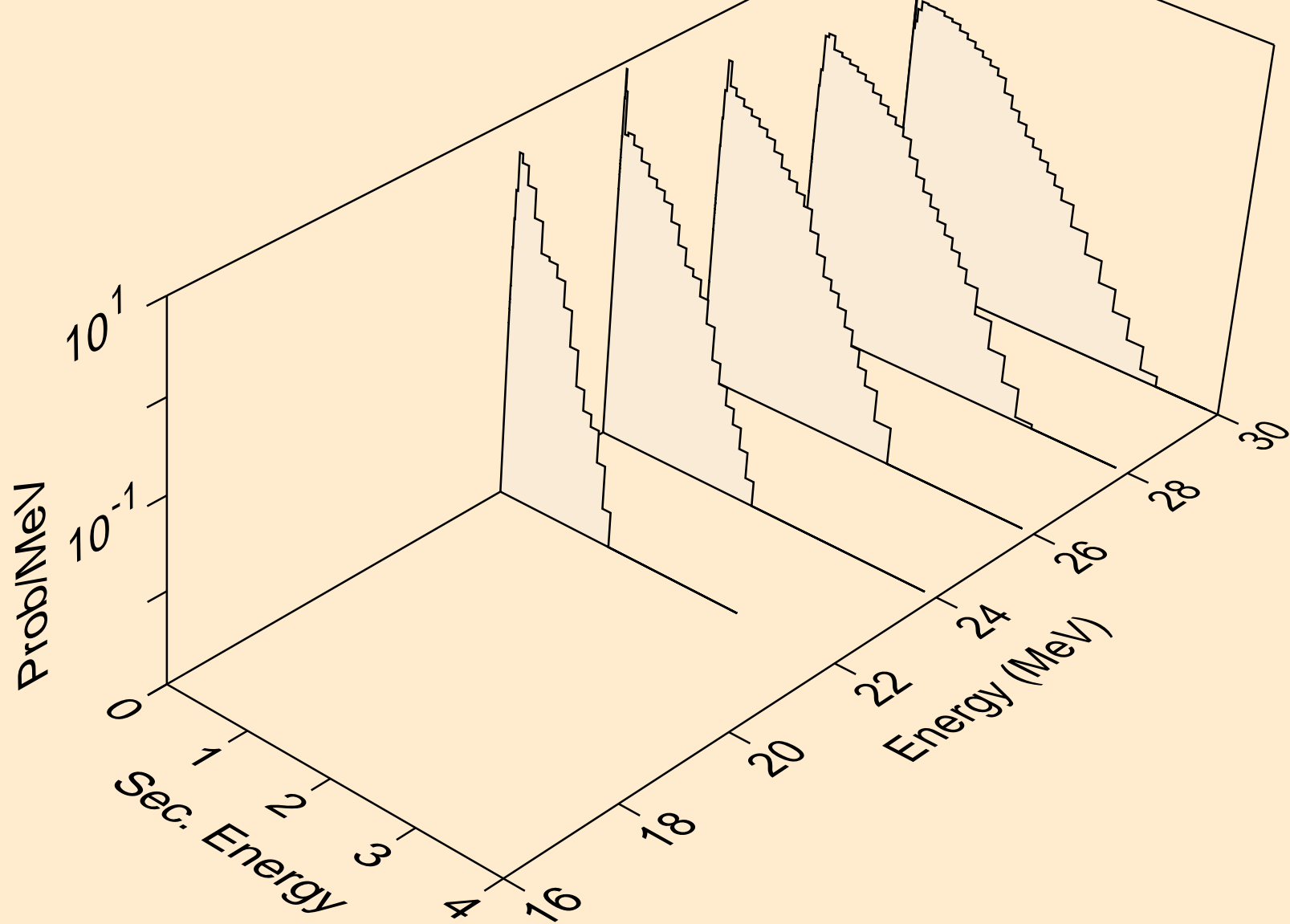

I132 NEUTRON ACER TENDL-2024 LIBRARY; T=0.K  
Neutron emission for (n,4n)

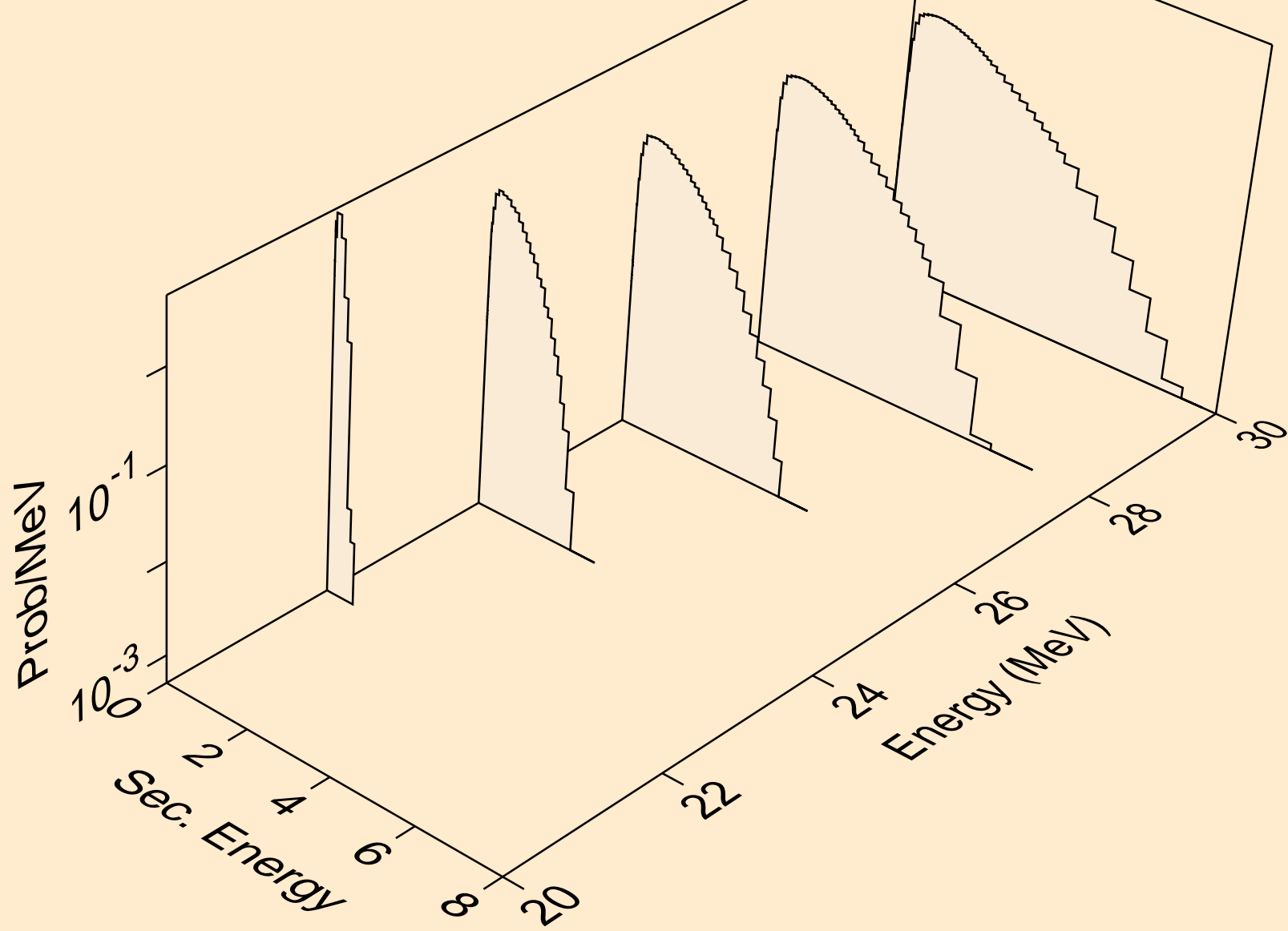

I132 NEUTRON ACER TENDL-2024 LIBRARY; T=0.K  
Neutron emission for (n,2np)

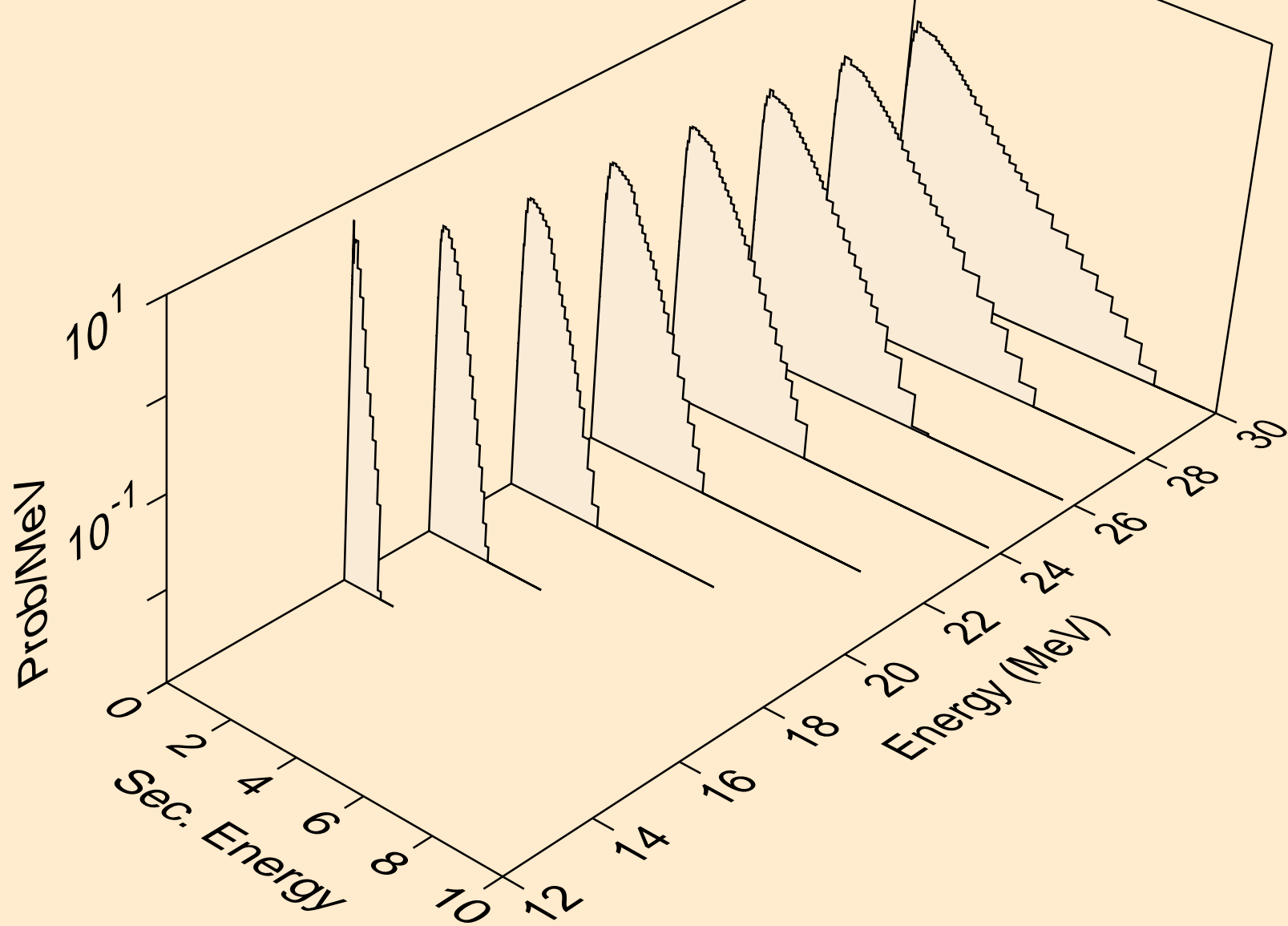

I132 NEUTRON ACER TENDL-2024 LIBRARY; T=0.K  
Neutron emission for (n,3np)

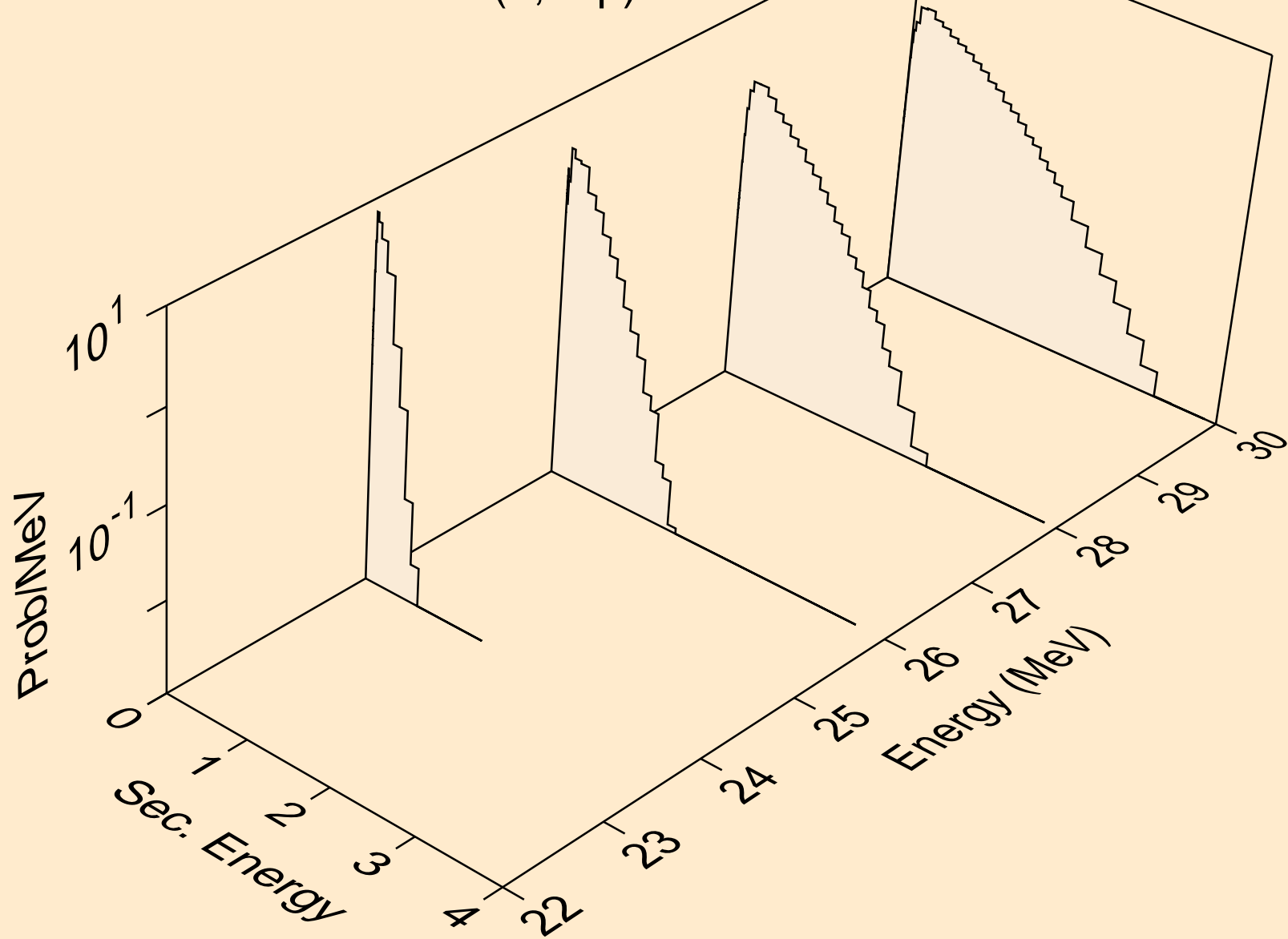

I132 NEUTRON ACER TENDL-2024 LIBRARY; T=0.K  
Neutron emission for (n,n2p)

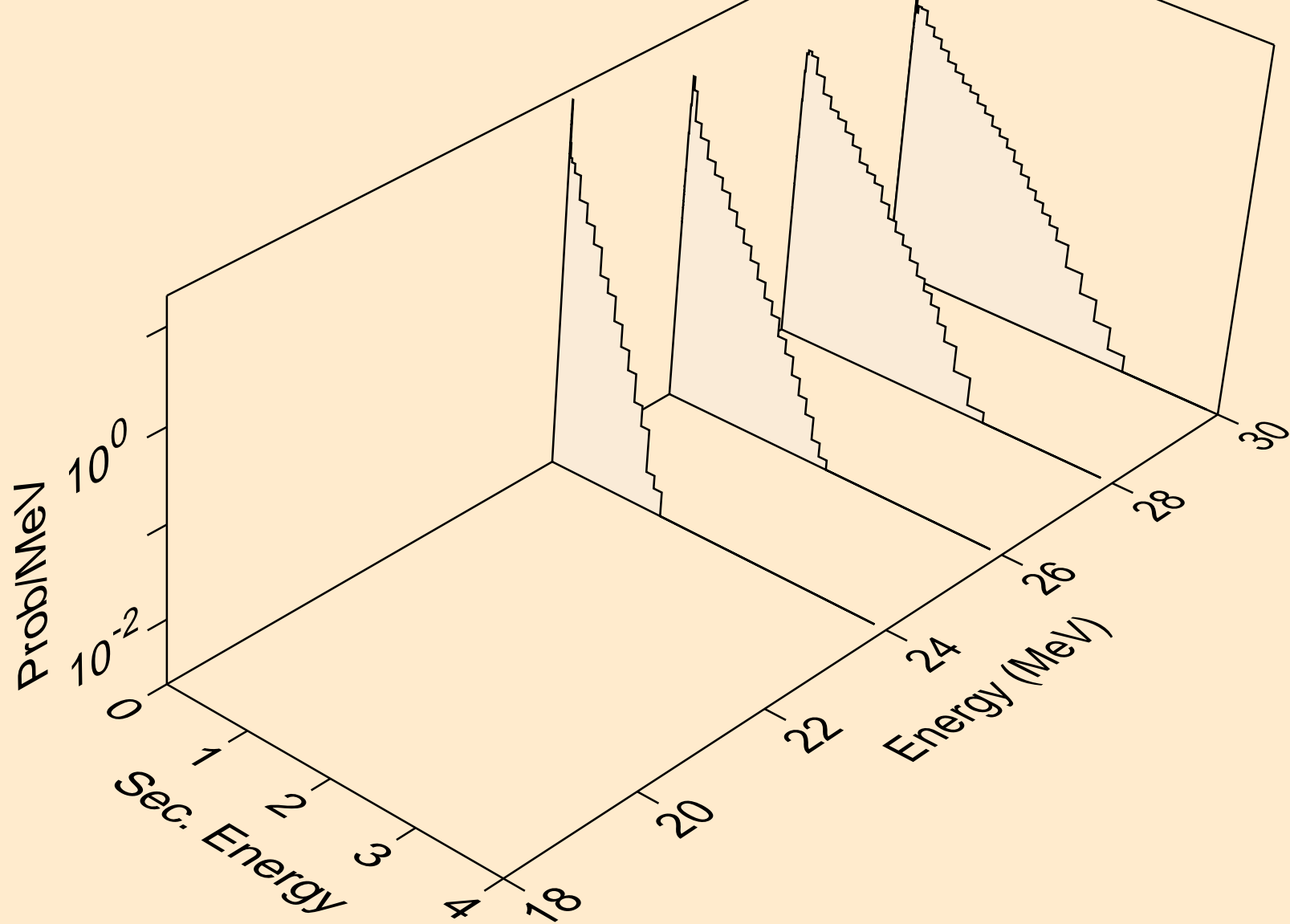

I132 NEUTRON ACER TENDL-2024 LIBRARY; T=0.K  
Neutron emission for (n,n\*c)

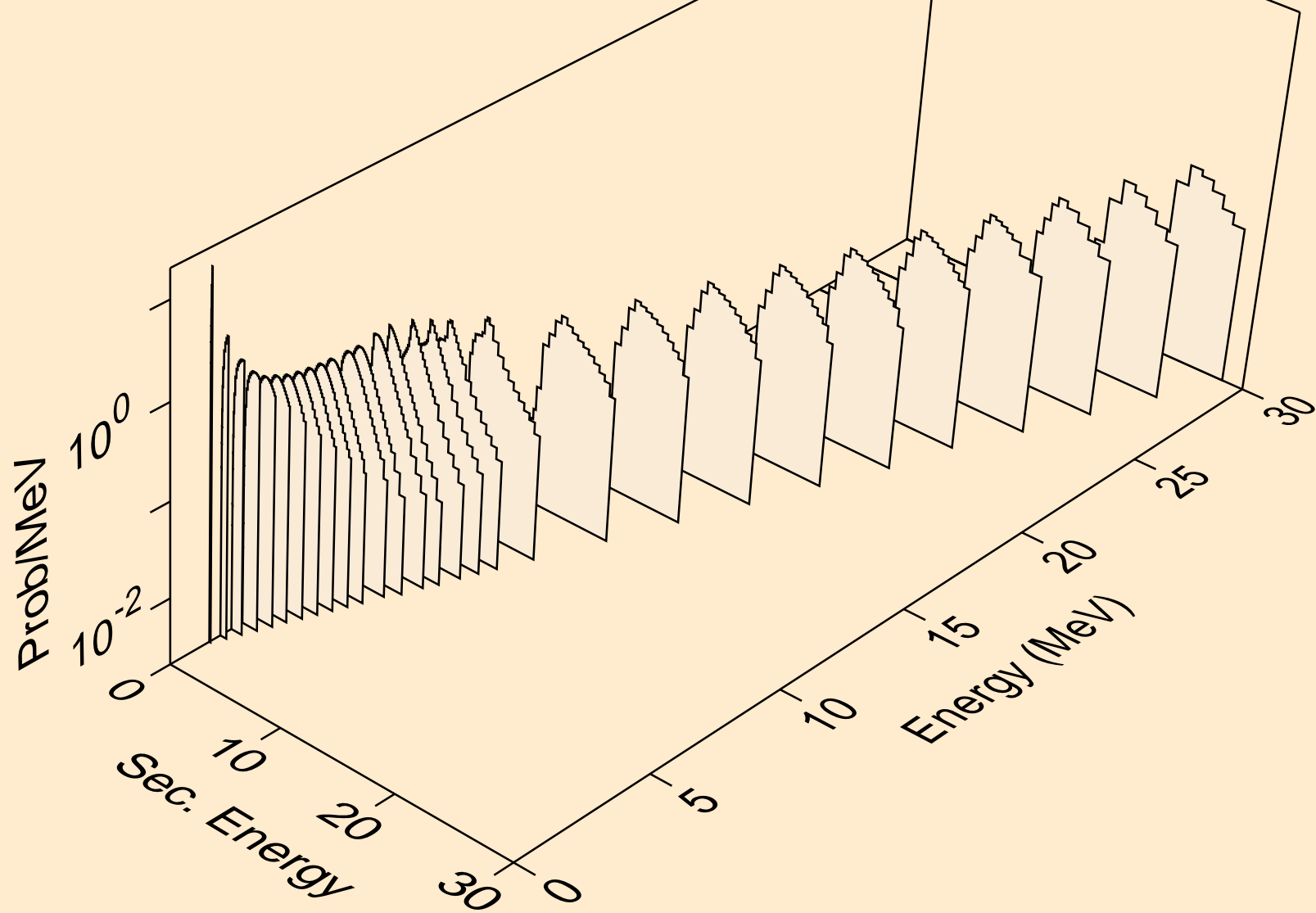

I132 NEUTRON ACER TENDL-2024 LIBRARY; T=0.K  
Photon emission for (n,x)

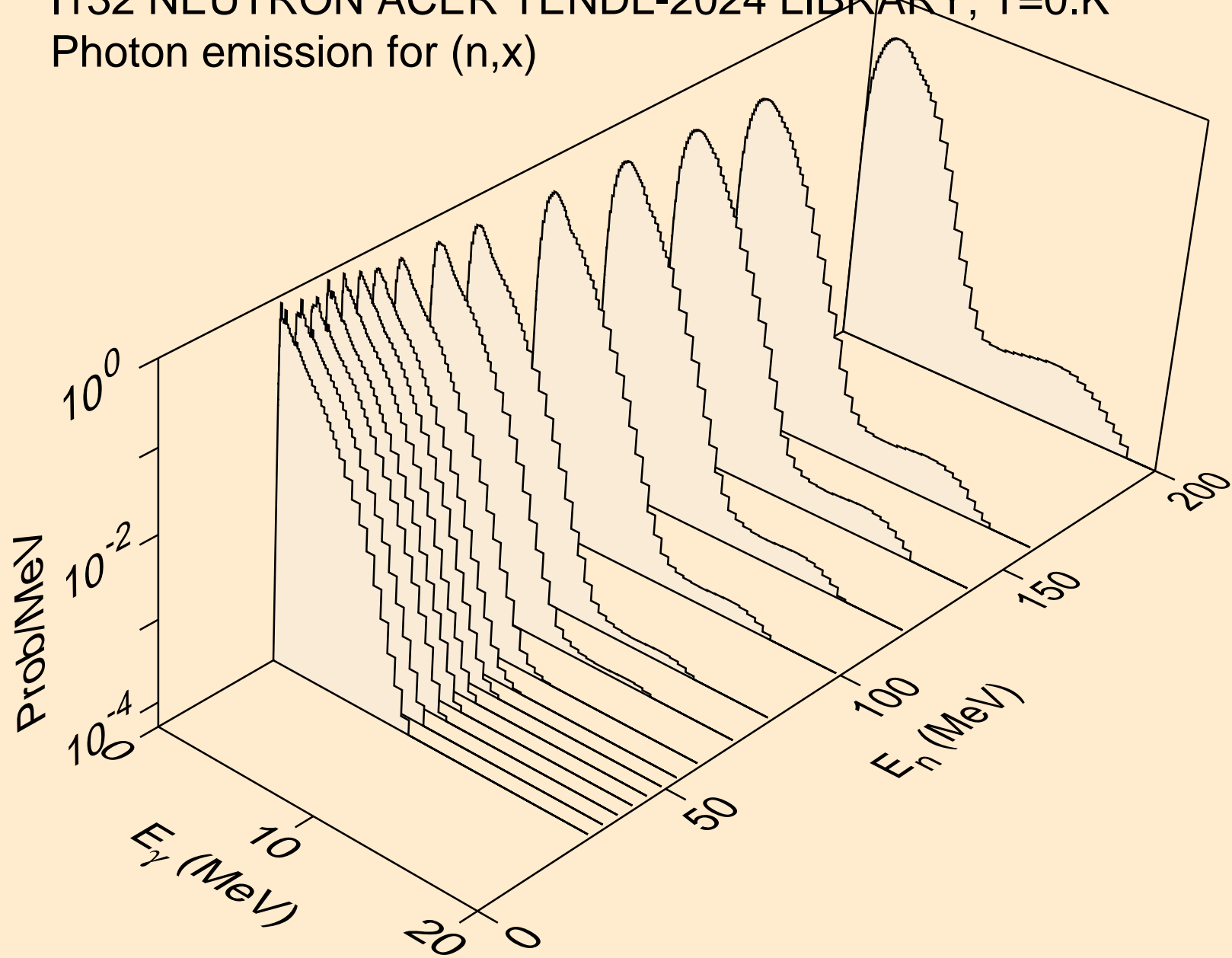

I132 NEUTRON ACER TENDL-2024 LIBRARY; T=0.K  
Photon emission for (n,2nd)

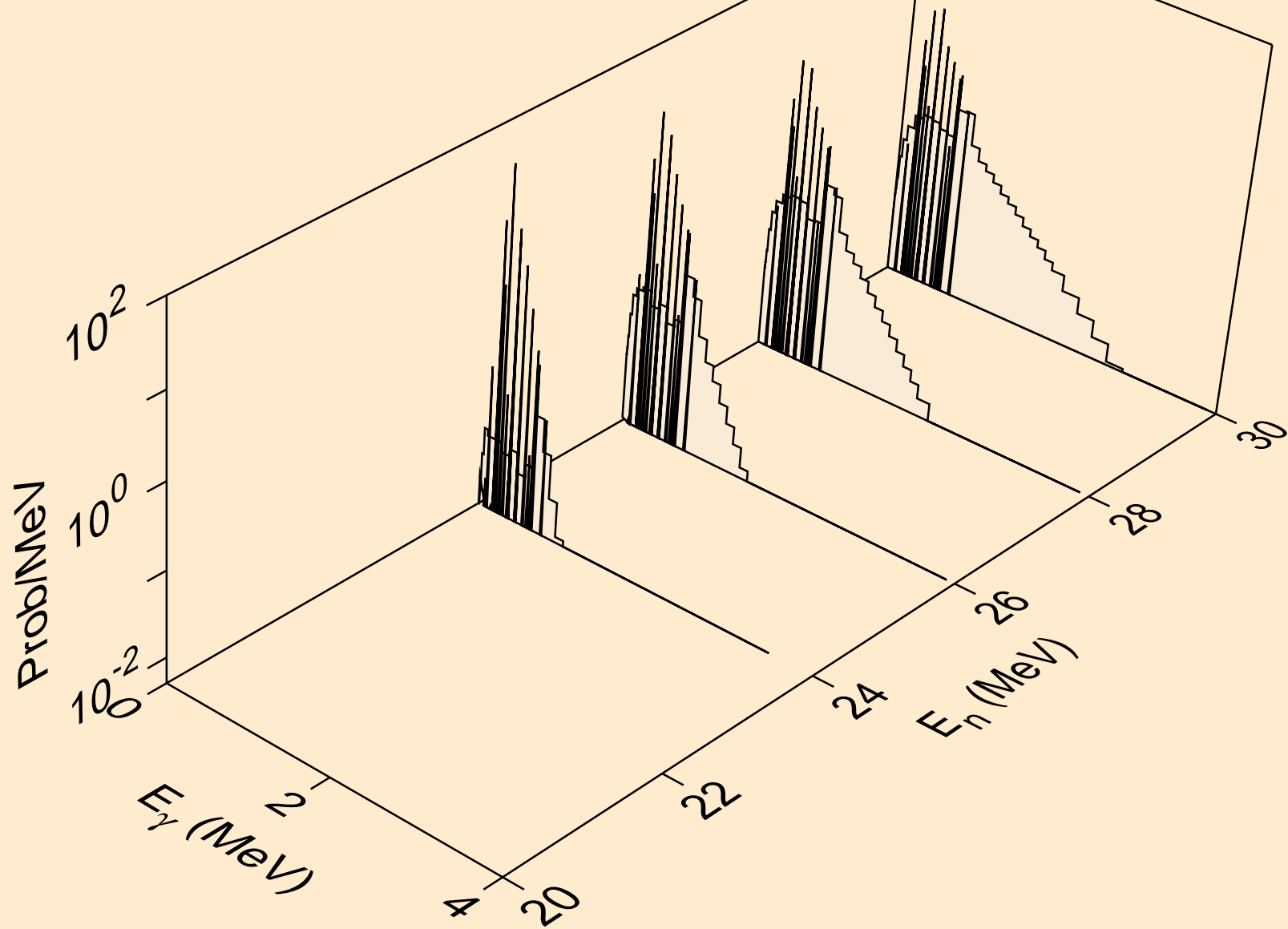

I132 NEUTRON ACER TENDL-2024 LIBRARY; T=0.K  
Photon emission for (n,2n)

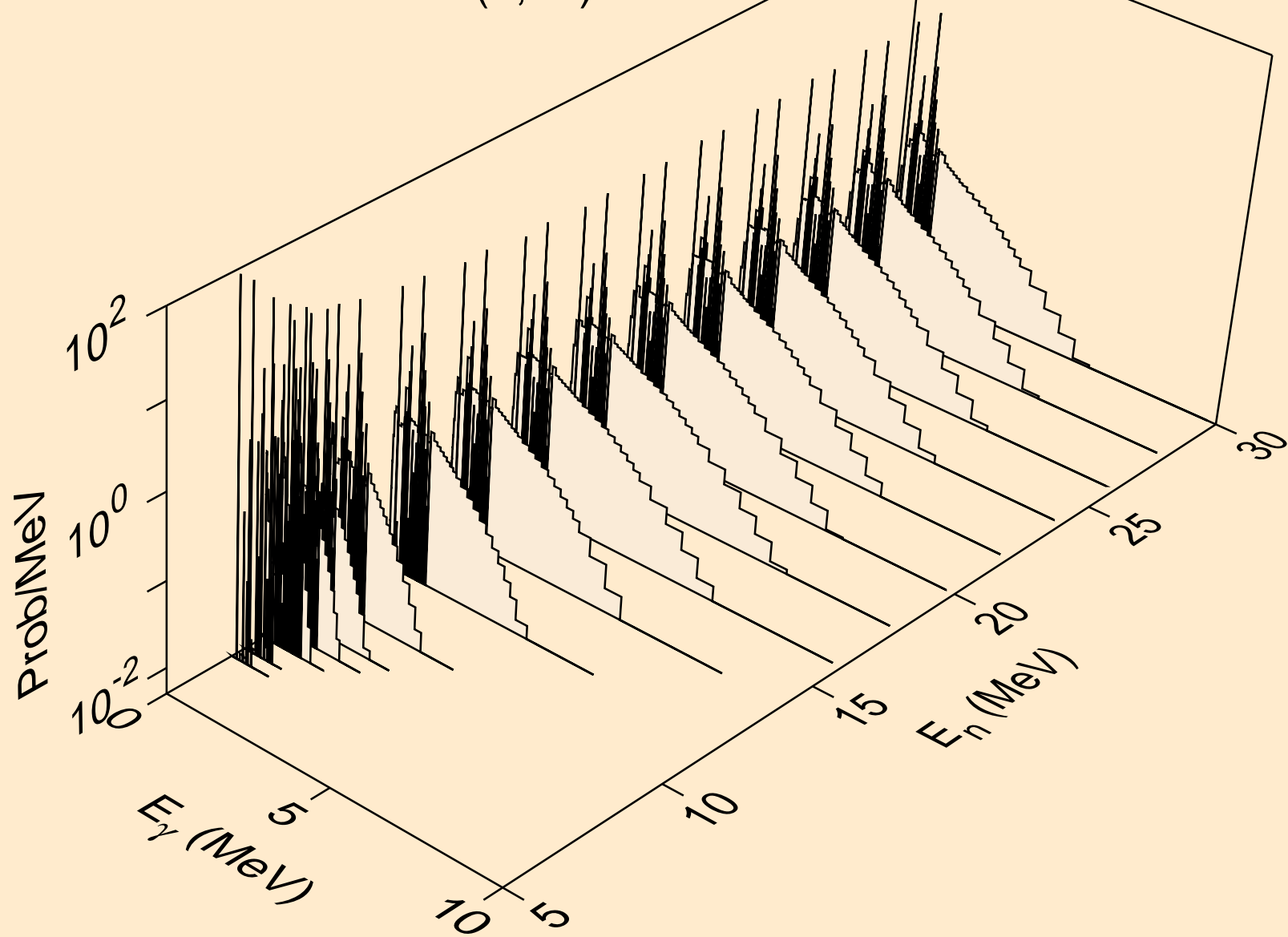

I132 NEUTRON ACER TENDL-2024 LIBRARY; T=0.K  
Photon emission for (n,3n)

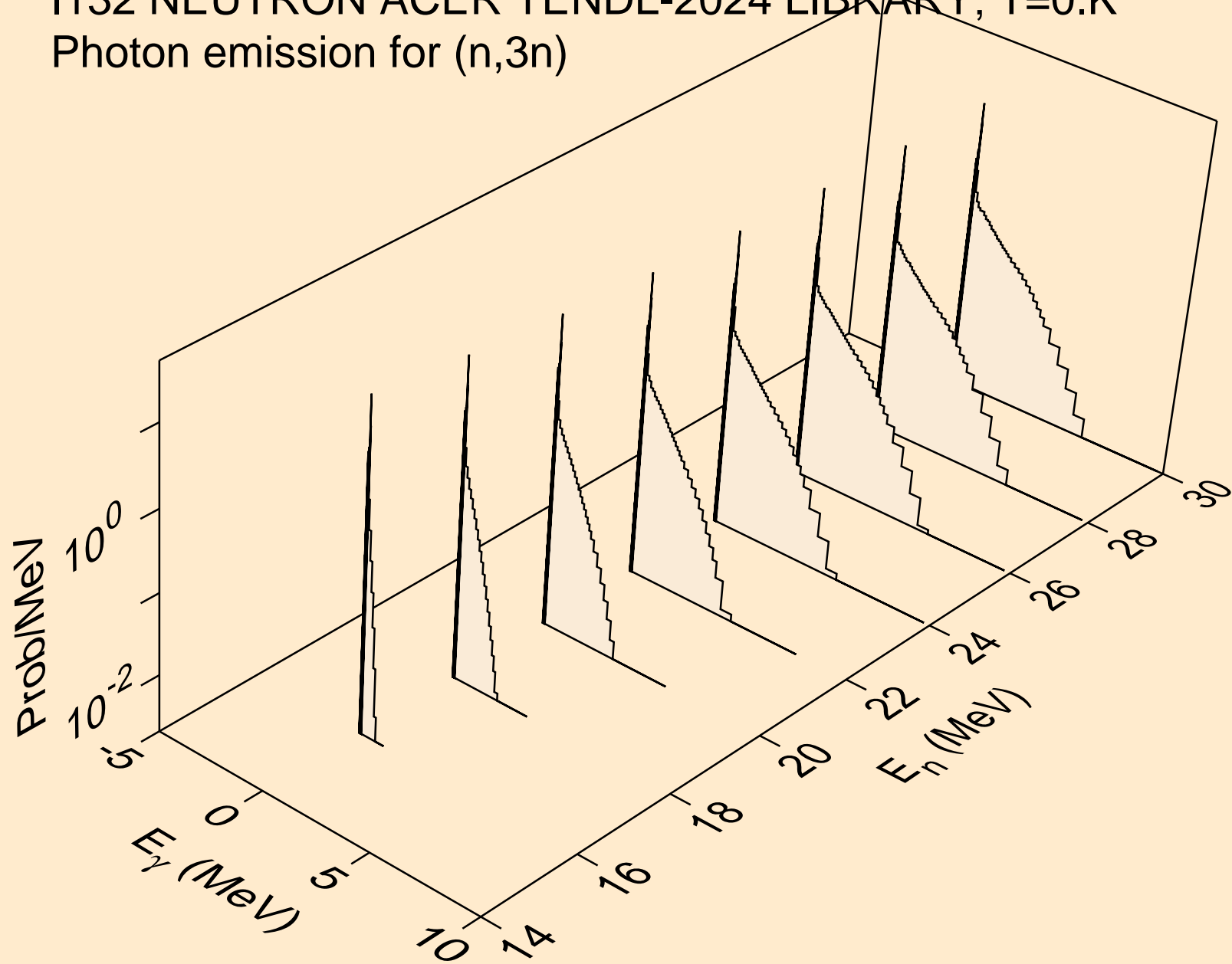

I132 NEUTRON ACER TENDL-2024 LIBRARY; T=0.K  
Photon emission for (n,n\*)a

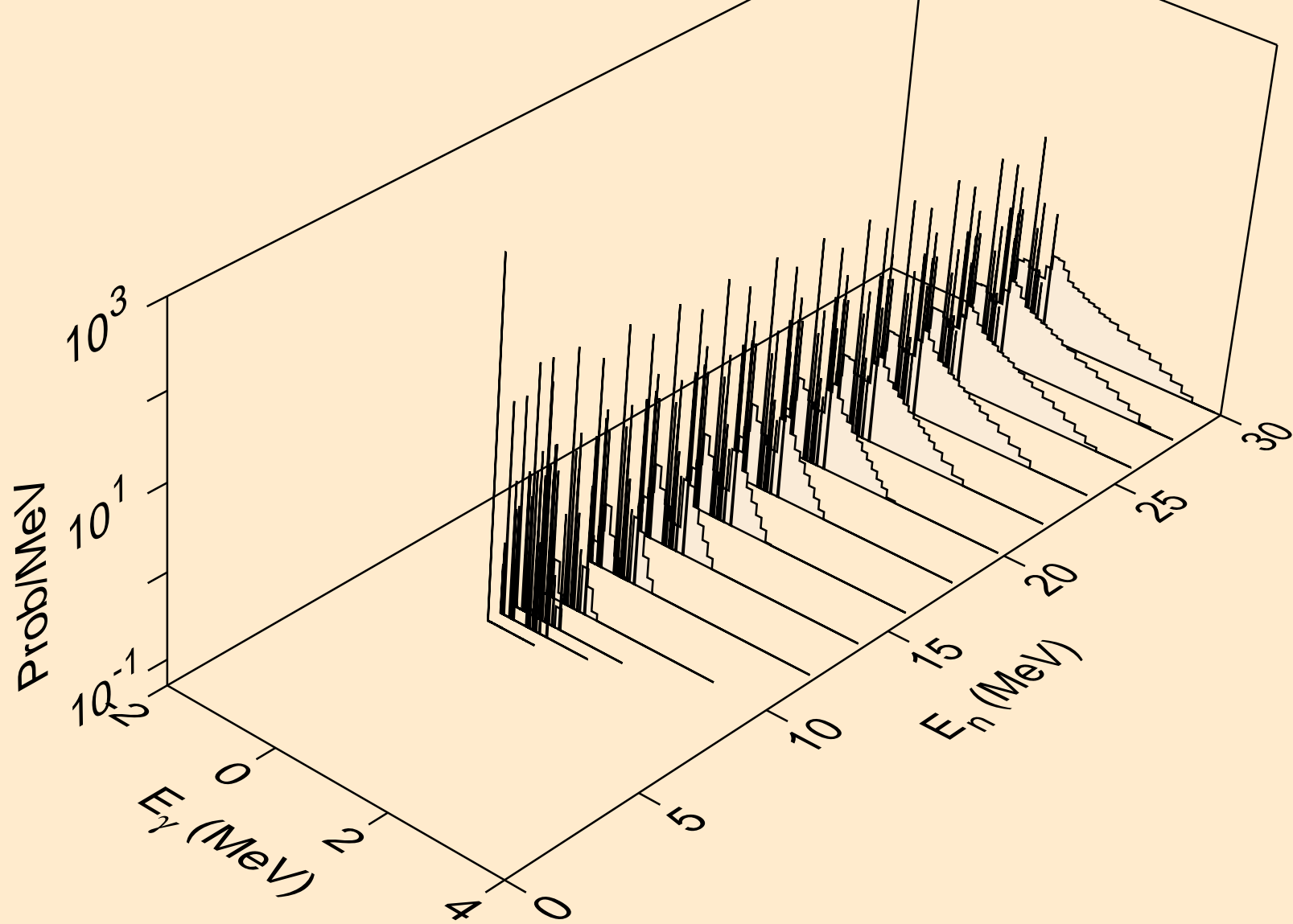

I132 NEUTRON ACER TENDL-2024 LIBRARY; T=0.K  
Photon emission for (n,2n)a

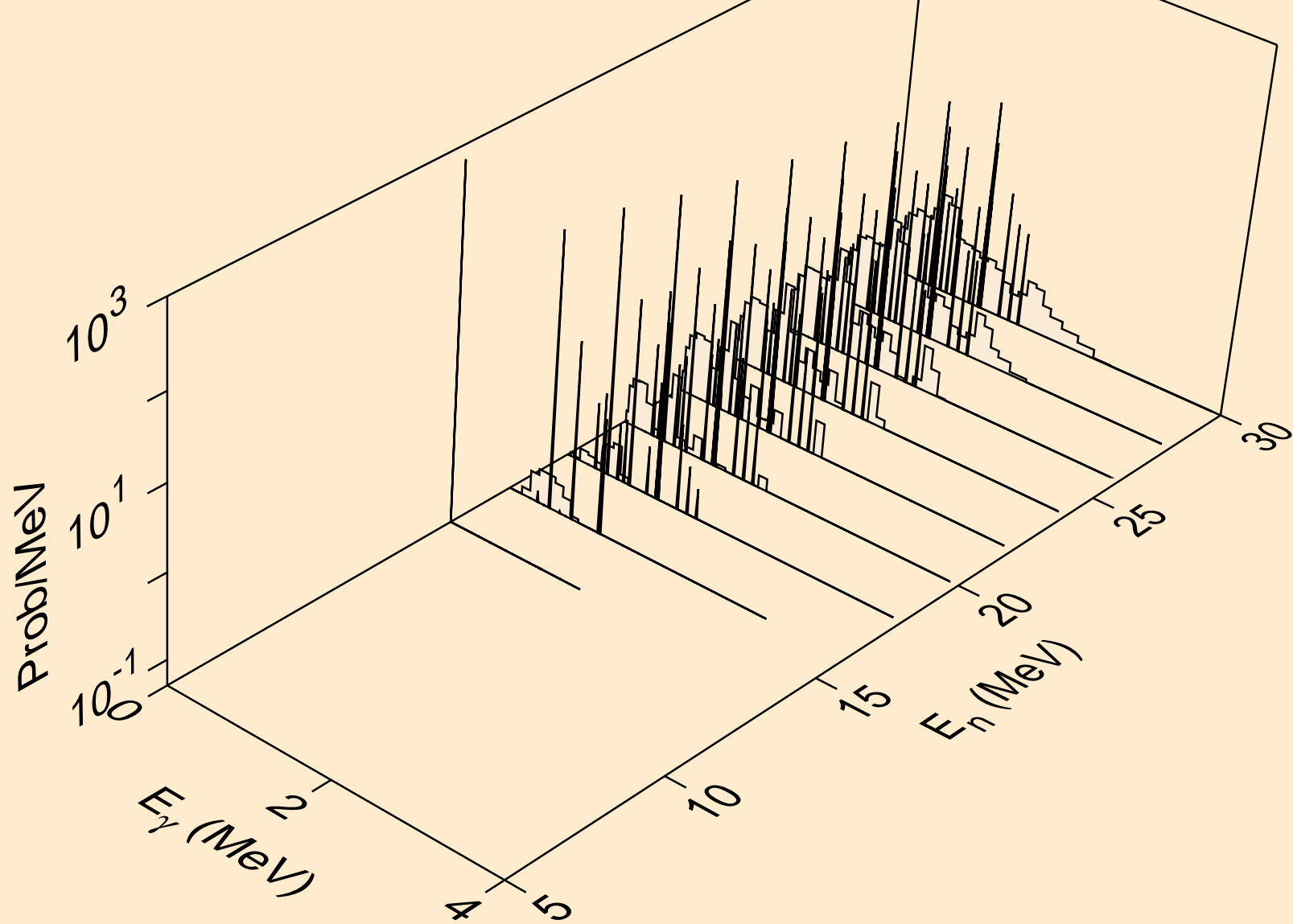

I132 NEUTRON ACER TENDL-2024 LIBRARY; T=0.K  
Photon emission for (n,3n)a

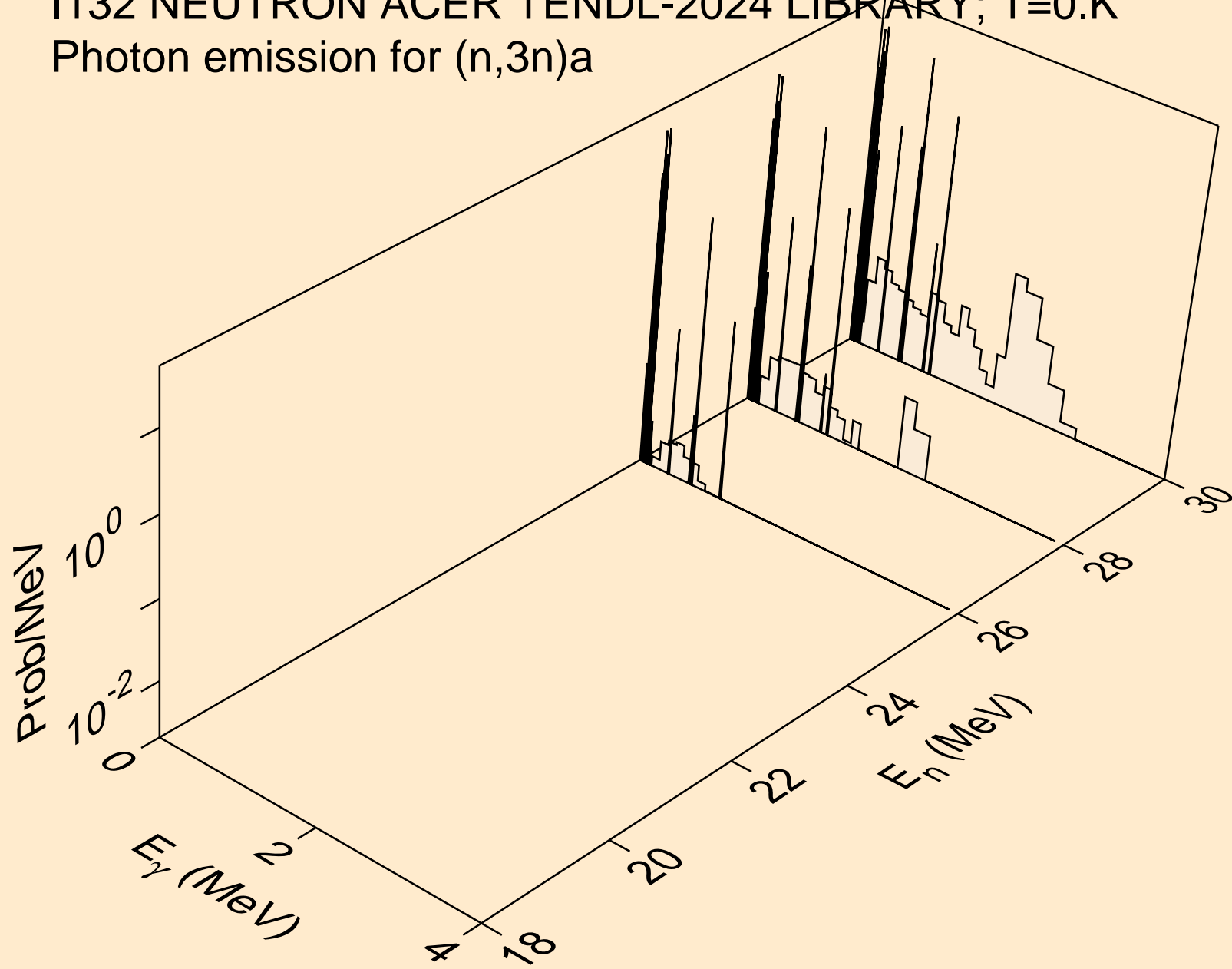

I132 NEUTRON ACER TENDL-2024 LIBRARY; T=0.K  
Photon emission for (n,n\*)p

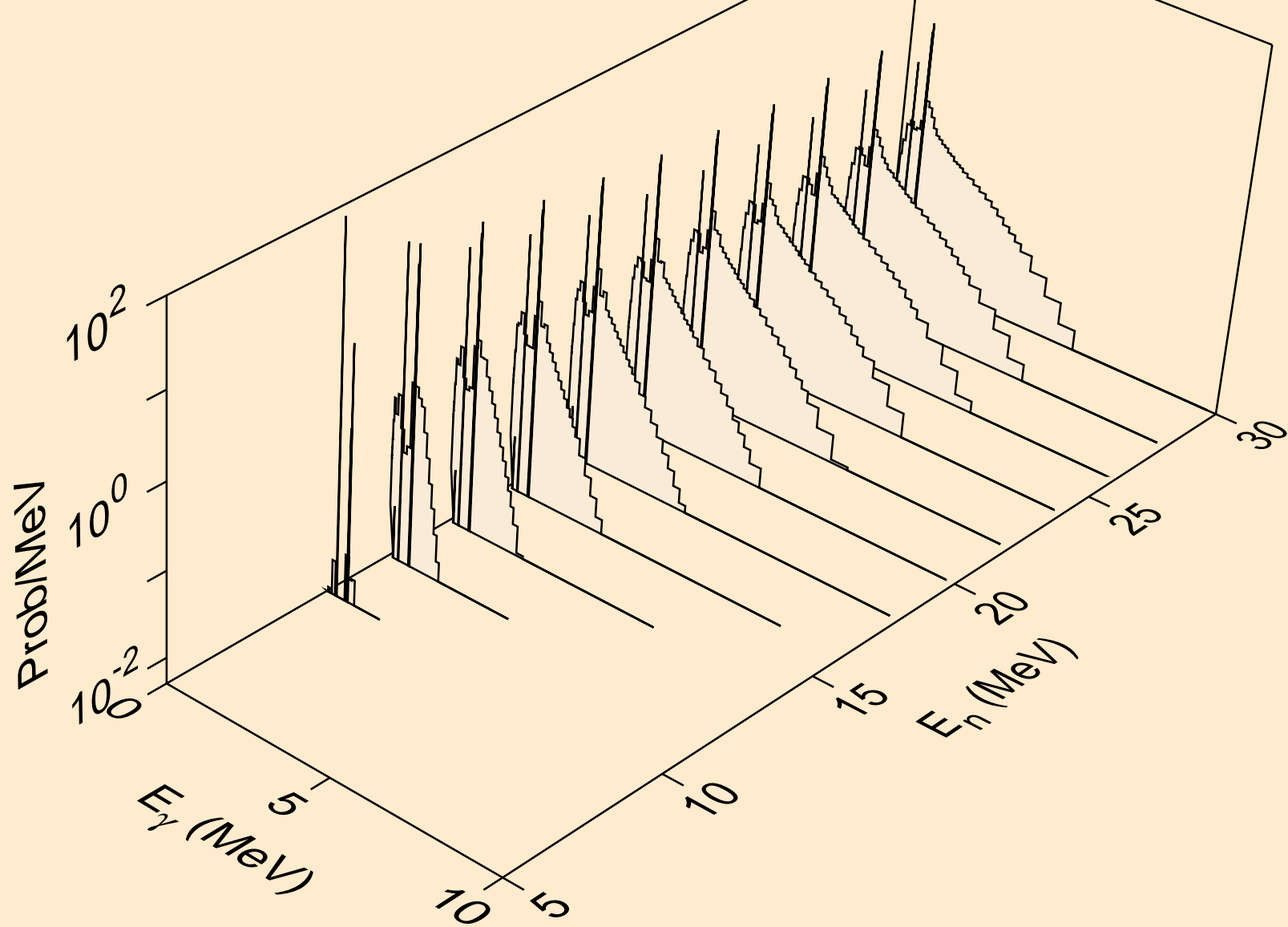

I132 NEUTRON ACER TENDL-2024 LIBRARY; T=0.K  
Photon emission for (n,n\*)d

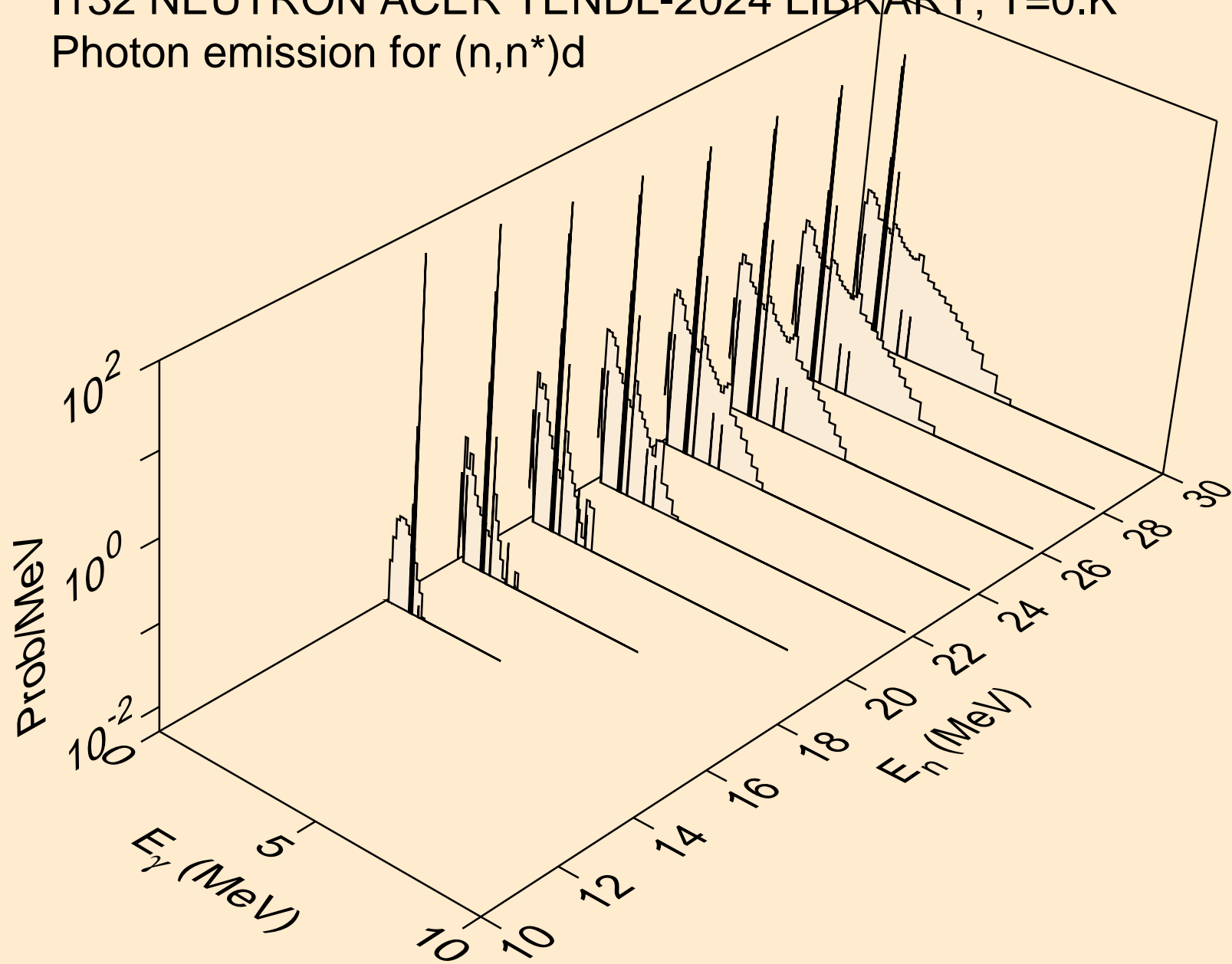

I132 NEUTRON ACER TENDL-2024 LIBRARY; T=0.K  
Photon emission for (n,n\*)t

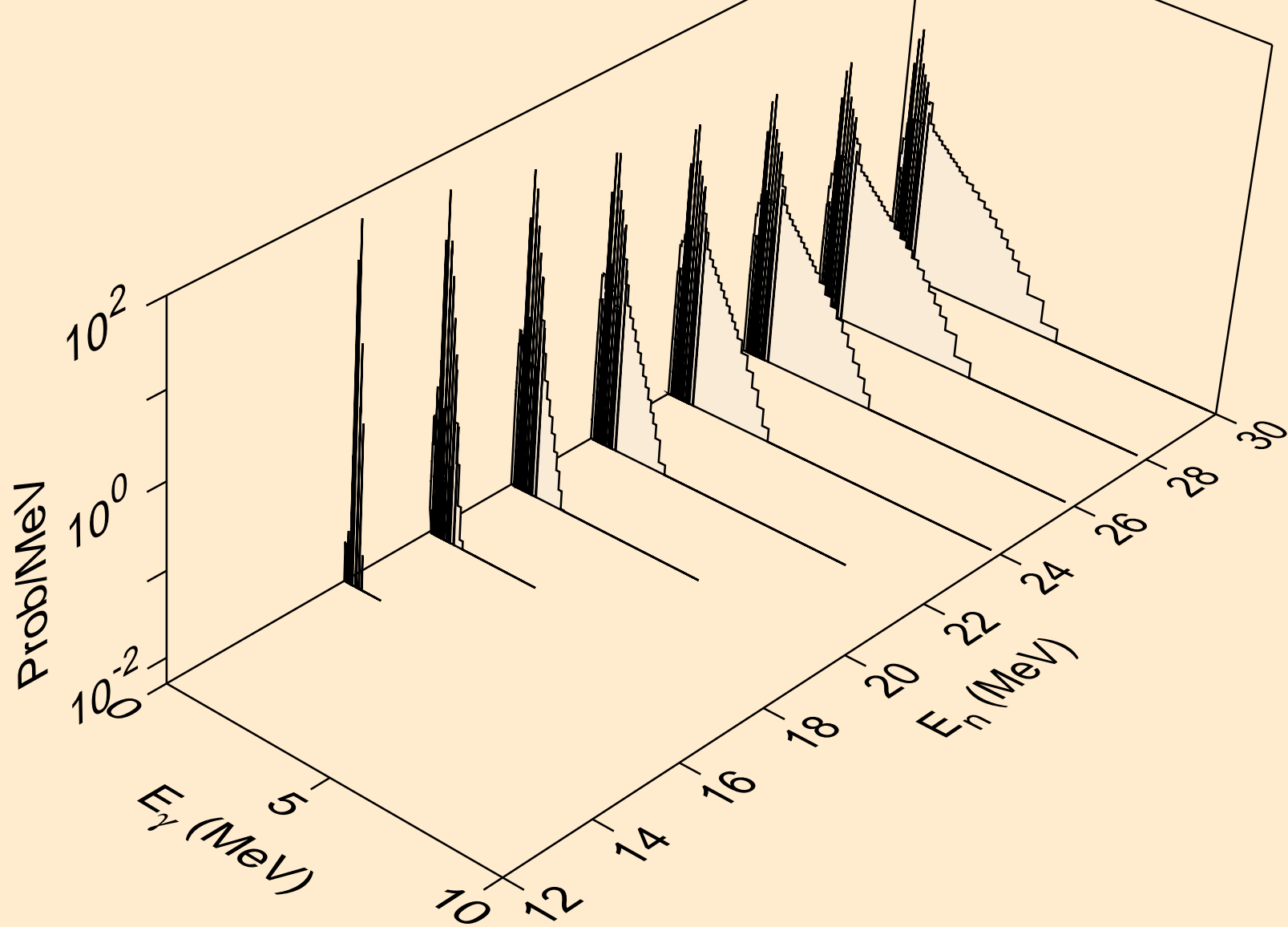

I132 NEUTRON ACER TENDL-2024 LIBRARY; T=0.K  
Photon emission for (n,n\*)he3

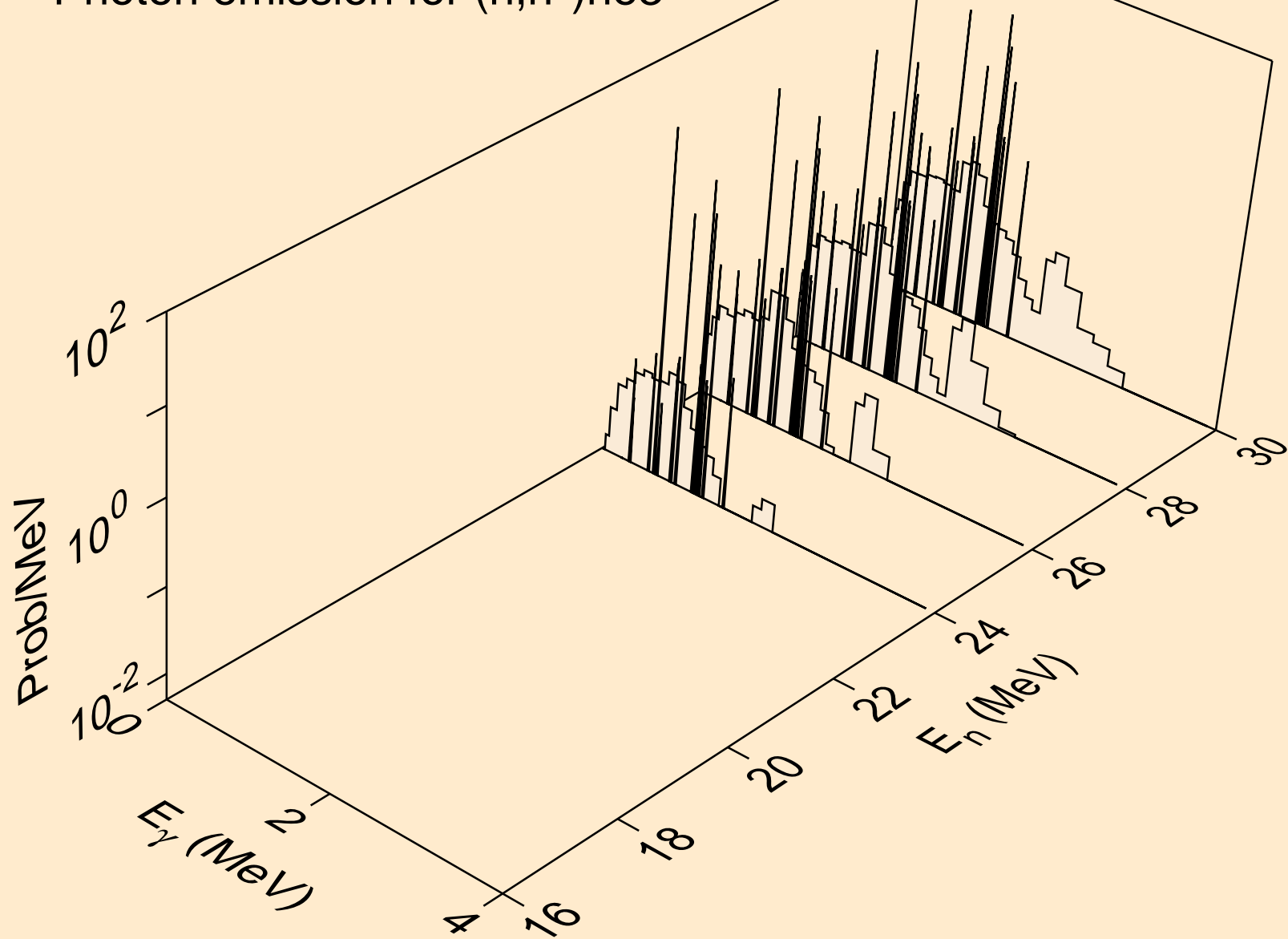

I132 NEUTRON ACER TENDL-2024 LIBRARY; T=0.K  
Photon emission for (n,4n)

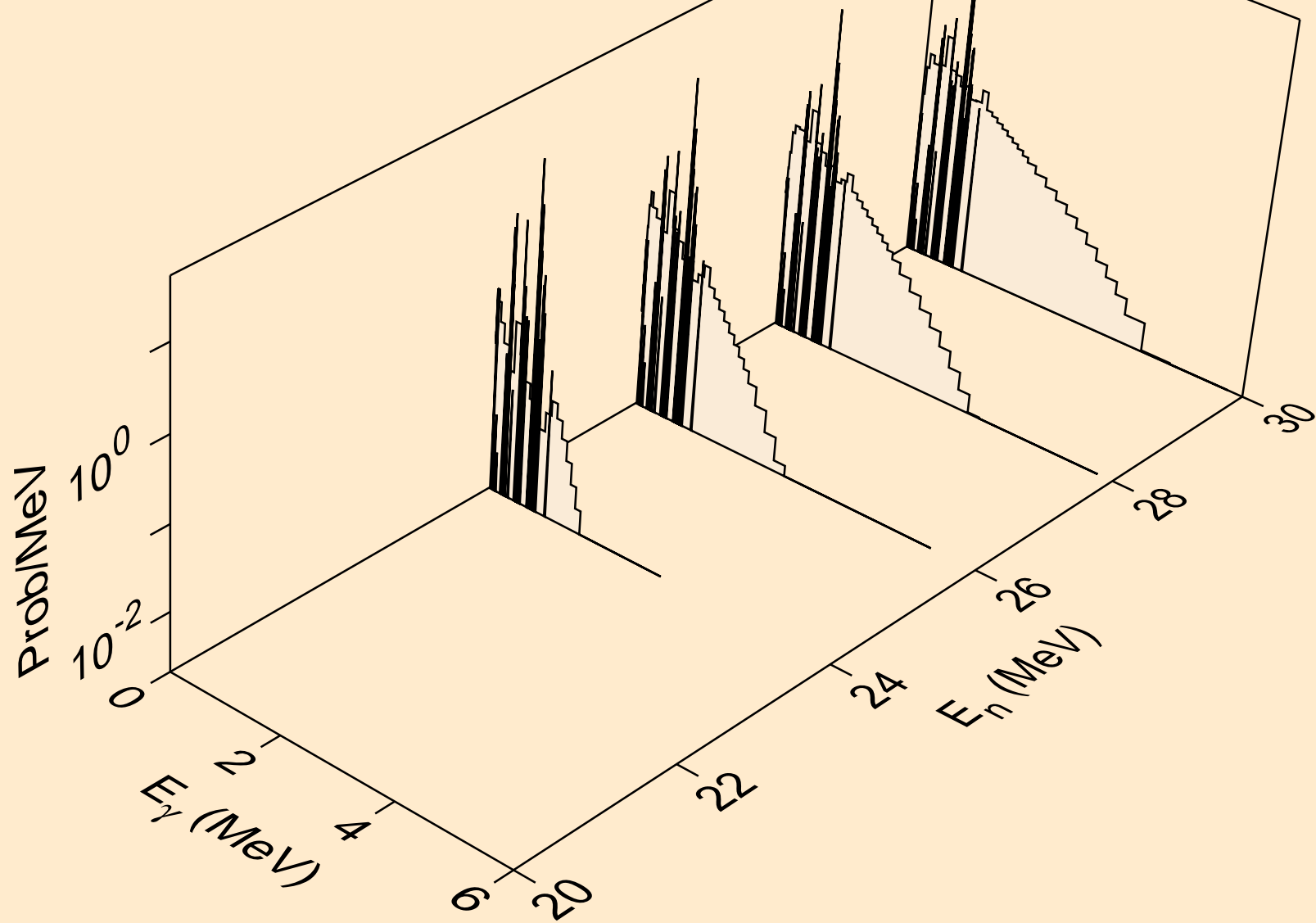

I132 NEUTRON ACER TENDL-2024 LIBRARY; T=0.K  
Photon emission for (n,2np)

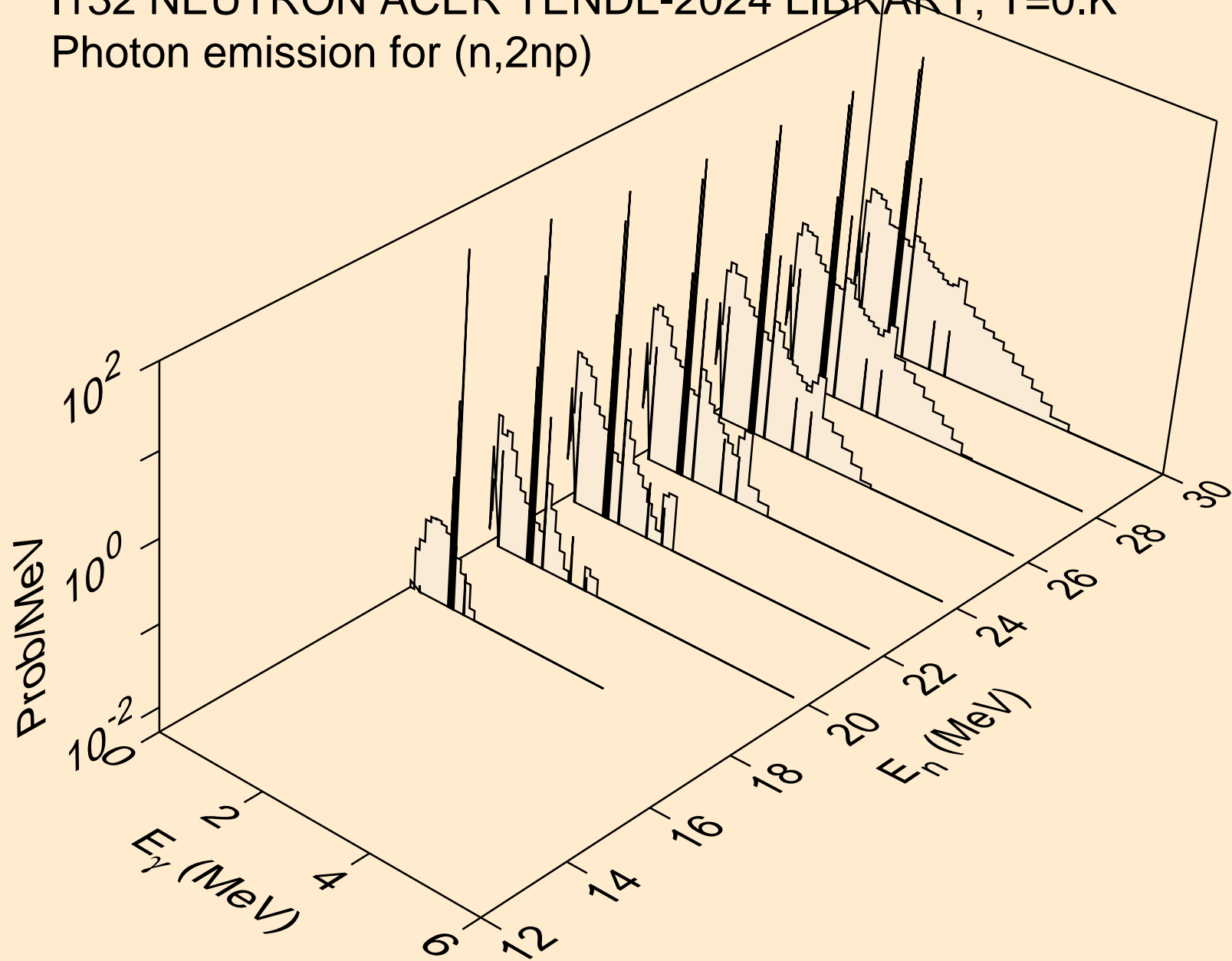

I132 NEUTRON ACER TENDL-2024 LIBRARY; T=0.K  
Photon emission for (n,3np)

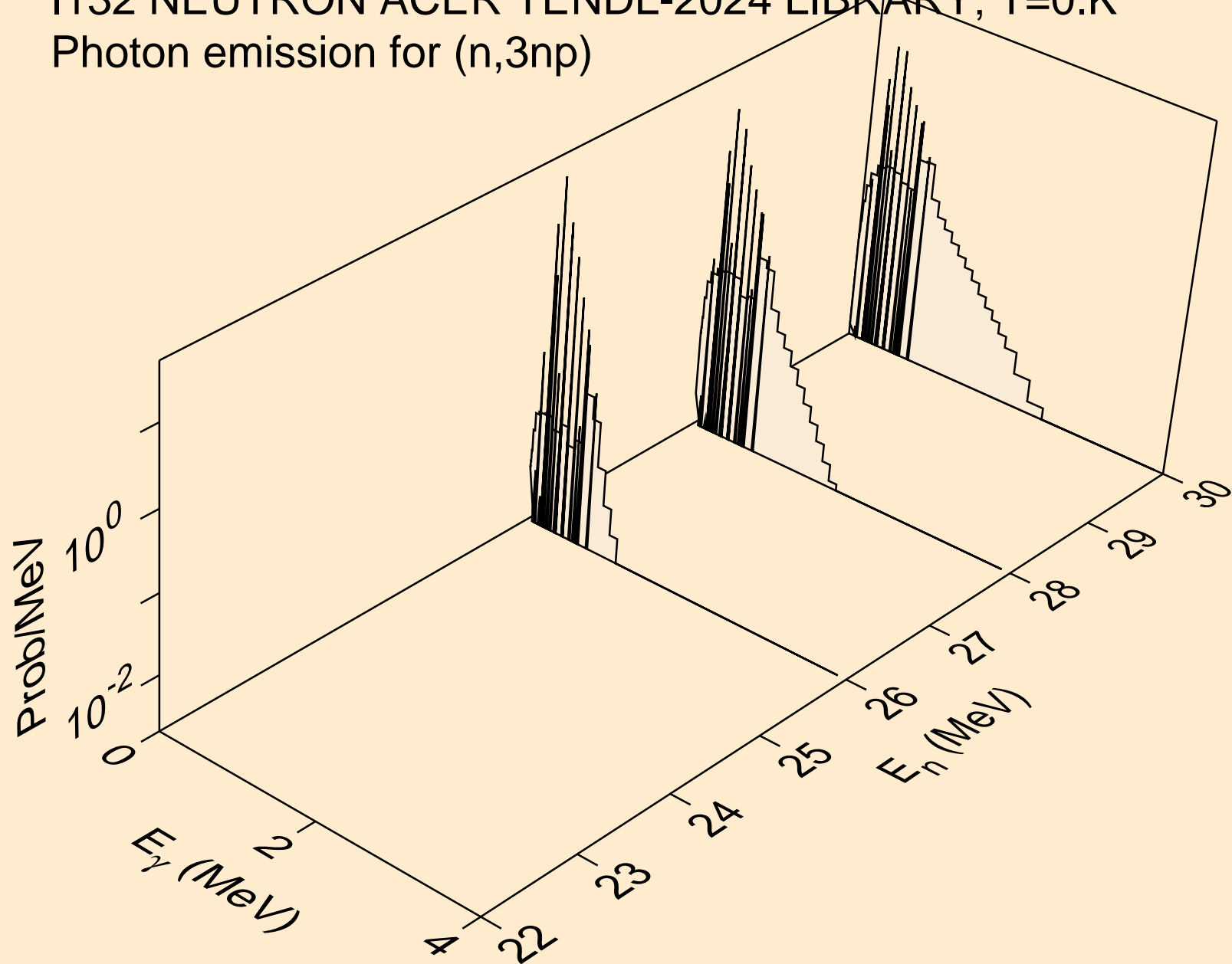

I132 NEUTRON ACER TENDL-2024 LIBRARY; T=0.K  
Photon emission for (n,n2p)

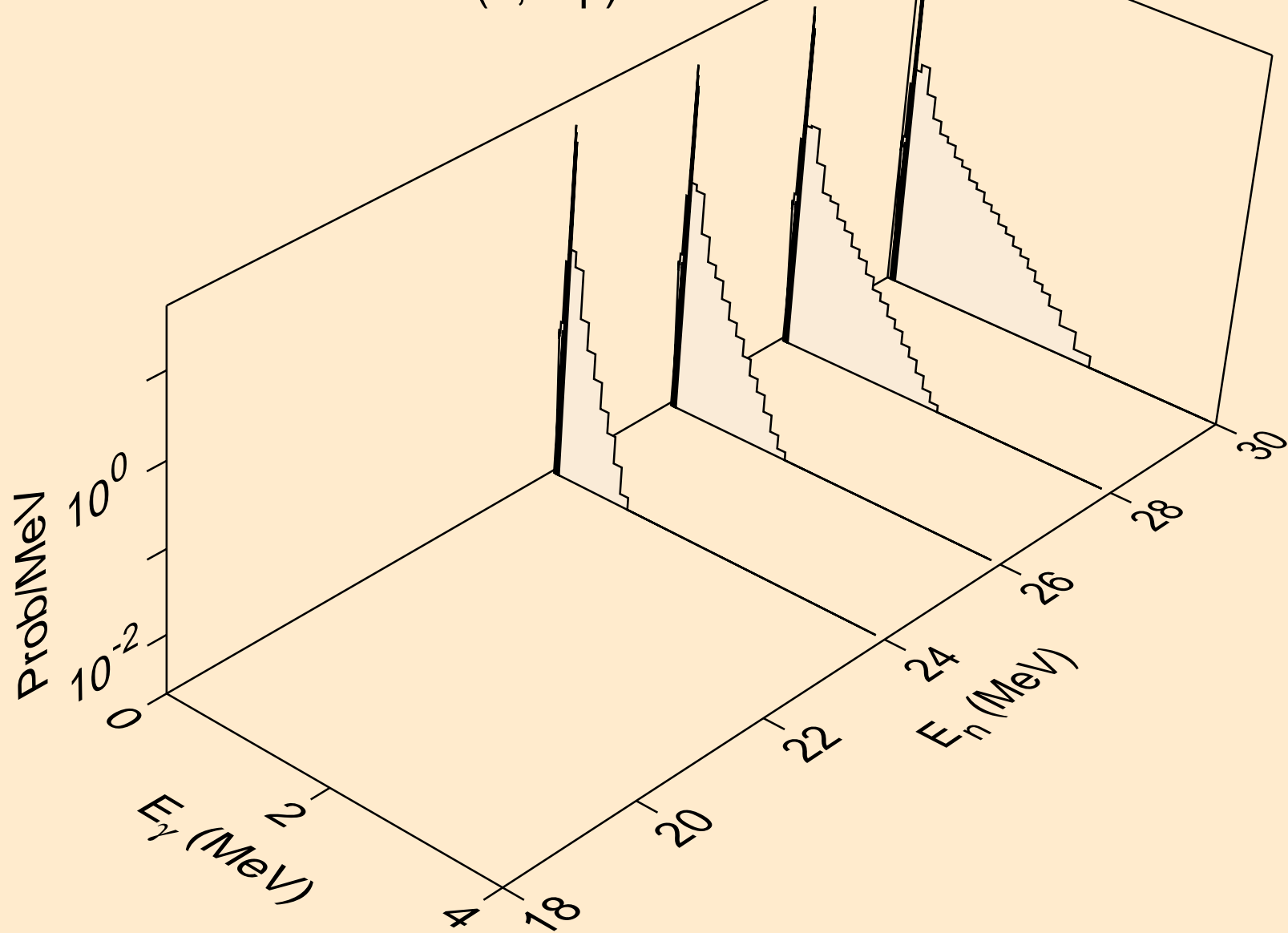

I132 NEUTRON ACER TENDL-2024 LIBRARY; T=0.K  
Photon emission for (n,n\*c)

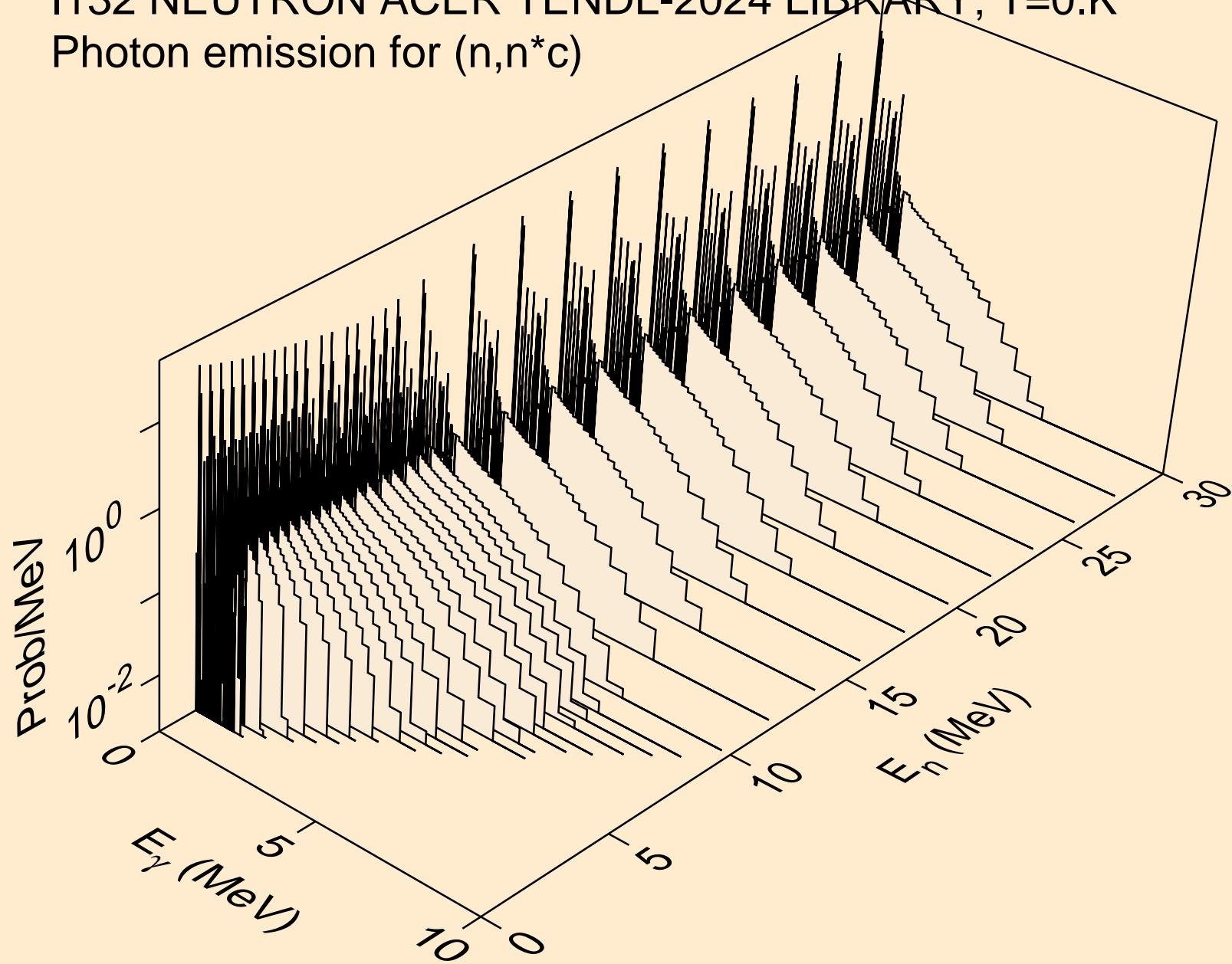

I132 NEUTRON ACER TENDL-2024 LIBRARY; T=0.K  
Photon emission for (n,gma)

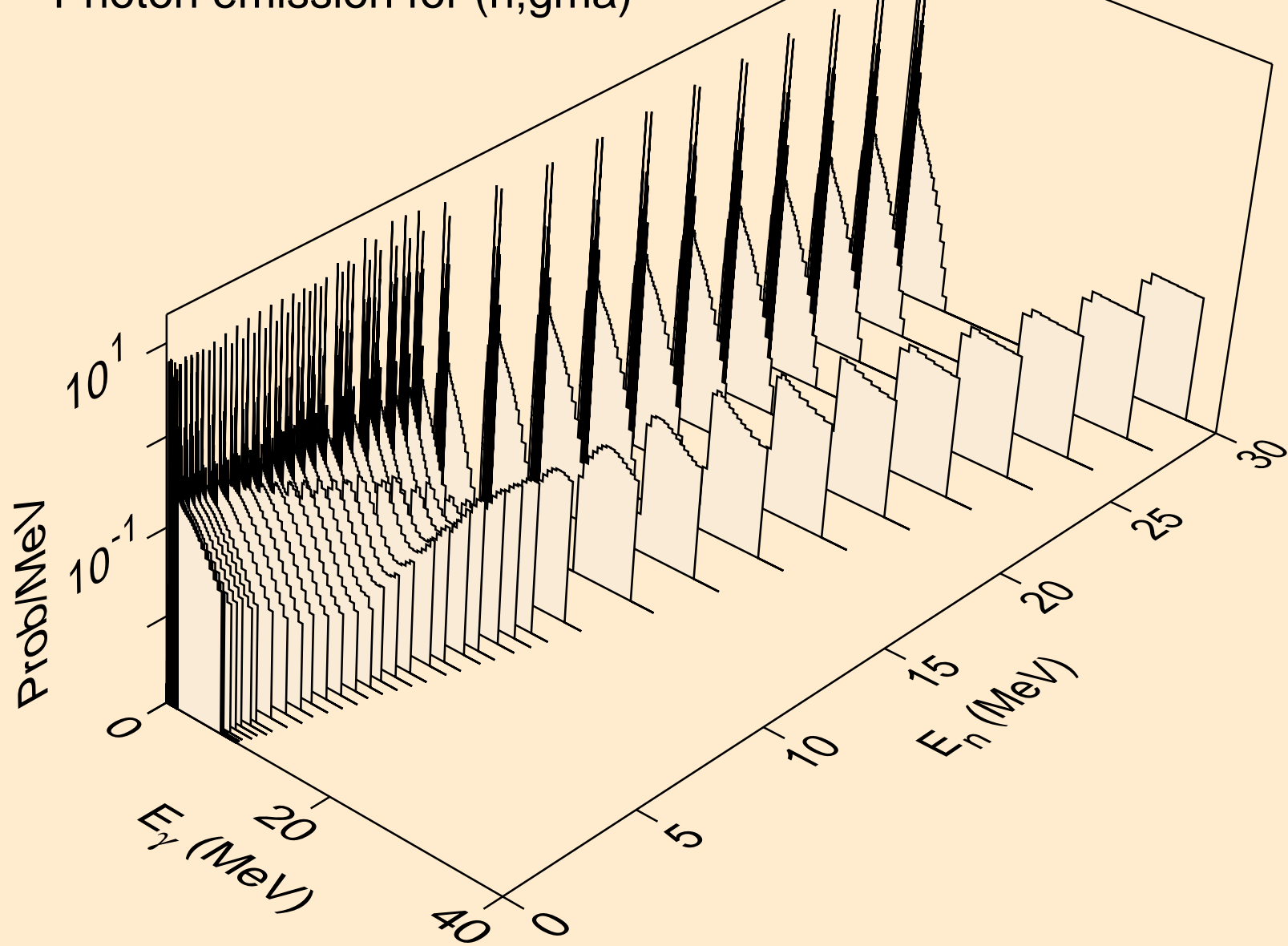

I132 NEUTRON ACER TENDL-2024 LIBRARY; T=0.K  
Photon emission for (n,p)

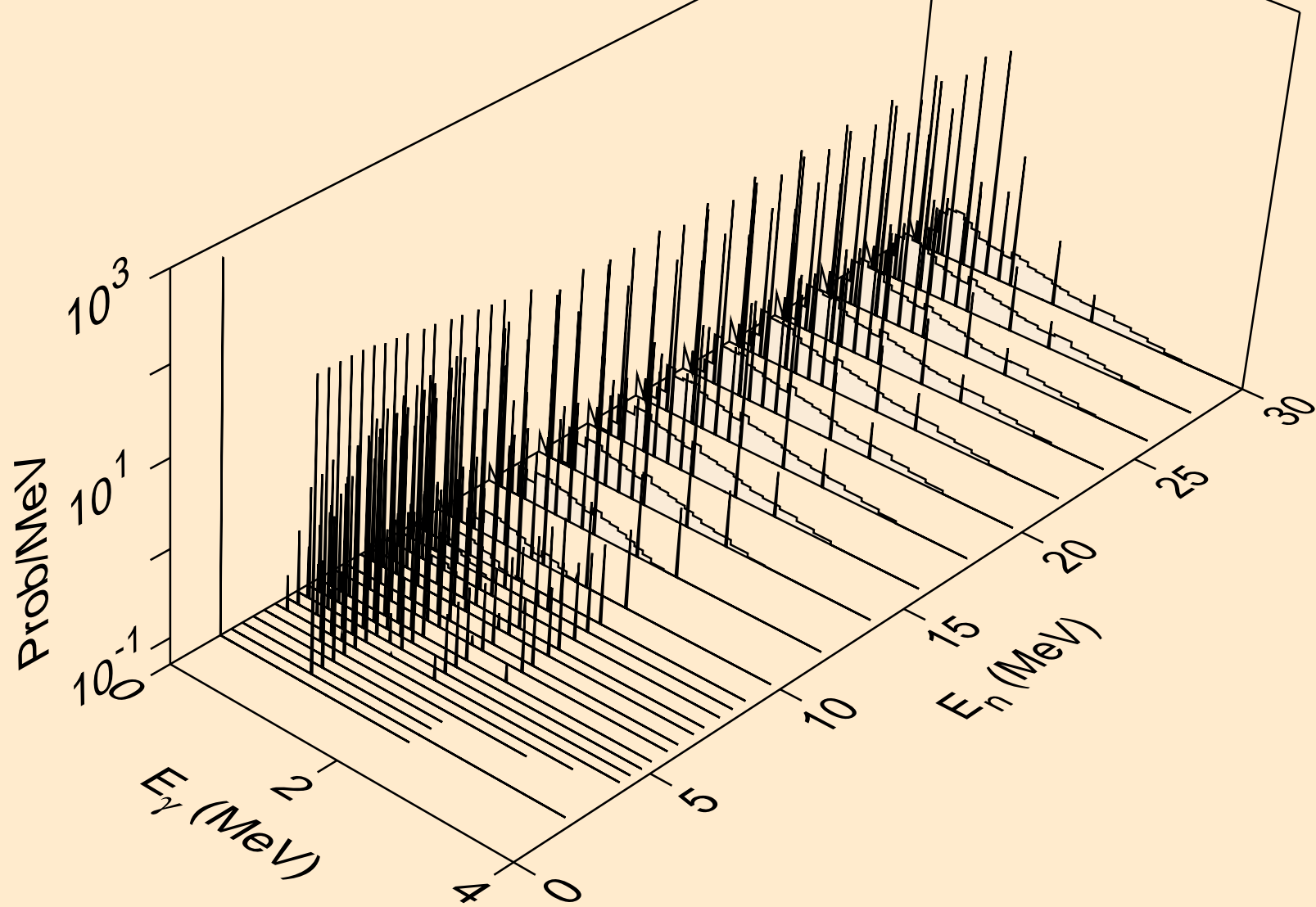

I132 NEUTRON ACER TENDL-2024 LIBRARY; T=0.K  
Photon emission for (n,d)

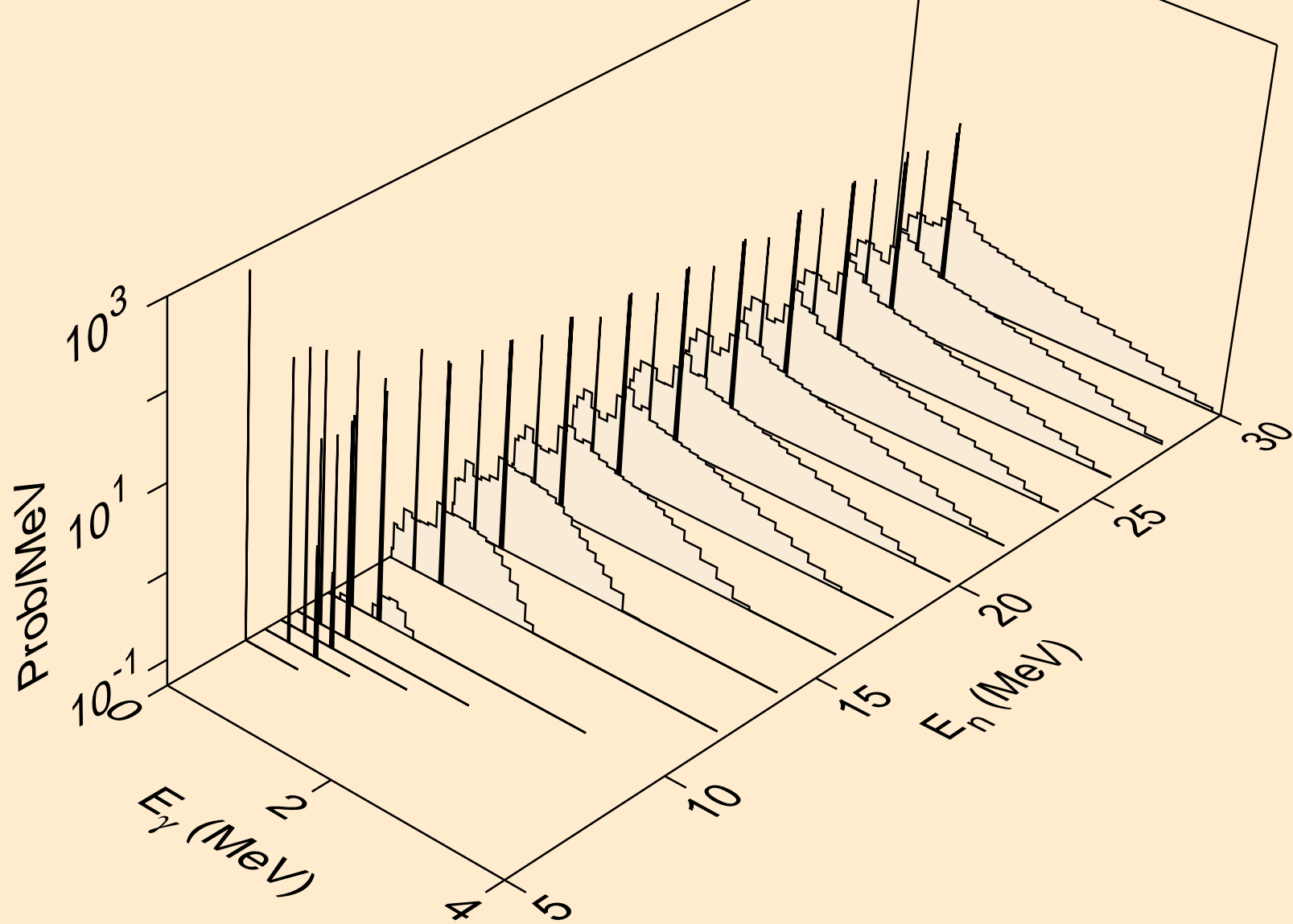

I132 NEUTRON ACER TENDL-2024 LIBRARY; T=0.K  
Photon emission for (n,t)

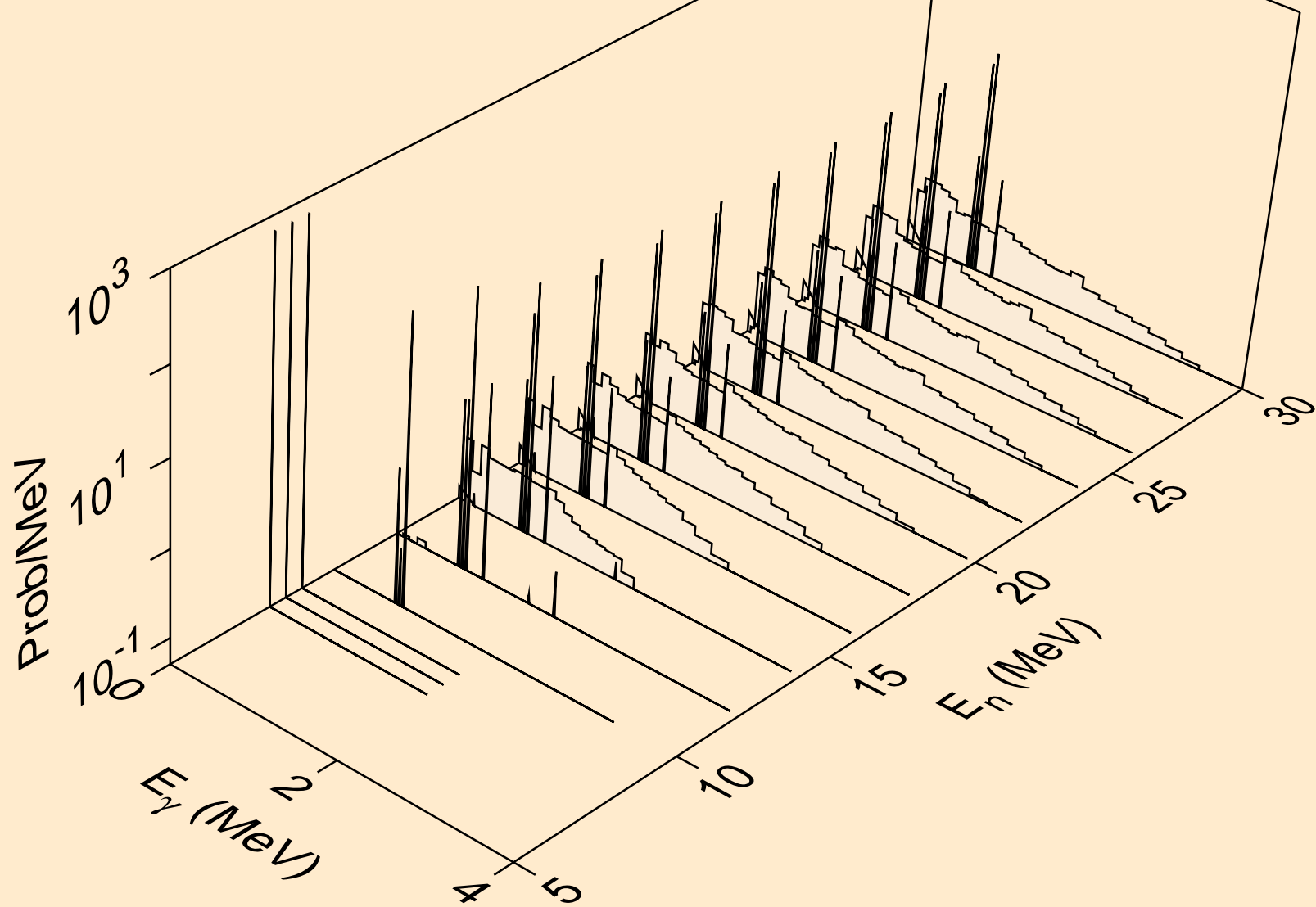

I132 NEUTRON ACER TENDL-2024 LIBRARY; T=0.K  
Photon emission for (n,he3)

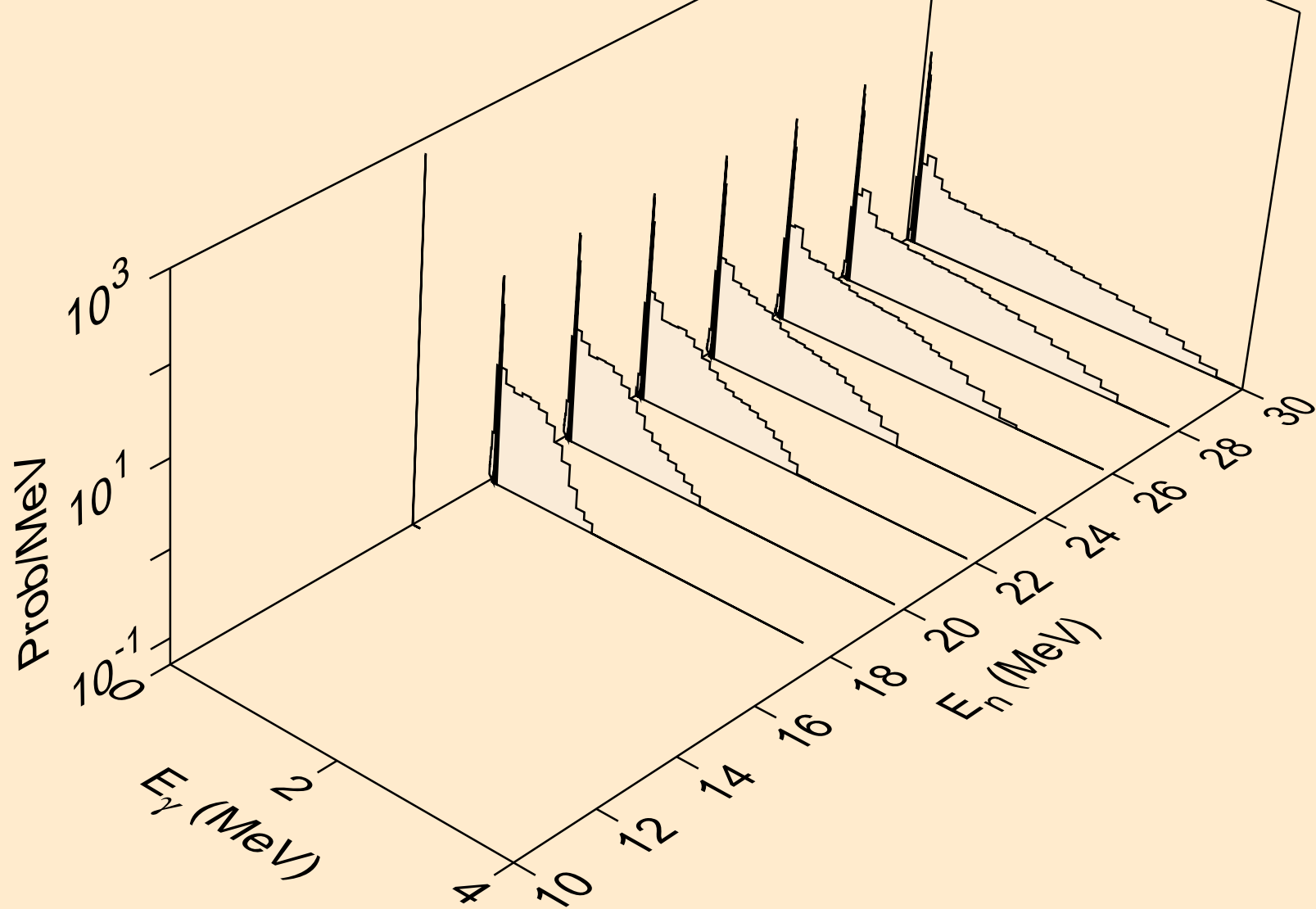

I132 NEUTRON ACER TENDL-2024 LIBRARY; T=0.K  
Photon emission for (n,a)

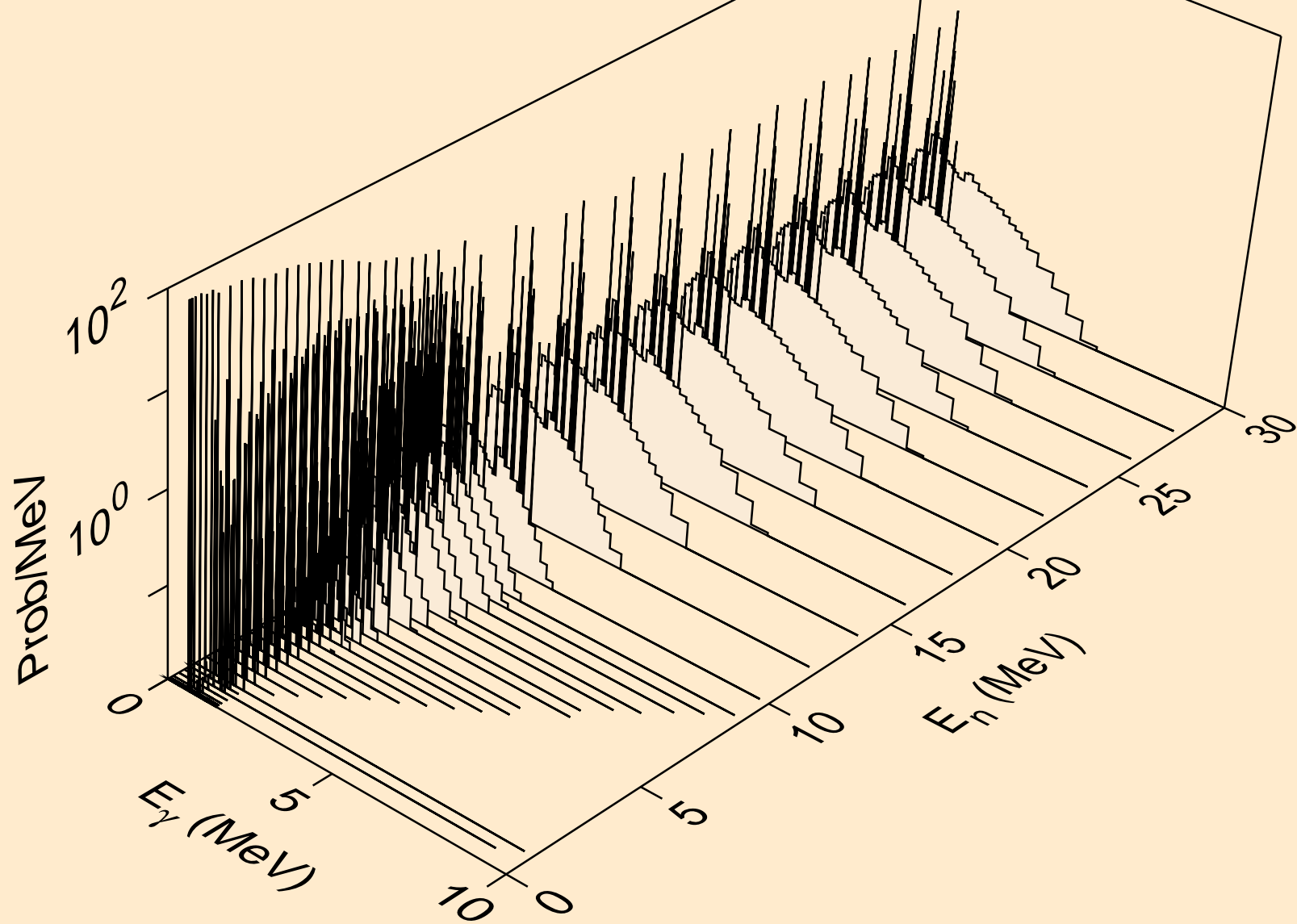

I132 NEUTRON ACER TENDL-2024 LIBRARY; T=0.K  
Photon emission for (n,2p)

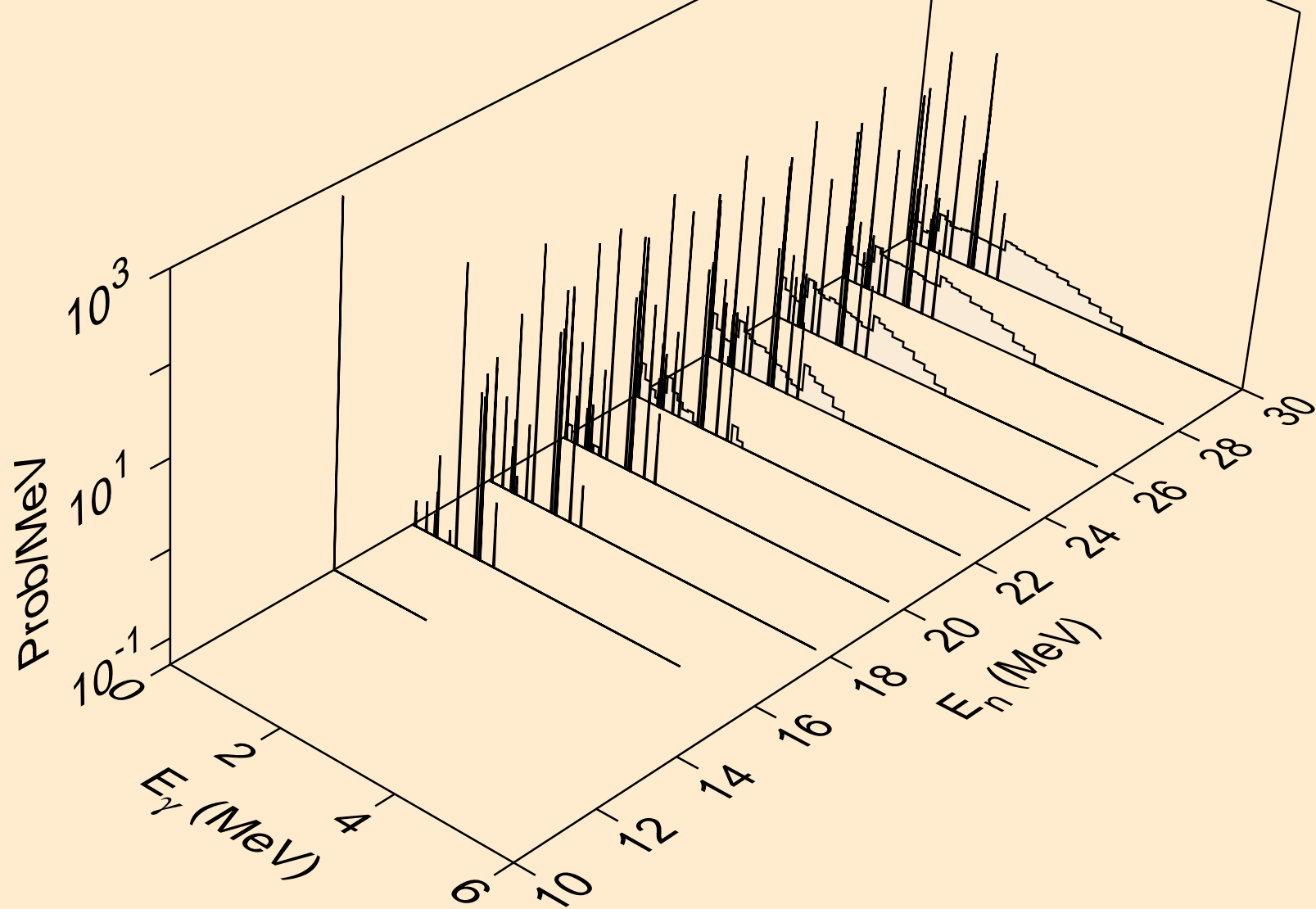

I132 NEUTRON ACER TENDL-2024 LIBRARY; T=0.K  
Photon emission for (n,pa)

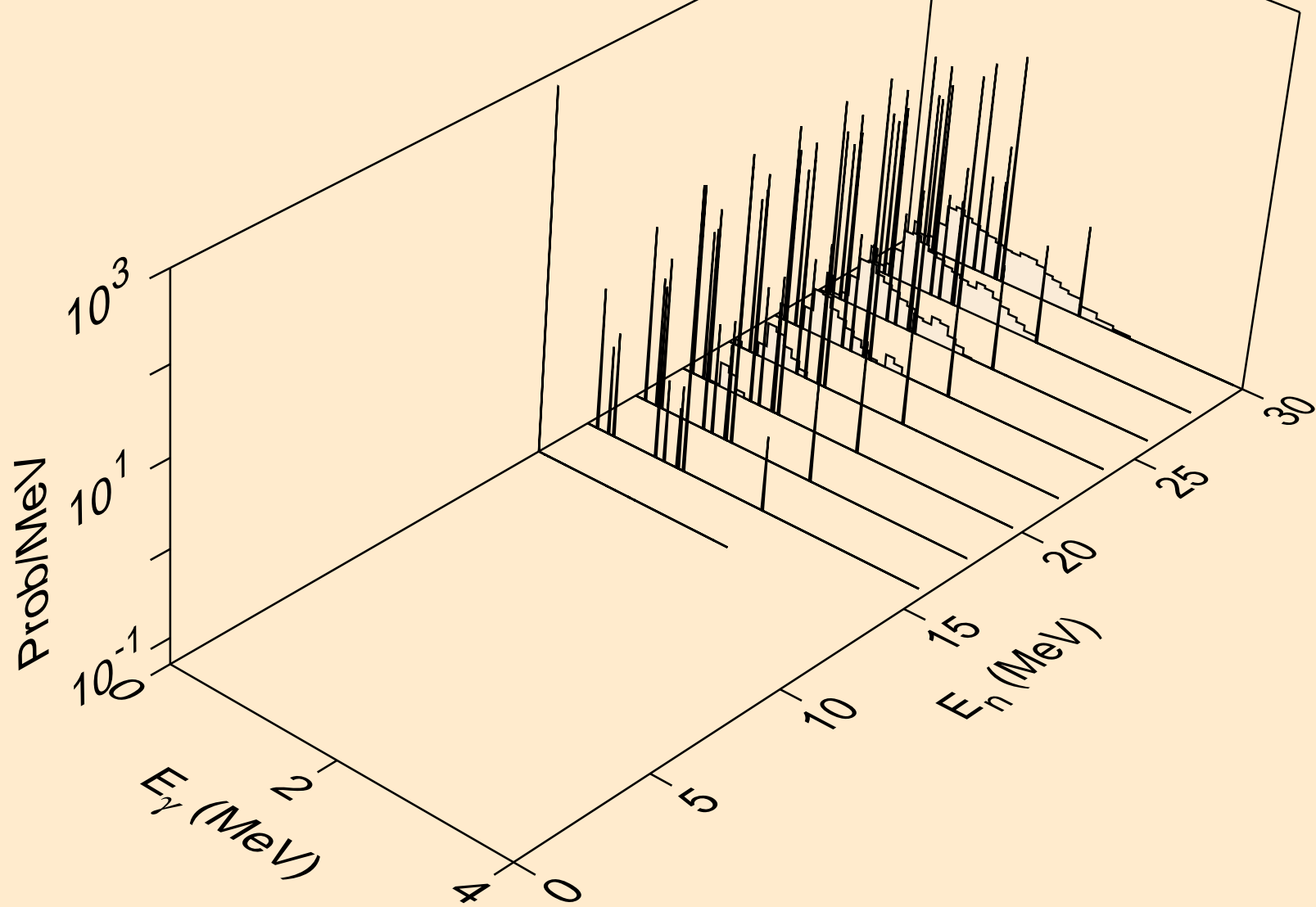

I132 NEUTRON ACER TENDL-2024 LIBRARY; T=0.K  
Photon emission for (n,pd)

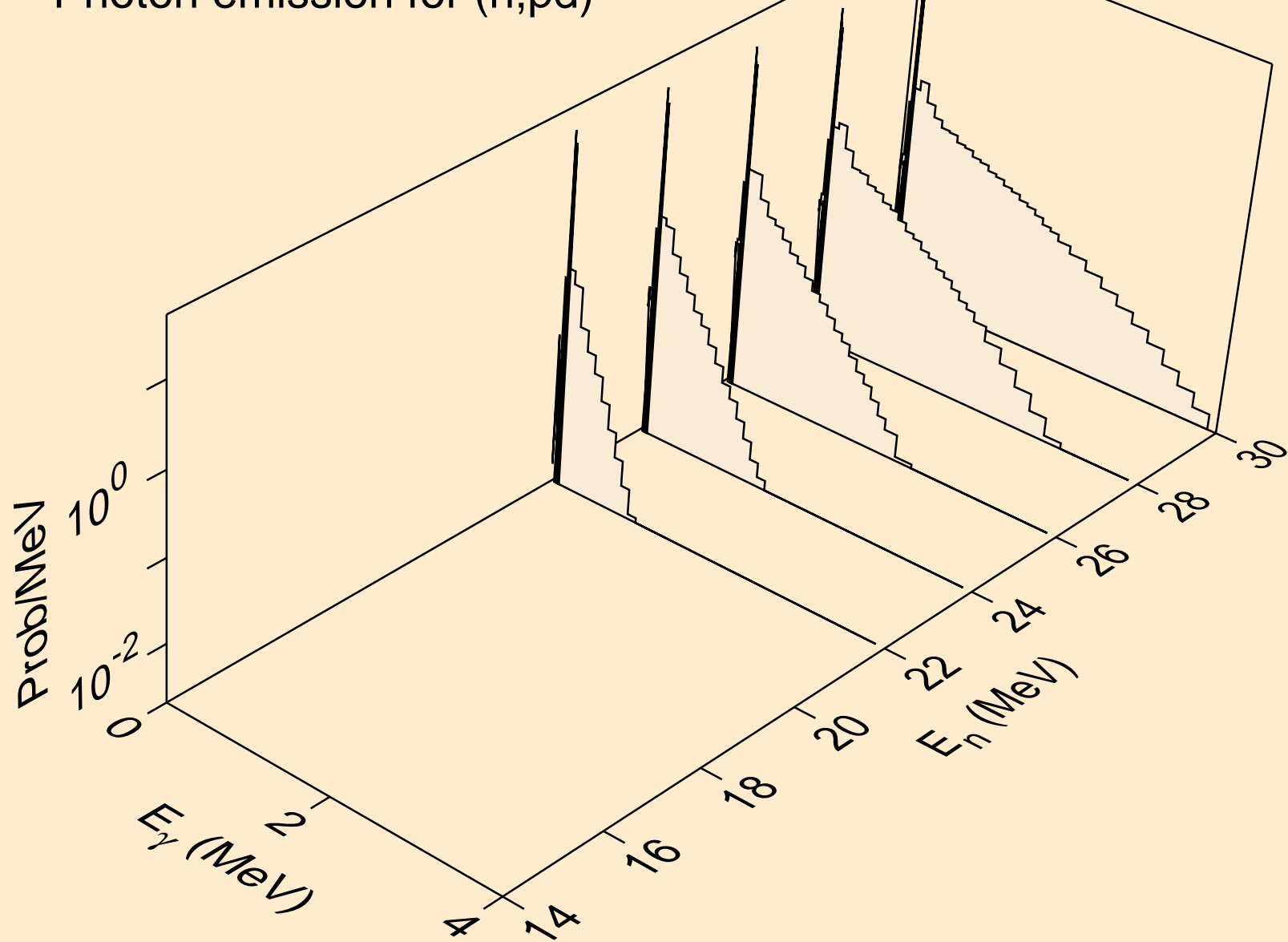

I132 NEUTRON ACER TENDL-2024 LIBRARY; T=0.K  
Photon emission for (n,pt)

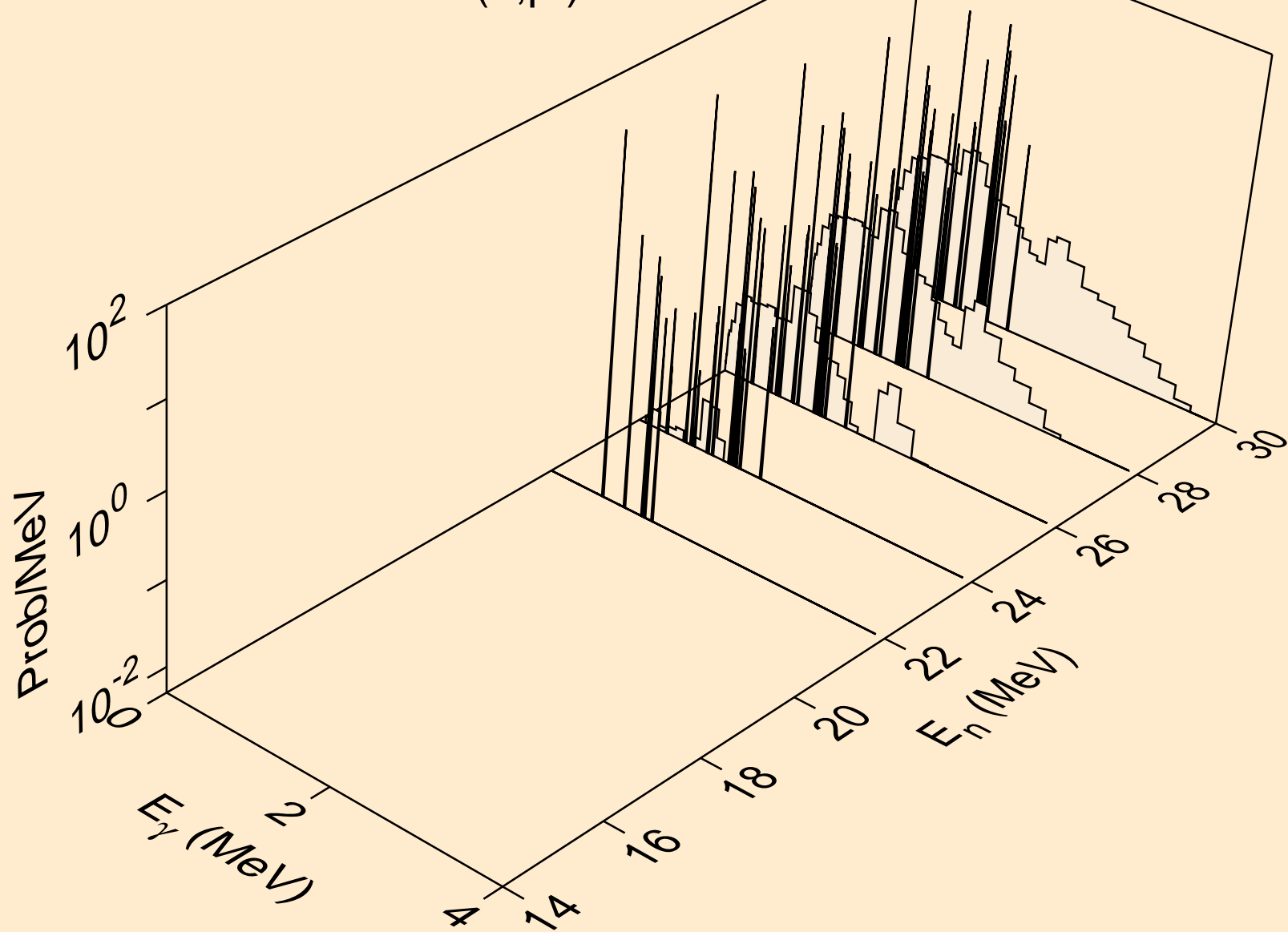

I132 NEUTRON ACER TENDL-2024 LIBRARY; T=0.K  
thermal capture photon spectrum

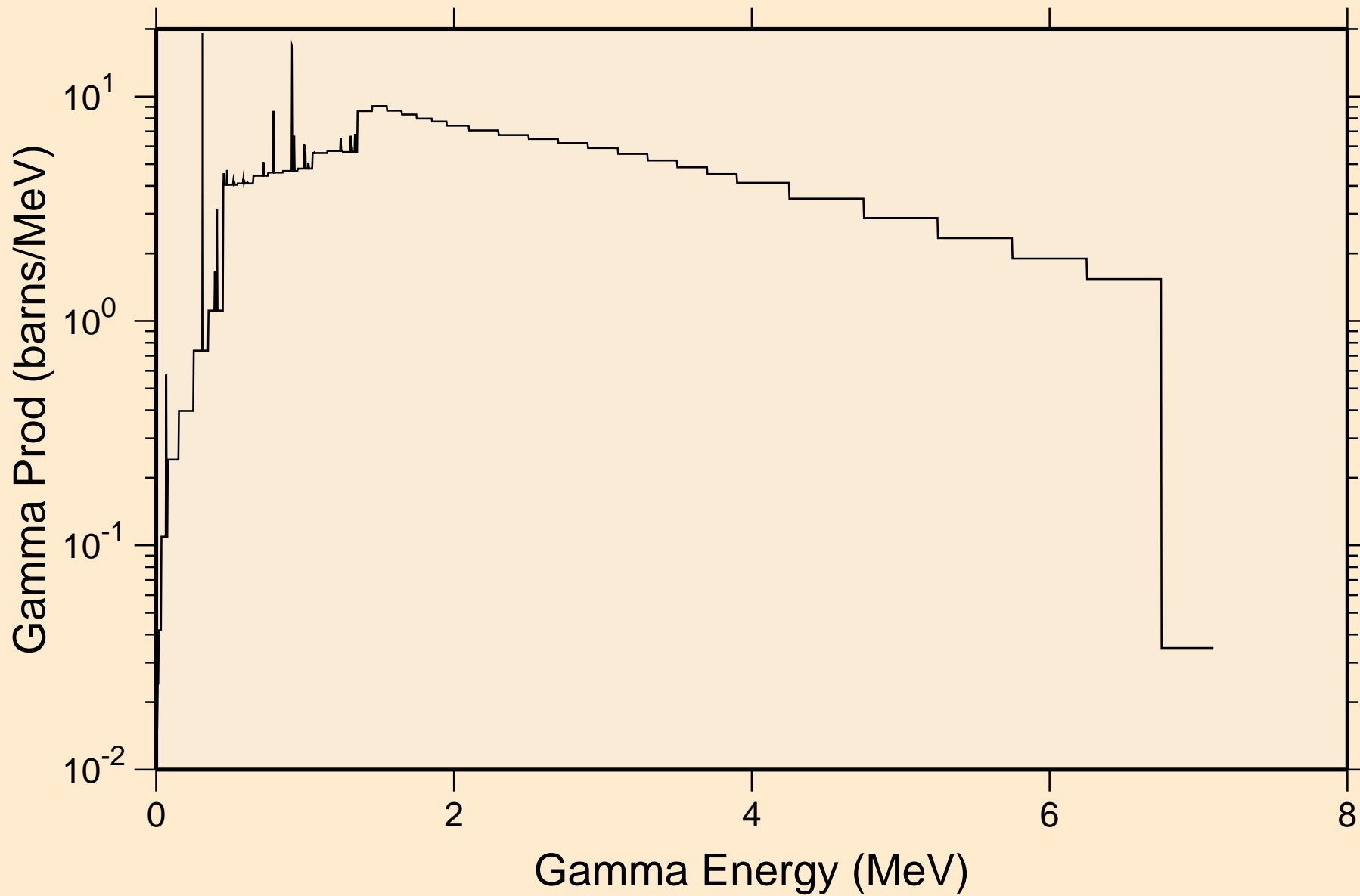

I132 NEUTRON ACER TENDL-2024 LIBRARY; T=0.K  
14 MeV photon spectrum

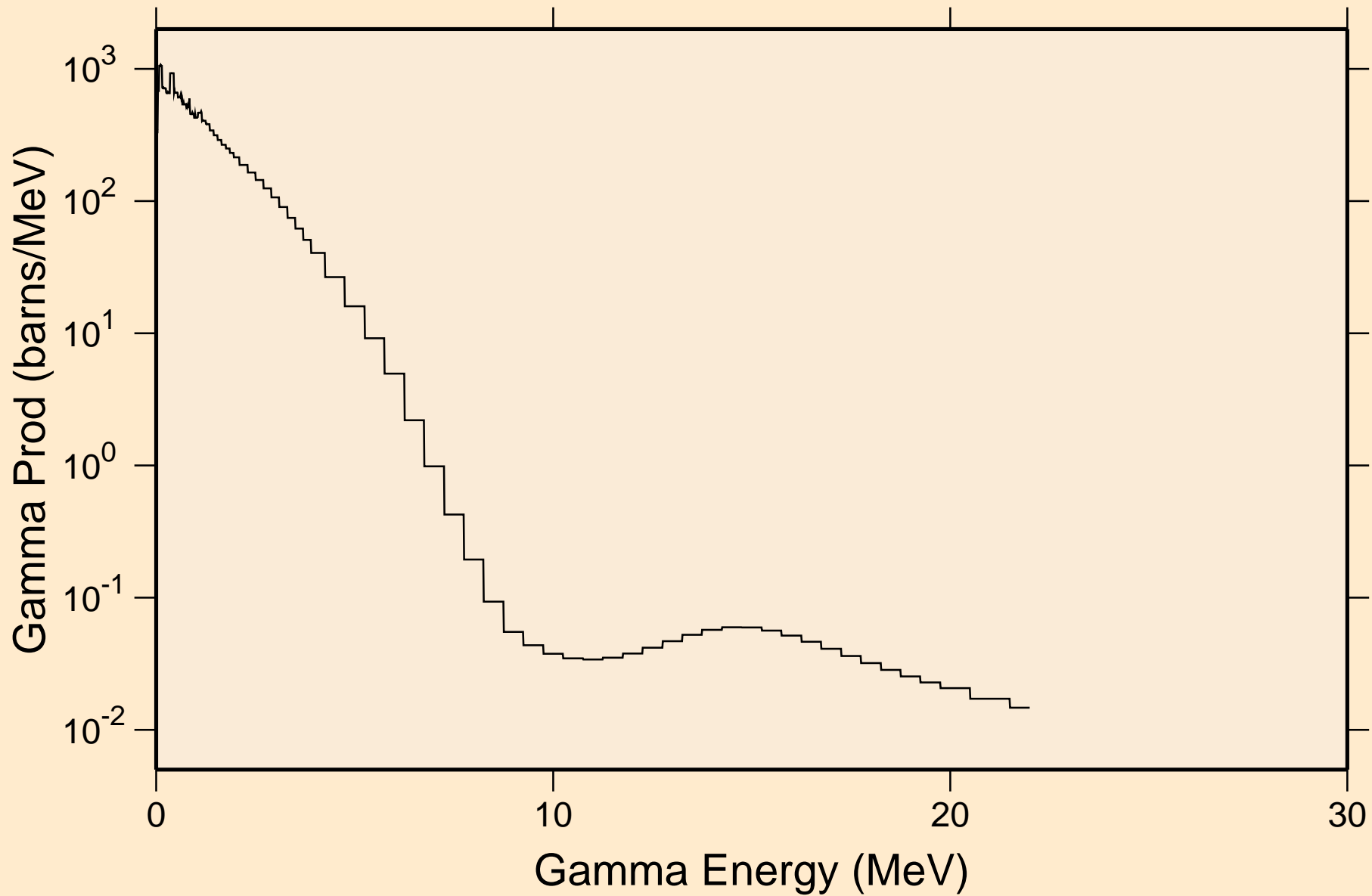

# I132 NEUTRON ACER TENDL-2024 LIBRARY; T=0.K

## Particle heating contributions

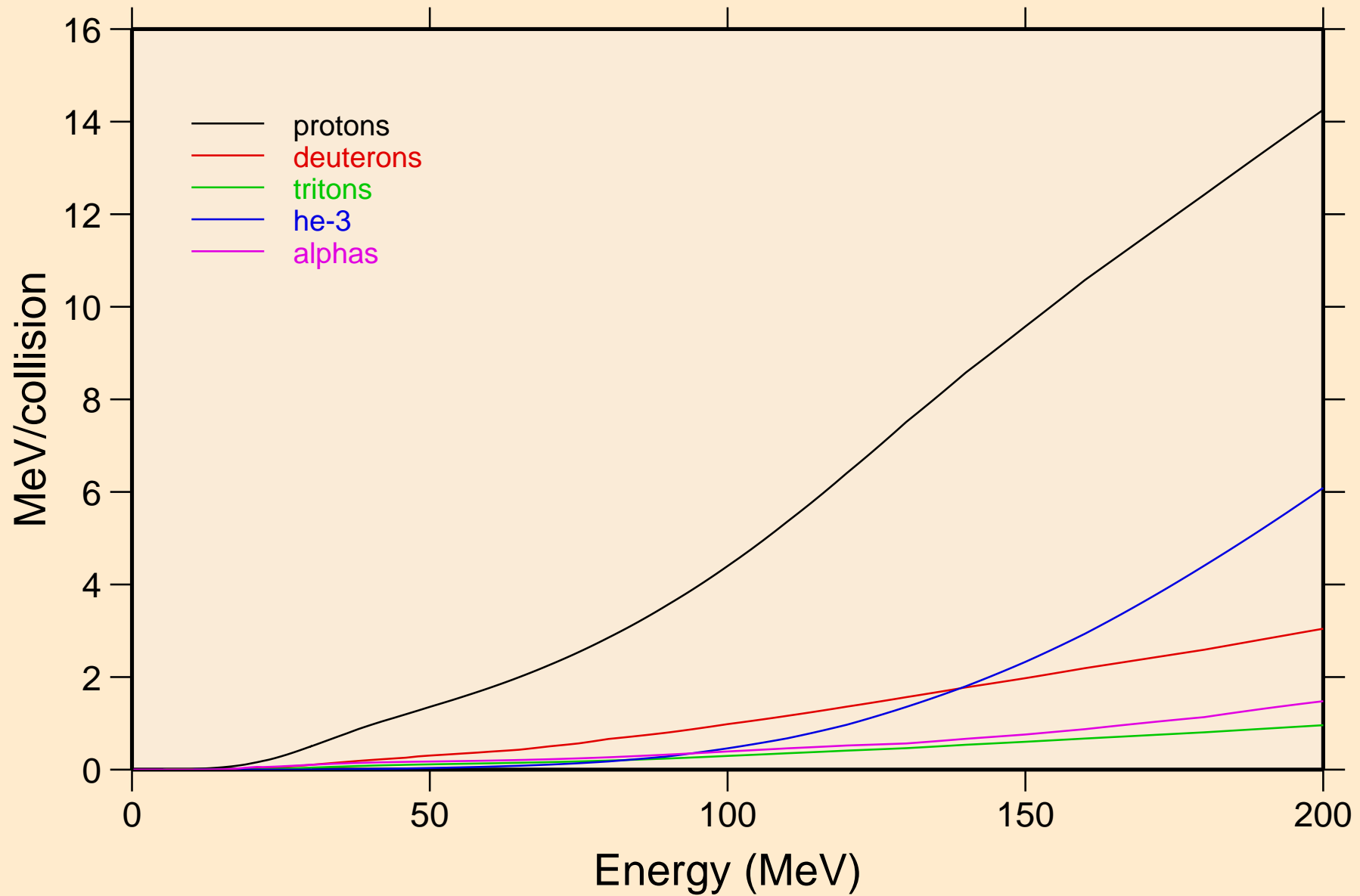

# I132 NEUTRON ACER TENDL-2024 LIBRARY; T=0.K

## Recoil Heating

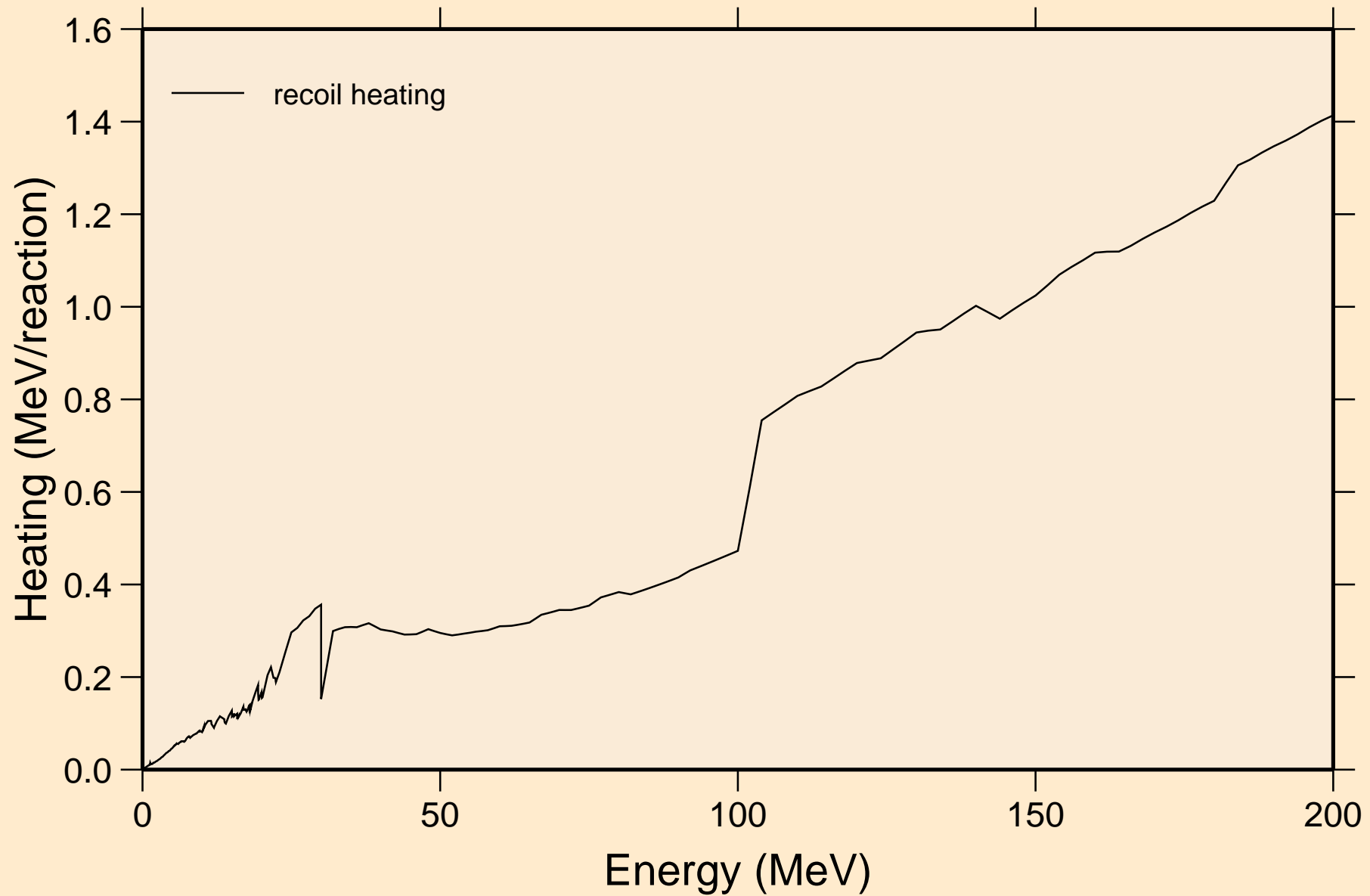

# I132 NEUTRON ACER TENDL-2024 LIBRARY; T=0.K

## Particle production cross sections

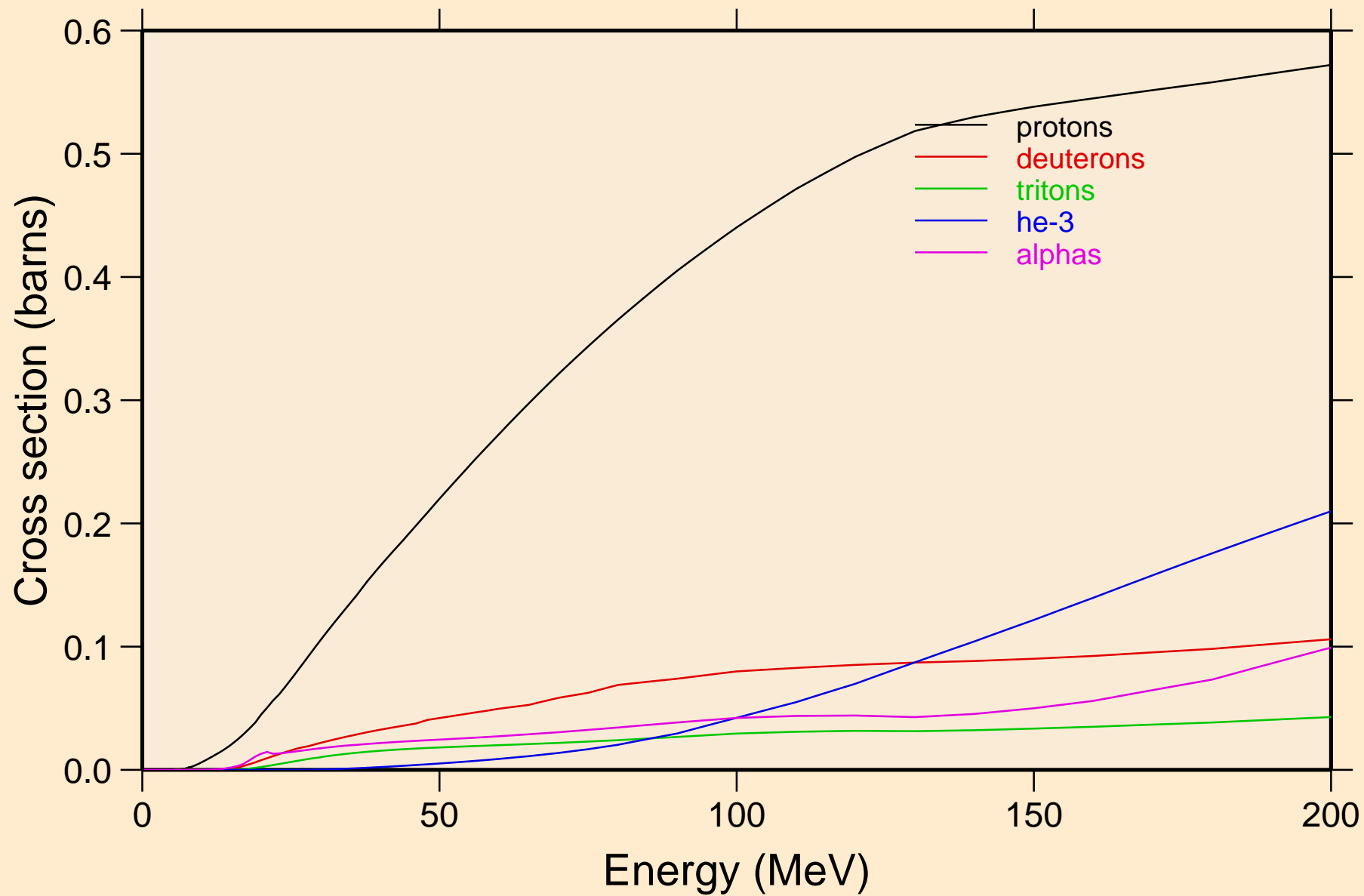

I132 NEUTRON ACER TENDL-2024 LIBRARY; T=0.K  
protons from (n,x)

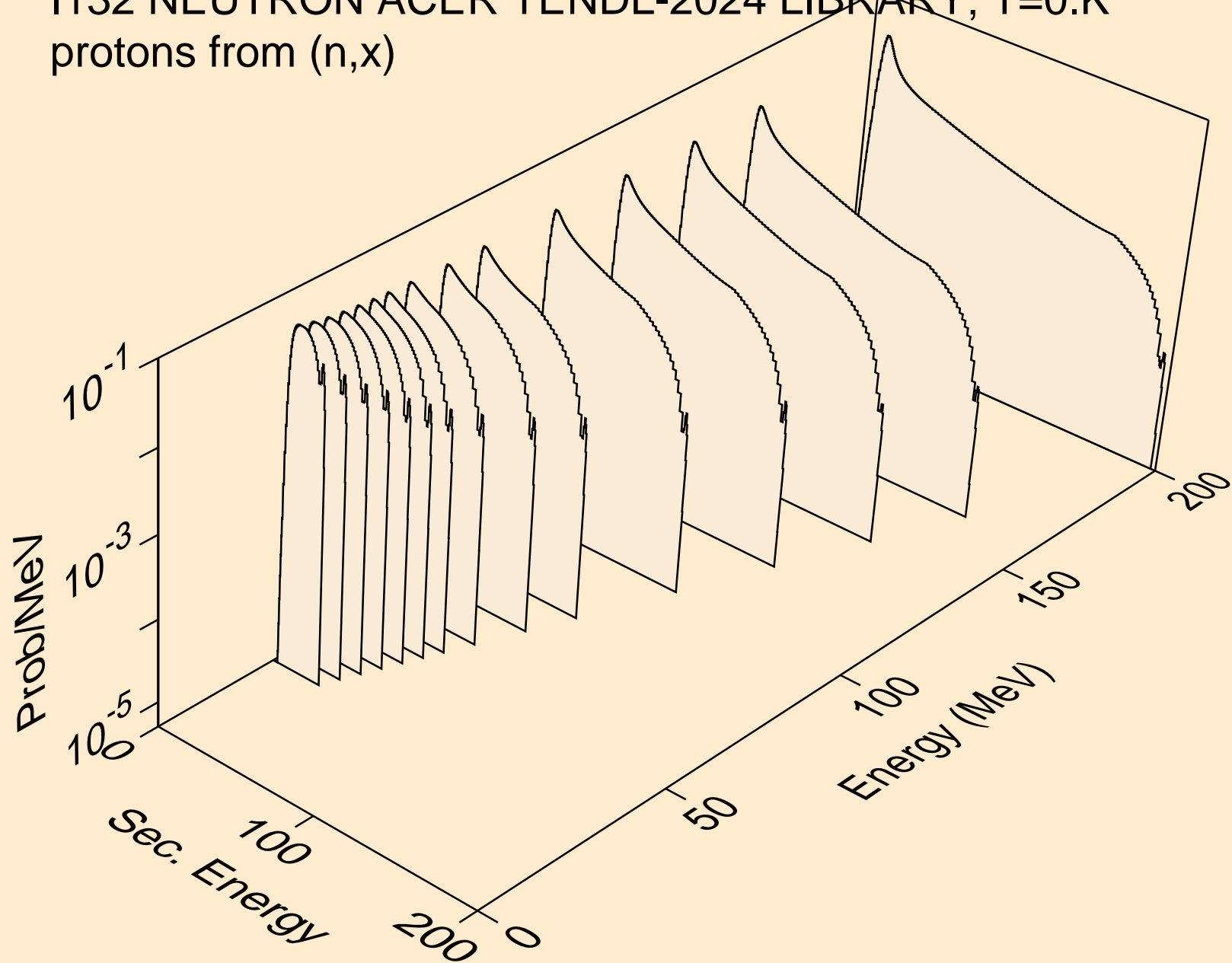

I132 NEUTRON ACER TENDL-2024 LIBRARY; T=0.K  
protons from (n,n\*)p

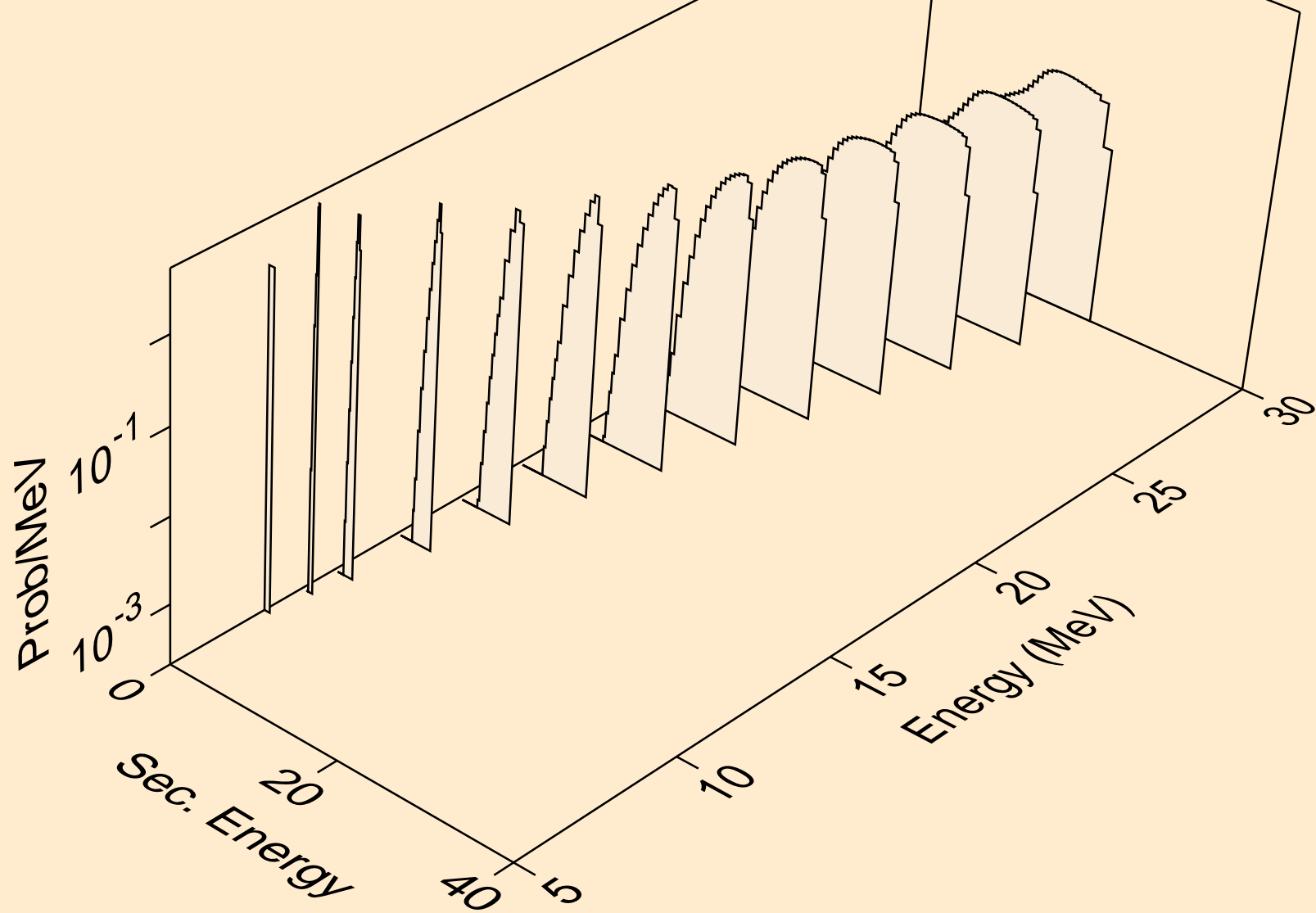

I132 NEUTRON ACER TENDL-2024 LIBRARY; T=0.K  
protons from (n,2np)

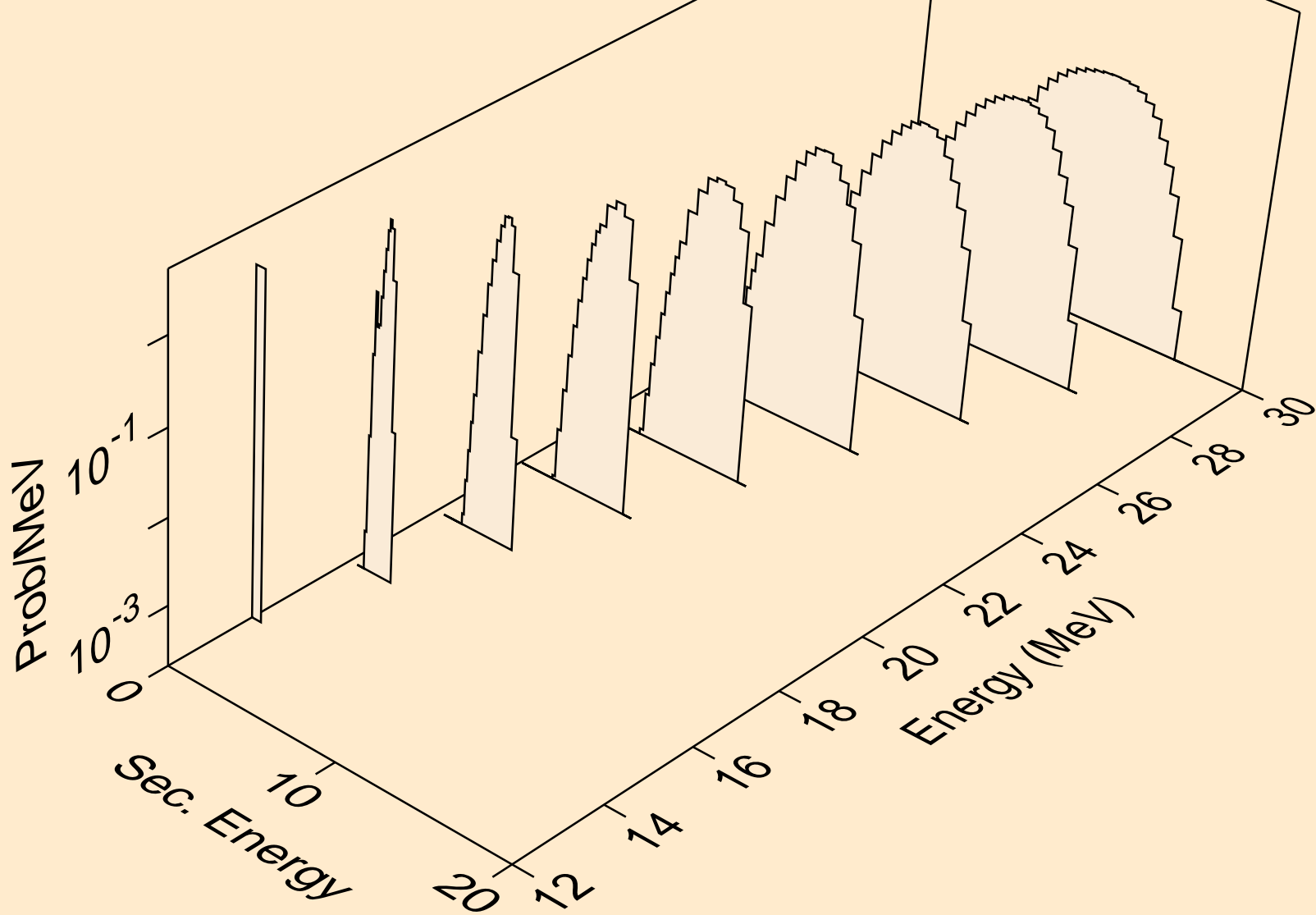

I132 NEUTRON ACER TENDL-2024 LIBRARY; T=0.K  
protons from (n,3np)

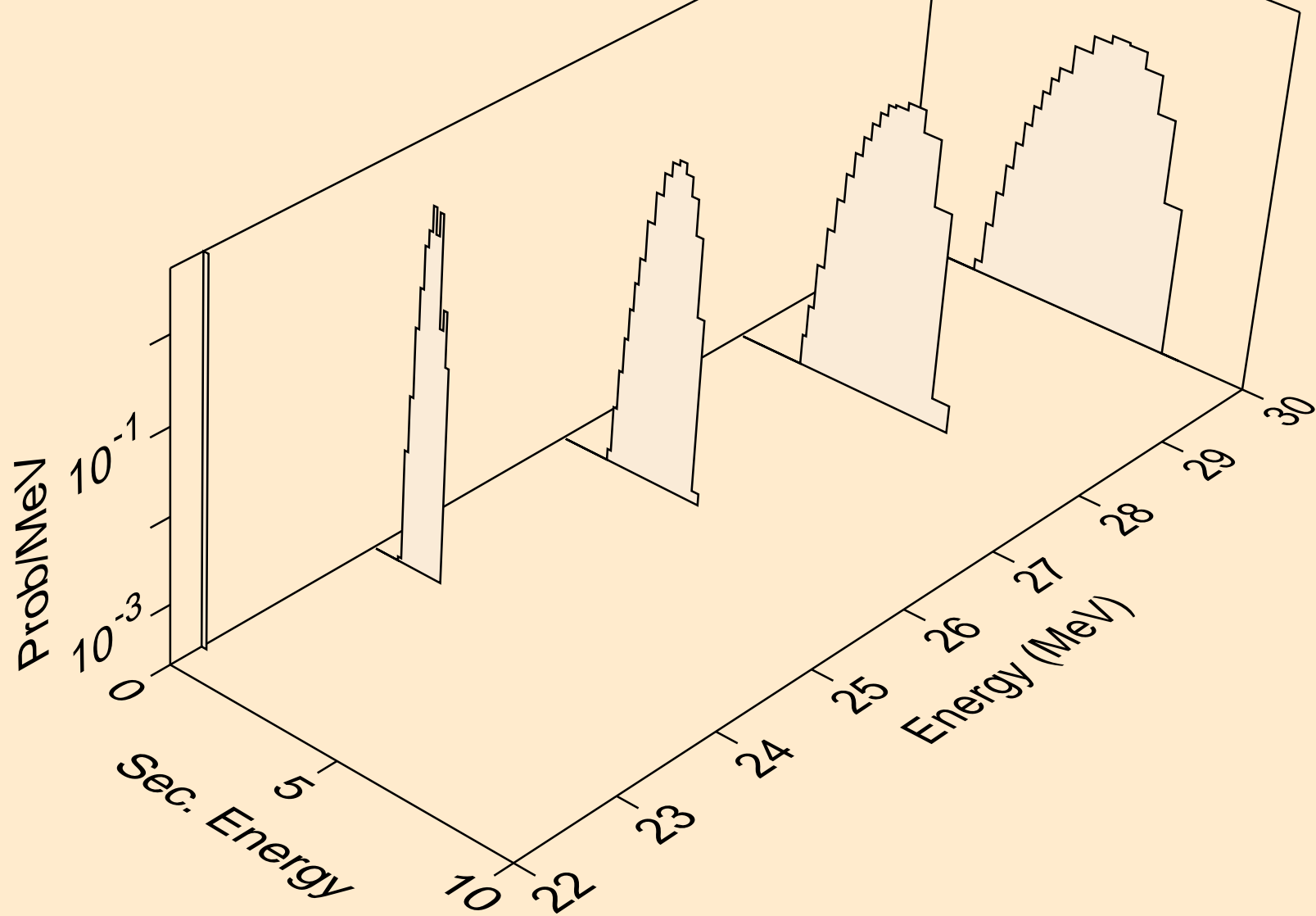

I132 NEUTRON ACER TENDL-2024 LIBRARY; T=0.K  
protons from (n,n2p)

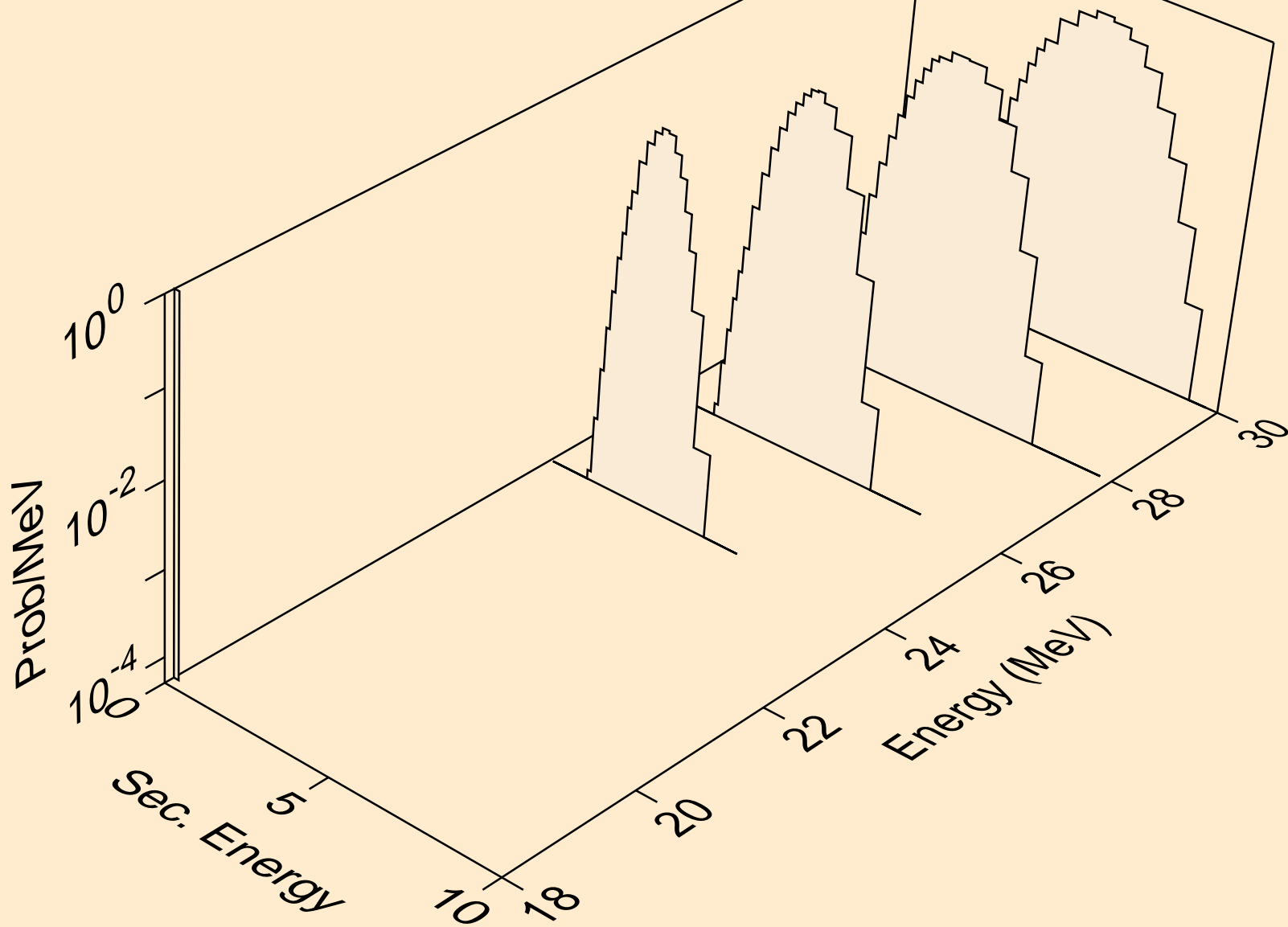

I132 NEUTRON ACER TENDL-2024 LIBRARY; T=0.K  
protons from (n,p)

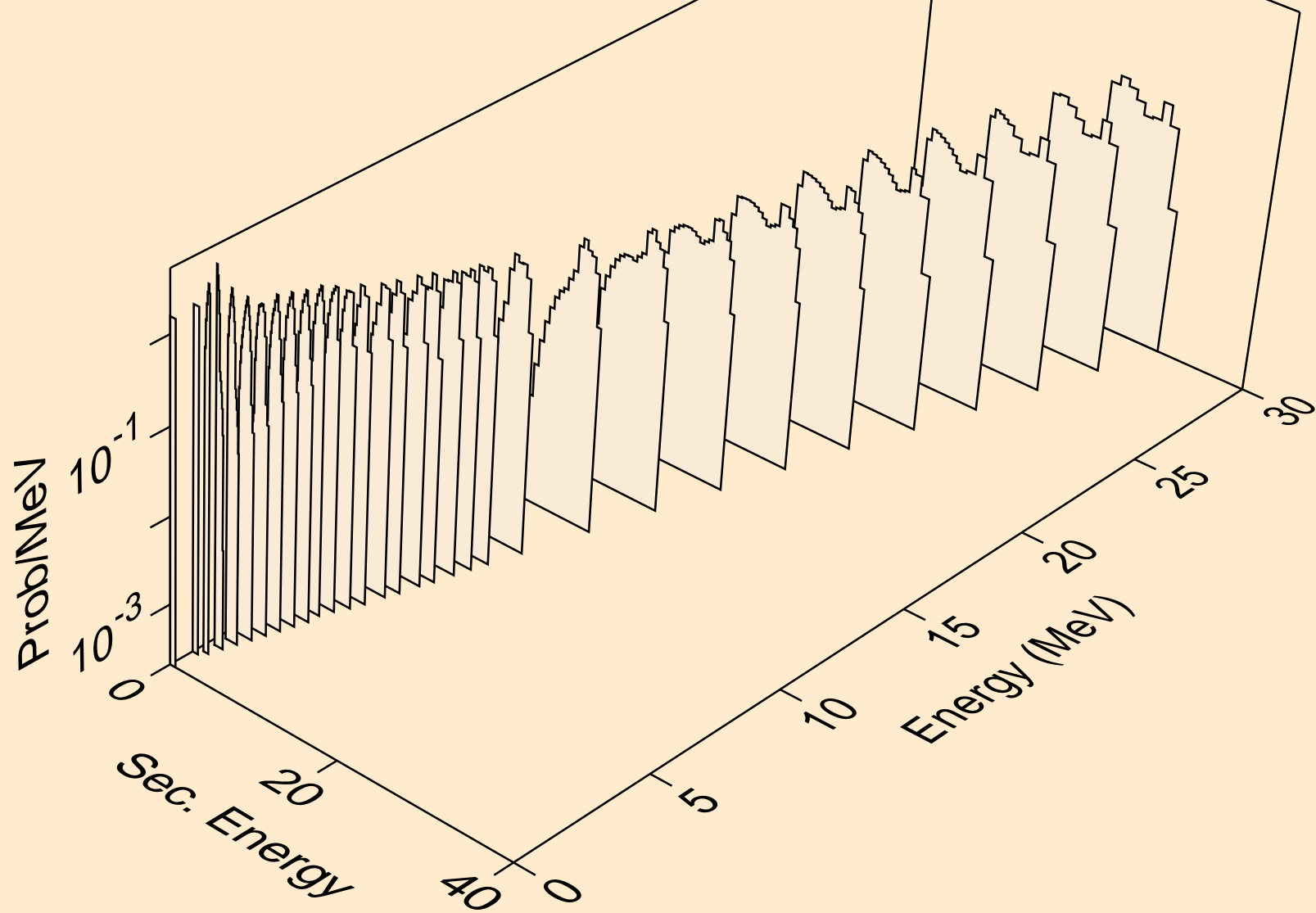

I132 NEUTRON ACER TENDL-2024 LIBRARY; T=0.K  
protons from (n,2p)

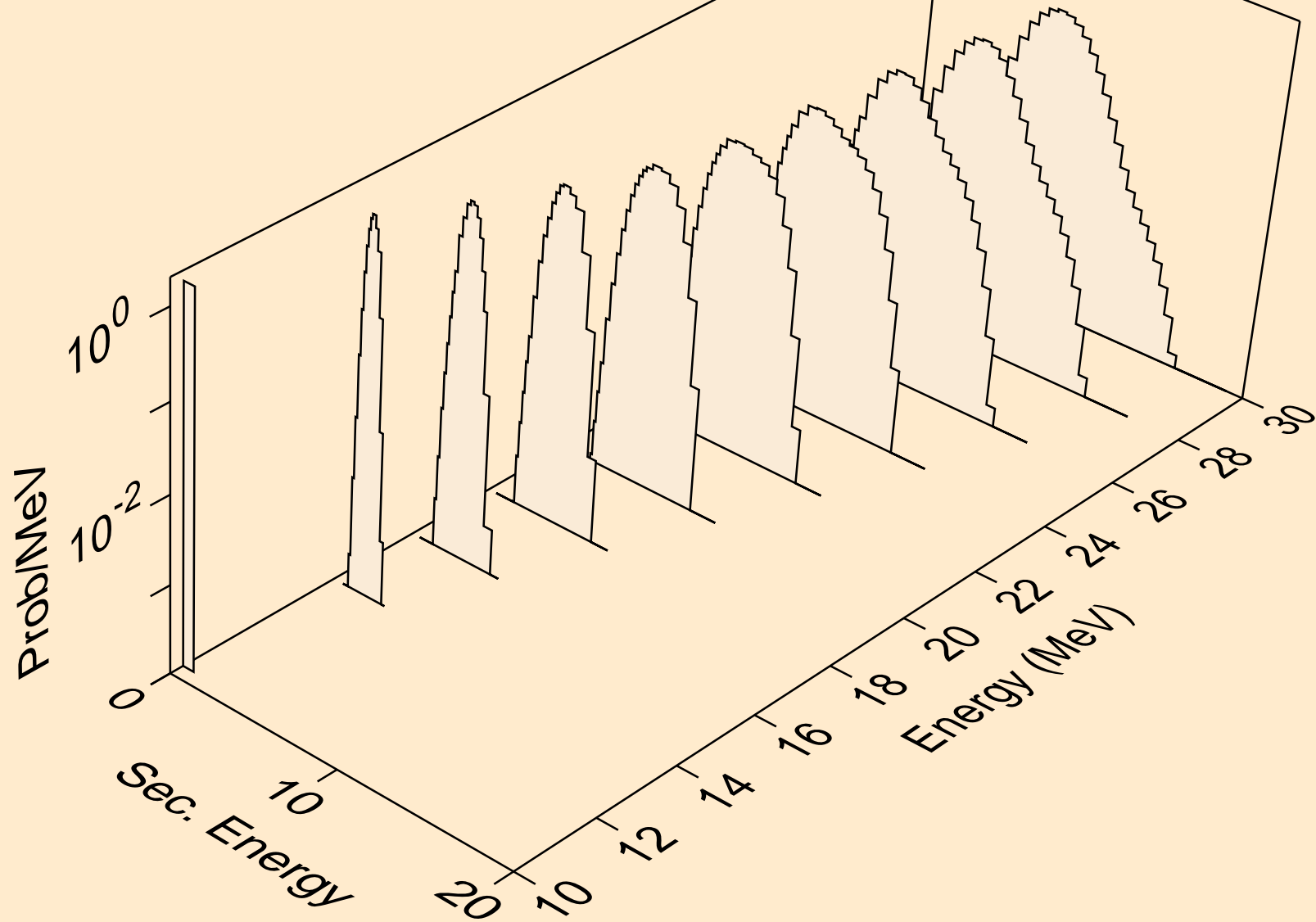

I132 NEUTRON ACER TENDL-2024 LIBRARY; T=0.K  
protons from (n,p)

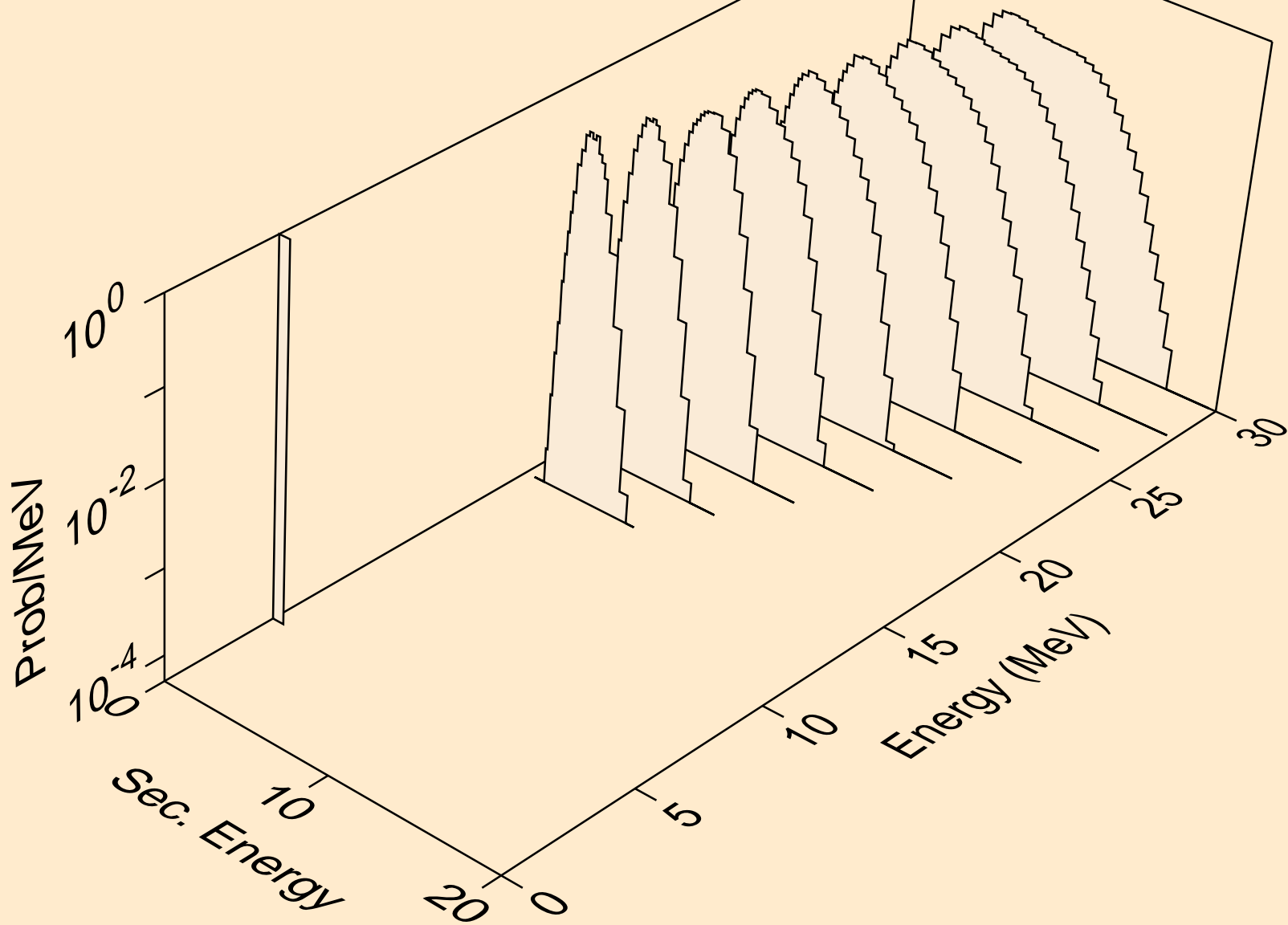

I132 NEUTRON ACER TENDL-2024 LIBRARY; T=0.K  
protons from (n,pd)

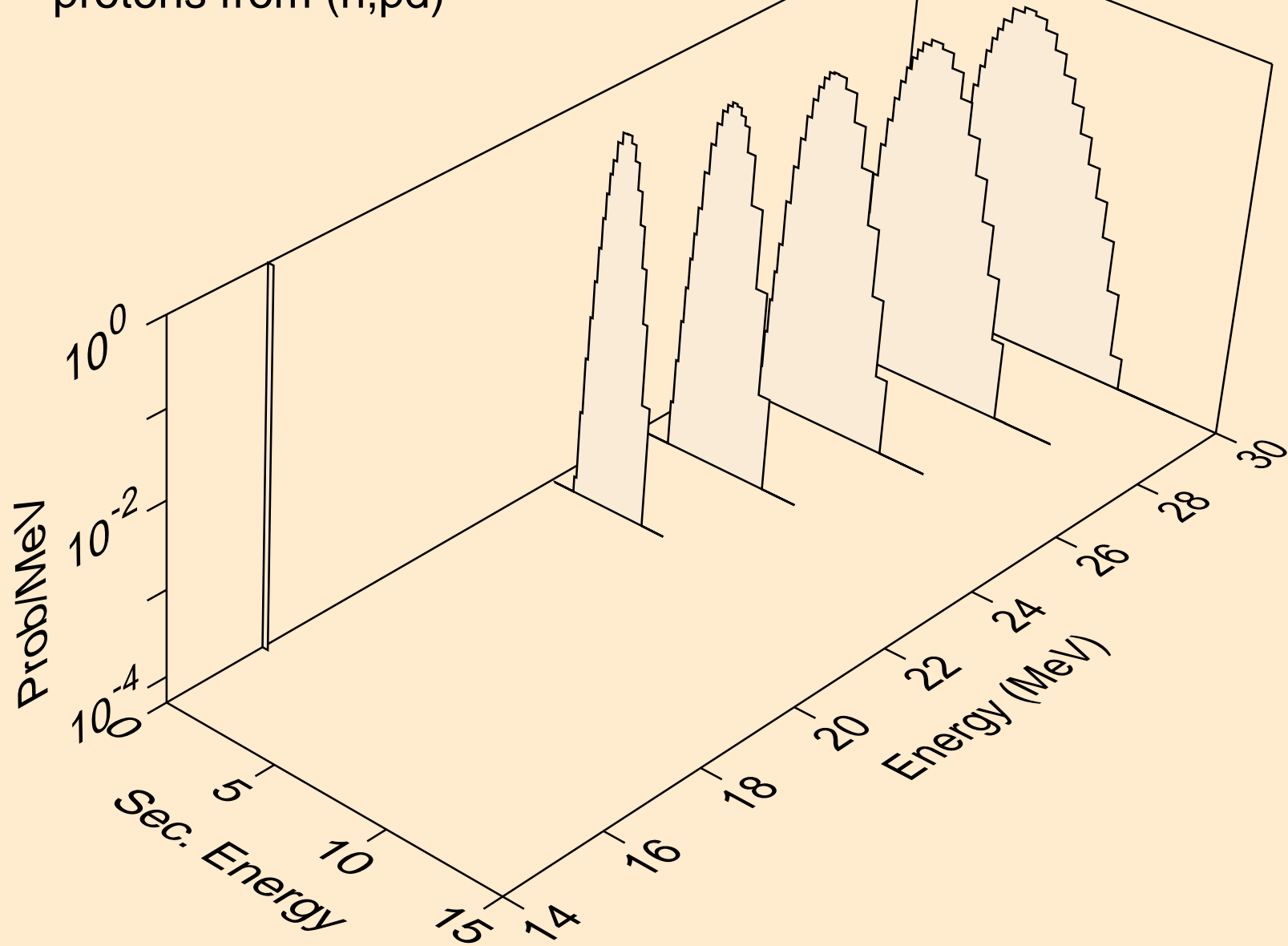

I132 NEUTRON ACER TENDL-2024 LIBRARY; T=0.K  
protons from (n,pt)

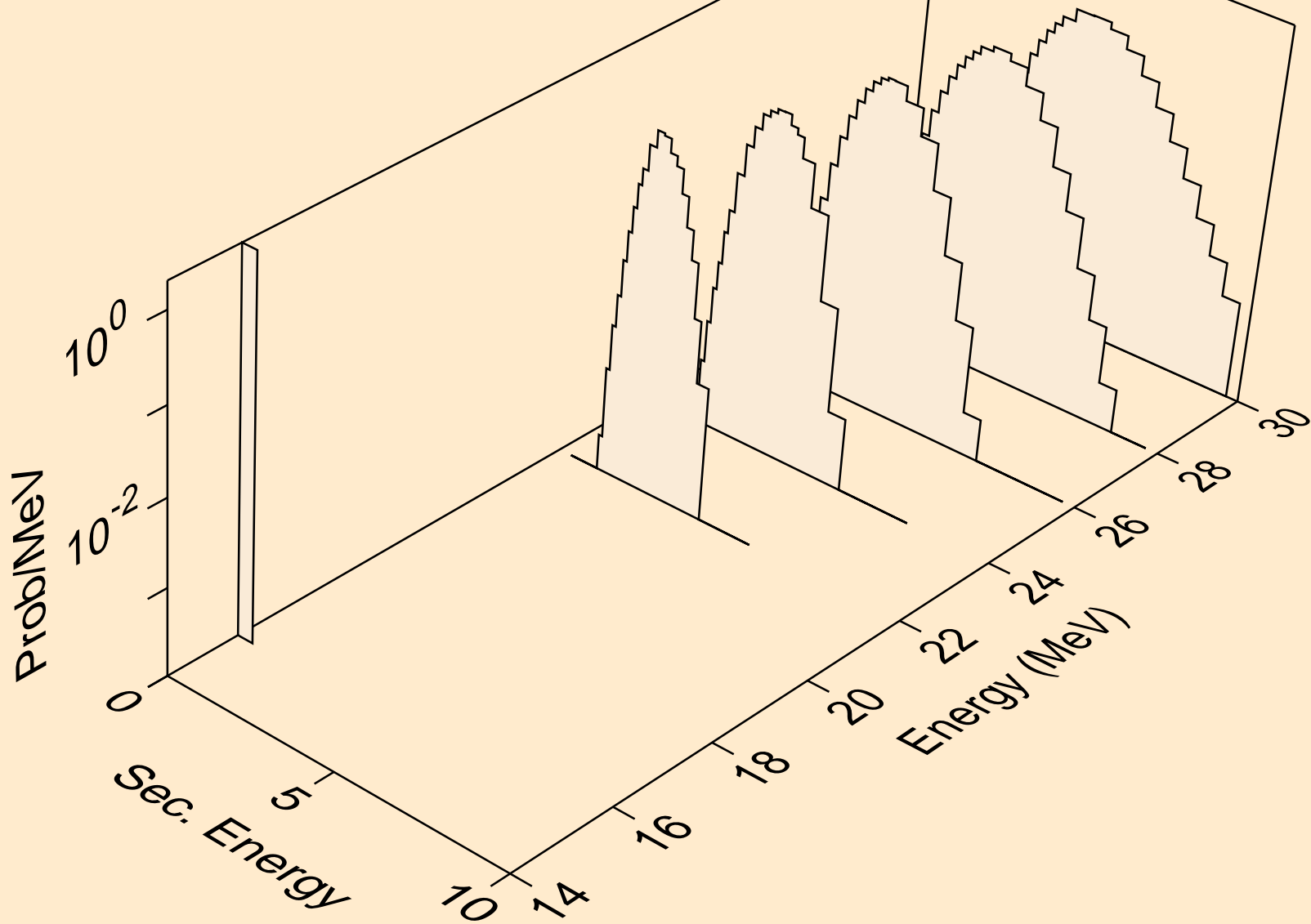

I132 NEUTRON ACER TENDL-2024 LIBRARY; T=0.K  
deuterons from (n,x)

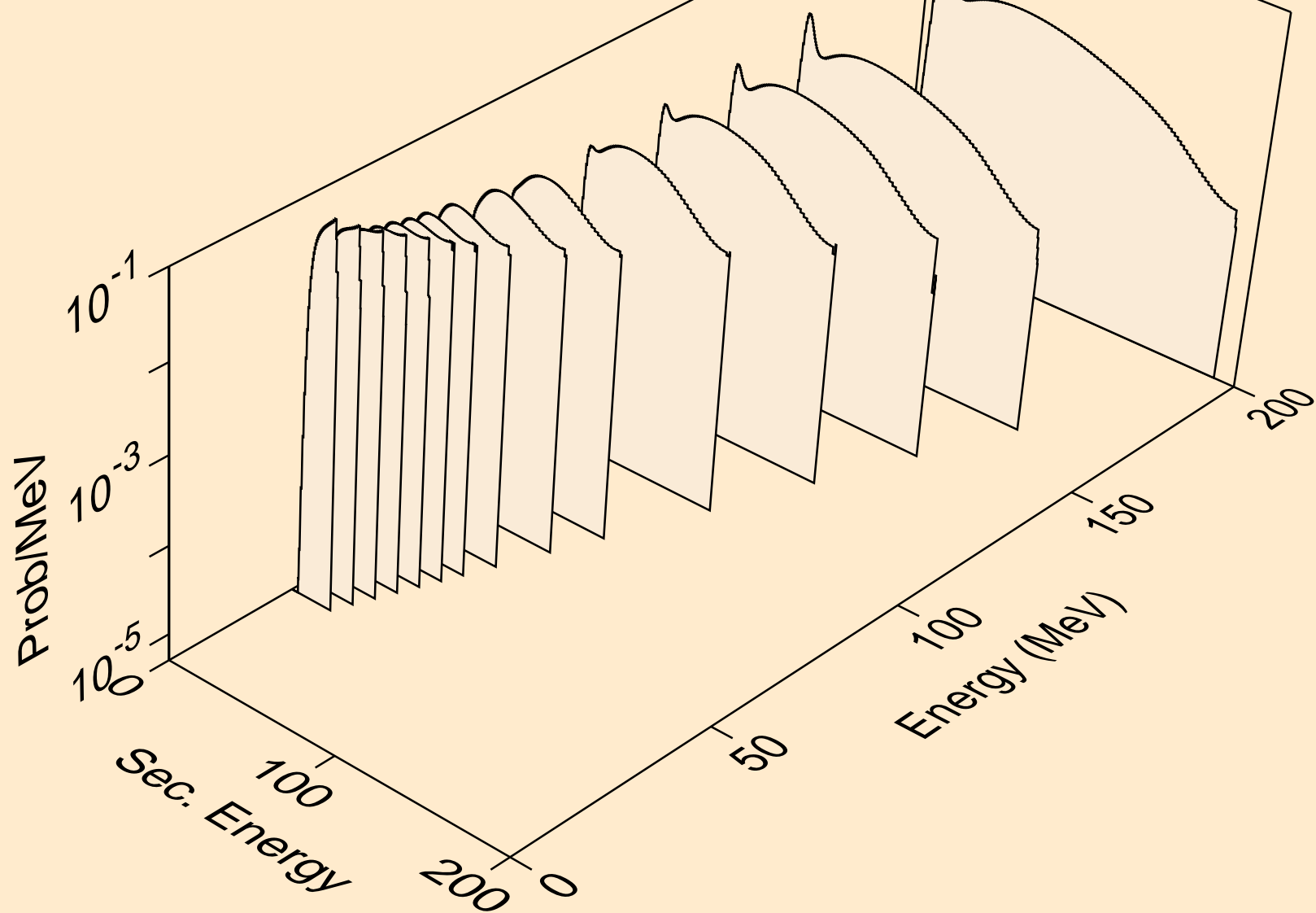

I132 NEUTRON ACER TENDL-2024 LIBRARY; T=0.K  
deuterons from (n,2nd)

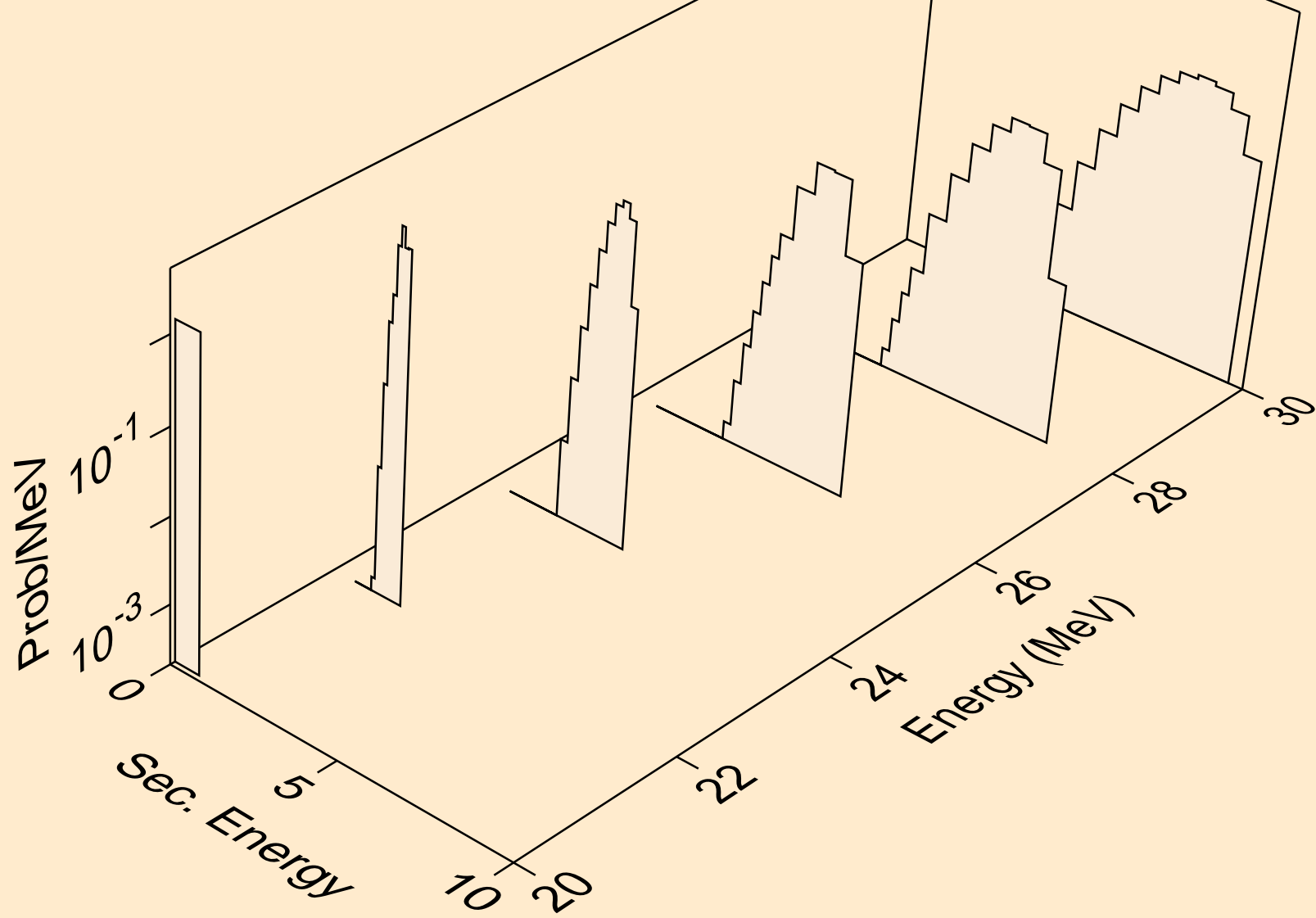

I132 NEUTRON ACER TENDL-2024 LIBRARY; T=0.K  
deuterons from (n,n\*)d

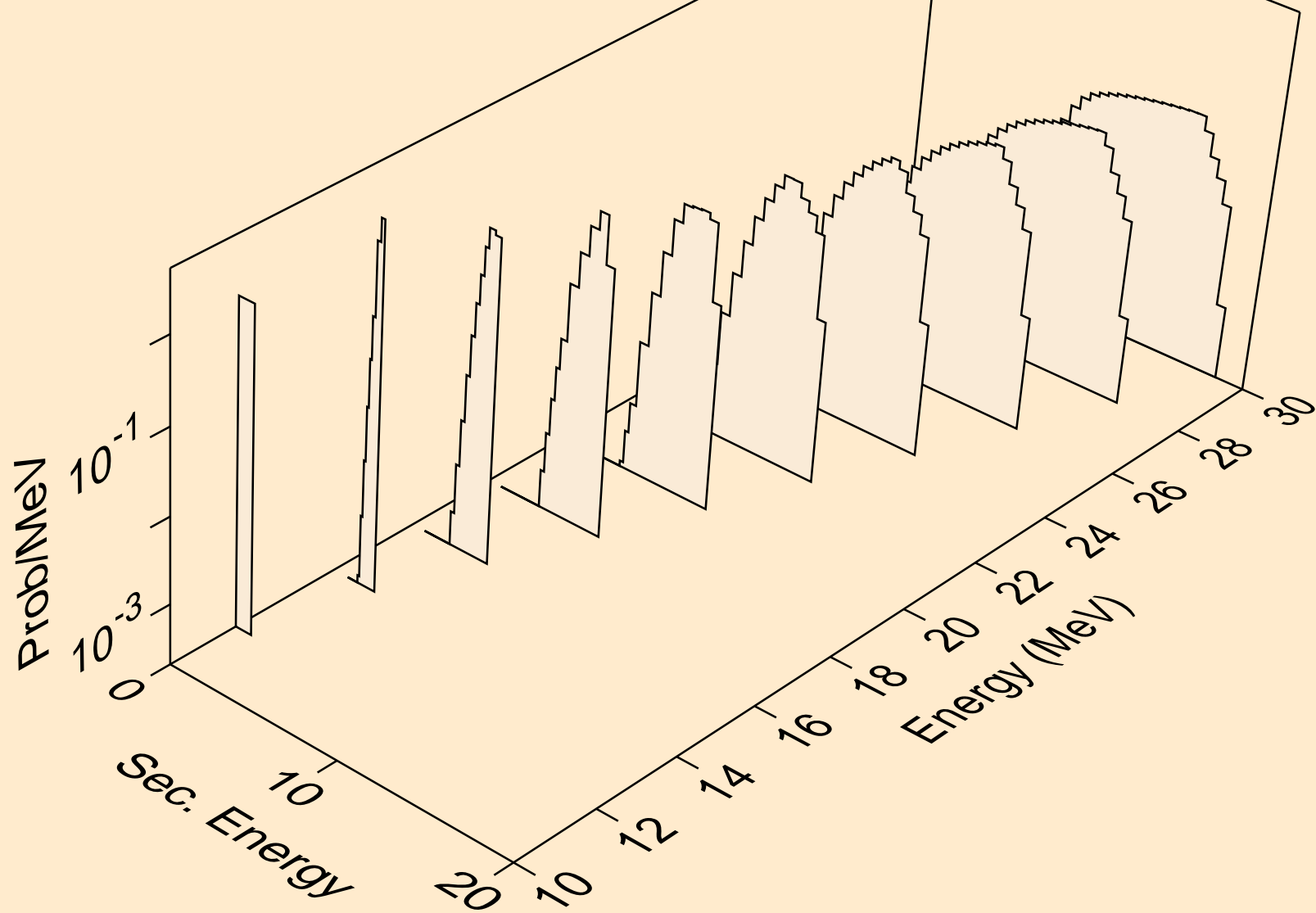

I132 NEUTRON ACER TENDL-2024 LIBRARY; T=0.K  
deuterons from (n,d)

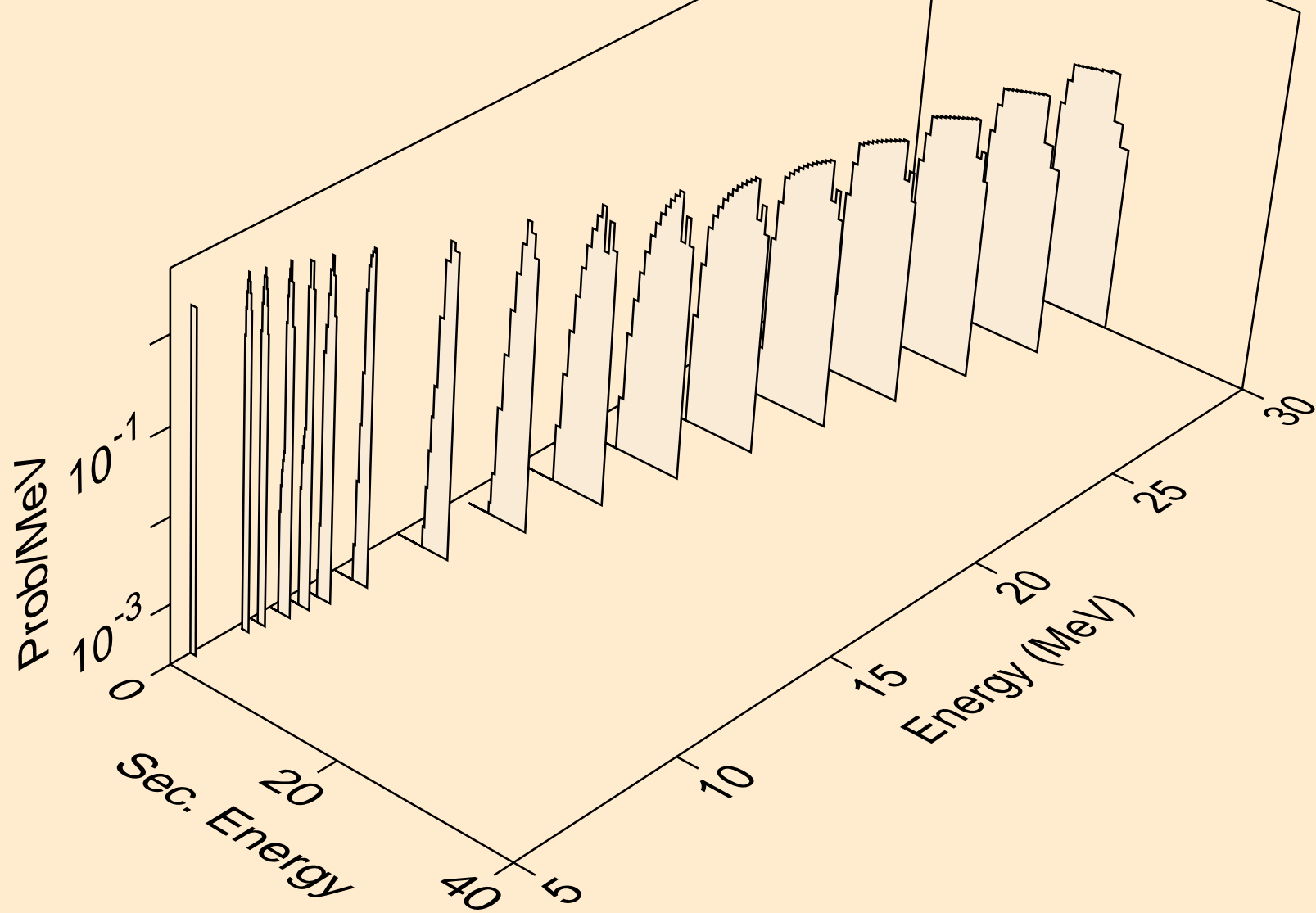

I132 NEUTRON ACER TENDL-2024 LIBRARY; T=0.K  
deuterons from (n,pd)

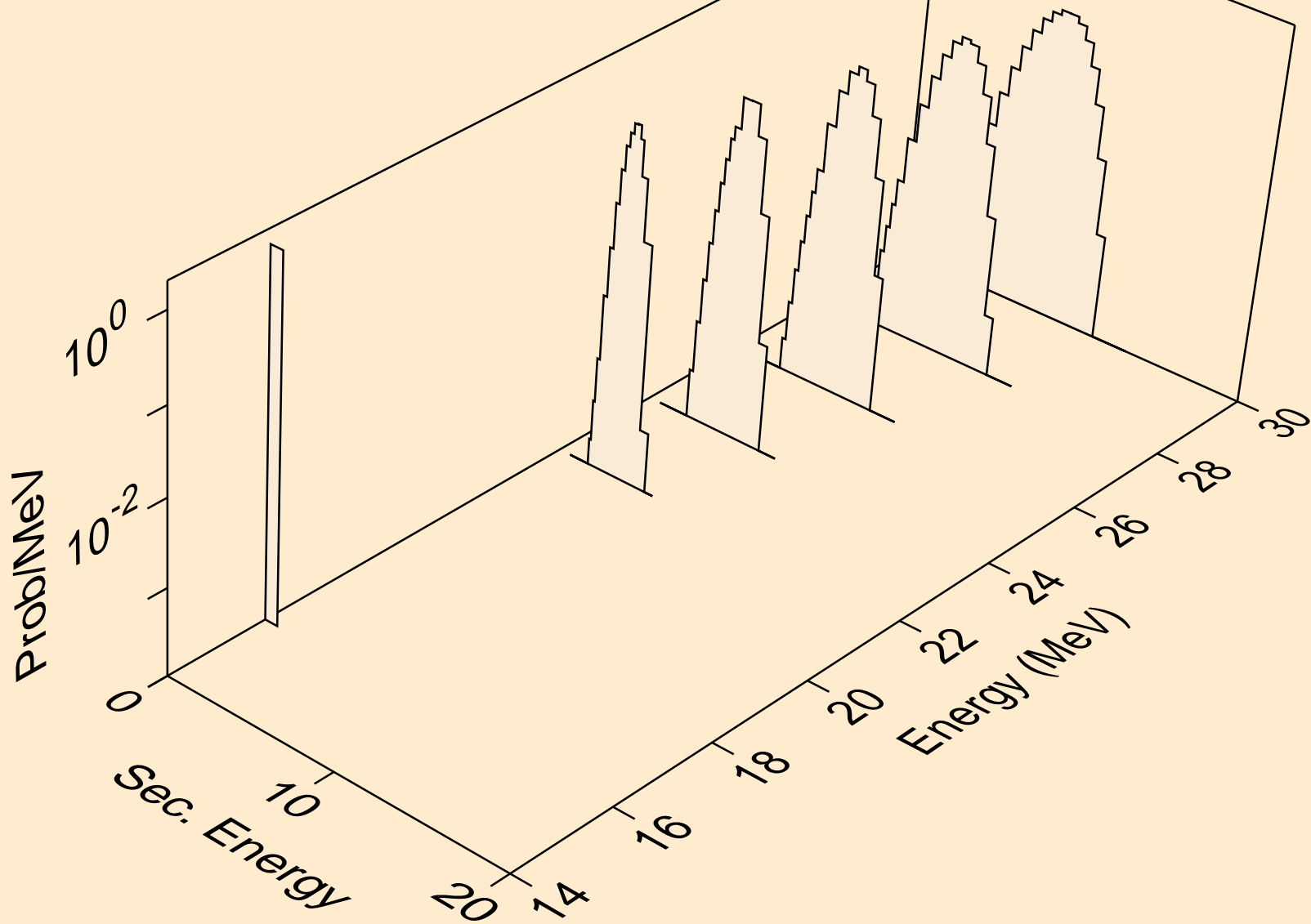

I132 NEUTRON ACER TENDL-2024 LIBRARY; T=0.K  
tritons from (n,x)

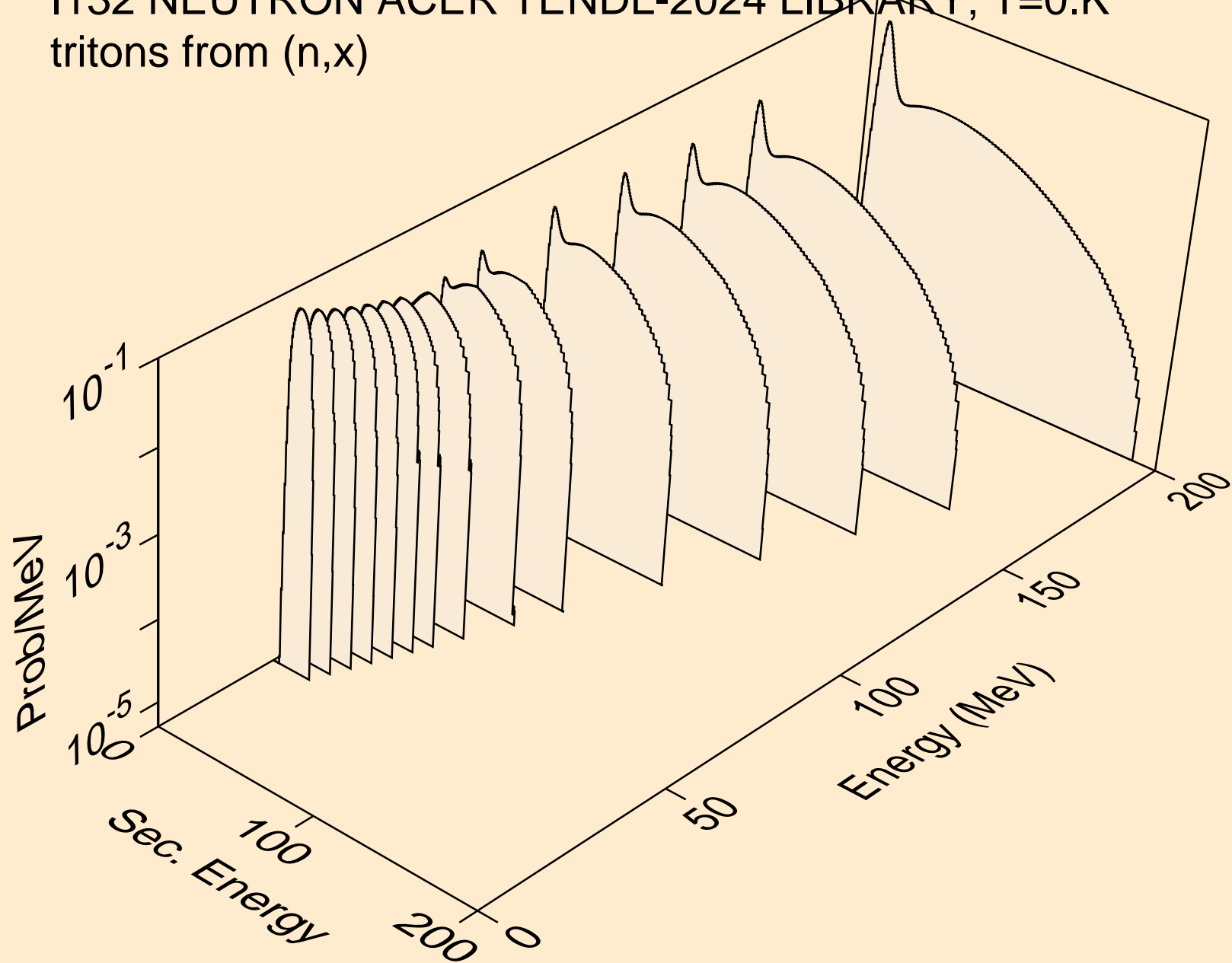

I132 NEUTRON ACER TENDL-2024 LIBRARY; T=0.K  
tritons from (n,n\*)t

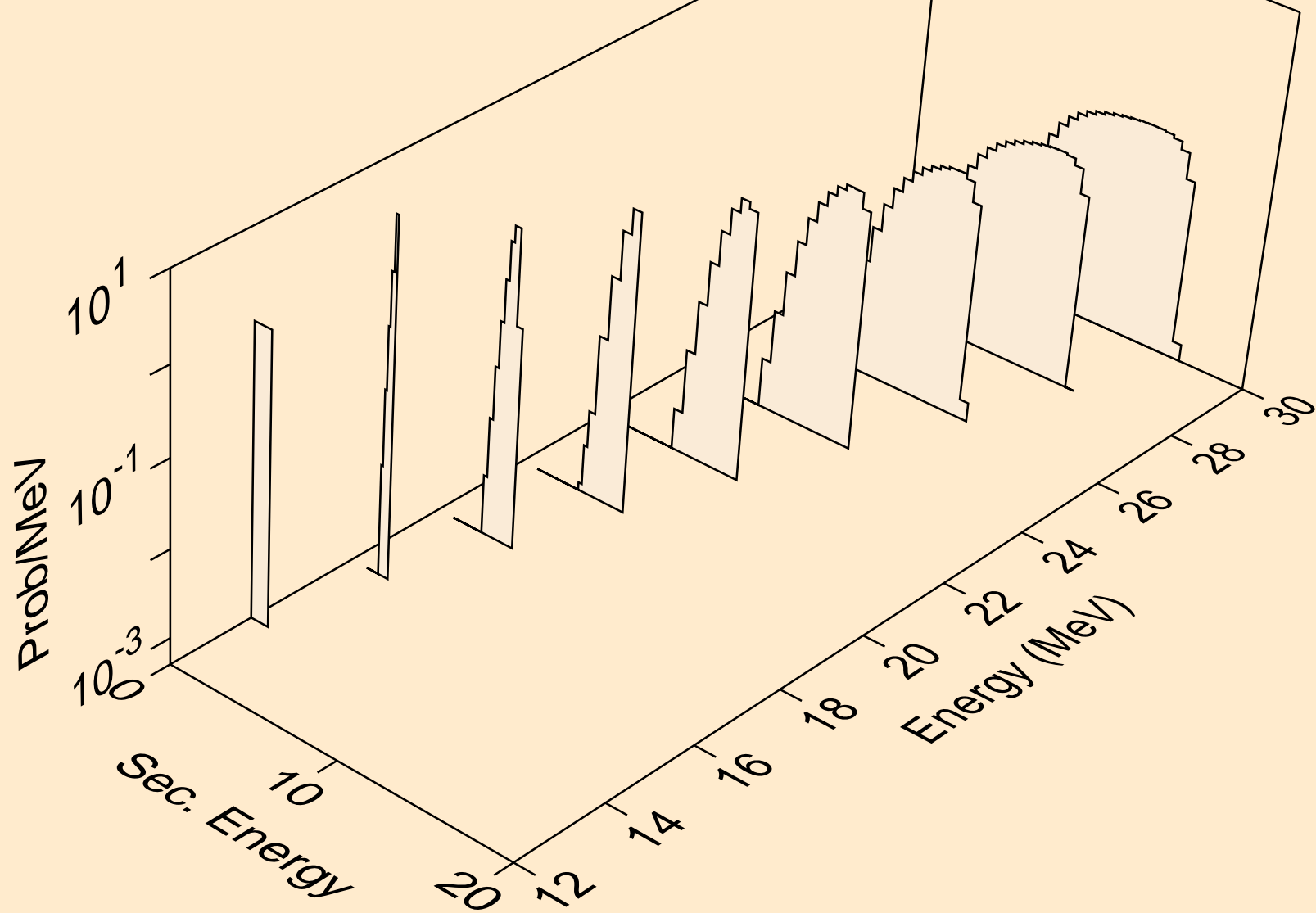

I132 NEUTRON ACER TENDL-2024 LIBRARY; T=0.K  
tritons from (n,t)

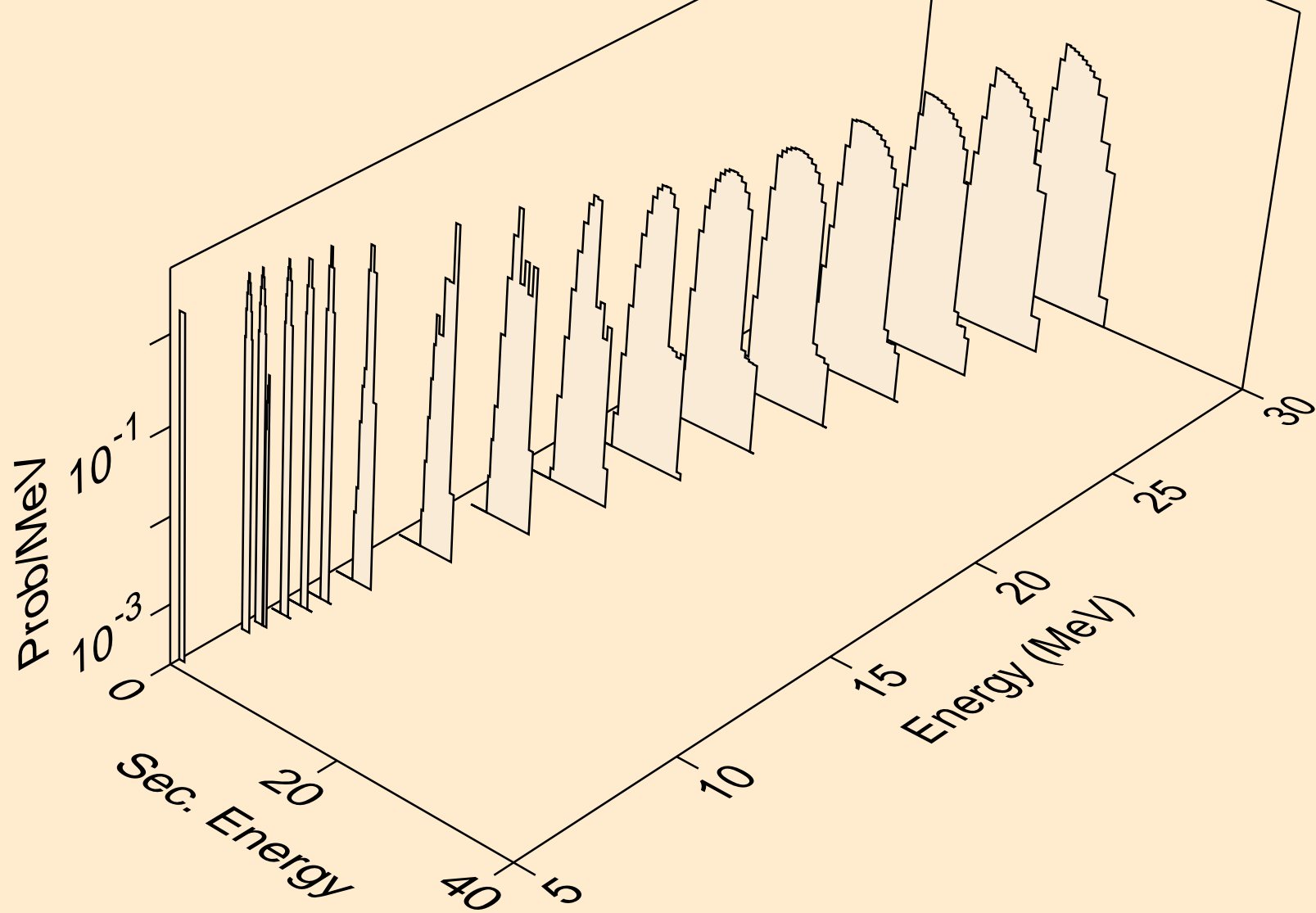

I132 NEUTRON ACER TENDL-2024 LIBRARY; T=0.K  
tritons from (n,pt)

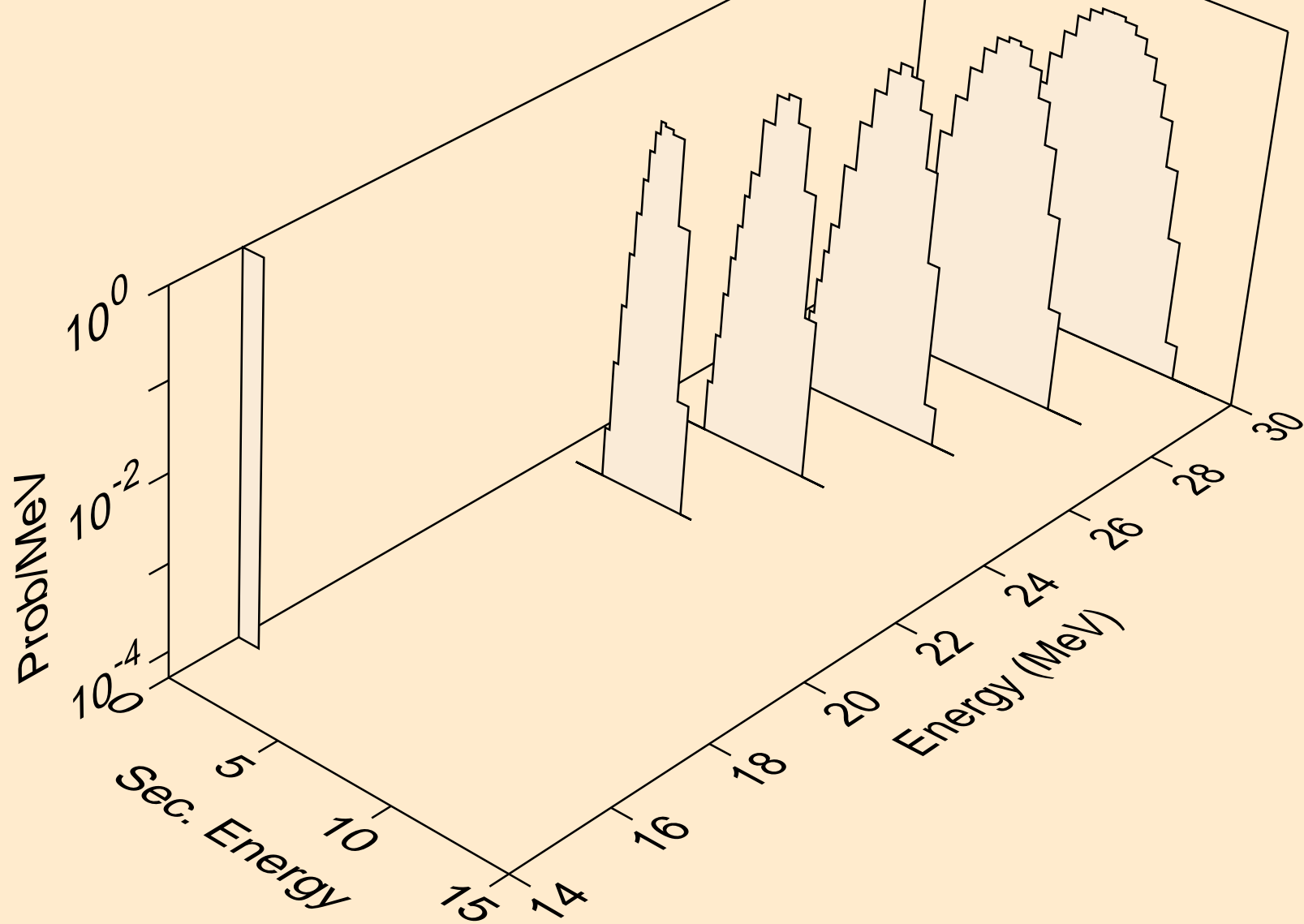

I132 NEUTRON ACER TENDL-2024 LIBRARY; T=0.K  
he3s from (n,x)

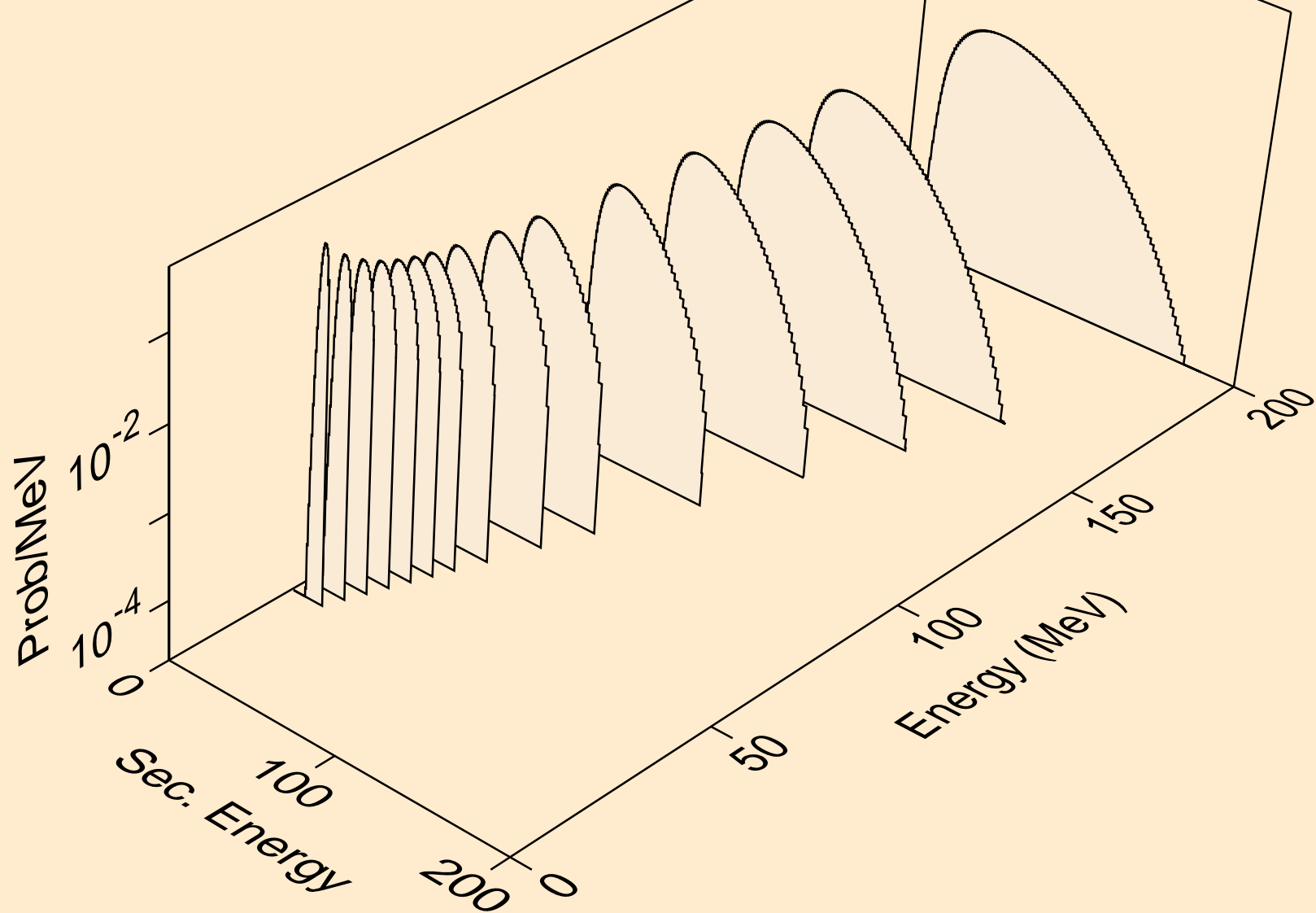

I132 NEUTRON ACER TENDL-2024 LIBRARY; T=0.K  
he3s from (n,n\*)he3

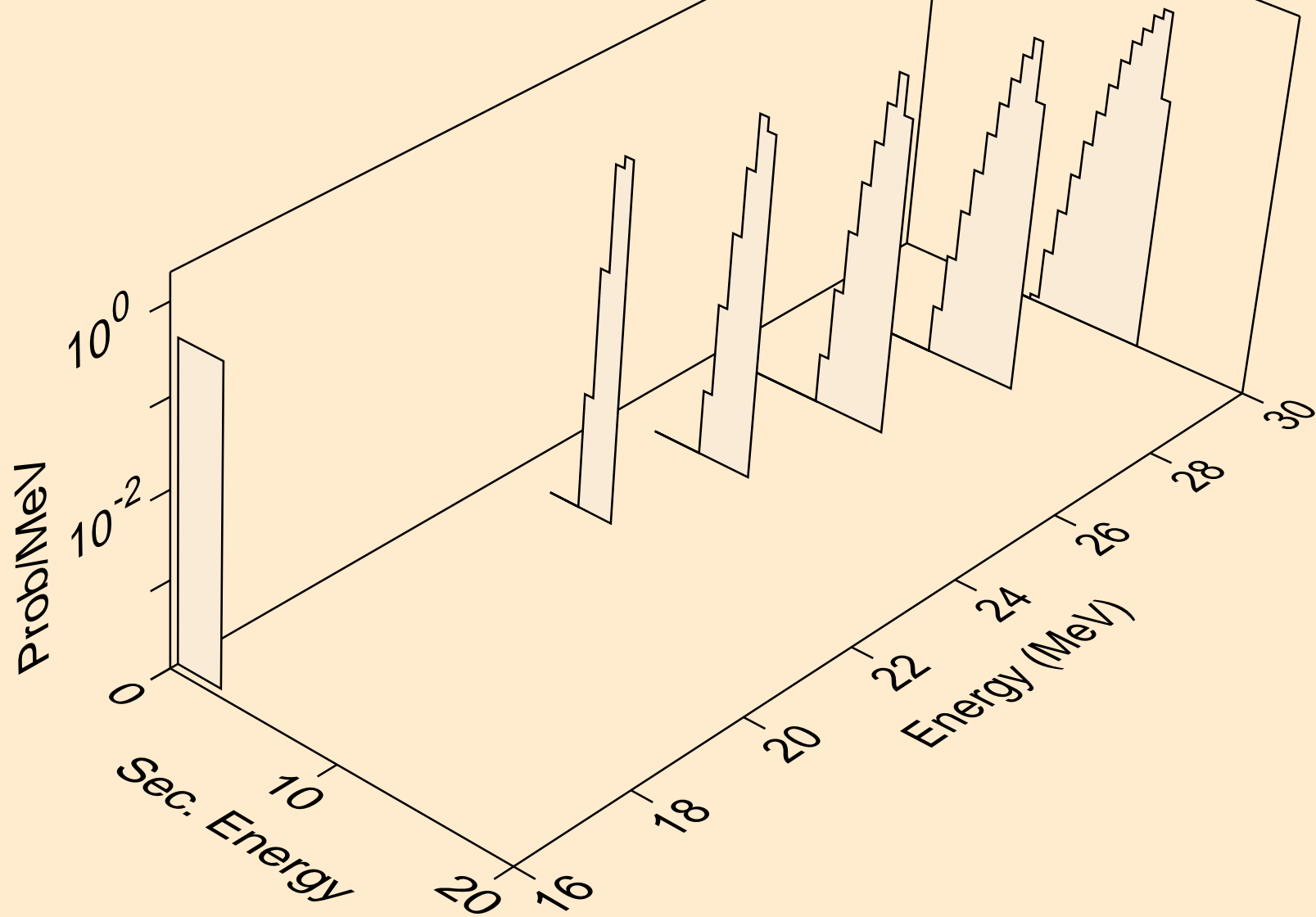

I132 NEUTRON ACER TENDL-2024 LIBRARY; T=0.K  
he3s from (n,he3)

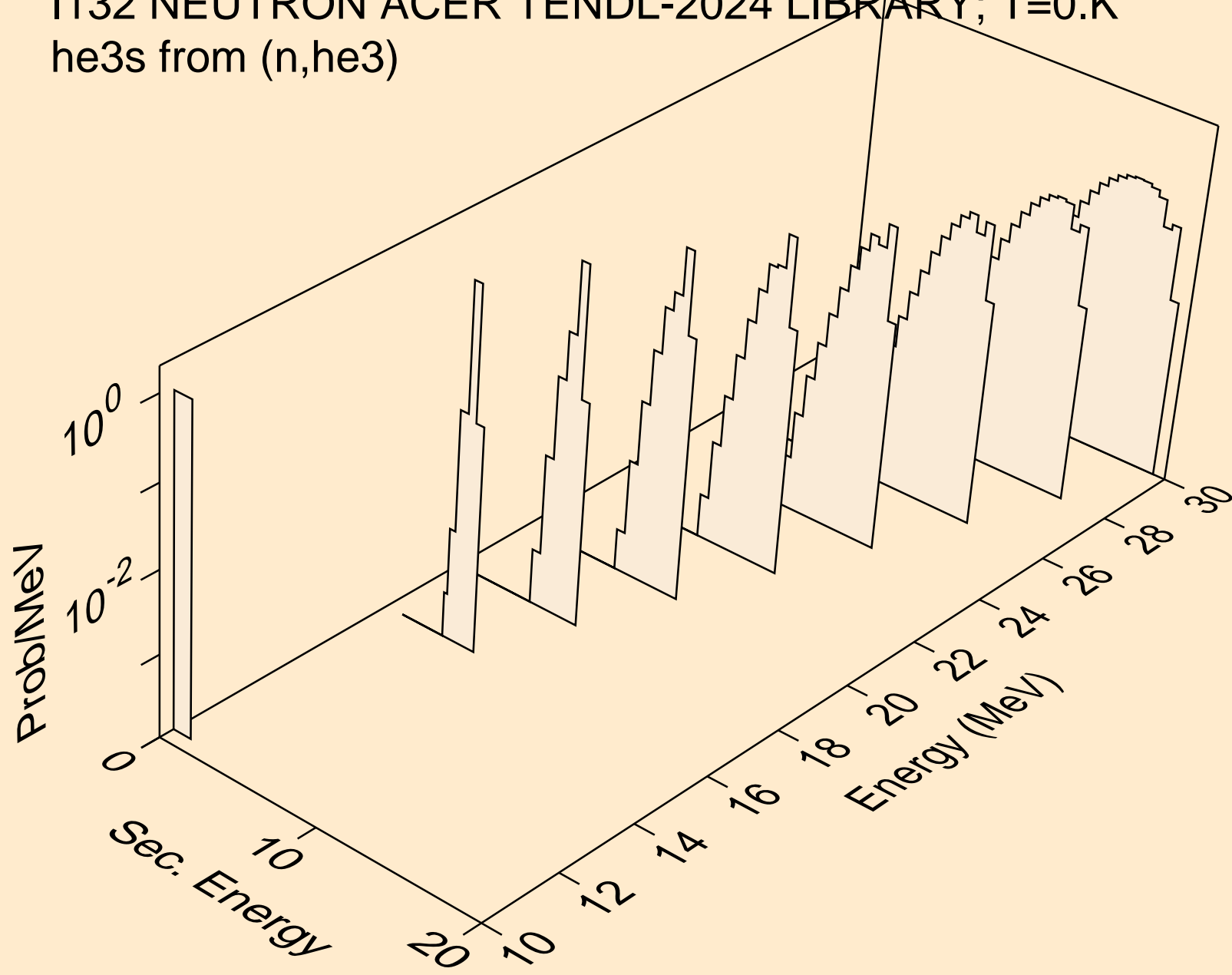

I132 NEUTRON ACER TENDL-2024 LIBRARY; T=0.K  
alphas from (n,x)

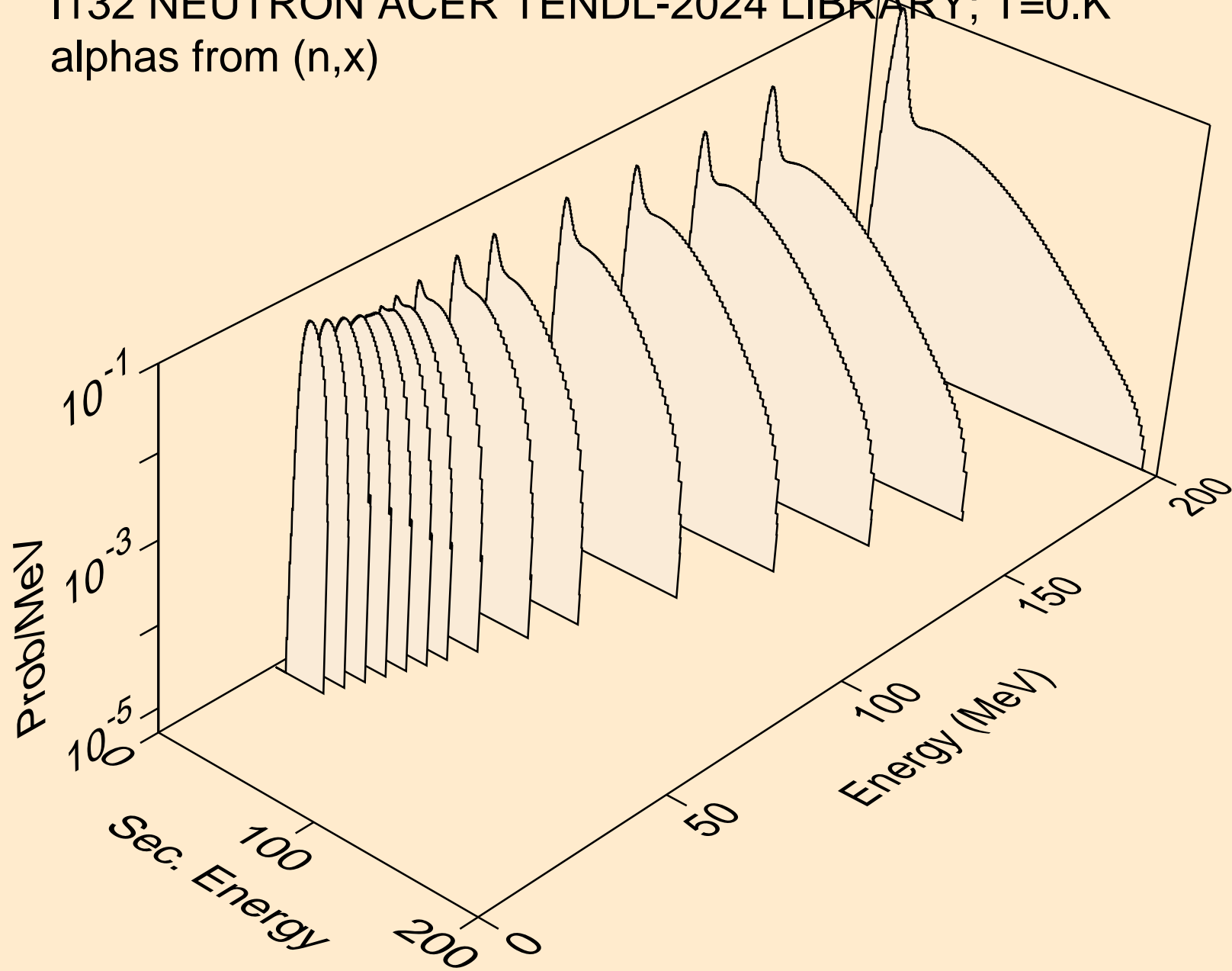

I132 NEUTRON ACER TENDL-2024 LIBRARY; T=0.K  
alphas from (n,n\*)a

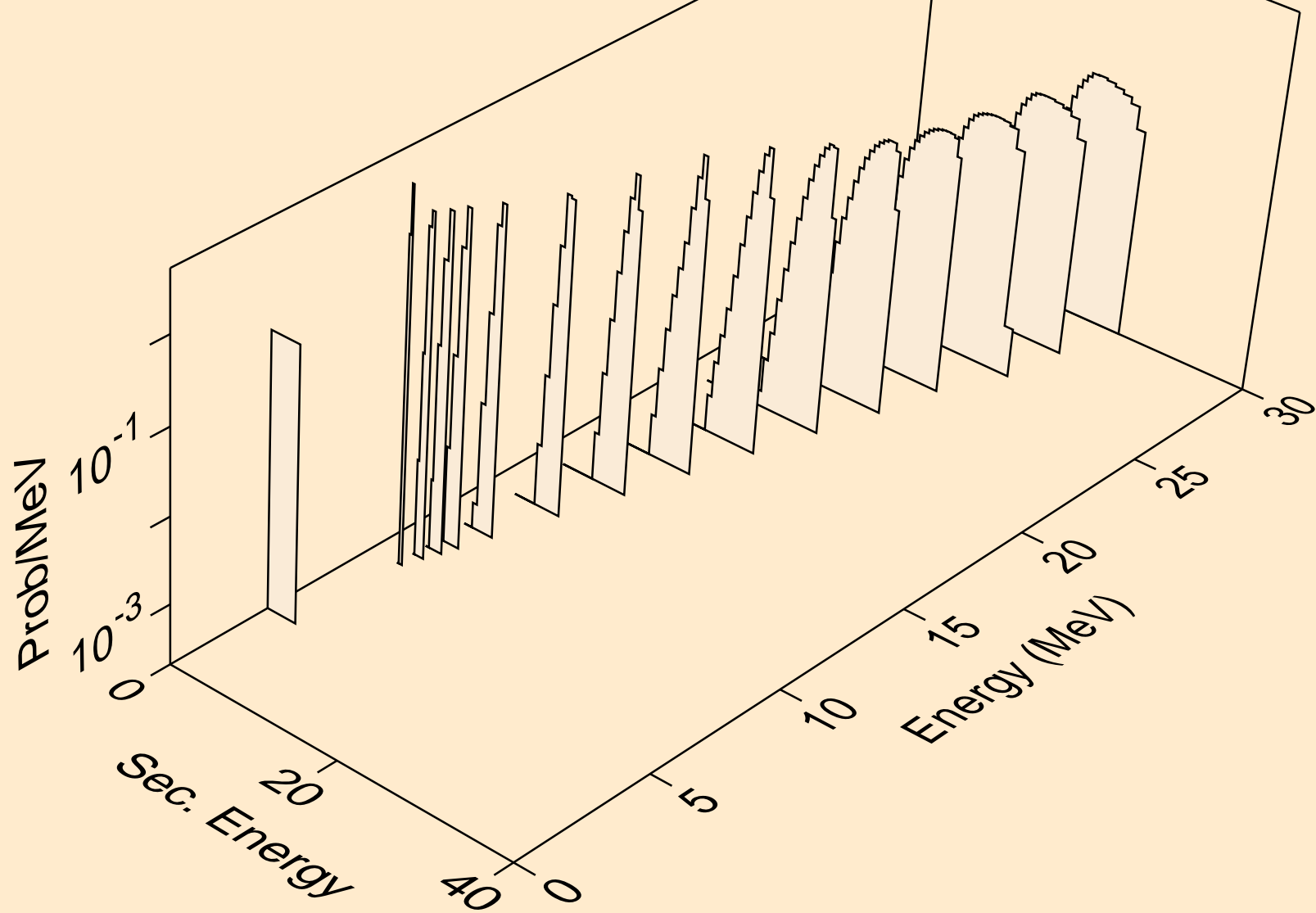

I132 NEUTRON ACER TENDL-2024 LIBRARY; T=0.K  
alphas from (n,2n)a

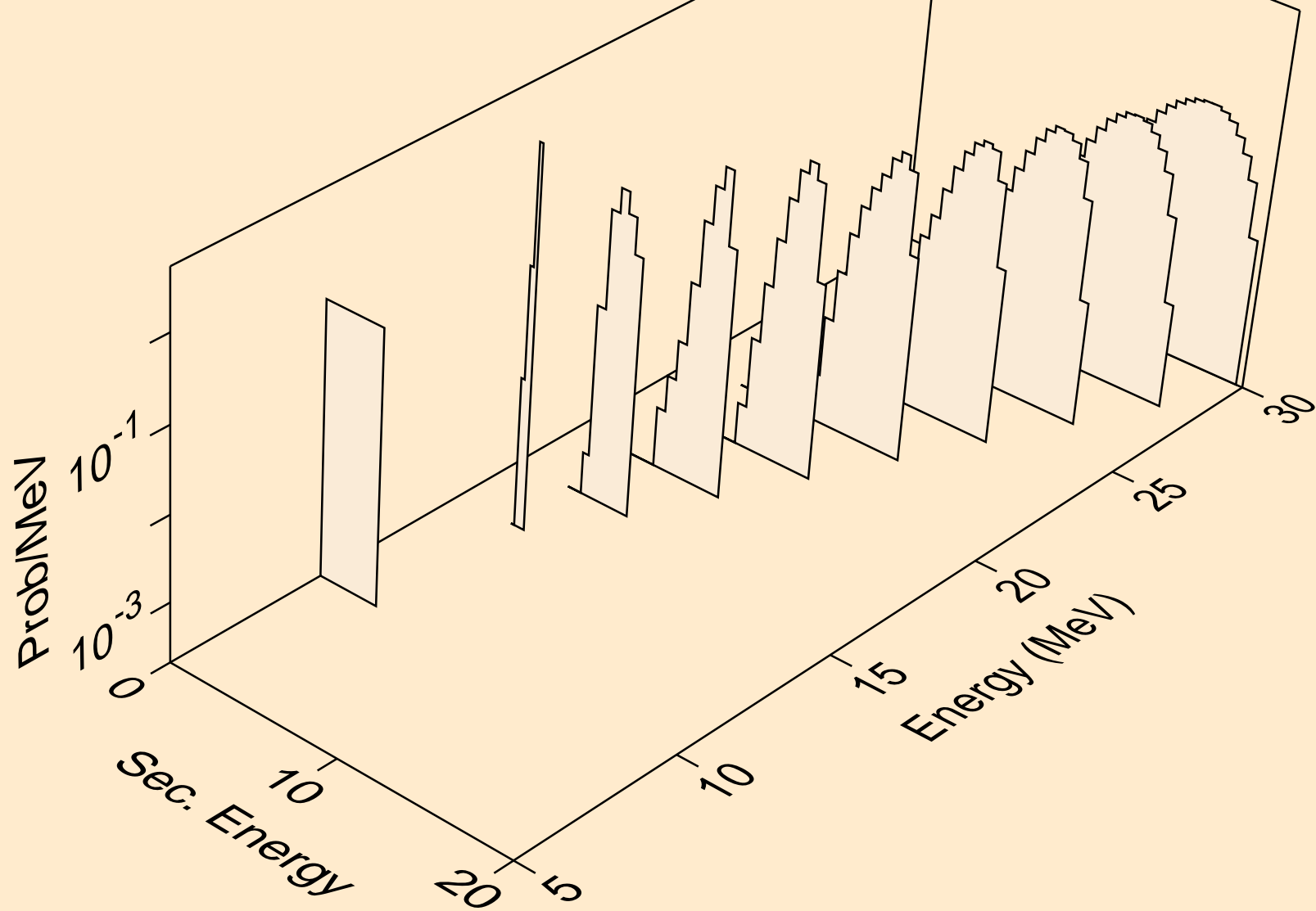

I132 NEUTRON ACER TENDL-2024 LIBRARY; T=0.K  
alphas from (n,3n)a

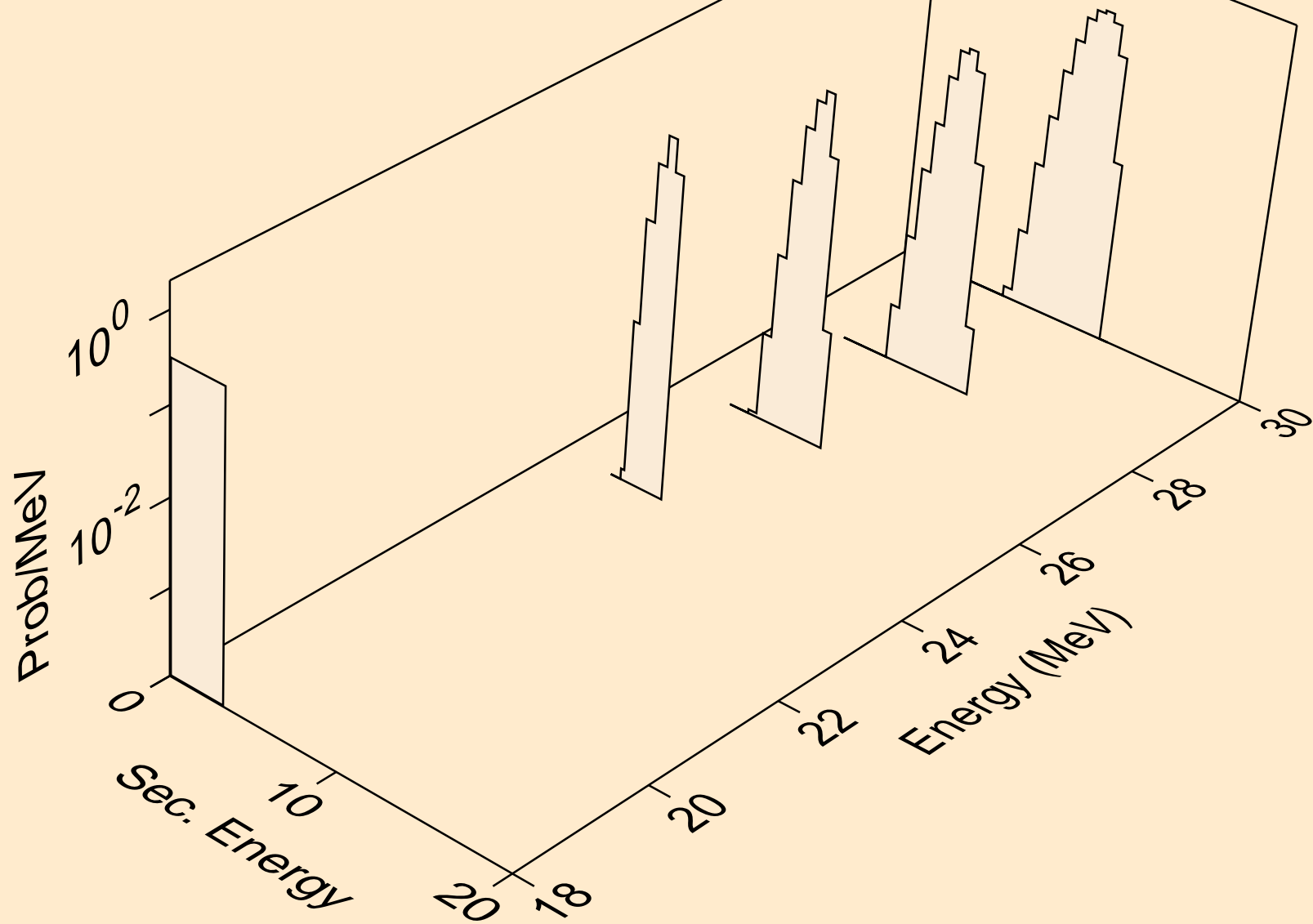

I132 NEUTRON ACER TENDL-2024 LIBRARY; T=0.K  
alphas from (n,a)

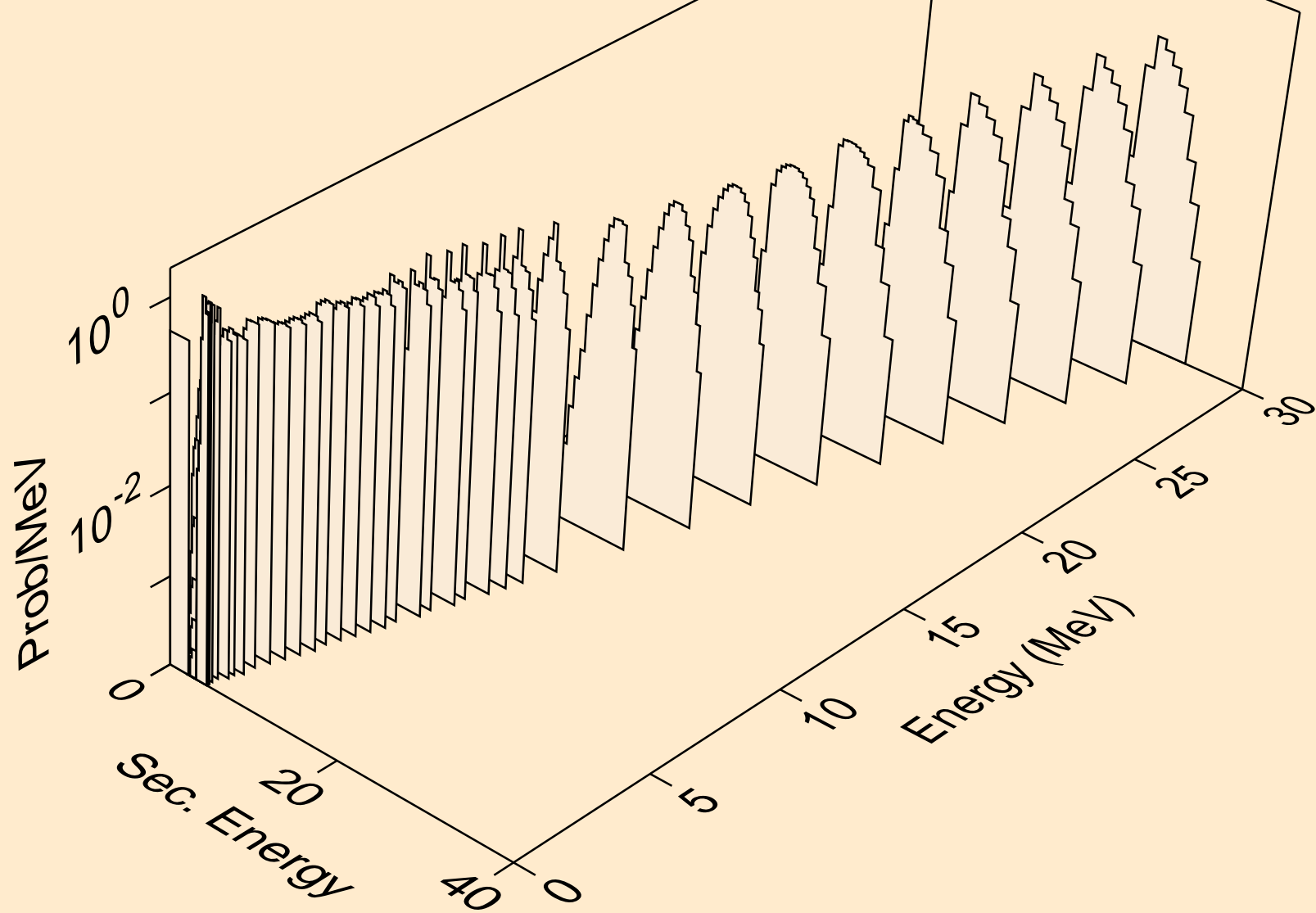

I132 NEUTRON ACER TENDL-2024 LIBRARY; T=0.K  
alphas from (n,pa)

