

MG024 NEUTRON ACER TENDL-2024 LIBRARY; T=0.K

Principal cross sections

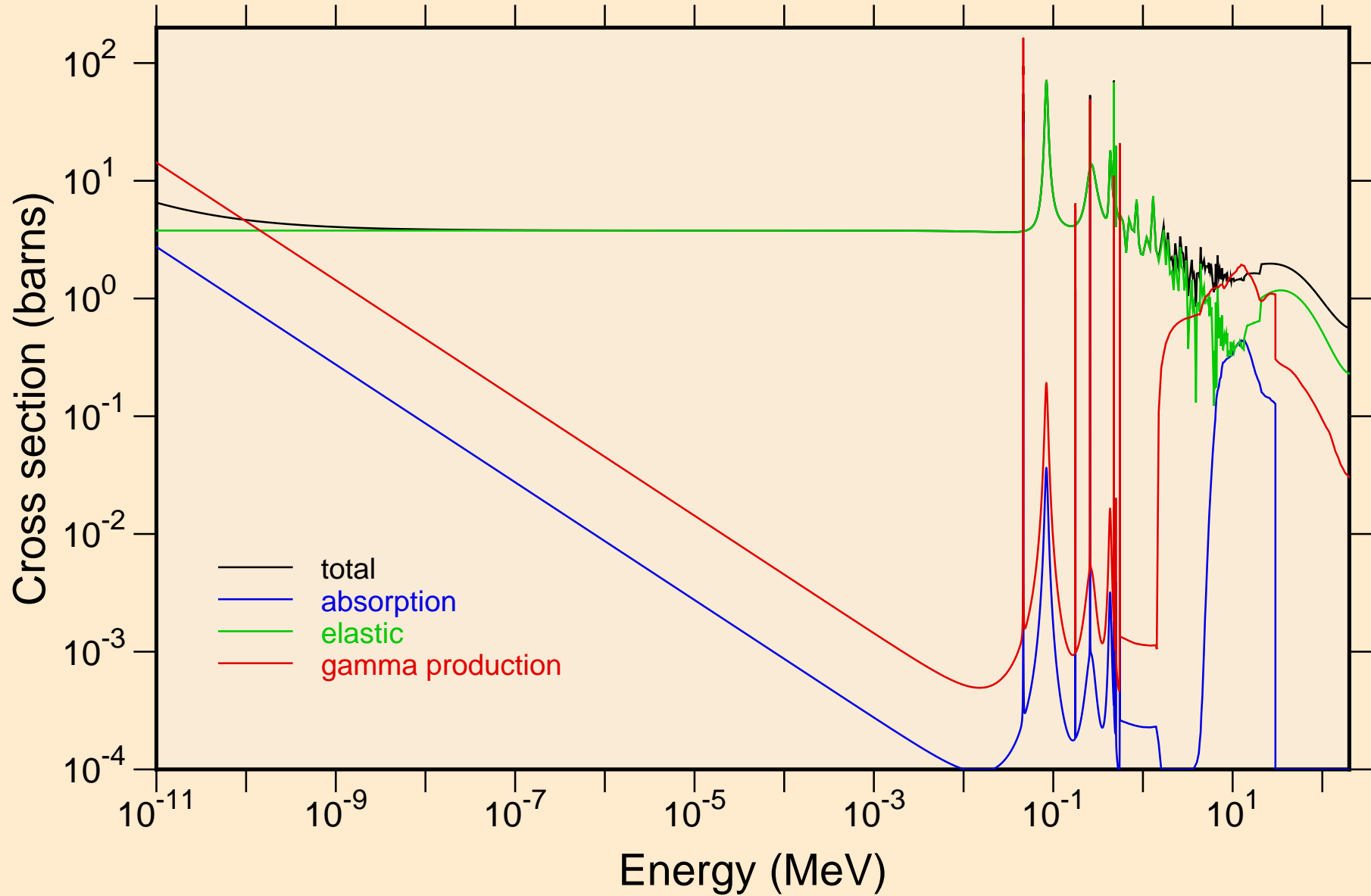

MG024 NEUTRON ACER TENDL-2024 LIBRARY; T=0.K
resonance total cross section

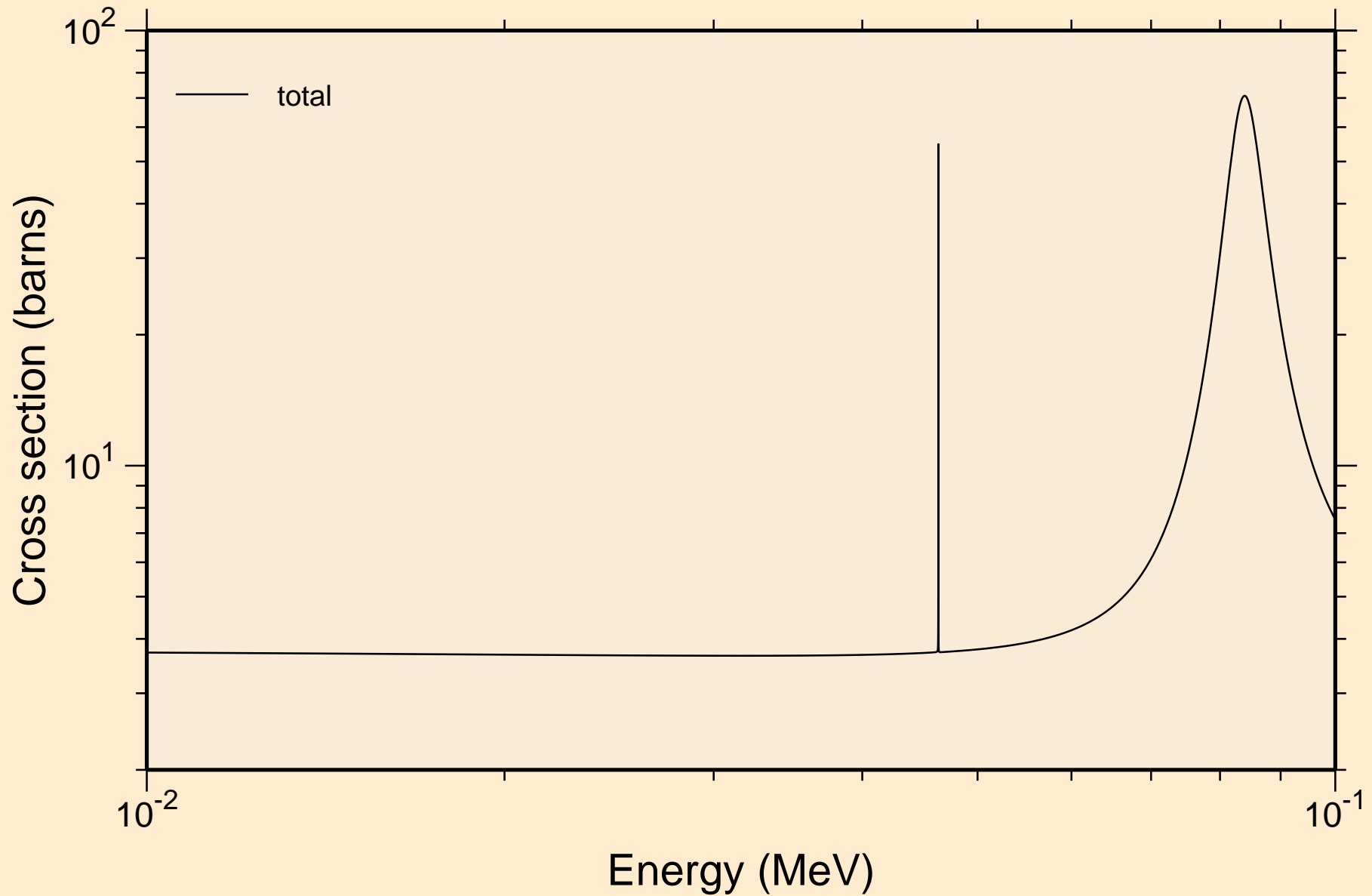

MG024 NEUTRON ACER TENDL-2024 LIBRARY; T=0.K
resonance total cross section

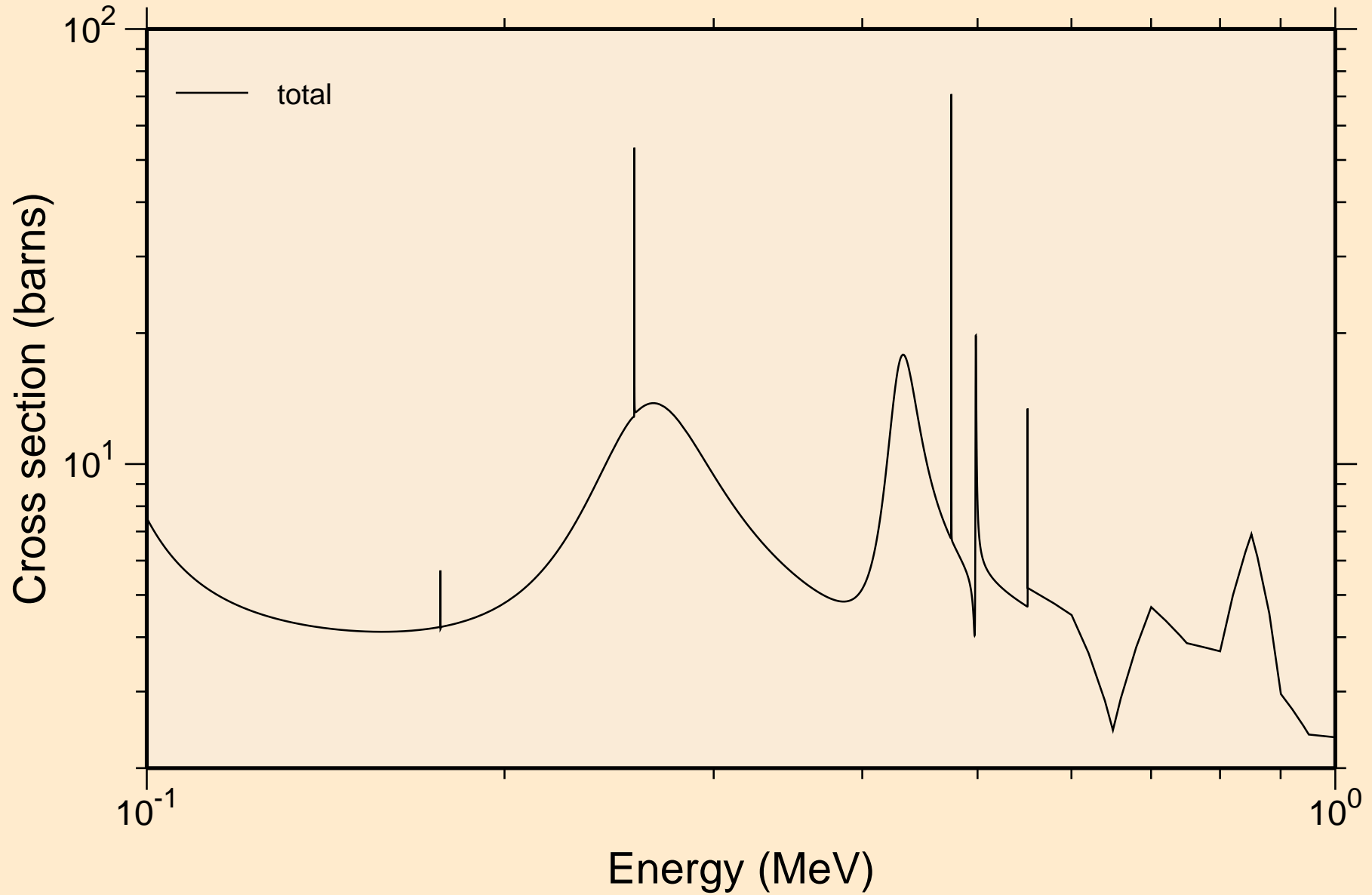

MG024 NEUTRON ACER TENDL-2024 LIBRARY; T=0.K
resonance total cross section

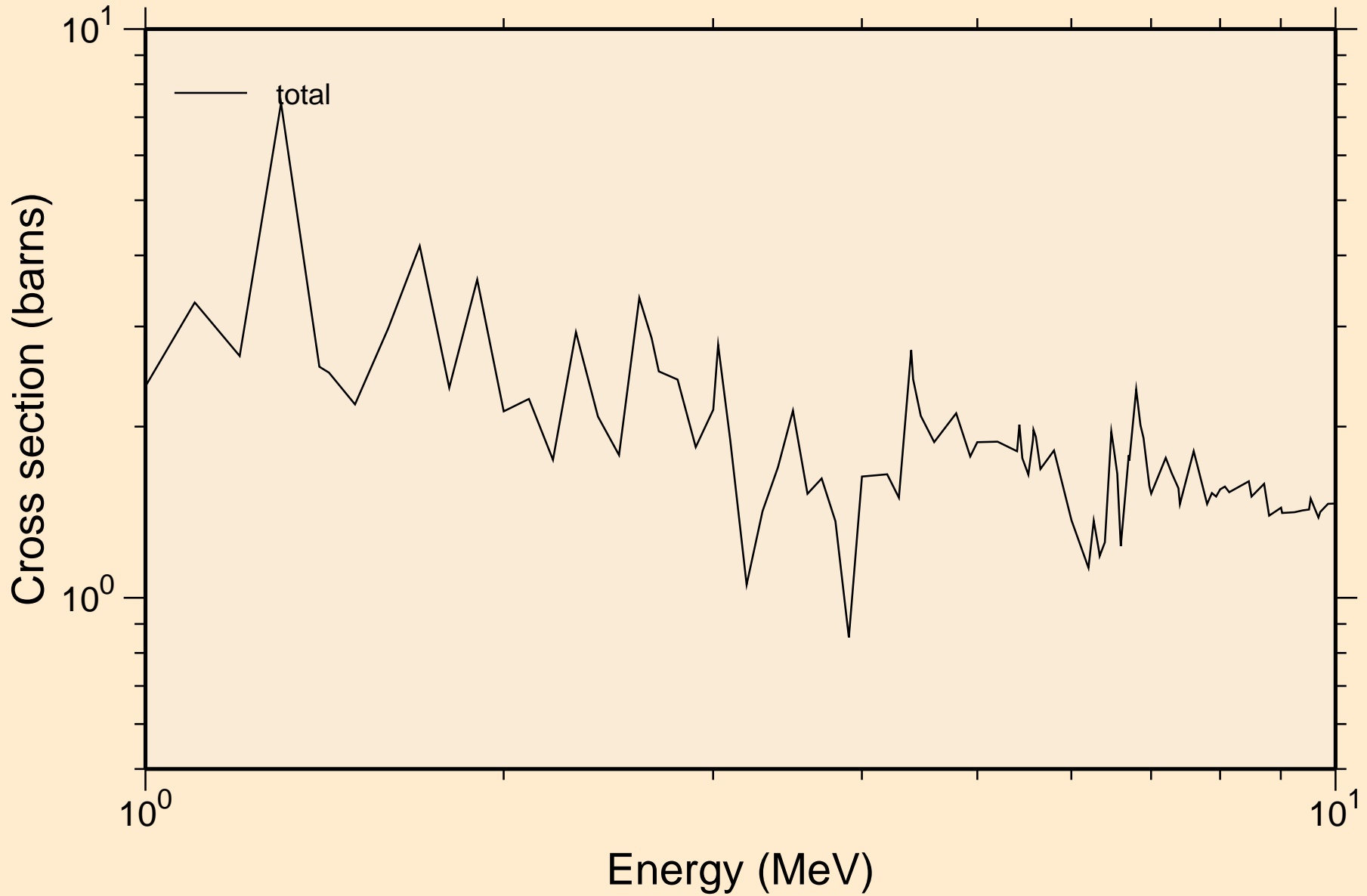

MG024 NEUTRON ACER TENDL-2024 LIBRARY; T=0.K
resonance absorption cross sections

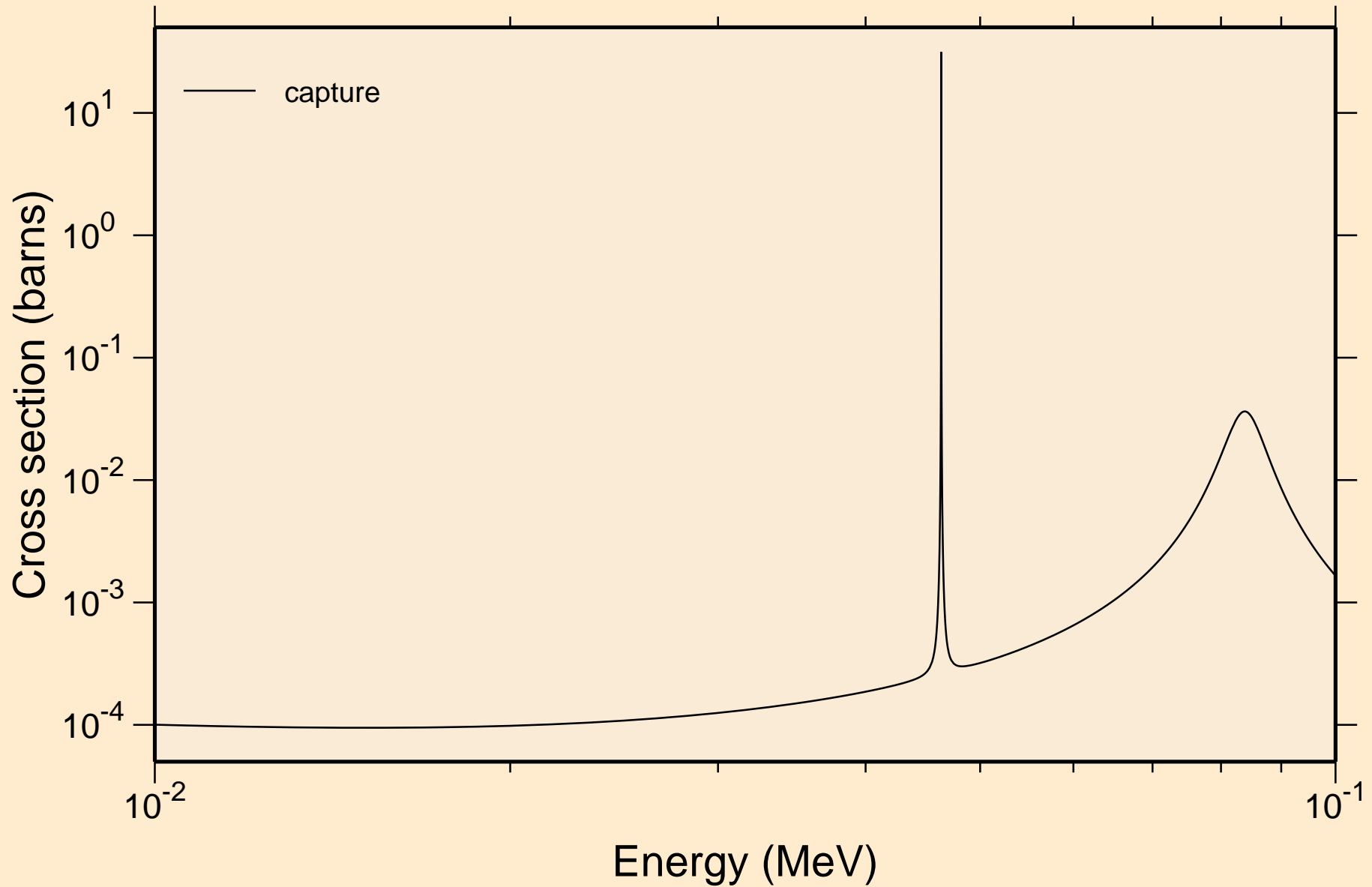

MG024 NEUTRON ACER TENDL-2024 LIBRARY; T=0.K
resonance absorption cross sections

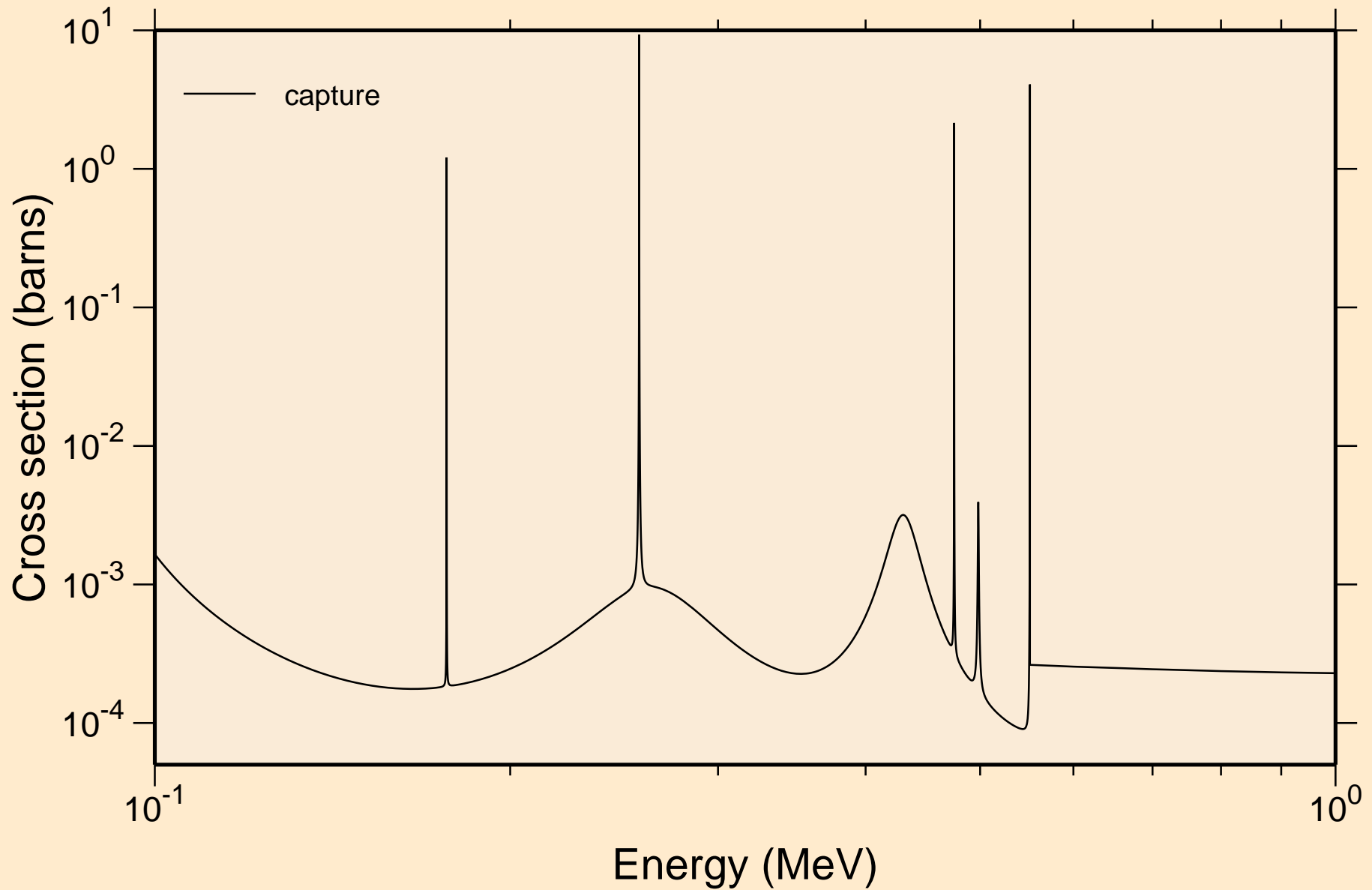

MG024 NEUTRON ACER TENDL-2024 LIBRARY; T=0.K
resonance absorption cross sections

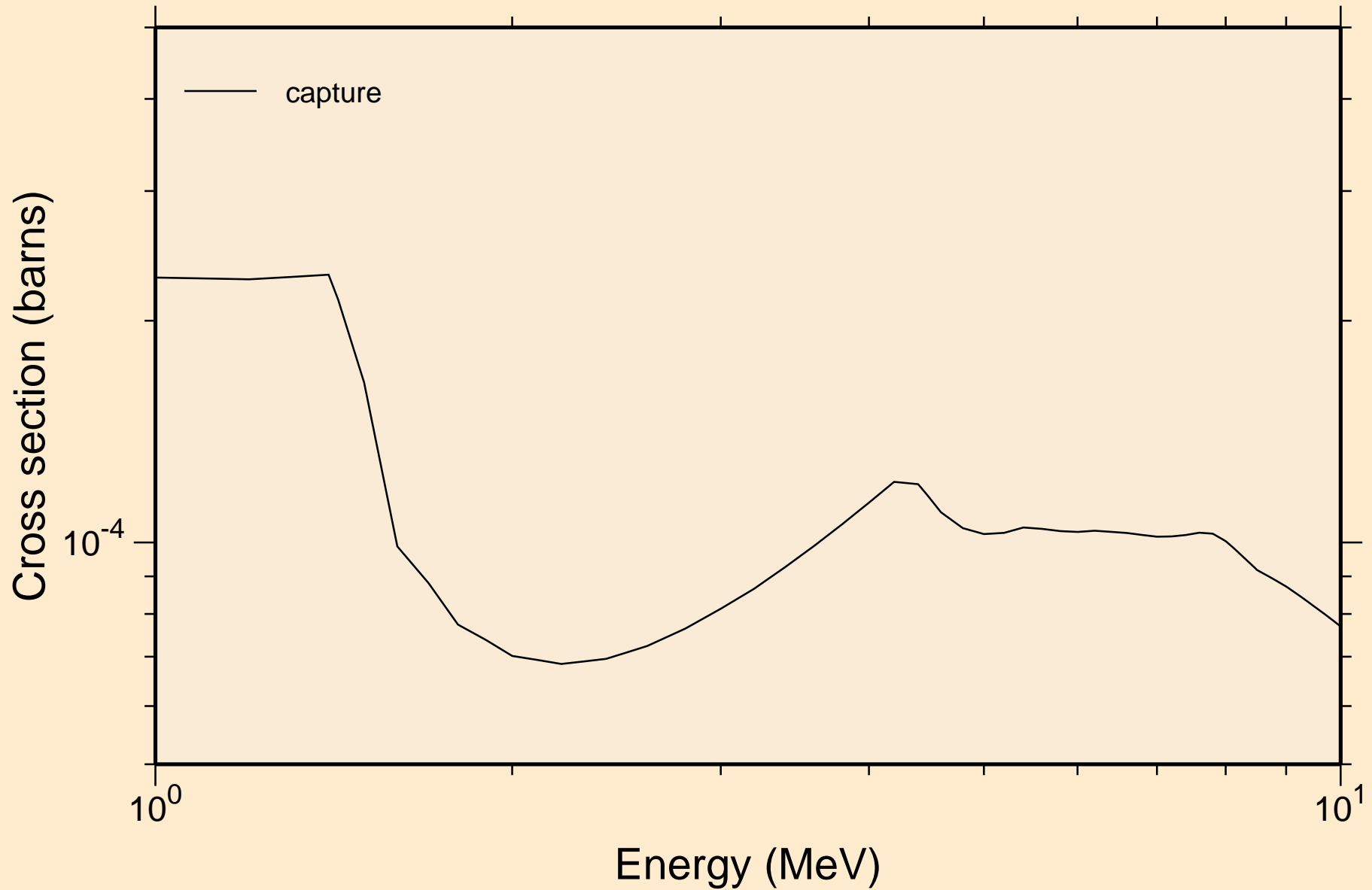

MG024 NEUTRON ACER TENDL-2024 LIBRARY; T=0.K
Heating

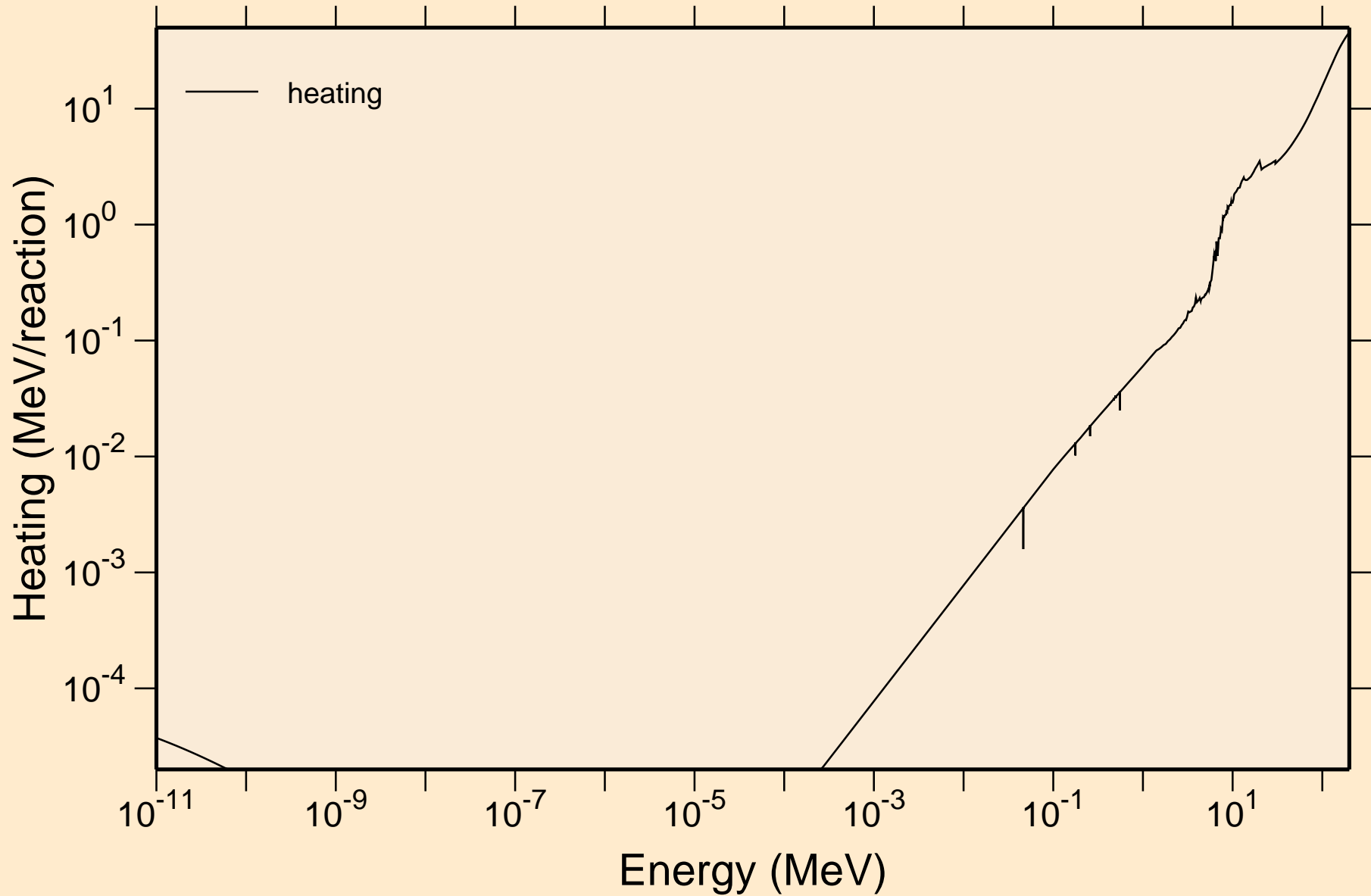

MG024 NEUTRON ACER TENDL-2024 LIBRARY; T=0.K

Damage

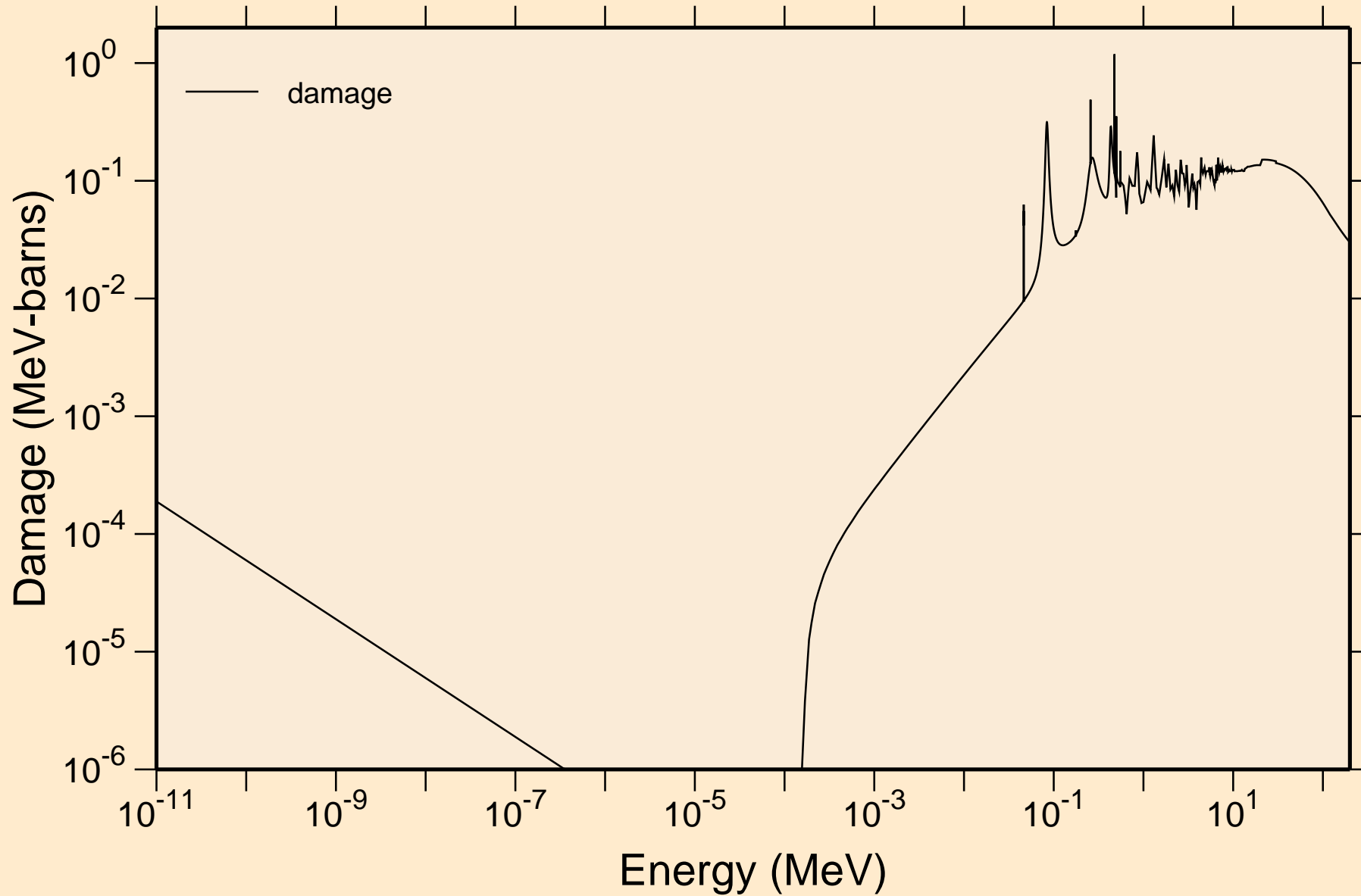

MG024 NEUTRON ACER TENDL-2024 LIBRARY; T=0.K
Non-threshold reactions

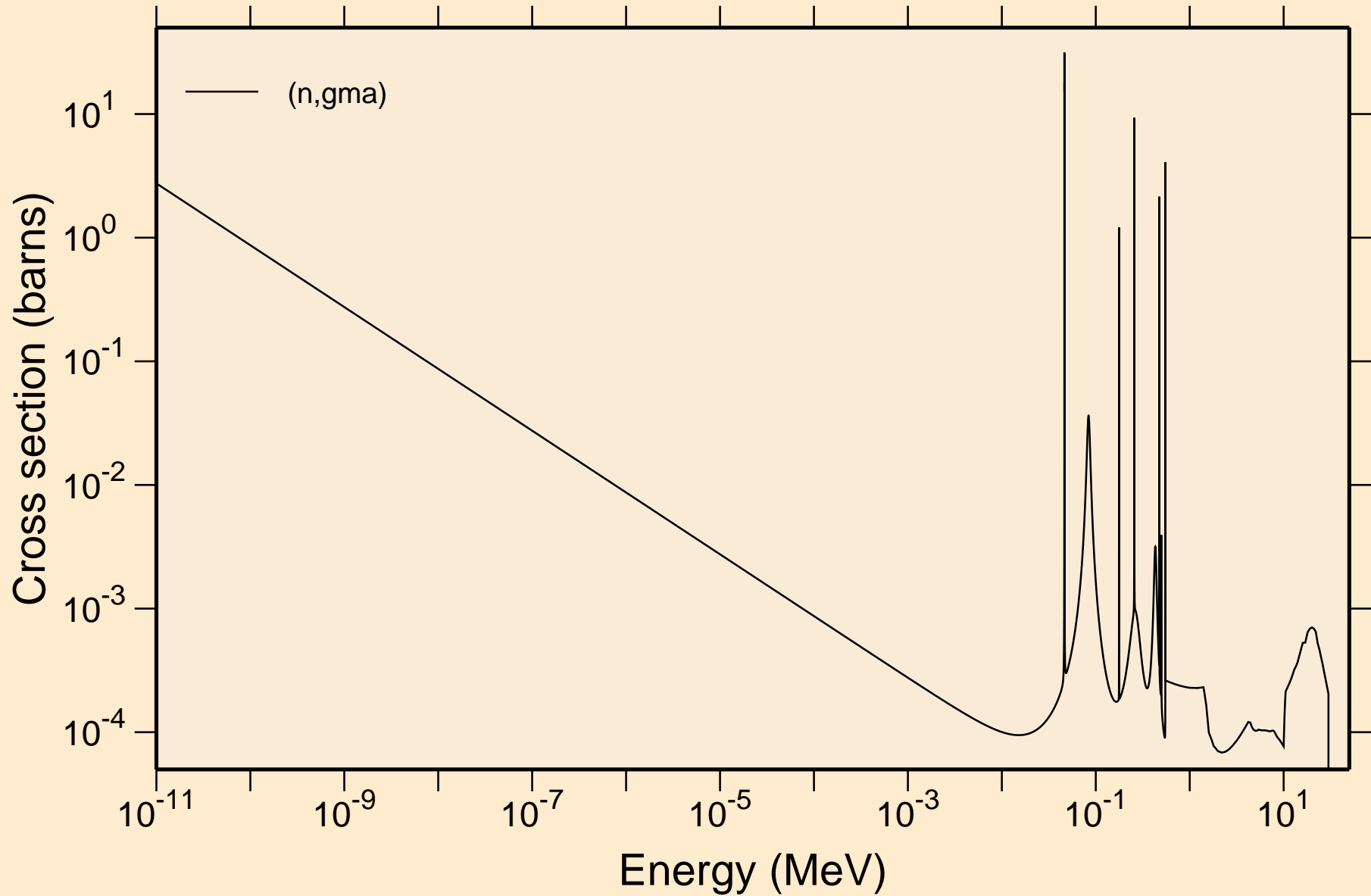

MG024 NEUTRON ACER TENDL-2024 LIBRARY; T=0.K

Principal cross sections

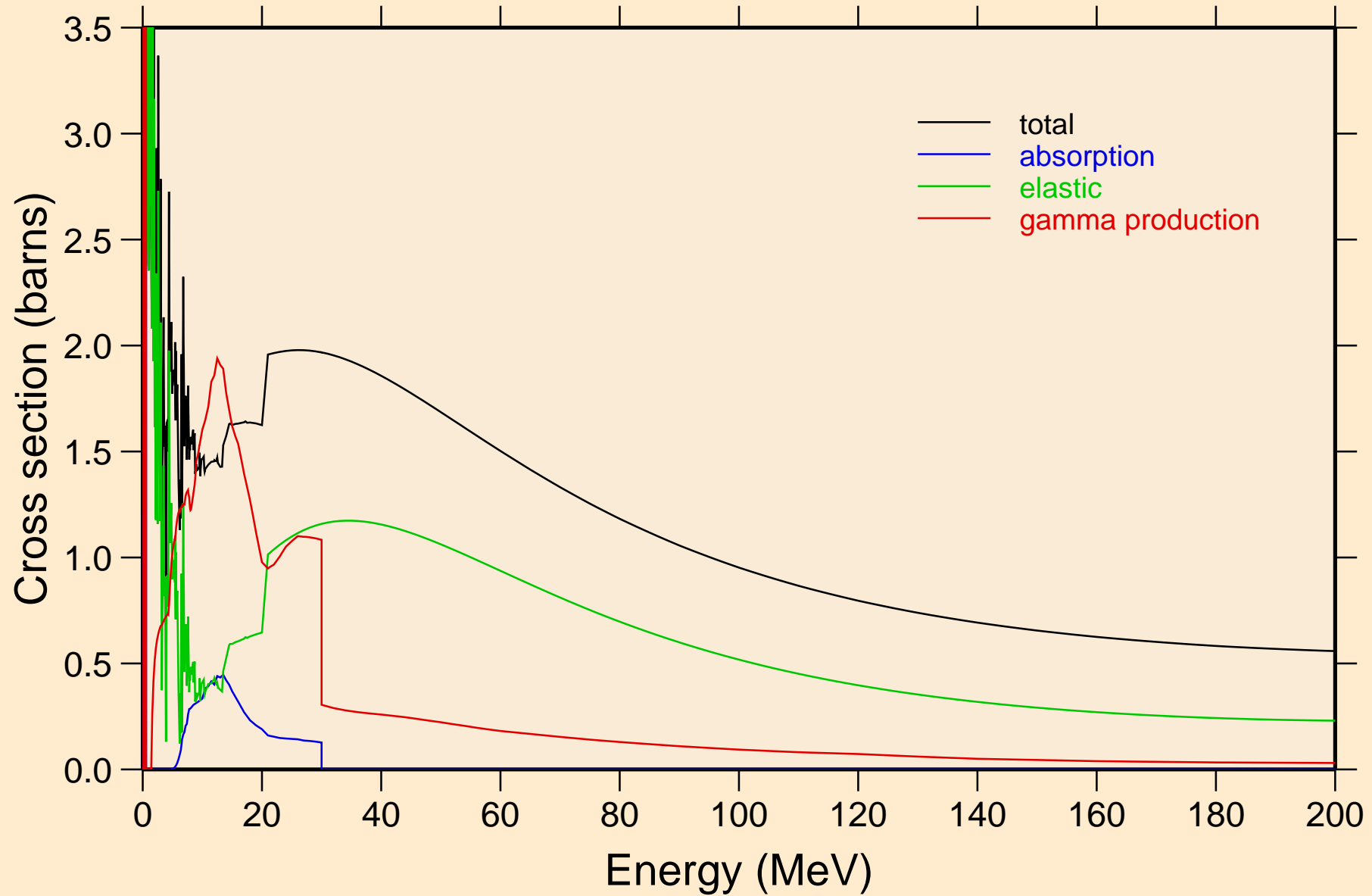

MG024 NEUTRON ACER TENDL-2024 LIBRARY; T=0.K

Heating

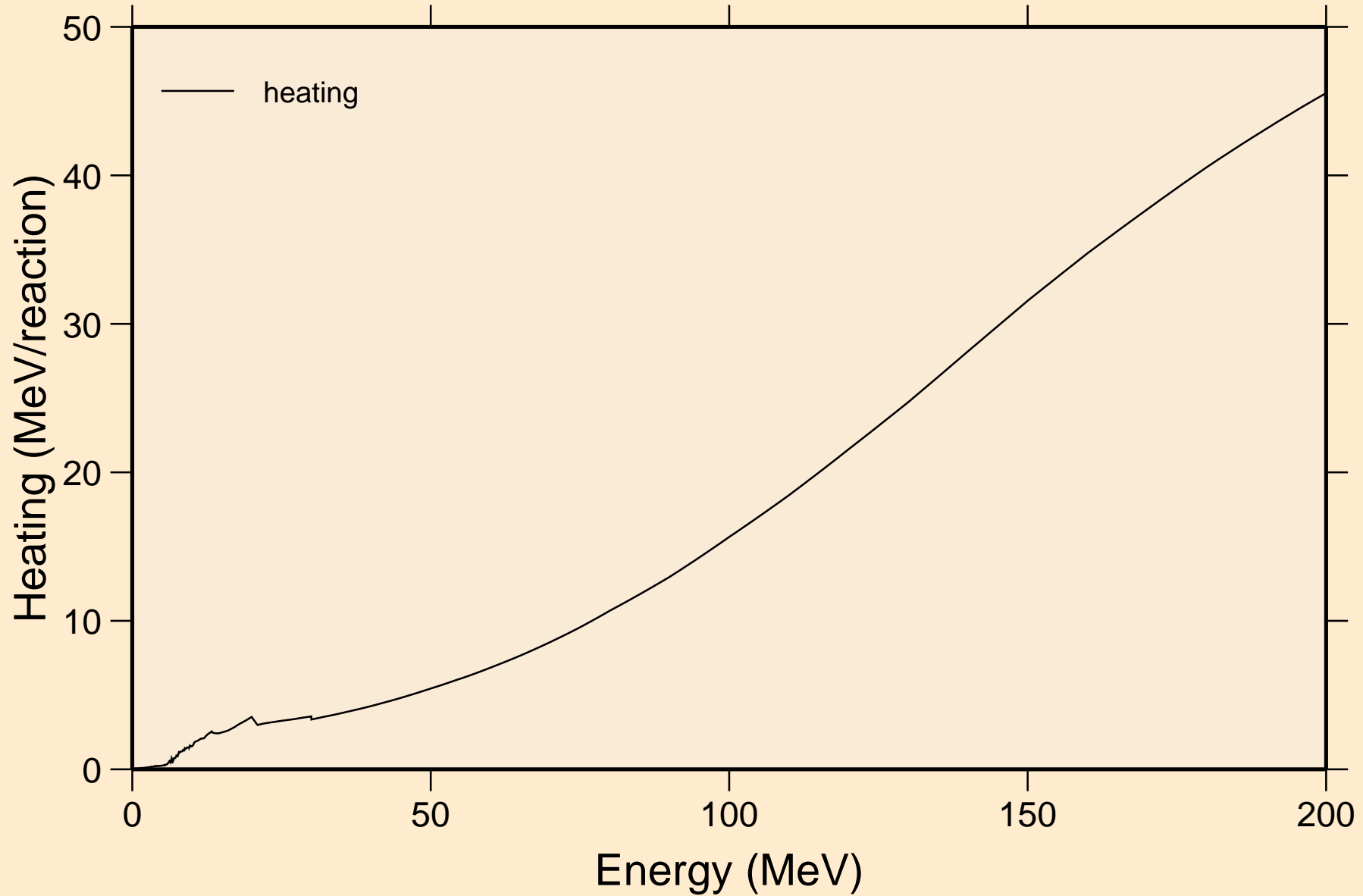

MG024 NEUTRON ACER TENDL-2024 LIBRARY; T=0.K

Damage

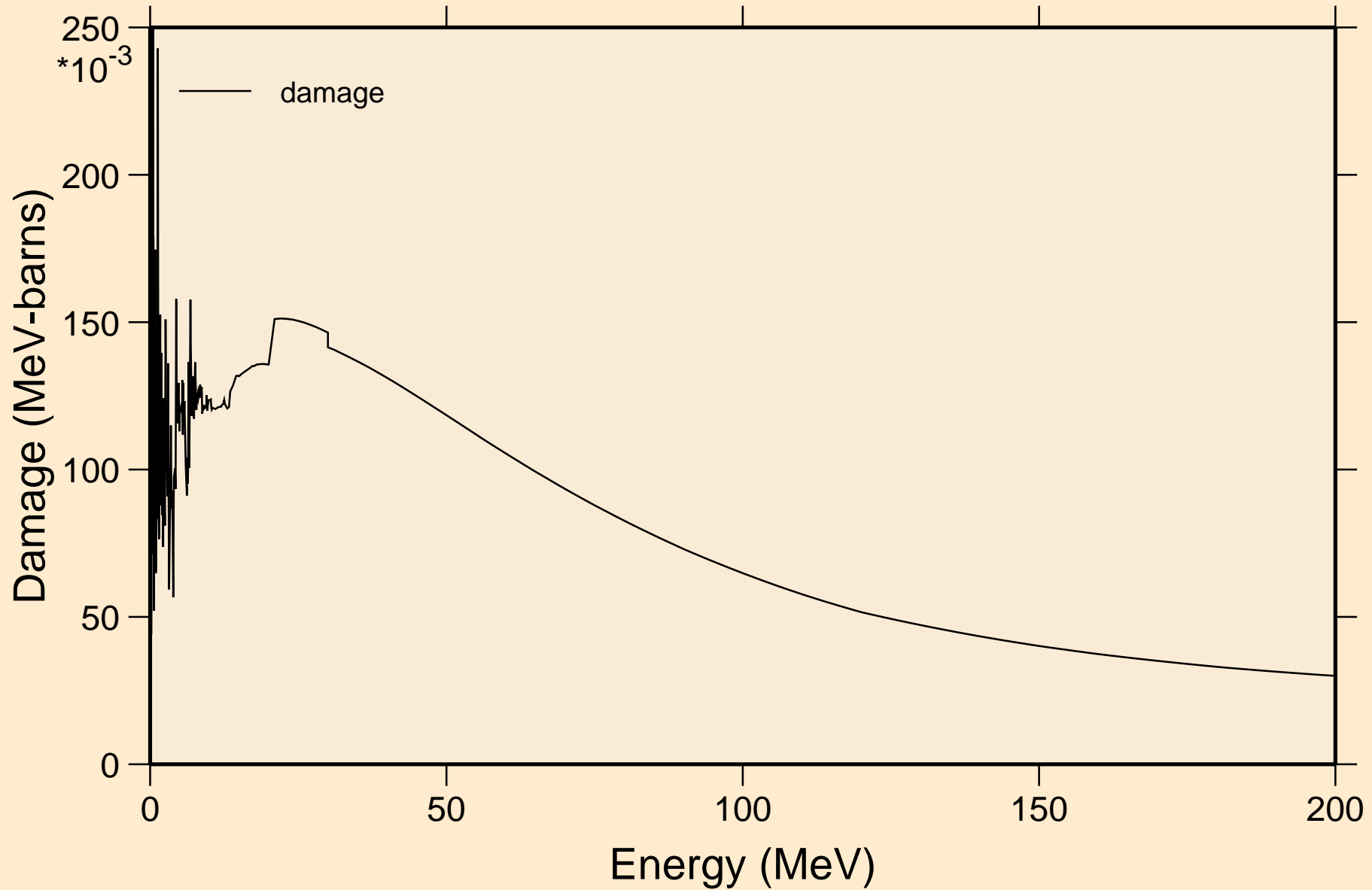

MG024 NEUTRON ACER TENDL-2024 LIBRARY; T=0.K
Non-threshold reactions

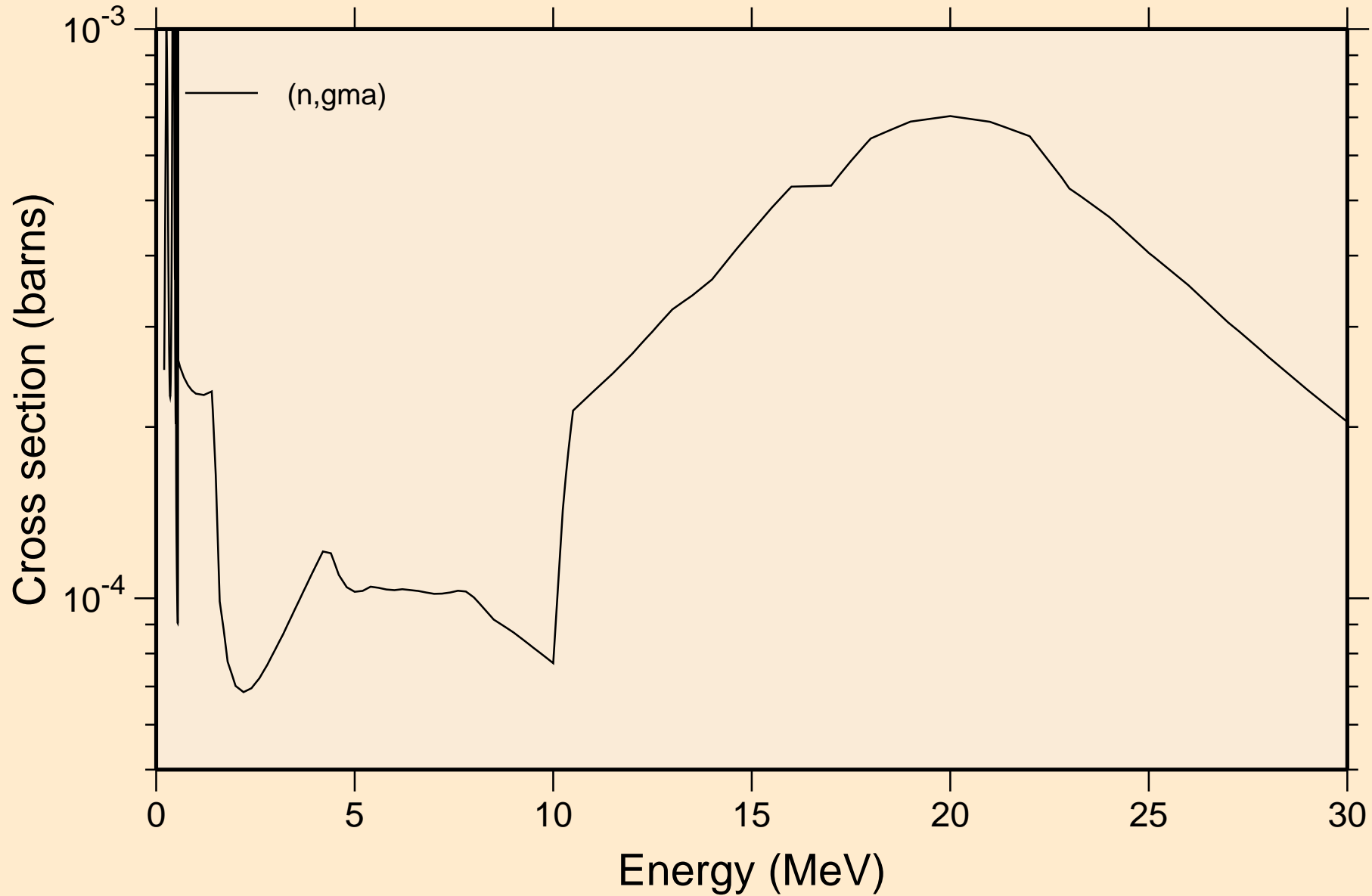

MG024 NEUTRON ACER TENDL-2024 LIBRARY; T=0.K
Inelastic levels

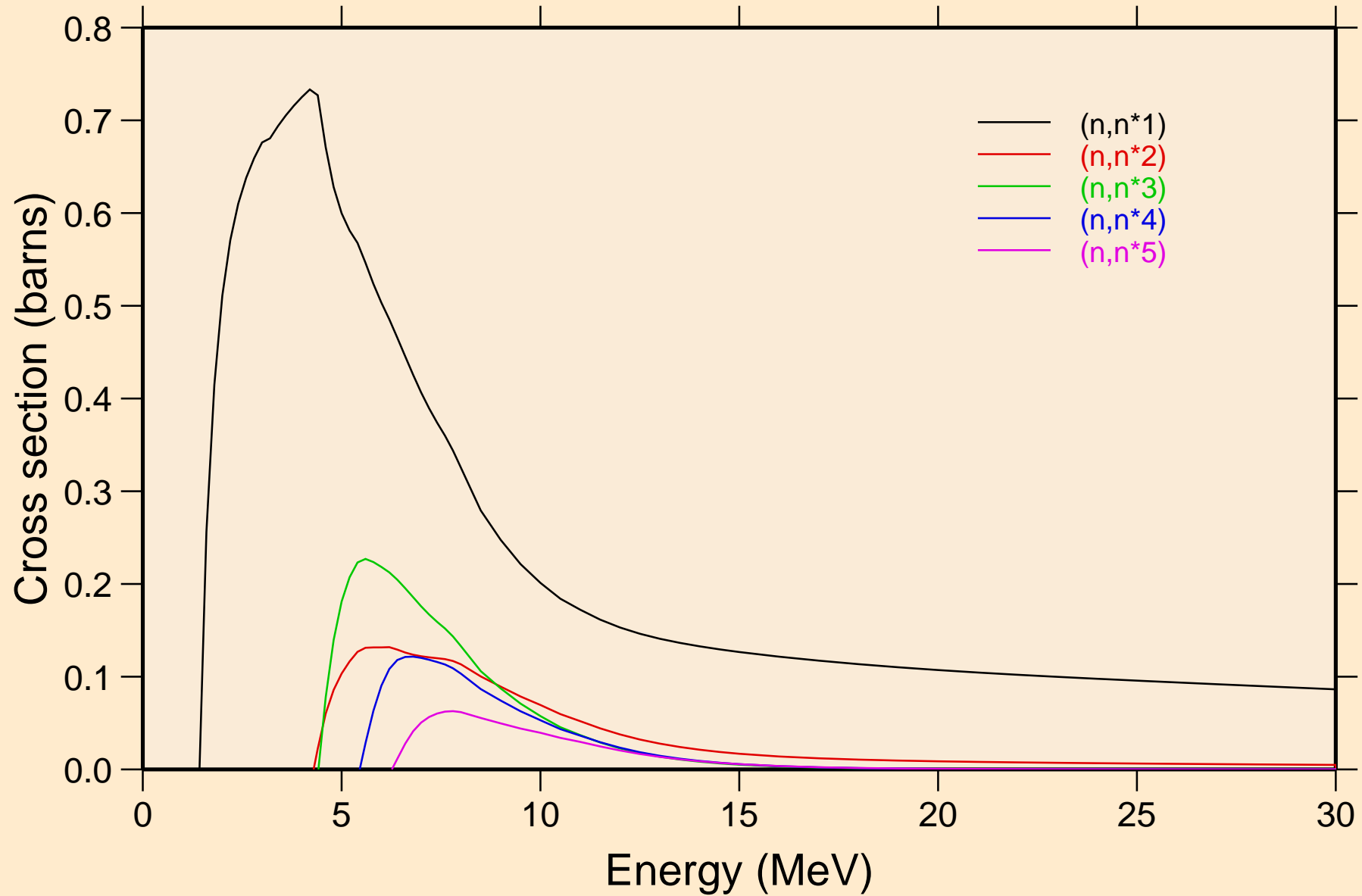

MG024 NEUTRON ACER TENDL-2024 LIBRARY; T=0.K
Inelastic levels

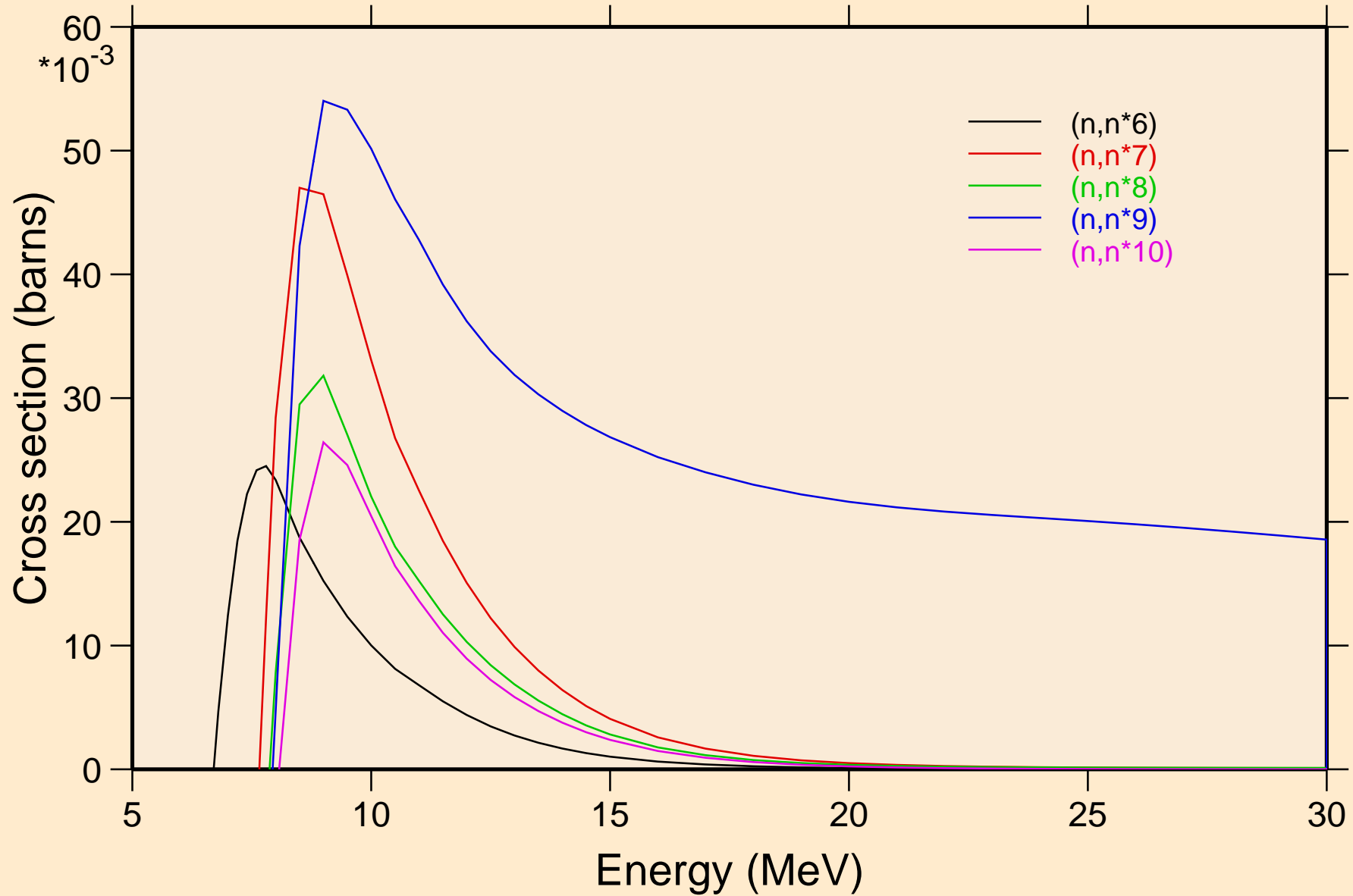

MG024 NEUTRON ACER TENDL-2024 LIBRARY; T=0.K
Inelastic levels

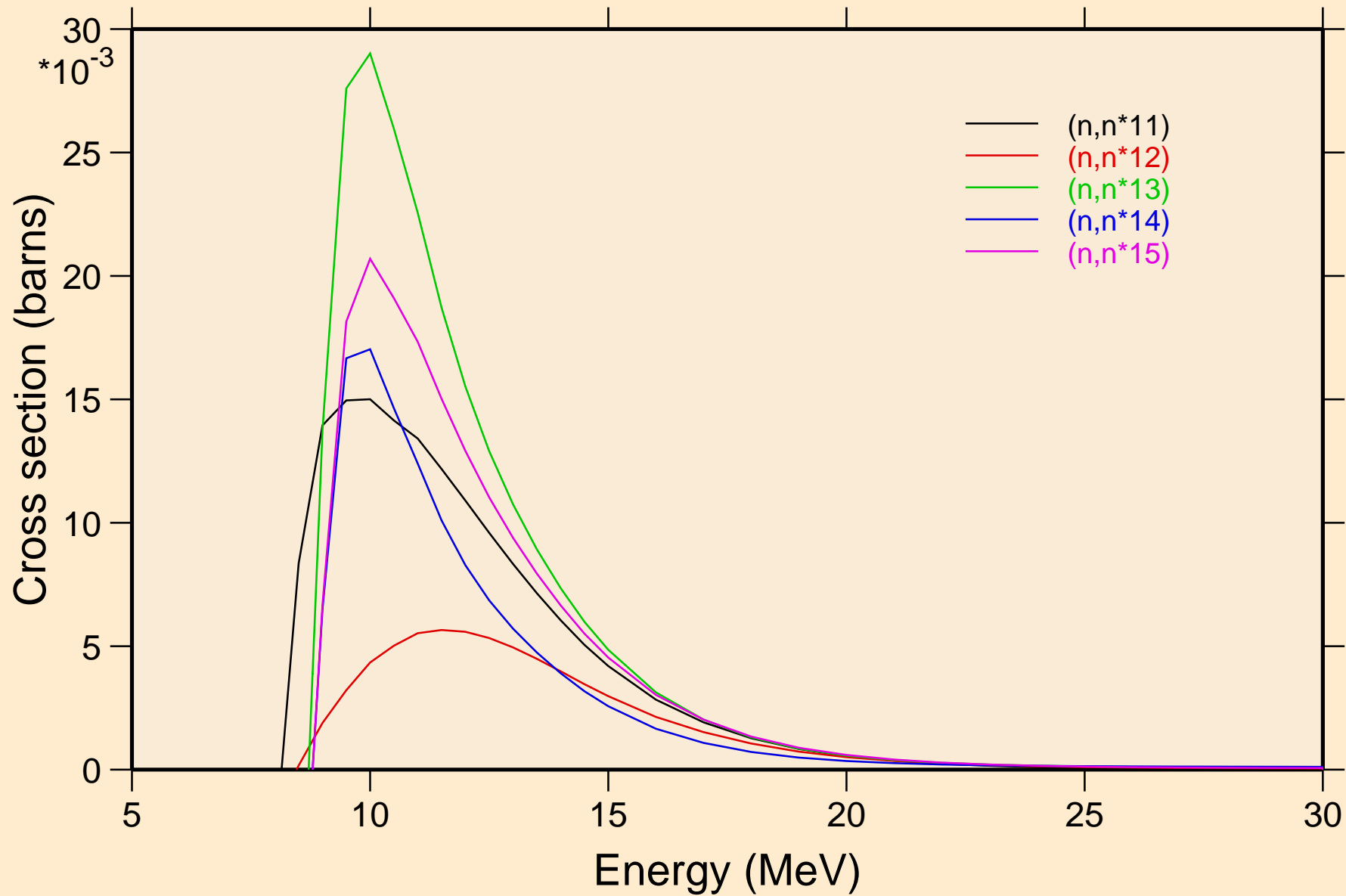

MG024 NEUTRON ACER TENDL-2024 LIBRARY; T=0.K
Inelastic levels

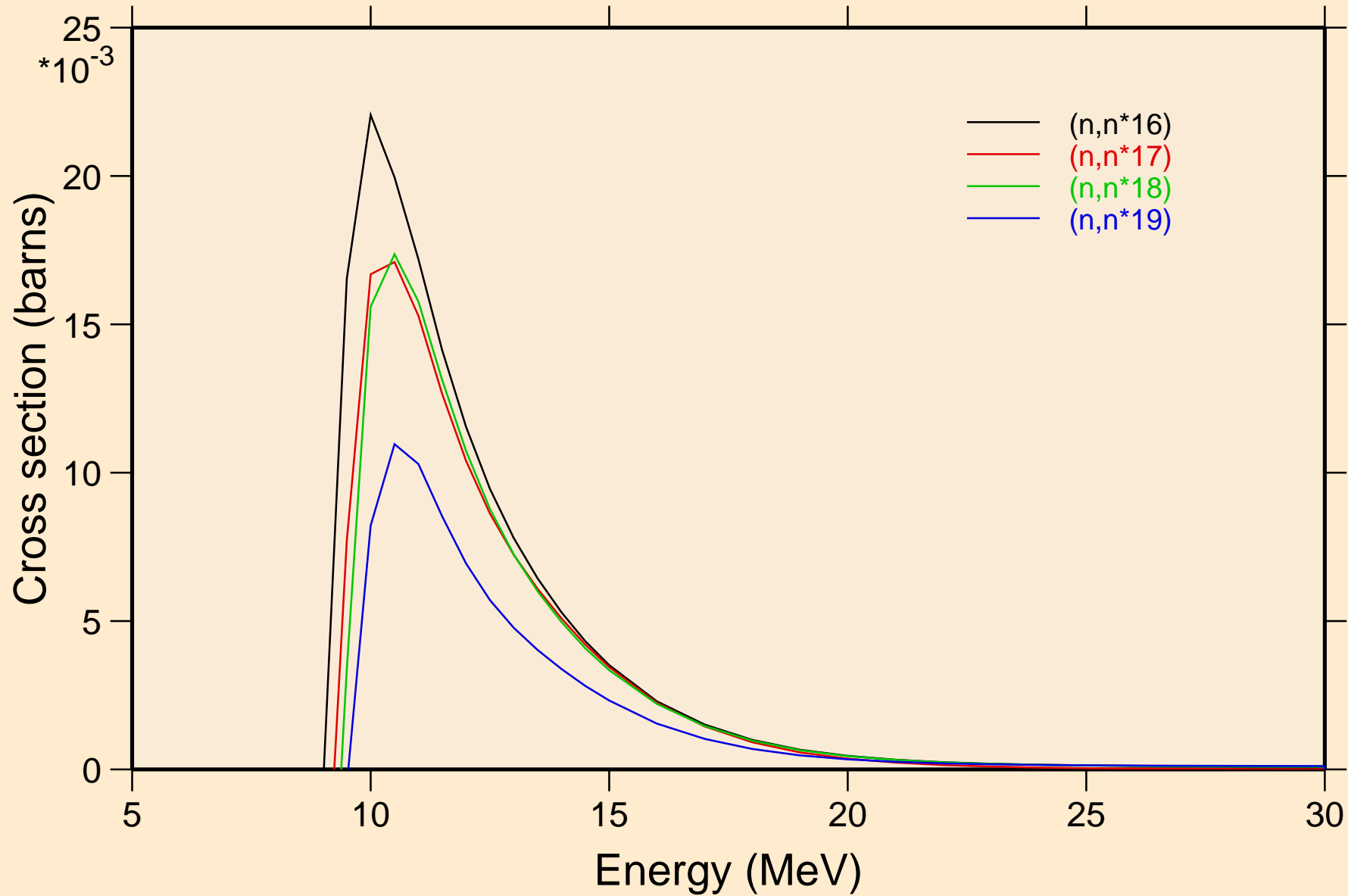

MG024 NEUTRON ACER TENDL-2024 LIBRARY; T=0.K

Threshold reactions

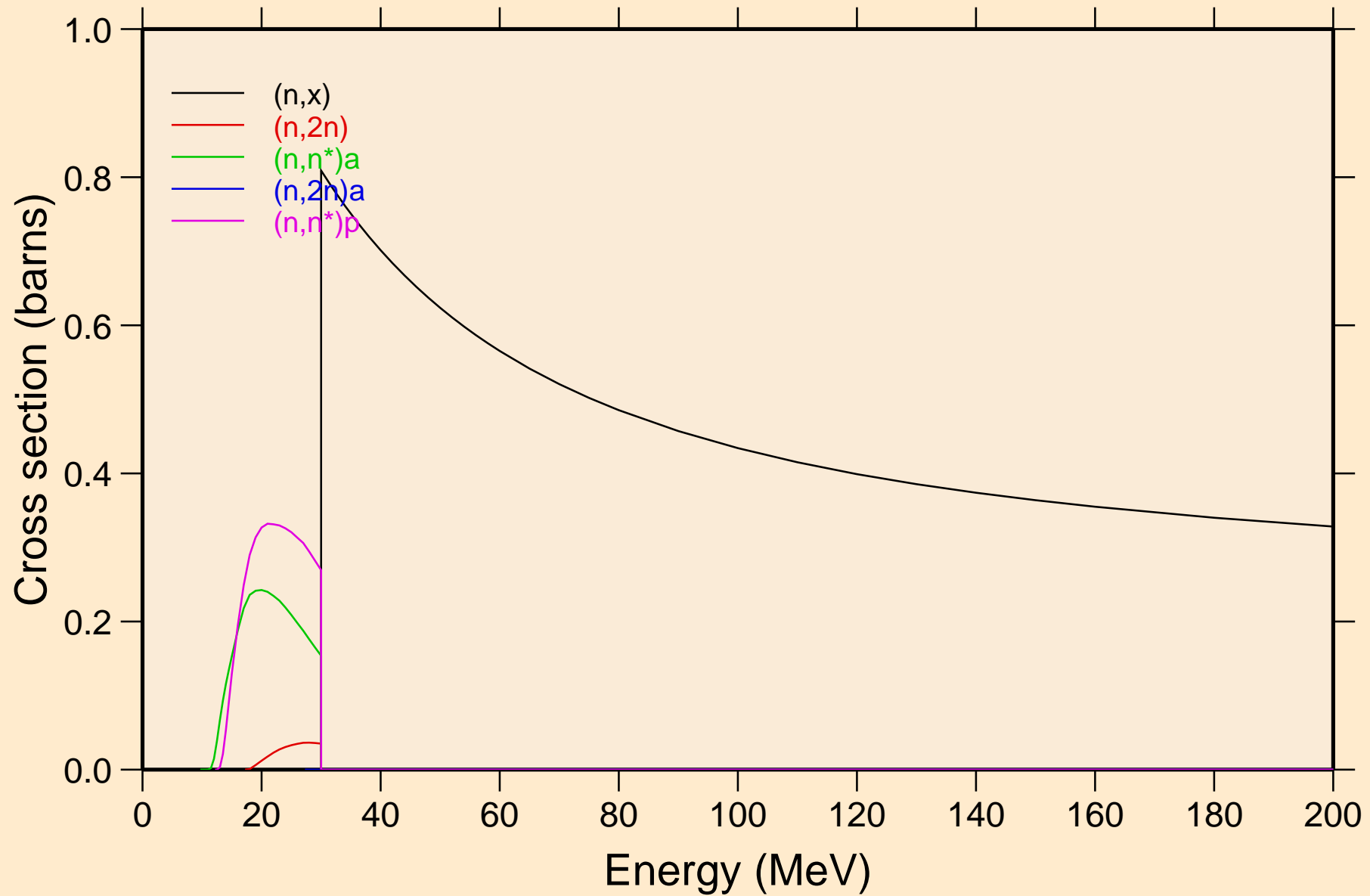

MG024 NEUTRON ACER TENDL-2024 LIBRARY; T=0.K

Threshold reactions

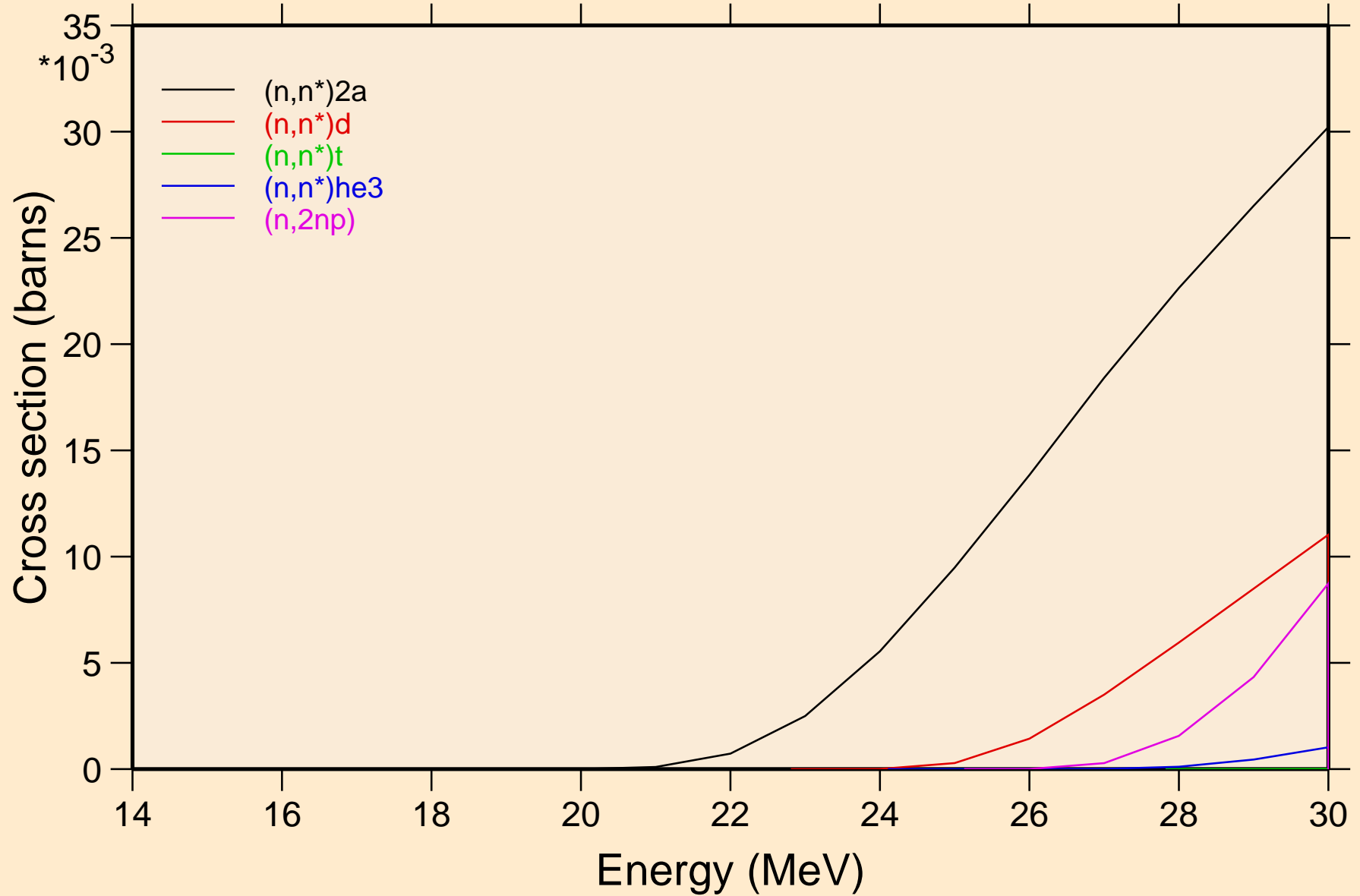

MG024 NEUTRON ACER TENDL-2024 LIBRARY; T=0.K

Threshold reactions

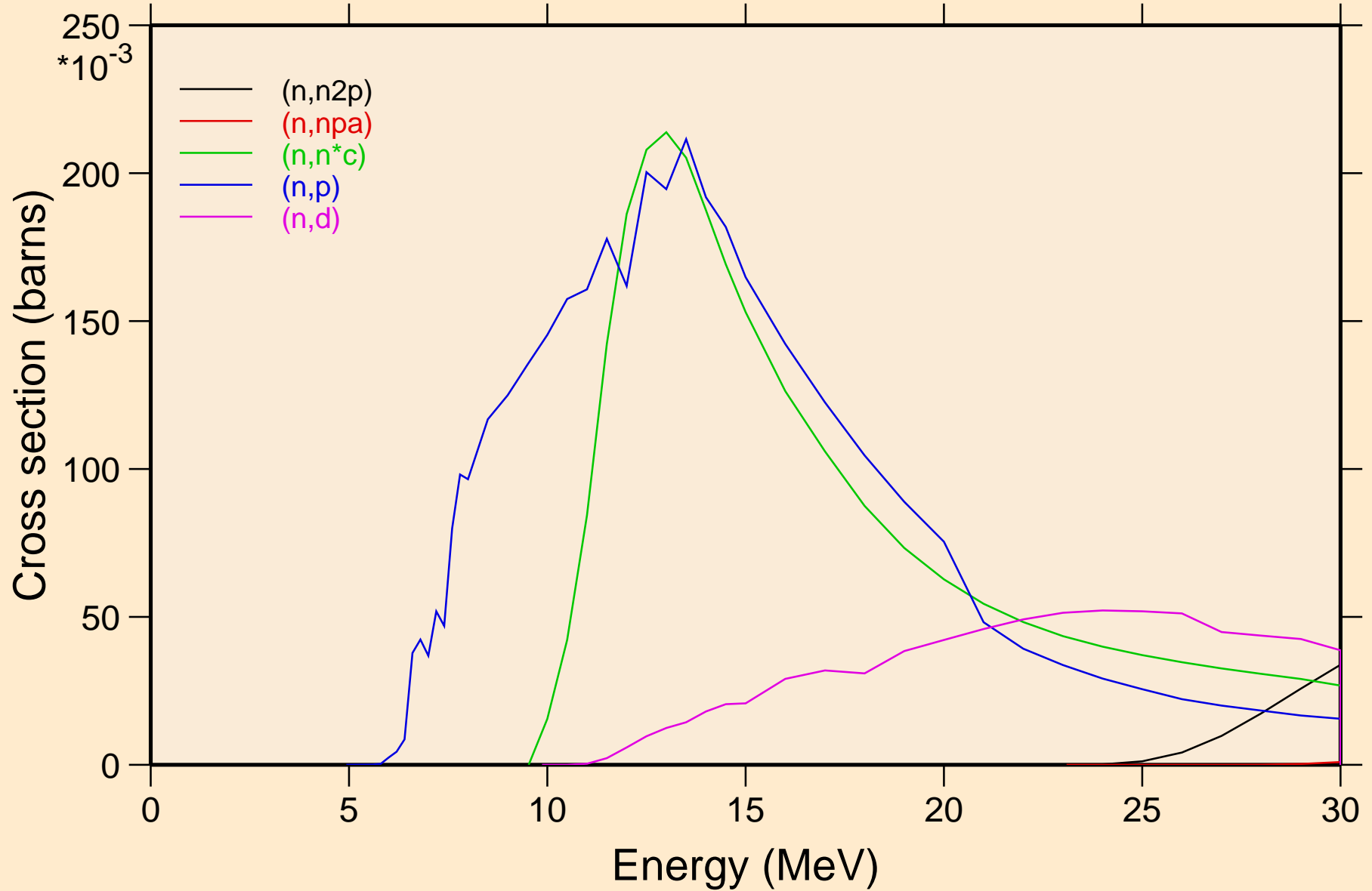

MG024 NEUTRON ACER TENDL-2024 LIBRARY; T=0.K

Threshold reactions

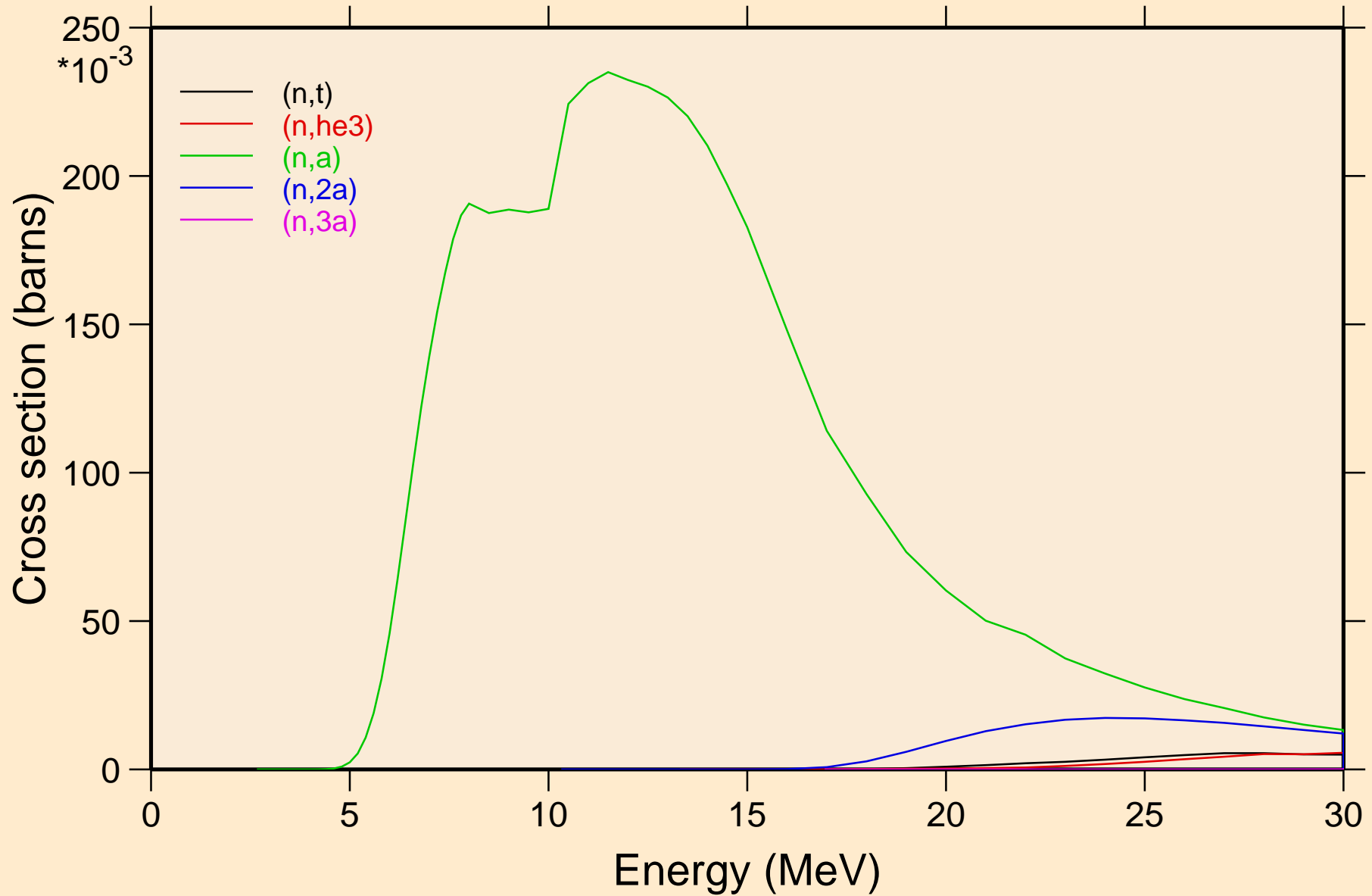

MG024 NEUTRON ACER TENDL-2024 LIBRARY; T=0.K

Threshold reactions

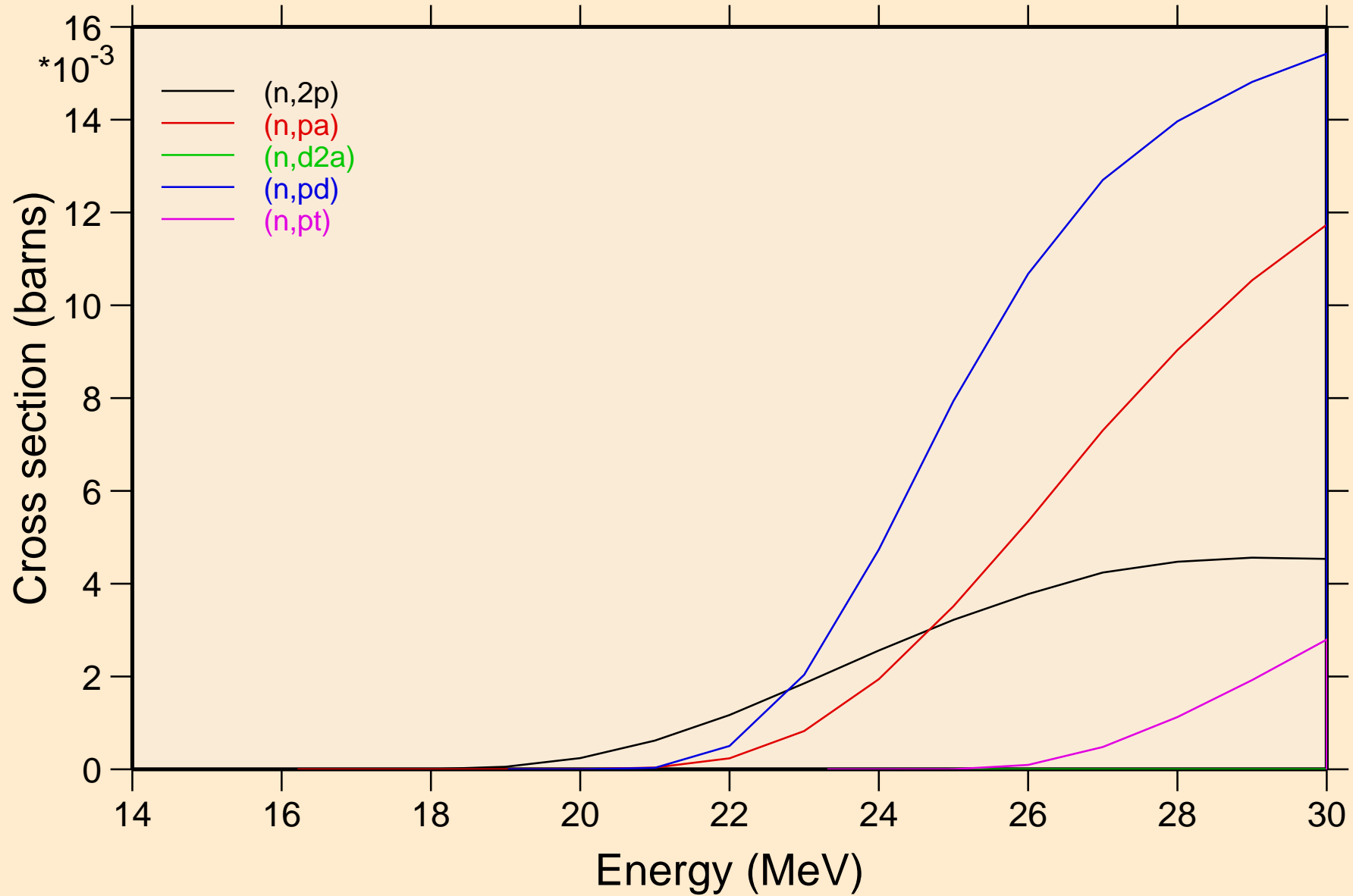

MG024 NEUTRON ACER TENDL-2024 LIBRARY; T=0.K
Threshold reactions

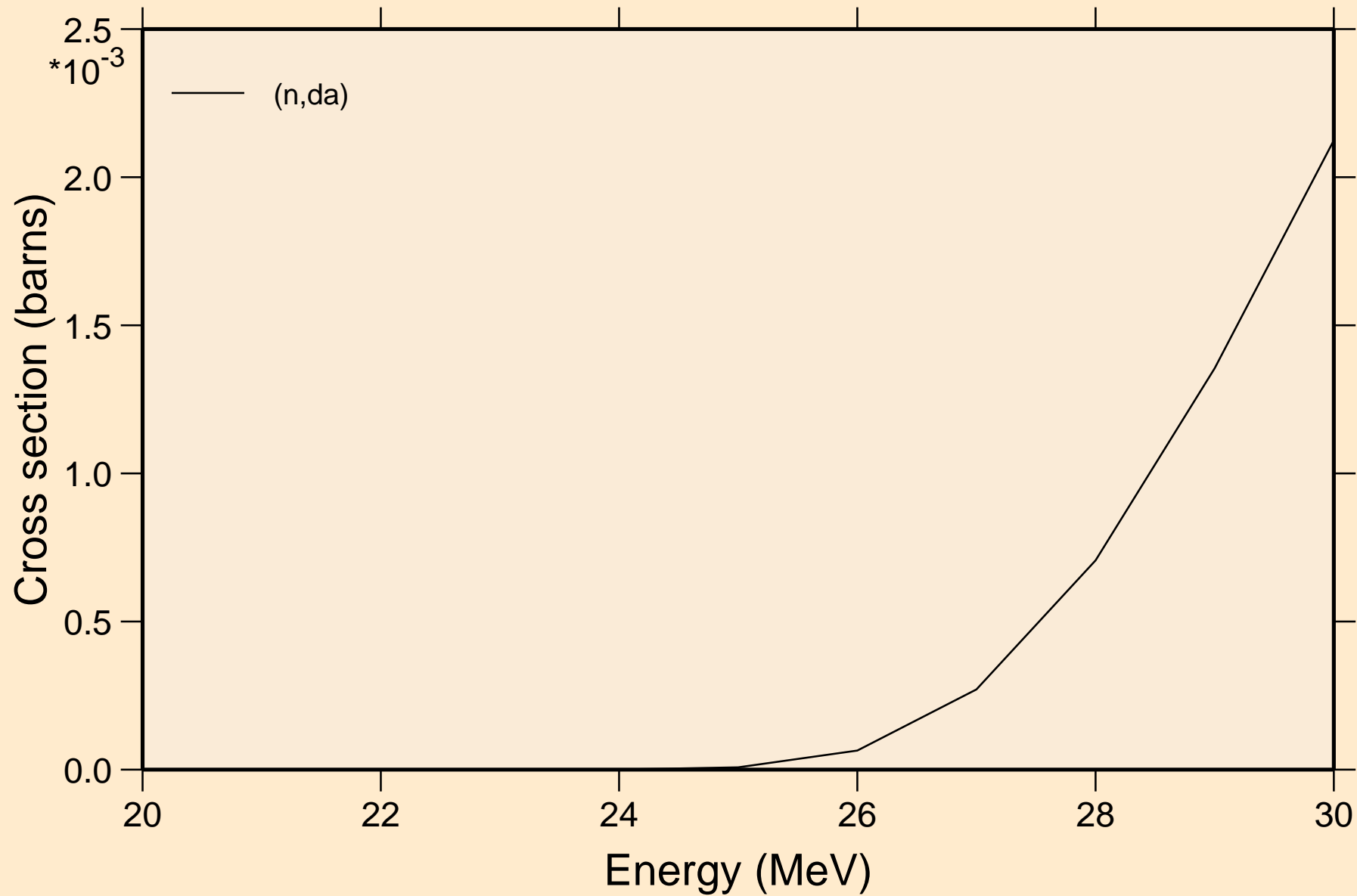

MG024 NEUTRON ACER TENDL-2024 LIBRARY; T=0.K

Threshold reactions

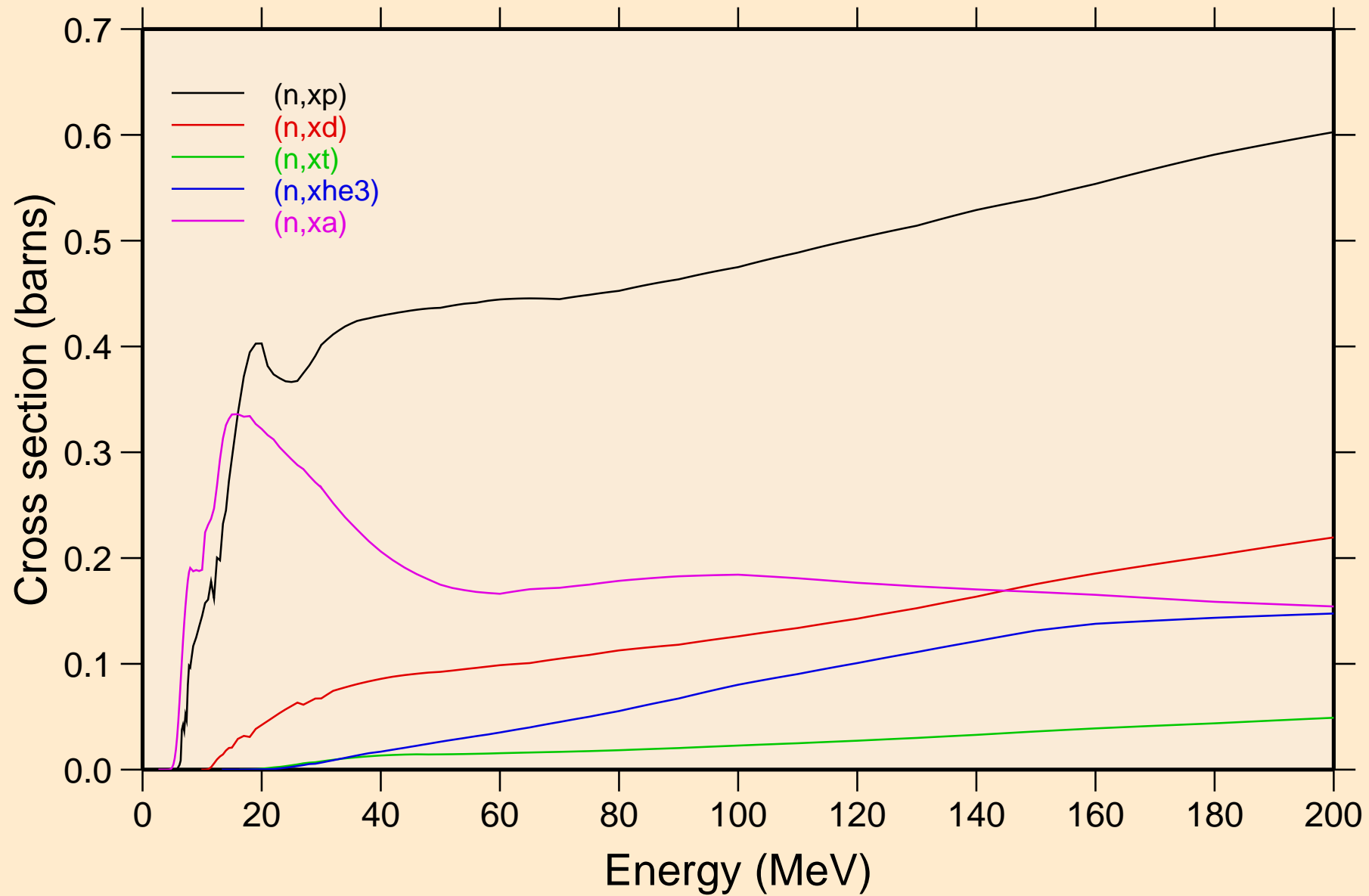

MG024 NEUTRON ACER TENDL-2024 LIBRARY; T=0.K
angular distribution for elastic

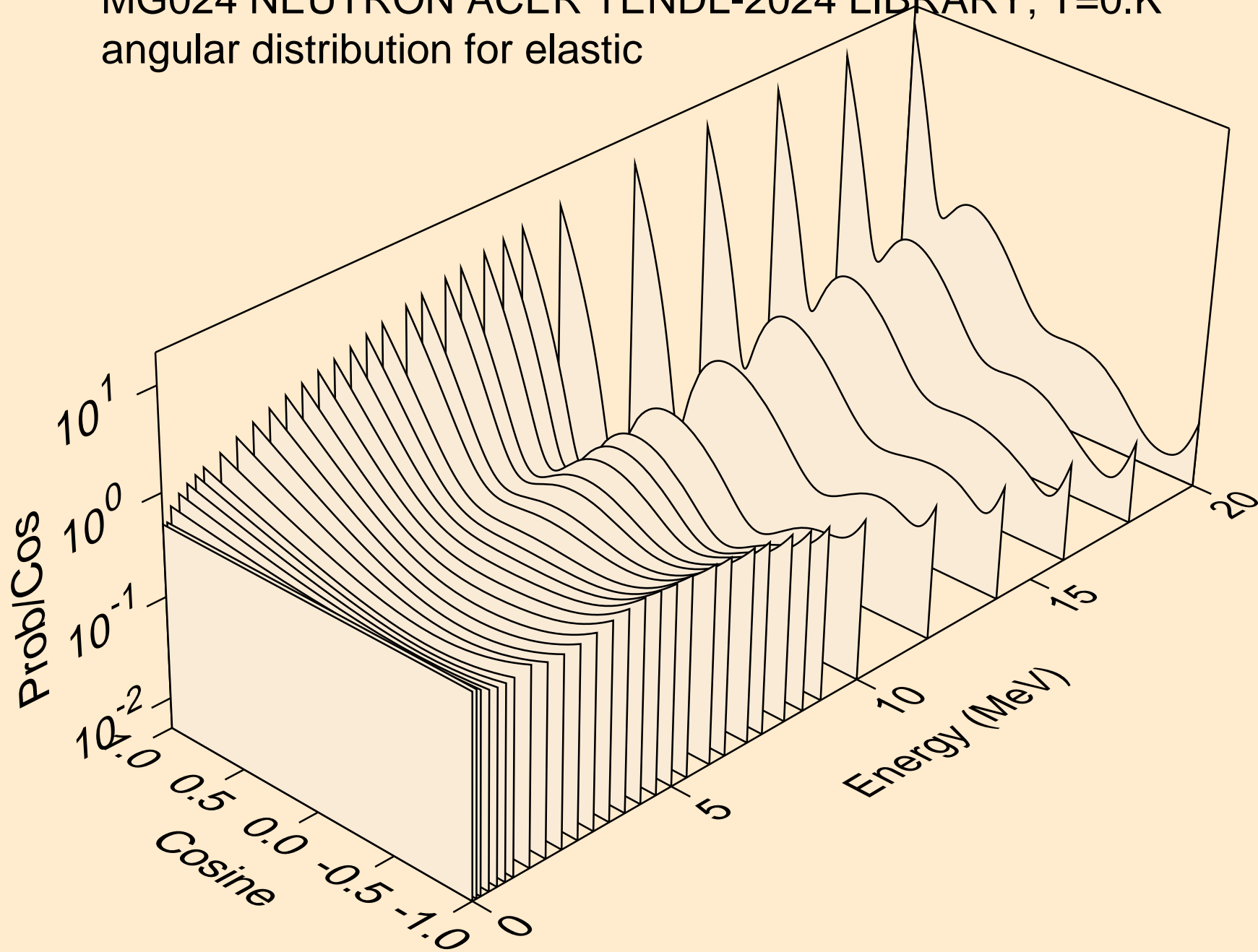

MG024 NEUTRON ACER TENDL-2024 LIBRARY; T=0.K
angular distribution for elastic

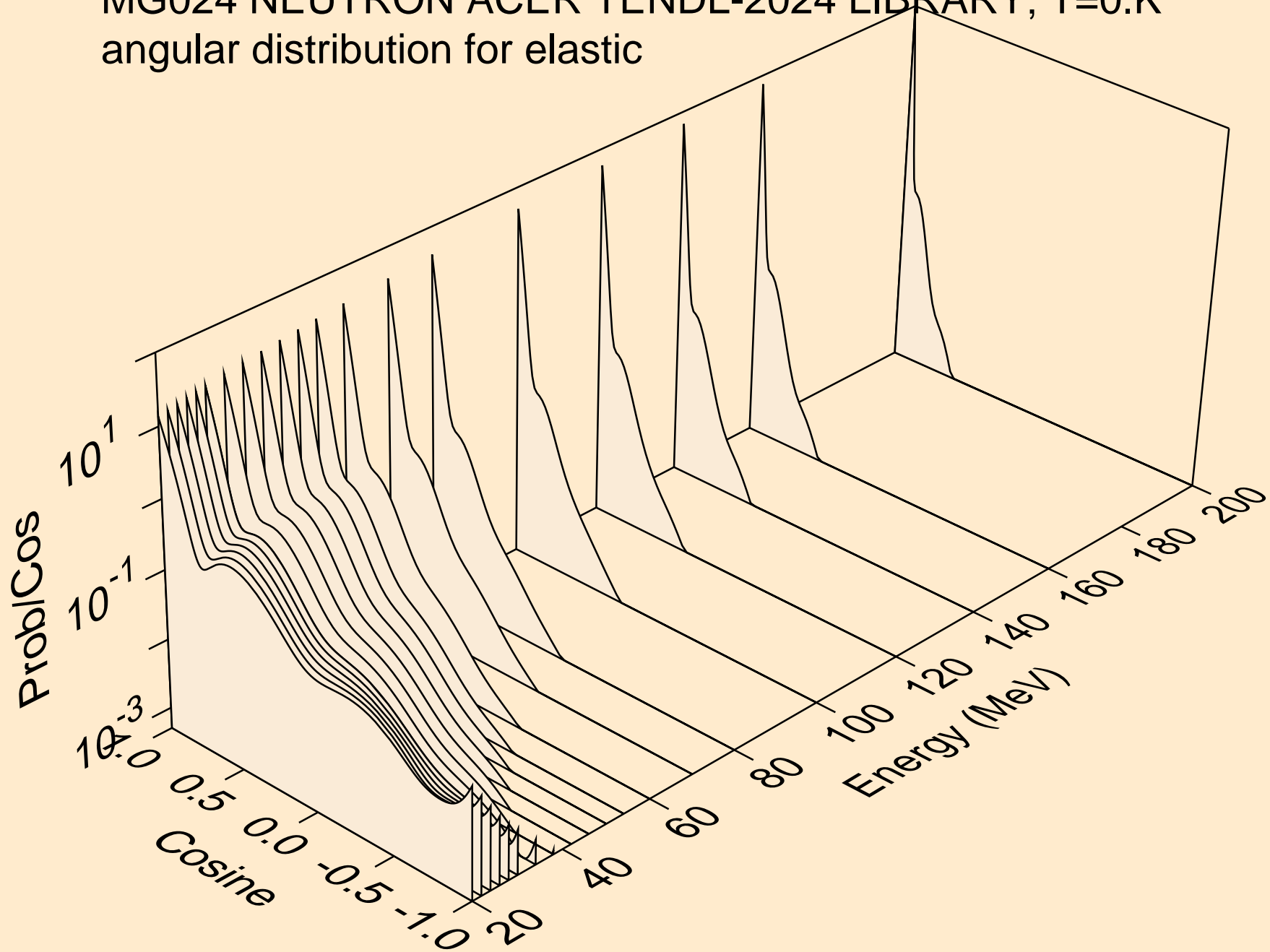

MG024 NEUTRON ACER TENDL-2024 LIBRARY; T=0.K
angular distribution for (n,n*1)

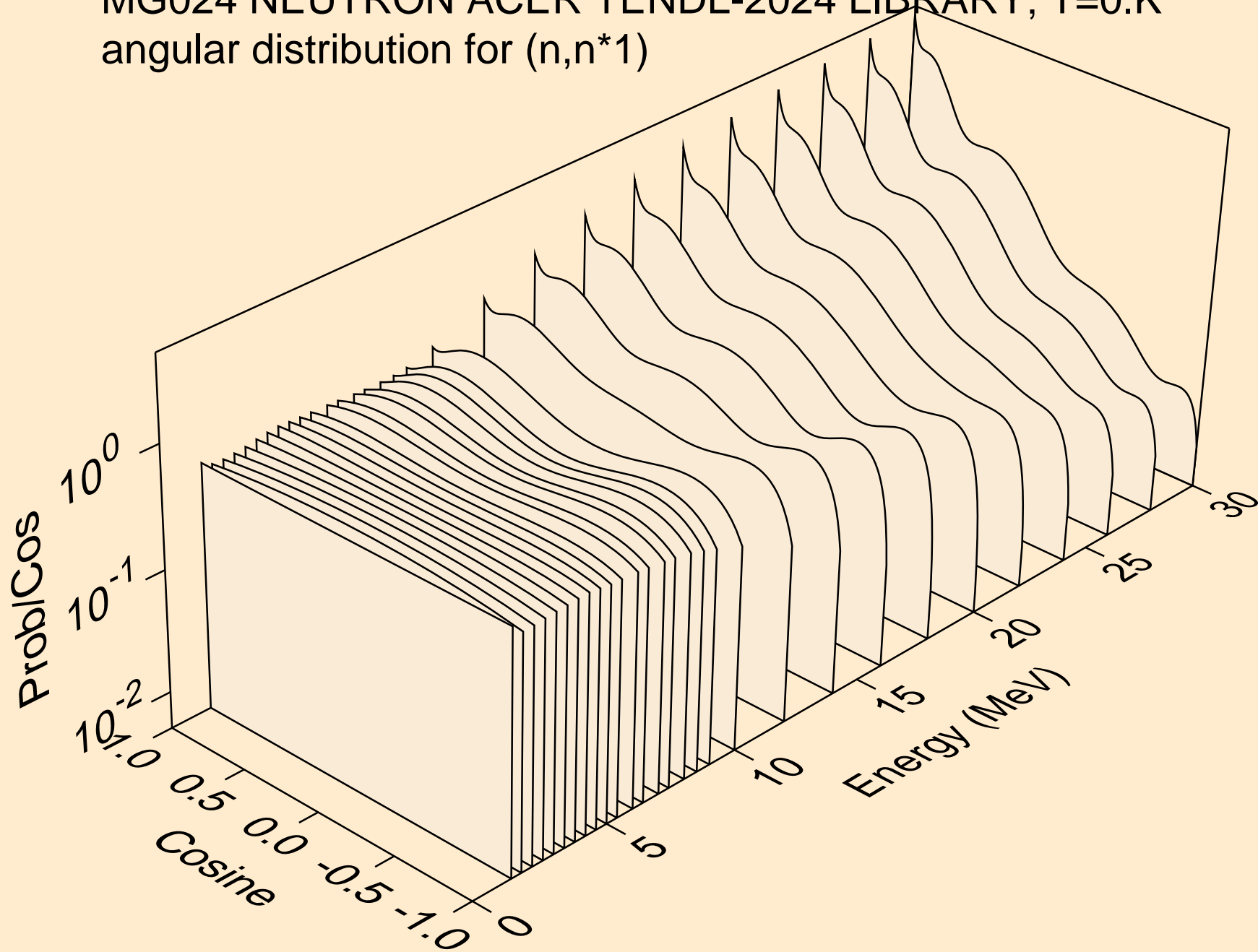

MG024 NEUTRON ACER TENDL-2024 LIBRARY; T=0.K
angular distribution for (n,n*2)

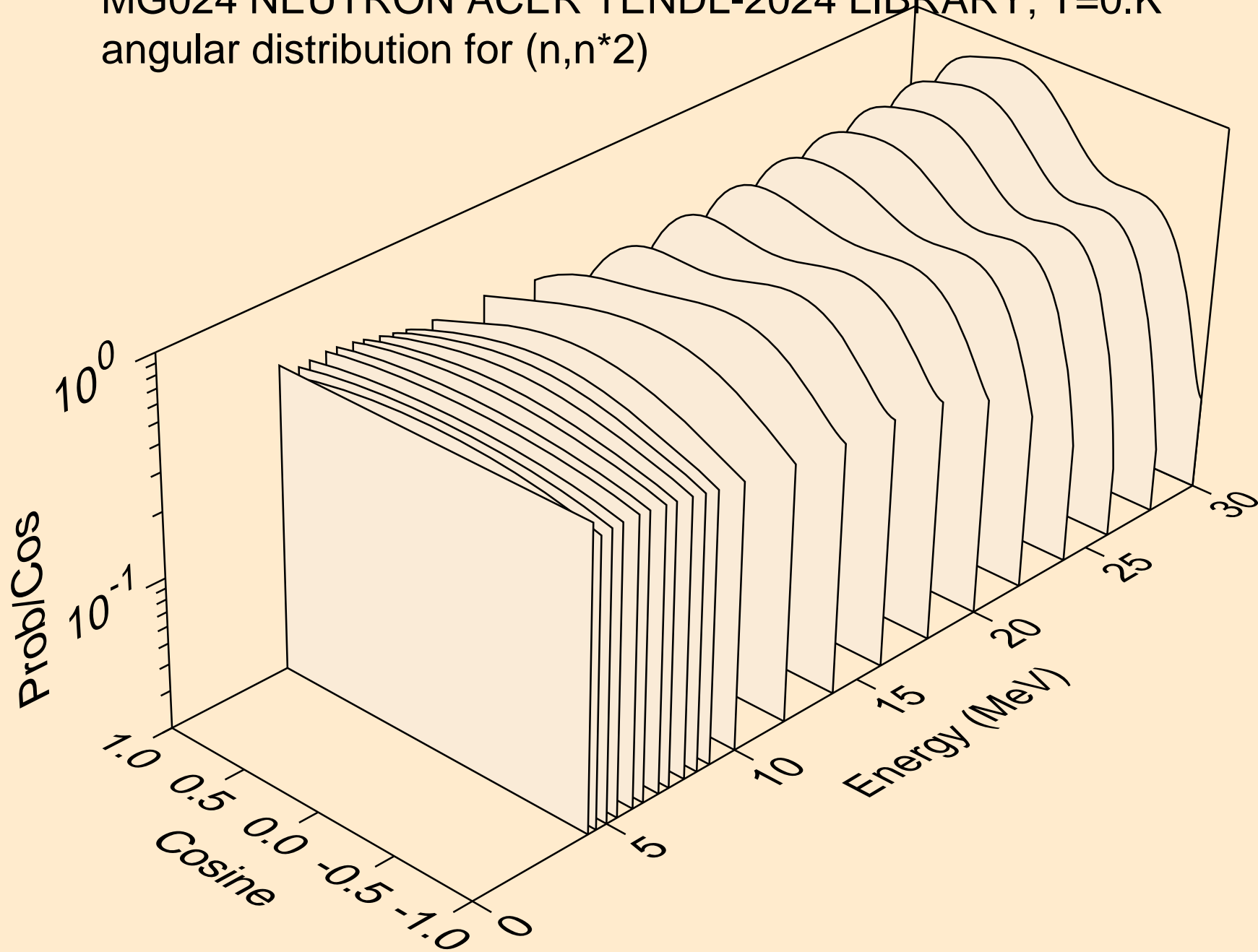

MG024 NEUTRON ACER TENDL-2024 LIBRARY; T=0.K
angular distribution for (n,n*3)

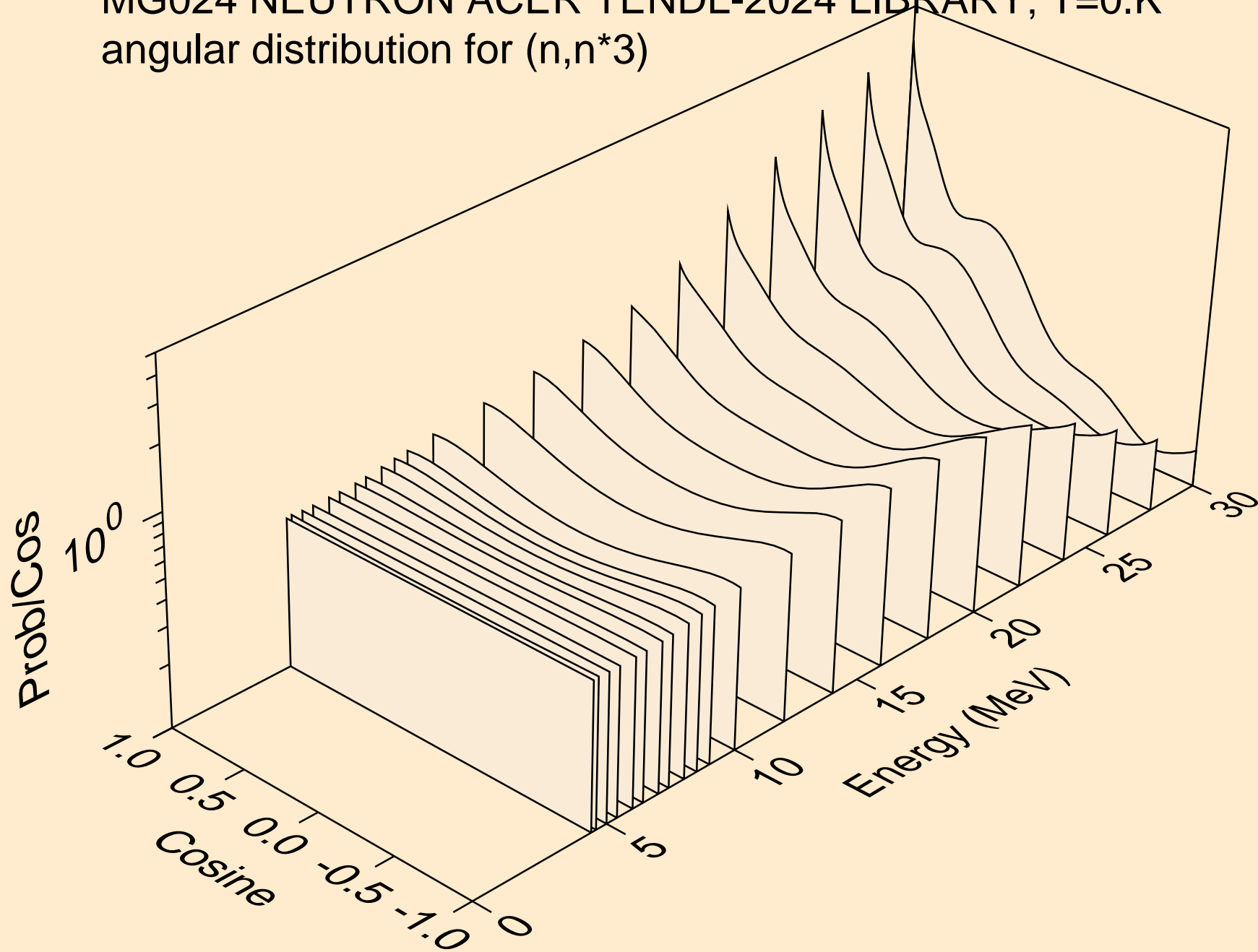

MG024 NEUTRON ACER TENDL-2024 LIBRARY; T=0.K
angular distribution for (n,n*4)

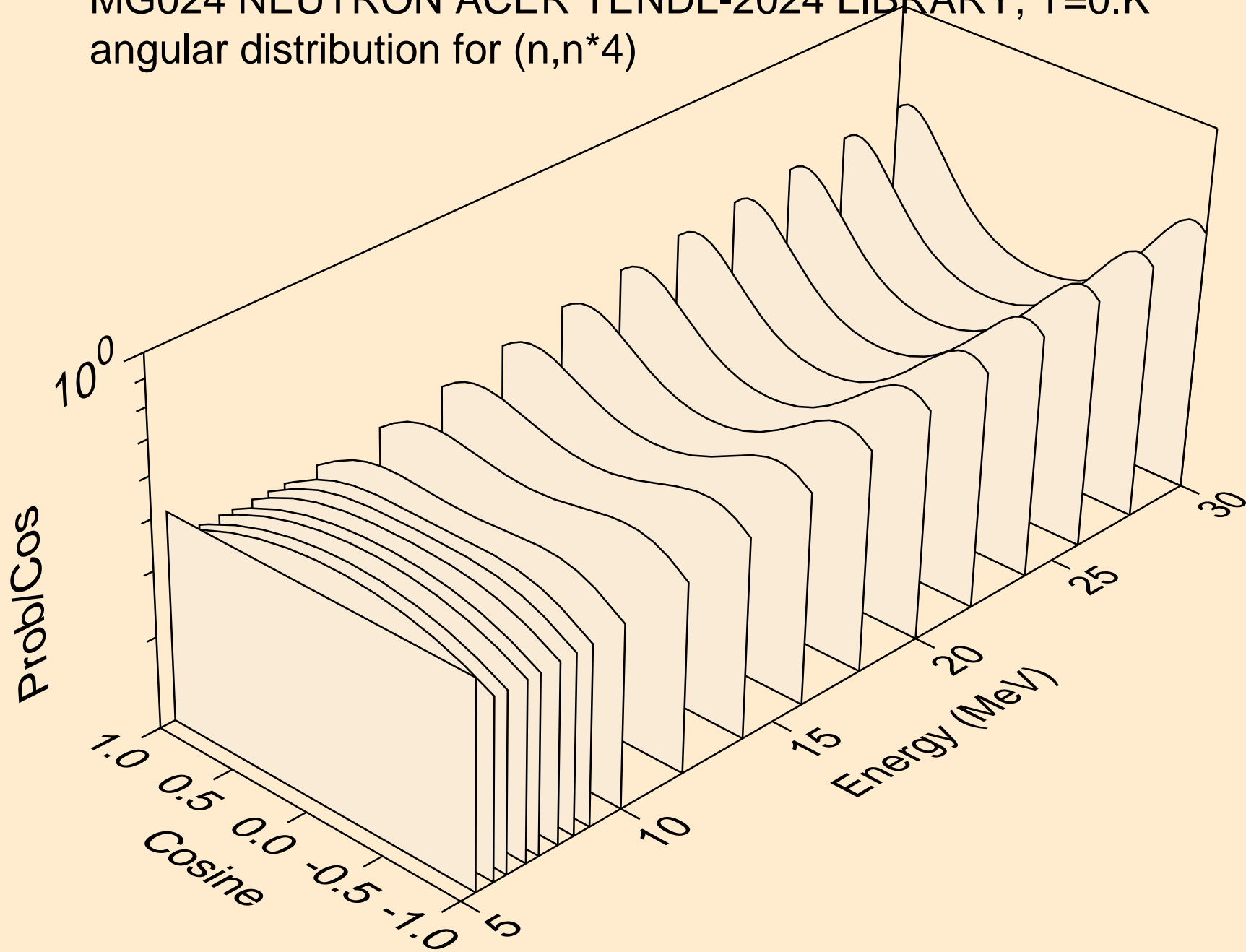

MG024 NEUTRON ACER TENDL-2024 LIBRARY; T=0.K
angular distribution for (n,n*5)

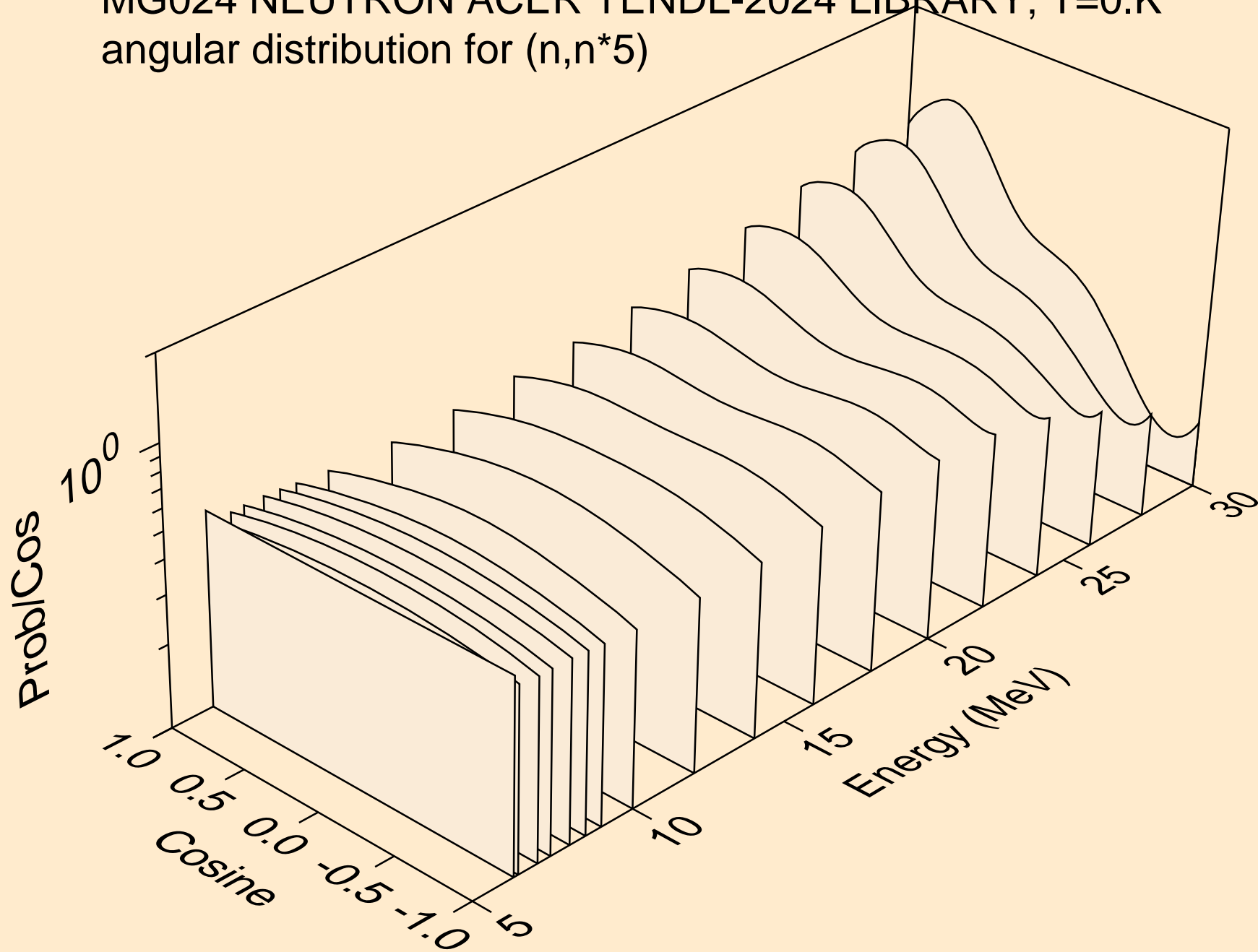

MG024 NEUTRON ACER TENDL-2024 LIBRARY; T=0.K
angular distribution for (n,n*6)

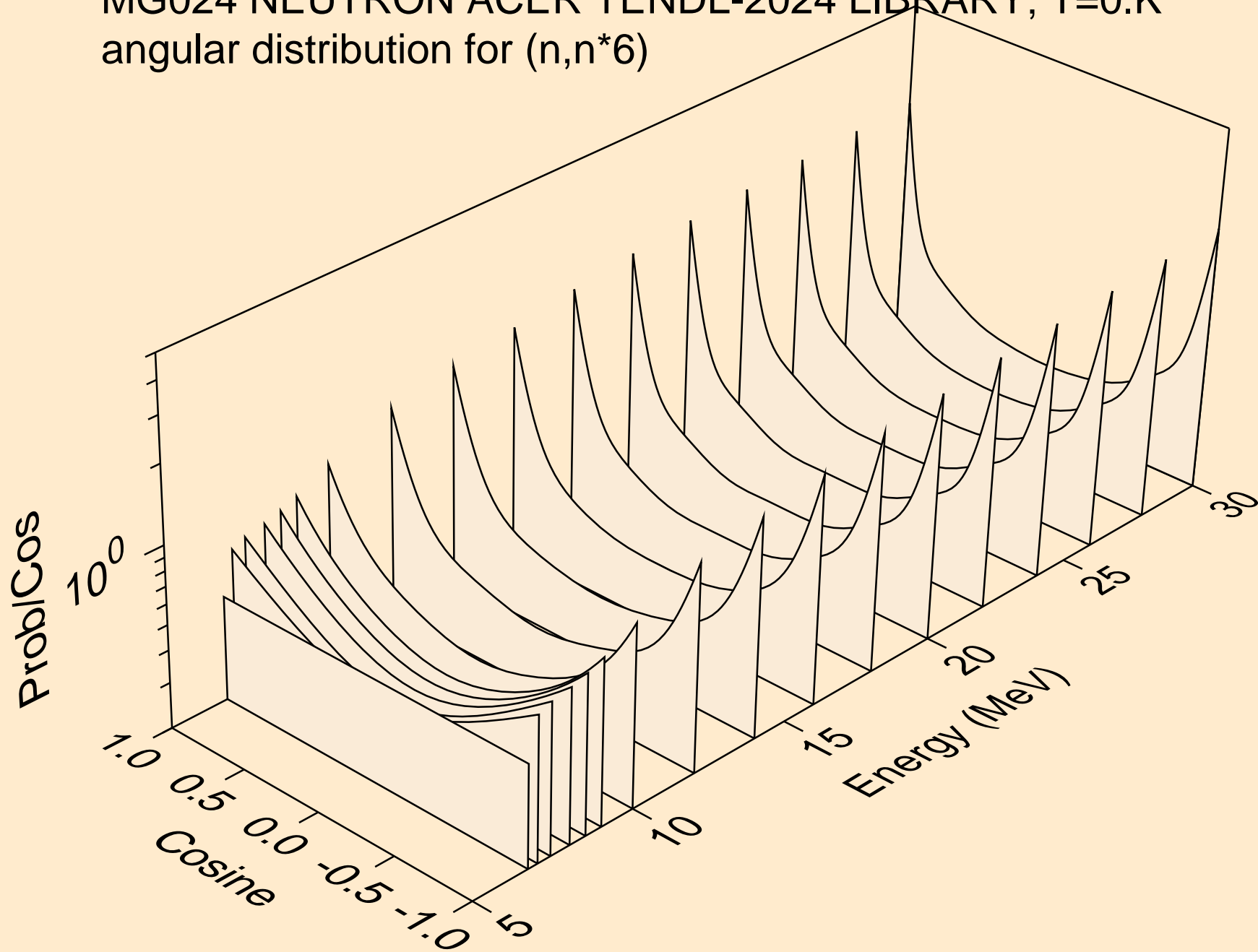

MG024 NEUTRON ACER TENDL-2024 LIBRARY; T=0.K
angular distribution for (n,n*7)

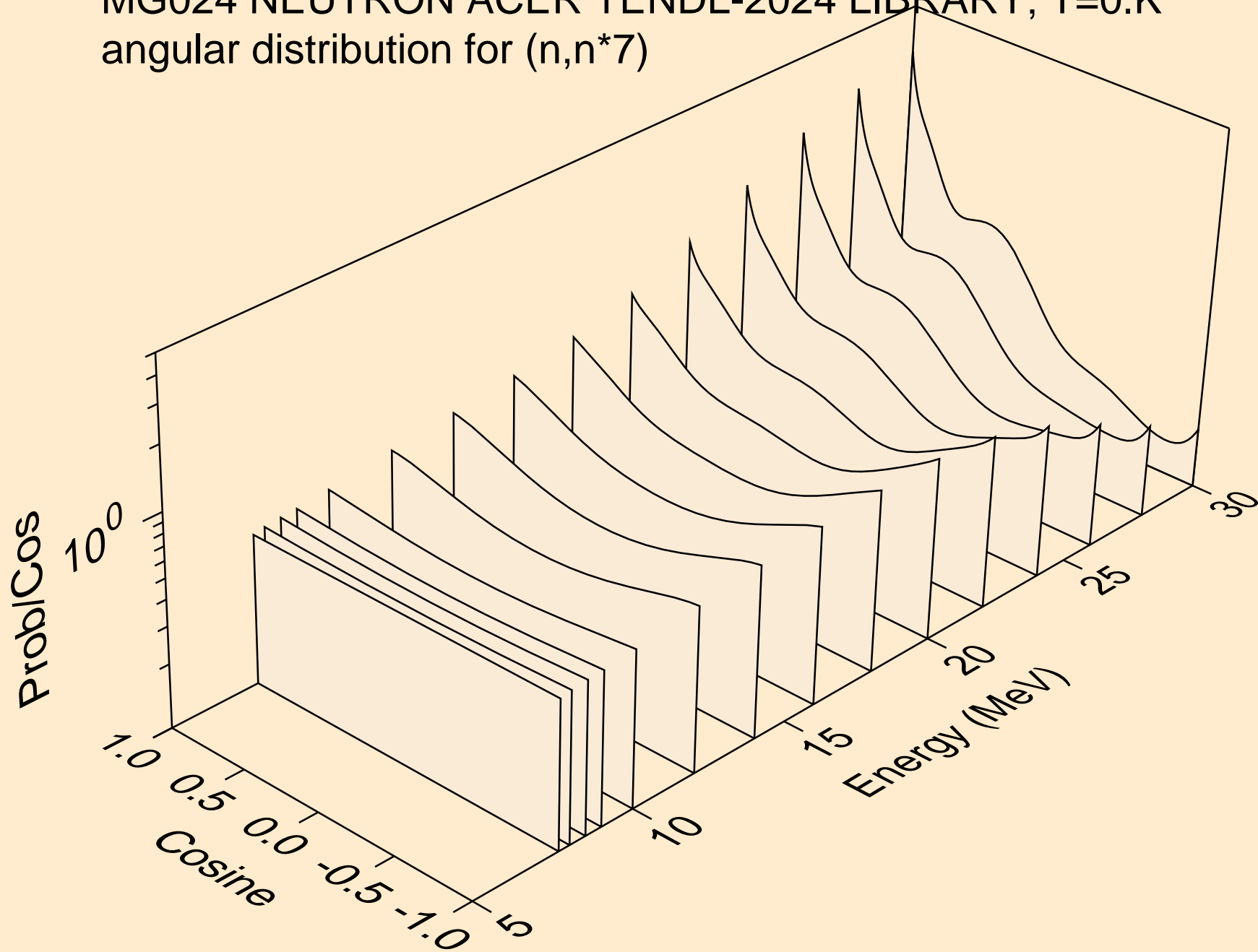

MG024 NEUTRON ACER TENDL-2024 LIBRARY; T=0.K
angular distribution for (n,n*8)

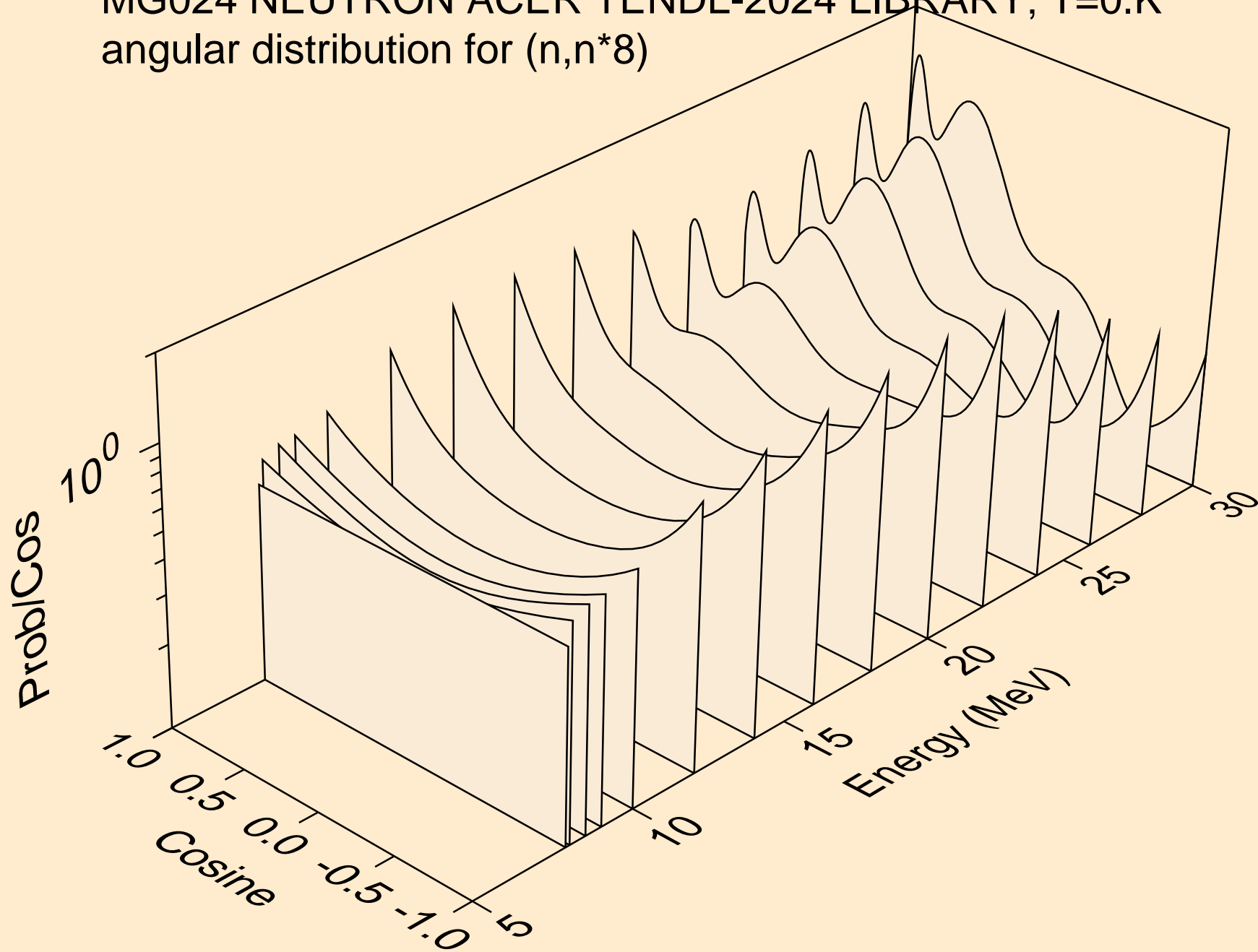

MG024 NEUTRON ACER TENDL-2024 LIBRARY; T=0.K
angular distribution for (n,n*9)

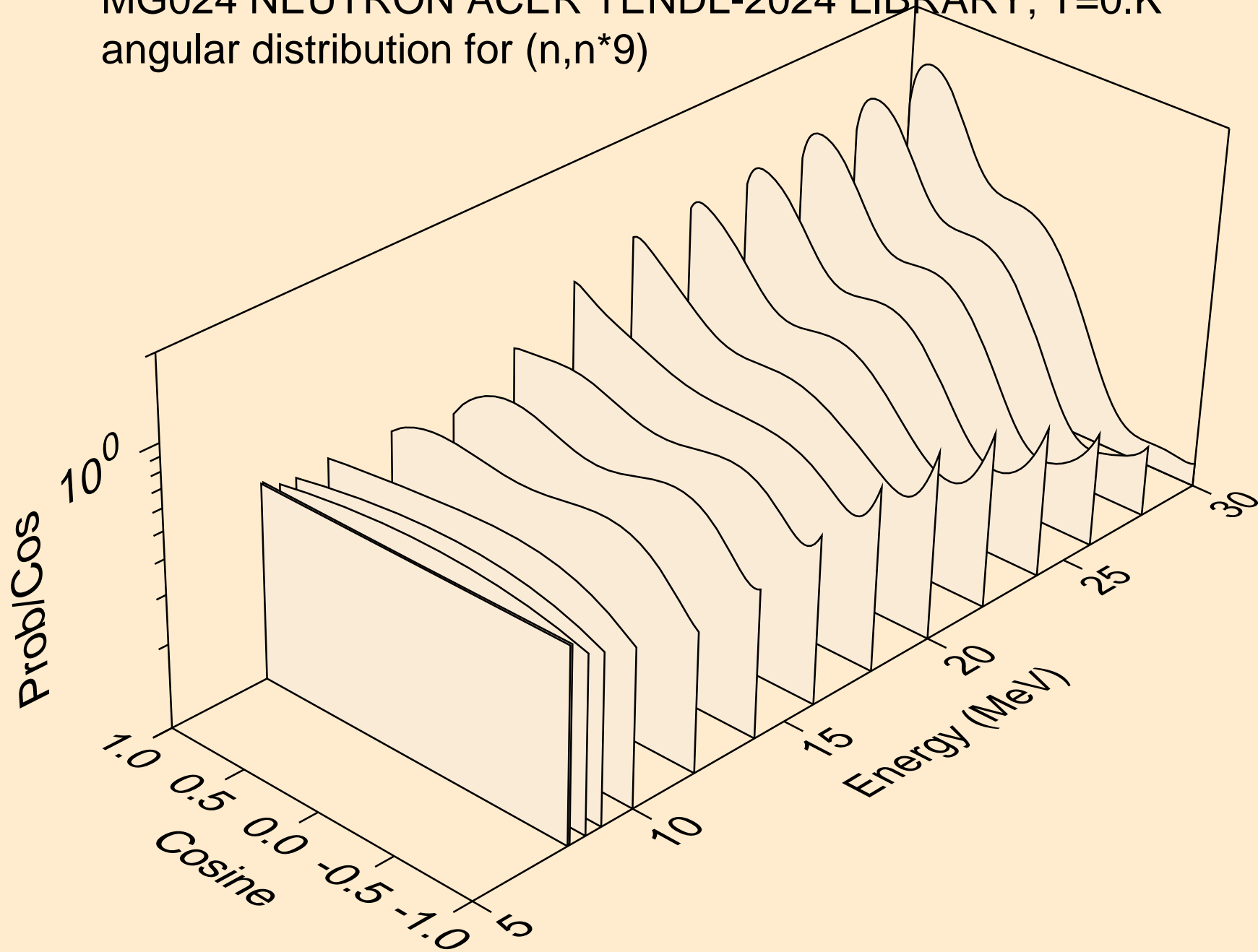

MG024 NEUTRON ACER TENDL-2024 LIBRARY; T=0.K
angular distribution for (n,n*10)

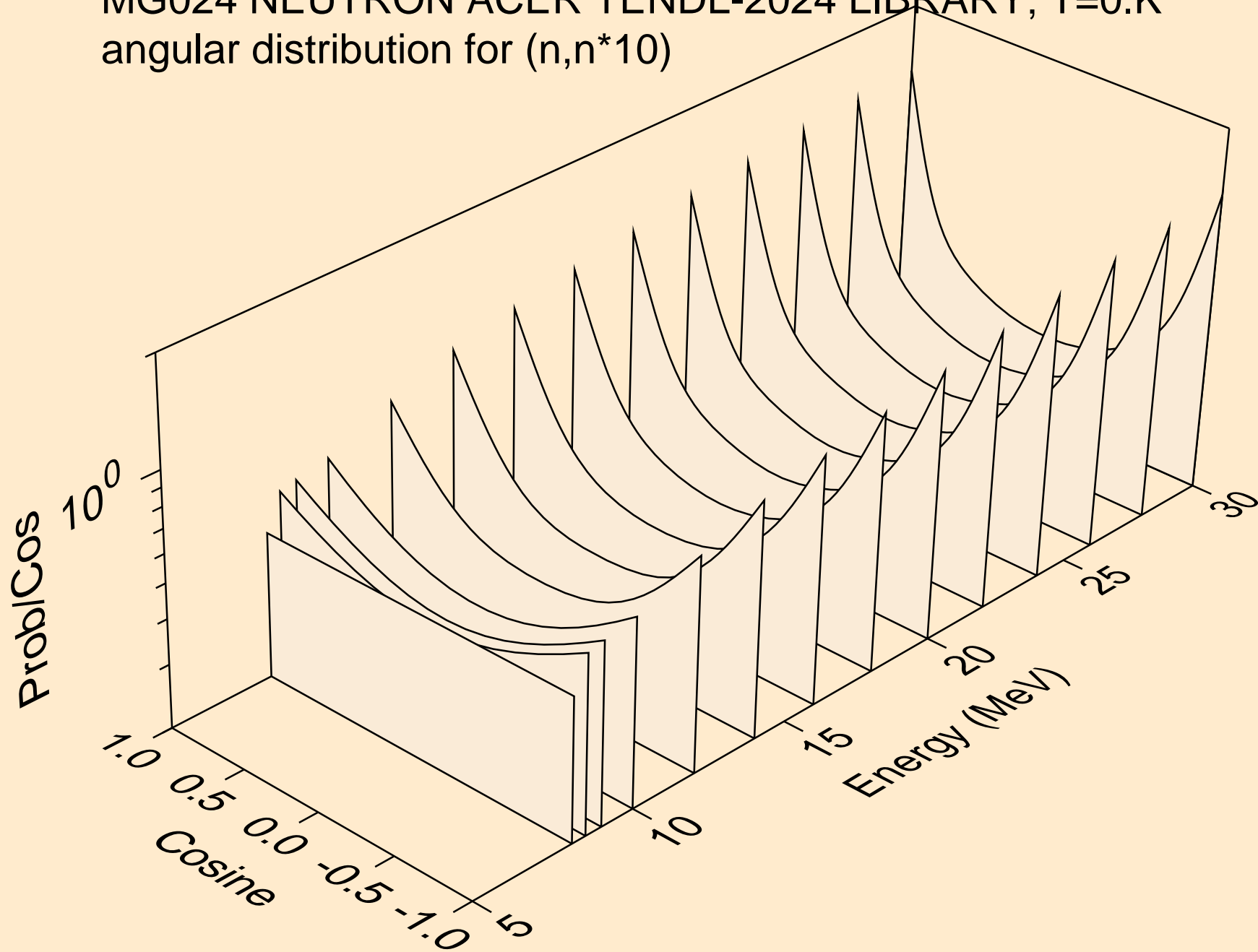

MG024 NEUTRON ACER TENDL-2024 LIBRARY; T=0.K
angular distribution for (n,n*11)

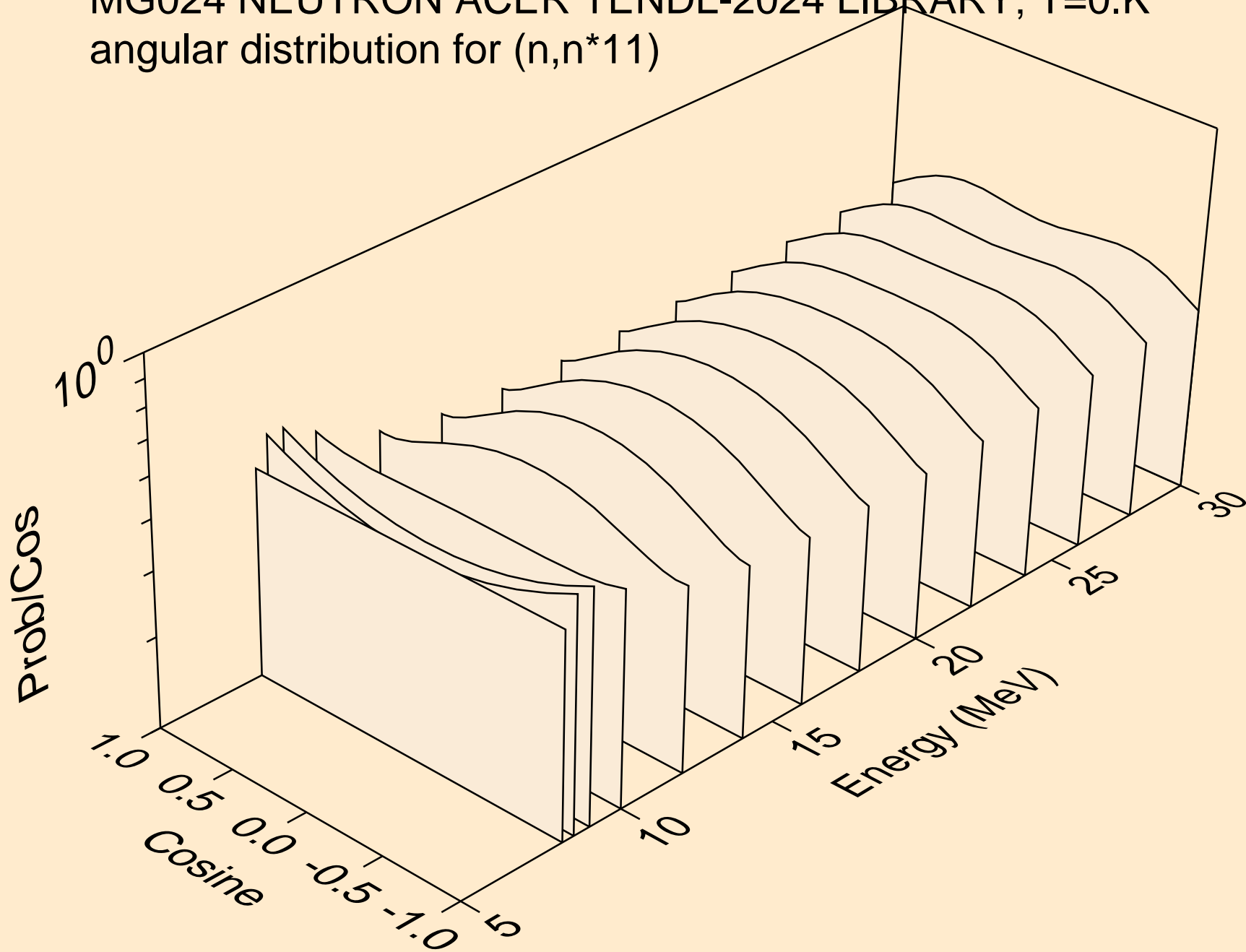

MG024 NEUTRON ACER TENDL-2024 LIBRARY; T=0.K
angular distribution for (n,n*12)

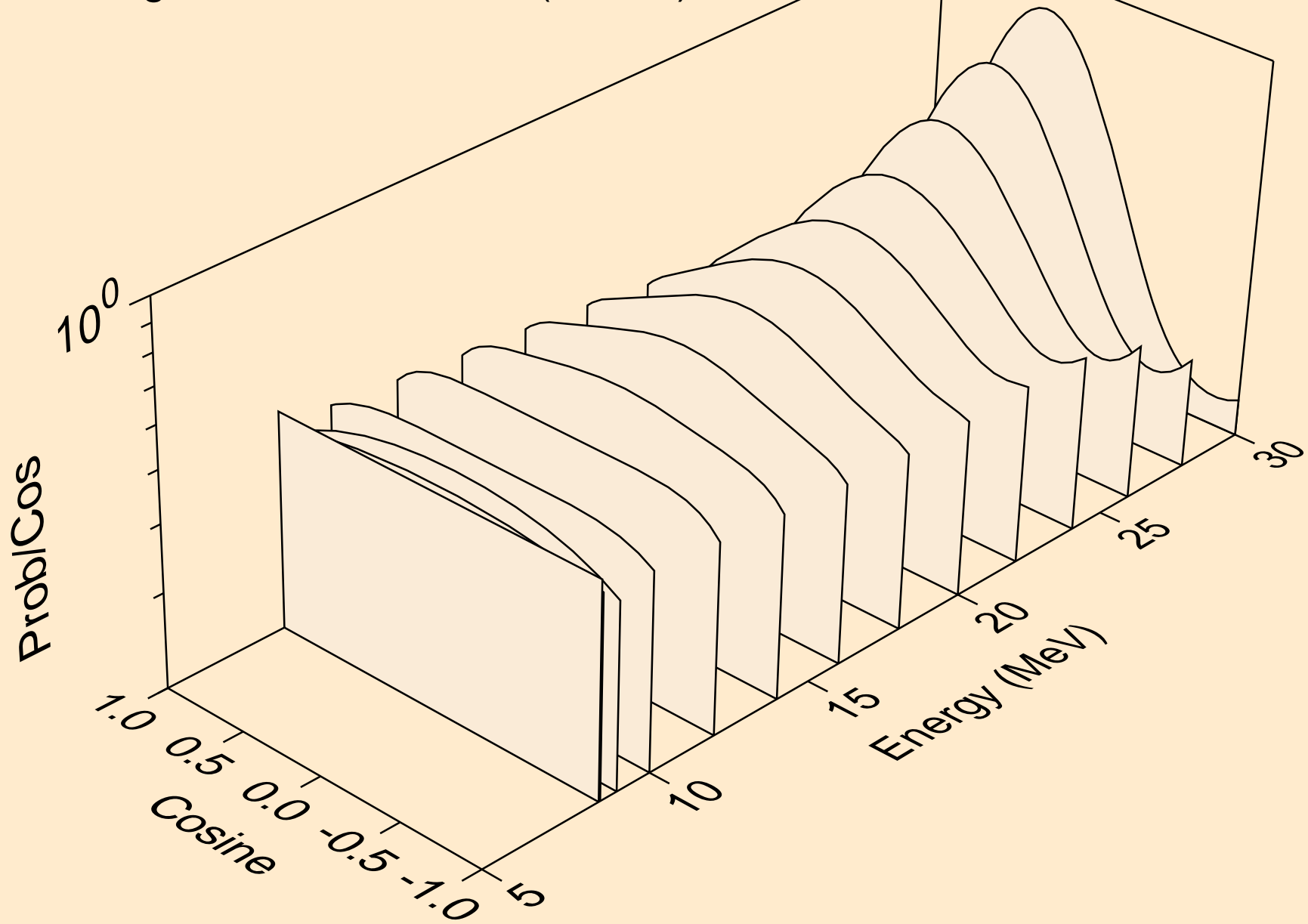

MG024 NEUTRON ACER TENDL-2024 LIBRARY; T=0.K
angular distribution for (n,n*13)

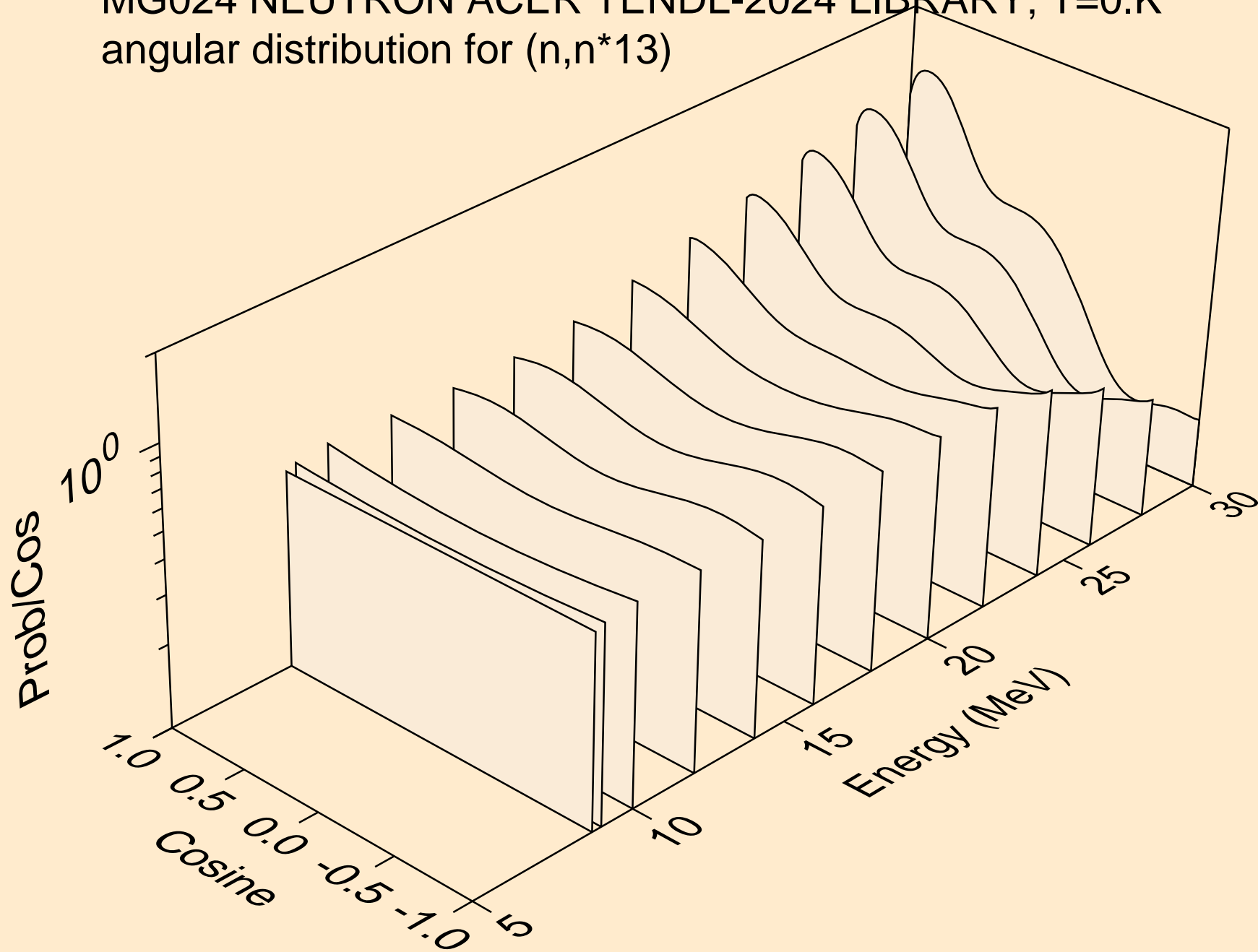

MG024 NEUTRON ACER TENDL-2024 LIBRARY; T=0.K
angular distribution for (n,n*14)

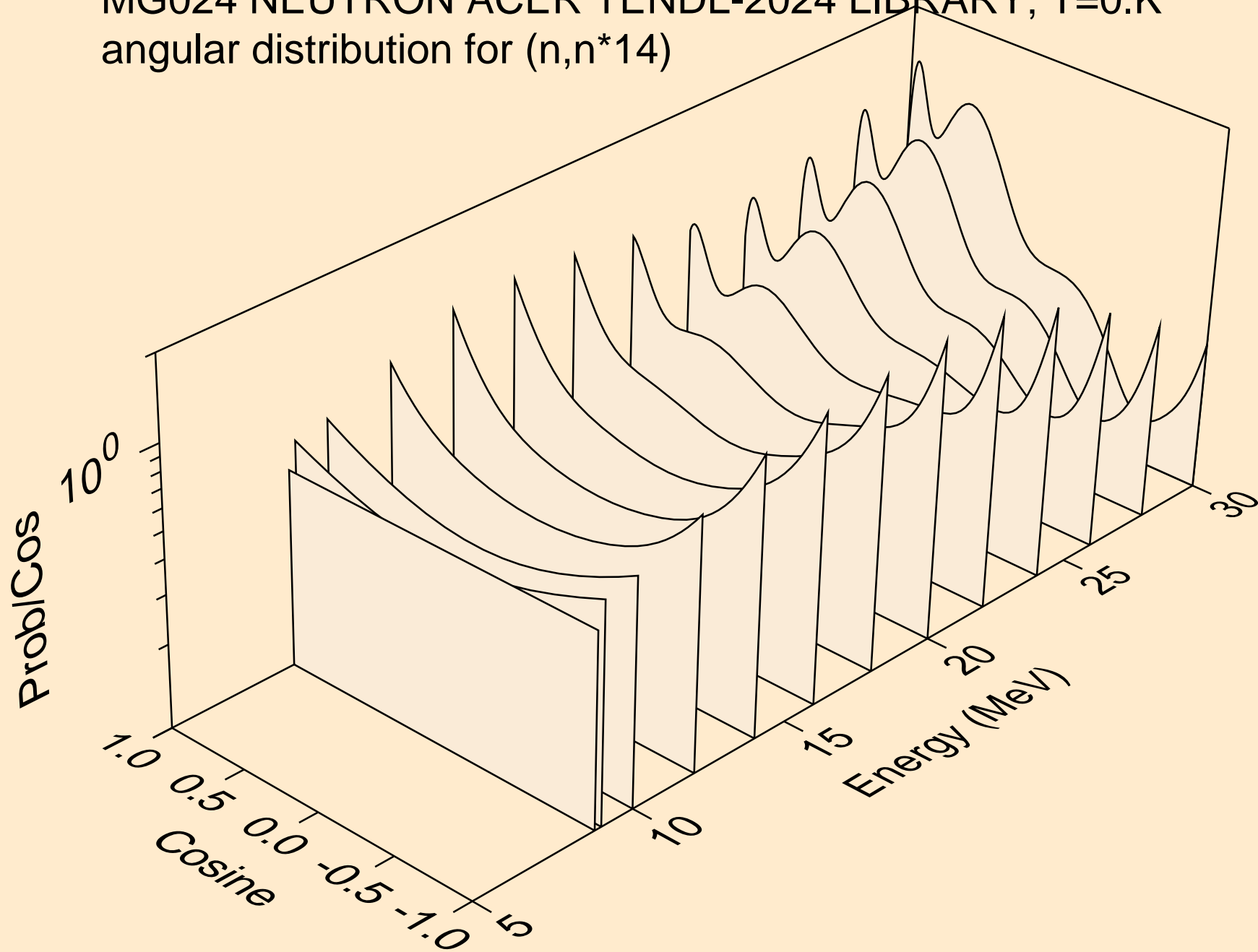

MG024 NEUTRON ACER TENDL-2024 LIBRARY; T=0.K
angular distribution for (n,n*15)

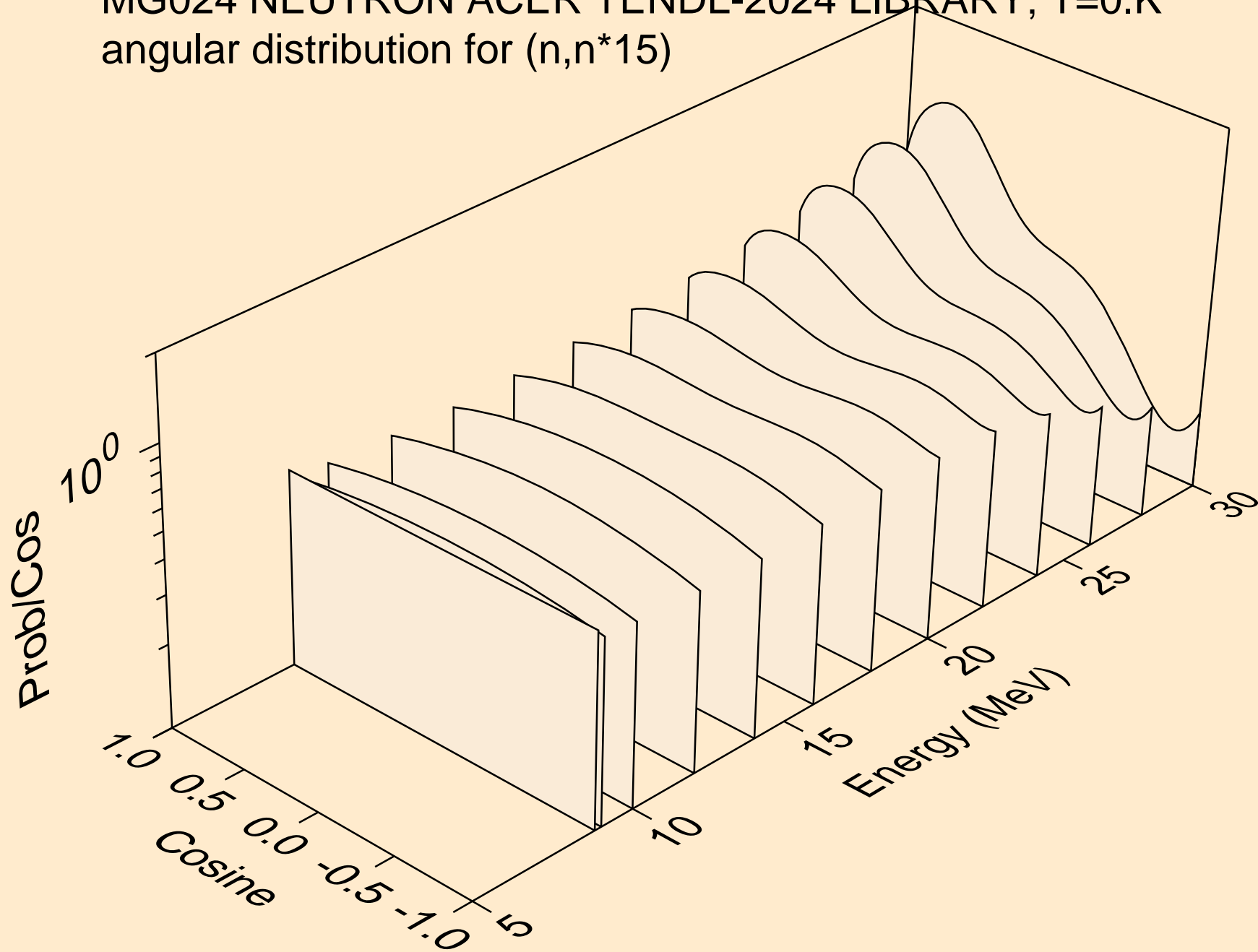

MG024 NEUTRON ACER TENDL-2024 LIBRARY; T=0.K
angular distribution for (n,n*16)

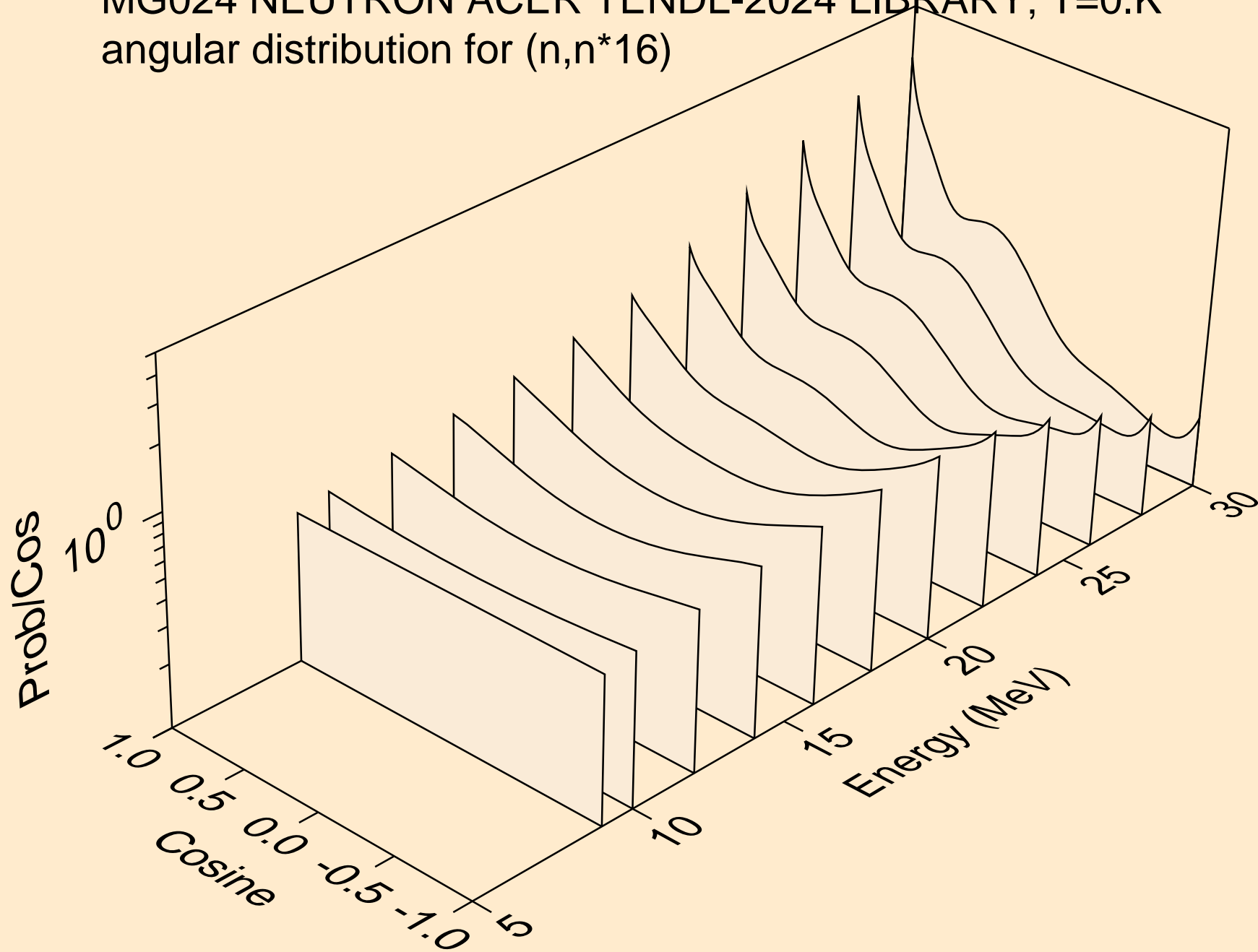

MG024 NEUTRON ACER TENDL-2024 LIBRARY; T=0.K
angular distribution for (n,n*17)

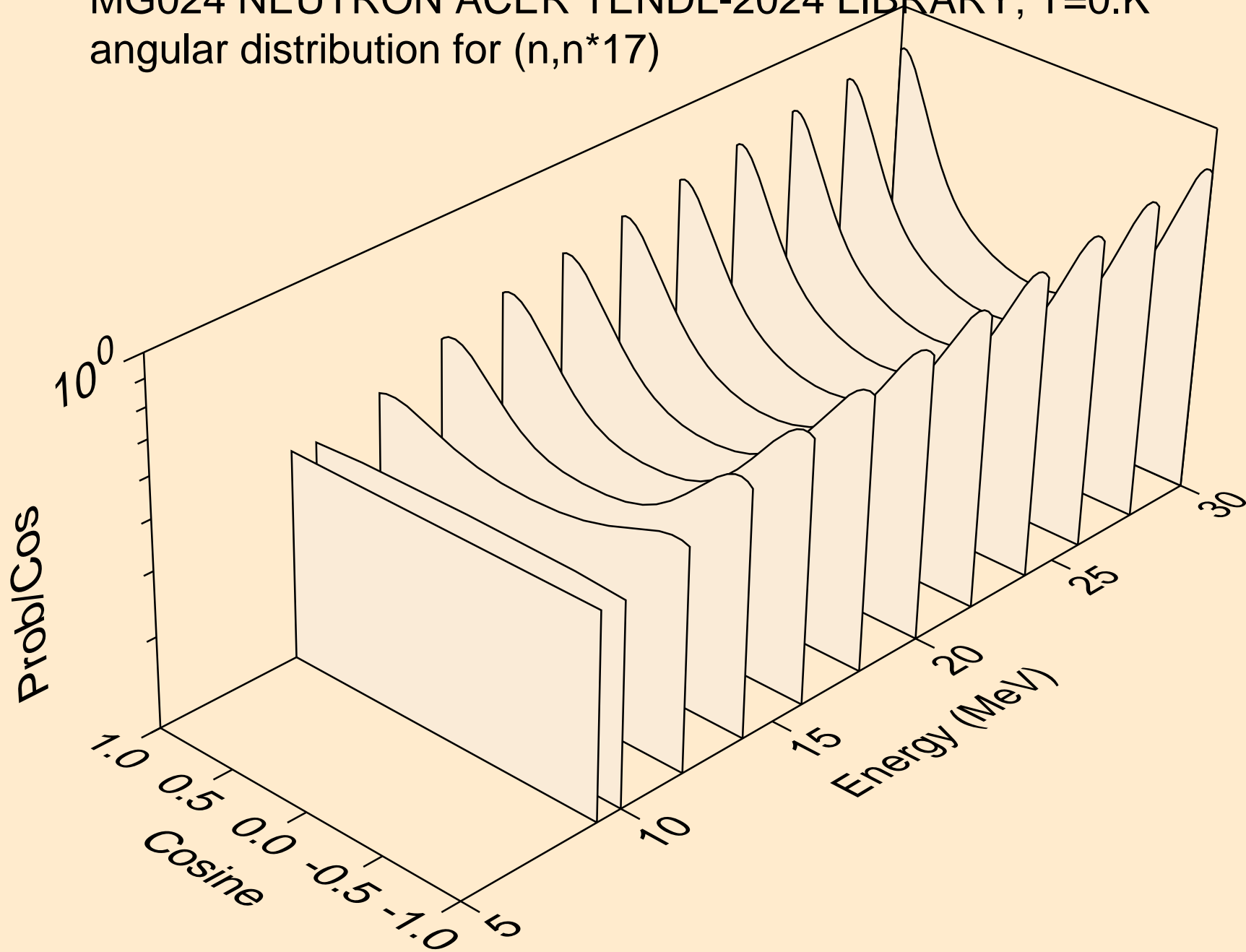

MG024 NEUTRON ACER TENDL-2024 LIBRARY; T=0.K
angular distribution for (n,n*18)

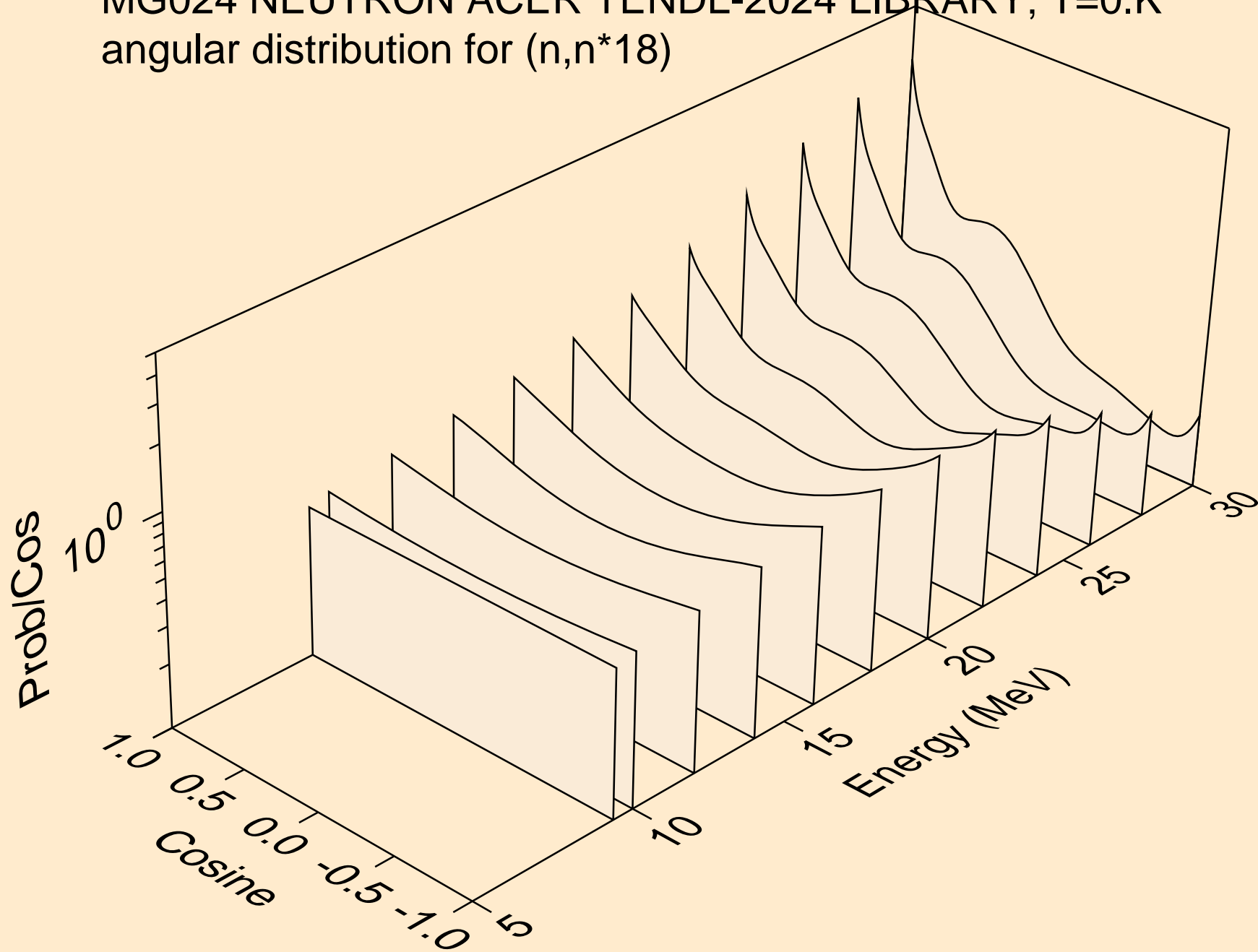

MG024 NEUTRON ACER TENDL-2024 LIBRARY; T=0.K
angular distribution for (n,n*19)

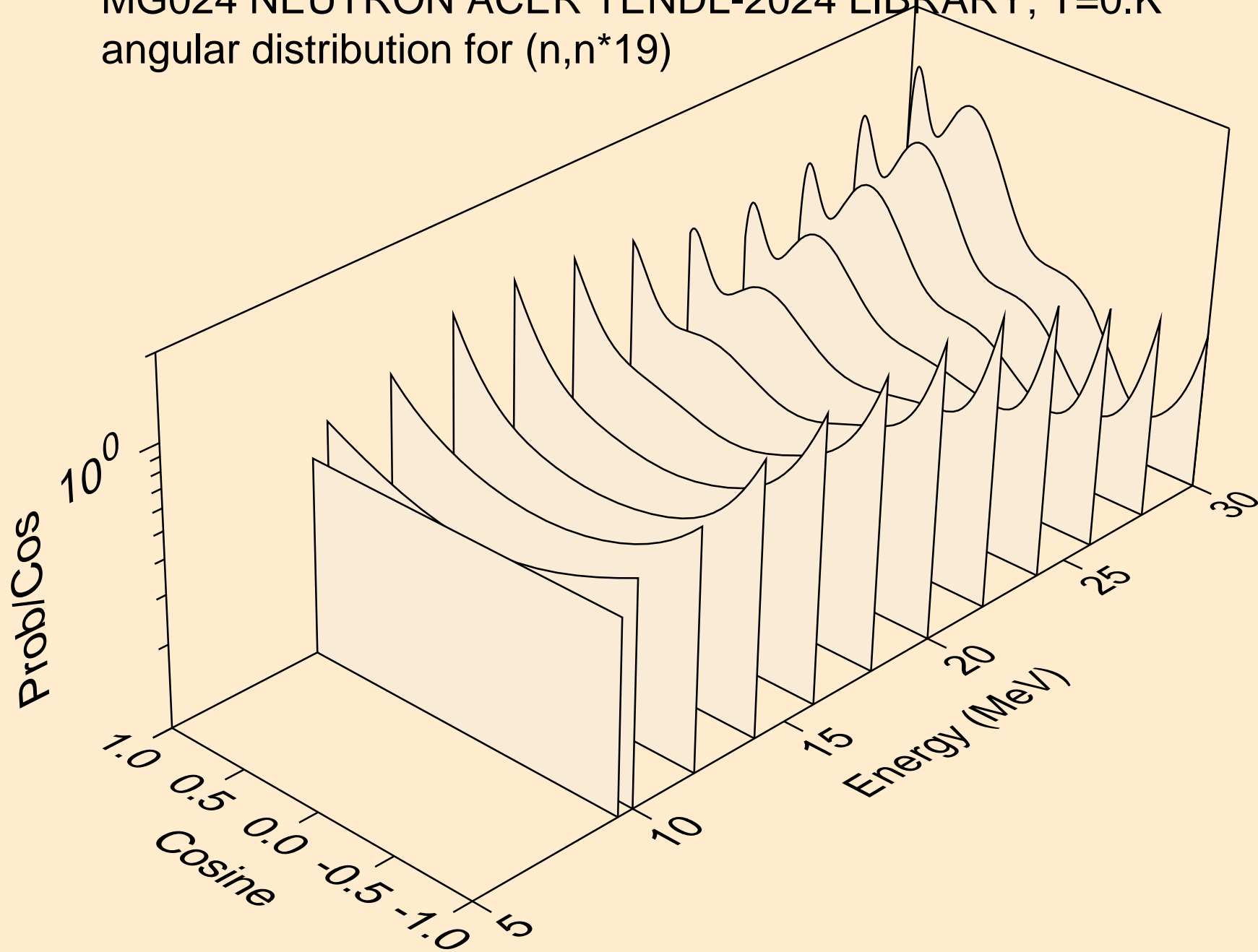

MG024 NEUTRON ACER TENDL-2024 LIBRARY; T=0.K
Neutron emission for (n,x)

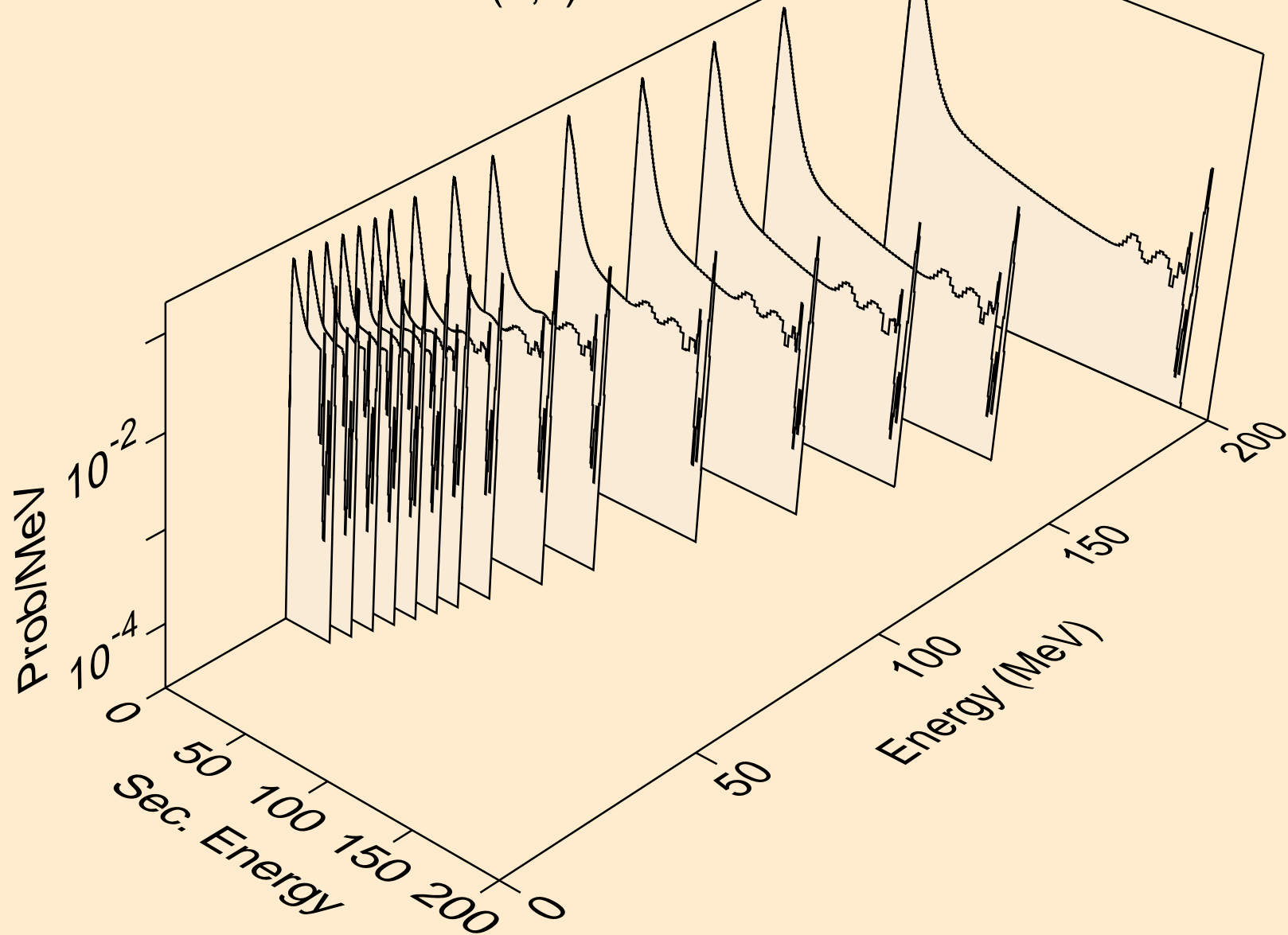

MG024 NEUTRON ACER TENDL-2024 LIBRARY; T=0.K
Neutron emission for (n,2n)

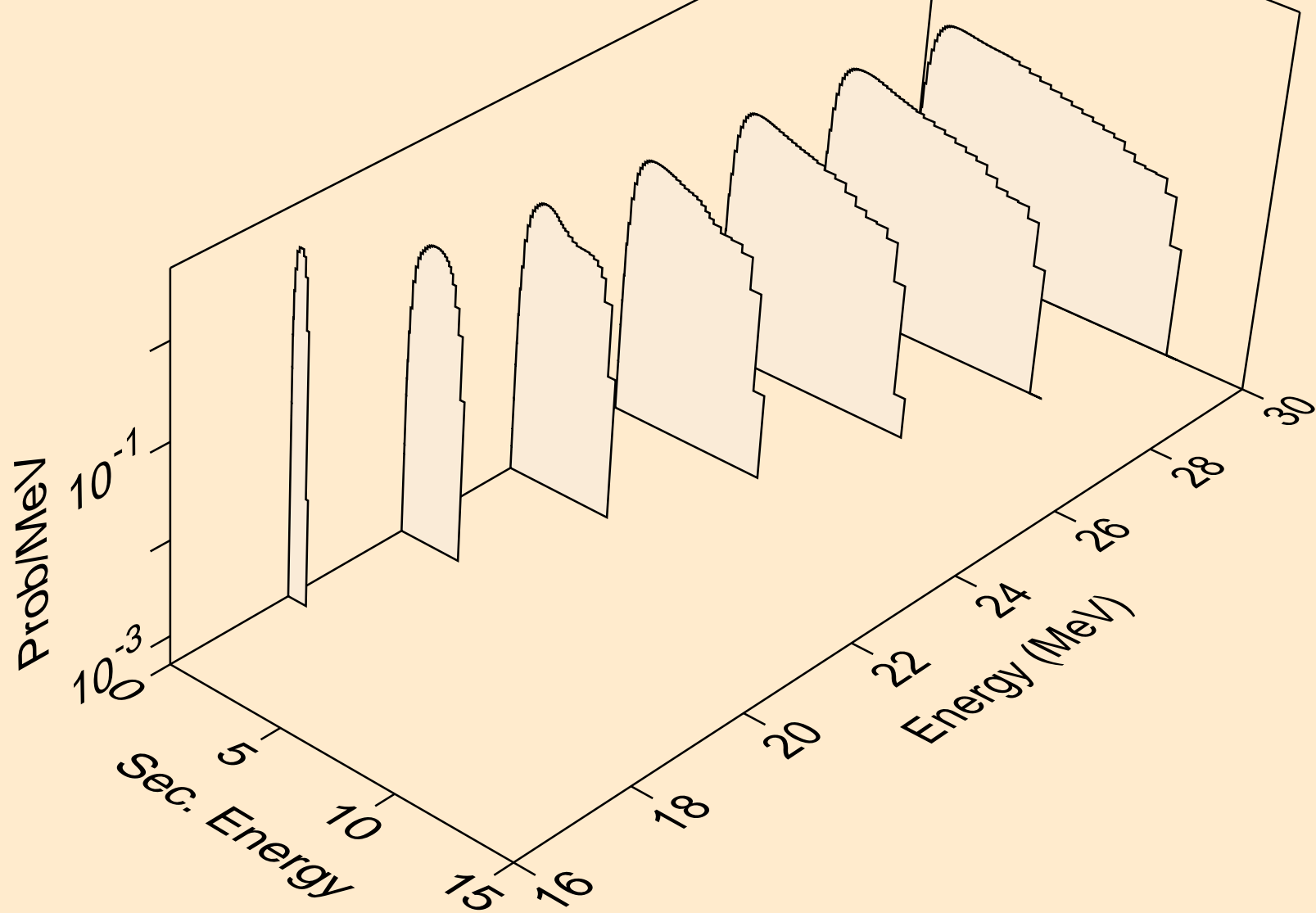

MG024 NEUTRON ACER TENDL-2024 LIBRARY; T=0.K
Neutron emission for (n,n*)a

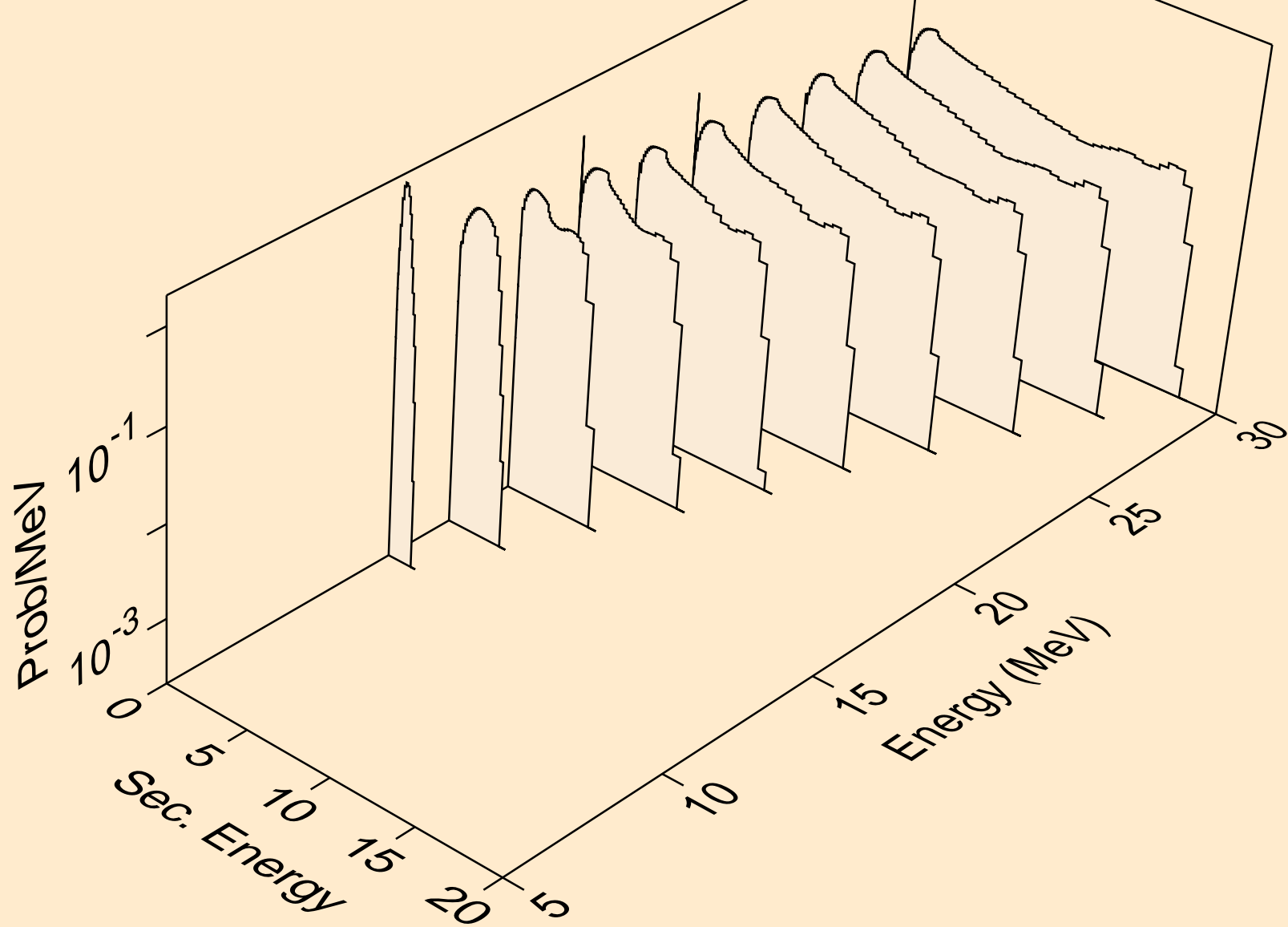

MG024 NEUTRON ACER TENDL-2024 LIBRARY; T=0.K
Neutron emission for (n,2n)a

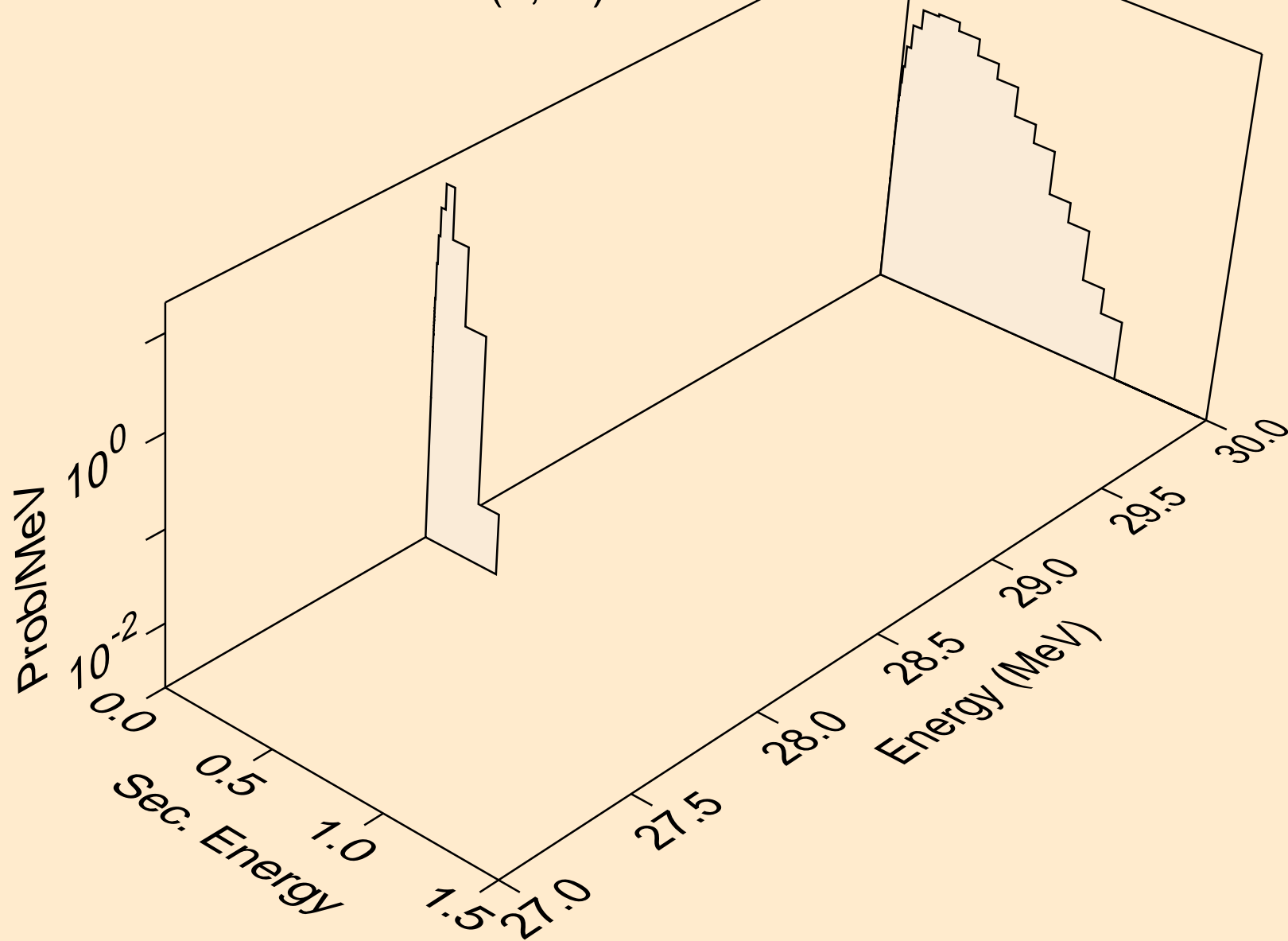

MG024 NEUTRON ACER TENDL-2024 LIBRARY; T=0.K
Neutron emission for (n,n*)p

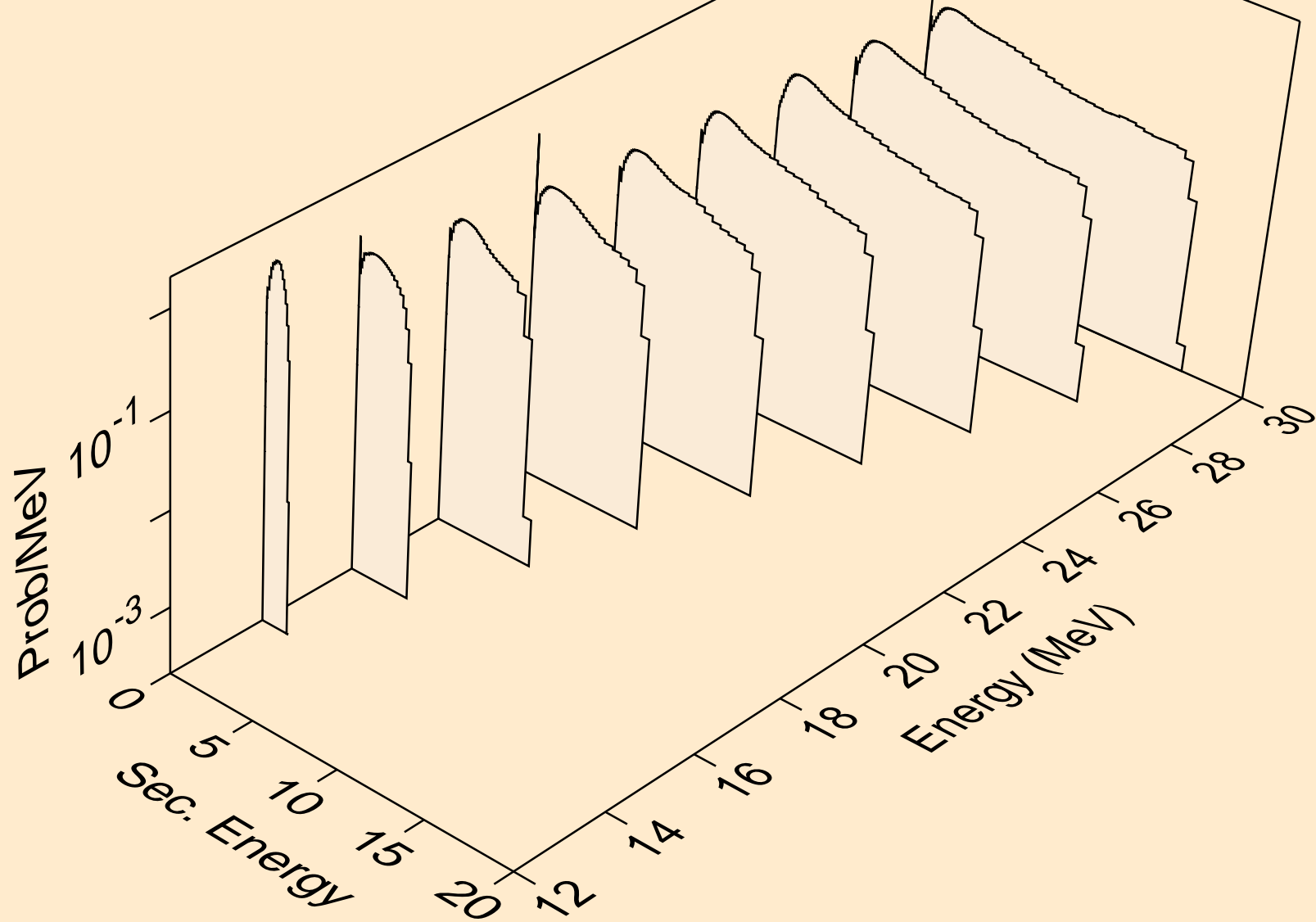

MG024 NEUTRON ACER TENDL-2024 LIBRARY; T=0.K
Neutron emission for (n,n*)2a

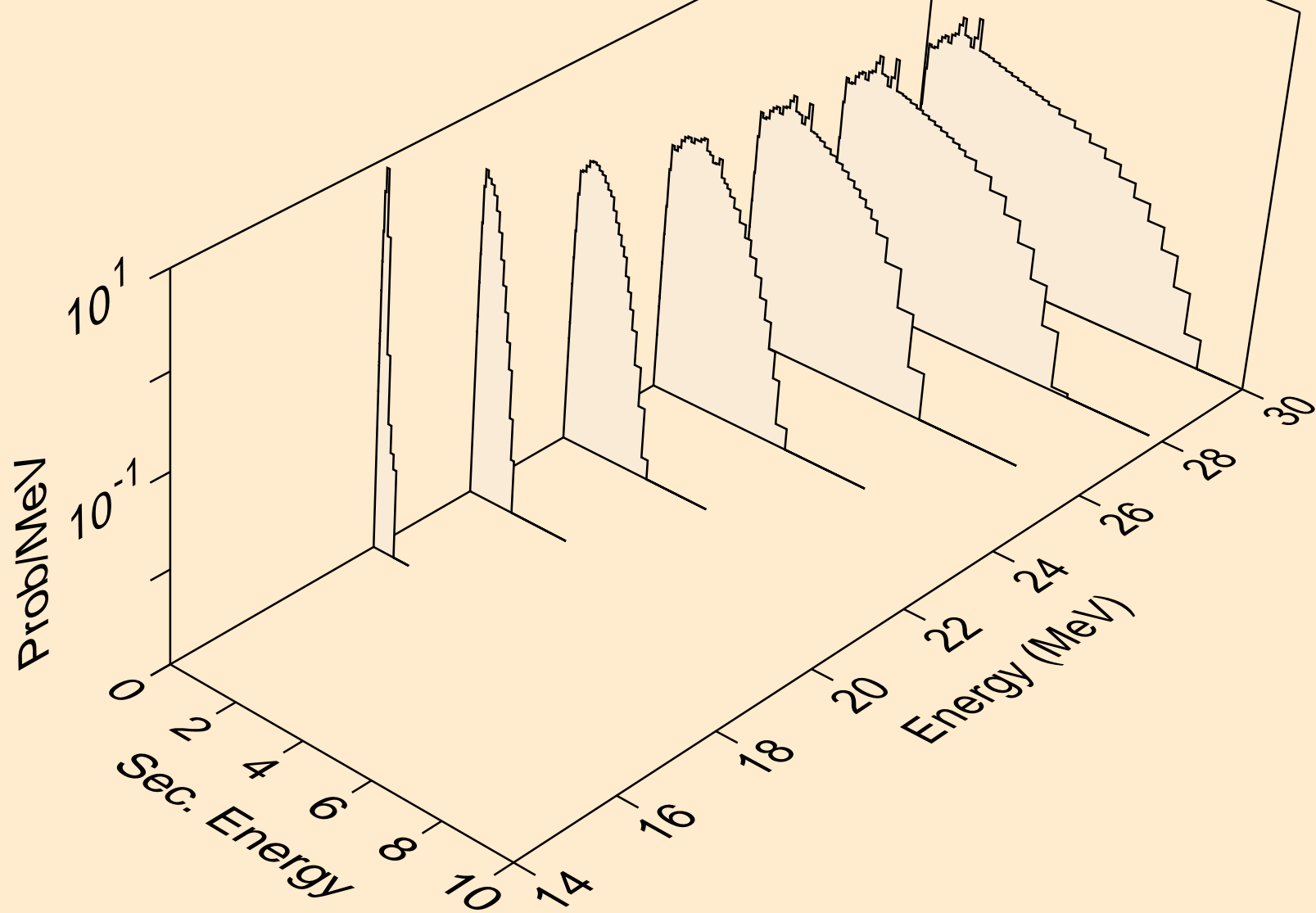

MG024 NEUTRON ACER TENDL-2024 LIBRARY; T=0.K
Neutron emission for (n,n*)d

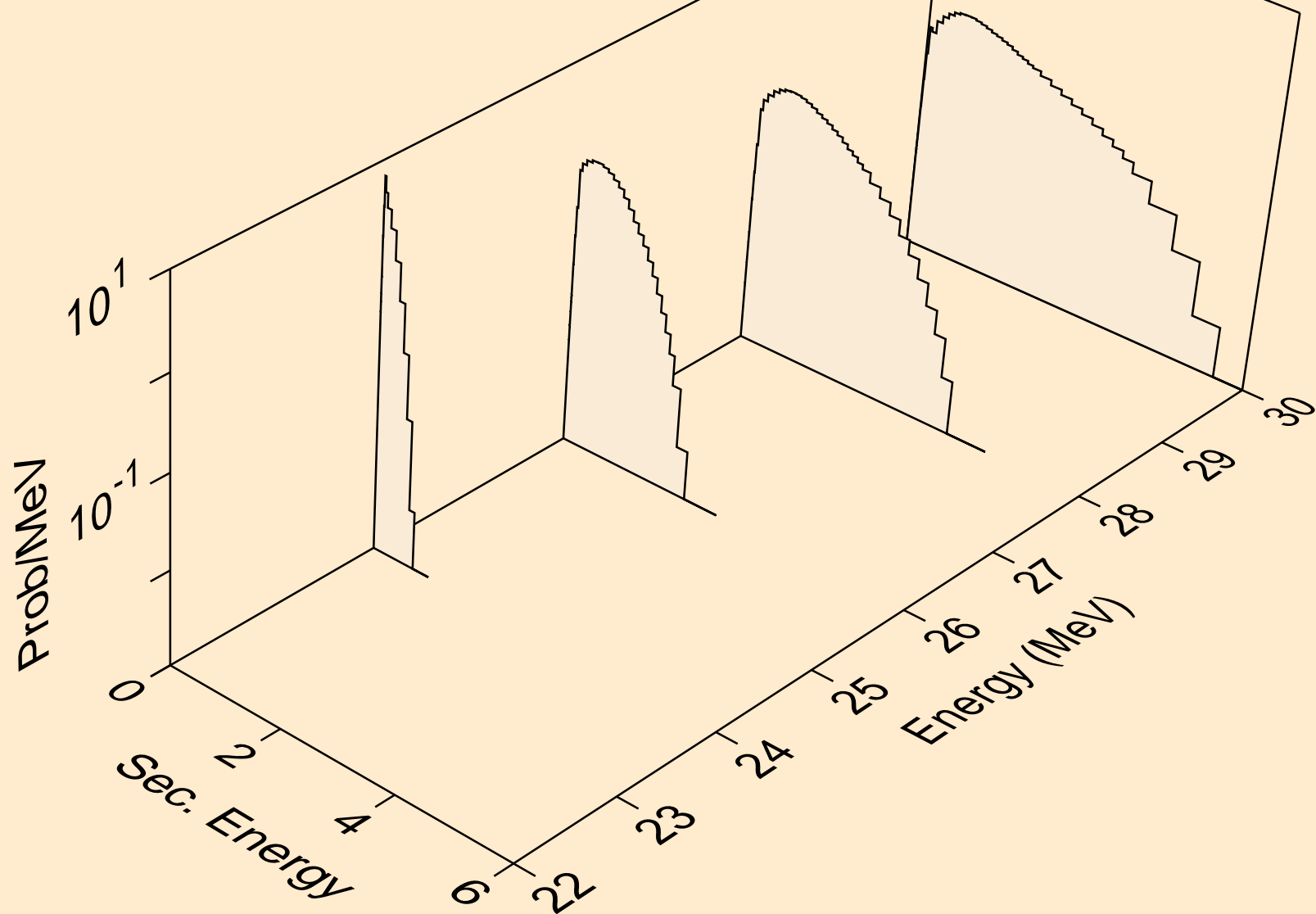

MG024 NEUTRON ACER TENDL-2024 LIBRARY; T=0.K
Neutron emission for (n,n*)t

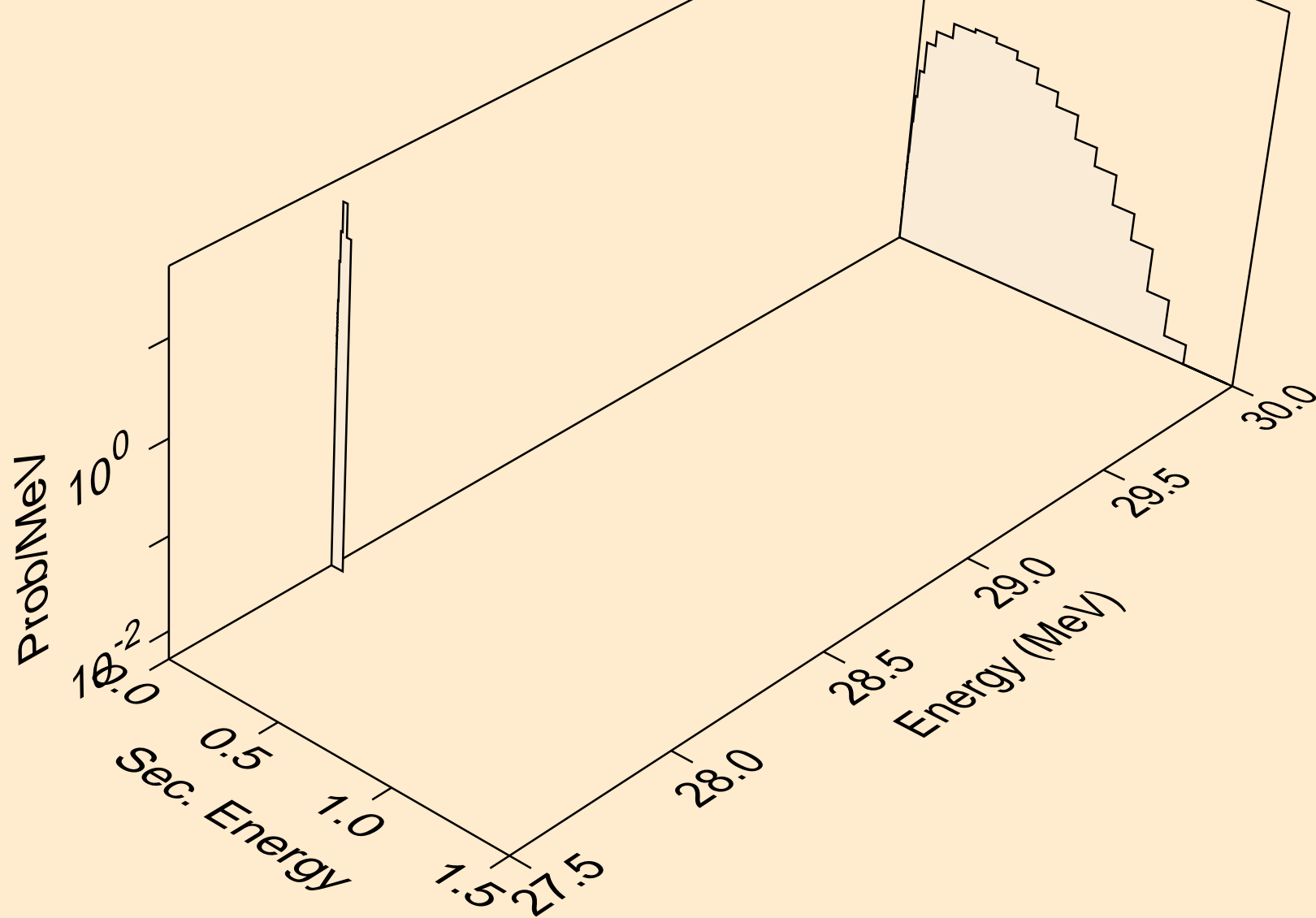

MG024 NEUTRON ACER TENDL-2024 LIBRARY; T=0.K
Neutron emission for (n,n*)he3

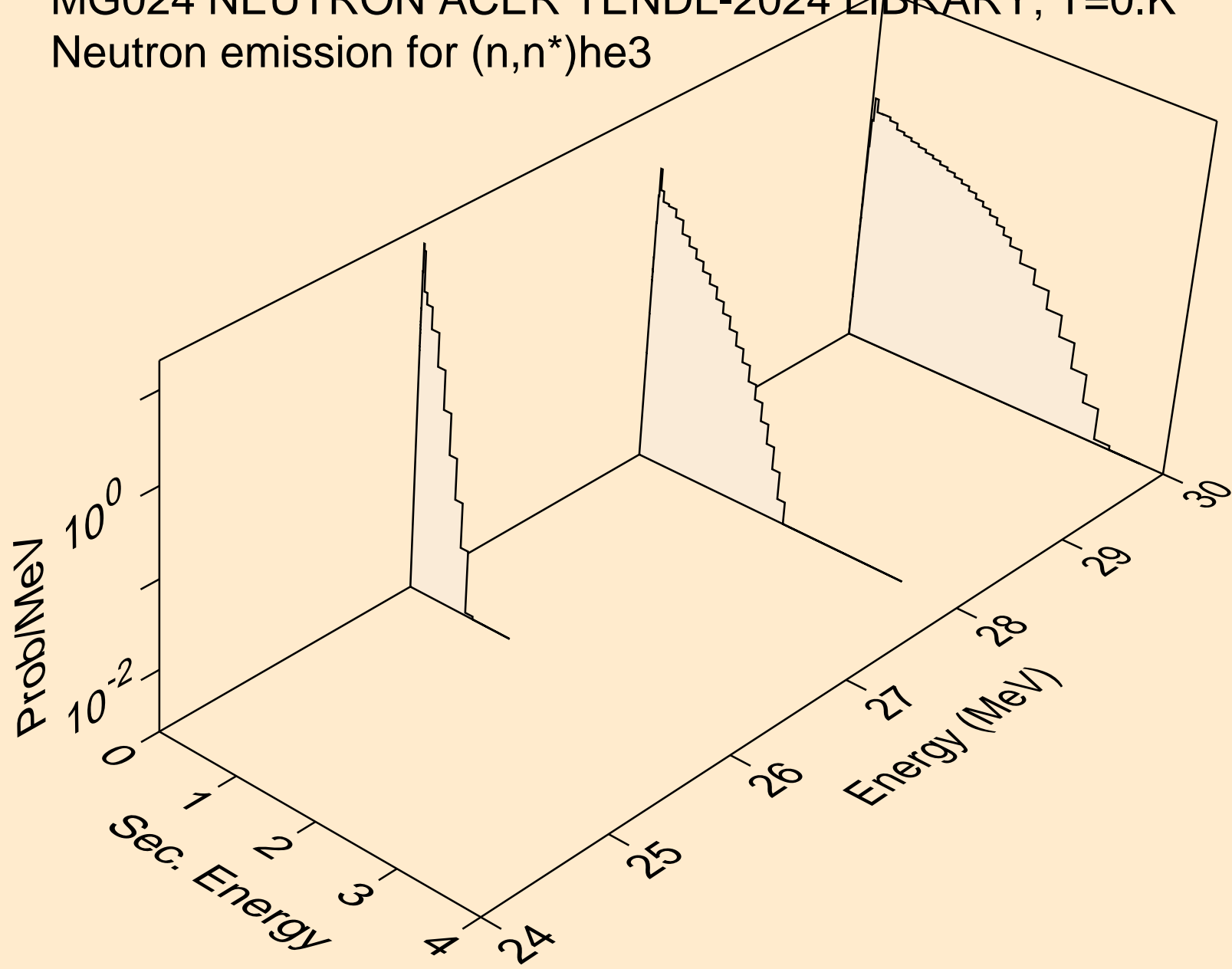

MG024 NEUTRON ACER TENDL-2024 LIBRARY; T=0.K
Neutron emission for (n,2np)

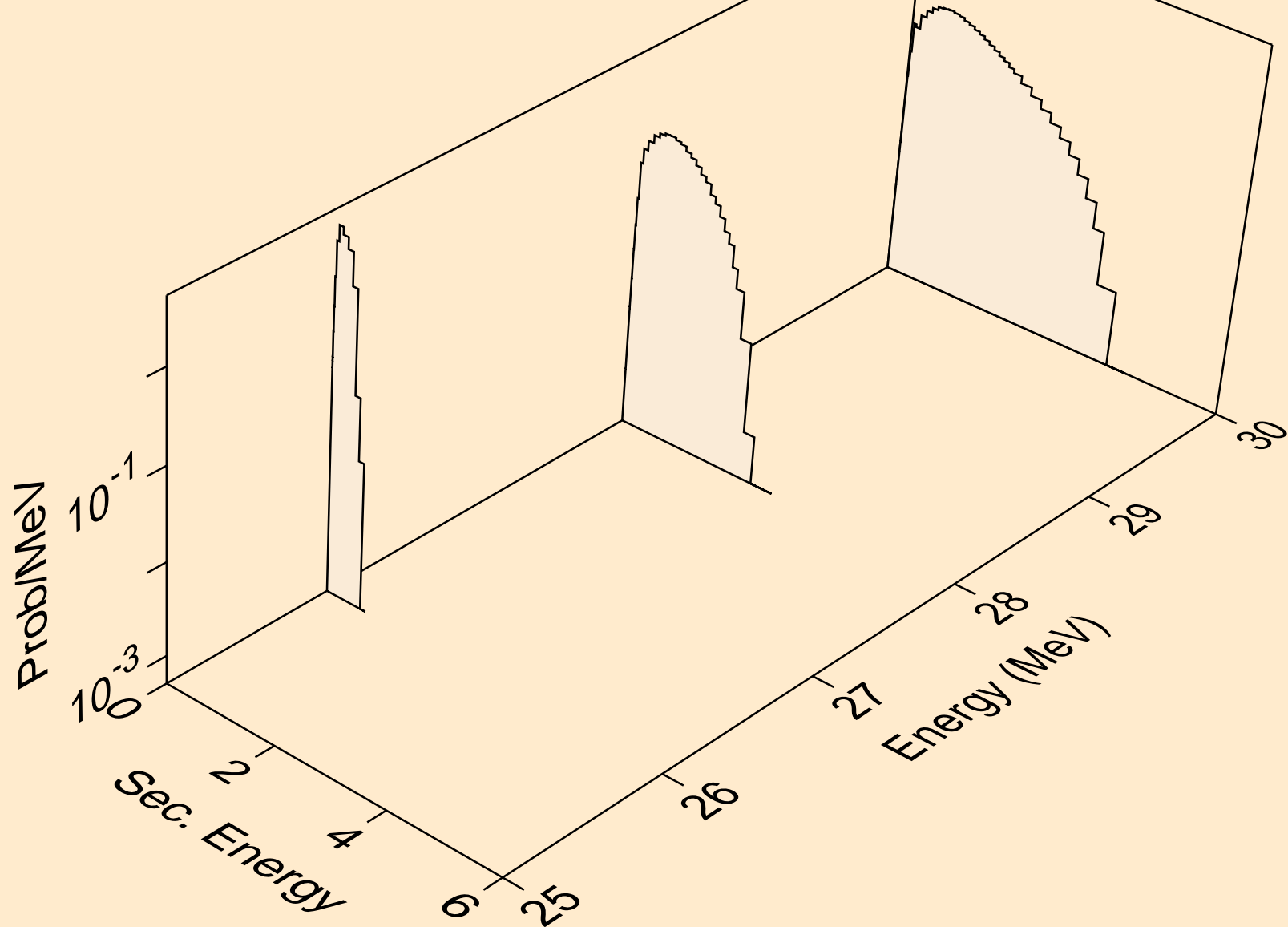

MG024 NEUTRON ACER TENDL-2024 LIBRARY; T=0.K
Neutron emission for (n,n2p)

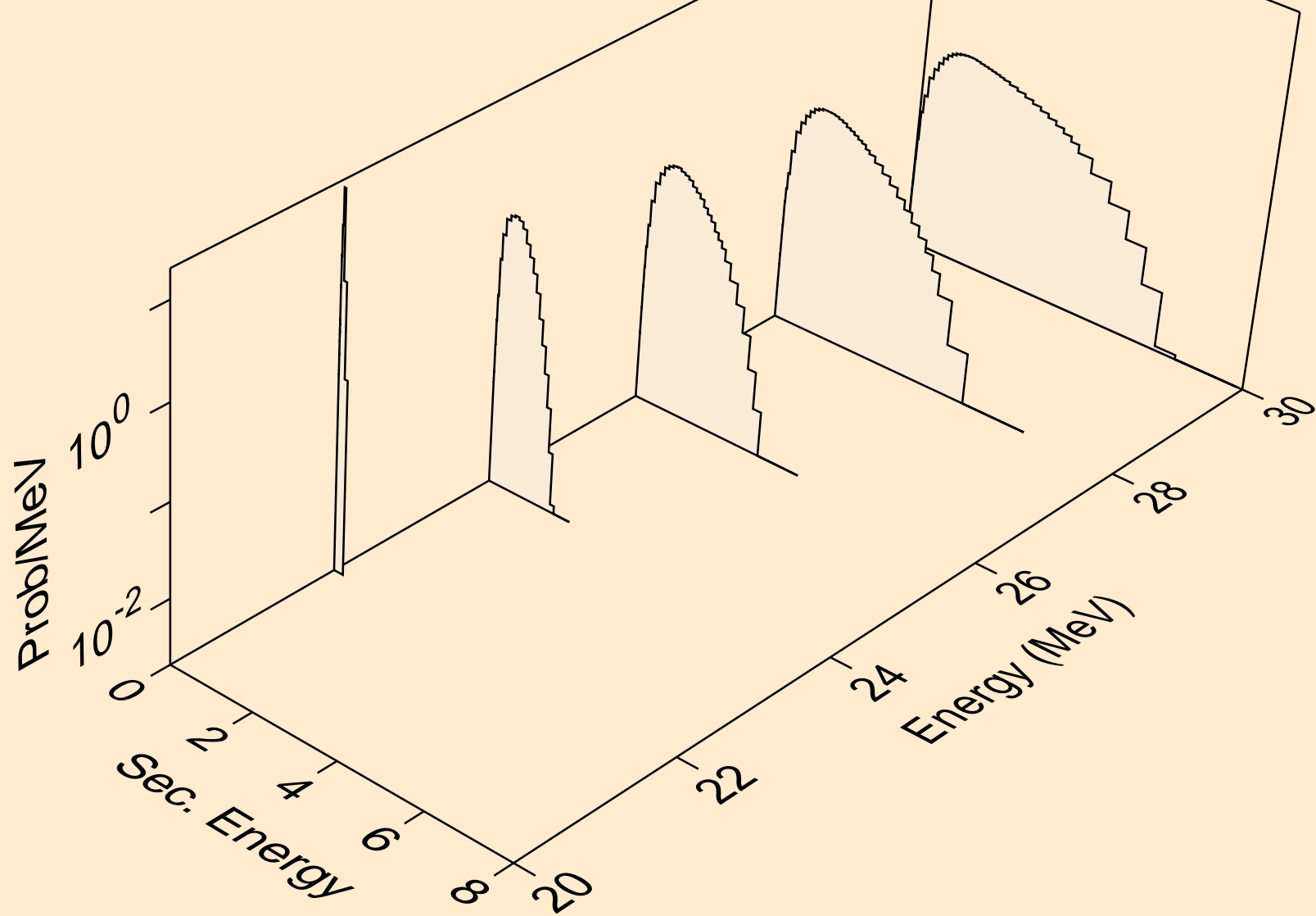

MG024 NEUTRON ACER TENDL-2024 LIBRARY; T=0.K
Neutron emission for (n,npa)

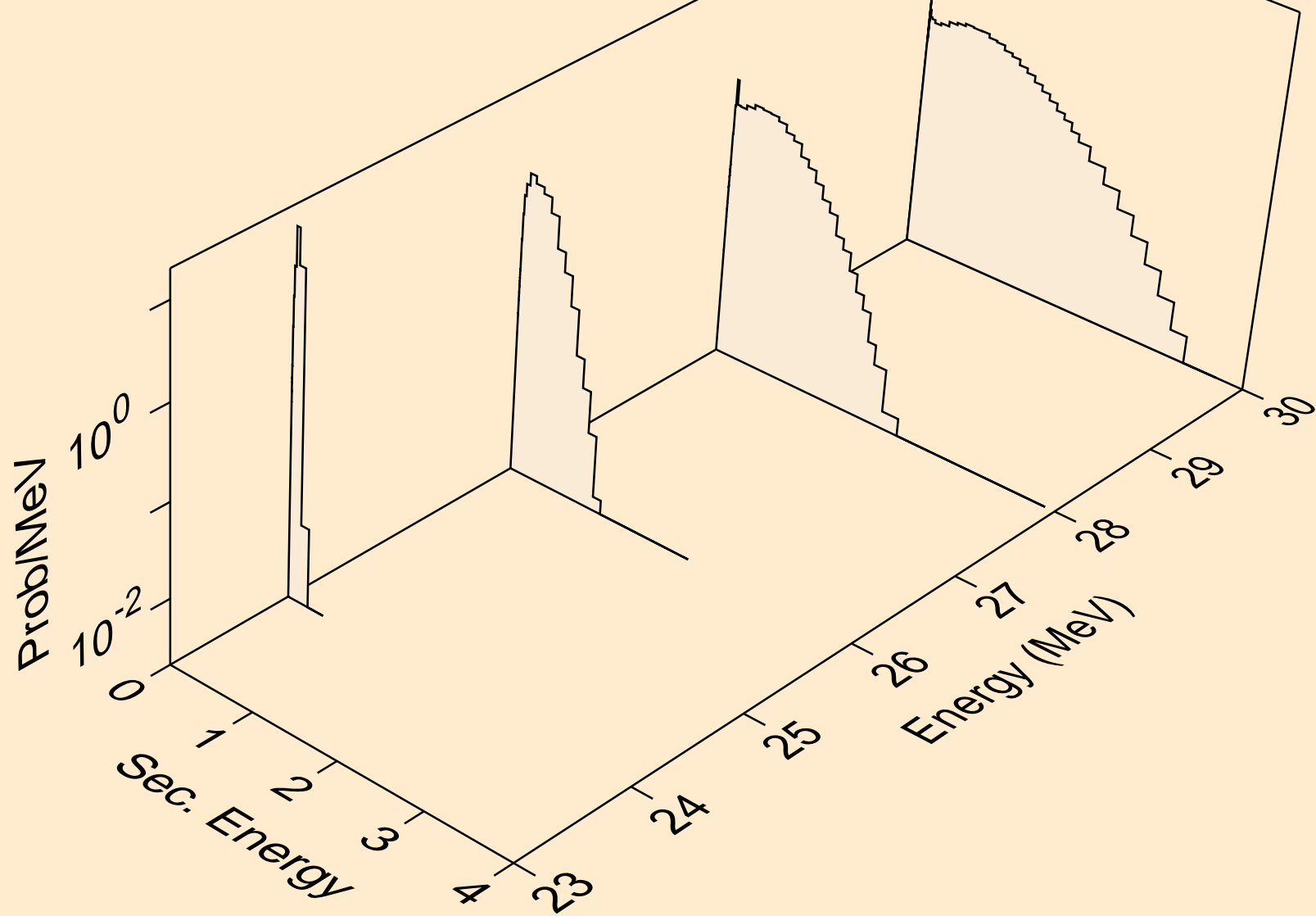

MG024 NEUTRON ACER TENDL-2024 LIBRARY; T=0.K
Neutron emission for (n,n*c)

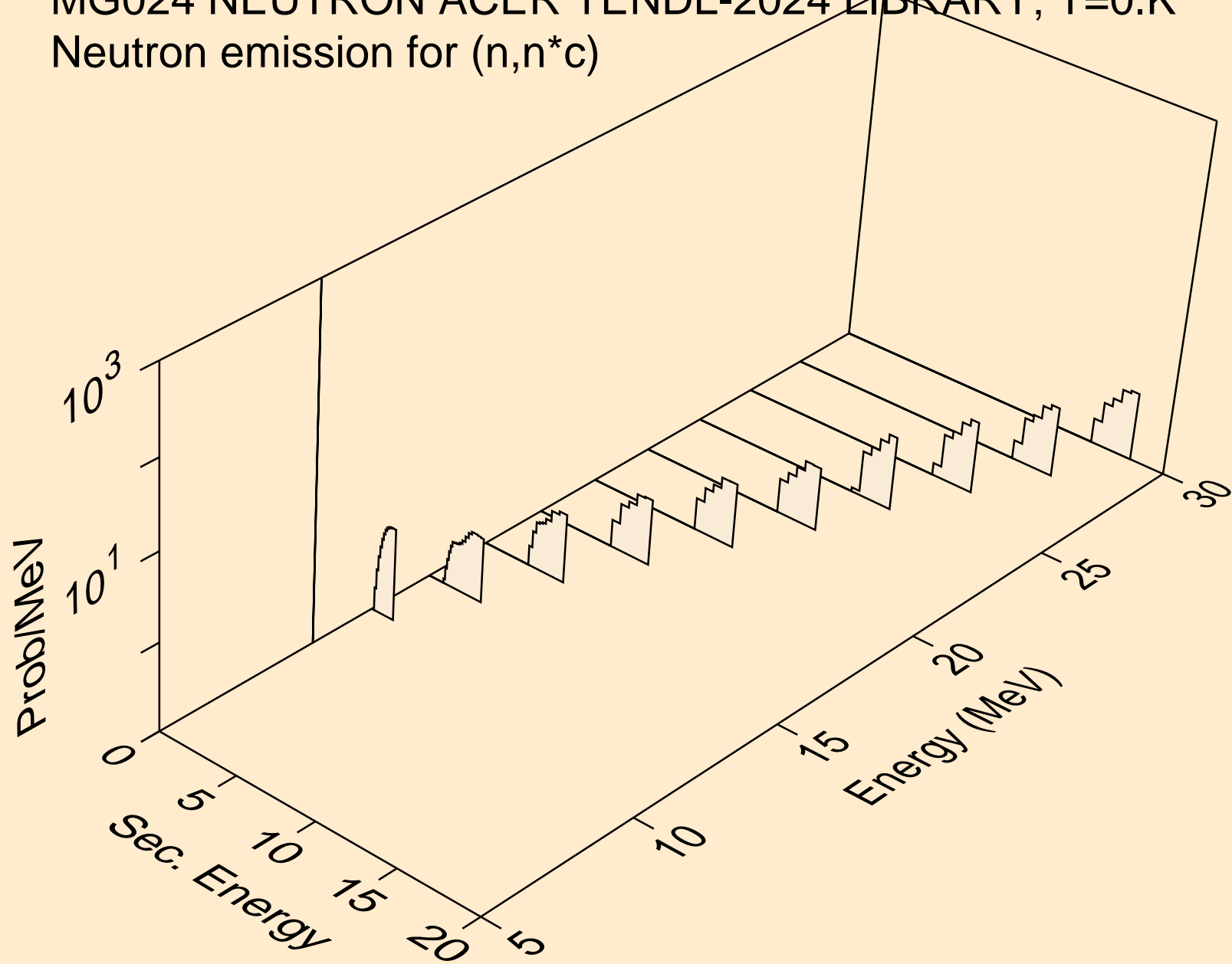

MG024 NEUTRON ACER TENDL-2024 LIBRARY; T=0.K
Photon emission for (n,x)

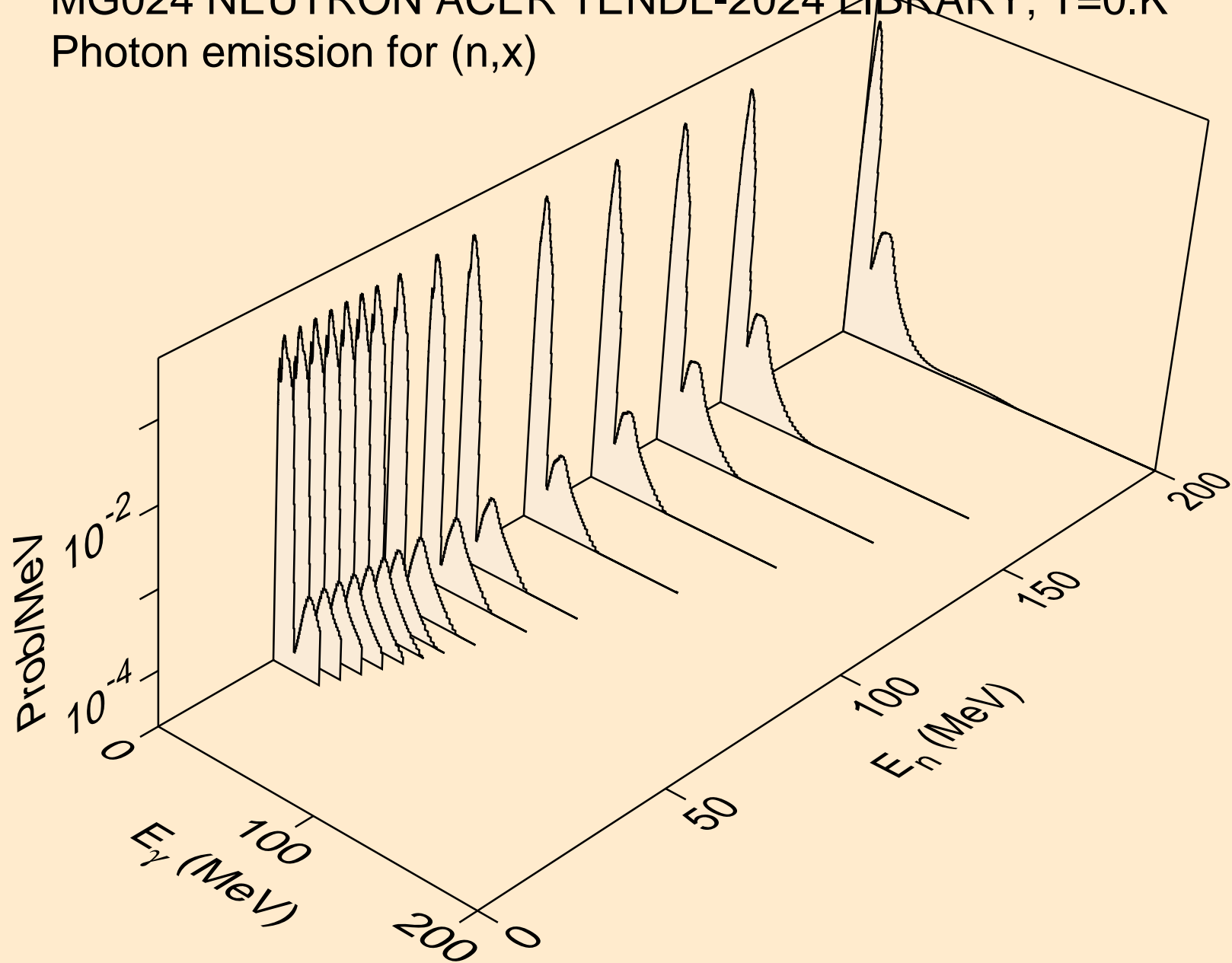

MG024 NEUTRON ACER TENDL-2024 LIBRARY; T=0.K
Photon emission for (n,2n)

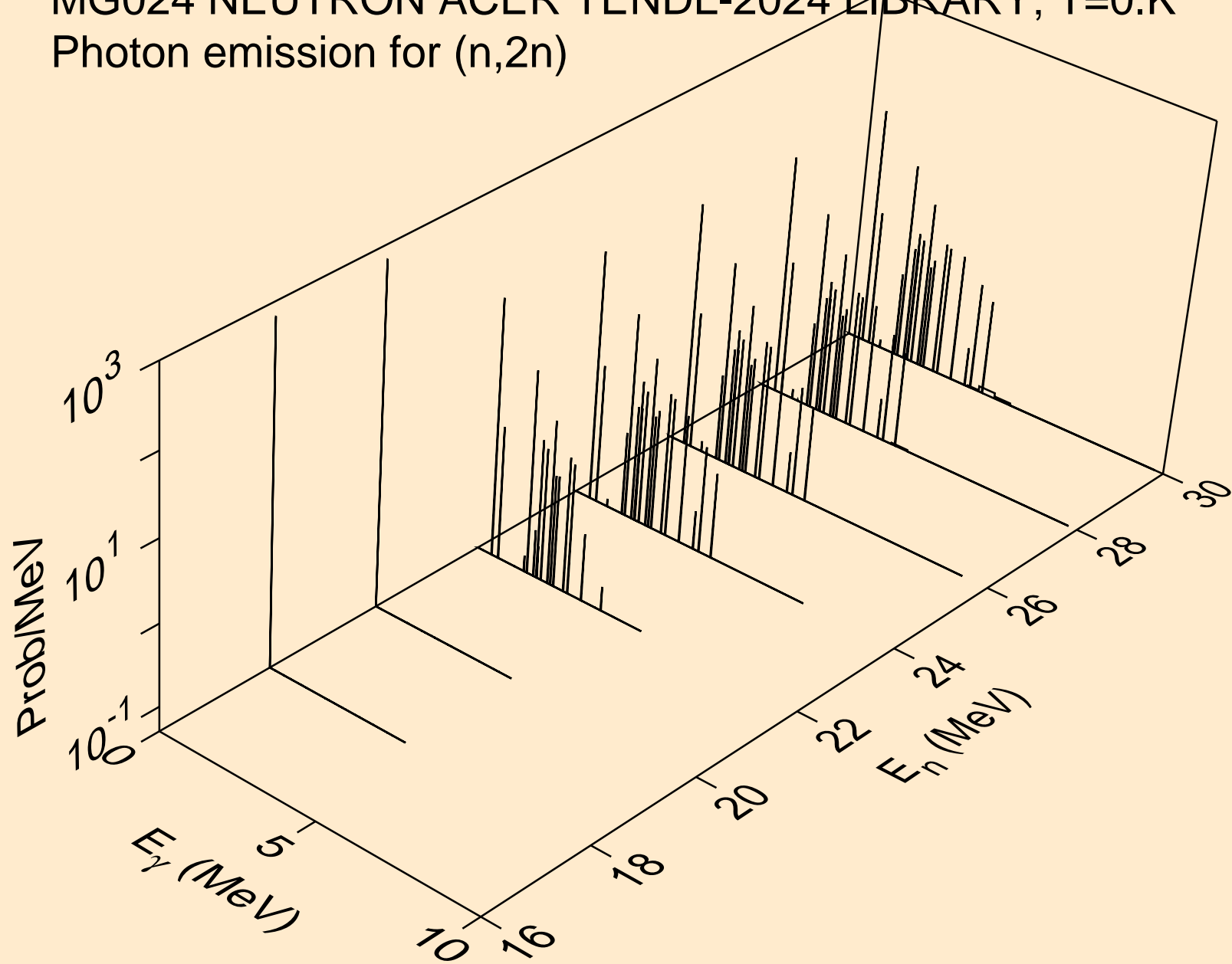

MG024 NEUTRON ACER TENDL-2024 LIBRARY; T=0.K
Photon emission for (n,n*)a

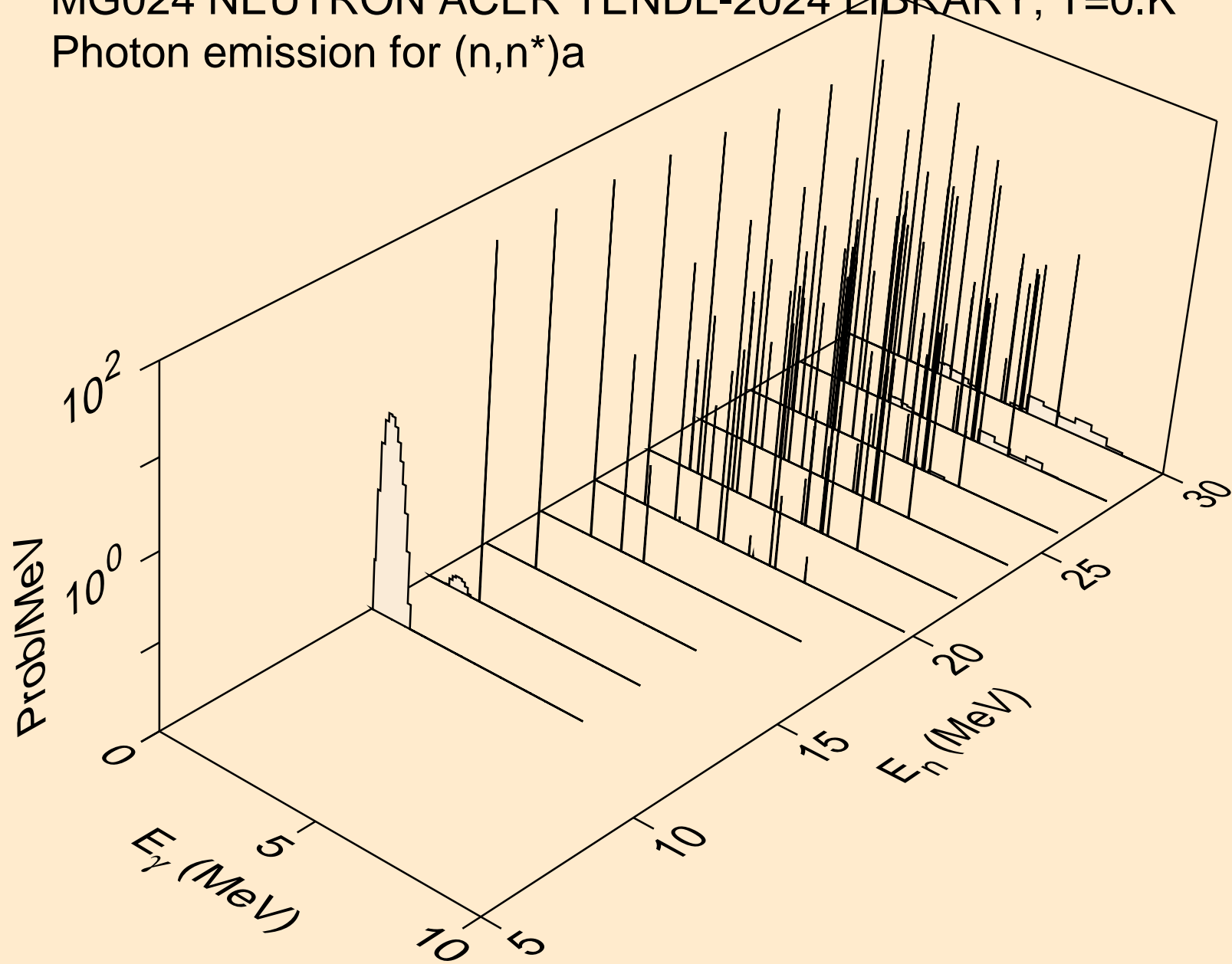

MG024 NEUTRON ACER TENDL-2024 LIBRARY; T=0.K
Photon emission for (n,2n)a

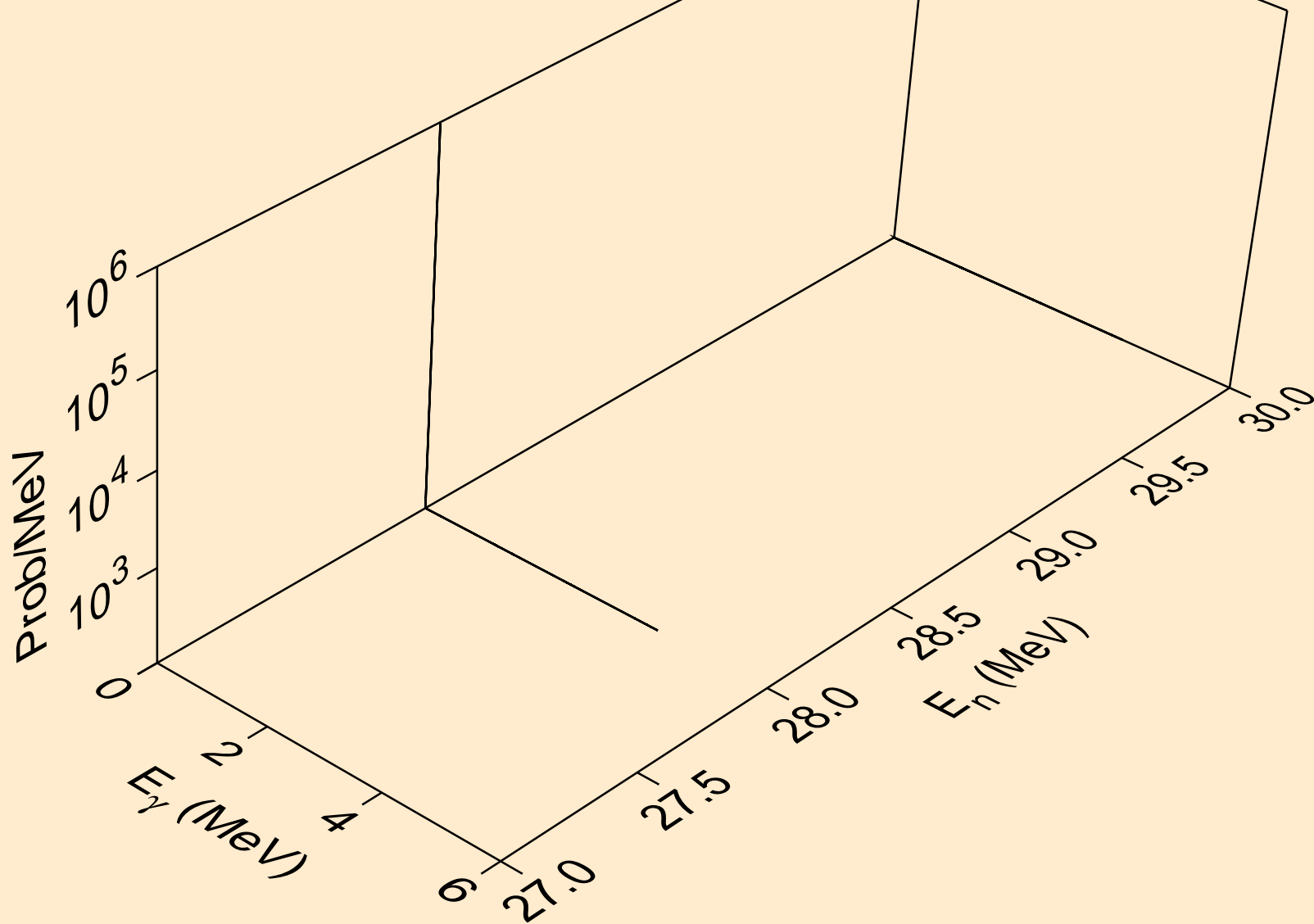

MG024 NEUTRON ACER TENDL-2024 LIBRARY; T=0.K
Photon emission for (n,n*)p

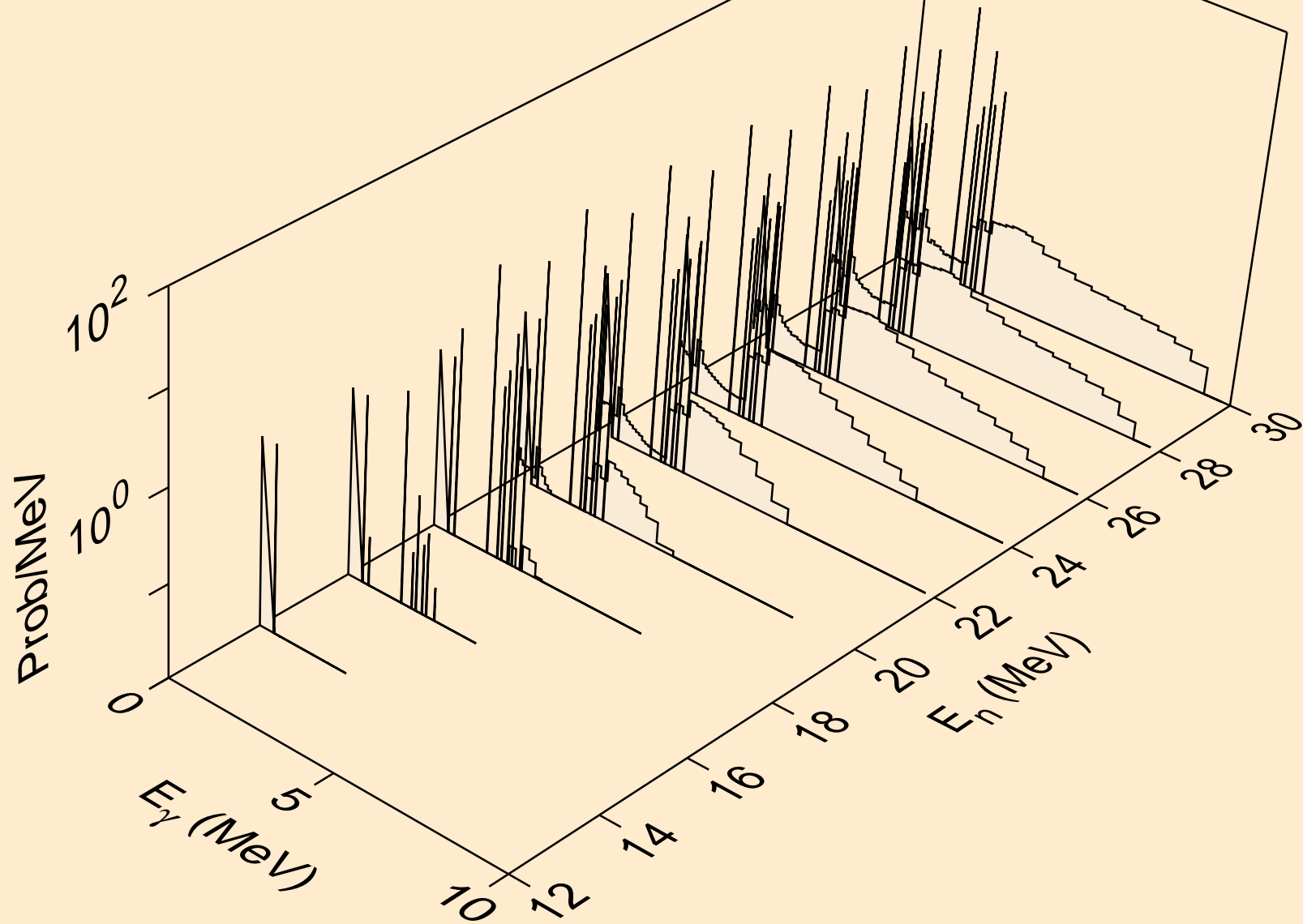

MG024 NEUTRON ACER TENDL-2024 LIBRARY; T=0.K
Photon emission for (n,n*)2a

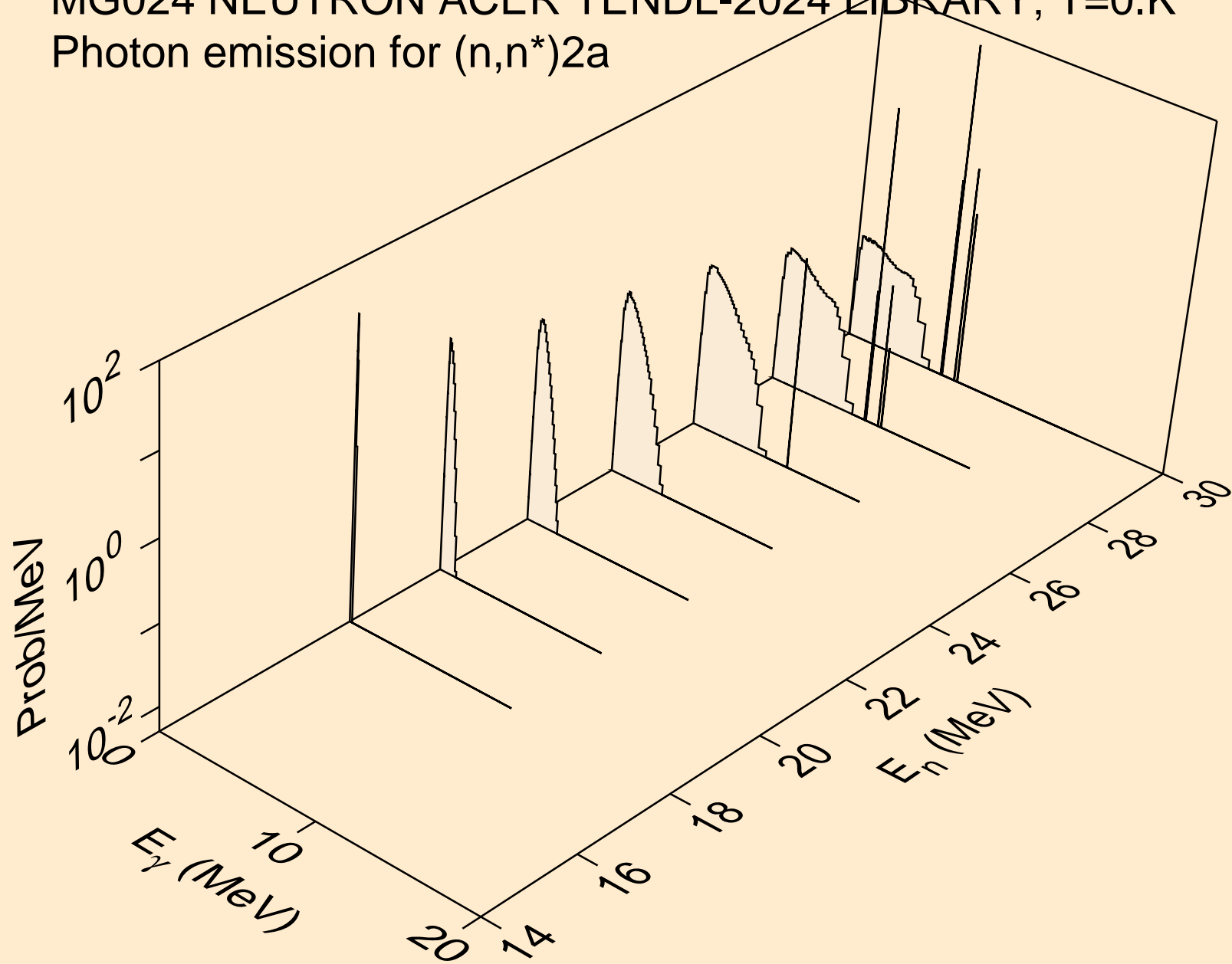

MG024 NEUTRON ACER TENDL-2024 LIBRARY; T=0.K
Photon emission for (n,n*)d

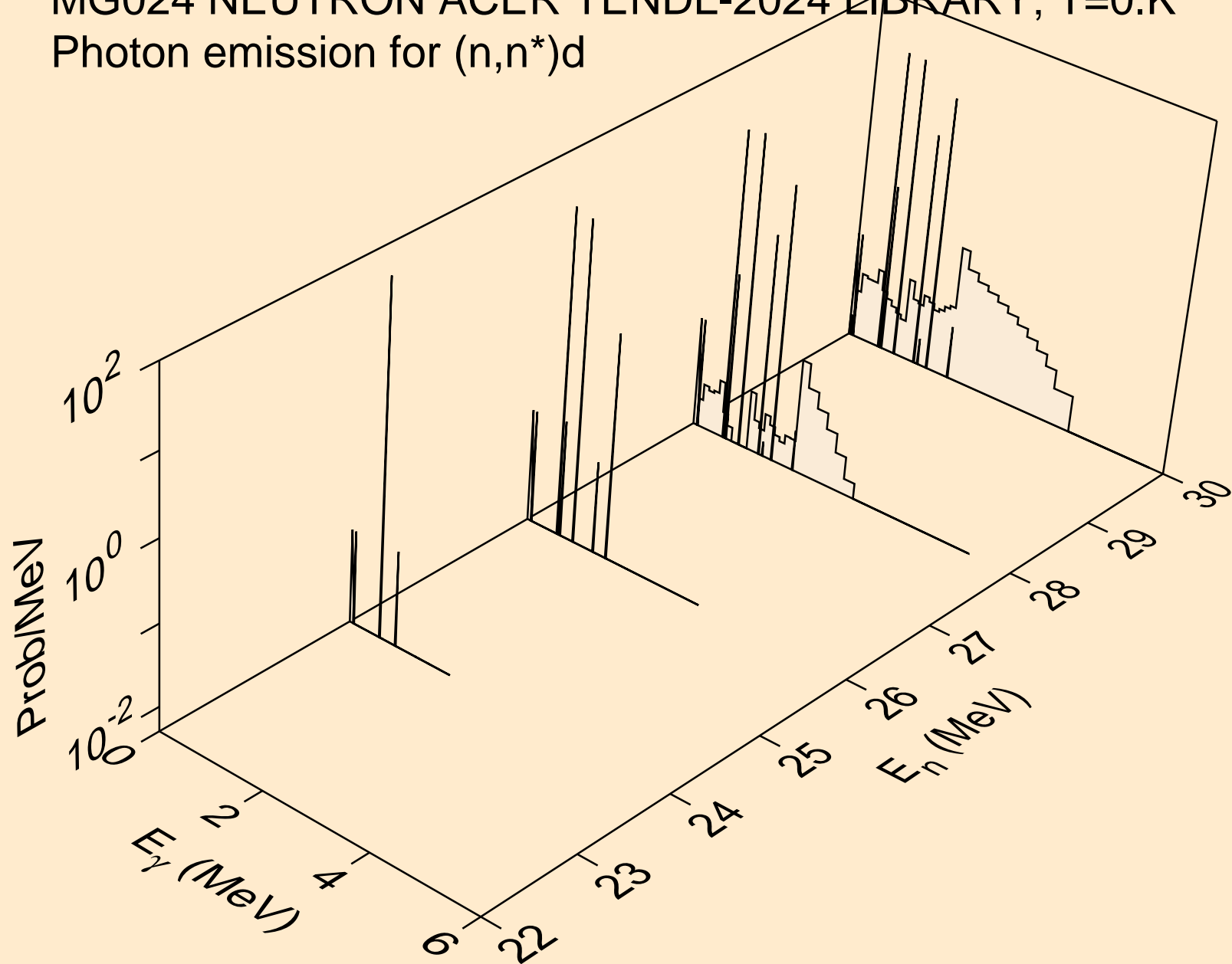

MG024 NEUTRON ACER TENDL-2024 LIBRARY; T=0.K
Photon emission for (n,n*)t

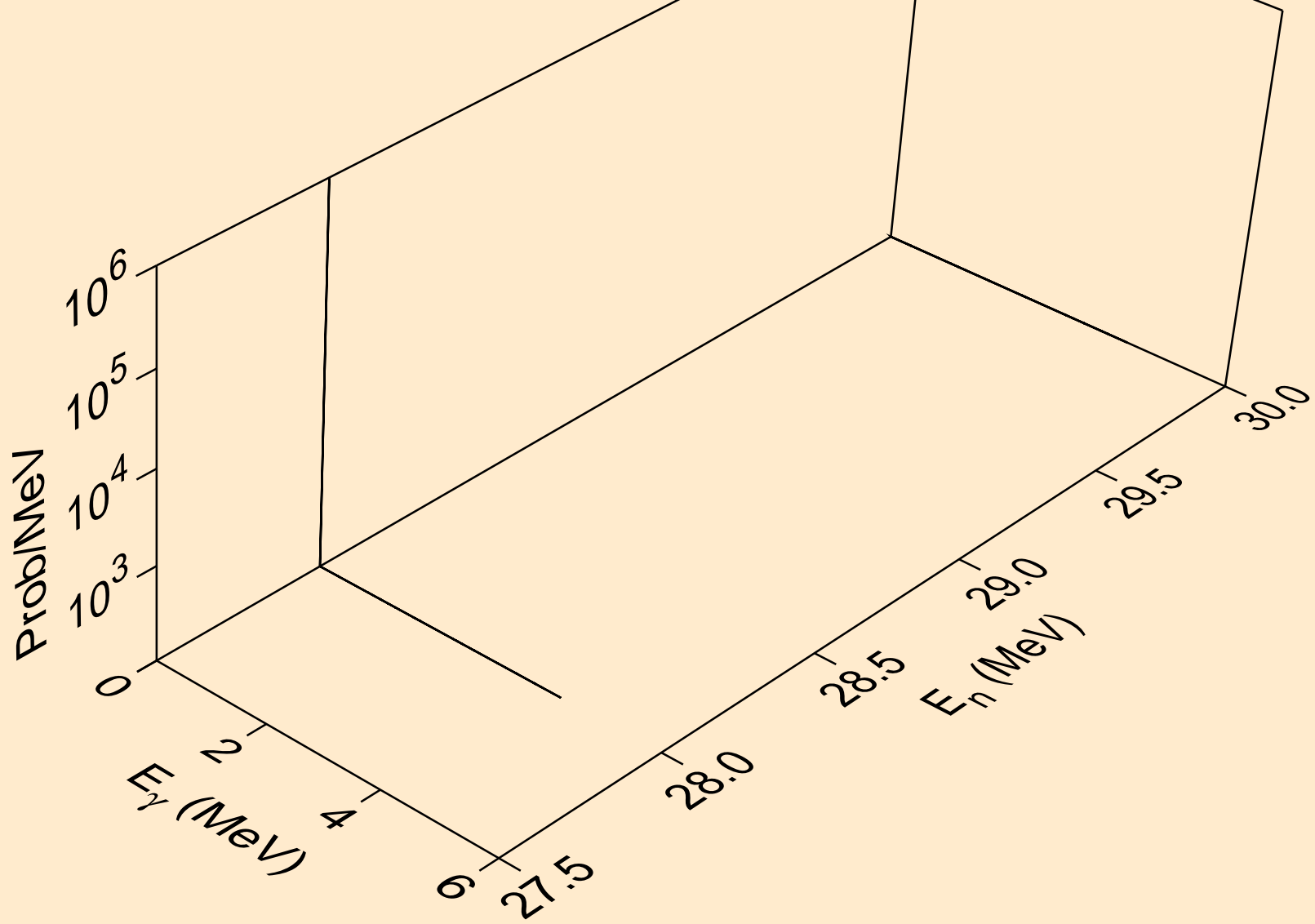

MG024 NEUTRON ACER TENDL-2024 LIBRARY; T=0.K
Photon emission for (n,n*)he3

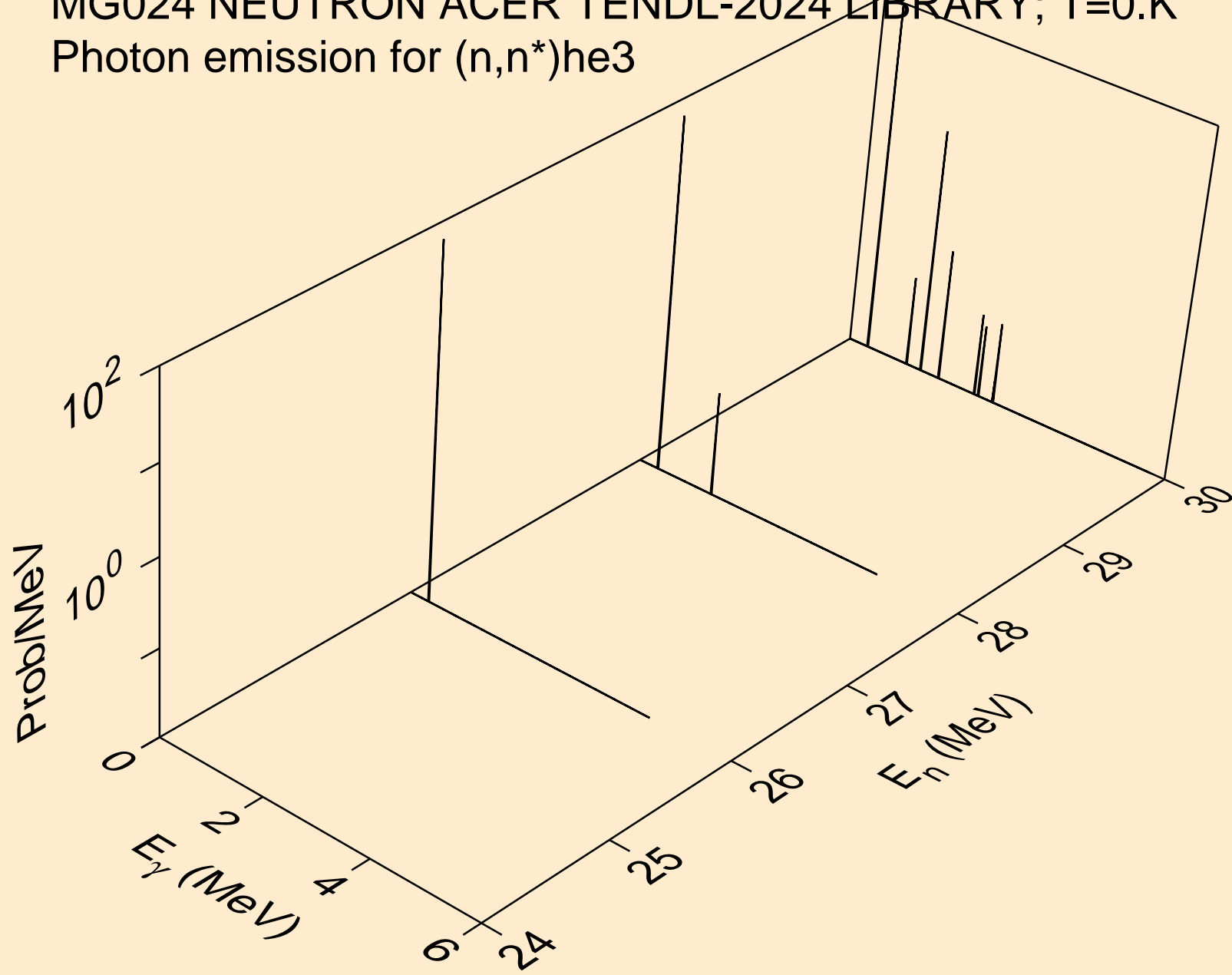

MG024 NEUTRON ACER TENDL-2024 LIBRARY; T=0.K
Photon emission for (n,2np)

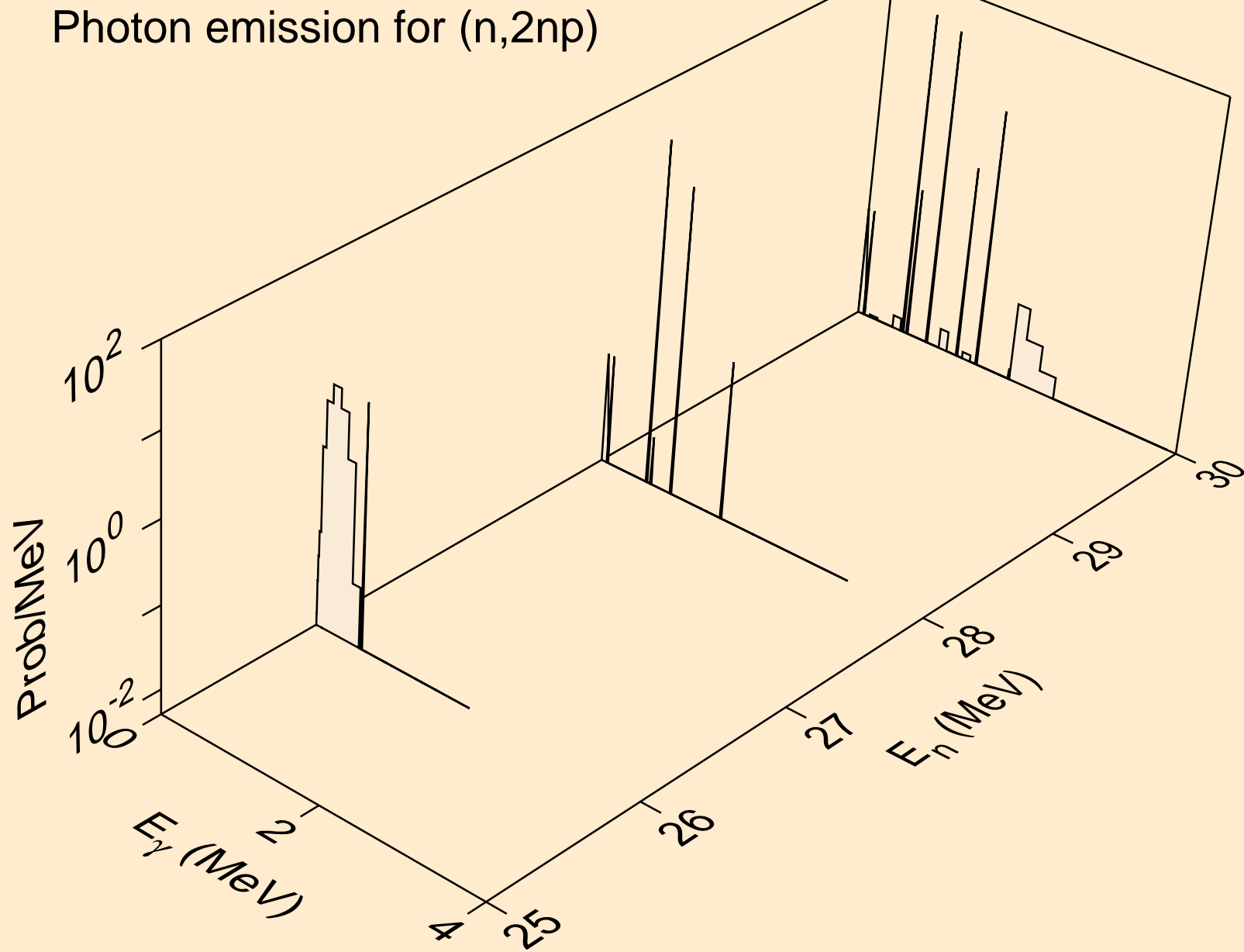

MG024 NEUTRON ACER TENDL-2024 LIBRARY; T=0.K
Photon emission for (n,n2p)

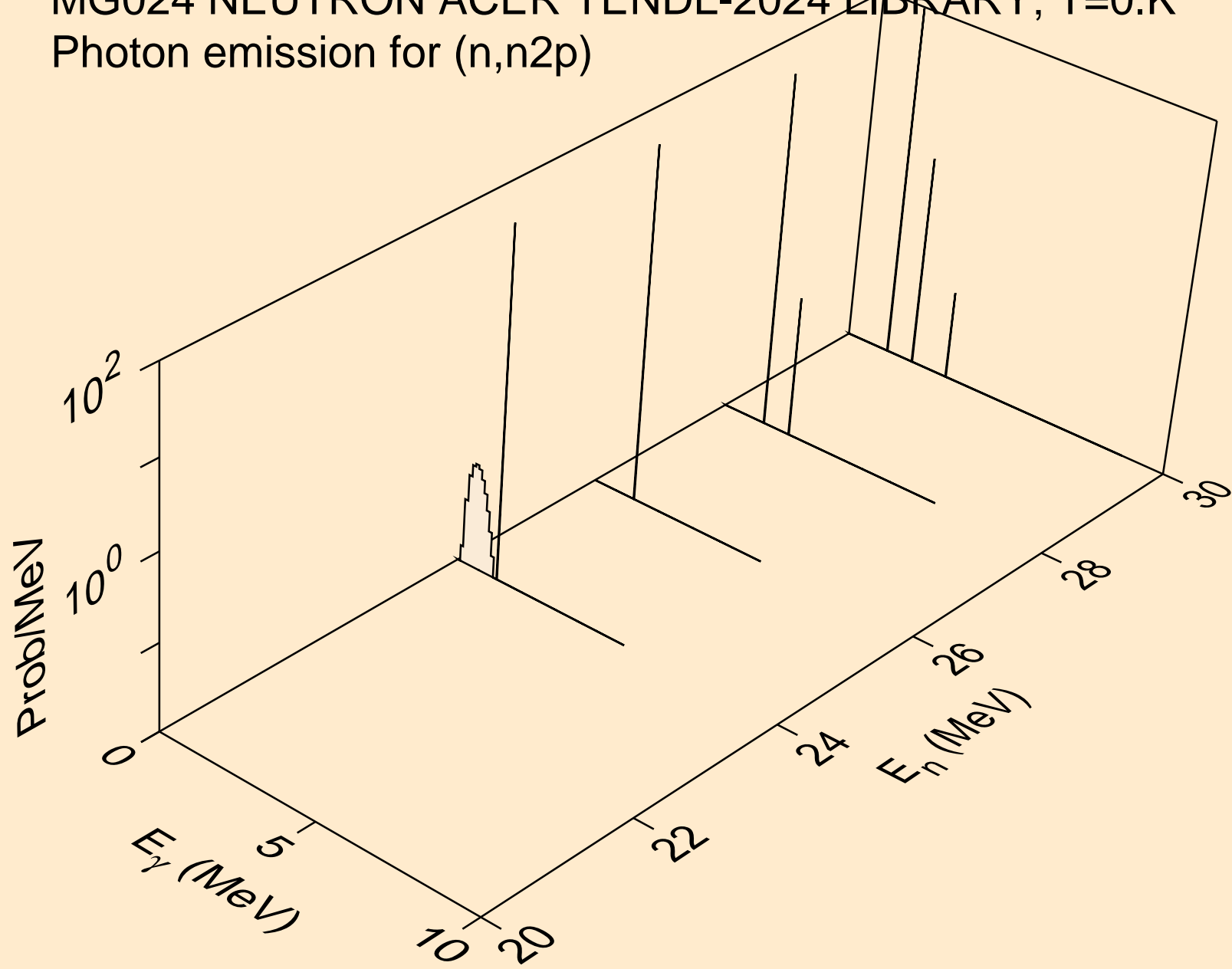

MG024 NEUTRON ACER TENDL-2024 LIBRARY; T=0.K
Photon emission for (n,npa)

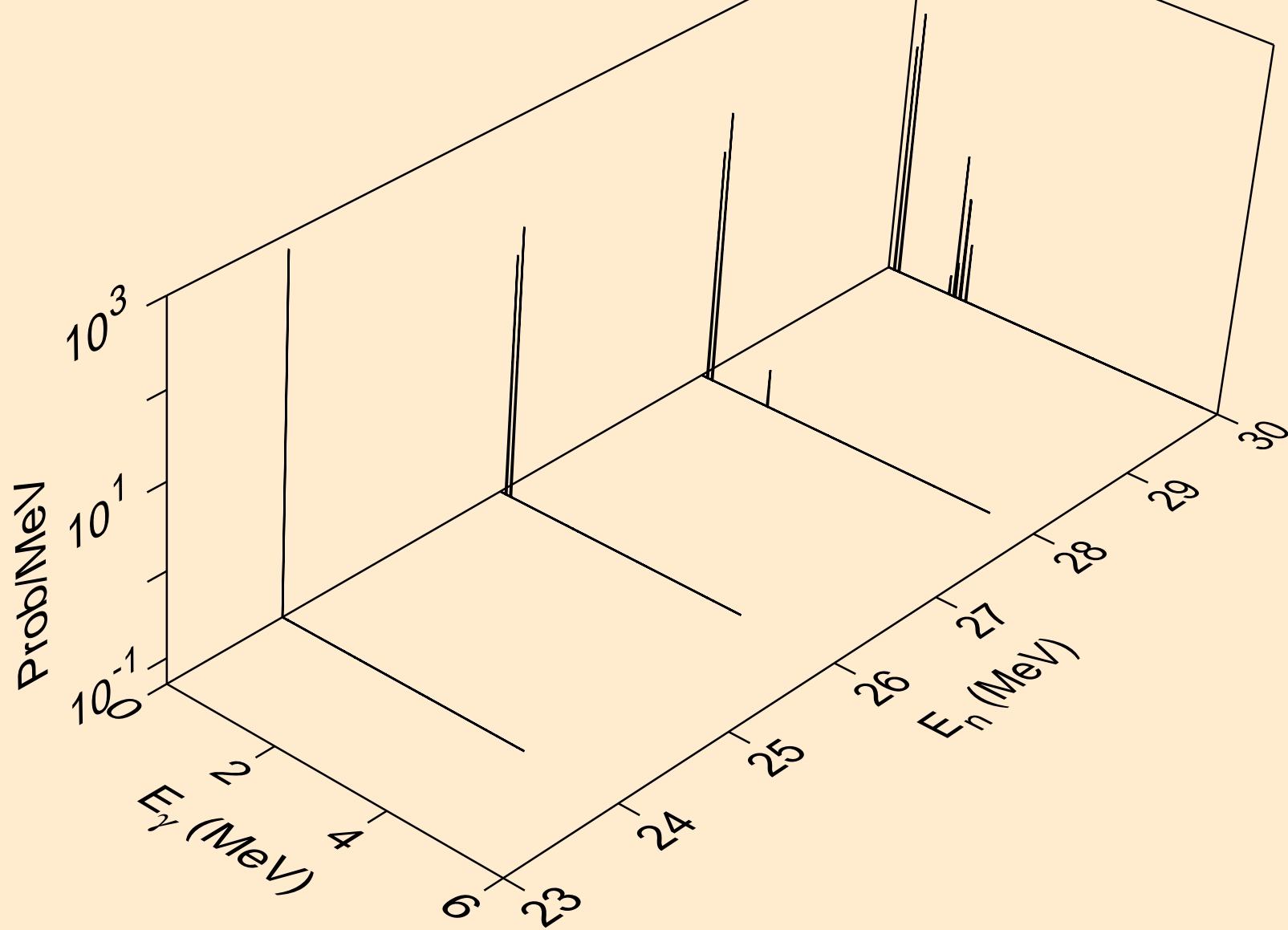

MG024 NEUTRON ACER TENDL-2024 LIBRARY; T=0.K
Photon emission for (n,n*c)

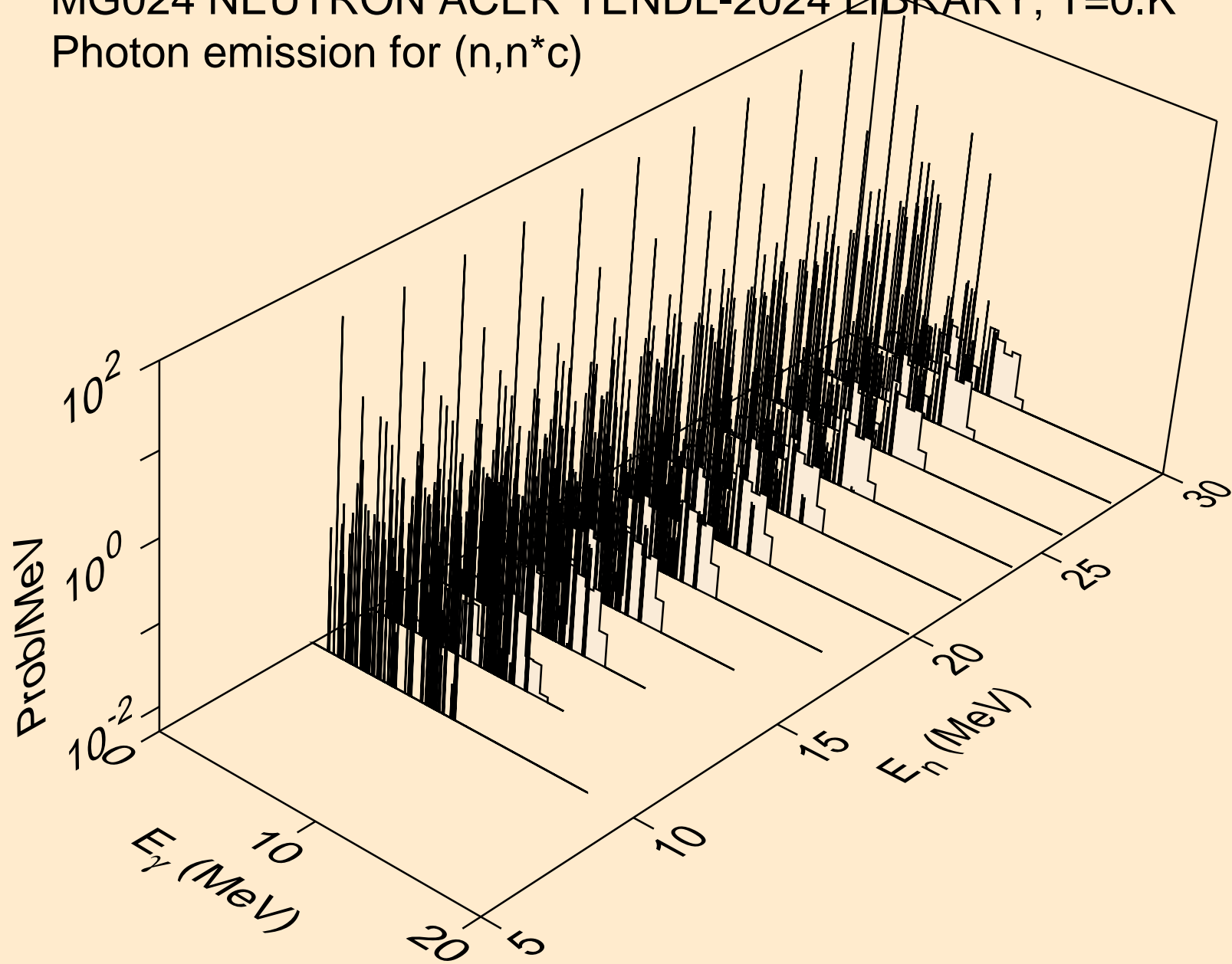

MG024 NEUTRON ACER TENDL-2024 LIBRARY; T=0.K
Photon emission for (n,gma)

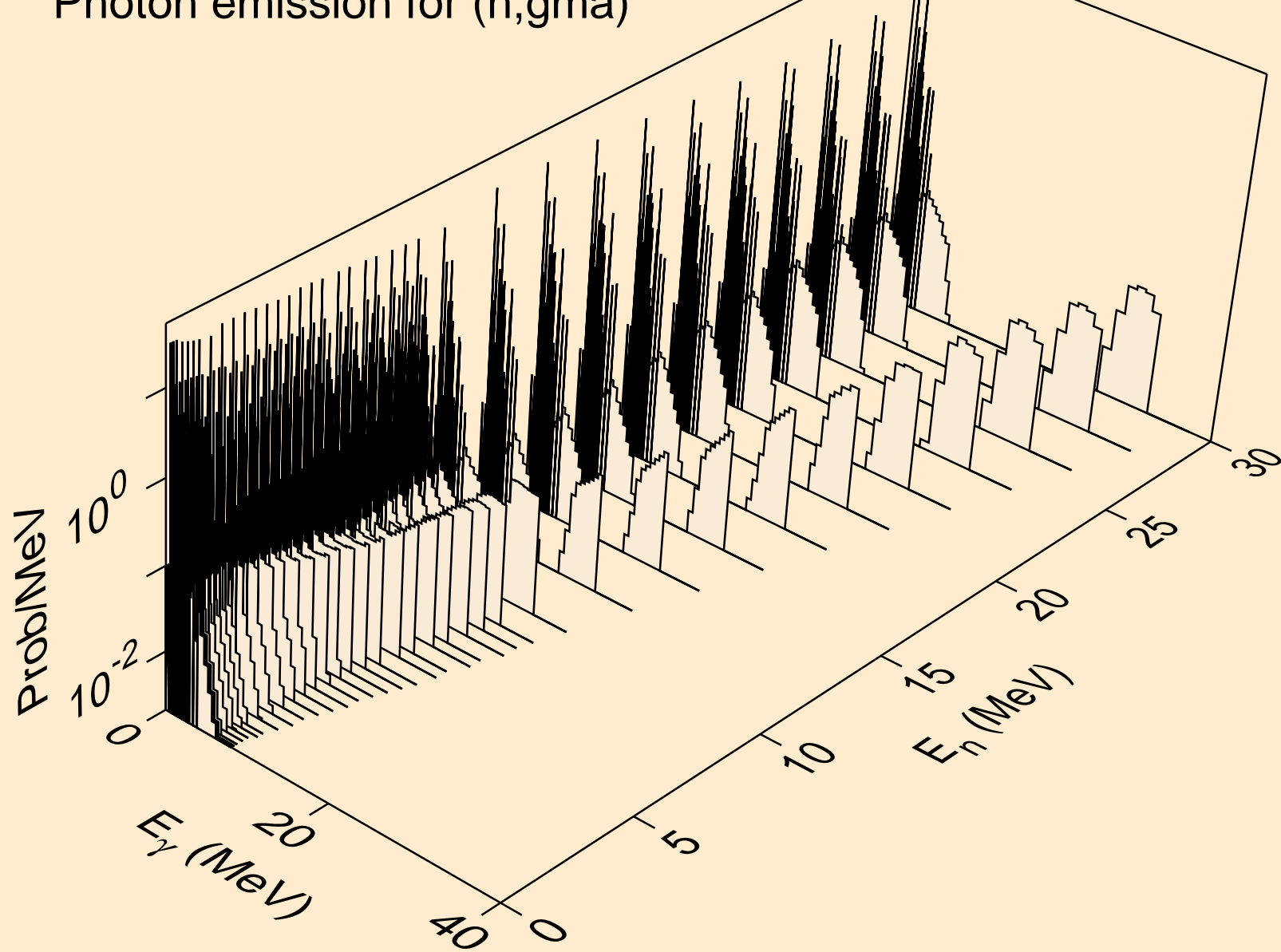

MG024 NEUTRON ACER TENDL-2024 LIBRARY; T=0.K
Photon emission for (n,p)

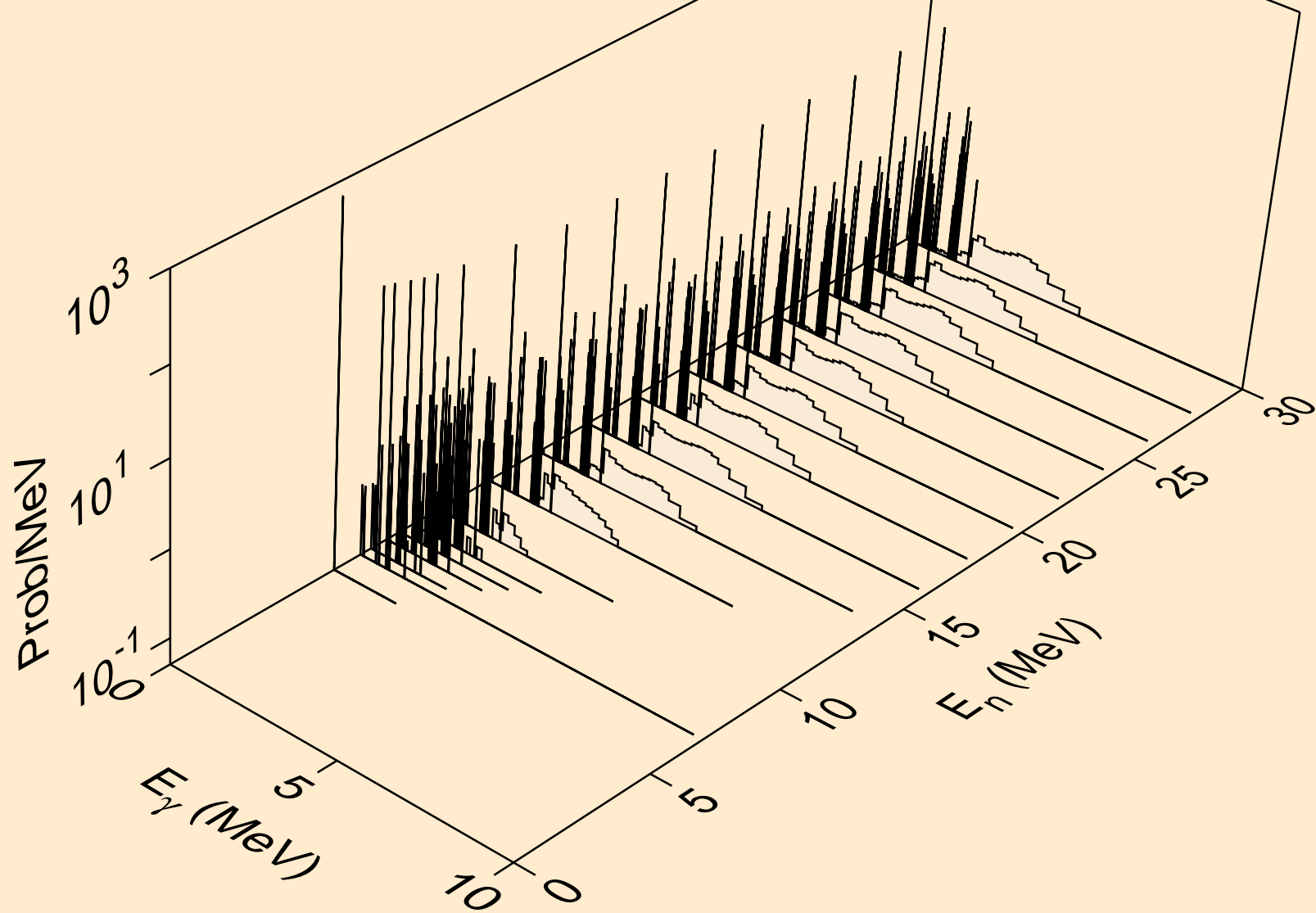

MG024 NEUTRON ACER TENDL-2024 LIBRARY; T=0.K
Photon emission for (n,d)

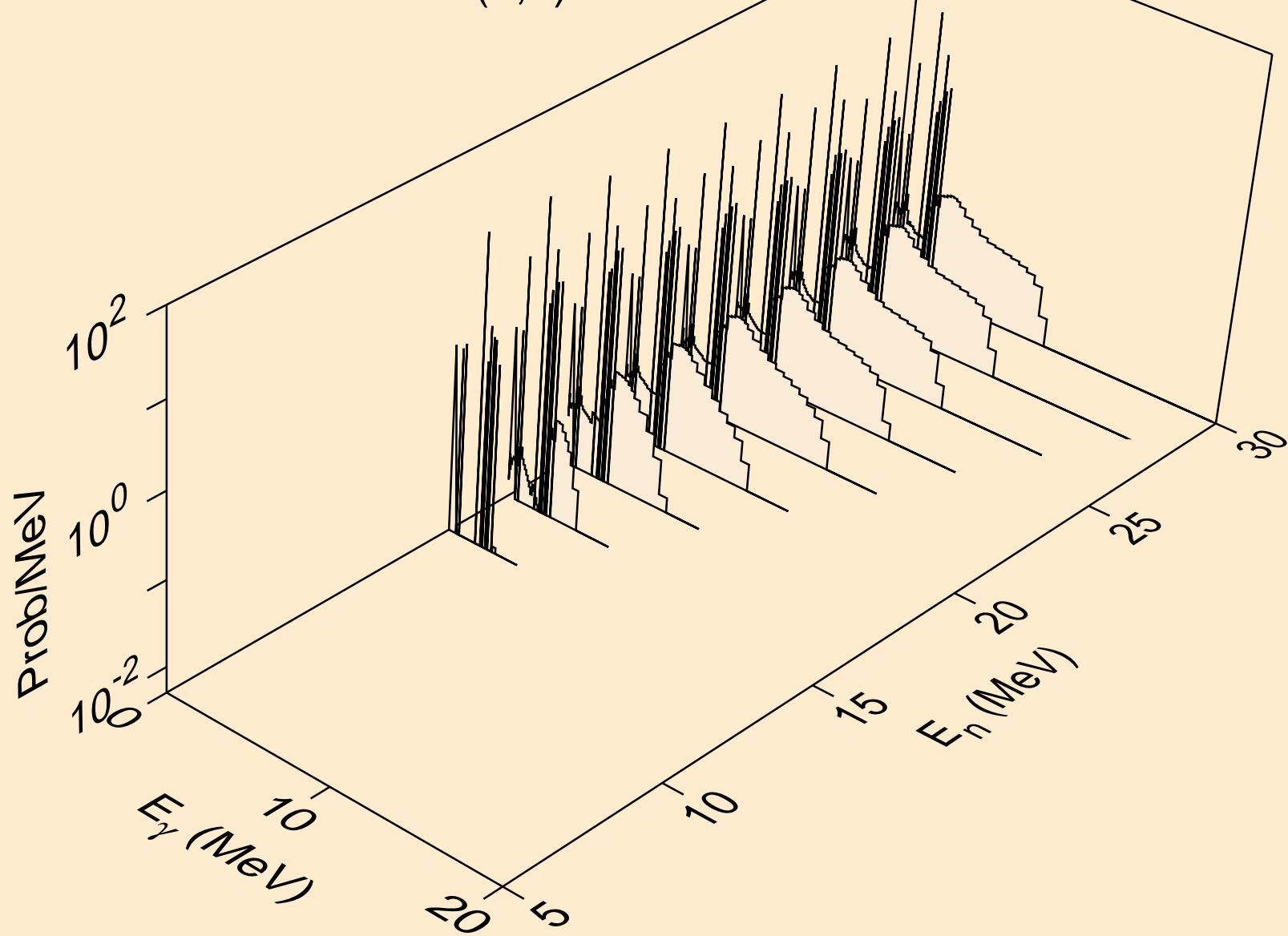

MG024 NEUTRON ACER TENDL-2024 LIBRARY; T=0.K
Photon emission for (n,t)

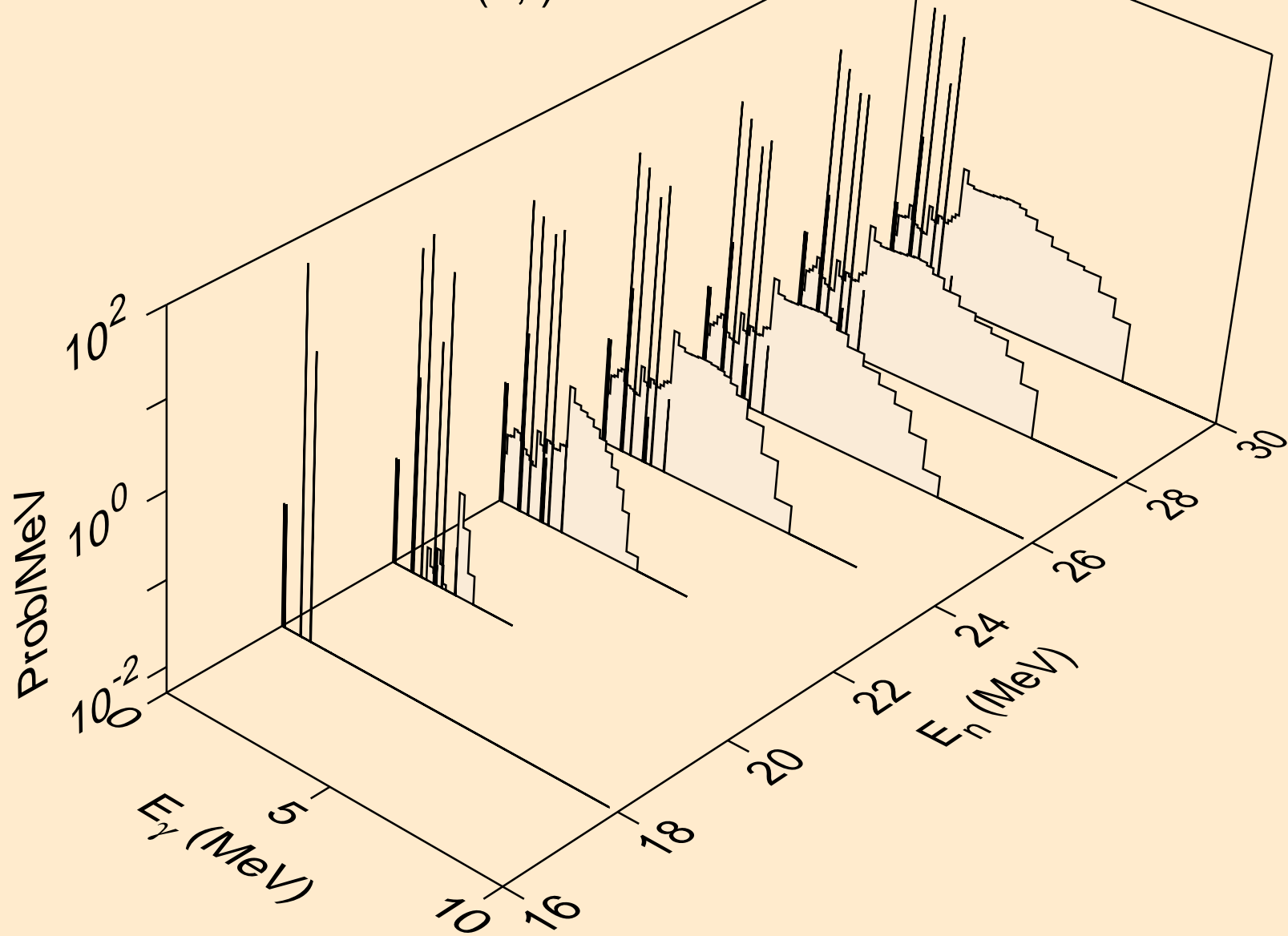

MG024 NEUTRON ACER TENDL-2024 LIBRARY; T=0.K
Photon emission for (n,he3)

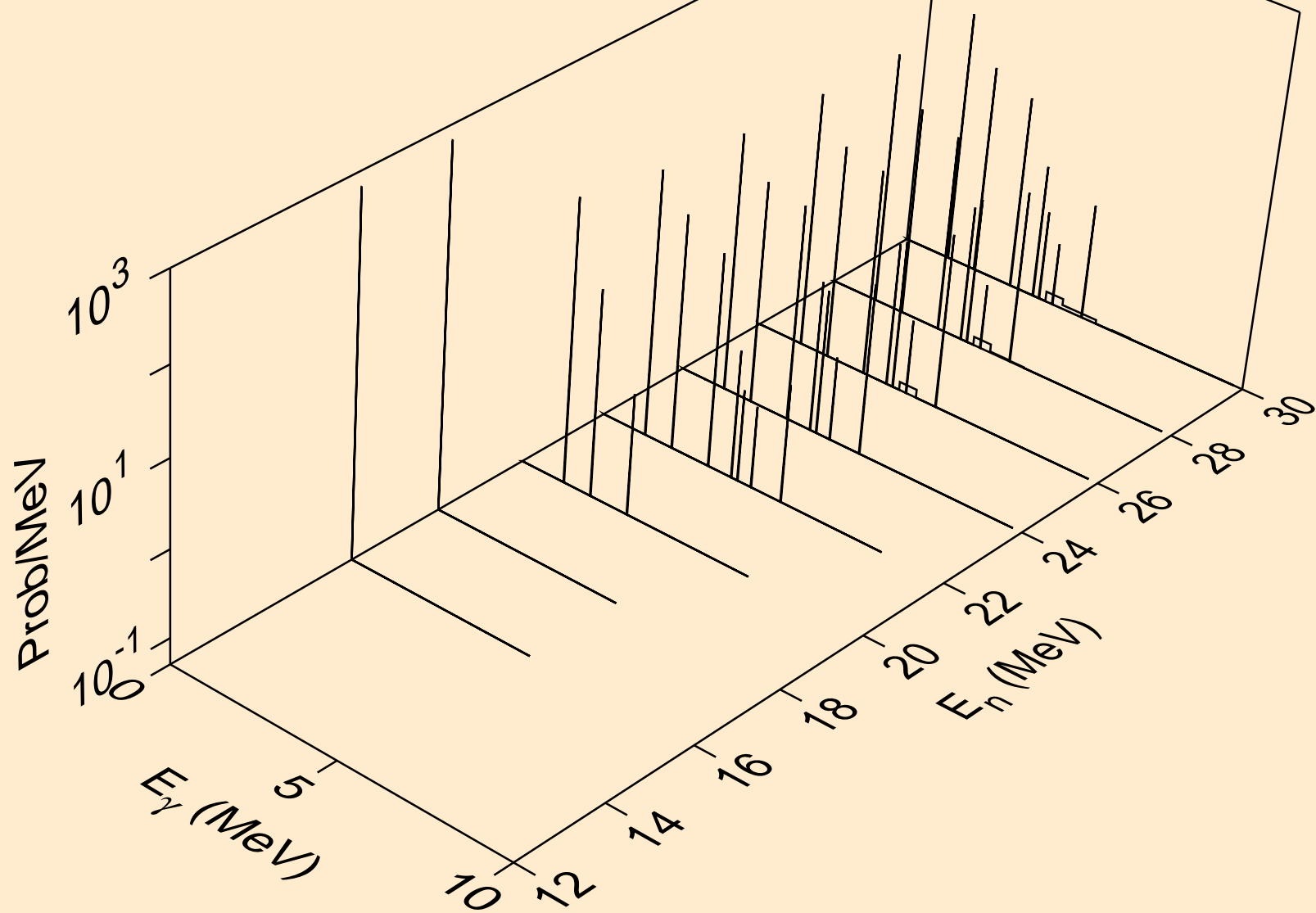

MG024 NEUTRON ACER TENDL-2024 LIBRARY; T=0.K
Photon emission for (n,a)

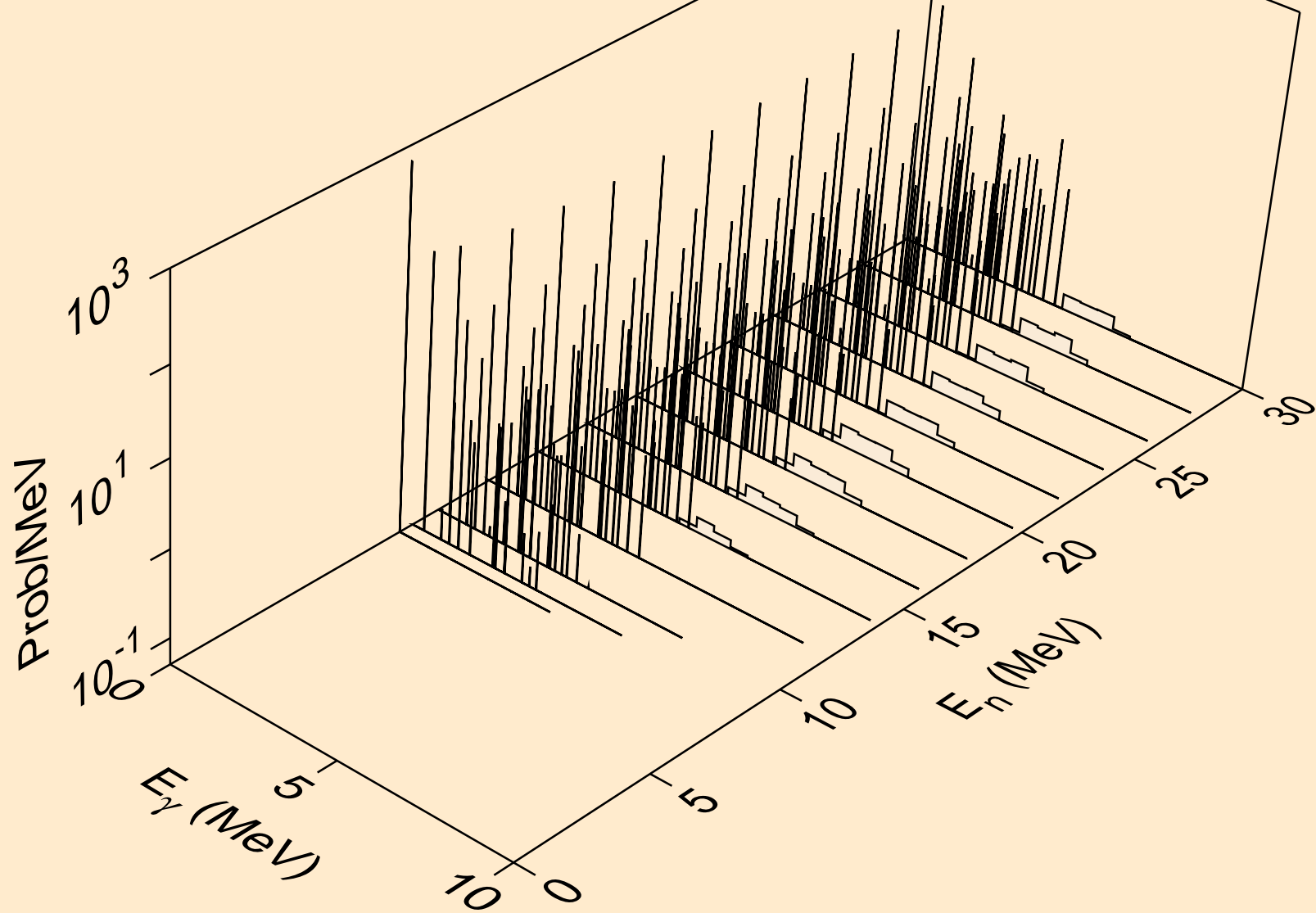

MG024 NEUTRON ACER TENDL-2024 LIBRARY; T=0.K
Photon emission for (n,2a)

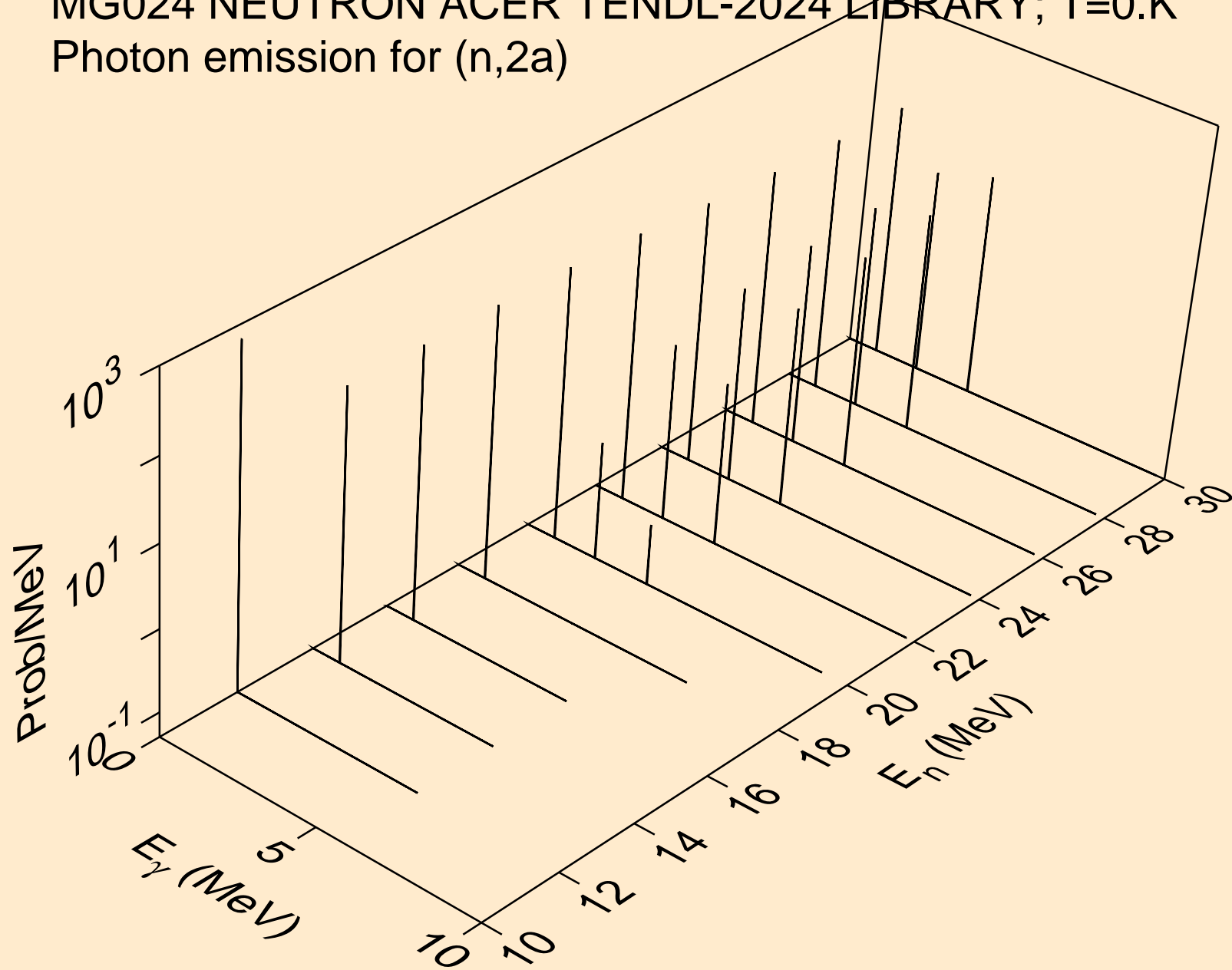

MG024 NEUTRON ACER TENDL-2024 LIBRARY; T=0.K
Photon emission for (n,3a)

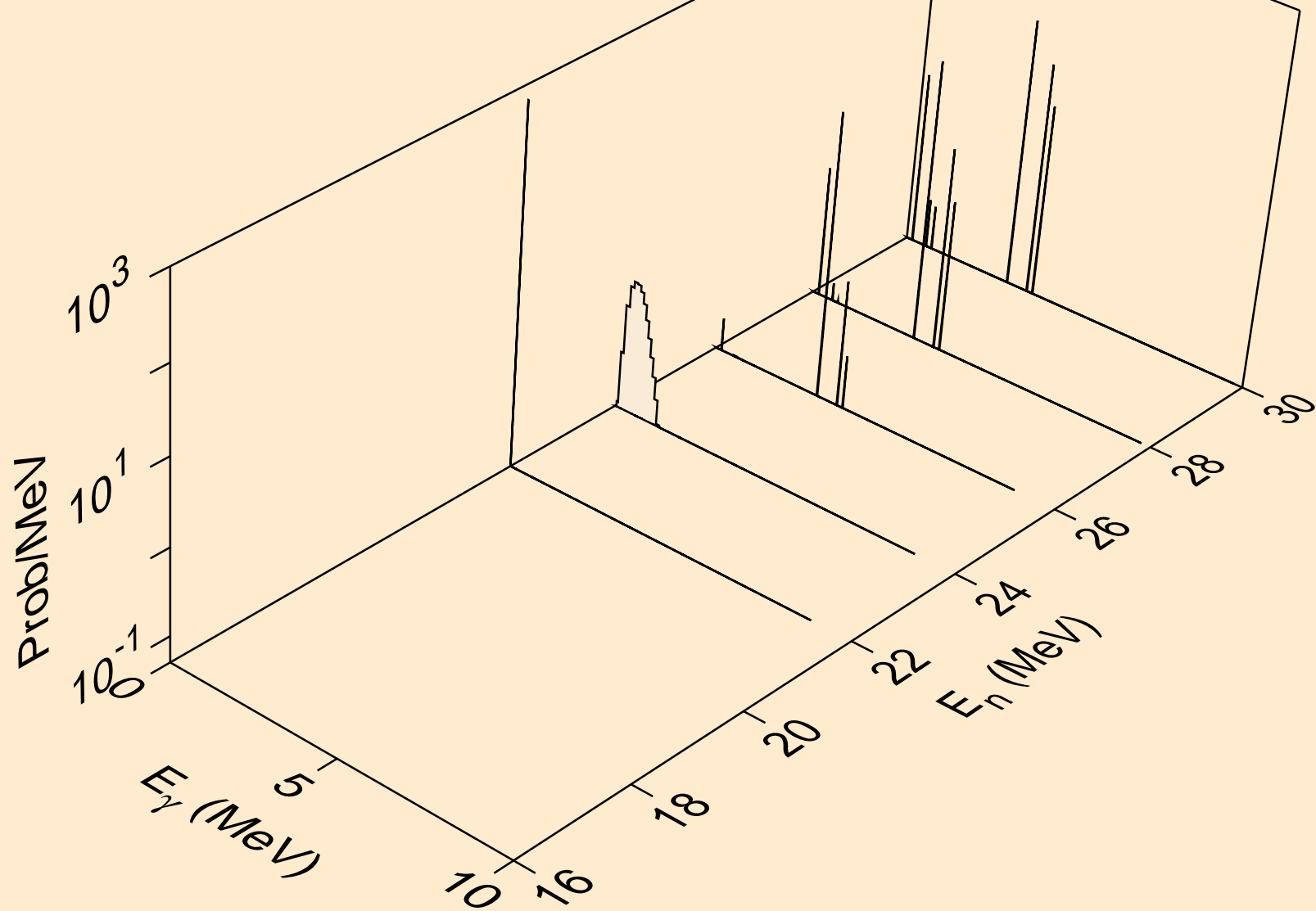

MG024 NEUTRON ACER TENDL-2024 LIBRARY; T=0.K
Photon emission for (n,2p)

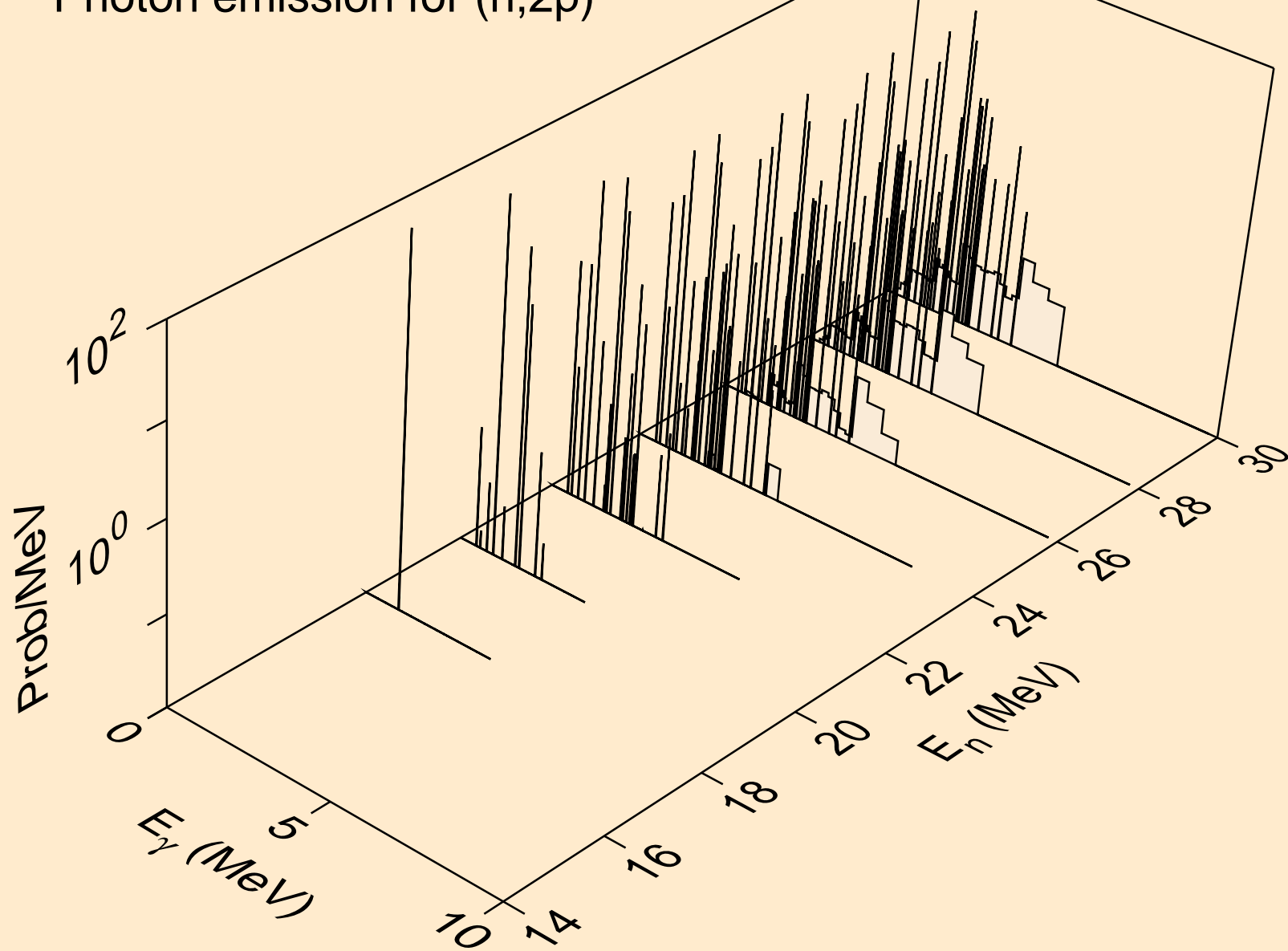

MG024 NEUTRON ACER TENDL-2024 LIBRARY; T=0.K
Photon emission for (n,pa)

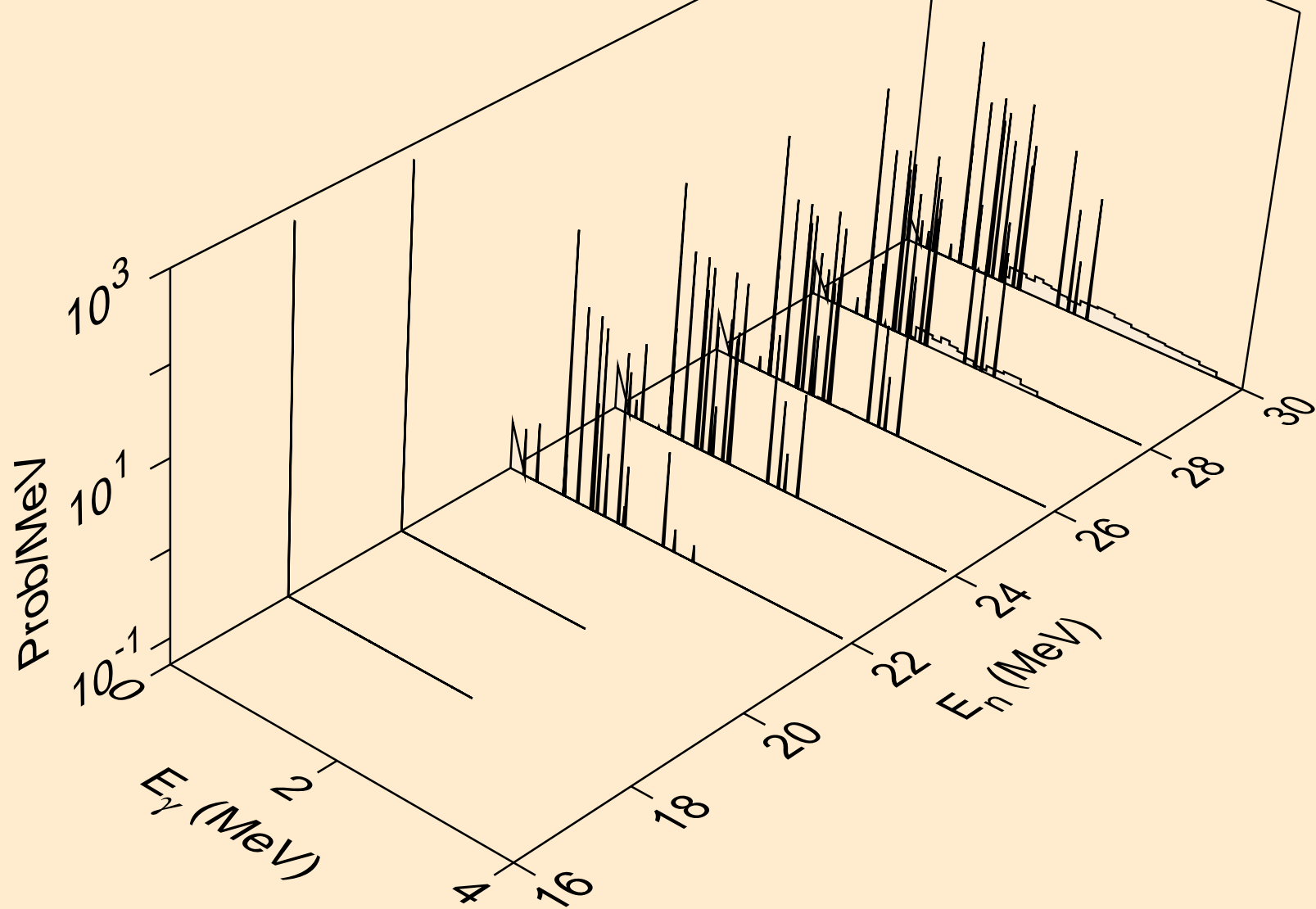

MG024 NEUTRON ACER TENDL-2024 LIBRARY; T=0.K
Photon emission for (n,d2a)

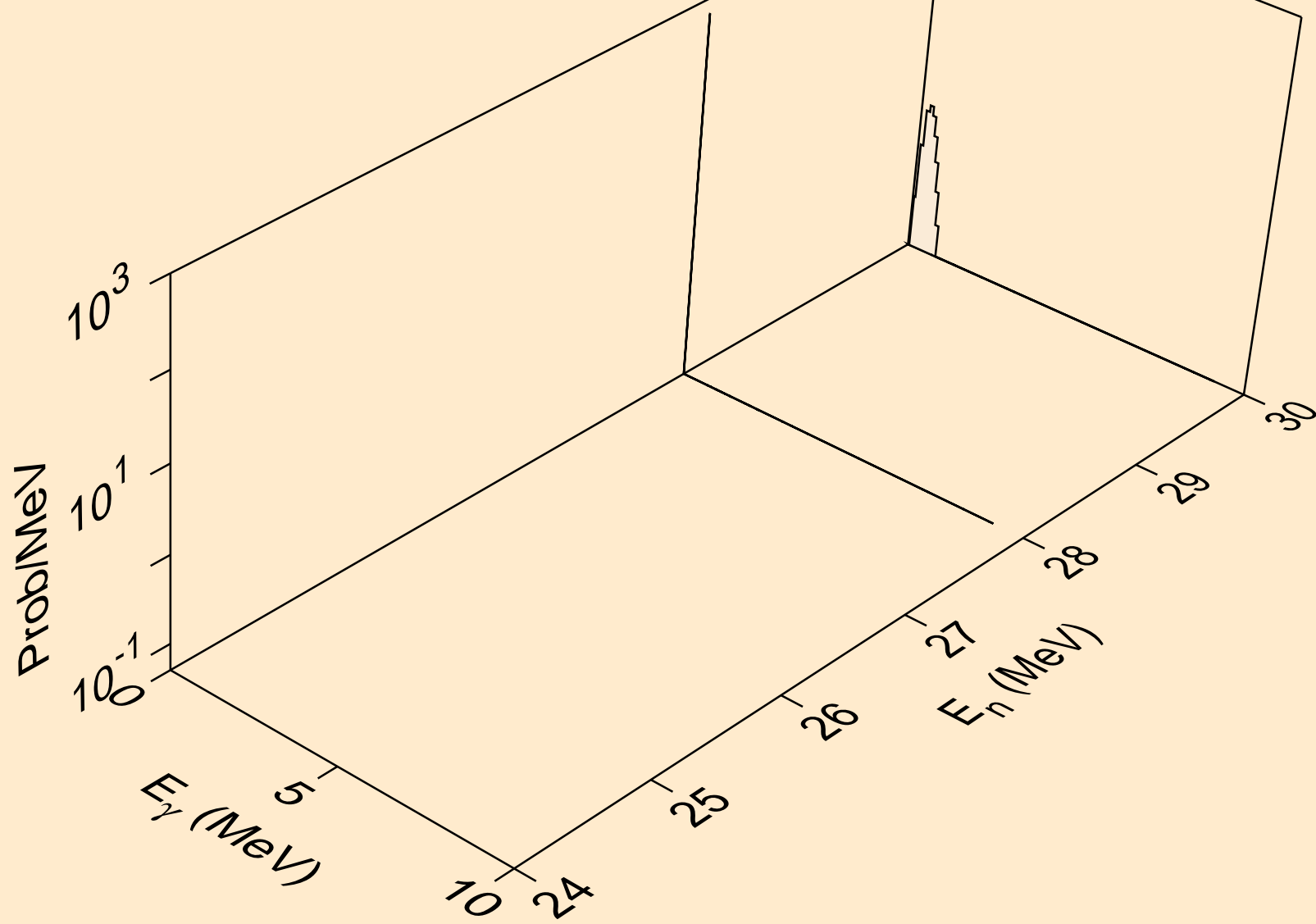

MG024 NEUTRON ACER TENDL-2024 LIBRARY; T=0.K
Photon emission for (n,pd)

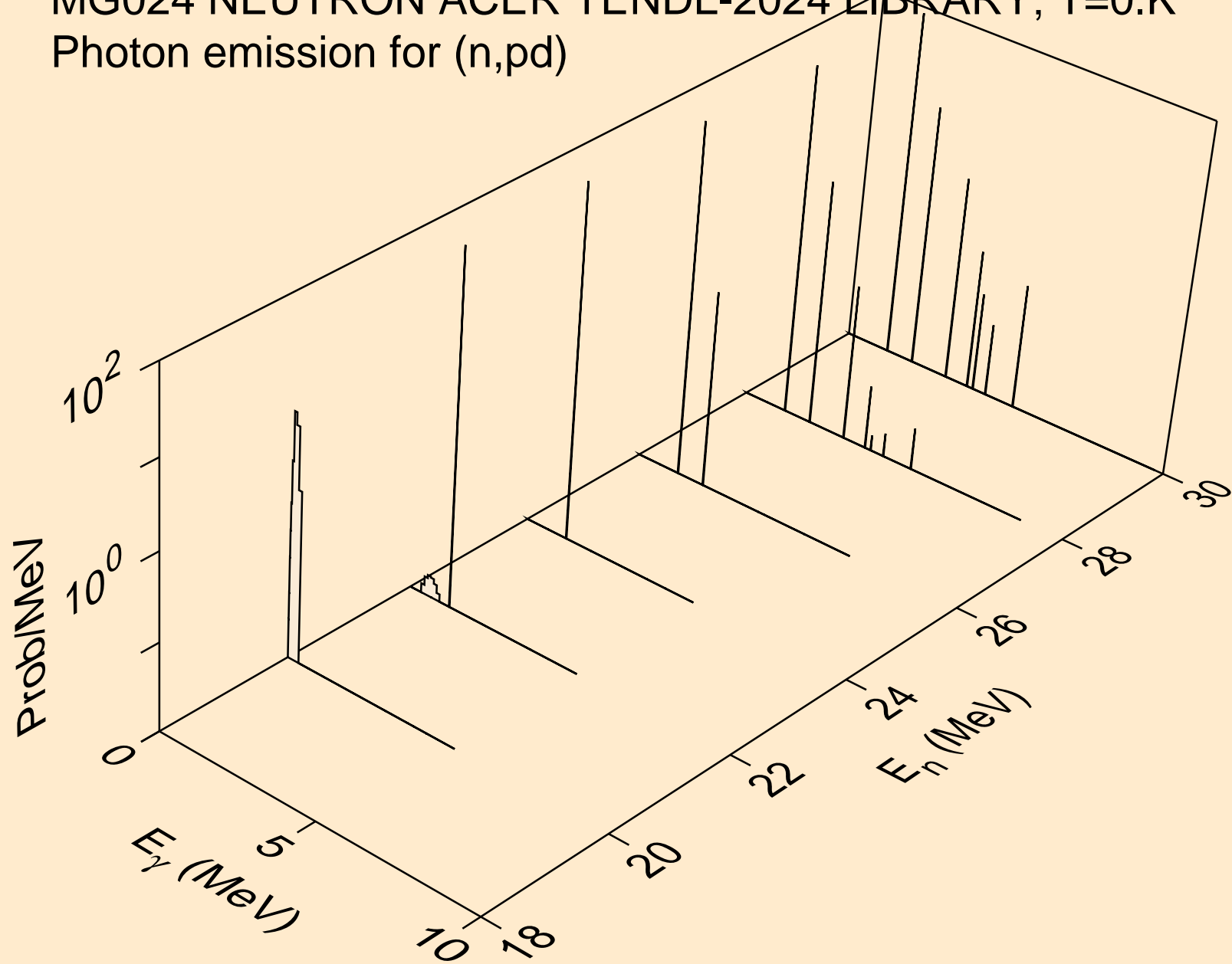

MG024 NEUTRON ACER TENDL-2024 LIBRARY; T=0.K
Photon emission for (n,pt)

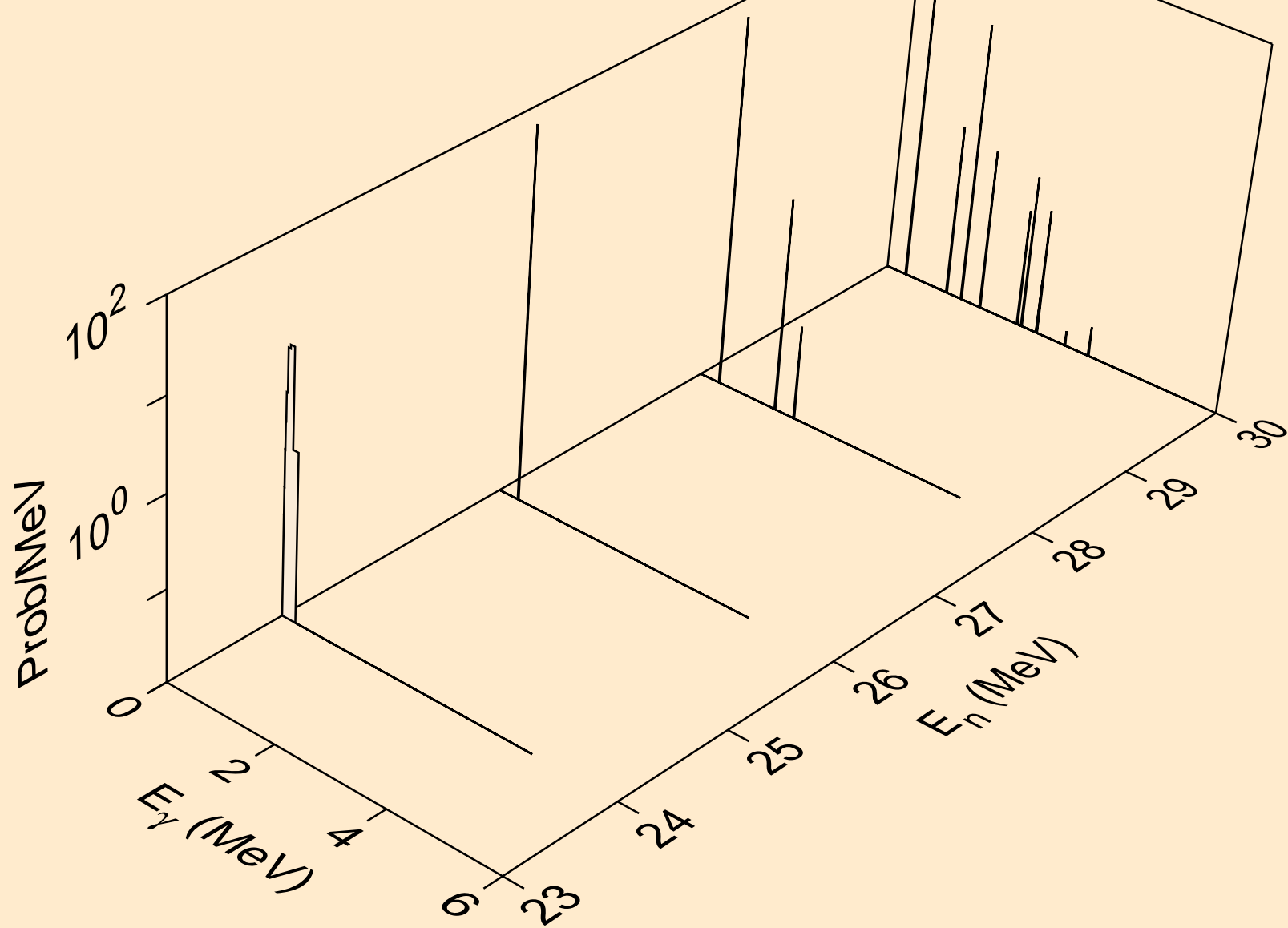

MG024 NEUTRON ACER TENDL-2024 LIBRARY; T=0.K
Photon emission for (n,da)

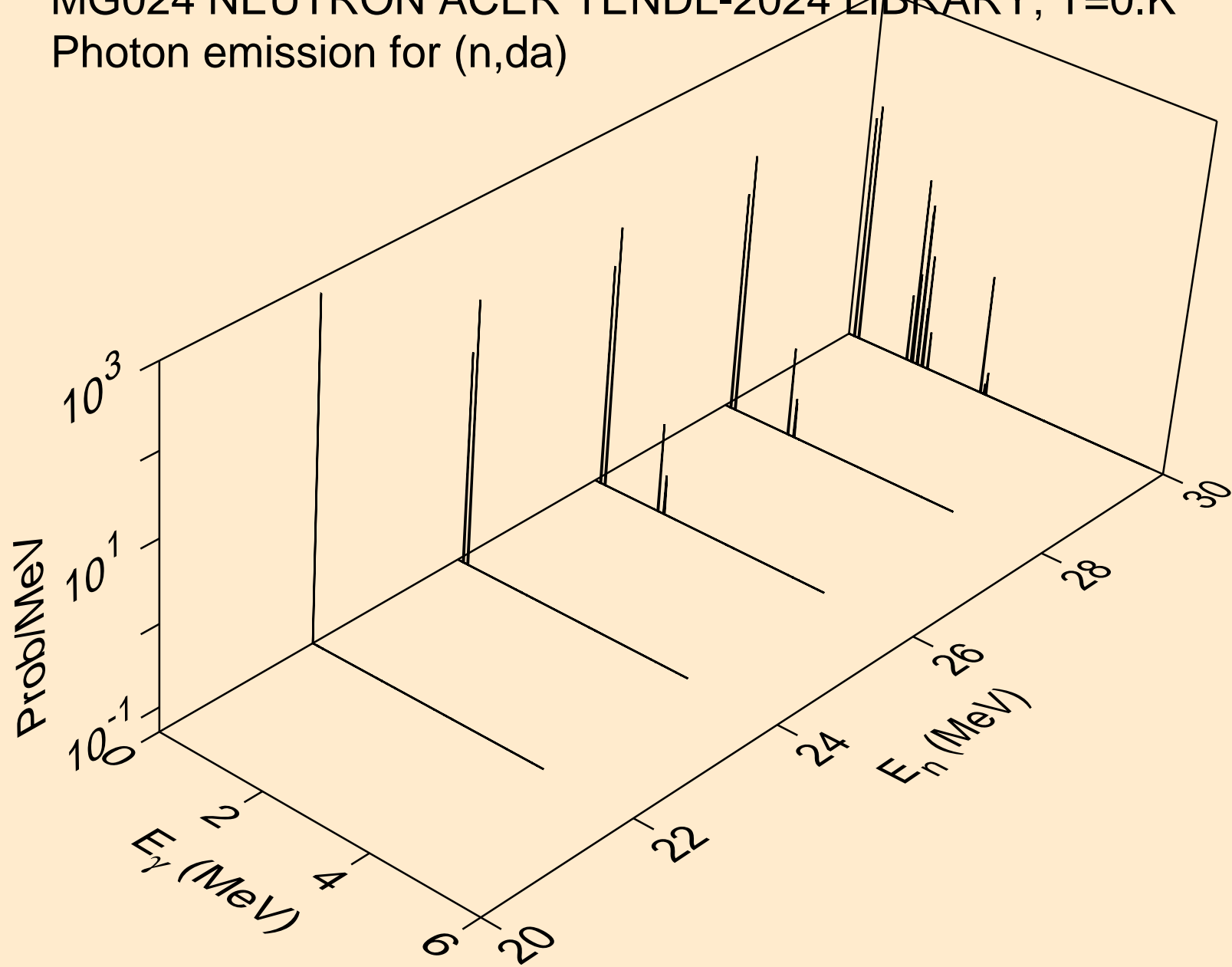

MG024 NEUTRON ACER TENDL-2024 LIBRARY; T=0.K
thermal capture photon spectrum

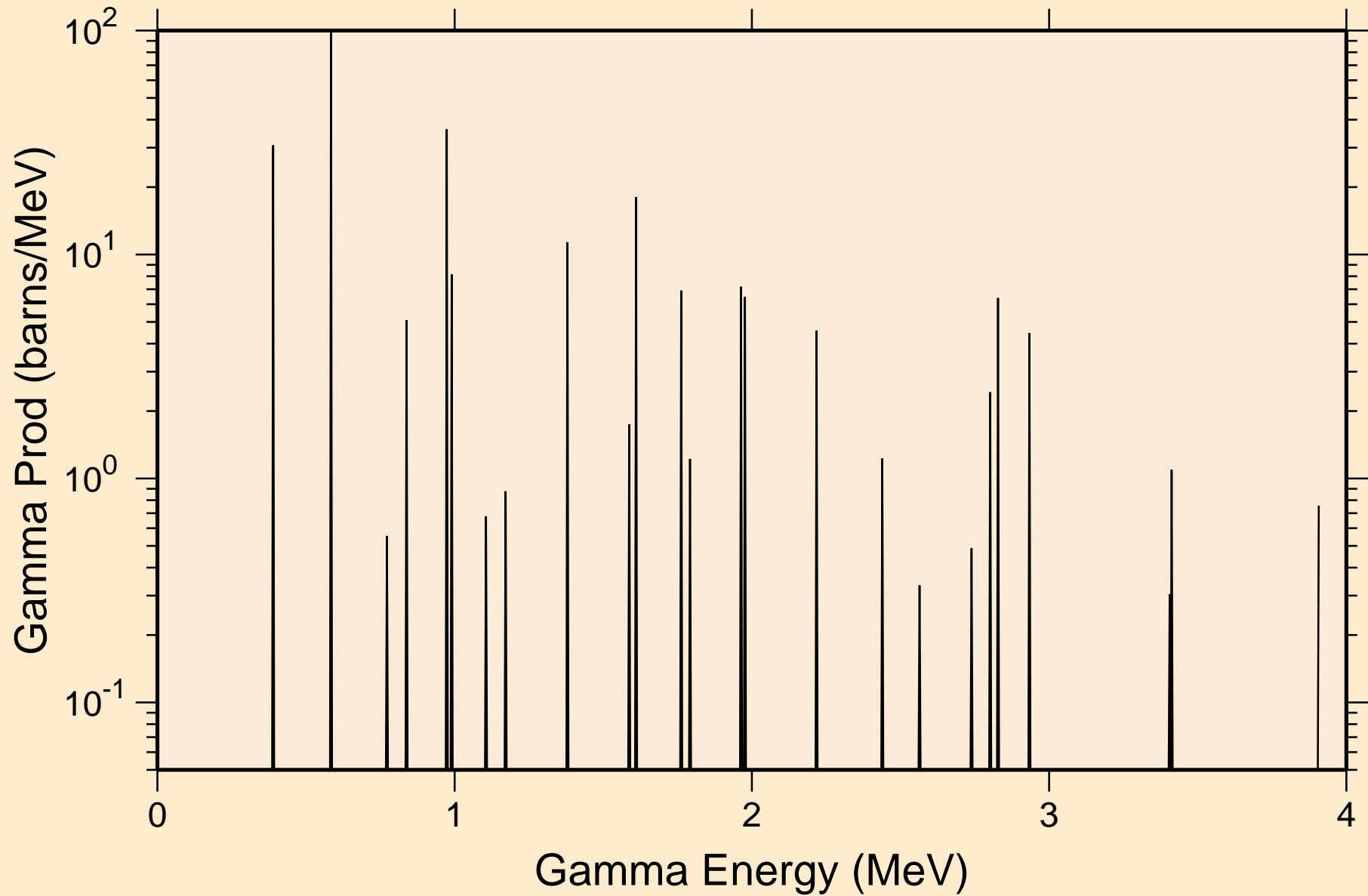

MG024 NEUTRON ACER TENDL-2024 LIBRARY; T=0.K
14 MeV photon spectrum

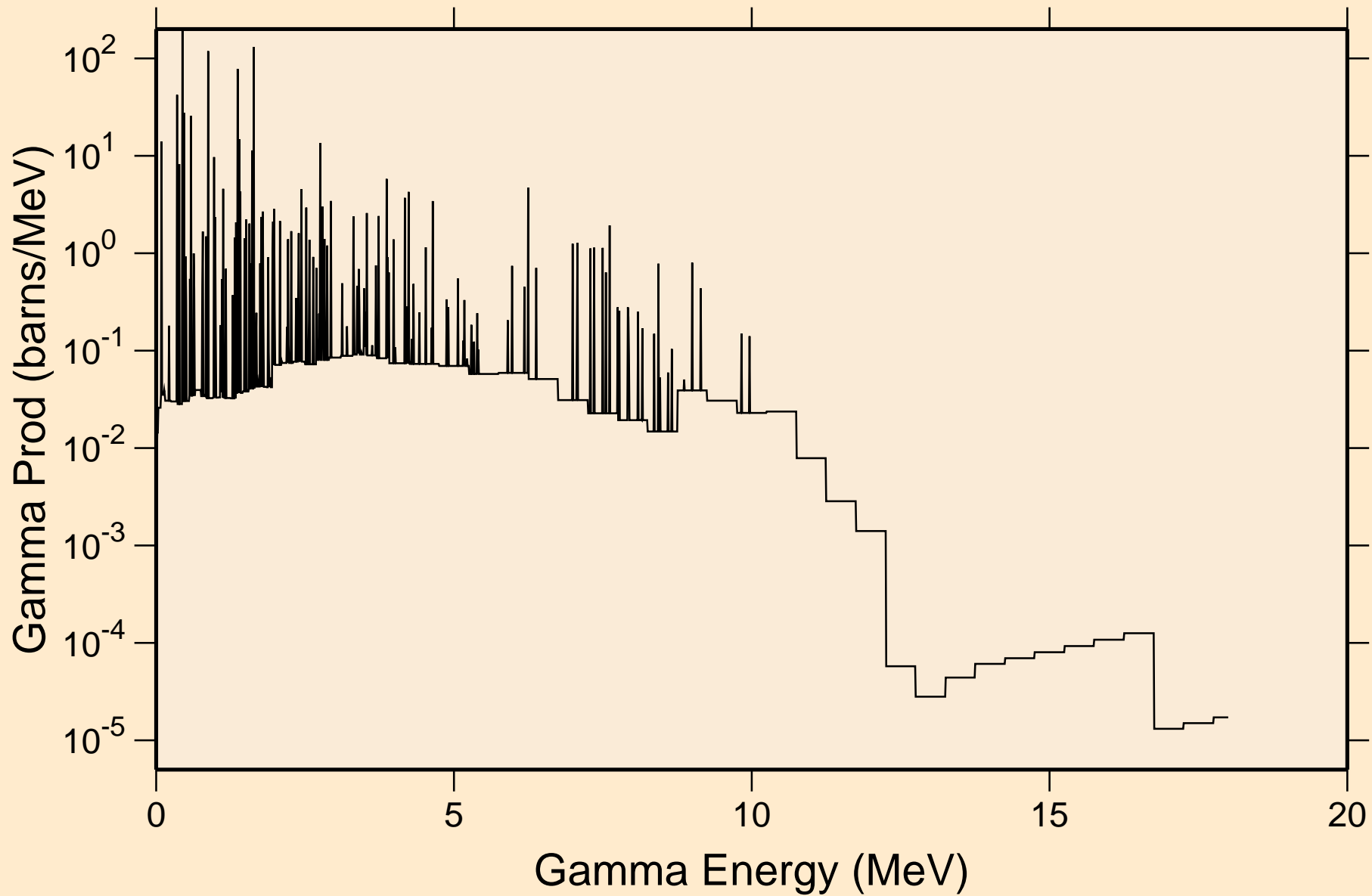

MG024 NEUTRON ACER TENDL-2024 LIBRARY; T=0.K

Particle heating contributions

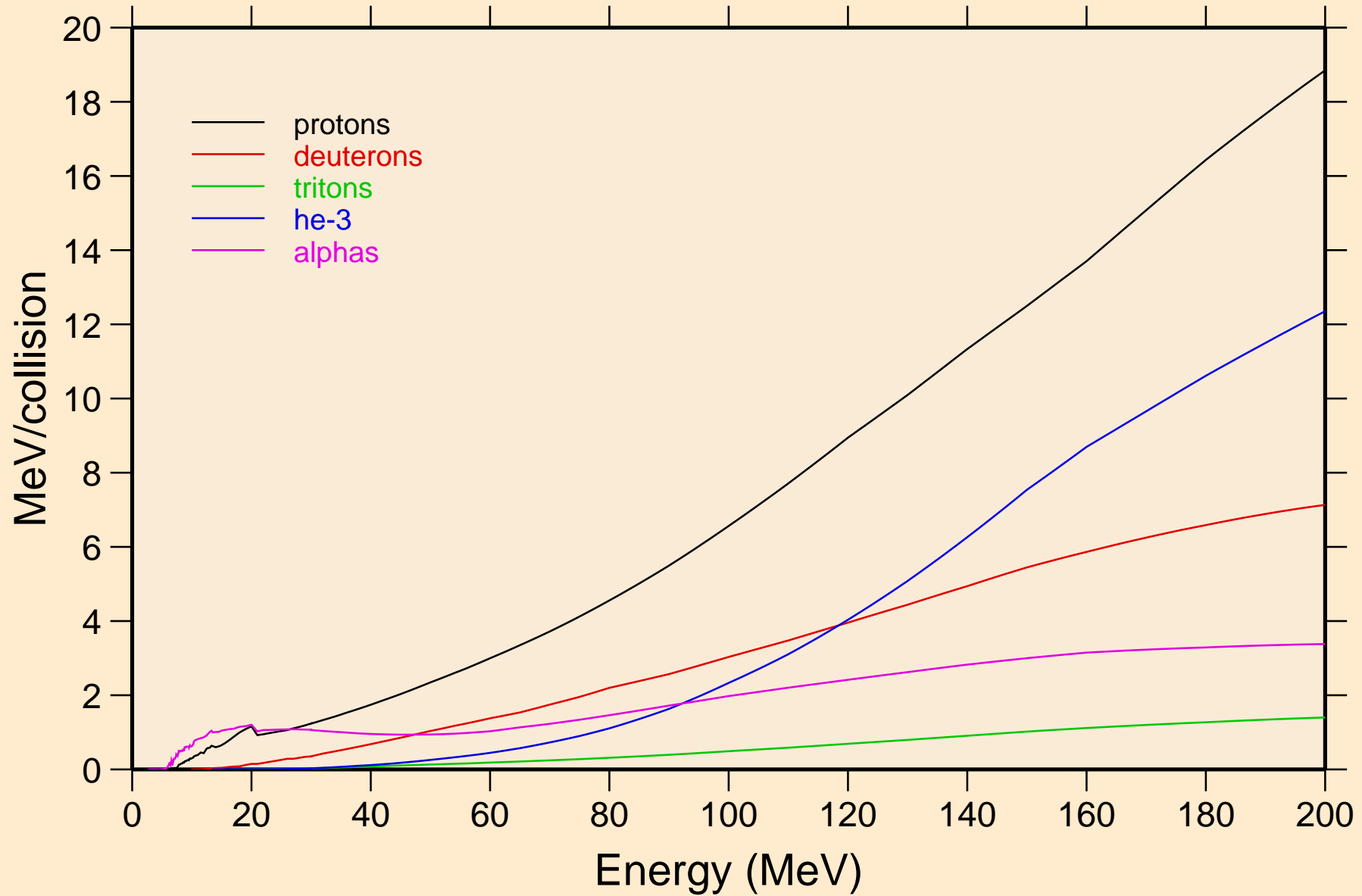

MG024 NEUTRON ACER TENDL-2024 LIBRARY; T=0.K
Recoil Heating

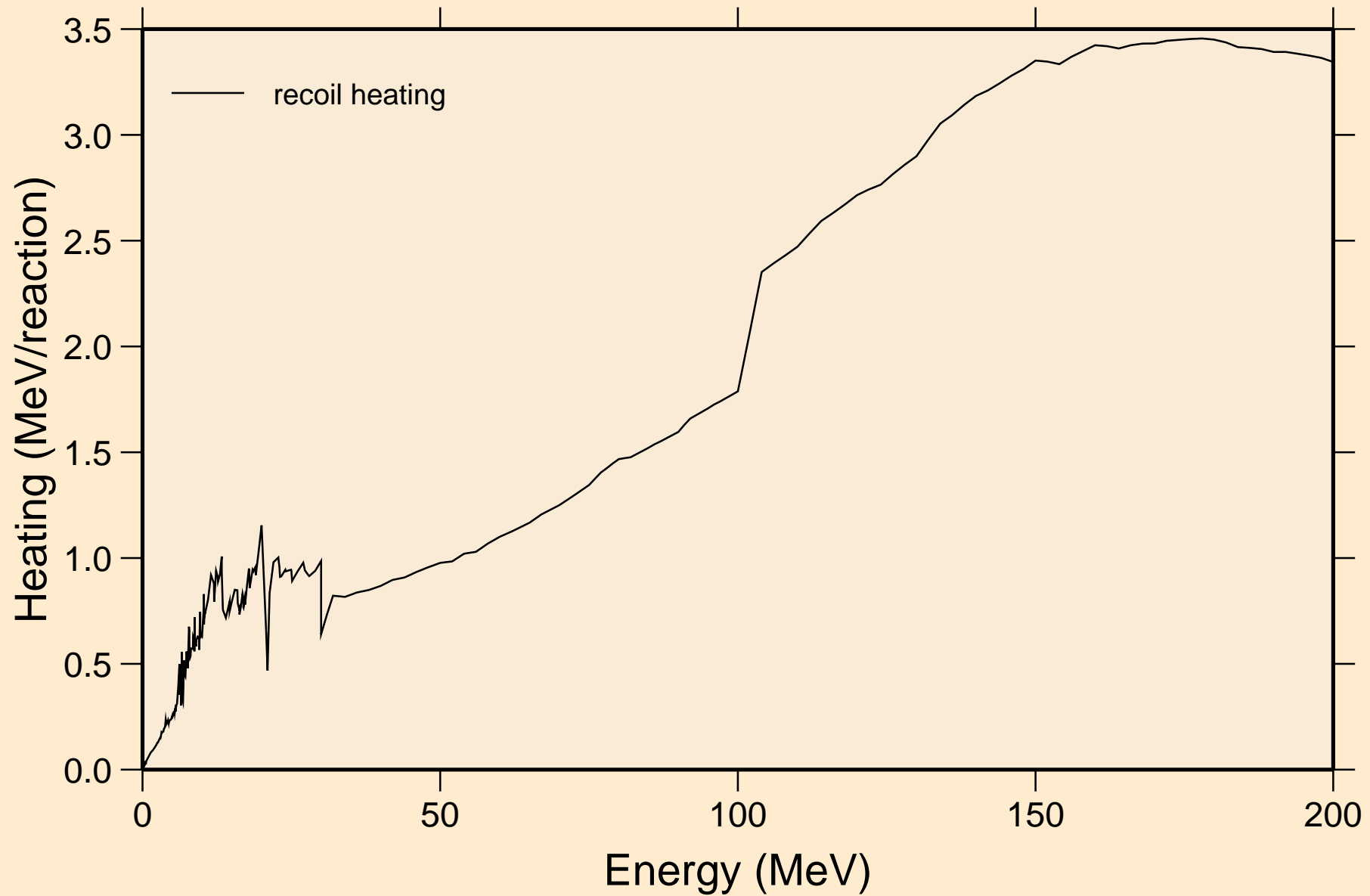

MG024 NEUTRON ACER TENDL-2024 LIBRARY; T=0.K

Particle production cross sections

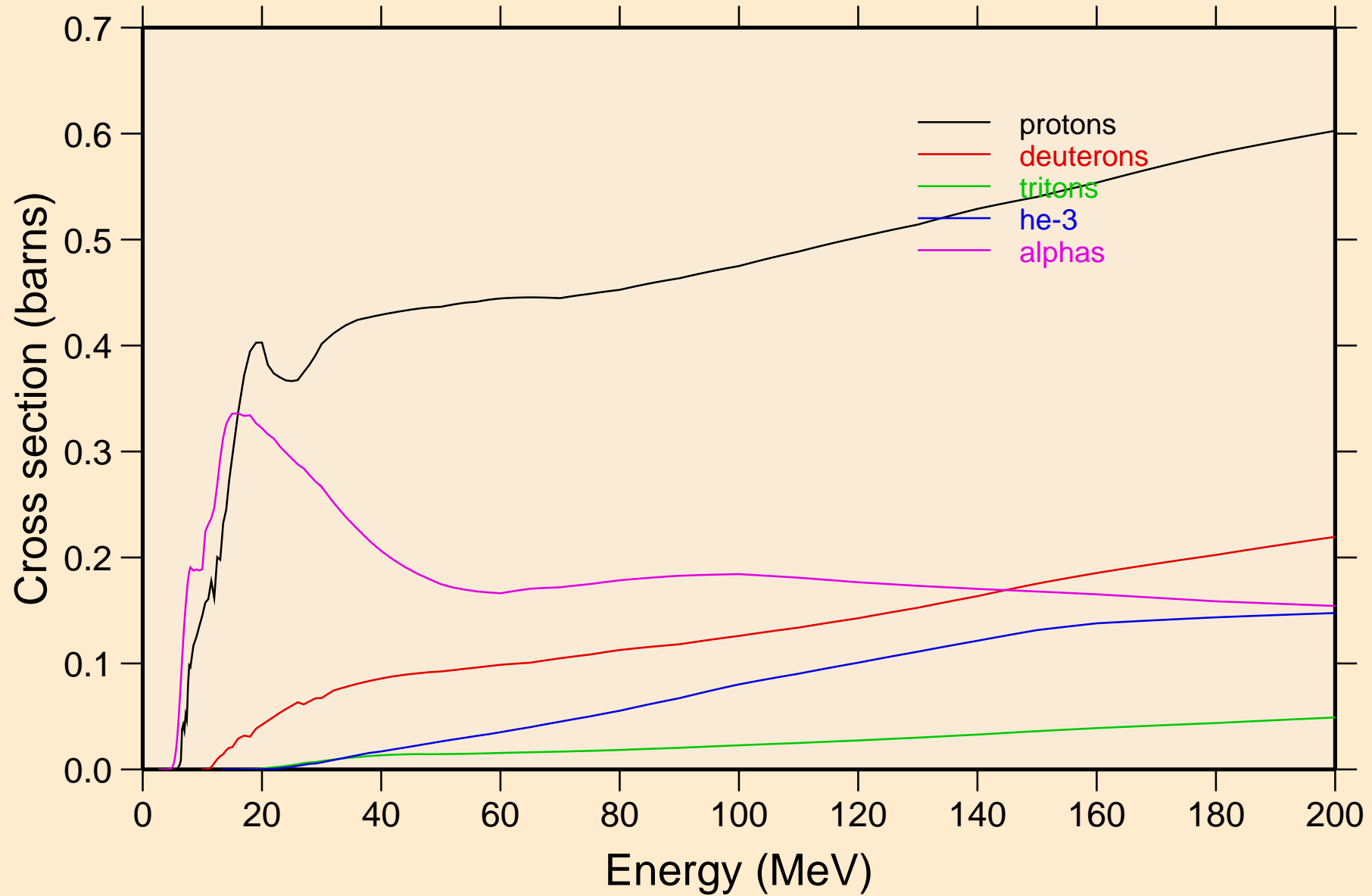

MG024 NEUTRON ACER TENDL-2024 LIBRARY; T=0.K
protons from (n,x)

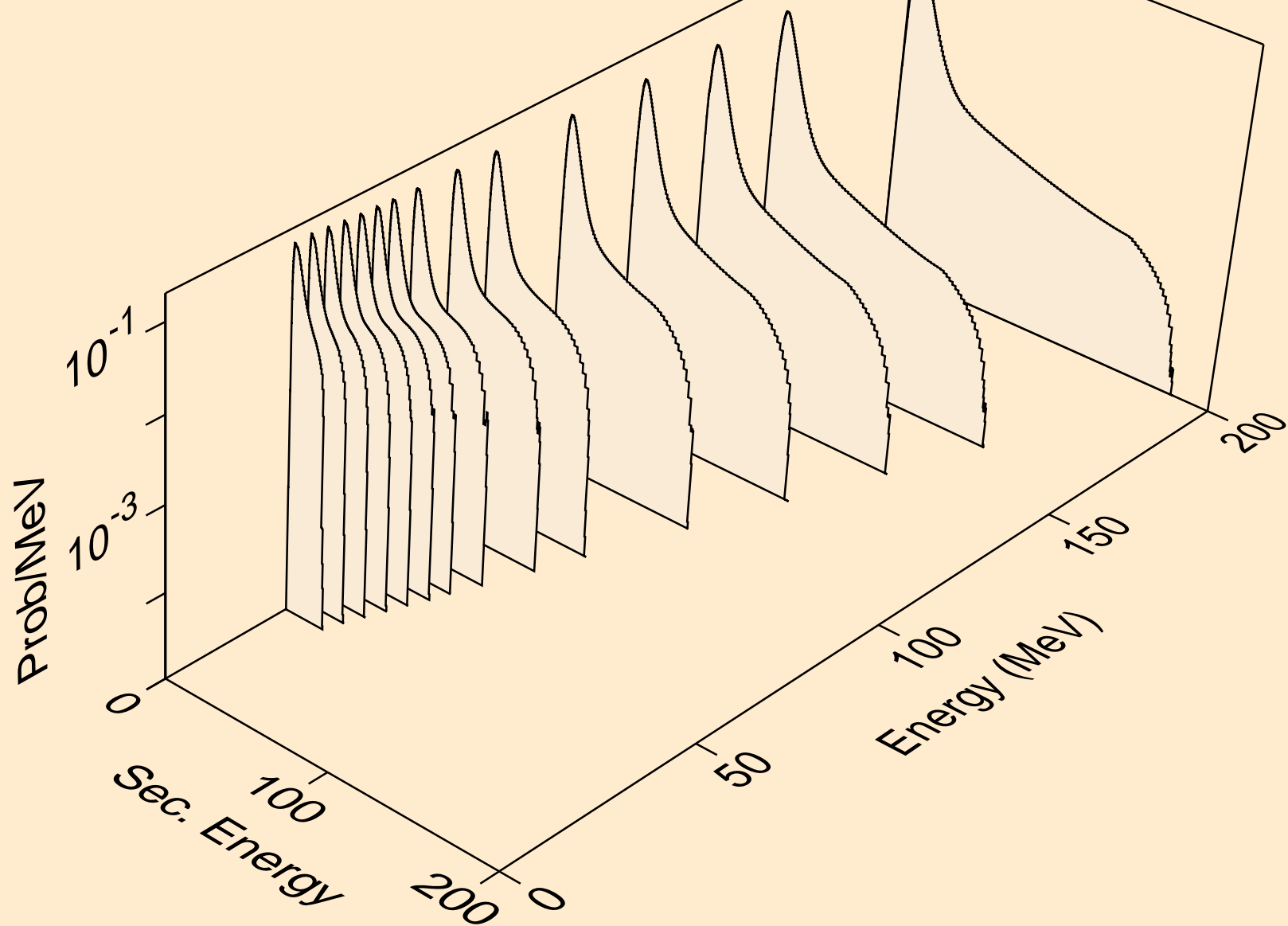

MG024 NEUTRON ACER TENDL-2024 LIBRARY; T=0.K
protons from (n,n*)p

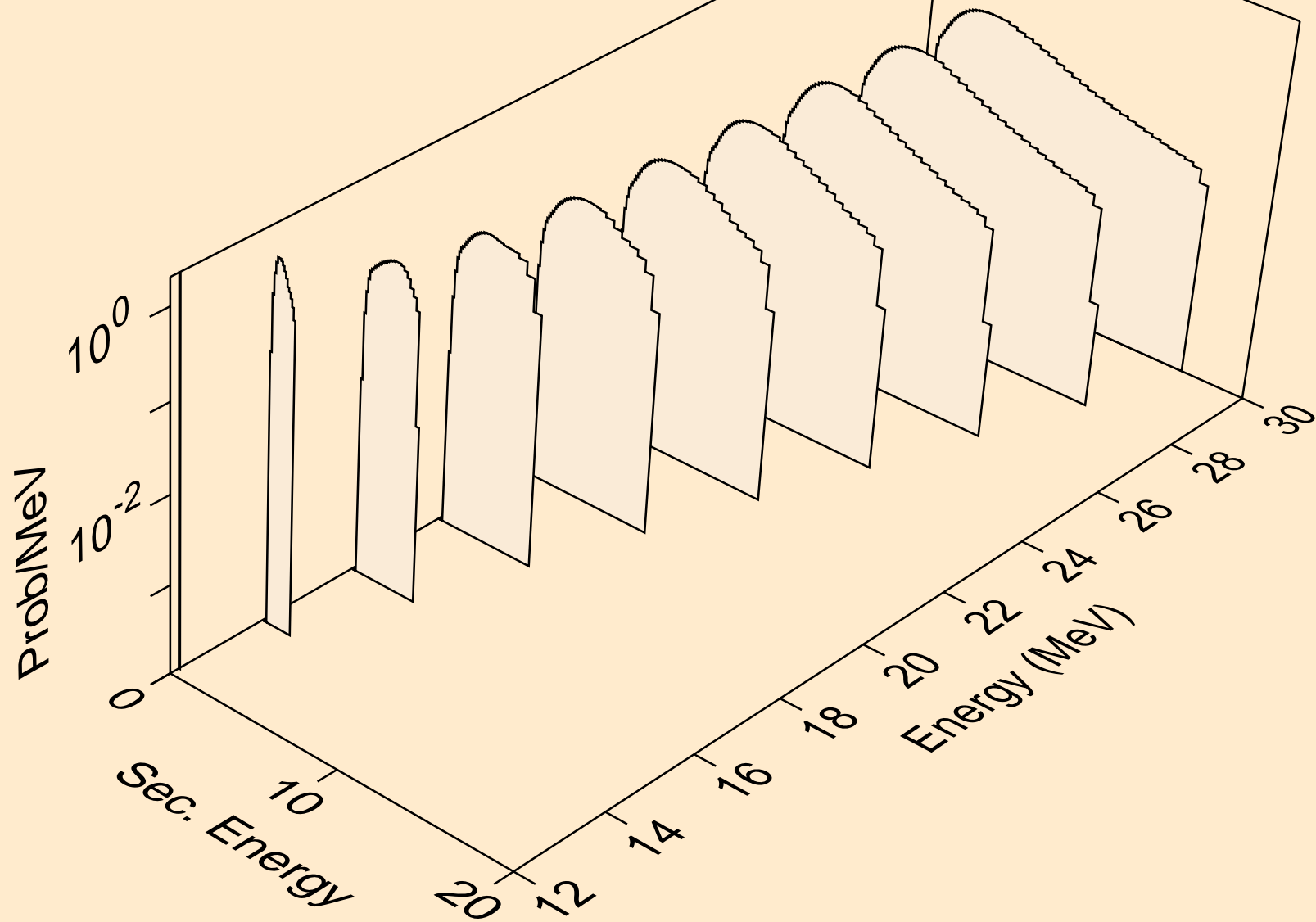

MG024 NEUTRON ACER TENDL-2024 LIBRARY; T=0.K
protons from (n,2np)

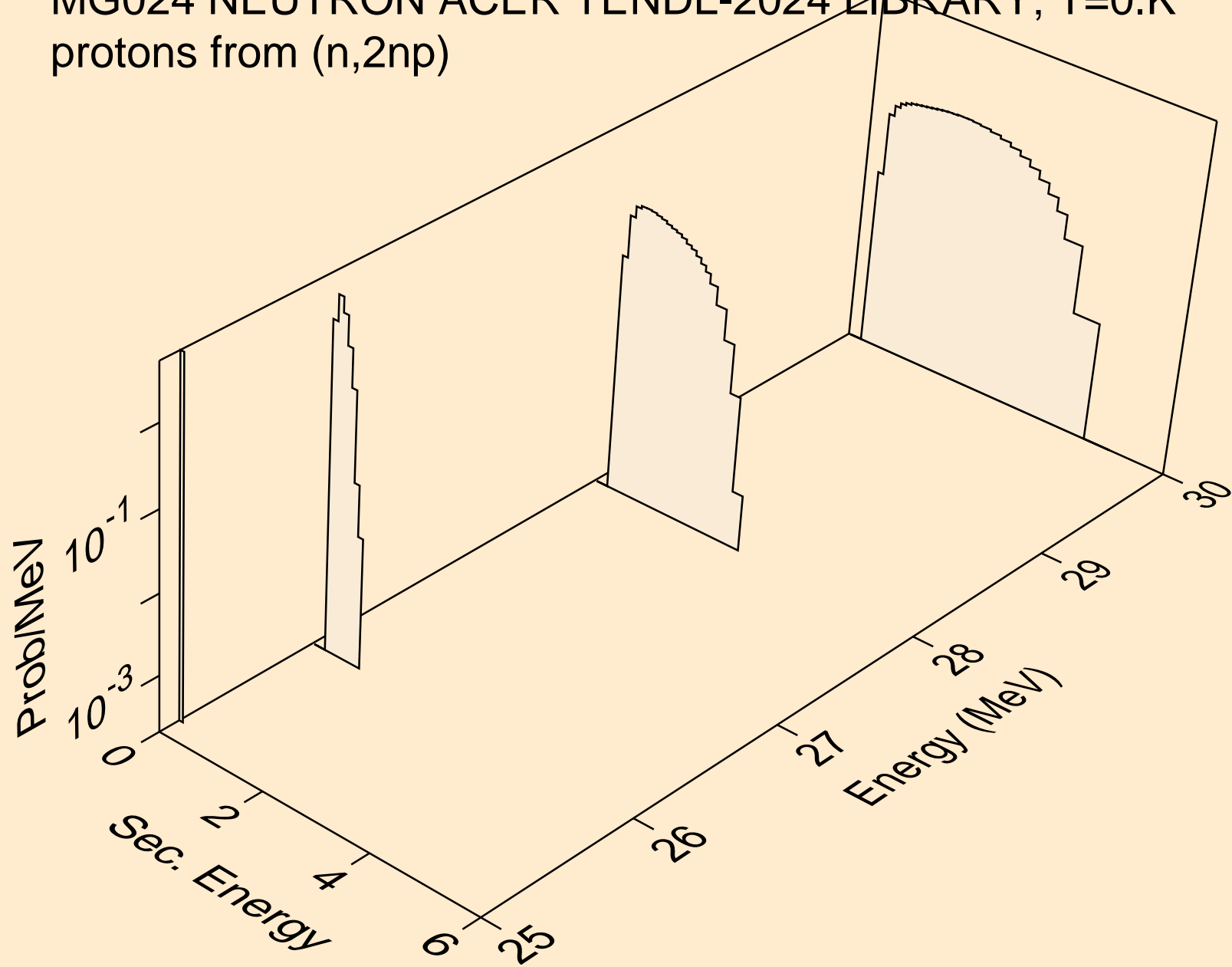

MG024 NEUTRON ACER TENDL-2024 LIBRARY; T=0.K
protons from (n,n2p)

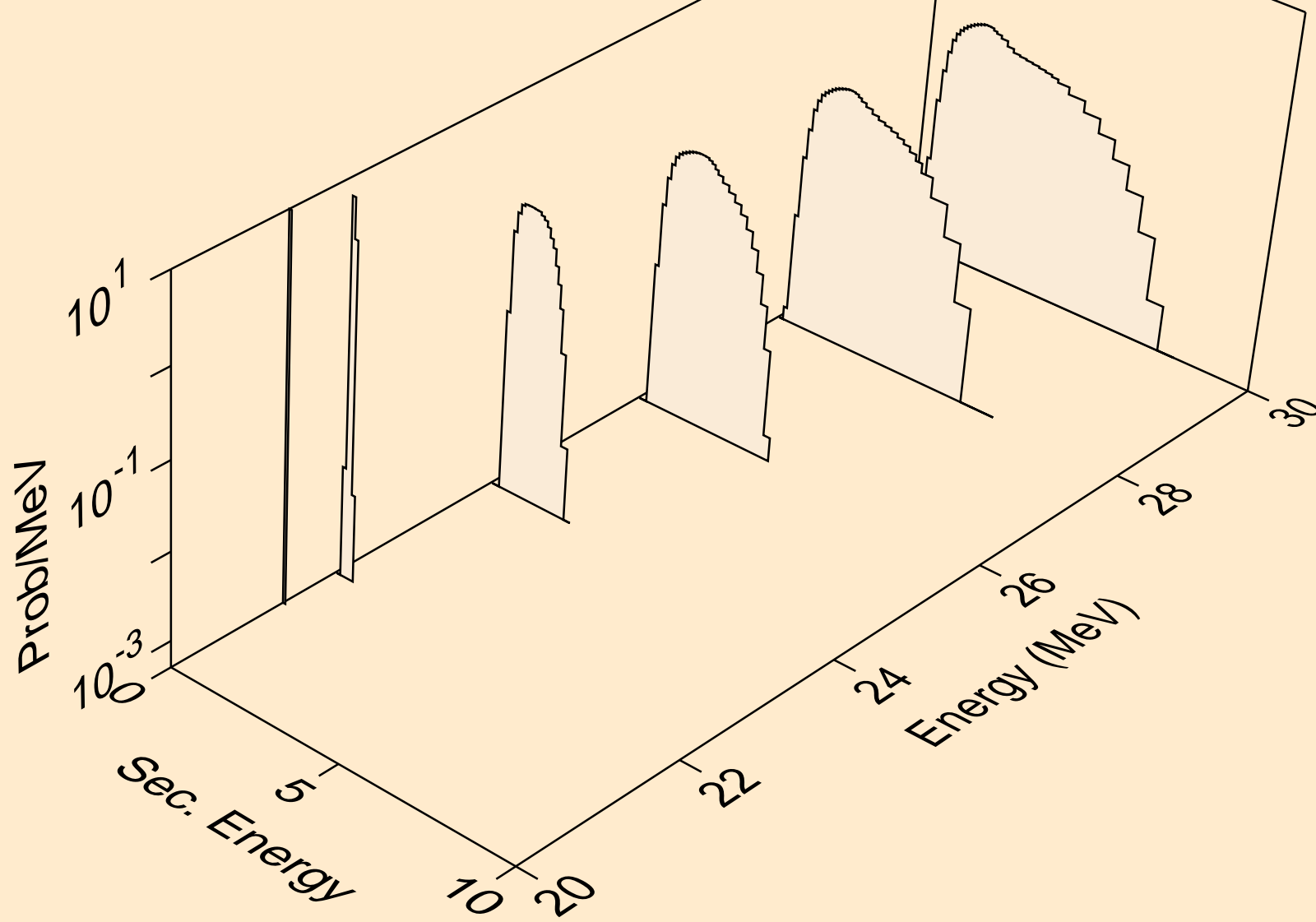

MG024 NEUTRON ACER TENDL-2024 LIBRARY; T=0.K
protons from (n,npa)

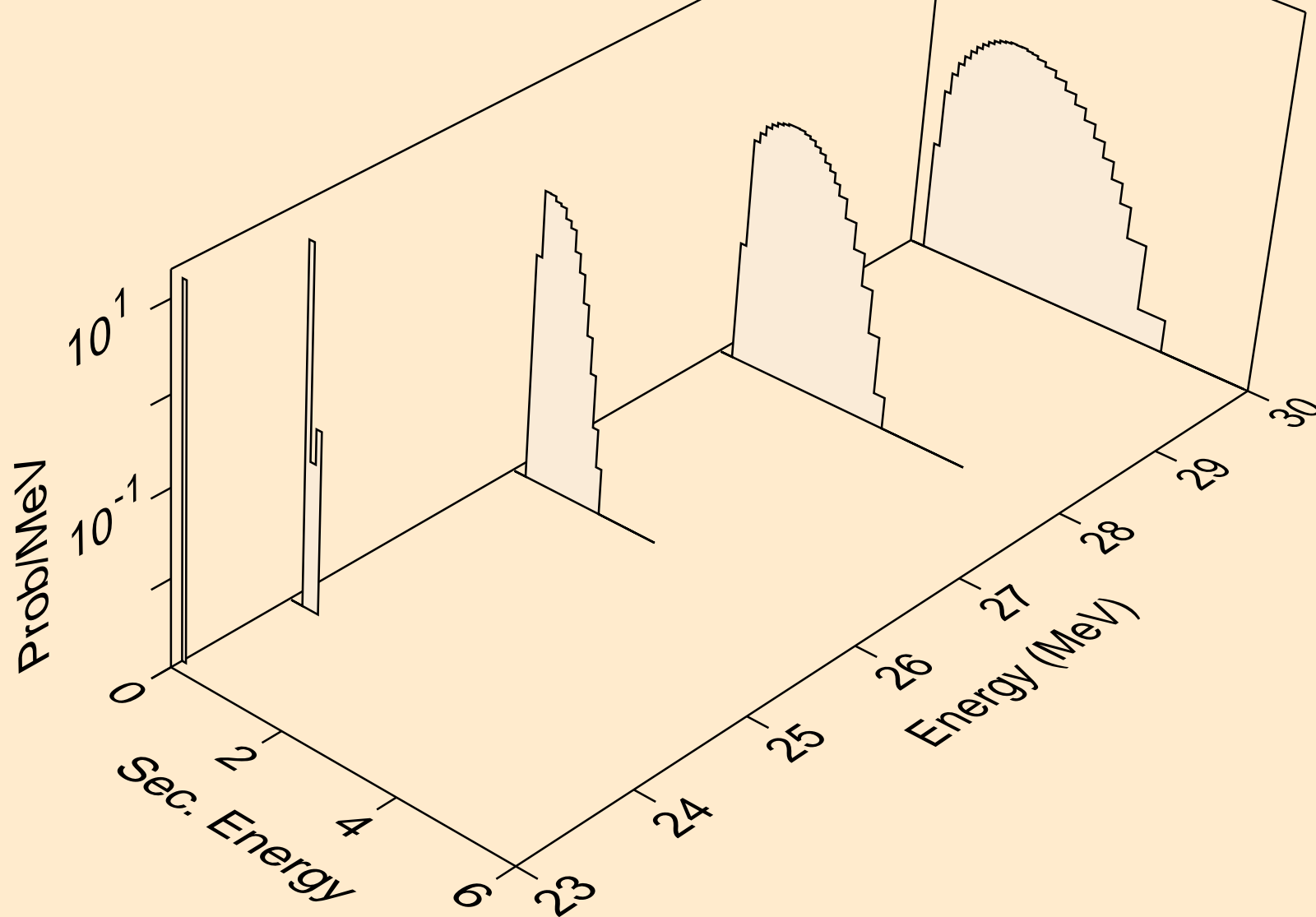

MG024 NEUTRON ACER TENDL-2024 LIBRARY; T=0.K
protons from (n,p)

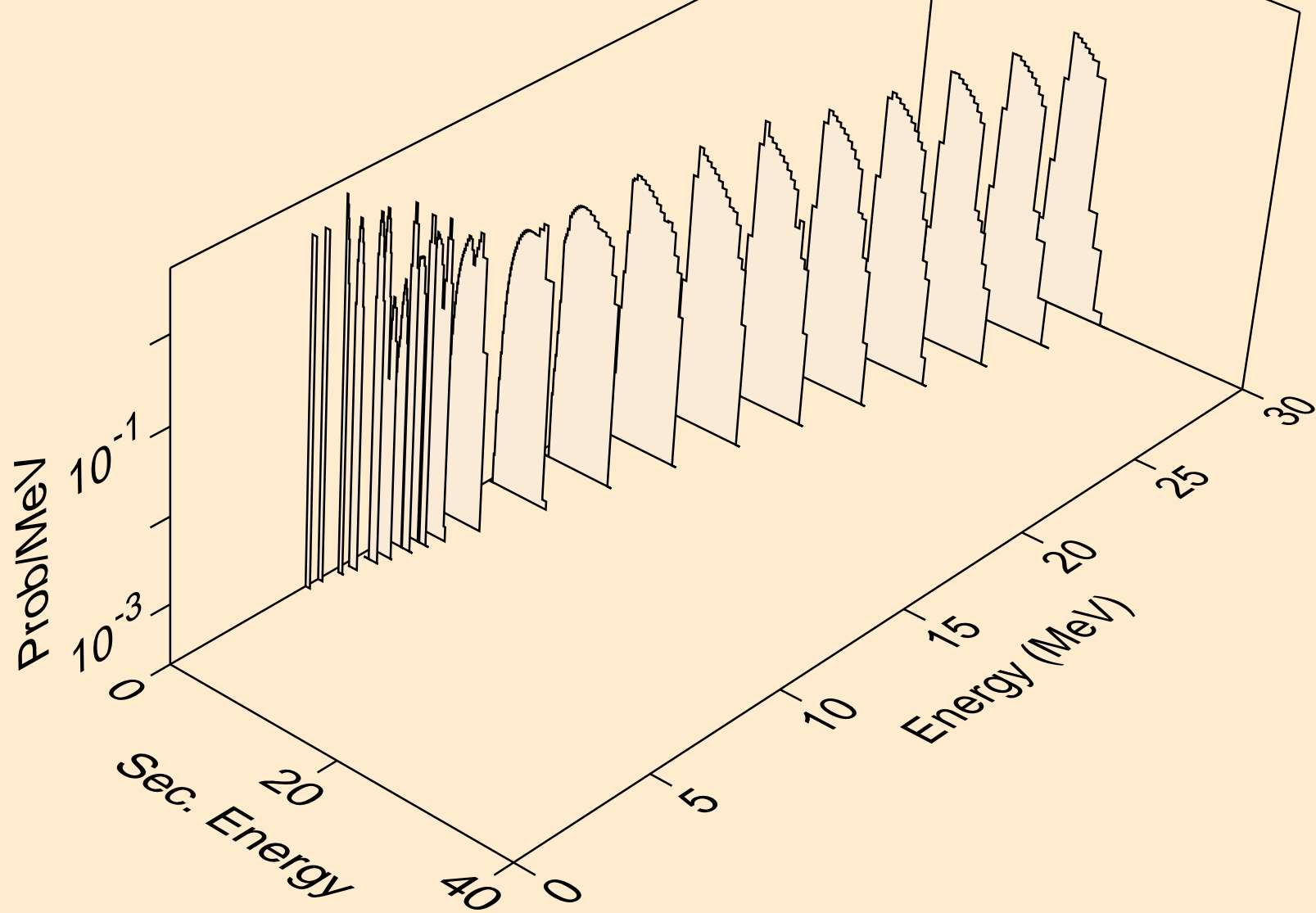

MG024 NEUTRON ACER TENDL-2024 LIBRARY; T=0.K
protons from (n,2p)

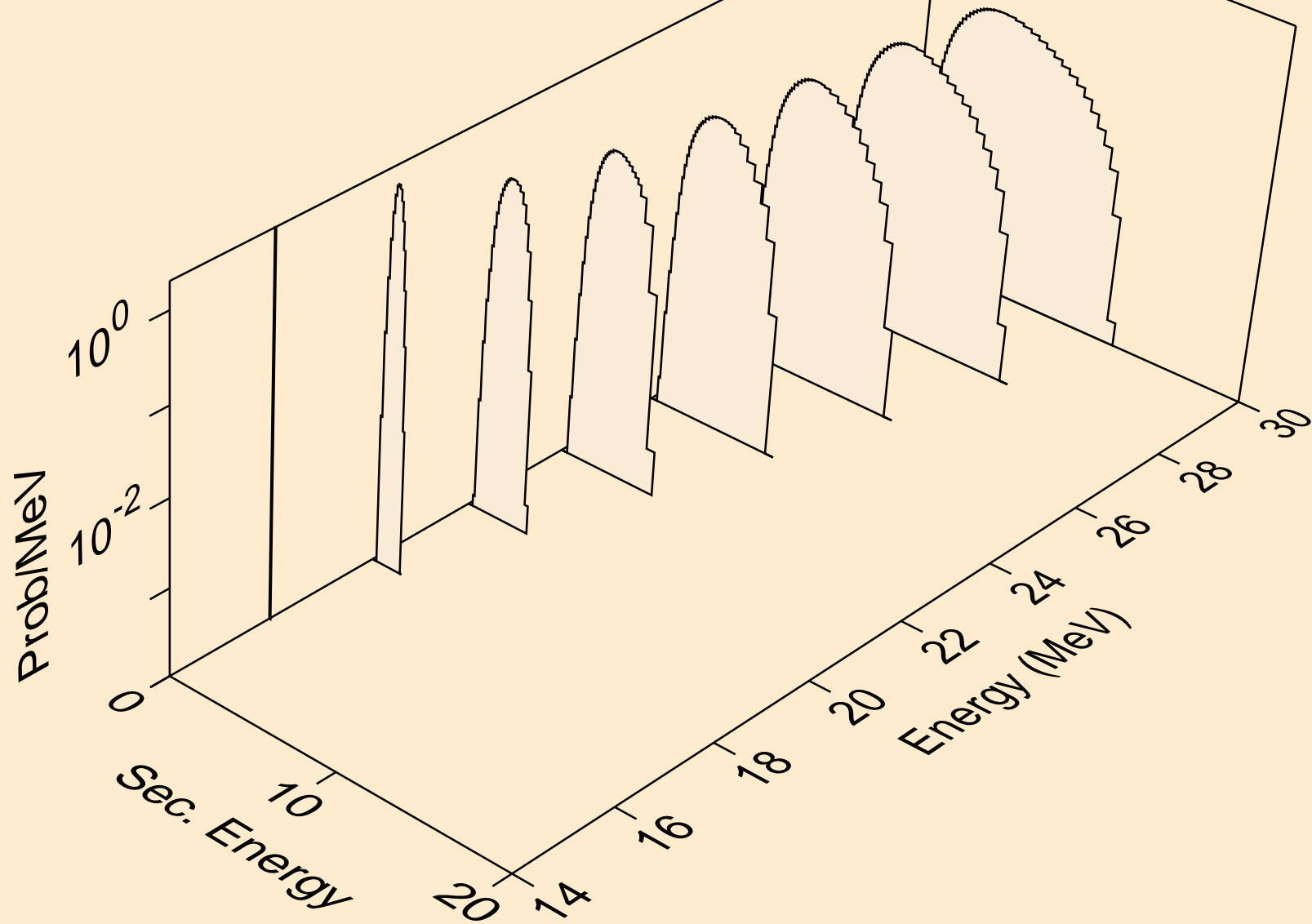

MG024 NEUTRON ACER TENDL-2024 LIBRARY; T=0.K
protons from (n,p)

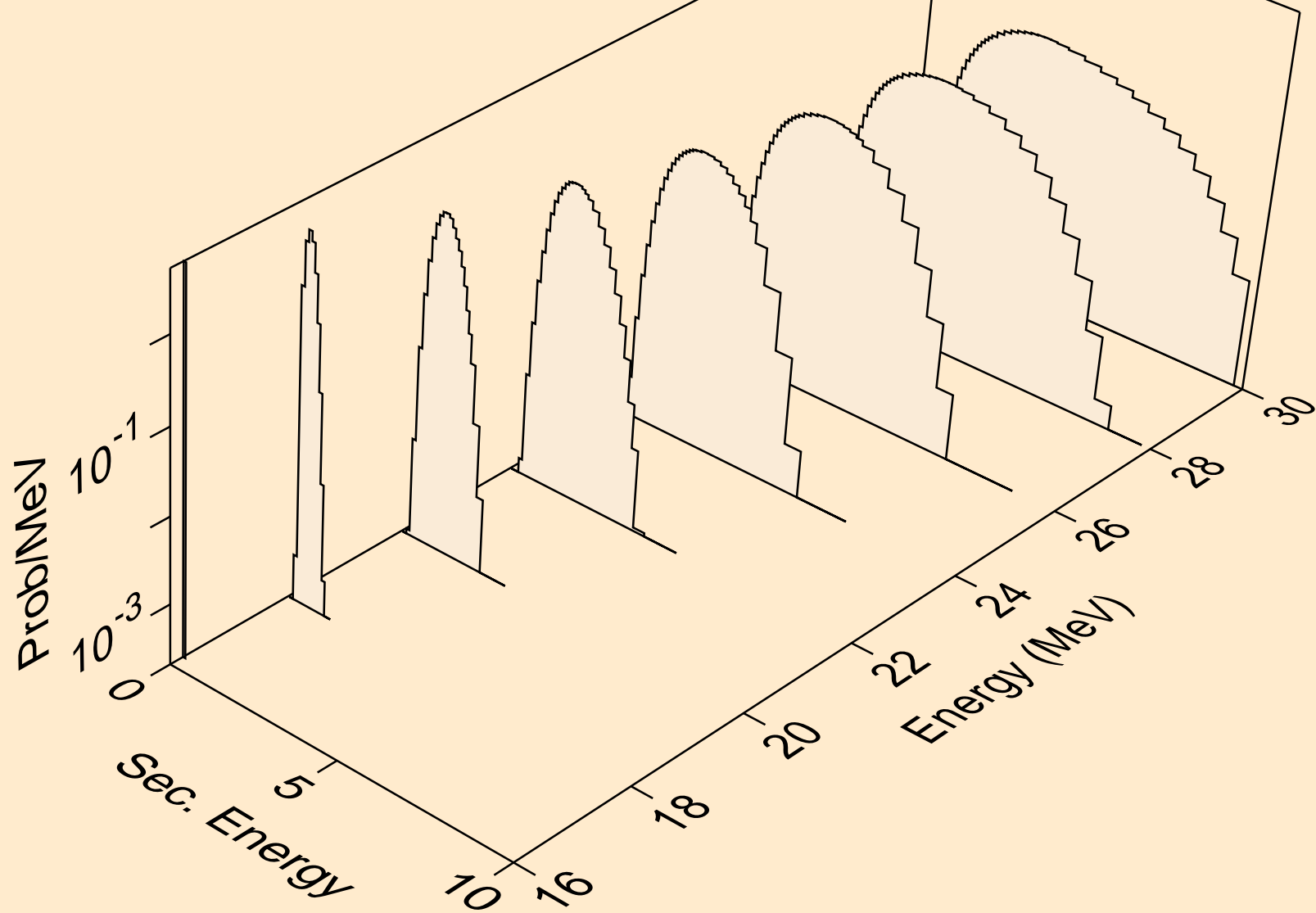

MG024 NEUTRON ACER TENDL-2024 LIBRARY; T=0.K
protons from (n,pd)

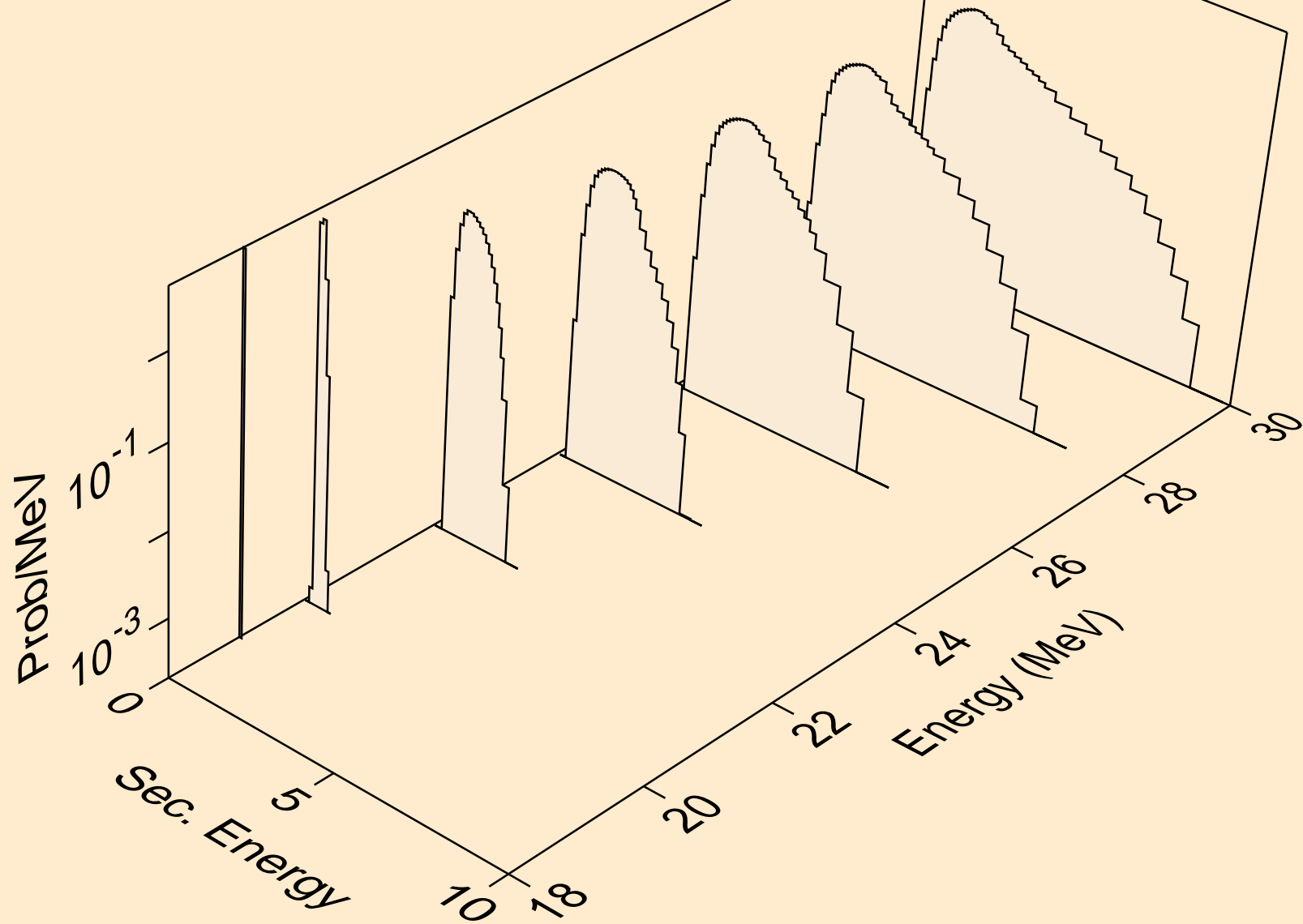

MG024 NEUTRON ACER TENDL-2024 LIBRARY; T=0.K
protons from (n,pt)

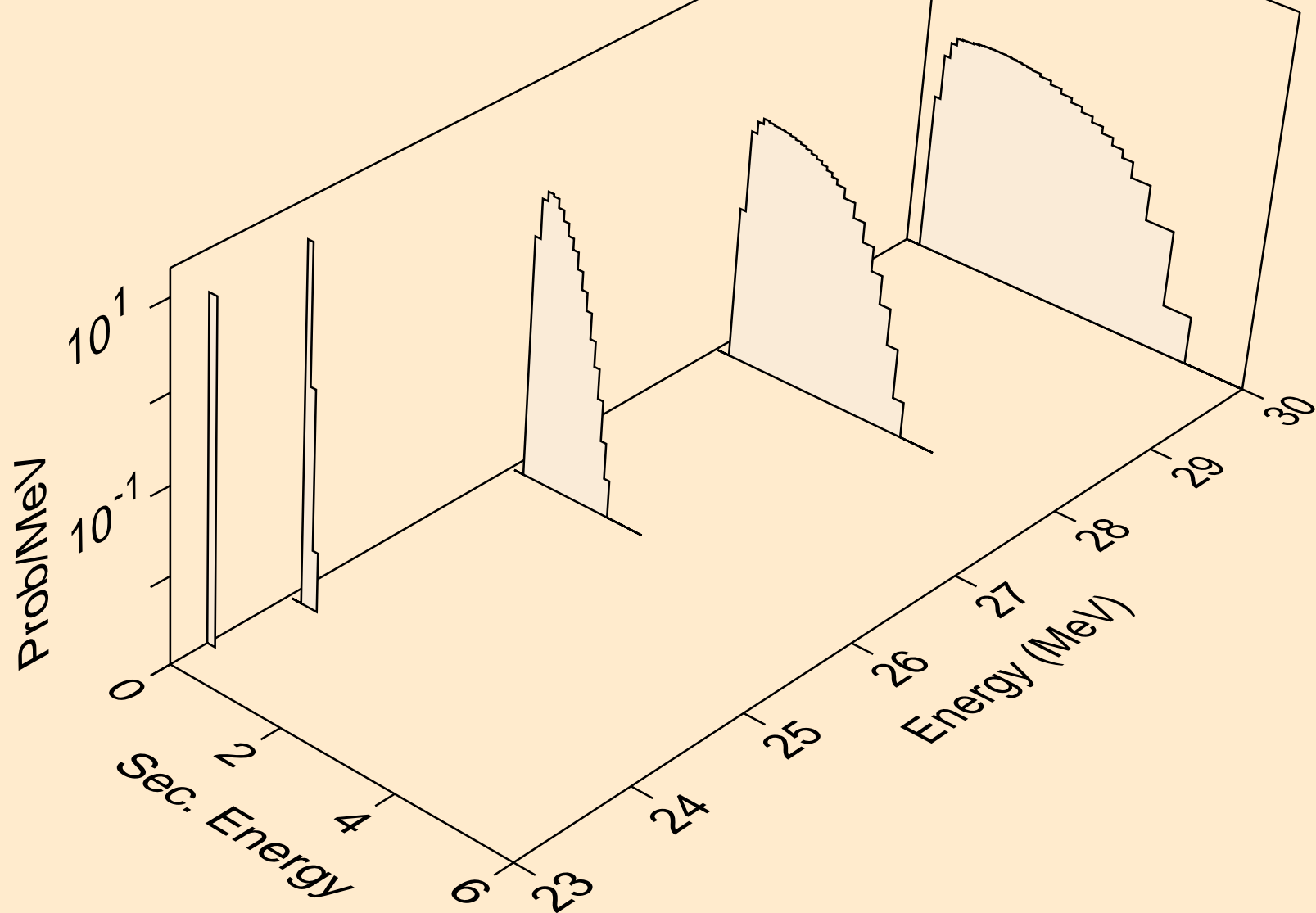

MG024 NEUTRON ACER TENDL-2024 LIBRARY; T=0.K
deuterons from (n,x)

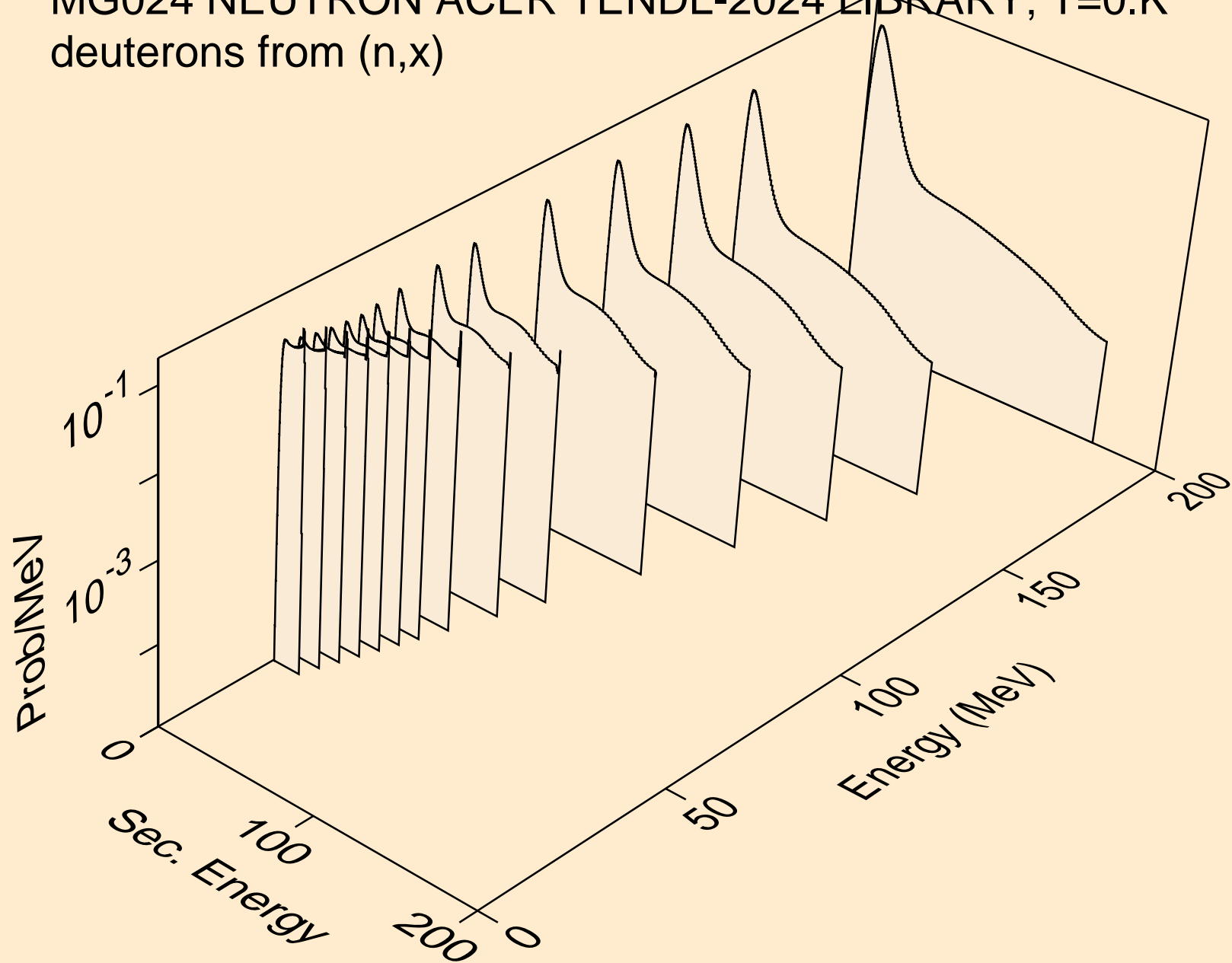

MG024 NEUTRON ACER TENDL-2024 LIBRARY; T=0.K
deuterons from (n,n*)d

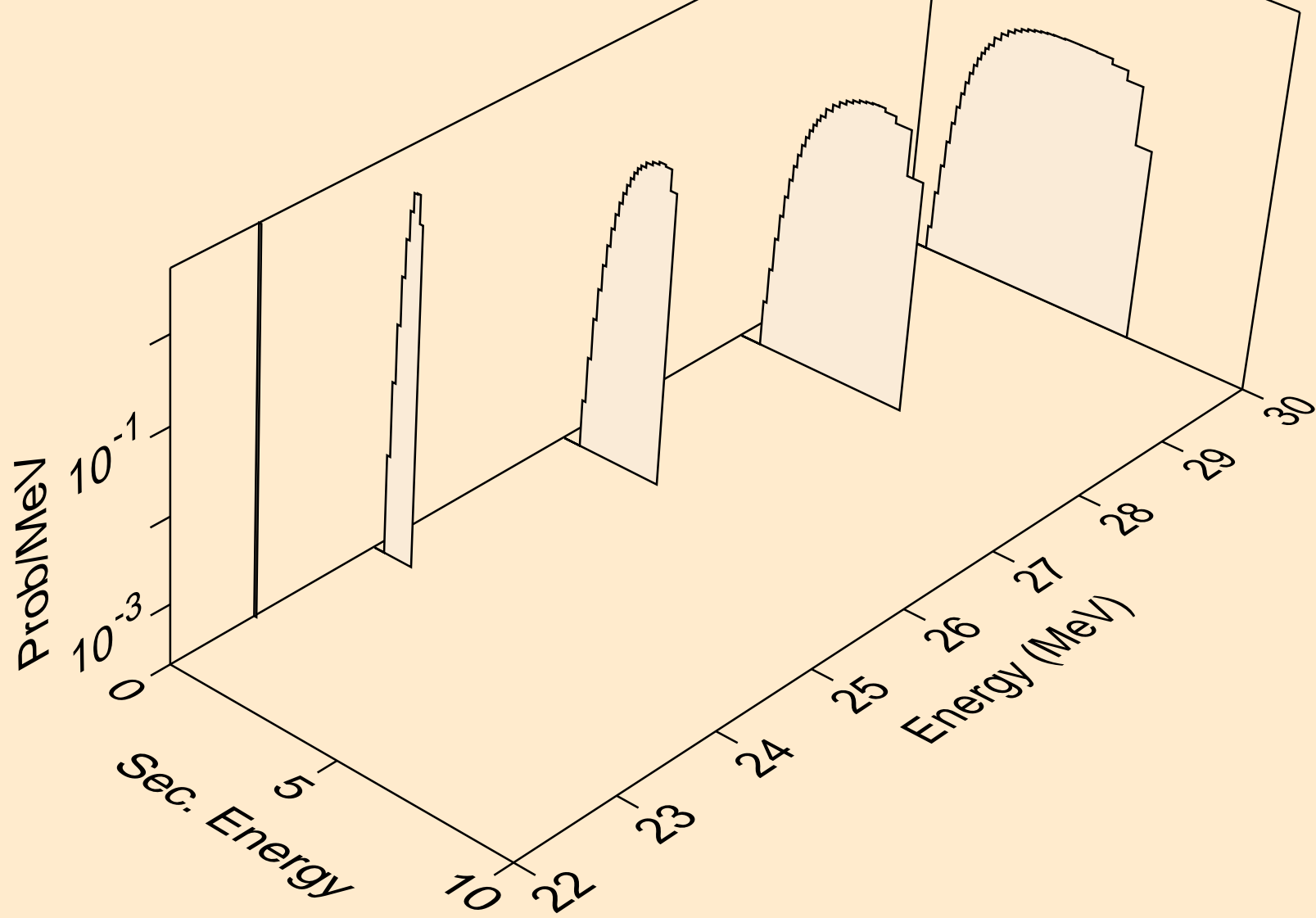

MG024 NEUTRON ACER TENDL-2024 LIBRARY; T=0.K
deuterons from (n,d)

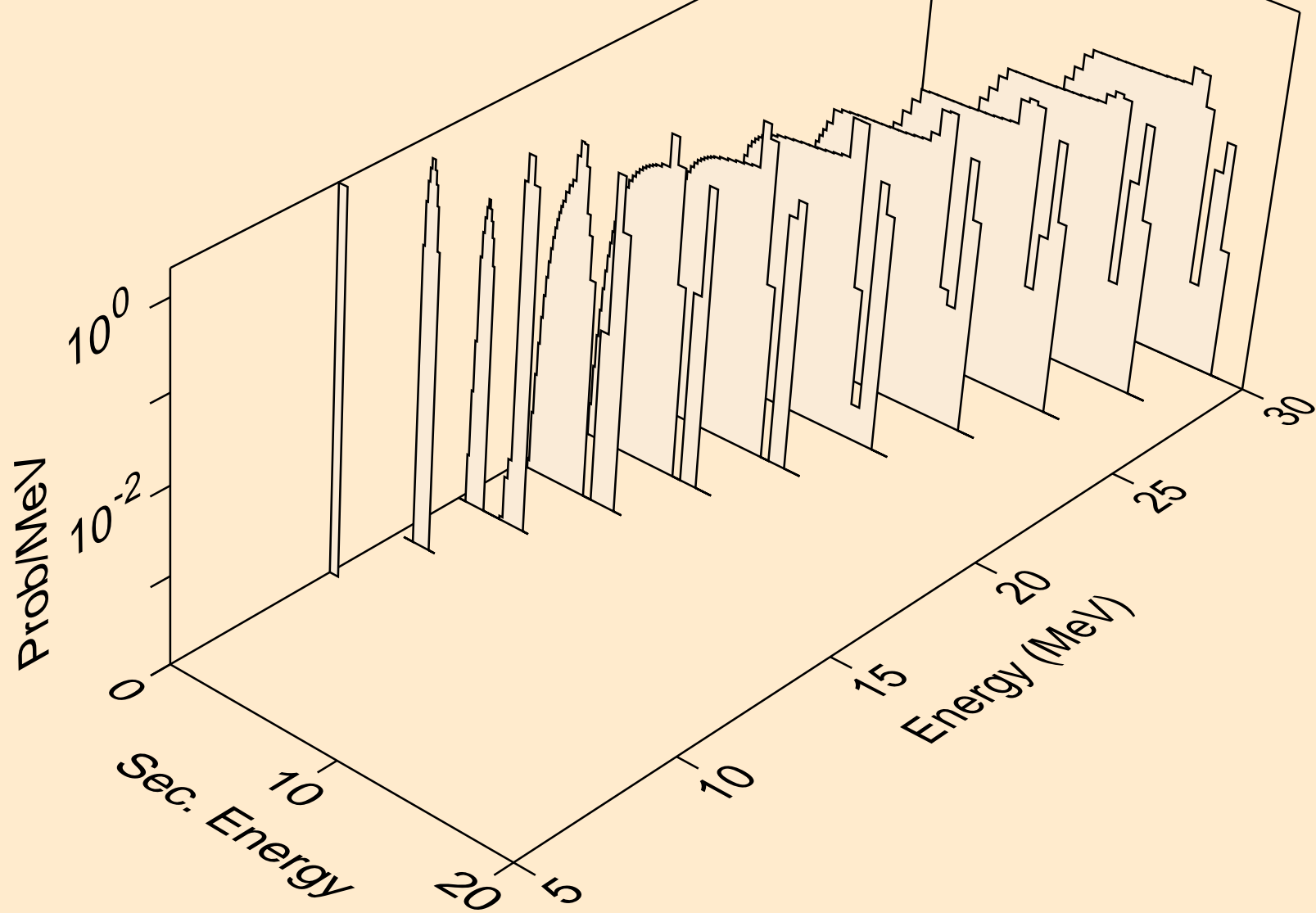

MG024 NEUTRON ACER TENDL-2024 LIBRARY; T=0.K
deuterons from (n,d2a)

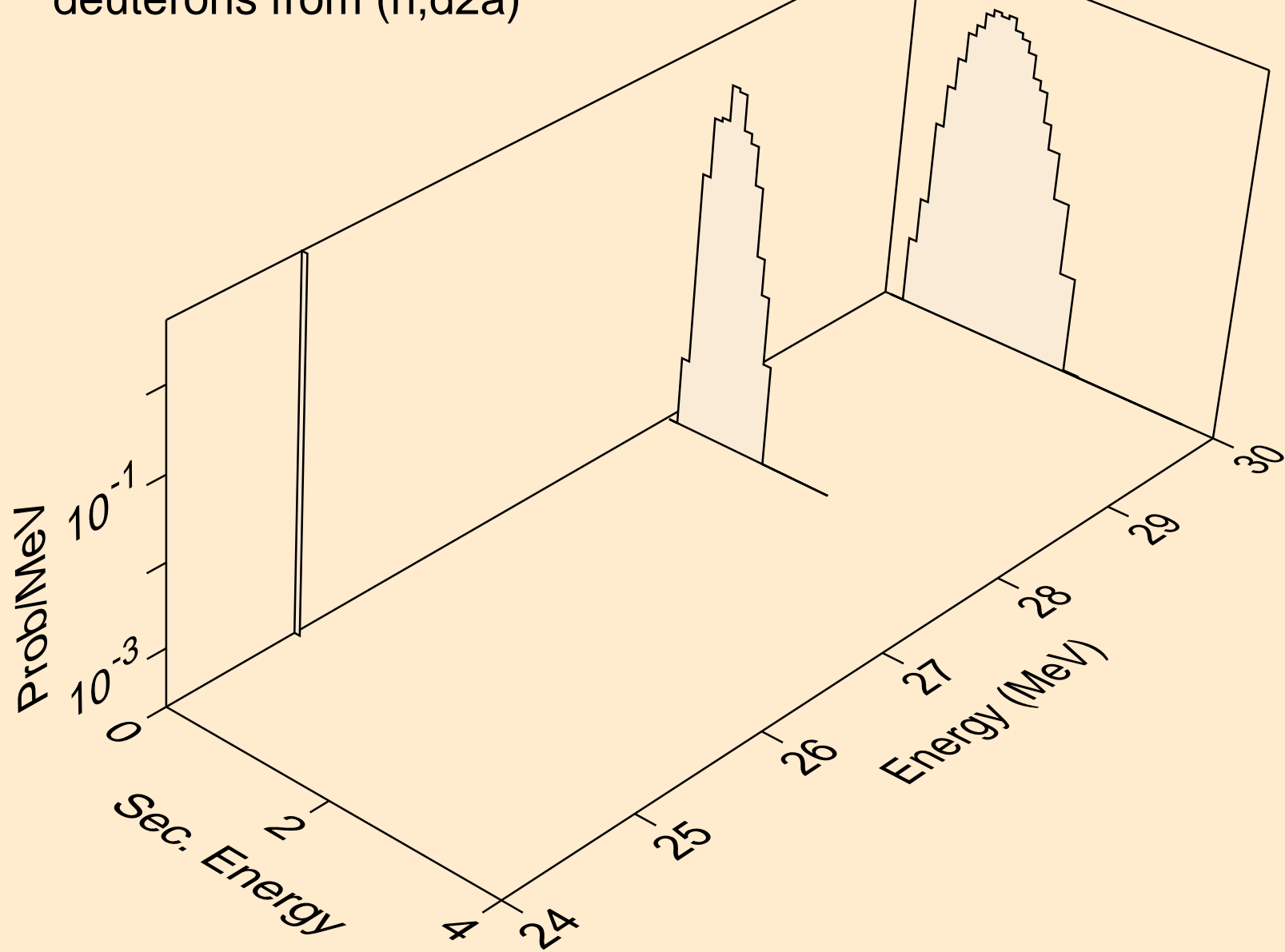

MG024 NEUTRON ACER TENDL-2024 LIBRARY; T=0.K
deuterons from (n,pd)

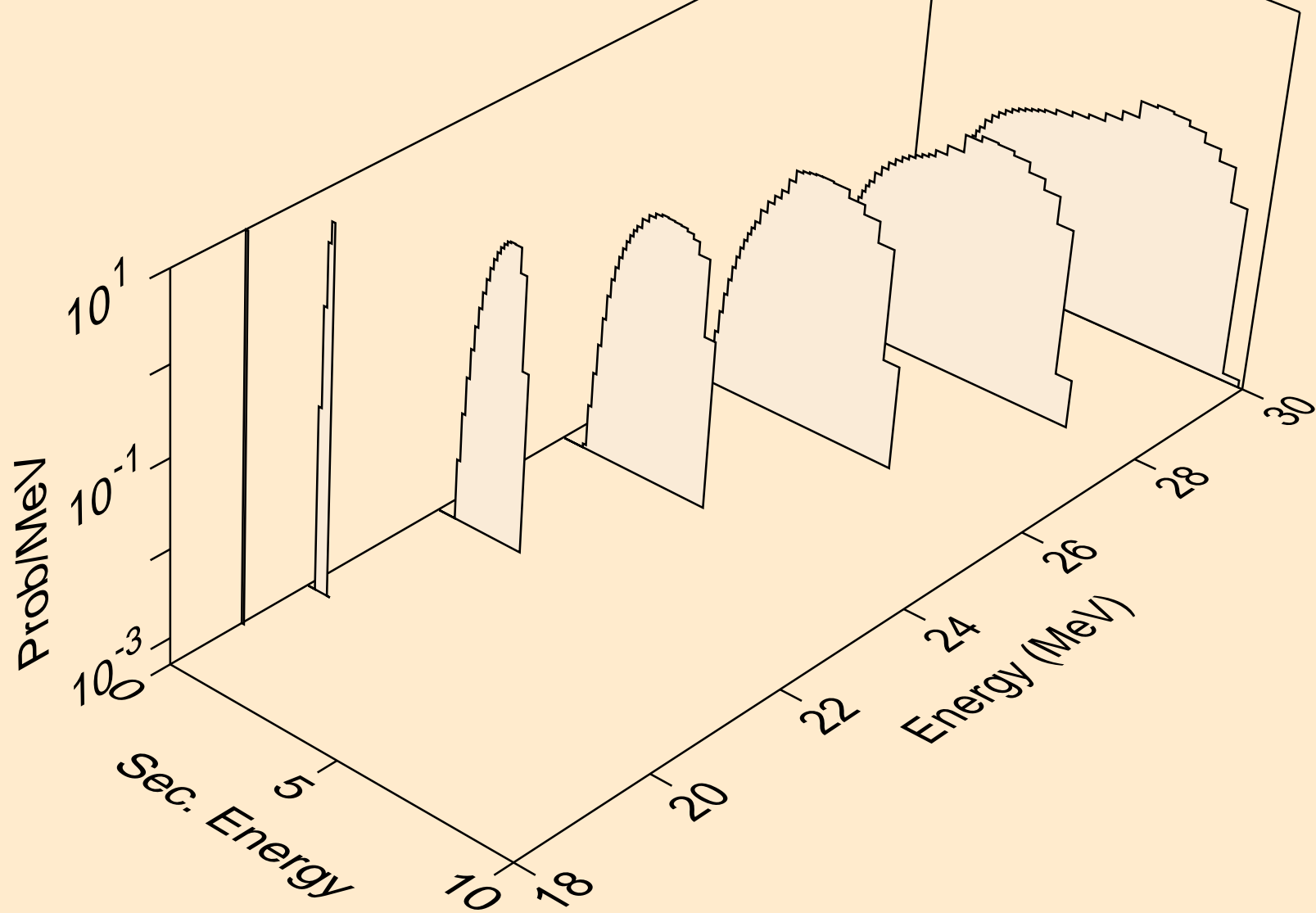

MG024 NEUTRON ACER TENDL-2024 LIBRARY; T=0.K
deuterons from (n,da)

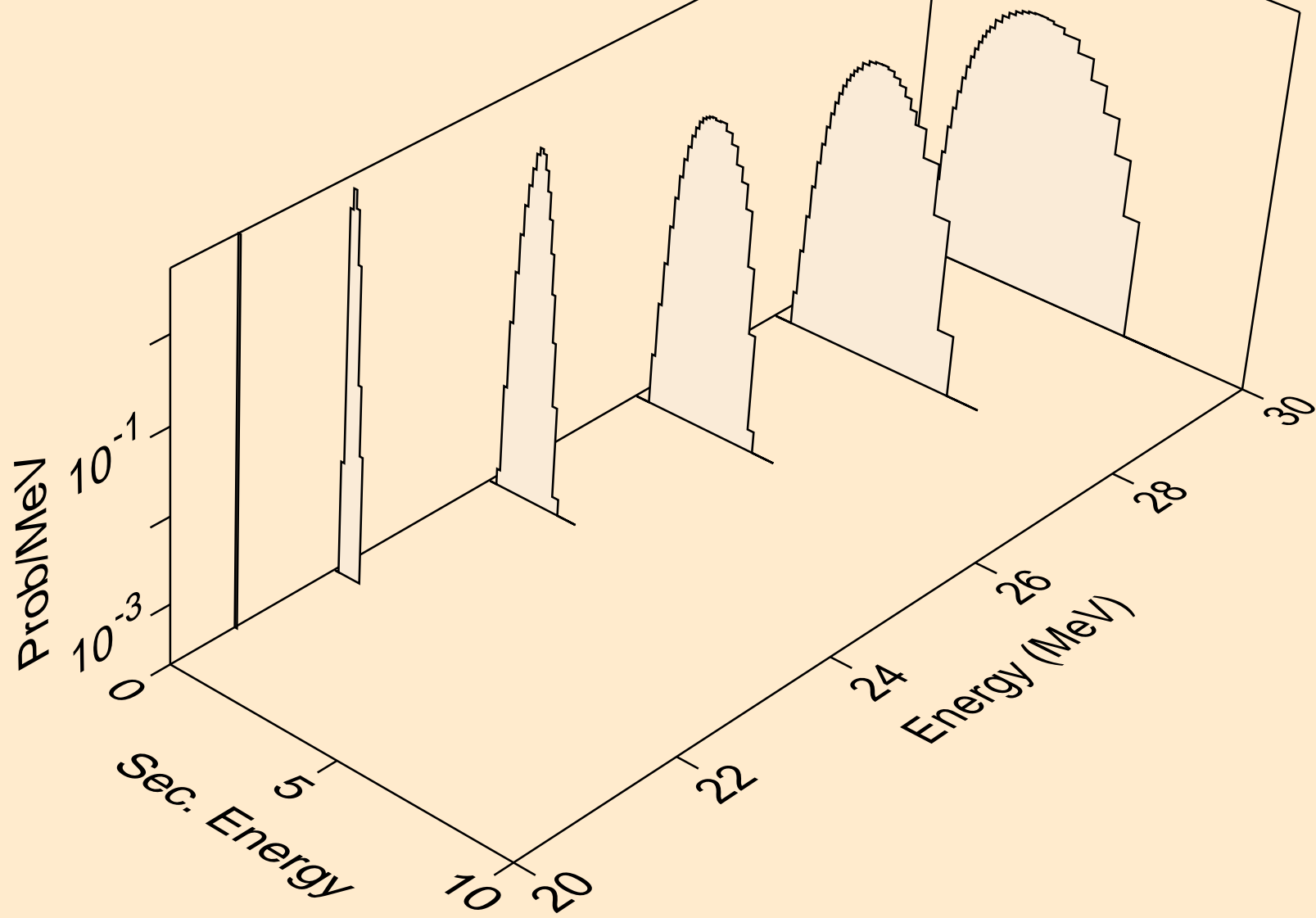

MG024 NEUTRON ACER TENDL-2024 LIBRARY; T=0.K
tritons from (n,x)

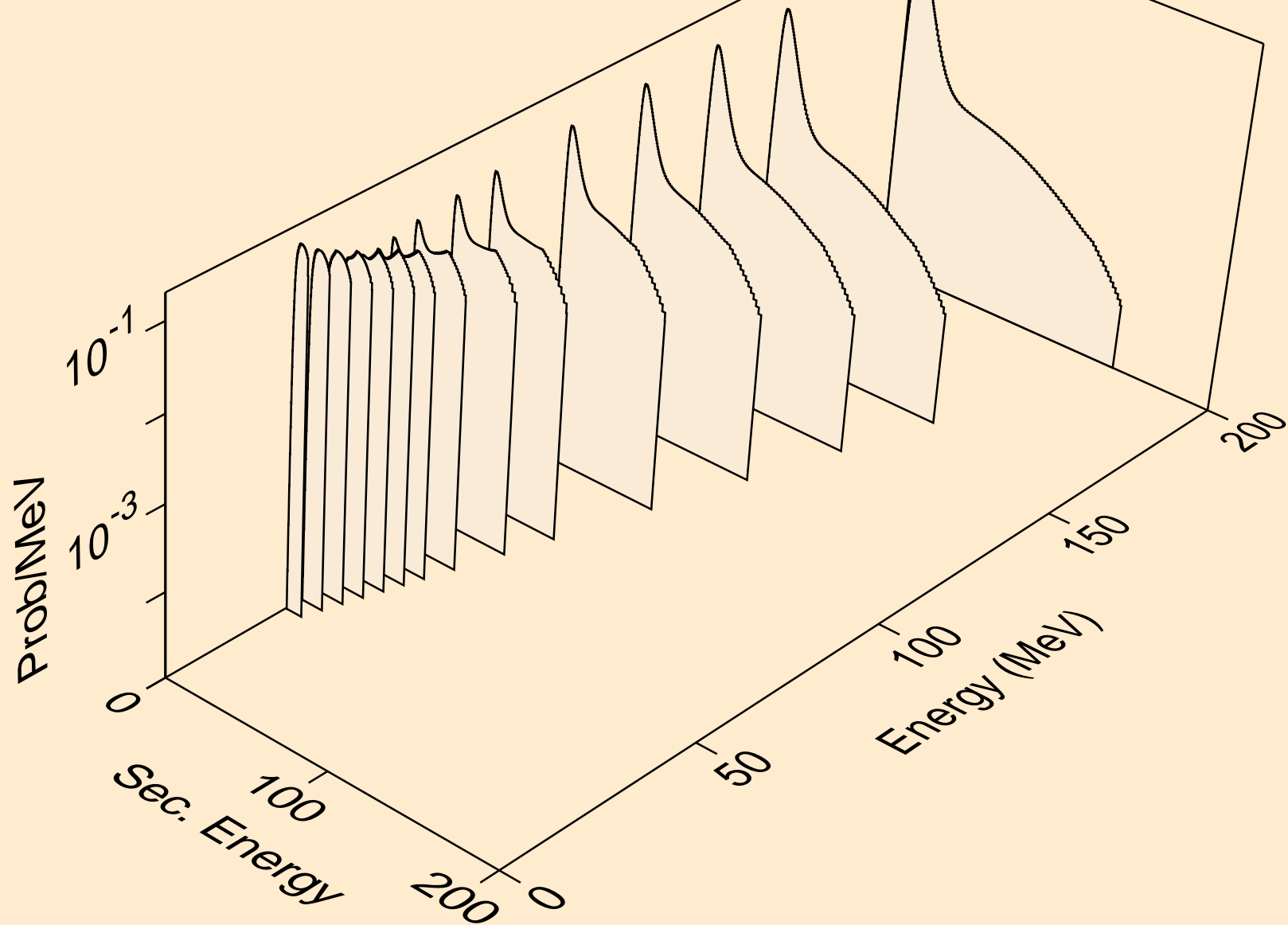

MG024 NEUTRON ACER TENDL-2024 LIBRARY; T=0.K
tritons from (n,n*)t

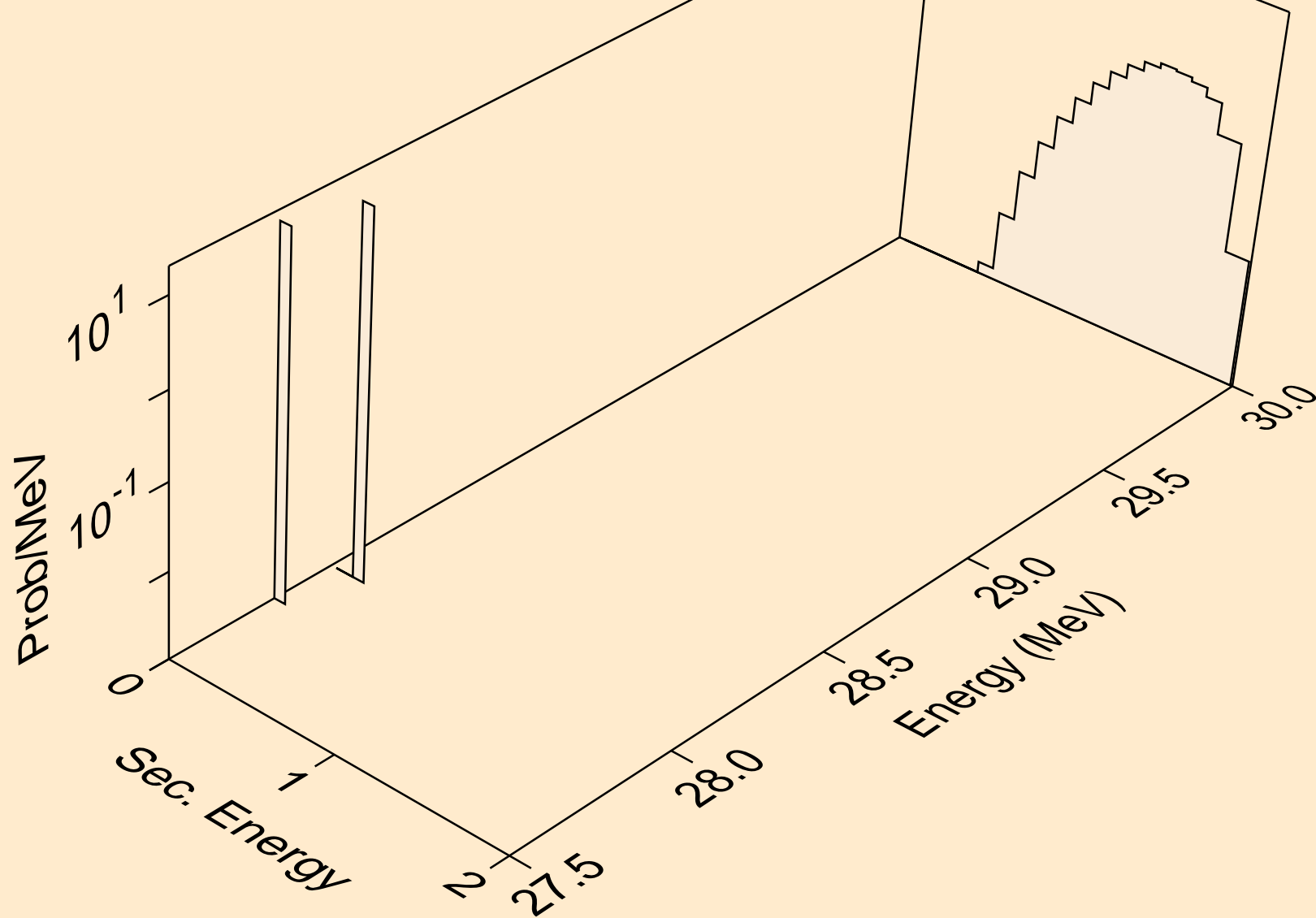

MG024 NEUTRON ACER TENDL-2024 LIBRARY; T=0.K
tritons from (n,t)

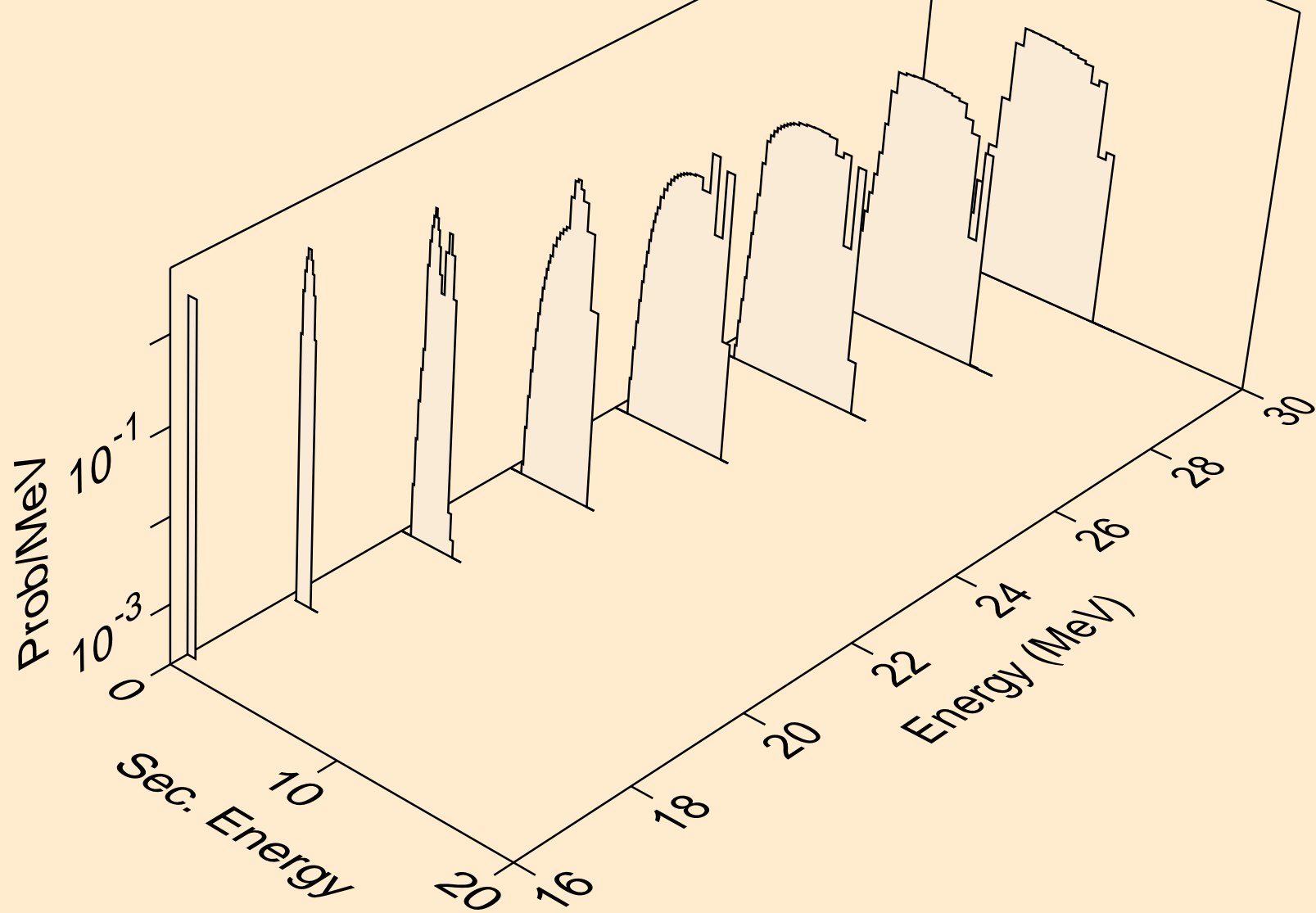

MG024 NEUTRON ACER TENDL-2024 LIBRARY; T=0.K
tritons from (n,pt)

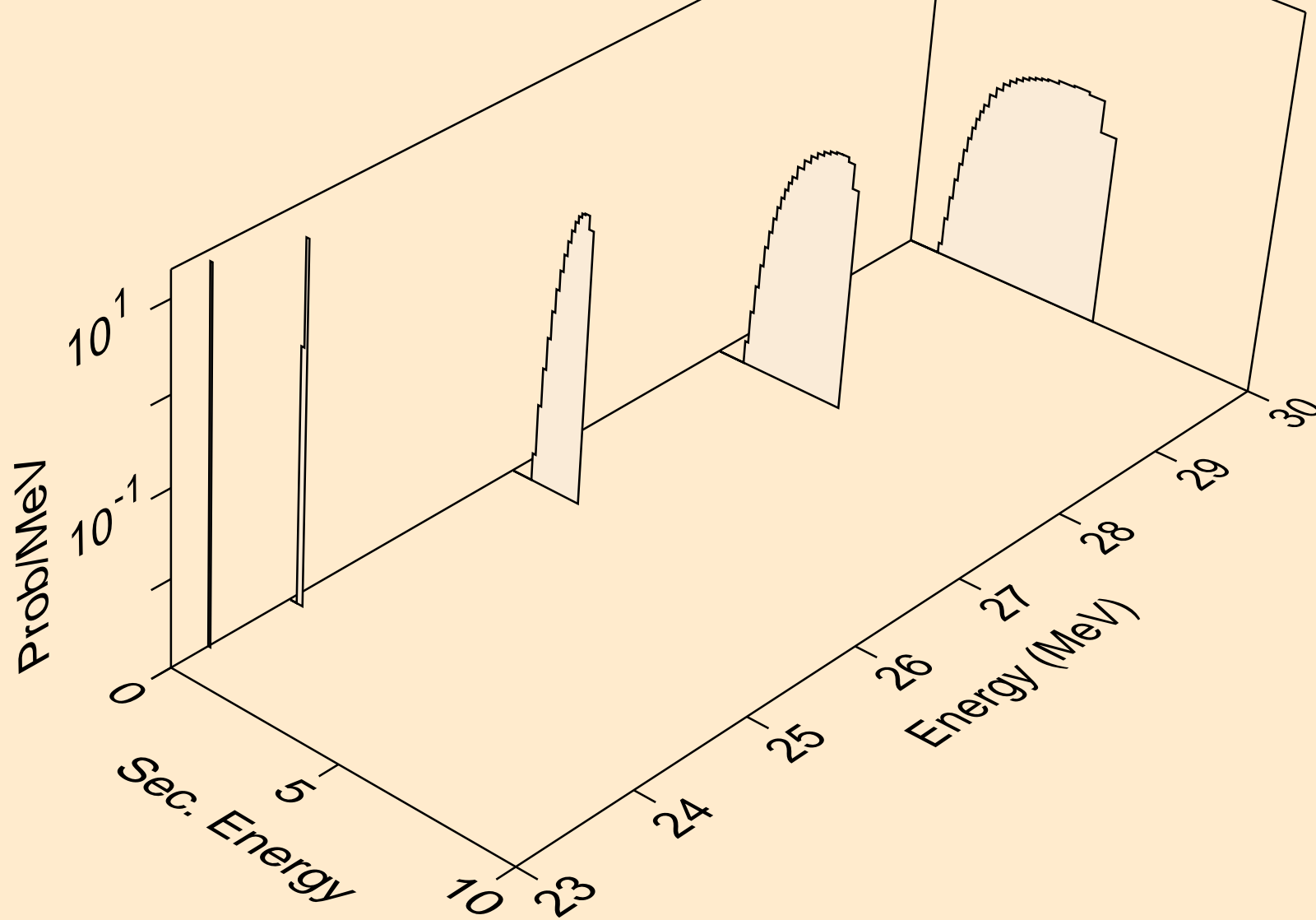

MG024 NEUTRON ACER TENDL-2024 LIBRARY; T=0.K
he3s from (n,x)

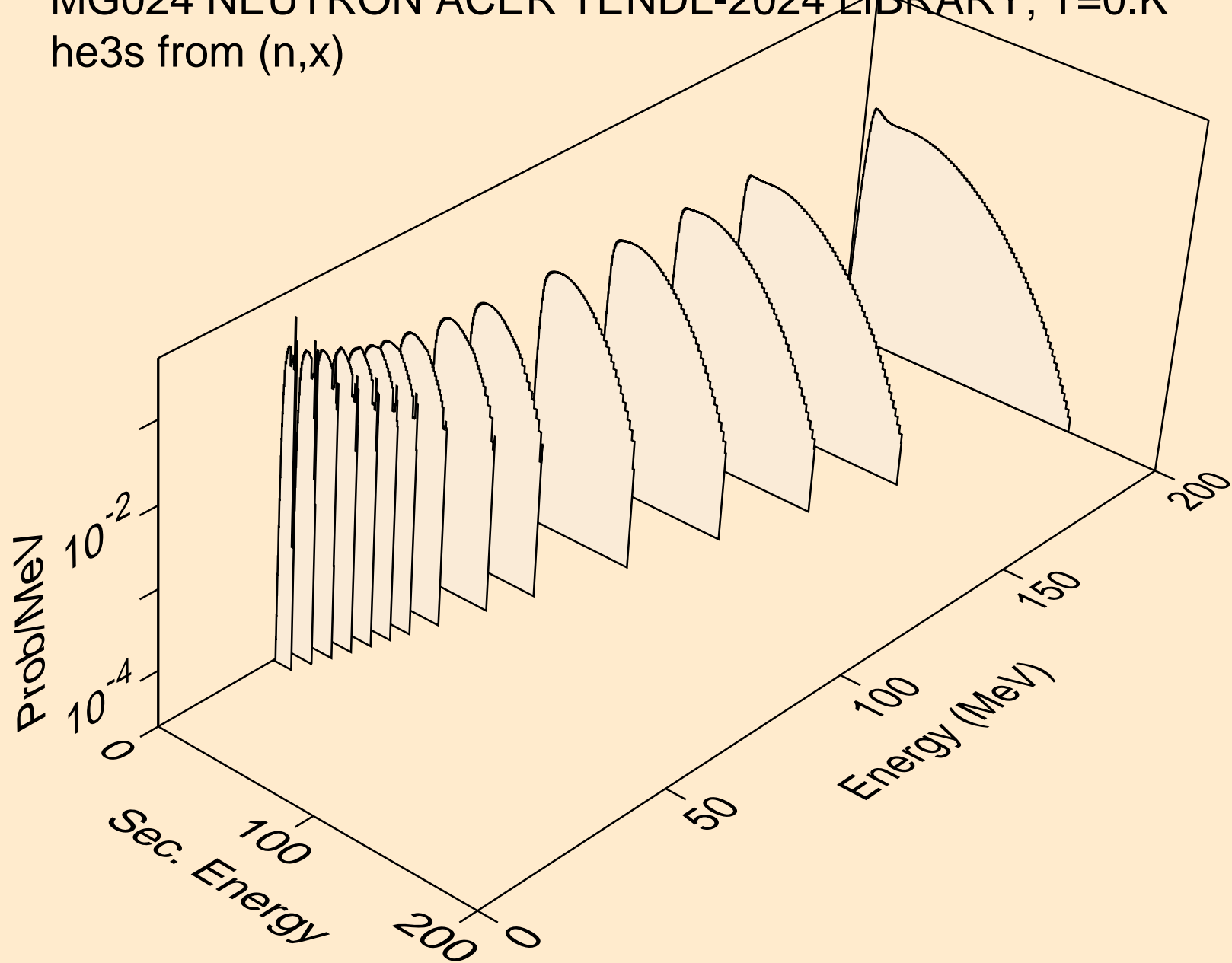

MG024 NEUTRON ACER TENDL-2024 LIBRARY; T=0.K
he3s from (n,n*)he3

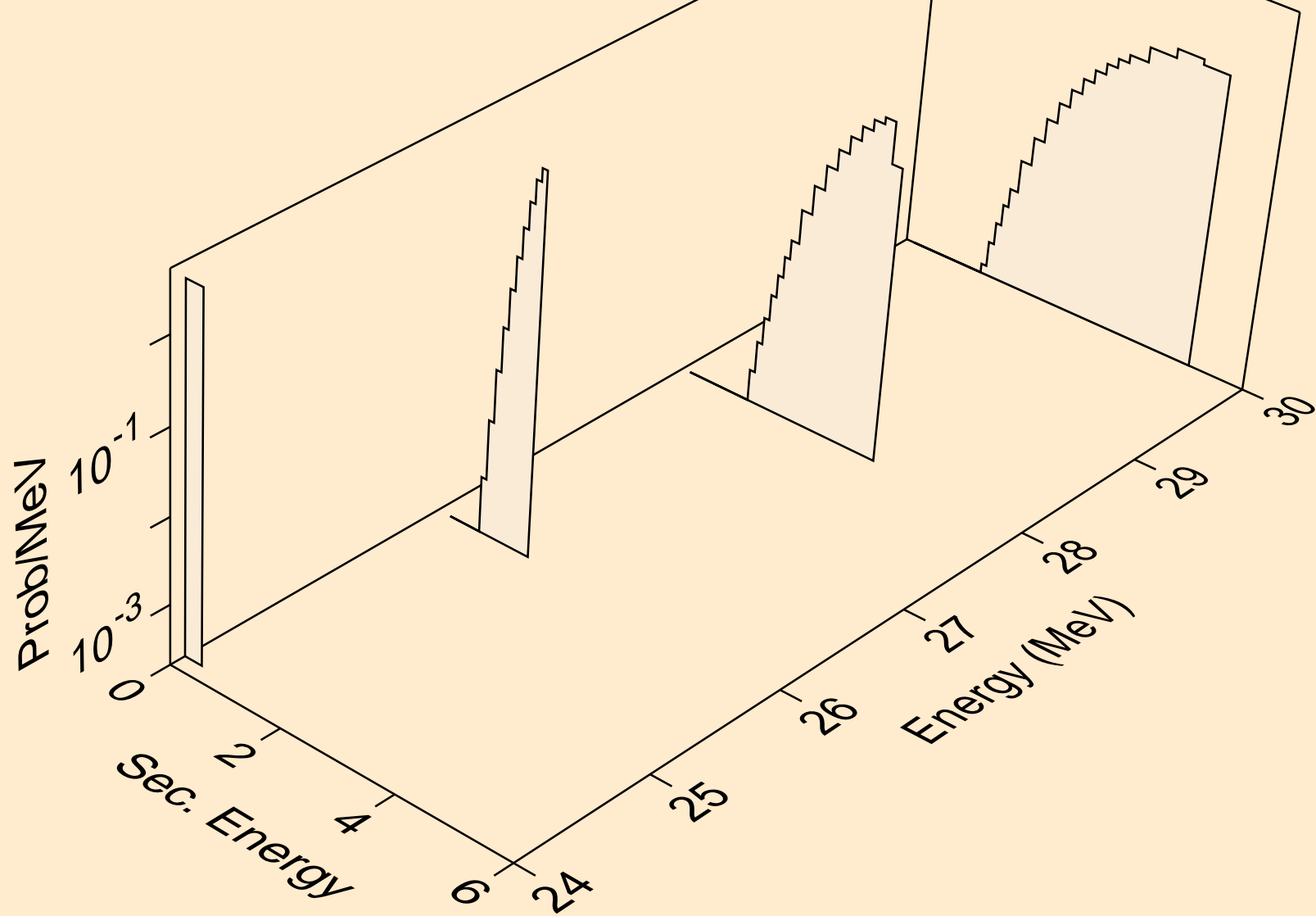

MG024 NEUTRON ACER TENDL-2024 LIBRARY; T=0.K
he3s from (n,he3)

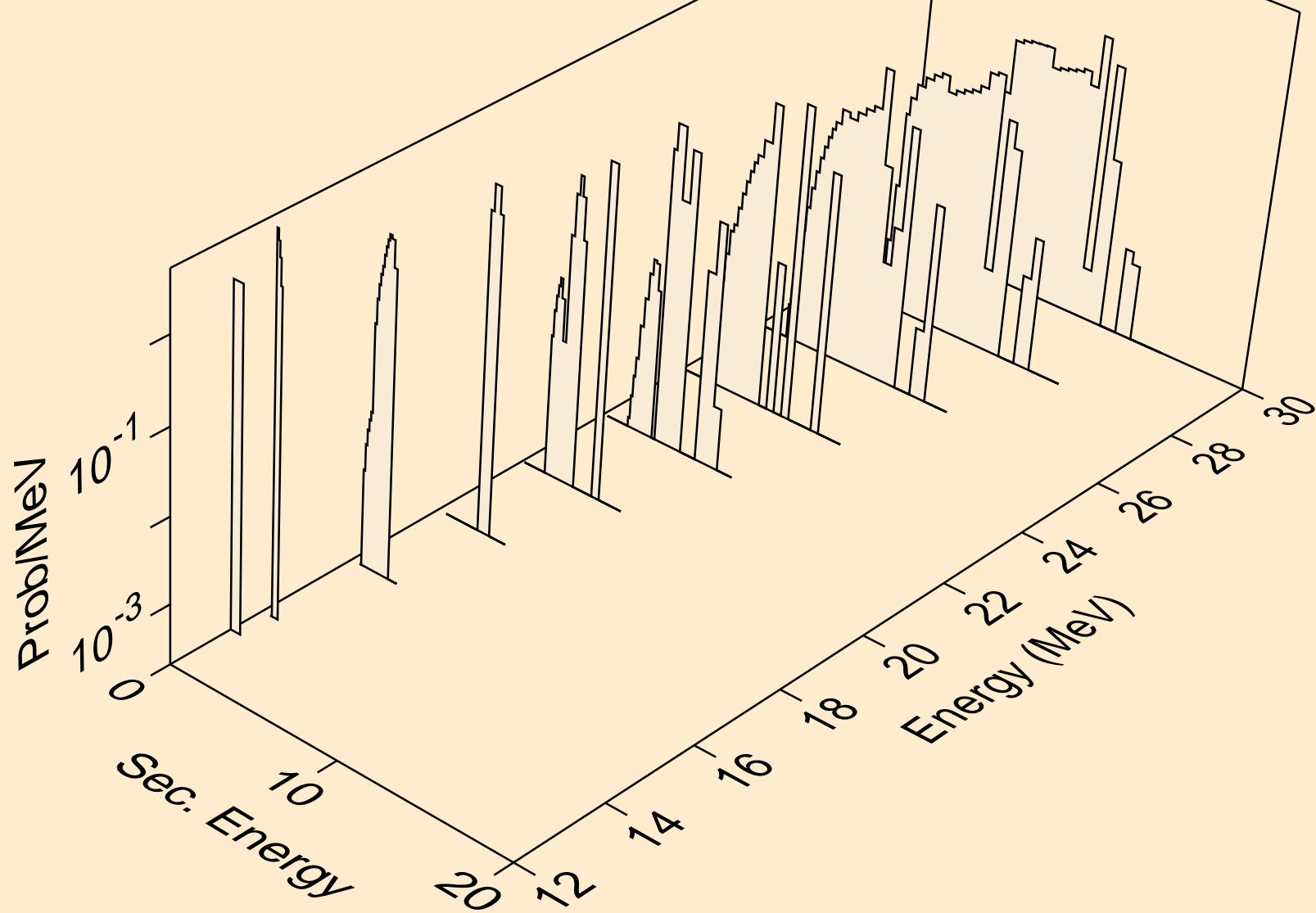

MG024 NEUTRON ACER TENDL-2024 LIBRARY; T=0.K
alphas from (n,x)

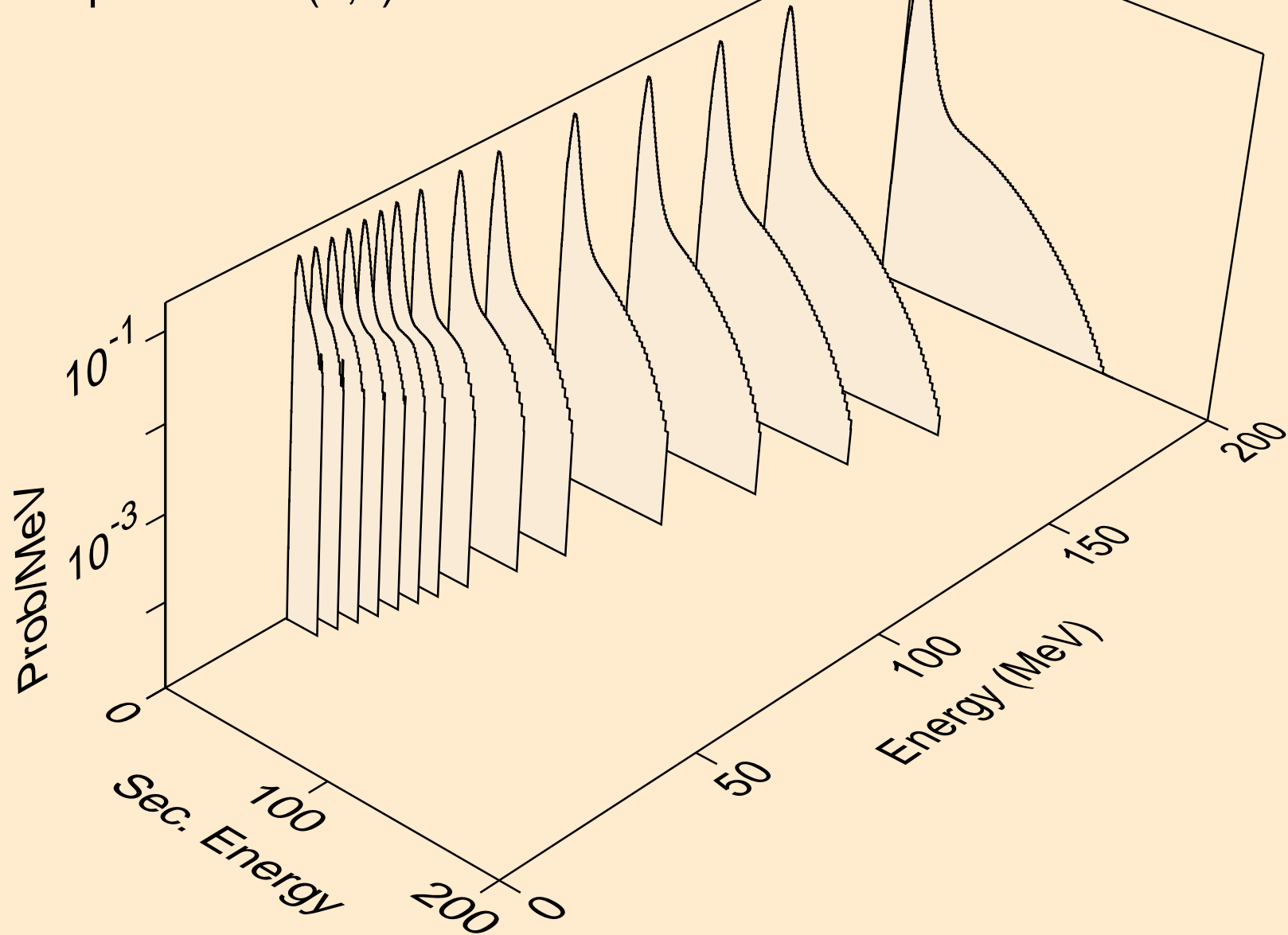

MG024 NEUTRON ACER TENDL-2024 LIBRARY; T=0.K
alphas from (n,n*)a

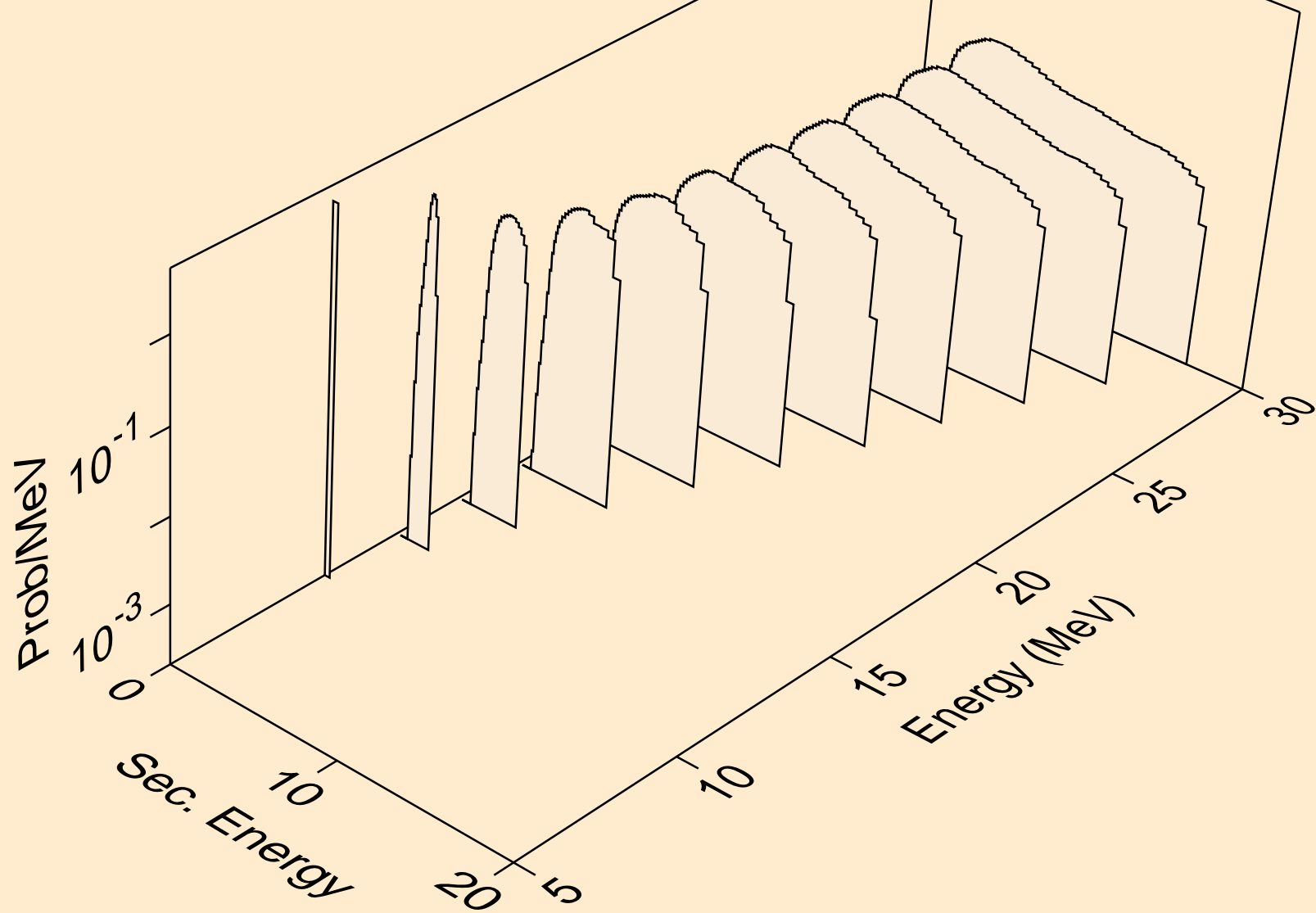

MG024 NEUTRON ACER TENDL-2024 LIBRARY; T=0.K
alphas from (n,2n)a

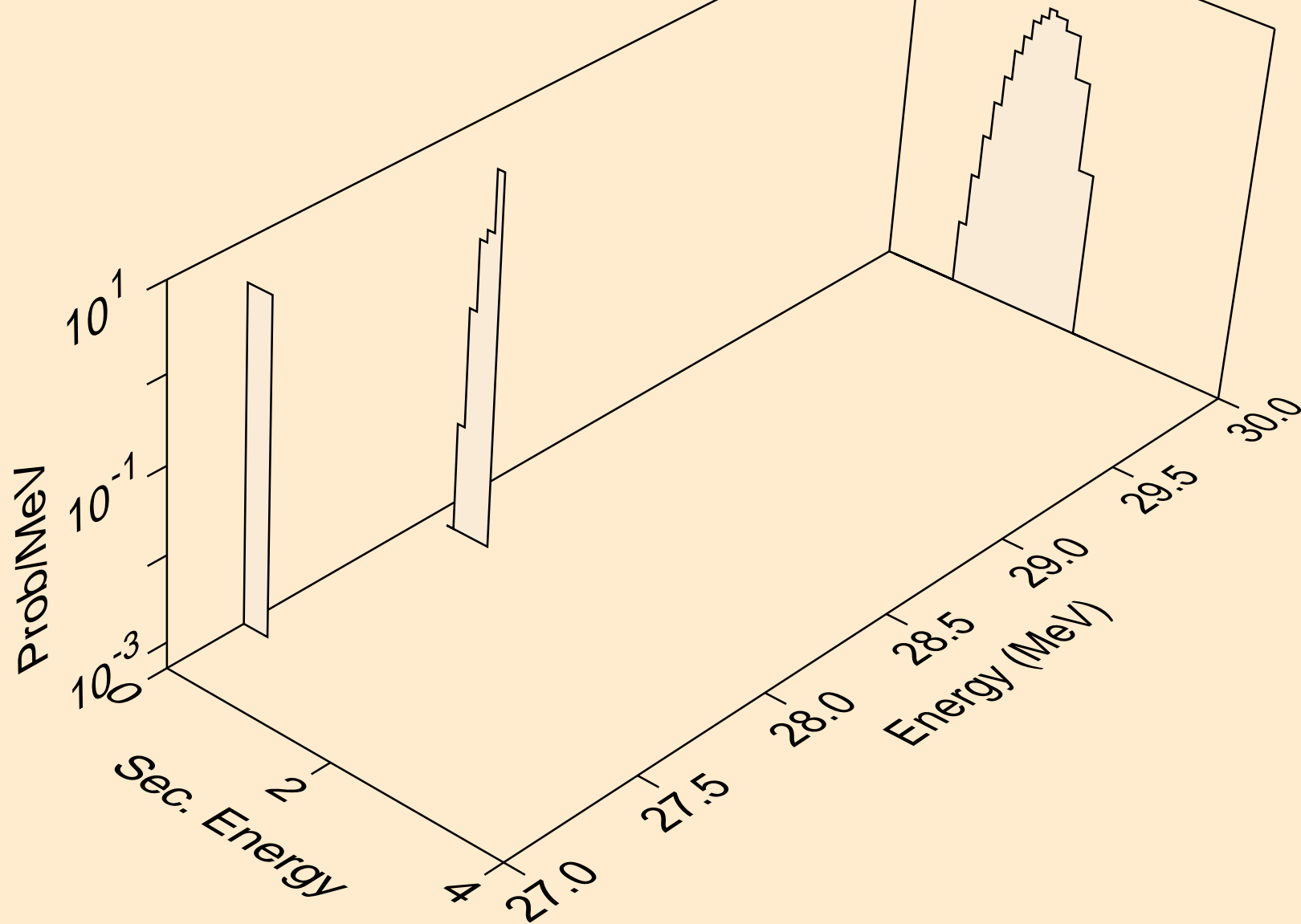

MG024 NEUTRON ACER TENDL-2024 LIBRARY; T=0.K
alphas from (n,n*)2a

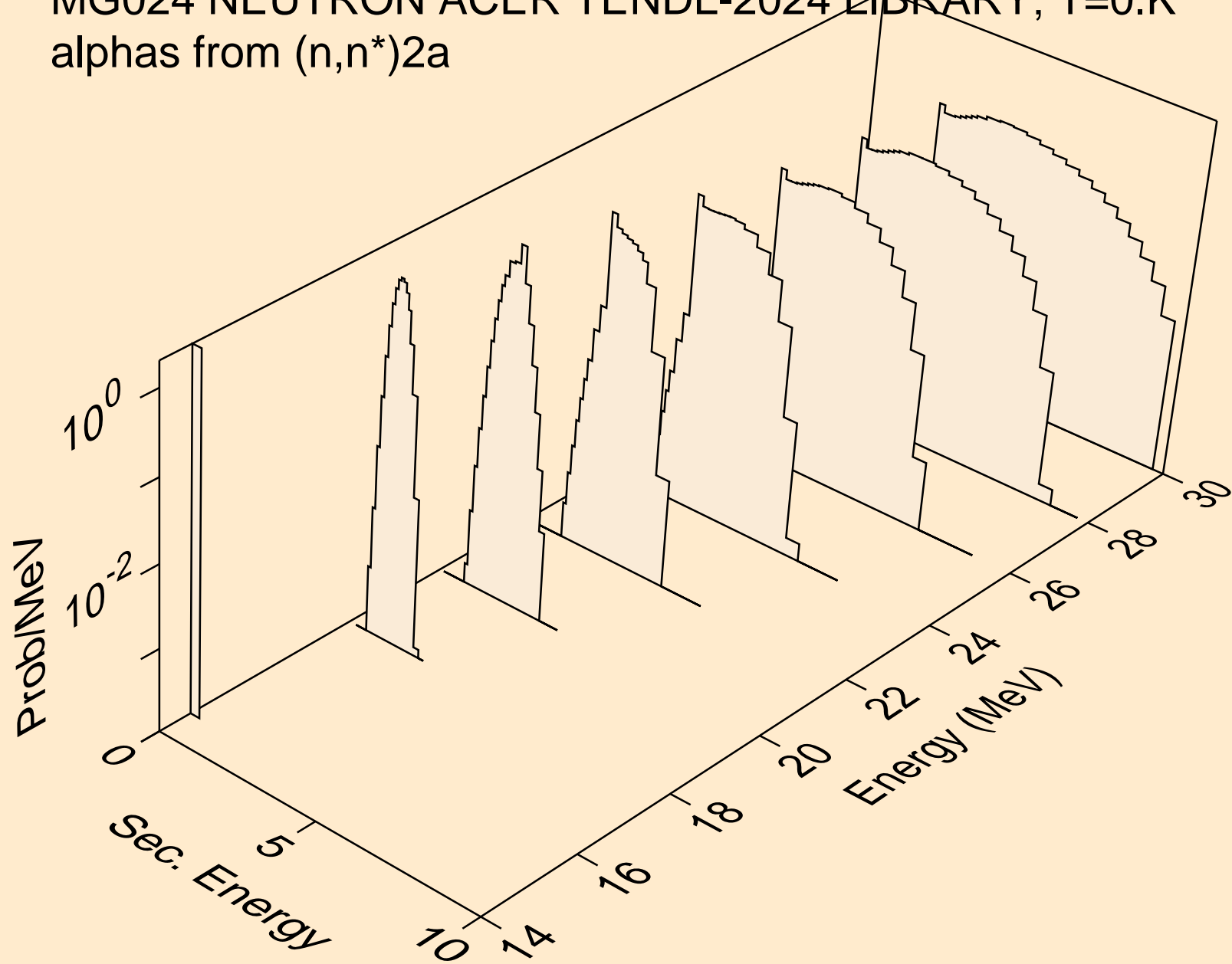

MG024 NEUTRON ACER TENDL-2024 LIBRARY; T=0.K
alphas from (n,npa)

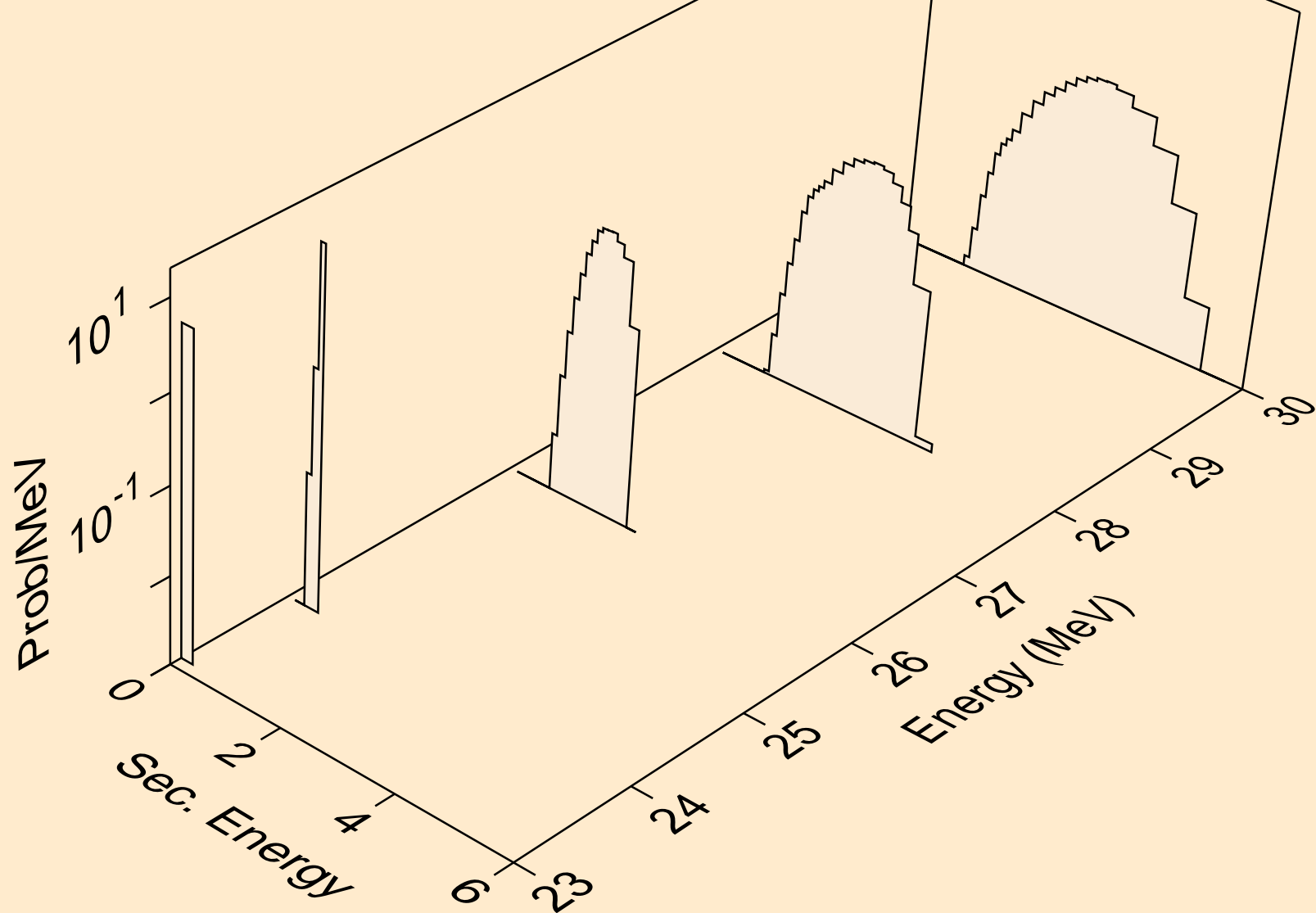

MG024 NEUTRON ACER TENDL-2024 LIBRARY; T=0.K
alphas from (n,a)

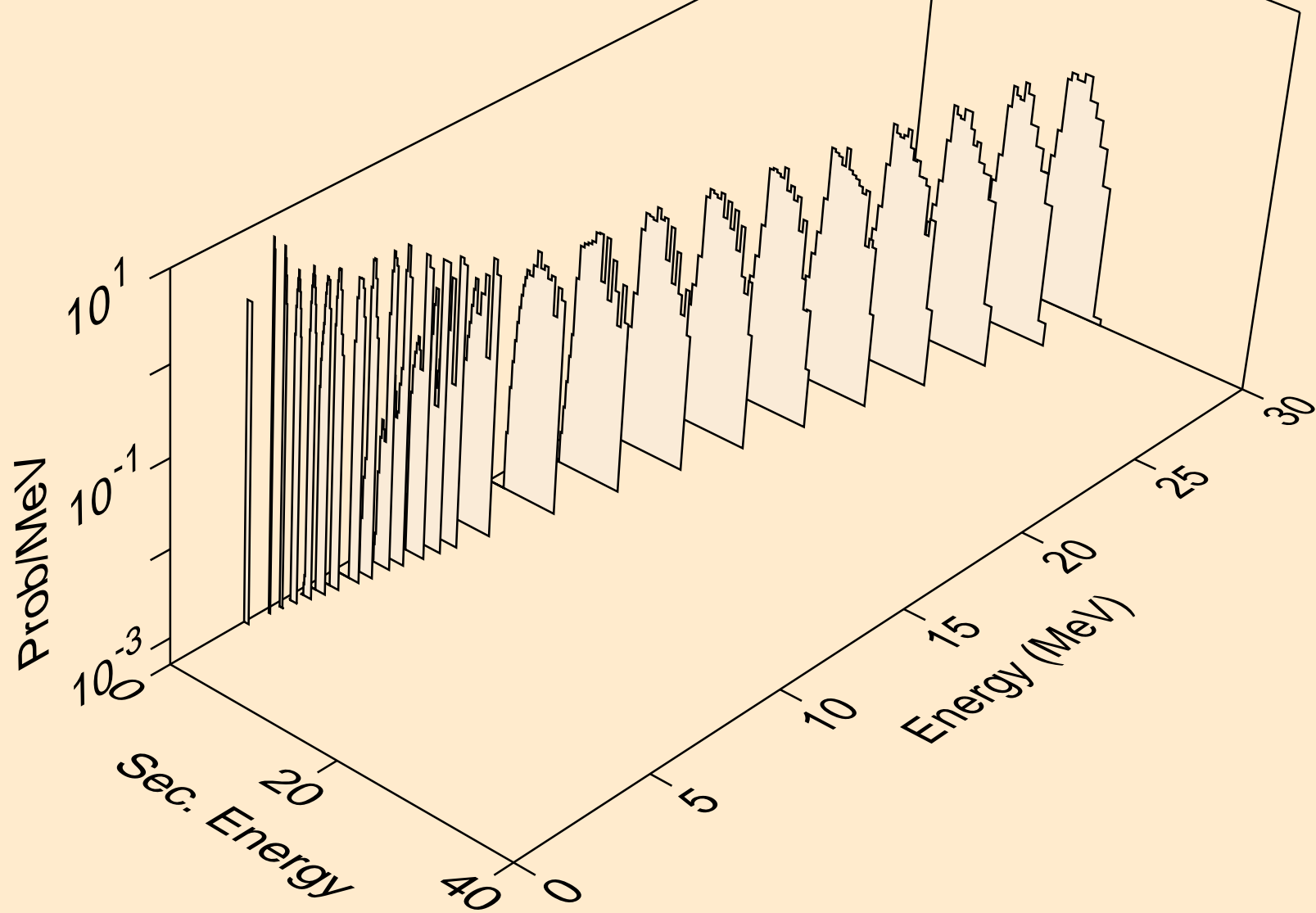

MG024 NEUTRON ACER TENDL-2024 LIBRARY; T=0.K
alphas from (n,2a)

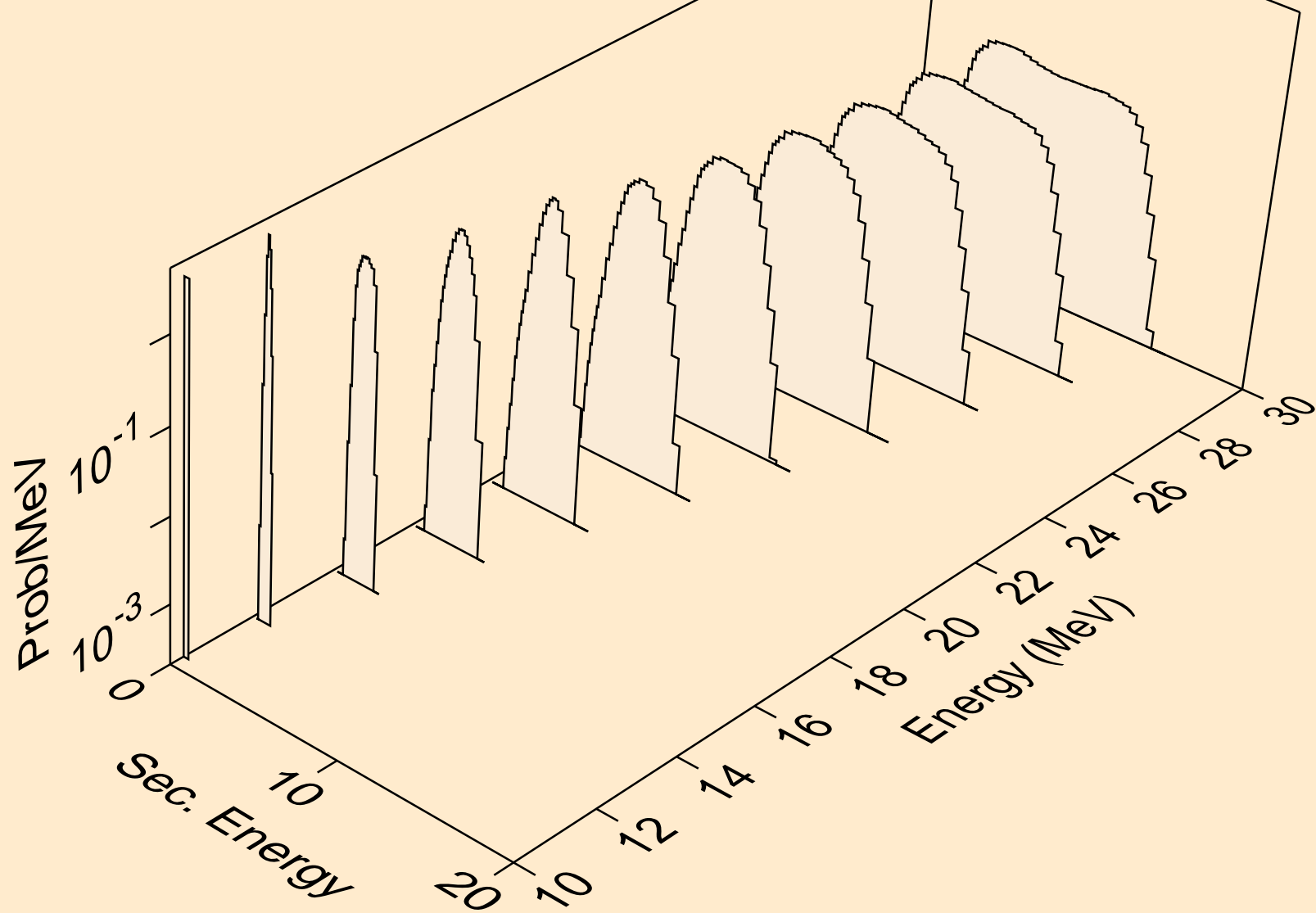

MG024 NEUTRON ACER TENDL-2024 LIBRARY; T=0.K
alphas from (n,3a)

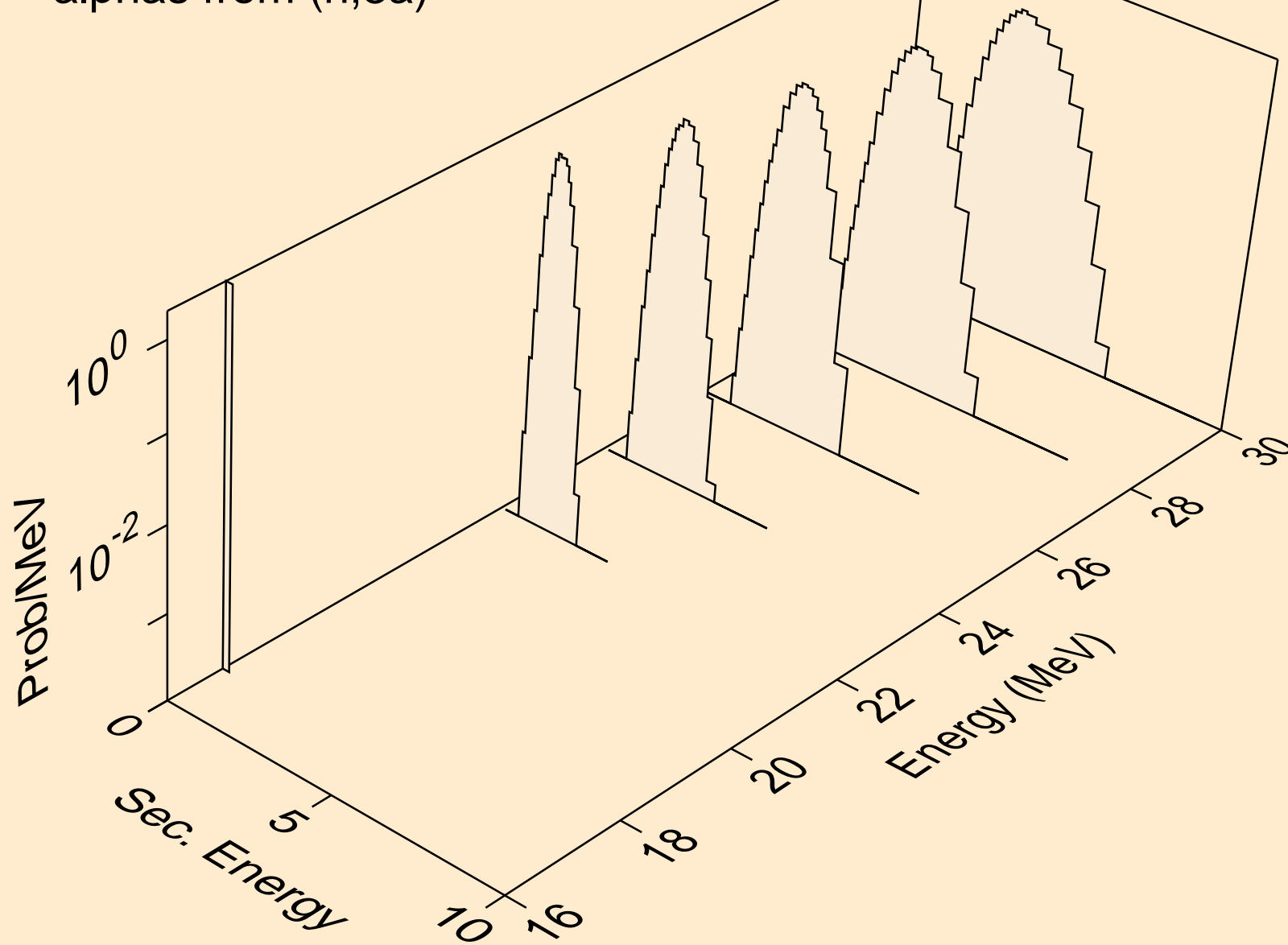

MG024 NEUTRON ACER TENDL-2024 LIBRARY; T=0.K
alphas from (n,pa)

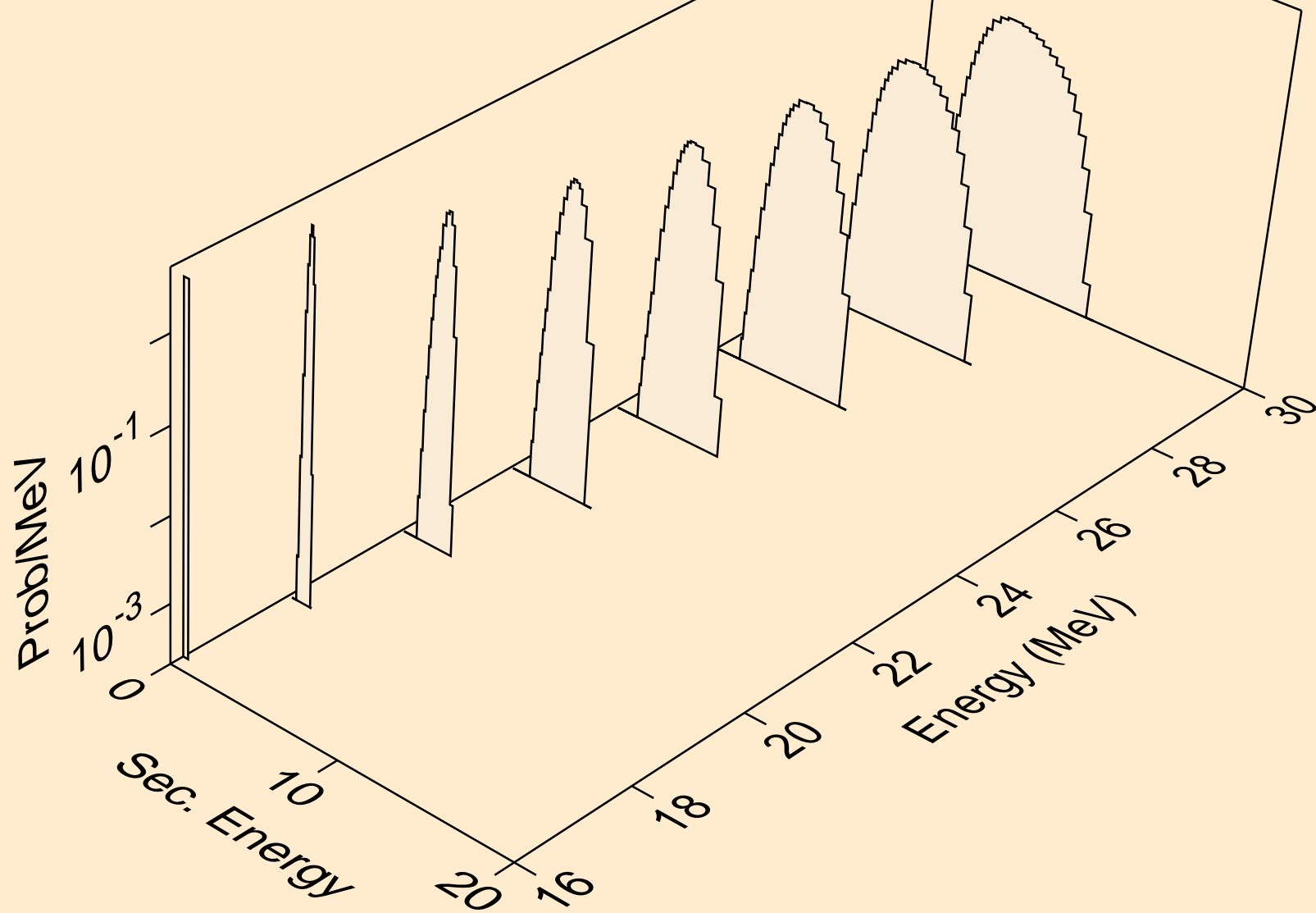

MG024 NEUTRON ACER TENDL-2024 LIBRARY; T=0.K
alphas from (n,d2a)

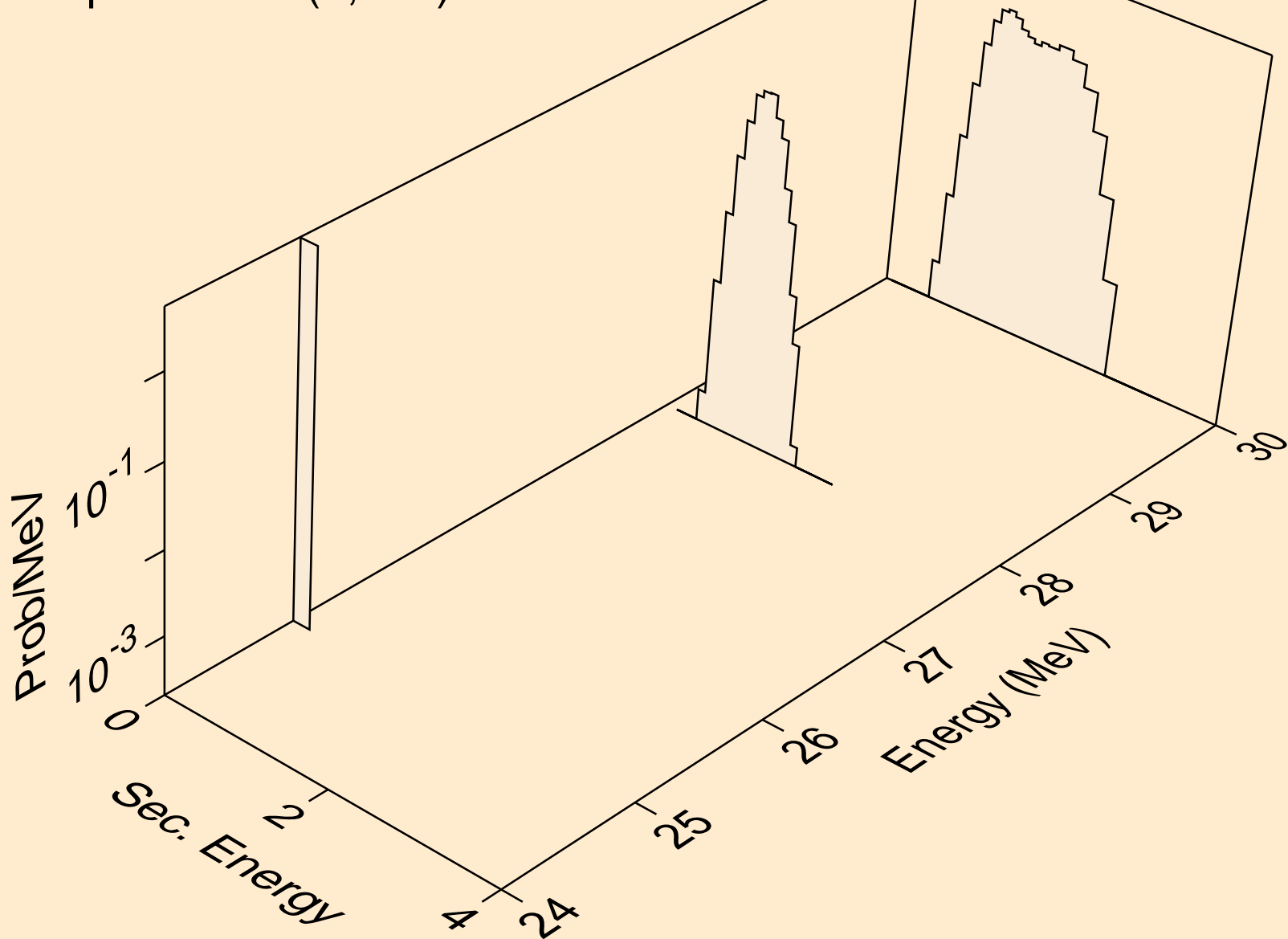

MG024 NEUTRON ACER TENDL-2024 LIBRARY; T=0.K
alphas from (n,da)

