

MO094 NEUTRON ACER TENDL-2024 LIBRARY; T=0.K
Principal cross sections

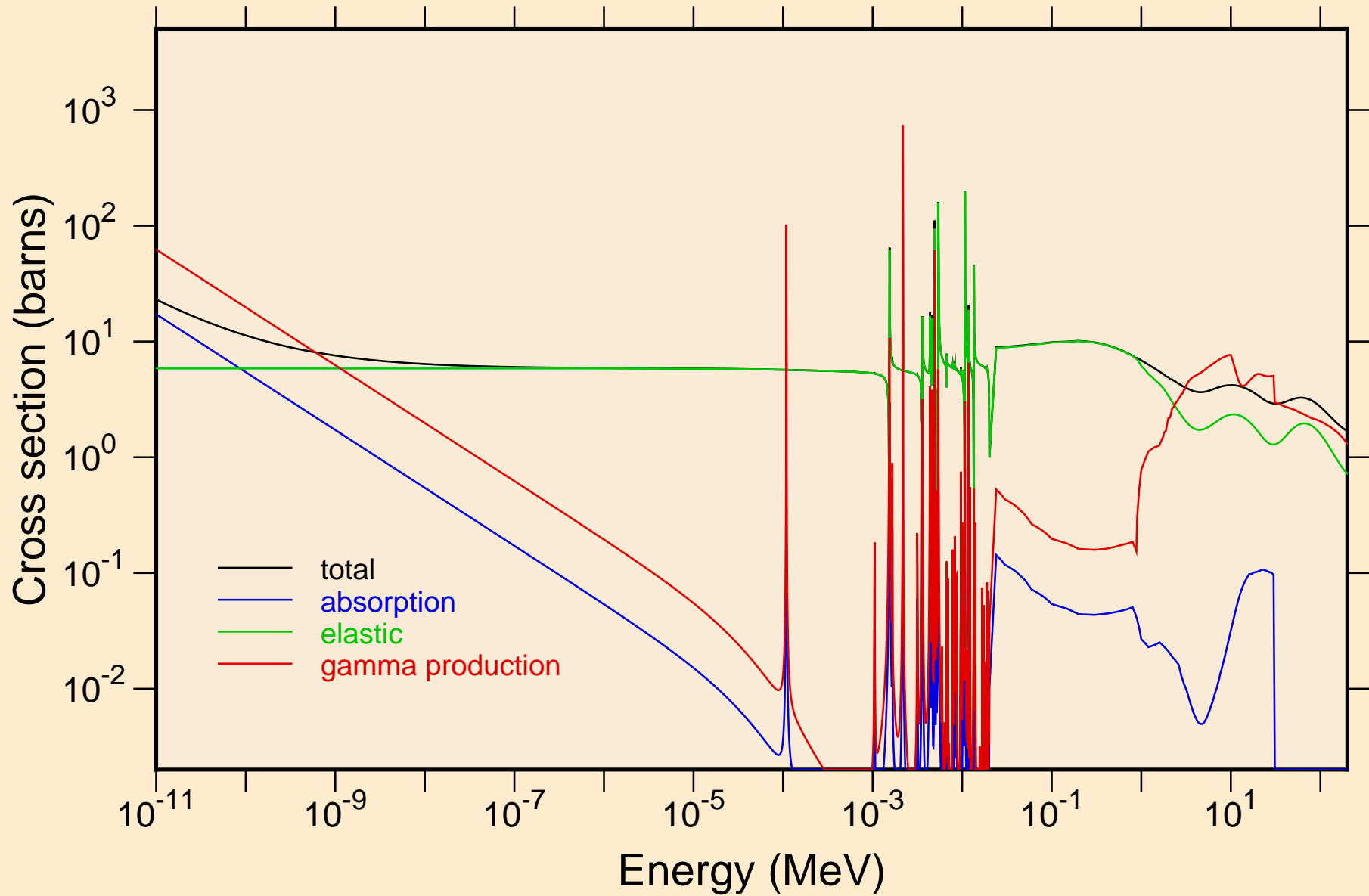

MO094 NEUTRON ACER TENDL-2024 LIBRARY; T=0.K
resonance total cross section

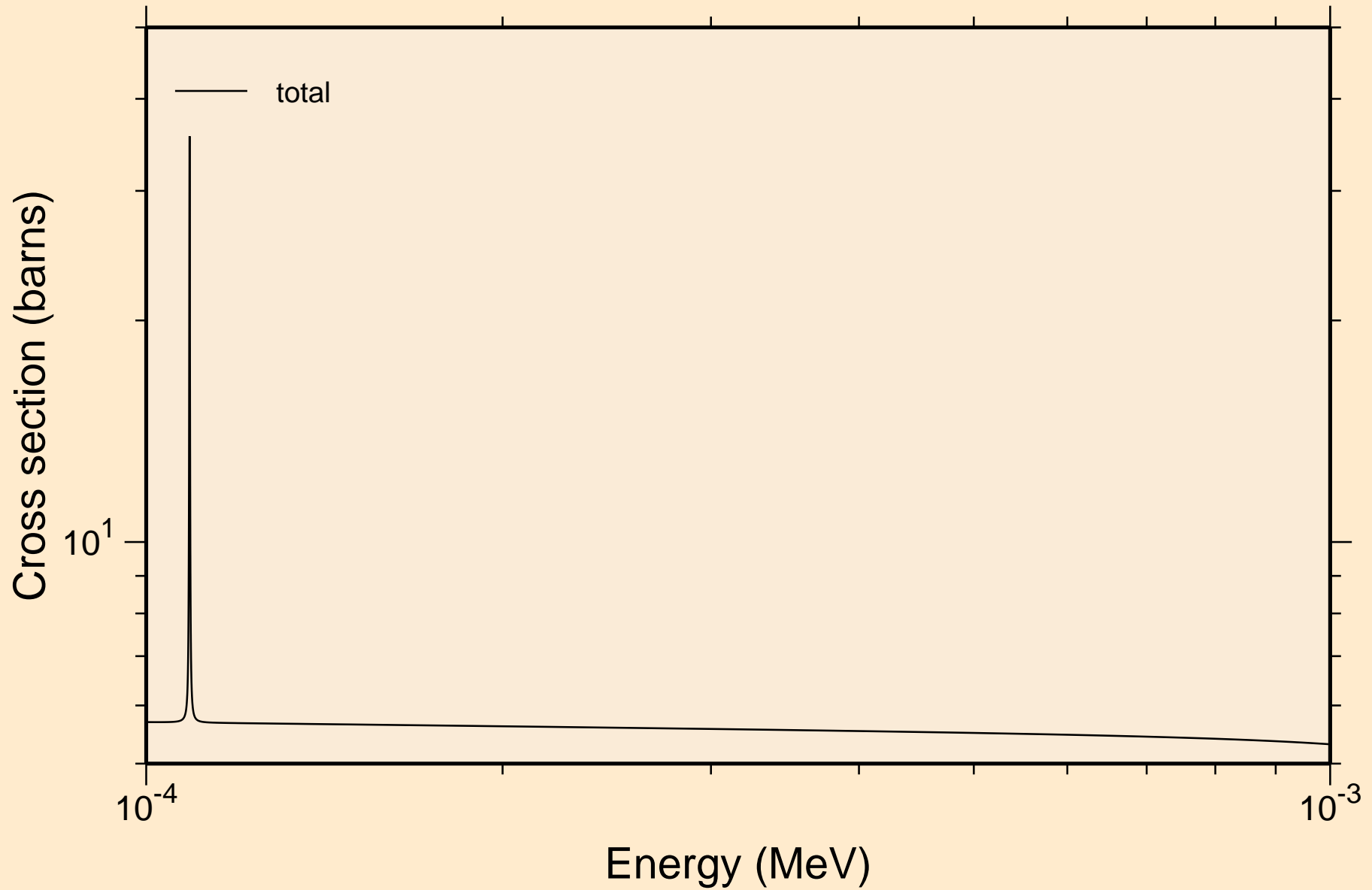

MO094 NEUTRON ACER TENDL-2024 LIBRARY; T=0.K
resonance total cross section

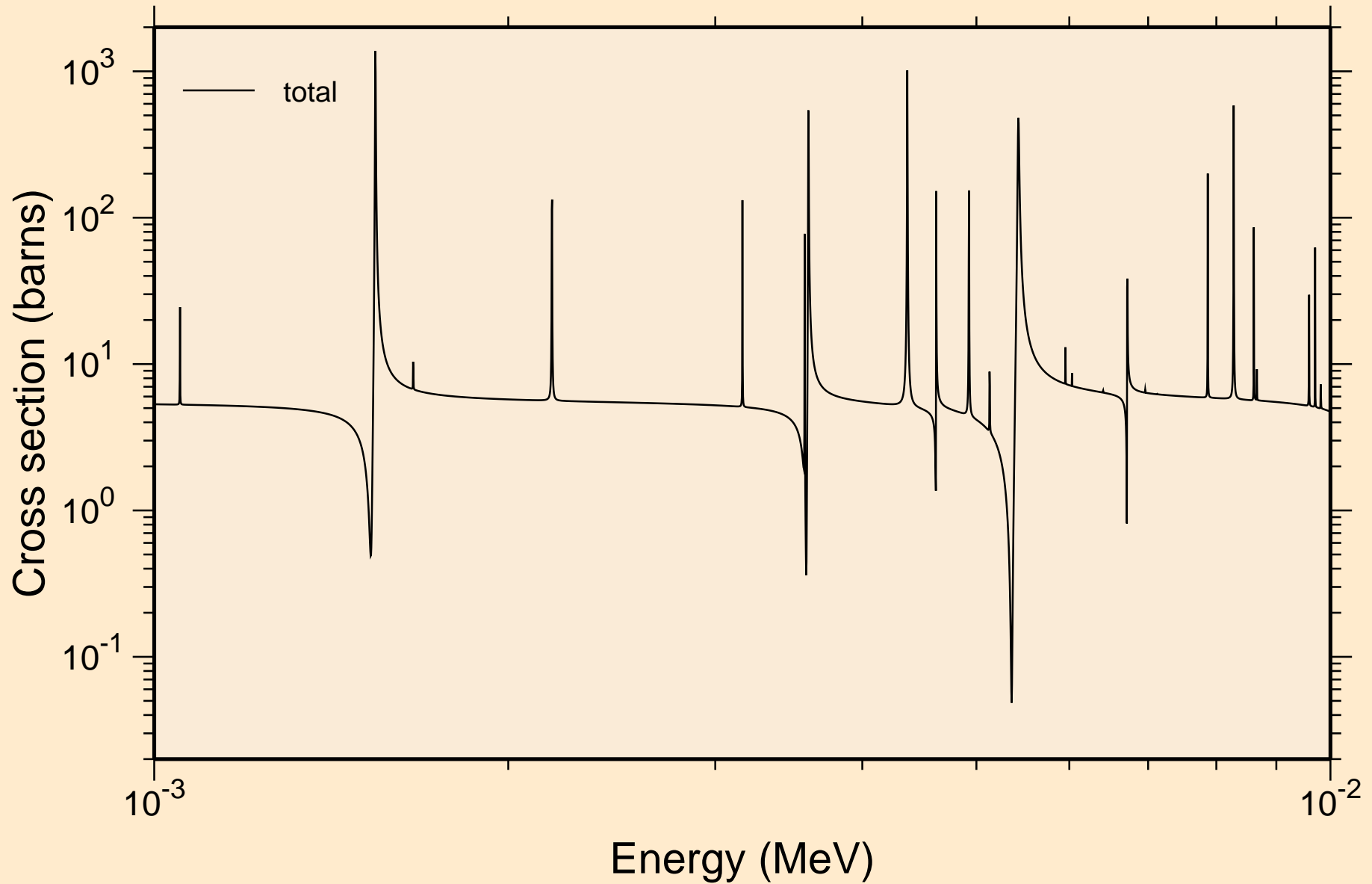

MO094 NEUTRON ACER TENDL-2024 LIBRARY; T=0.K
resonance total cross section

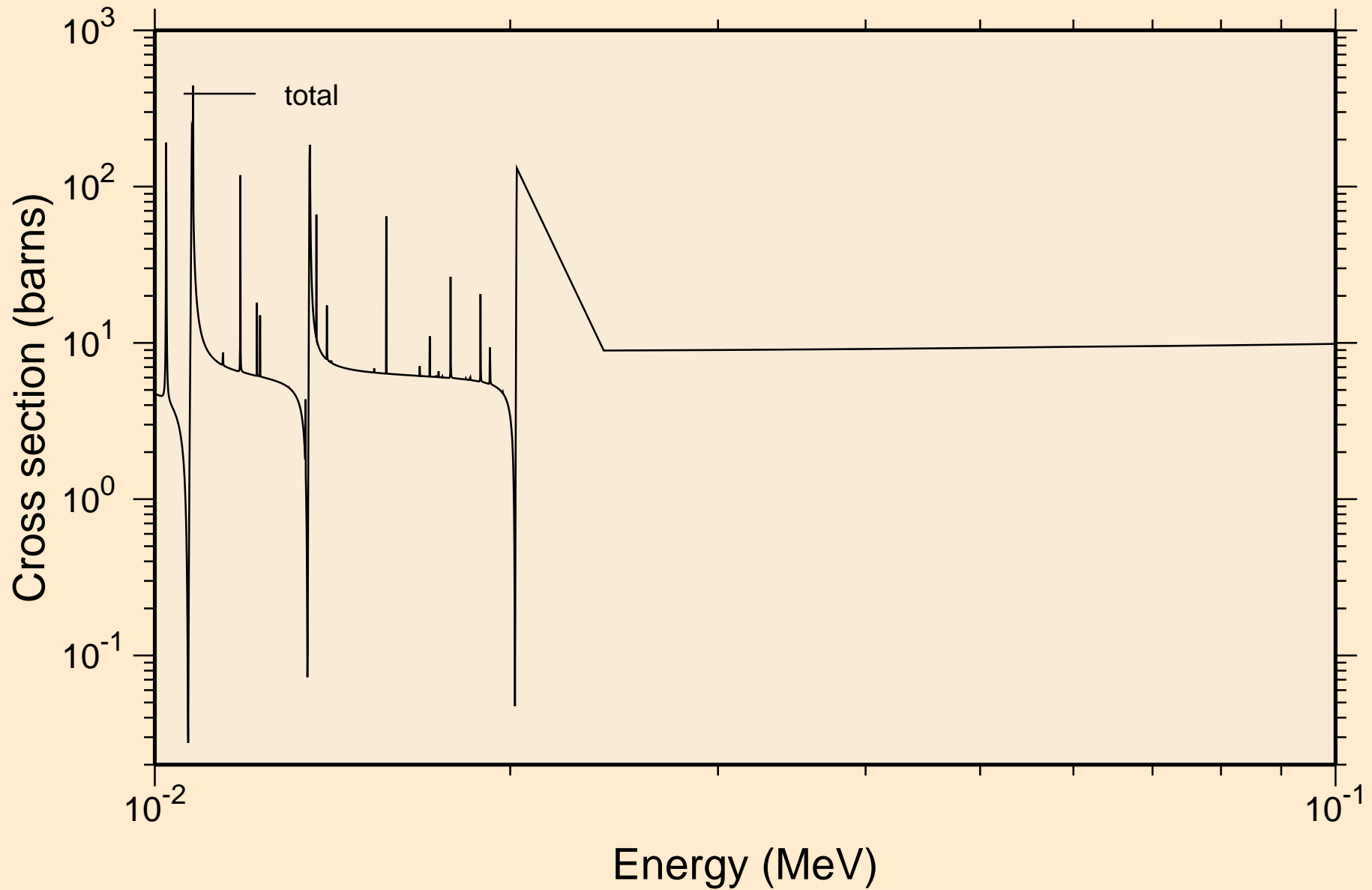

MO094 NEUTRON ACER TENDL-2024 LIBRARY; T=0.K
resonance total cross section

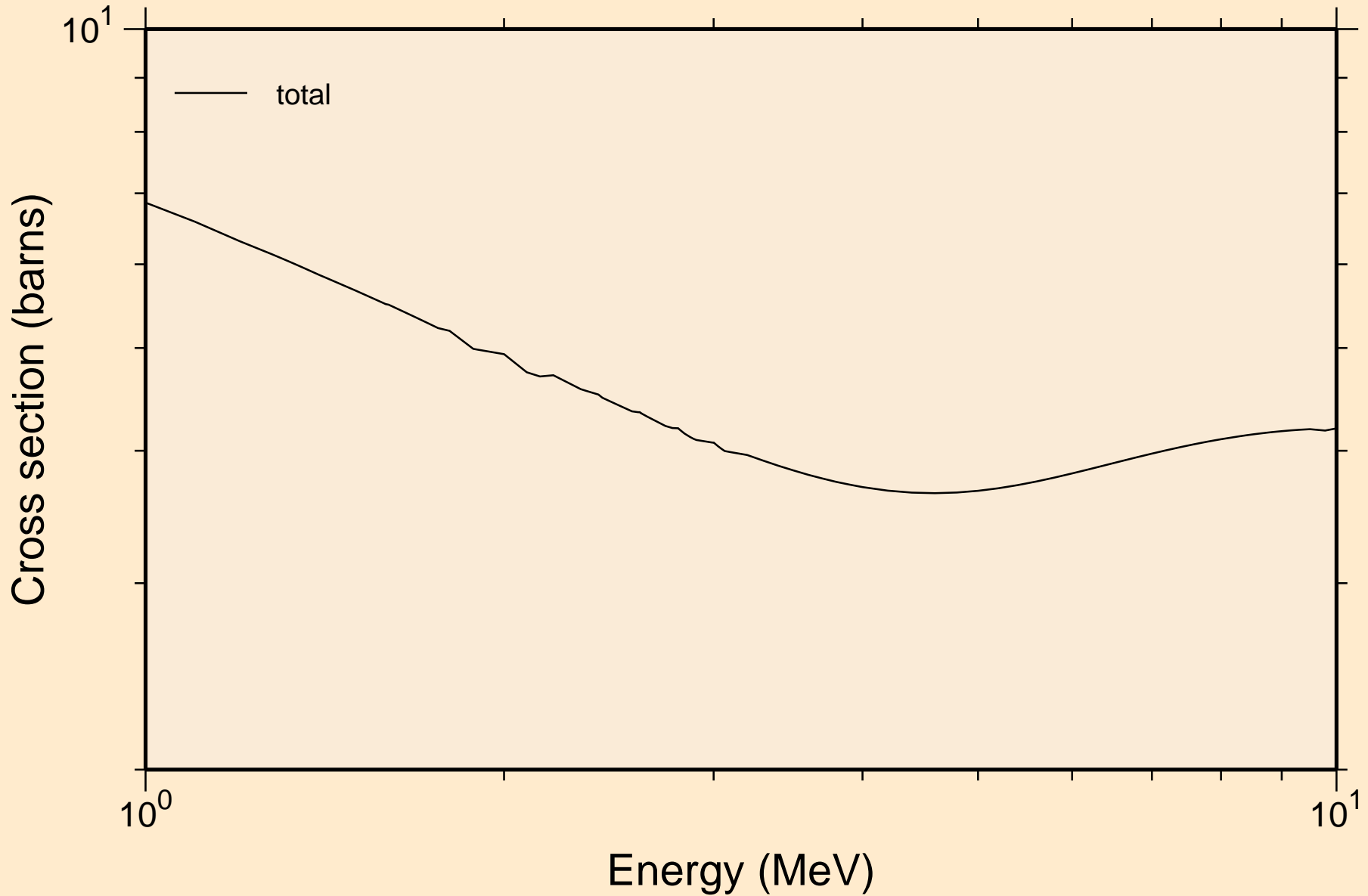

MO094 NEUTRON ACER TENDL-2024 LIBRARY; T=0.K
resonance absorption cross sections

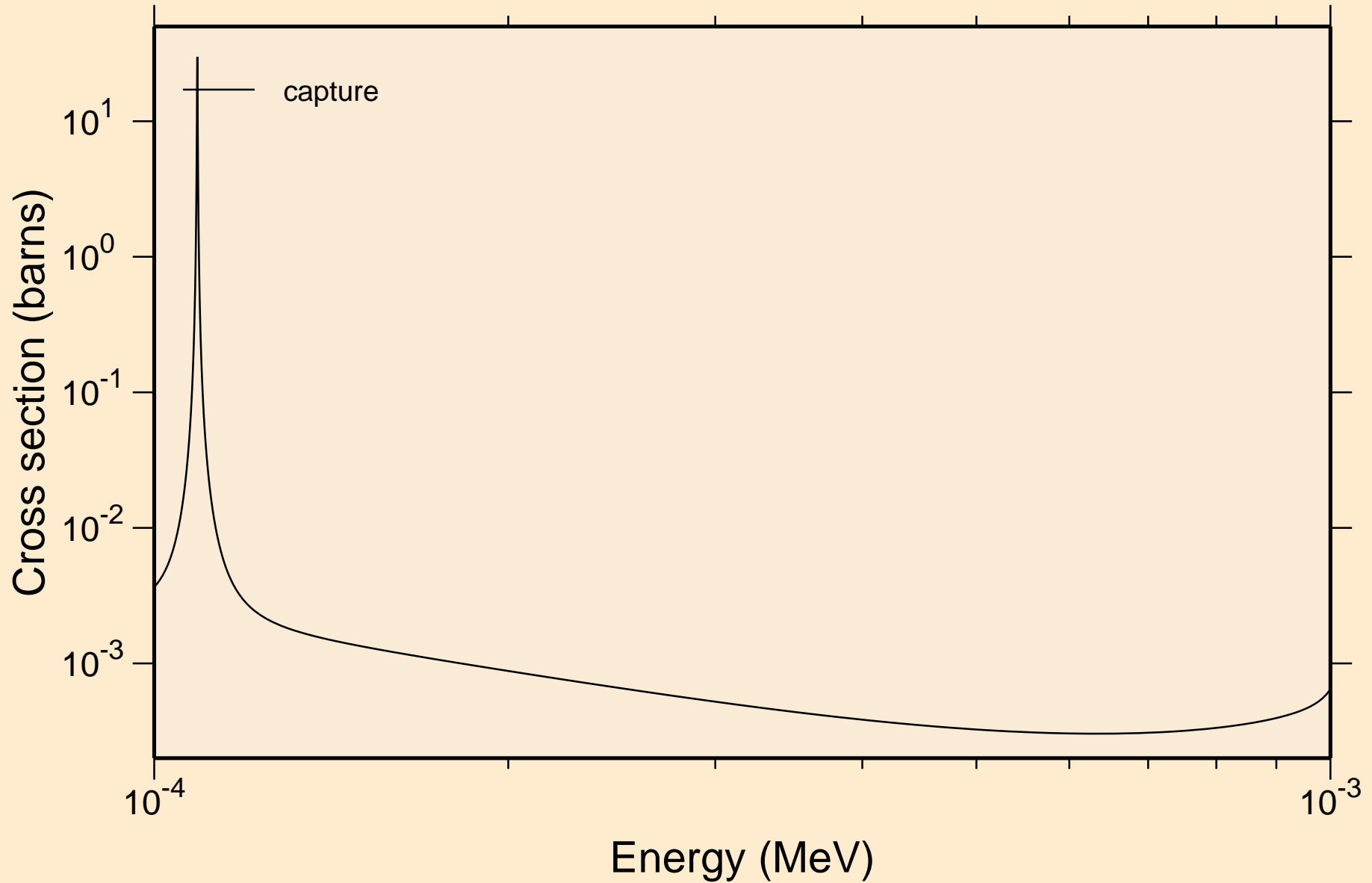

MO094 NEUTRON ACER TENDL-2024 LIBRARY; T=0.K
resonance absorption cross sections

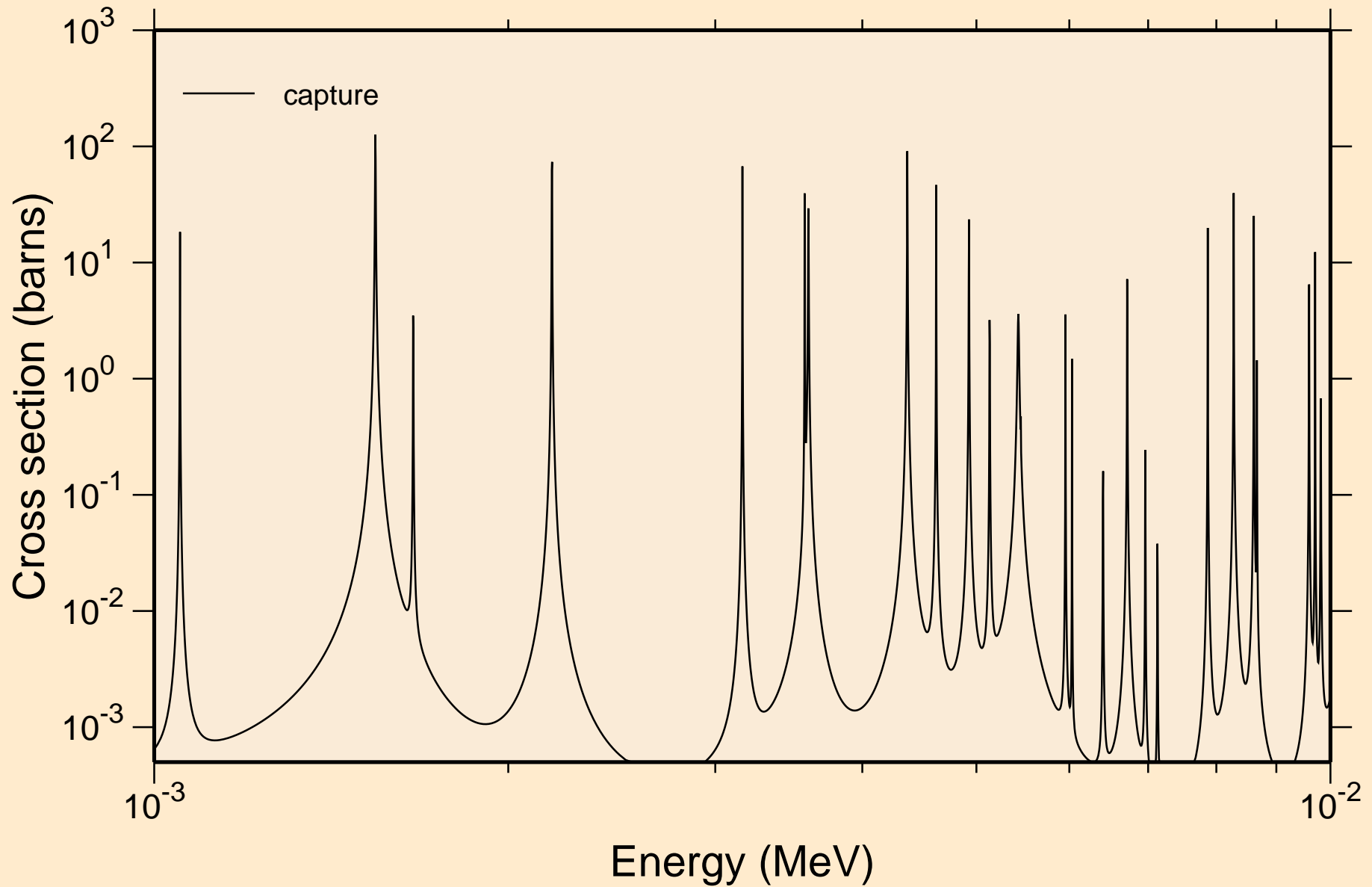

MO094 NEUTRON ACER TENDL-2024 LIBRARY; T=0.K
resonance absorption cross sections

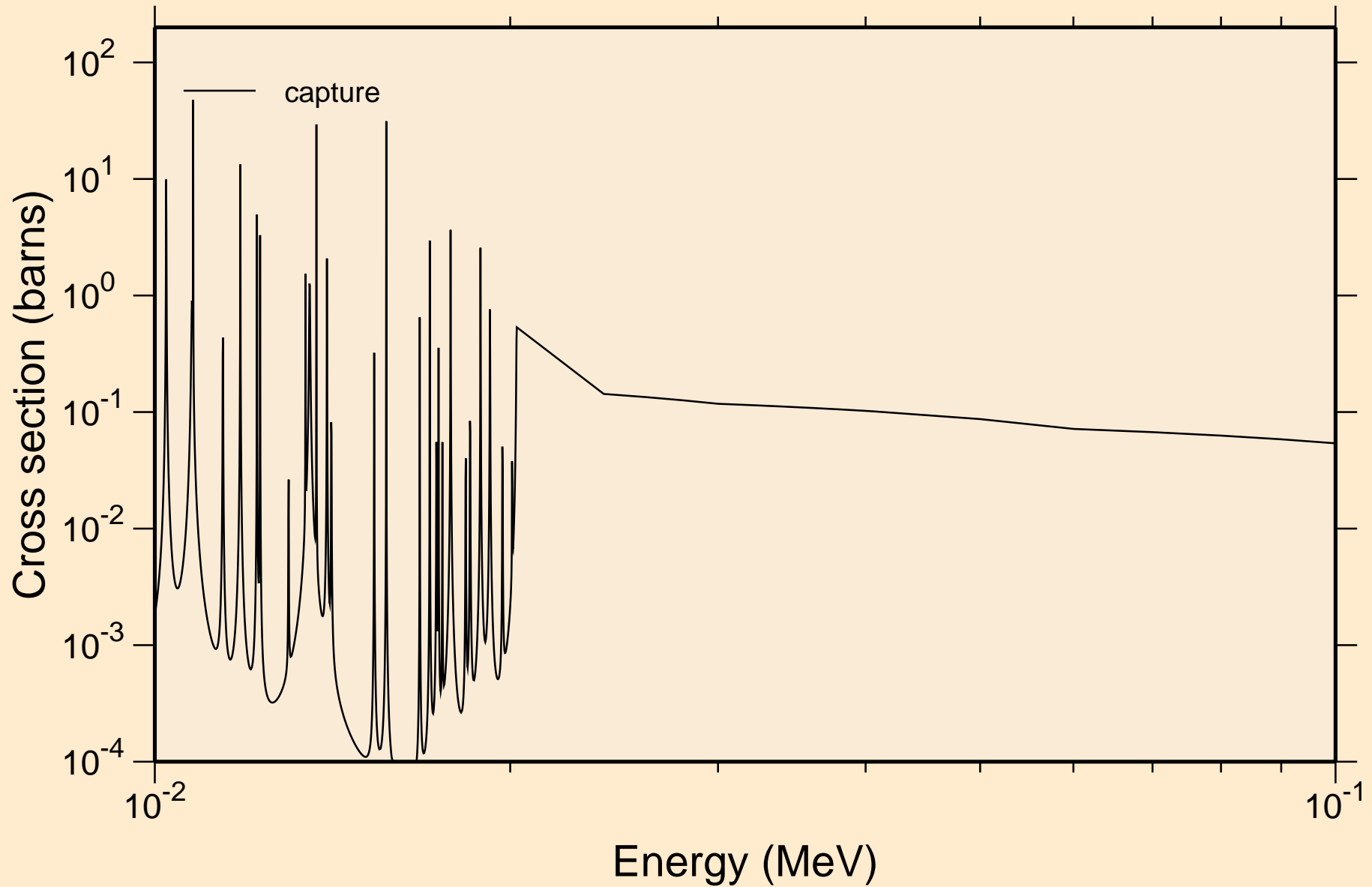

MO094 NEUTRON ACER TENDL-2024 LIBRARY; T=0.K
resonance absorption cross sections

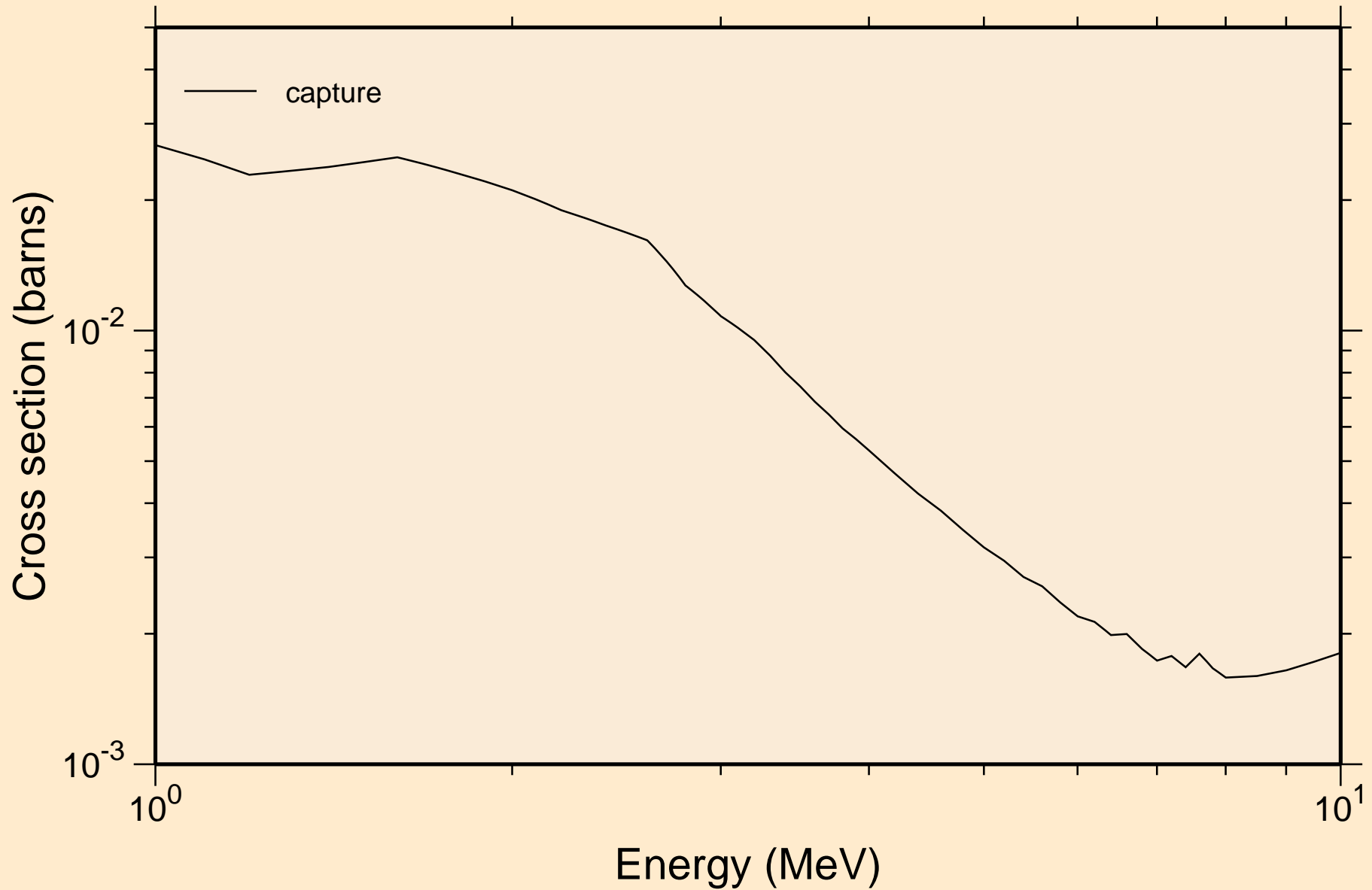

MO094 NEUTRON ACER TENDL-2024 LIBRARY; T=0.K
Heating

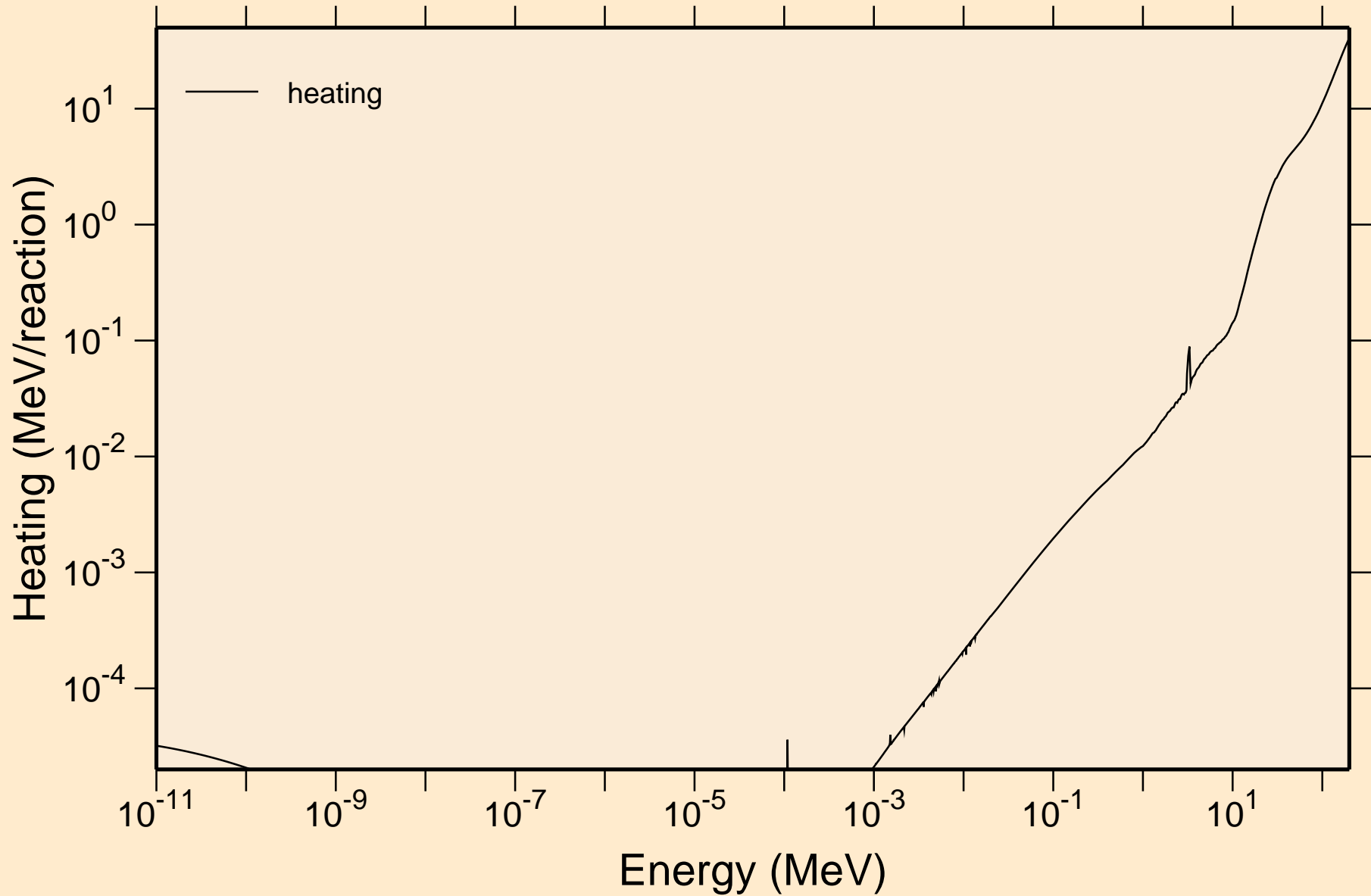

MO094 NEUTRON ACER TENDL-2024 LIBRARY; T=0.K

Damage

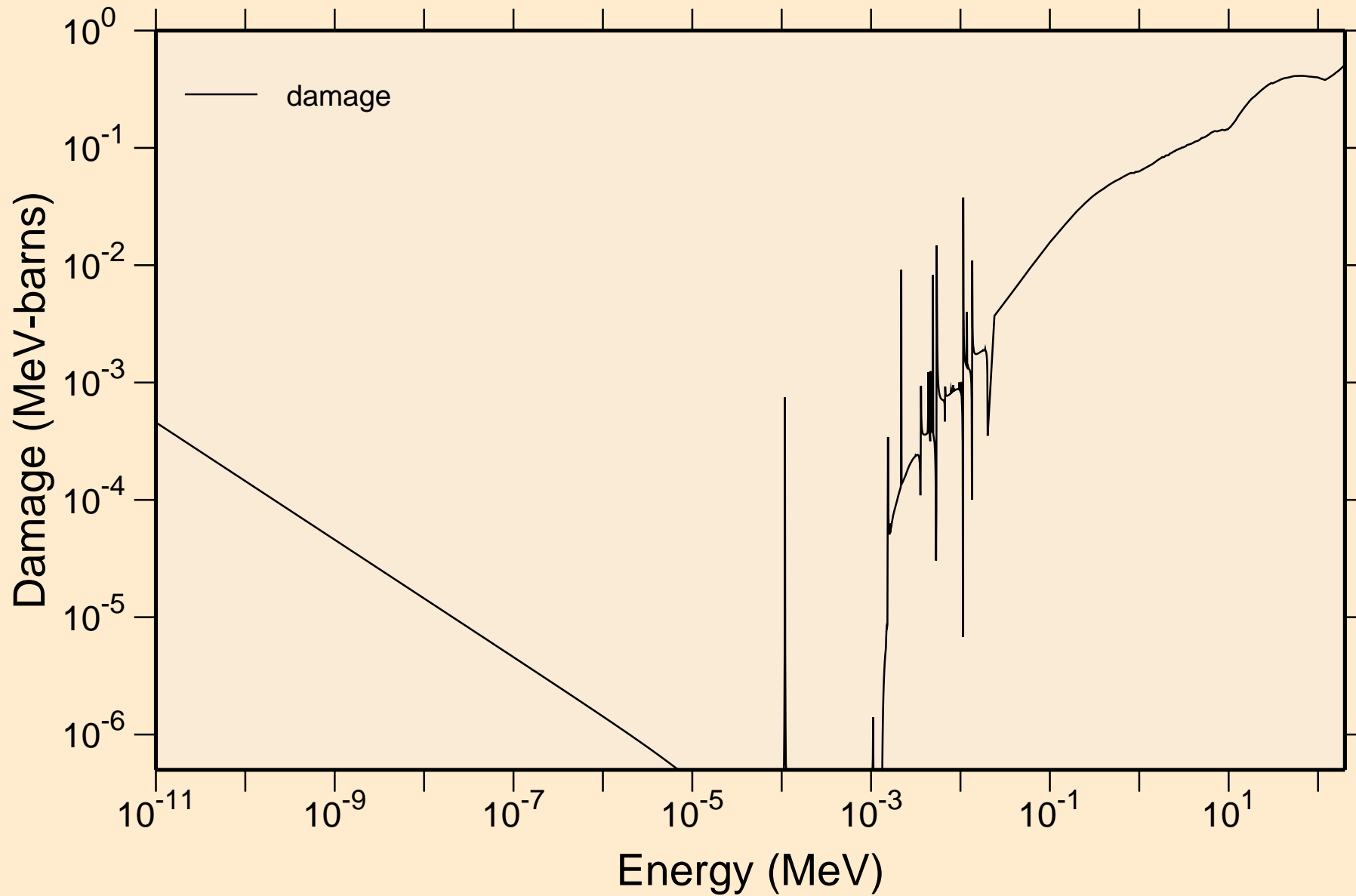

MO094 NEUTRON ACER TENDL-2024 LIBRARY; T=0.K
Non-threshold reactions

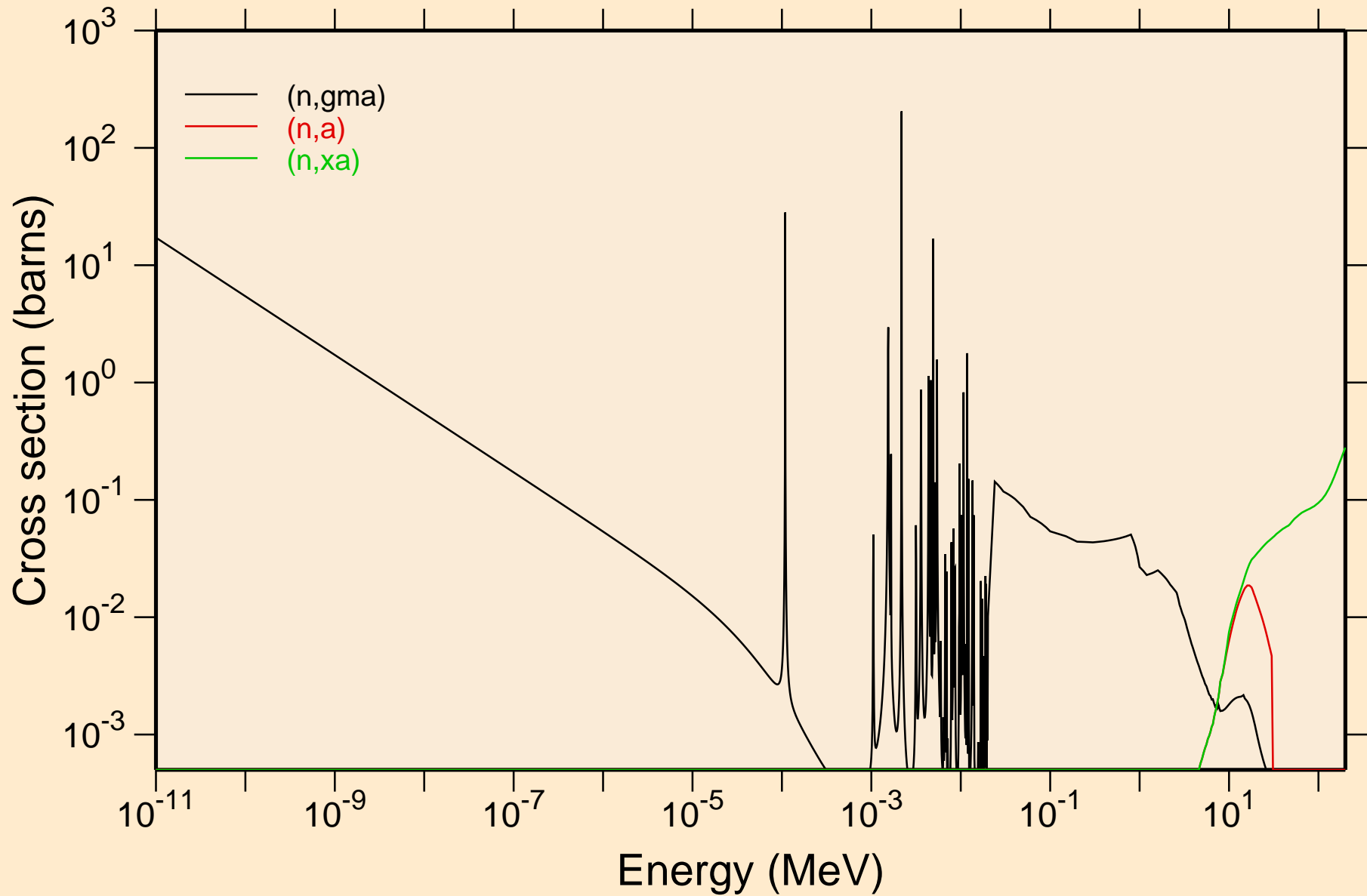

MO094 NEUTRON ACER TENDL-2024 LIBRARY; T=0.K

Principal cross sections

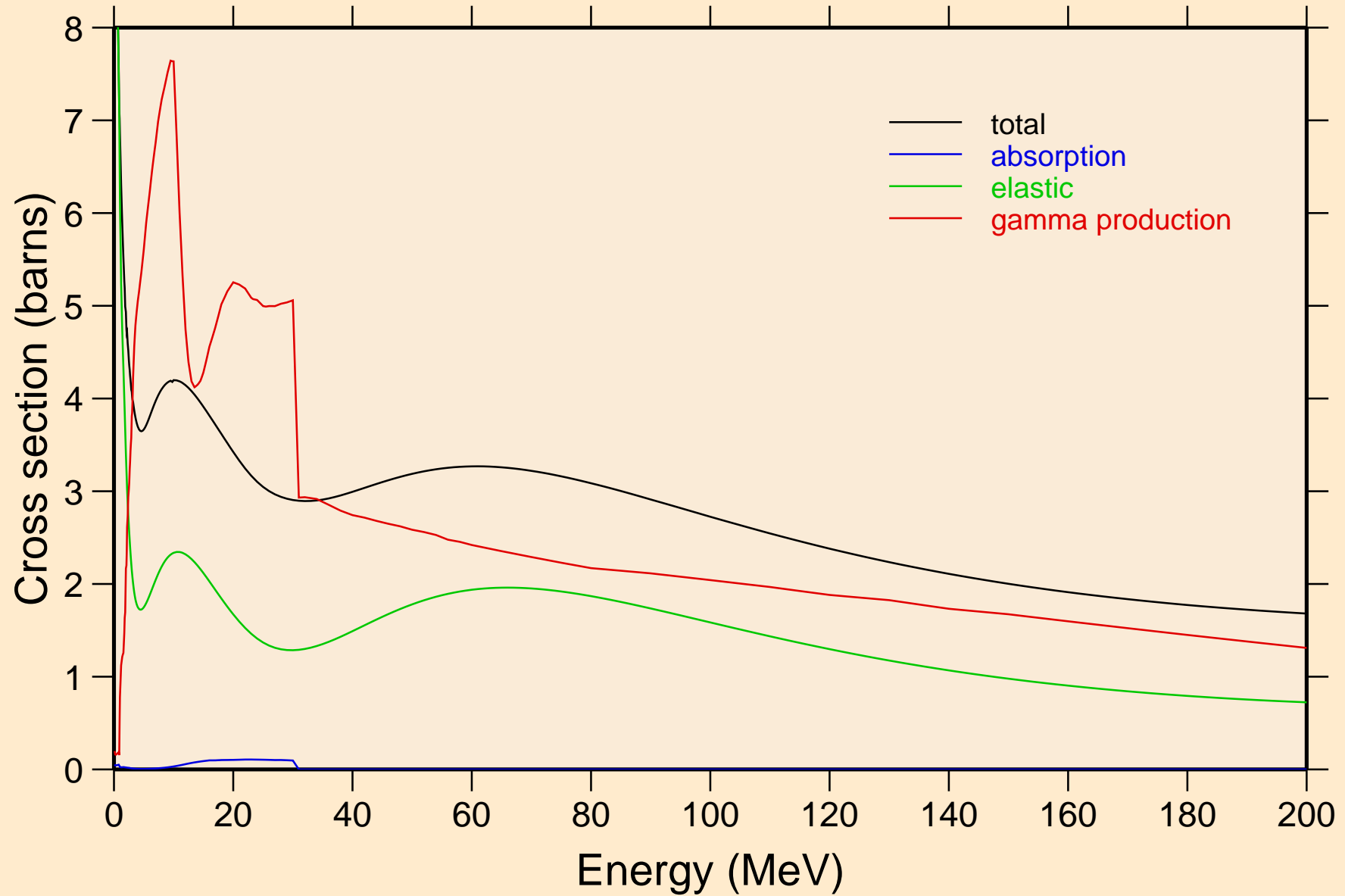

MO094 NEUTRON ACER TENDL-2024 LIBRARY; T=0.K

Heating

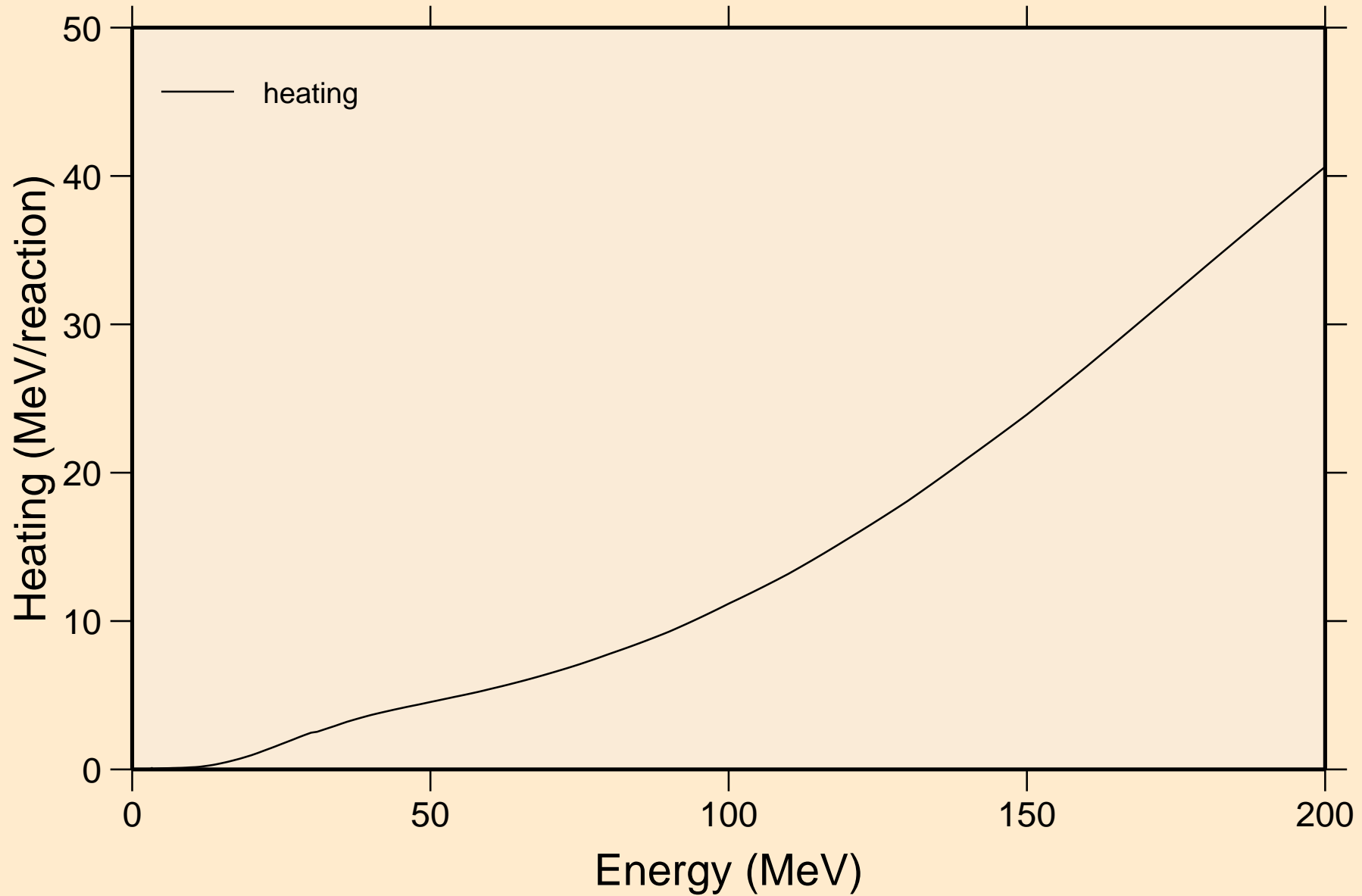

MO094 NEUTRON ACER TENDL-2024 LIBRARY; T=0.K
Damage

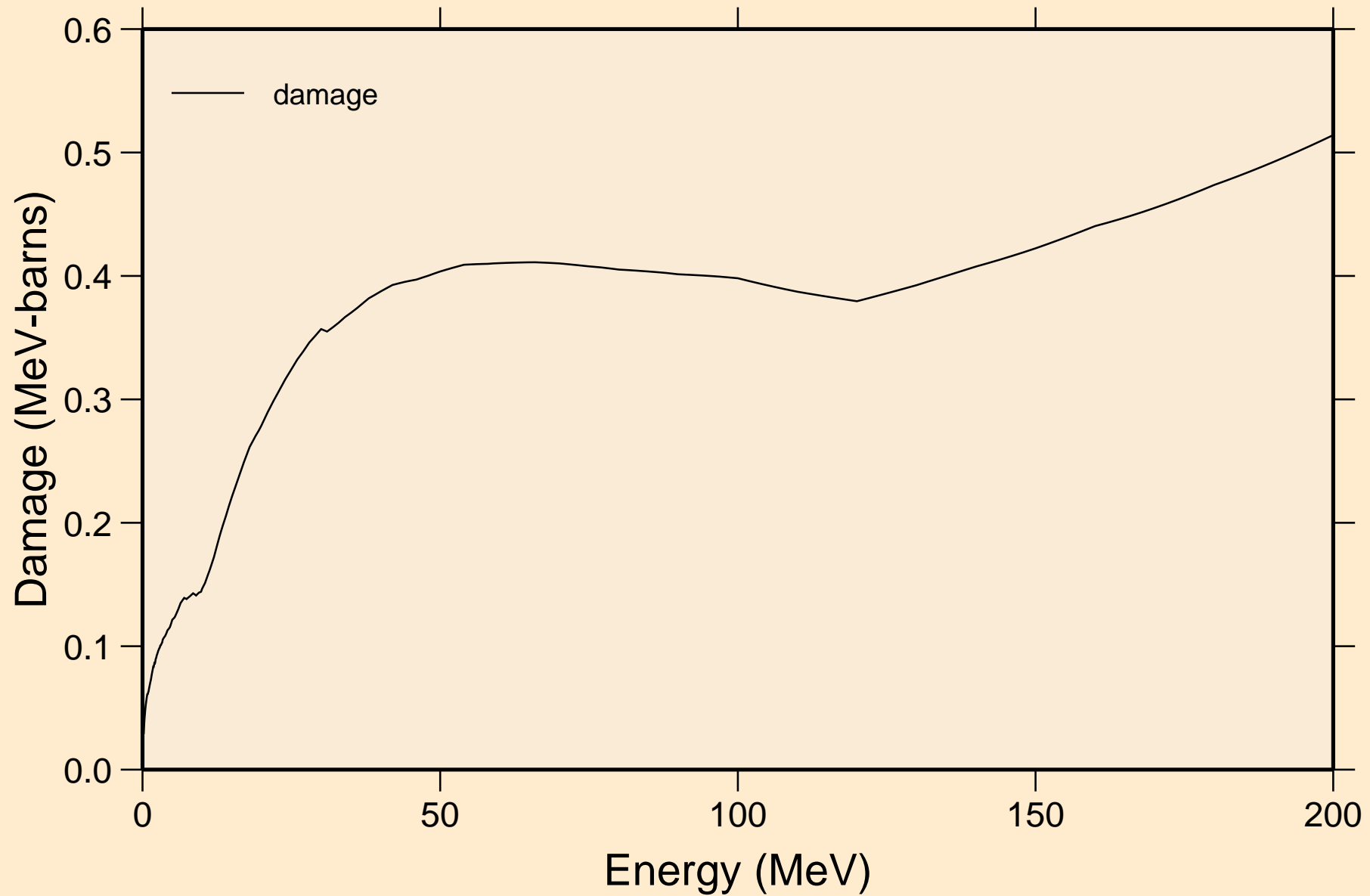

MO094 NEUTRON ACER TENDL-2024 LIBRARY; T=0.K
Non-threshold reactions

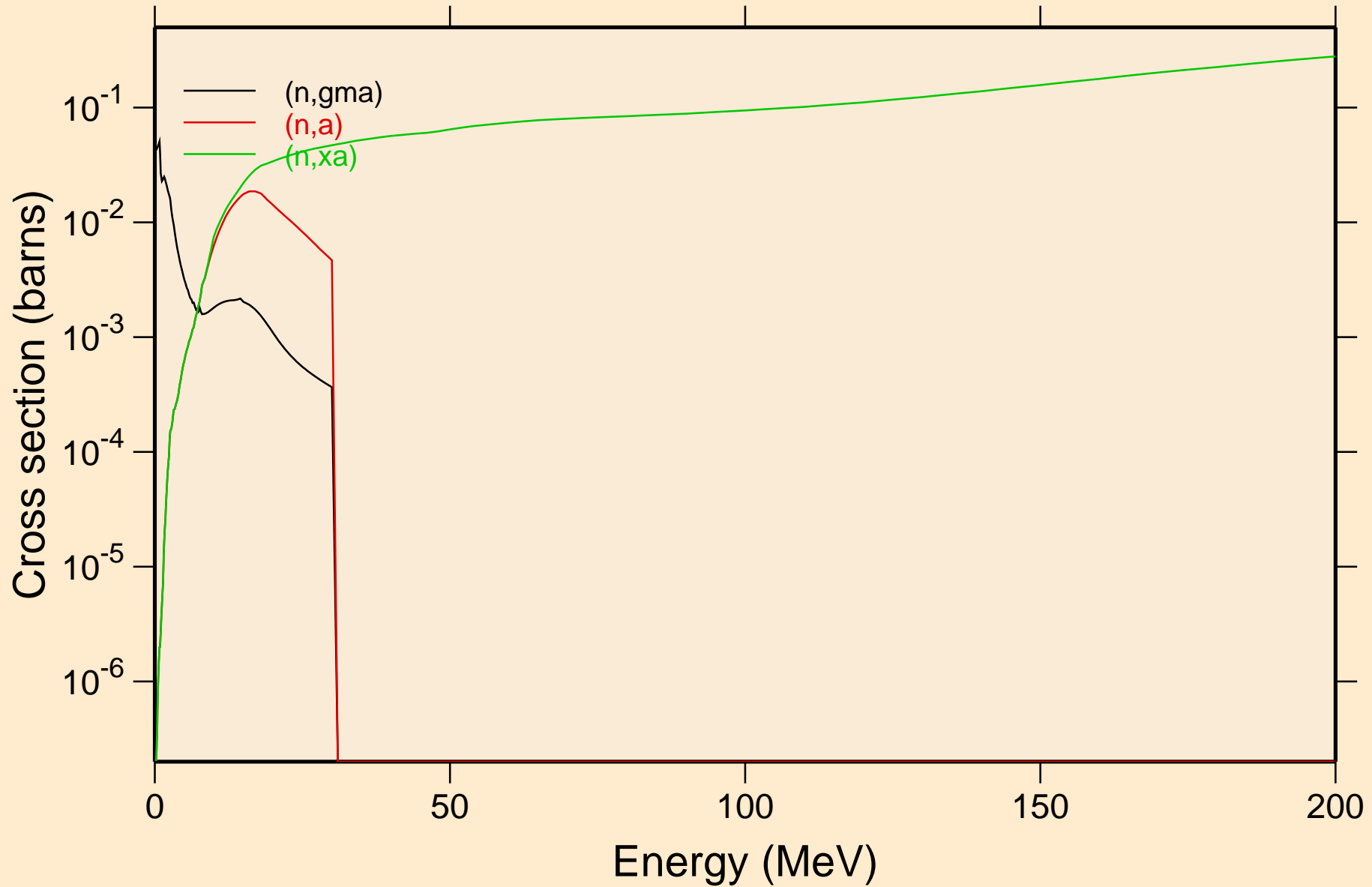

MO094 NEUTRON ACER TENDL-2024 LIBRARY; T=0.K
Inelastic levels

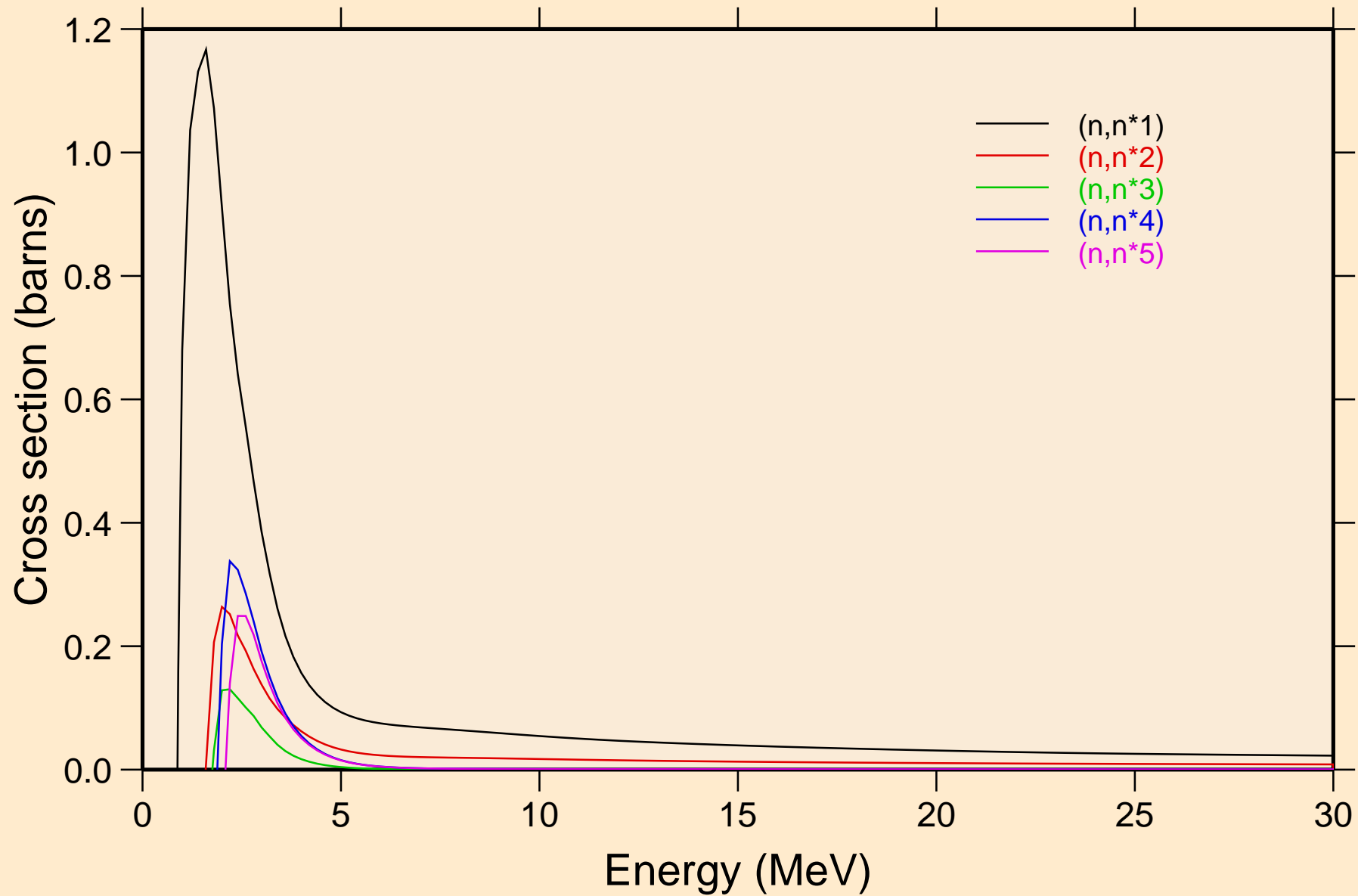

MO094 NEUTRON ACER TENDL-2024 LIBRARY; T=0.K
Inelastic levels

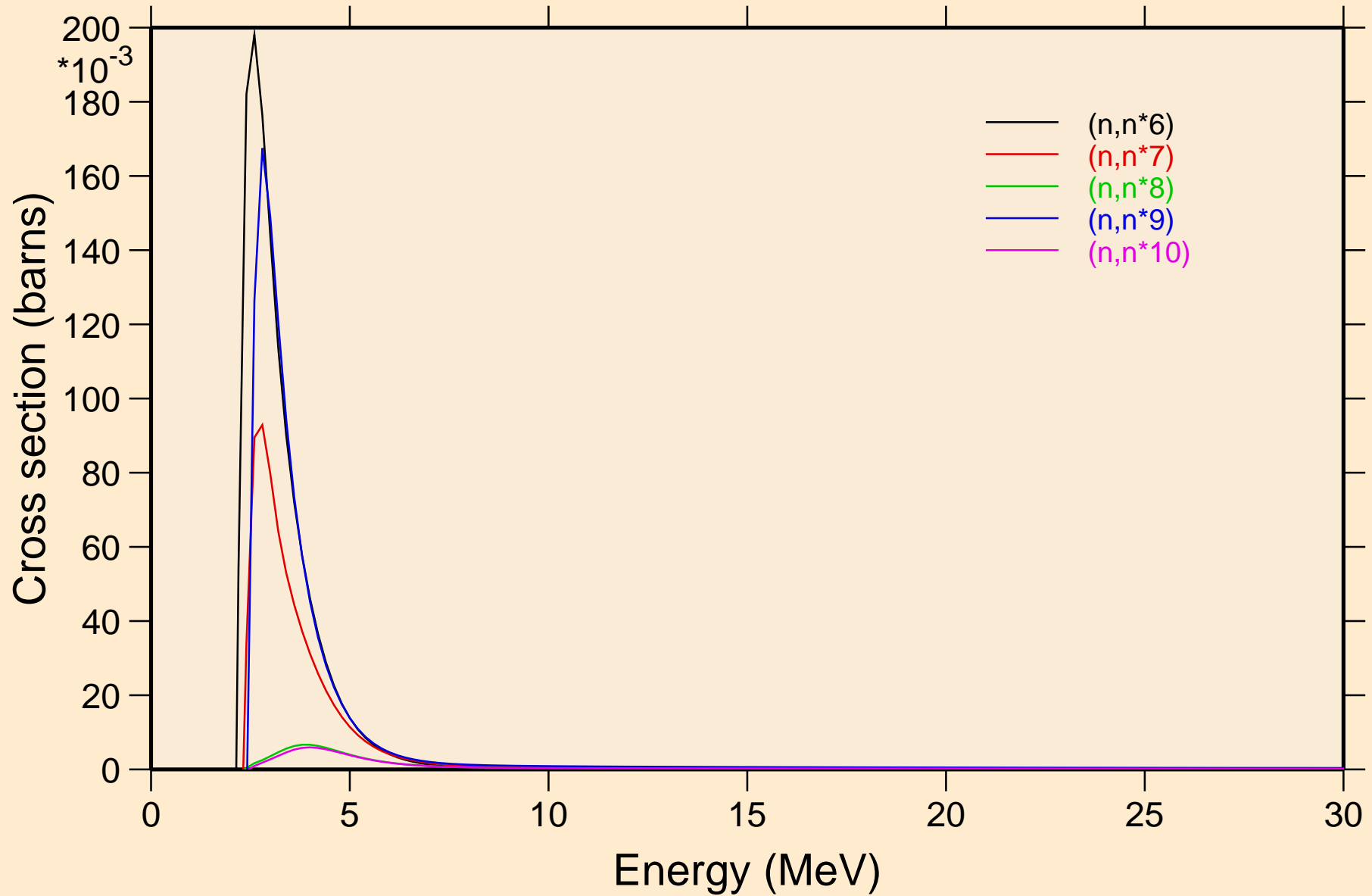

MO094 NEUTRON ACER TENDL-2024 LIBRARY; T=0.K
Inelastic levels

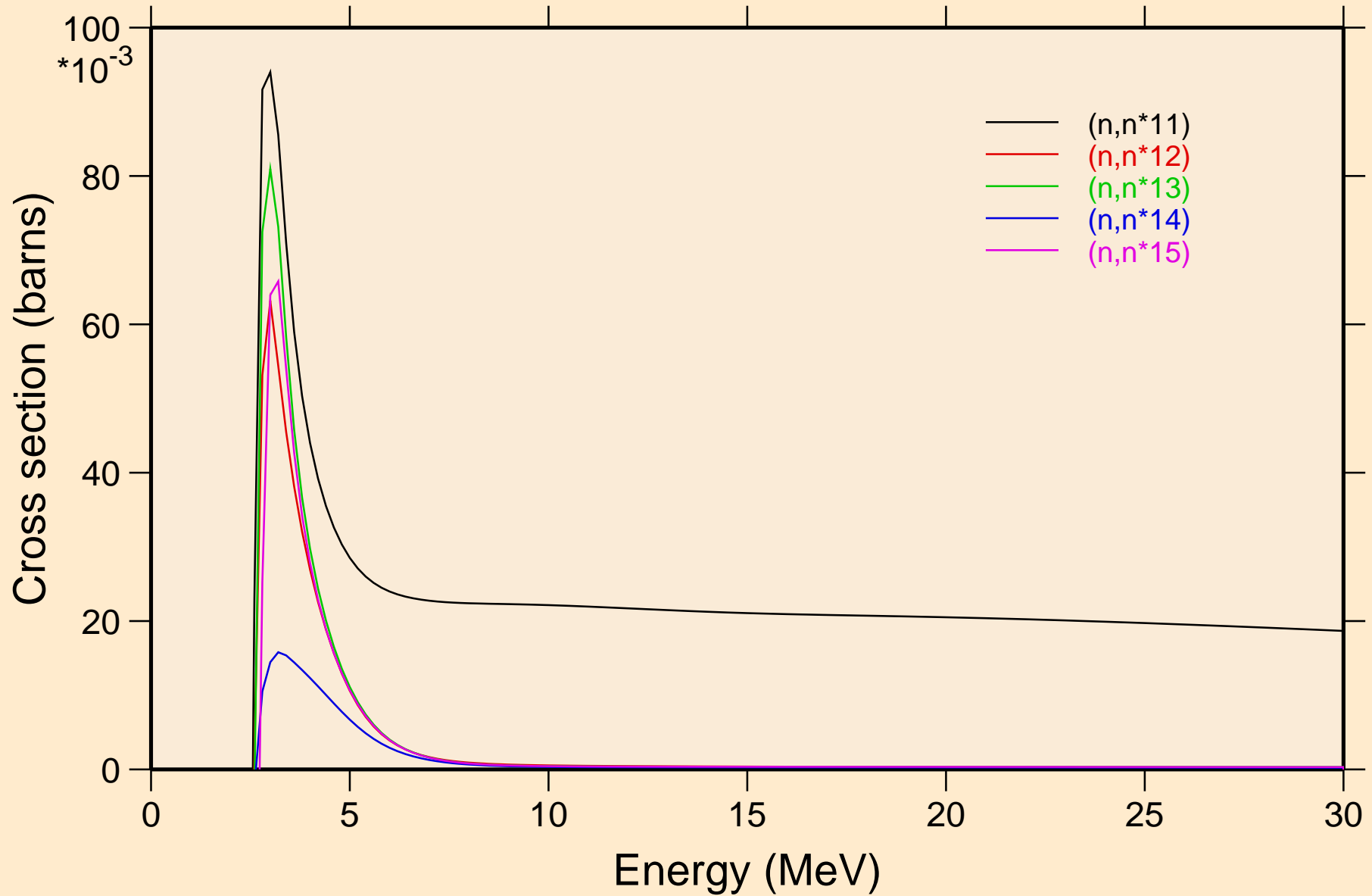

MO094 NEUTRON ACER TENDL-2024 LIBRARY; T=0.K
Inelastic levels

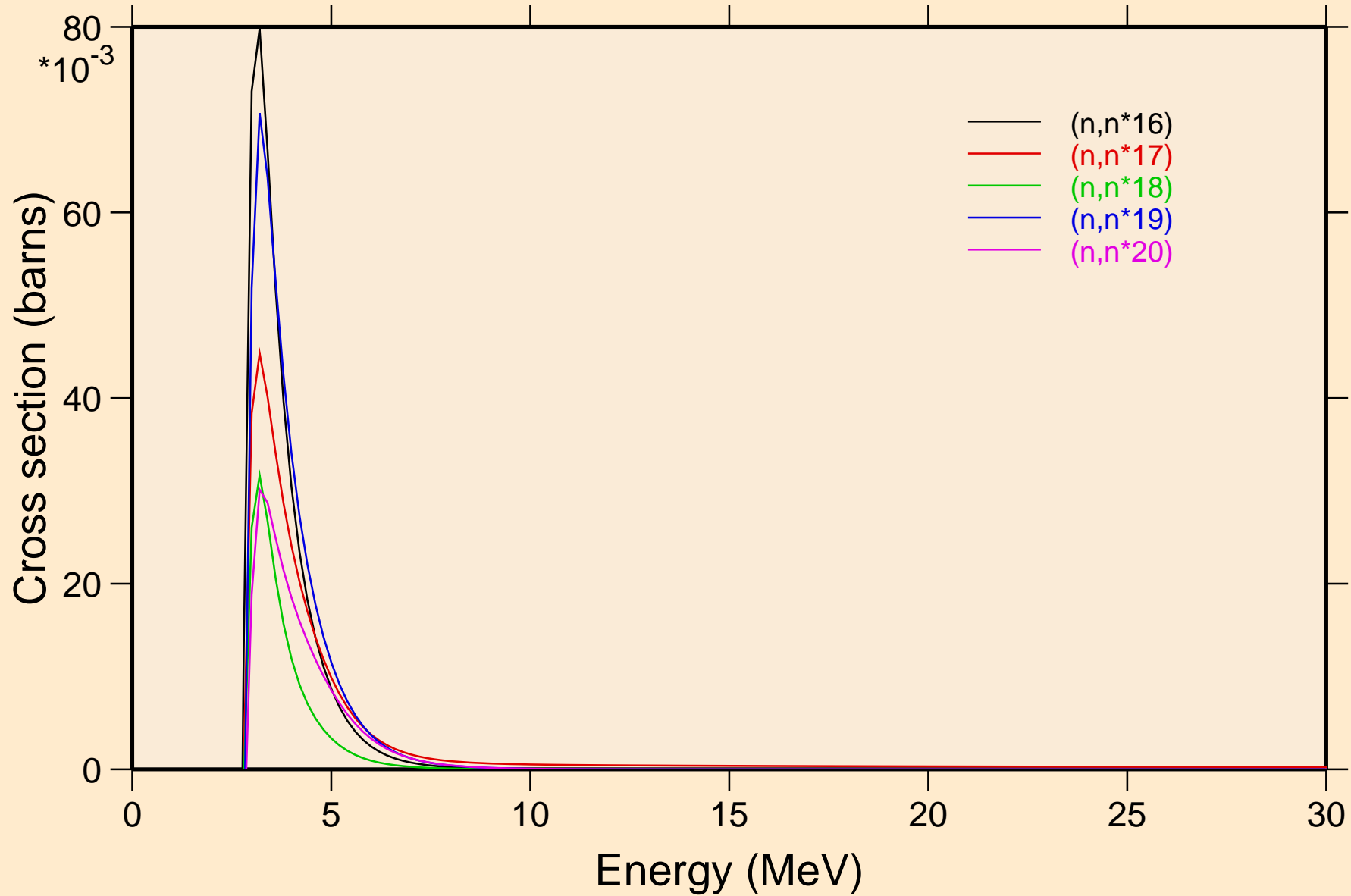

MO094 NEUTRON ACER TENDL-2024 LIBRARY; T=0.K
Inelastic levels

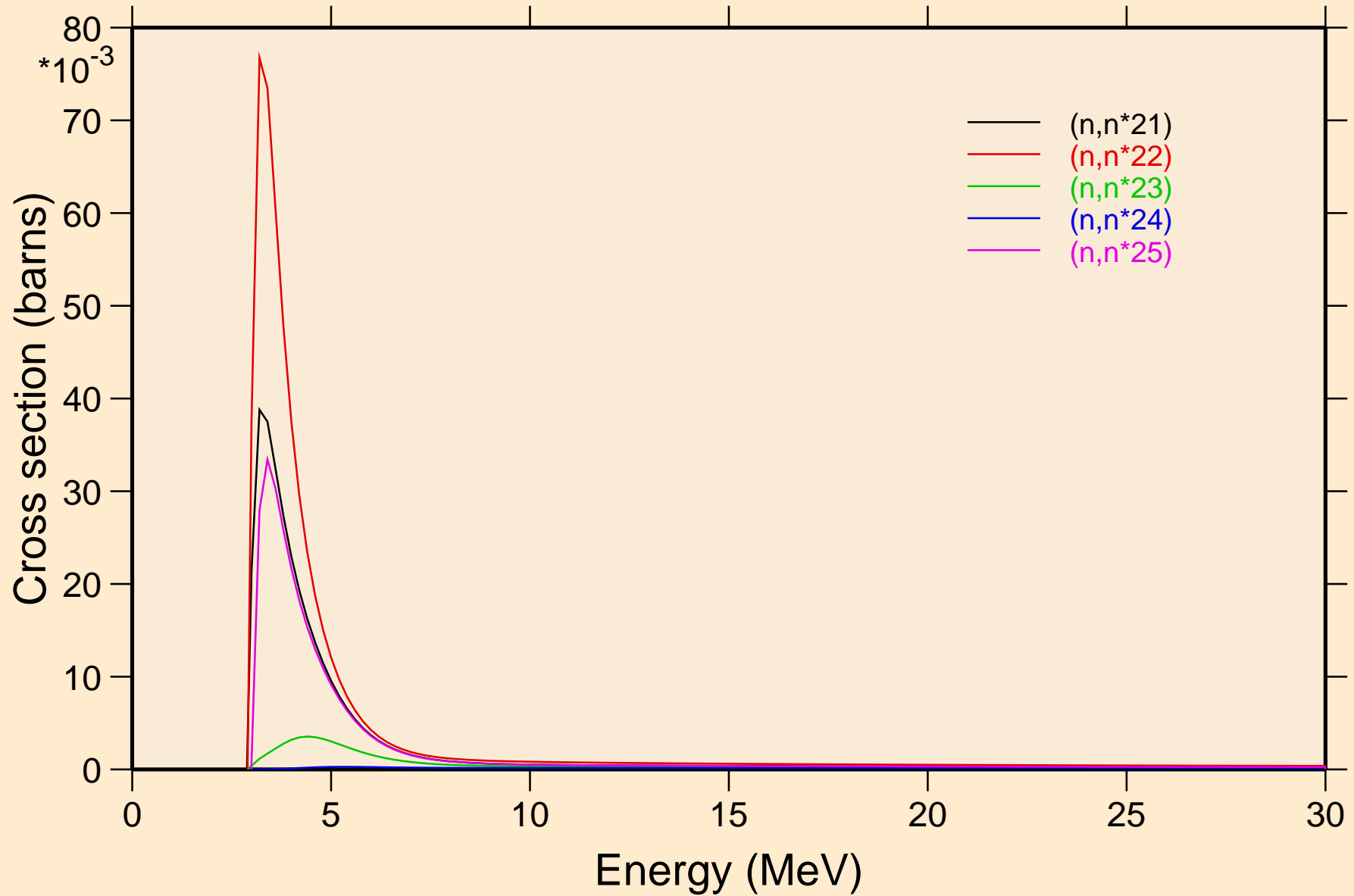

MO094 NEUTRON ACER TENDL-2024 LIBRARY; T=0.K
Inelastic levels

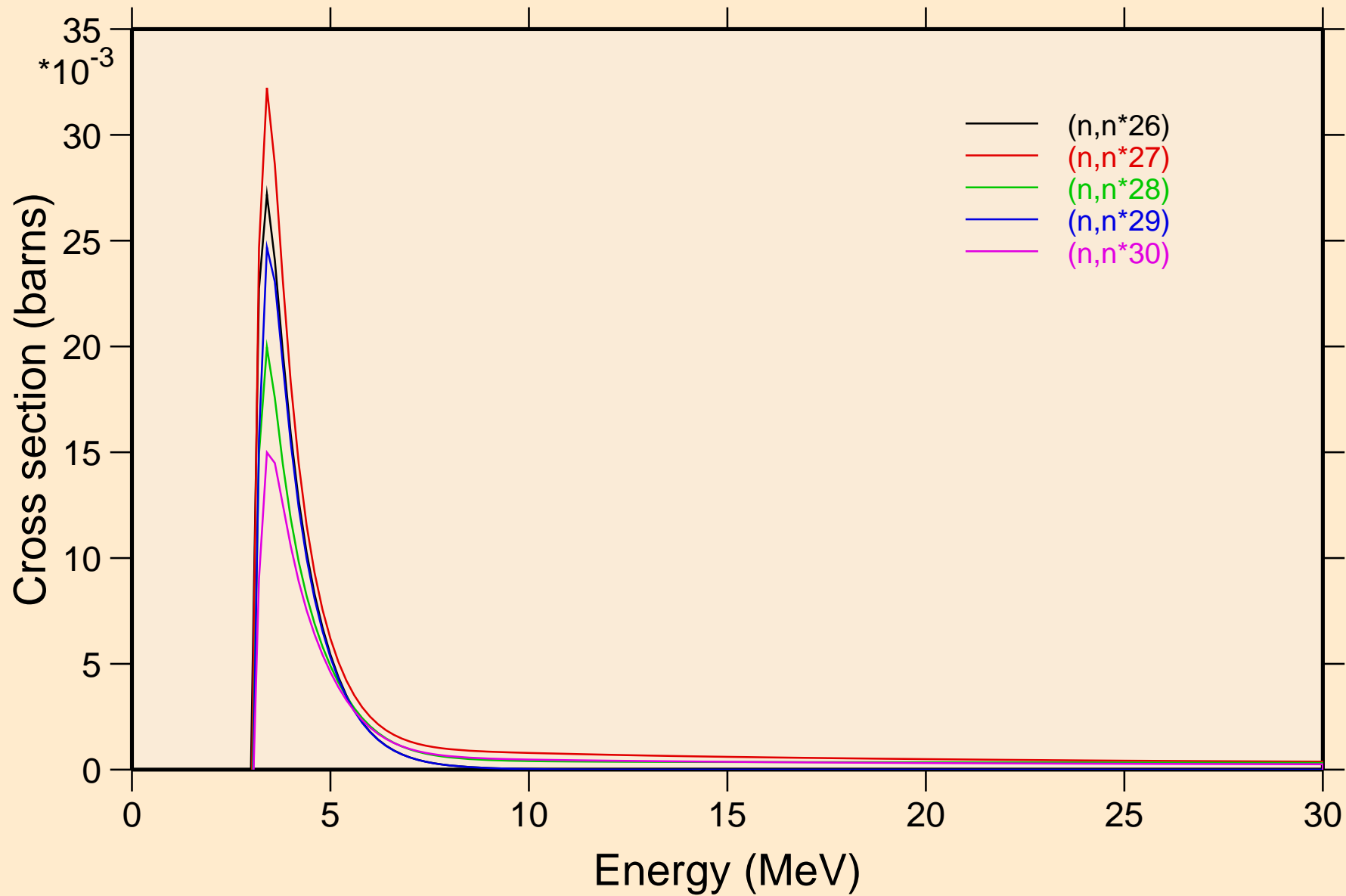

MO094 NEUTRON ACER TENDL-2024 LIBRARY; T=0.K
Threshold reactions

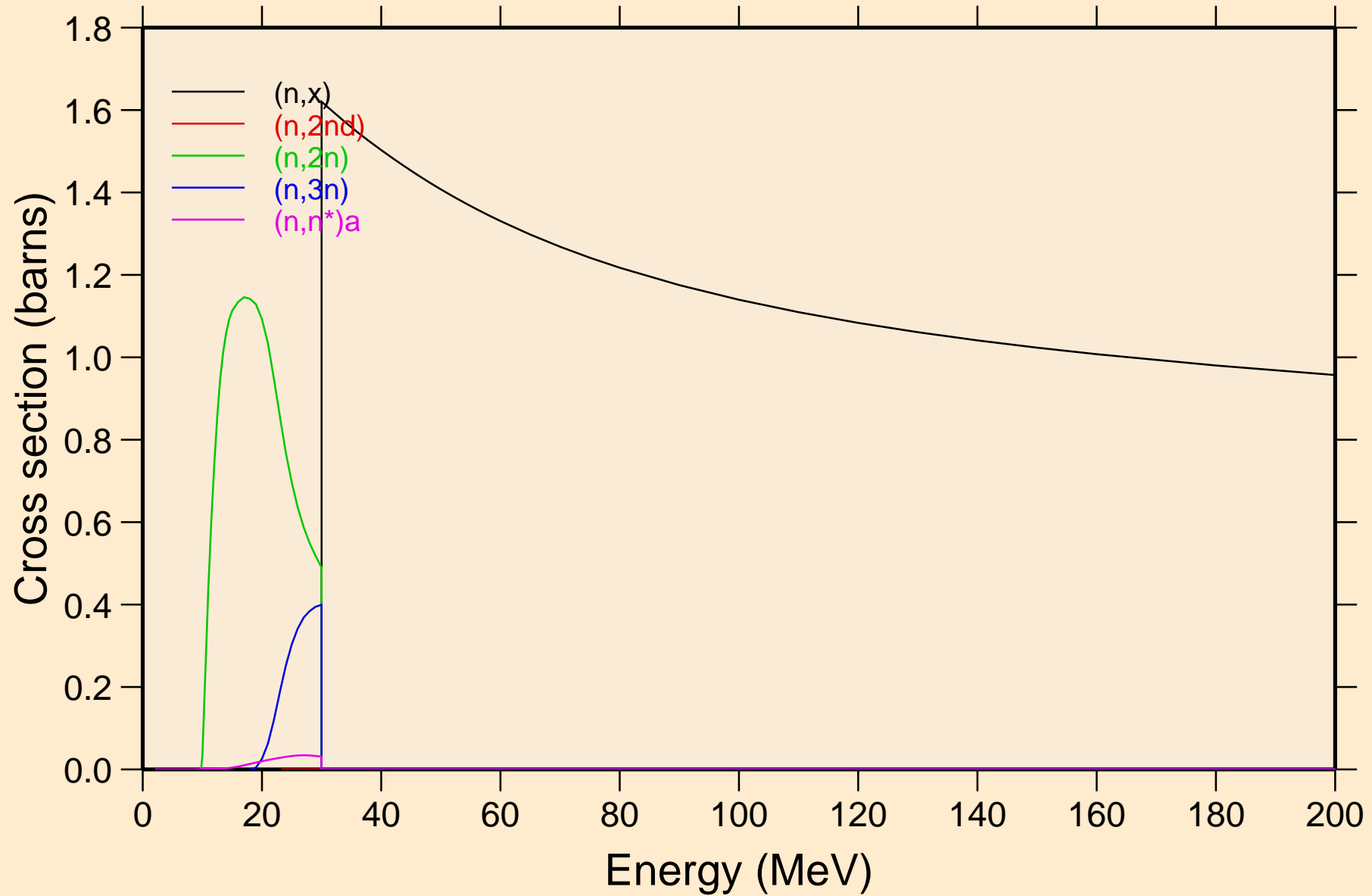

MO094 NEUTRON ACER TENDL-2024 LIBRARY; T=0.K
Threshold reactions

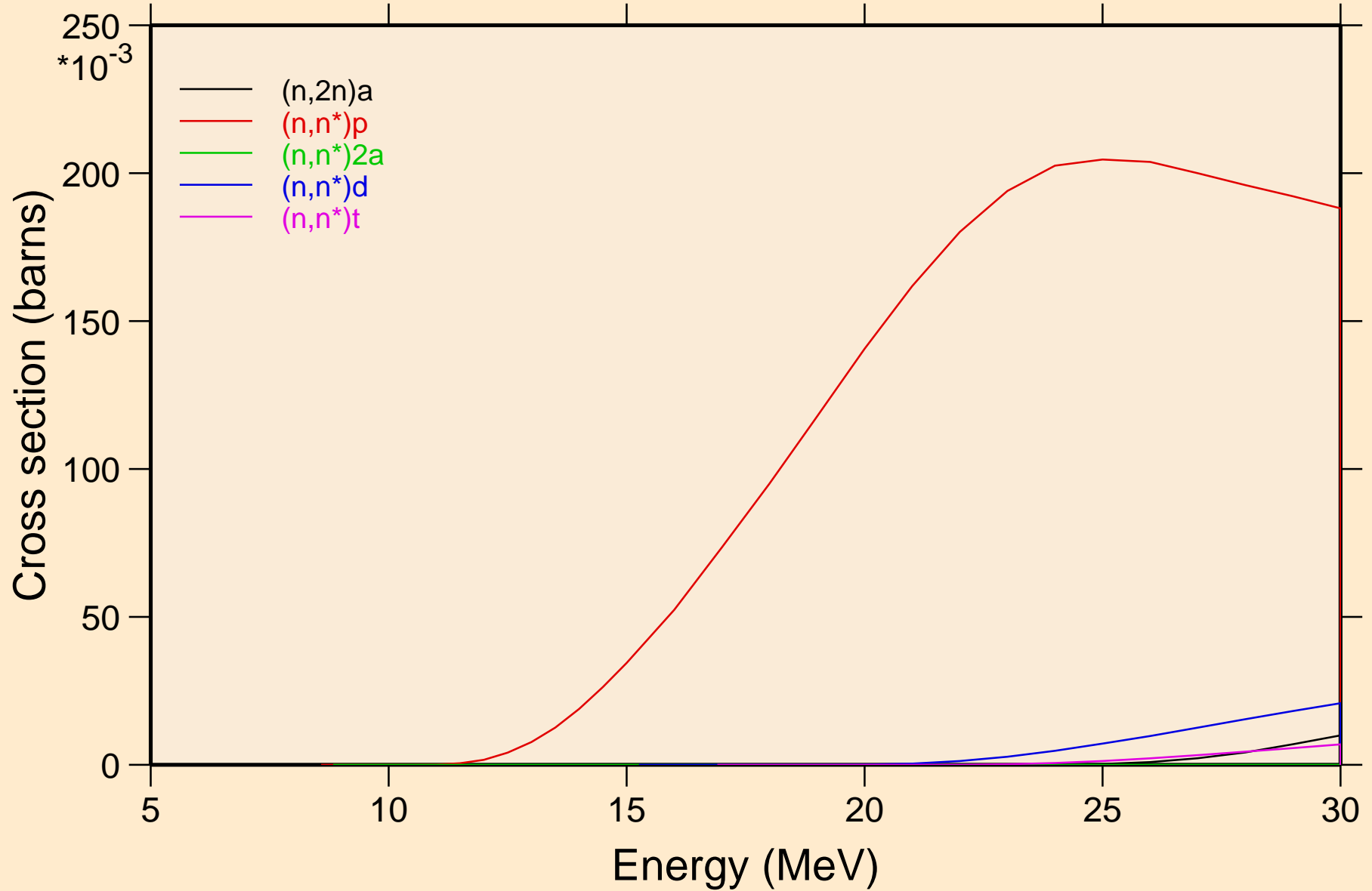

MO094 NEUTRON ACER TENDL-2024 LIBRARY; T=0.K
Threshold reactions

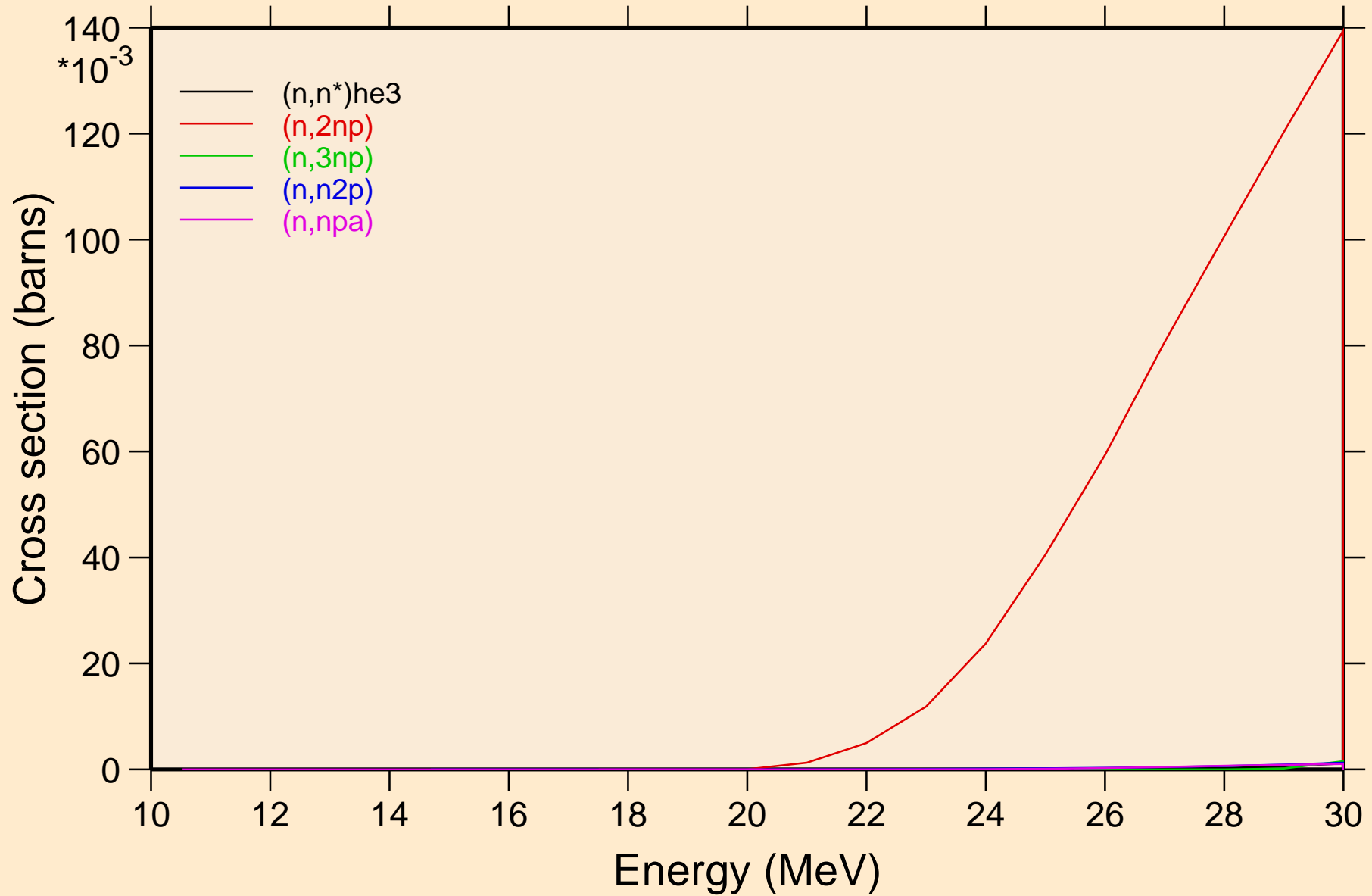

MO094 NEUTRON ACER TENDL-2024 LIBRARY; T=0.K
Threshold reactions

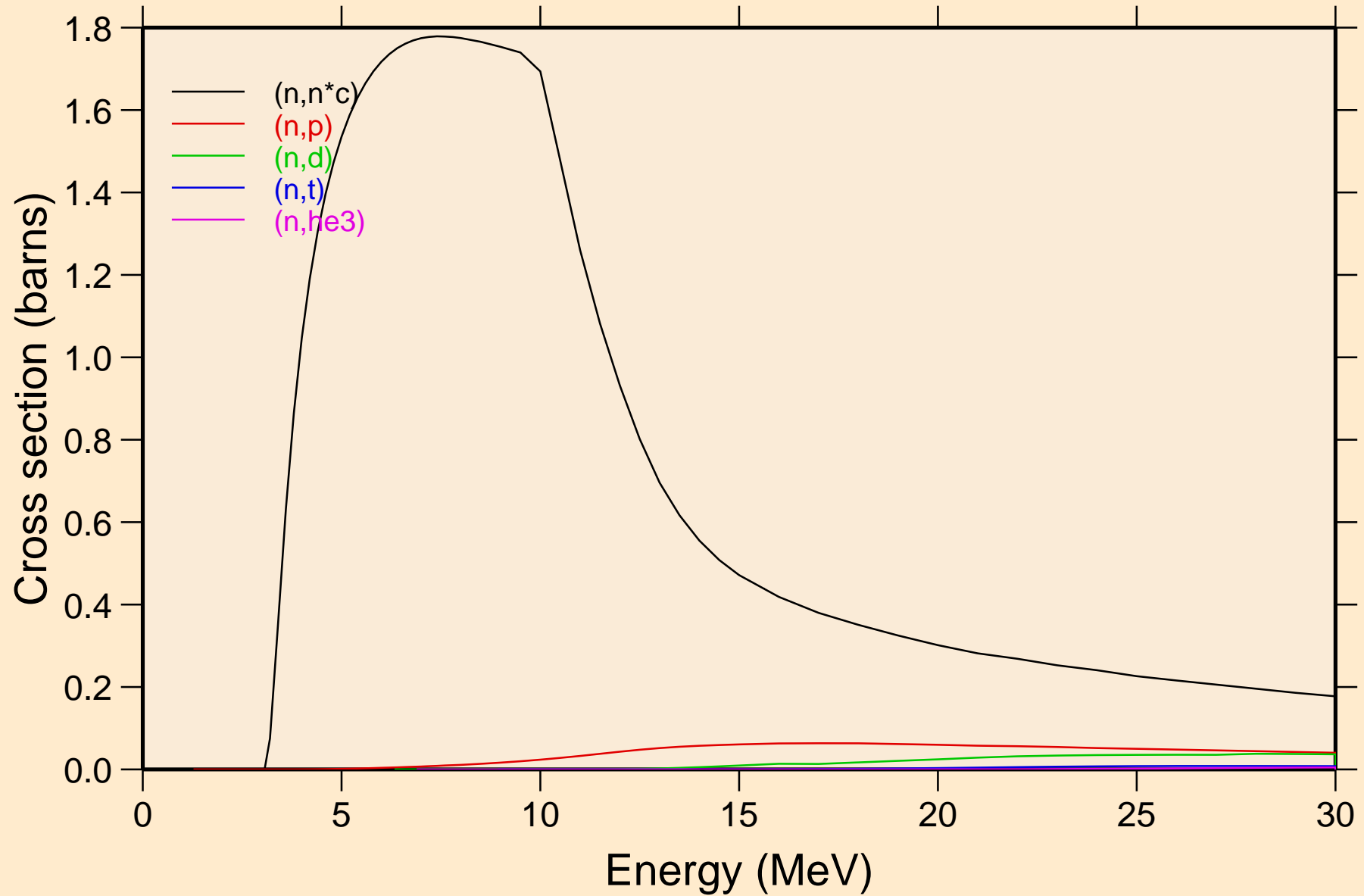

MO094 NEUTRON ACER TENDL-2024 LIBRARY; T=0.K
Threshold reactions

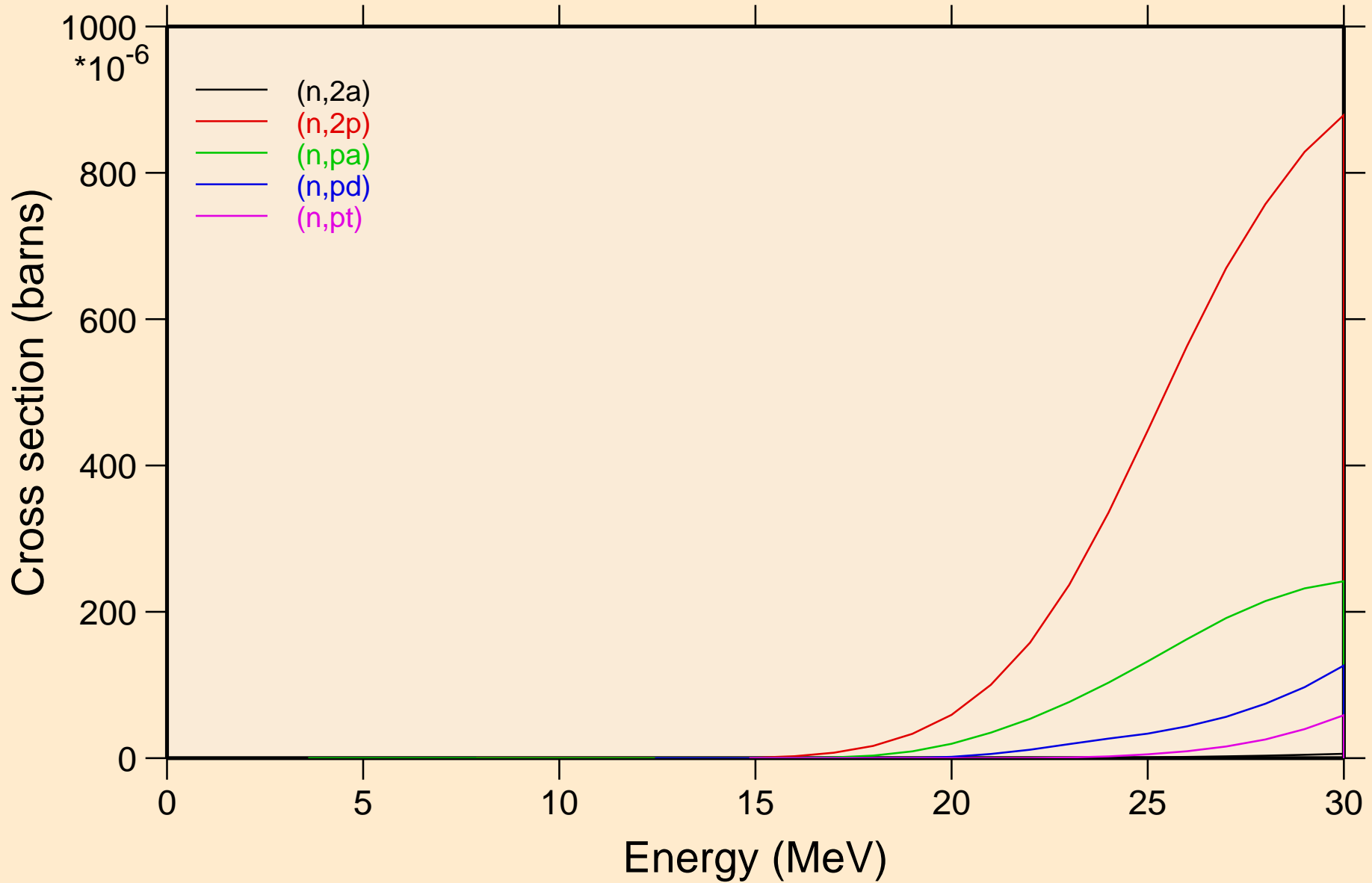

MO094 NEUTRON ACER TENDL-2024 LIBRARY; T=0.K
Threshold reactions

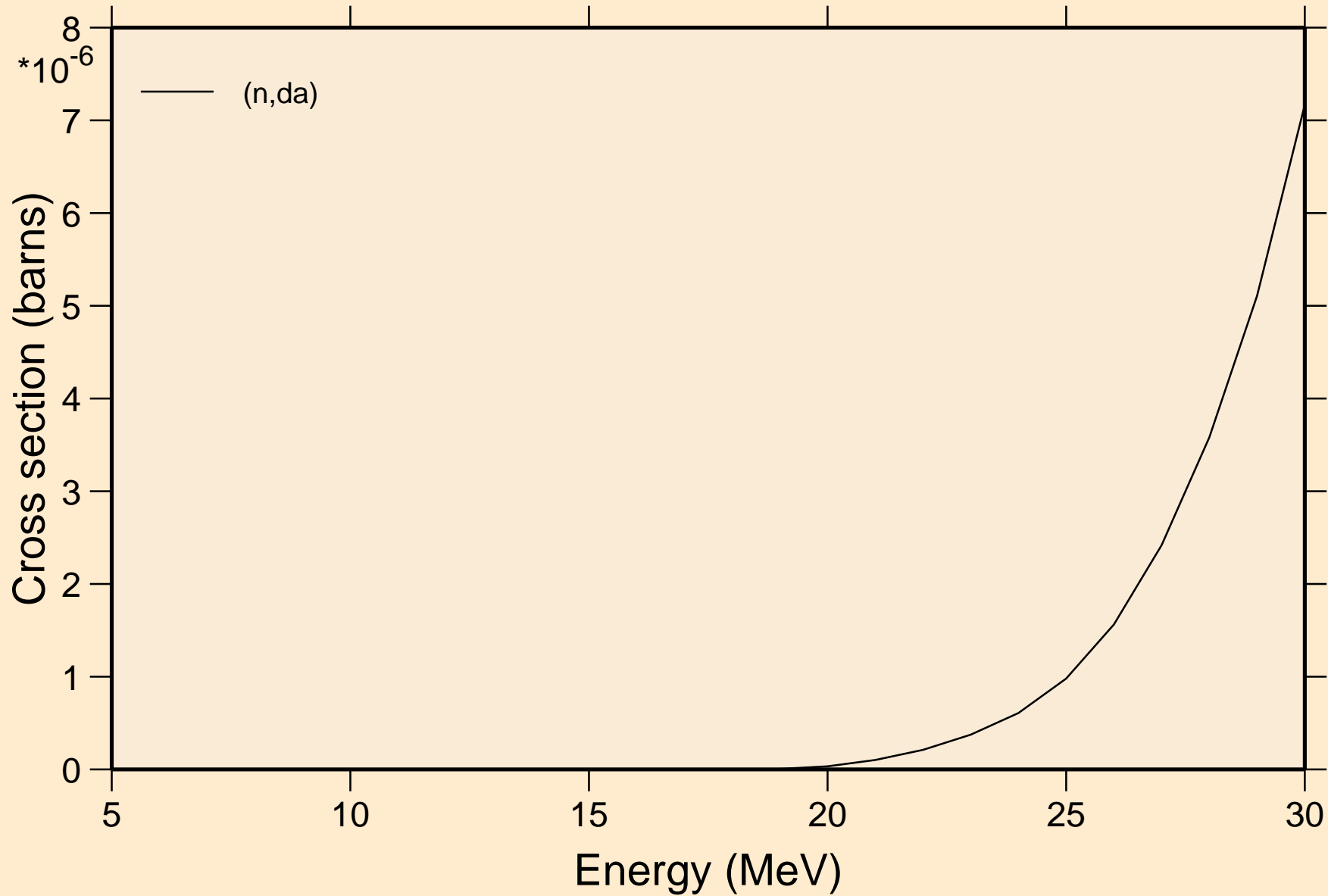

MO094 NEUTRON ACER TENDL-2024 LIBRARY; T=0.K
Threshold reactions

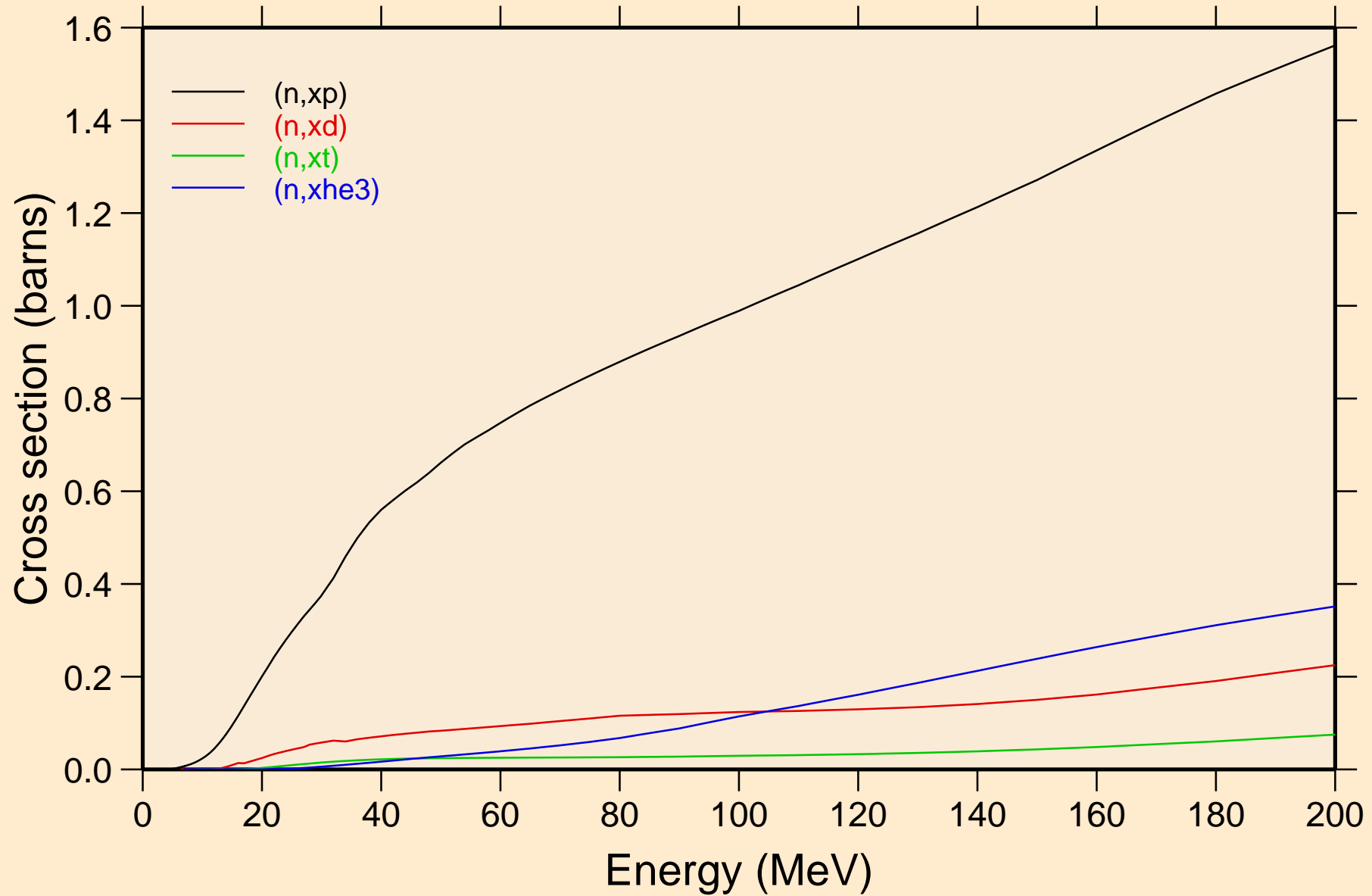

MO094 NEUTRON ACER TENDL-2024 LIBRARY; T=0.K
angular distribution for elastic

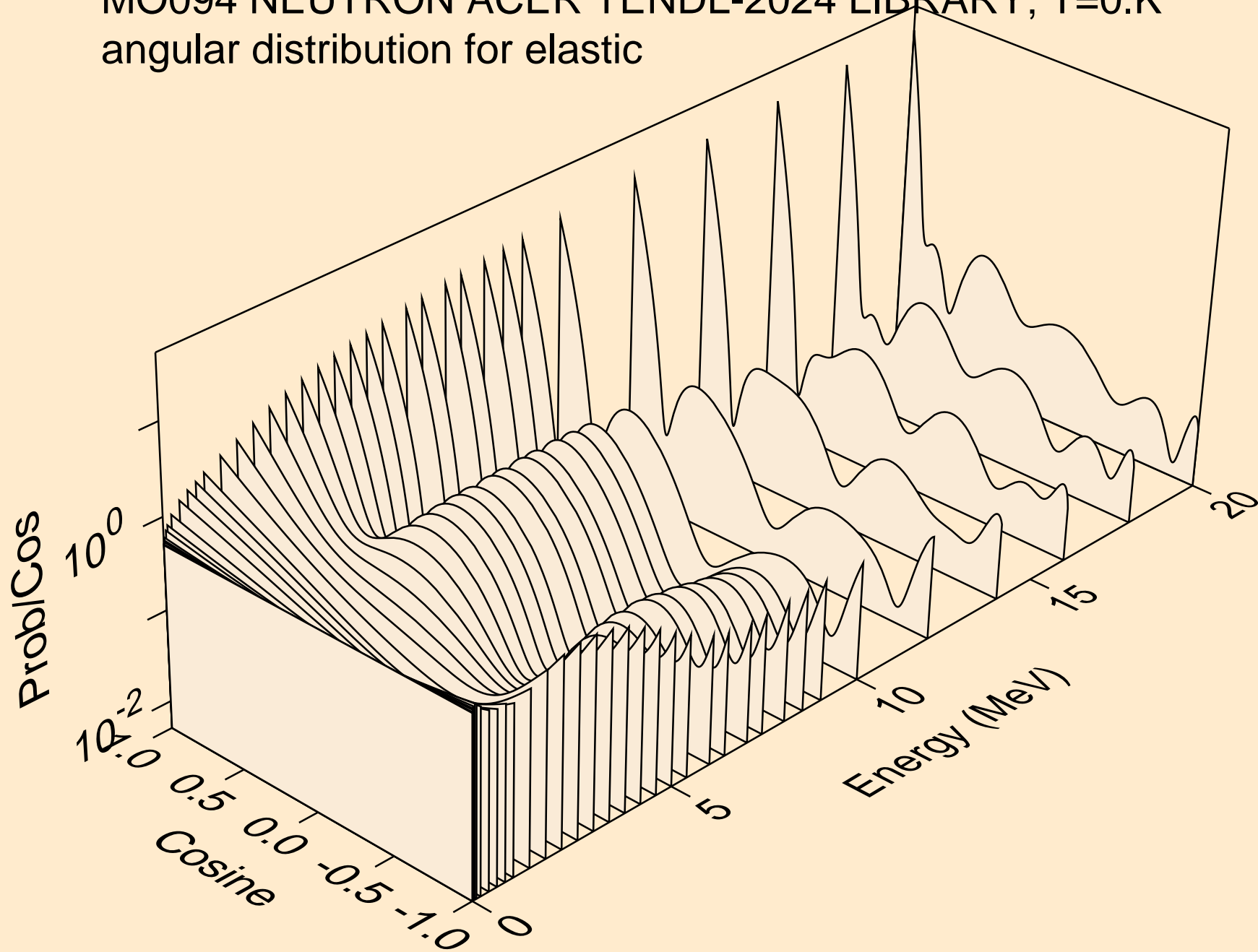

MO094 NEUTRON ACER TENDL-2024 LIBRARY; T=0.K
angular distribution for elastic

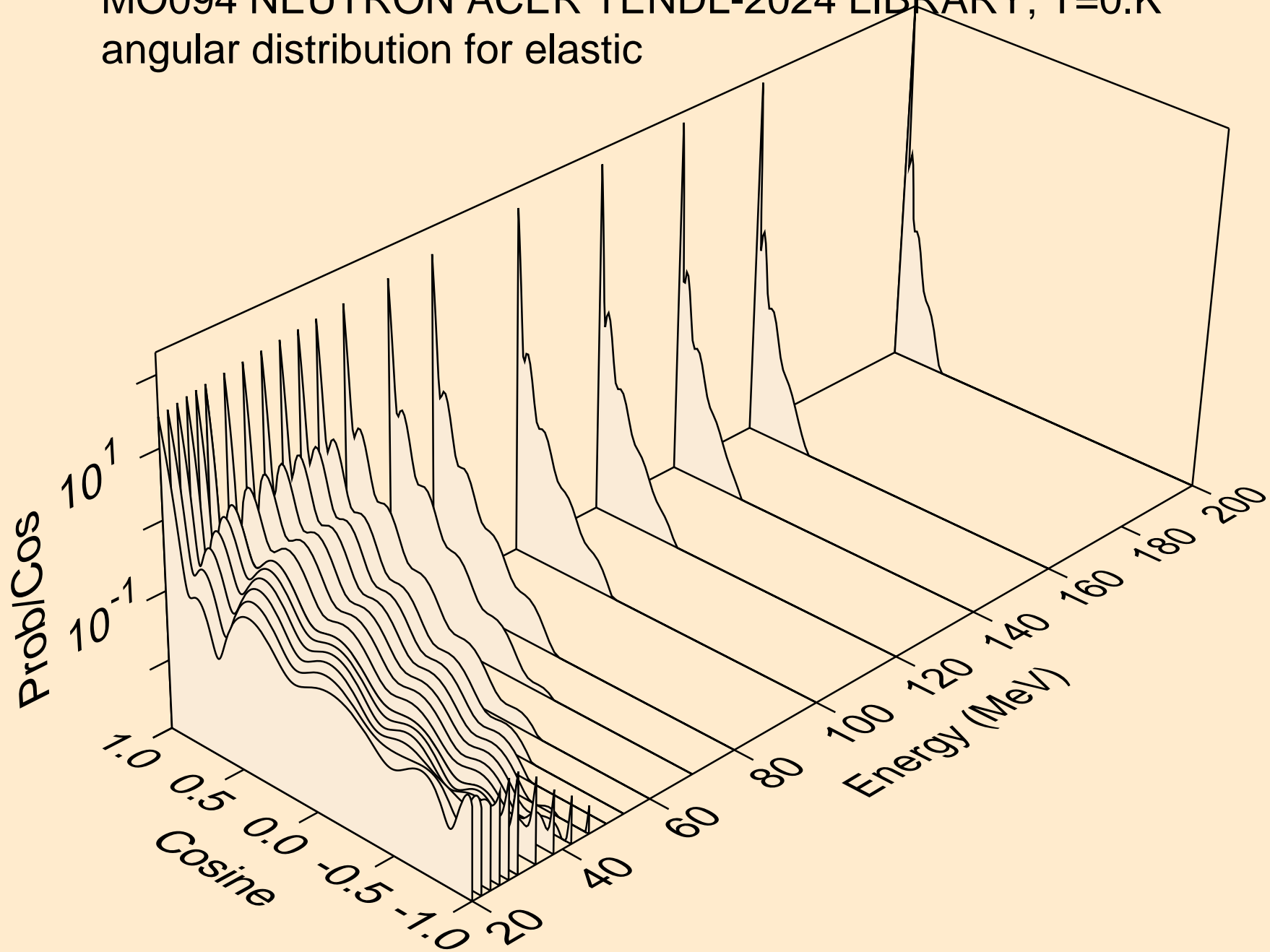

MO094 NEUTRON ACER TENDL-2024 LIBRARY; T=0.K
angular distribution for (n,n*1)

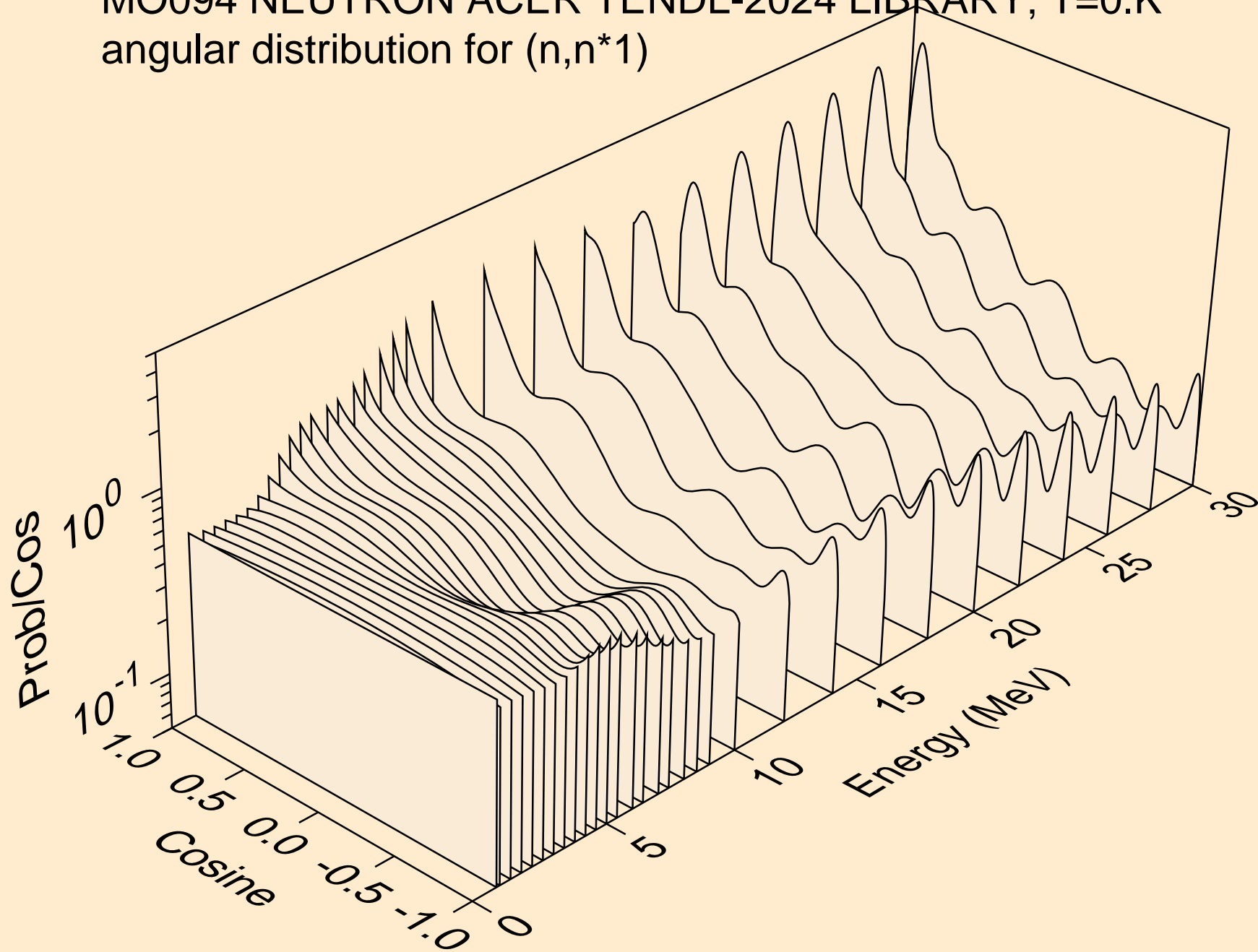

MO094 NEUTRON ACER TENDL-2024 LIBRARY; T=0.K
angular distribution for (n,n*2)

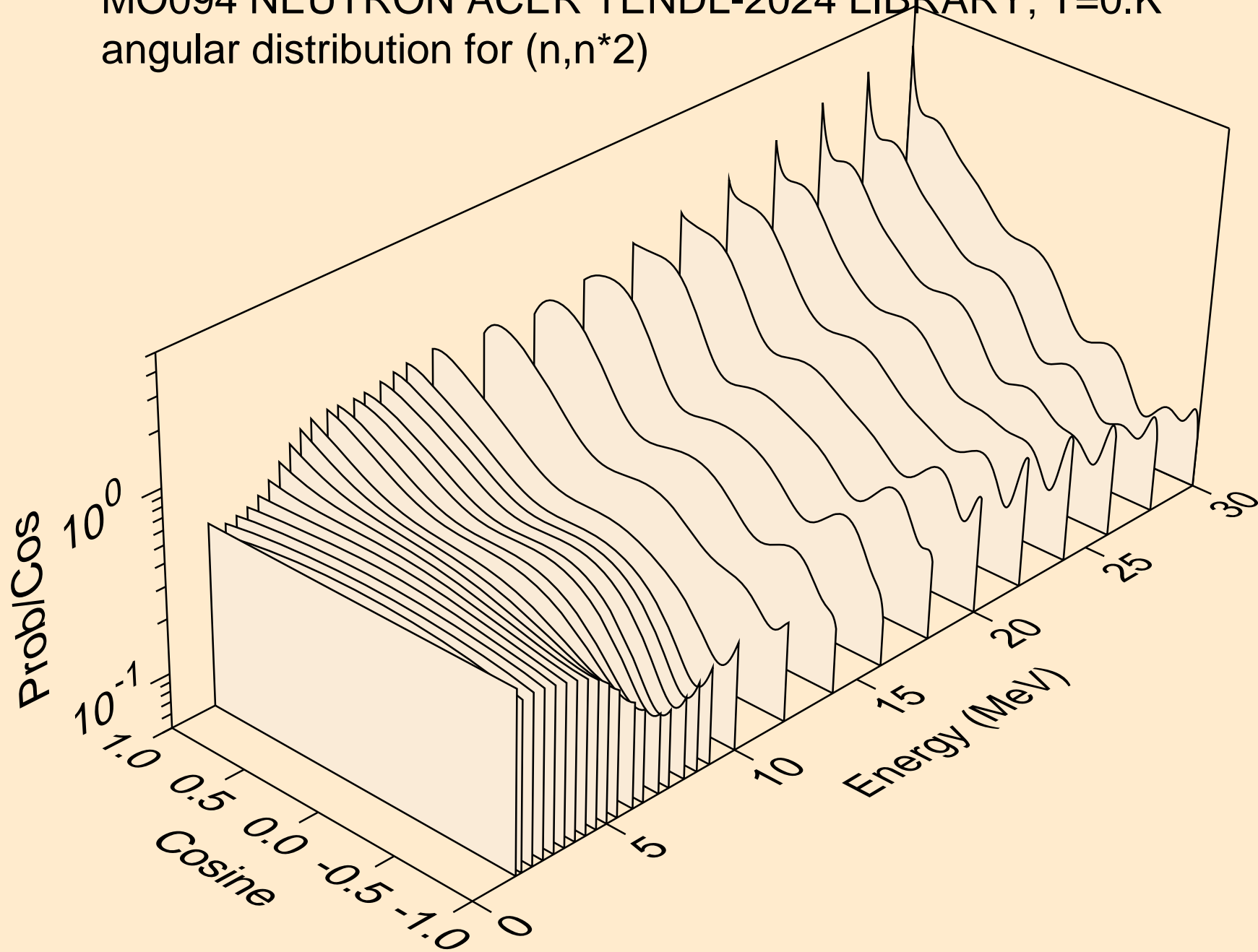

MO094 NEUTRON ACER TENDL-2024 LIBRARY; T=0.K
angular distribution for (n,n*3)

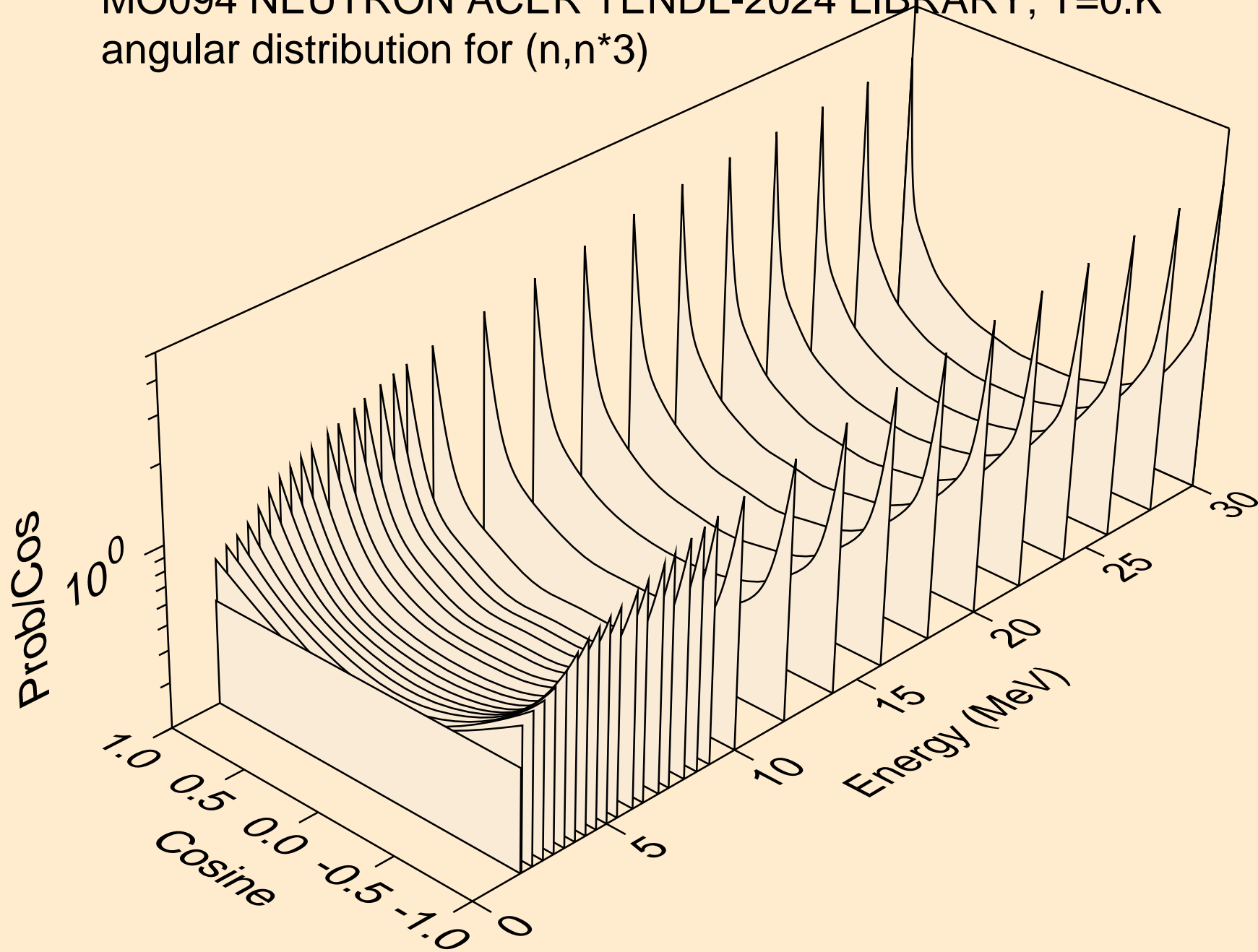

MO094 NEUTRON ACER TENDL-2024 LIBRARY; T=0.K
angular distribution for (n,n*4)

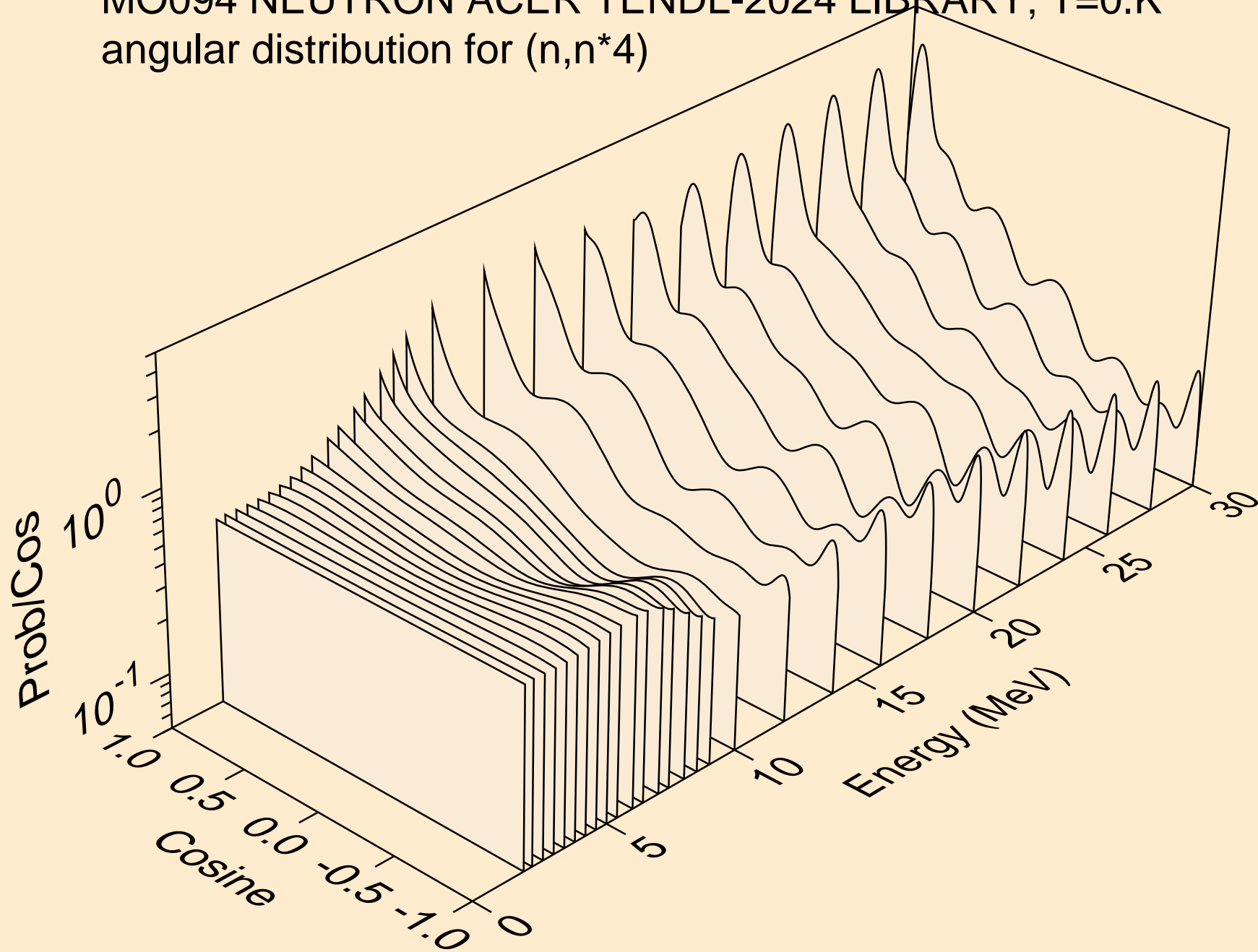

MO094 NEUTRON ACER TENDL-2024 LIBRARY; T=0.K
angular distribution for (n,n*5)

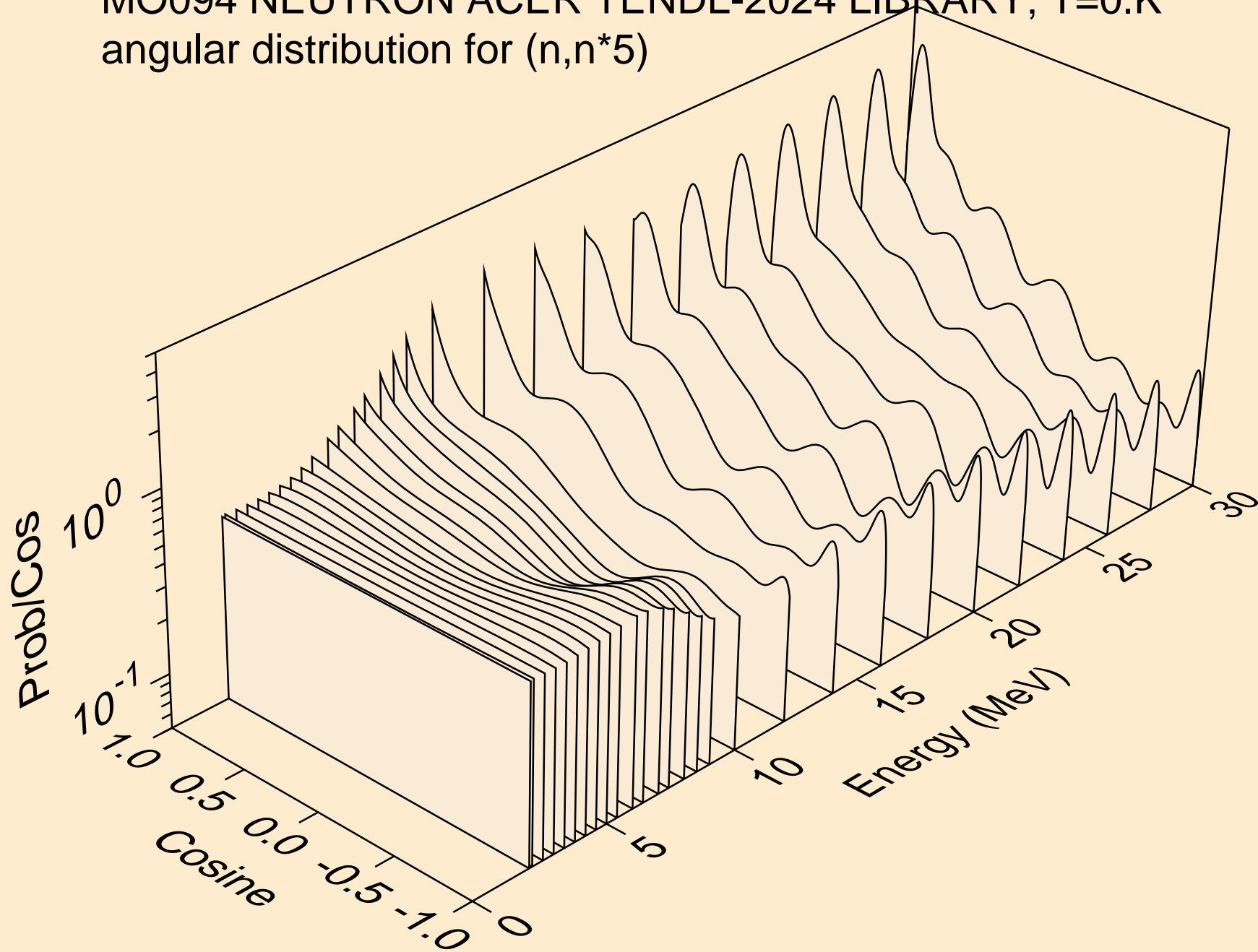

MO094 NEUTRON ACER TENDL-2024 LIBRARY; T=0.K
angular distribution for (n,n*6)

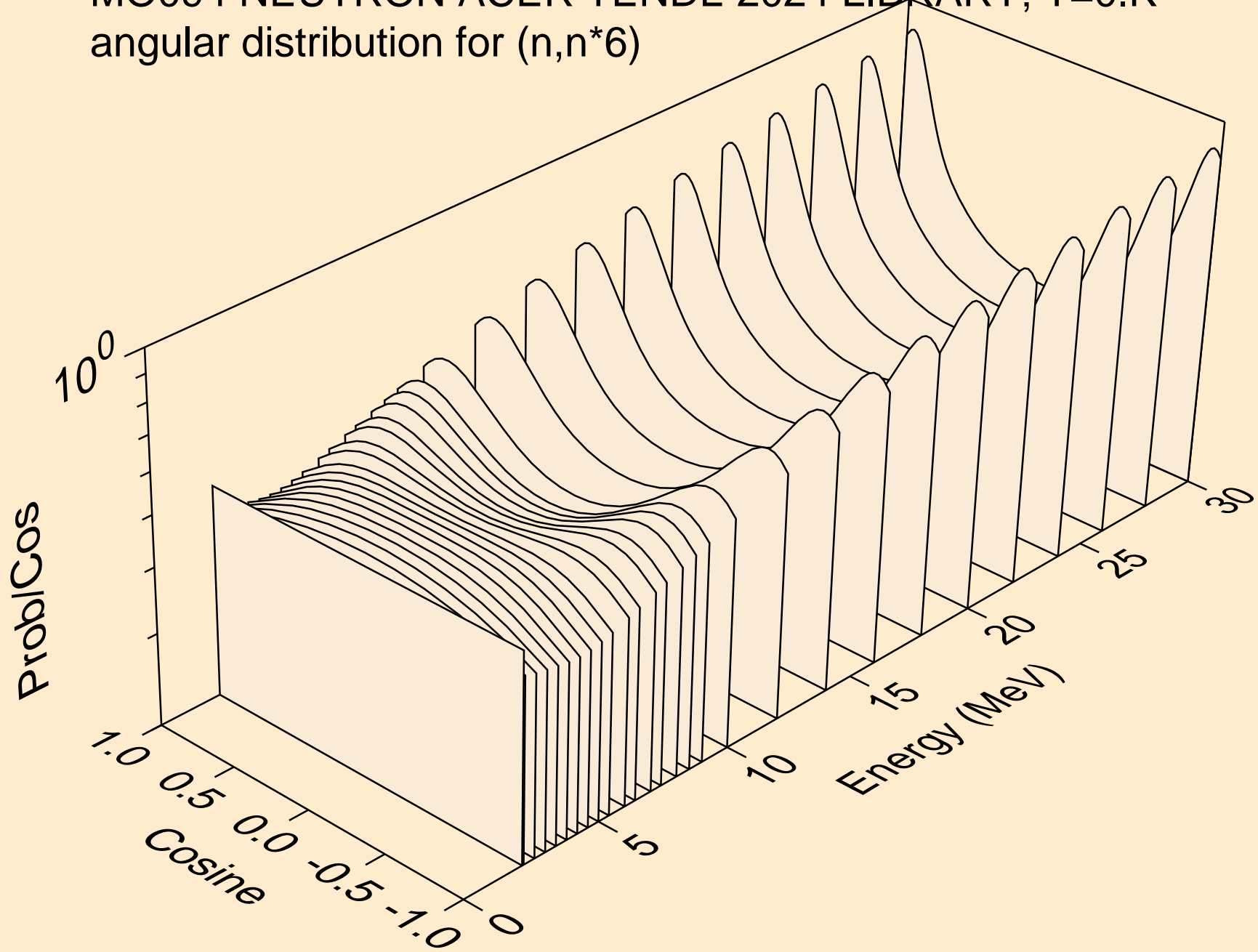

MO094 NEUTRON ACER TENDL-2024 LIBRARY; T=0.K
angular distribution for (n,n*7)

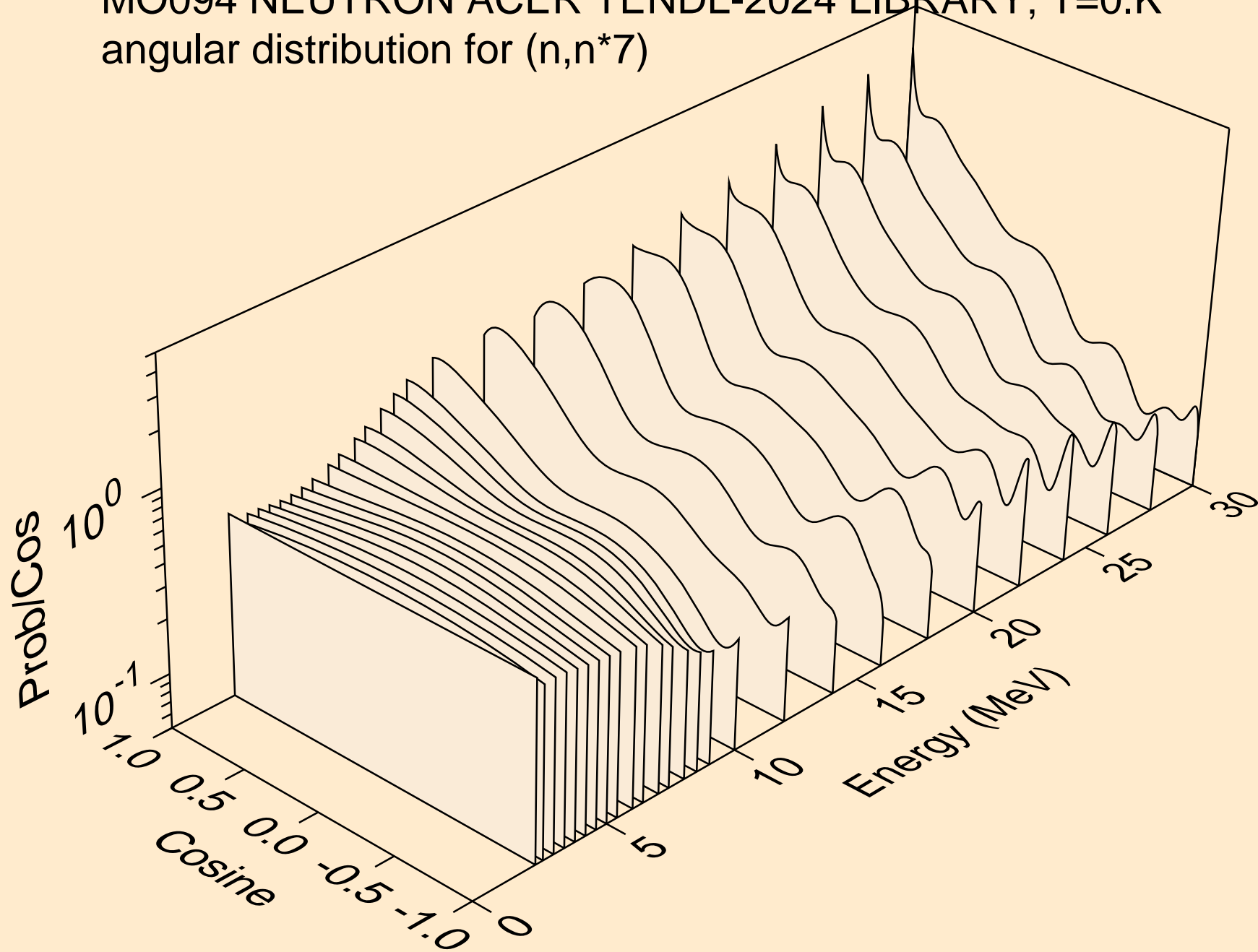

MO094 NEUTRON ACER TENDL-2024 LIBRARY; T=0.K
angular distribution for (n,n*8)

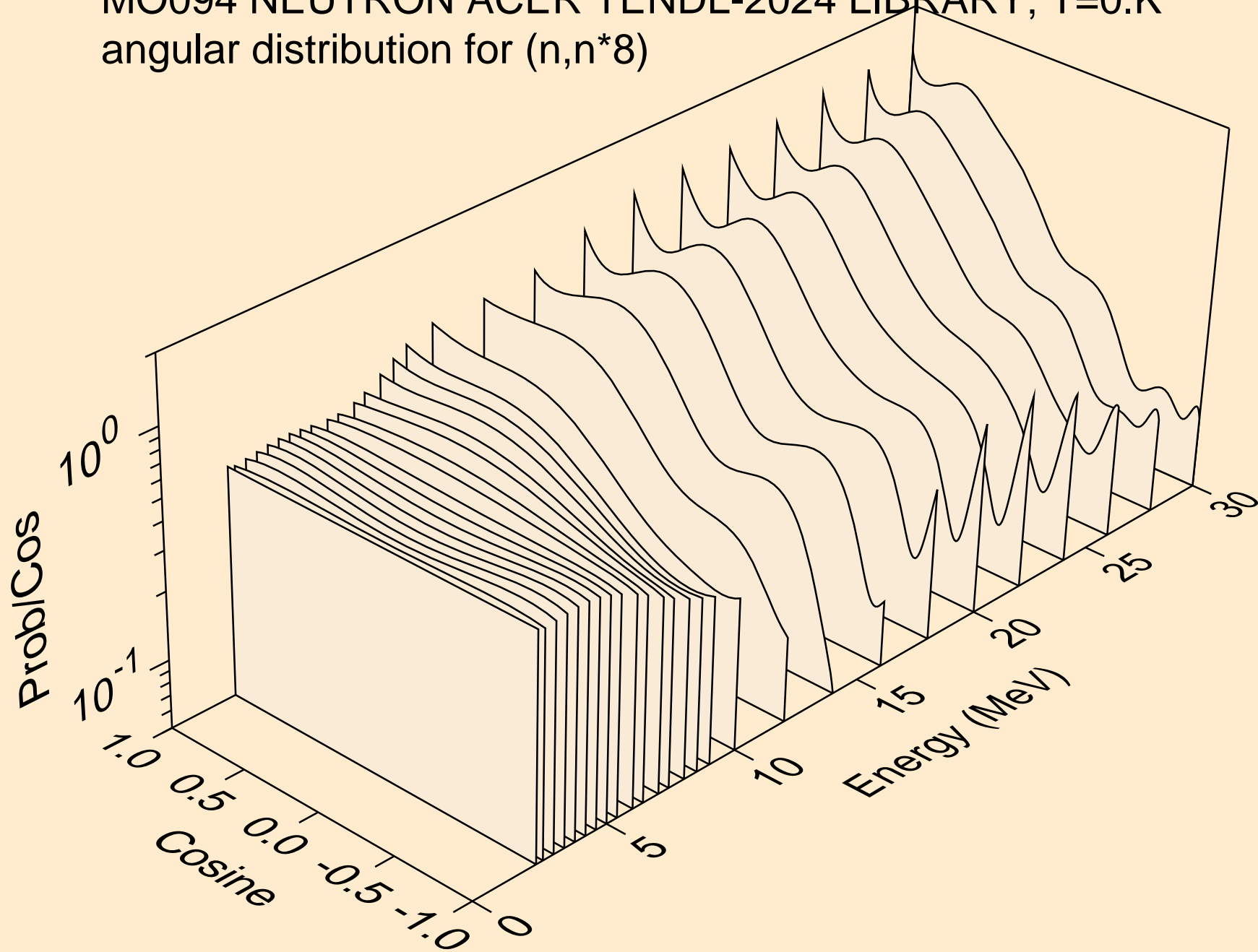

MO094 NEUTRON ACER TENDL-2024 LIBRARY; T=0.K
angular distribution for (n,n*9)

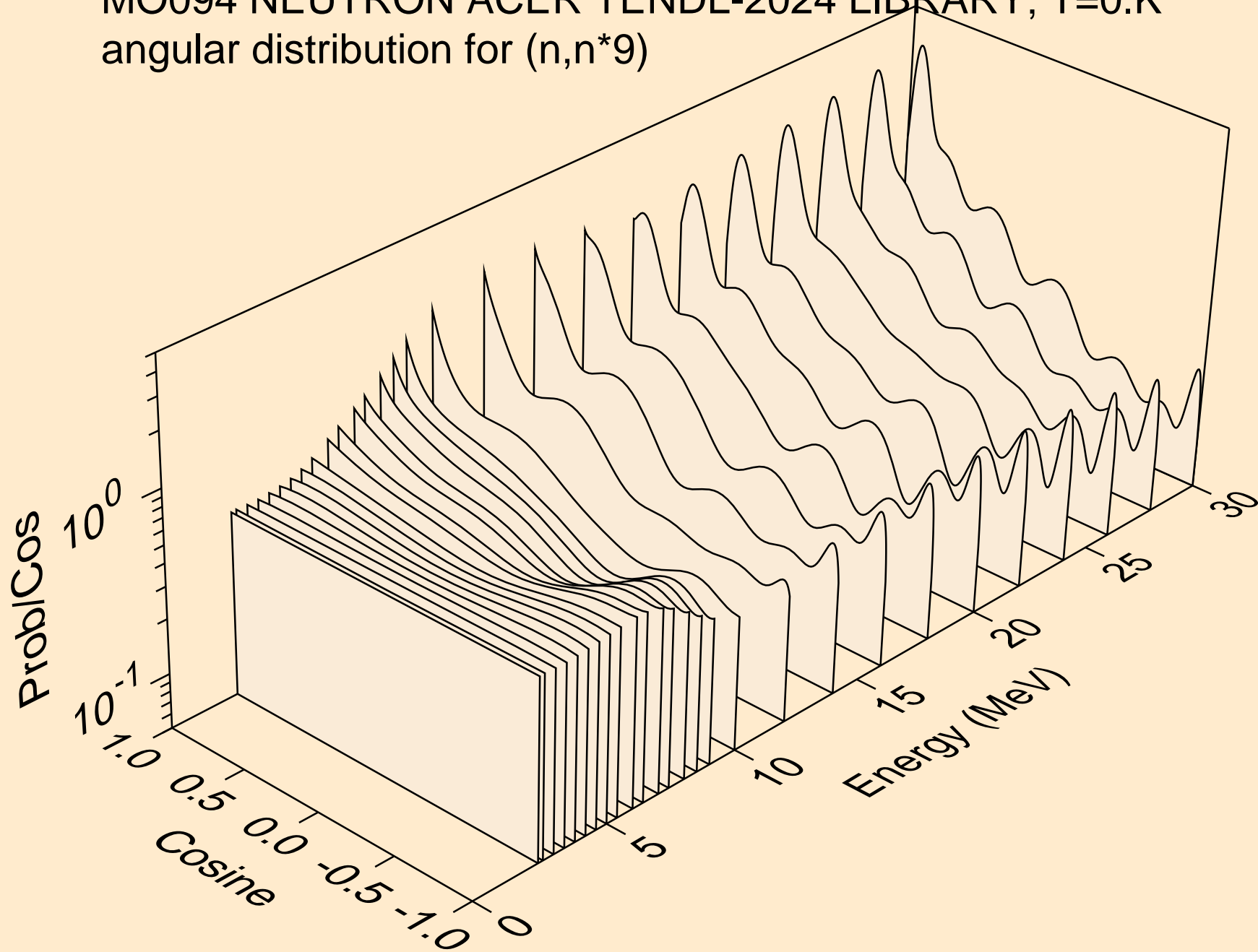

MO094 NEUTRON ACER TENDL-2024 LIBRARY; T=0.K
angular distribution for (n,n*10)

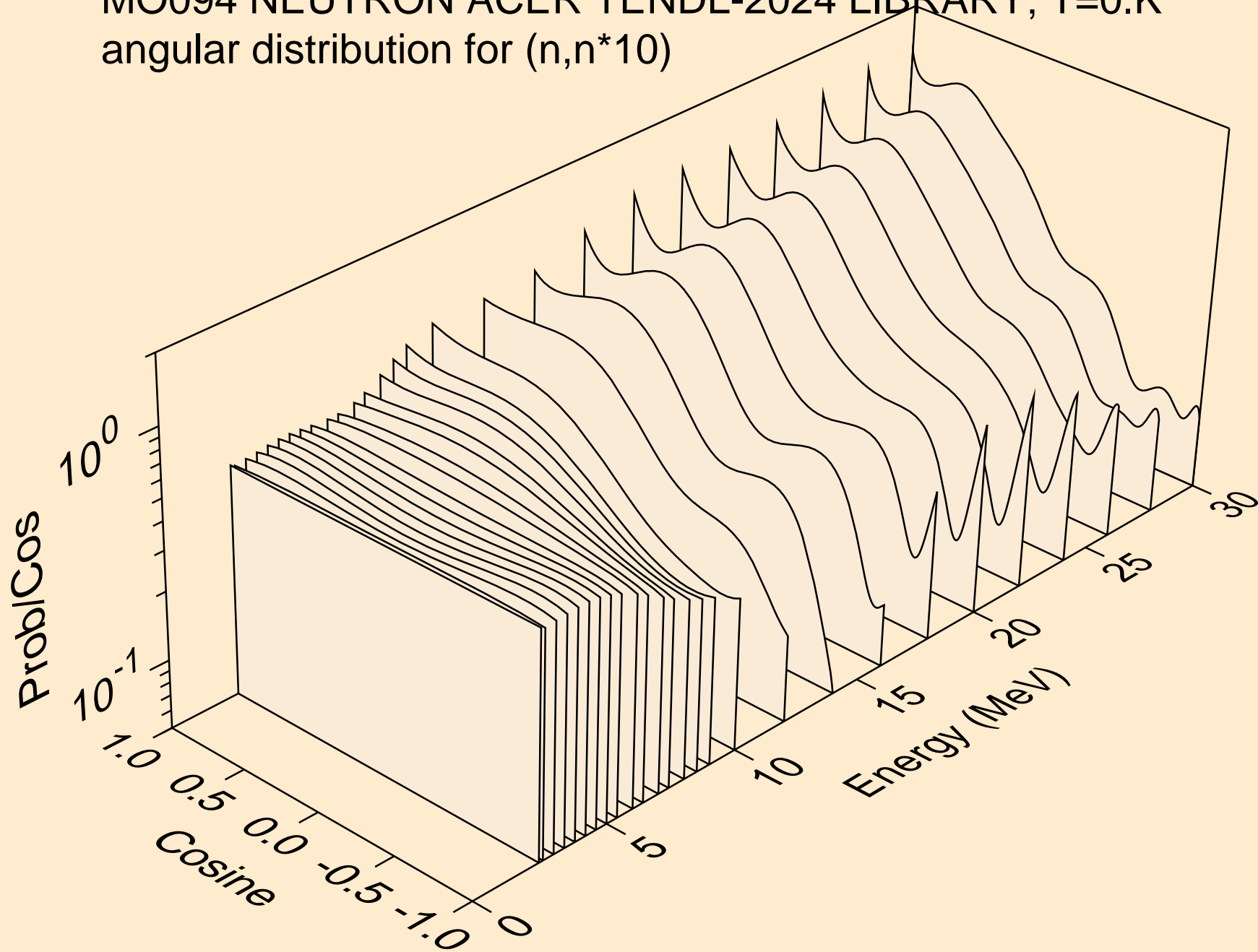

MO094 NEUTRON ACER TENDL-2024 LIBRARY; T=0.K
angular distribution for (n,n*11)

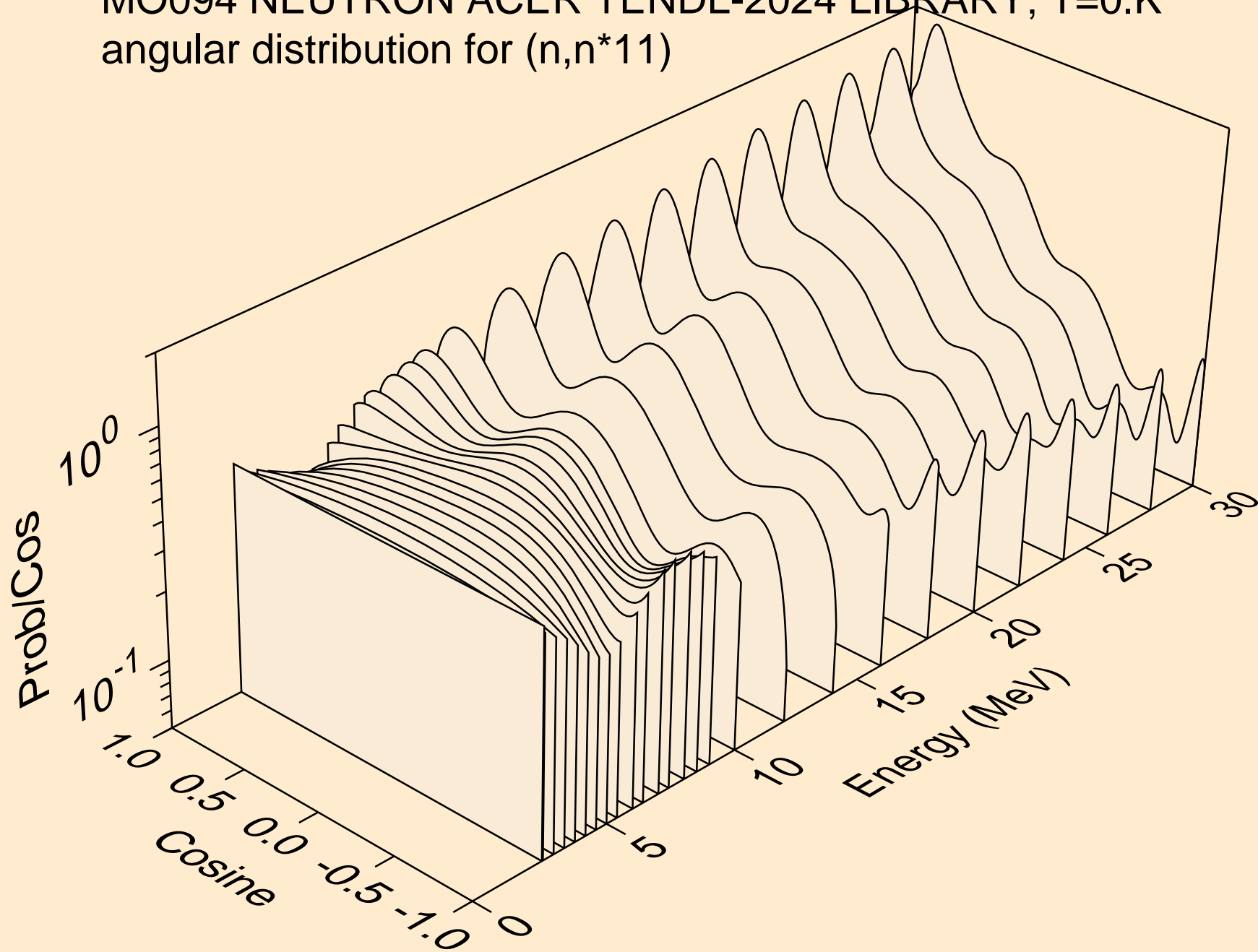

MO094 NEUTRON ACER TENDL-2024 LIBRARY; T=0.K
angular distribution for (n,n*12)

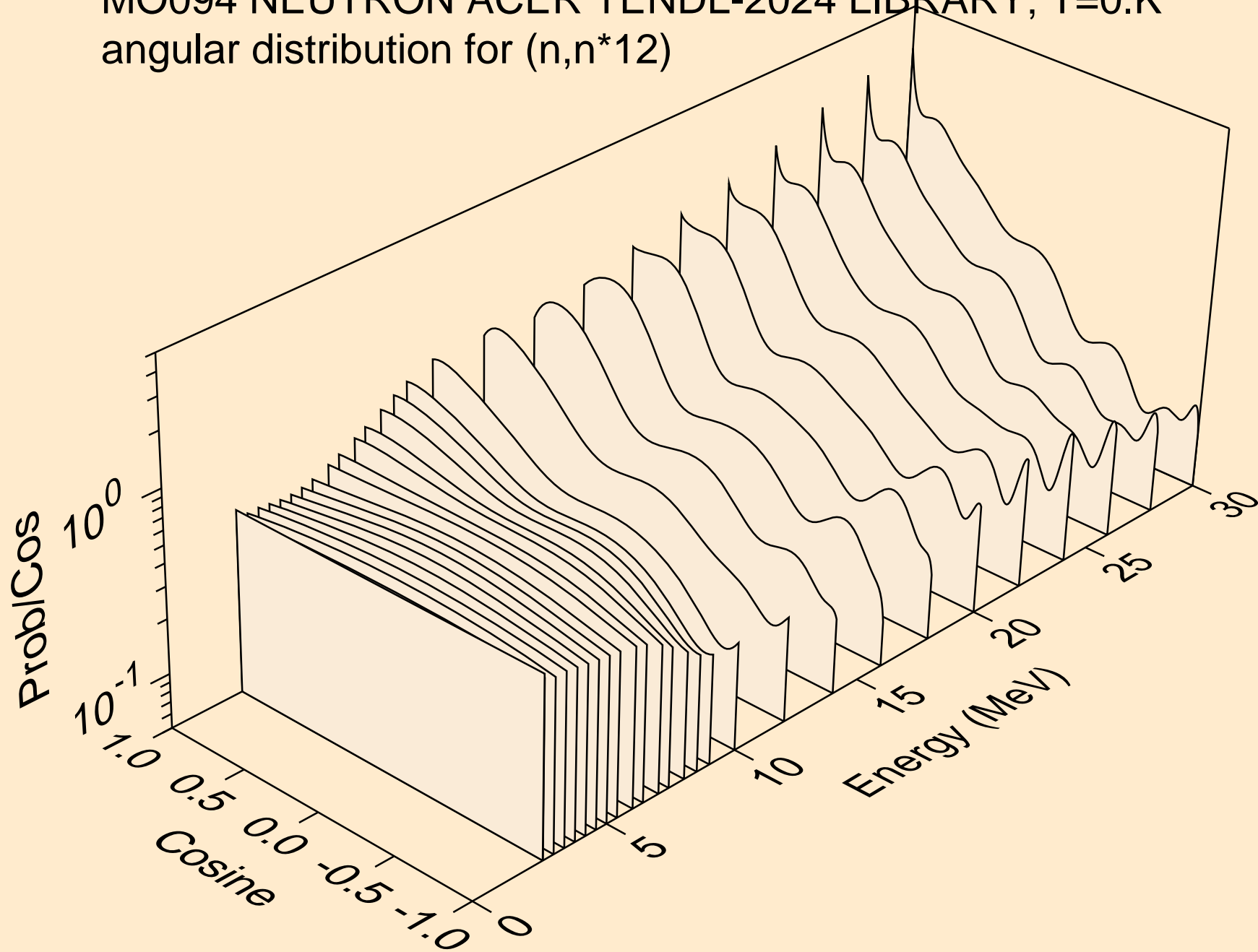

MO094 NEUTRON ACER TENDL-2024 LIBRARY; T=0.K
angular distribution for (n,n*13)

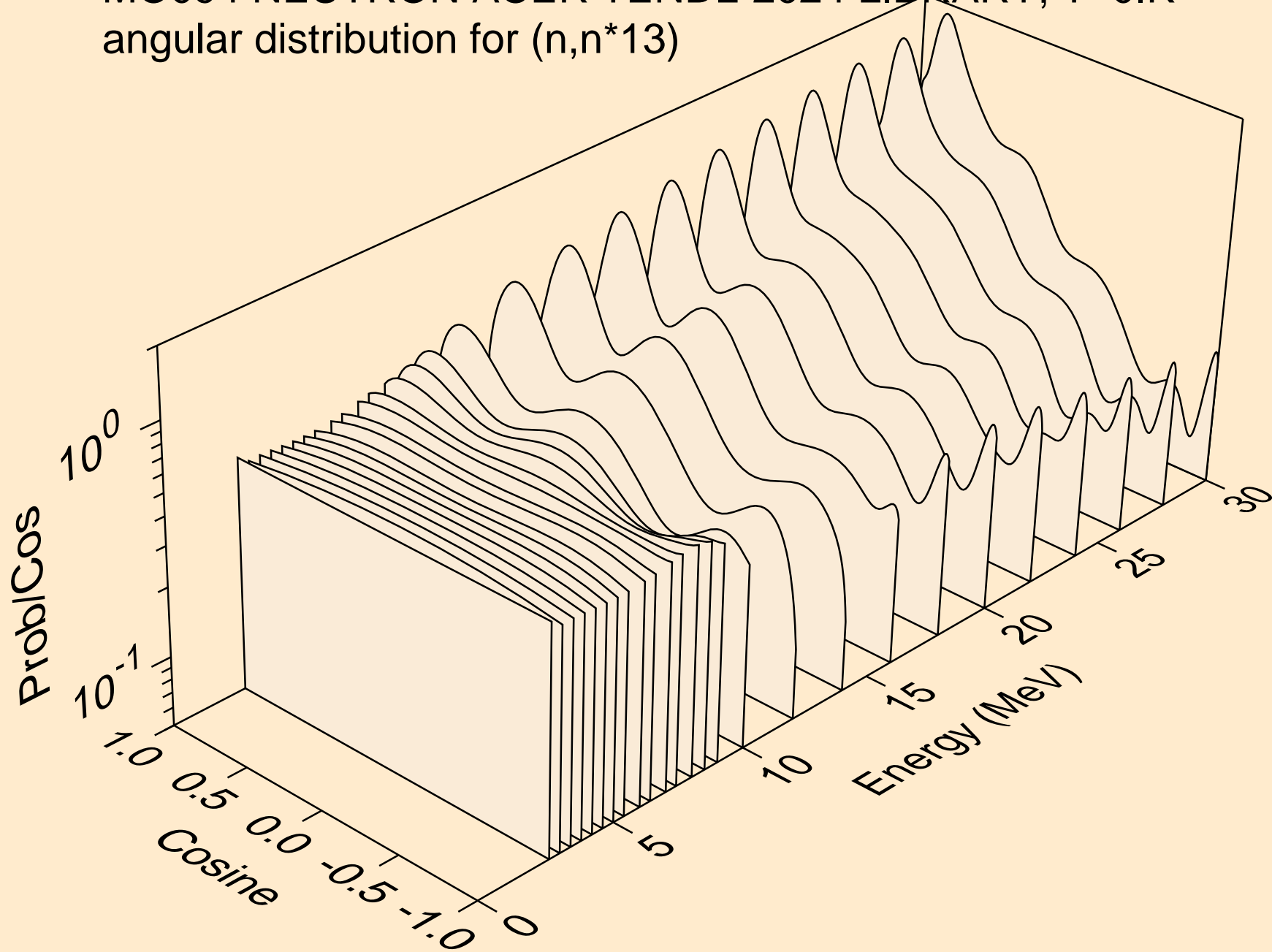

MO094 NEUTRON ACER TENDL-2024 LIBRARY; T=0.K
angular distribution for (n,n*14)

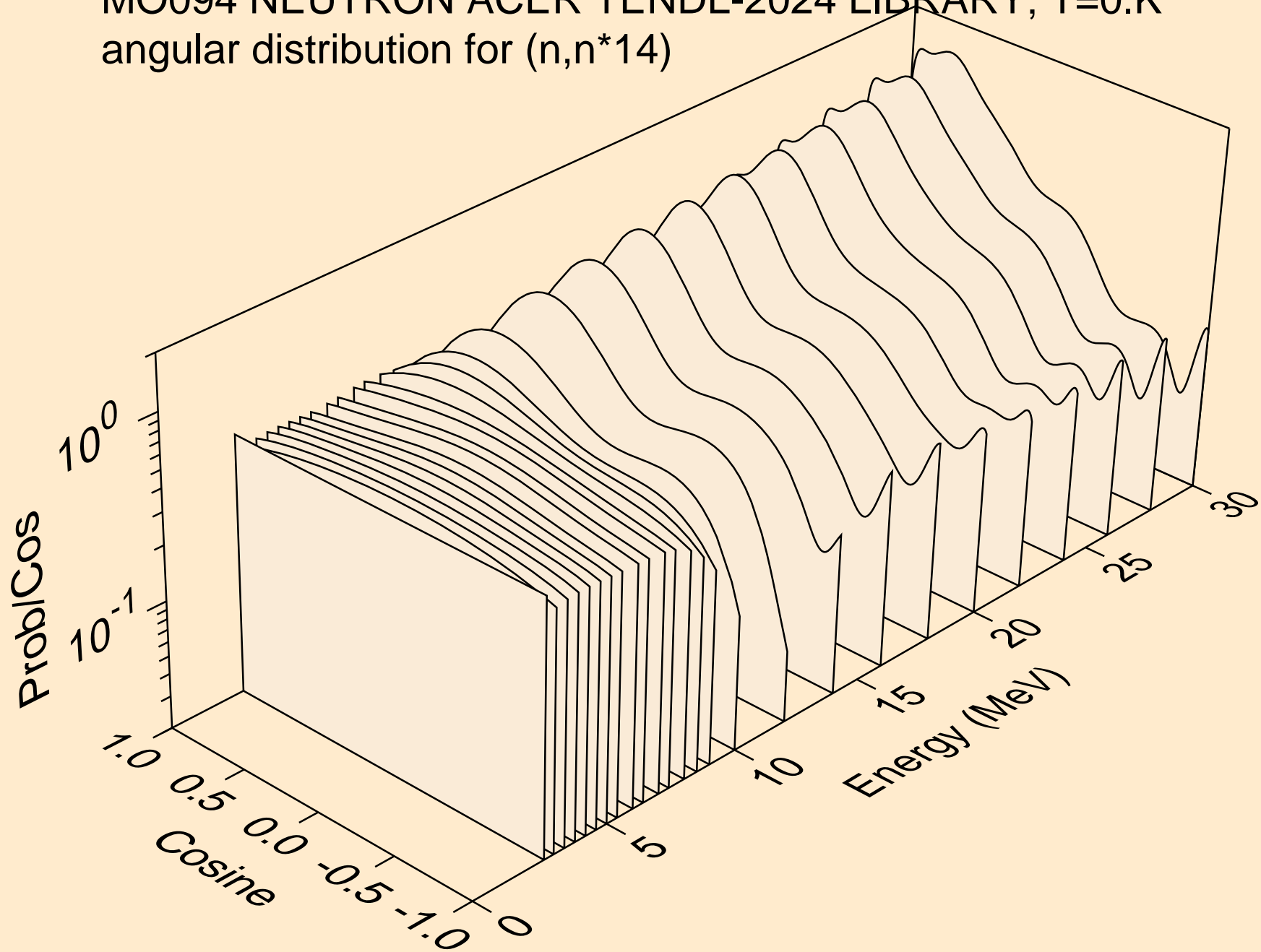

MO094 NEUTRON ACER TENDL-2024 LIBRARY; T=0.K
angular distribution for (n,n*15)

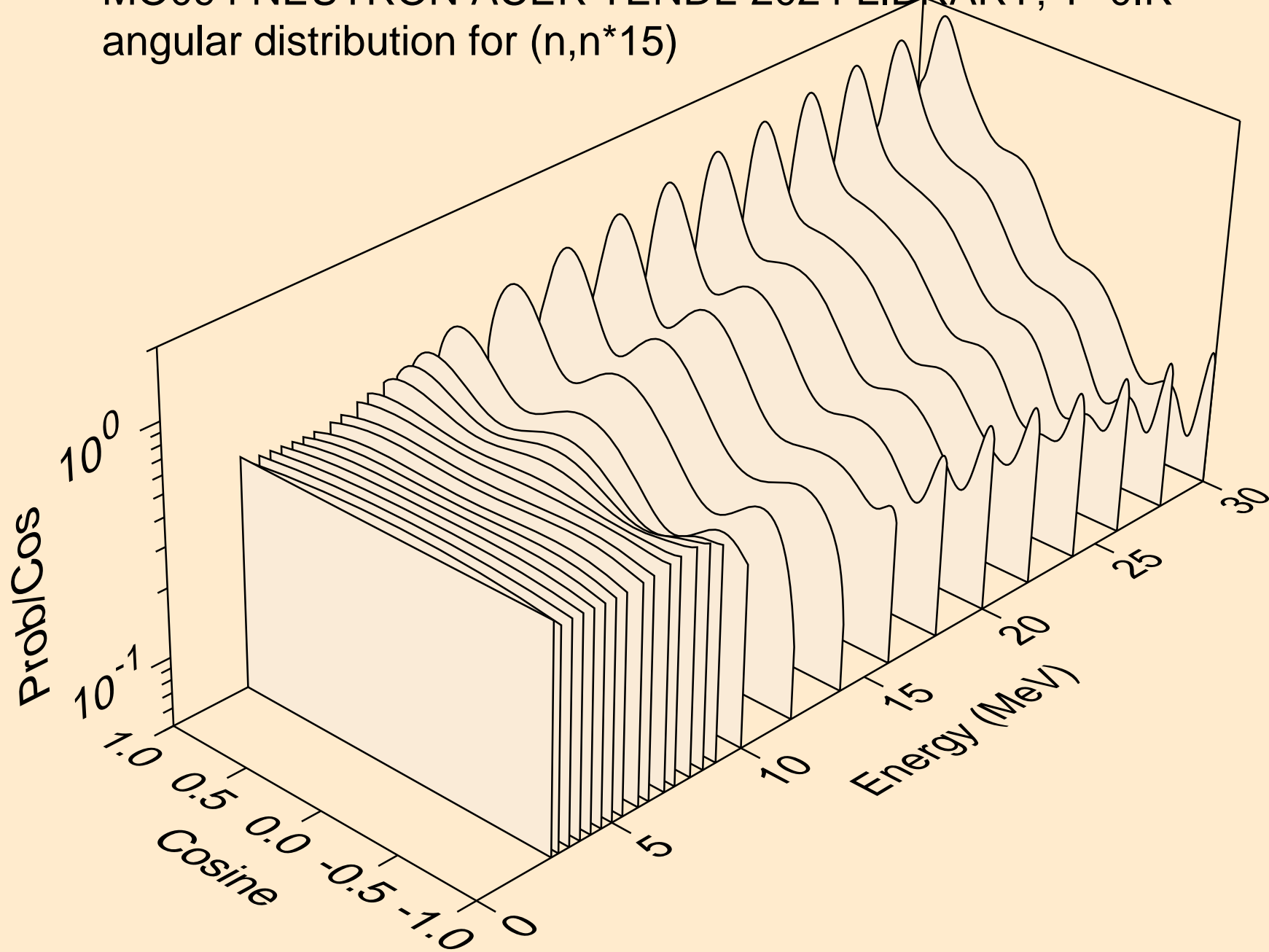

MO094 NEUTRON ACER TENDL-2024 LIBRARY; T=0.K
angular distribution for (n,n*16)

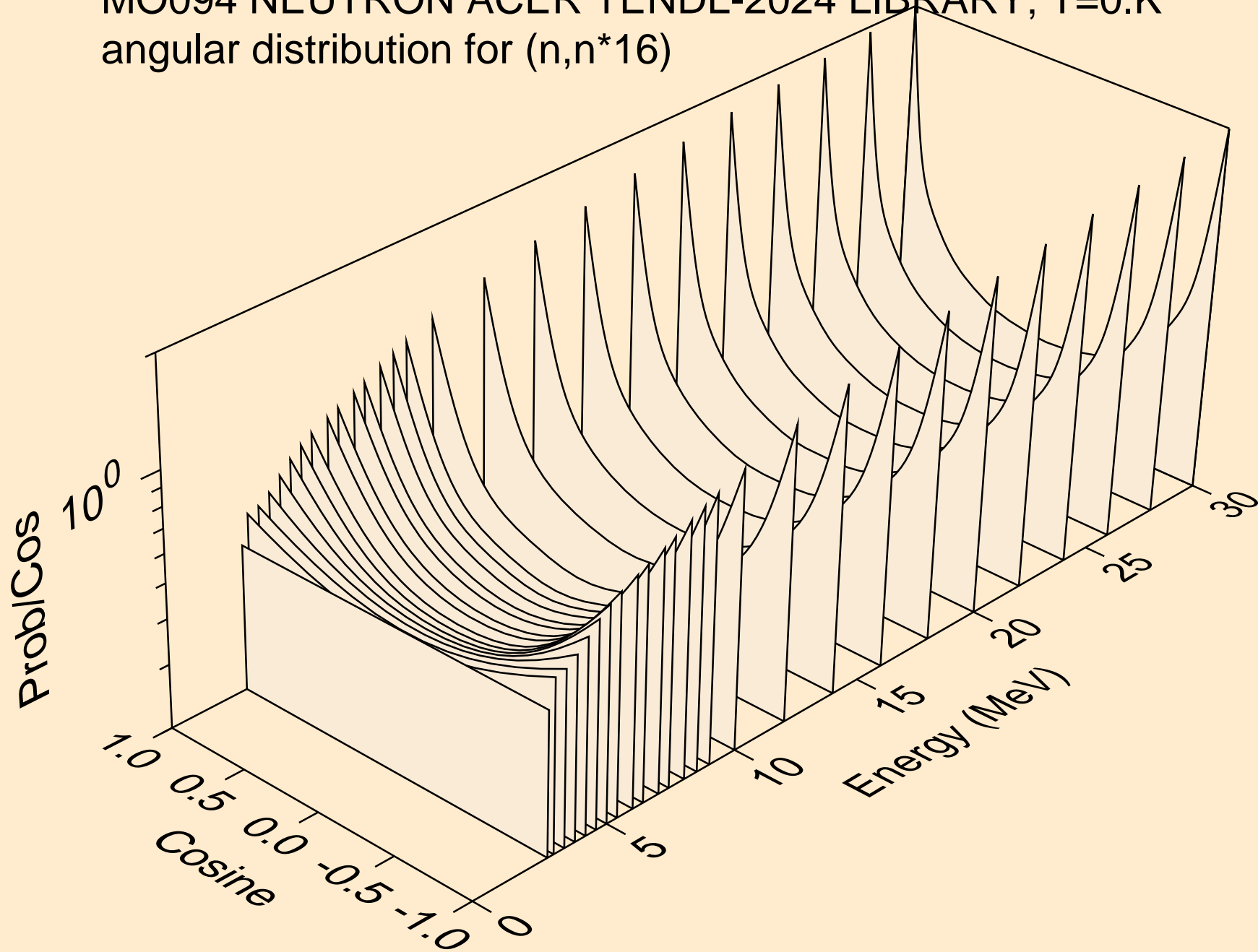

MO094 NEUTRON ACER TENDL-2024 LIBRARY; T=0.K
angular distribution for (n,n*17)

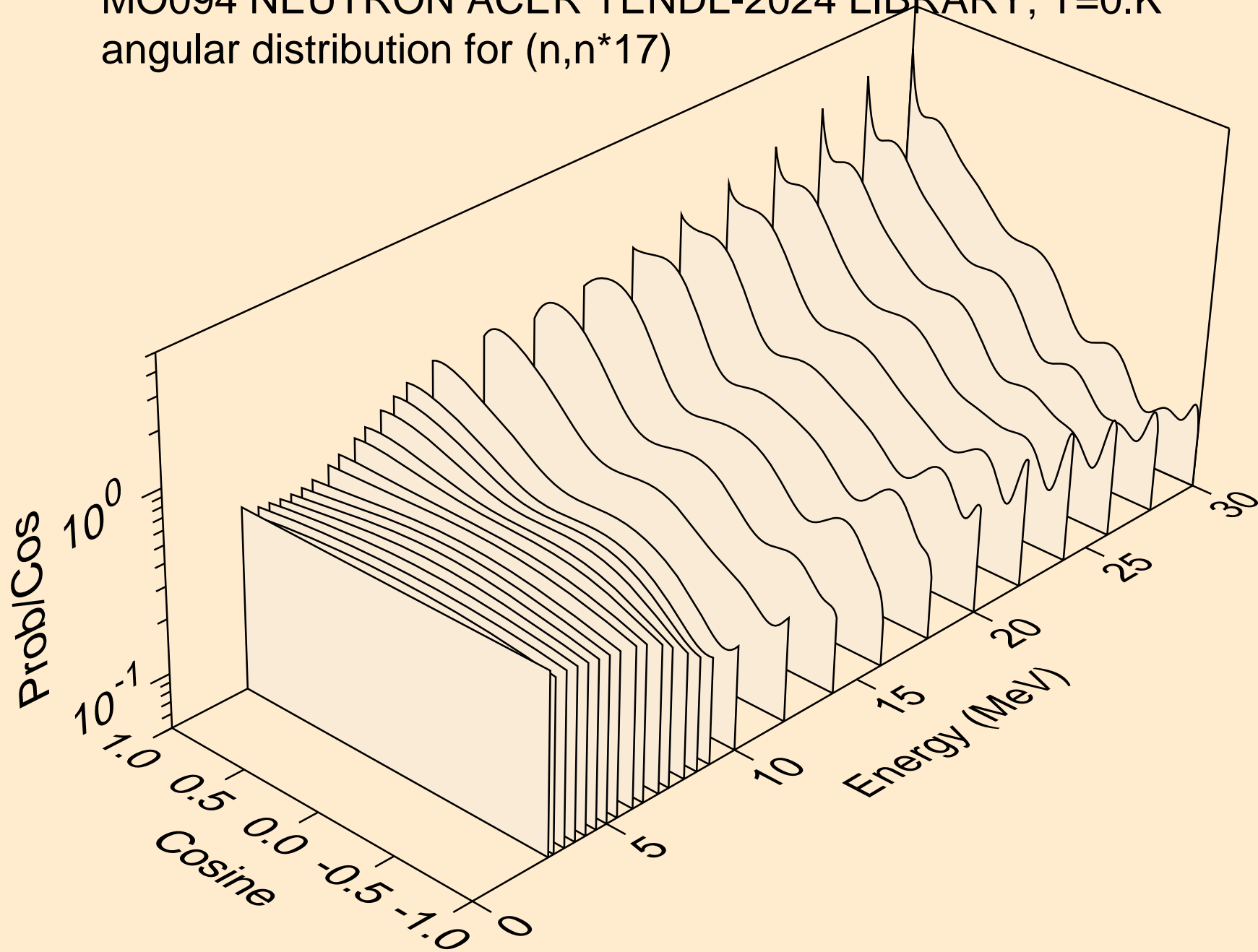

MO094 NEUTRON ACER TENDL-2024 LIBRARY; T=0.K
angular distribution for (n,n*18)

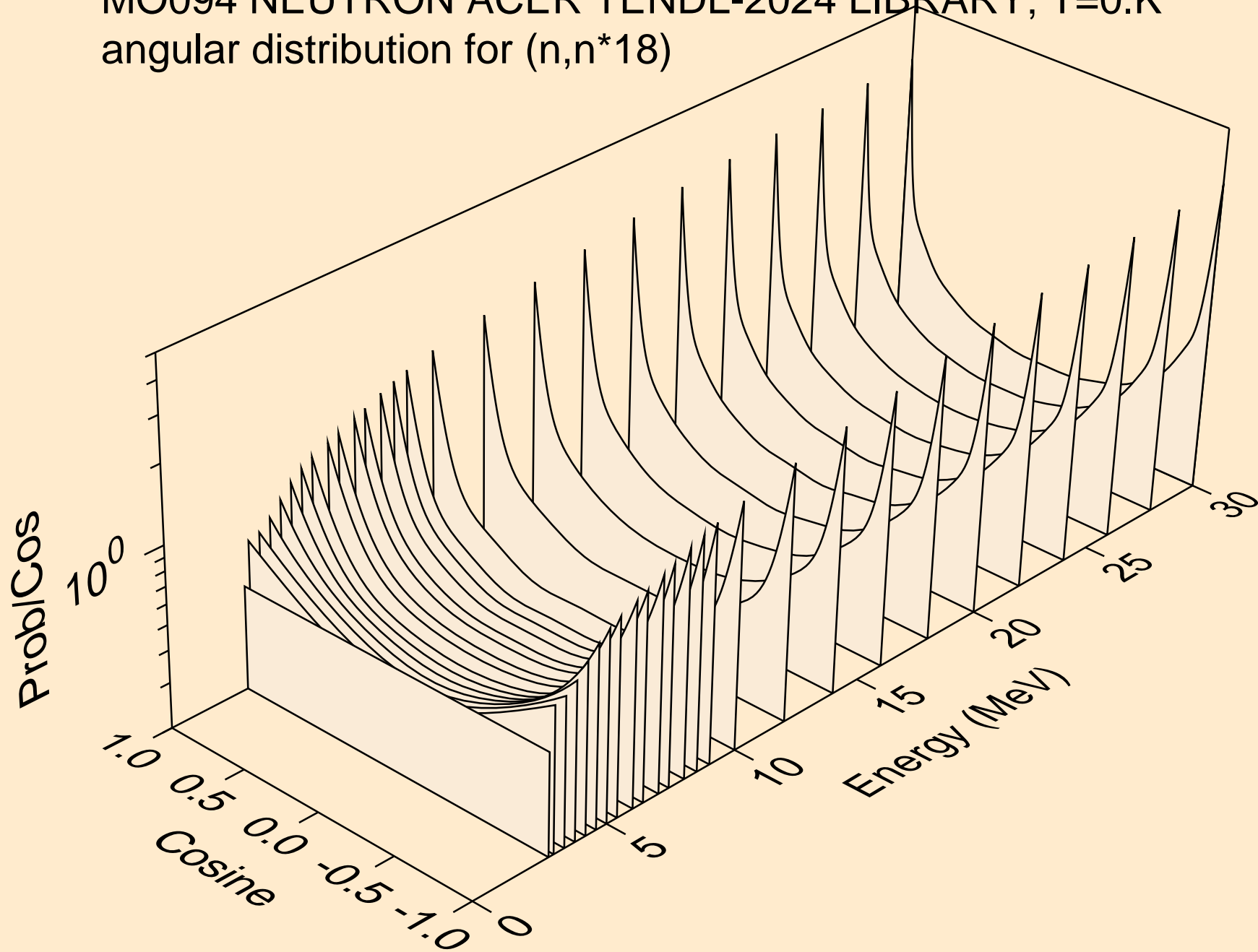

MO094 NEUTRON ACER TENDL-2024 LIBRARY; T=0.K
angular distribution for (n,n*19)

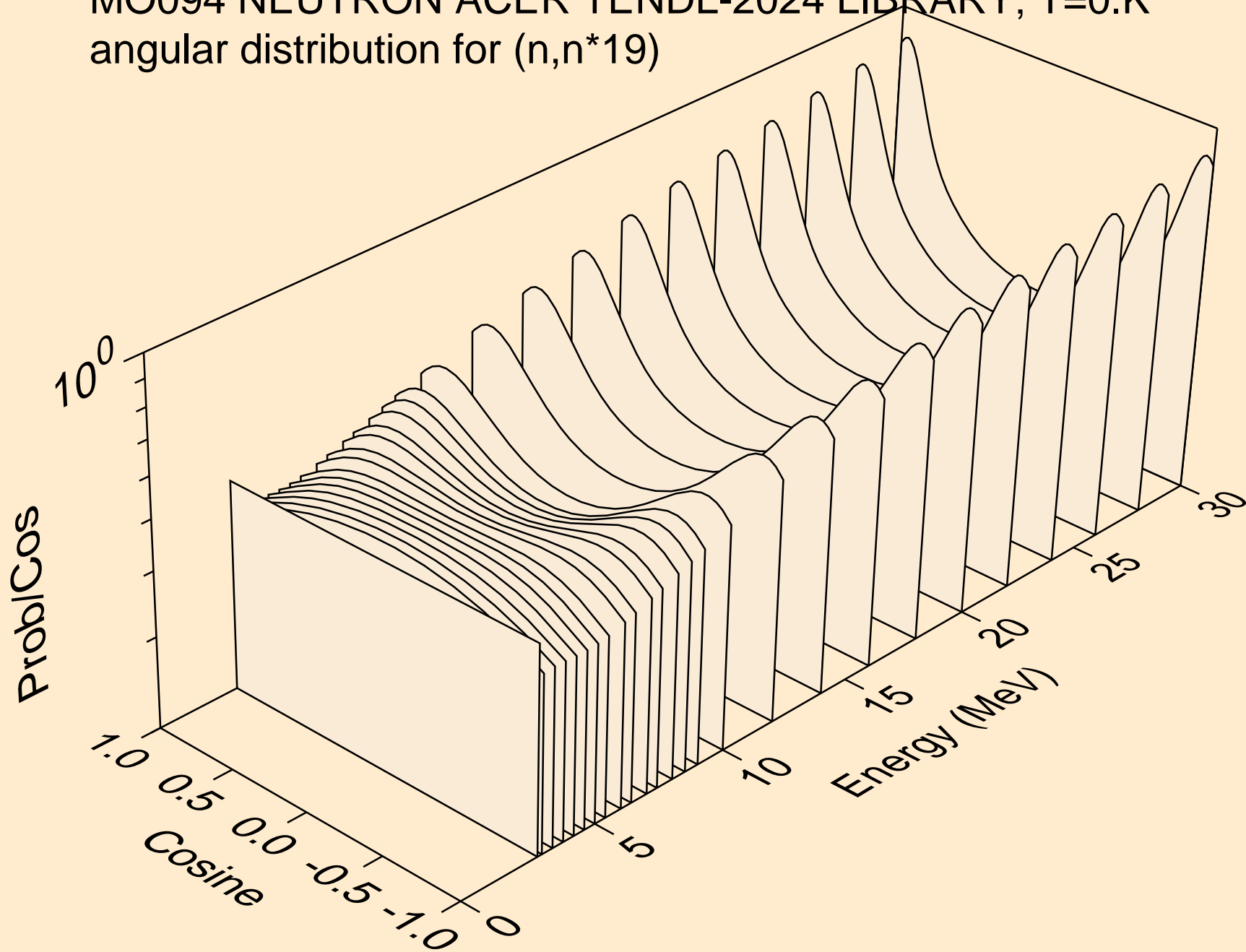

MO094 NEUTRON ACER TENDL-2024 LIBRARY; T=0.K
angular distribution for (n,n*20)

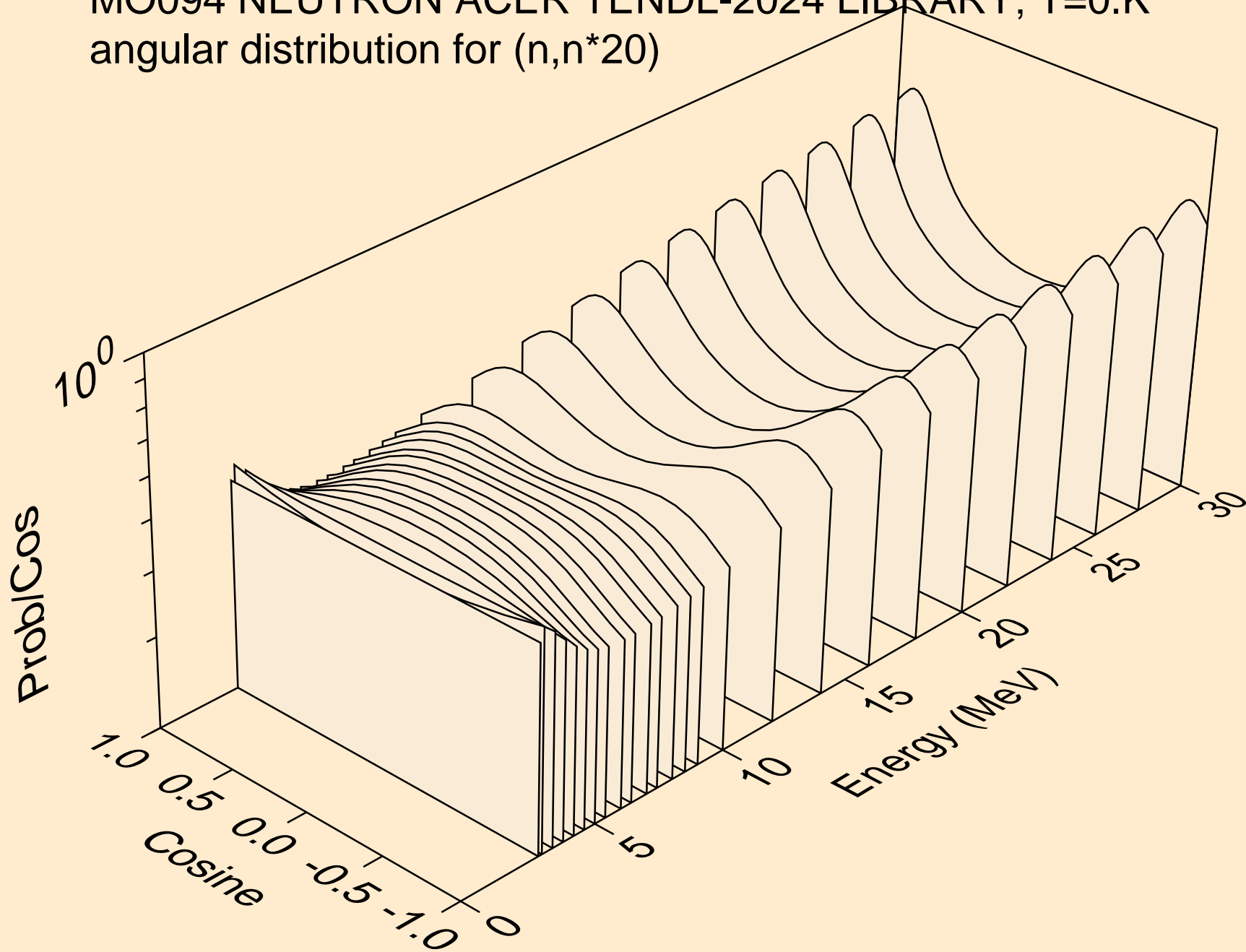

MO094 NEUTRON ACER TENDL-2024 LIBRARY; T=0.K
angular distribution for (n,n*21)

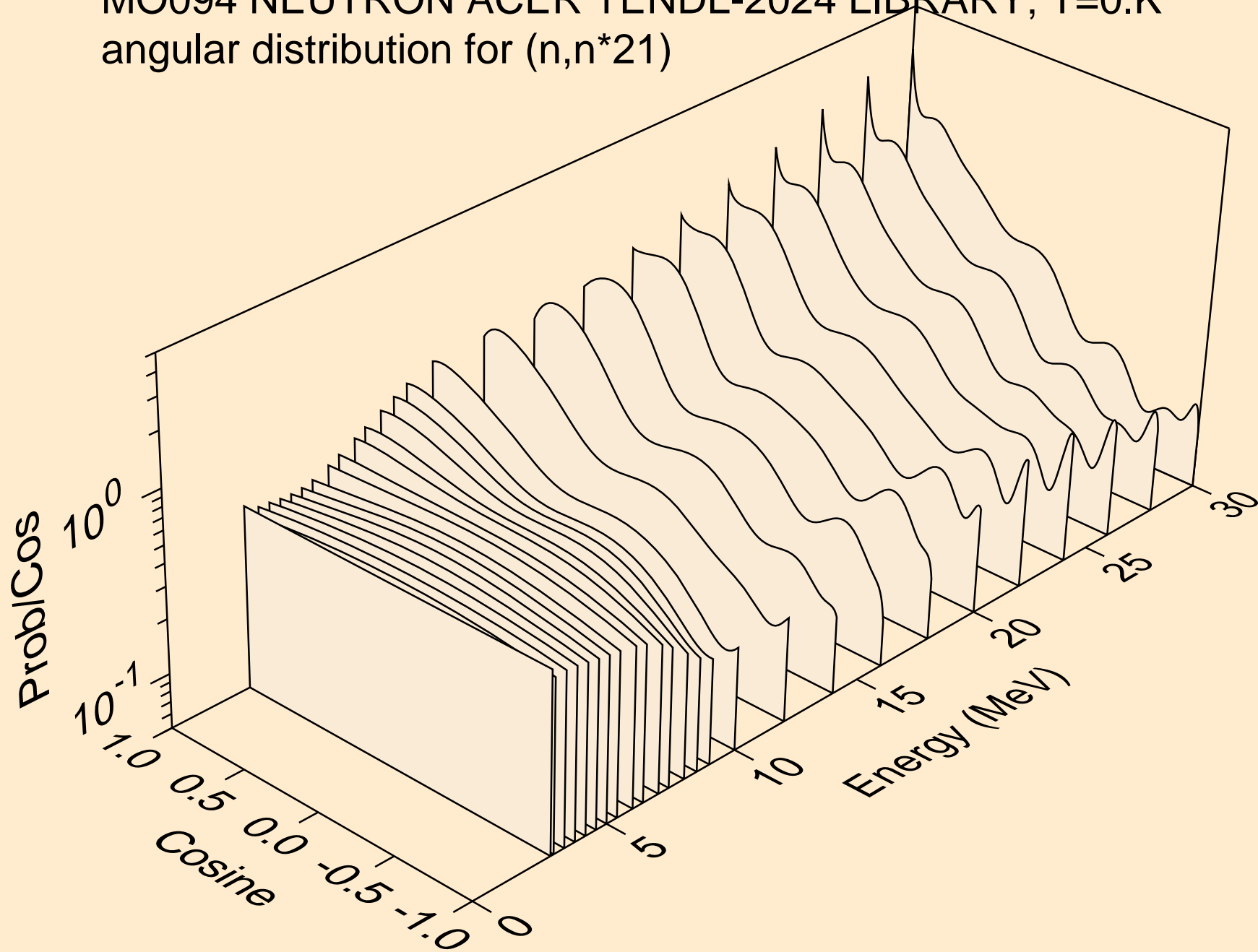

MO094 NEUTRON ACER TENDL-2024 LIBRARY; T=0.K
angular distribution for (n,n*22)

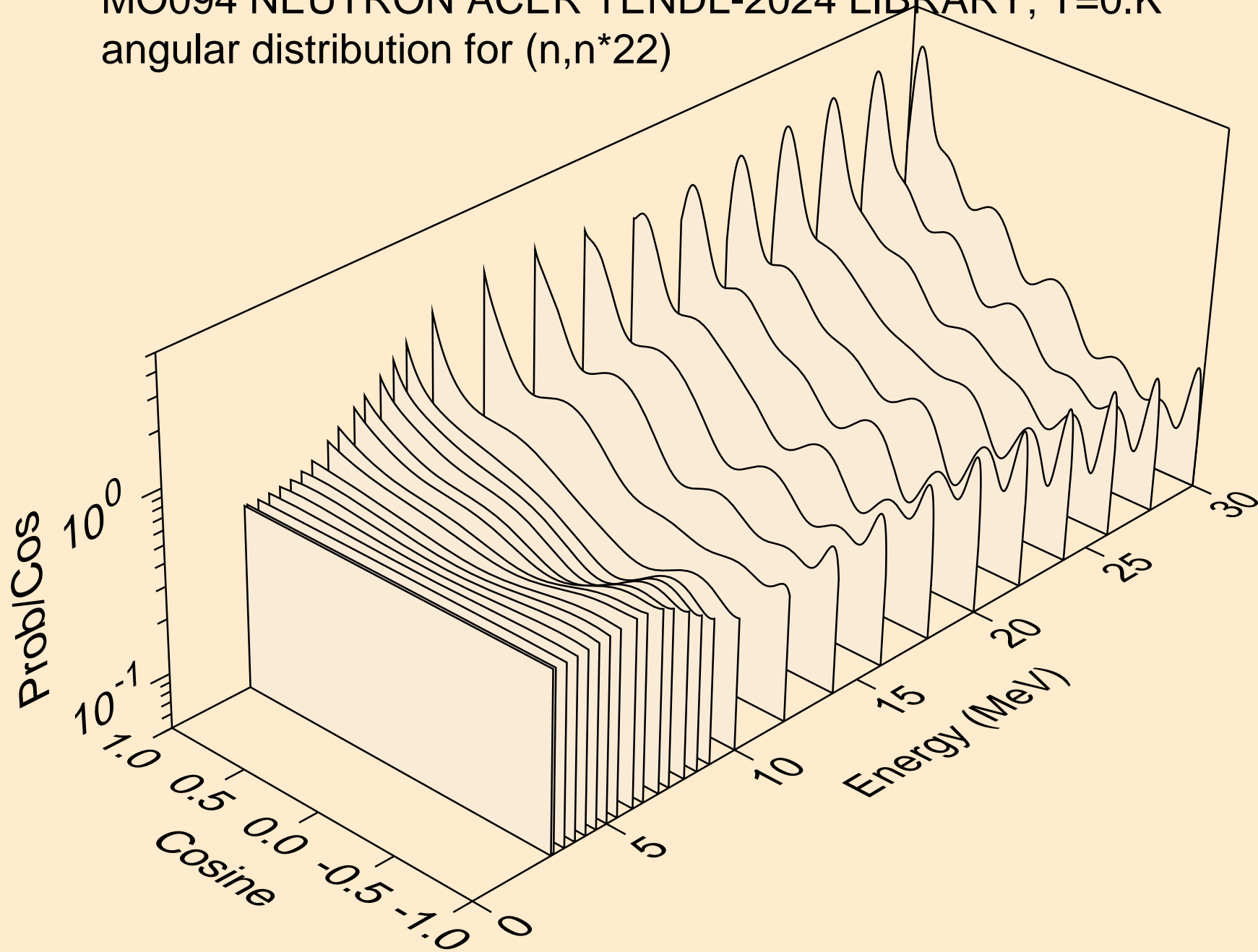

MO094 NEUTRON ACER TENDL-2024 LIBRARY; T=0.K
angular distribution for (n,n*23)

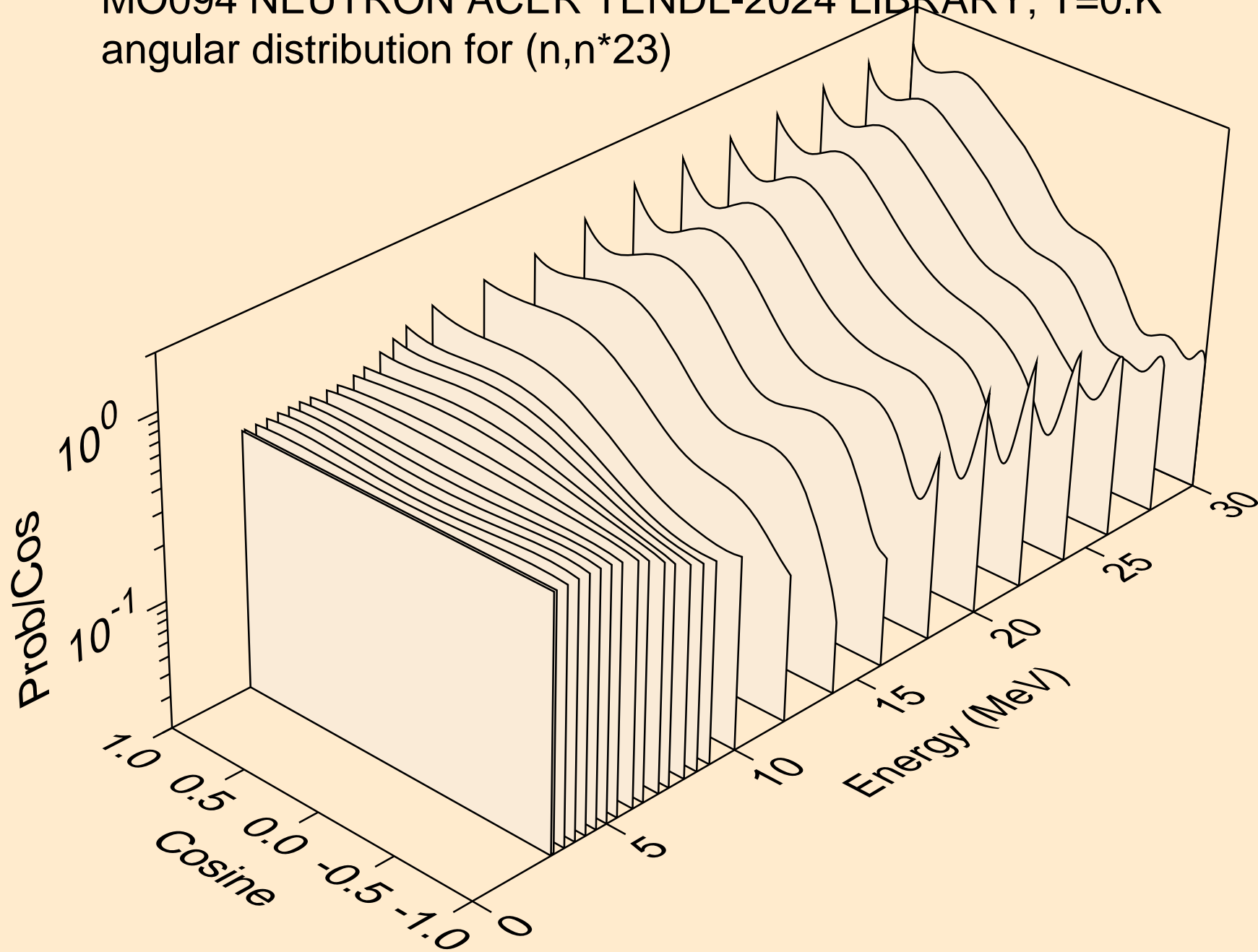

MO094 NEUTRON ACER TENDL-2024 LIBRARY; T=0.K
angular distribution for (n,n*24)

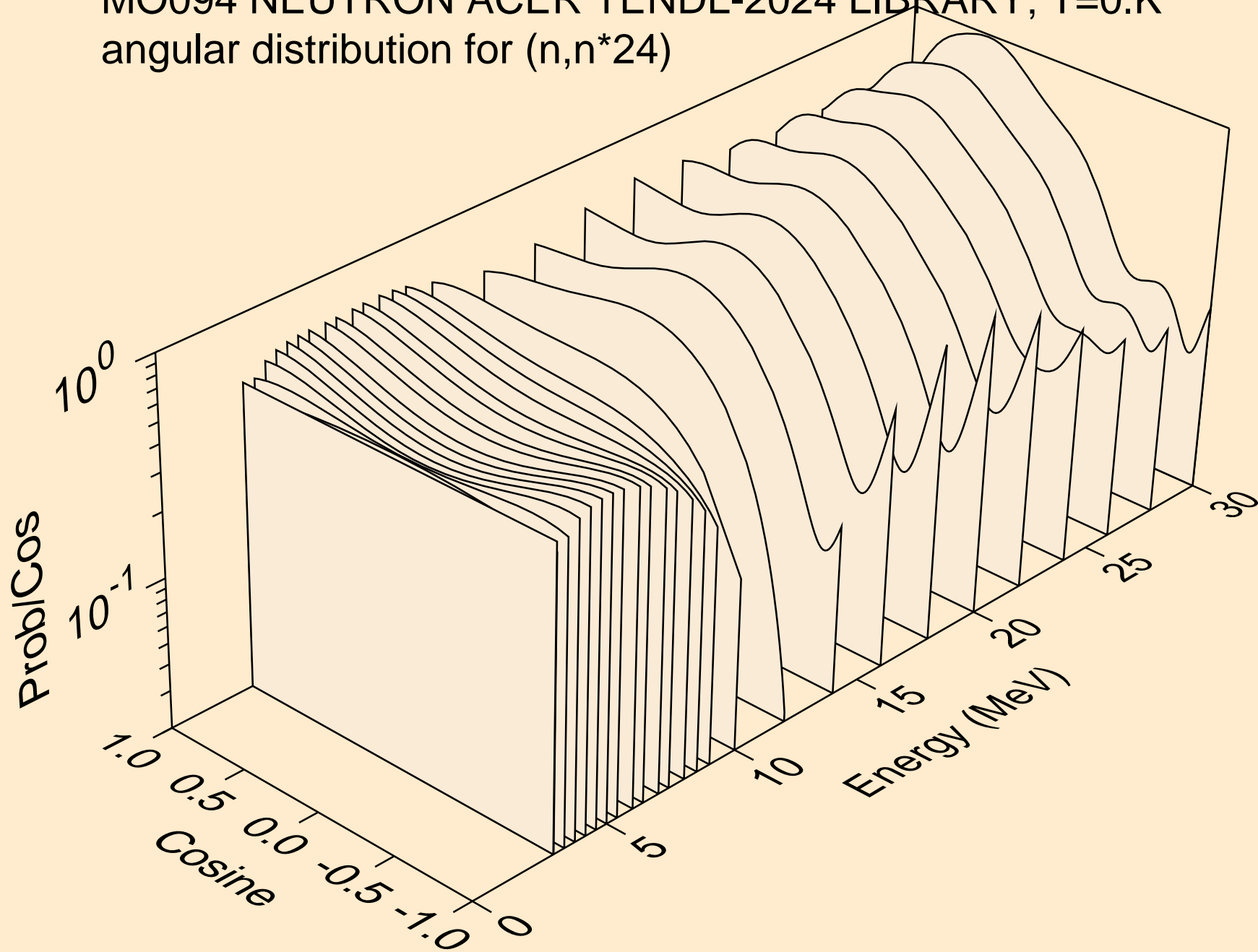

MO094 NEUTRON ACER TENDL-2024 LIBRARY; T=0.K
angular distribution for (n,n*25)

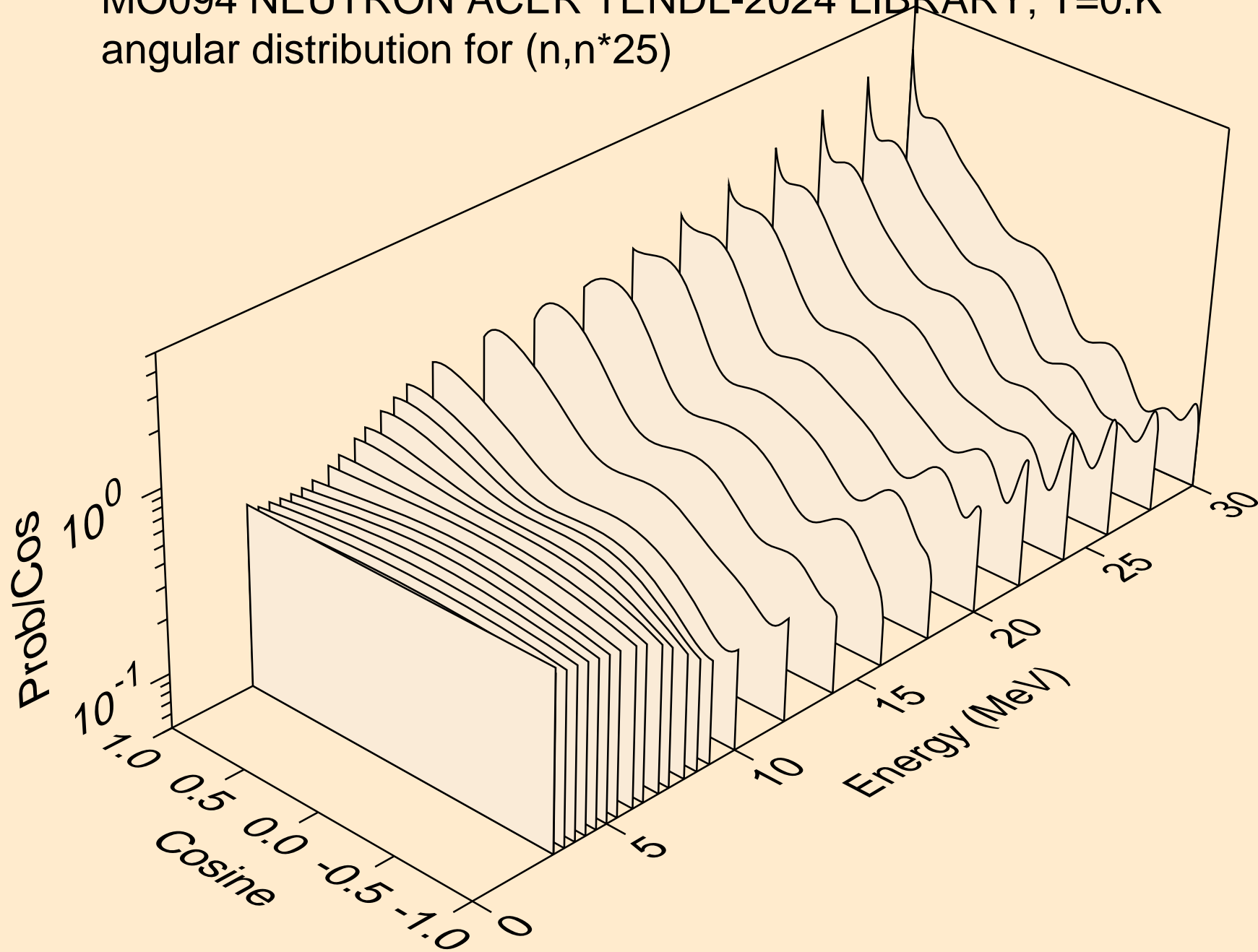

MO094 NEUTRON ACER TENDL-2024 LIBRARY; T=0.K
angular distribution for (n,n*26)

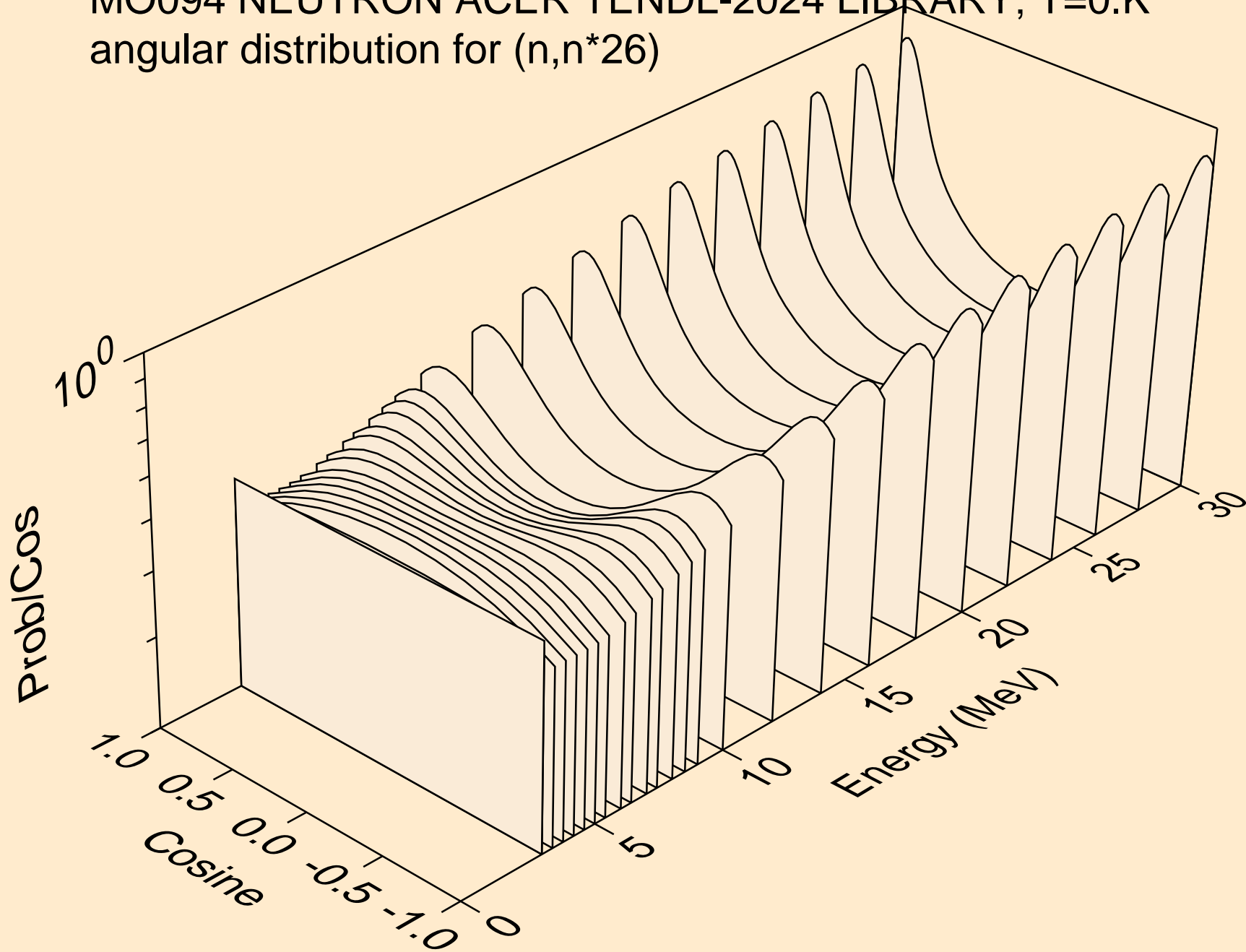

MO094 NEUTRON ACER TENDL-2024 LIBRARY; T=0.K
angular distribution for (n,n*27)

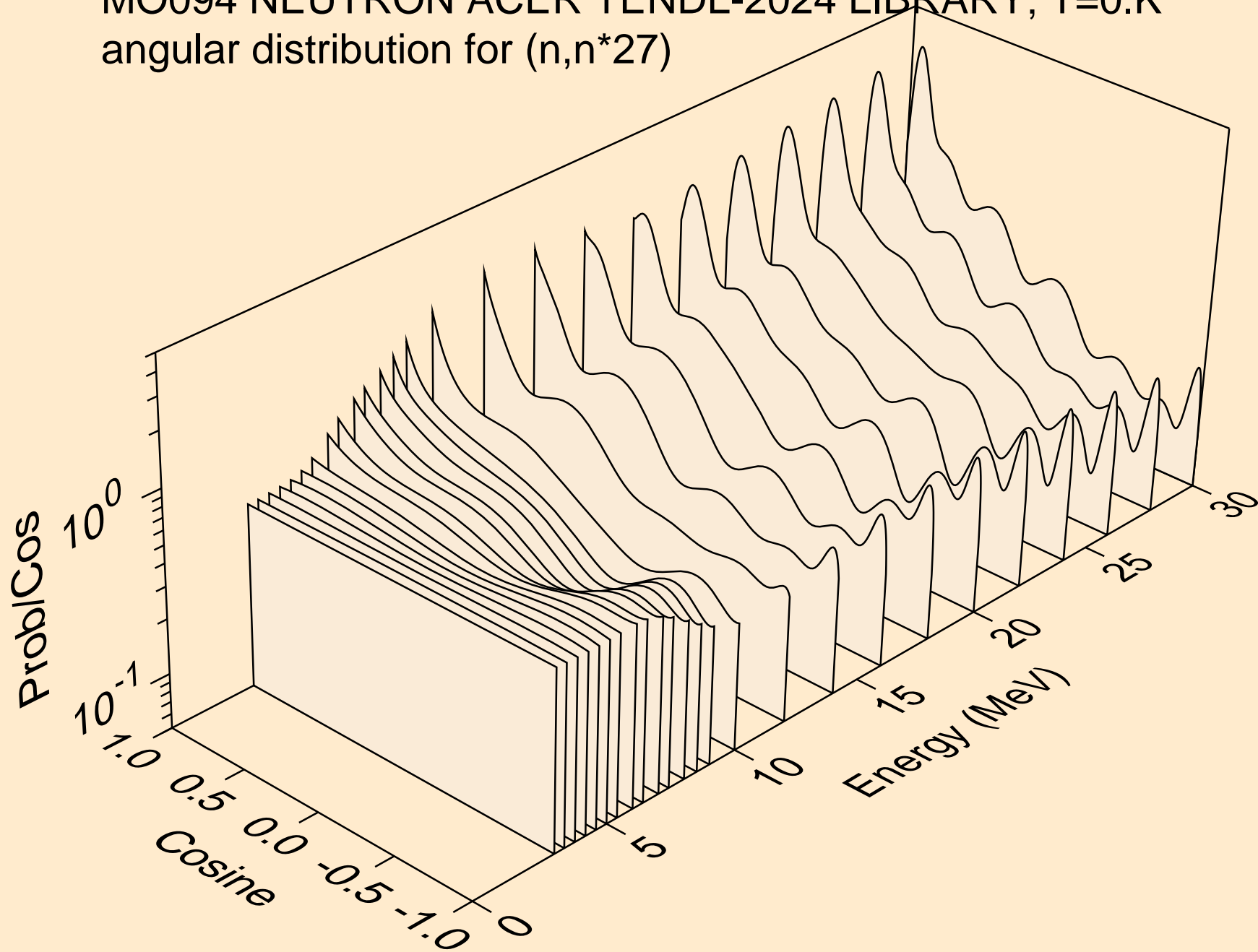

MO094 NEUTRON ACER TENDL-2024 LIBRARY; T=0.K
angular distribution for (n,n*28)

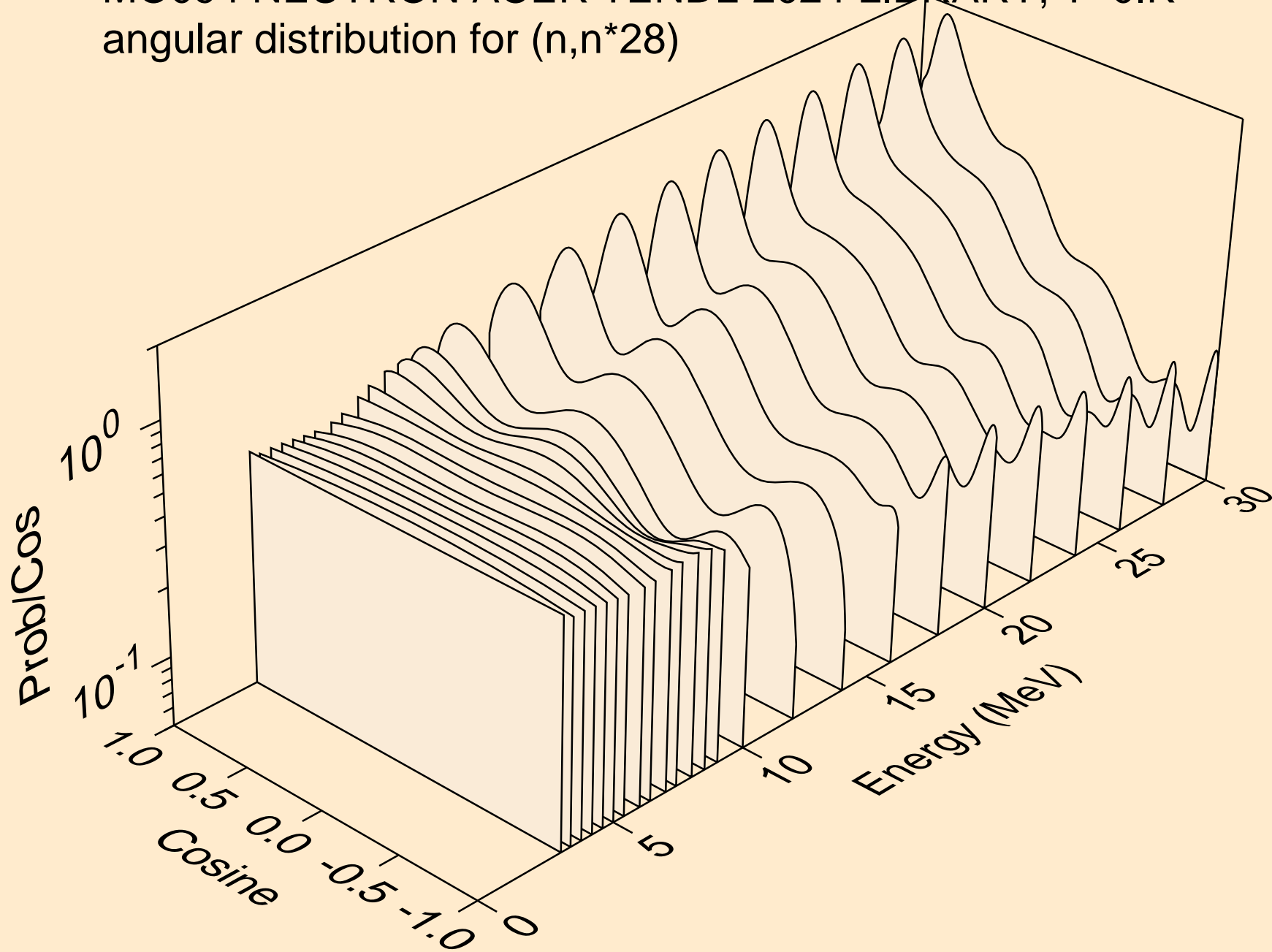

MO094 NEUTRON ACER TENDL-2024 LIBRARY; T=0.K
angular distribution for (n,n*29)

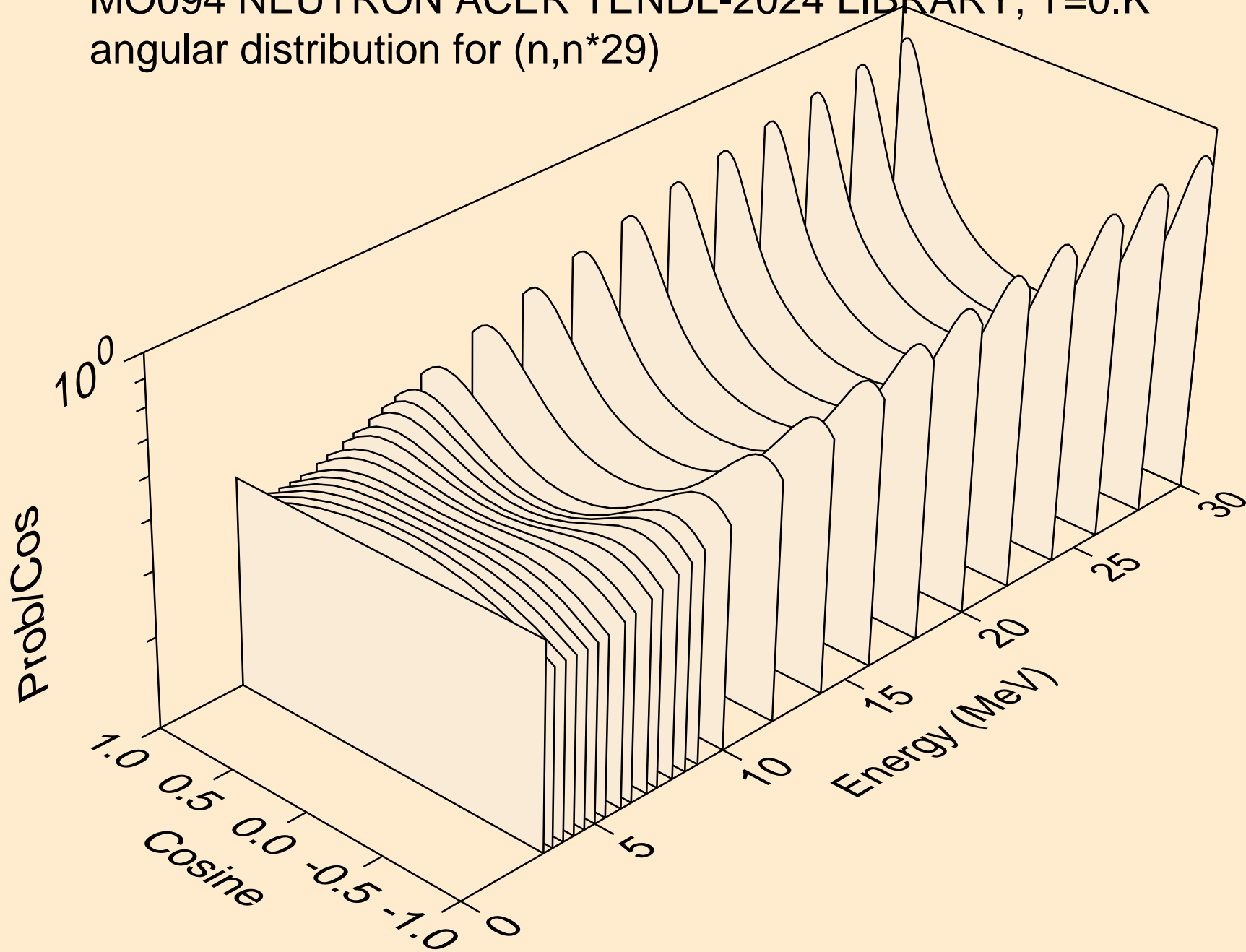

MO094 NEUTRON ACER TENDL-2024 LIBRARY; T=0.K
angular distribution for (n,n*30)

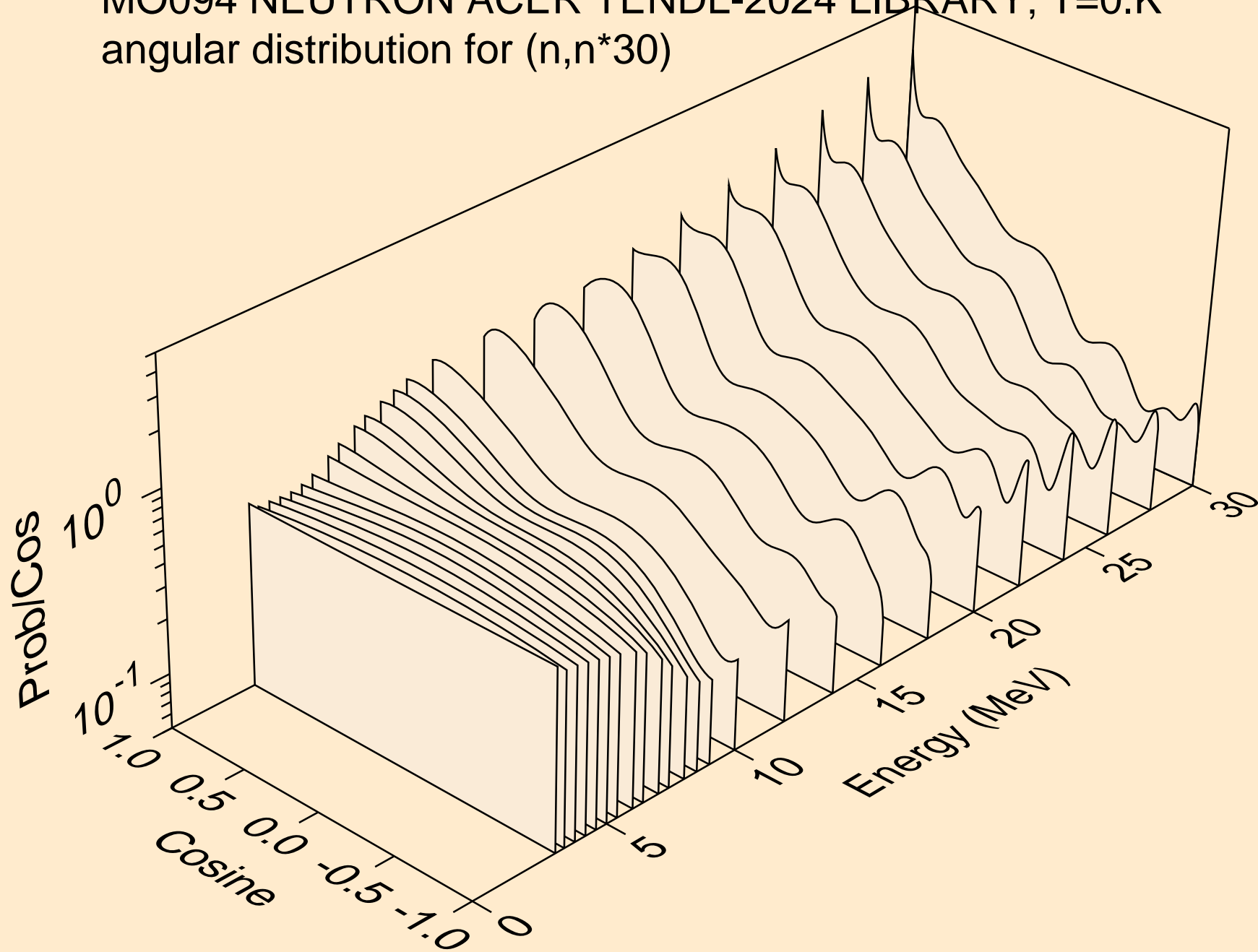

MO094 NEUTRON ACER TENDL-2024 LIBRARY; T=0.K
Neutron emission for (n,x)

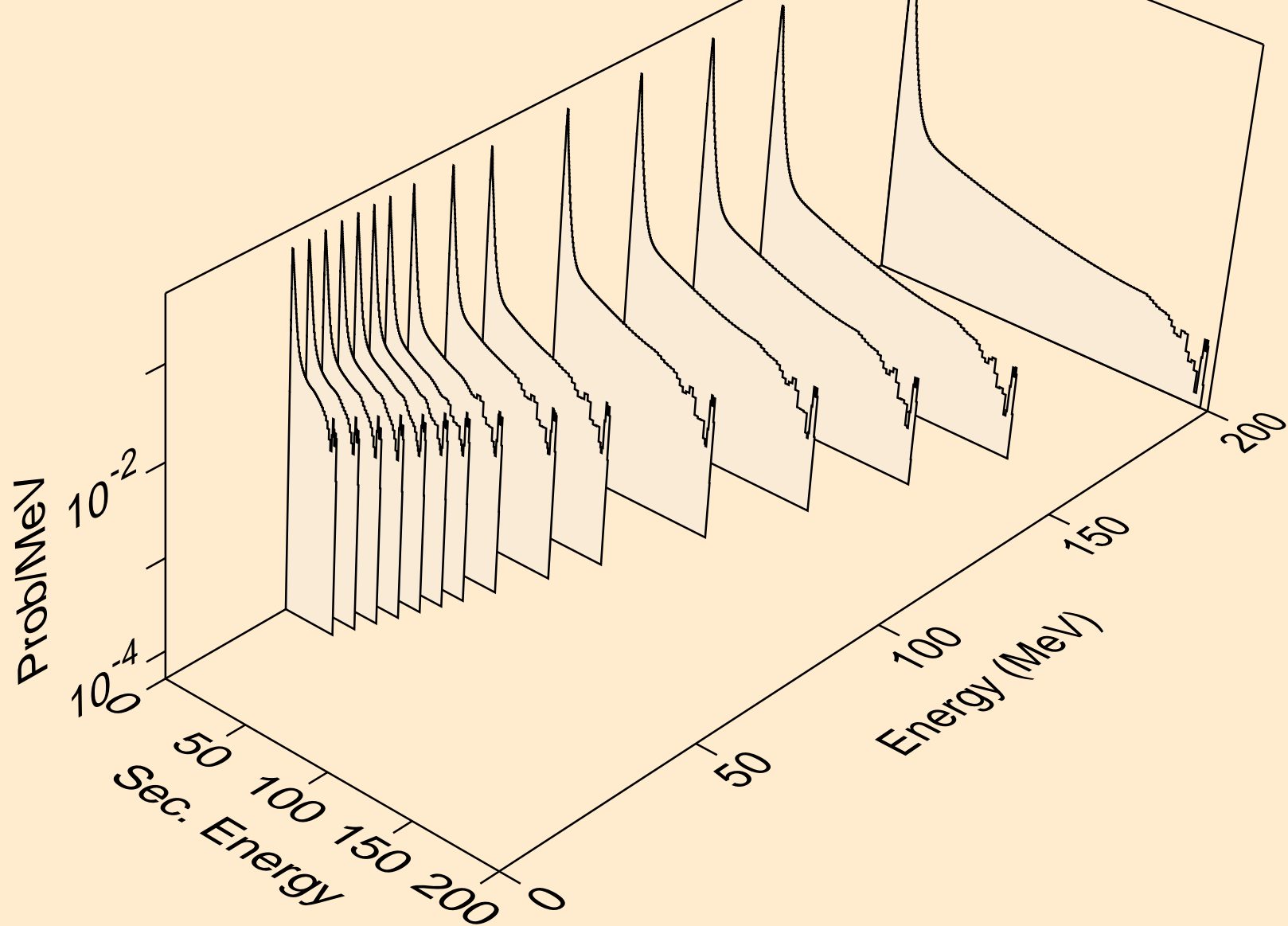

MO094 NEUTRON ACER TENDL-2024 LIBRARY; T=0.K
Neutron emission for (n,2nd)

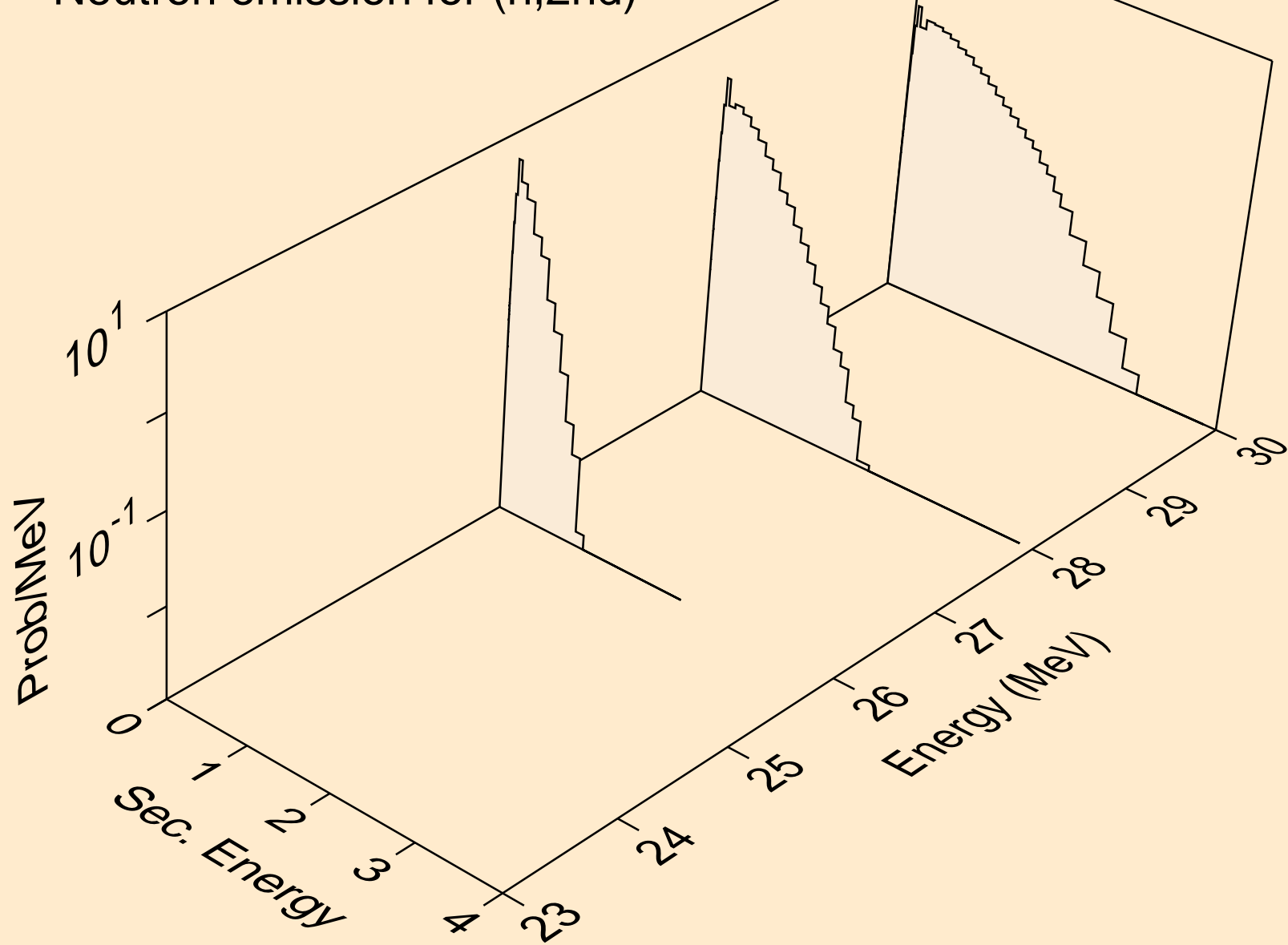

MO094 NEUTRON ACER TENDL-2024 LIBRARY; T=0.K
Neutron emission for (n,2n)

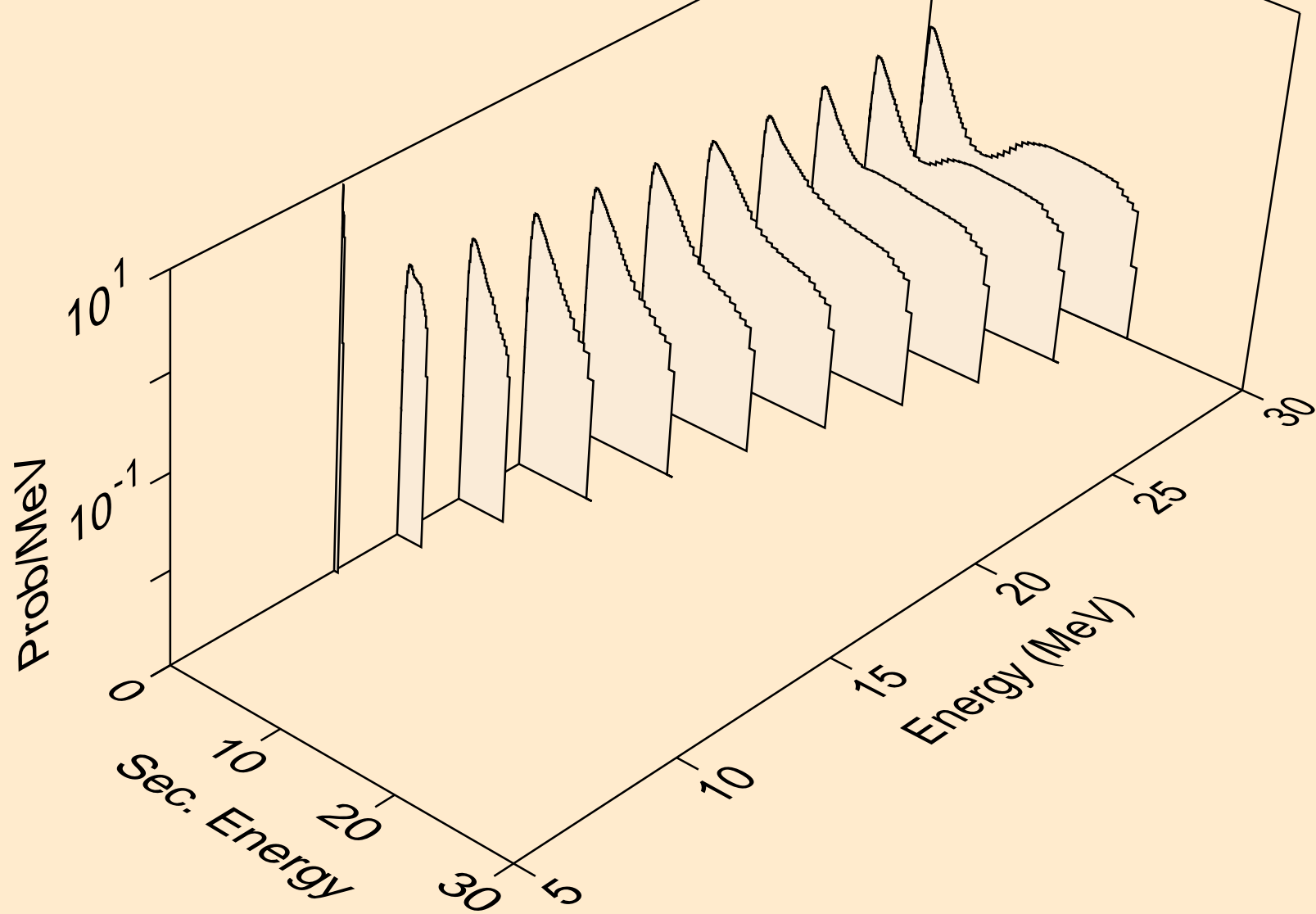

MO094 NEUTRON ACER TENDL-2024 LIBRARY; T=0.K
Neutron emission for (n,3n)

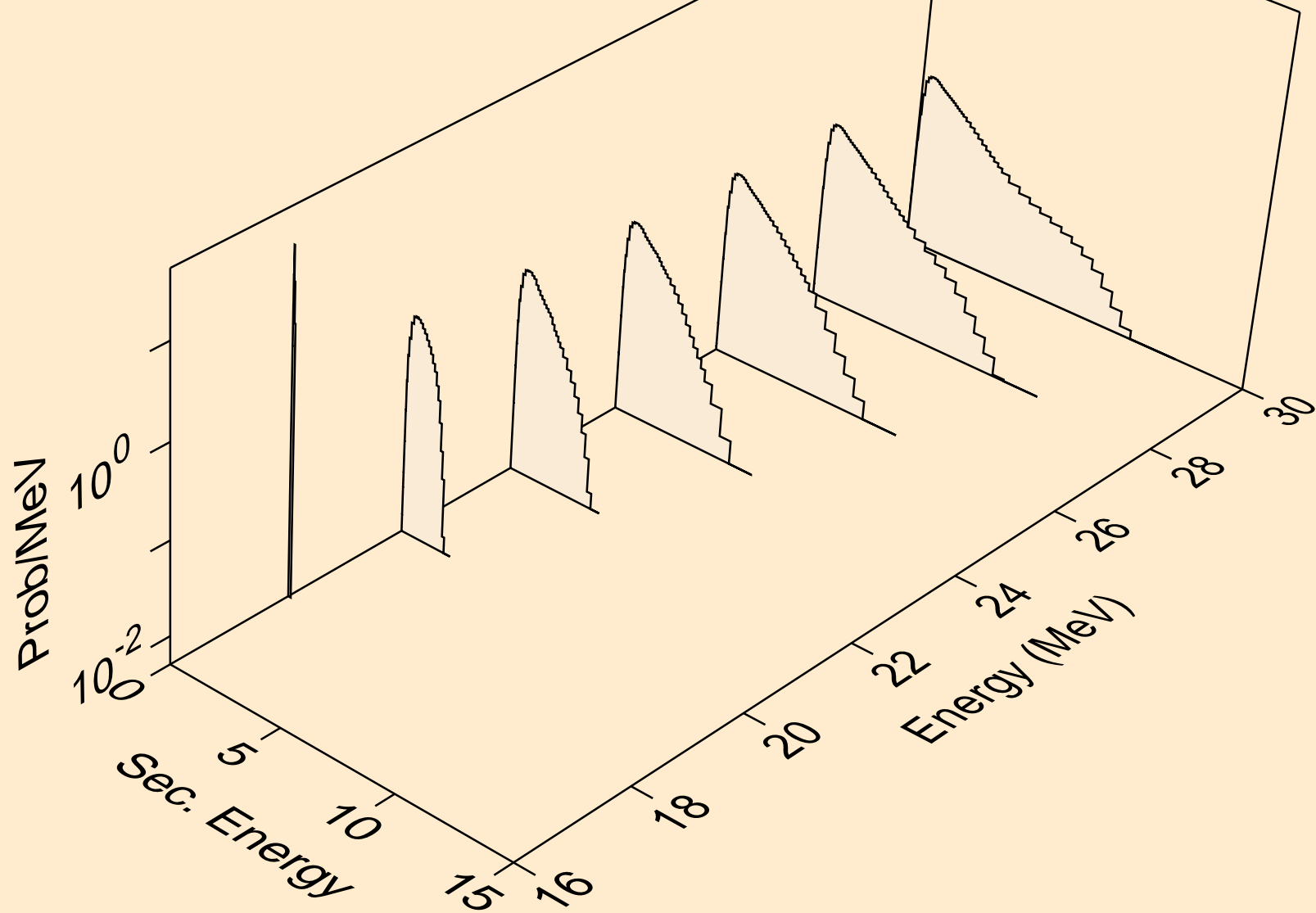

MO094 NEUTRON ACER TENDL-2024 LIBRARY; T=0.K
Neutron emission for (n,n*)a

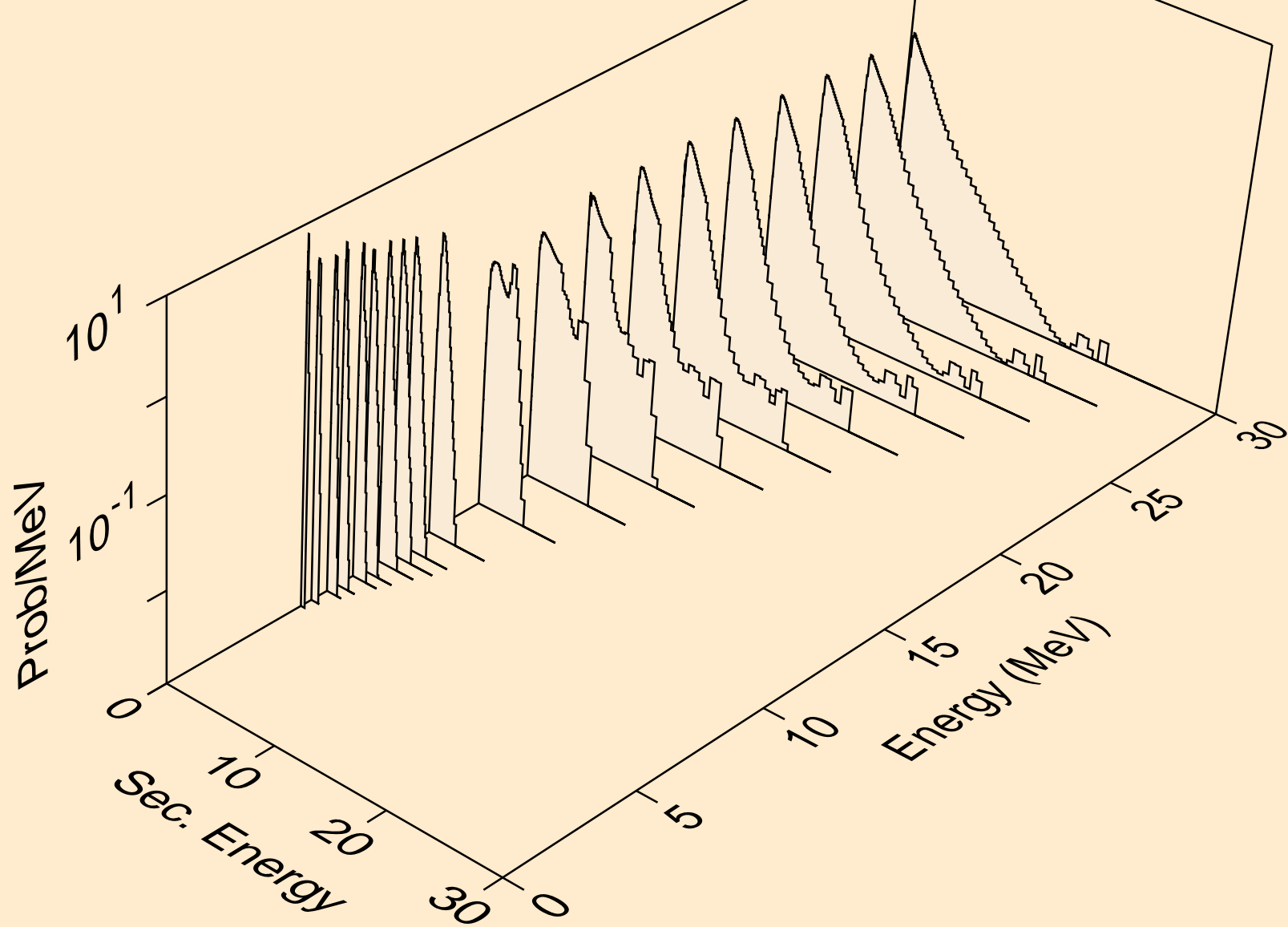

MO094 NEUTRON ACER TENDL-2024 LIBRARY; T=0.K
Neutron emission for (n,2n)a

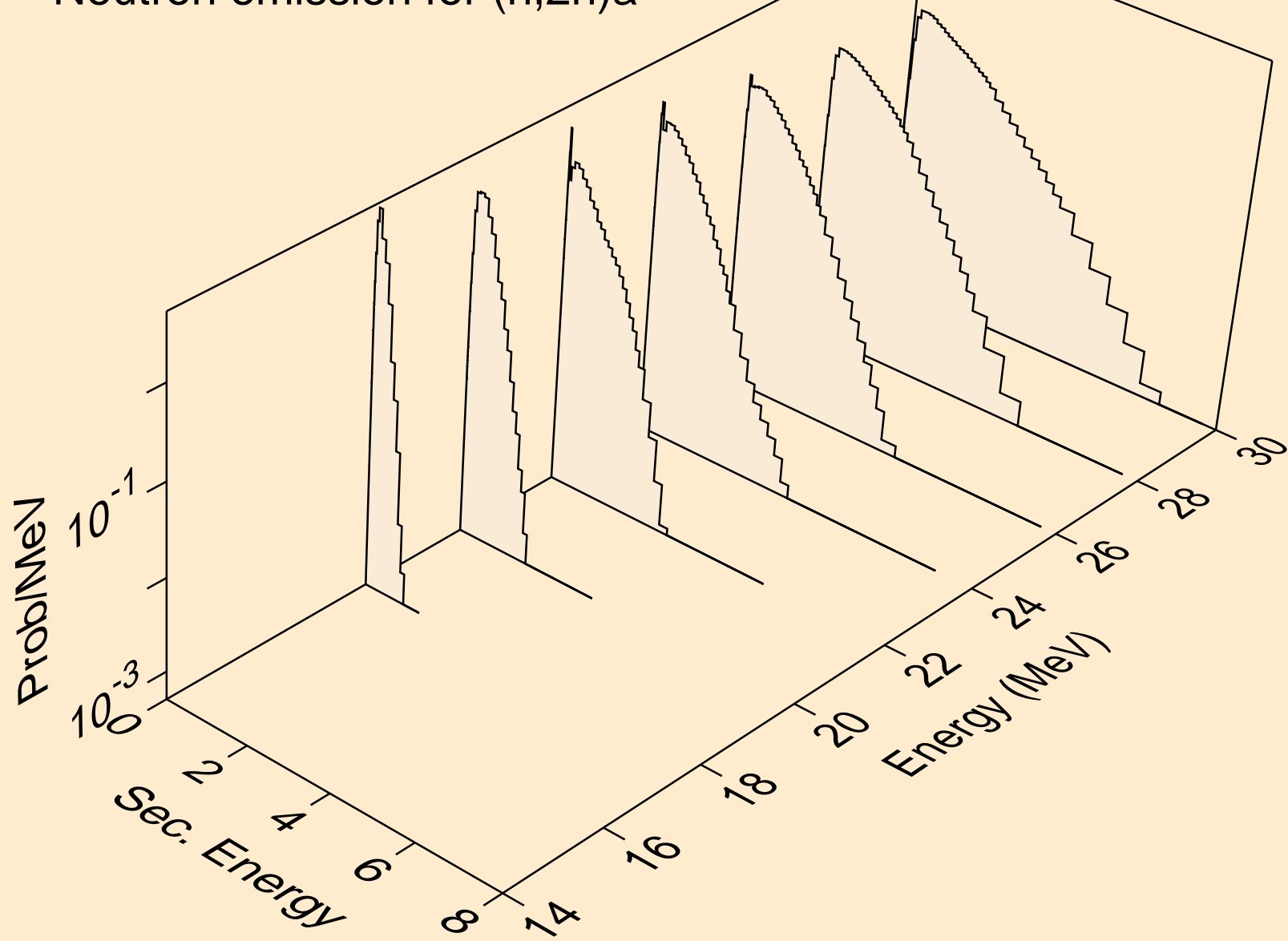

MO094 NEUTRON ACER TENDL-2024 LIBRARY; T=0.K
Neutron emission for (n,n*)p

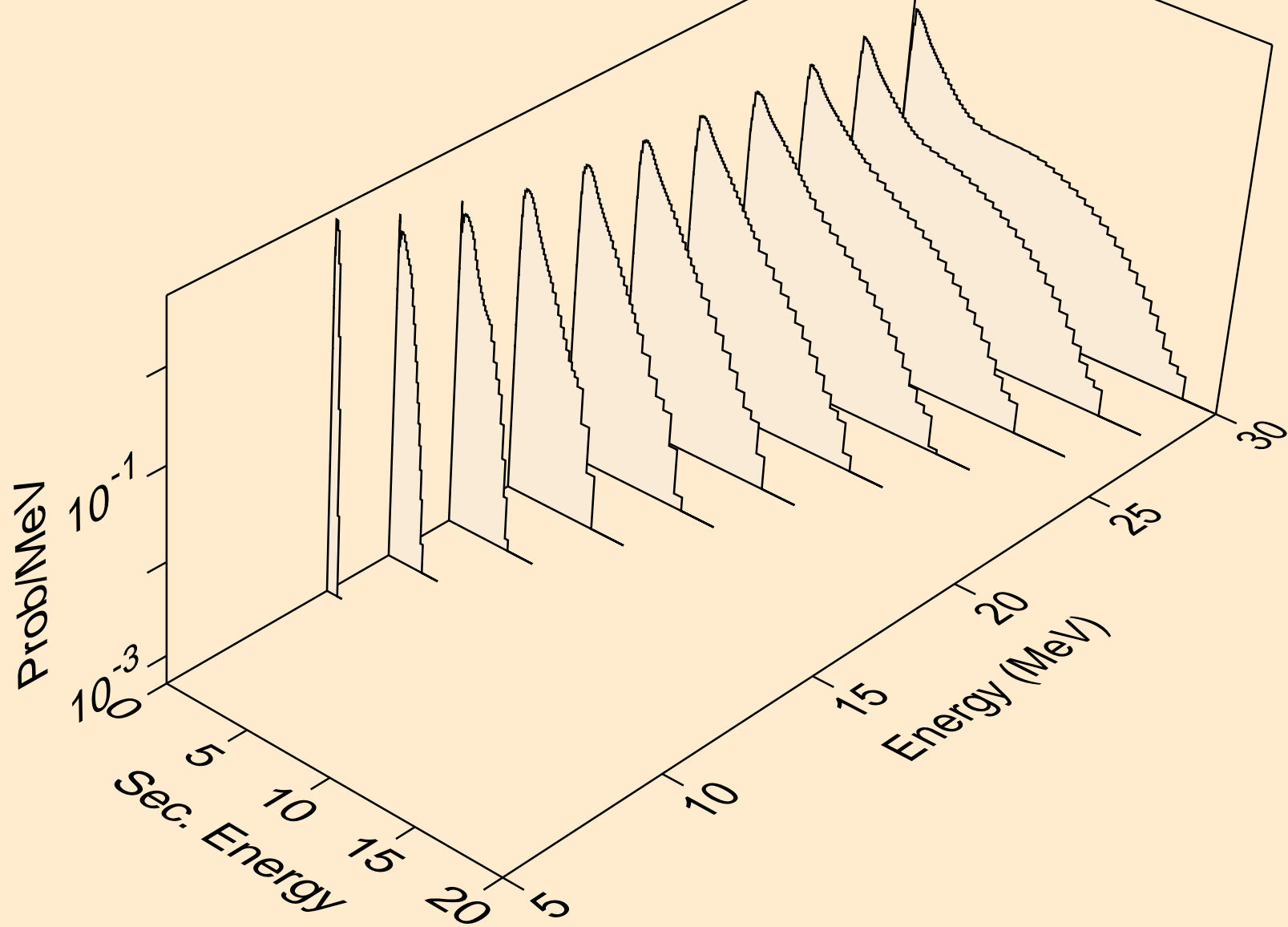

MO094 NEUTRON ACER TENDL-2024 LIBRARY; T=0.K
Neutron emission for (n,n*)2a

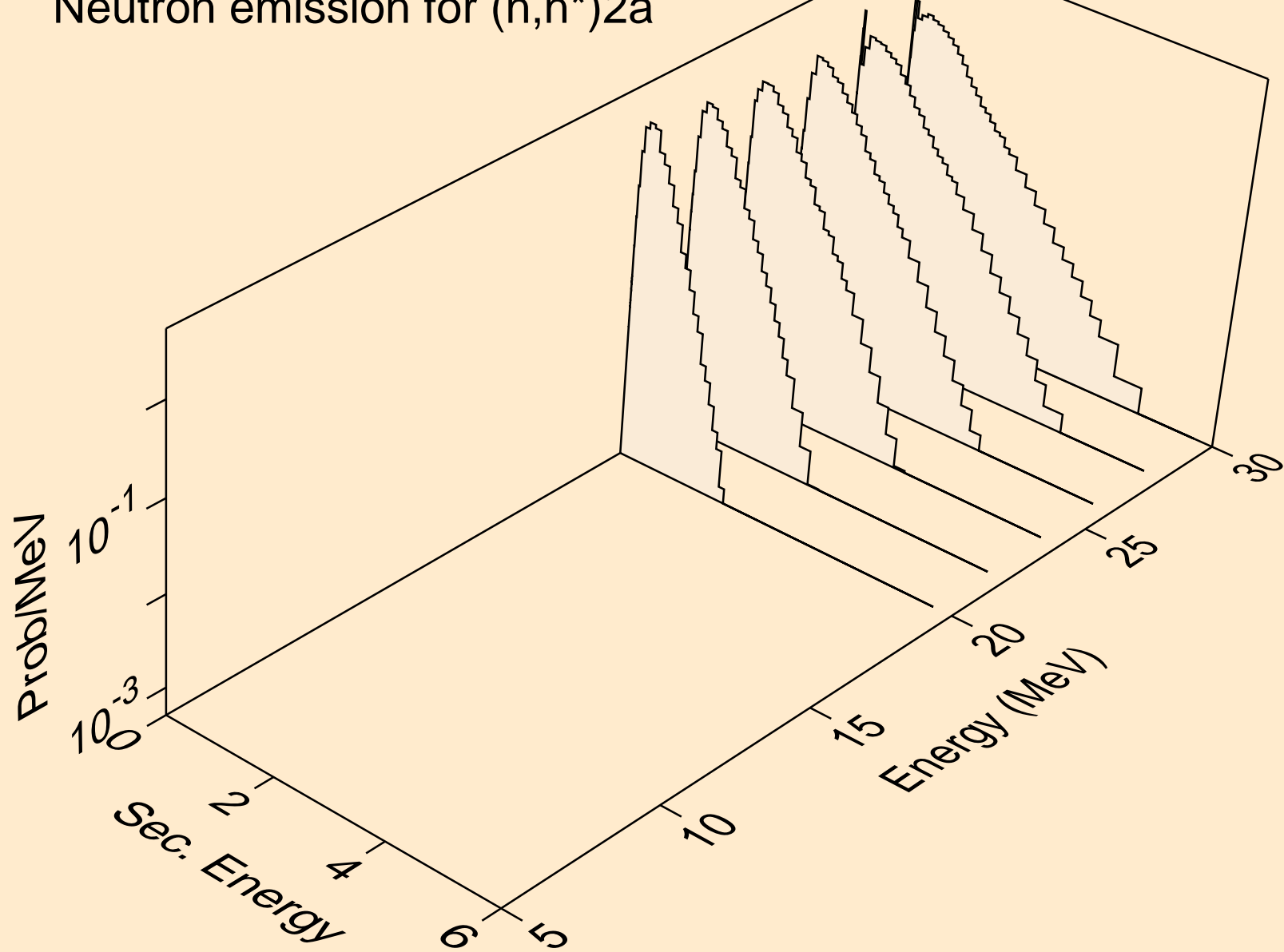

MO094 NEUTRON ACER TENDL-2024 LIBRARY; T=0.K
Neutron emission for (n,n*)d

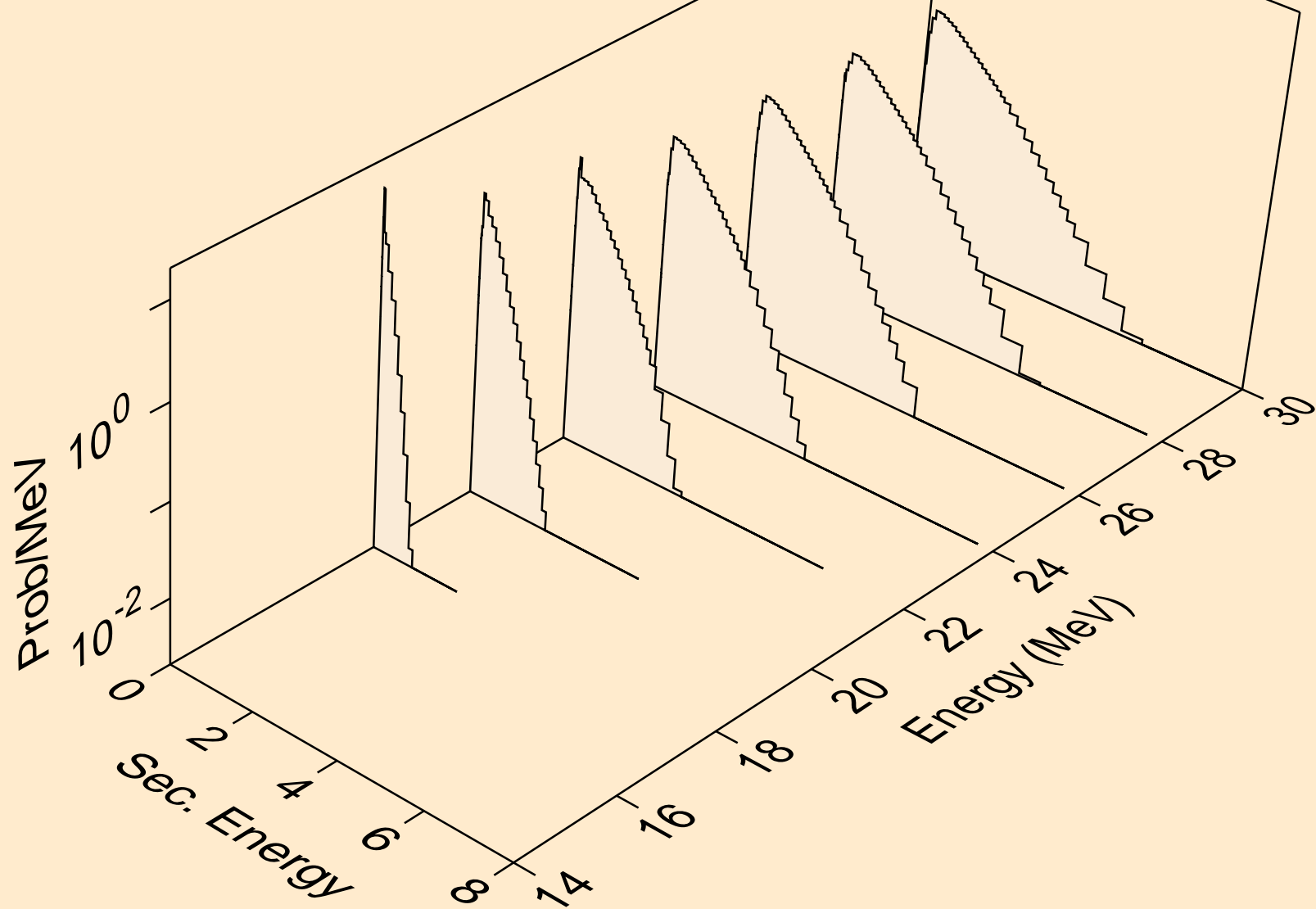

MO094 NEUTRON ACER TENDL-2024 LIBRARY; T=0.K
Neutron emission for (n,n*)t

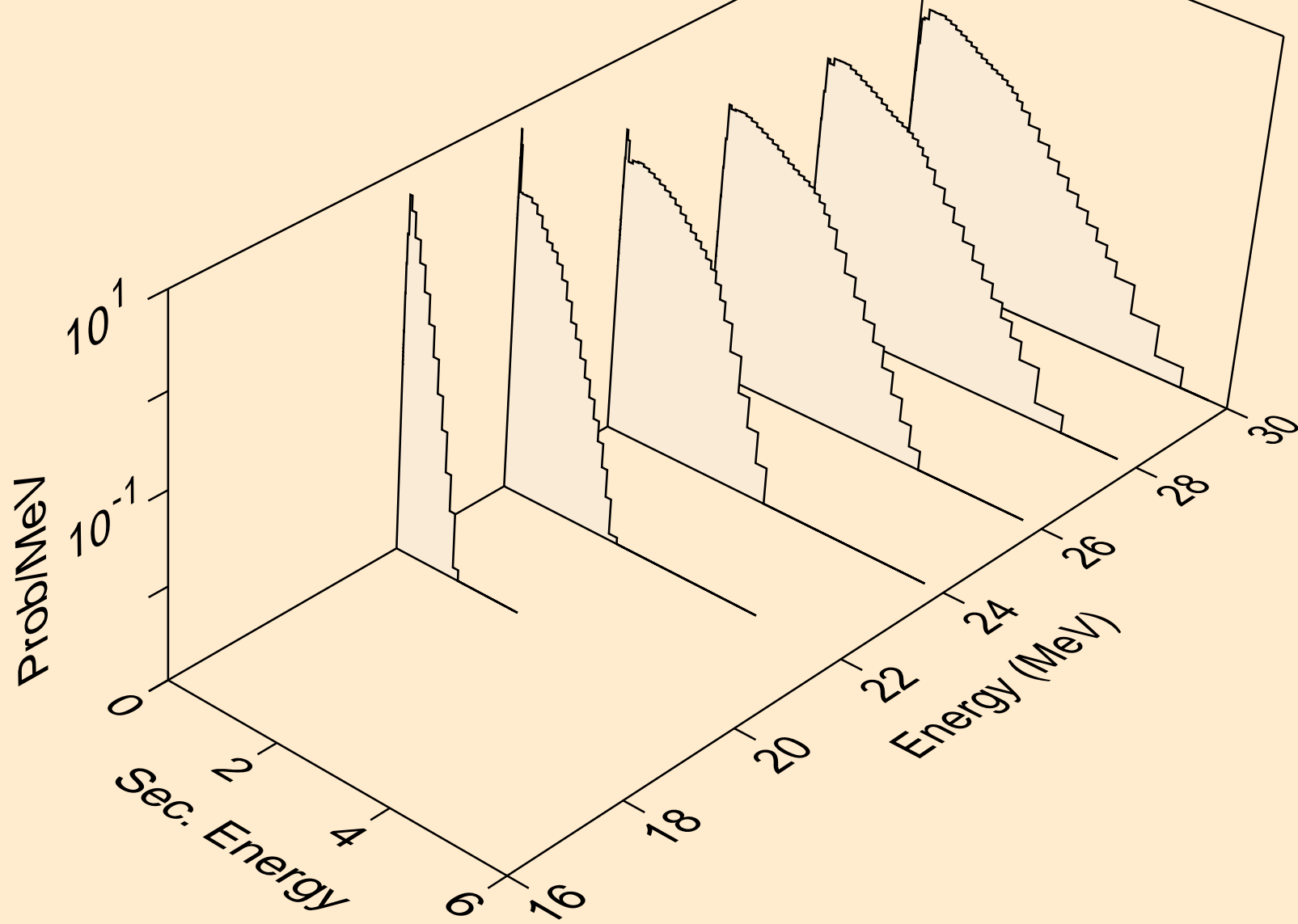

MO094 NEUTRON ACER TENDL-2024 LIBRARY; T=0.K
Neutron emission for (n,n*)he3

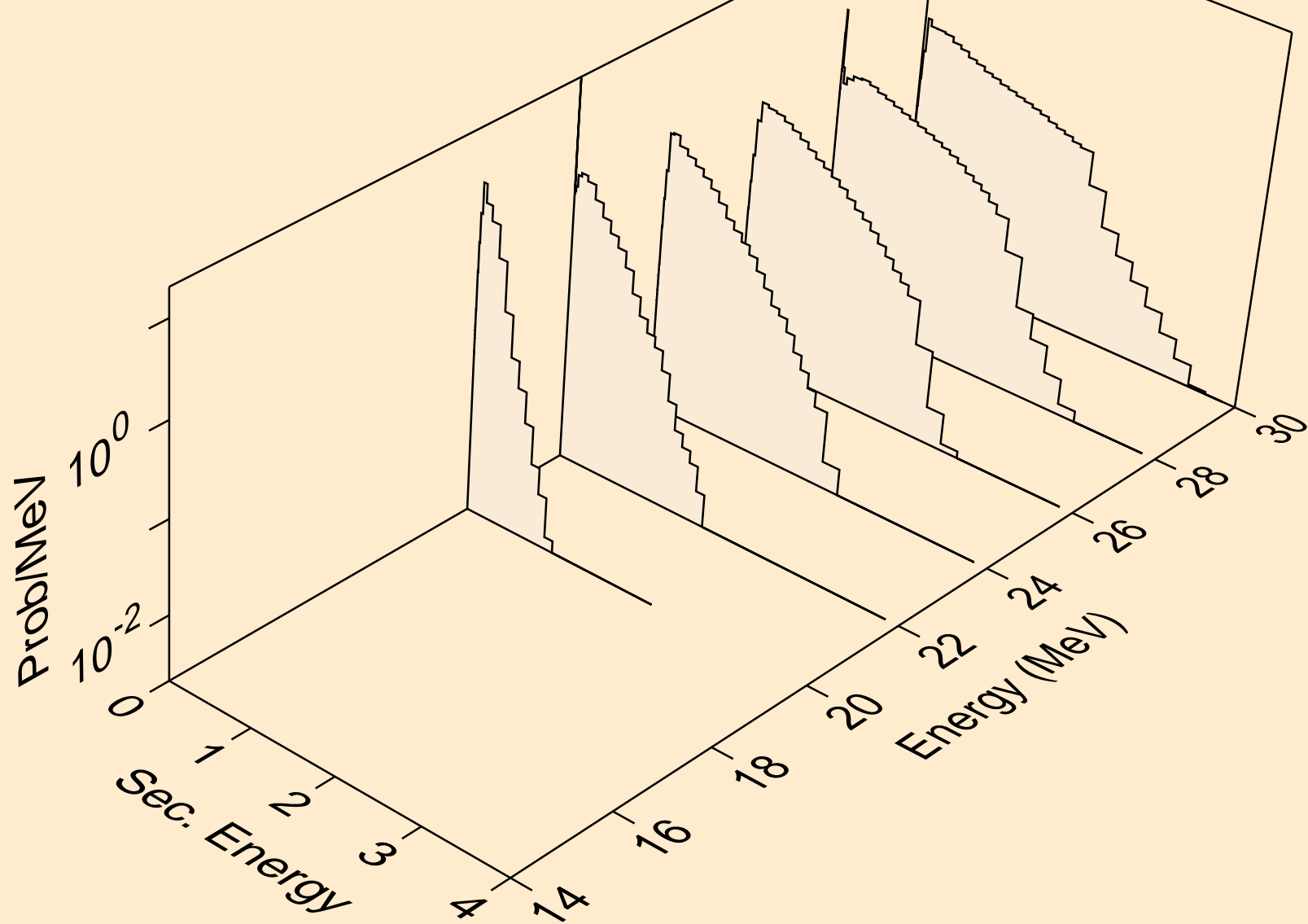

MO094 NEUTRON ACER TENDL-2024 LIBRARY; T=0.K
Neutron emission for (n,2np)

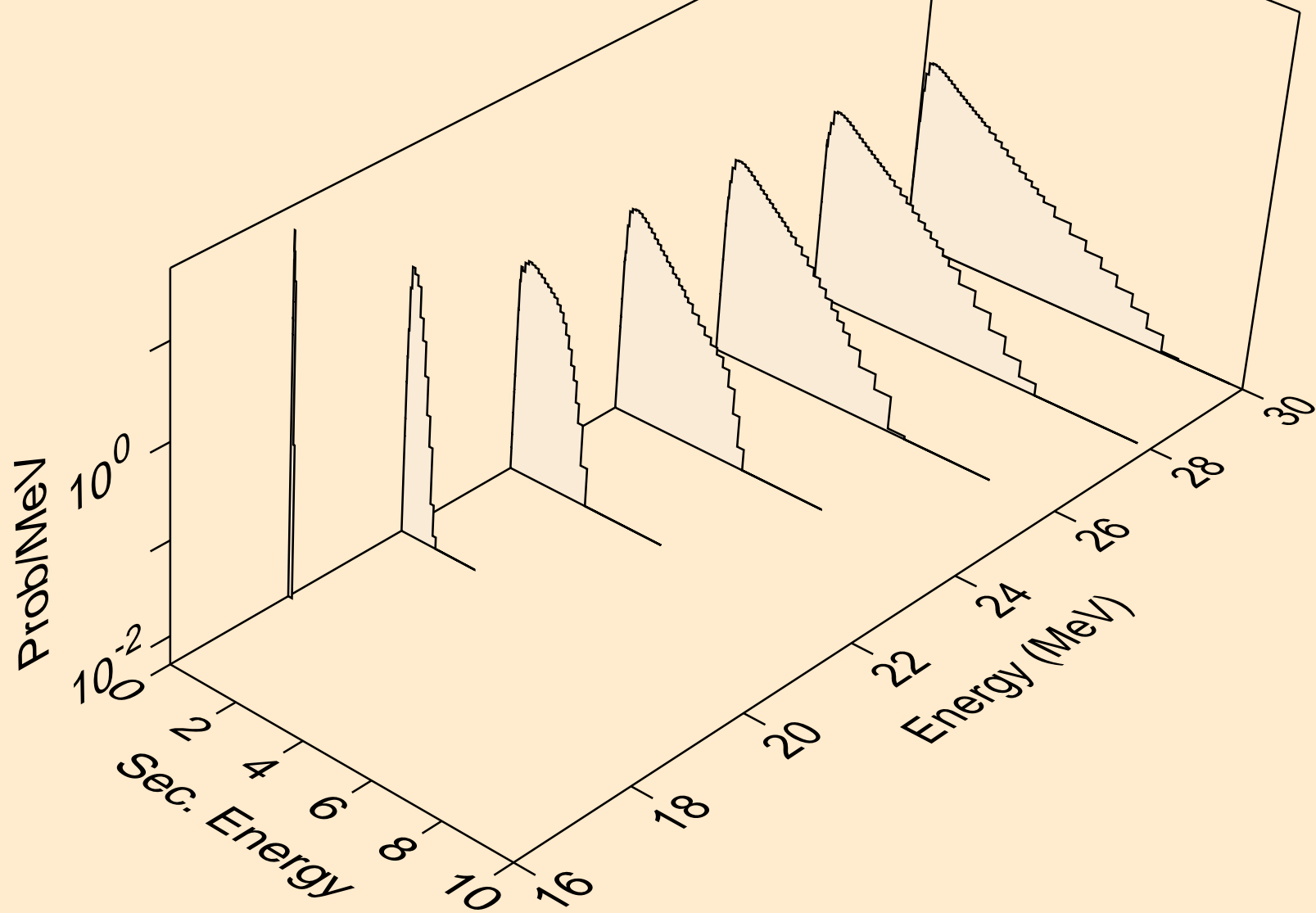

MO094 NEUTRON ACER TENDL-2024 LIBRARY; T=0.K
Neutron emission for (n,3np)

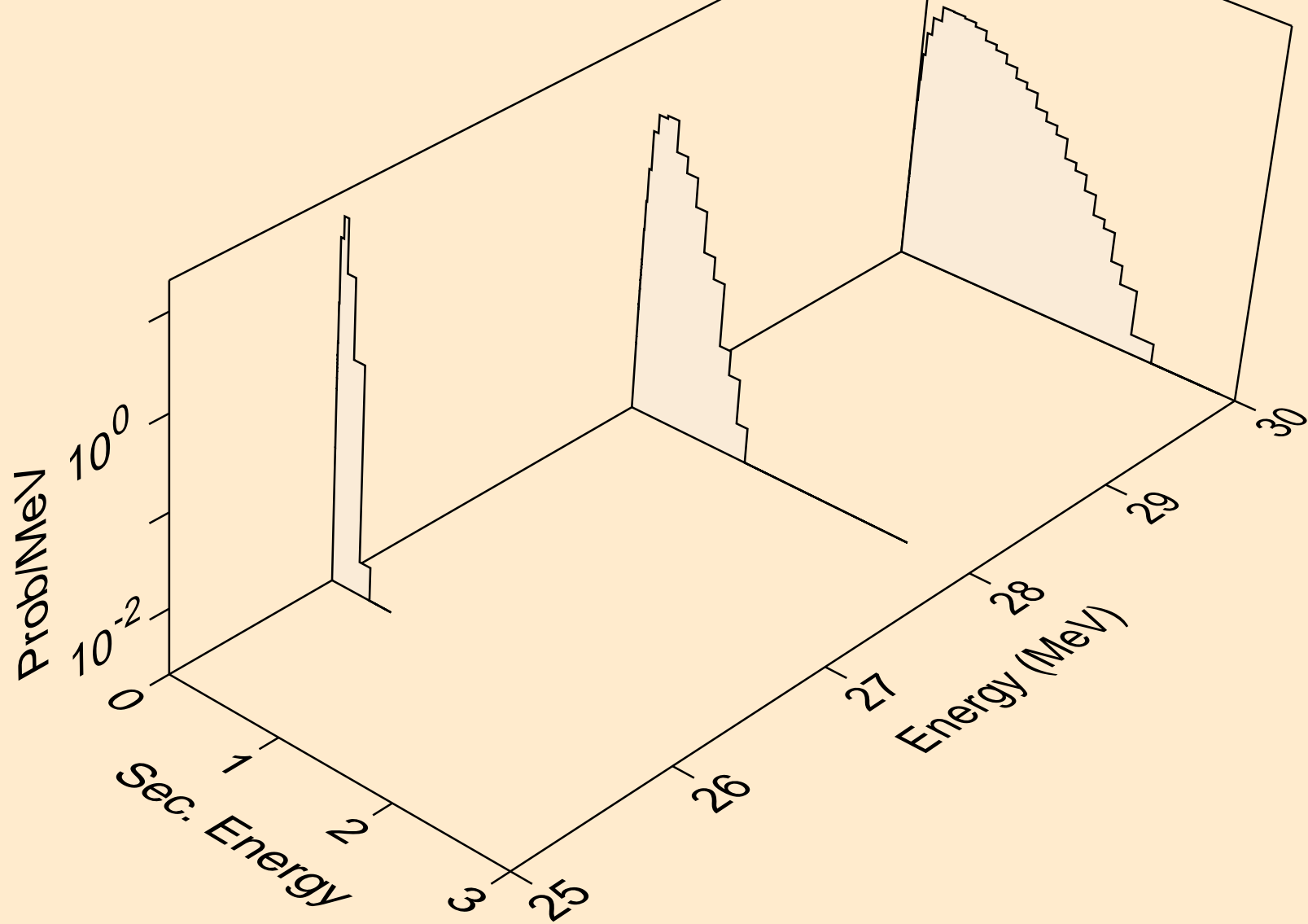

MO094 NEUTRON ACER TENDL-2024 LIBRARY; T=0.K
Neutron emission for (n,n2p)

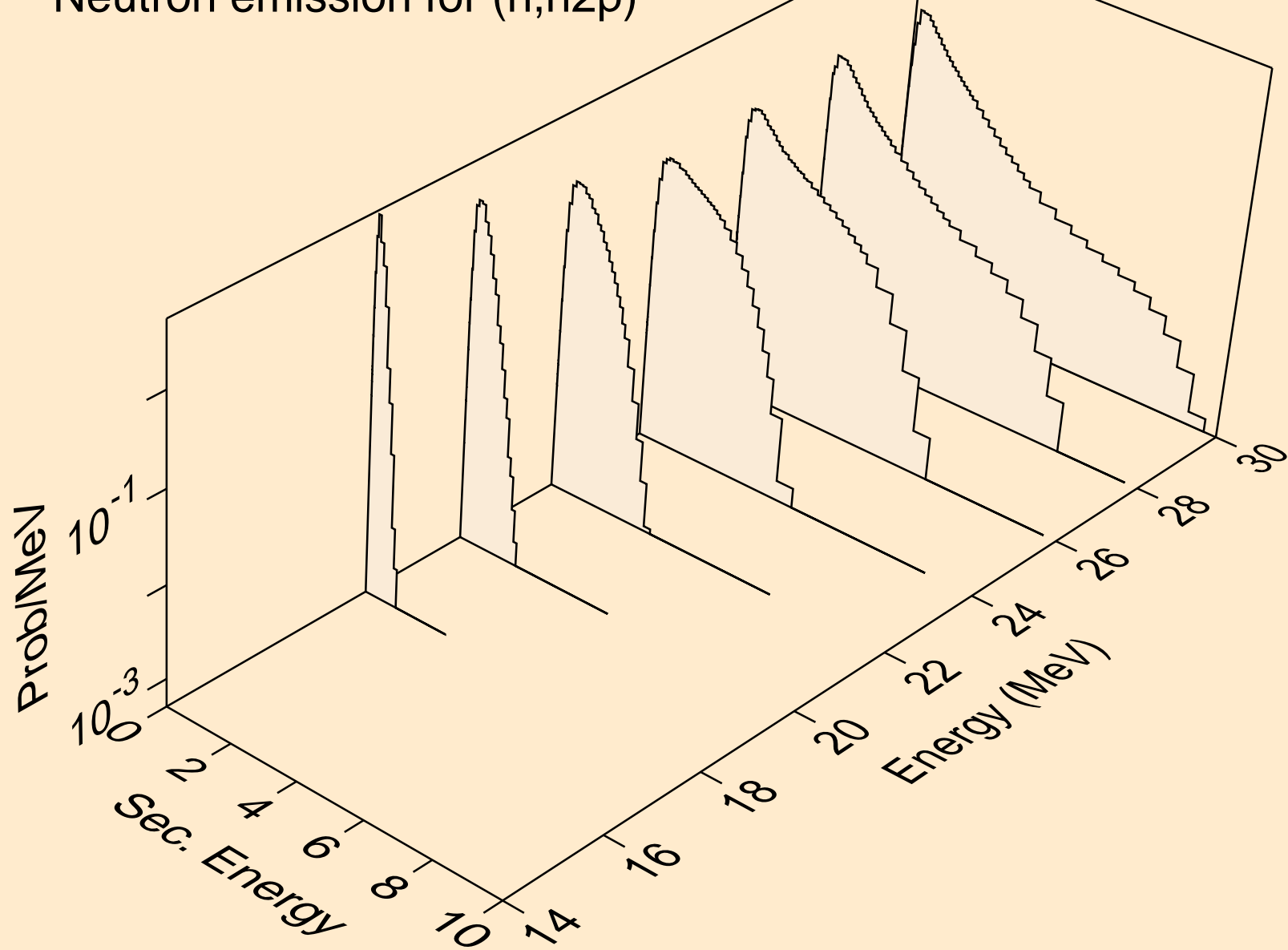

MO094 NEUTRON ACER TENDL-2024 LIBRARY; T=0.K
Neutron emission for (n,npa)

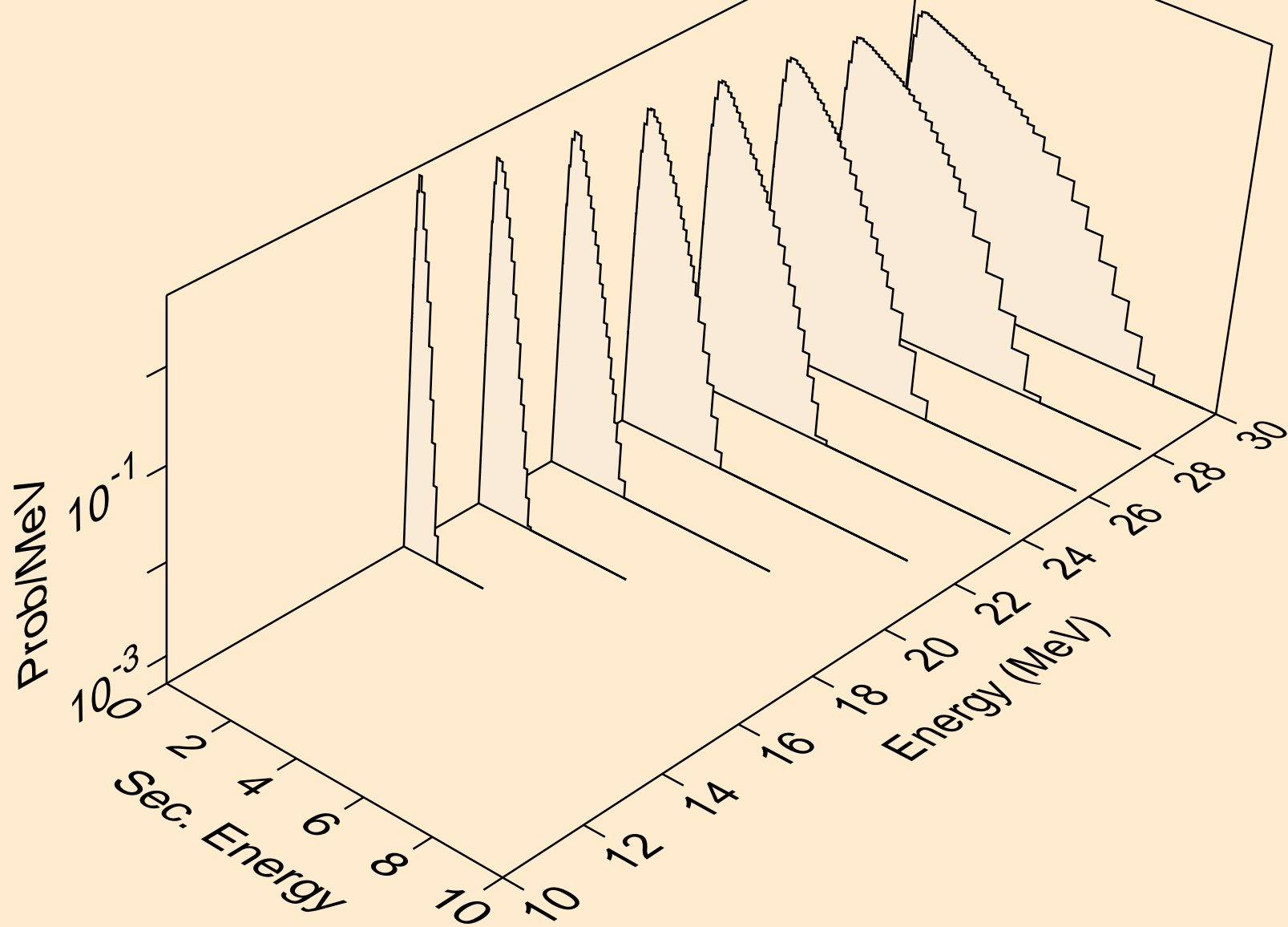

MO094 NEUTRON ACER TENDL-2024 LIBRARY; T=0.K
Neutron emission for (n,n*c)

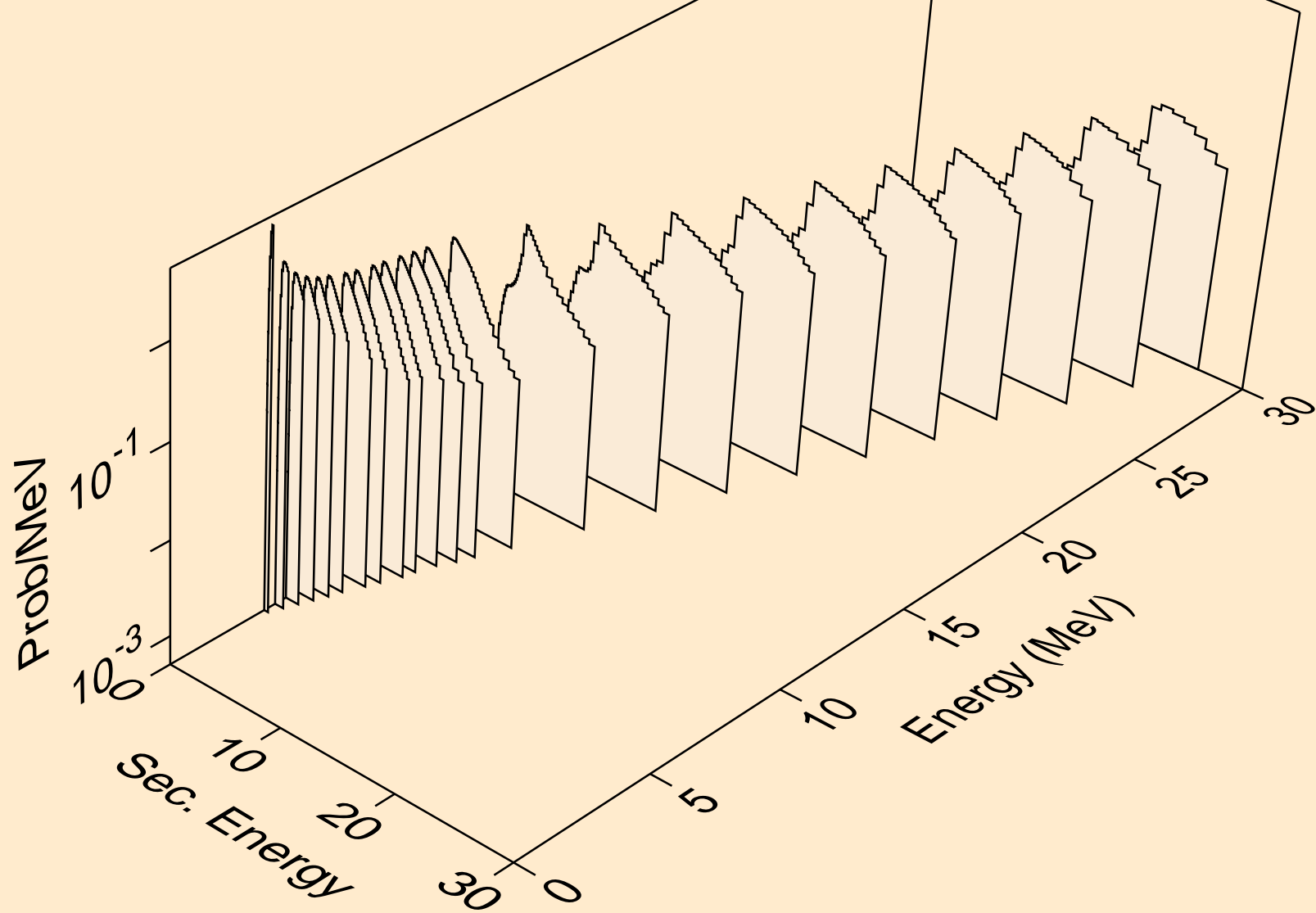

MO094 NEUTRON ACER TENDL-2024 LIBRARY; T=0.K
Photon emission for (n,x)

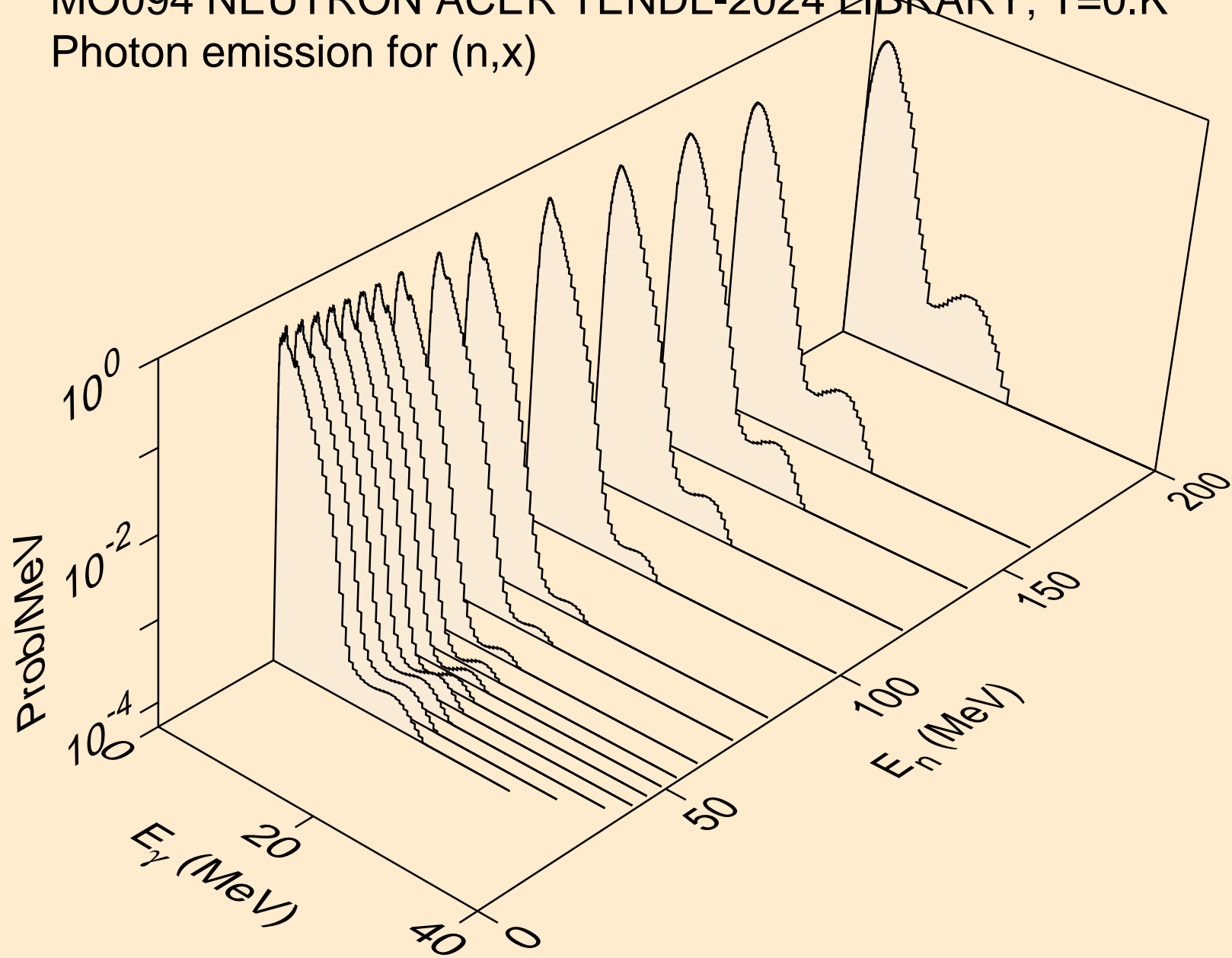

MO094 NEUTRON ACER TENDL-2024 LIBRARY; T=0.K
Photon emission for (n,2nd)

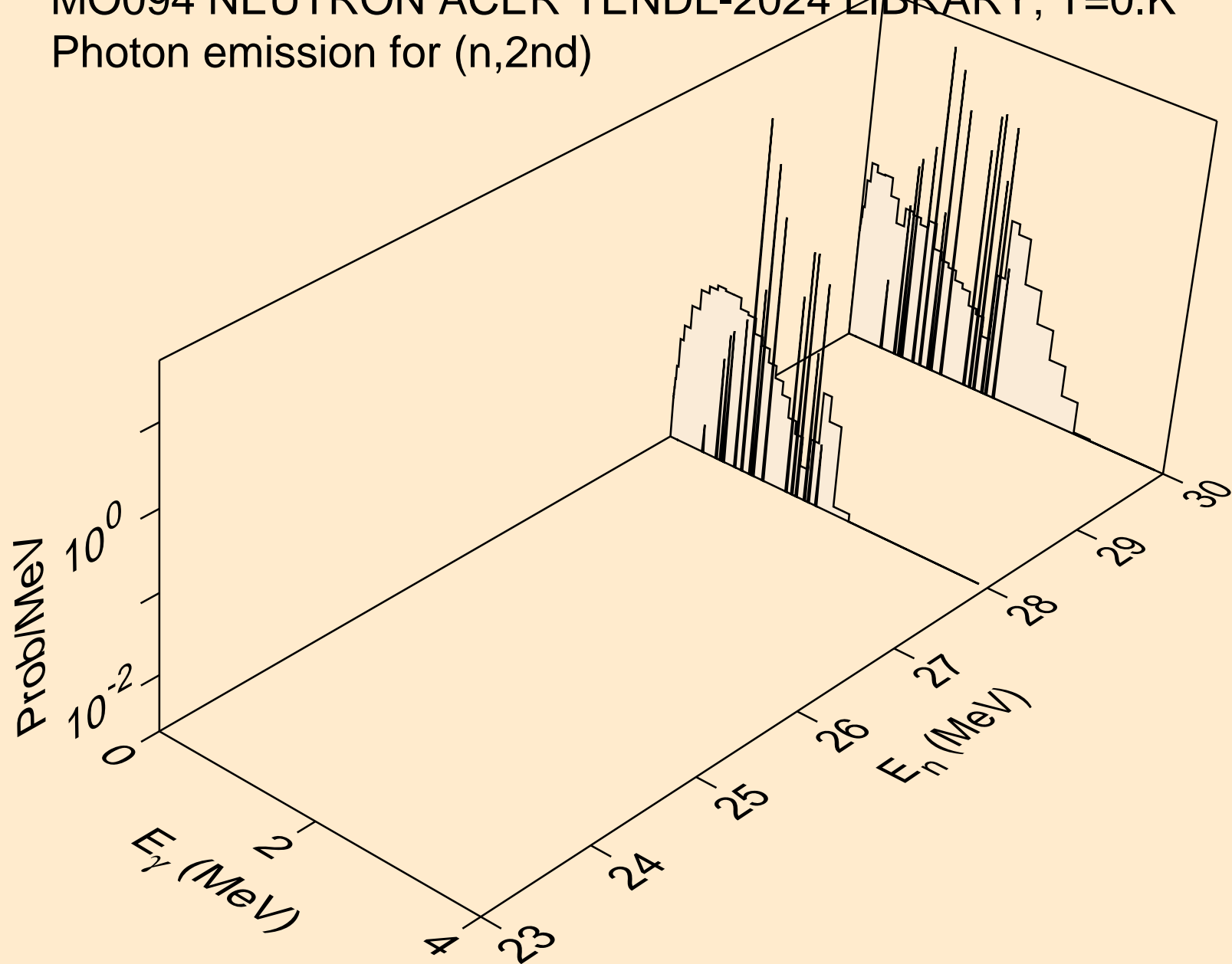

MO094 NEUTRON ACER TENDL-2024 LIBRARY; T=0.K
Photon emission for (n,2n)

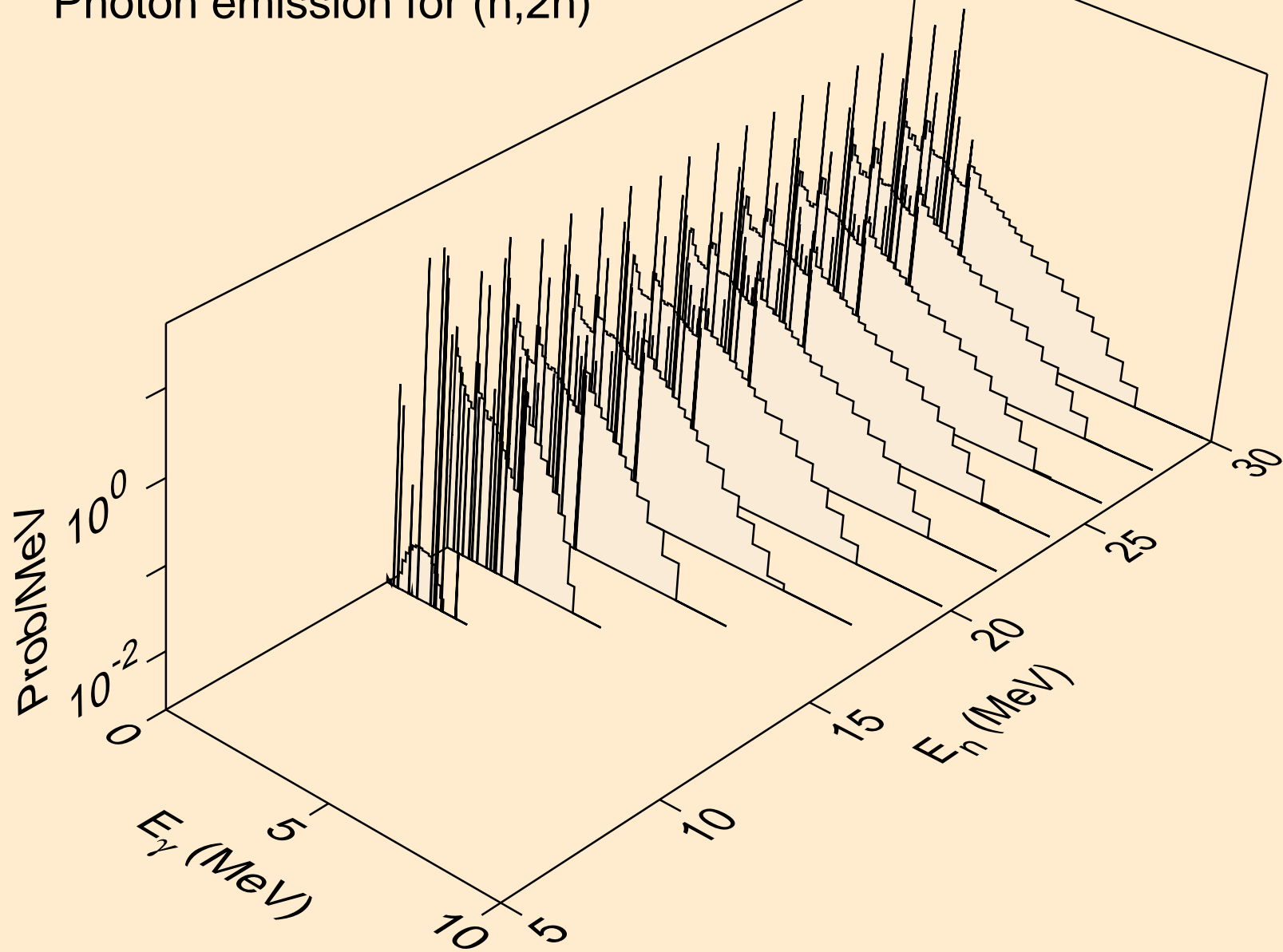

MO094 NEUTRON ACER TENDL-2024 LIBRARY; T=0.K
Photon emission for (n,3n)

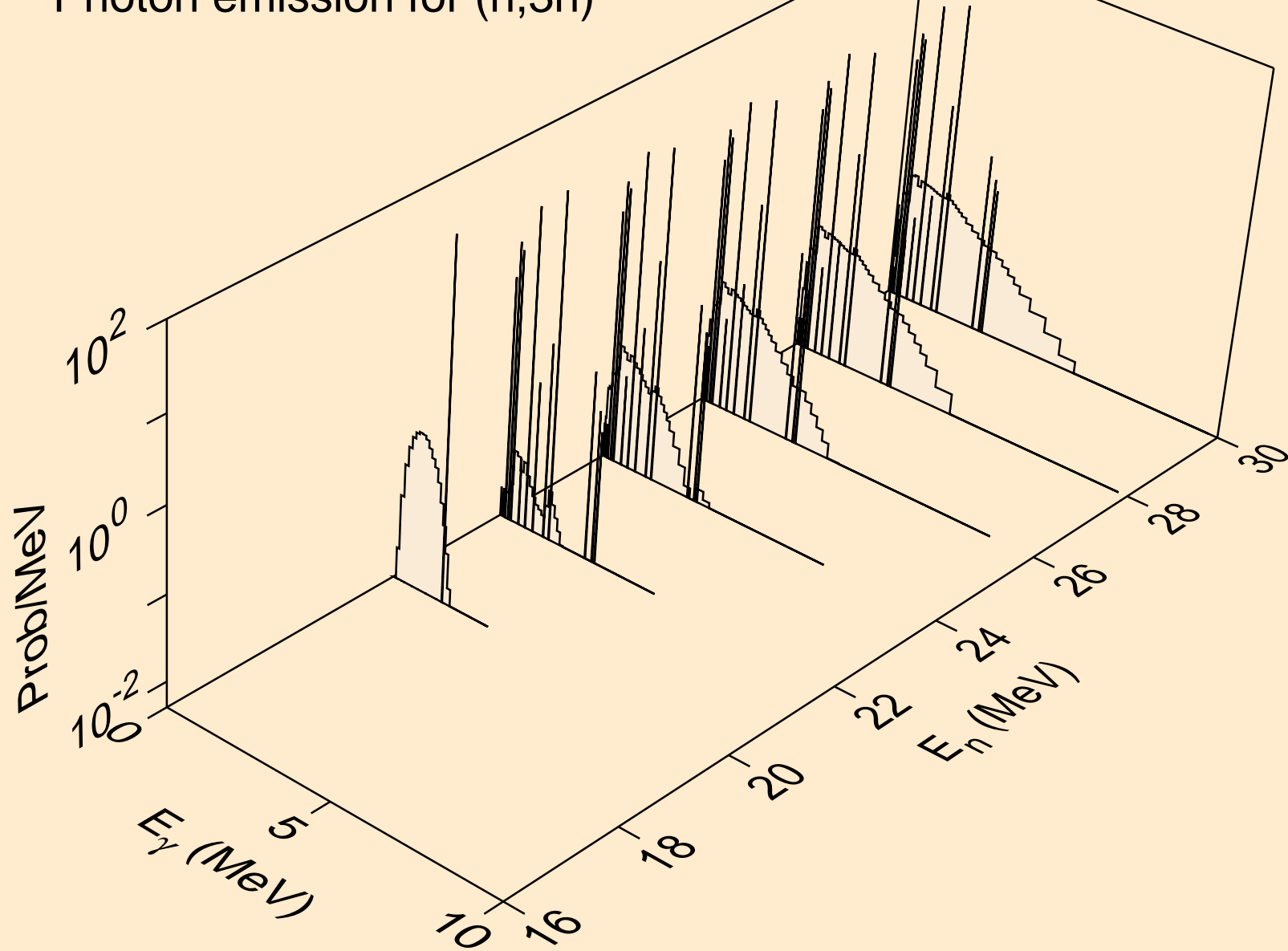

MO094 NEUTRON ACER TENDL-2024 LIBRARY; T=0.K
Photon emission for (n,n*)a

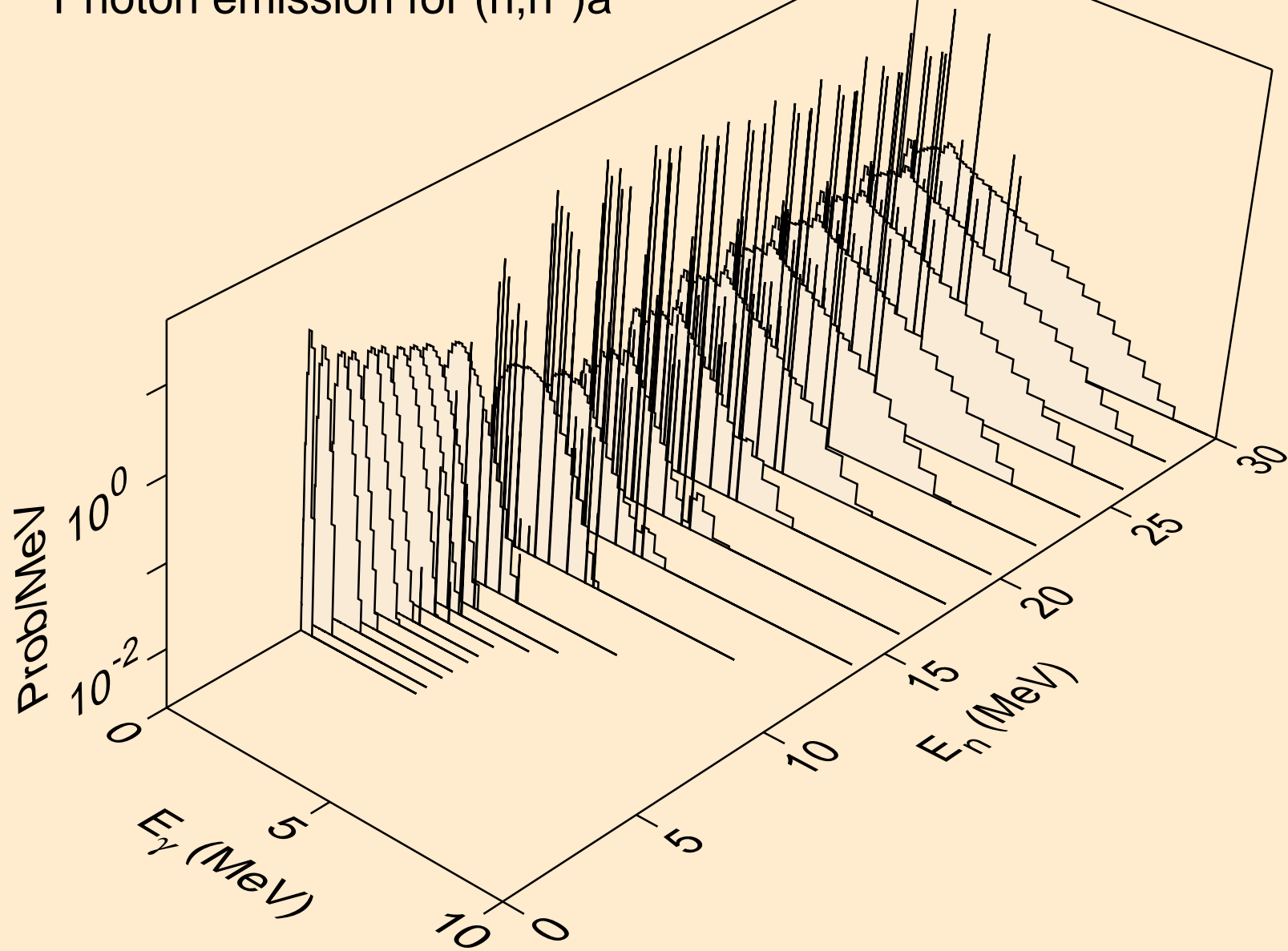

MO094 NEUTRON ACER TENDL-2024 LIBRARY; T=0.K
Photon emission for (n,2n)a

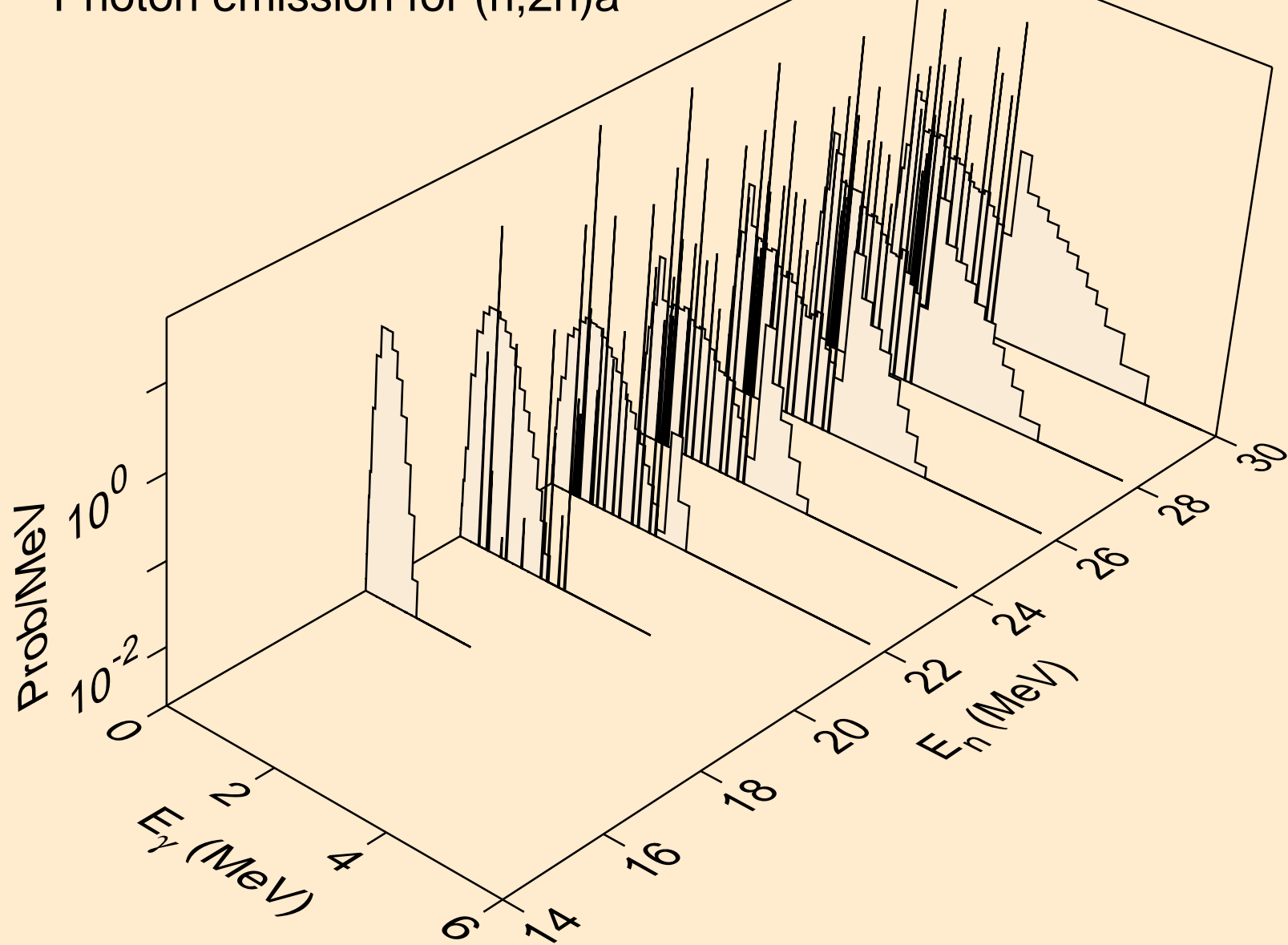

MO094 NEUTRON ACER TENDL-2024 LIBRARY; T=0.K
Photon emission for (n,n*)p

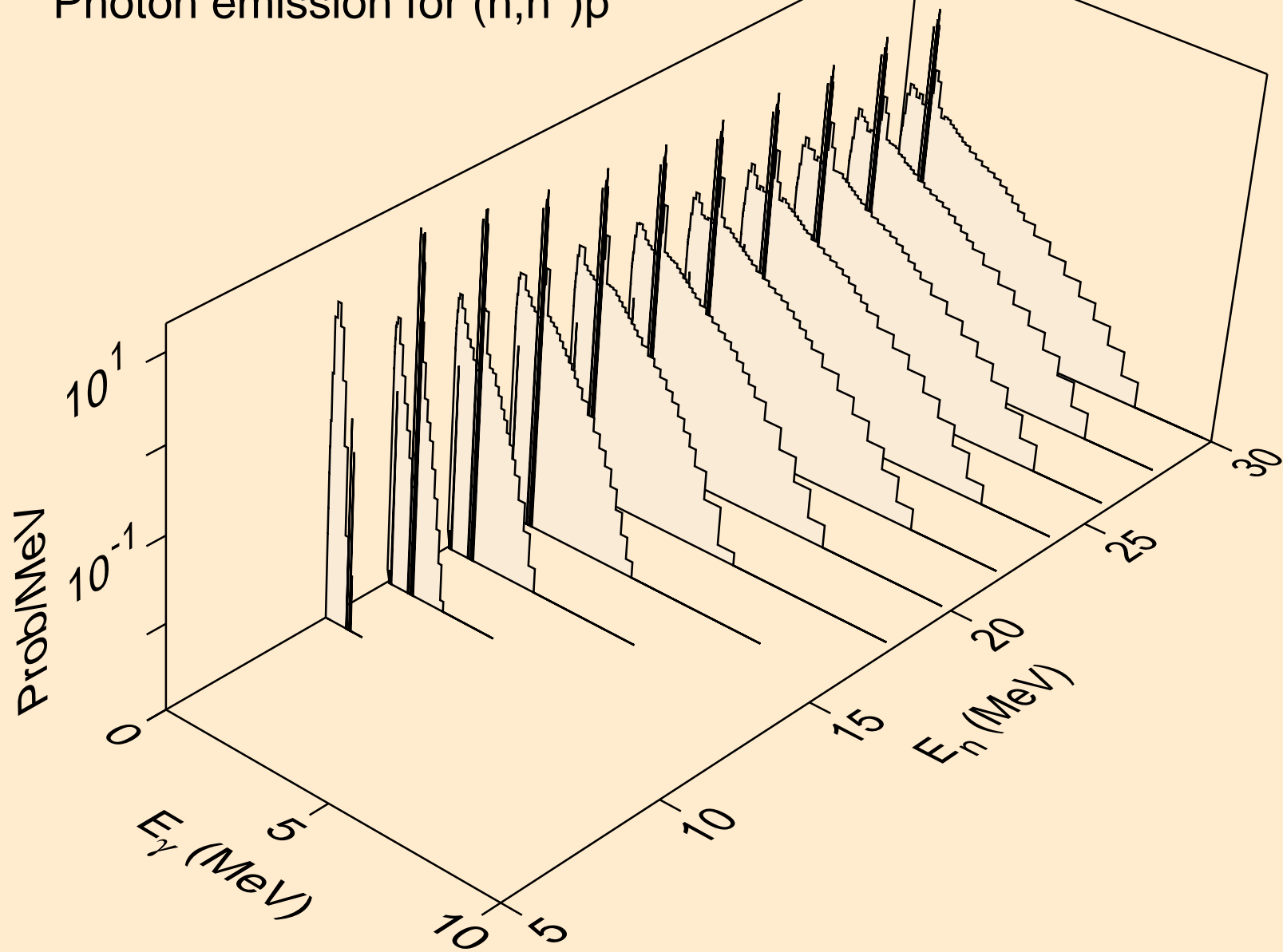

MO094 NEUTRON ACER TENDL-2024 LIBRARY; T=0.K
Photon emission for (n,n*)2a

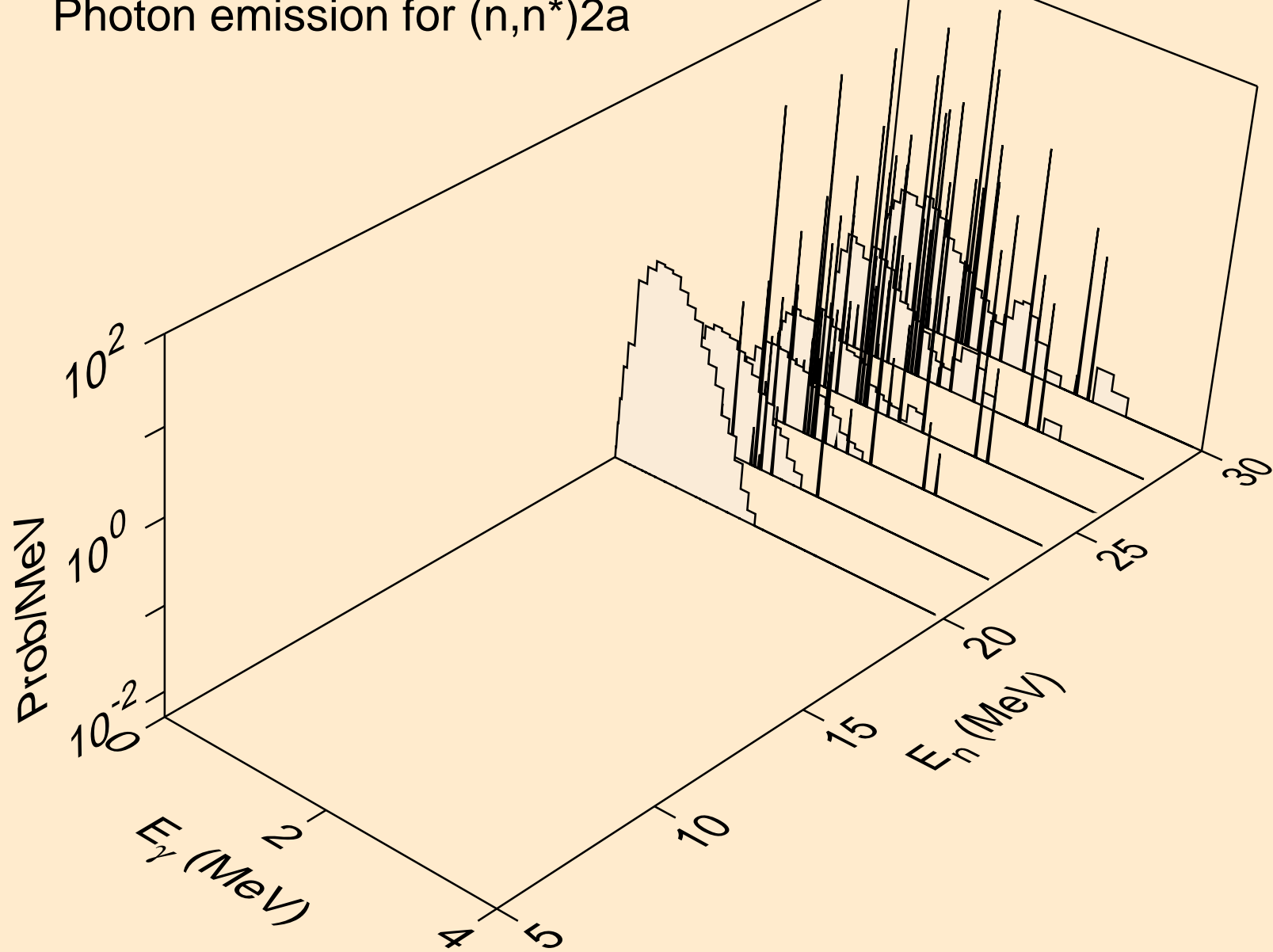

MO094 NEUTRON ACER TENDL-2024 LIBRARY; T=0.K
Photon emission for (n,n*)d

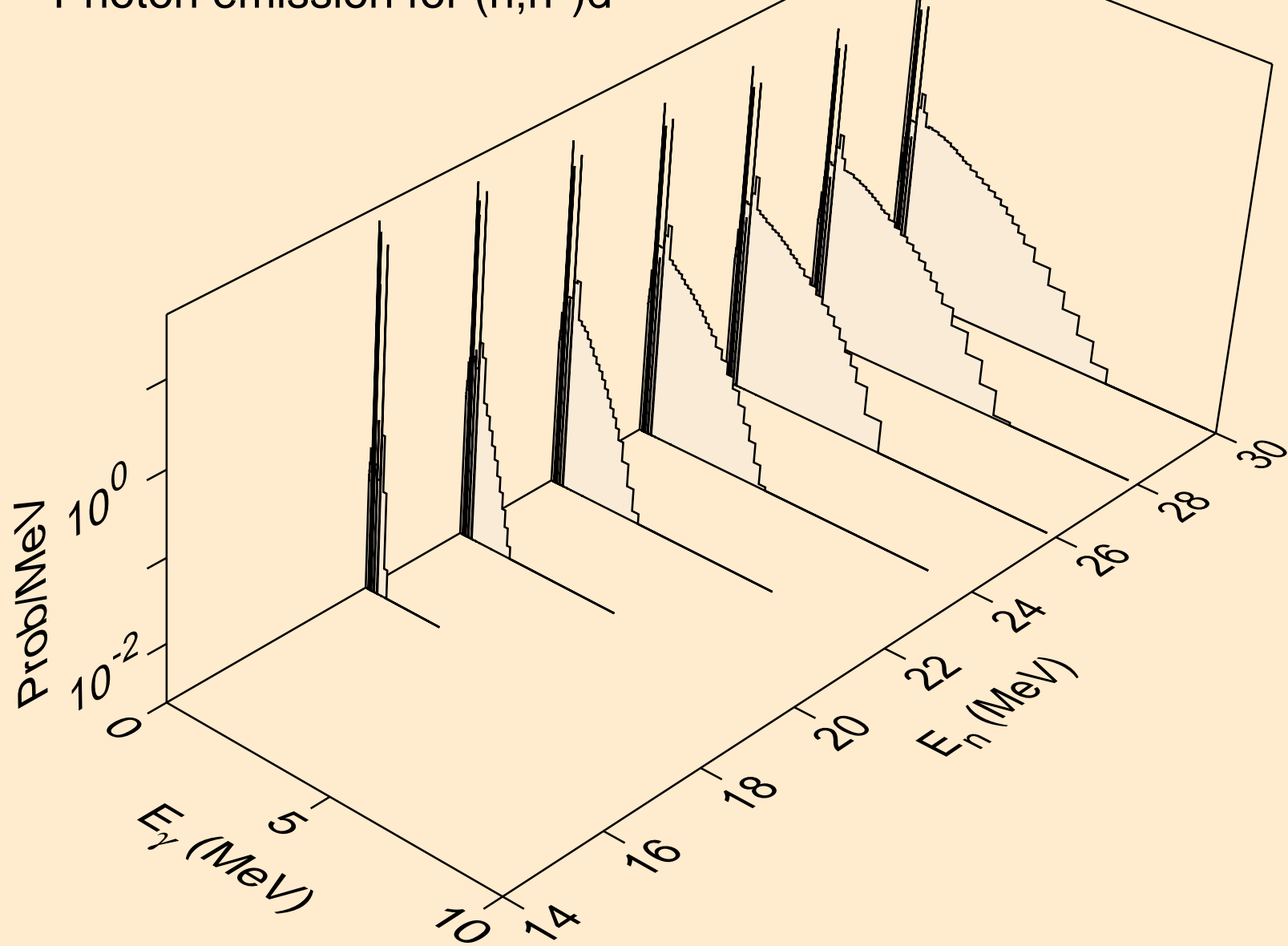

MO094 NEUTRON ACER TENDL-2024 LIBRARY; T=0.K
Photon emission for (n,n*)t

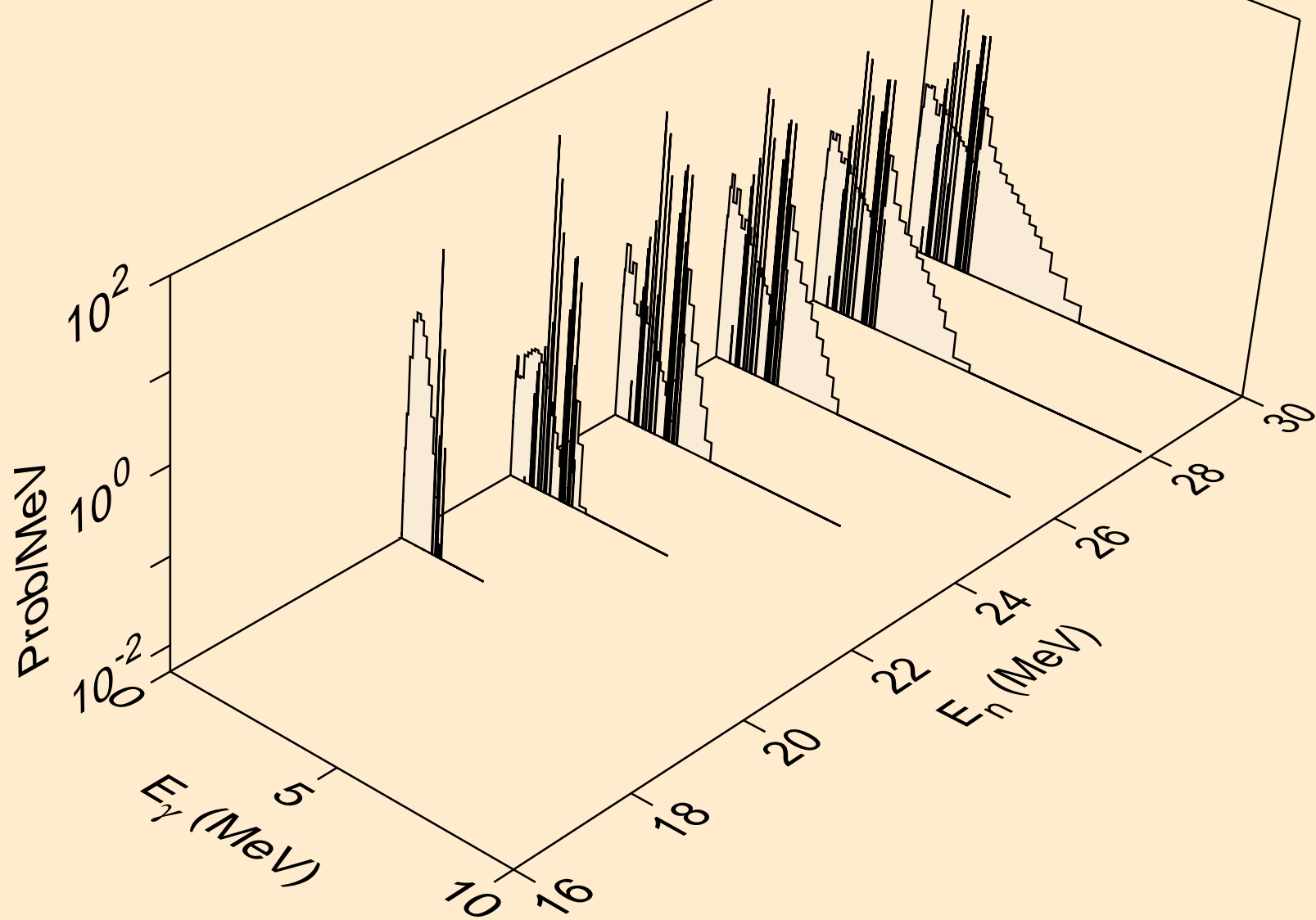

MO094 NEUTRON ACER TENDL-2024 LIBRARY; T=0.K
Photon emission for (n,n*)he3

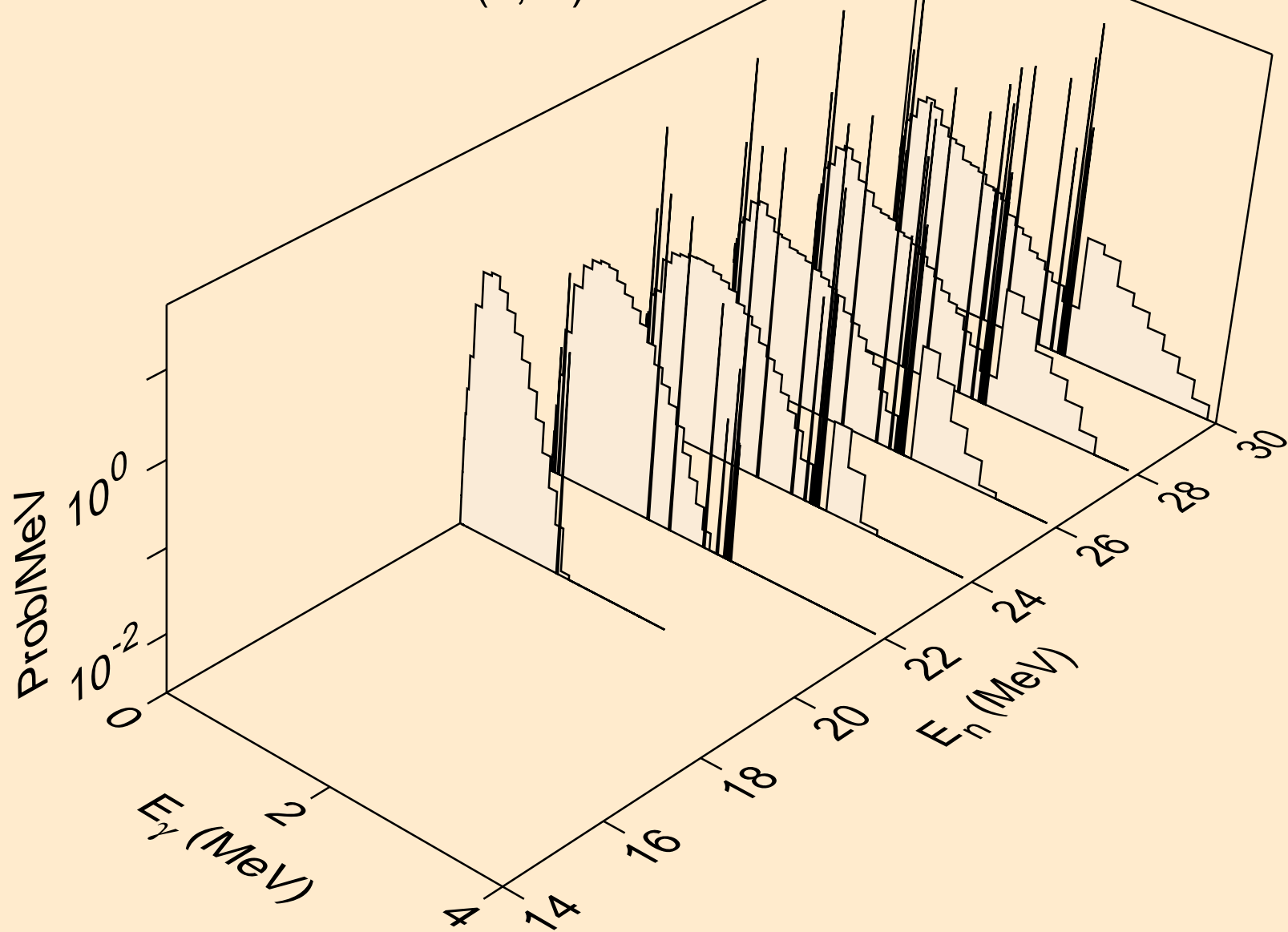

MO094 NEUTRON ACER TENDL-2024 LIBRARY; T=0.K
Photon emission for (n,2np)

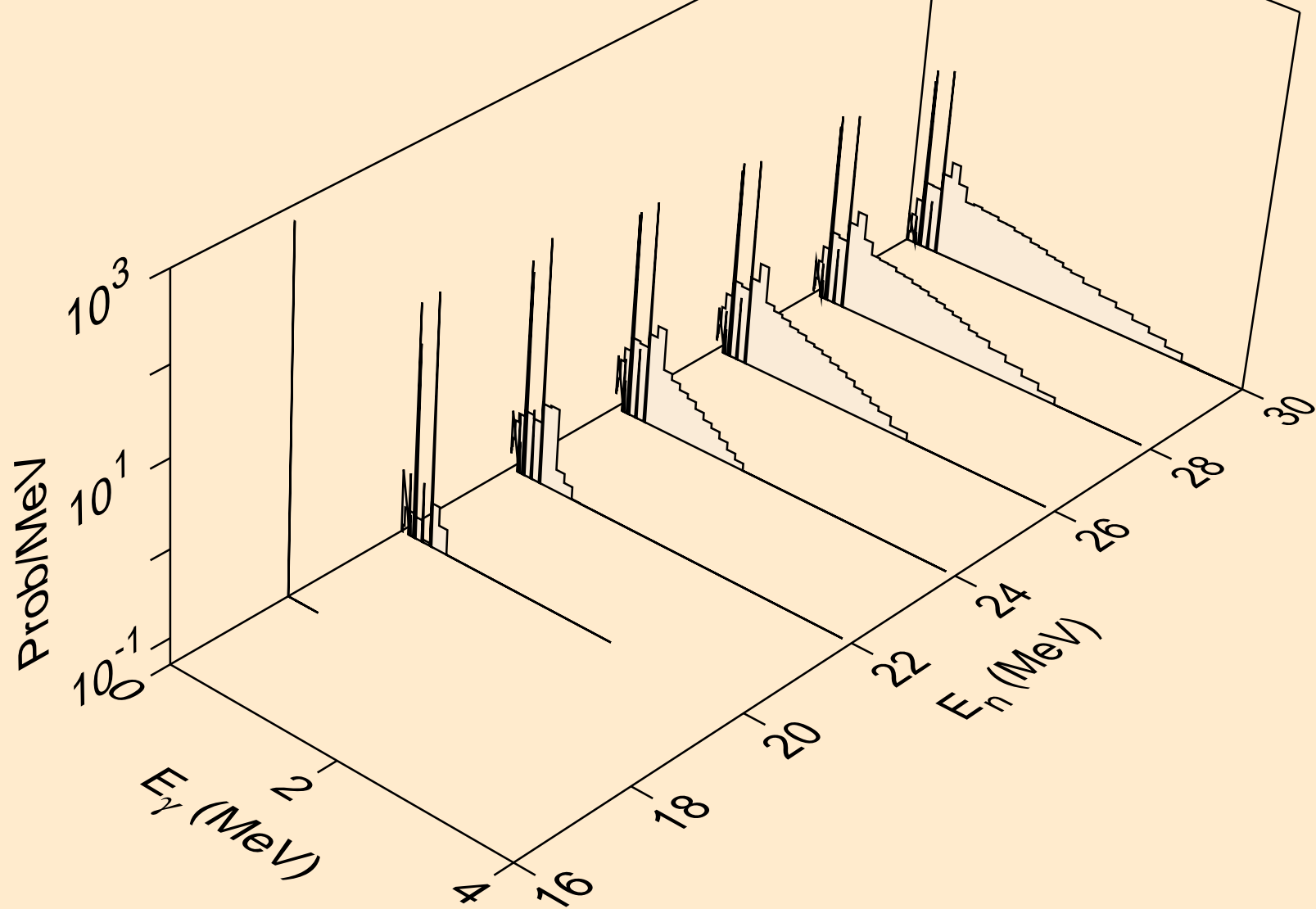

MO094 NEUTRON ACER TENDL-2024 LIBRARY; T=0.K
Photon emission for (n,3np)

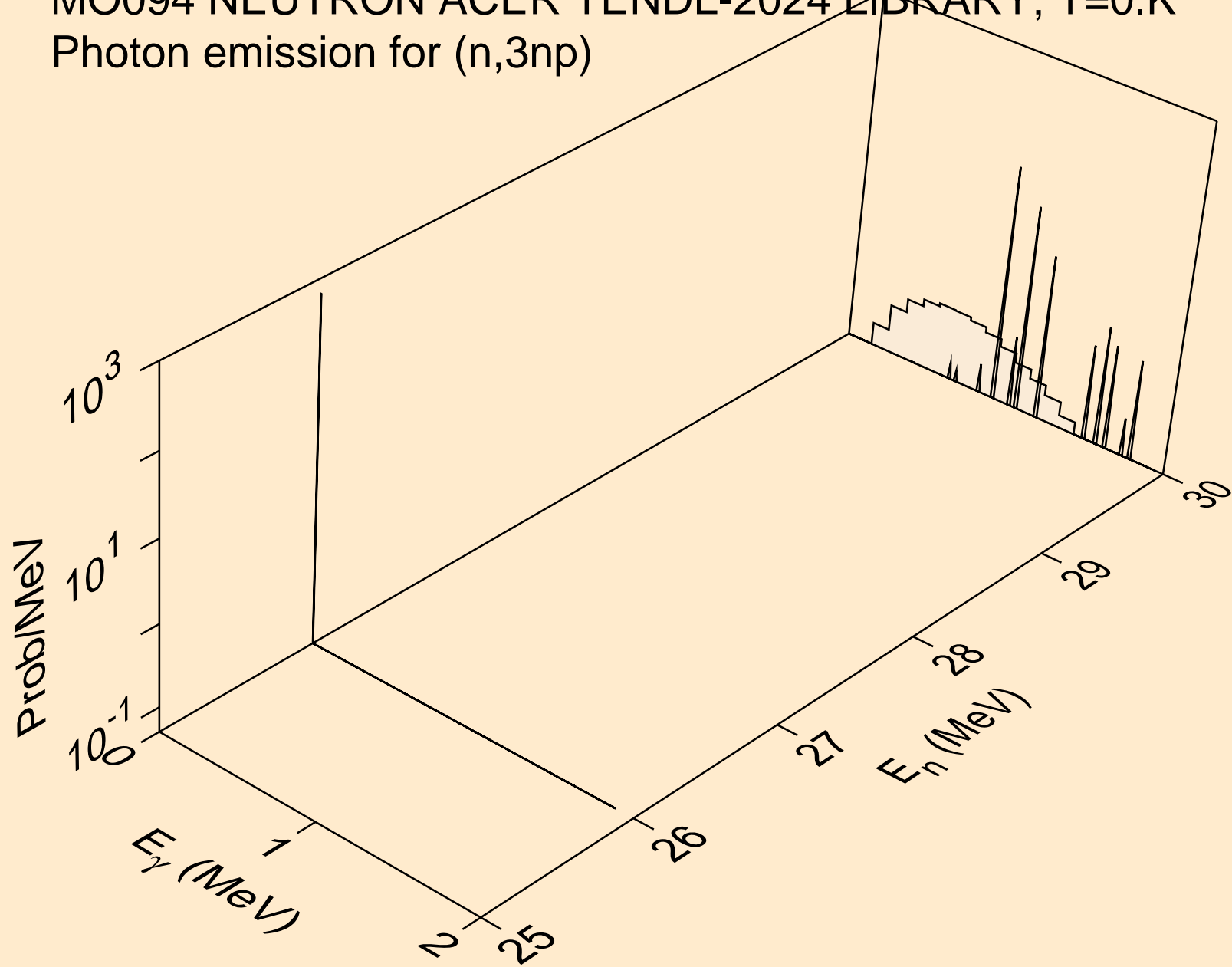

MO094 NEUTRON ACER TENDL-2024 LIBRARY; T=0.K
Photon emission for (n,n2p)

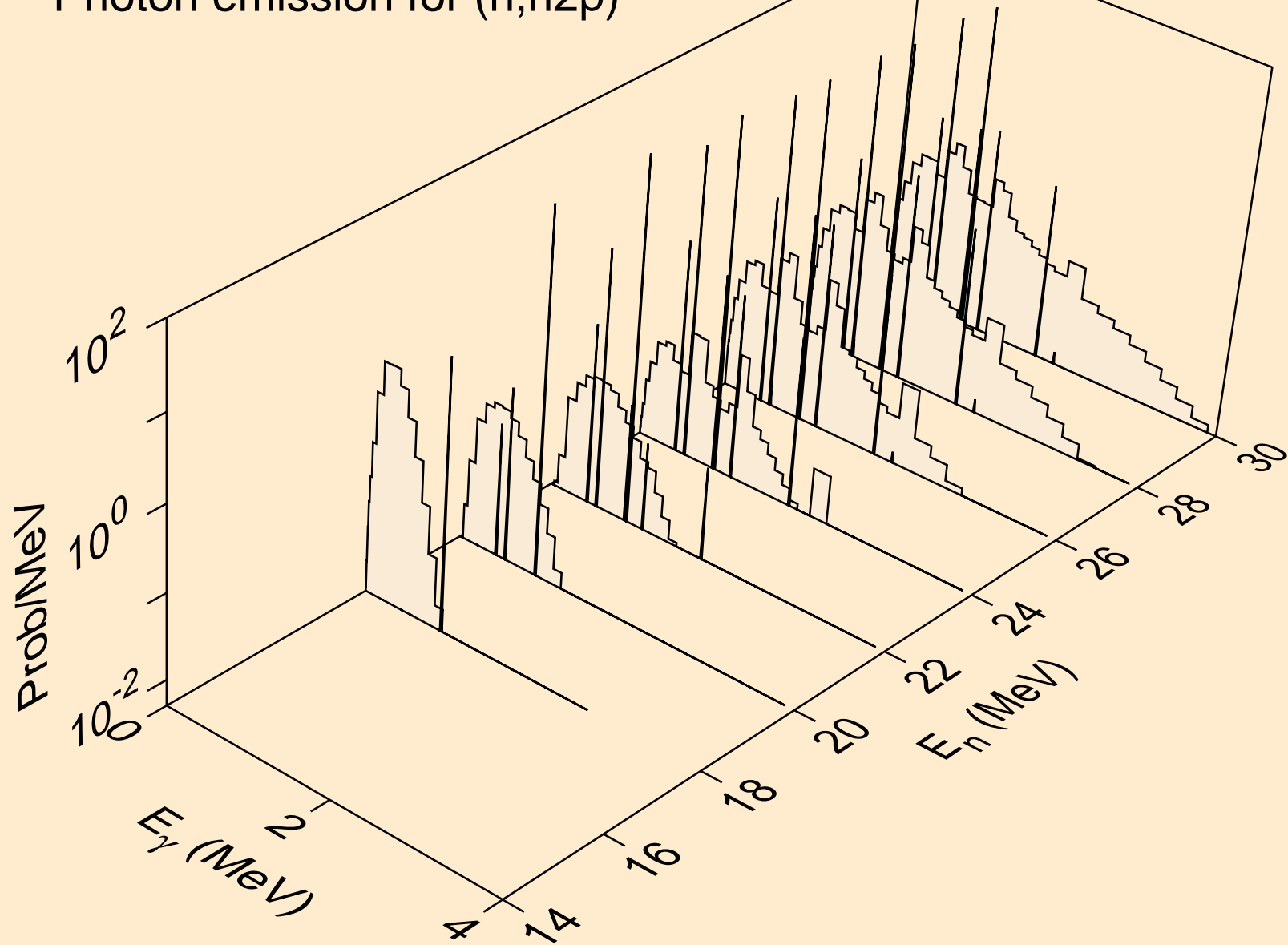

MO094 NEUTRON ACER TENDL-2024 LIBRARY; T=0.K
Photon emission for (n,npa)

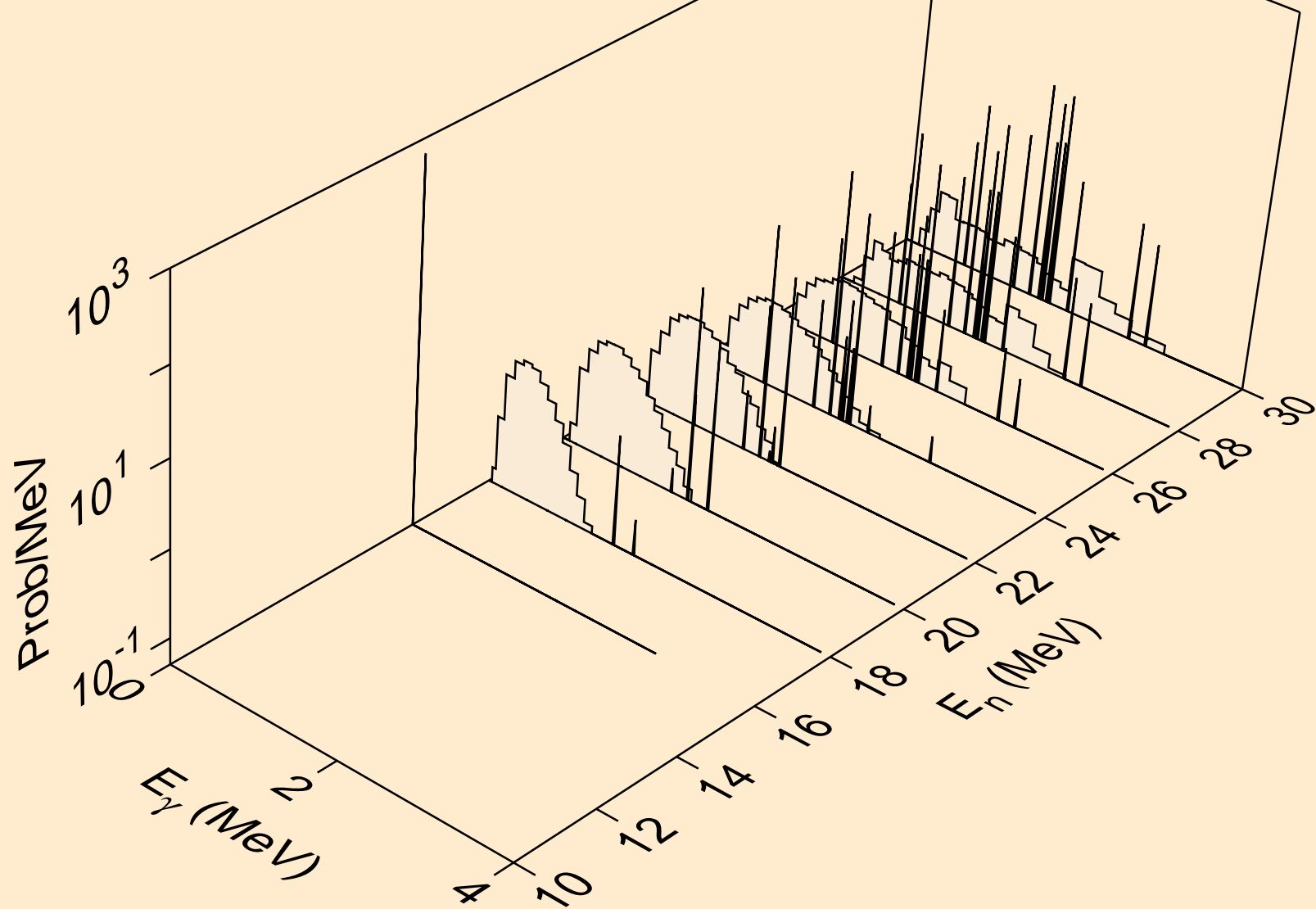

MO094 NEUTRON ACER TENDL-2024 LIBRARY; T=0.K
Photon emission for (n,n*c)

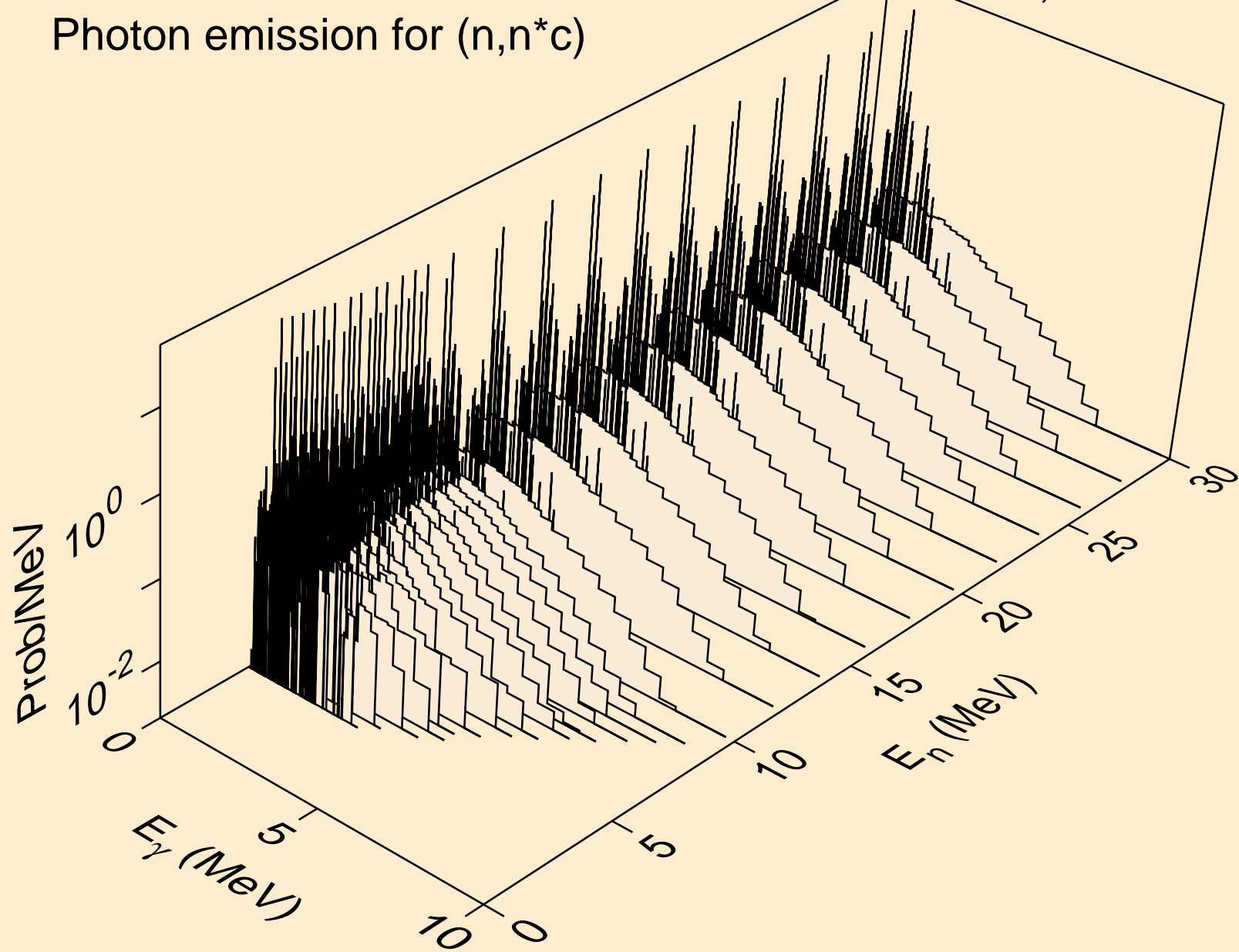

MO094 NEUTRON ACER TENDL-2024 LIBRARY; T=0.K
Photon emission for (n,gma)

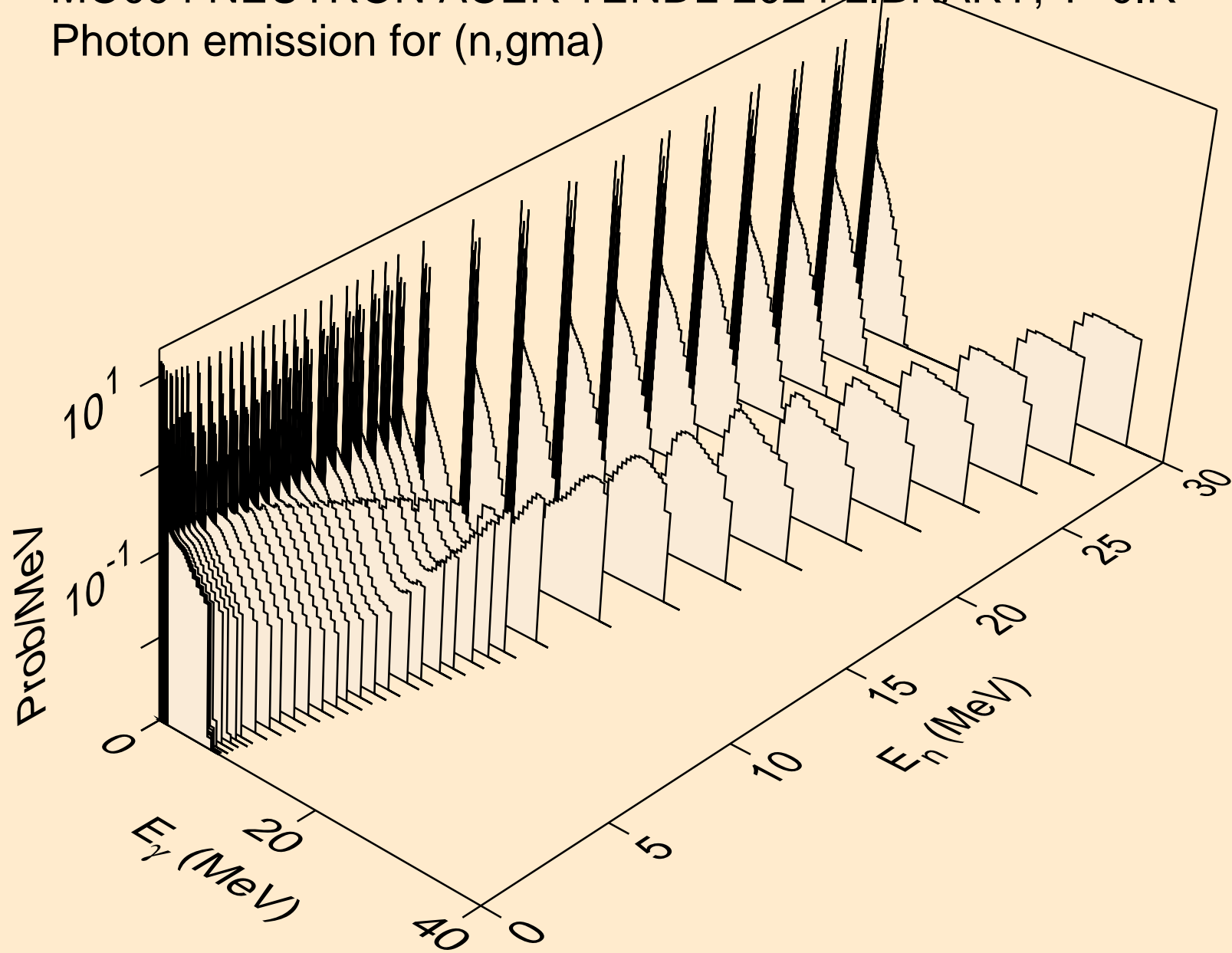

MO094 NEUTRON ACER TENDL-2024 LIBRARY; T=0.K
Photon emission for (n,p)

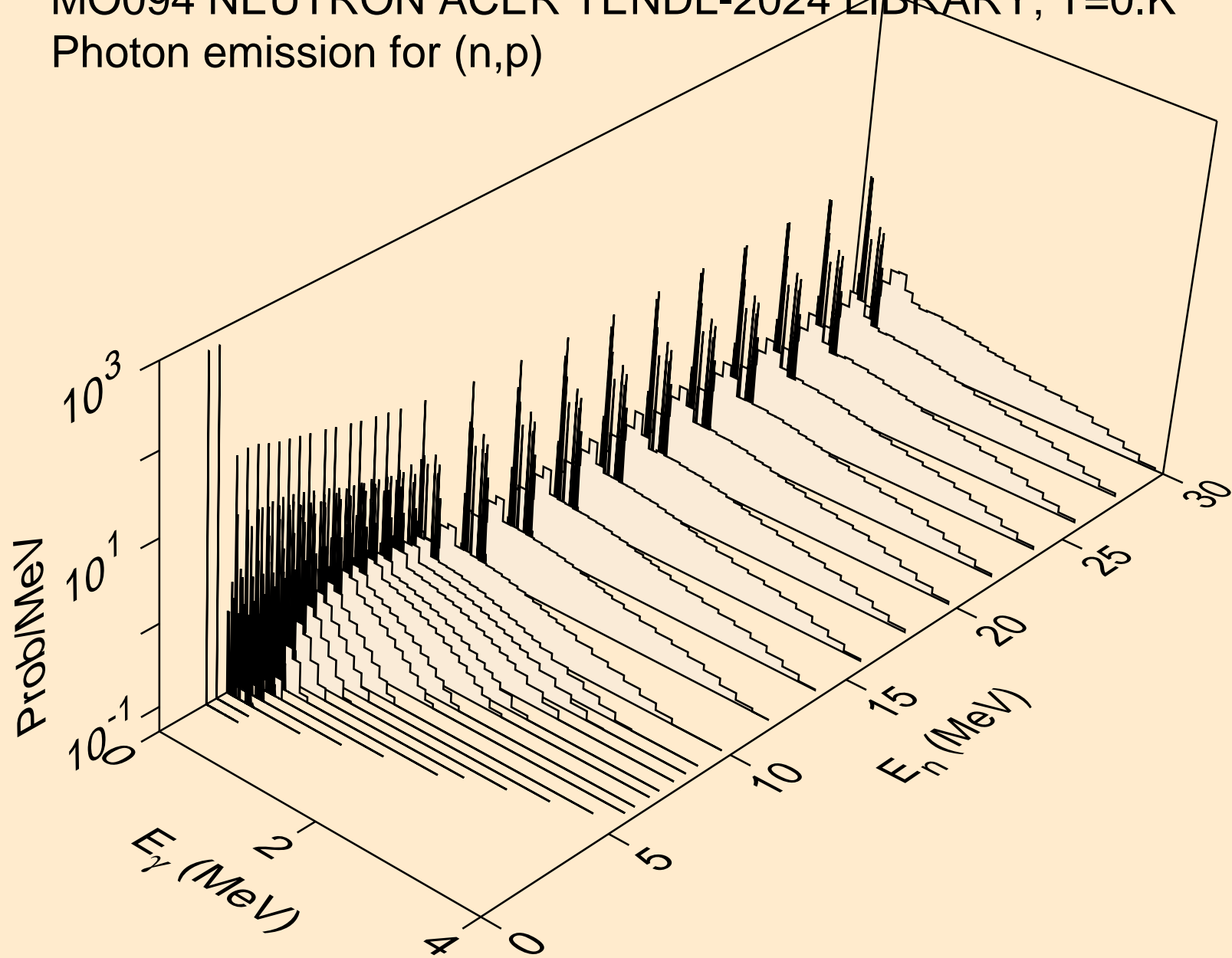

MO094 NEUTRON ACER TENDL-2024 LIBRARY; T=0.K
Photon emission for (n,d)

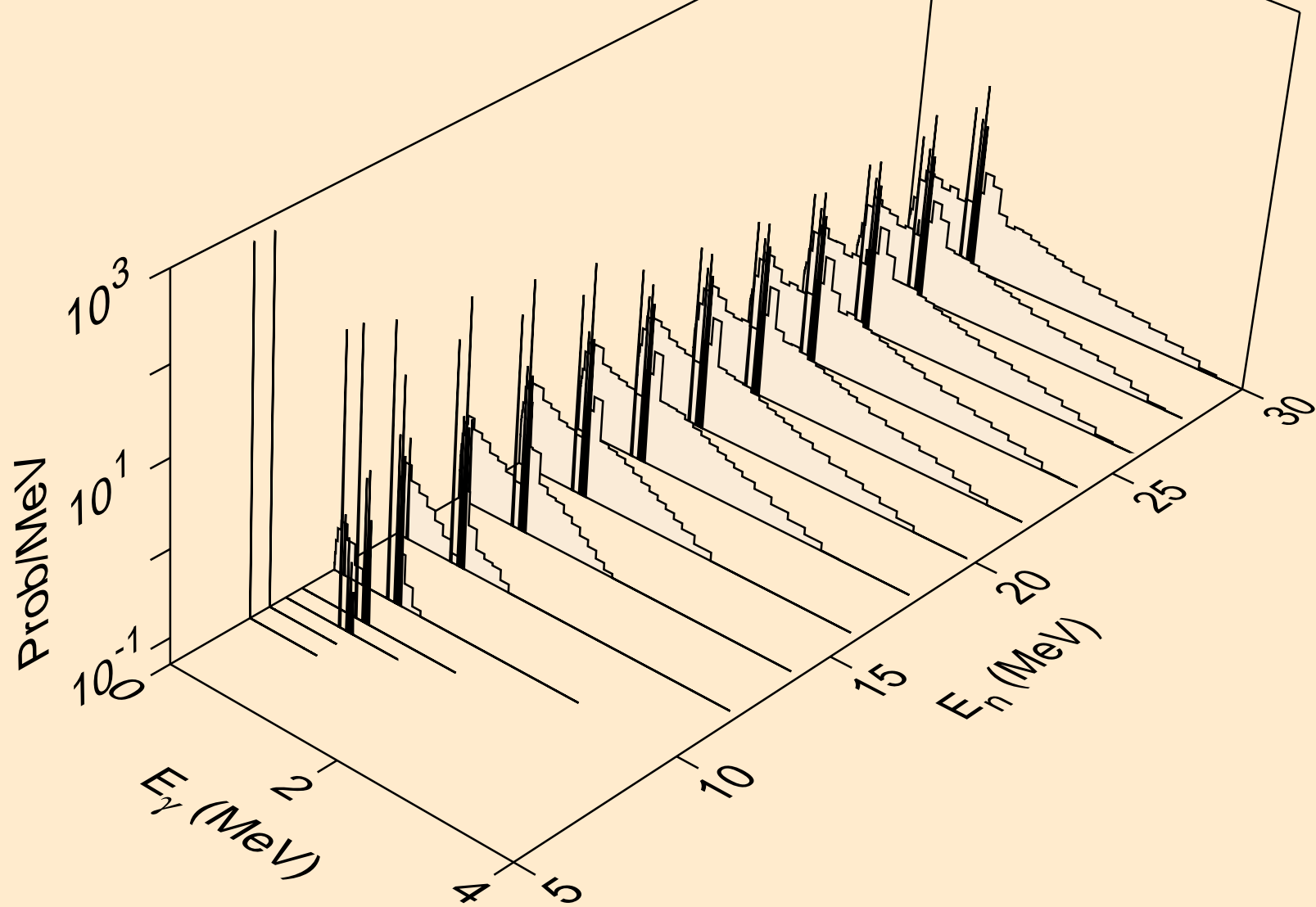

MO094 NEUTRON ACER TENDL-2024 LIBRARY; T=0.K
Photon emission for (n,t)

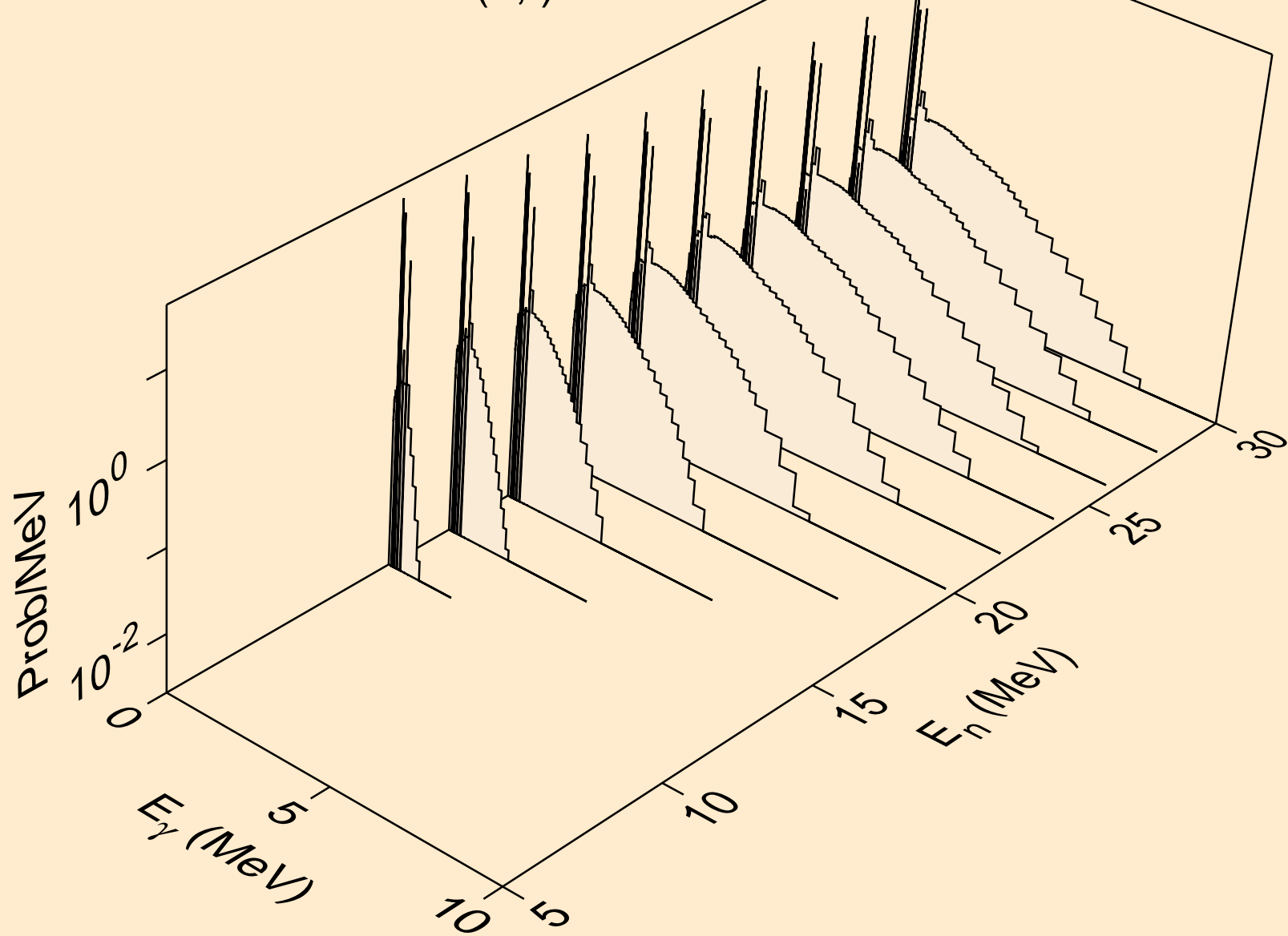

MO094 NEUTRON ACER TENDL-2024 LIBRARY; T=0.K
Photon emission for (n,he3)

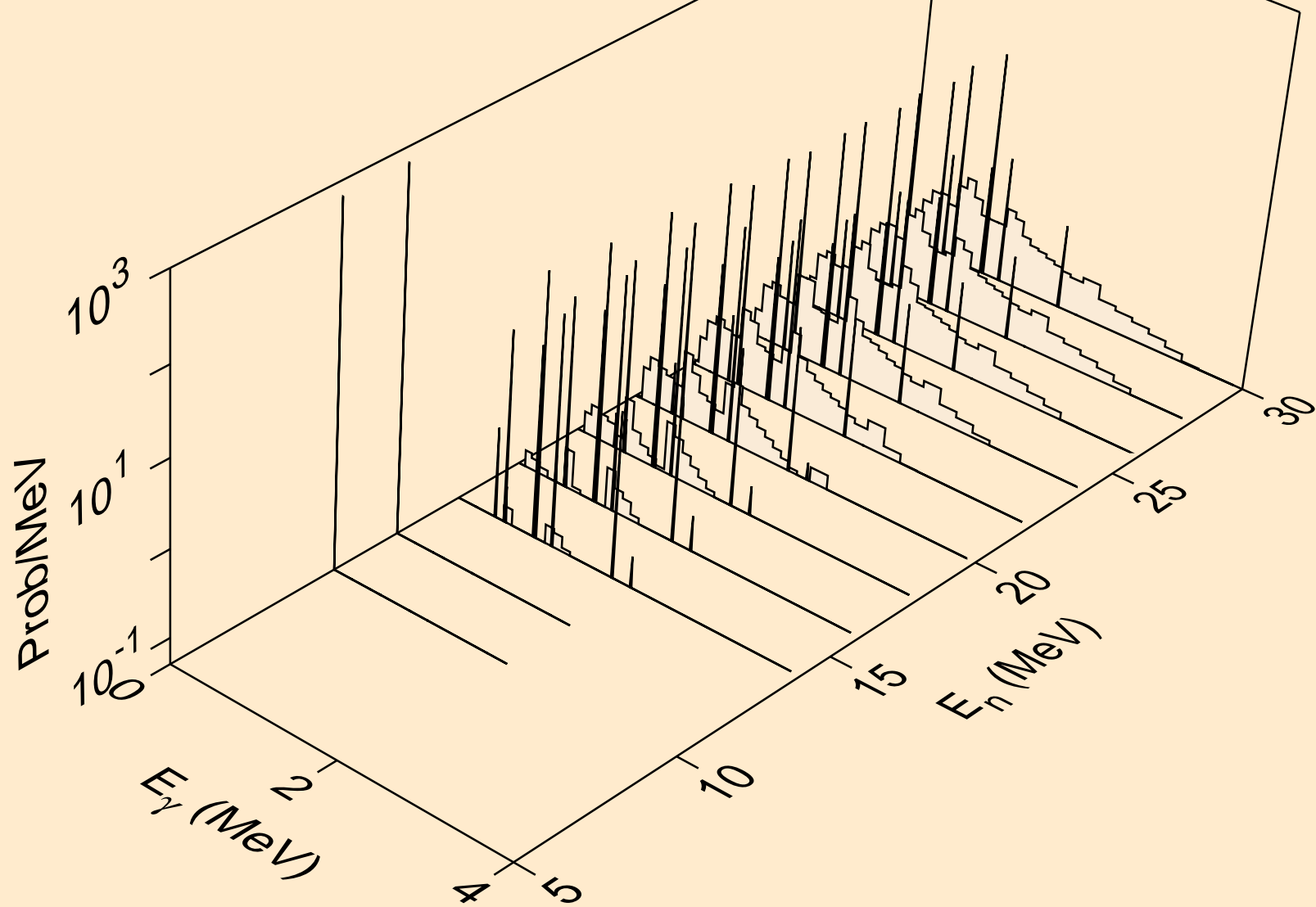

MO094 NEUTRON ACER TENDL-2024 LIBRARY; T=0.K
Photon emission for (n,a)

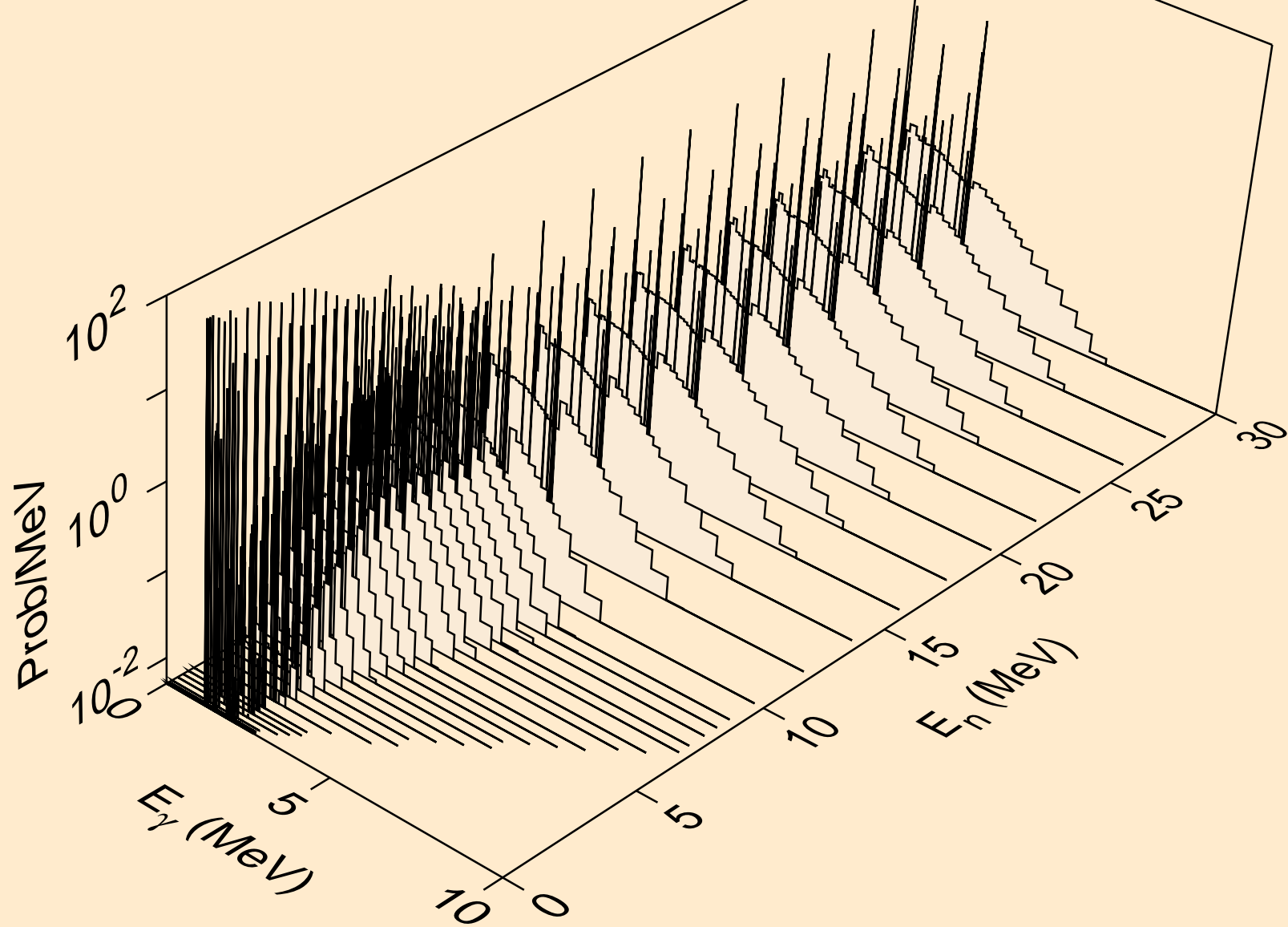

MO094 NEUTRON ACER TENDL-2024 LIBRARY; T=0.K
Photon emission for (n,2a)

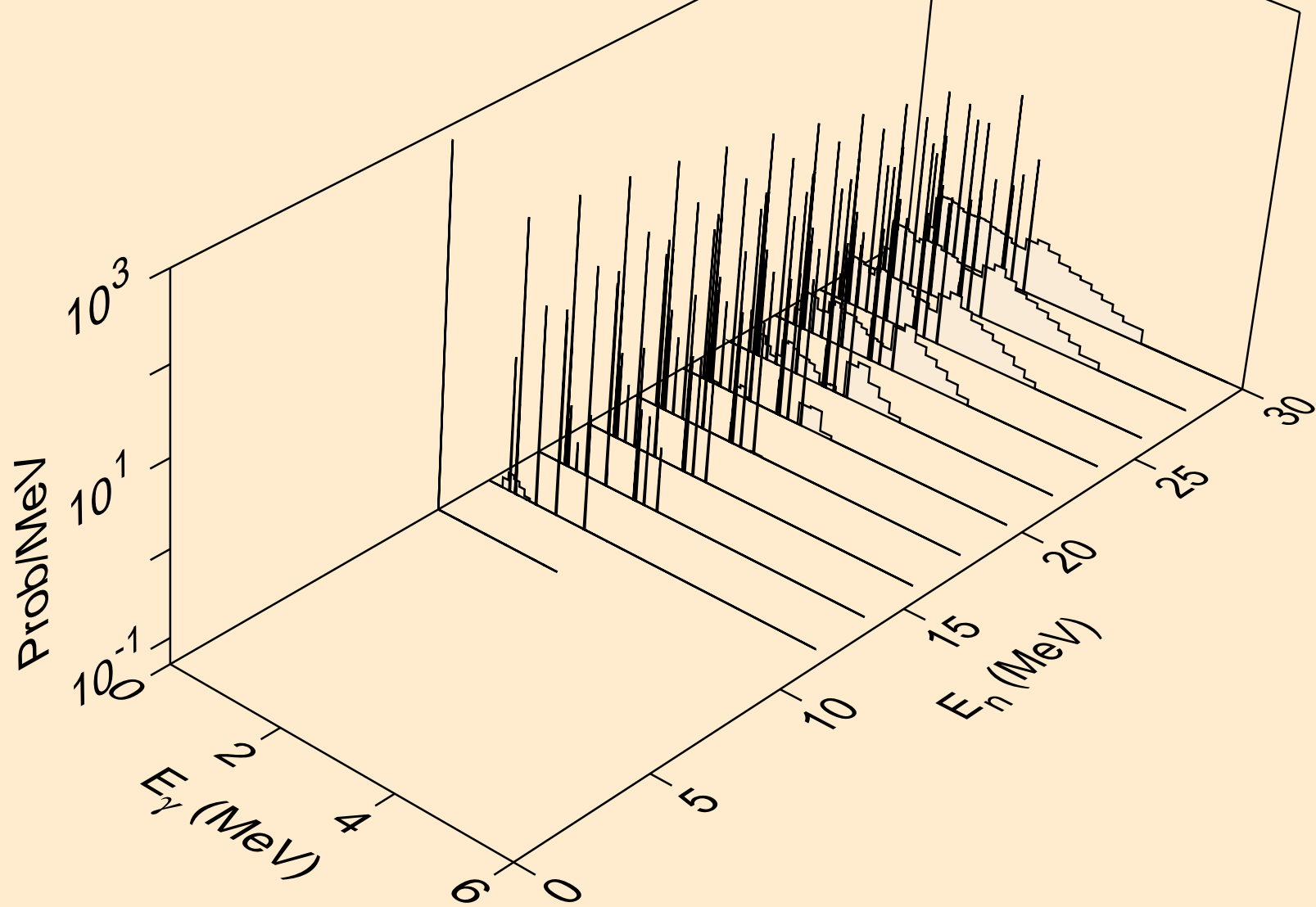

MO094 NEUTRON ACER TENDL-2024 LIBRARY; T=0.K
Photon emission for (n,2p)

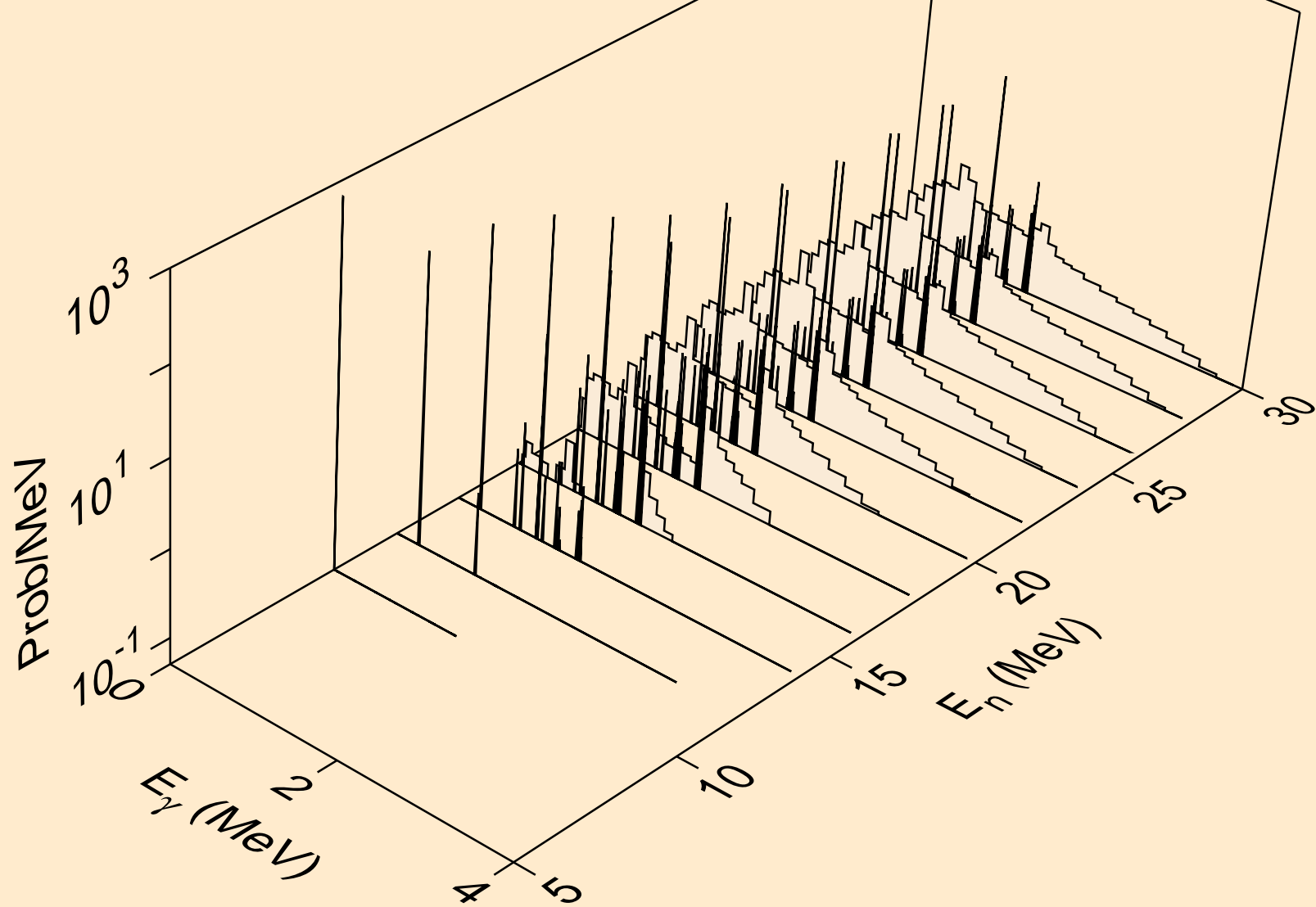

MO094 NEUTRON ACER TENDL-2024 LIBRARY; T=0.K
Photon emission for (n,p α)

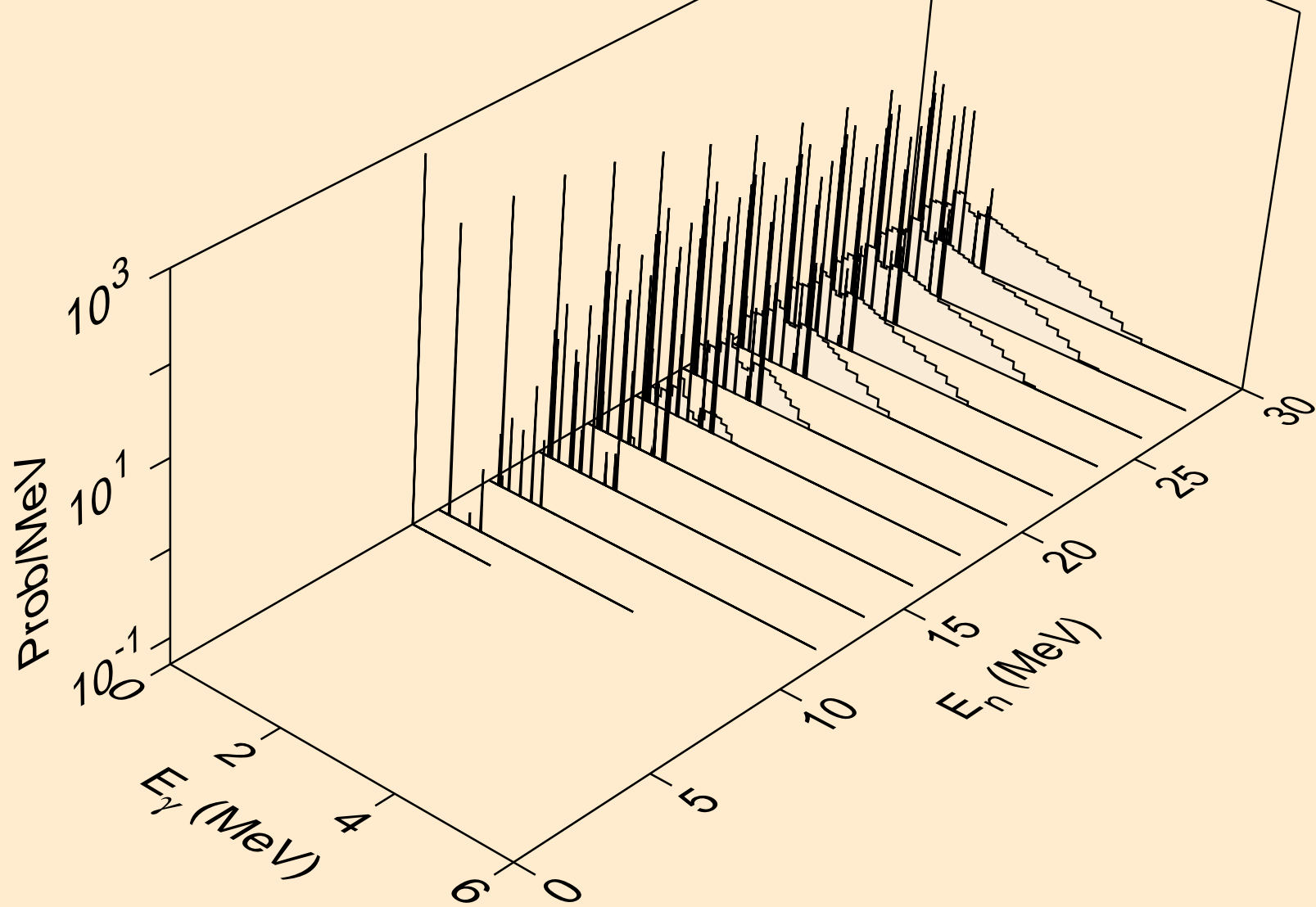

MO094 NEUTRON ACER TENDL-2024 LIBRARY; T=0.K
Photon emission for (n,pd)

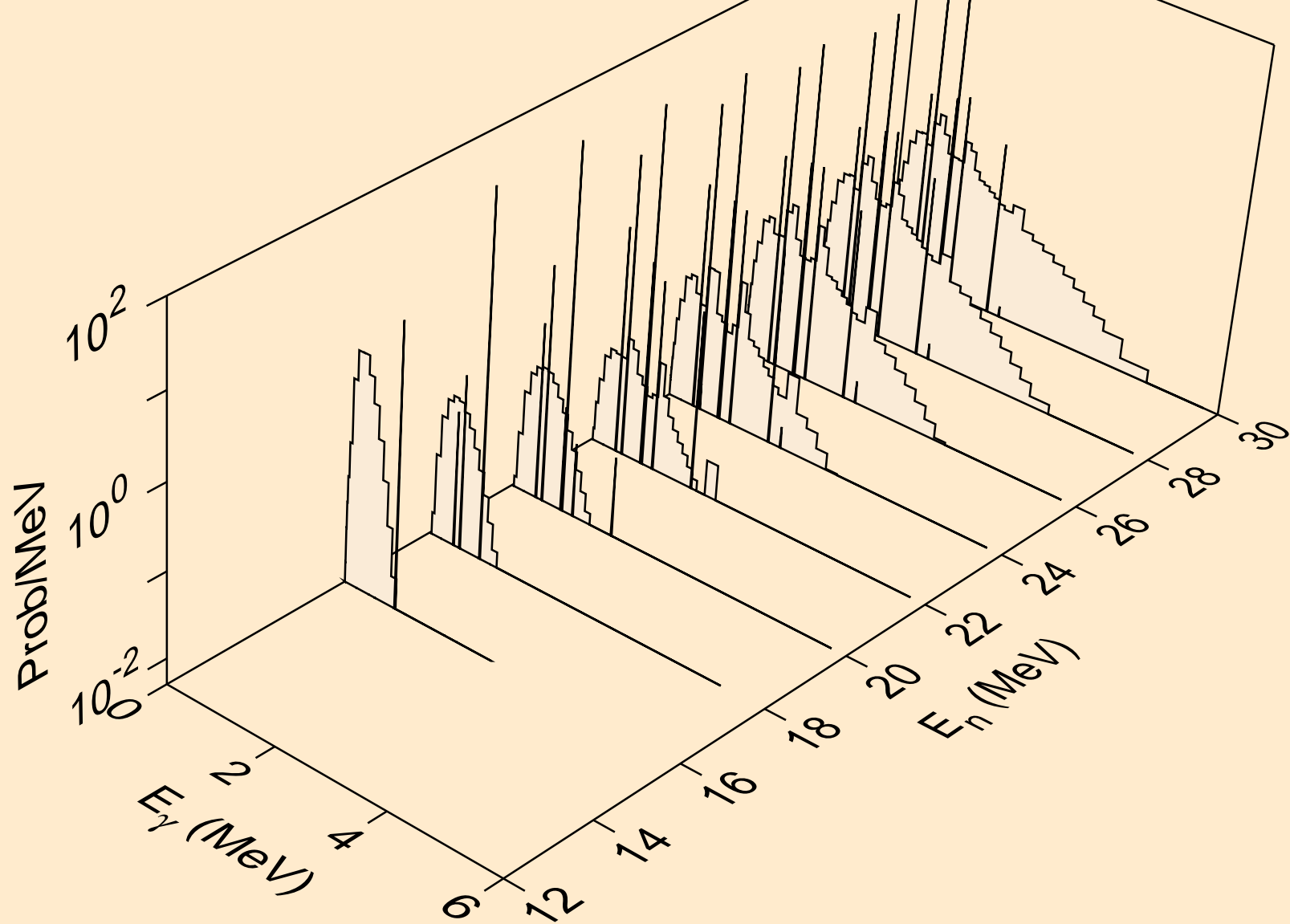

MO094 NEUTRON ACER TENDL-2024 LIBRARY; T=0.K
Photon emission for (n,pt)

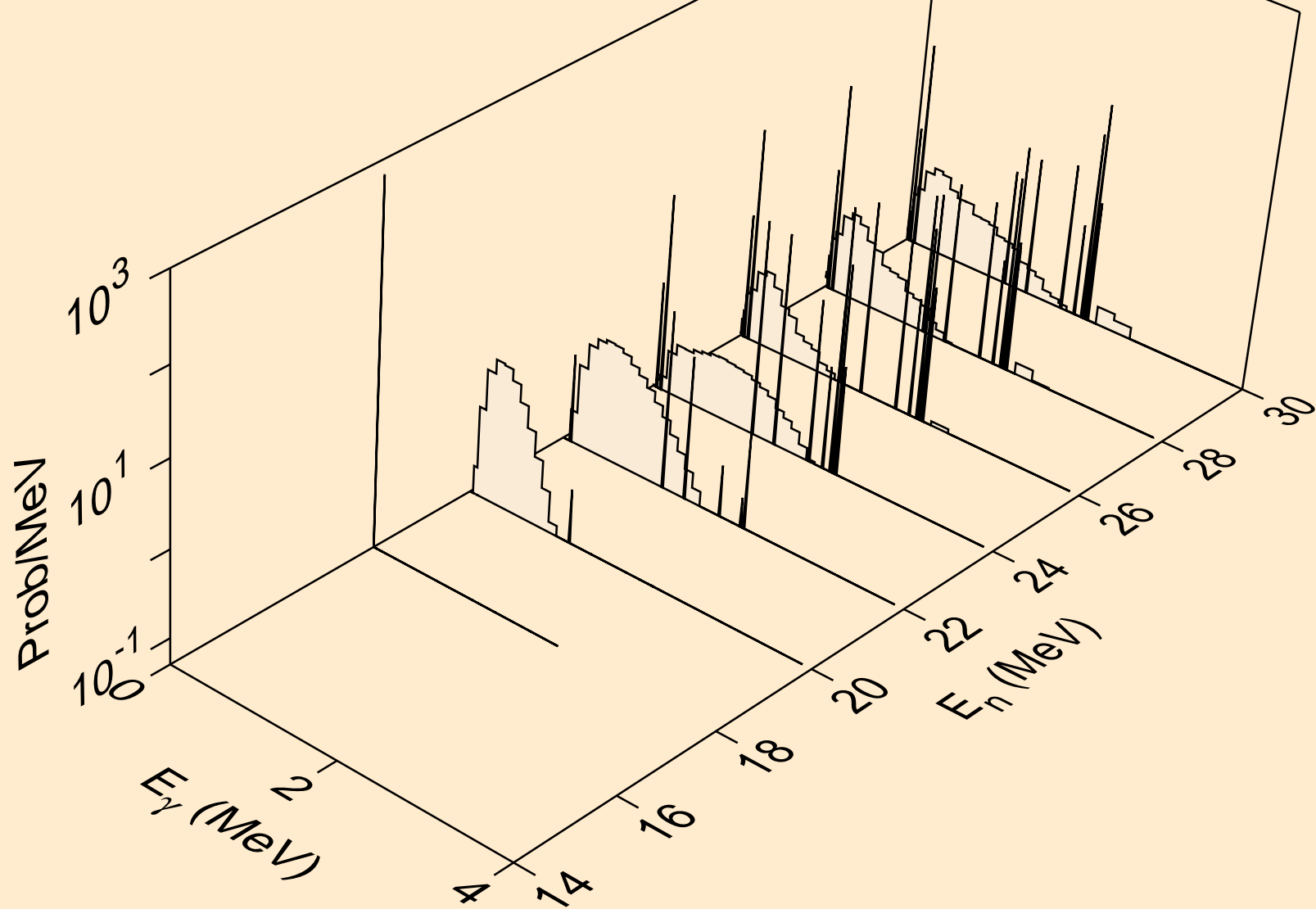

MO094 NEUTRON ACER TENDL-2024 LIBRARY; T=0.K
Photon emission for (n,da)

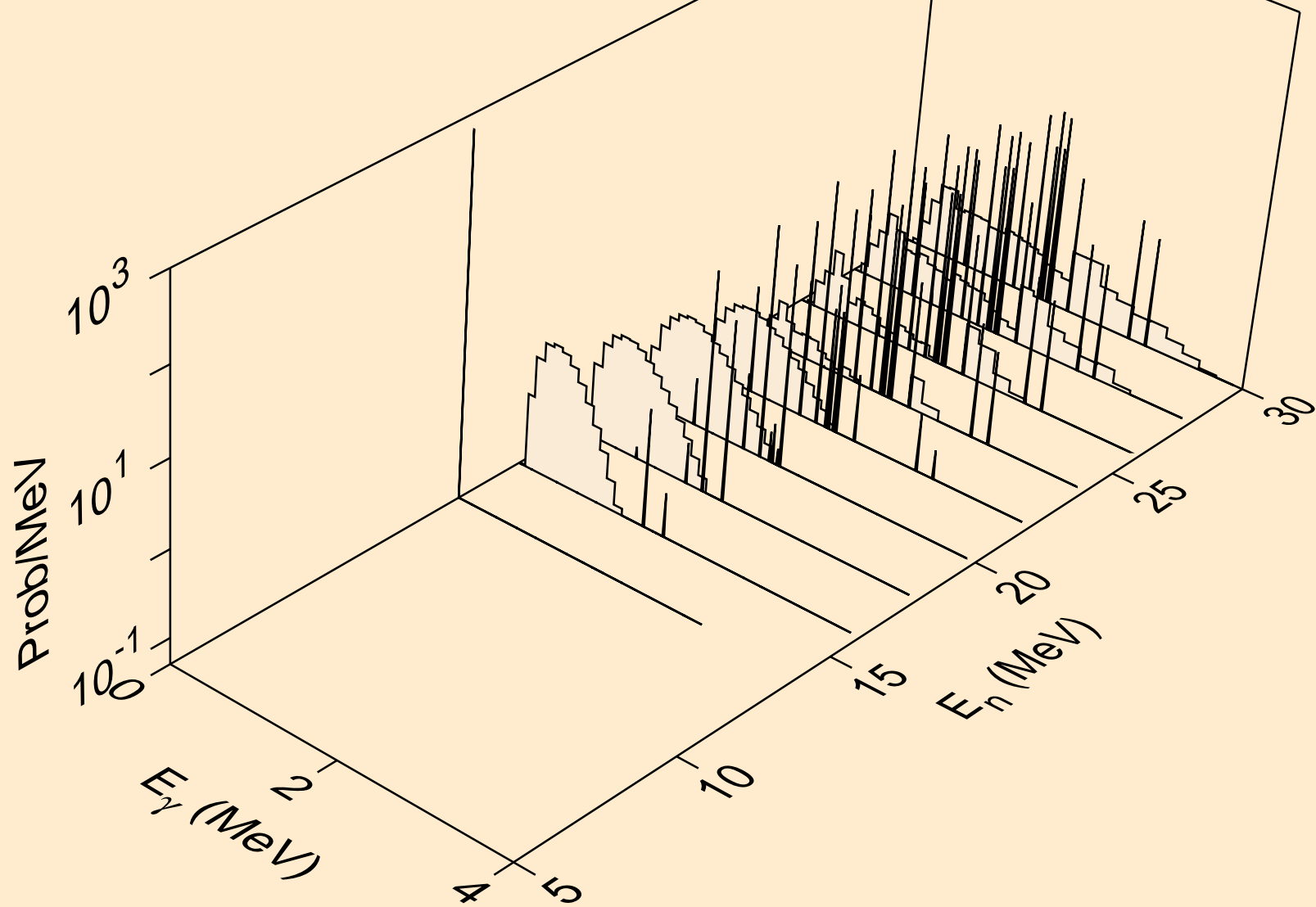

MO094 NEUTRON ACER TENDL-2024 LIBRARY; T=0.K
thermal capture photon spectrum

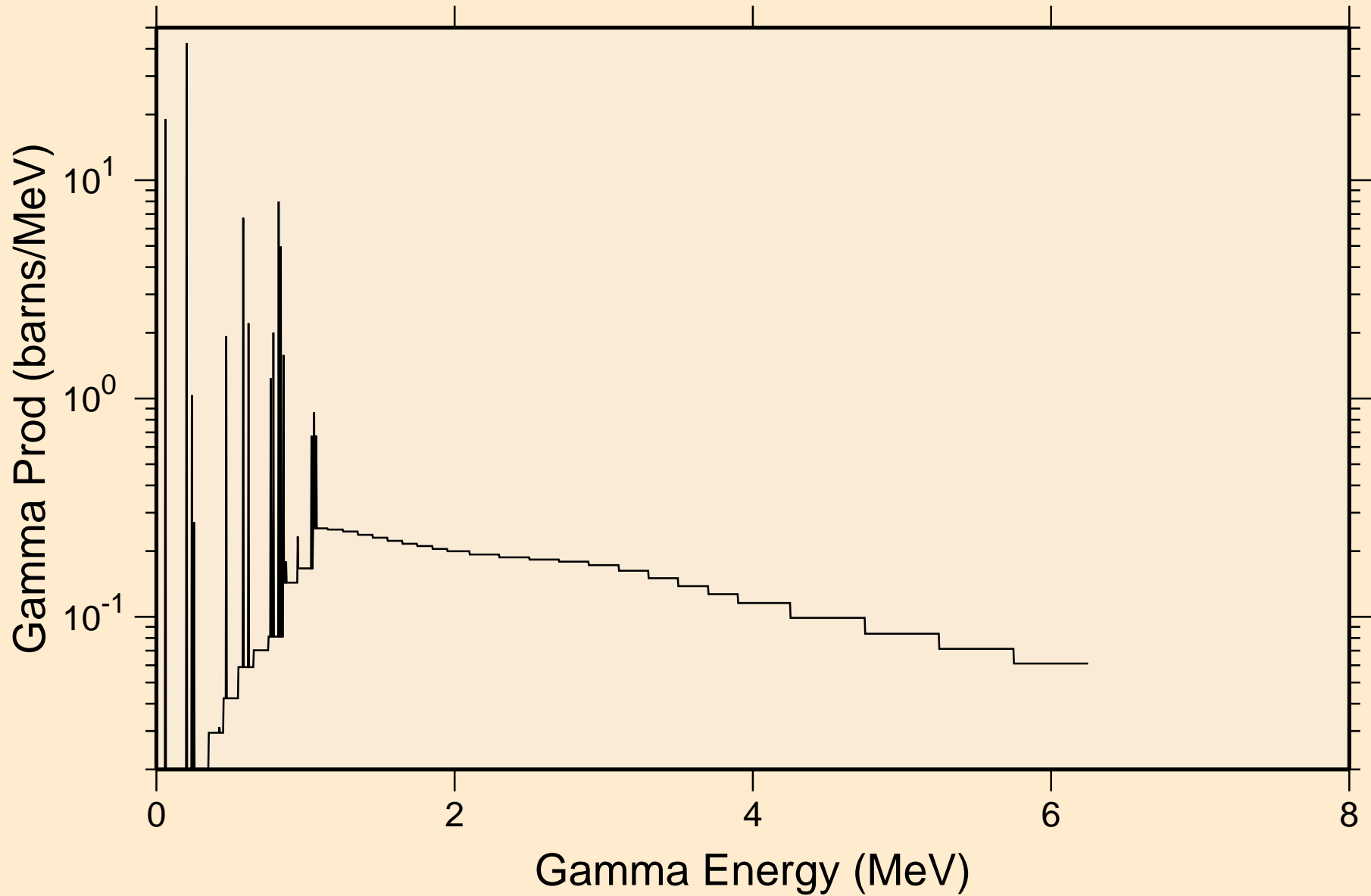

MO094 NEUTRON ACER TENDL-2024 LIBRARY; T=0.K
14 MeV photon spectrum

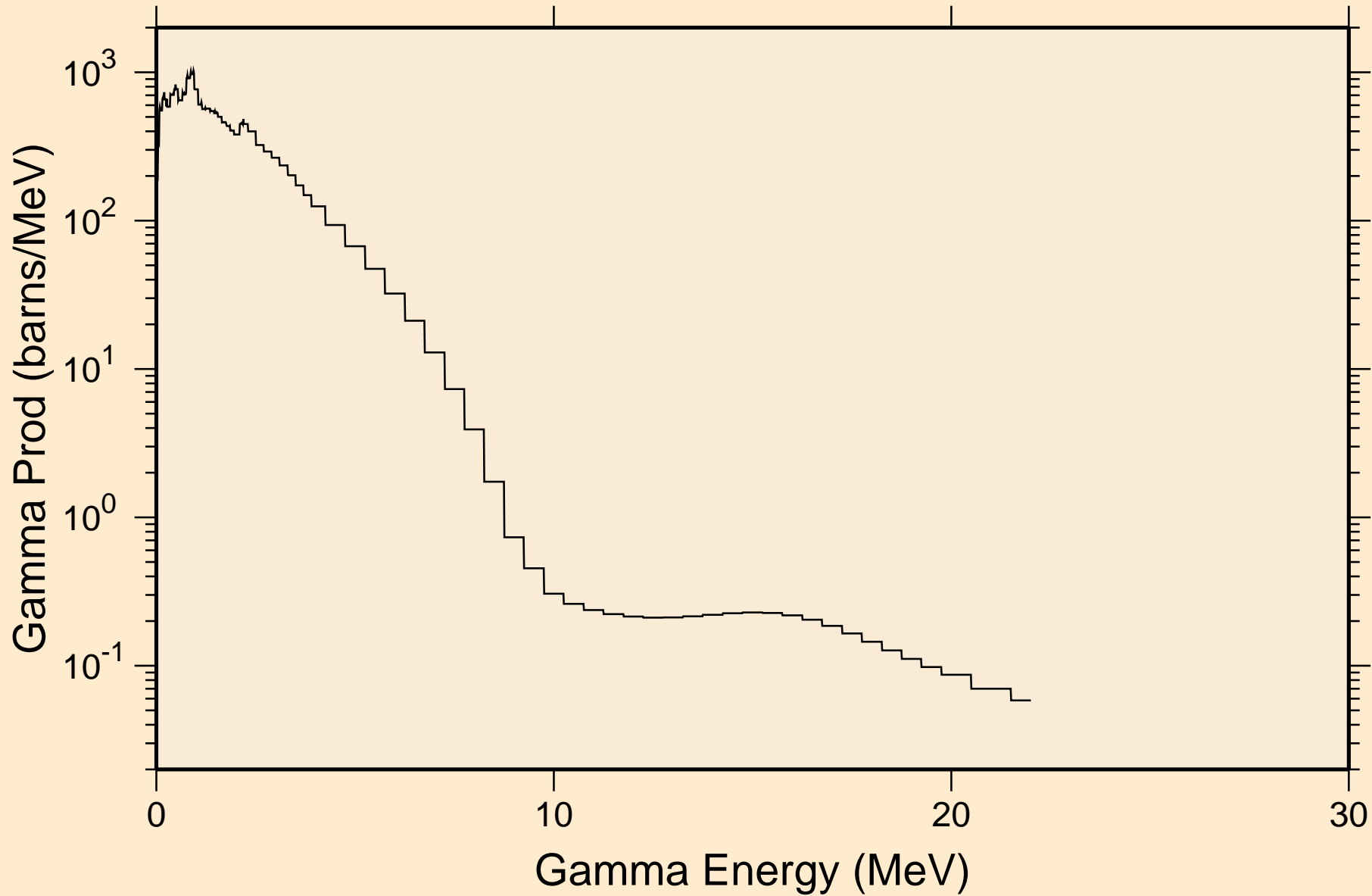

MO094 NEUTRON ACER TENDL-2024 LIBRARY; T=0.K
Particle heating contributions

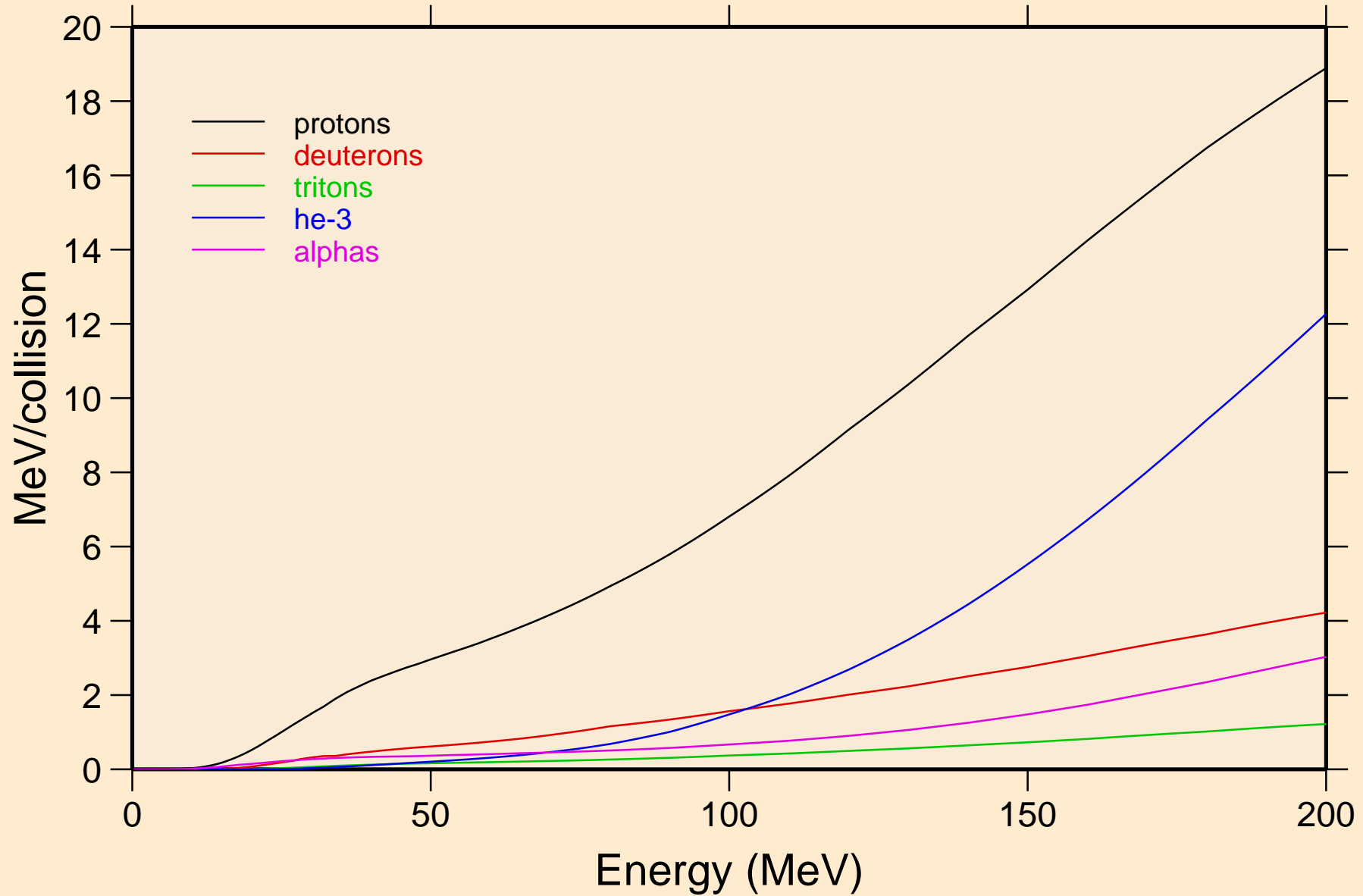

MO094 NEUTRON ACER TENDL-2024 LIBRARY; T=0.K
Recoil Heating

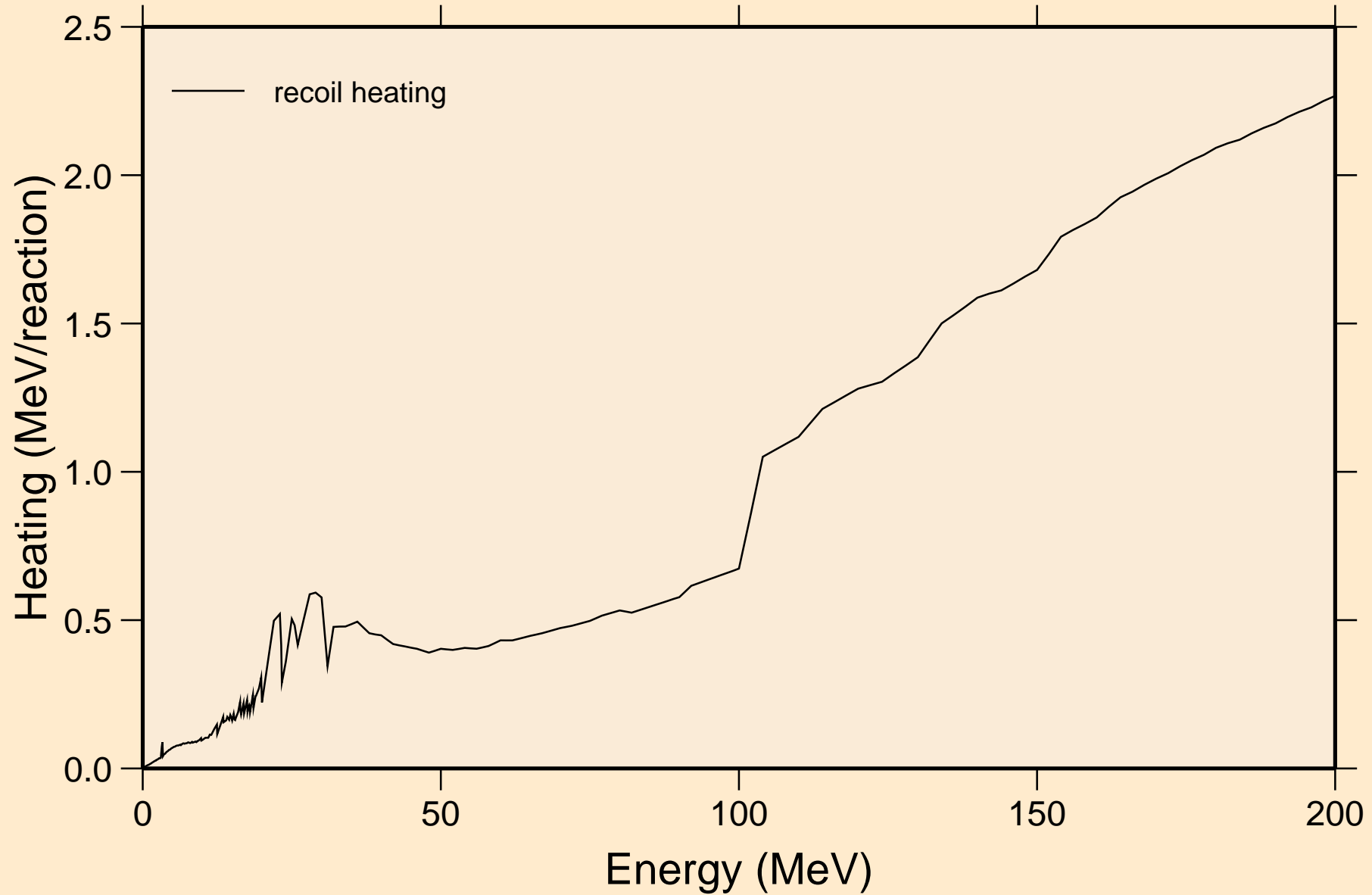

MO094 NEUTRON ACER TENDL-2024 LIBRARY; T=0.K
Particle production cross sections

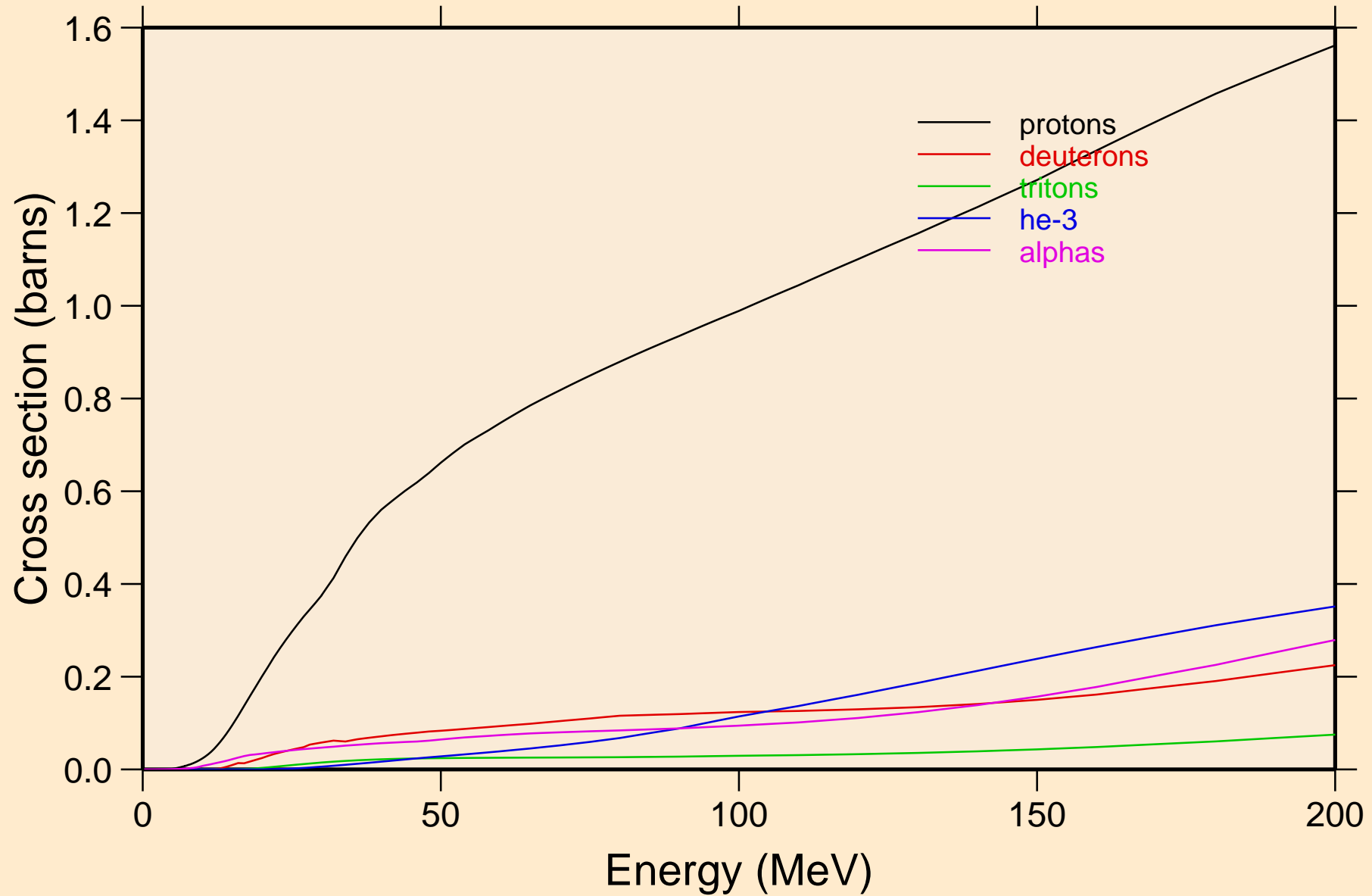

MO094 NEUTRON ACER TENDL-2024 LIBRARY; T=0.K
protons from (n,x)

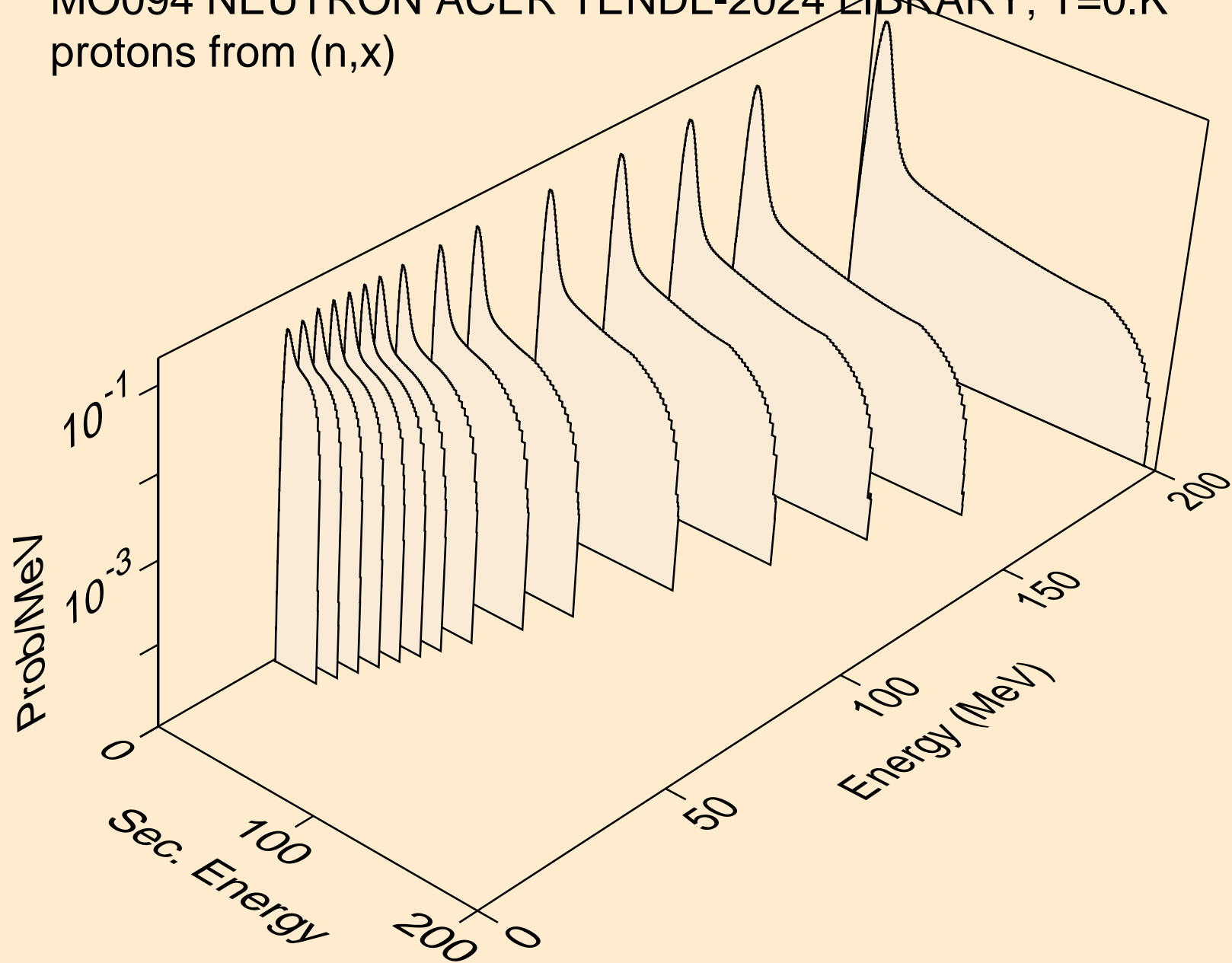

MO094 NEUTRON ACER TENDL-2024 LIBRARY; T=0.K
protons from (n,n*)p

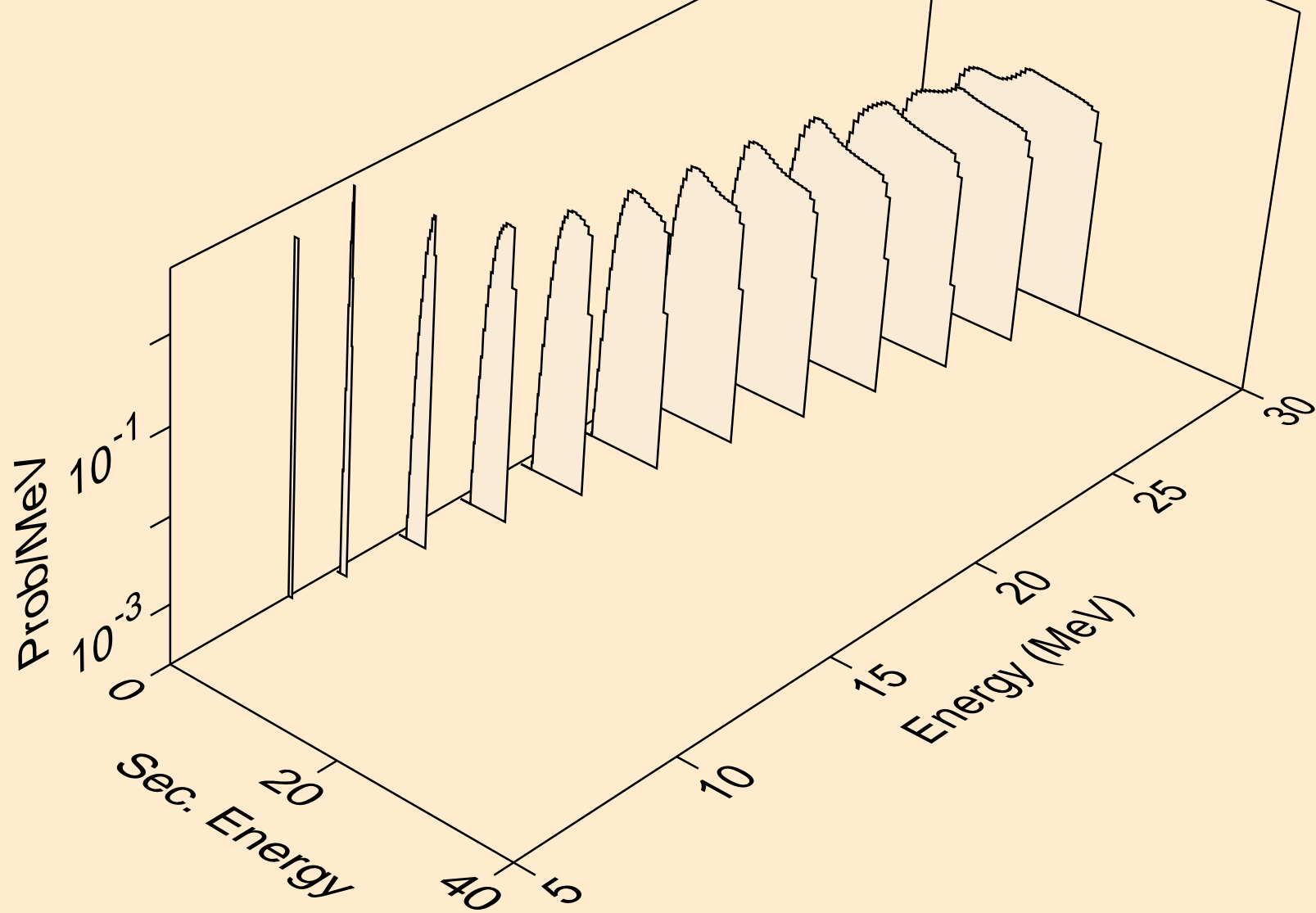

MO094 NEUTRON ACER TENDL-2024 LIBRARY; T=0.K
protons from (n,2np)

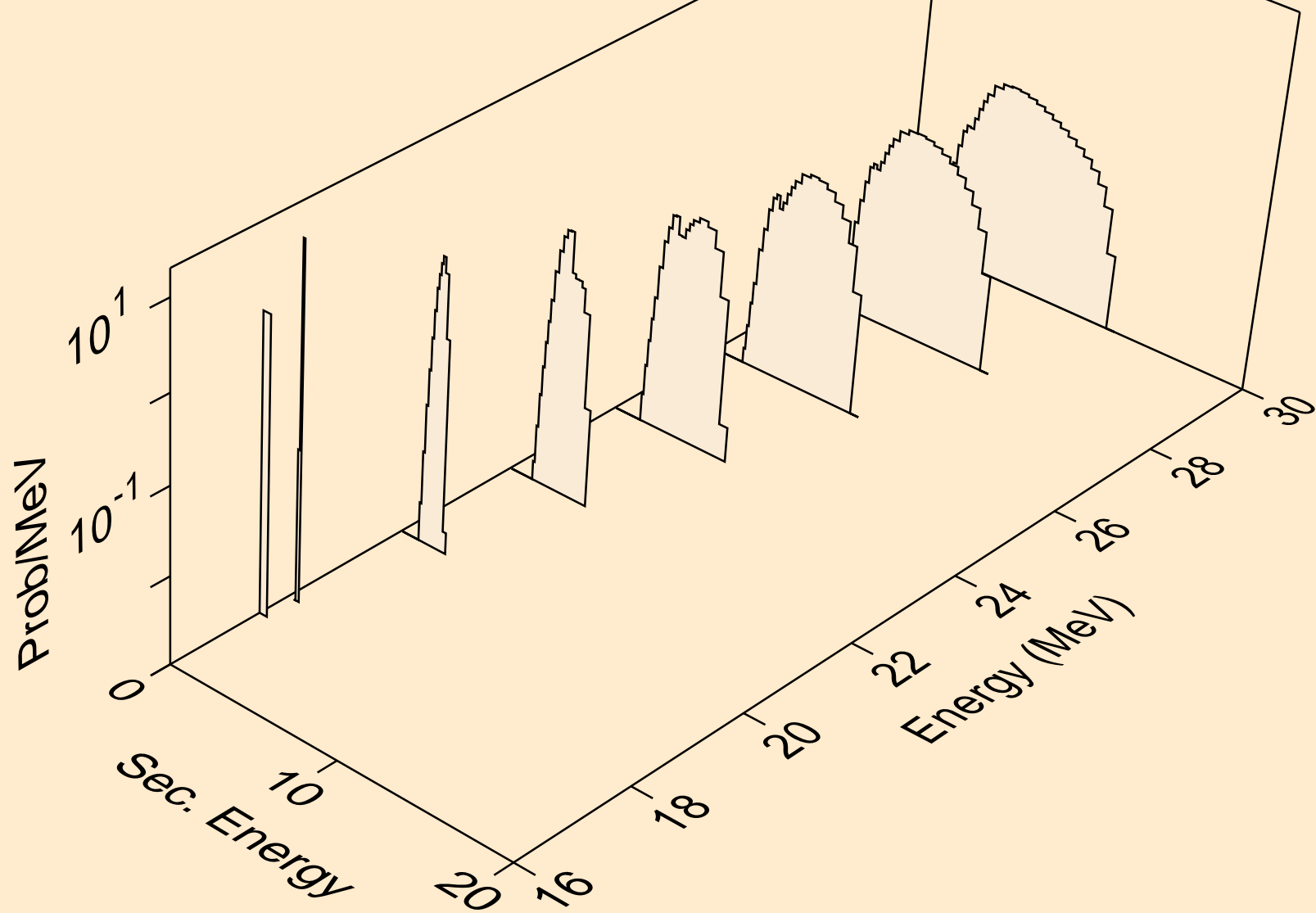

MO094 NEUTRON ACER TENDL-2024 LIBRARY; T=0.K
protons from (n,3np)

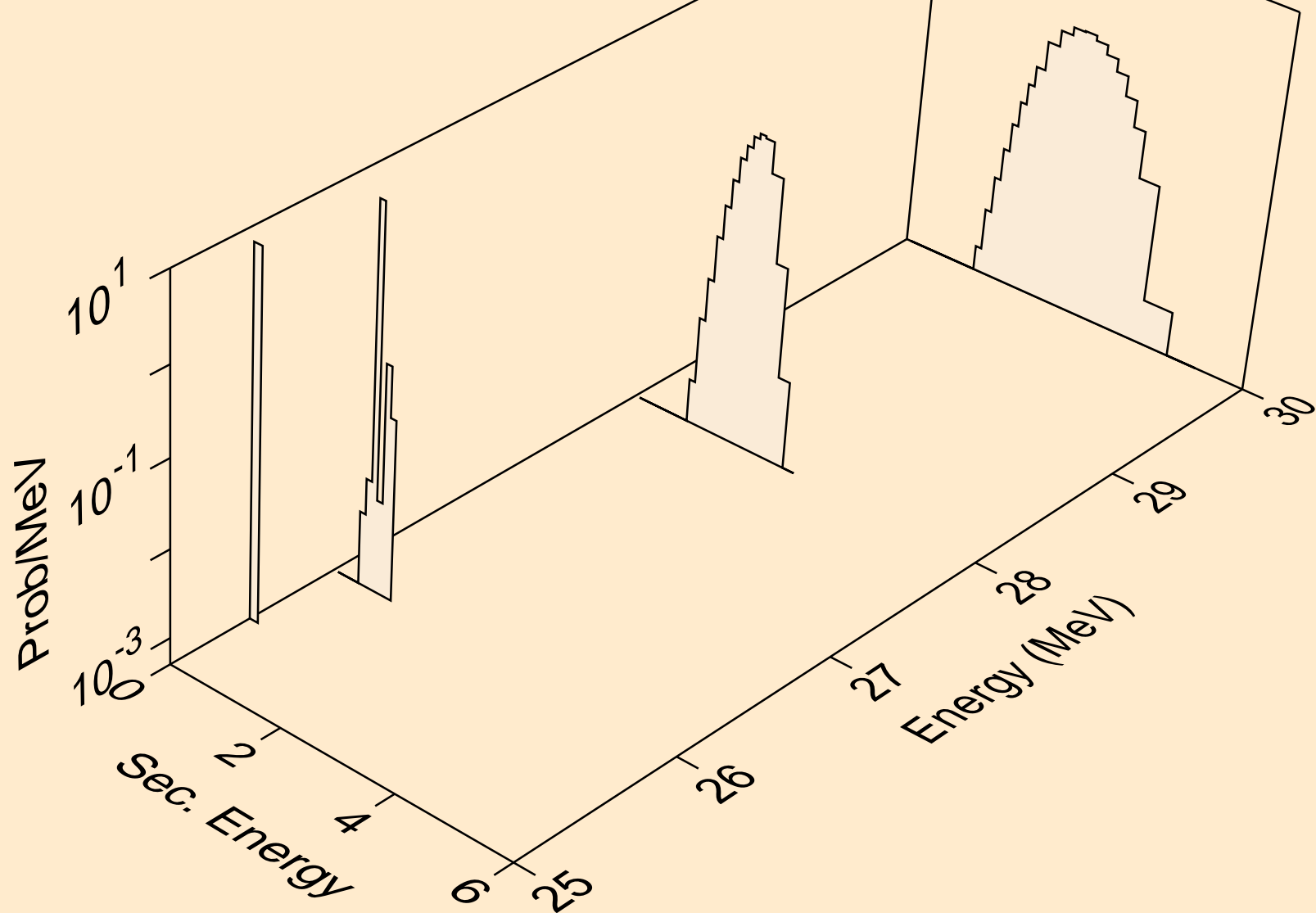

MO094 NEUTRON ACER TENDL-2024 LIBRARY; T=0.K
protons from (n,n2p)

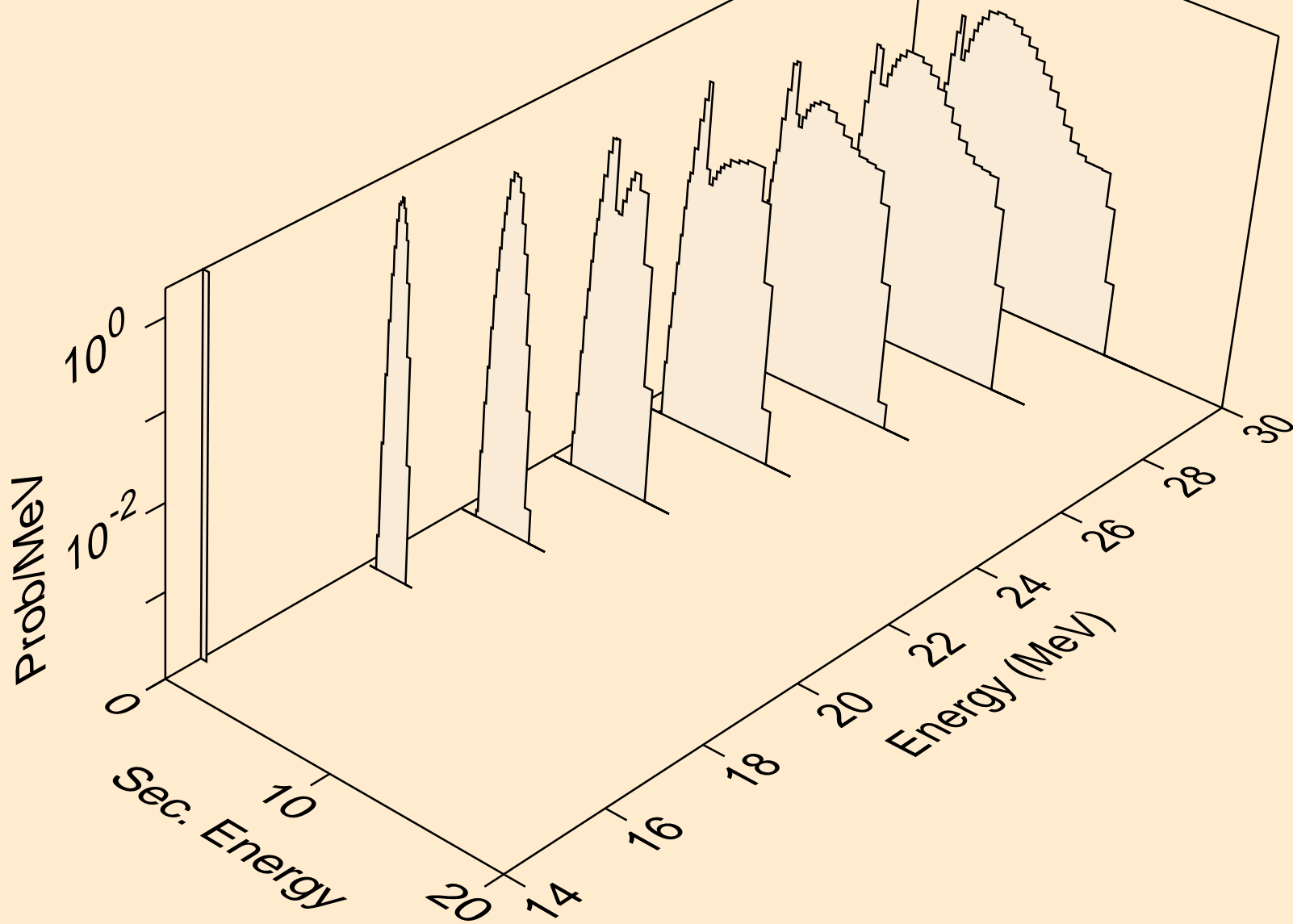

MO094 NEUTRON ACER TENDL-2024 LIBRARY; T=0.K
protons from (n,npa)

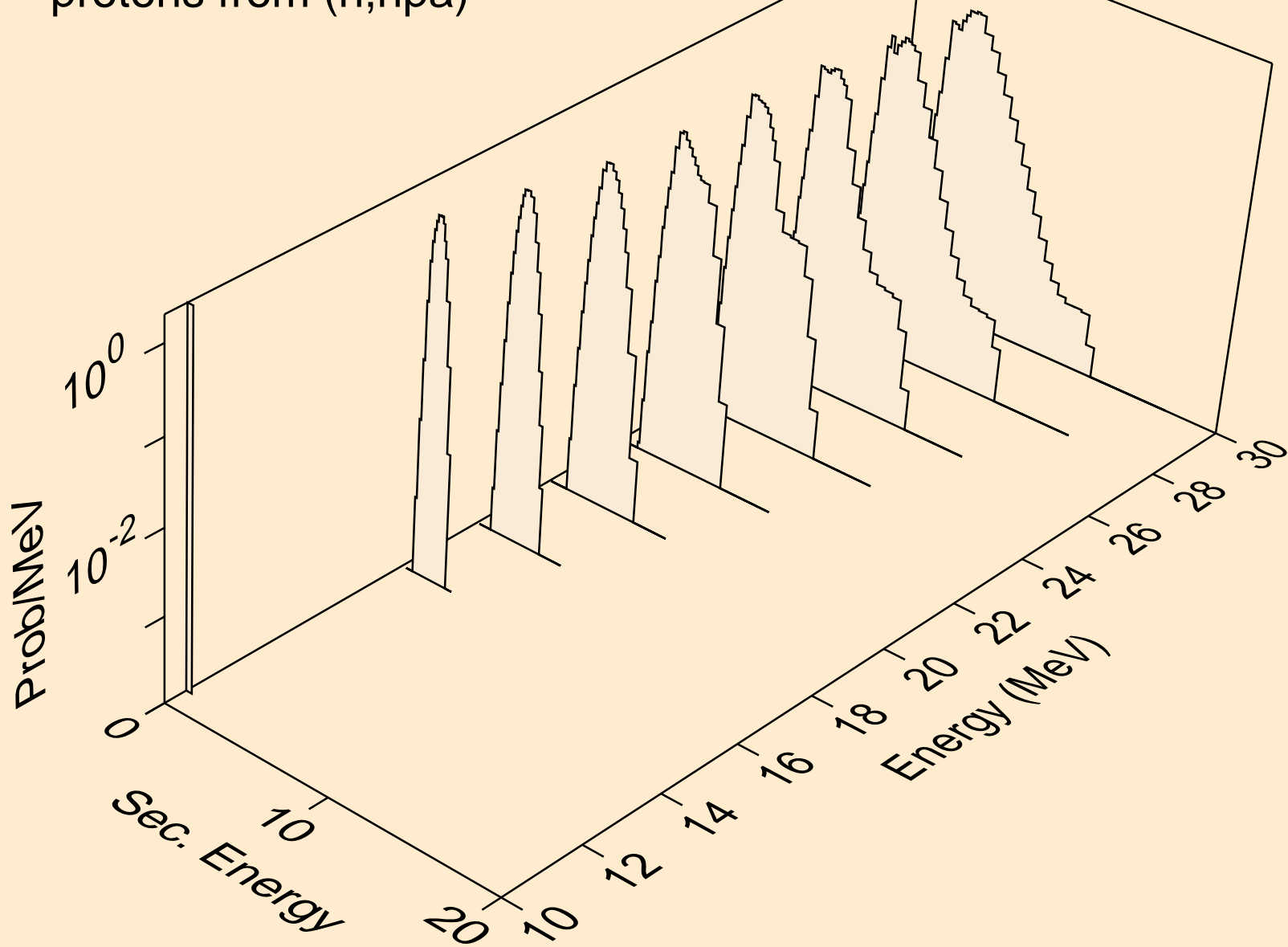

MO094 NEUTRON ACER TENDL-2024 LIBRARY; T=0.K
protons from (n,p)

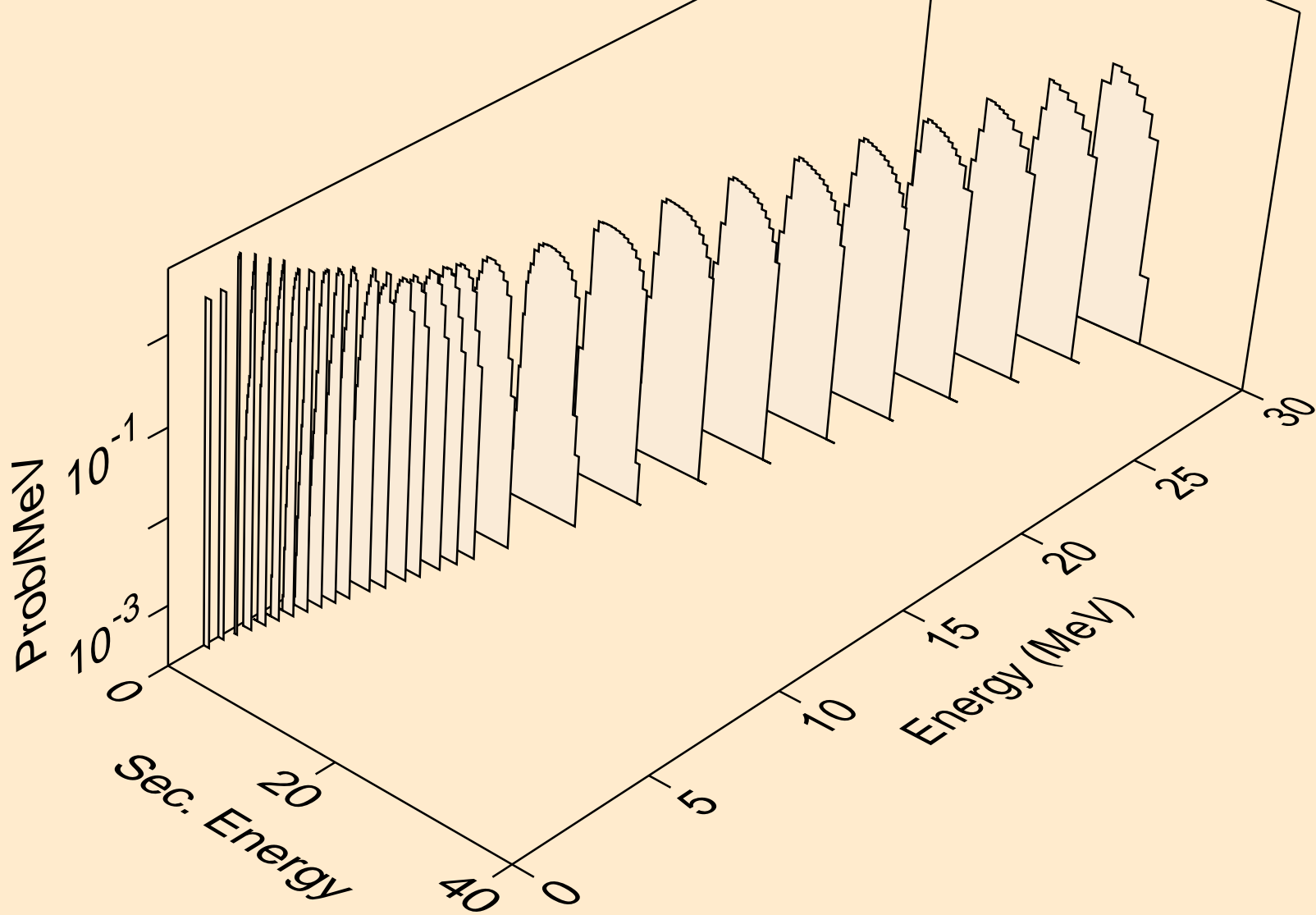

MO094 NEUTRON ACER TENDL-2024 LIBRARY; T=0.K
protons from (n,2p)

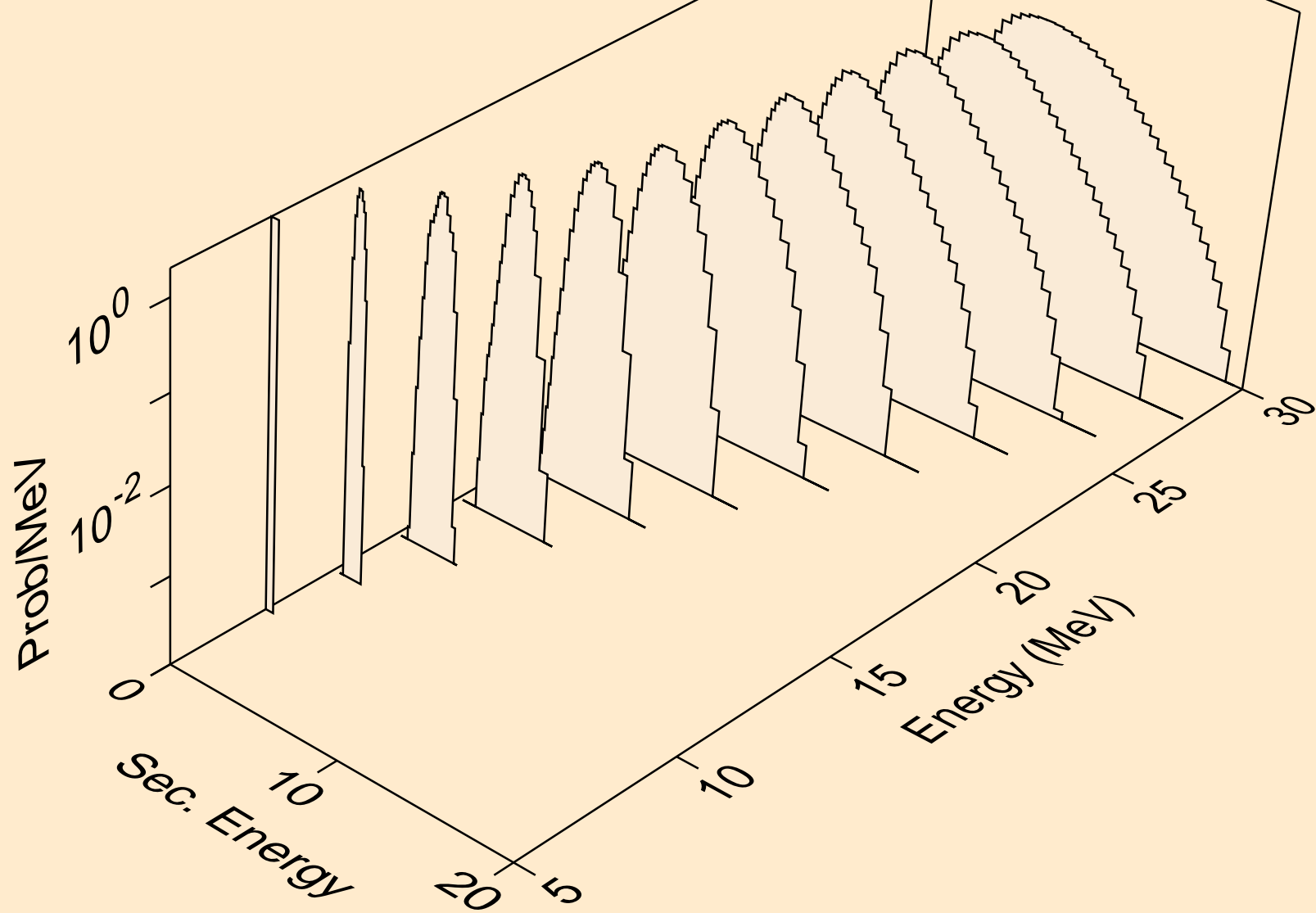

MO094 NEUTRON ACER TENDL-2024 LIBRARY; T=0.K
protons from (n,p)

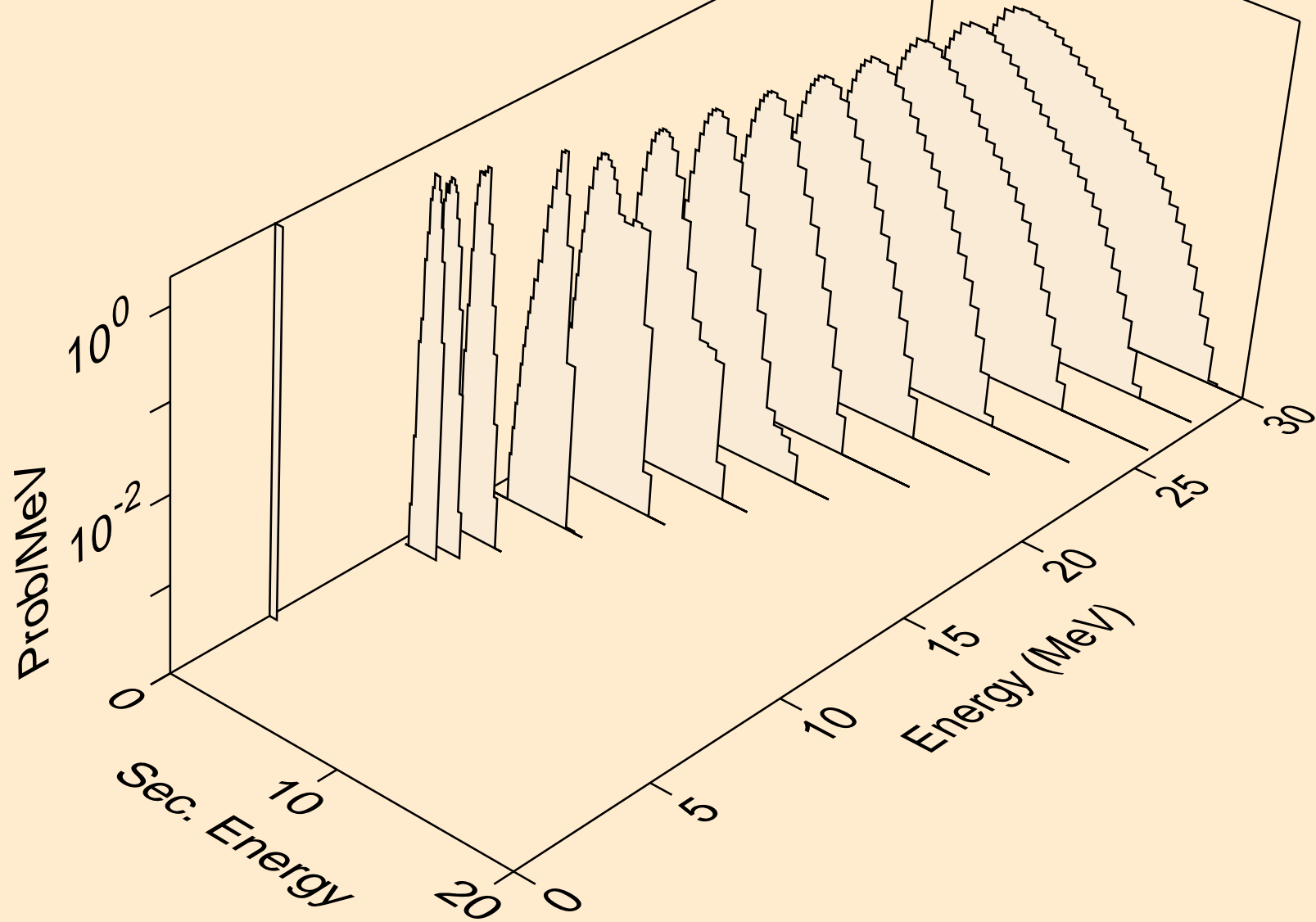

MO094 NEUTRON ACER TENDL-2024 LIBRARY; T=0.K
protons from (n,pd)

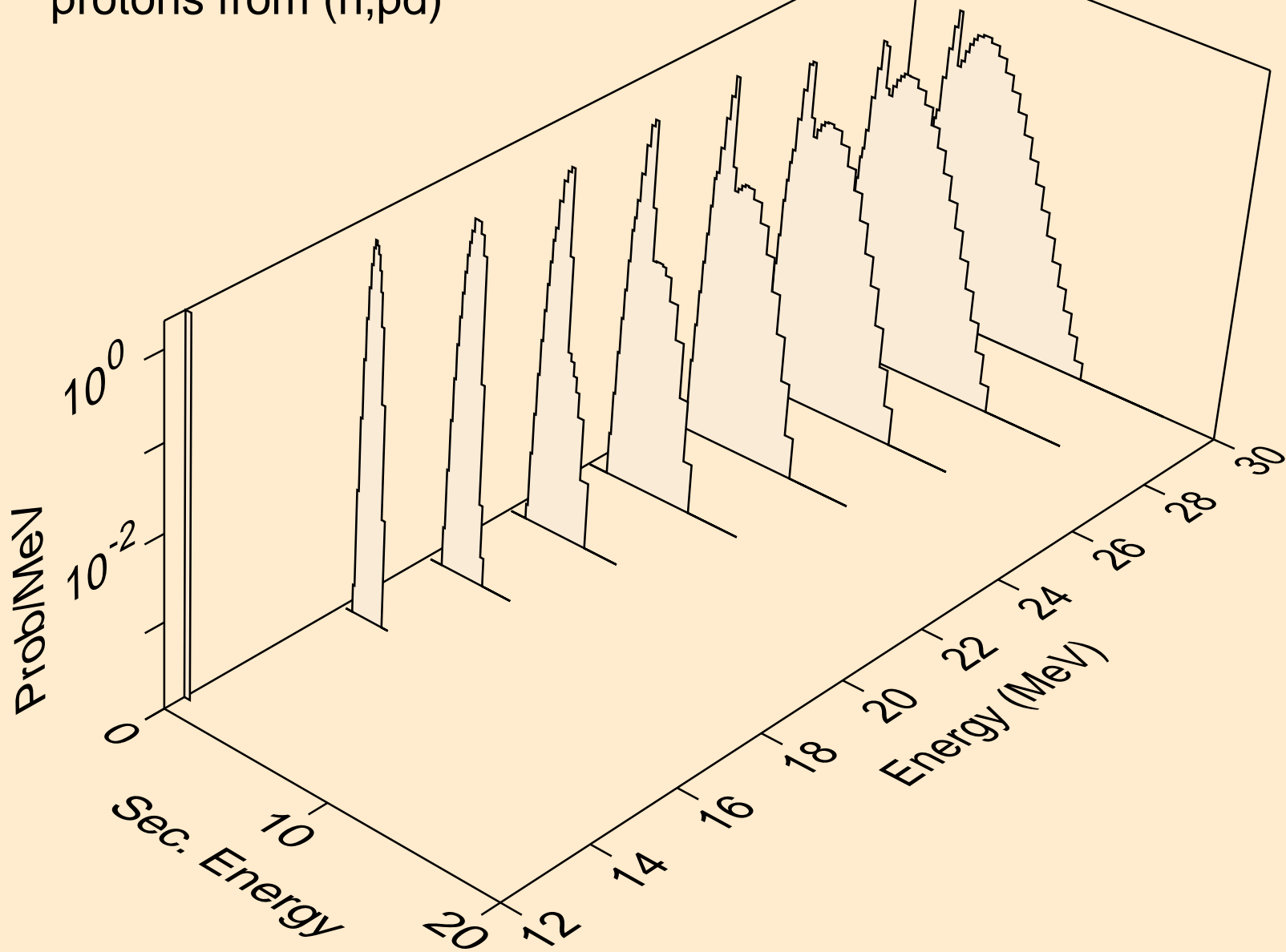

MO094 NEUTRON ACER TENDL-2024 LIBRARY; T=0.K
protons from (n,pt)

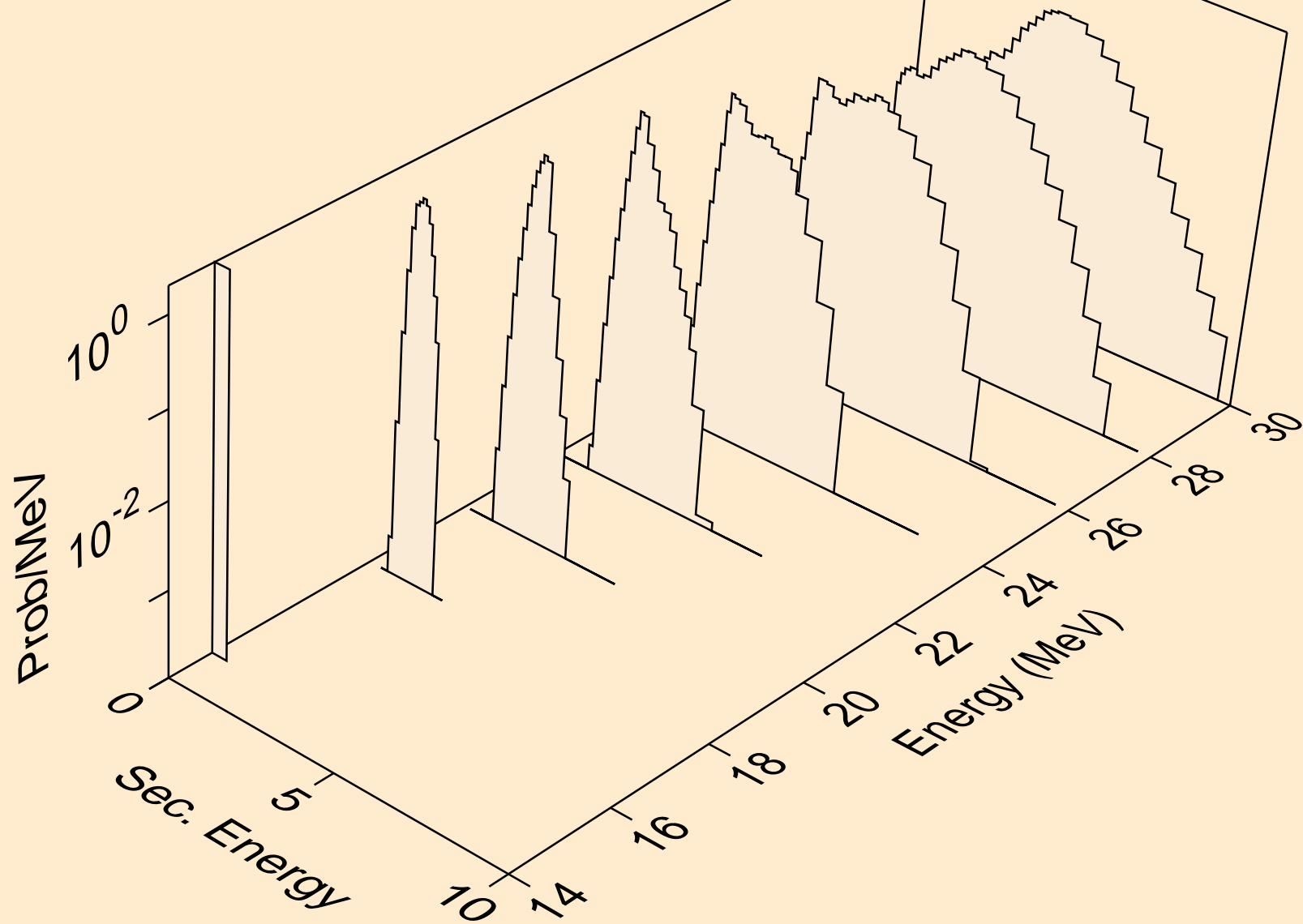

MO094 NEUTRON ACER TENDL-2024 LIBRARY; T=0.K
deuterons from (n,x)

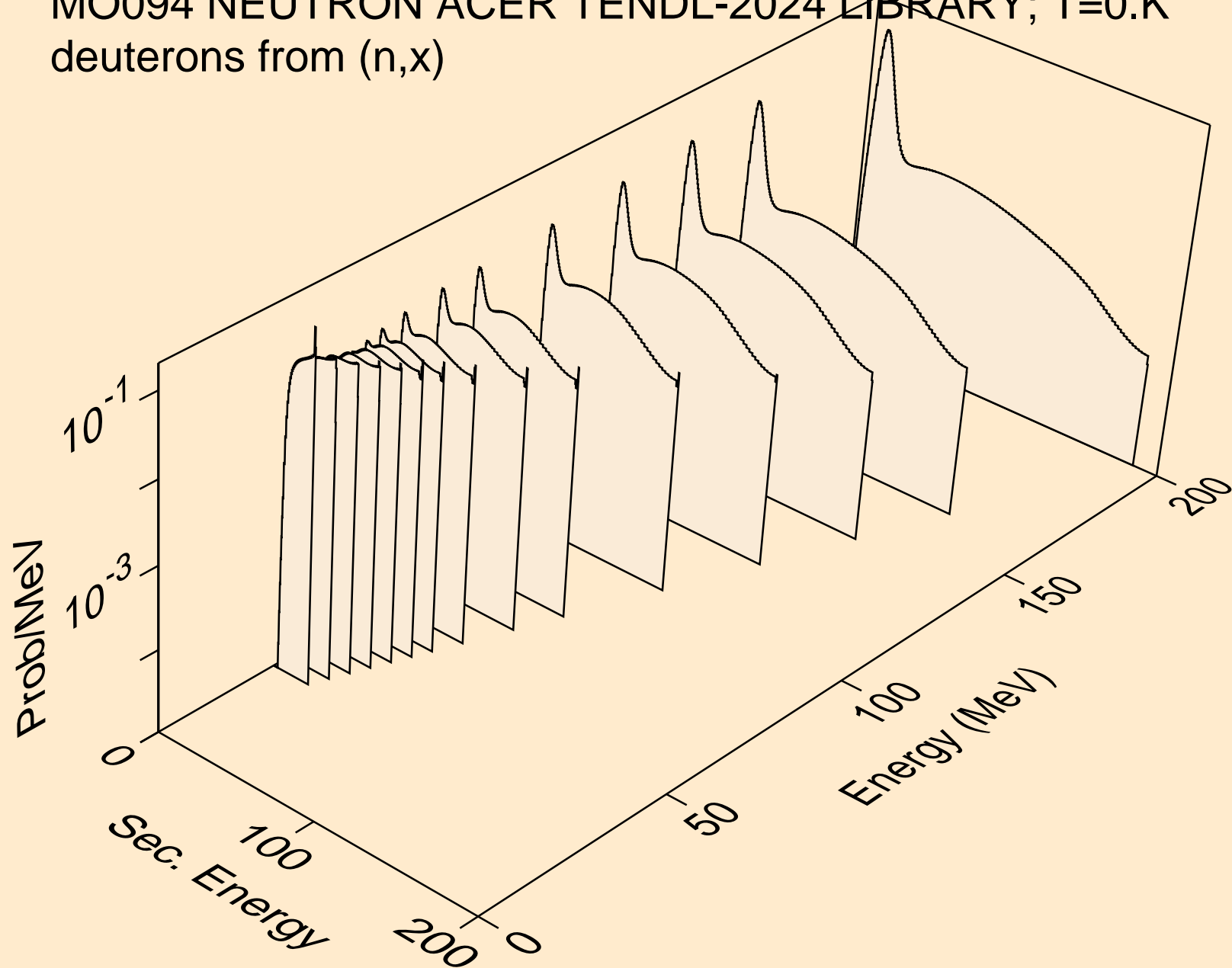

MO094 NEUTRON ACER TENDL-2024 LIBRARY; T=0.K
deuterons from (n,2nd)

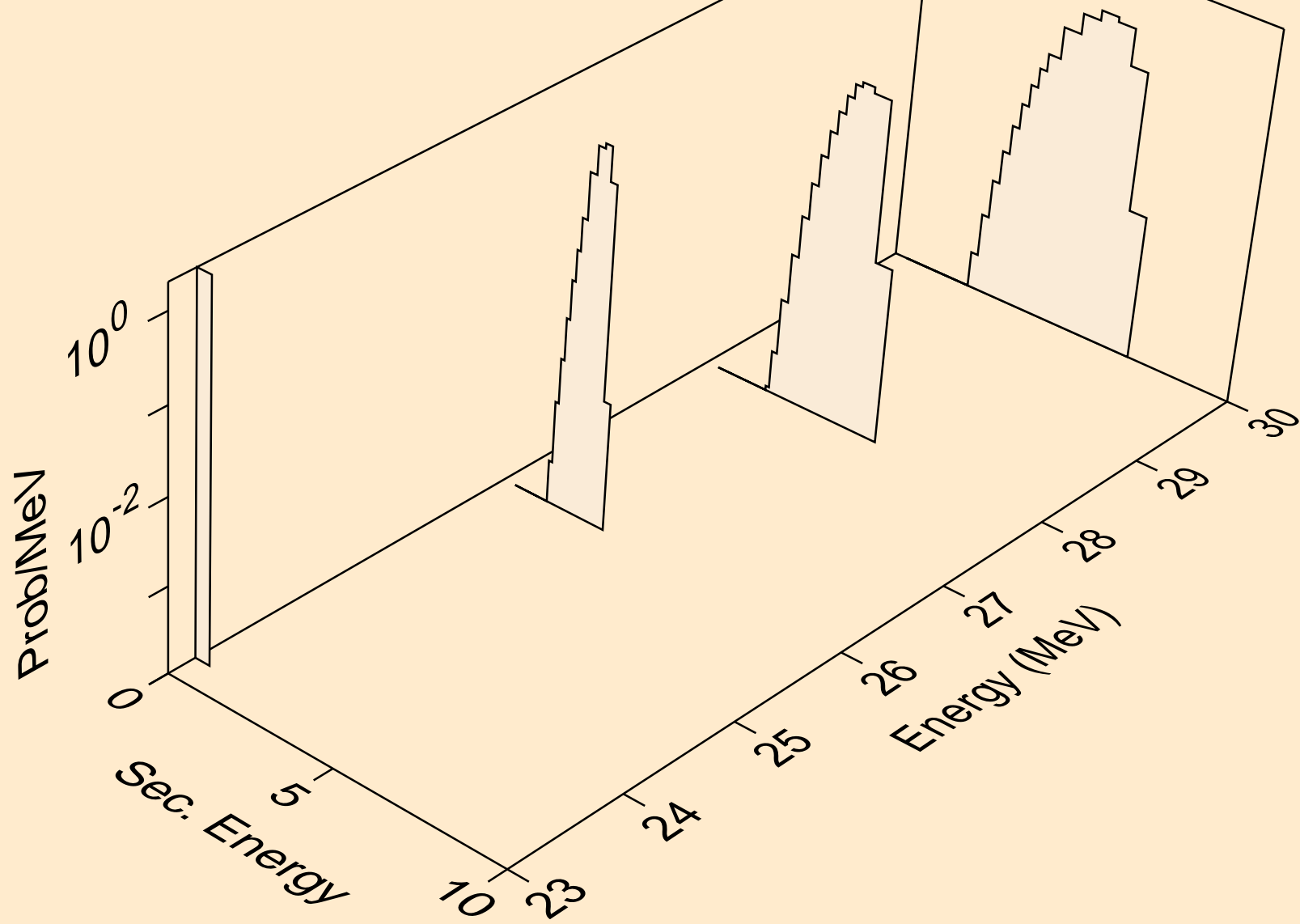

MO094 NEUTRON ACER TENDL-2024 LIBRARY; T=0.K
deuterons from (n,n*)d

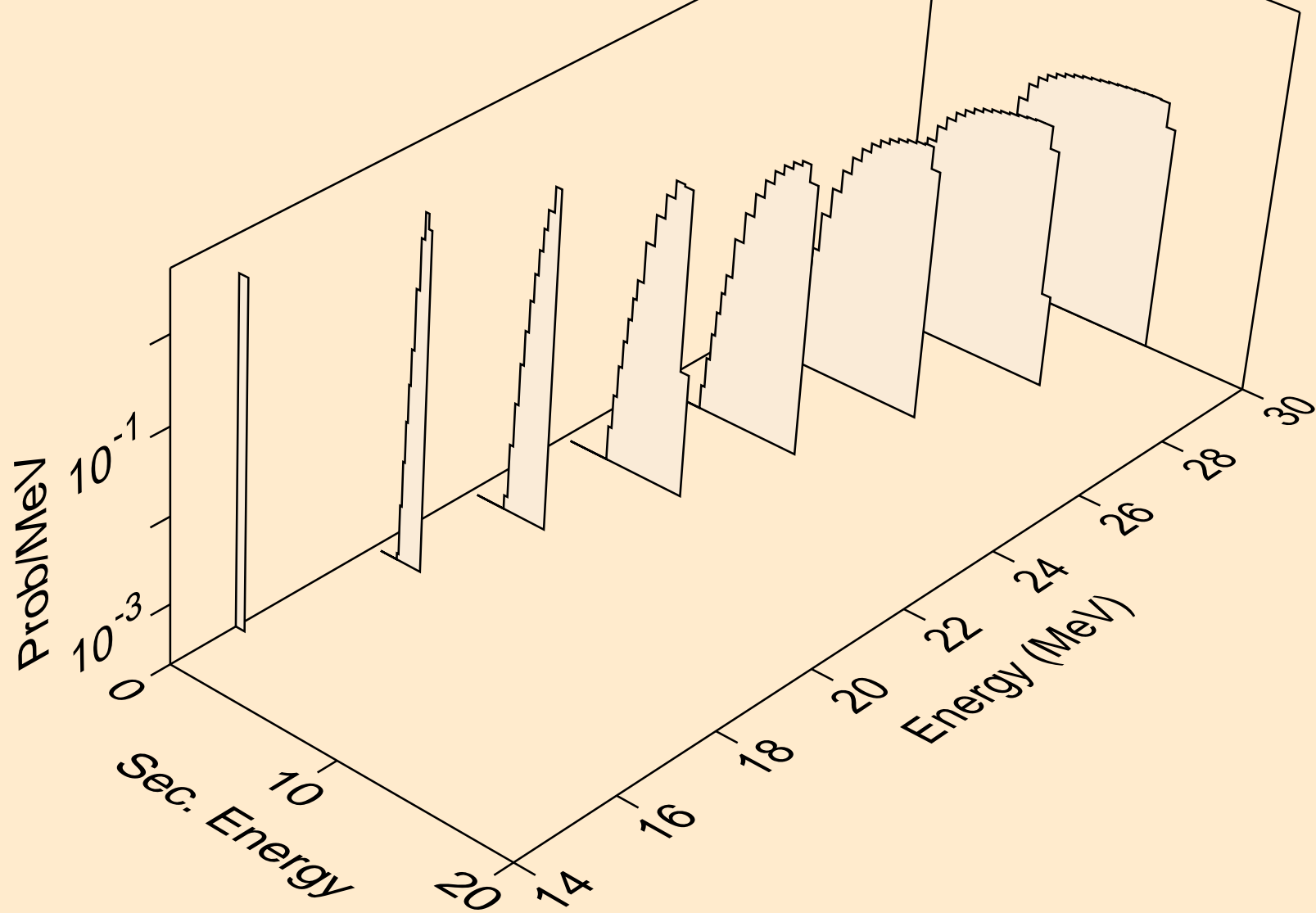

MO094 NEUTRON ACER TENDL-2024 LIBRARY; T=0.K
deuterons from (n,d)

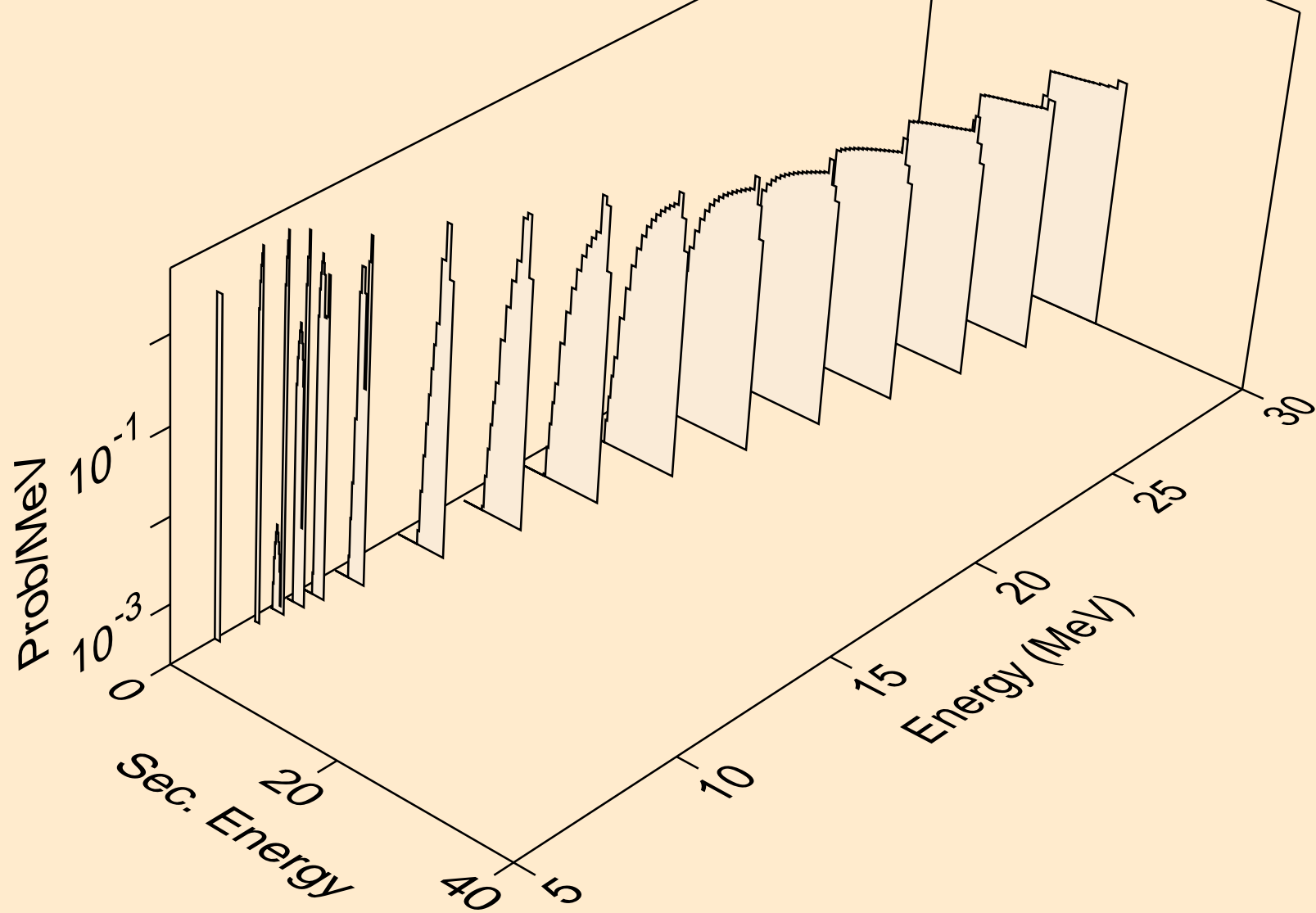

MO094 NEUTRON ACER TENDL-2024 LIBRARY; T=0.K
deuterons from (n,pd)

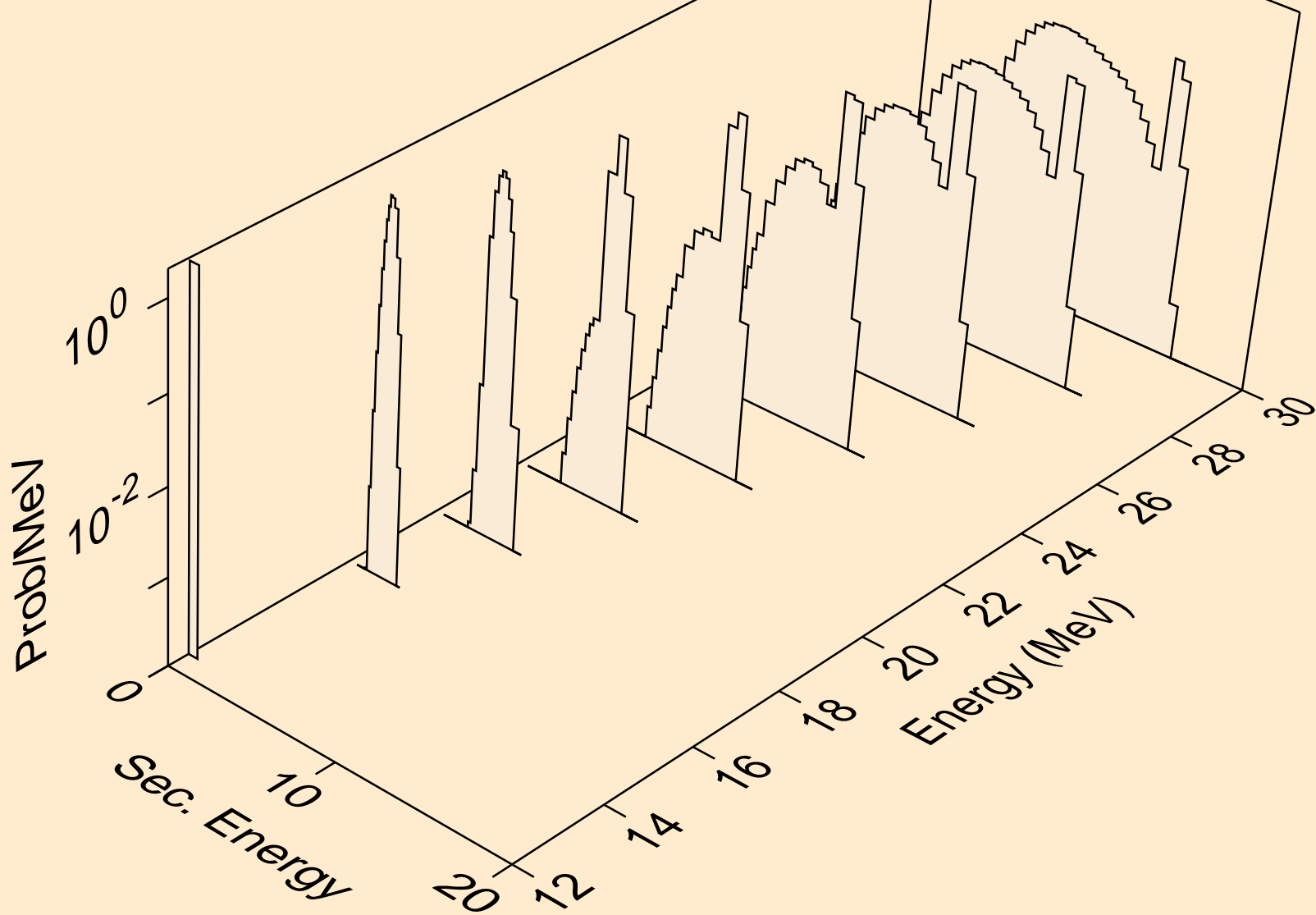

MO094 NEUTRON ACER TENDL-2024 LIBRARY; T=0.K
deuterons from (n,da)

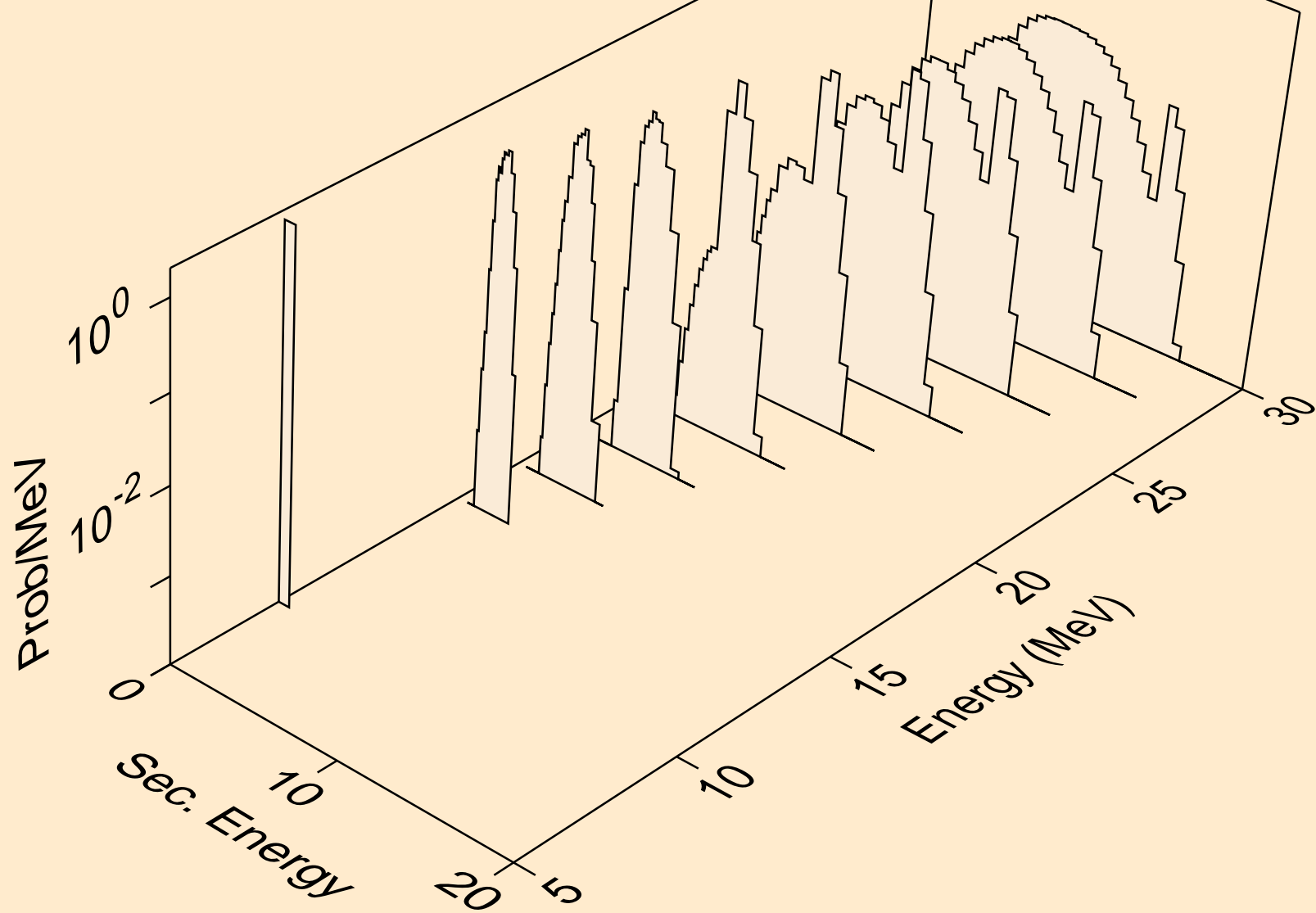

MO094 NEUTRON ACER TENDL-2024 LIBRARY; T=0.K
tritons from (n,x)

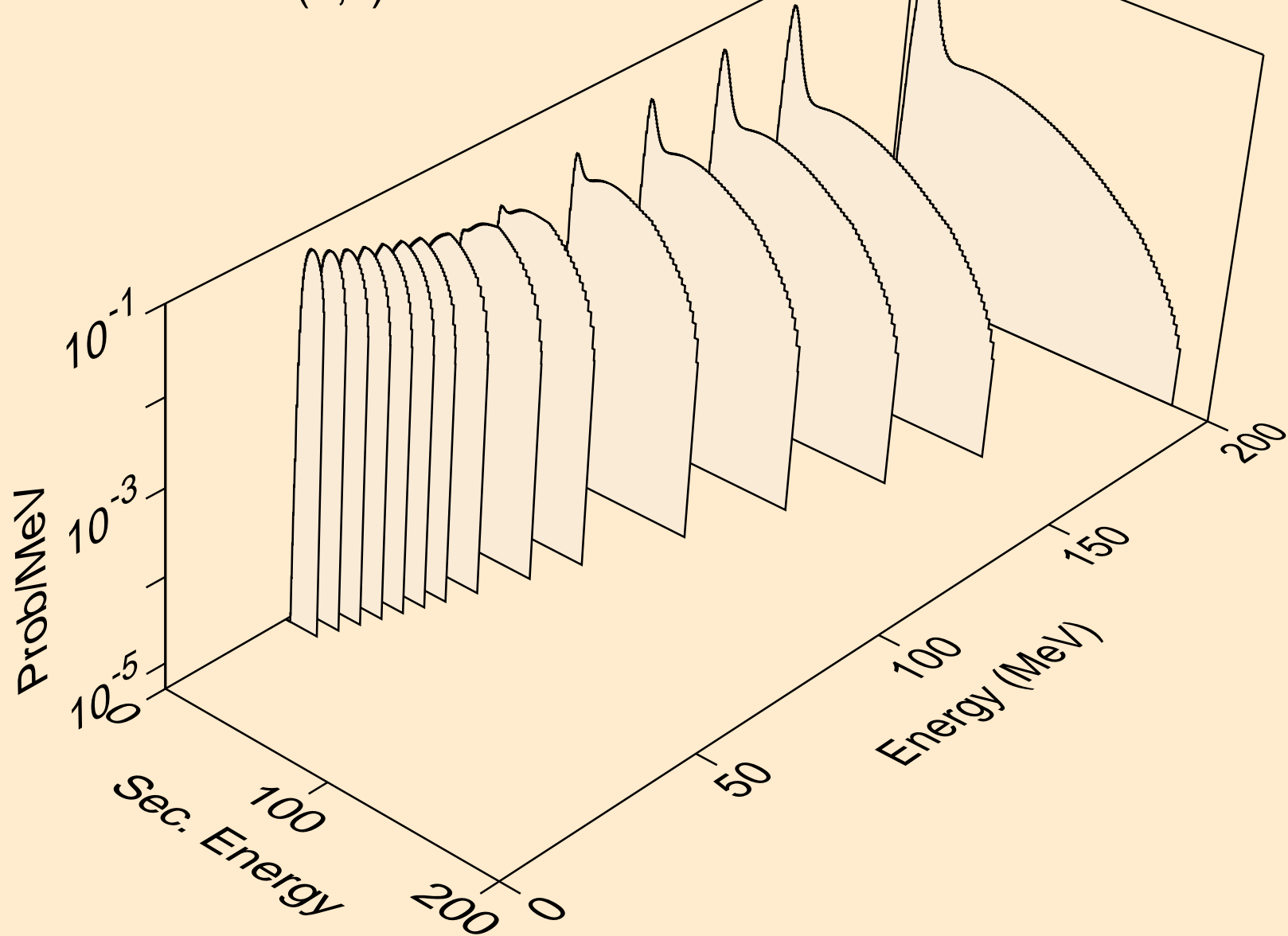

MO094 NEUTRON ACER TENDL-2024 LIBRARY; T=0.K
tritons from (n,n*)t

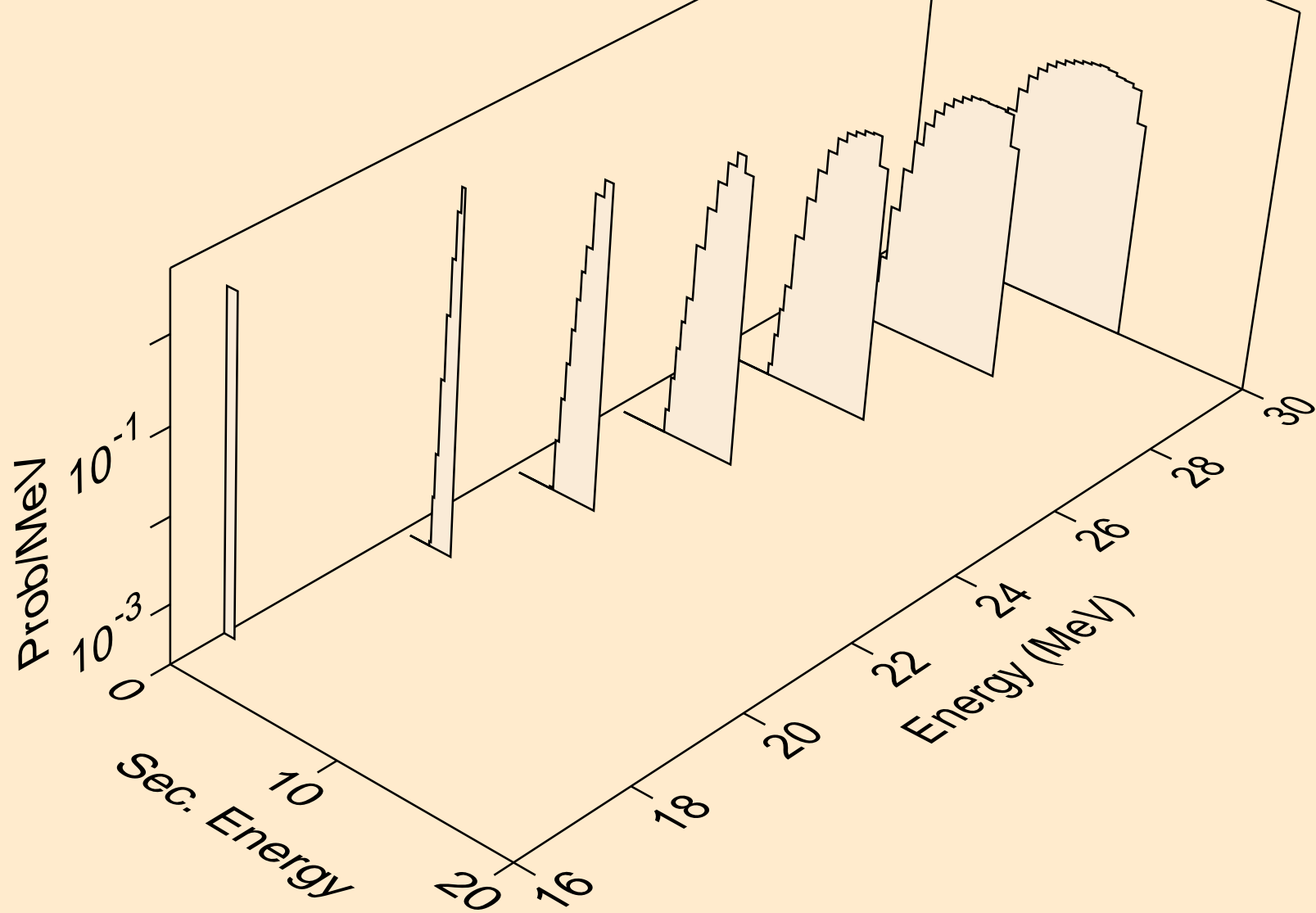

MO094 NEUTRON ACER TENDL-2024 LIBRARY; T=0.K
tritons from (n,t)

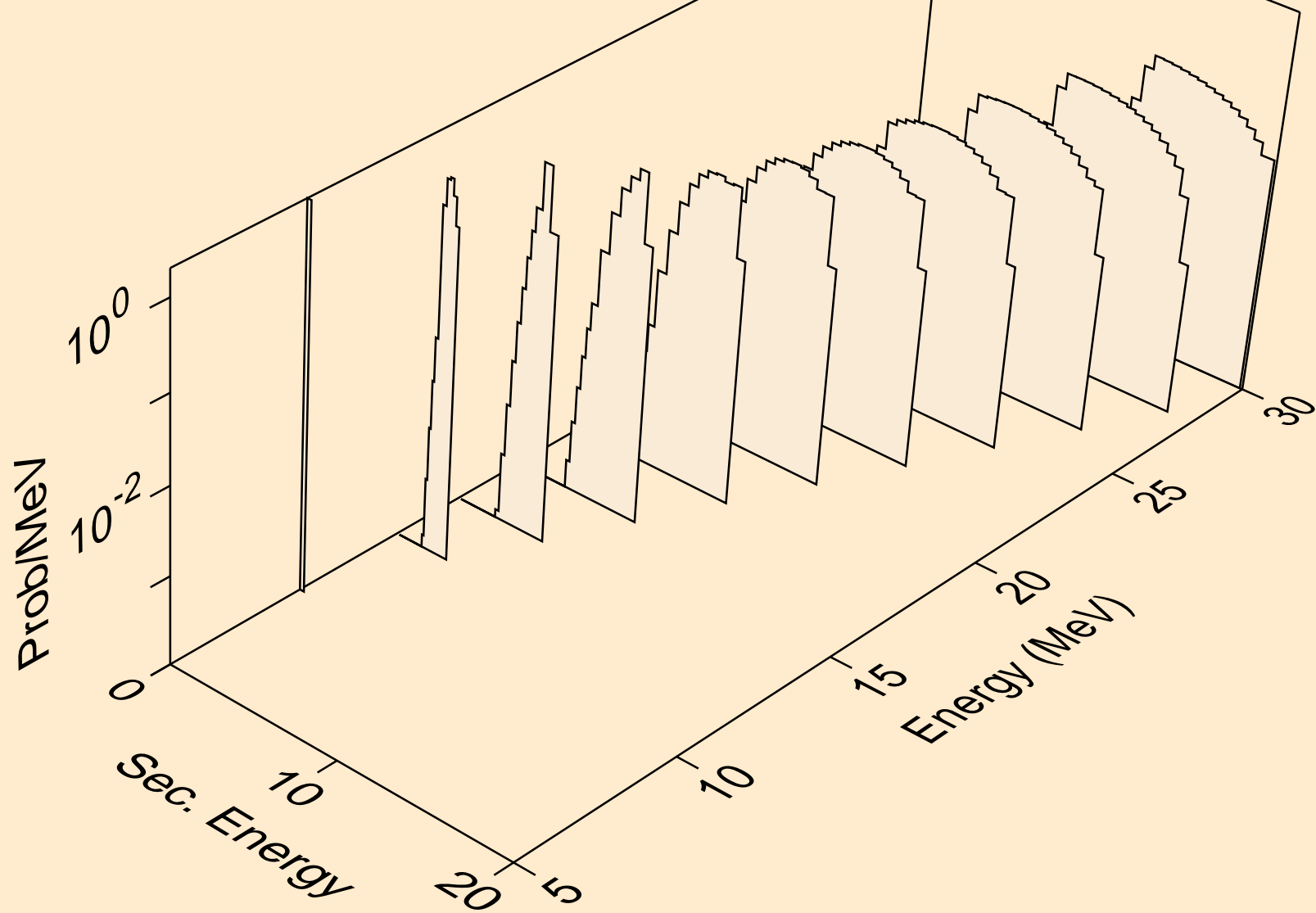

MO094 NEUTRON ACER TENDL-2024 LIBRARY; T=0.K
tritons from (n,pt)

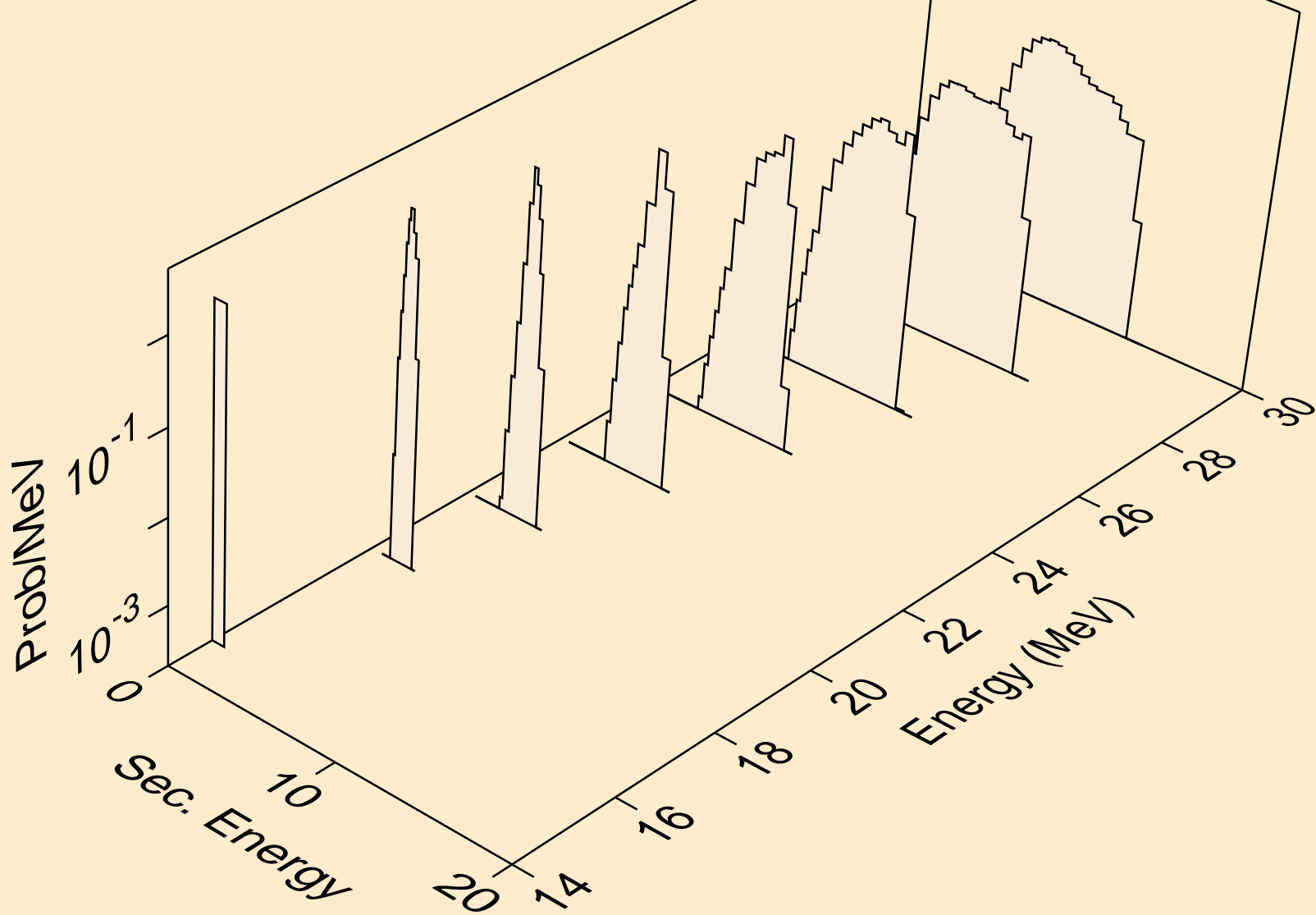

MO094 NEUTRON ACER TENDL-2024 LIBRARY; T=0.K
he3s from (n,x)

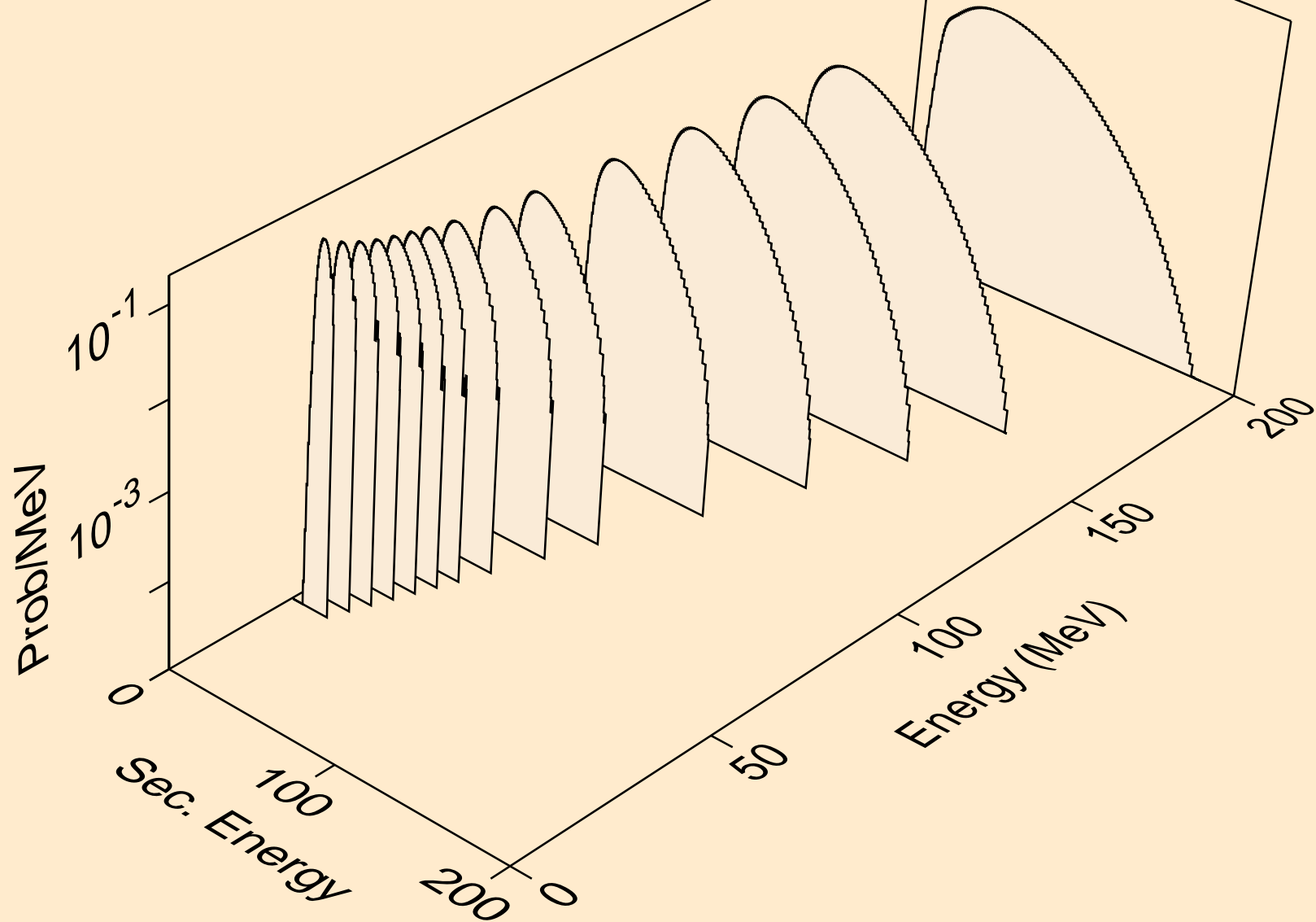

MO094 NEUTRON ACER TENDL-2024 LIBRARY; T=0.K
he3s from (n,n*)he3

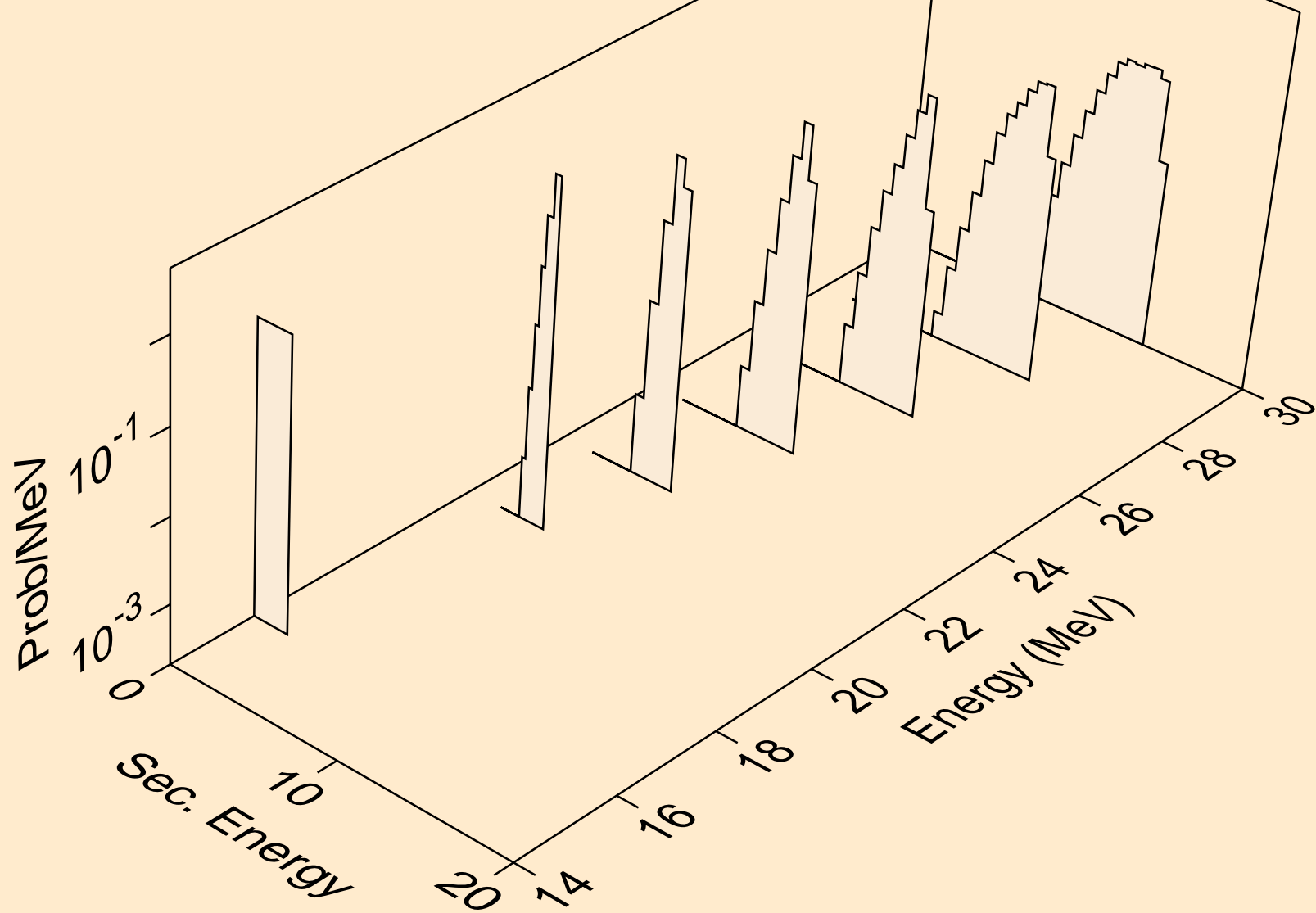

MO094 NEUTRON ACER TENDL-2024 LIBRARY; T=0.K
he3s from (n,he3)

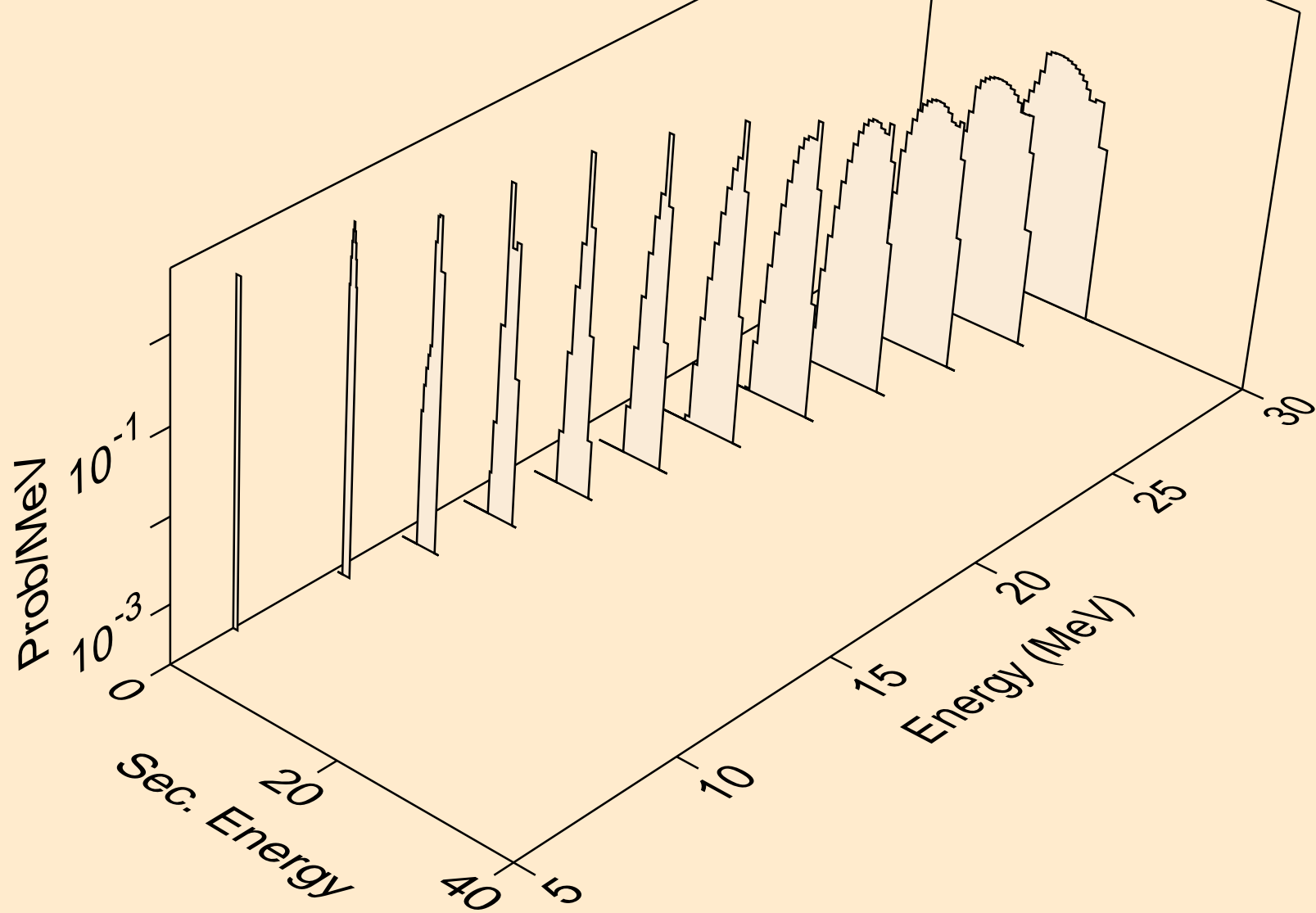

MO094 NEUTRON ACER TENDL-2024 LIBRARY; T=0.K
alphas from (n,x)

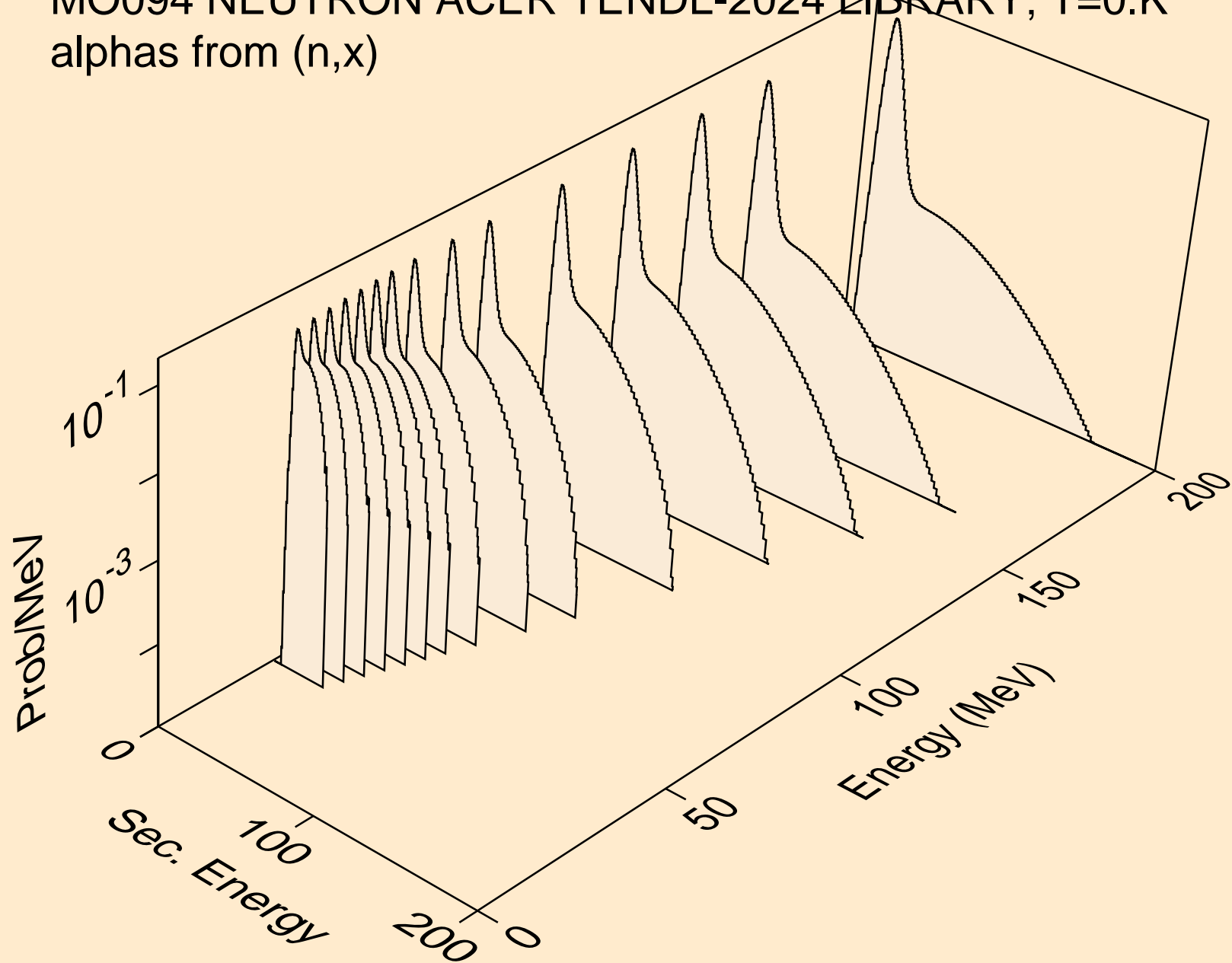

MO094 NEUTRON ACER TENDL-2024 LIBRARY; T=0.K
alphas from (n,n*)a

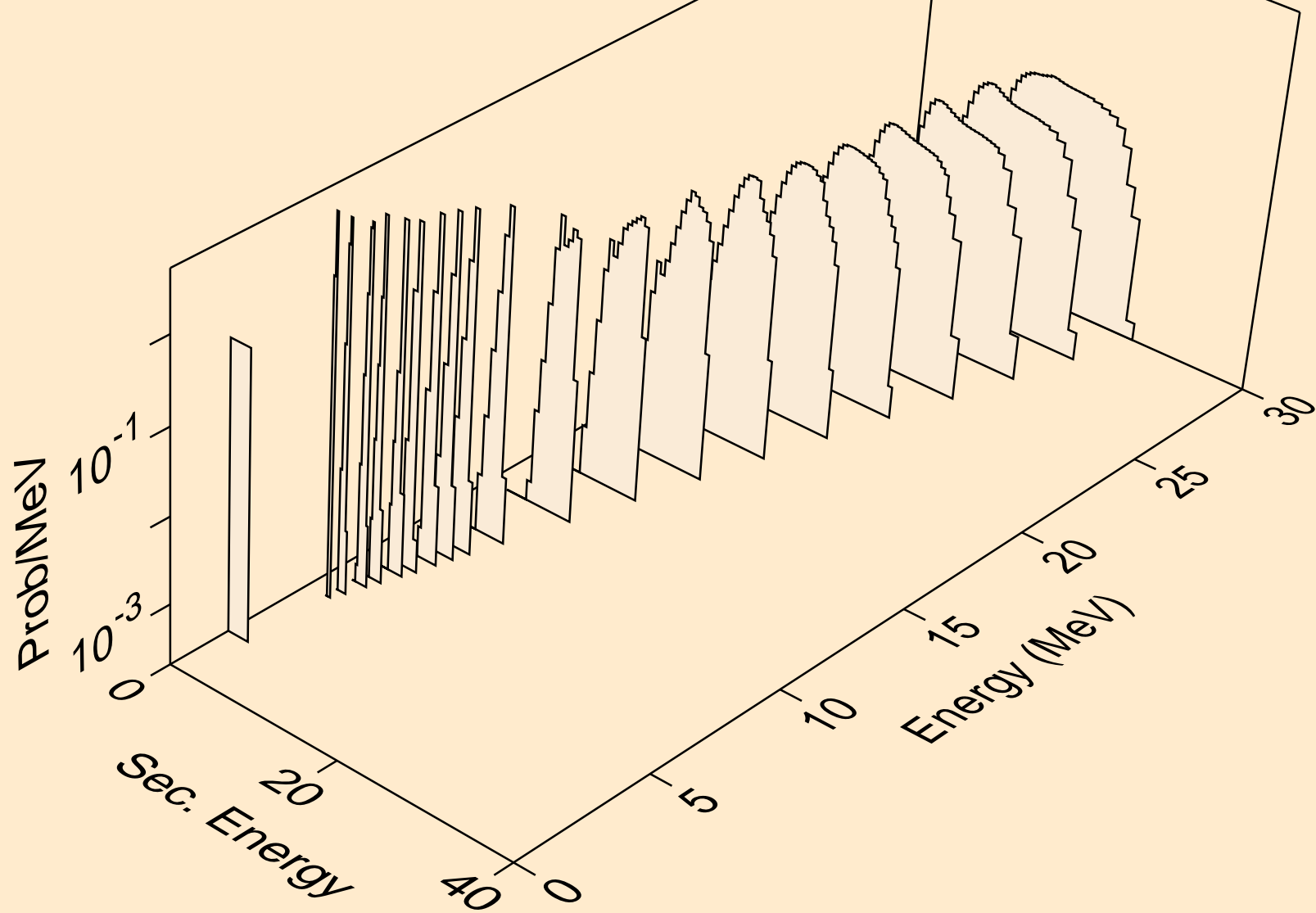

MO094 NEUTRON ACER TENDL-2024 LIBRARY; T=0.K
alphas from (n,2n)a

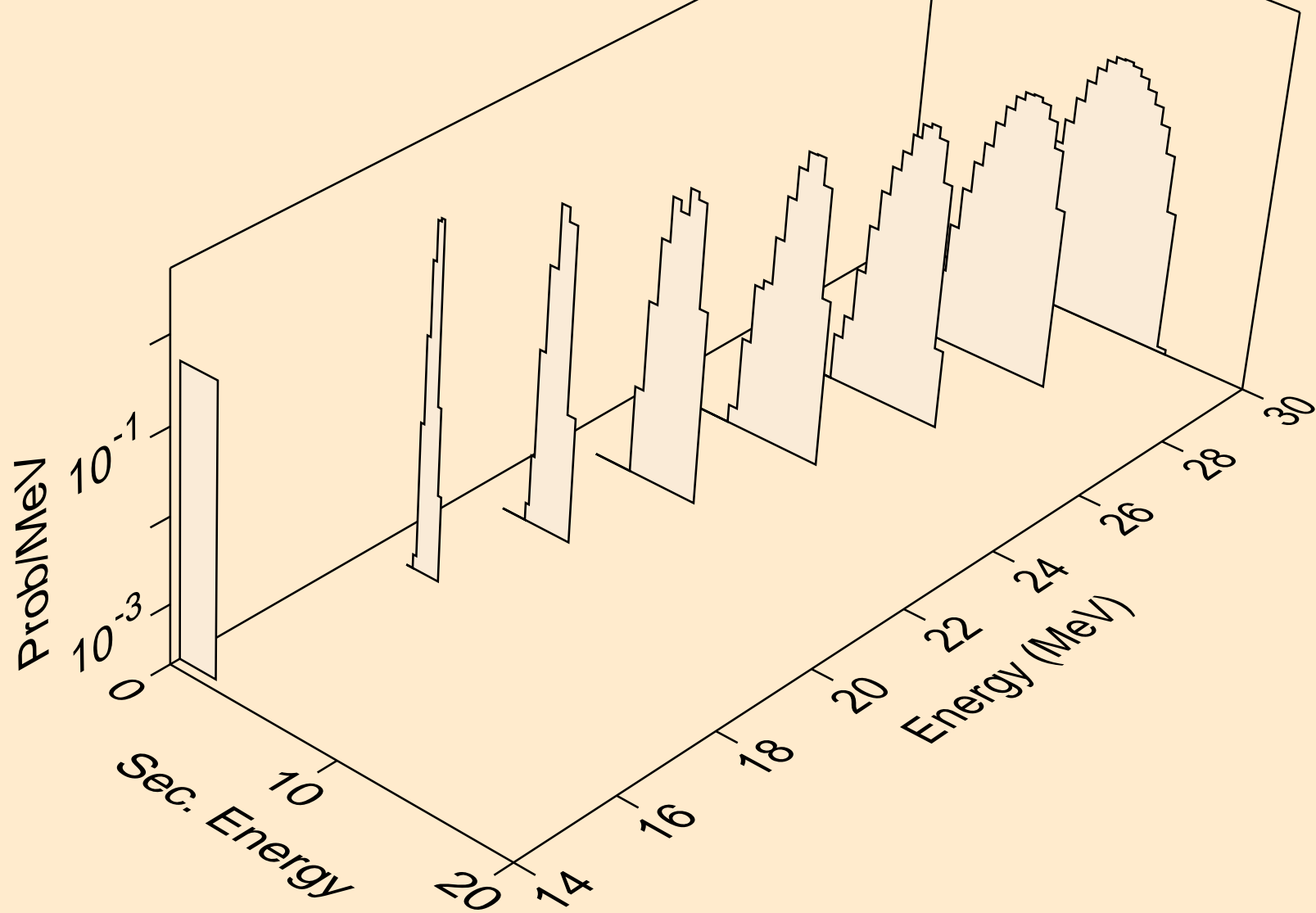

MO094 NEUTRON ACER TENDL-2024 LIBRARY; T=0.K
alphas from (n,n*)2a

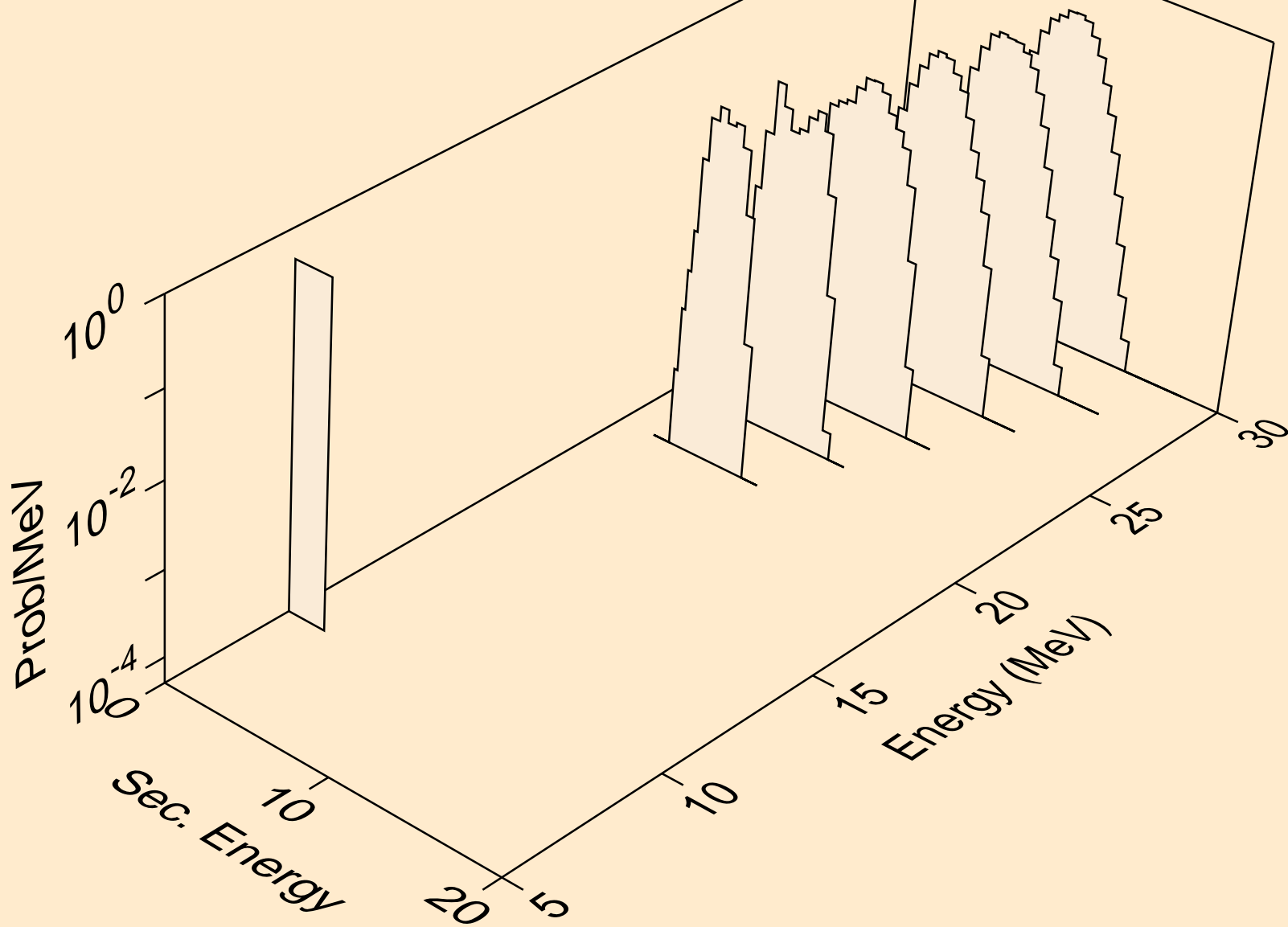

MO094 NEUTRON ACER TENDL-2024 LIBRARY; T=0.K
alphas from (n,npa)

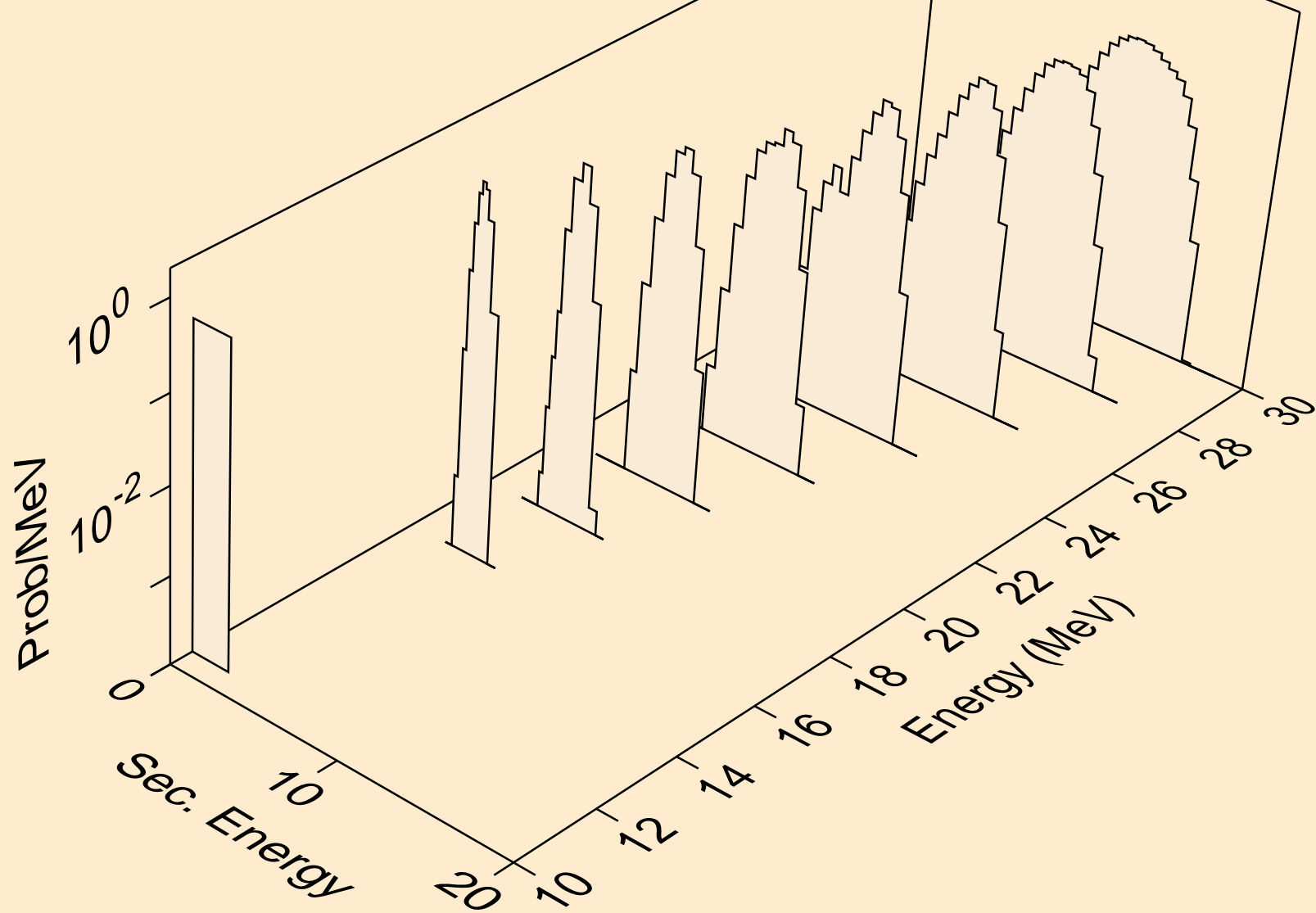

MO094 NEUTRON ACER TENDL-2024 LIBRARY; T=0.K
alphas from (n,a)

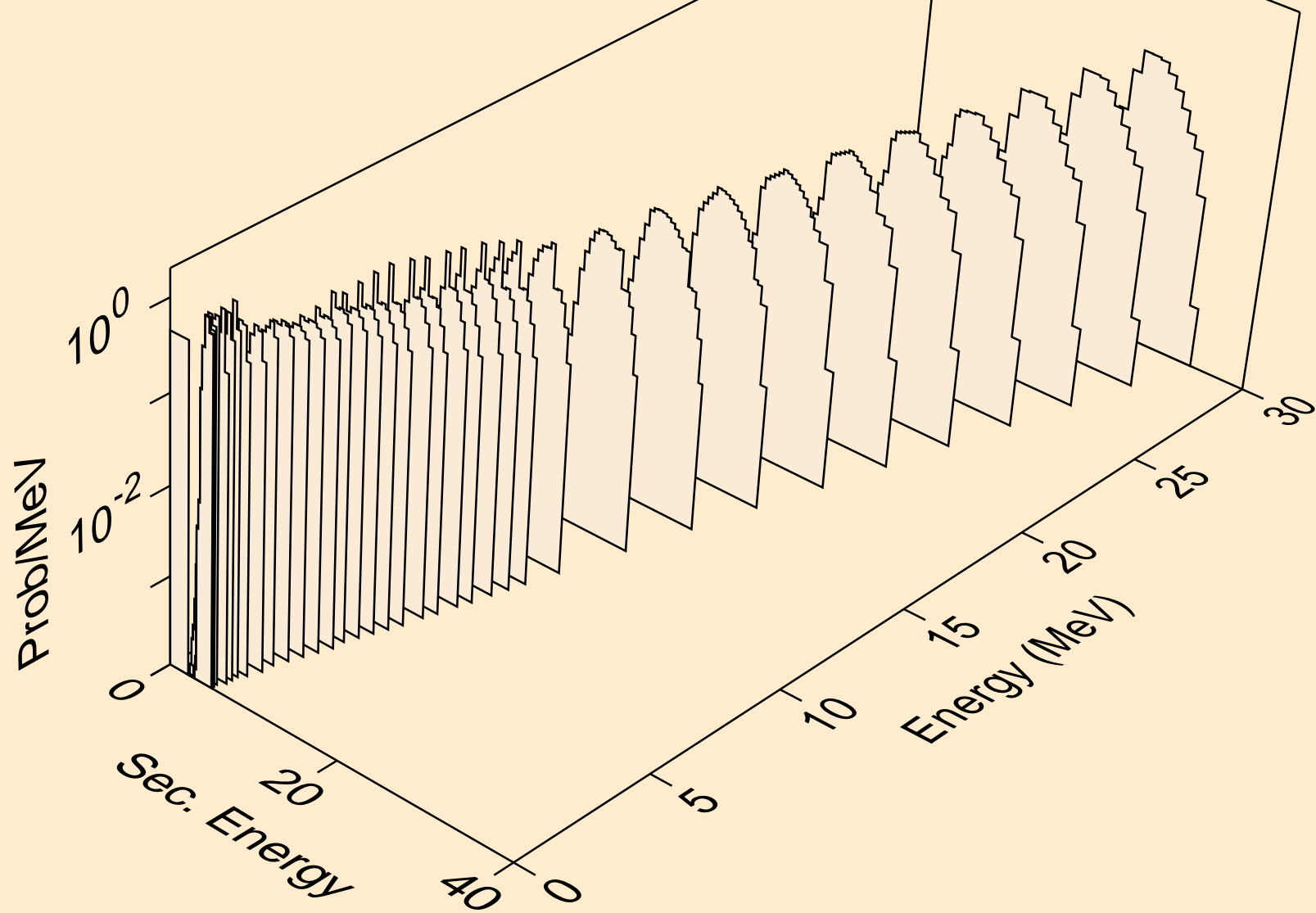

MO094 NEUTRON ACER TENDL-2024 LIBRARY; T=0.K
alphas from (n,2a)

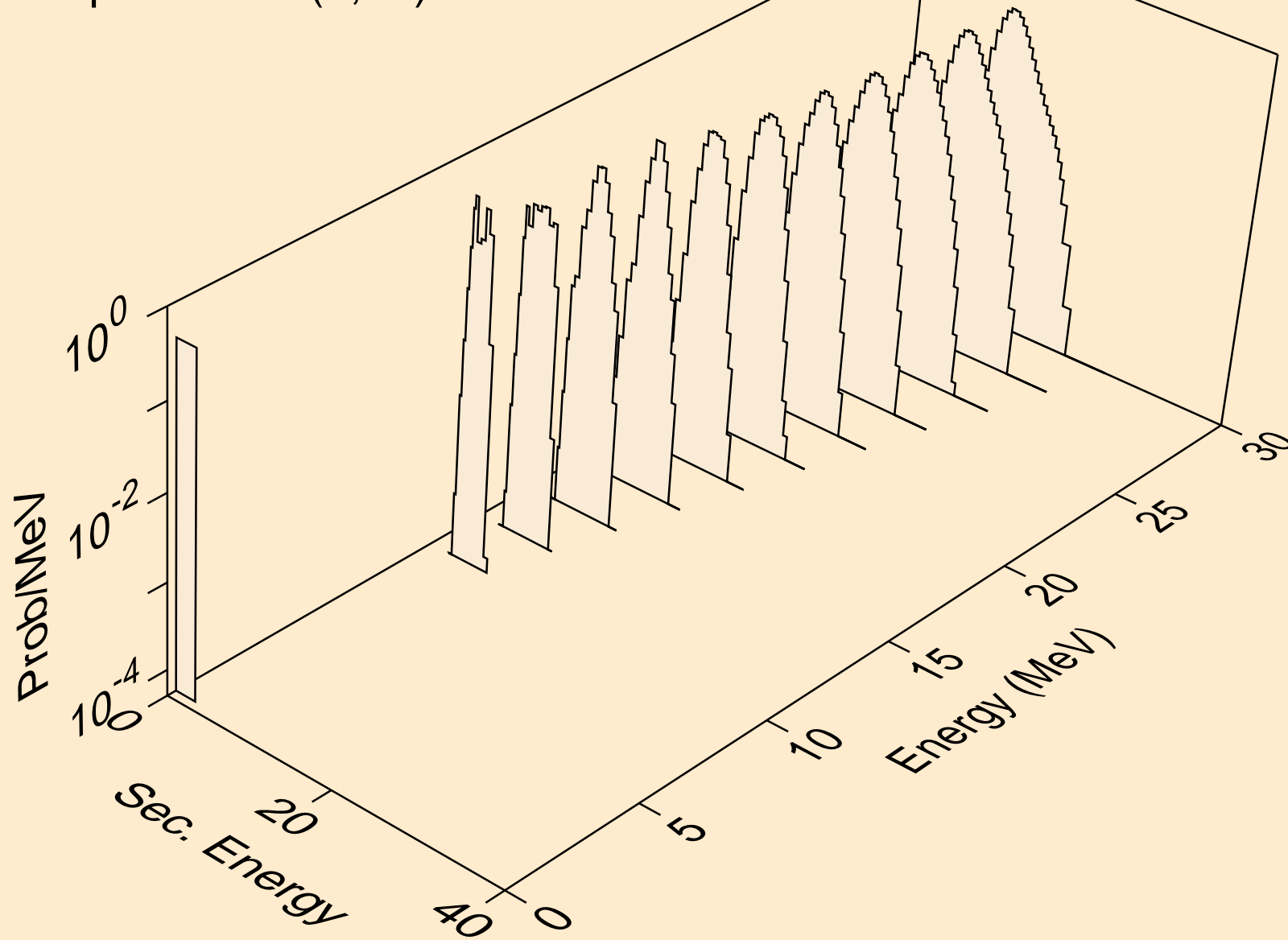

MO094 NEUTRON ACER TENDL-2024 LIBRARY; T=0.K
alphas from (n,pa)

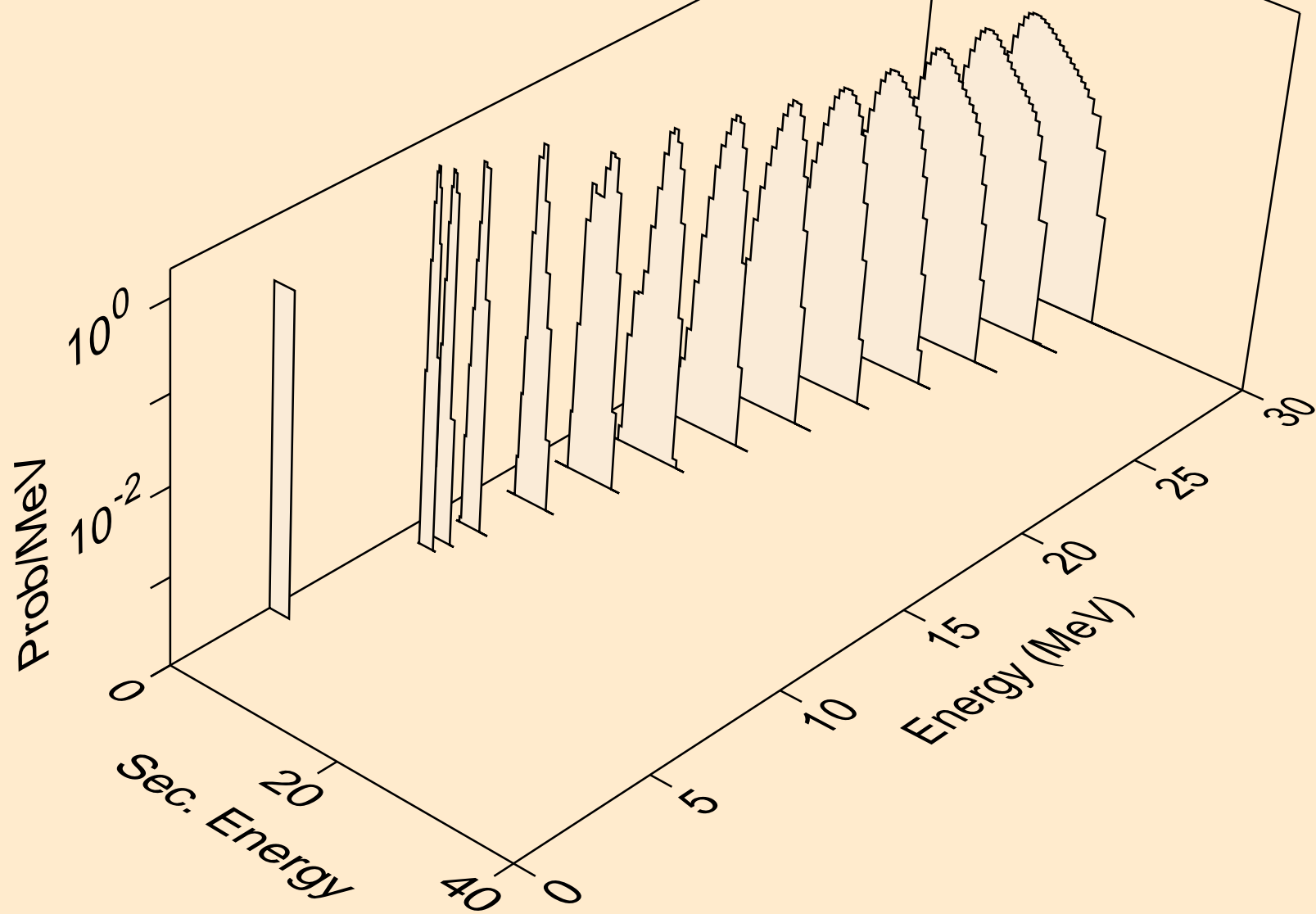

MO094 NEUTRON ACER TENDL-2024 LIBRARY; T=0.K
alphas from (n,da)

