

PB187 NEUTRON ACER TENDL-2024 LIBRARY; T=0.K
Principal cross sections

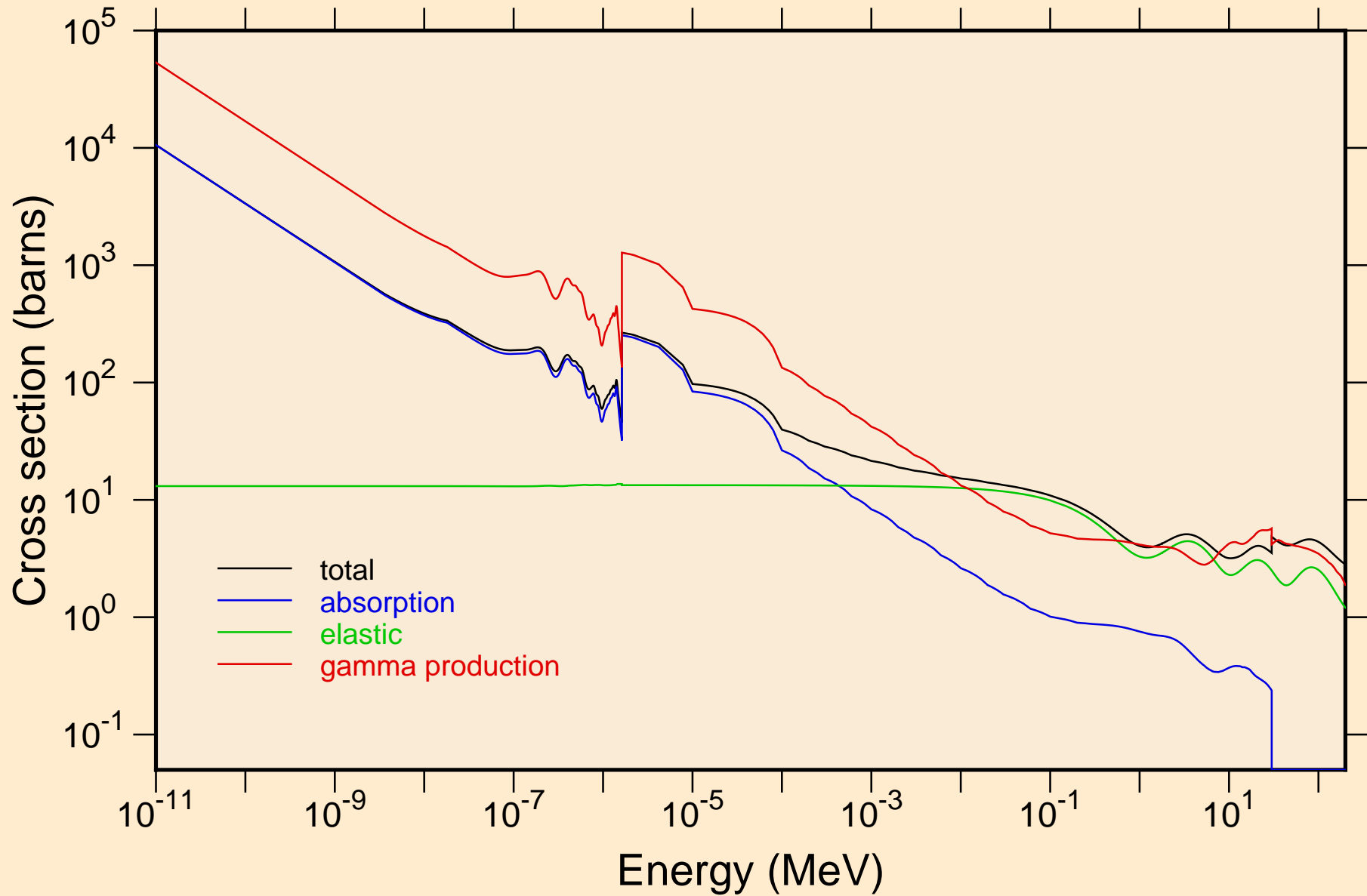

PB187 NEUTRON ACER TENDL-2024 LIBRARY; T=0.K
Heating

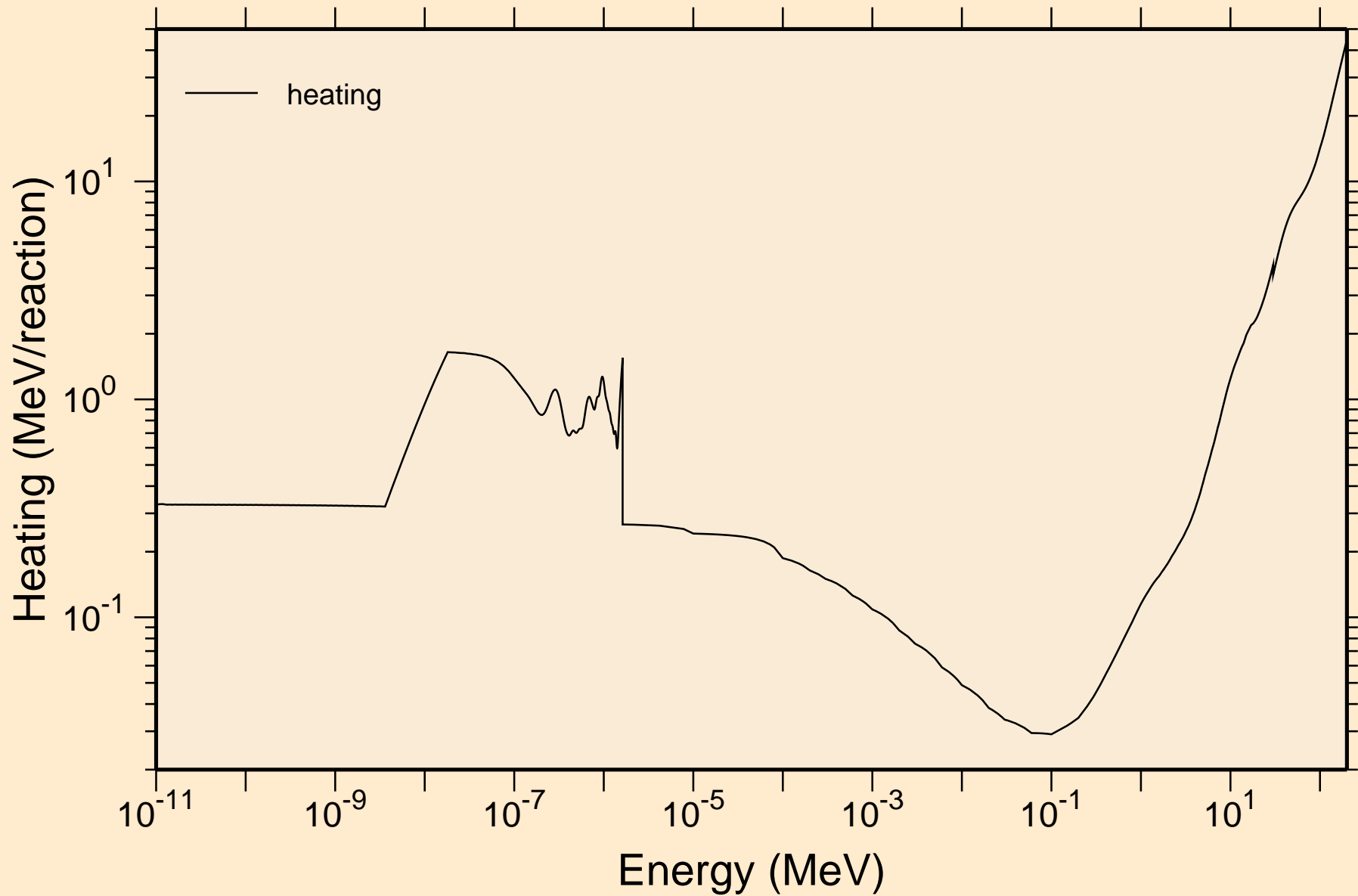

PB187 NEUTRON ACER TENDL-2024 LIBRARY; T=0.K
Damage

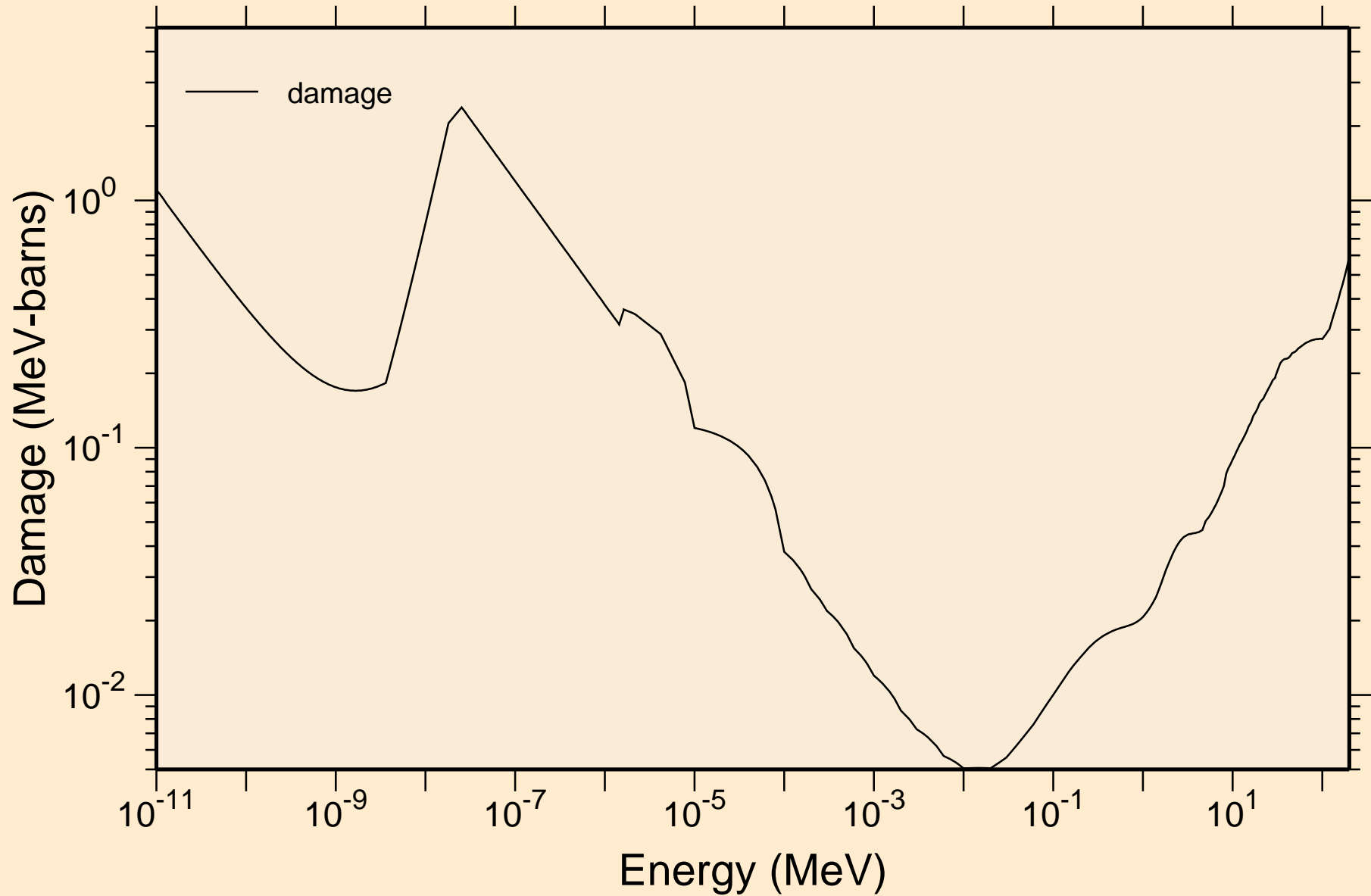

PB187 NEUTRON ACER TENDL-2024 LIBRARY; T=0.K
Non-threshold reactions

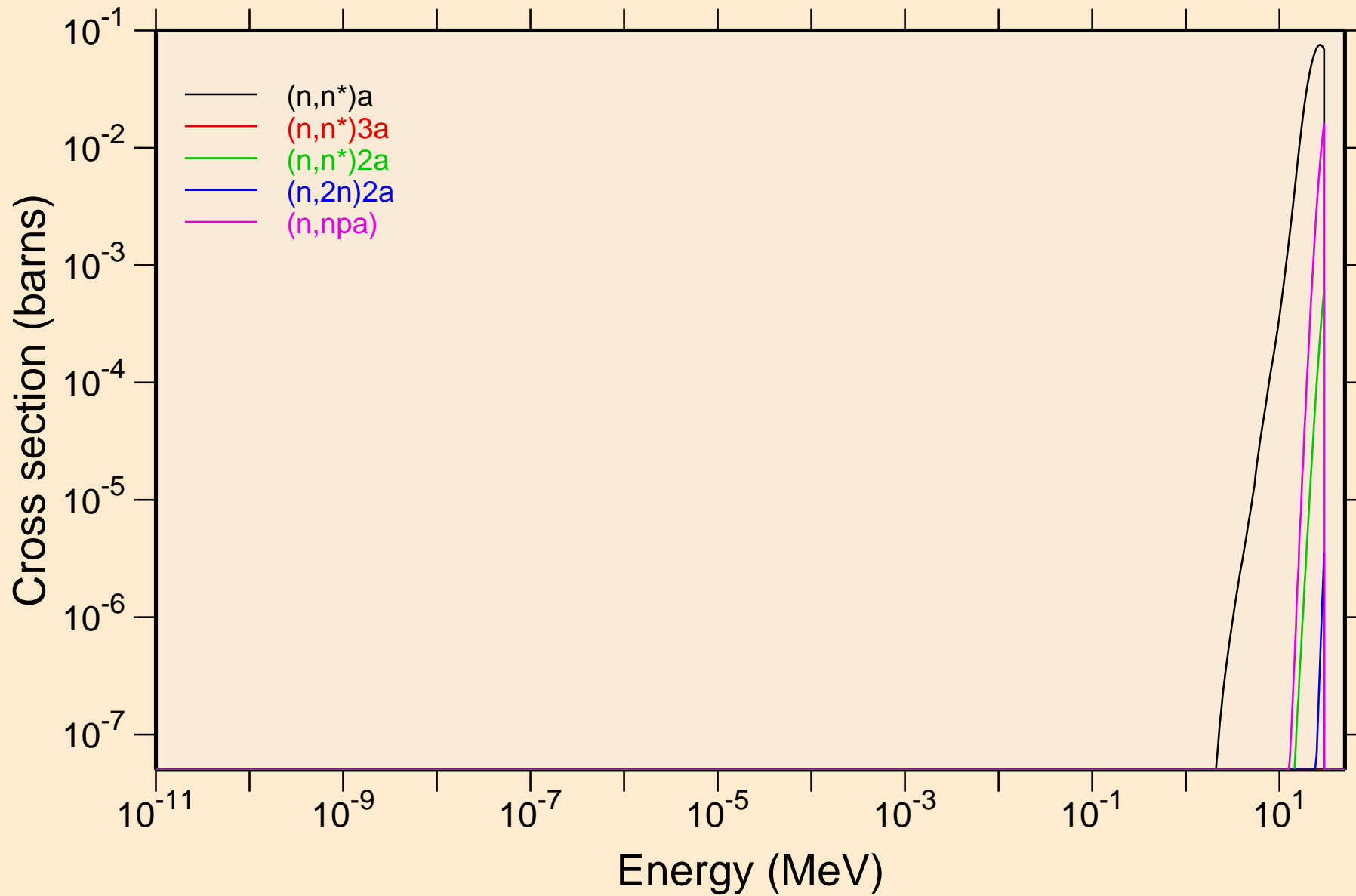

PB187 NEUTRON ACER TENDL-2024 LIBRARY; T=0.K
Non-threshold reactions

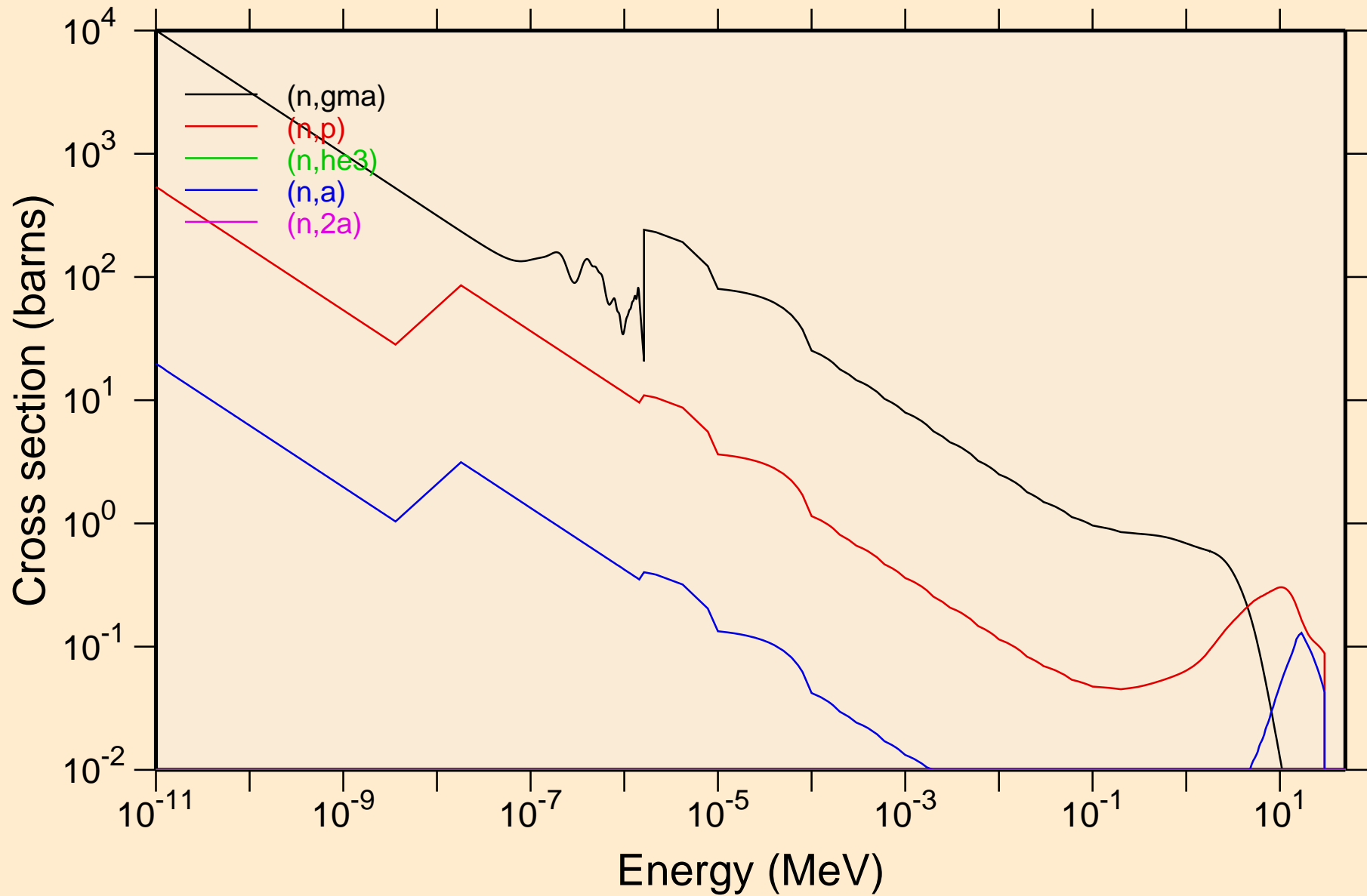

PB187 NEUTRON ACER TENDL-2024 LIBRARY; T=0.K
Non-threshold reactions

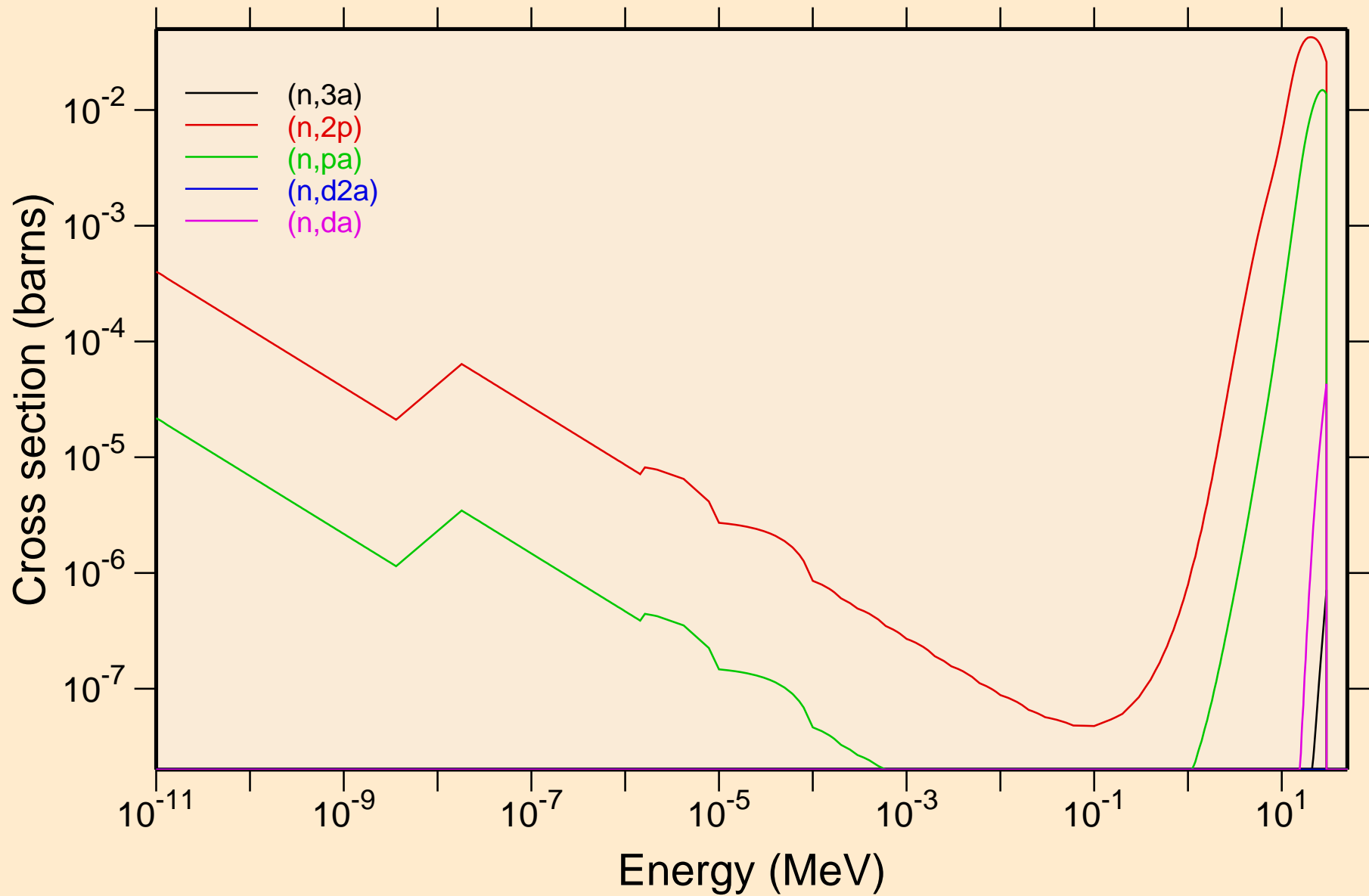

PB187 NEUTRON ACER TENDL-2024 LIBRARY; T=0.K
Non-threshold reactions

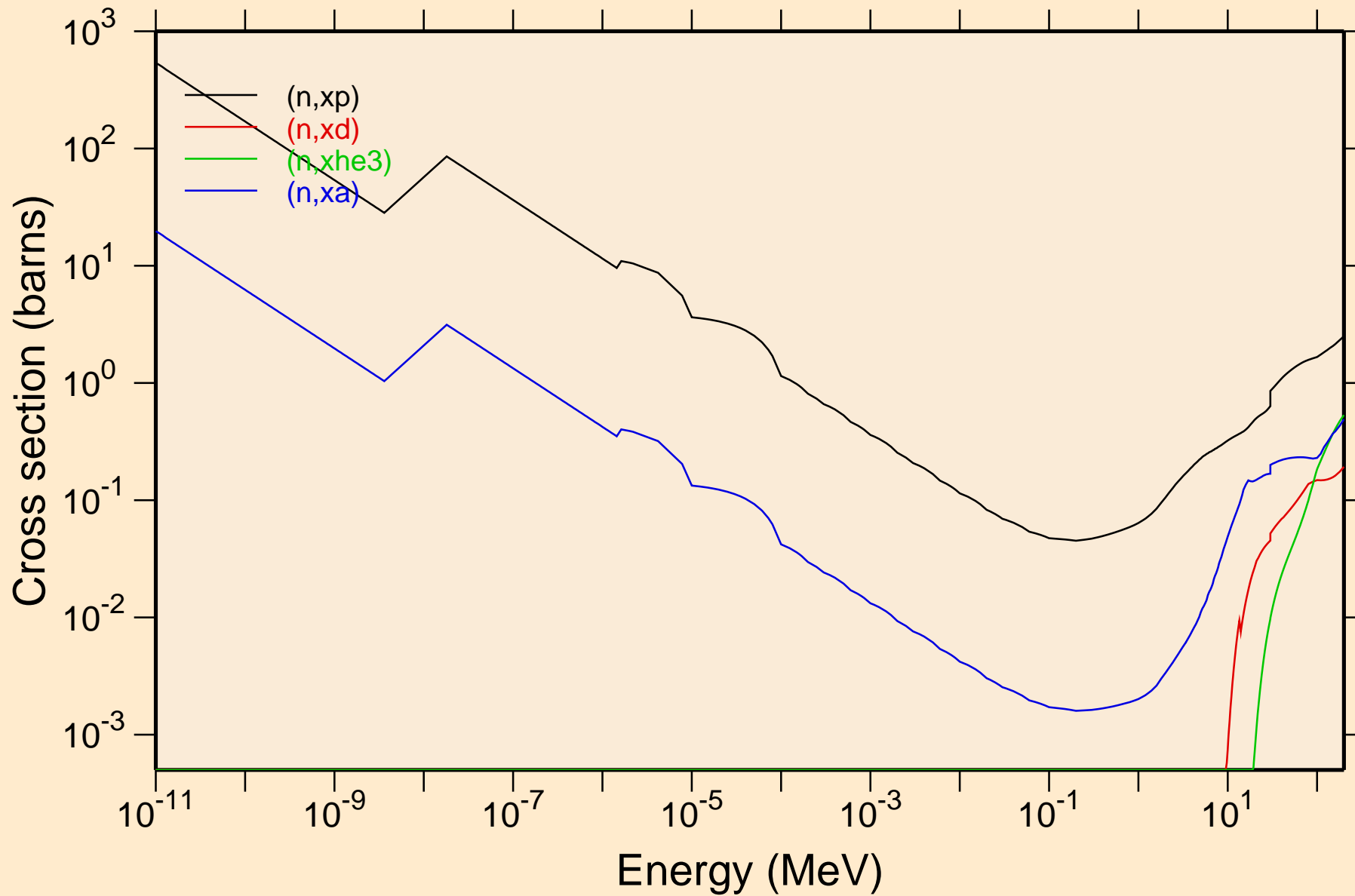

PB187 NEUTRON ACER TENDL-2024 LIBRARY; T=0.K
Principal cross sections

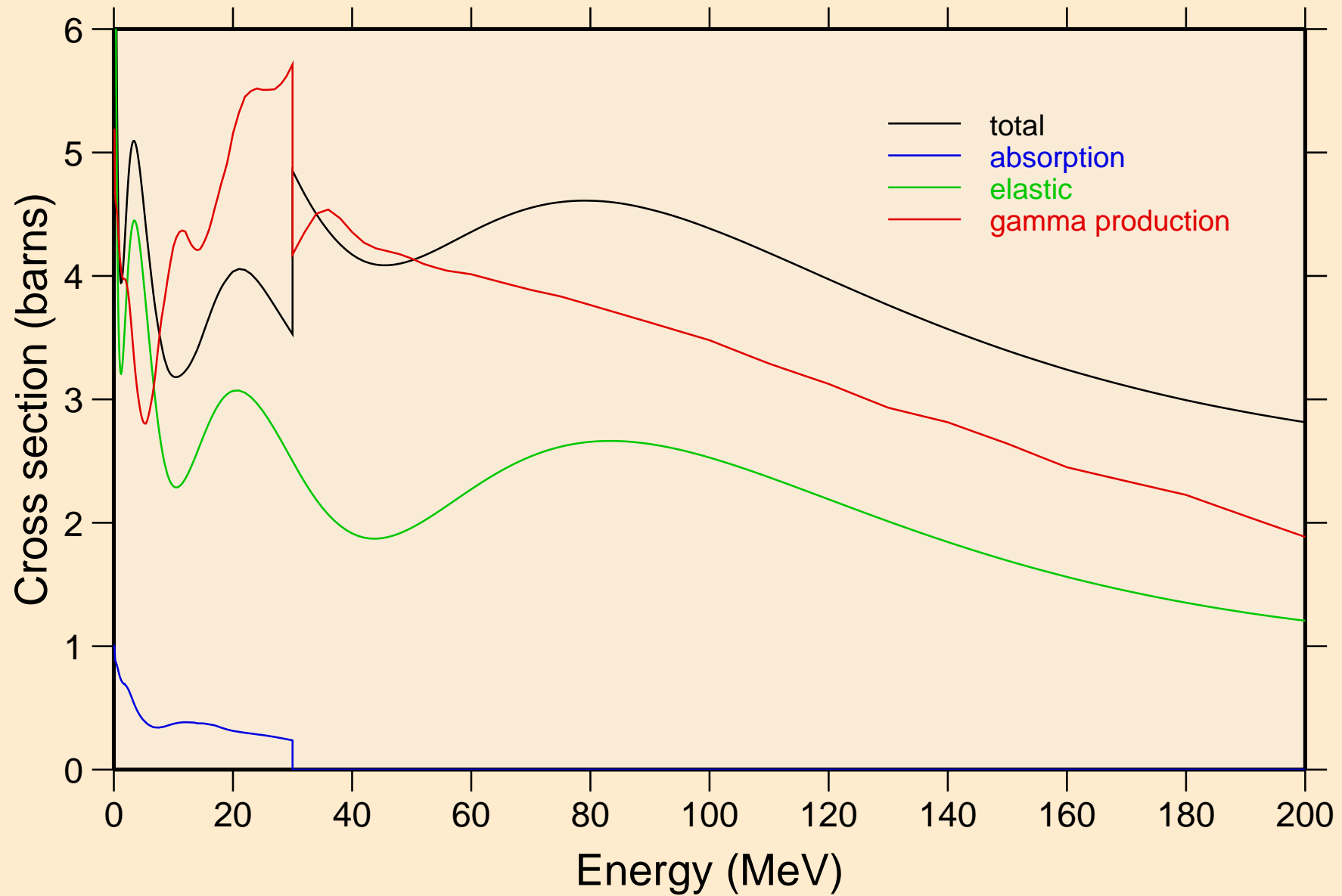

PB187 NEUTRON ACER TENDL-2024 LIBRARY; T=0.K

Heating

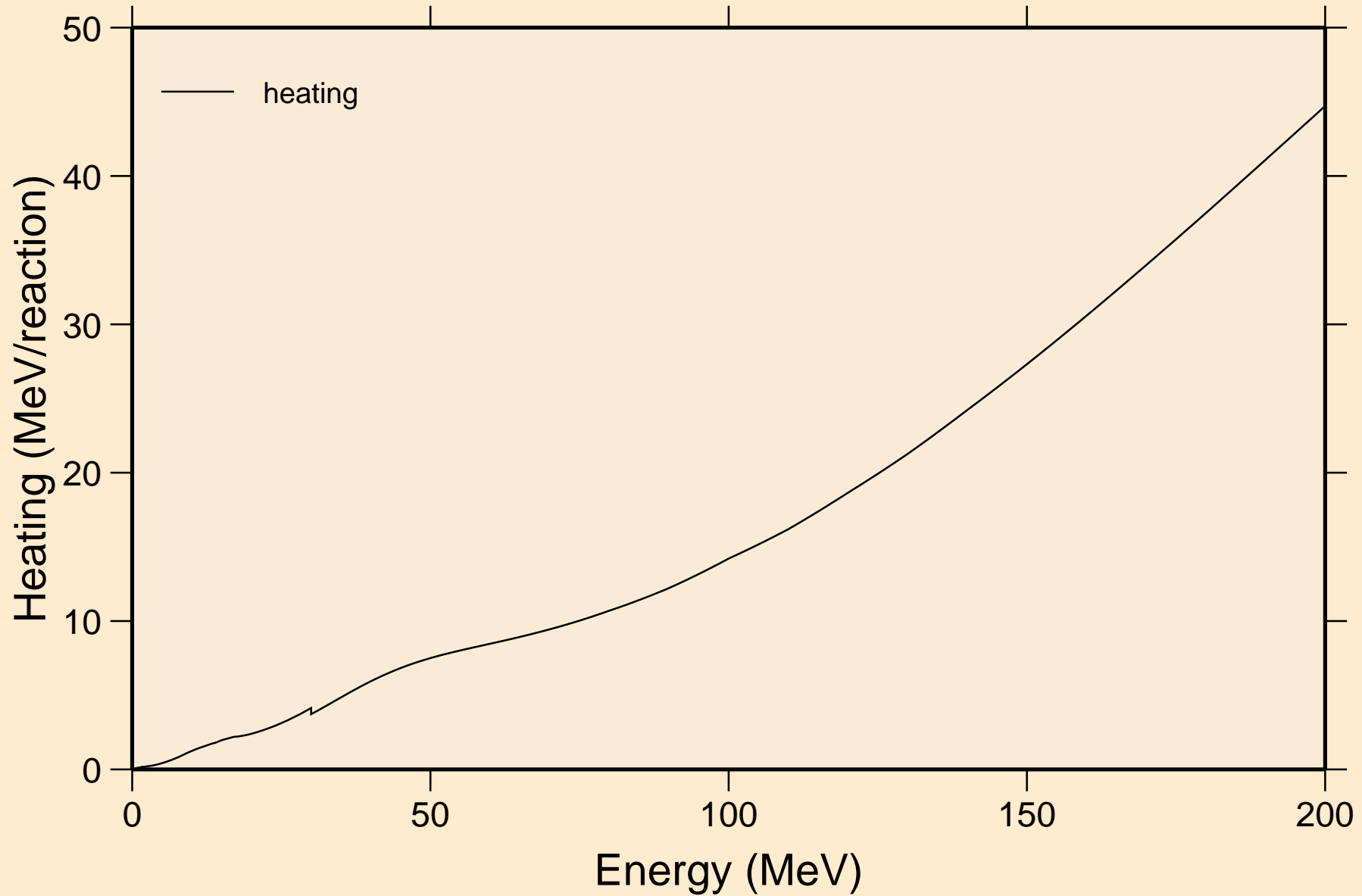

PB187 NEUTRON ACER TENDL-2024 LIBRARY; T=0.K
Damage

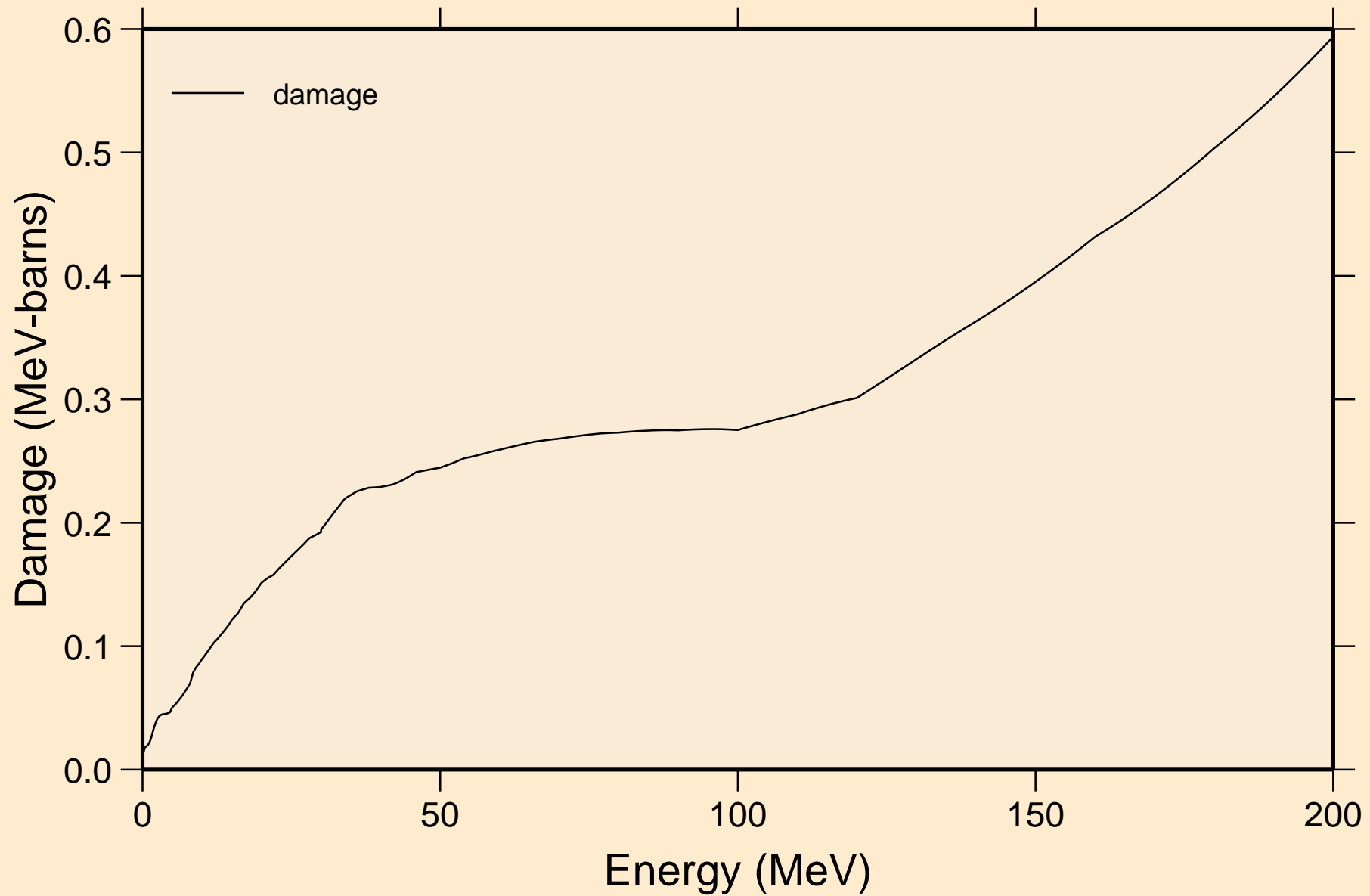

PB187 NEUTRON ACER TENDL-2024 LIBRARY; T=0.K
Non-threshold reactions

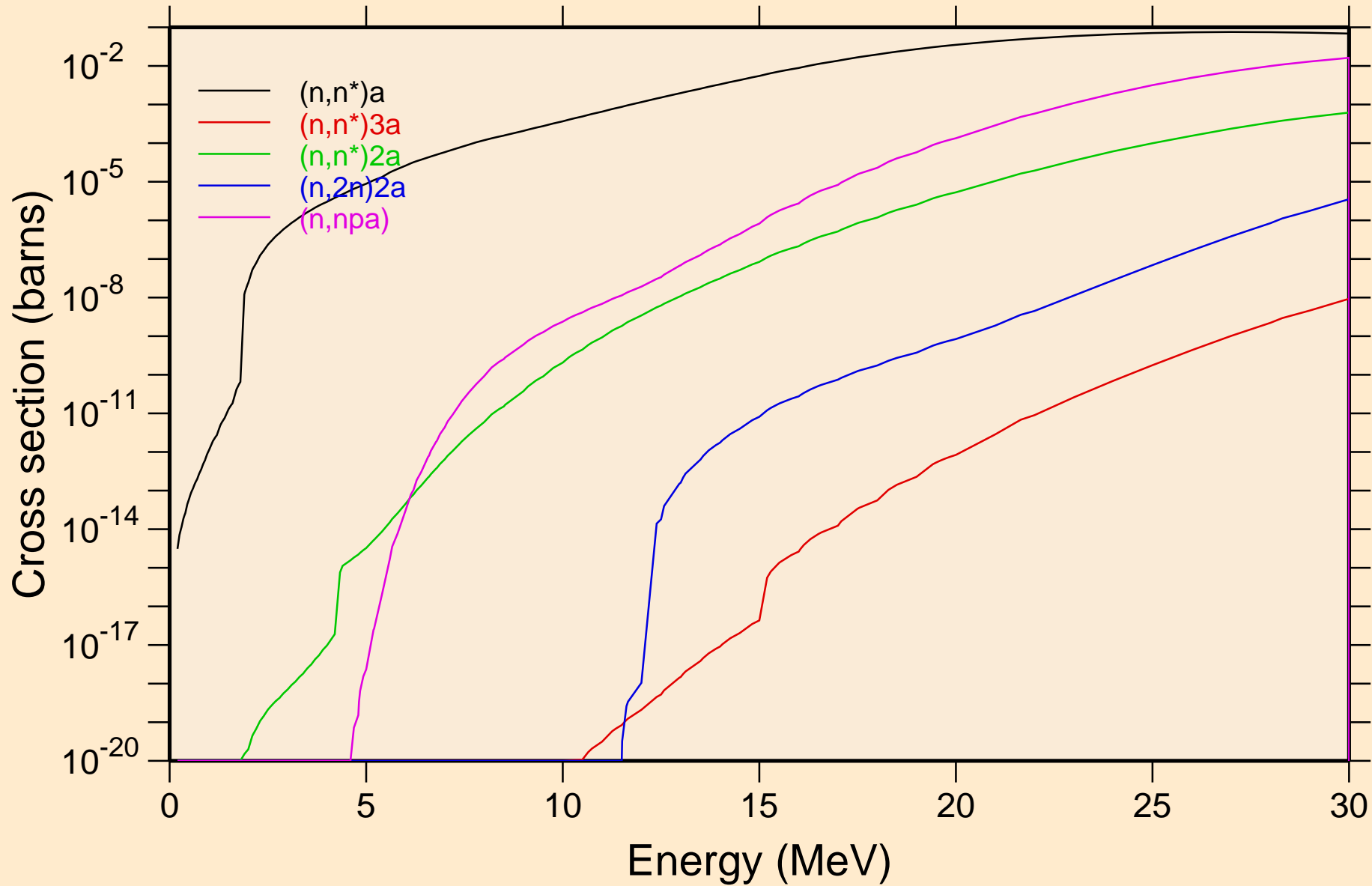

PB187 NEUTRON ACER TENDL-2024 LIBRARY; T=0.K

Non-threshold reactions

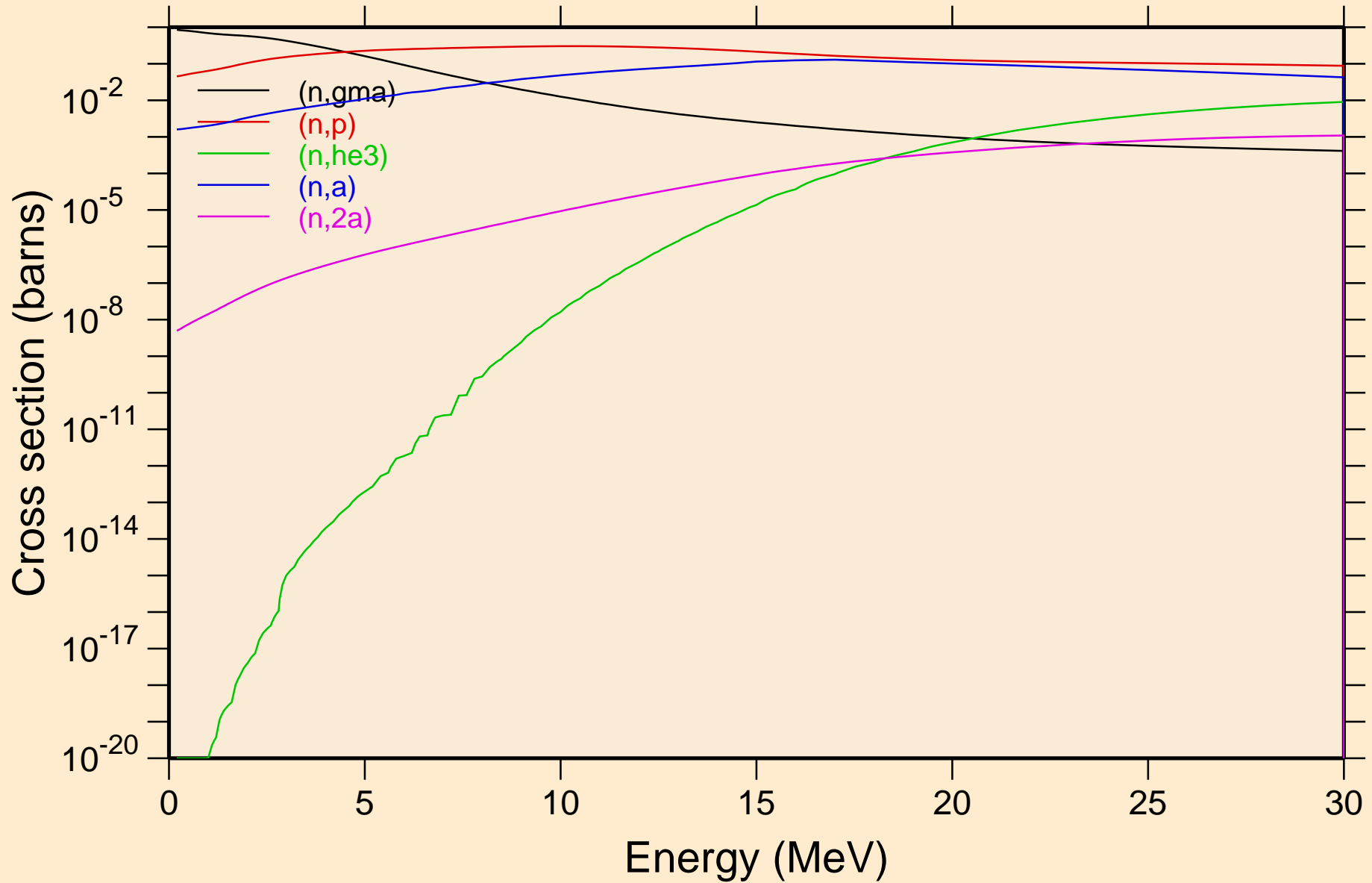

PB187 NEUTRON ACER TENDL-2024 LIBRARY; T=0.K
Non-threshold reactions

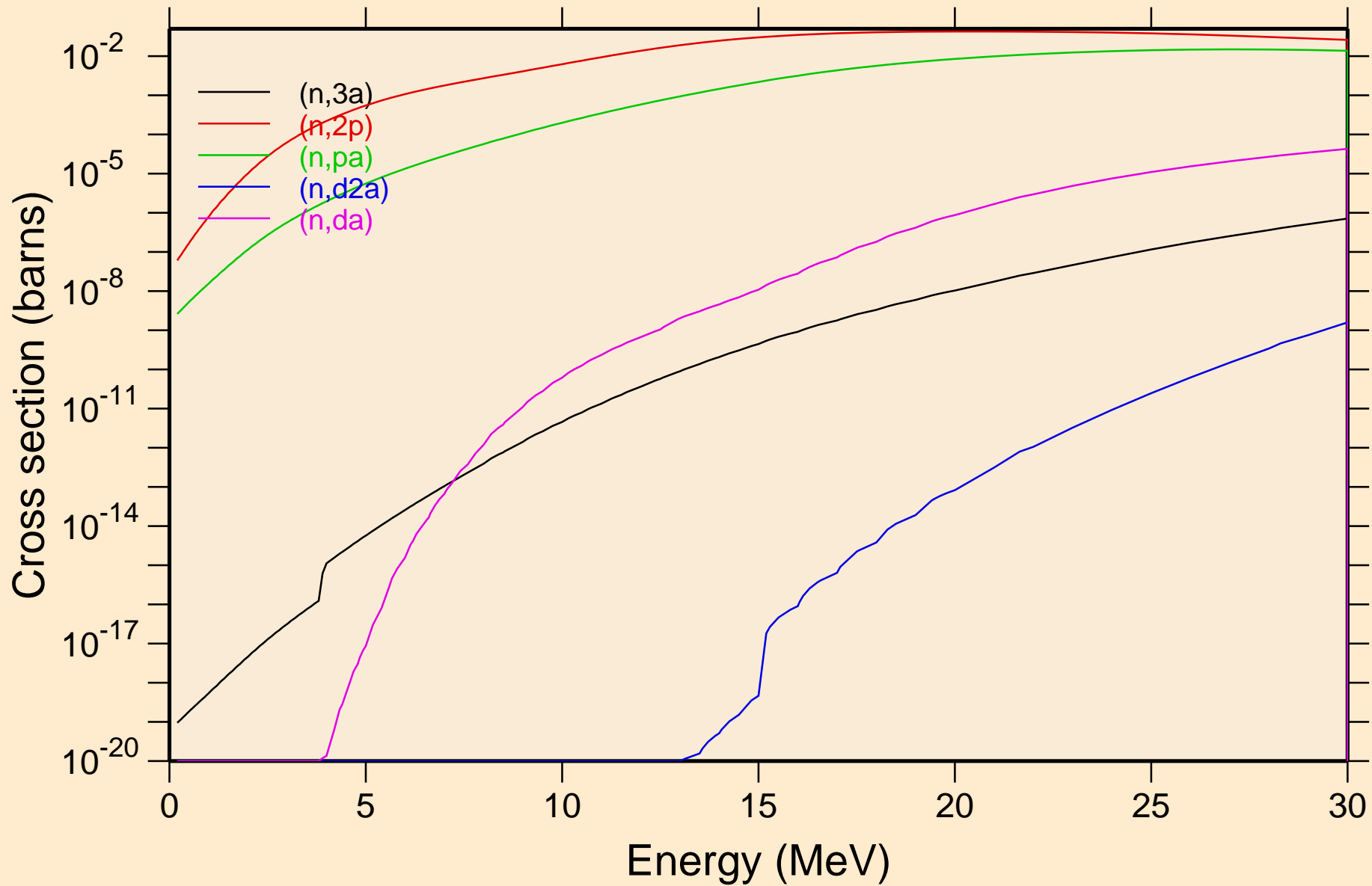

PB187 NEUTRON ACER TENDL-2024 LIBRARY; T=0.K
Non-threshold reactions

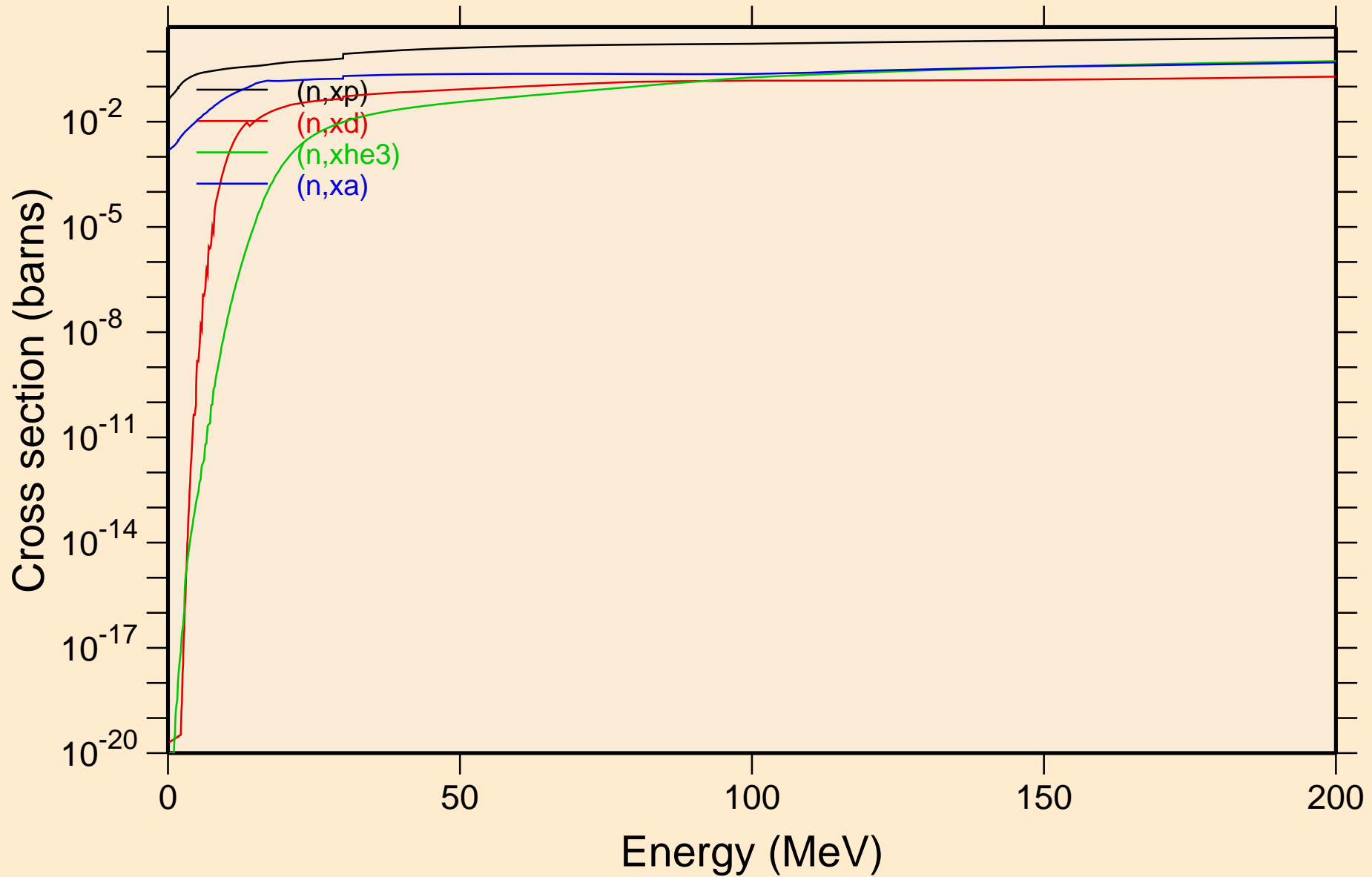

PB187 NEUTRON ACER TENDL-2024 LIBRARY; T=0.K
Inelastic levels

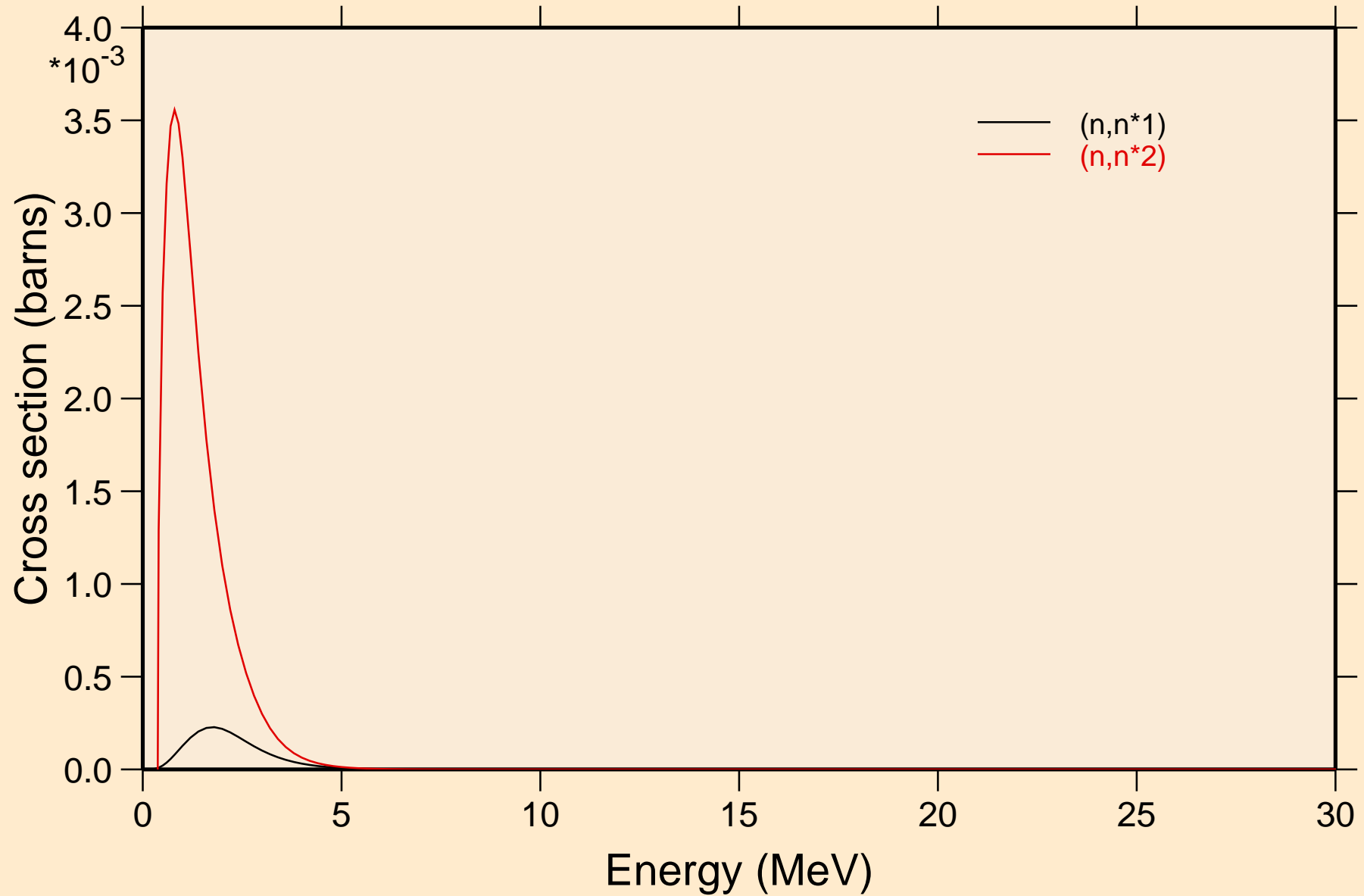

PB187 NEUTRON ACER TENDL-2024 LIBRARY; T=0.K
Threshold reactions

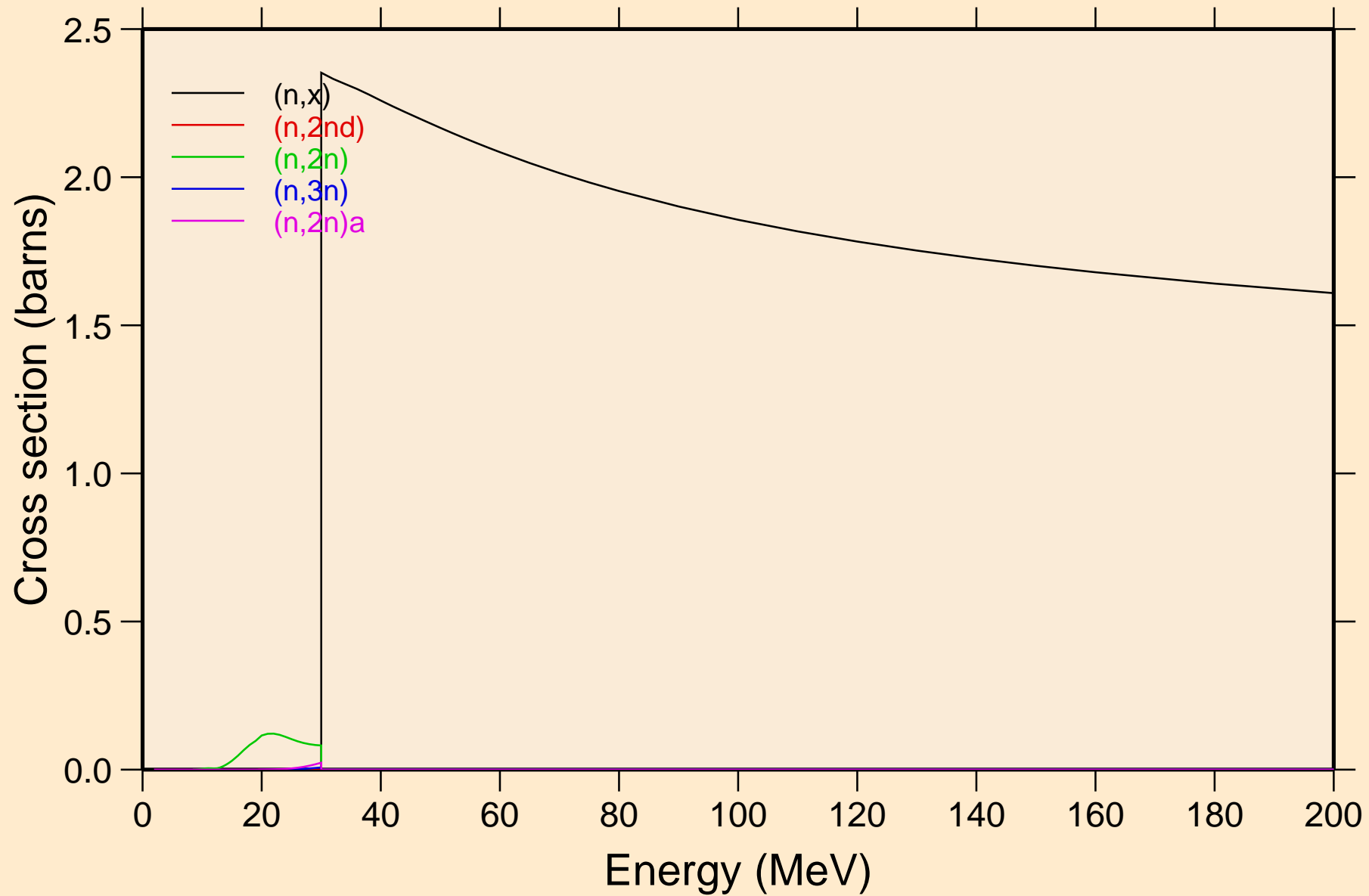

PB187 NEUTRON ACER TENDL-2024 LIBRARY; T=0.K
Threshold reactions

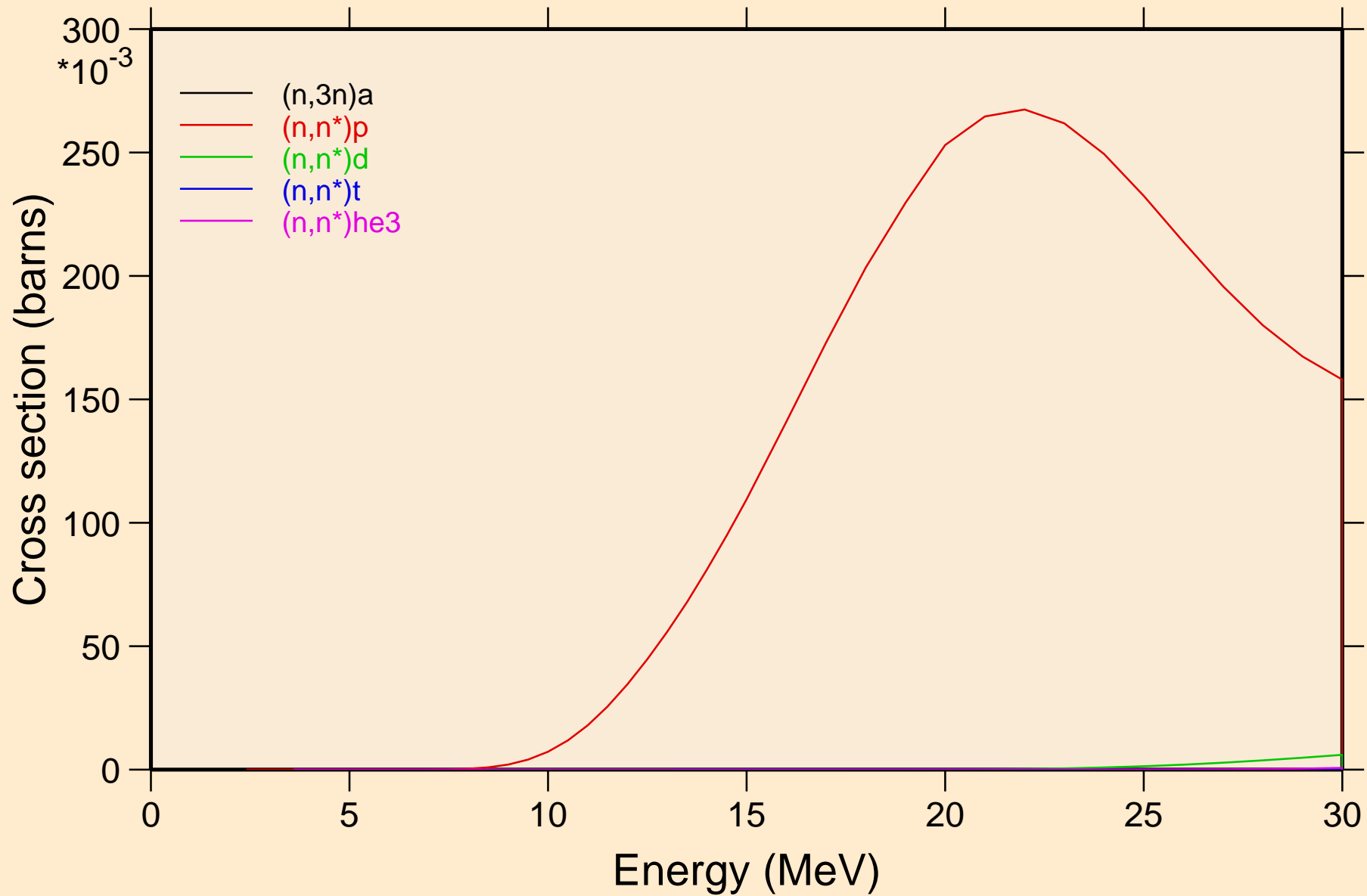

PB187 NEUTRON ACER TENDL-2024 LIBRARY; T=0.K
Threshold reactions

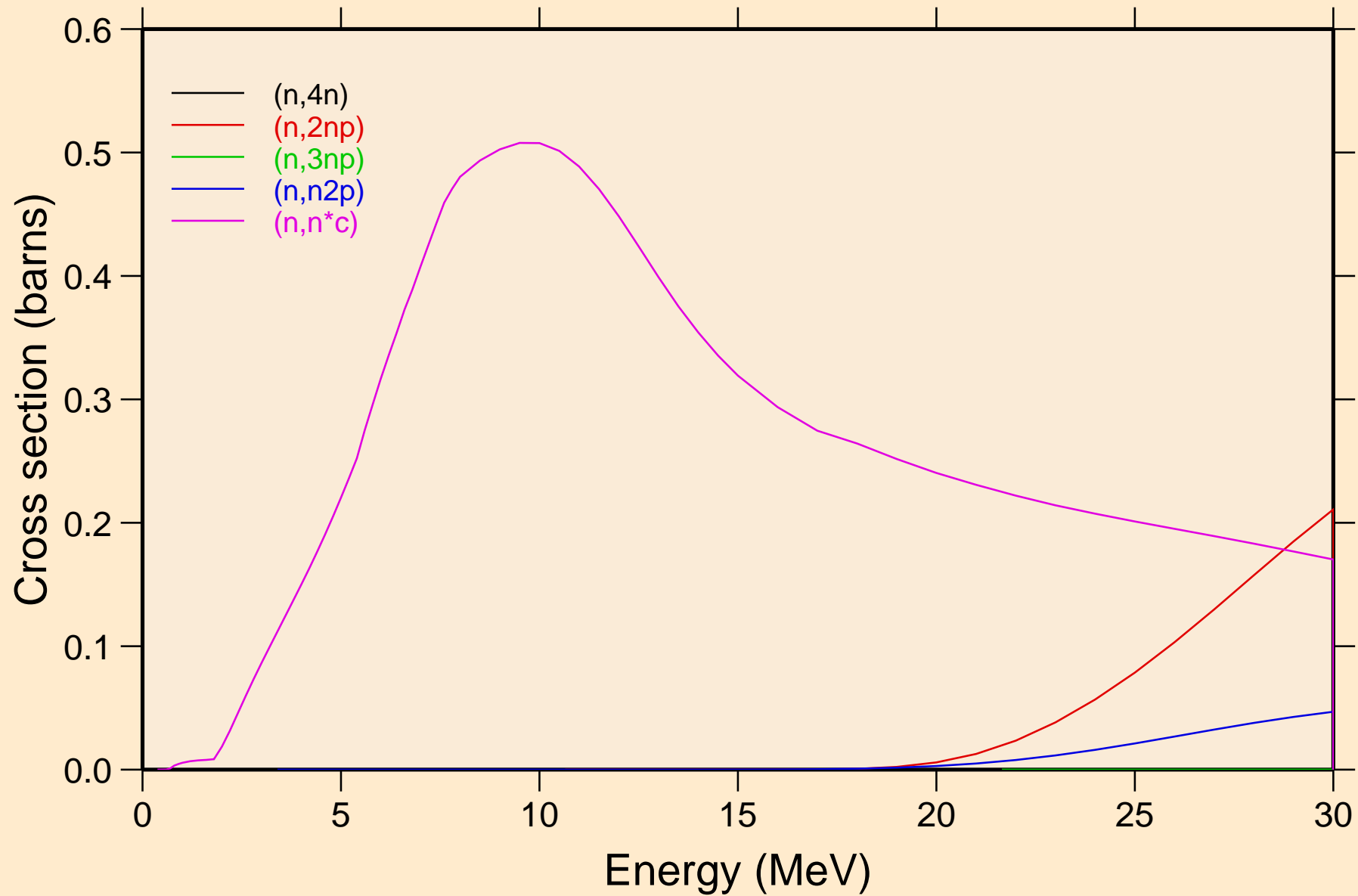

PB187 NEUTRON ACER TENDL-2024 LIBRARY; T=0.K

Threshold reactions

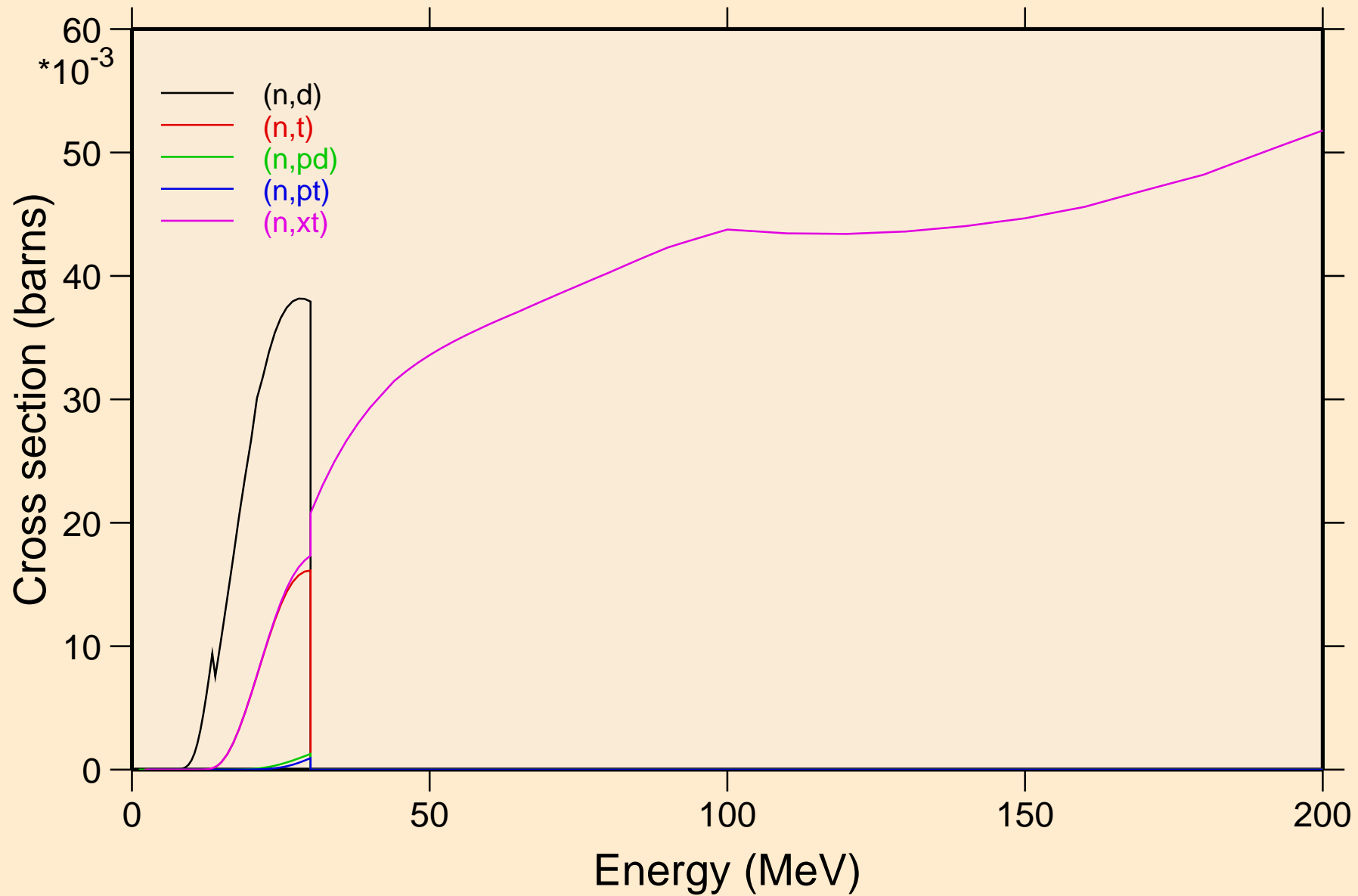

PB187 NEUTRON ACER TENDL-2024 LIBRARY; T=0.K
angular distribution for elastic

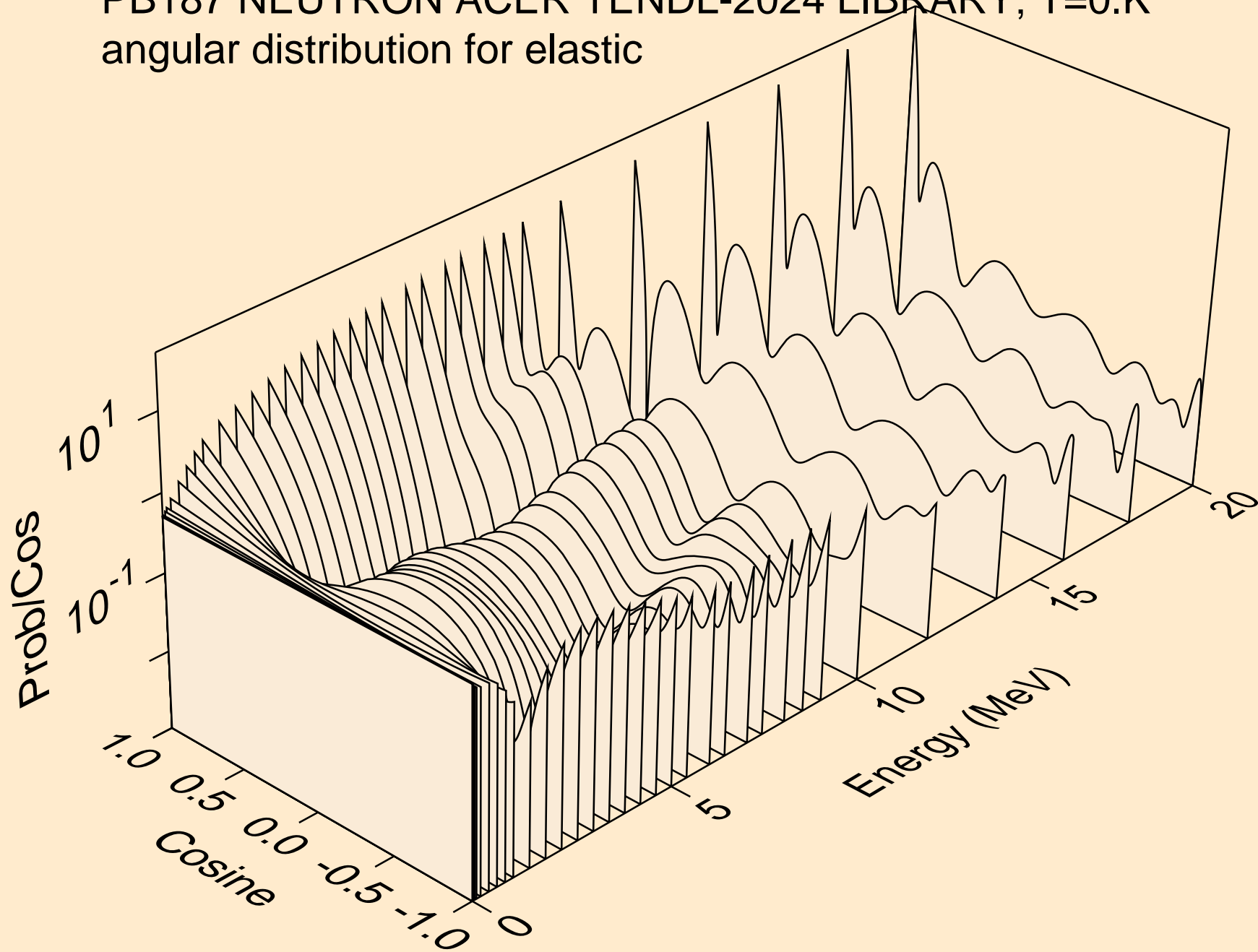

PB187 NEUTRON ACER TENDL-2024 LIBRARY; T=0.K
angular distribution for elastic

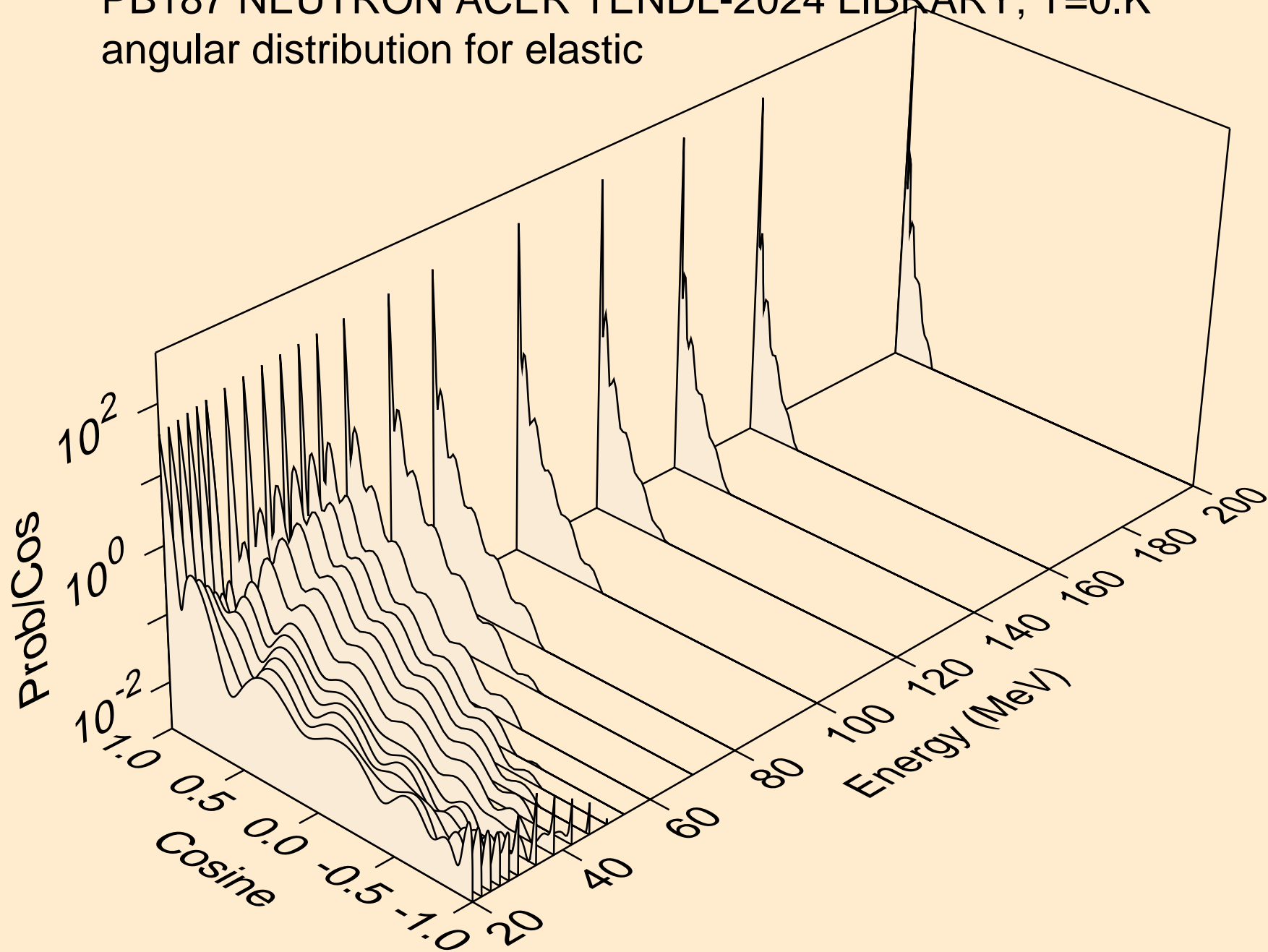

PB187 NEUTRON ACER TENDL-2024 LIBRARY; T=0.K
angular distribution for (n,n*1)

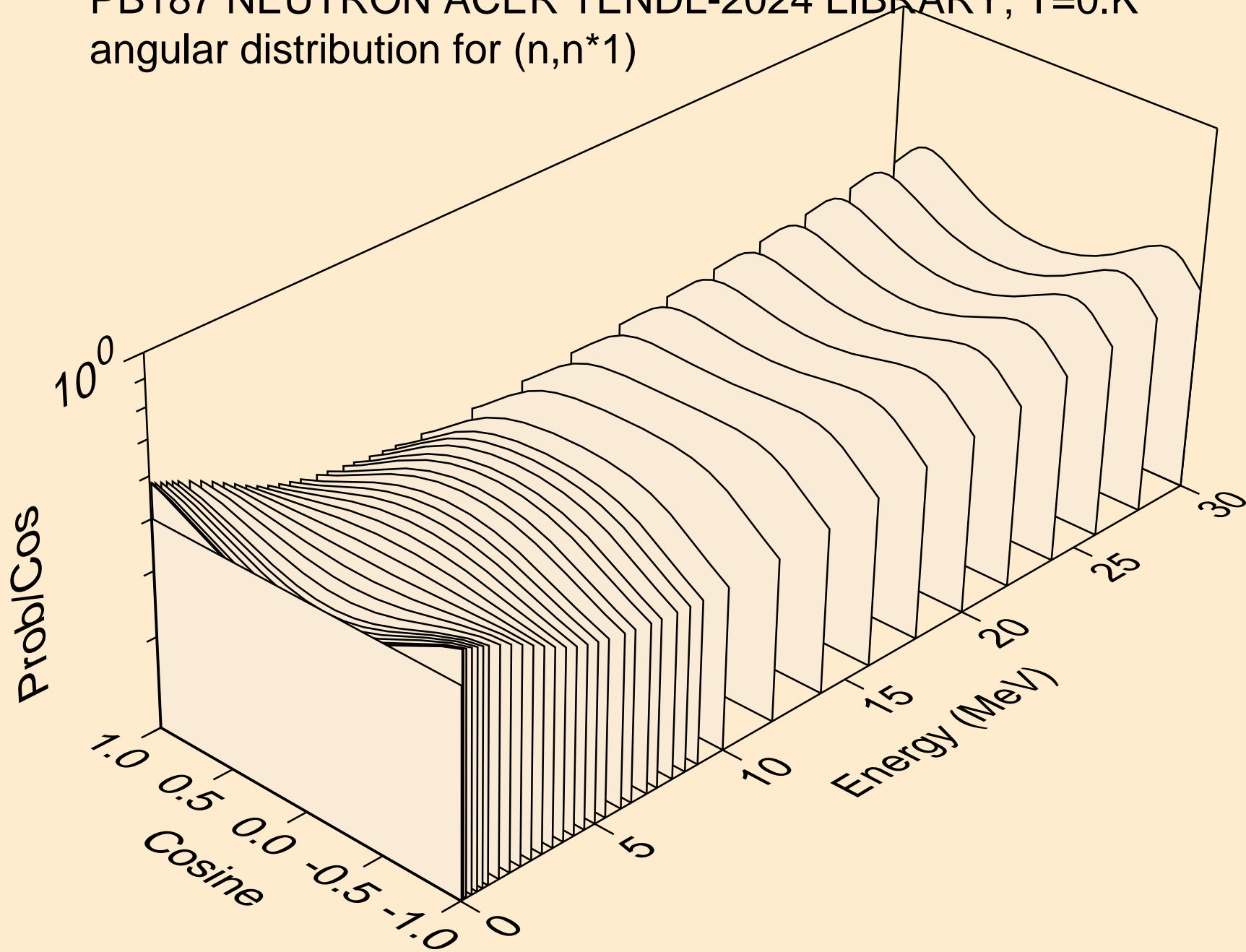

PB187 NEUTRON ACER TENDL-2024 LIBRARY; T=0.K
angular distribution for (n,n*2)

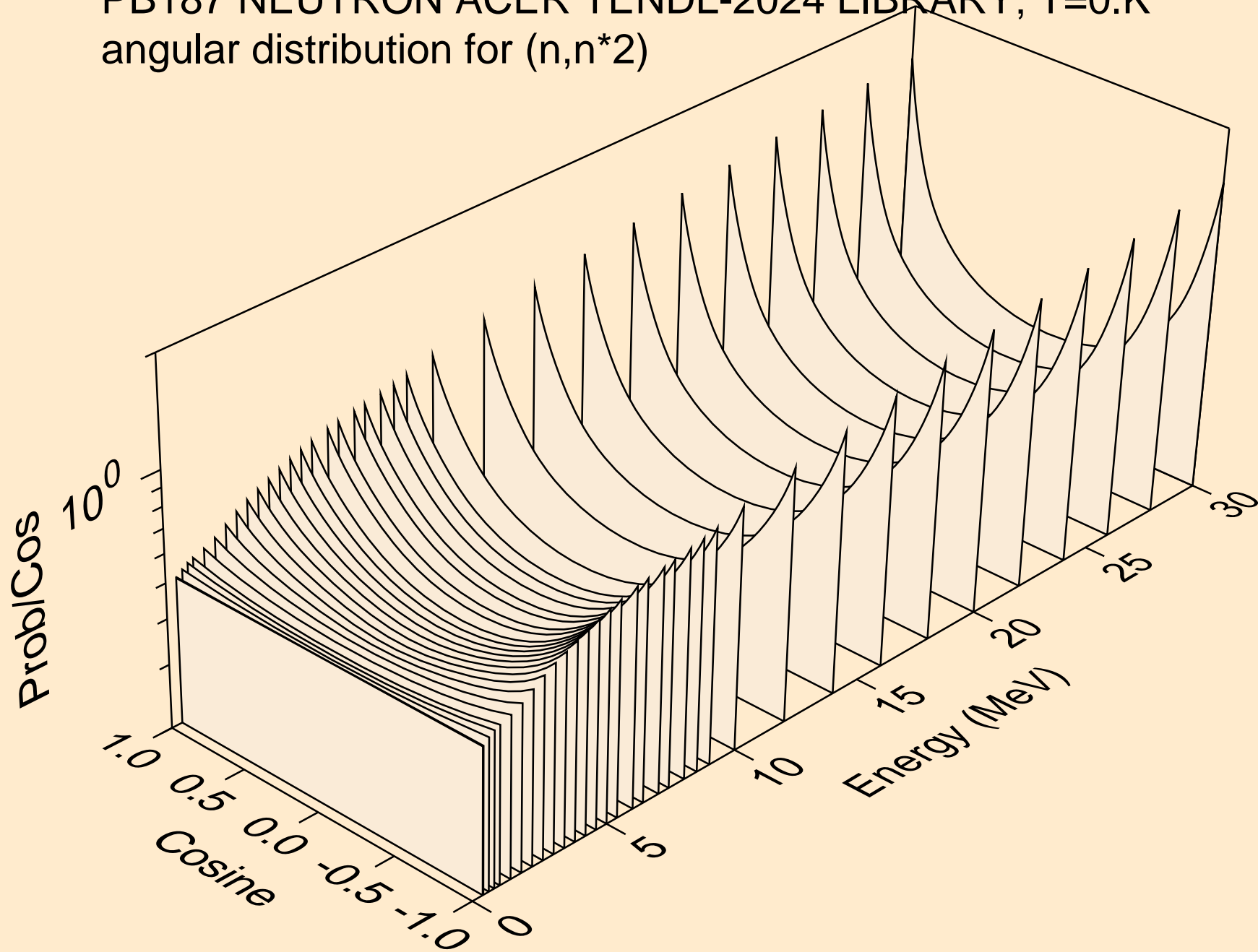

PB187 NEUTRON ACER TENDL-2024 LIBRARY; T=0.K
Neutron emission for (n,x)

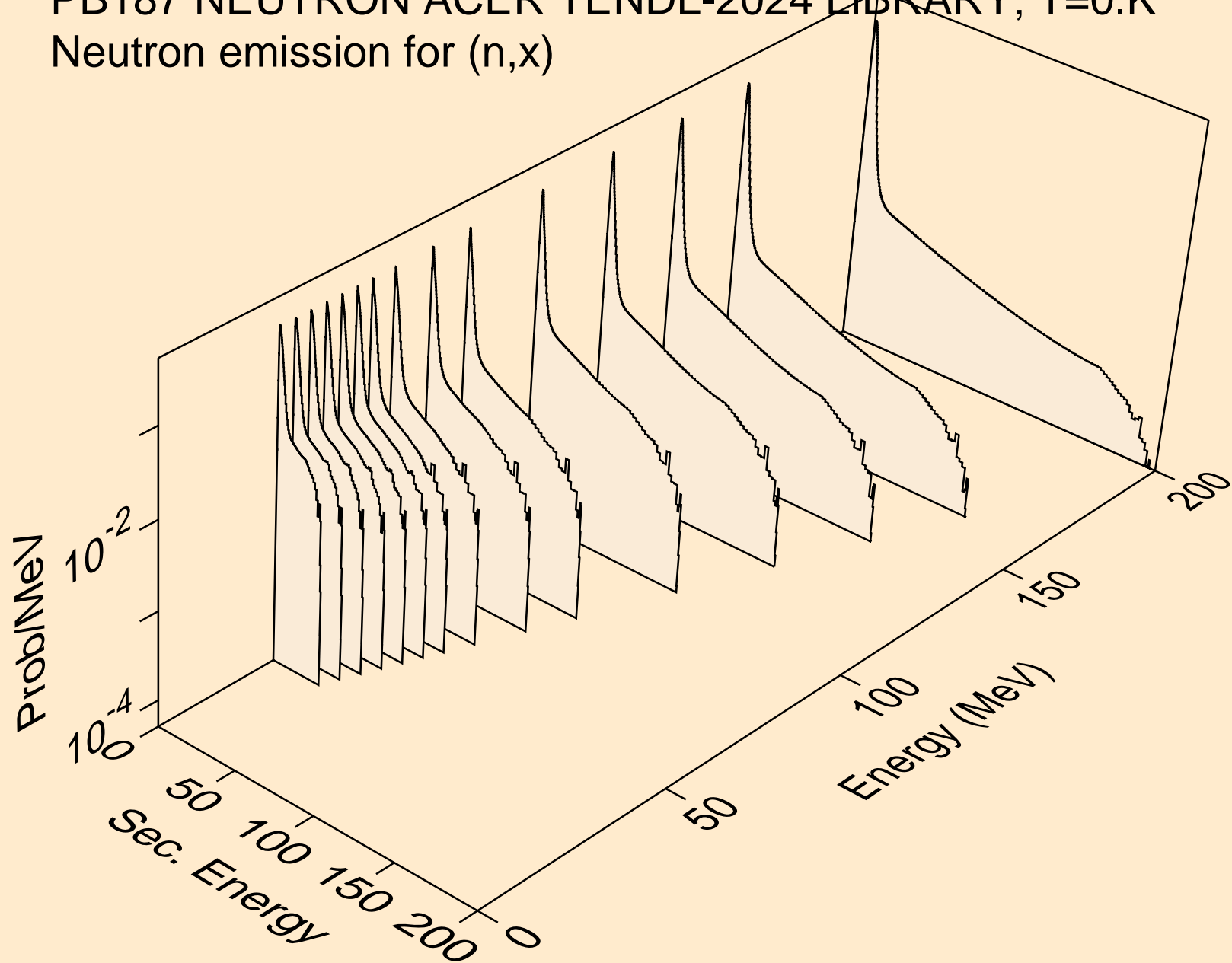

PB187 NEUTRON ACER TENDL-2024 LIBRARY; T=0.K
Neutron emission for (n,2nd)

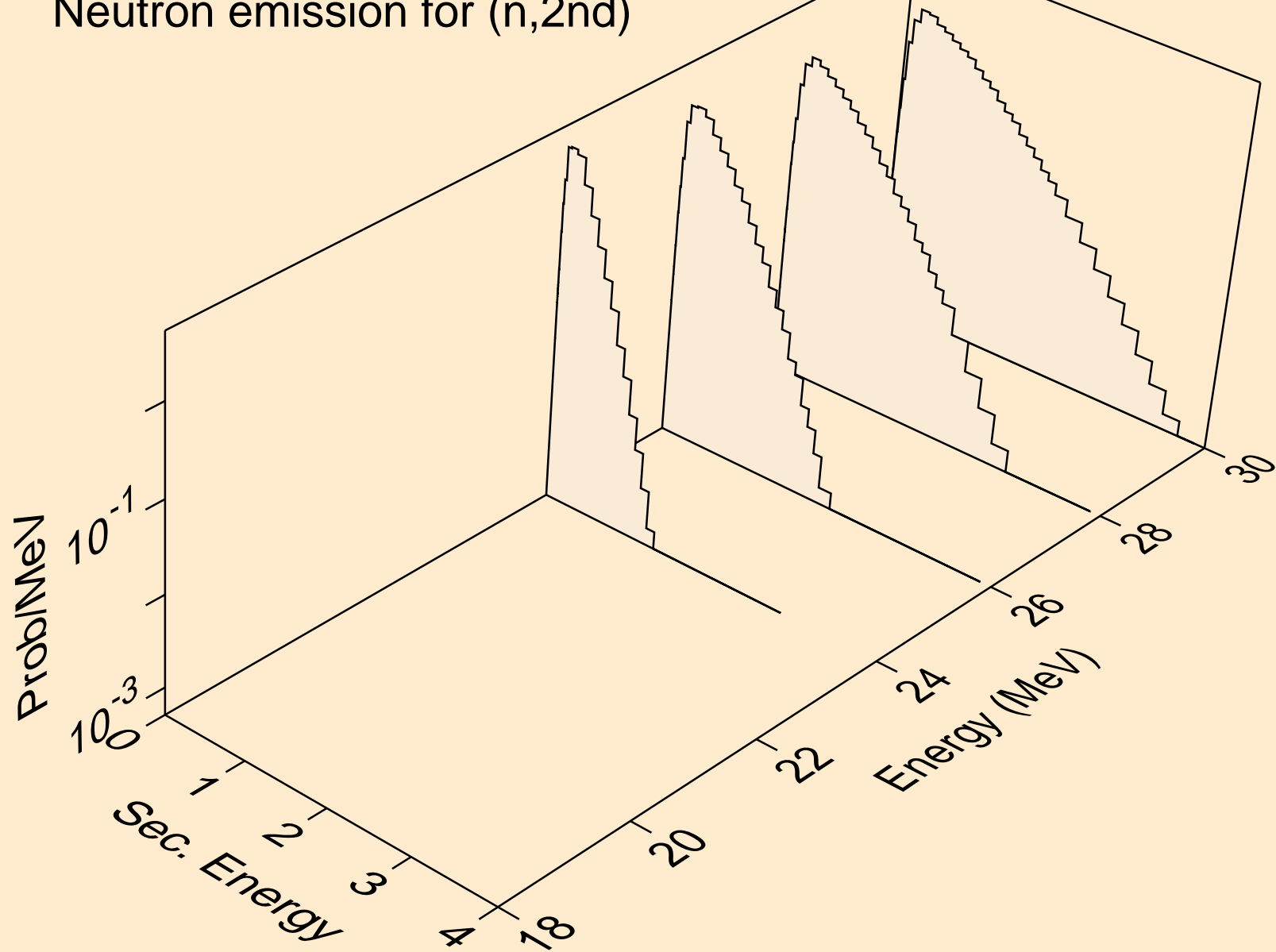

PB187 NEUTRON ACER TENDL-2024 LIBRARY; T=0.K
Neutron emission for (n,2n)

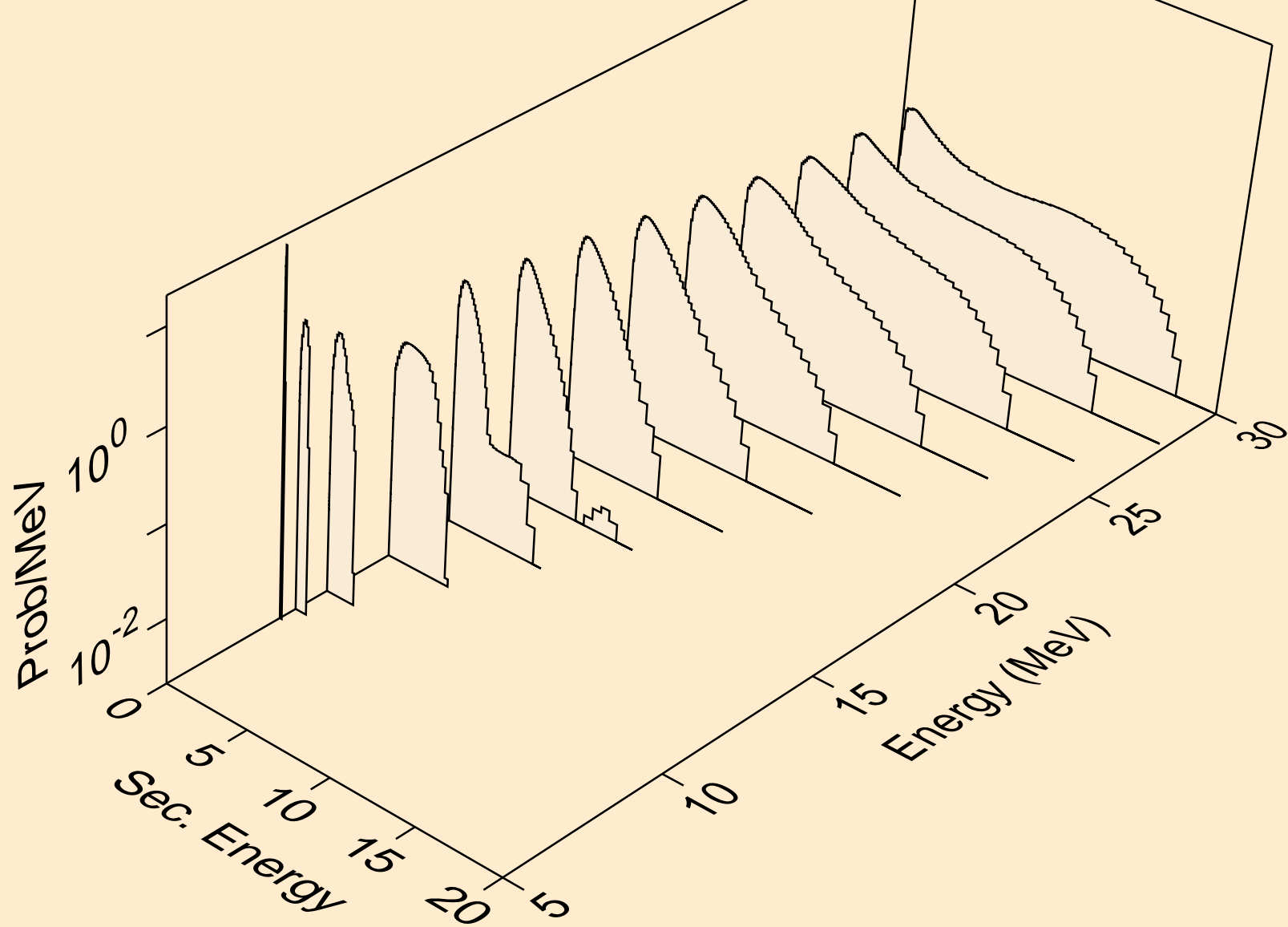

PB187 NEUTRON ACER TENDL-2024 LIBRARY; T=0.K
Neutron emission for (n,3n)

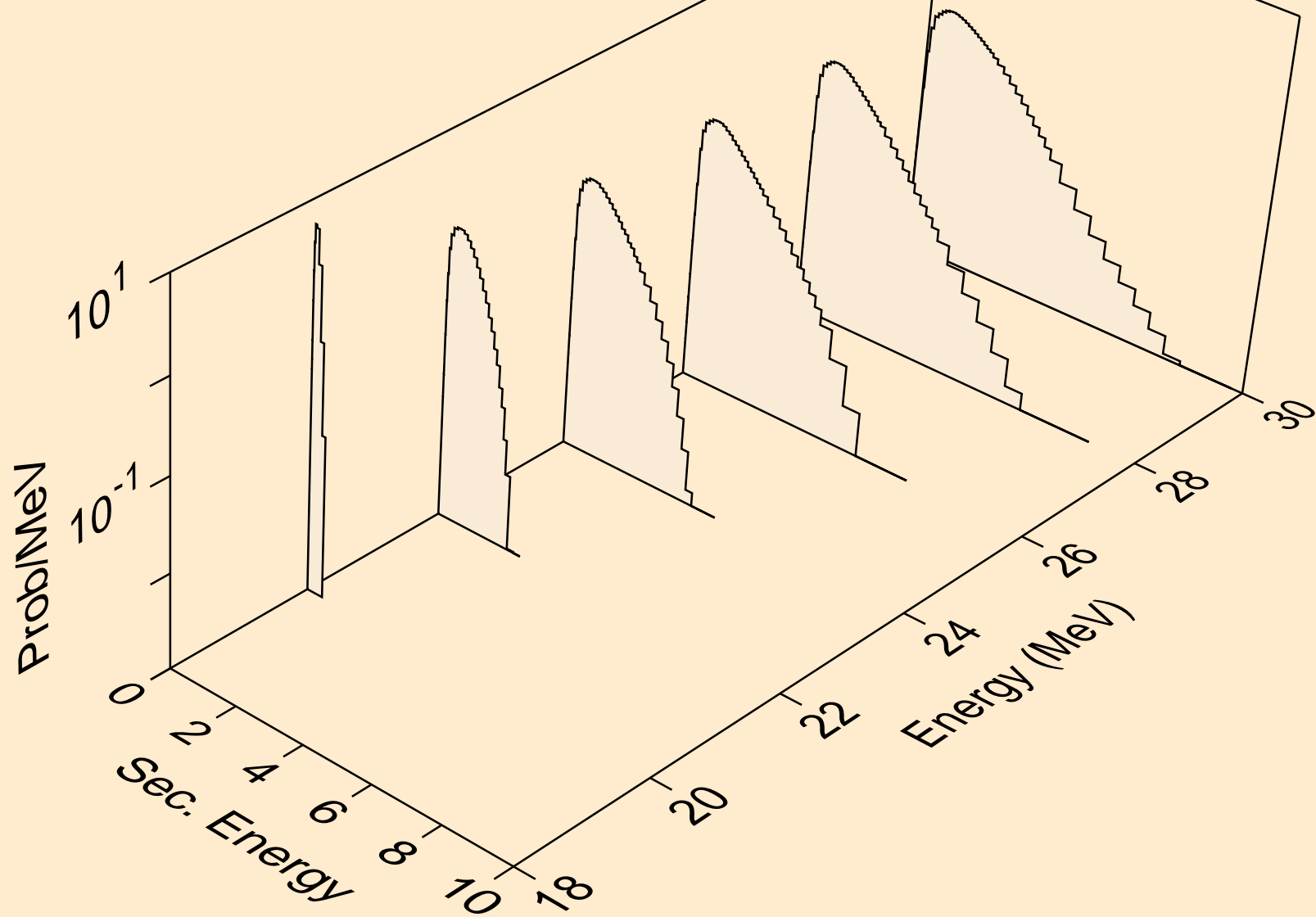

PB187 NEUTRON ACER TENDL-2024 LIBRARY; T=0.K
Neutron emission for (n,n*)a

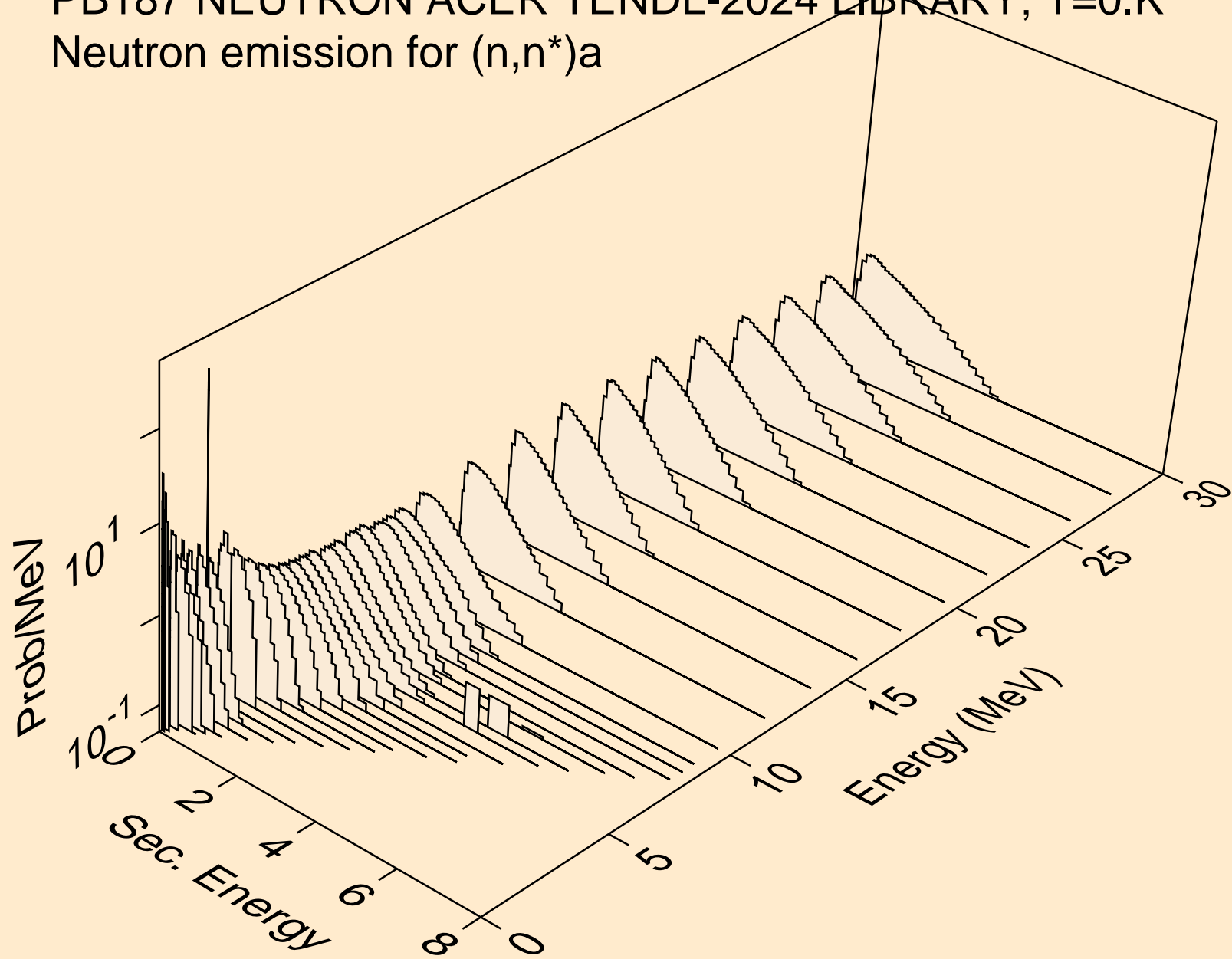

PB187 NEUTRON ACER TENDL-2024 LIBRARY; T=0.K
Neutron emission for (n,n*)3a

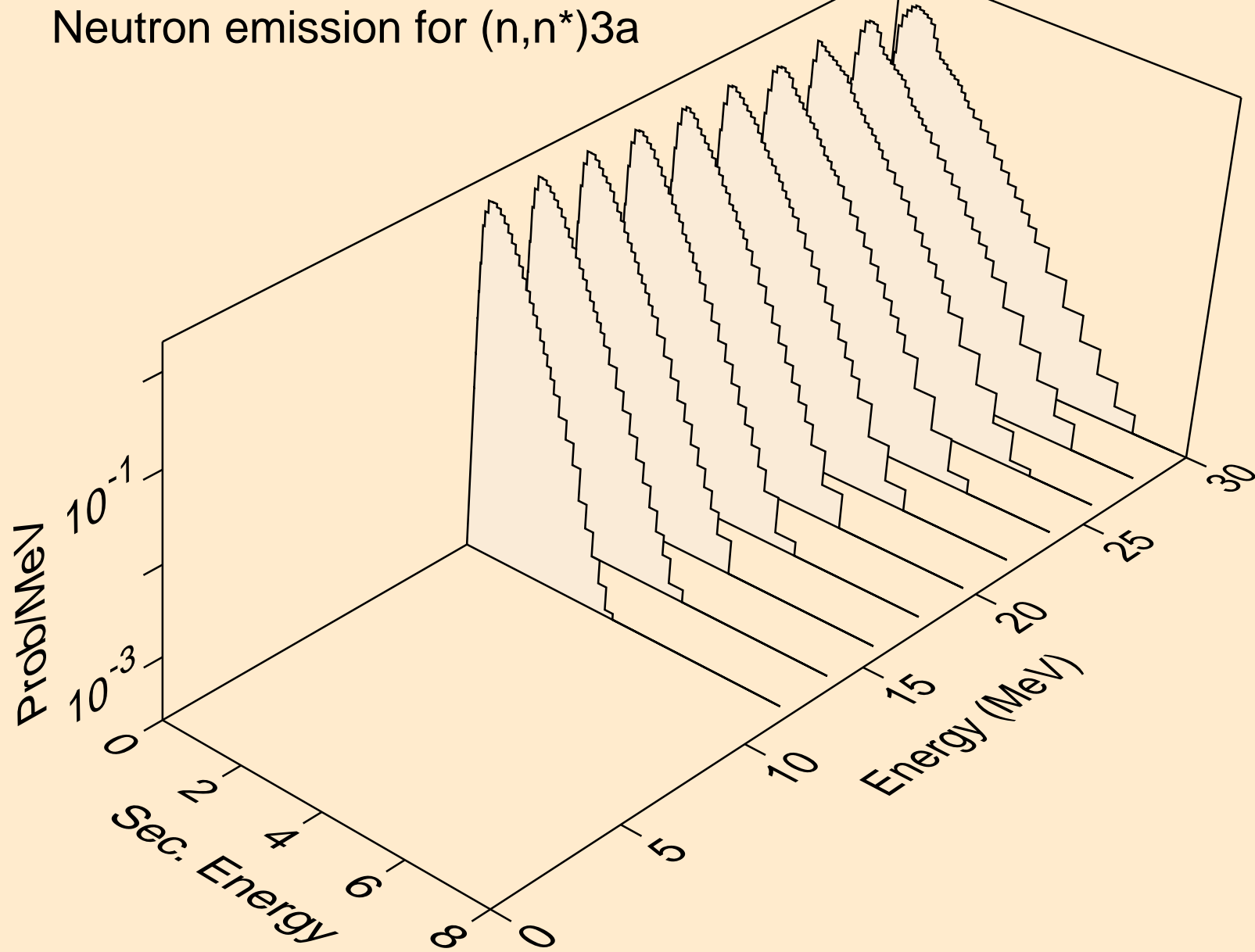

PB187 NEUTRON ACER TENDL-2024 LIBRARY; T=0.K
Neutron emission for (n,2n)a

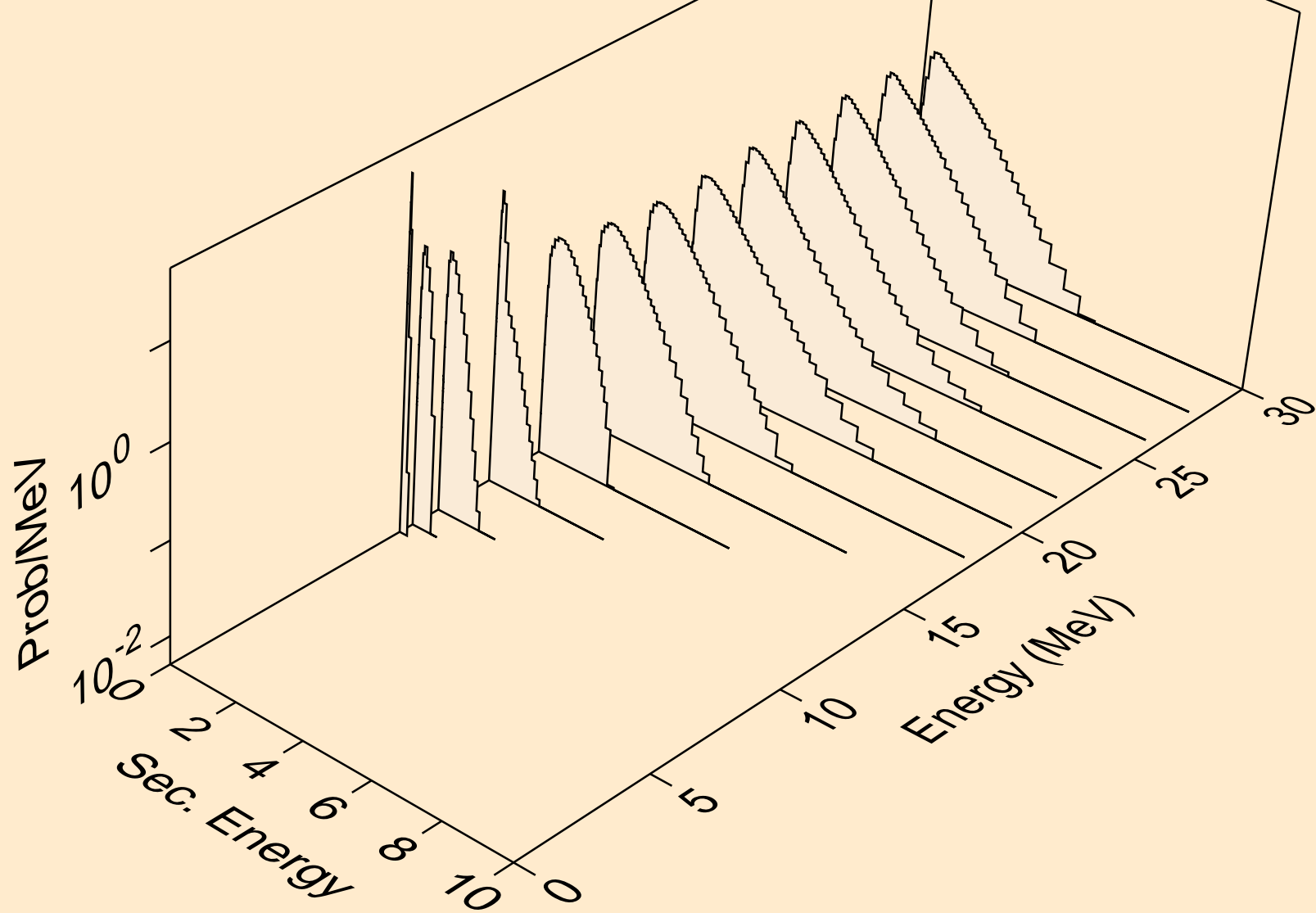

PB187 NEUTRON ACER TENDL-2024 LIBRARY; T=0.K
Neutron emission for (n,3n)a

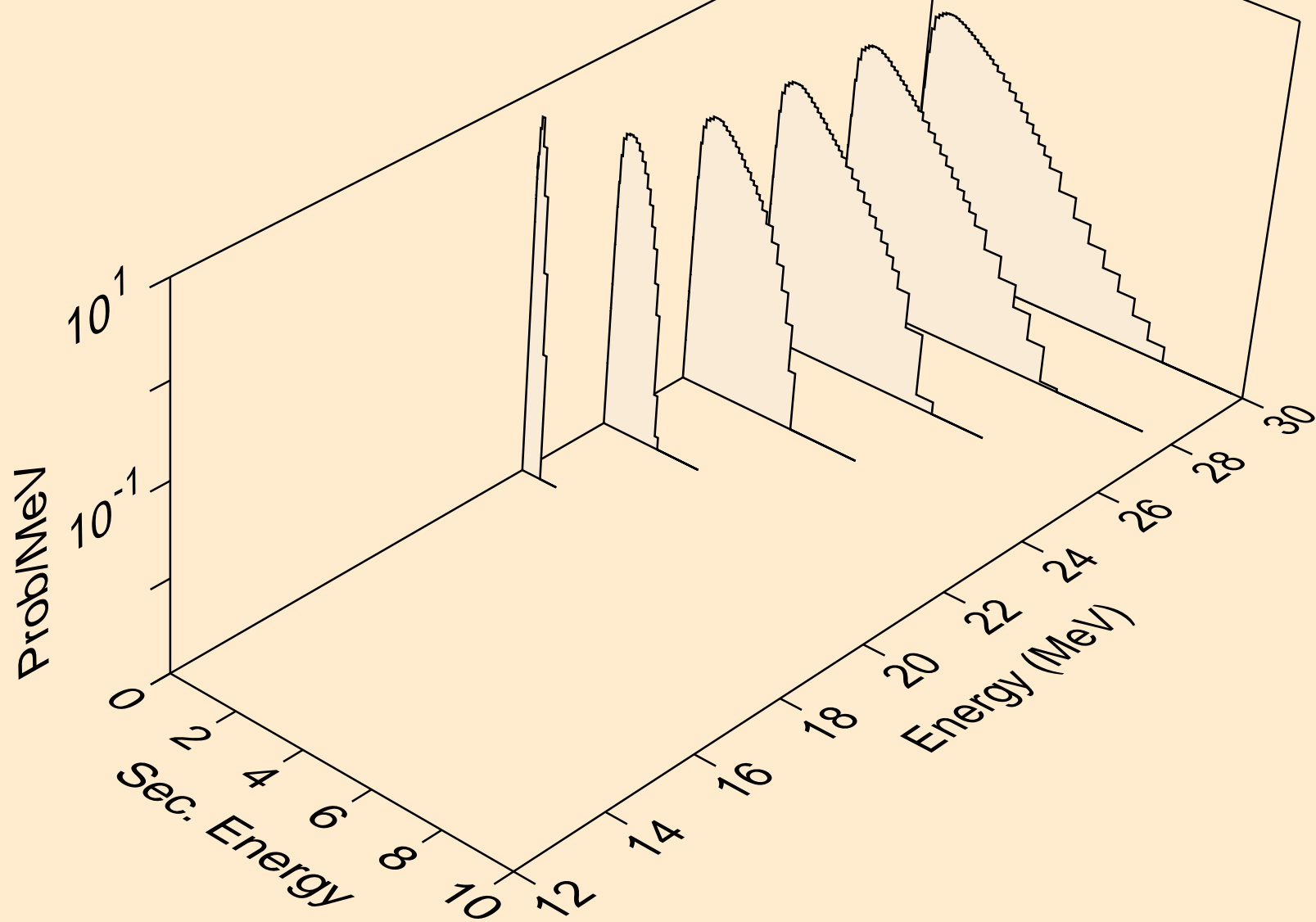

PB187 NEUTRON ACER TENDL-2024 LIBRARY; T=0.K
Neutron emission for (n,n*)p

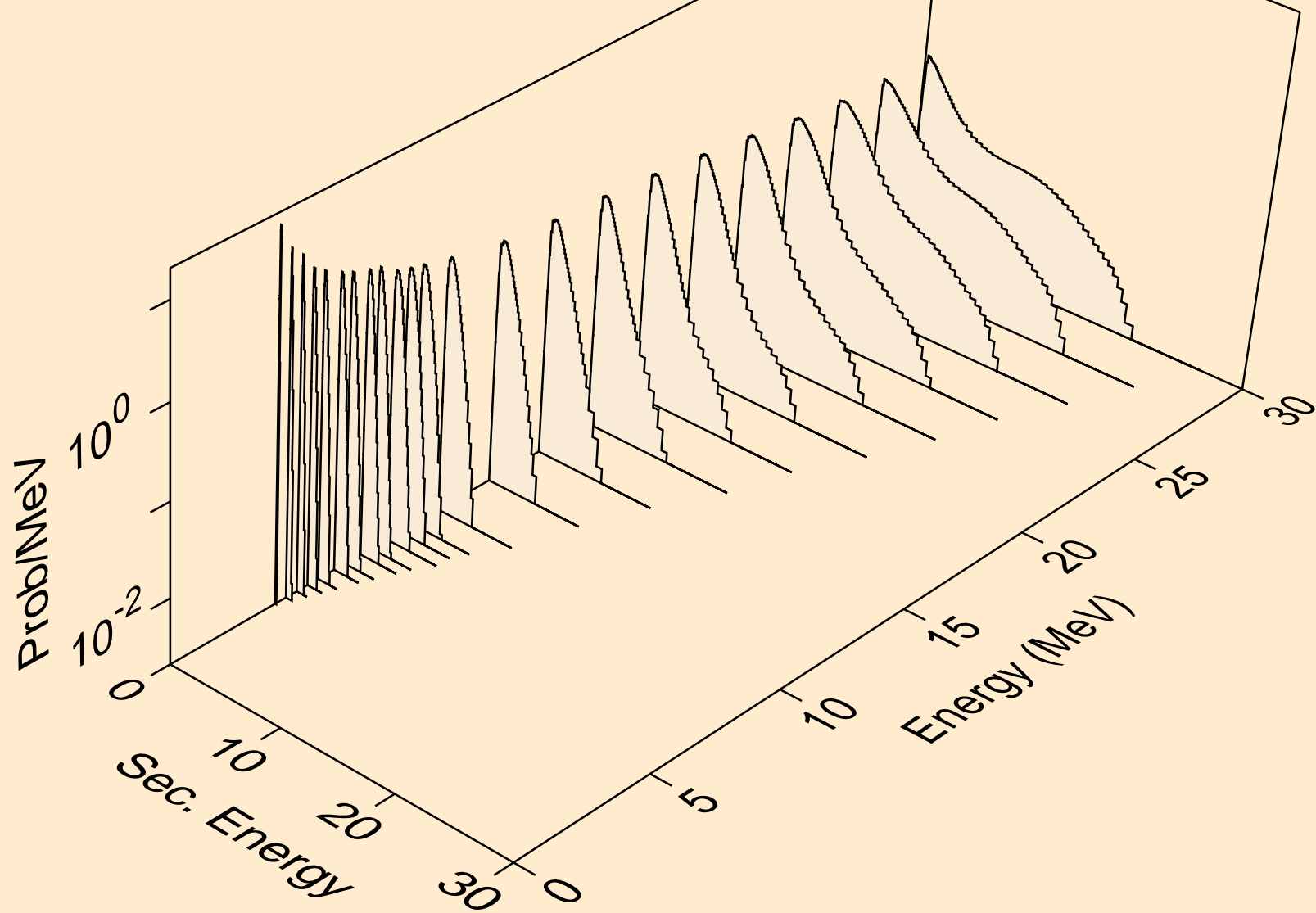

PB187 NEUTRON ACER TENDL-2024 LIBRARY; T=0.K
Neutron emission for (n,n*)2a

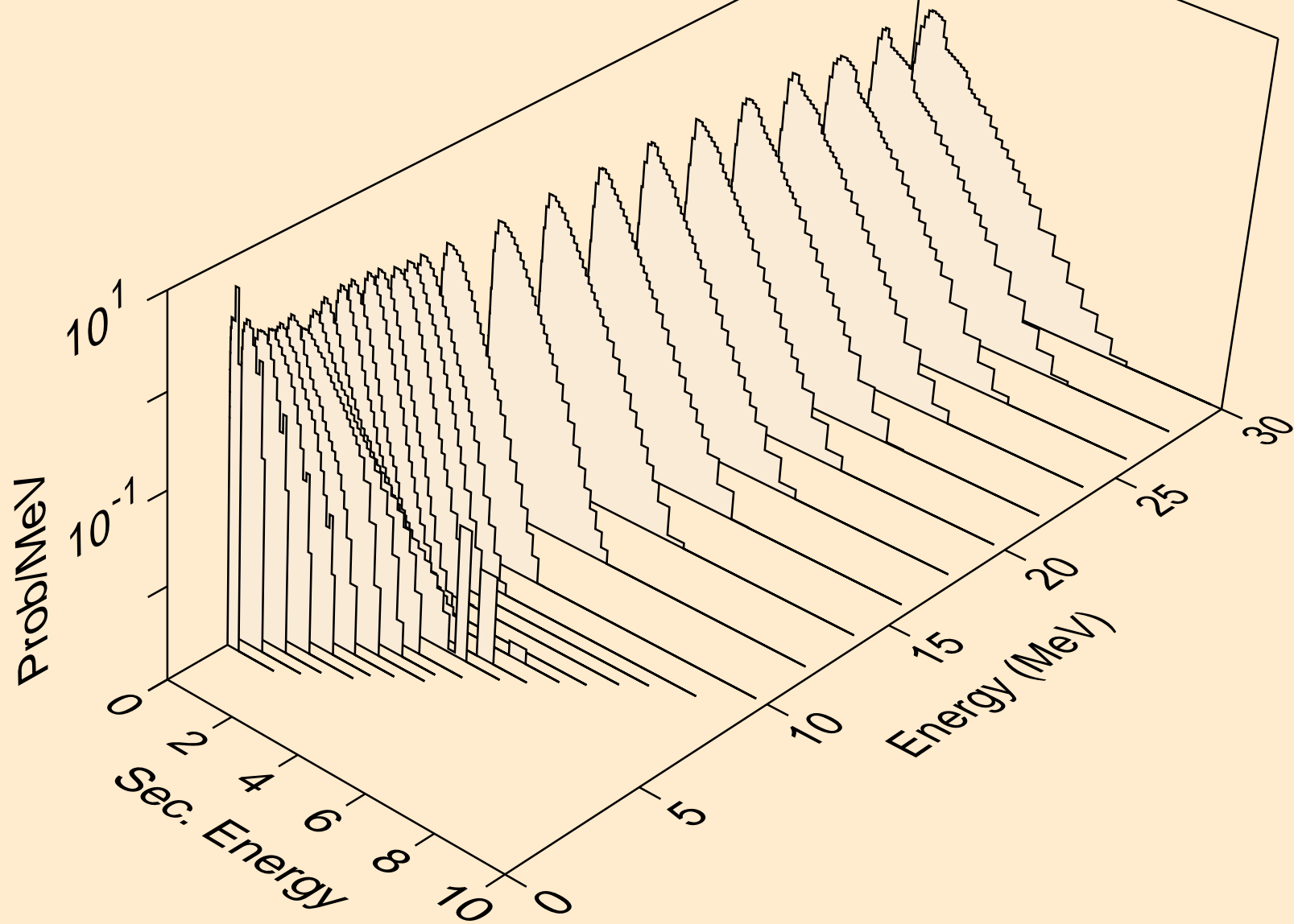

PB187 NEUTRON ACER TENDL-2024 LIBRARY; T=0.K
Neutron emission for (n,2n)2a

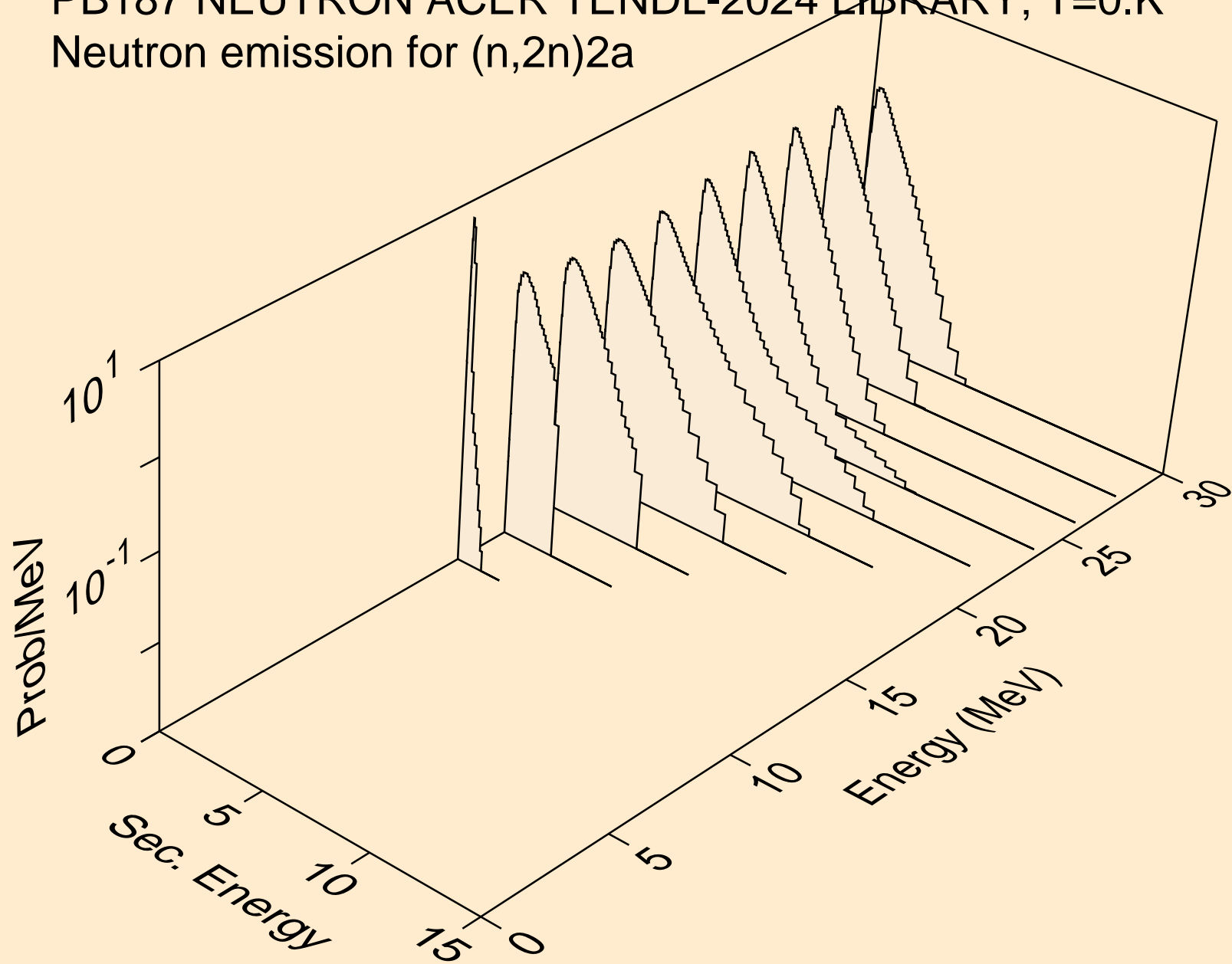

PB187 NEUTRON ACER TENDL-2024 LIBRARY; T=0.K
Neutron emission for (n,n*)d

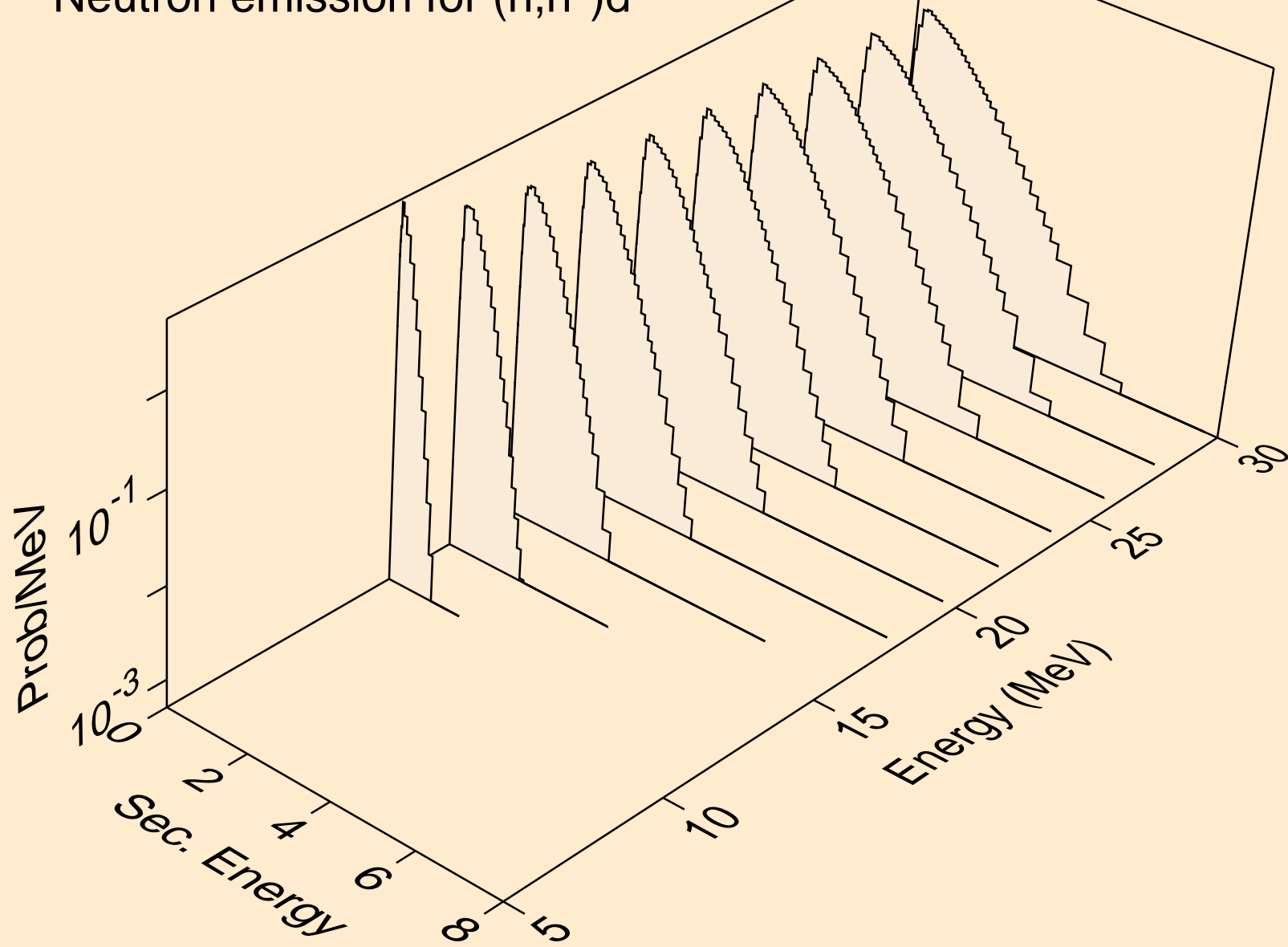

PB187 NEUTRON ACER TENDL-2024 LIBRARY; T=0.K
Neutron emission for (n,n*)t

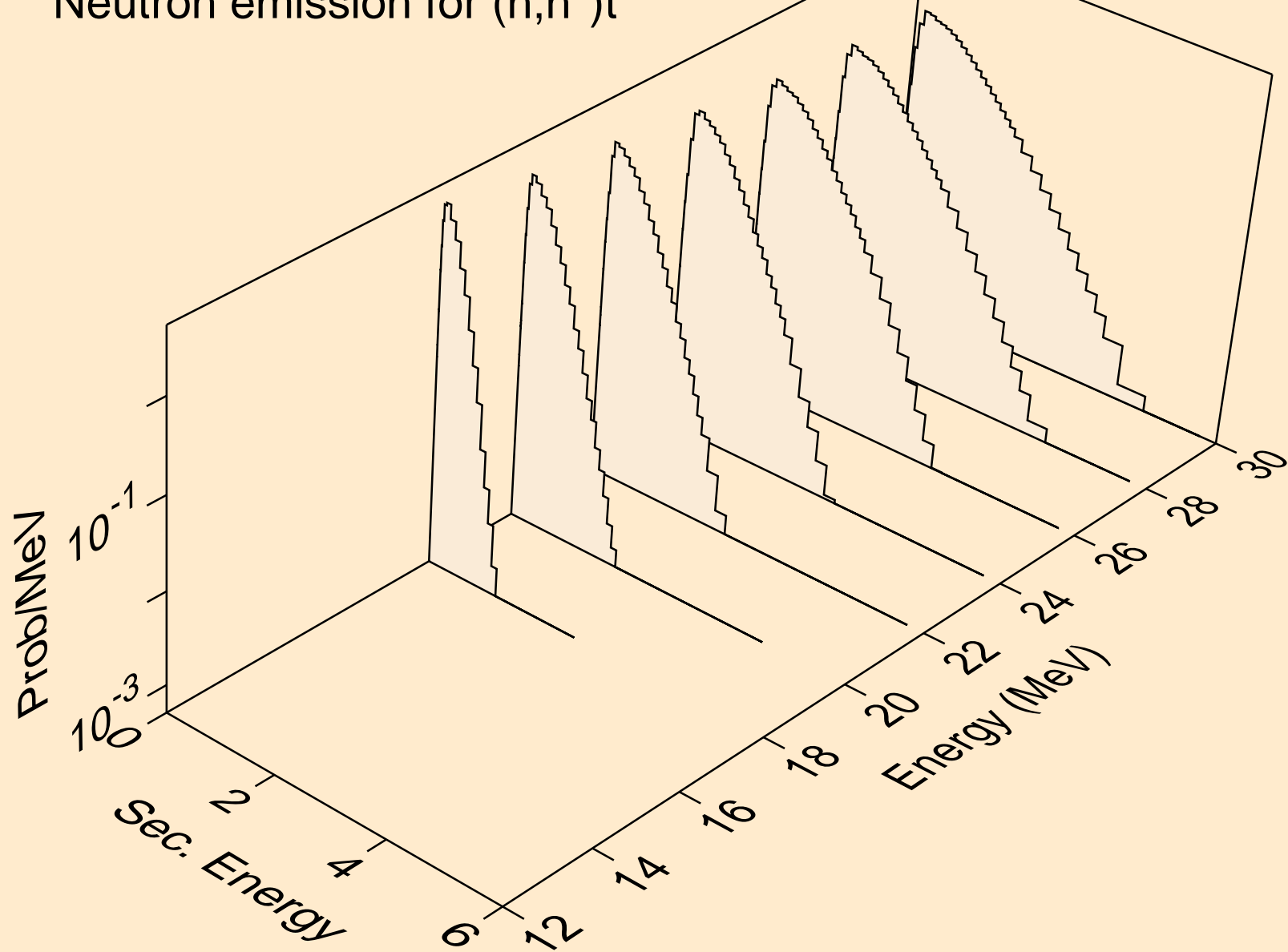

PB187 NEUTRON ACER TENDL-2024 LIBRARY; T=0.K
Neutron emission for (n,n*)he3

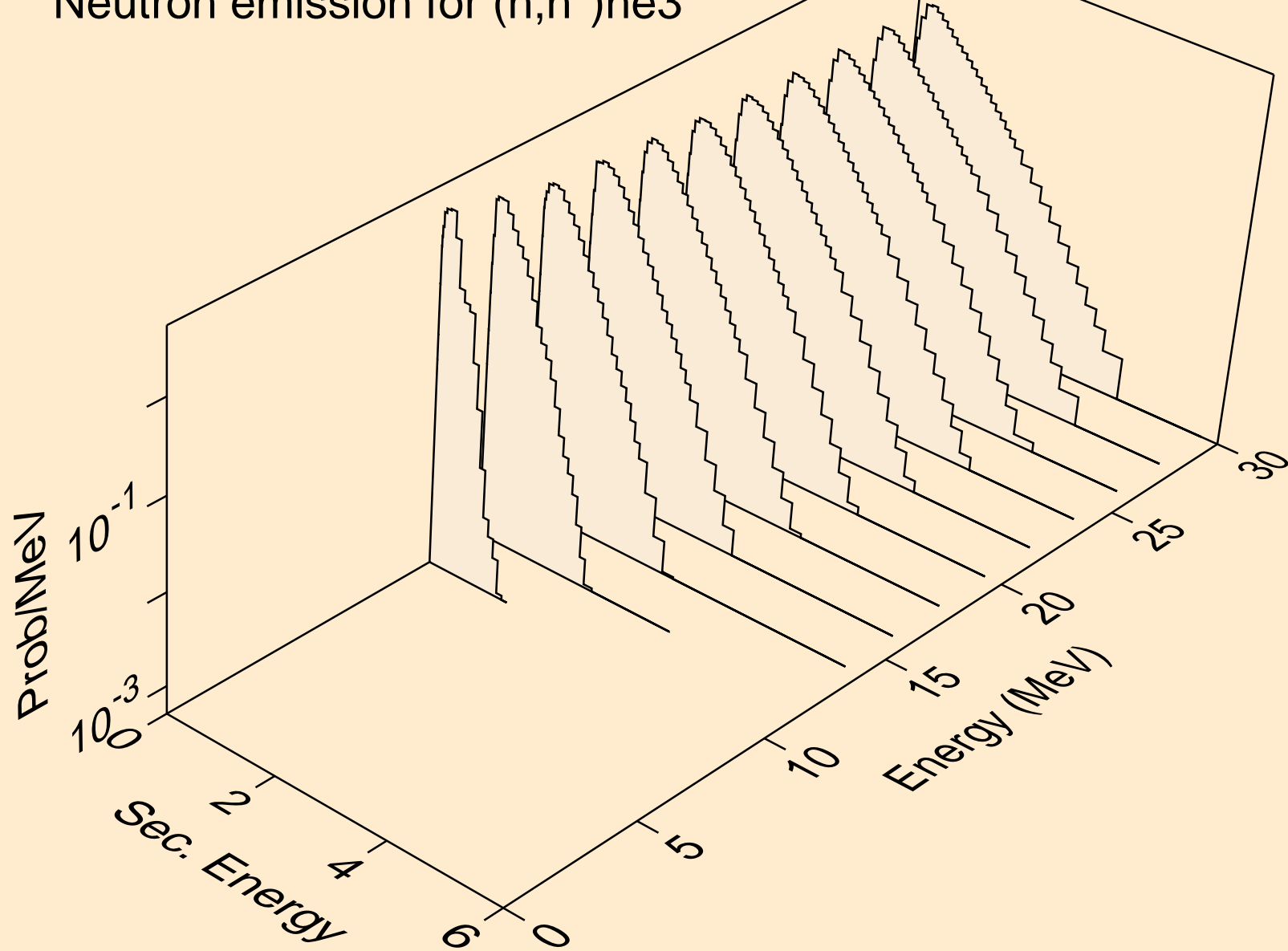

PB187 NEUTRON ACER TENDL-2024 LIBRARY; T=0.K
Neutron emission for (n,4n)

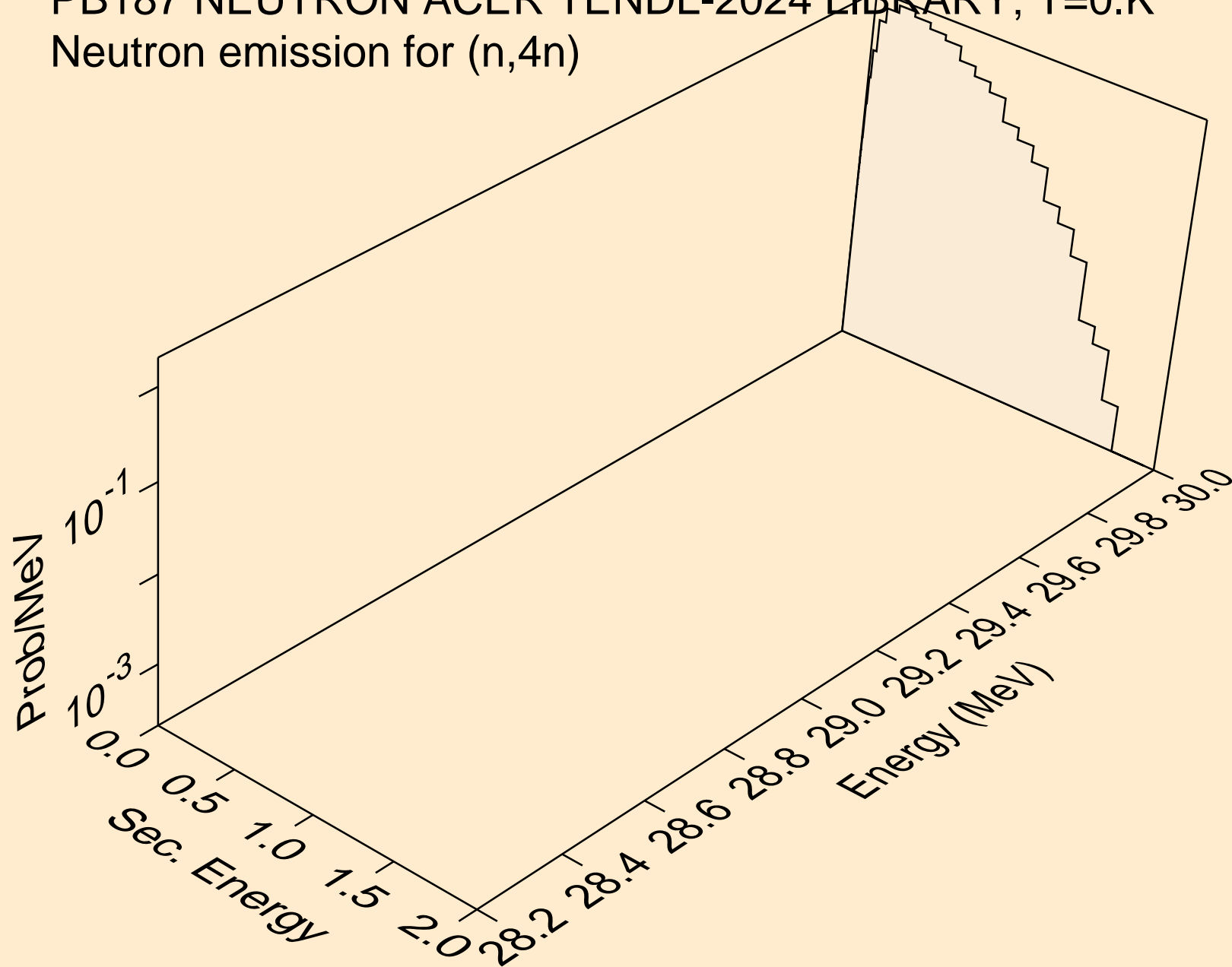

PB187 NEUTRON ACER TENDL-2024 LIBRARY; T=0.K
Neutron emission for (n,2np)

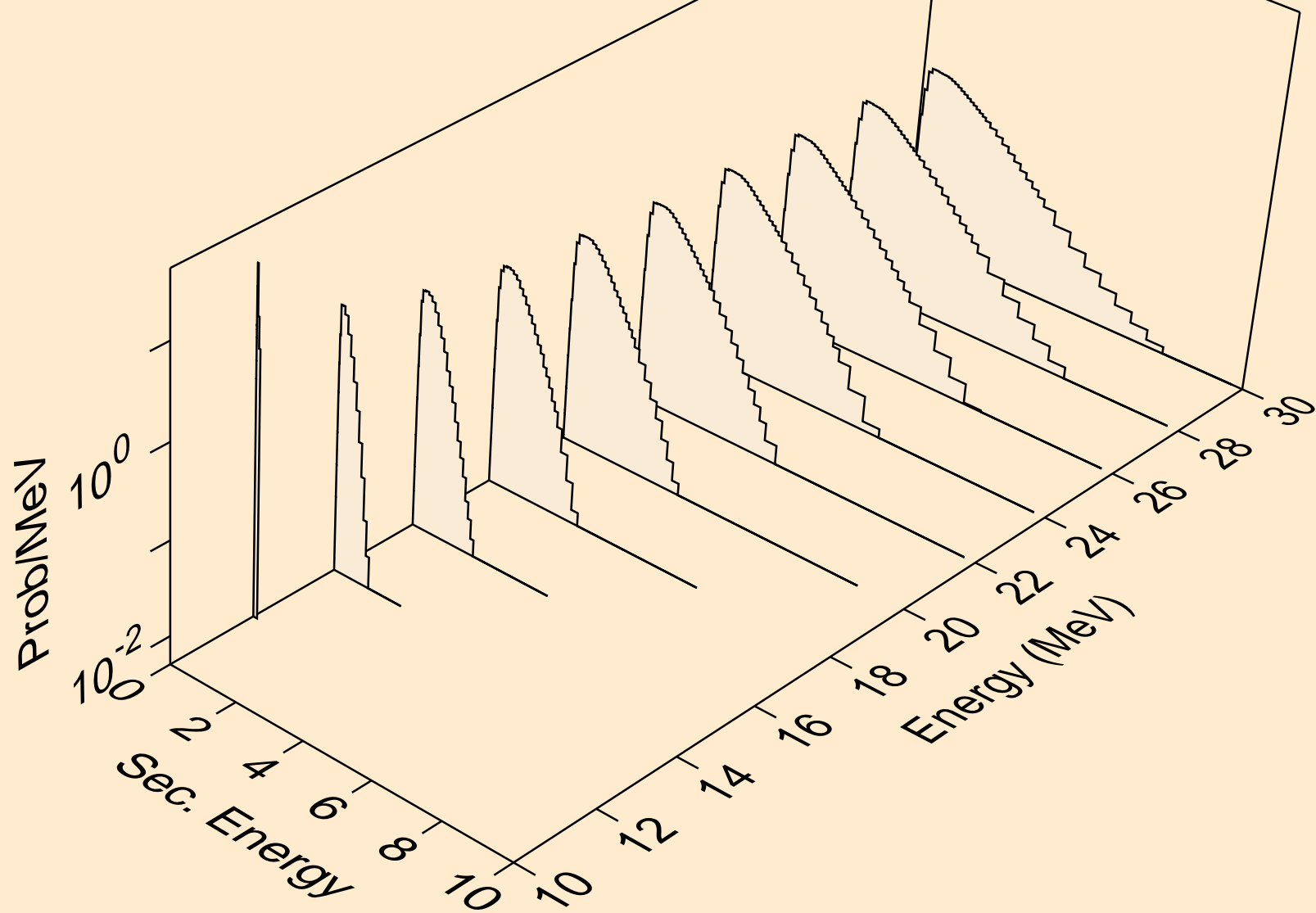

PB187 NEUTRON ACER TENDL-2024 LIBRARY; T=0.K
Neutron emission for (n,3np)

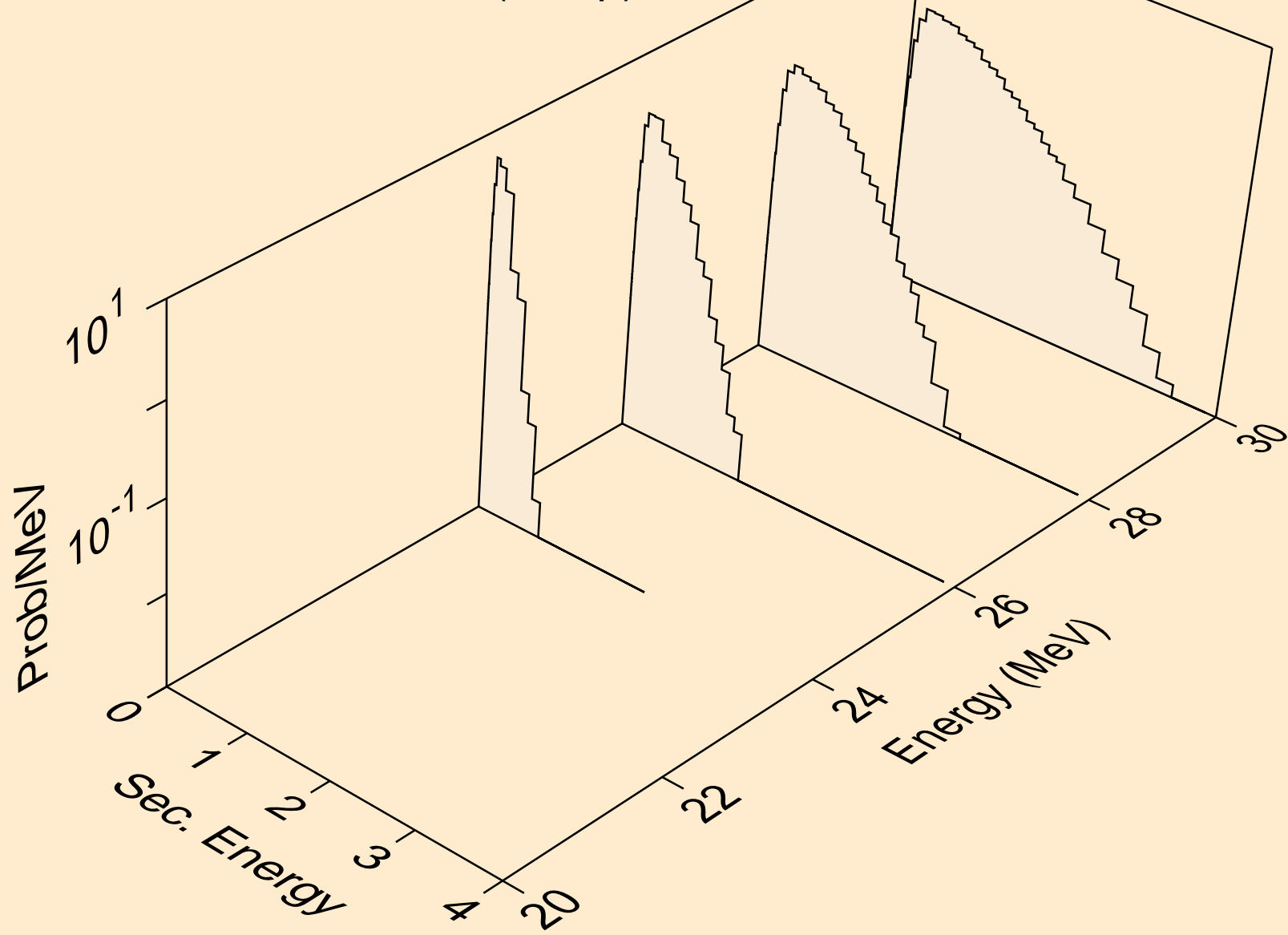

PB187 NEUTRON ACER TENDL-2024 LIBRARY; T=0.K
Neutron emission for (n,n2p)

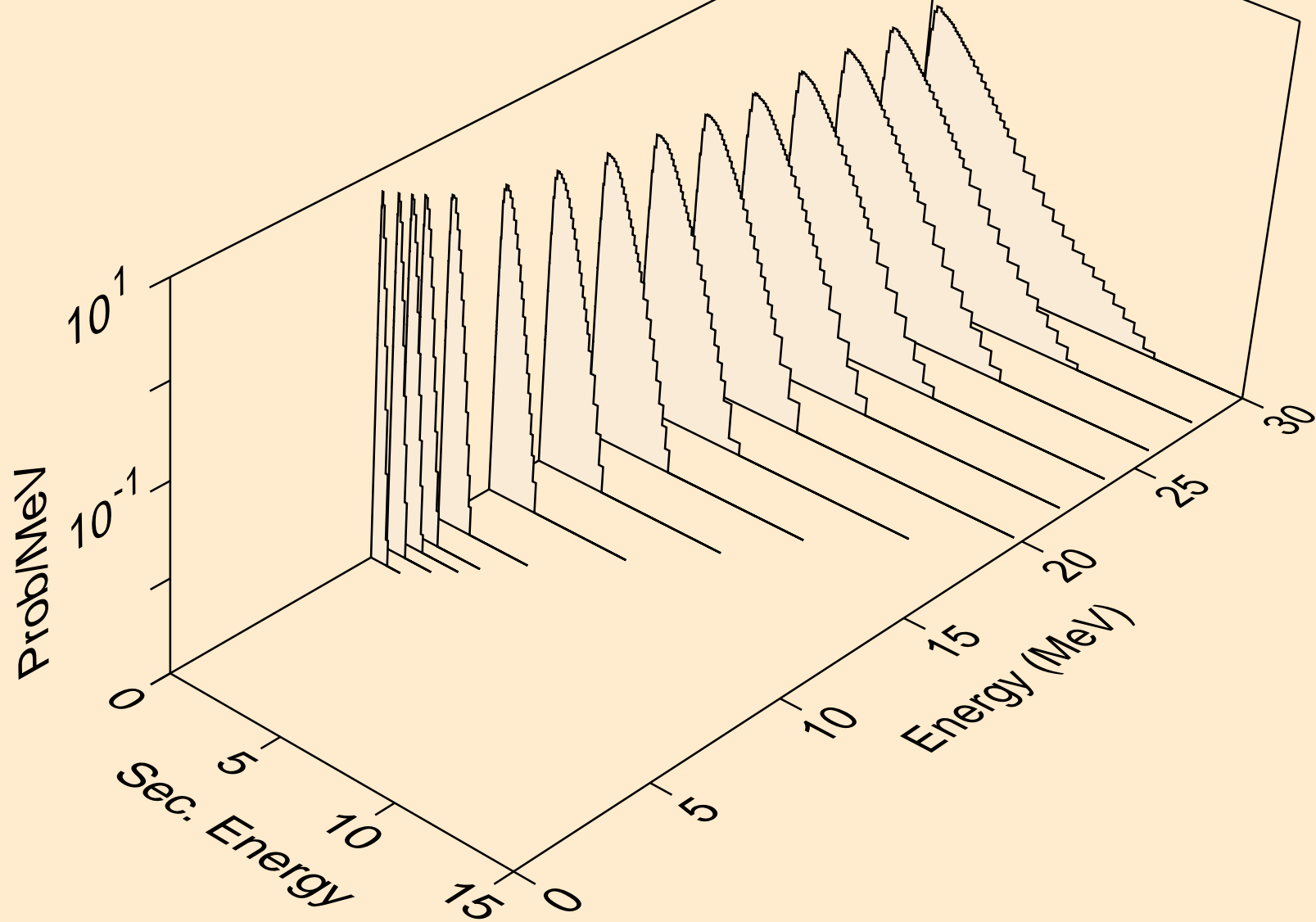

PB187 NEUTRON ACER TENDL-2024 LIBRARY; T=0.K
Neutron emission for (n,npa)

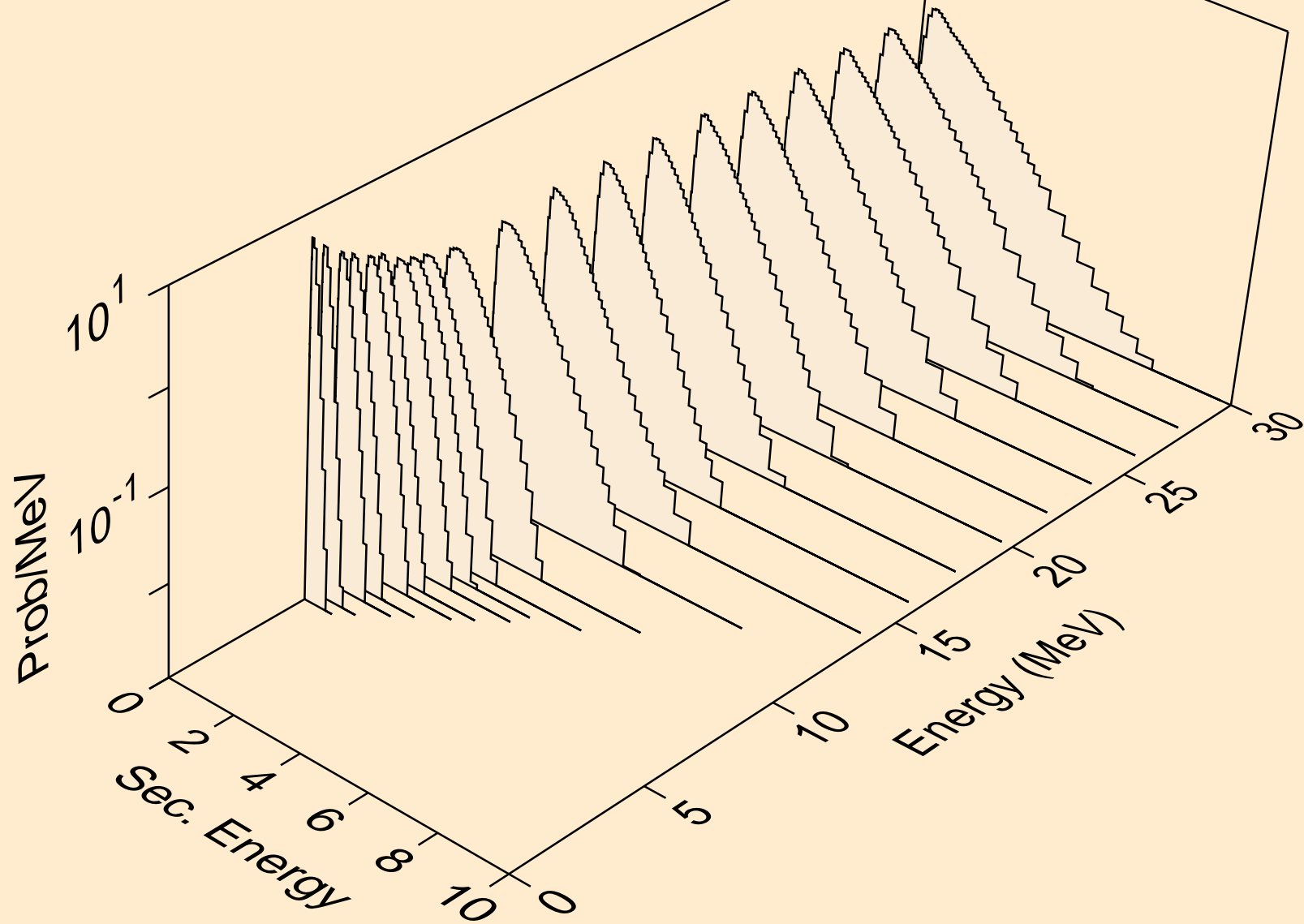

PB187 NEUTRON ACER TENDL-2024 LIBRARY; T=0.K
Neutron emission for (n,n*c)

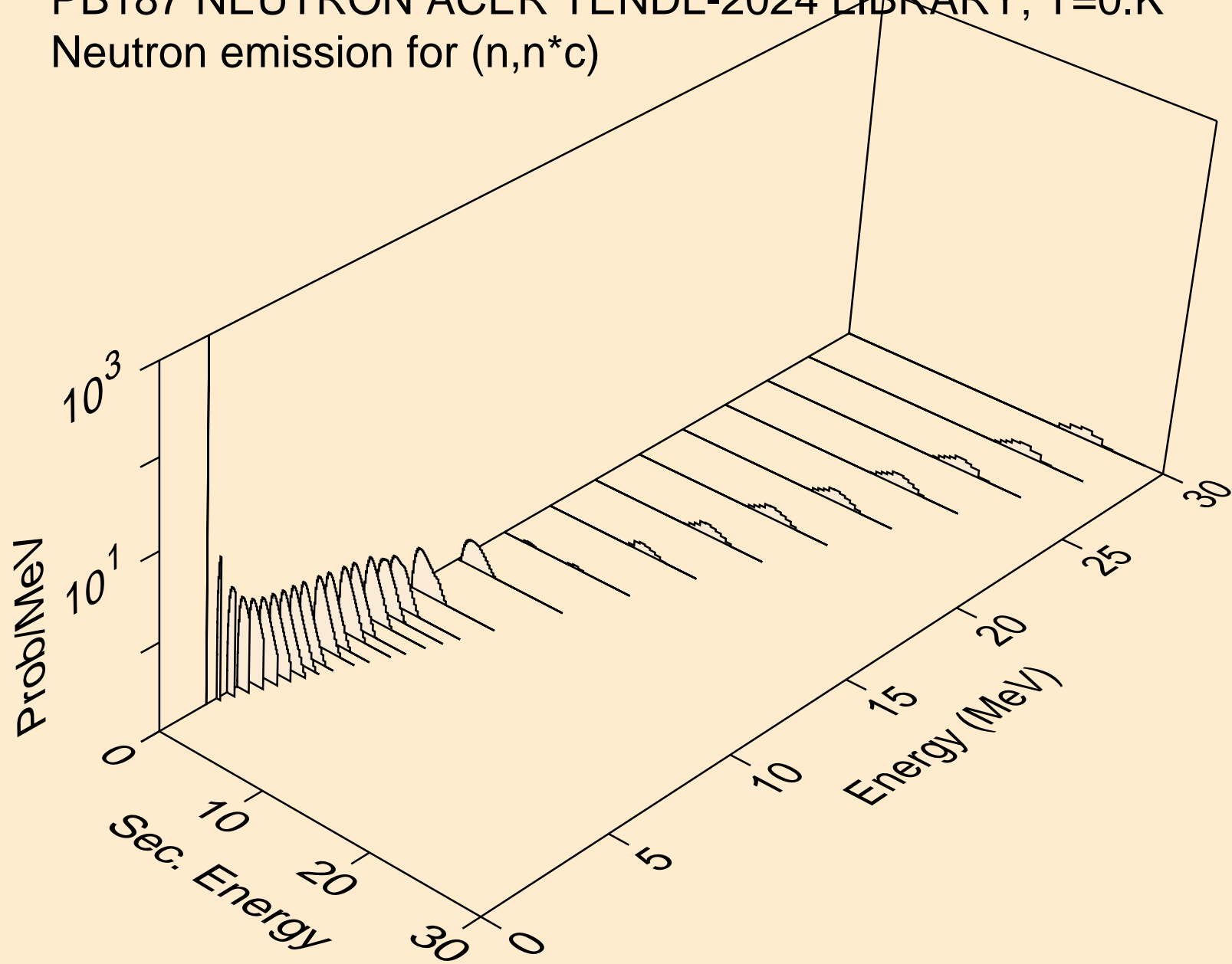

PB187 NEUTRON ACER TENDL-2024 LIBRARY; T=0.K
Photon emission for (n,x)

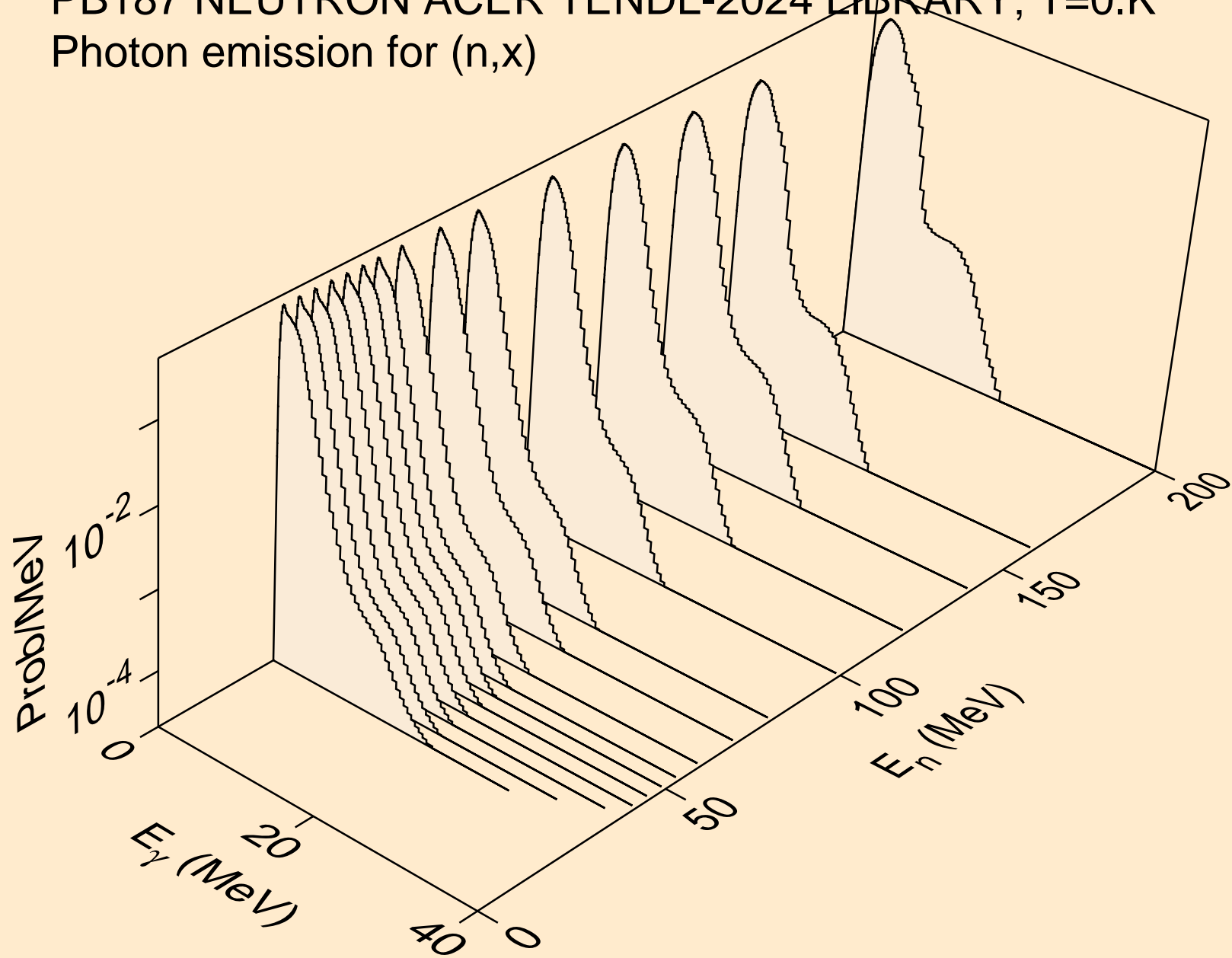

PB187 NEUTRON ACER TENDL-2024 LIBRARY; T=0.K
Photon emission for (n,2nd)

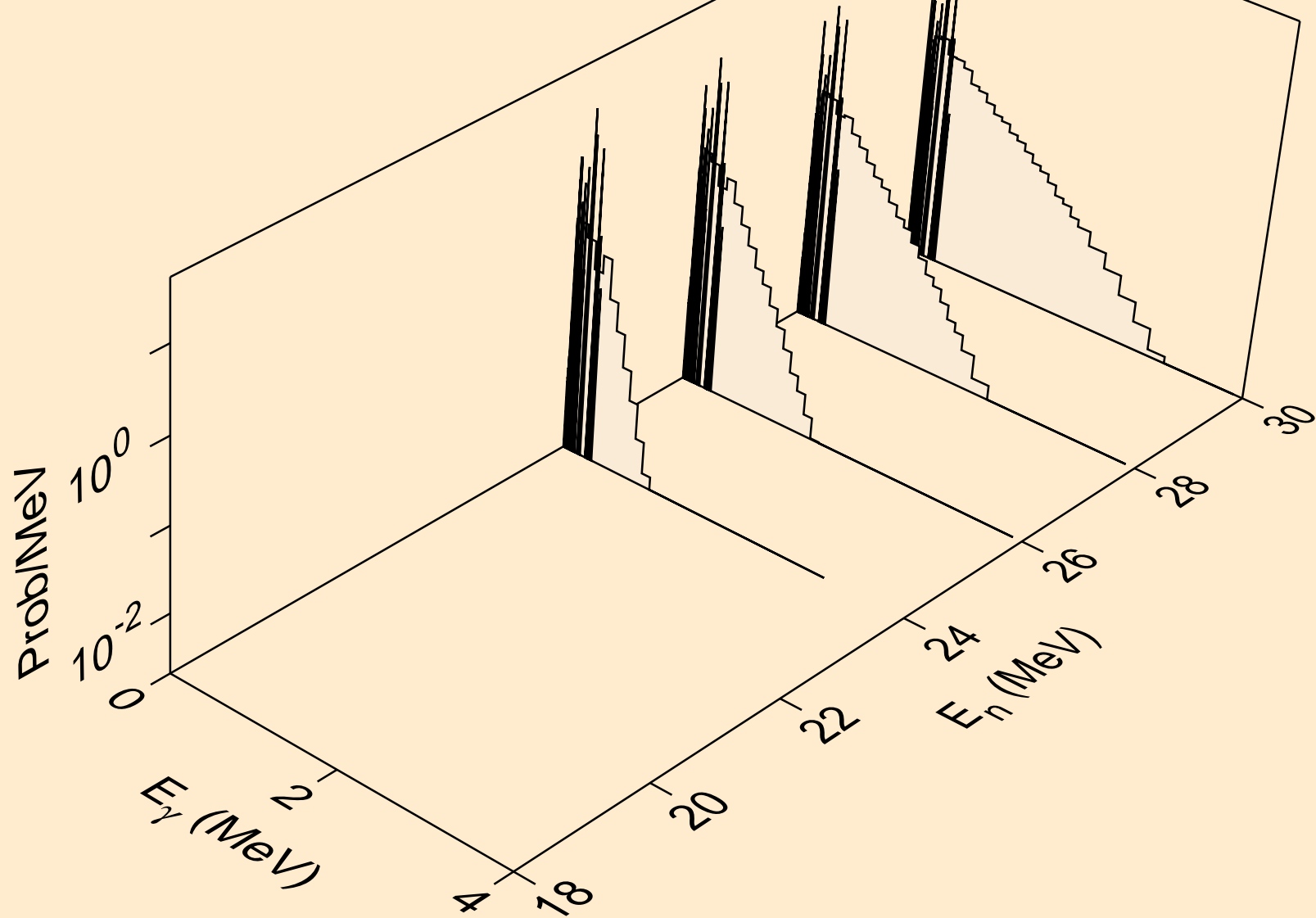

PB187 NEUTRON ACER TENDL-2024 LIBRARY; T=0.K
Photon emission for (n,2n)

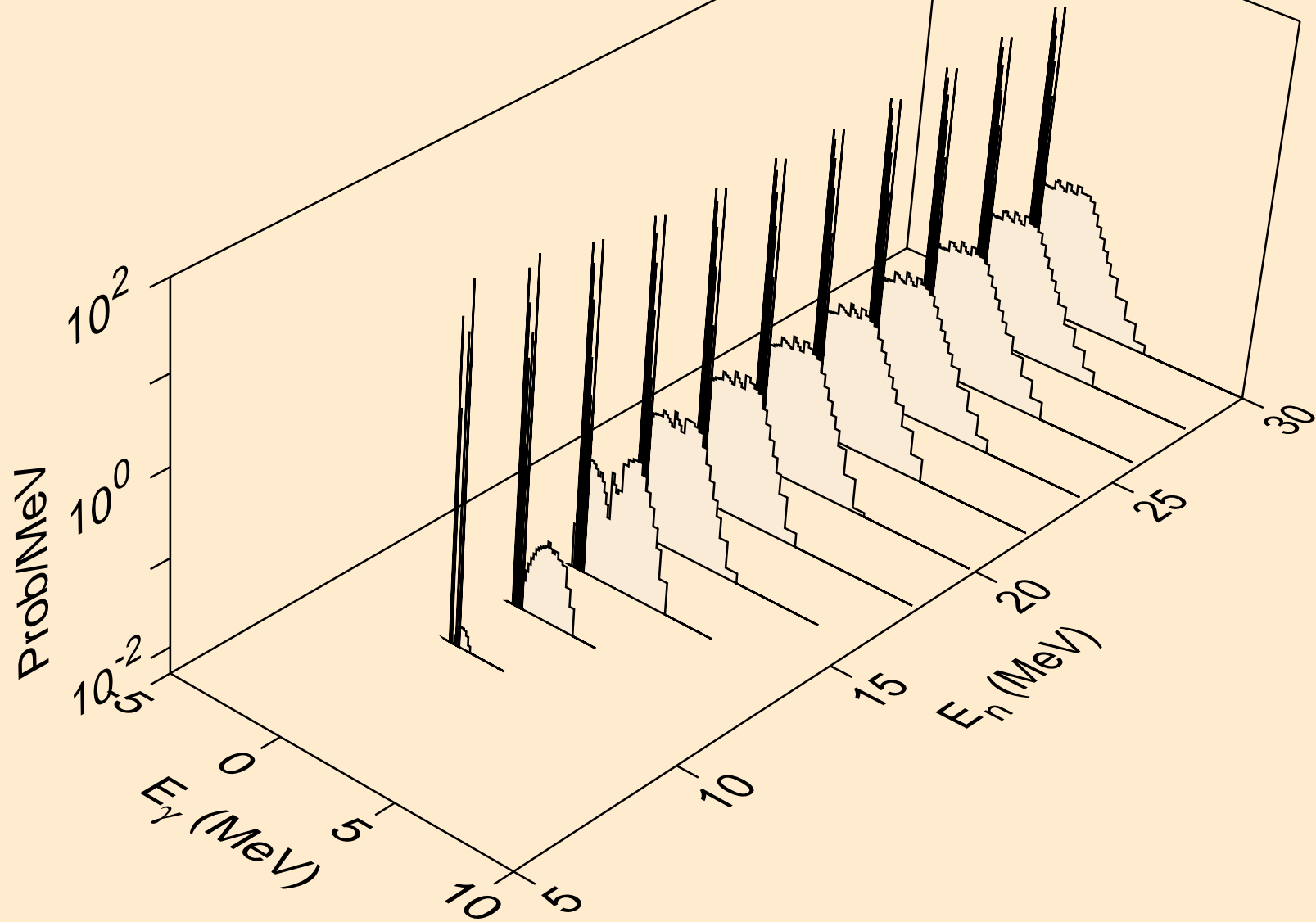

PB187 NEUTRON ACER TENDL-2024 LIBRARY; T=0.K
Photon emission for (n,3n)

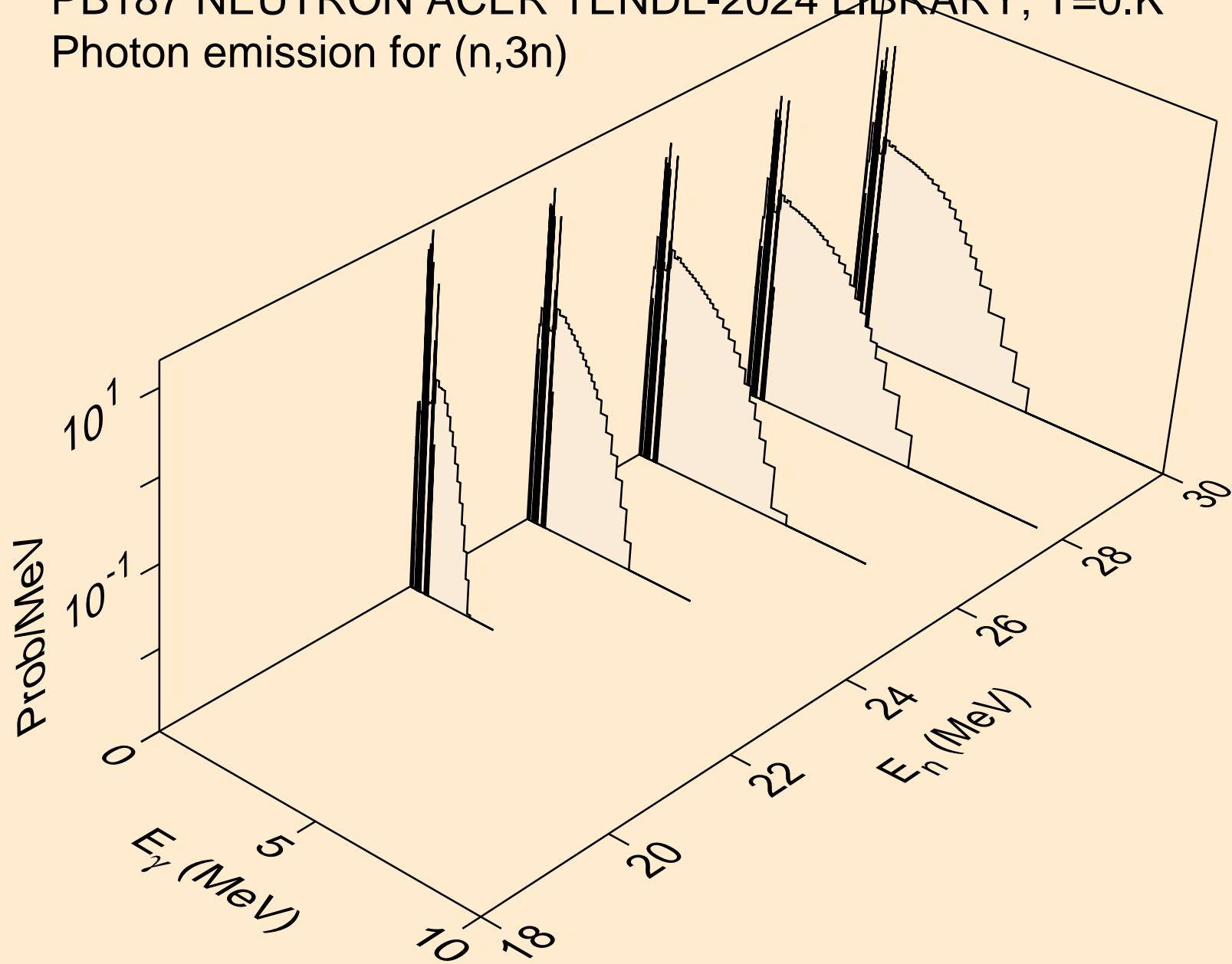

PB187 NEUTRON ACER TENDL-2024 LIBRARY; T=0.K
Photon emission for (n,n*)a

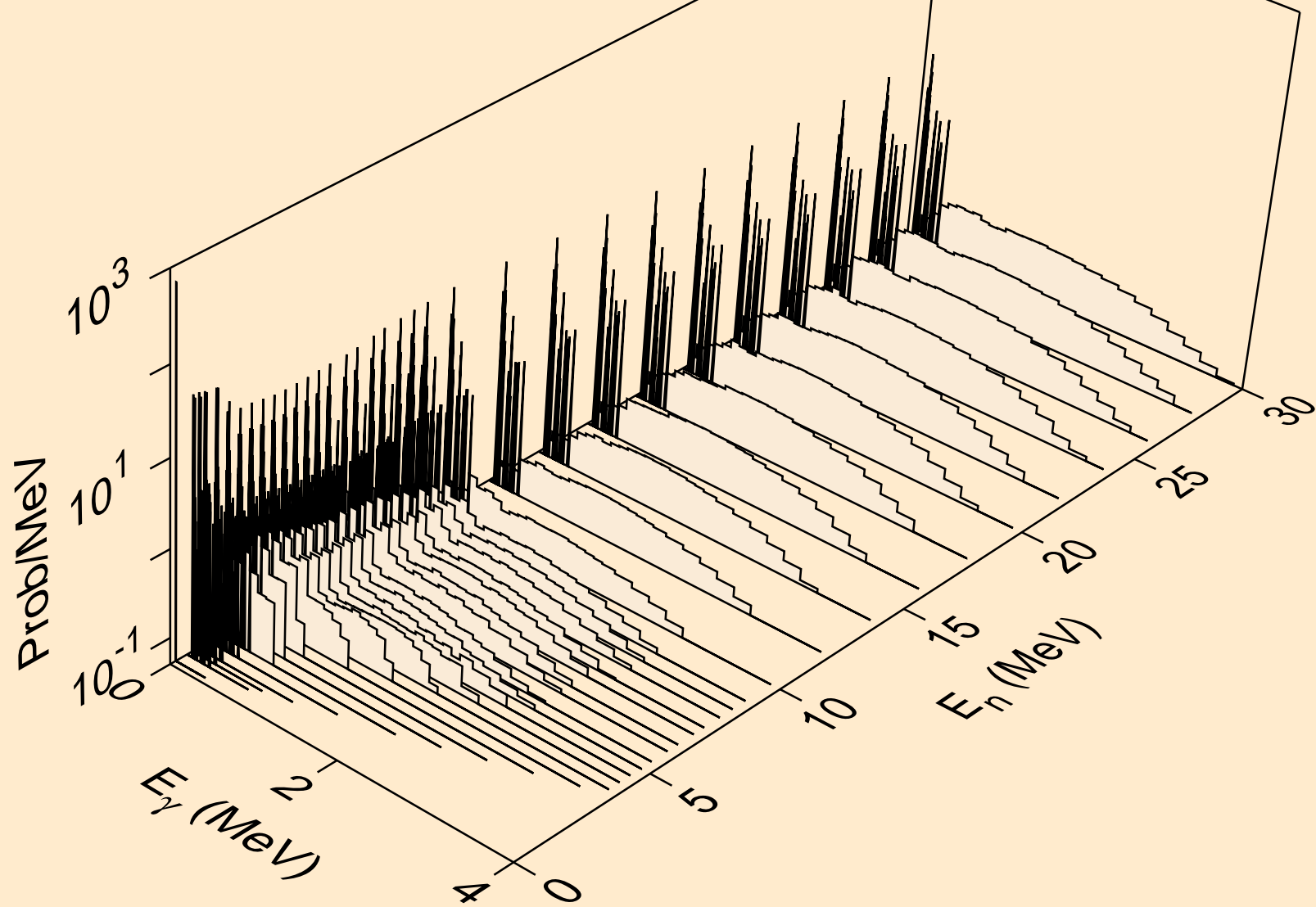

PB187 NEUTRON ACER TENDL-2024 LIBRARY; T=0.K
Photon emission for (n,n*)3a

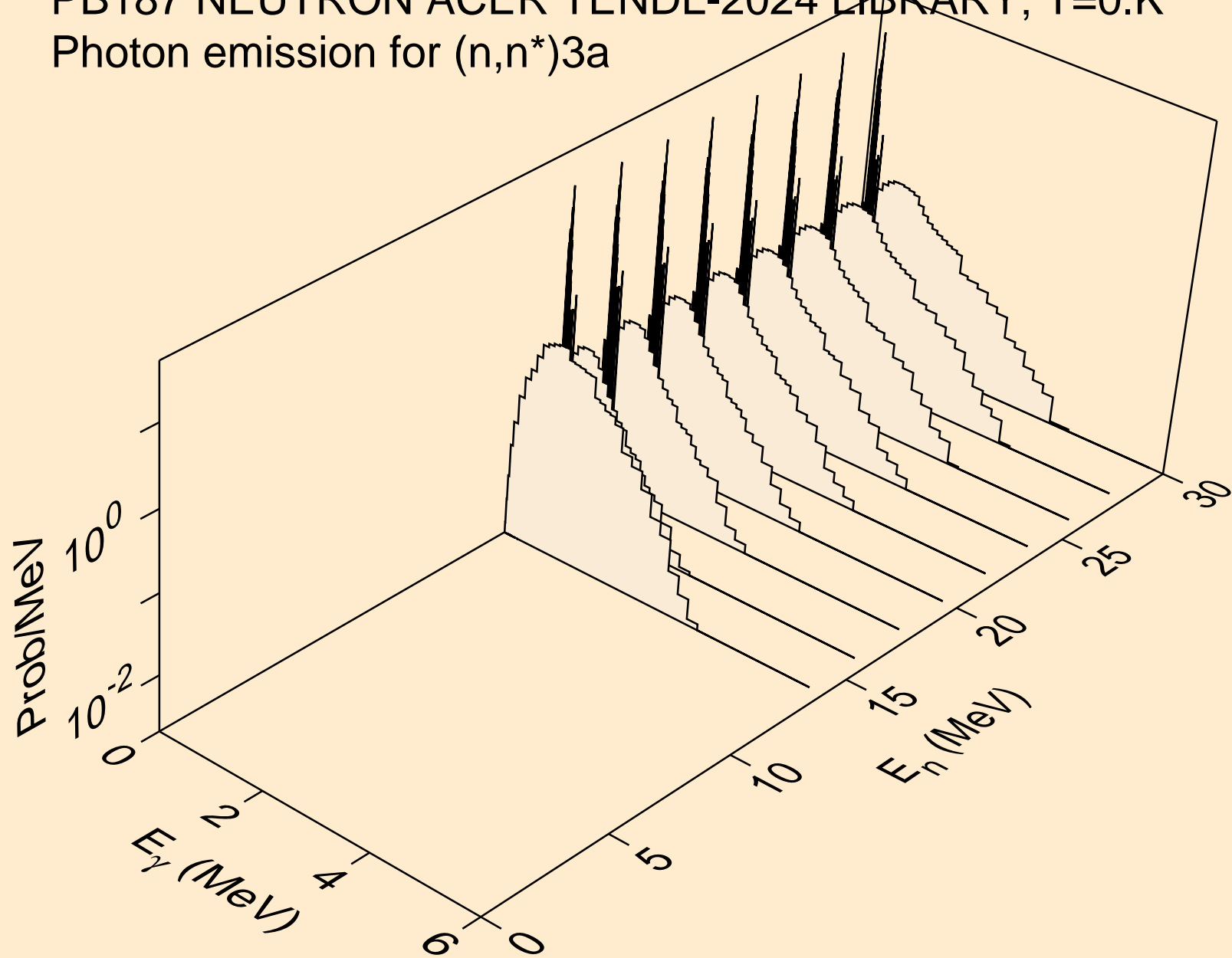

PB187 NEUTRON ACER TENDL-2024 LIBRARY; T=0.K
Photon emission for (n,2n)a

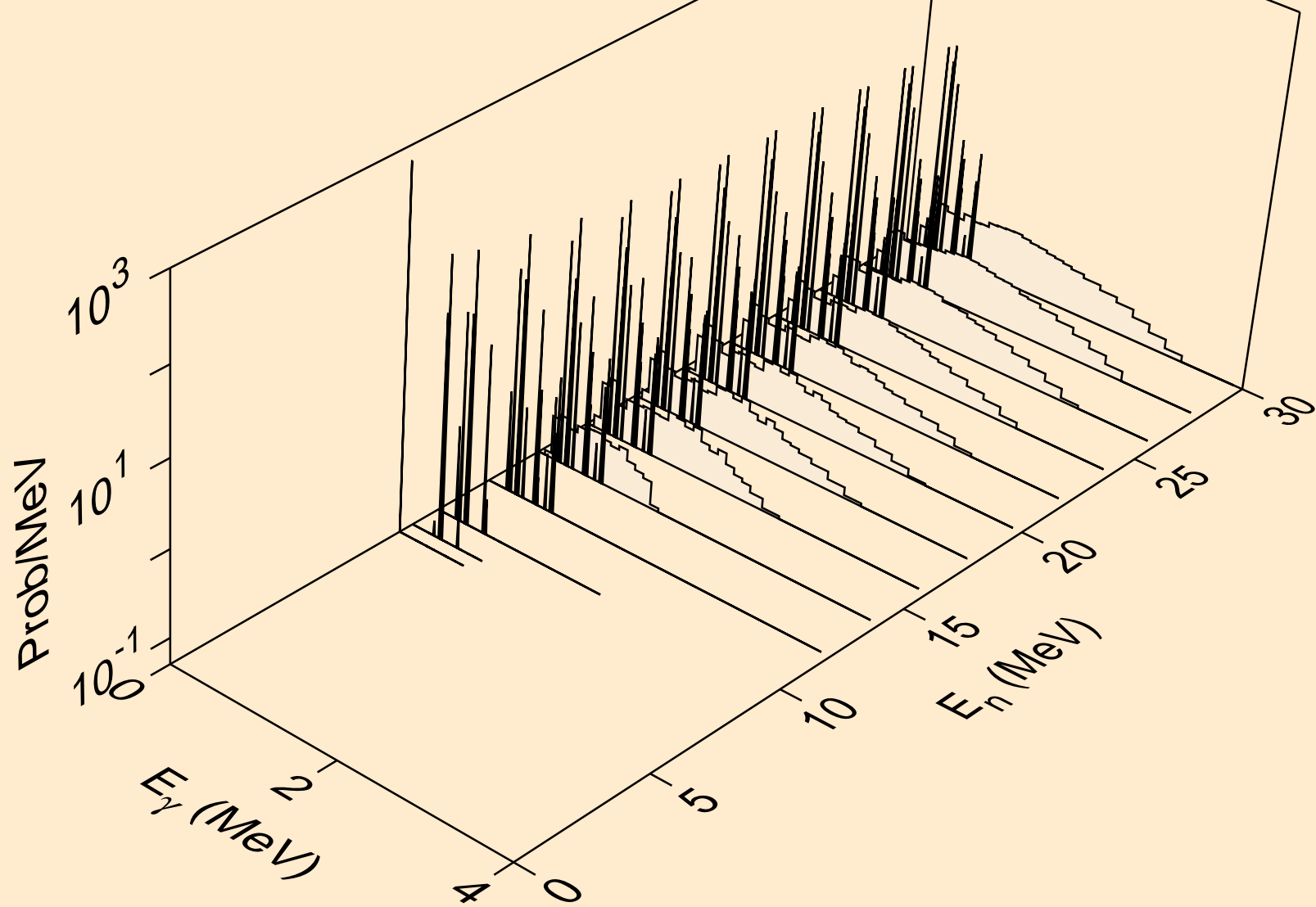

PB187 NEUTRON ACER TENDL-2024 LIBRARY; T=0.K
Photon emission for (n,3n)a

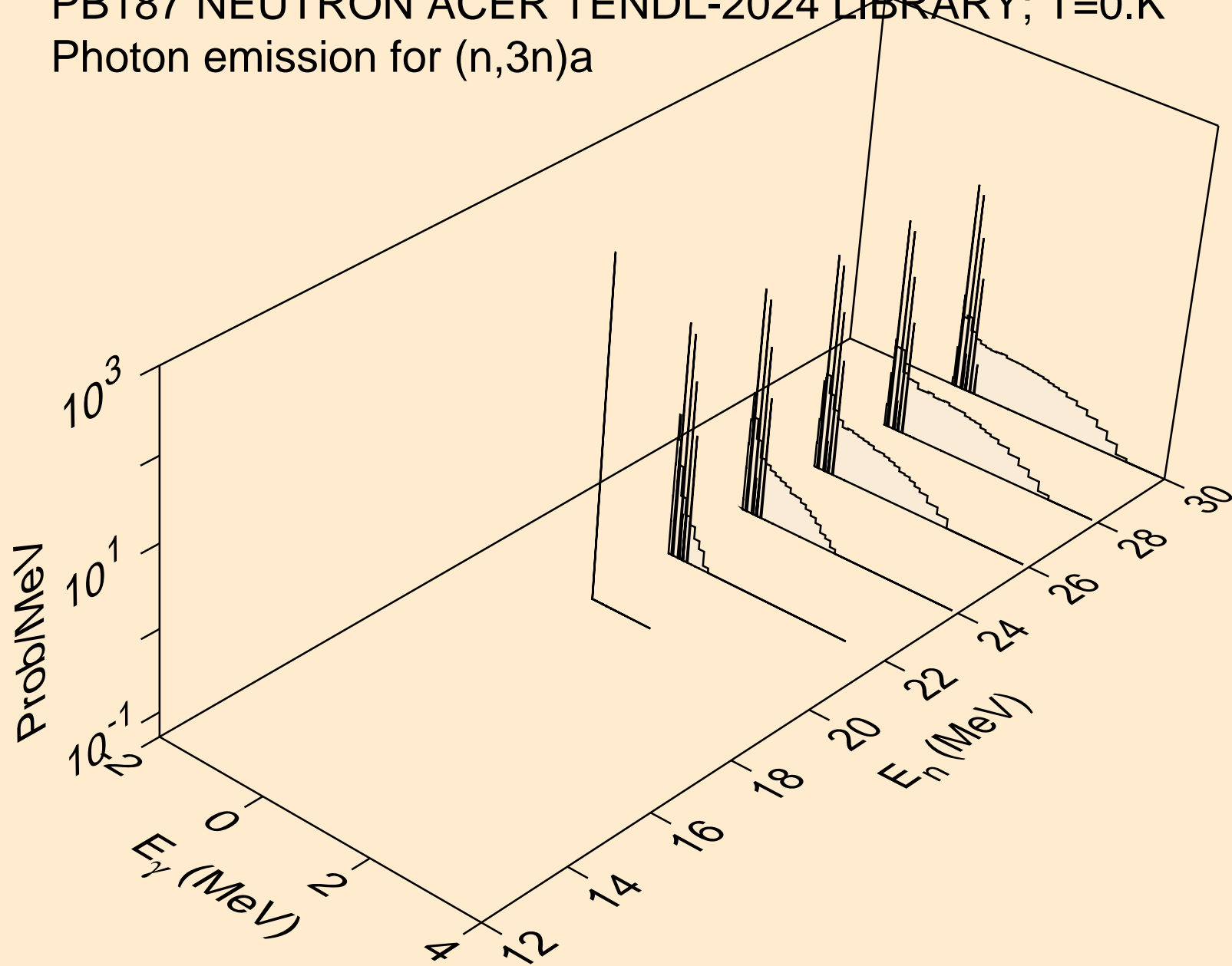

PB187 NEUTRON ACER TENDL-2024 LIBRARY; T=0.K
Photon emission for (n,n*)p

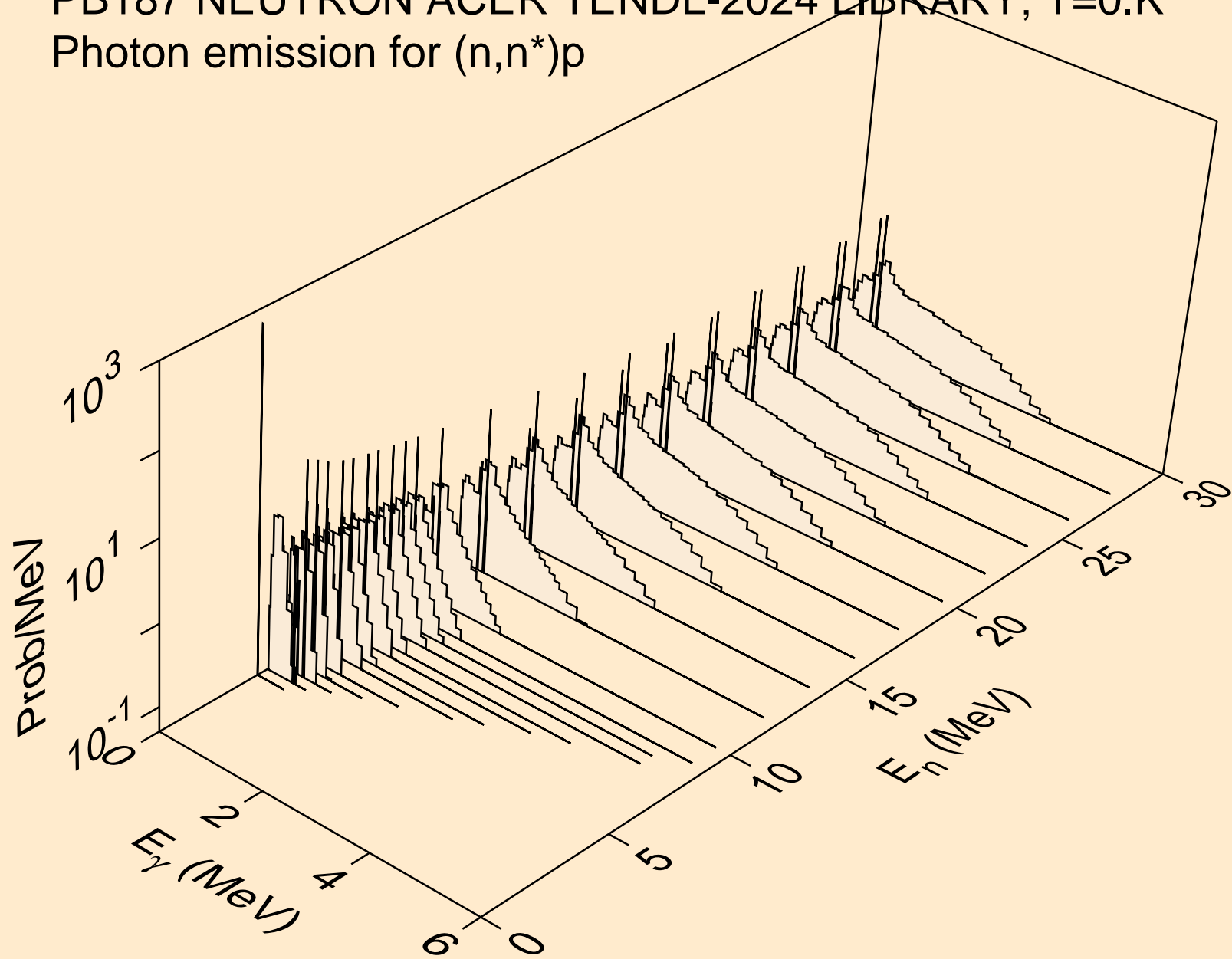

PB187 NEUTRON ACER TENDL-2024 LIBRARY; T=0.K
Photon emission for (n,n*)2a

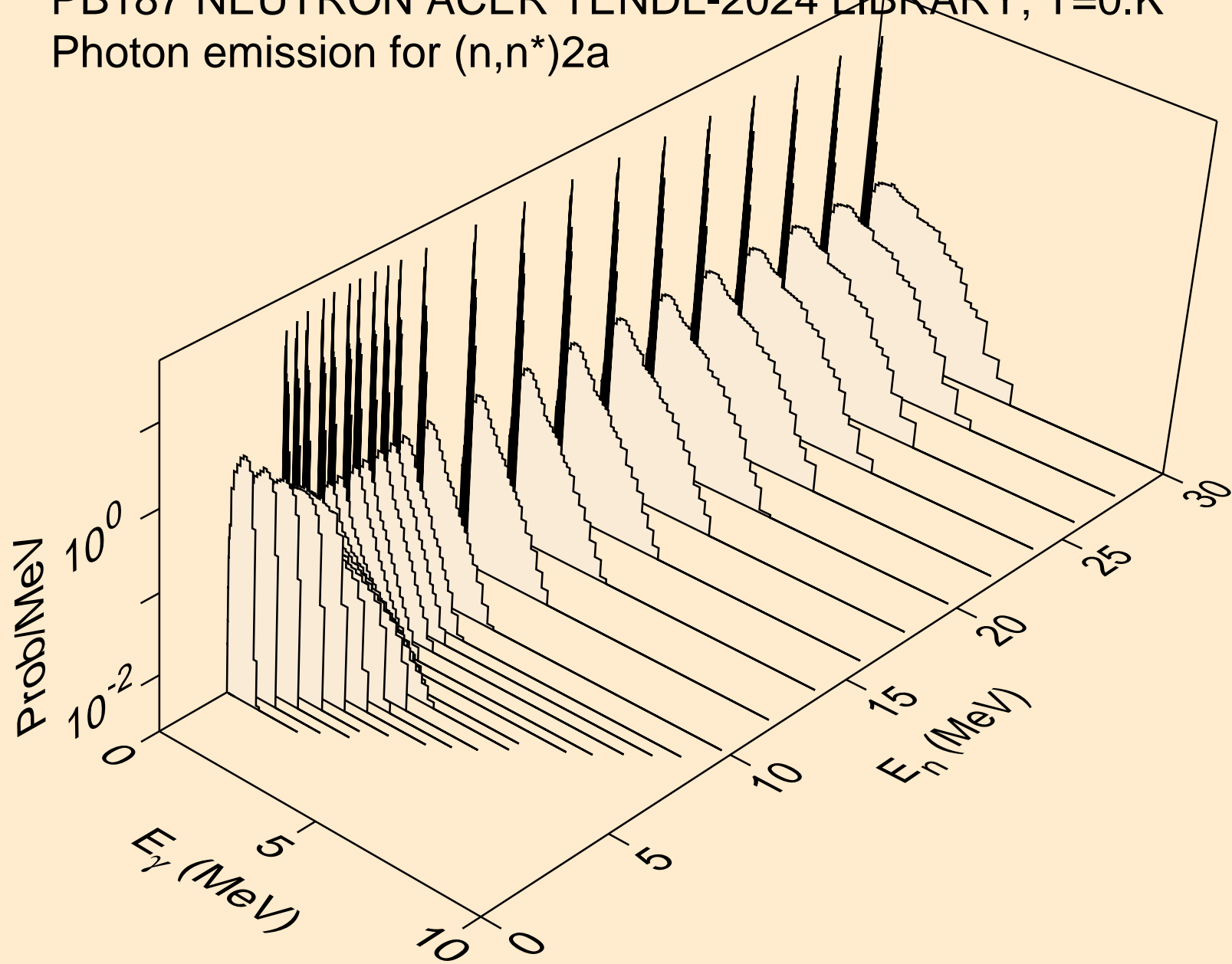

PB187 NEUTRON ACER TENDL-2024 LIBRARY; T=0.K
Photon emission for (n,2n)2a

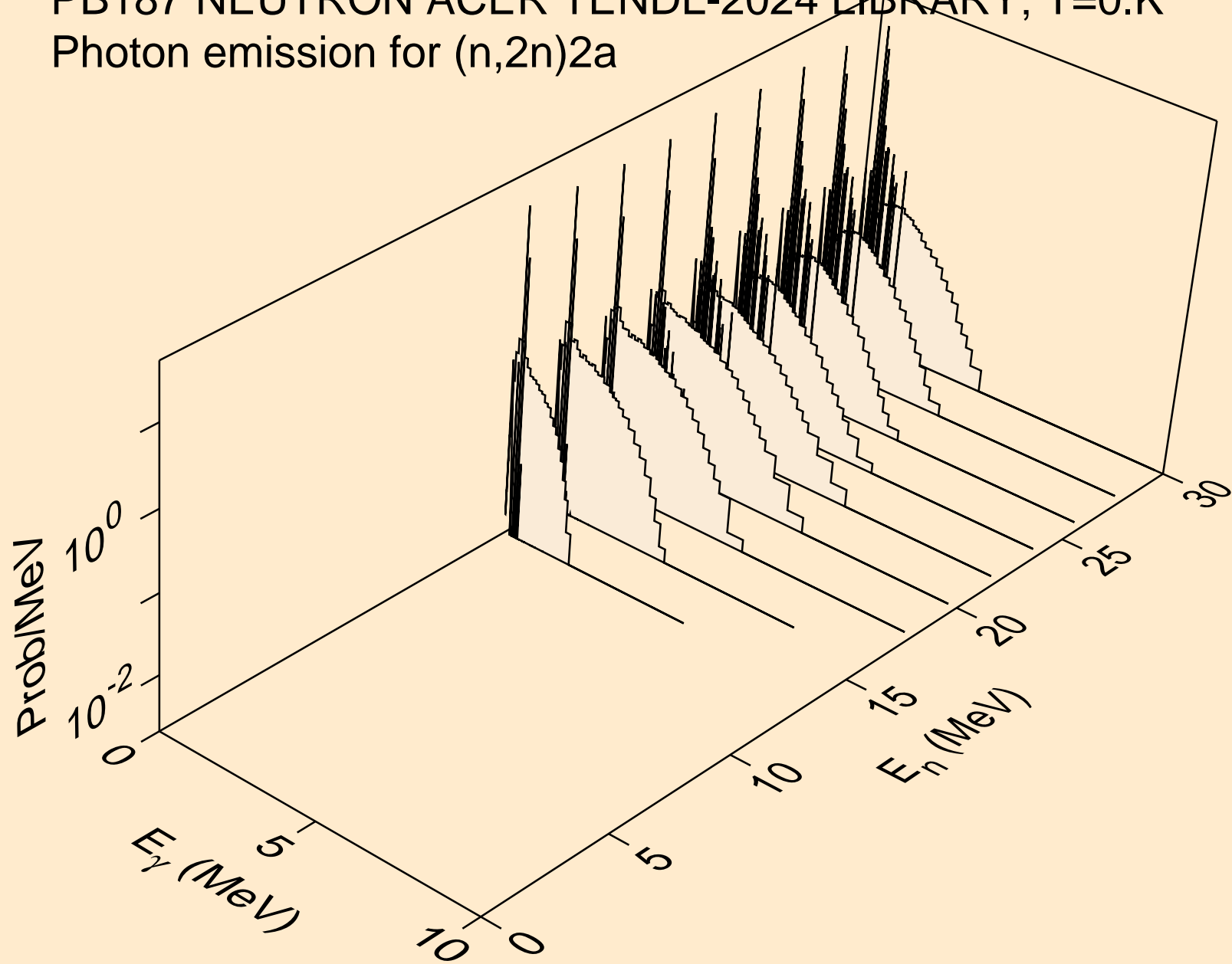

PB187 NEUTRON ACER TENDL-2024 LIBRARY; T=0.K
Photon emission for (n,n*)d

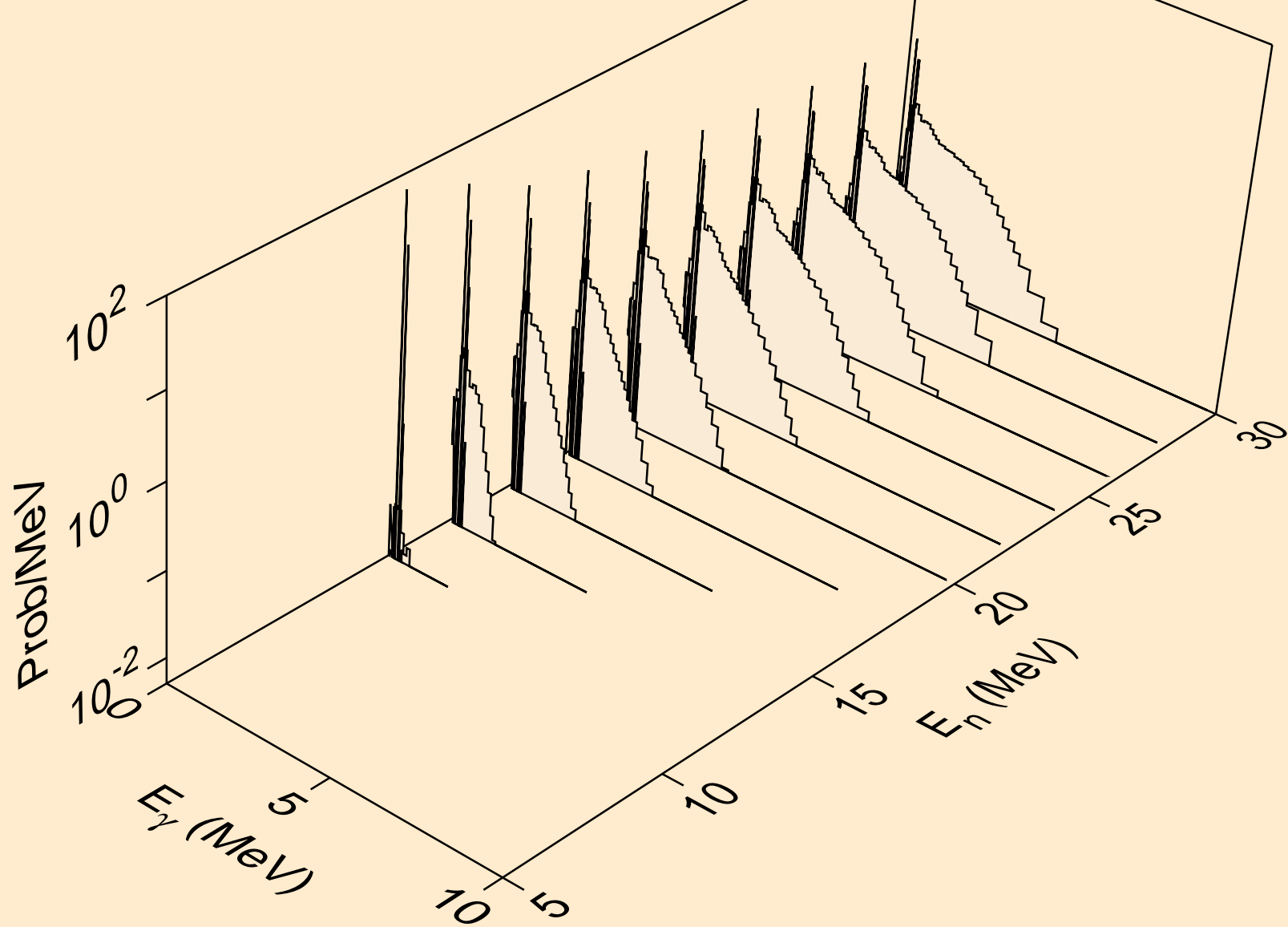

PB187 NEUTRON ACER TENDL-2024 LIBRARY; T=0.K
Photon emission for (n,n*)t

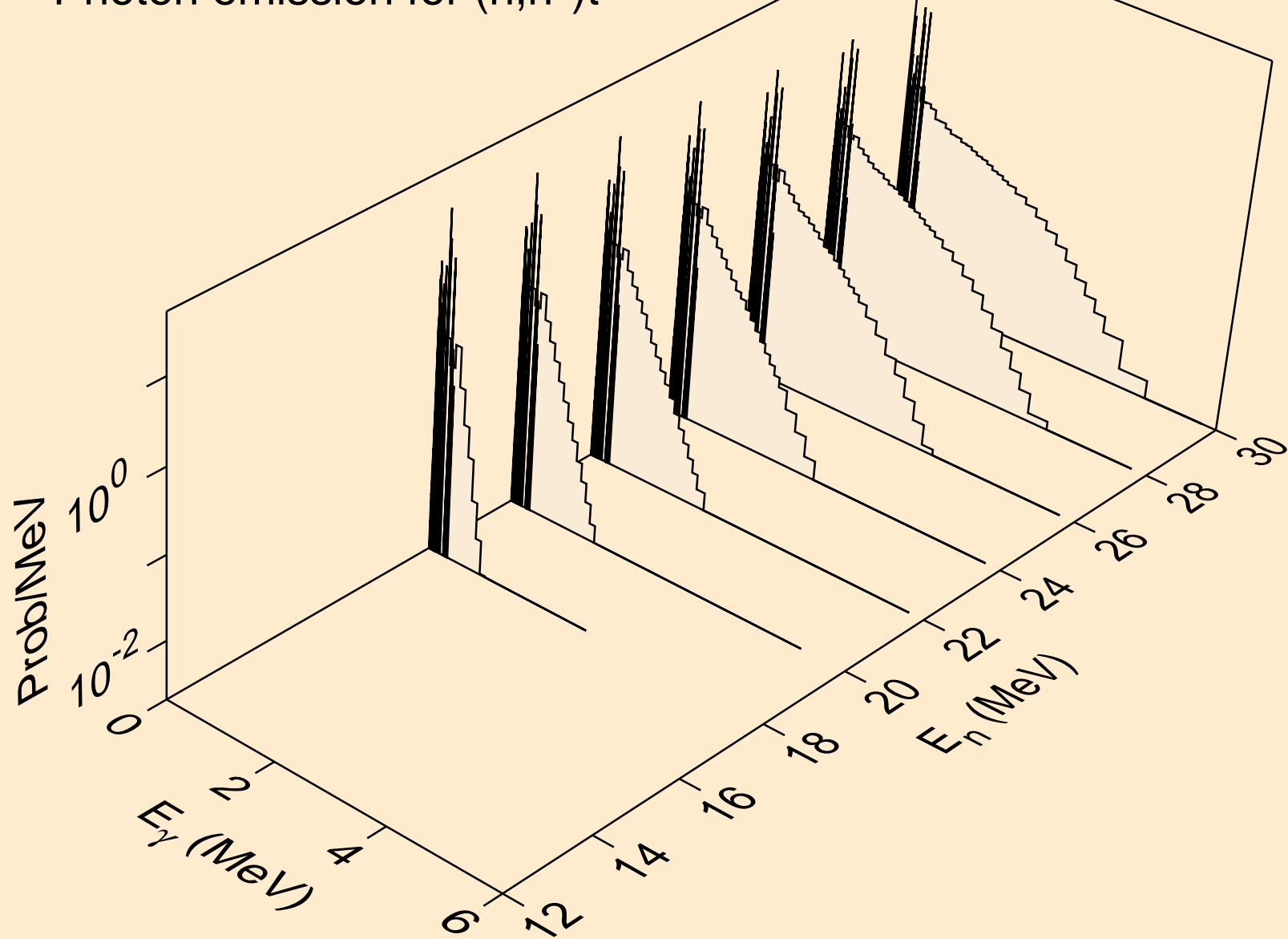

PB187 NEUTRON ACER TENDL-2024 LIBRARY; T=0.K
Photon emission for (n,n*)he3

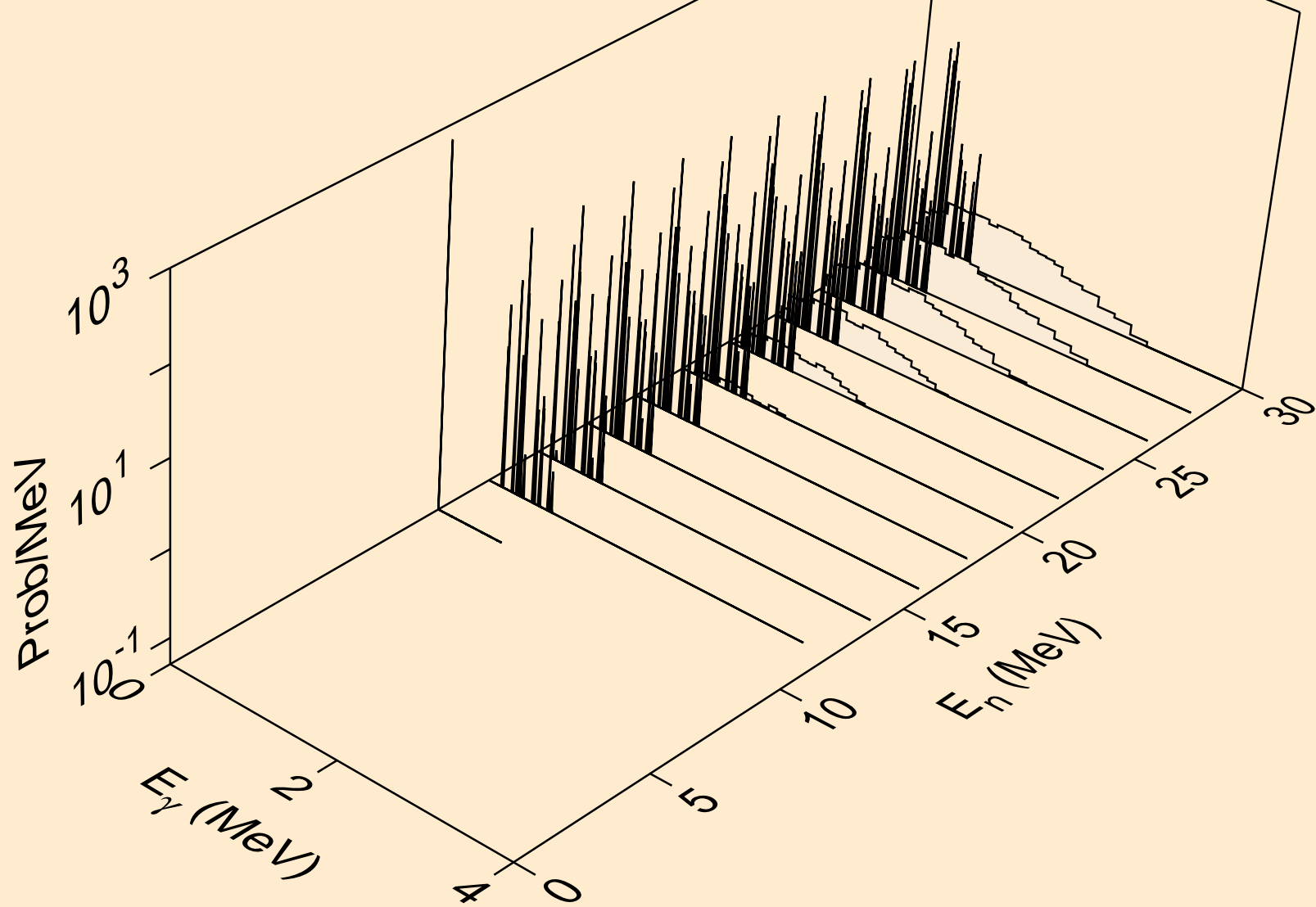

PB187 NEUTRON ACER TENDL-2024 LIBRARY; T=0.K
Photon emission for (n,4n)

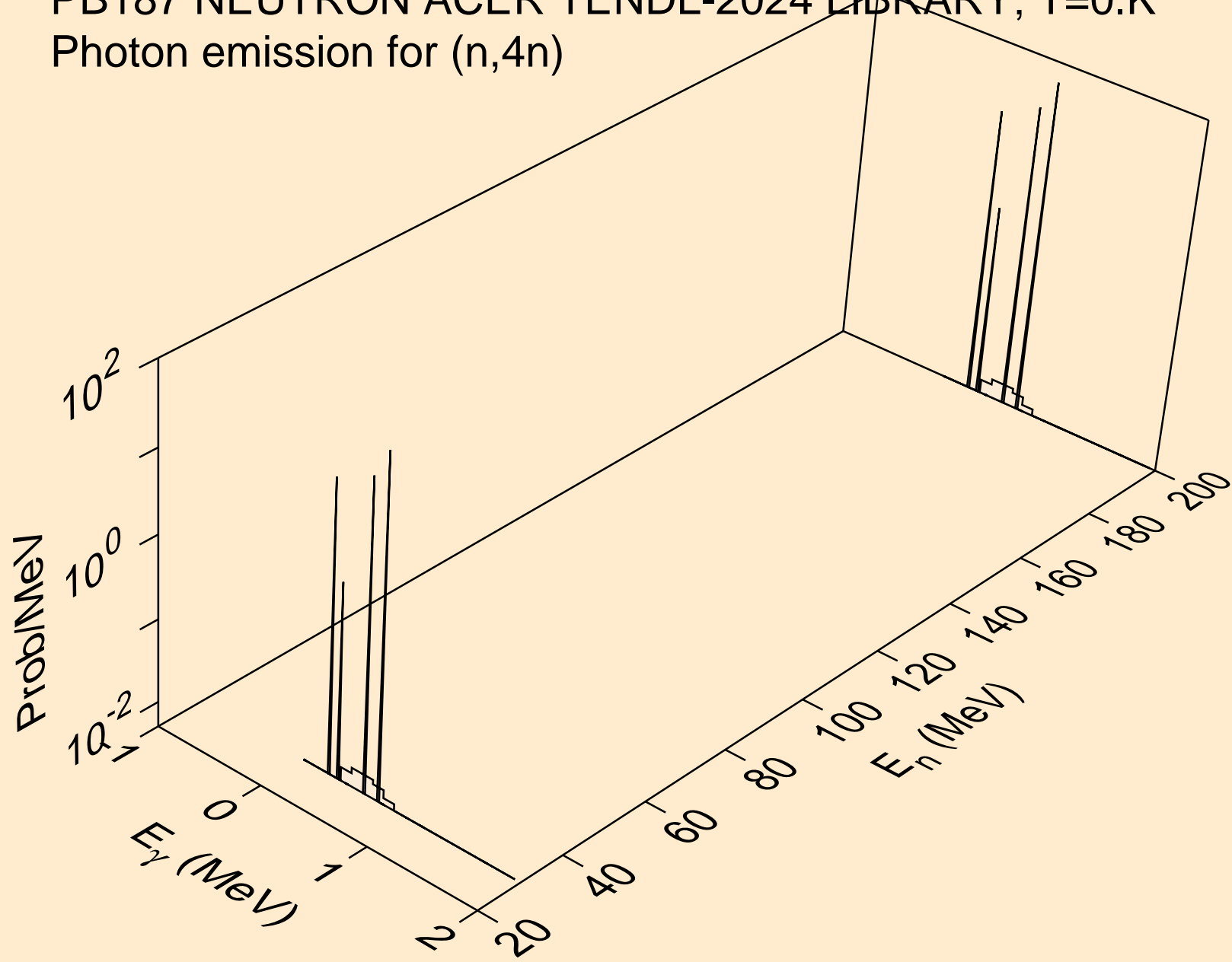

PB187 NEUTRON ACER TENDL-2024 LIBRARY; T=0.K
Photon emission for (n,2np)

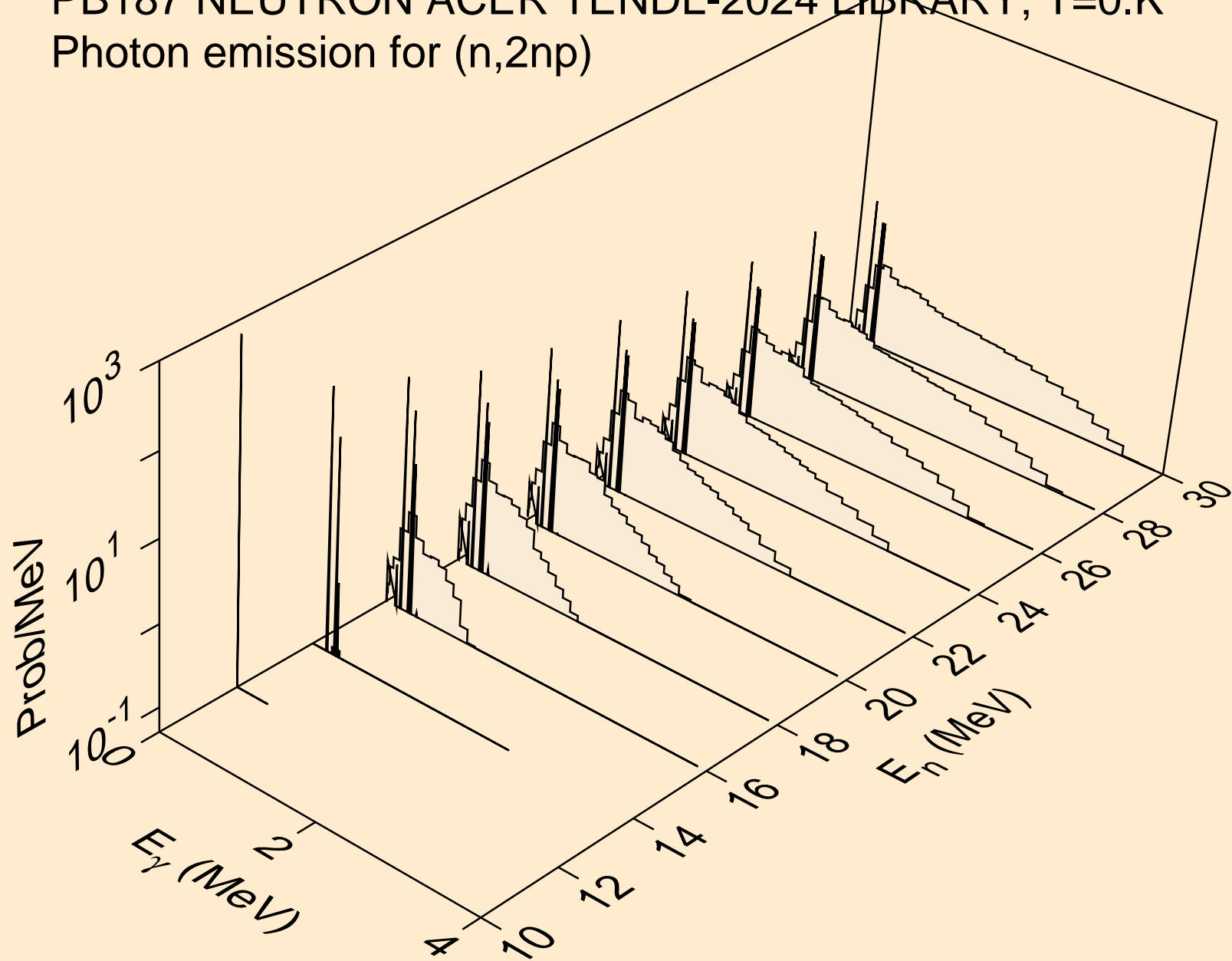

PB187 NEUTRON ACER TENDL-2024 LIBRARY; T=0.K
Photon emission for (n,3np)

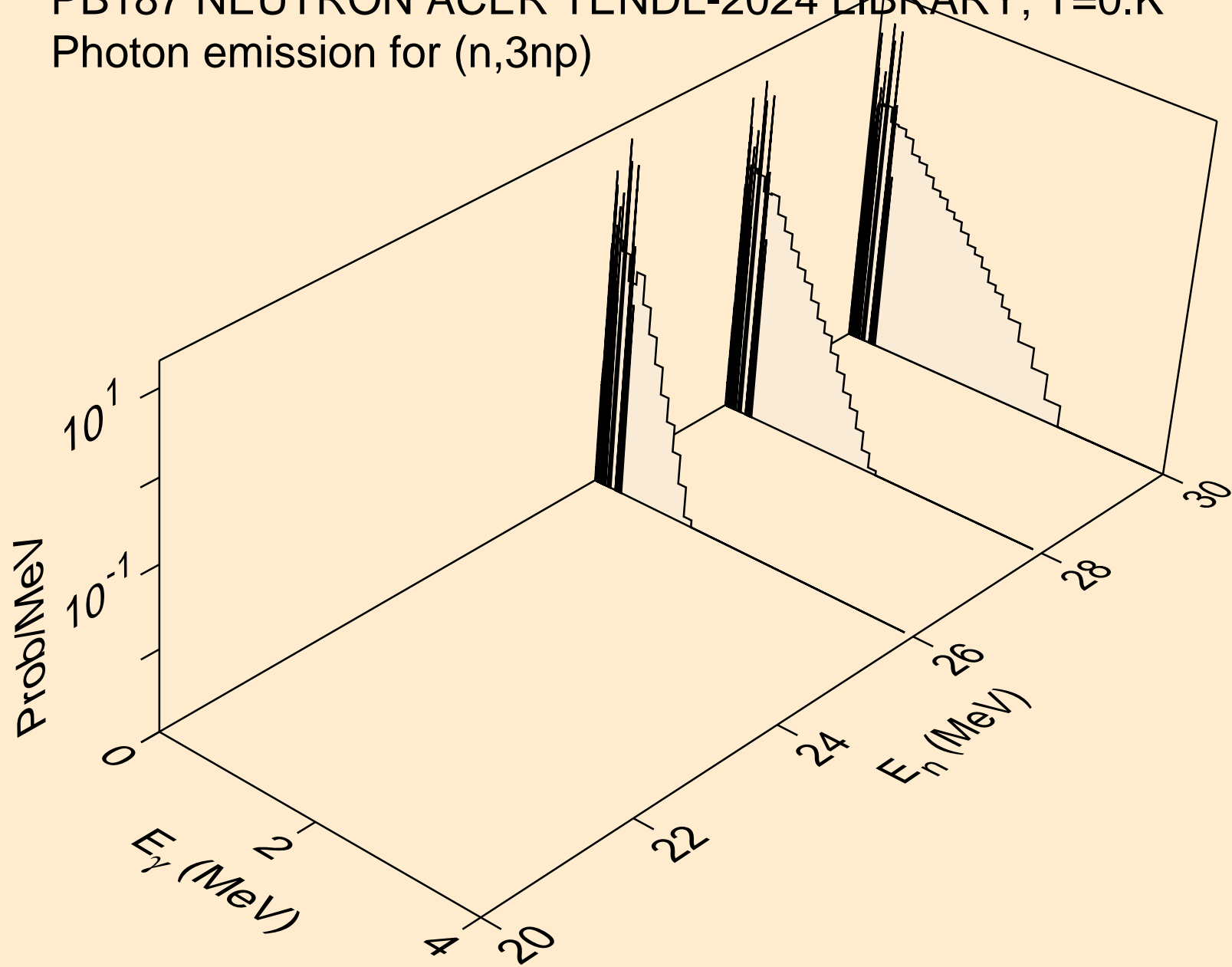

PB187 NEUTRON ACER TENDL-2024 LIBRARY; T=0.K
Photon emission for (n,n2p)

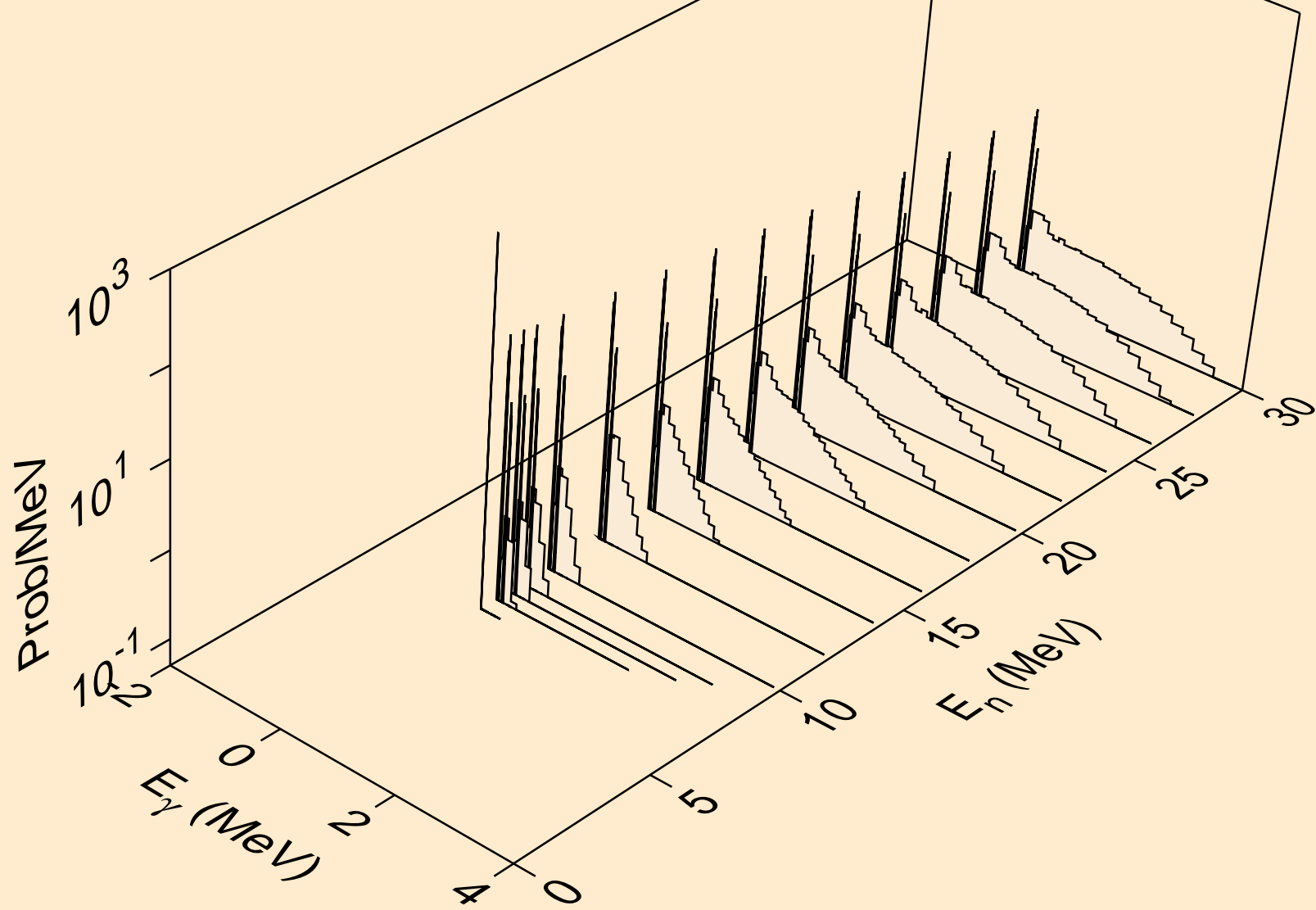

PB187 NEUTRON ACER TENDL-2024 LIBRARY; T=0.K
Photon emission for (n,npa)

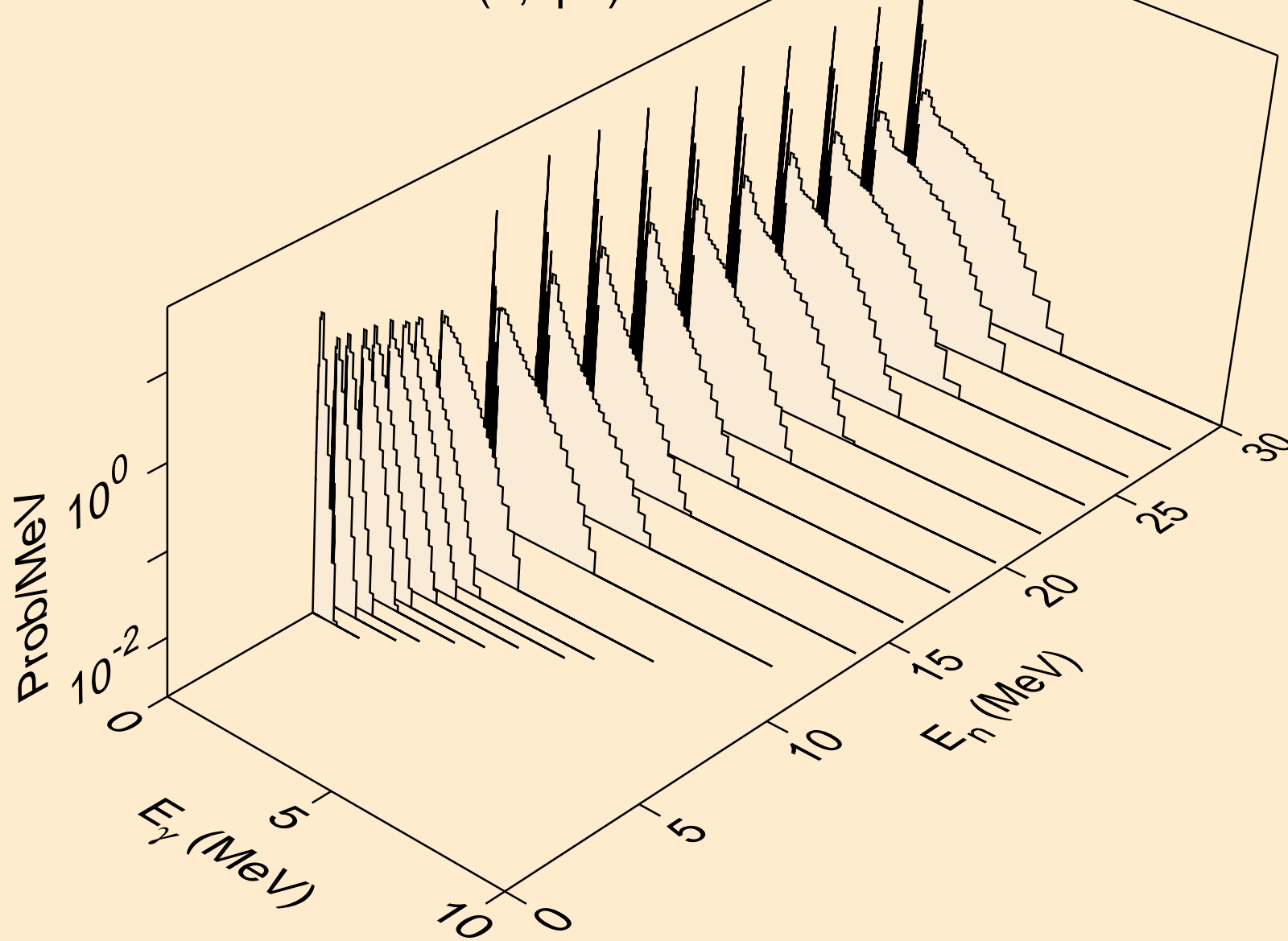

PB187 NEUTRON ACER TENDL-2024 LIBRARY; T=0.K
Photon emission for (n,n*c)

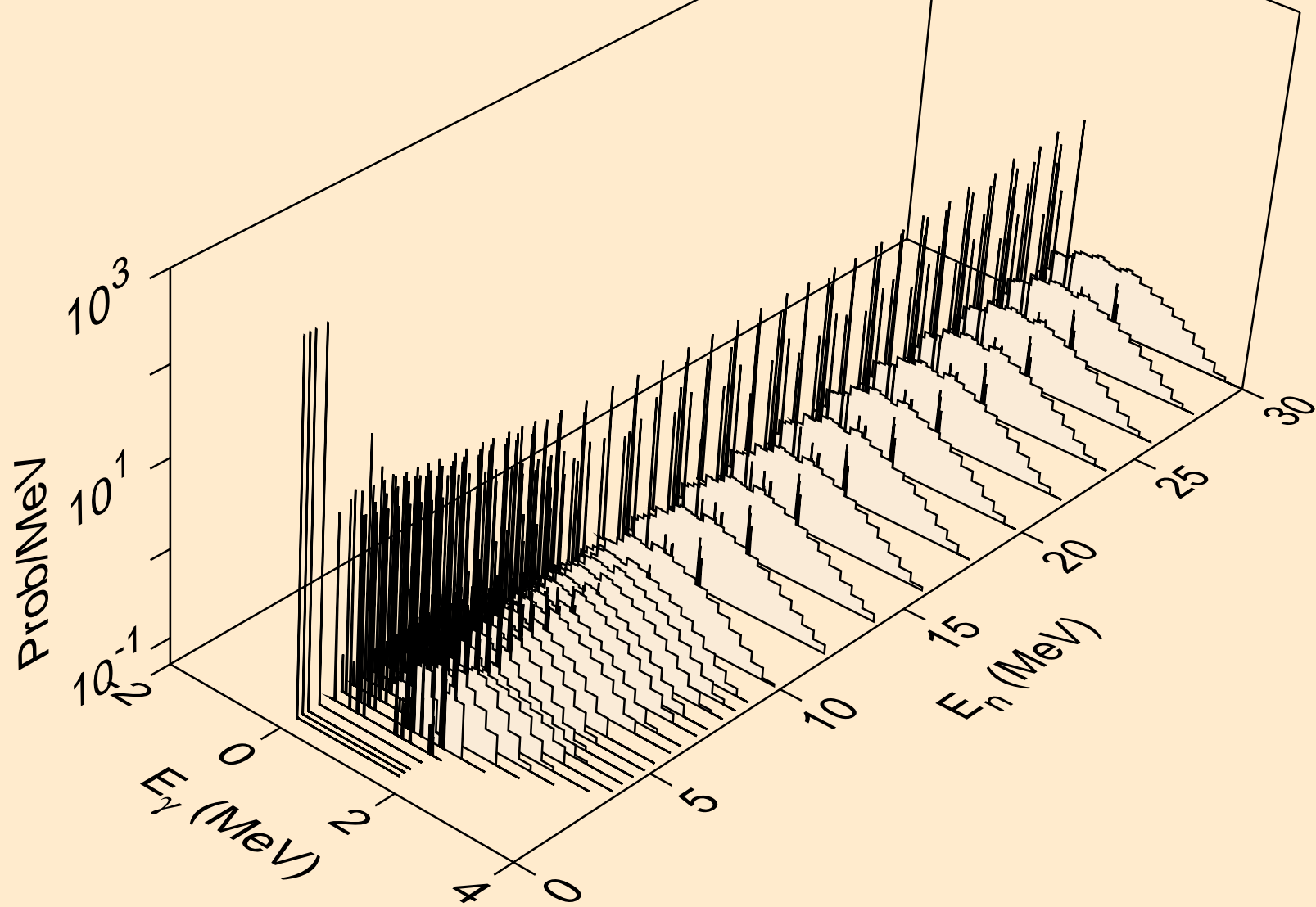

PB187 NEUTRON ACER TENDL-2024 LIBRARY; T=0.K
Photon emission for (n,gma)

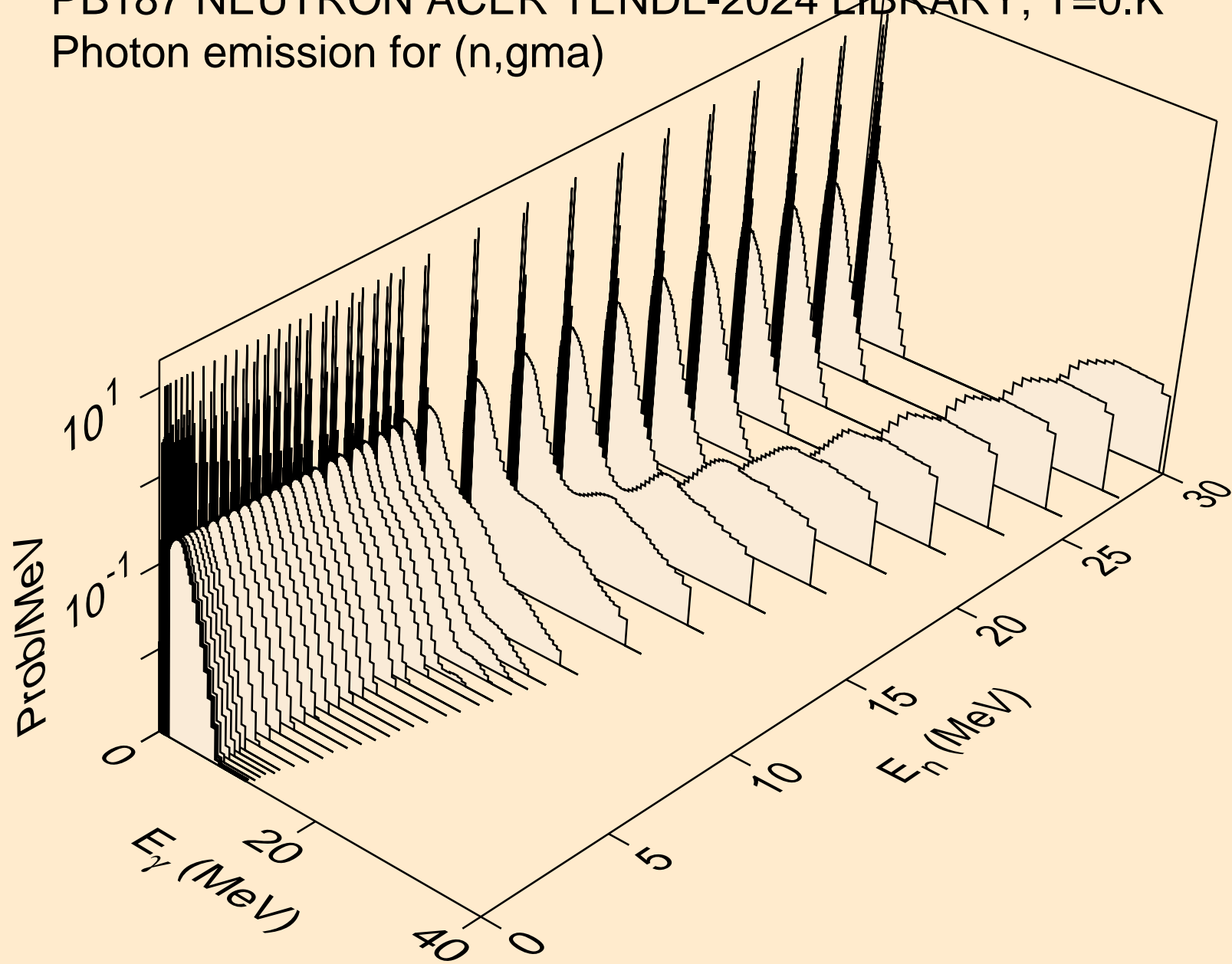

PB187 NEUTRON ACER TENDL-2024 LIBRARY; T=0.K
Photon emission for (n,p)

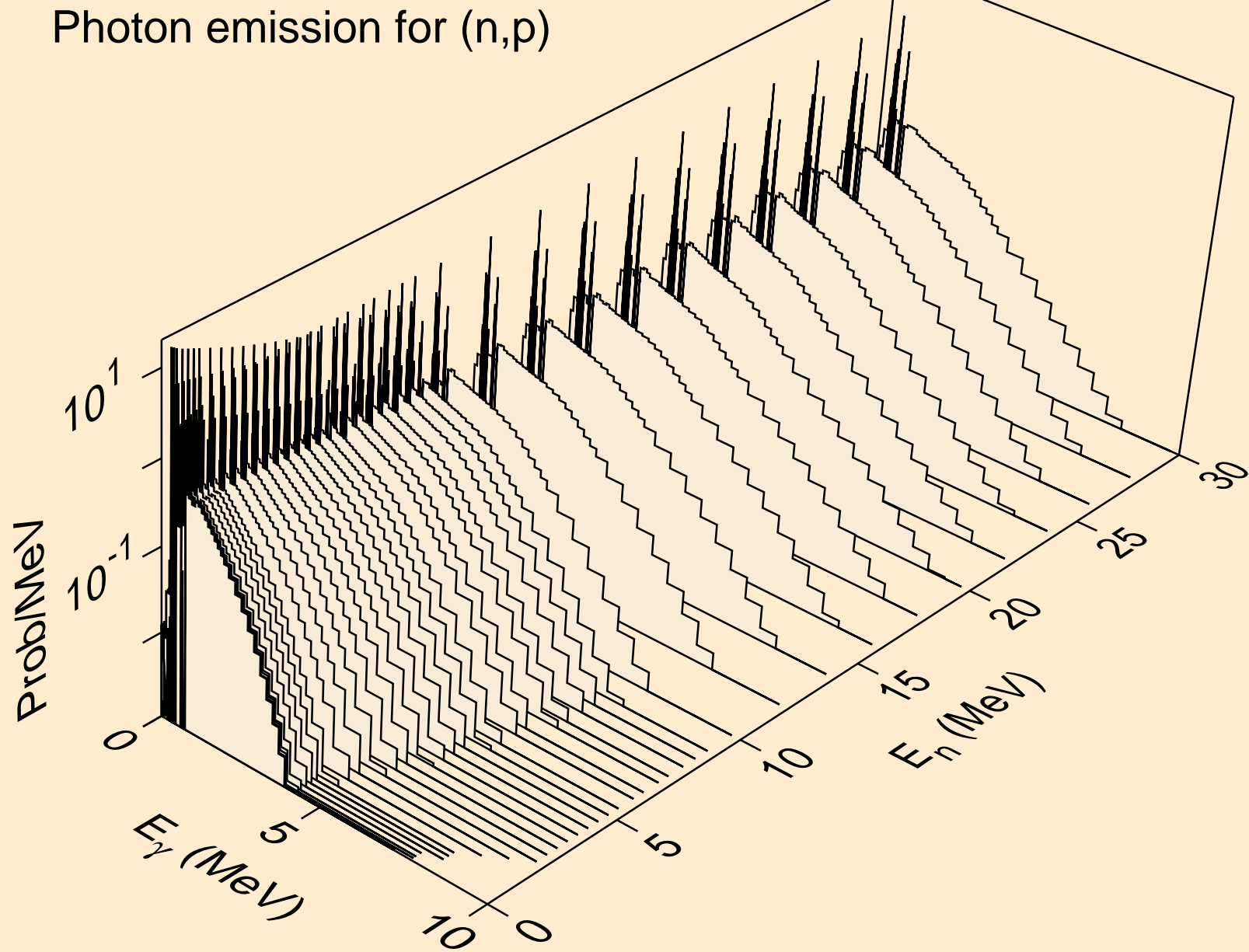

PB187 NEUTRON ACER TENDL-2024 LIBRARY; T=0.K
Photon emission for (n,d)

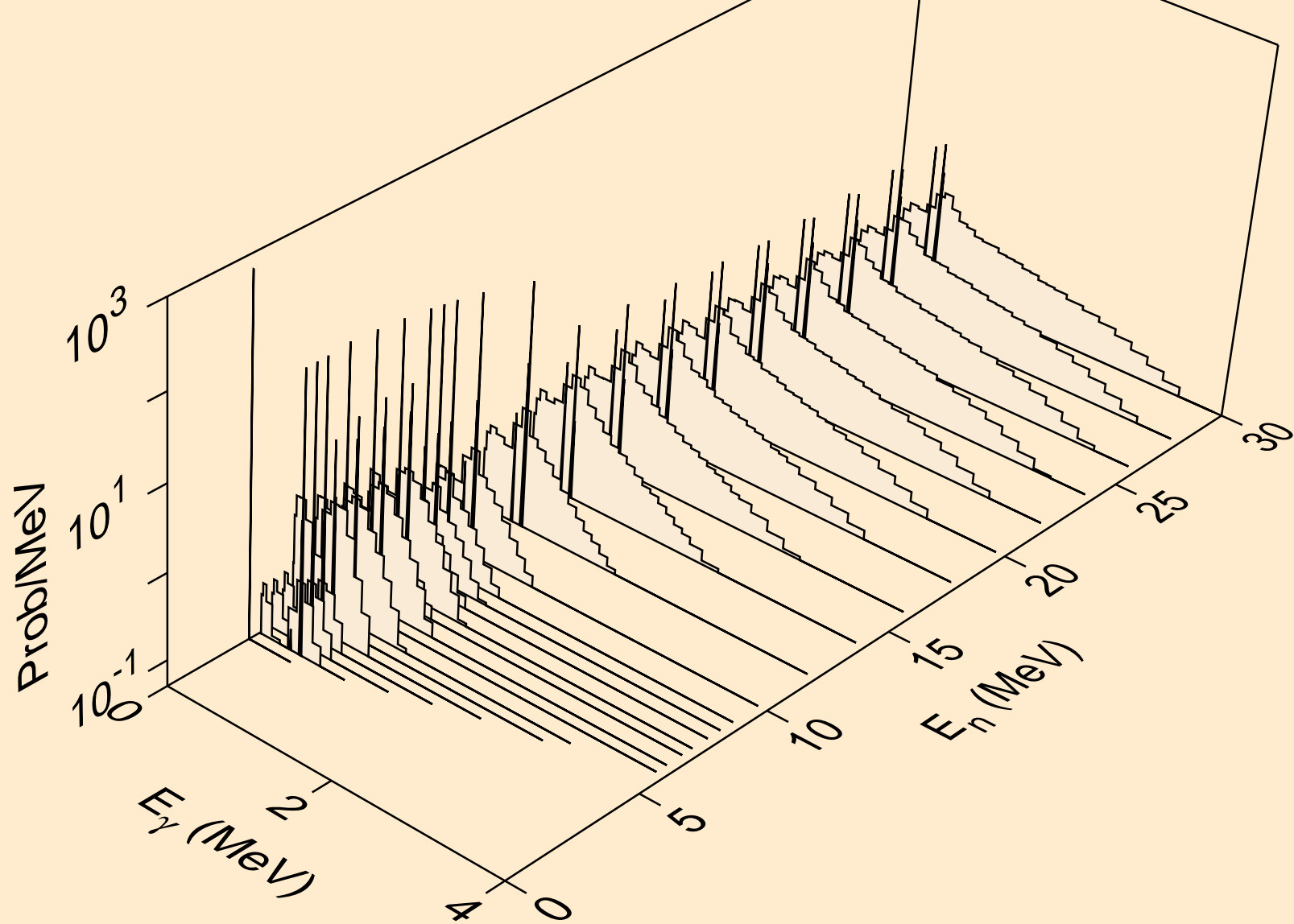

PB187 NEUTRON ACER TENDL-2024 LIBRARY; T=0.K
Photon emission for (n,t)

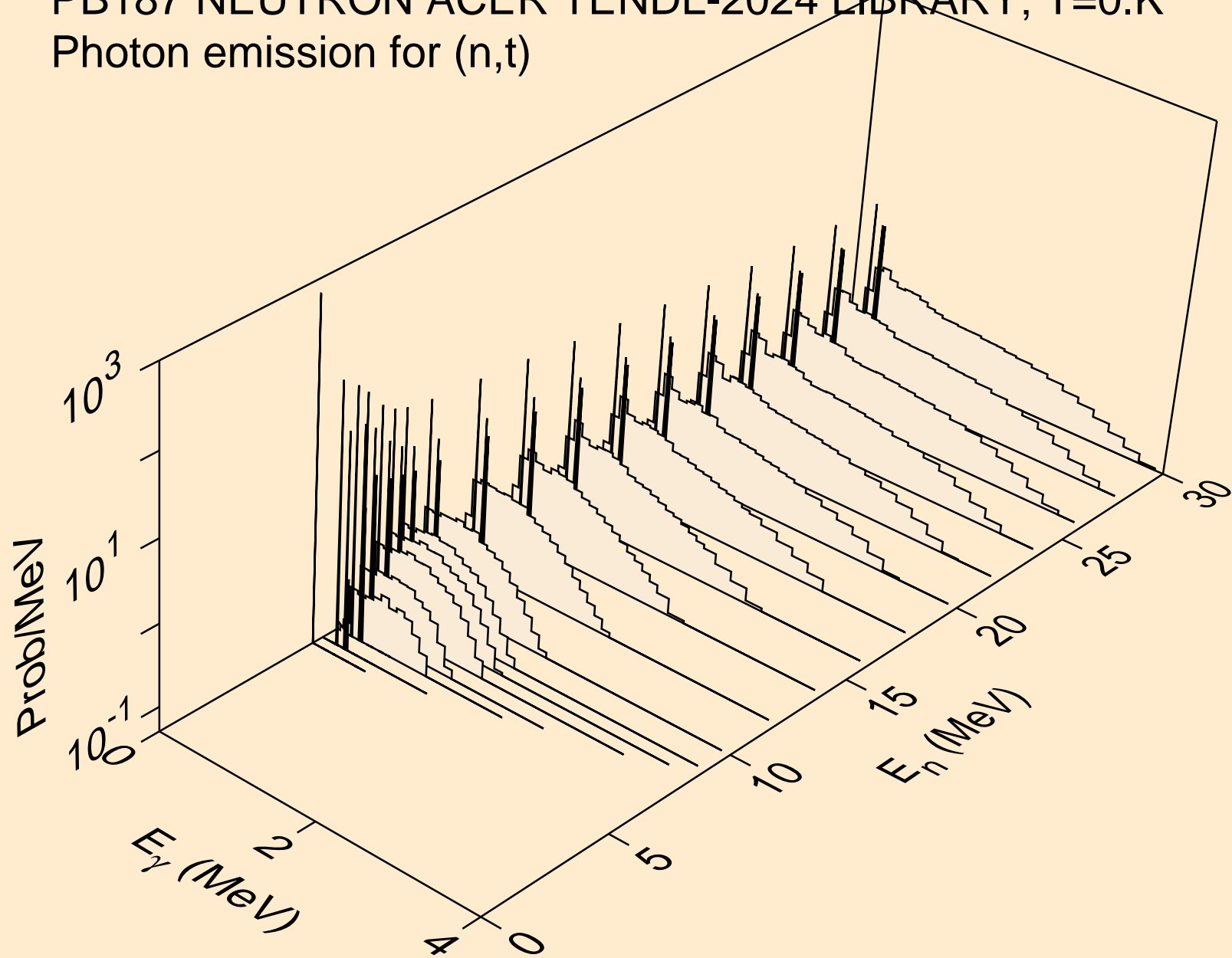

PB187 NEUTRON ACER TENDL-2024 LIBRARY; T=0.K
Photon emission for (n,he3)

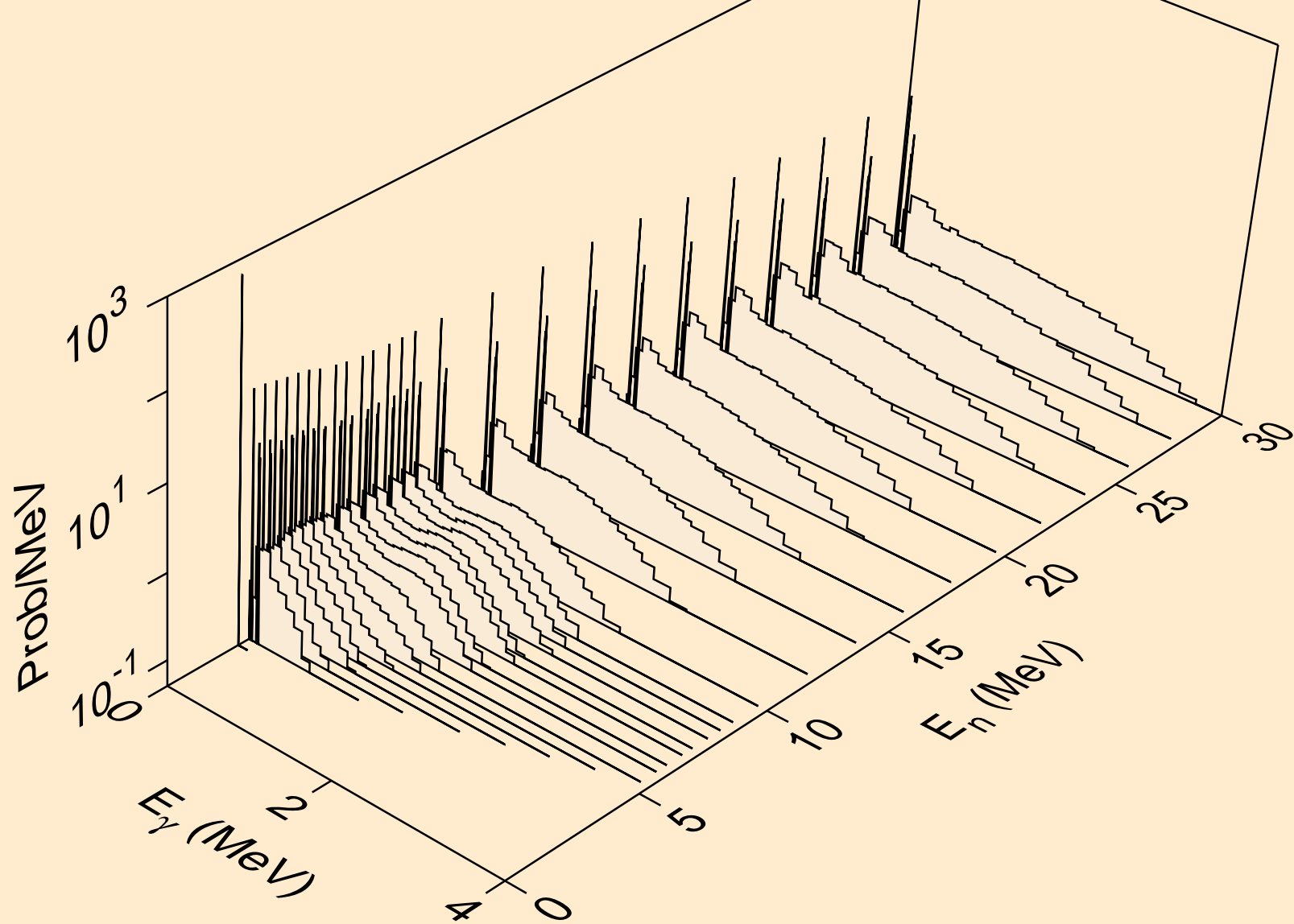

PB187 NEUTRON ACER TENDL-2024 LIBRARY; T=0.K
Photon emission for (n,a)

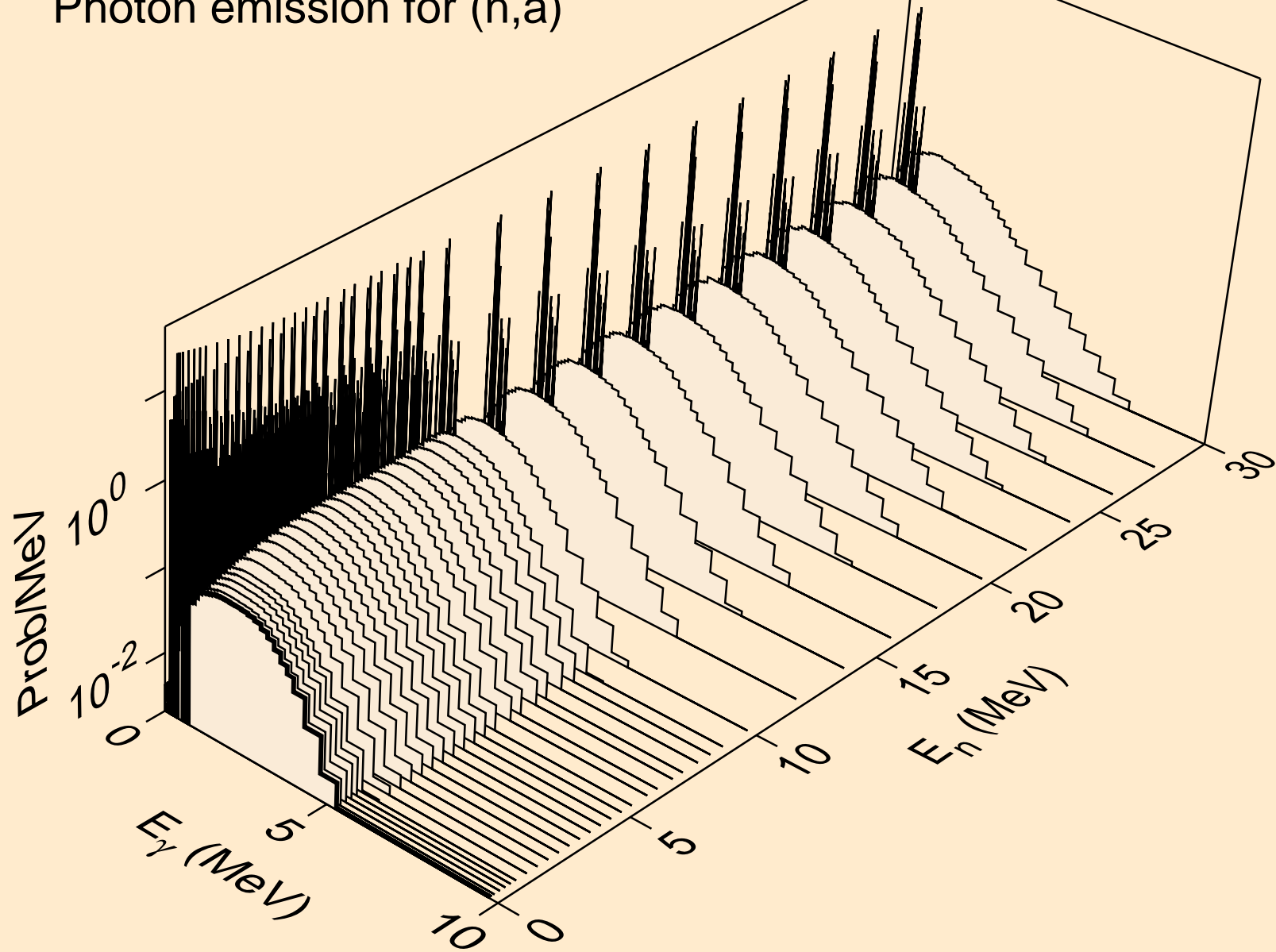

PB187 NEUTRON ACER TENDL-2024 LIBRARY; T=0.K
Photon emission for (n,2a)

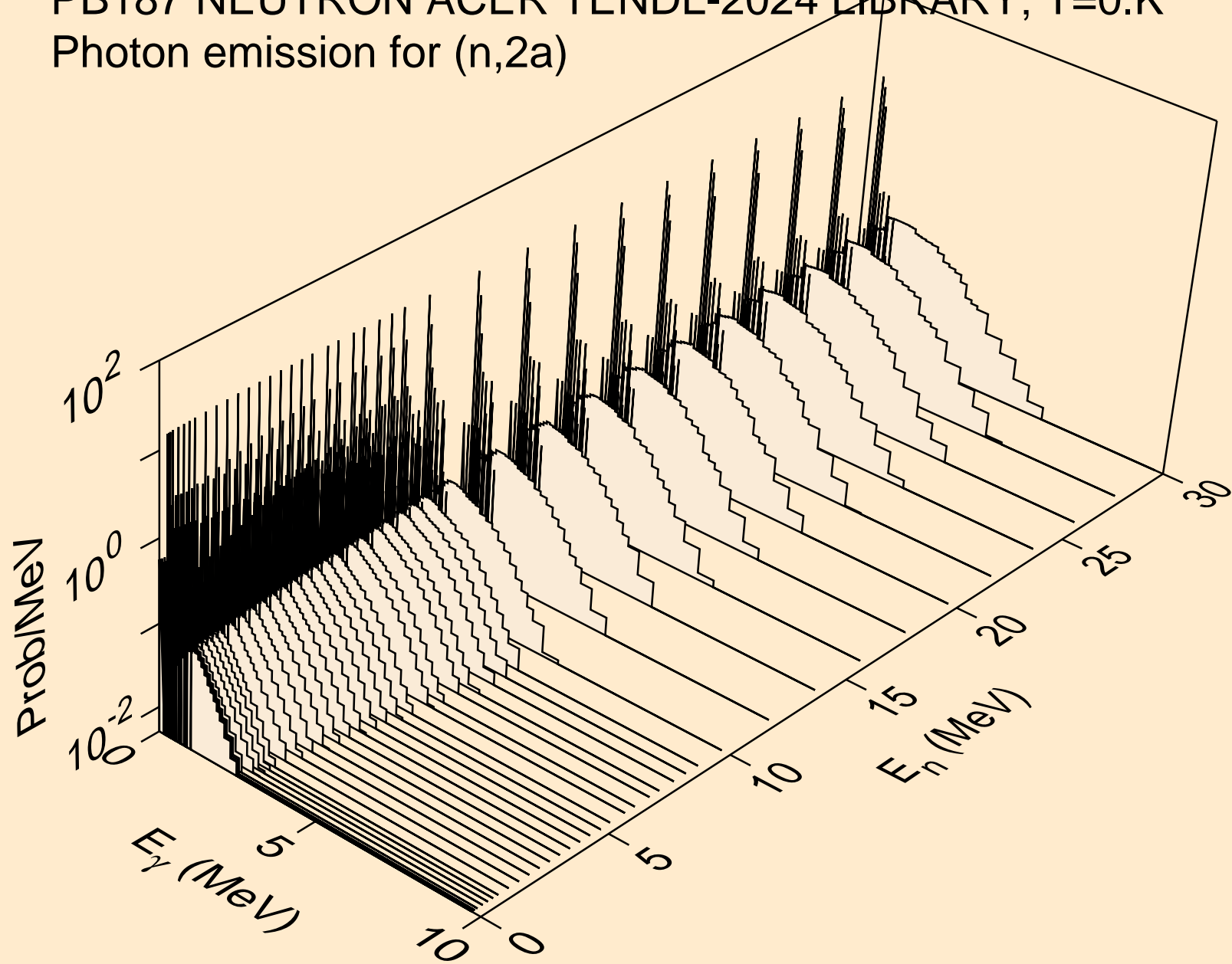

PB187 NEUTRON ACER TENDL-2024 LIBRARY; T=0.K
Photon emission for (n,3a)

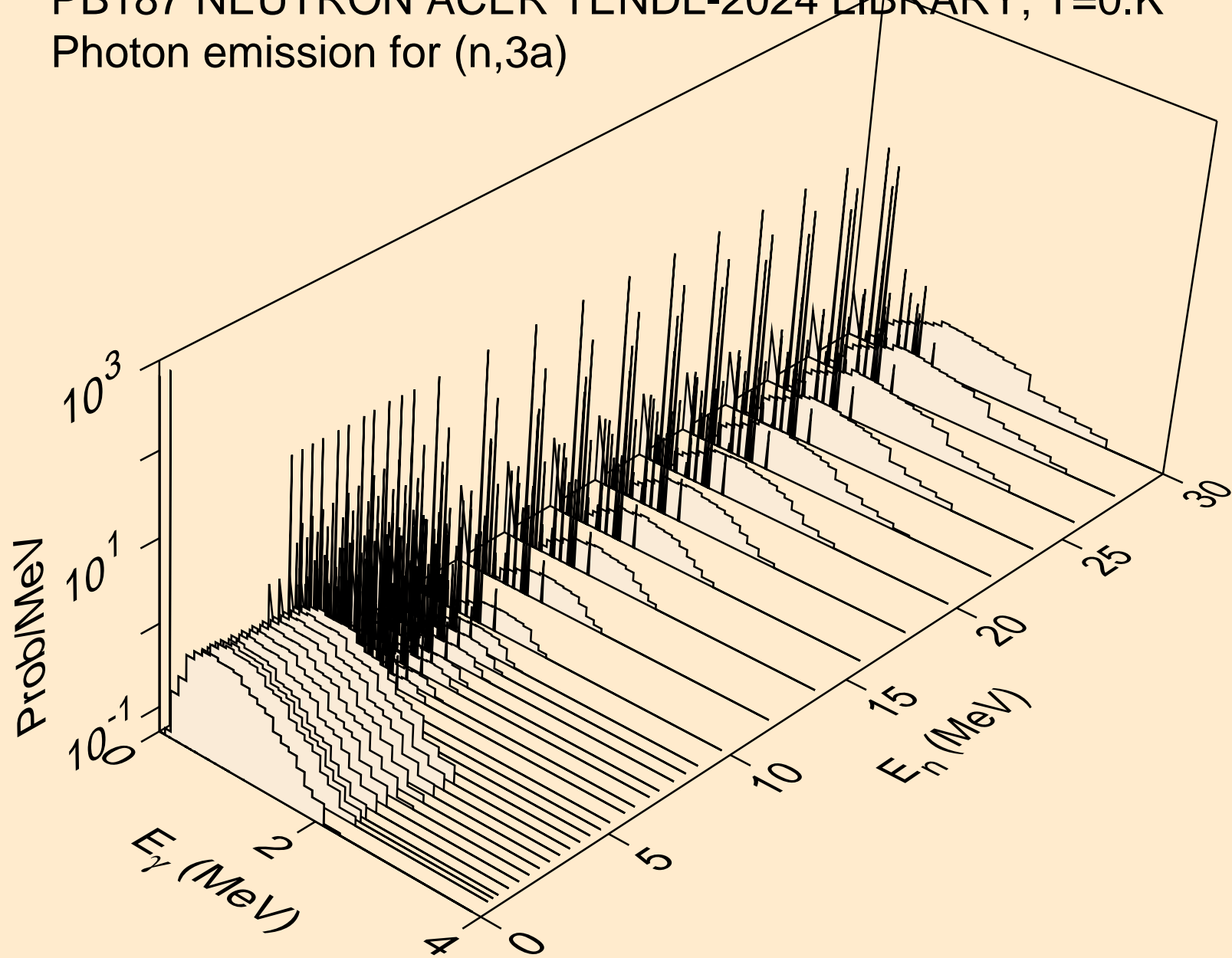

PB187 NEUTRON ACER TENDL-2024 LIBRARY; T=0.K
Photon emission for (n,2p)

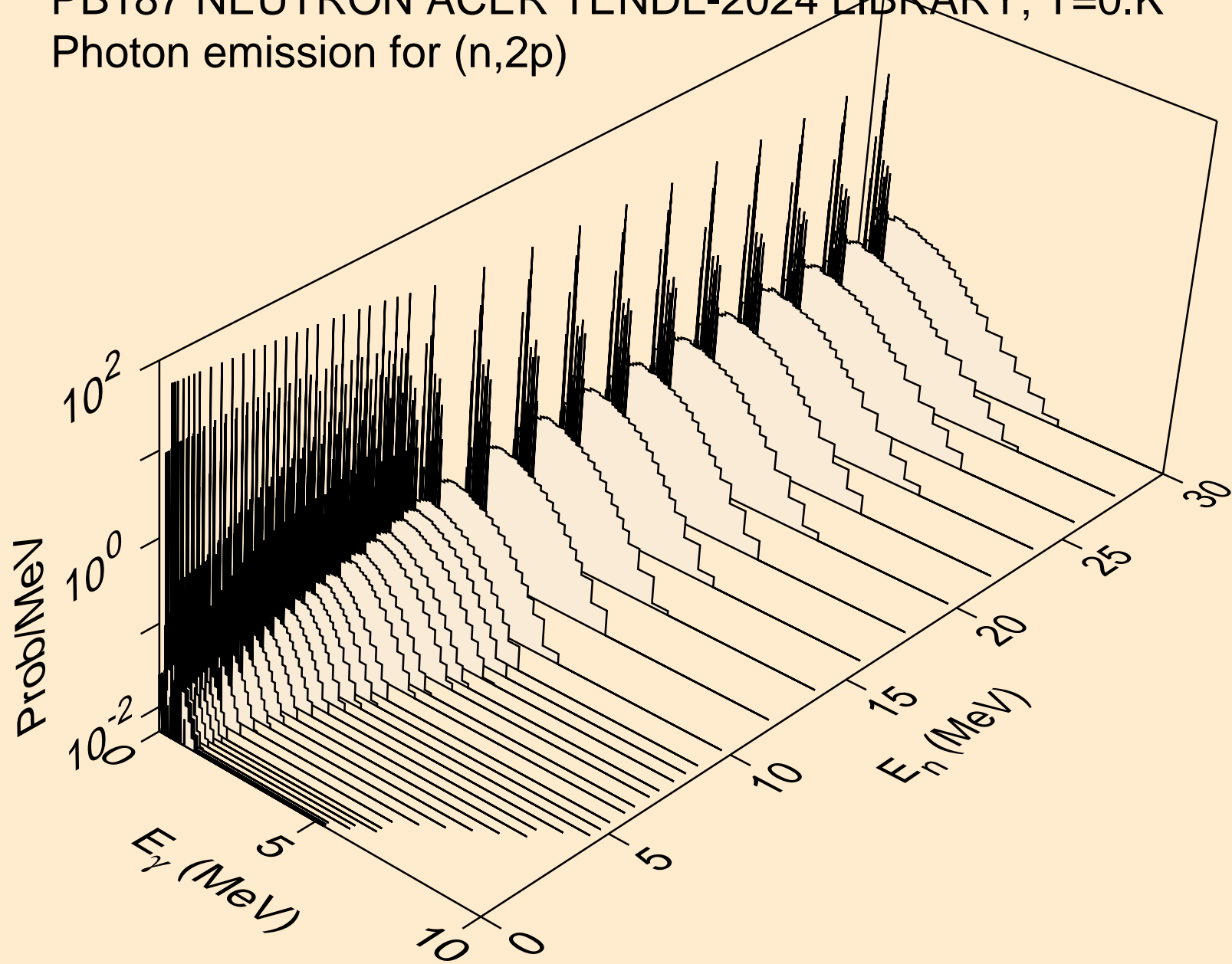

PB187 NEUTRON ACER TENDL-2024 LIBRARY; T=0.K
Photon emission for (n,p α)

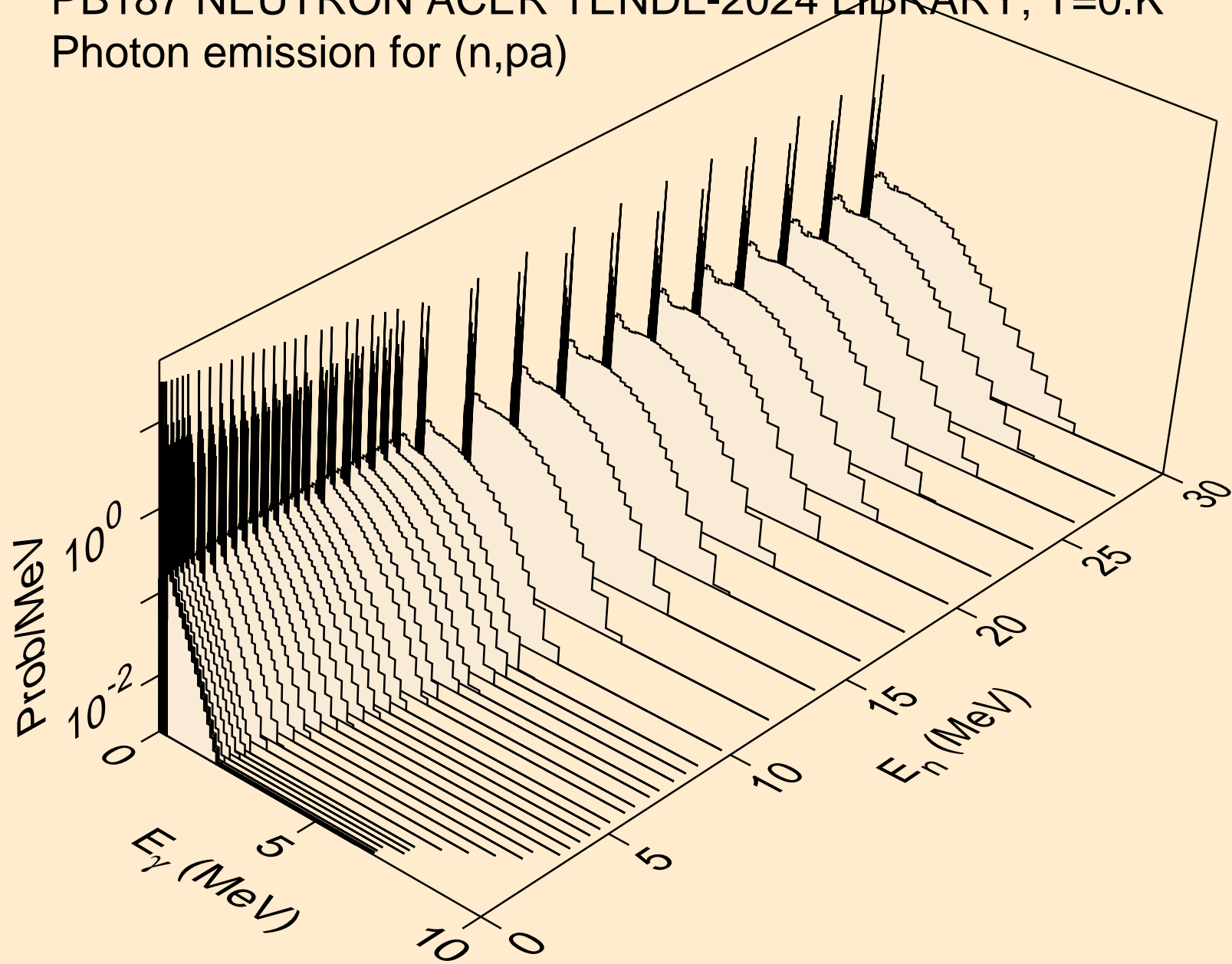

PB187 NEUTRON ACER TENDL-2024 LIBRARY; T=0.K
Photon emission for (n,d2a)

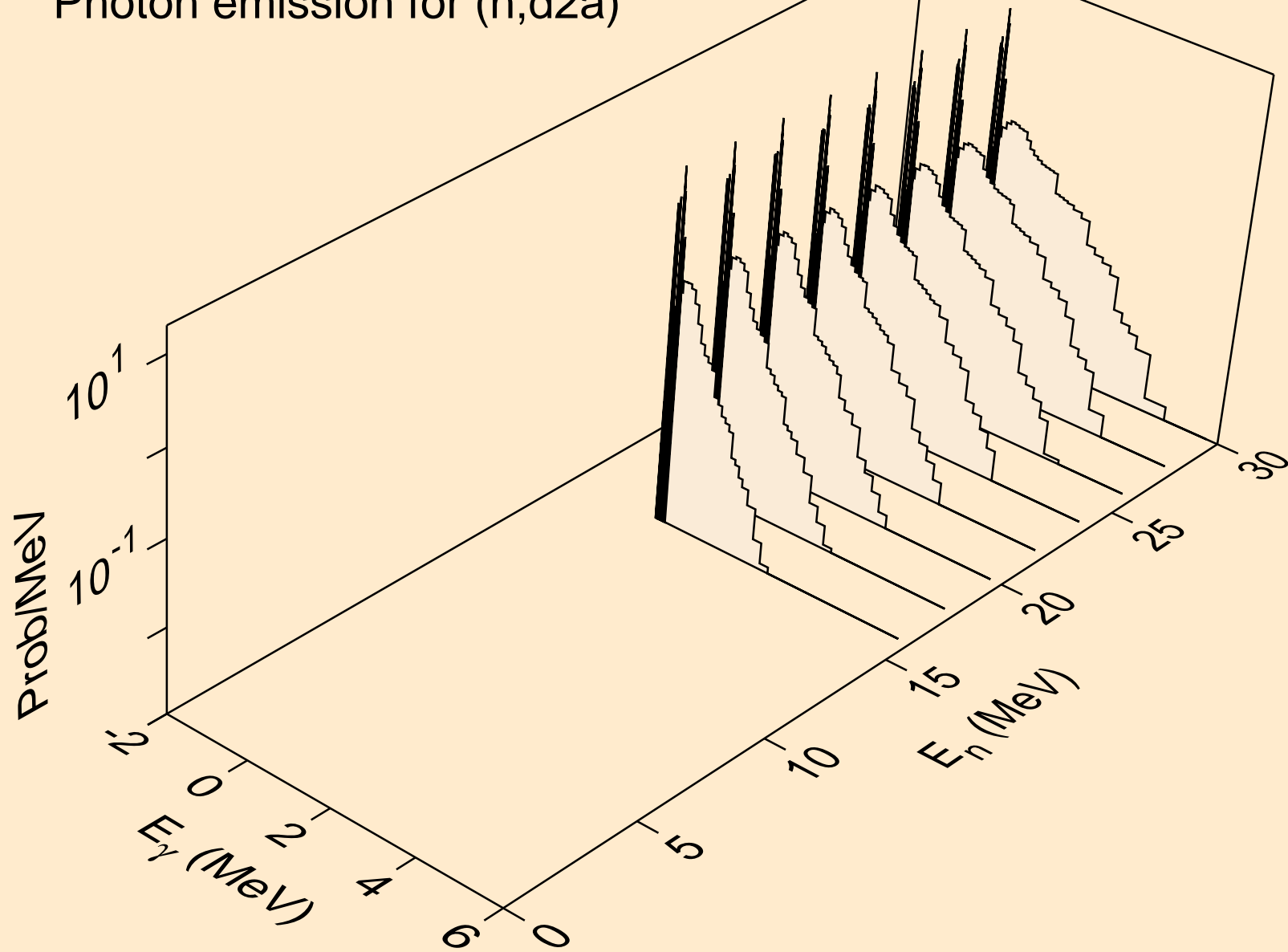

PB187 NEUTRON ACER TENDL-2024 LIBRARY; T=0.K
Photon emission for (n,pd)

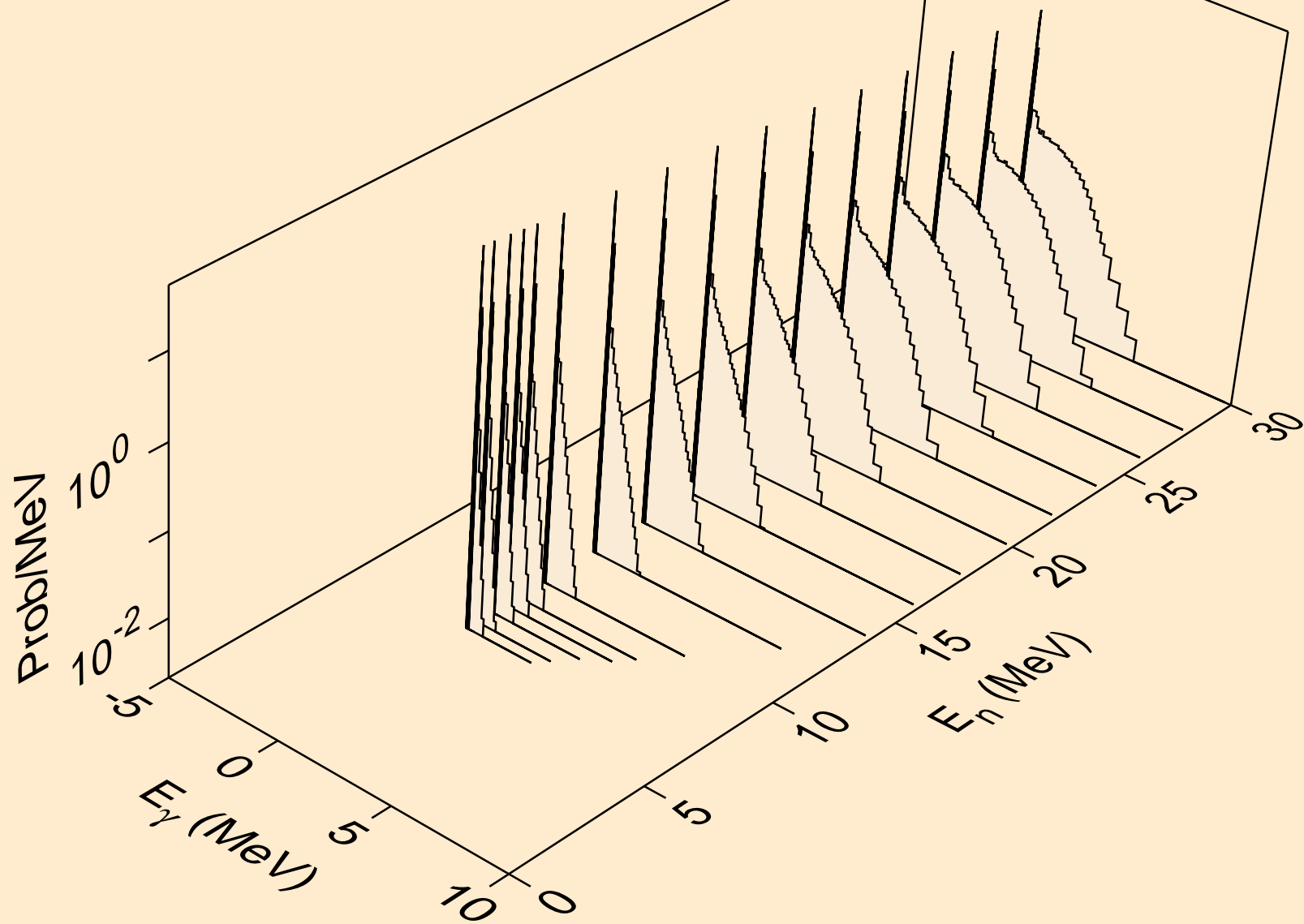

PB187 NEUTRON ACER TENDL-2024 LIBRARY; T=0.K
Photon emission for (n,pt)

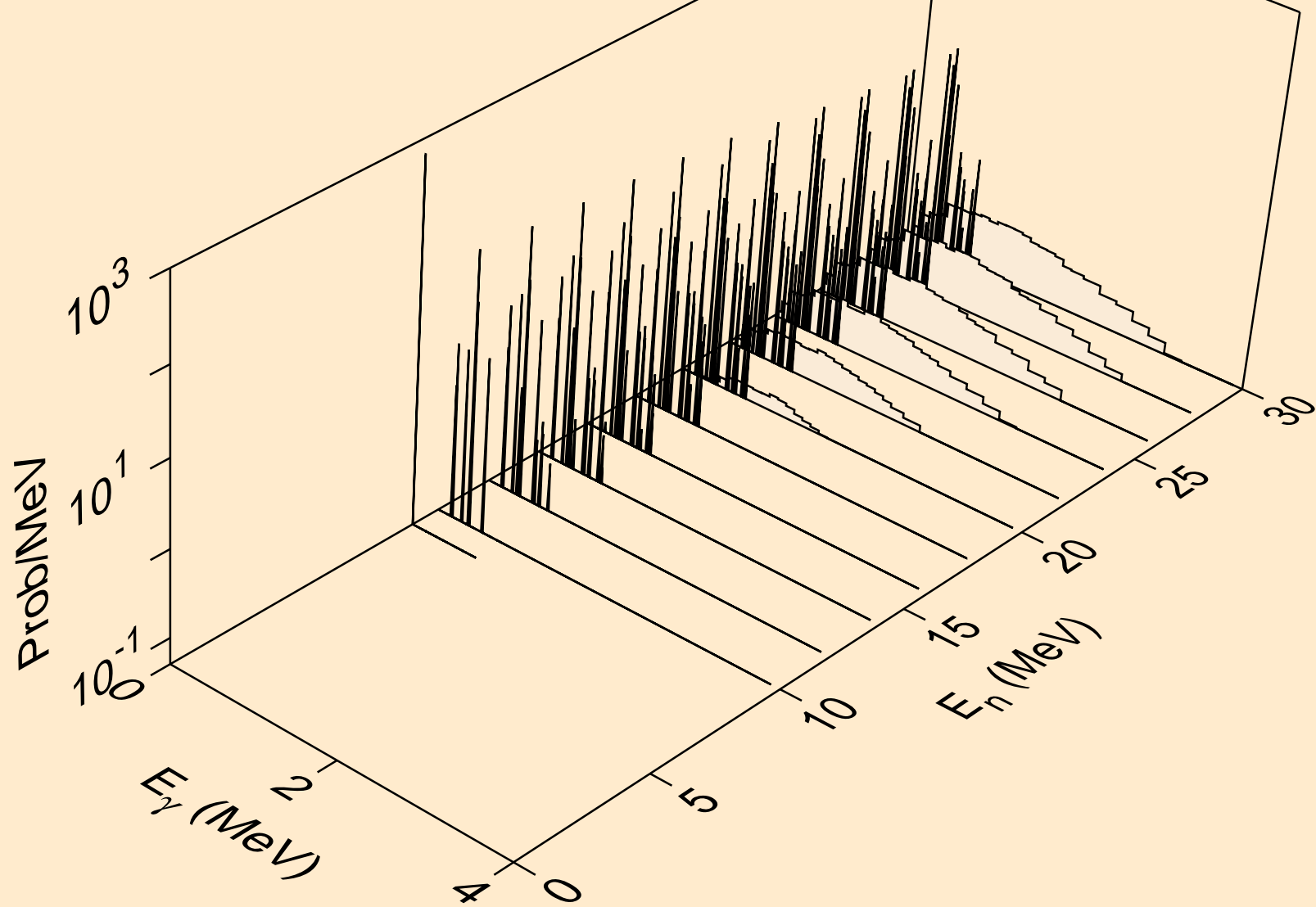

PB187 NEUTRON ACER TENDL-2024 LIBRARY; T=0.K
Photon emission for (n,da)

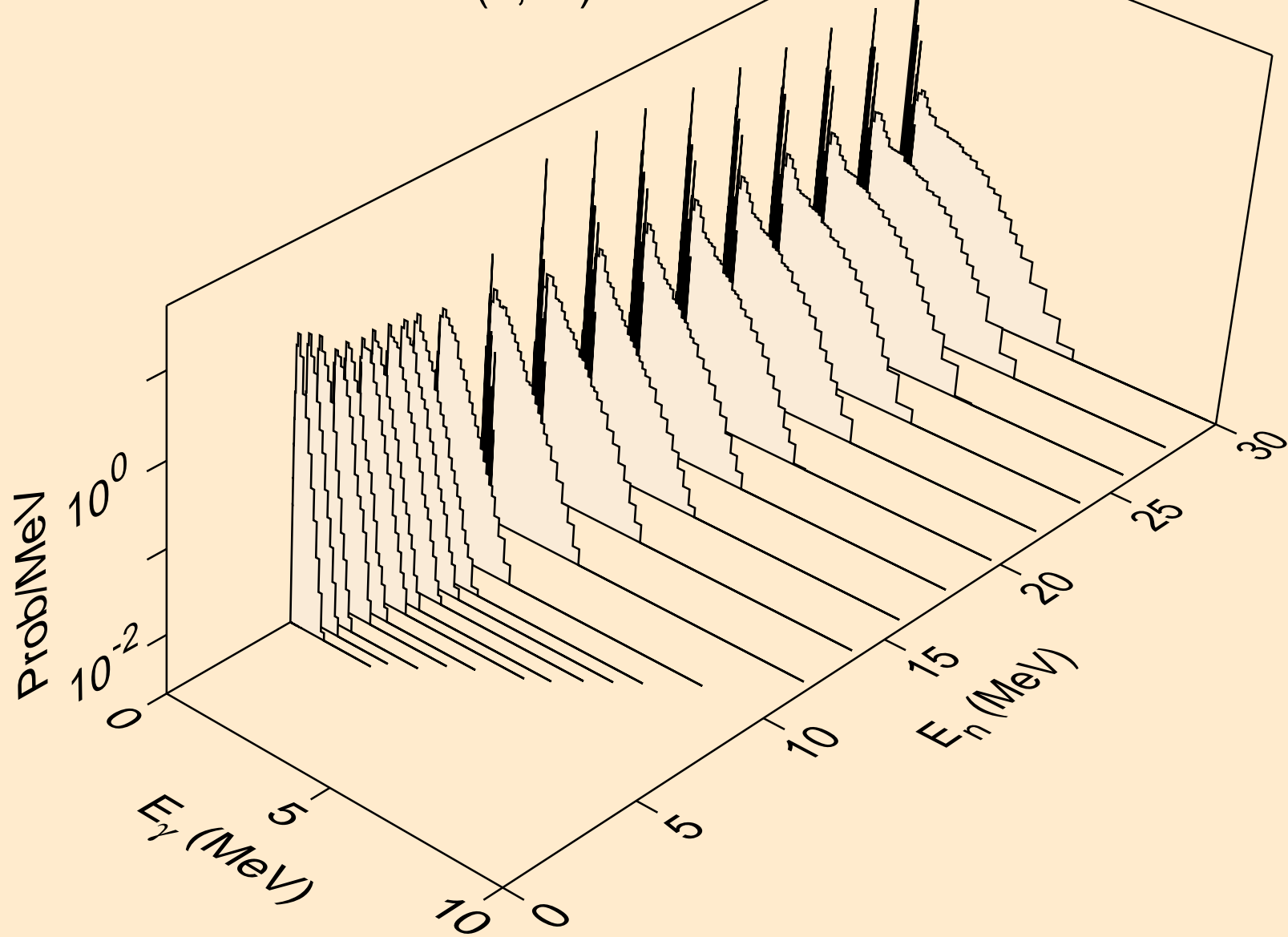

PB187 NEUTRON ACER TENDL-2024 LIBRARY; T=0.K
thermal capture photon spectrum

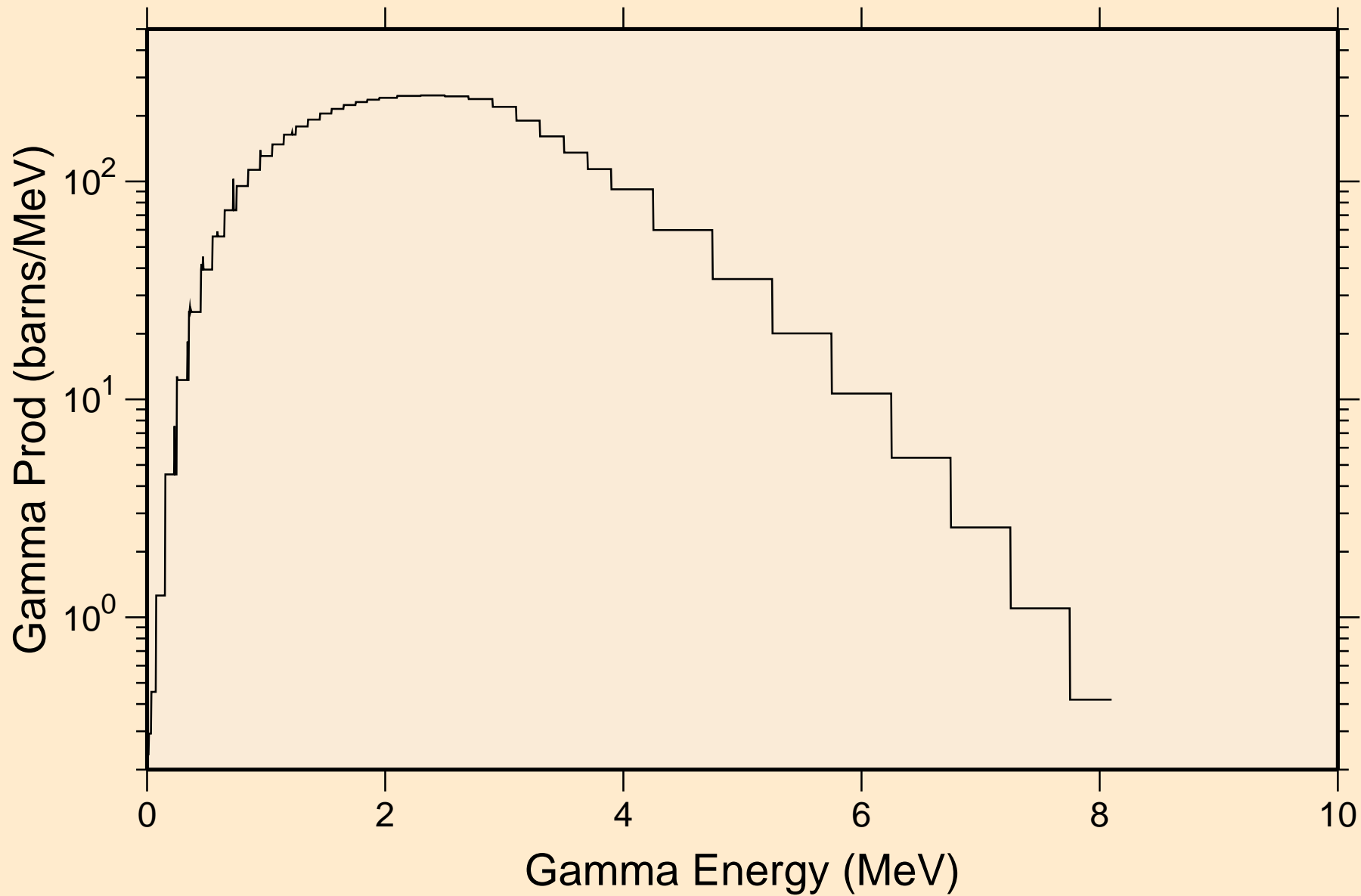

PB187 NEUTRON ACER TENDL-2024 LIBRARY; T=0.K
14 MeV photon spectrum

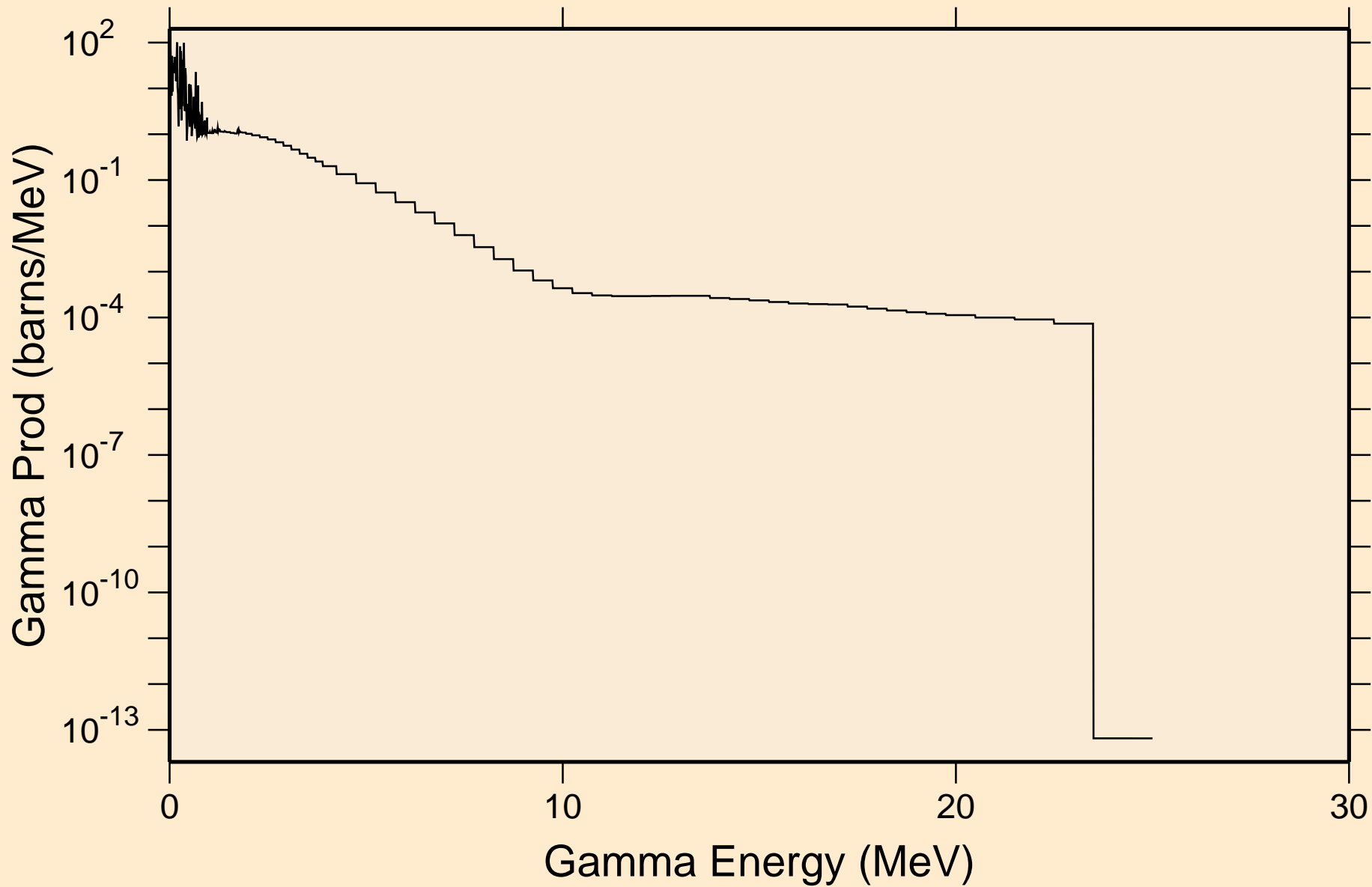

PB187 NEUTRON ACER TENDL-2024 LIBRARY; T=0.K
Particle heating contributions

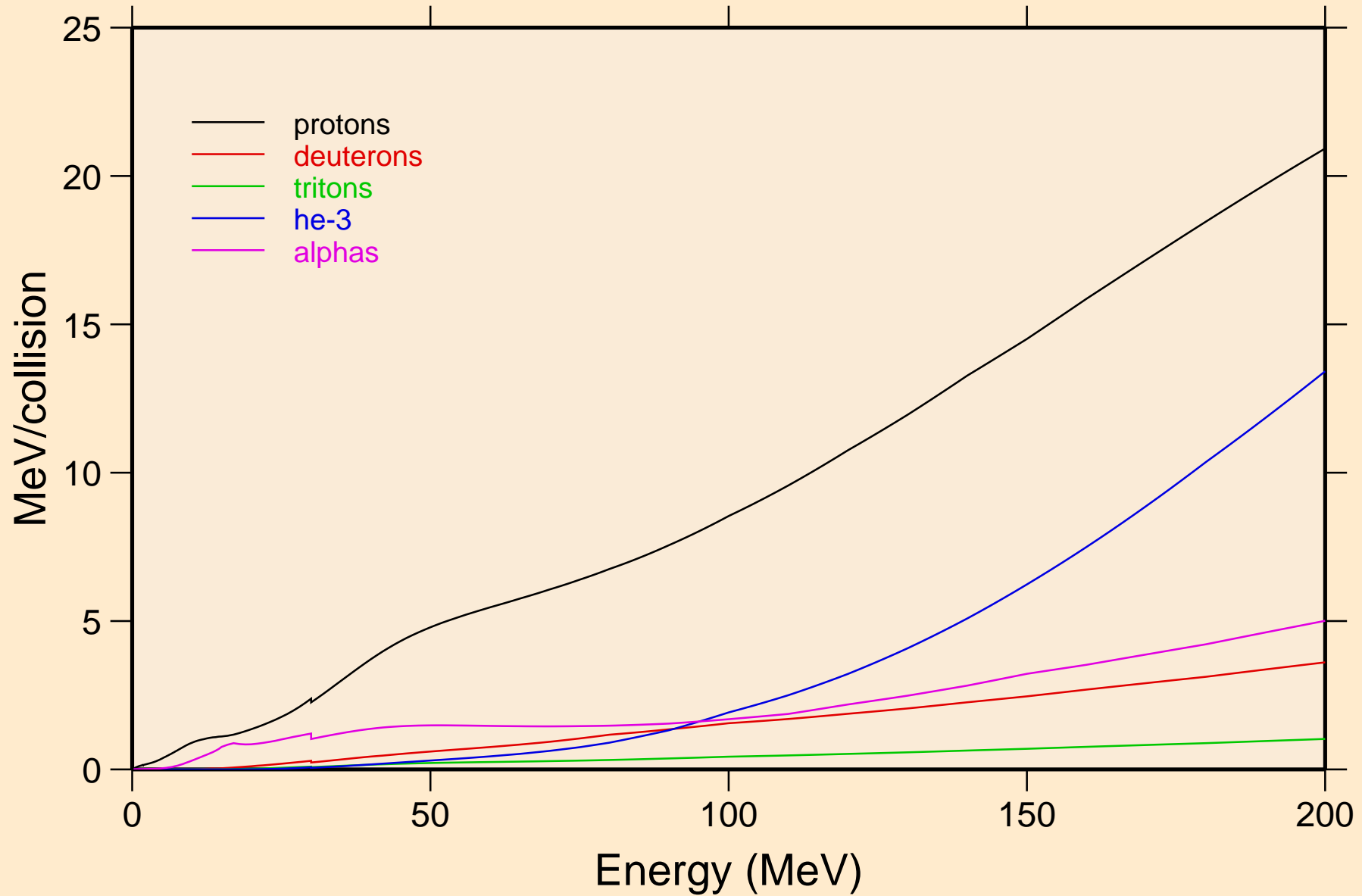

PB187 NEUTRON ACER TENDL-2024 LIBRARY; T=0.K
Recoil Heating

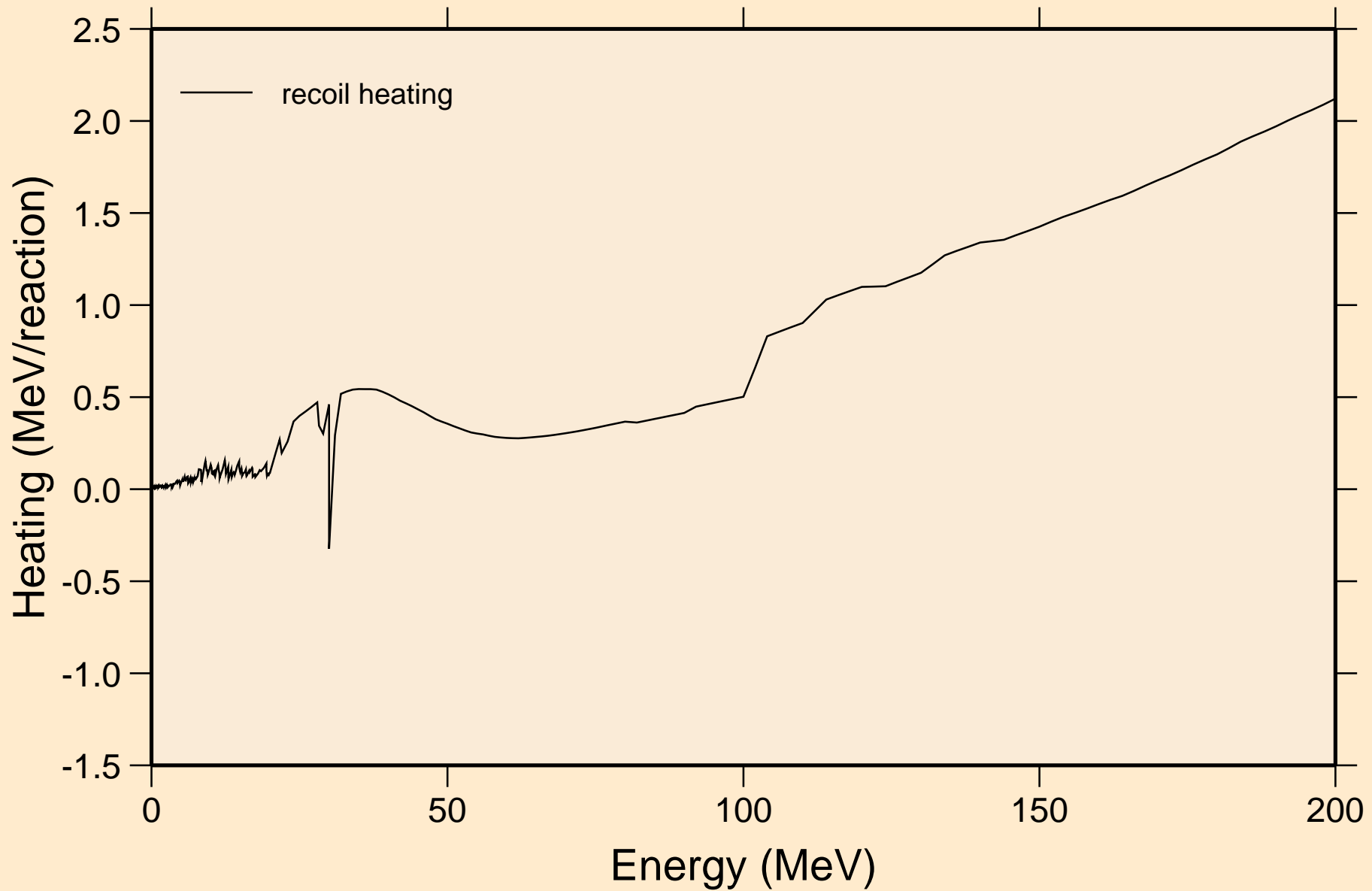

PB187 NEUTRON ACER TENDL-2024 LIBRARY; T=0.K
Particle production cross sections

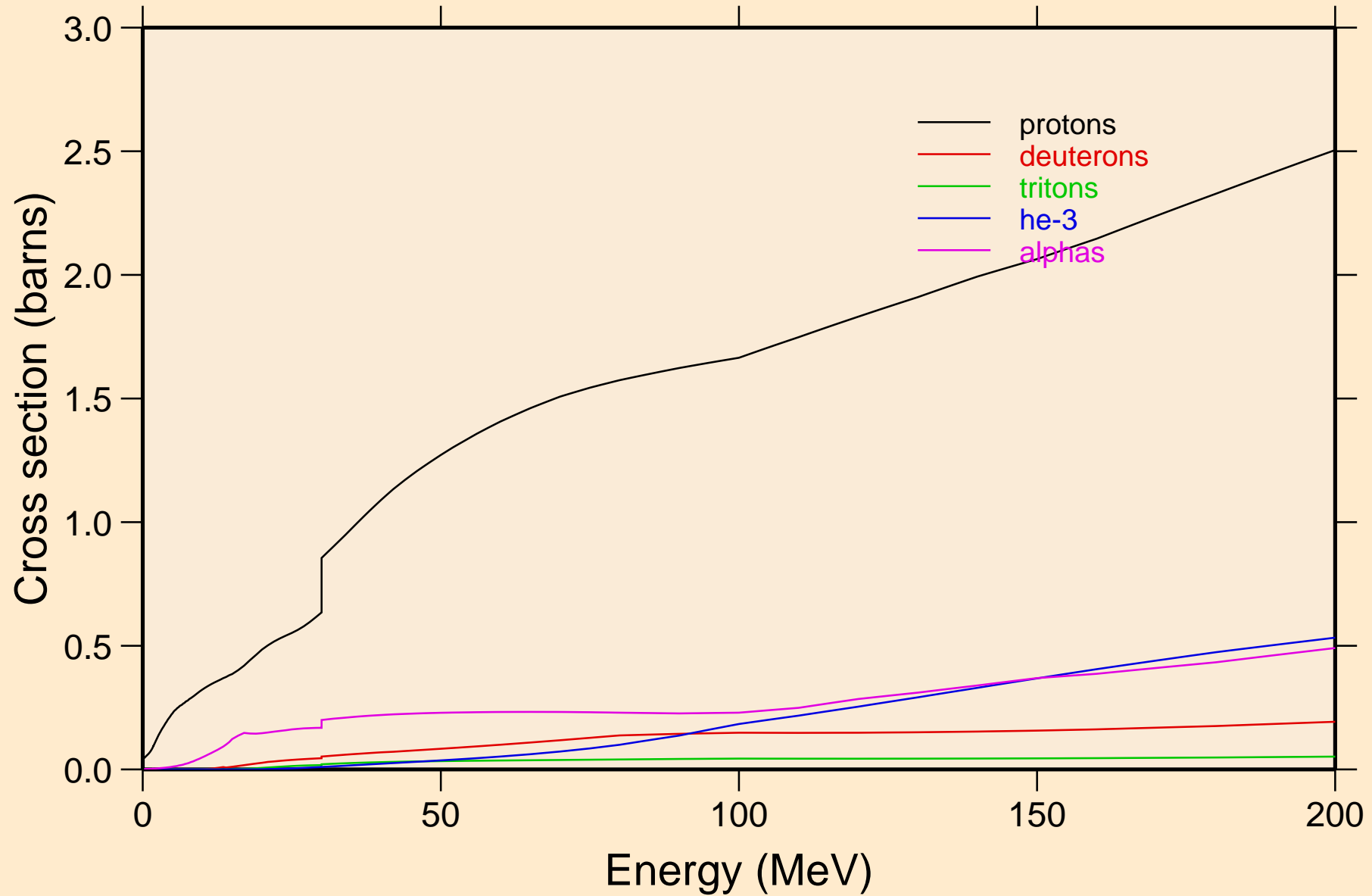

PB187 NEUTRON ACER TENDL-2024 LIBRARY; T=0.K
protons from (n,x)

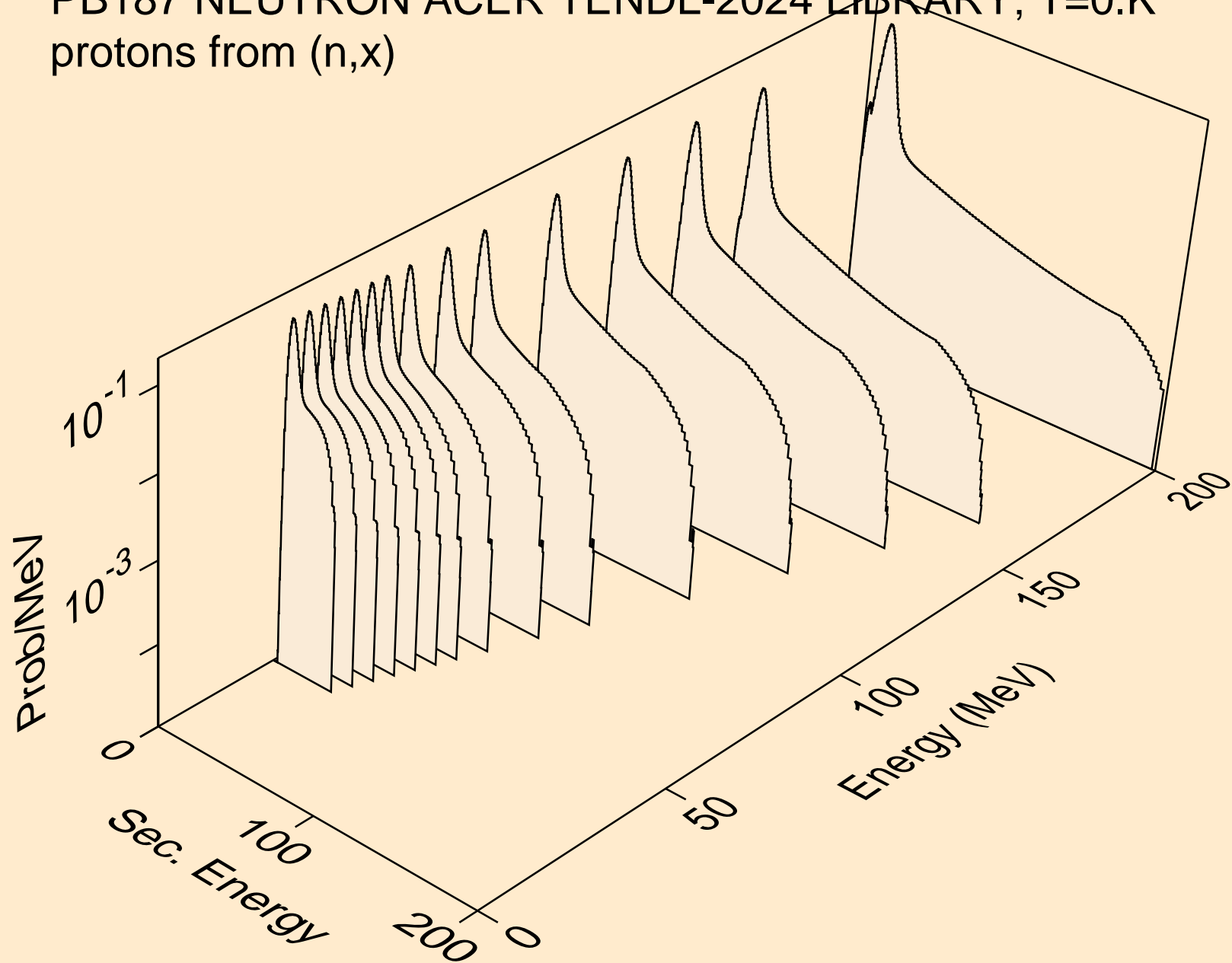

PB187 NEUTRON ACER TENDL-2024 LIBRARY; T=0.K
protons from (n,n*)p

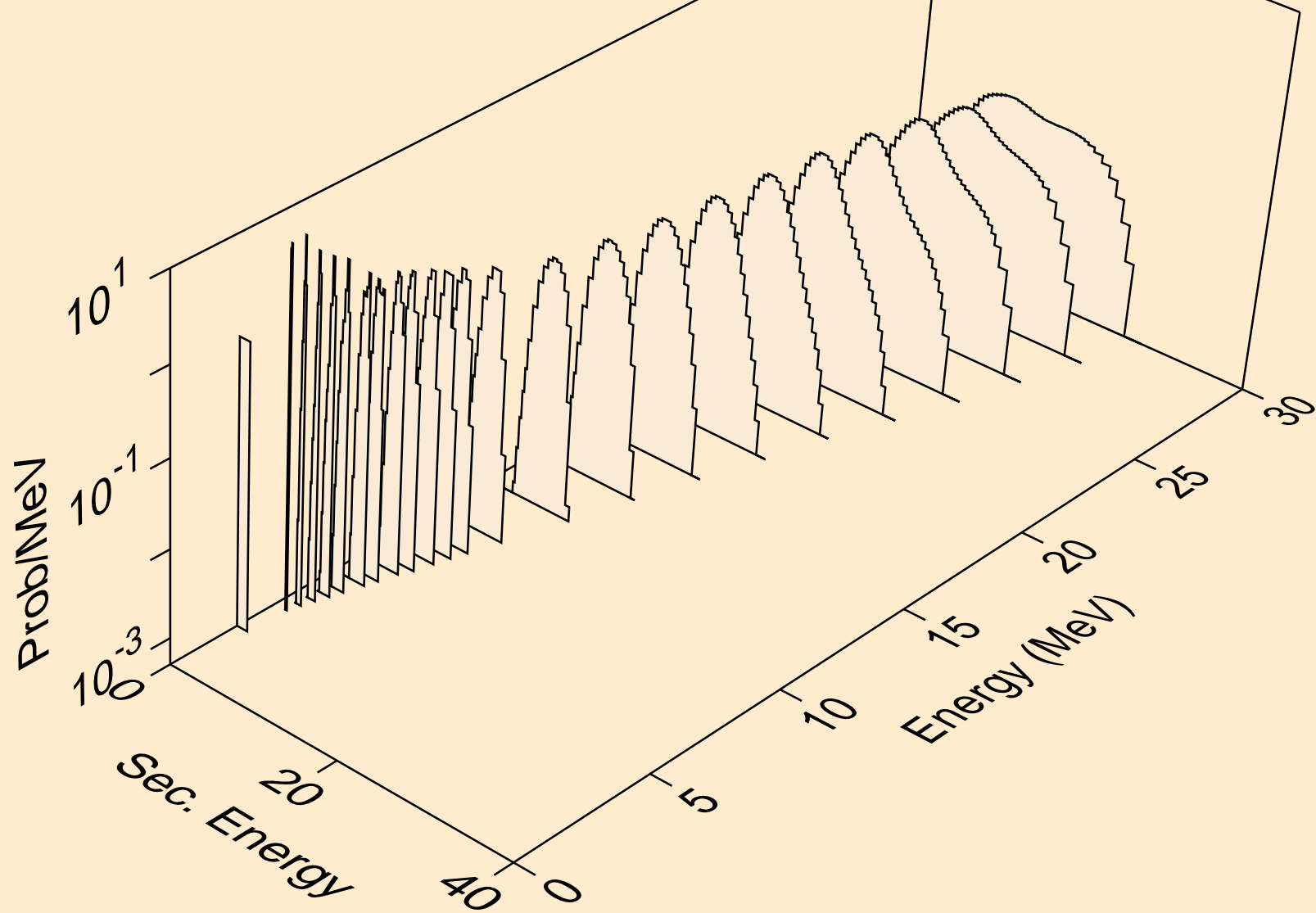

PB187 NEUTRON ACER TENDL-2024 LIBRARY; T=0.K
protons from (n,2np)

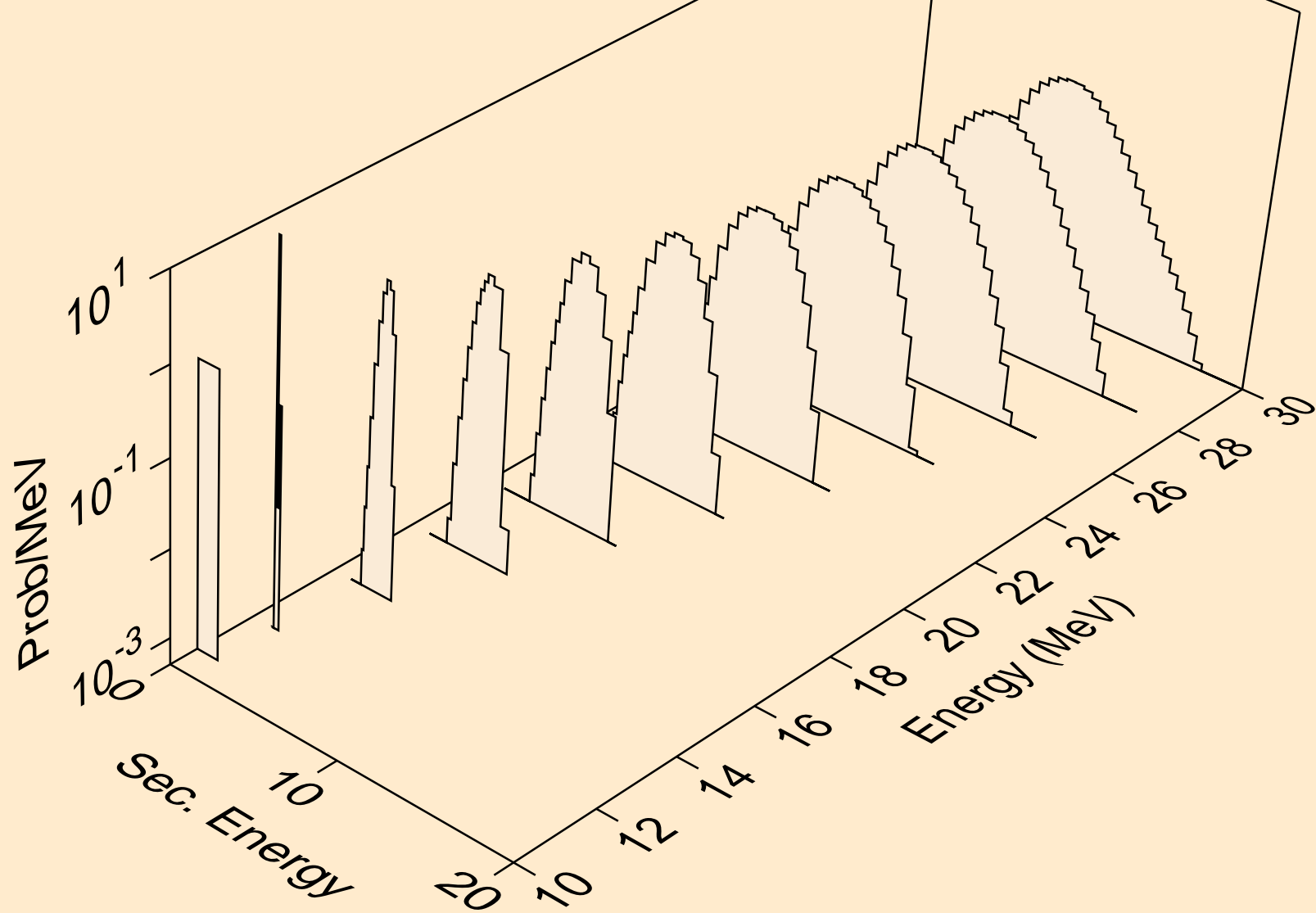

PB187 NEUTRON ACER TENDL-2024 LIBRARY; T=0.K
protons from (n,3np)

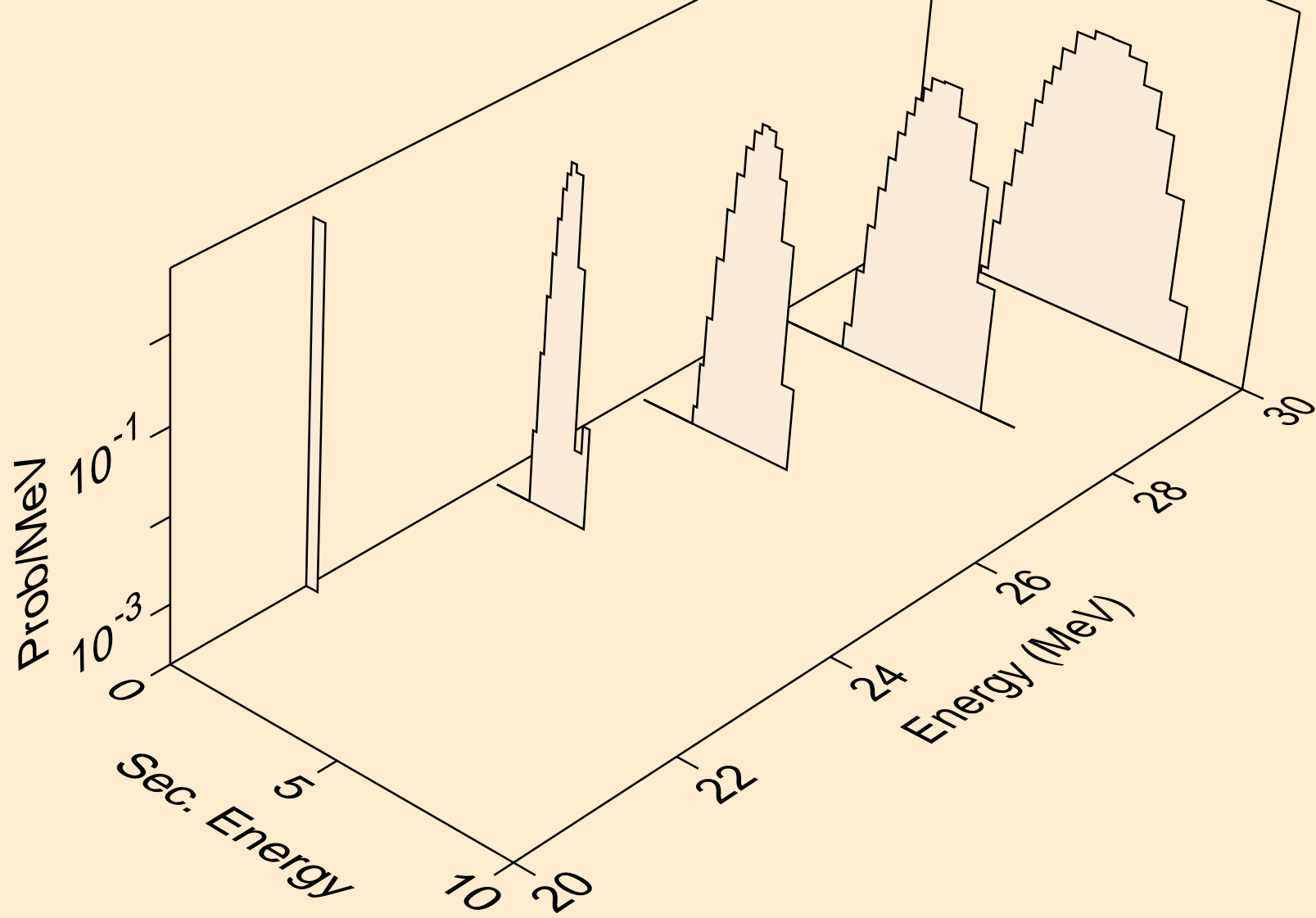

PB187 NEUTRON ACER TENDL-2024 LIBRARY; T=0.K
protons from (n,n2p)

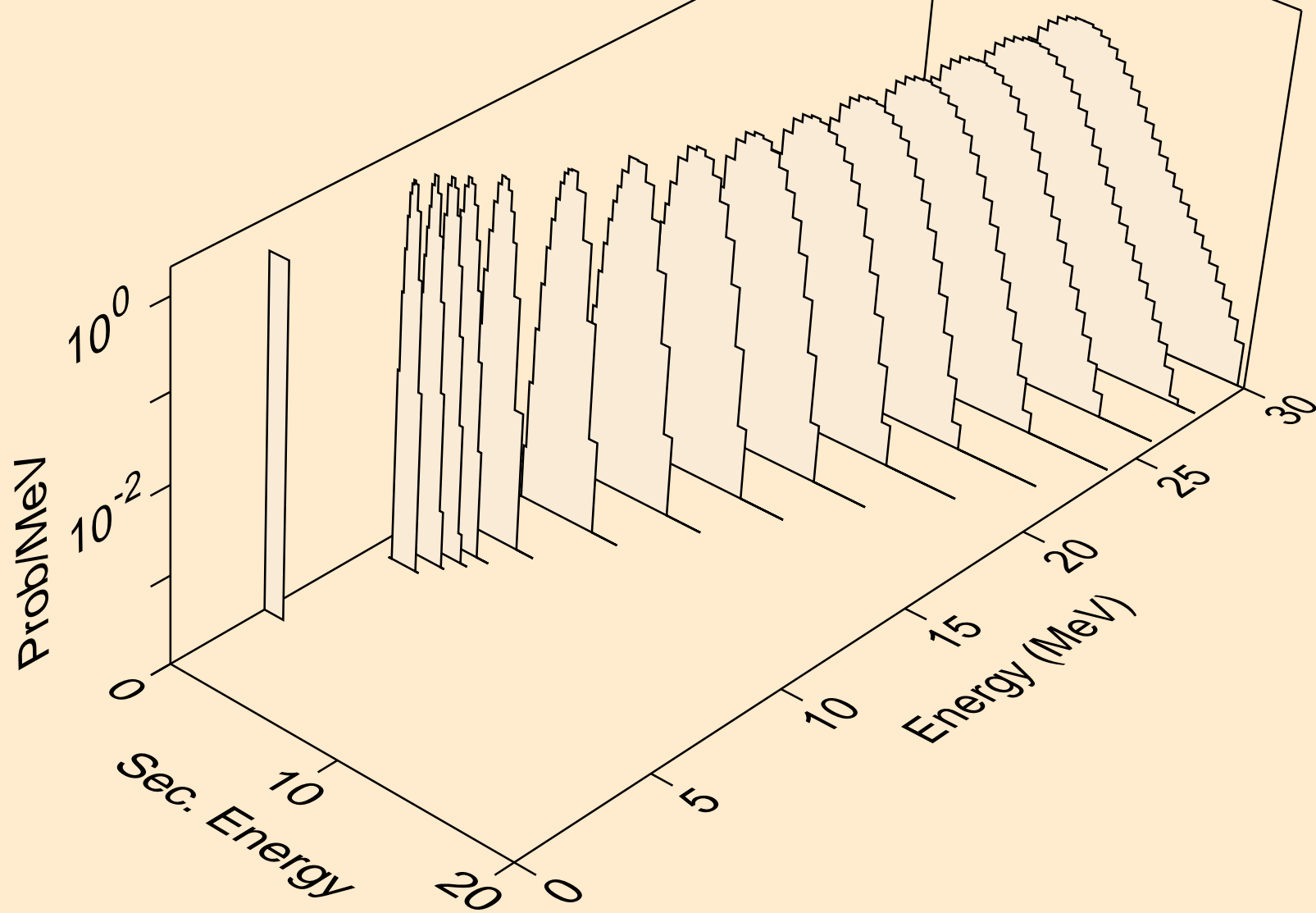

PB187 NEUTRON ACER TENDL-2024 LIBRARY; T=0.K
protons from (n,npa)

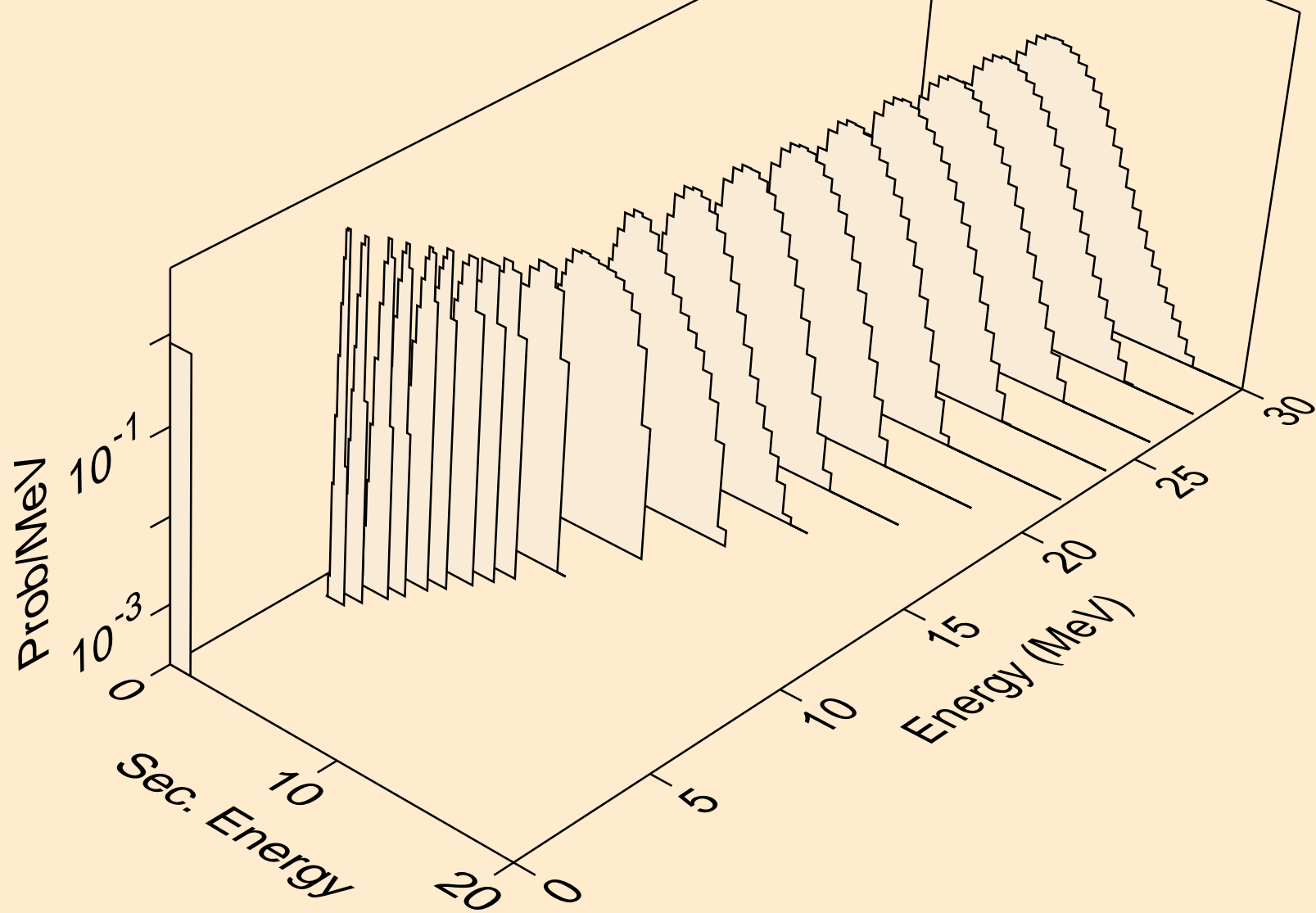

PB187 NEUTRON ACER TENDL-2024 LIBRARY; T=0.K
protons from (n,p)

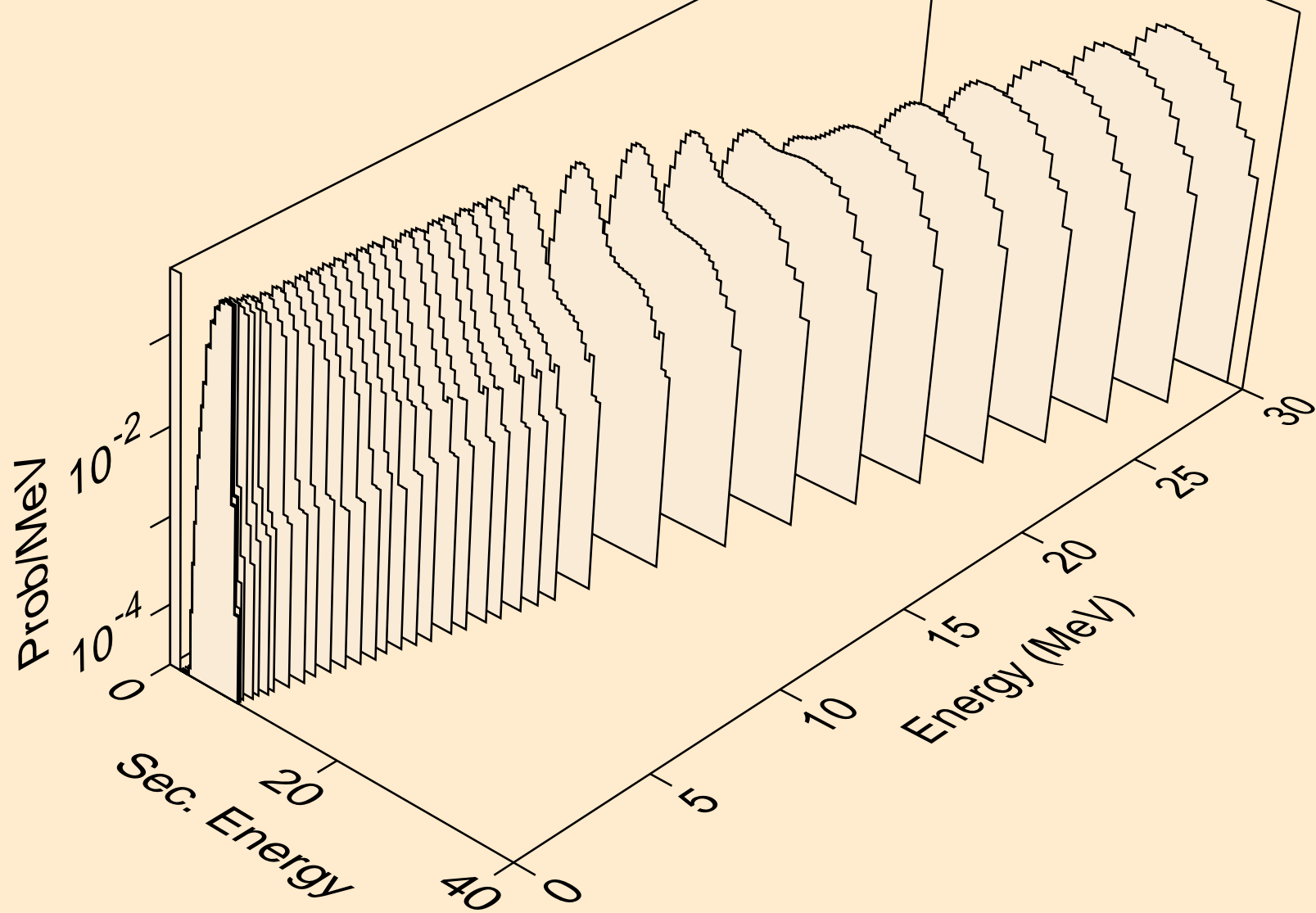

PB187 NEUTRON ACER TENDL-2024 LIBRARY; T=0.K
protons from (n,2p)

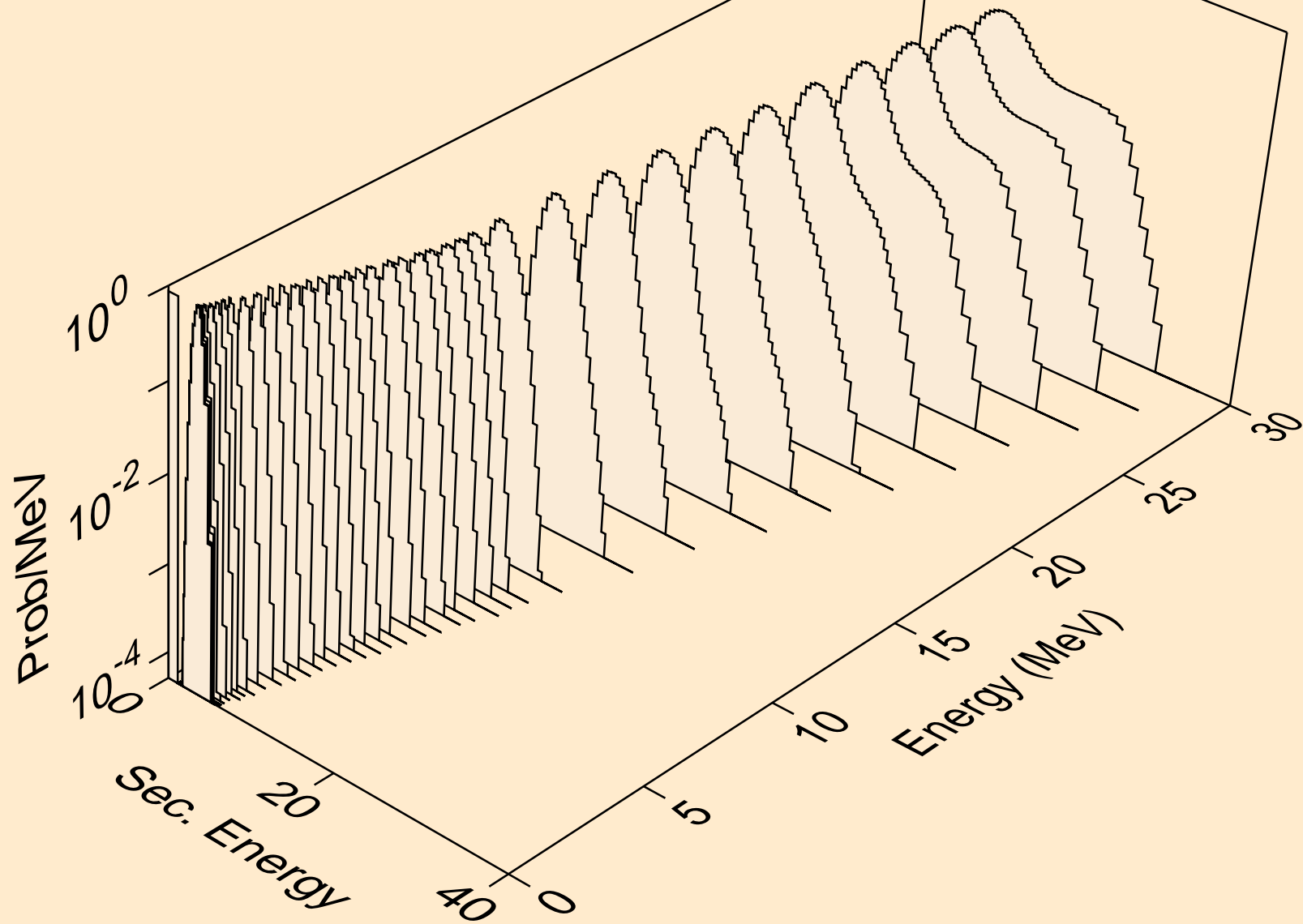

PB187 NEUTRON ACER TENDL-2024 LIBRARY; T=0.K
protons from (n,p)

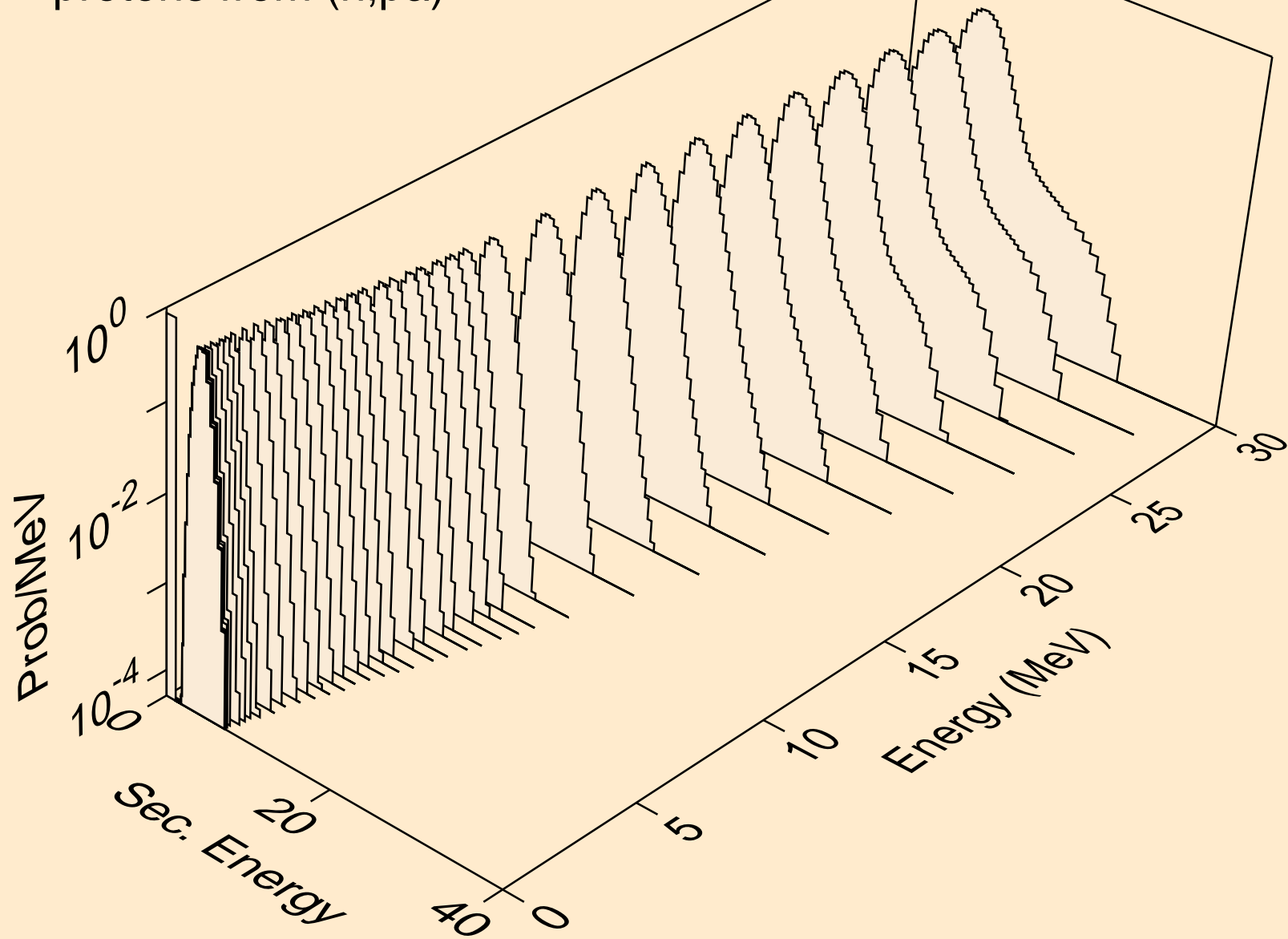

PB187 NEUTRON ACER TENDL-2024 LIBRARY; T=0.K
protons from (n,pd)

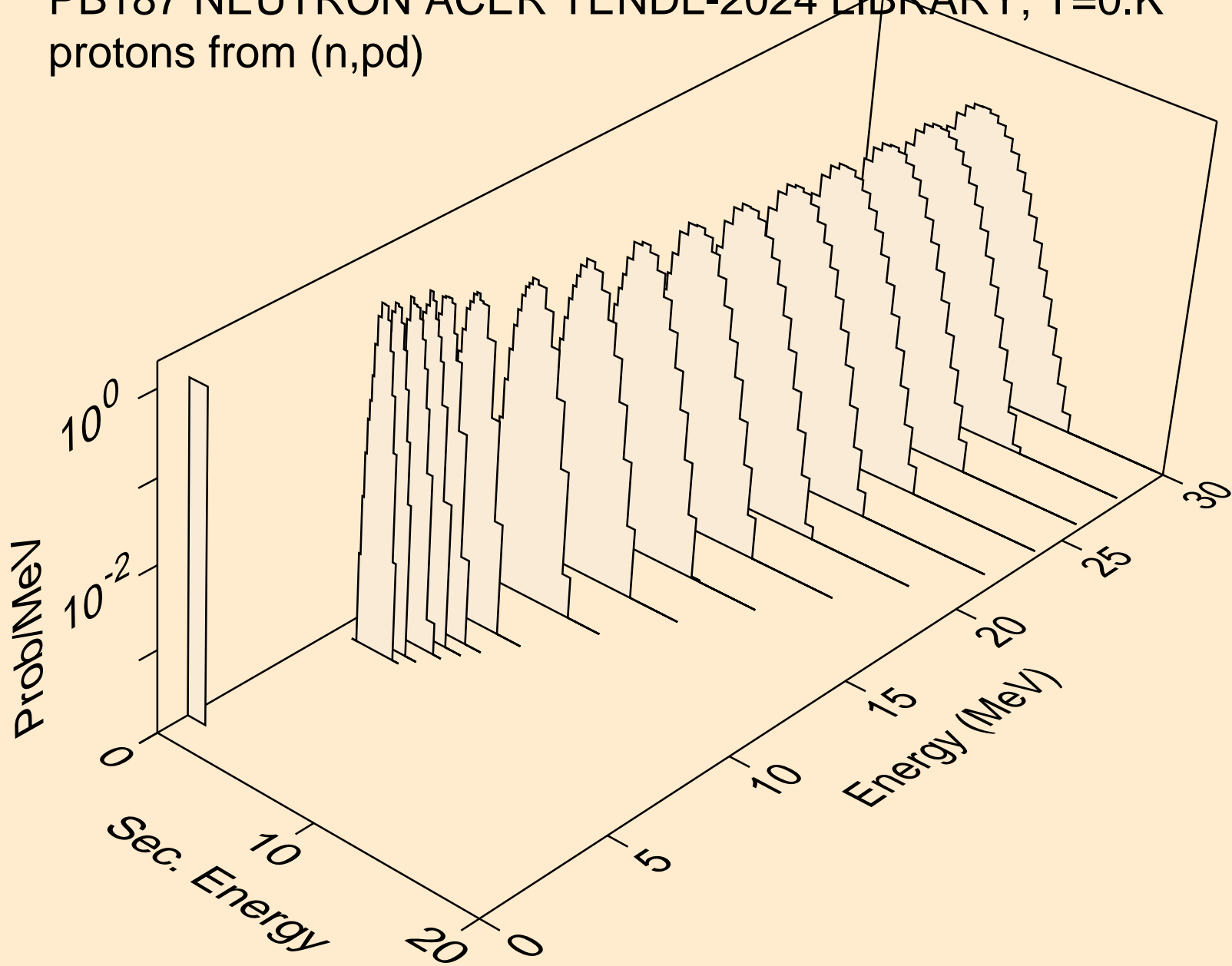

PB187 NEUTRON ACER TENDL-2024 LIBRARY; T=0.K
protons from (n,pt)

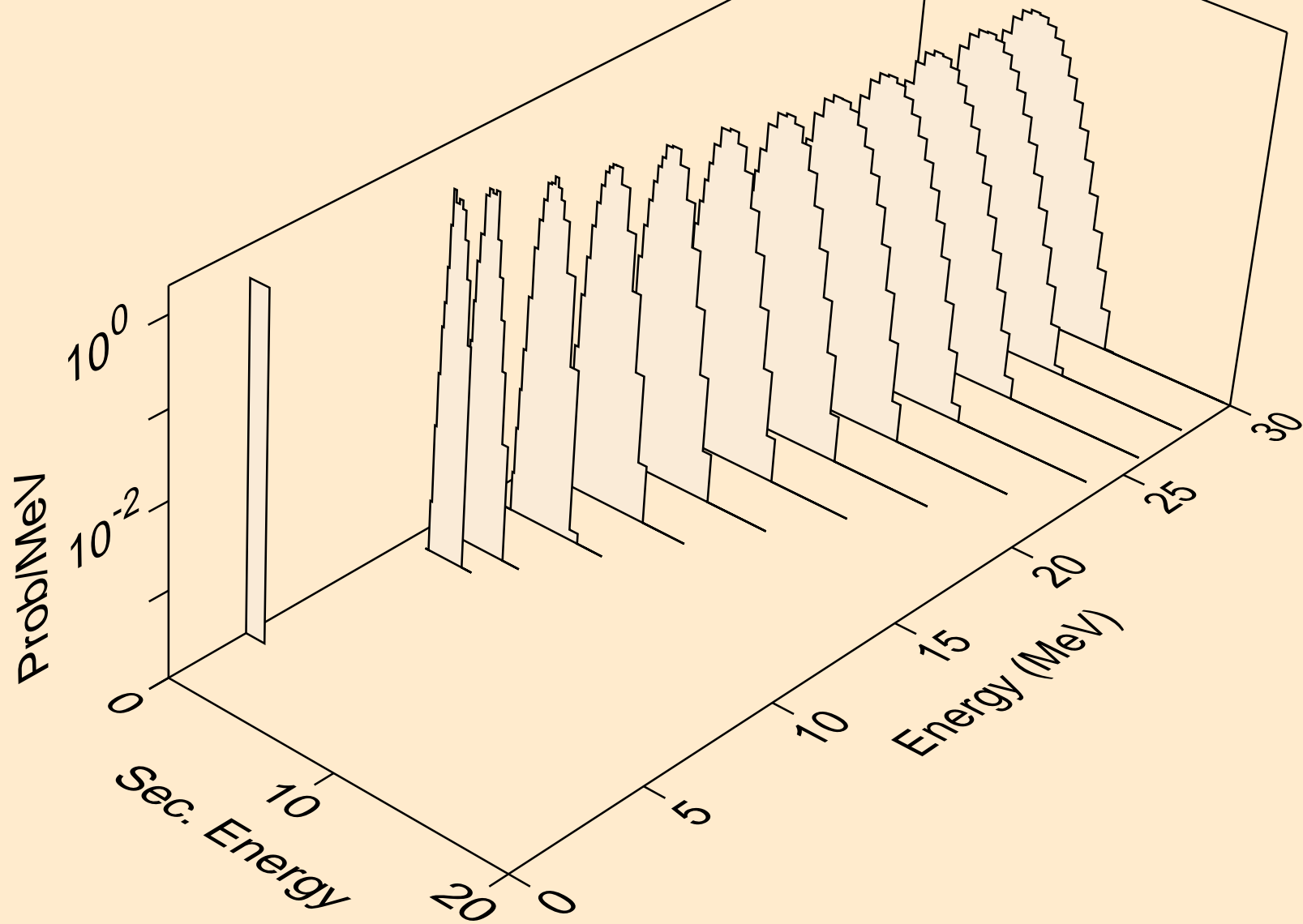

PB187 NEUTRON ACER TENDL-2024 LIBRARY; T=0.K
deuterons from (n,x)

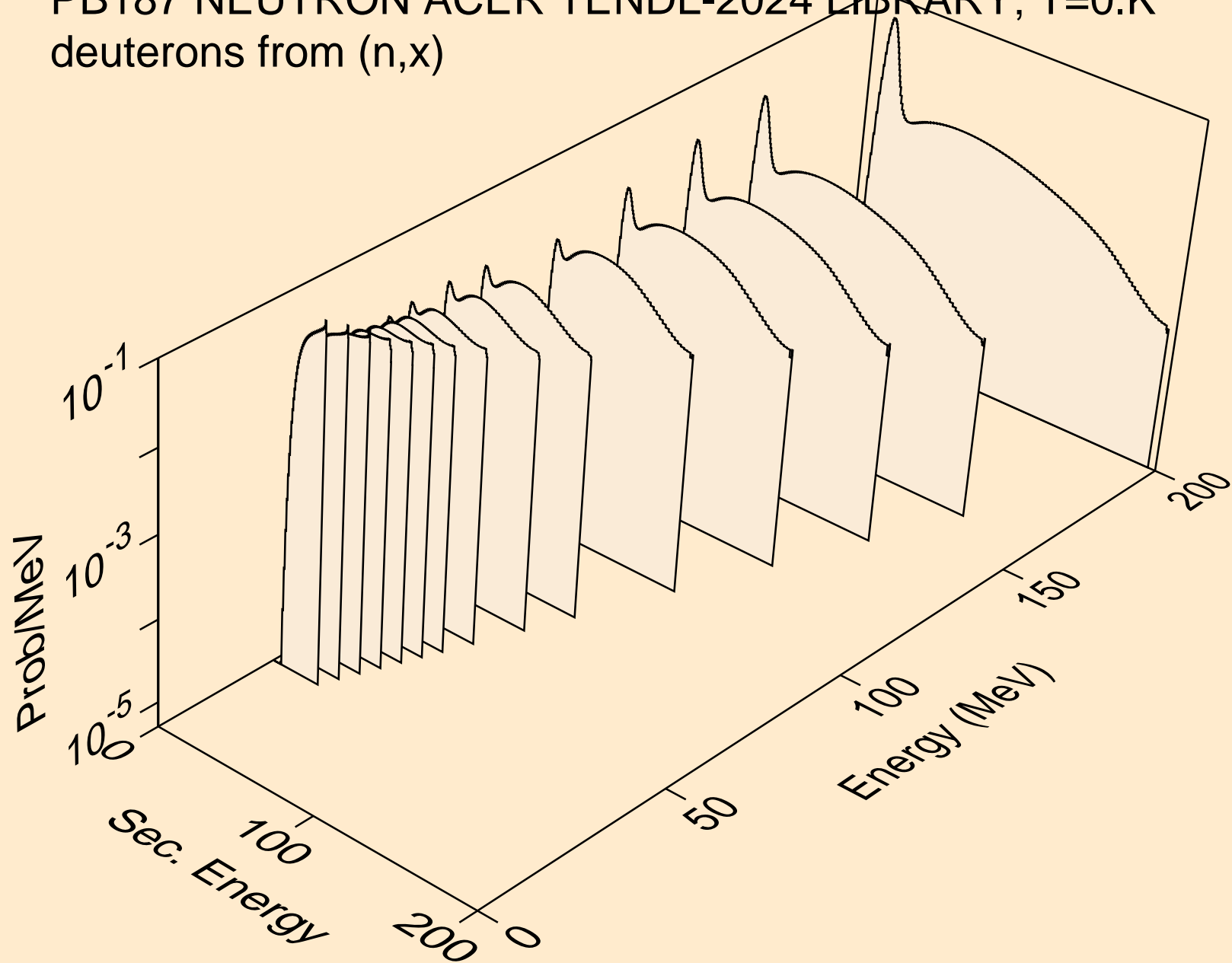

PB187 NEUTRON ACER TENDL-2024 LIBRARY; T=0.K
deuterons from (n,2nd)

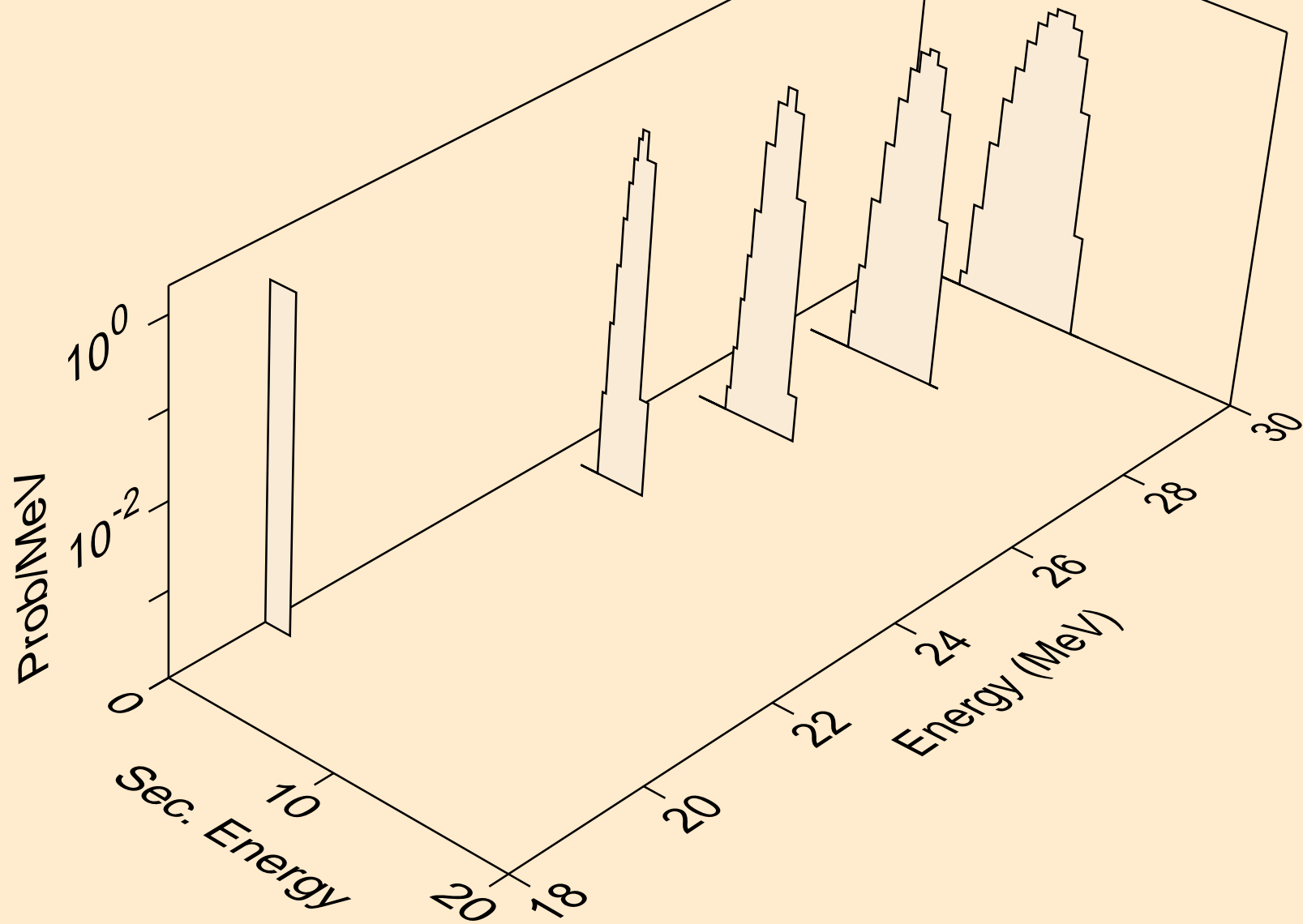

PB187 NEUTRON ACER TENDL-2024 LIBRARY; T=0.K
deuterons from (n,n*)d

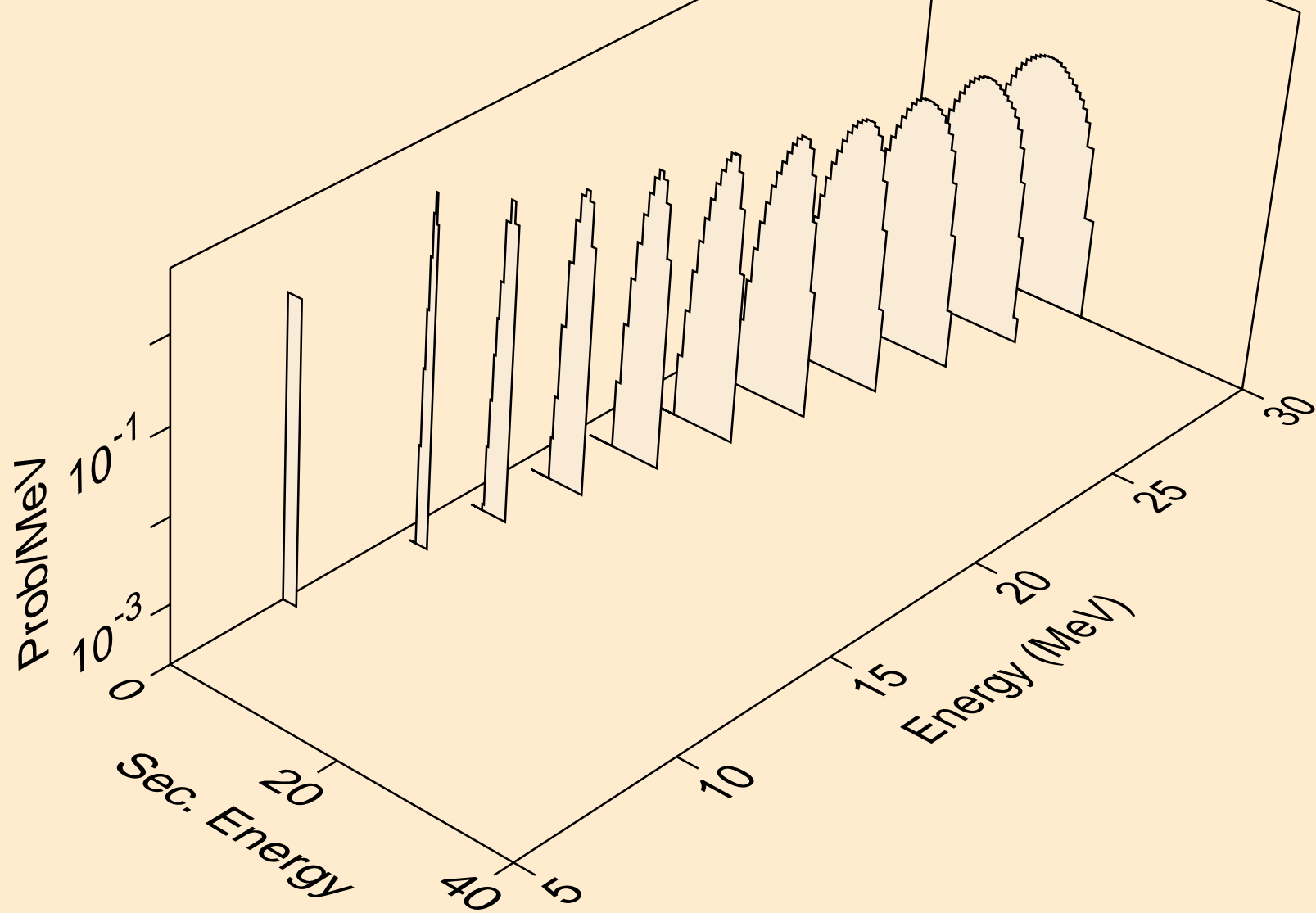

PB187 NEUTRON ACER TENDL-2024 LIBRARY; T=0.K
deuterons from (n,d)

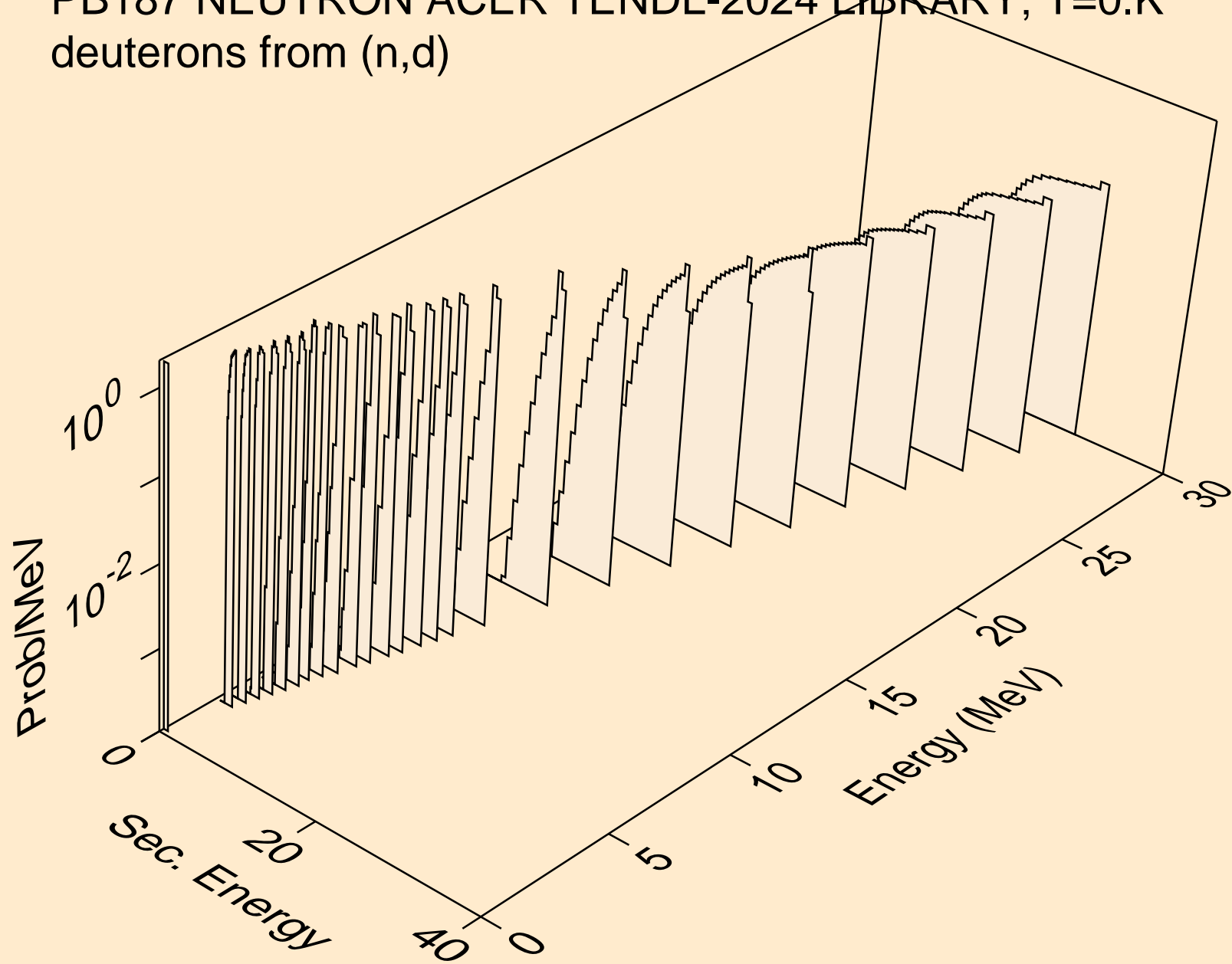

PB187 NEUTRON ACER TENDL-2024 LIBRARY; T=0.K
deuterons from (n,d2a)

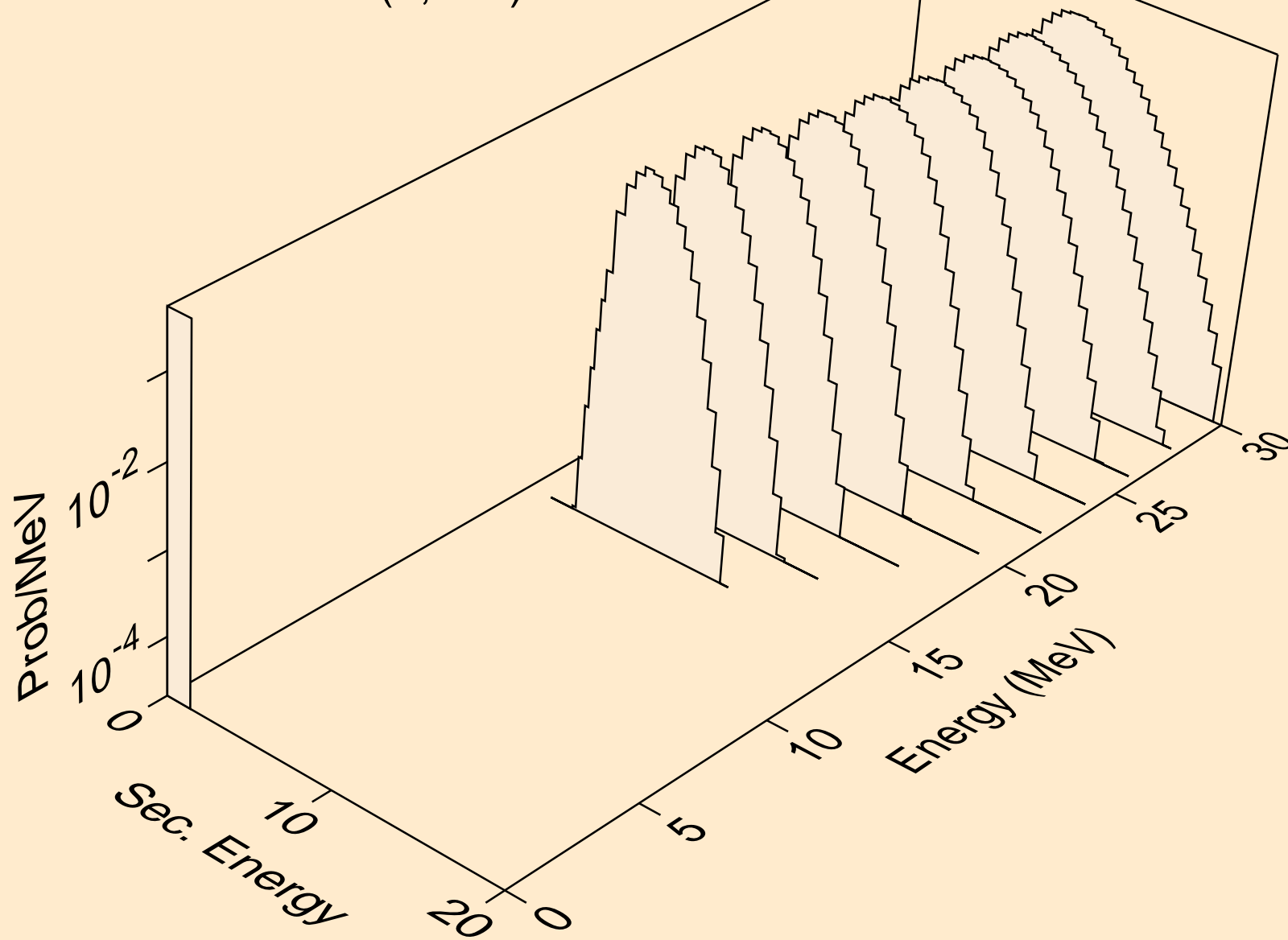

PB187 NEUTRON ACER TENDL-2024 LIBRARY; T=0.K
deuterons from (n,pd)

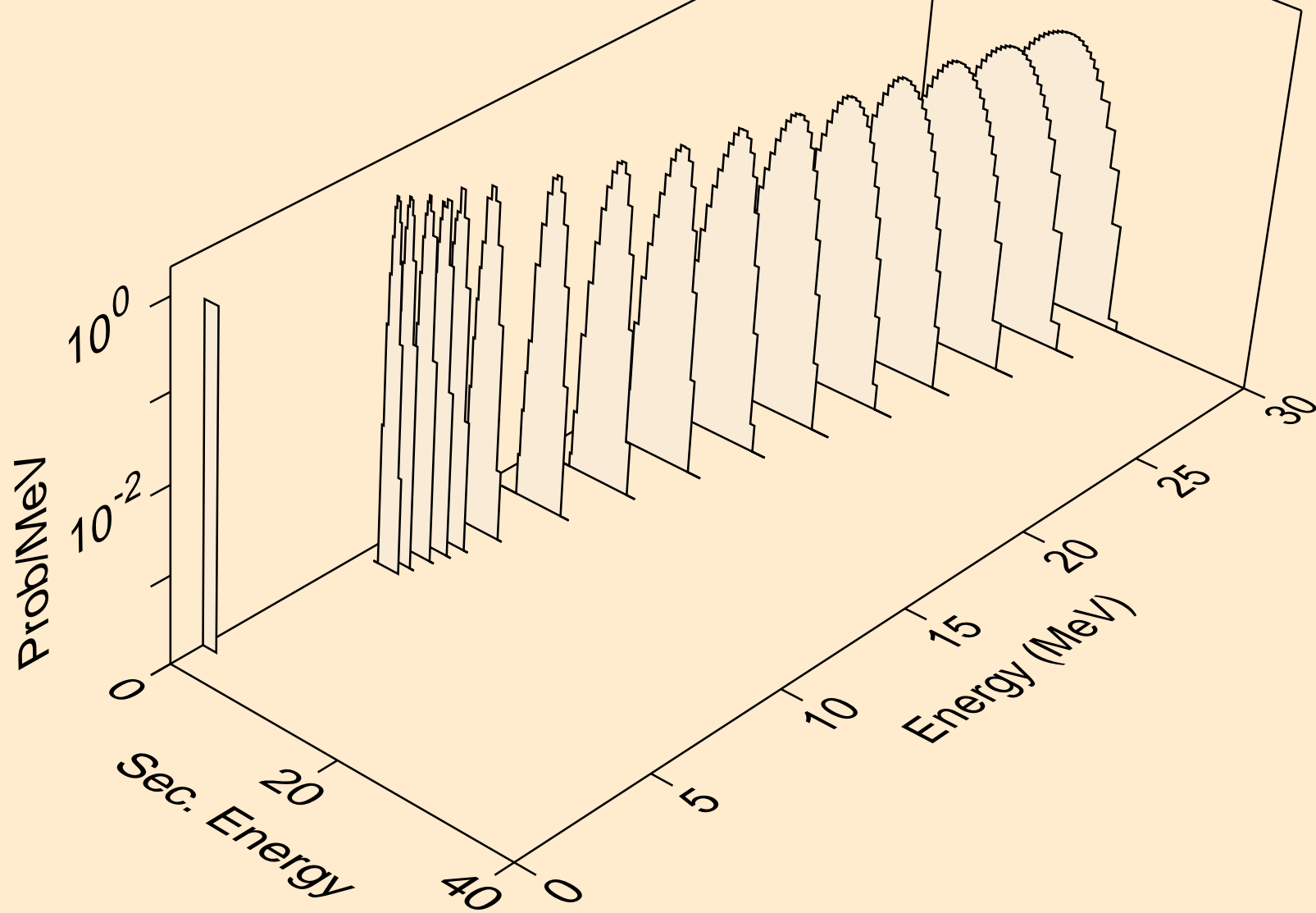

PB187 NEUTRON ACER TENDL-2024 LIBRARY; T=0.K
deuterons from (n,da)

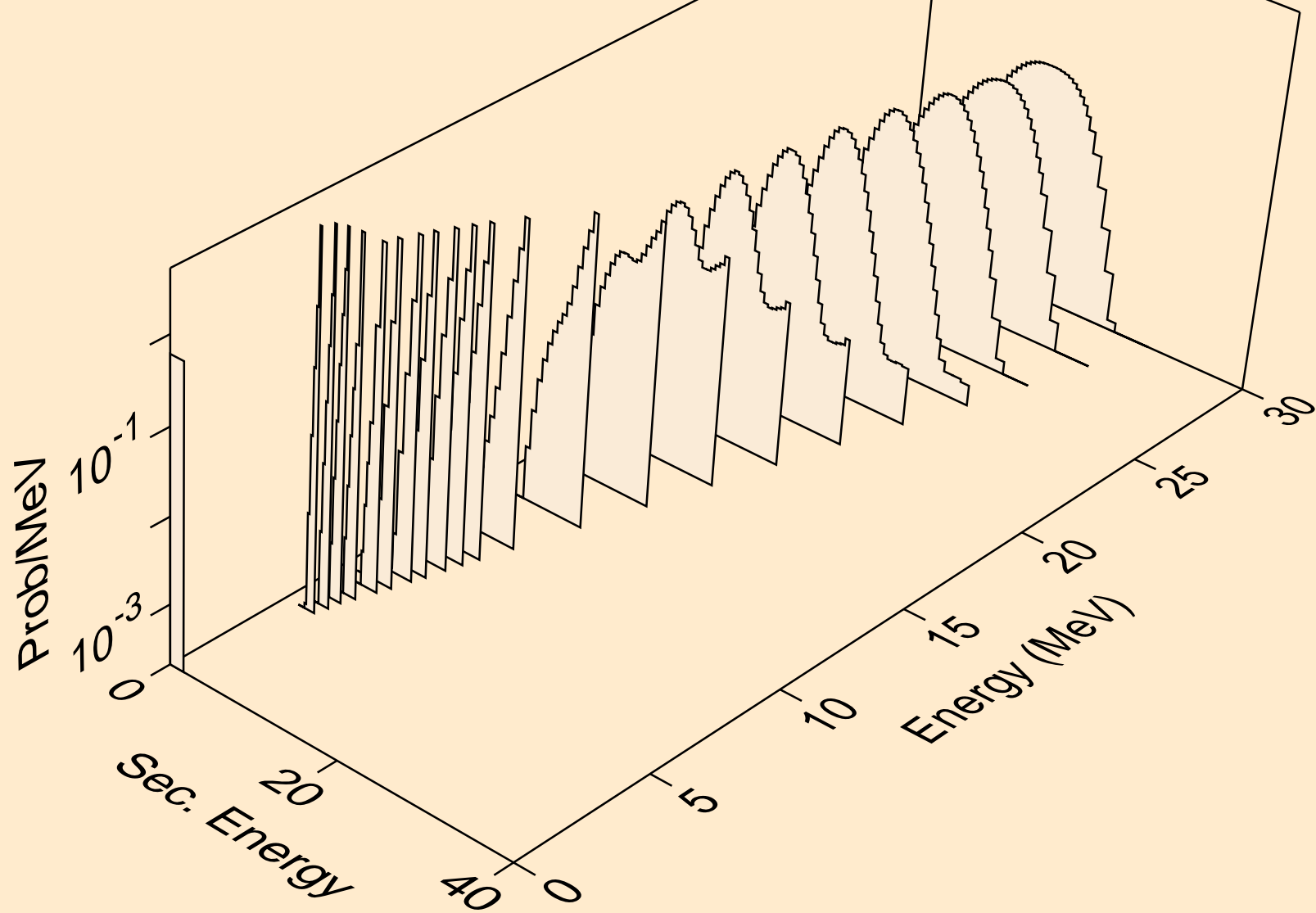

PB187 NEUTRON ACER TENDL-2024 LIBRARY; T=0.K
tritons from (n,x)

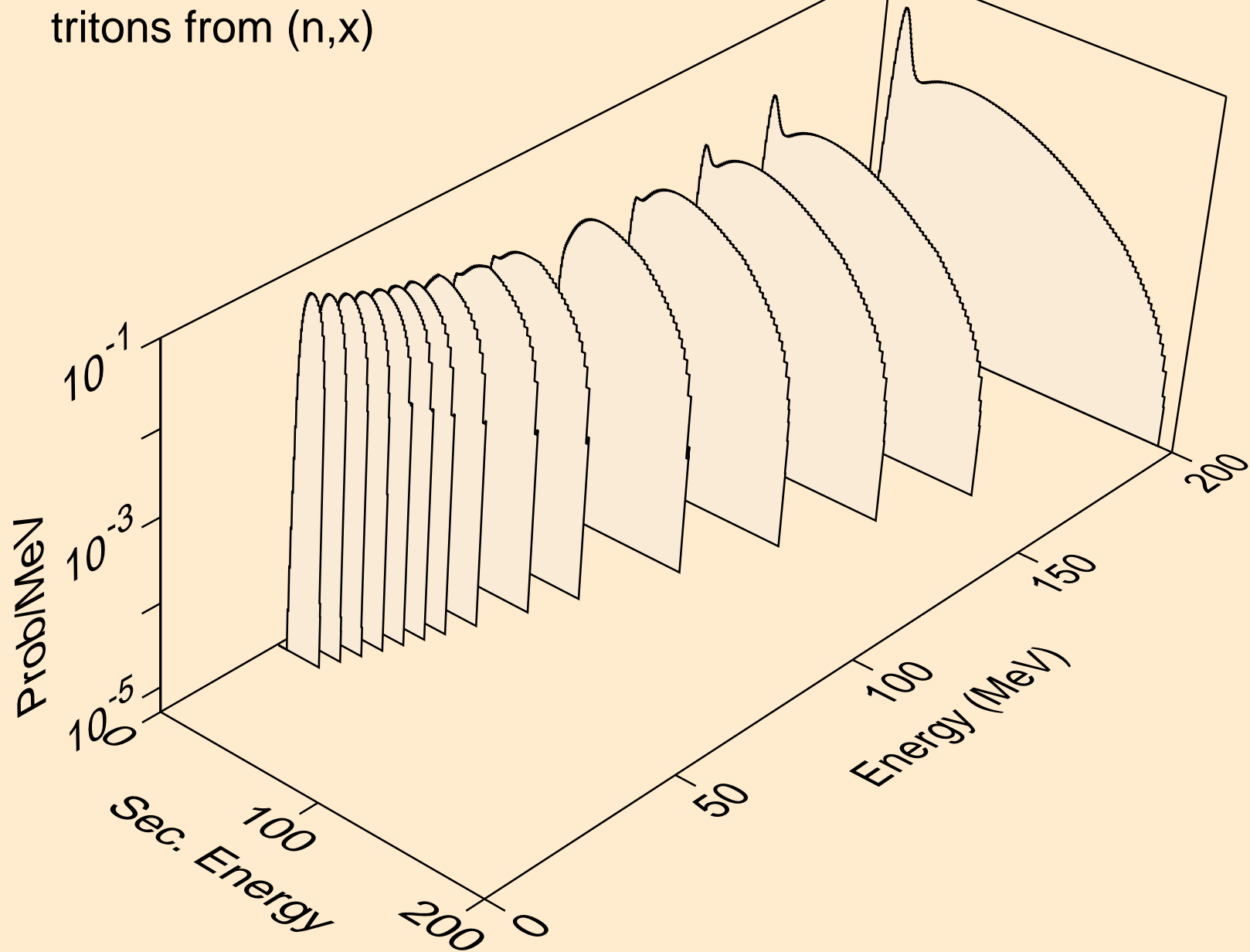

PB187 NEUTRON ACER TENDL-2024 LIBRARY; T=0.K
tritons from (n,n*)t

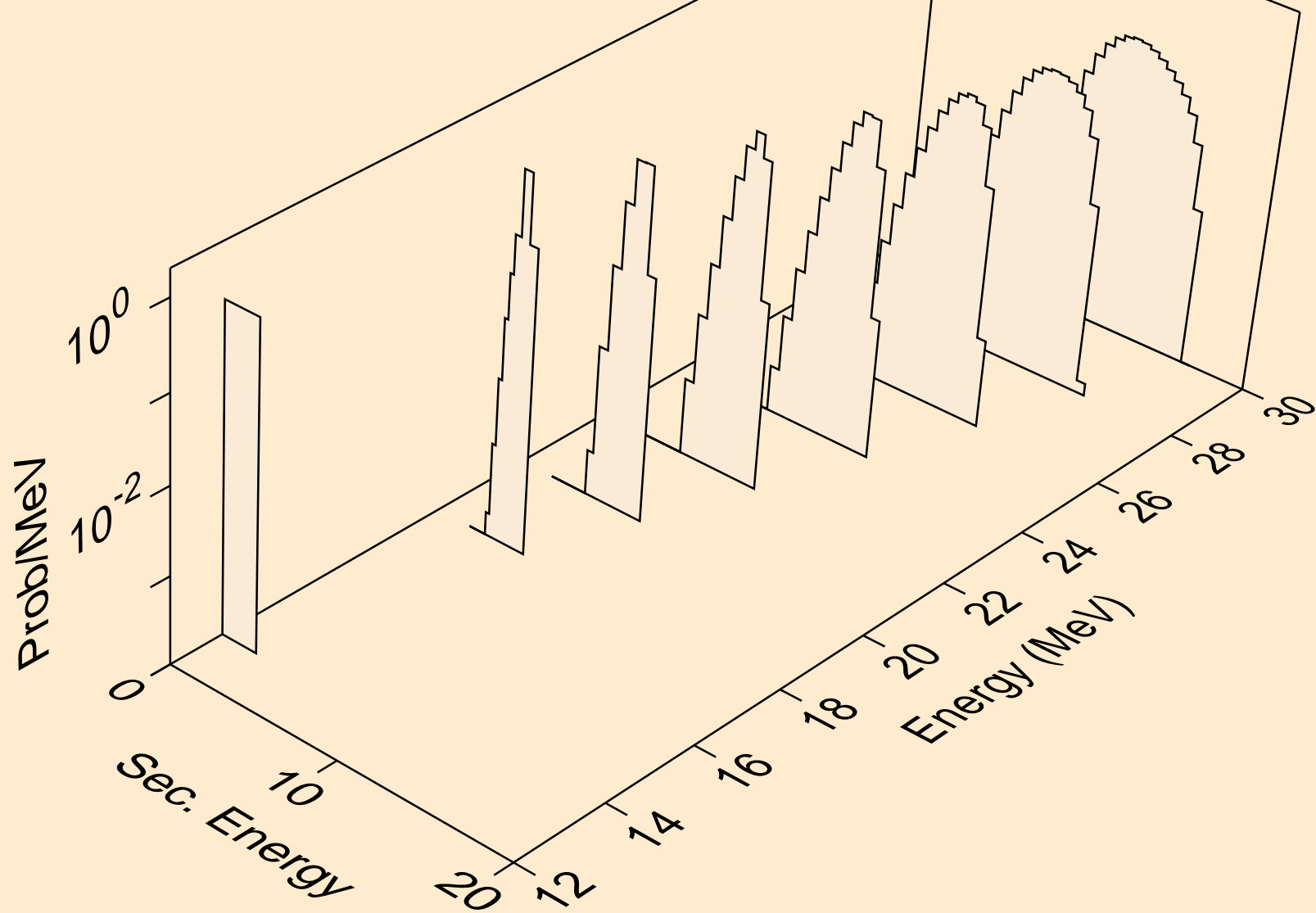

PB187 NEUTRON ACER TENDL-2024 LIBRARY; T=0.K
tritons from (n,t)

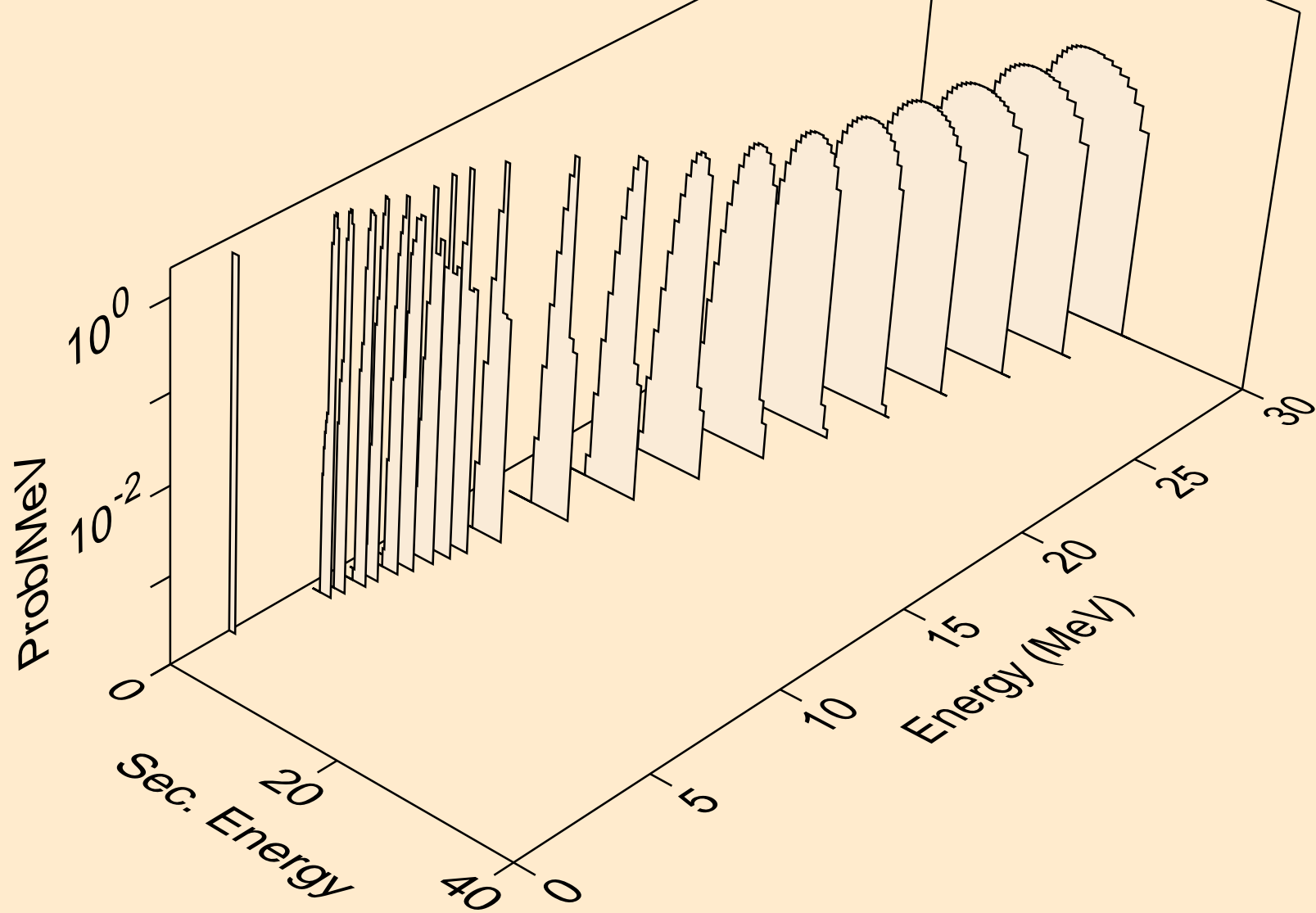

PB187 NEUTRON ACER TENDL-2024 LIBRARY; T=0.K
tritons from (n,pt)

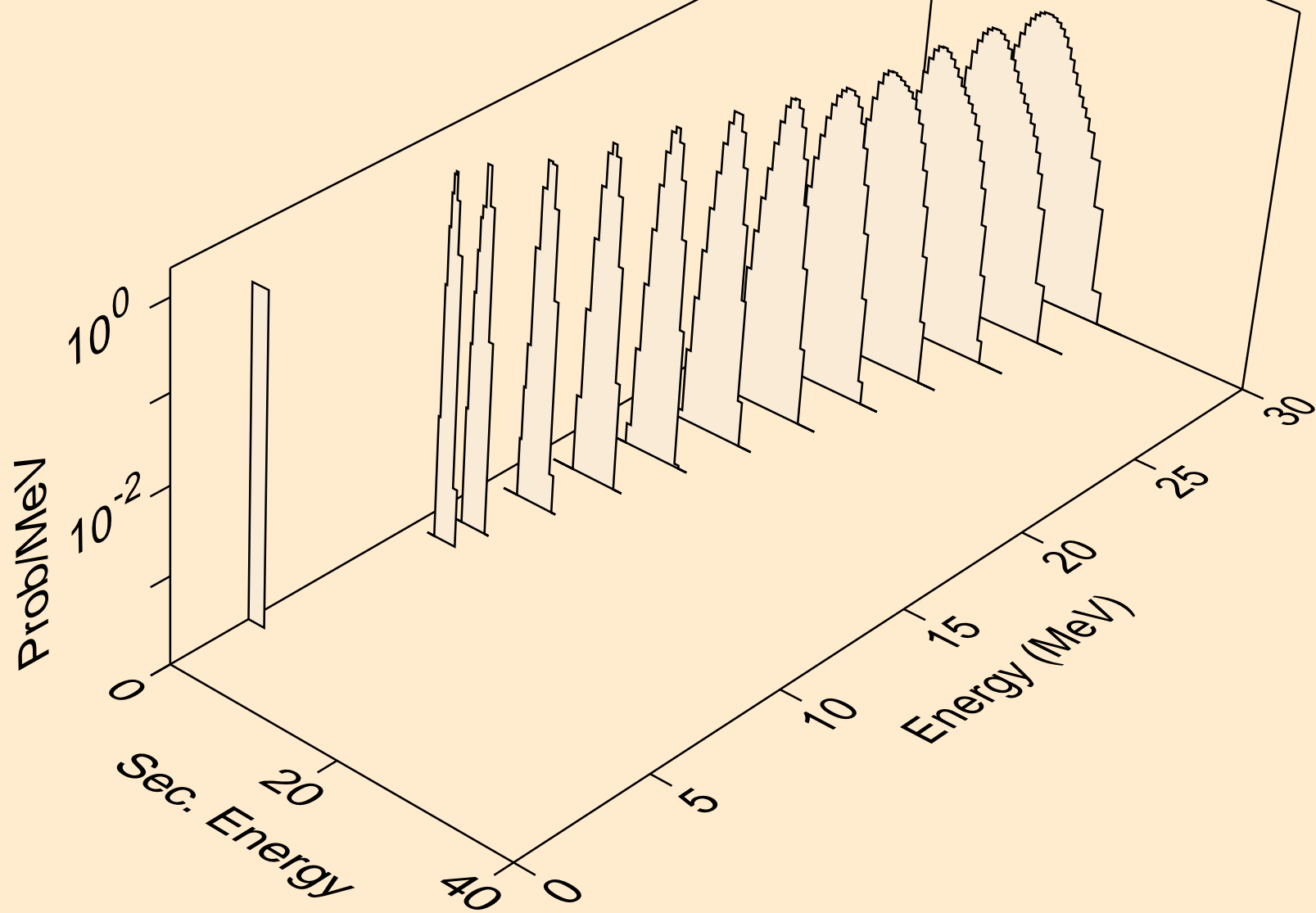

PB187 NEUTRON ACER TENDL-2024 LIBRARY; T=0.K
he3s from (n,x)

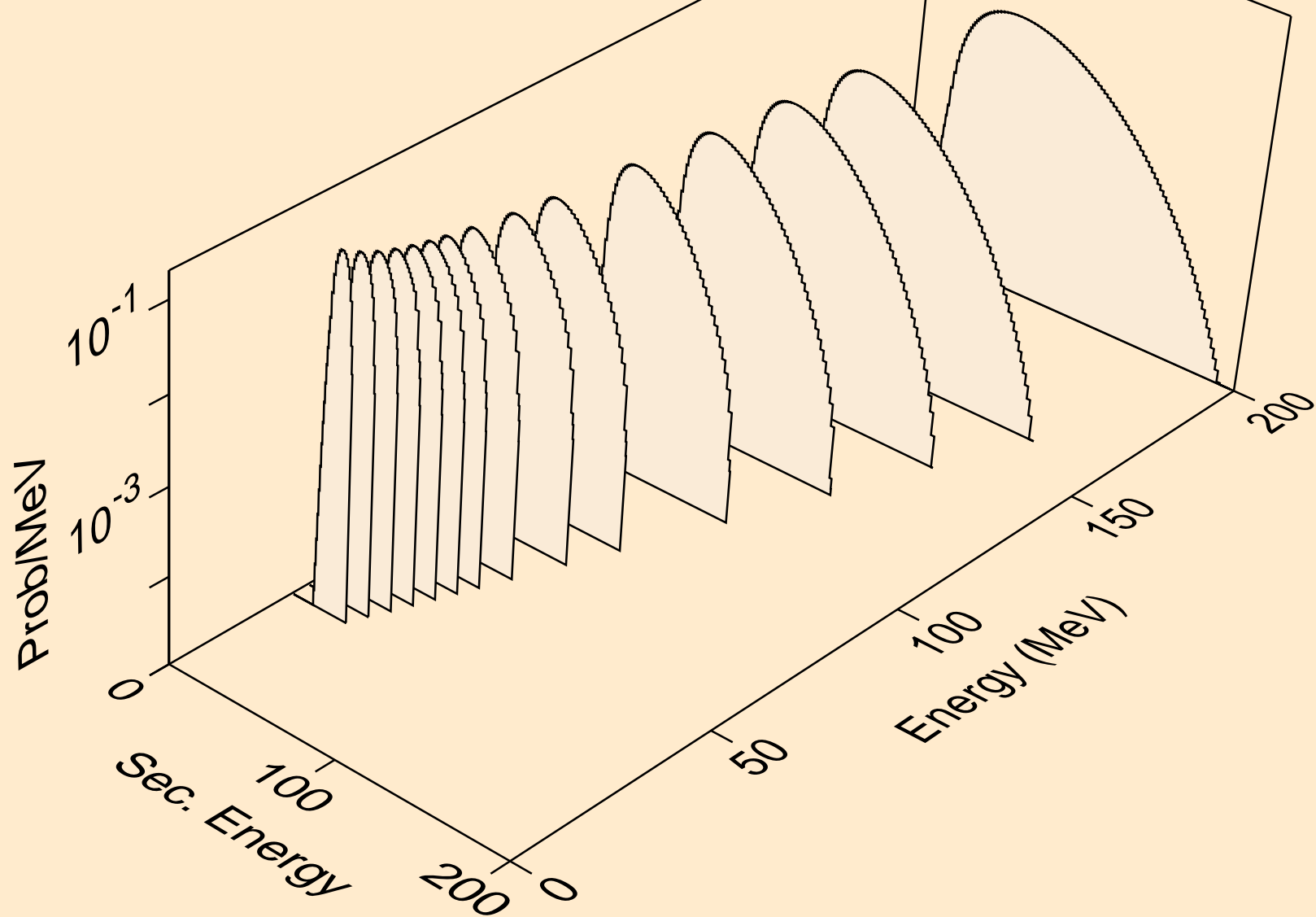

PB187 NEUTRON ACER TENDL-2024 LIBRARY; T=0.K
he3s from (n,n*)he3

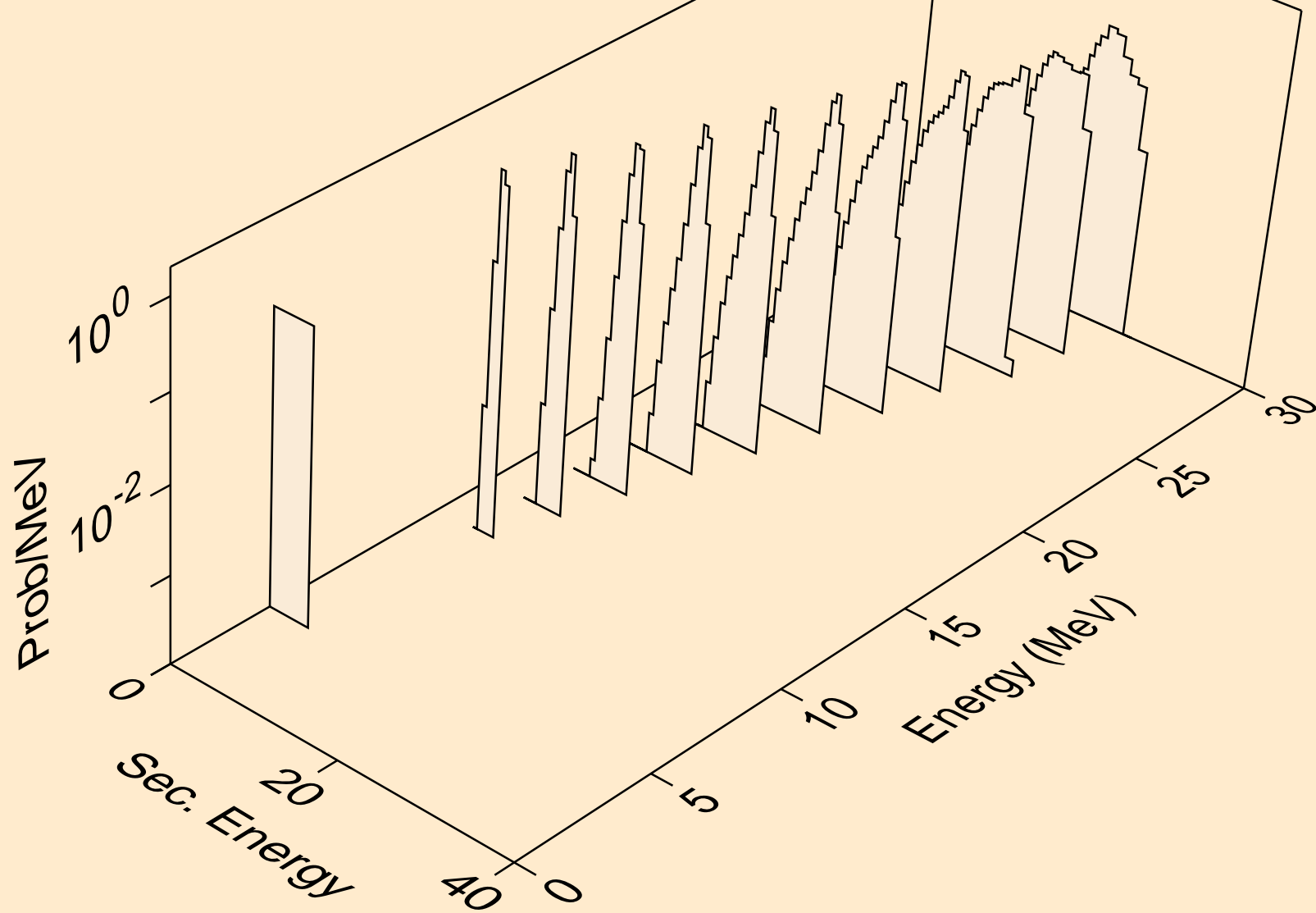

PB187 NEUTRON ACER TENDL-2024 LIBRARY; T=0.K
he3s from (n,he3)

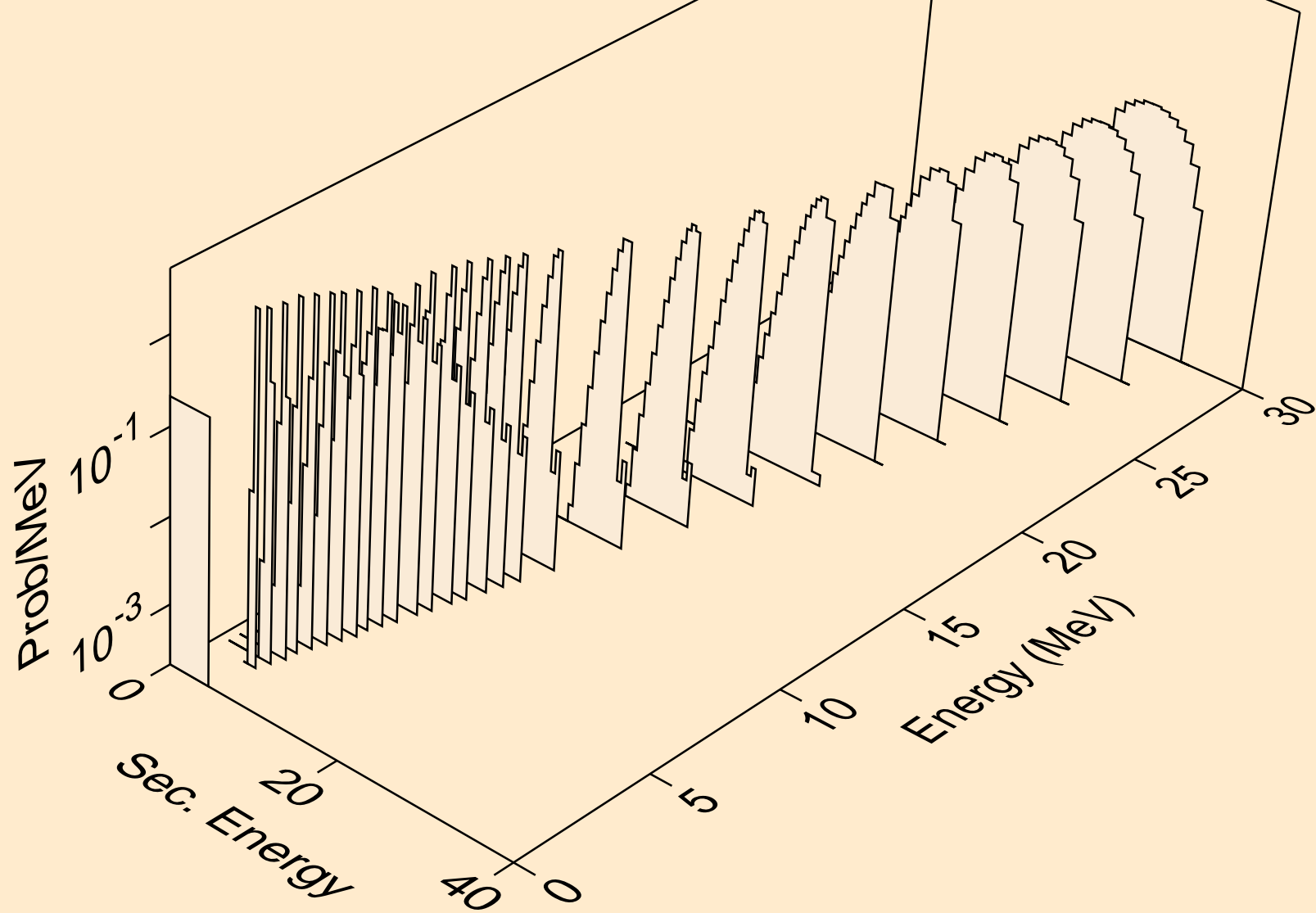

PB187 NEUTRON ACER TENDL-2024 LIBRARY; T=0.K
alphas from (n,x)

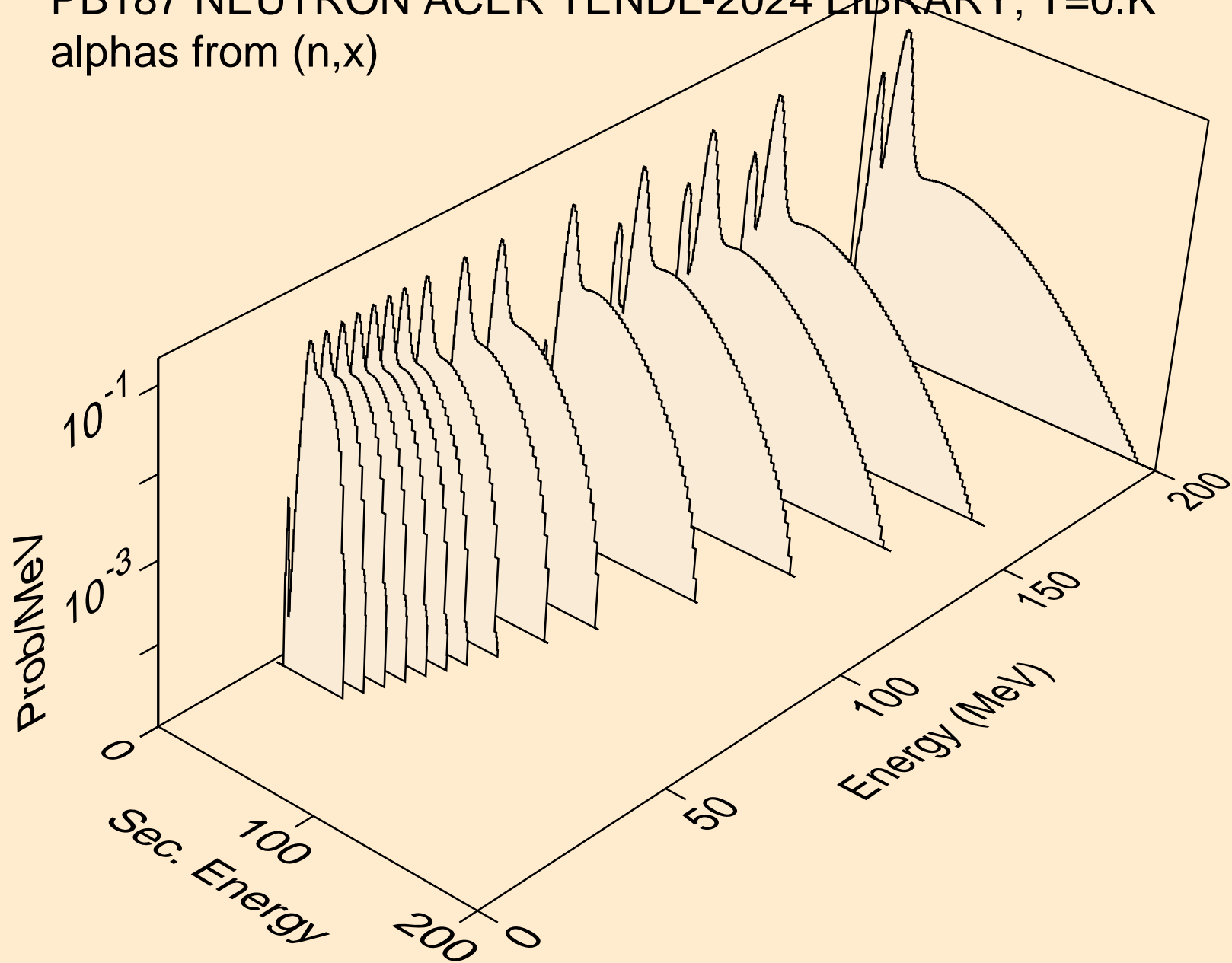

PB187 NEUTRON ACER TENDL-2024 LIBRARY; T=0.K
alphas from (n,n*)a

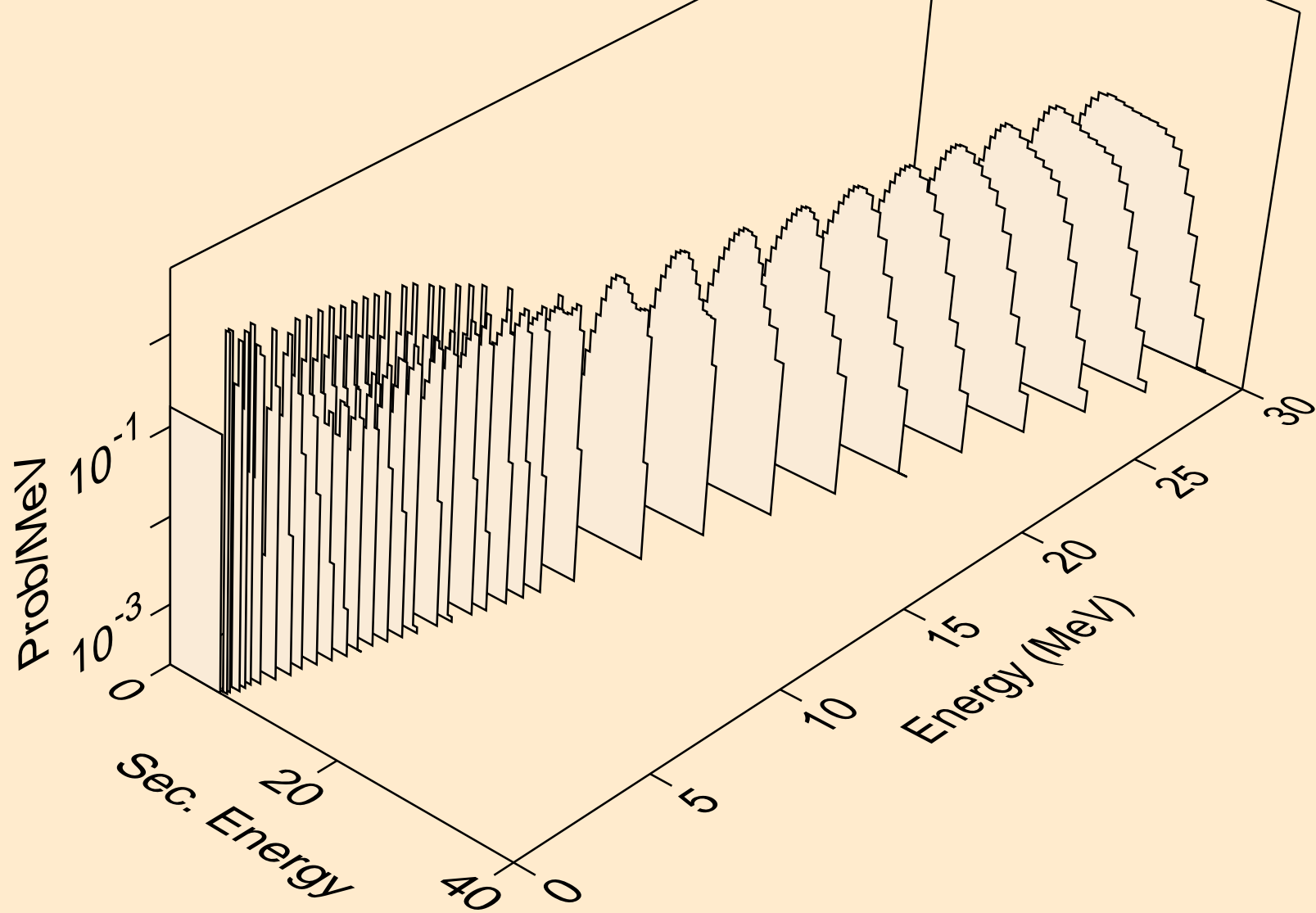

PB187 NEUTRON ACER TENDL-2024 LIBRARY; T=0.K
alphas from (n,n*)3a

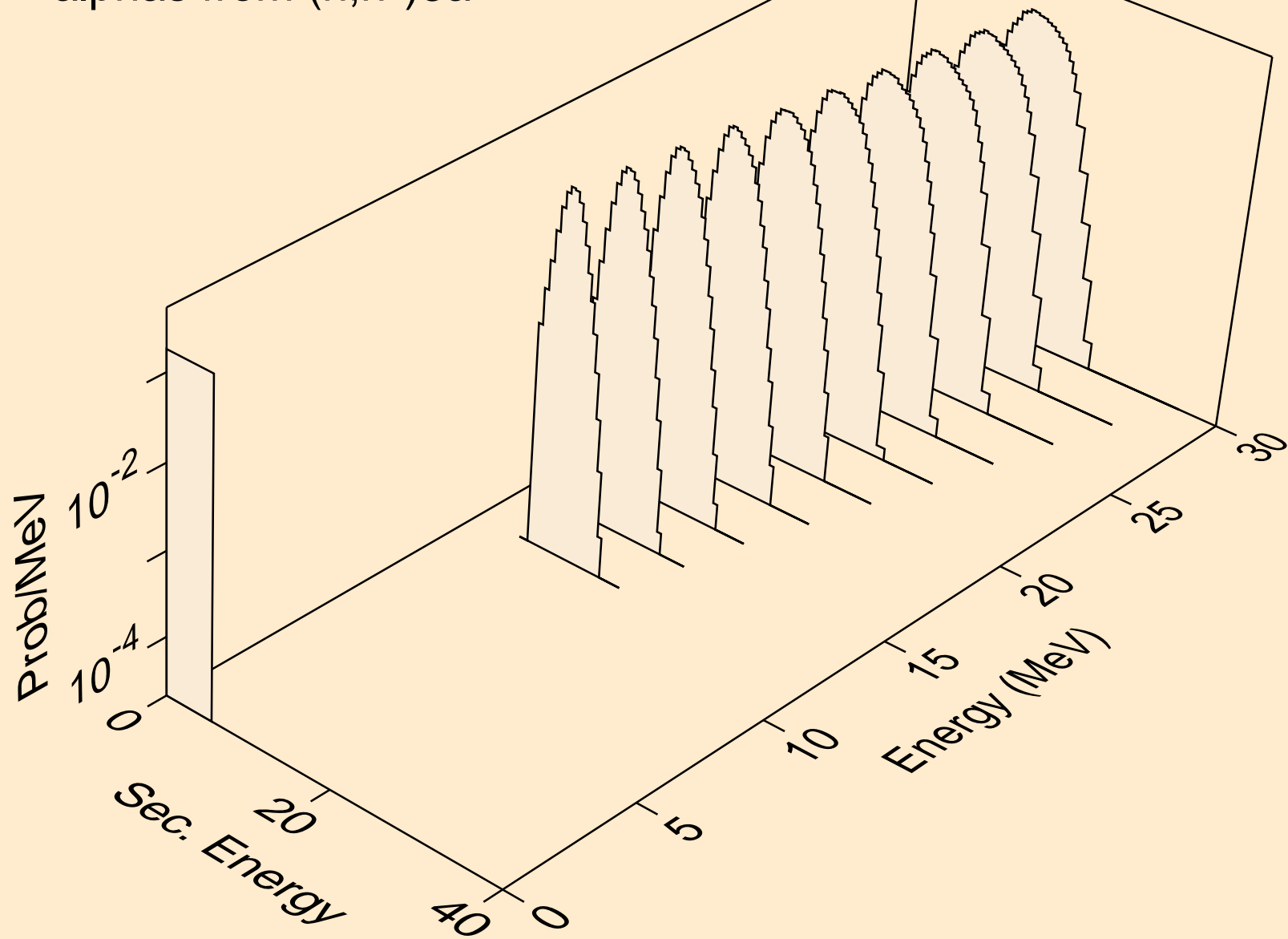

PB187 NEUTRON ACER TENDL-2024 LIBRARY; T=0.K
alphas from (n,2n)a

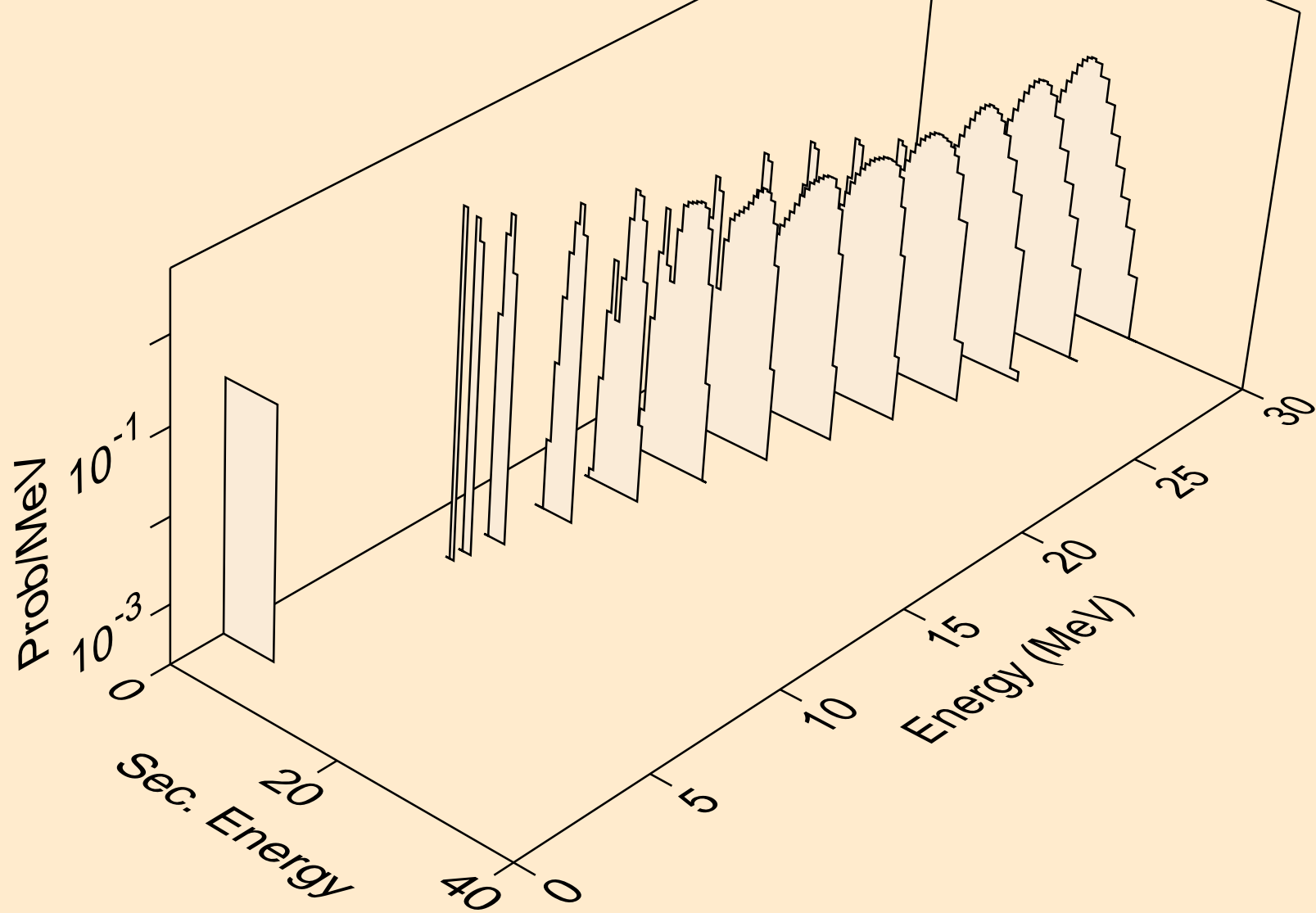

PB187 NEUTRON ACER TENDL-2024 LIBRARY; T=0.K
alphas from (n,3n)a

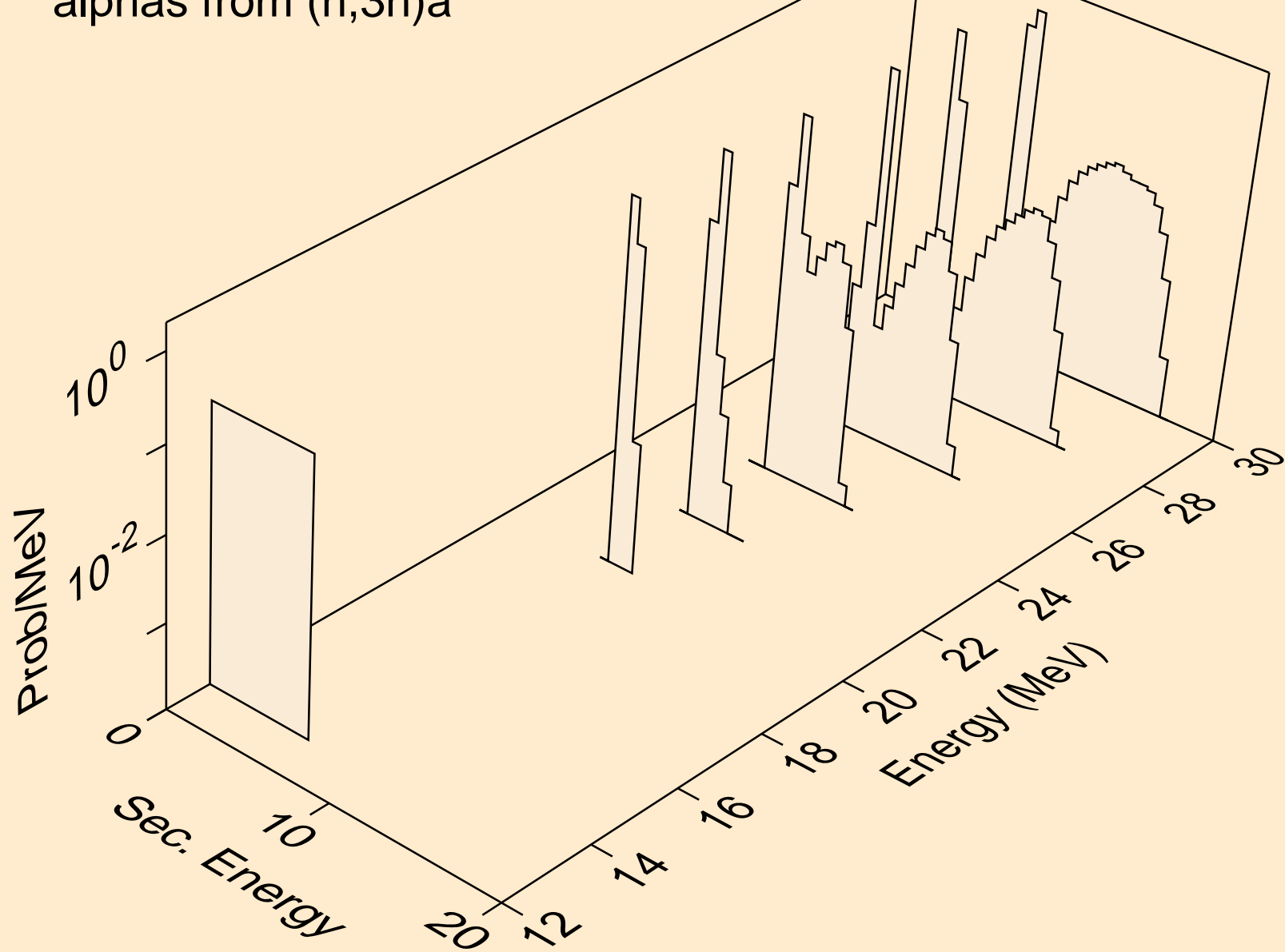

PB187 NEUTRON ACER TENDL-2024 LIBRARY; T=0.K
alphas from (n,n*)2a

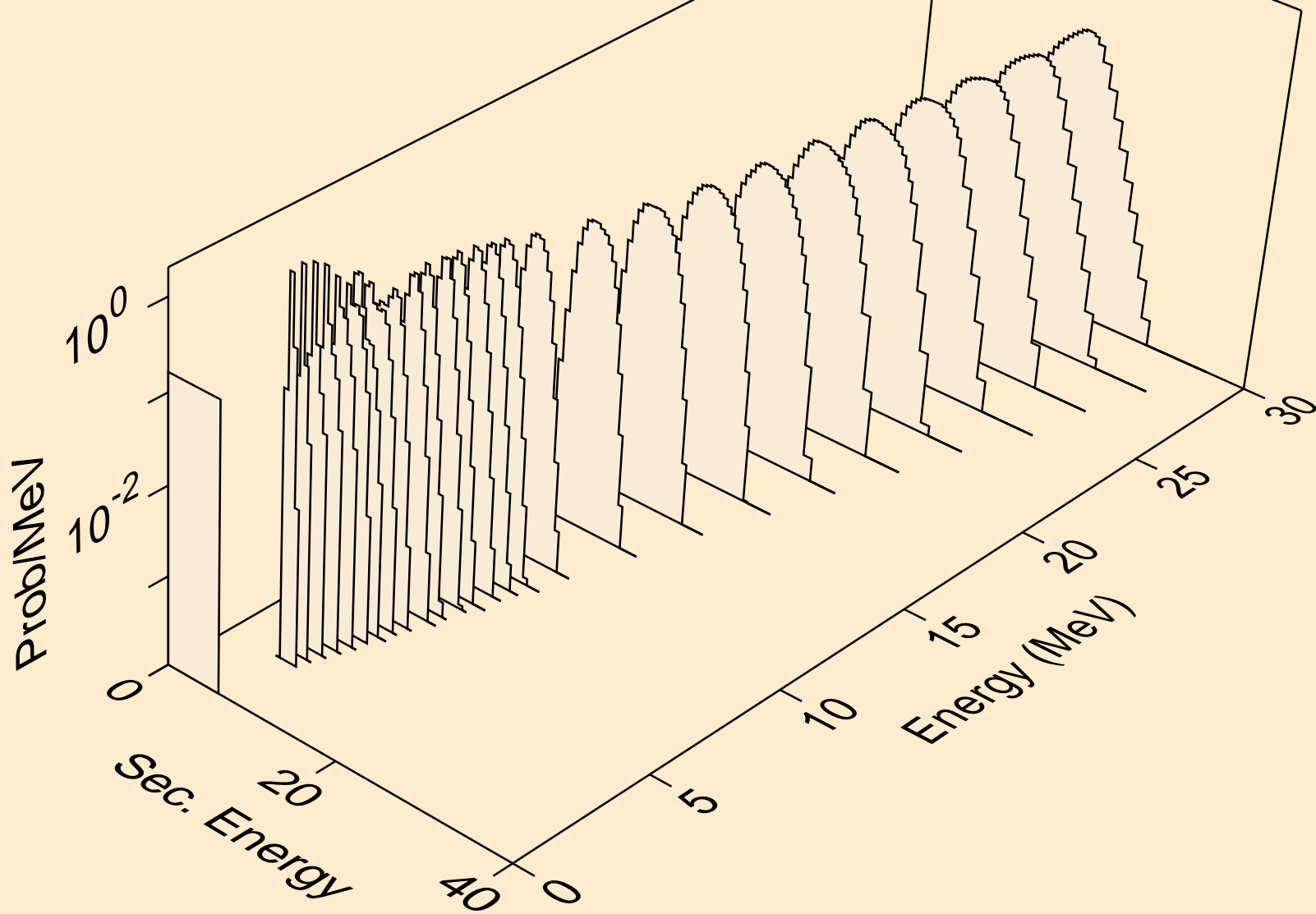

PB187 NEUTRON ACER TENDL-2024 LIBRARY; T=0.K
alphas from (n,2n)2a

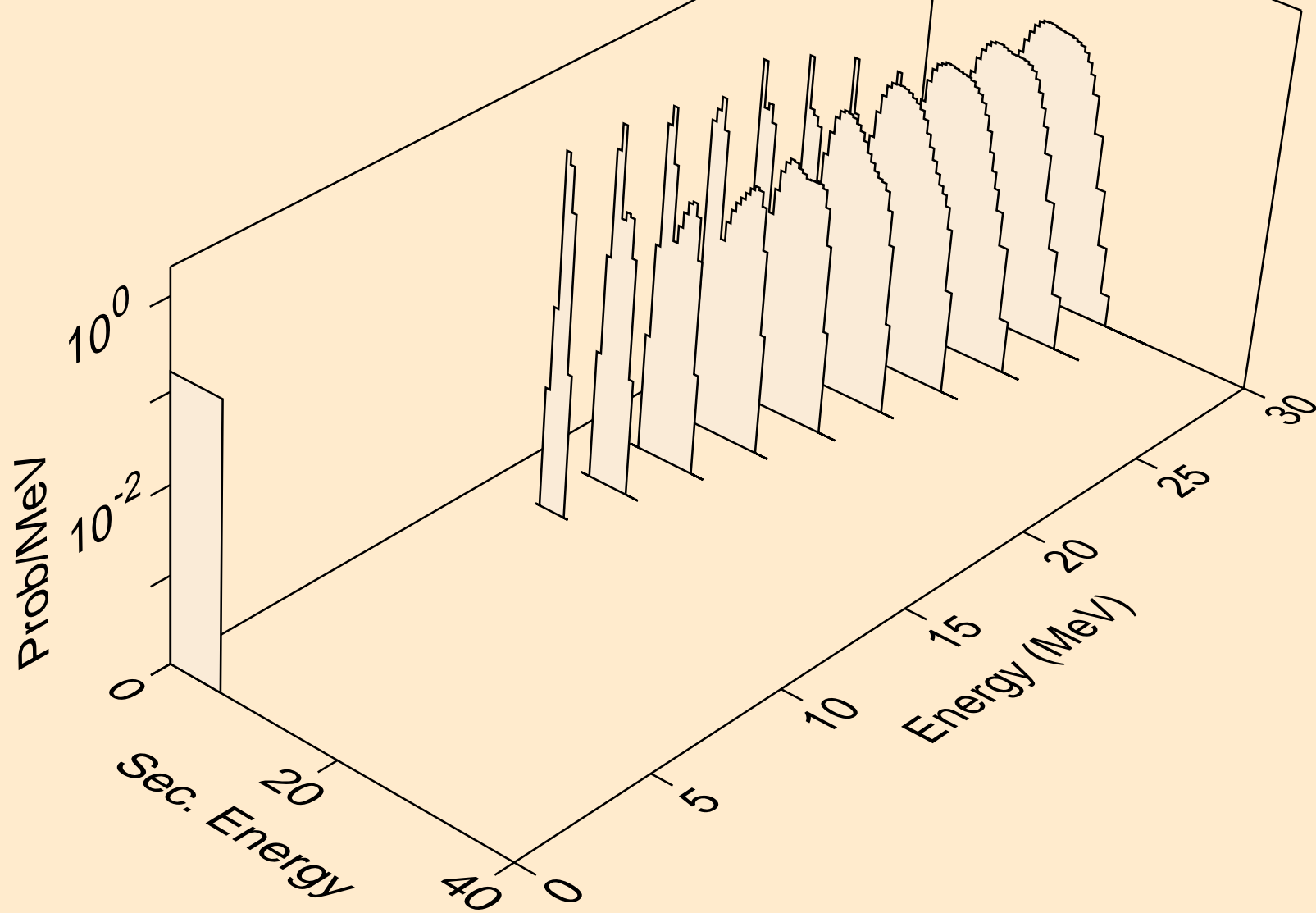

PB187 NEUTRON ACER TENDL-2024 LIBRARY; T=0.K
alphas from (n,npa)

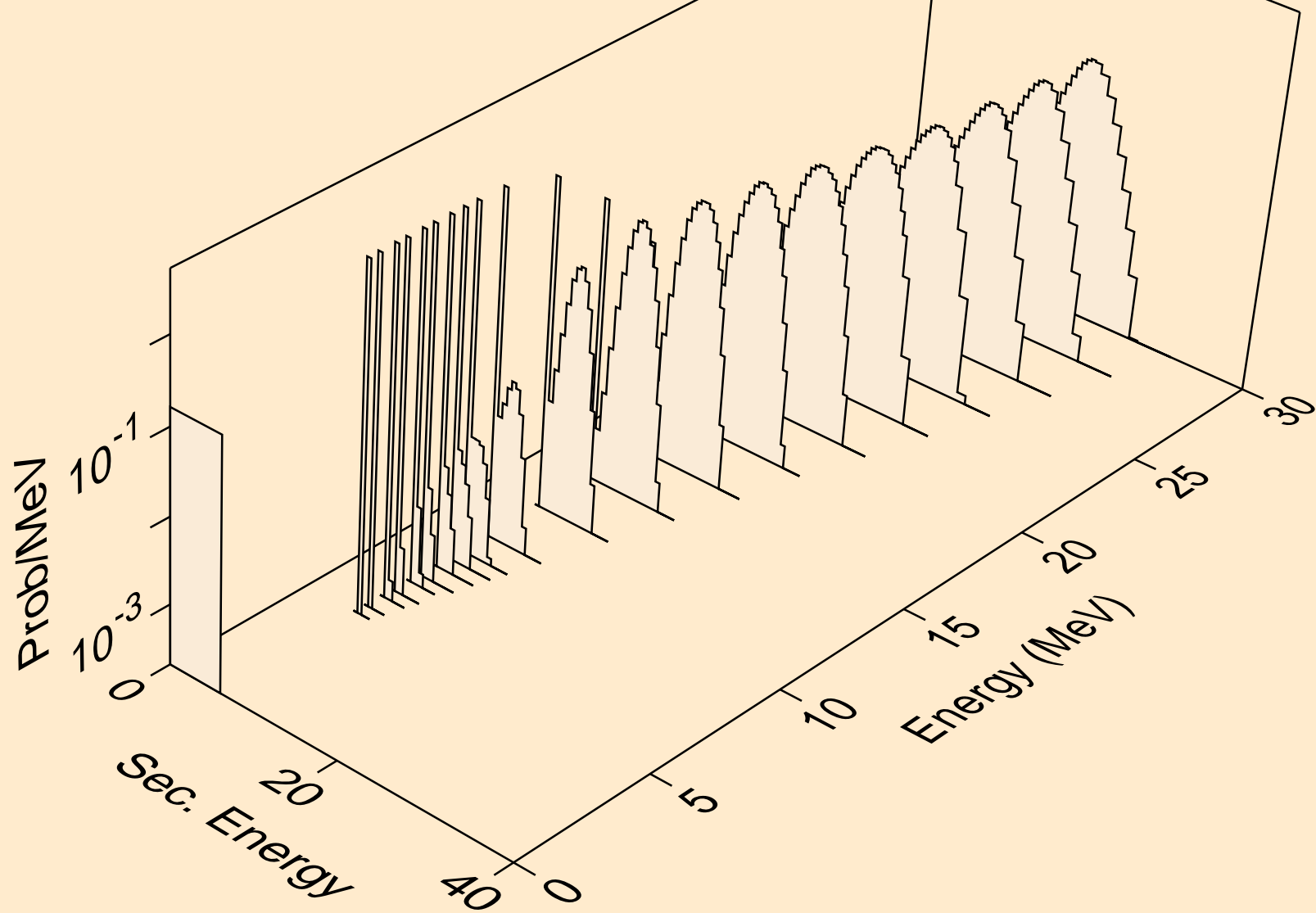

PB187 NEUTRON ACER TENDL-2024 LIBRARY; T=0.K
alphas from (n,a)

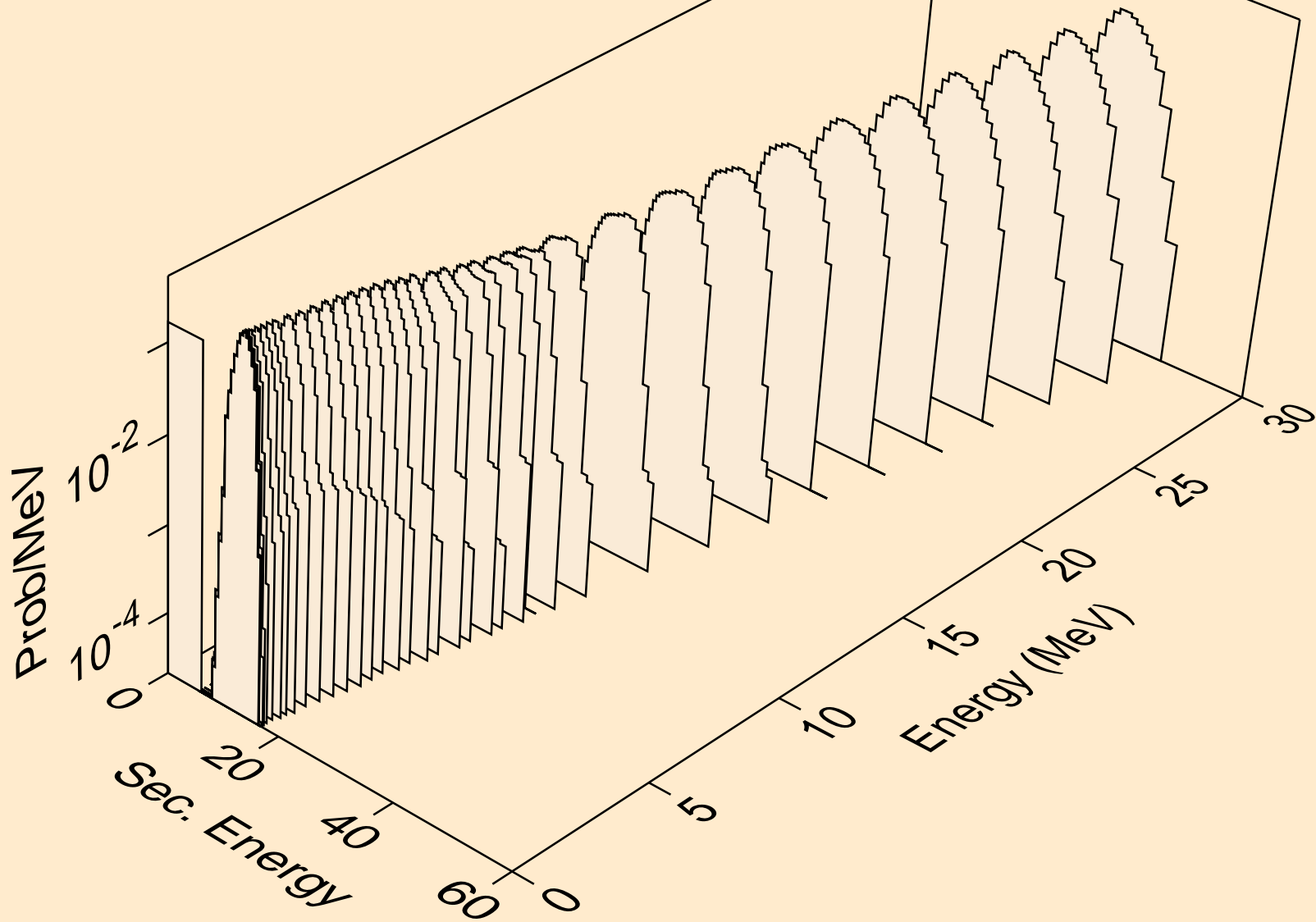

PB187 NEUTRON ACER TENDL-2024 LIBRARY; T=0.K
alphas from (n,2a)

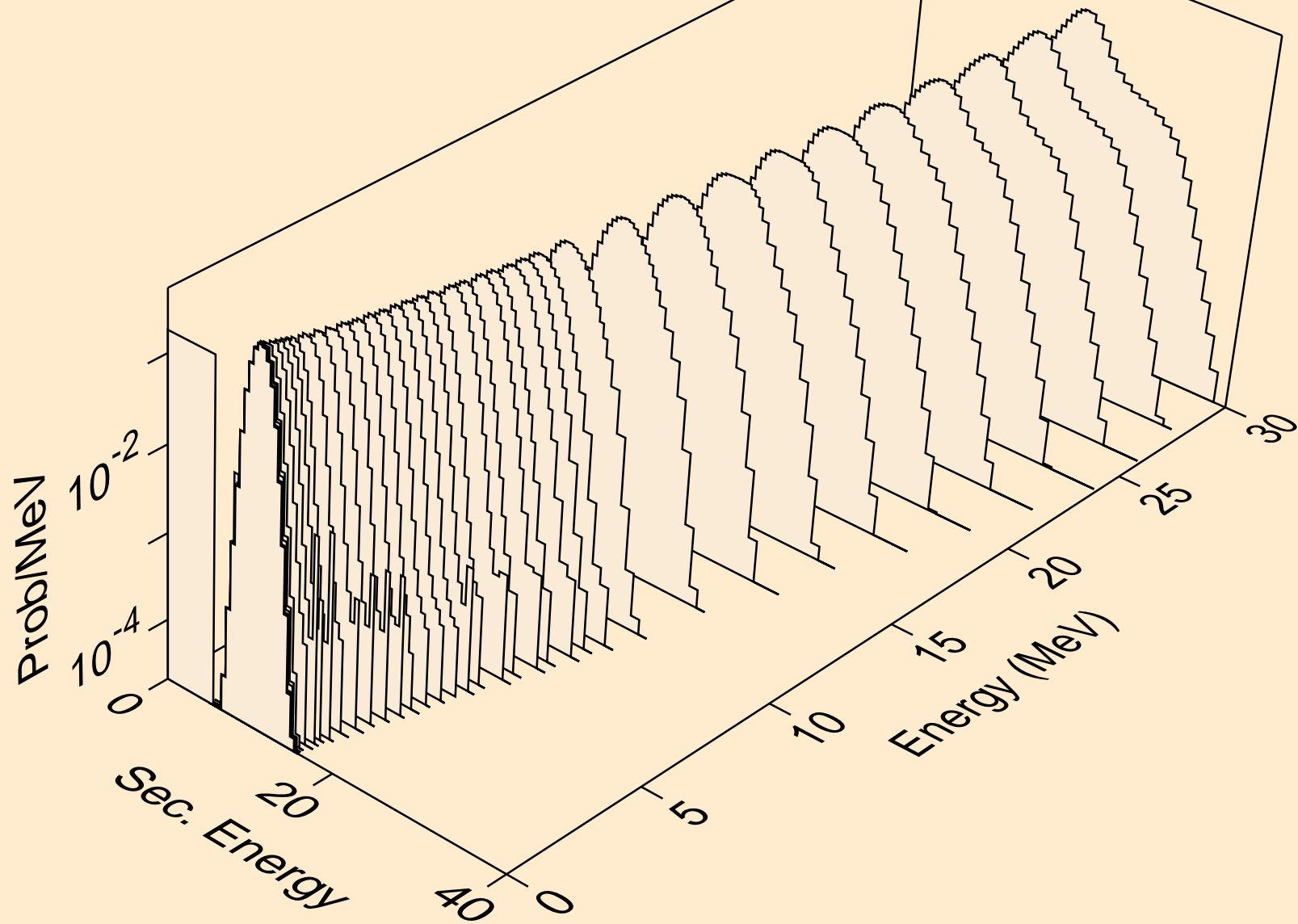

PB187 NEUTRON ACER TENDL-2024 LIBRARY; T=0.K
alphas from (n,3a)

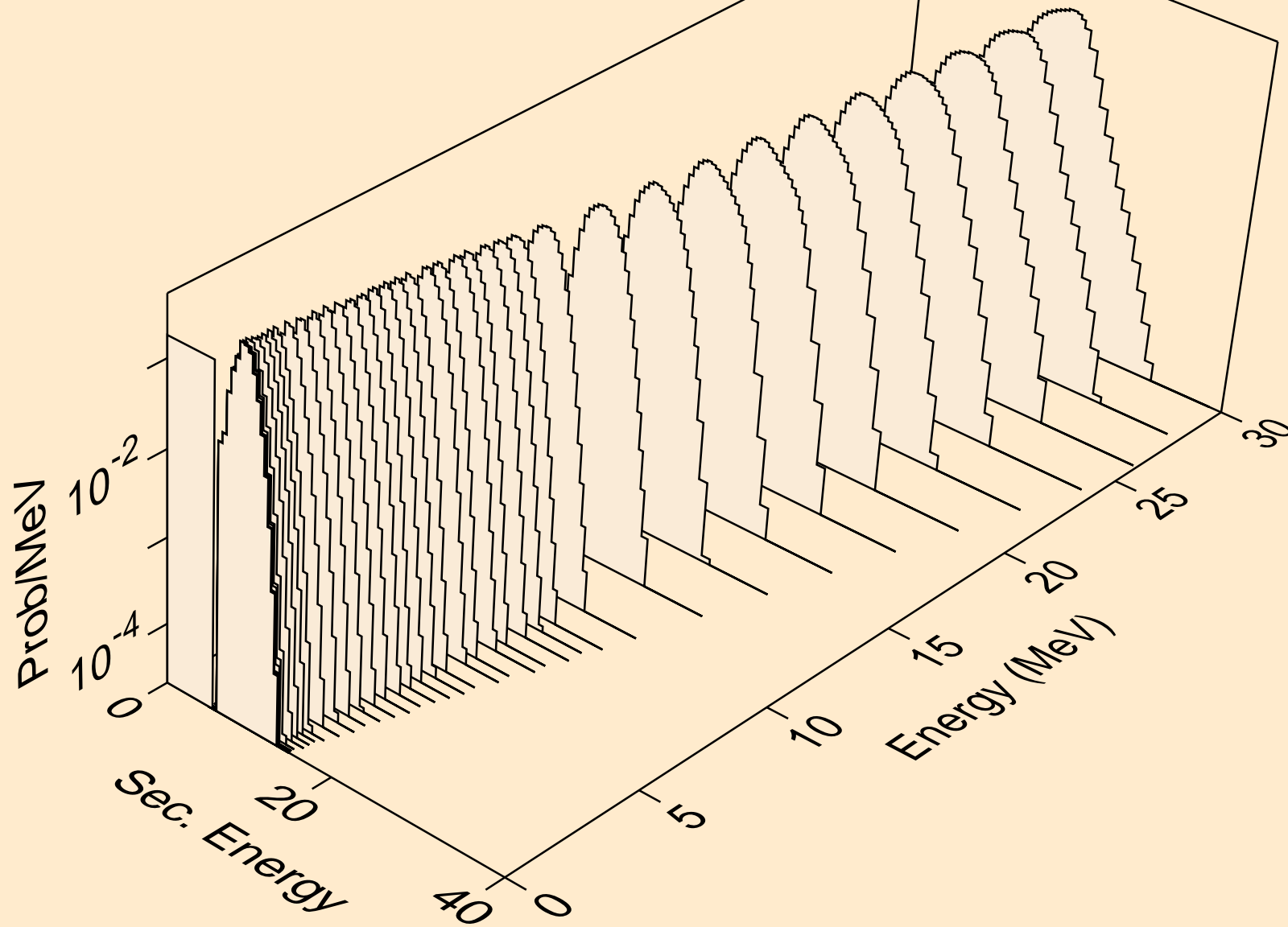

PB187 NEUTRON ACER TENDL-2024 LIBRARY; T=0.K
alphas from (n,pa)

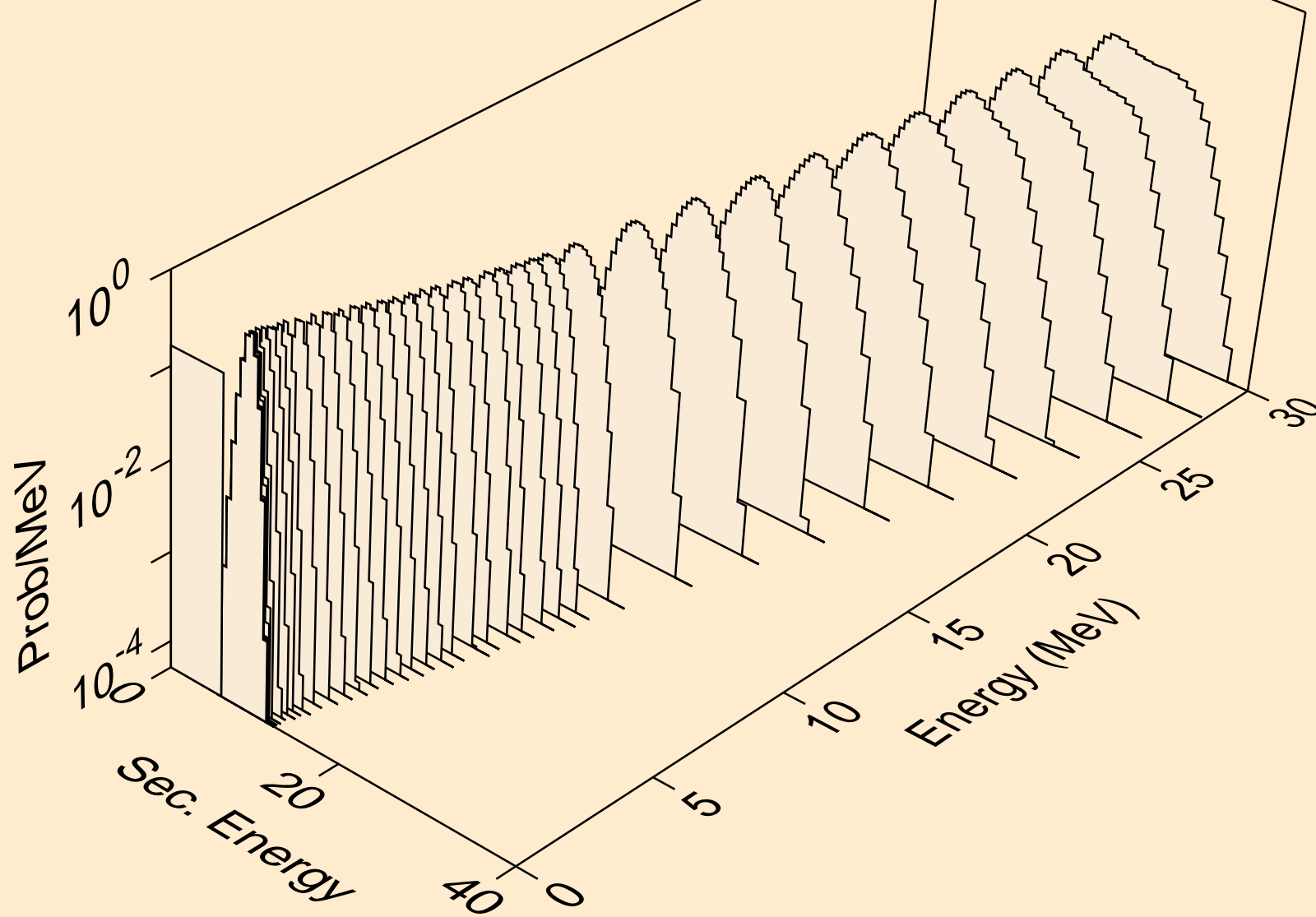

PB187 NEUTRON ACER TENDL-2024 LIBRARY; T=0.K
alphas from (n,d2a)

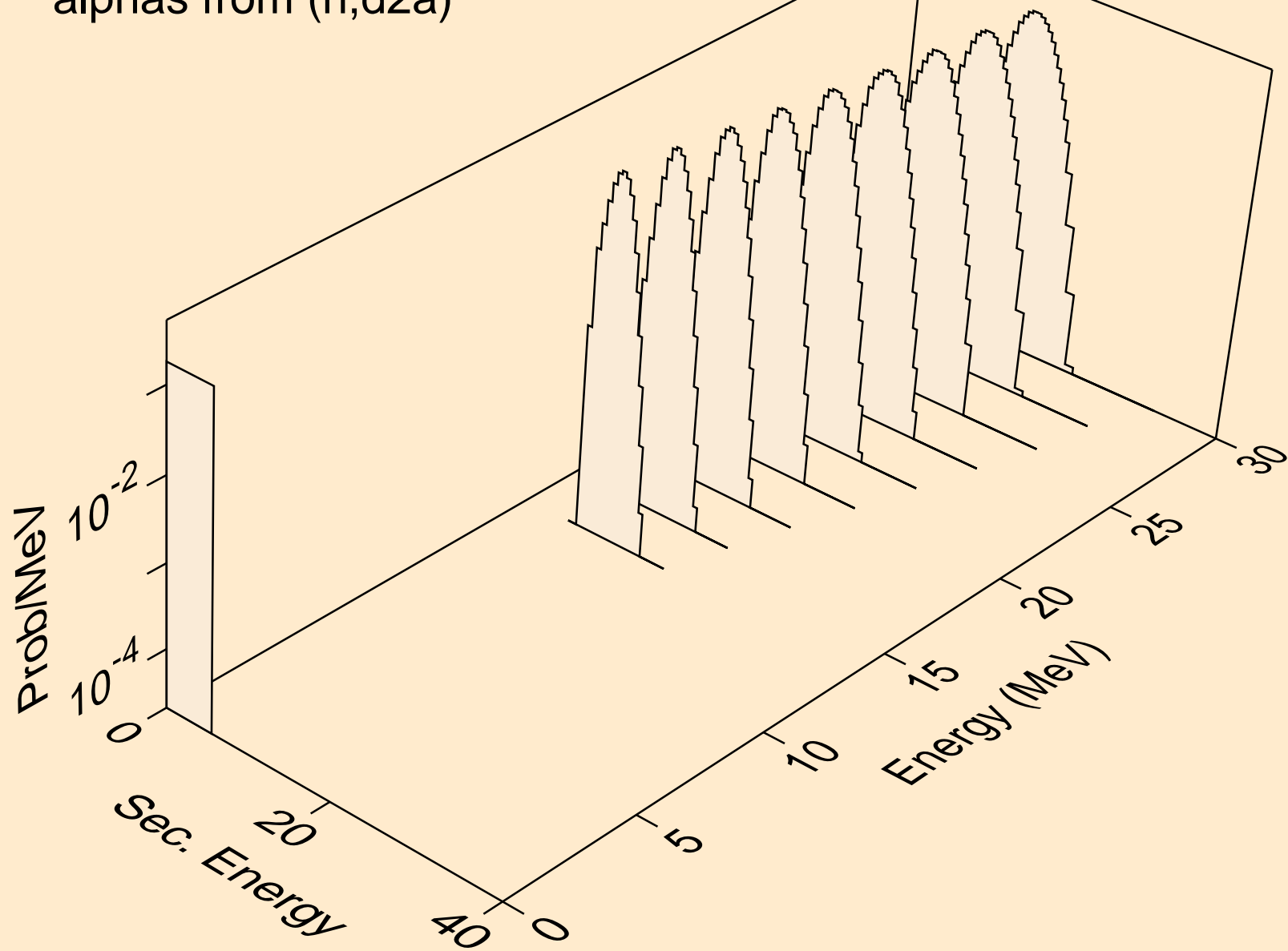

PB187 NEUTRON ACER TENDL-2024 LIBRARY; T=0.K
alphas from (n,da)

