

PD093 NEUTRON ACER TENDL-2024 LIBRARY; T=0.K  
Principal cross sections

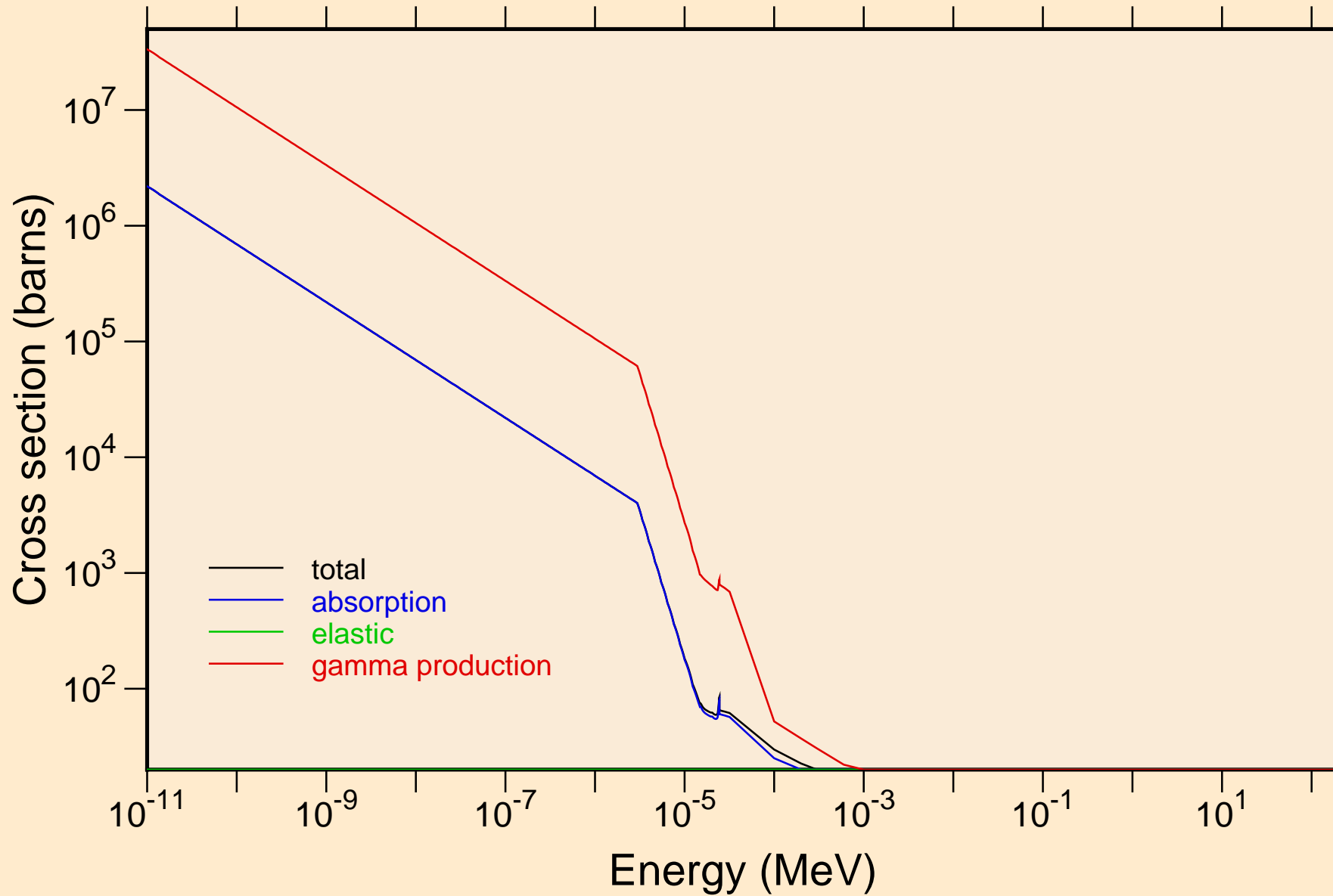

# PD093 NEUTRON ACER TENDL-2024 LIBRARY; T=0.K

## Heating

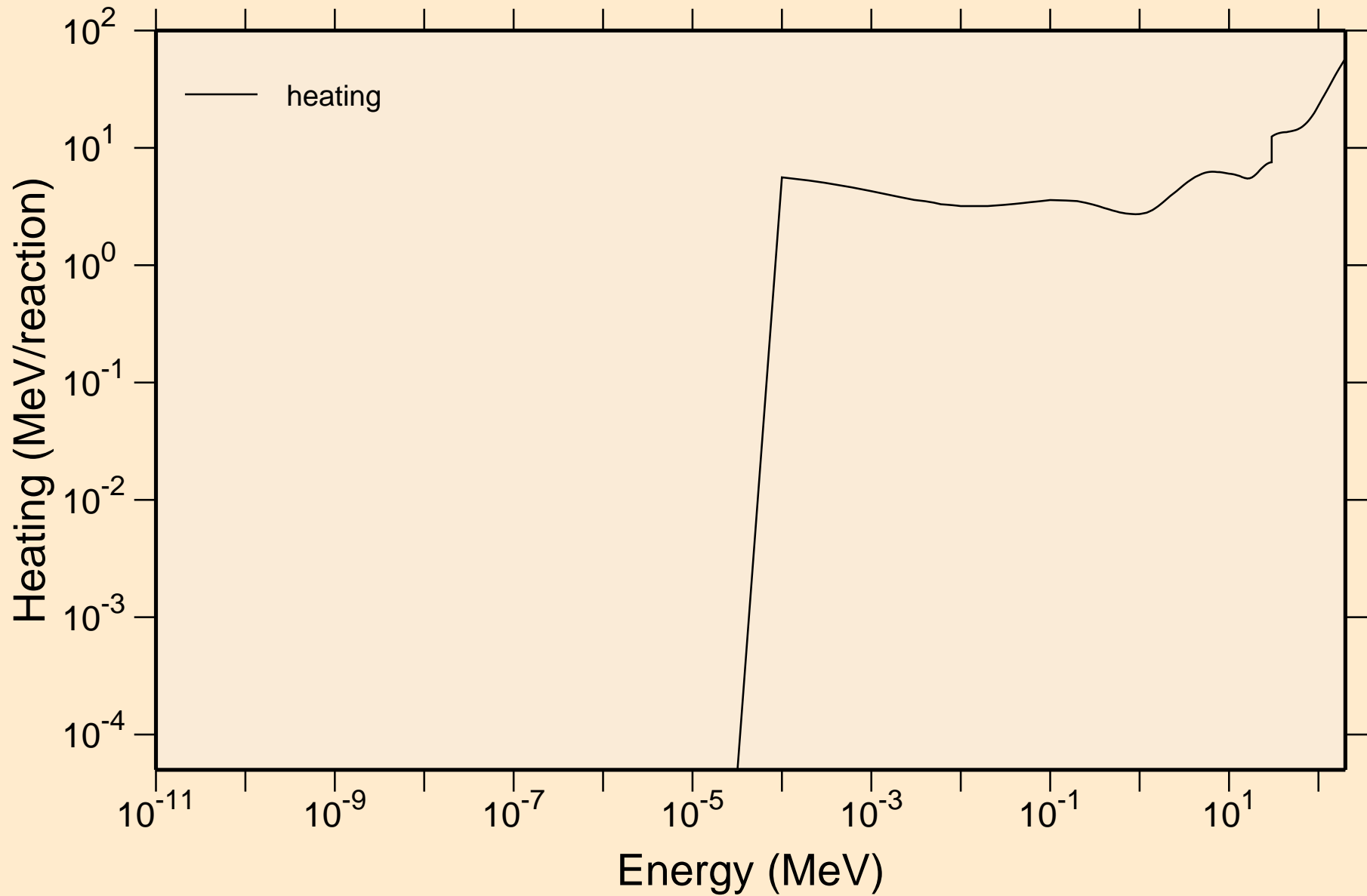

PD093 NEUTRON ACER TENDL-2024 LIBRARY; T=0.K  
Damage

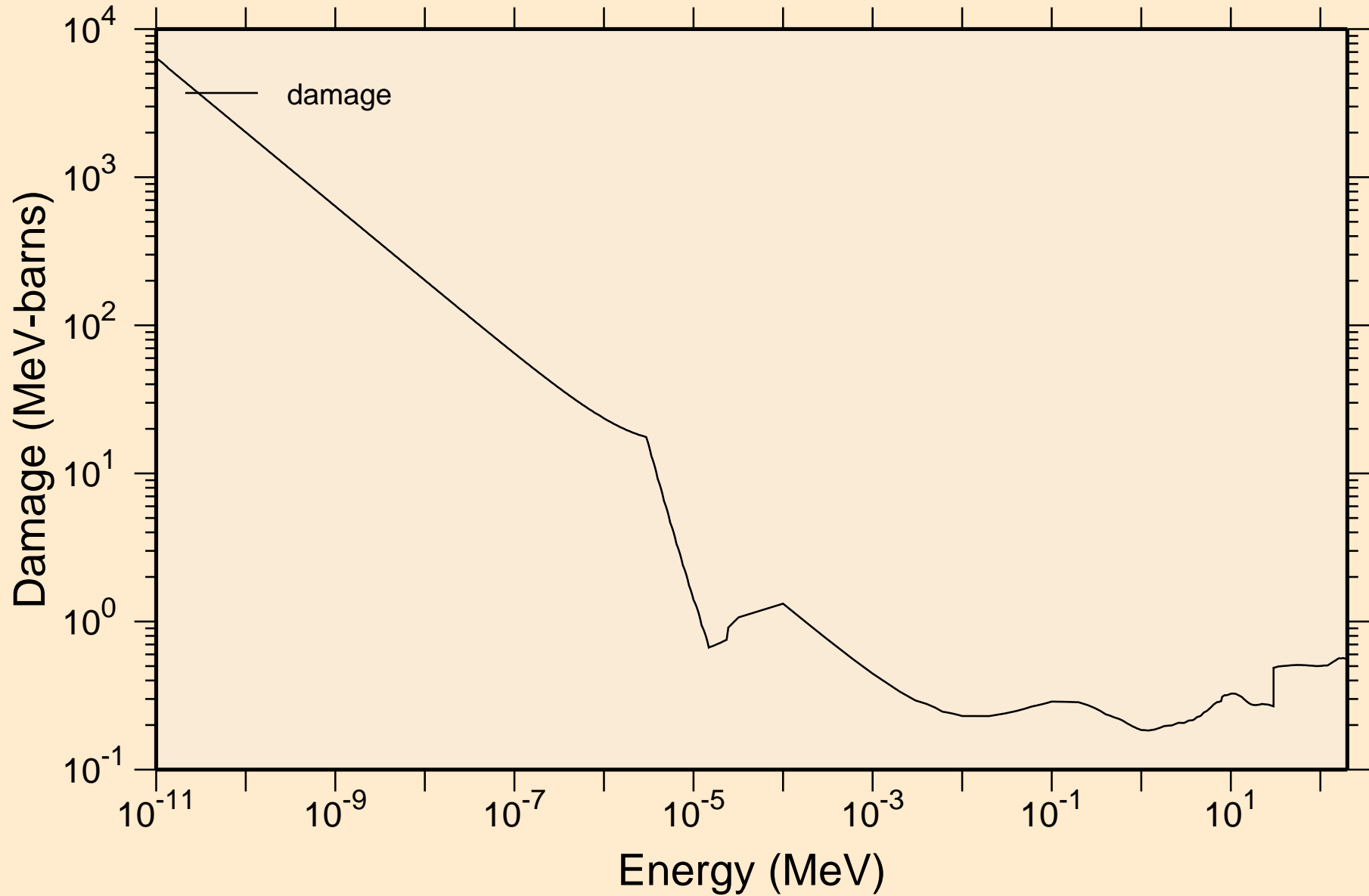

PD093 NEUTRON ACER TENDL-2024 LIBRARY; T=0.K  
Non-threshold reactions

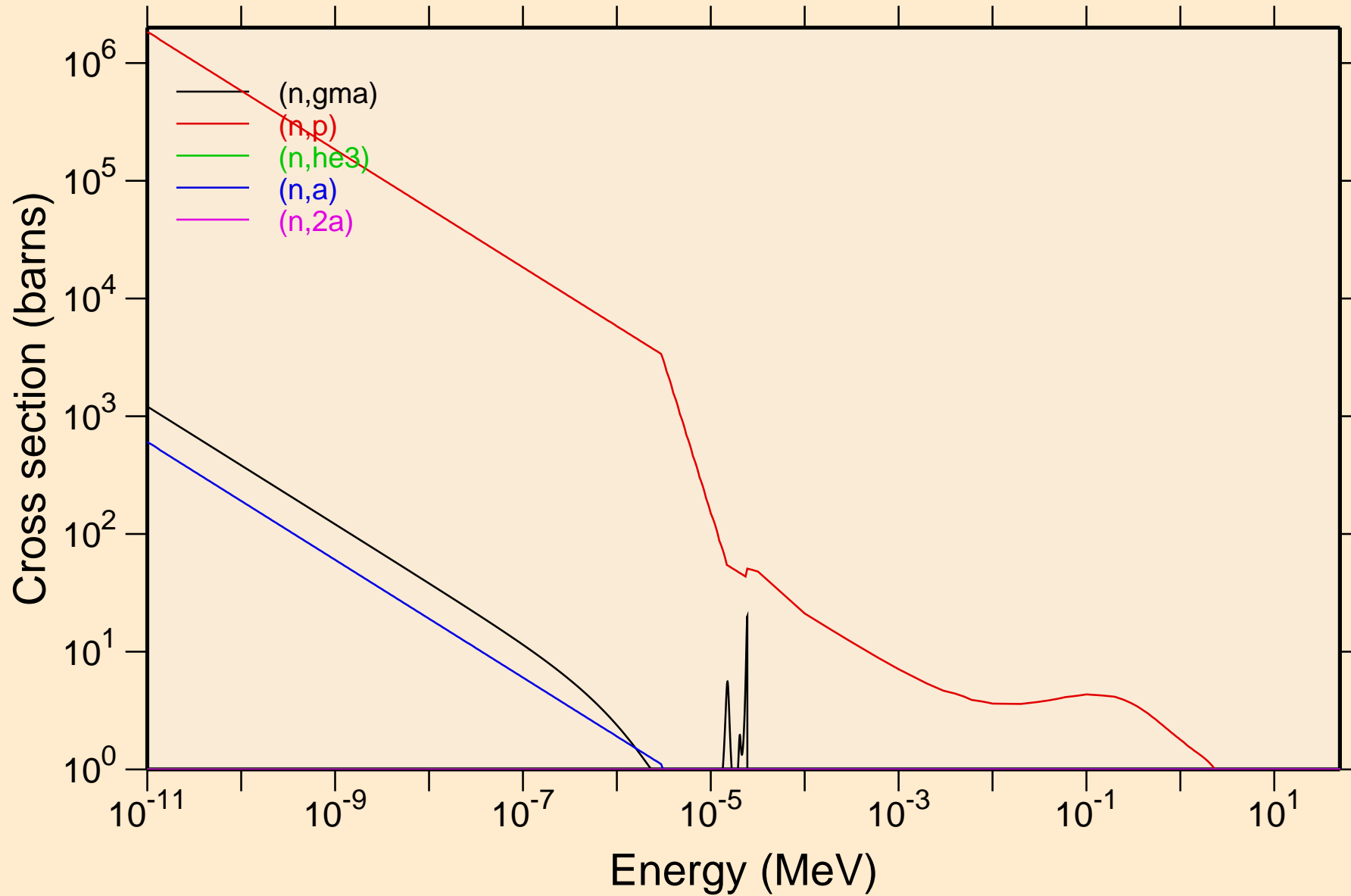

PD093 NEUTRON ACER TENDL-2024 LIBRARY; T=0.K  
Non-threshold reactions

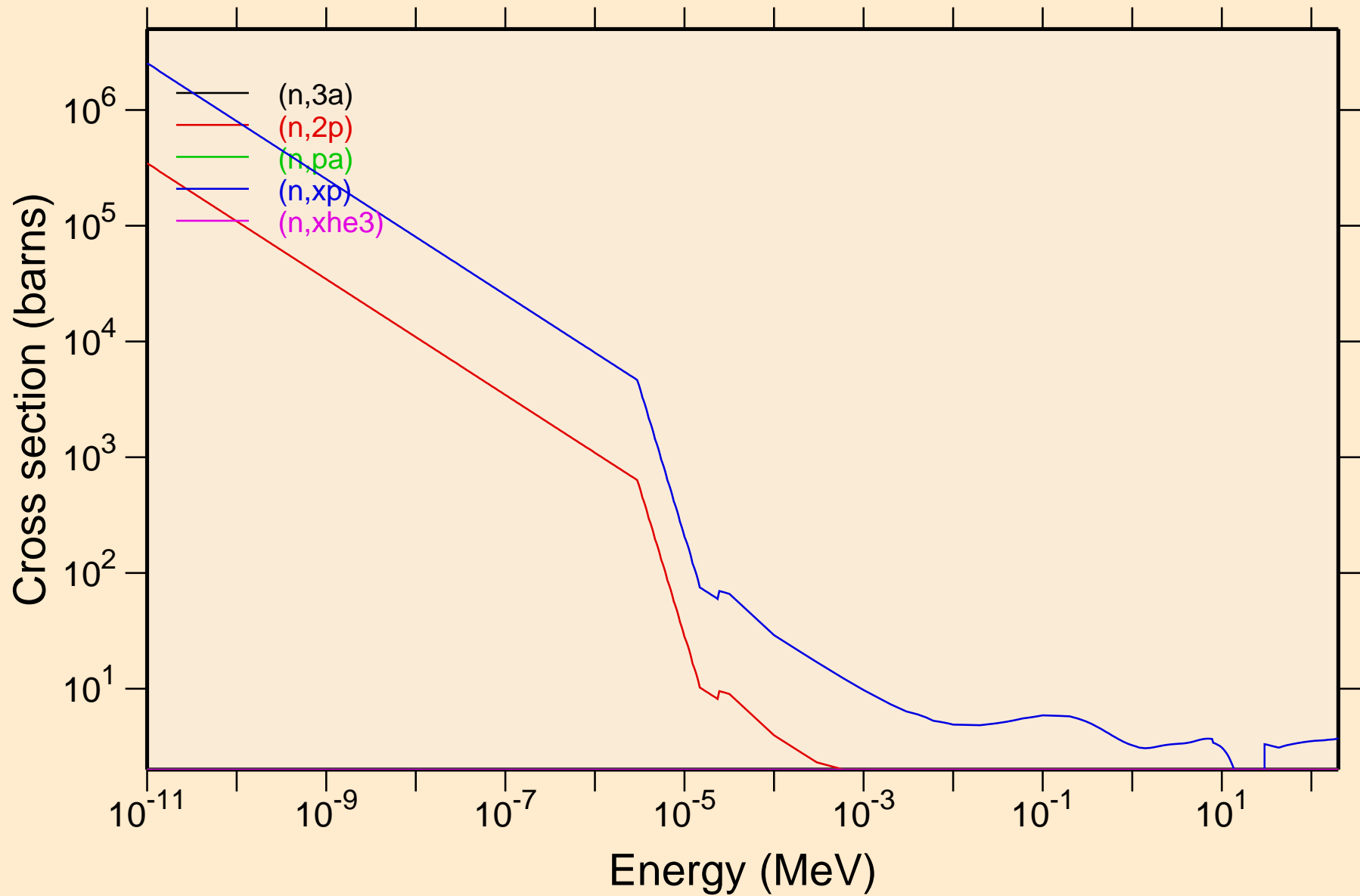

PD093 NEUTRON ACER TENDL-2024 LIBRARY; T=0.K  
Non-threshold reactions

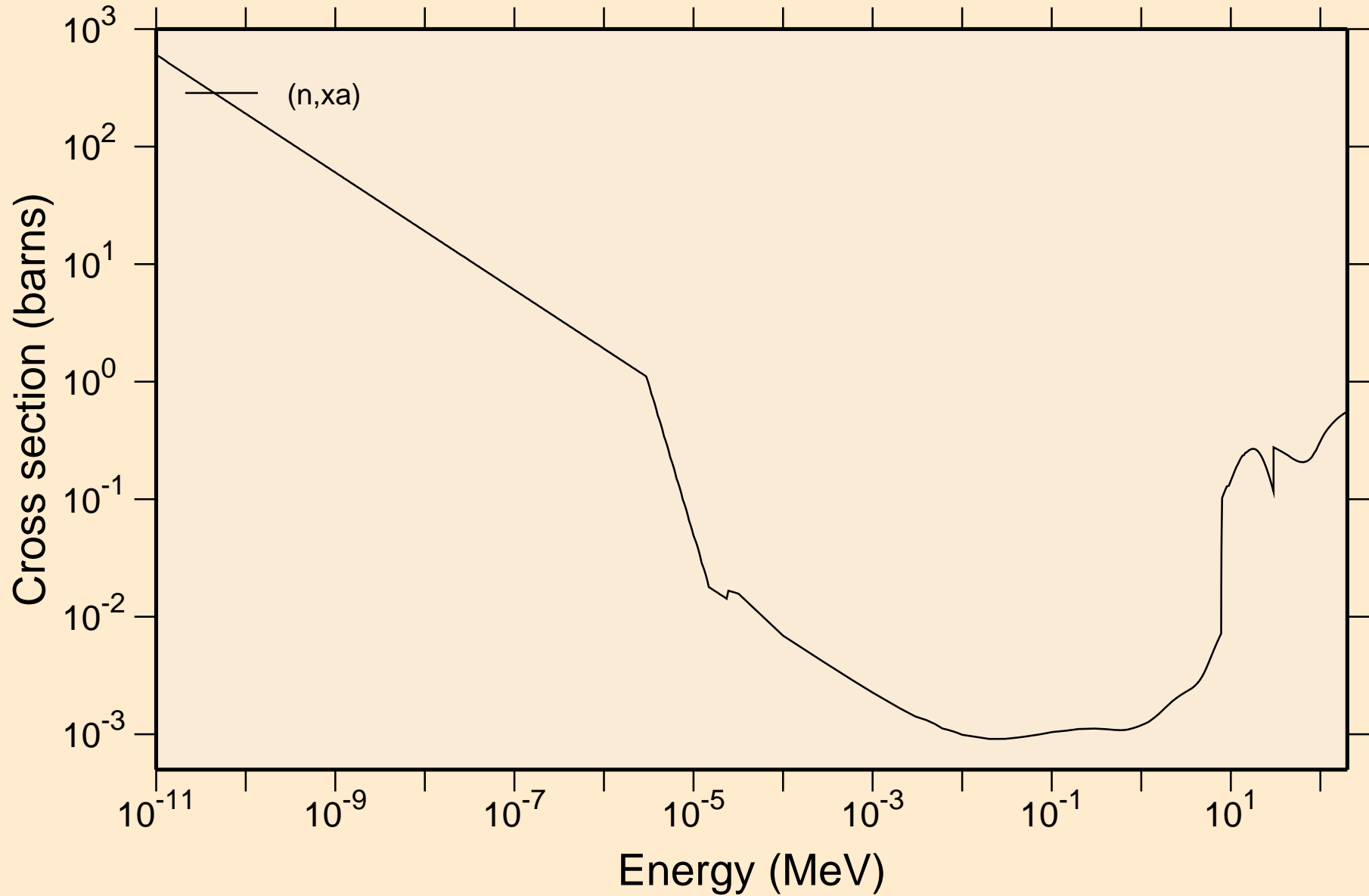

# PD093 NEUTRON ACER TENDL-2024 LIBRARY; T=0.K

## Principal cross sections

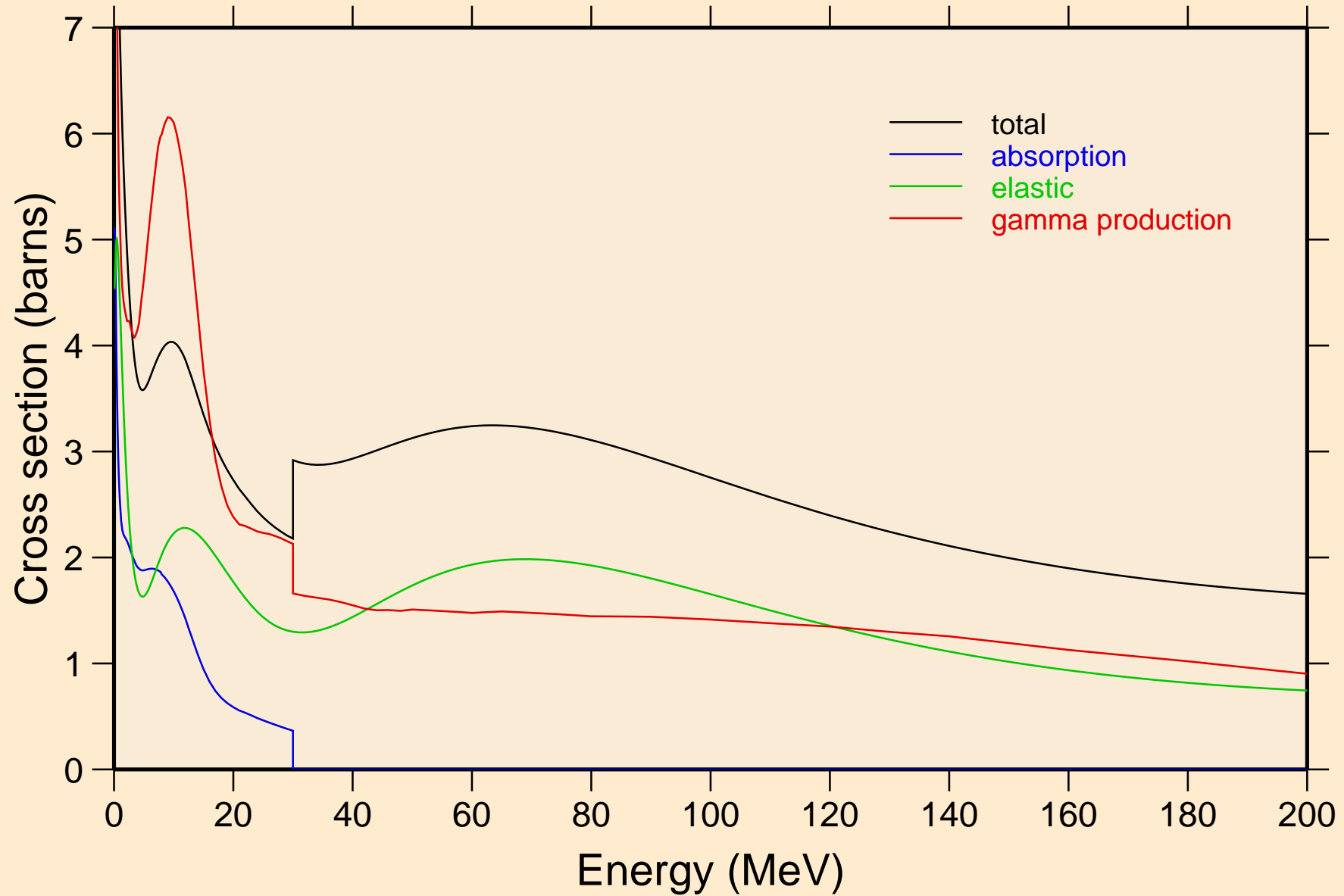

# PD093 NEUTRON ACER TENDL-2024 LIBRARY; T=0.K

## Heating

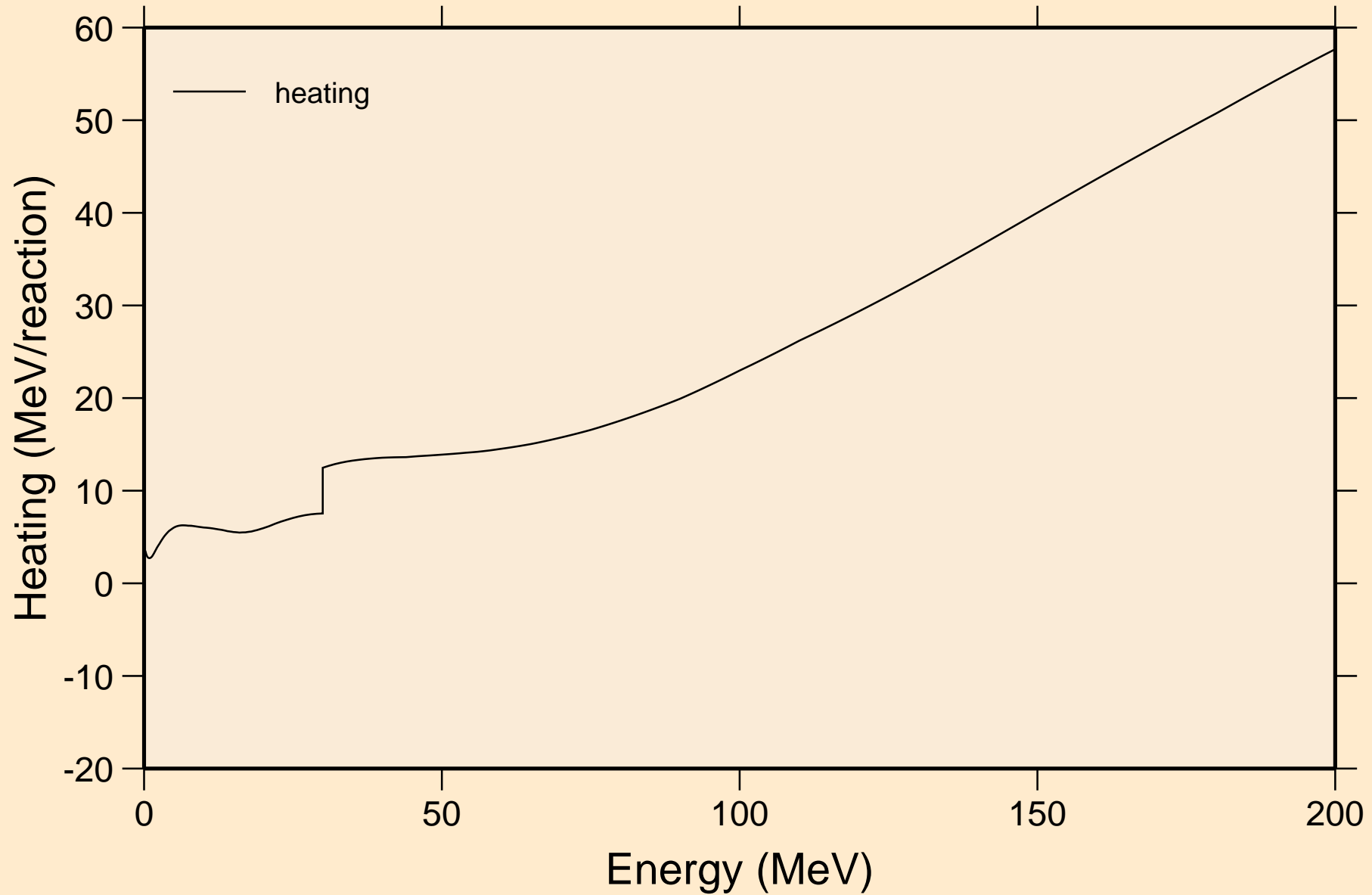

# PD093 NEUTRON ACER TENDL-2024 LIBRARY; T=0.K

## Damage

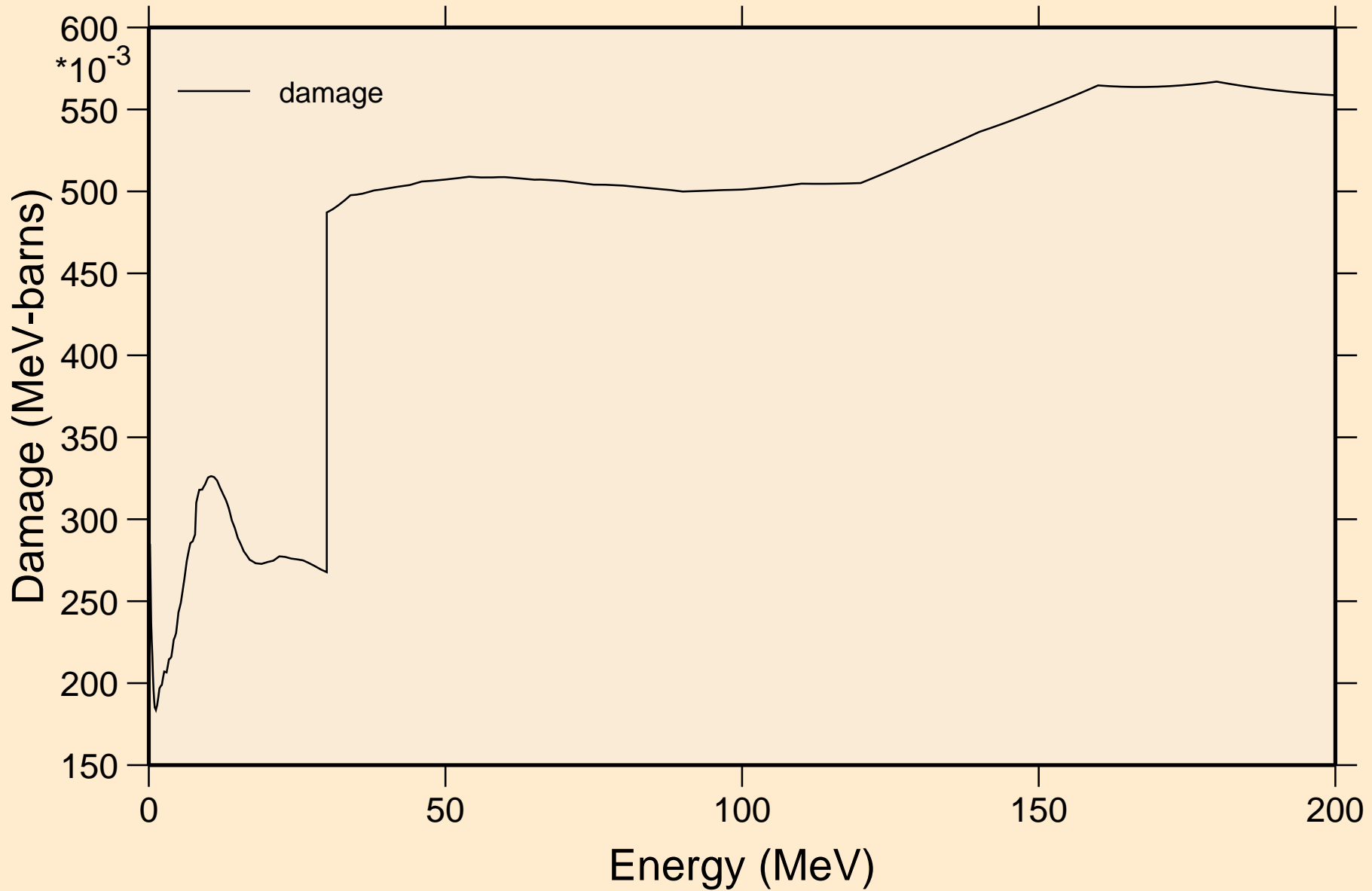

PD093 NEUTRON ACER TENDL-2024 LIBRARY; T=0.K  
Non-threshold reactions

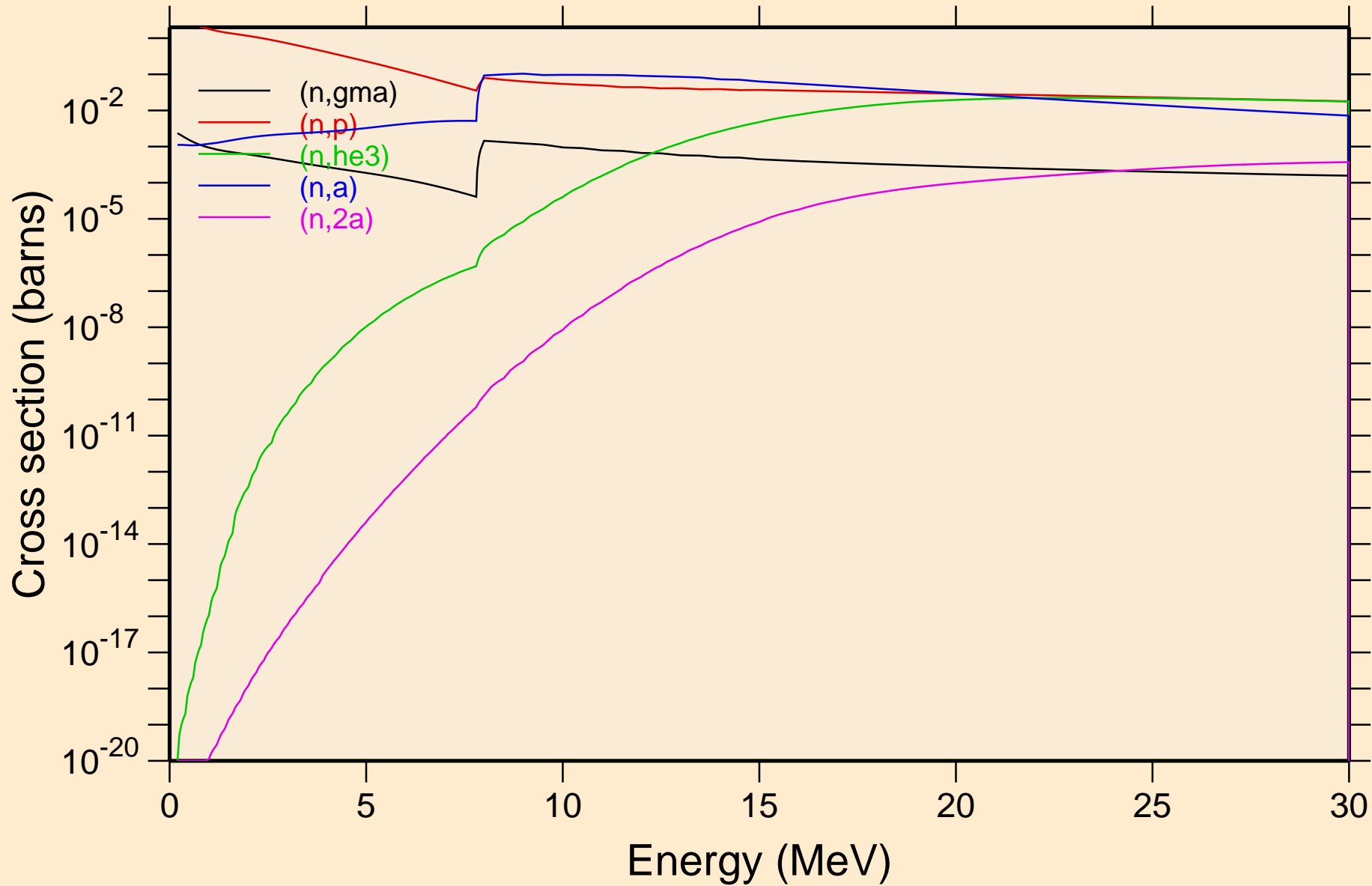

PD093 NEUTRON ACER TENDL-2024 LIBRARY; T=0.K  
Non-threshold reactions

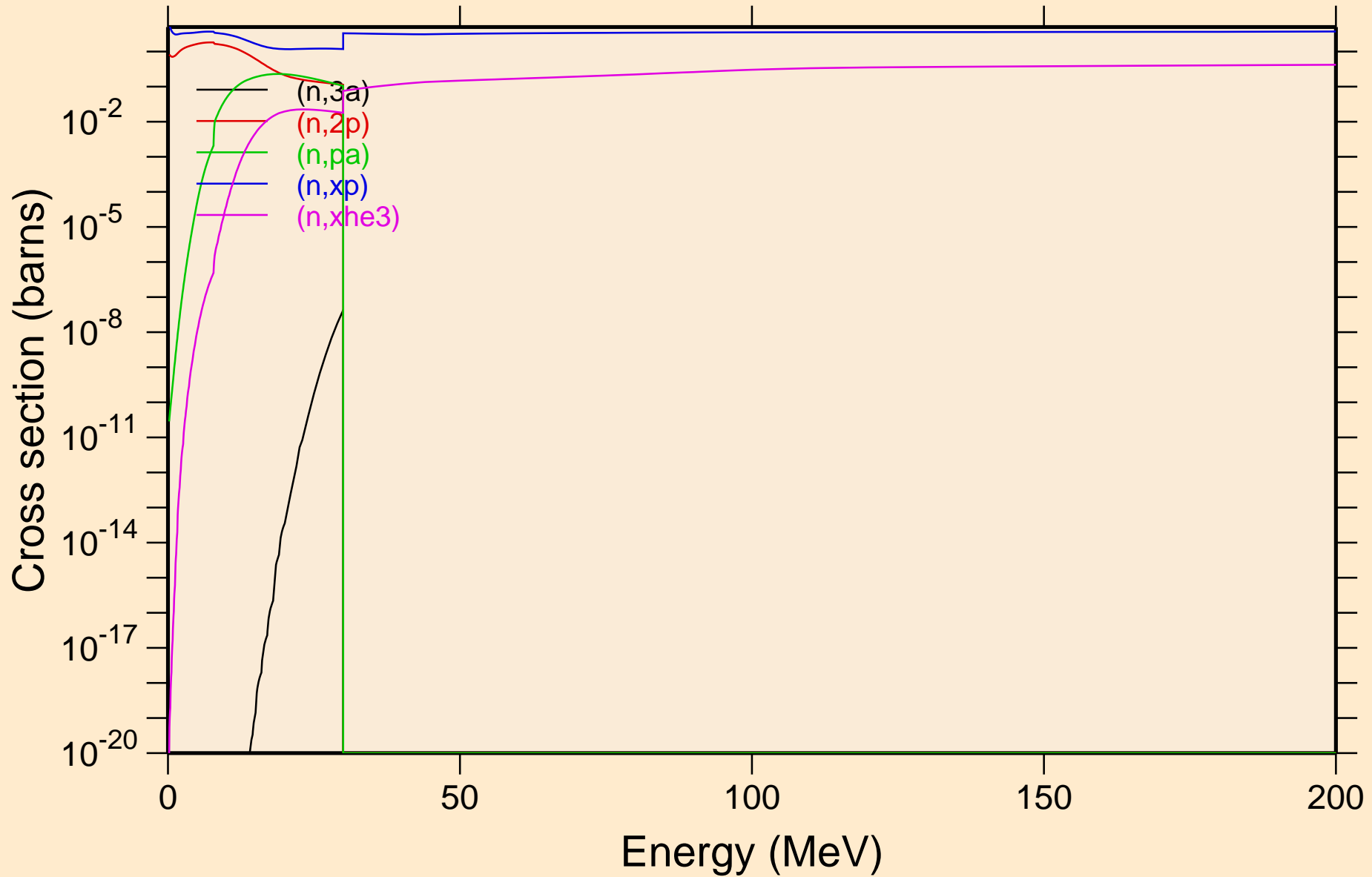

PD093 NEUTRON ACER TENDL-2024 LIBRARY; T=0.K  
Non-threshold reactions

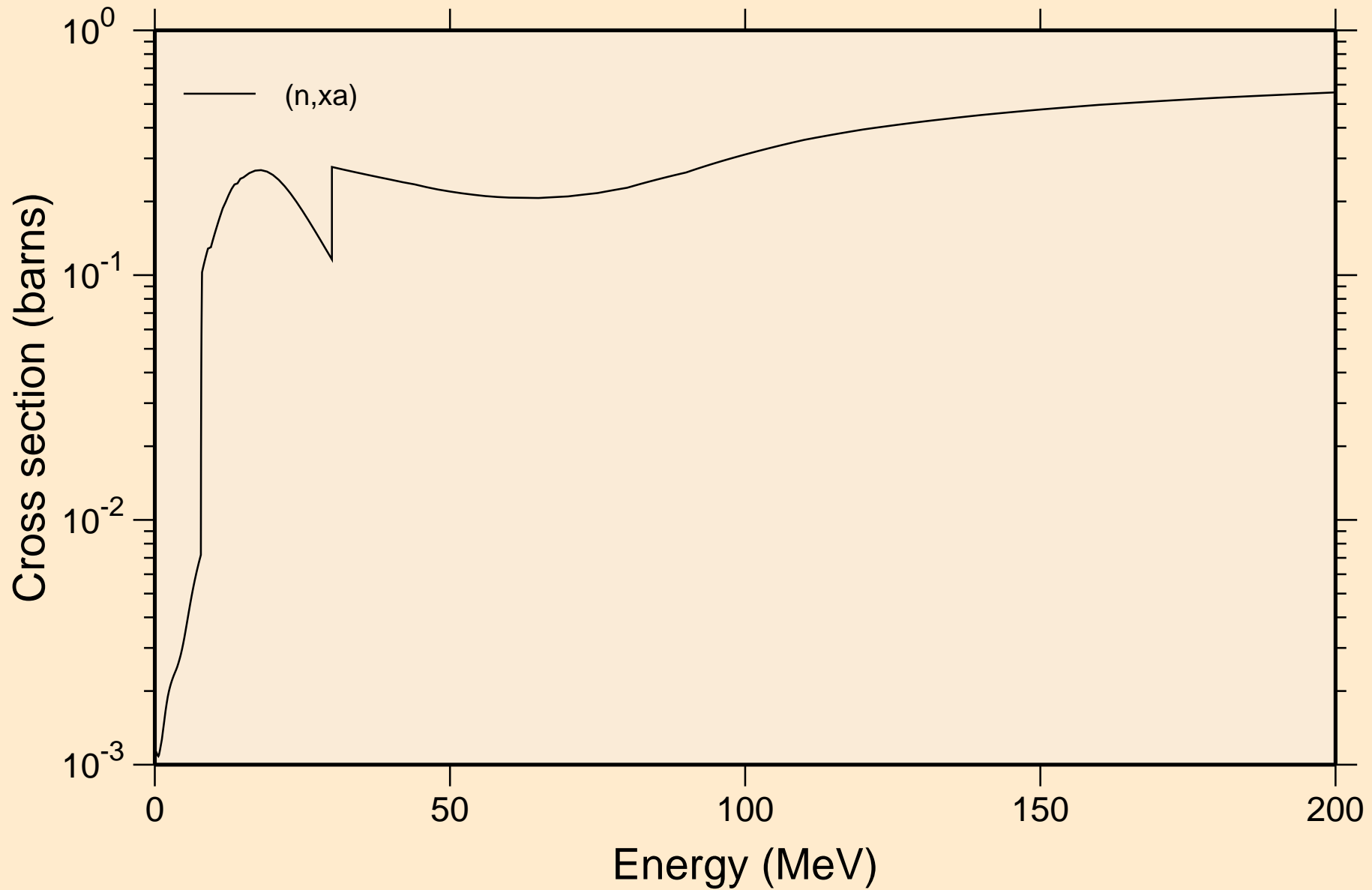

PD093 NEUTRON ACER TENDL-2024 LIBRARY; T=0.K  
Inelastic levels

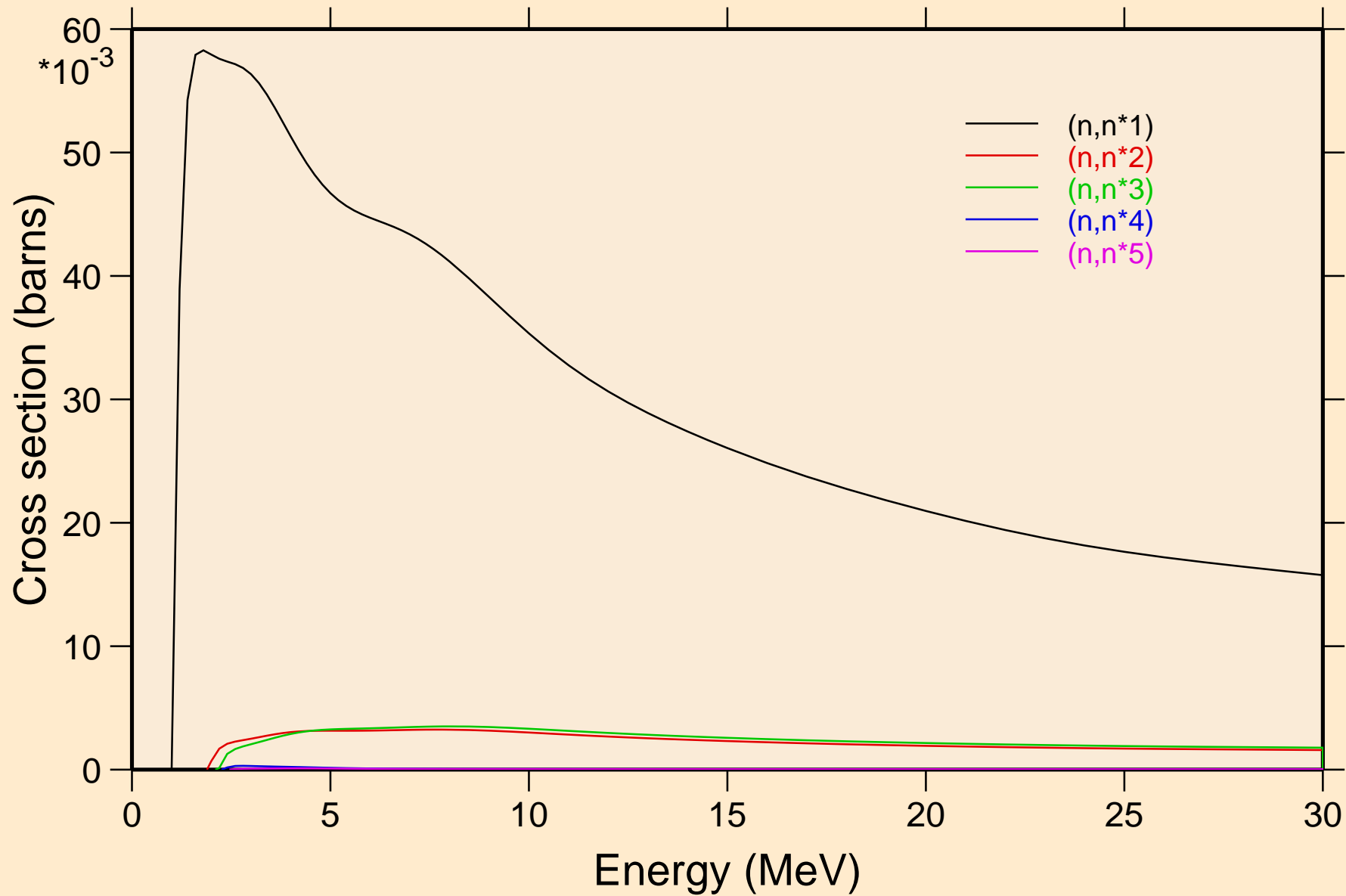

PD093 NEUTRON ACER TENDL-2024 LIBRARY; T=0.K  
Inelastic levels

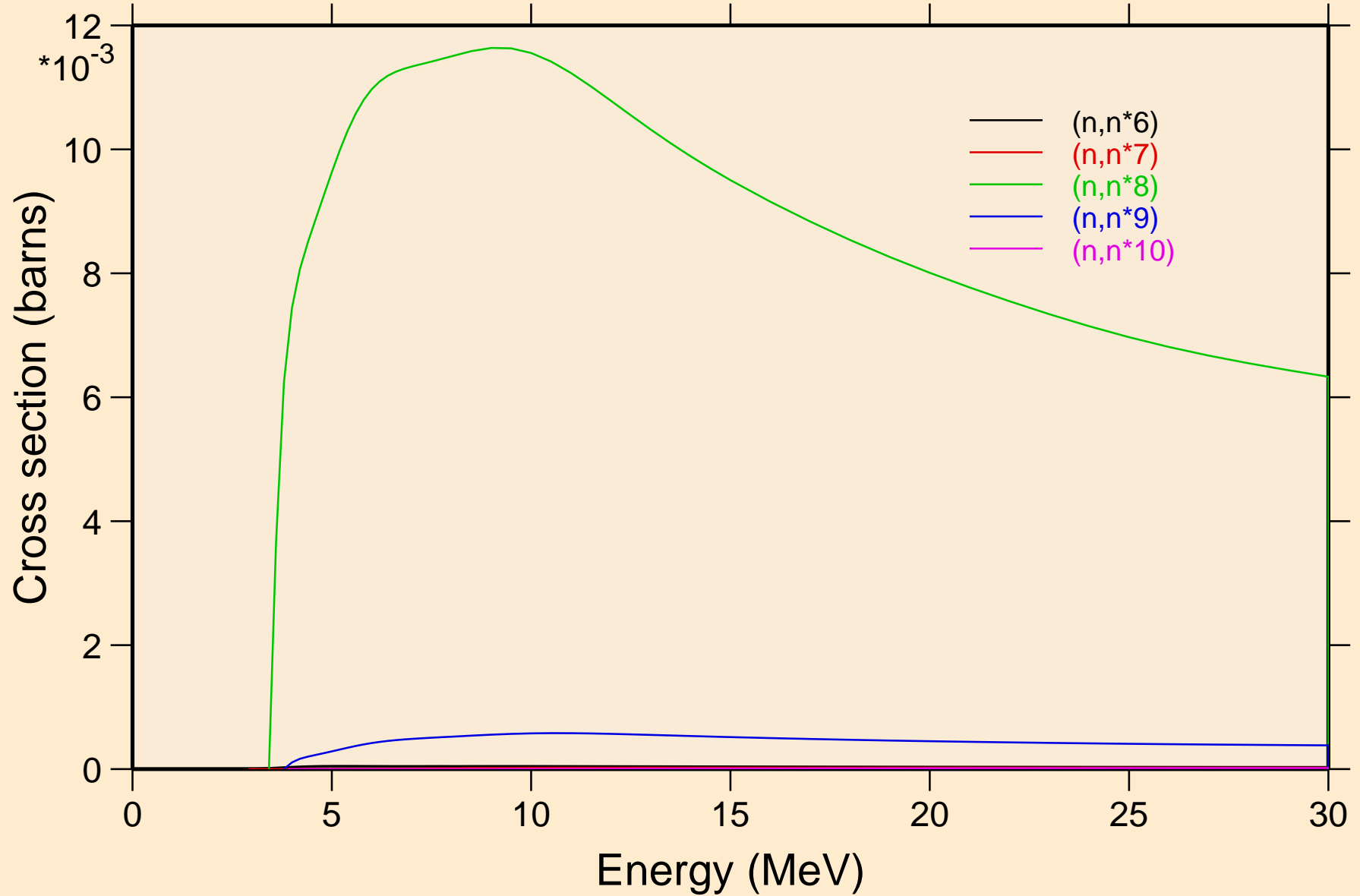

PD093 NEUTRON ACER TENDL-2024 LIBRARY; T=0.K  
Inelastic levels

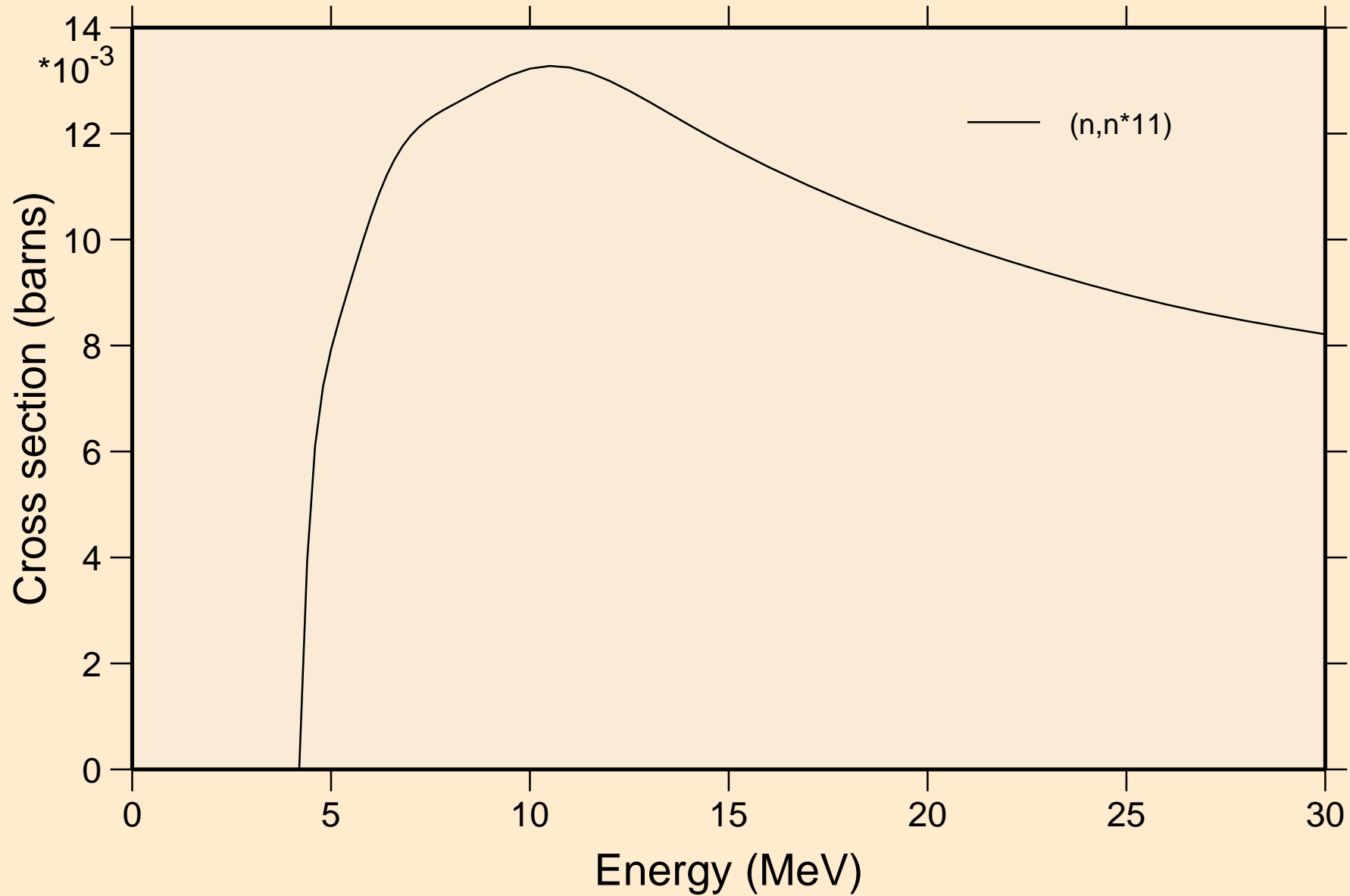

PD093 NEUTRON ACER TENDL-2024 LIBRARY; T=0.K  
Threshold reactions

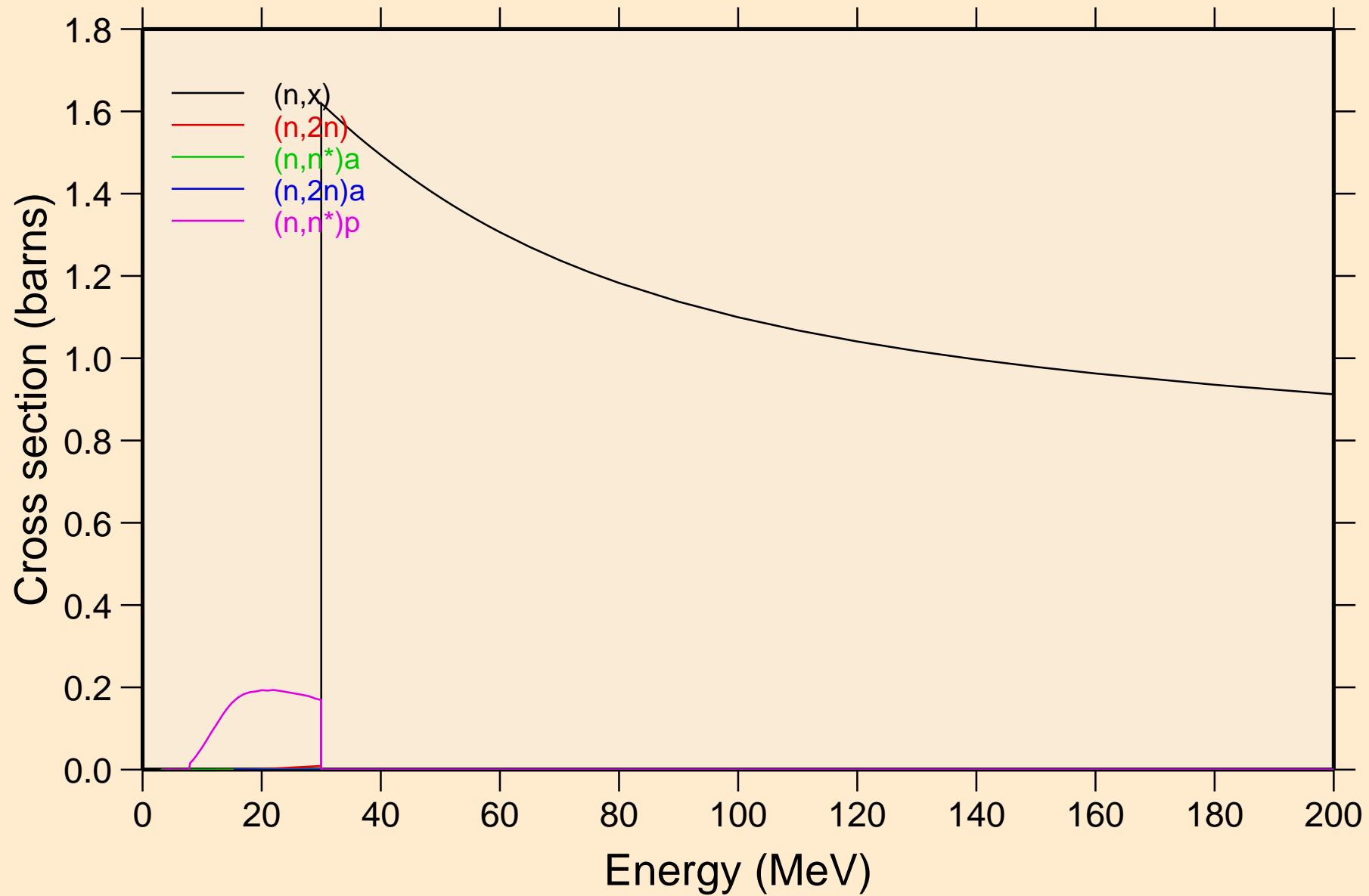

PD093 NEUTRON ACER TENDL-2024 LIBRARY; T=0.K  
Threshold reactions

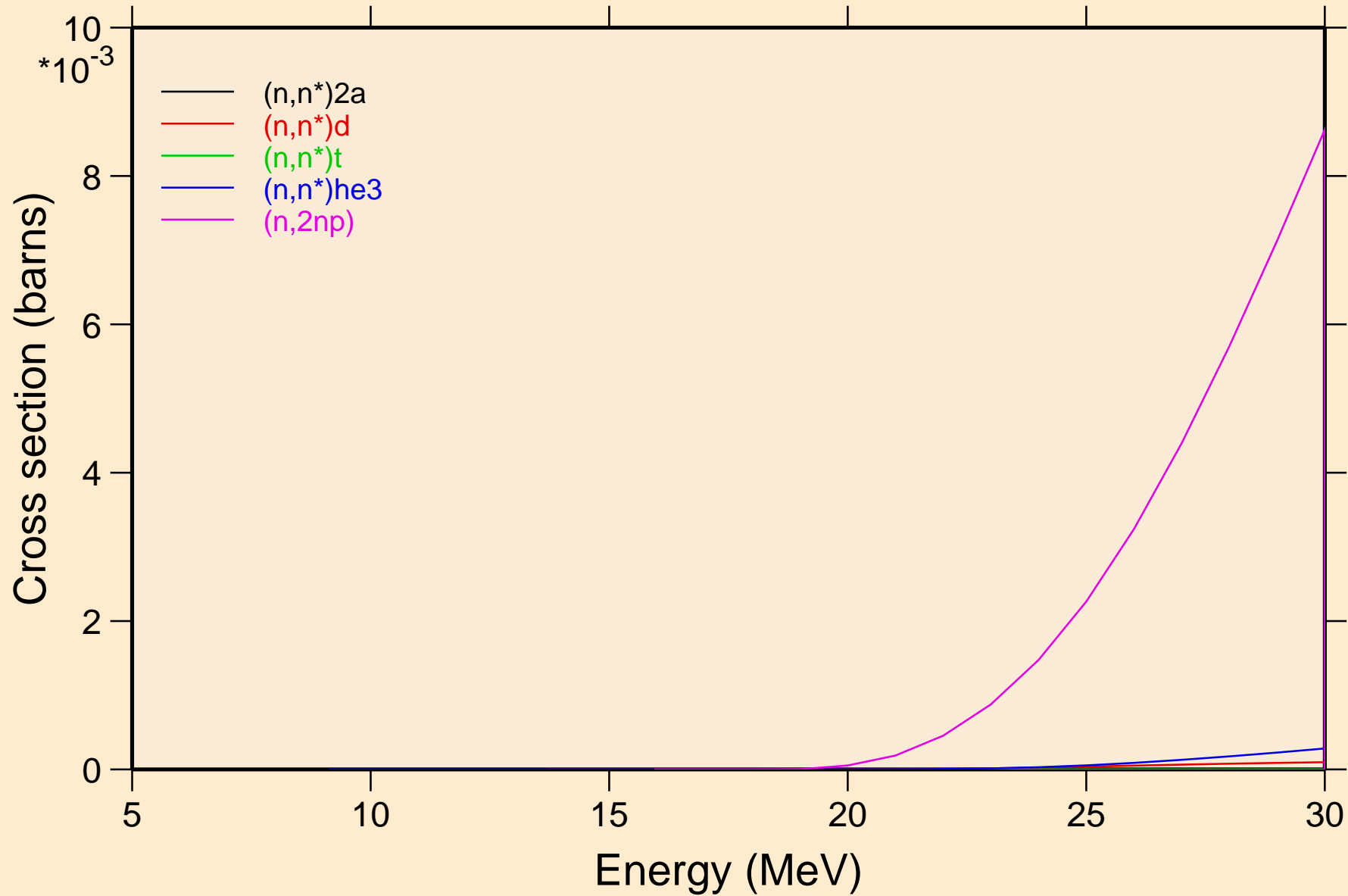

PD093 NEUTRON ACER TENDL-2024 LIBRARY; T=0.K  
Threshold reactions

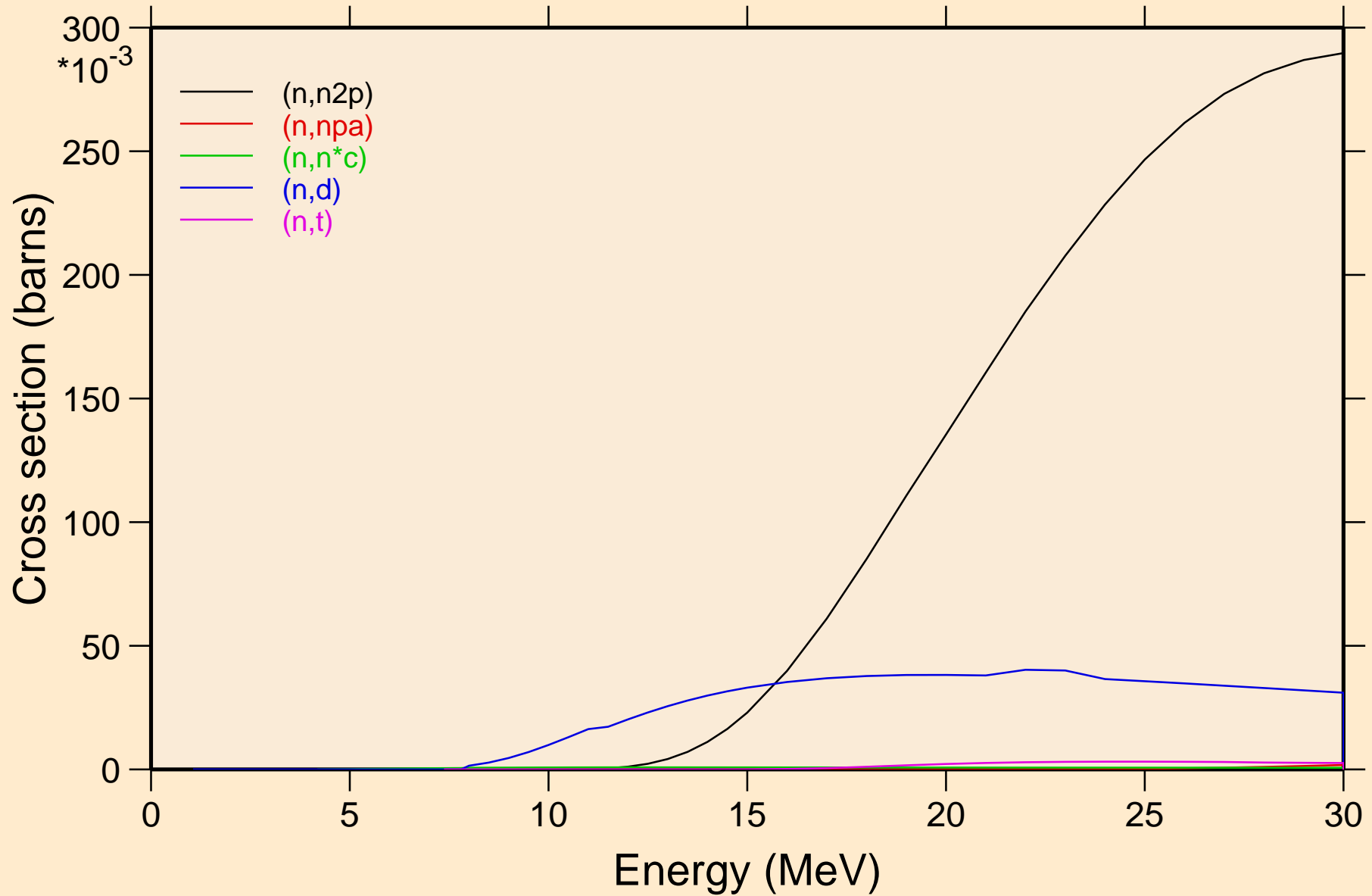

PD093 NEUTRON ACER TENDL-2024 LIBRARY; T=0.K  
Threshold reactions

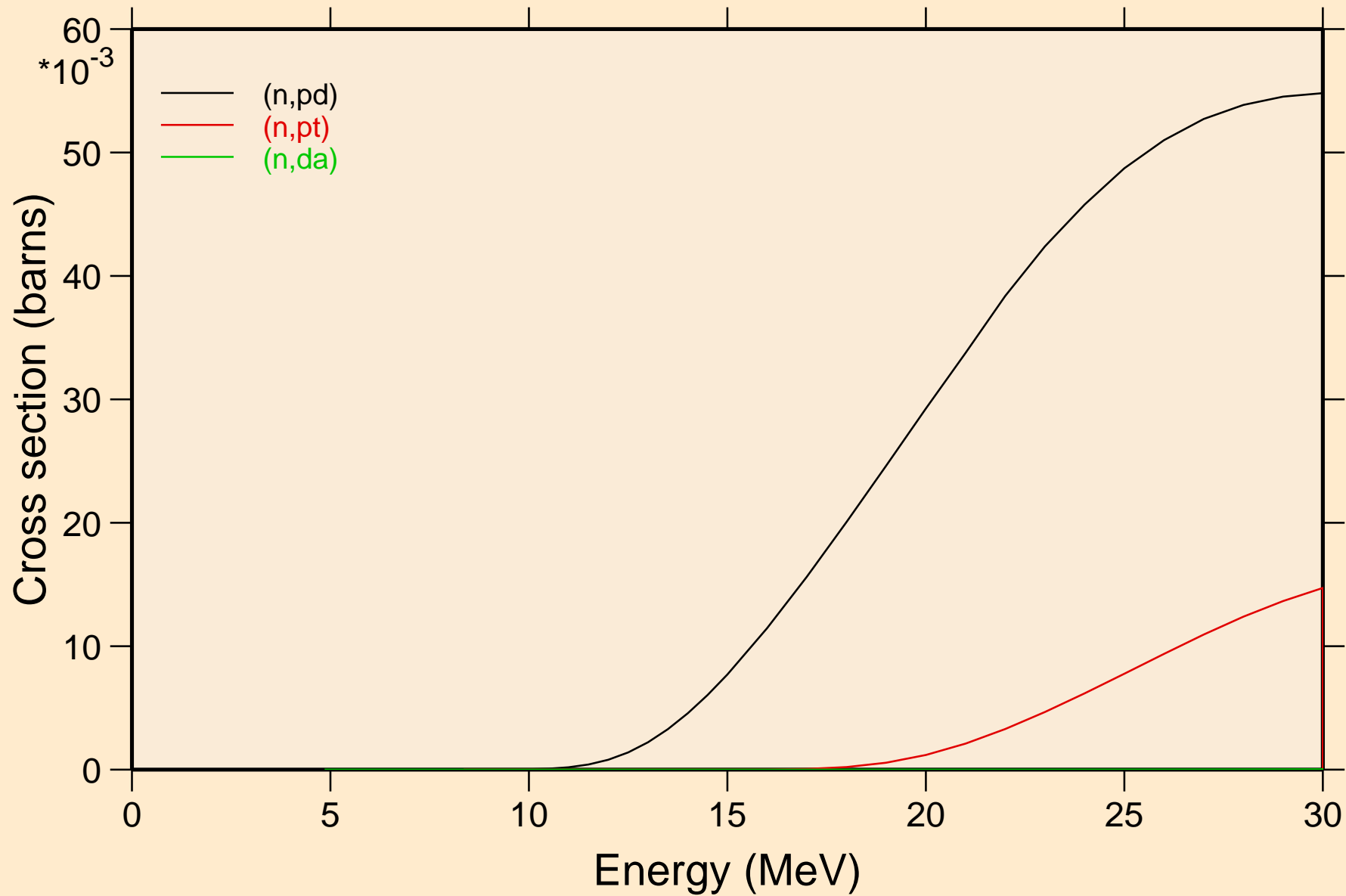

PD093 NEUTRON ACER TENDL-2024 LIBRARY; T=0.K  
Threshold reactions

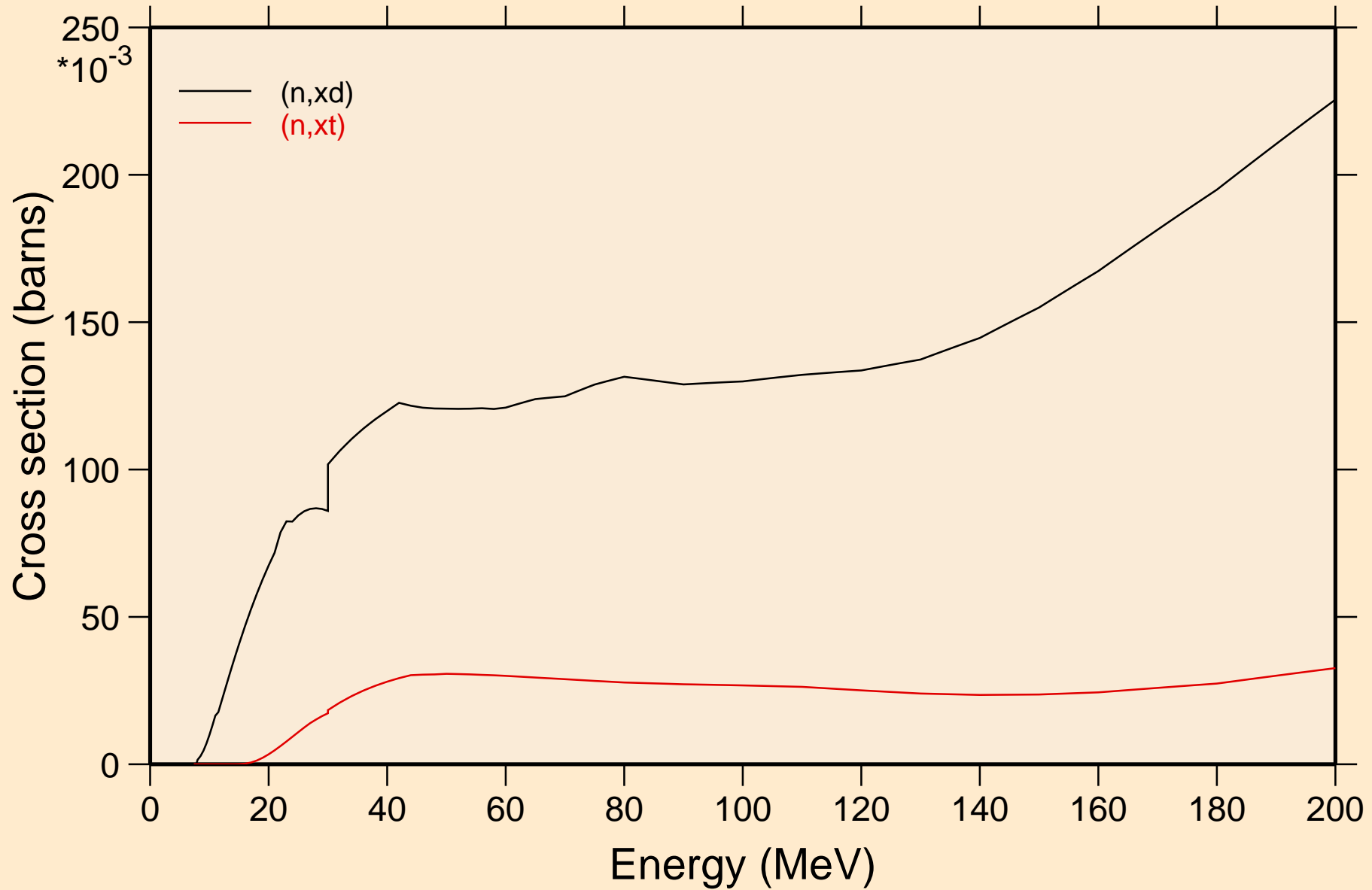

PD093 NEUTRON ACER TENDL-2024 LIBRARY; T=0.K  
angular distribution for elastic

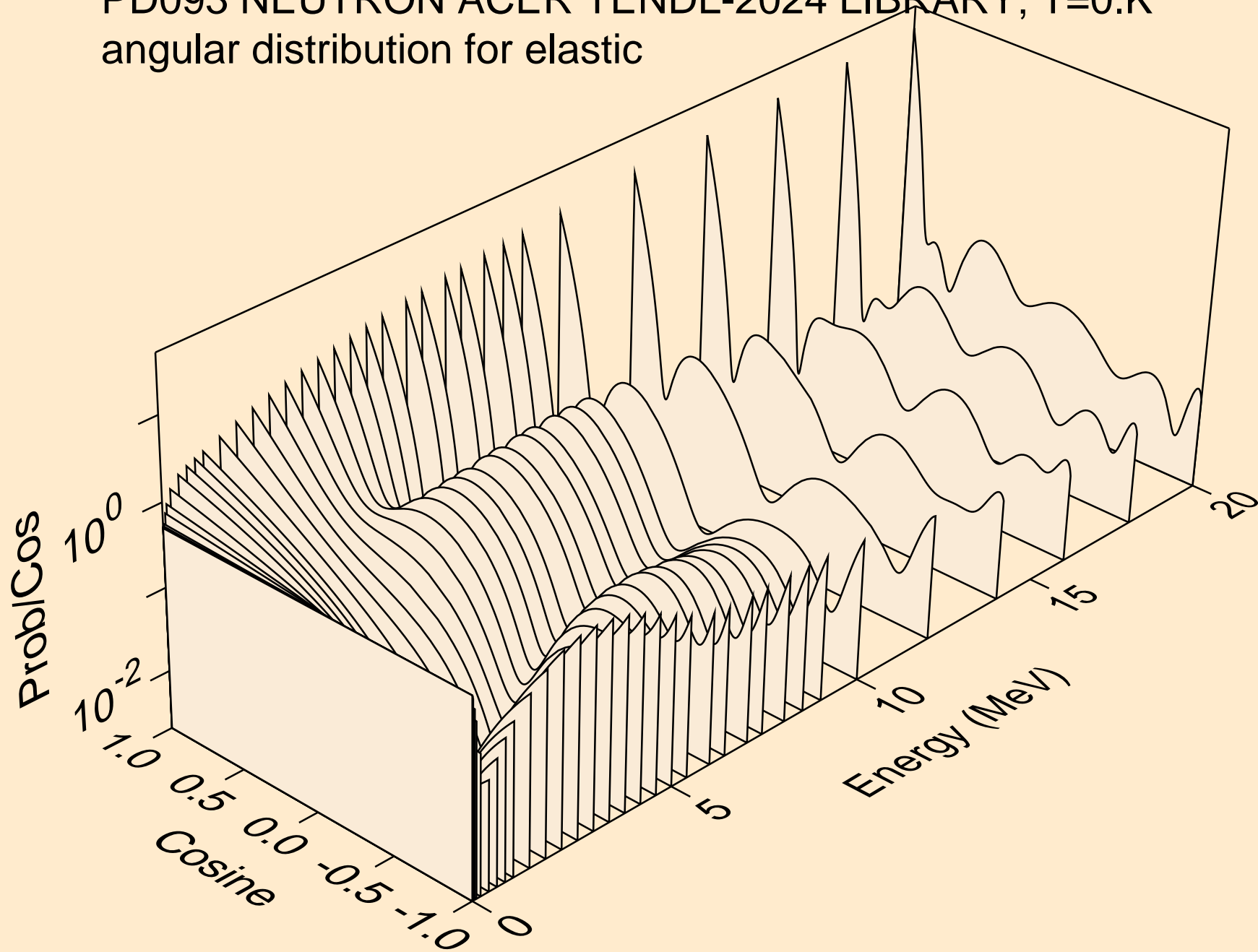

PD093 NEUTRON ACER TENDL-2024 LIBRARY; T=0.K  
angular distribution for elastic

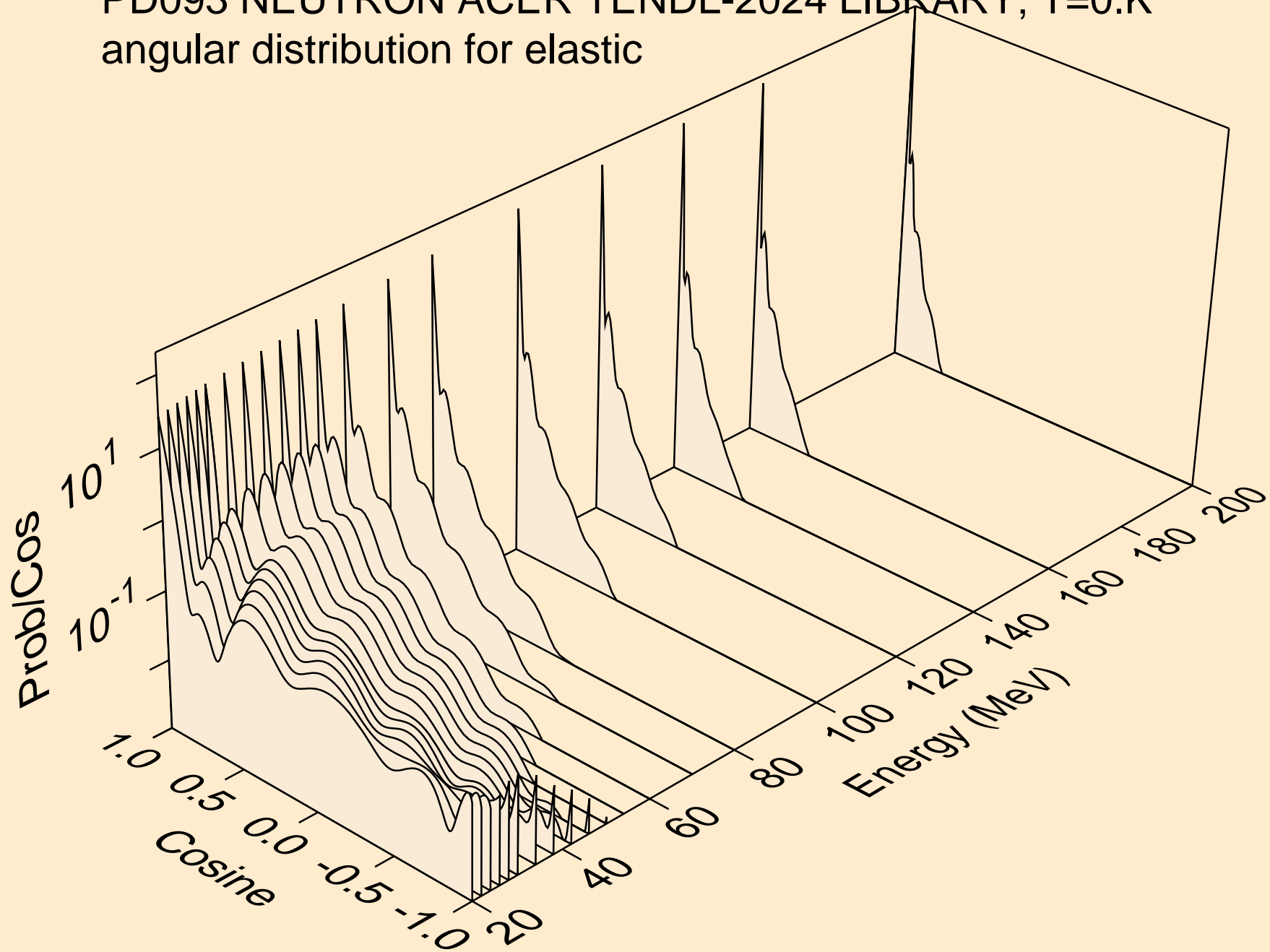

PD093 NEUTRON ACER TENDL-2024 LIBRARY; T=0.K  
angular distribution for (n,n\*1)

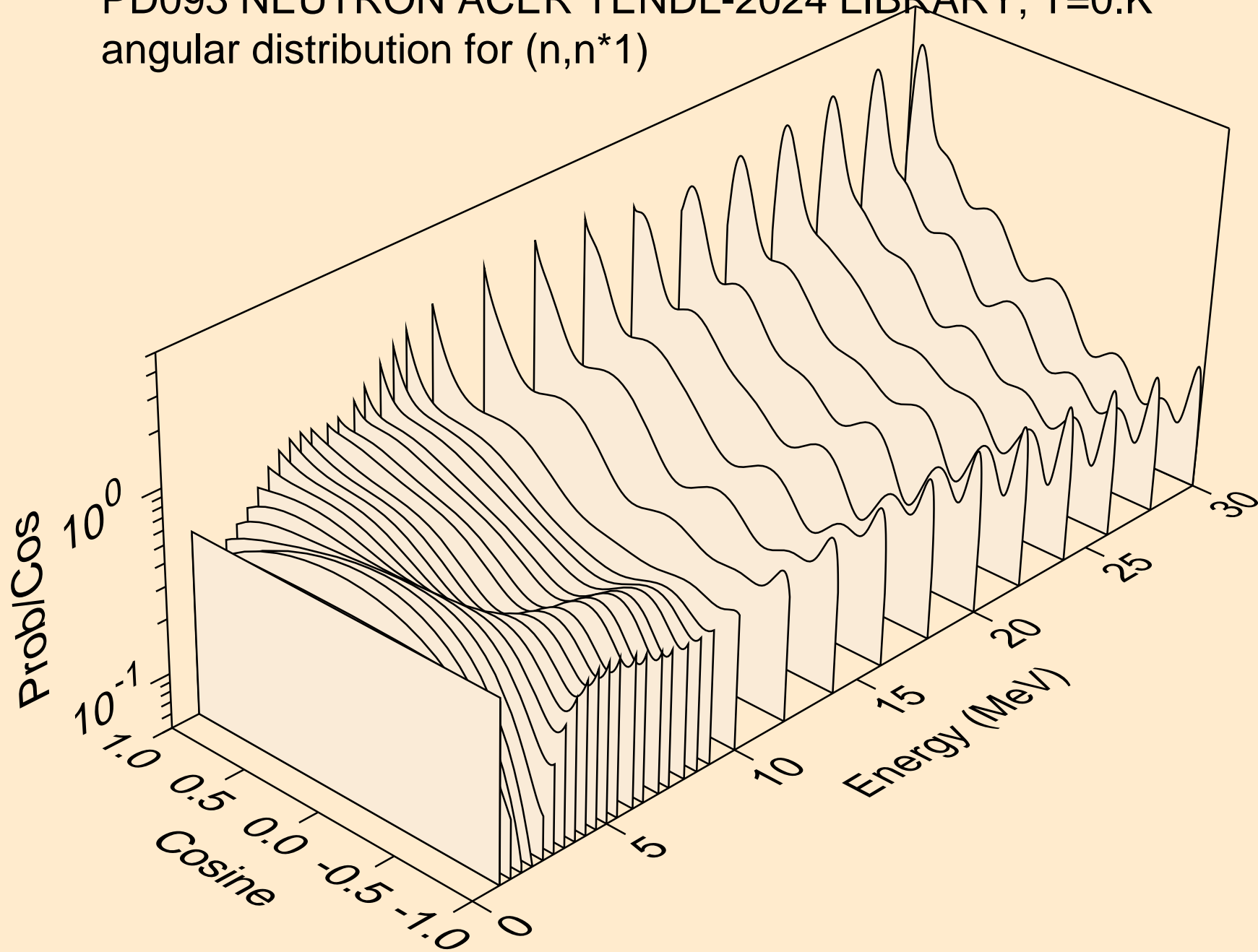

PD093 NEUTRON ACER TENDL-2024 LIBRARY; T=0.K  
angular distribution for (n,n\*2)

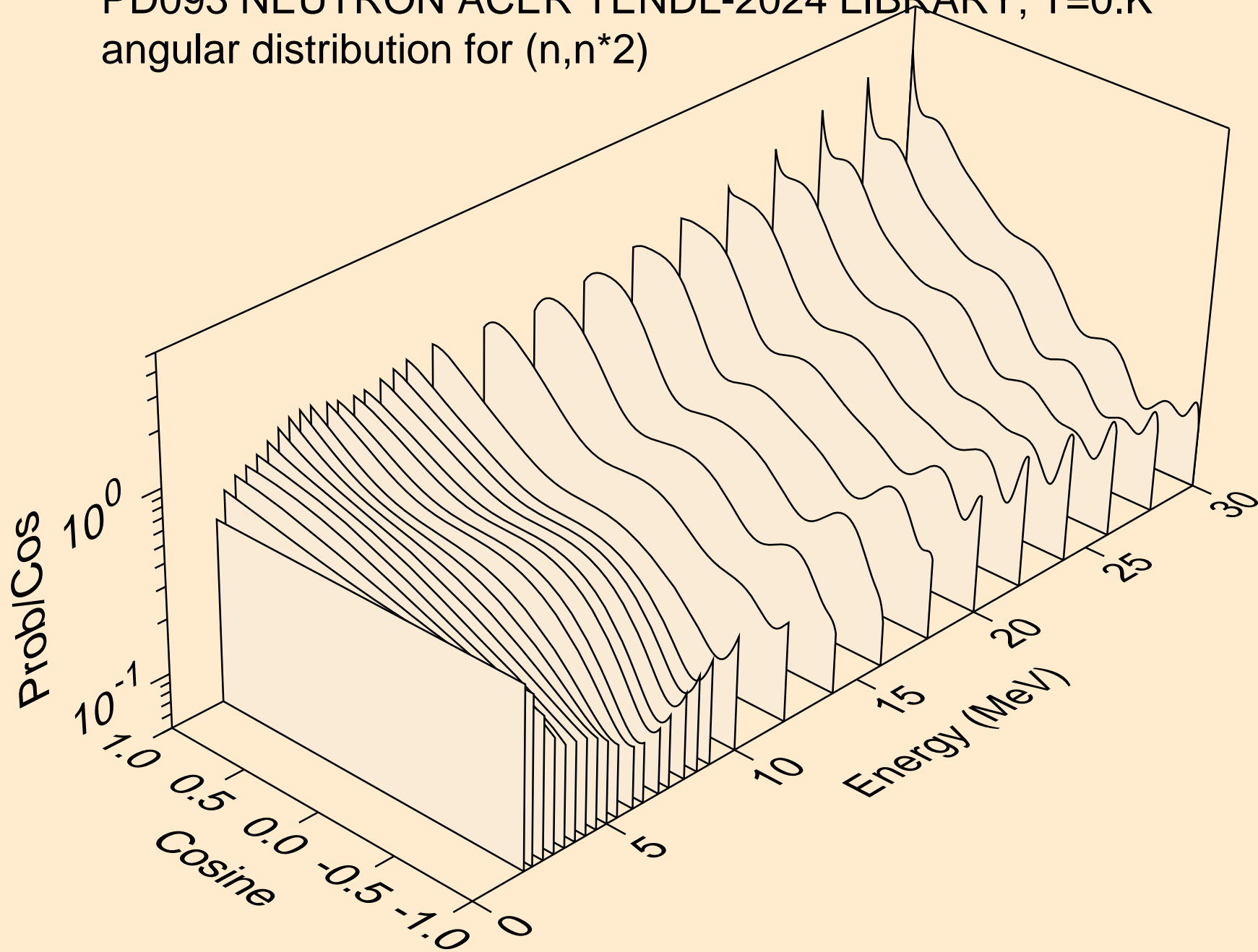

PD093 NEUTRON ACER TENDL-2024 LIBRARY; T=0.K  
angular distribution for (n,n\*3)

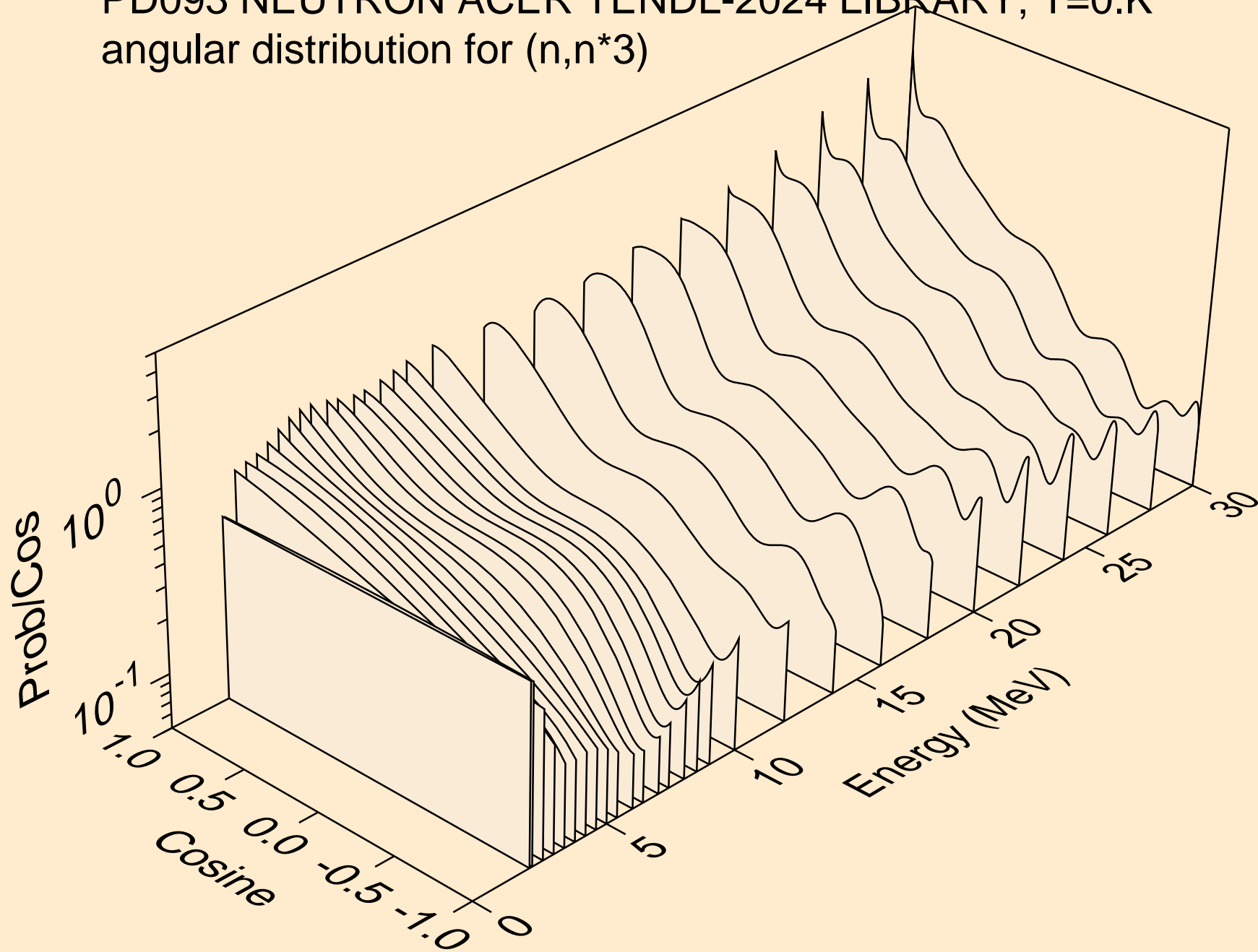

PD093 NEUTRON ACER TENDL-2024 LIBRARY; T=0.K  
angular distribution for (n,n\*4)

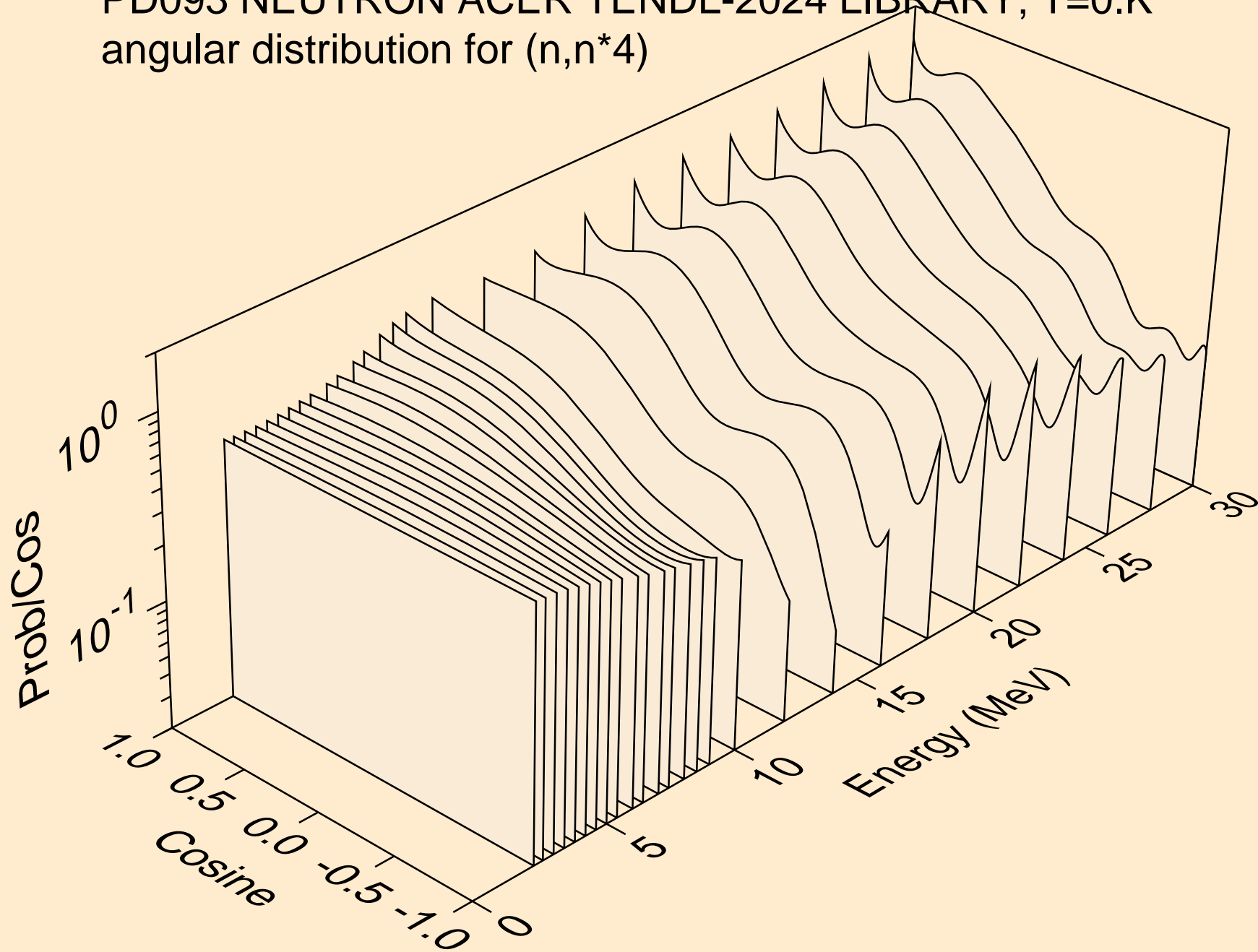

PD093 NEUTRON ACER TENDL-2024 LIBRARY; T=0.K  
angular distribution for (n,n\*5)

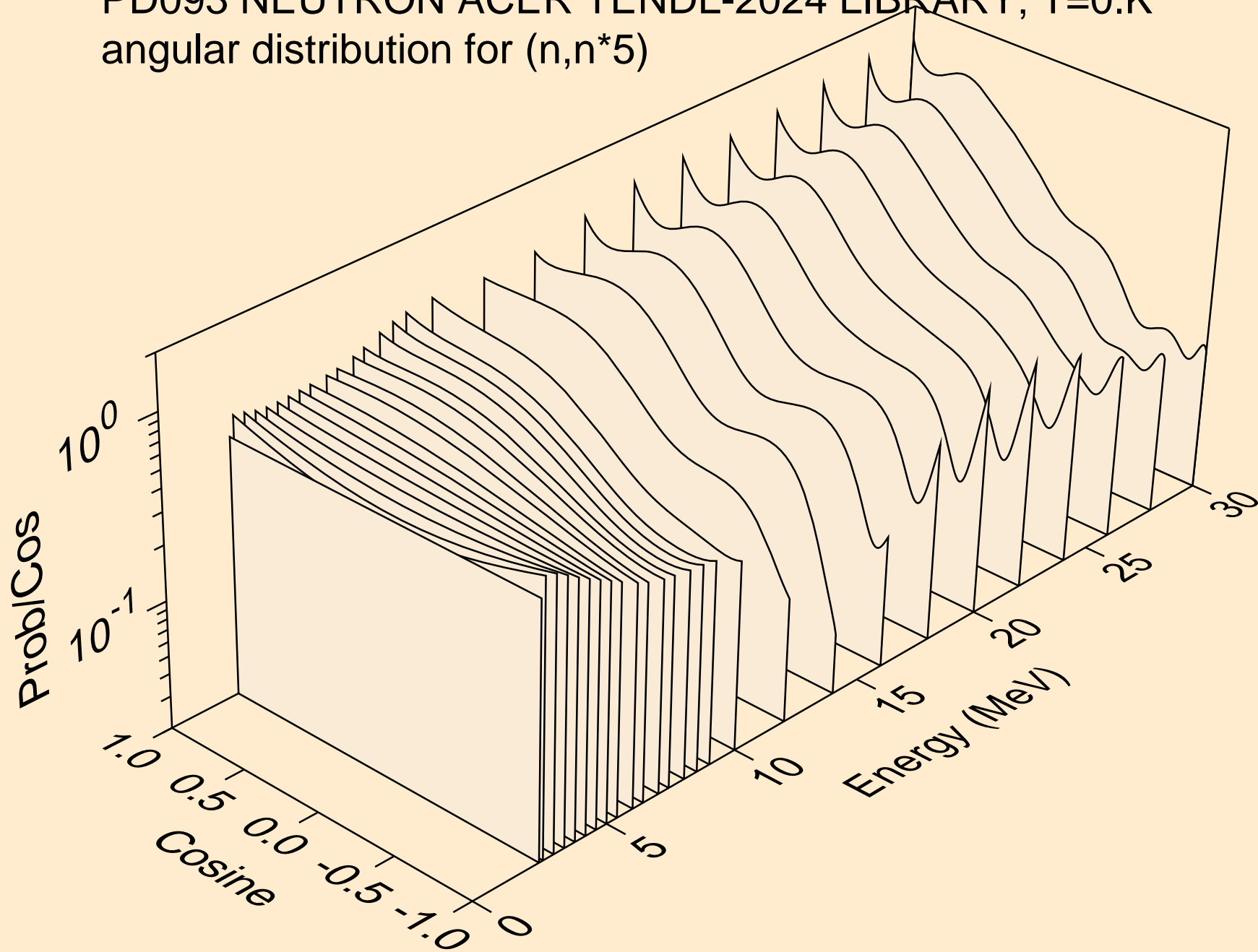

PD093 NEUTRON ACER TENDL-2024 LIBRARY; T=0.K  
angular distribution for (n,n\*6)

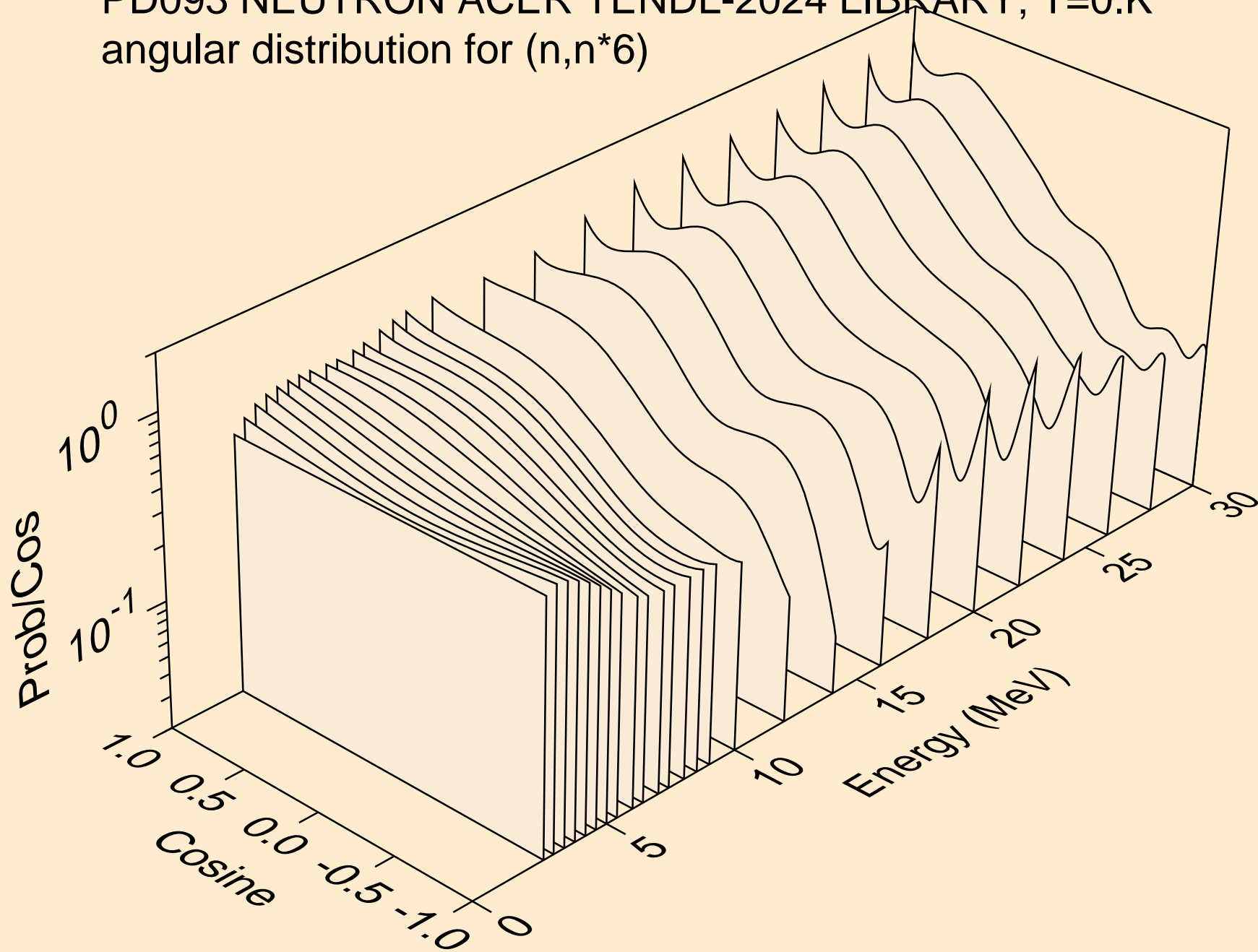

PD093 NEUTRON ACER TENDL-2024 LIBRARY; T=0.K  
angular distribution for (n,n\*7)

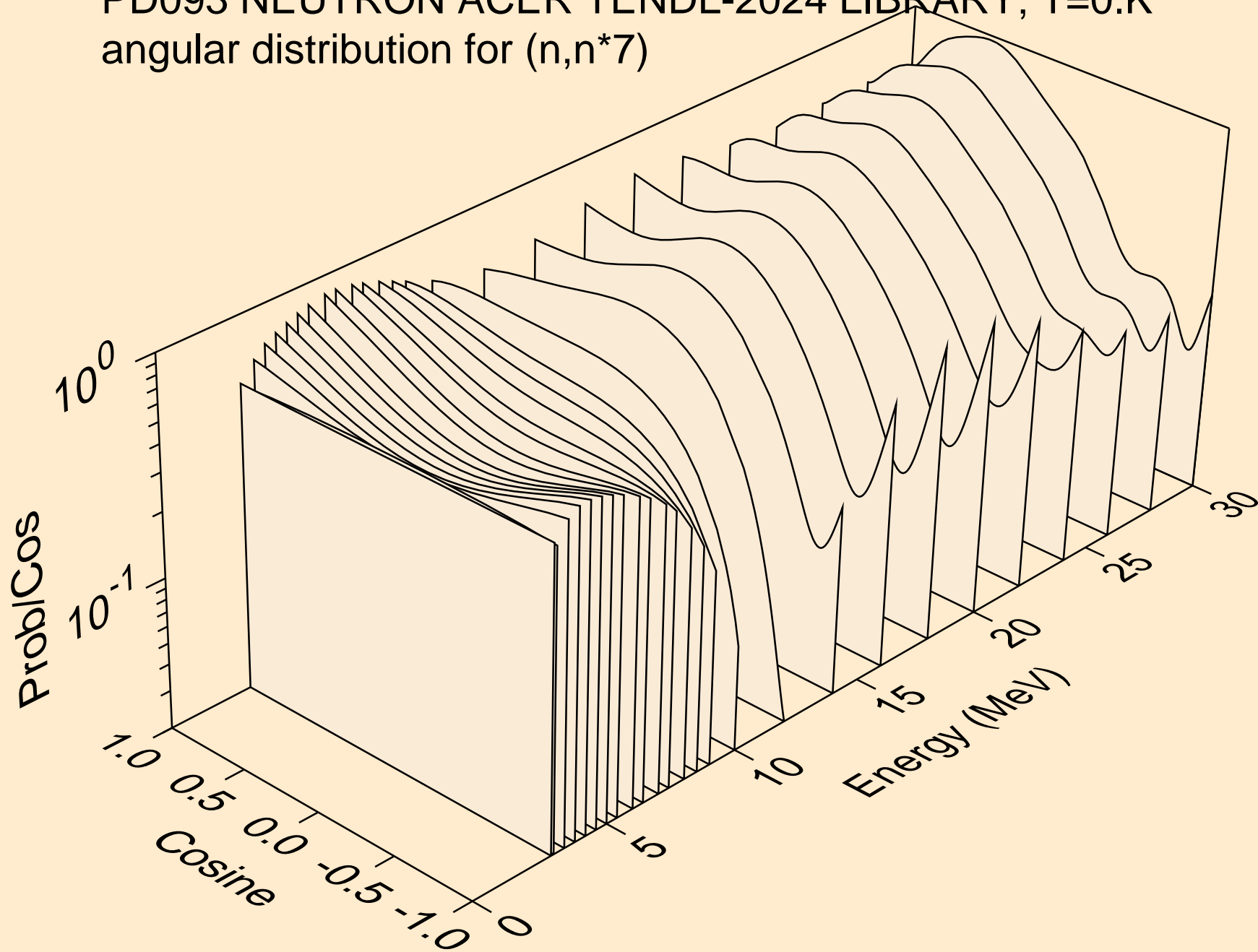

PD093 NEUTRON ACER TENDL-2024 LIBRARY; T=0.K  
angular distribution for (n,n\*8)

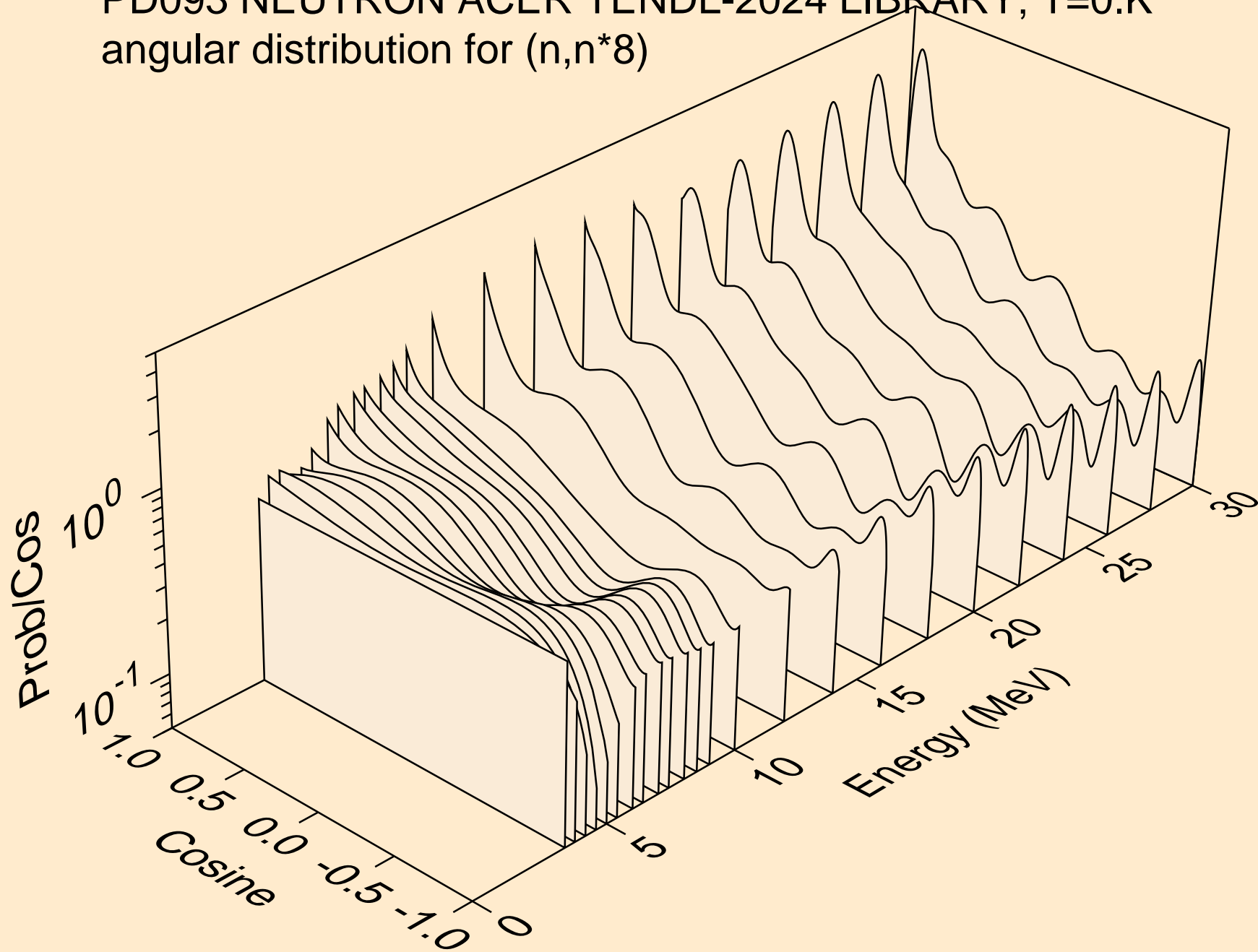

PD093 NEUTRON ACER TENDL-2024 LIBRARY; T=0.K  
angular distribution for (n,n\*9)

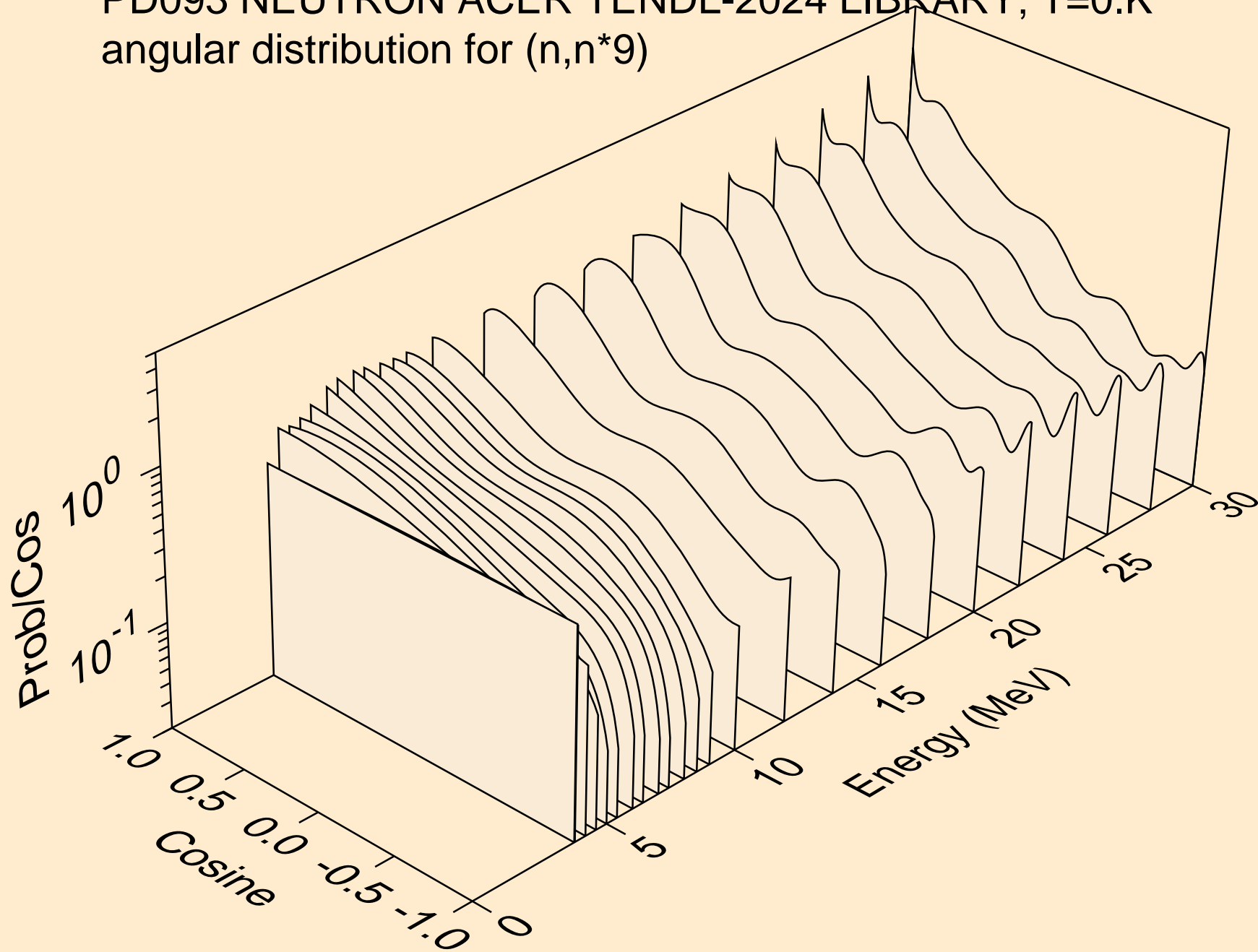

PD093 NEUTRON ACER TENDL-2024 LIBRARY; T=0.K  
angular distribution for (n,n\*10)

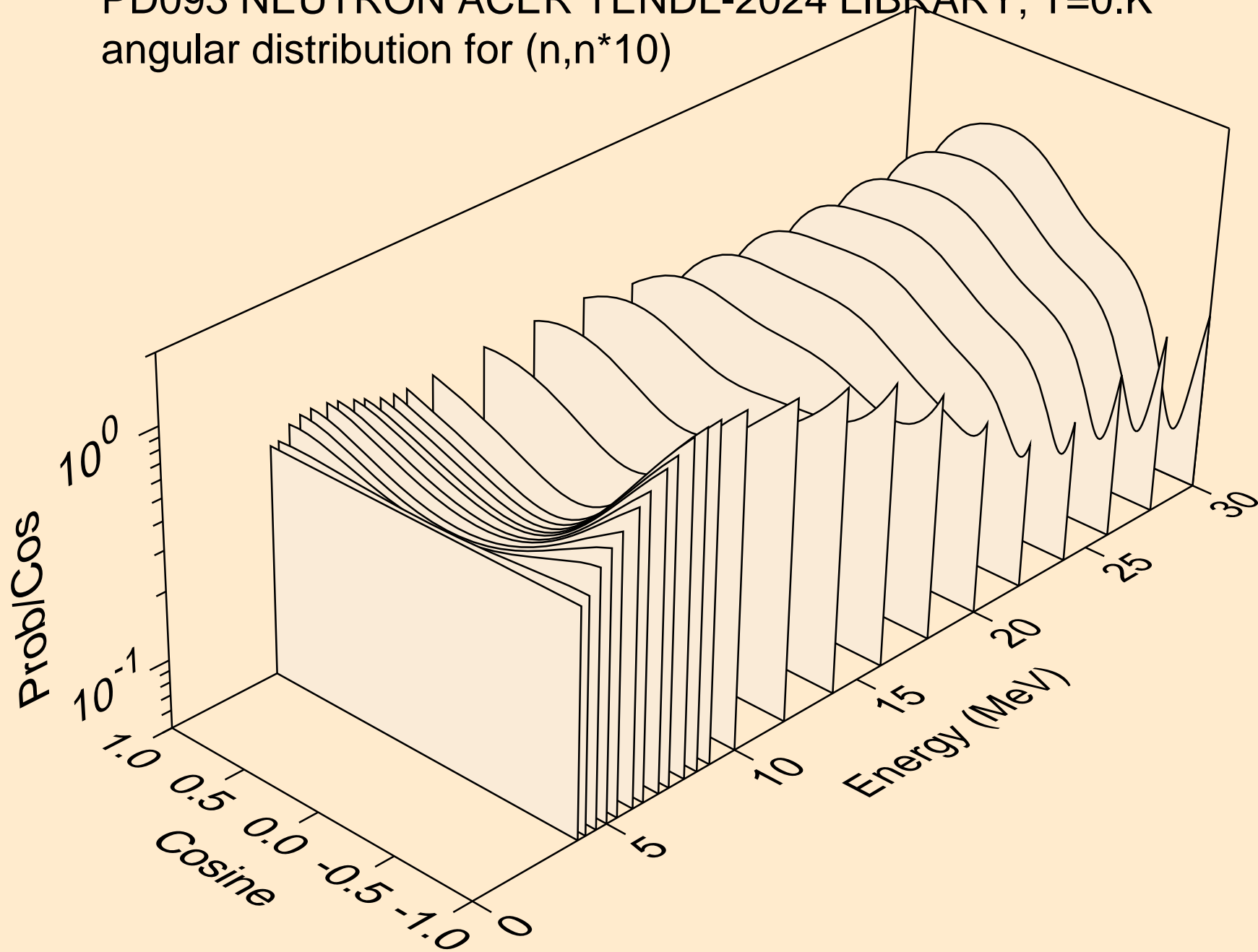

PD093 NEUTRON ACER TENDL-2024 LIBRARY; T=0.K  
angular distribution for (n,n\*11)

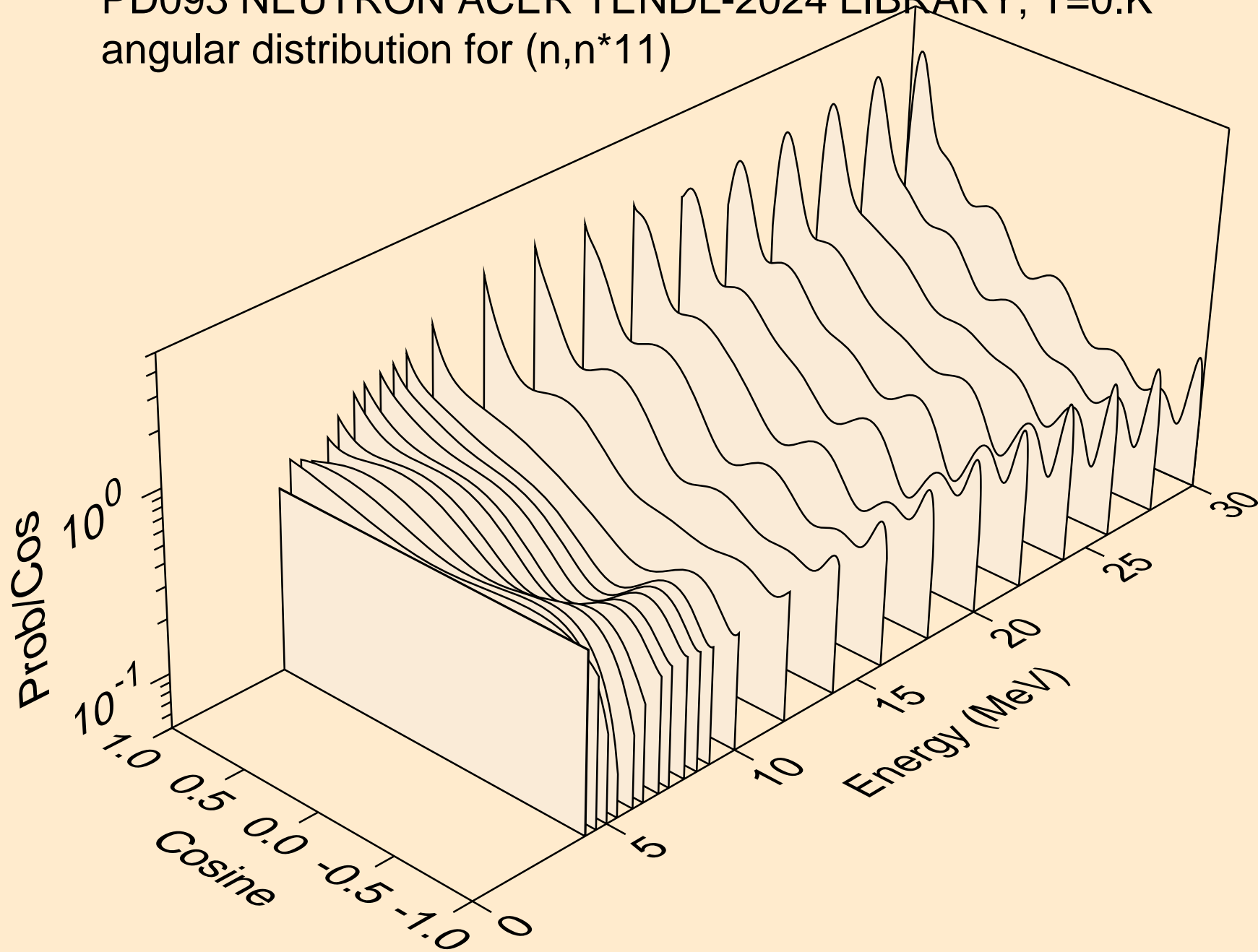

PD093 NEUTRON ACER TENDL-2024 LIBRARY; T=0.K  
Neutron emission for (n,x)

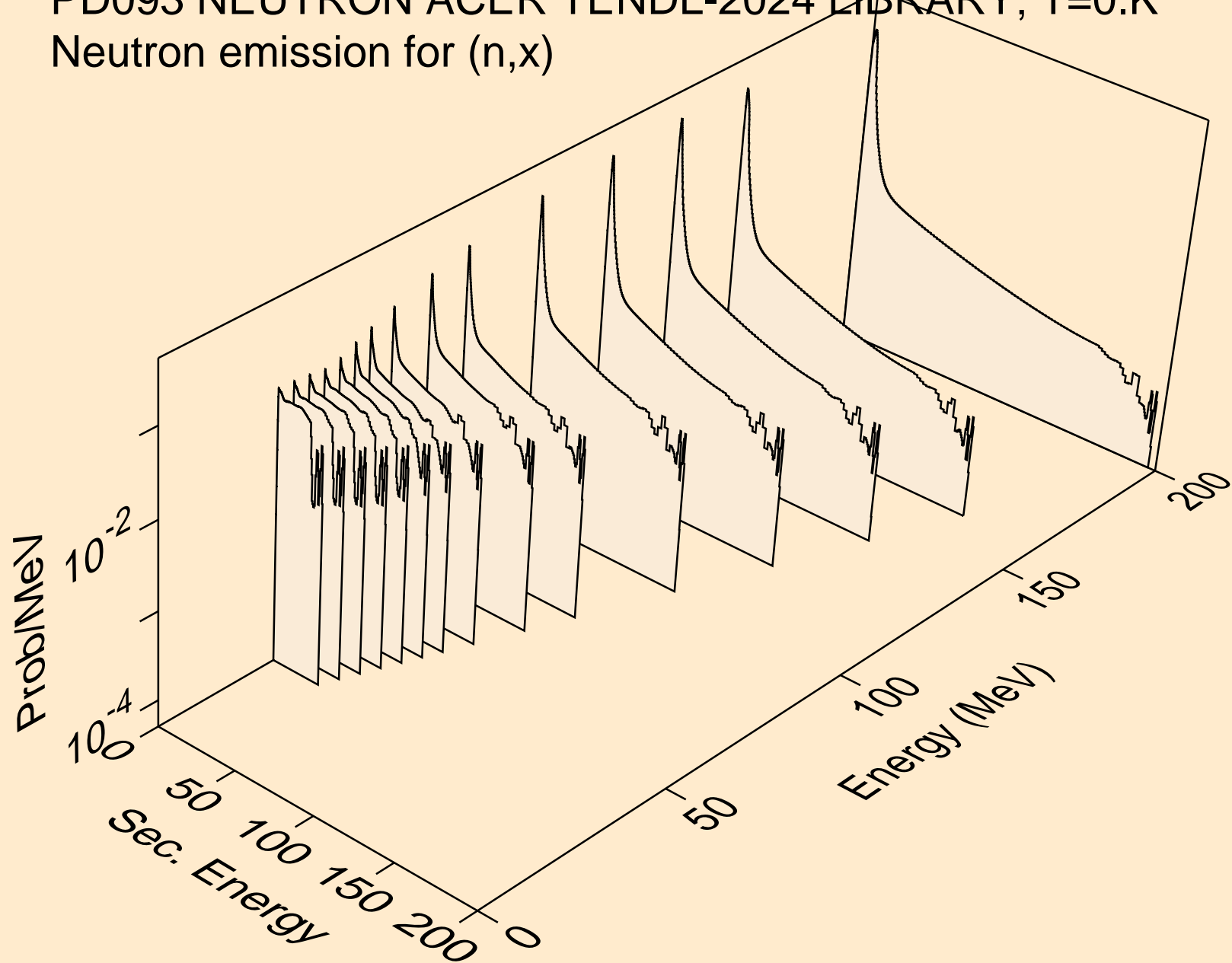

PD093 NEUTRON ACER TENDL-2024 LIBRARY; T=0.K  
Neutron emission for (n,2n)

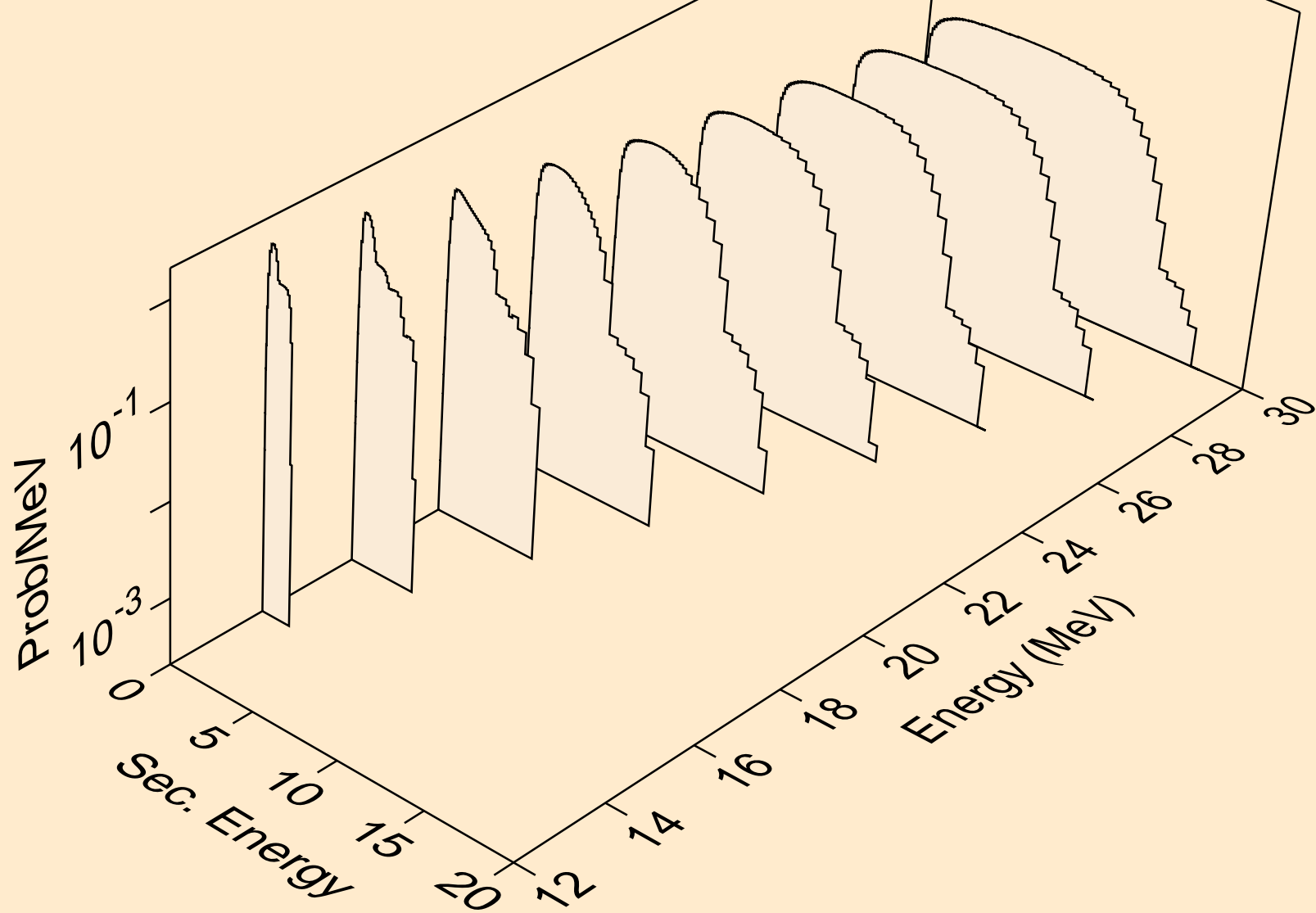

PD093 NEUTRON ACER TENDL-2024 LIBRARY; T=0.K  
Neutron emission for (n,n\*)a

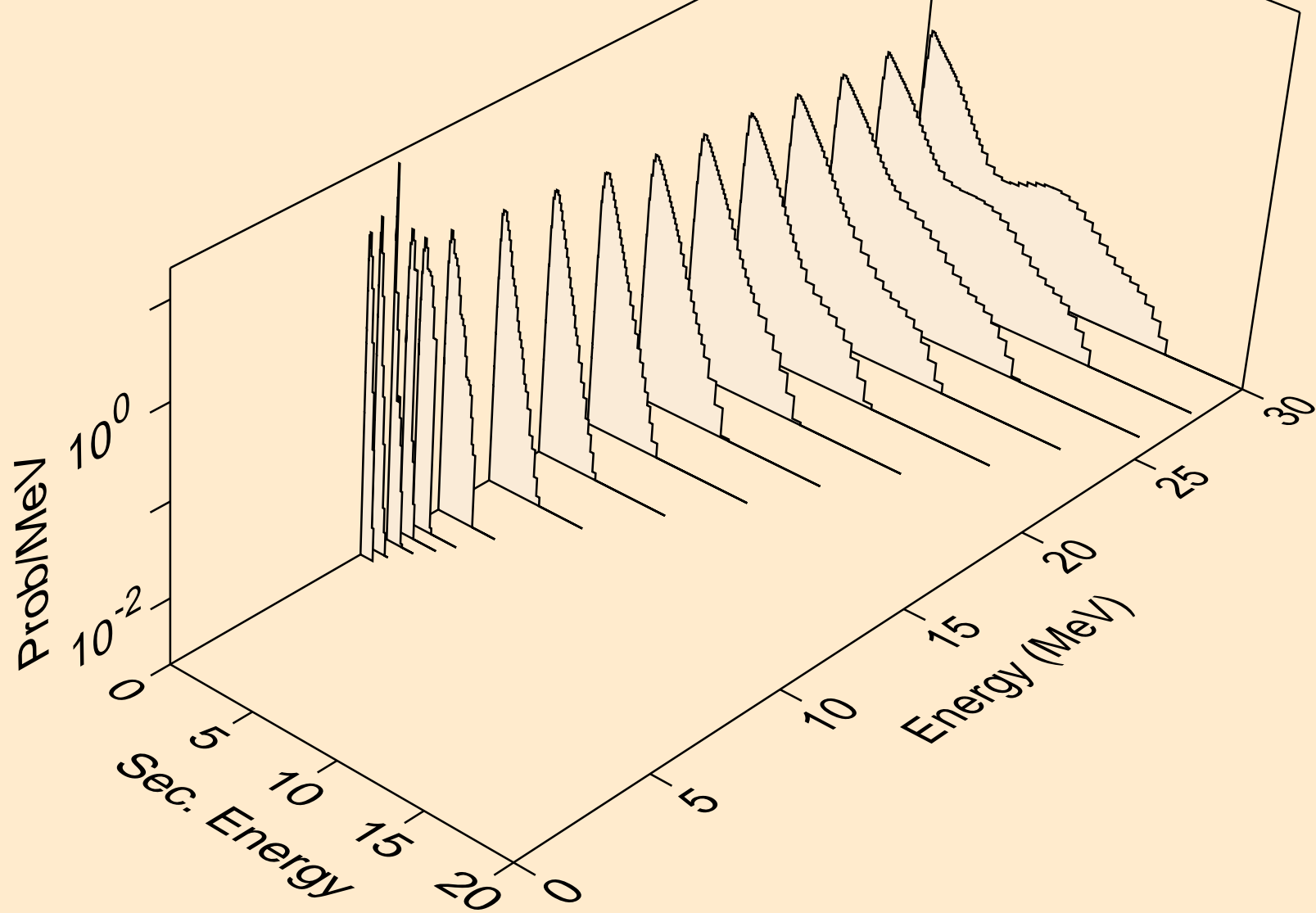

PD093 NEUTRON ACER TENDL-2024 LIBRARY; T=0.K  
Neutron emission for (n,2n)<sub>a</sub>

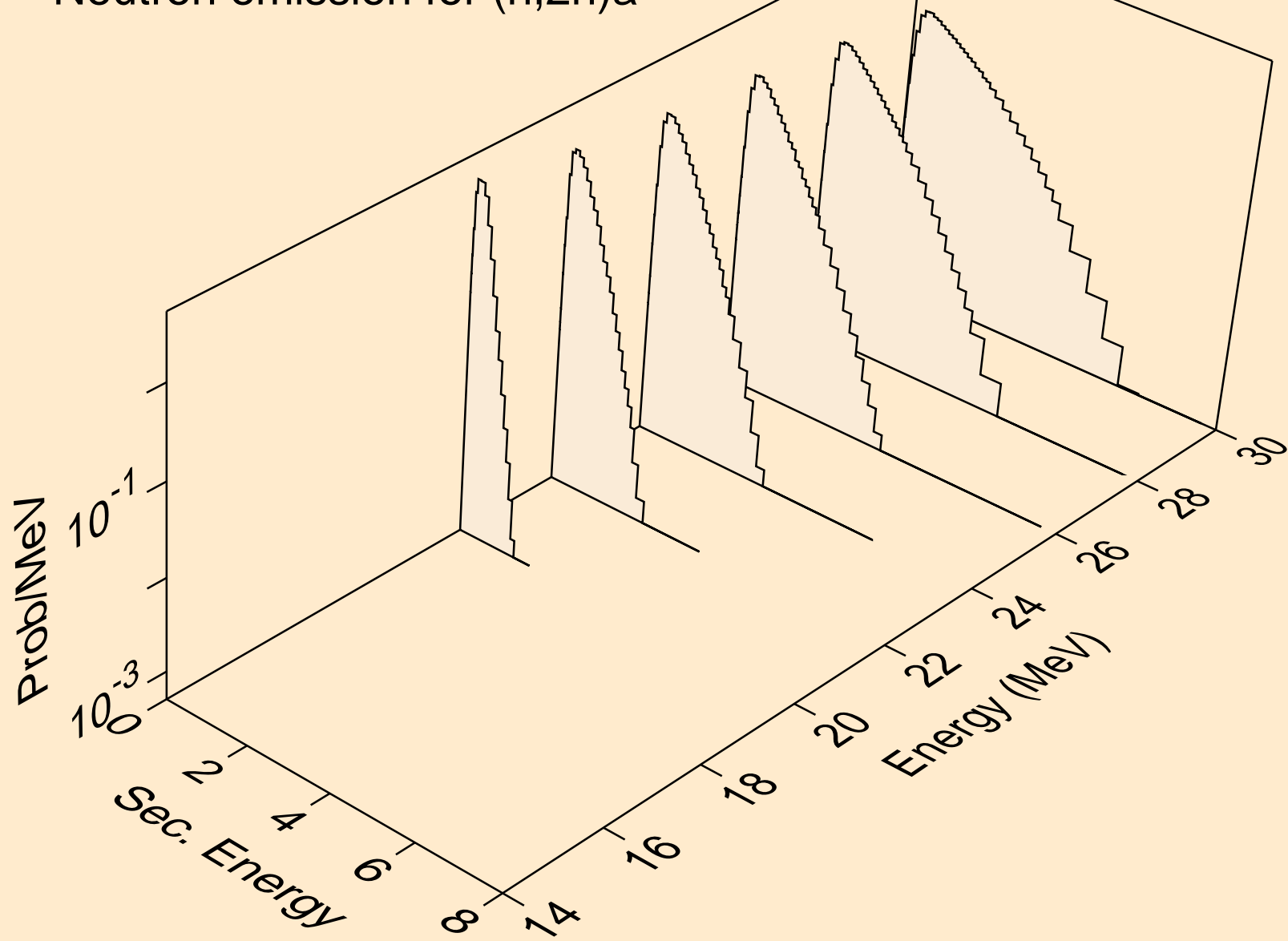

PD093 NEUTRON ACER TENDL-2024 LIBRARY; T=0.K  
Neutron emission for (n,n\*)p

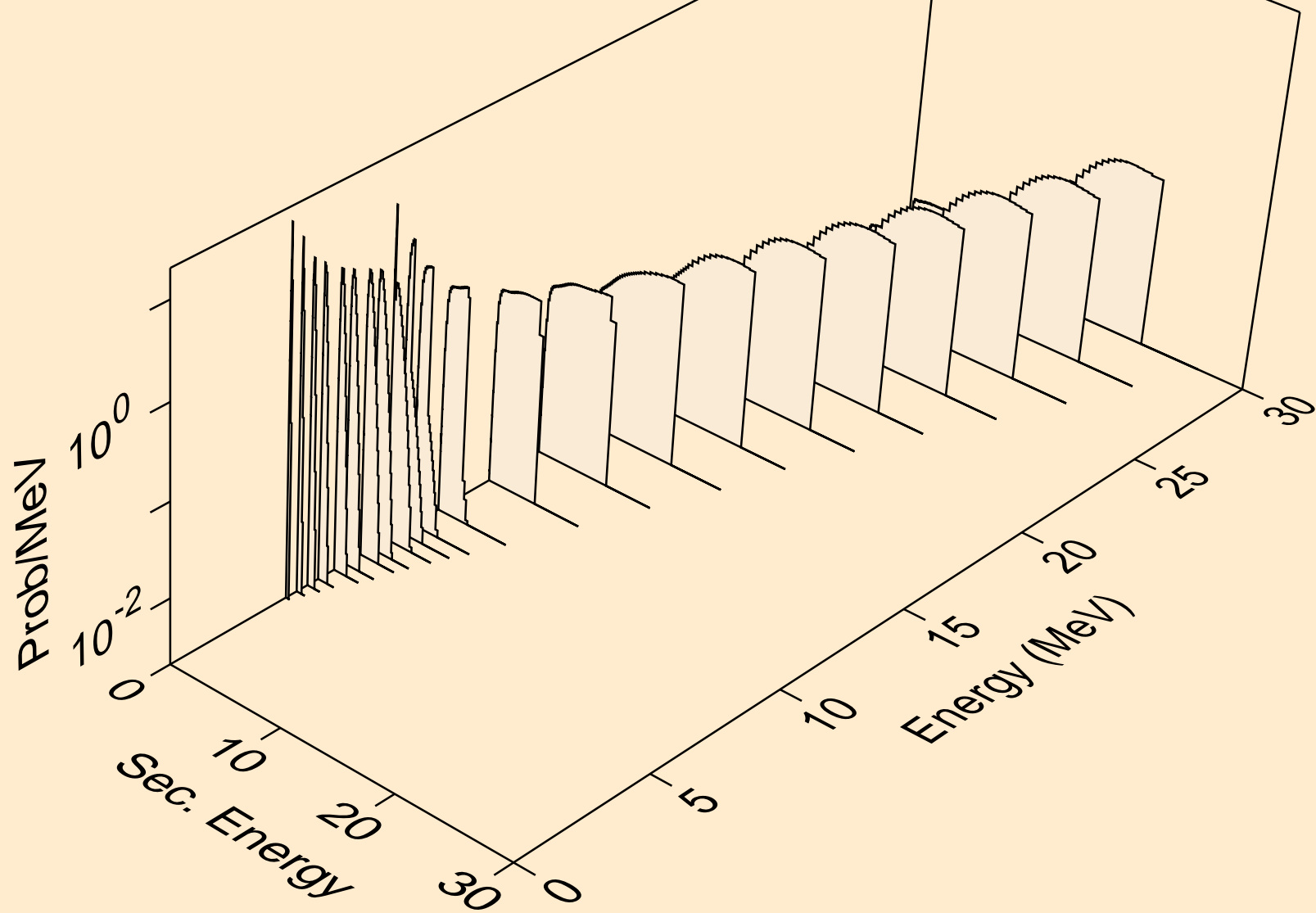

PD093 NEUTRON ACER TENDL-2024 LIBRARY; T=0.K  
Neutron emission for (n,n\*)2a

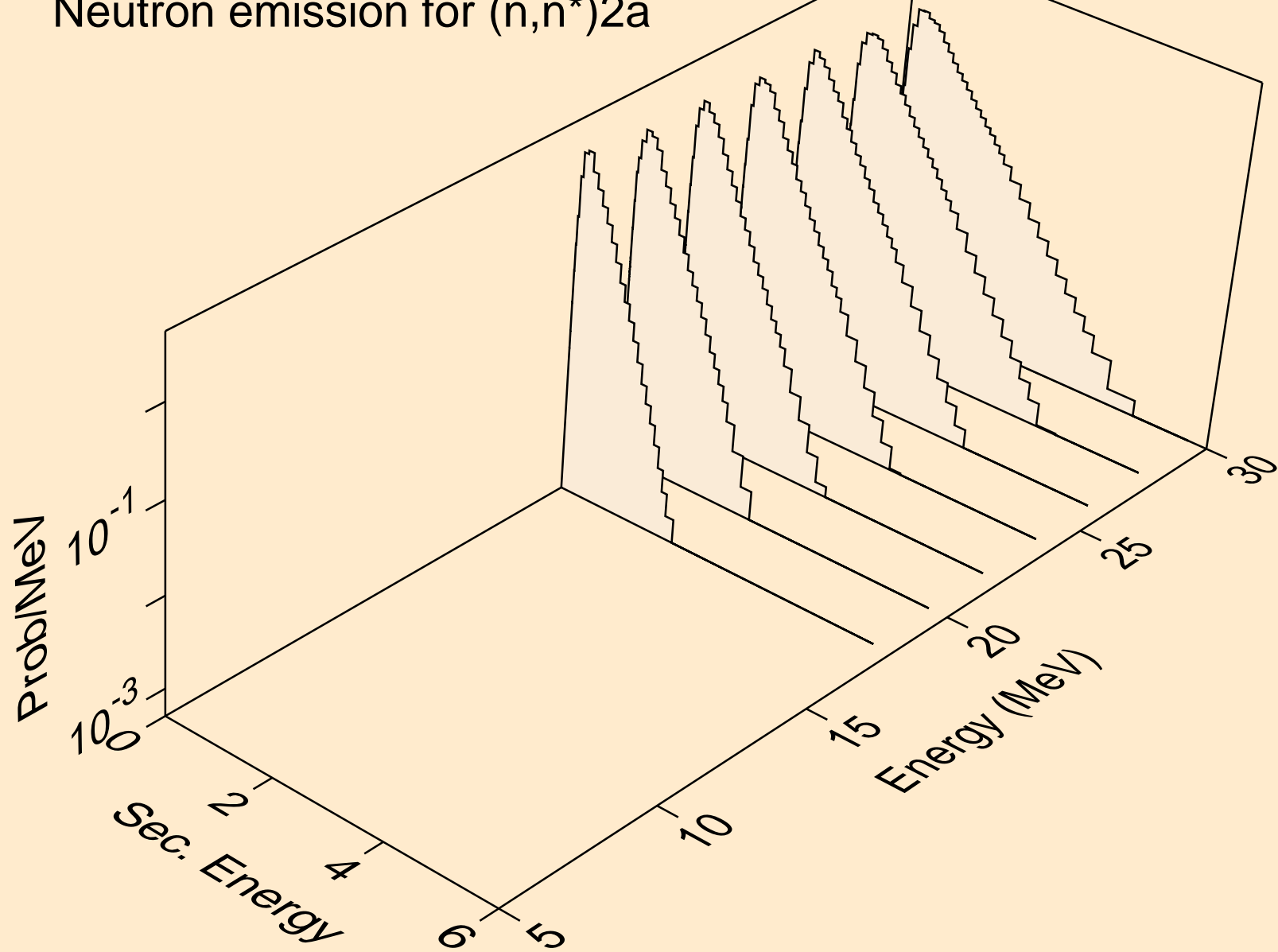

PD093 NEUTRON ACER TENDL-2024 LIBRARY; T=0.K  
Neutron emission for (n,n\*)d

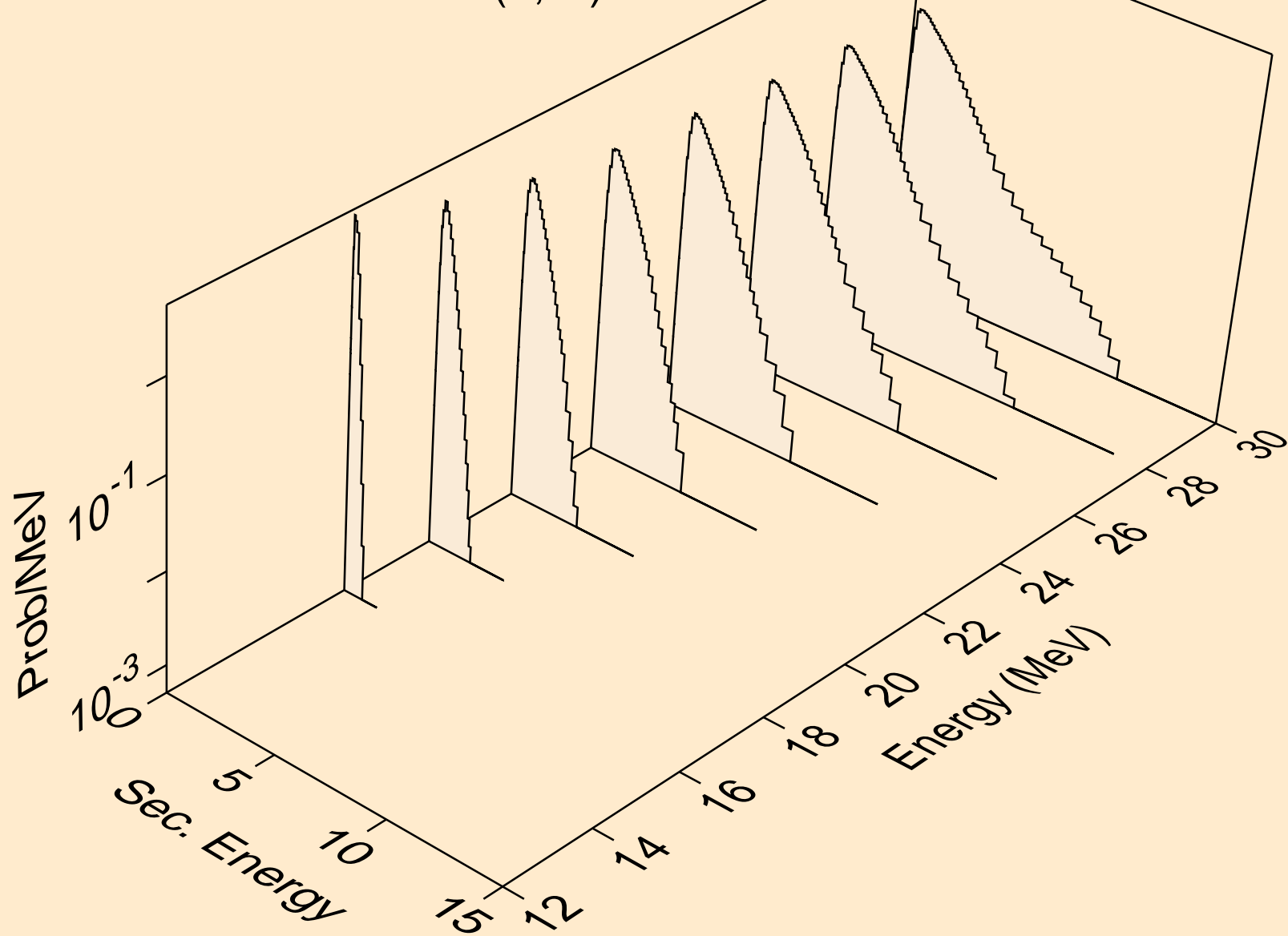

PD093 NEUTRON ACER TENDL-2024 LIBRARY; T=0.K  
Neutron emission for (n,n\*)t

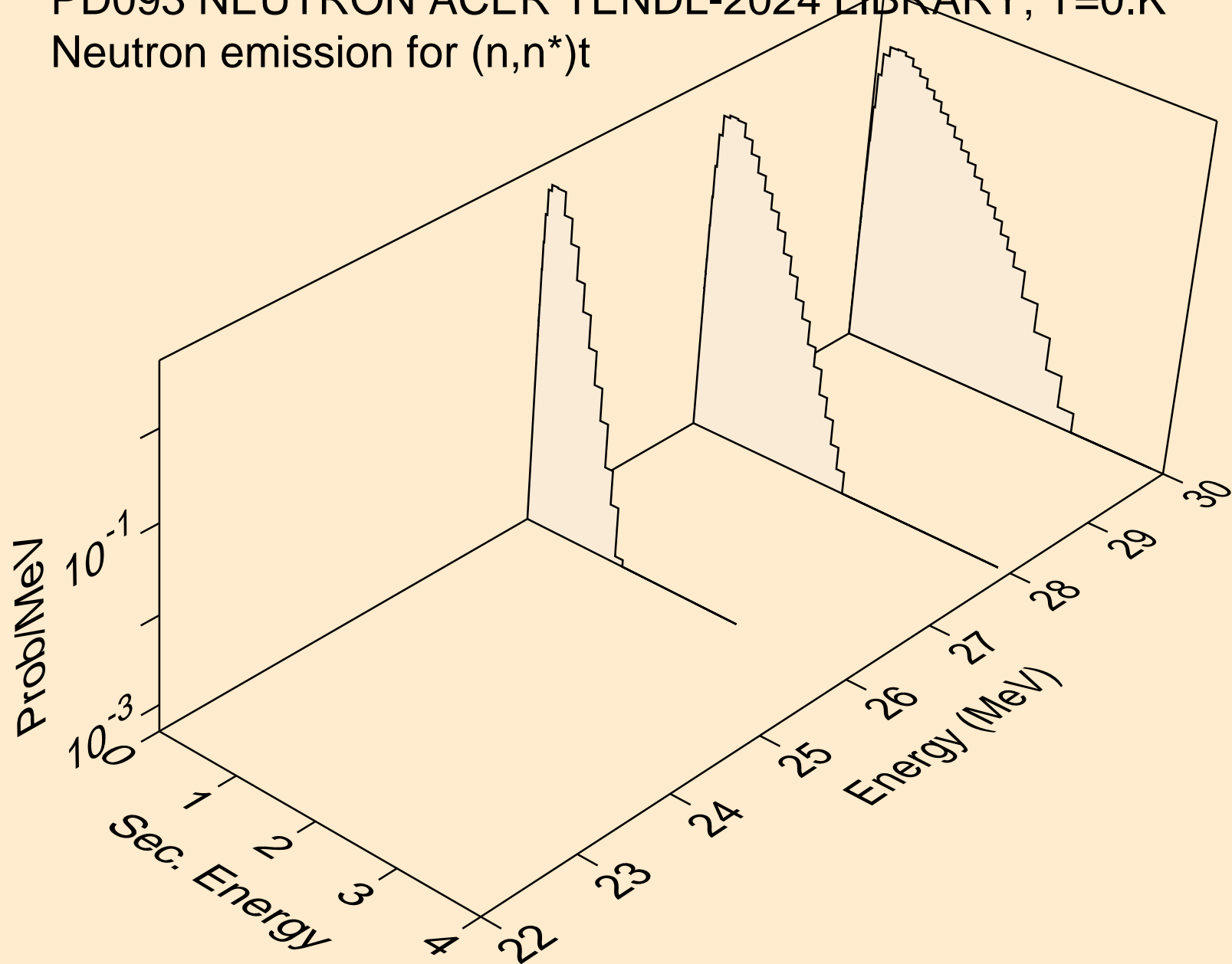

PD093 NEUTRON ACER TENDL-2024 LIBRARY; T=0.K  
Neutron emission for (n,n\*)he3

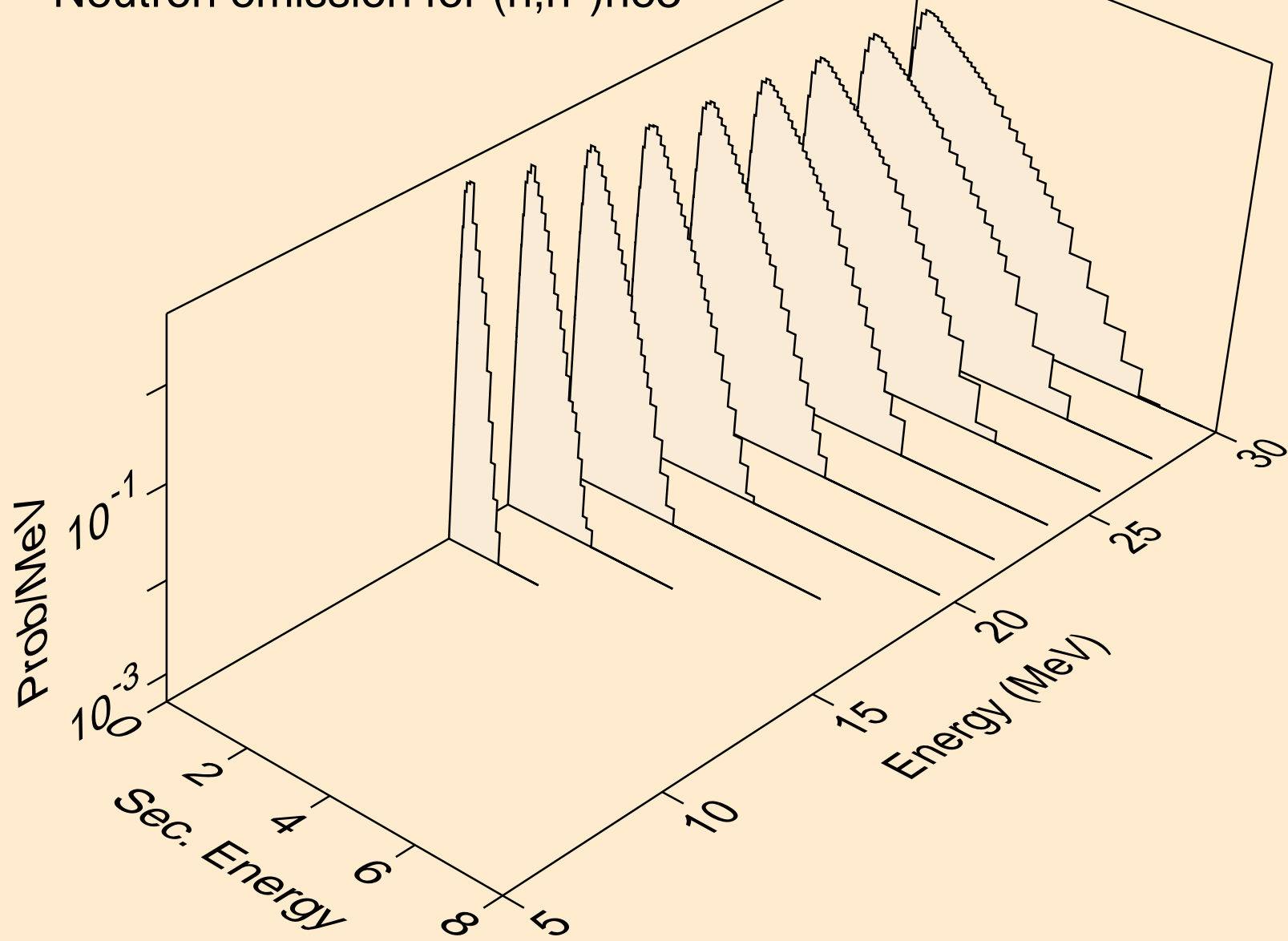

PD093 NEUTRON ACER TENDL-2024 LIBRARY; T=0.K  
Neutron emission for (n,2np)

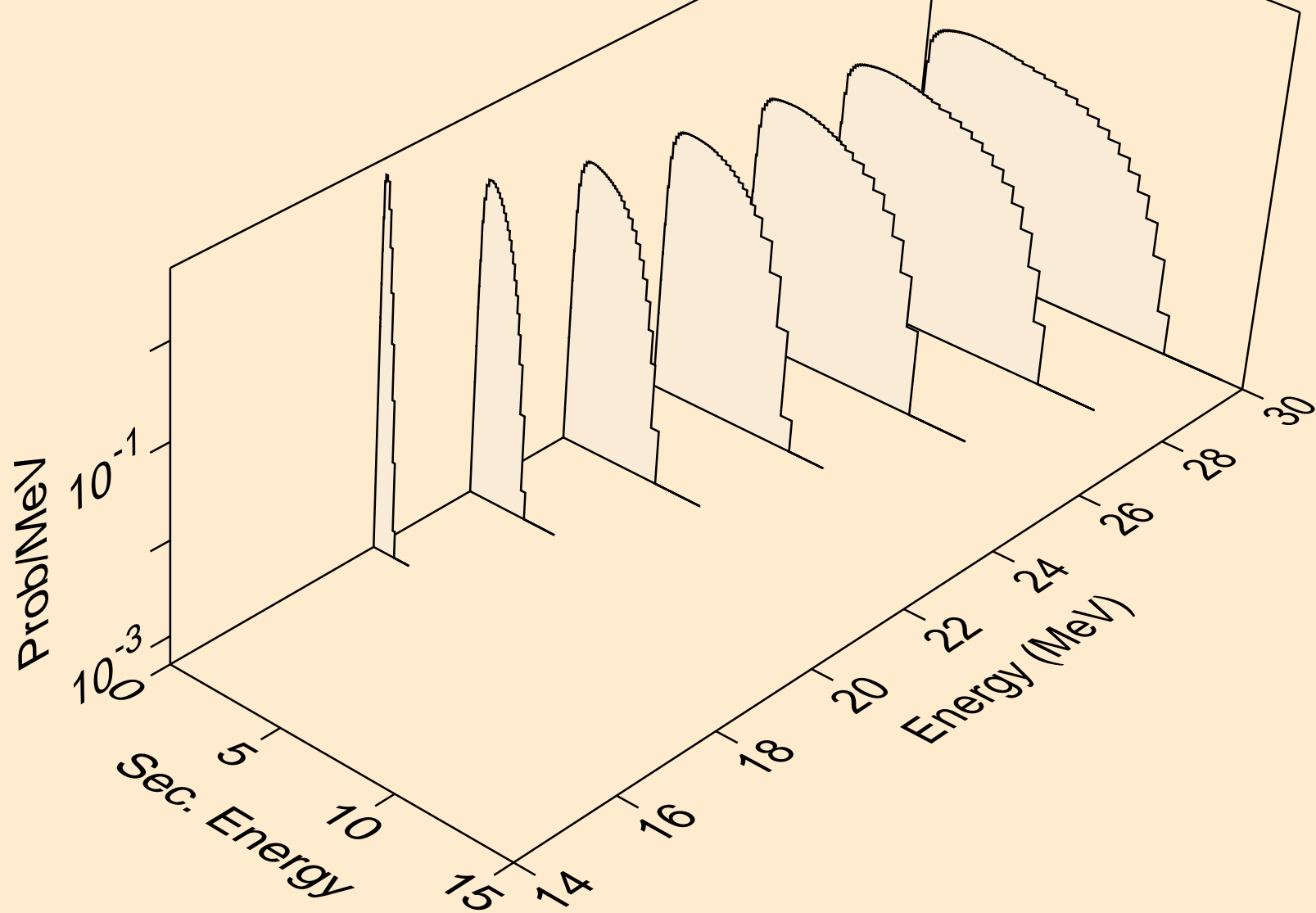

PD093 NEUTRON ACER TENDL-2024 LIBRARY; T=0.K  
Neutron emission for (n,n2p)

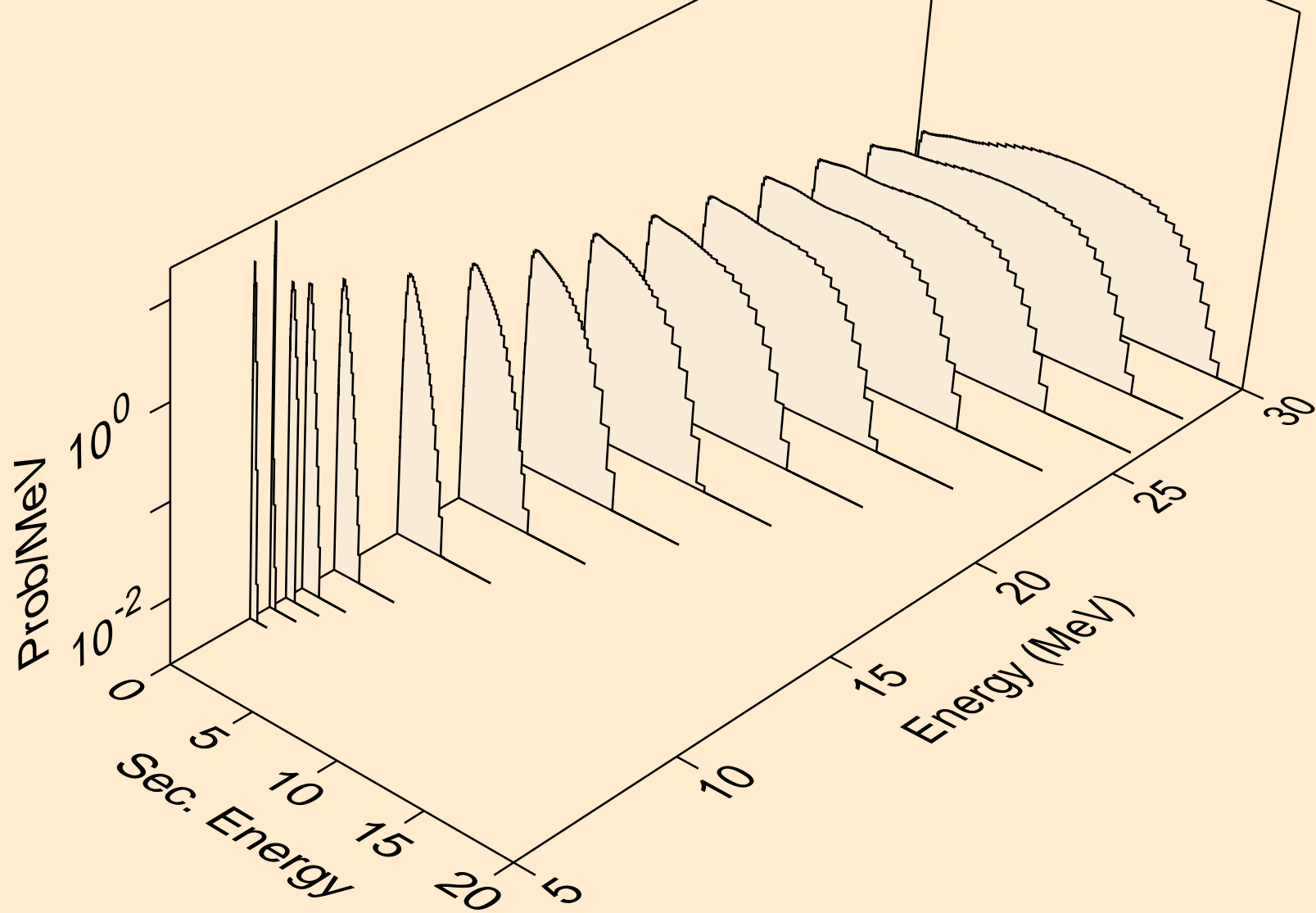

PD093 NEUTRON ACER TENDL-2024 LIBRARY; T=0.K  
Neutron emission for (n,npa)

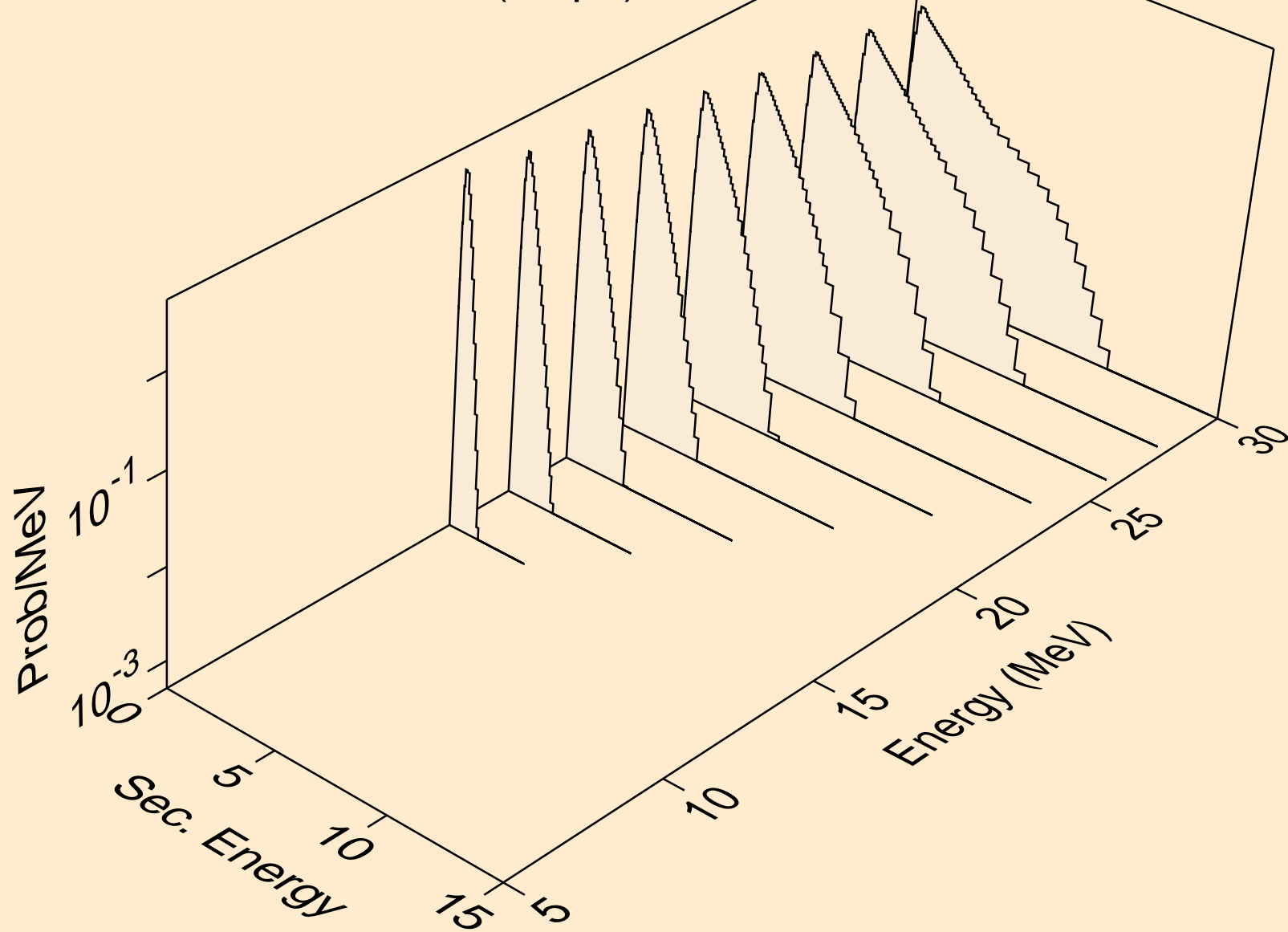

PD093 NEUTRON ACER TENDL-2024 LIBRARY; T=0.K  
Neutron emission for (n,n\*c)

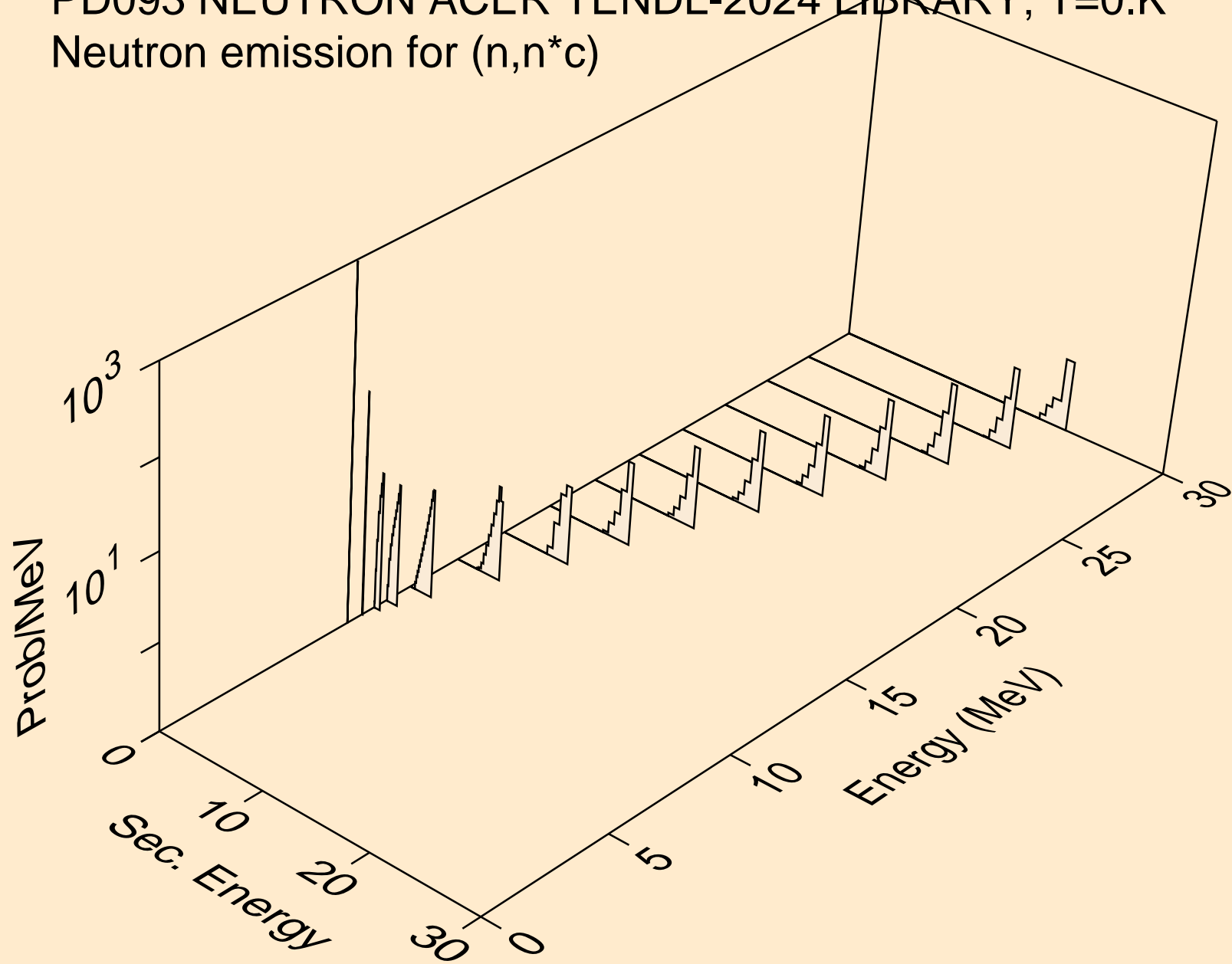

PD093 NEUTRON ACER TENDL-2024 LIBRARY; T=0.K  
Photon emission for (n,x)

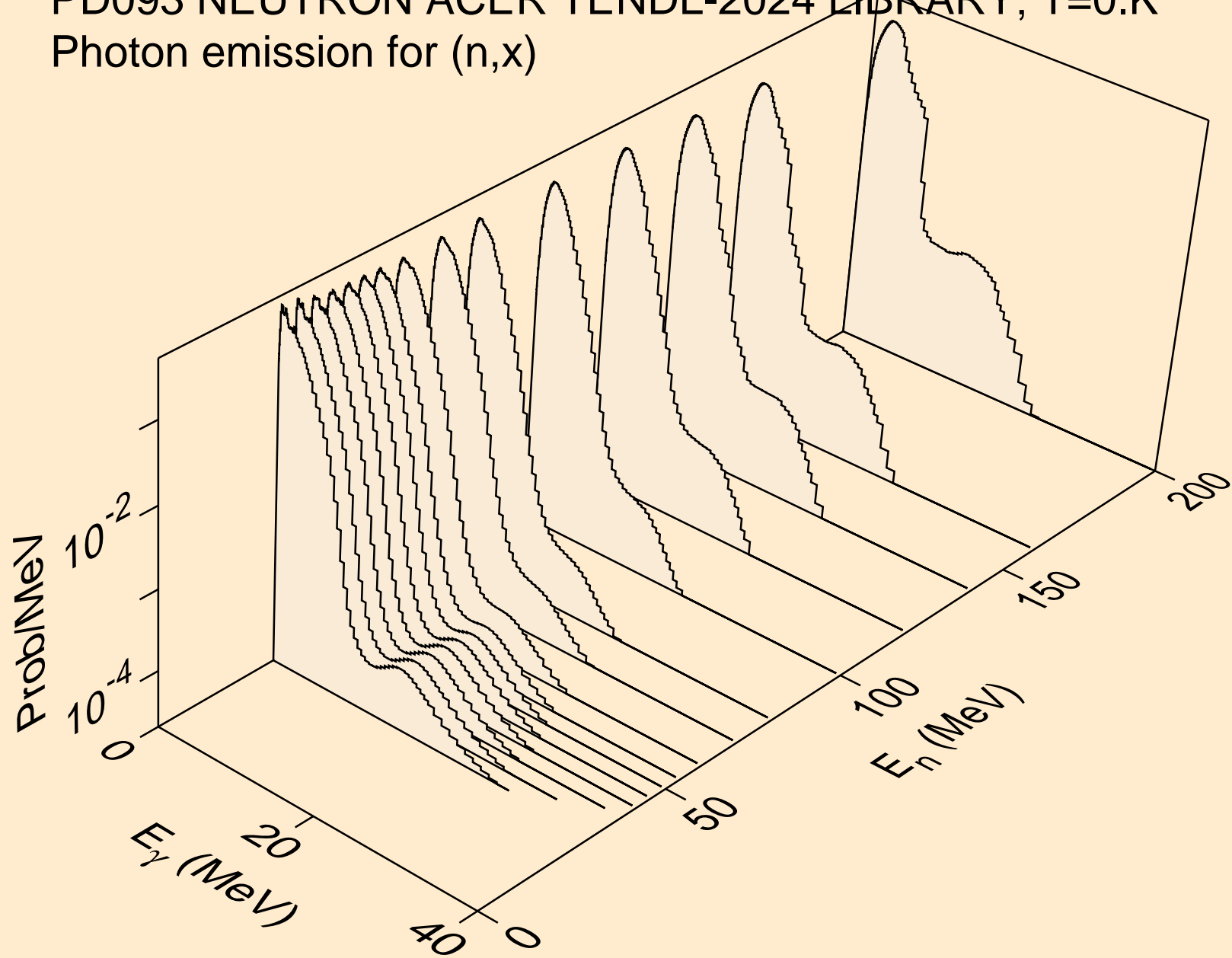

PD093 NEUTRON ACER TENDL-2024 LIBRARY; T=0.K  
Photon emission for (n,2n)

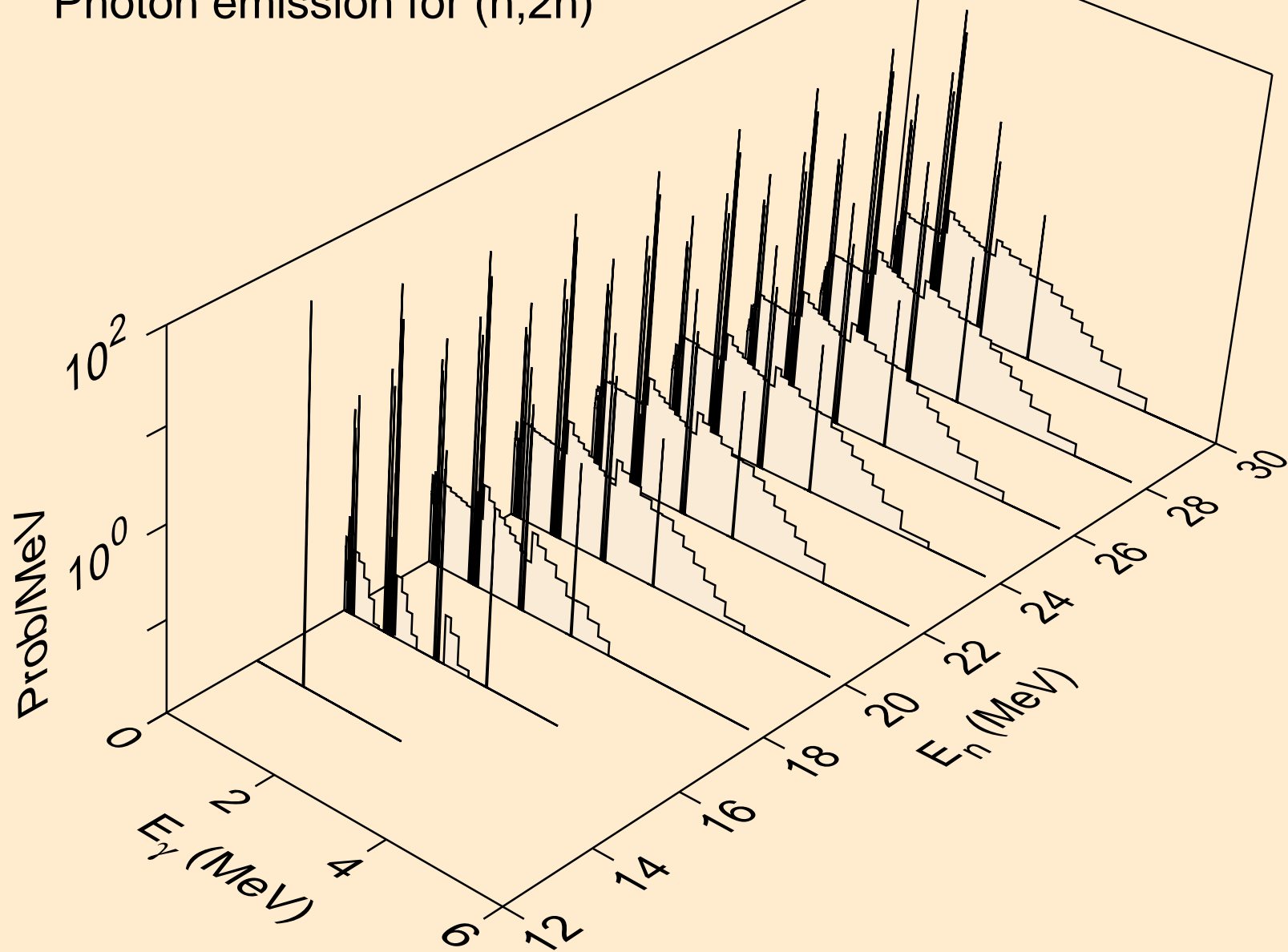

PD093 NEUTRON ACER TENDL-2024 LIBRARY; T=0.K  
Photon emission for (n,n\*)a

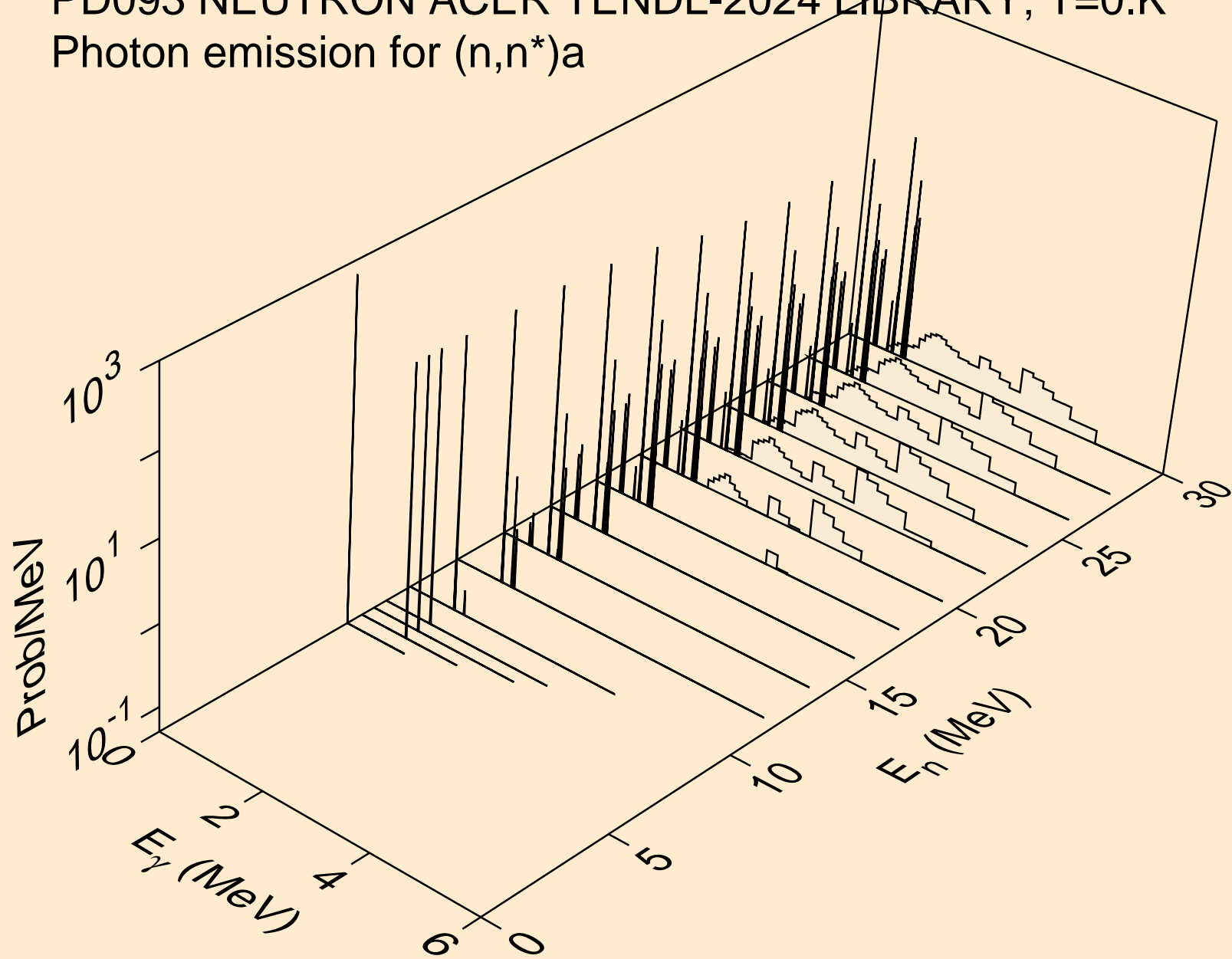

PD093 NEUTRON ACER TENDL-2024 LIBRARY; T=0.K  
Photon emission for (n,2n)a

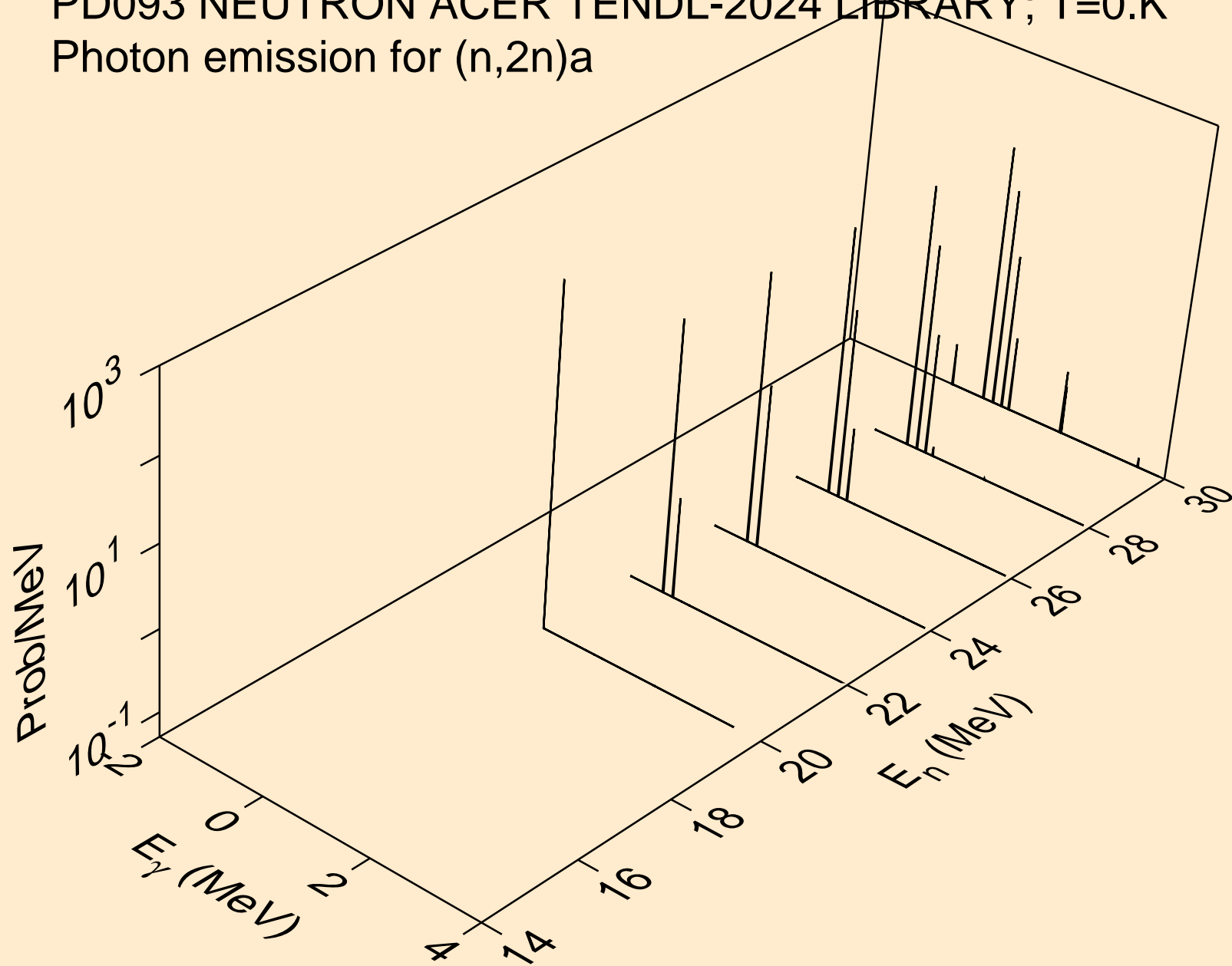

PD093 NEUTRON ACER TENDL-2024 LIBRARY; T=0.K  
Photon emission for (n,n\*)p

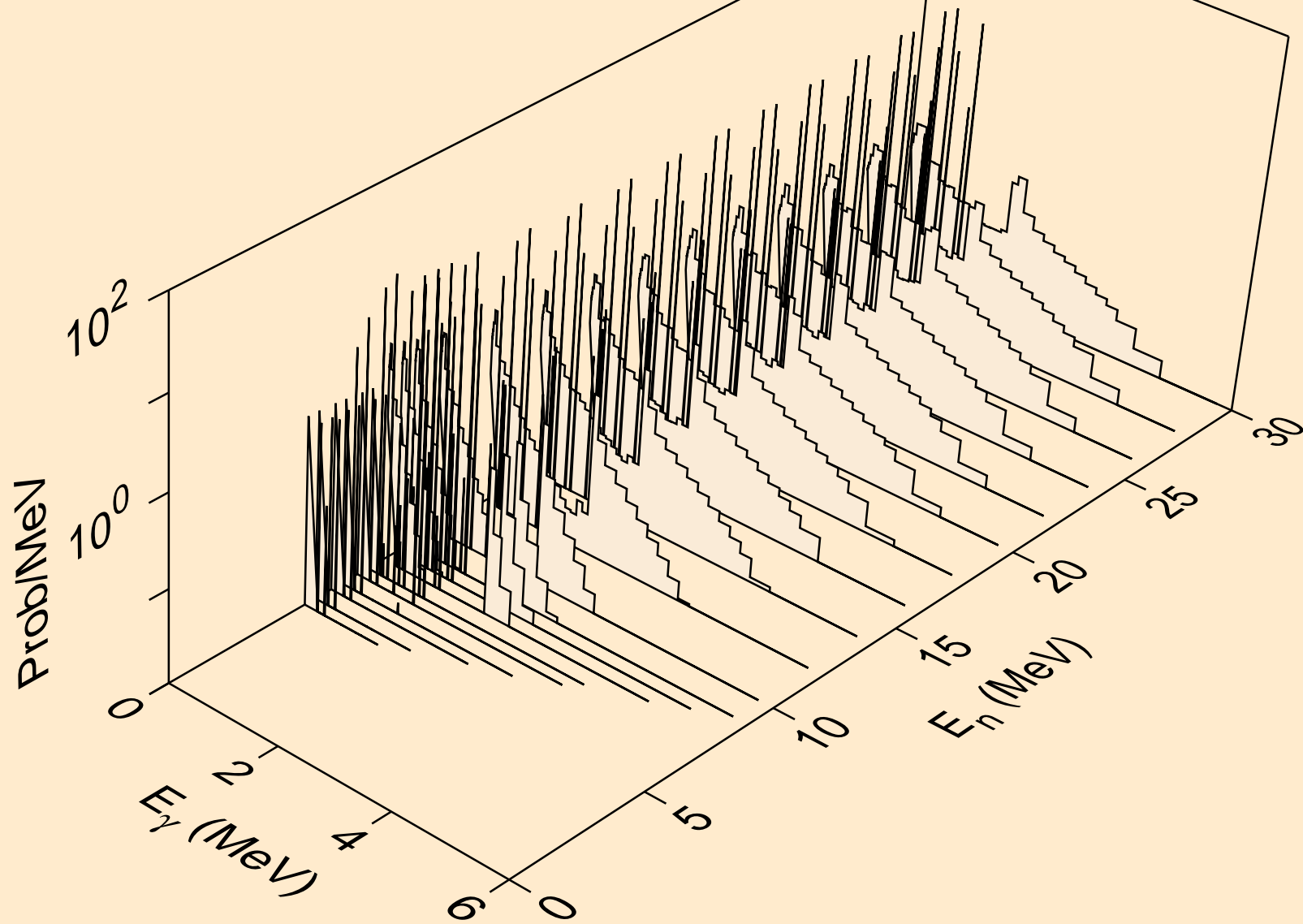

PD093 NEUTRON ACER TENDL-2024 LIBRARY; T=0.K  
Photon emission for (n,n\*)2a

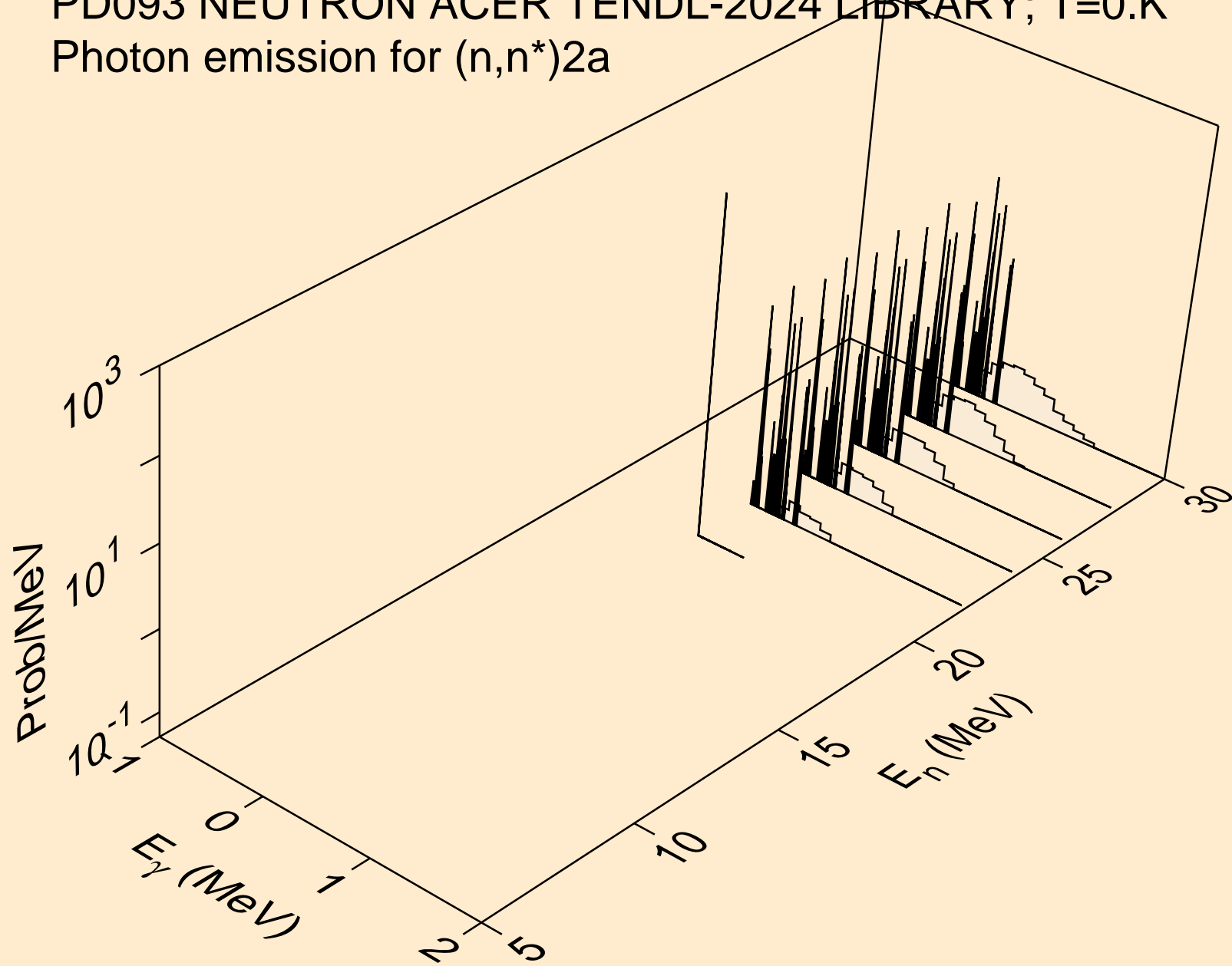

PD093 NEUTRON ACER TENDL-2024 LIBRARY; T=0.K  
Photon emission for (n,n\*)d

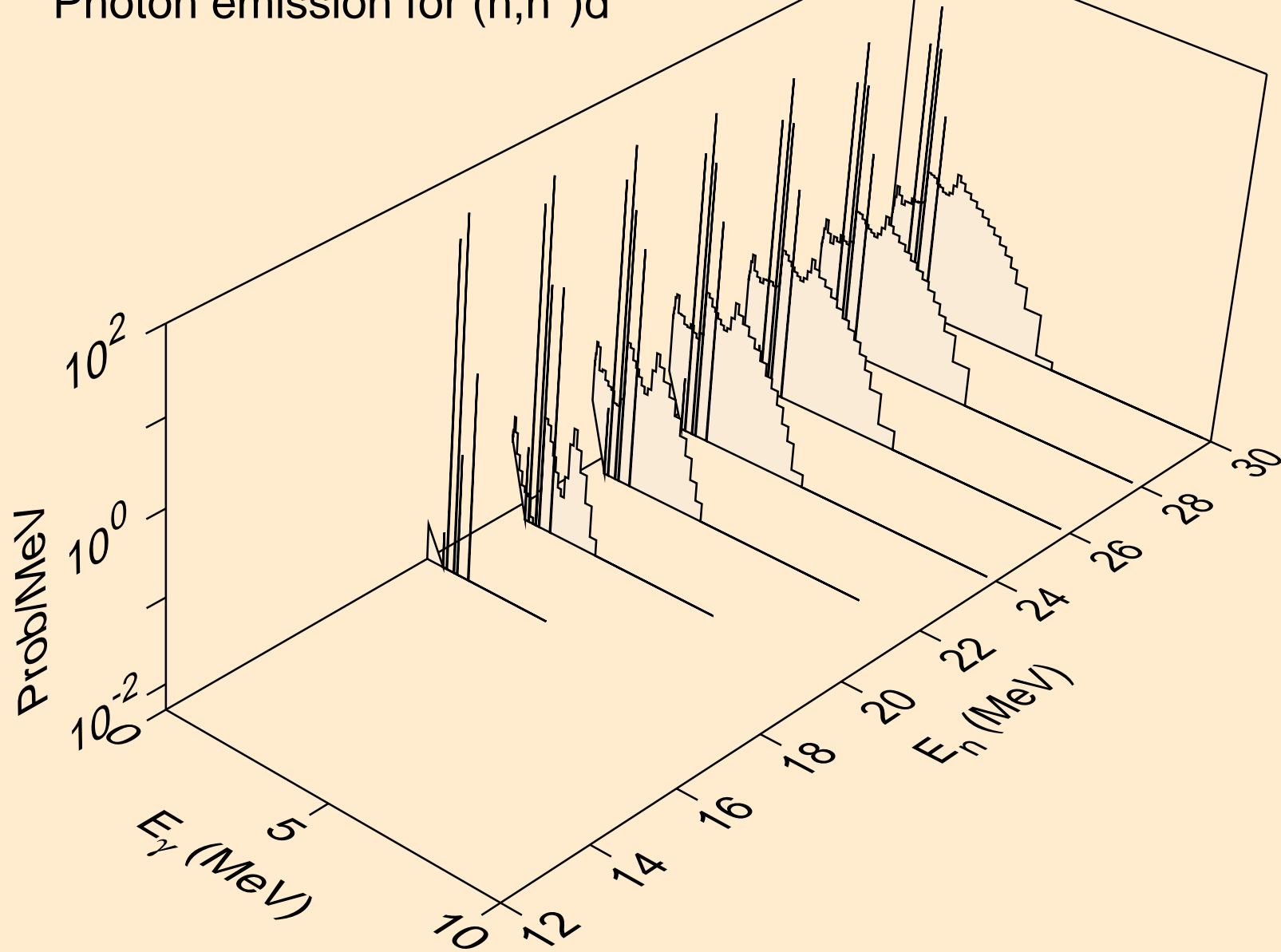

PD093 NEUTRON ACER TENDL-2024 LIBRARY; T=0.K  
Photon emission for (n,n\*)t

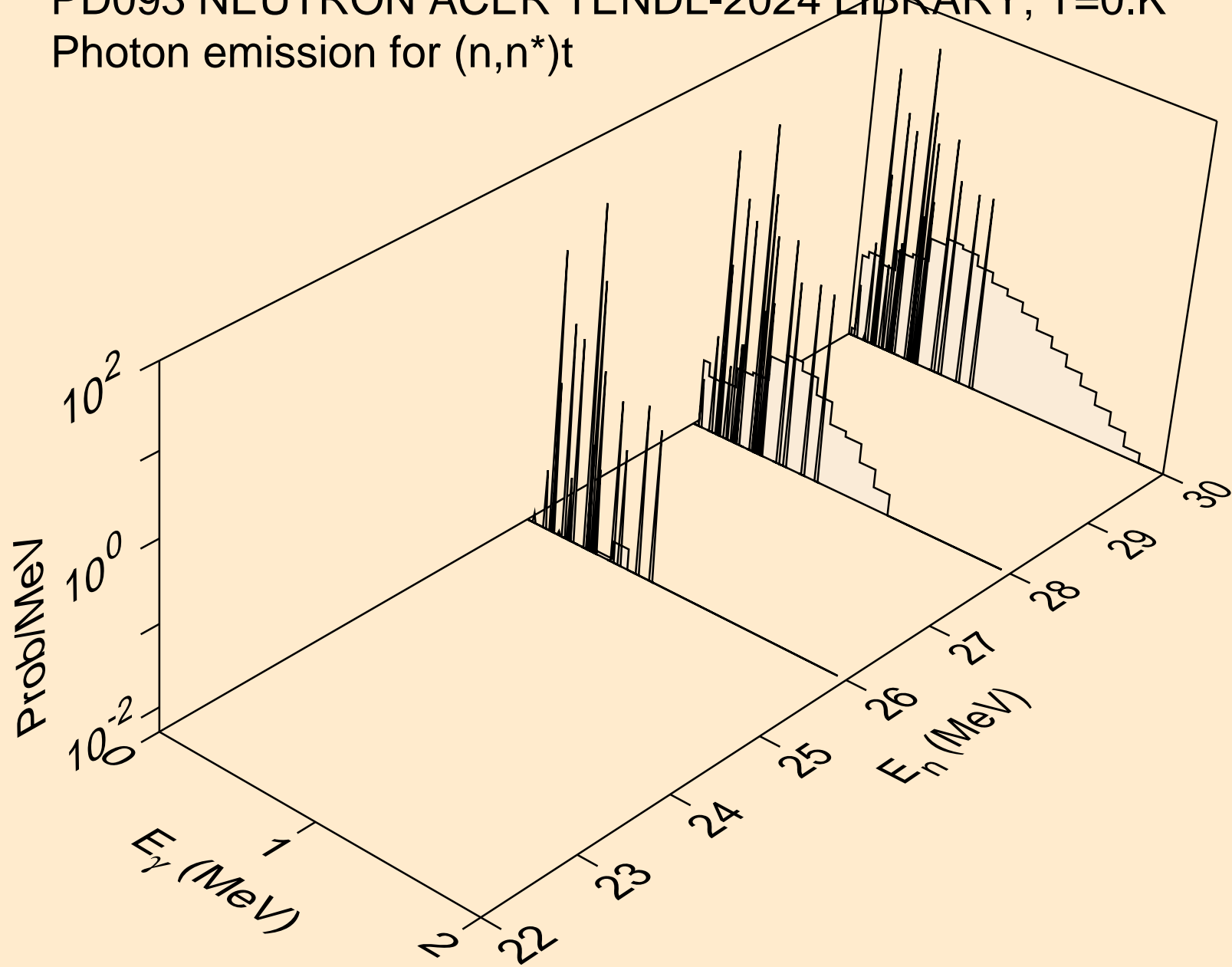

PD093 NEUTRON ACER TENDL-2024 LIBRARY; T=0.K  
Photon emission for (n,n\*)he3

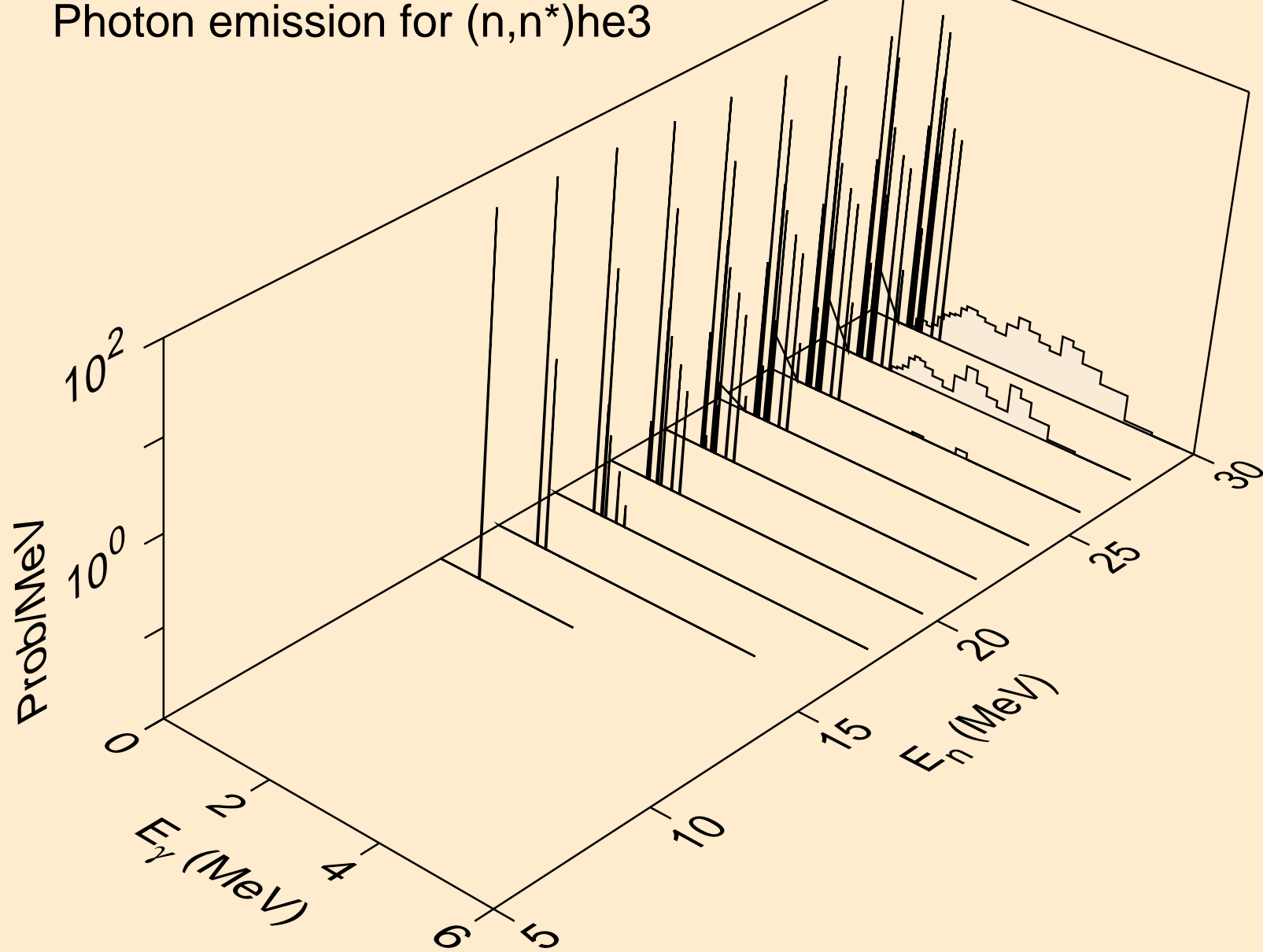

PD093 NEUTRON ACER TENDL-2024 LIBRARY; T=0.K  
Photon emission for (n,2np)

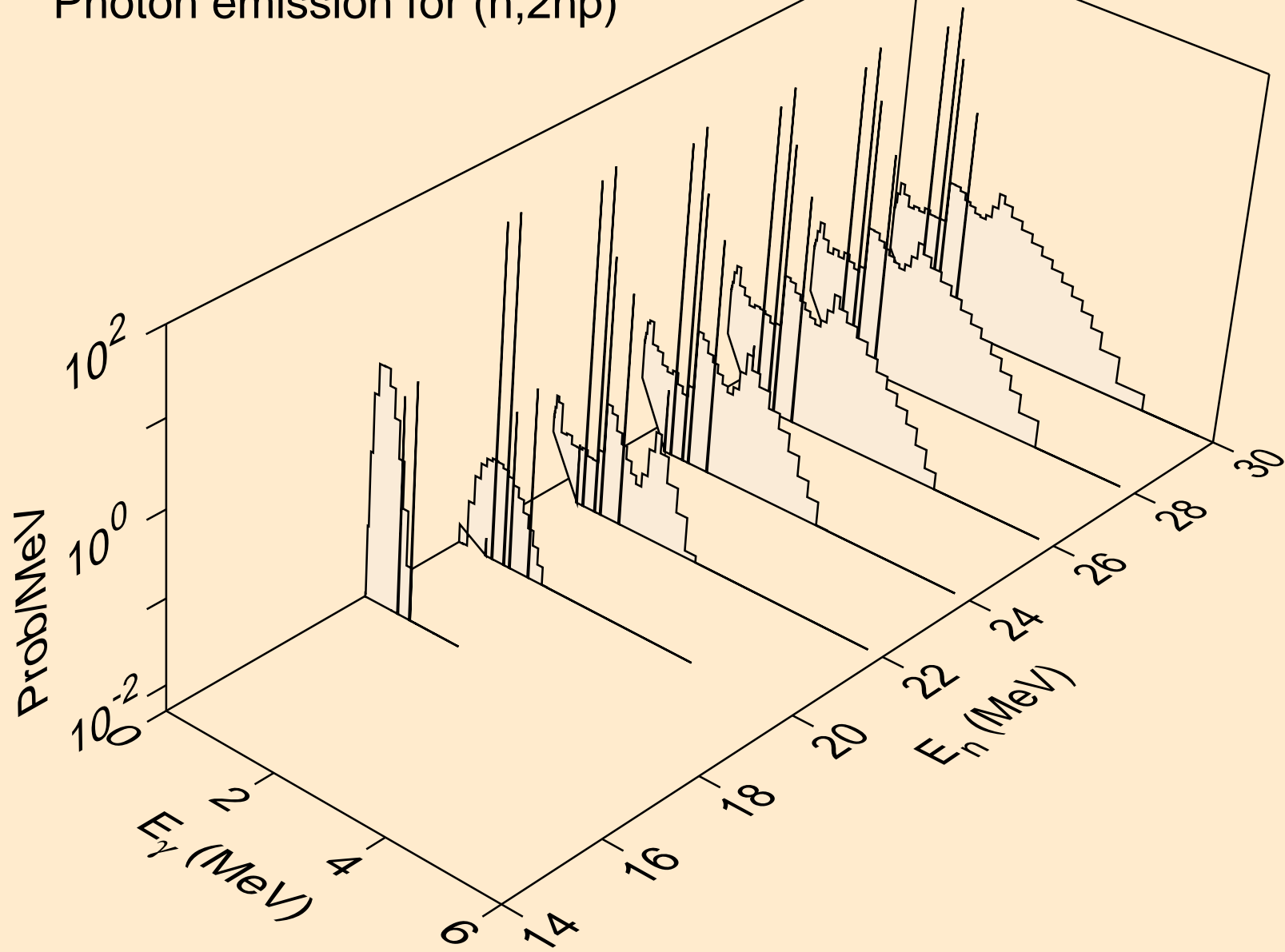

PD093 NEUTRON ACER TENDL-2024 LIBRARY; T=0.K  
Photon emission for (n,n2p)

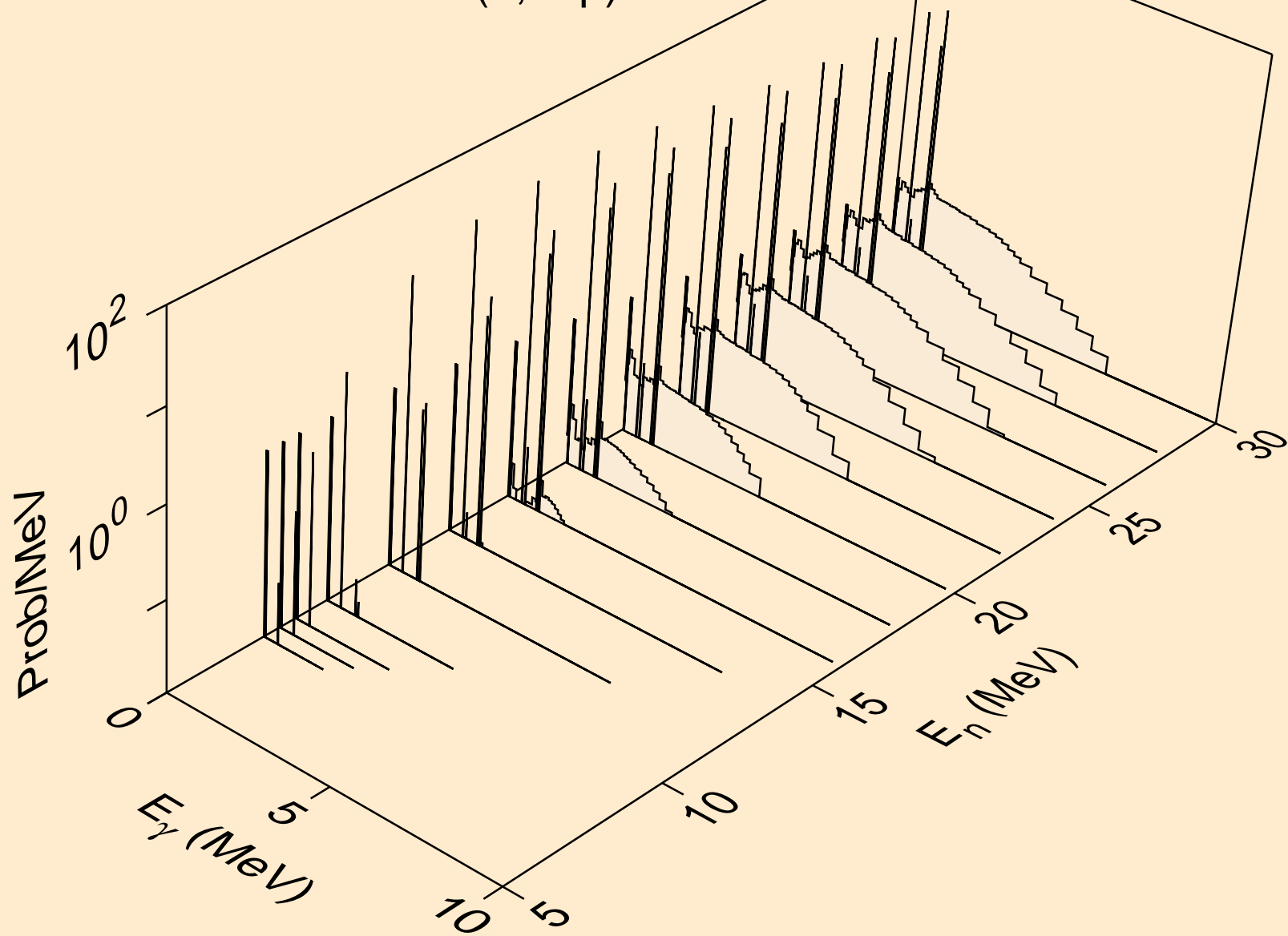

PD093 NEUTRON ACER TENDL-2024 LIBRARY; T=0.K  
Photon emission for (n,npa)

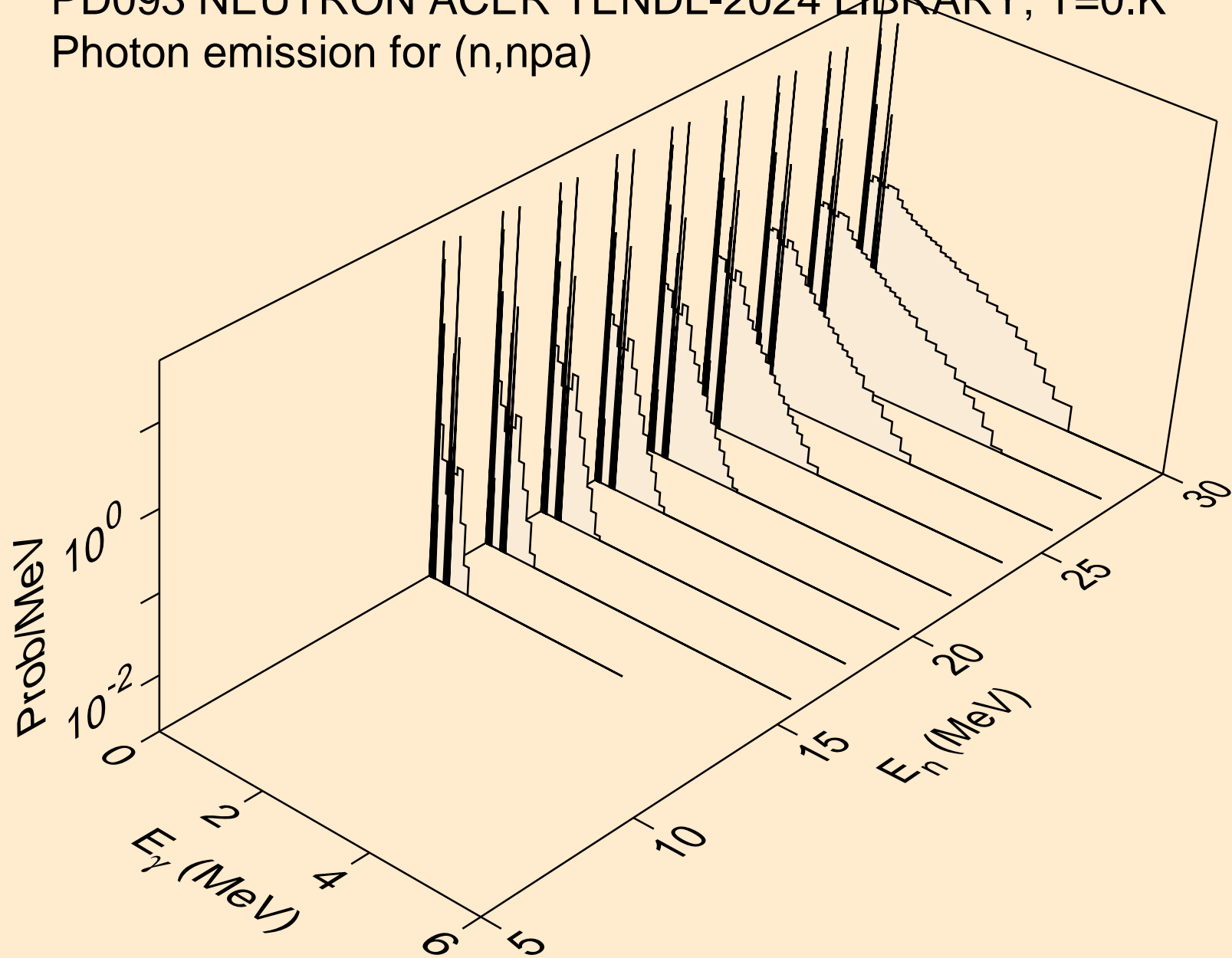

PD093 NEUTRON ACER TENDL-2024 LIBRARY; T=0.K  
Photon emission for (n,n\*c)

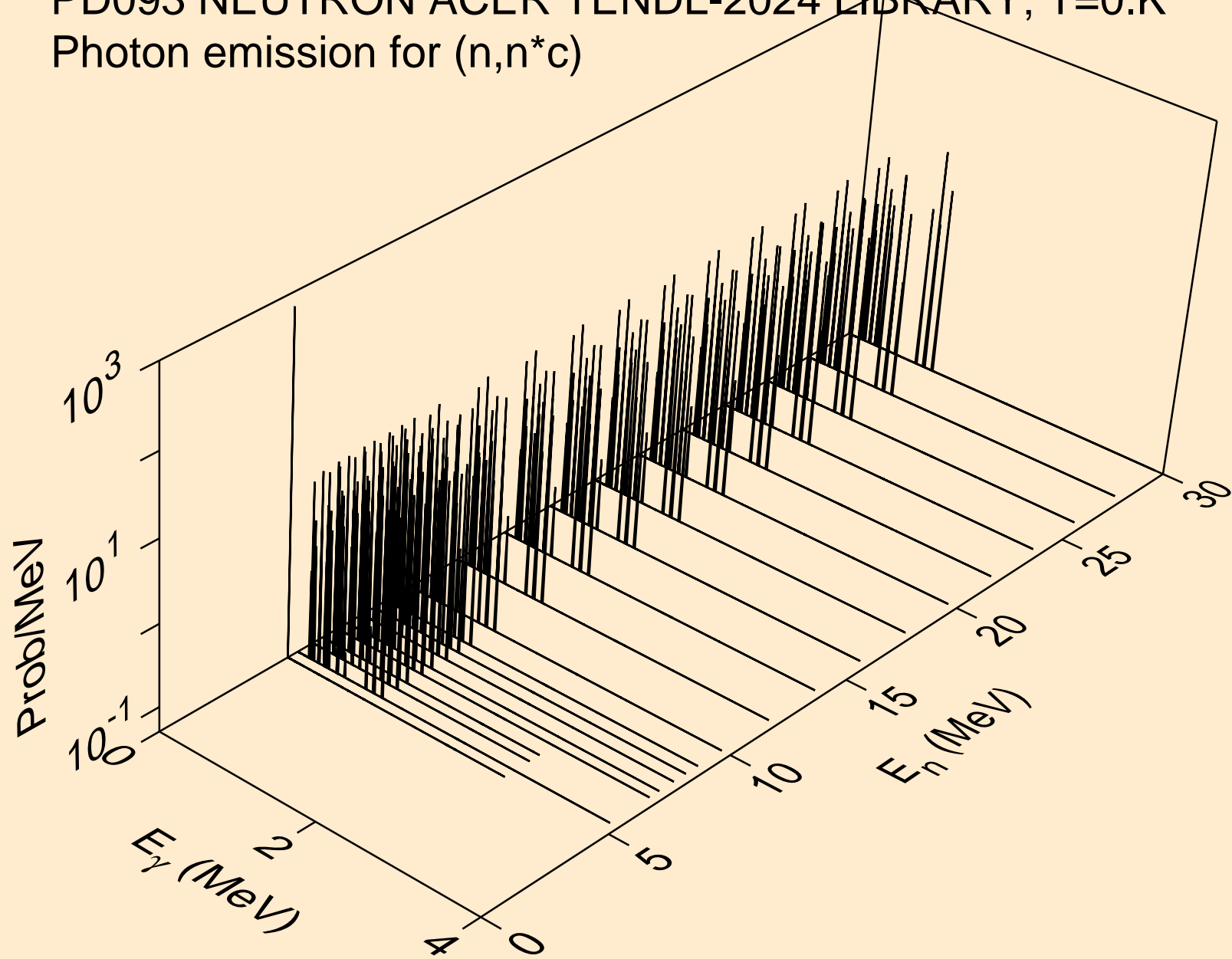

PD093 NEUTRON ACER TENDL-2024 LIBRARY; T=0.K  
Photon emission for (n,gma)

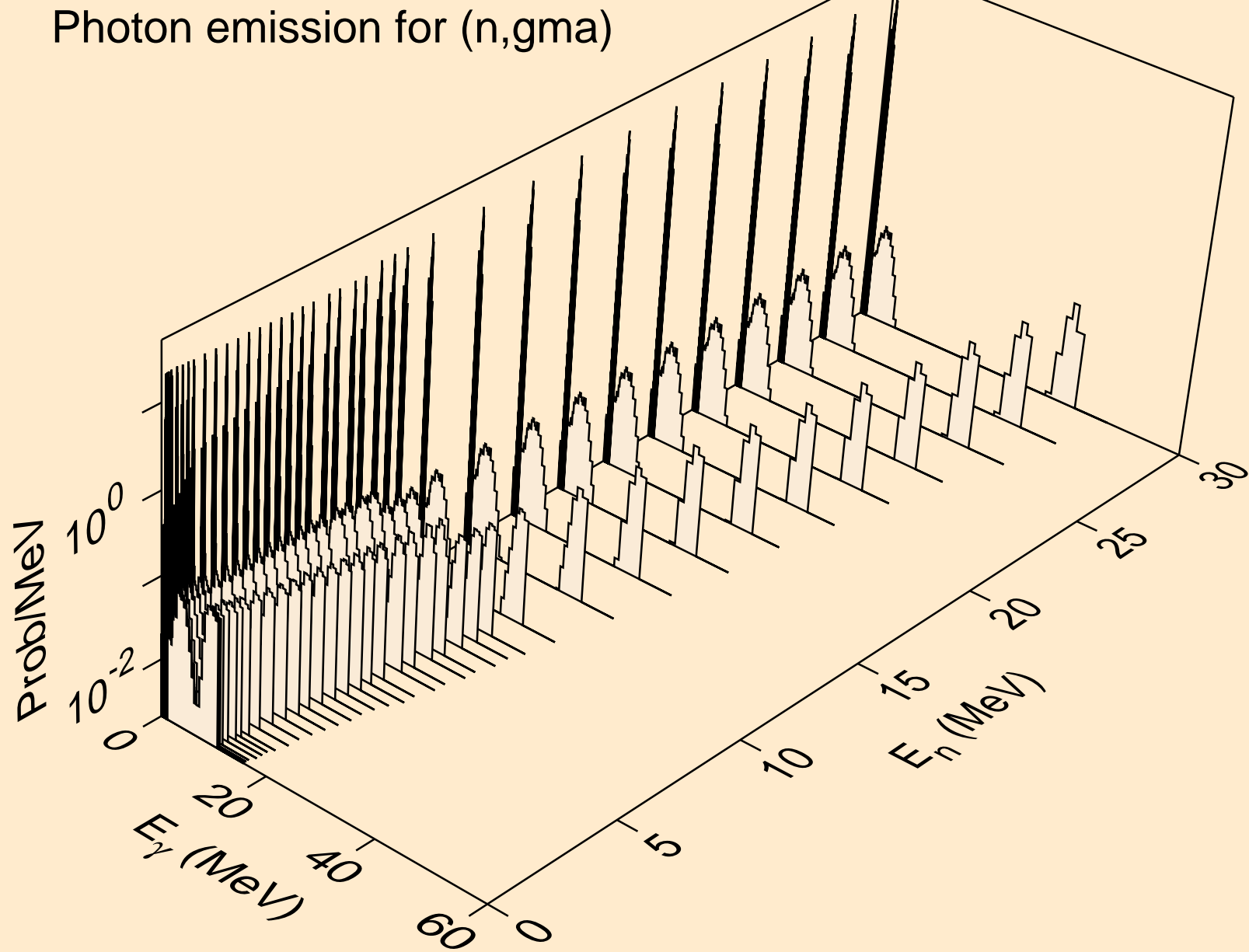

PD093 NEUTRON ACER TENDL-2024 LIBRARY; T=0.K  
Photon emission for (n,p)

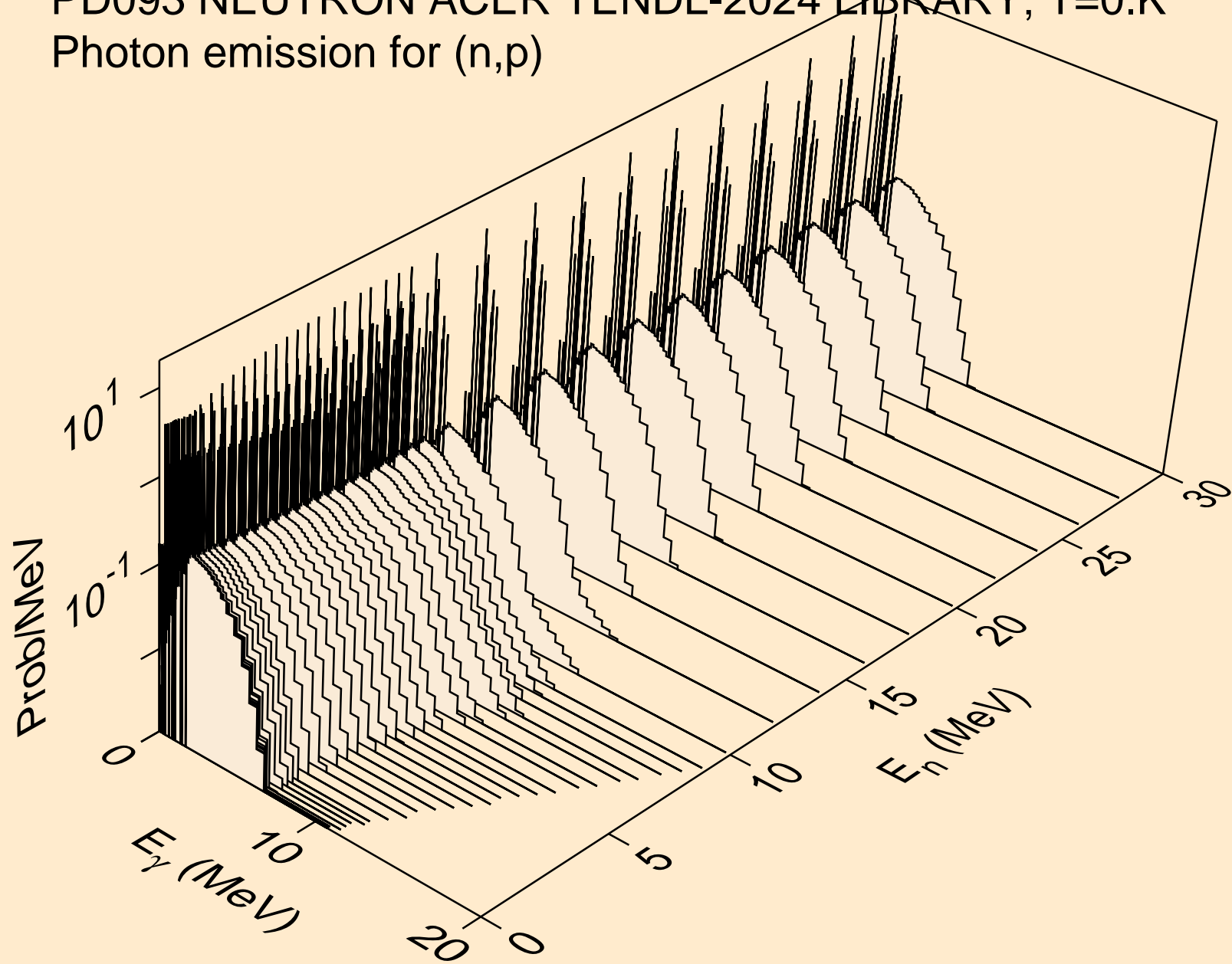

PD093 NEUTRON ACER TENDL-2024 LIBRARY; T=0.K  
Photon emission for (n,d)

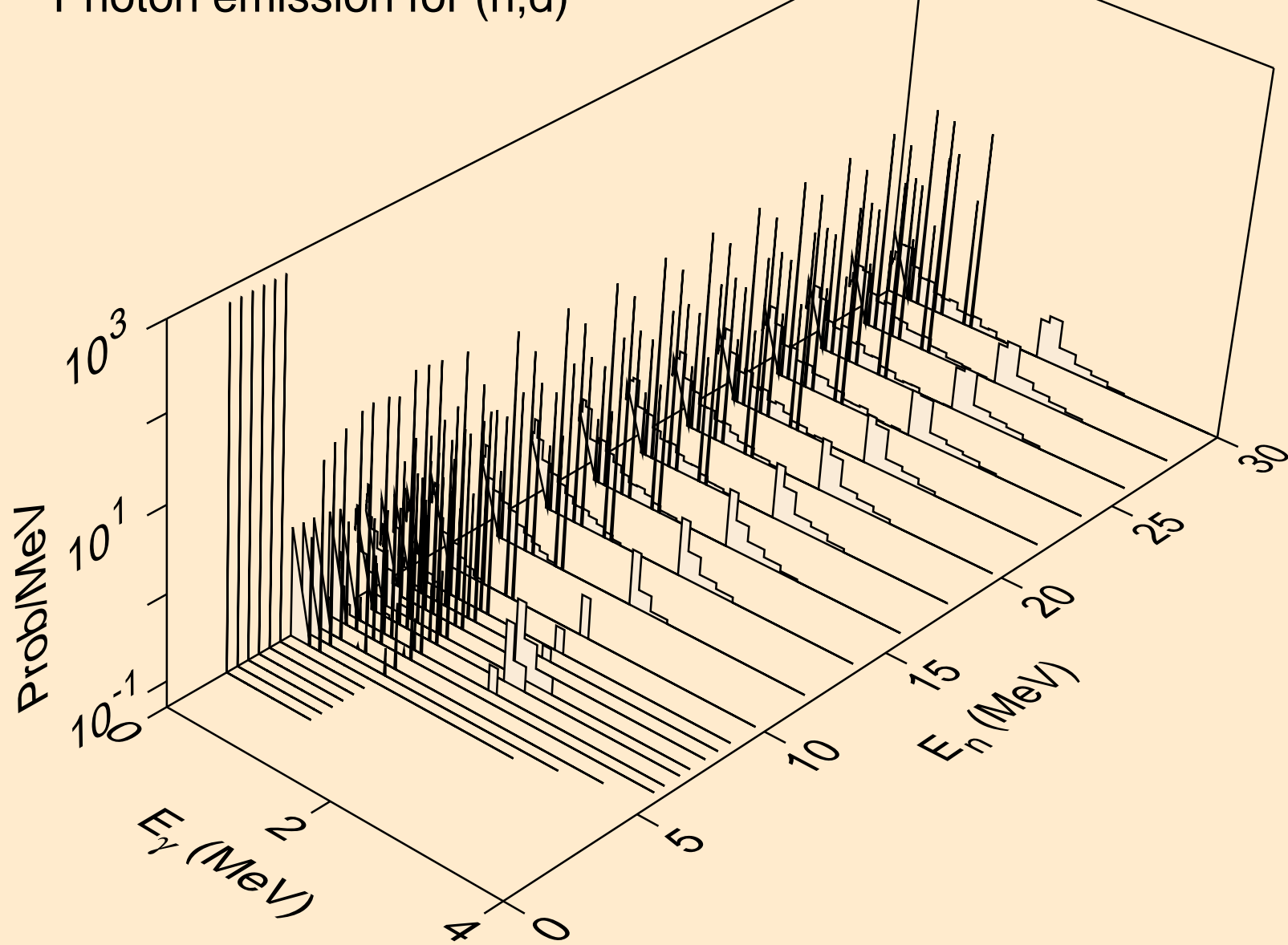

PD093 NEUTRON ACER TENDL-2024 LIBRARY; T=0.K  
Photon emission for (n,t)

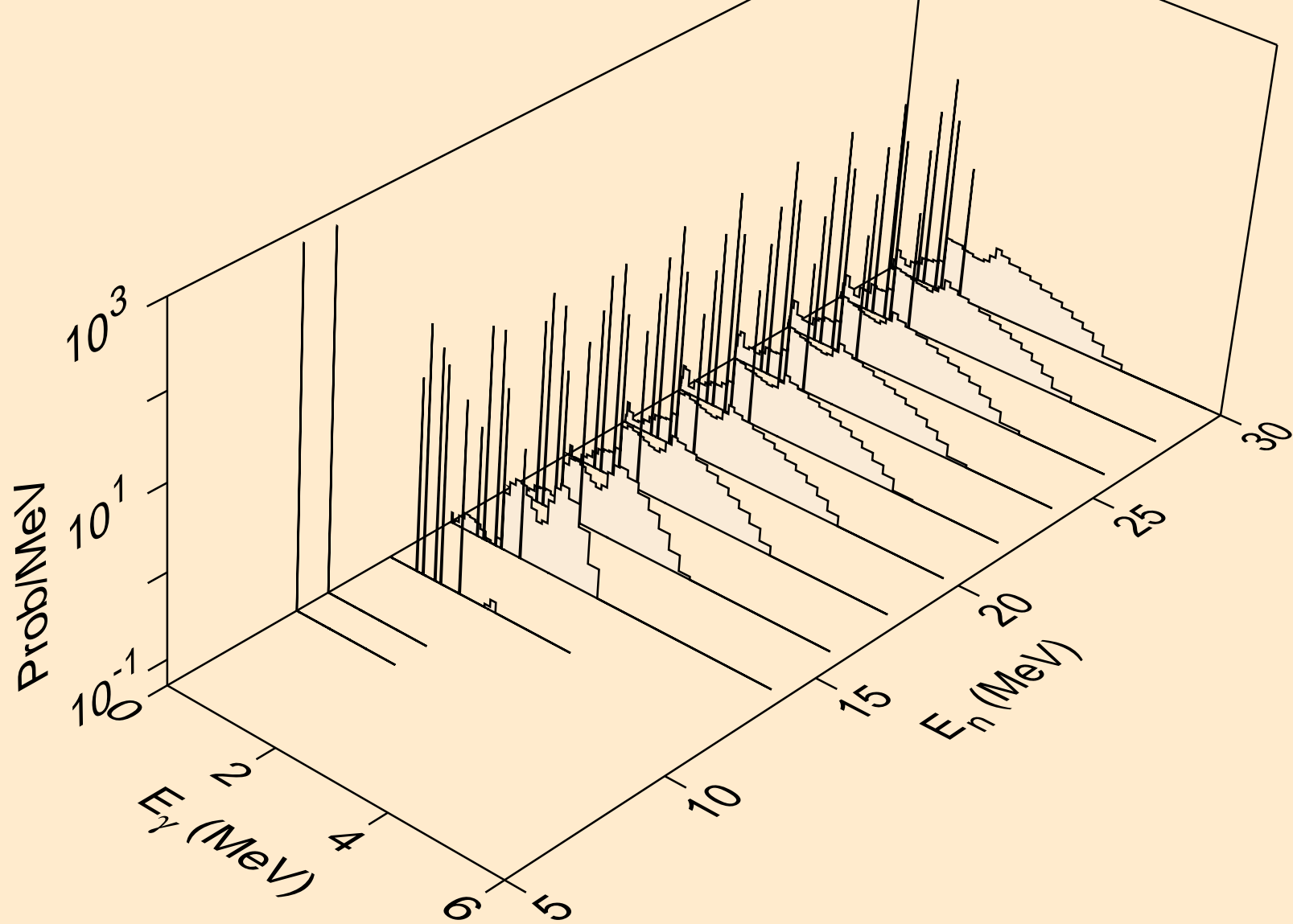

PD093 NEUTRON ACER TENDL-2024 LIBRARY; T=0.K  
Photon emission for (n,he3)

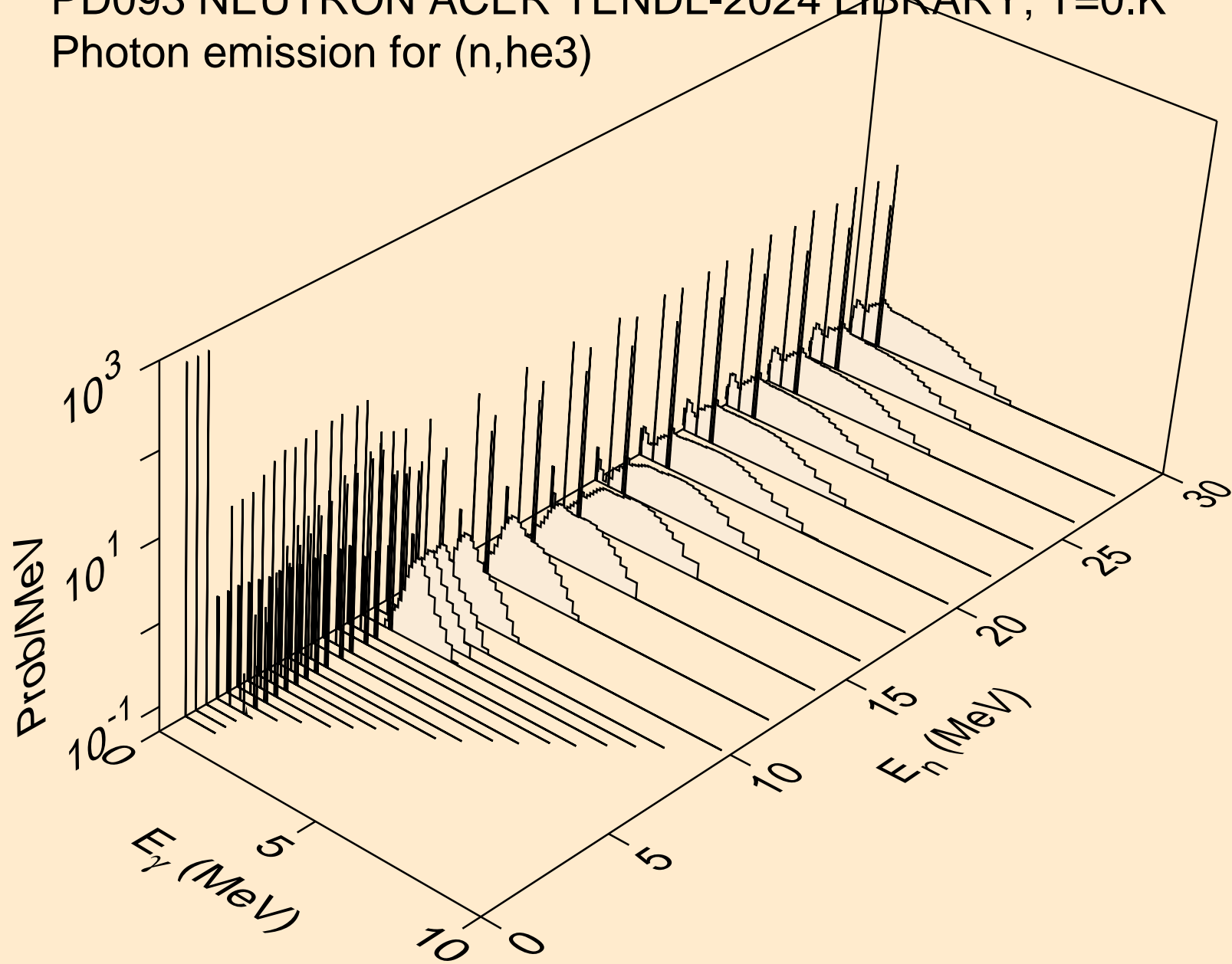

PD093 NEUTRON ACER TENDL-2024 LIBRARY; T=0.K  
Photon emission for (n,a)

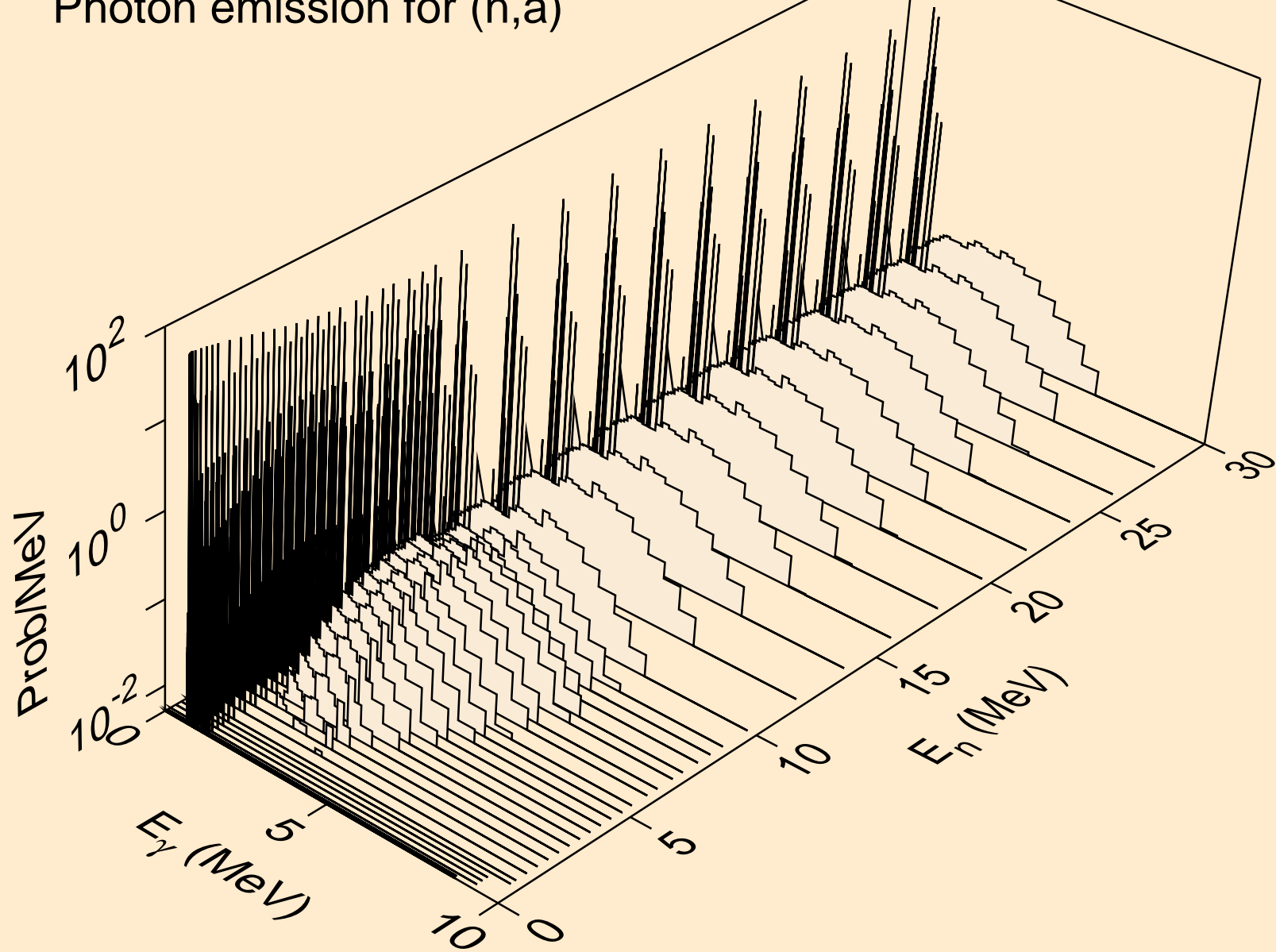

PD093 NEUTRON ACER TENDL-2024 LIBRARY; T=0.K  
Photon emission for (n,2a)

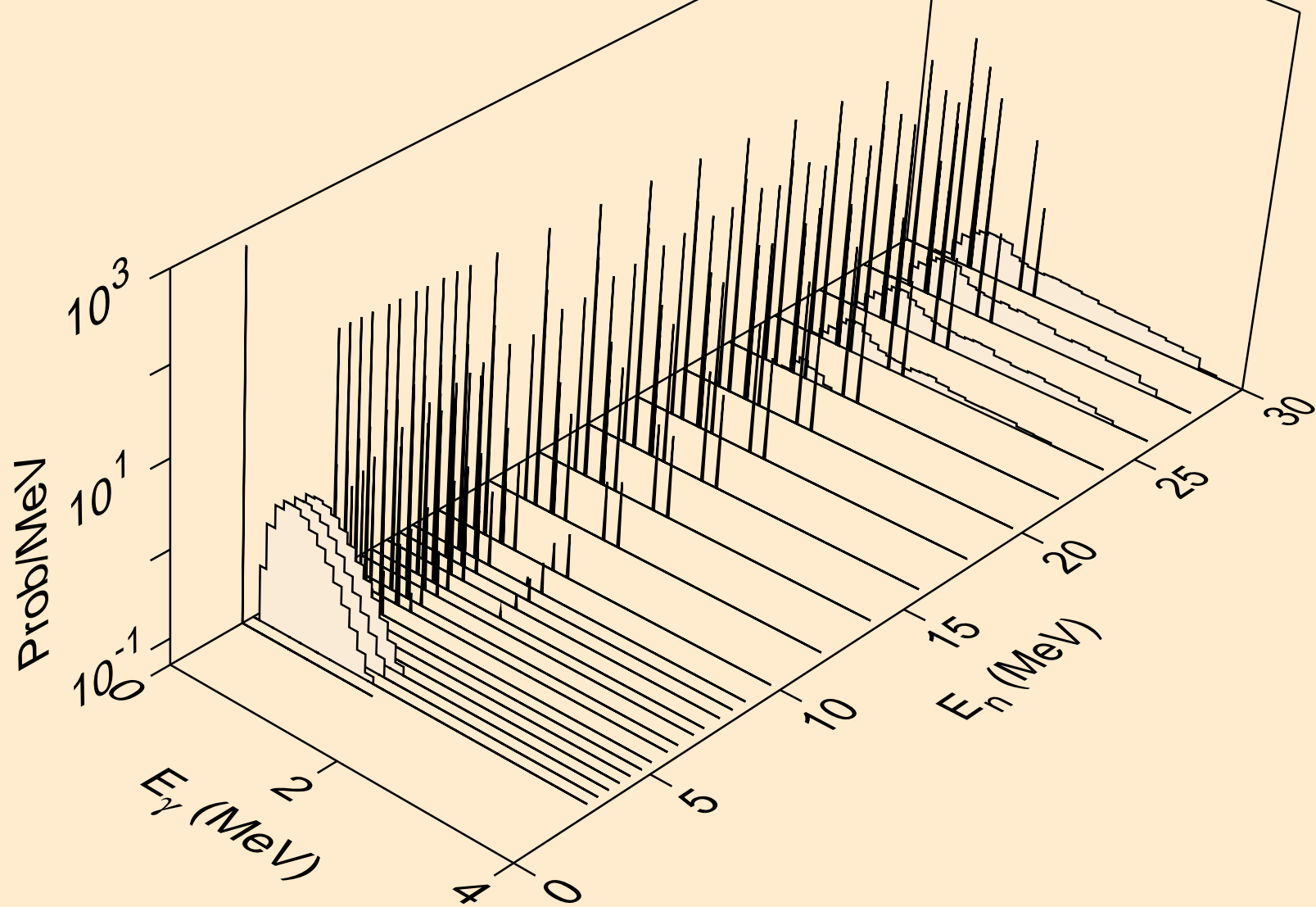

PD093 NEUTRON ACER TENDL-2024 LIBRARY; T=0.K  
Photon emission for (n,3a)

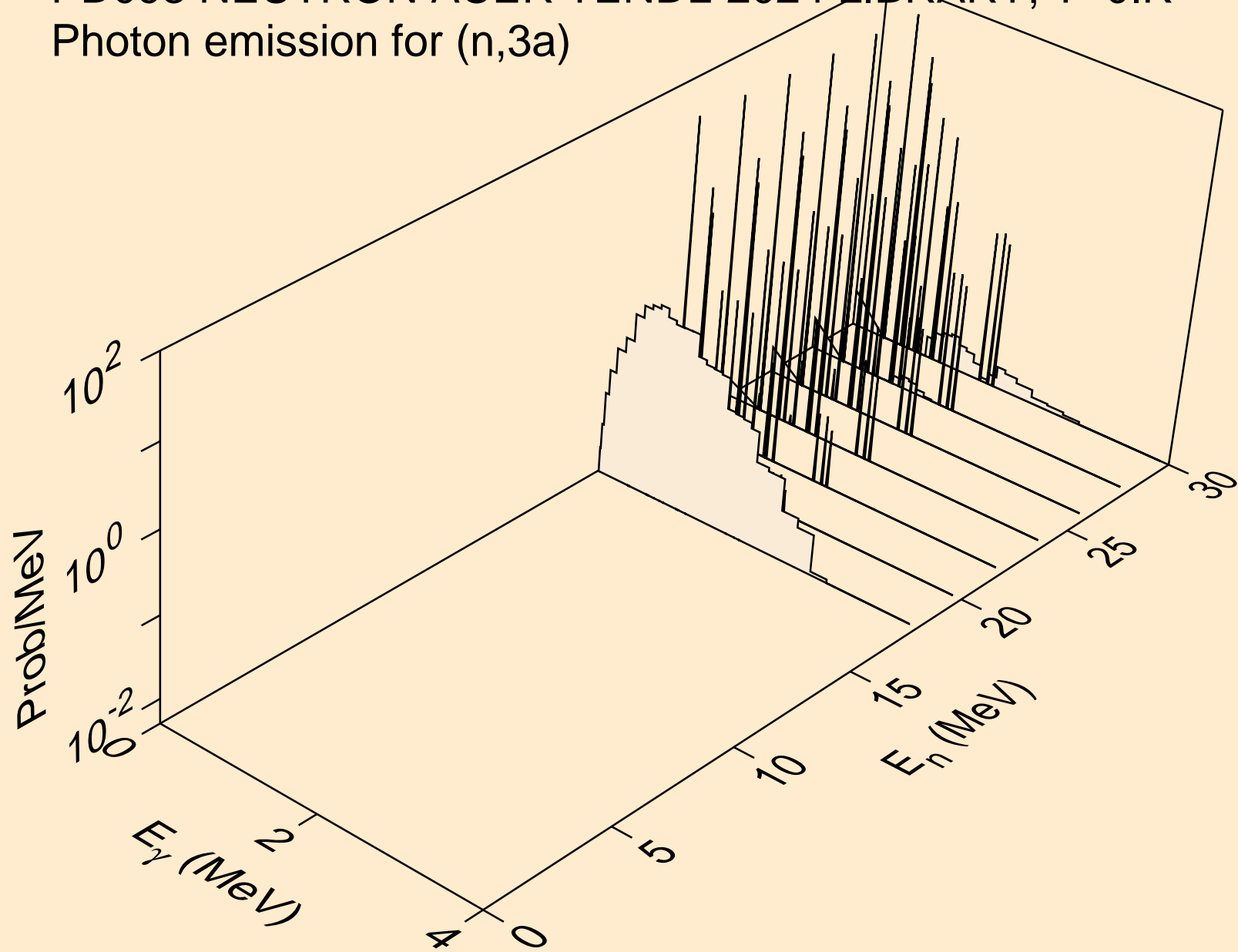

PD093 NEUTRON ACER TENDL-2024 LIBRARY; T=0.K  
Photon emission for (n,2p)

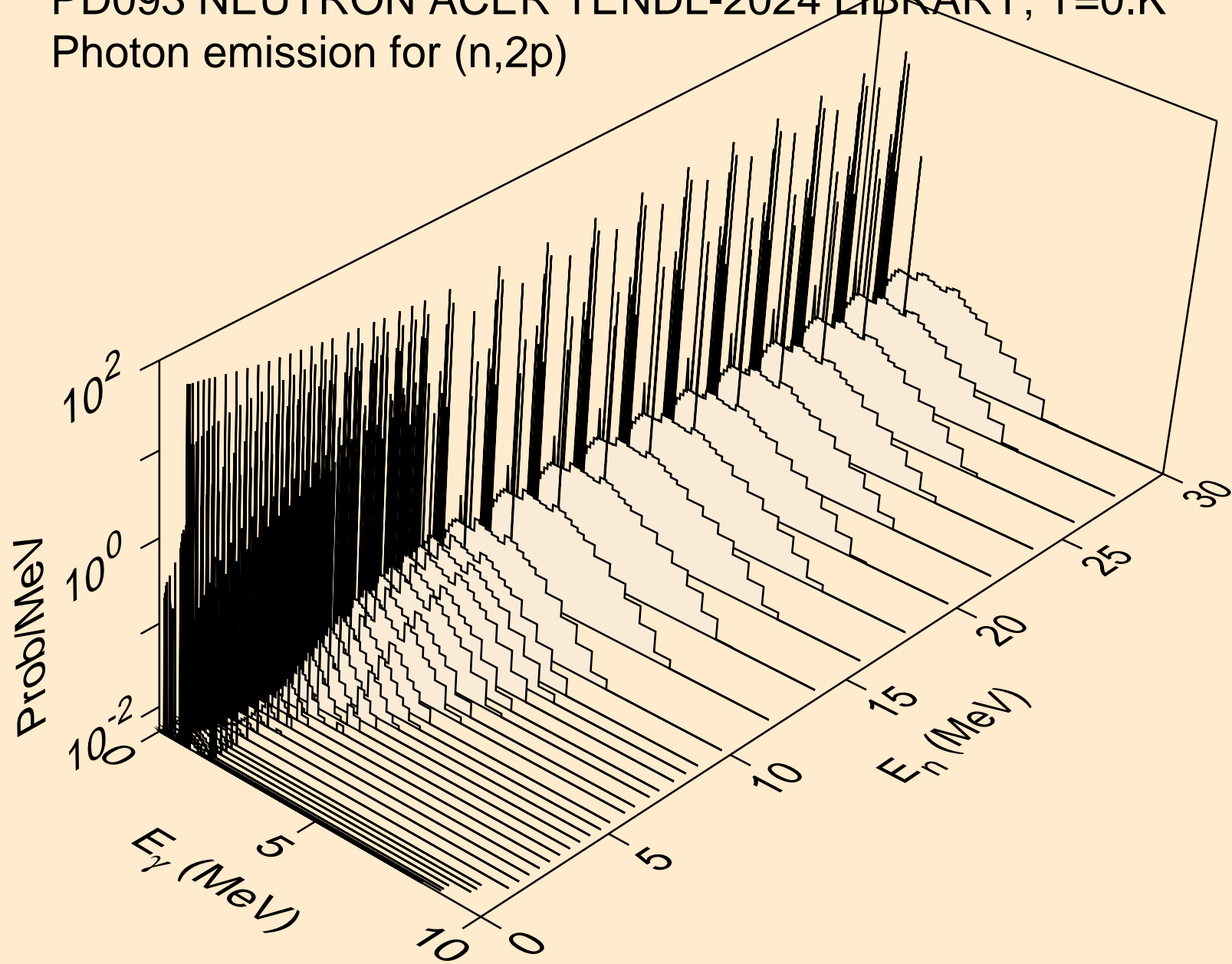

PD093 NEUTRON ACER TENDL-2024 LIBRARY; T=0.K  
Photon emission for (n,p $\alpha$ )

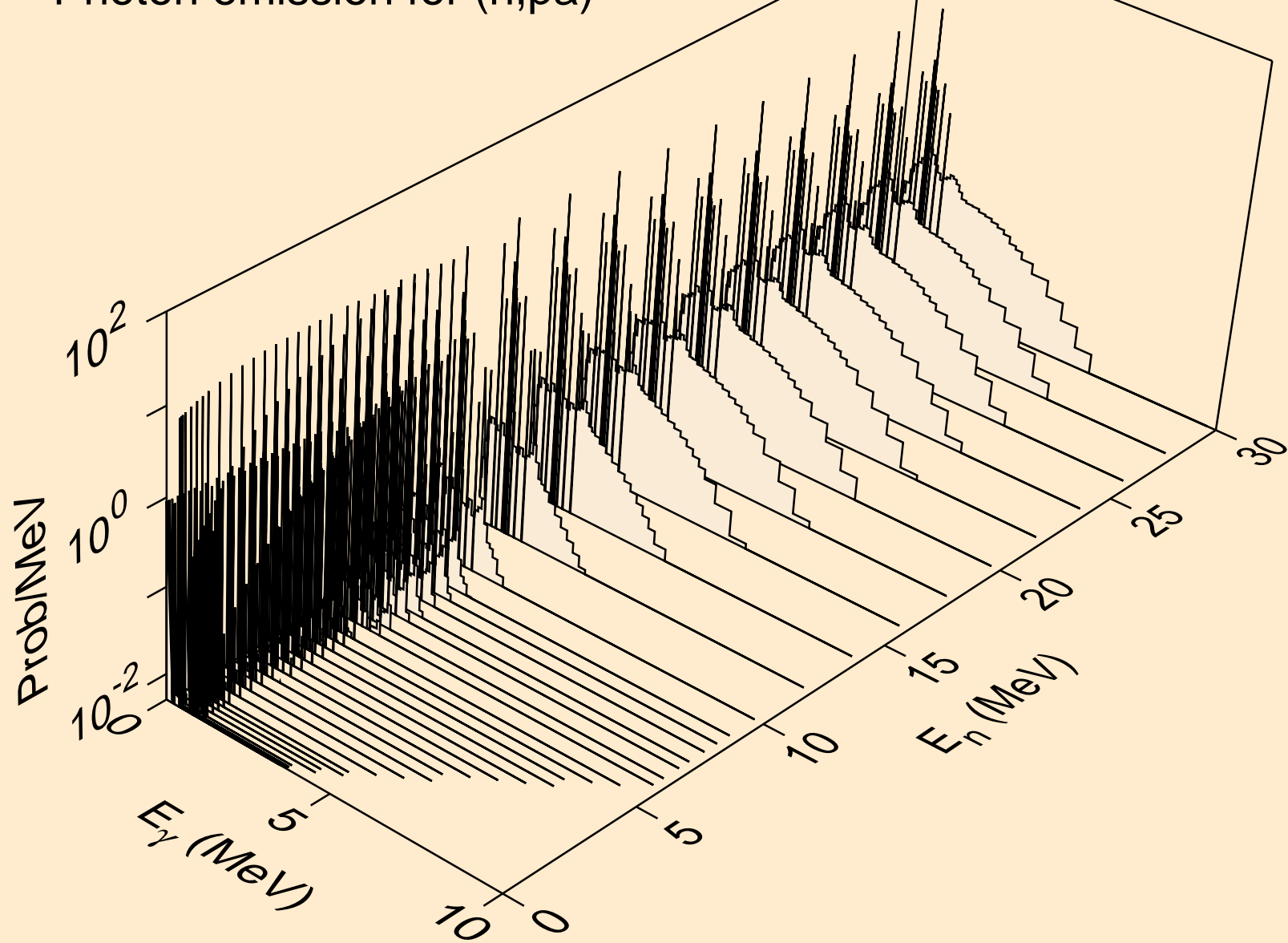

PD093 NEUTRON ACER TENDL-2024 LIBRARY; T=0.K  
Photon emission for (n,pd)

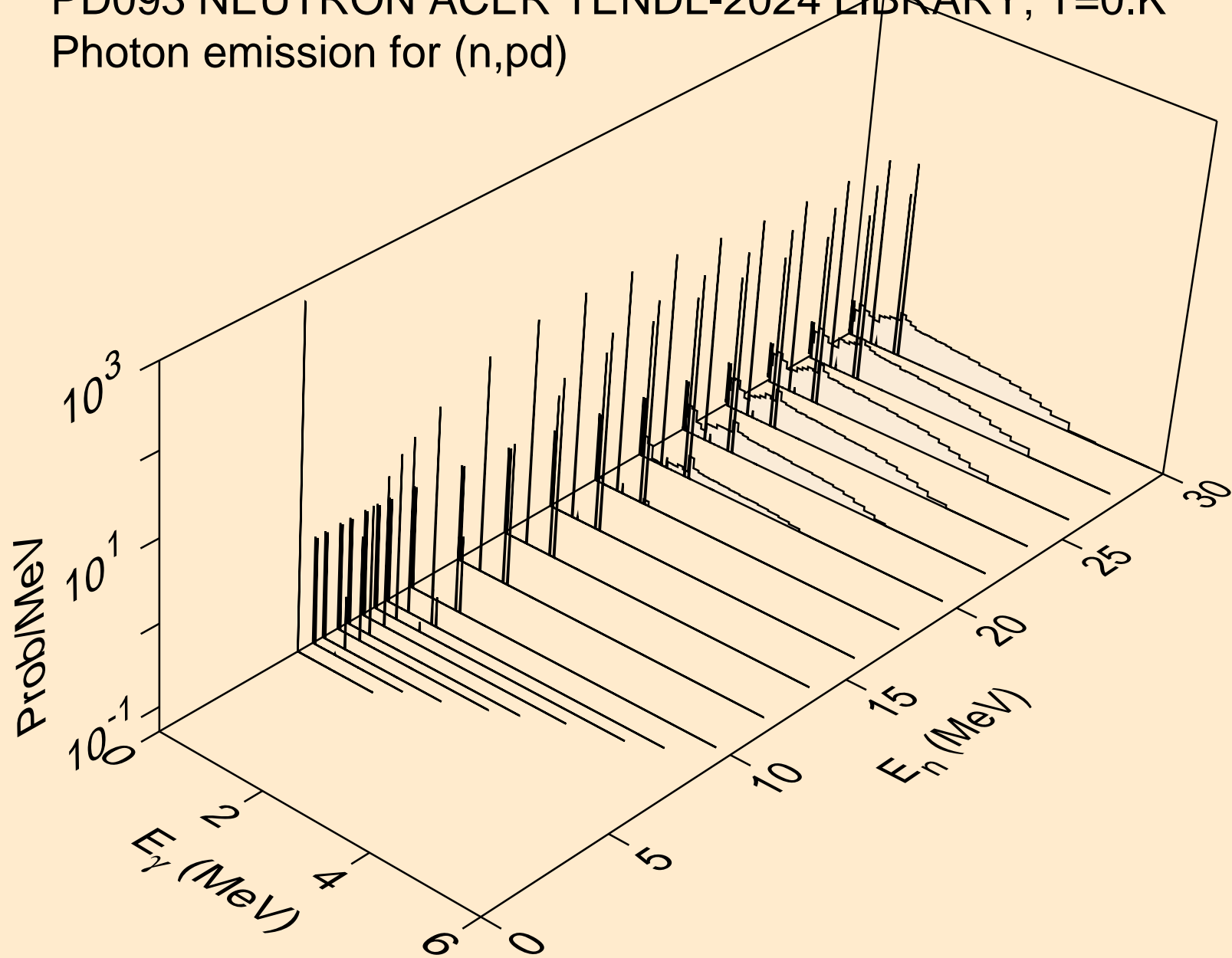

PD093 NEUTRON ACER TENDL-2024 LIBRARY; T=0.K  
Photon emission for (n,pt)

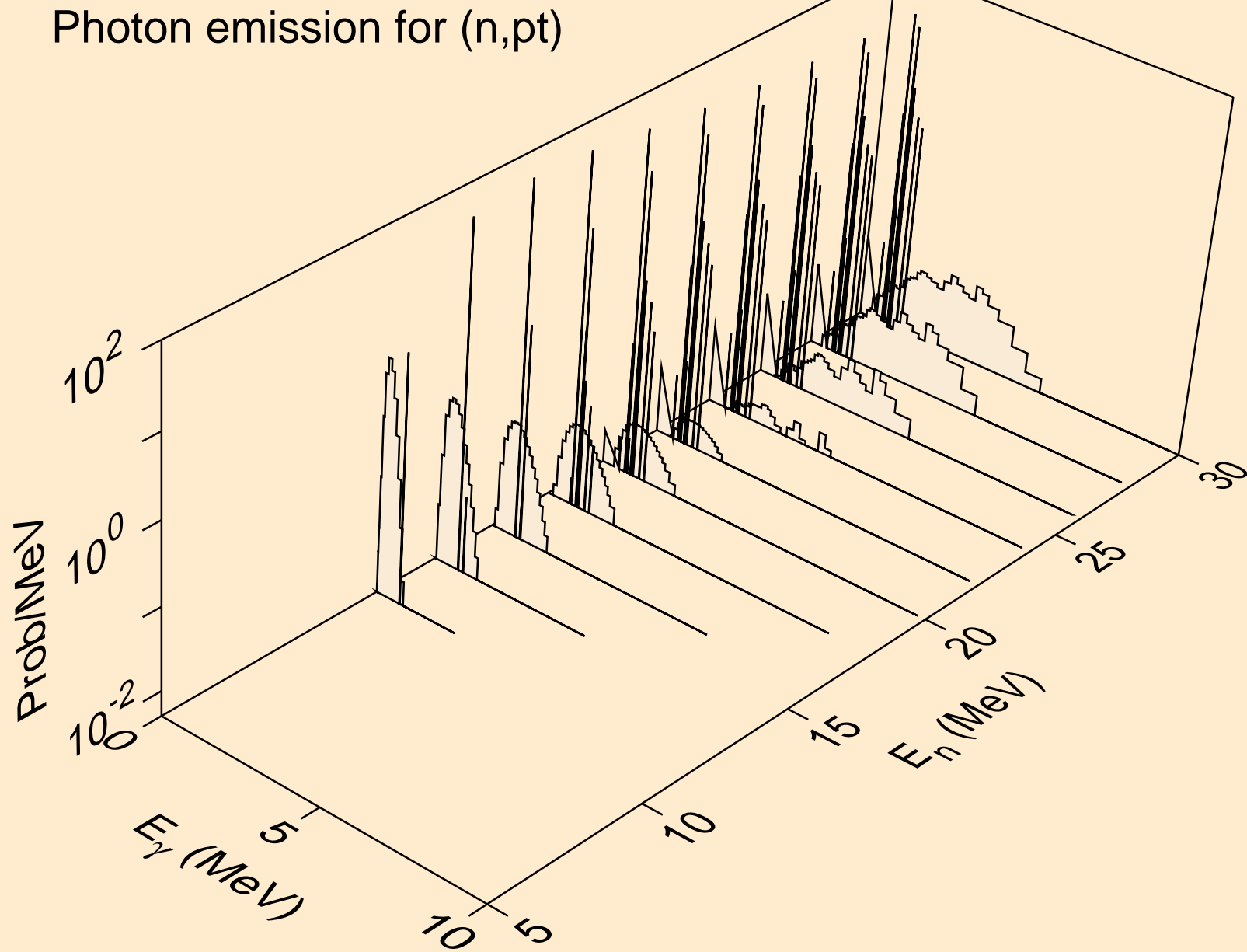

PD093 NEUTRON ACER TENDL-2024 LIBRARY; T=0.K  
Photon emission for (n,da)

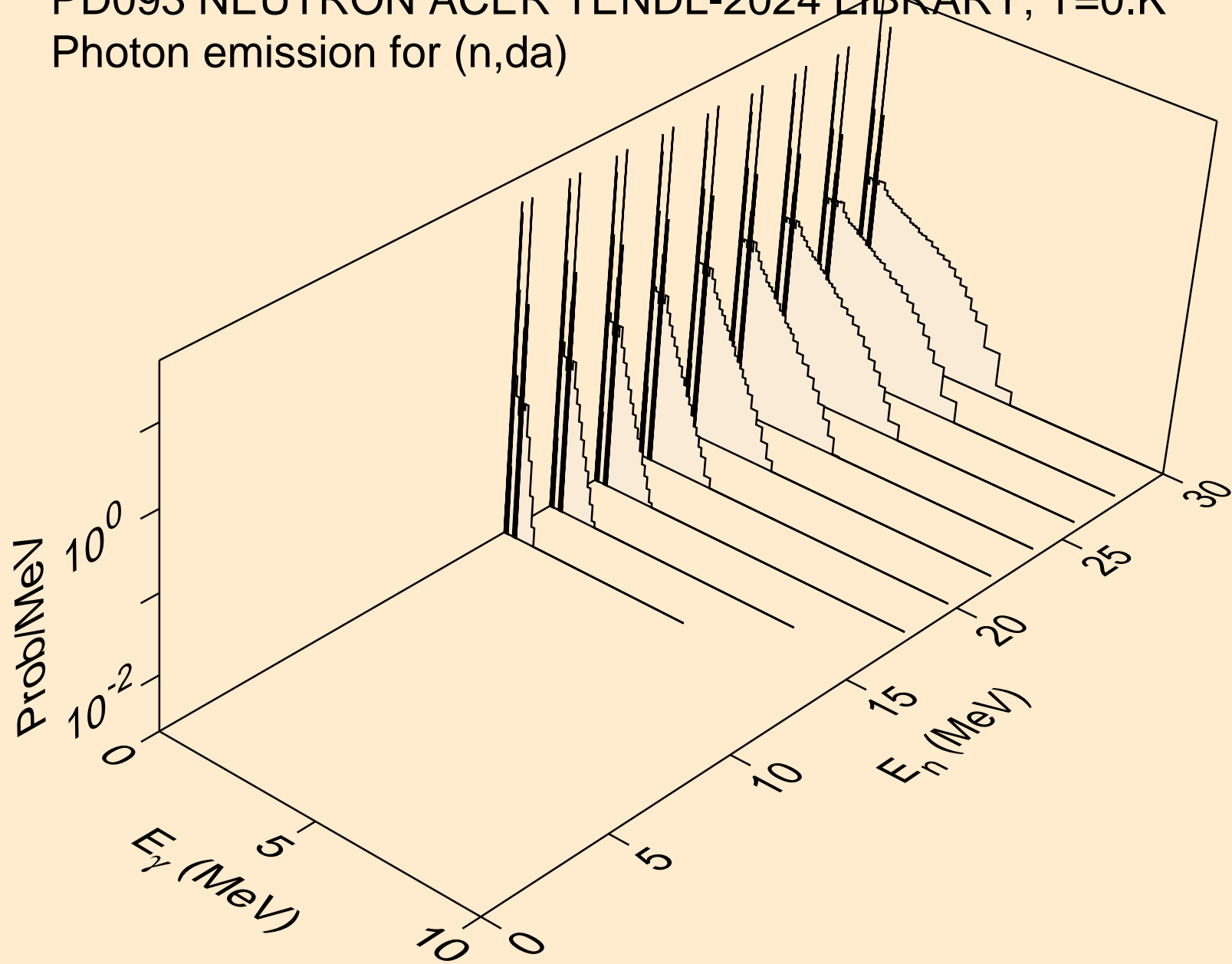

PD093 NEUTRON ACER TENDL-2024 LIBRARY; T=0.K  
thermal capture photon spectrum

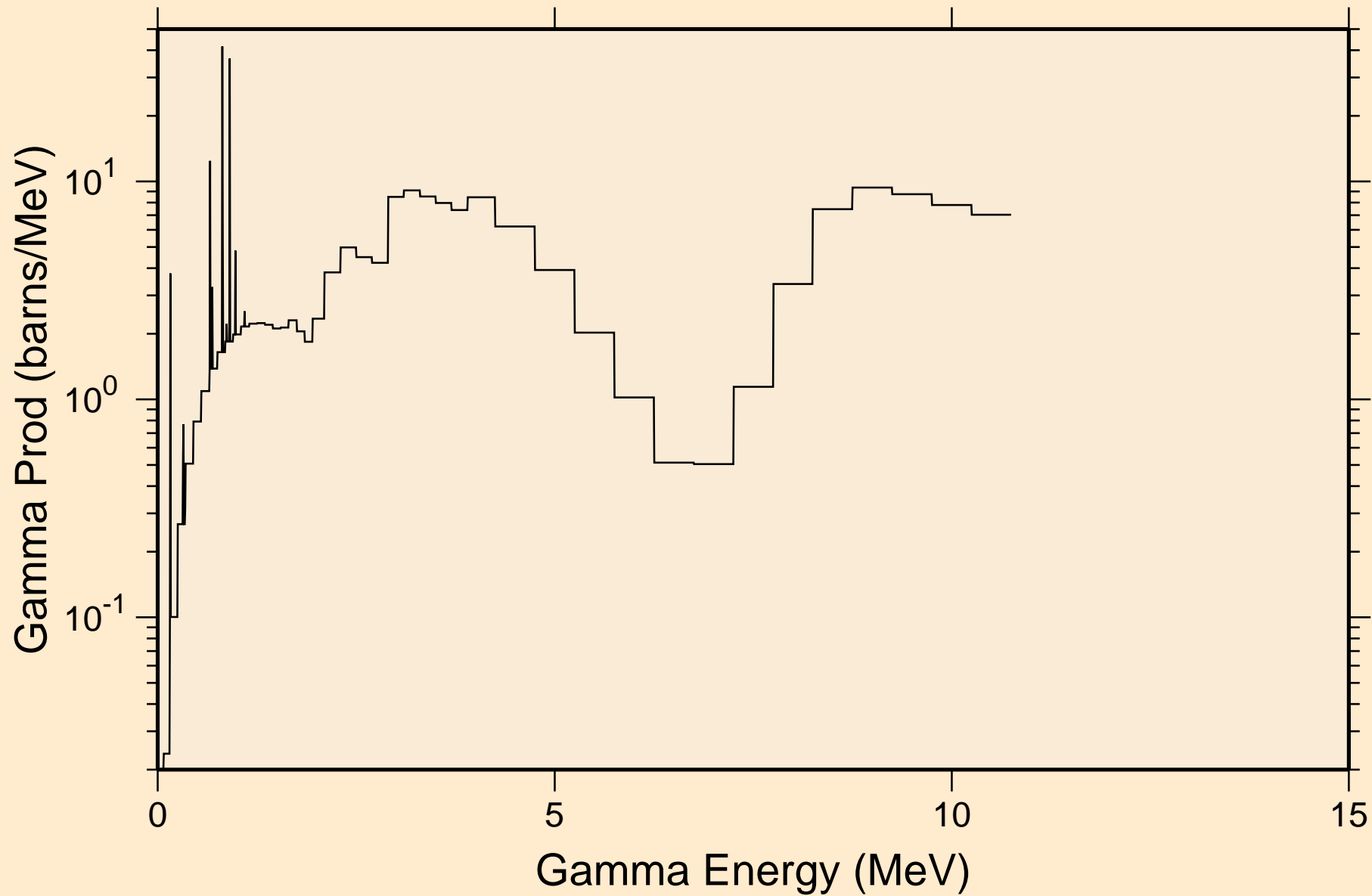

PD093 NEUTRON ACER TENDL-2024 LIBRARY; T=0.K  
14 MeV photon spectrum

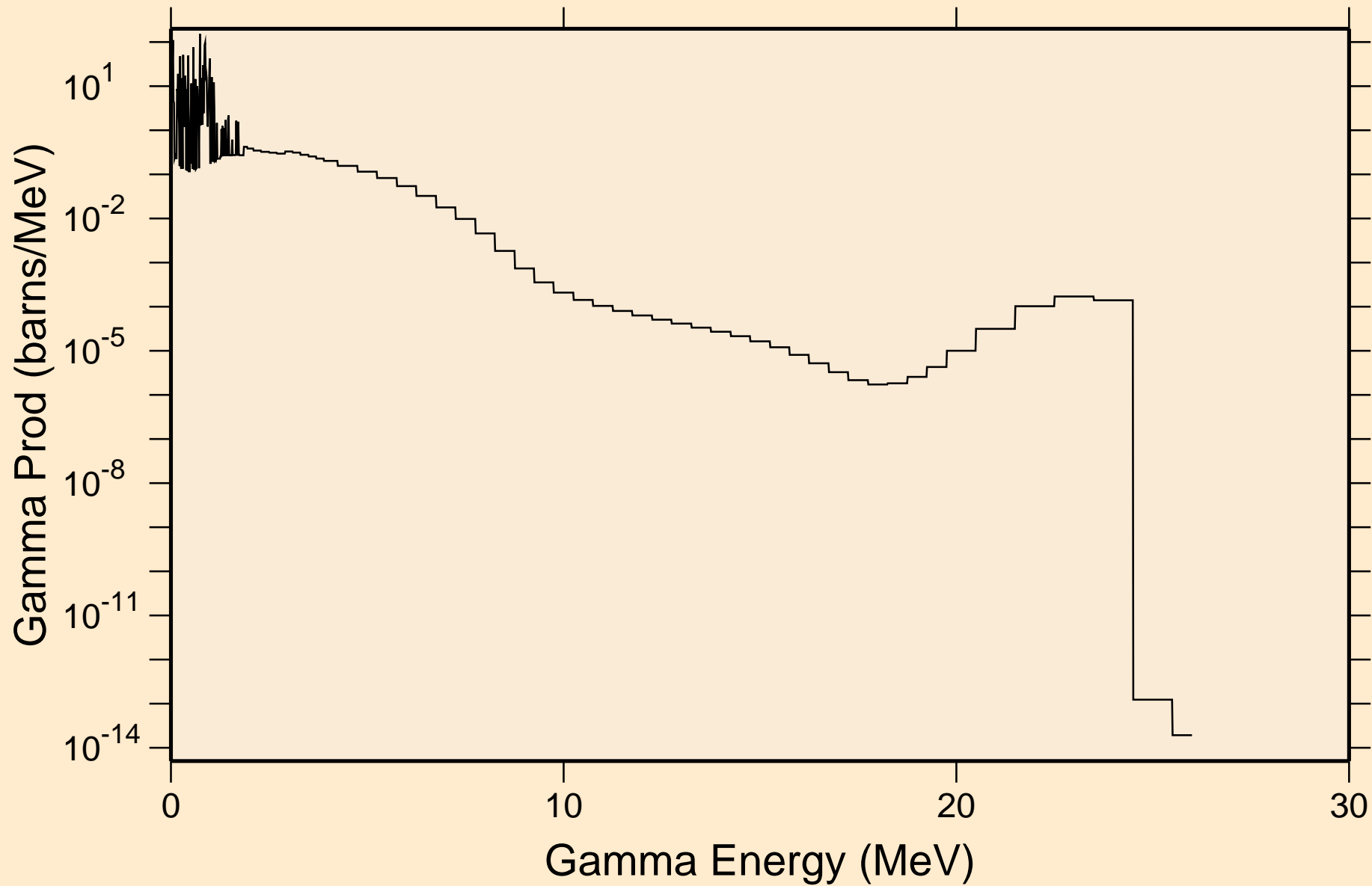

# PD093 NEUTRON ACER TENDL-2024 LIBRARY; T=0.K

## Particle heating contributions

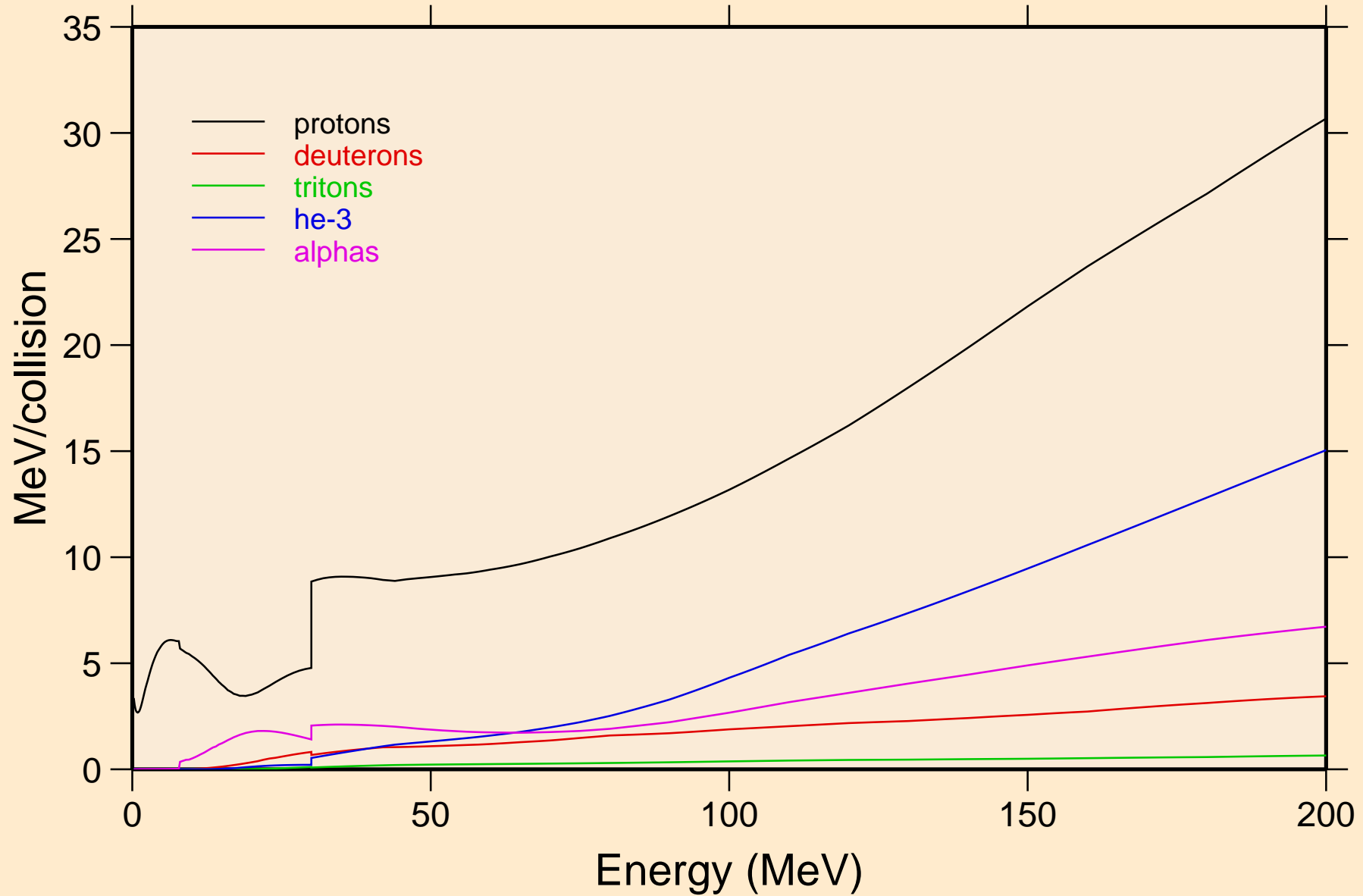

PD093 NEUTRON ACER TENDL-2024 LIBRARY; T=0.K  
Recoil Heating

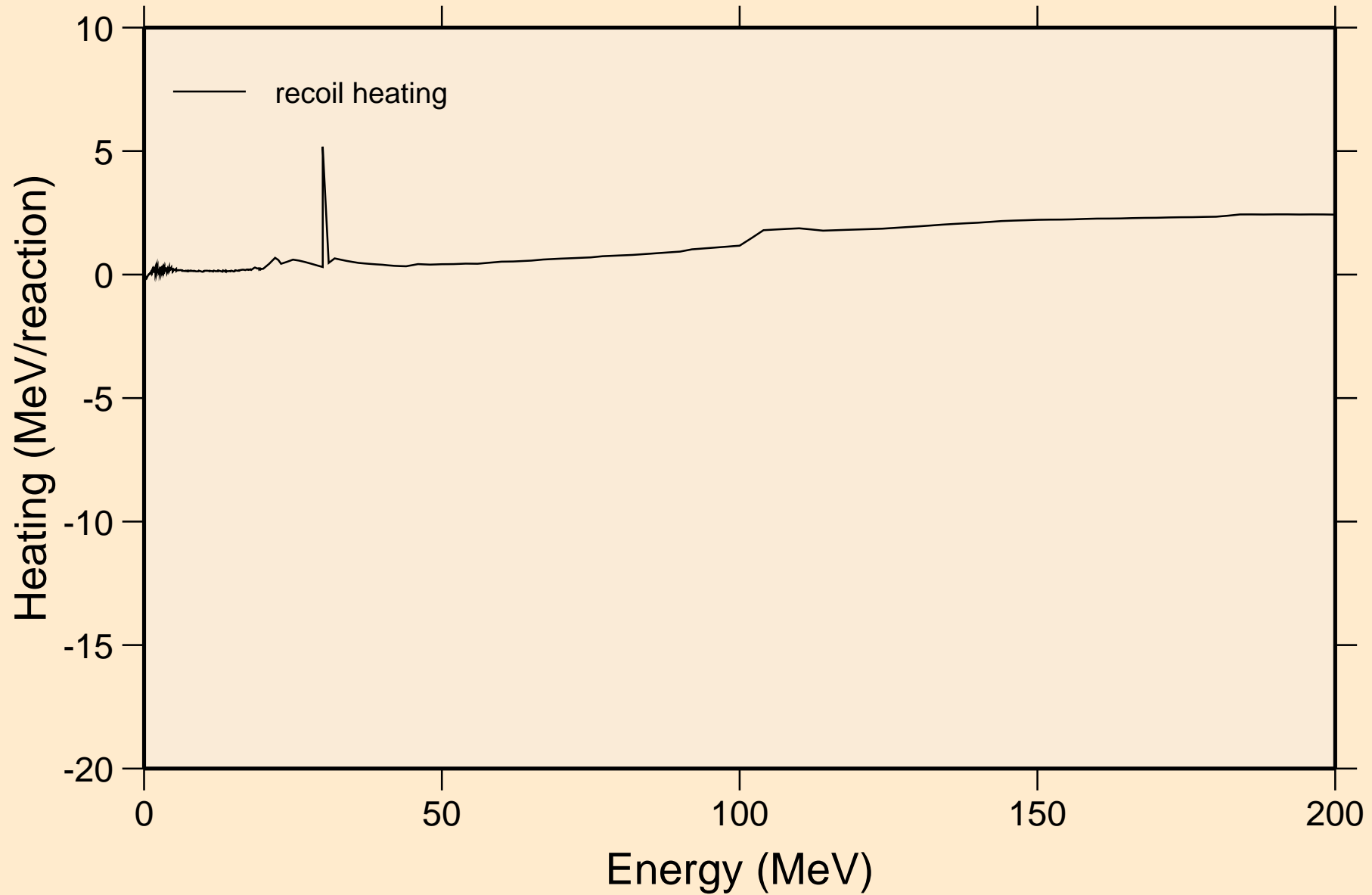

PD093 NEUTRON ACER TENDL-2024 LIBRARY; T=0.K  
Particle production cross sections

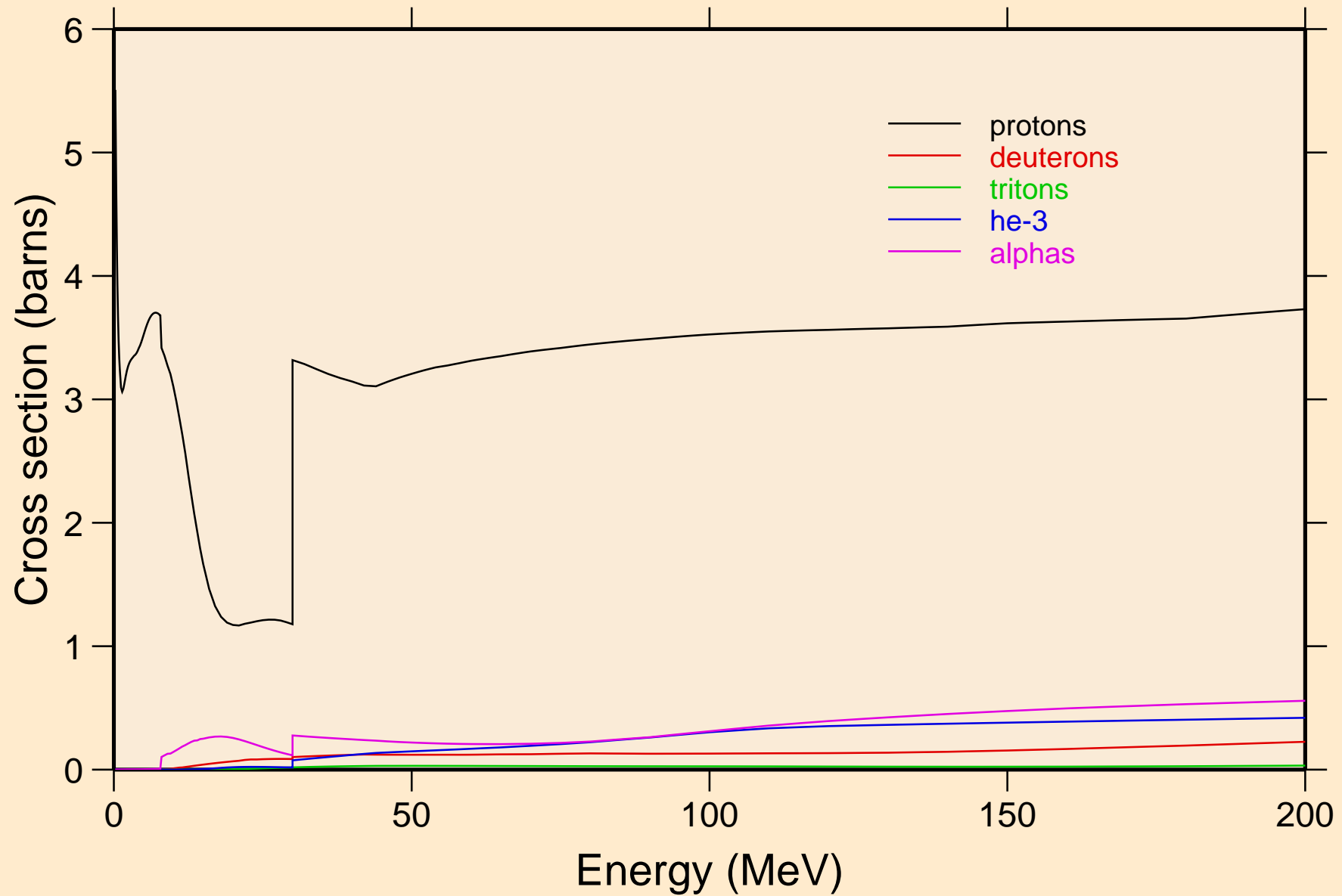

PD093 NEUTRON ACER TENDL-2024 LIBRARY; T=0.K  
protons from (n,x)

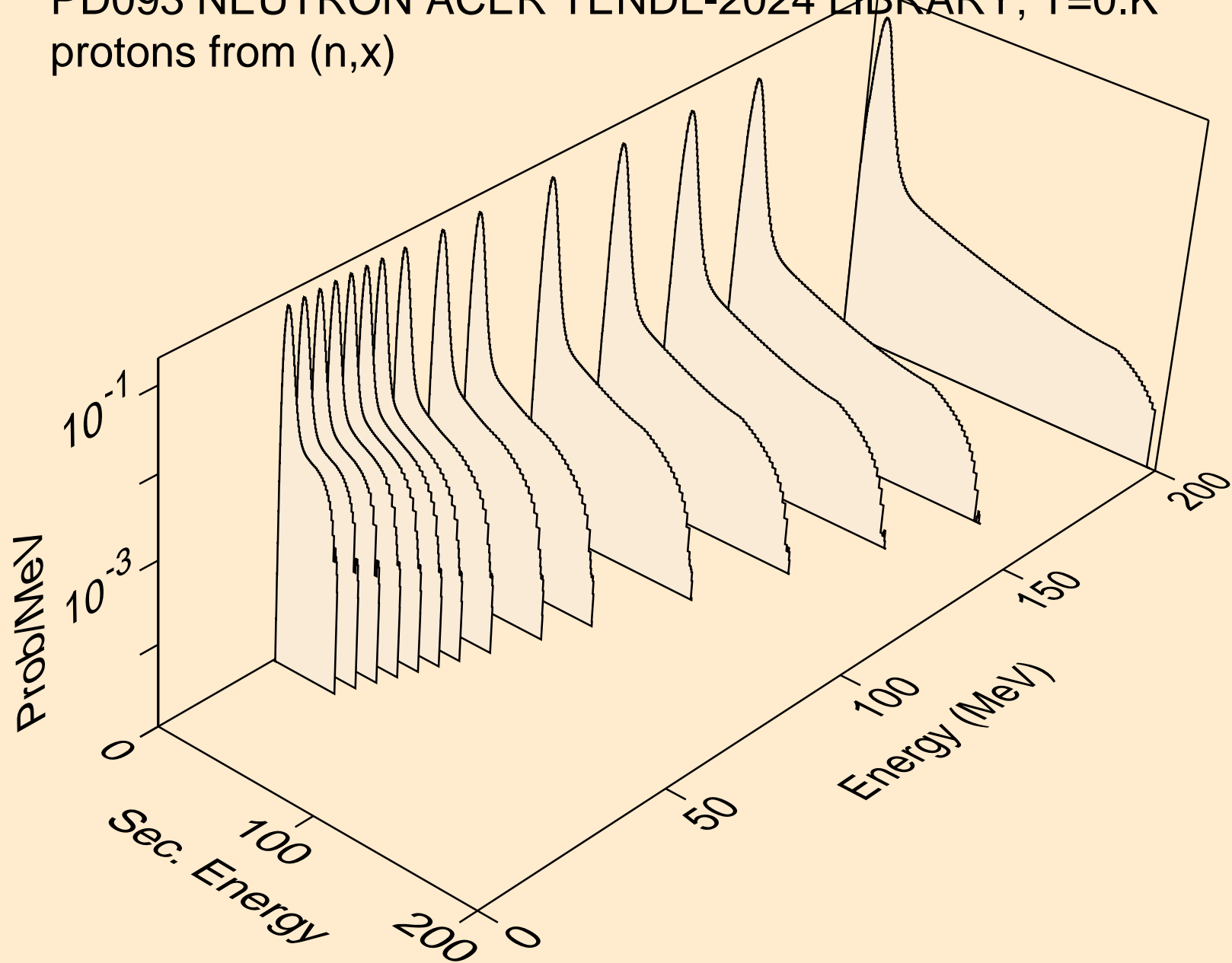

PD093 NEUTRON ACER TENDL-2024 LIBRARY; T=0.K  
protons from (n,n\*)p

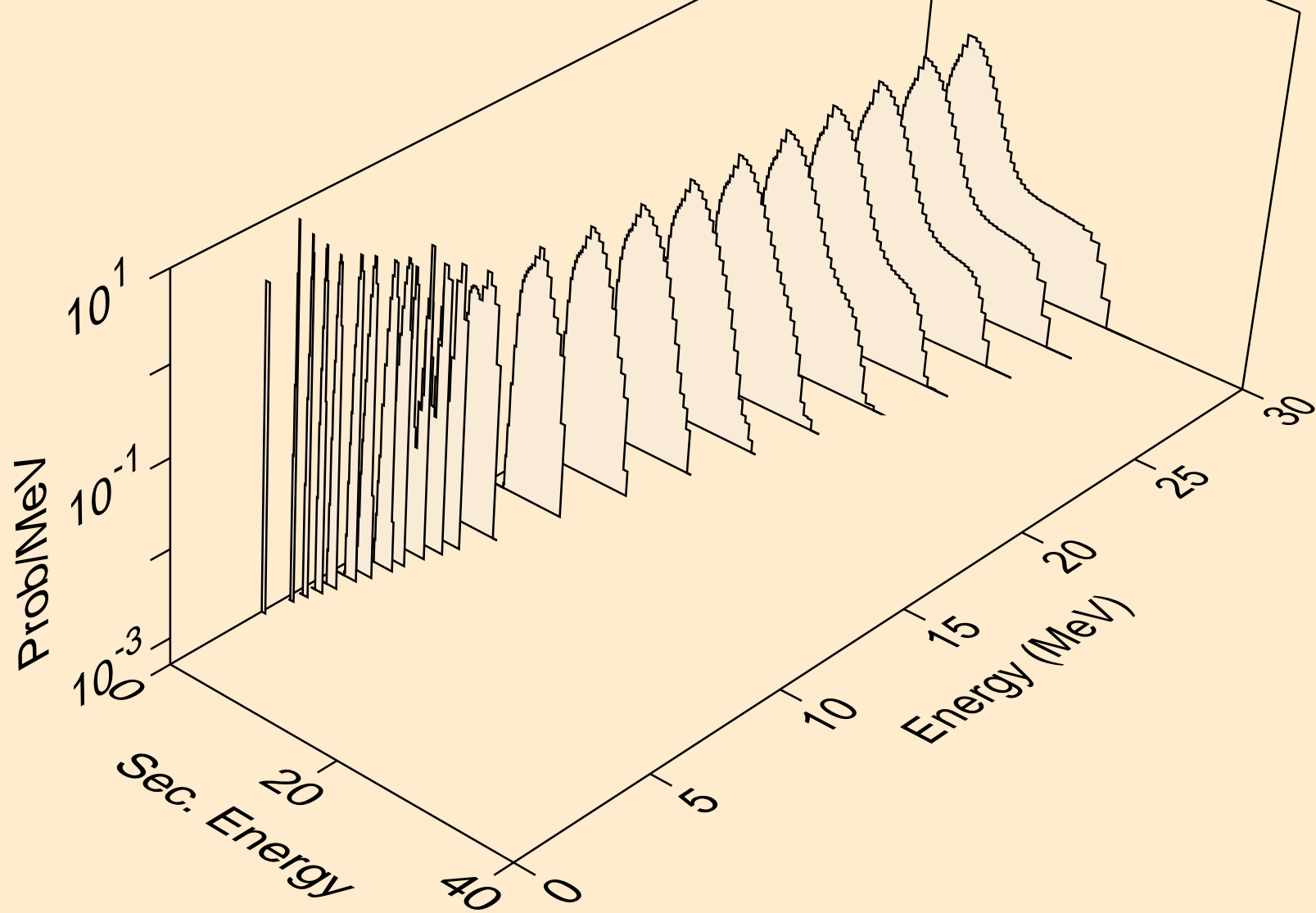

PD093 NEUTRON ACER TENDL-2024 LIBRARY; T=0.K  
protons from (n,2np)

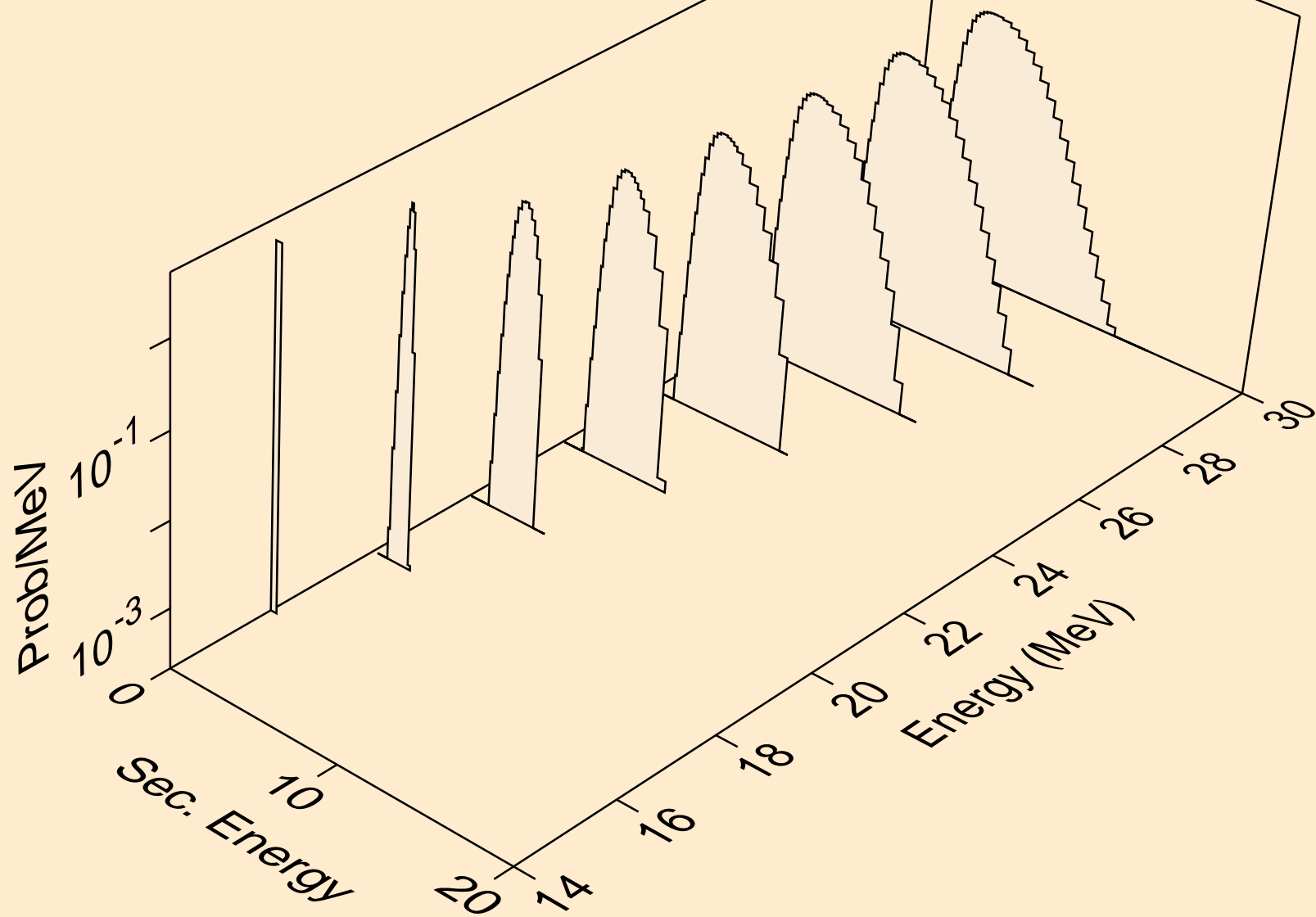

PD093 NEUTRON ACER TENDL-2024 LIBRARY; T=0.K  
protons from (n,n2p)

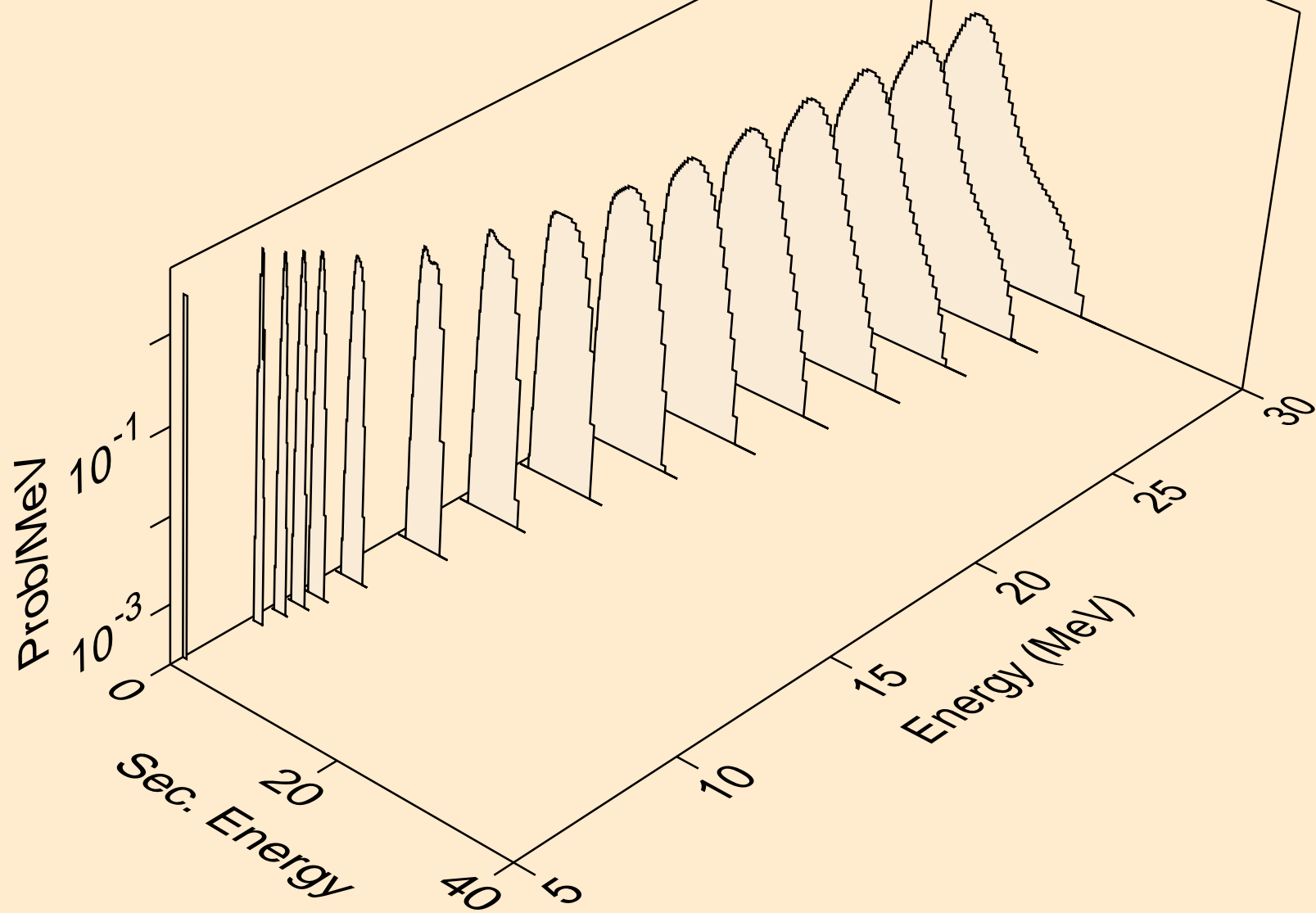

PD093 NEUTRON ACER TENDL-2024 LIBRARY; T=0.K  
protons from (n,npa)

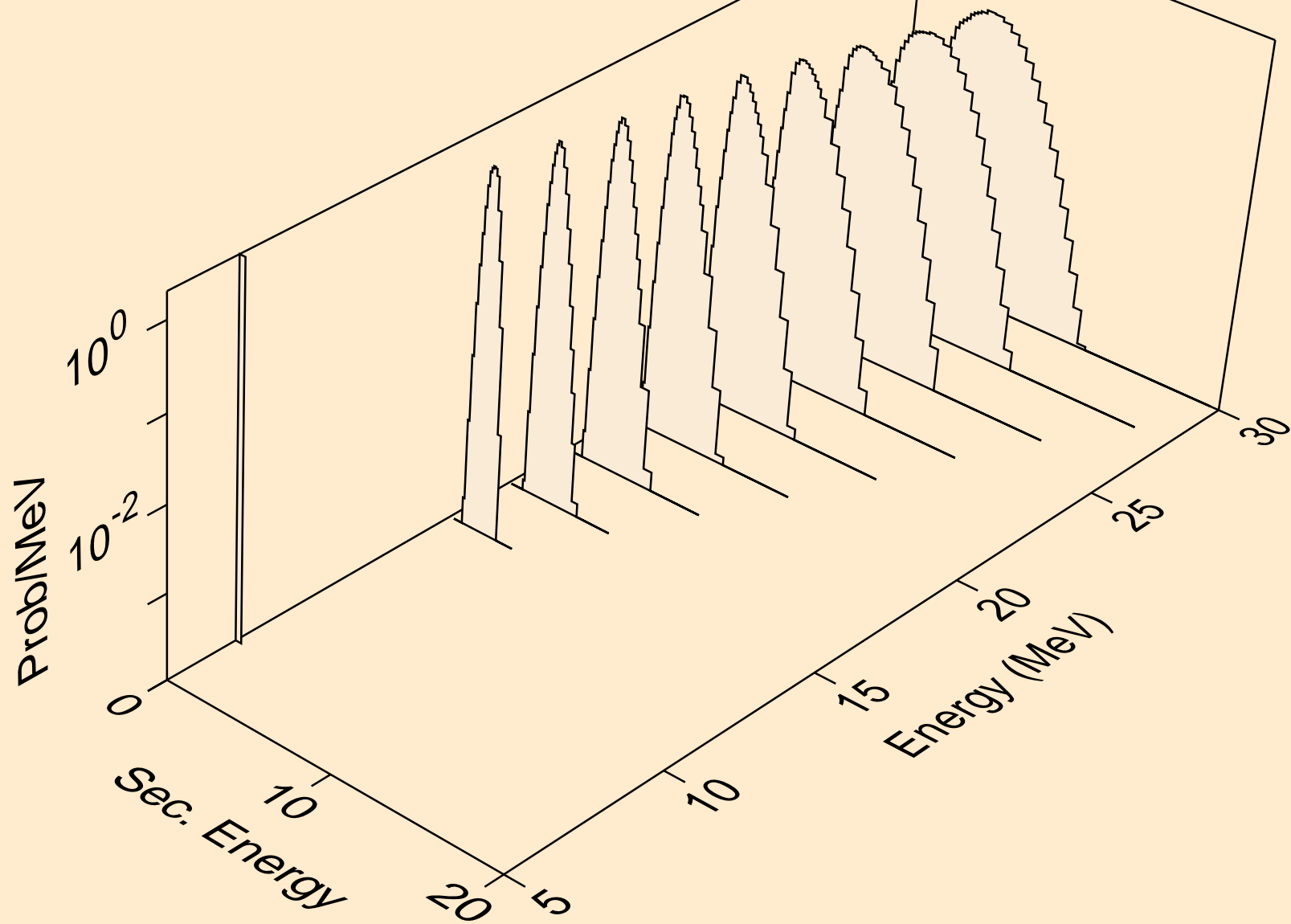

PD093 NEUTRON ACER TENDL-2024 LIBRARY; T=0.K  
protons from (n,p)

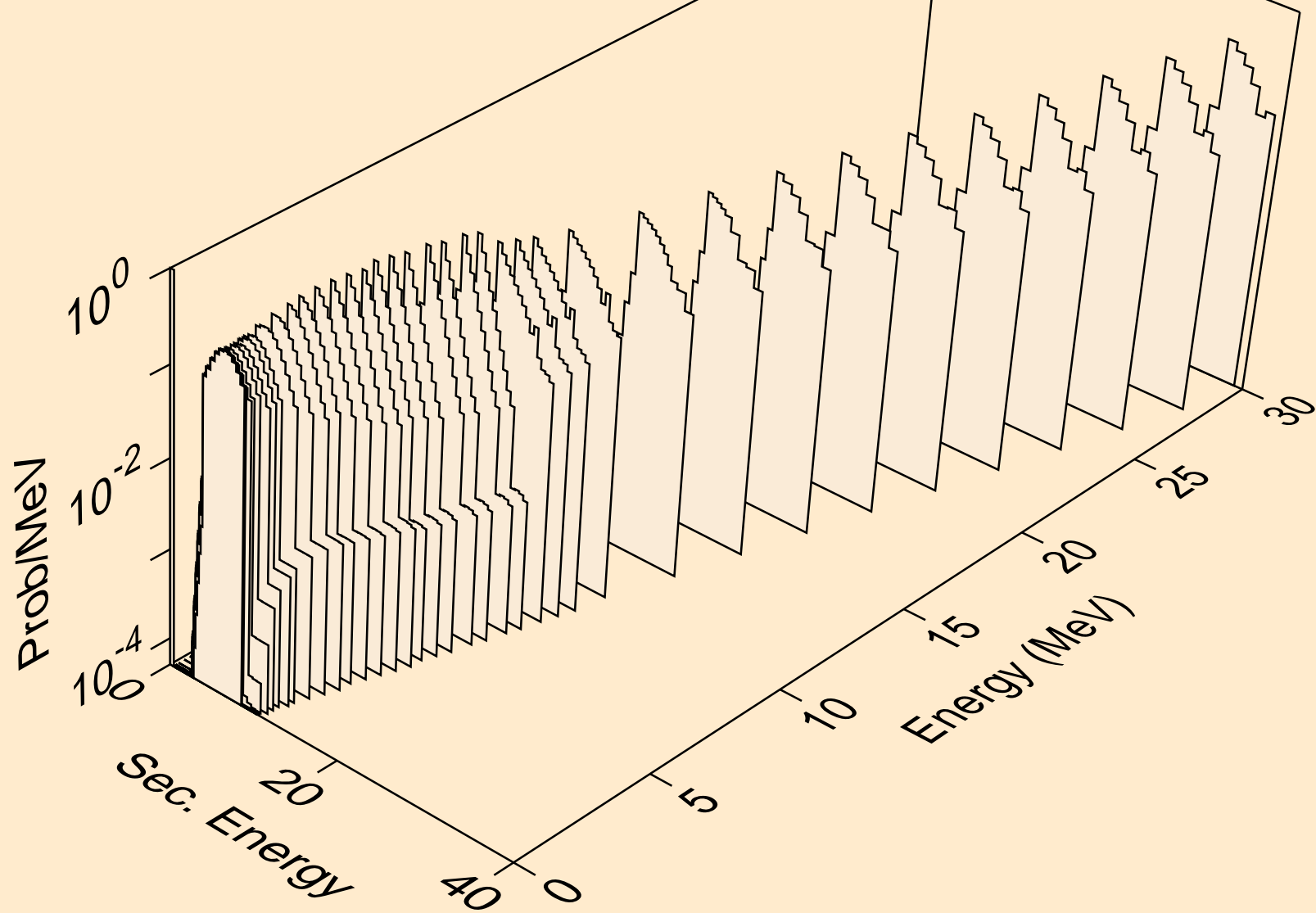

PD093 NEUTRON ACER TENDL-2024 LIBRARY; T=0.K  
protons from (n,2p)

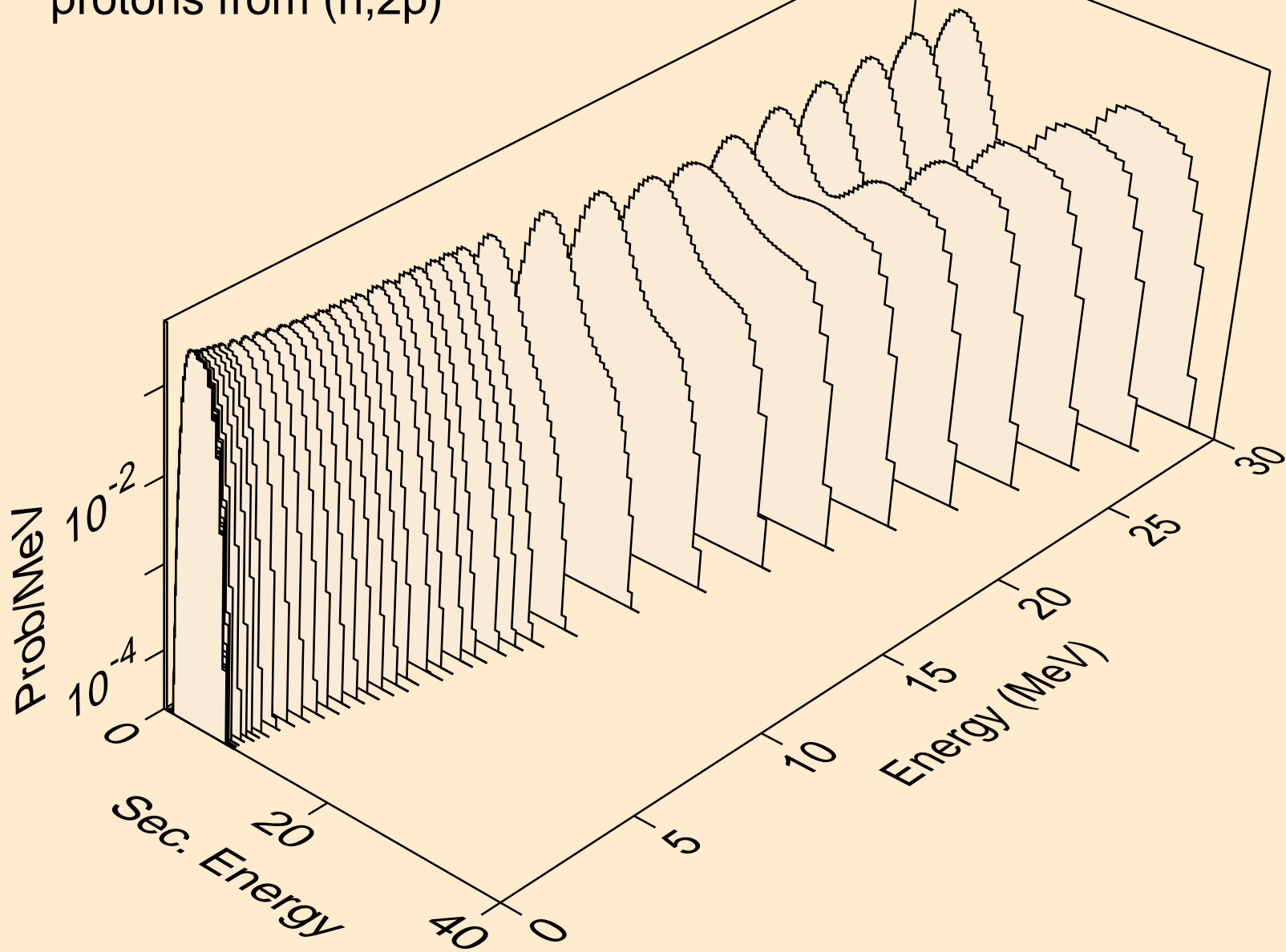

PD093 NEUTRON ACER TENDL-2024 LIBRARY; T=0.K  
protons from (n,p)

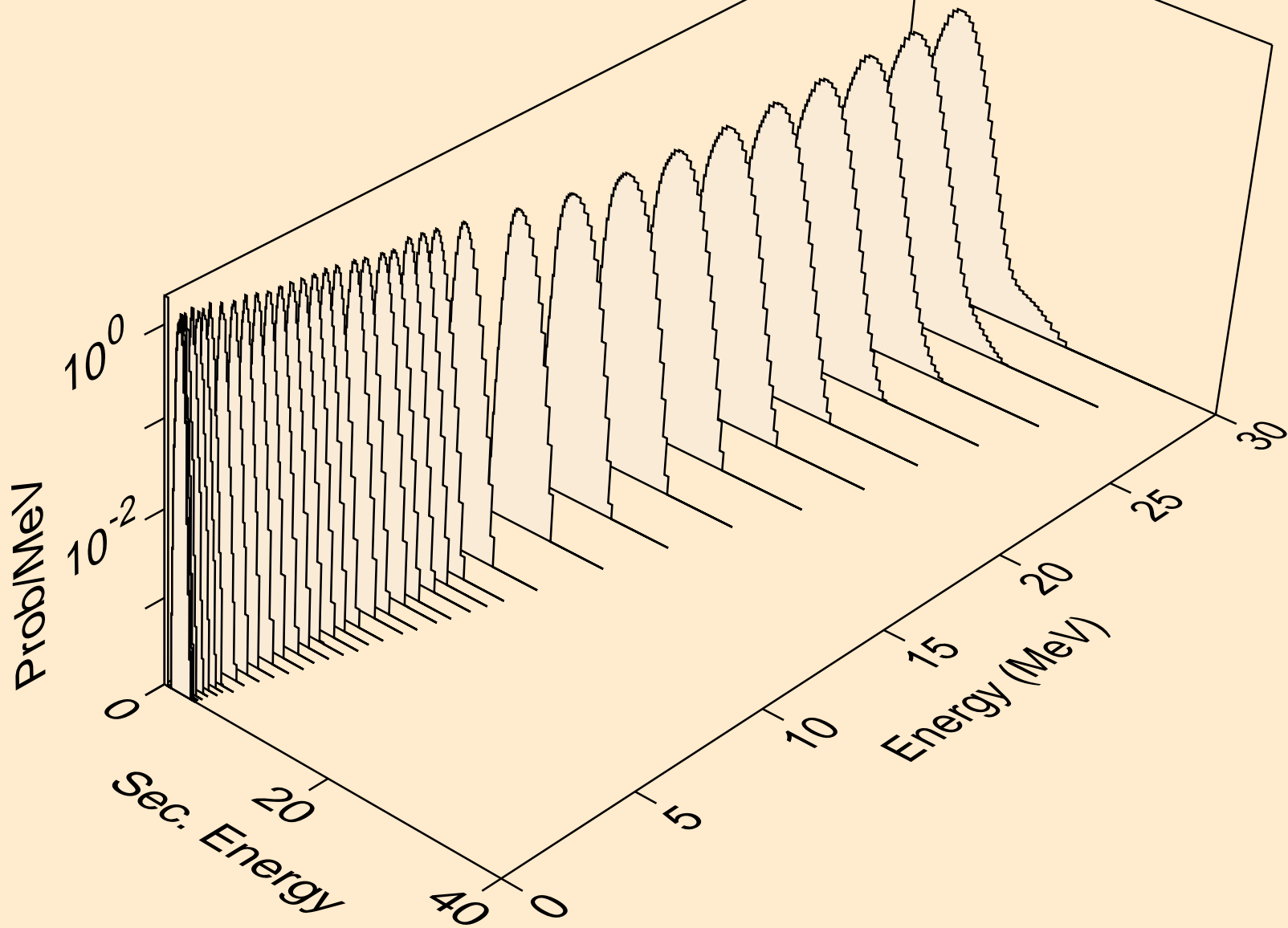

PD093 NEUTRON ACER TENDL-2024 LIBRARY; T=0.K  
protons from (n,pd)

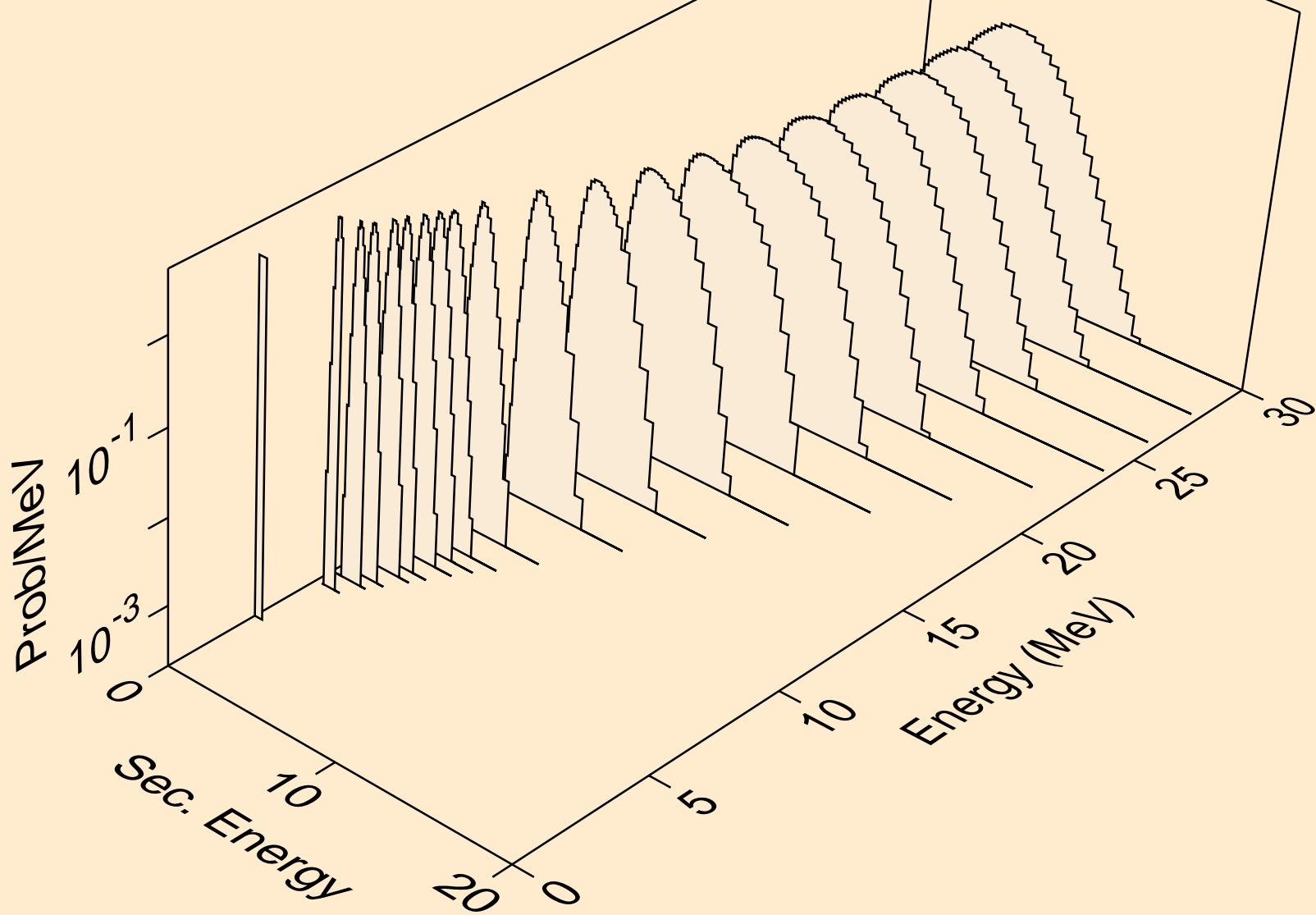

PD093 NEUTRON ACER TENDL-2024 LIBRARY; T=0.K  
protons from (n,pt)

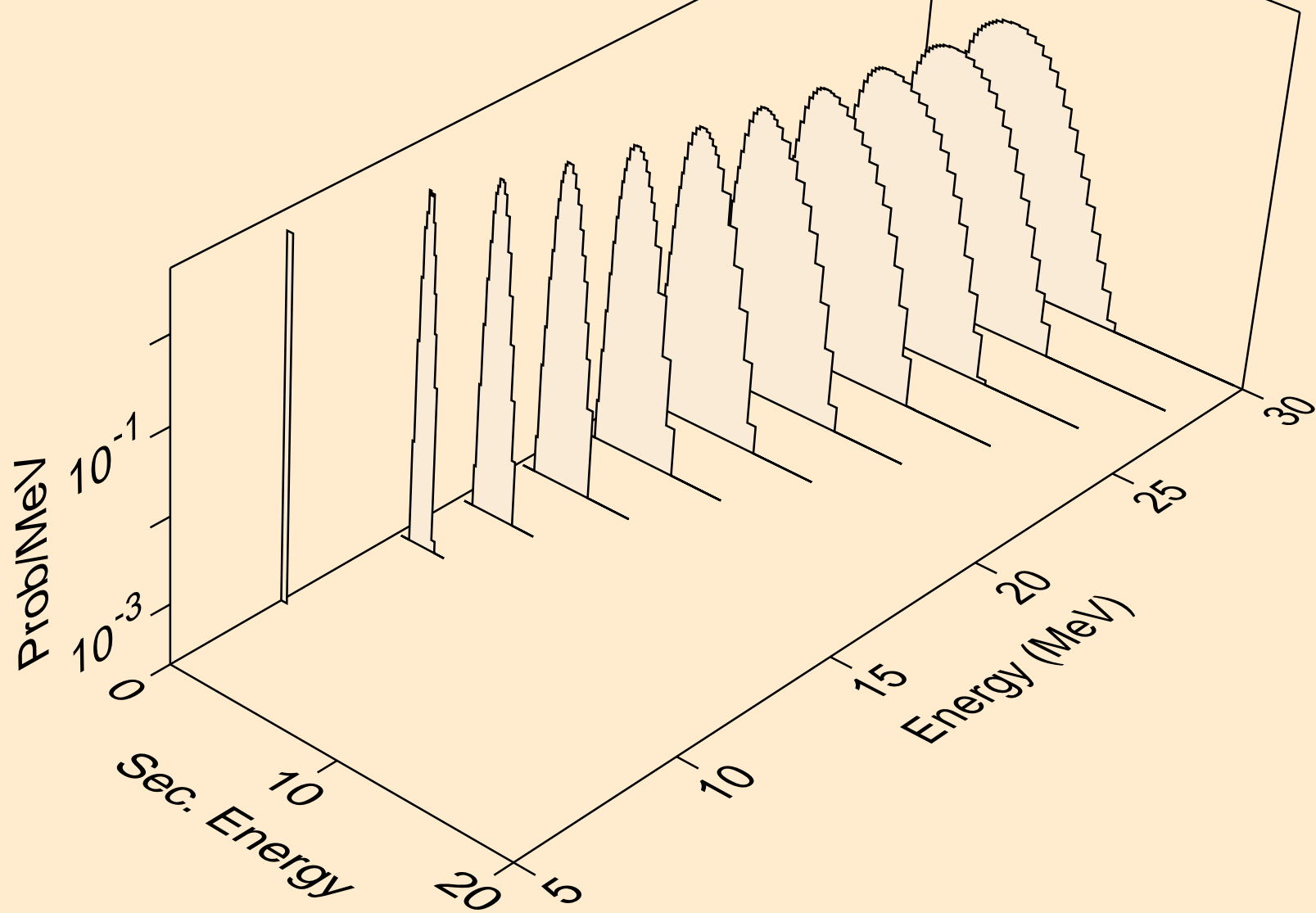

PD093 NEUTRON ACER TENDL-2024 LIBRARY; T=0.K  
deuterons from (n,x)

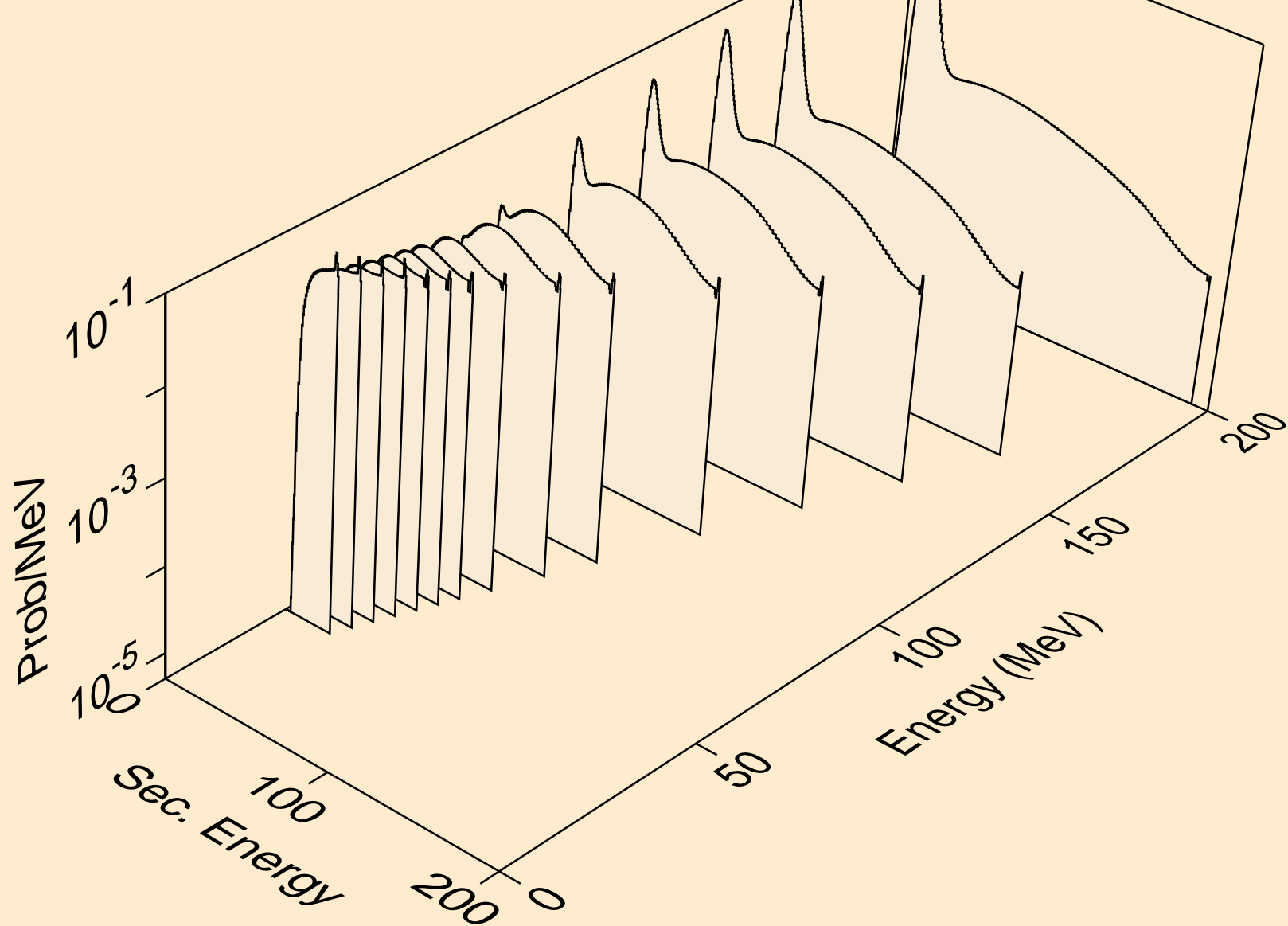

PD093 NEUTRON ACER TENDL-2024 LIBRARY; T=0.K  
deuterons from (n,n\*)d

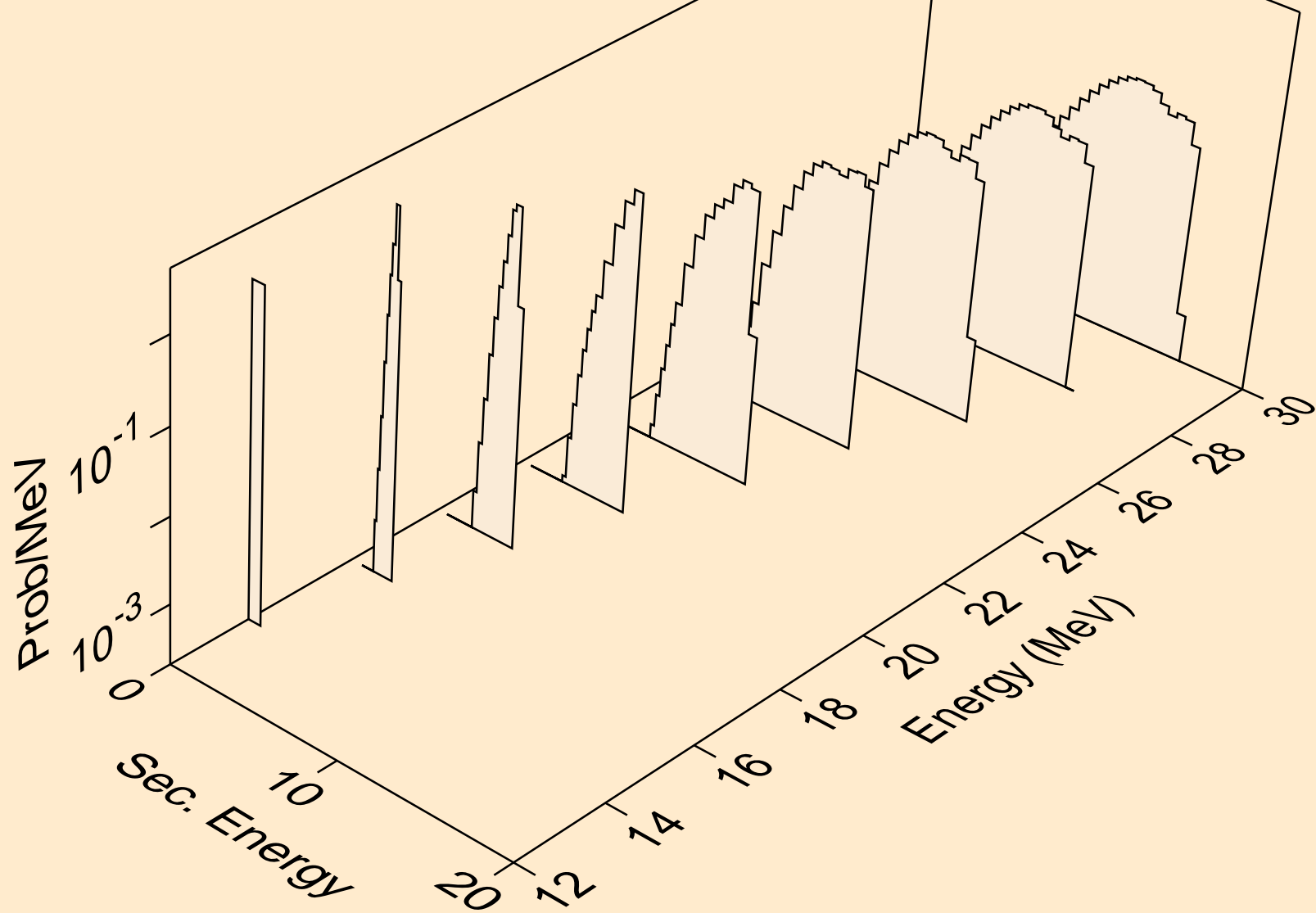

PD093 NEUTRON ACER TENDL-2024 LIBRARY; T=0.K  
deuterons from (n,d)

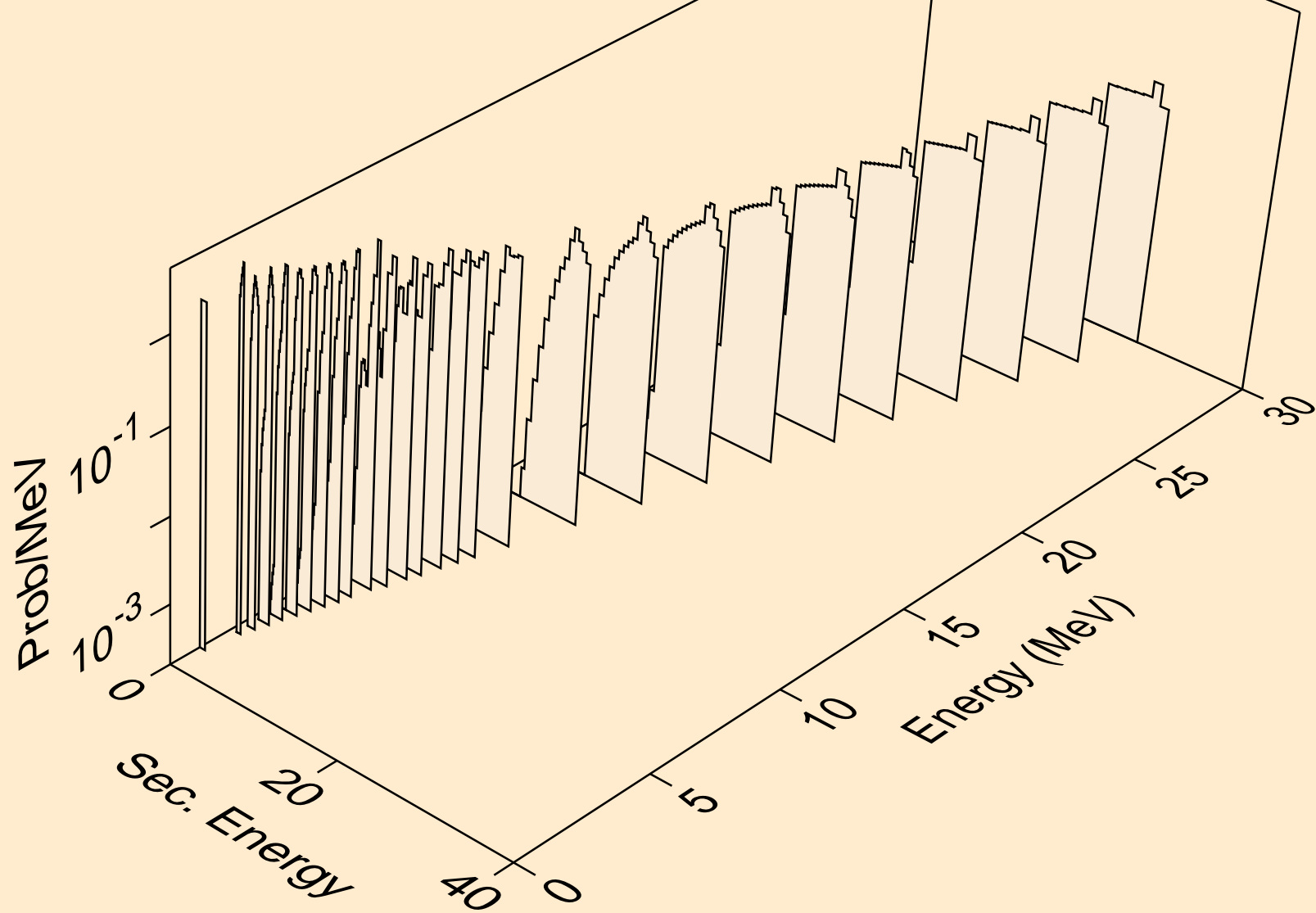

PD093 NEUTRON ACER TENDL-2024 LIBRARY; T=0.K  
deuterons from (n,pd)

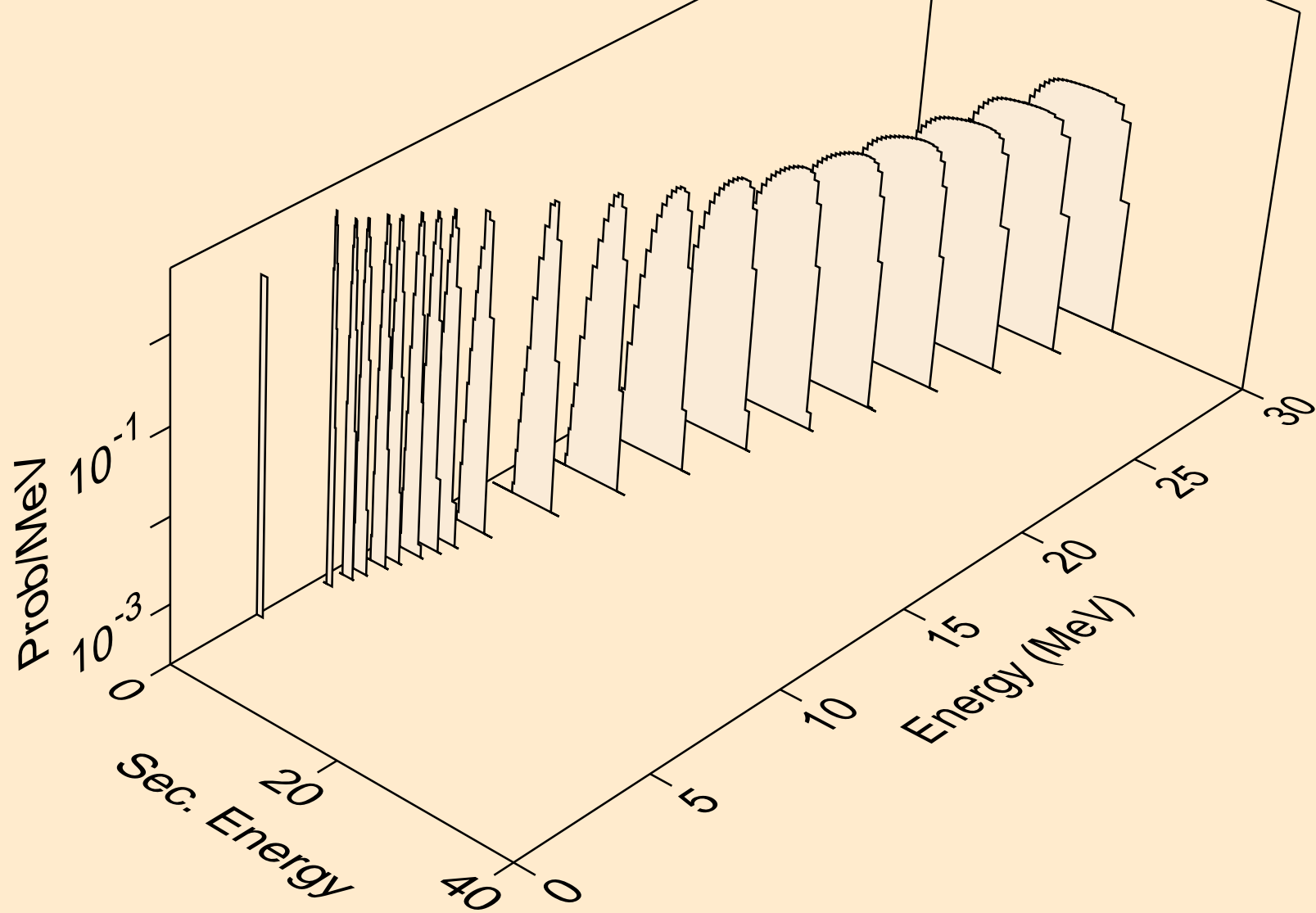

PD093 NEUTRON ACER TENDL-2024 LIBRARY; T=0.K  
deuterons from (n,da)

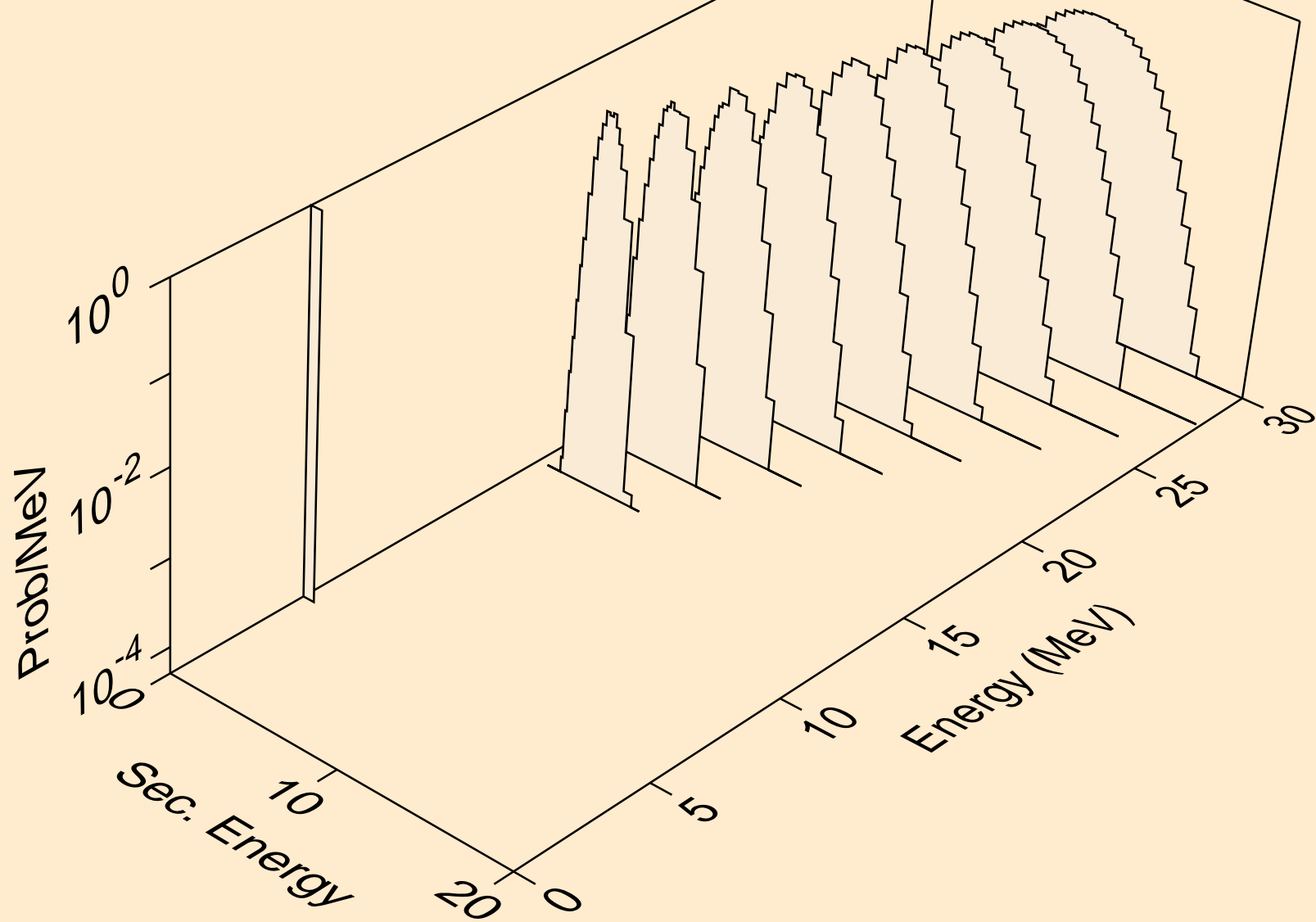

PD093 NEUTRON ACER TENDL-2024 LIBRARY; T=0.K  
tritons from (n,x)

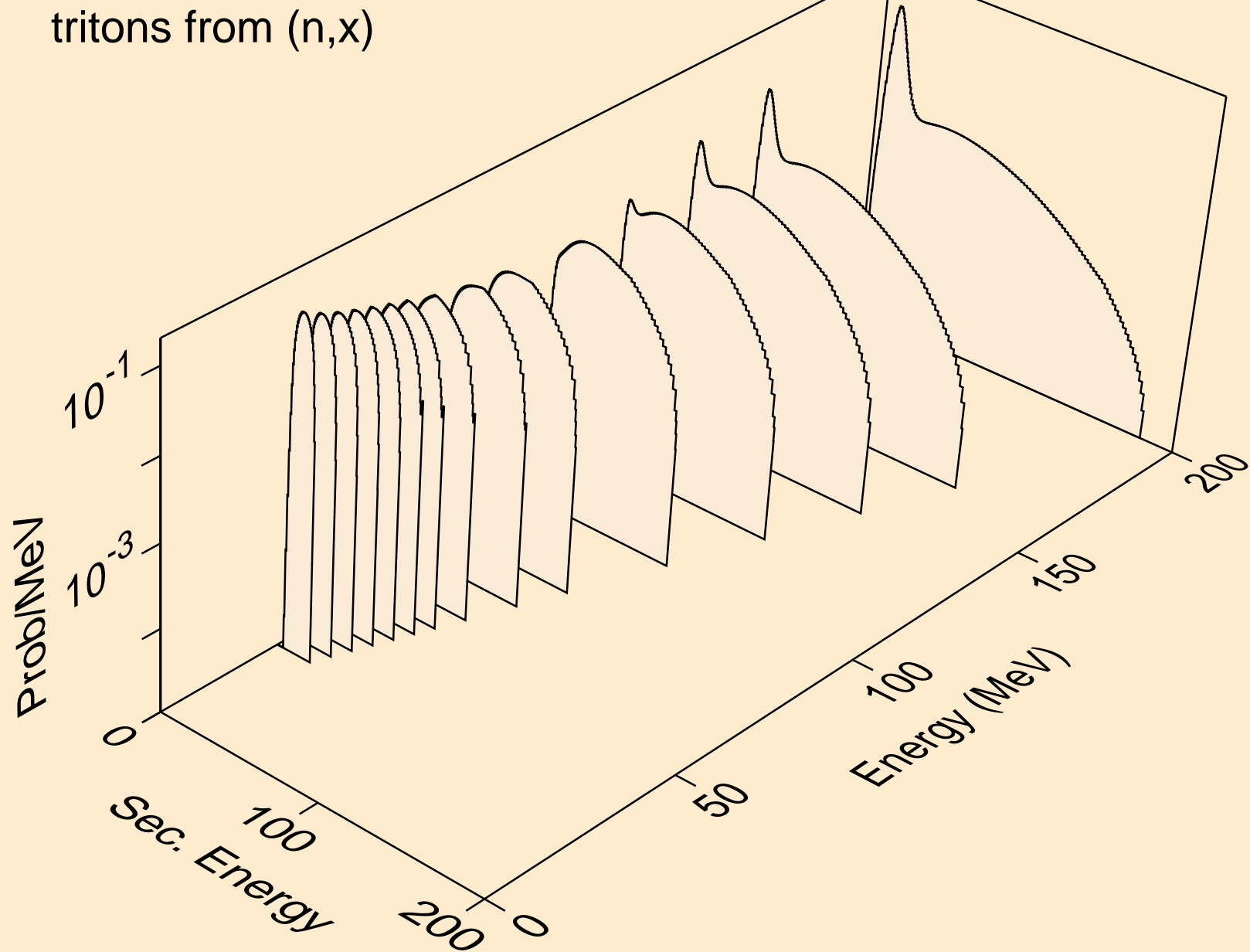

PD093 NEUTRON ACER TENDL-2024 LIBRARY; T=0.K  
tritons from (n,n\*)t

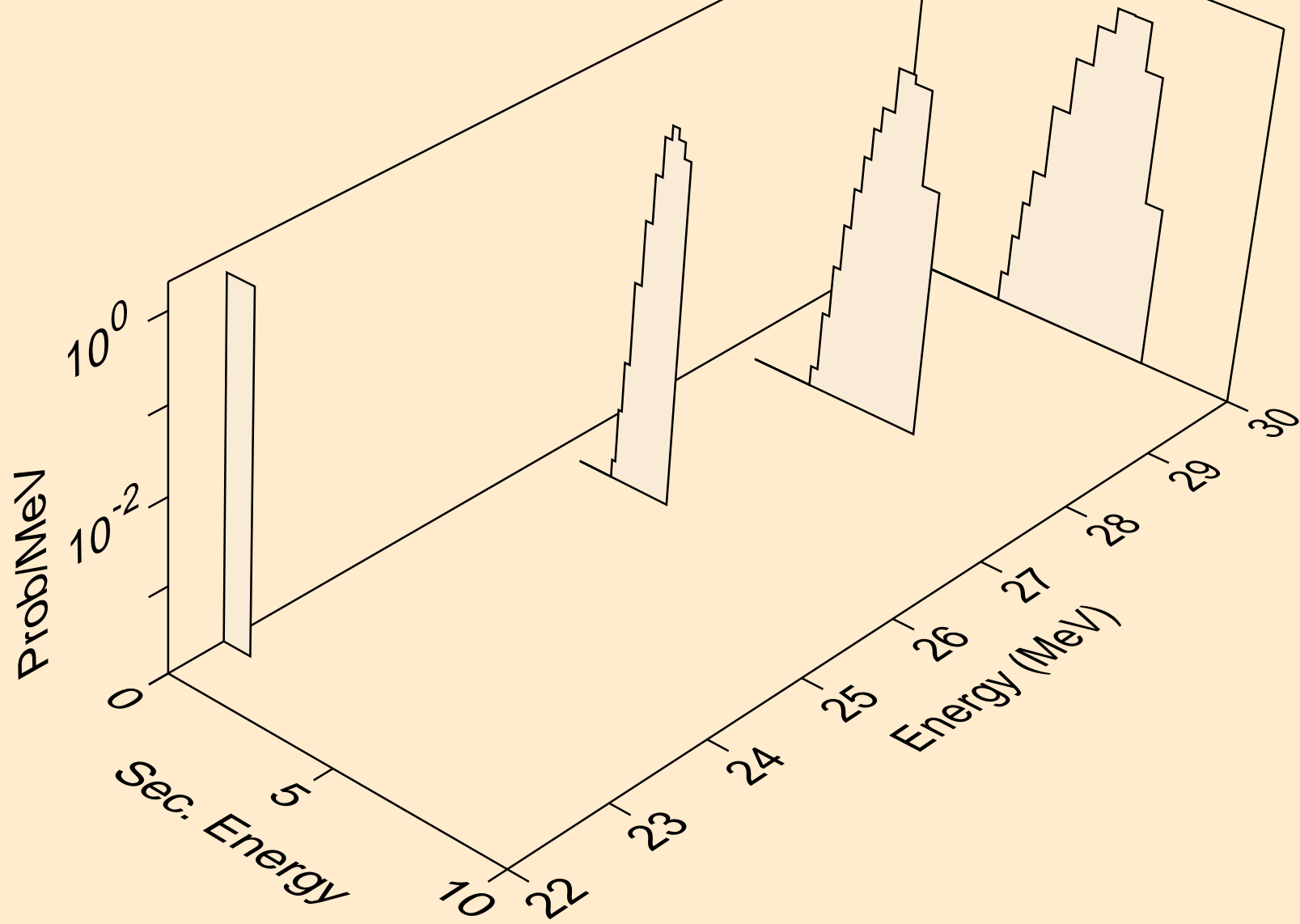

PD093 NEUTRON ACER TENDL-2024 LIBRARY; T=0.K  
tritons from (n,t)

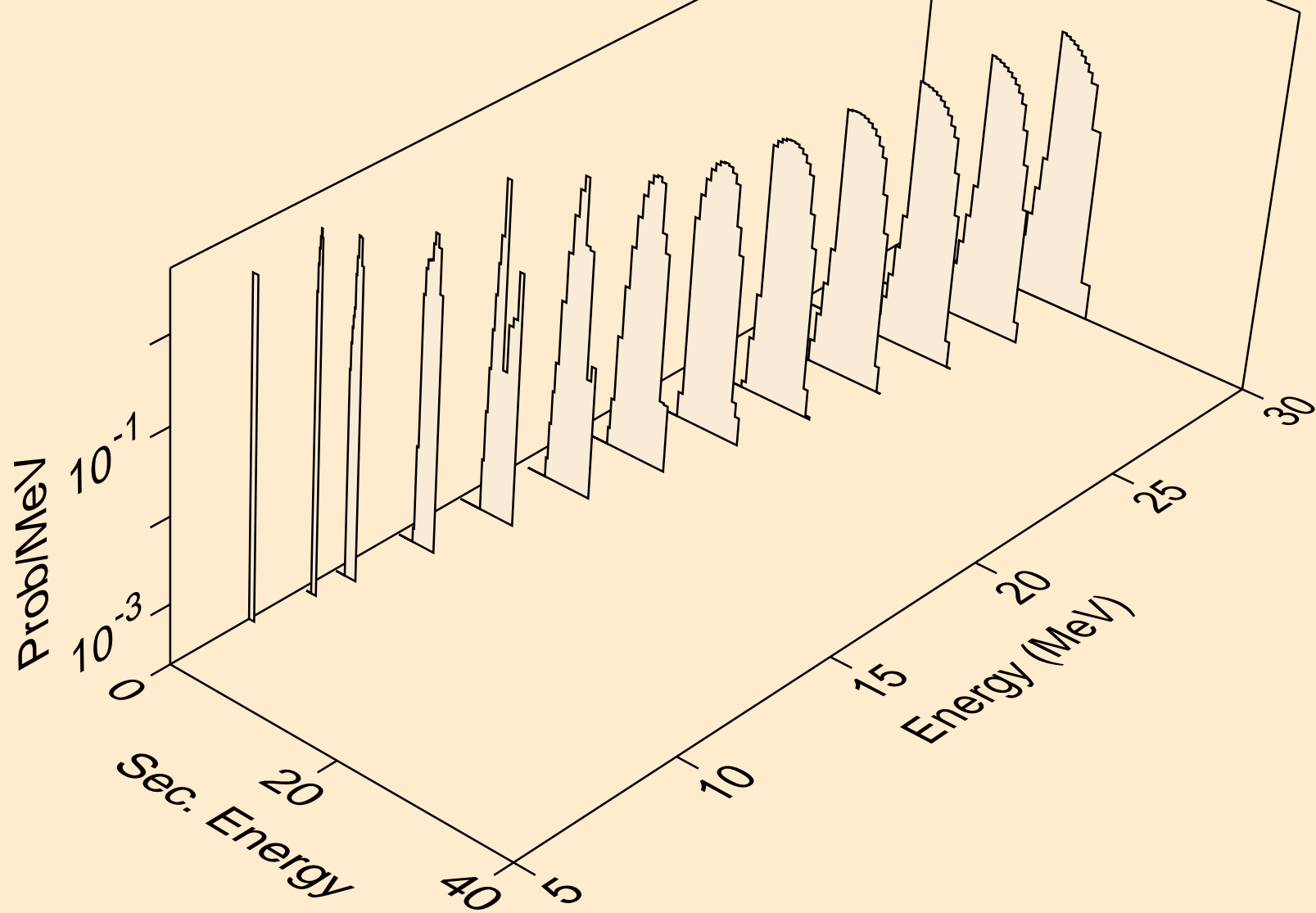

PD093 NEUTRON ACER TENDL-2024 LIBRARY; T=0.K  
tritons from (n,pt)

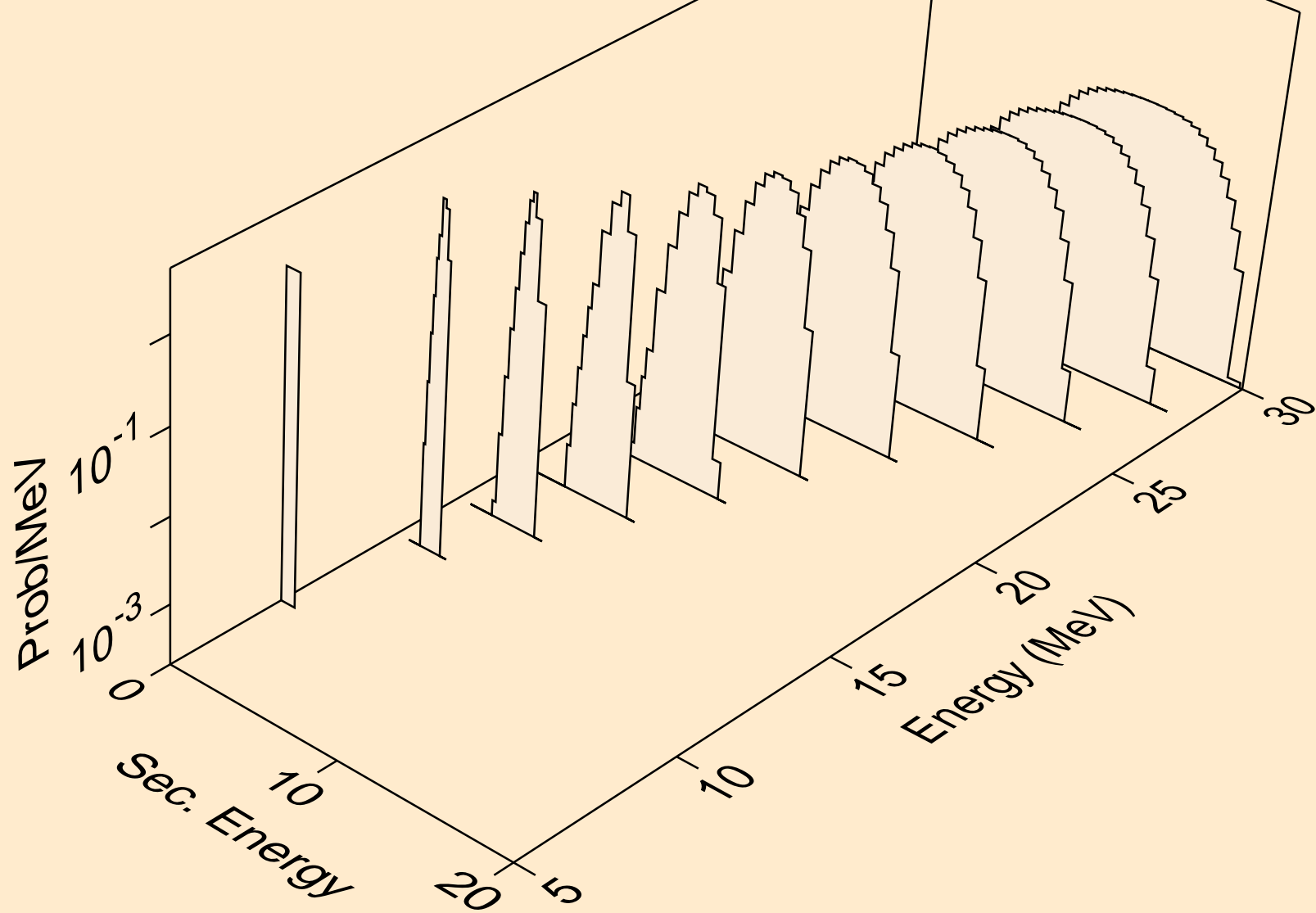

PD093 NEUTRON ACER TENDL-2024 LIBRARY; T=0.K  
he3s from (n,x)

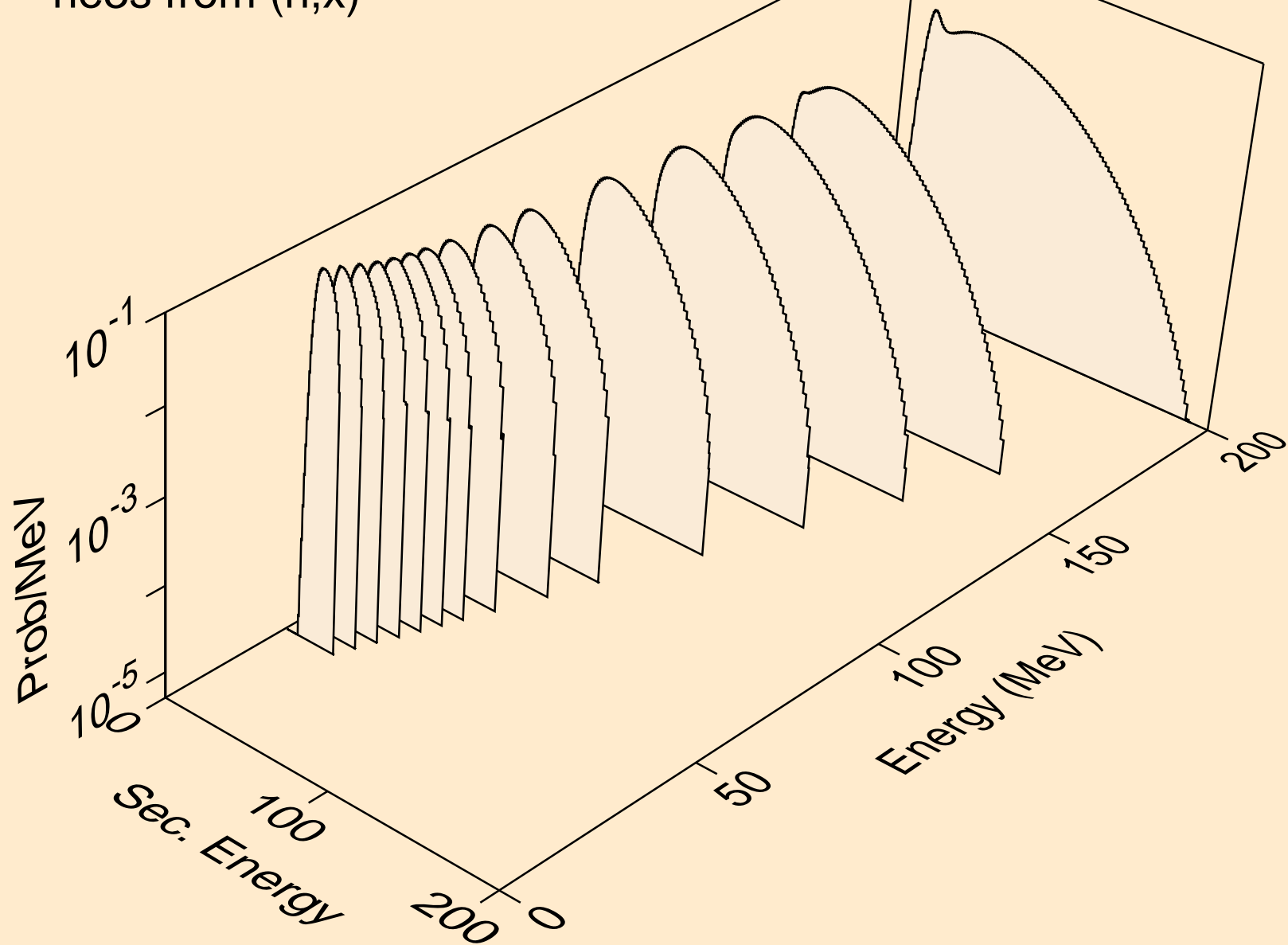

PD093 NEUTRON ACER TENDL-2024 LIBRARY; T=0.K  
he3s from (n,n\*)he3

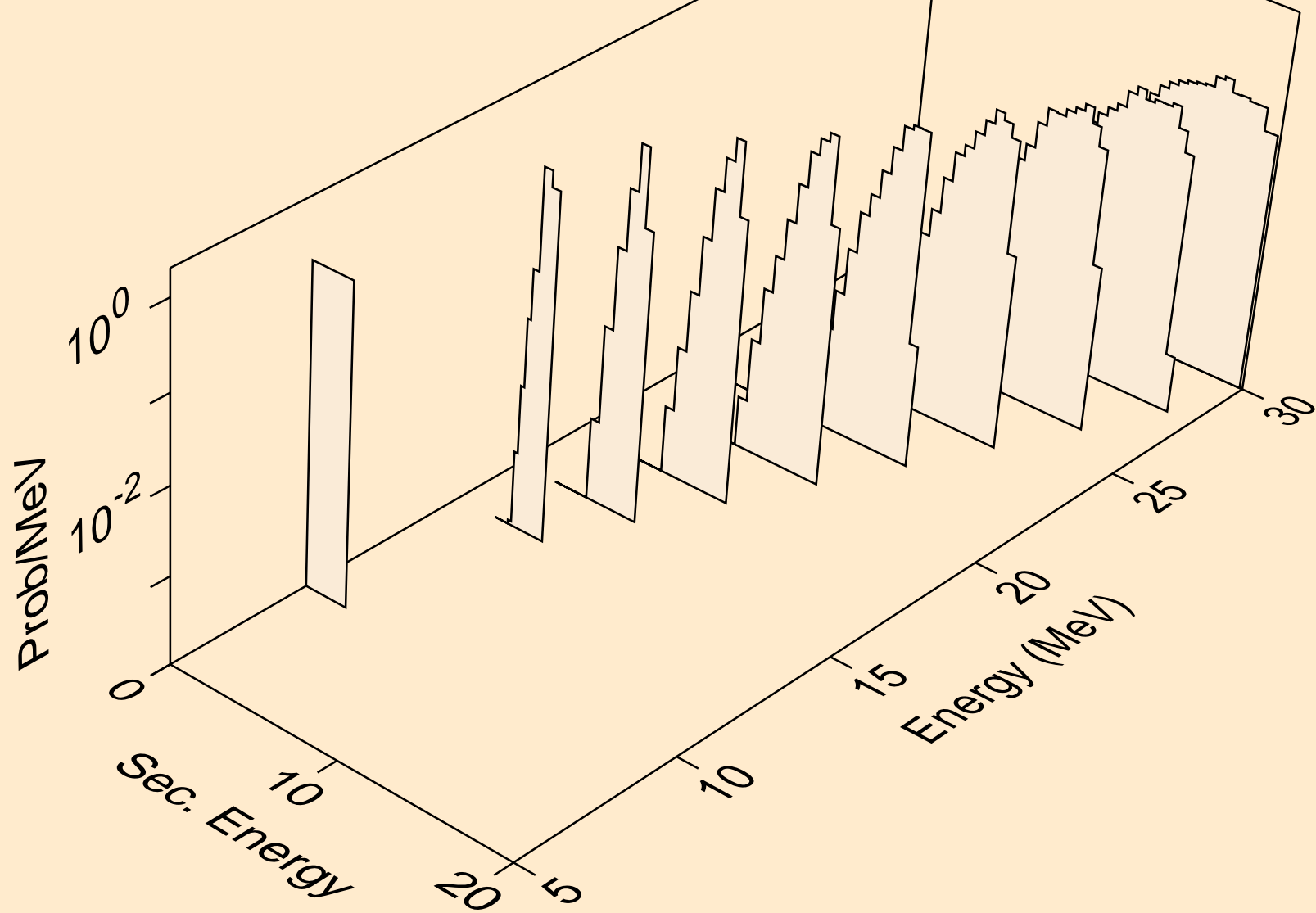

PD093 NEUTRON ACER TENDL-2024 LIBRARY; T=0.K  
he3s from (n,he3)

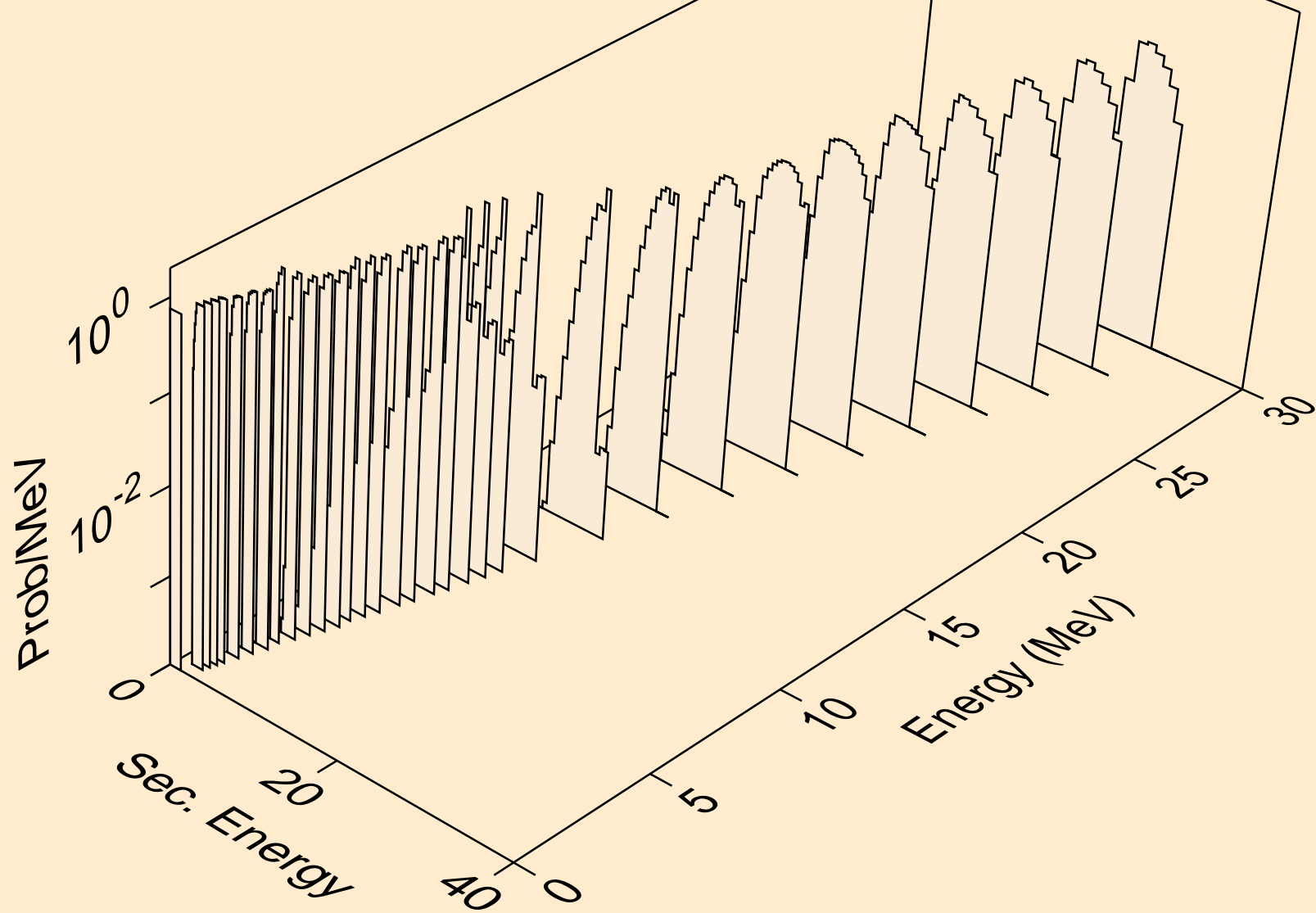

PD093 NEUTRON ACER TENDL-2024 LIBRARY; T=0.K  
alphas from (n,x)

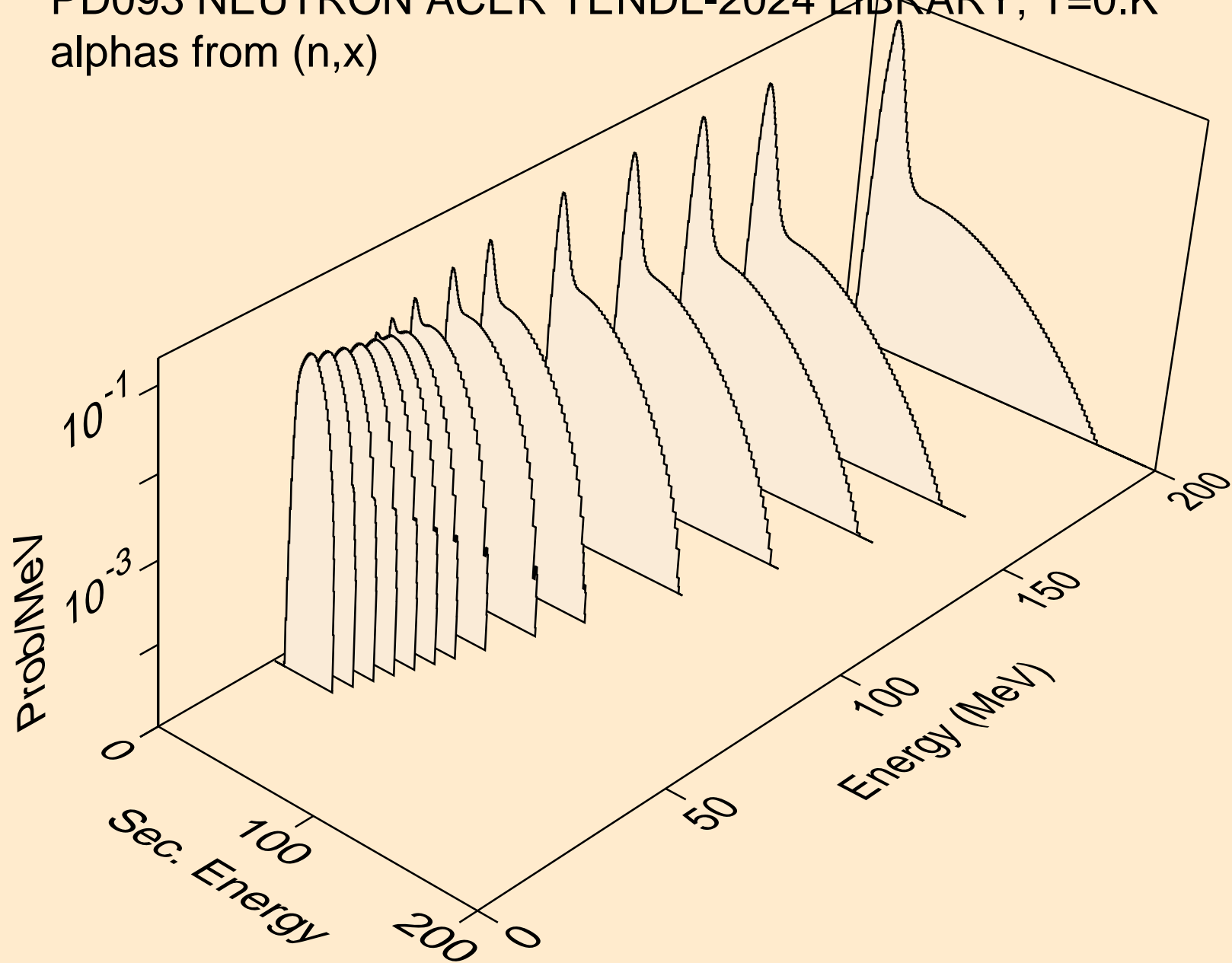

PD093 NEUTRON ACER TENDL-2024 LIBRARY; T=0.K  
alphas from (n,n\*)a

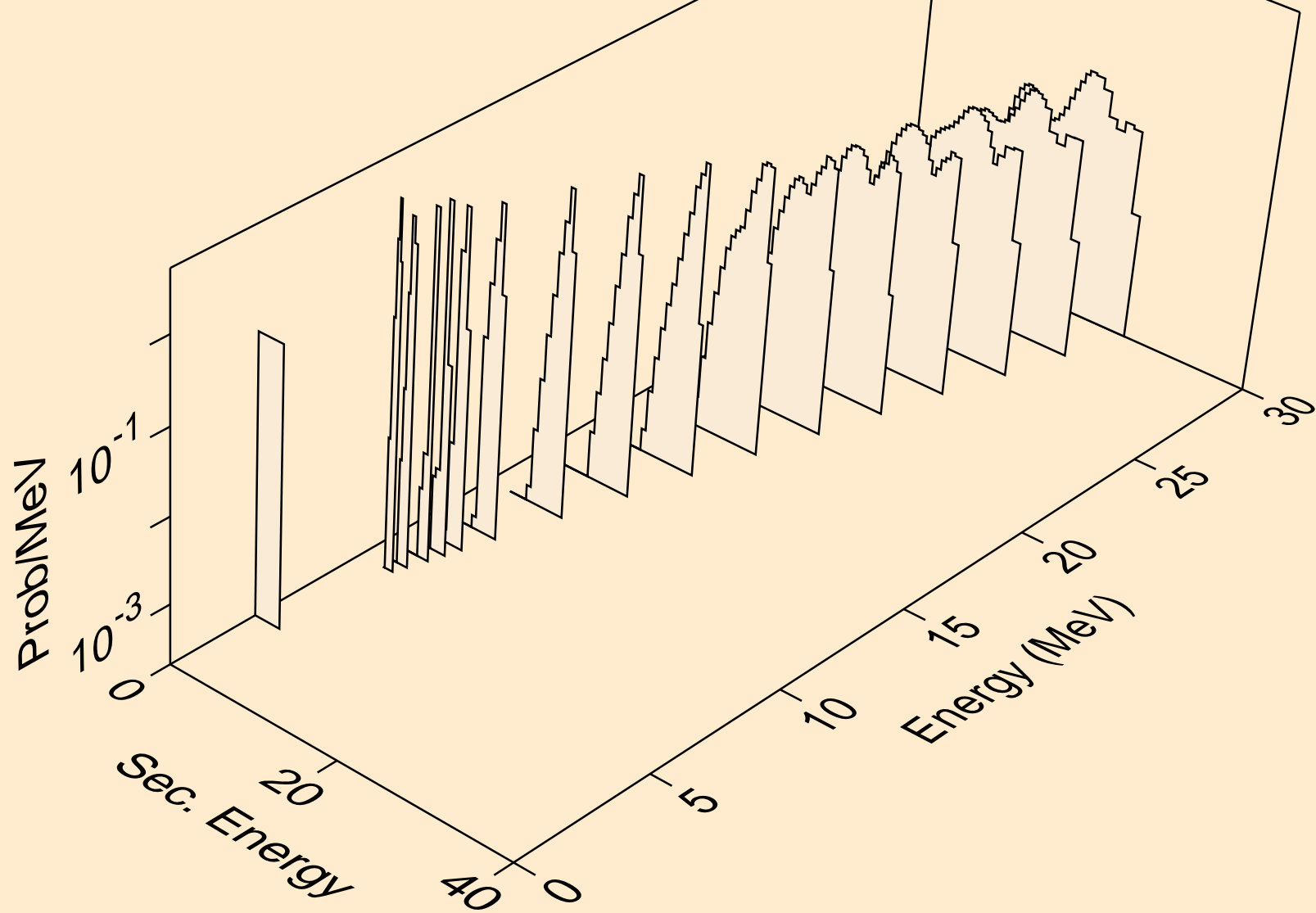

PD093 NEUTRON ACER TENDL-2024 LIBRARY; T=0.K  
alphas from (n,2n)a

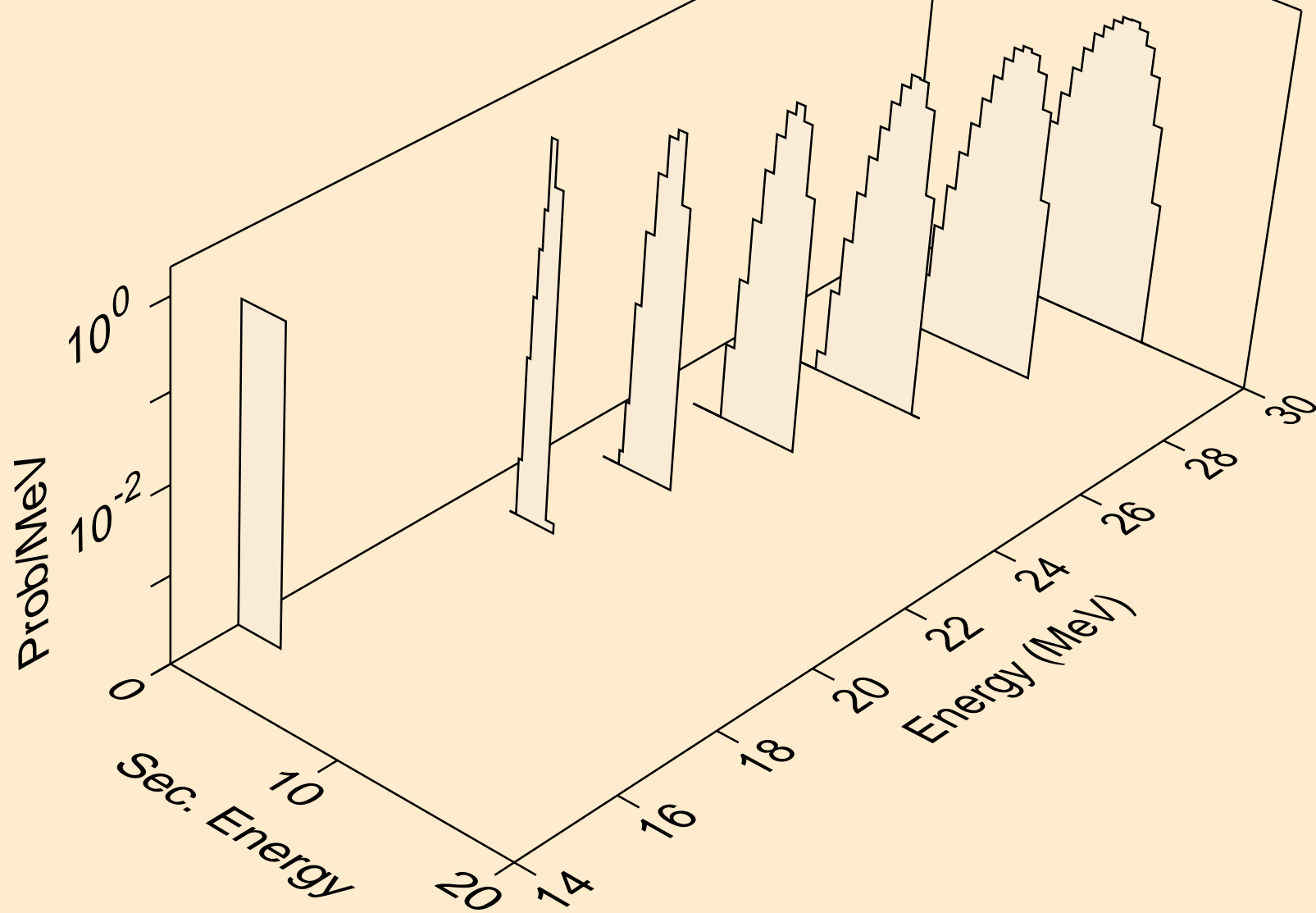

PD093 NEUTRON ACER TENDL-2024 LIBRARY; T=0.K  
alphas from (n,n\*)2a

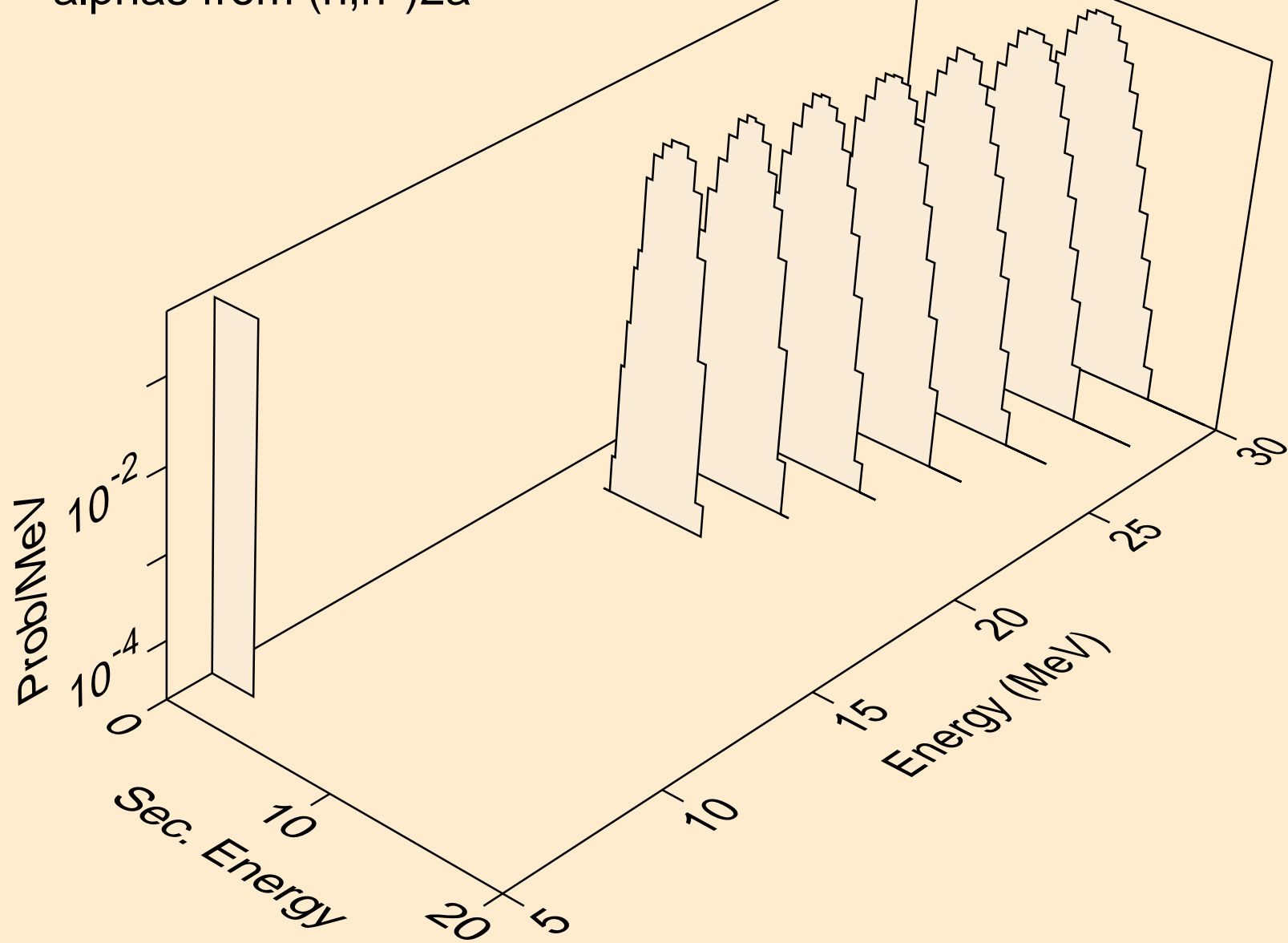

PD093 NEUTRON ACER TENDL-2024 LIBRARY; T=0.K  
alphas from (n,npa)

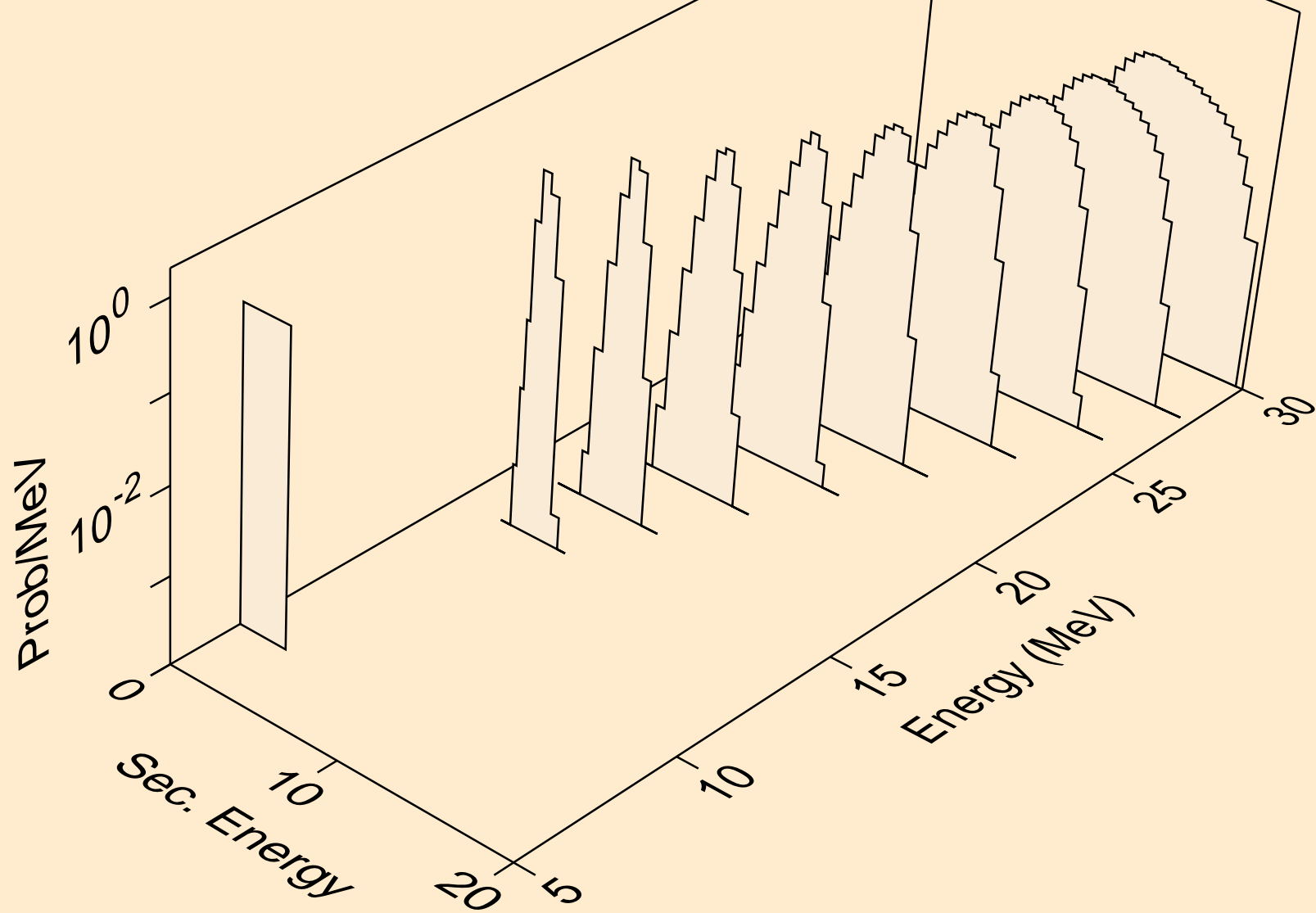

PD093 NEUTRON ACER TENDL-2024 LIBRARY; T=0.K  
alphas from (n,a)

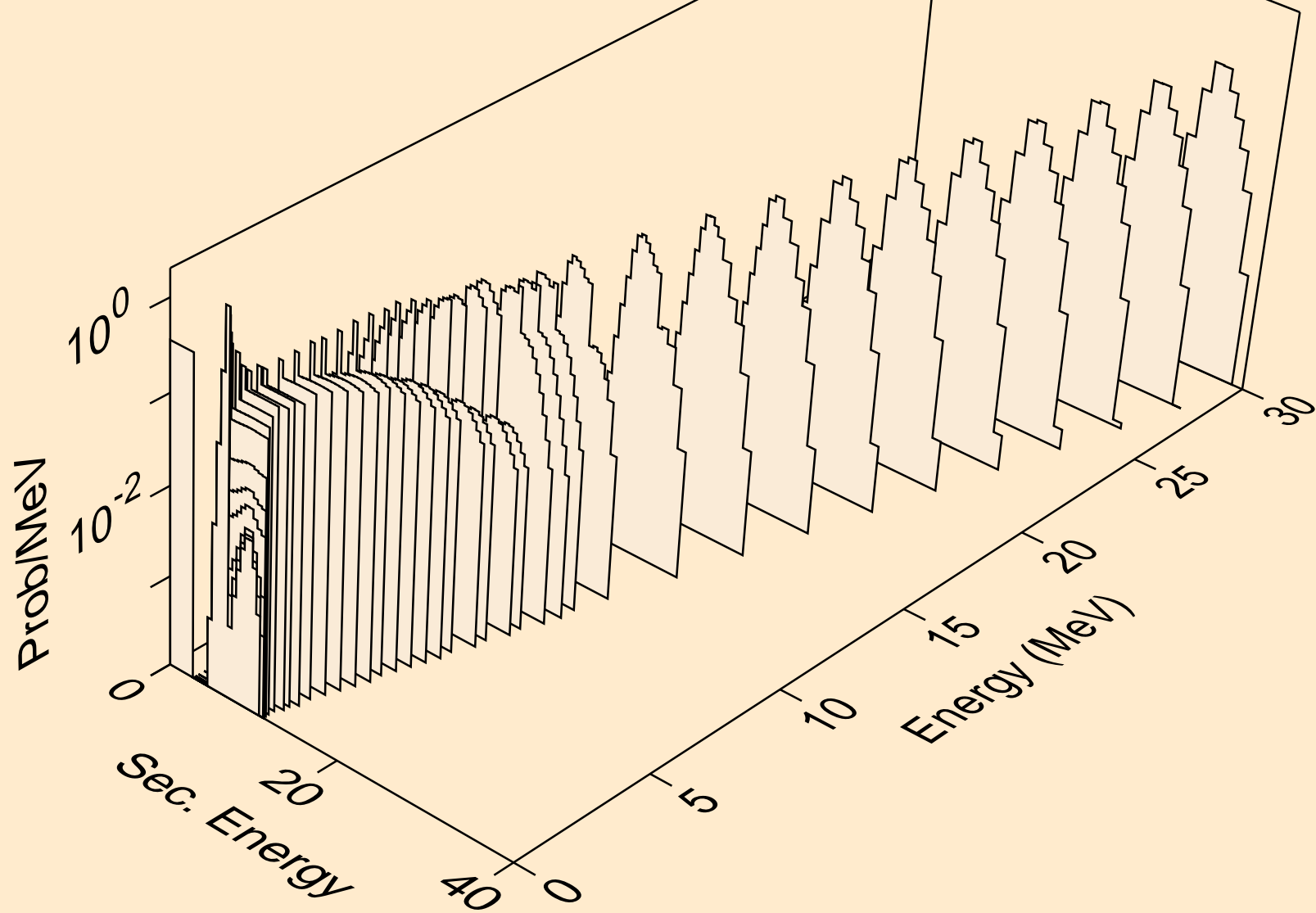

PD093 NEUTRON ACER TENDL-2024 LIBRARY; T=0.K  
alphas from (n,2a)

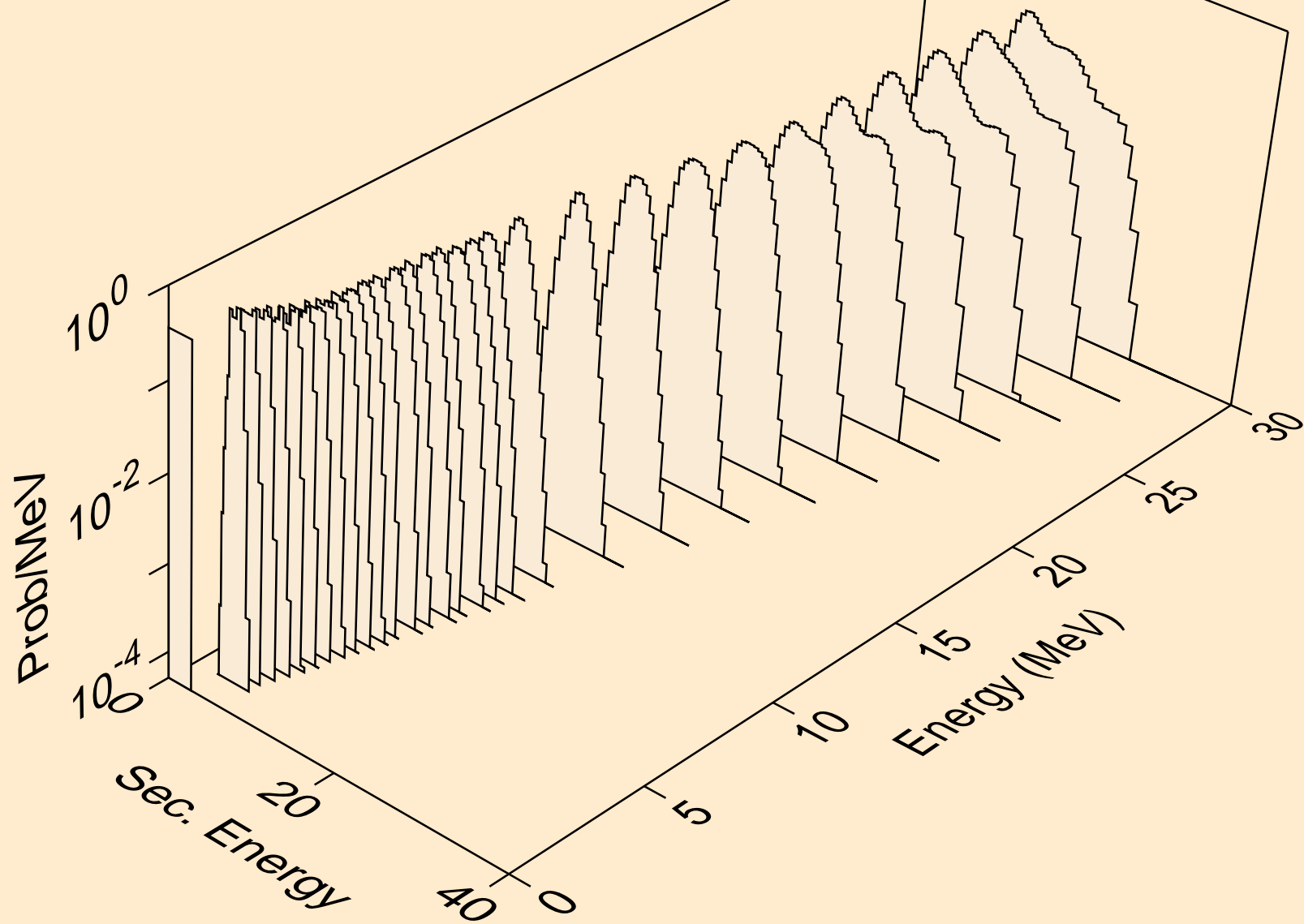

PD093 NEUTRON ACER TENDL-2024 LIBRARY; T=0.K  
alphas from (n,3a)

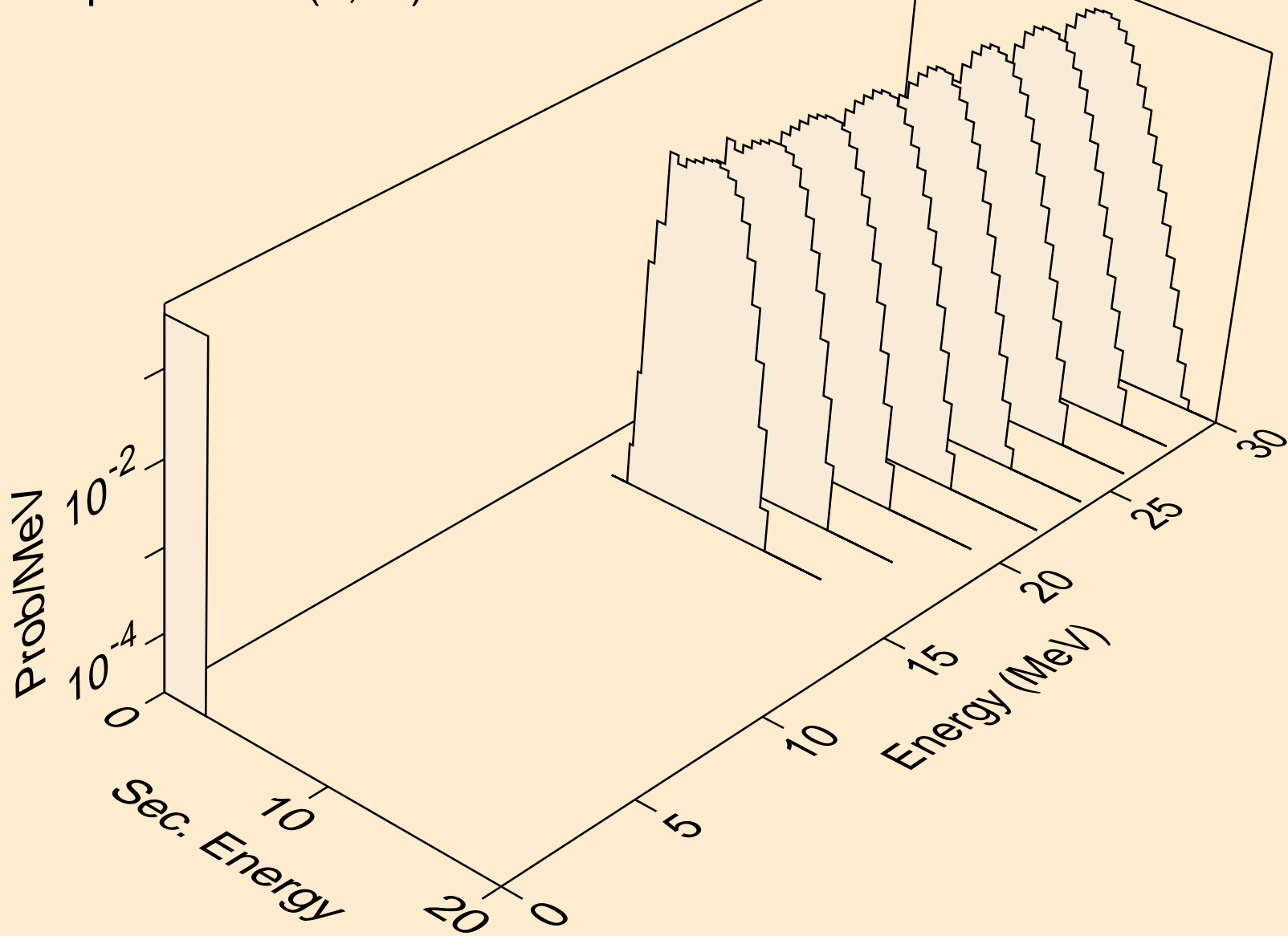

PD093 NEUTRON ACER TENDL-2024 LIBRARY; T=0.K  
alphas from (n,pa)

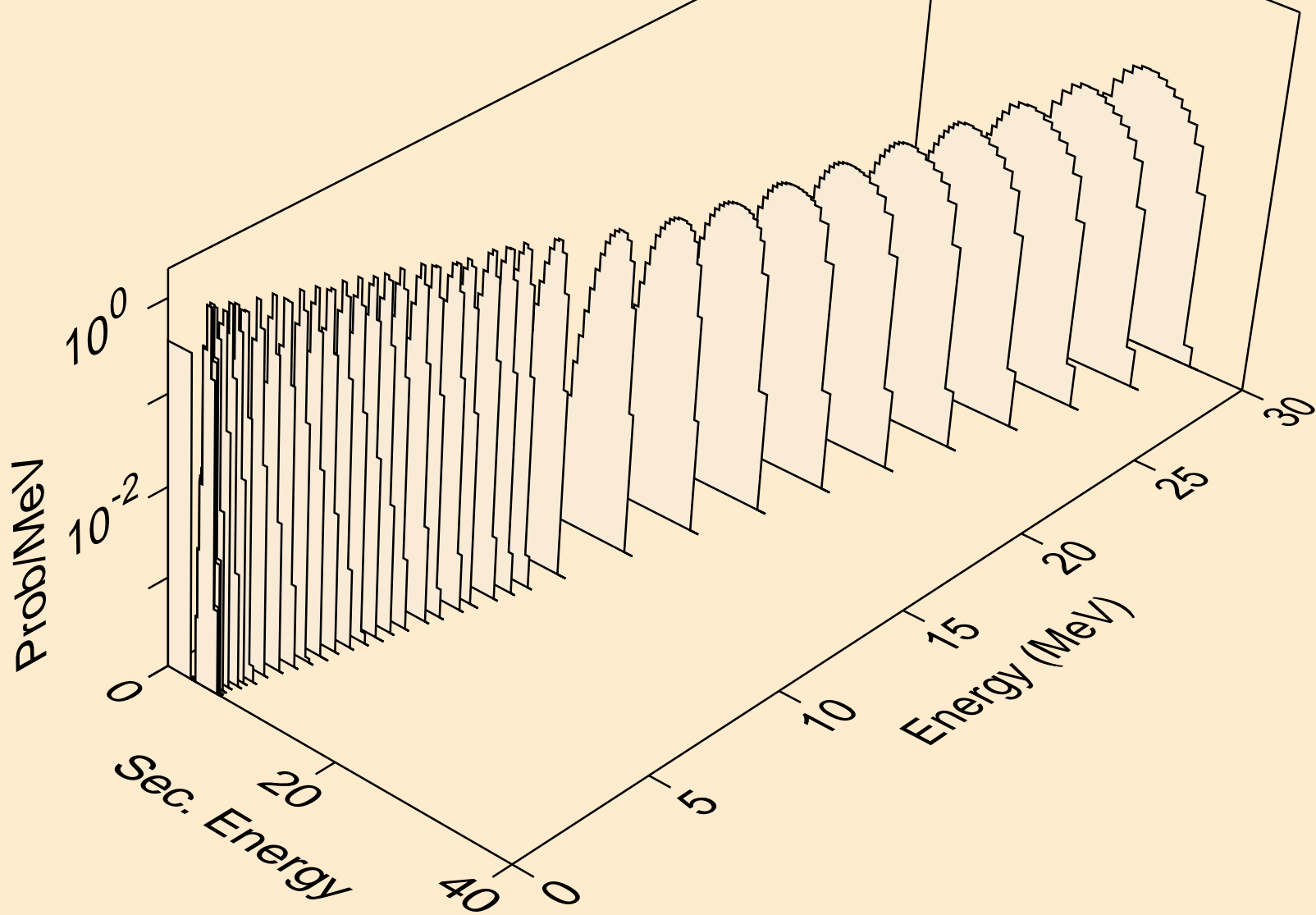

PD093 NEUTRON ACER TENDL-2024 LIBRARY; T=0.K  
alphas from (n,da)

