

# RN201 NEUTRON ACER TENDL-2024 LIBRARY; T=0.K

## Principal cross sections

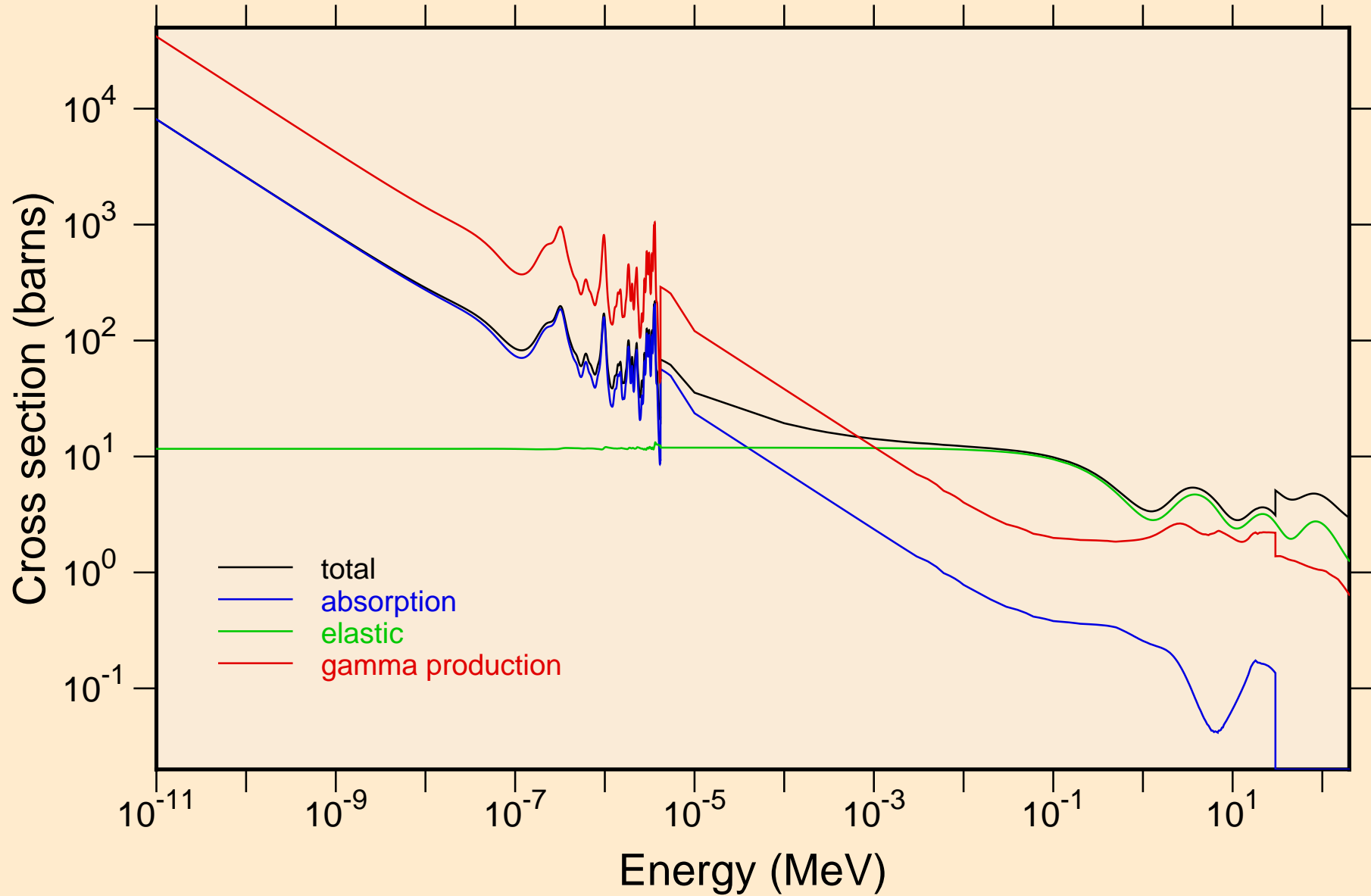

RN201 NEUTRON ACER TENDL-2024 LIBRARY; T=0.K  
Heating

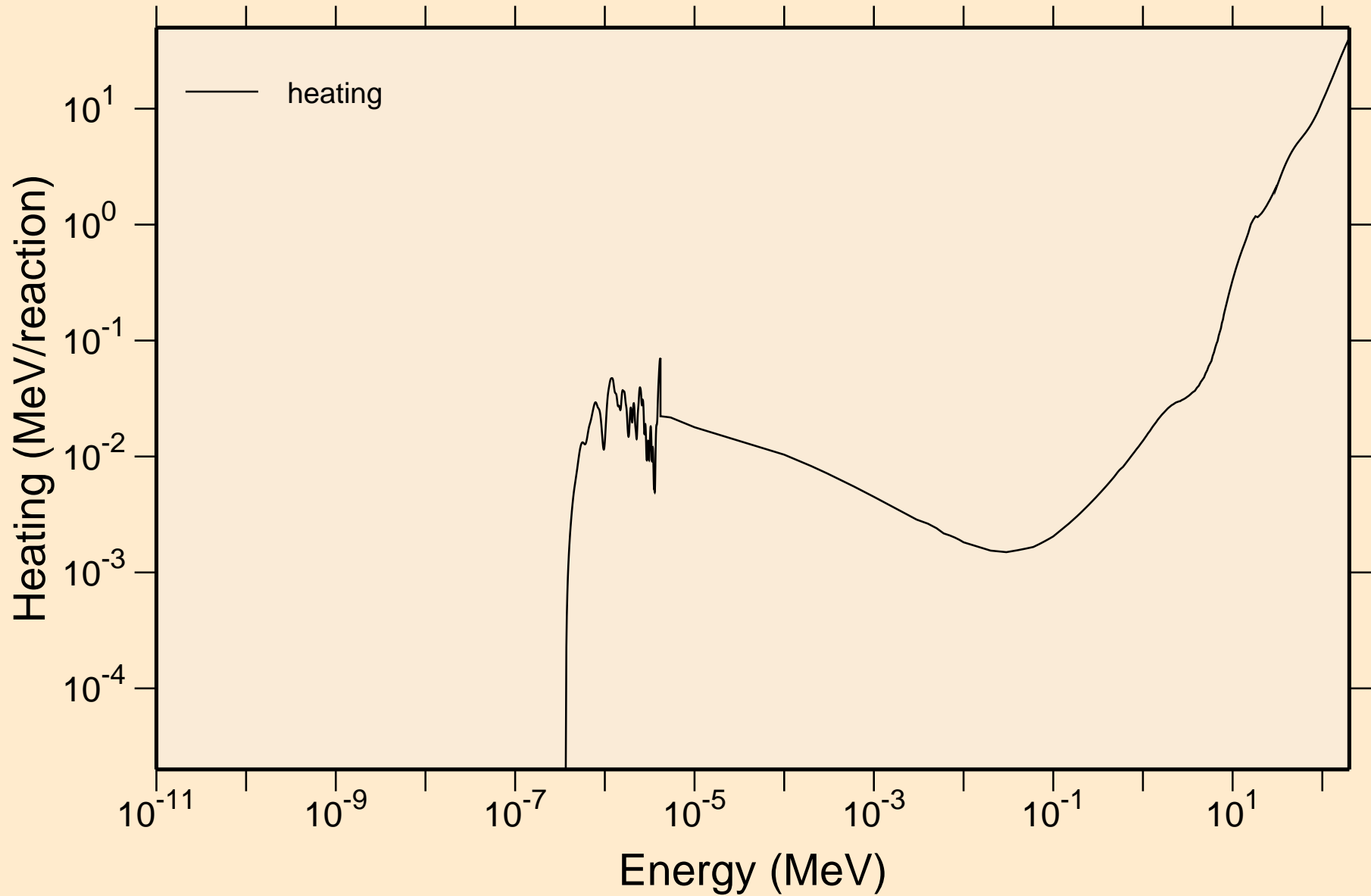

RN201 NEUTRON ACER TENDL-2024 LIBRARY; T=0.K  
Damage

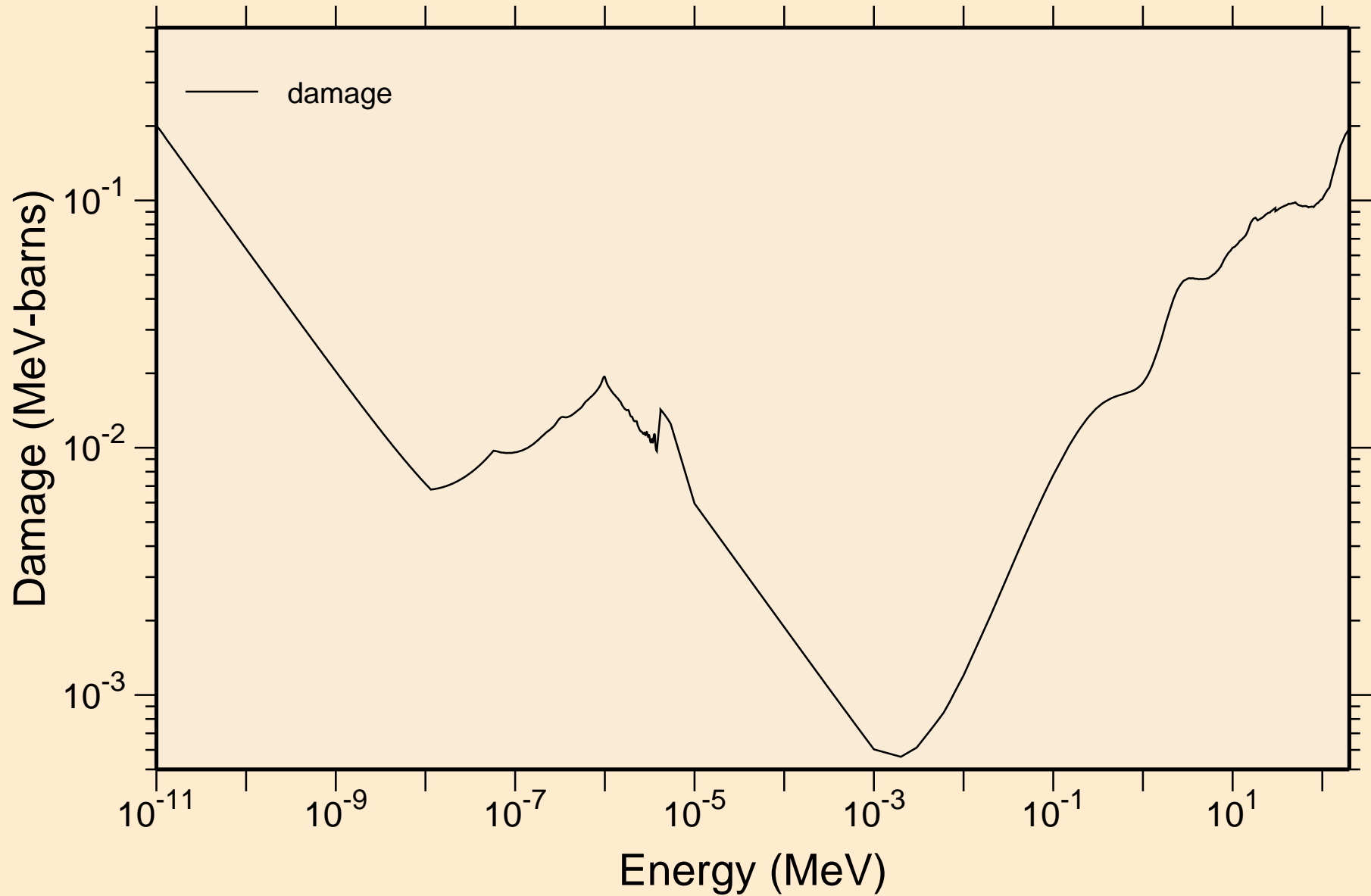

RN201 NEUTRON ACER TENDL-2024 LIBRARY; T=0.K  
Non-threshold reactions

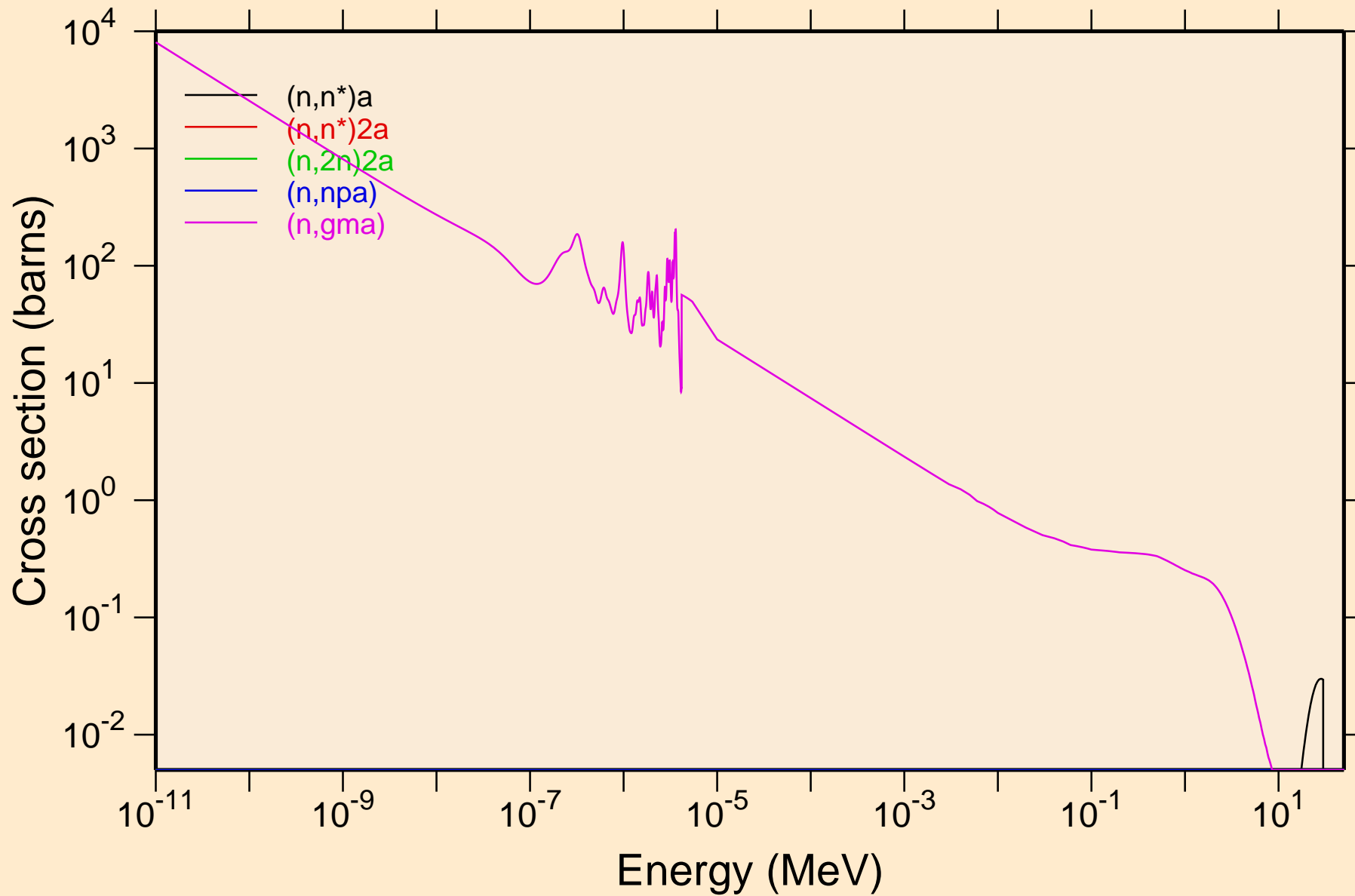

RN201 NEUTRON ACER TENDL-2024 LIBRARY; T=0.K  
Non-threshold reactions

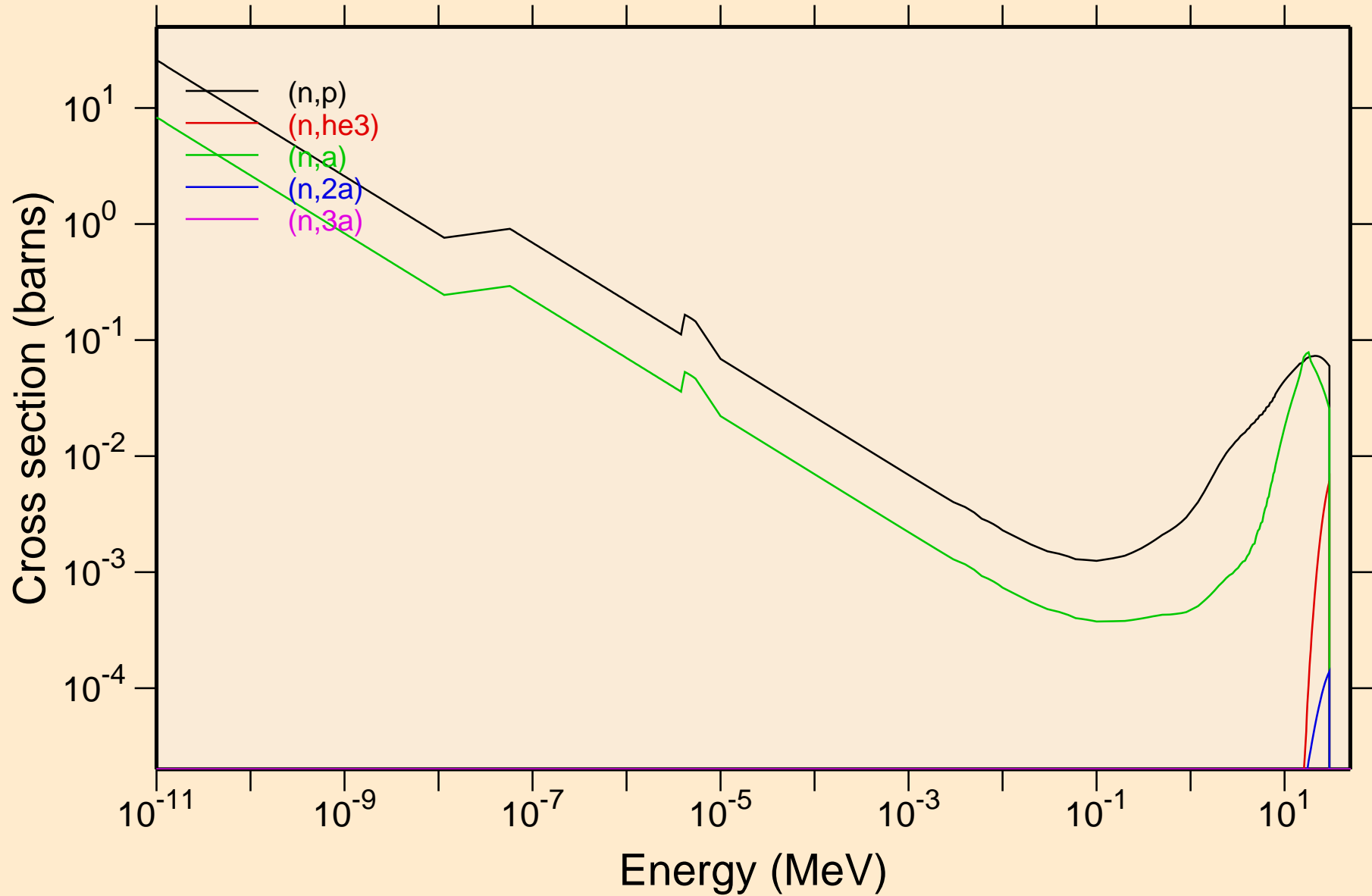

RN201 NEUTRON ACER TENDL-2024 LIBRARY; T=0.K  
Non-threshold reactions

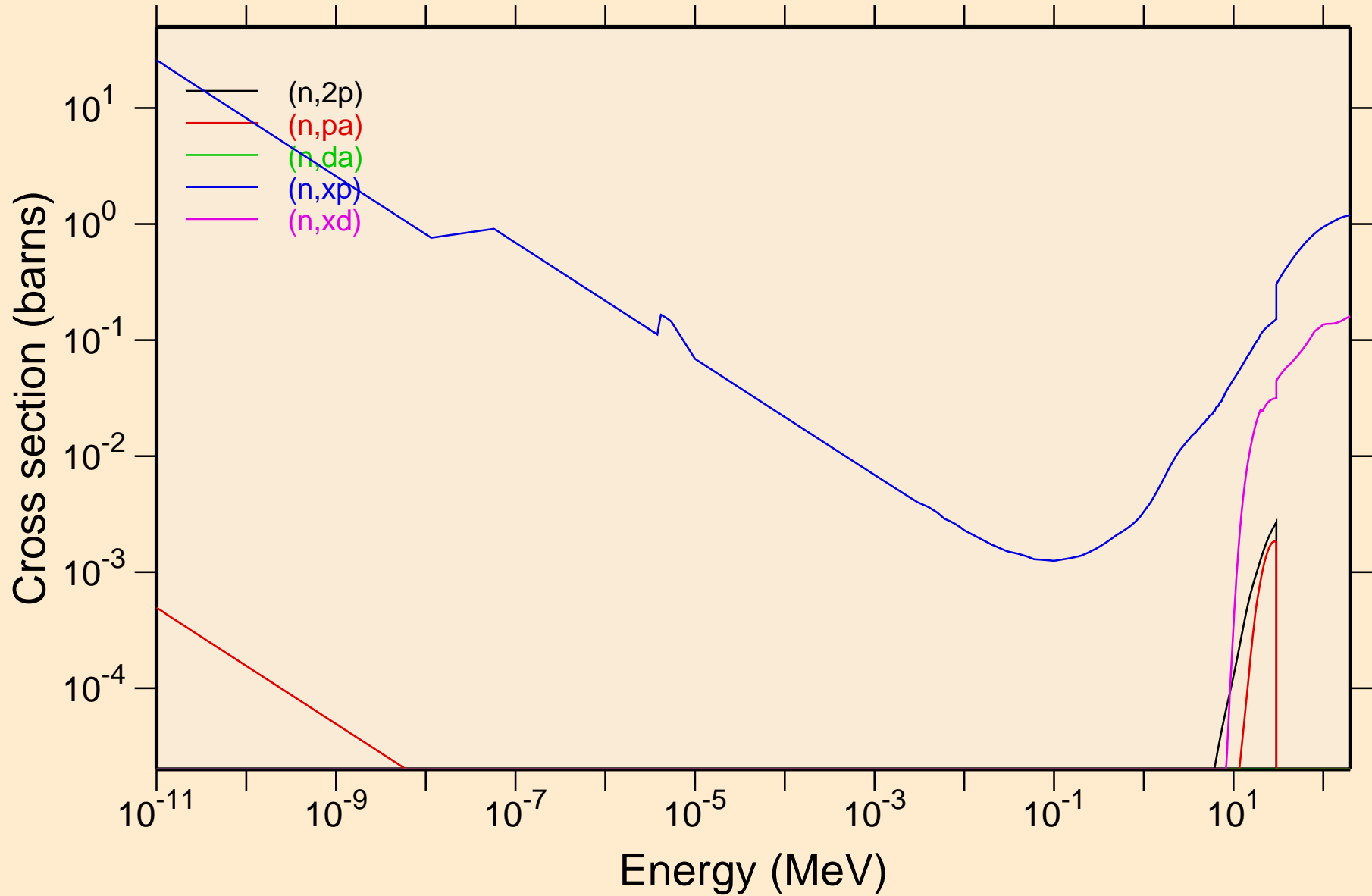

RN201 NEUTRON ACER TENDL-2024 LIBRARY; T=0.K  
Non-threshold reactions

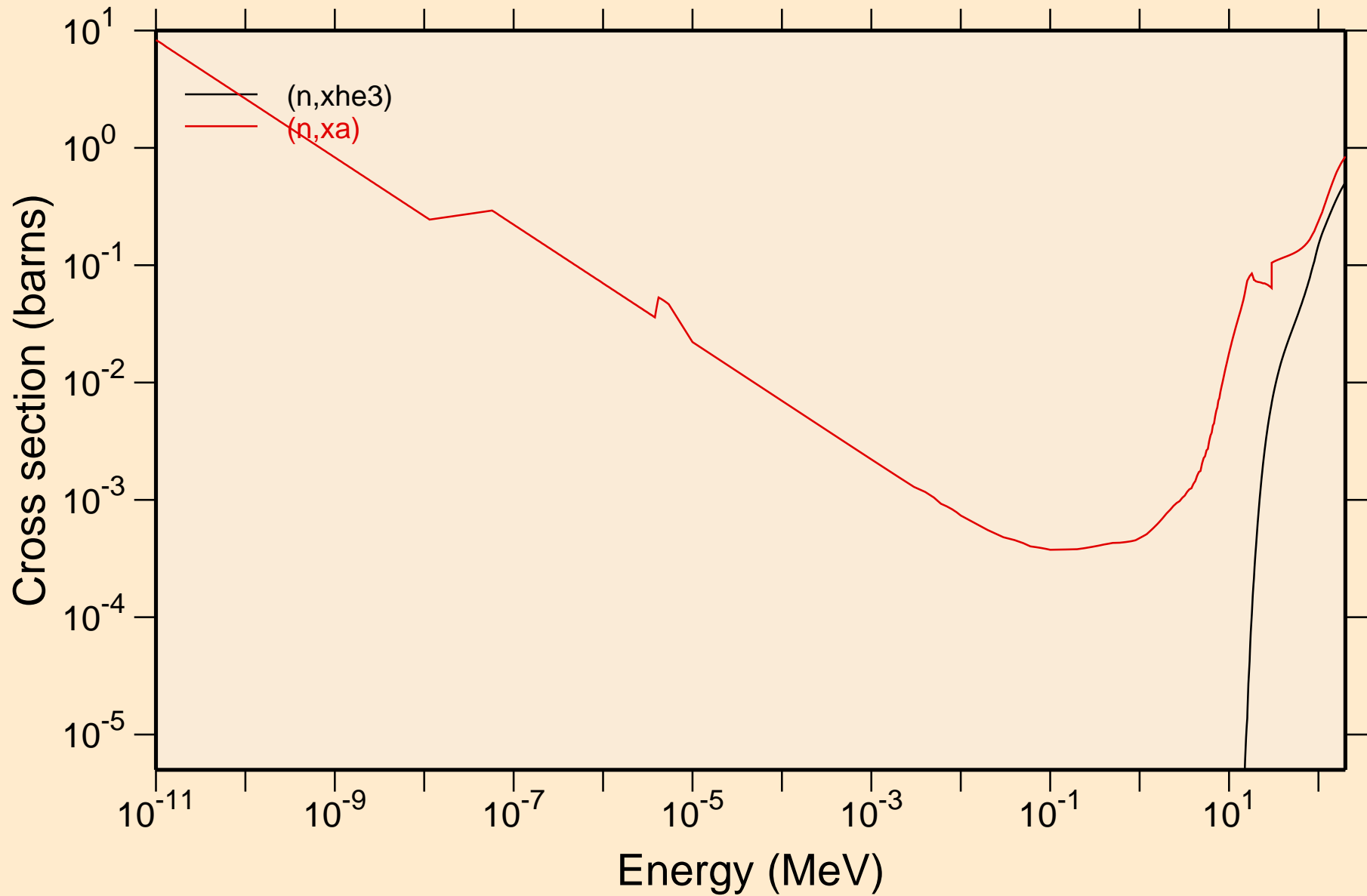

# RN201 NEUTRON ACER TENDL-2024 LIBRARY; T=0.K

## Principal cross sections

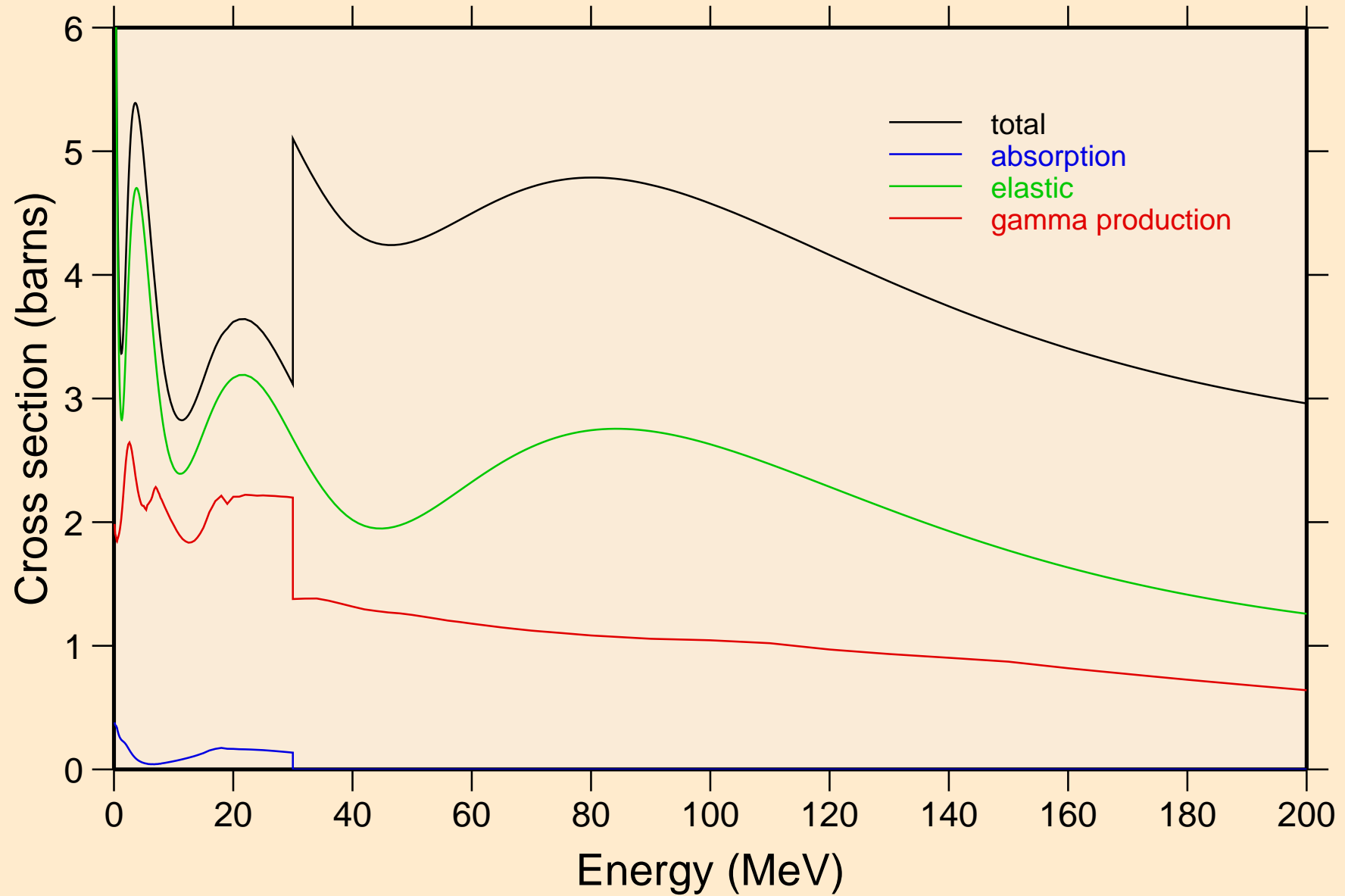

# RN201 NEUTRON ACER TENDL-2024 LIBRARY; T=0.K

## Heating

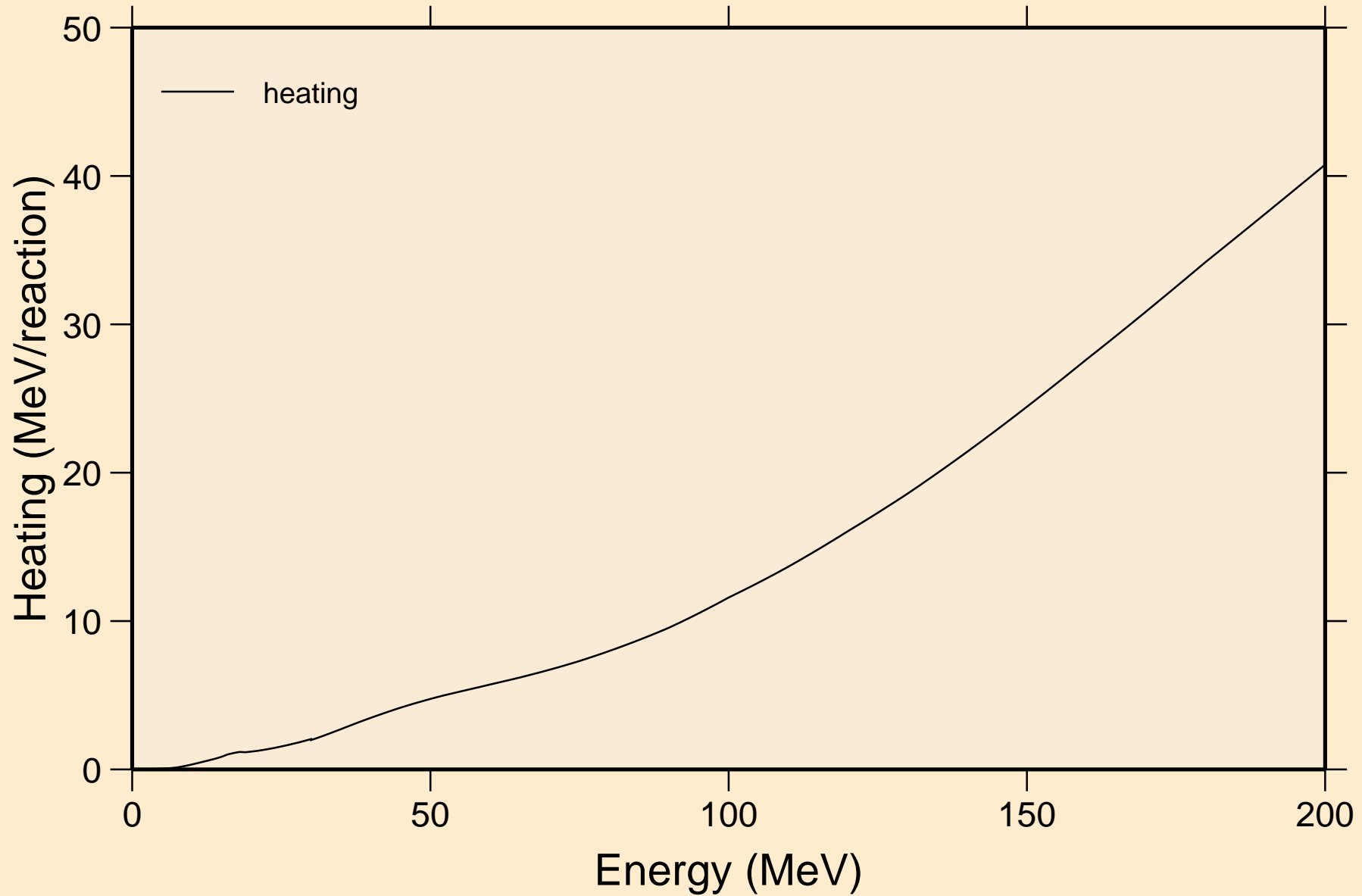

# RN201 NEUTRON ACER TENDL-2024 LIBRARY; T=0.K

## Damage

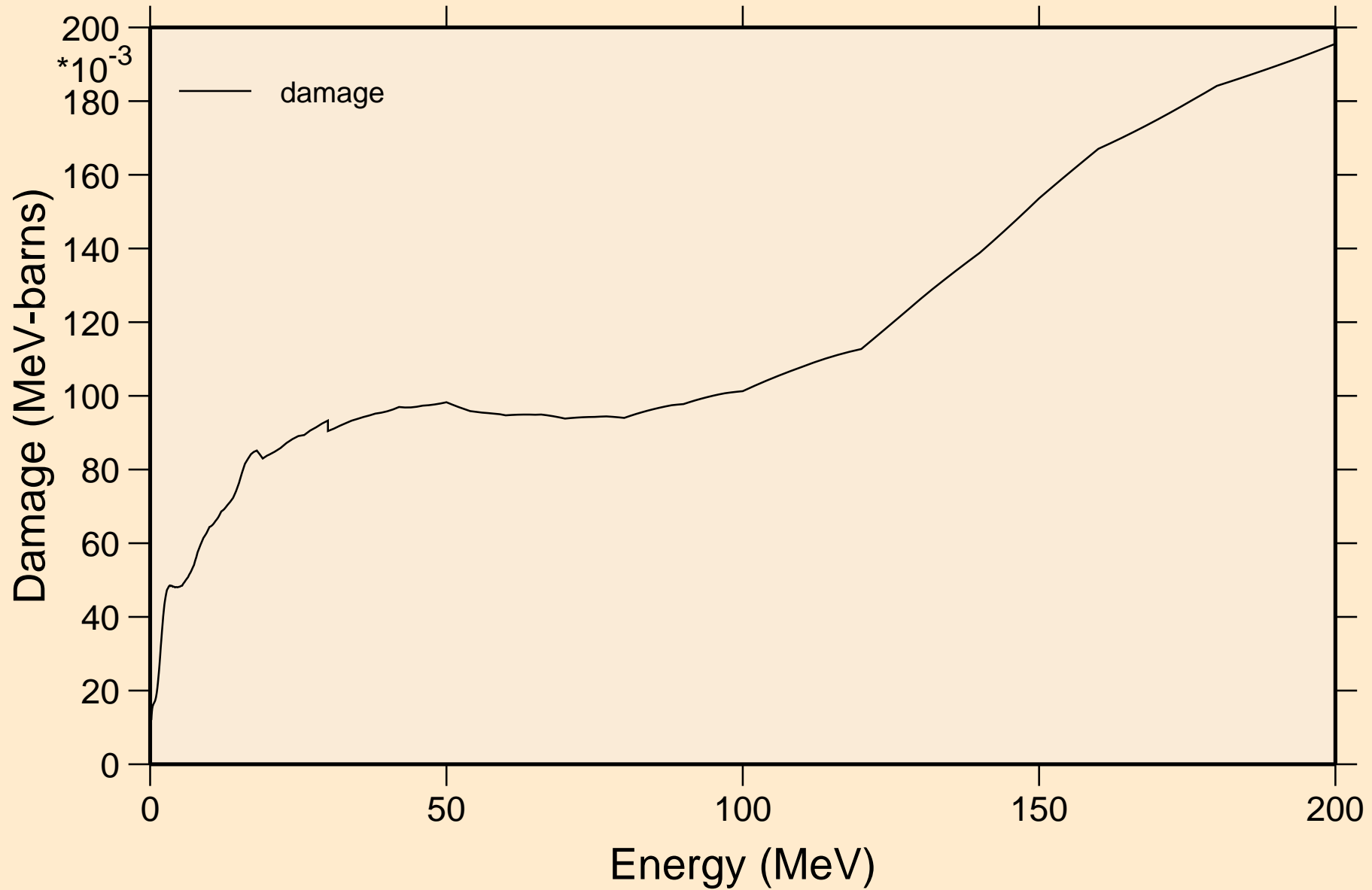

RN201 NEUTRON ACER TENDL-2024 LIBRARY; T=0.K  
Non-threshold reactions

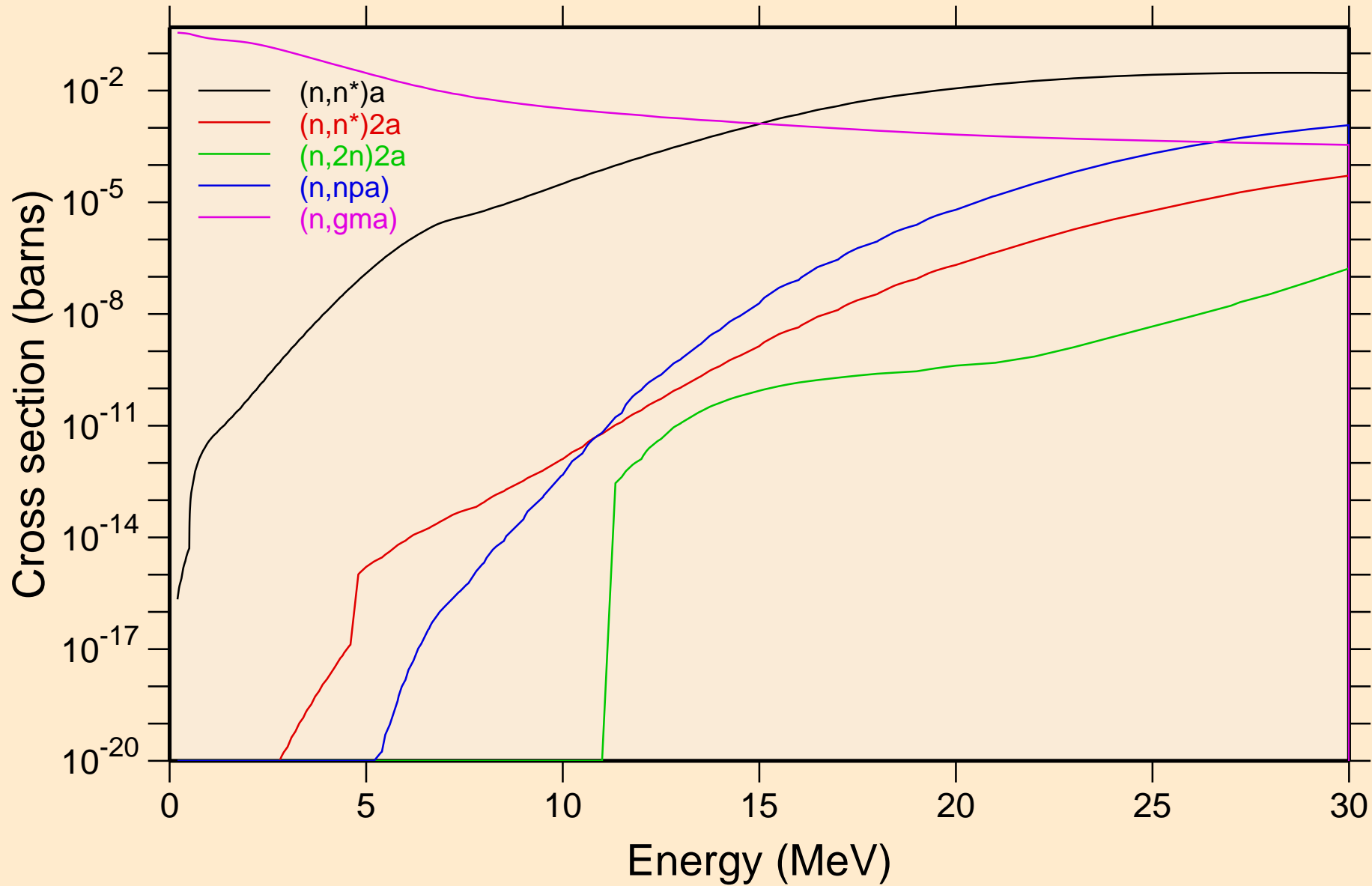

# RN201 NEUTRON ACER TENDL-2024 LIBRARY; T=0.K

## Non-threshold reactions

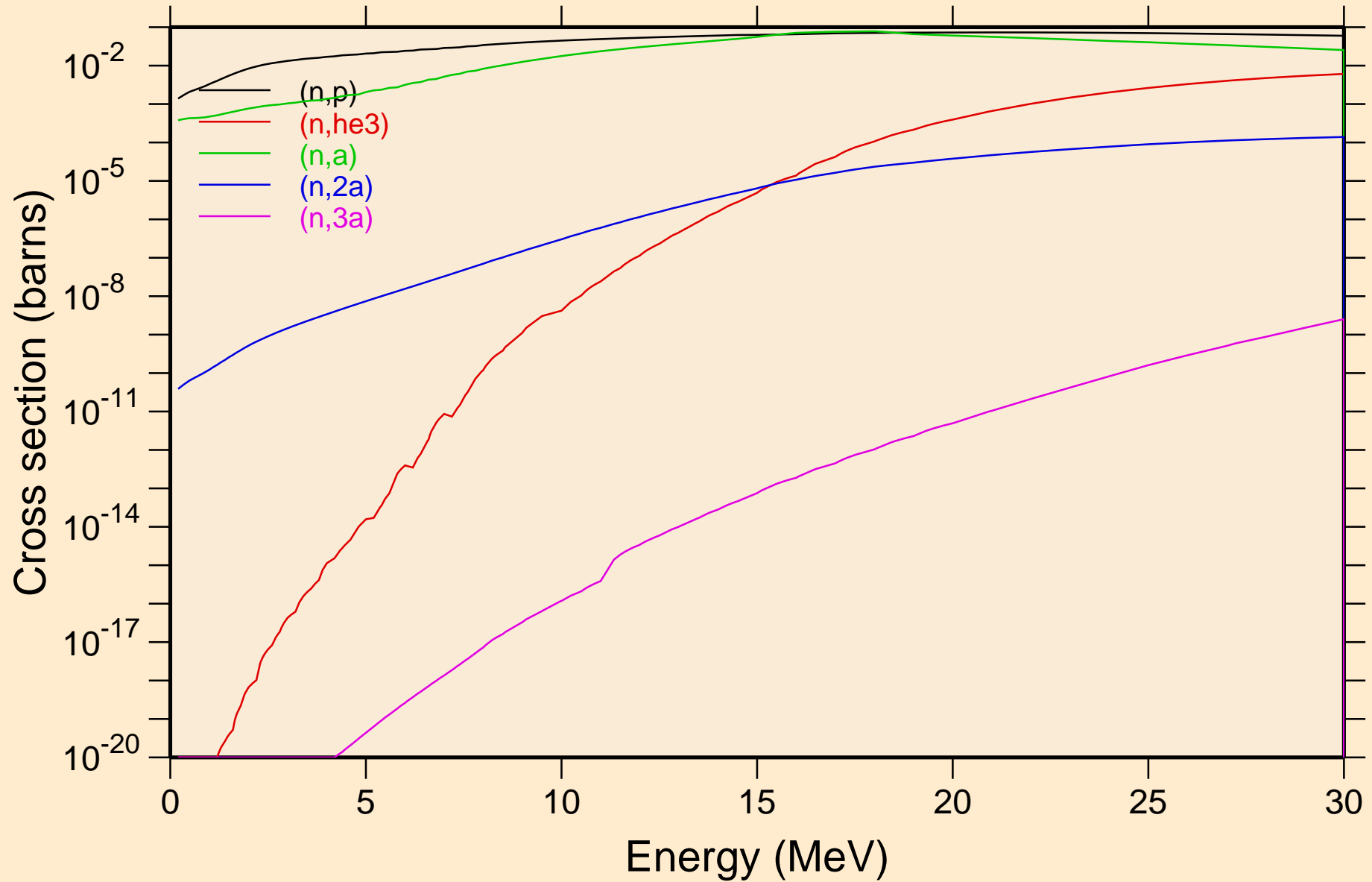

# RN201 NEUTRON ACER TENDL-2024 LIBRARY; T=0.K

## Non-threshold reactions

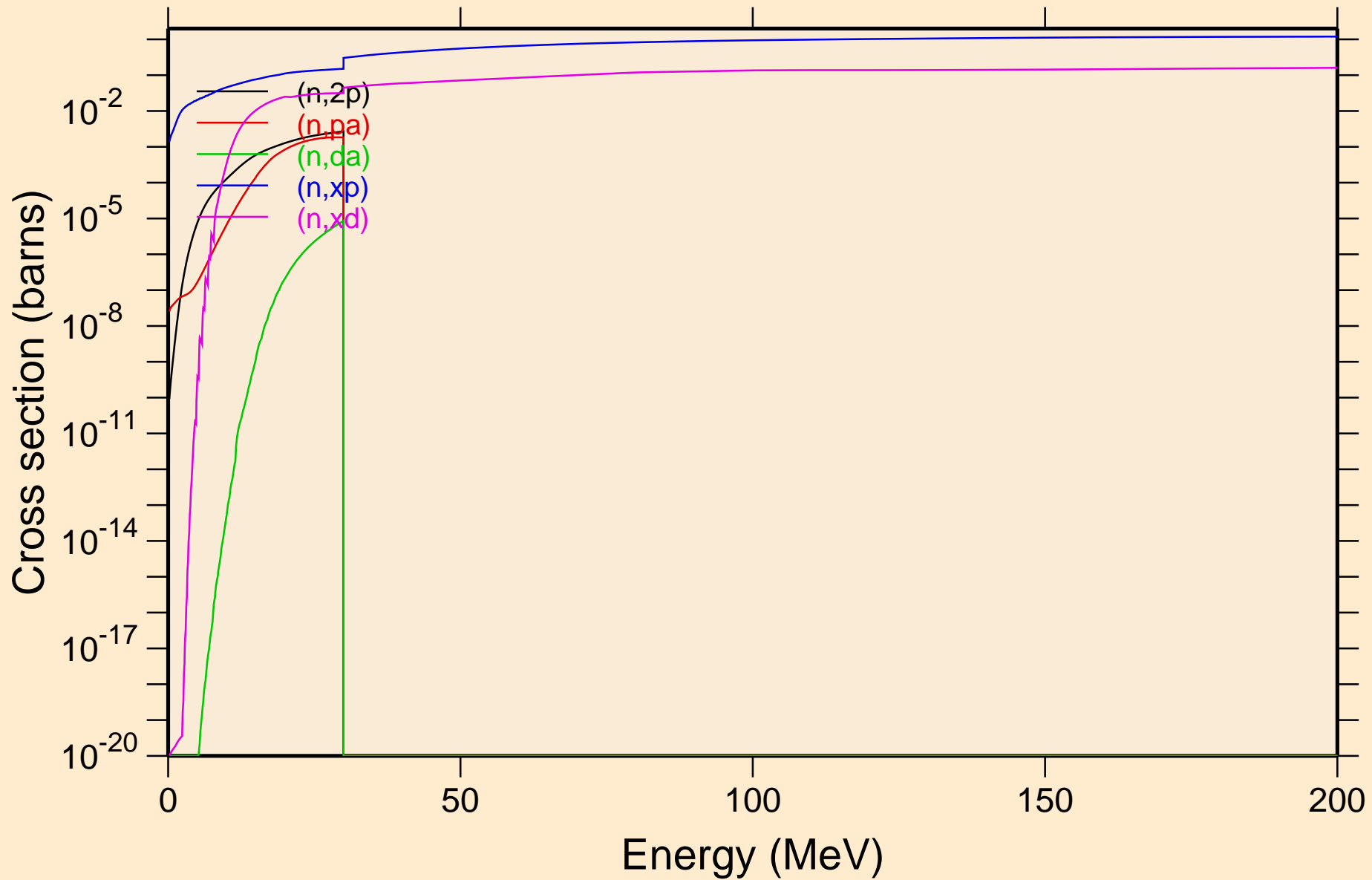

RN201 NEUTRON ACER TENDL-2024 LIBRARY; T=0.K  
Non-threshold reactions

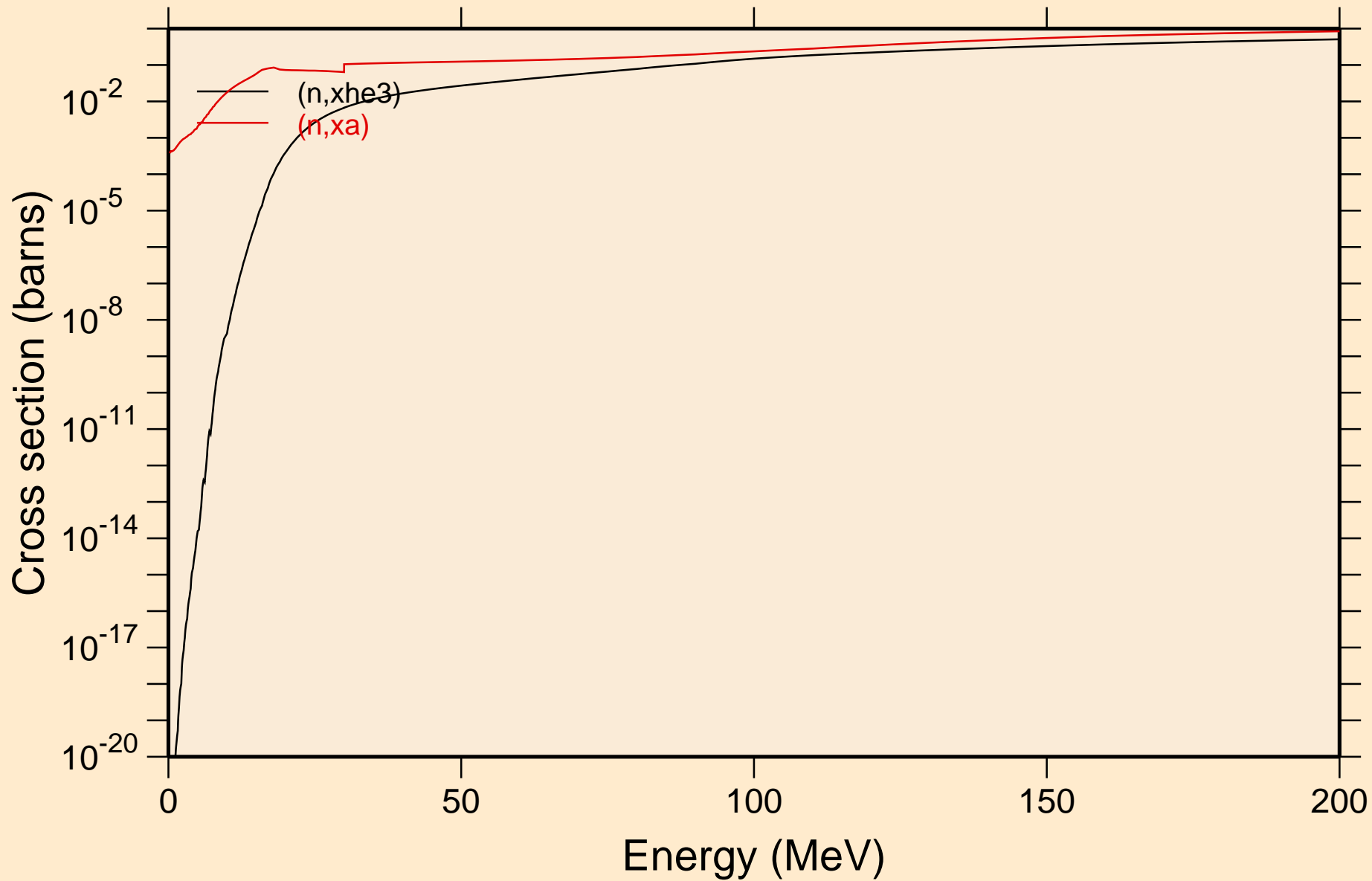

RN201 NEUTRON ACER TENDL-2024 LIBRARY; T=0.K  
Inelastic levels

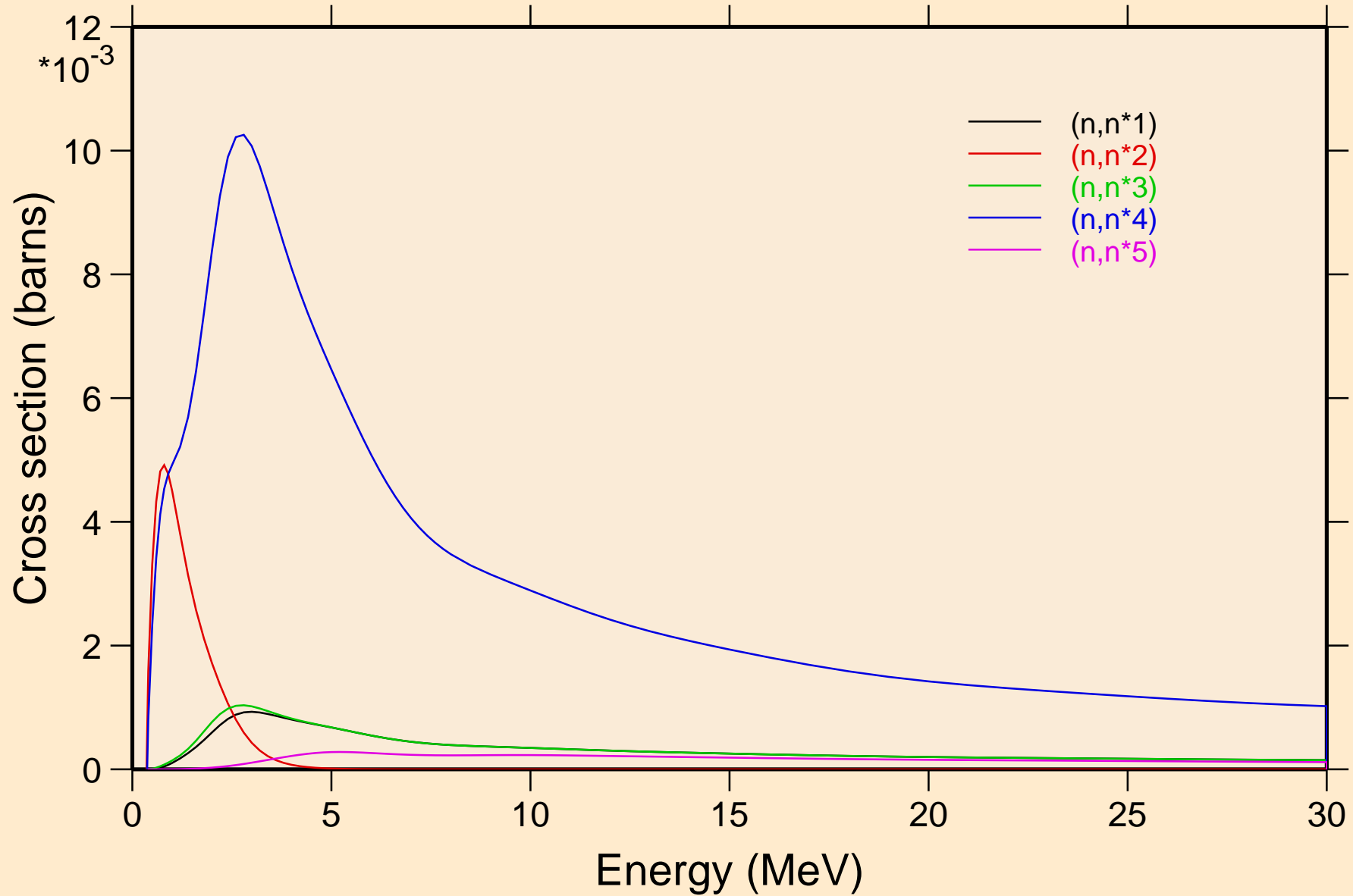

RN201 NEUTRON ACER TENDL-2024 LIBRARY; T=0.K  
Inelastic levels

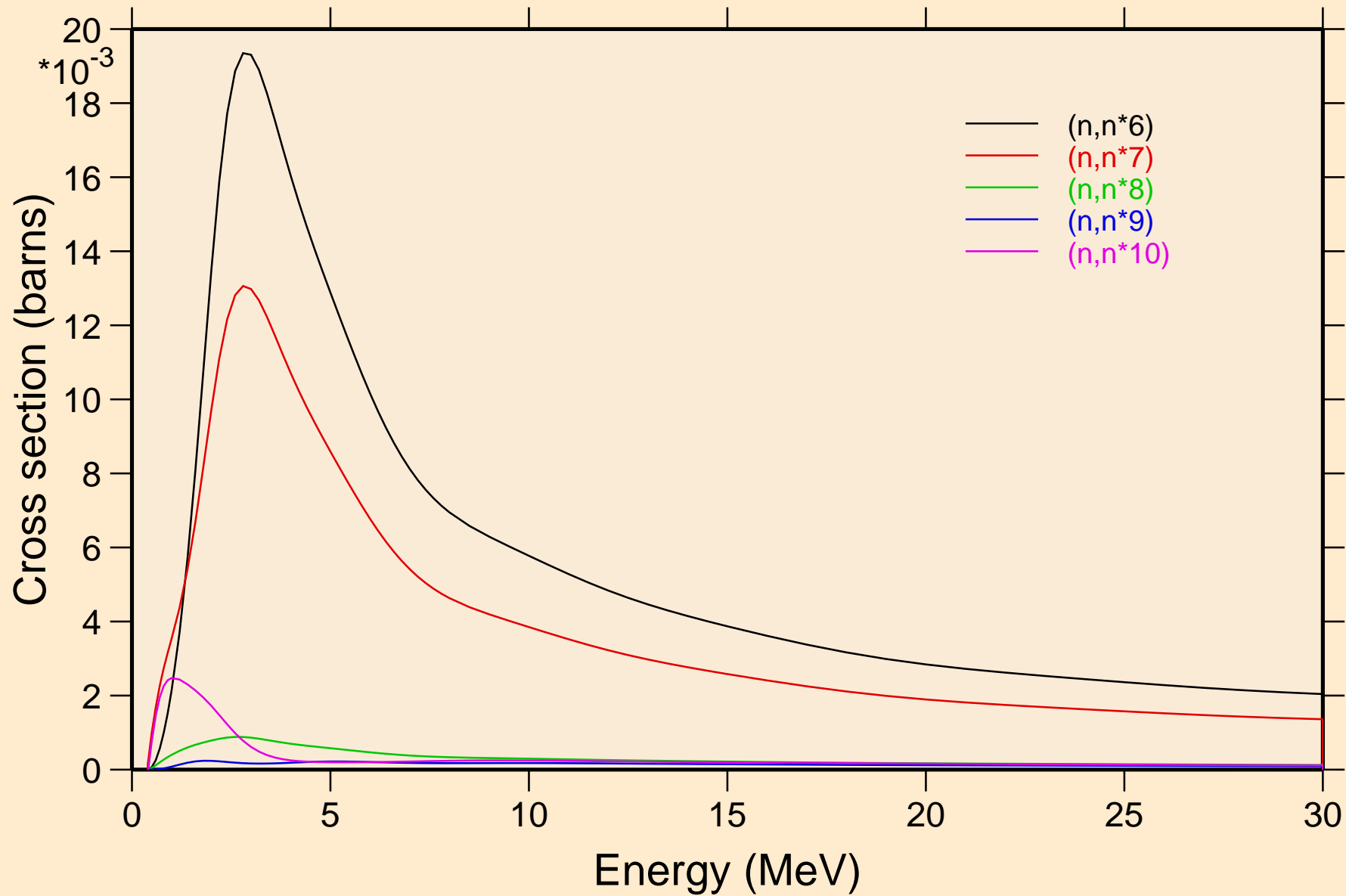

RN201 NEUTRON ACER TENDL-2024 LIBRARY; T=0.K  
Inelastic levels

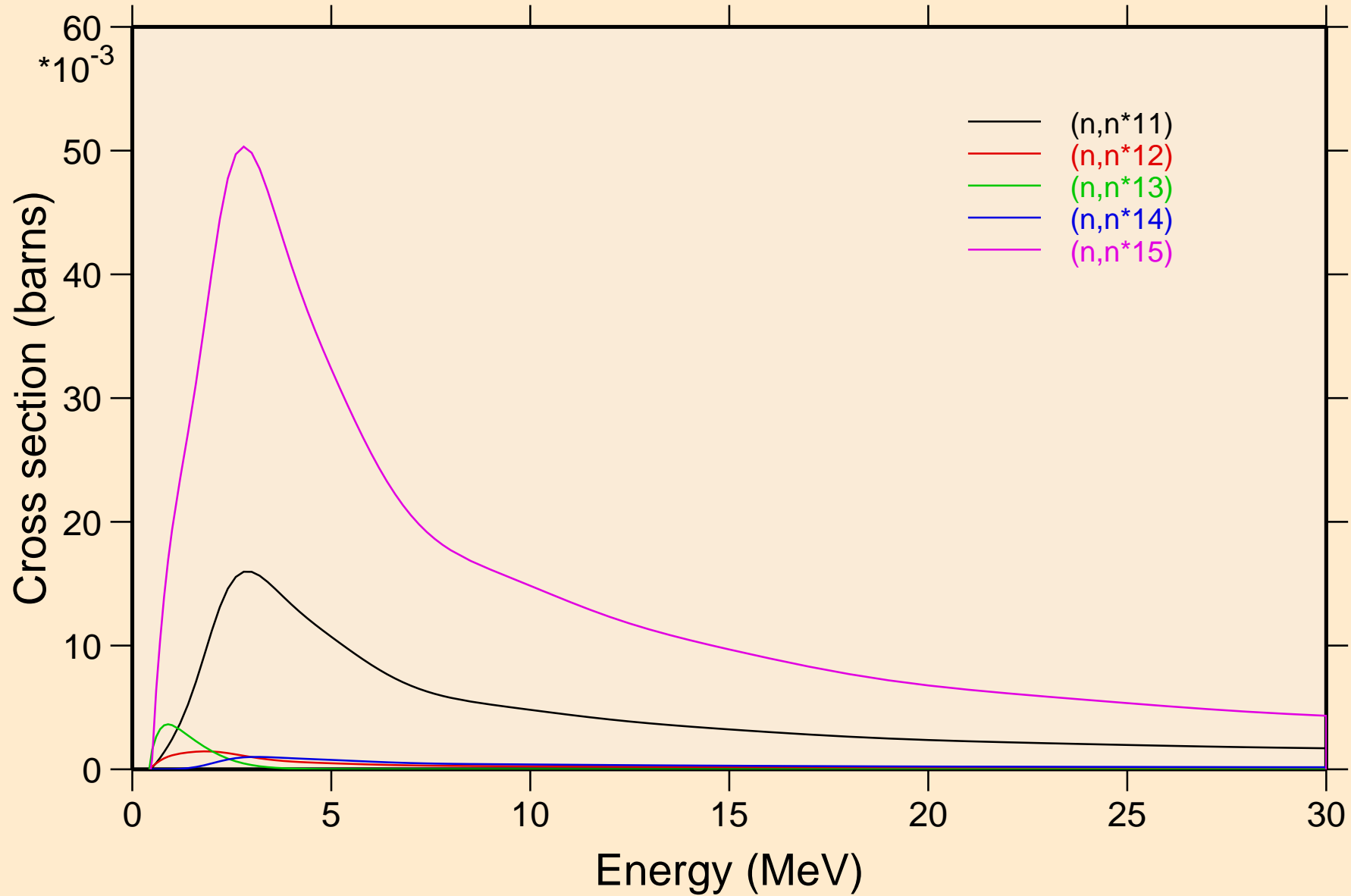

RN201 NEUTRON ACER TENDL-2024 LIBRARY; T=0.K  
Inelastic levels

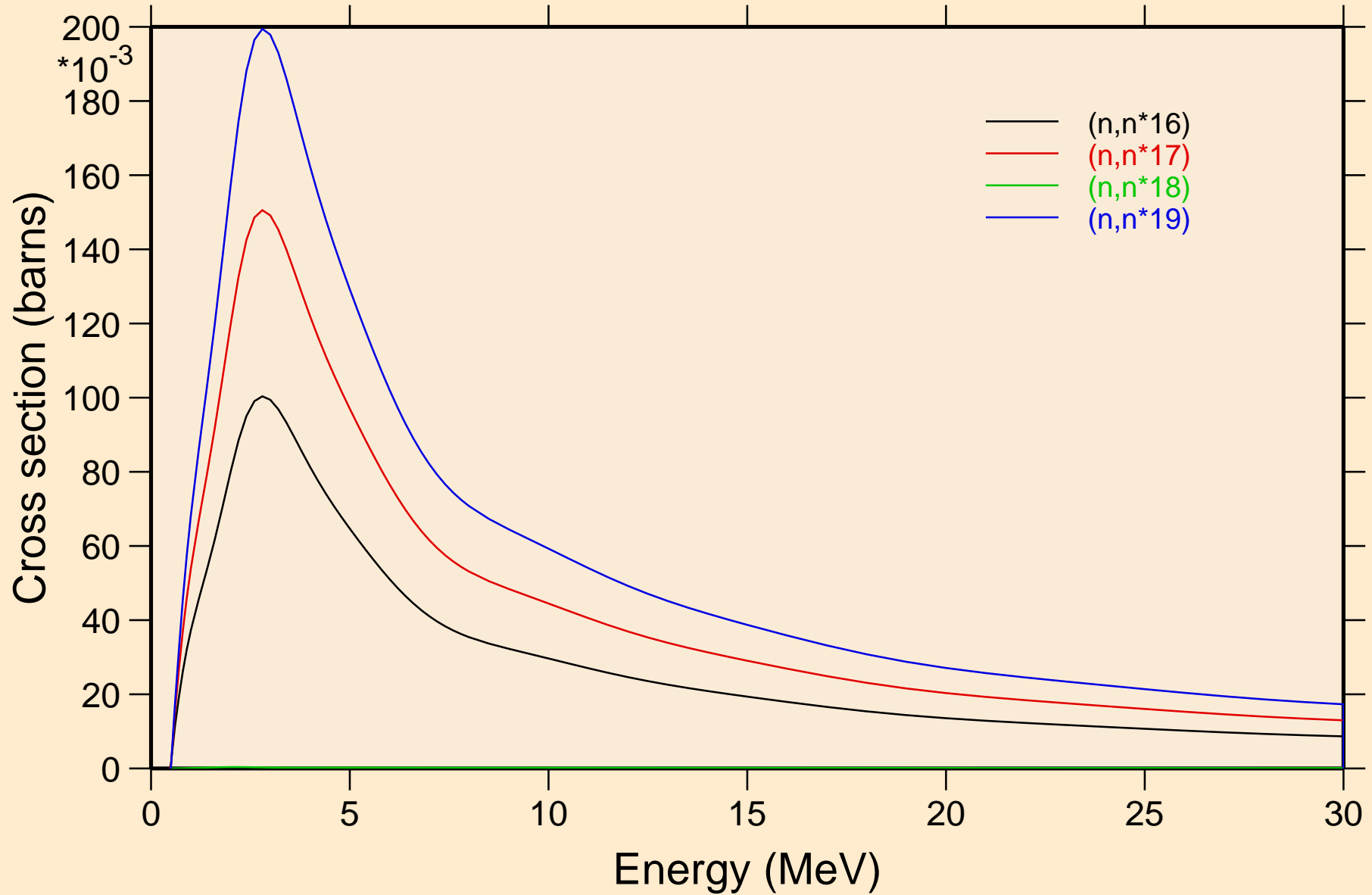

RN201 NEUTRON ACER TENDL-2024 LIBRARY; T=0.K  
Threshold reactions

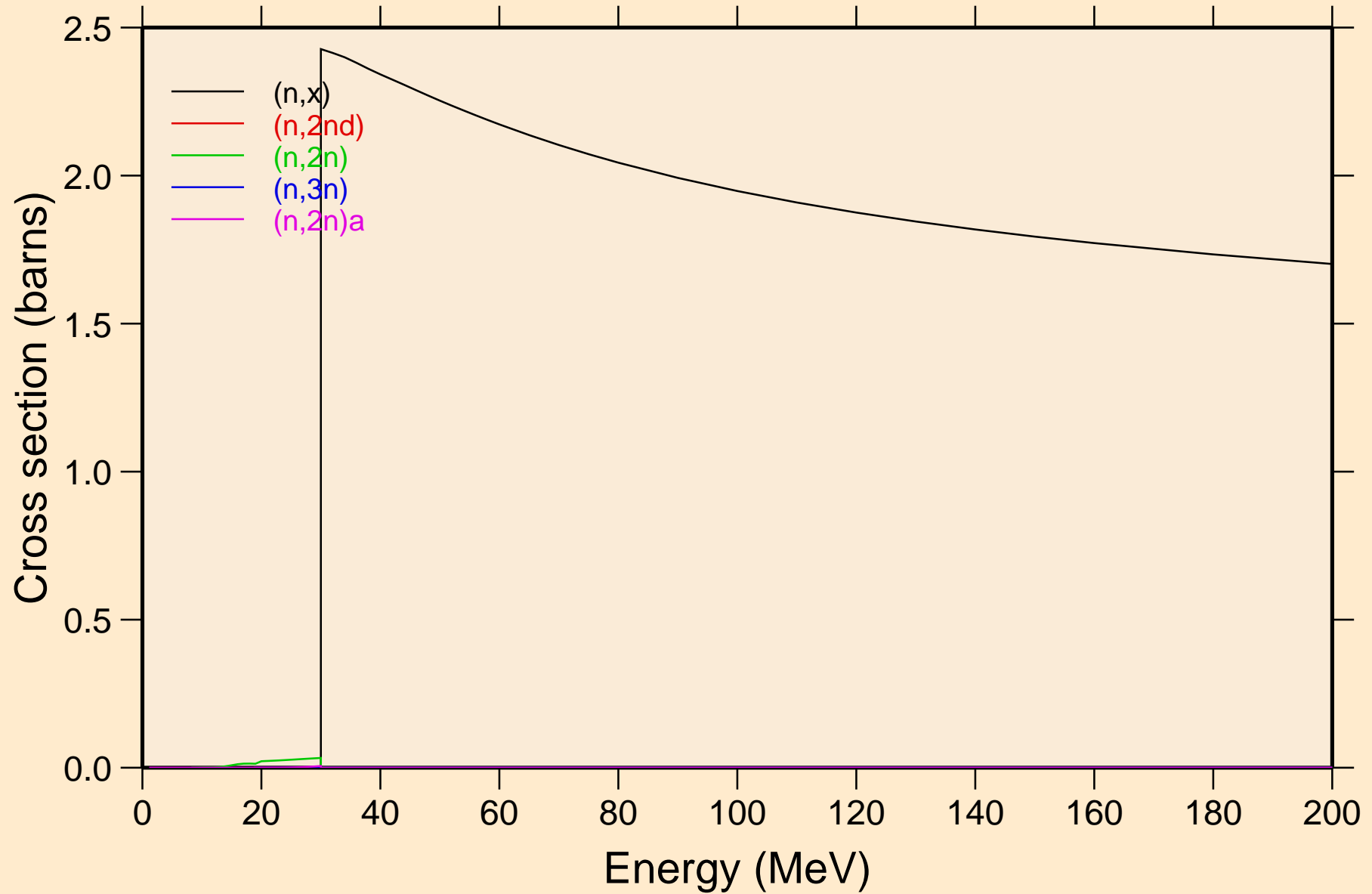

# RN201 NEUTRON ACER TENDL-2024 LIBRARY; T=0.K

## Threshold reactions

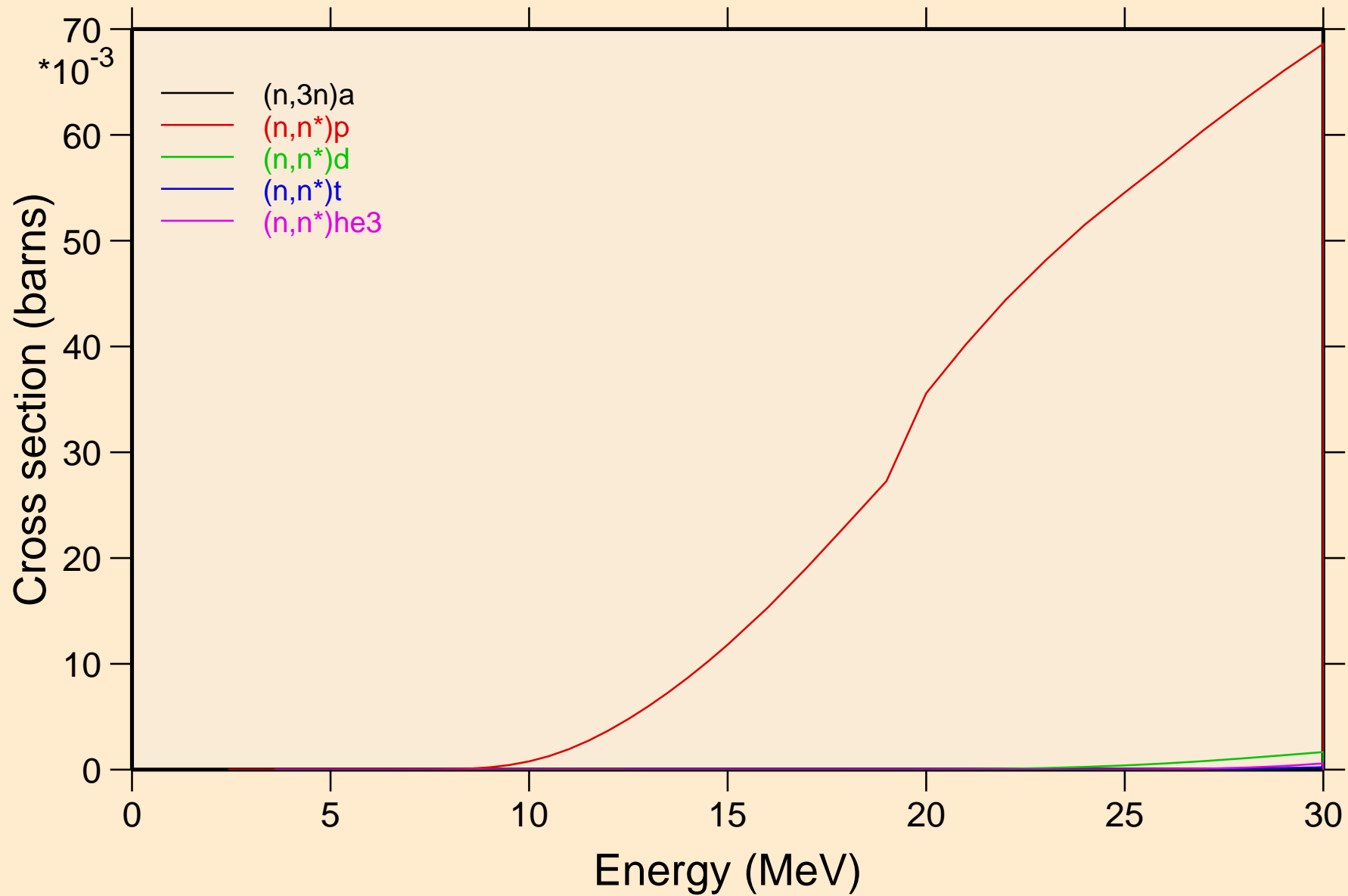

RN201 NEUTRON ACER TENDL-2024 LIBRARY; T=0.K  
Threshold reactions

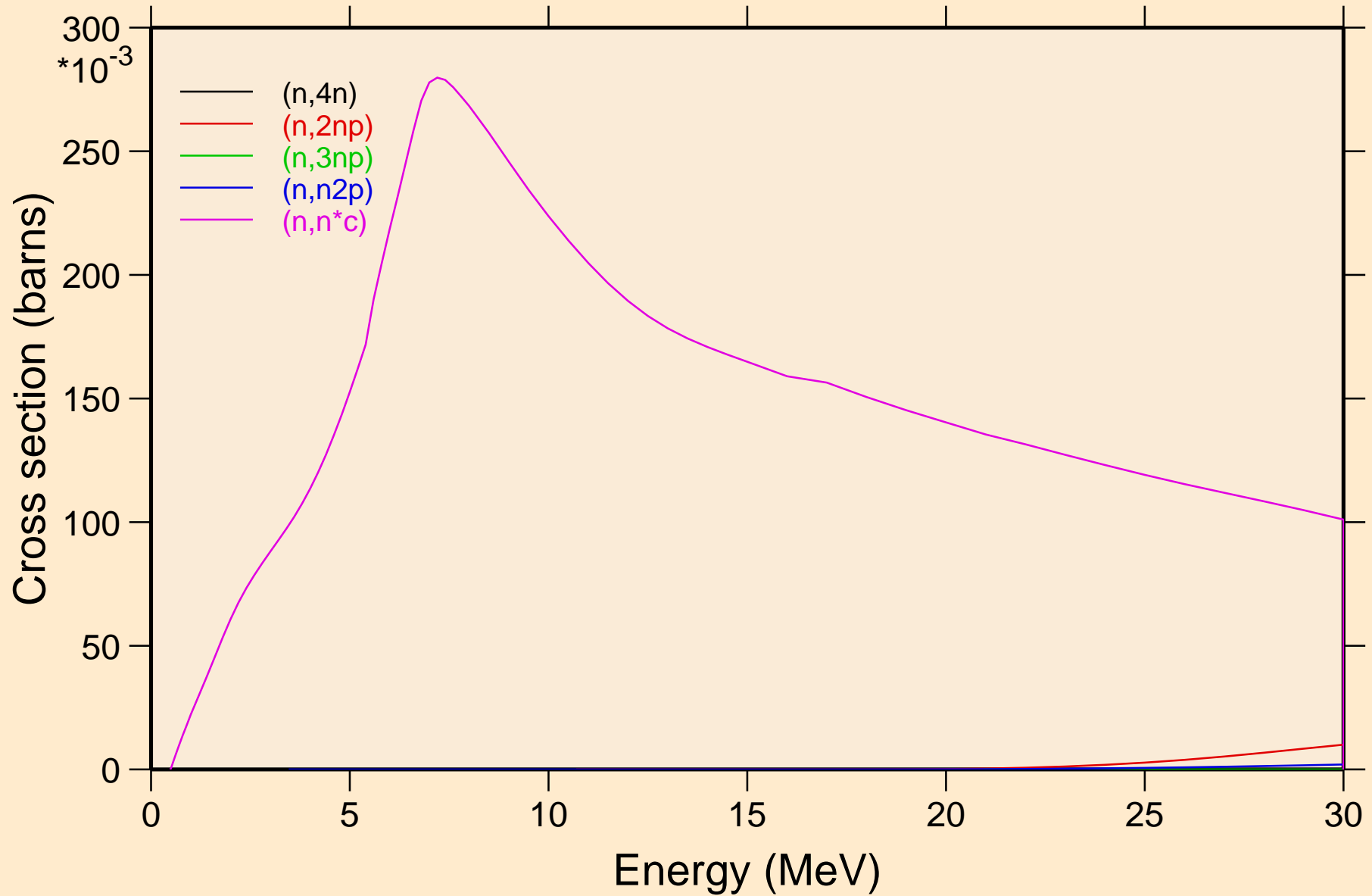

# RN201 NEUTRON ACER TENDL-2024 LIBRARY; T=0.K

## Threshold reactions

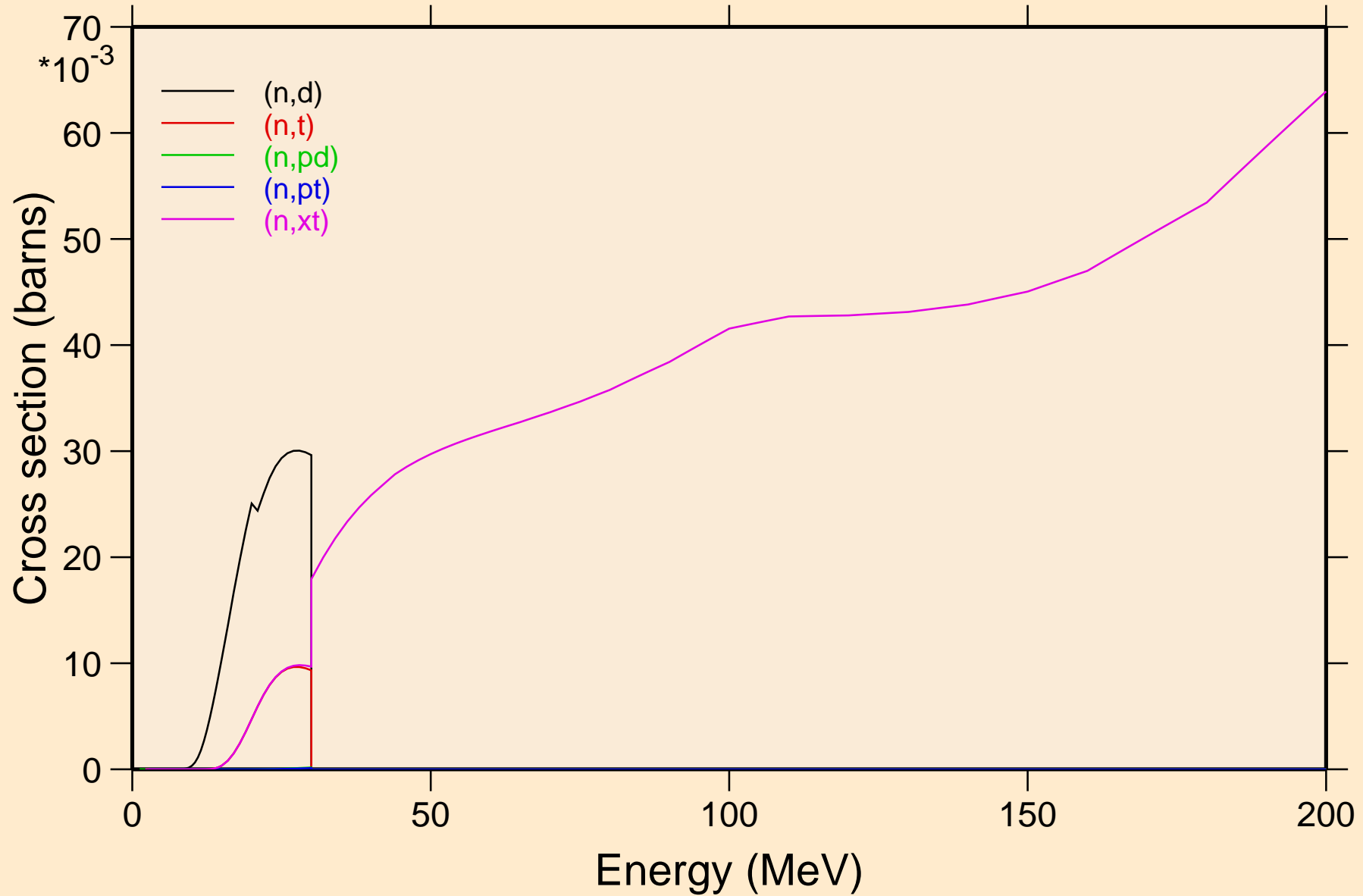

RN201 NEUTRON ACER TENDL-2024 LIBRARY; T=0.K  
angular distribution for elastic

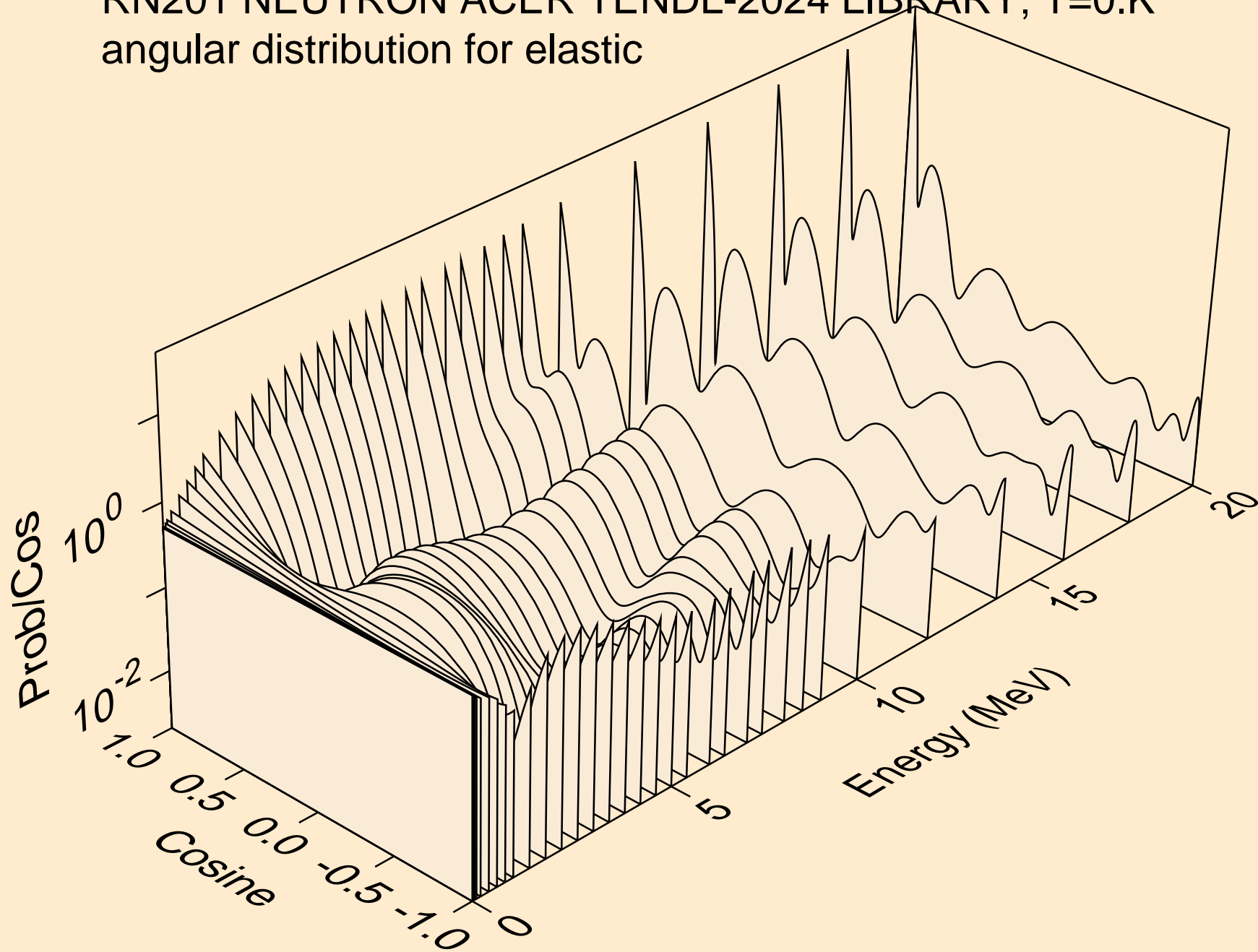

RN201 NEUTRON ACER TENDL-2024 LIBRARY; T=0.K  
angular distribution for elastic

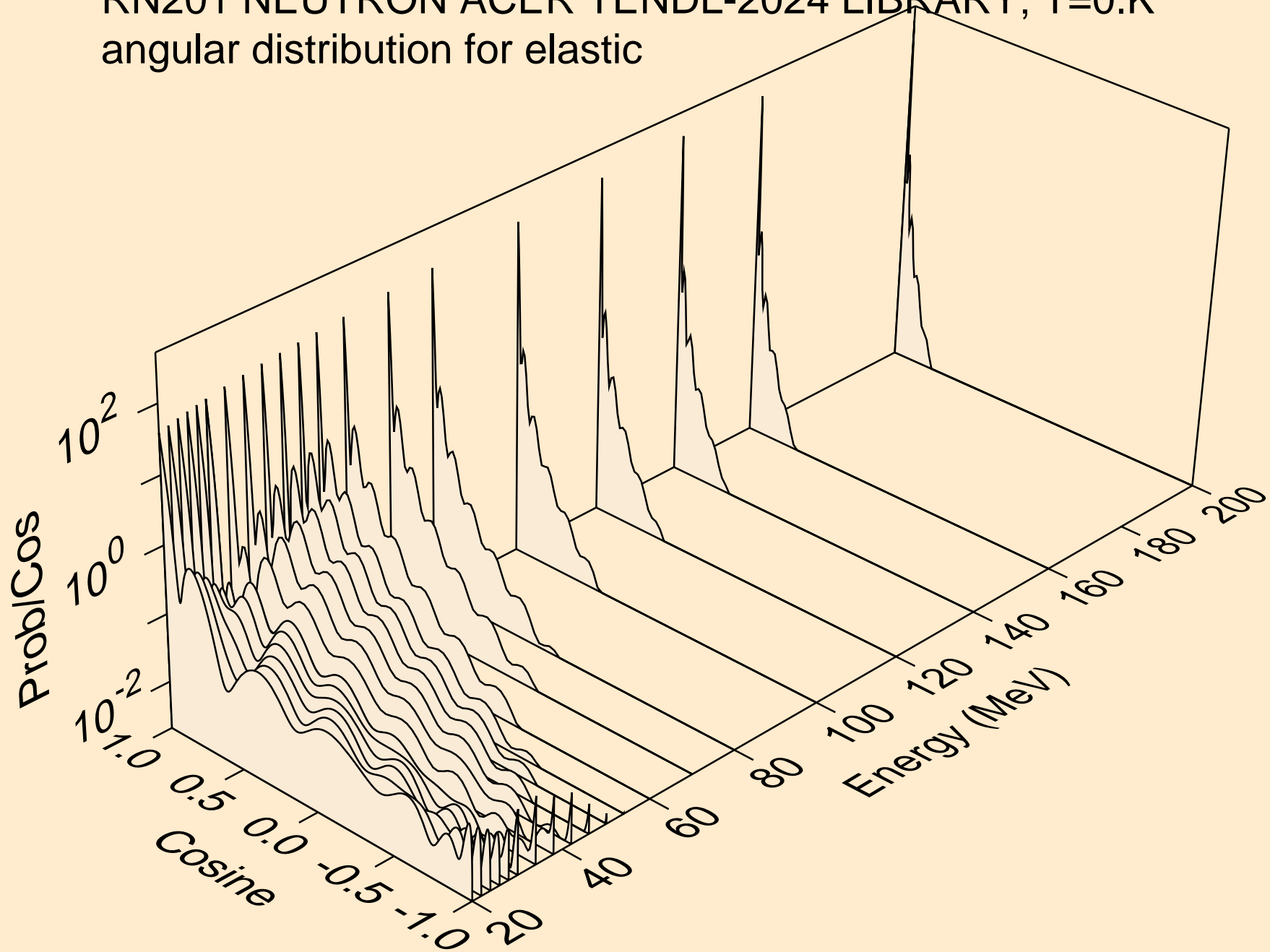

RN201 NEUTRON ACER TENDL-2024 LIBRARY; T=0.K  
angular distribution for (n,n\*1)

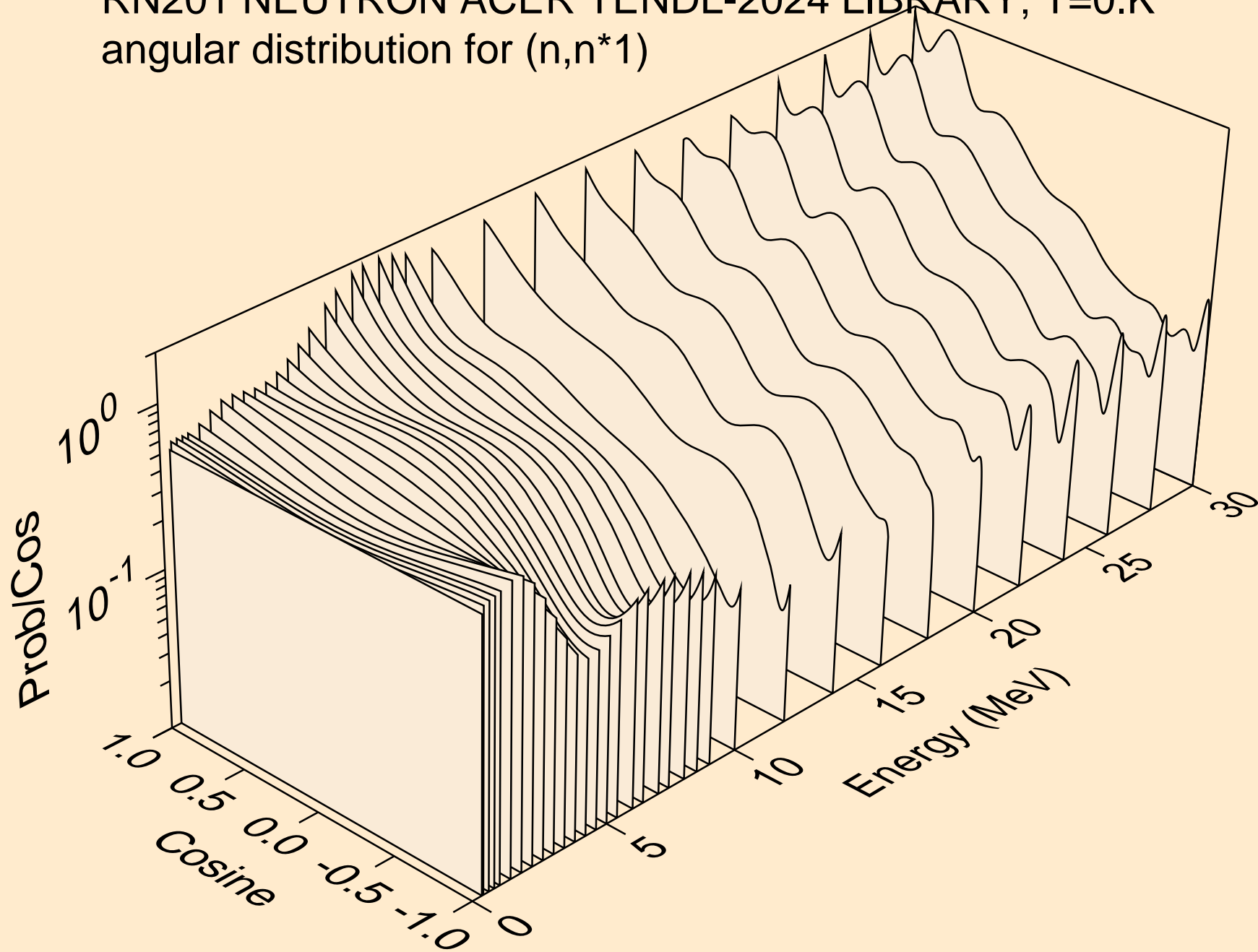

RN201 NEUTRON ACER TENDL-2024 LIBRARY; T=0.K  
angular distribution for (n,n\*2)

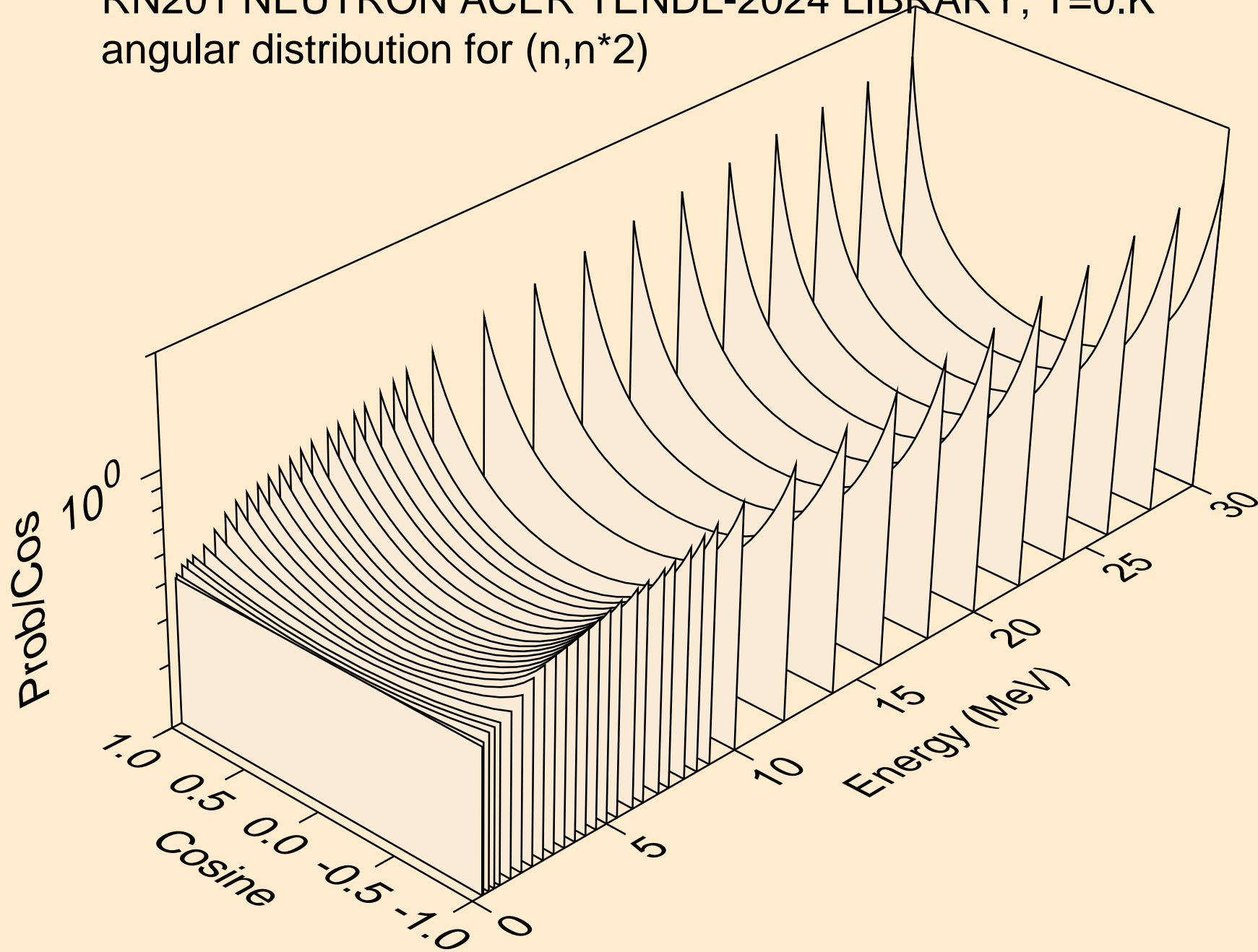

RN201 NEUTRON ACER TENDL-2024 LIBRARY; T=0.K  
angular distribution for (n,n\*3)

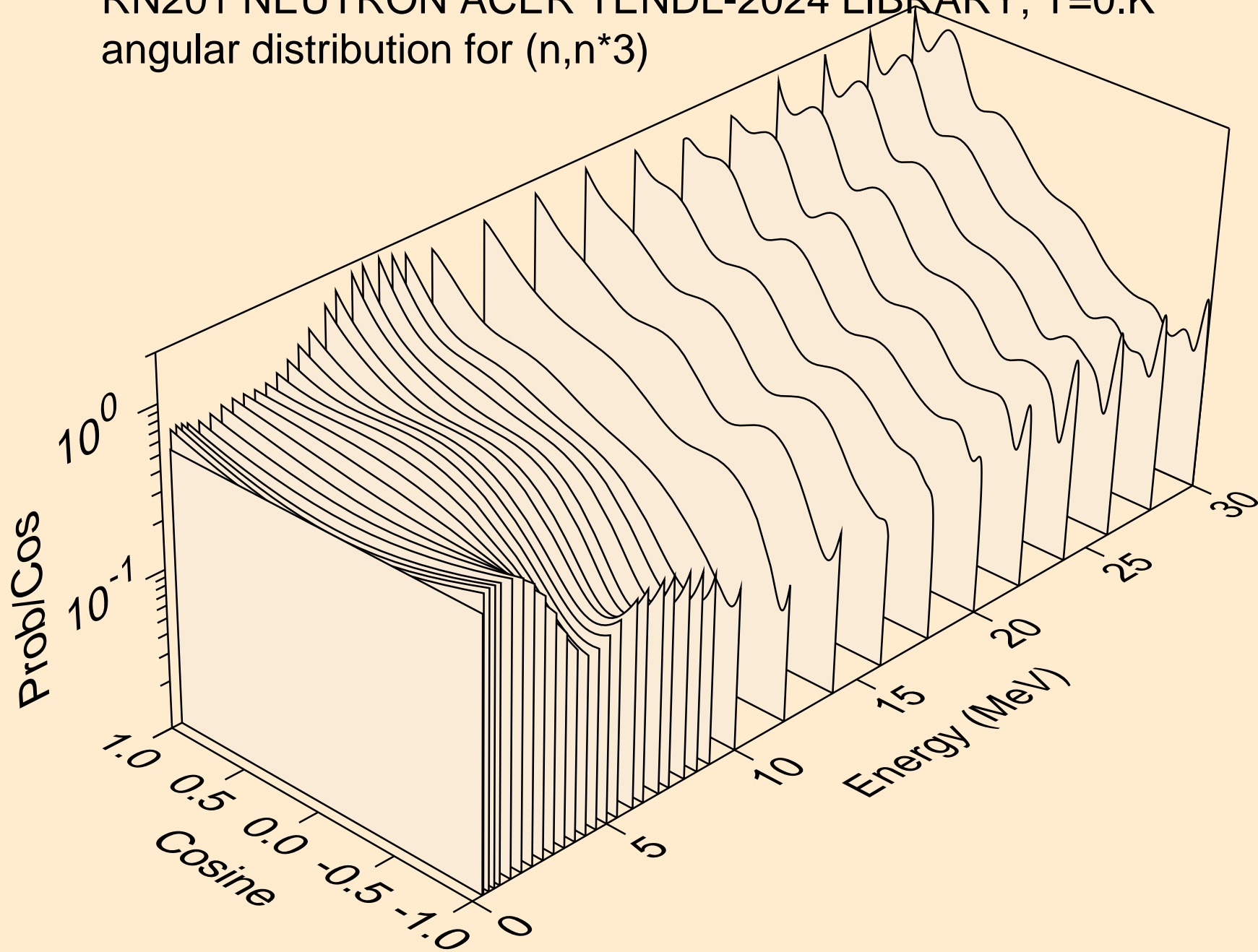

RN201 NEUTRON ACER TENDL-2024 LIBRARY; T=0.K  
angular distribution for (n,n\*4)

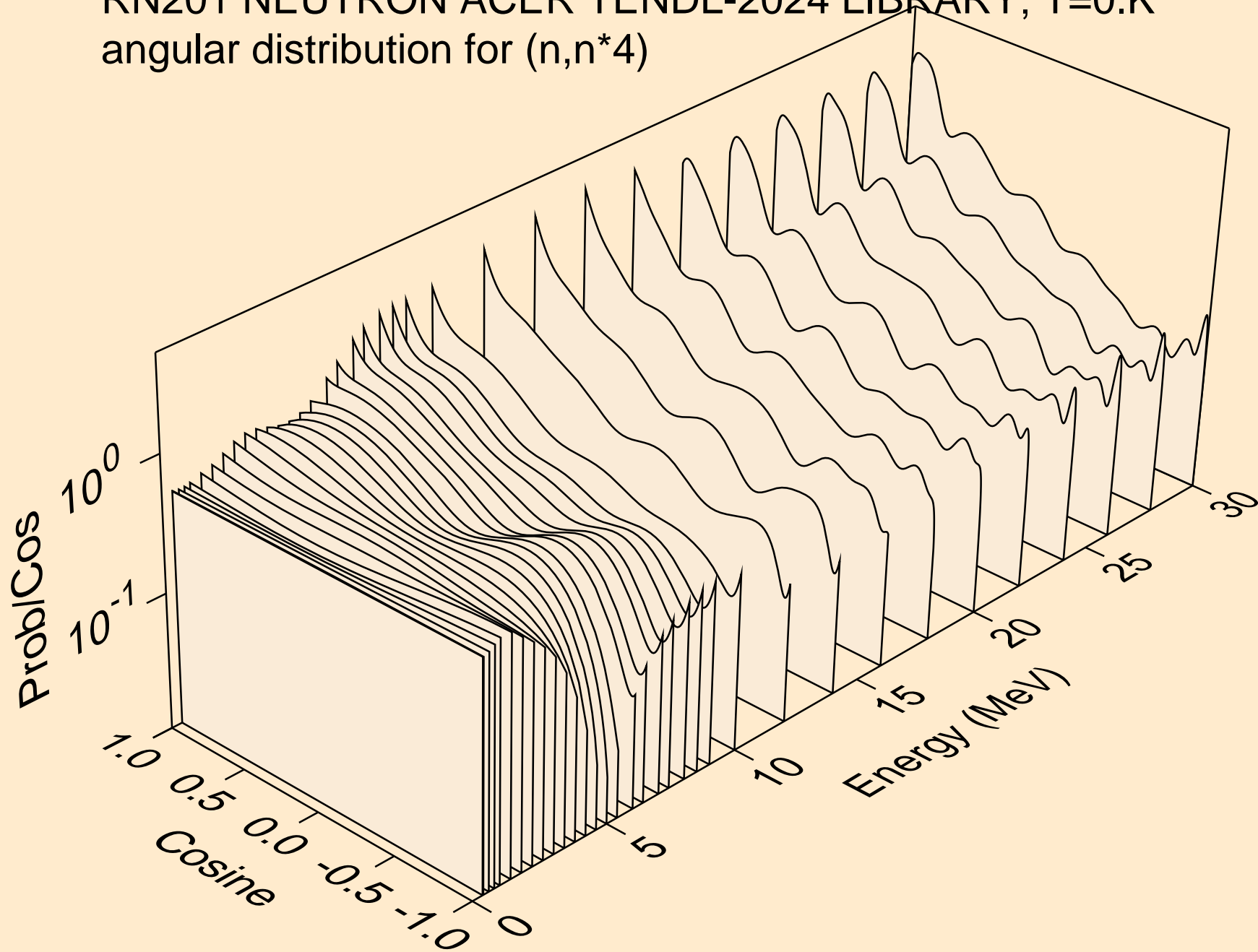

RN201 NEUTRON ACER TENDL-2024 LIBRARY; T=0.K  
angular distribution for (n,n\*5)

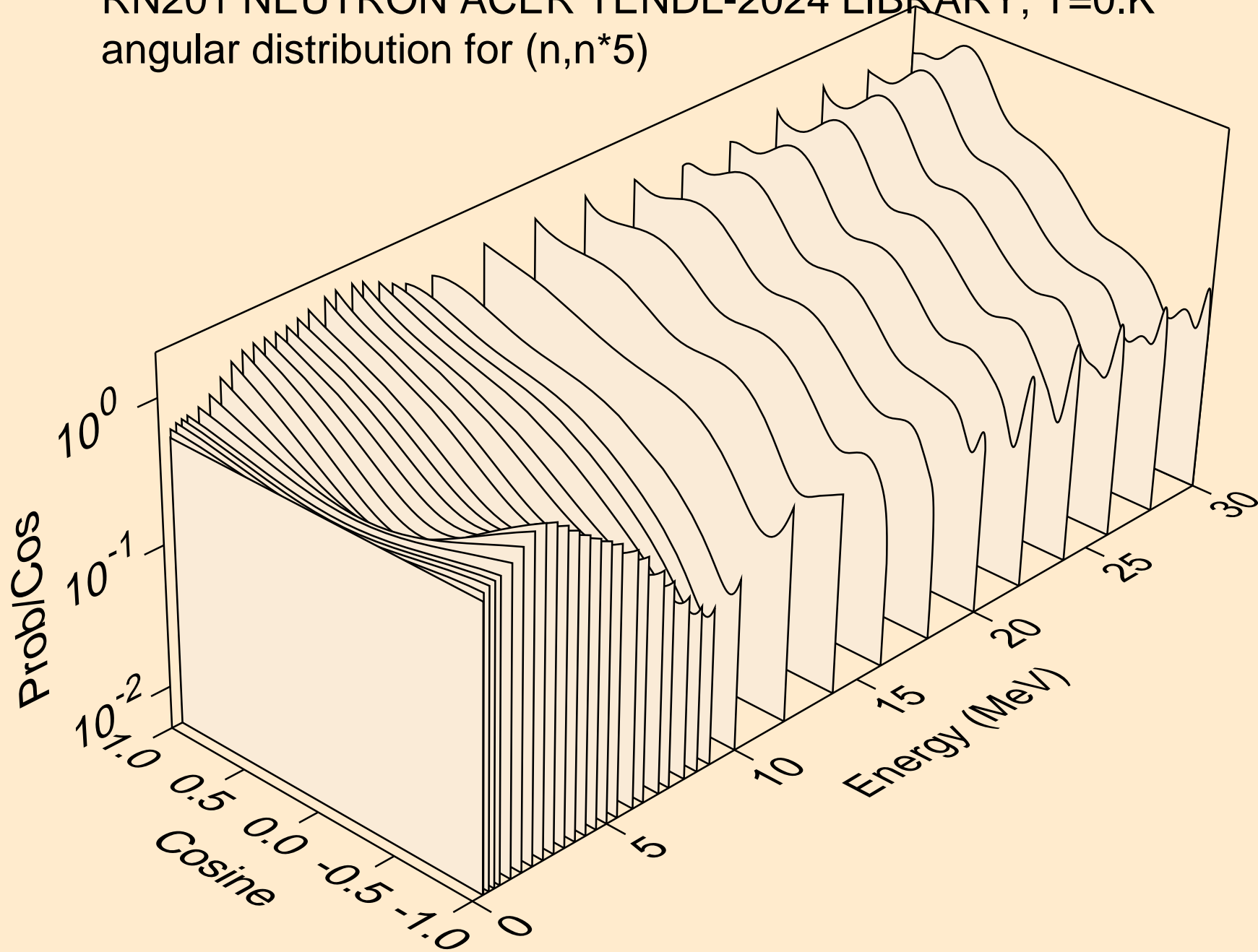

RN201 NEUTRON ACER TENDL-2024 LIBRARY; T=0.K  
angular distribution for (n,n\*6)

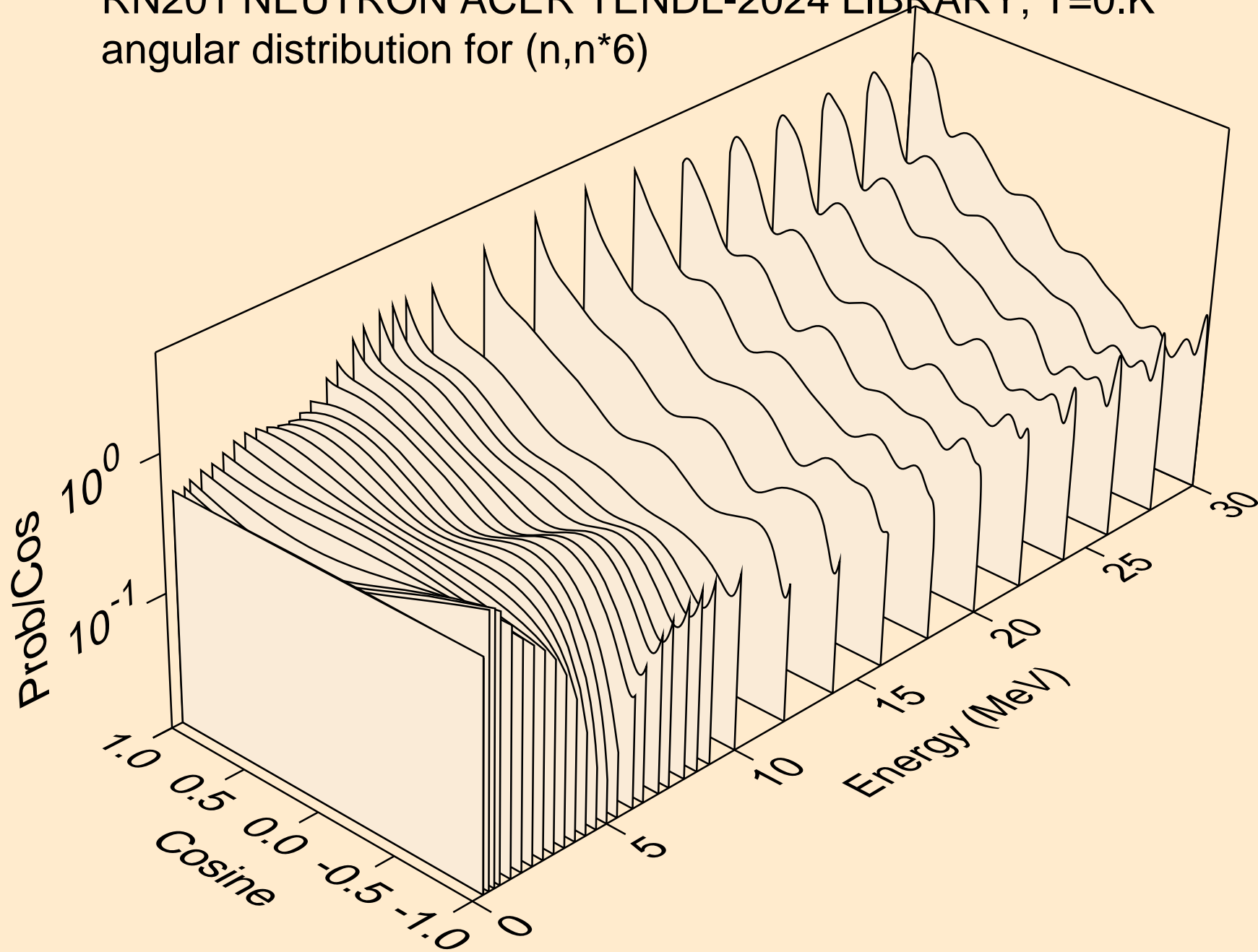

RN201 NEUTRON ACER TENDL-2024 LIBRARY; T=0.K  
angular distribution for (n,n\*7)

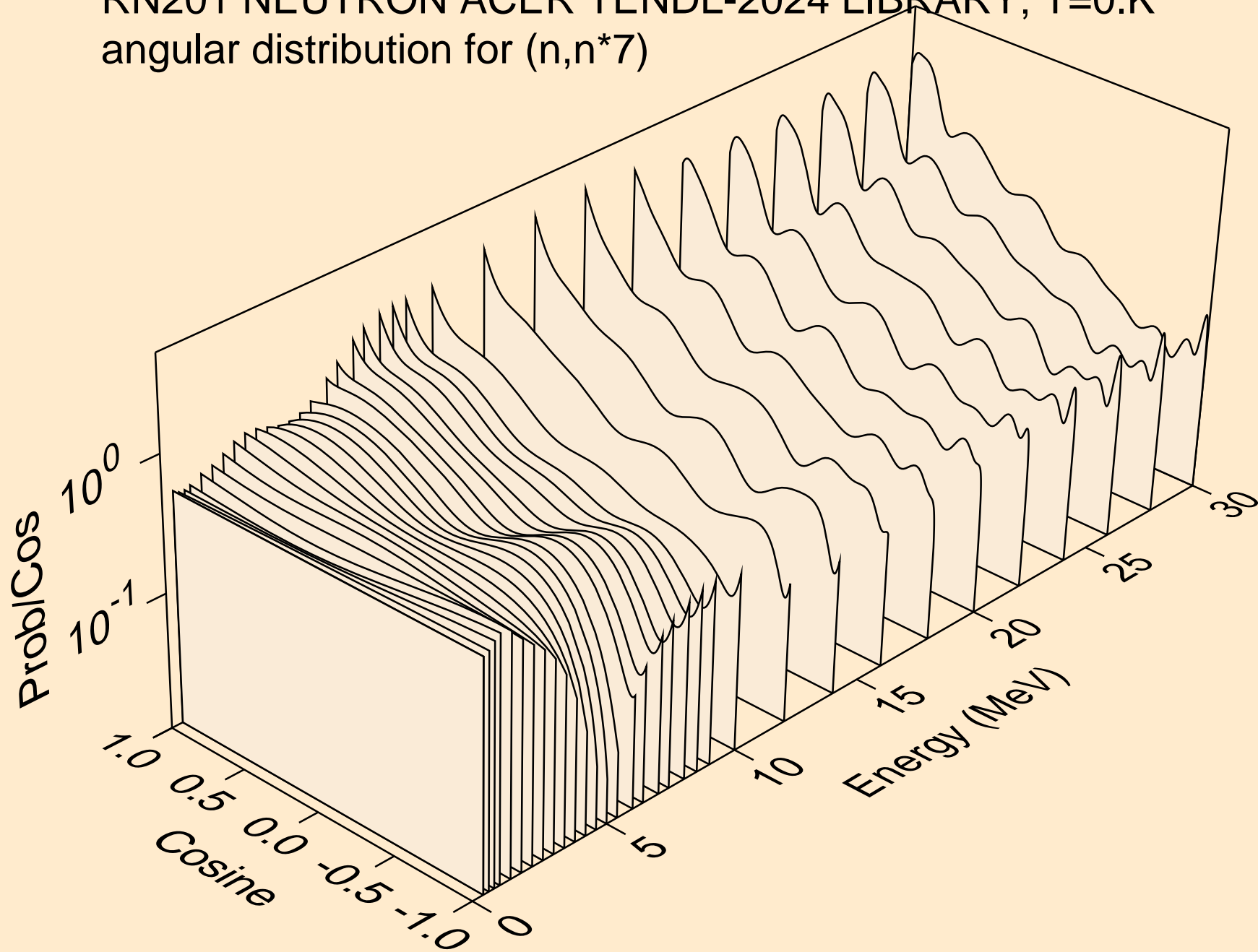

RN201 NEUTRON ACER TENDL-2024 LIBRARY; T=0.K  
angular distribution for (n,n\*8)

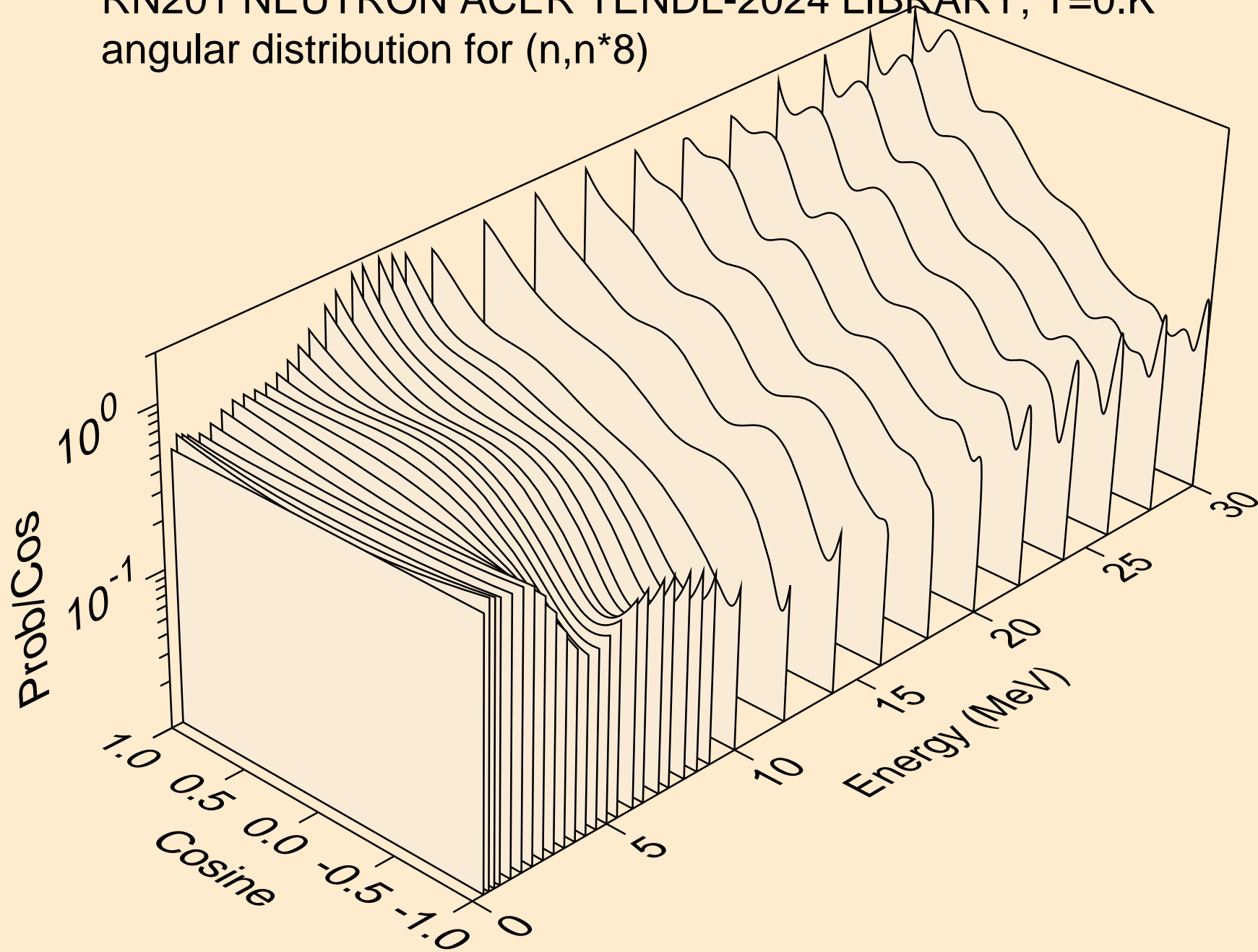

RN201 NEUTRON ACER TENDL-2024 LIBRARY; T=0.K  
angular distribution for (n,n\*9)

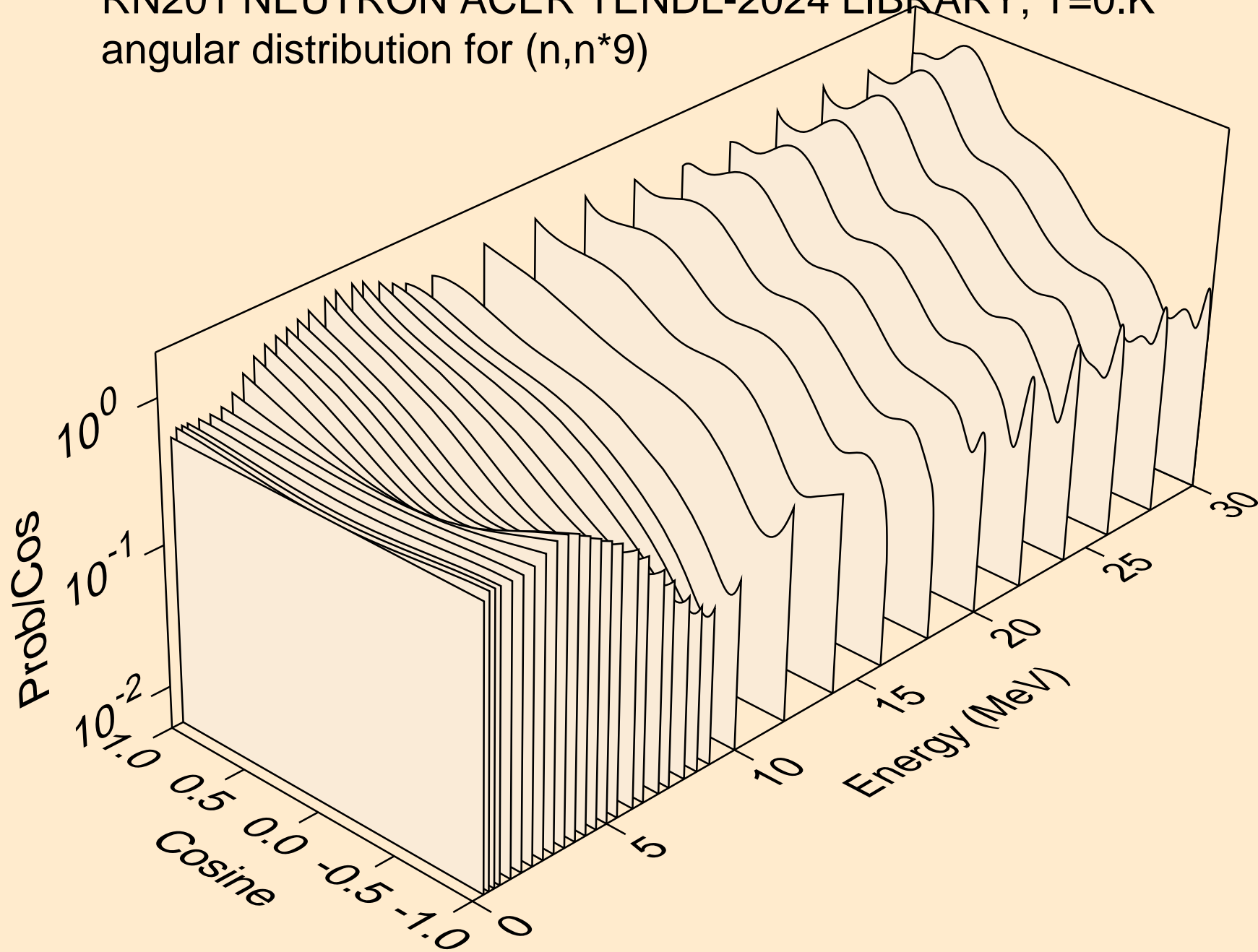

RN201 NEUTRON ACER TENDL-2024 LIBRARY; T=0.K  
angular distribution for (n,n\*10)

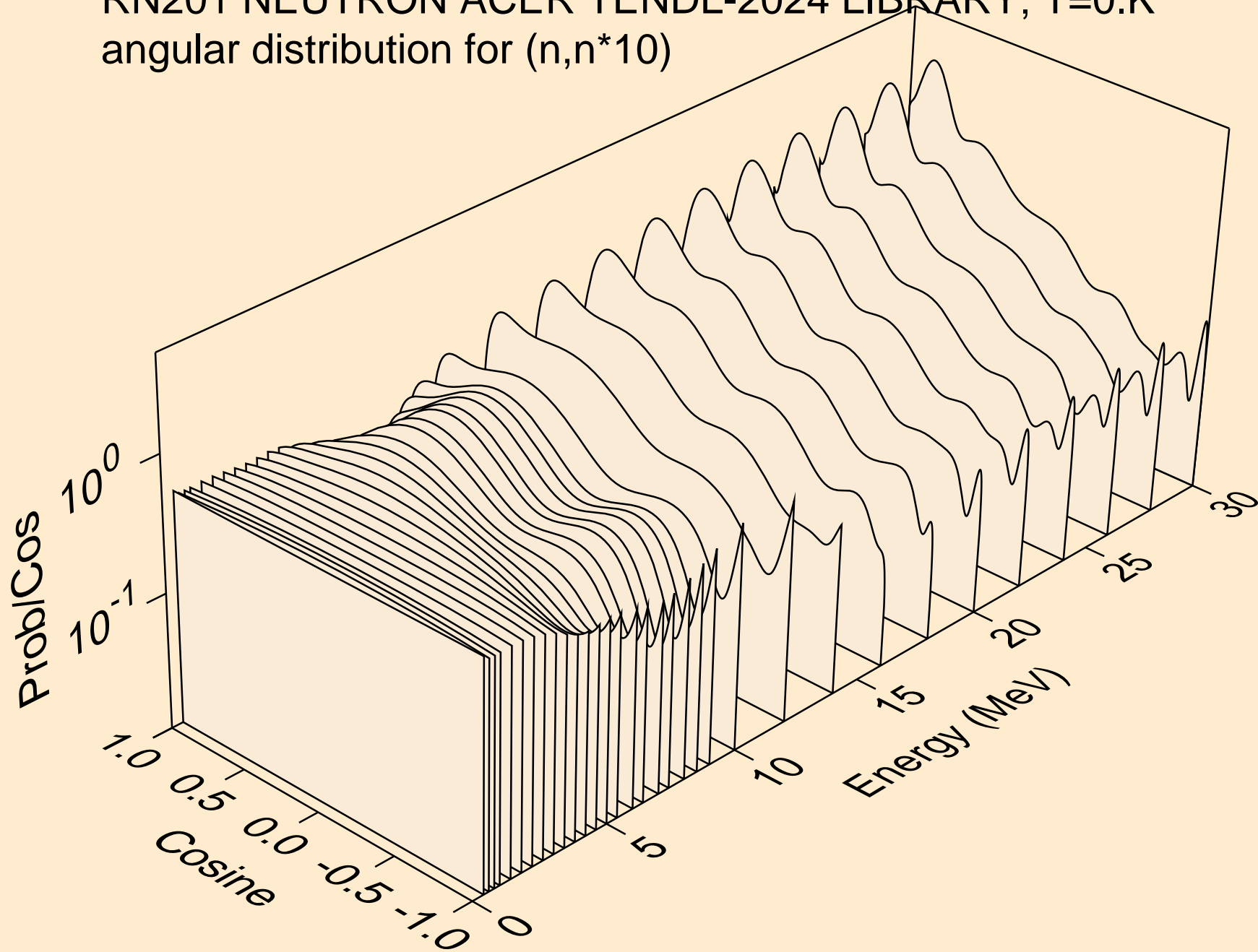

RN201 NEUTRON ACER TENDL-2024 LIBRARY; T=0.K  
angular distribution for (n,n\*11)

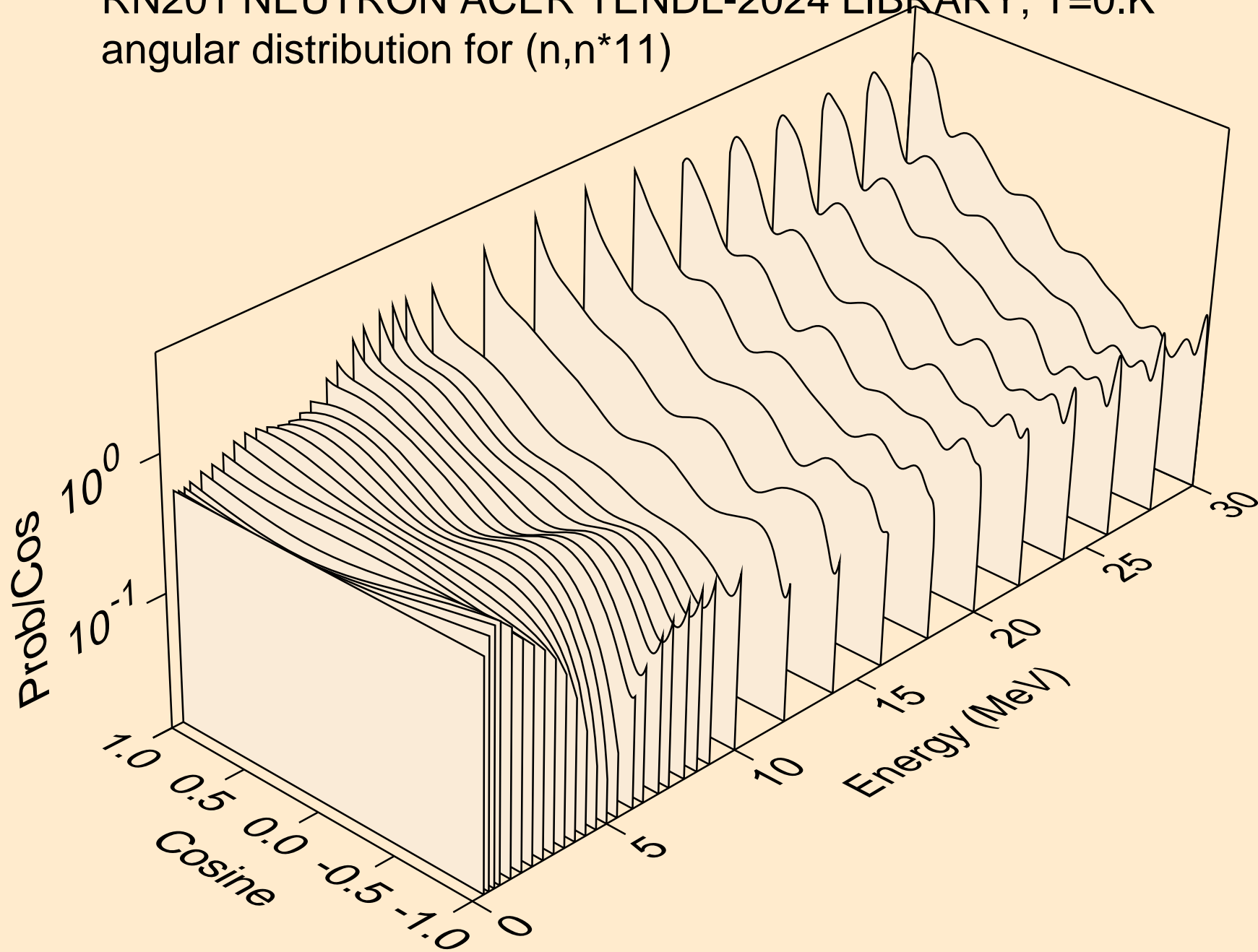

RN201 NEUTRON ACER TENDL-2024 LIBRARY; T=0.K  
angular distribution for (n,n\*12)

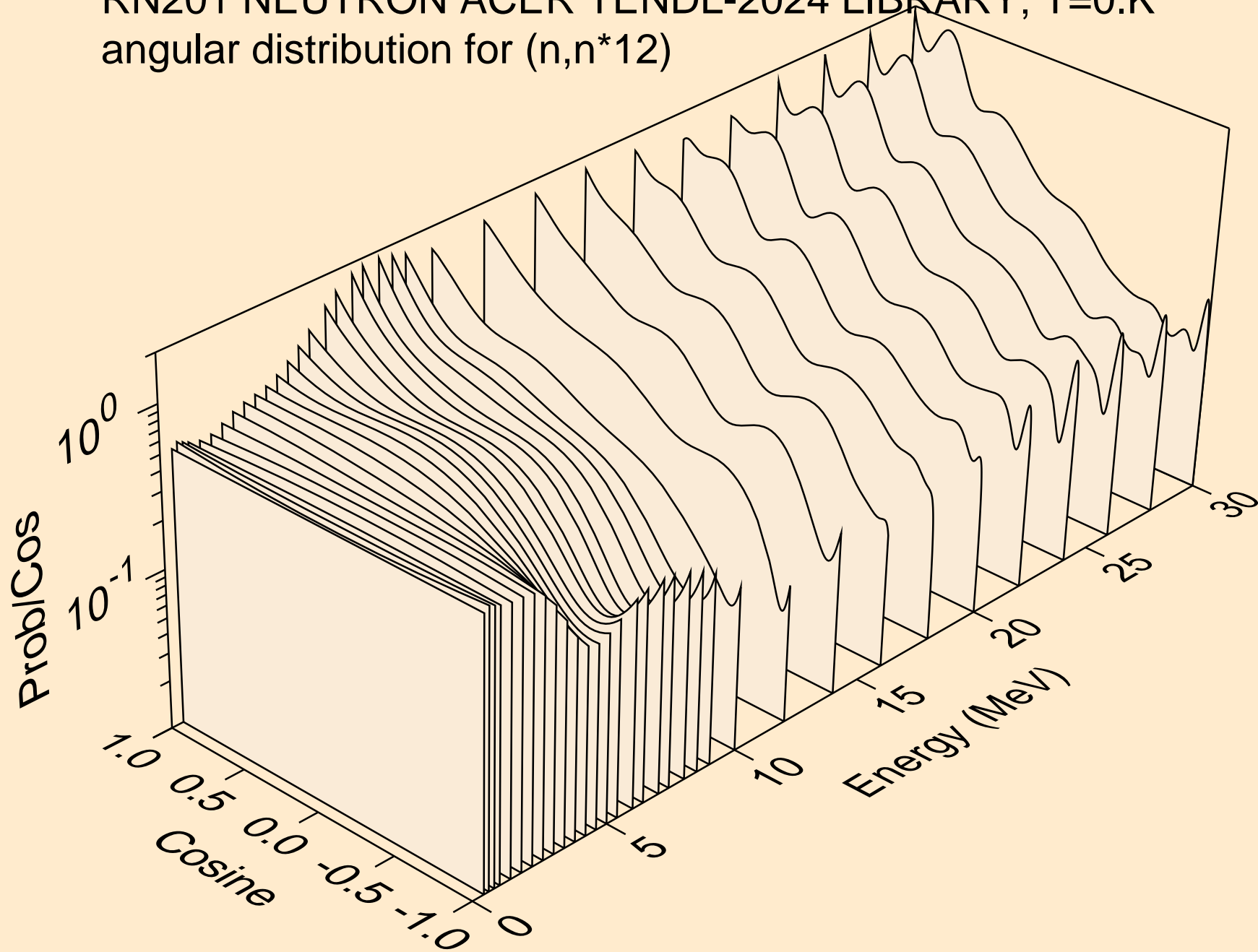

RN201 NEUTRON ACER TENDL-2024 LIBRARY; T=0.K  
angular distribution for (n,n\*13)

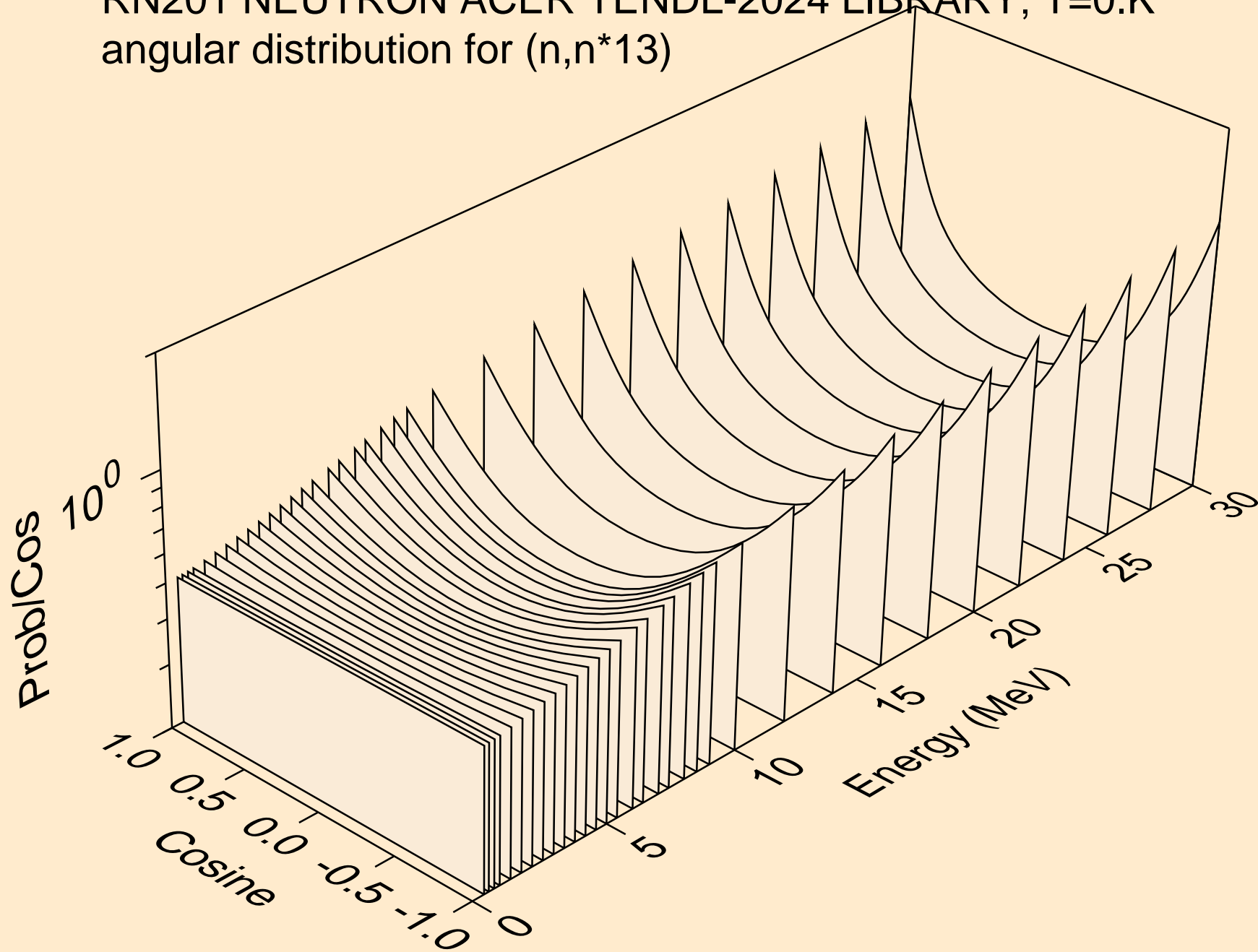

RN201 NEUTRON ACER TENDL-2024 LIBRARY; T=0.K  
angular distribution for (n,n\*14)

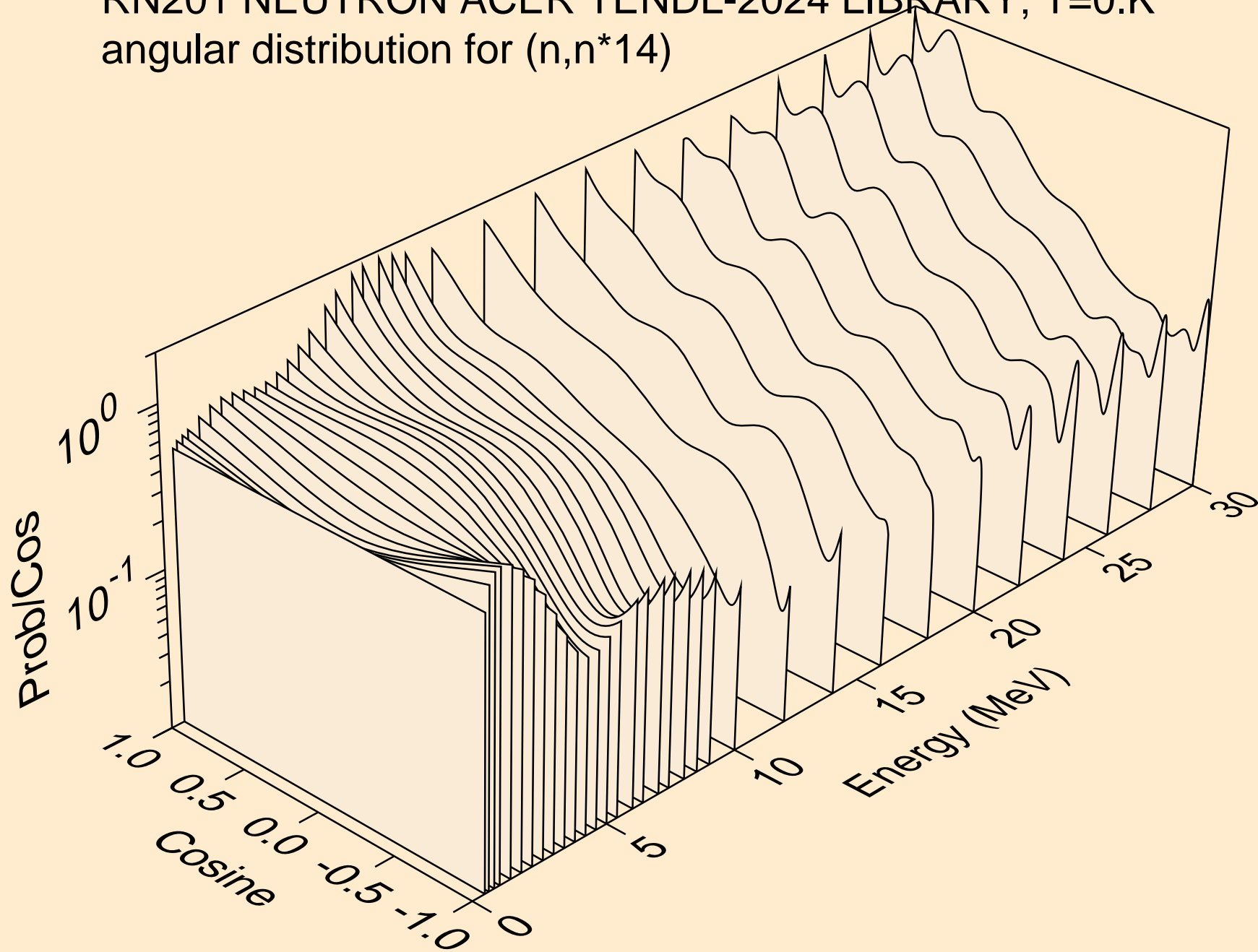

RN201 NEUTRON ACER TENDL-2024 LIBRARY; T=0.K  
angular distribution for (n,n\*15)

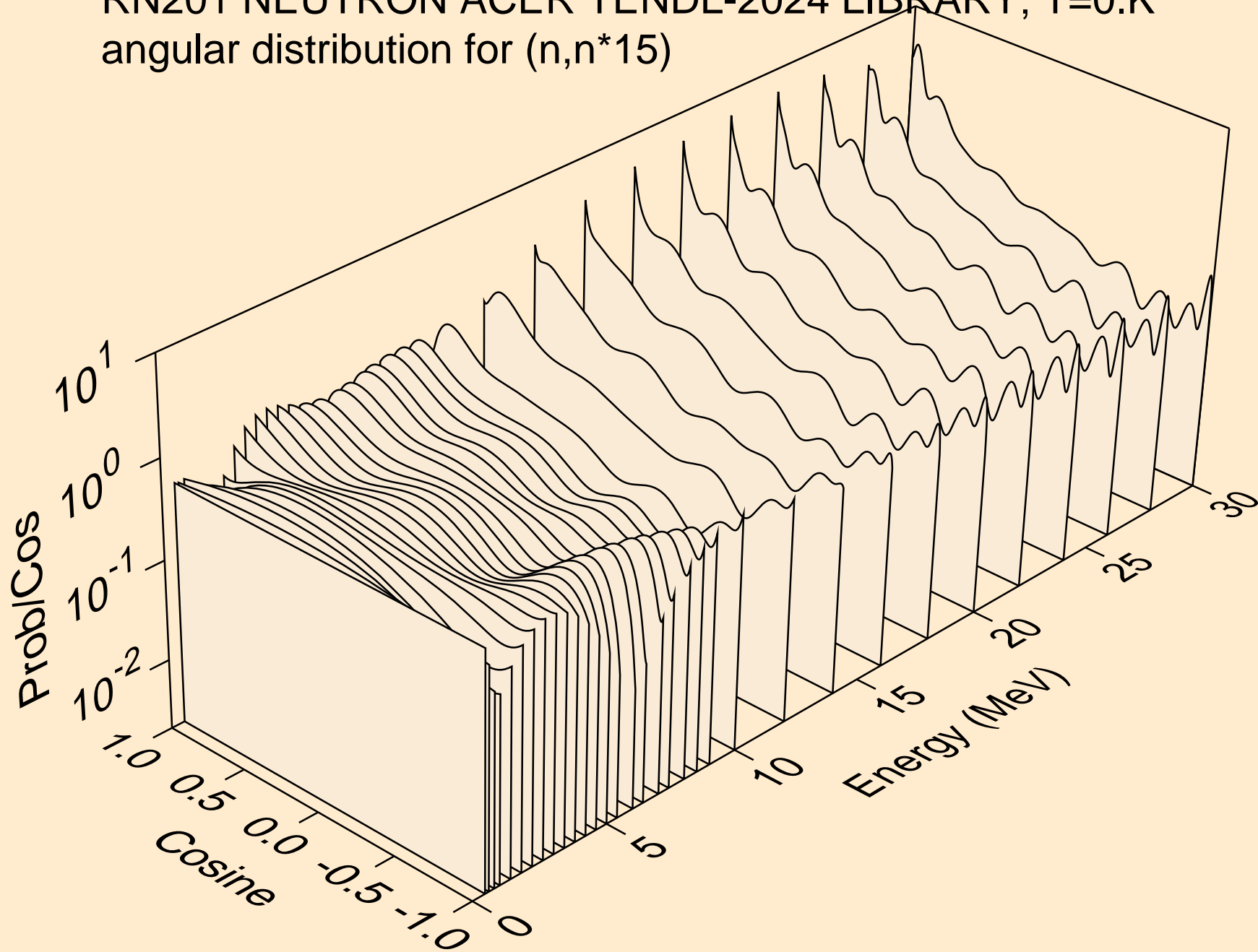

RN201 NEUTRON ACER TENDL-2024 LIBRARY; T=0.K  
angular distribution for (n,n\*16)

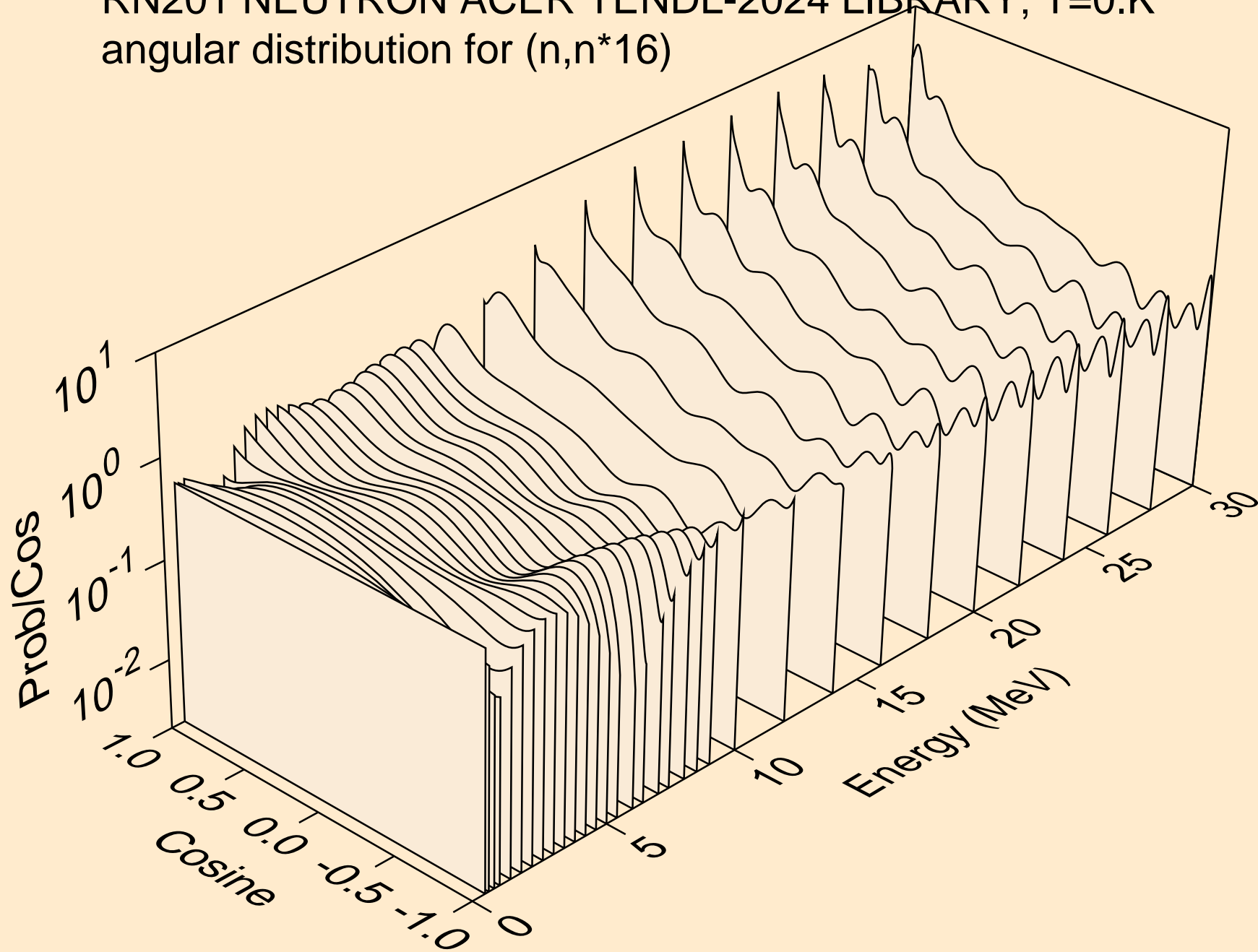

RN201 NEUTRON ACER TENDL-2024 LIBRARY; T=0.K  
angular distribution for (n,n\*17)

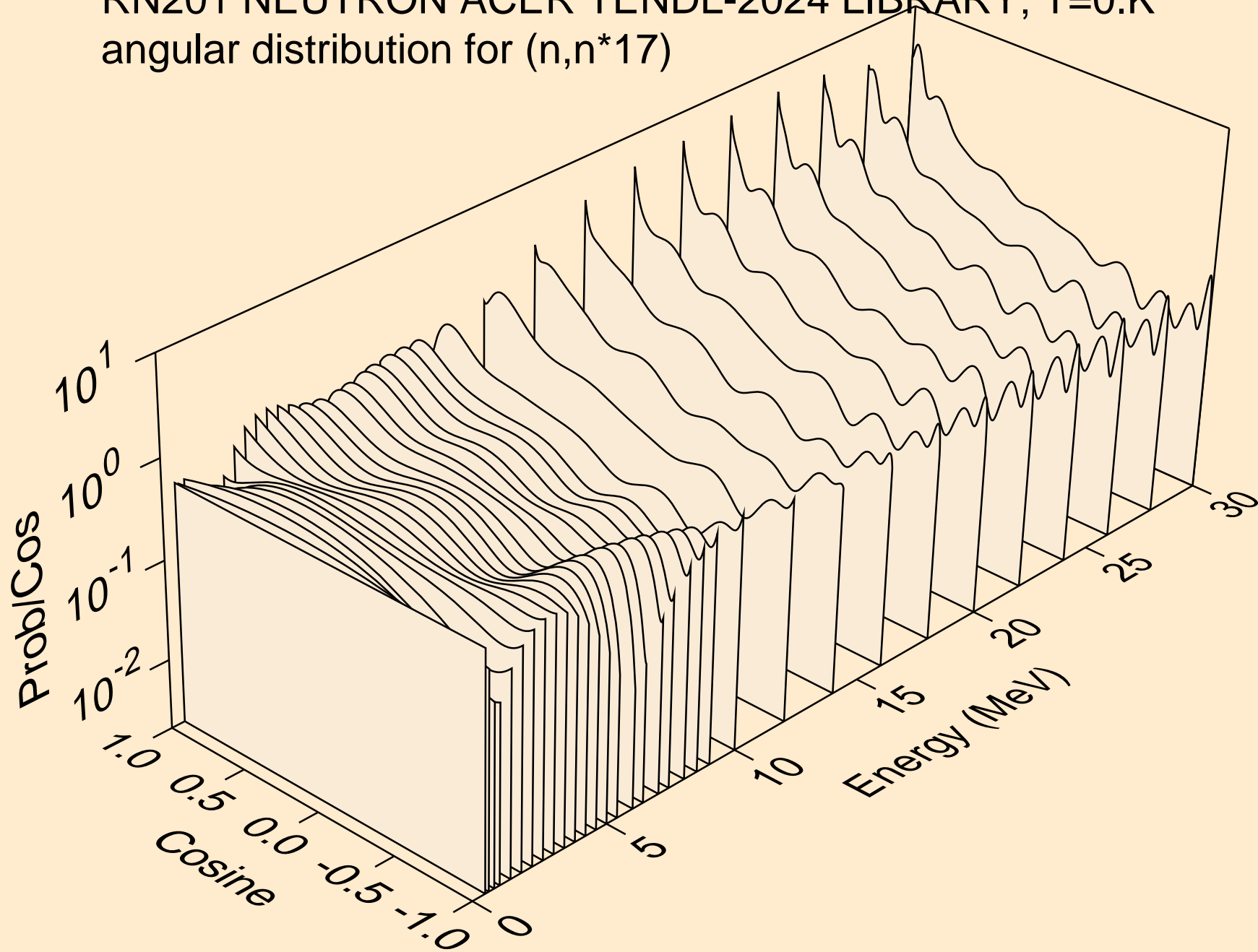

RN201 NEUTRON ACER TENDL-2024 LIBRARY; T=0.K  
angular distribution for (n,n\*18)

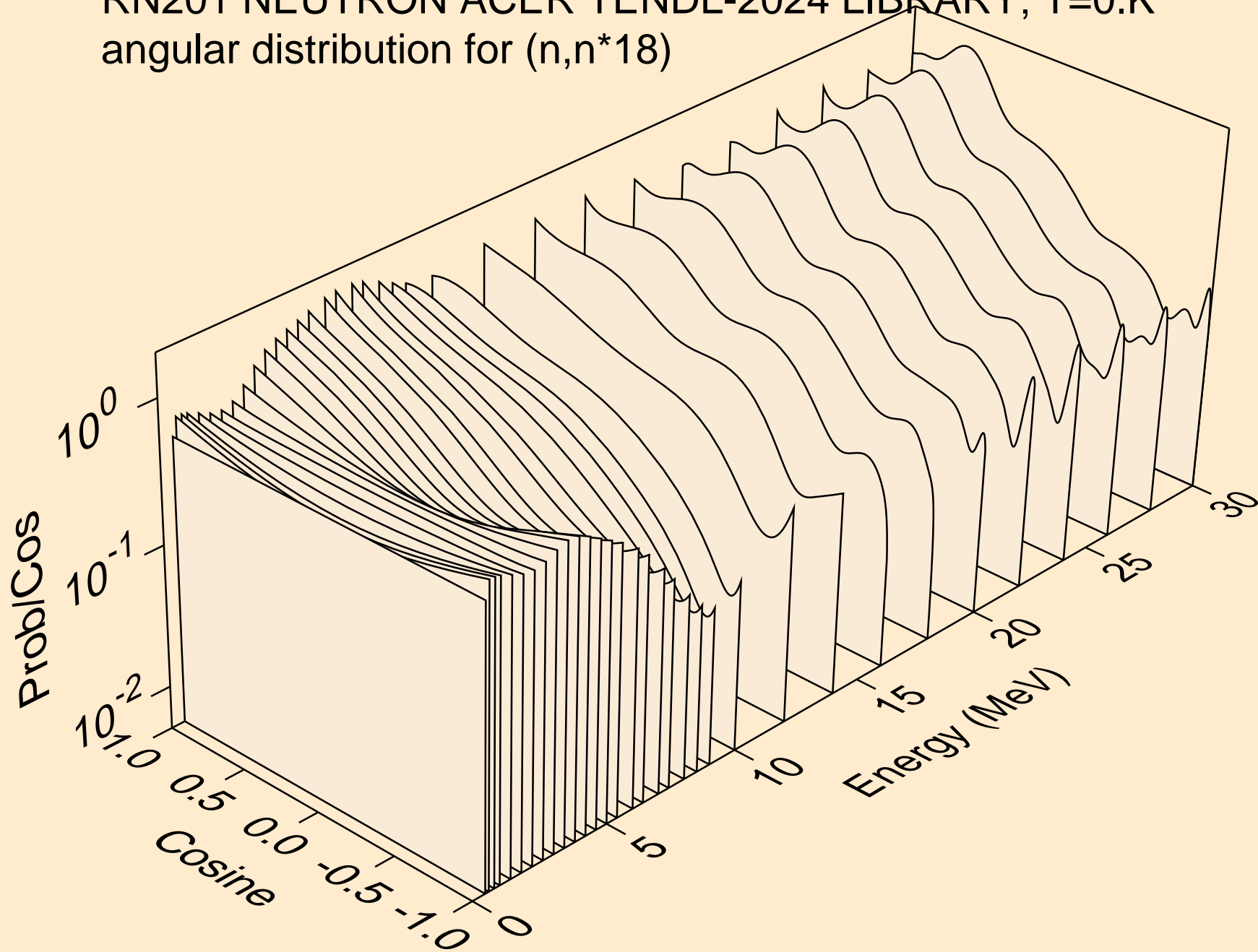

RN201 NEUTRON ACER TENDL-2024 LIBRARY; T=0.K  
angular distribution for (n,n\*19)

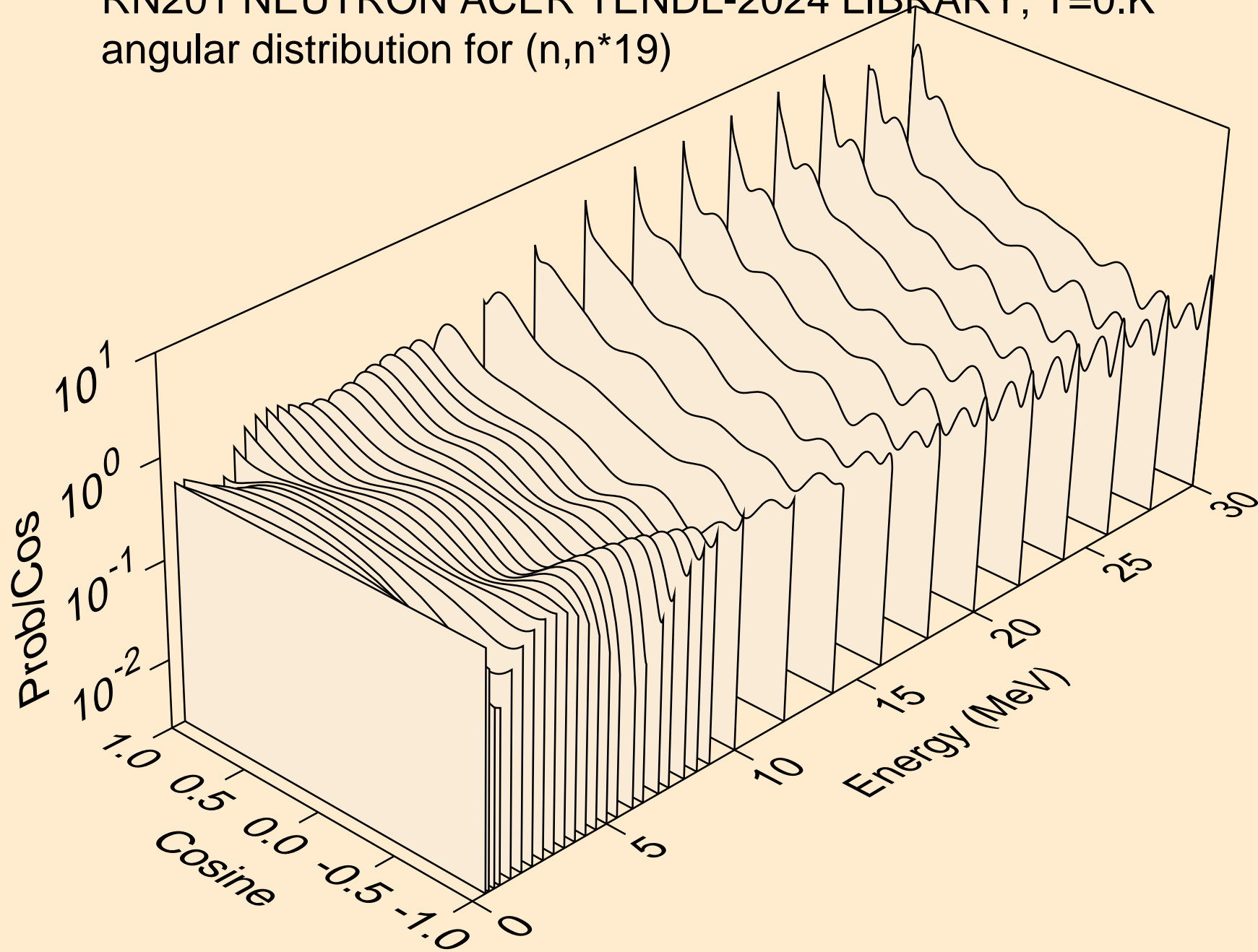

RN201 NEUTRON ACER TENDL-2024 LIBRARY; T=0.K  
Neutron emission for (n,x)

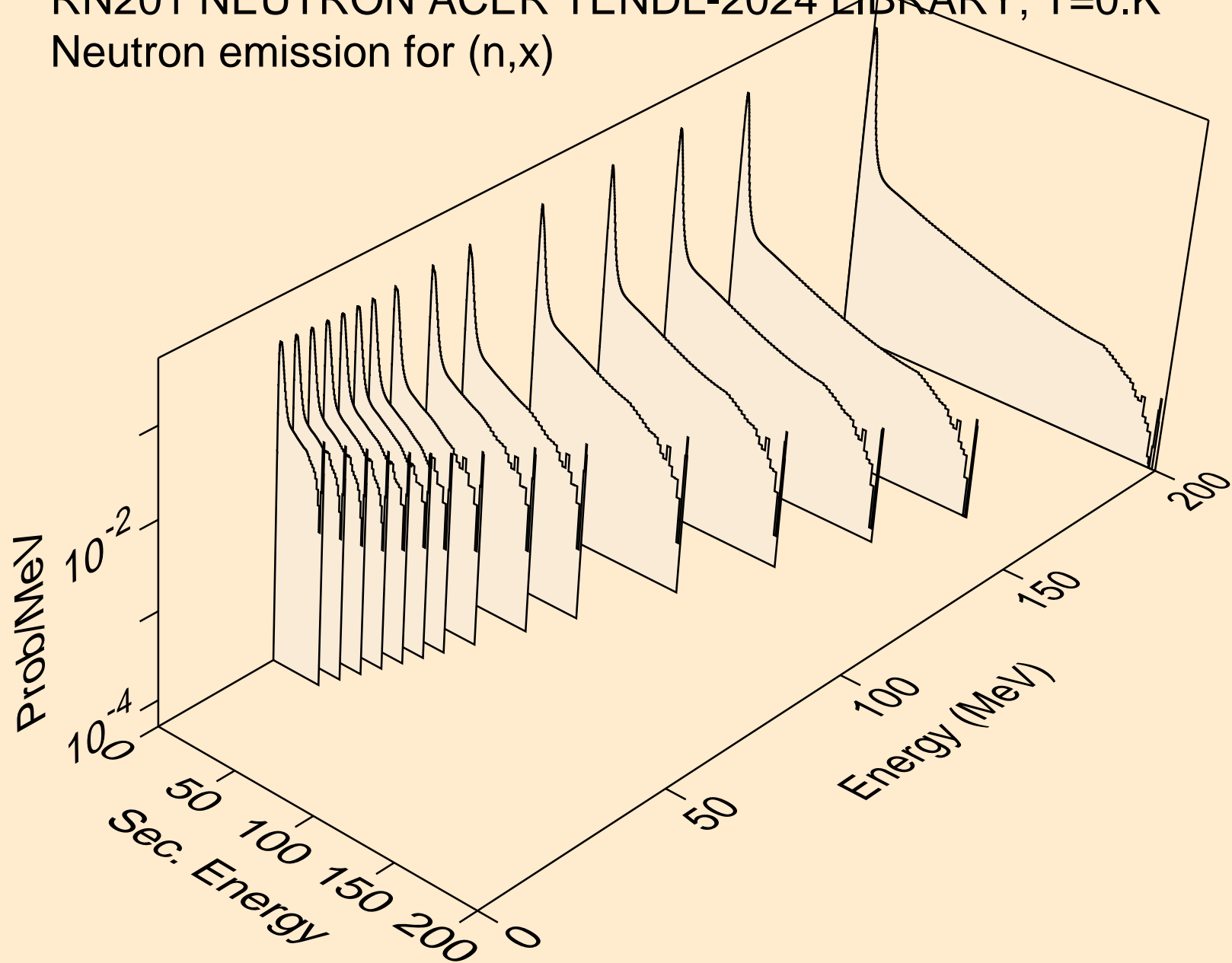

RN201 NEUTRON ACER TENDL-2024 LIBRARY; T=0.K  
Neutron emission for (n,2nd)

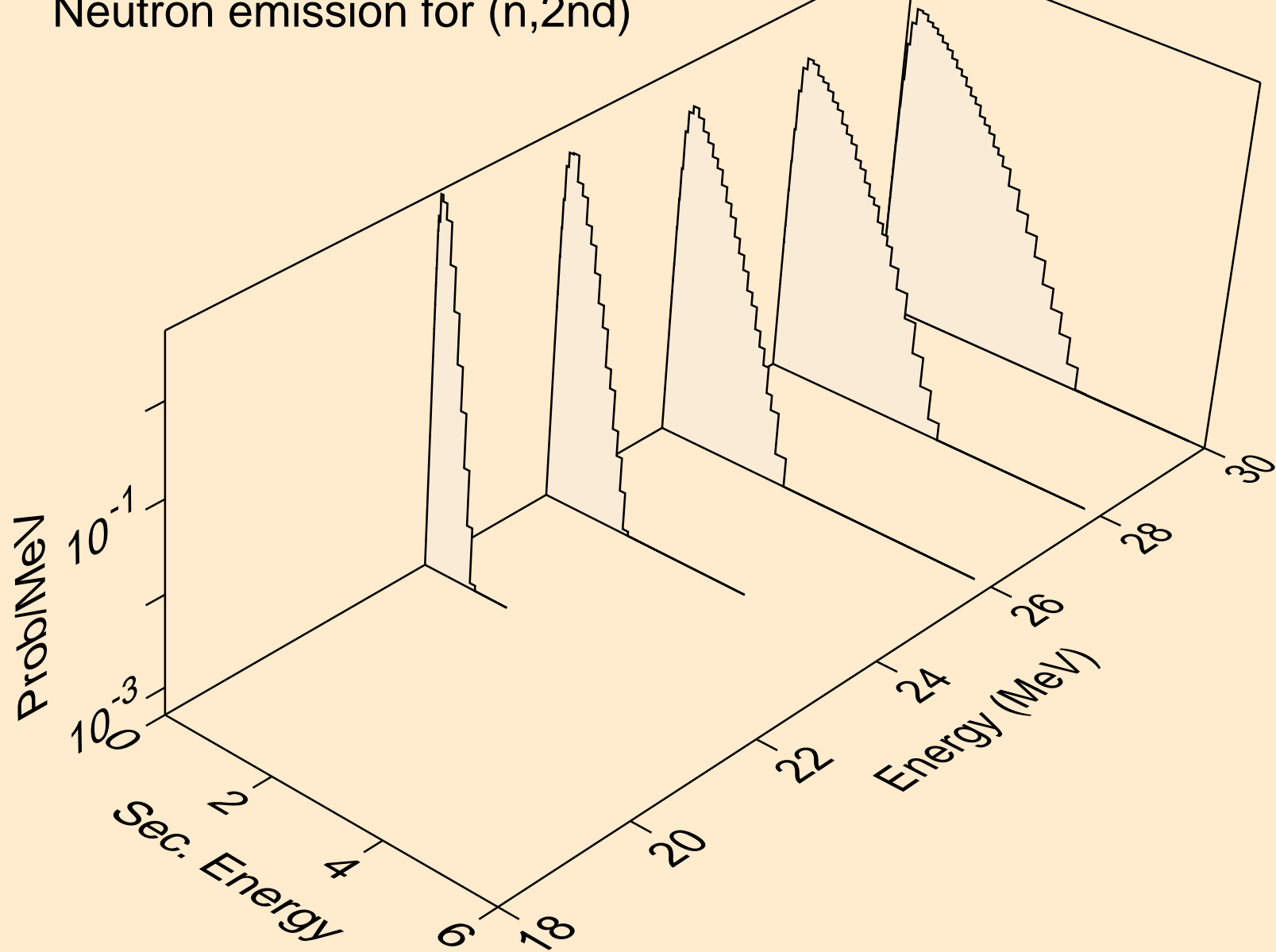

RN201 NEUTRON ACER TENDL-2024 LIBRARY; T=0.K  
Neutron emission for (n,2n)

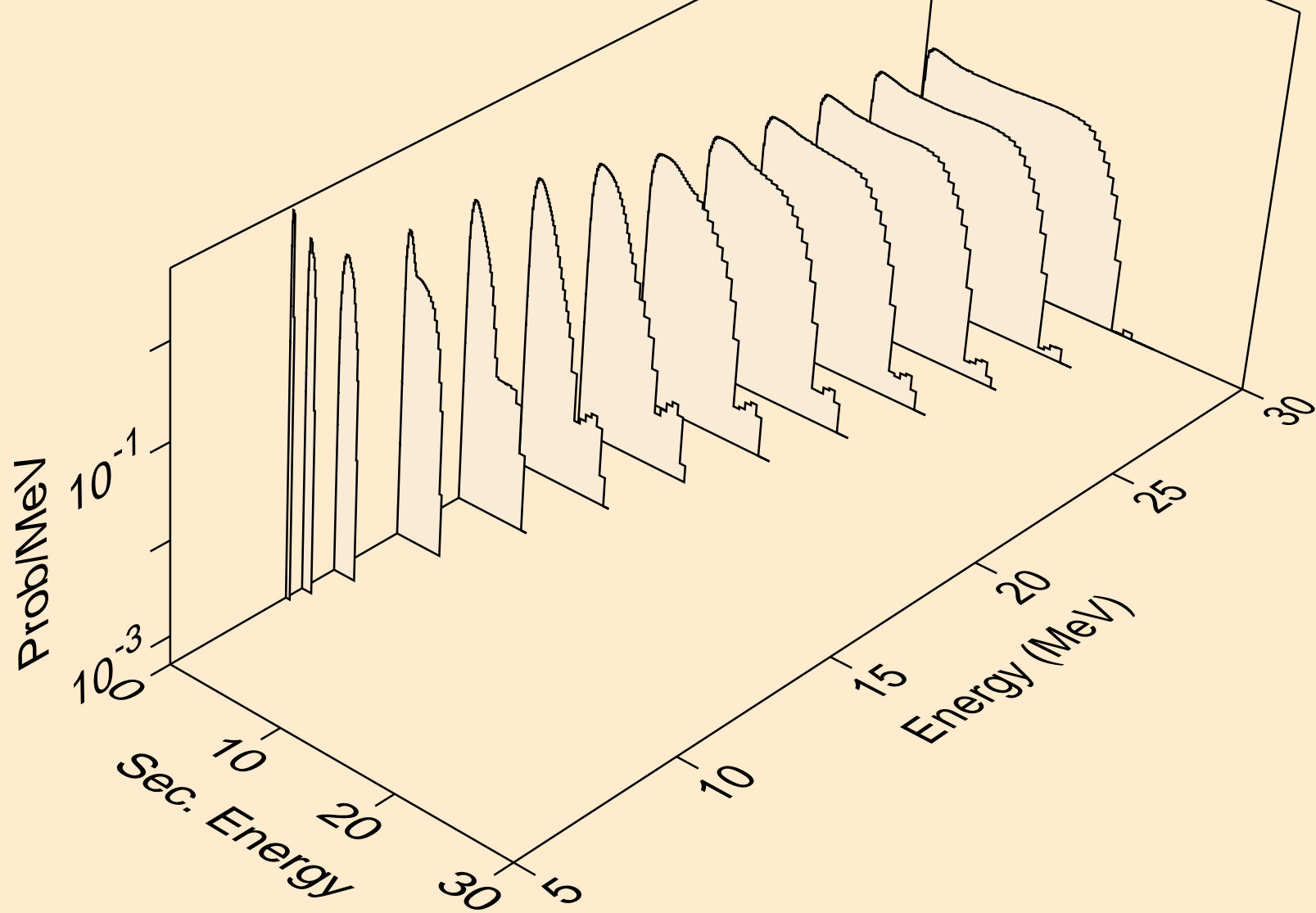

RN201 NEUTRON ACER TENDL-2024 LIBRARY; T=0.K  
Neutron emission for (n,3n)

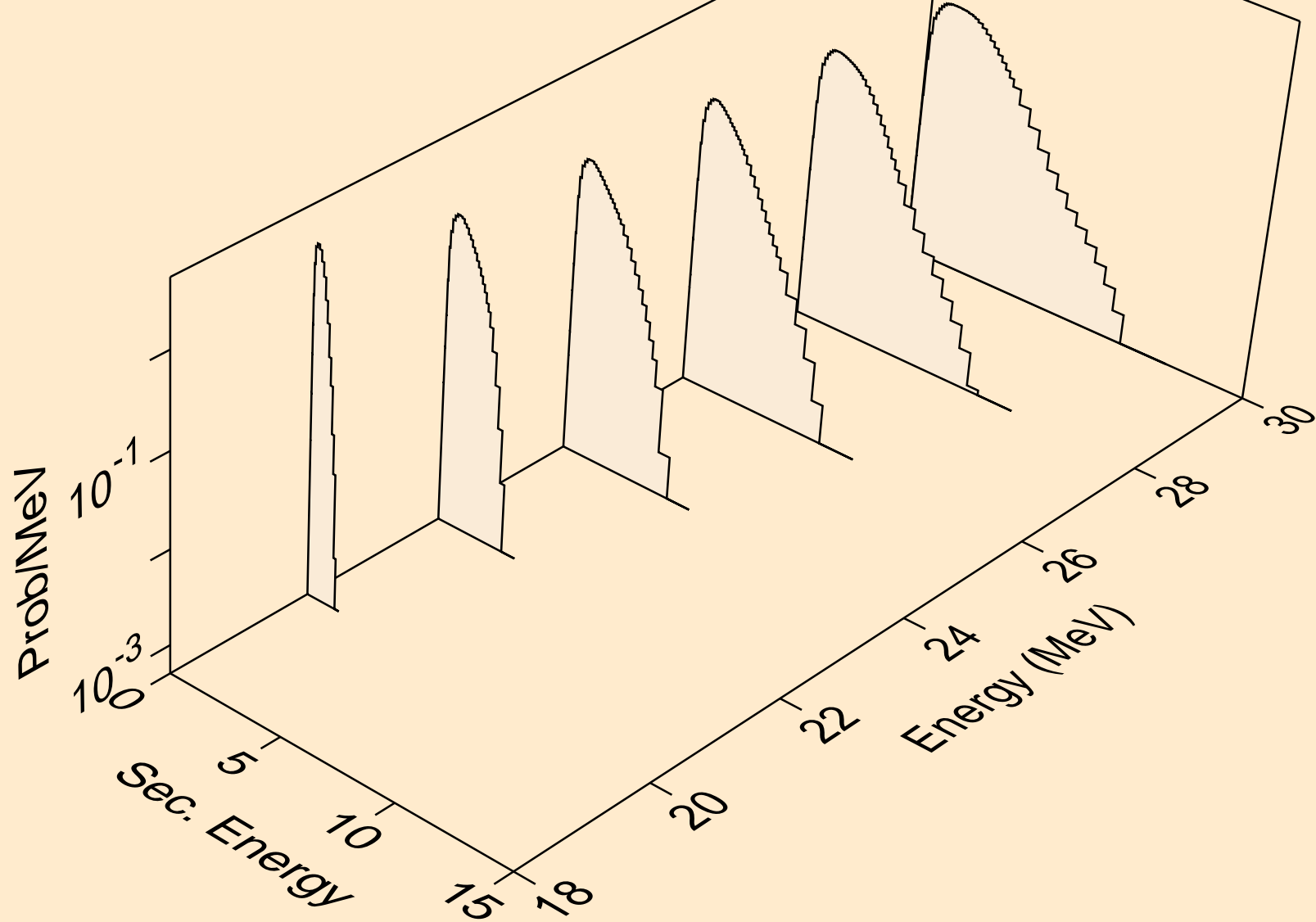

RN201 NEUTRON ACER TENDL-2024 LIBRARY; T=0.K  
Neutron emission for (n,n\*)a

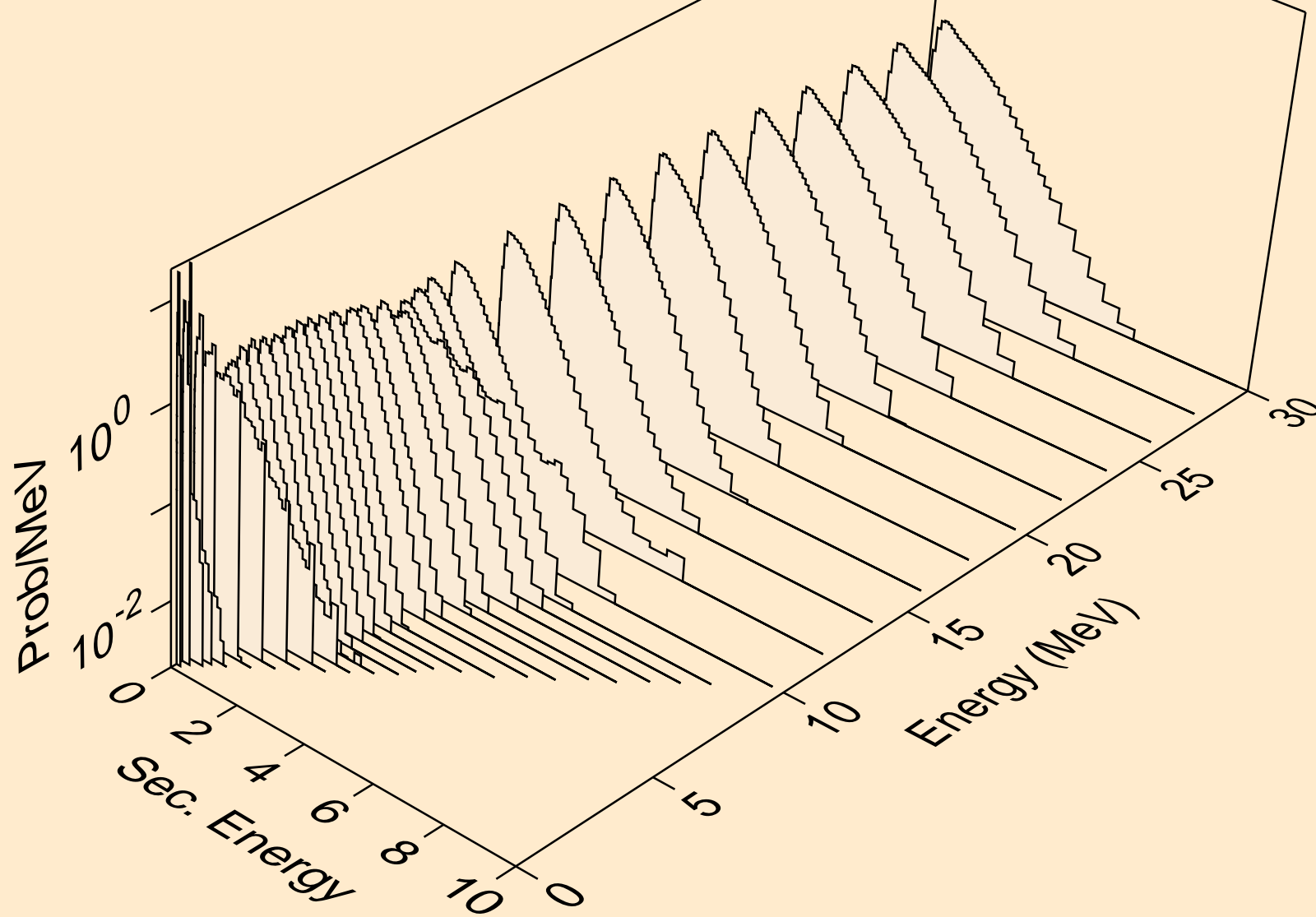

RN201 NEUTRON ACER TENDL-2024 LIBRARY; T=0.K  
Neutron emission for (n,2n)a

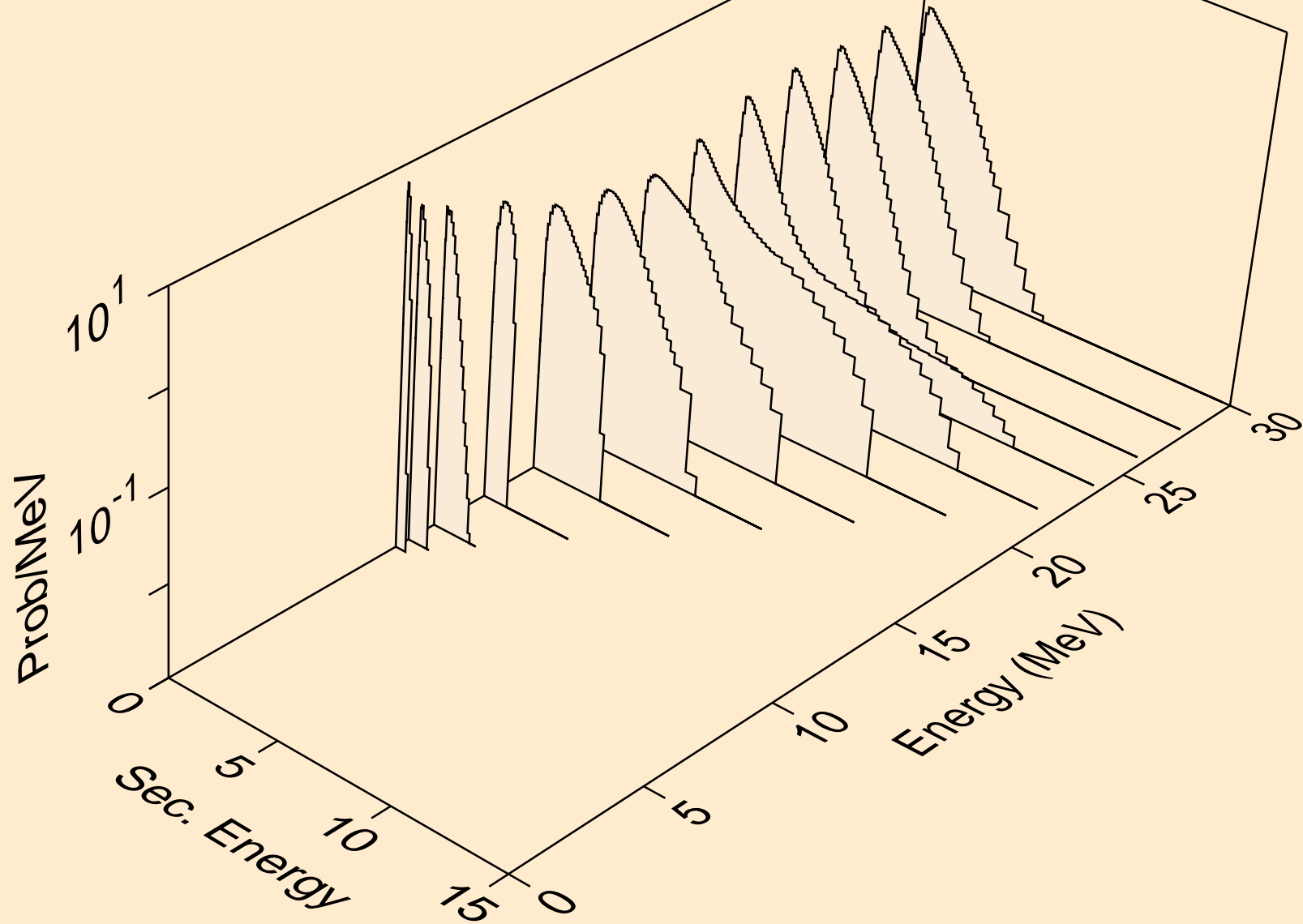

RN201 NEUTRON ACER TENDL-2024 LIBRARY; T=0.K  
Neutron emission for (n,3n)a

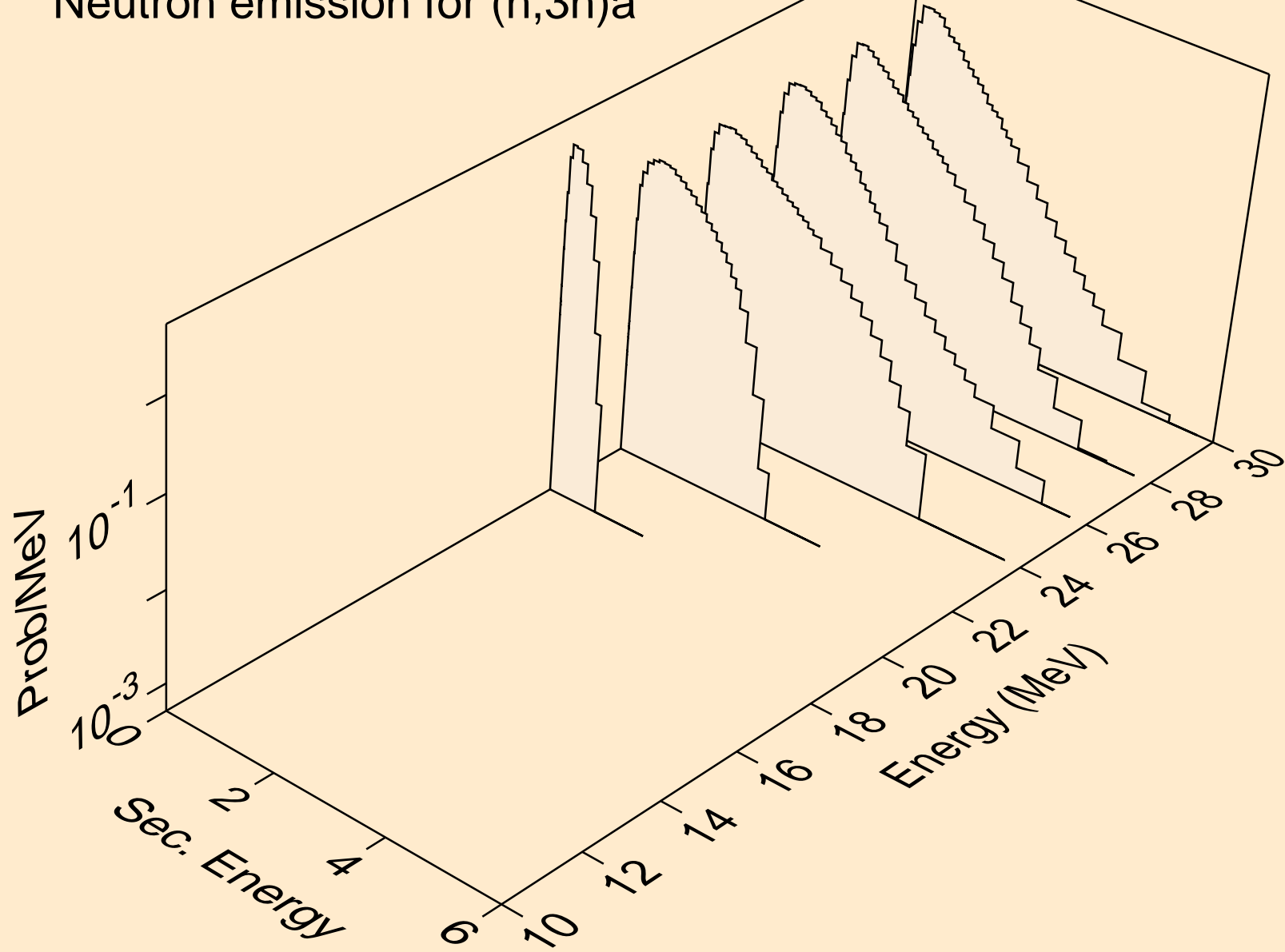

RN201 NEUTRON ACER TENDL-2024 LIBRARY; T=0.K  
Neutron emission for (n,n\*)p

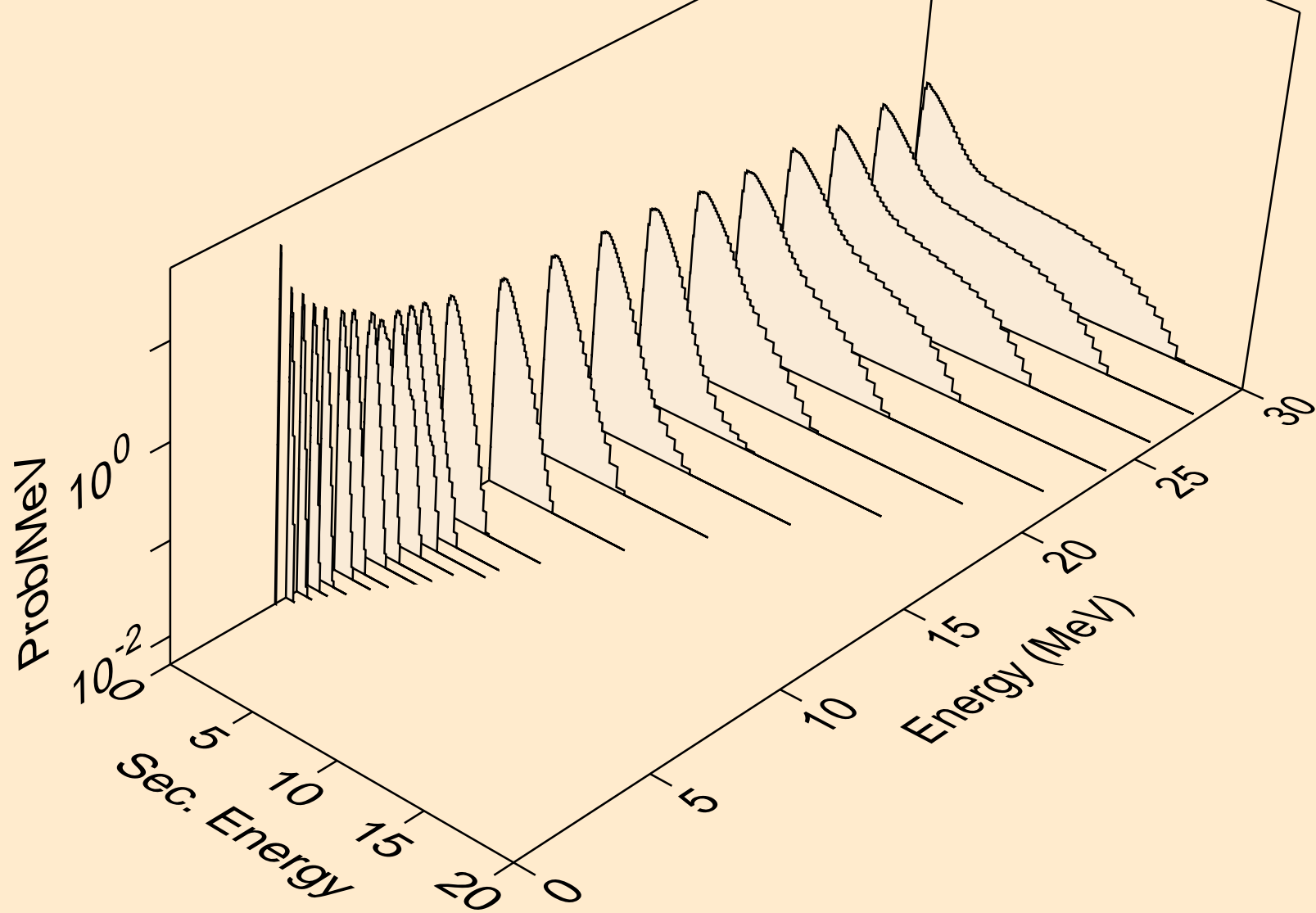

RN201 NEUTRON ACER TENDL-2024 LIBRARY; T=0.K  
Neutron emission for (n,n\*)2a

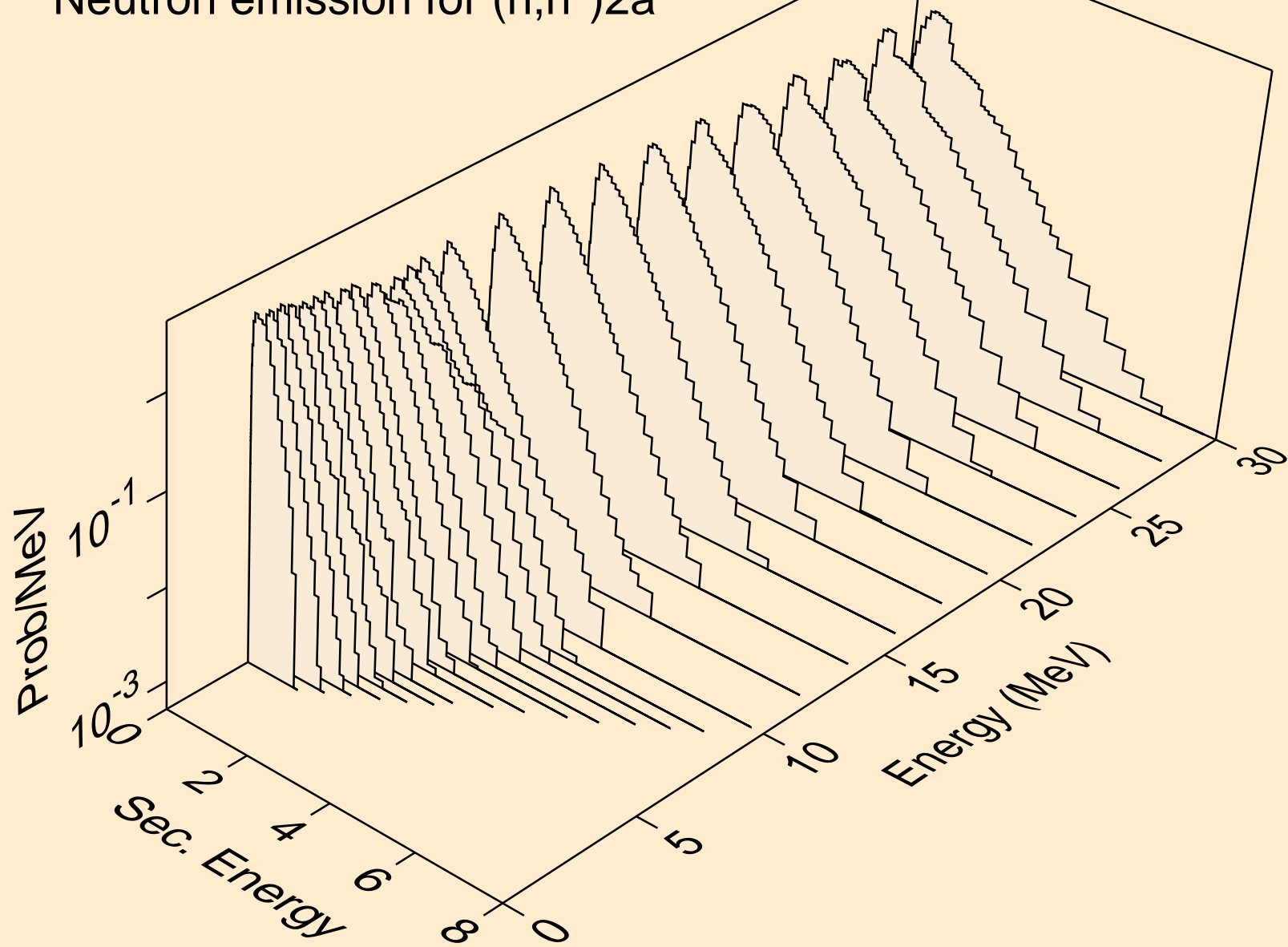

RN201 NEUTRON ACER TENDL-2024 LIBRARY; T=0.K  
Neutron emission for (n,2n)2a

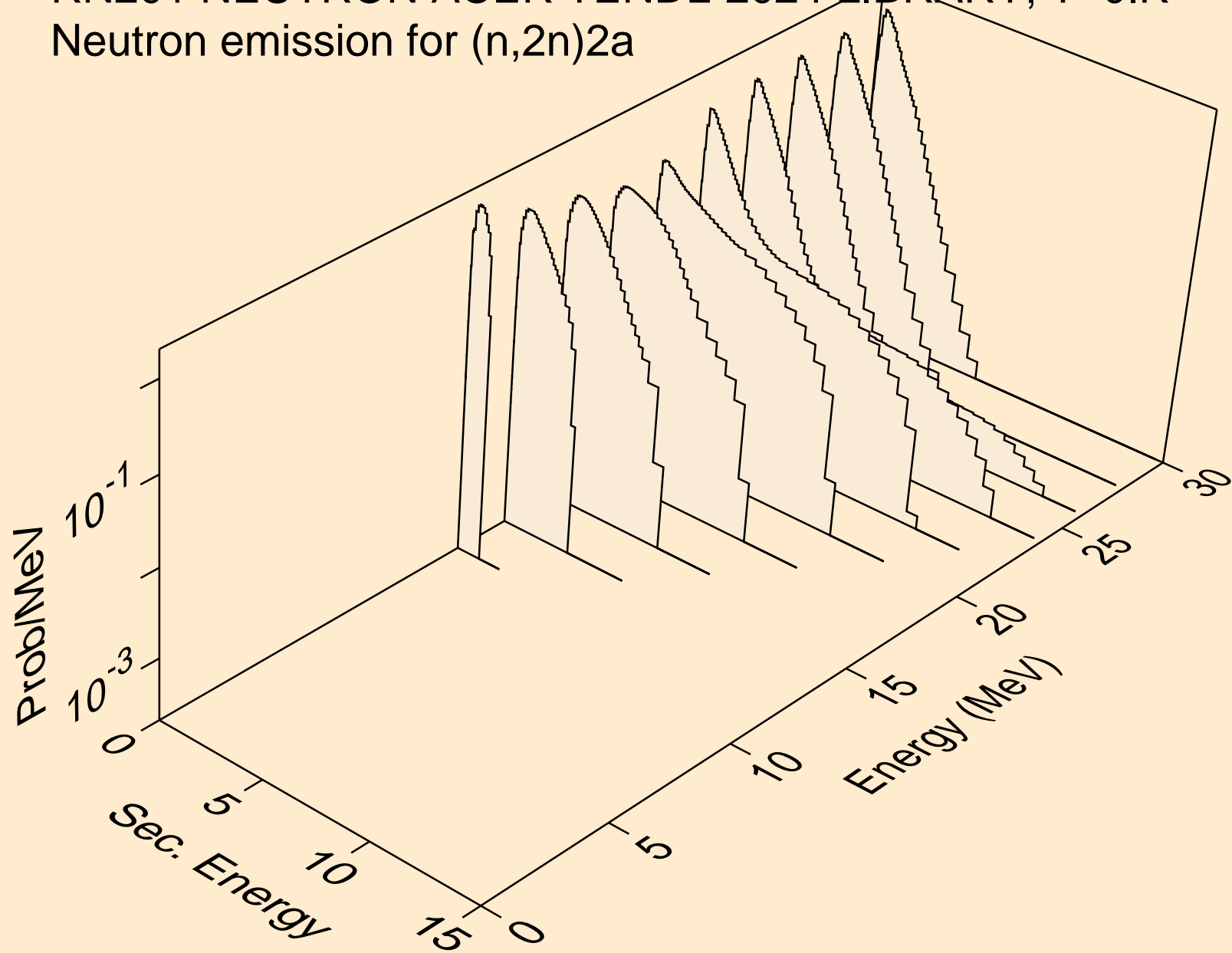

RN201 NEUTRON ACER TENDL-2024 LIBRARY; T=0.K  
Neutron emission for (n,n\*)d

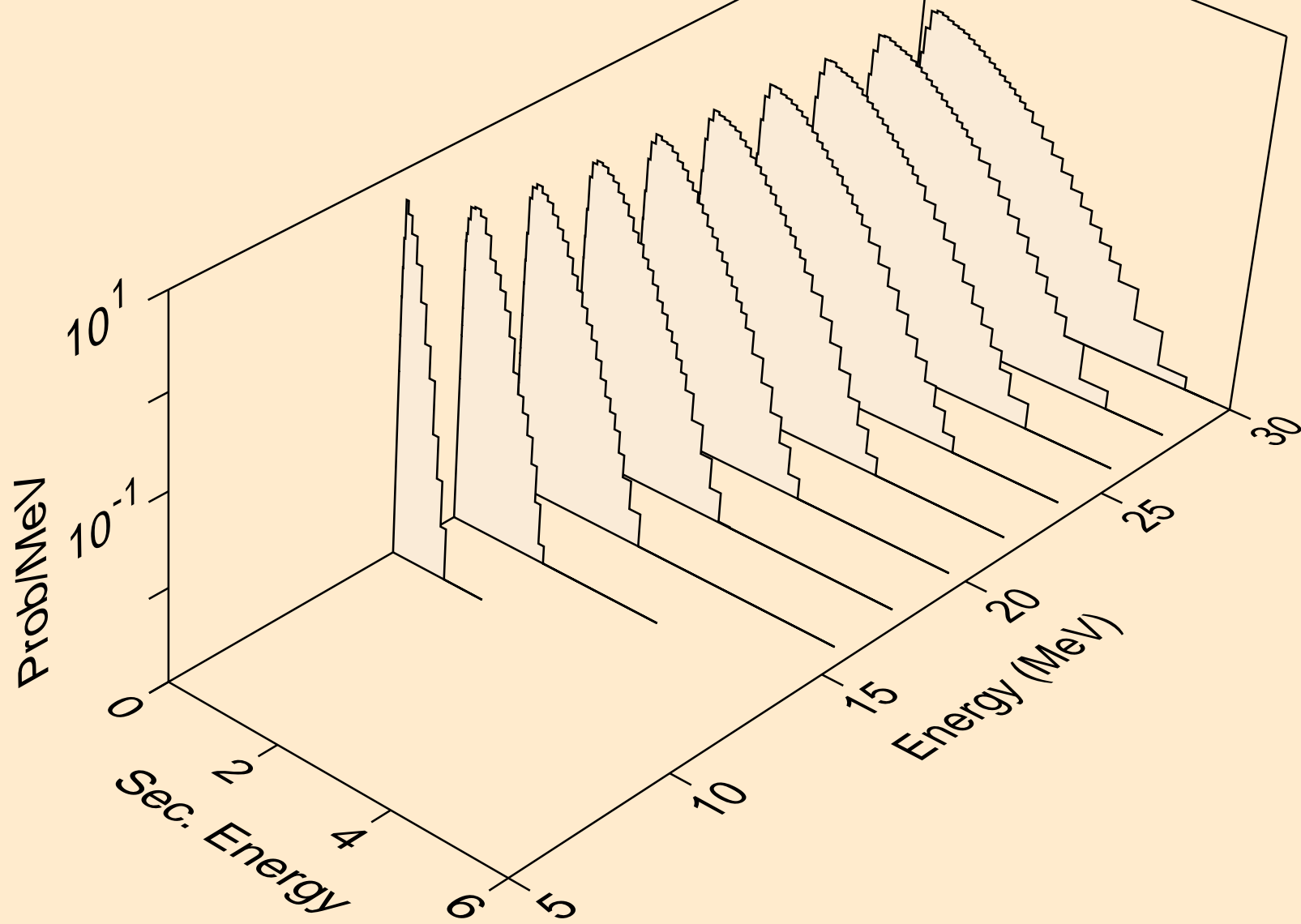

RN201 NEUTRON ACER TENDL-2024 LIBRARY; T=0.K  
Neutron emission for (n,n\*)t

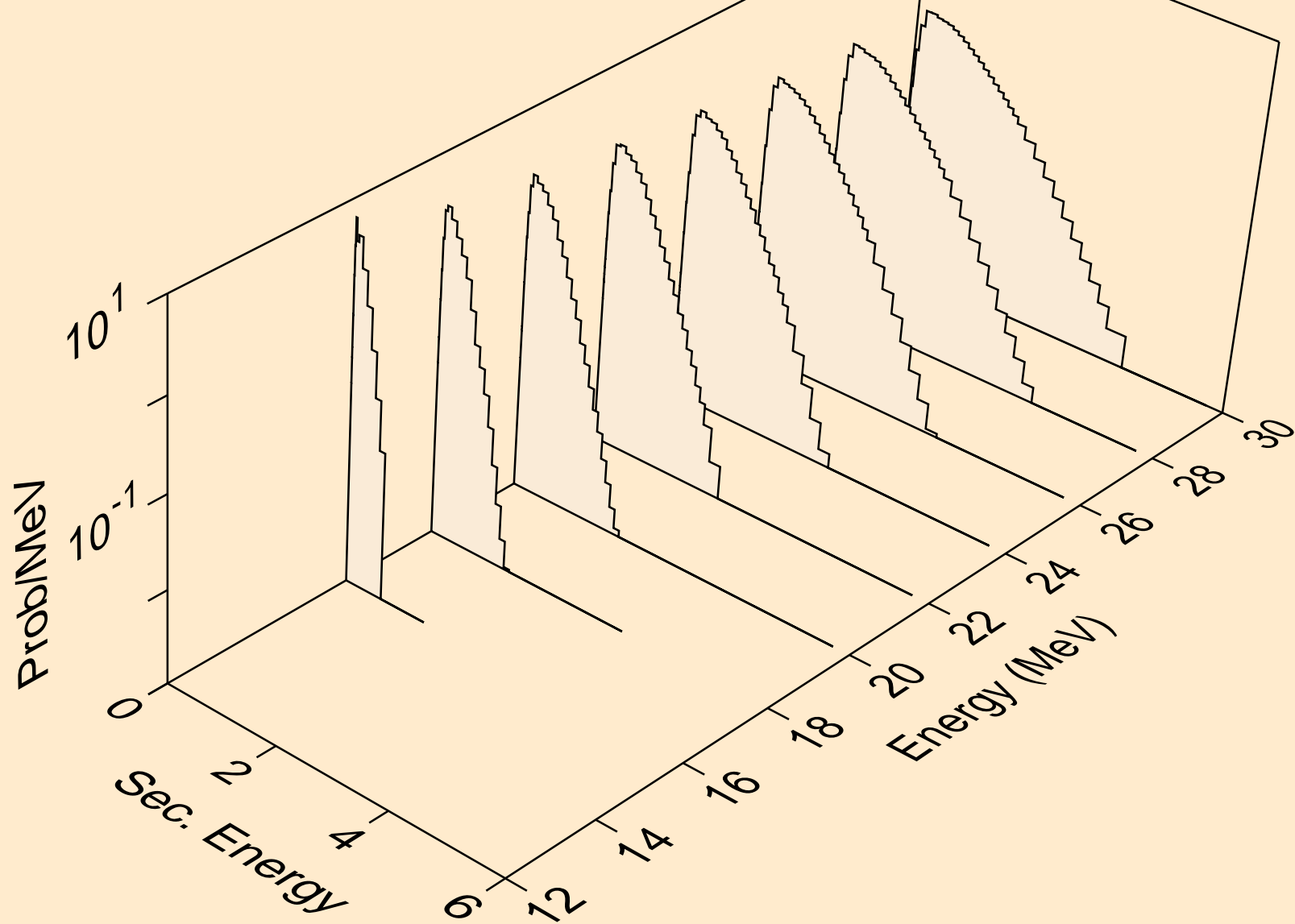

RN201 NEUTRON ACER TENDL-2024 LIBRARY; T=0.K  
Neutron emission for (n,n\*)he3

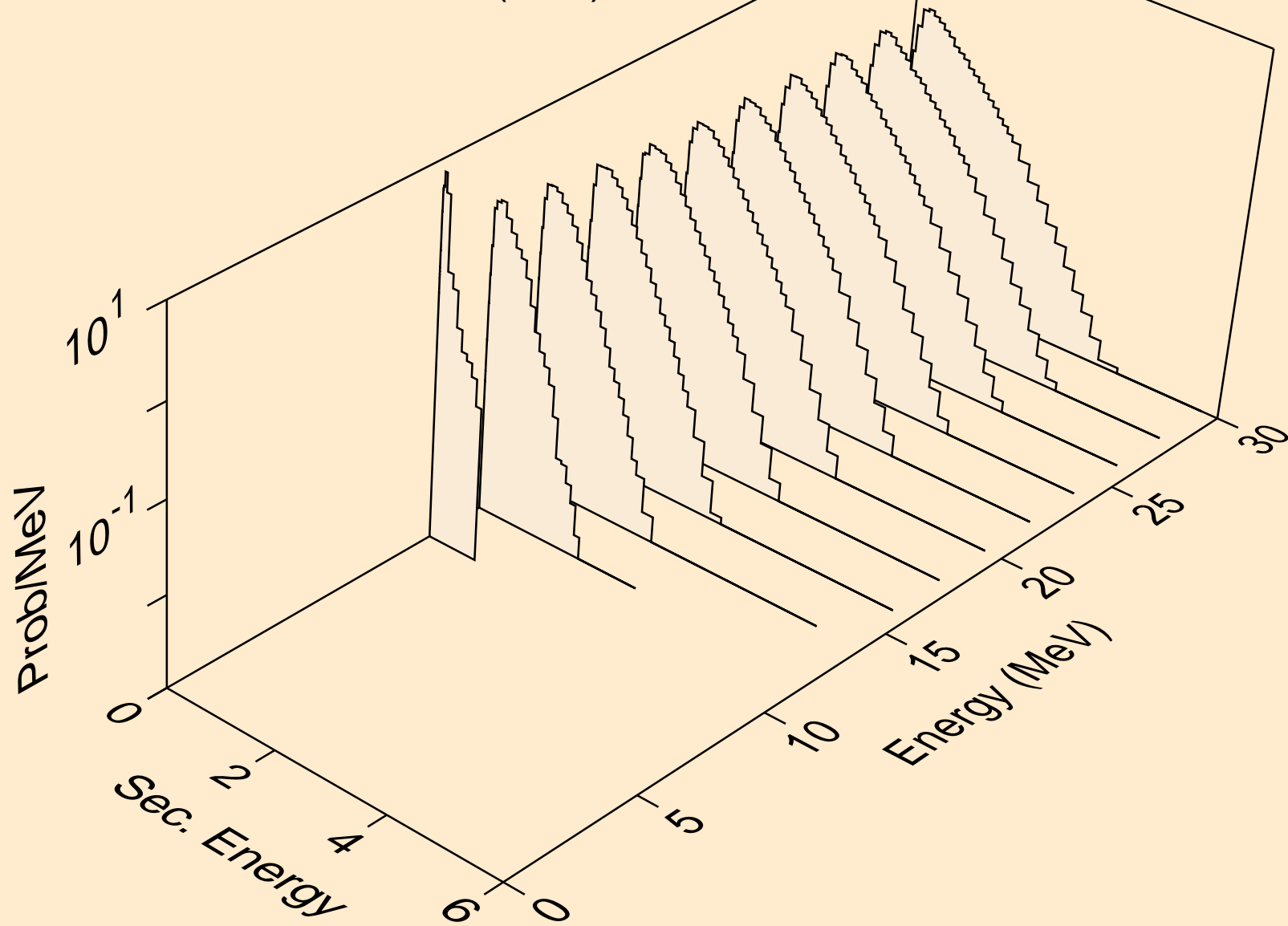

RN201 NEUTRON ACER TENDL-2024 LIBRARY; T=0.K  
Neutron emission for (n,4n)

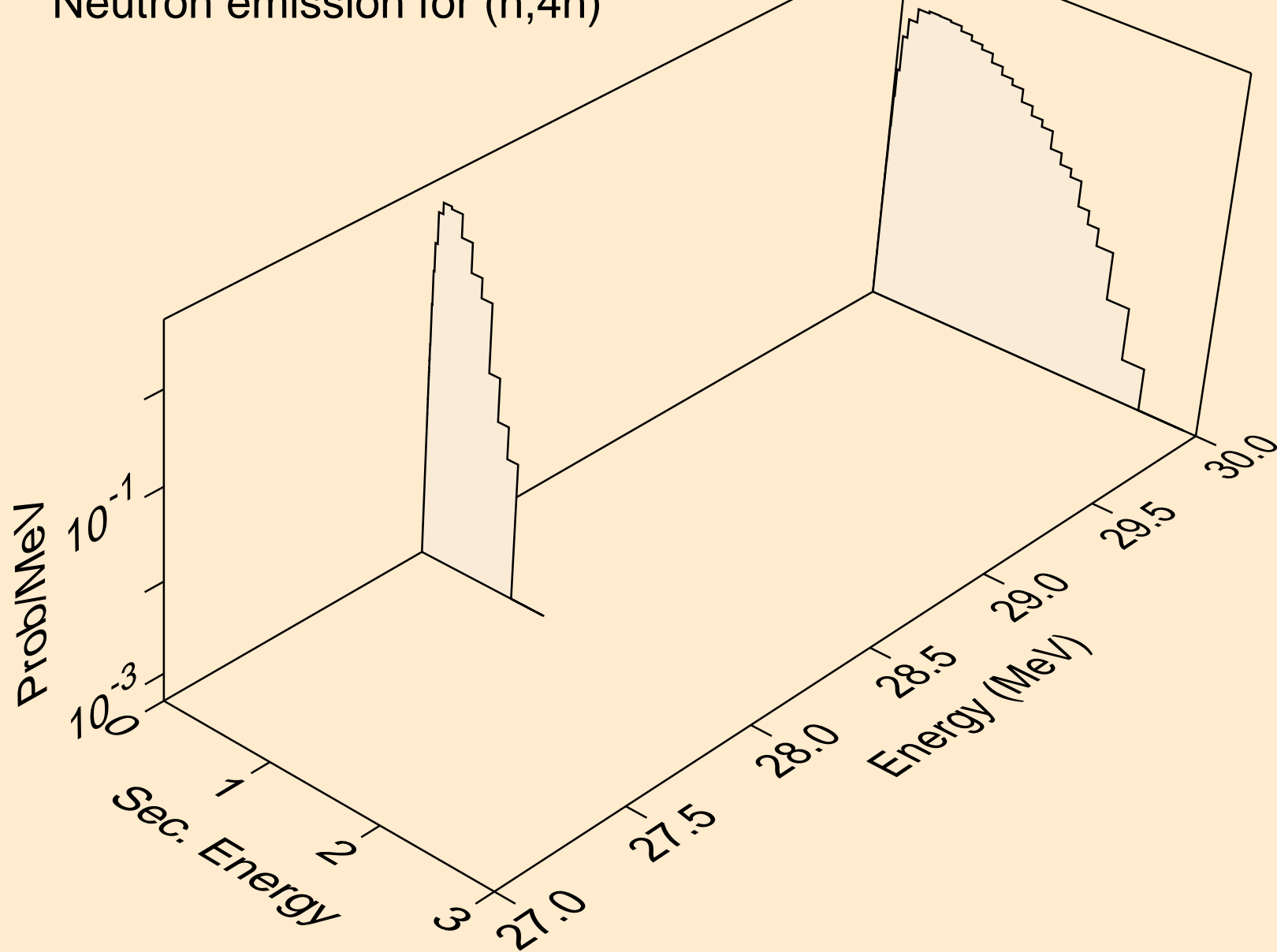

RN201 NEUTRON ACER TENDL-2024 LIBRARY; T=0.K  
Neutron emission for (n,2np)

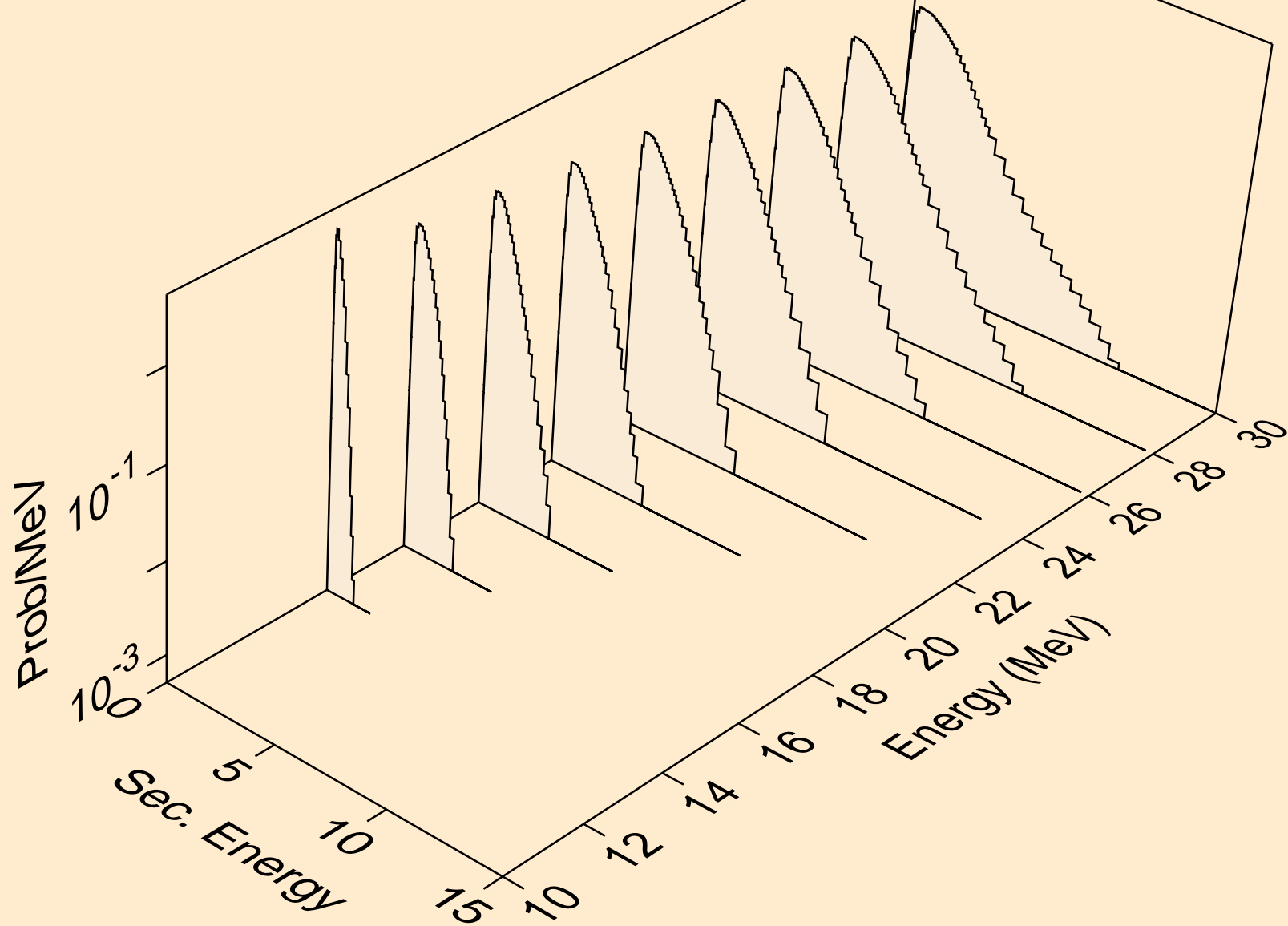

RN201 NEUTRON ACER TENDL-2024 LIBRARY; T=0.K  
Neutron emission for (n,3np)

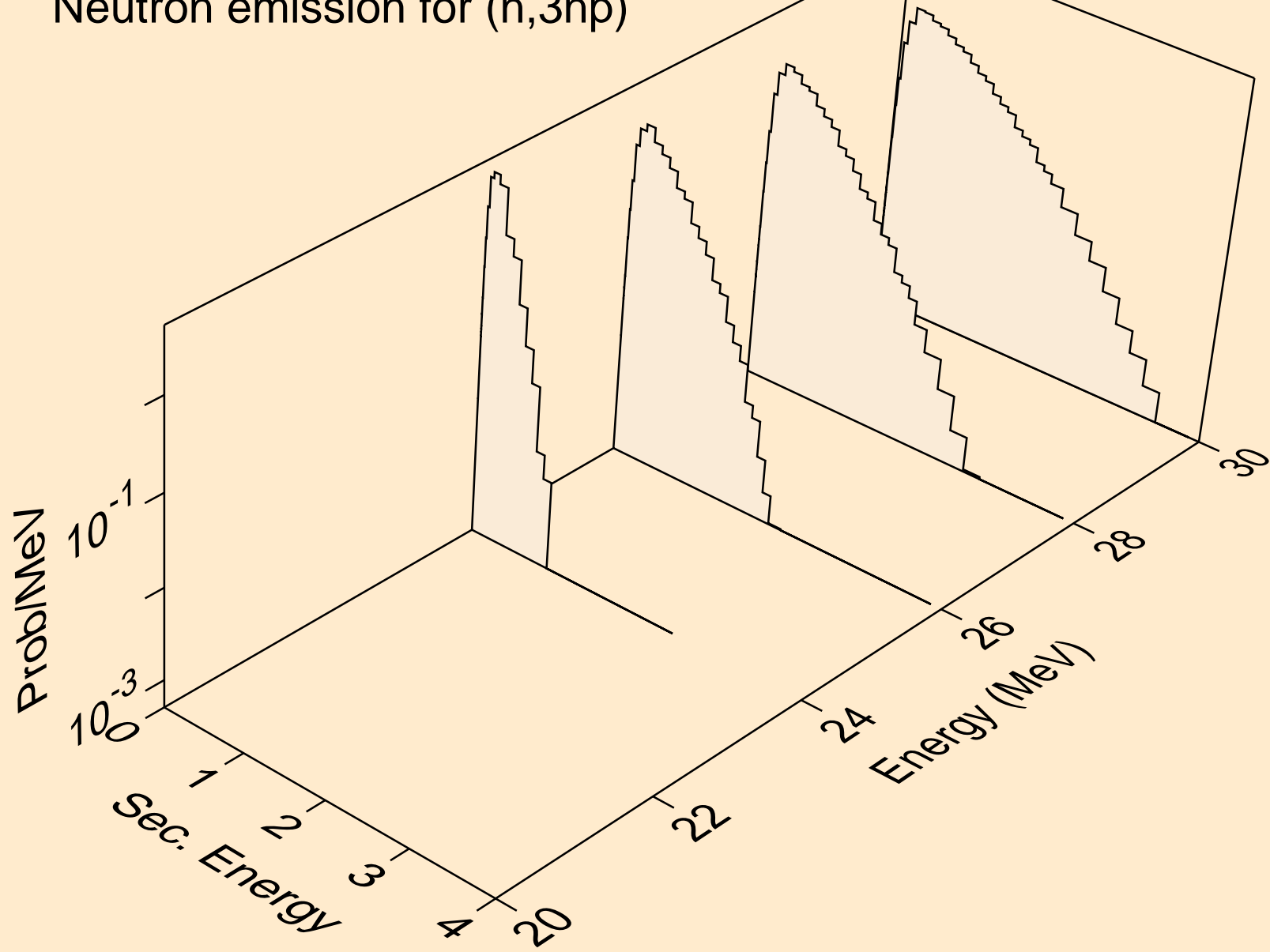

RN201 NEUTRON ACER TENDL-2024 LIBRARY; T=0.K  
Neutron emission for (n,n2p)

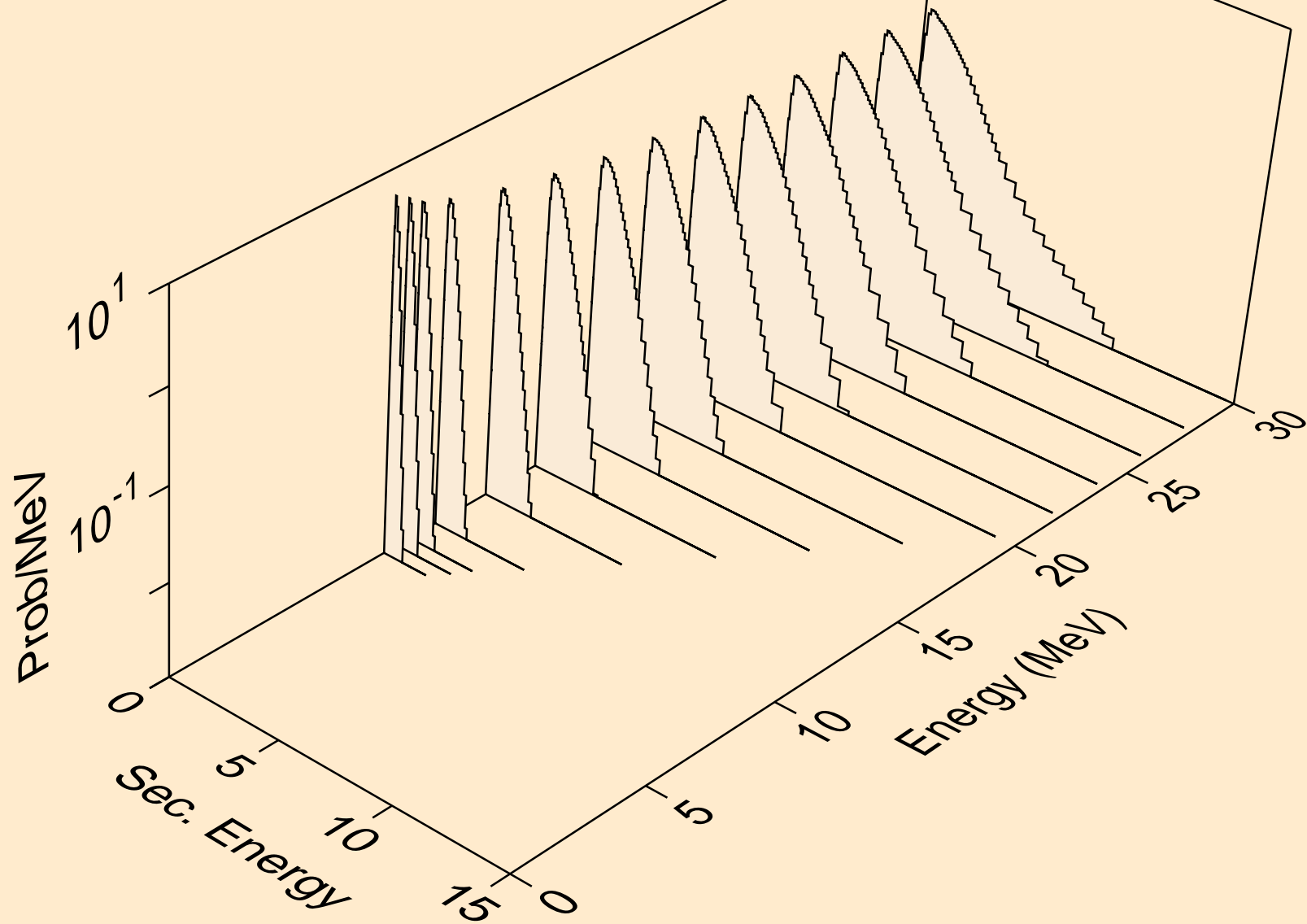

RN201 NEUTRON ACER TENDL-2024 LIBRARY; T=0.K  
Neutron emission for (n,npa)

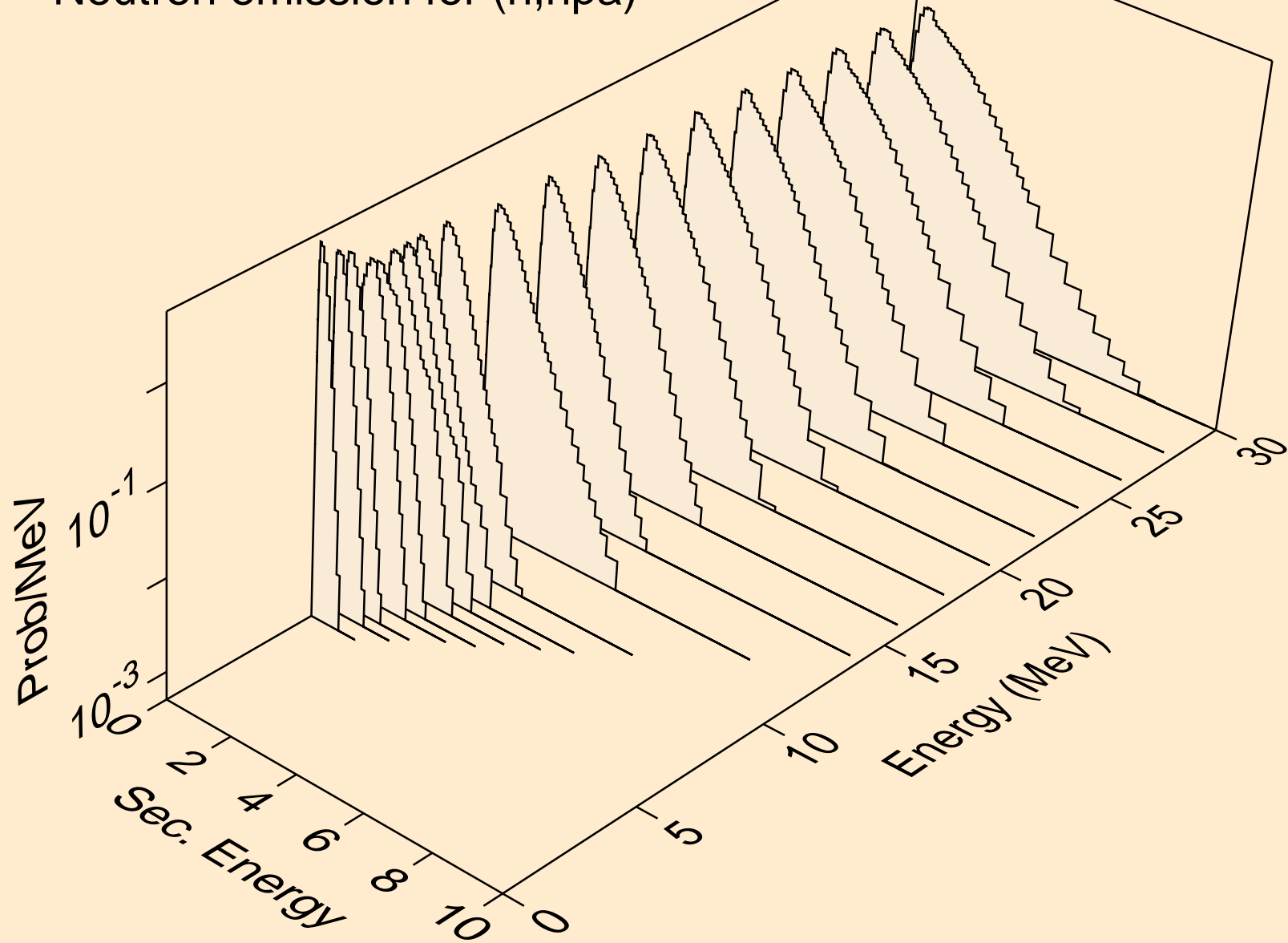

RN201 NEUTRON ACER TENDL-2024 LIBRARY; T=0.K  
Neutron emission for (n,n\*c)

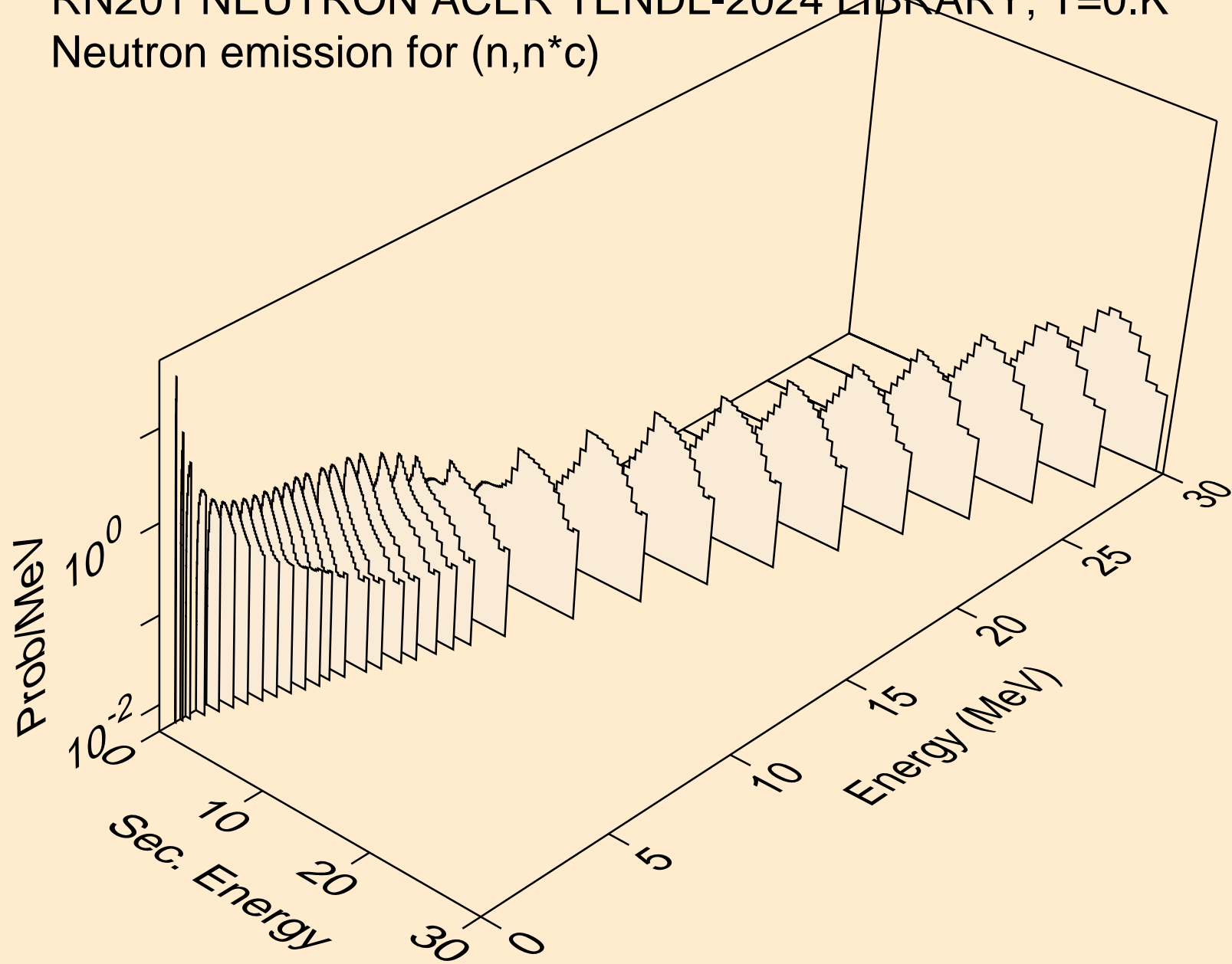

RN201 NEUTRON ACER TENDL-2024 LIBRARY; T=0.K  
Photon emission for (n,x)

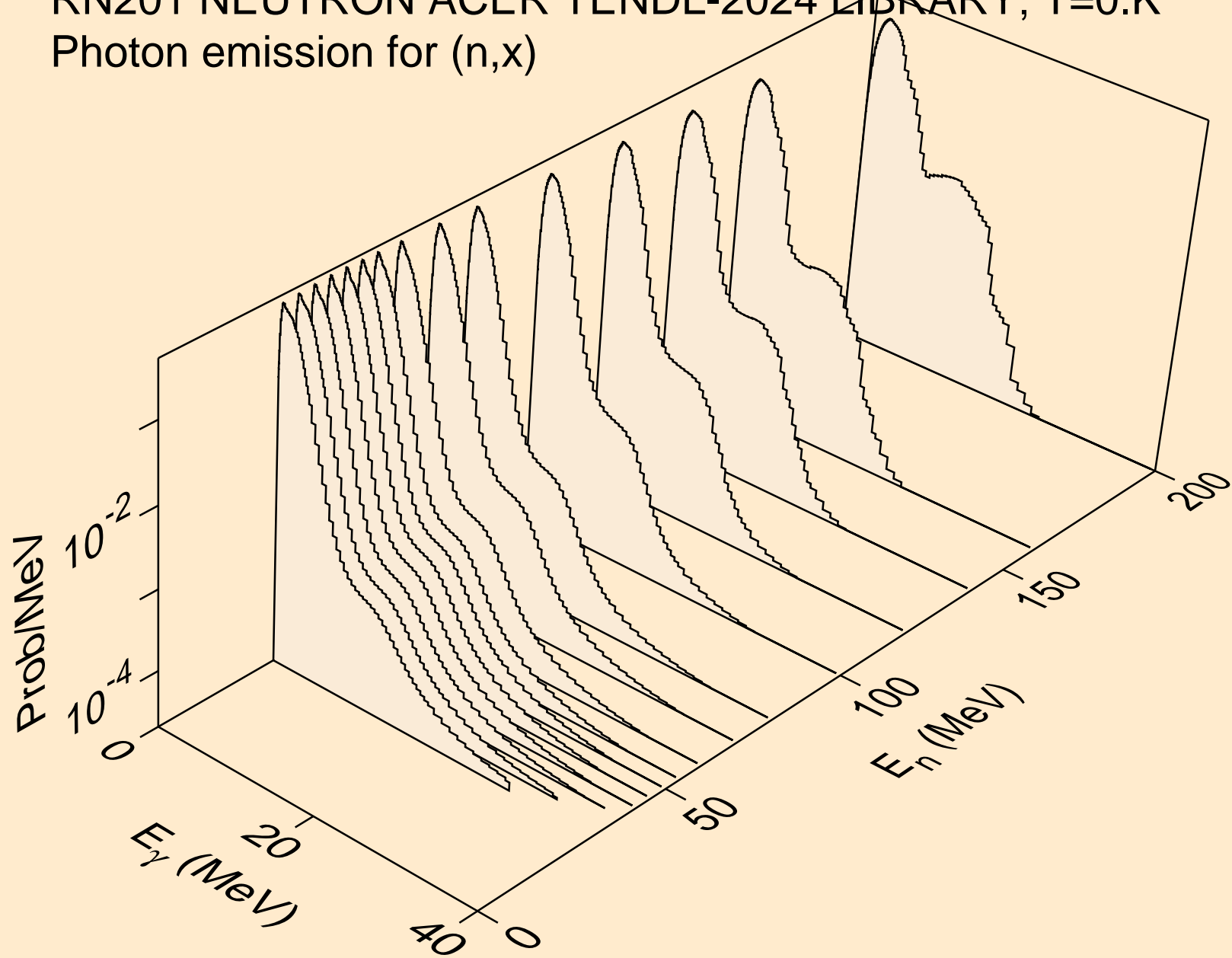

RN201 NEUTRON ACER TENDL-2024 LIBRARY; T=0.K  
Photon emission for (n,2nd)

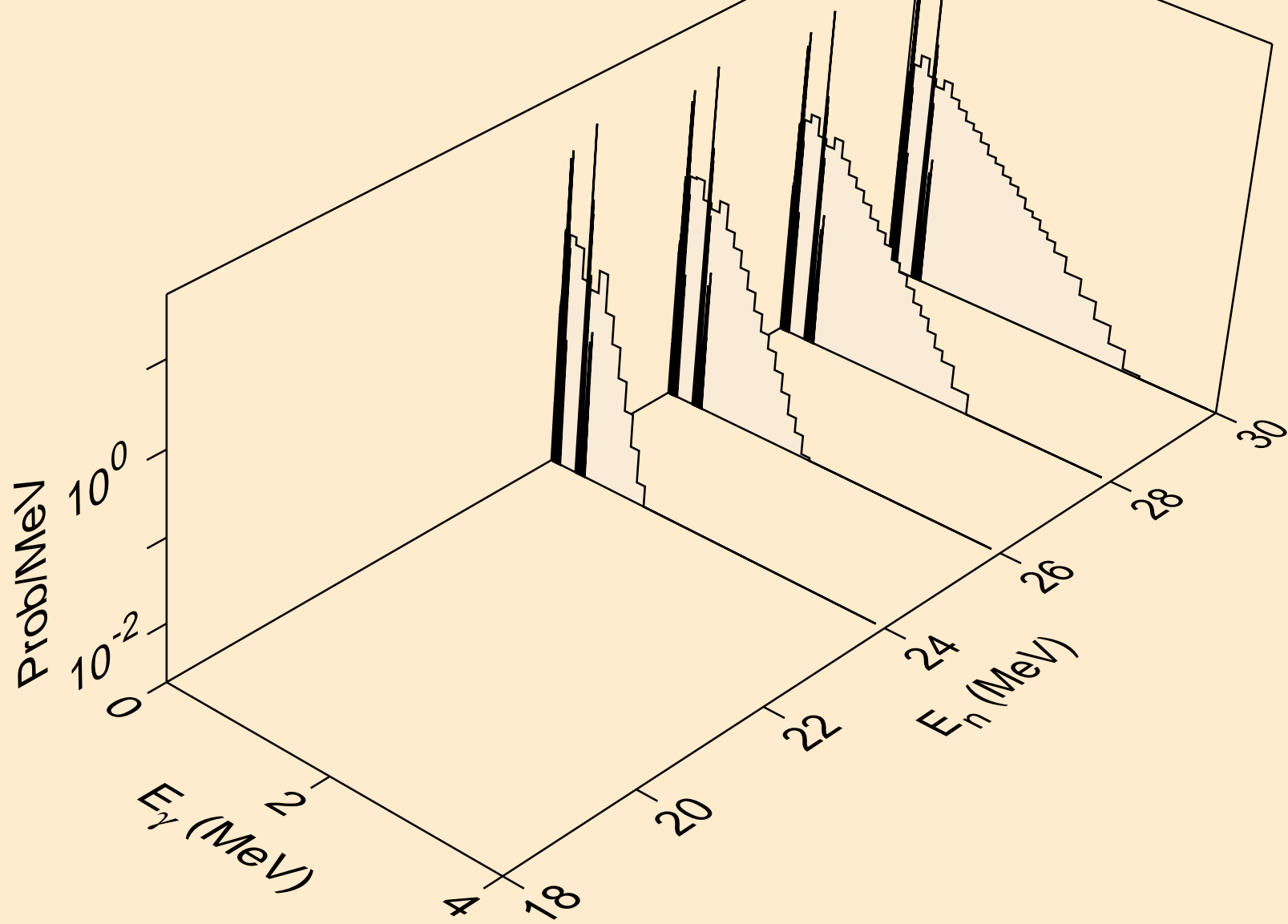

RN201 NEUTRON ACER TENDL-2024 LIBRARY; T=0.K  
Photon emission for (n,2n)

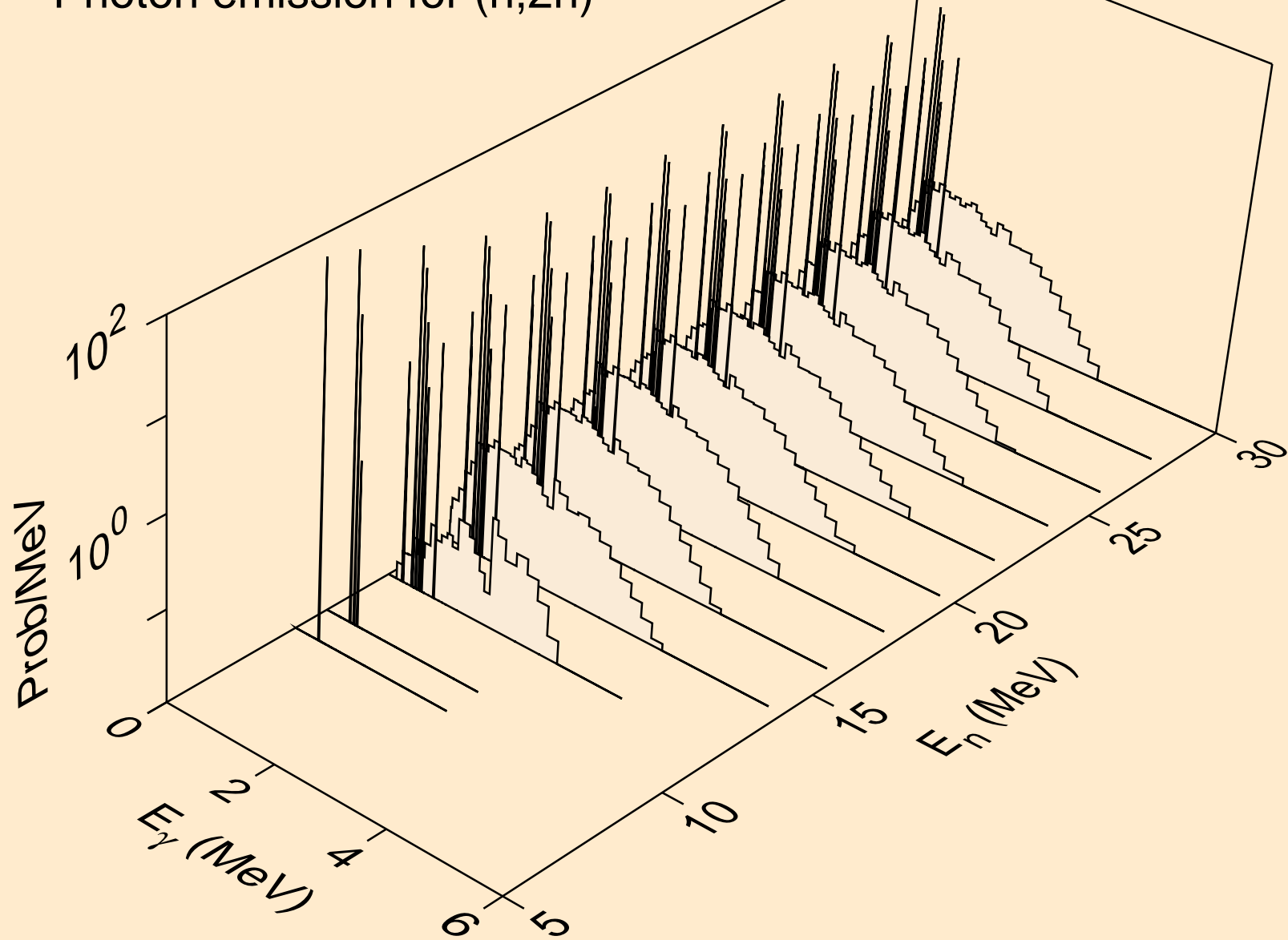

RN201 NEUTRON ACER TENDL-2024 LIBRARY; T=0.K  
Photon emission for (n,3n)

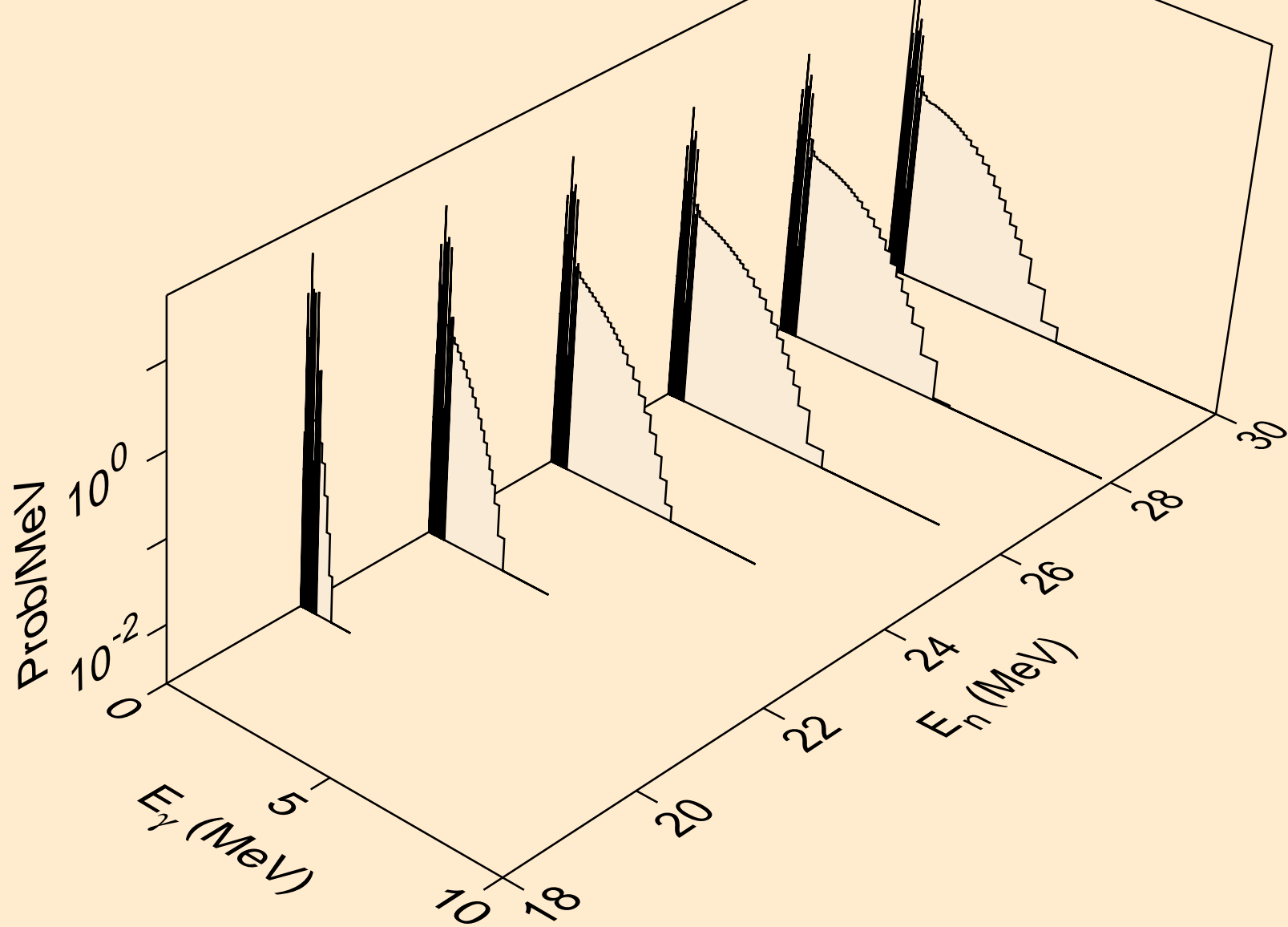

RN201 NEUTRON ACER TENDL-2024 LIBRARY; T=0.K  
Photon emission for (n,n\*)a

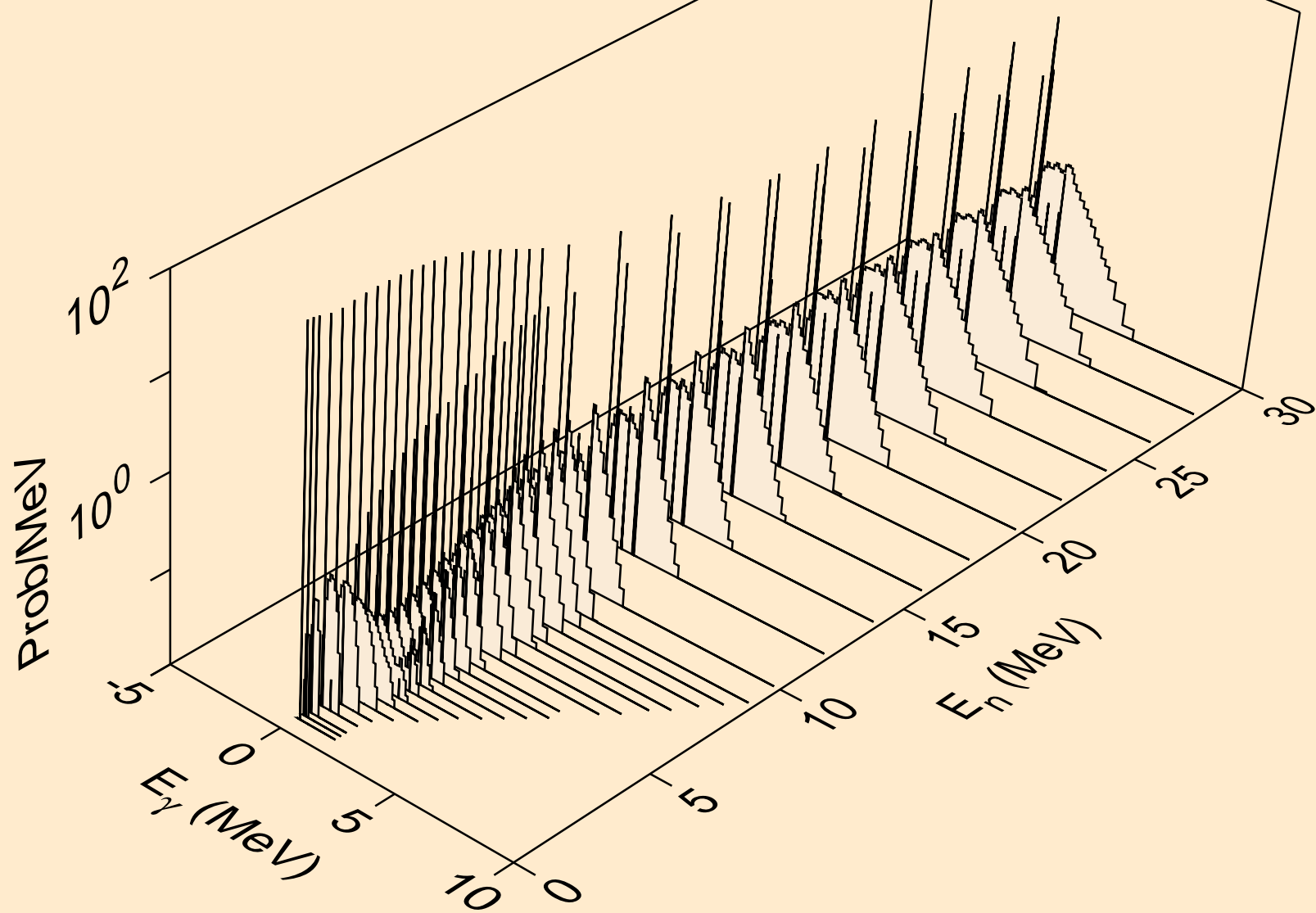

RN201 NEUTRON ACER TENDL-2024 LIBRARY; T=0.K  
Photon emission for (n,2n)a

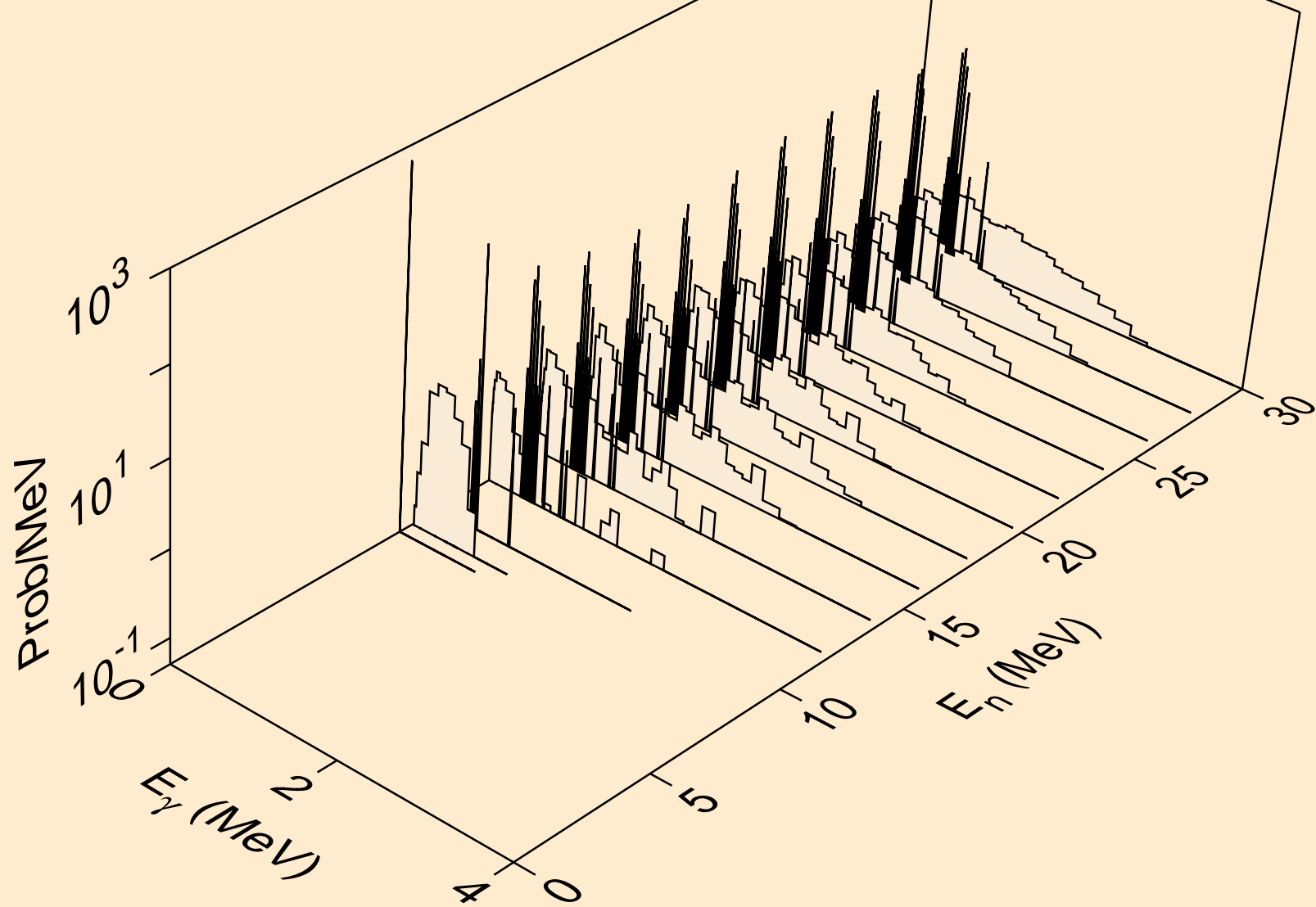

RN201 NEUTRON ACER TENDL-2024 LIBRARY; T=0.K  
Photon emission for (n,3n)a

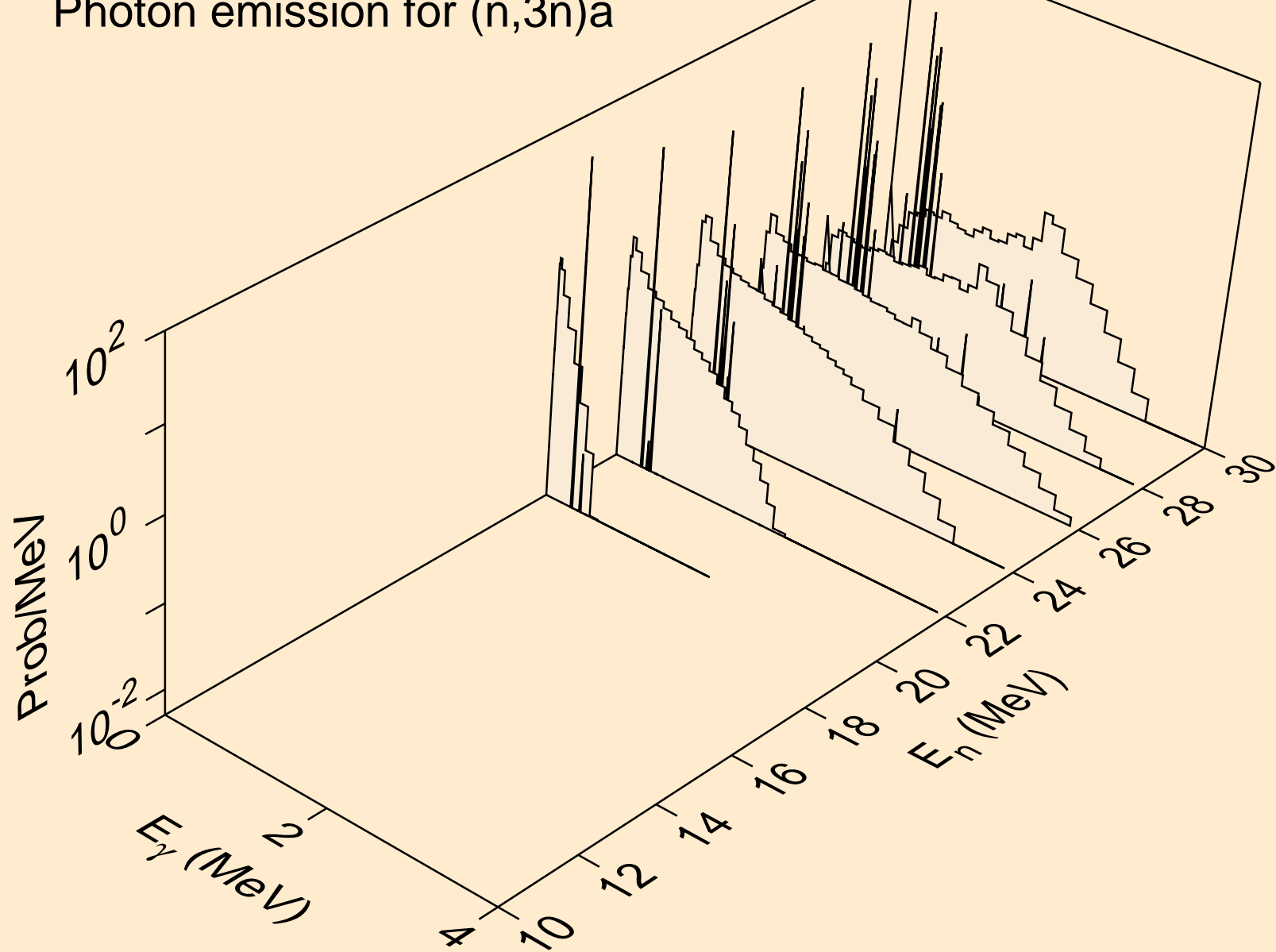

RN201 NEUTRON ACER TENDL-2024 LIBRARY; T=0.K  
Photon emission for (n,n\*)p

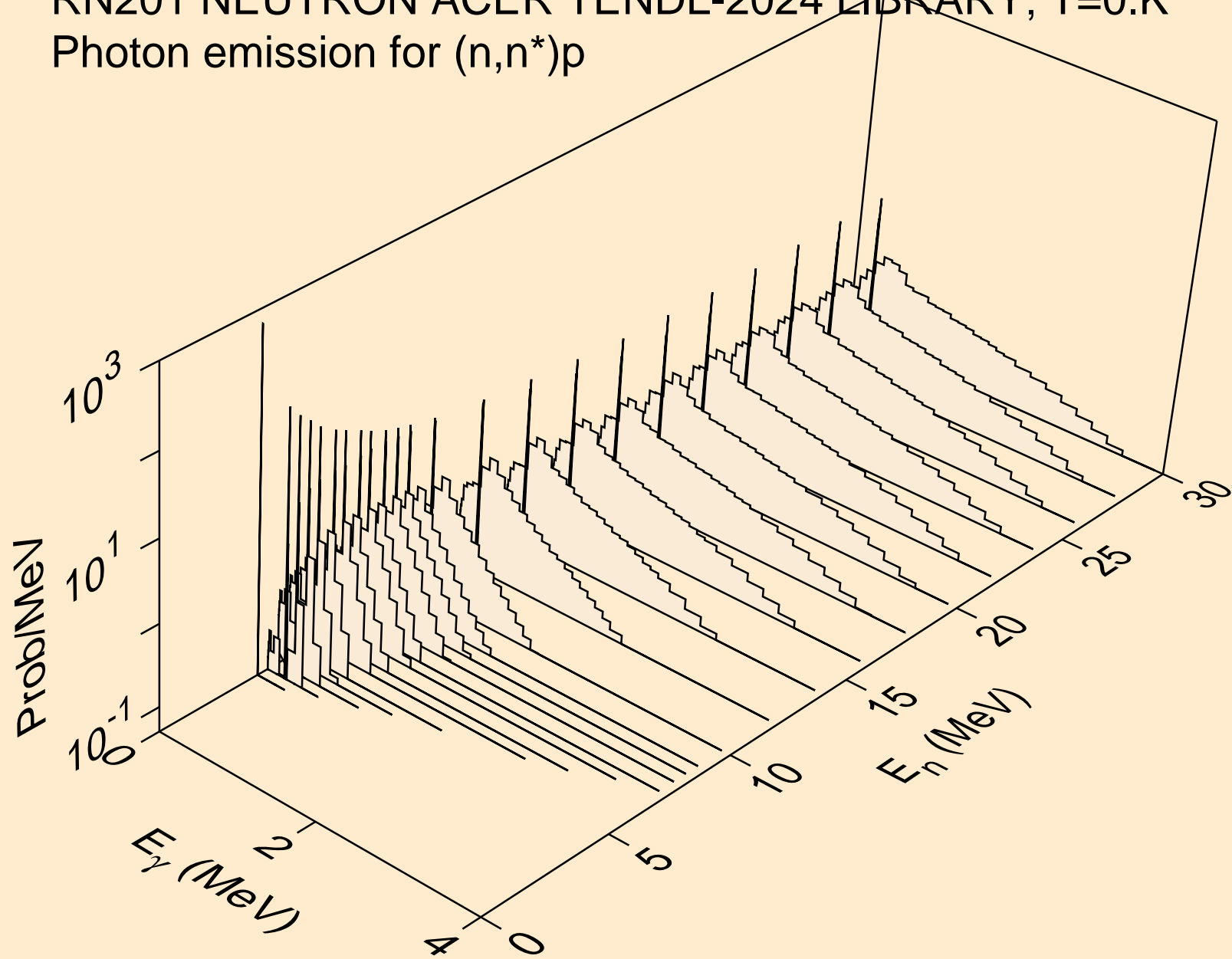

RN201 NEUTRON ACER TENDL-2024 LIBRARY; T=0.K  
Photon emission for (n,n\*)2a

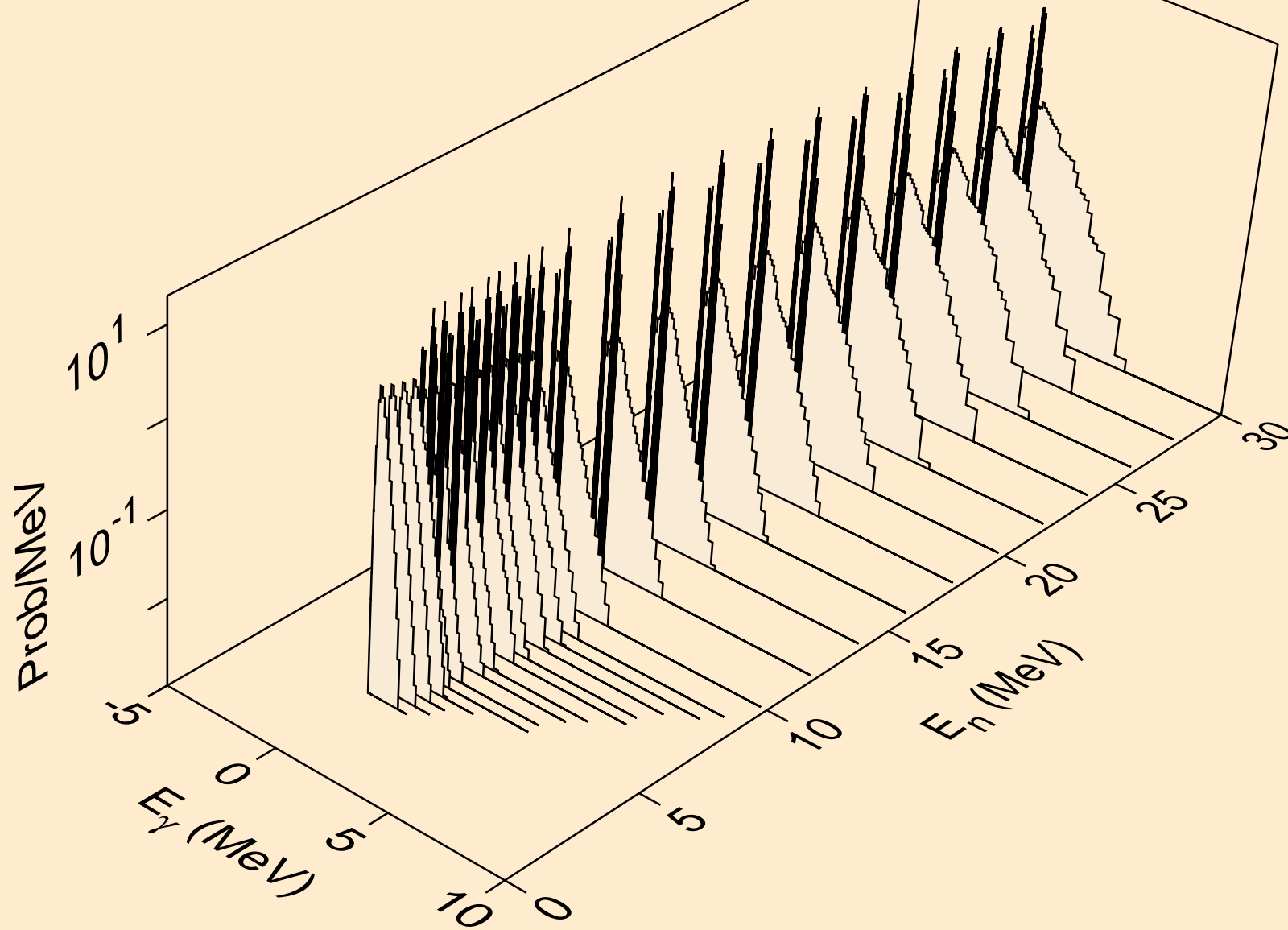

RN201 NEUTRON ACER TENDL-2024 LIBRARY; T=0.K  
Photon emission for (n,2n)2a

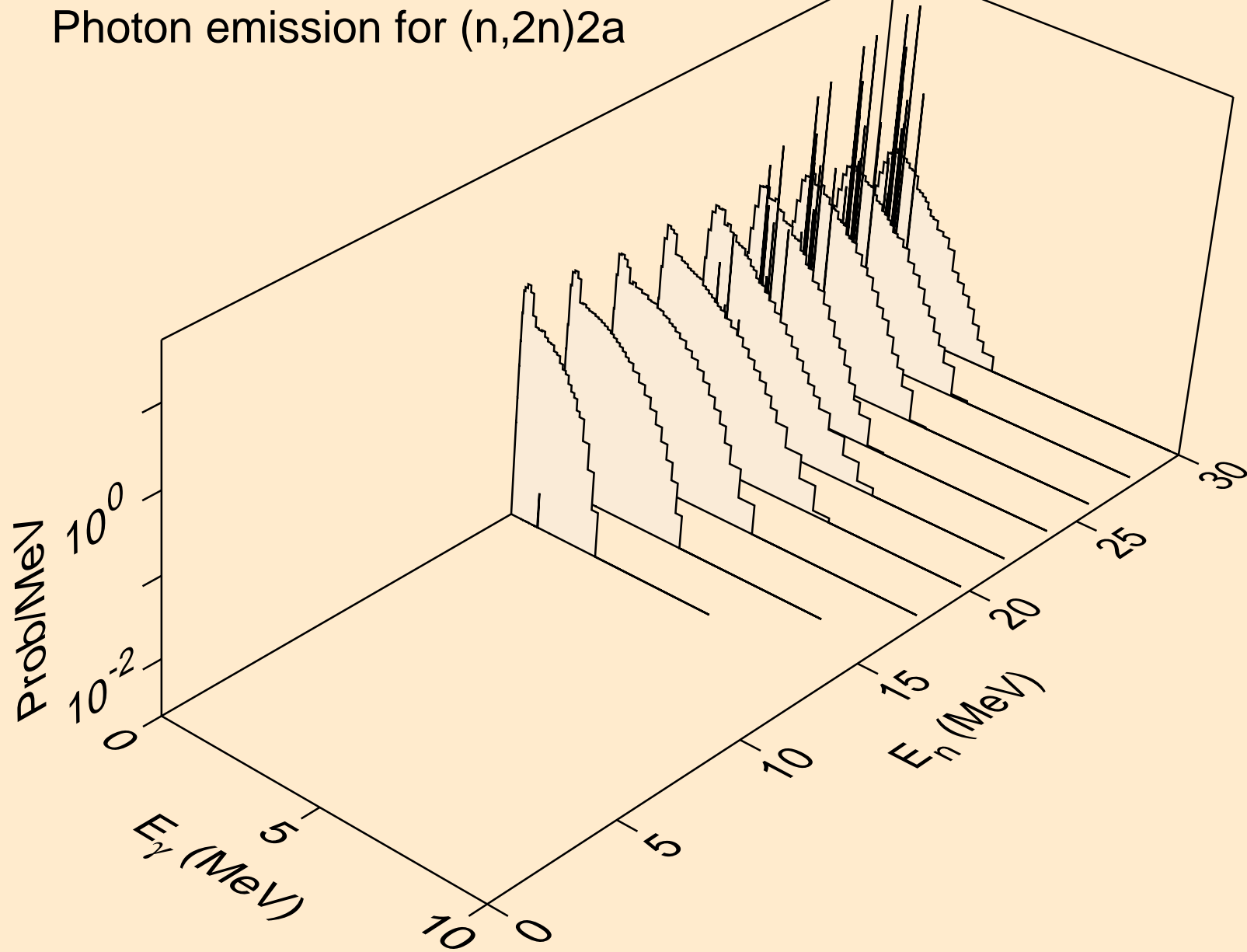

RN201 NEUTRON ACER TENDL-2024 LIBRARY; T=0.K  
Photon emission for (n,n\*)d

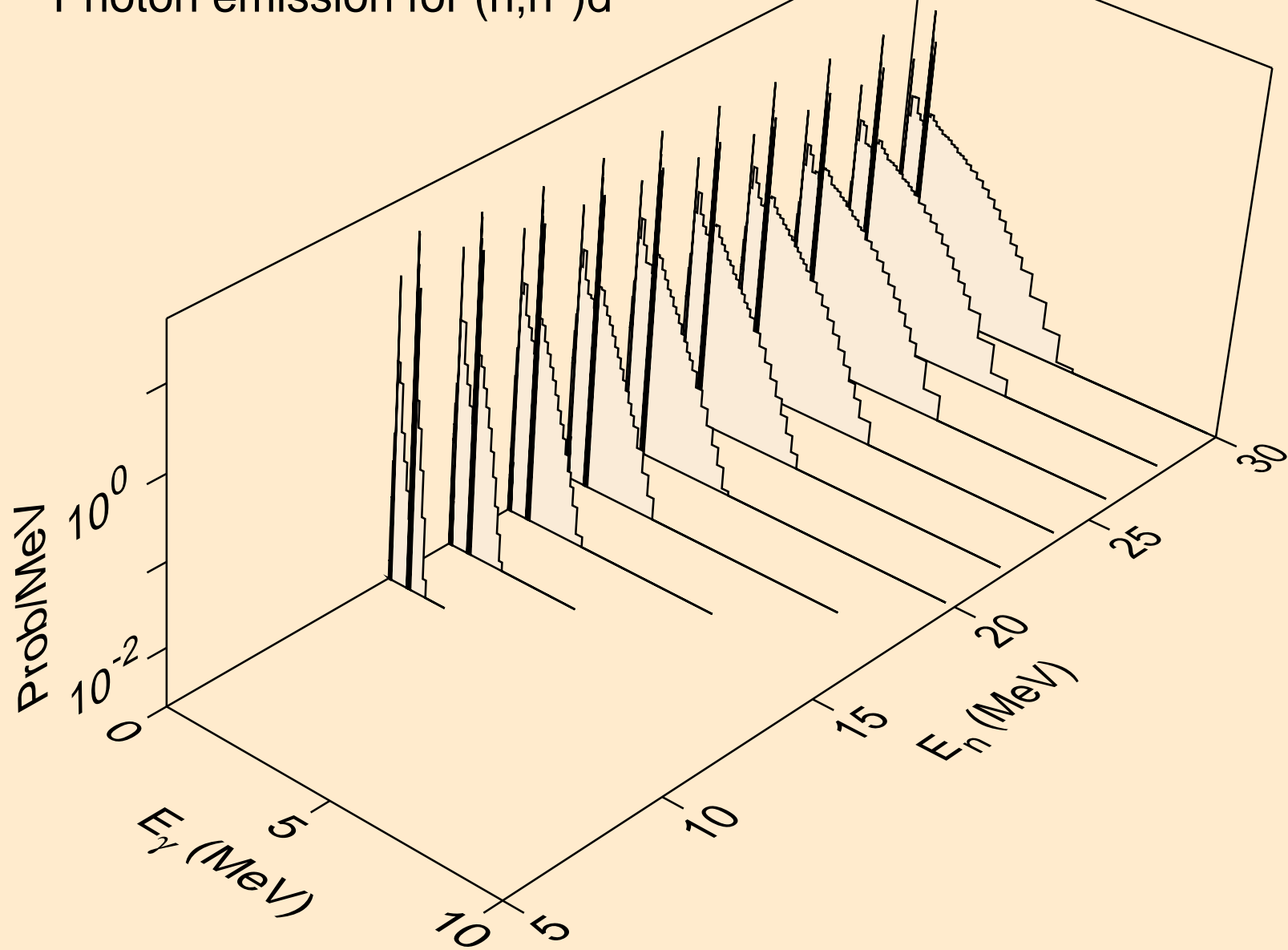

RN201 NEUTRON ACER TENDL-2024 LIBRARY; T=0.K  
Photon emission for (n,n\*)t

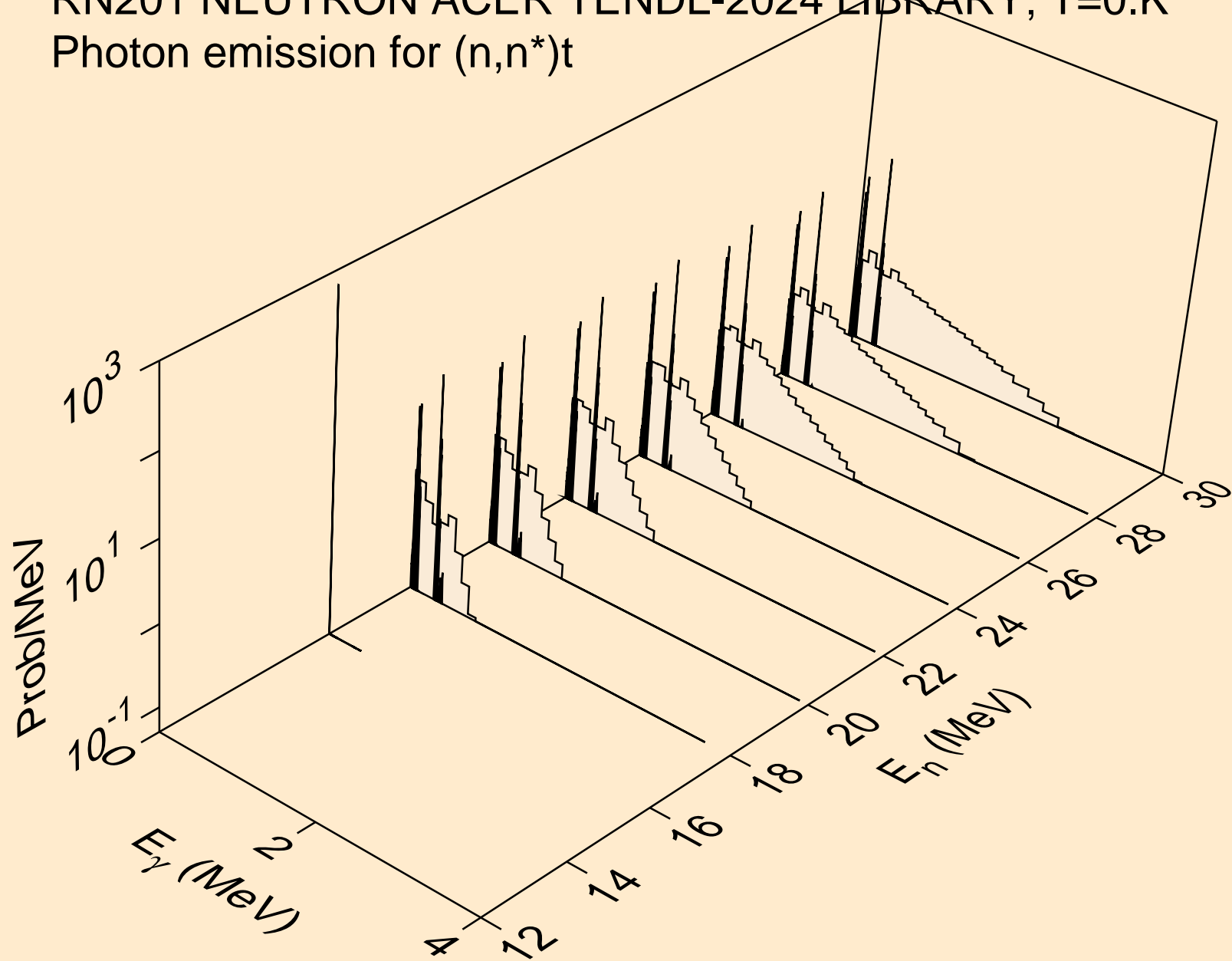

RN201 NEUTRON ACER TENDL-2024 LIBRARY; T=0.K  
Photon emission for (n,n\*)he3

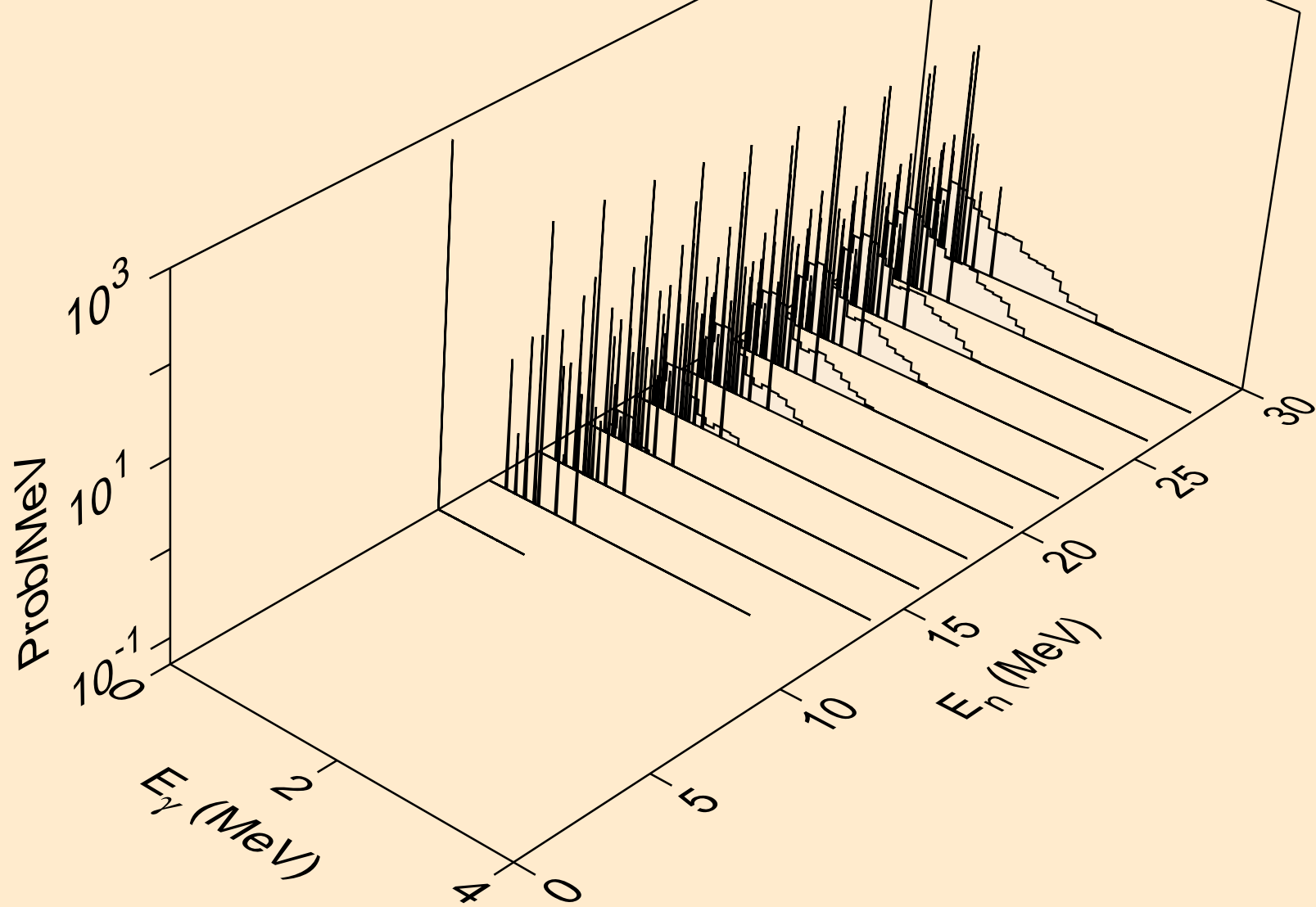

RN201 NEUTRON ACER TENDL-2024 LIBRARY; T=0.K  
Photon emission for (n,4n)

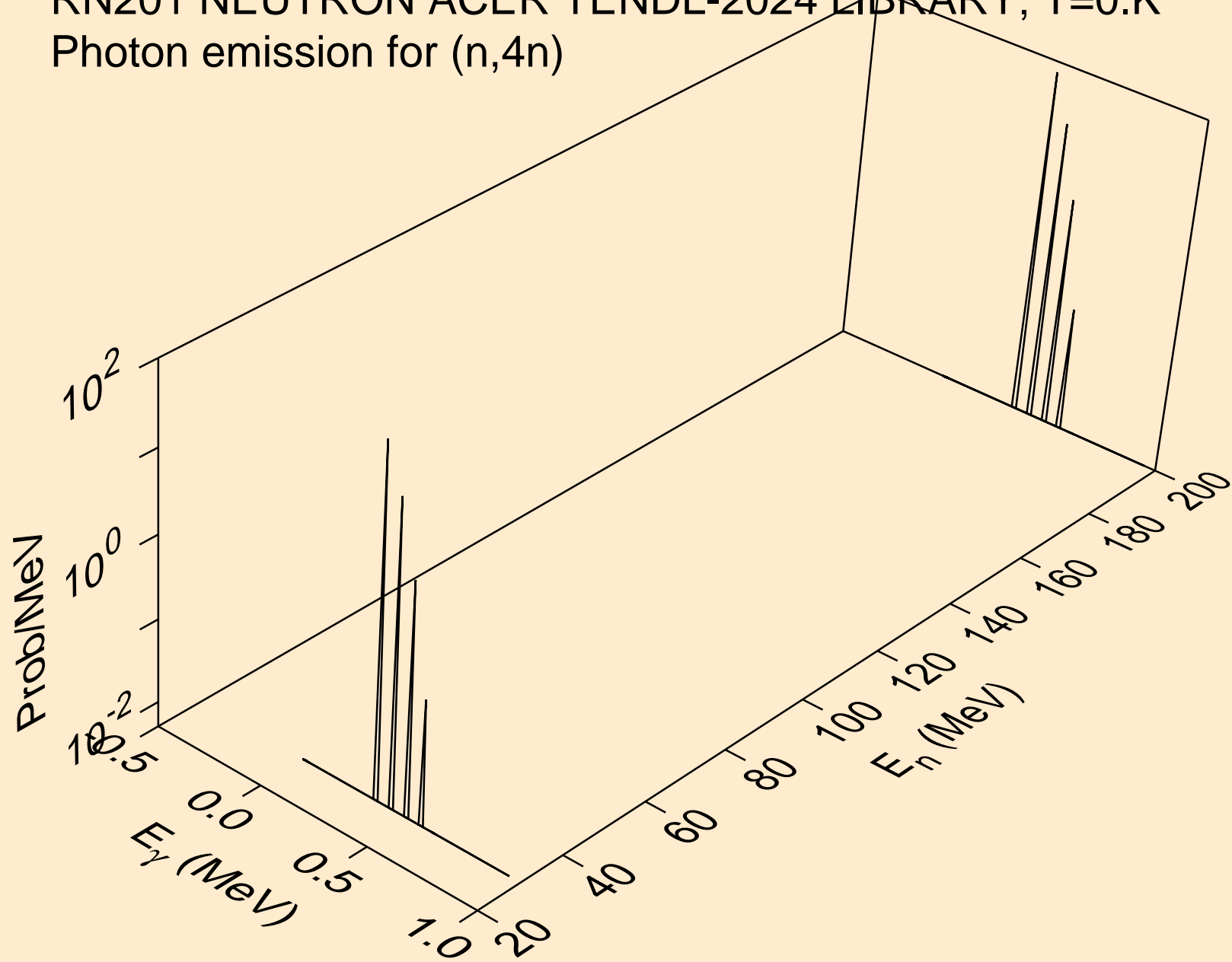

RN201 NEUTRON ACER TENDL-2024 LIBRARY; T=0.K  
Photon emission for (n,2np)

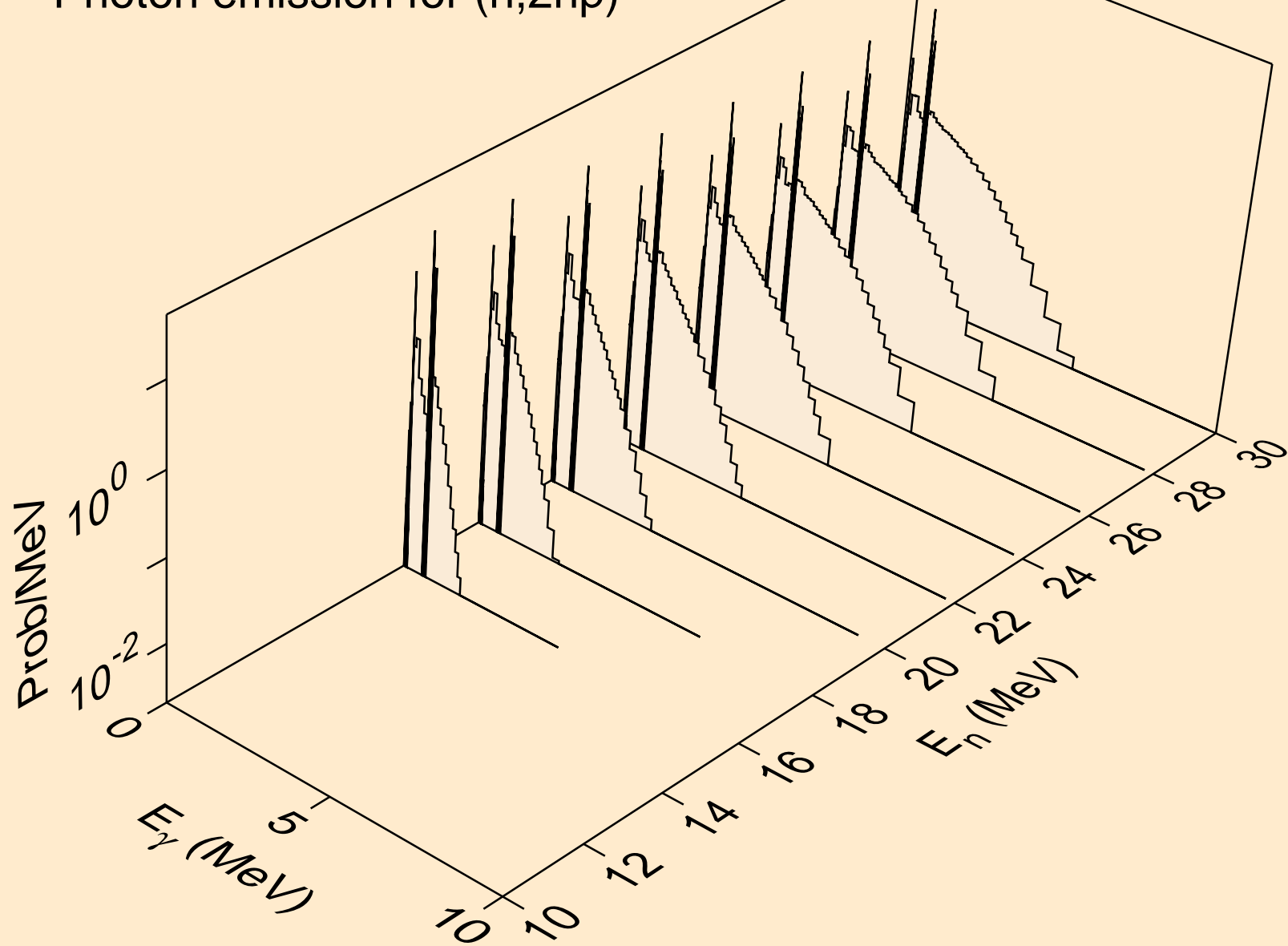

RN201 NEUTRON ACER TENDL-2024 LIBRARY; T=0.K  
Photon emission for (n,3np)

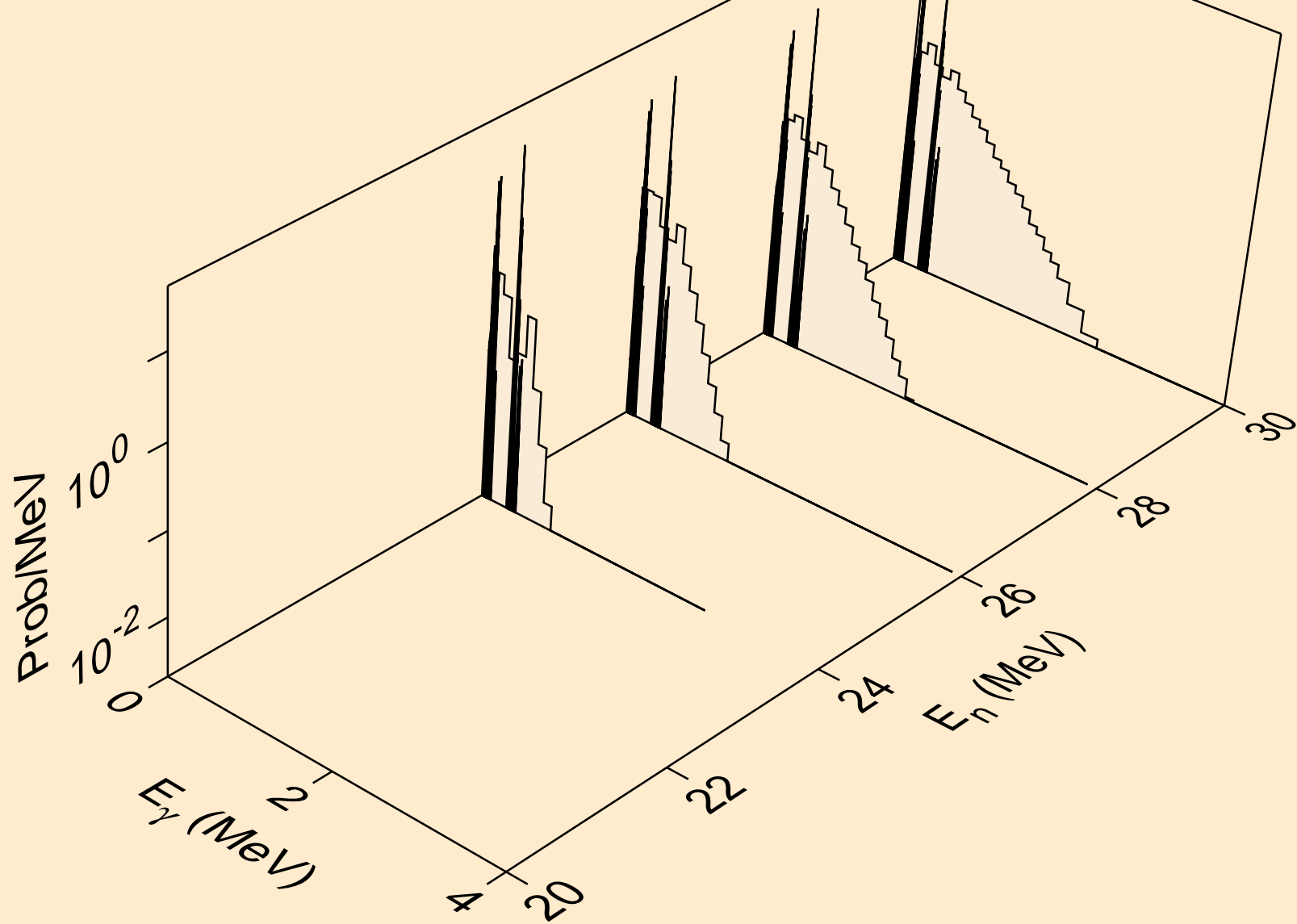

RN201 NEUTRON ACER TENDL-2024 LIBRARY; T=0.K  
Photon emission for (n,n2p)

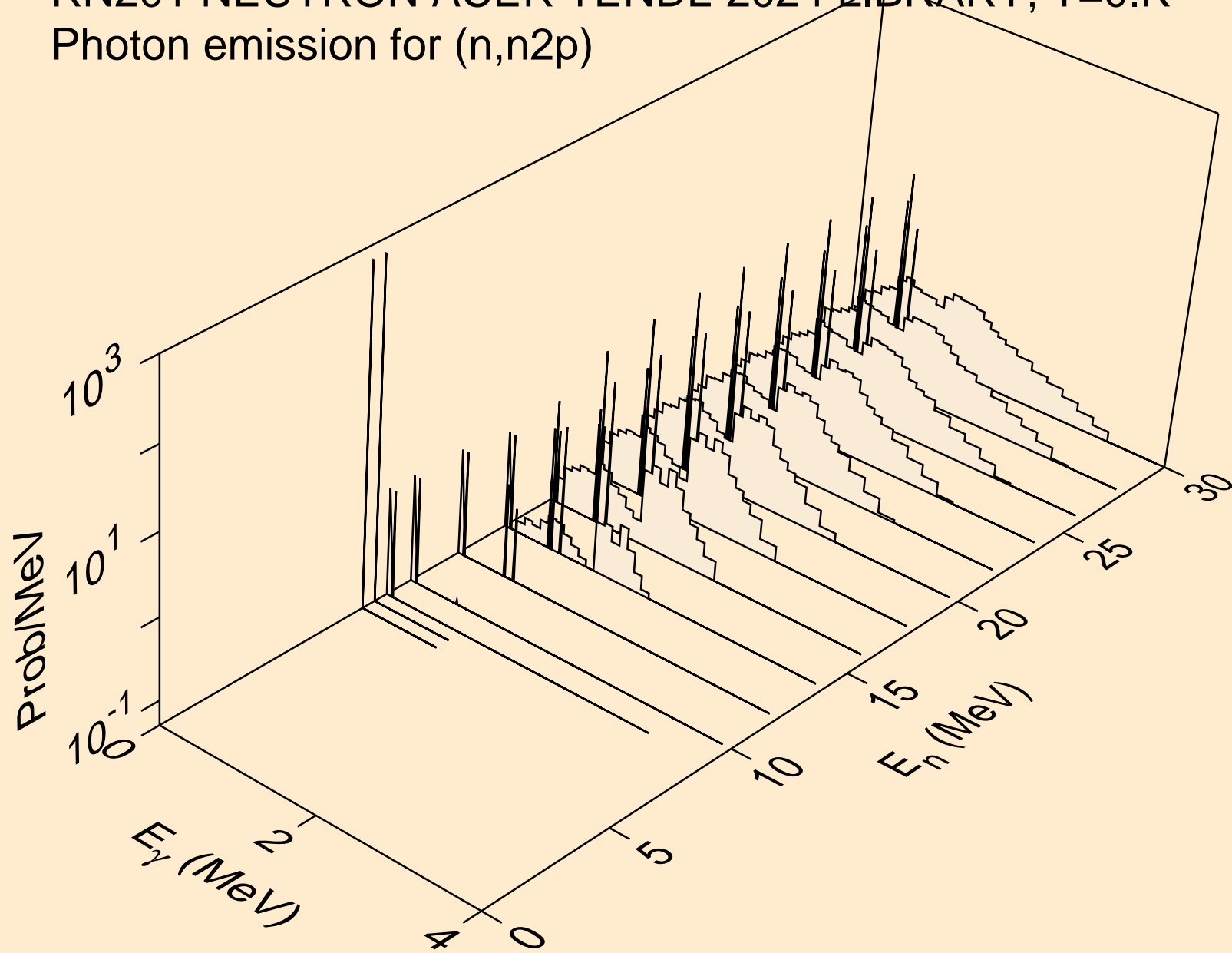

RN201 NEUTRON ACER TENDL-2024 LIBRARY; T=0.K  
Photon emission for (n,npa)

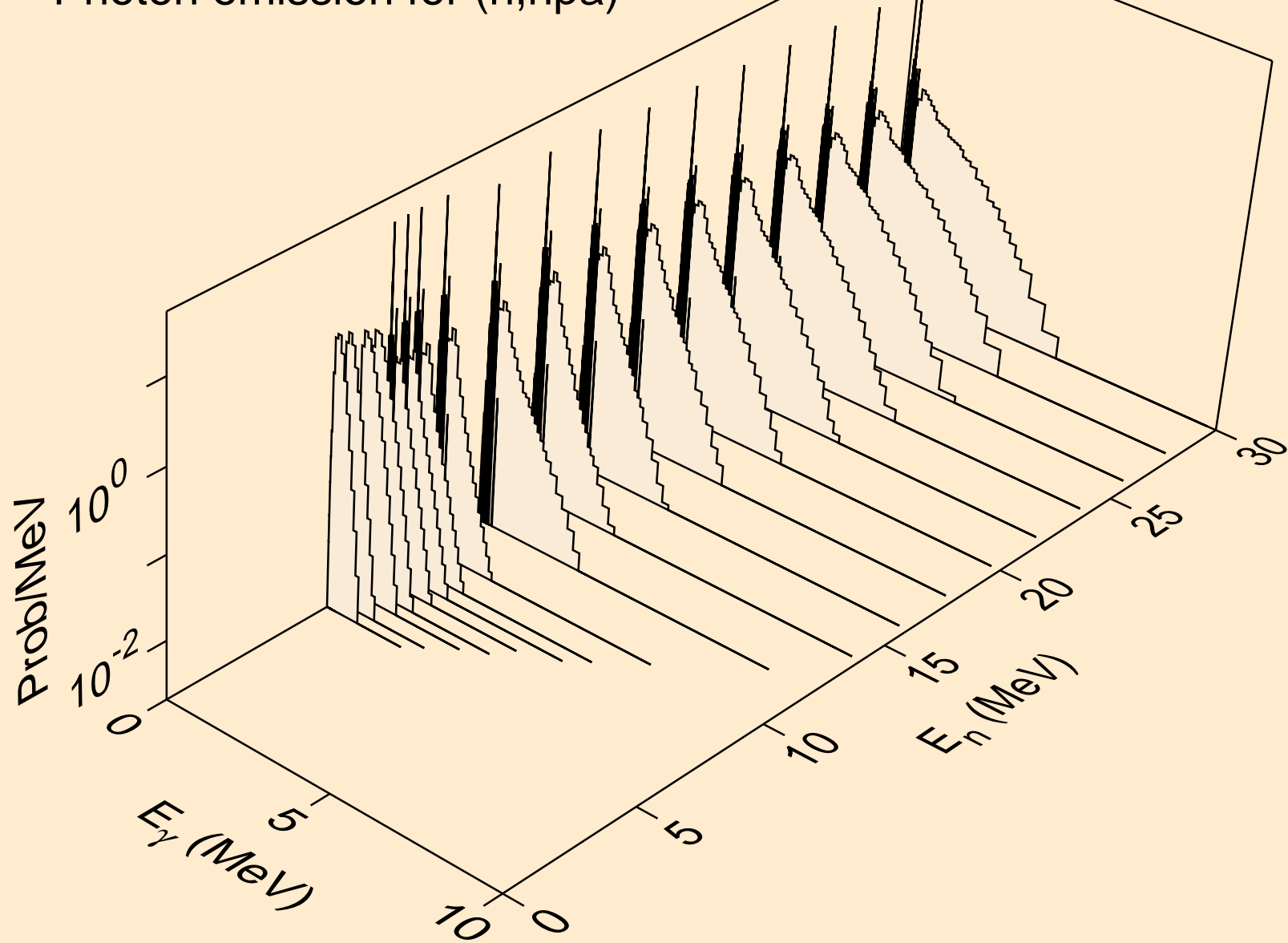

RN201 NEUTRON ACER TENDL-2024 LIBRARY; T=0.K  
Photon emission for (n,n\*c)

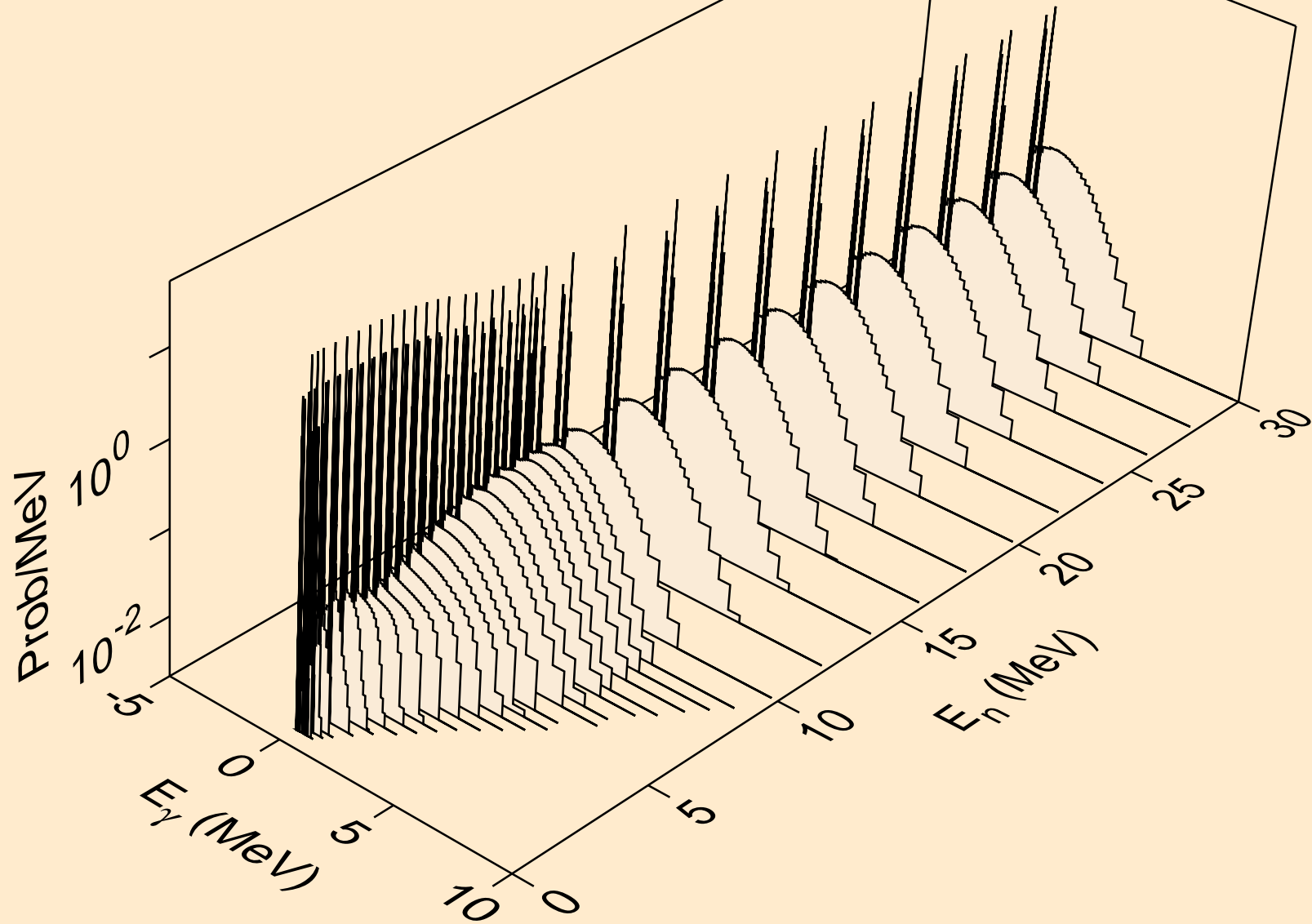

RN201 NEUTRON ACER TENDL-2024 LIBRARY; T=0.K  
Photon emission for (n,gma)

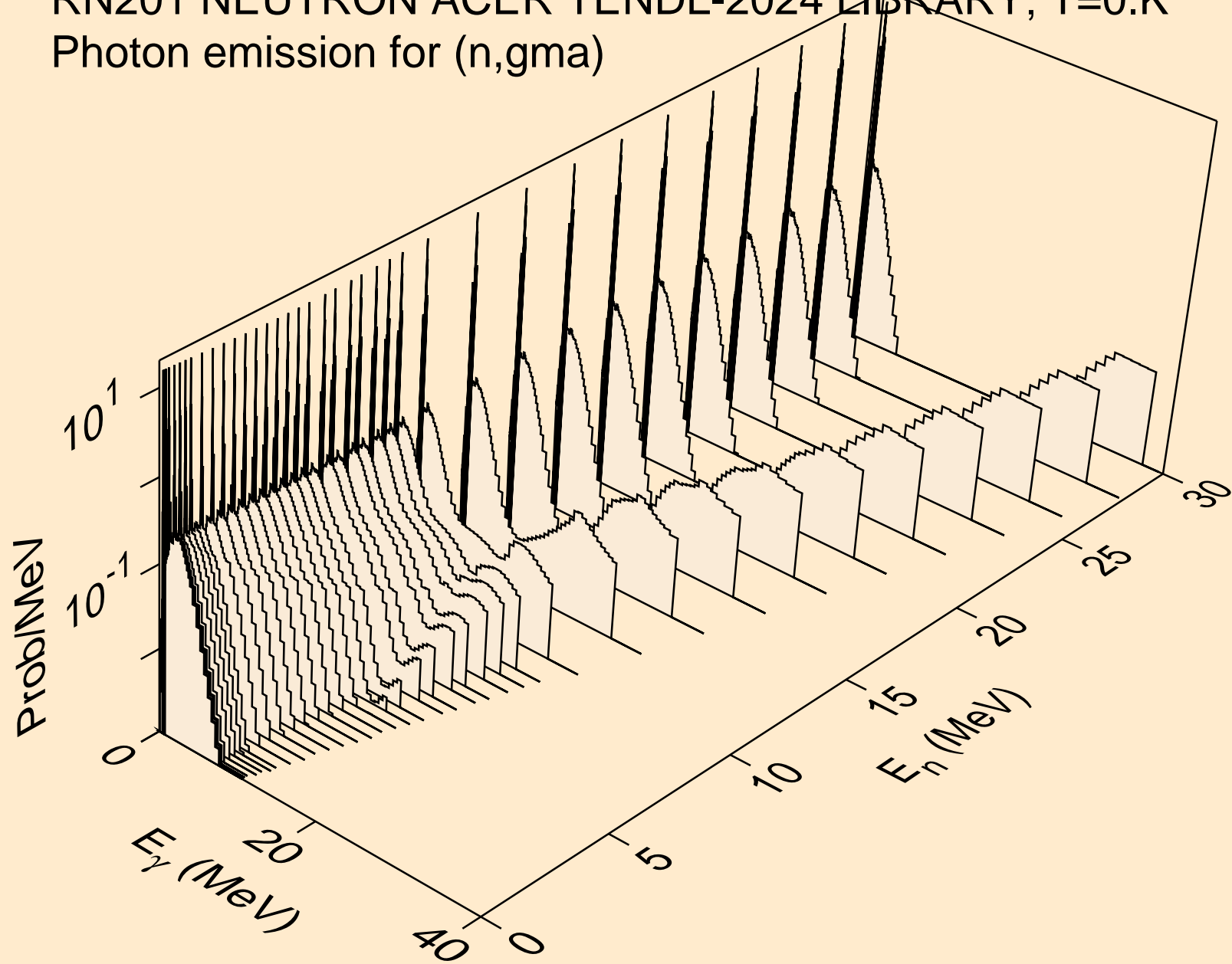

RN201 NEUTRON ACER TENDL-2024 LIBRARY; T=0.K  
Photon emission for (n,p)

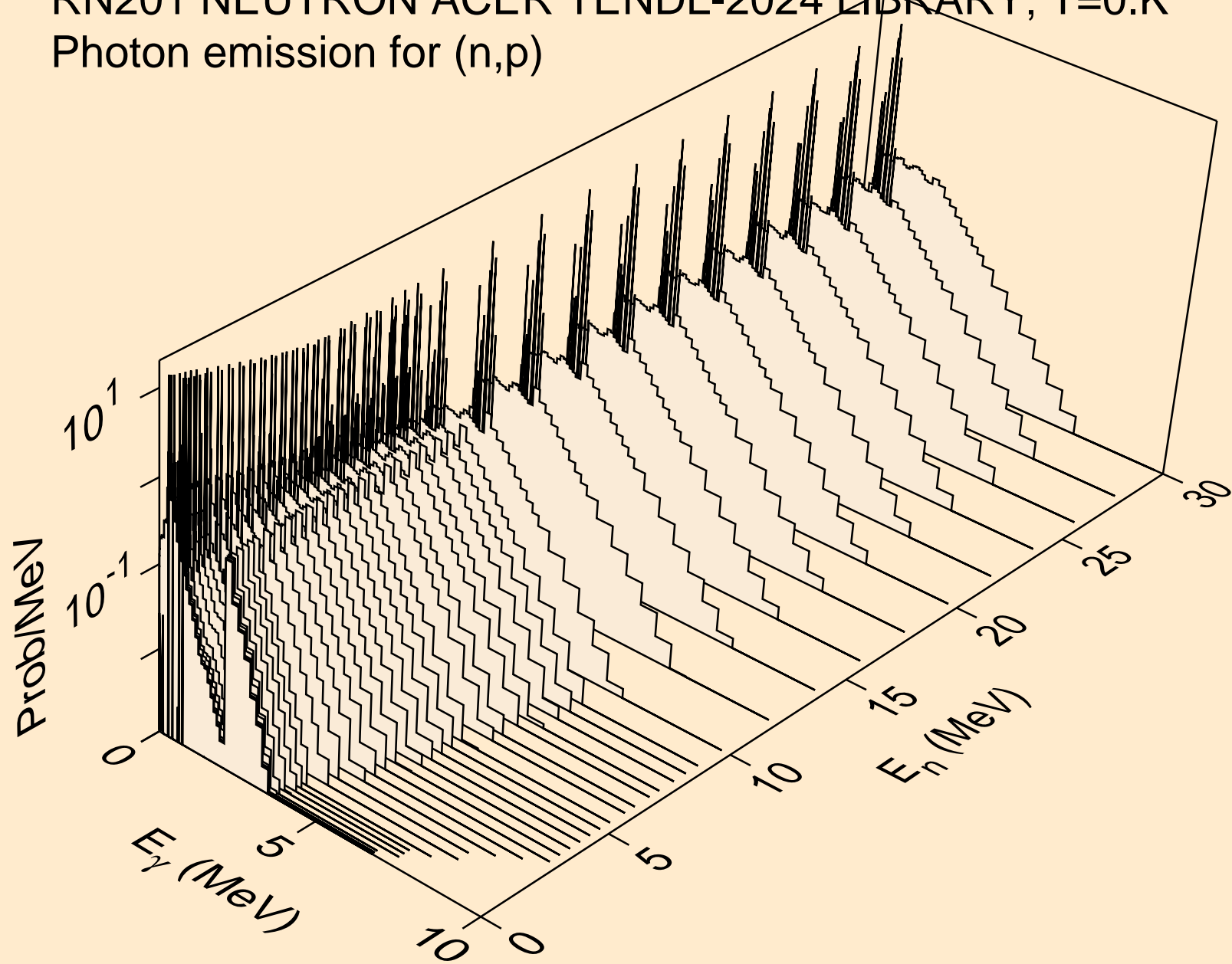

RN201 NEUTRON ACER TENDL-2024 LIBRARY; T=0.K  
Photon emission for (n,d)

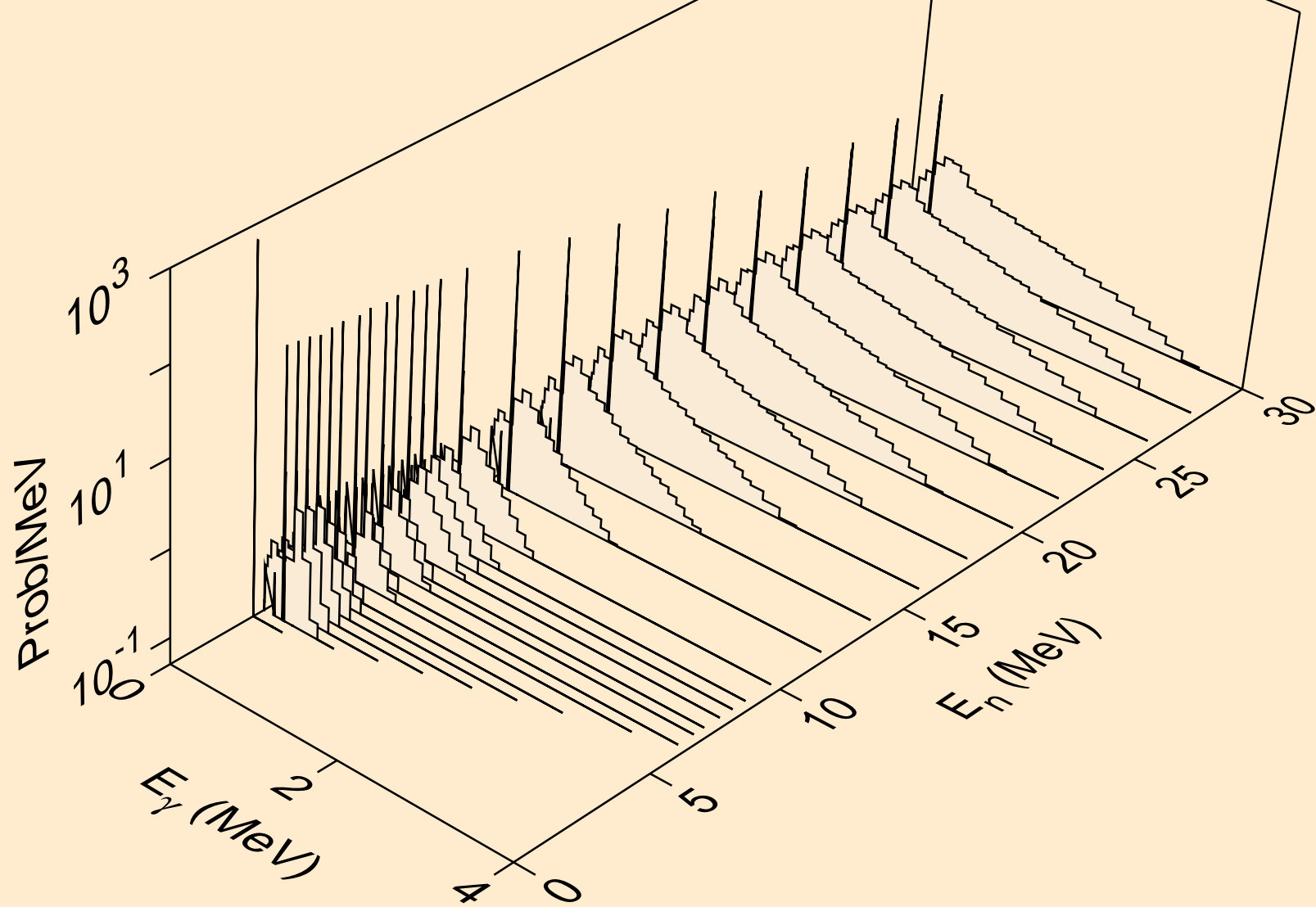

RN201 NEUTRON ACER TENDL-2024 LIBRARY; T=0.K  
Photon emission for (n,t)

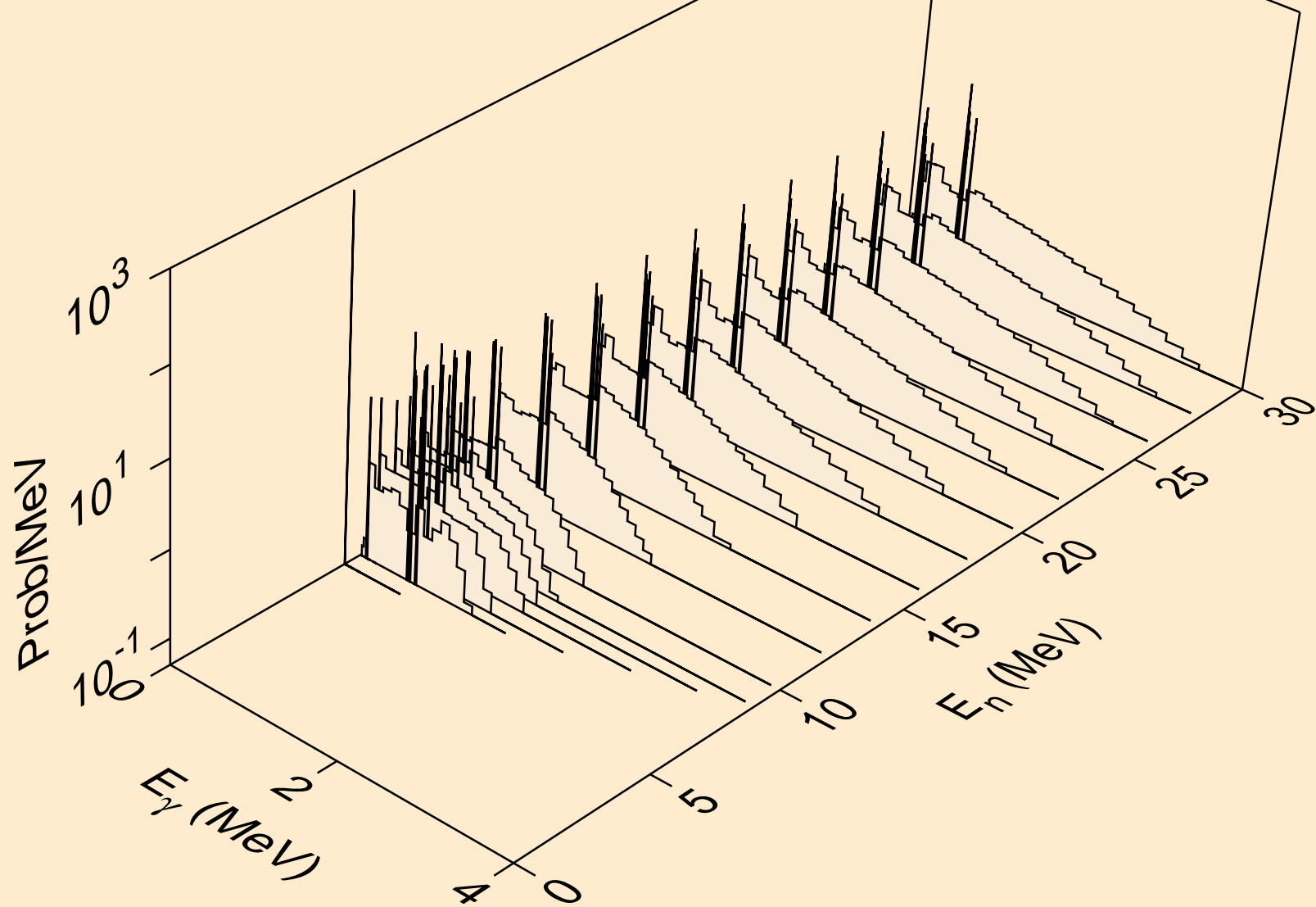

RN201 NEUTRON ACER TENDL-2024 LIBRARY; T=0.K  
Photon emission for (n,he3)

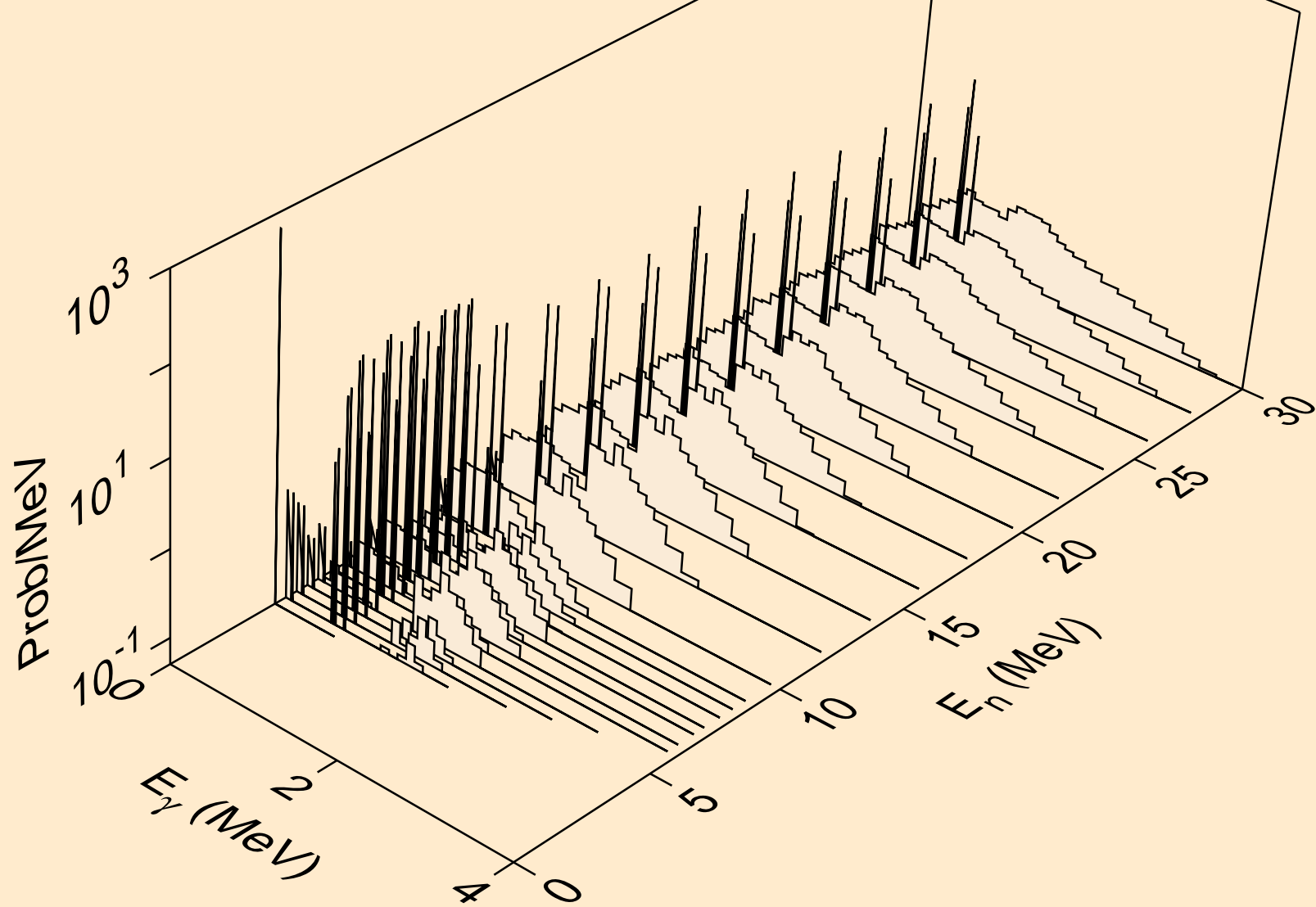

RN201 NEUTRON ACER TENDL-2024 LIBRARY; T=0.K  
Photon emission for (n,a)

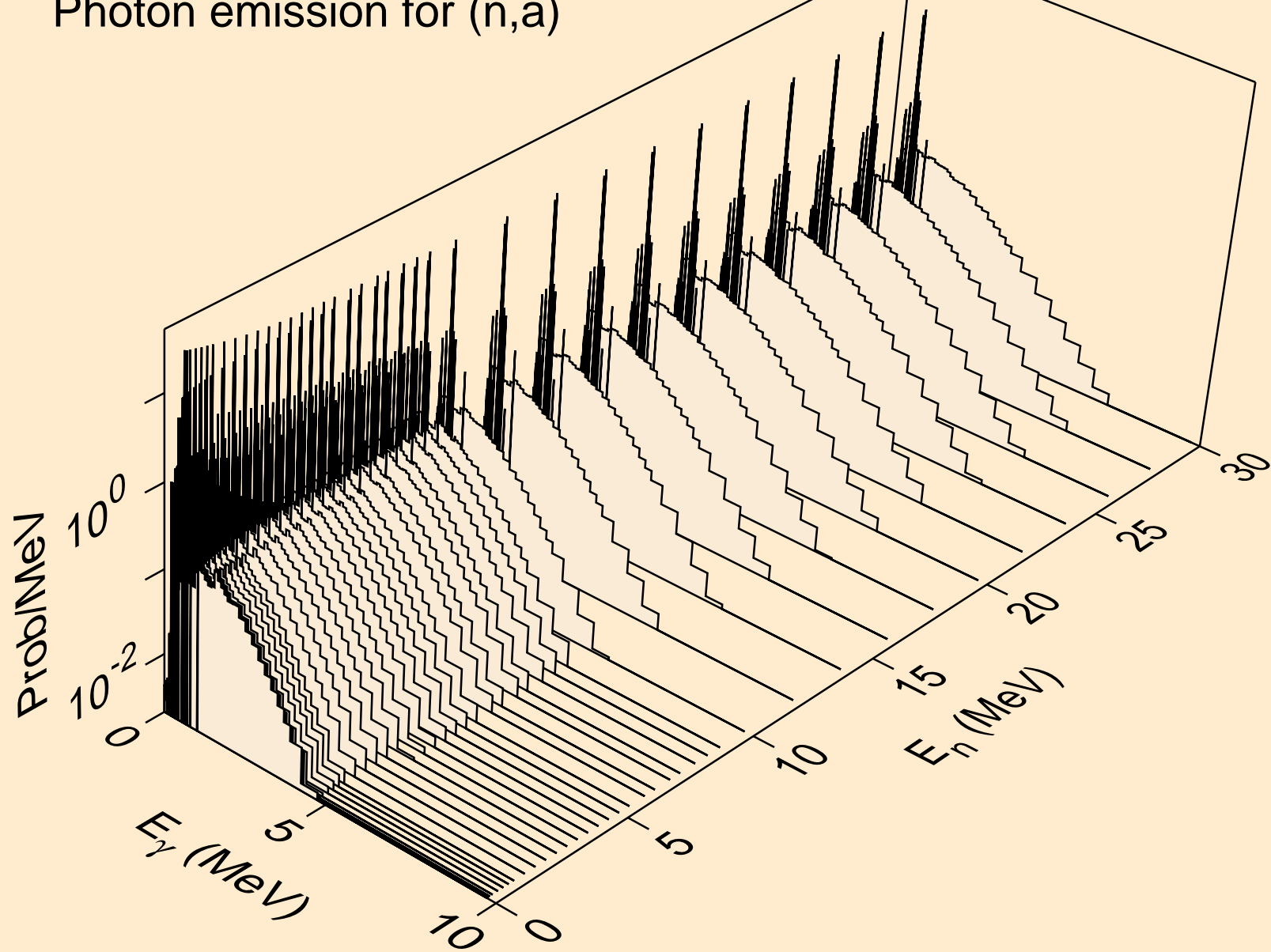

RN201 NEUTRON ACER TENDL-2024 LIBRARY; T=0.K  
Photon emission for (n,2a)

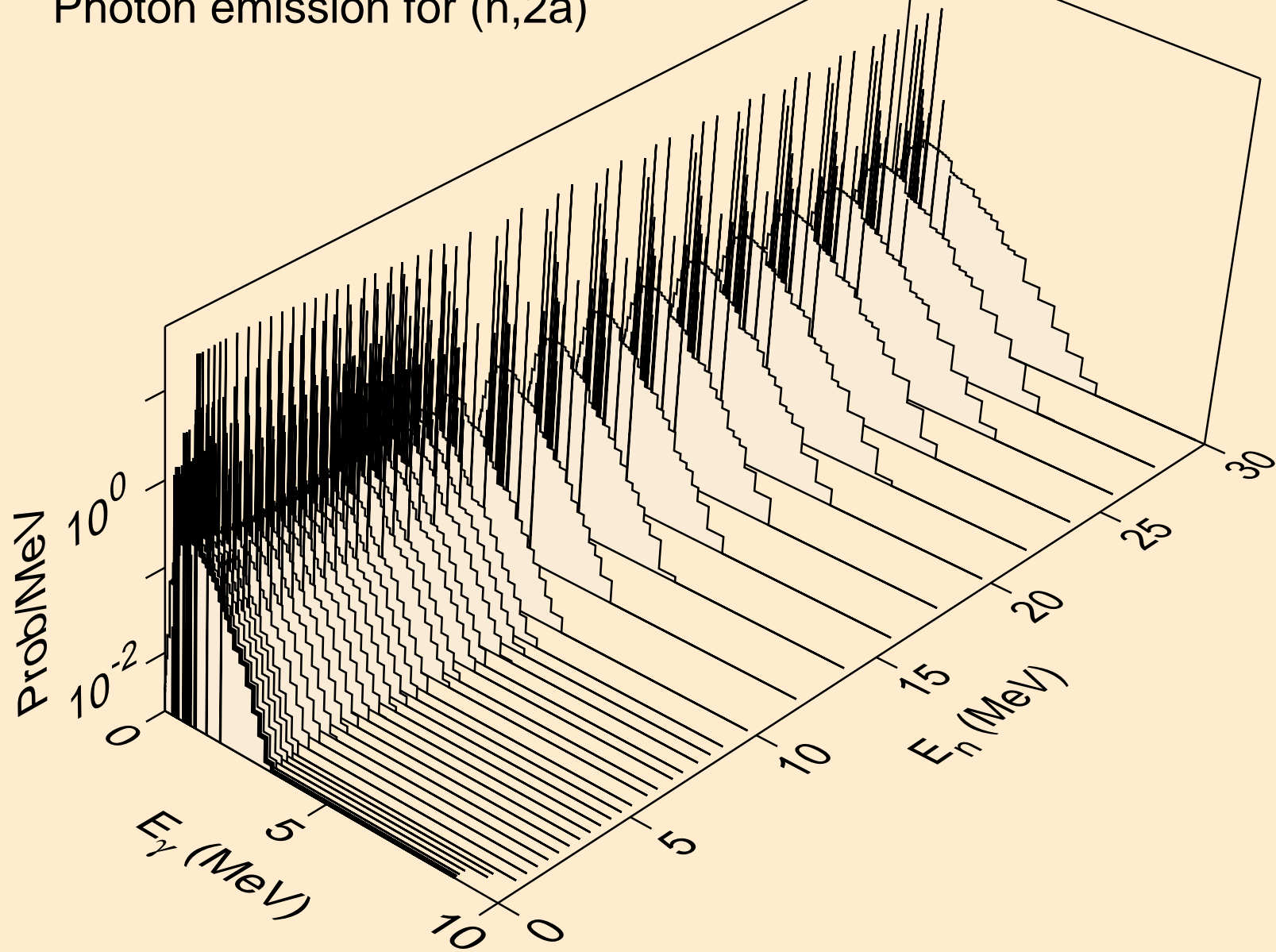

RN201 NEUTRON ACER TENDL-2024 LIBRARY; T=0.K  
Photon emission for (n,3a)

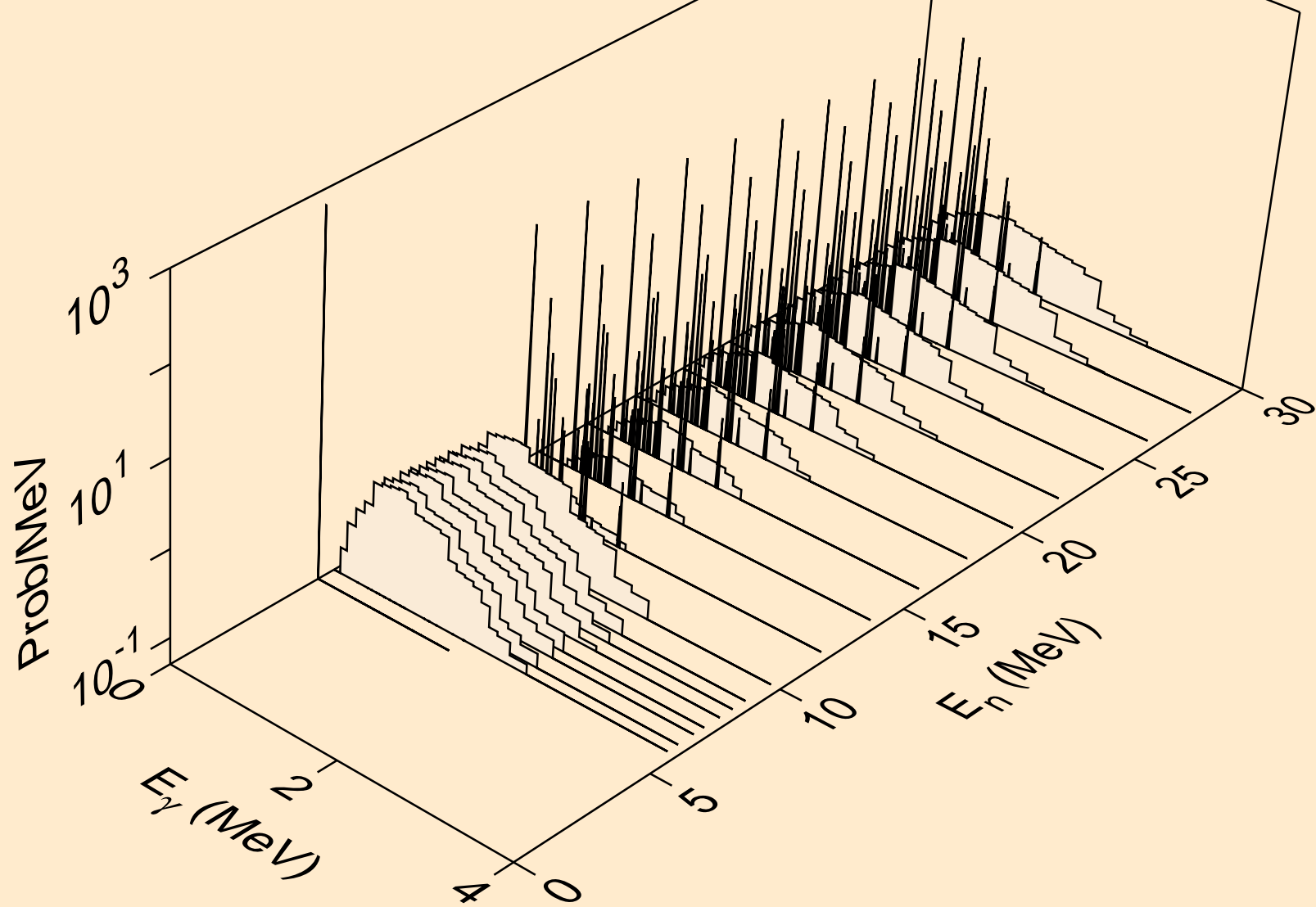

RN201 NEUTRON ACER TENDL-2024 LIBRARY; T=0.K  
Photon emission for (n,2p)

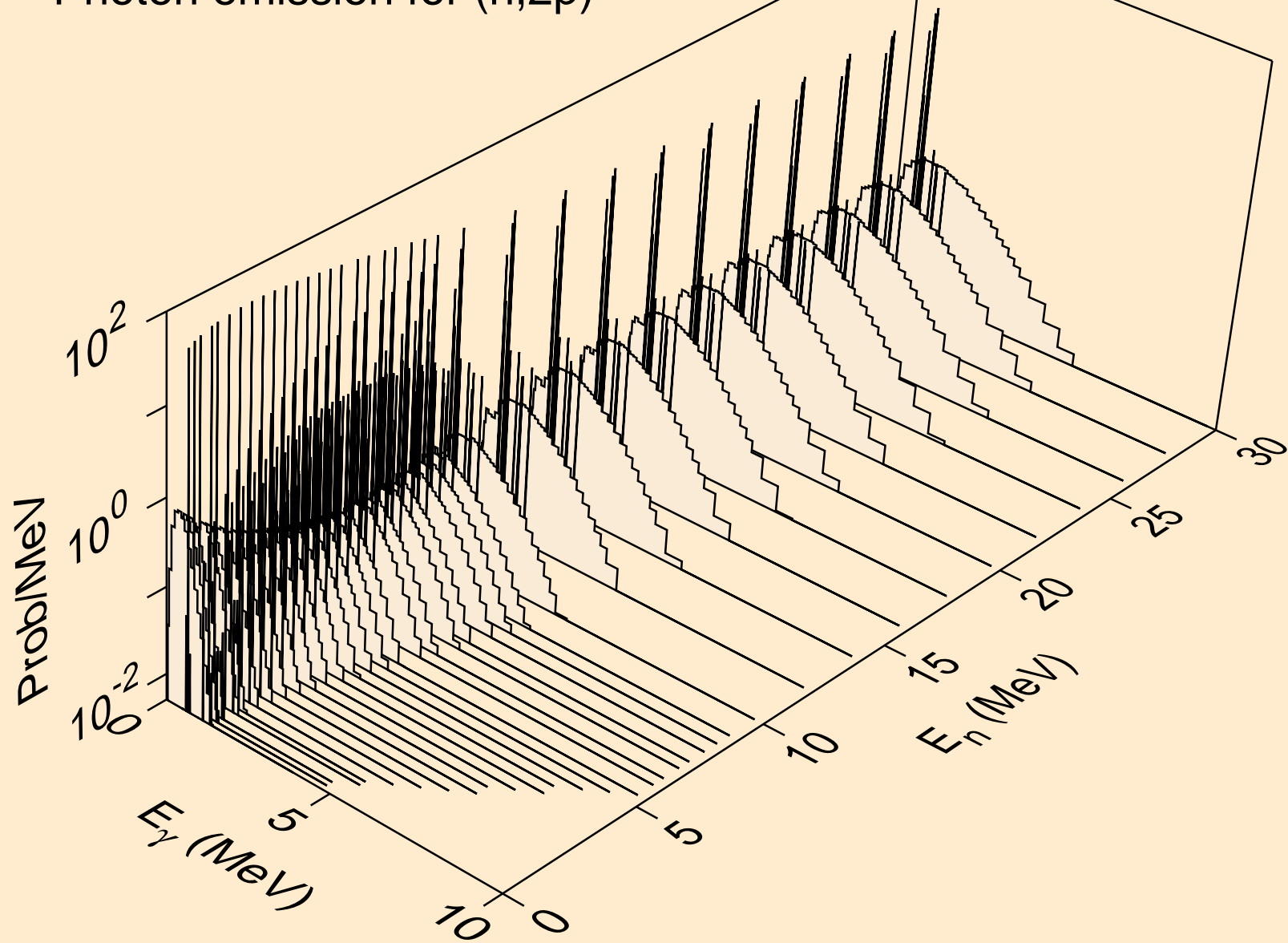

RN201 NEUTRON ACER TENDL-2024 LIBRARY; T=0.K  
Photon emission for (n,p $\alpha$ )

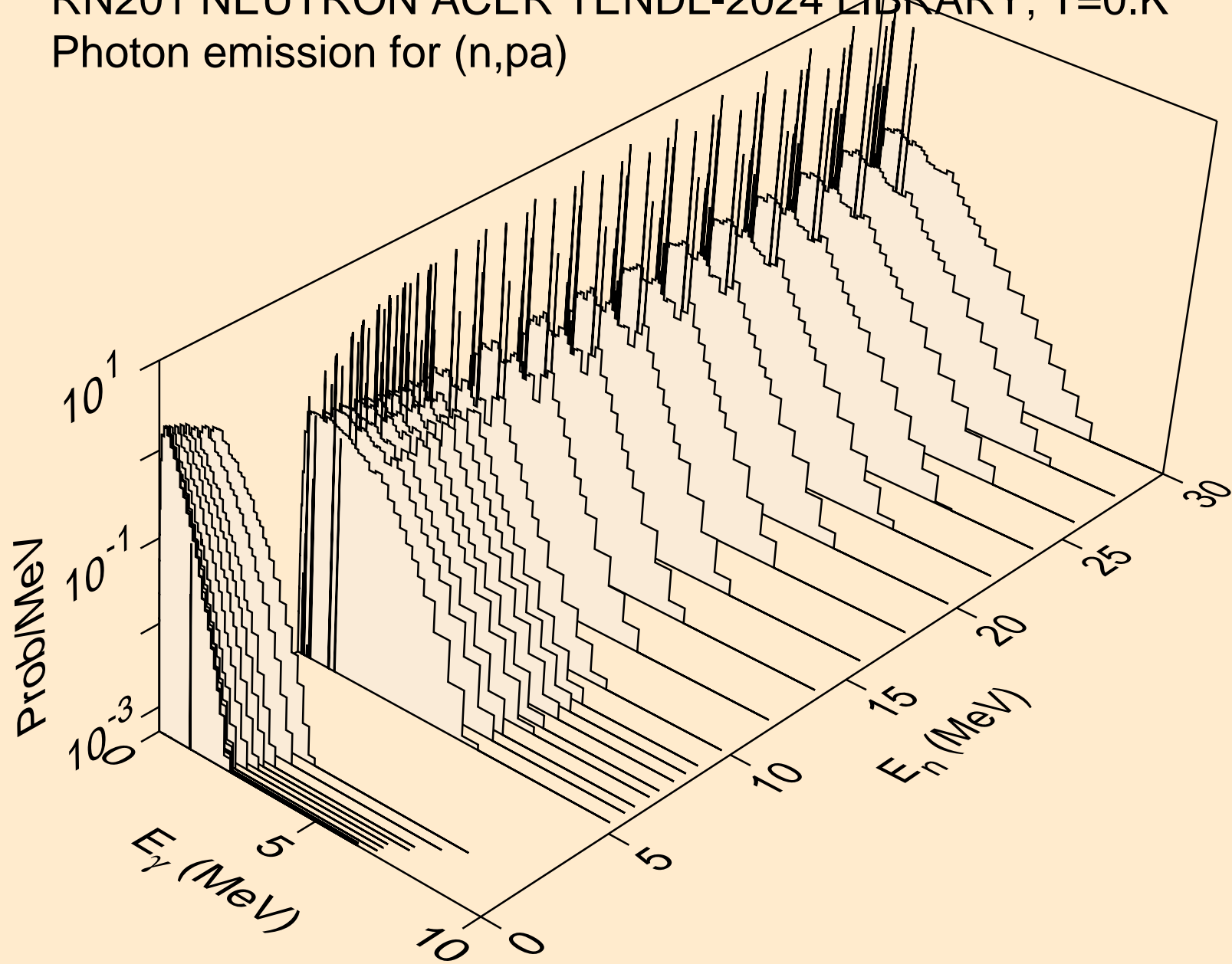

RN201 NEUTRON ACER TENDL-2024 LIBRARY; T=0.K  
Photon emission for (n,pd)

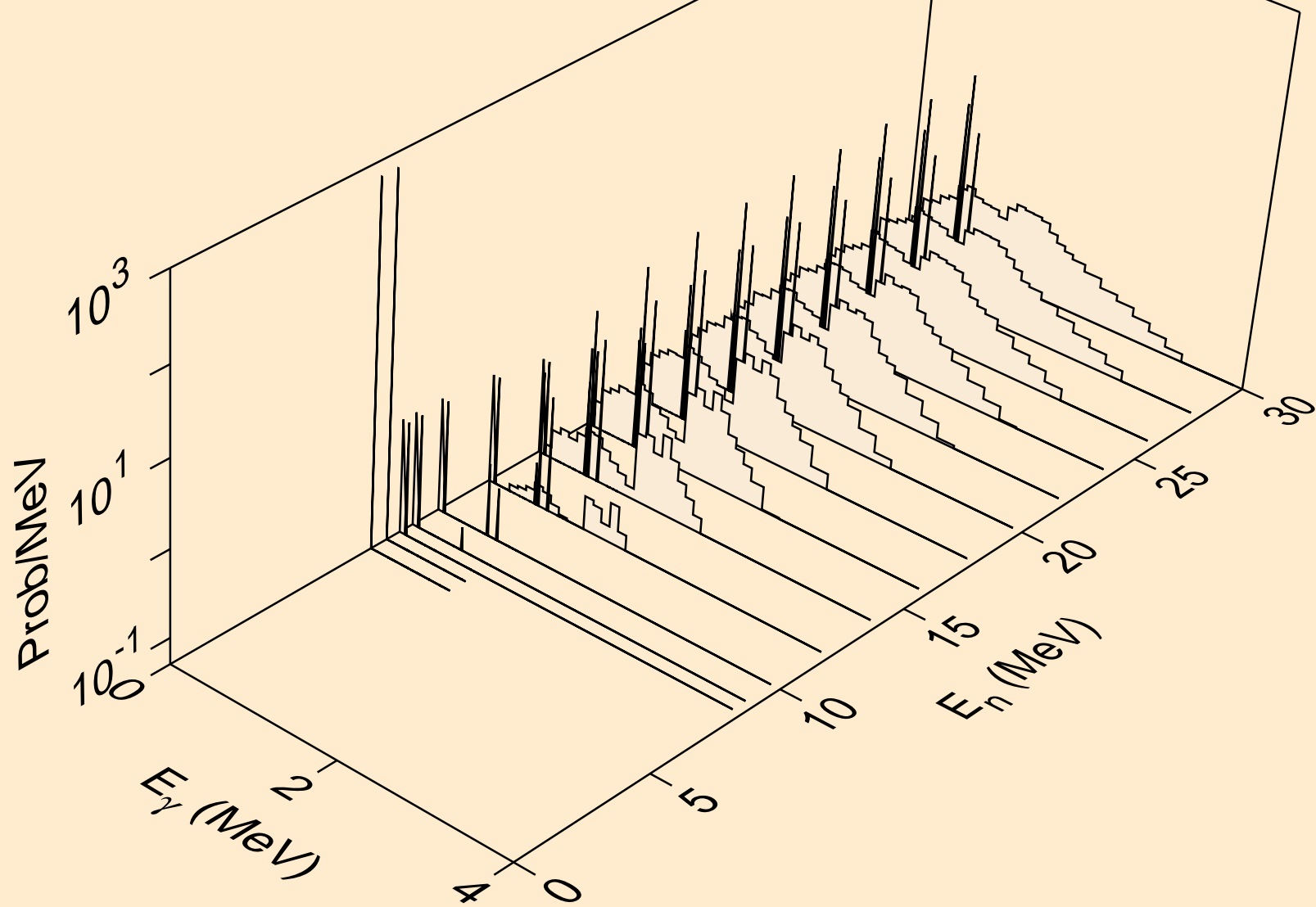

RN201 NEUTRON ACER TENDL-2024 LIBRARY; T=0.K  
Photon emission for (n,pt)

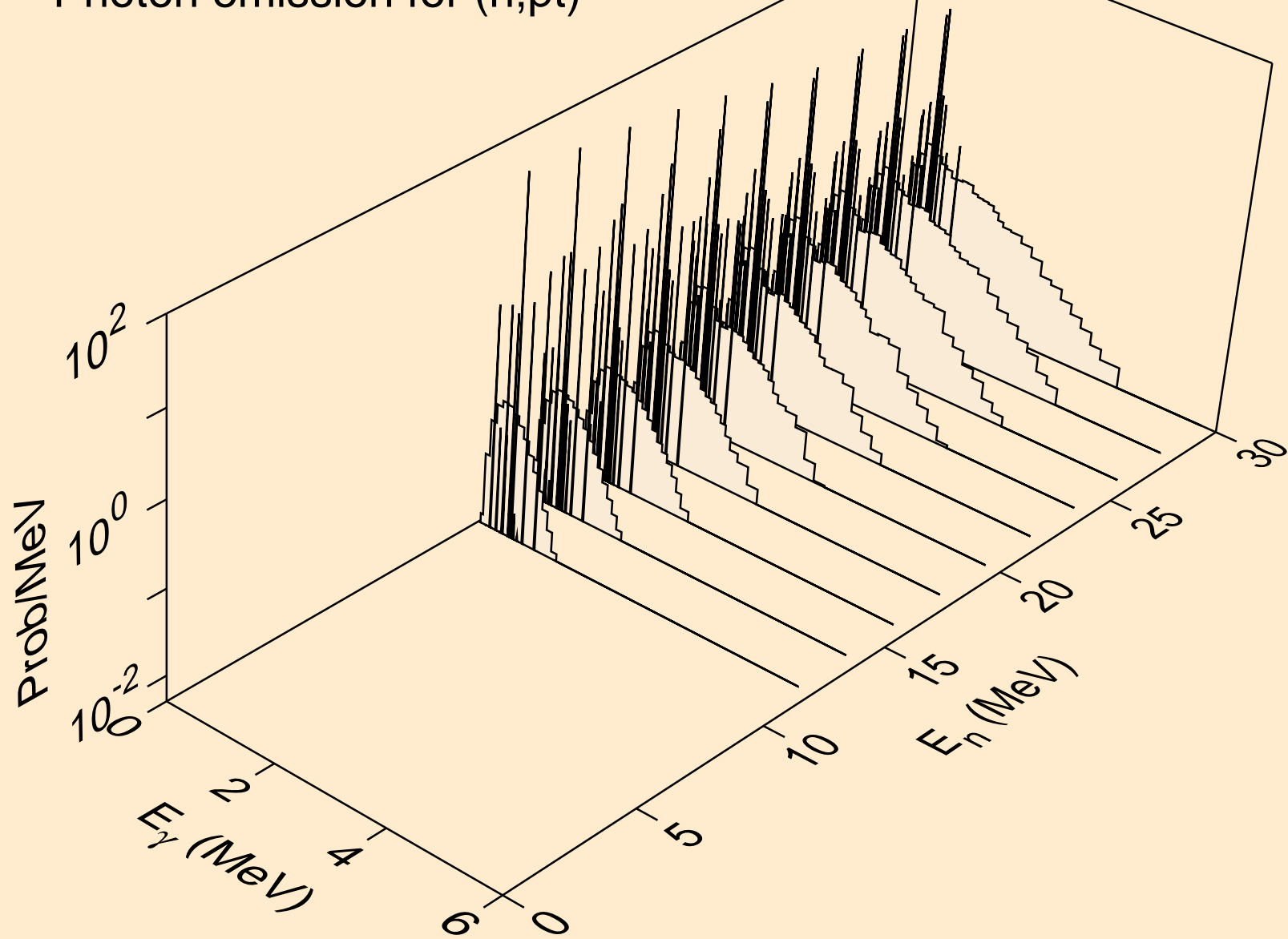

RN201 NEUTRON ACER TENDL-2024 LIBRARY; T=0.K  
Photon emission for (n,da)

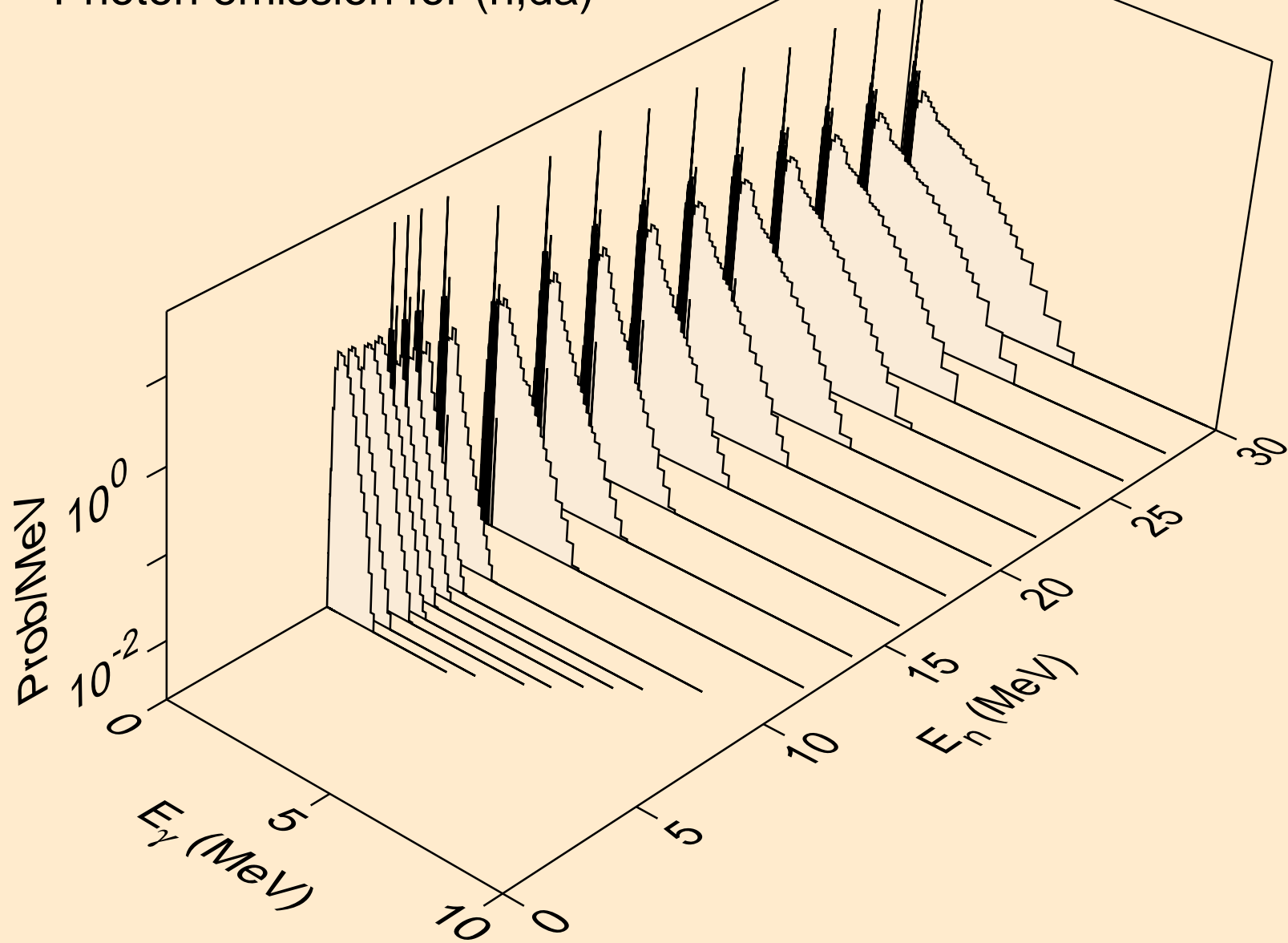

RN201 NEUTRON ACER TENDL-2024 LIBRARY; T=0.K  
thermal capture photon spectrum

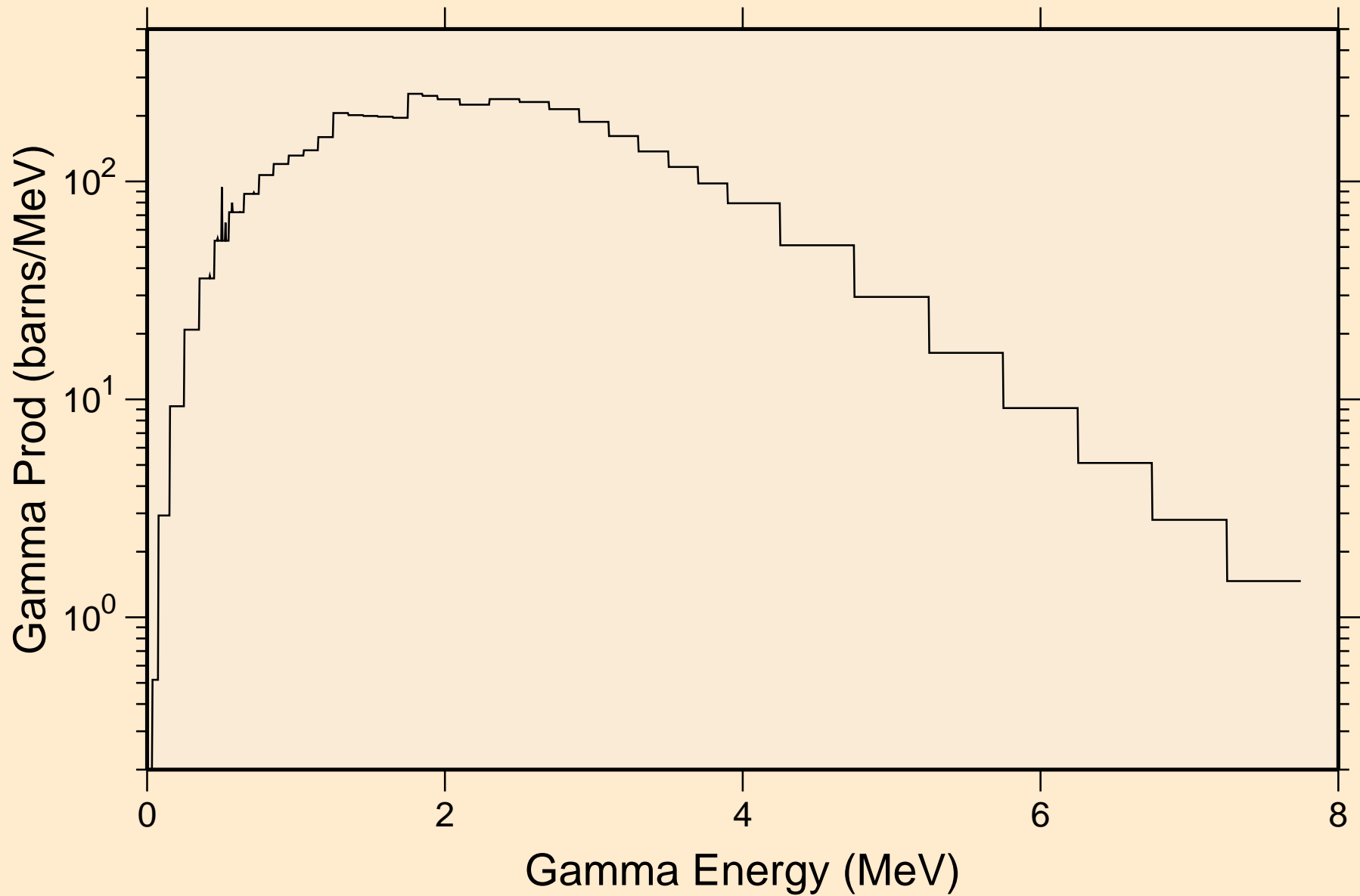

RN201 NEUTRON ACER TENDL-2024 LIBRARY; T=0.K  
14 MeV photon spectrum

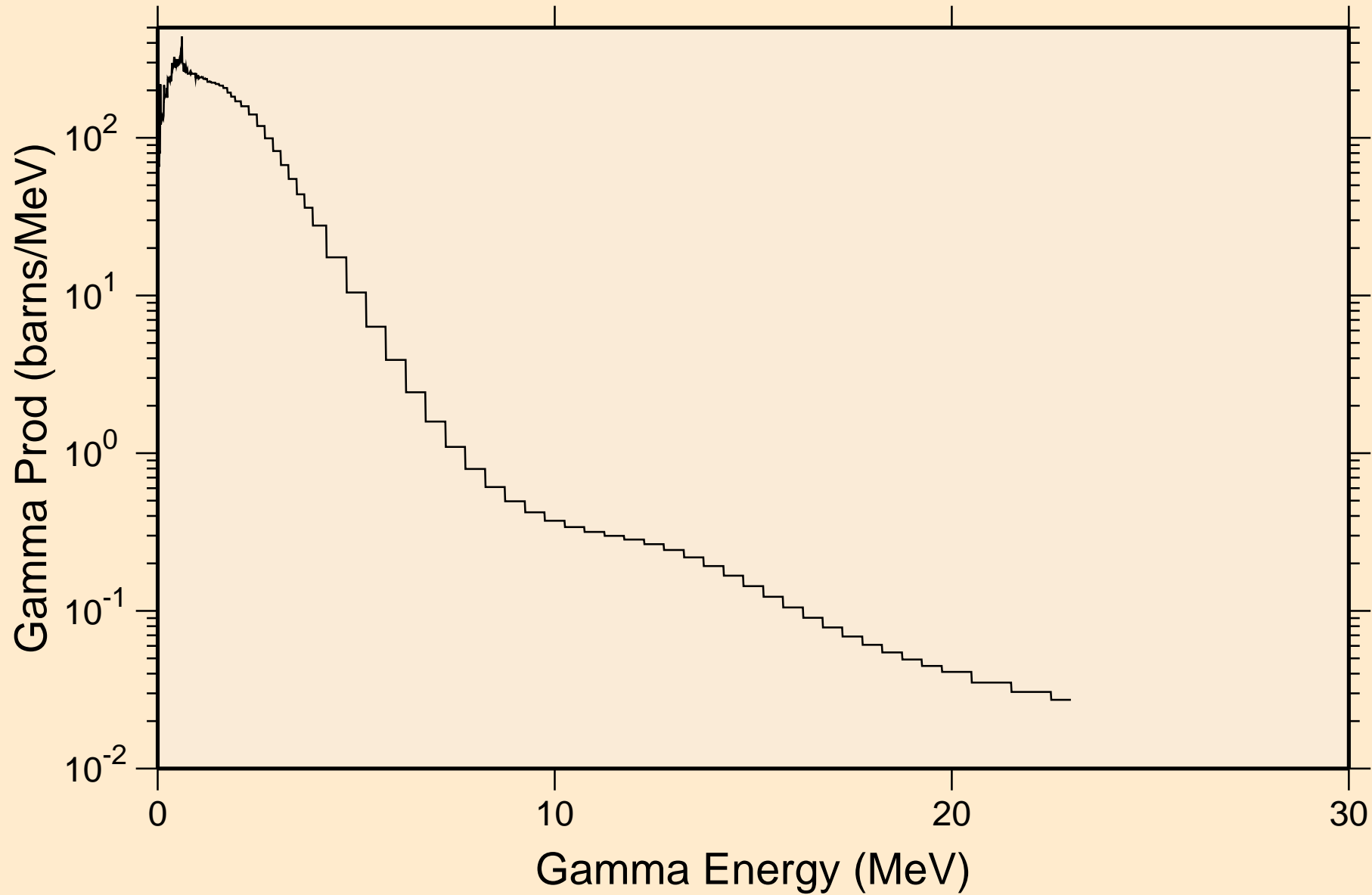

# RN201 NEUTRON ACER TENDL-2024 LIBRARY; T=0.K

## Particle heating contributions

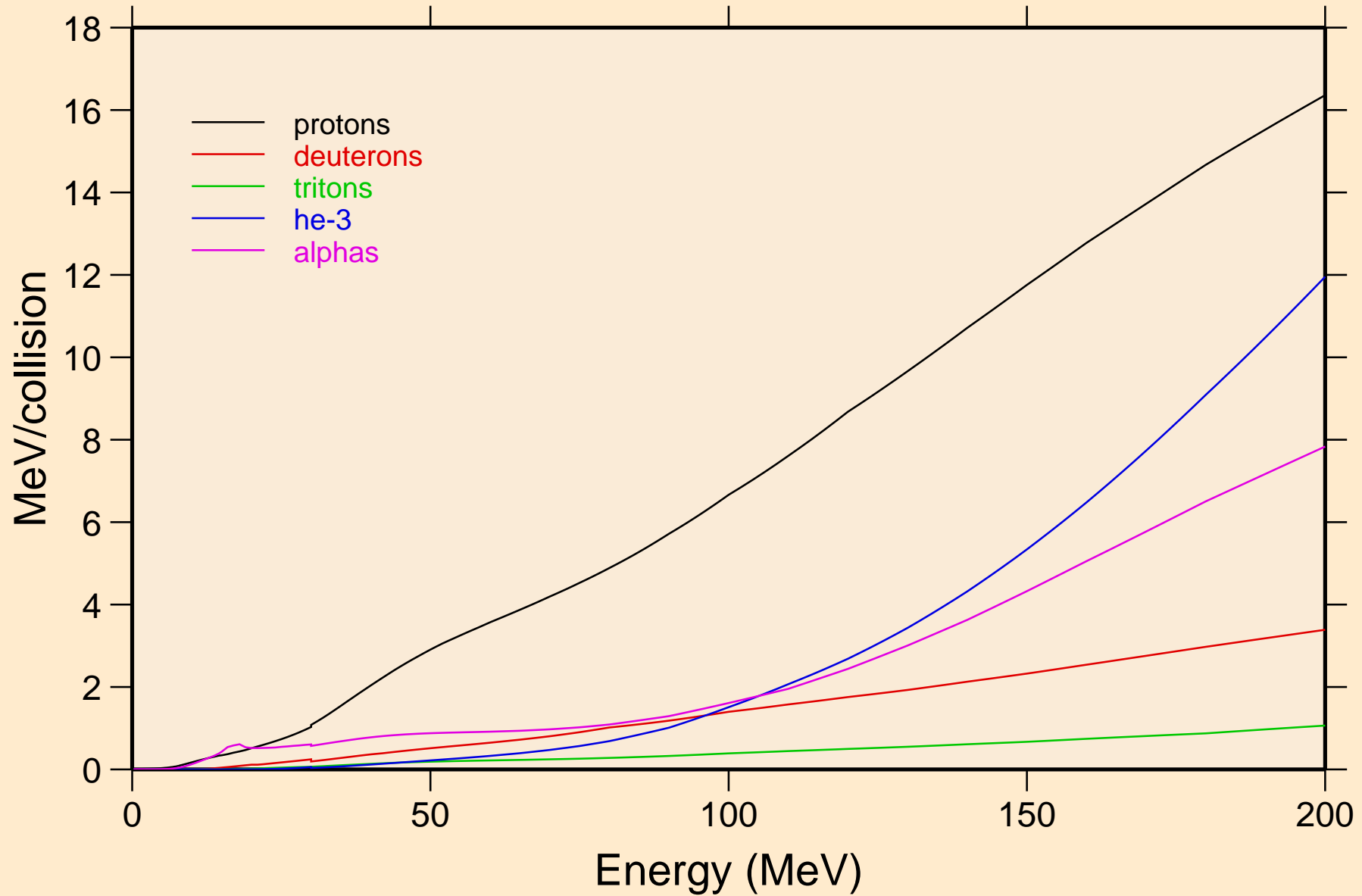

RN201 NEUTRON ACER TENDL-2024 LIBRARY; T=0.K  
Recoil Heating

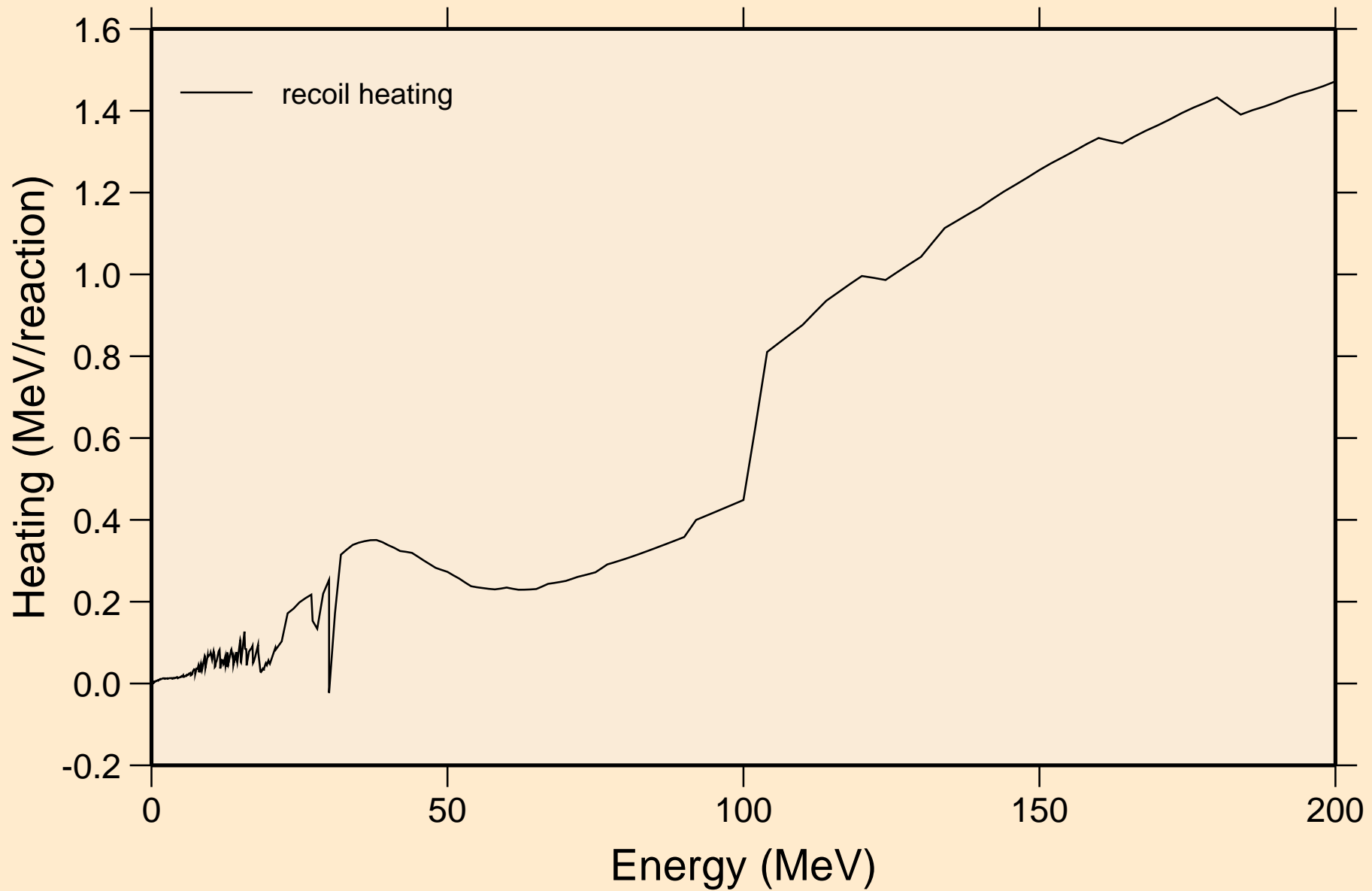

RN201 NEUTRON ACER TENDL-2024 LIBRARY; T=0.K  
Particle production cross sections

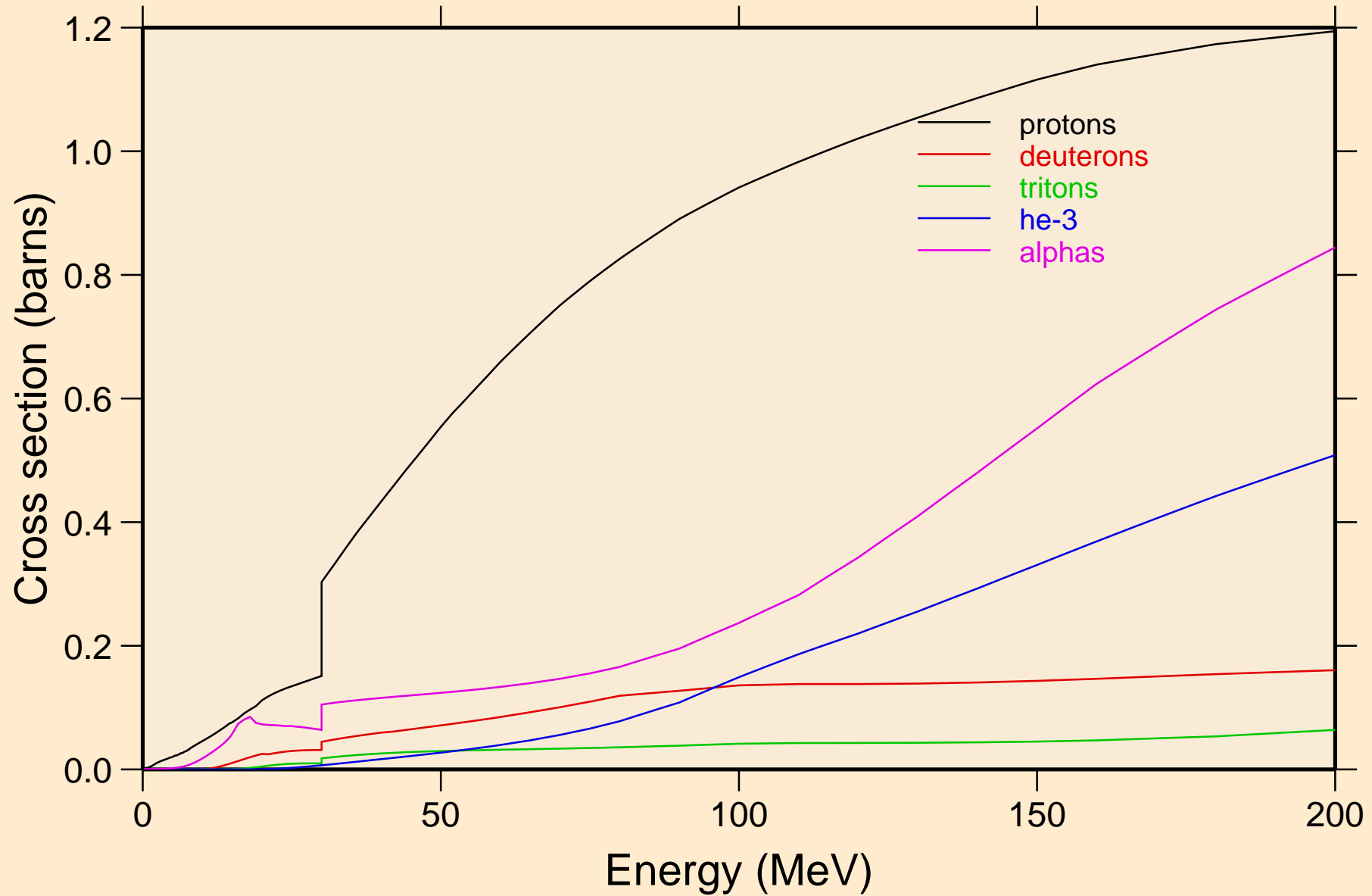

RN201 NEUTRON ACER TENDL-2024 LIBRARY; T=0.K  
protons from (n,x)

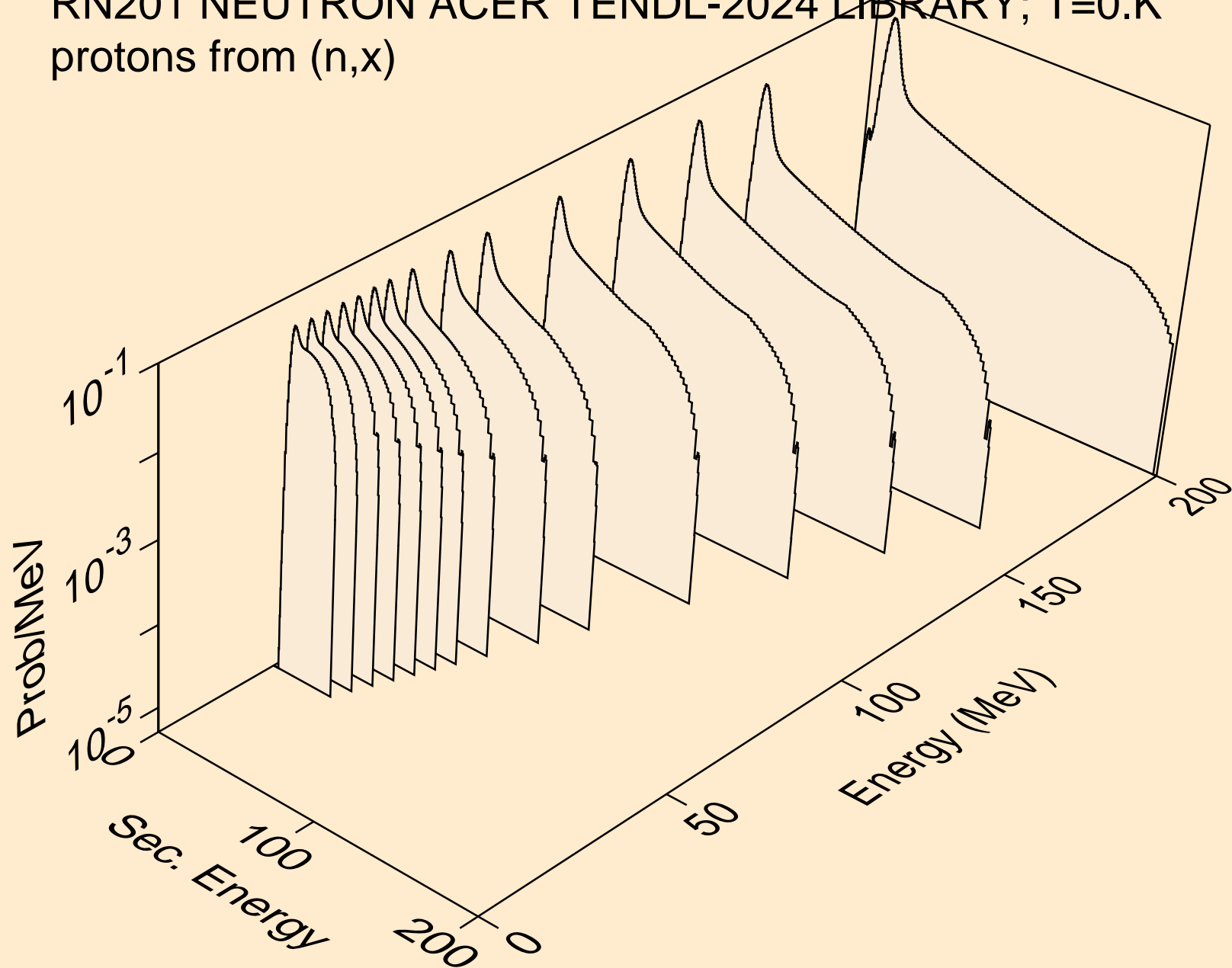

RN201 NEUTRON ACER TENDL-2024 LIBRARY; T=0.K  
protons from (n,n\*)p

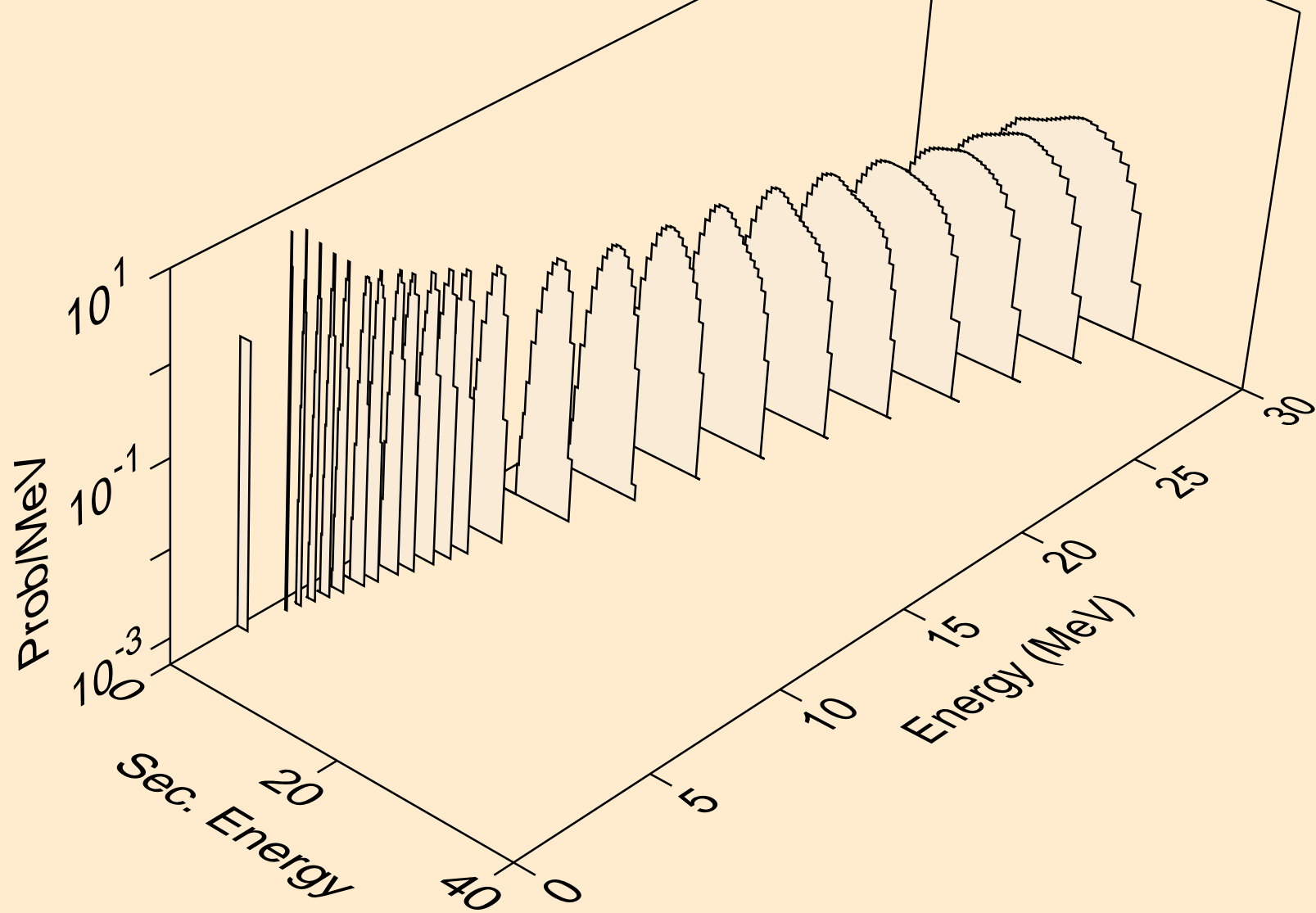

RN201 NEUTRON ACER TENDL-2024 LIBRARY; T=0.K  
protons from (n,2np)

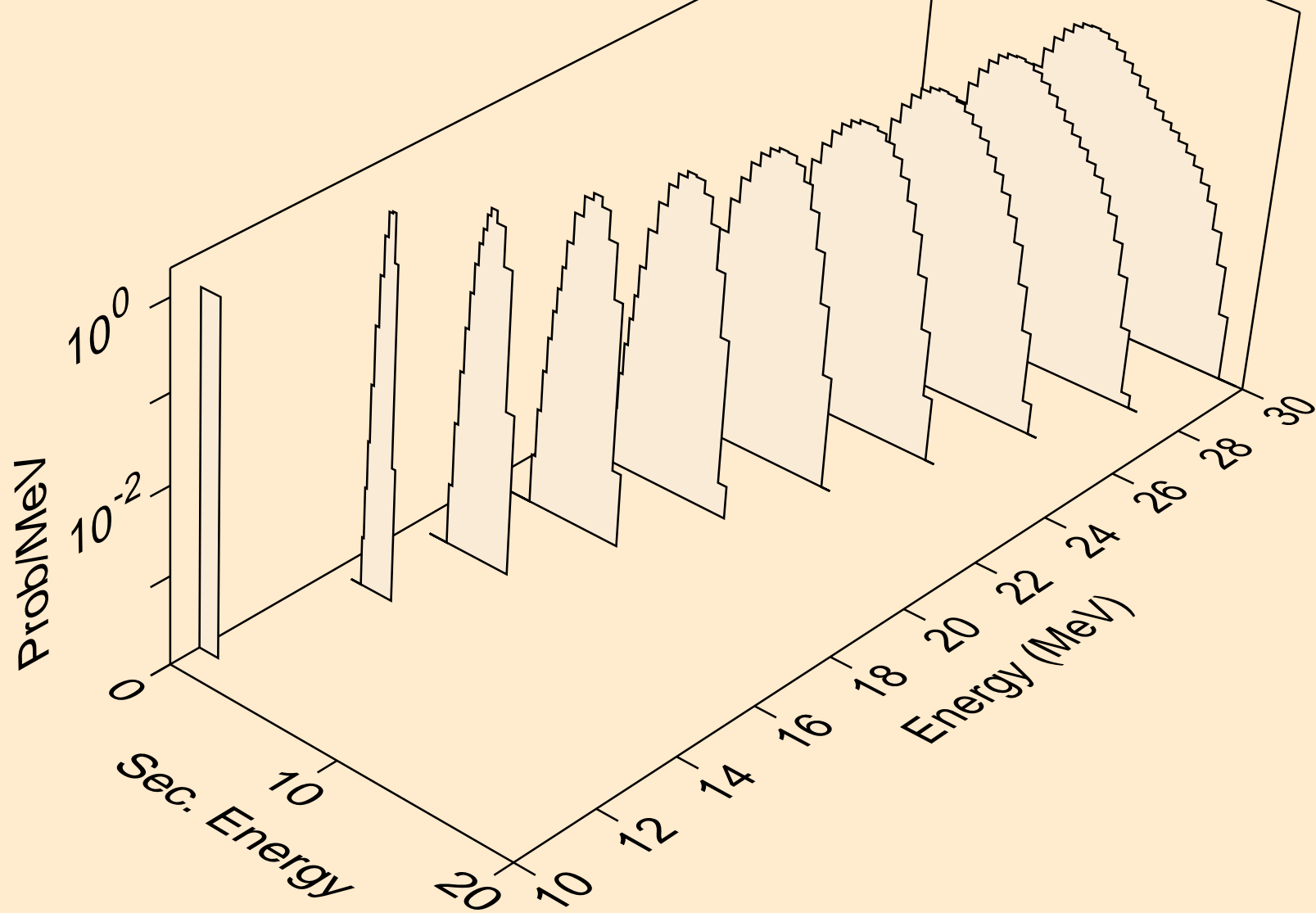

RN201 NEUTRON ACER TENDL-2024 LIBRARY; T=0.K  
protons from (n,3np)

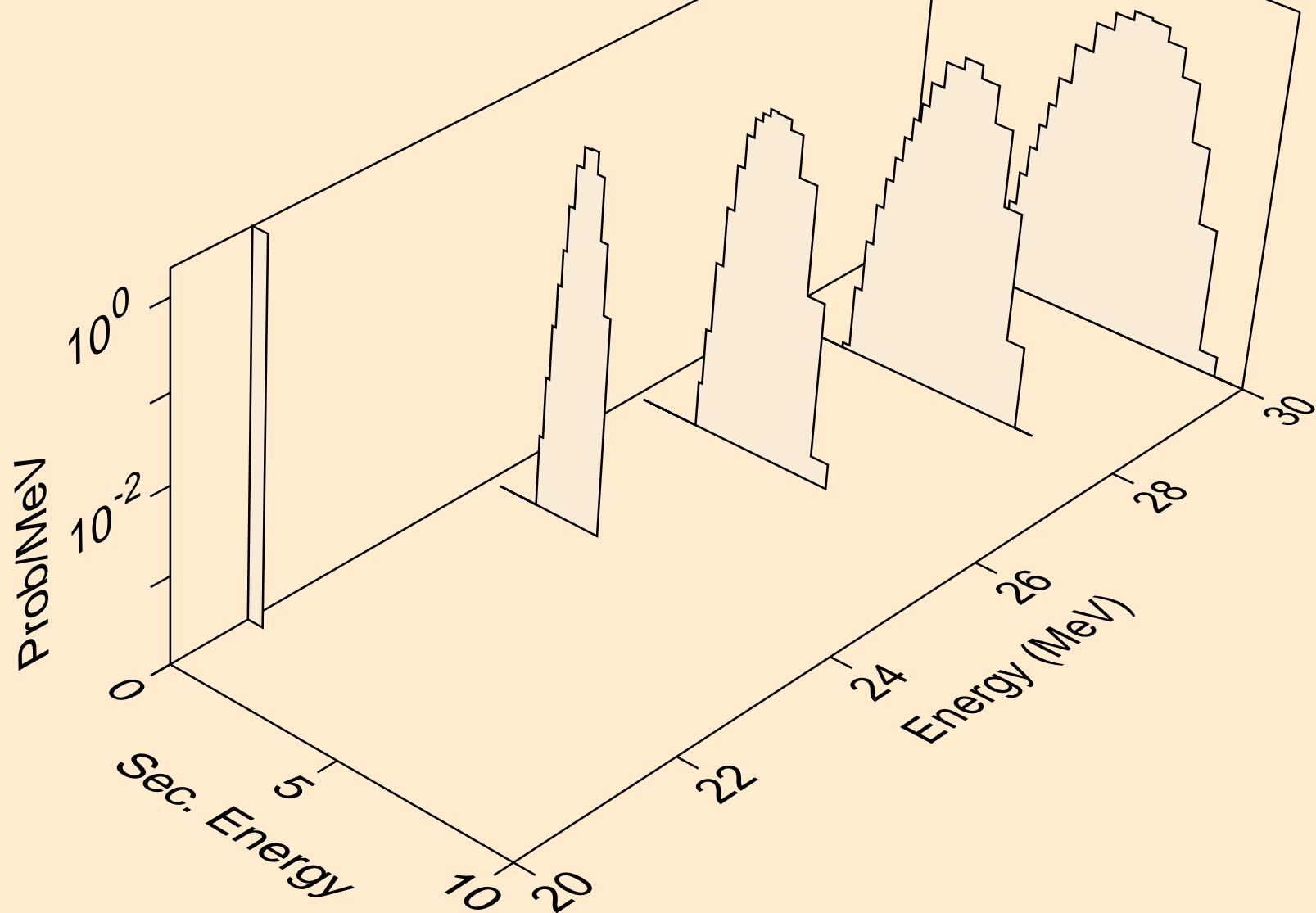

RN201 NEUTRON ACER TENDL-2024 LIBRARY; T=0.K  
protons from (n,n2p)

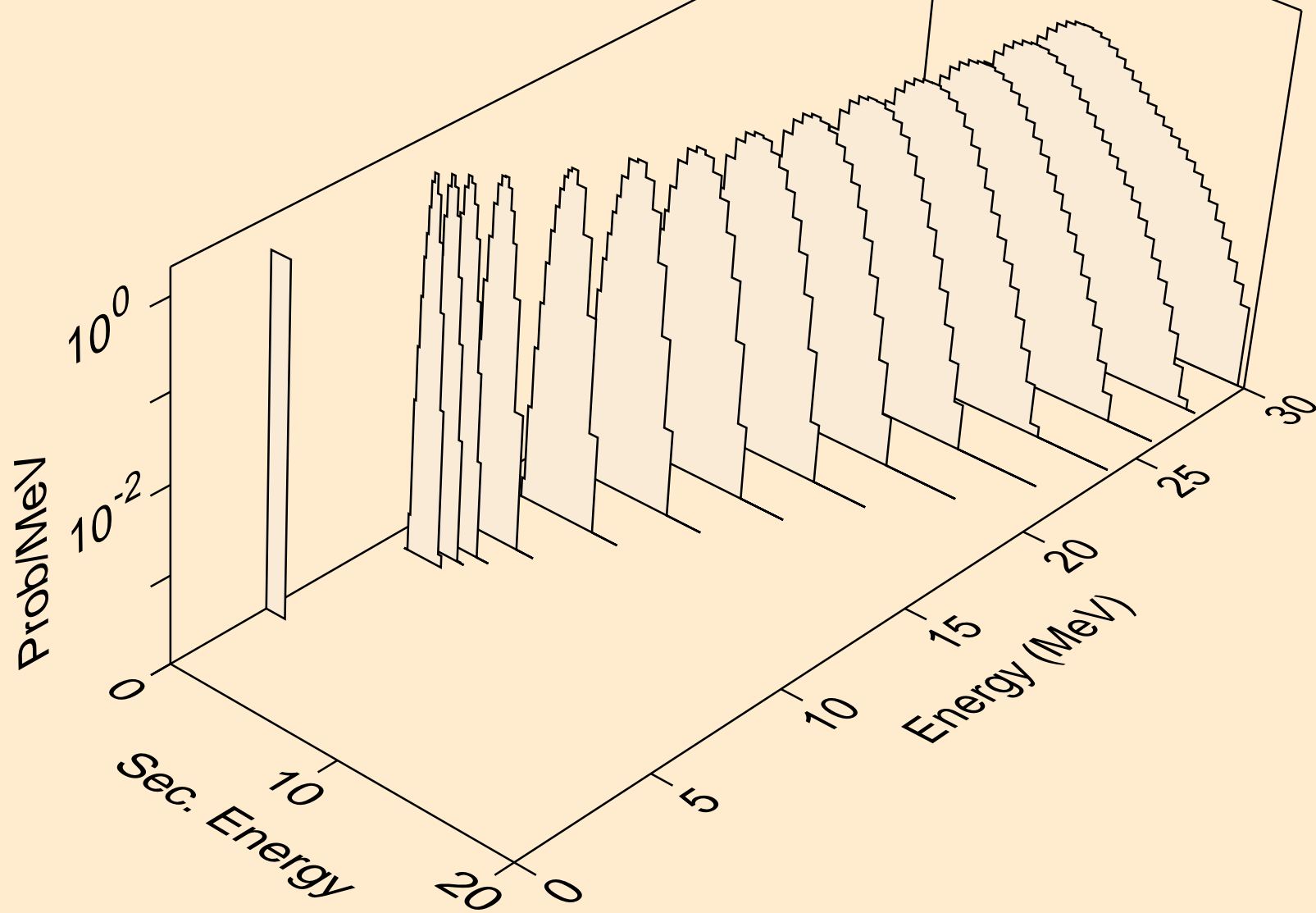

RN201 NEUTRON ACER TENDL-2024 LIBRARY; T=0.K  
protons from (n,npa)

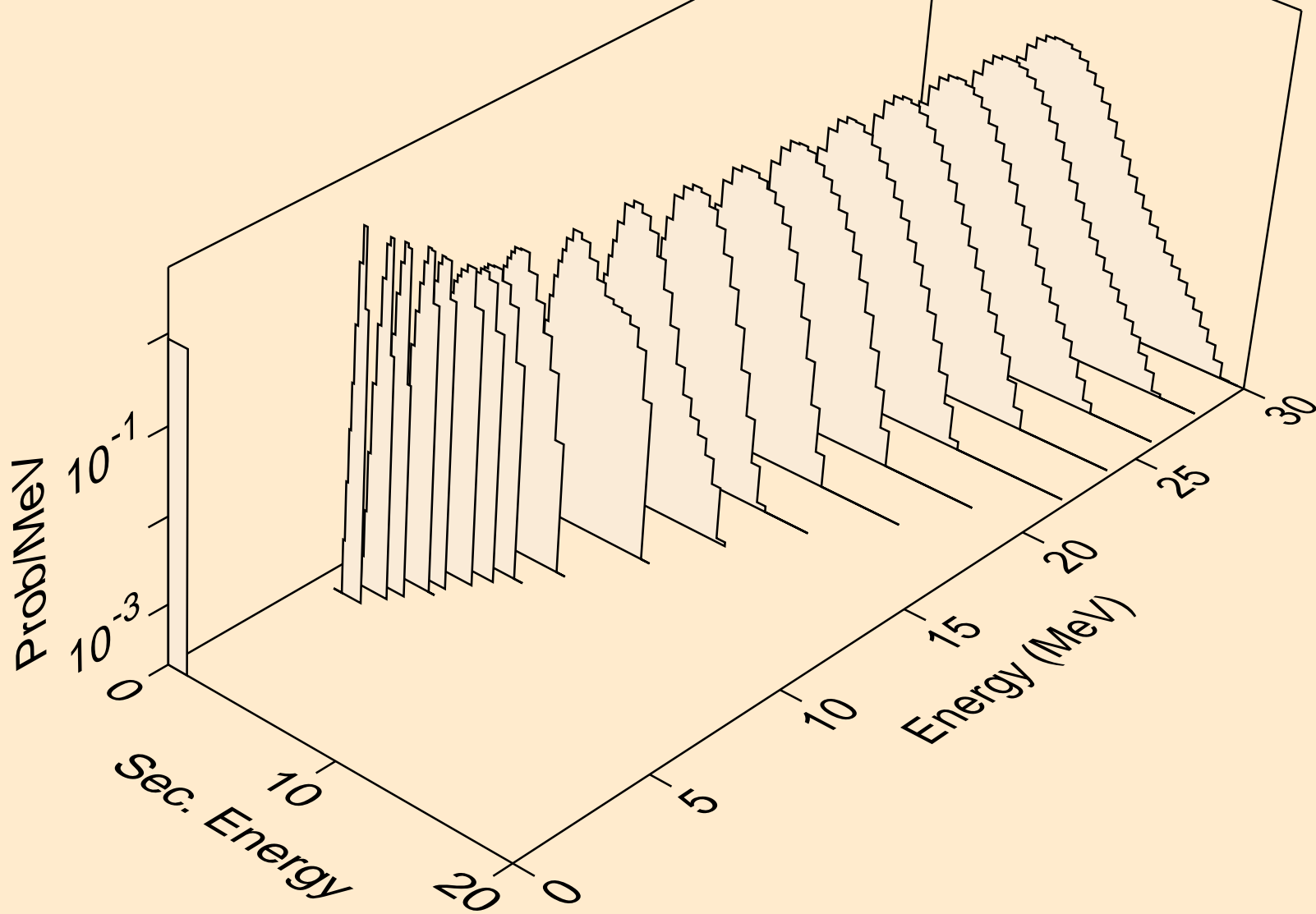

RN201 NEUTRON ACER TENDL-2024 LIBRARY; T=0.K  
protons from (n,p)

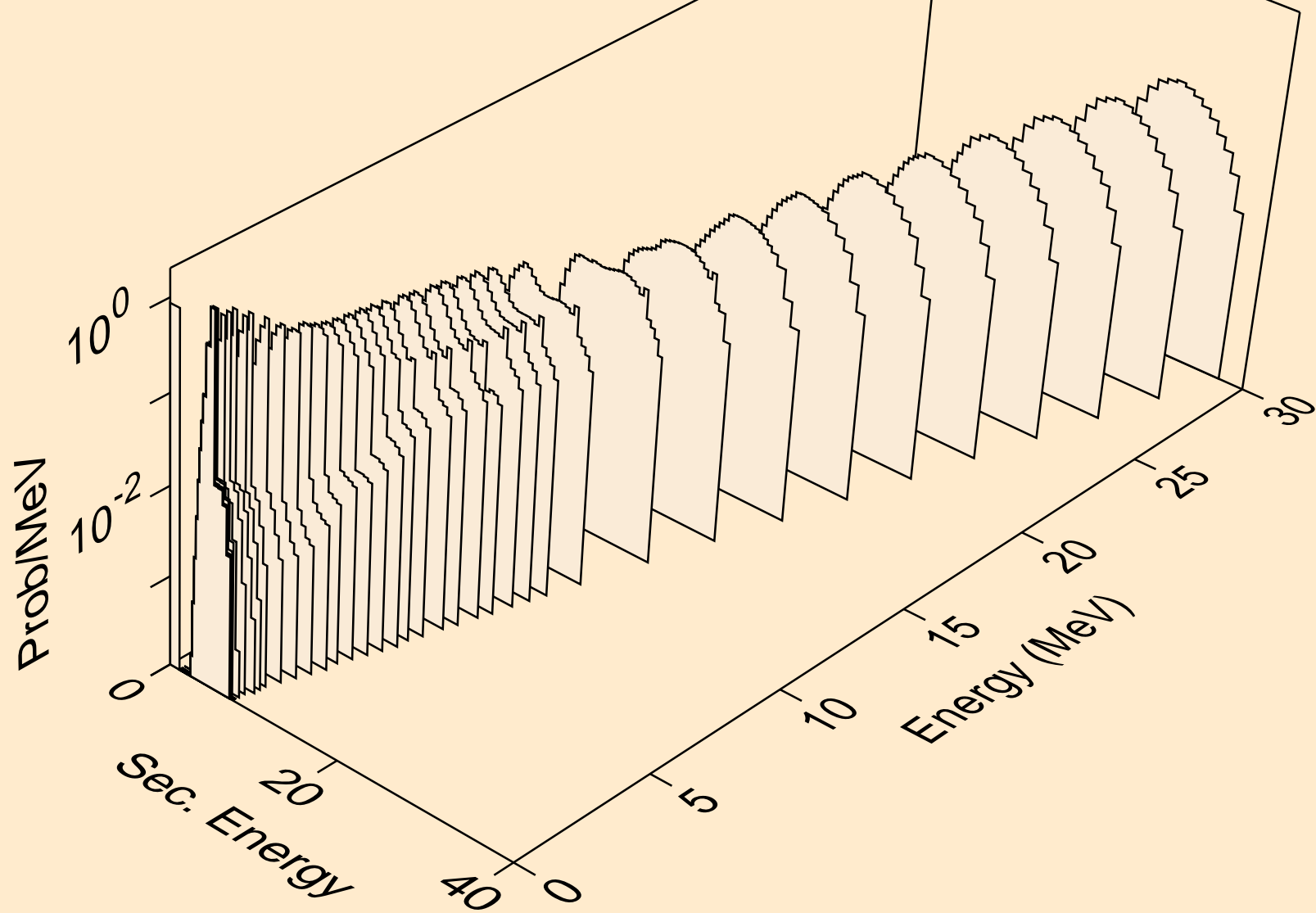

RN201 NEUTRON ACER TENDL-2024 LIBRARY; T=0.K  
protons from (n,2p)

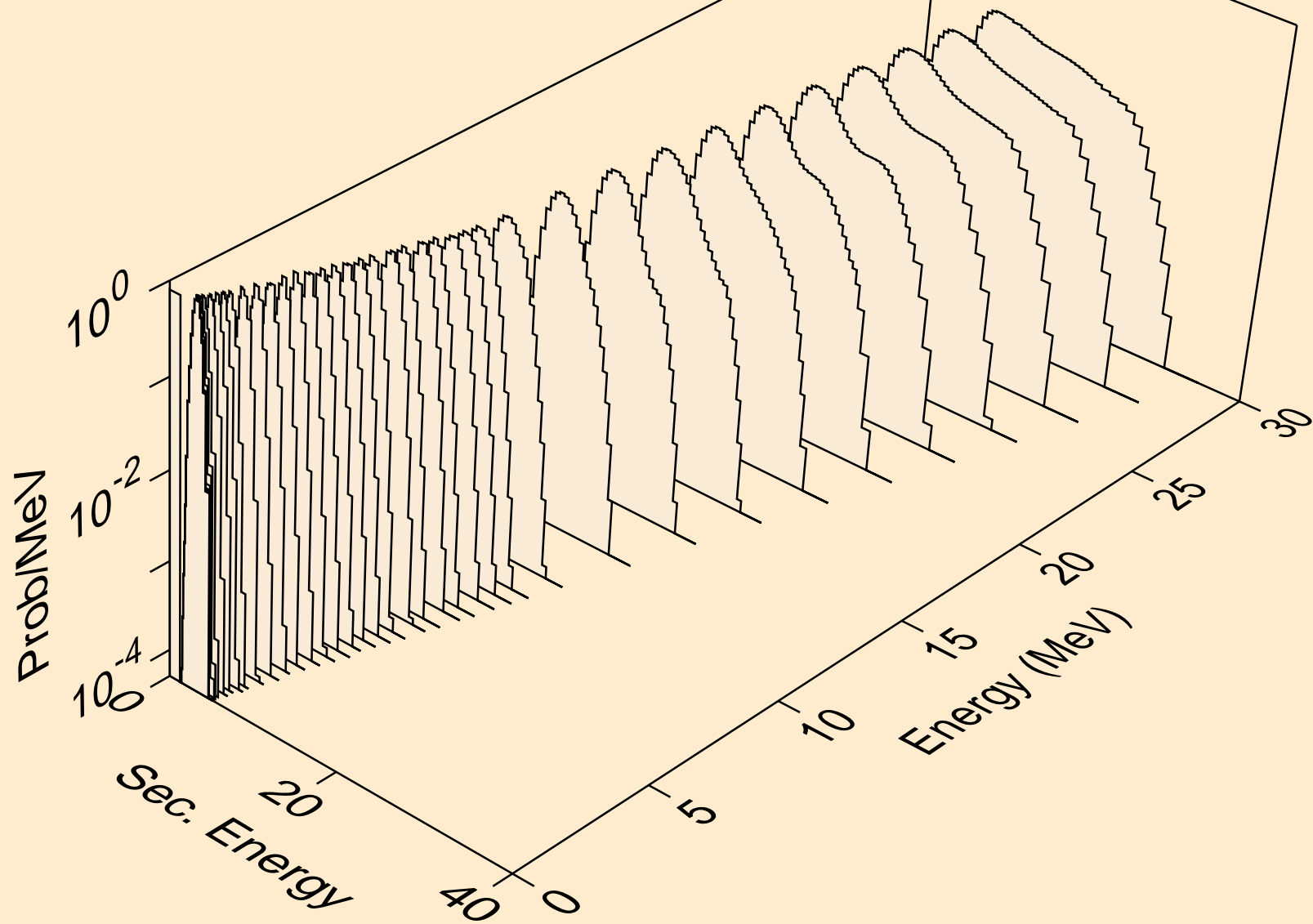

RN201 NEUTRON ACER TENDL-2024 LIBRARY; T=0.K  
protons from (n,p)

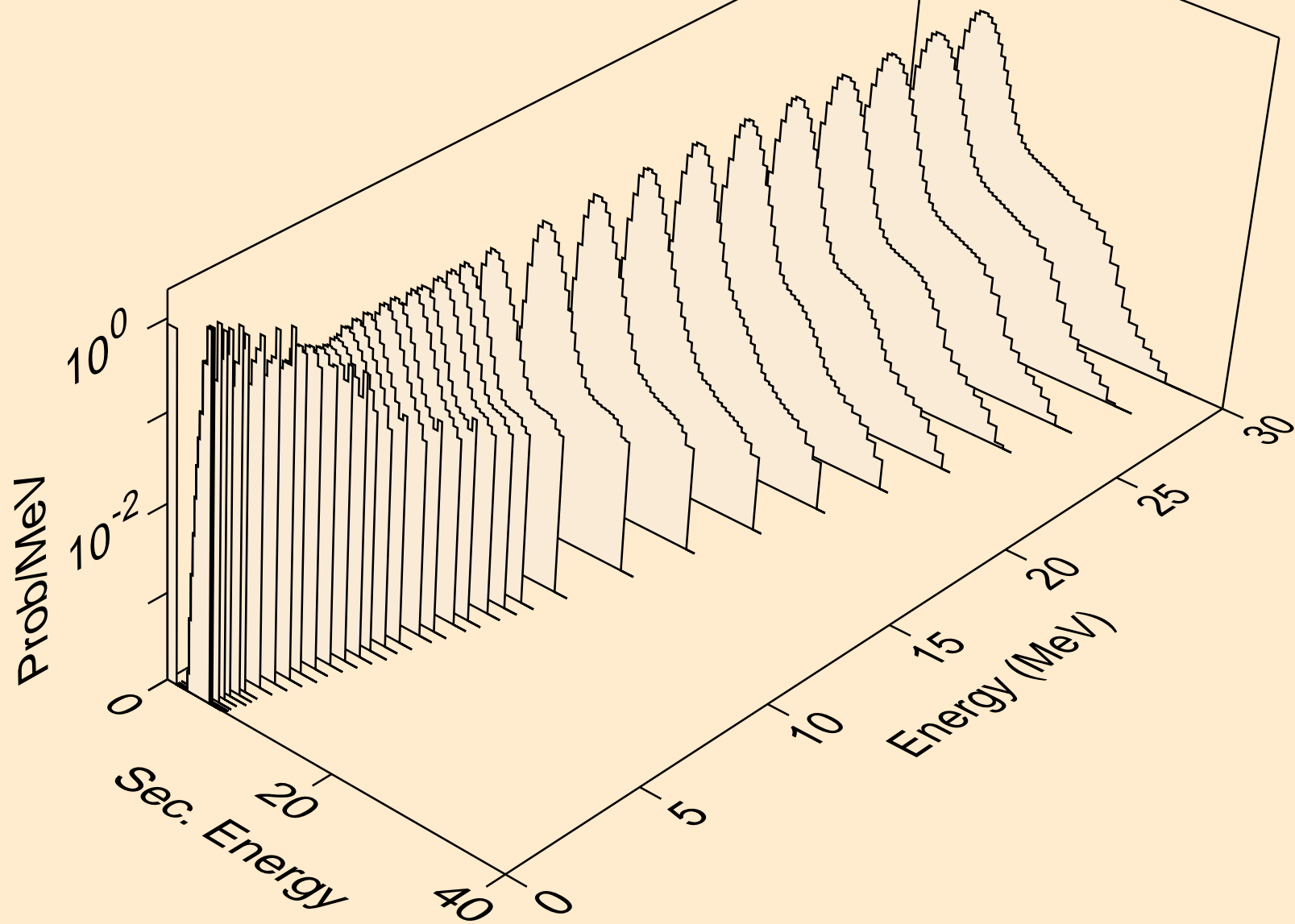

RN201 NEUTRON ACER TENDL-2024 LIBRARY; T=0.K  
protons from (n,pd)

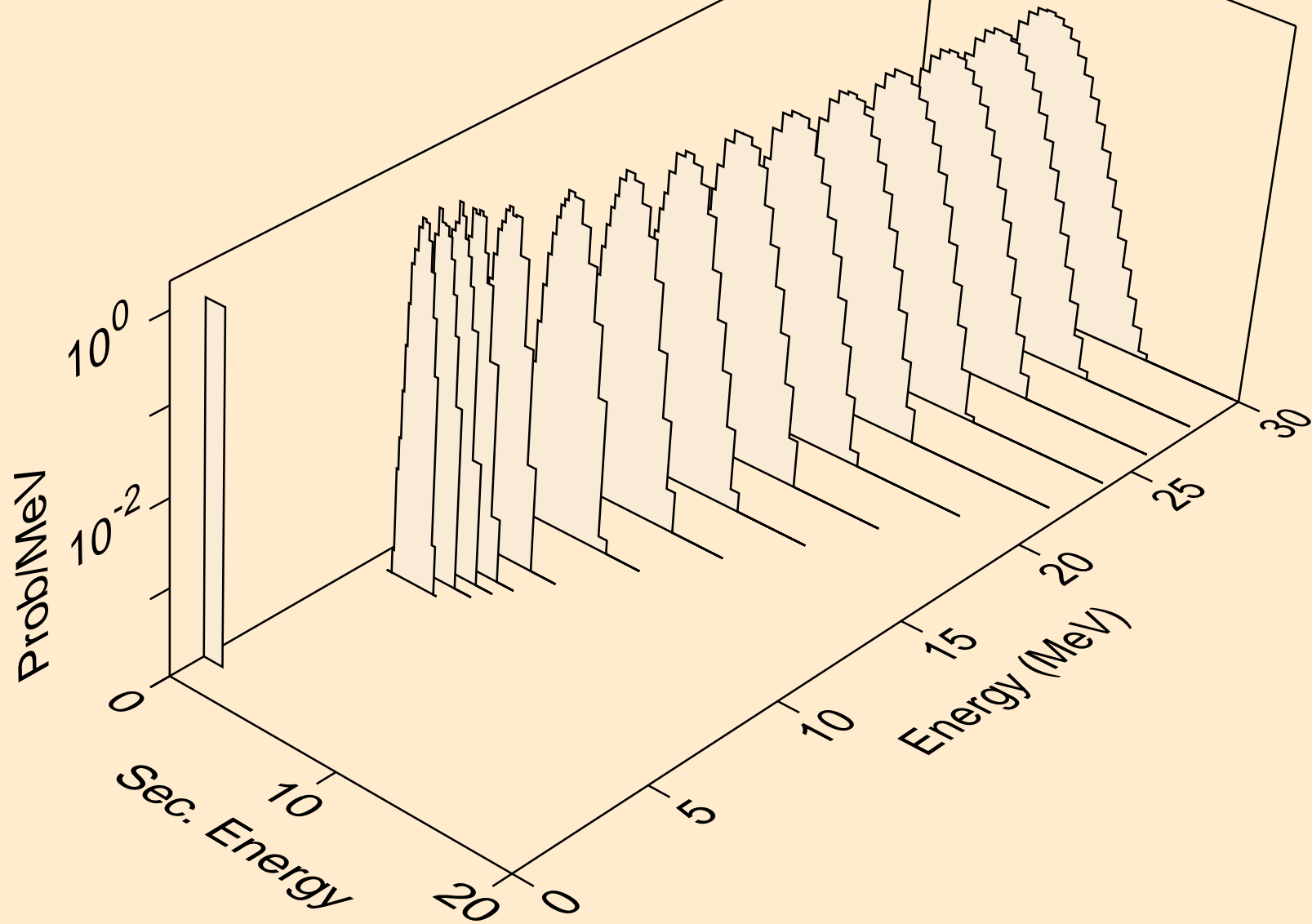

RN201 NEUTRON ACER TENDL-2024 LIBRARY; T=0.K  
protons from (n,pt)

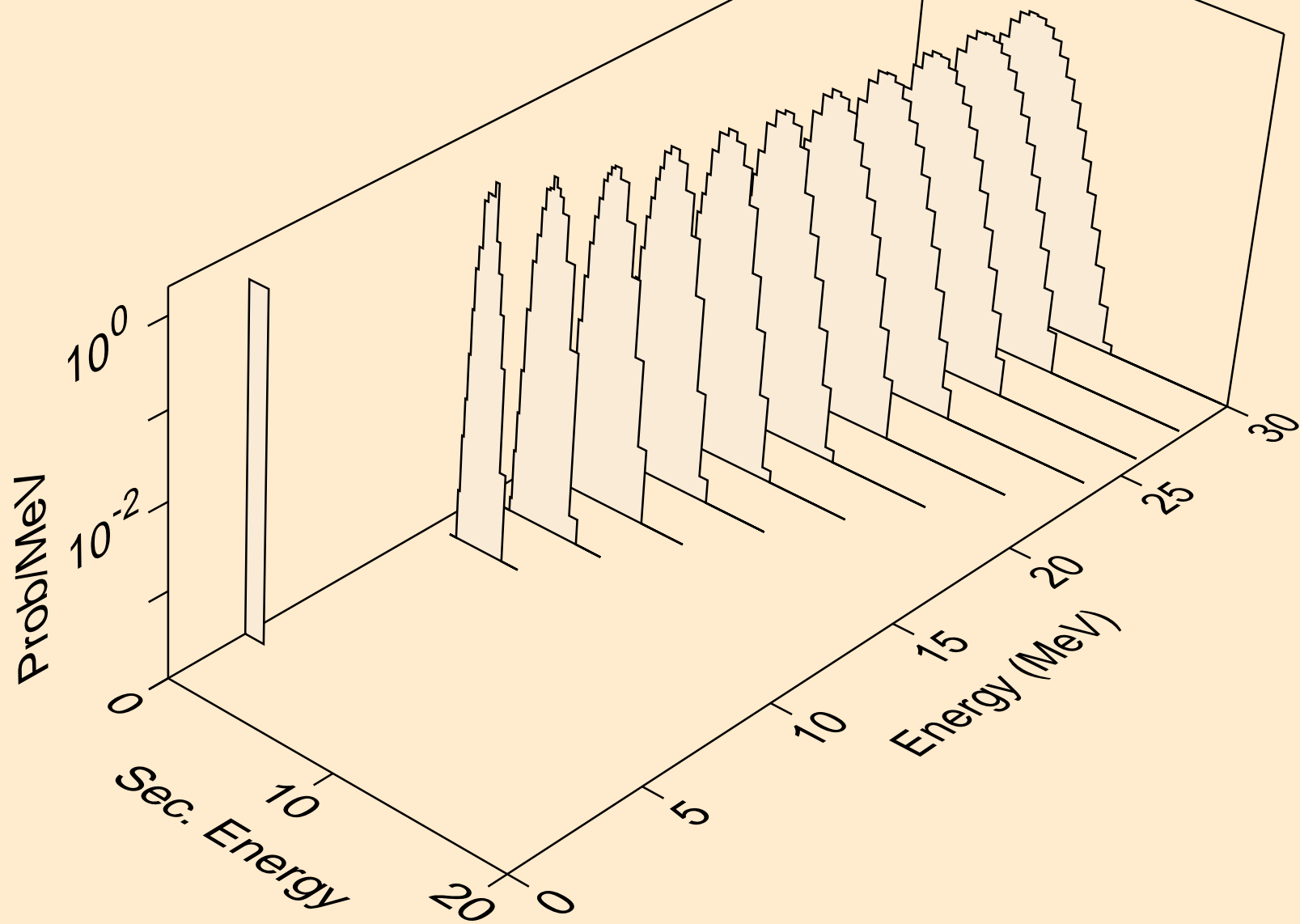

RN201 NEUTRON ACER TENDL-2024 LIBRARY; T=0.K  
deuterons from (n,x)

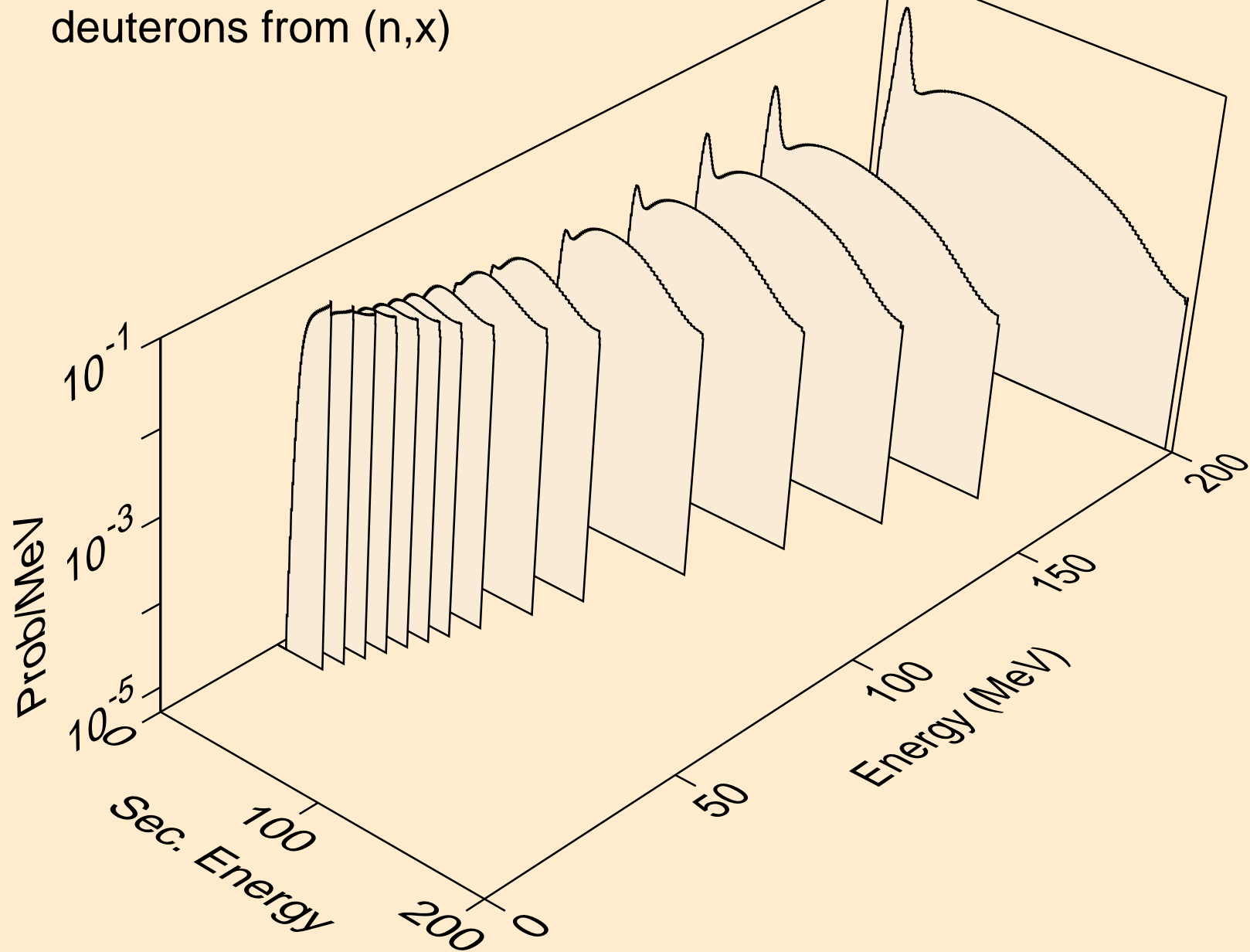

RN201 NEUTRON ACER TENDL-2024 LIBRARY; T=0.K  
deuterons from (n,2nd)

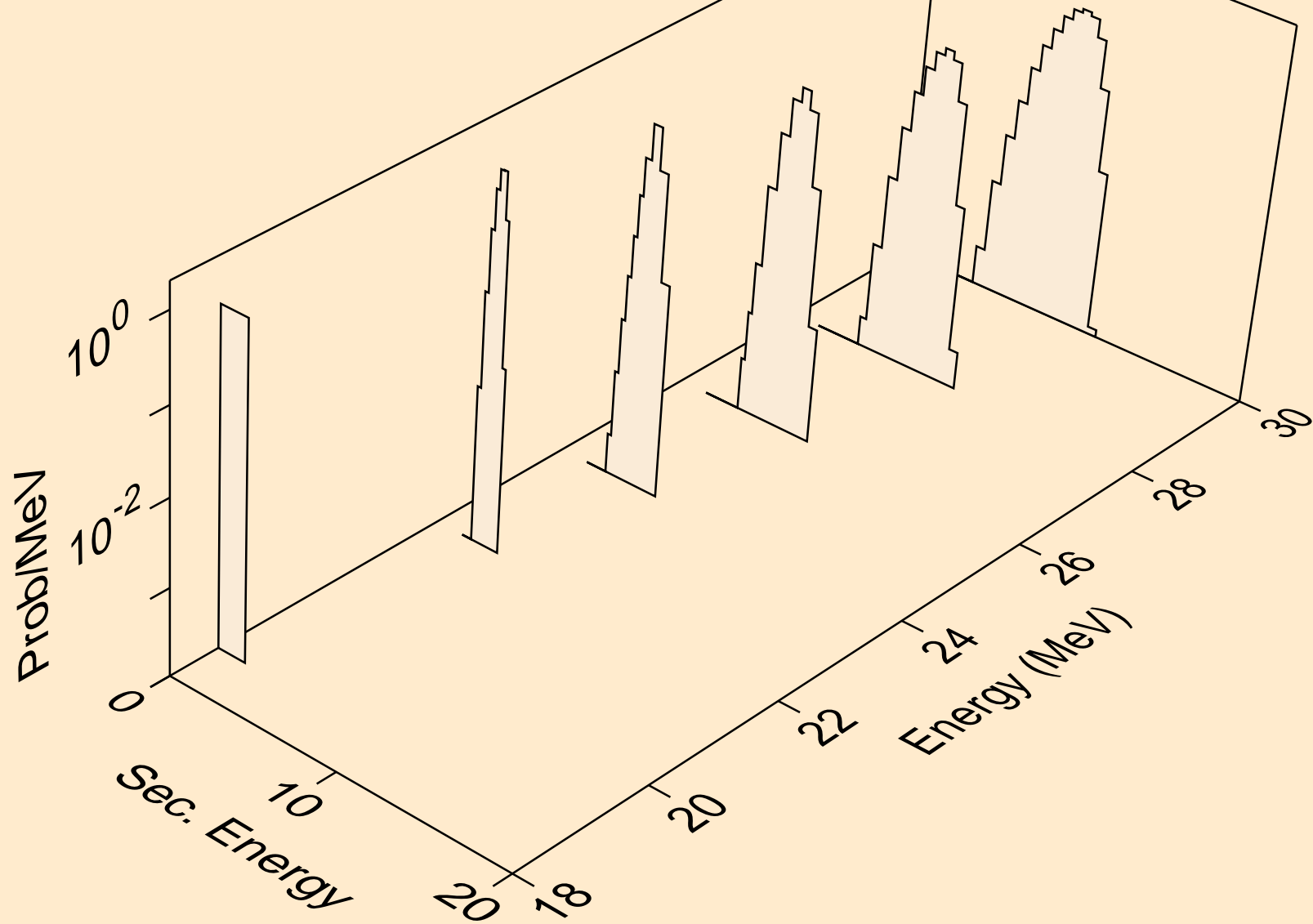

RN201 NEUTRON ACER TENDL-2024 LIBRARY; T=0.K  
deuterons from (n,n\*)d

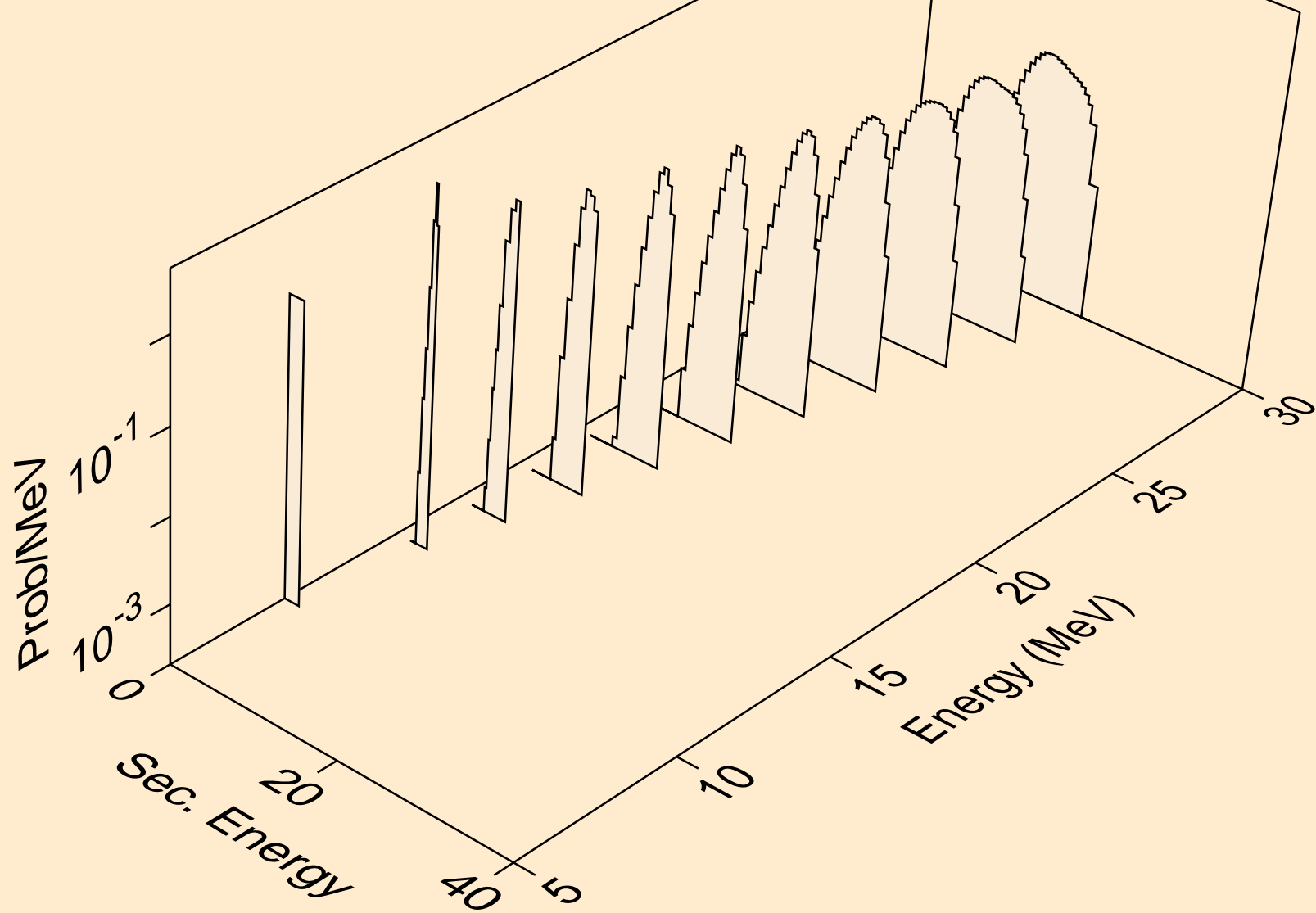

RN201 NEUTRON ACER TENDL-2024 LIBRARY; T=0.K  
deuterons from (n,d)

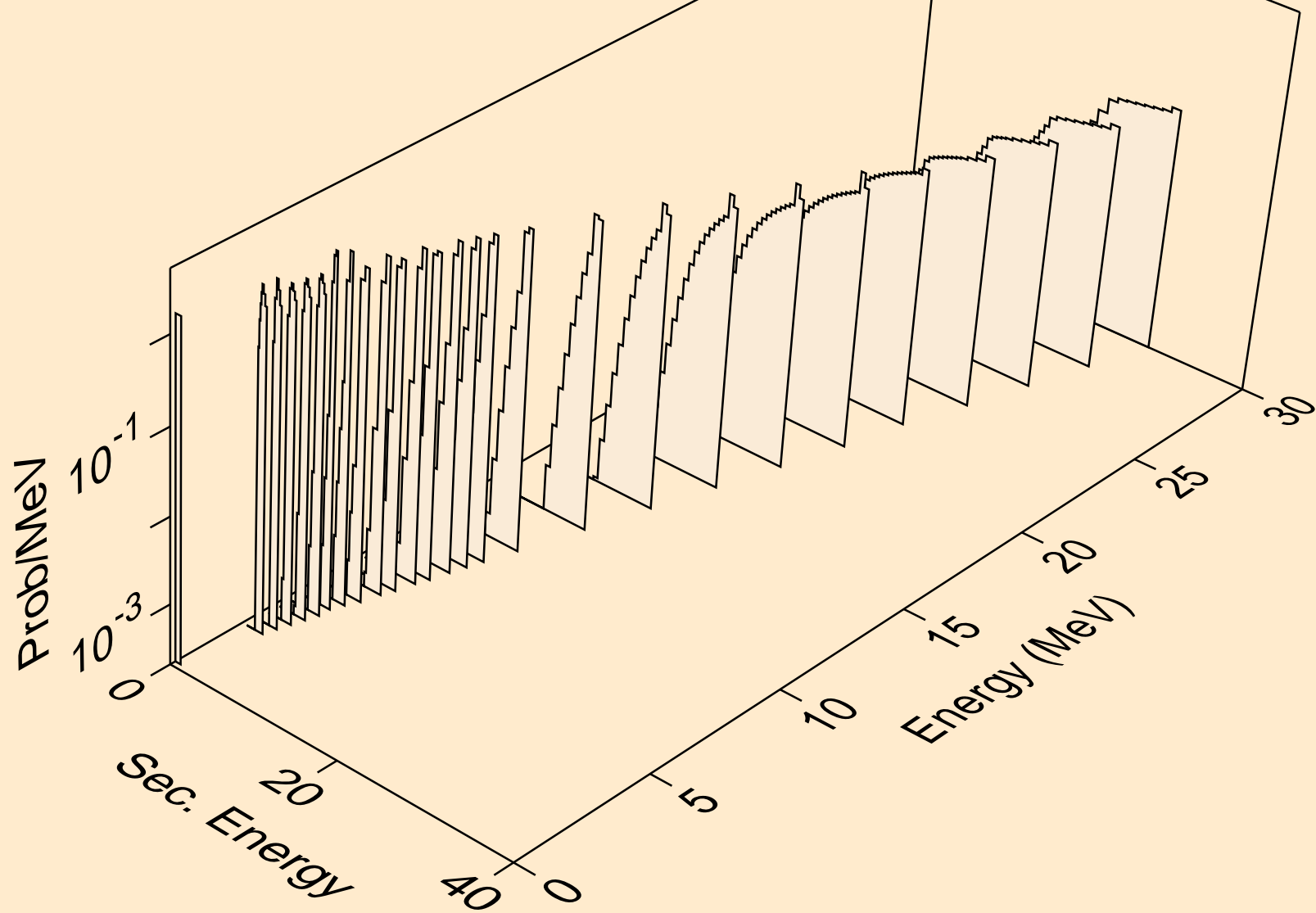

RN201 NEUTRON ACER TENDL-2024 LIBRARY; T=0.K  
deuterons from (n,pd)

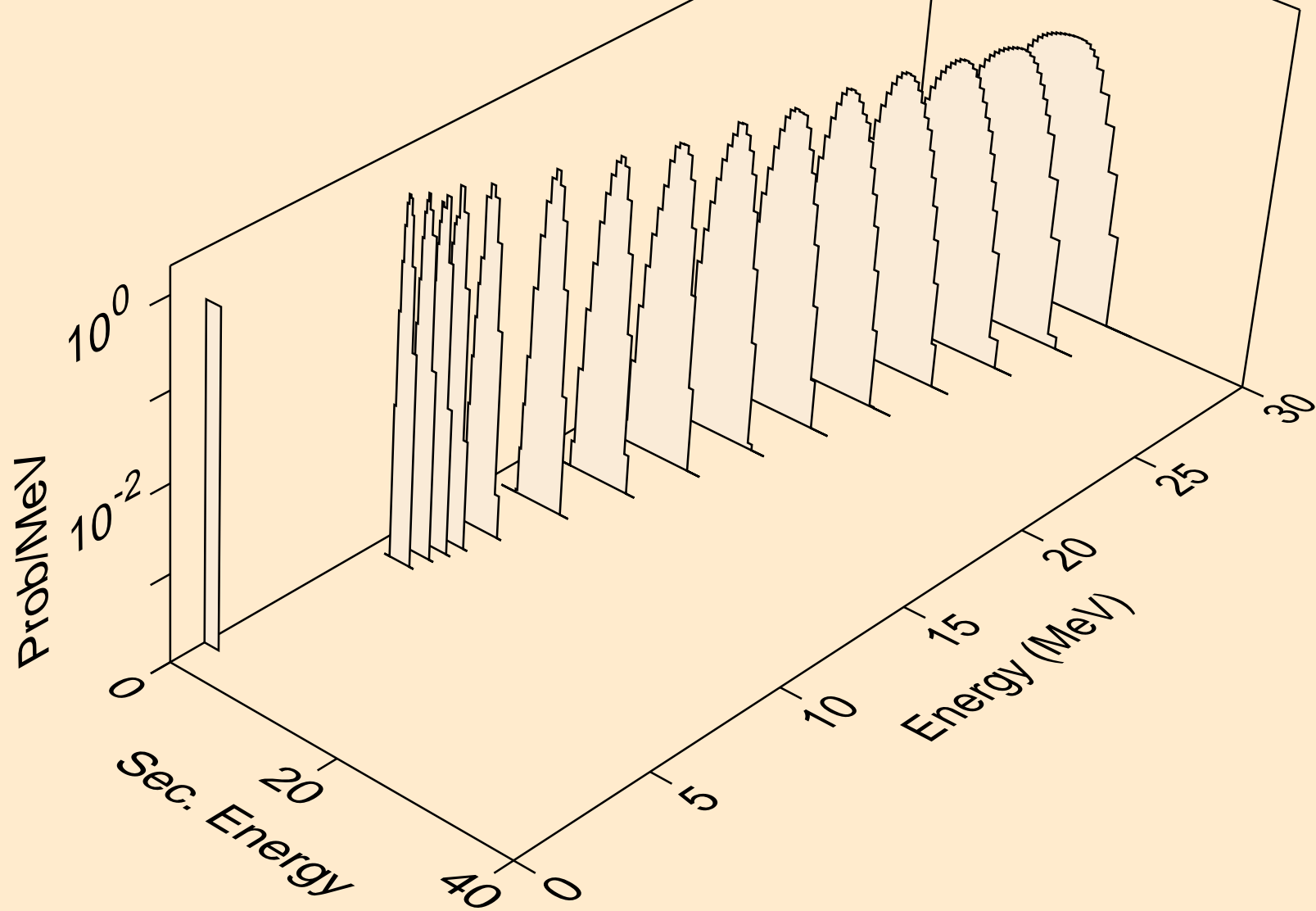

RN201 NEUTRON ACER TENDL-2024 LIBRARY; T=0.K  
deuterons from (n,da)

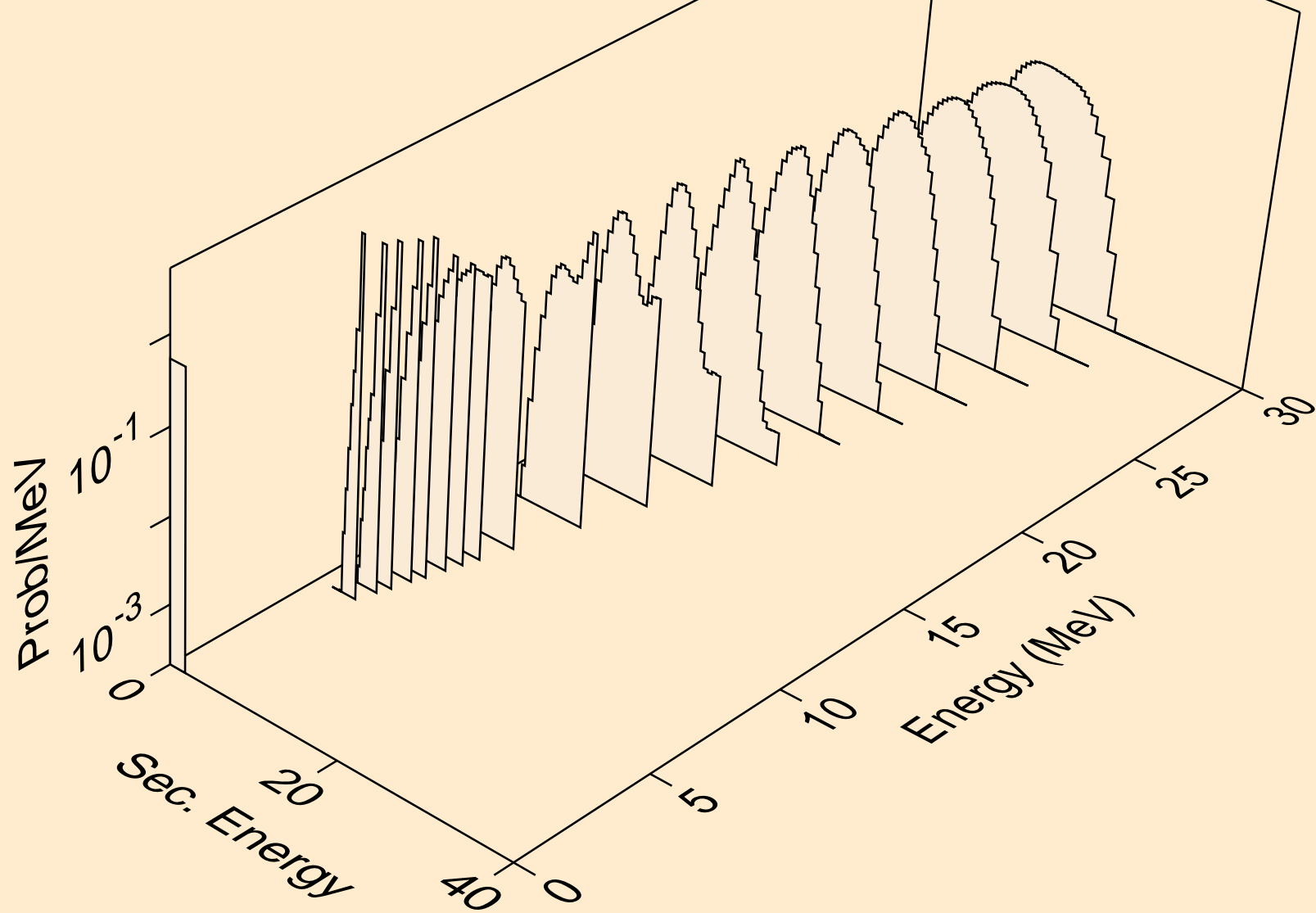

RN201 NEUTRON ACER TENDL-2024 LIBRARY; T=0.K  
tritons from (n,x)

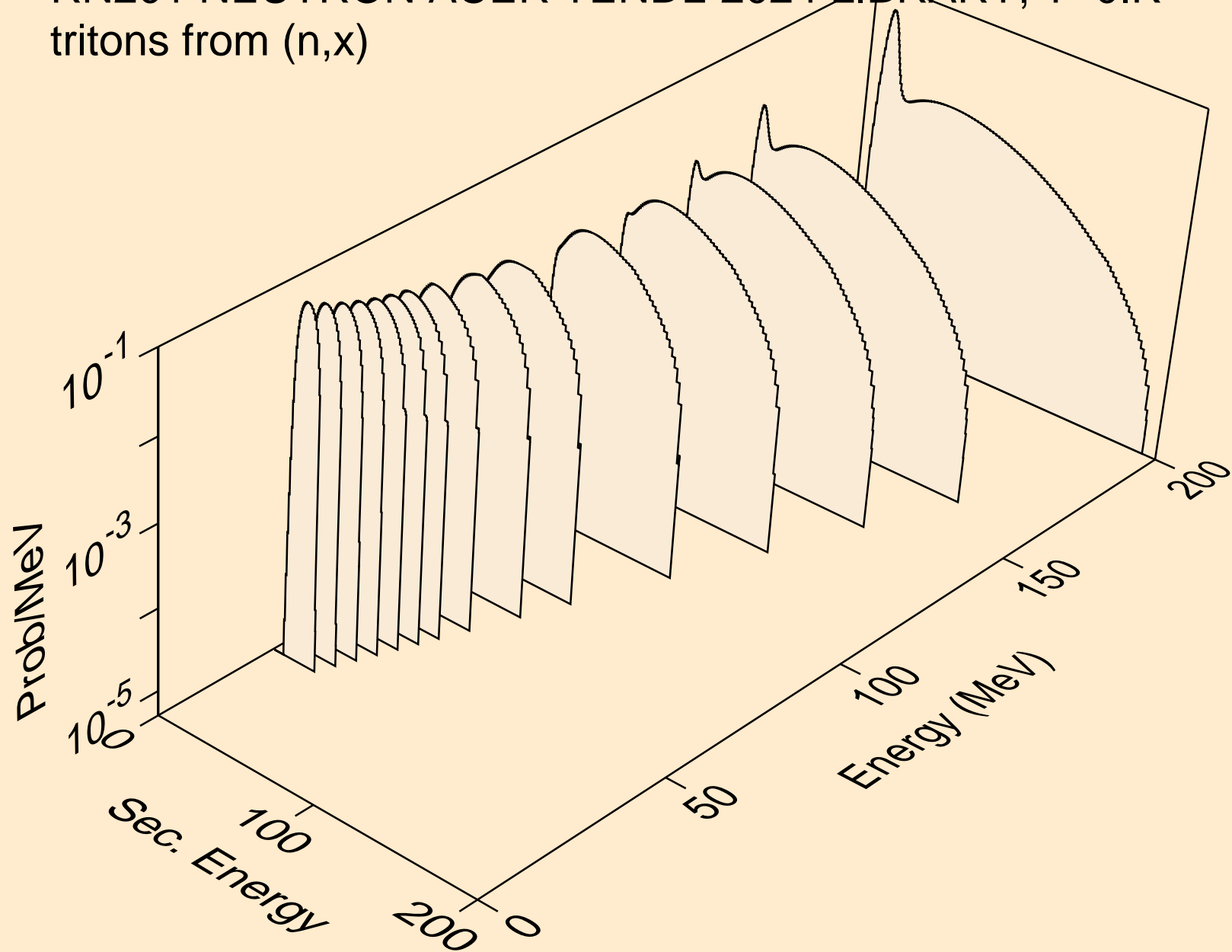

RN201 NEUTRON ACER TENDL-2024 LIBRARY; T=0.K  
tritons from (n,n\*)t

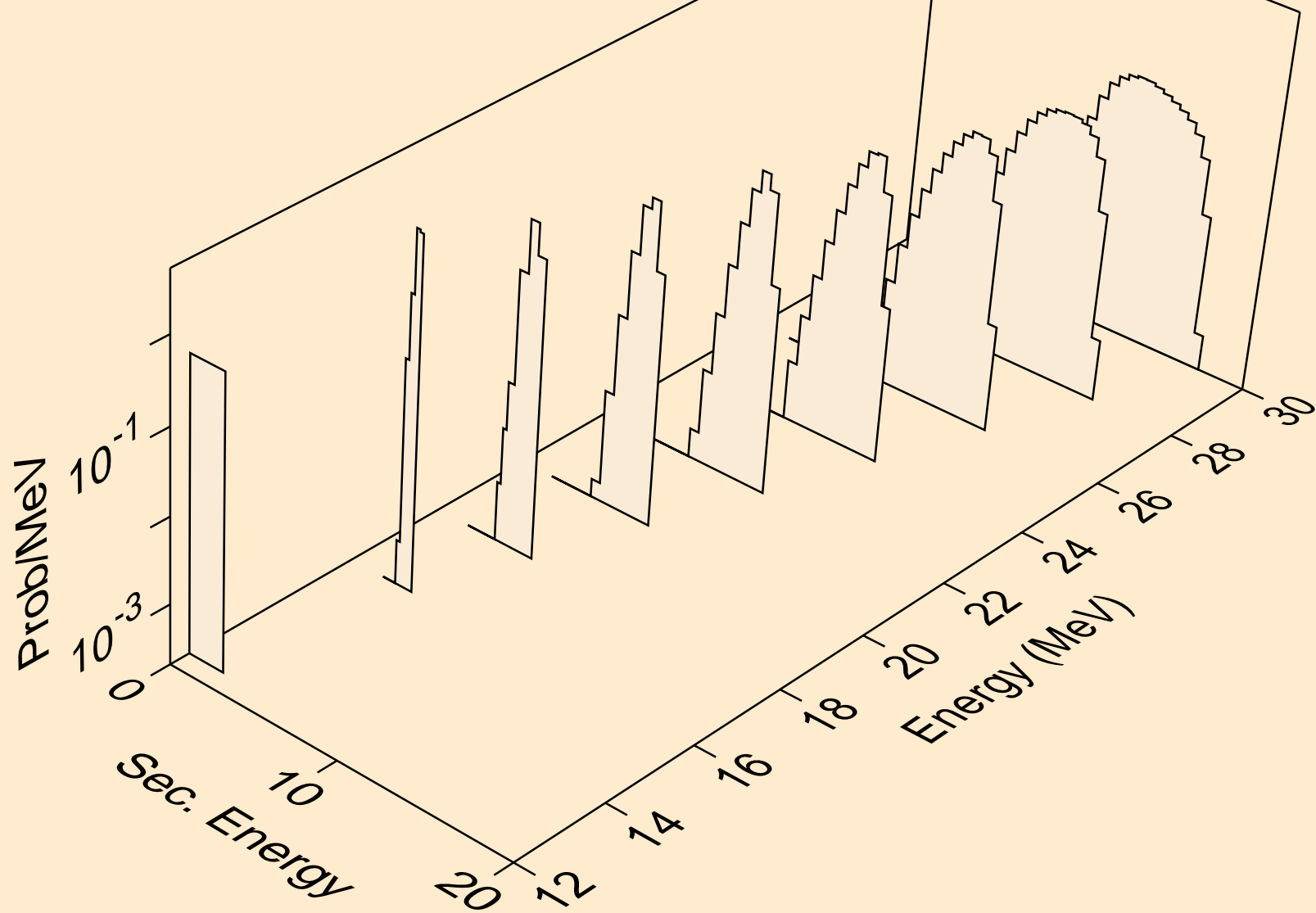

RN201 NEUTRON ACER TENDL-2024 LIBRARY; T=0.K  
tritons from (n,t)

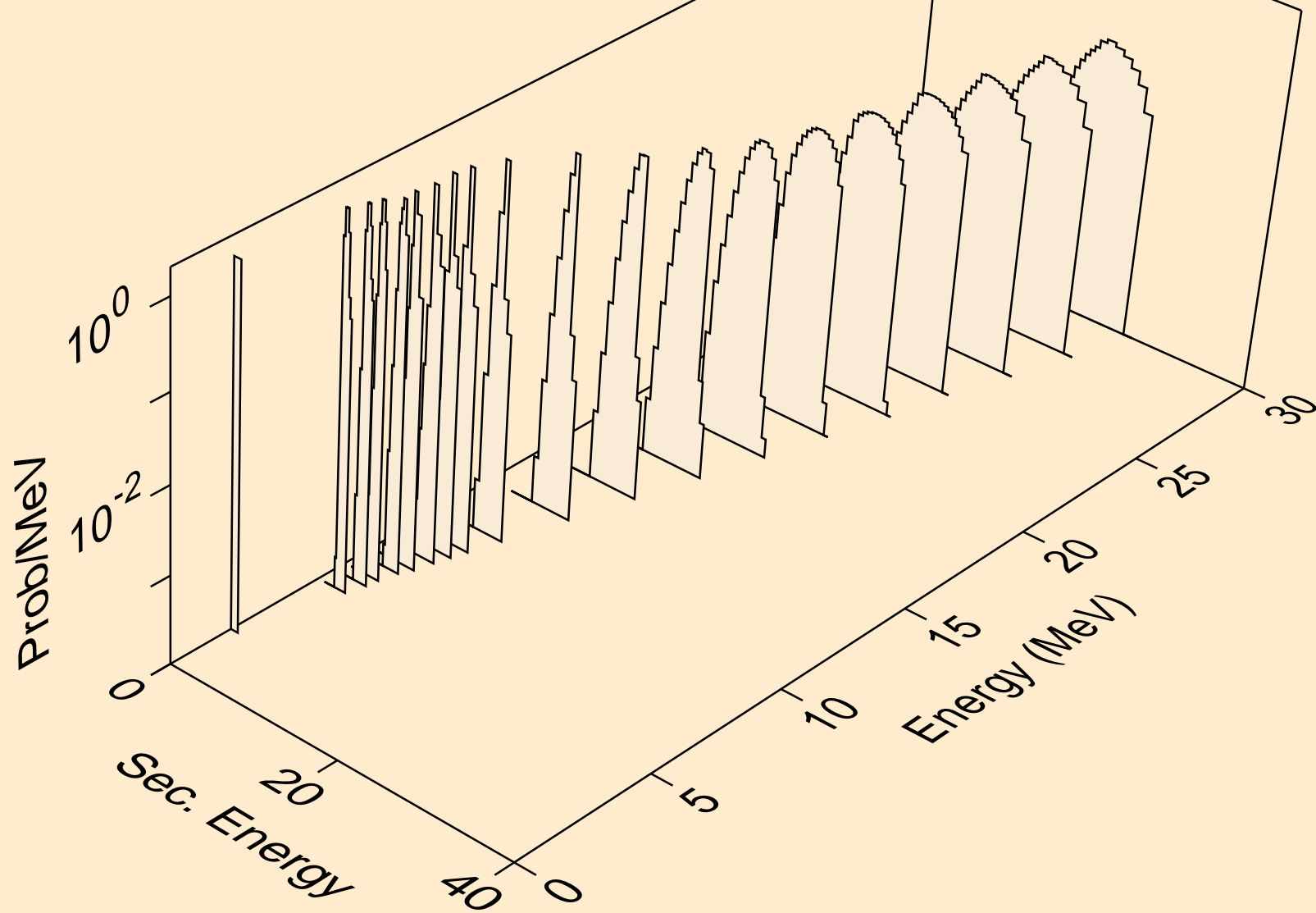

RN201 NEUTRON ACER TENDL-2024 LIBRARY; T=0.K  
tritons from (n,pt)

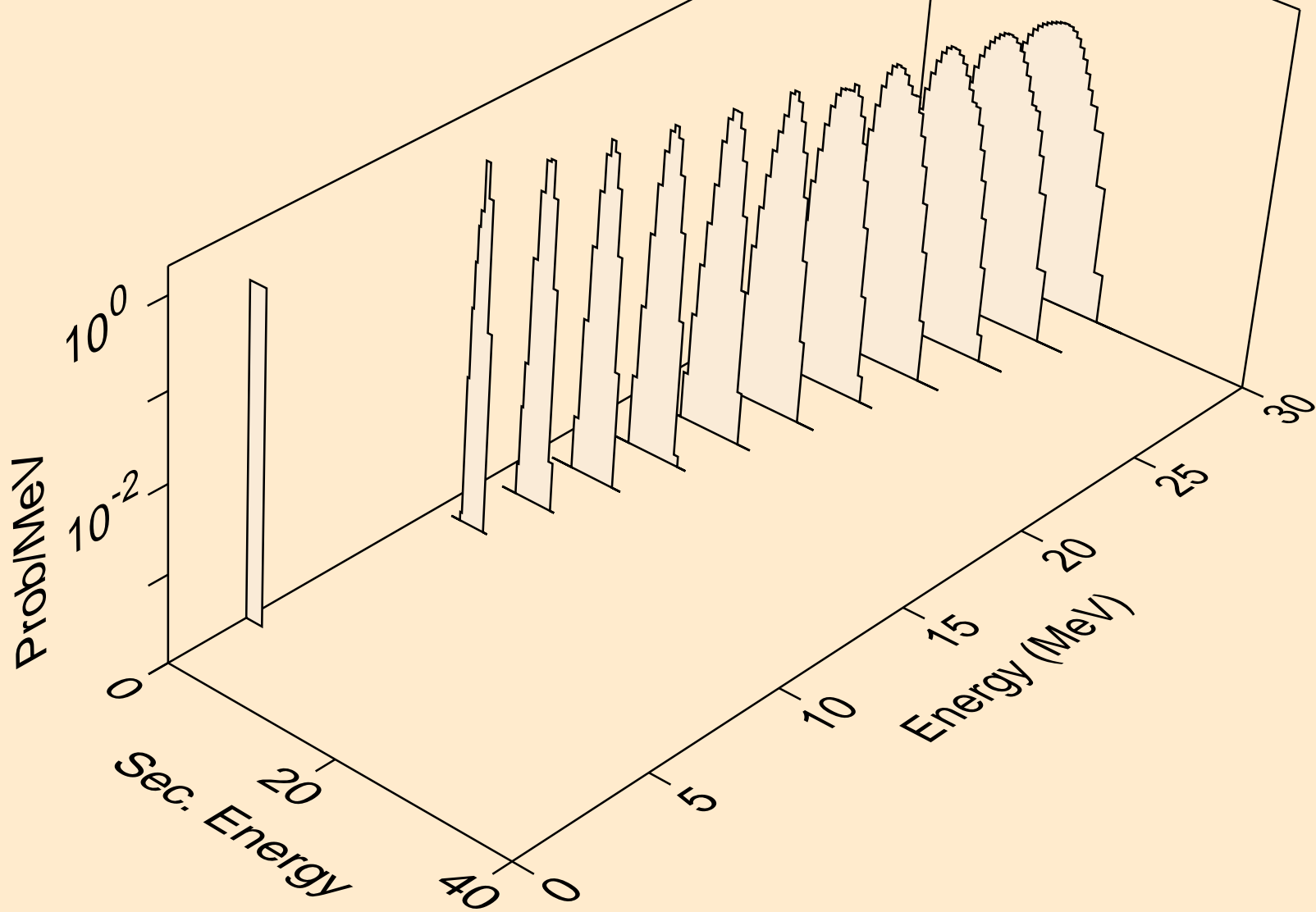

RN201 NEUTRON ACER TENDL-2024 LIBRARY; T=0.K  
he3s from (n,x)

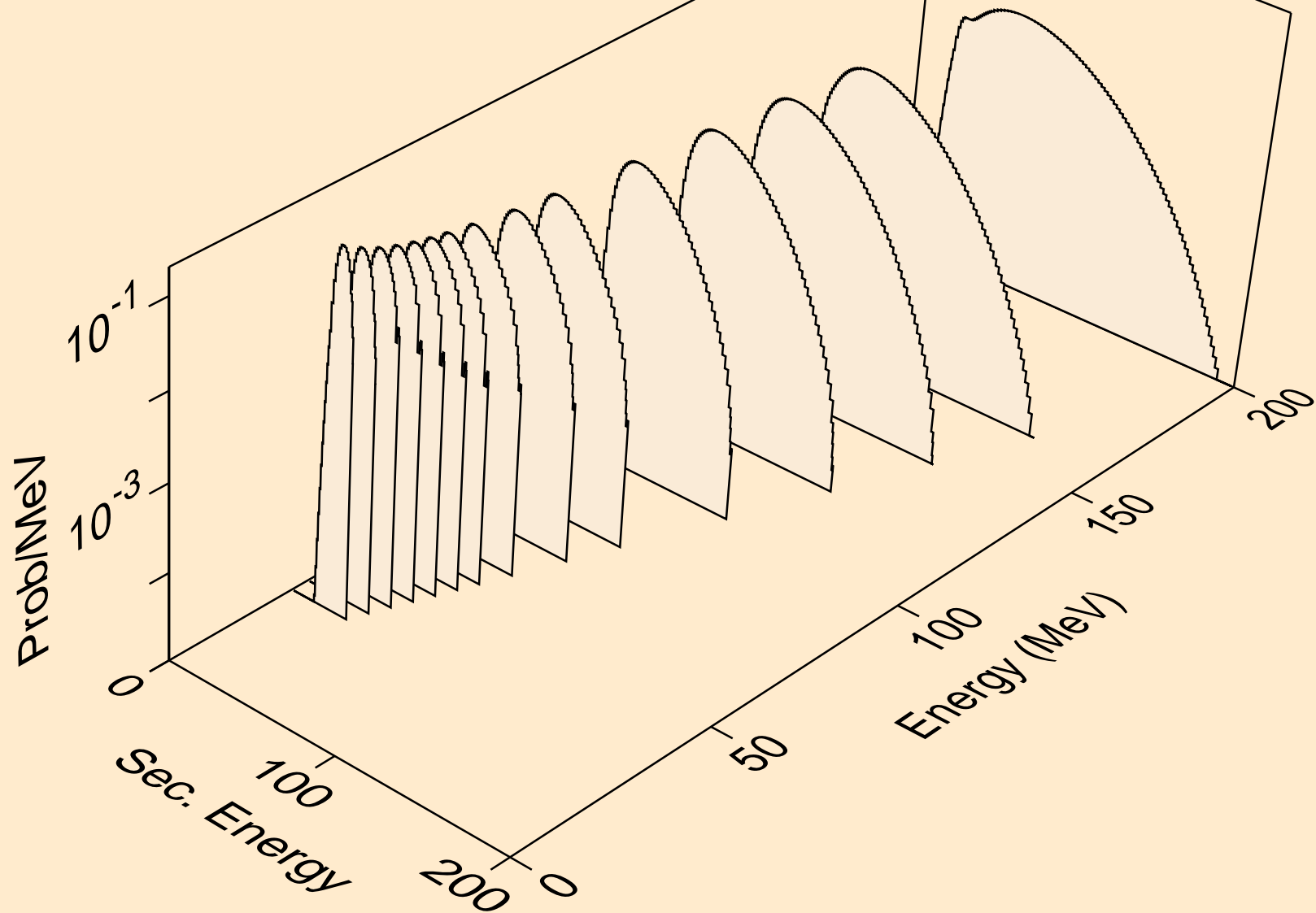

RN201 NEUTRON ACER TENDL-2024 LIBRARY; T=0.K  
he3s from (n,n\*)he3

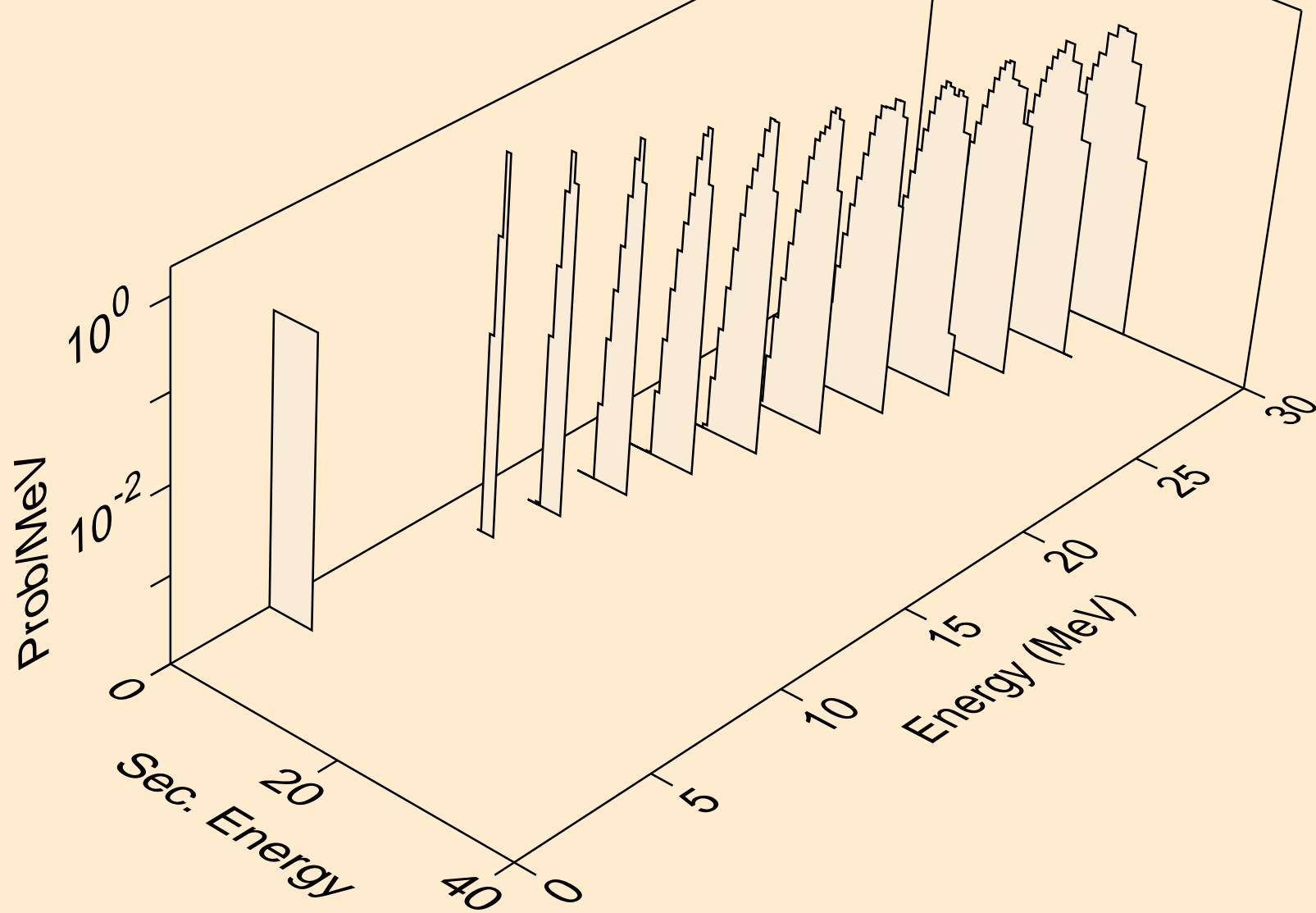

RN201 NEUTRON ACER TENDL-2024 LIBRARY; T=0.K  
he3s from (n,he3)

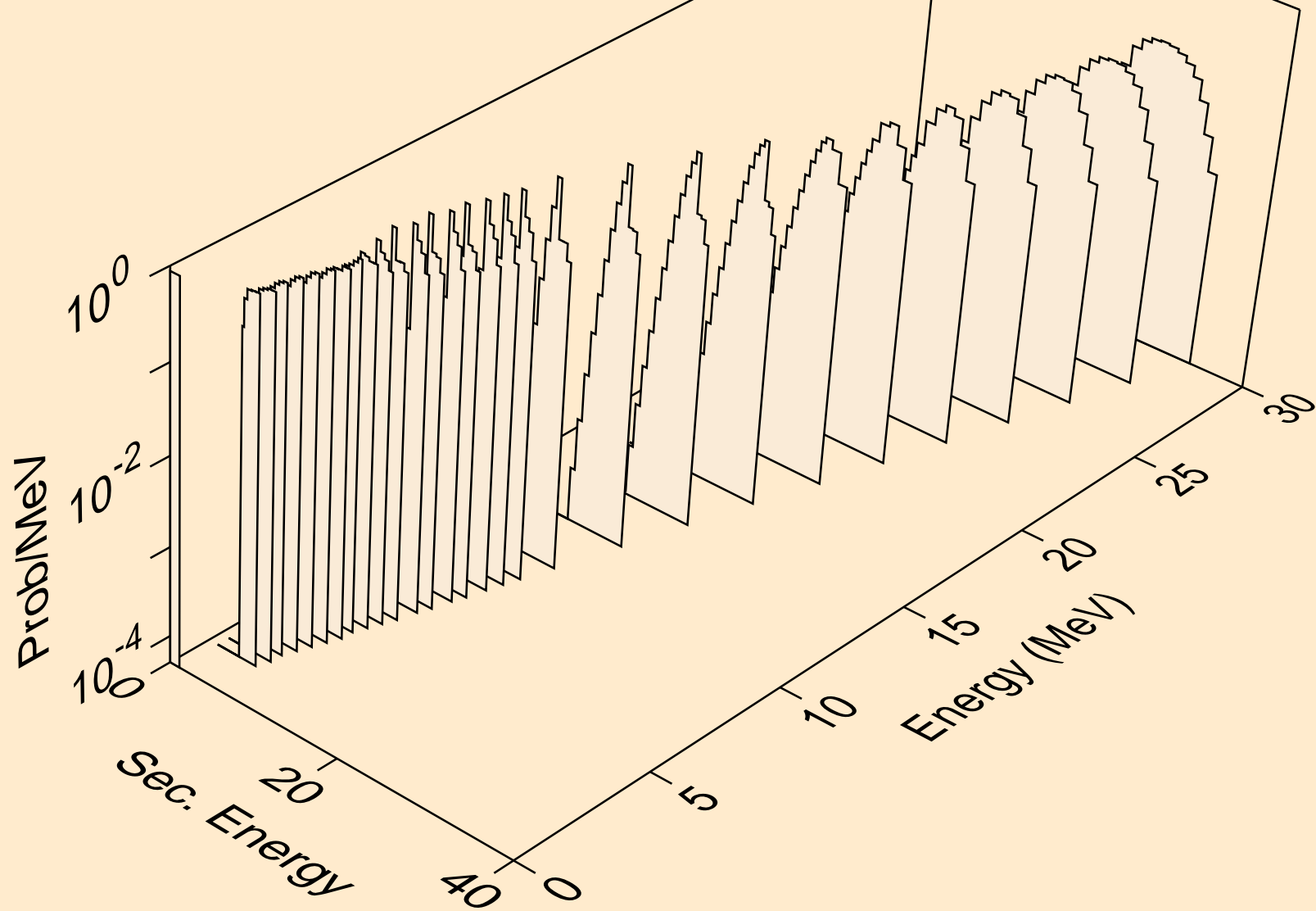

RN201 NEUTRON ACER TENDL-2024 LIBRARY; T=0.K  
alphas from (n,x)

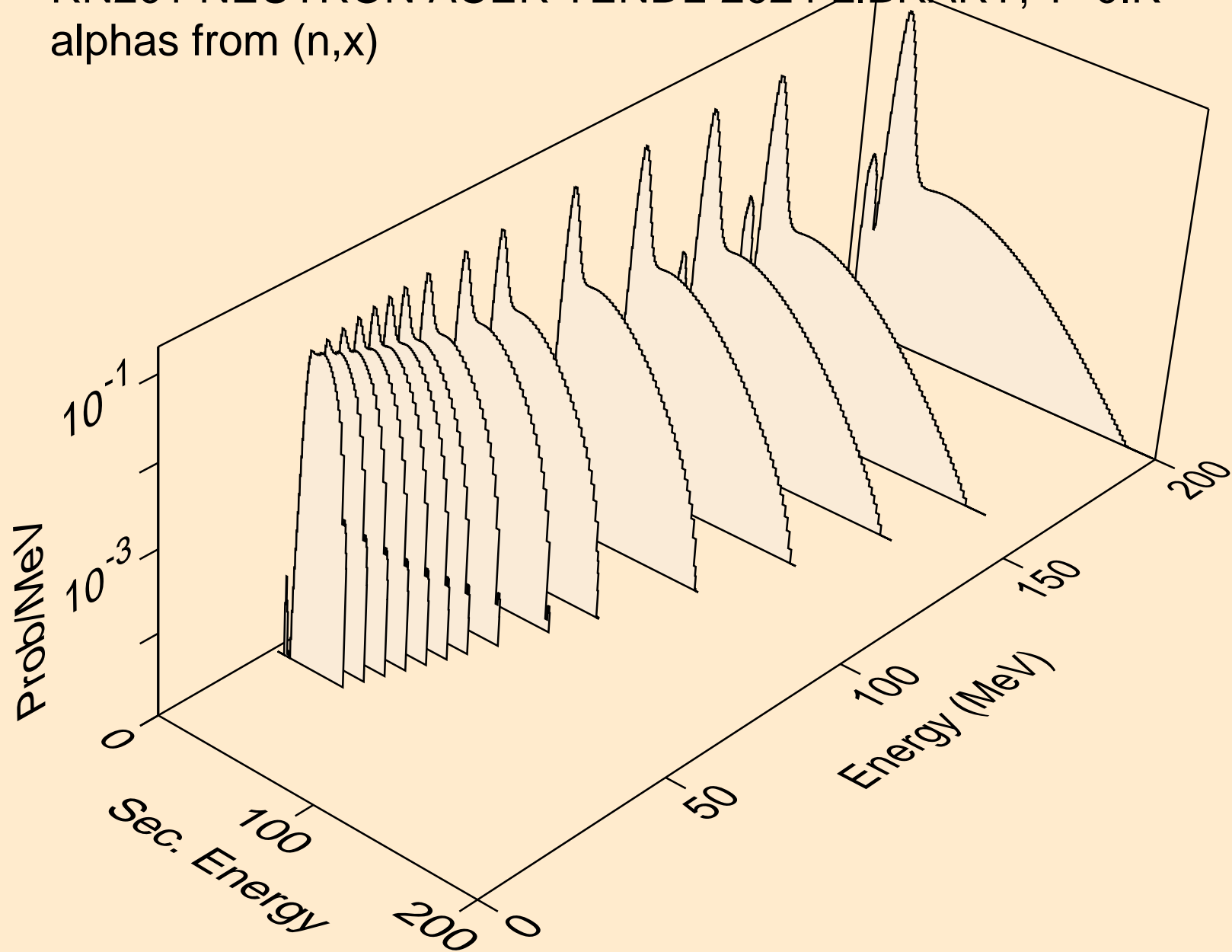

RN201 NEUTRON ACER TENDL-2024 LIBRARY; T=0.K  
alphas from (n,n\*)a

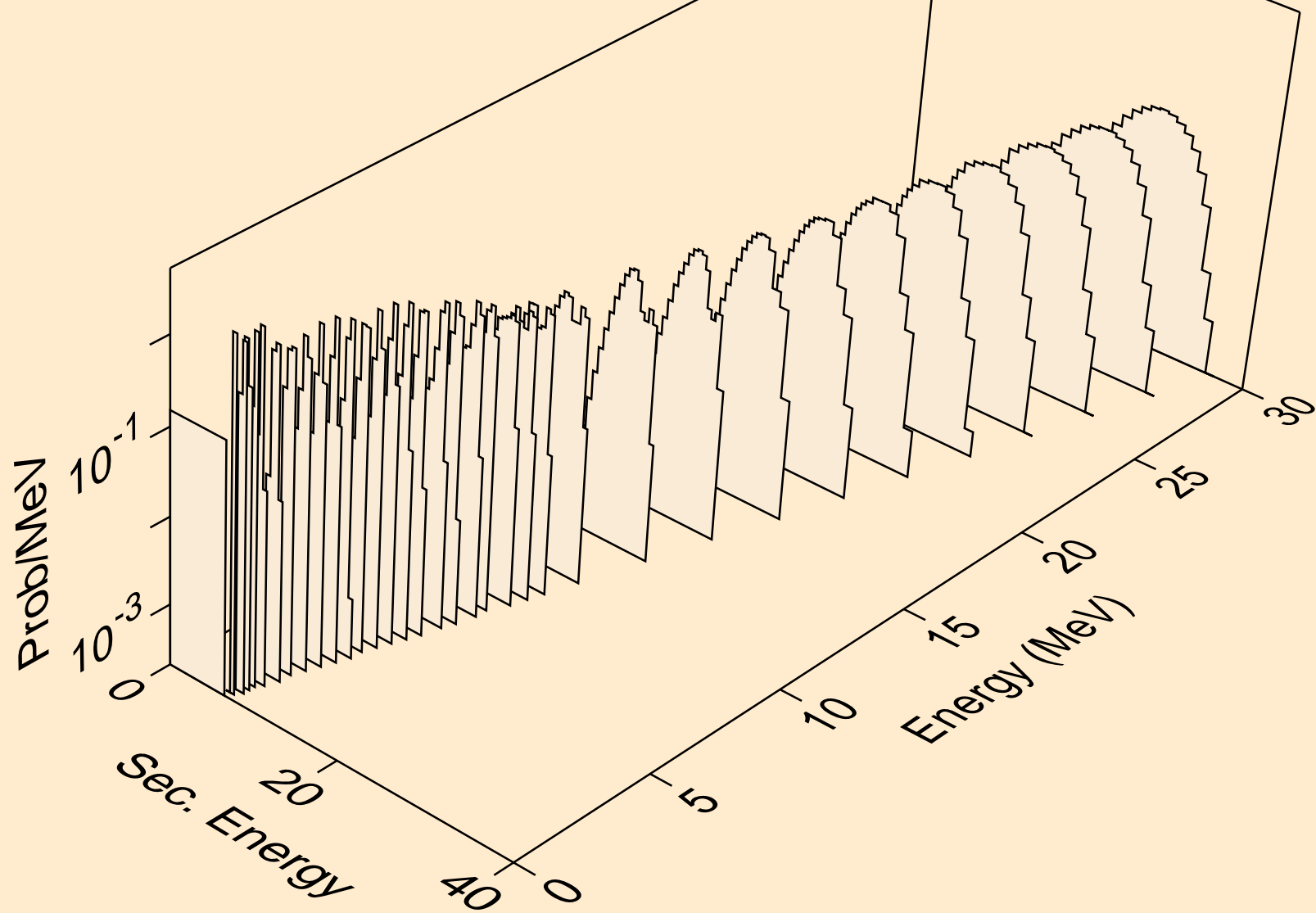

RN201 NEUTRON ACER TENDL-2024 LIBRARY; T=0.K  
alphas from (n,2n)a

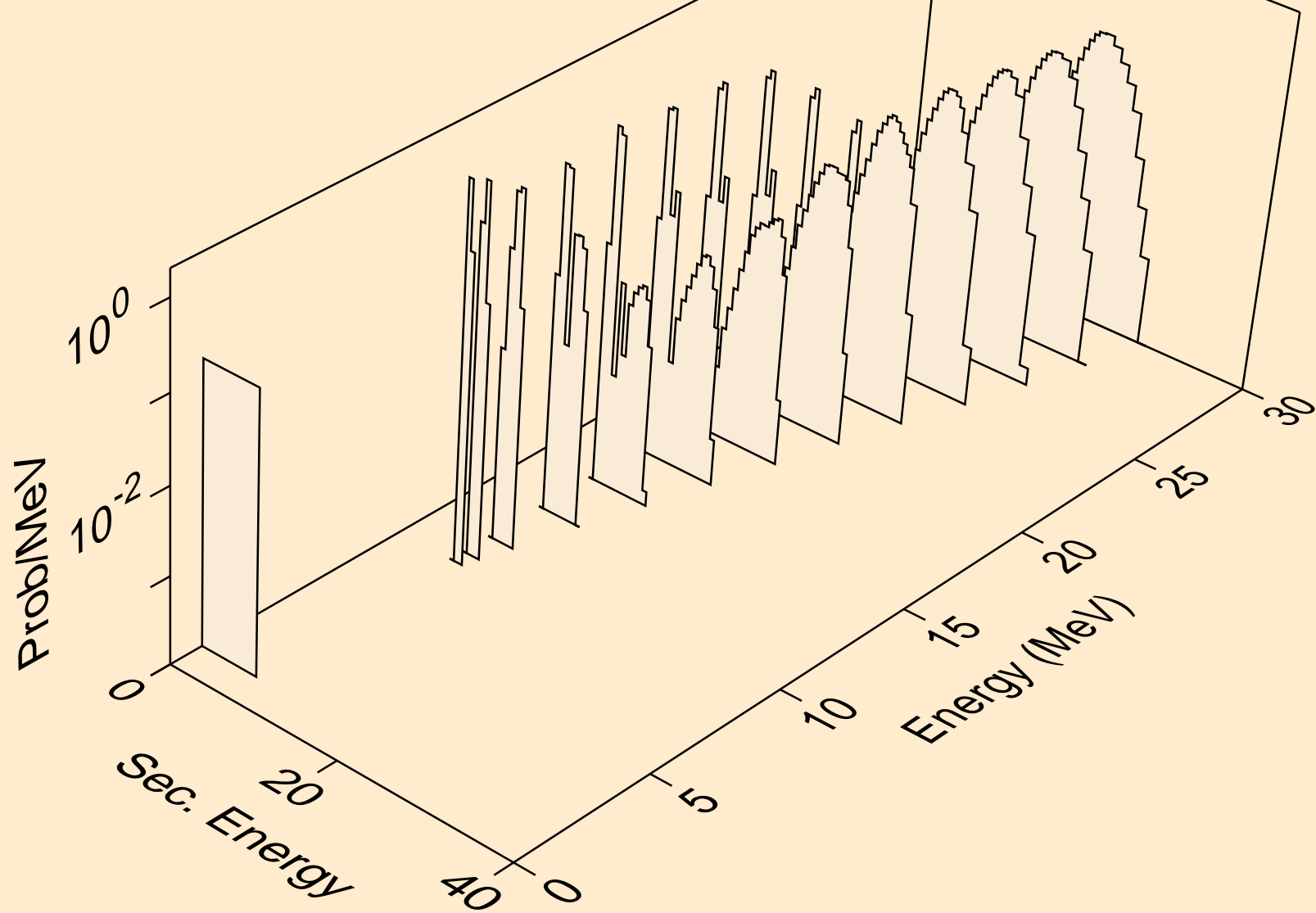

RN201 NEUTRON ACER TENDL-2024 LIBRARY; T=0.K  
alphas from (n,3n)a

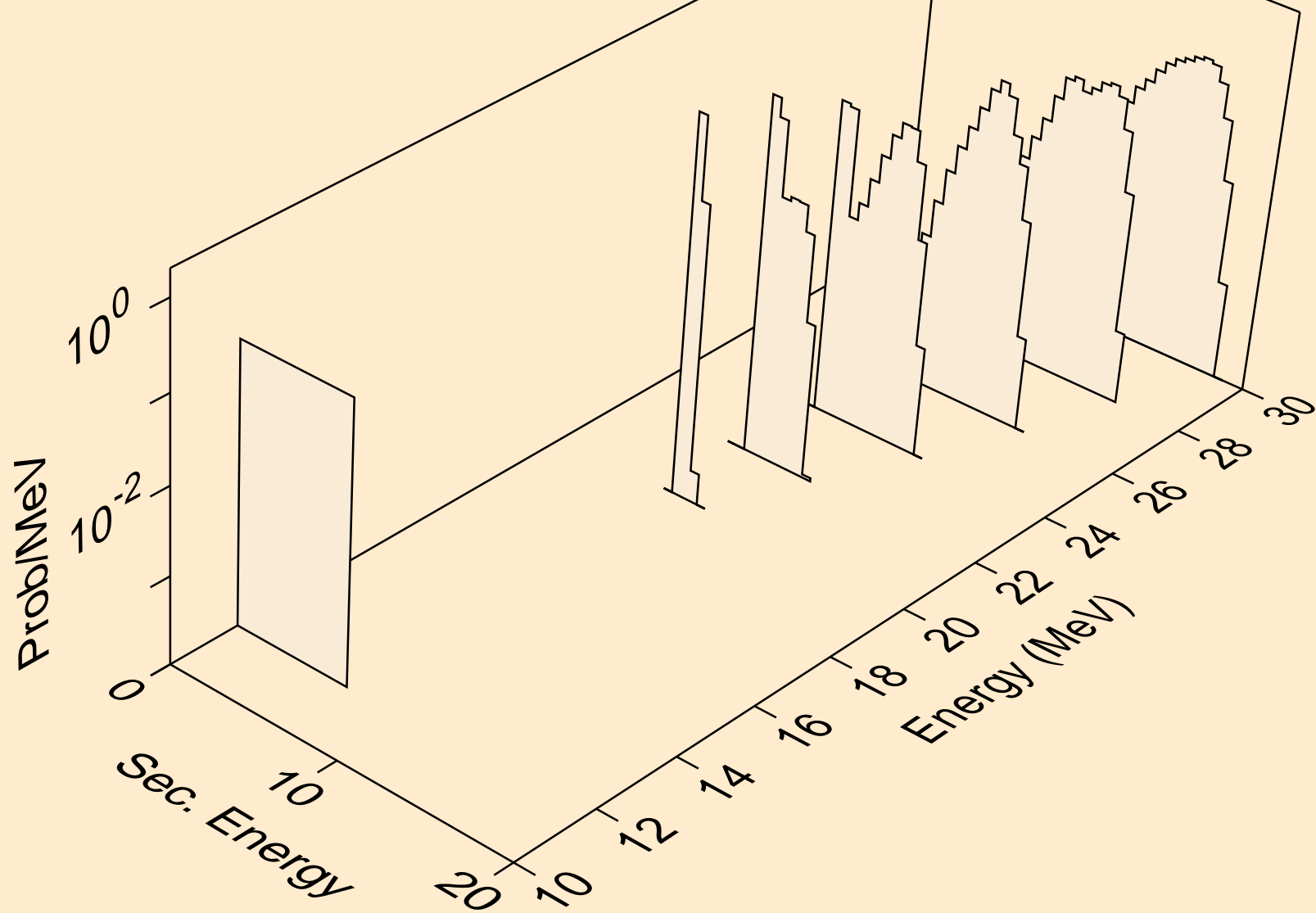

RN201 NEUTRON ACER TENDL-2024 LIBRARY; T=0.K  
alphas from (n,n\*)2a

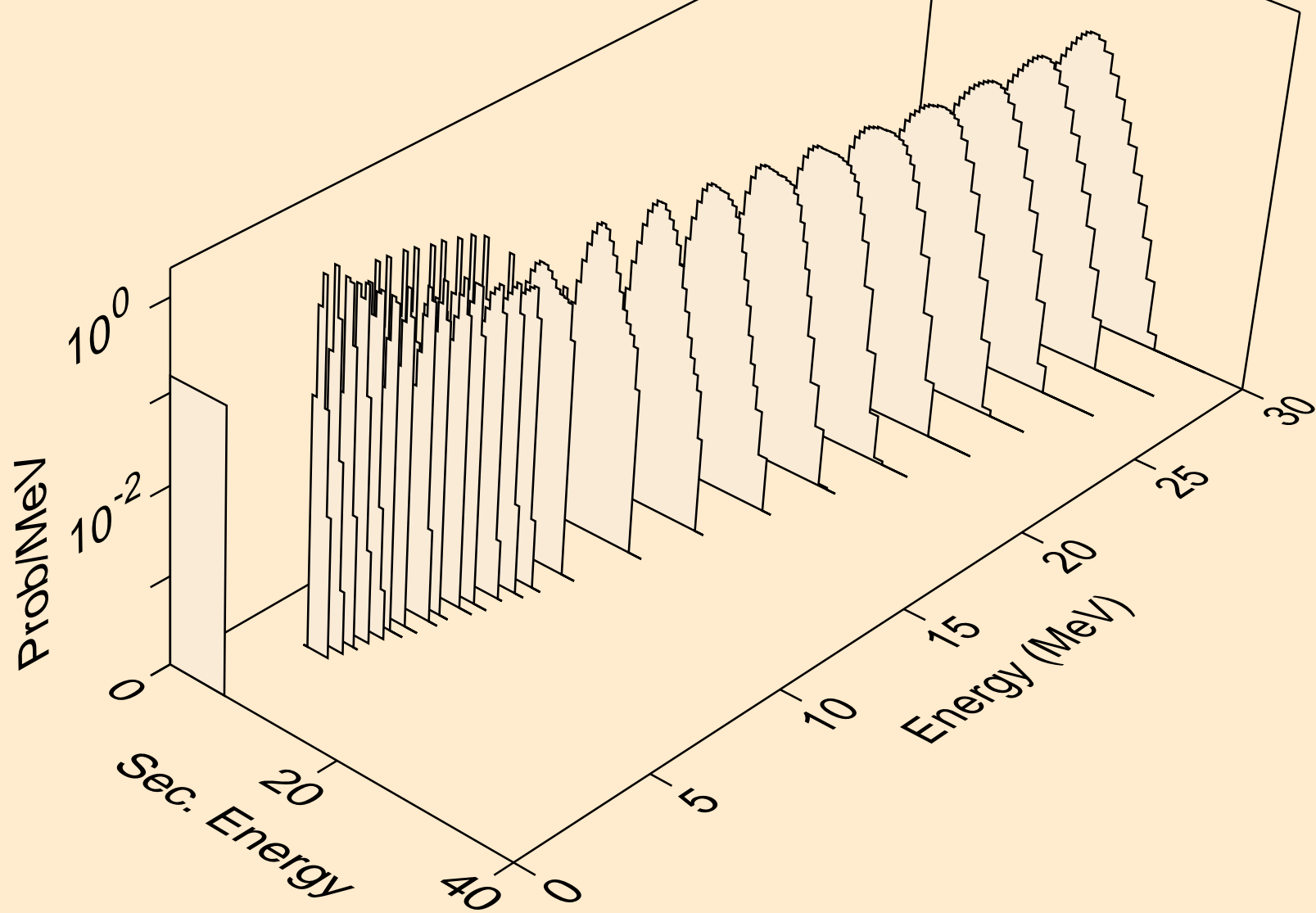

RN201 NEUTRON ACER TENDL-2024 LIBRARY; T=0.K  
alphas from (n,2n)2a

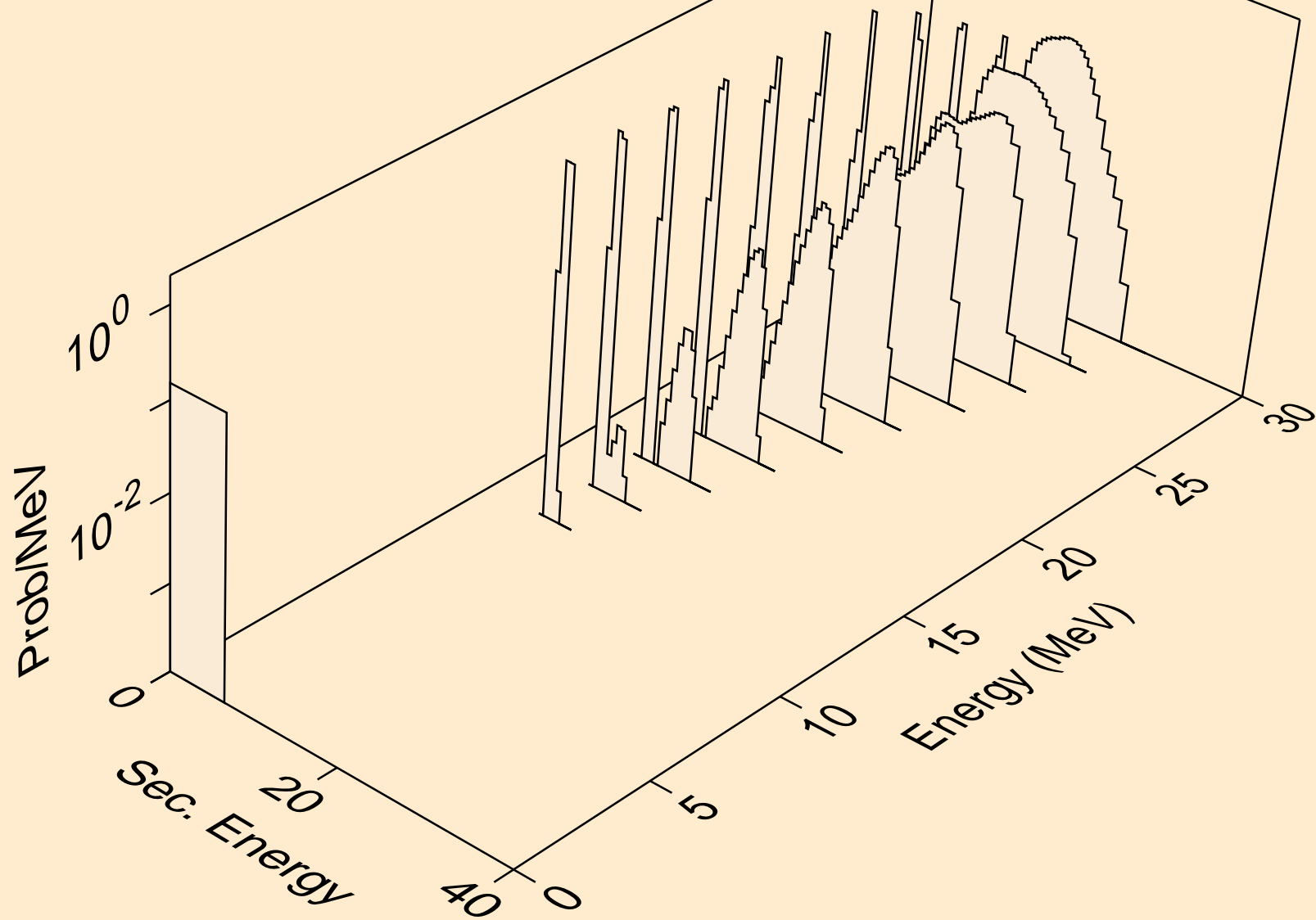

RN201 NEUTRON ACER TENDL-2024 LIBRARY; T=0.K  
alphas from (n,npa)

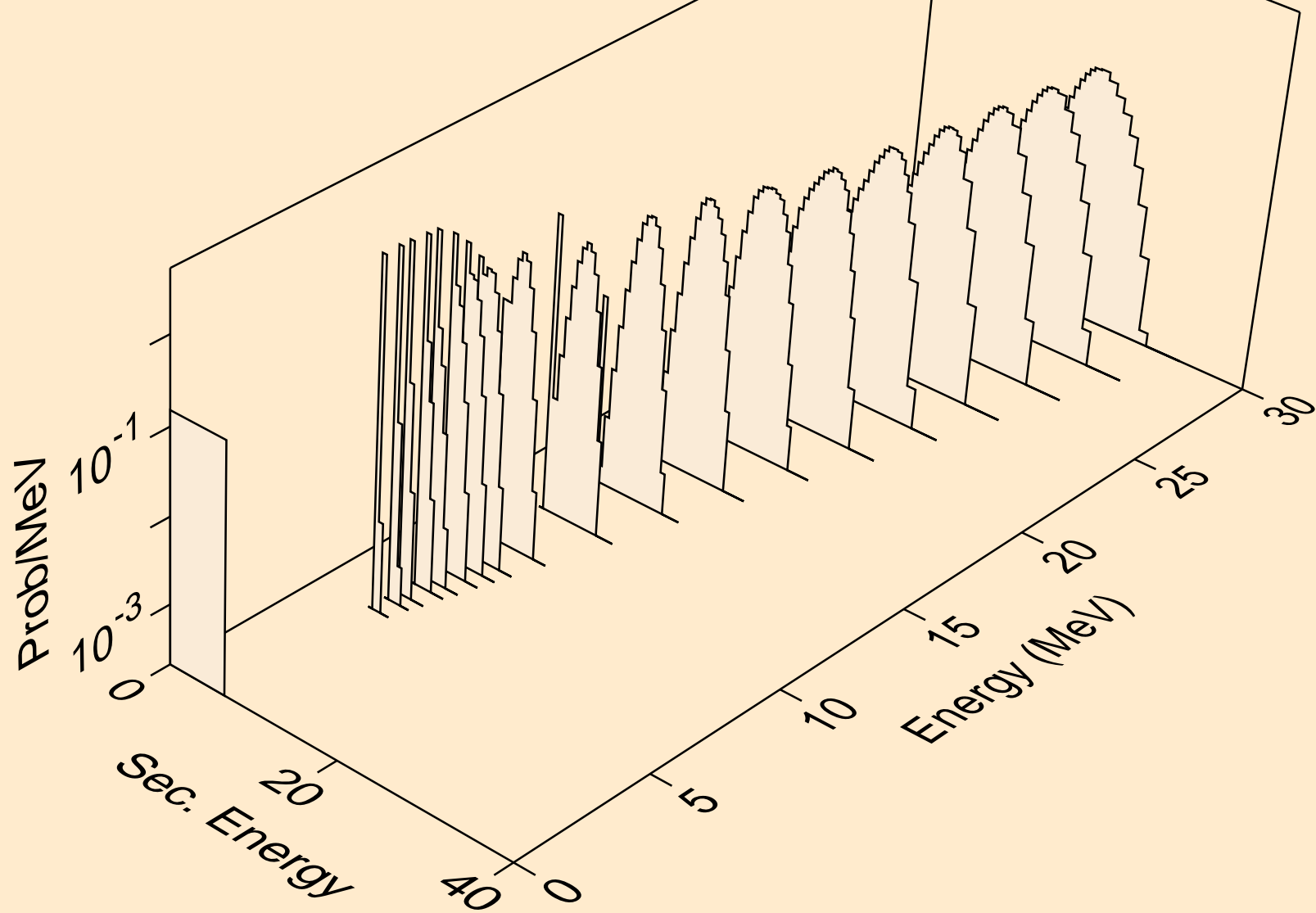

RN201 NEUTRON ACER TENDL-2024 LIBRARY; T=0.K  
alphas from (n,a)

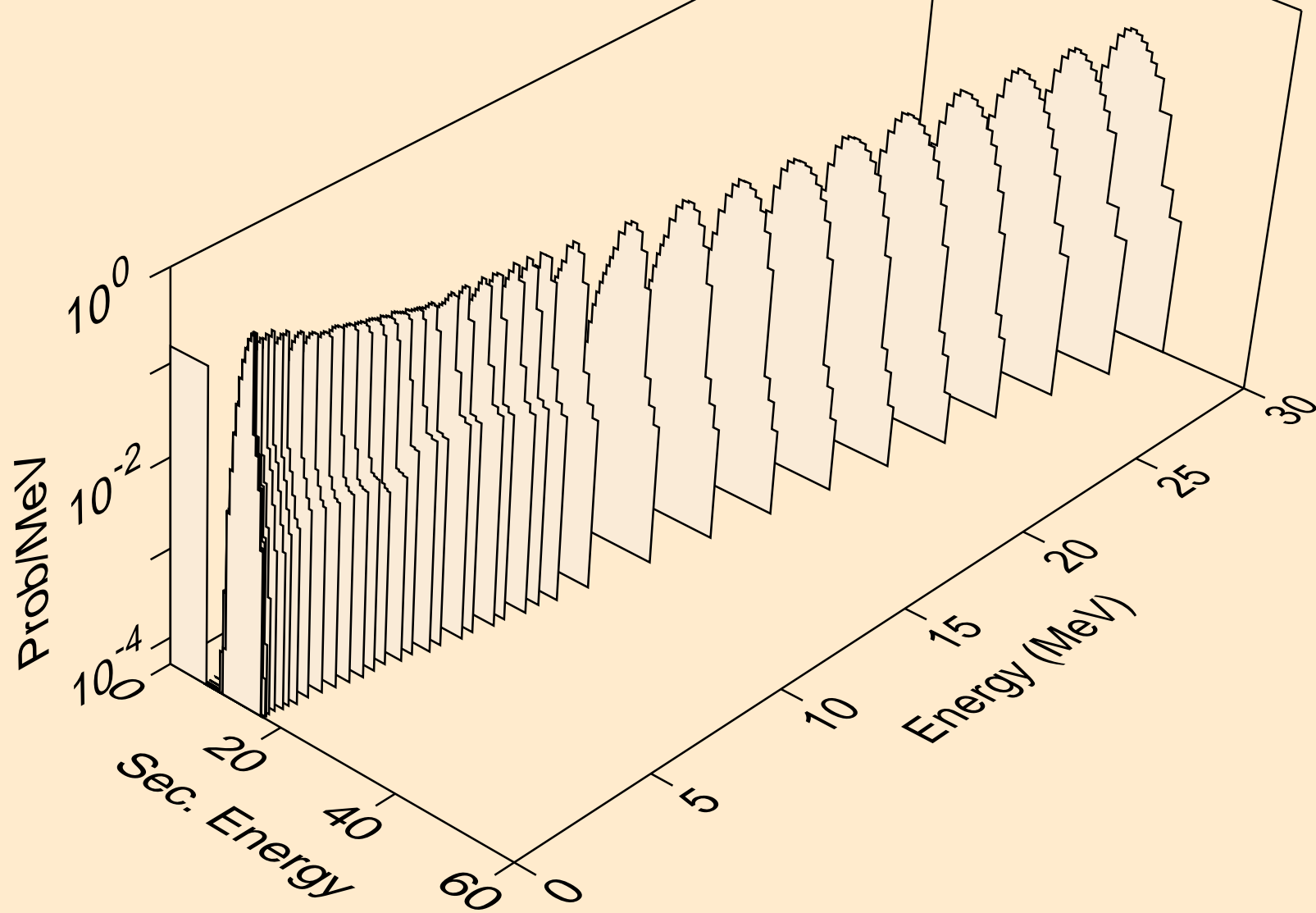

RN201 NEUTRON ACER TENDL-2024 LIBRARY; T=0.K  
alphas from (n,2a)

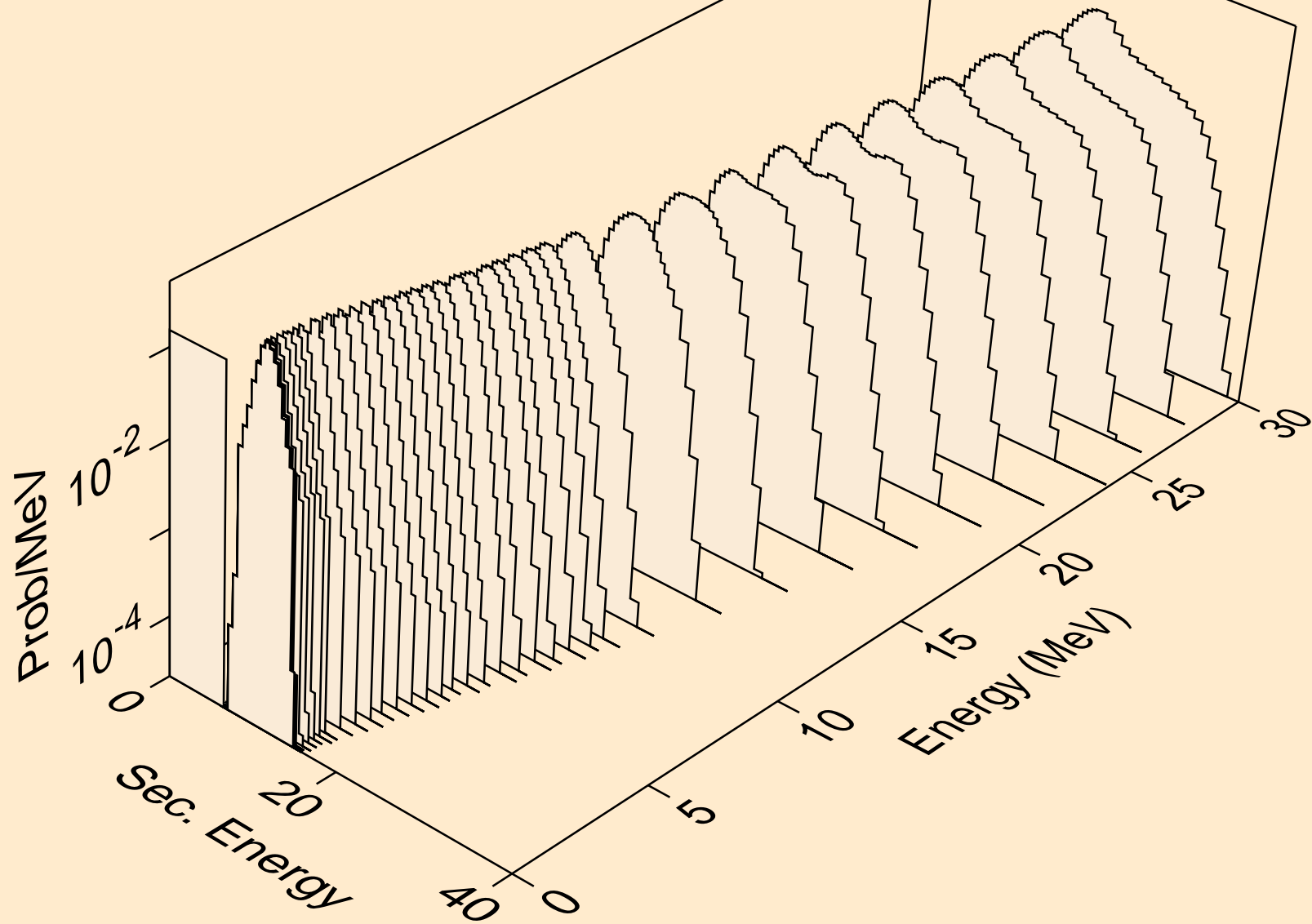

RN201 NEUTRON ACER TENDL-2024 LIBRARY; T=0.K  
alphas from (n,3a)

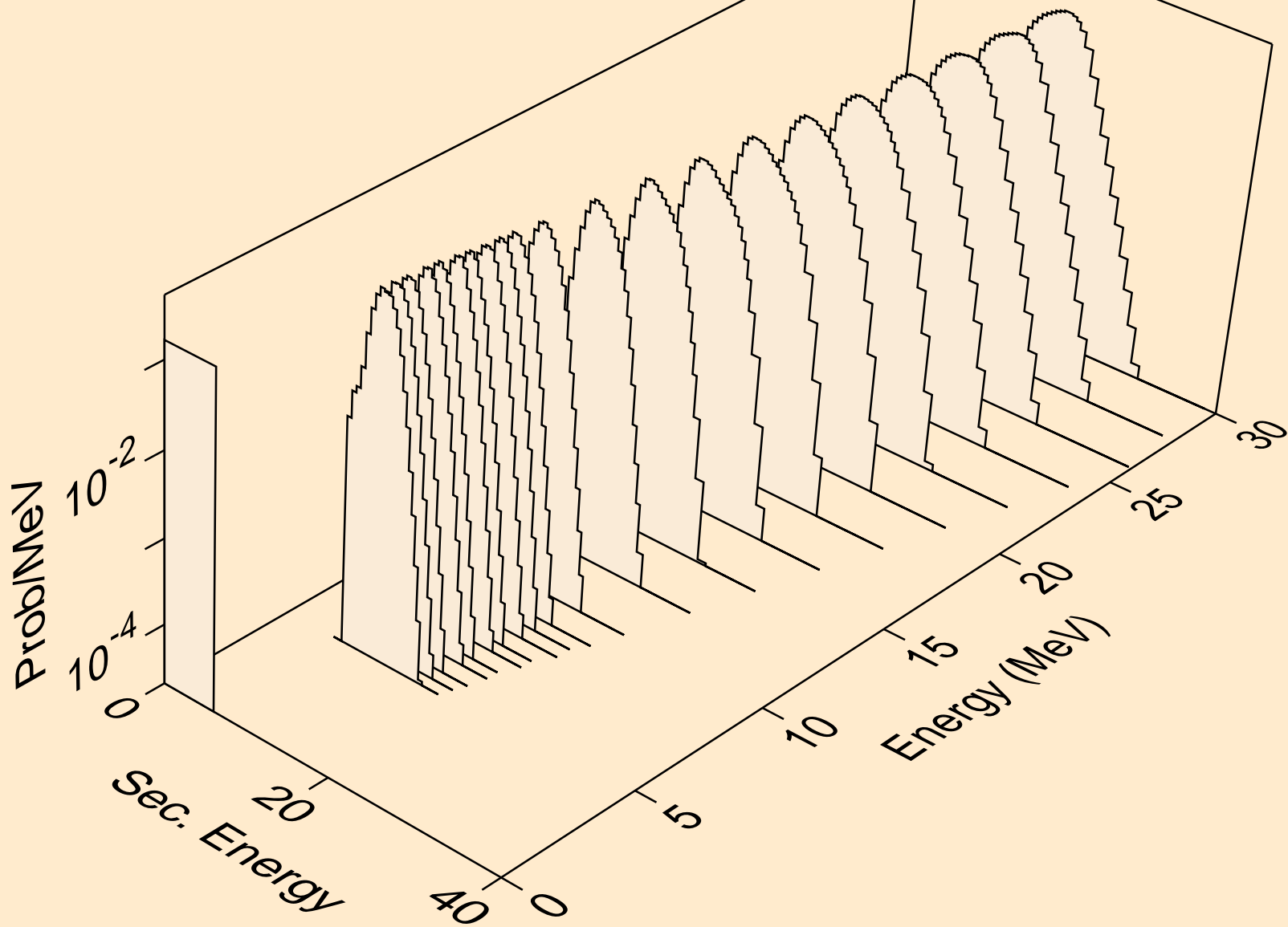

RN201 NEUTRON ACER TENDL-2024 LIBRARY; T=0.K  
alphas from (n,pa)

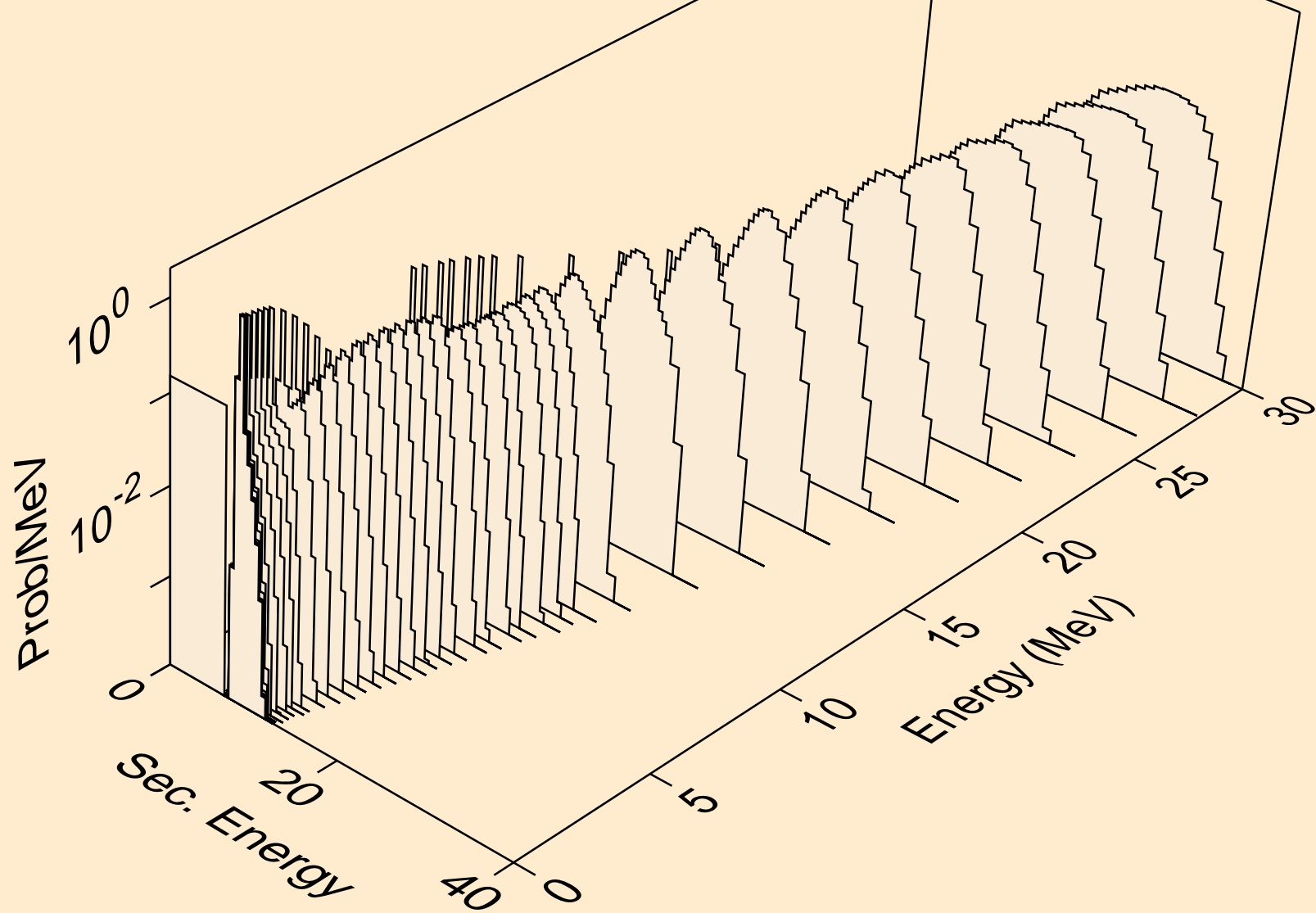

RN201 NEUTRON ACER TENDL-2024 LIBRARY; T=0.K  
alphas from (n,da)

