

RN204 NEUTRON ACER TENDL-2024 LIBRARY; T=0.K

Principal cross sections

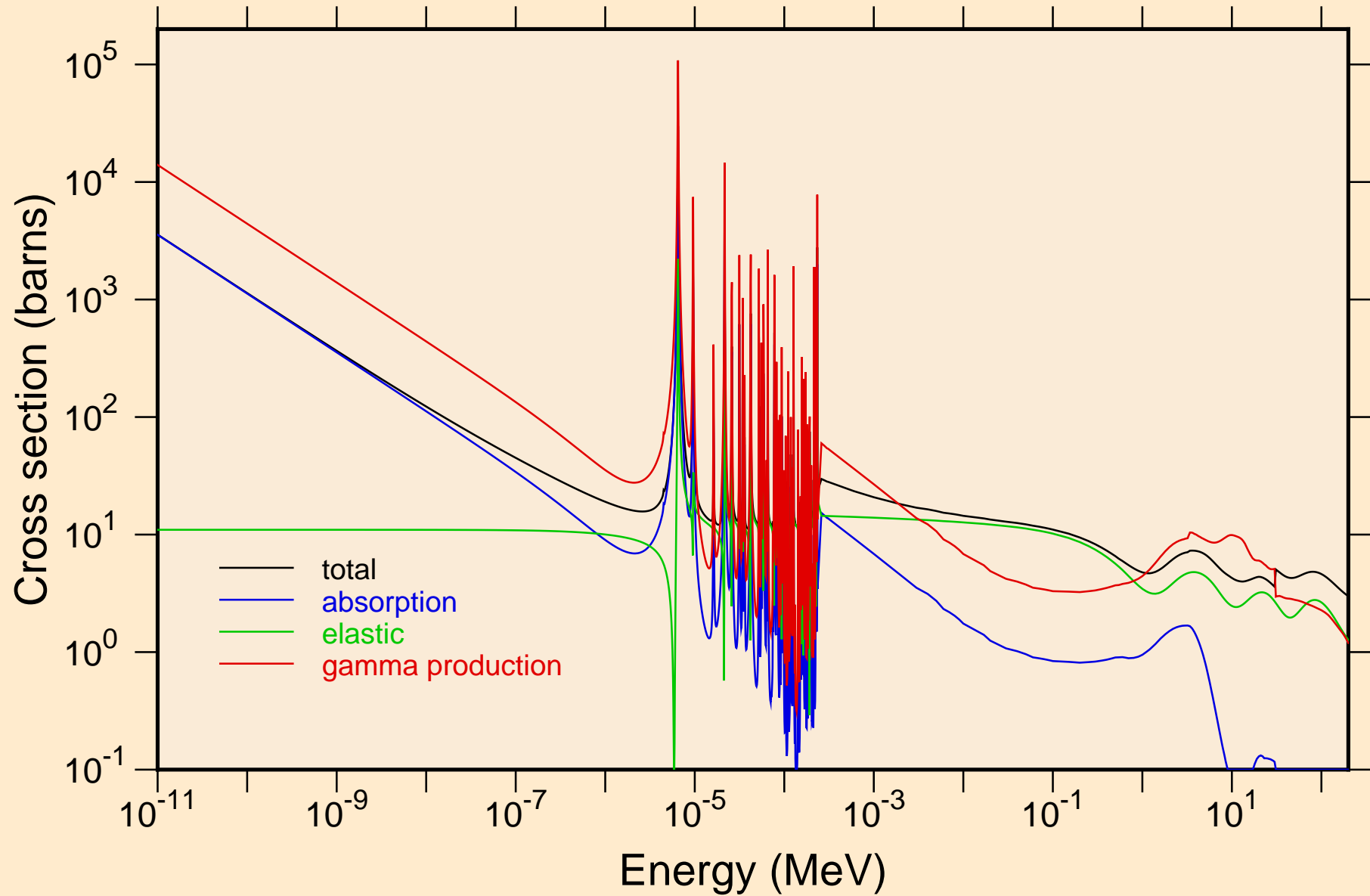

RN204 NEUTRON ACER TENDL-2024 LIBRARY; T=0.K
resonance total cross section

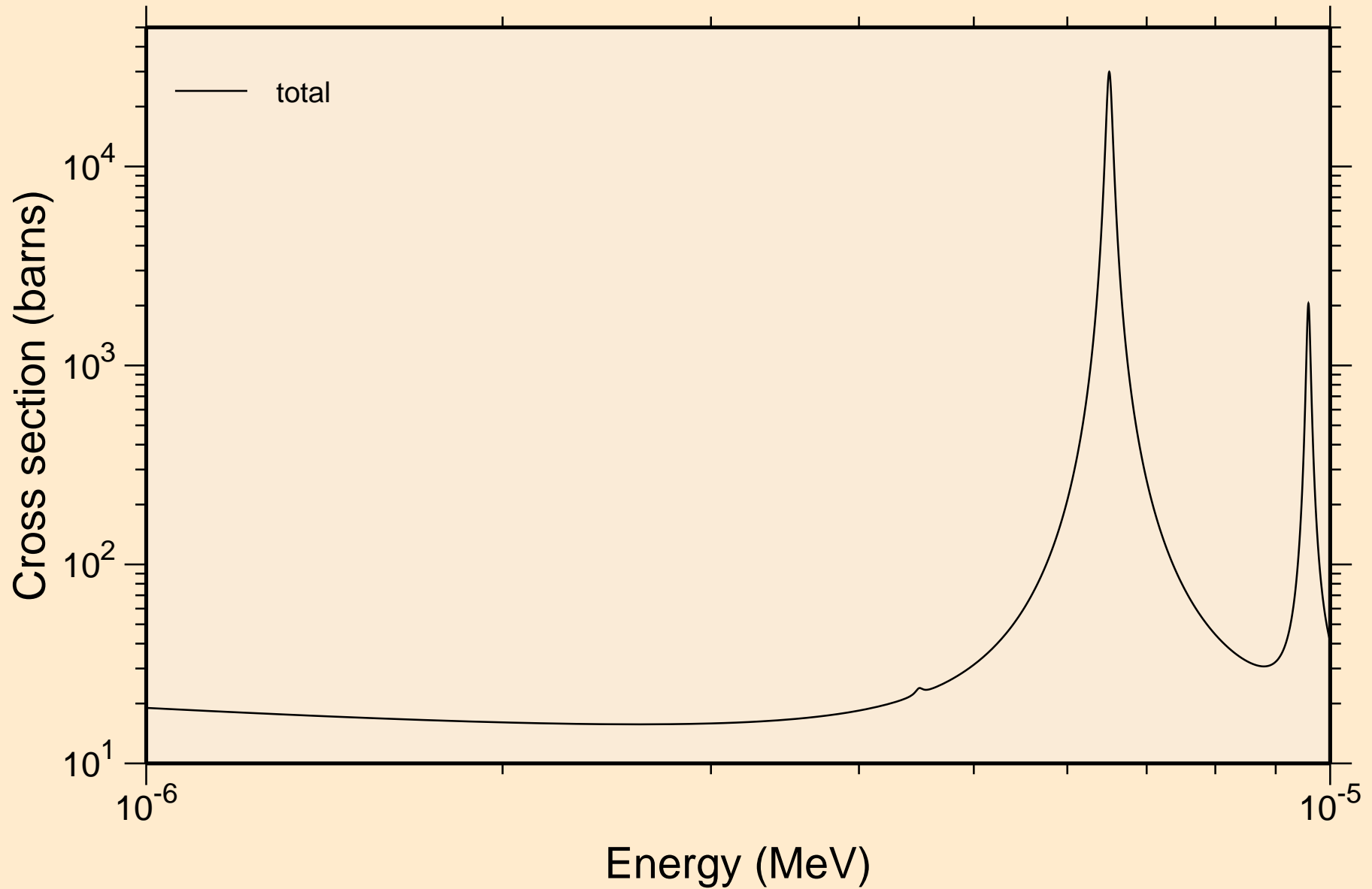

RN204 NEUTRON ACER TENDL-2024 LIBRARY; T=0.K
resonance total cross section

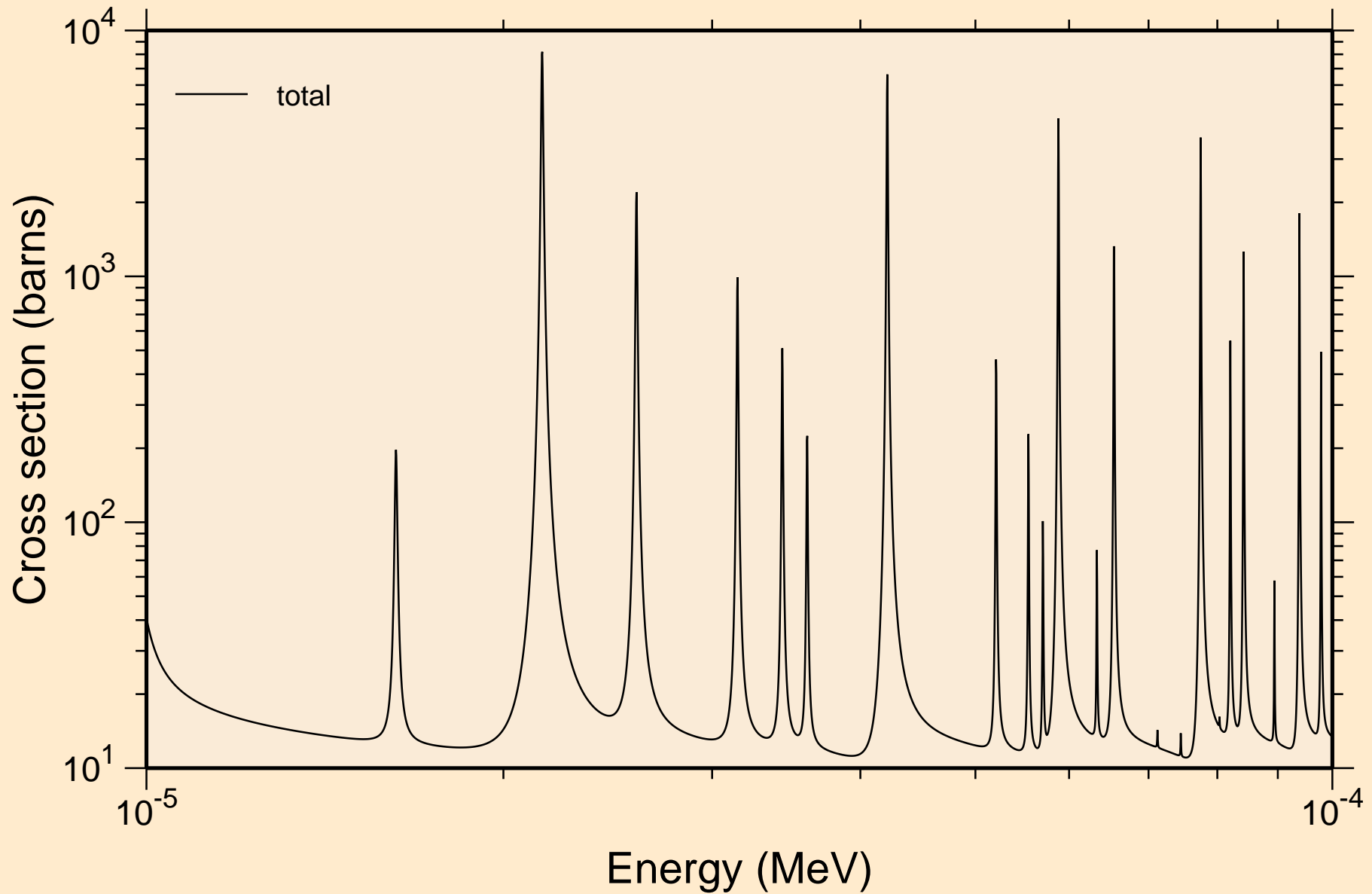

RN204 NEUTRON ACER TENDL-2024 LIBRARY; T=0.K
resonance total cross section

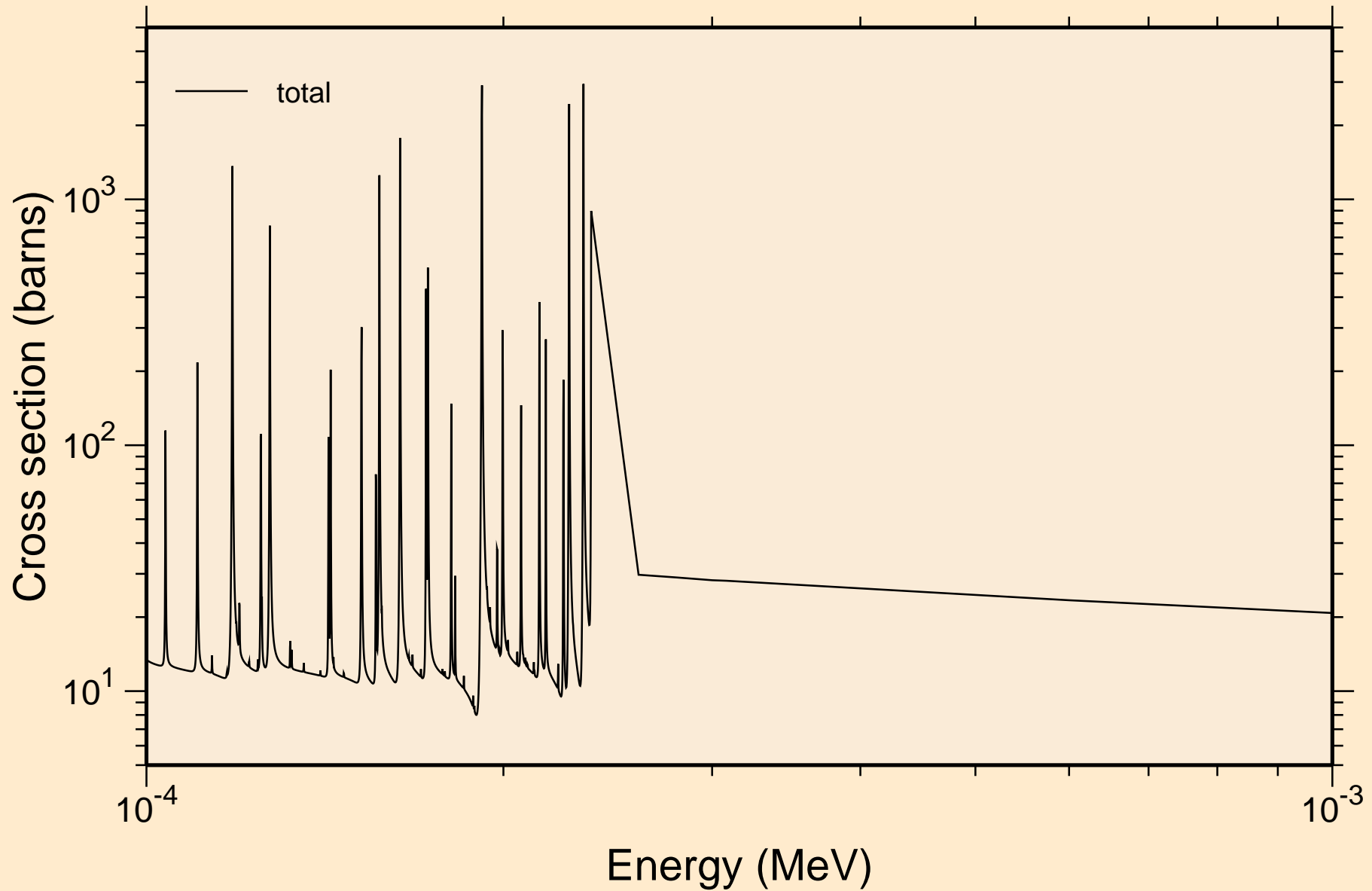

RN204 NEUTRON ACER TENDL-2024 LIBRARY; T=0.K
resonance total cross section

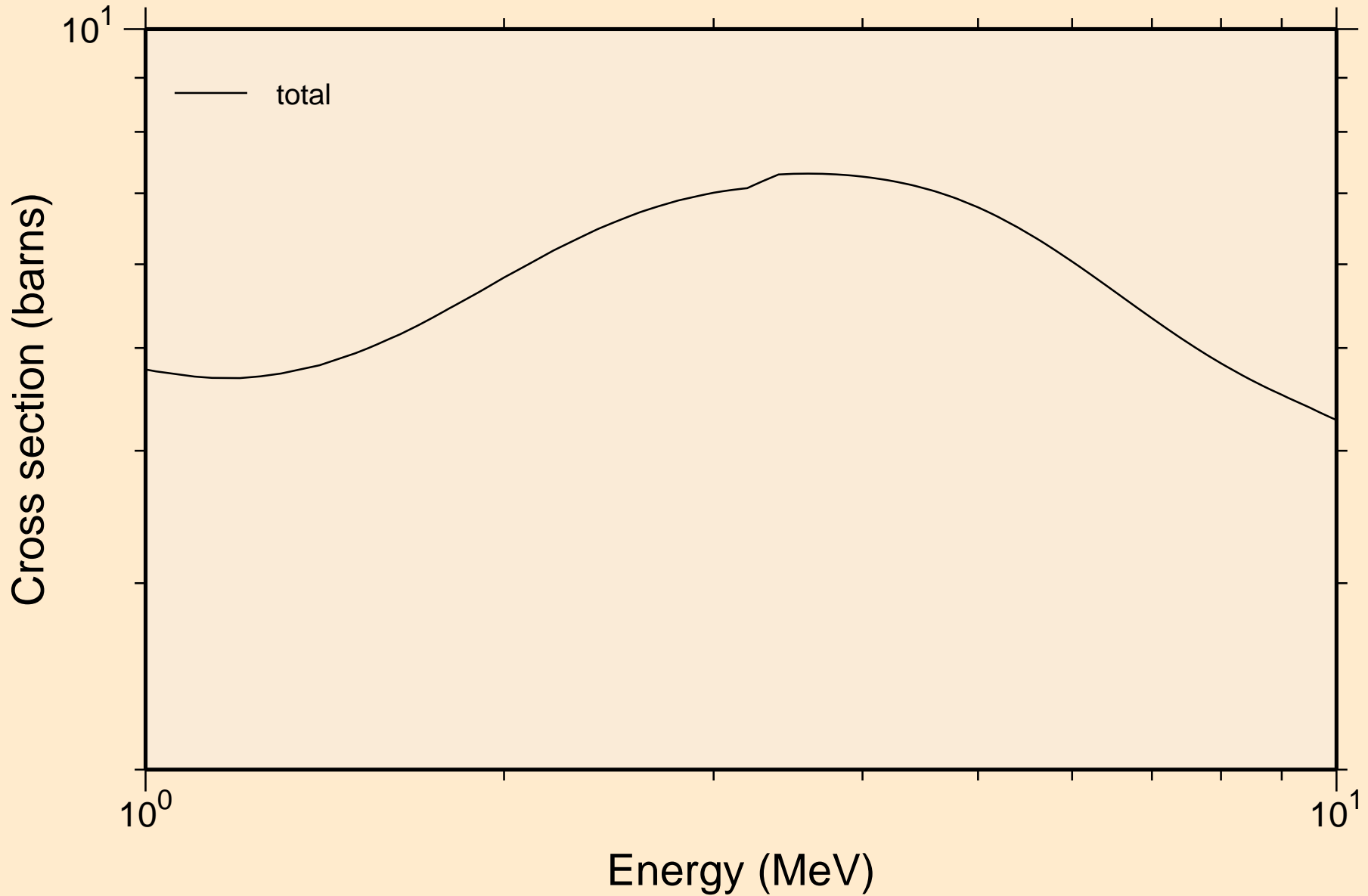

RN204 NEUTRON ACER TENDL-2024 LIBRARY; T=0.K
resonance absorption cross sections

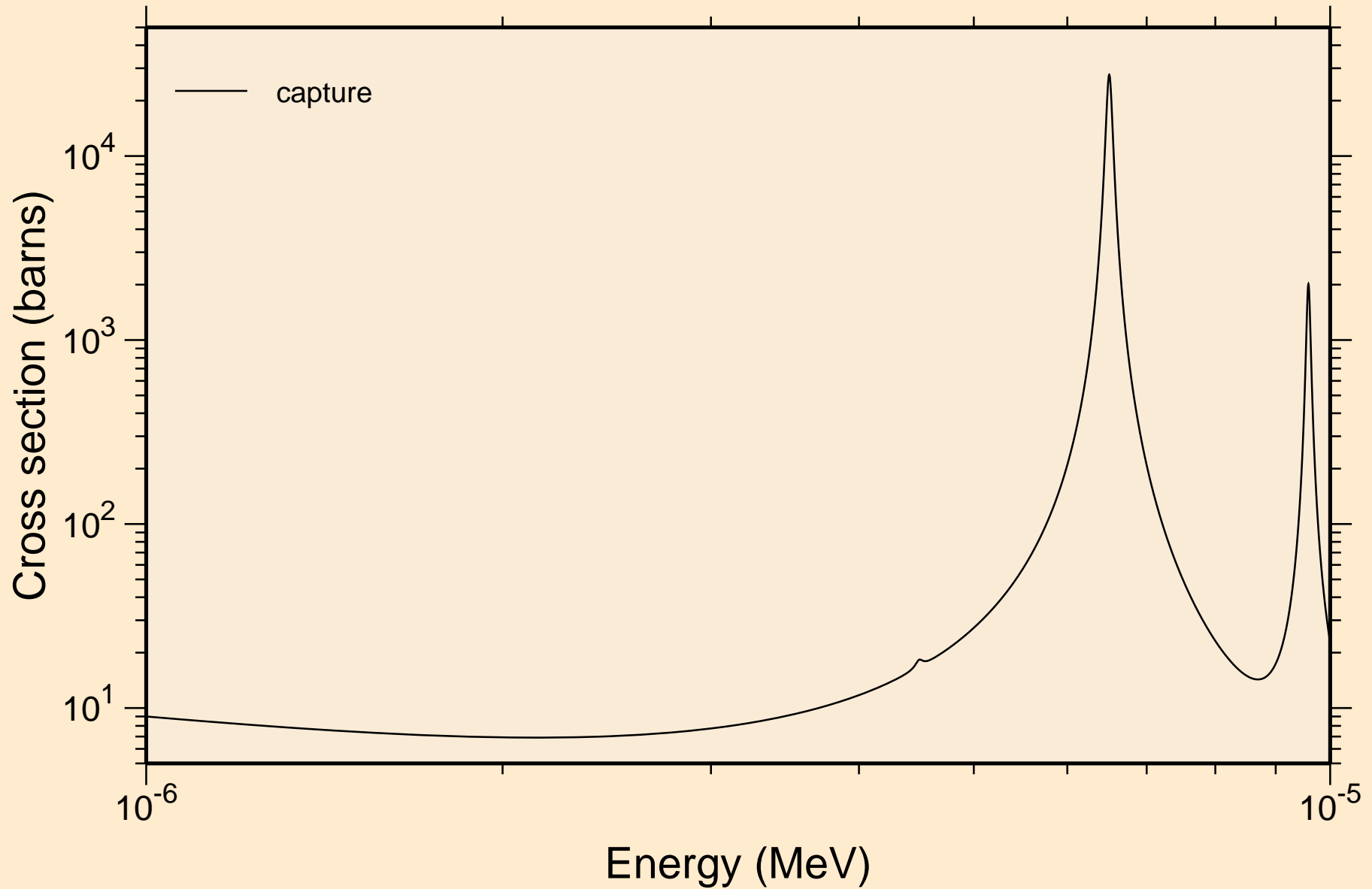

RN204 NEUTRON ACER TENDL-2024 LIBRARY; T=0.K
resonance absorption cross sections

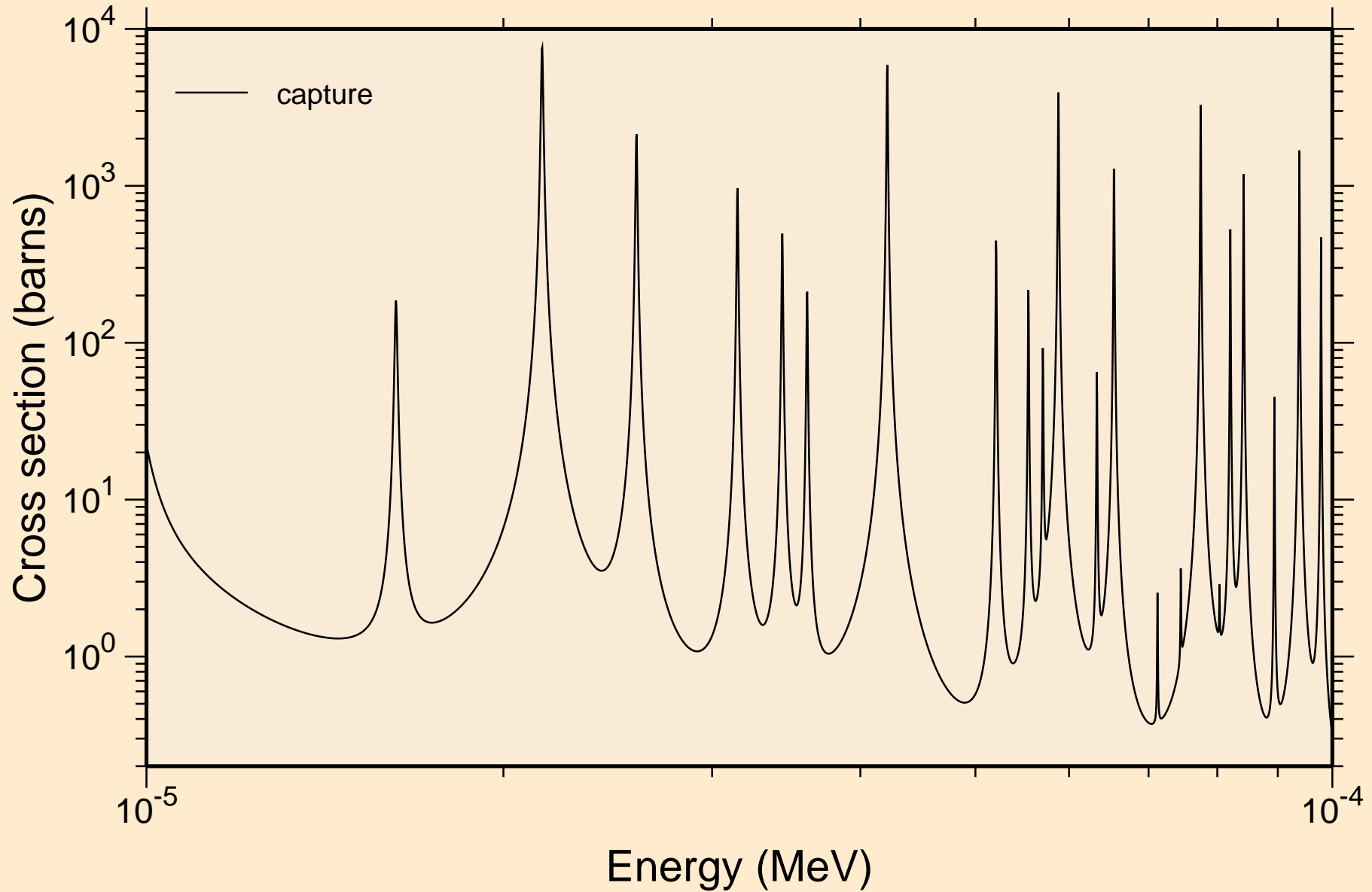

RN204 NEUTRON ACER TENDL-2024 LIBRARY; T=0.K
resonance absorption cross sections

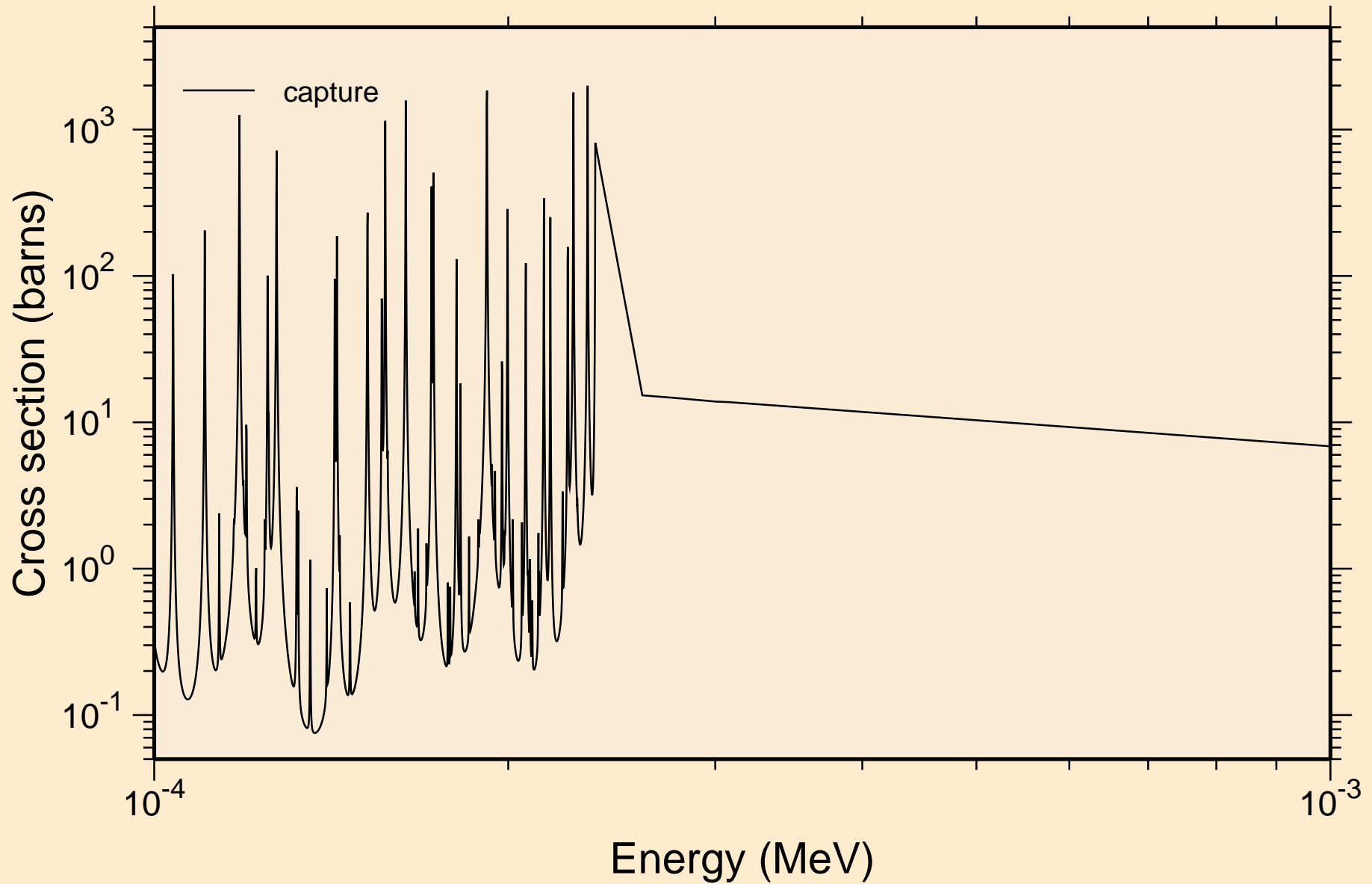

RN204 NEUTRON ACER TENDL-2024 LIBRARY; T=0.K
resonance absorption cross sections

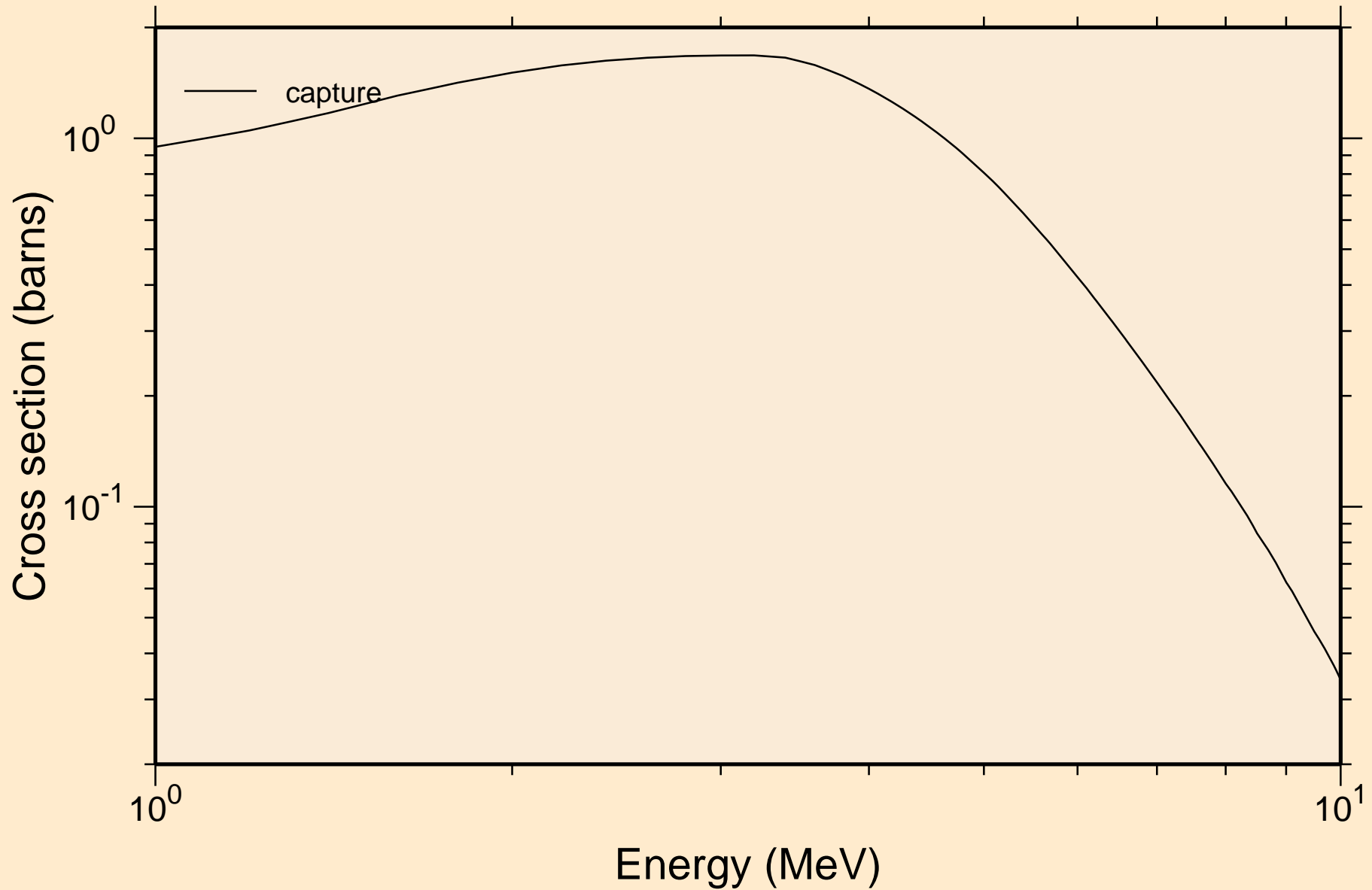

RN204 NEUTRON ACER TENDL-2024 LIBRARY; T=0.K
Heating

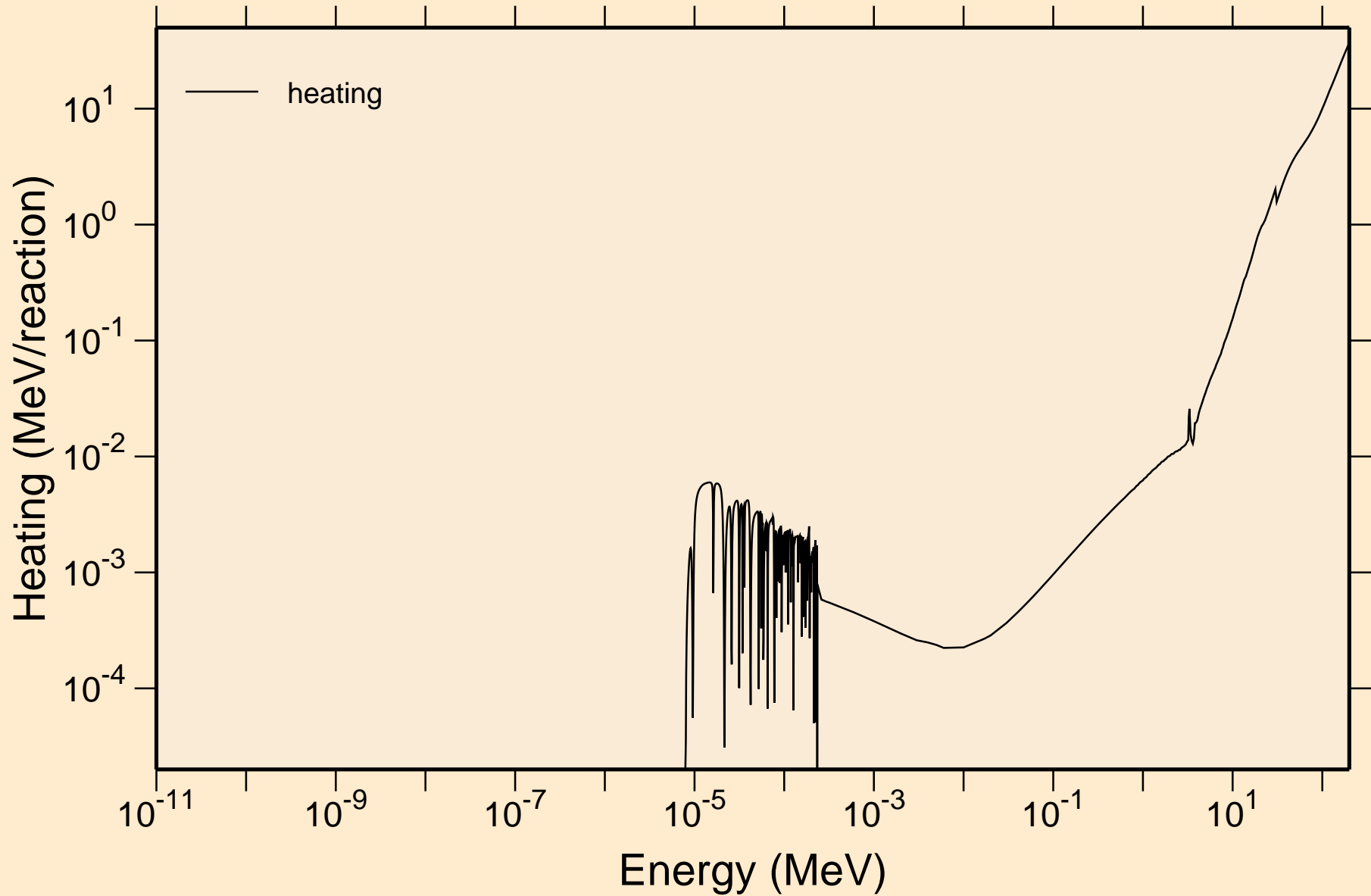

RN204 NEUTRON ACER TENDL-2024 LIBRARY; T=0.K

Damage

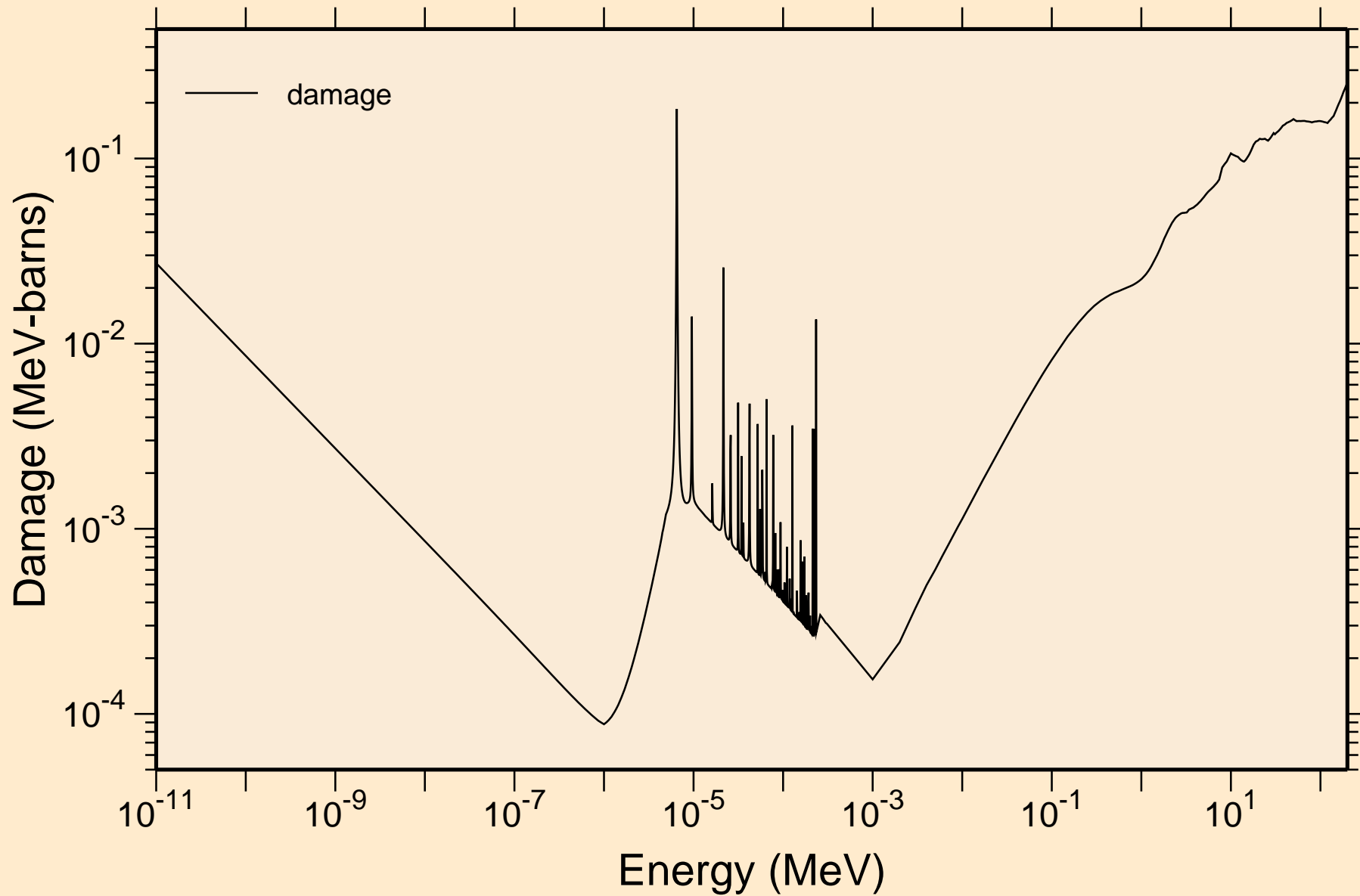

RN204 NEUTRON ACER TENDL-2024 LIBRARY; T=0.K
Non-threshold reactions

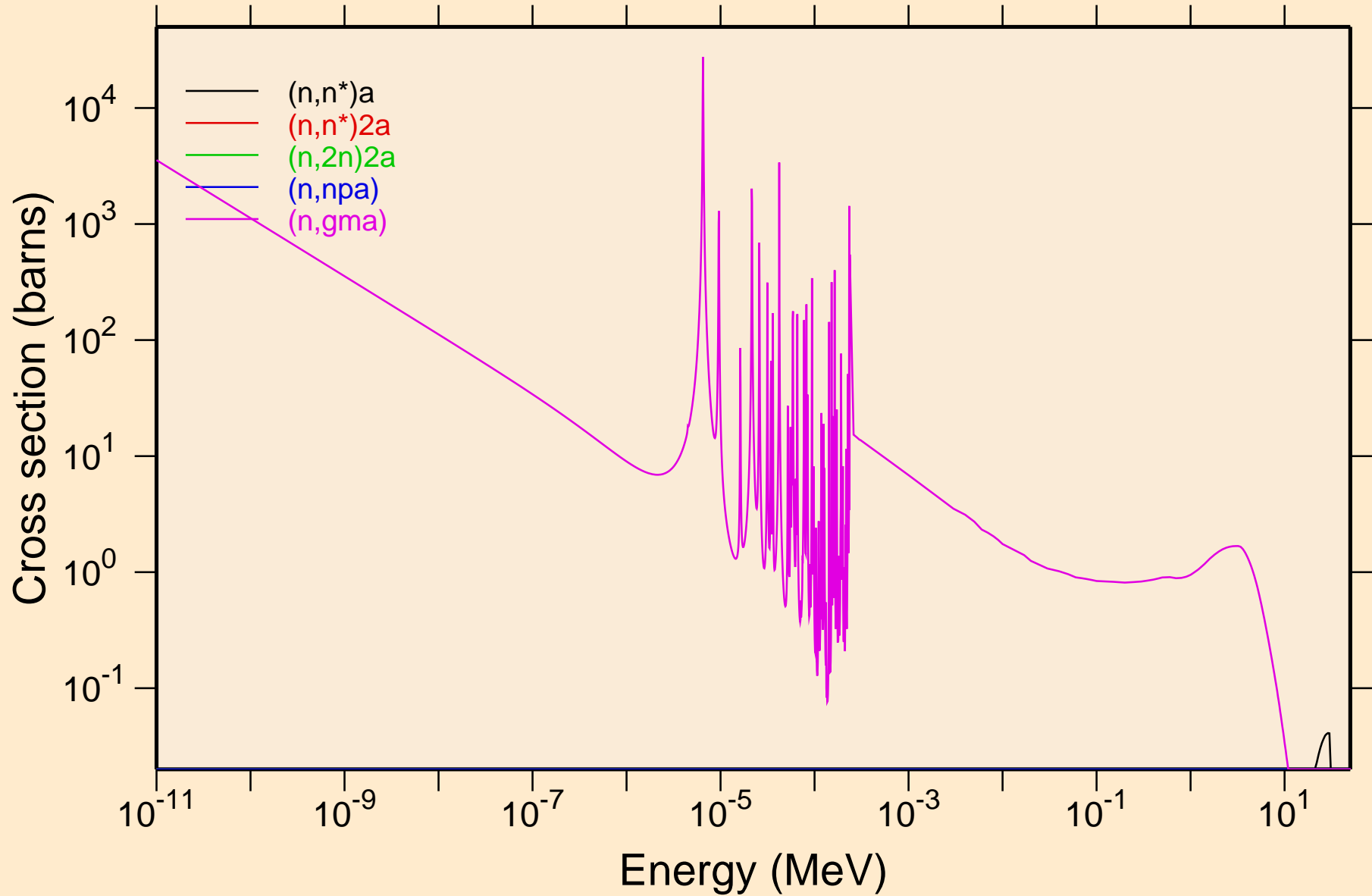

RN204 NEUTRON ACER TENDL-2024 LIBRARY; T=0.K
Non-threshold reactions

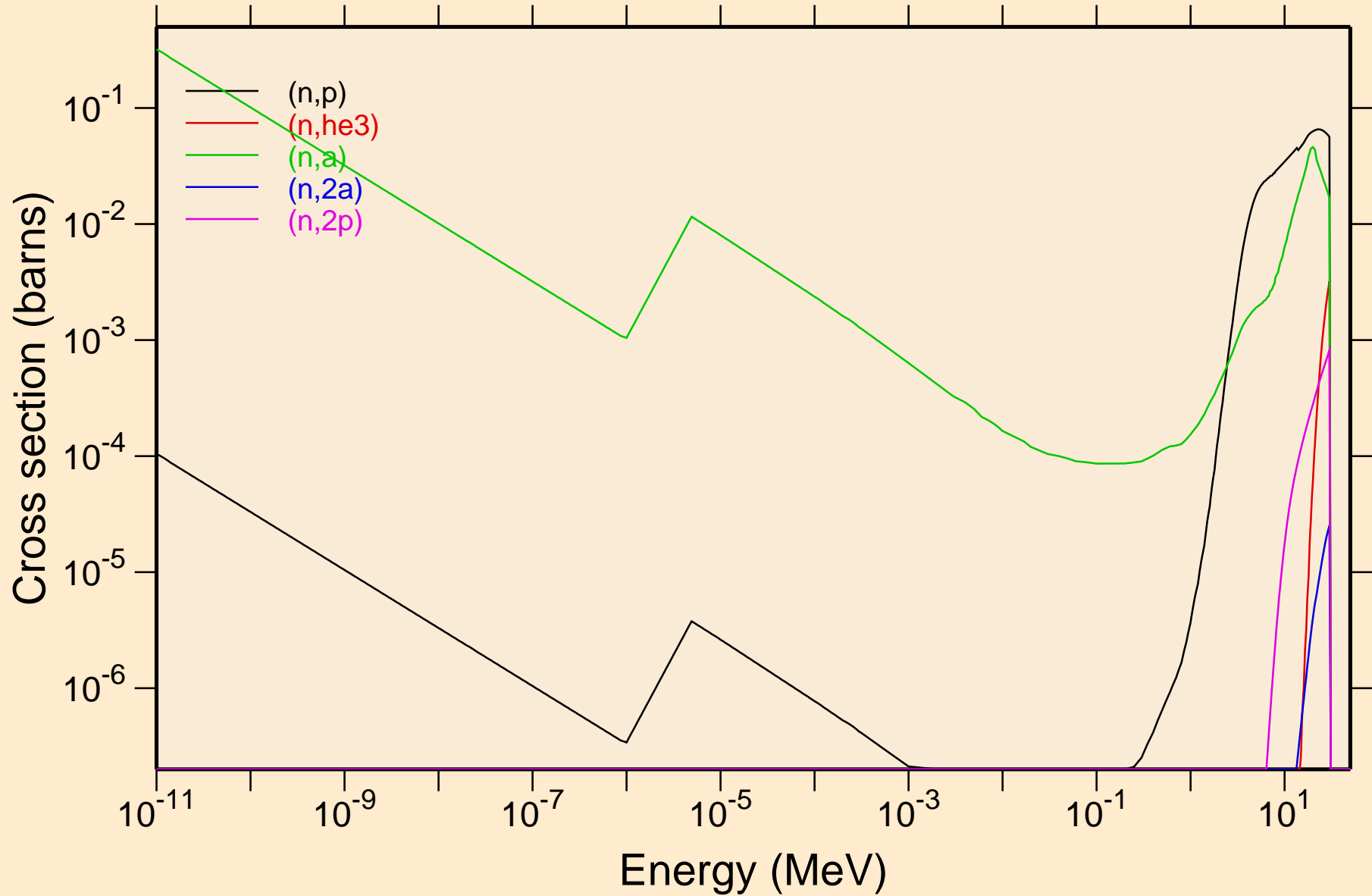

RN204 NEUTRON ACER TENDL-2024 LIBRARY; T=0.K
Non-threshold reactions

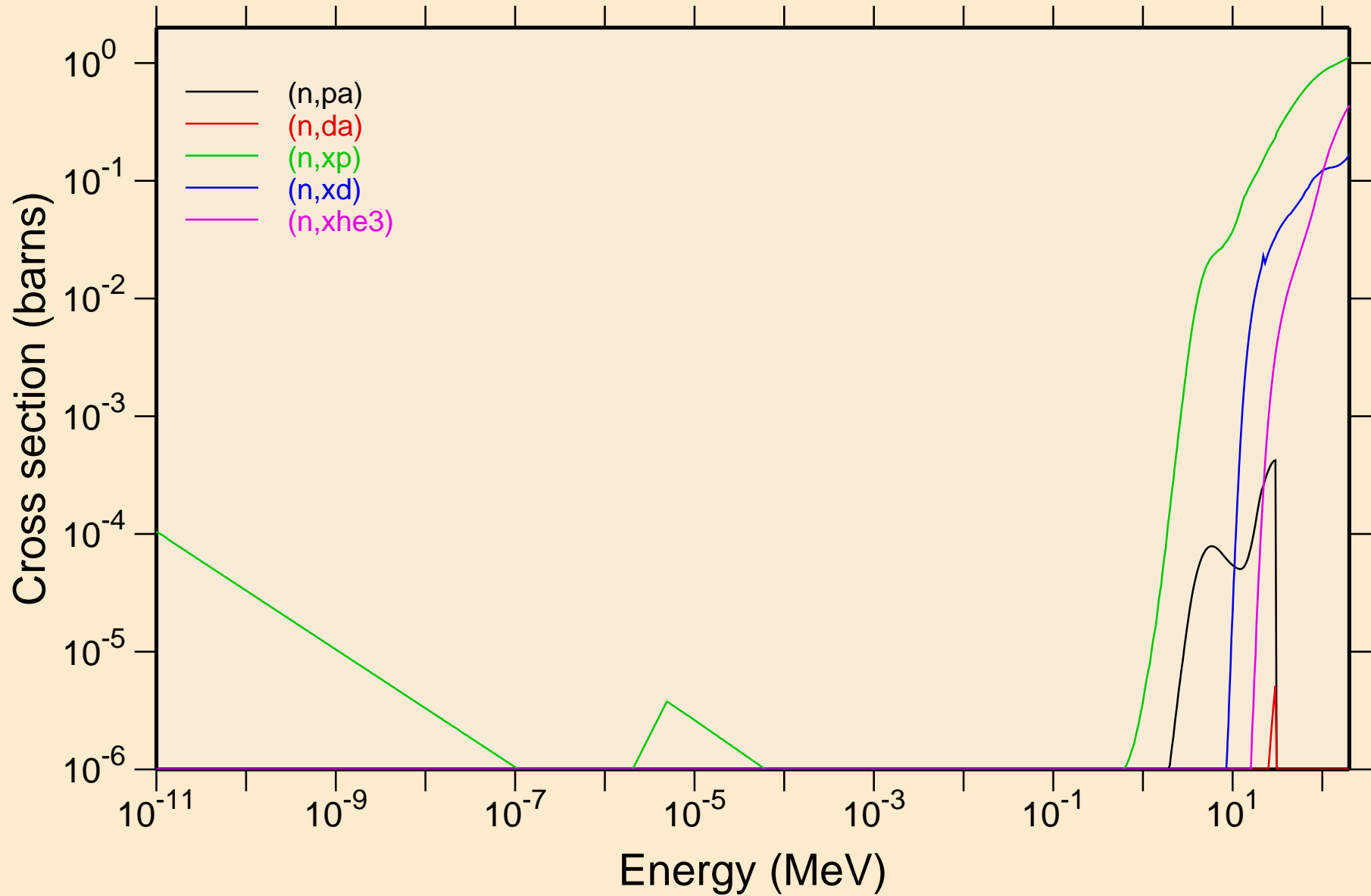

RN204 NEUTRON ACER TENDL-2024 LIBRARY; T=0.K
Non-threshold reactions

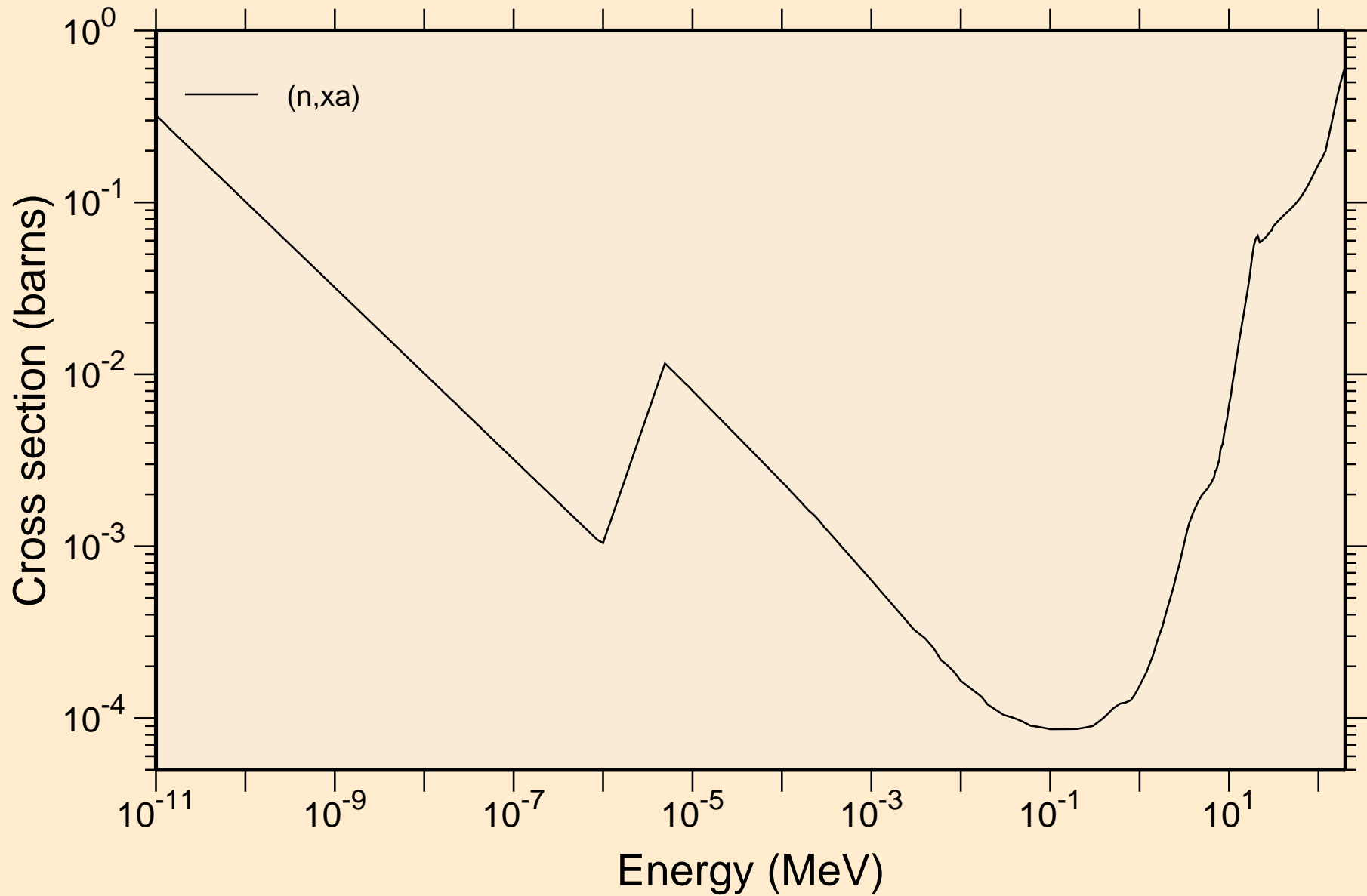

RN204 NEUTRON ACER TENDL-2024 LIBRARY; T=0.K

Principal cross sections

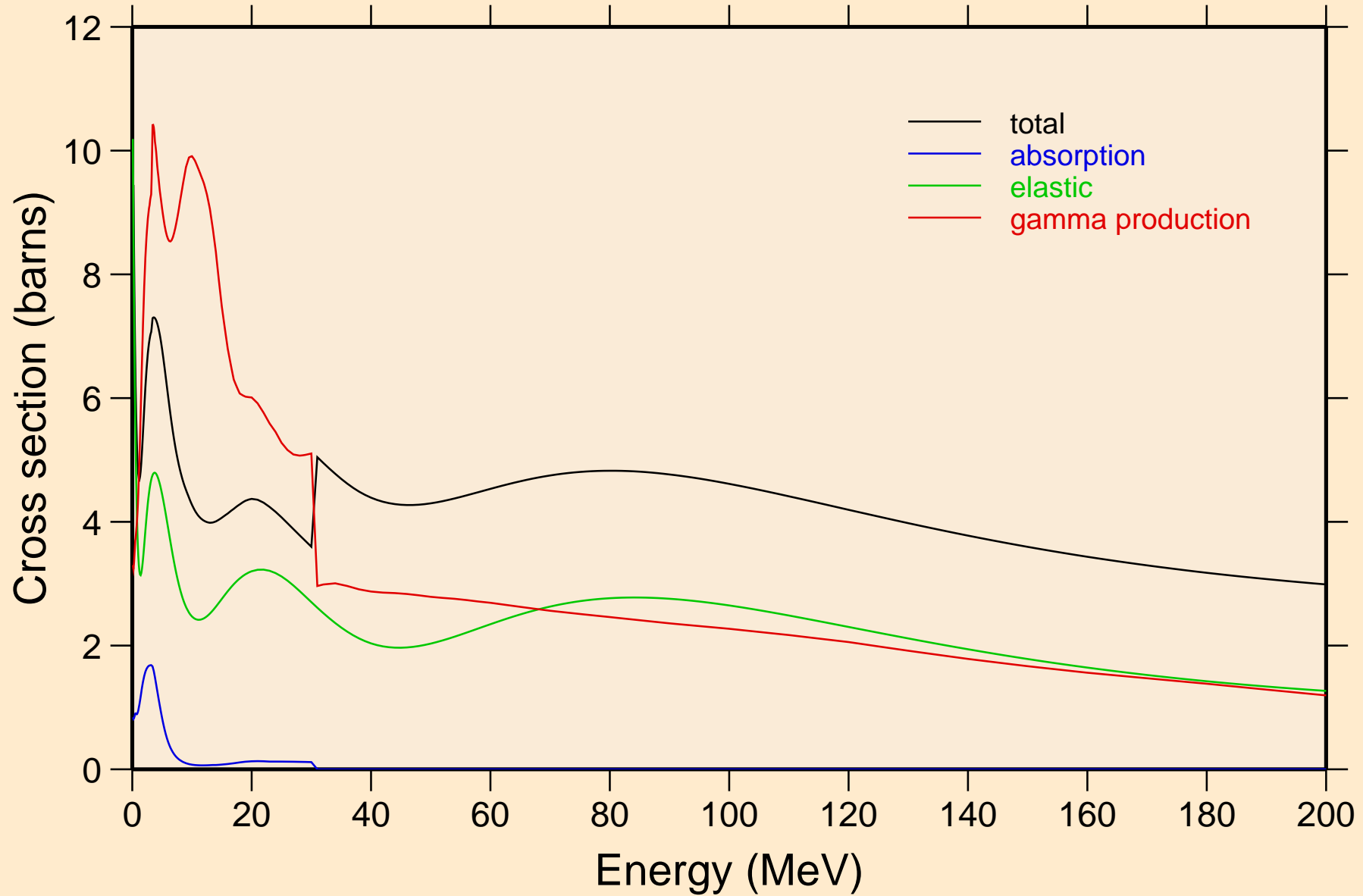

RN204 NEUTRON ACER TENDL-2024 LIBRARY; T=0.K

Heating

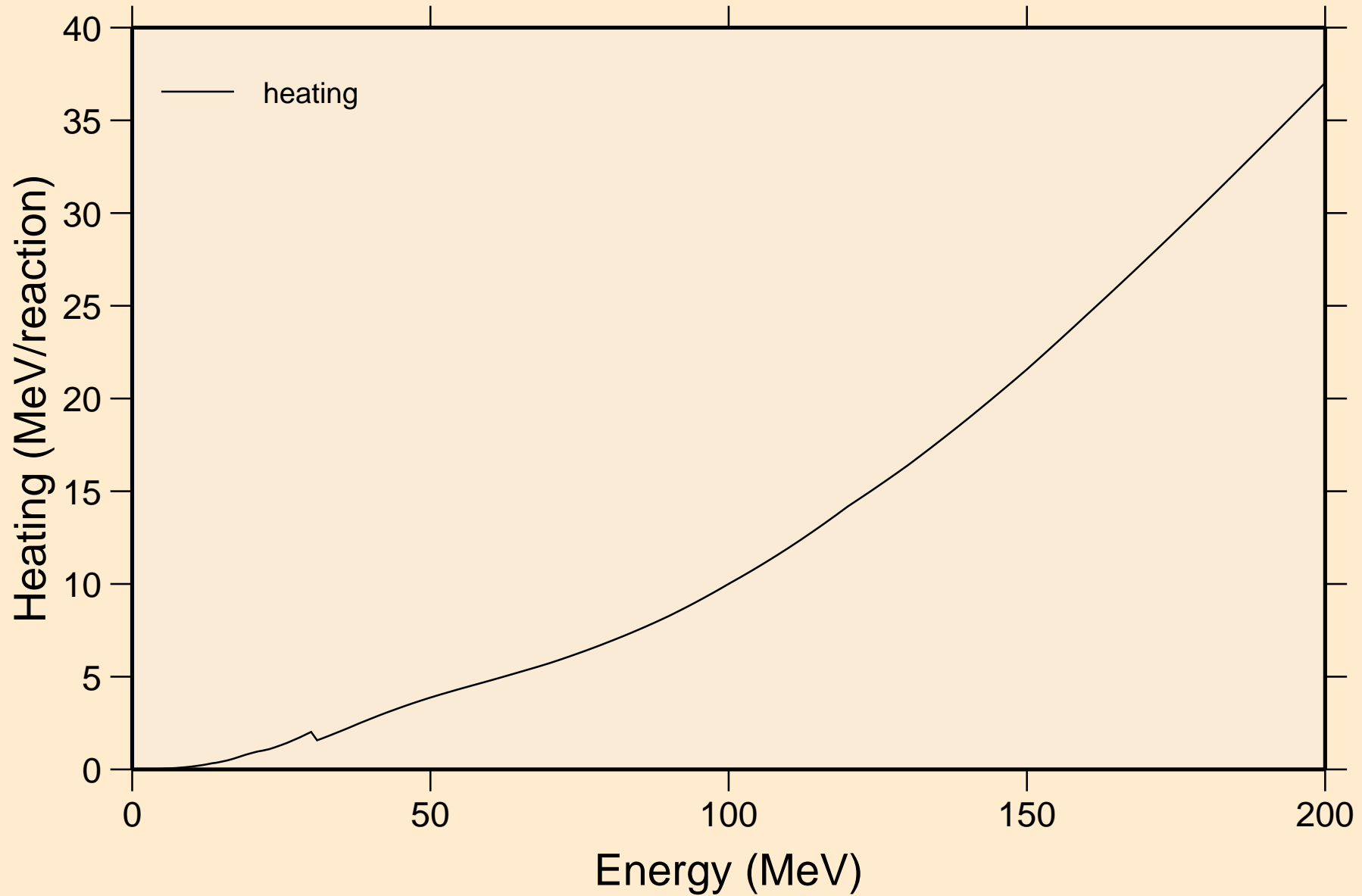

RN204 NEUTRON ACER TENDL-2024 LIBRARY; T=0.K
Damage

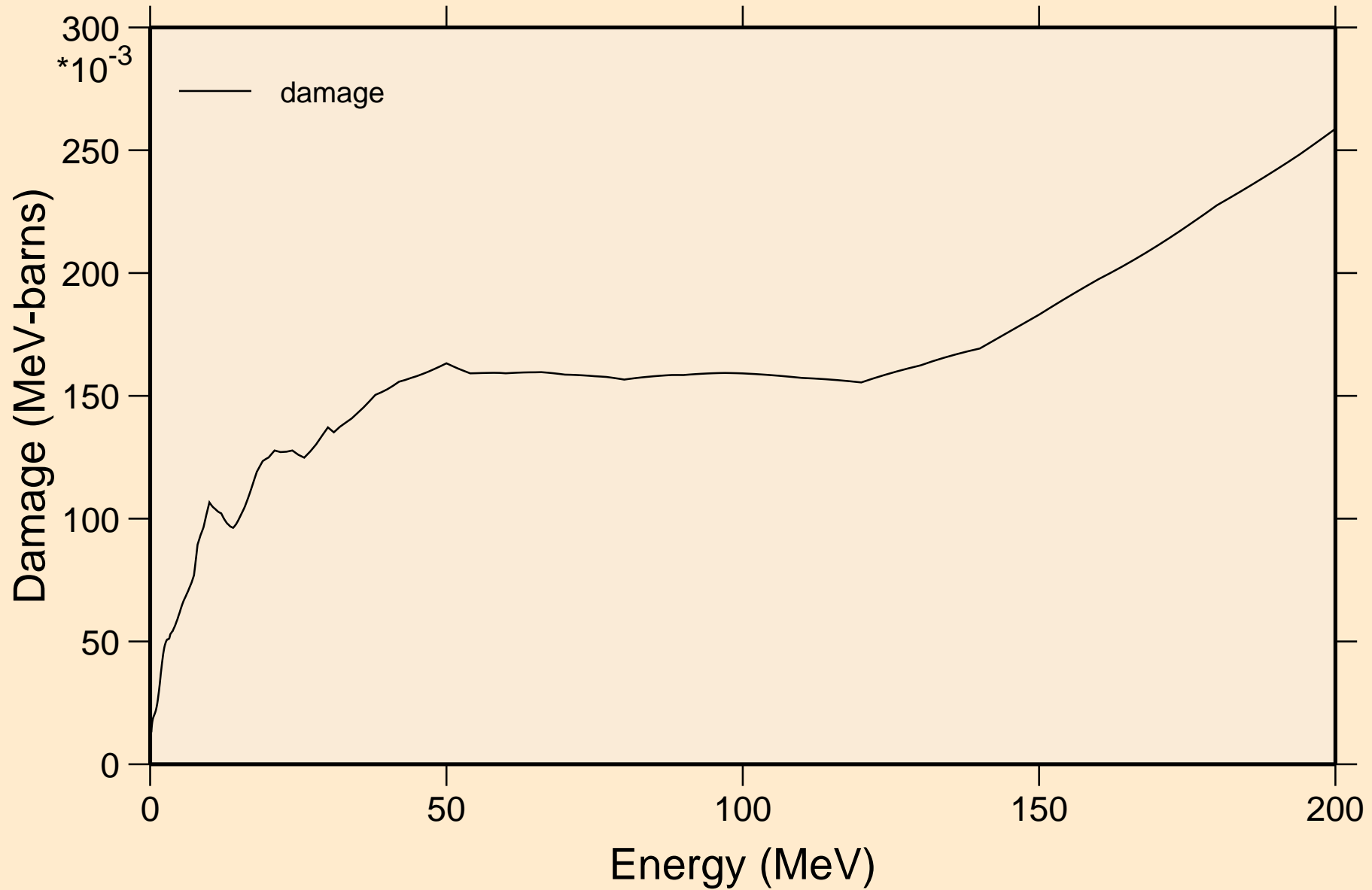

RN204 NEUTRON ACER TENDL-2024 LIBRARY; T=0.K
Non-threshold reactions

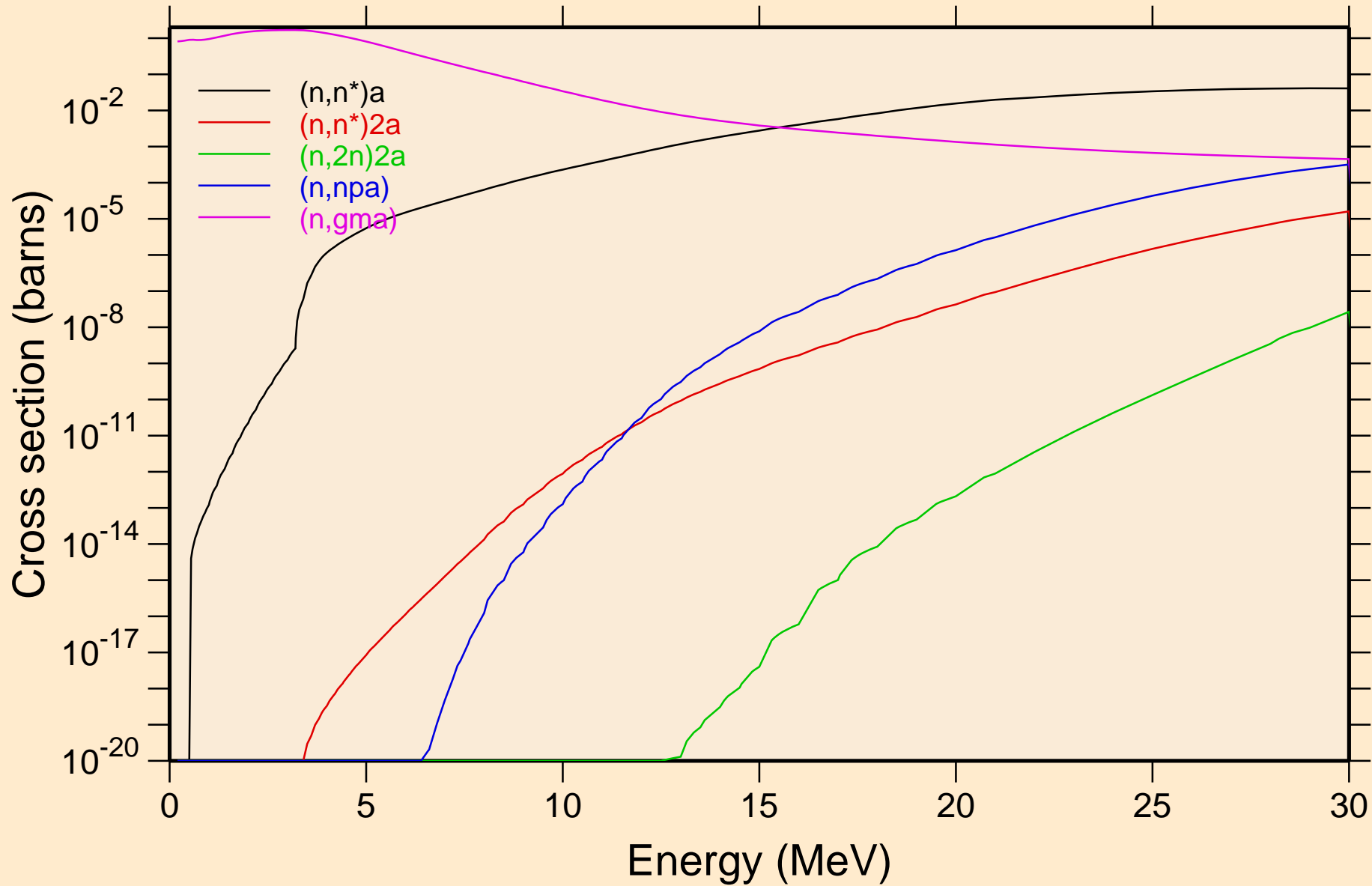

RN204 NEUTRON ACER TENDL-2024 LIBRARY; T=0.K
Non-threshold reactions

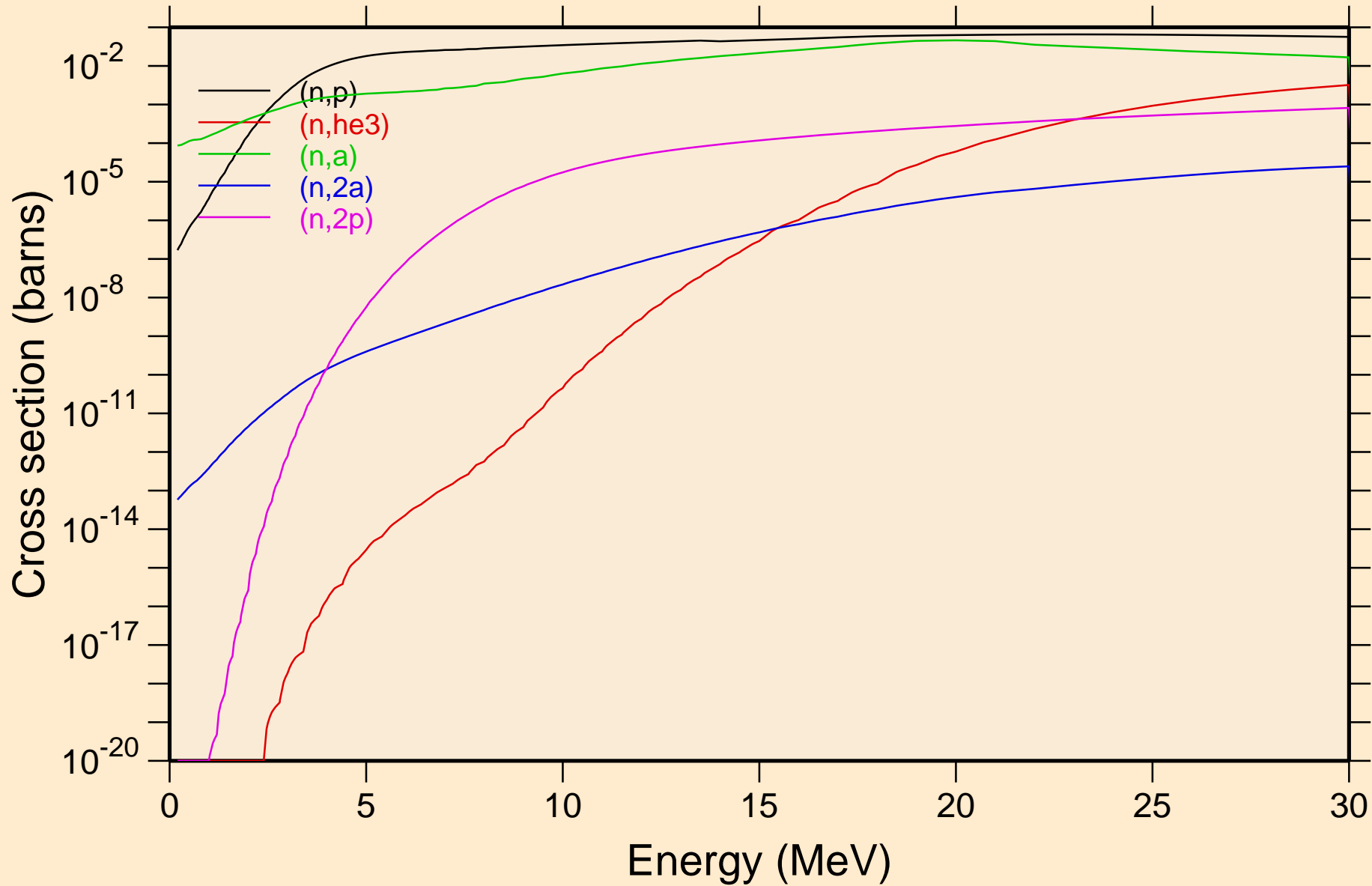

RN204 NEUTRON ACER TENDL-2024 LIBRARY; T=0.K
Non-threshold reactions

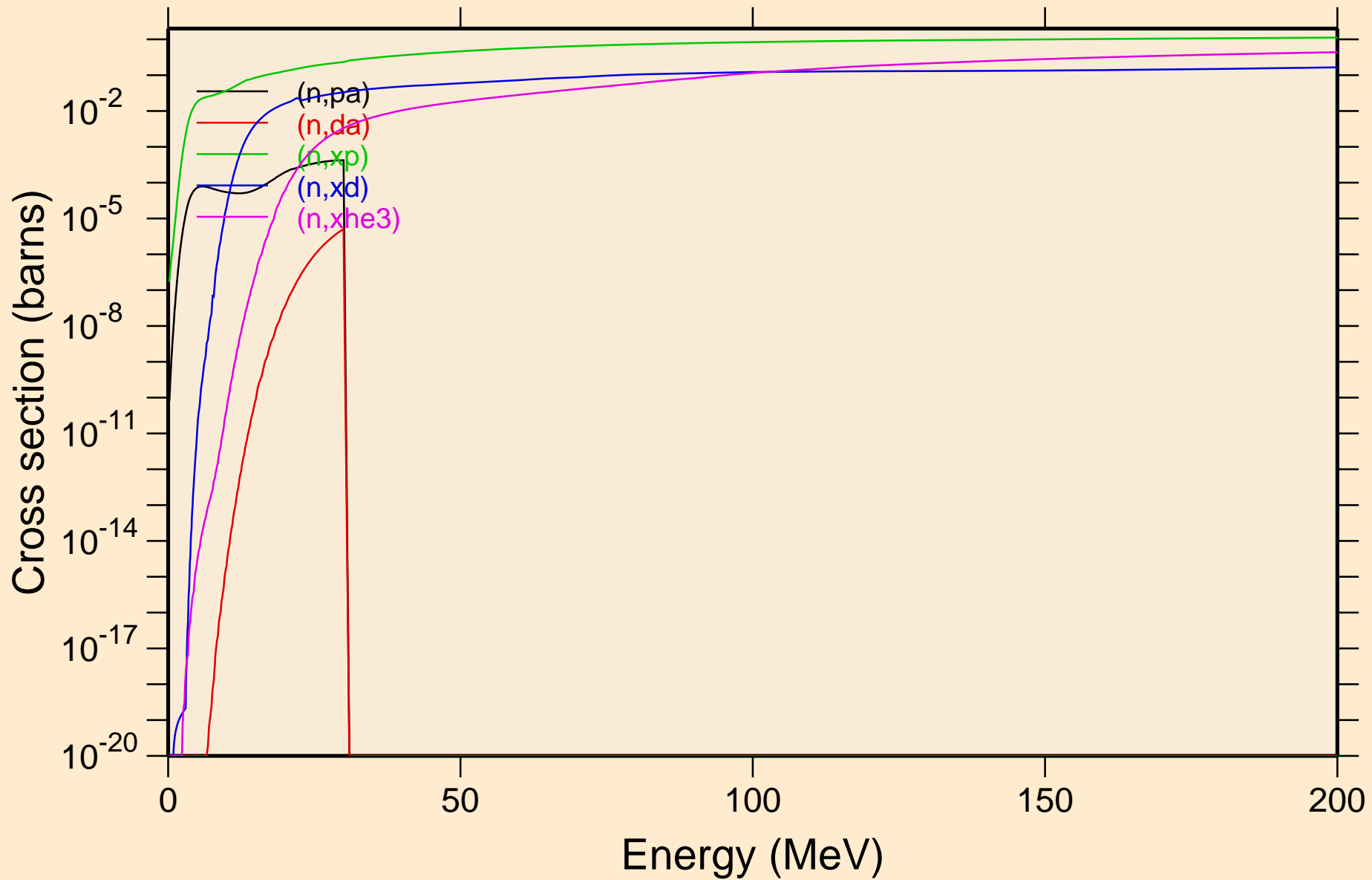

RN204 NEUTRON ACER TENDL-2024 LIBRARY; T=0.K
Non-threshold reactions

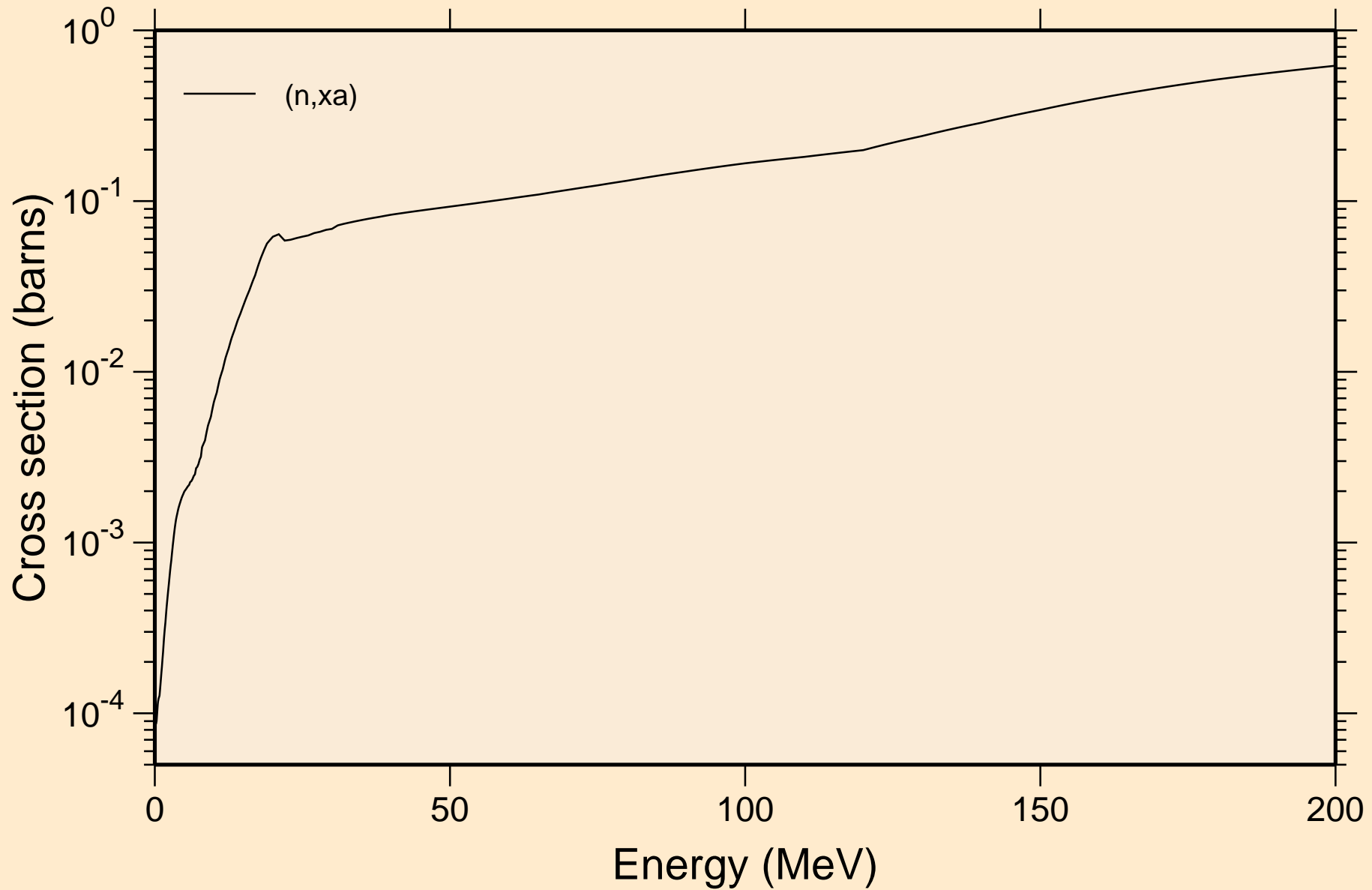

RN204 NEUTRON ACER TENDL-2024 LIBRARY; T=0.K
Inelastic levels

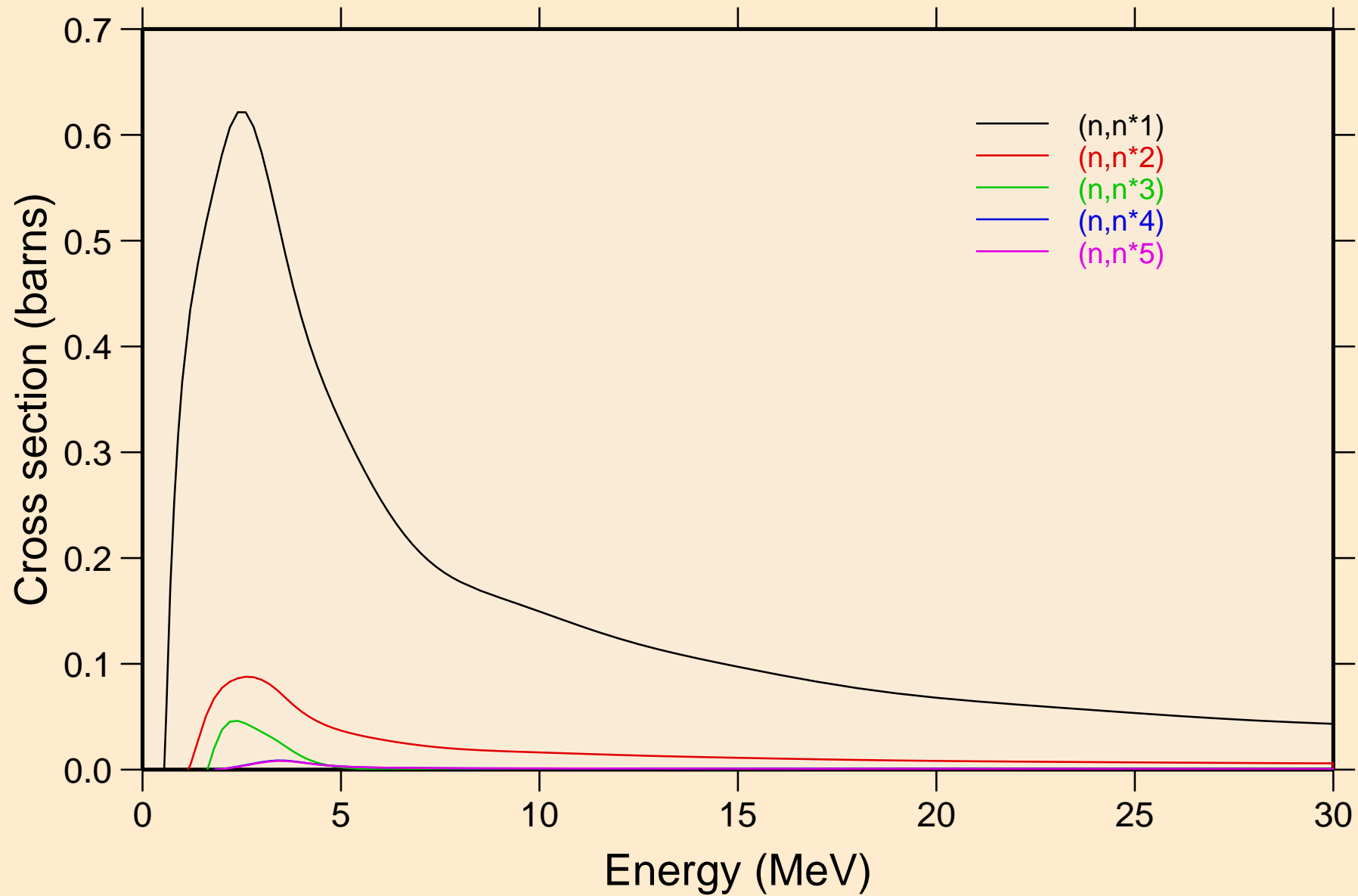

RN204 NEUTRON ACER TENDL-2024 LIBRARY; T=0.K
Inelastic levels

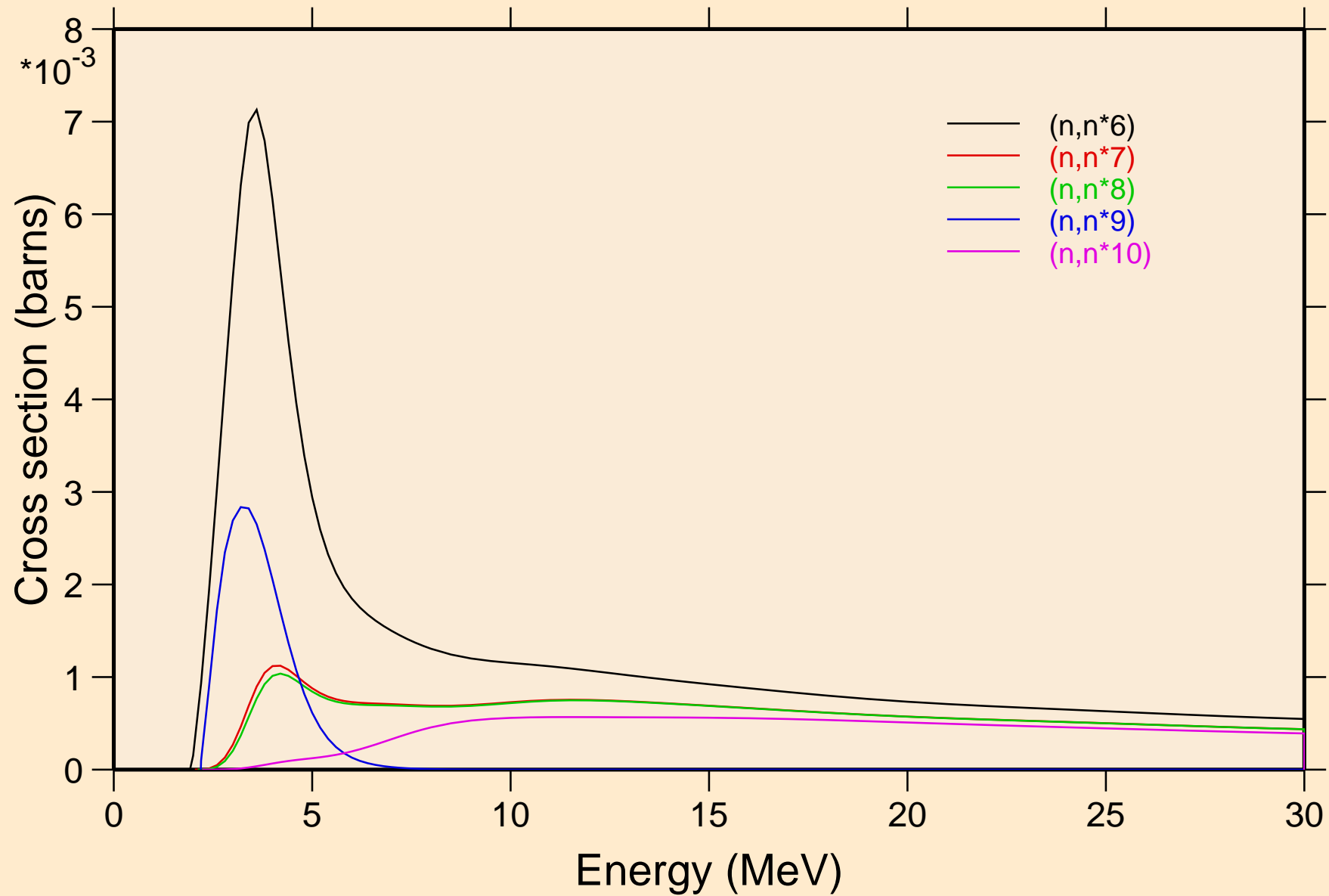

RN204 NEUTRON ACER TENDL-2024 LIBRARY; T=0.K
Inelastic levels

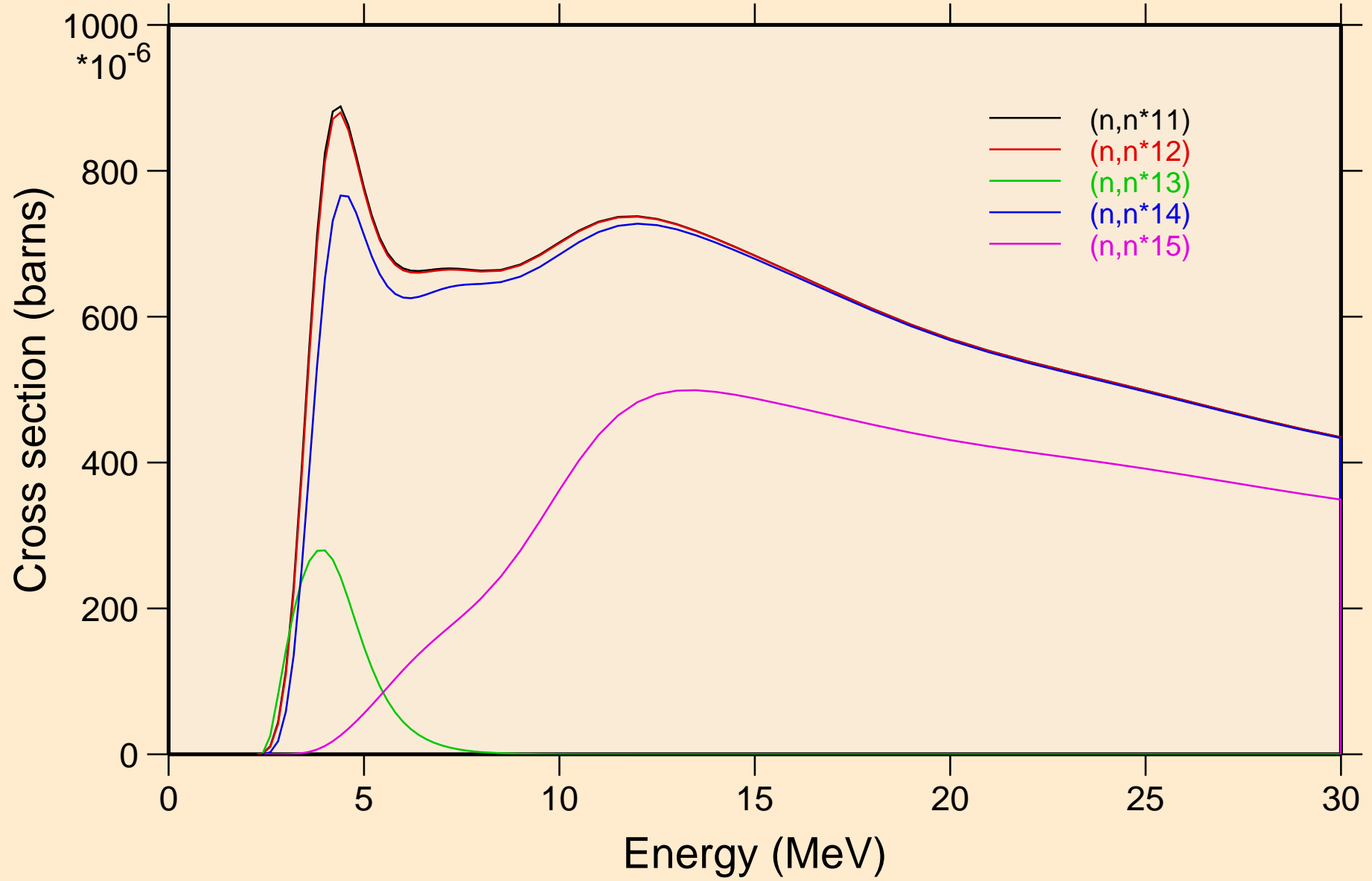

RN204 NEUTRON ACER TENDL-2024 LIBRARY; T=0.K
Inelastic levels

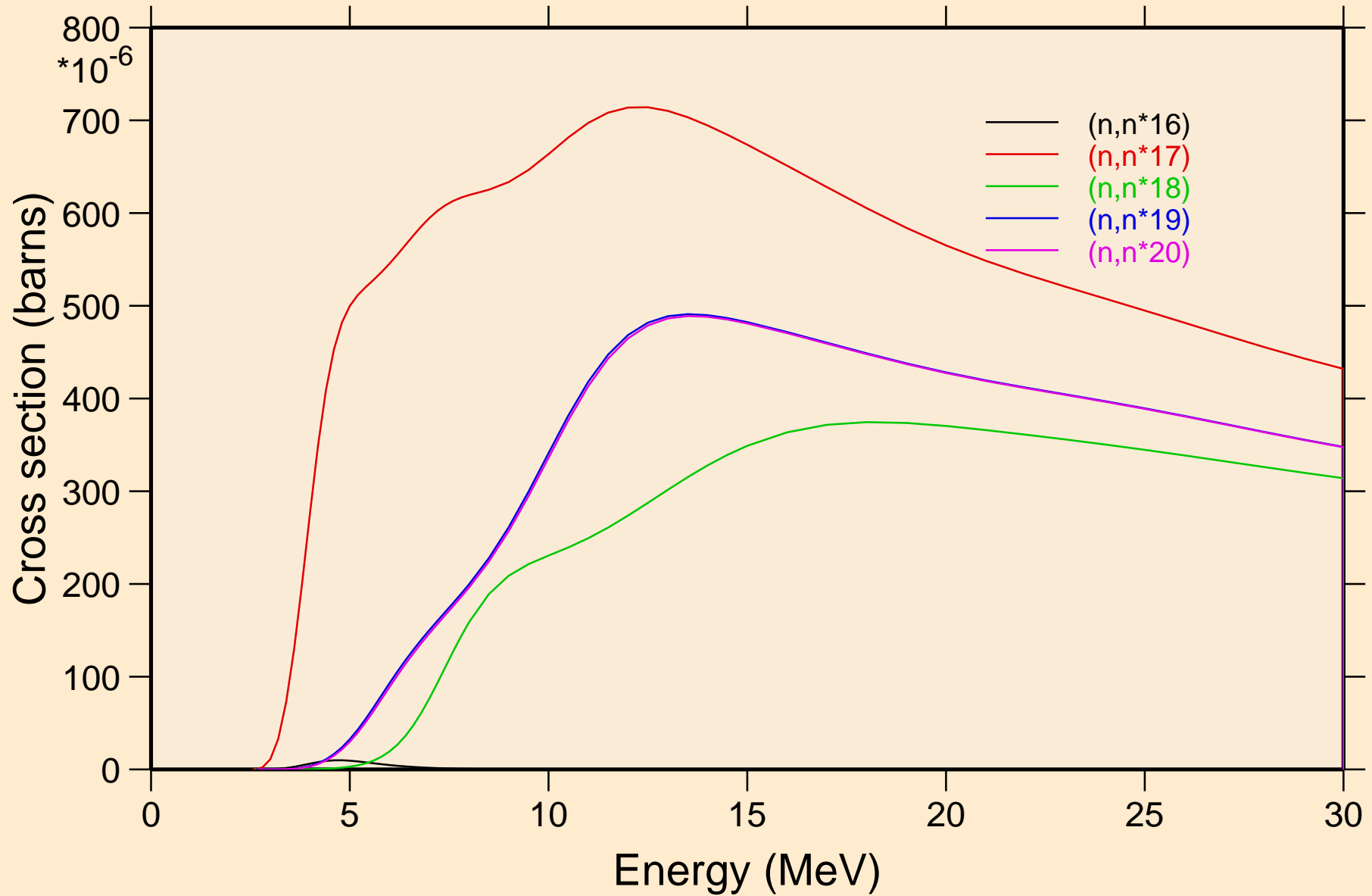

RN204 NEUTRON ACER TENDL-2024 LIBRARY; T=0.K
Inelastic levels

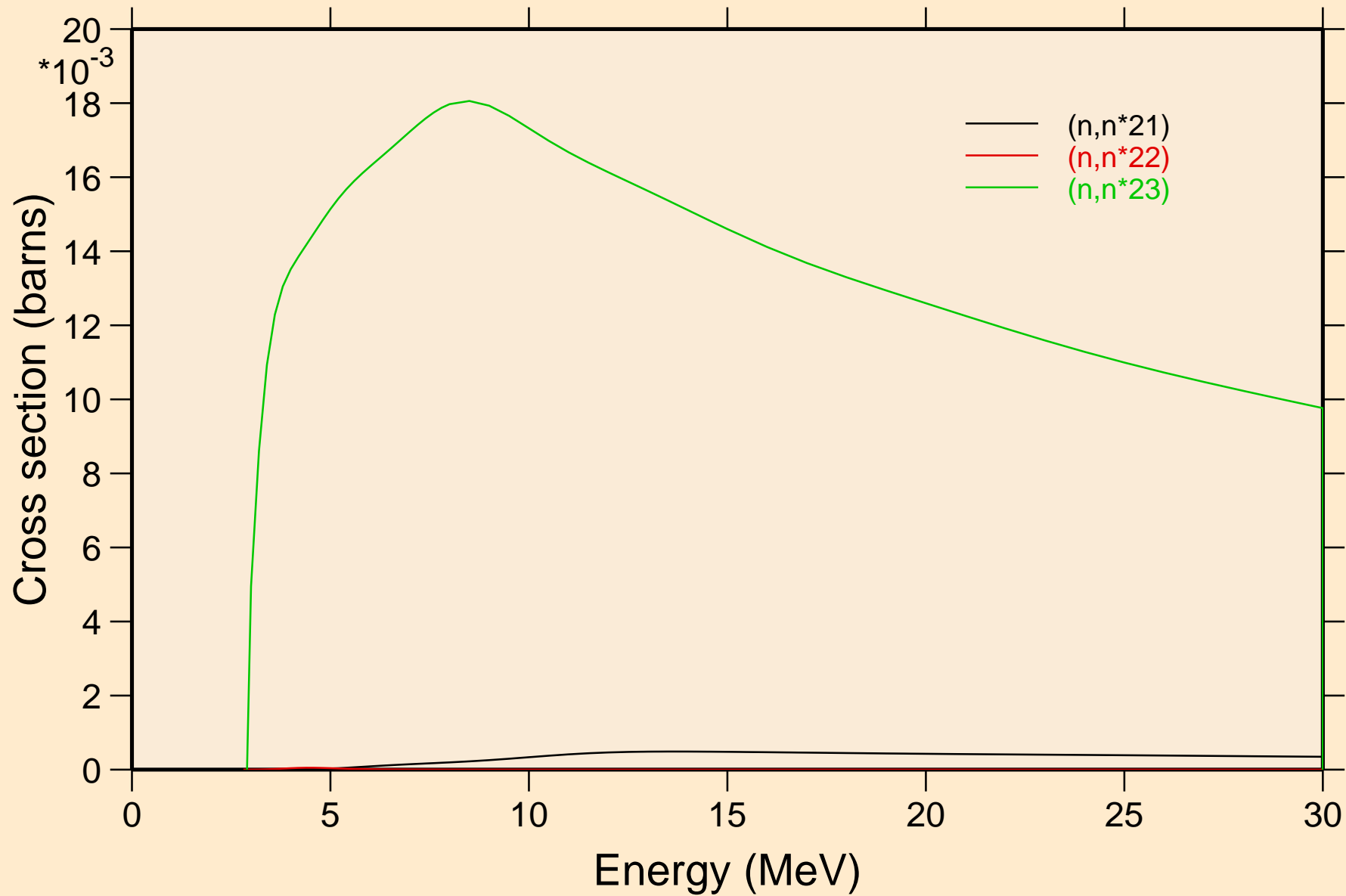

RN204 NEUTRON ACER TENDL-2024 LIBRARY; T=0.K

Threshold reactions

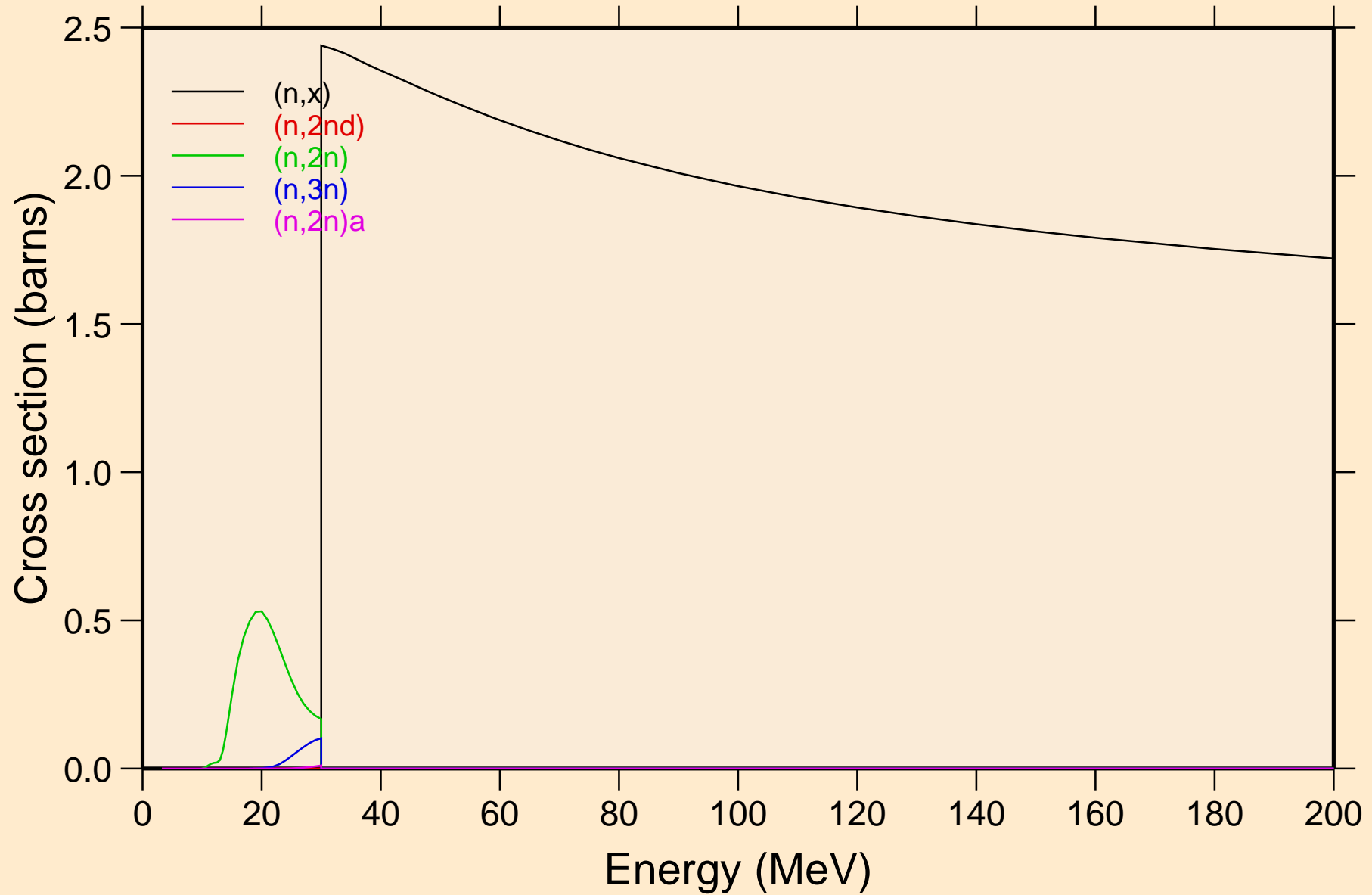

RN204 NEUTRON ACER TENDL-2024 LIBRARY; T=0.K
Threshold reactions

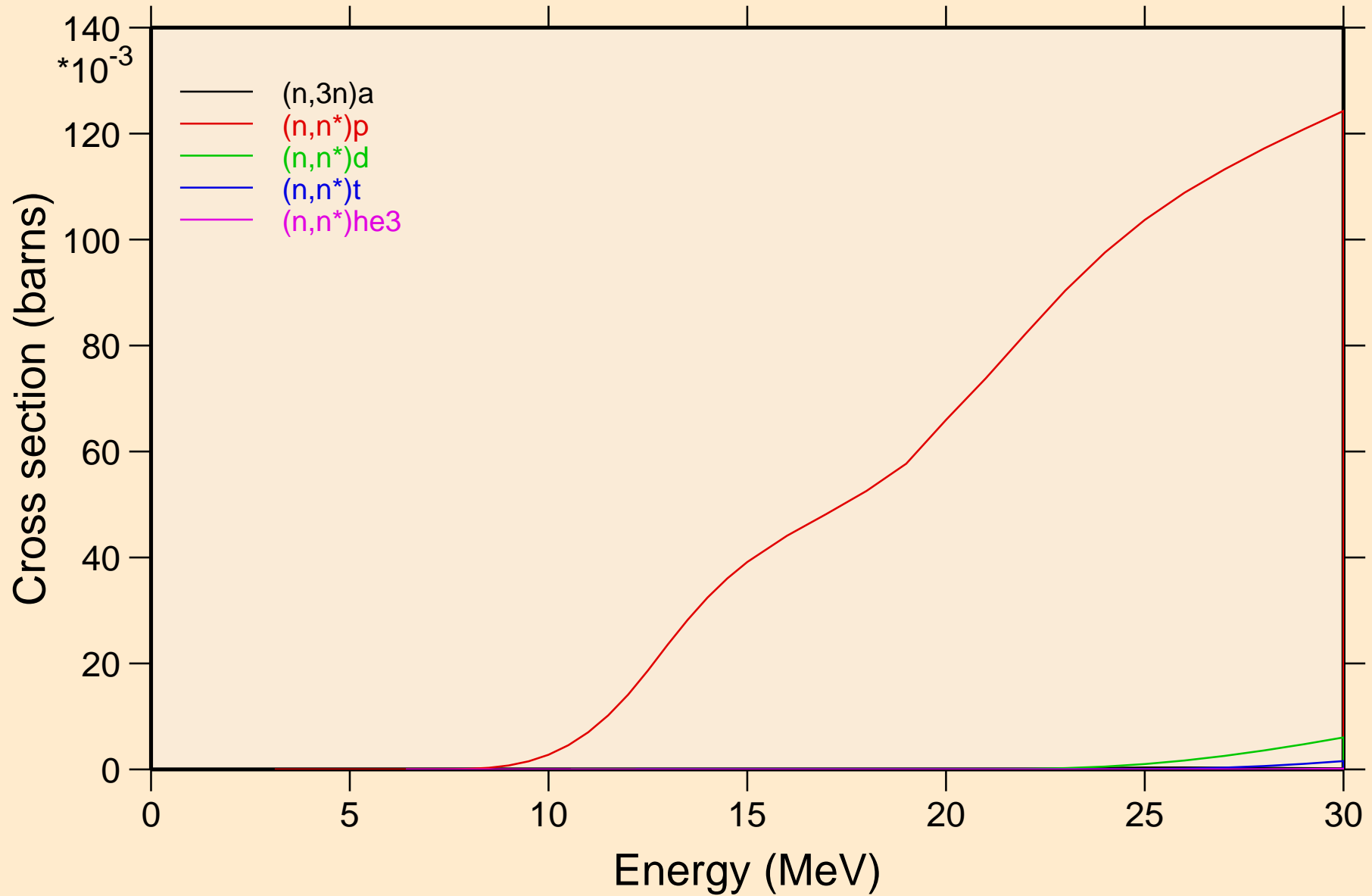

RN204 NEUTRON ACER TENDL-2024 LIBRARY; T=0.K
Threshold reactions

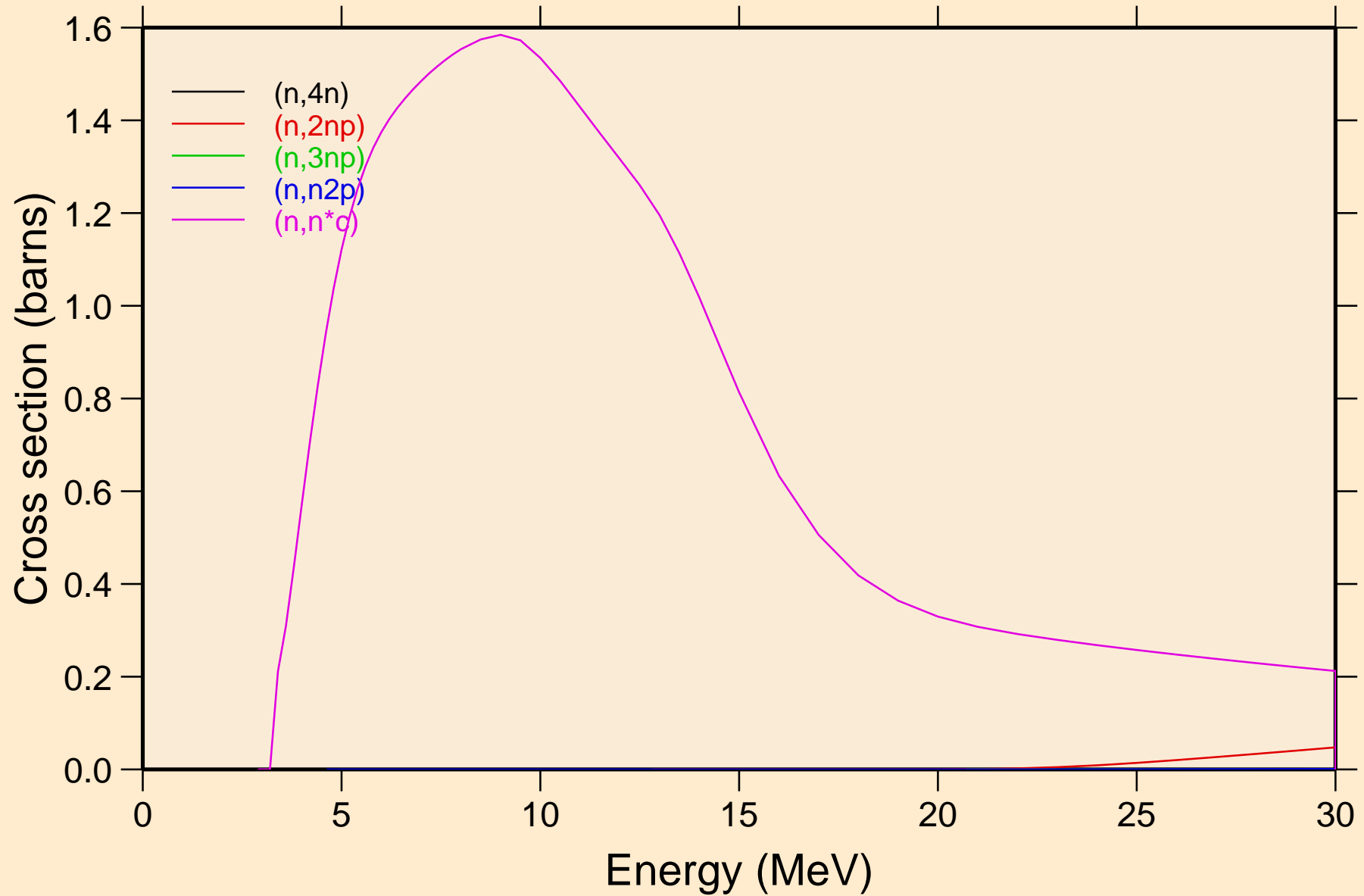

RN204 NEUTRON ACER TENDL-2024 LIBRARY; T=0.K

Threshold reactions

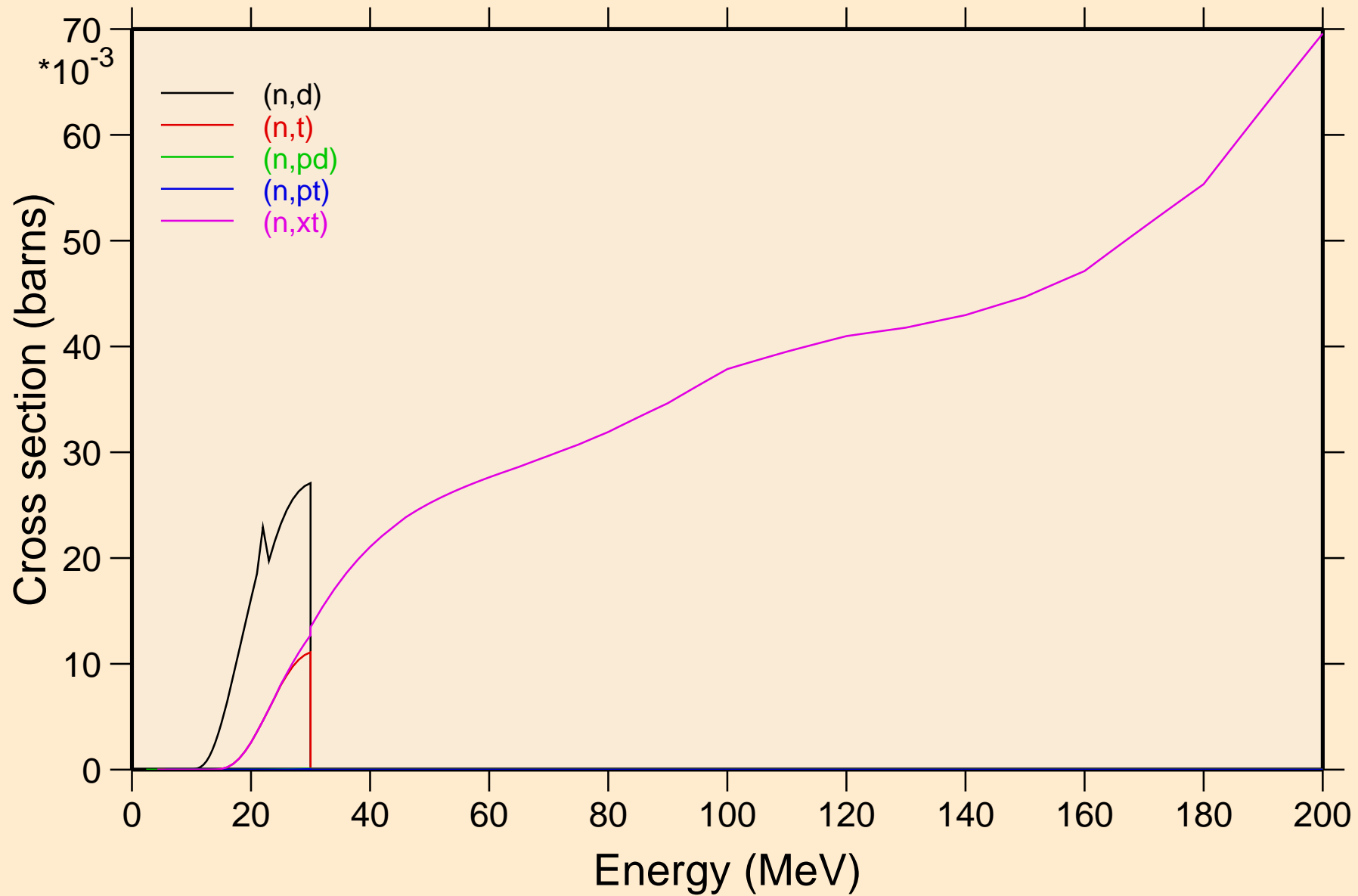

RN204 NEUTRON ACER TENDL-2024 LIBRARY; T=0.K
angular distribution for elastic

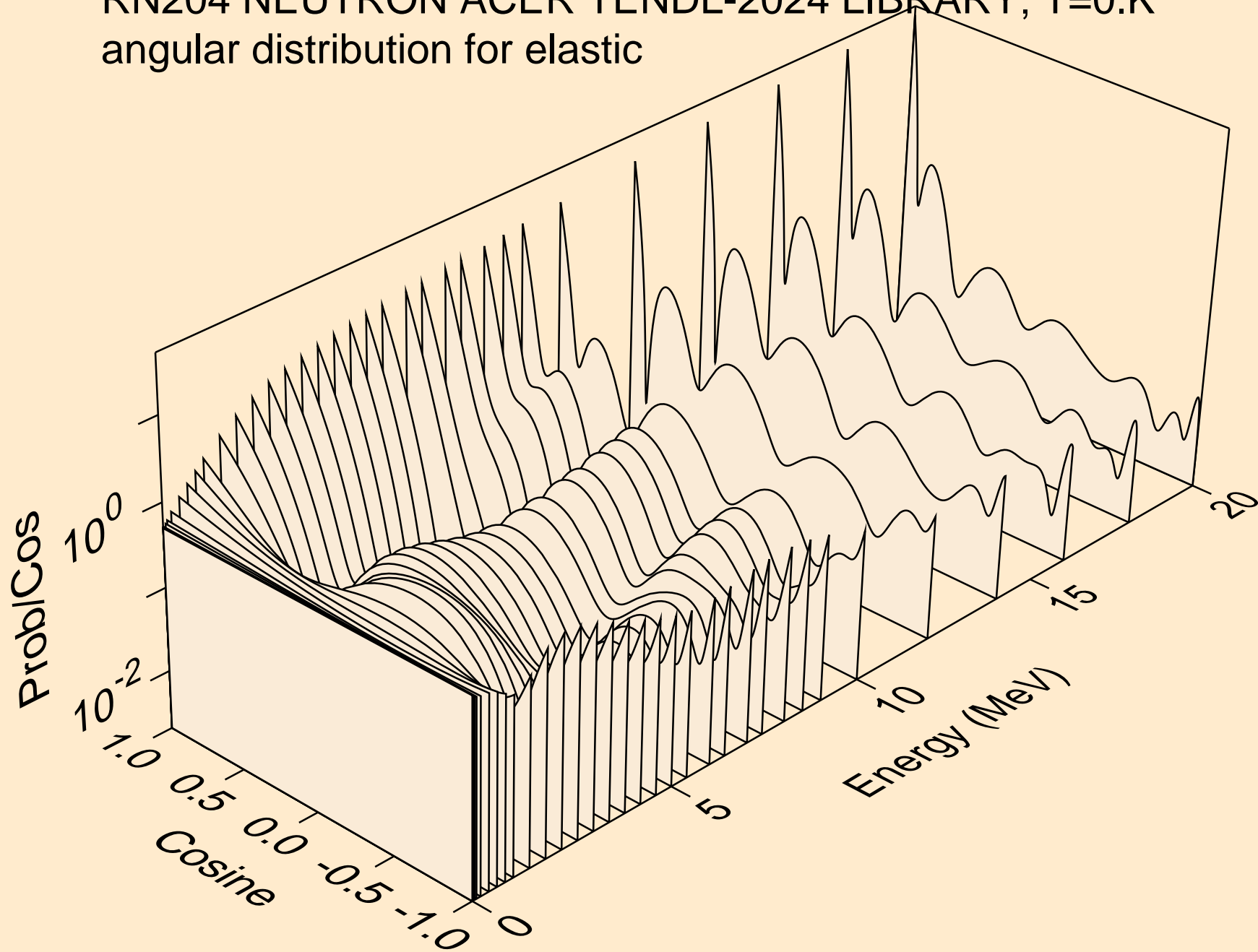

RN204 NEUTRON ACER TENDL-2024 LIBRARY; T=0.K
angular distribution for elastic

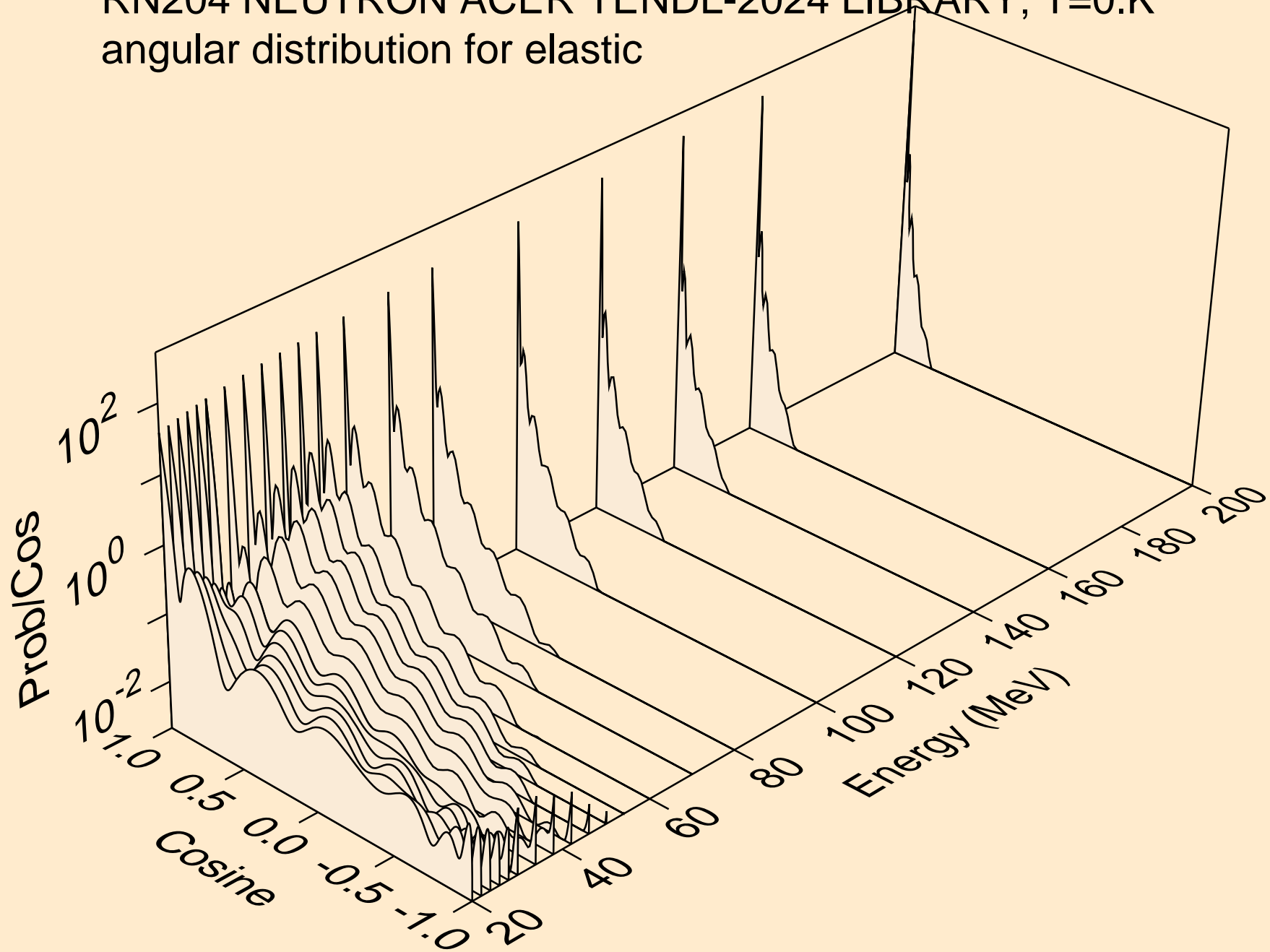

RN204 NEUTRON ACER TENDL-2024 LIBRARY; T=0.K
angular distribution for (n,n*1)

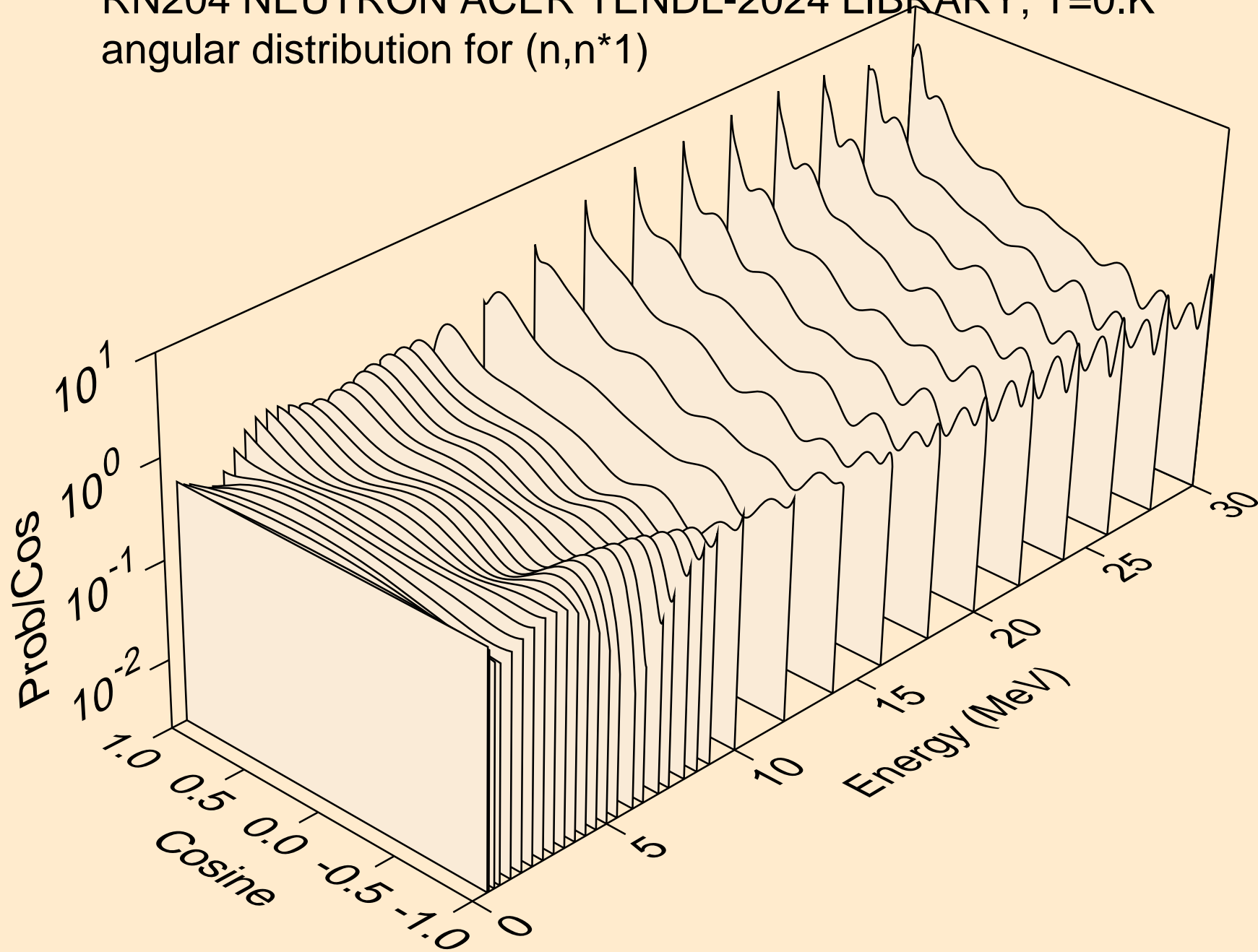

RN204 NEUTRON ACER TENDL-2024 LIBRARY; T=0.K
angular distribution for (n,n*2)

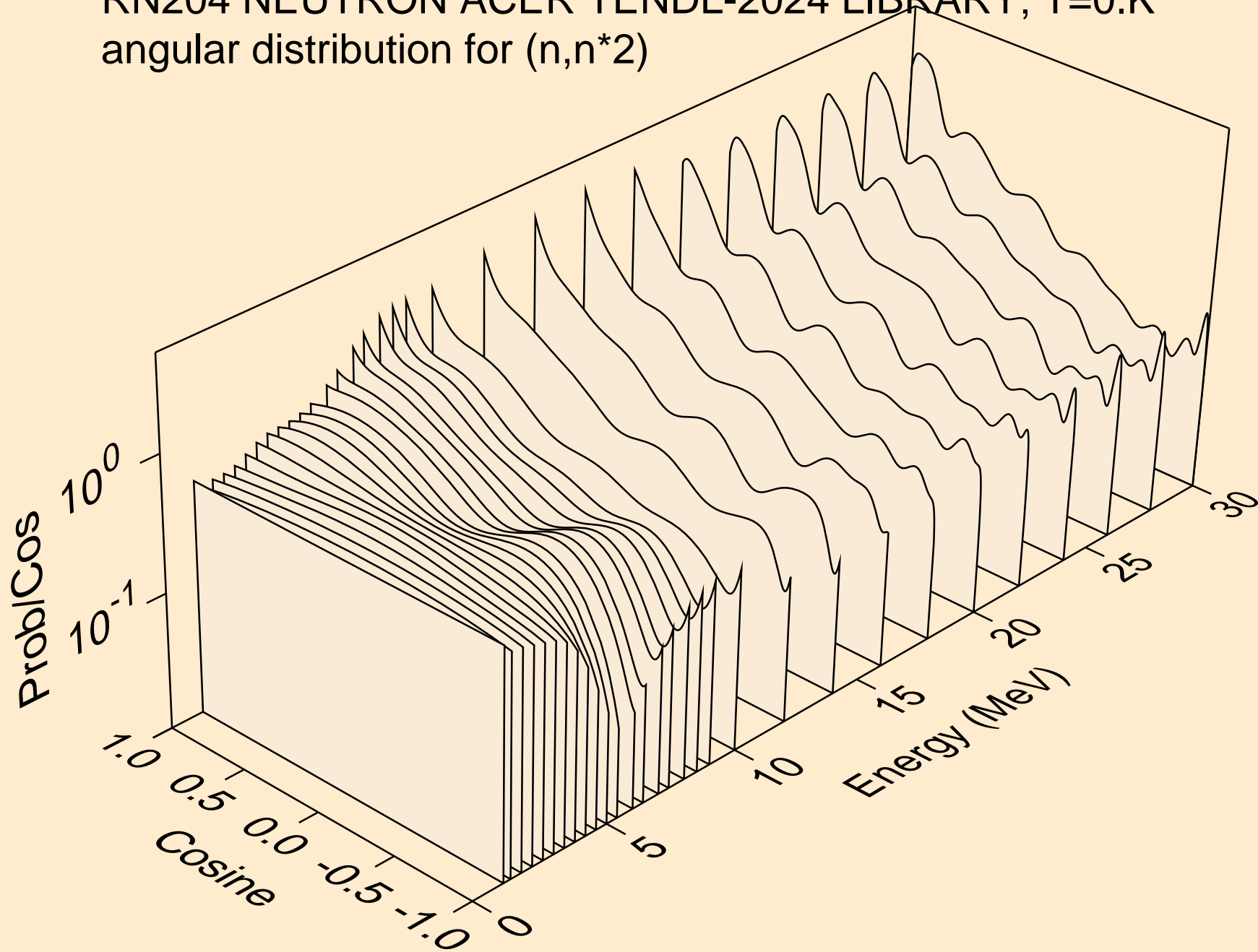

RN204 NEUTRON ACER TENDL-2024 LIBRARY; T=0.K
angular distribution for (n,n*3)

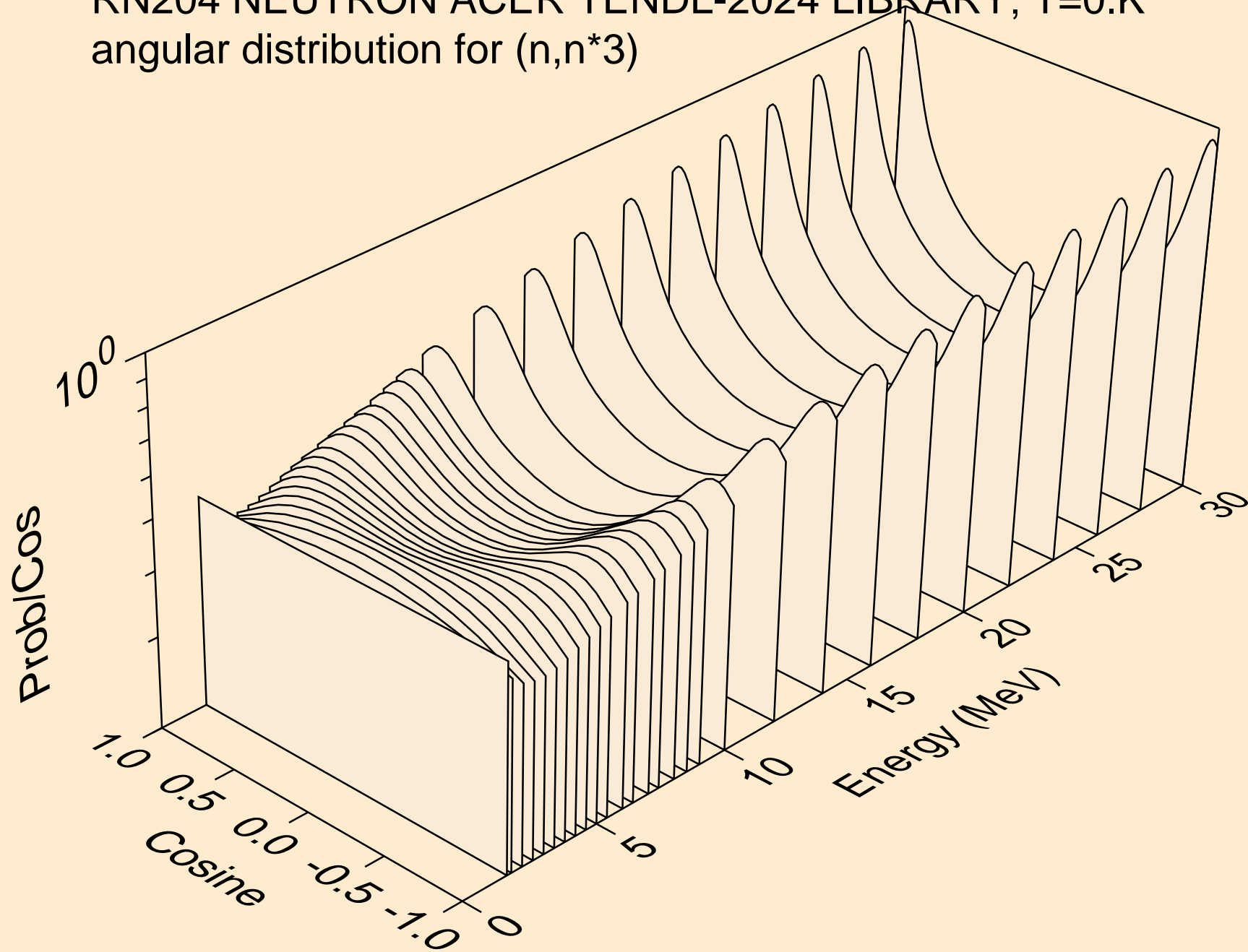

RN204 NEUTRON ACER TENDL-2024 LIBRARY; T=0.K
angular distribution for (n,n*4)

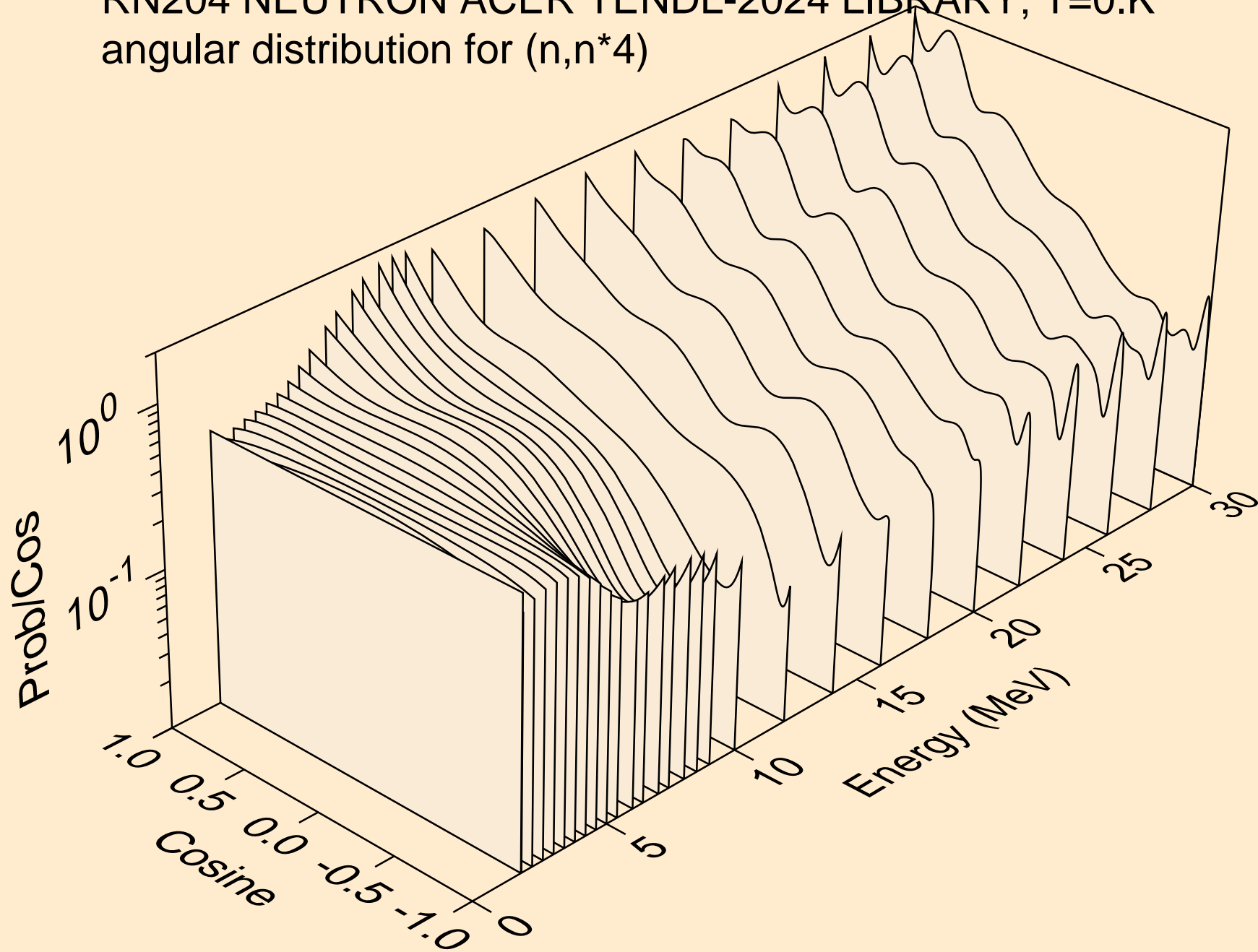

RN204 NEUTRON ACER TENDL-2024 LIBRARY; T=0.K
angular distribution for (n,n*5)

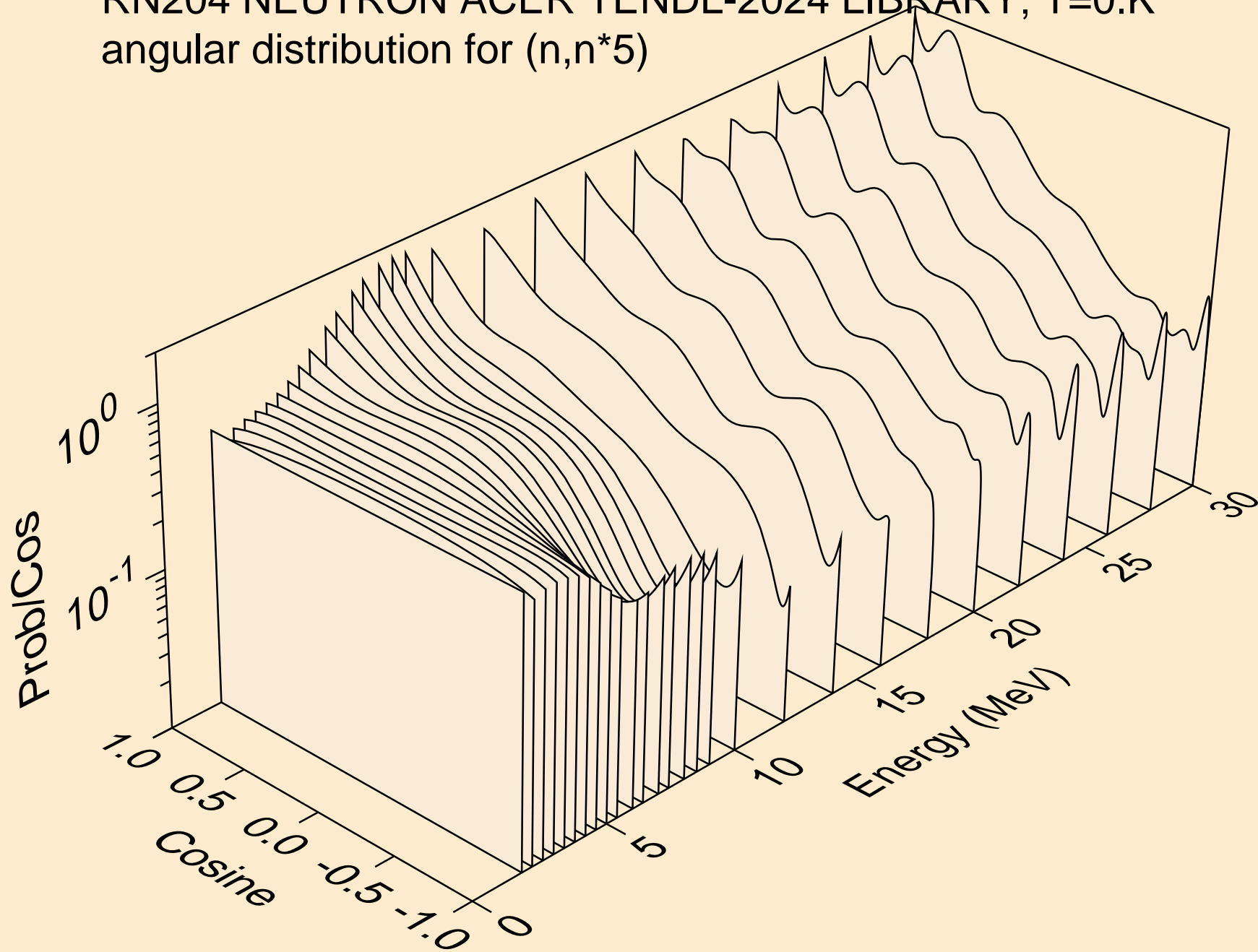

RN204 NEUTRON ACER TENDL-2024 LIBRARY; T=0.K
angular distribution for (n,n*6)

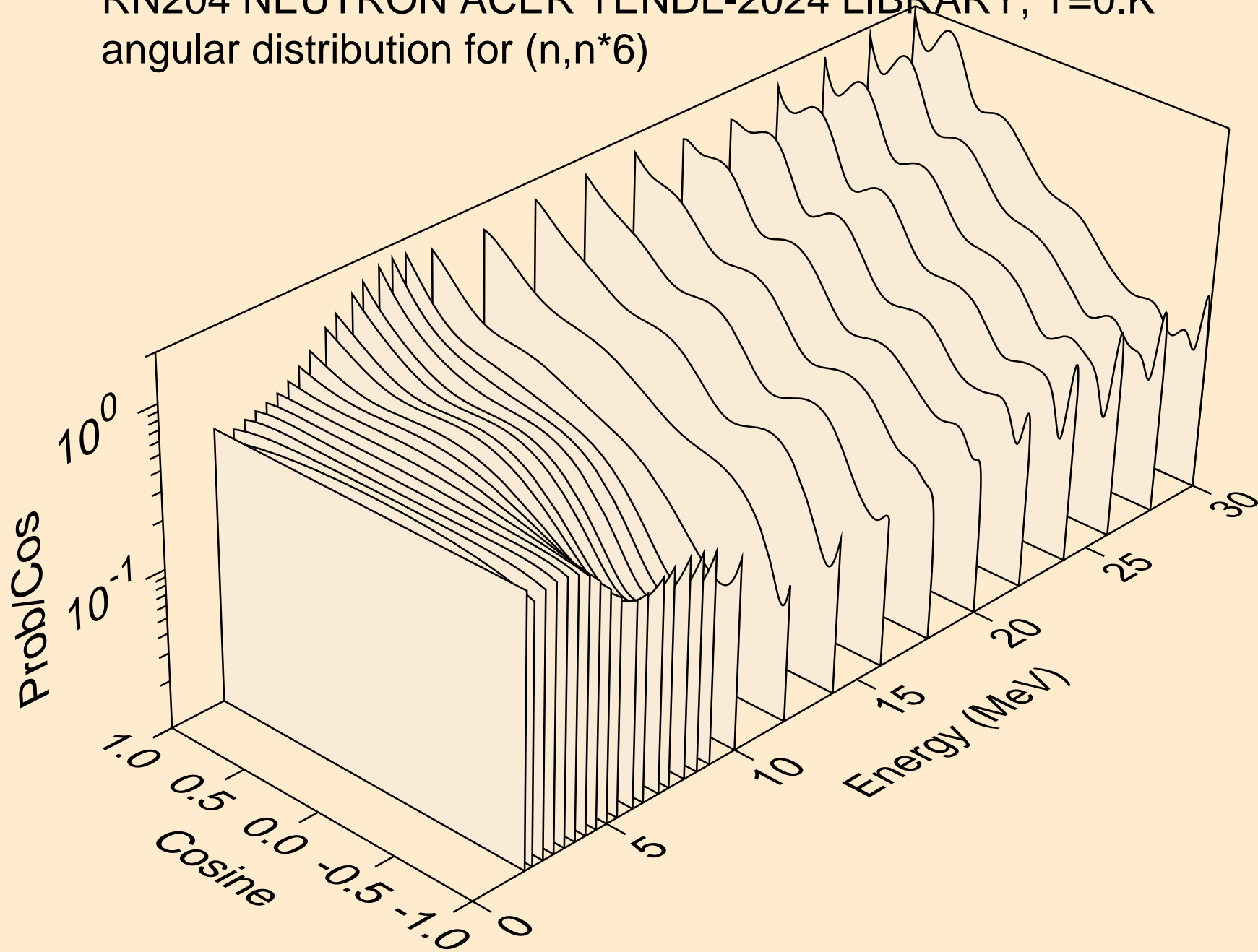

RN204 NEUTRON ACER TENDL-2024 LIBRARY; T=0.K
angular distribution for (n,n*7)

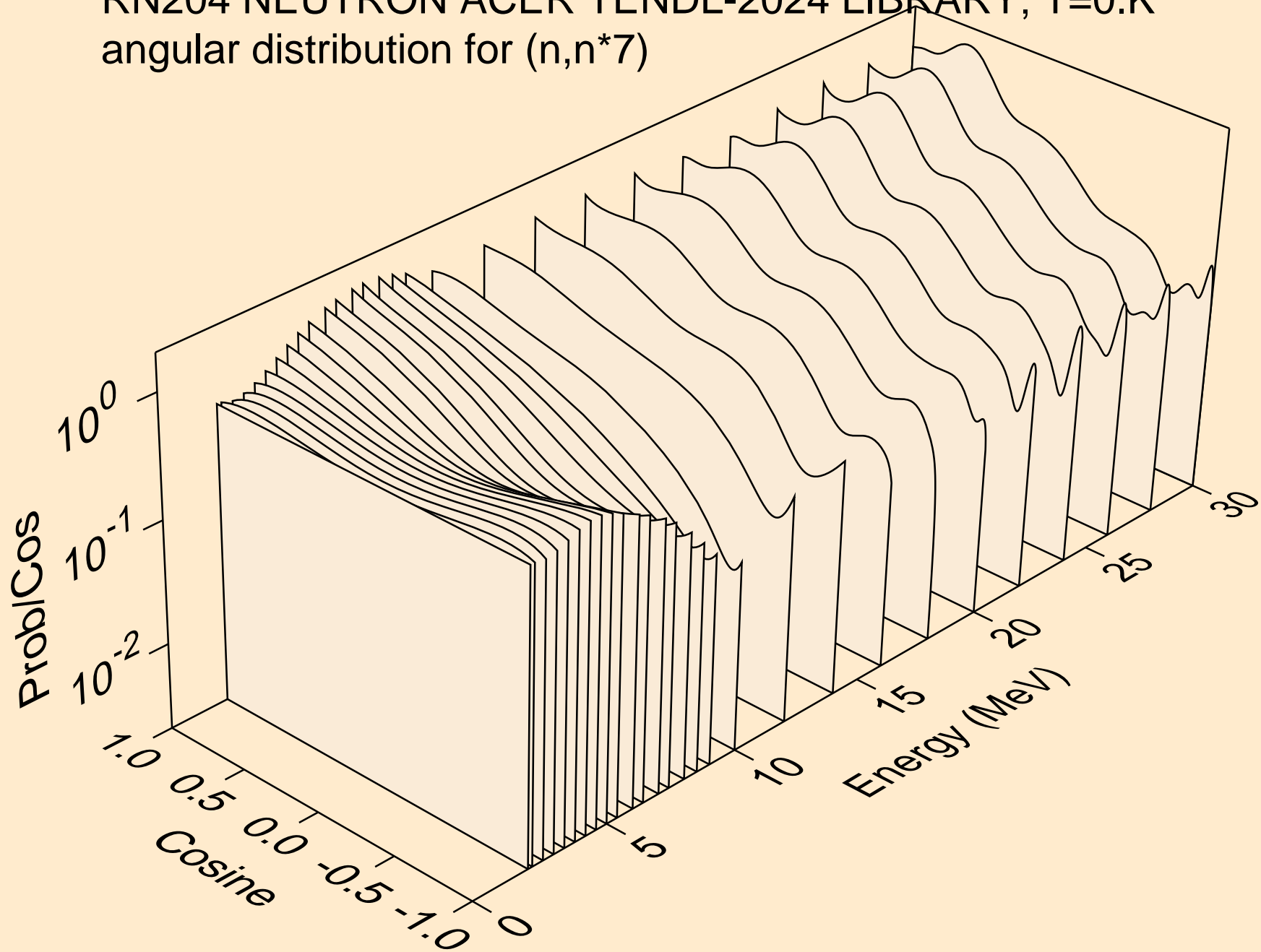

RN204 NEUTRON ACER TENDL-2024 LIBRARY; T=0.K
angular distribution for (n,n*8)

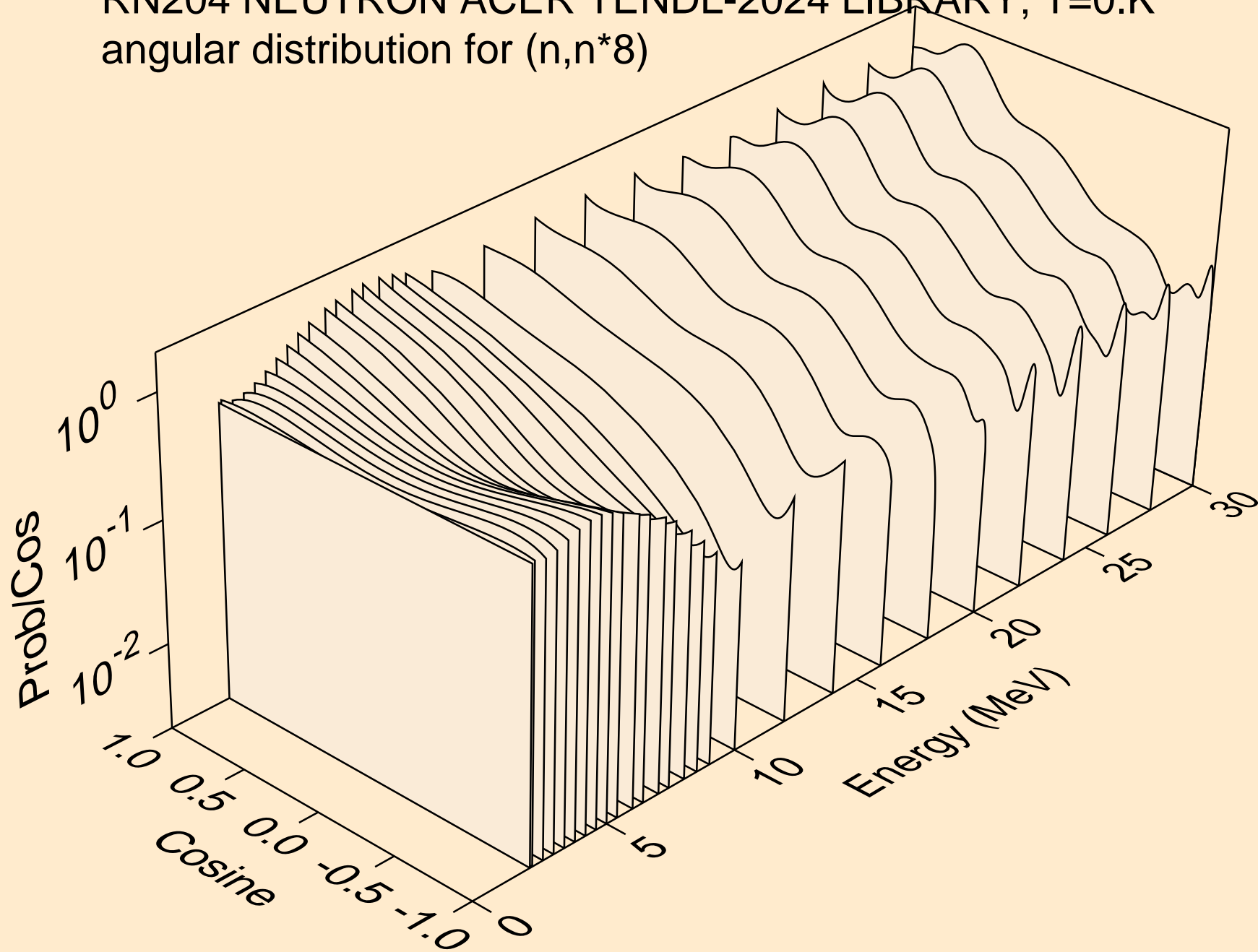

RN204 NEUTRON ACER TENDL-2024 LIBRARY; T=0.K
angular distribution for (n,n*9)

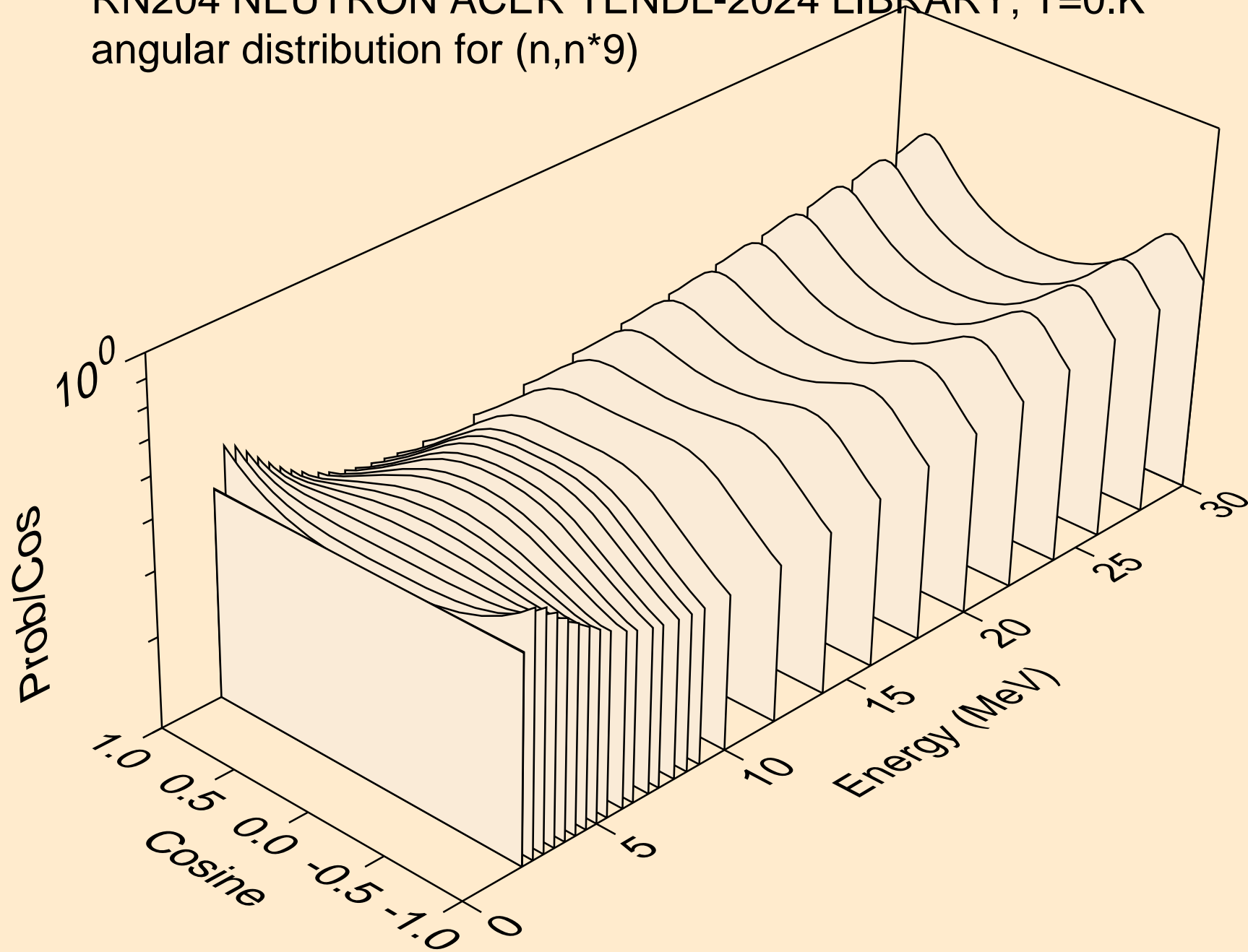

RN204 NEUTRON ACER TENDL-2024 LIBRARY; T=0.K
angular distribution for (n,n*10)

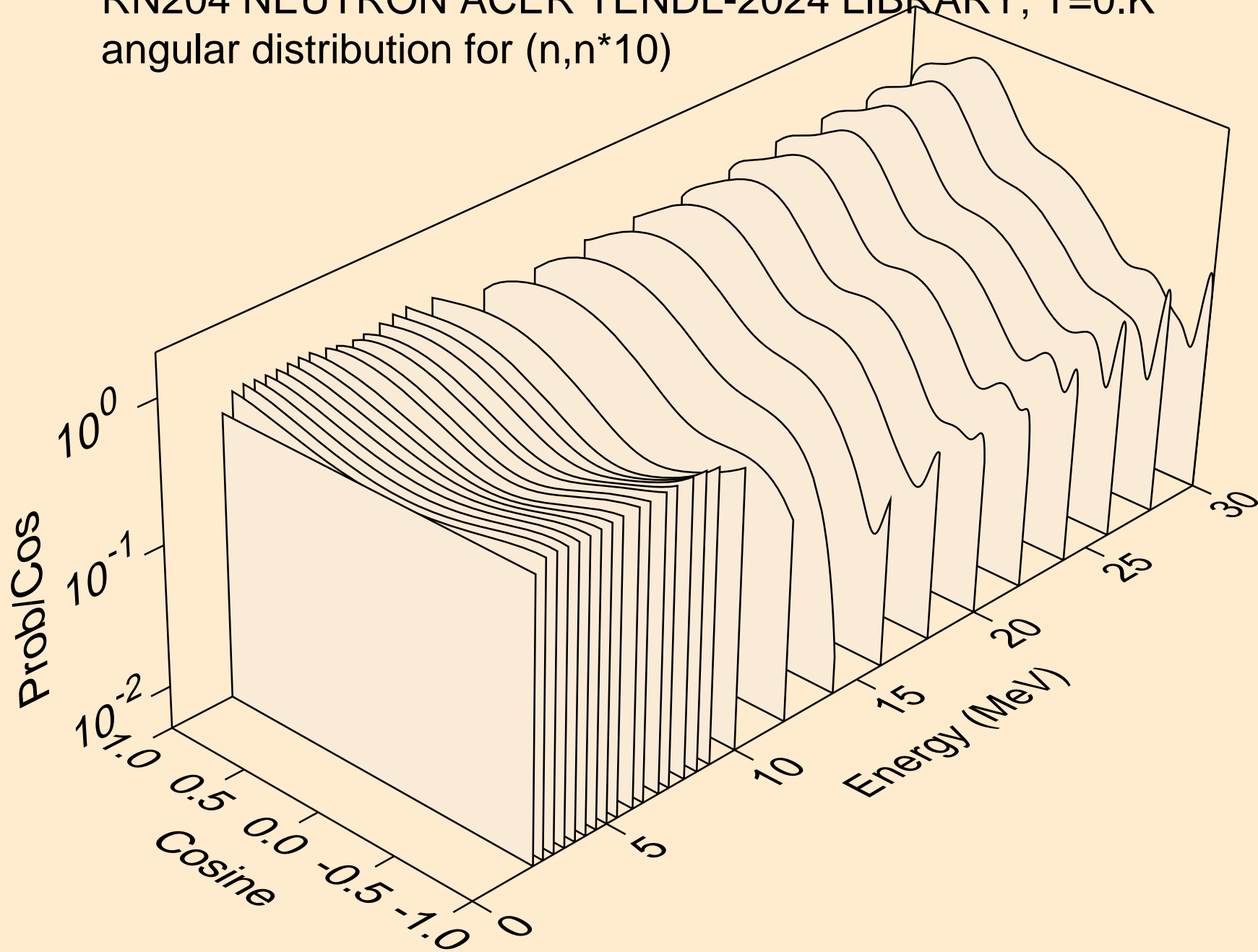

RN204 NEUTRON ACER TENDL-2024 LIBRARY; T=0.K
angular distribution for (n,n*11)

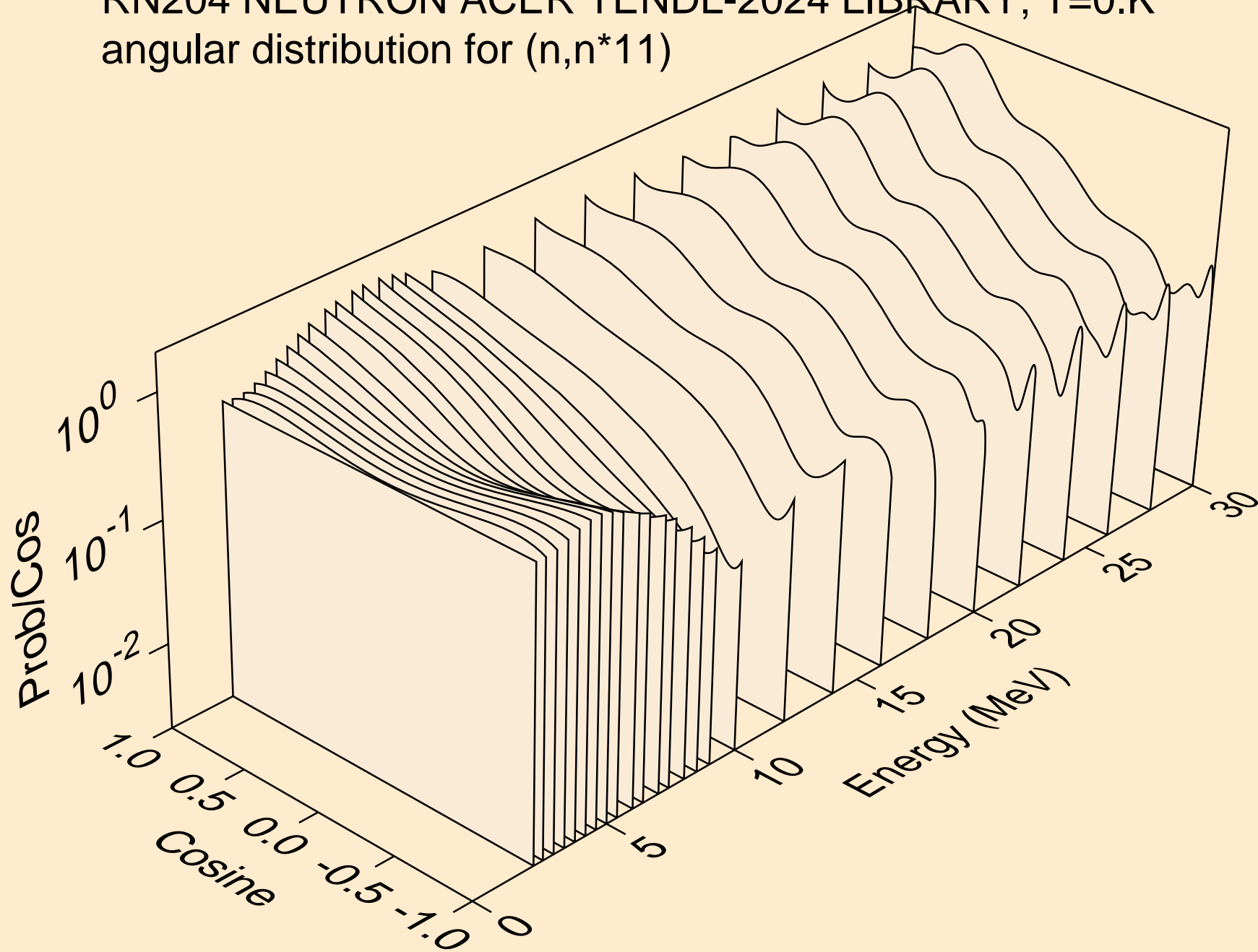

RN204 NEUTRON ACER TENDL-2024 LIBRARY; T=0.K
angular distribution for (n,n*12)

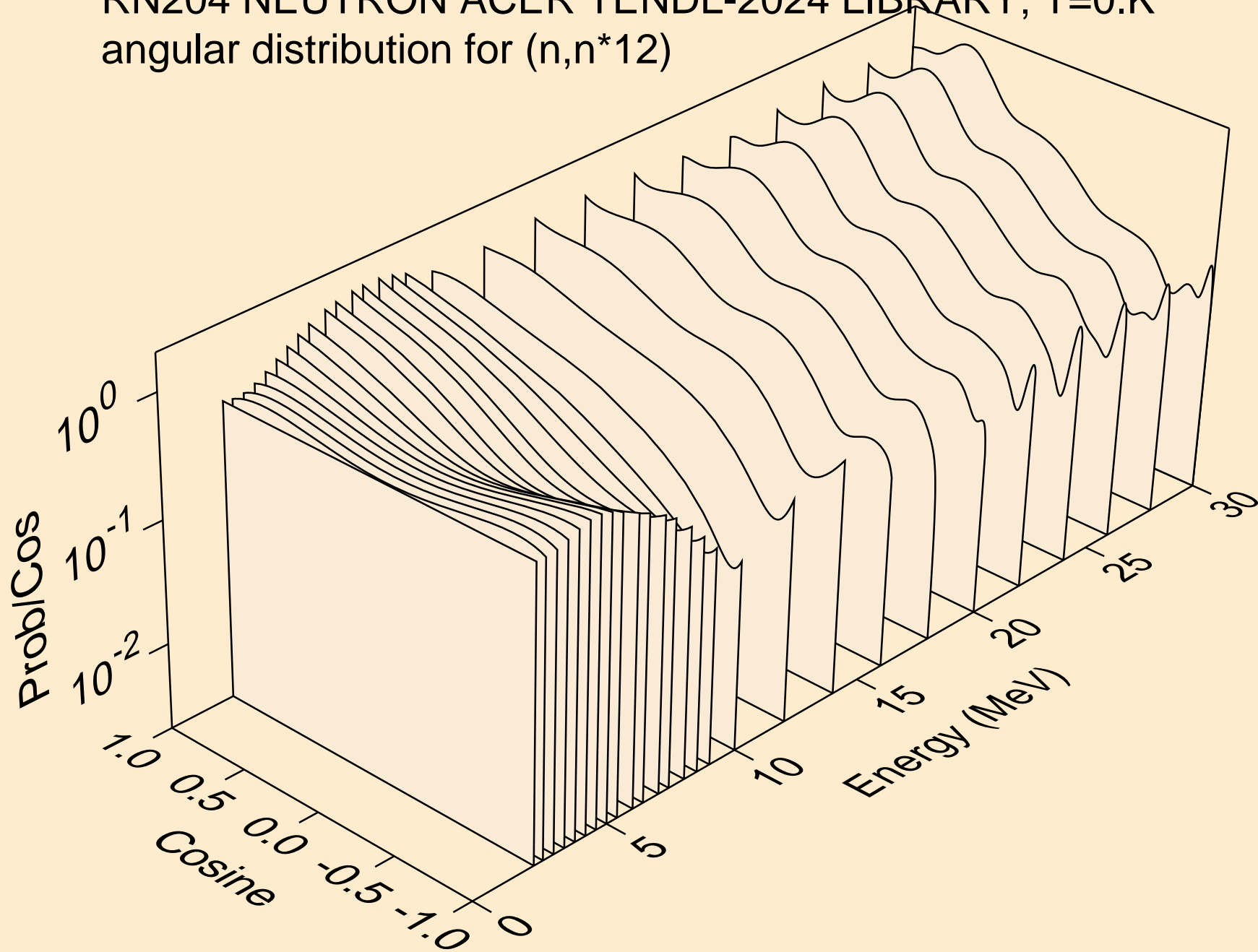

RN204 NEUTRON ACER TENDL-2024 LIBRARY; T=0.K
angular distribution for (n,n*13)

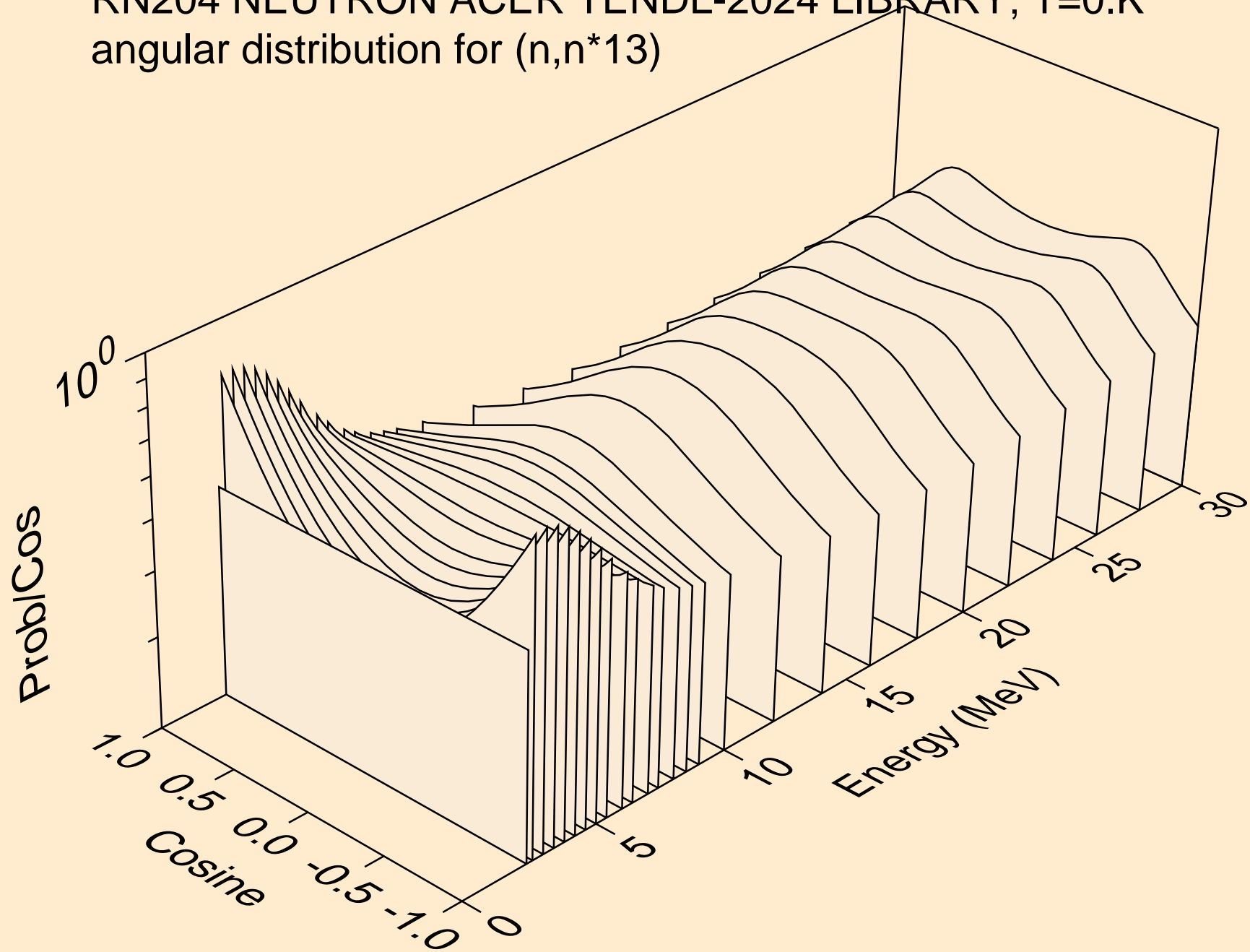

RN204 NEUTRON ACER TENDL-2024 LIBRARY; T=0.K
angular distribution for (n,n*14)

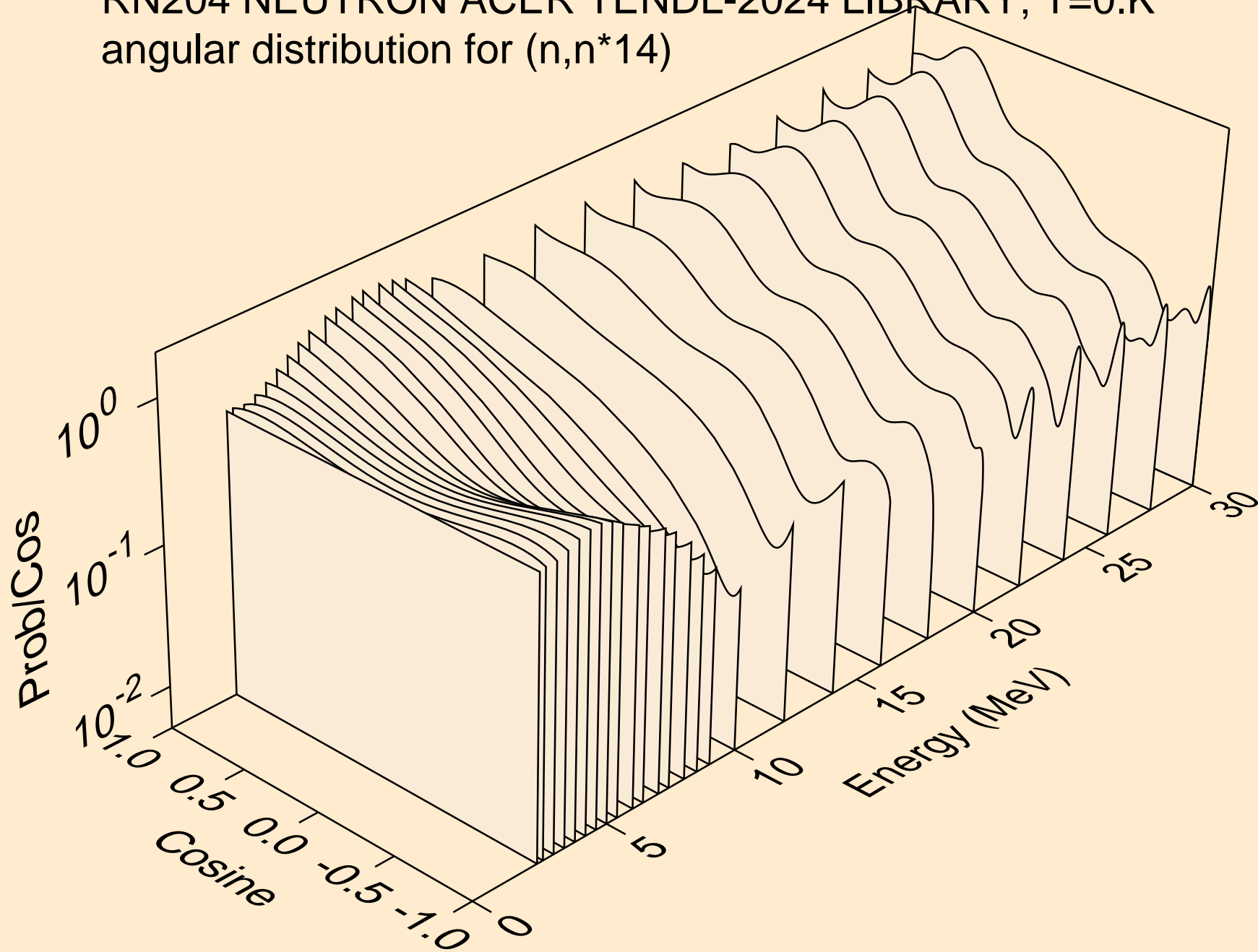

RN204 NEUTRON ACER TENDL-2024 LIBRARY; T=0.K
angular distribution for (n,n*15)

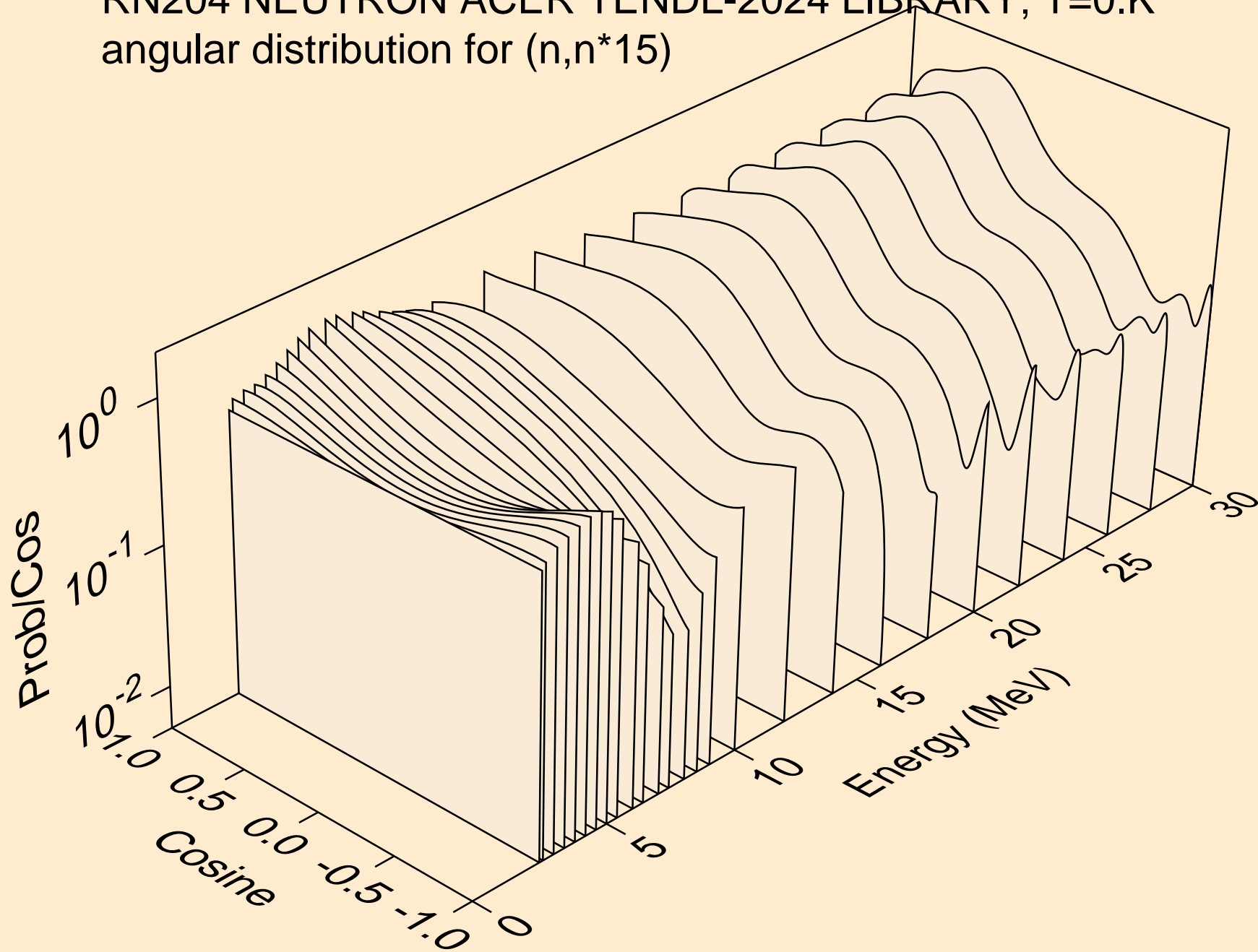

RN204 NEUTRON ACER TENDL-2024 LIBRARY; T=0.K
angular distribution for (n,n*16)

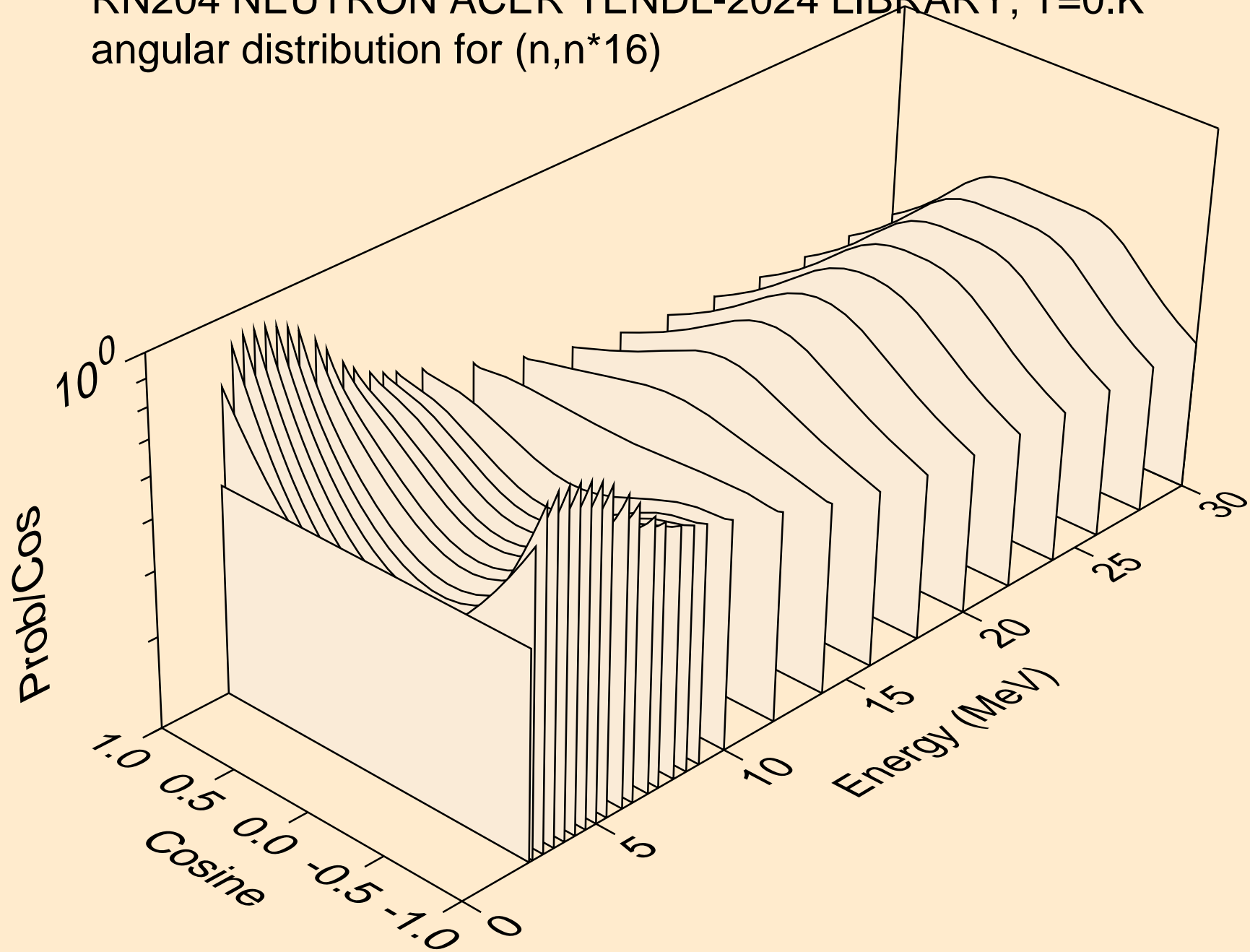

RN204 NEUTRON ACER TENDL-2024 LIBRARY; T=0.K
angular distribution for (n,n*17)

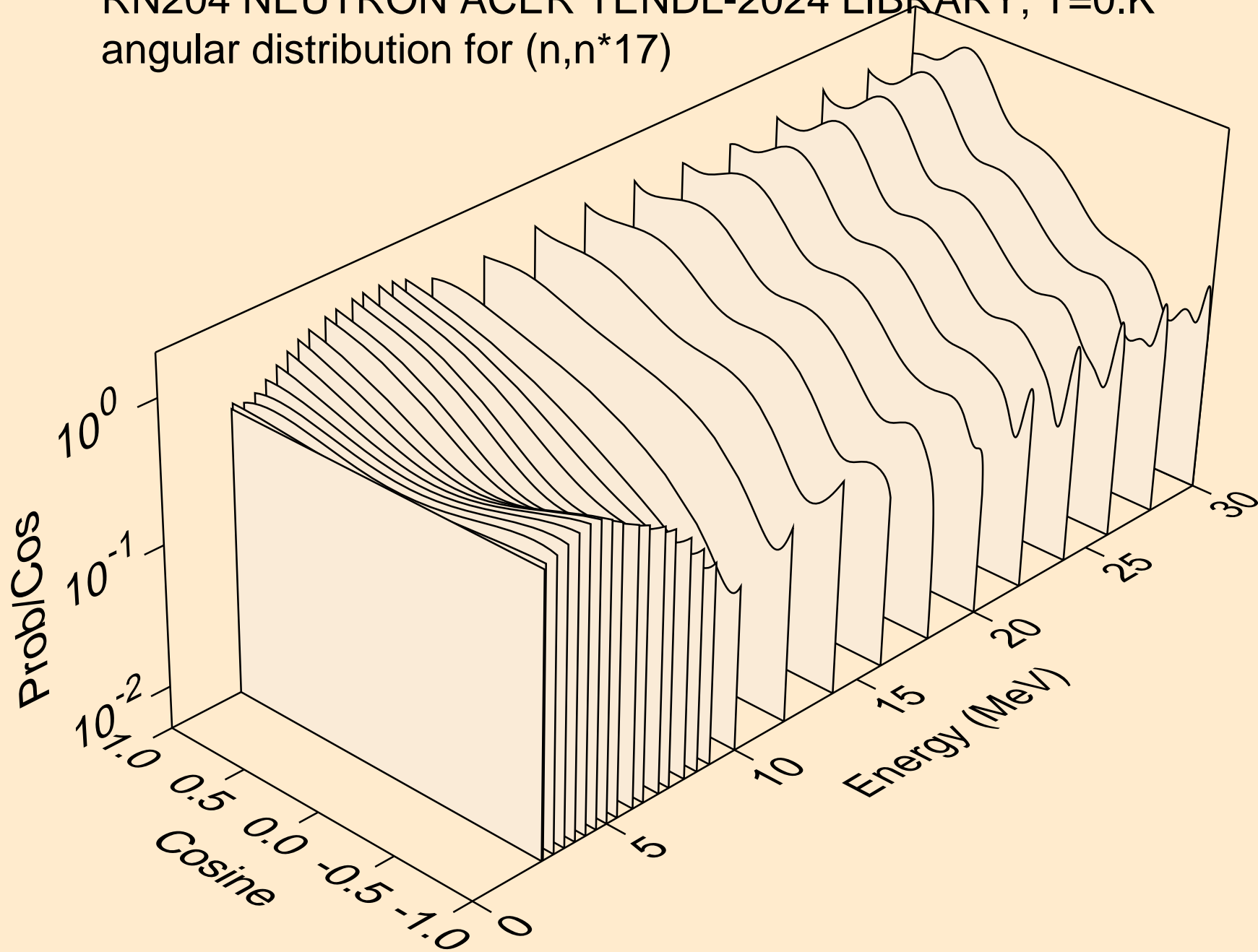

RN204 NEUTRON ACER TENDL-2024 LIBRARY; T=0.K
angular distribution for (n,n*18)

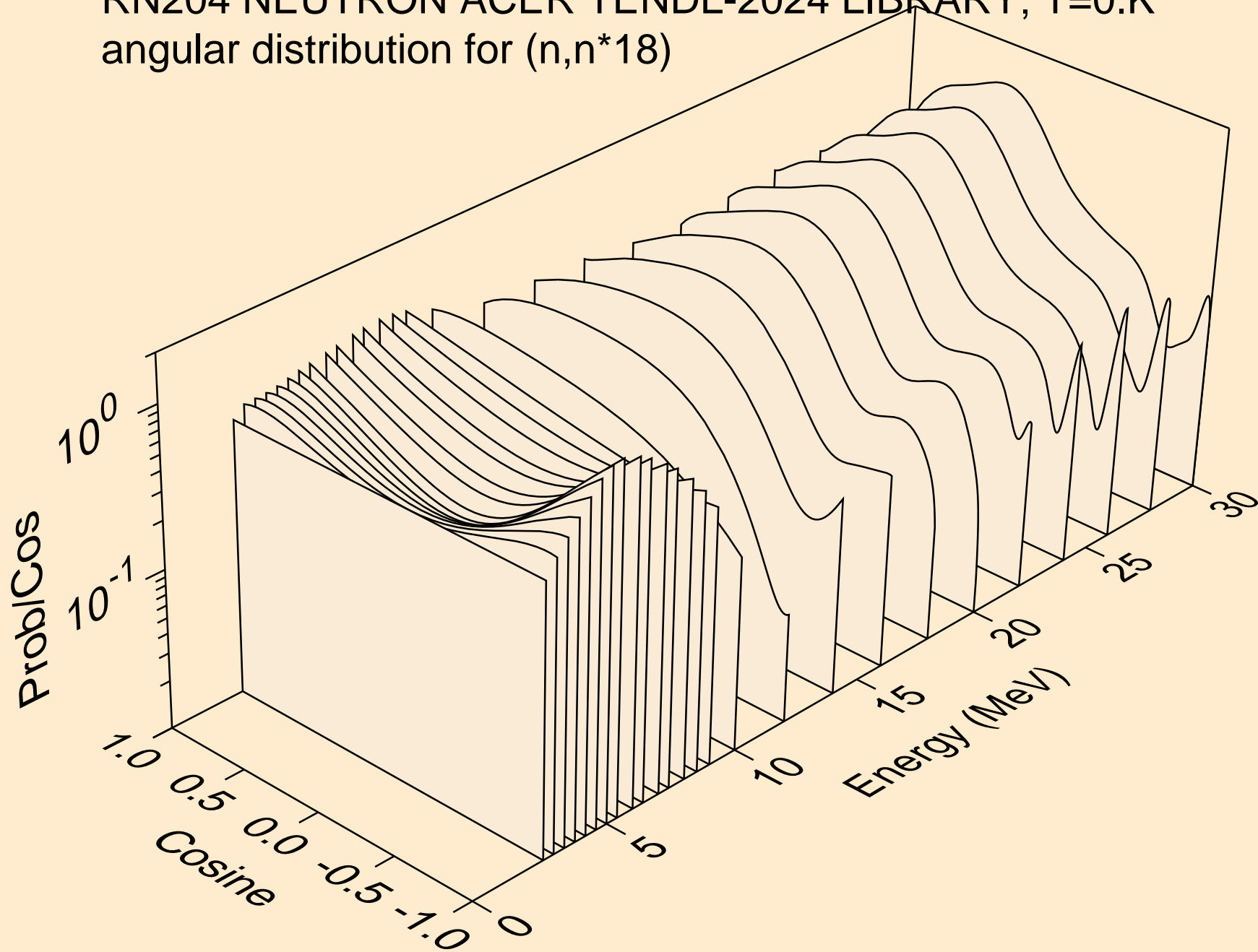

RN204 NEUTRON ACER TENDL-2024 LIBRARY; T=0.K
angular distribution for (n,n*19)

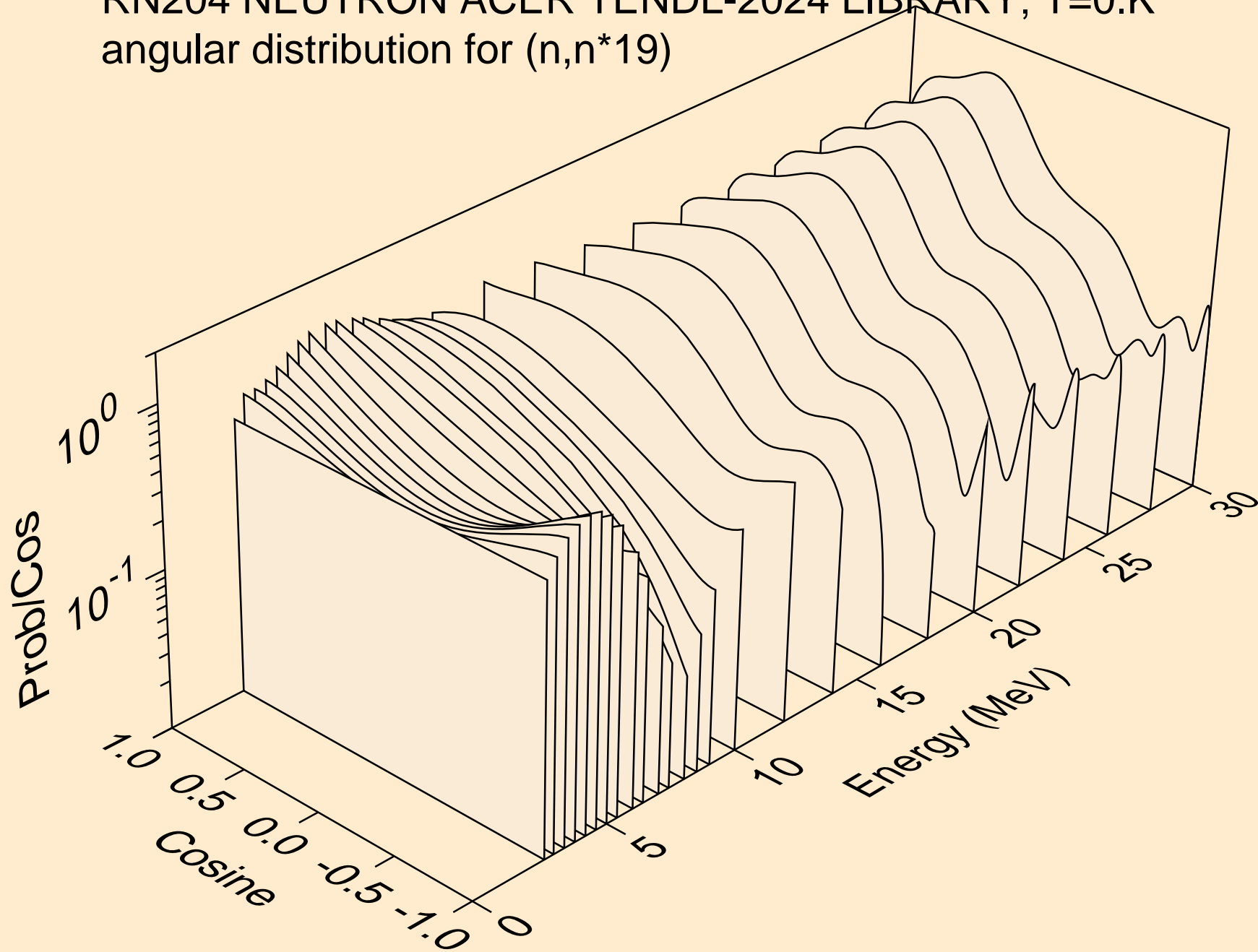

RN204 NEUTRON ACER TENDL-2024 LIBRARY; T=0.K
angular distribution for (n,n*20)

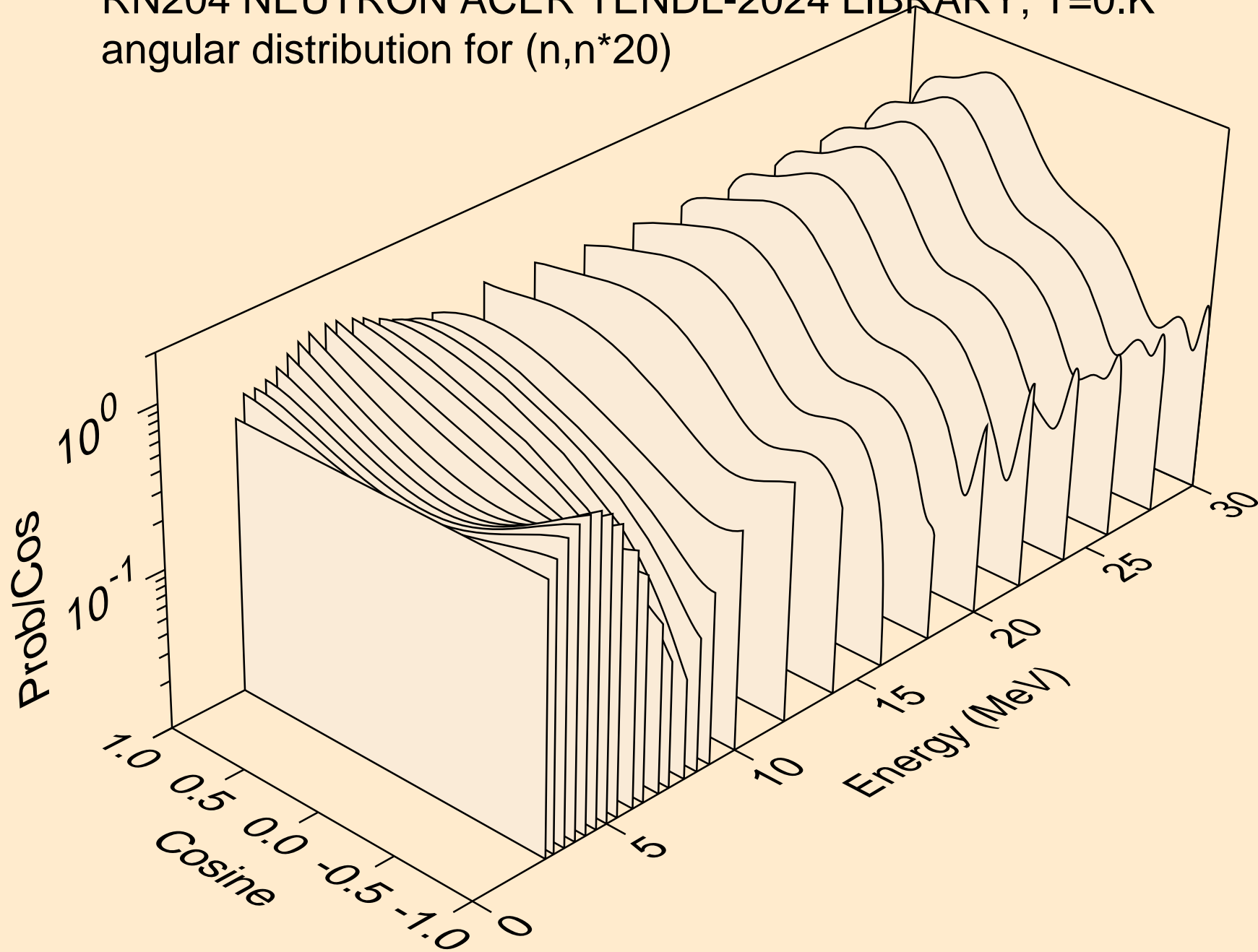

RN204 NEUTRON ACER TENDL-2024 LIBRARY; T=0.K
angular distribution for (n,n*21)

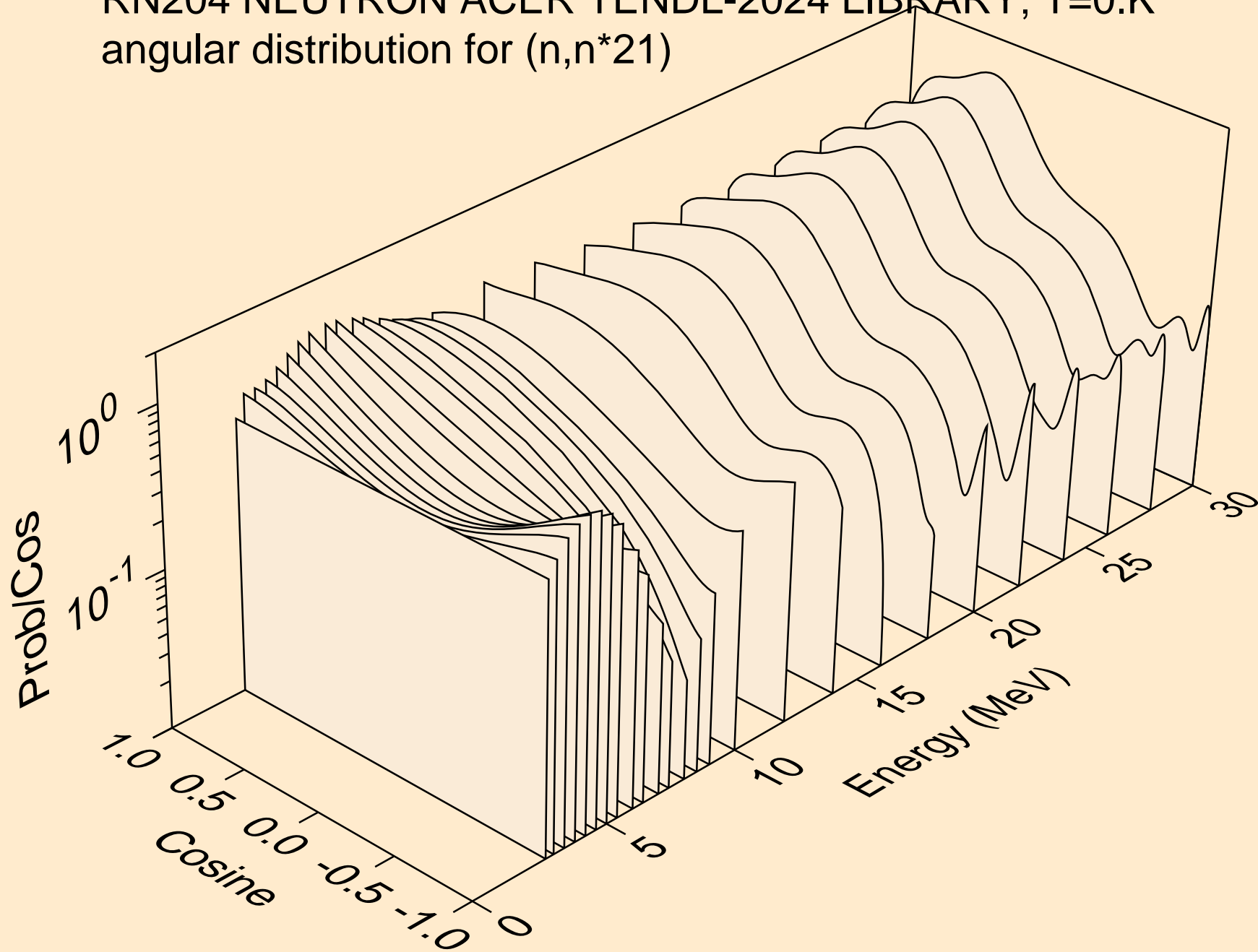

RN204 NEUTRON ACER TENDL-2024 LIBRARY; T=0.K
angular distribution for (n,n*22)

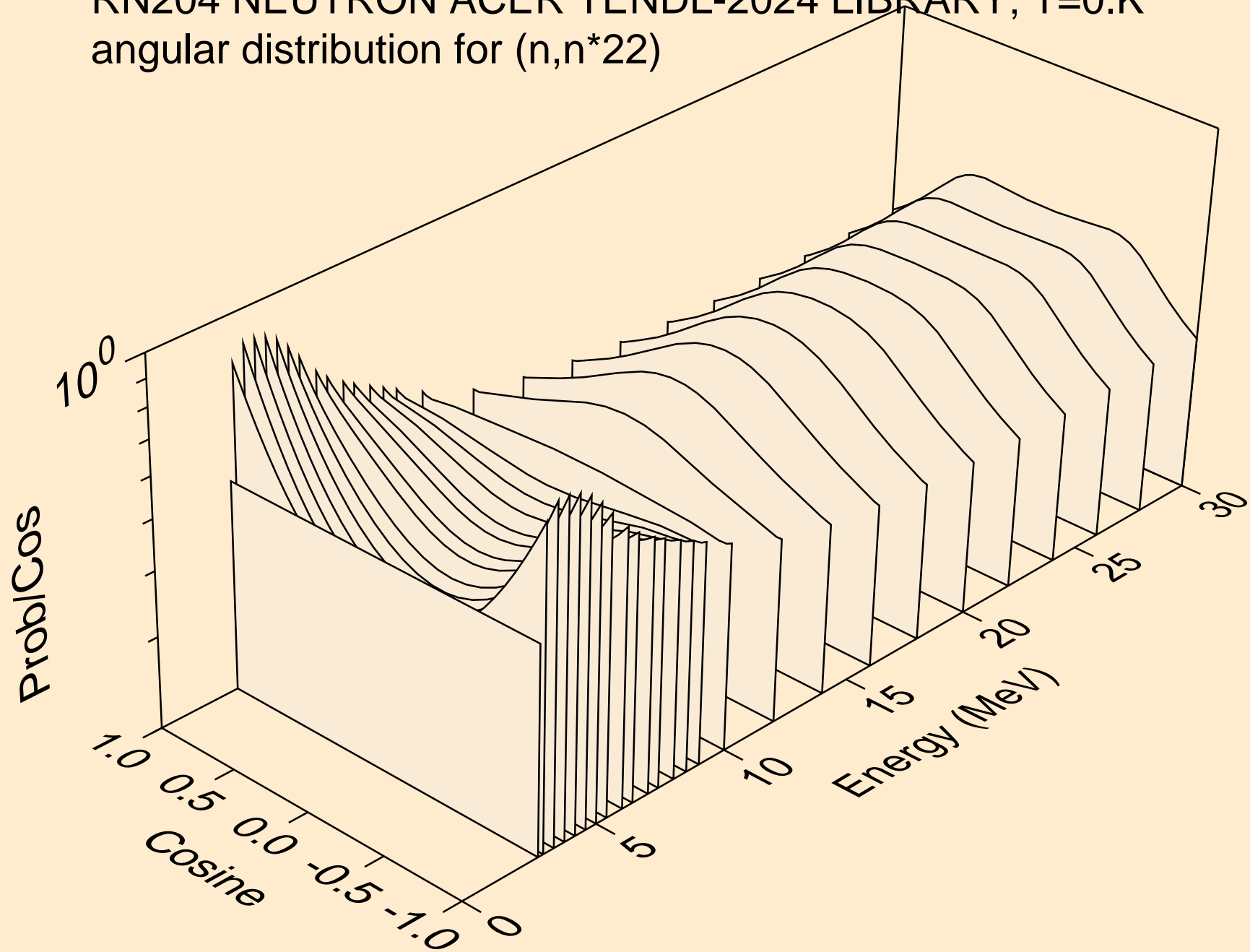

RN204 NEUTRON ACER TENDL-2024 LIBRARY; T=0.K
angular distribution for (n,n*23)

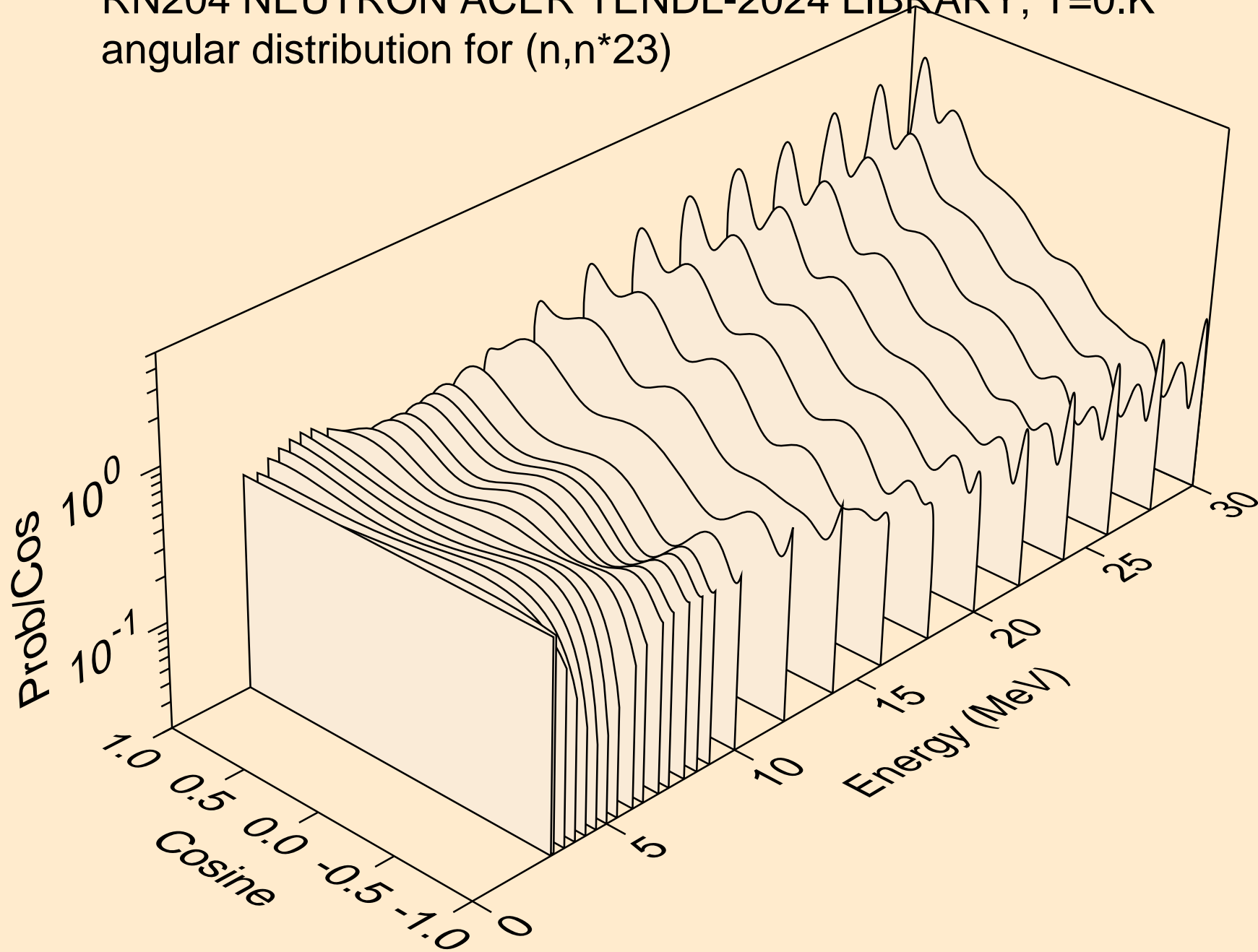

RN204 NEUTRON ACER TENDL-2024 LIBRARY; T=0.K
Neutron emission for (n,x)

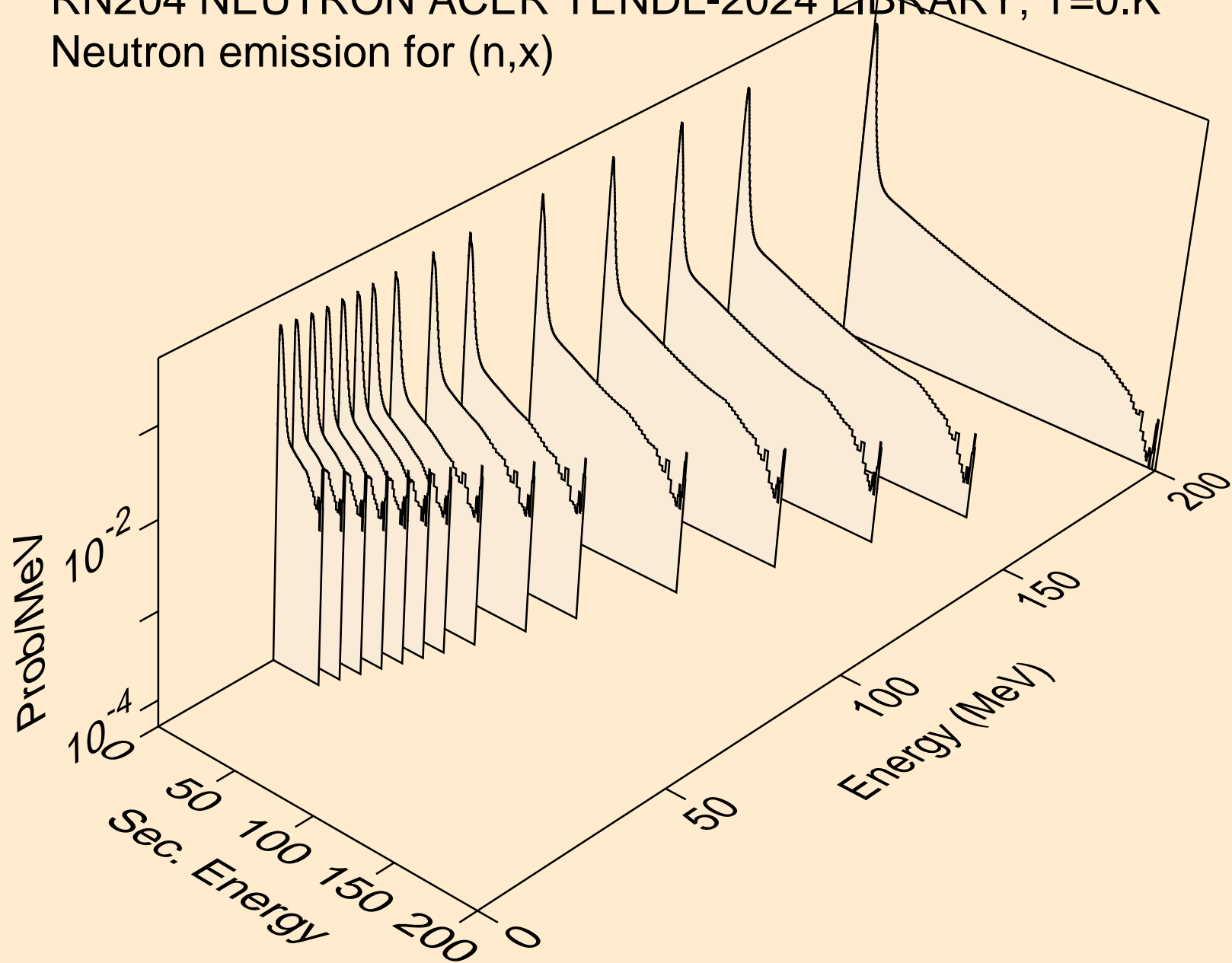

RN204 NEUTRON ACER TENDL-2024 LIBRARY; T=0.K
Neutron emission for (n,2nd)

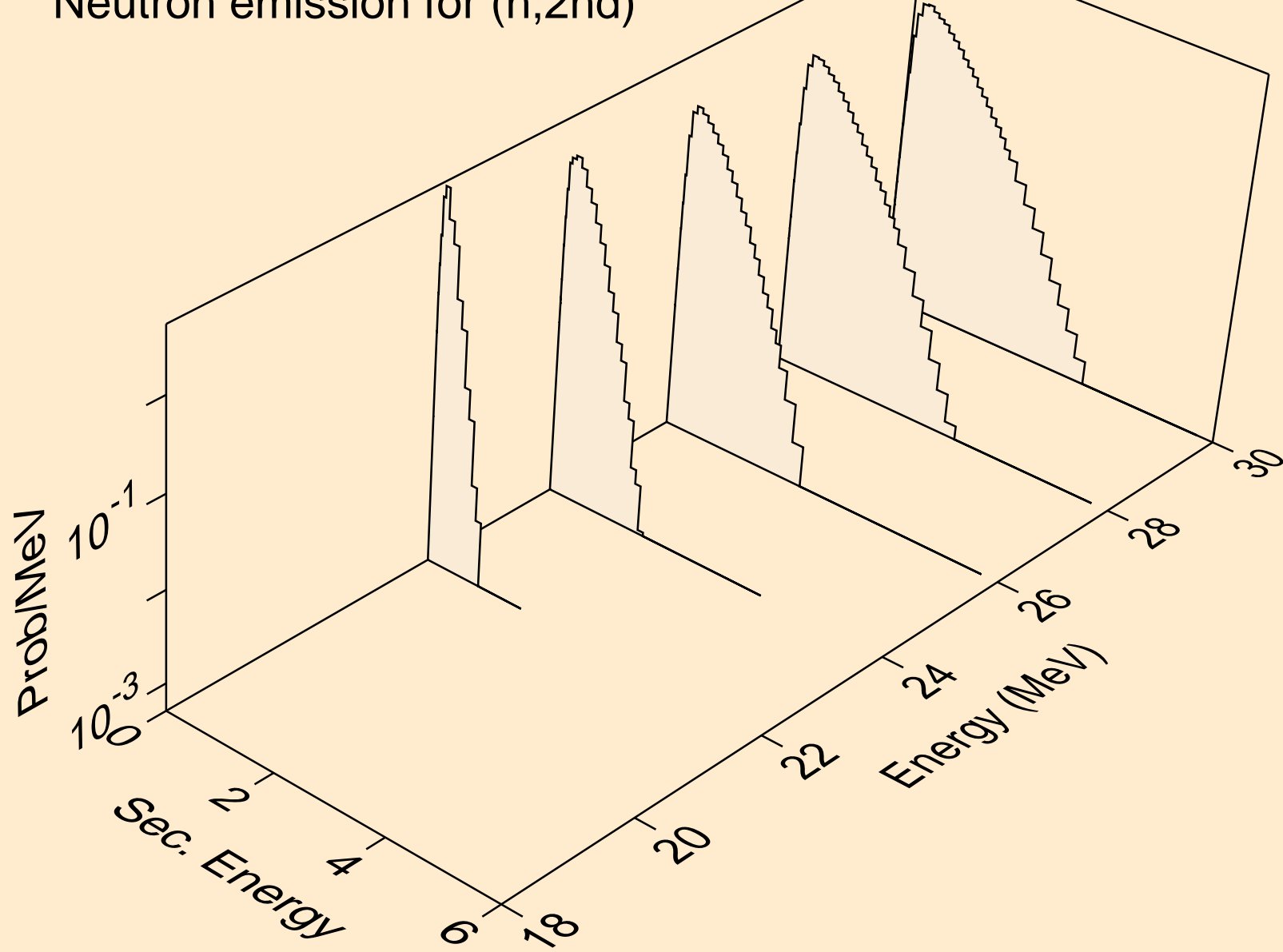

RN204 NEUTRON ACER TENDL-2024 LIBRARY; T=0.K
Neutron emission for (n,2n)

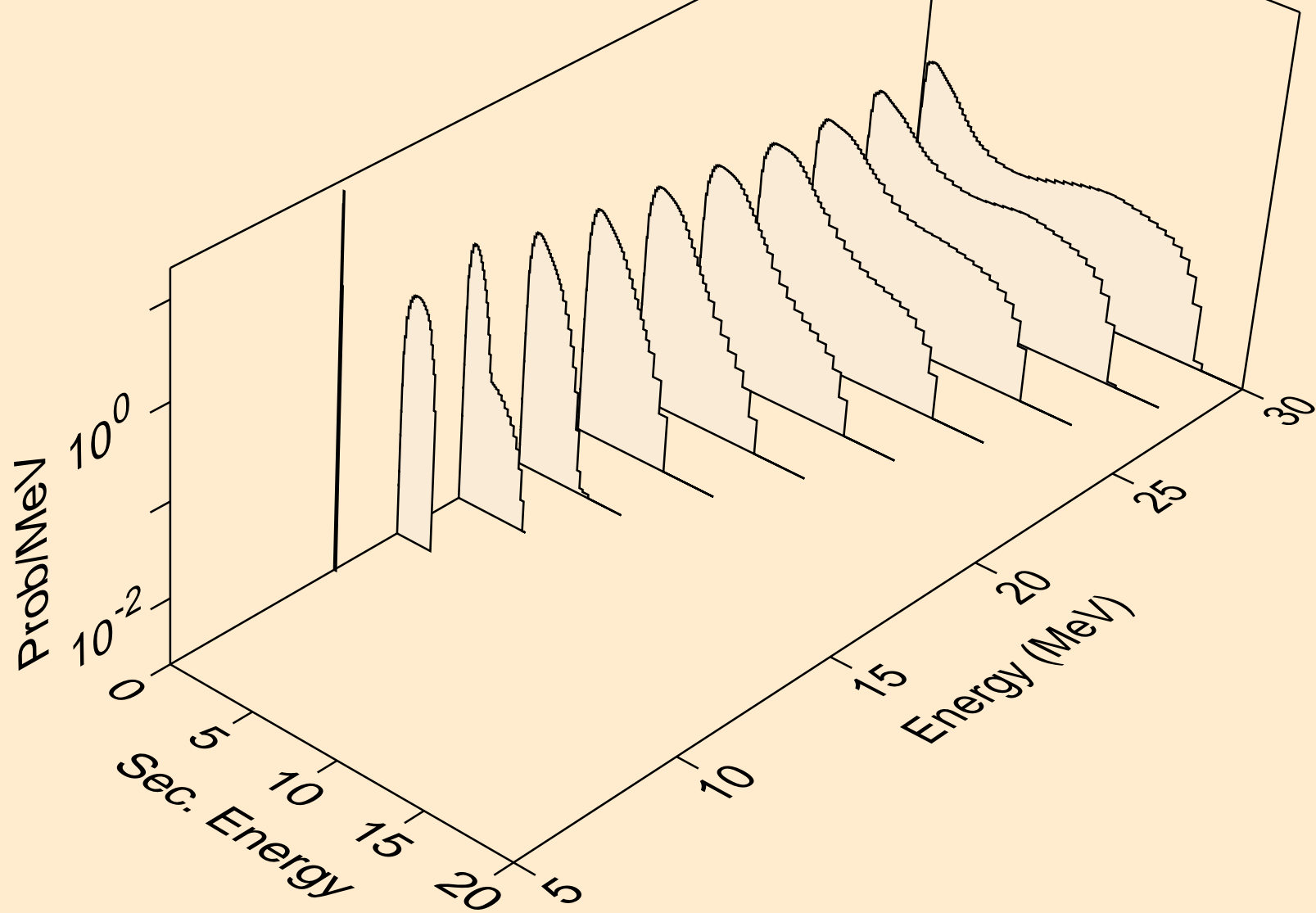

RN204 NEUTRON ACER TENDL-2024 LIBRARY; T=0.K
Neutron emission for (n,3n)

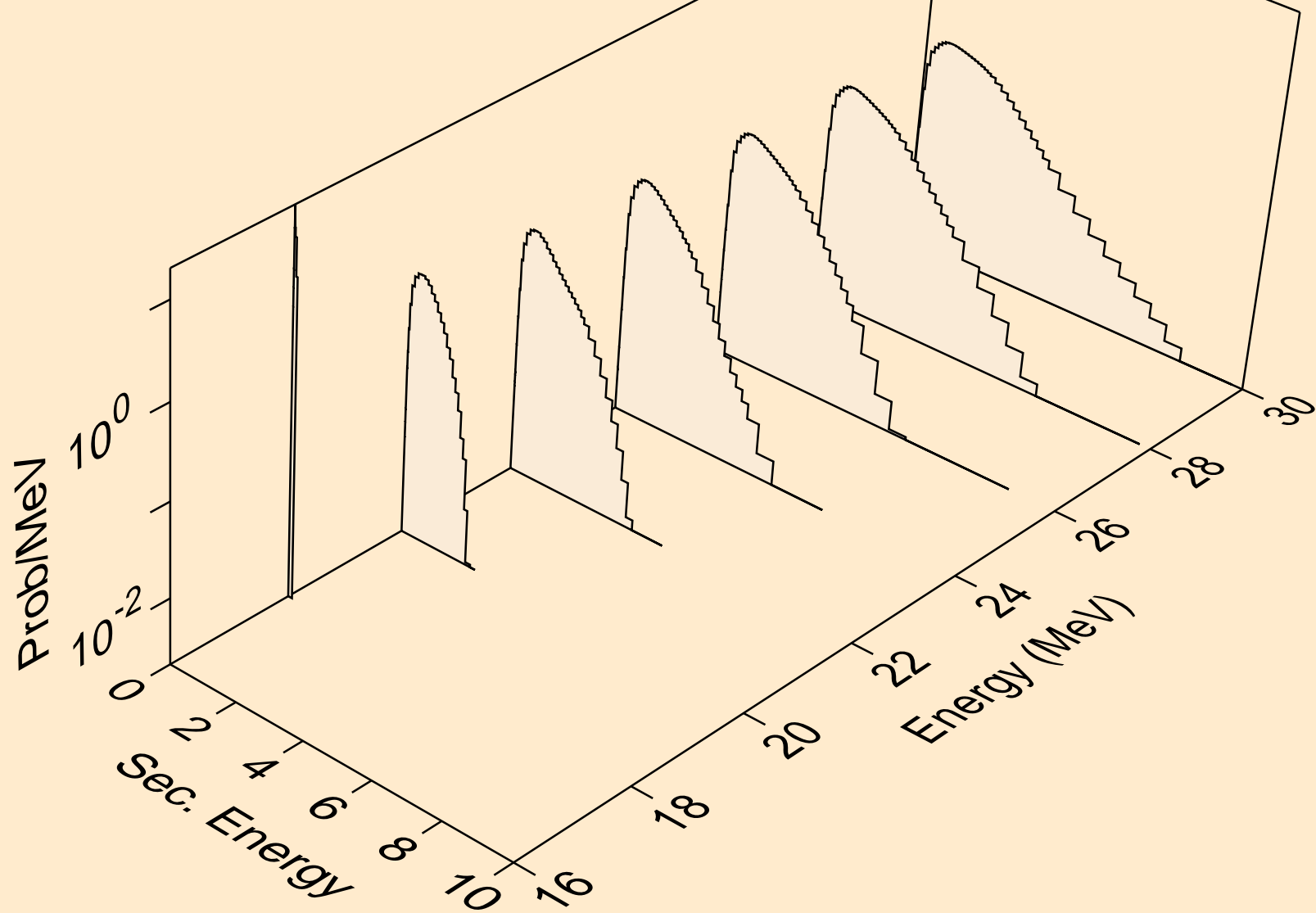

RN204 NEUTRON ACER TENDL-2024 LIBRARY; T=0.K
Neutron emission for (n,n*)a

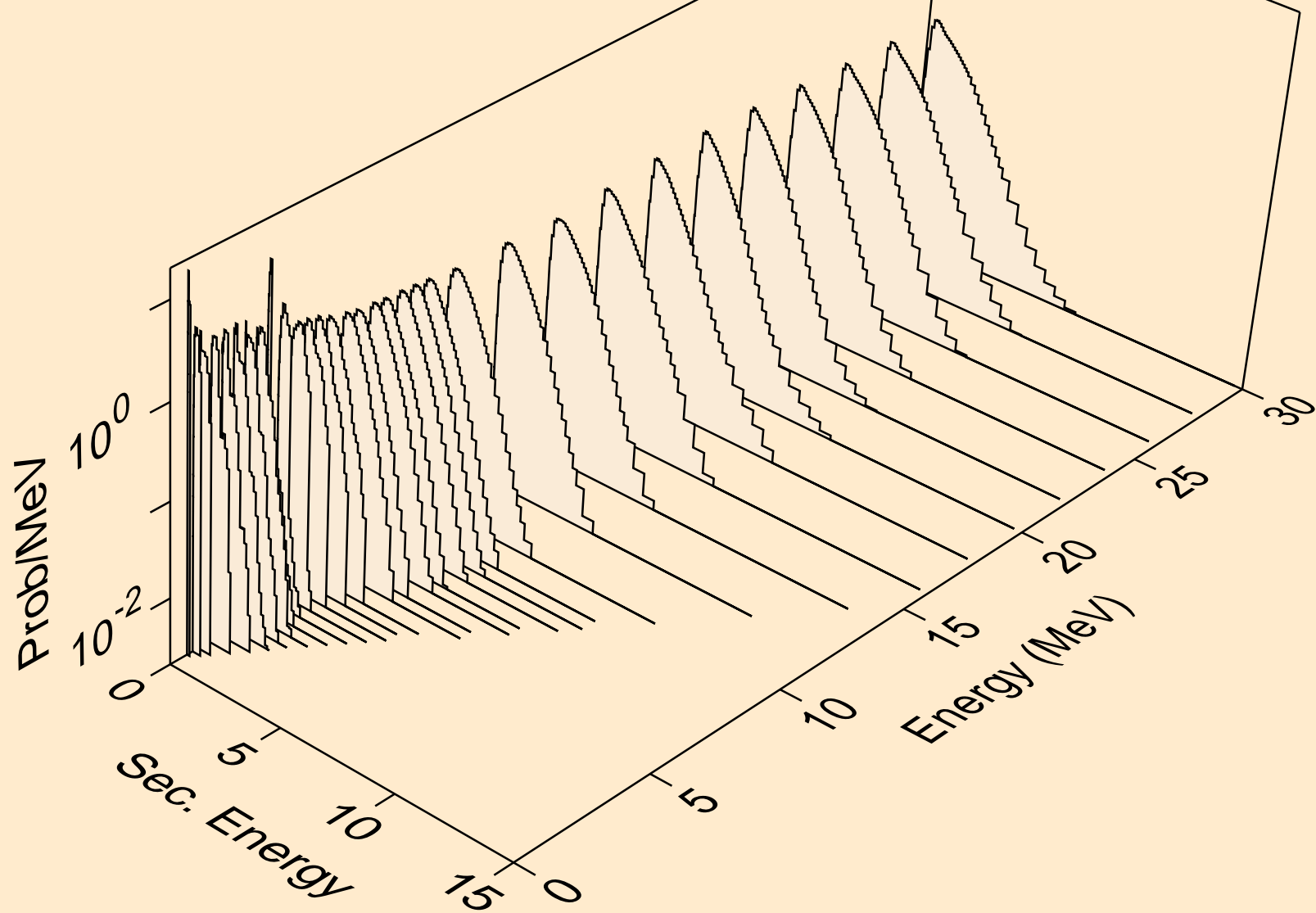

RN204 NEUTRON ACER TENDL-2024 LIBRARY; T=0.K
Neutron emission for (n,2n)a

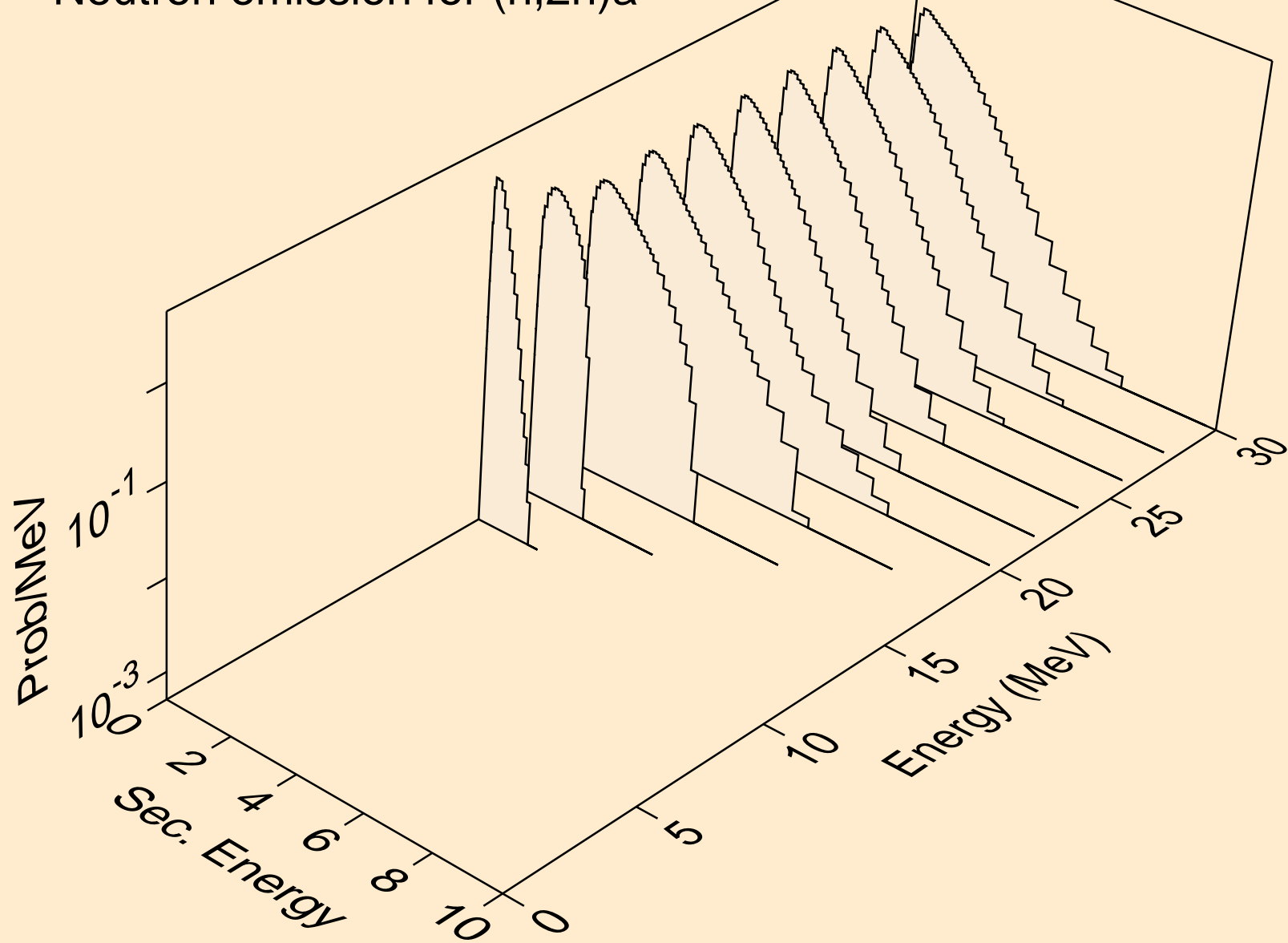

RN204 NEUTRON ACER TENDL-2024 LIBRARY; T=0.K
Neutron emission for (n,3n)a

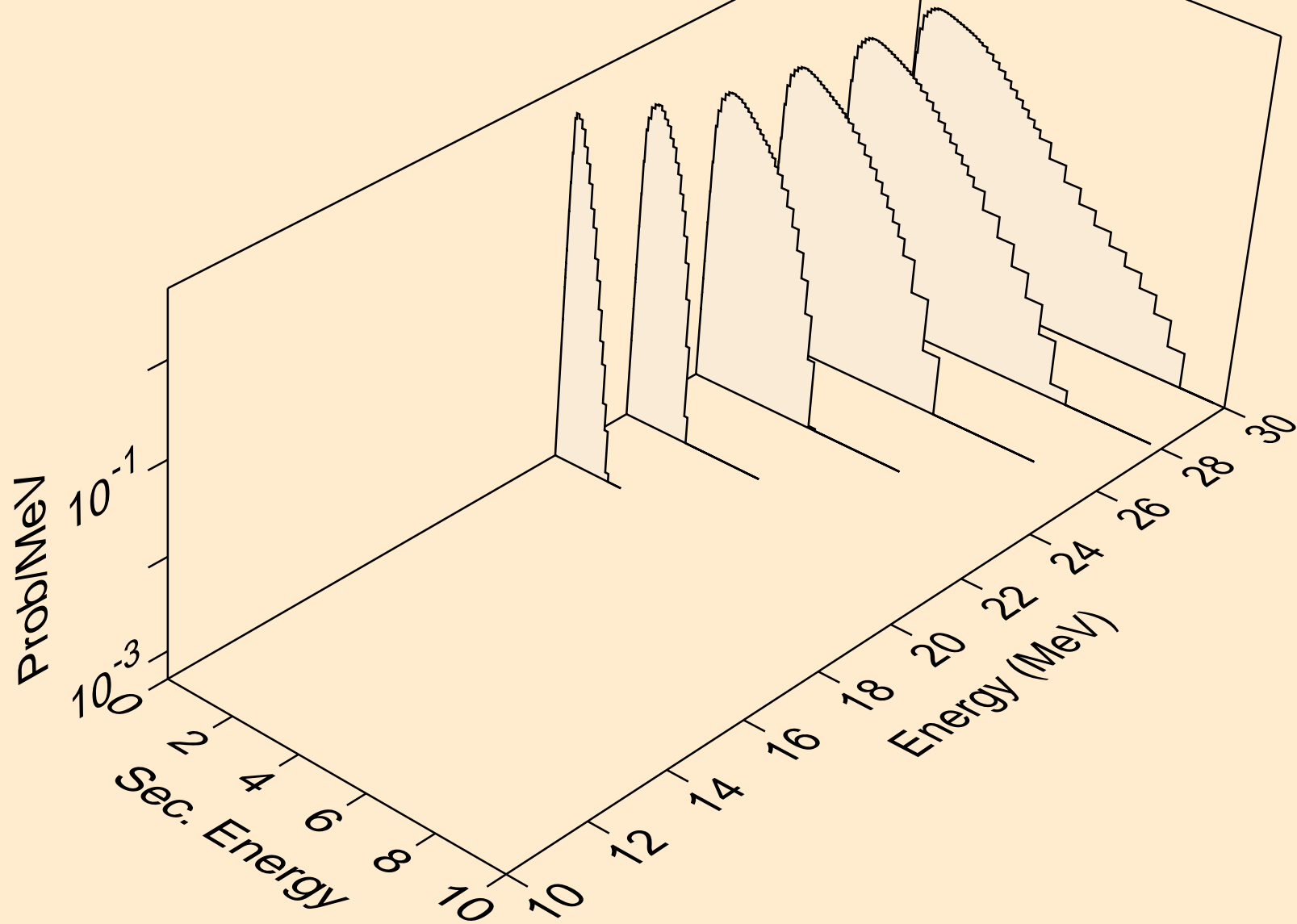

RN204 NEUTRON ACER TENDL-2024 LIBRARY; T=0.K
Neutron emission for (n,n*)p

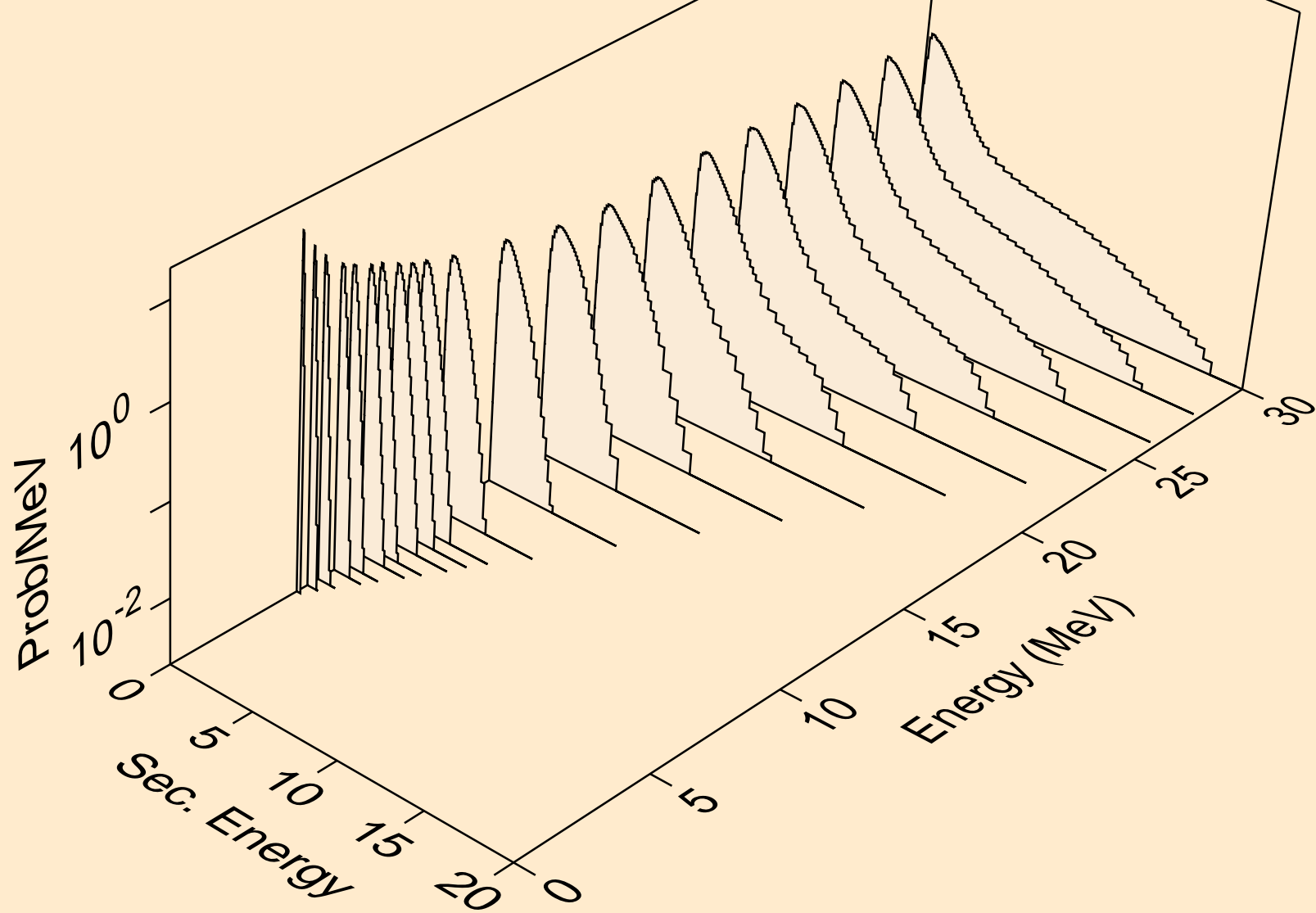

RN204 NEUTRON ACER TENDL-2024 LIBRARY; T=0.K
Neutron emission for (n,n*)2a

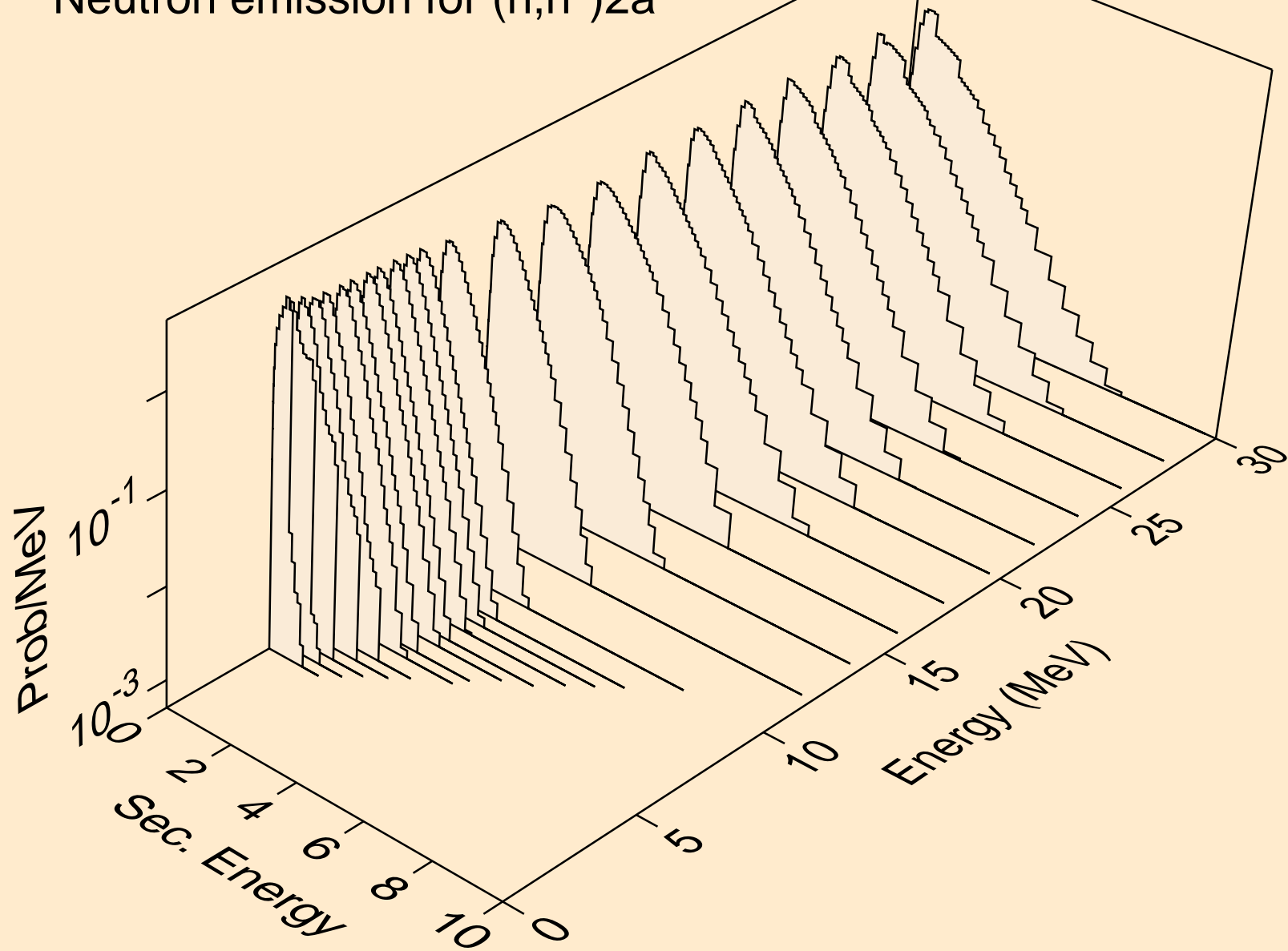

RN204 NEUTRON ACER TENDL-2024 LIBRARY; T=0.K
Neutron emission for (n,2n)2a

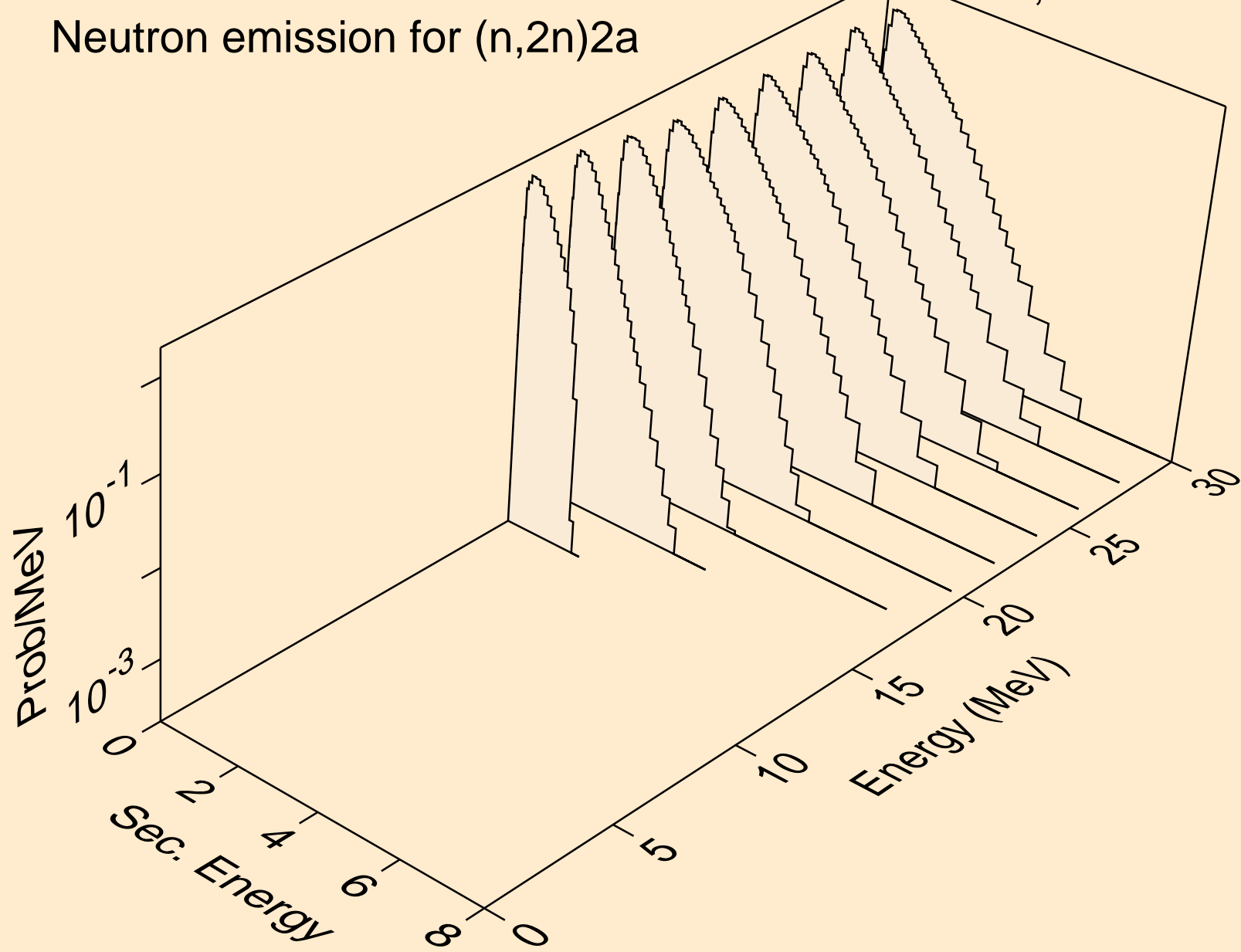

RN204 NEUTRON ACER TENDL-2024 LIBRARY; T=0.K
Neutron emission for (n,n*)d

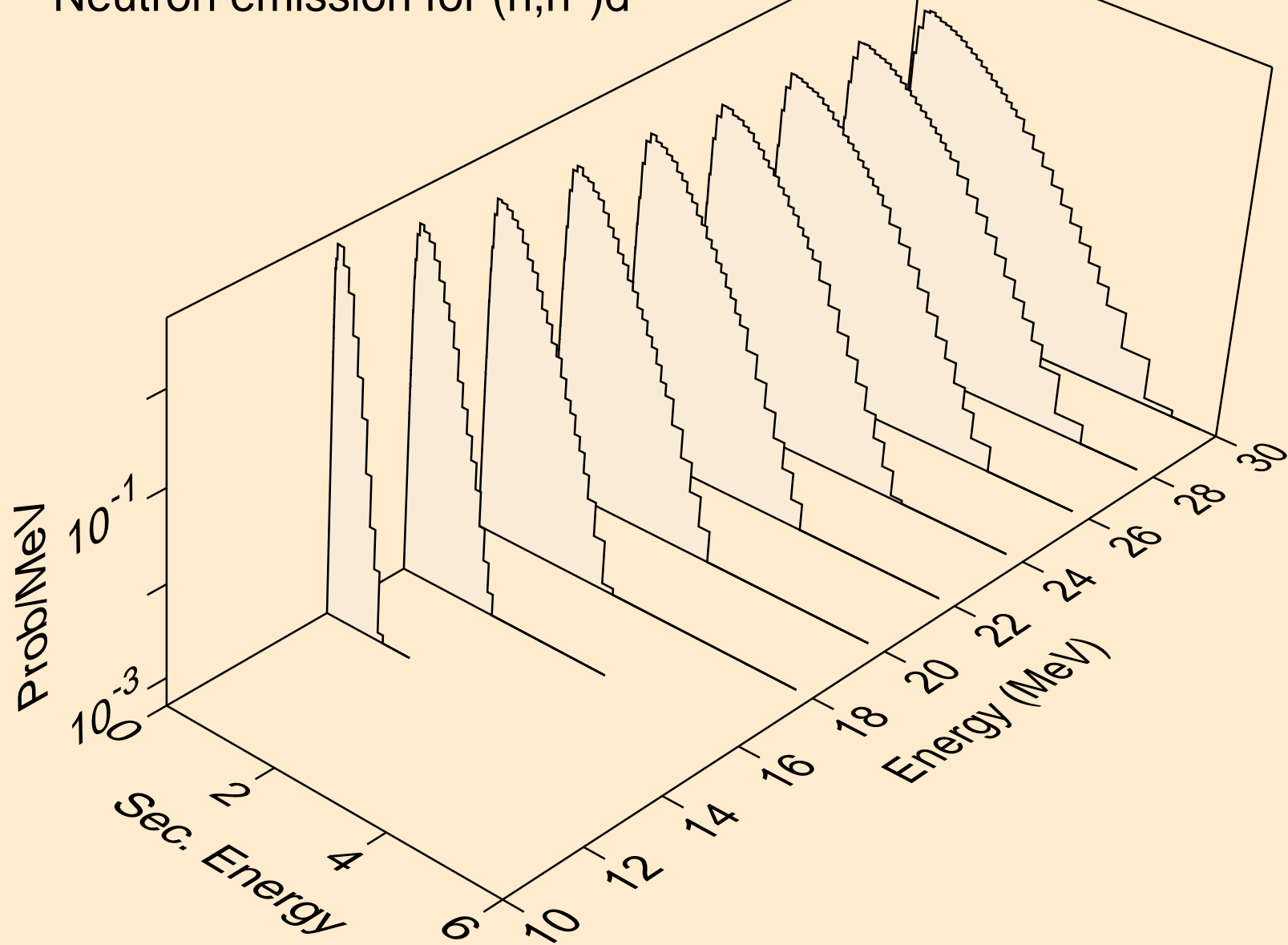

RN204 NEUTRON ACER TENDL-2024 LIBRARY; T=0.K
Neutron emission for (n,n*)t

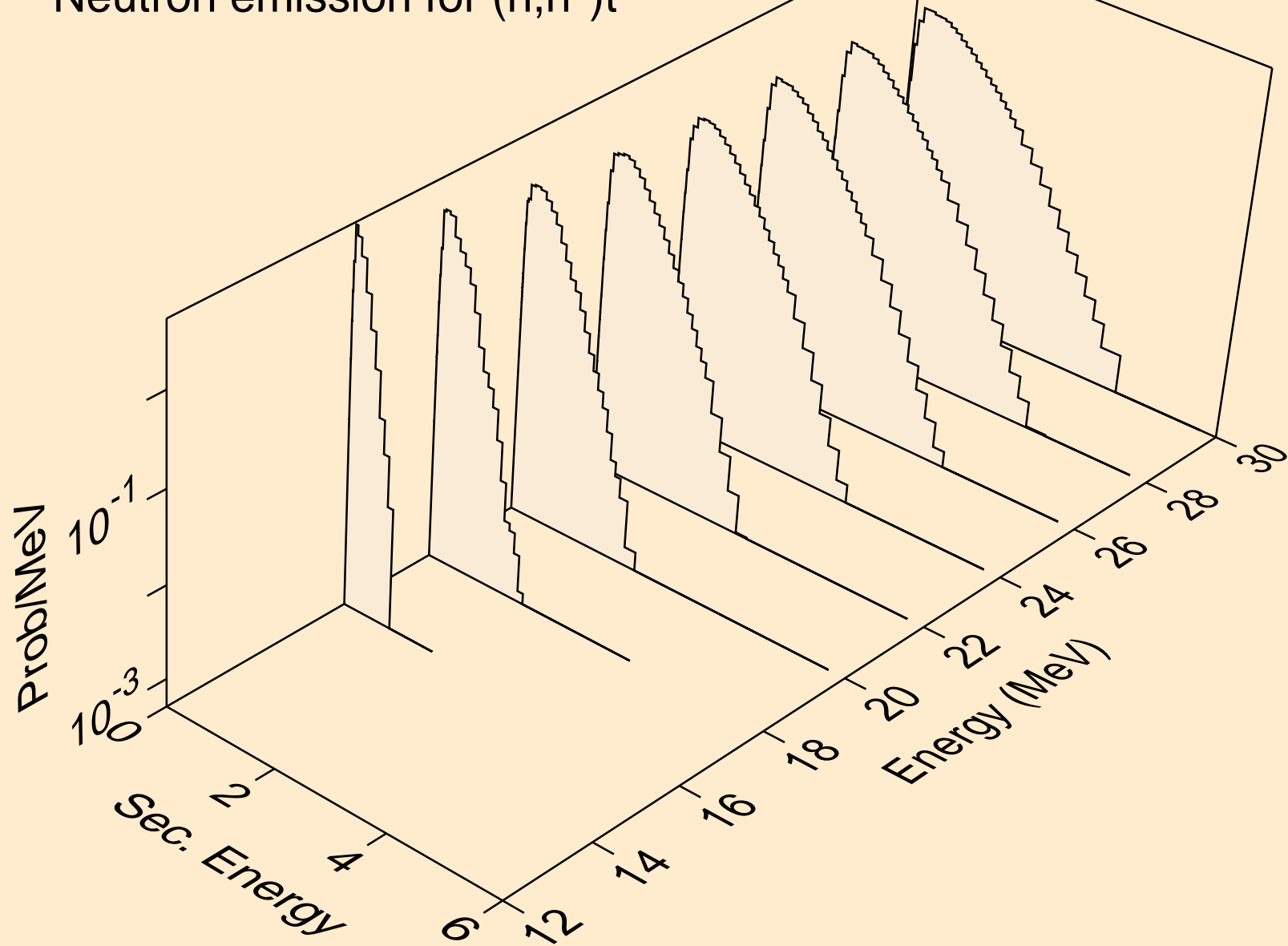

RN204 NEUTRON ACER TENDL-2024 LIBRARY; T=0.K
Neutron emission for (n,n*)he3

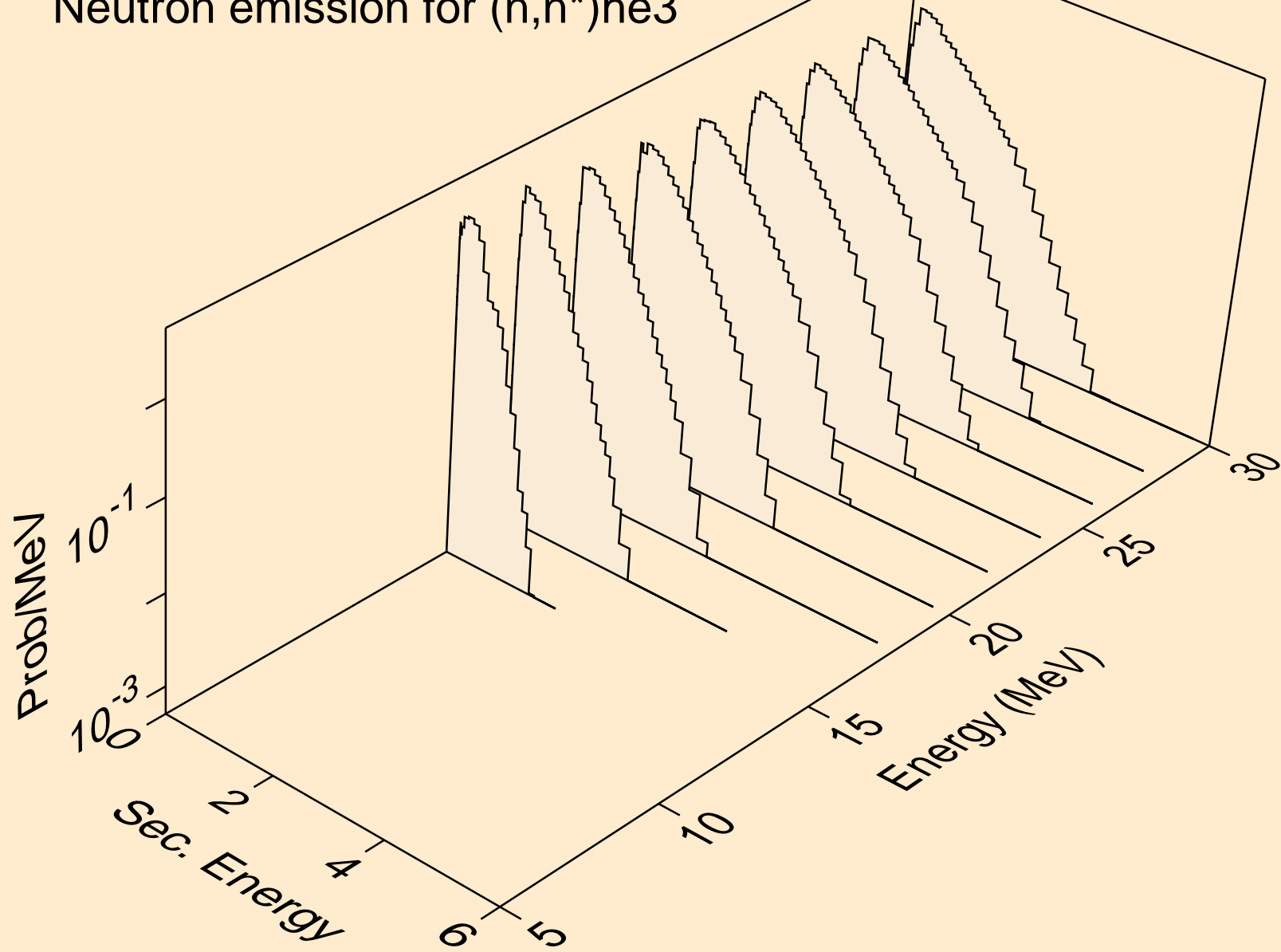

RN204 NEUTRON ACER TENDL-2024 LIBRARY; T=0.K
Neutron emission for (n,4n)

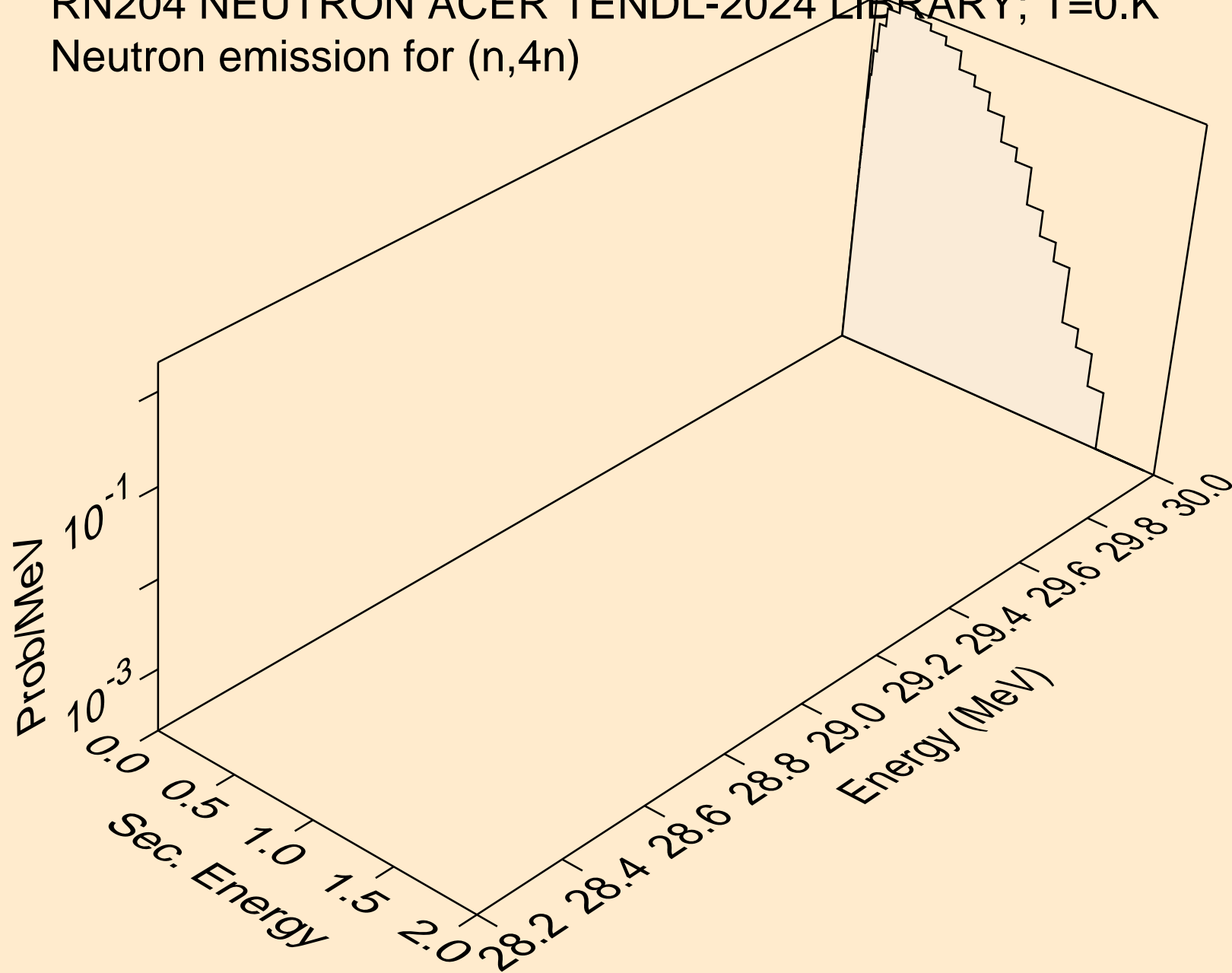

RN204 NEUTRON ACER TENDL-2024 LIBRARY; T=0.K
Neutron emission for (n,2np)

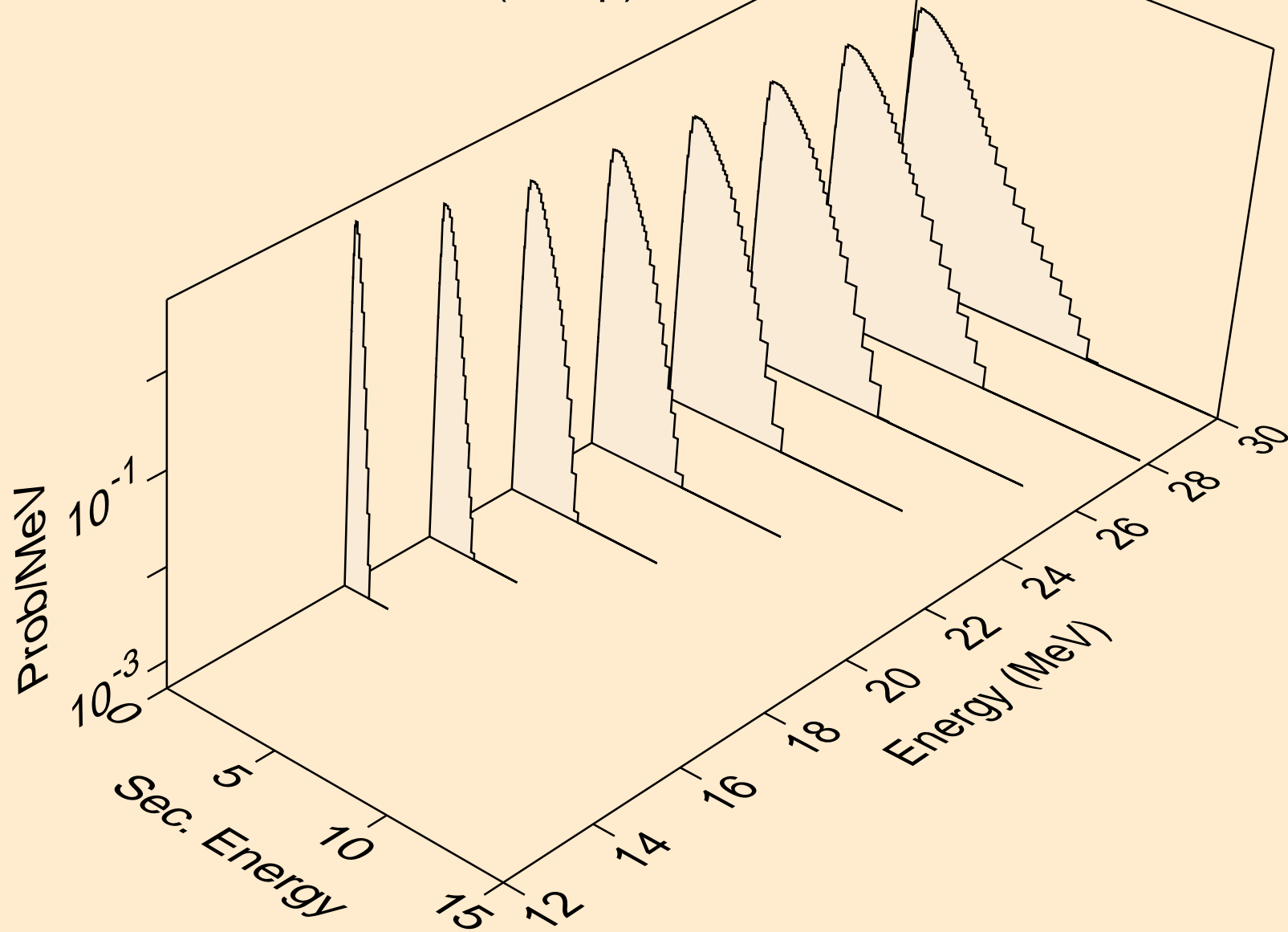

RN204 NEUTRON ACER TENDL-2024 LIBRARY; T=0.K
Neutron emission for (n,3np)

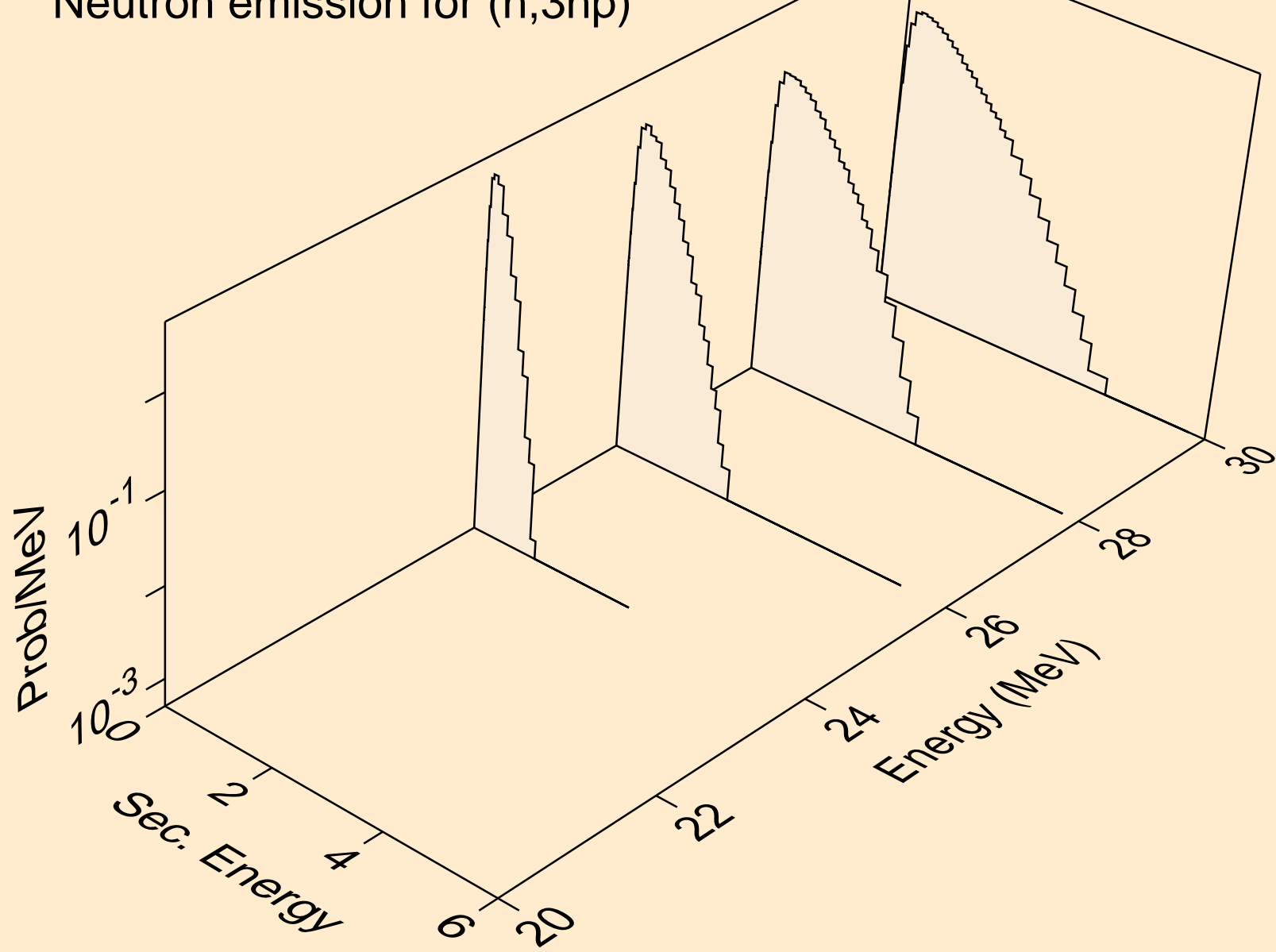

RN204 NEUTRON ACER TENDL-2024 LIBRARY; T=0.K
Neutron emission for (n,n2p)

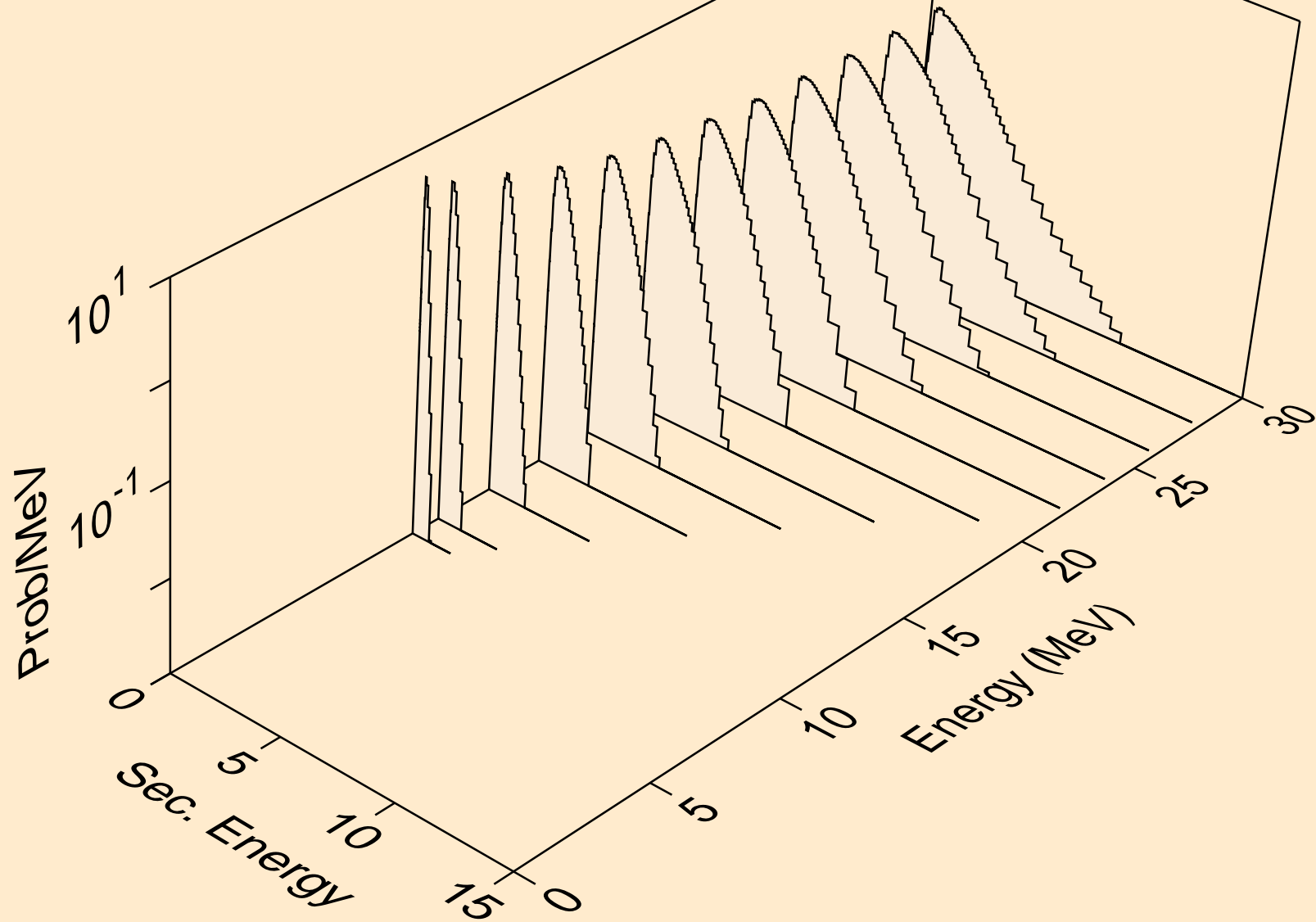

RN204 NEUTRON ACER TENDL-2024 LIBRARY; T=0.K
Neutron emission for (n,npa)

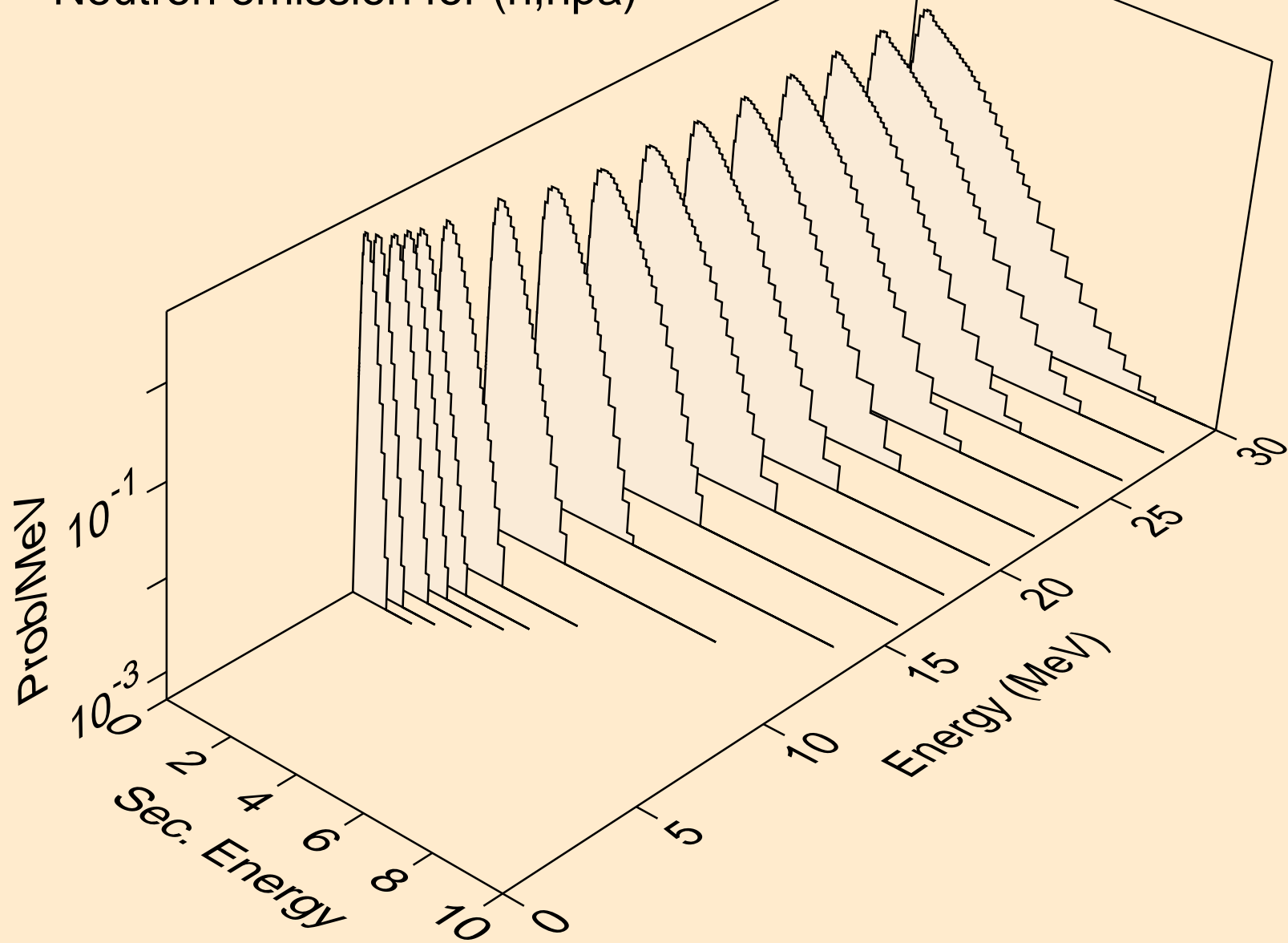

RN204 NEUTRON ACER TENDL-2024 LIBRARY; T=0.K
Neutron emission for (n,n*c)

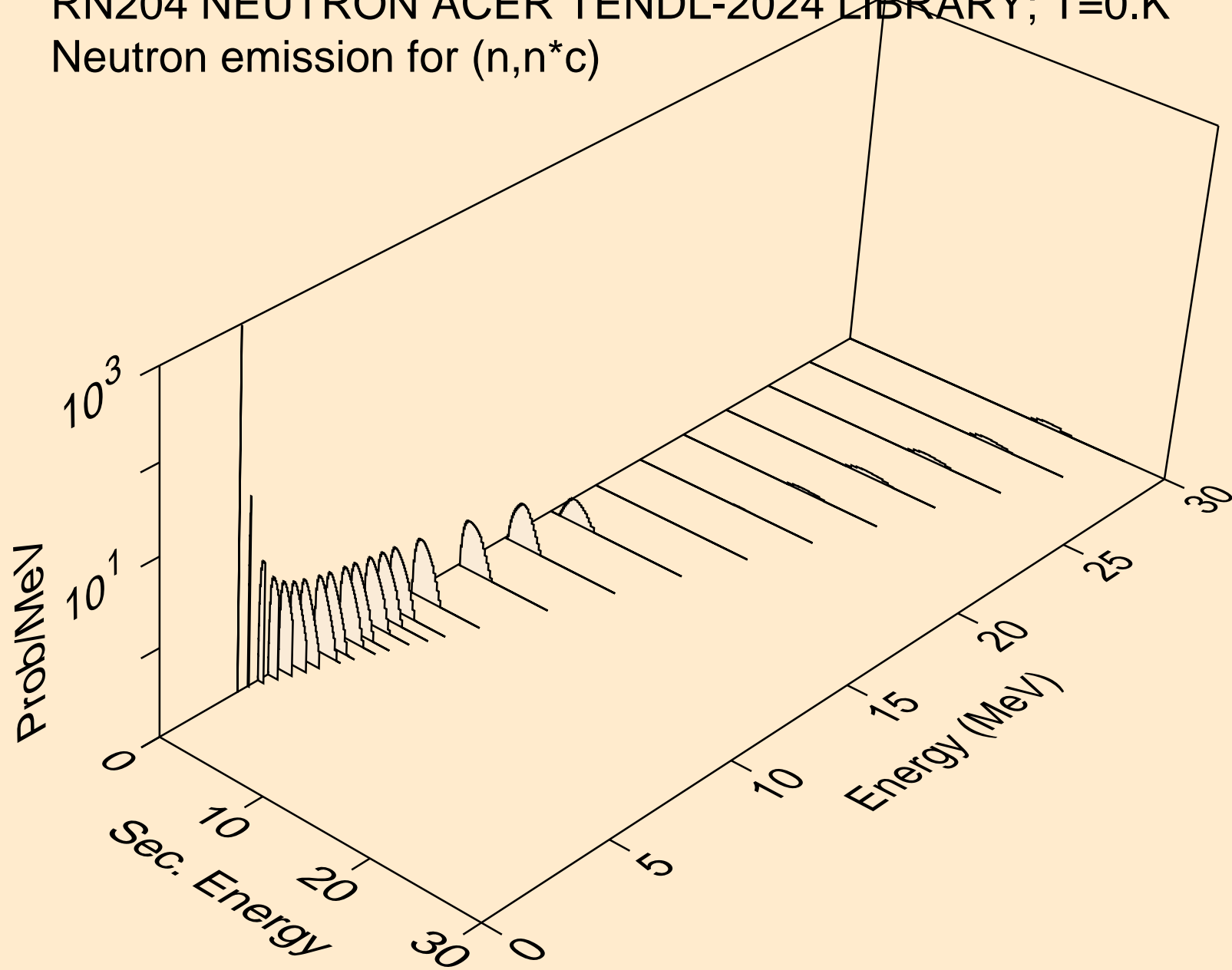

RN204 NEUTRON ACER TENDL-2024 LIBRARY; T=0.K
Photon emission for (n,x)

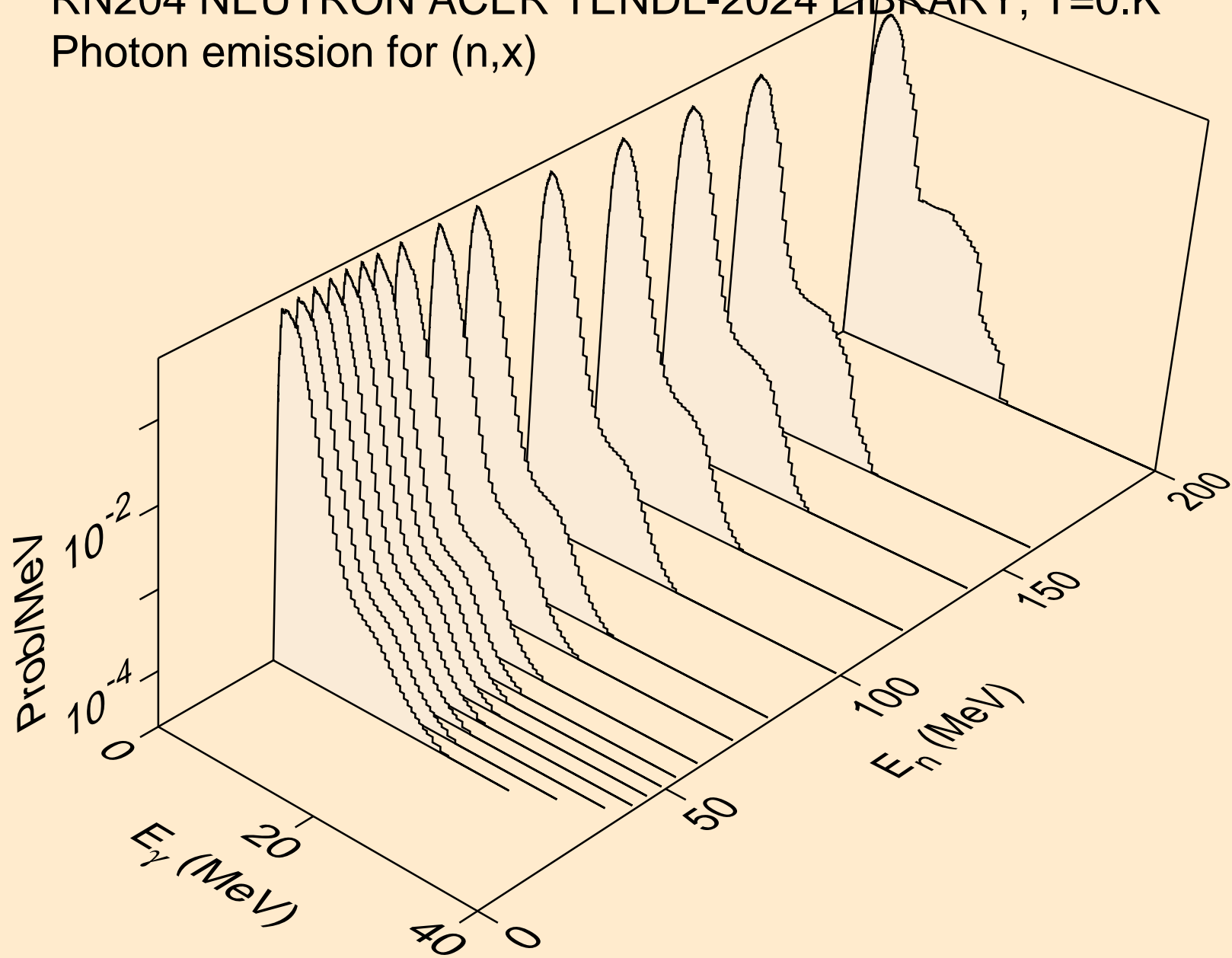

RN204 NEUTRON ACER TENDL-2024 LIBRARY; T=0.K
Photon emission for (n,2nd)

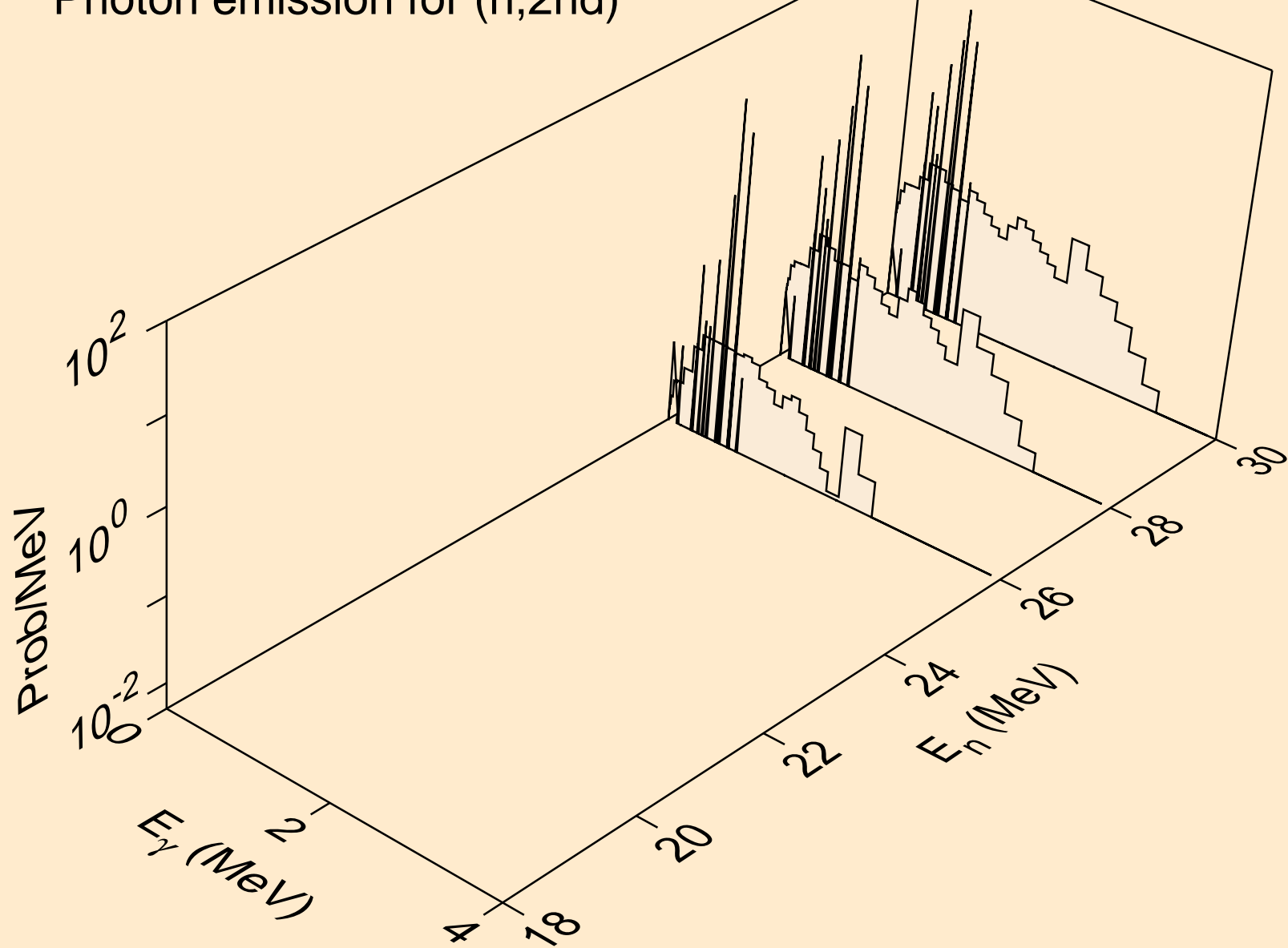

RN204 NEUTRON ACER TENDL-2024 LIBRARY; T=0.K
Photon emission for (n,2n)

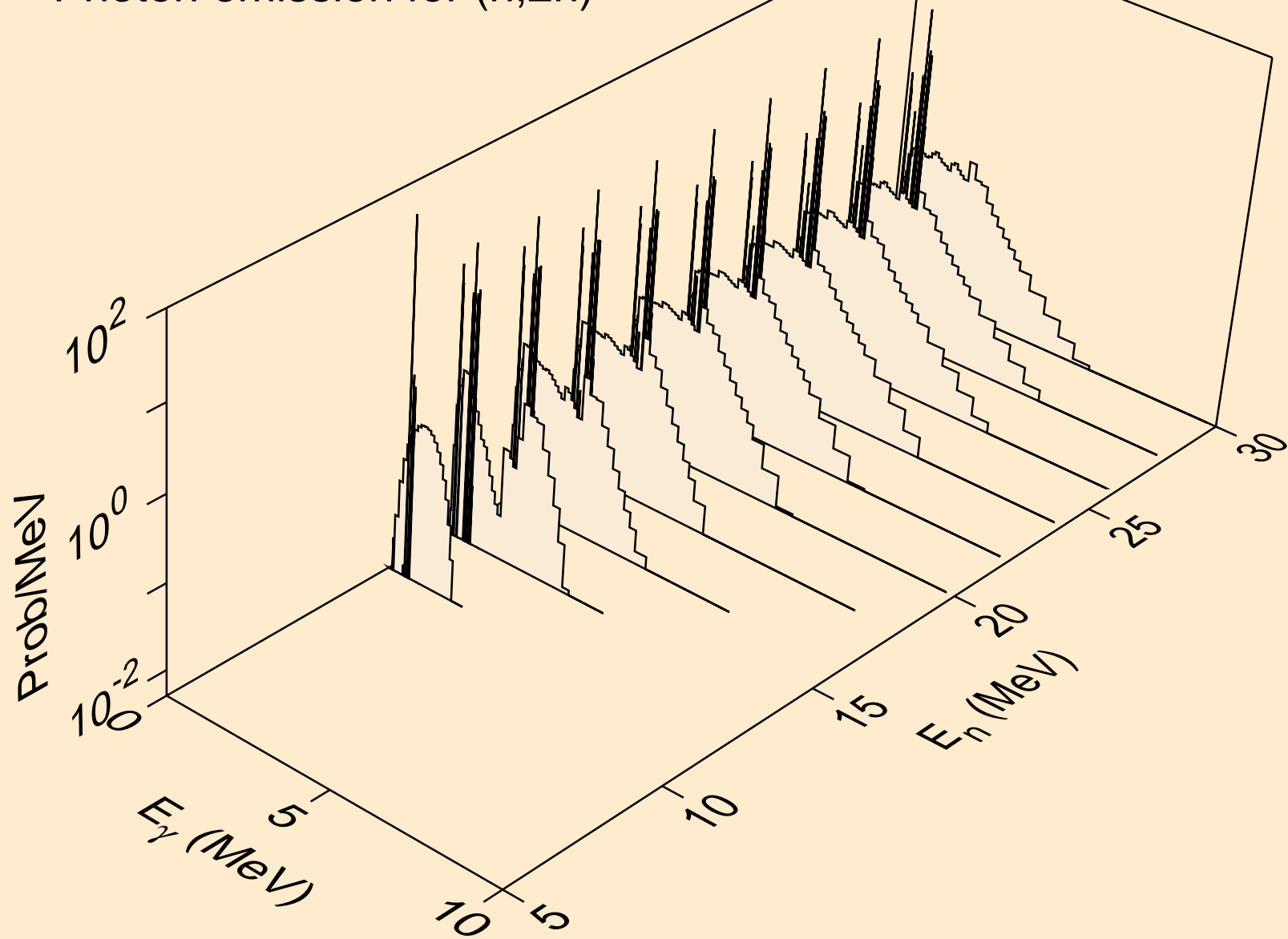

RN204 NEUTRON ACER TENDL-2024 LIBRARY; T=0.K
Photon emission for (n,3n)

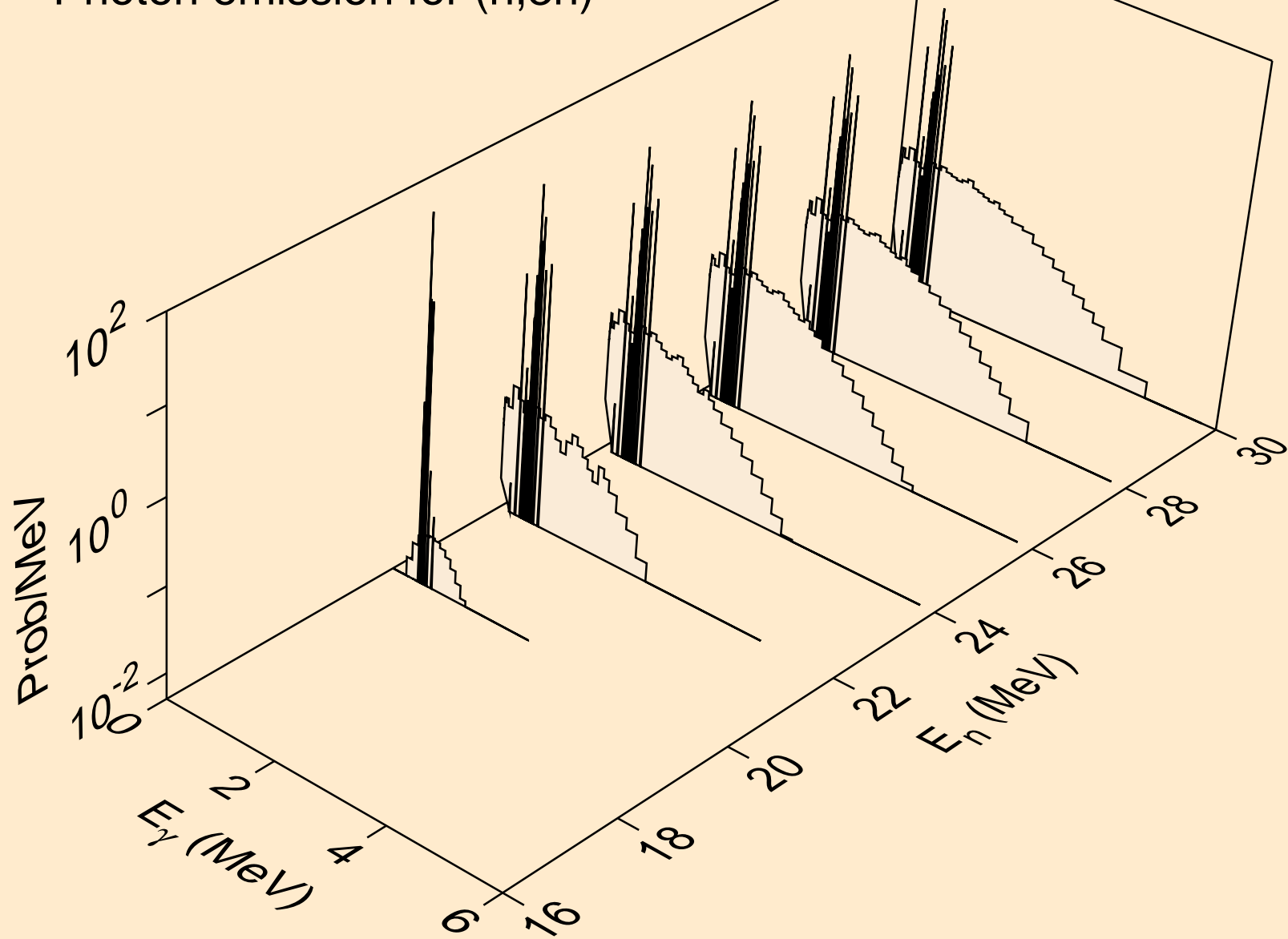

RN204 NEUTRON ACER TENDL-2024 LIBRARY; T=0.K
Photon emission for (n,n*)a

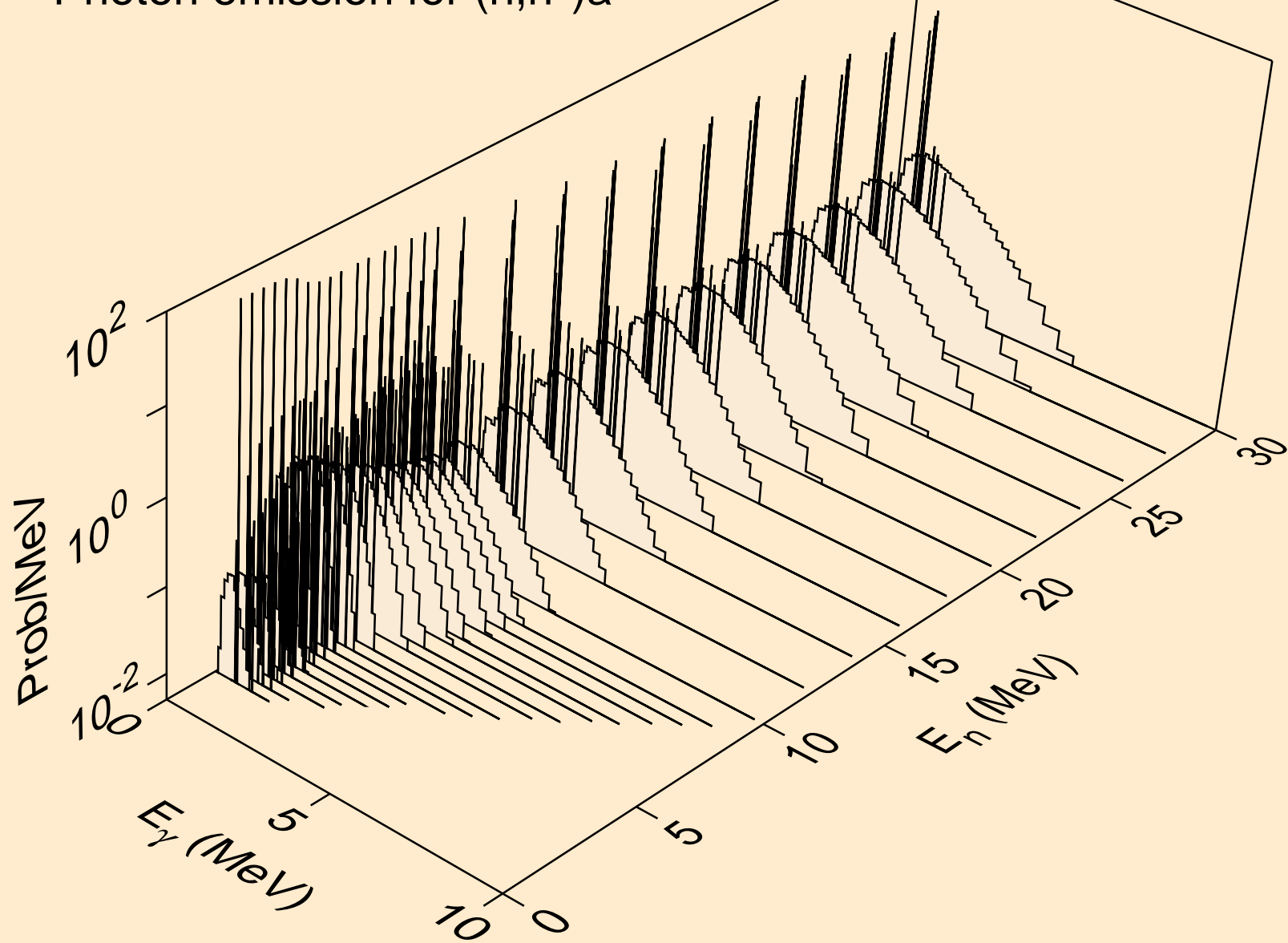

RN204 NEUTRON ACER TENDL-2024 LIBRARY; T=0.K
Photon emission for (n,2n)a

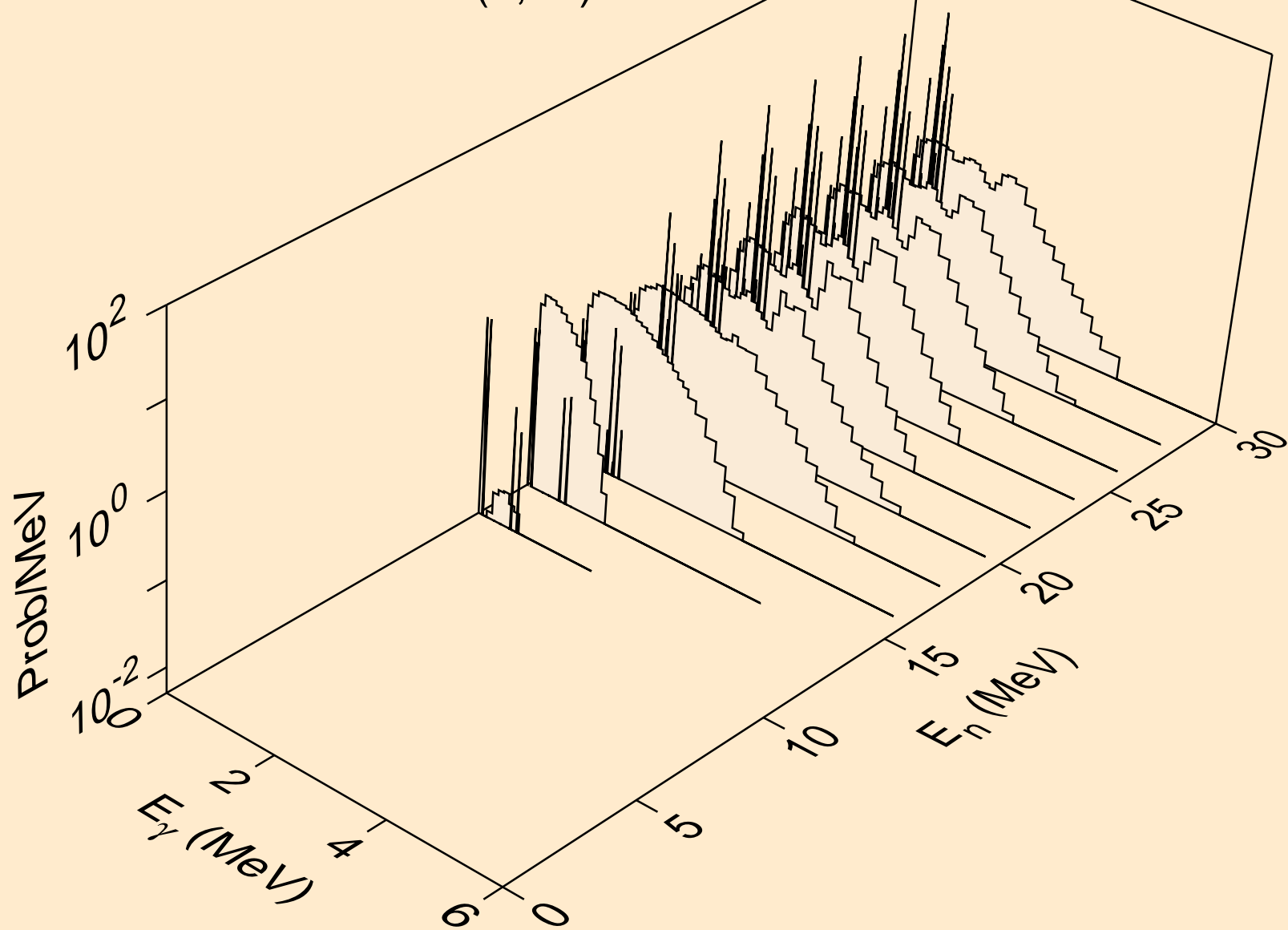

RN204 NEUTRON ACER TENDL-2024 LIBRARY; T=0.K
Photon emission for (n,3n)a

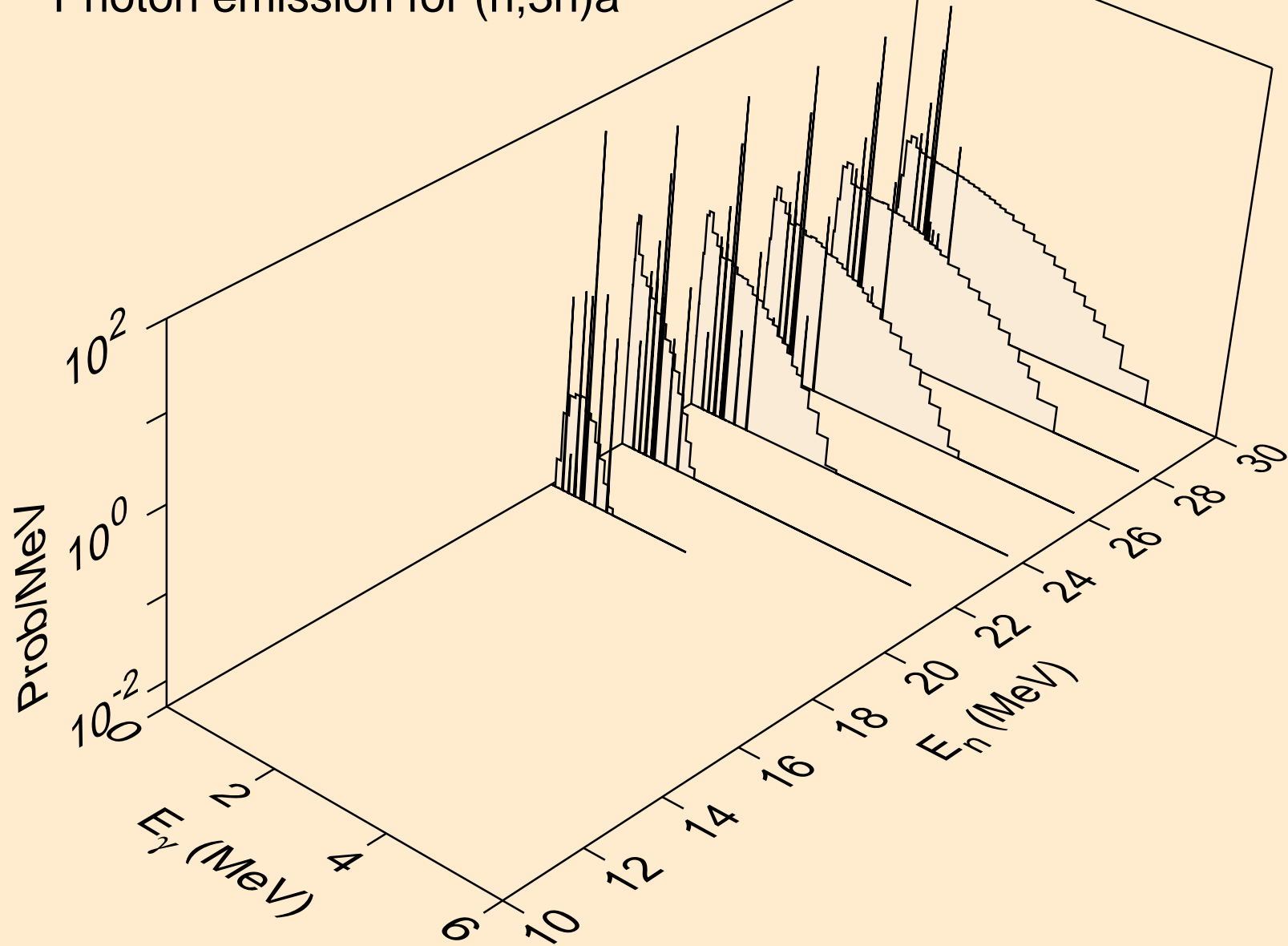

RN204 NEUTRON ACER TENDL-2024 LIBRARY; T=0.K
Photon emission for (n,n*)p

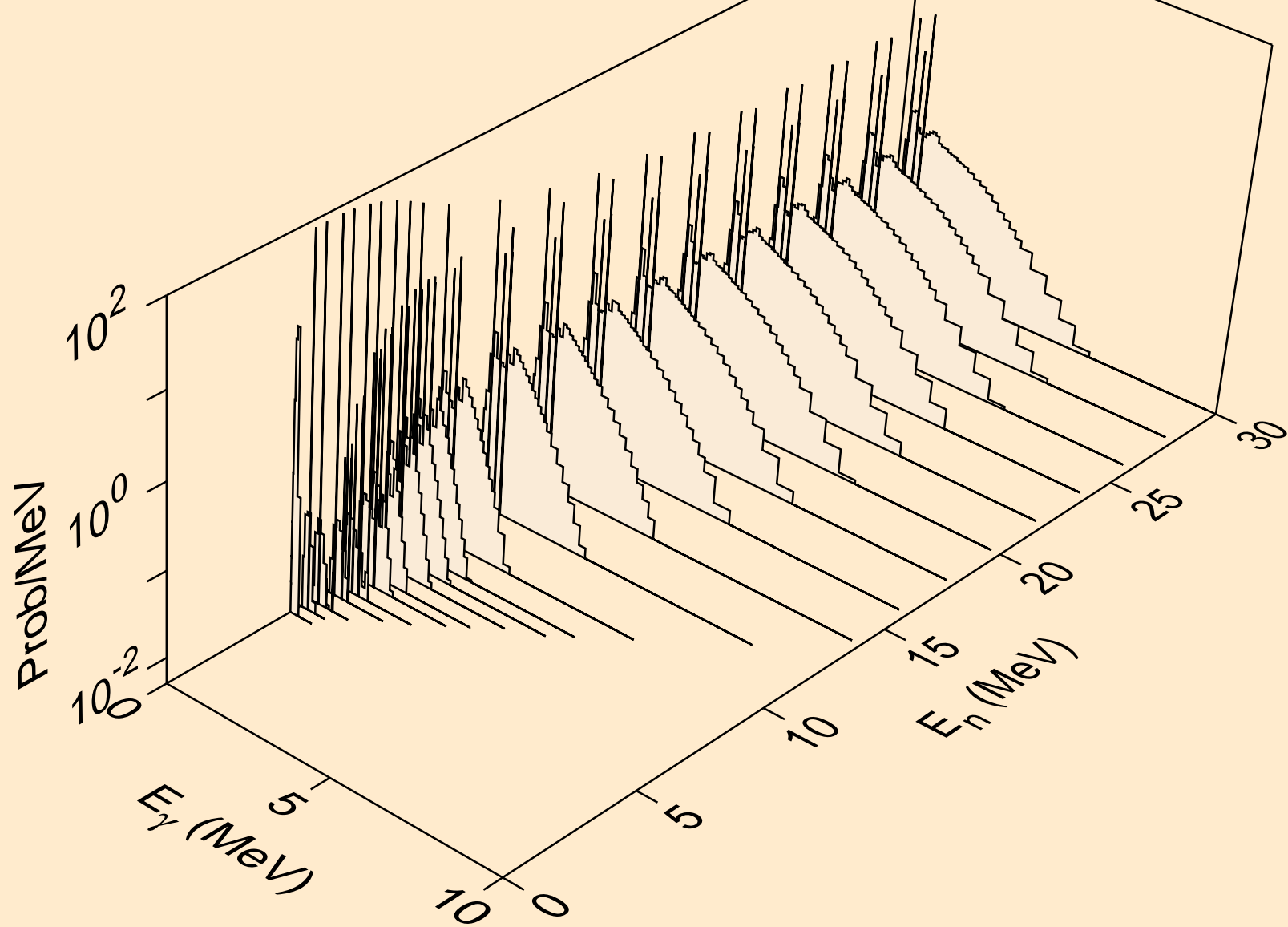

RN204 NEUTRON ACER TENDL-2024 LIBRARY; T=0.K
Photon emission for (n,n*)2a

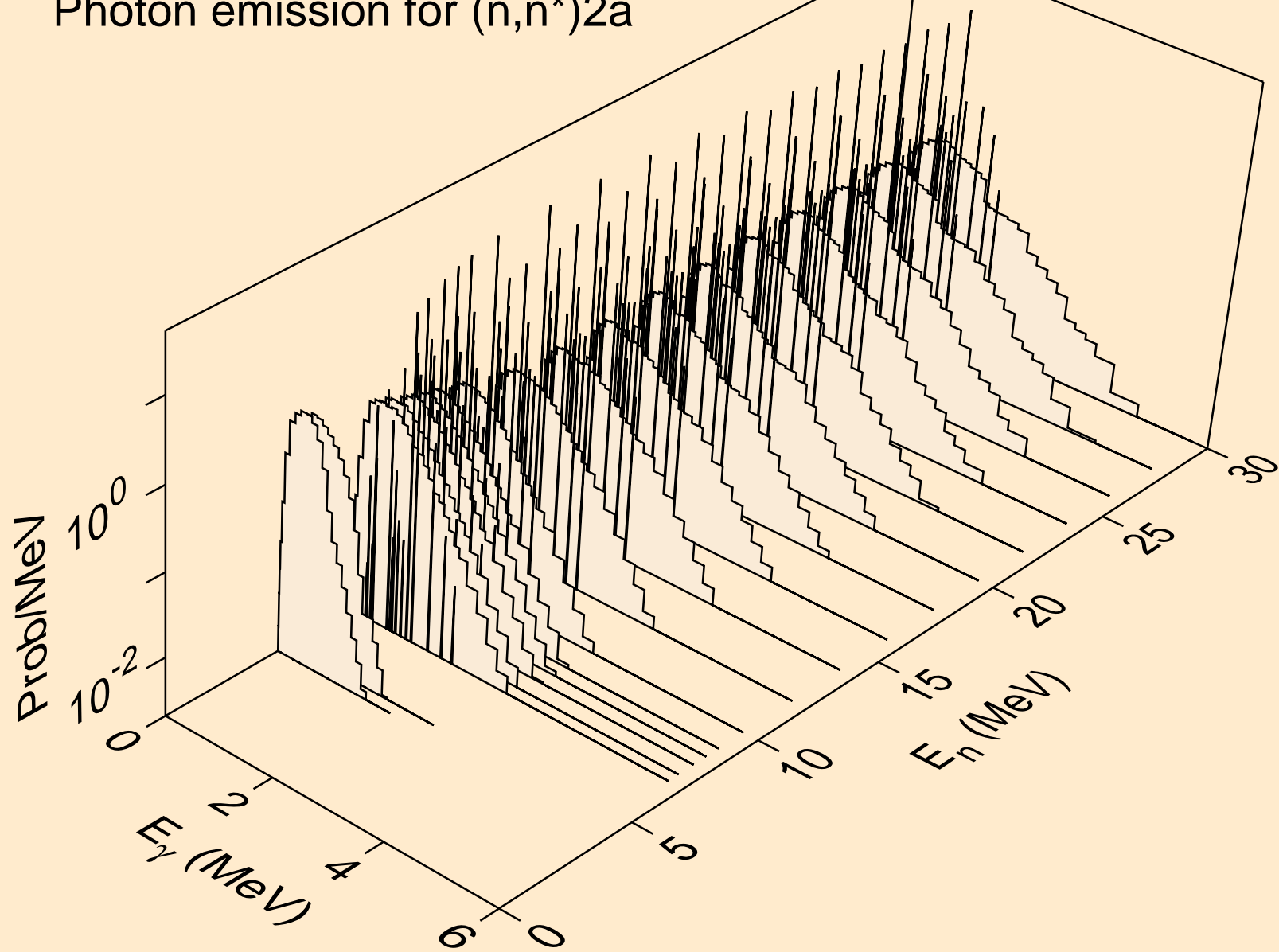

RN204 NEUTRON ACER TENDL-2024 LIBRARY; T=0.K
Photon emission for (n,2n)2a

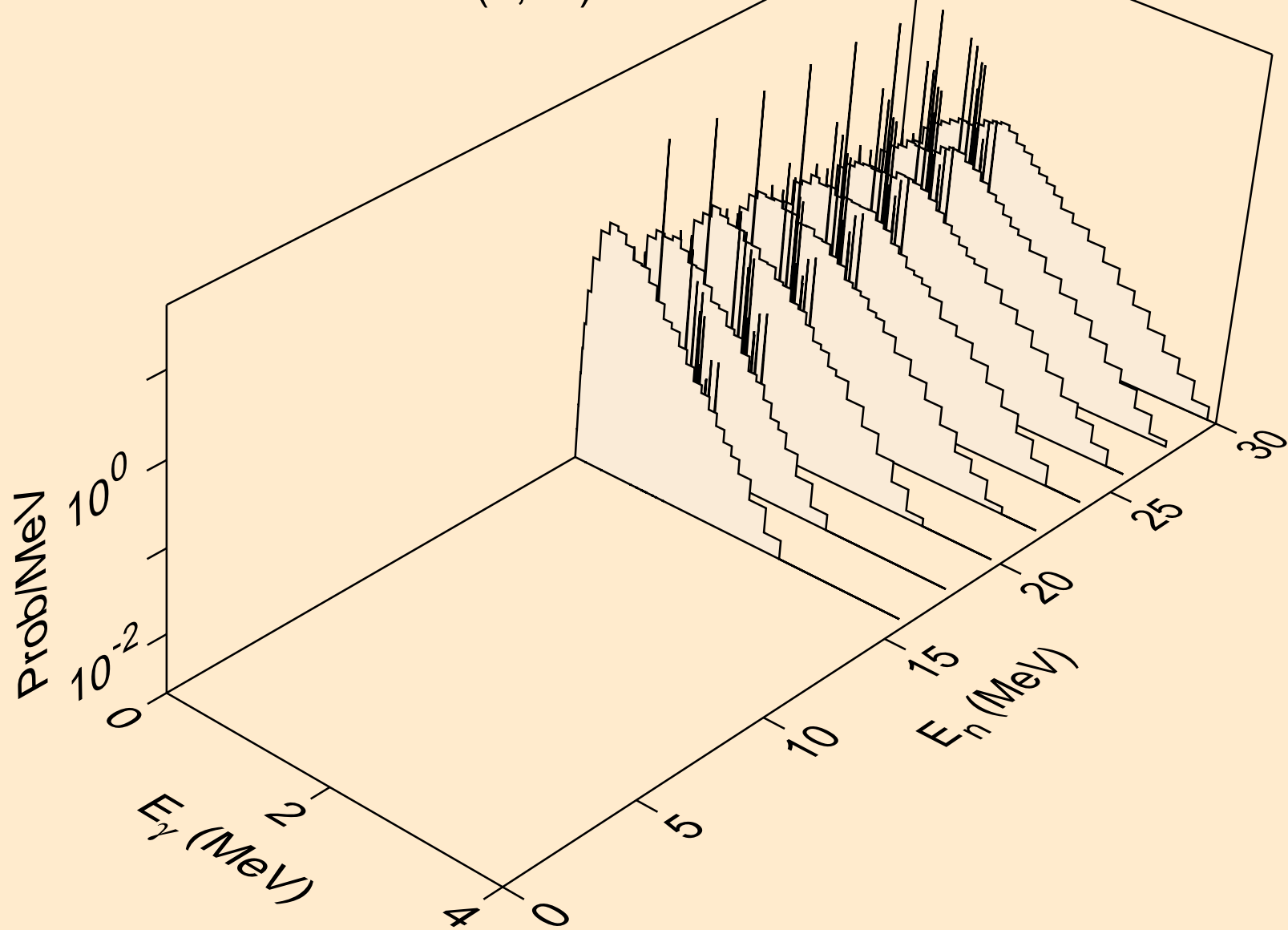

RN204 NEUTRON ACER TENDL-2024 LIBRARY; T=0.K
Photon emission for (n,n*)d

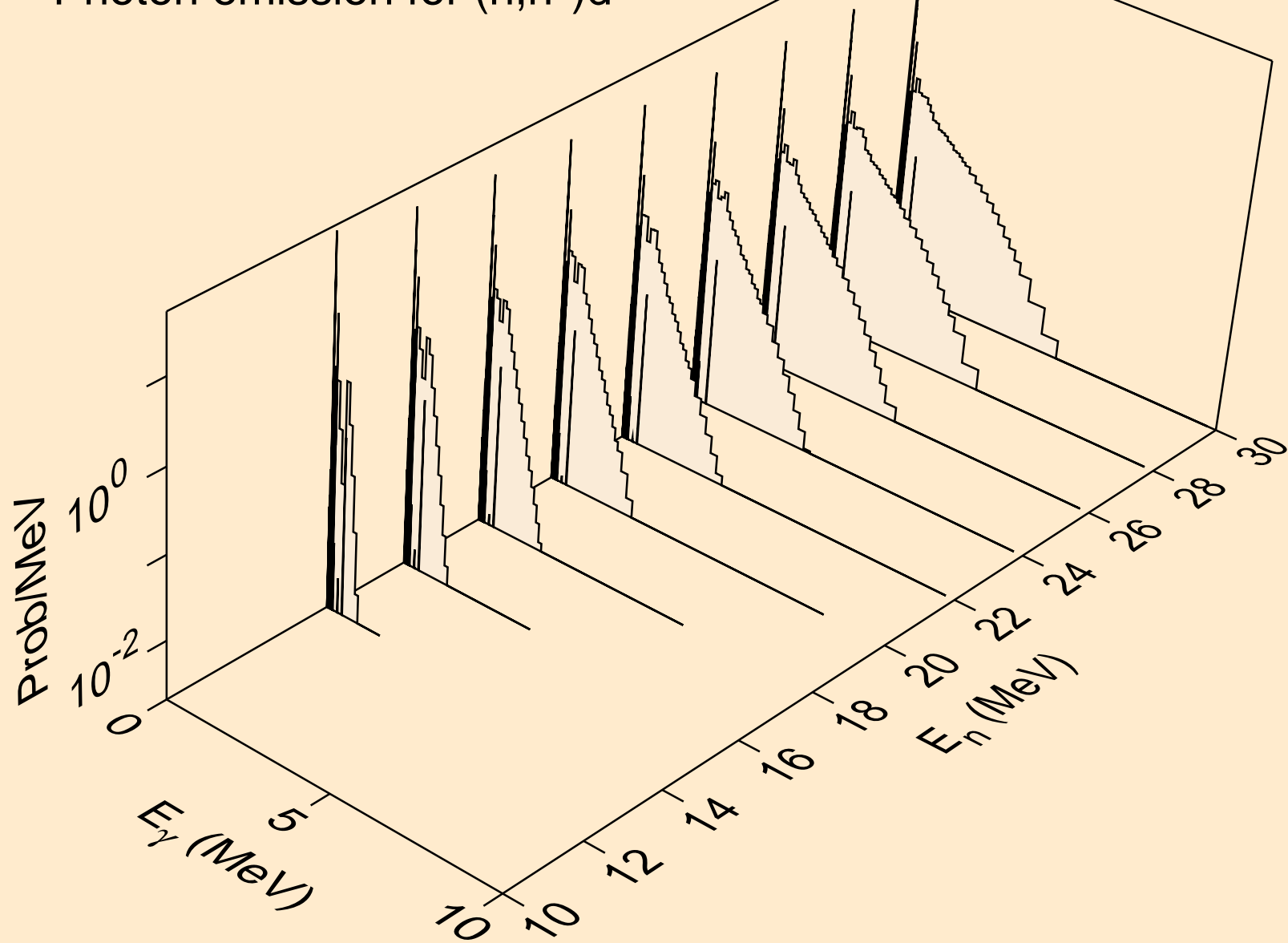

RN204 NEUTRON ACER TENDL-2024 LIBRARY; T=0.K
Photon emission for (n,n*)t

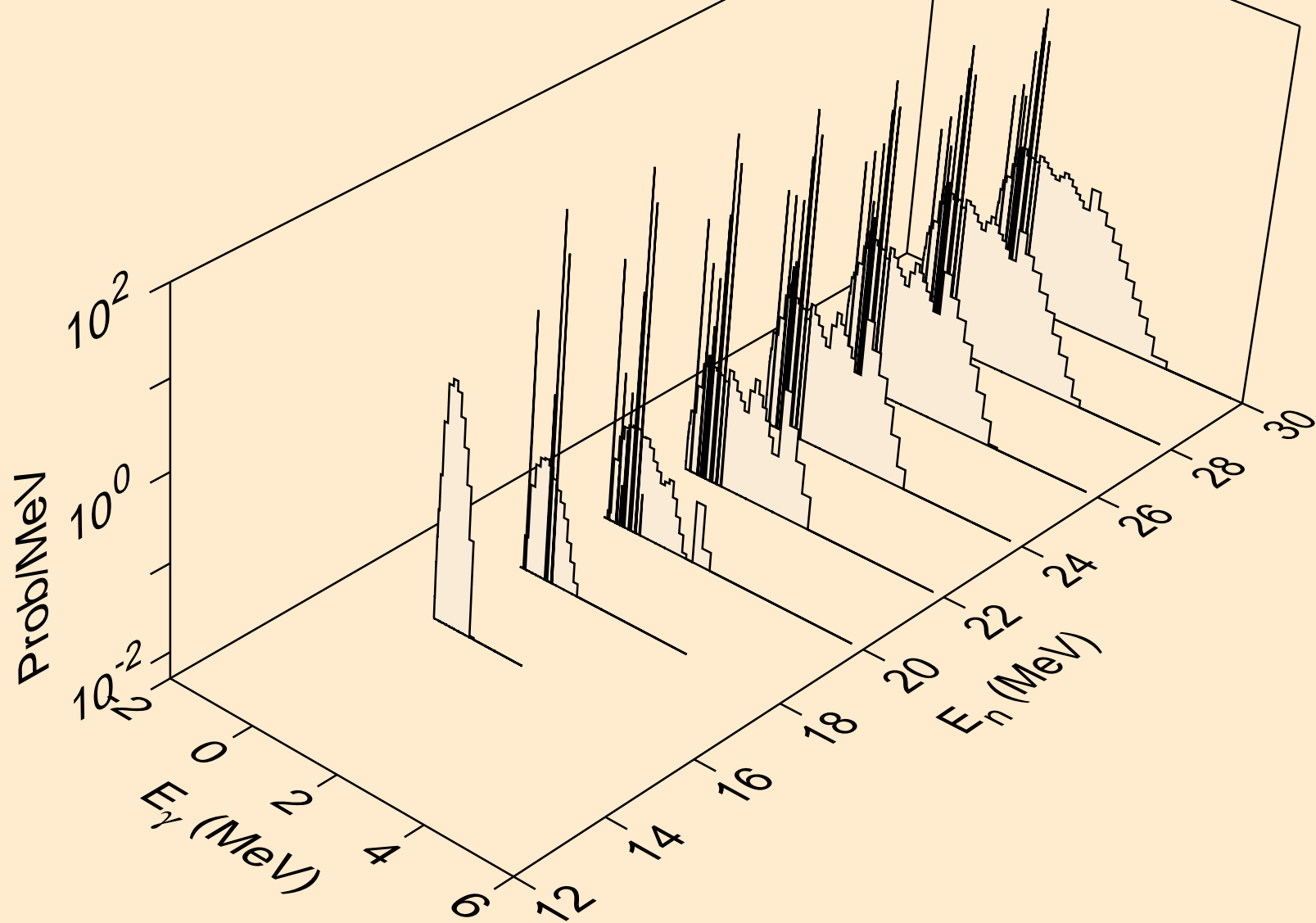

RN204 NEUTRON ACER TENDL-2024 LIBRARY; T=0.K
Photon emission for (n,n*)he3

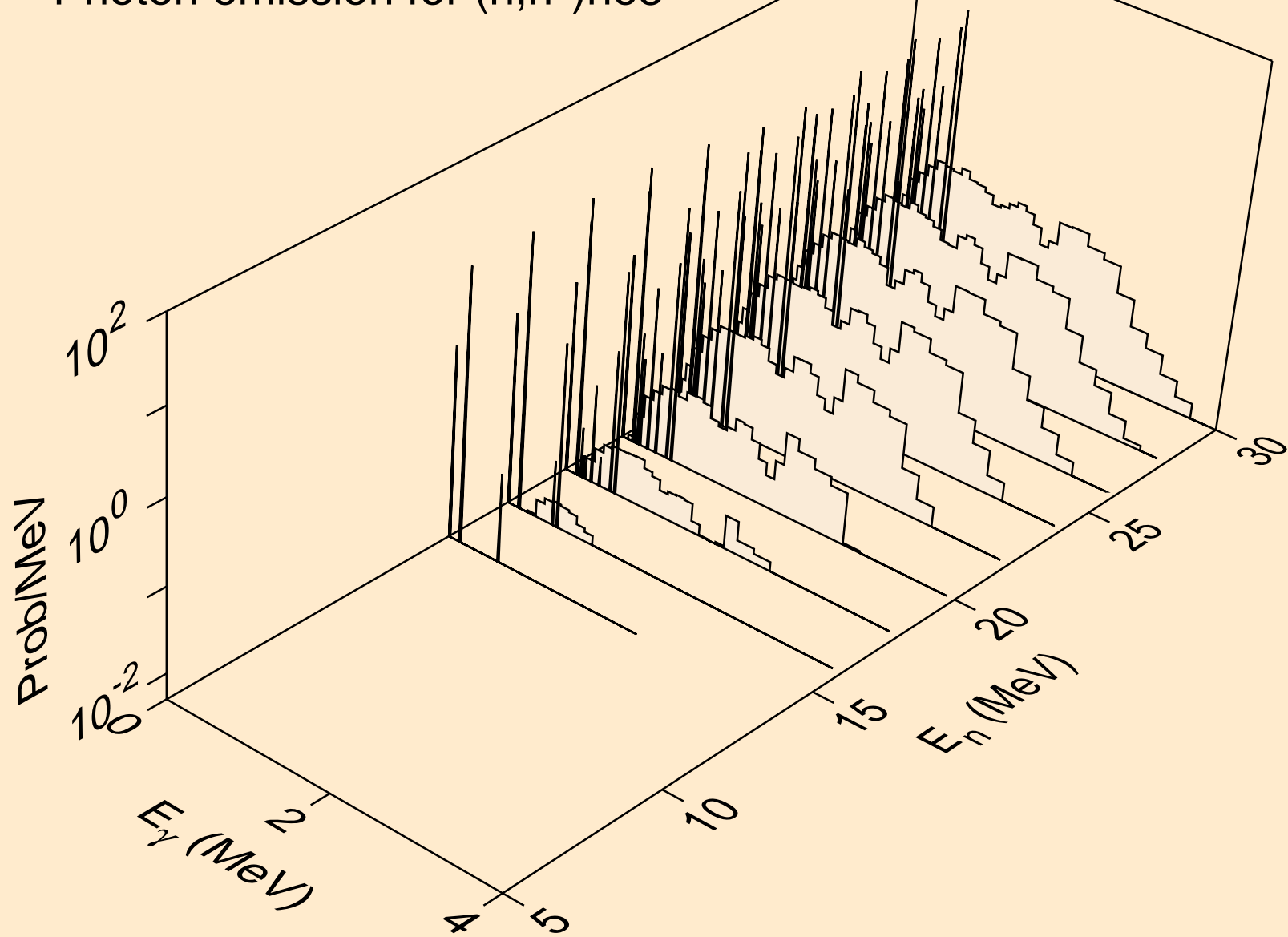

RN204 NEUTRON ACER TENDL-2024 LIBRARY; T=0.K
Photon emission for (n,4n)

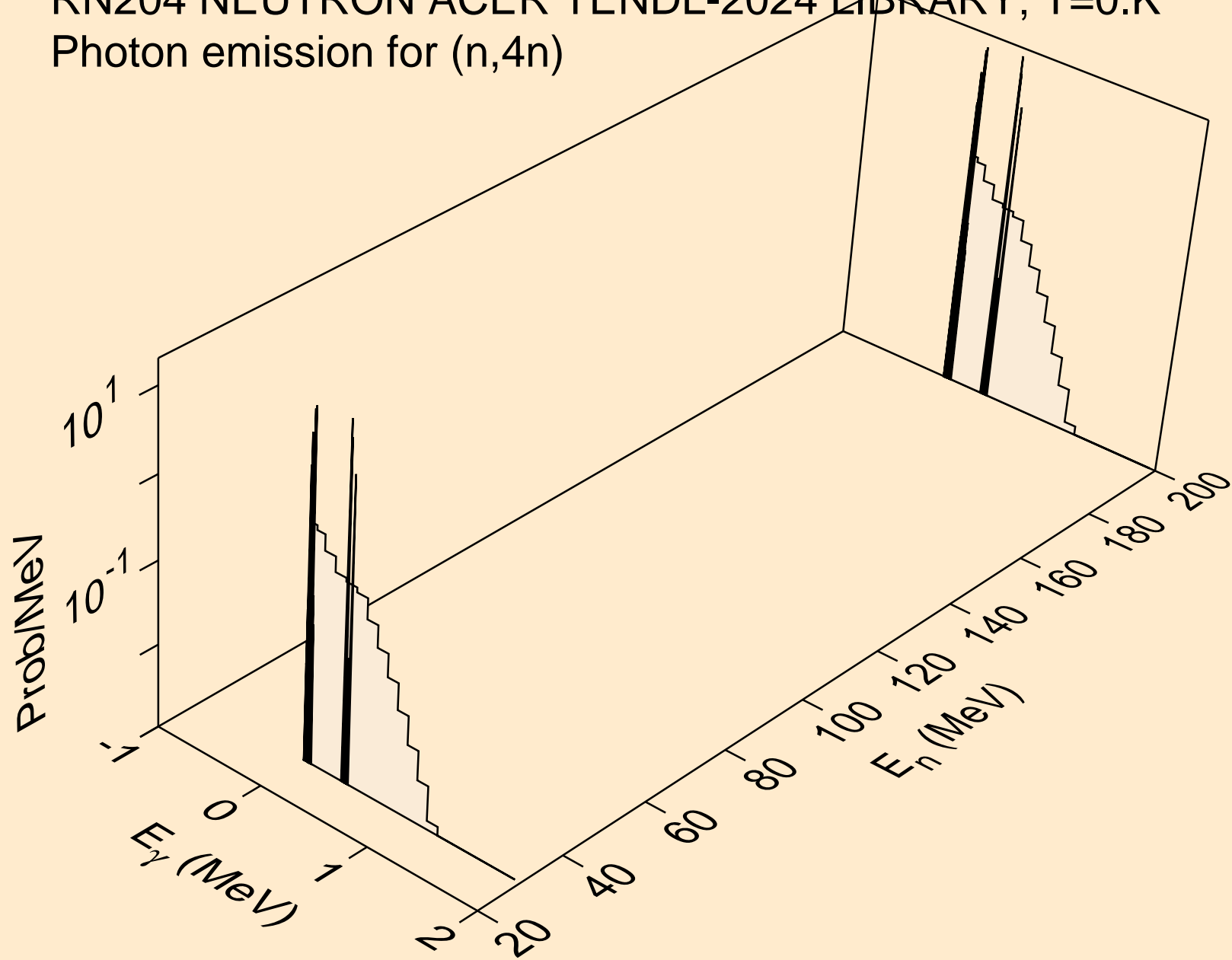

RN204 NEUTRON ACER TENDL-2024 LIBRARY; T=0.K
Photon emission for (n,2np)

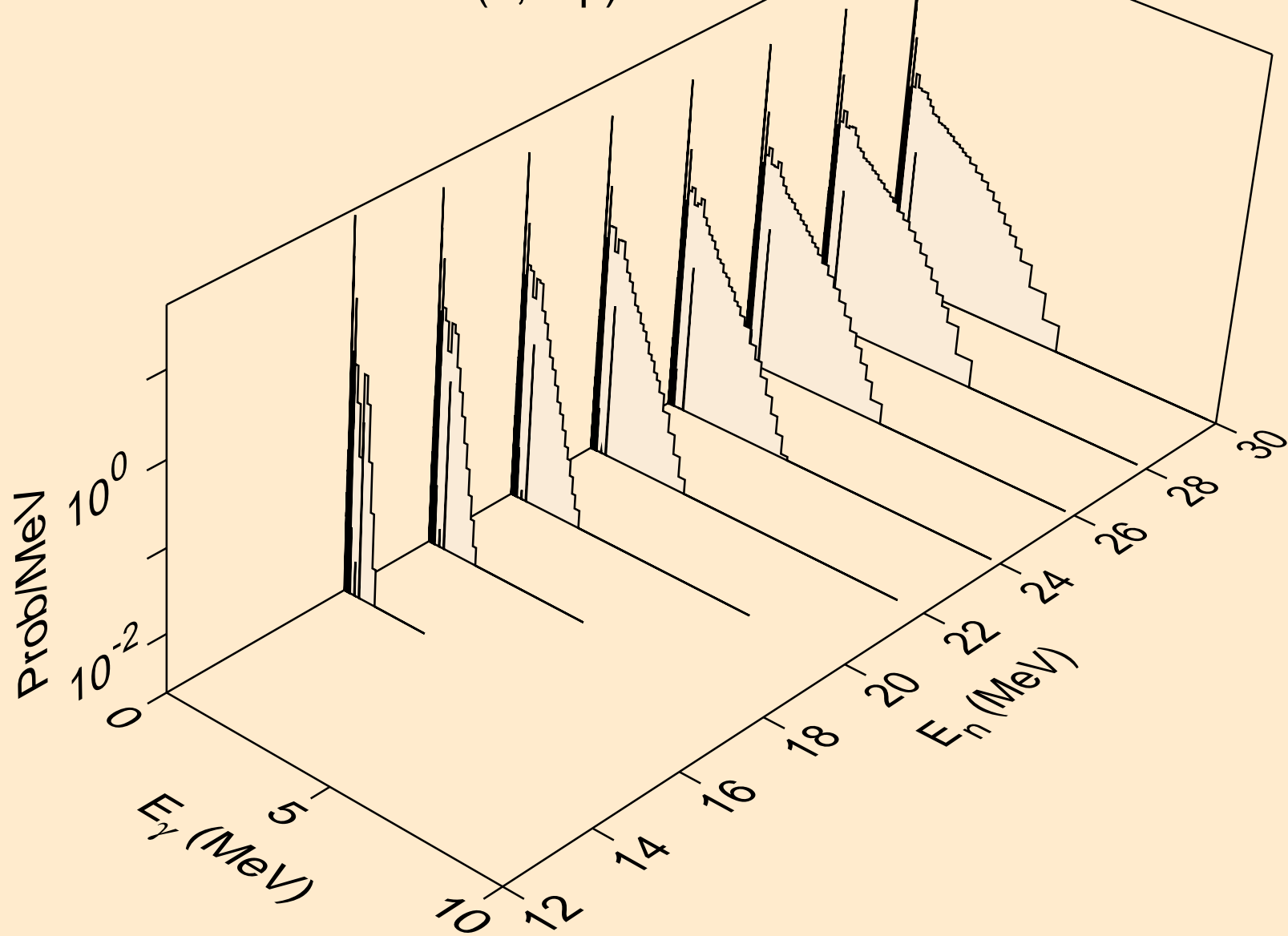

RN204 NEUTRON ACER TENDL-2024 LIBRARY; T=0.K
Photon emission for (n,3np)

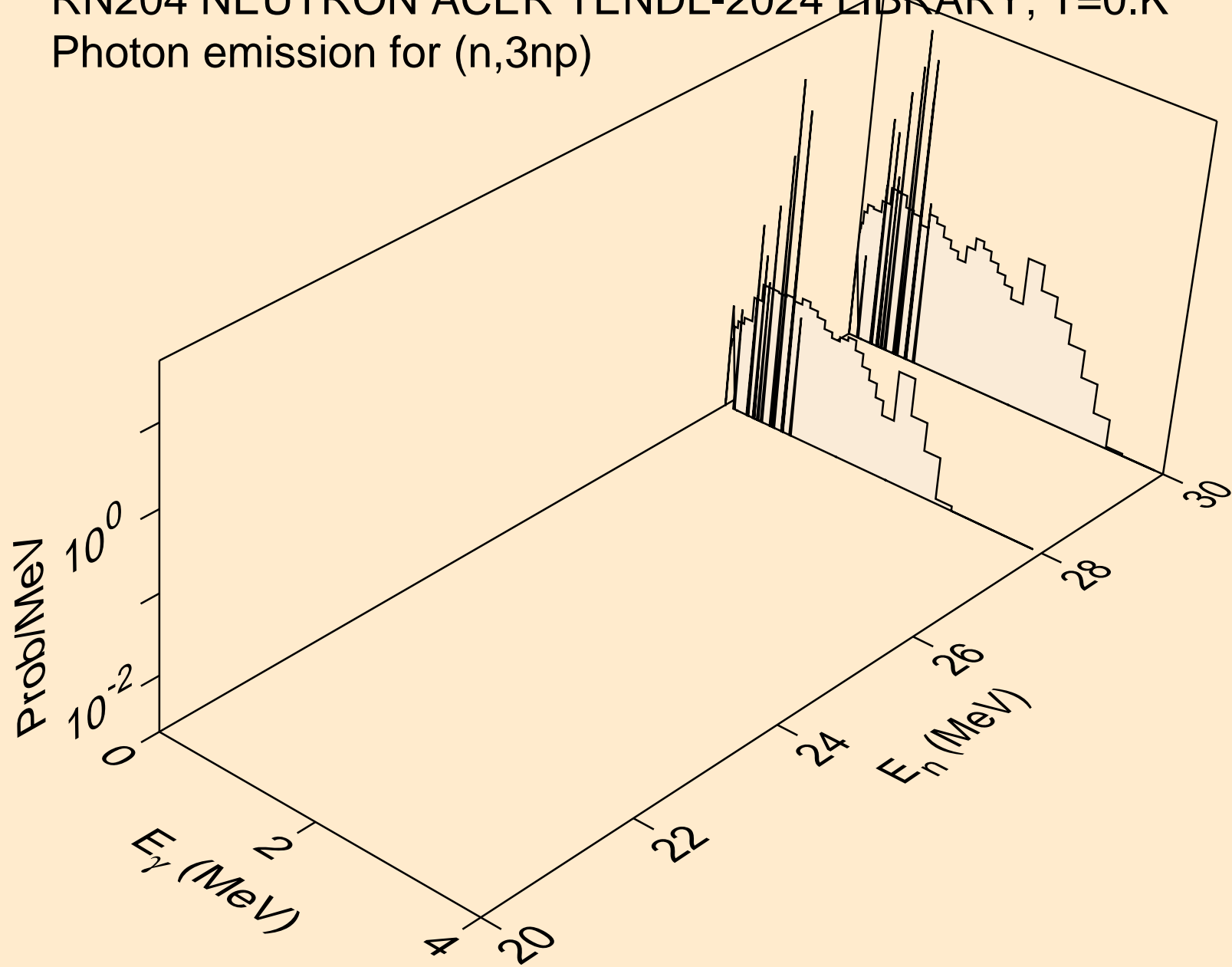

RN204 NEUTRON ACER TENDL-2024 LIBRARY; T=0.K
Photon emission for (n,n2p)

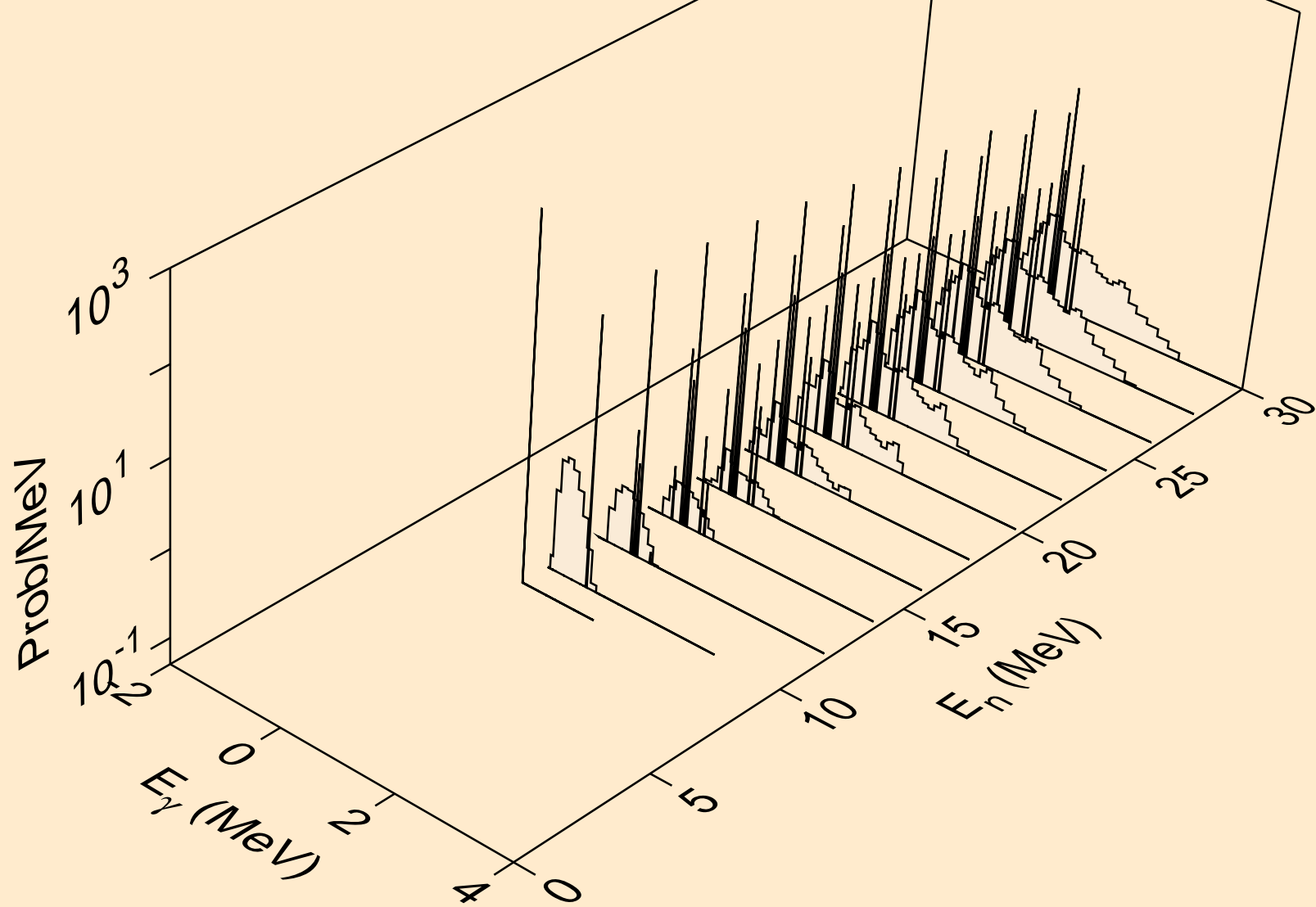

RN204 NEUTRON ACER TENDL-2024 LIBRARY; T=0.K
Photon emission for (n,npa)

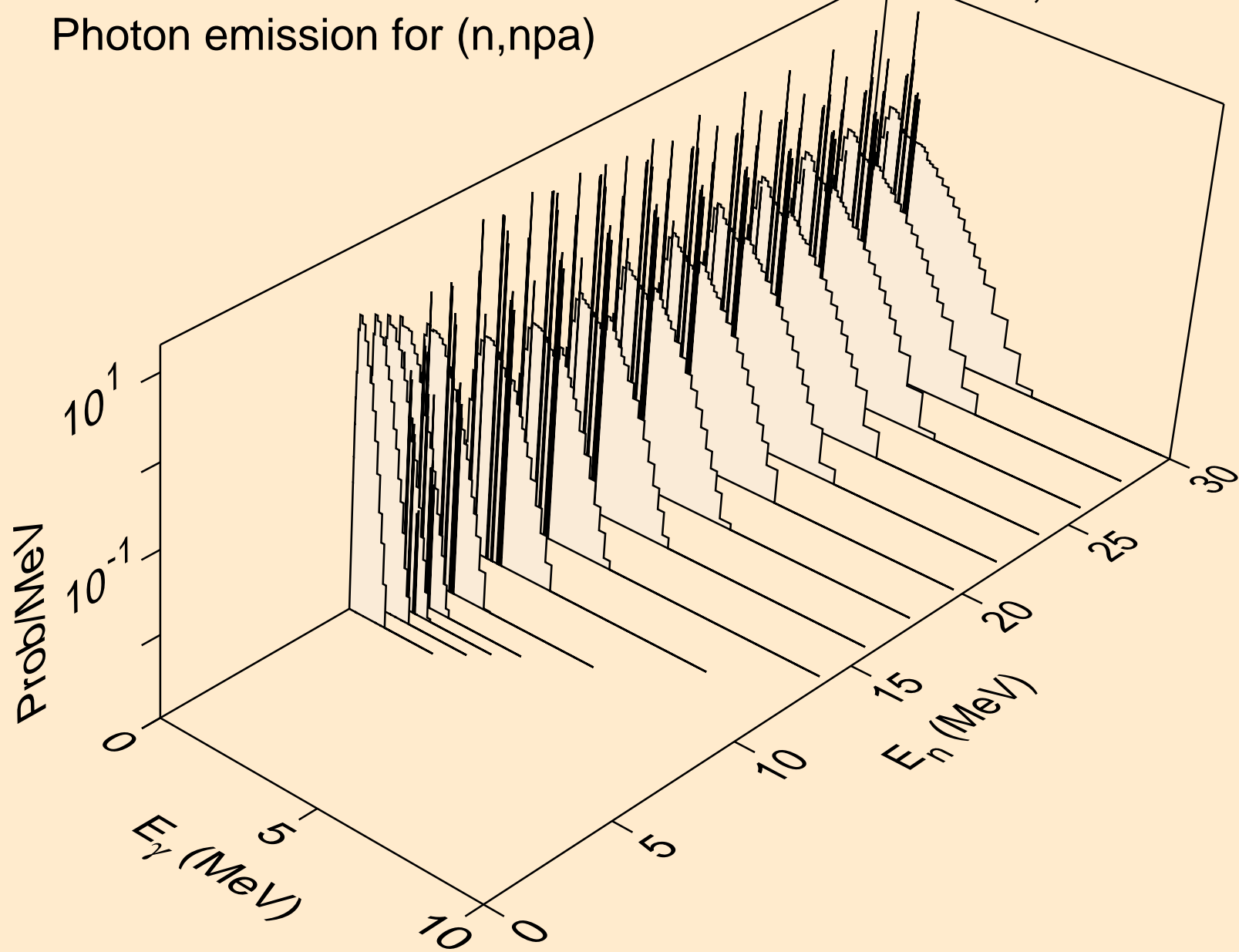

RN204 NEUTRON ACER TENDL-2024 LIBRARY; T=0.K
Photon emission for (n,n*c)

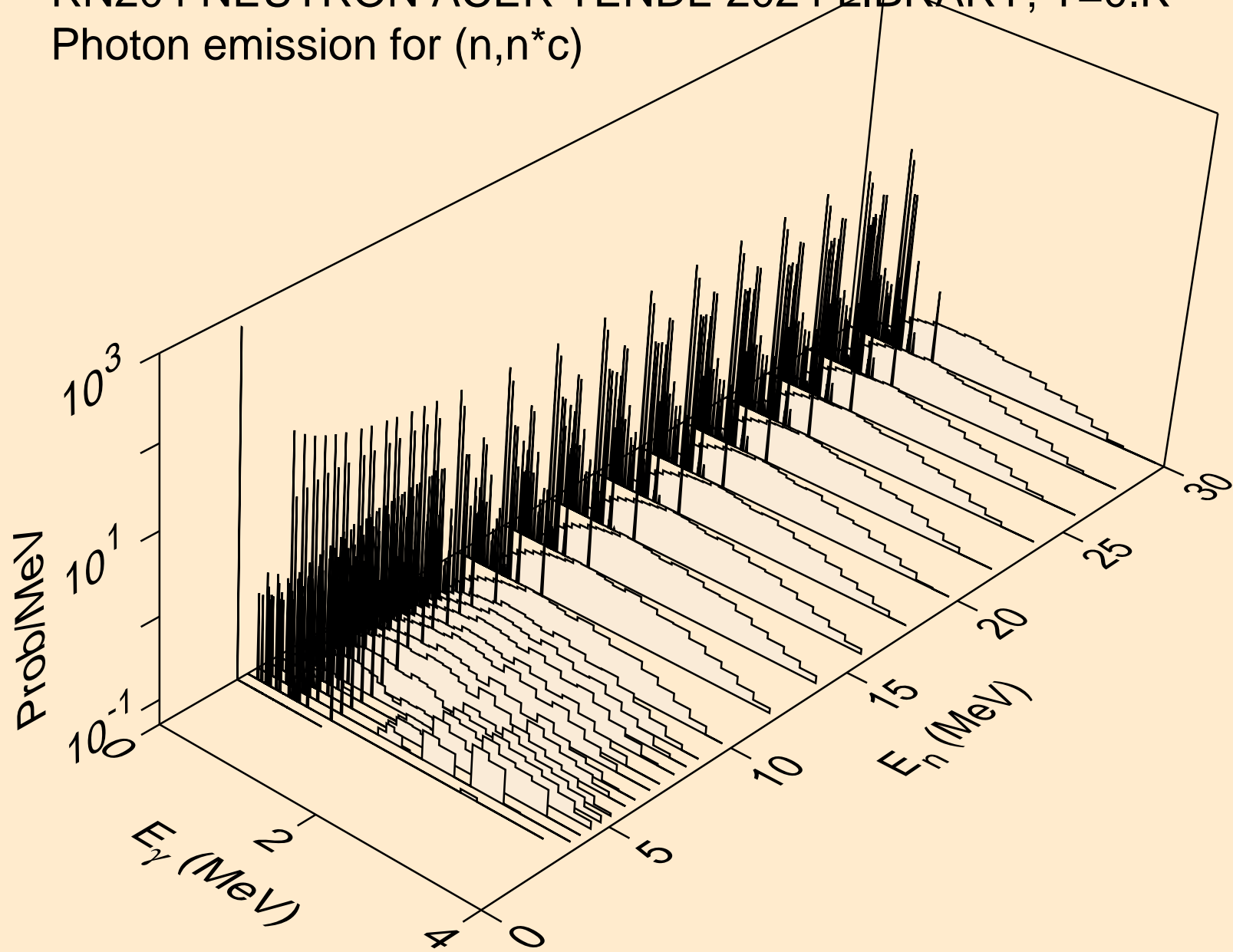

RN204 NEUTRON ACER TENDL-2024 LIBRARY; T=0.K
Photon emission for (n,gma)

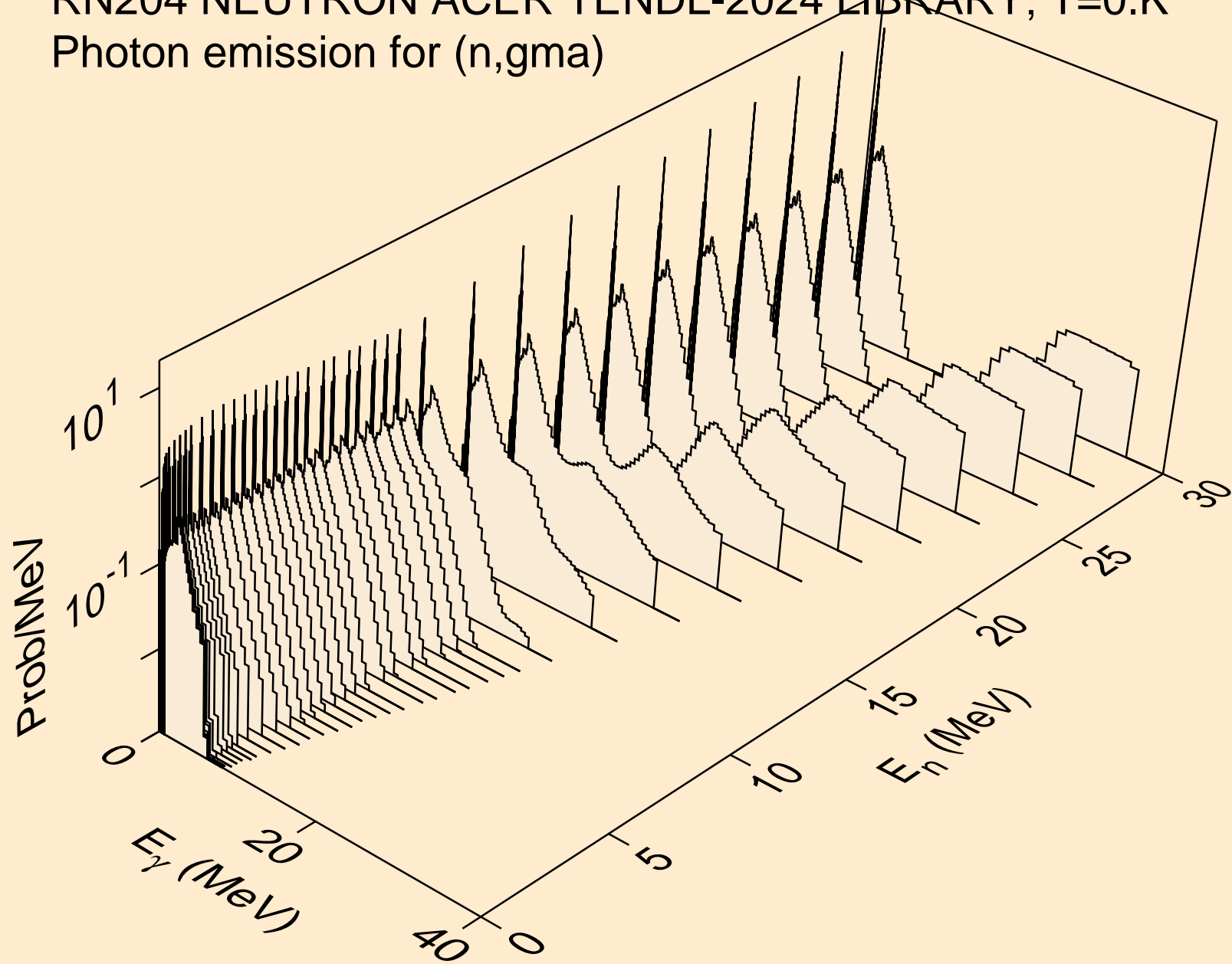

RN204 NEUTRON ACER TENDL-2024 LIBRARY; T=0.K
Photon emission for (n,p)

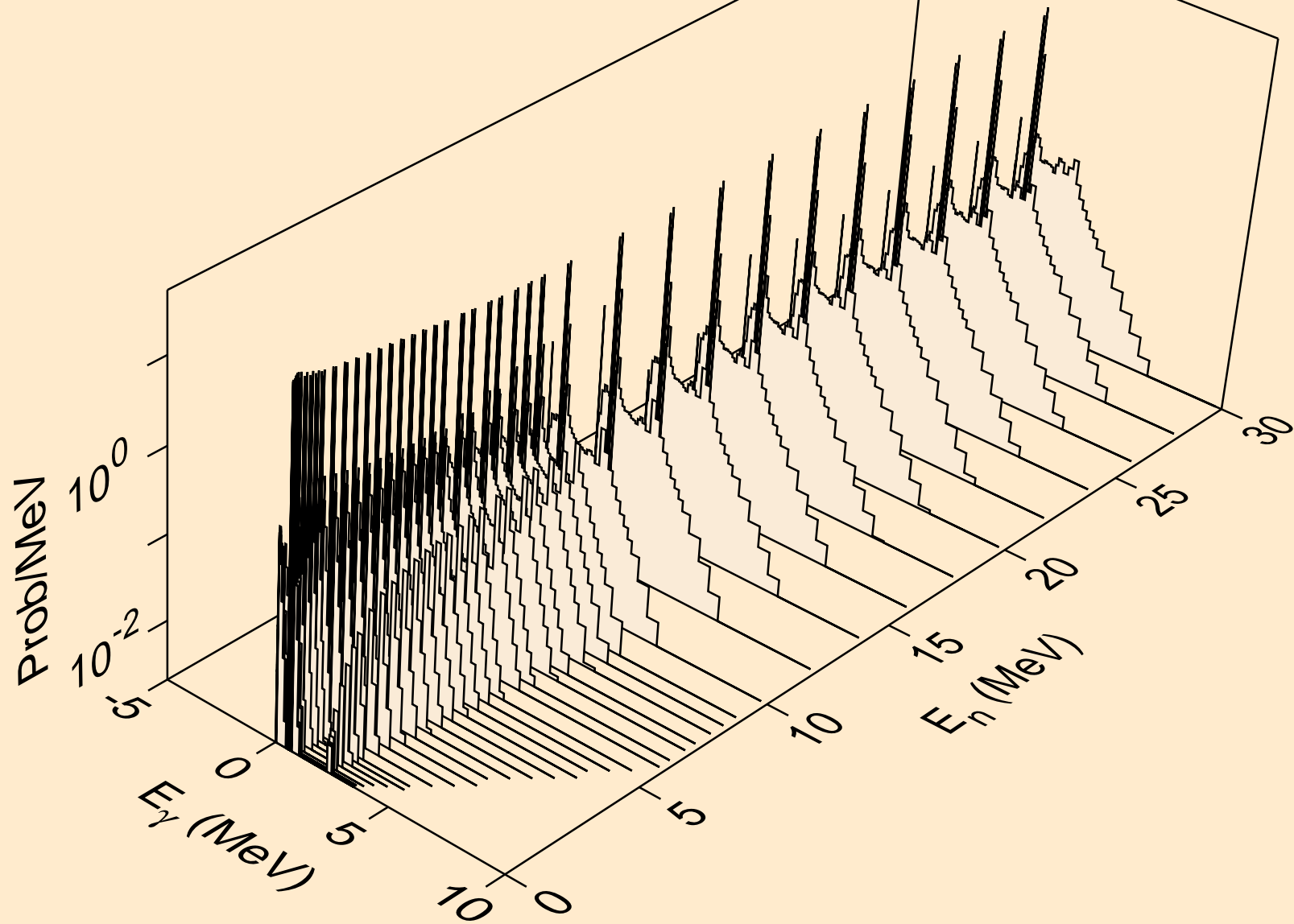

RN204 NEUTRON ACER TENDL-2024 LIBRARY; T=0.K
Photon emission for (n,d)

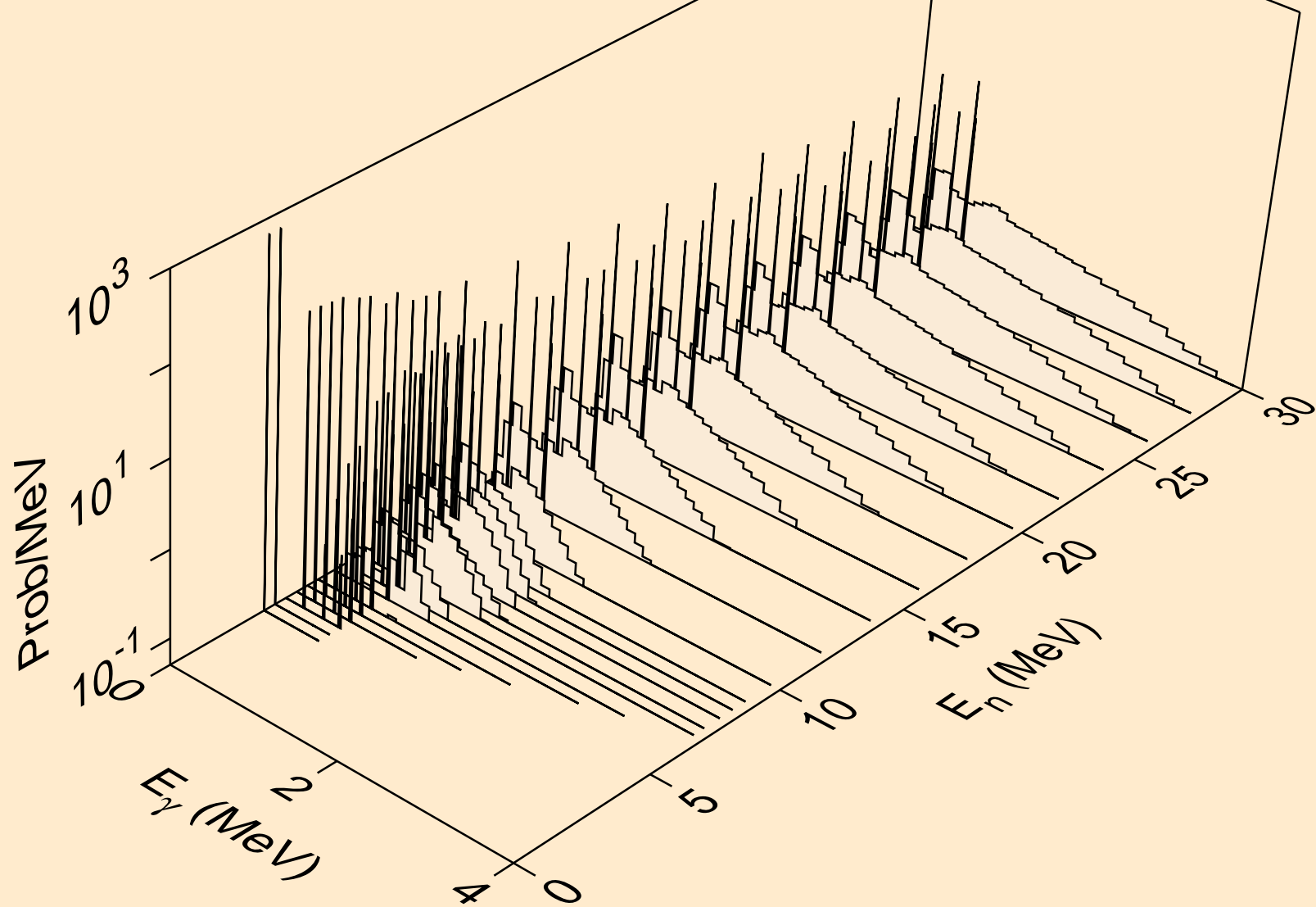

RN204 NEUTRON ACER TENDL-2024 LIBRARY; T=0.K
Photon emission for (n,t)

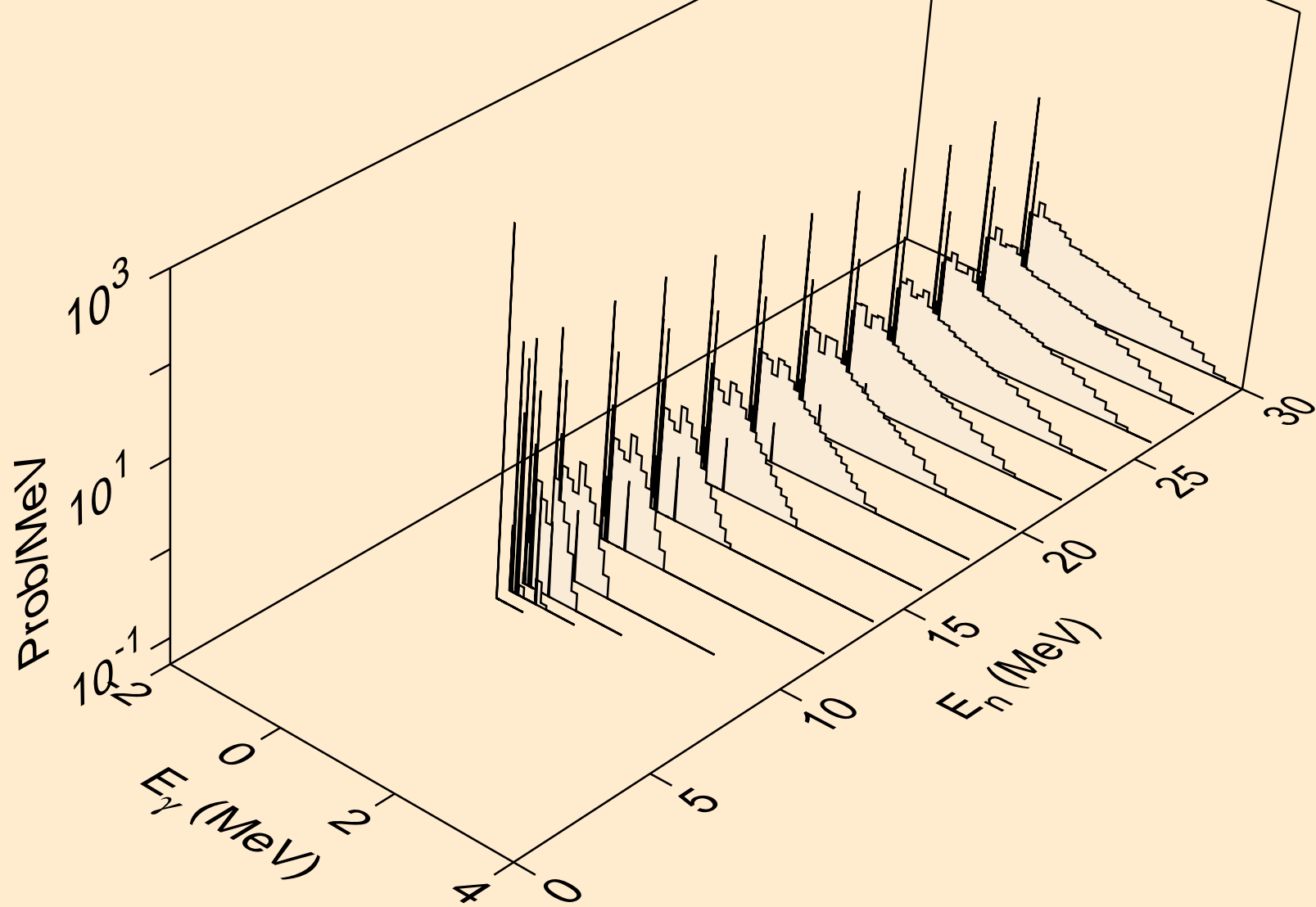

RN204 NEUTRON ACER TENDL-2024 LIBRARY; T=0.K
Photon emission for (n,he3)

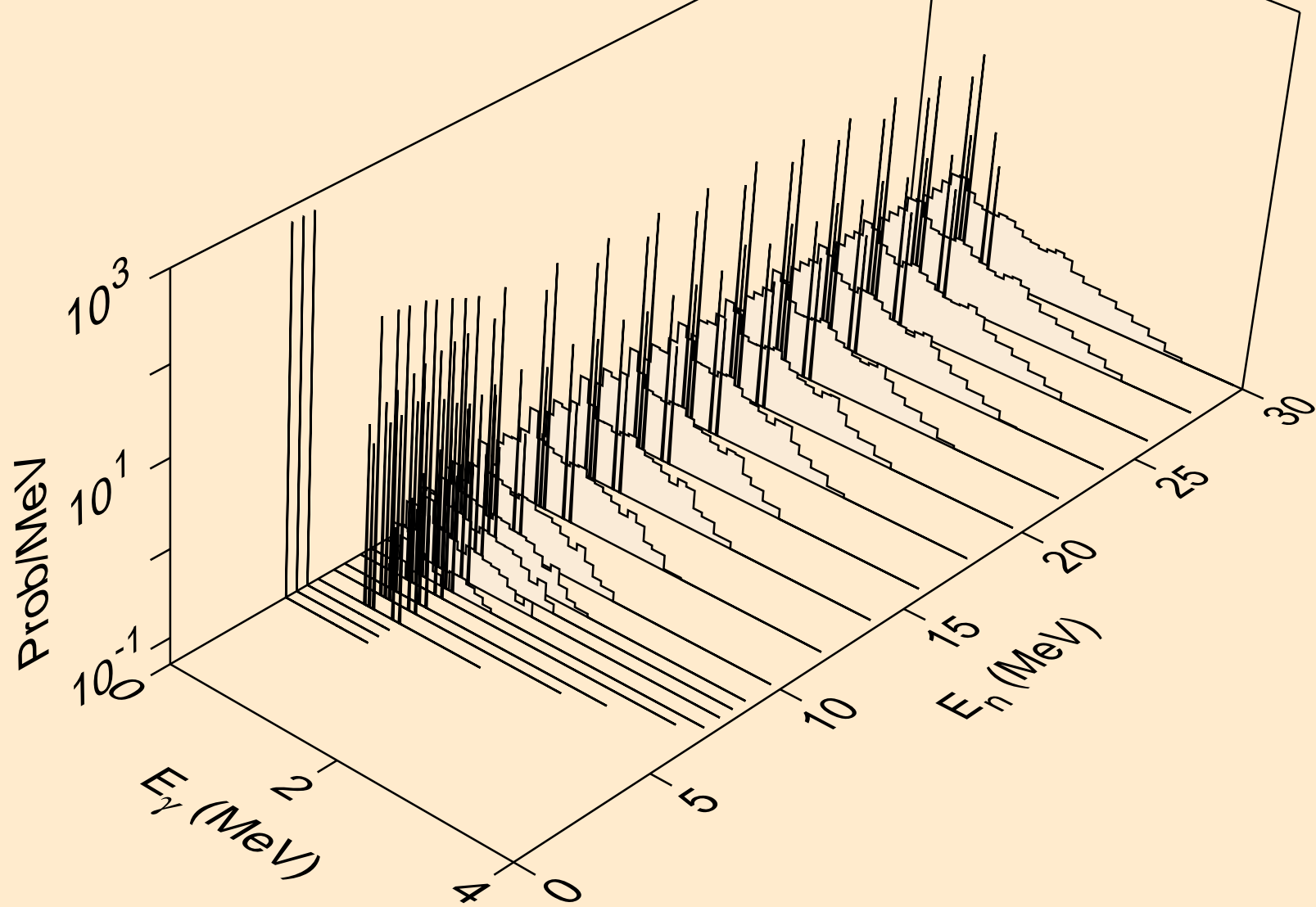

RN204 NEUTRON ACER TENDL-2024 LIBRARY; T=0.K
Photon emission for (n,a)

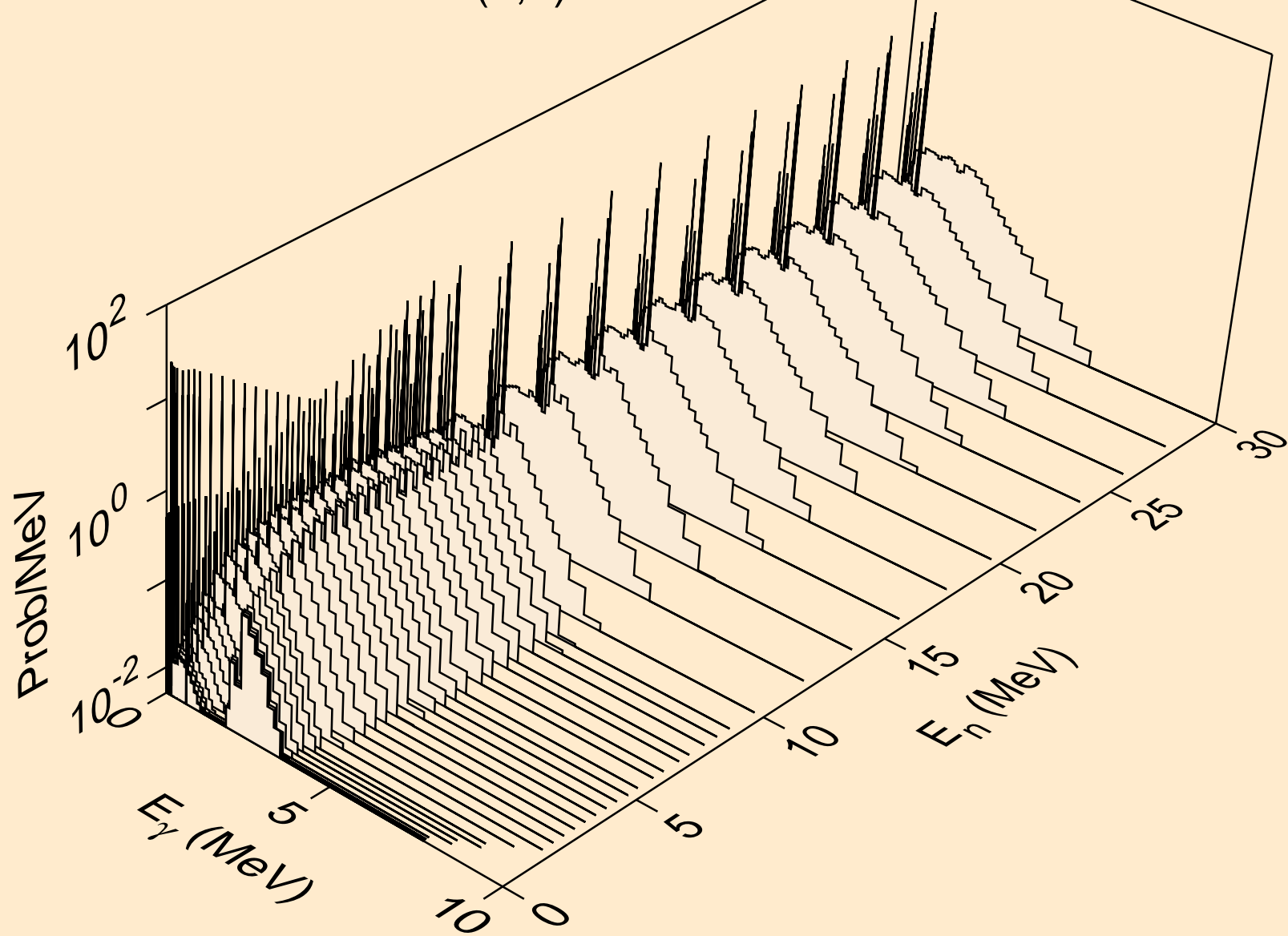

RN204 NEUTRON ACER TENDL-2024 LIBRARY; T=0.K
Photon emission for (n,2a)

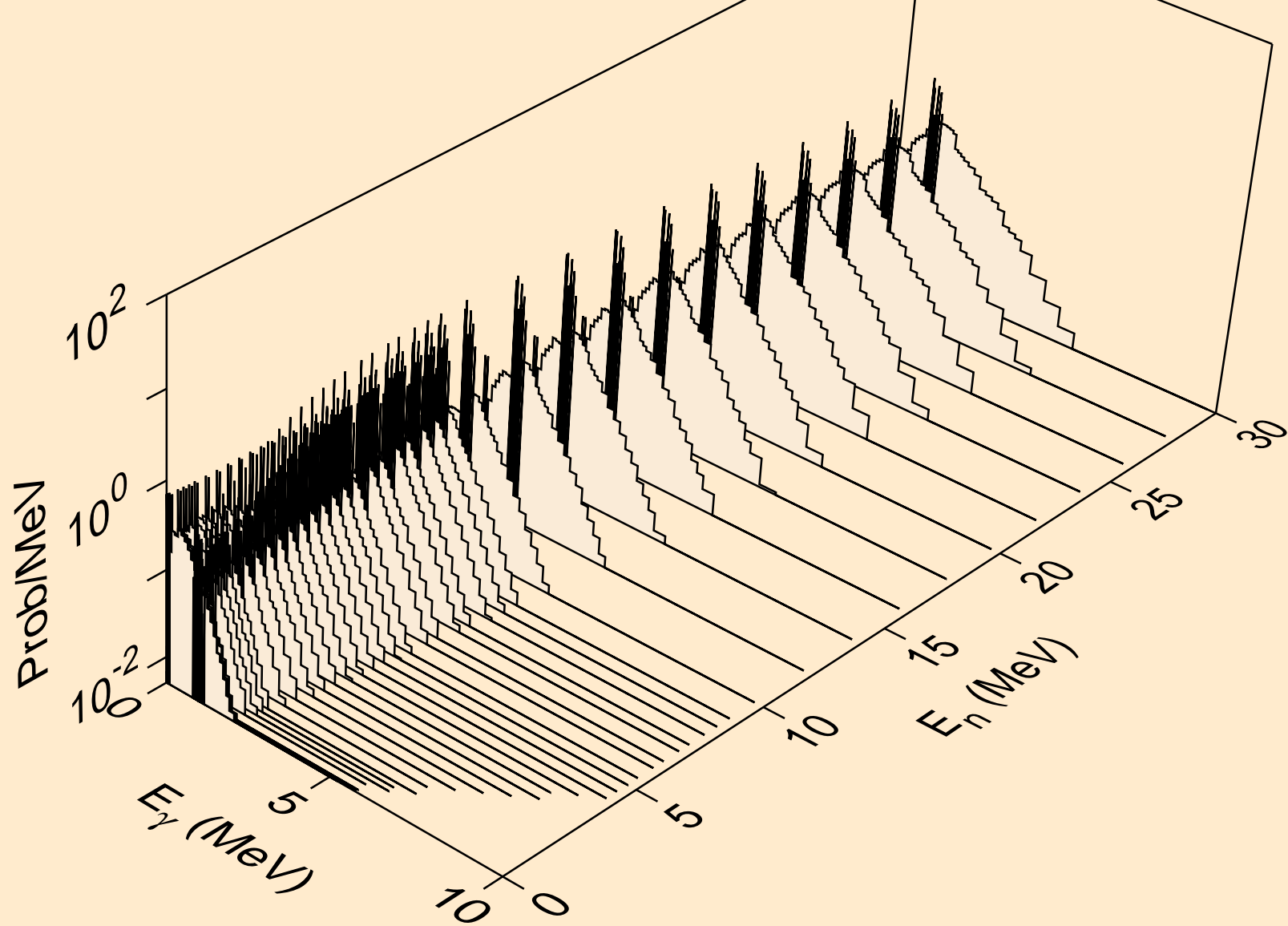

RN204 NEUTRON ACER TENDL-2024 LIBRARY; T=0.K
Photon emission for (n,2p)

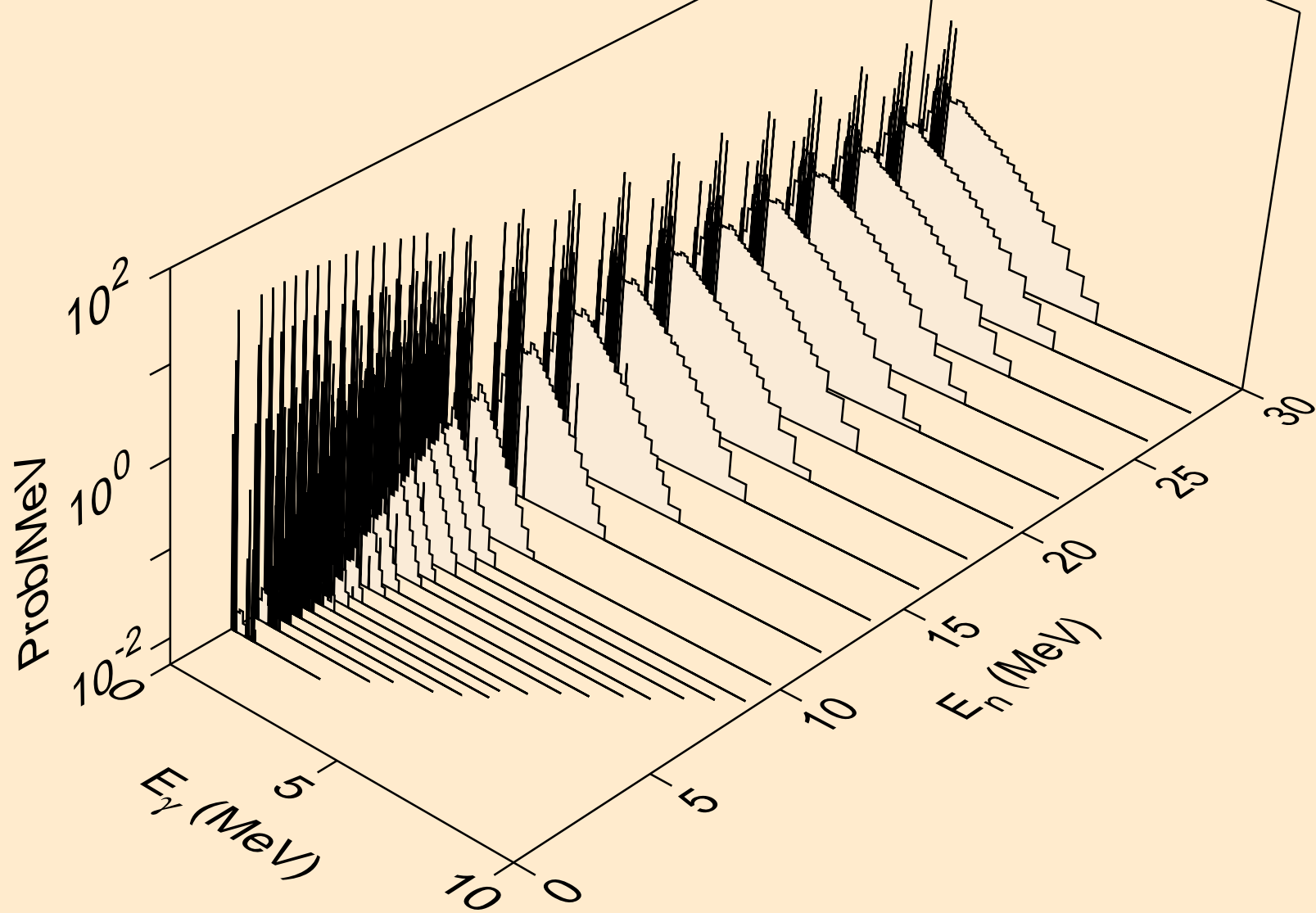

RN204 NEUTRON ACER TENDL-2024 LIBRARY; T=0.K
Photon emission for (n,p α)

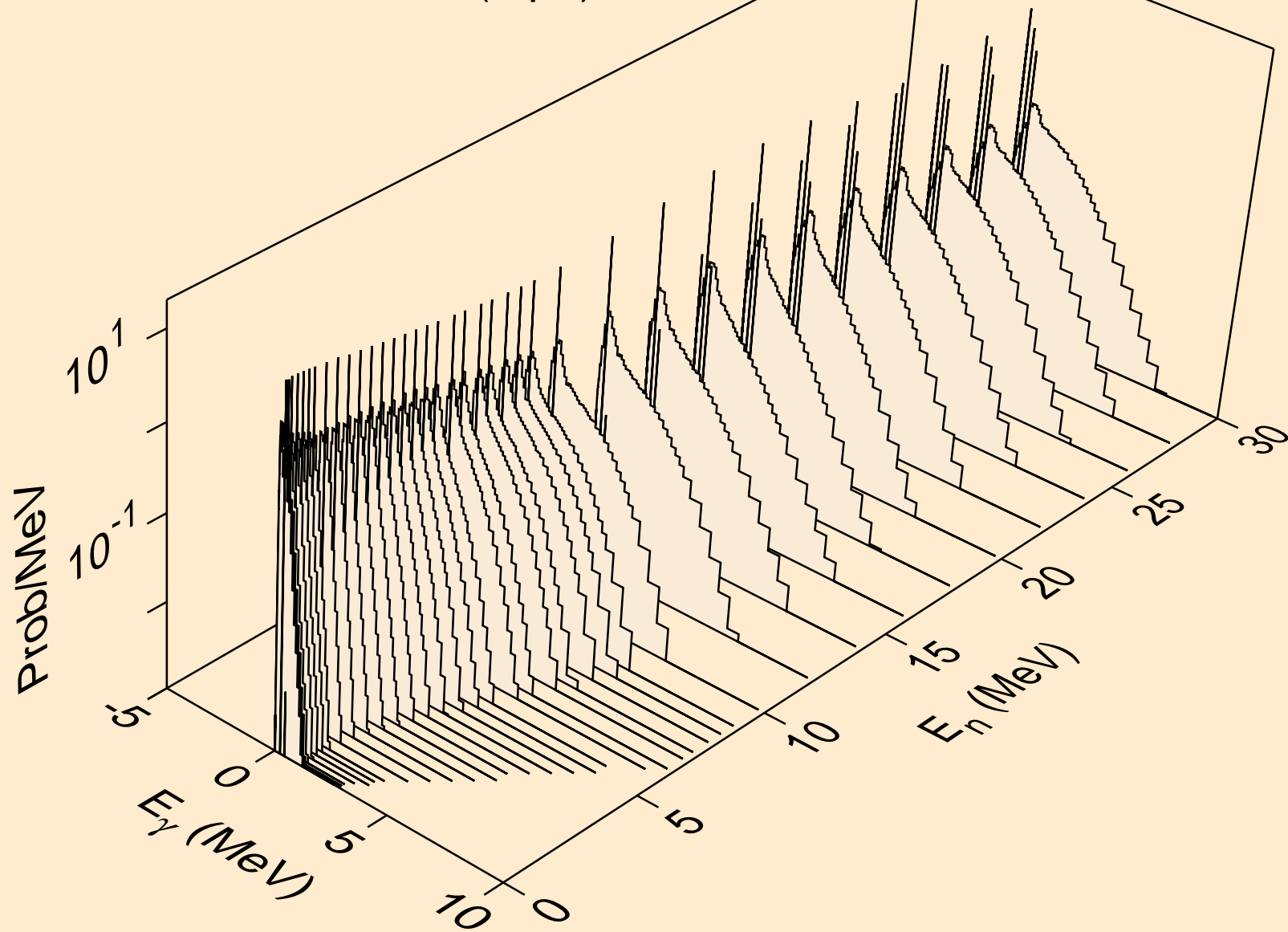

RN204 NEUTRON ACER TENDL-2024 LIBRARY; T=0.K
Photon emission for (n,pd)

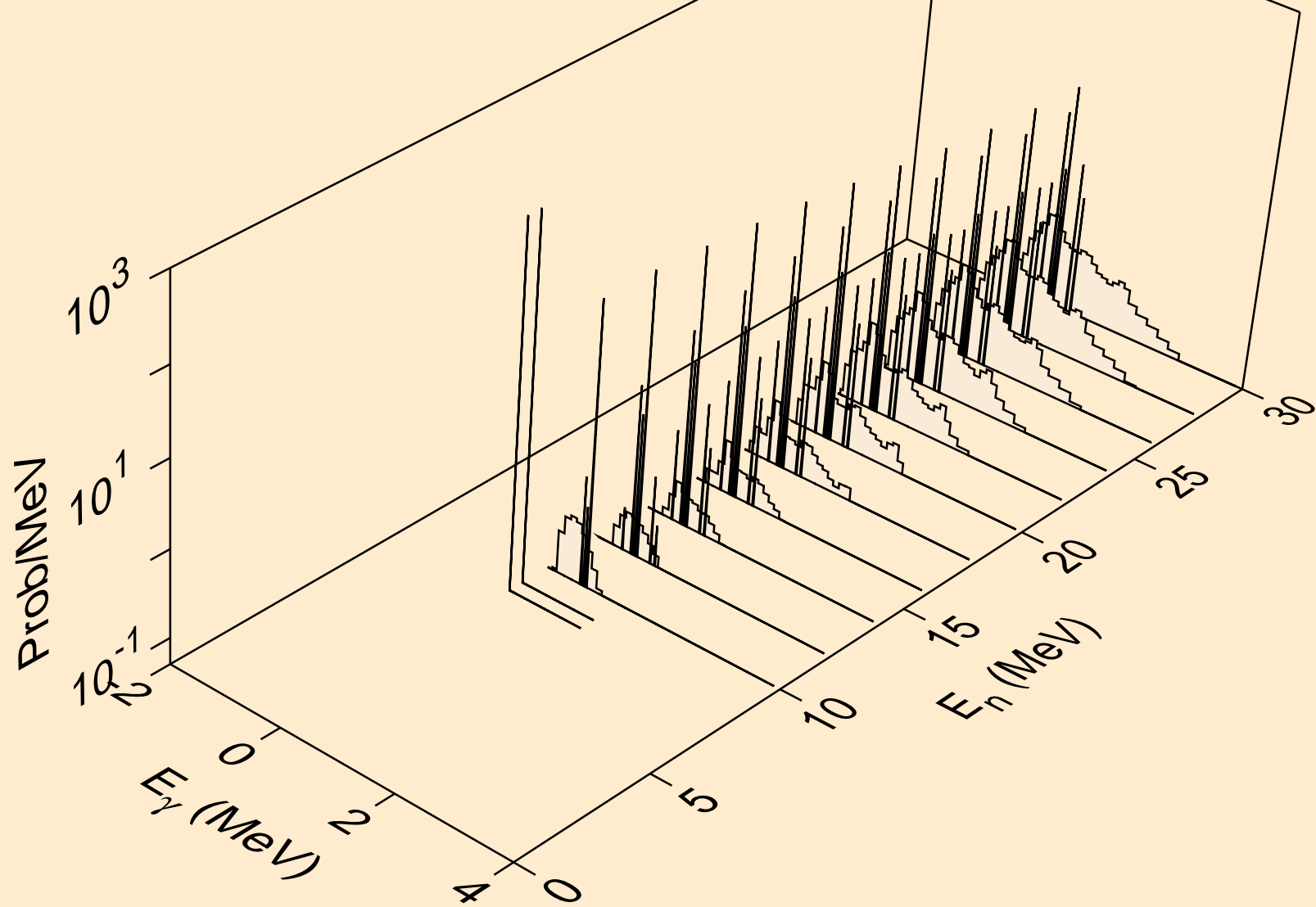

RN204 NEUTRON ACER TENDL-2024 LIBRARY; T=0.K
Photon emission for (n,pt)

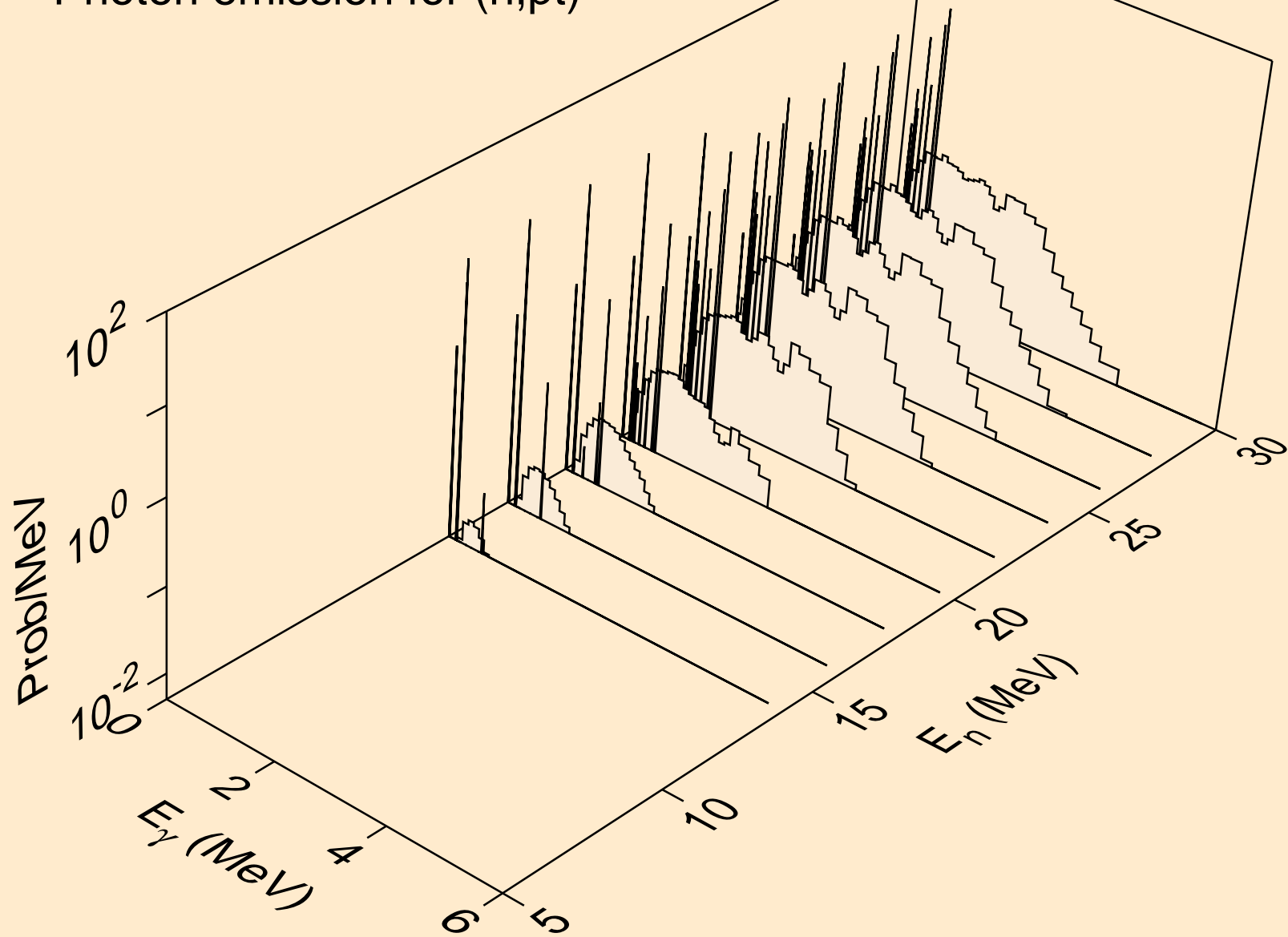

RN204 NEUTRON ACER TENDL-2024 LIBRARY; T=0.K
Photon emission for (n,da)

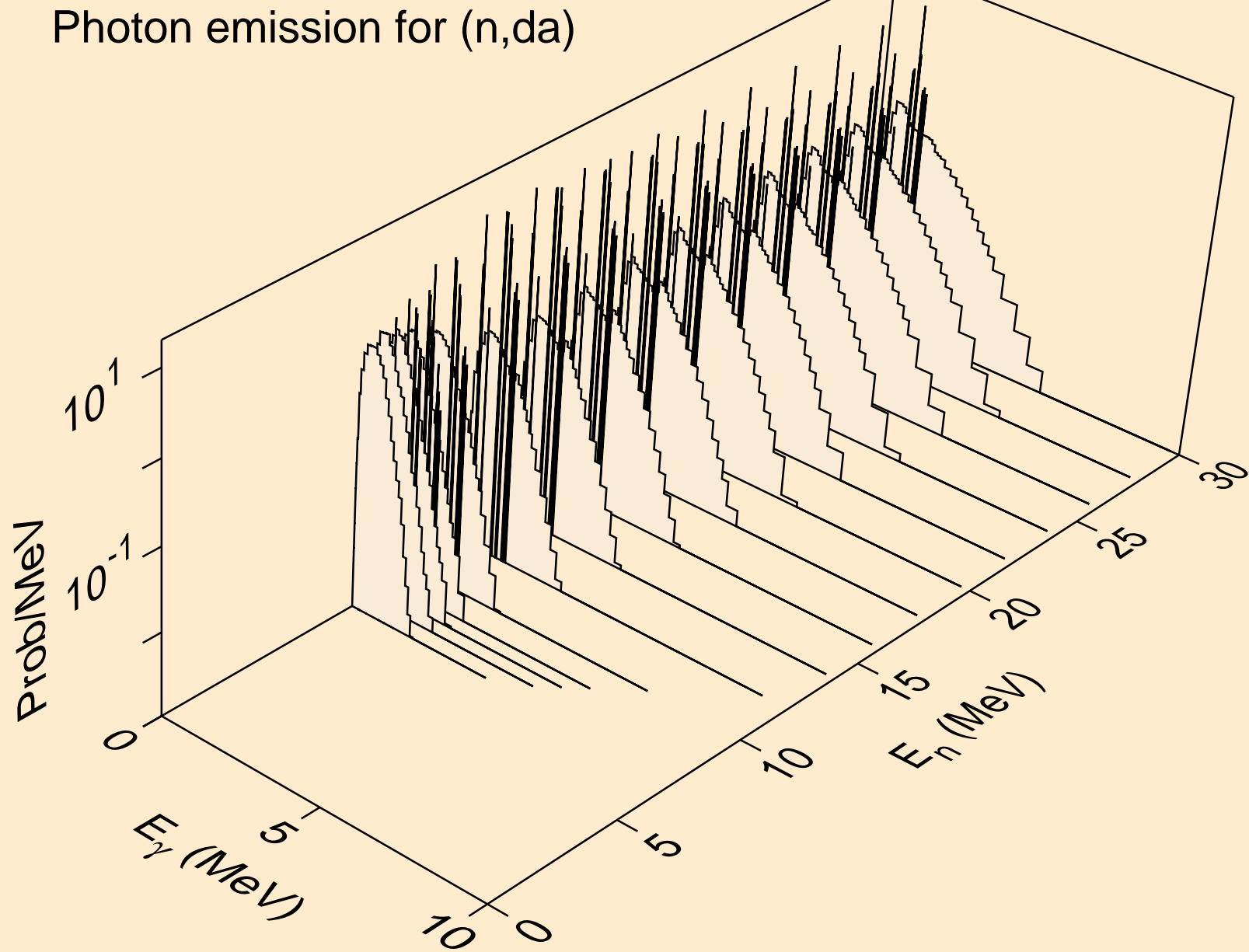

RN204 NEUTRON ACER TENDL-2024 LIBRARY; T=0.K
thermal capture photon spectrum

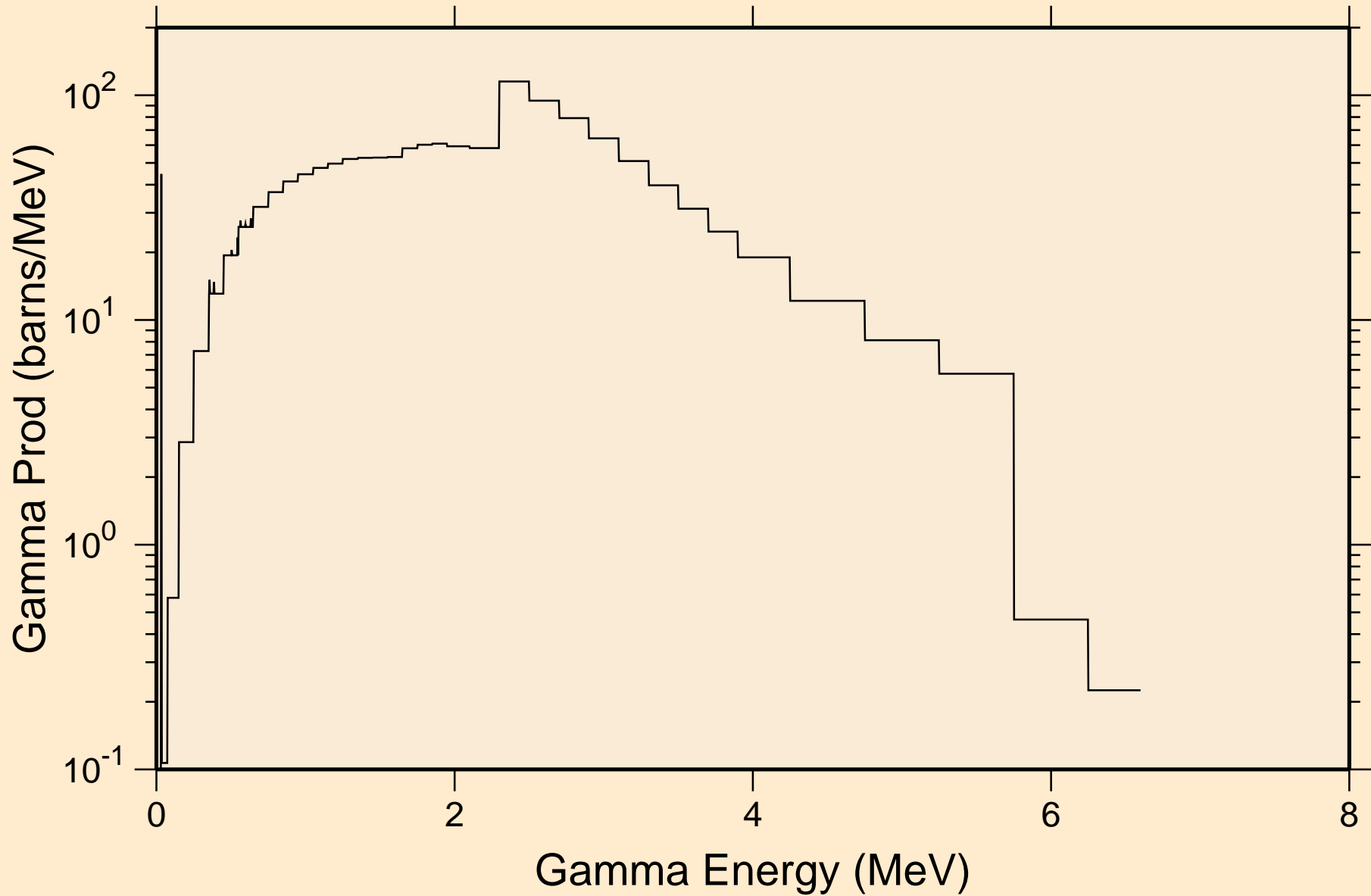

RN204 NEUTRON ACER TENDL-2024 LIBRARY; T=0.K
14 MeV photon spectrum

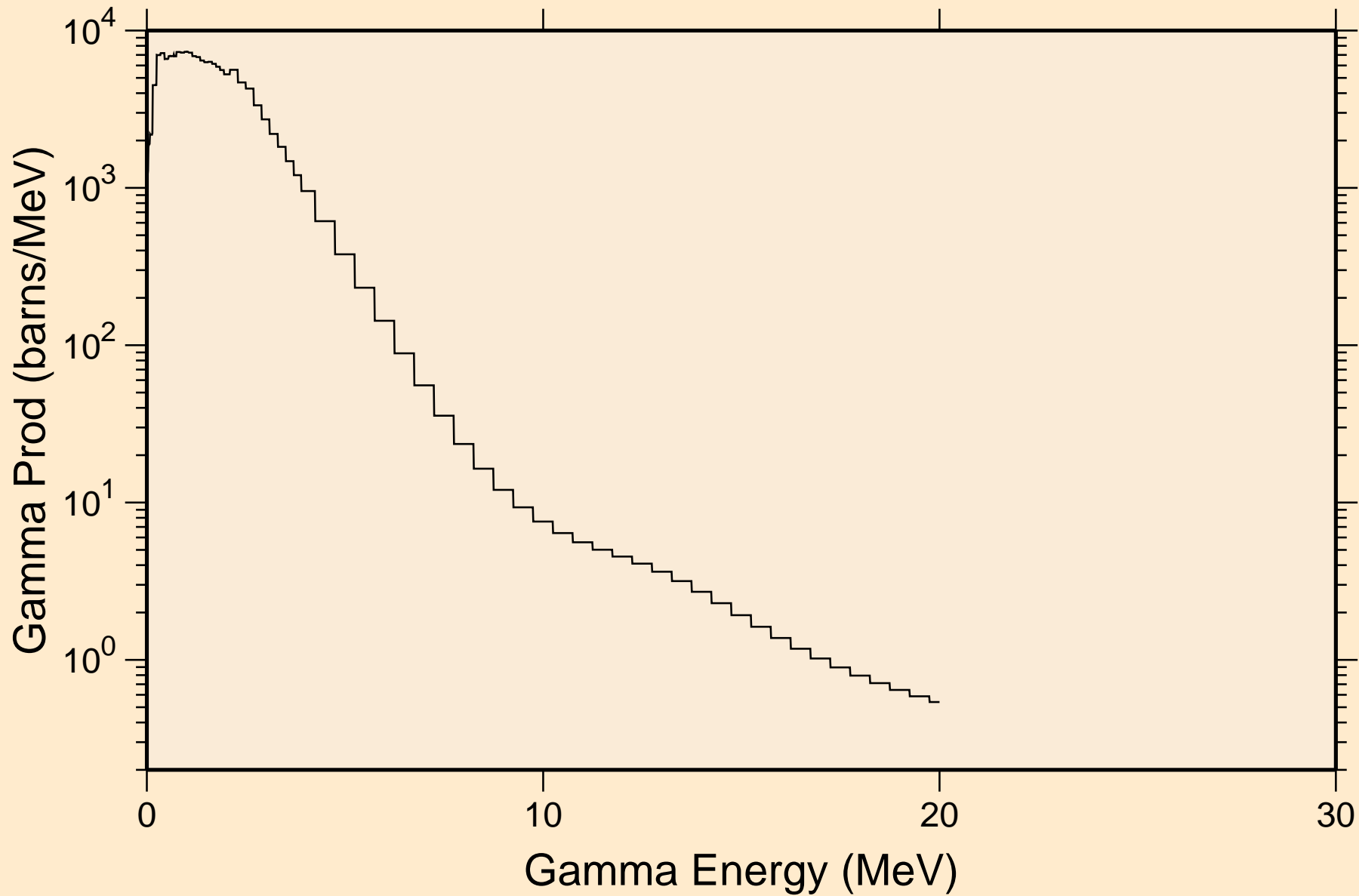

RN204 NEUTRON ACER TENDL-2024 LIBRARY; T=0.K

Particle heating contributions

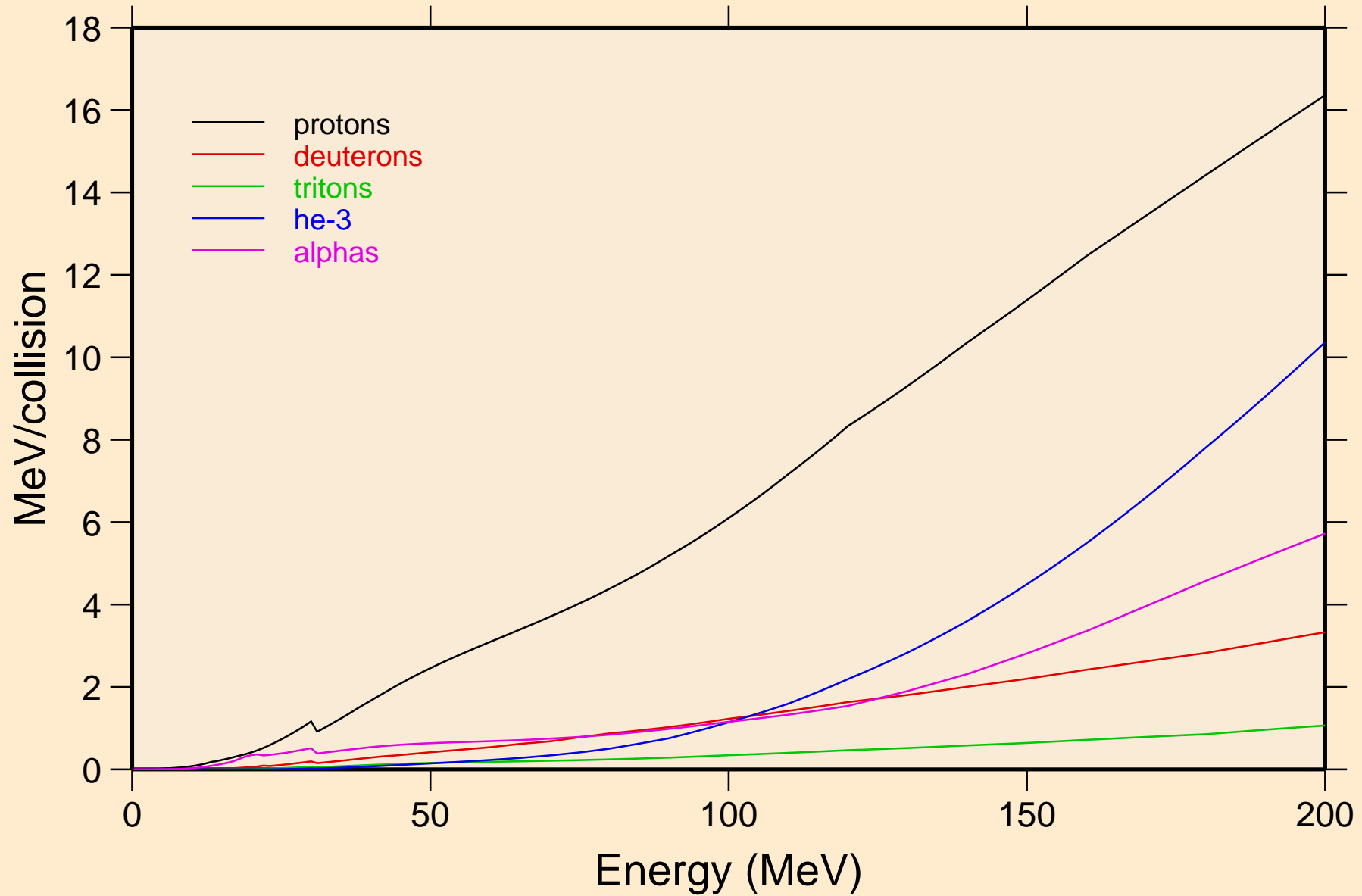

RN204 NEUTRON ACER TENDL-2024 LIBRARY; T=0.K
Recoil Heating

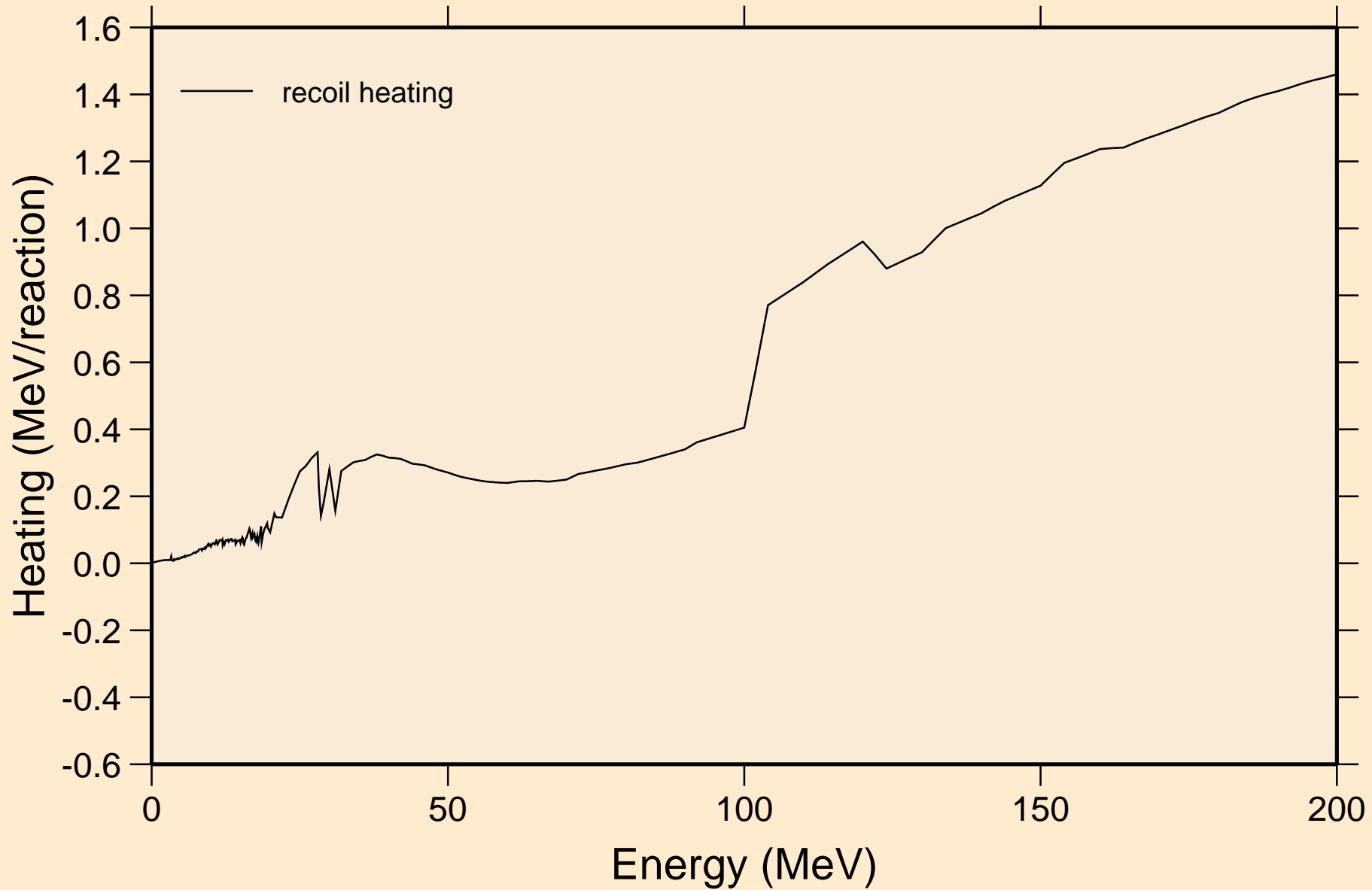

RN204 NEUTRON ACER TENDL-2024 LIBRARY; T=0.K
Particle production cross sections

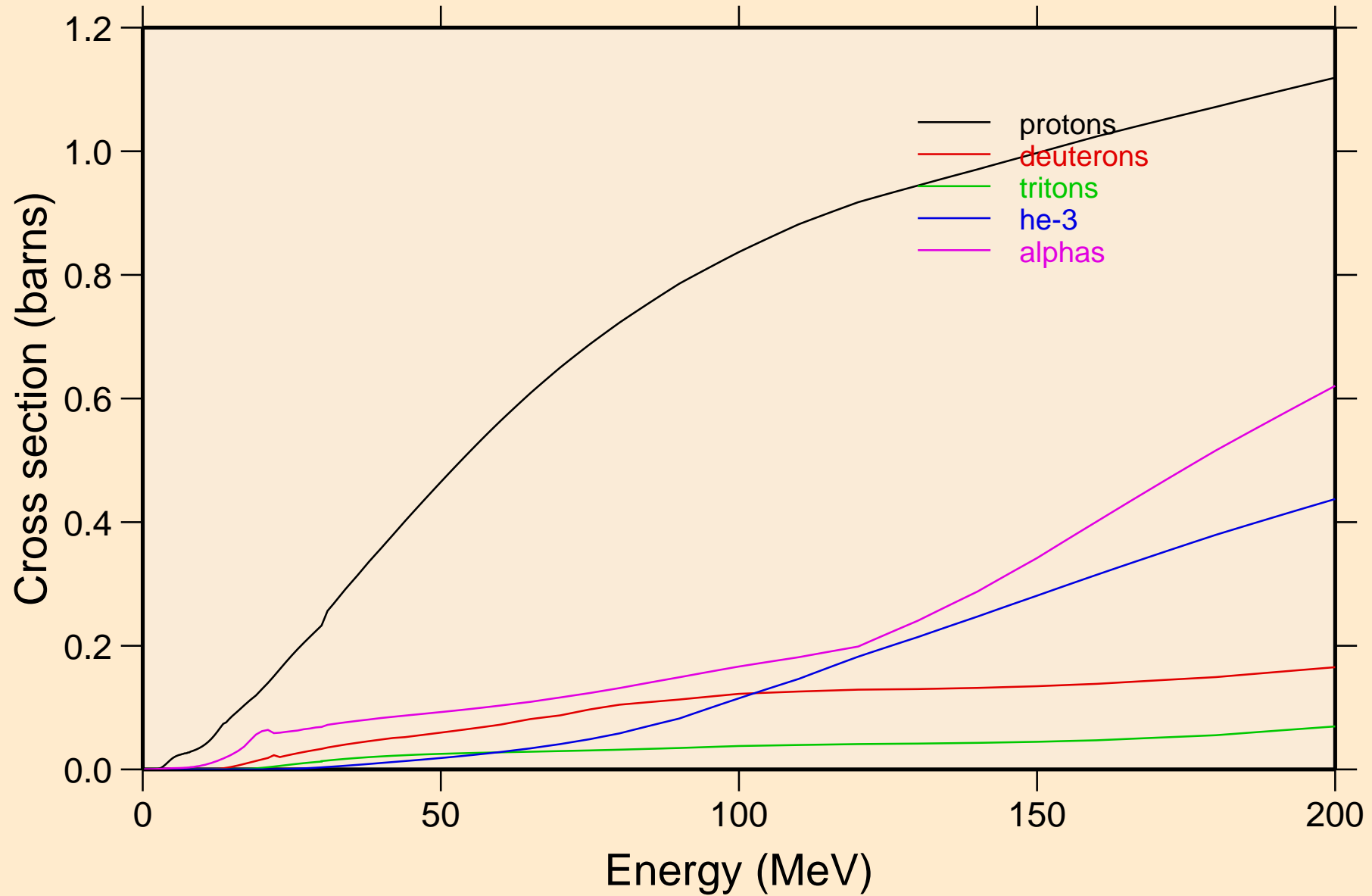

RN204 NEUTRON ACER TENDL-2024 LIBRARY; T=0.K
protons from (n,x)

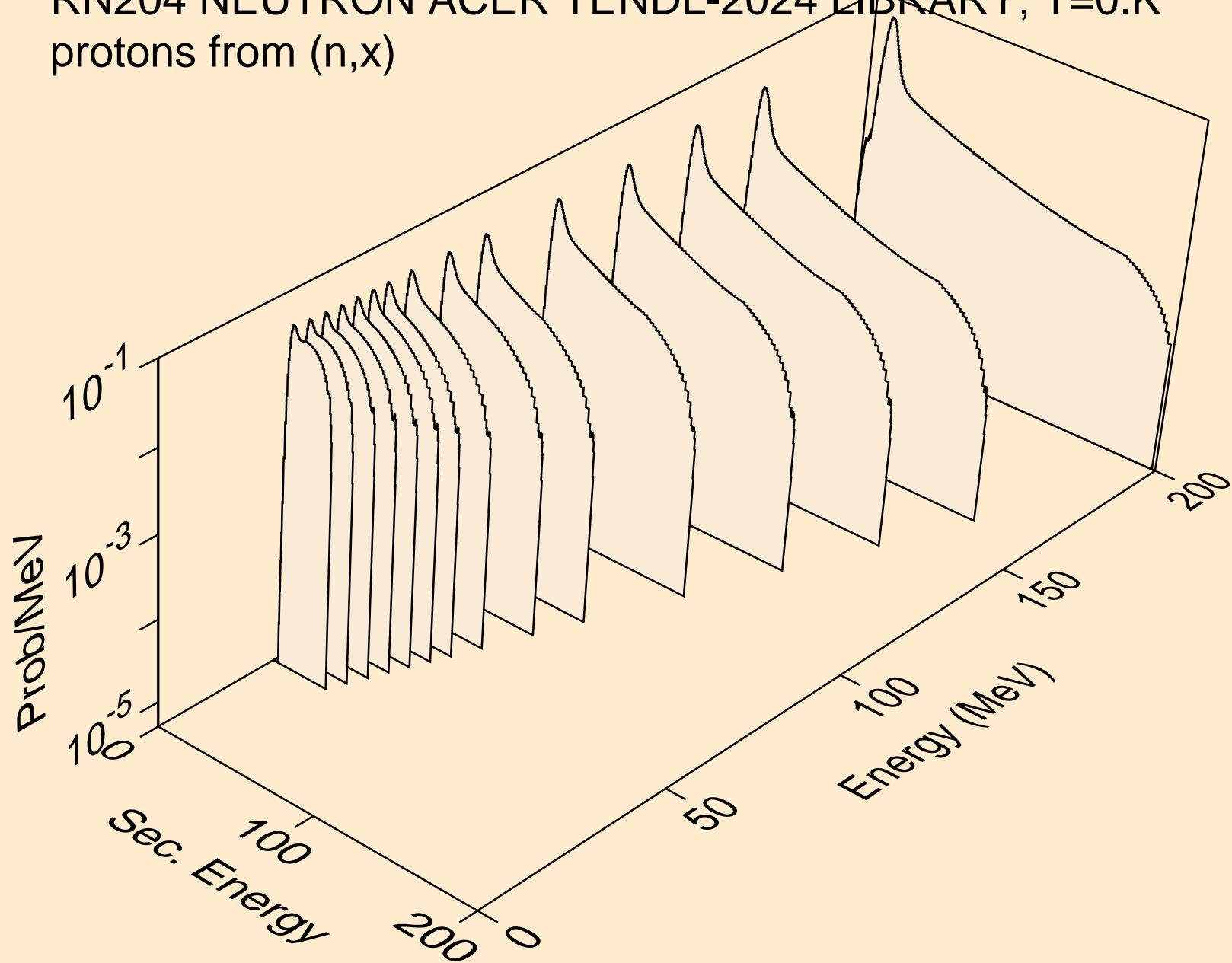

RN204 NEUTRON ACER TENDL-2024 LIBRARY; T=0.K
protons from (n,n*)p

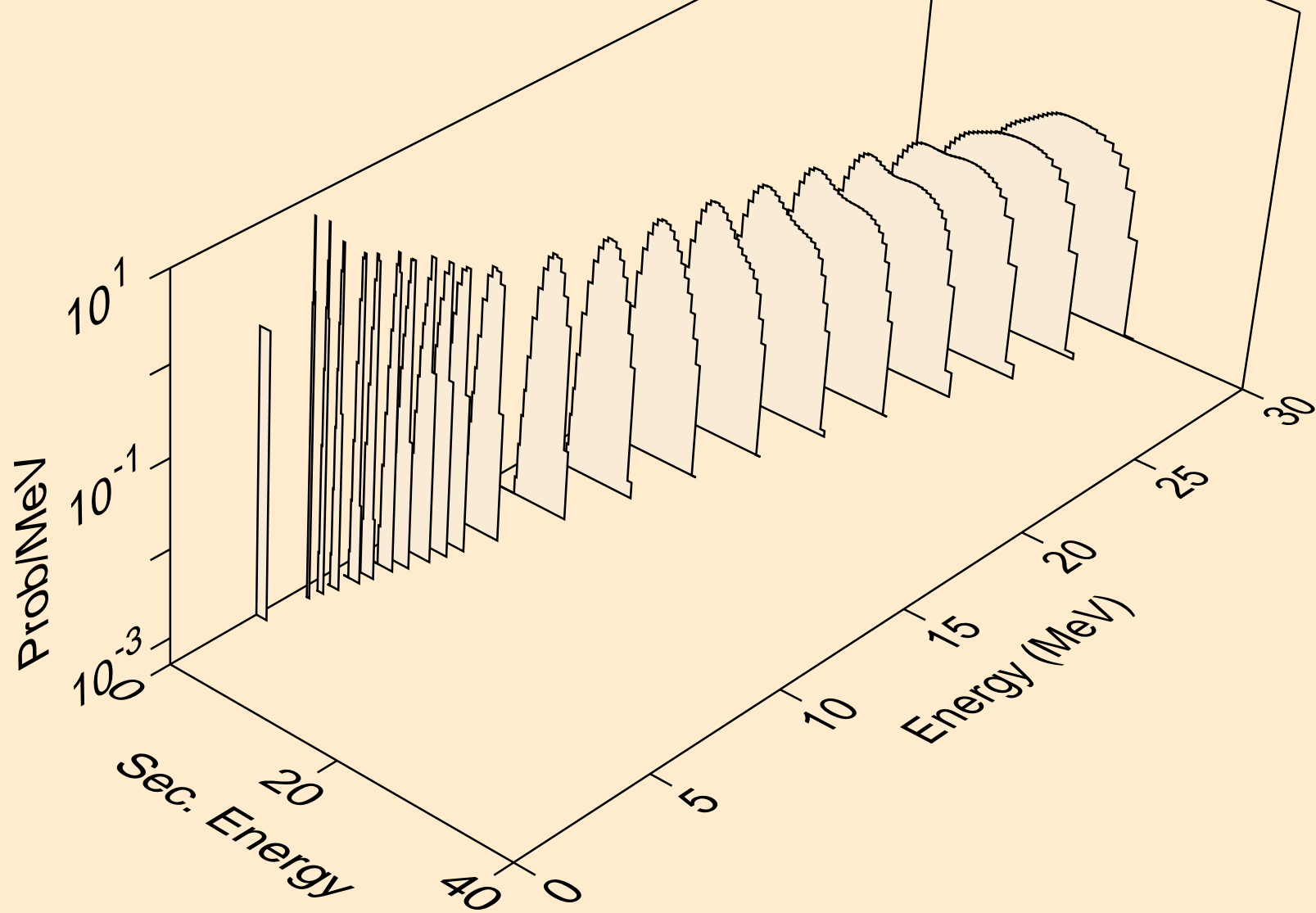

RN204 NEUTRON ACER TENDL-2024 LIBRARY; T=0.K
protons from (n,2np)

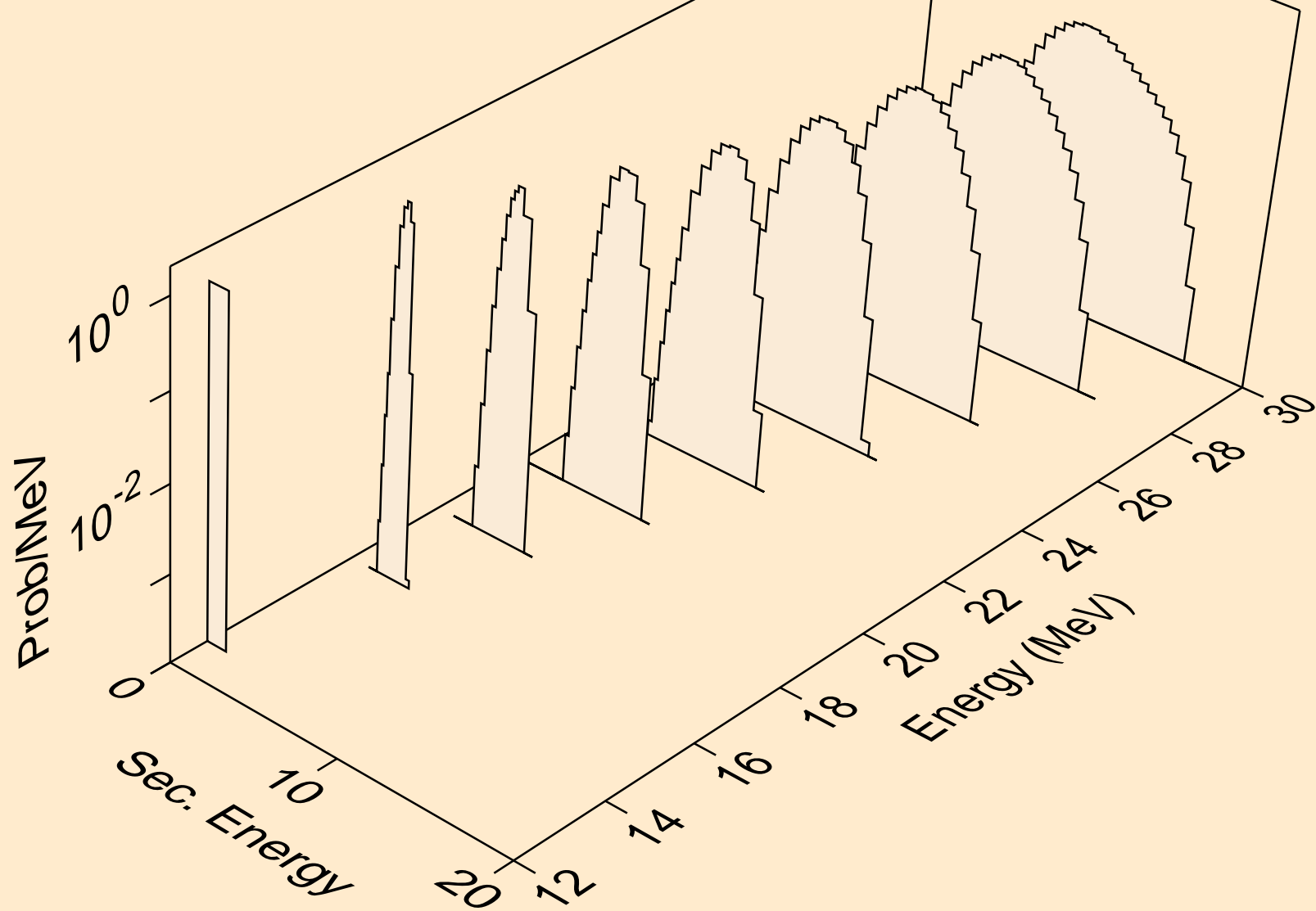

RN204 NEUTRON ACER TENDL-2024 LIBRARY; T=0.K
protons from (n,3np)

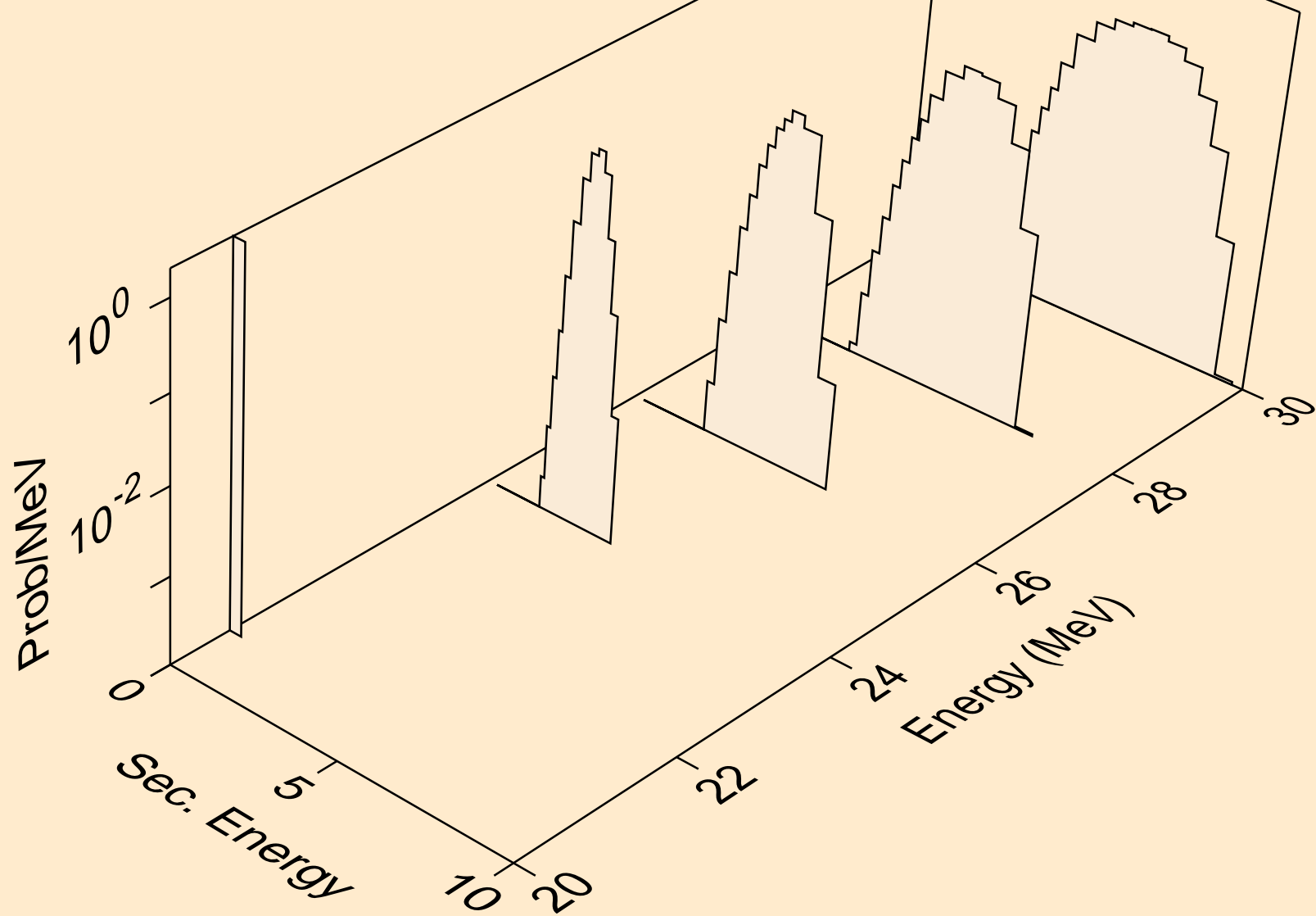

RN204 NEUTRON ACER TENDL-2024 LIBRARY; T=0.K
protons from (n,n2p)

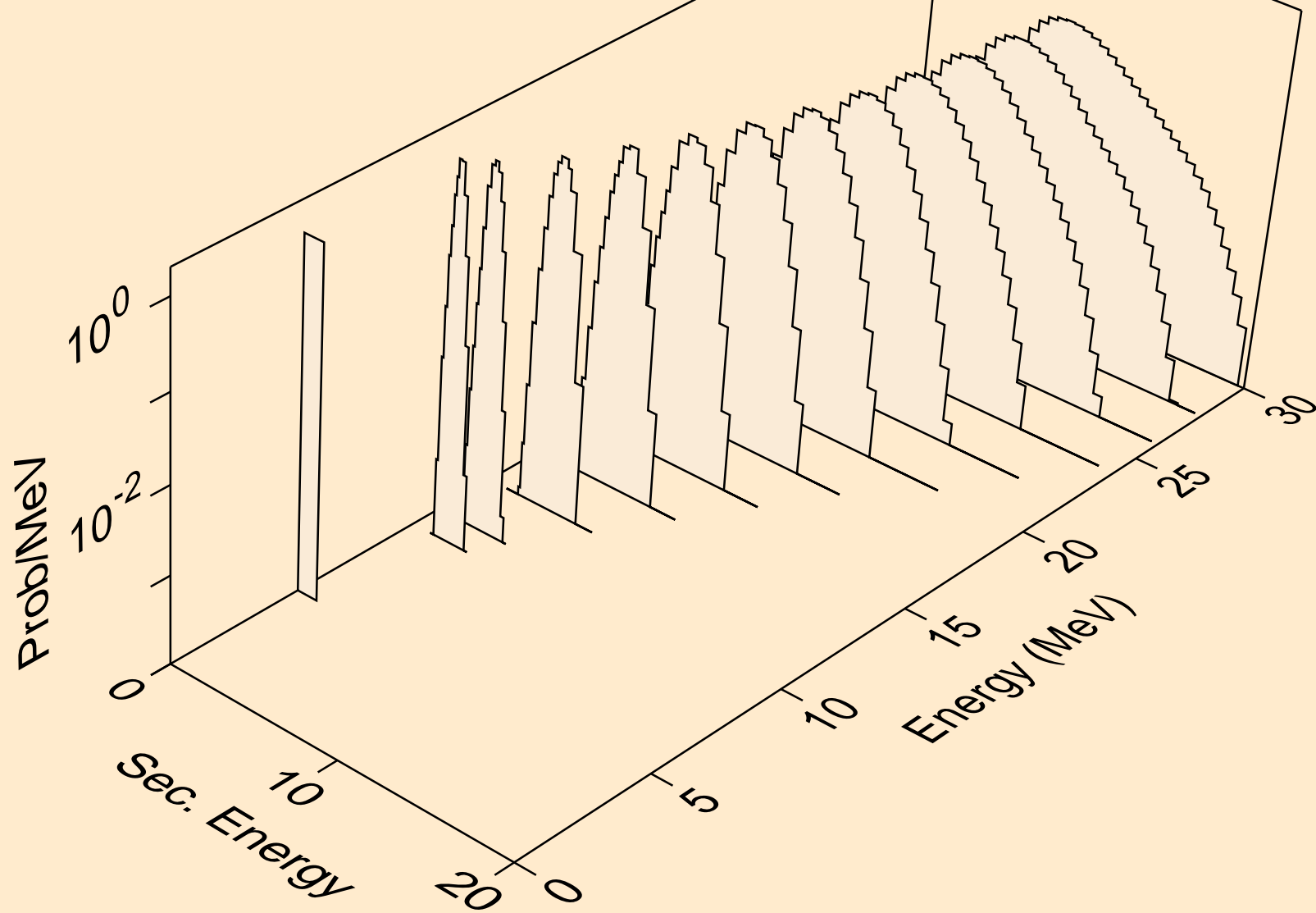

RN204 NEUTRON ACER TENDL-2024 LIBRARY; T=0.K
protons from (n,npa)

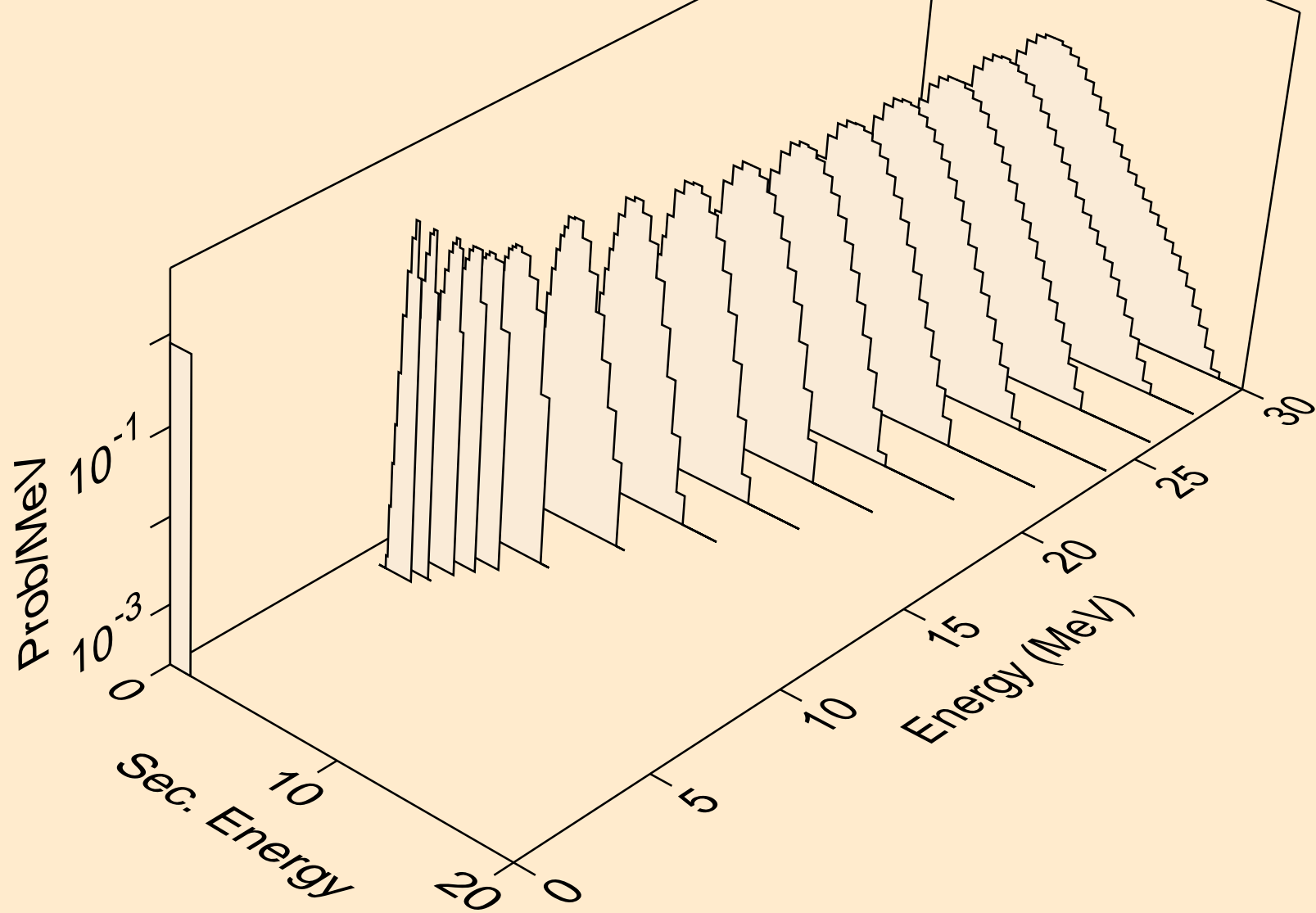

RN204 NEUTRON ACER TENDL-2024 LIBRARY; T=0.K
protons from (n,p)

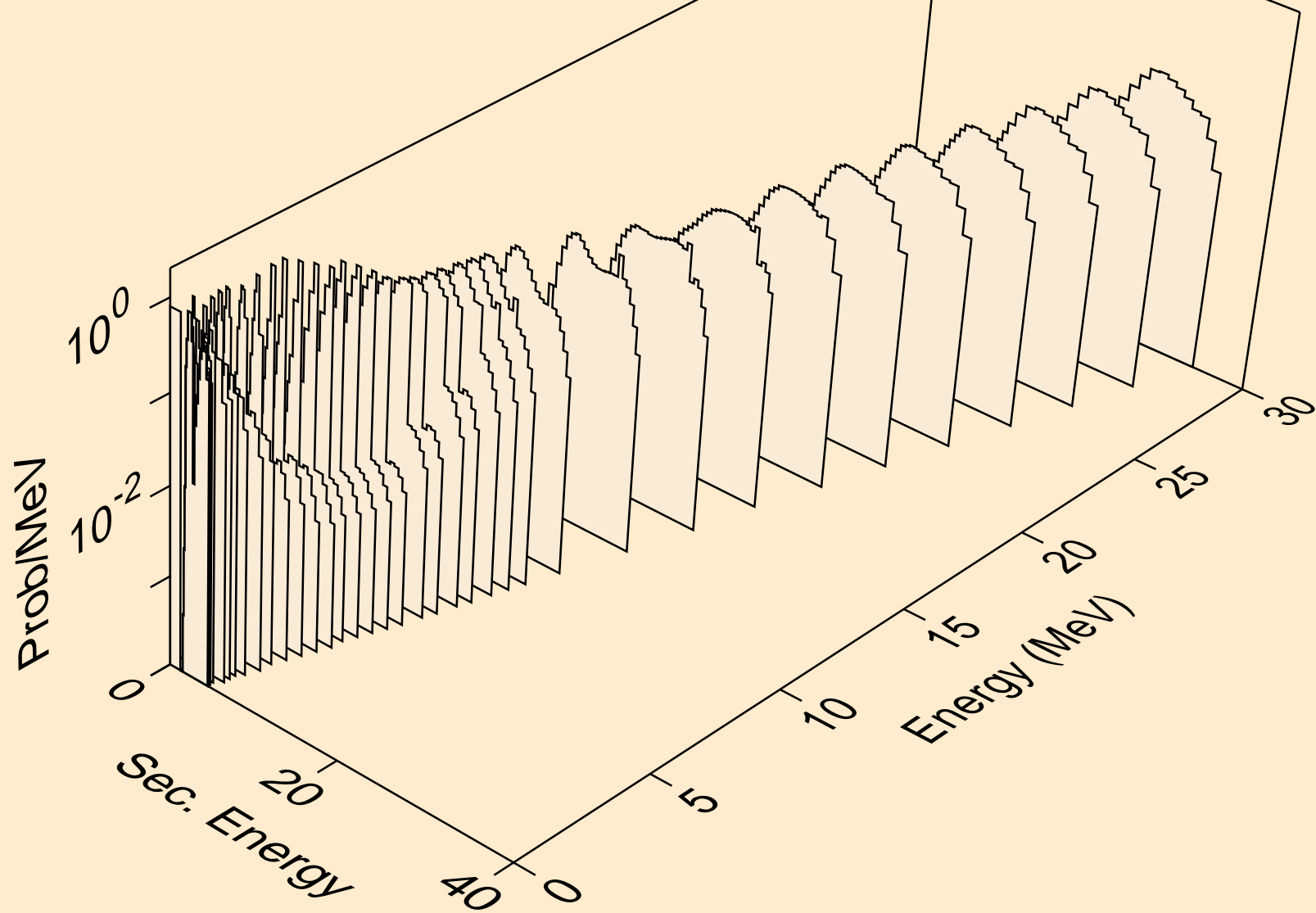

RN204 NEUTRON ACER TENDL-2024 LIBRARY; T=0.K
protons from (n,2p)

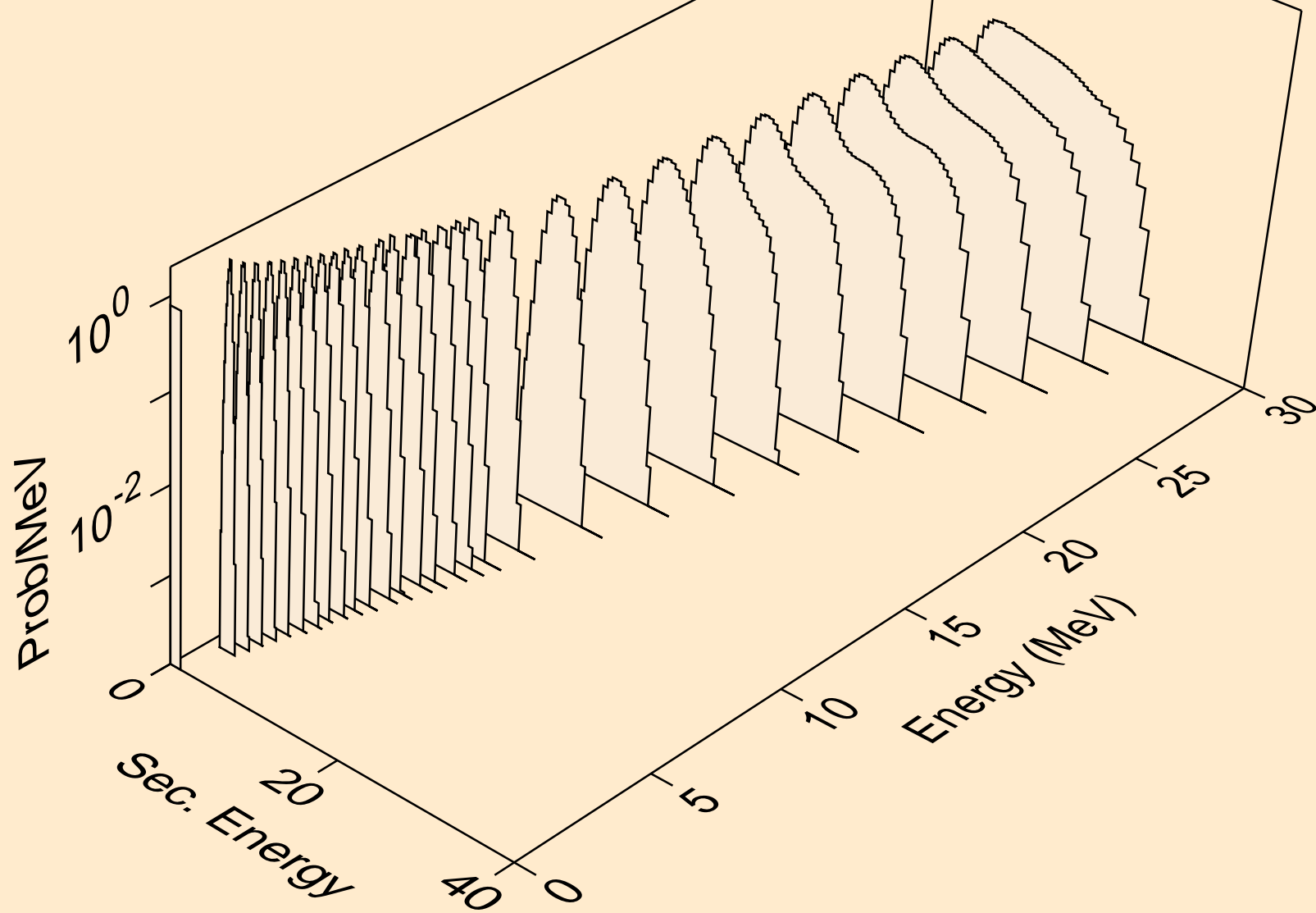

RN204 NEUTRON ACER TENDL-2024 LIBRARY; T=0.K
protons from (n,p)

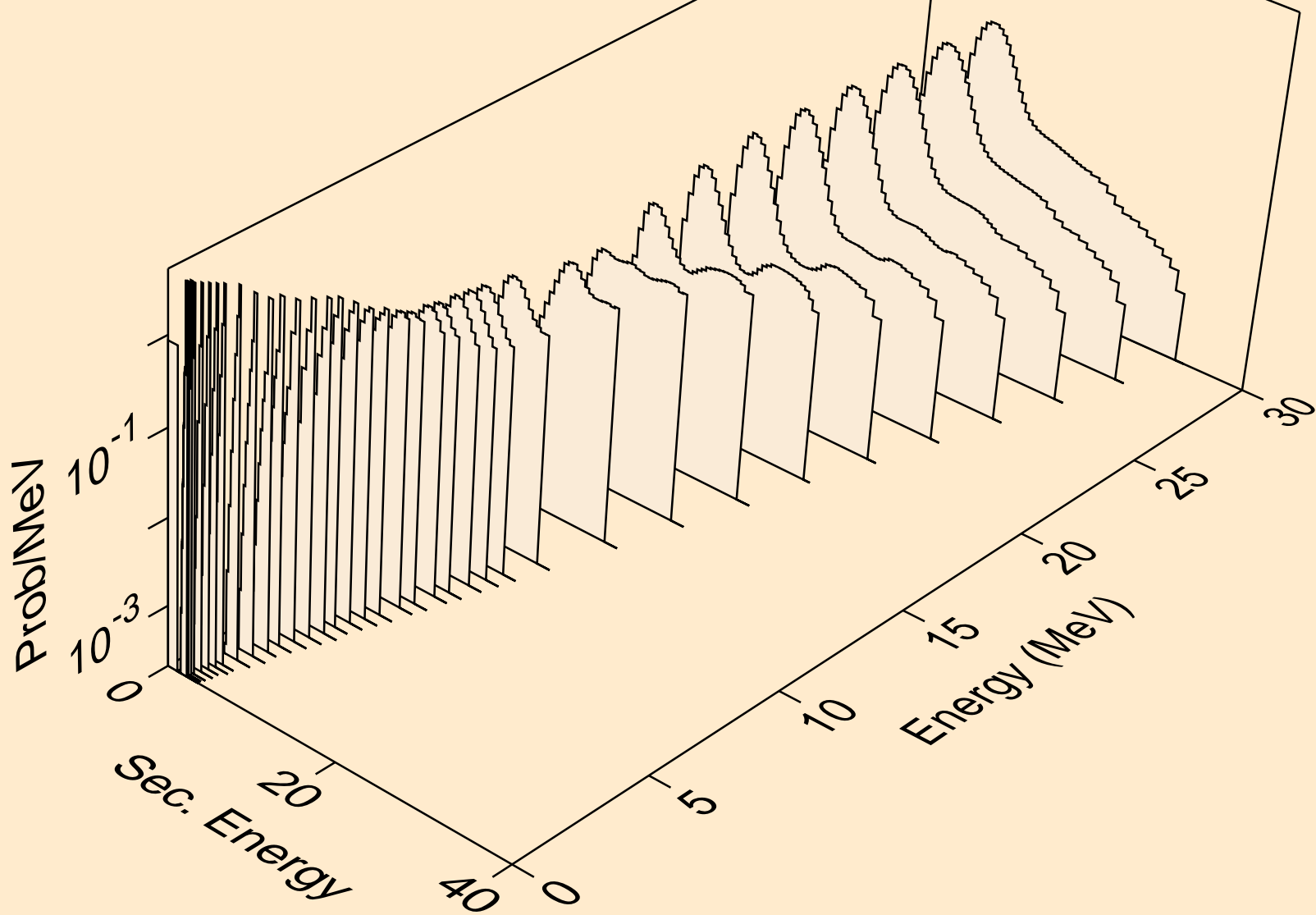

RN204 NEUTRON ACER TENDL-2024 LIBRARY; T=0.K
protons from (n,pd)

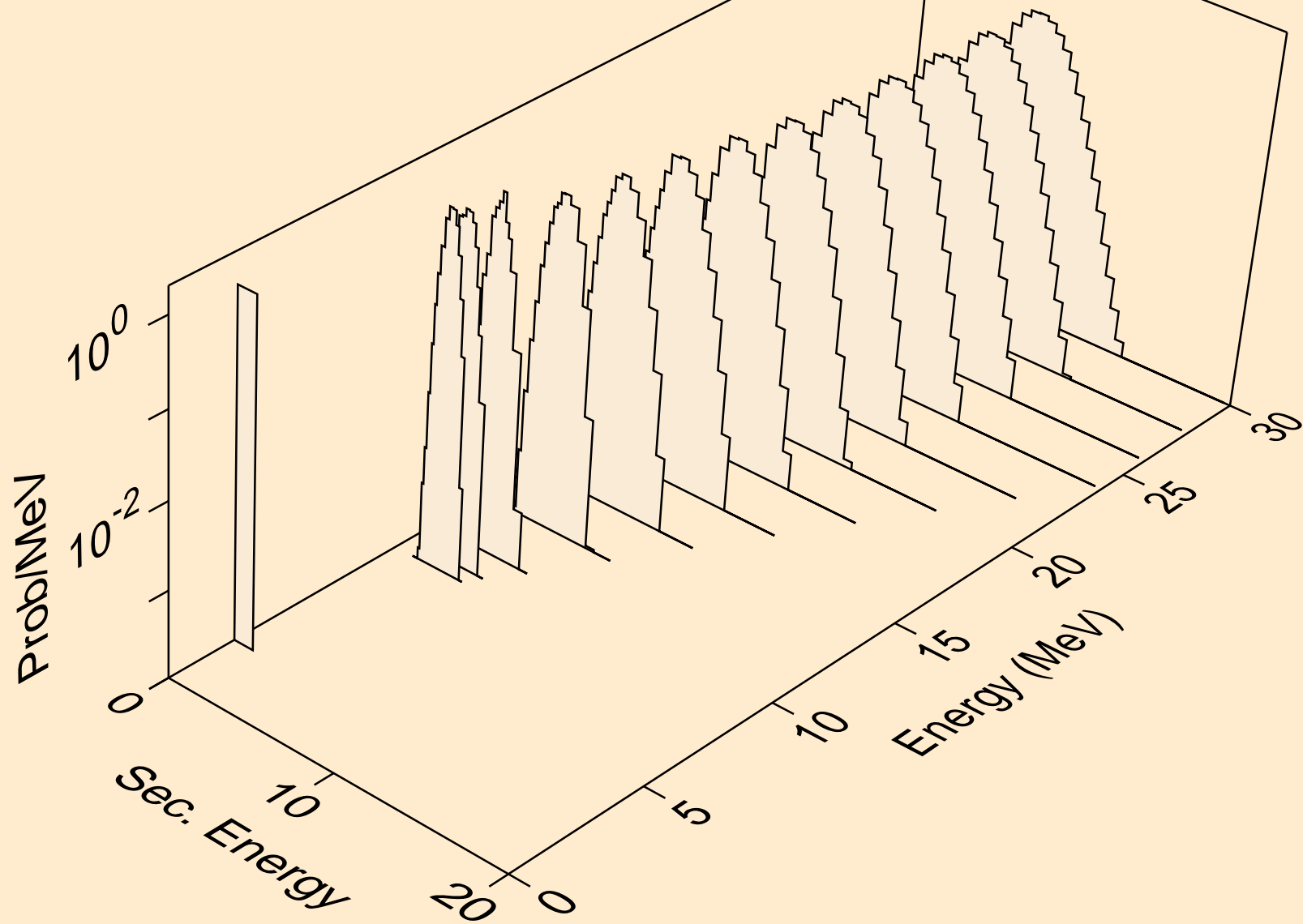

RN204 NEUTRON ACER TENDL-2024 LIBRARY; T=0.K
protons from (n,pt)

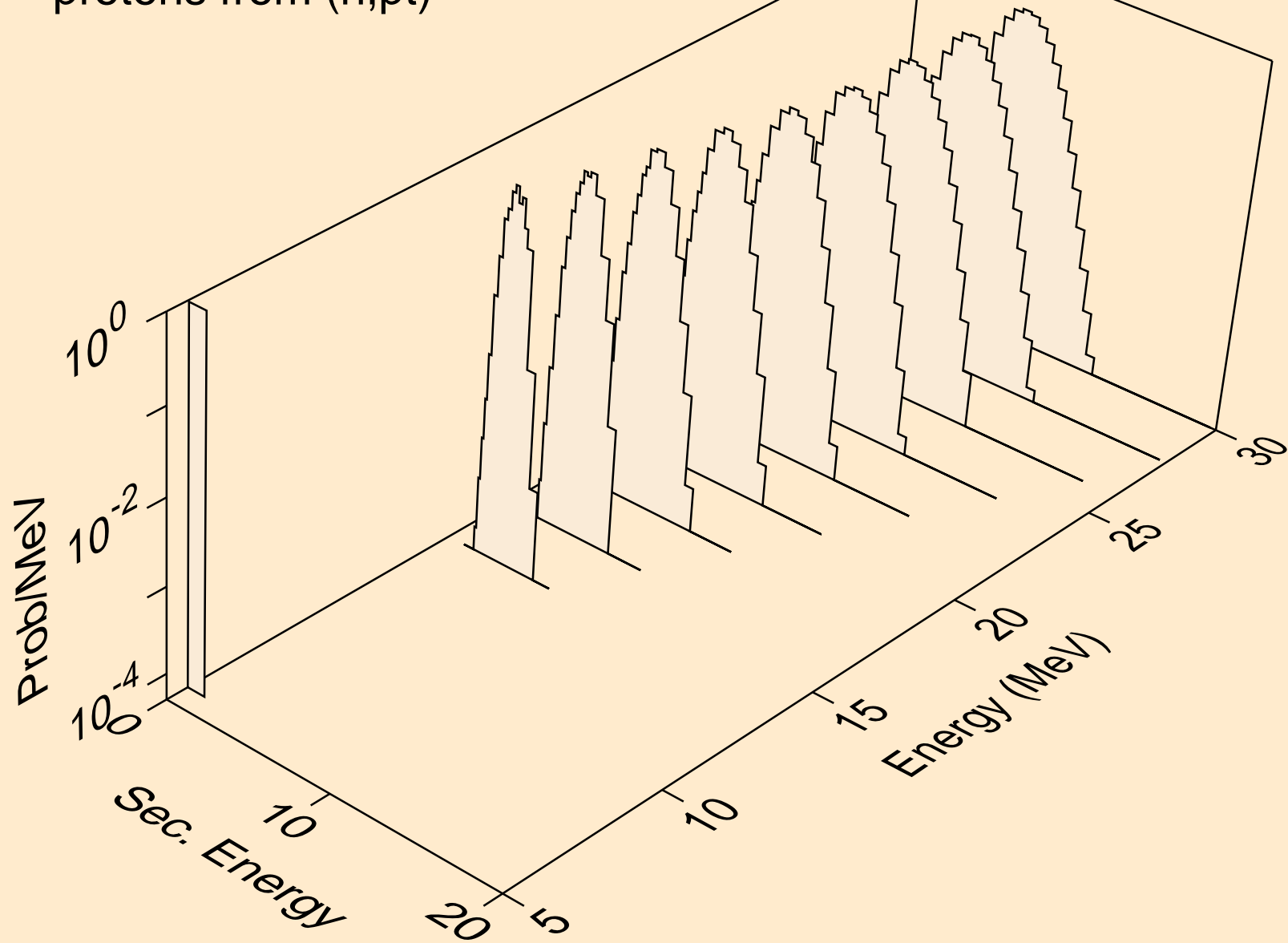

RN204 NEUTRON ACER TENDL-2024 LIBRARY; T=0.K
deuterons from (n,x)

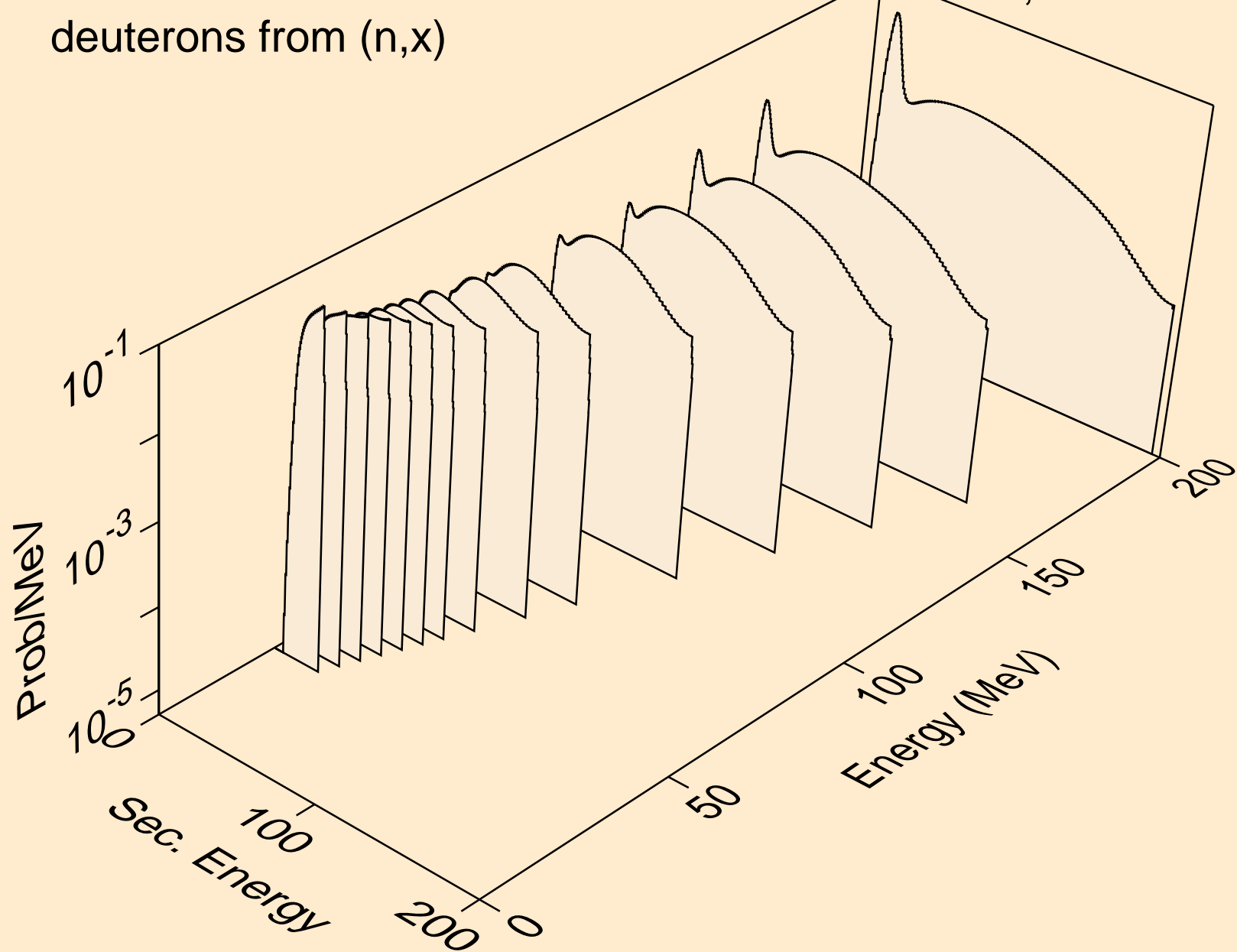

RN204 NEUTRON ACER TENDL-2024 LIBRARY; T=0.K
deuterons from (n,2nd)

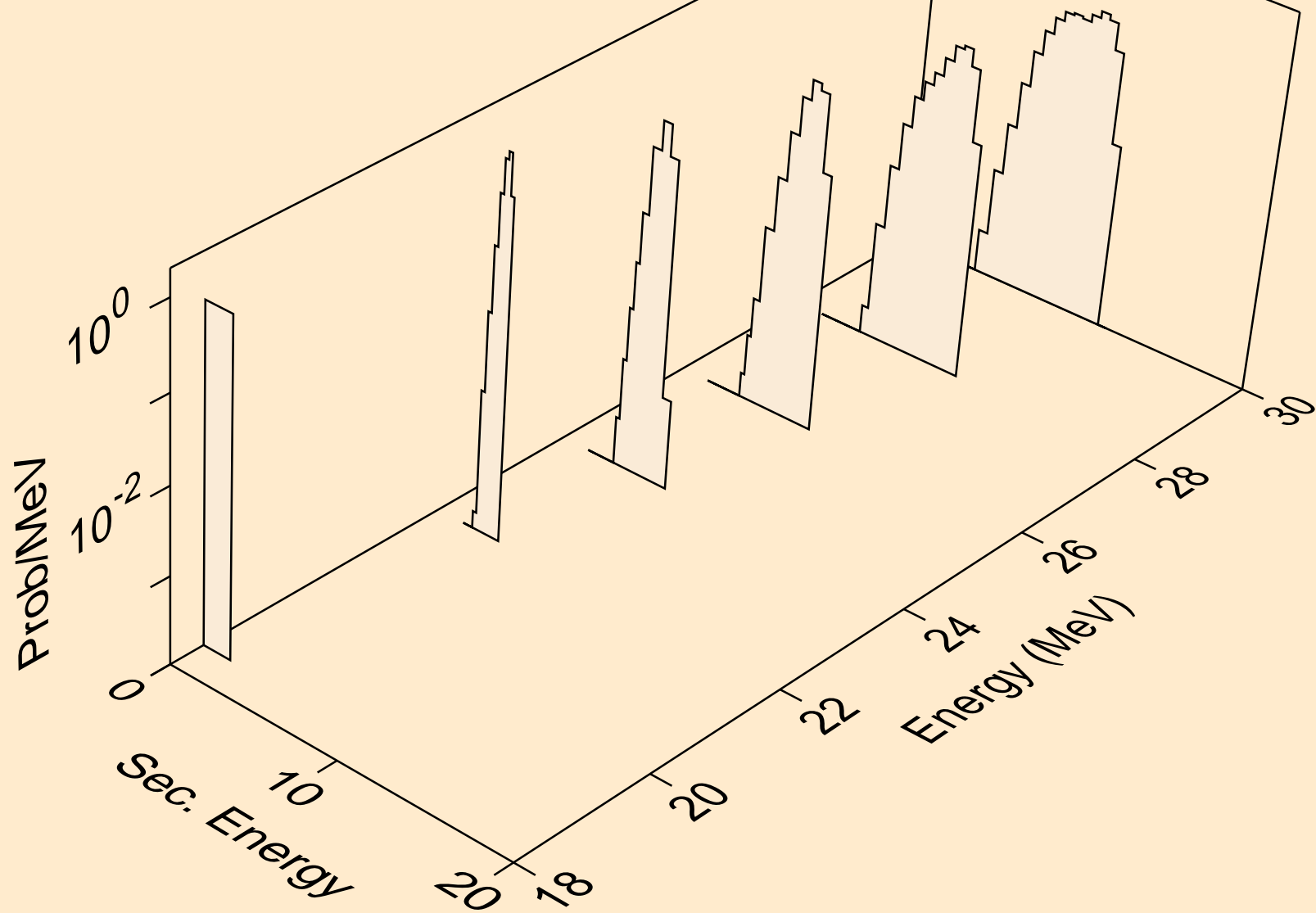

RN204 NEUTRON ACER TENDL-2024 LIBRARY; T=0.K
deuterons from (n,n*)d

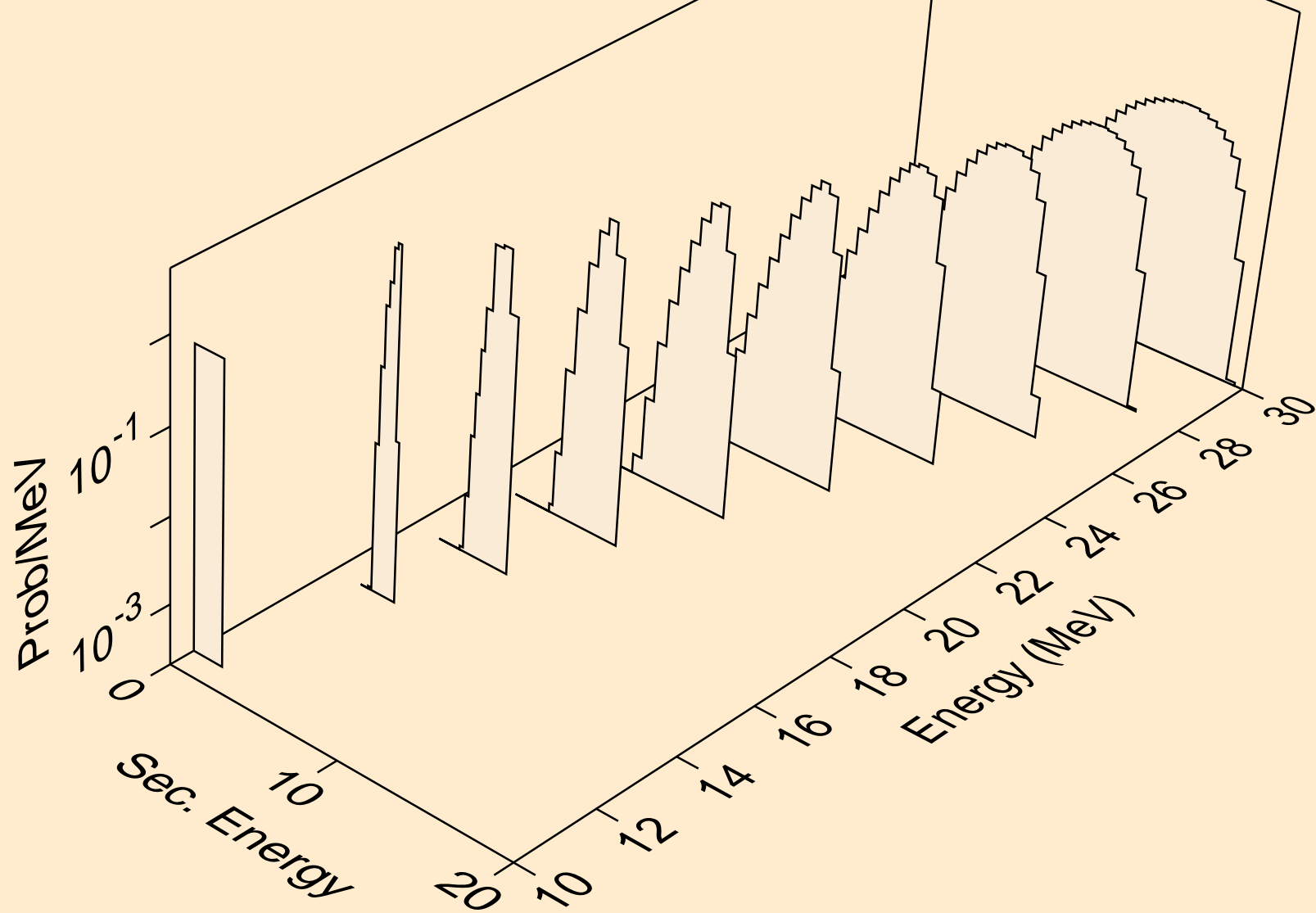

RN204 NEUTRON ACER TENDL-2024 LIBRARY; T=0.K
deuterons from (n,d)

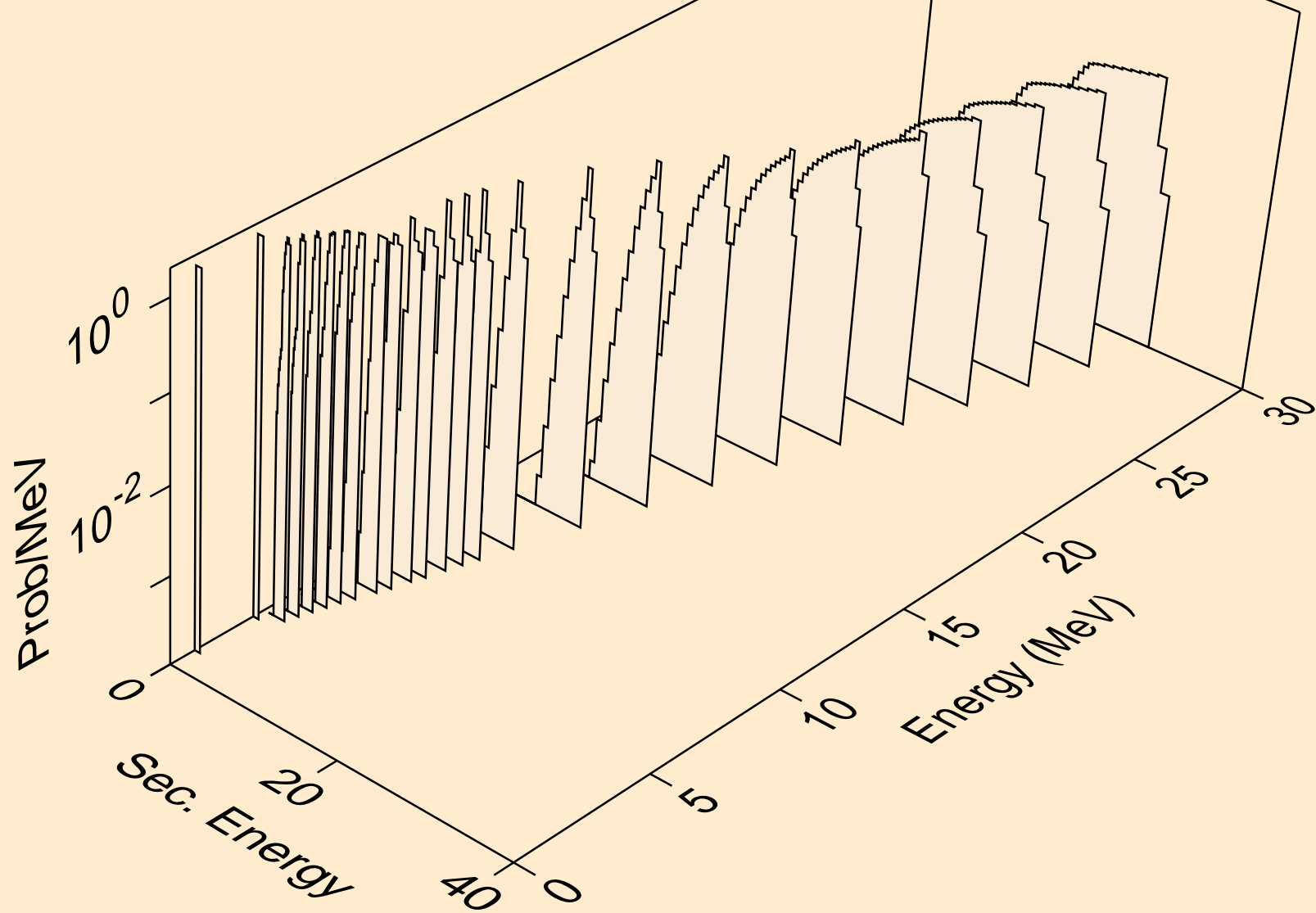

RN204 NEUTRON ACER TENDL-2024 LIBRARY; T=0.K
deuterons from (n,pd)

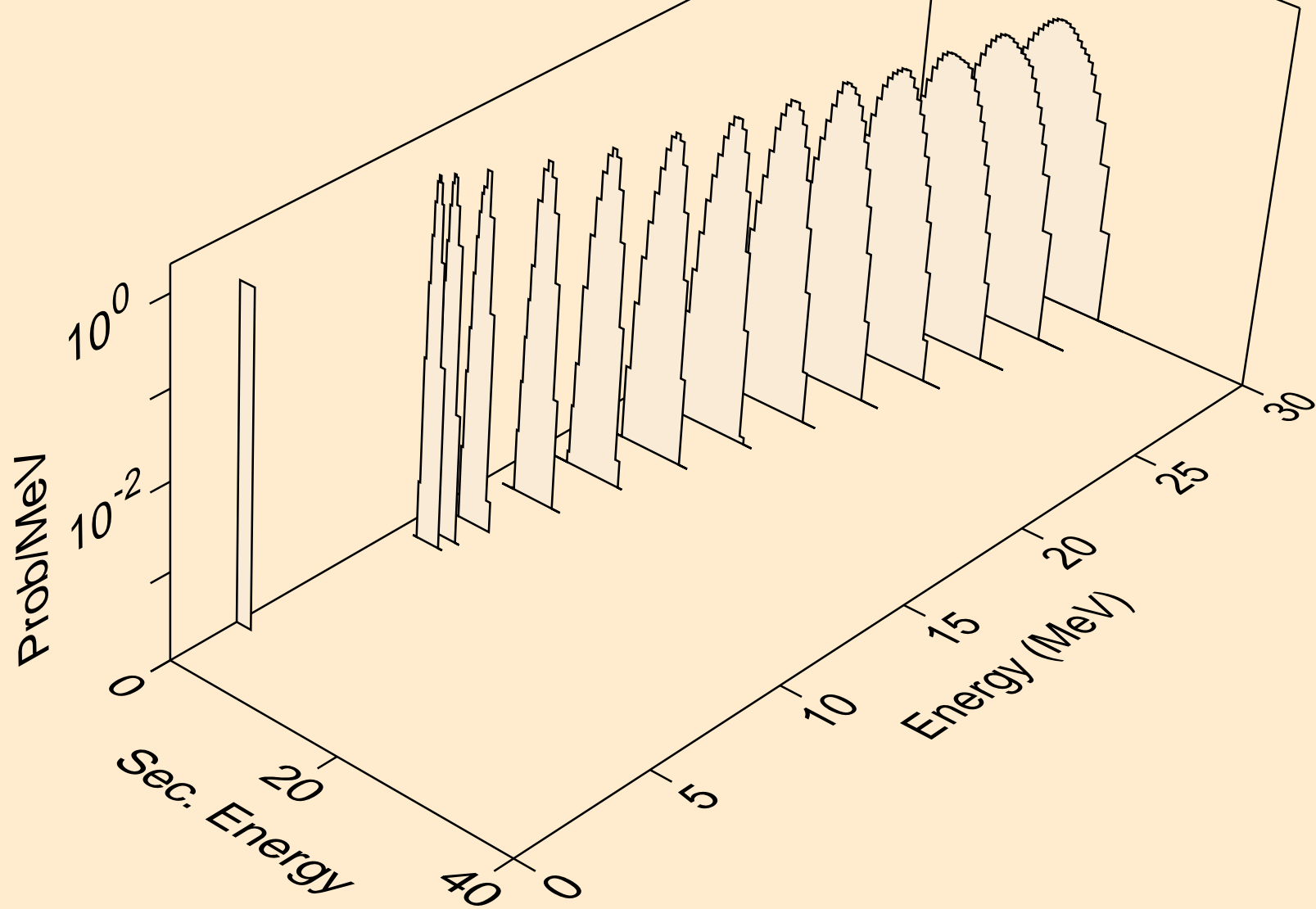

RN204 NEUTRON ACER TENDL-2024 LIBRARY; T=0.K
deuterons from (n,da)

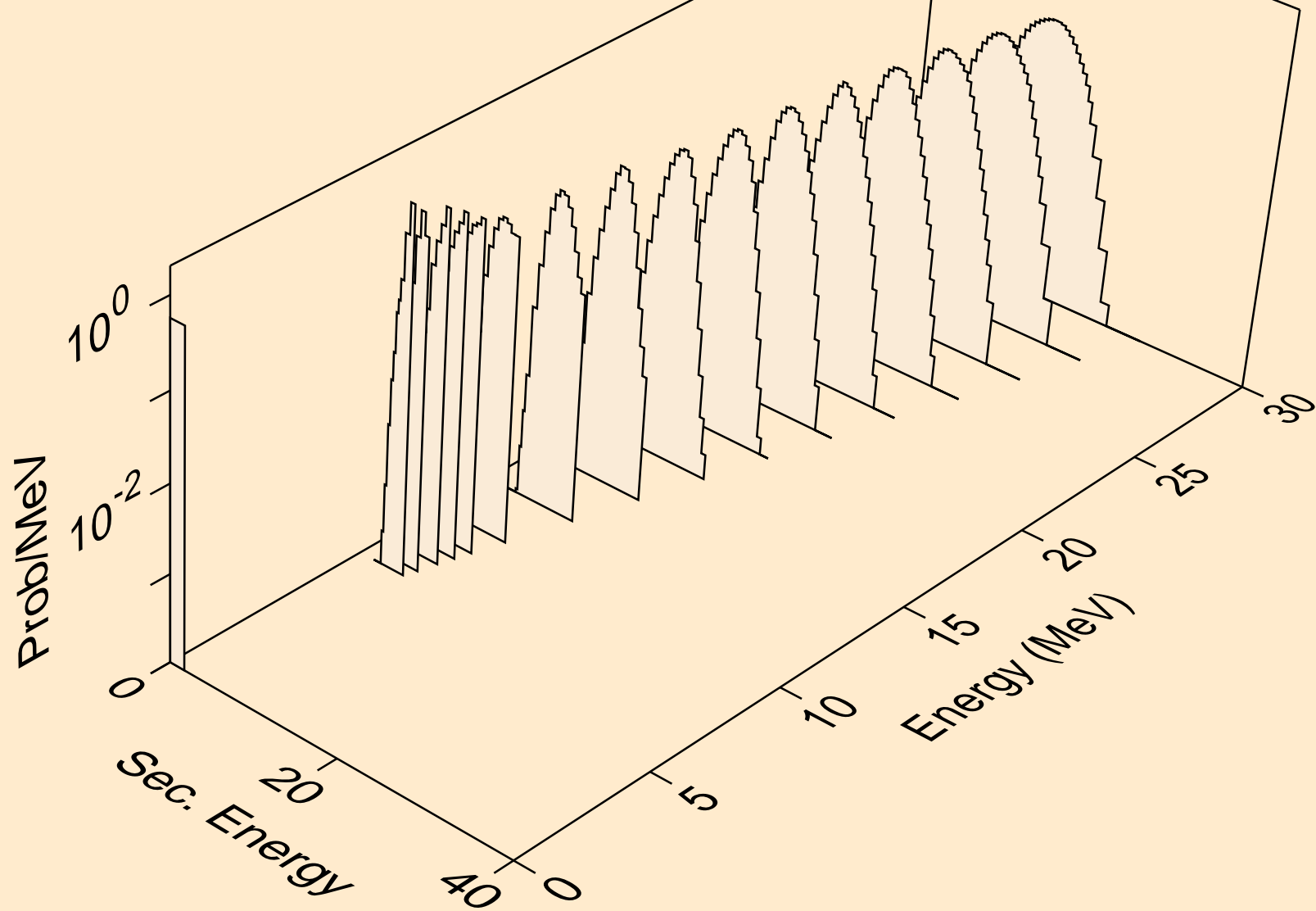

RN204 NEUTRON ACER TENDL-2024 LIBRARY; T=0.K
tritons from (n,x)

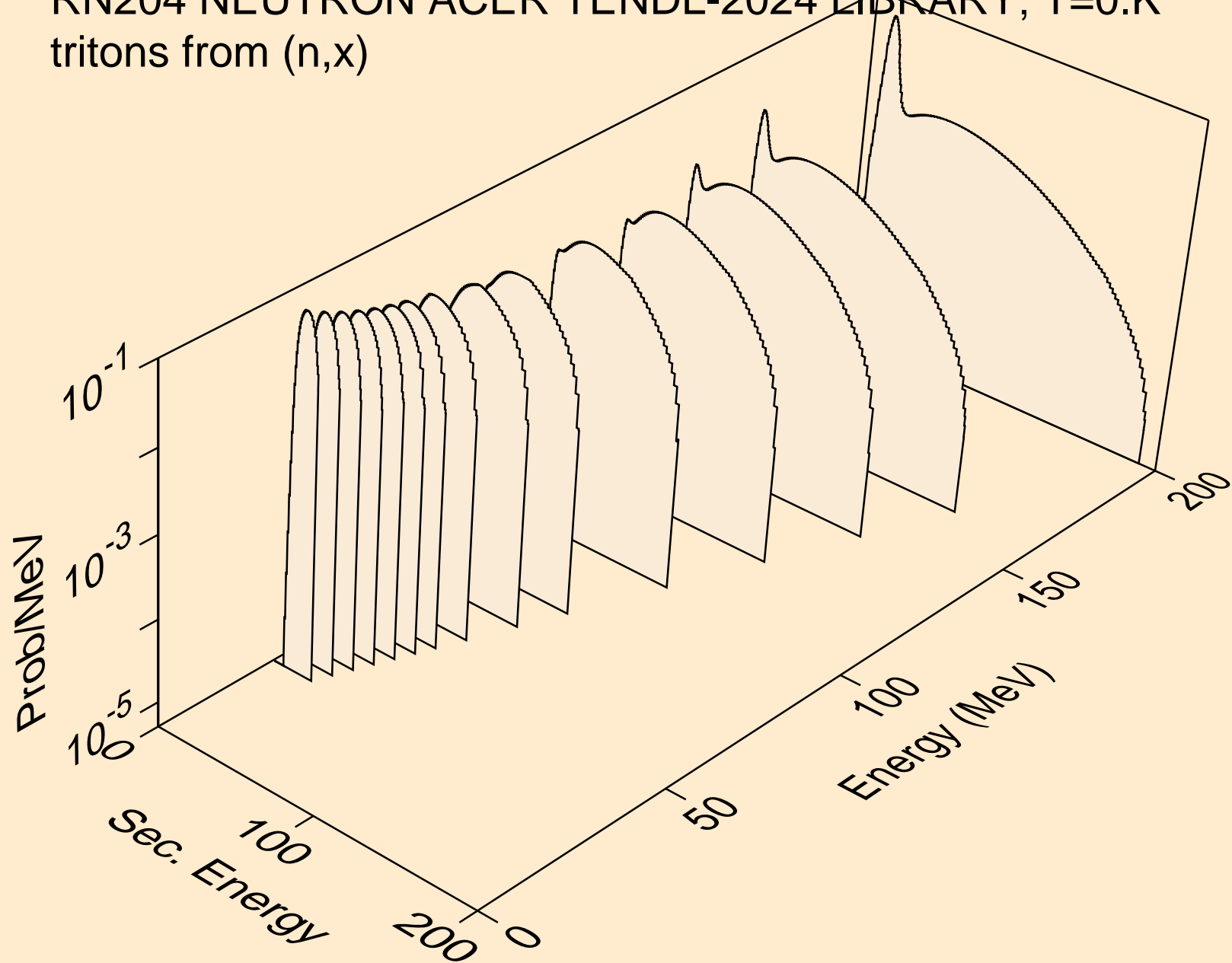

RN204 NEUTRON ACER TENDL-2024 LIBRARY; T=0.K
tritons from (n,n*)t

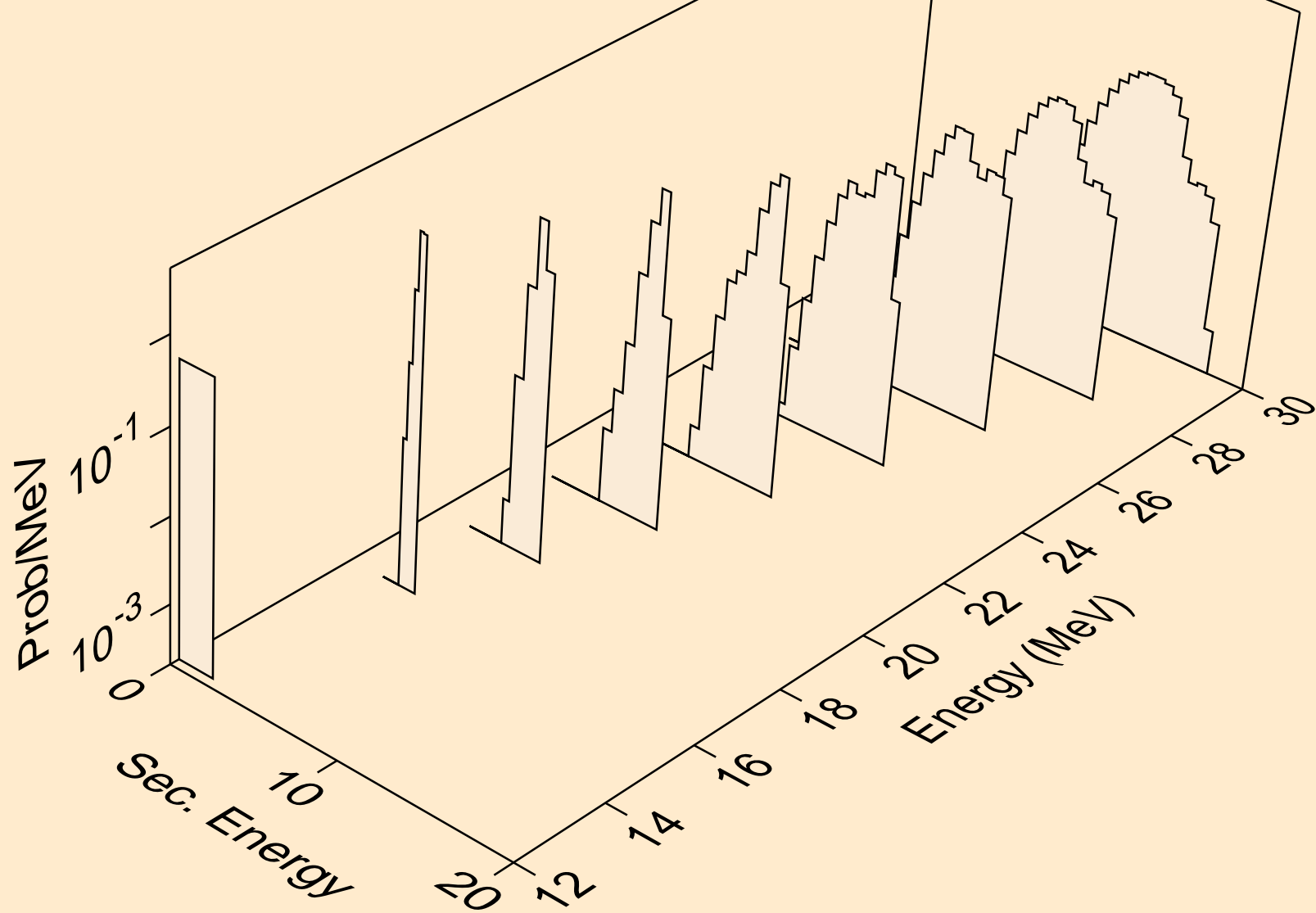

RN204 NEUTRON ACER TENDL-2024 LIBRARY; T=0.K
tritons from (n,t)

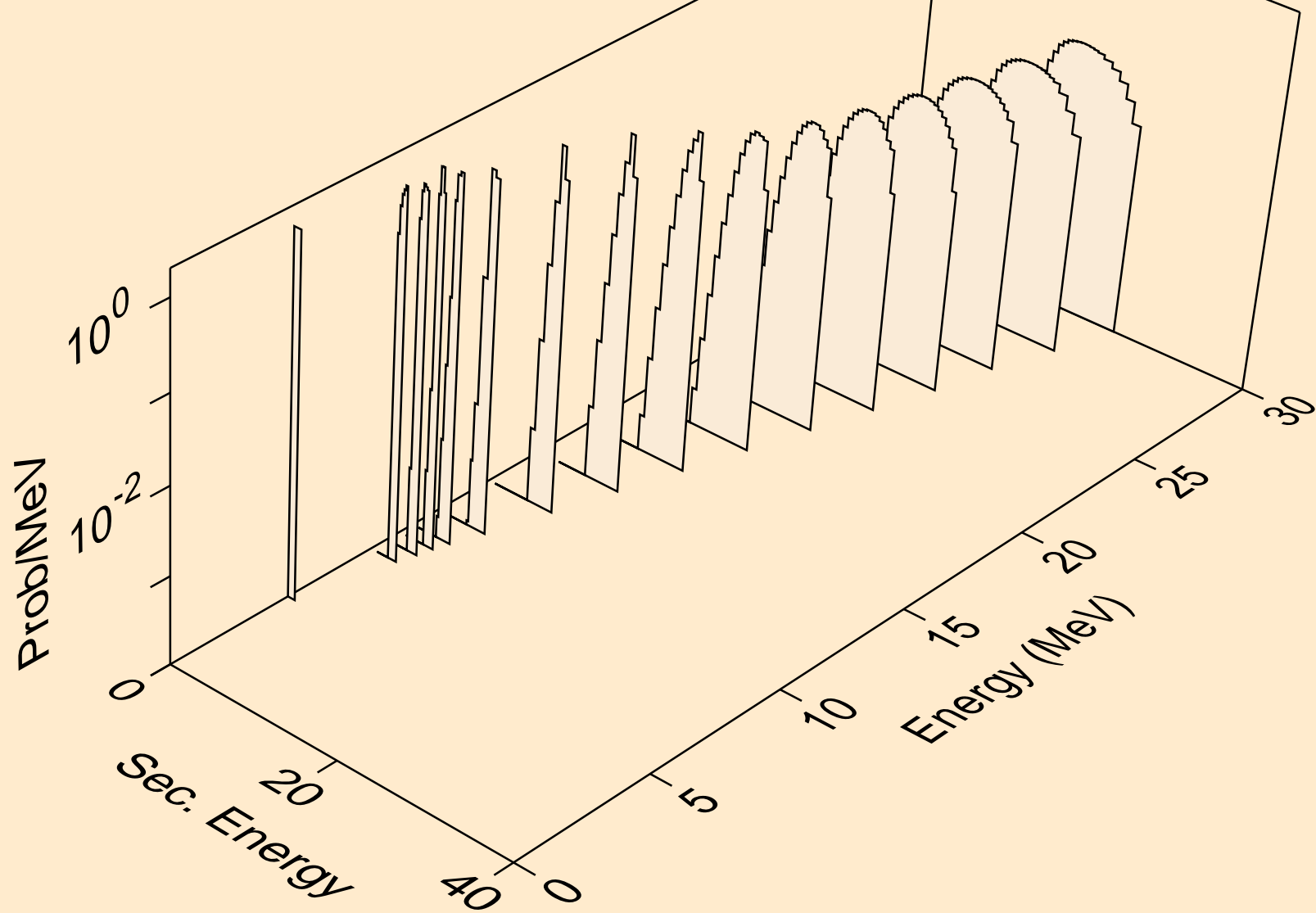

RN204 NEUTRON ACER TENDL-2024 LIBRARY; T=0.K
tritons from (n,pt)

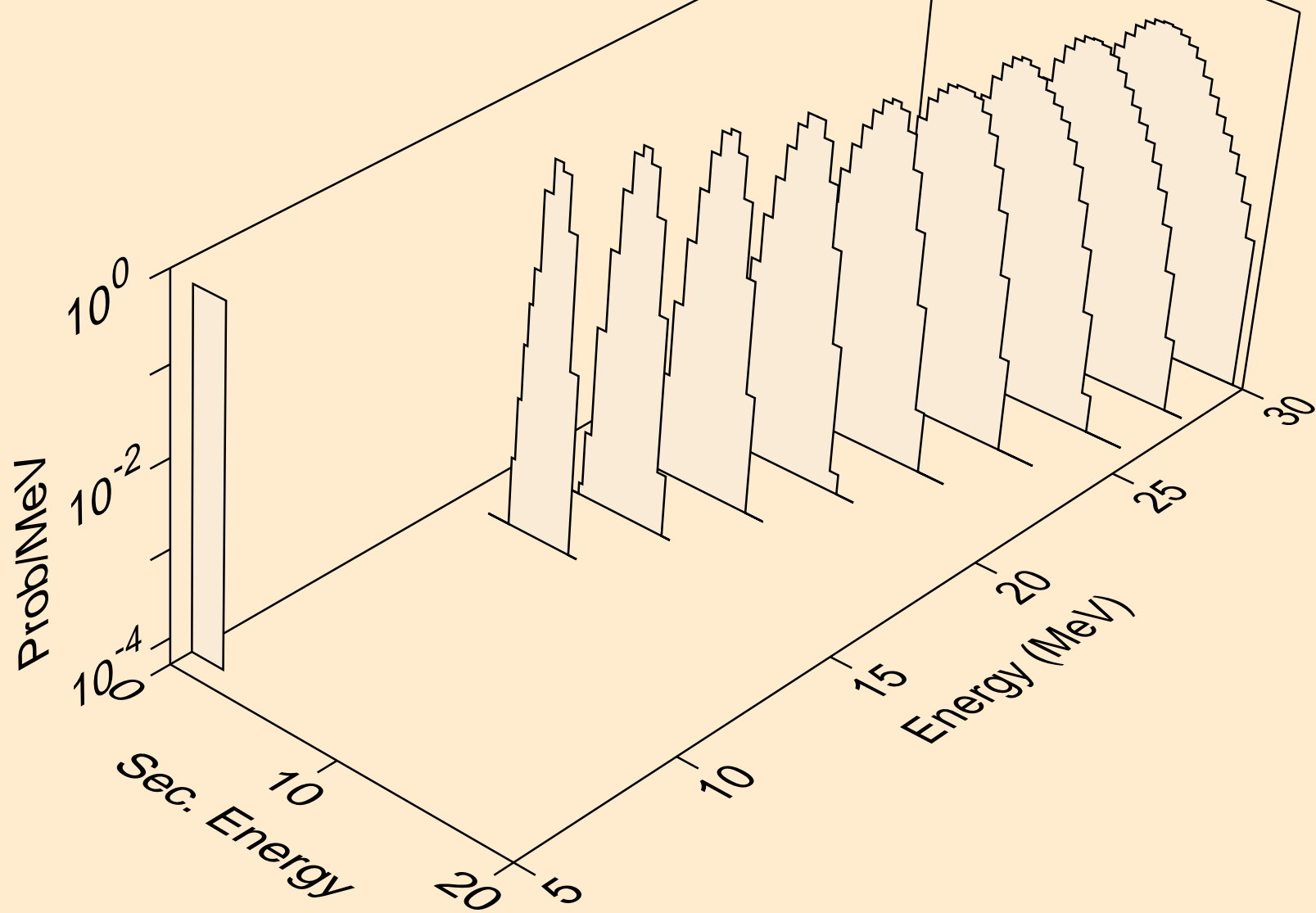

RN204 NEUTRON ACER TENDL-2024 LIBRARY; T=0.K
he3s from (n,x)

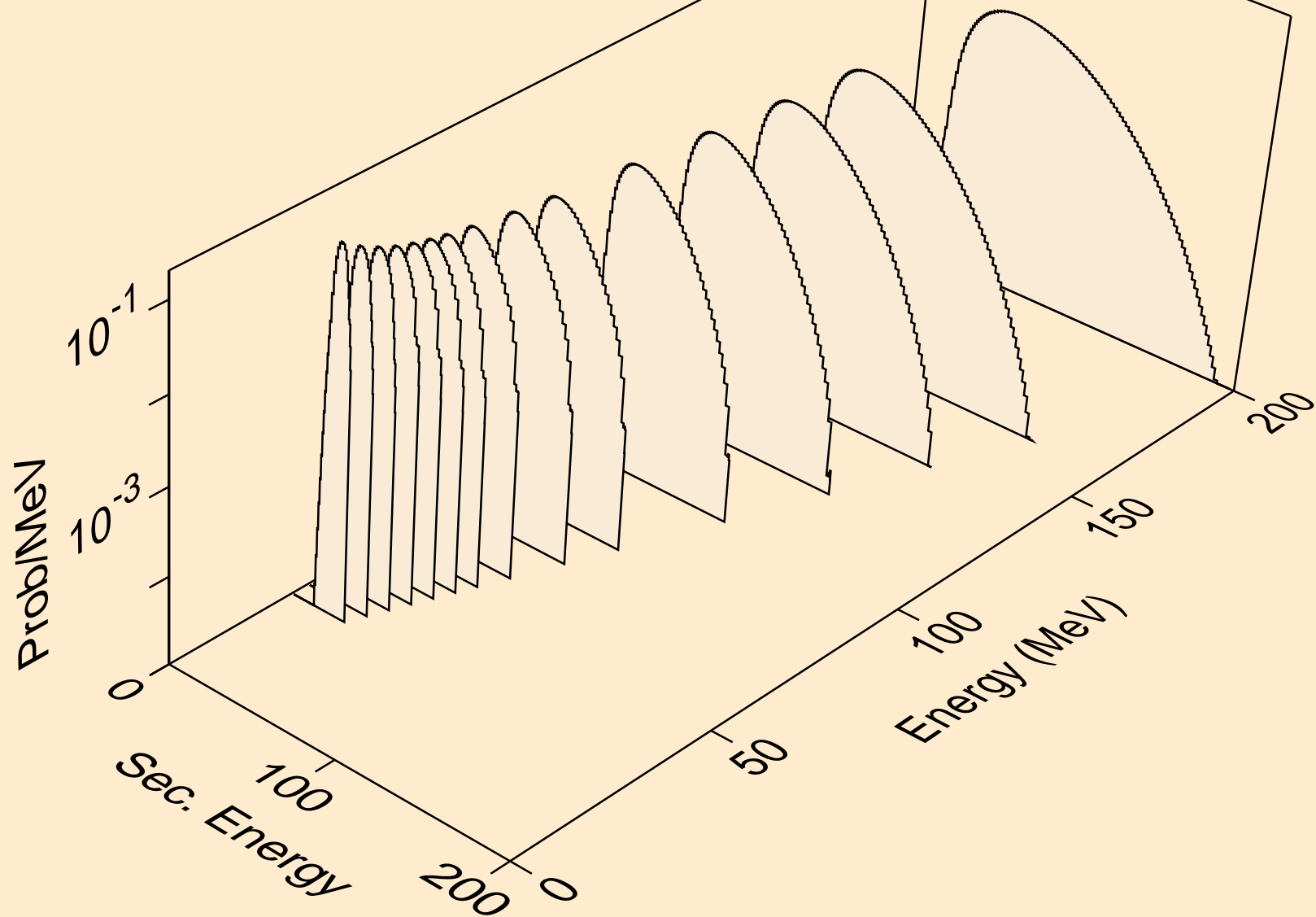

RN204 NEUTRON ACER TENDL-2024 LIBRARY; T=0.K
he3s from (n,n*)he3

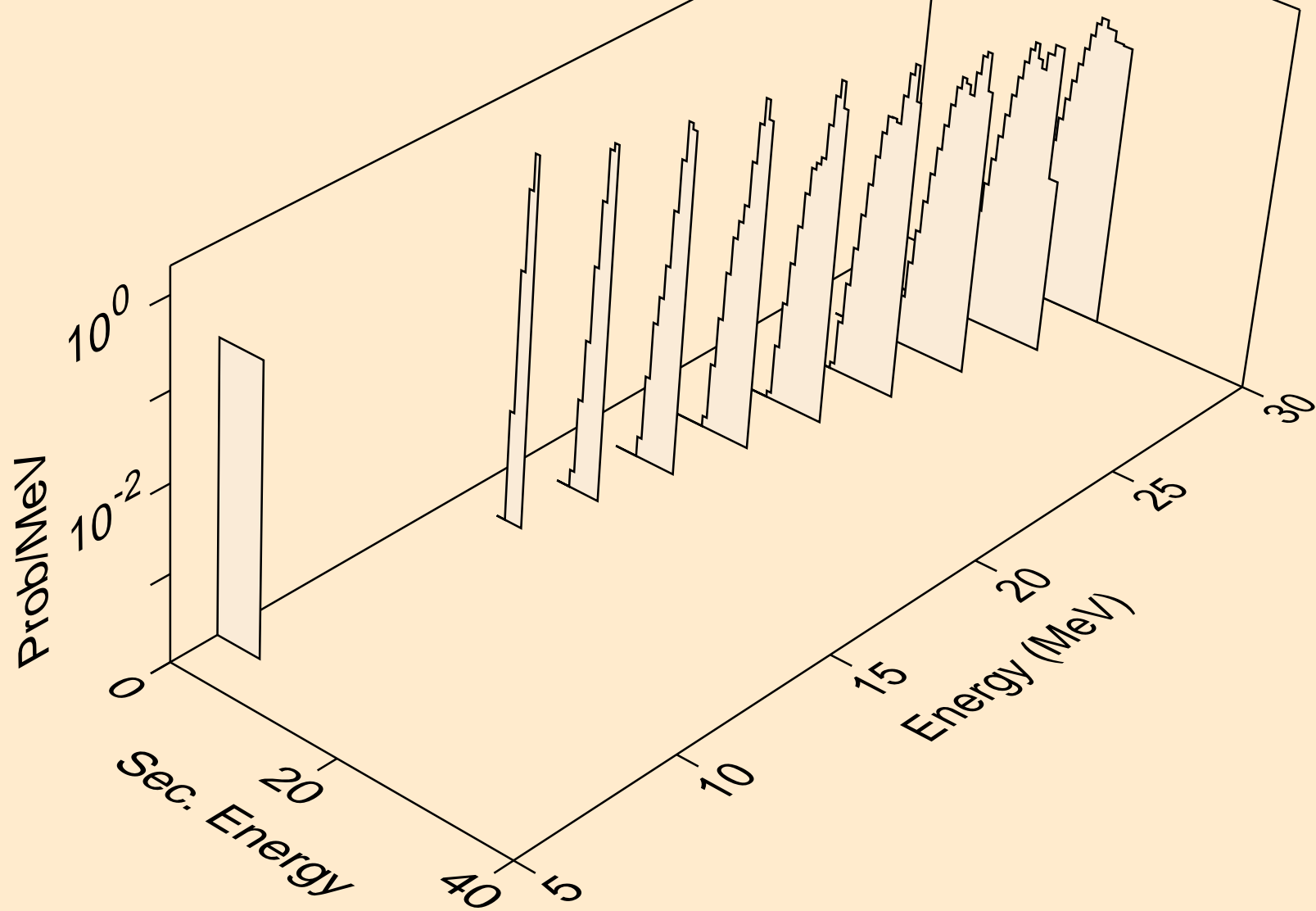

RN204 NEUTRON ACER TENDL-2024 LIBRARY; T=0.K
he3s from (n,he3)

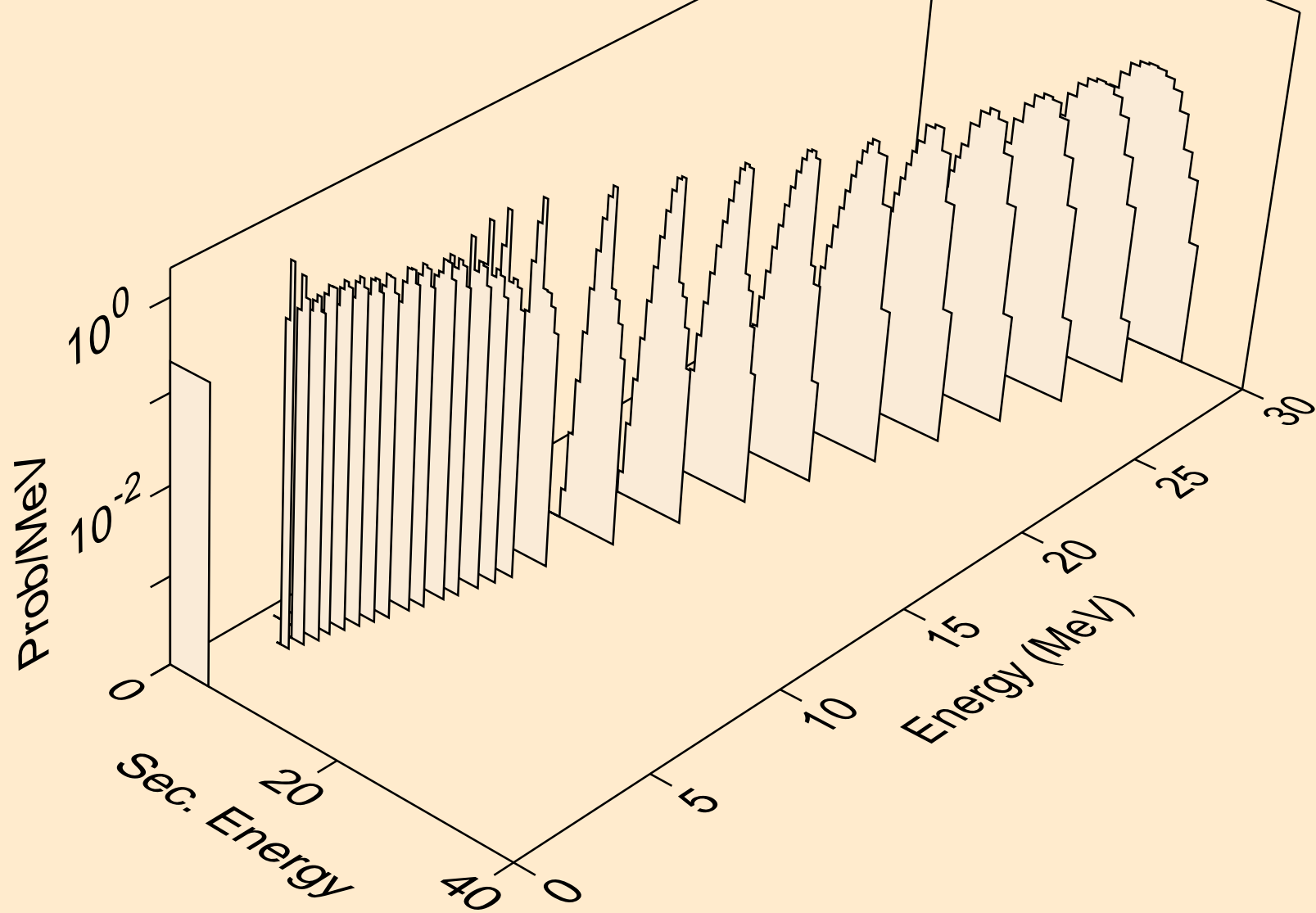

RN204 NEUTRON ACER TENDL-2024 LIBRARY; T=0.K
alphas from (n,x)

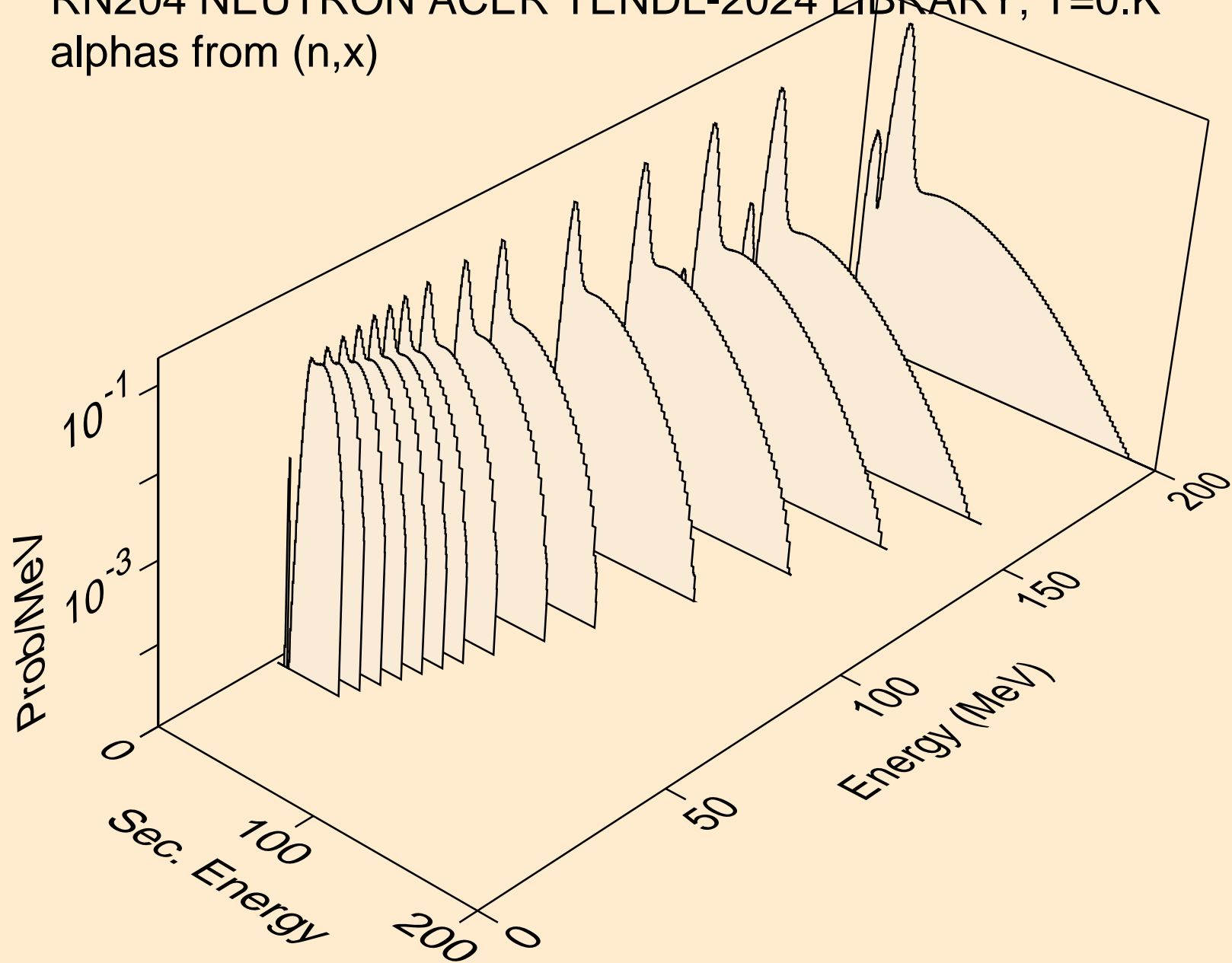

RN204 NEUTRON ACER TENDL-2024 LIBRARY; T=0.K
alphas from (n,n*)a

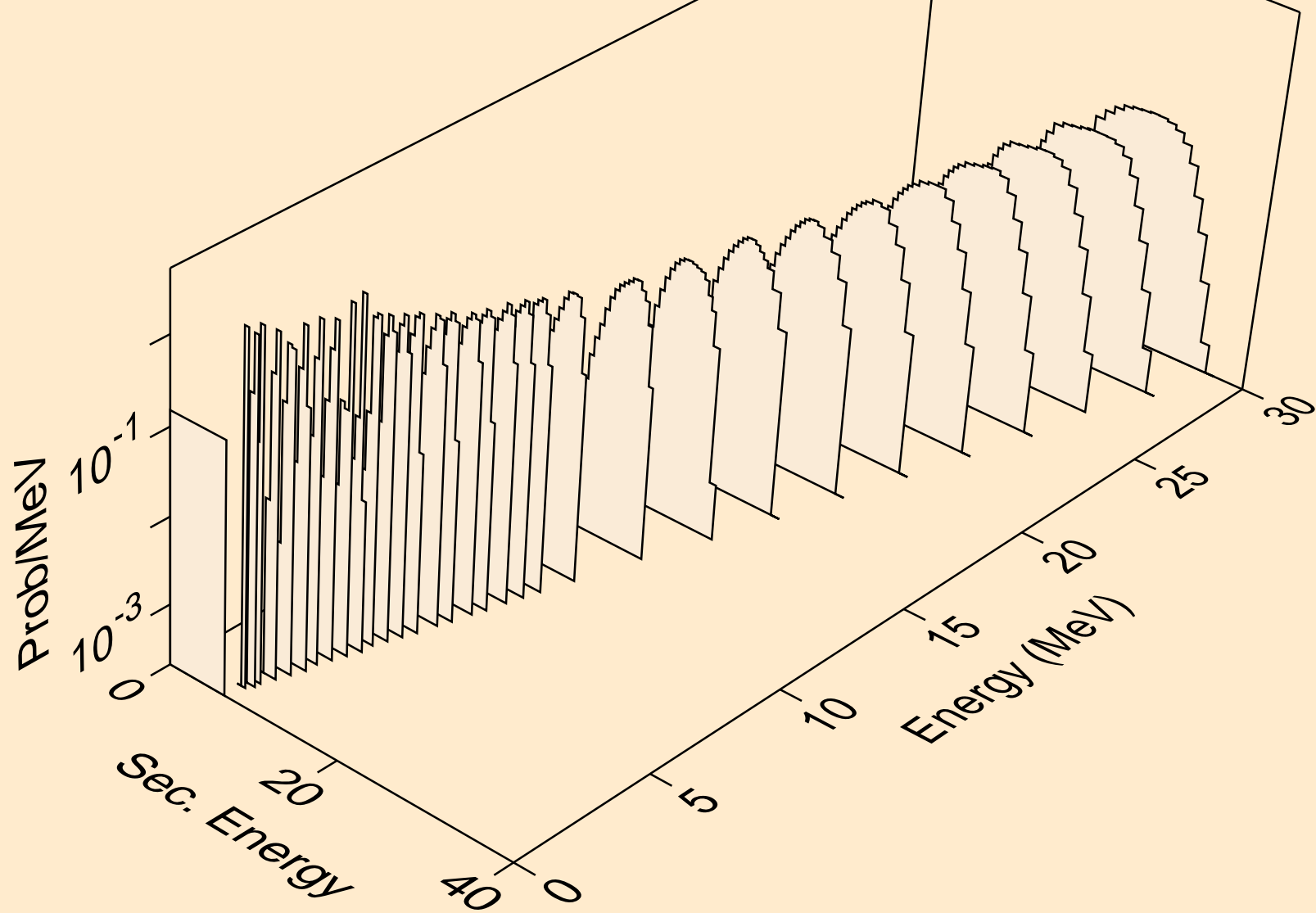

RN204 NEUTRON ACER TENDL-2024 LIBRARY; T=0.K
alphas from (n,2n)a

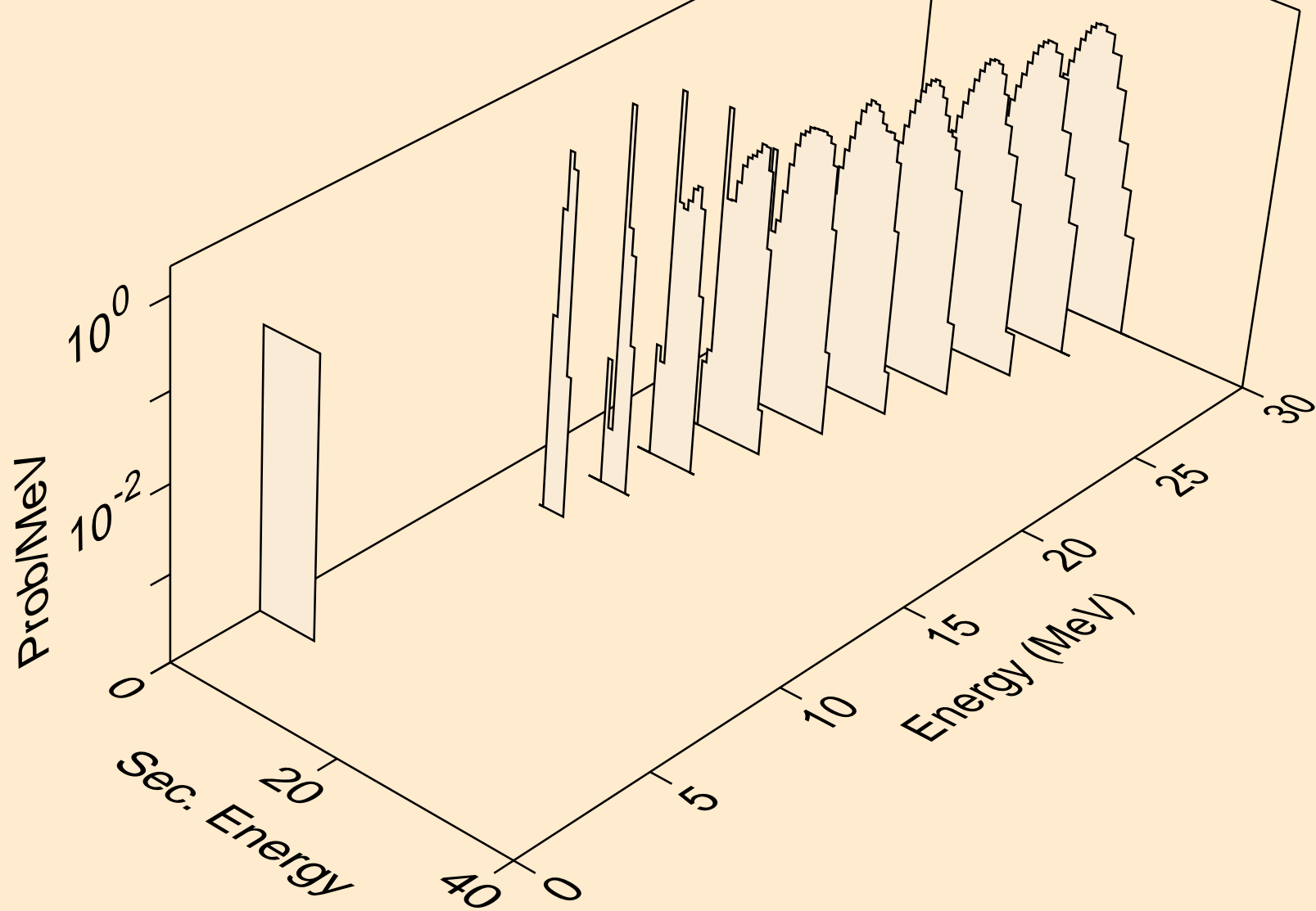

RN204 NEUTRON ACER TENDL-2024 LIBRARY; T=0.K
alphas from (n,3n)a

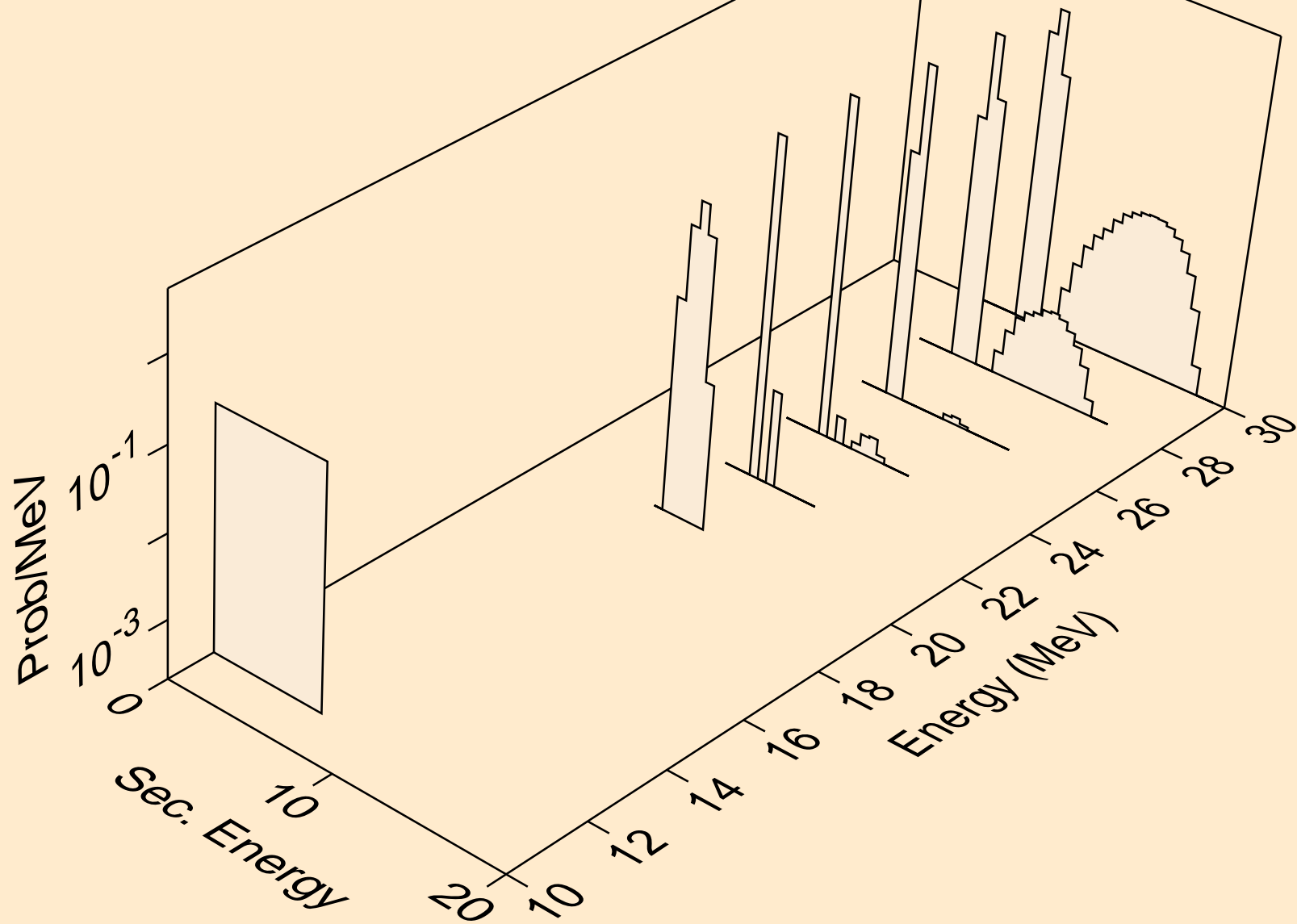

RN204 NEUTRON ACER TENDL-2024 LIBRARY; T=0.K
alphas from (n,n*)2a

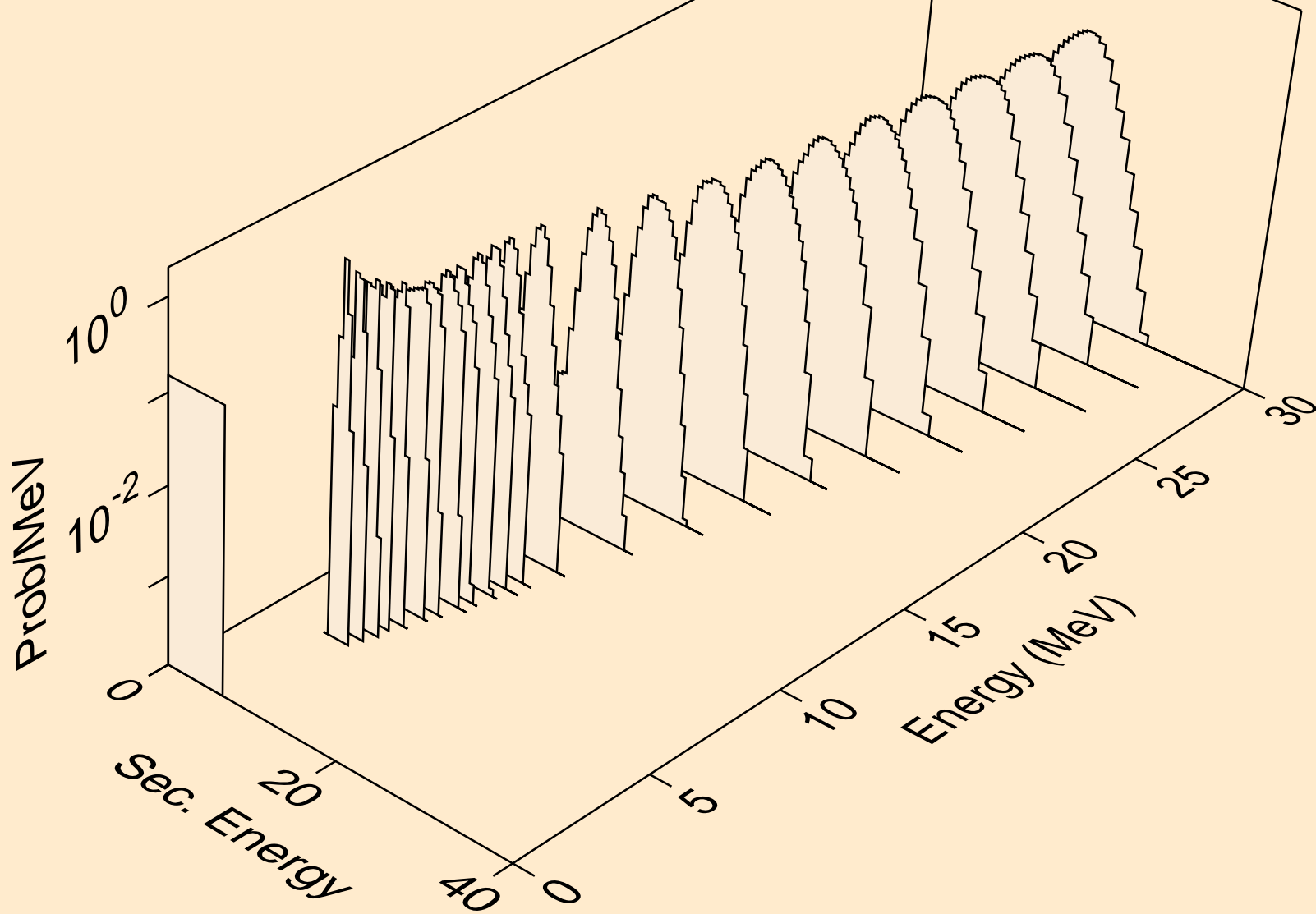

RN204 NEUTRON ACER TENDL-2024 LIBRARY; T=0.K
alphas from (n,2n)2a

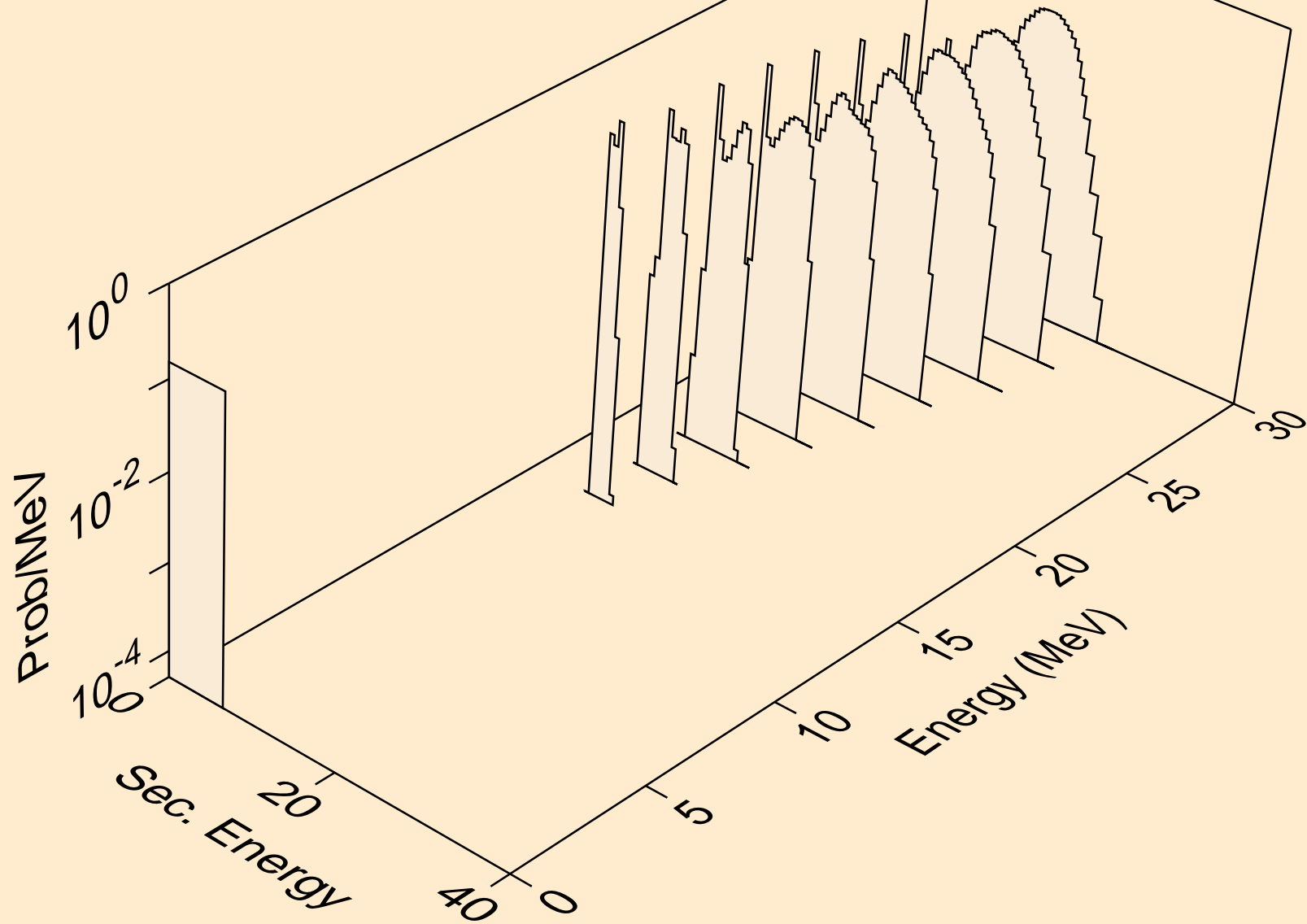

RN204 NEUTRON ACER TENDL-2024 LIBRARY; T=0.K
alphas from (n,npa)

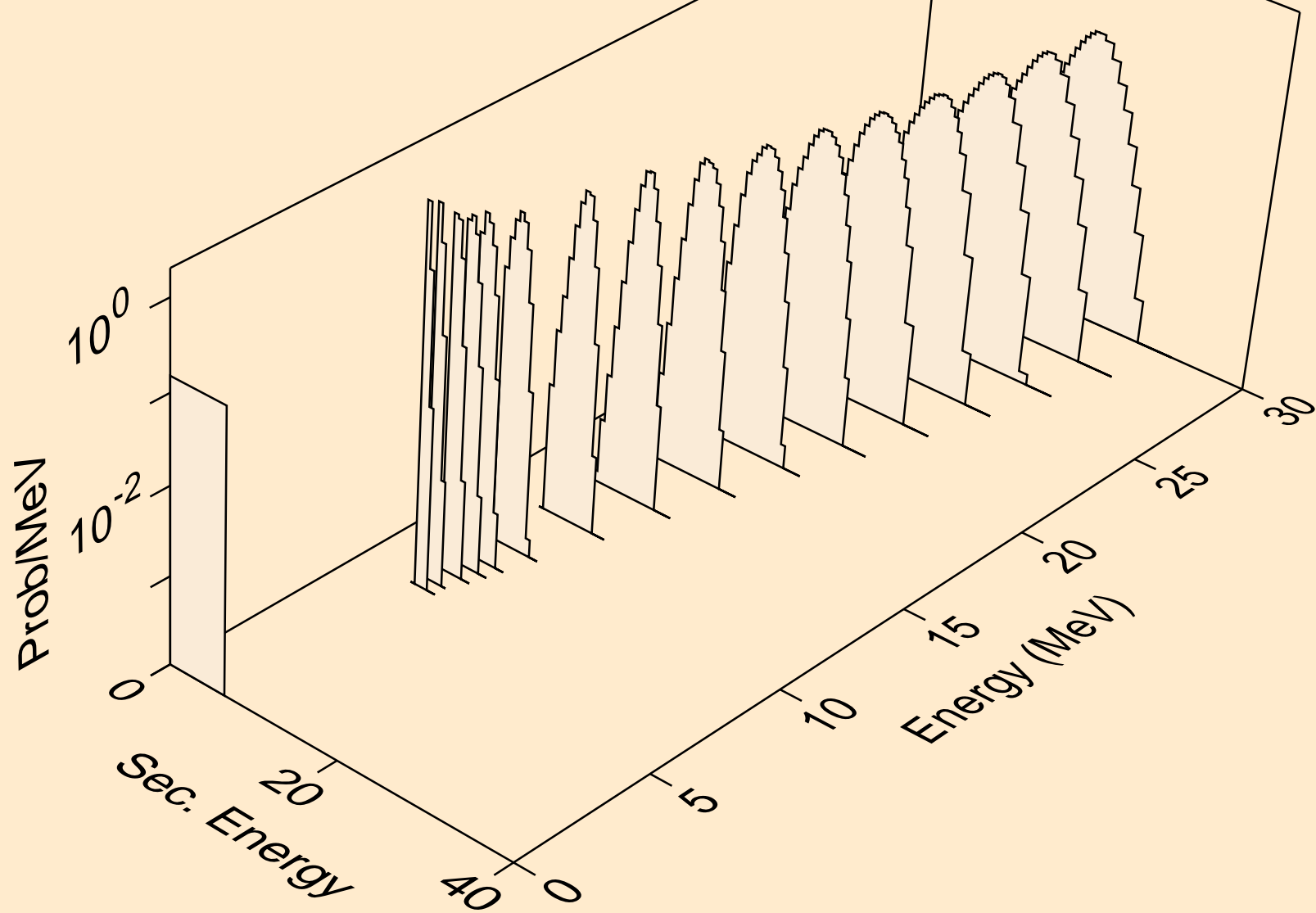

RN204 NEUTRON ACER TENDL-2024 LIBRARY; T=0.K
alphas from (n,a)

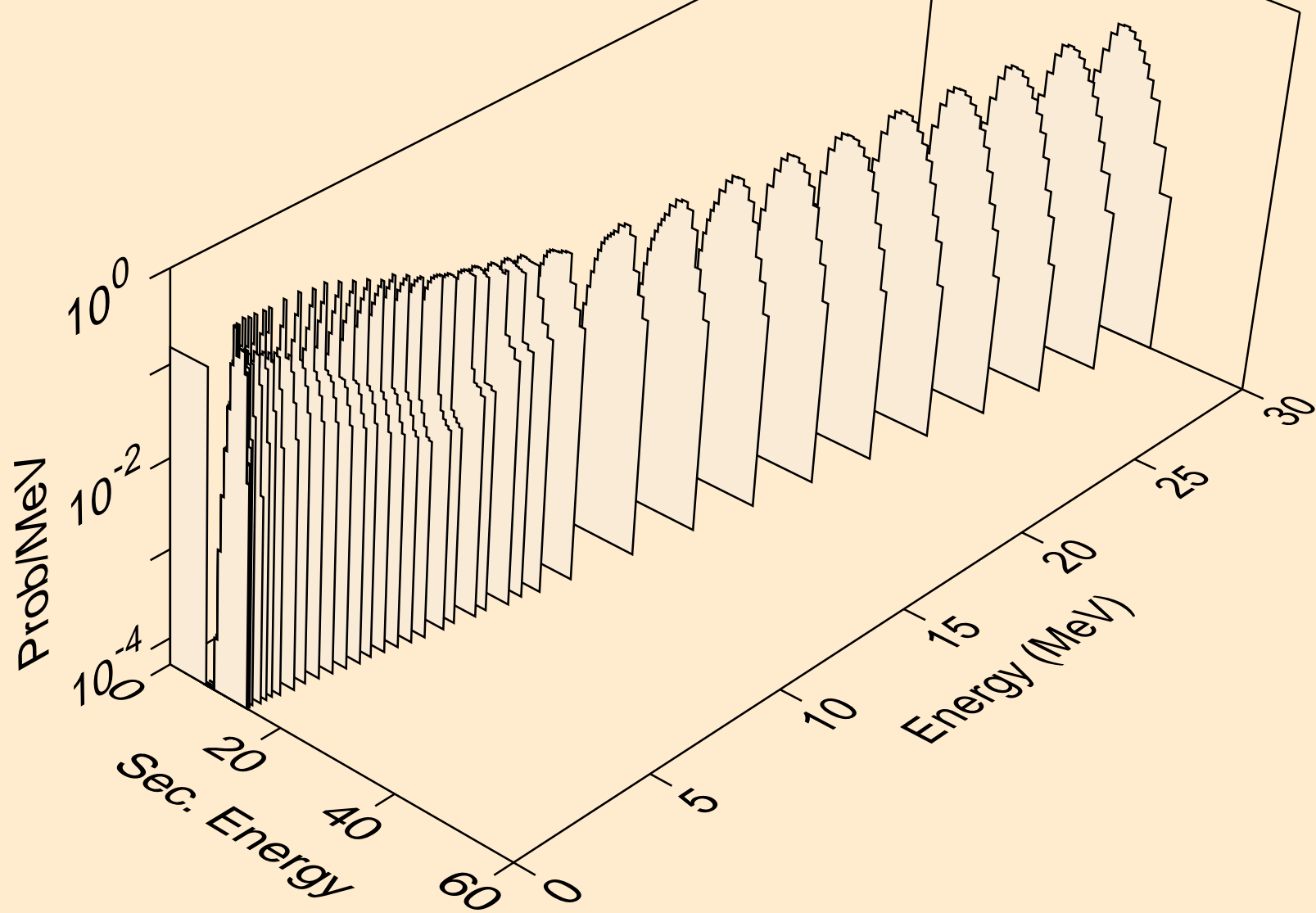

RN204 NEUTRON ACER TENDL-2024 LIBRARY; T=0.K
alphas from (n,2a)

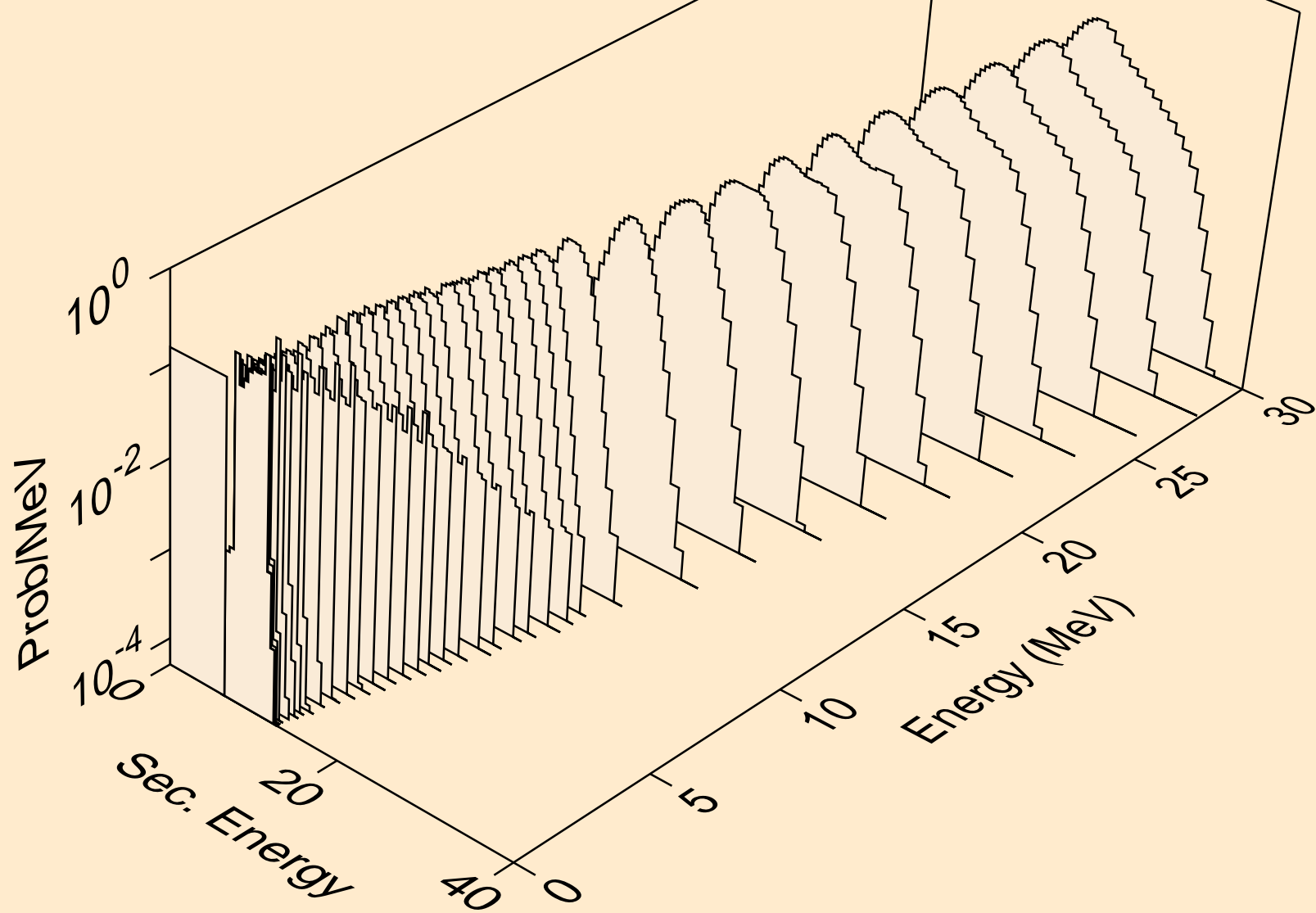

RN204 NEUTRON ACER TENDL-2024 LIBRARY; T=0.K
alphas from (n,pa)

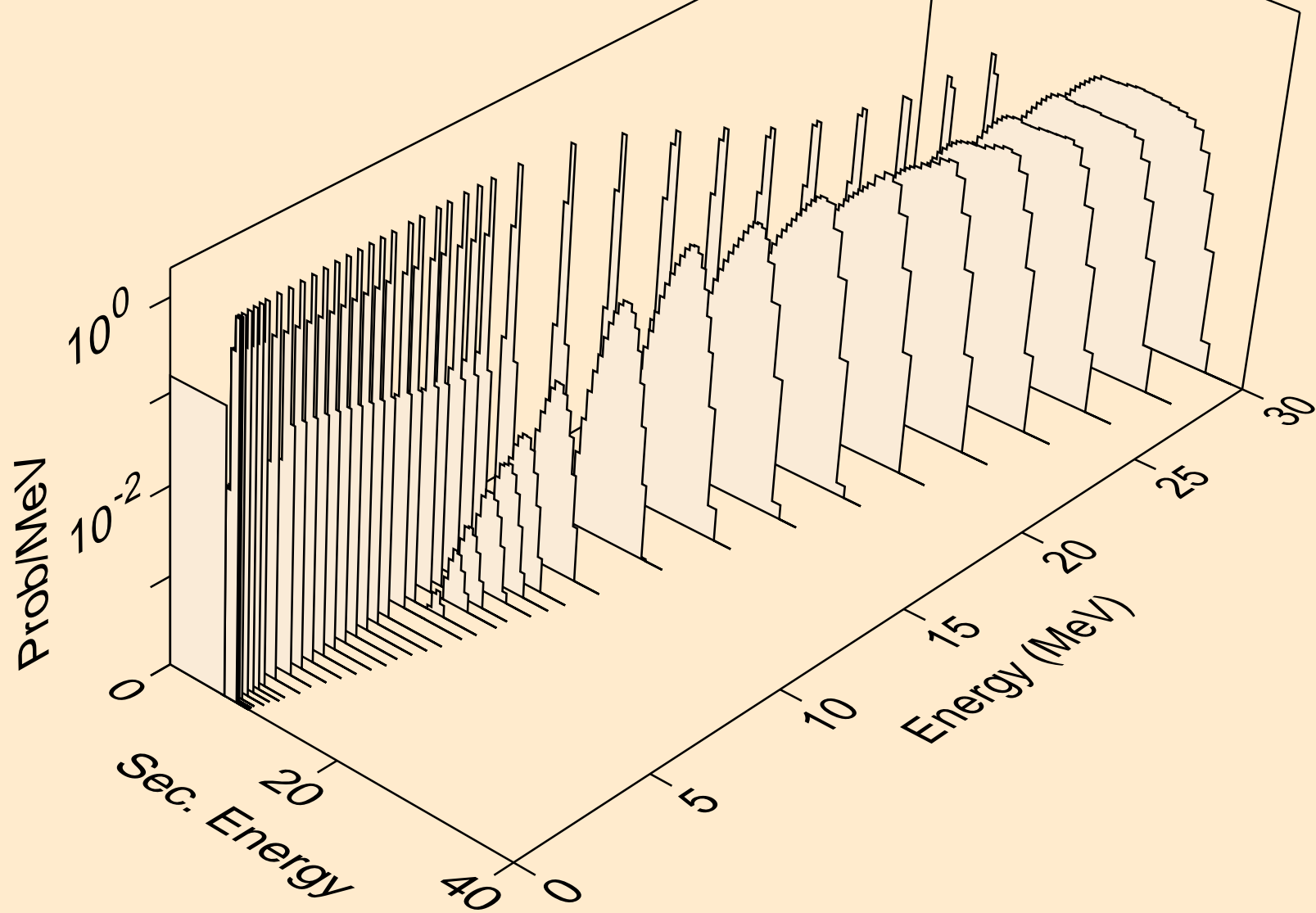

RN204 NEUTRON ACER TENDL-2024 LIBRARY; T=0.K
alphas from (n,da)

