

RN229 NEUTRON ACER TENDL-2024 LIBRARY; T=0.K

Principal cross sections

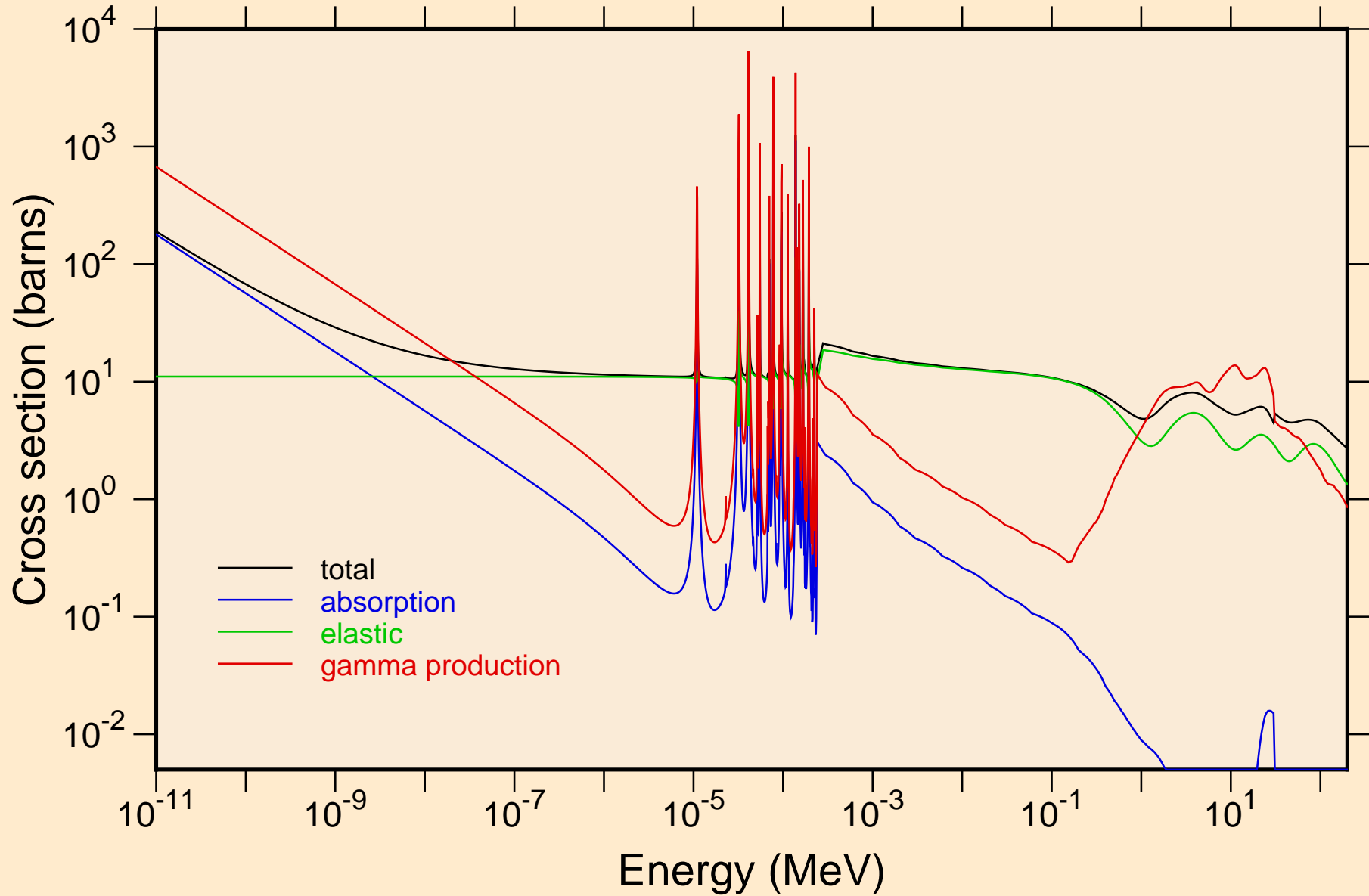

RN229 NEUTRON ACER TENDL-2024 LIBRARY; T=0.K
resonance total cross section

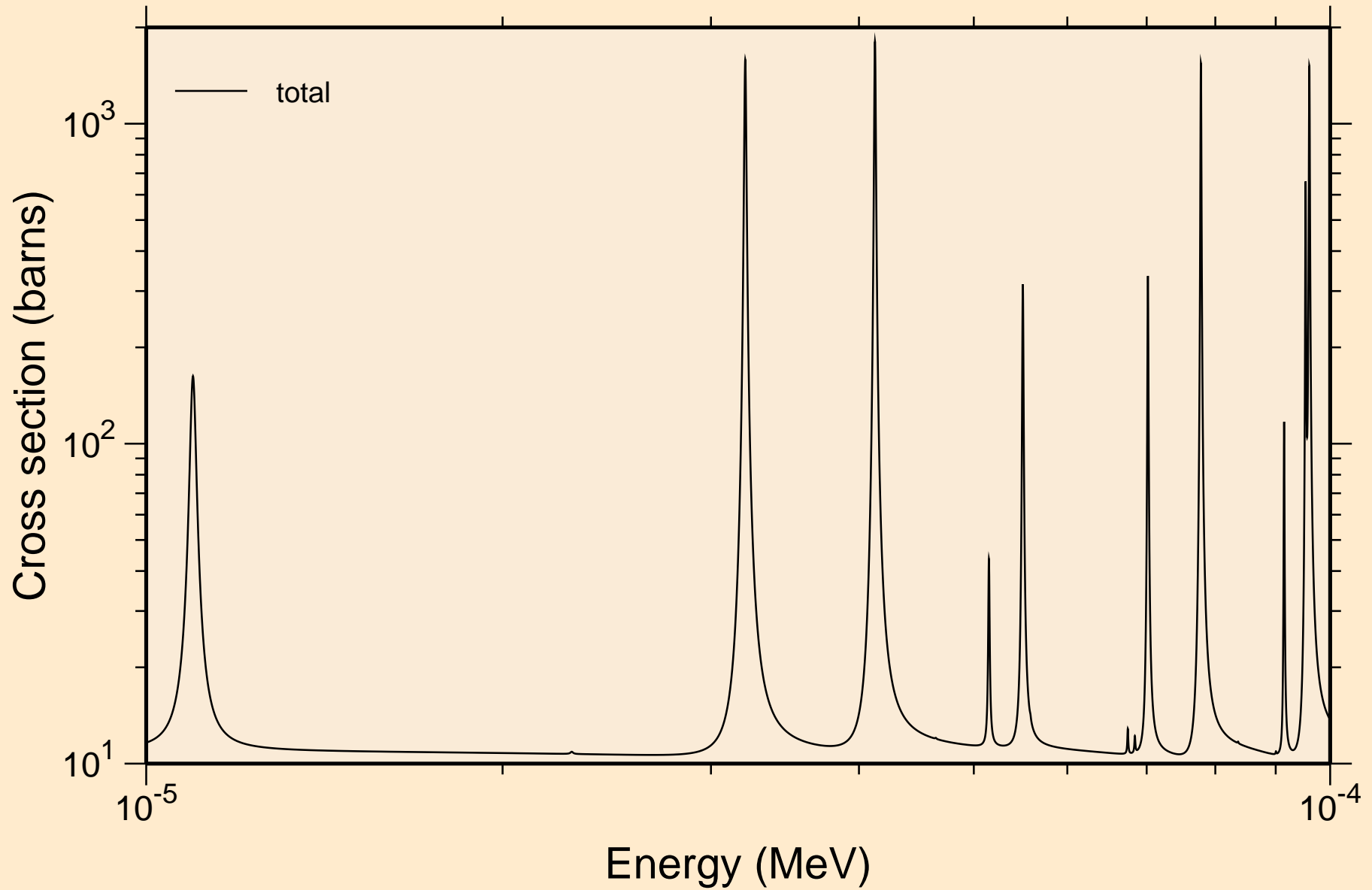

RN229 NEUTRON ACER TENDL-2024 LIBRARY; T=0.K
resonance total cross section

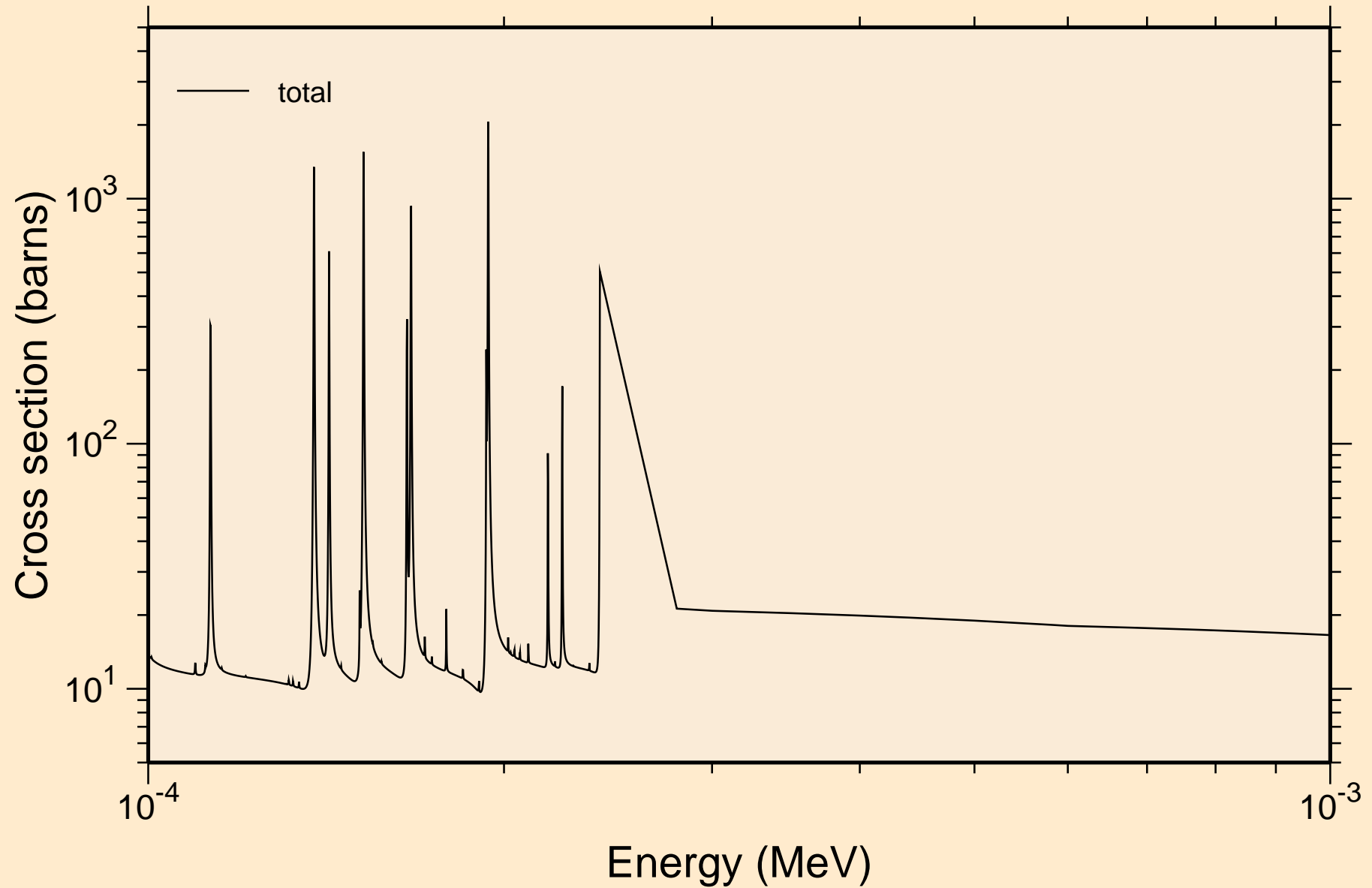

RN229 NEUTRON ACER TENDL-2024 LIBRARY; T=0.K
resonance total cross section

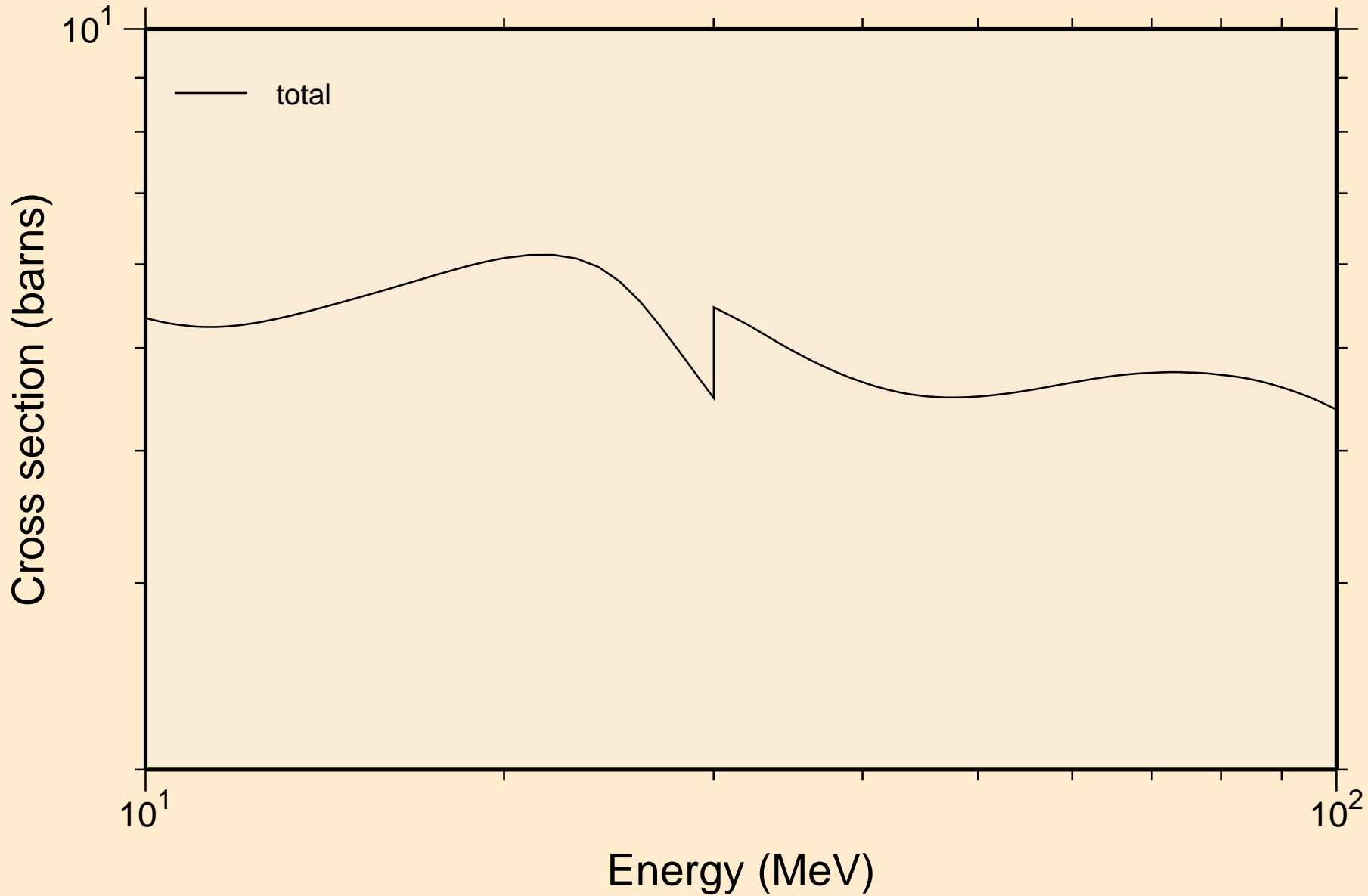

RN229 NEUTRON ACER TENDL-2024 LIBRARY; T=0.K

resonance absorption cross sections

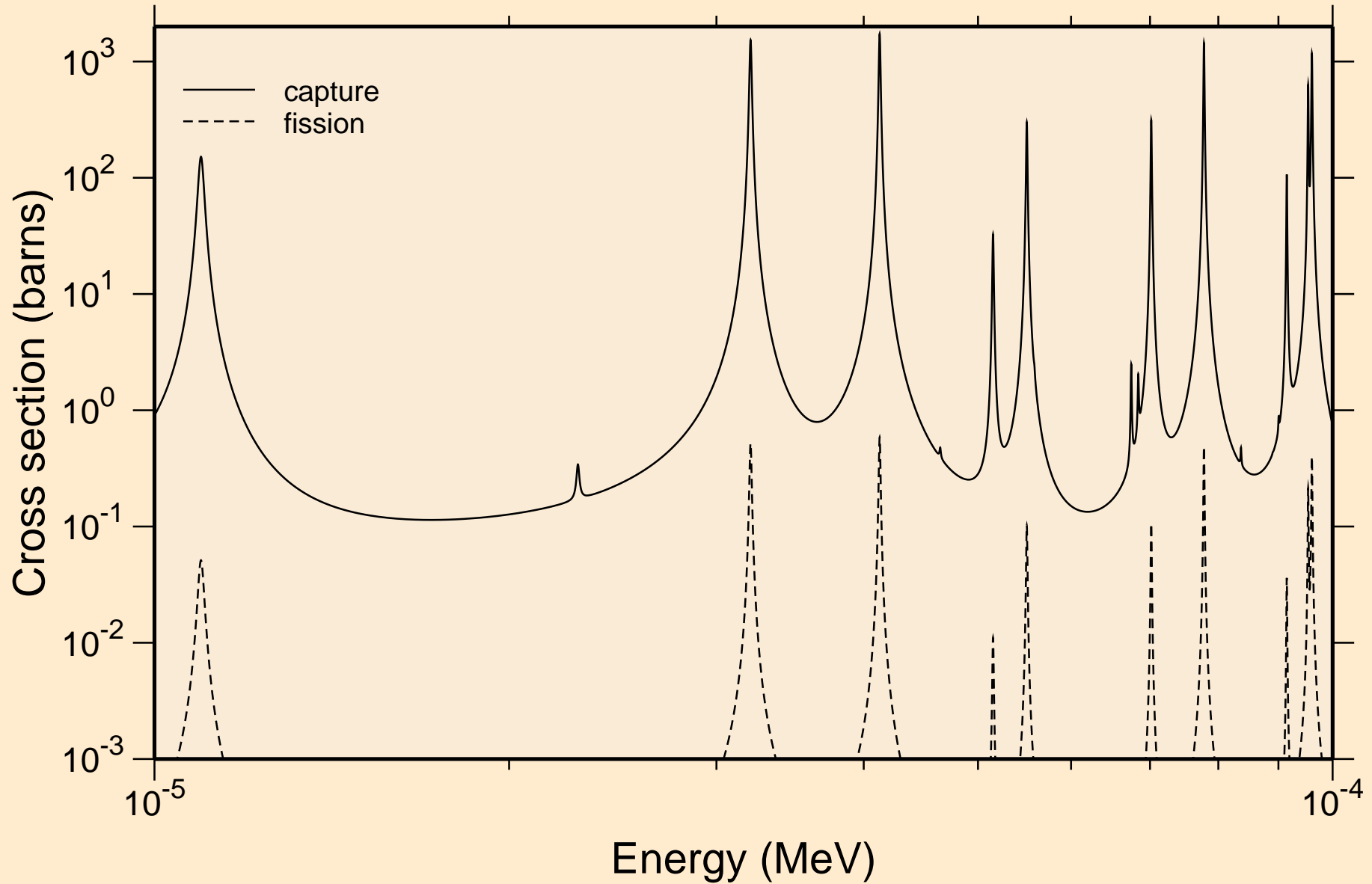

RN229 NEUTRON ACER TENDL-2024 LIBRARY; T=0.K
resonance absorption cross sections

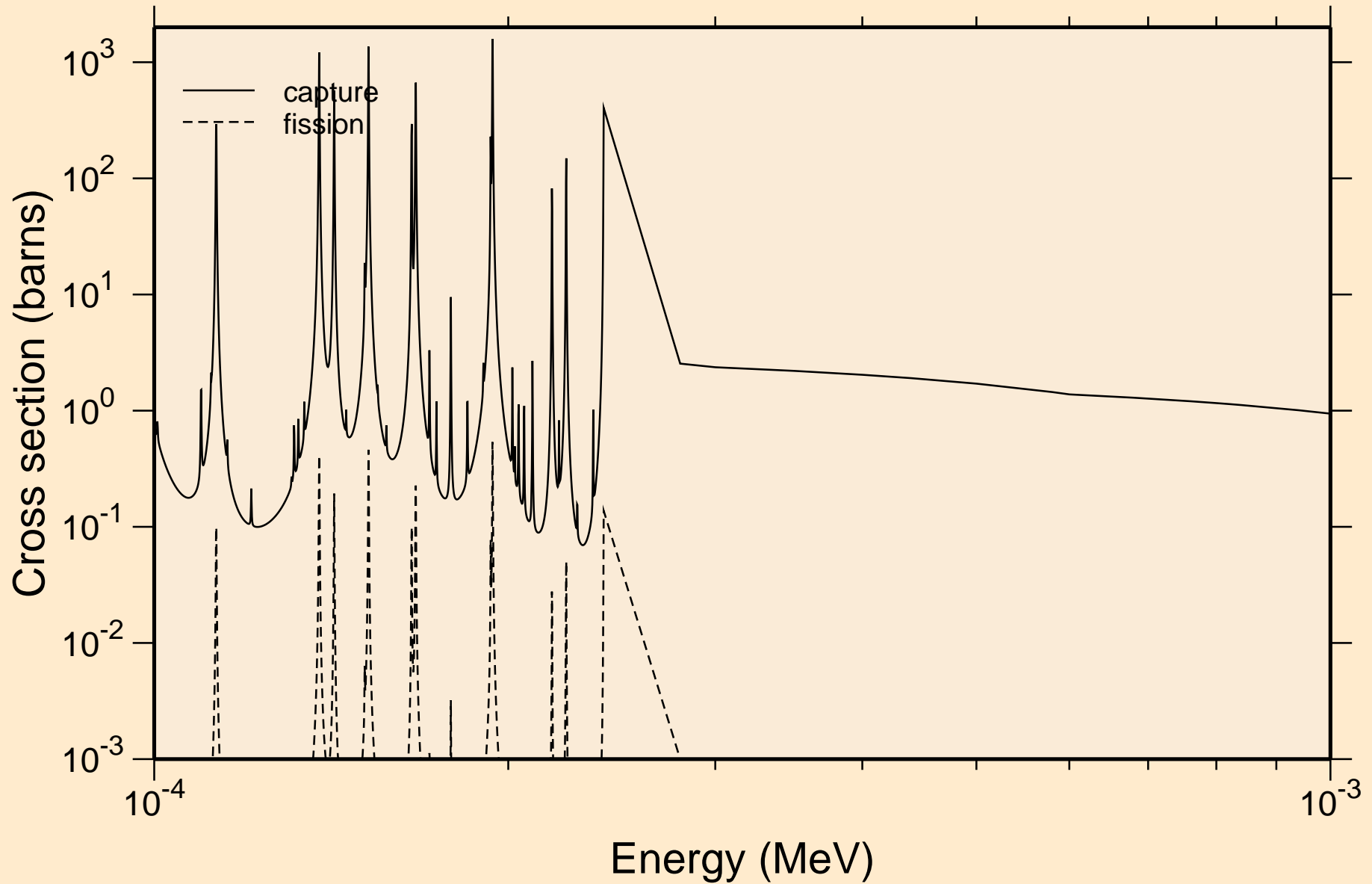

RN229 NEUTRON ACER TENDL-2024 LIBRARY; T=0.K
resonance absorption cross sections

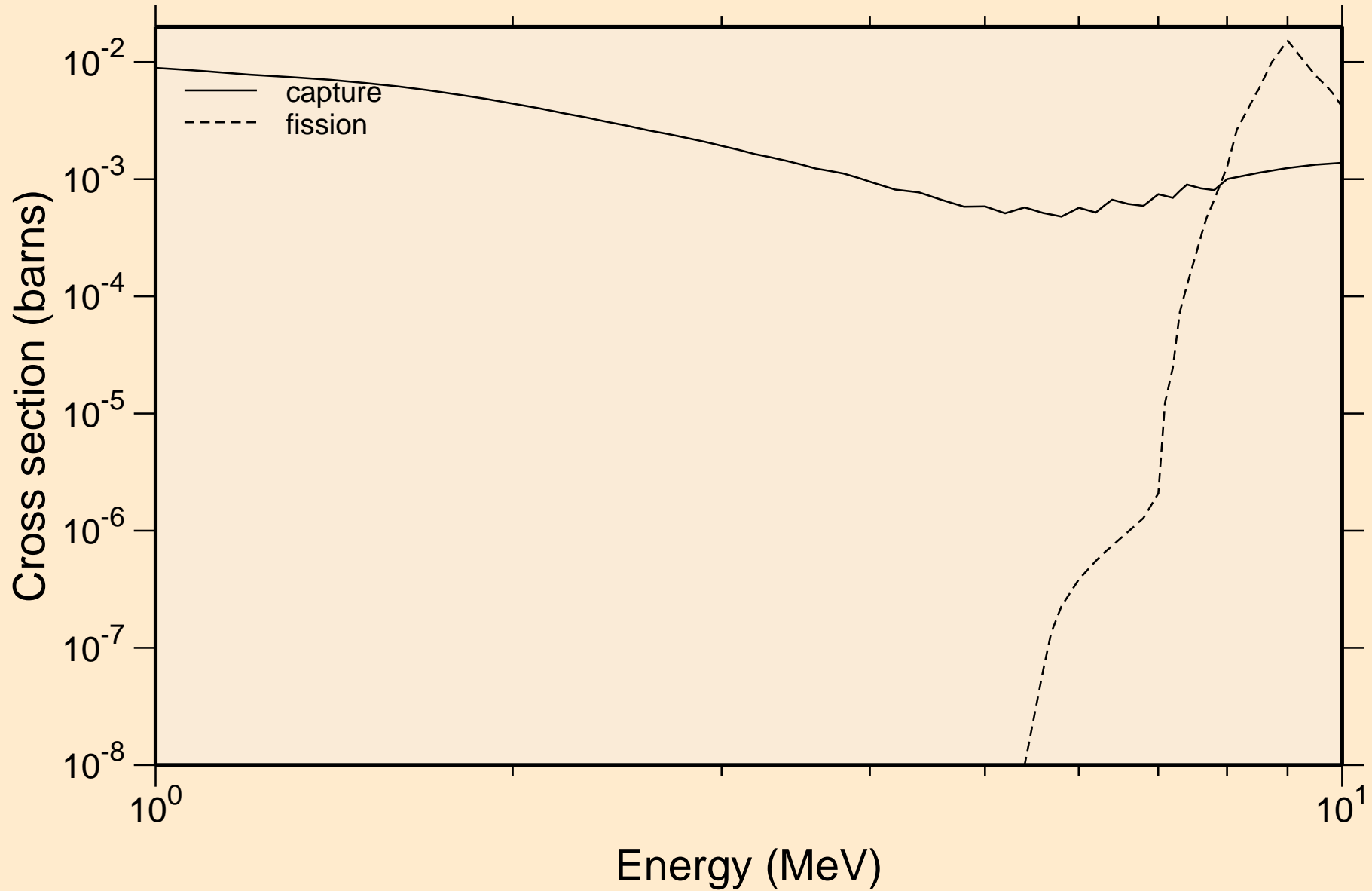

RN229 NEUTRON ACER TENDL-2024 LIBRARY; T=0.K
Heating

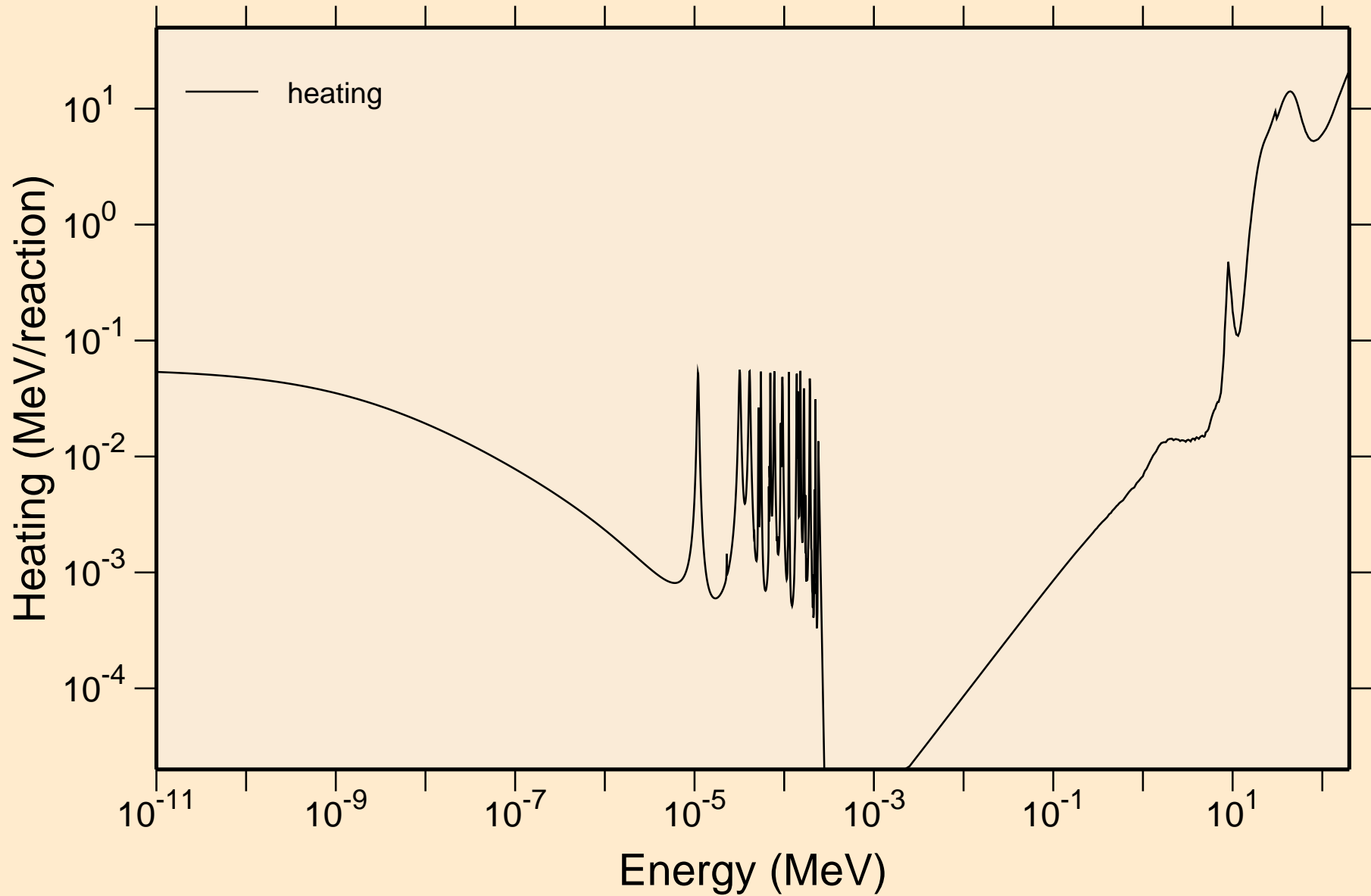

RN229 NEUTRON ACER TENDL-2024 LIBRARY; T=0.K
Damage

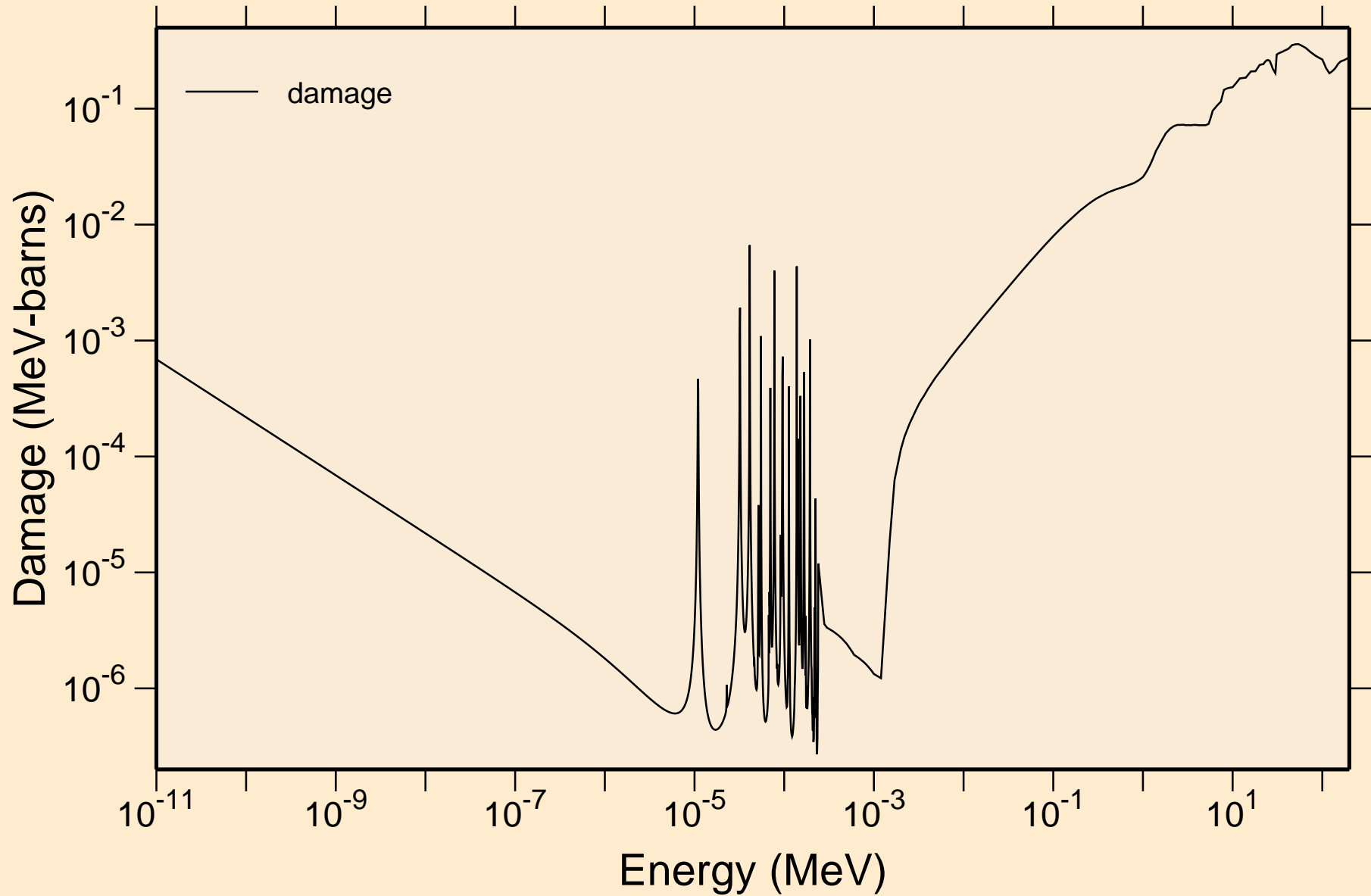

RN229 NEUTRON ACER TENDL-2024 LIBRARY; T=0.K

Non-threshold reactions

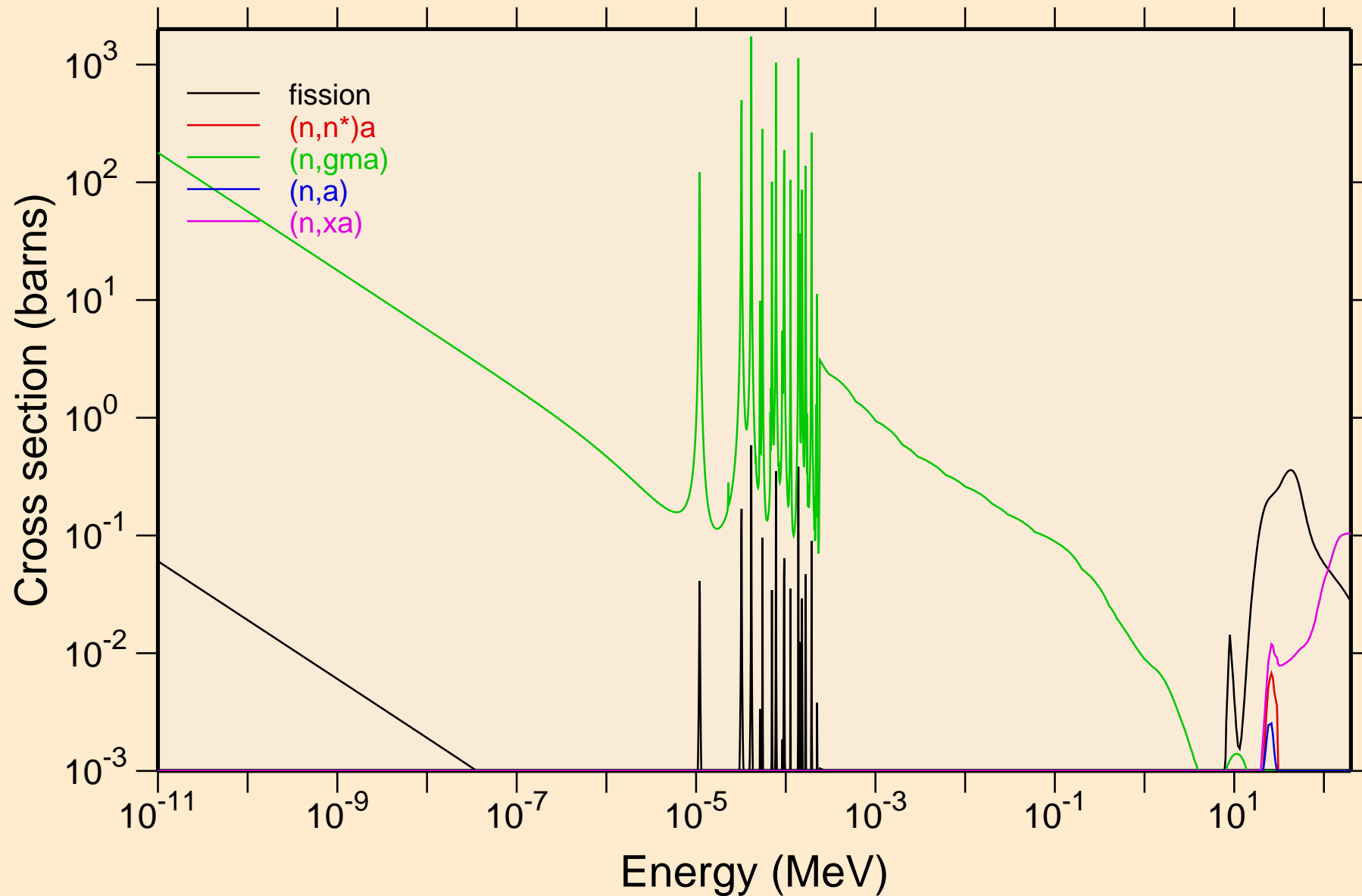

RN229 NEUTRON ACER TENDL-2024 LIBRARY; T=0.K

Principal cross sections

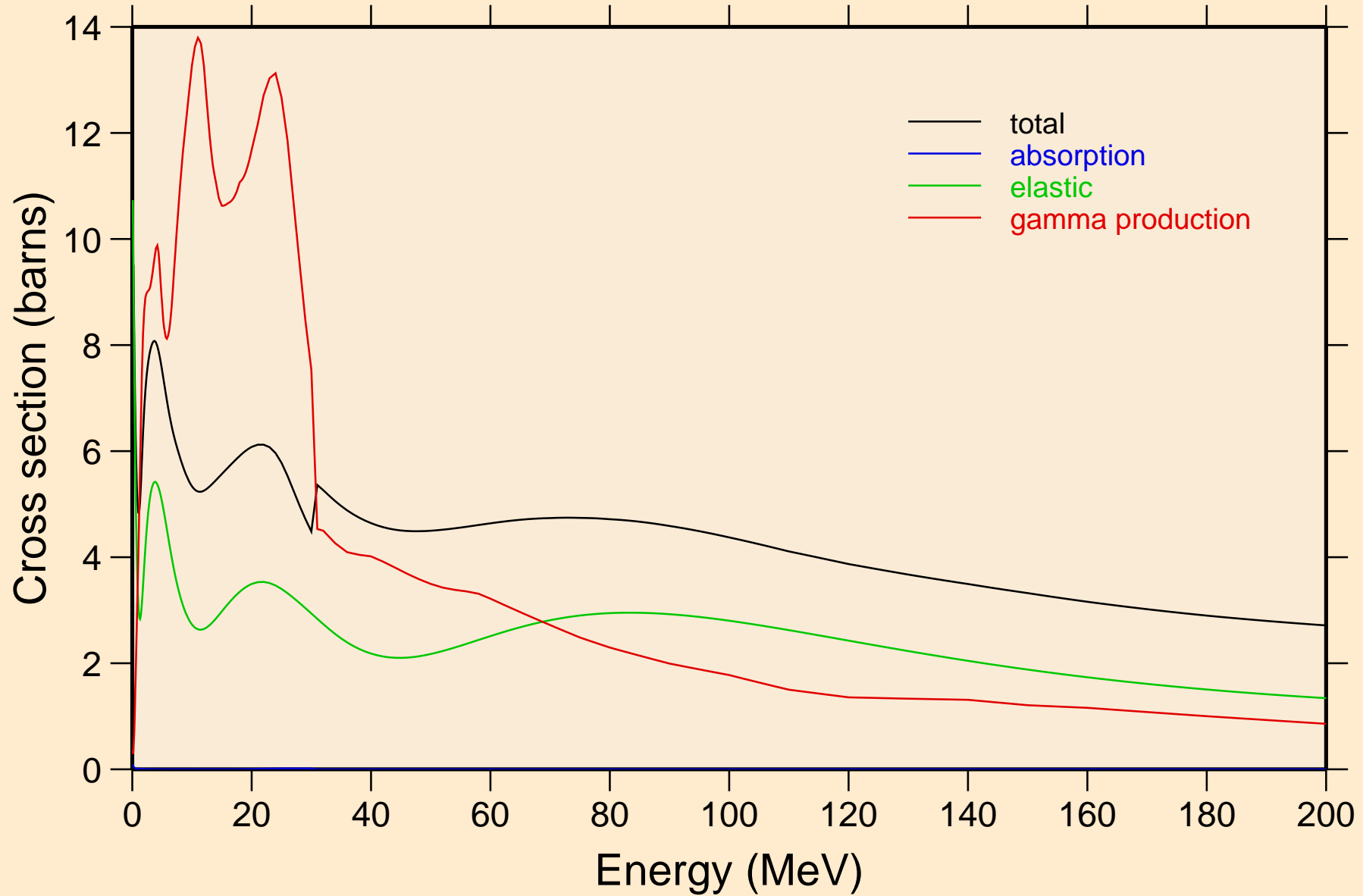

RN229 NEUTRON ACER TENDL-2024 LIBRARY; T=0.K

Heating

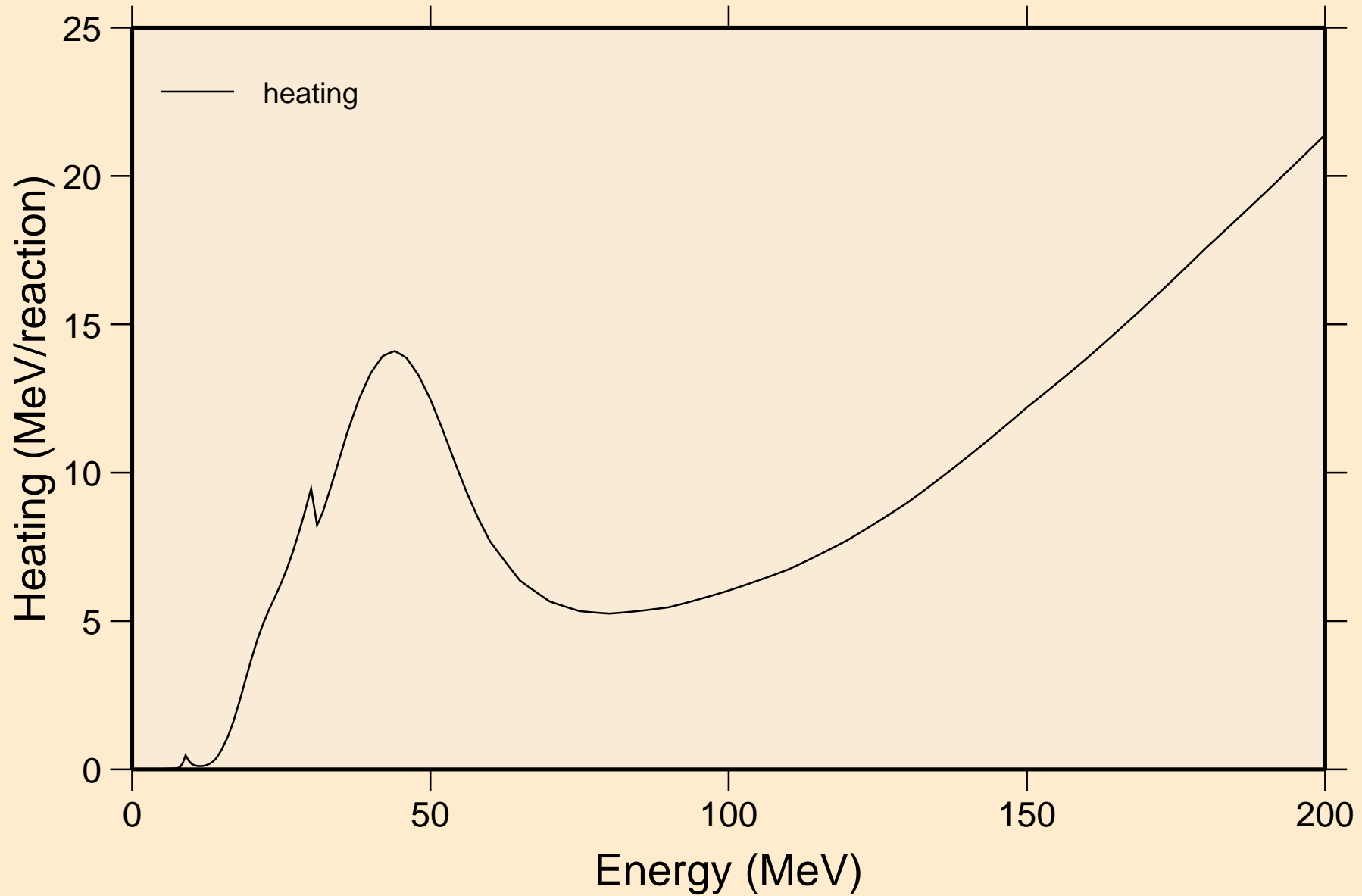

RN229 NEUTRON ACER TENDL-2024 LIBRARY; T=0.K

Damage

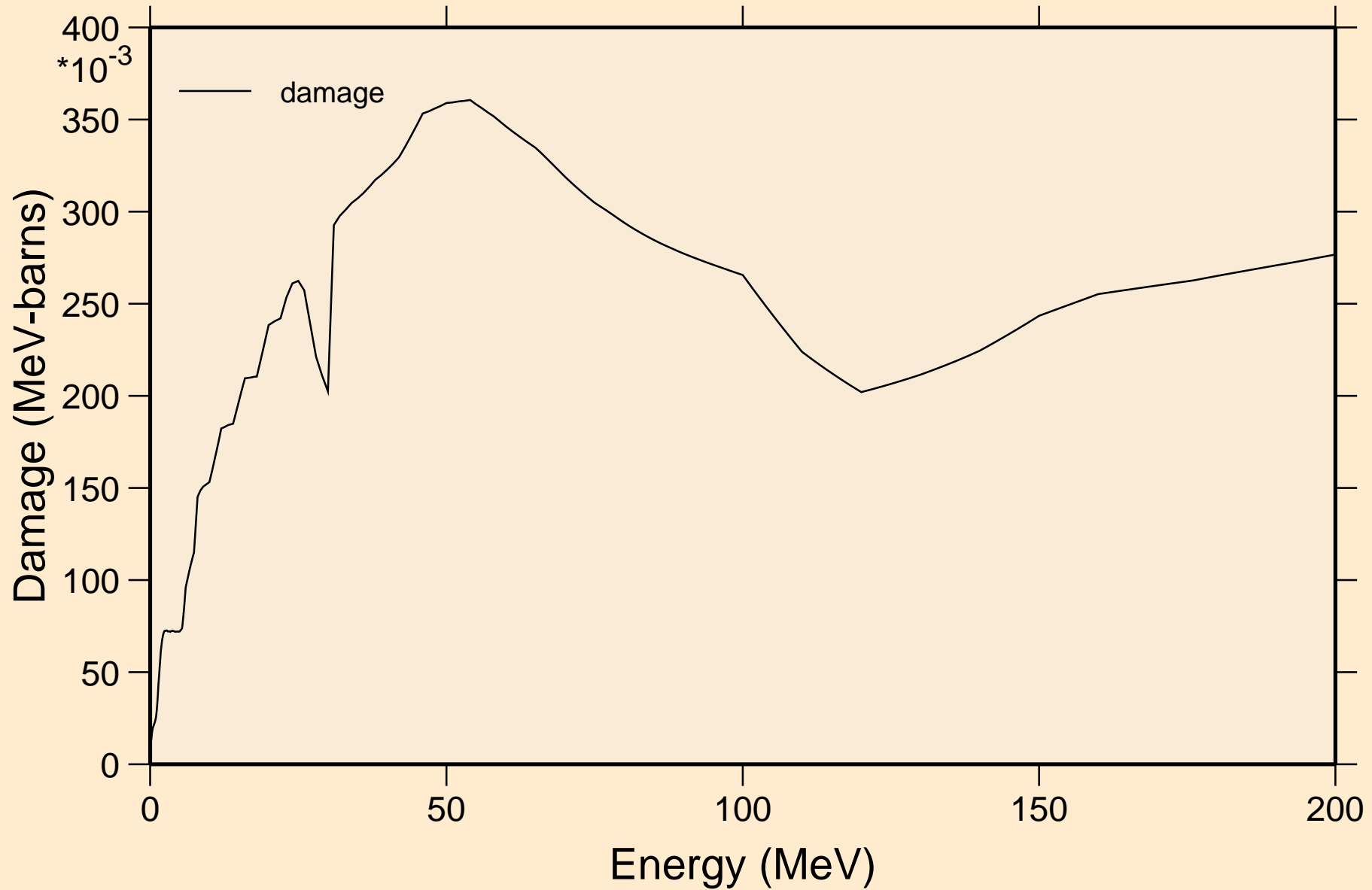

RN229 NEUTRON ACER TENDL-2024 LIBRARY; T=0.K

Non-threshold reactions

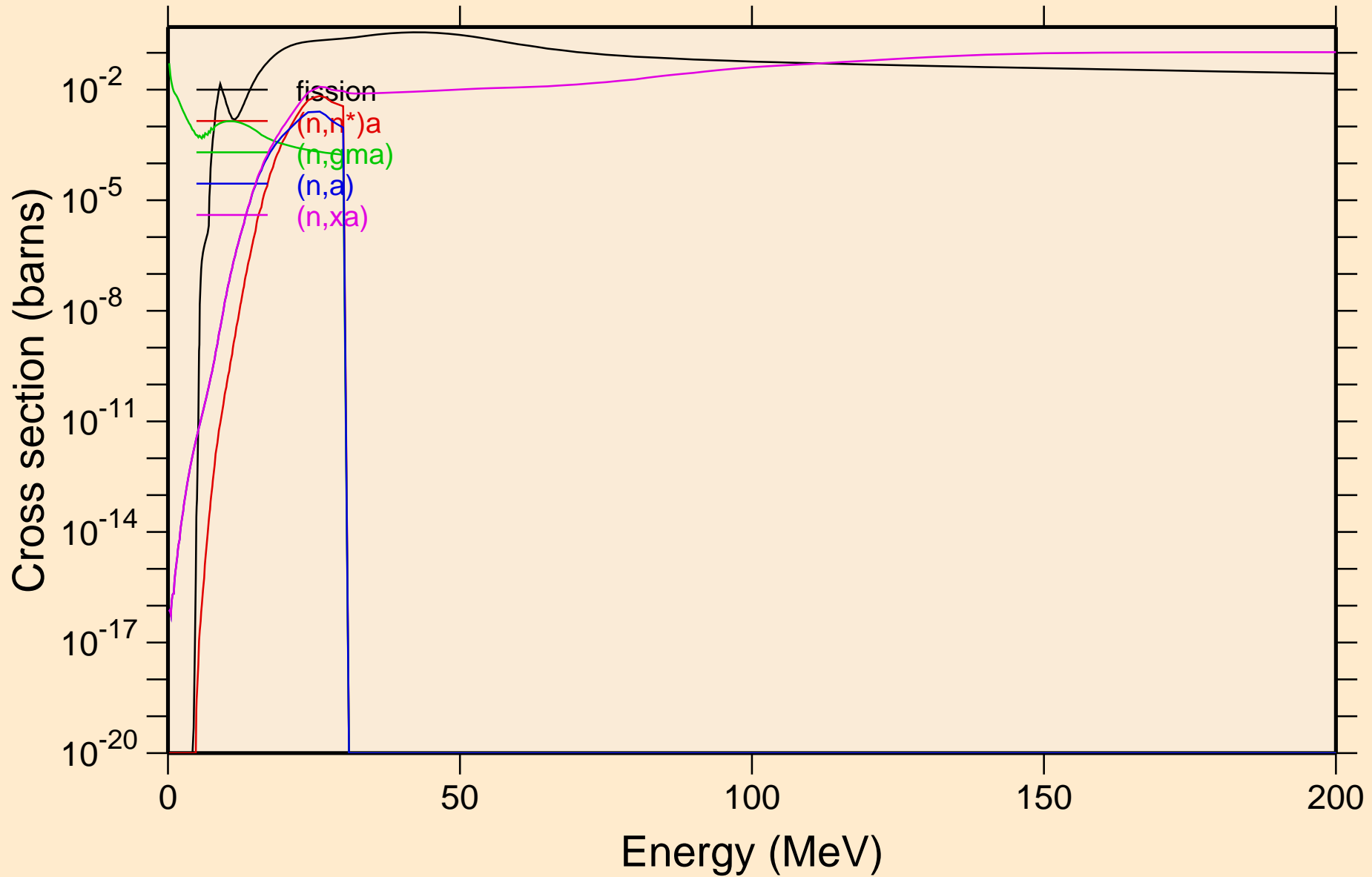

RN229 NEUTRON ACER TENDL-2024 LIBRARY; T=0.K
Inelastic levels

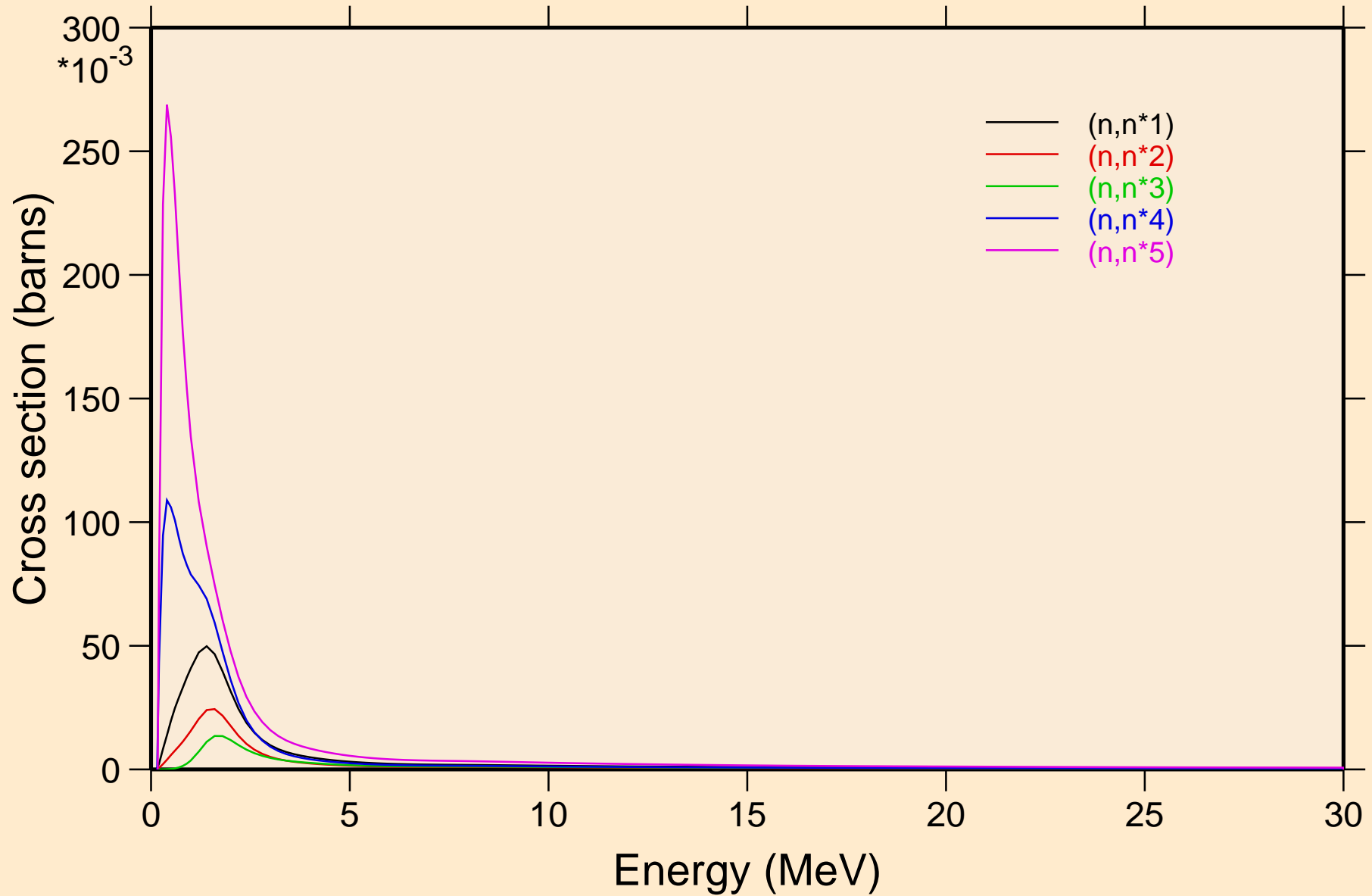

RN229 NEUTRON ACER TENDL-2024 LIBRARY; T=0.K
Inelastic levels

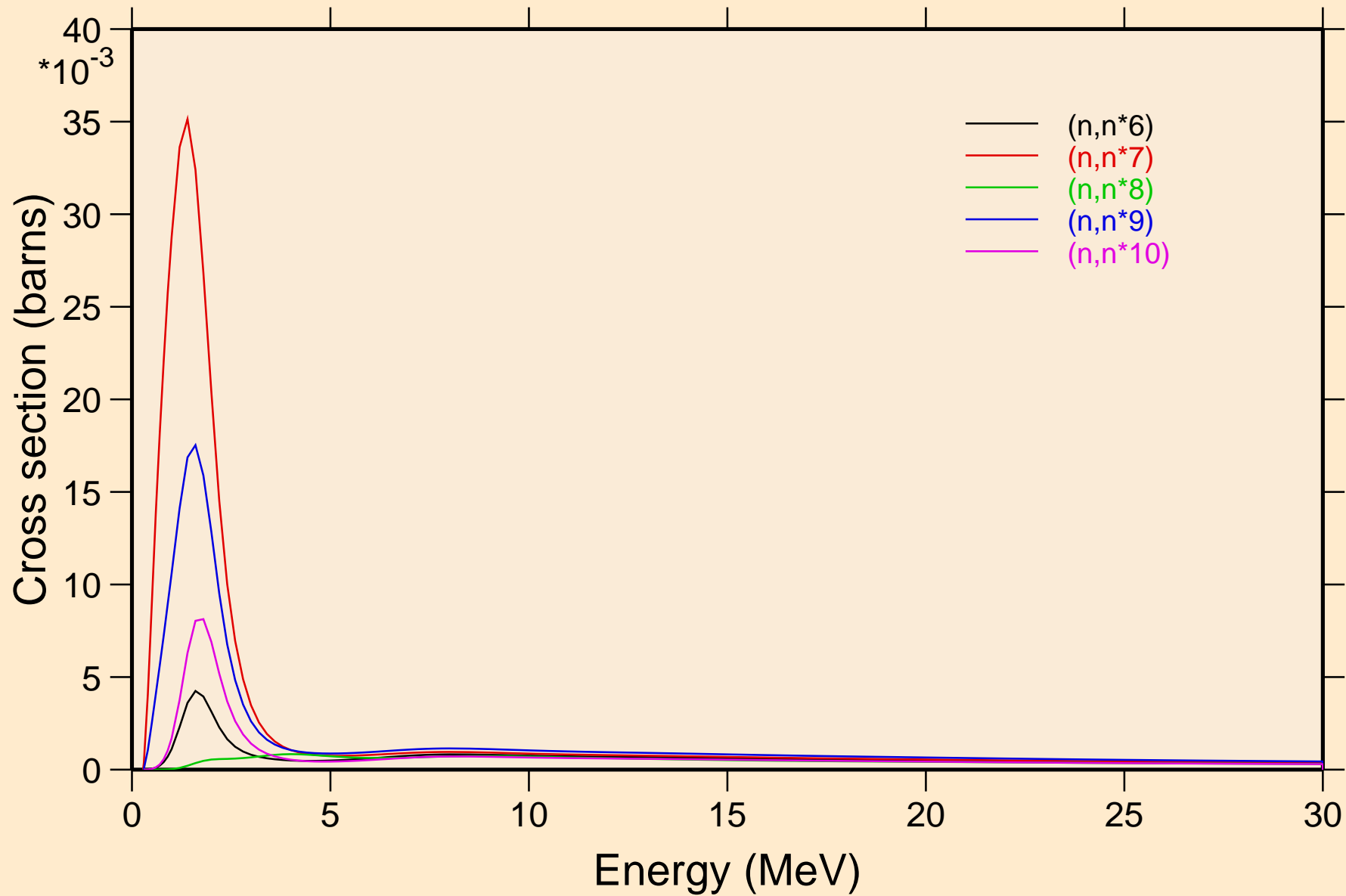

RN229 NEUTRON ACER TENDL-2024 LIBRARY; T=0.K
Inelastic levels

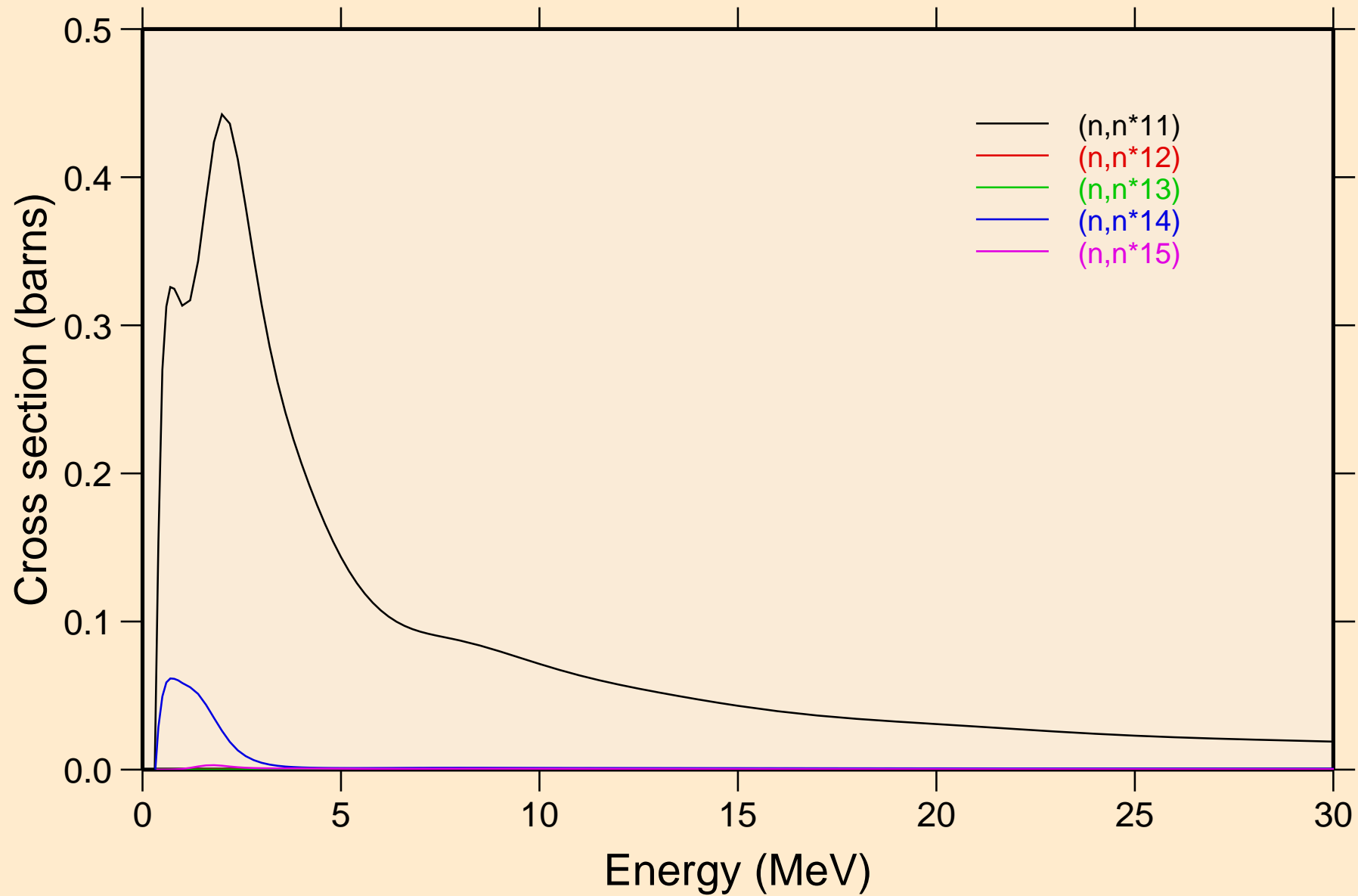

RN229 NEUTRON ACER TENDL-2024 LIBRARY; T=0.K
Inelastic levels

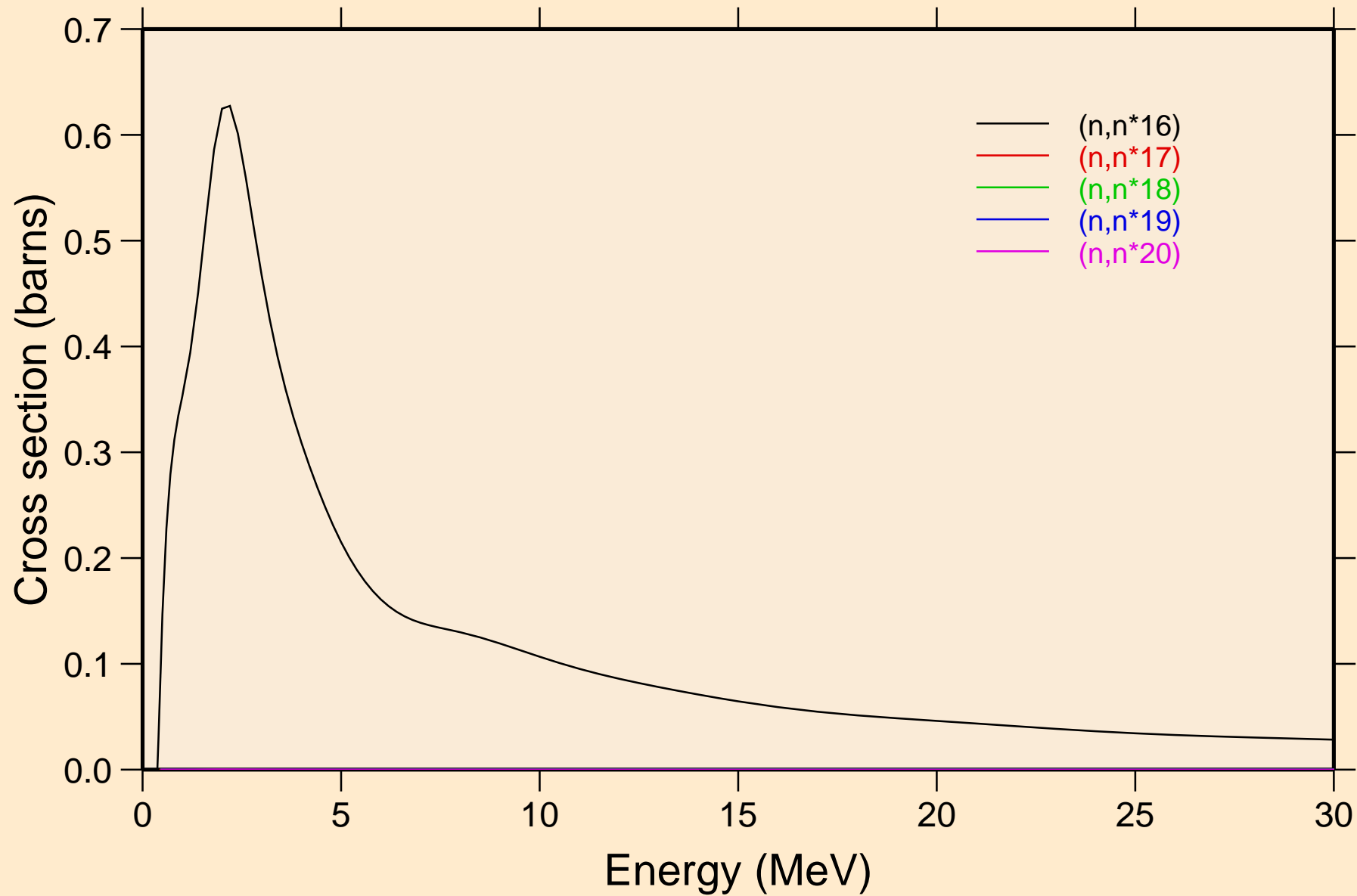

RN229 NEUTRON ACER TENDL-2024 LIBRARY; T=0.K
Inelastic levels

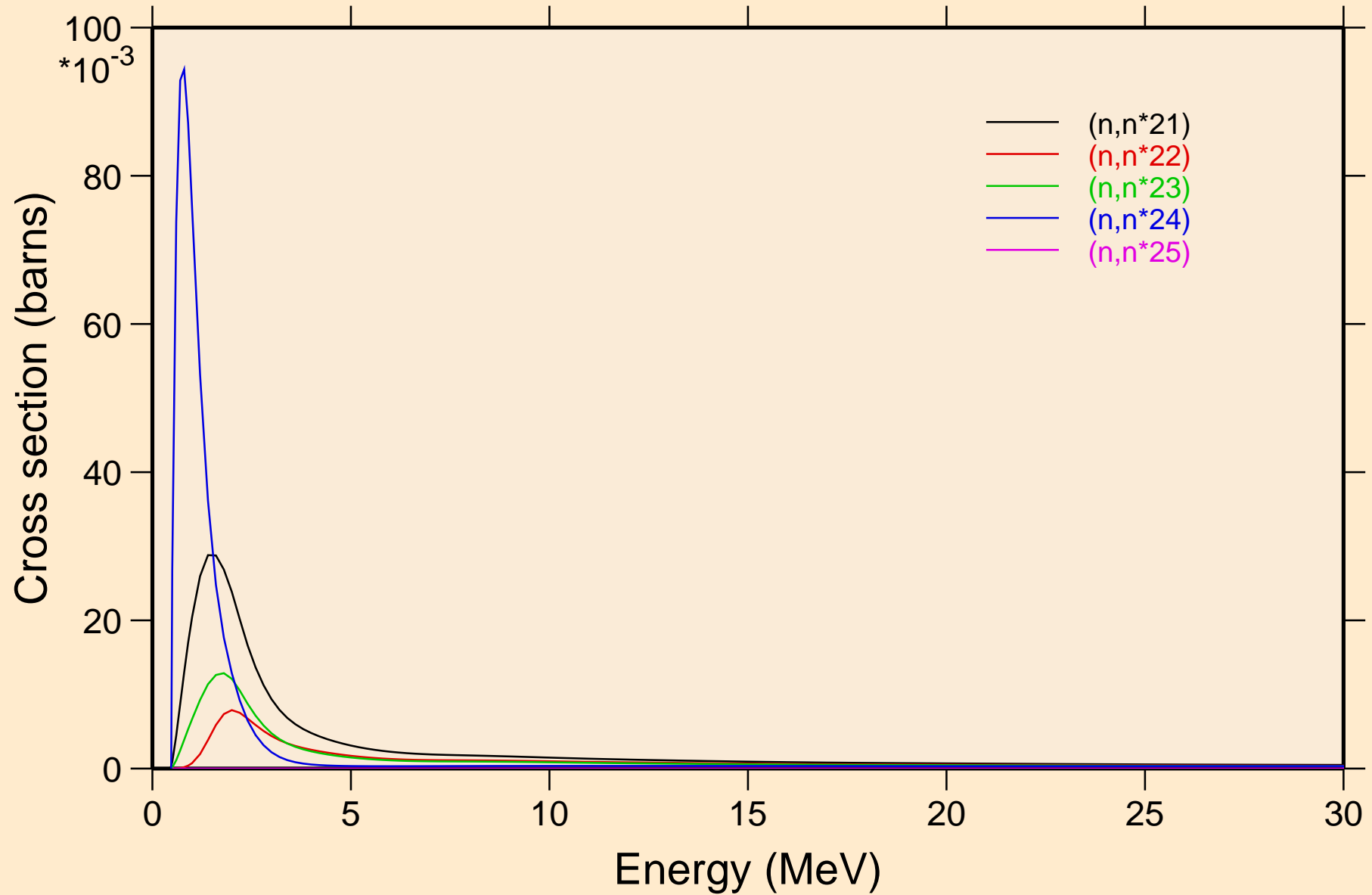

RN229 NEUTRON ACER TENDL-2024 LIBRARY; T=0.K
Inelastic levels

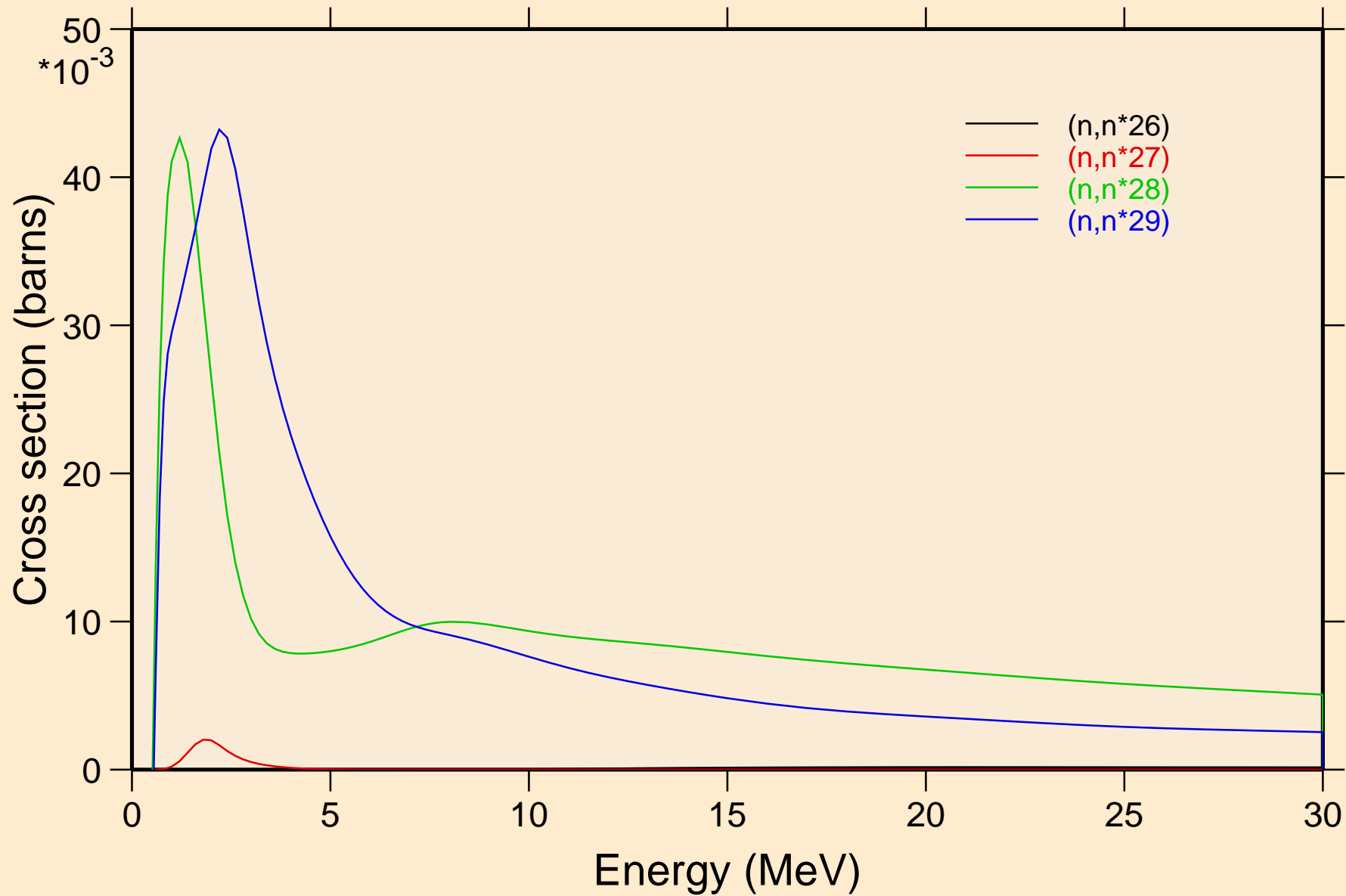

RN229 NEUTRON ACER TENDL-2024 LIBRARY; T=0.K

Threshold reactions

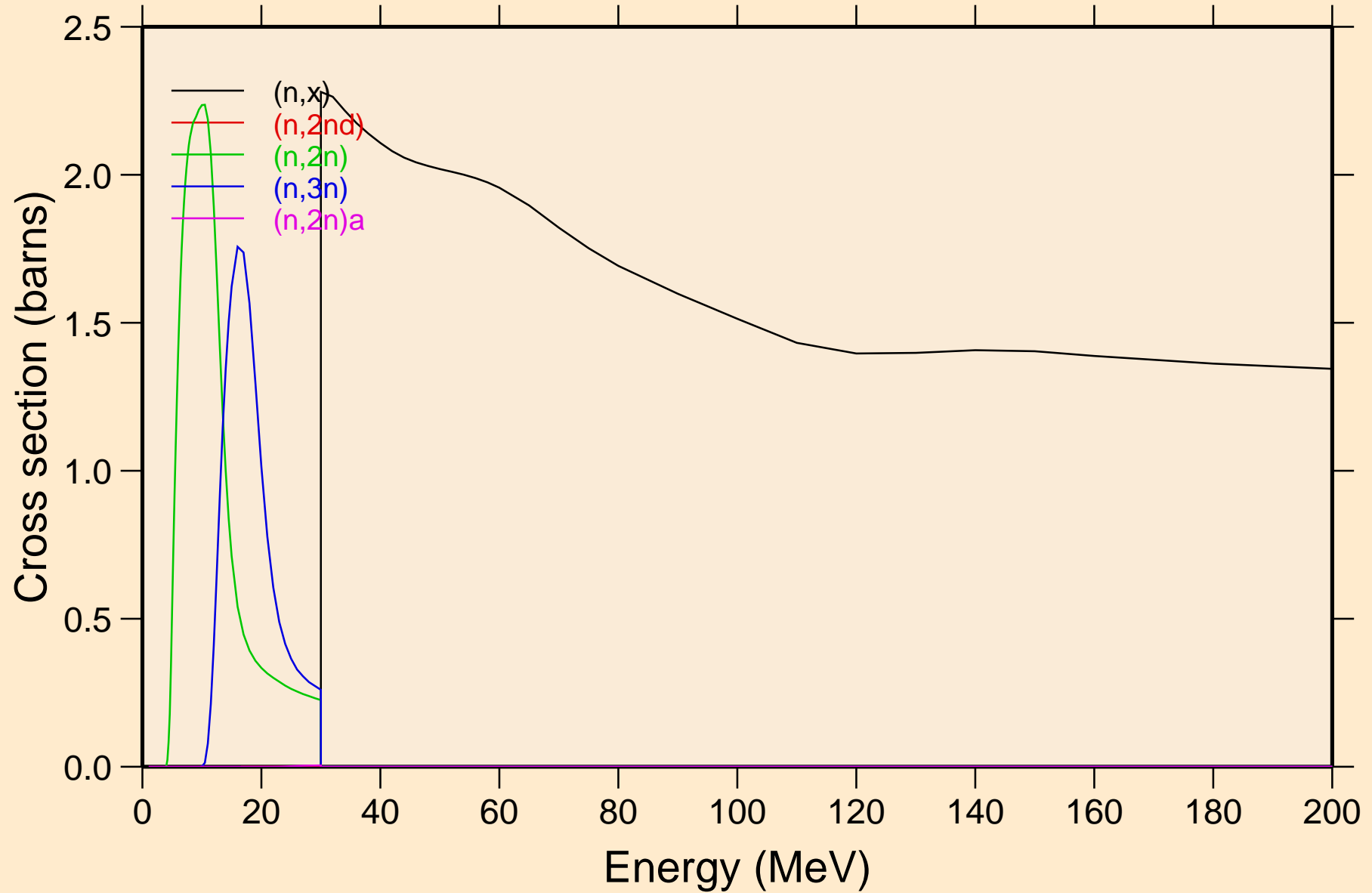

RN229 NEUTRON ACER TENDL-2024 LIBRARY; T=0.K

Threshold reactions

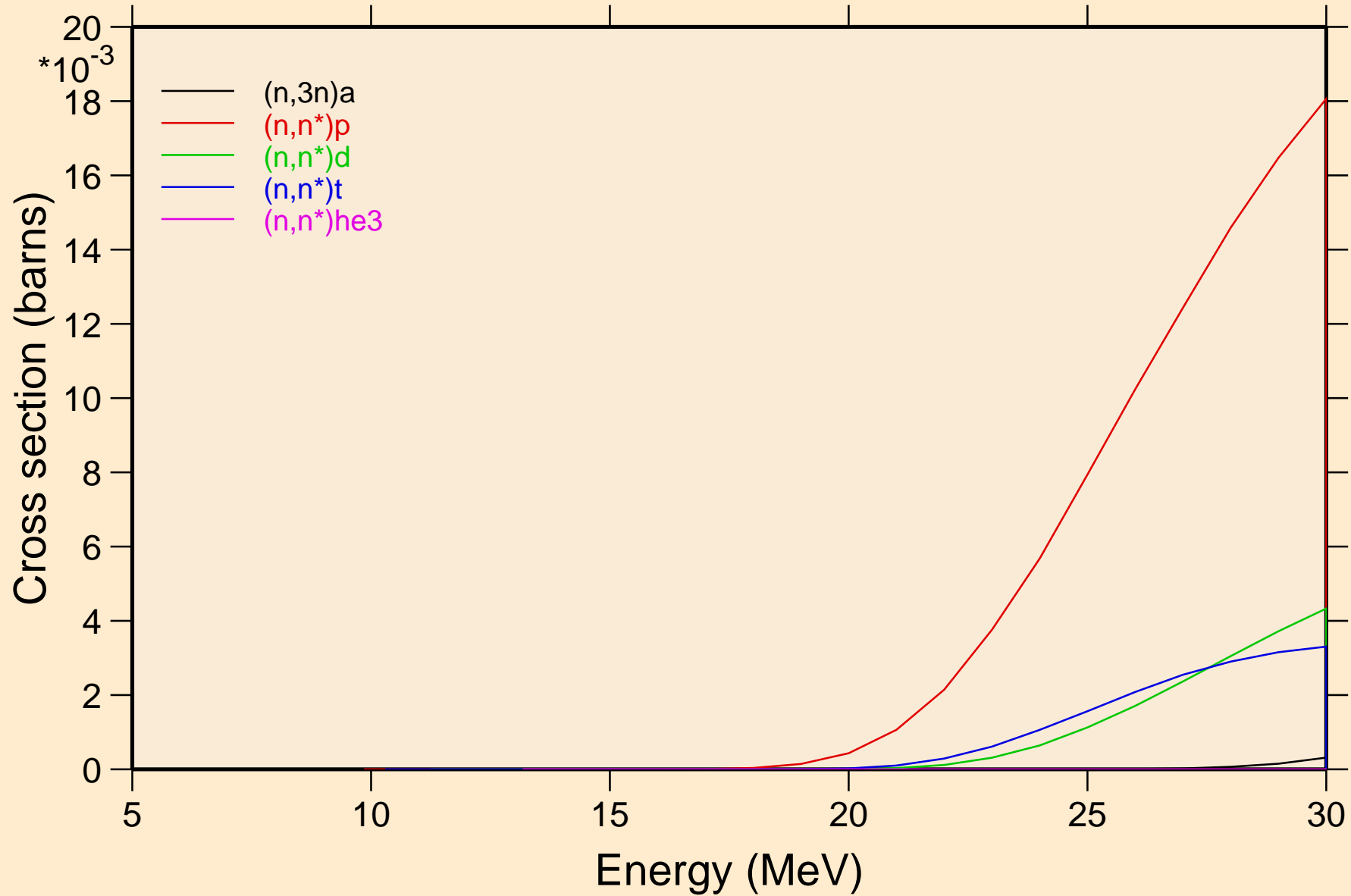

RN229 NEUTRON ACER TENDL-2024 LIBRARY; T=0.K
Threshold reactions

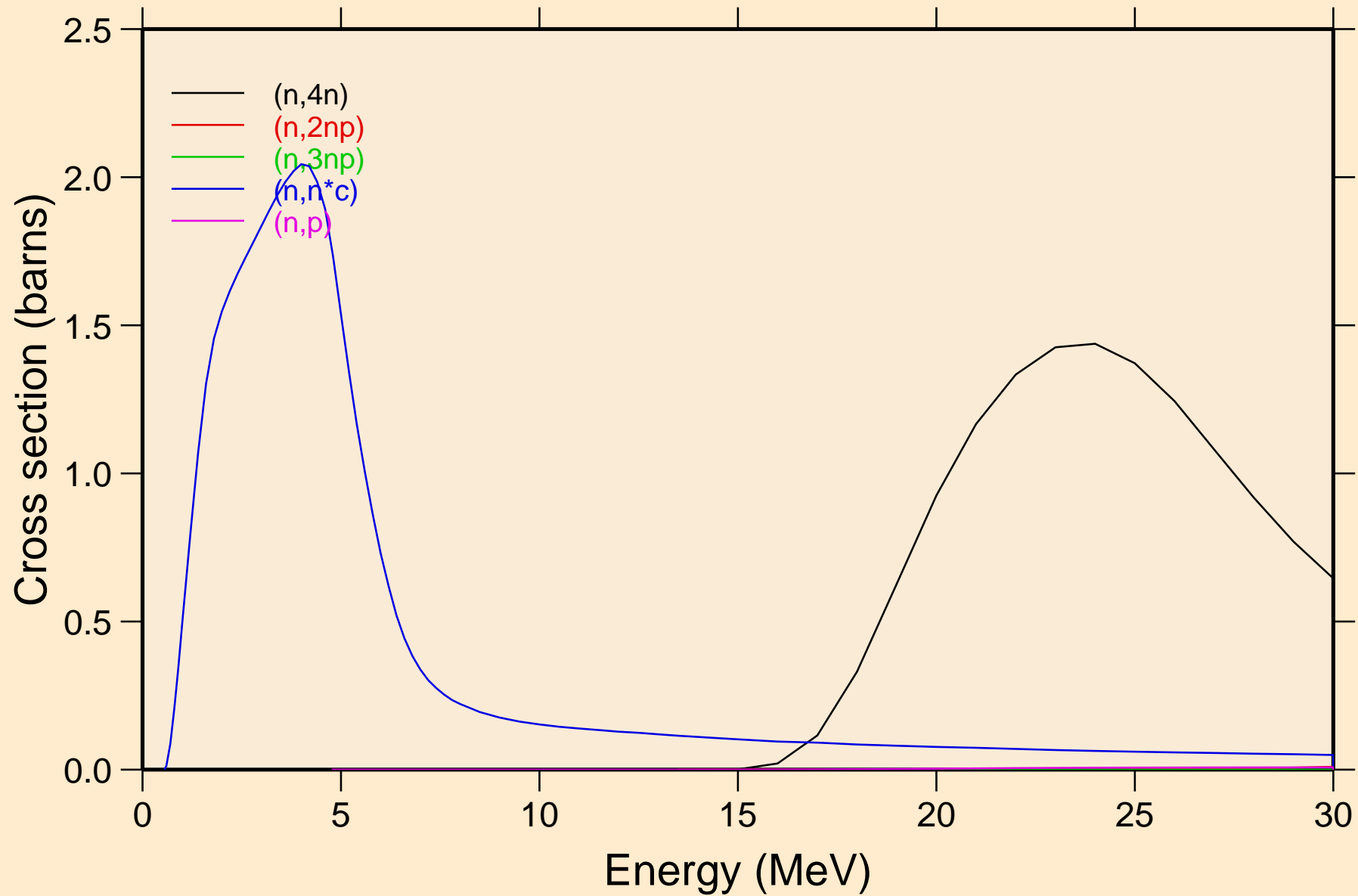

RN229 NEUTRON ACER TENDL-2024 LIBRARY; T=0.K
Threshold reactions

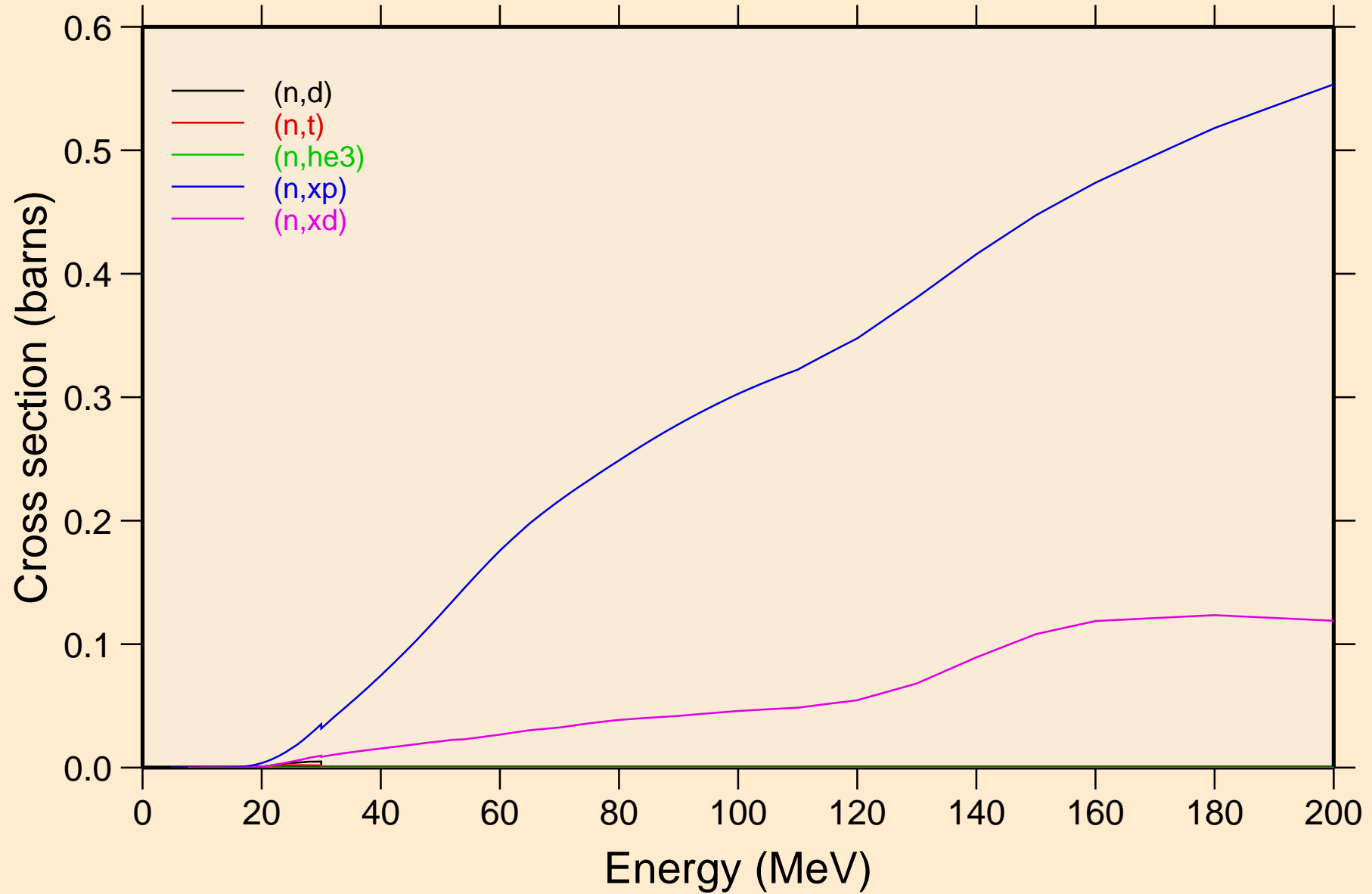

RN229 NEUTRON ACER TENDL-2024 LIBRARY; T=0.K
Threshold reactions

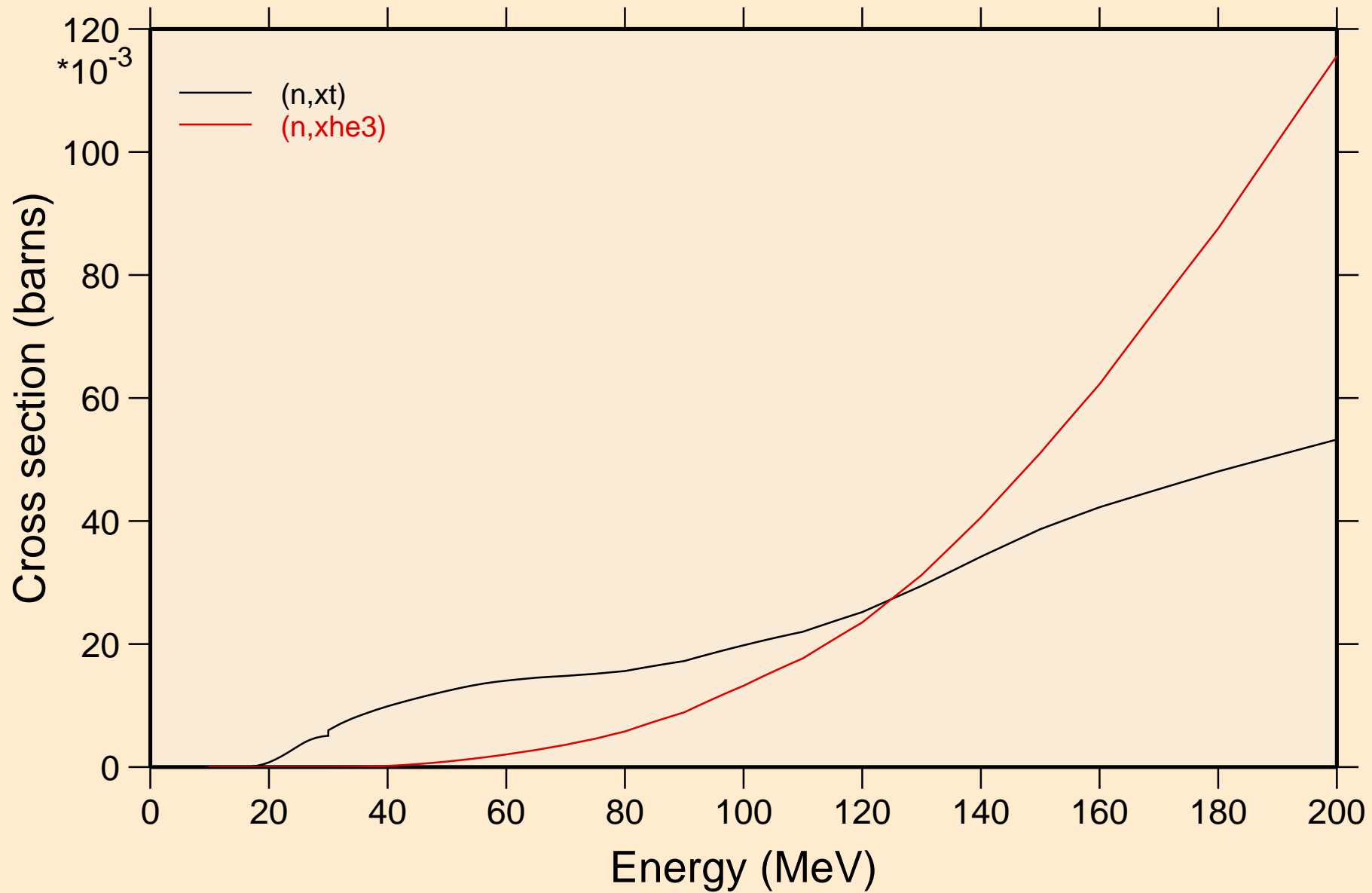

RN229 NEUTRON ACER TENDL-2024 LIBRARY; T=0.K
angular distribution for elastic

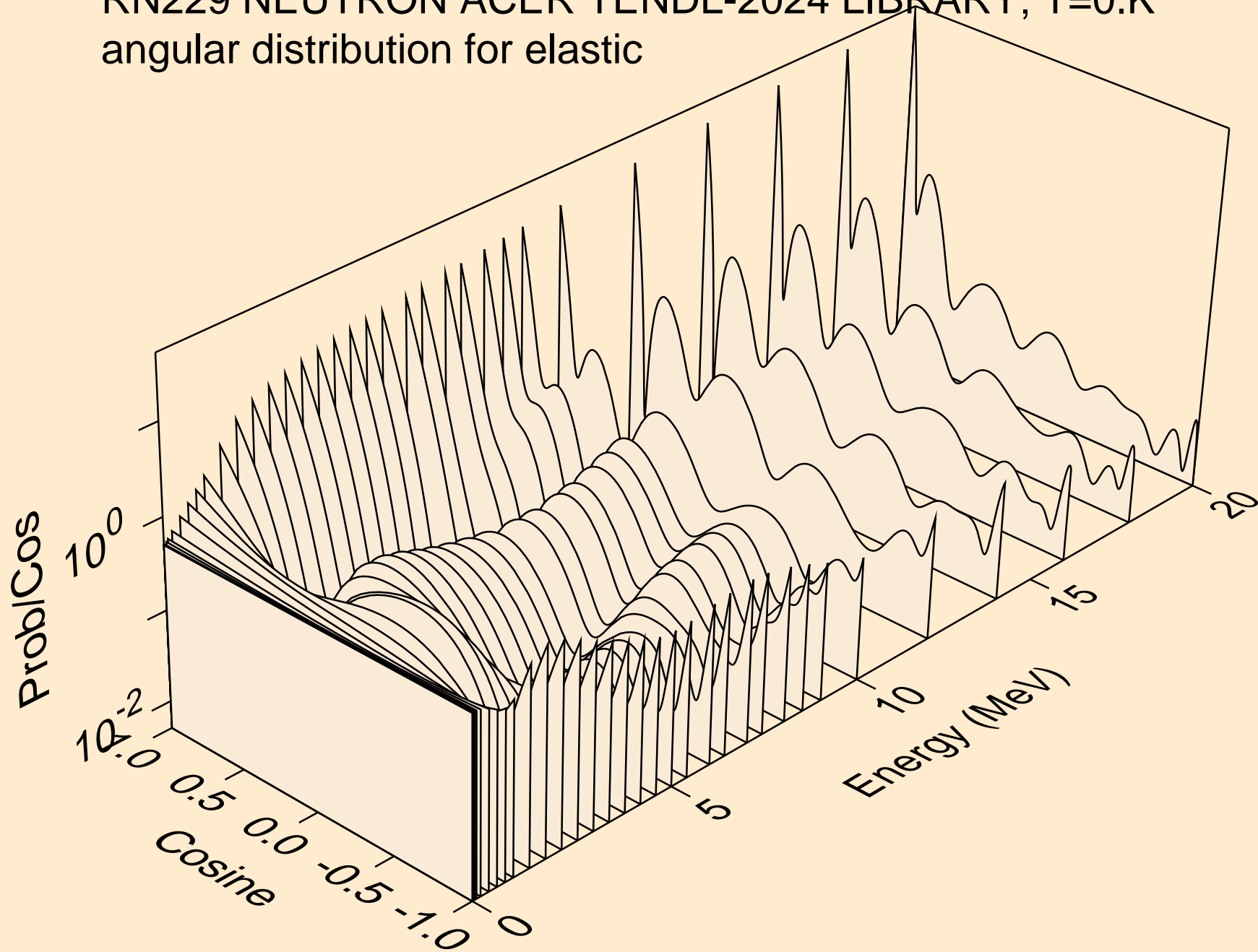

RN229 NEUTRON ACER TENDL-2024 LIBRARY; T=0.K
angular distribution for elastic

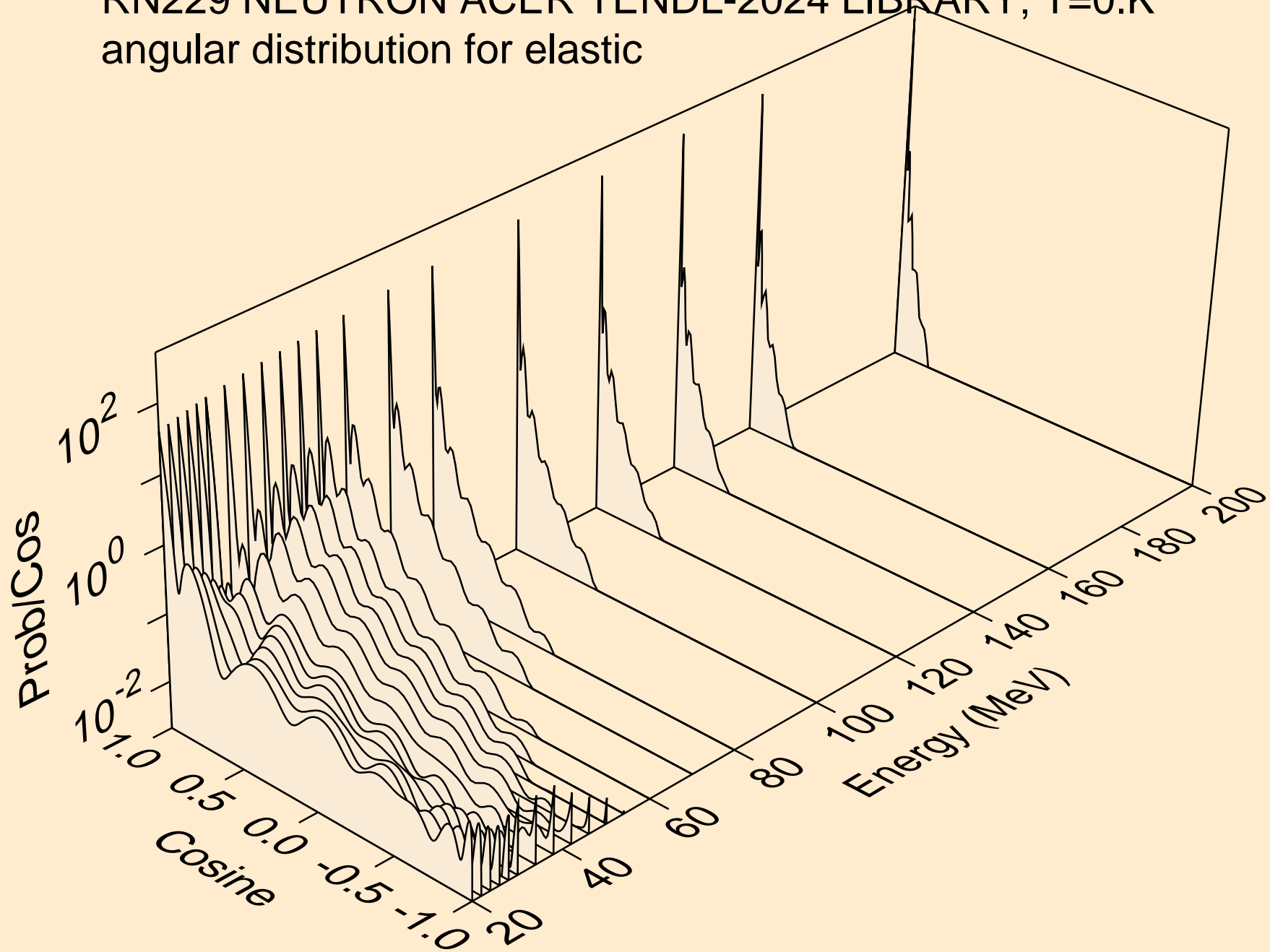

RN229 NEUTRON ACER TENDL-2024 LIBRARY; T=0.K
angular distribution for (n,n*1)

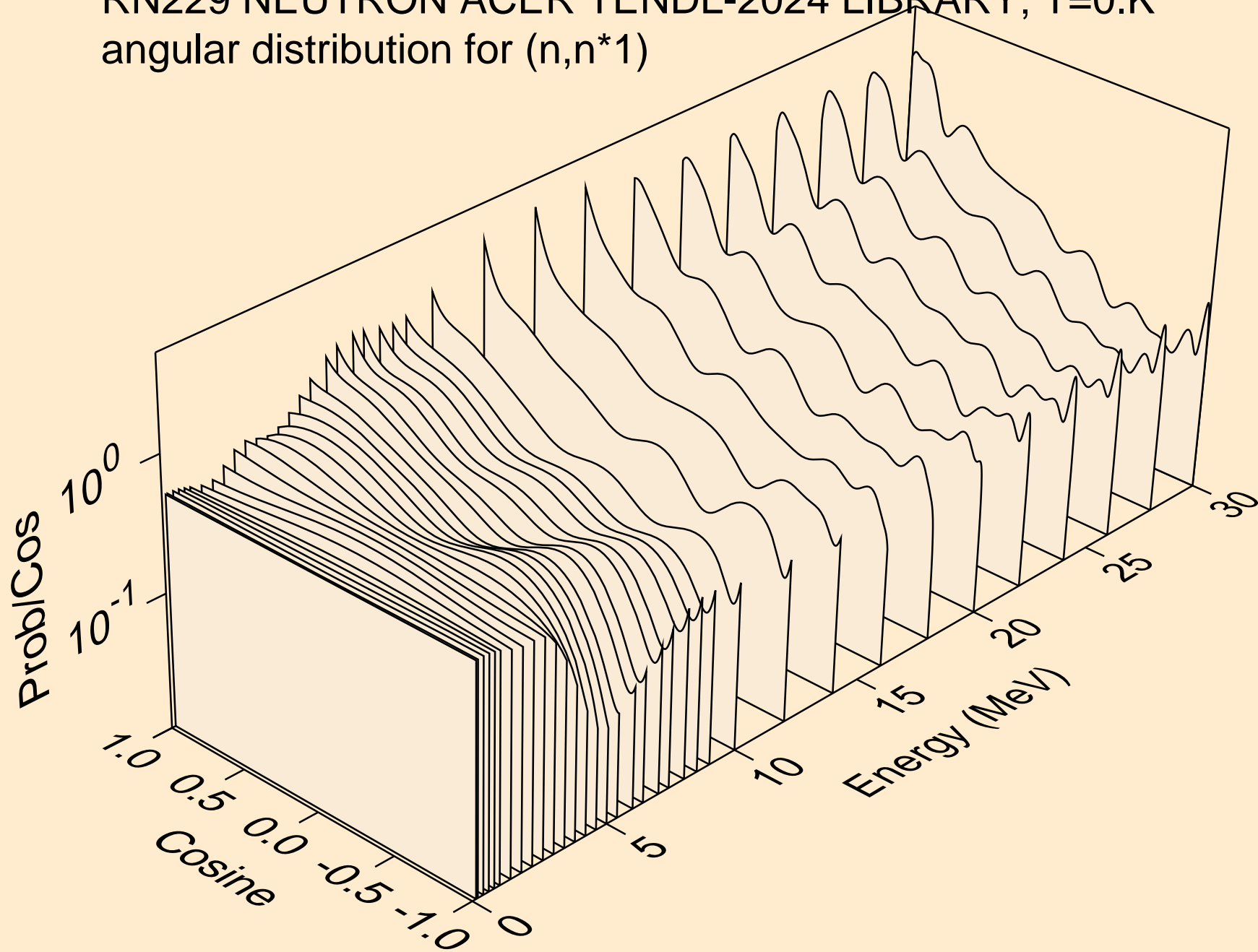

RN229 NEUTRON ACER TENDL-2024 LIBRARY; T=0.K
angular distribution for (n,n*2)

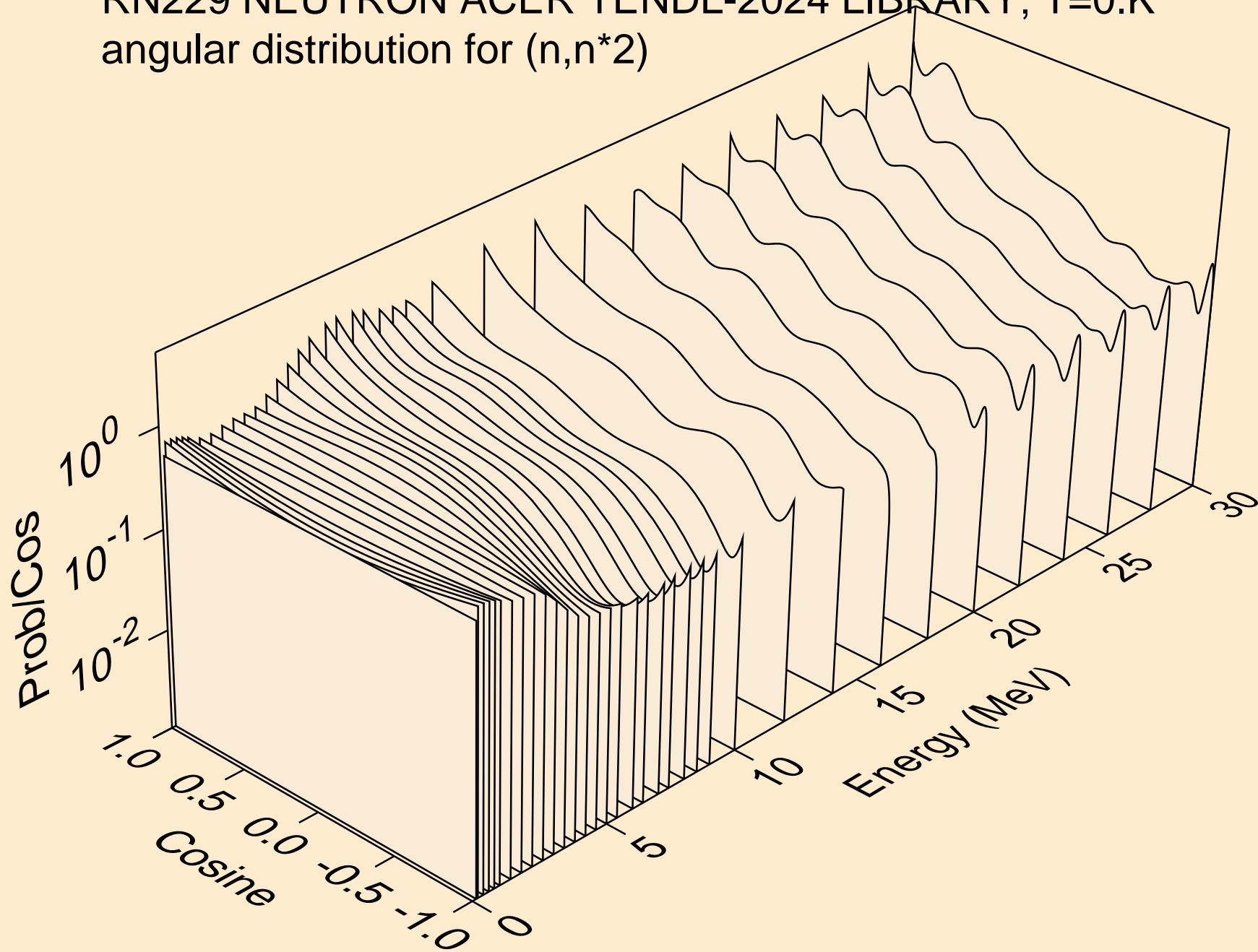

RN229 NEUTRON ACER TENDL-2024 LIBRARY; T=0.K
angular distribution for (n,n*3)

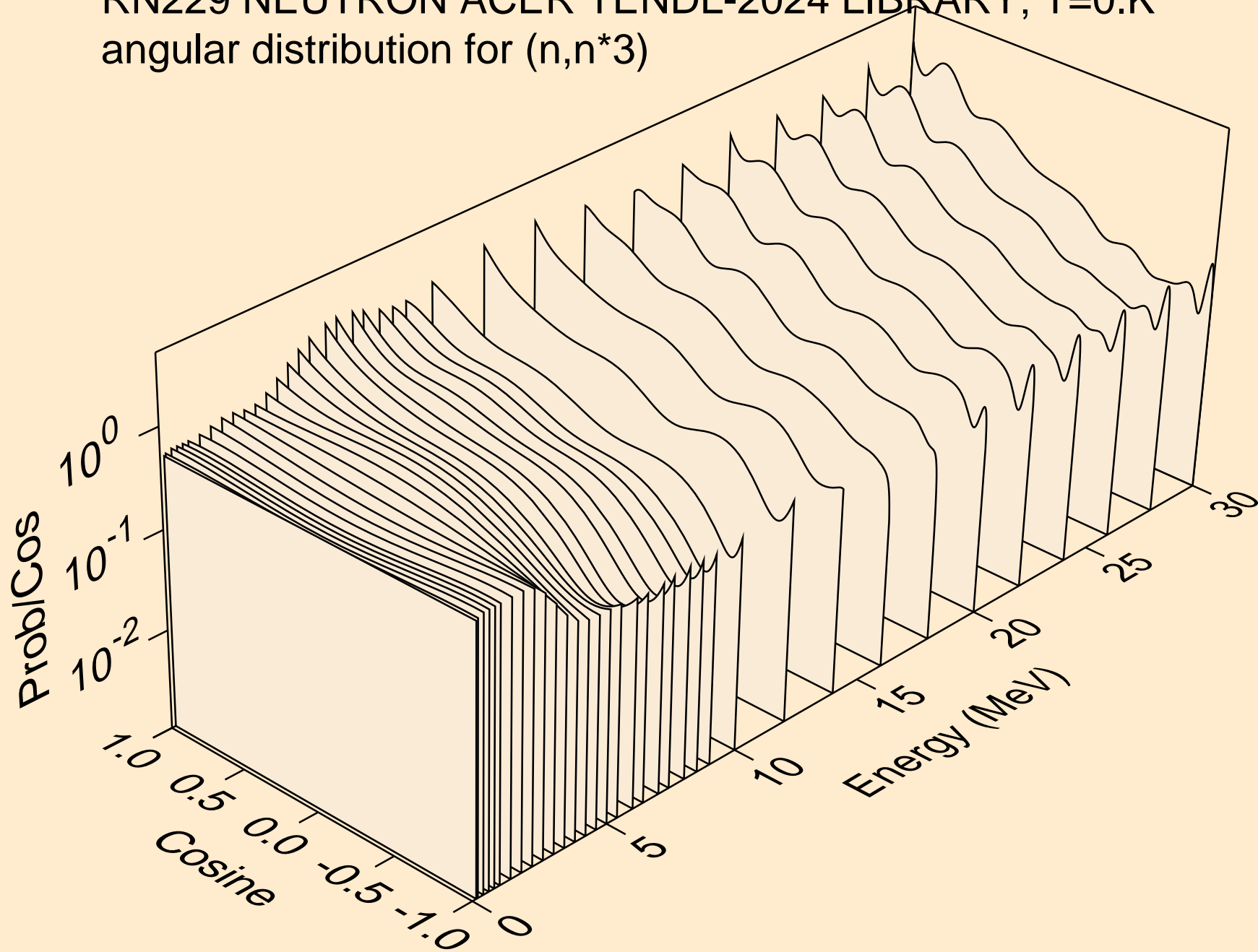

RN229 NEUTRON ACER TENDL-2024 LIBRARY; T=0.K
angular distribution for (n,n*4)

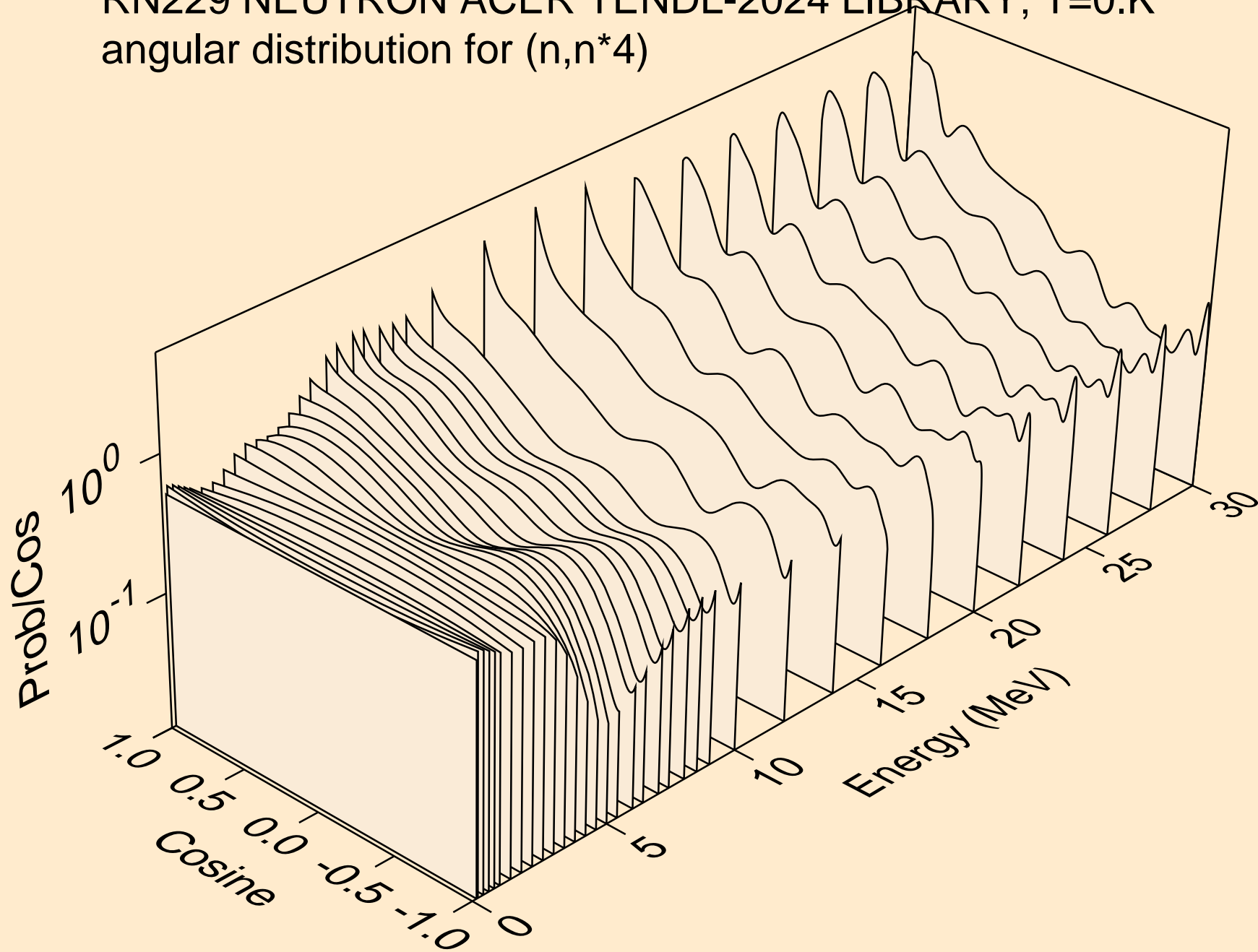

RN229 NEUTRON ACER TENDL-2024 LIBRARY; T=0.K
angular distribution for (n,n*5)

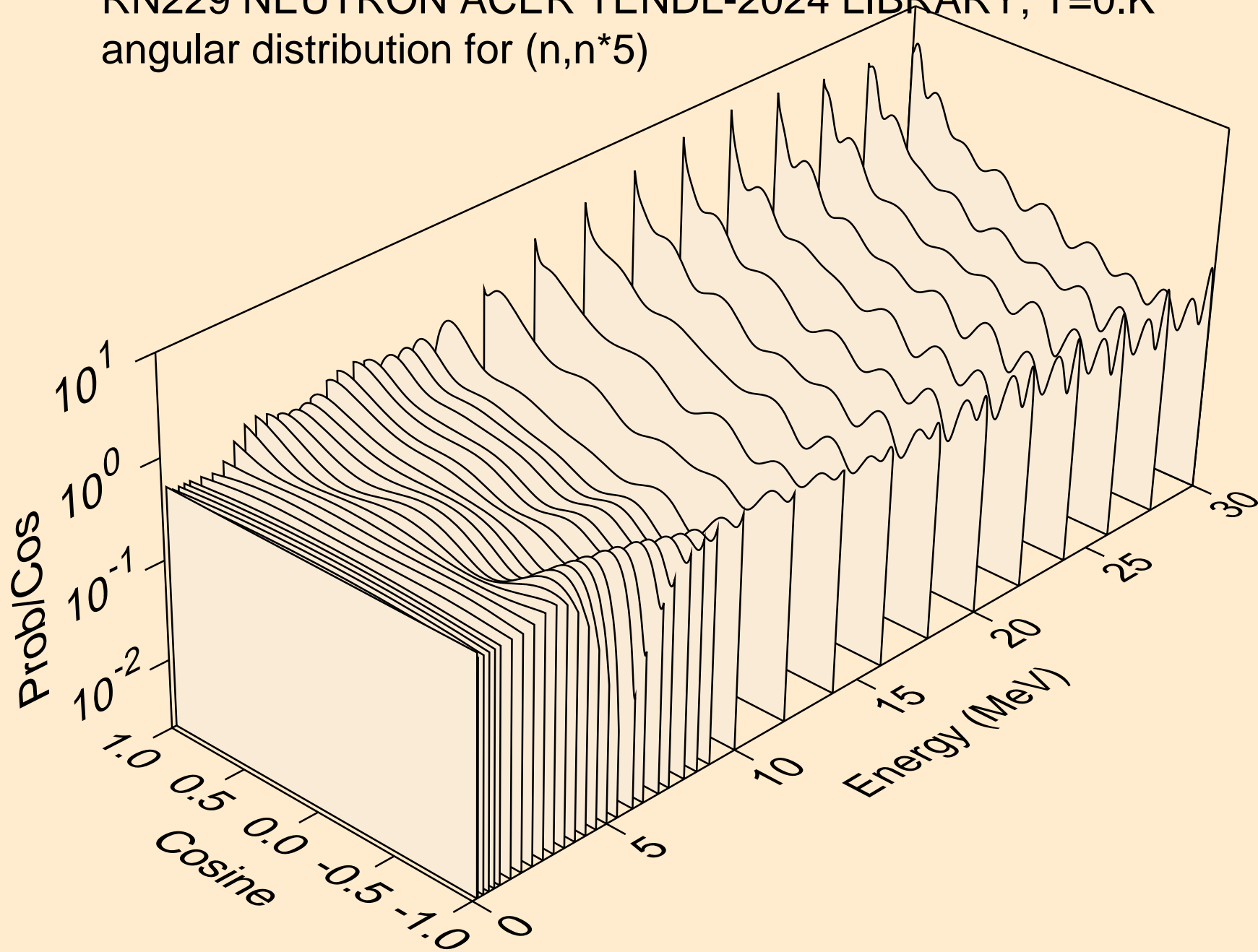

RN229 NEUTRON ACER TENDL-2024 LIBRARY; T=0.K
angular distribution for (n,n*6)

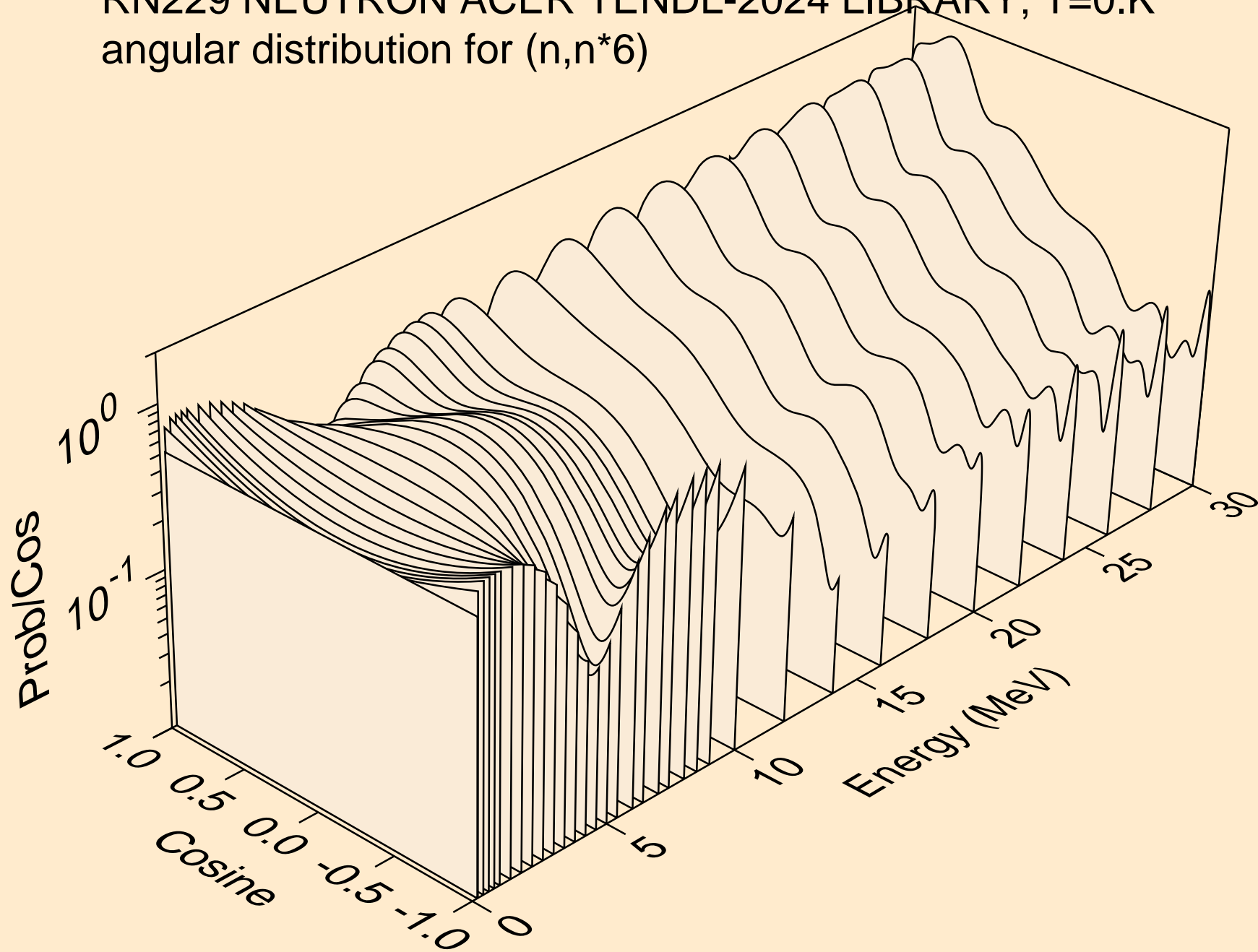

RN229 NEUTRON ACER TENDL-2024 LIBRARY; T=0.K
angular distribution for (n,n*7)

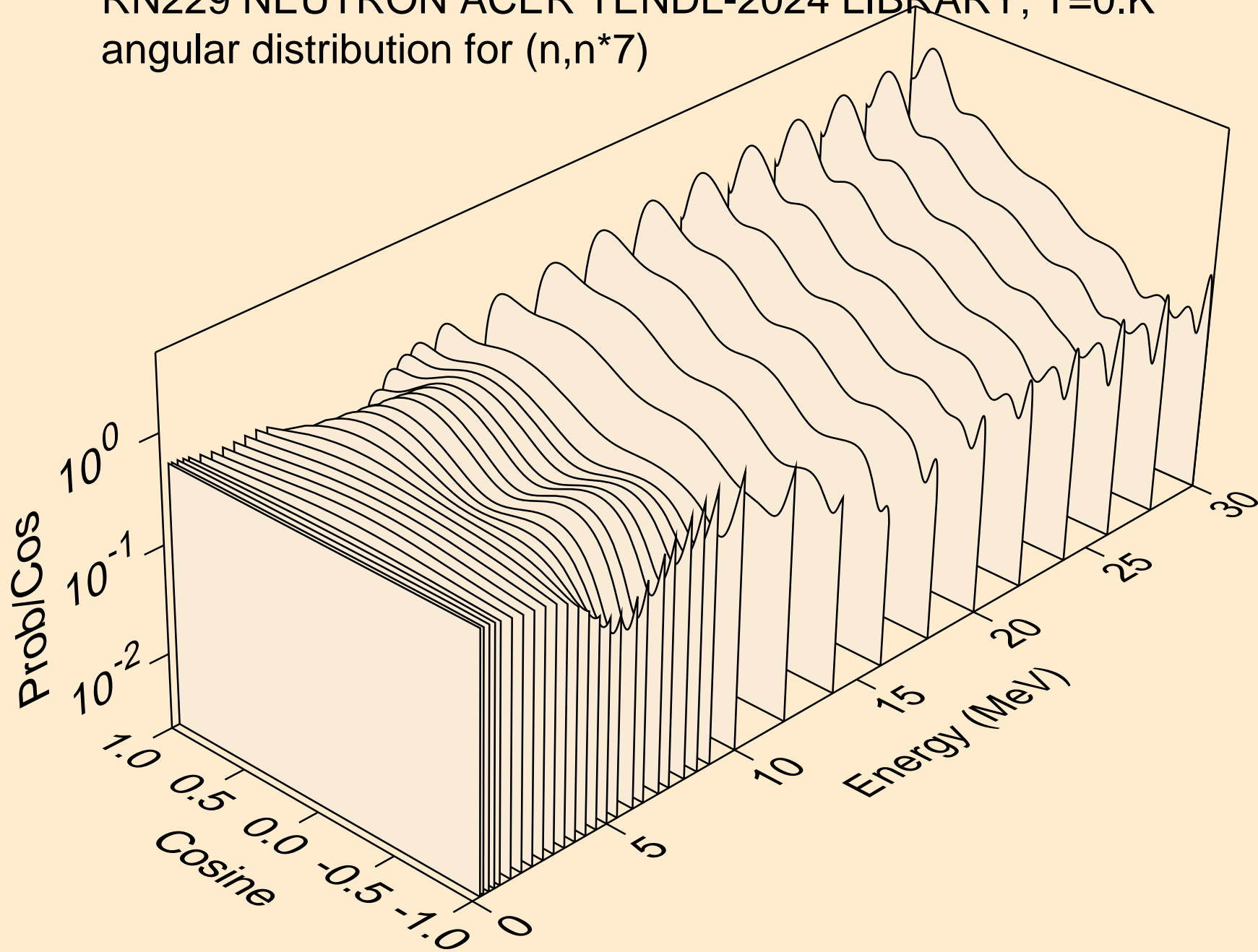

RN229 NEUTRON ACER TENDL-2024 LIBRARY; T=0.K
angular distribution for (n,n*8)

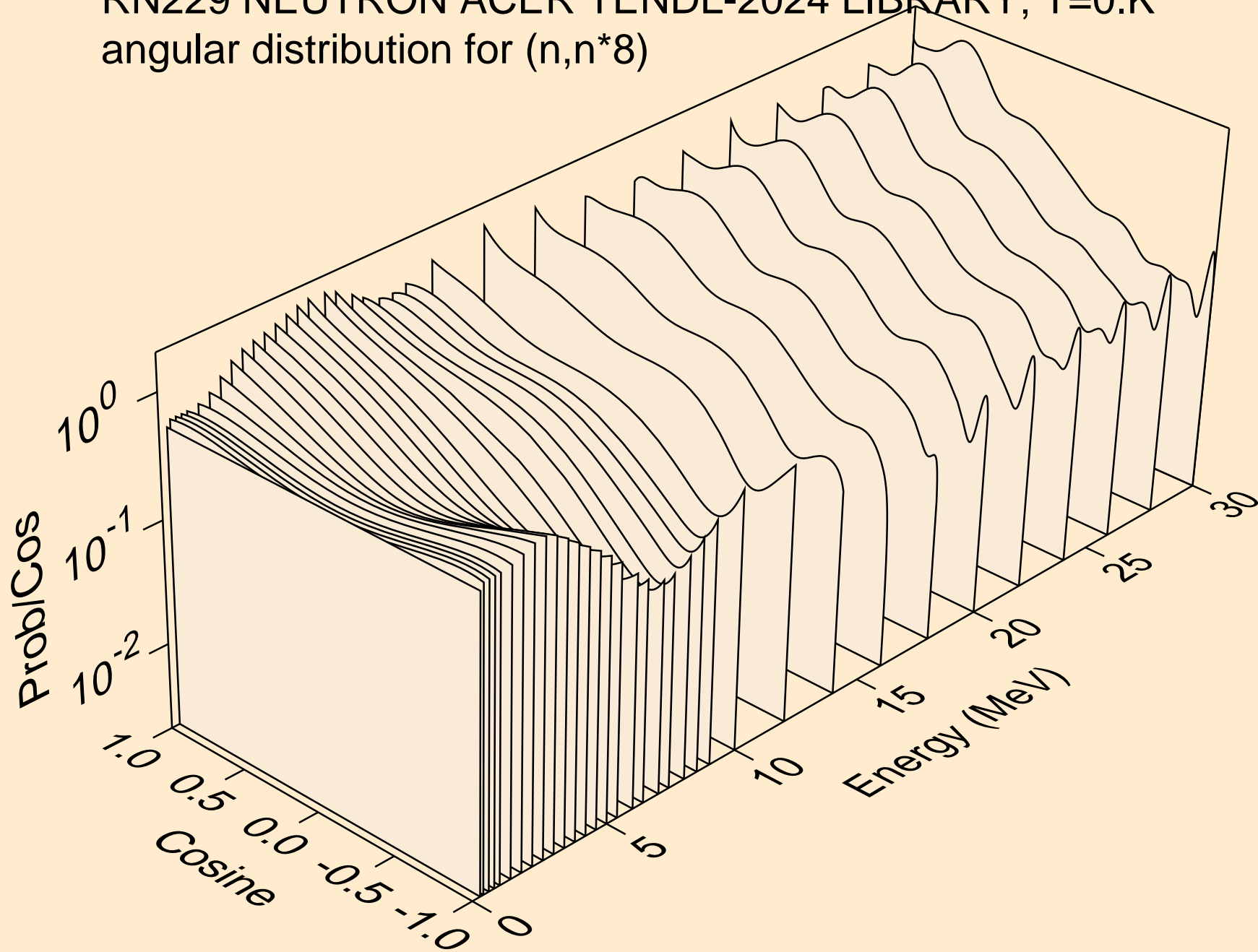

RN229 NEUTRON ACER TENDL-2024 LIBRARY; T=0.K
angular distribution for (n,n*9)

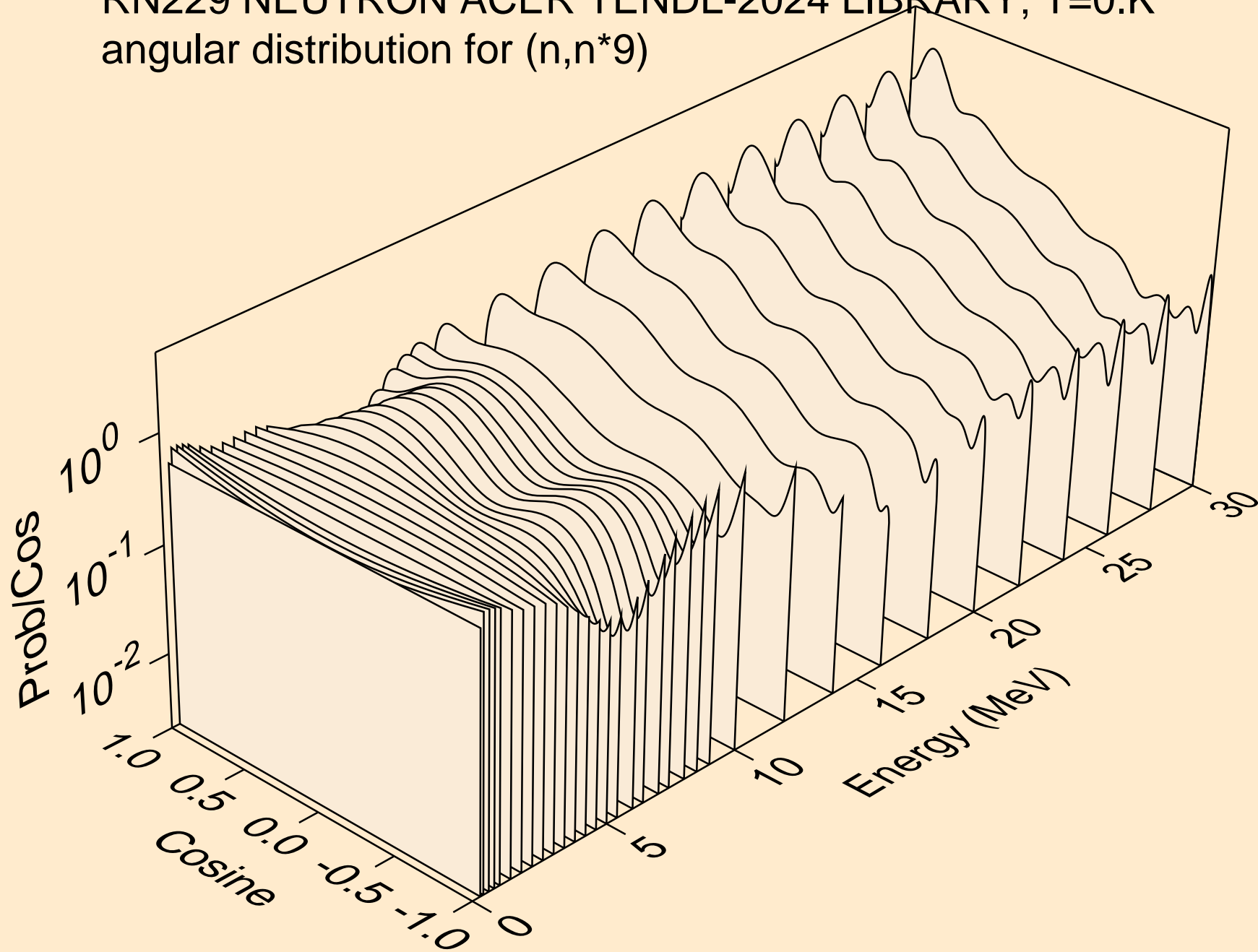

RN229 NEUTRON ACER TENDL-2024 LIBRARY; T=0.K
angular distribution for (n,n*10)

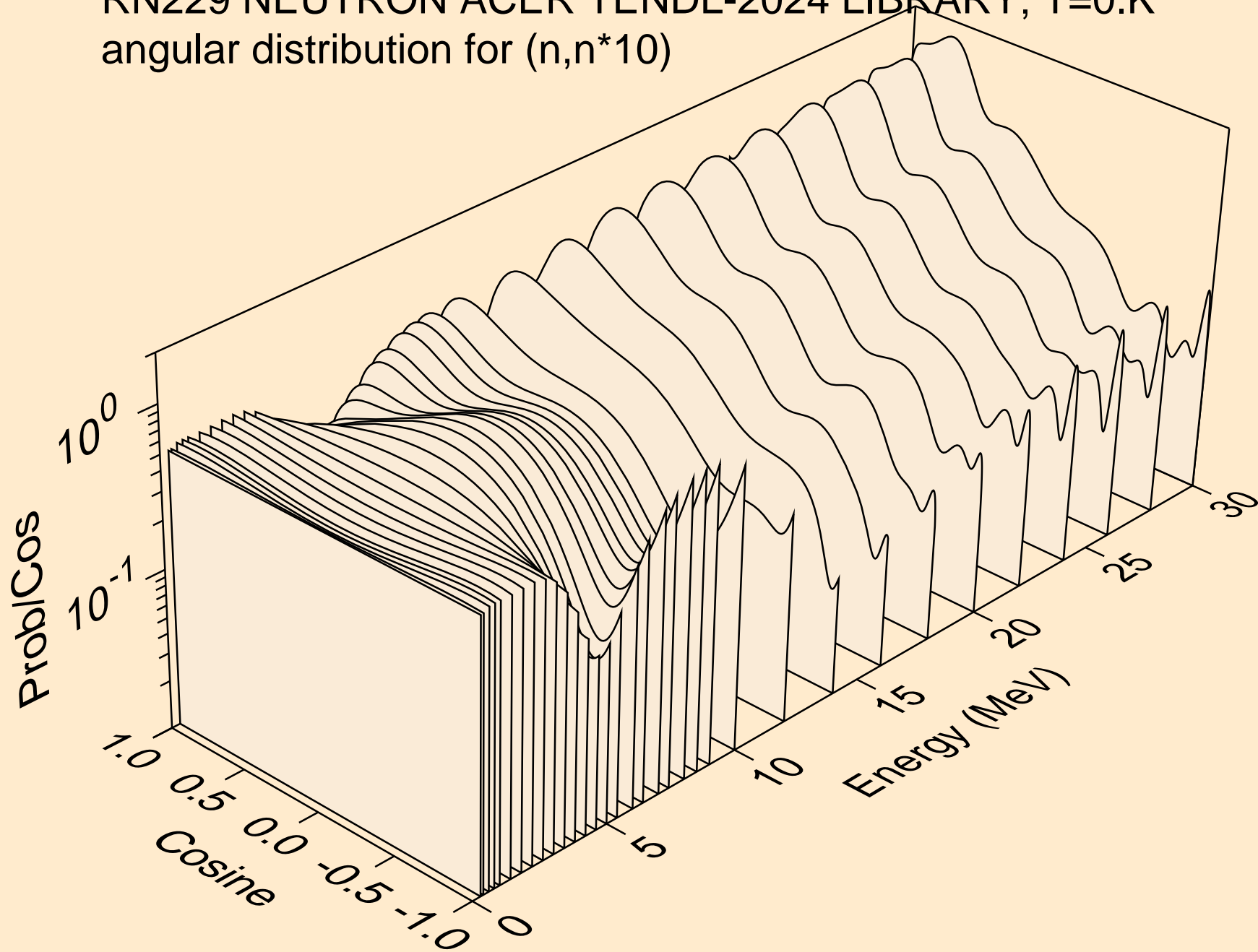

RN229 NEUTRON ACER TENDL-2024 LIBRARY; T=0.K
angular distribution for (n,n*11)

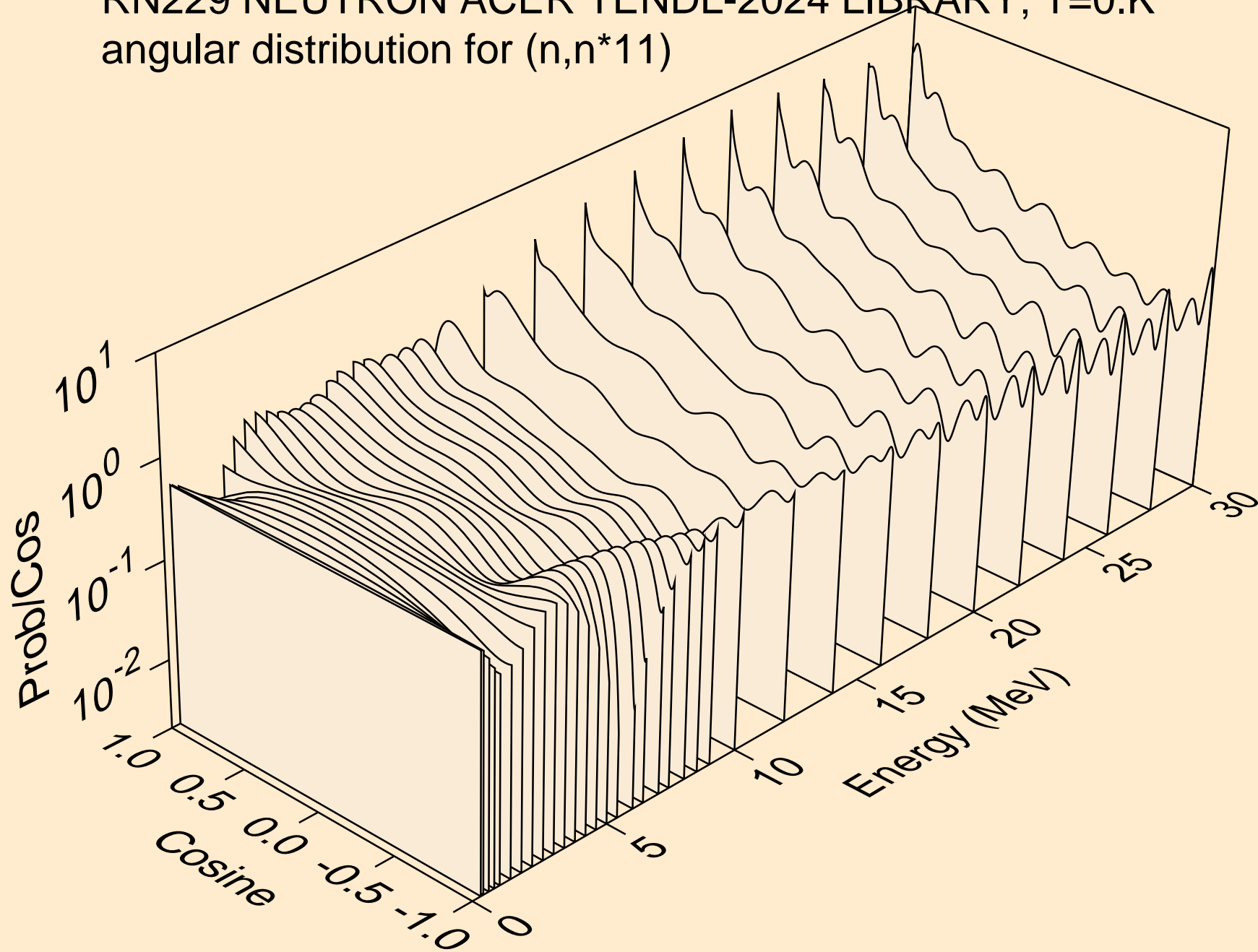

RN229 NEUTRON ACER TENDL-2024 LIBRARY; T=0.K
angular distribution for (n,n*12)

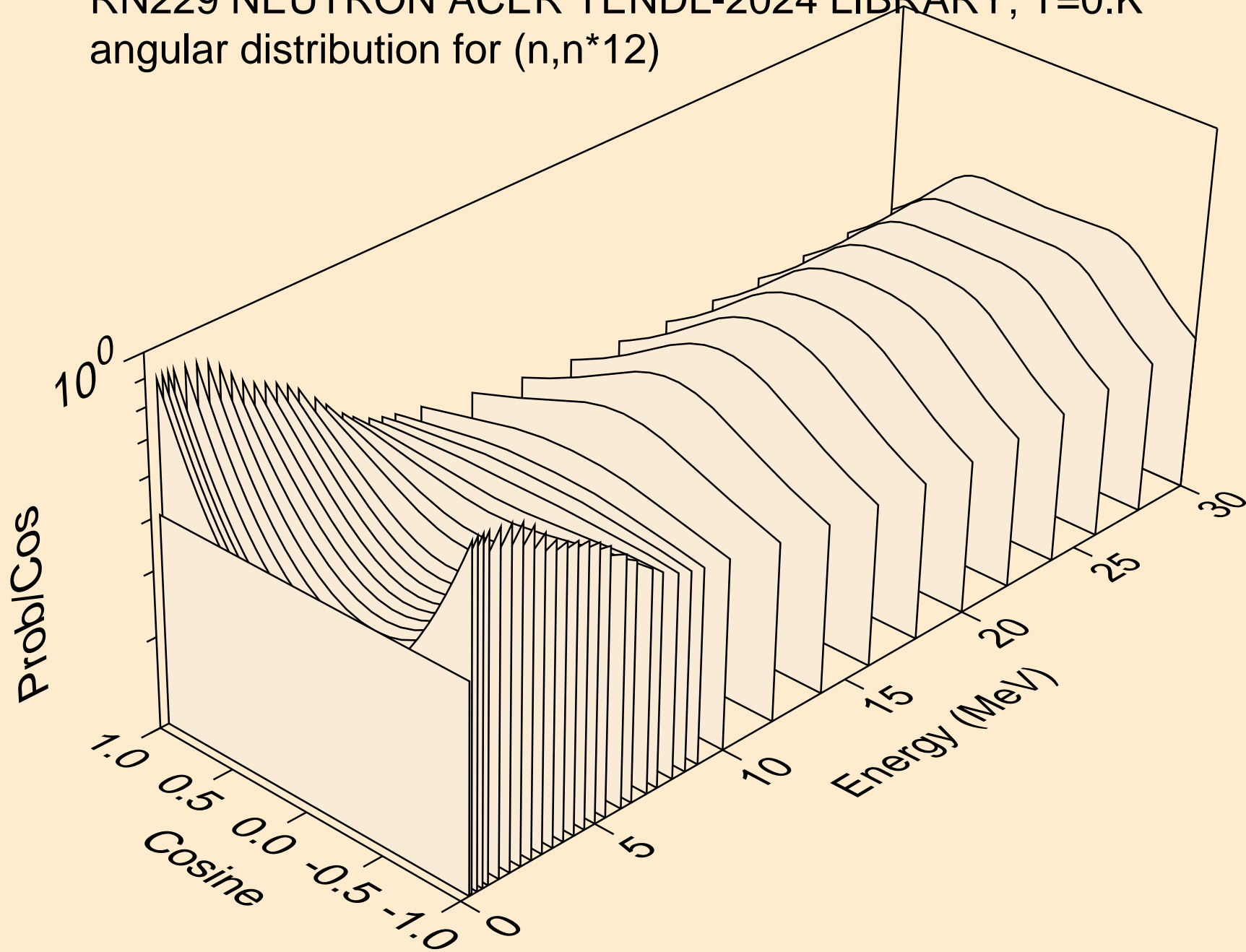

RN229 NEUTRON ACER TENDL-2024 LIBRARY; T=0.K
angular distribution for (n,n*13)

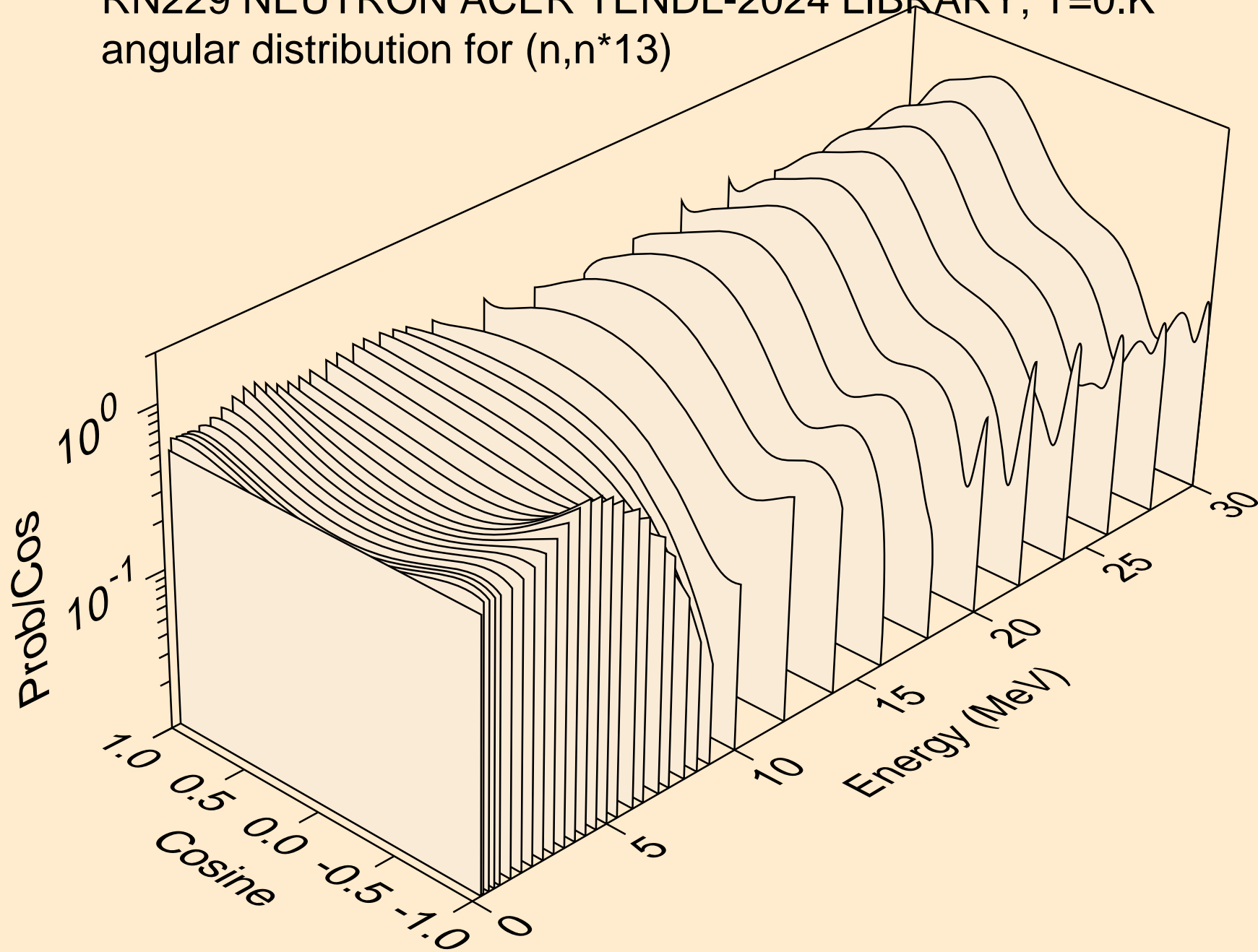

RN229 NEUTRON ACER TENDL-2024 LIBRARY; T=0.K
angular distribution for (n,n*14)

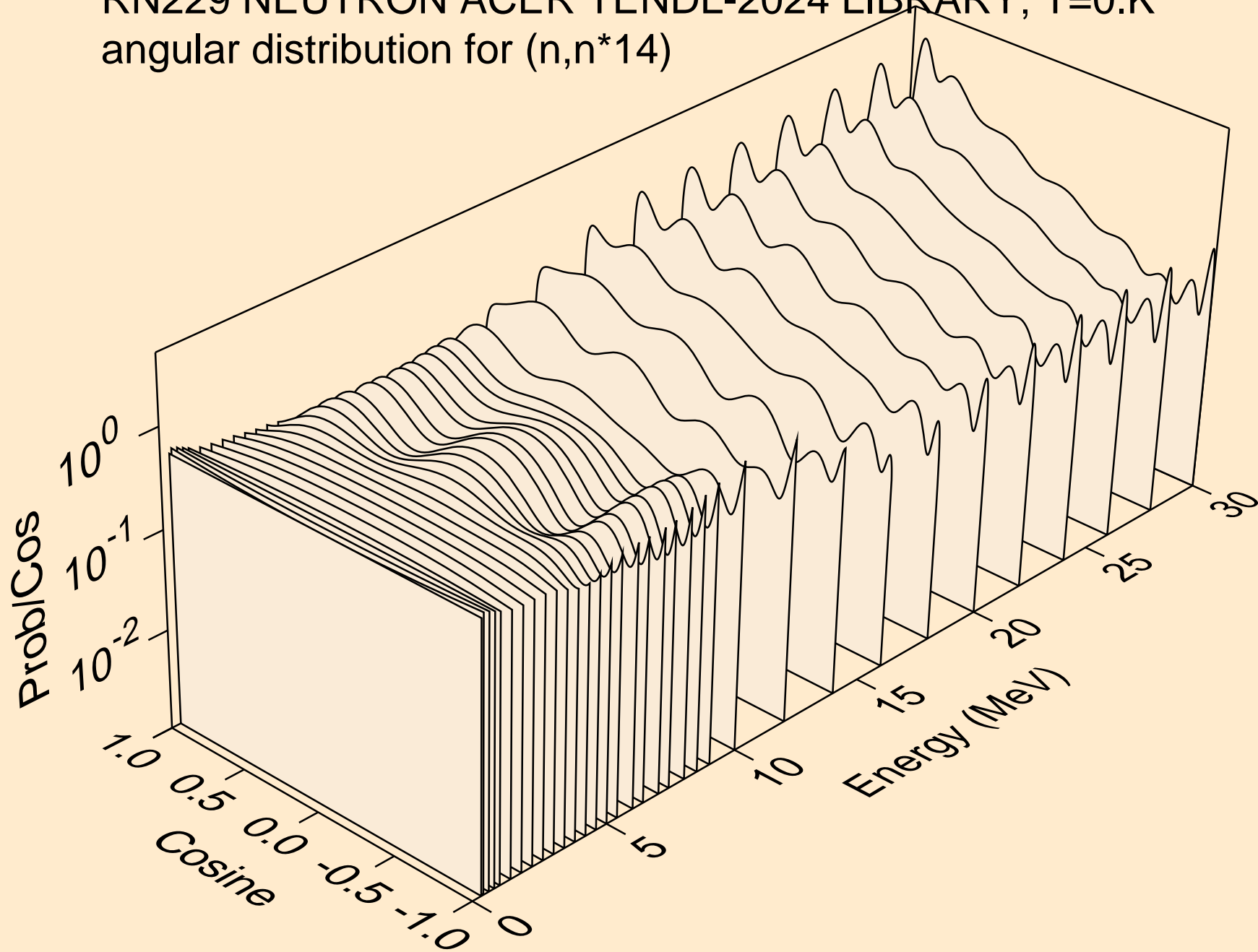

RN229 NEUTRON ACER TENDL-2024 LIBRARY; T=0.K
angular distribution for (n,n*15)

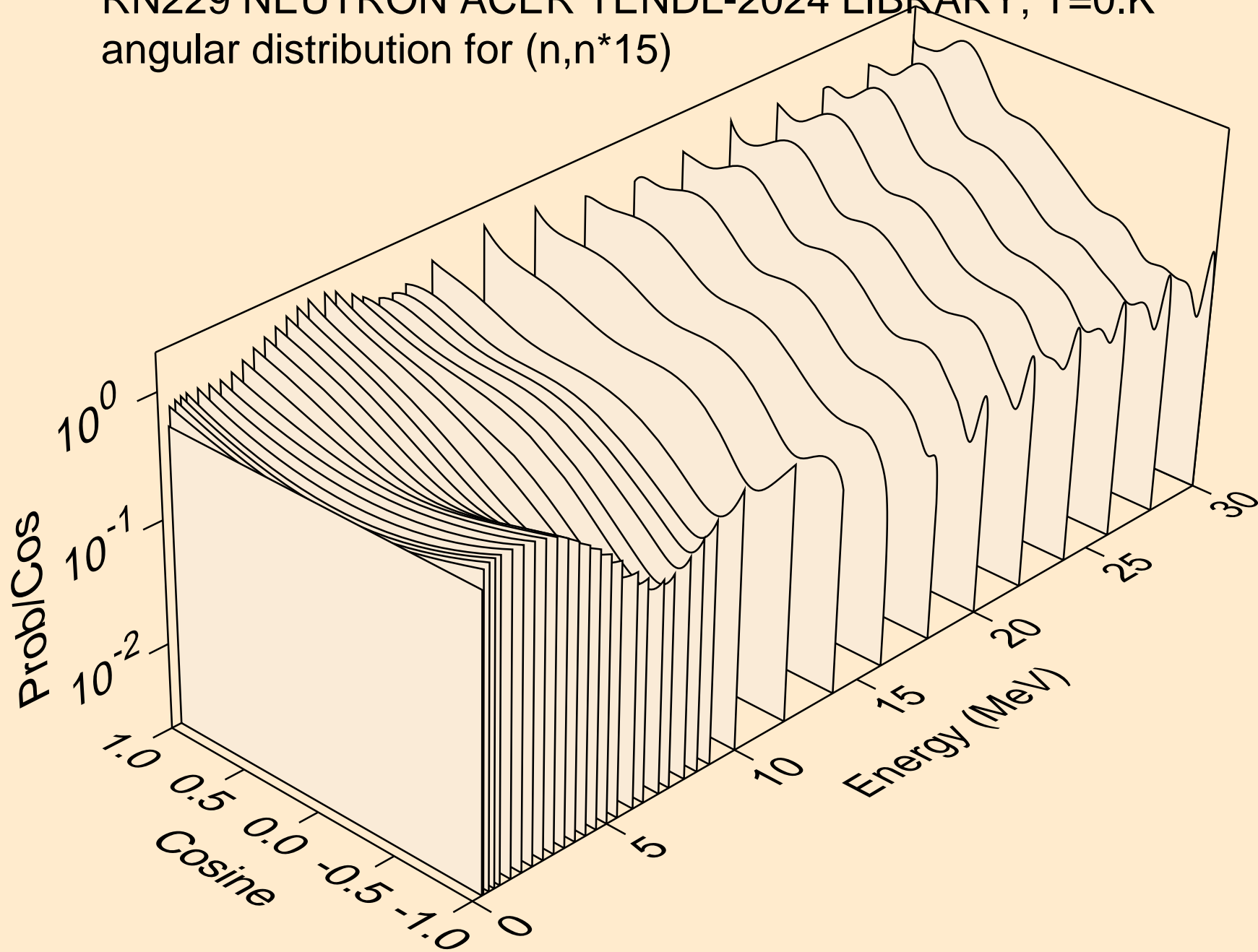

RN229 NEUTRON ACER TENDL-2024 LIBRARY; T=0.K
angular distribution for (n,n*16)

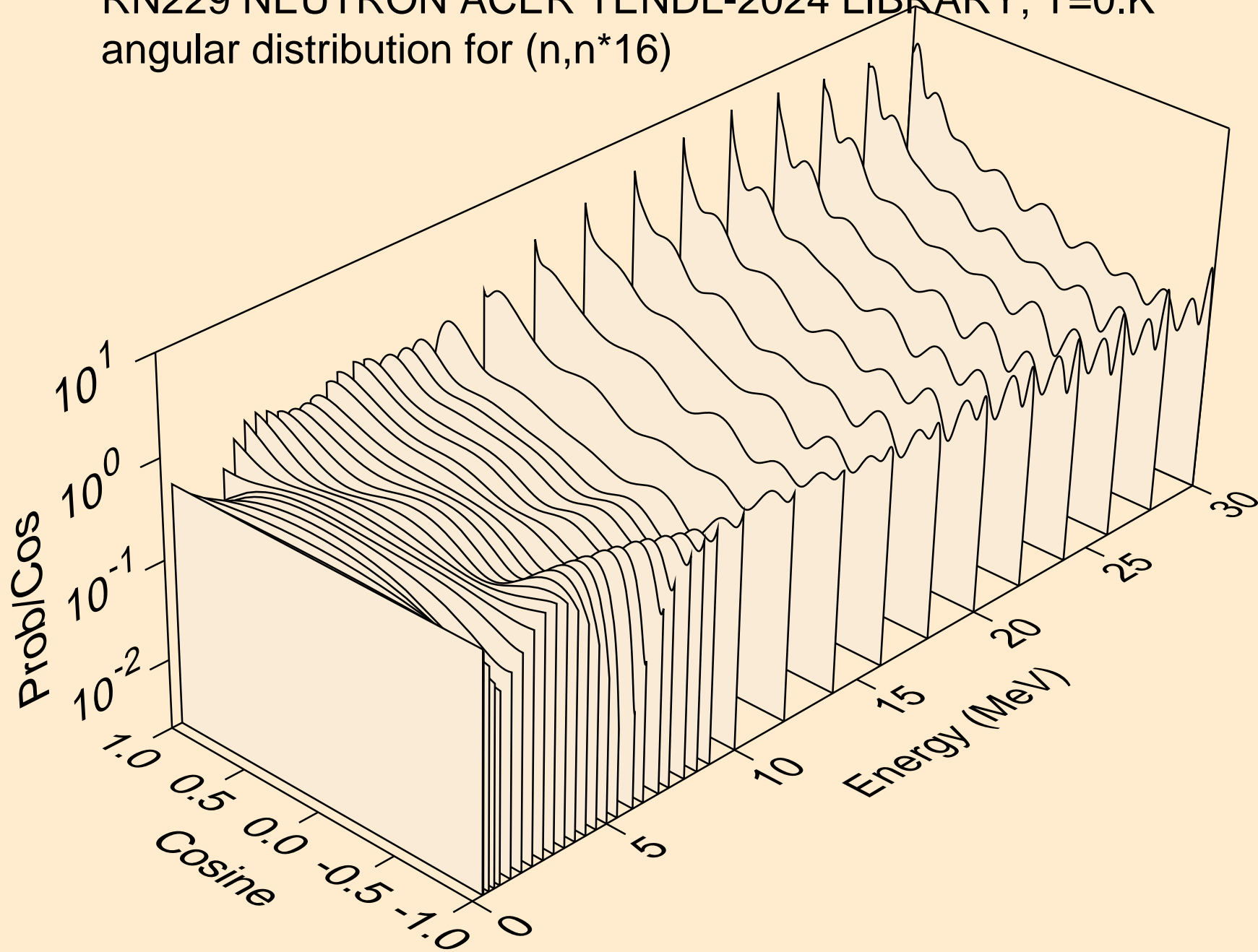

RN229 NEUTRON ACER TENDL-2024 LIBRARY; T=0.K
angular distribution for (n,n*17)

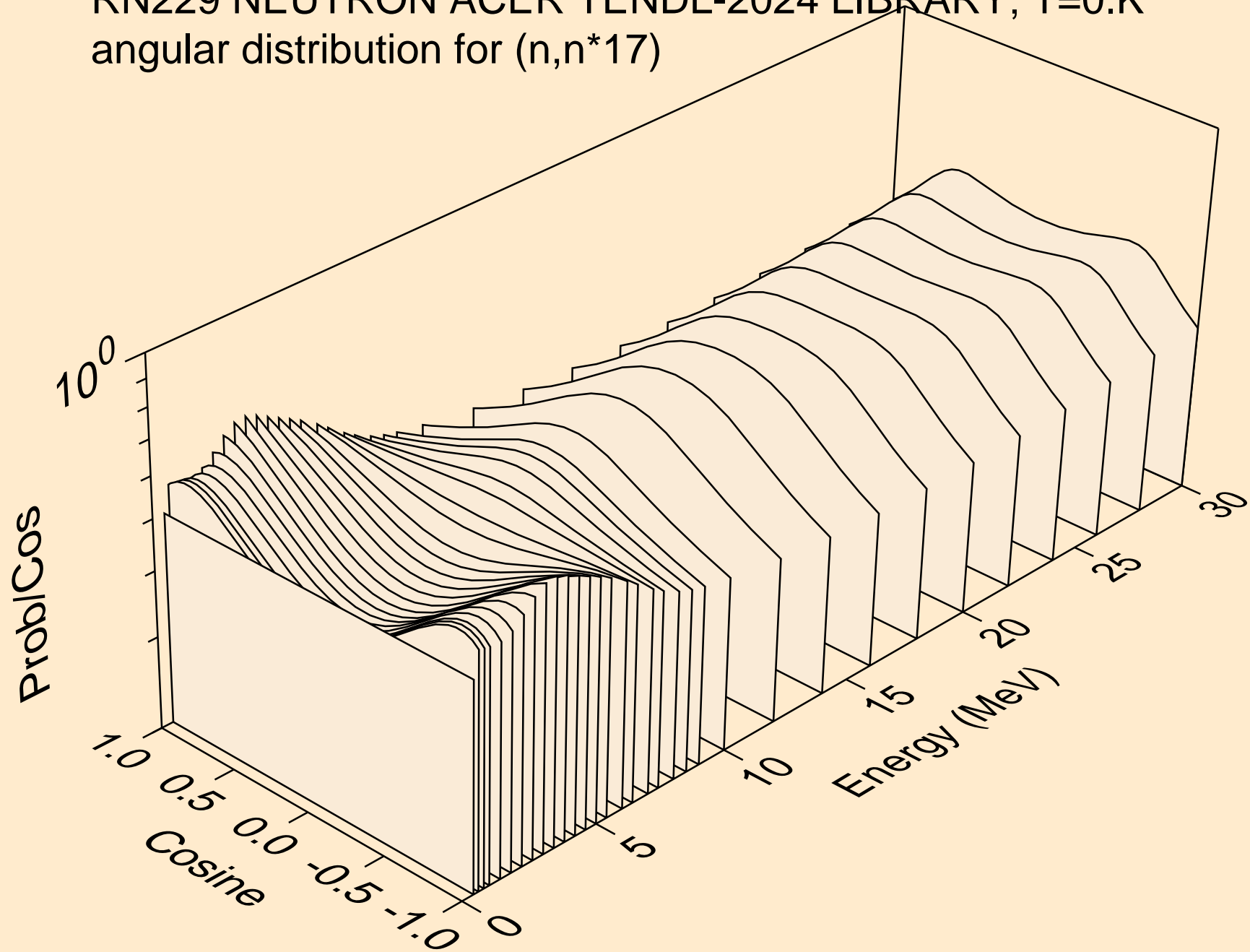

RN229 NEUTRON ACER TENDL-2024 LIBRARY; T=0.K
angular distribution for (n,n*18)

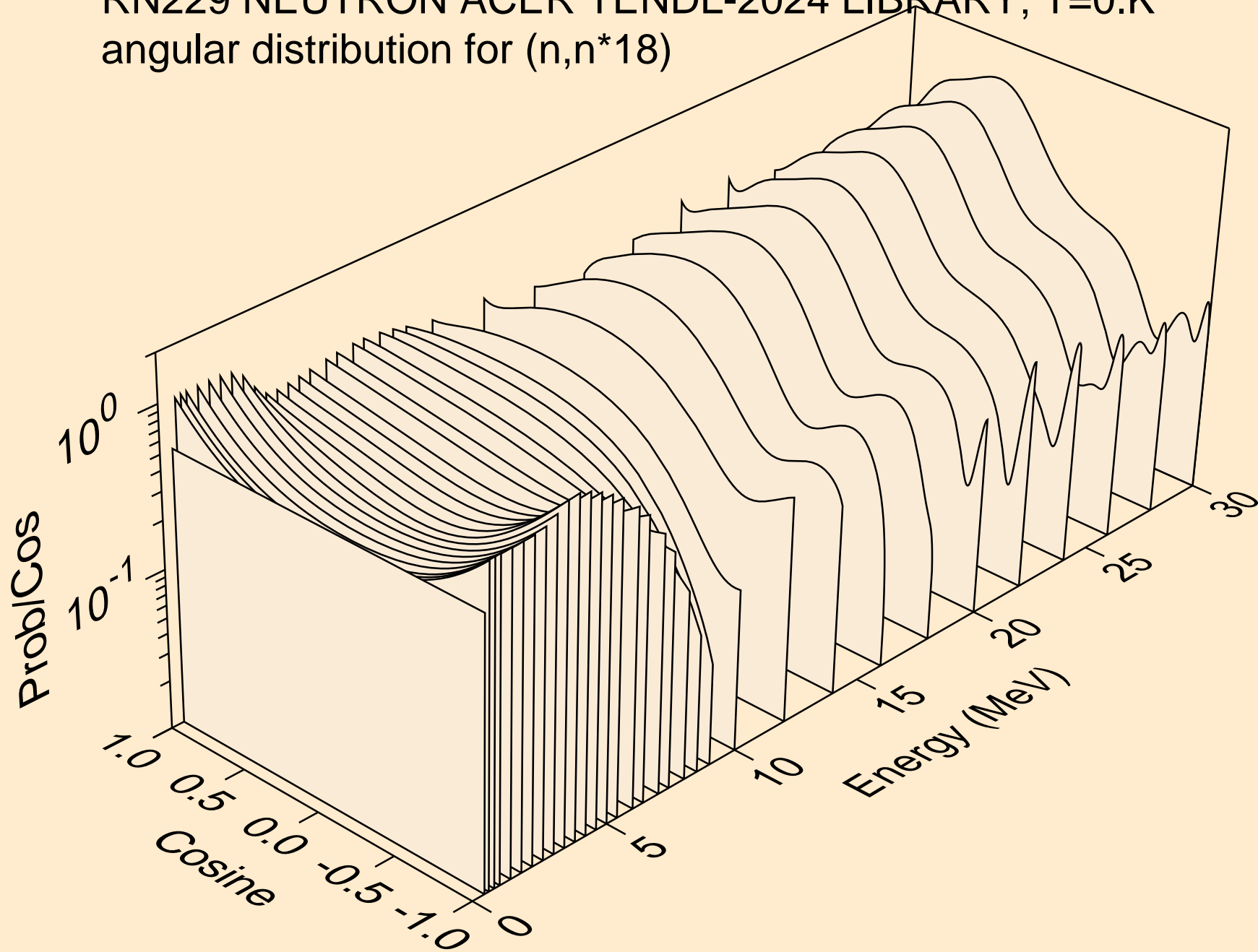

RN229 NEUTRON ACER TENDL-2024 LIBRARY; T=0.K
angular distribution for (n,n*19)

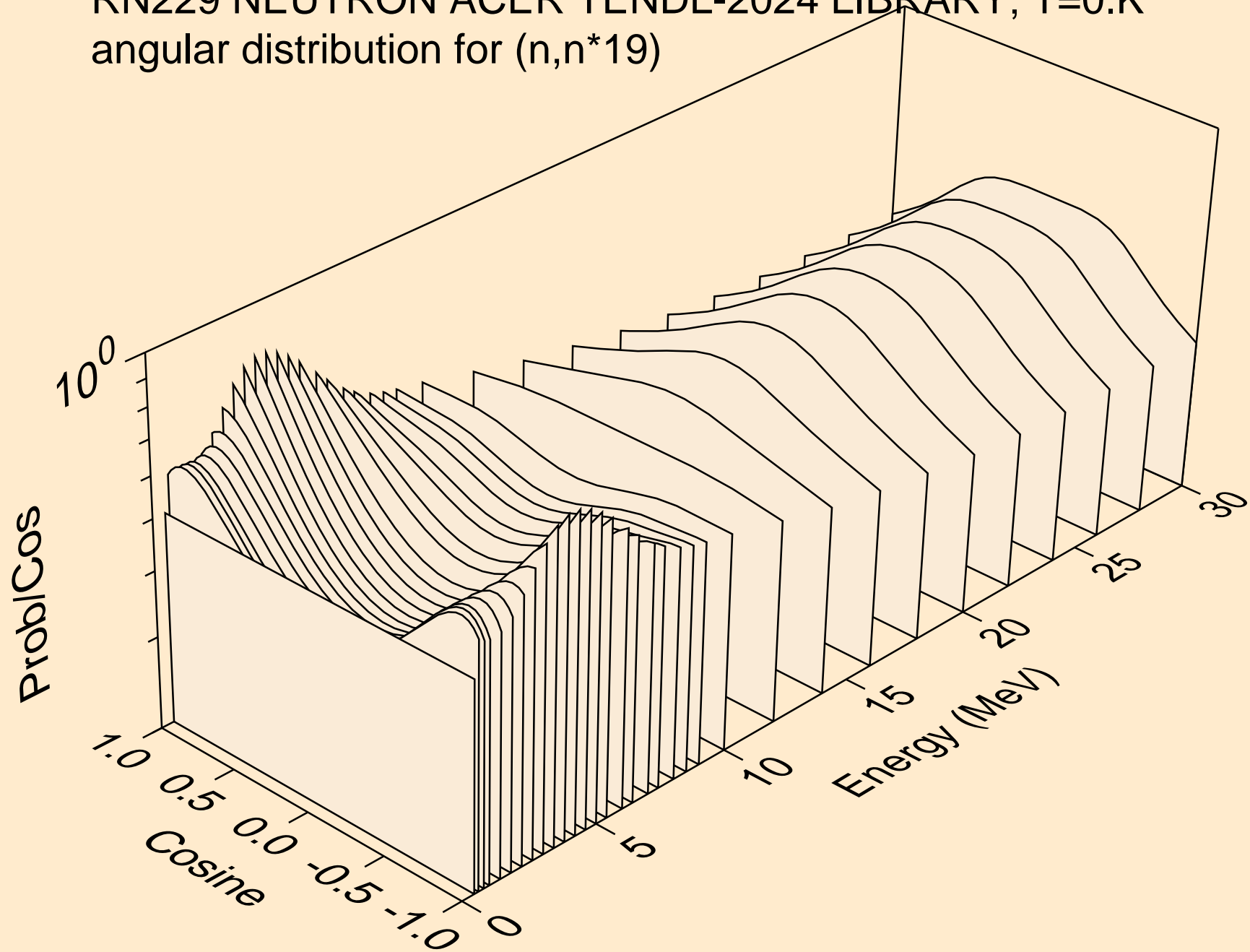

RN229 NEUTRON ACER TENDL-2024 LIBRARY; T=0.K
angular distribution for (n,n*20)

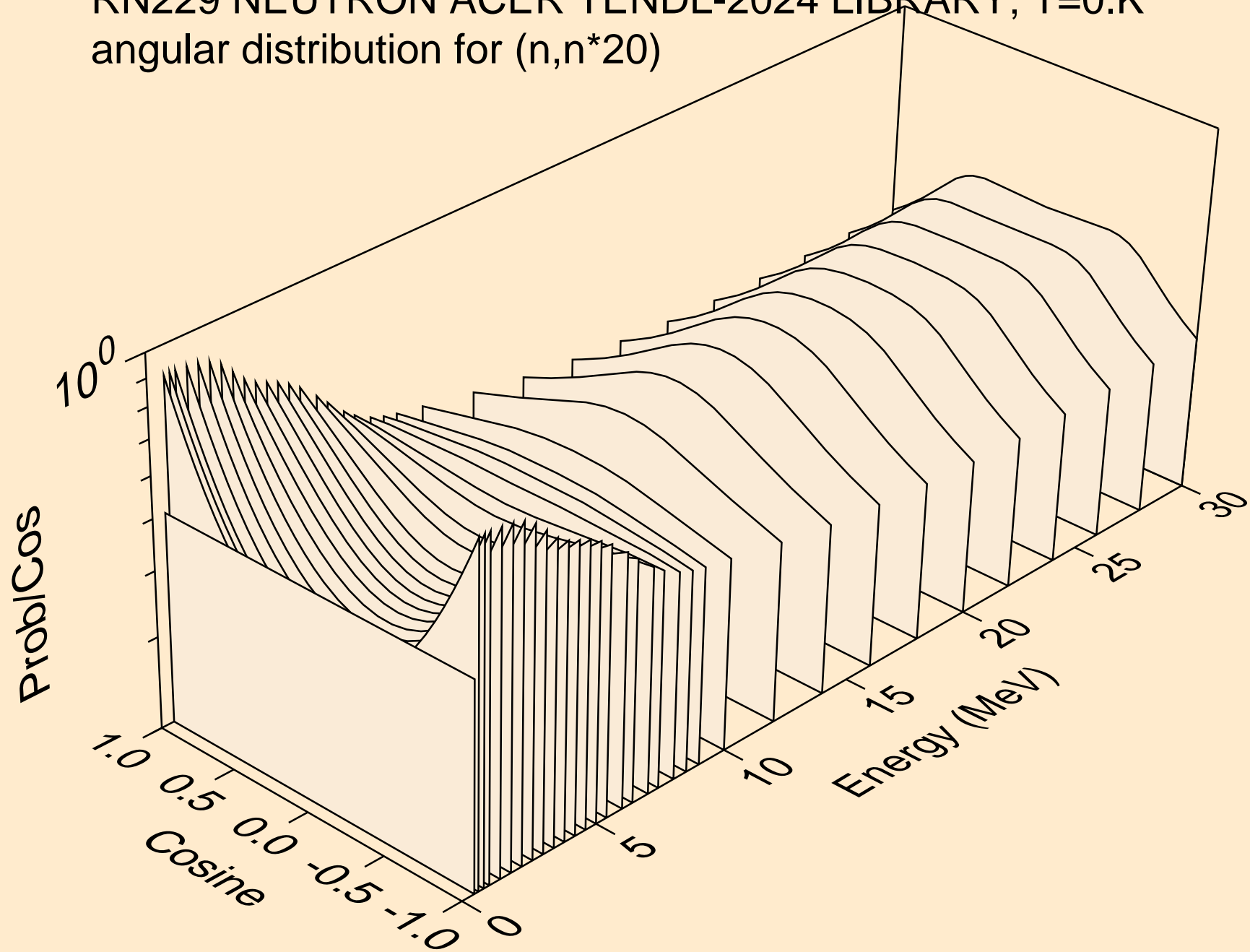

RN229 NEUTRON ACER TENDL-2024 LIBRARY; T=0.K
angular distribution for (n,n*21)

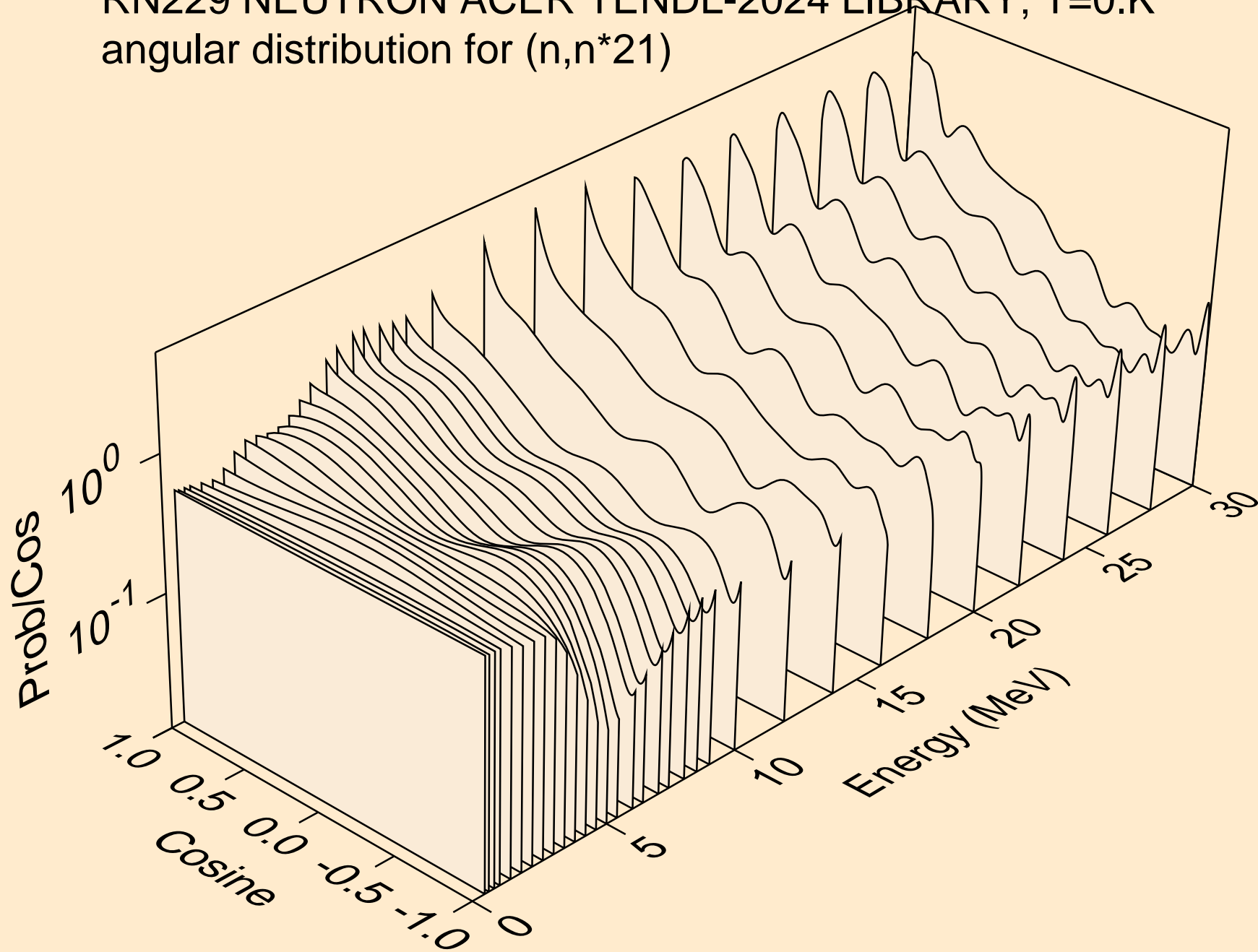

RN229 NEUTRON ACER TENDL-2024 LIBRARY; T=0.K
angular distribution for (n,n*22)

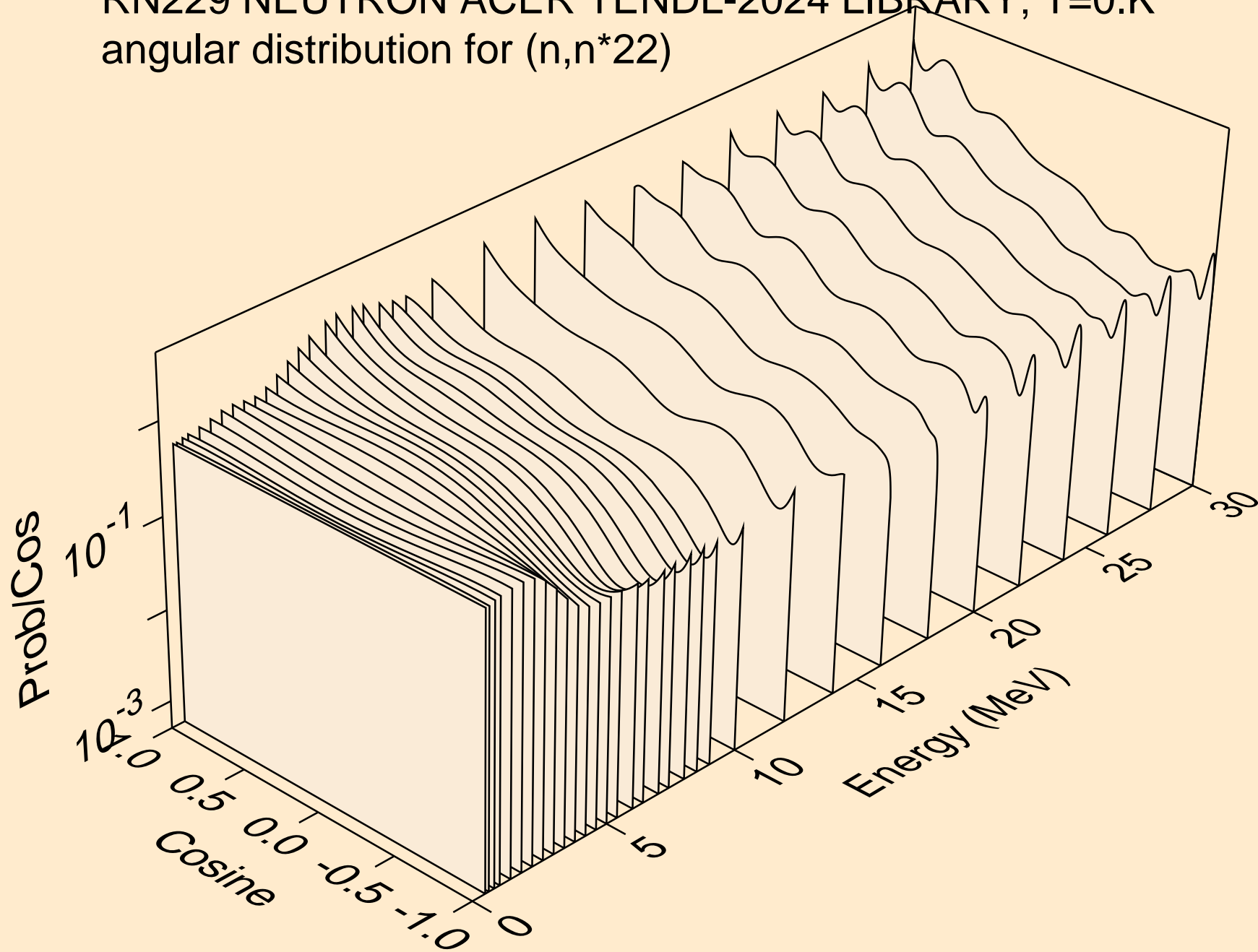

RN229 NEUTRON ACER TENDL-2024 LIBRARY; T=0.K
angular distribution for (n,n*23)

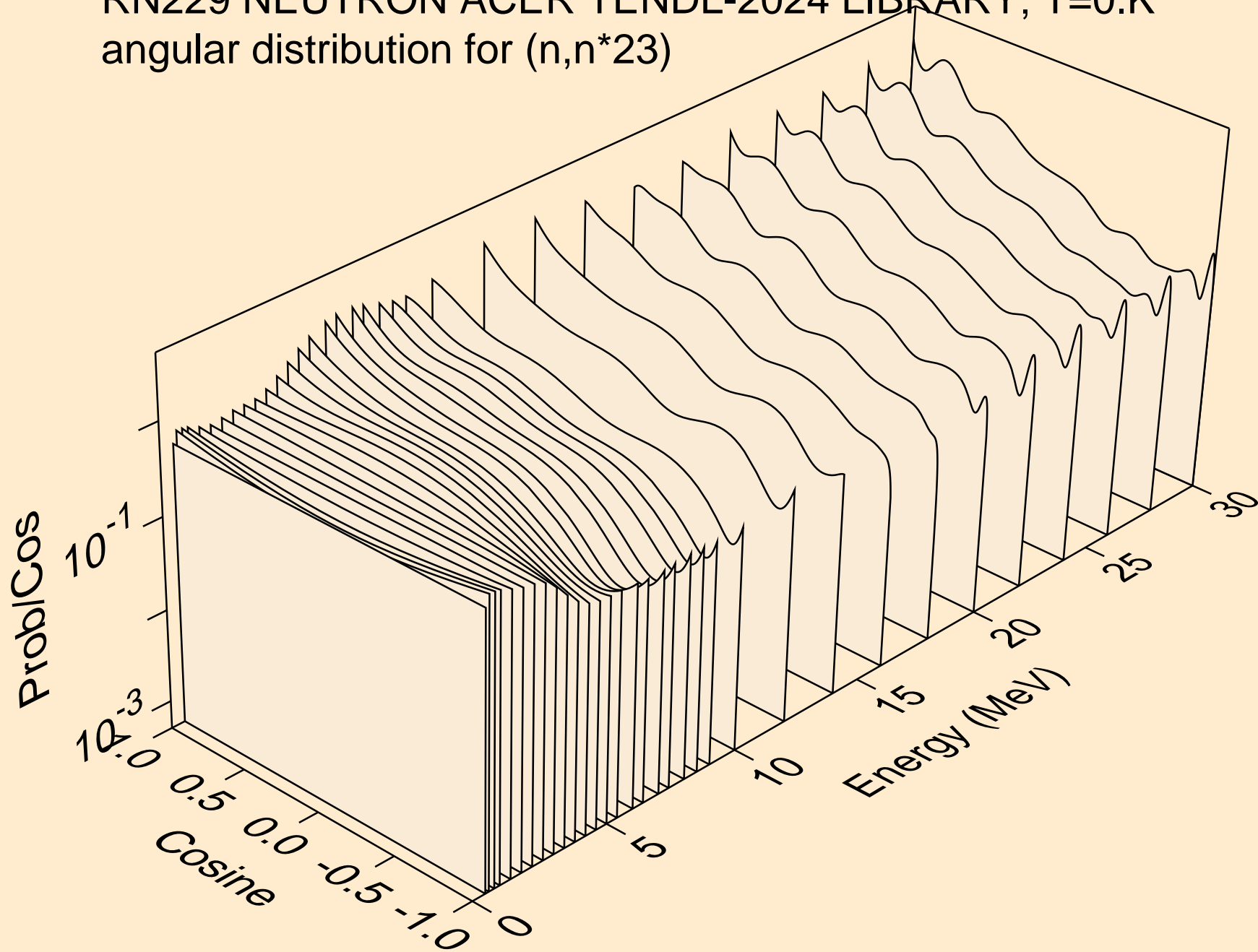

RN229 NEUTRON ACER TENDL-2024 LIBRARY; T=0.K
angular distribution for (n,n*24)

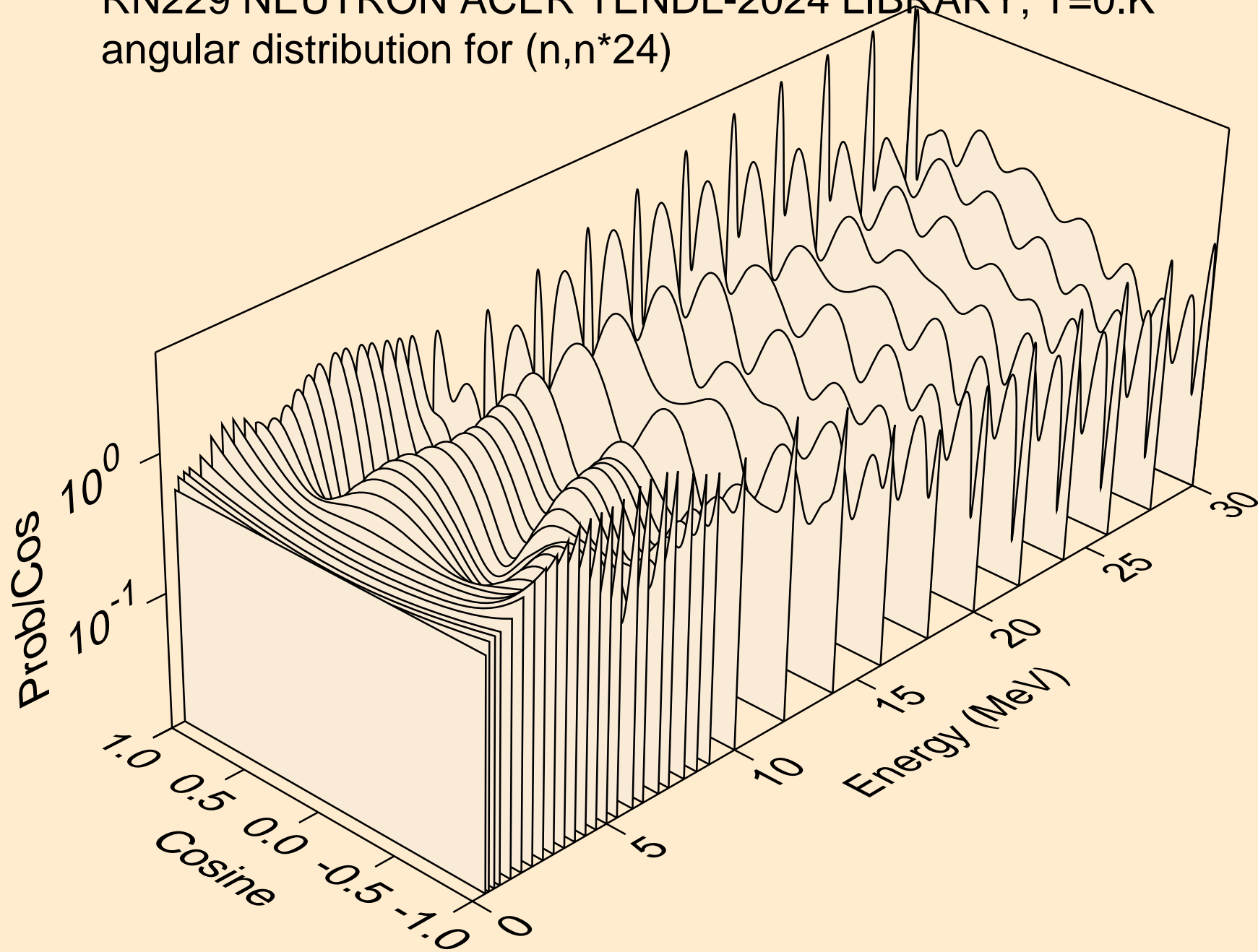

RN229 NEUTRON ACER TENDL-2024 LIBRARY; T=0.K
angular distribution for (n,n*25)

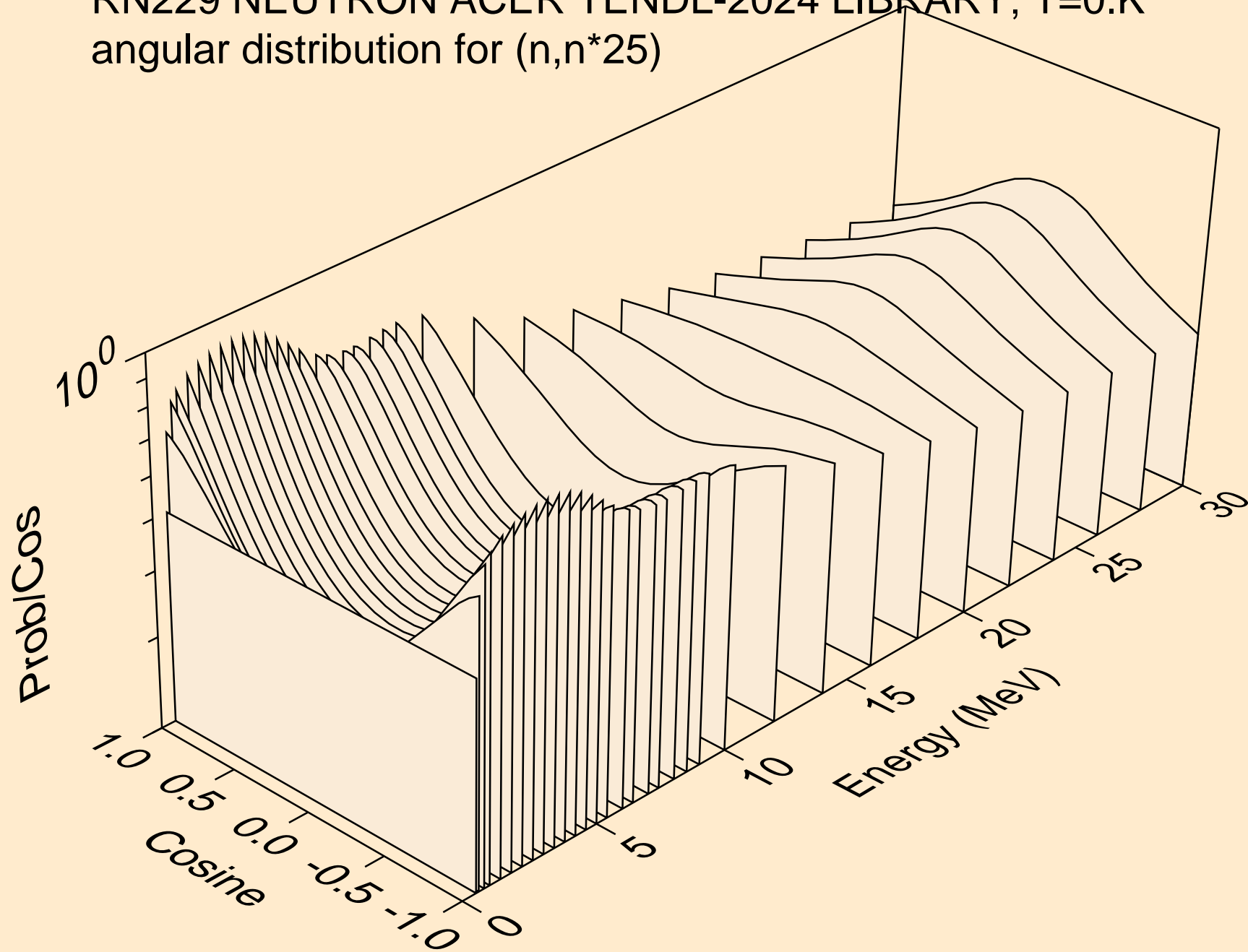

RN229 NEUTRON ACER TENDL-2024 LIBRARY; T=0.K
angular distribution for (n,n*26)

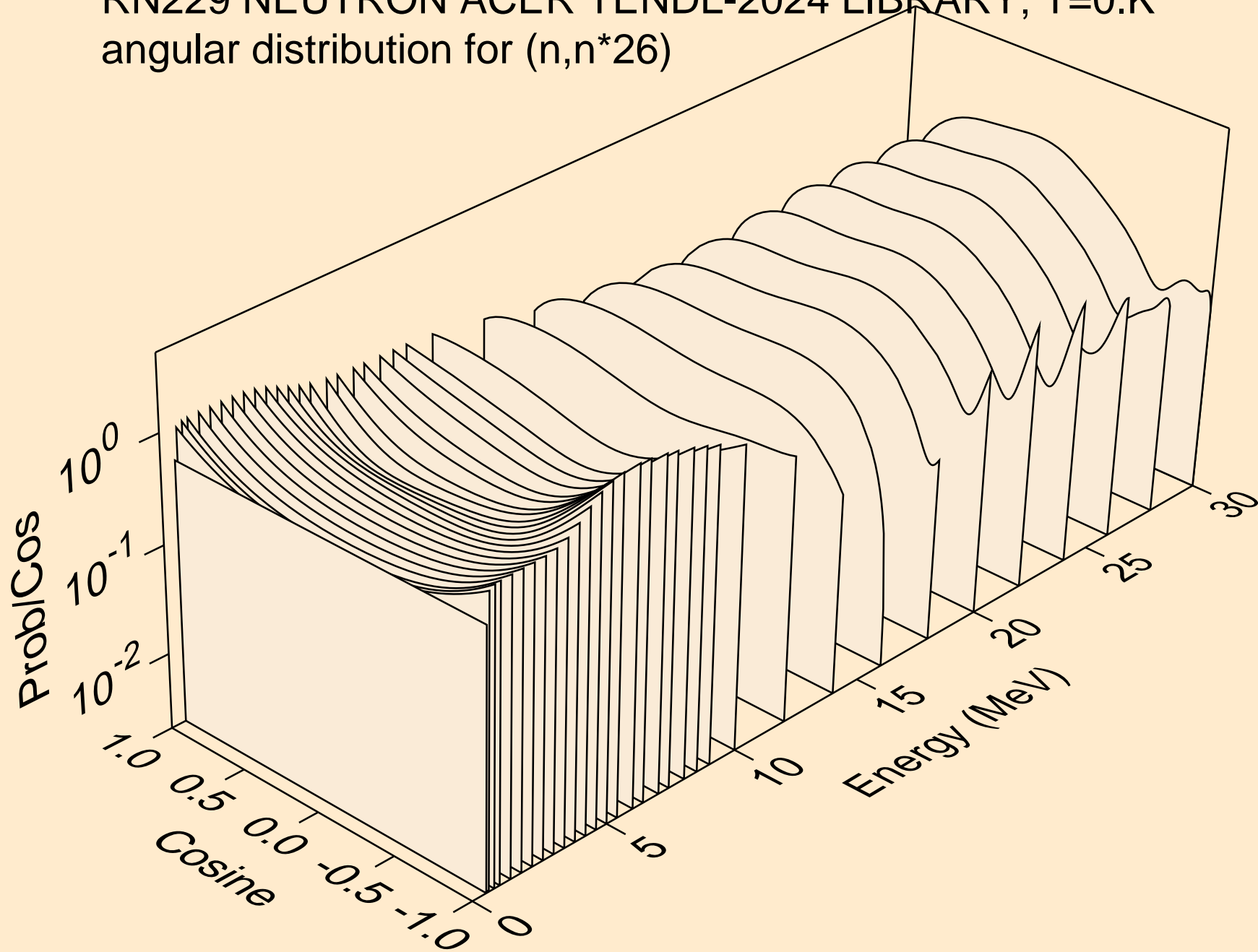

RN229 NEUTRON ACER TENDL-2024 LIBRARY; T=0.K
angular distribution for (n,n*27)

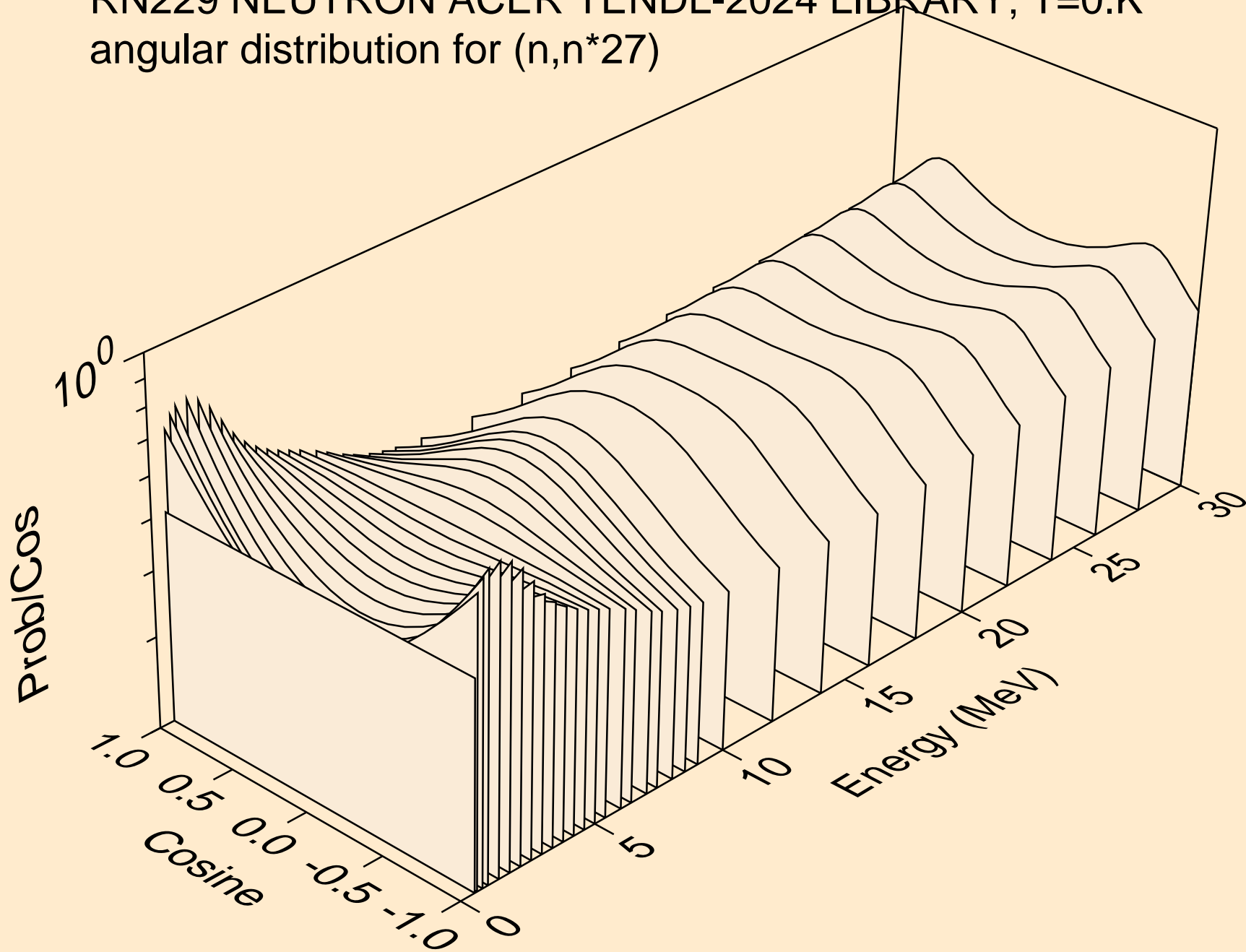

RN229 NEUTRON ACER TENDL-2024 LIBRARY; T=0.K
angular distribution for (n,n*28)

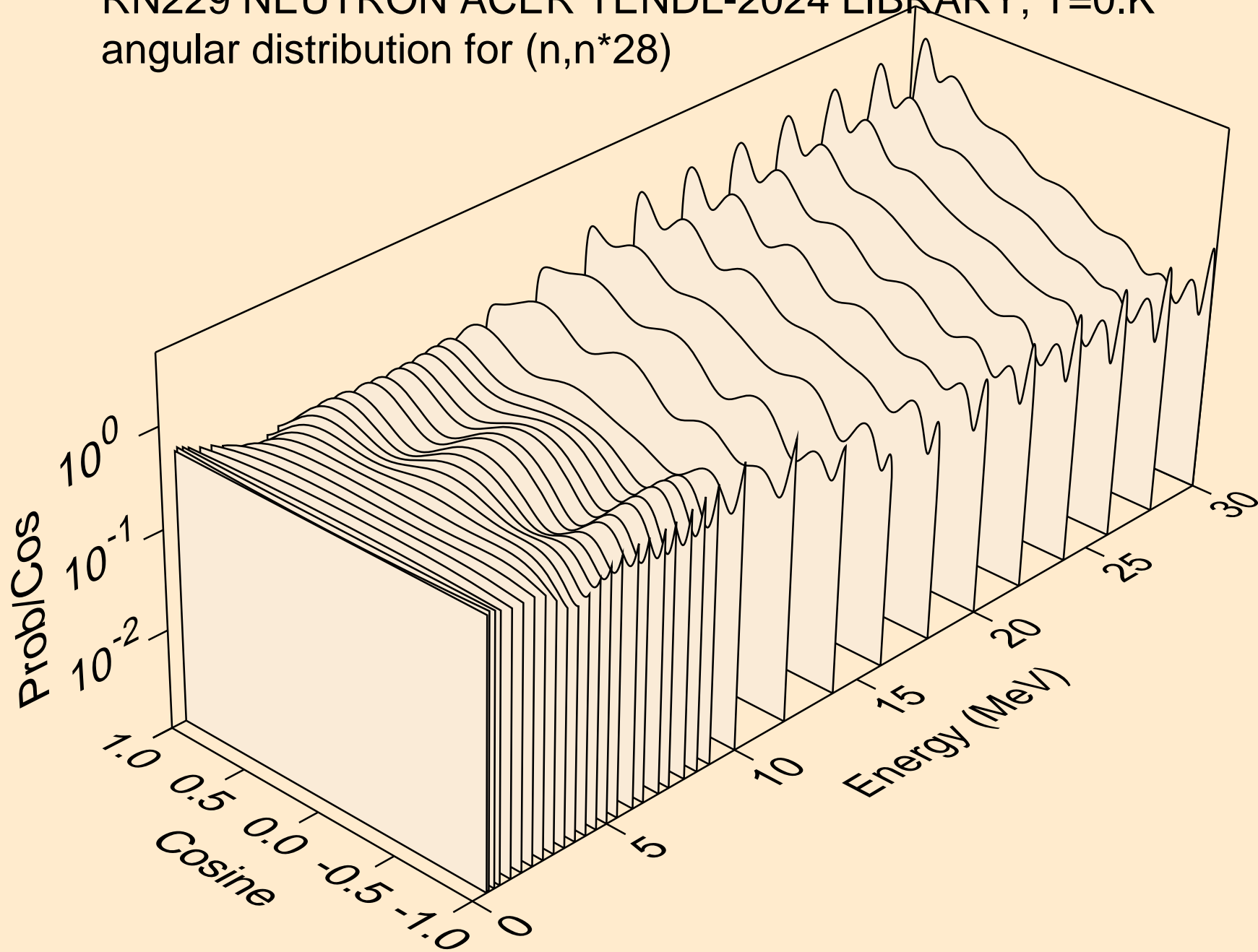

RN229 NEUTRON ACER TENDL-2024 LIBRARY; T=0.K
angular distribution for (n,n*29)

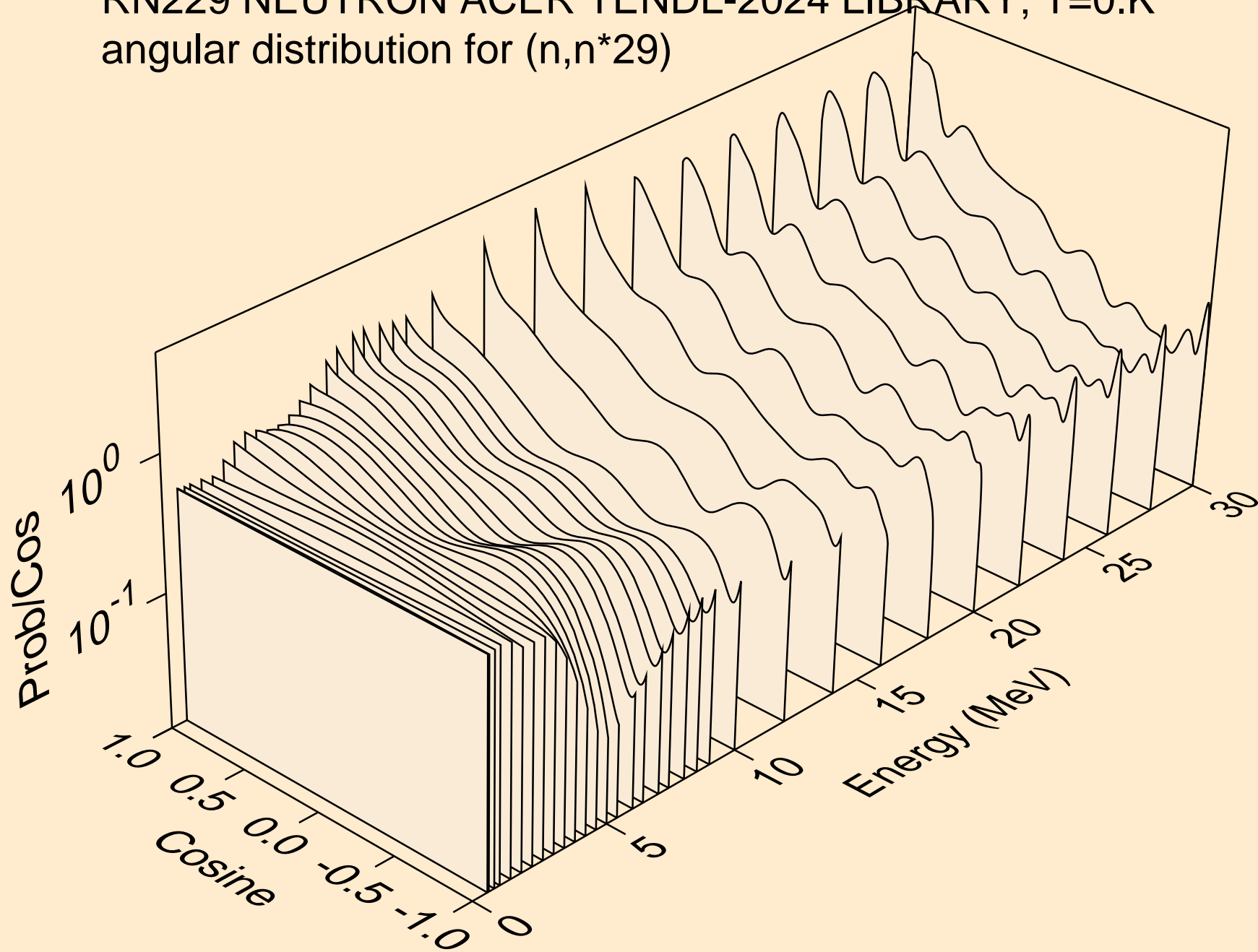

RN229 NEUTRON ACER TENDL-2024 LIBRARY; T=0.K

Total fission nubar

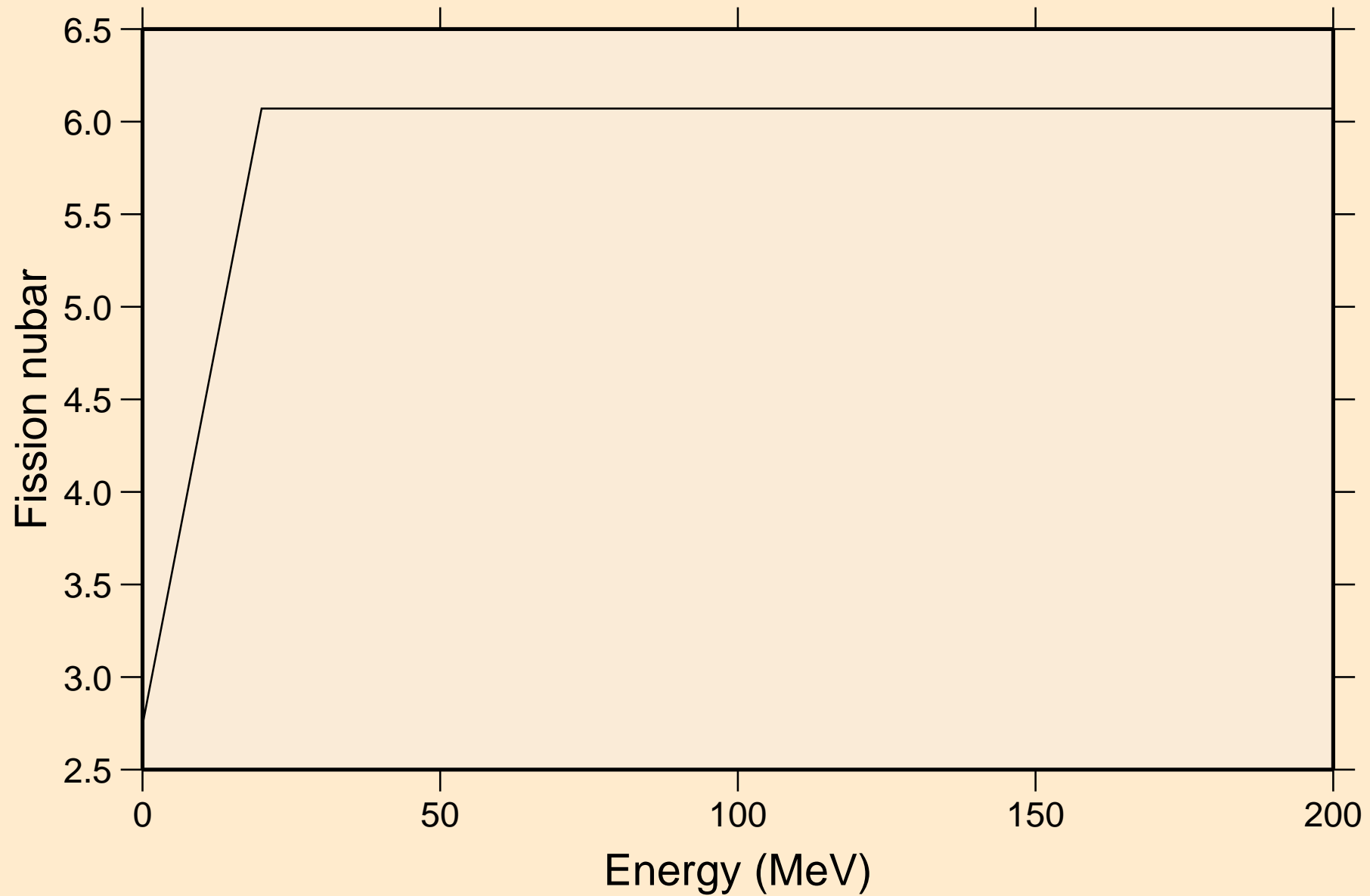

RN229 NEUTRON ACER TENDL-2024 LIBRARY; T=0.K
Neutron emission for (n,x)

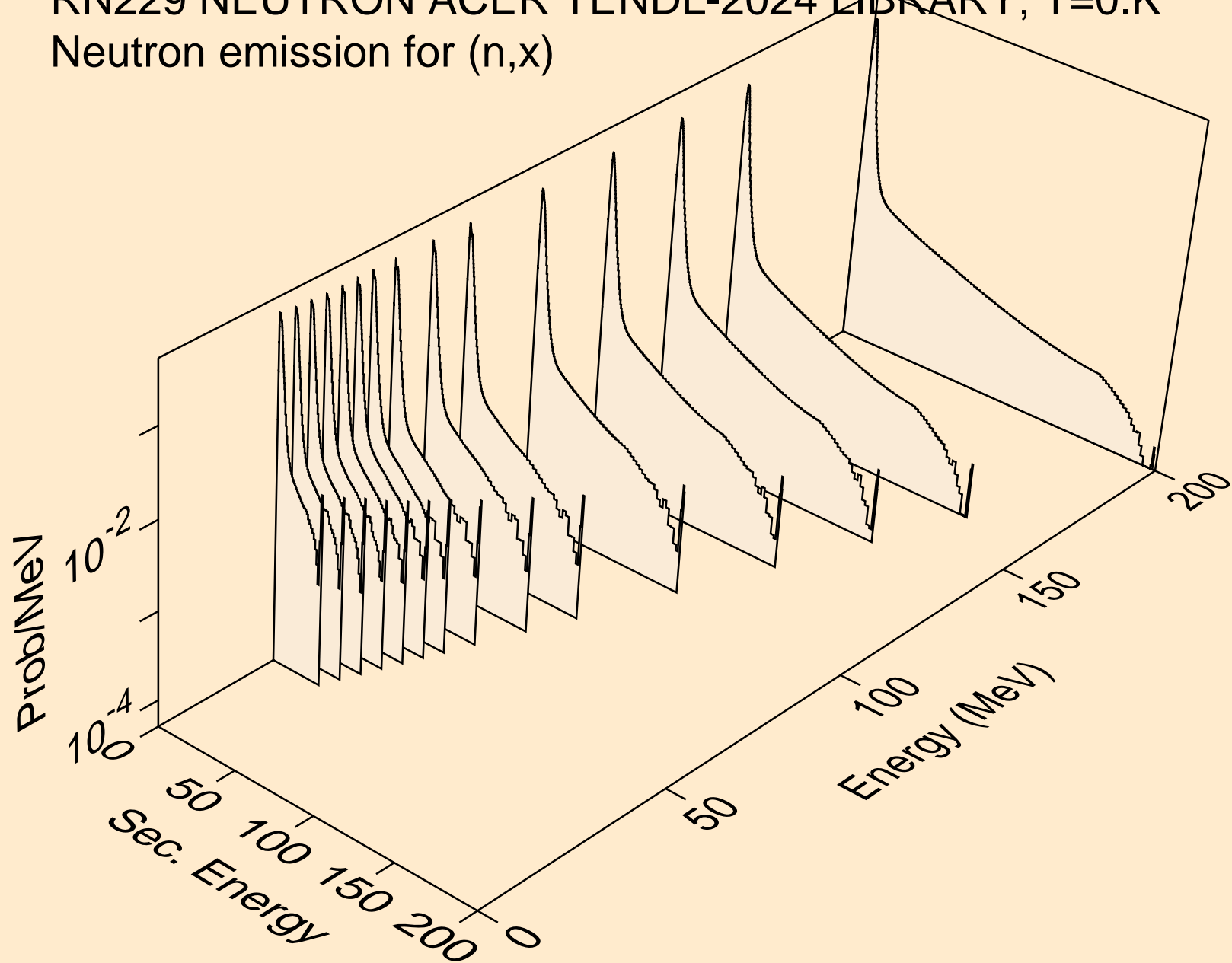

RN229 NEUTRON ACER TENDL-2024 LIBRARY; T=0.K
Neutron emission for (n,2nd)

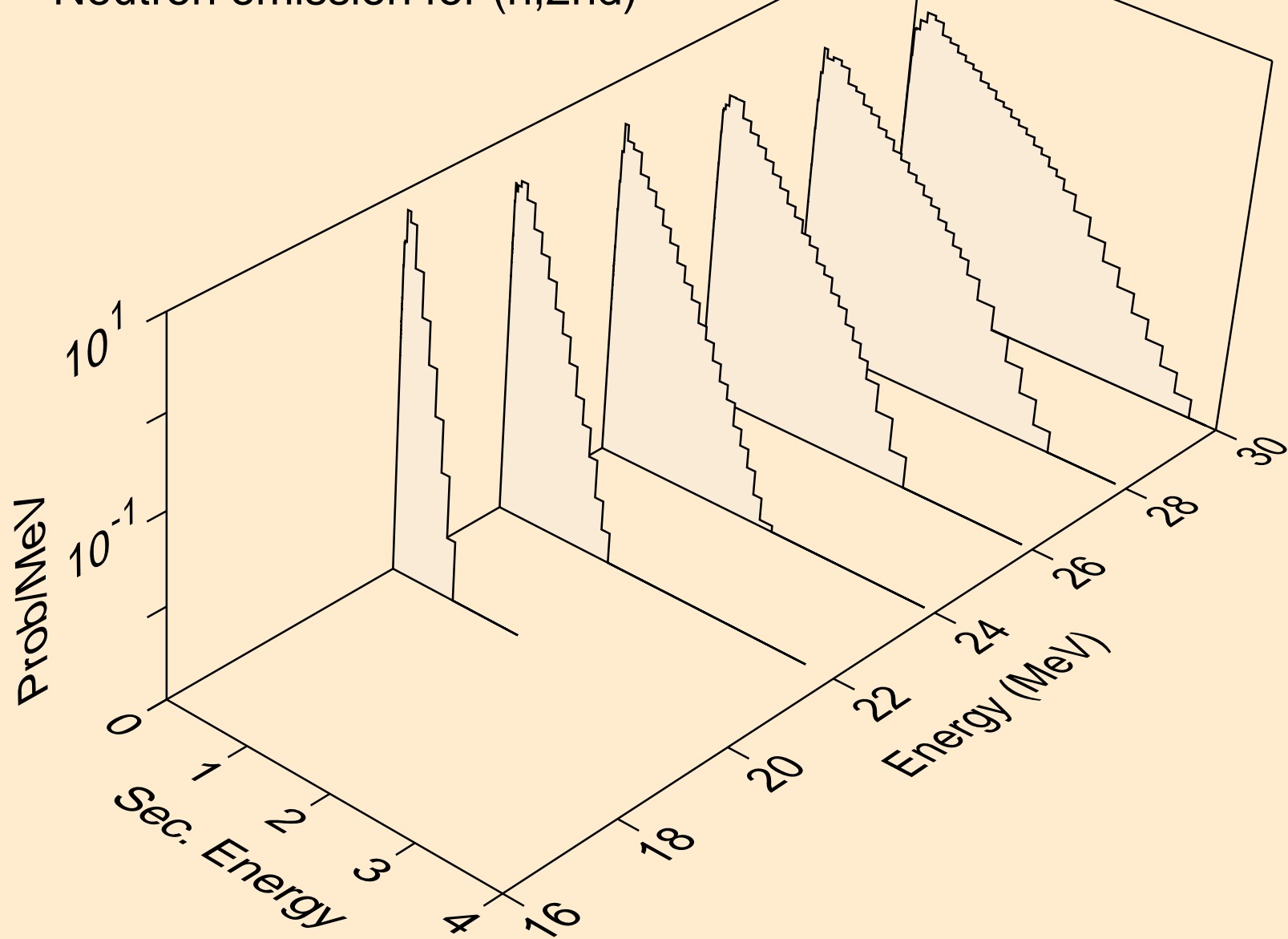

RN229 NEUTRON ACER TENDL-2024 LIBRARY; T=0.K
Neutron emission for (n,2n)

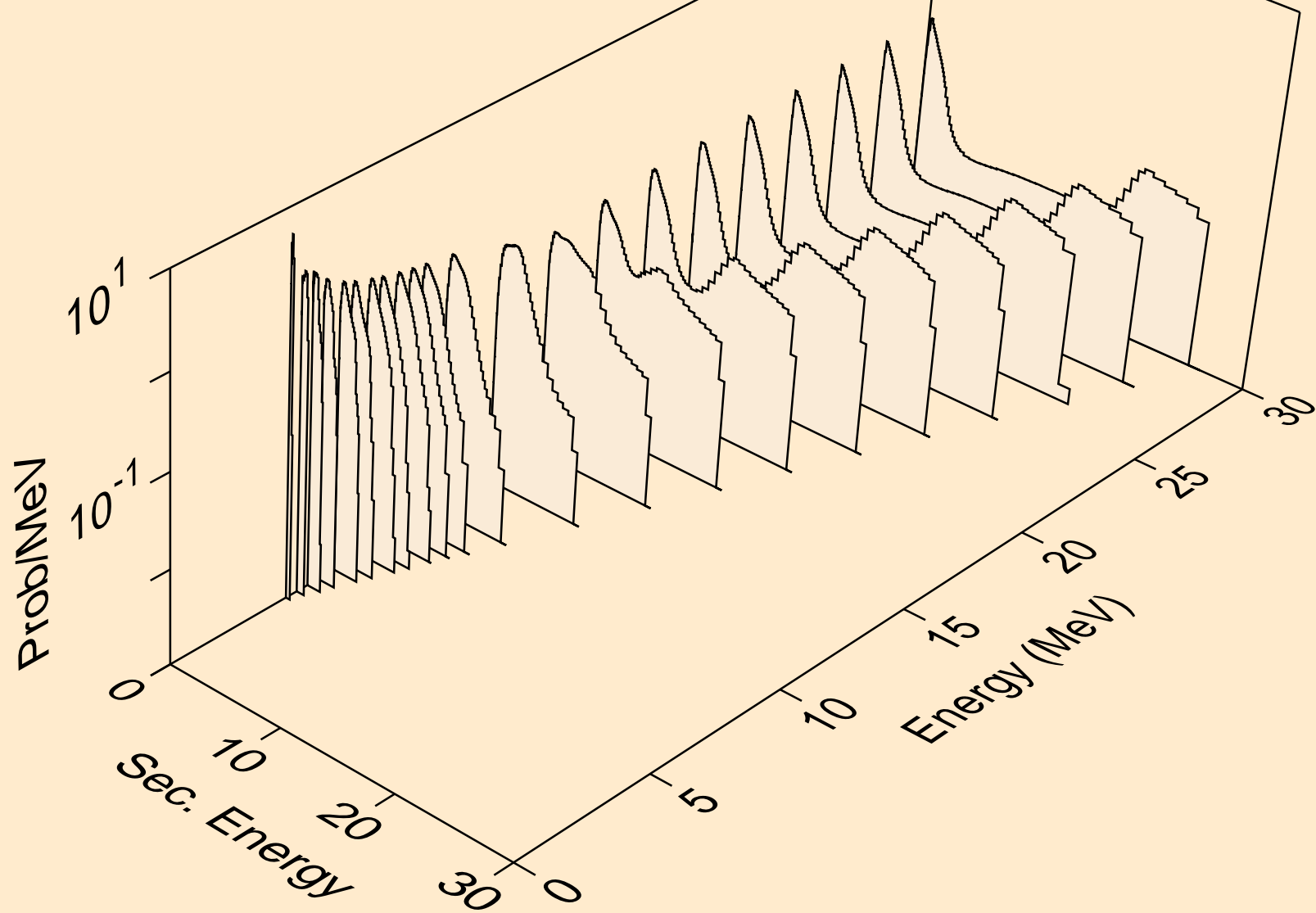

RN229 NEUTRON ACER TENDL-2024 LIBRARY; T=0.K
Neutron emission for (n,3n)

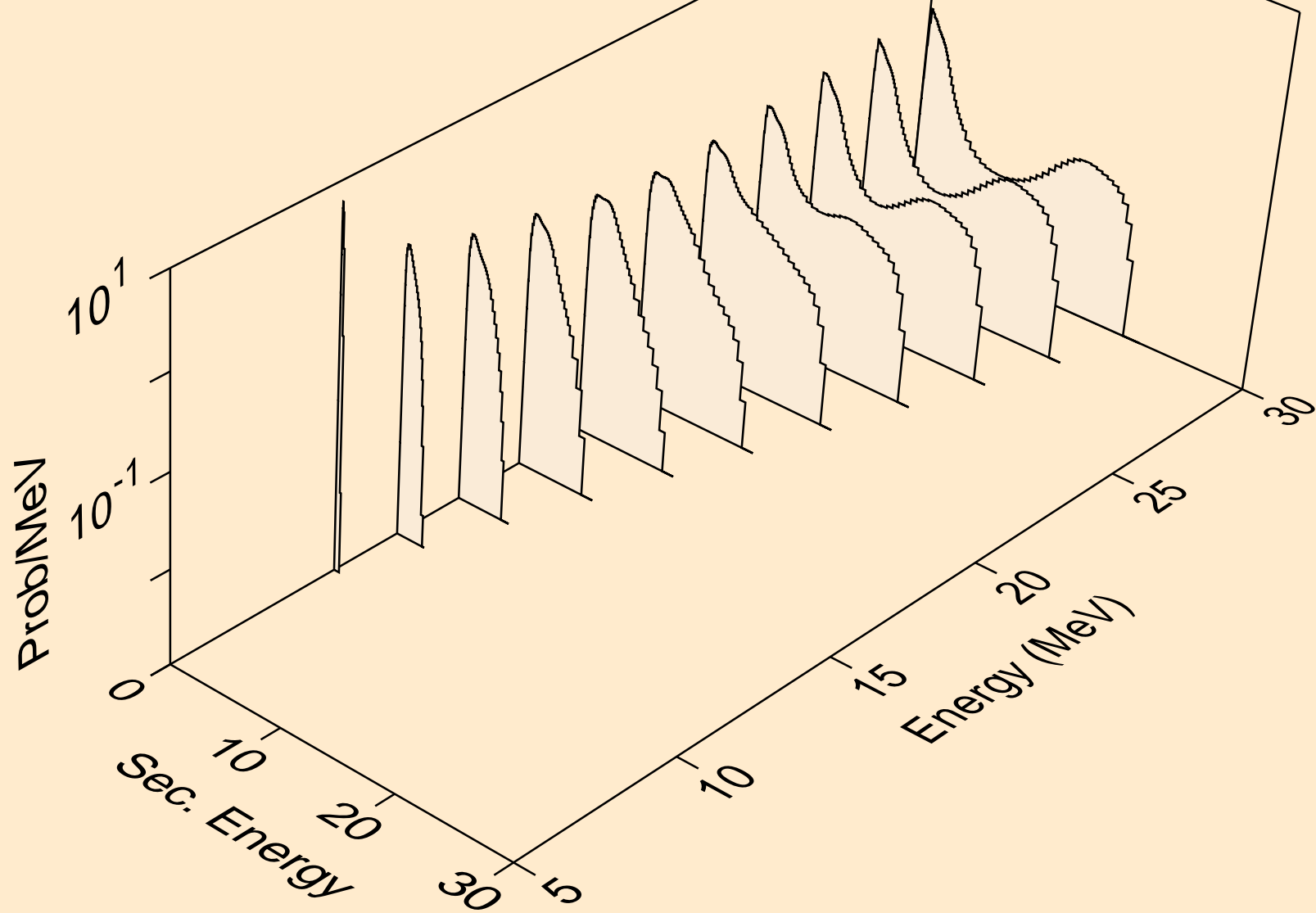

RN229 NEUTRON ACER TENDL-2024 LIBRARY; T=0.K
Neutron emission for fission

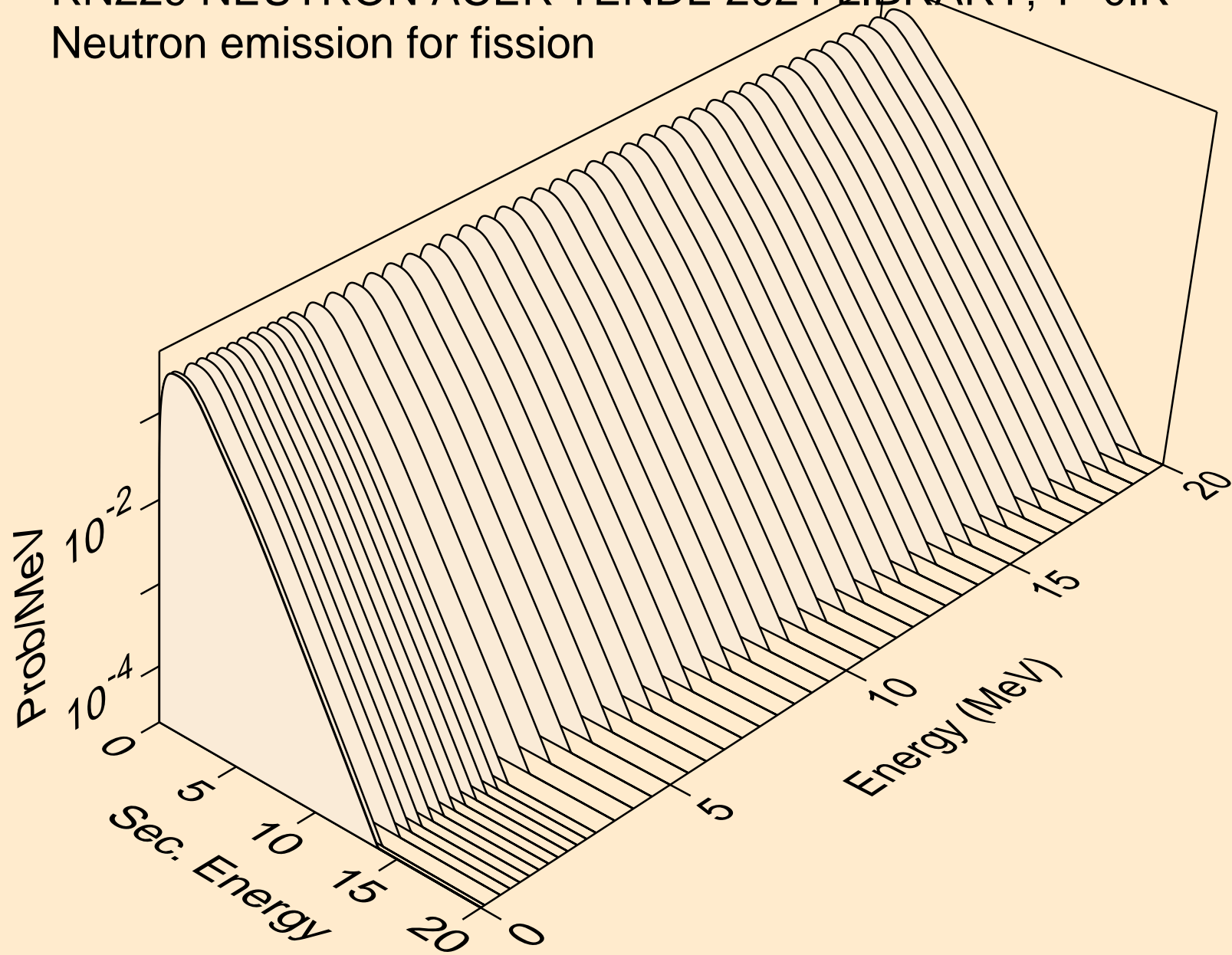

RN229 NEUTRON ACER TENDL-2024 LIBRARY; T=0.K
Neutron emission for (n,n*)a

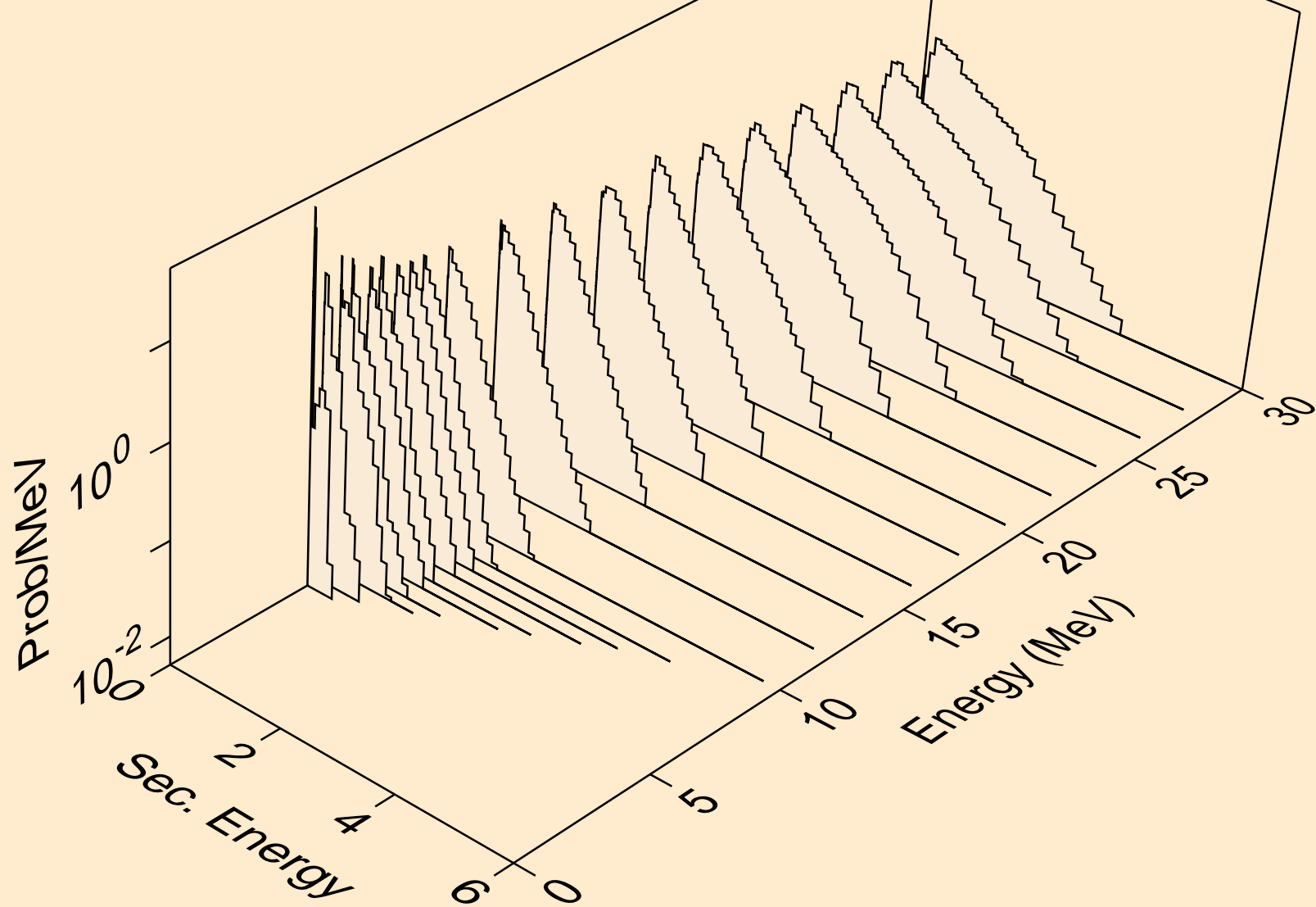

RN229 NEUTRON ACER TENDL-2024 LIBRARY; T=0.K
Neutron emission for (n,2n)a

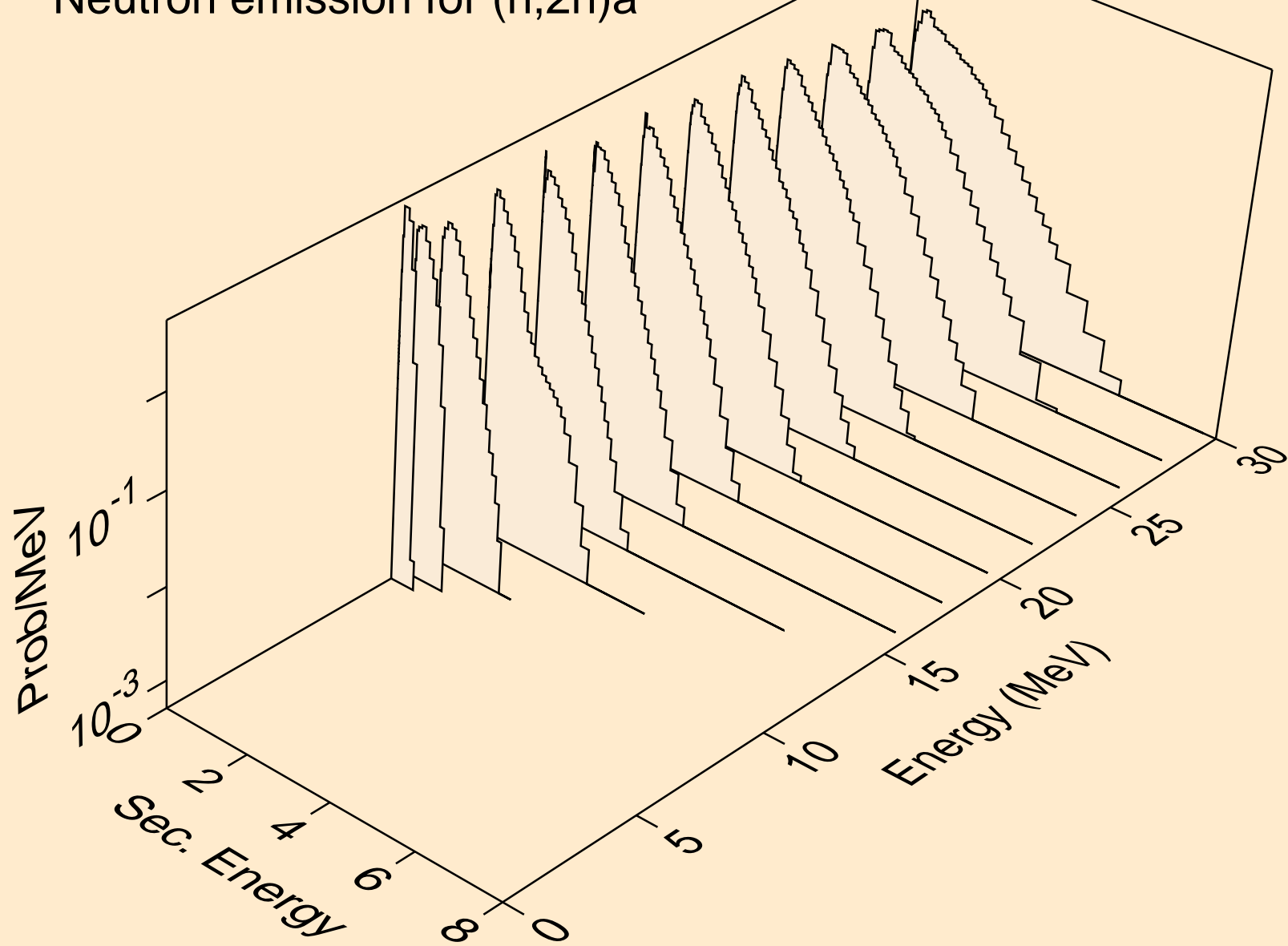

RN229 NEUTRON ACER TENDL-2024 LIBRARY; T=0.K
Neutron emission for (n,3n)a

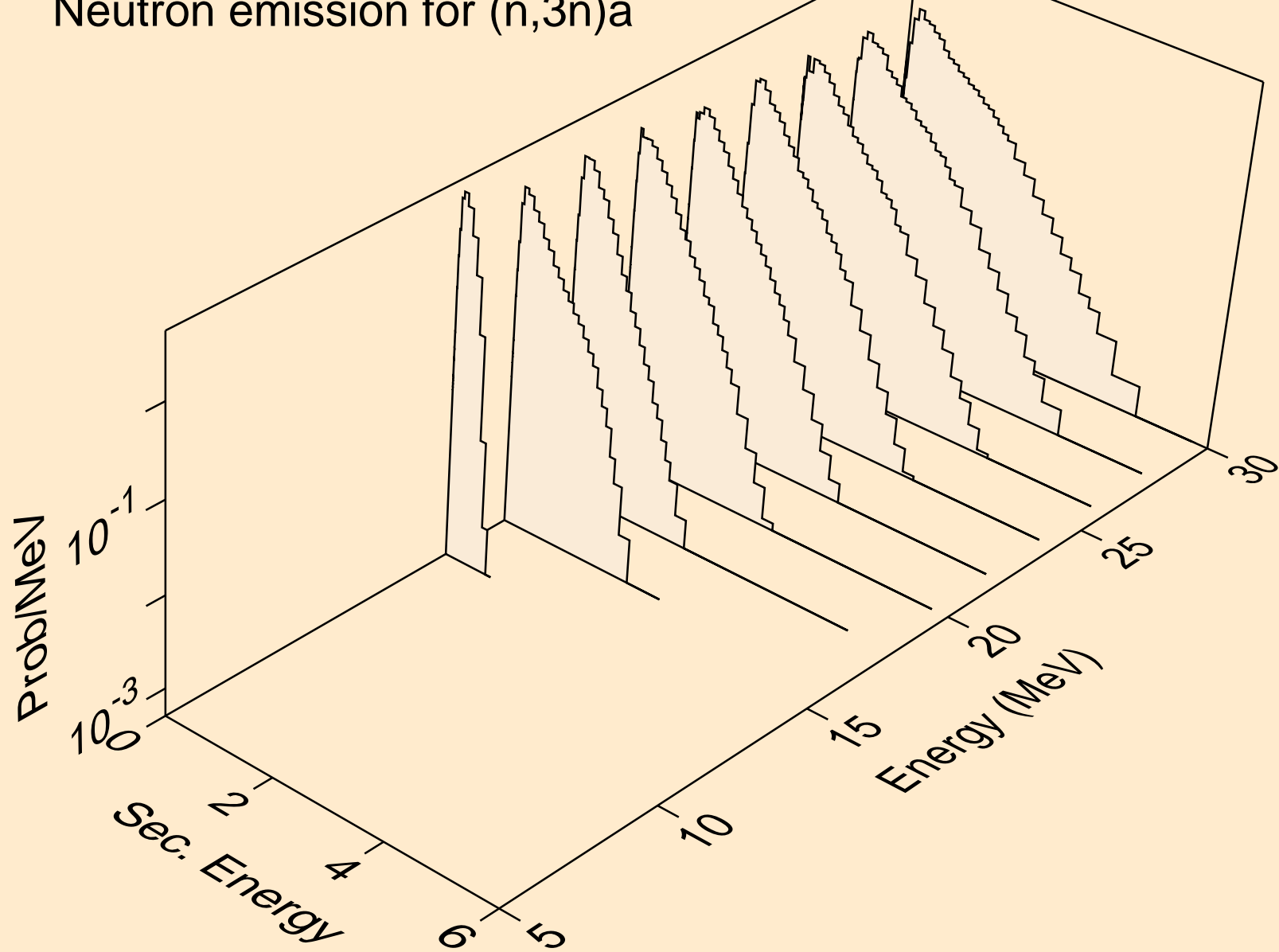

RN229 NEUTRON ACER TENDL-2024 LIBRARY; T=0.K
Neutron emission for (n,n*)p

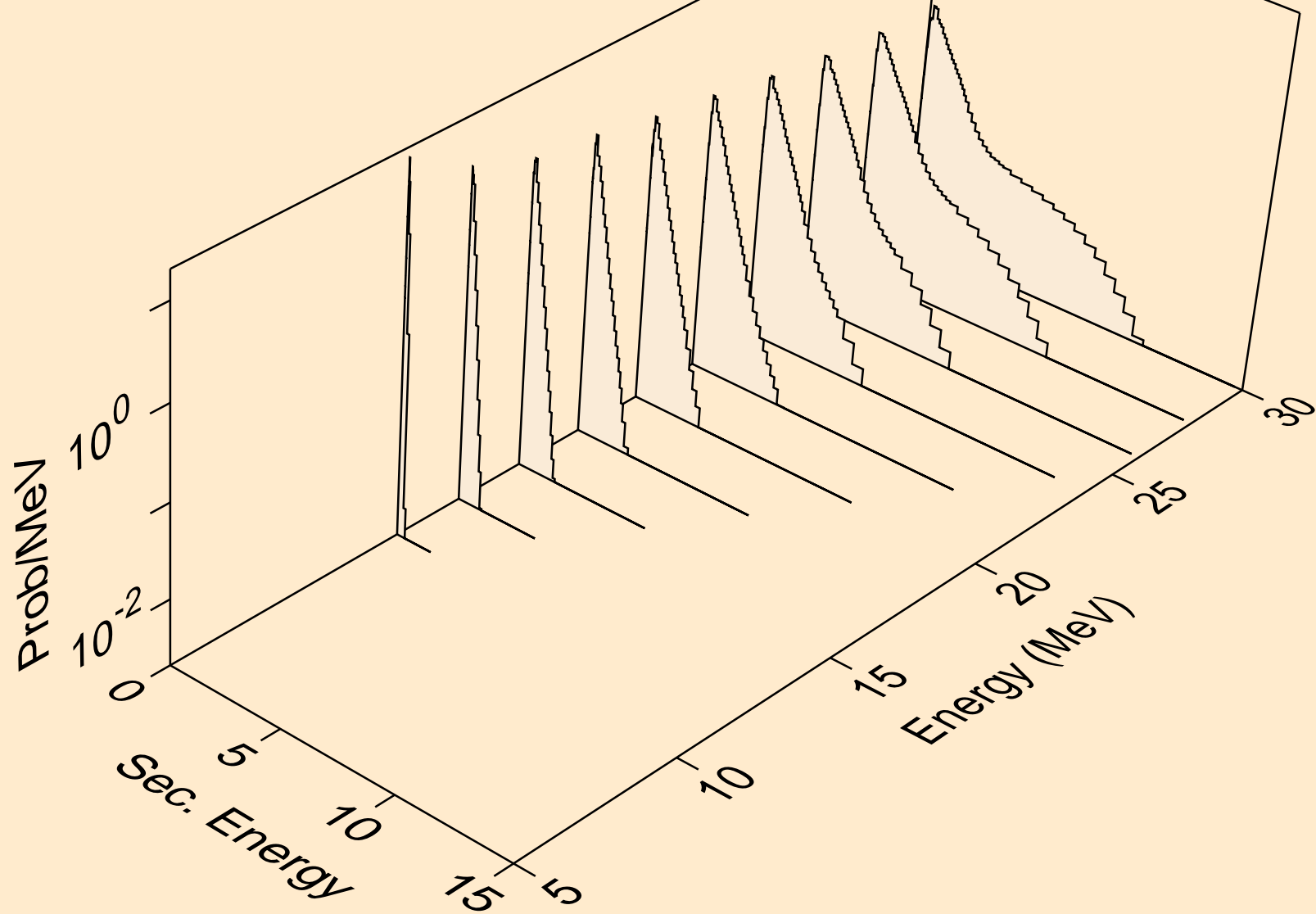

RN229 NEUTRON ACER TENDL-2024 LIBRARY; T=0.K
Neutron emission for (n,n*)d

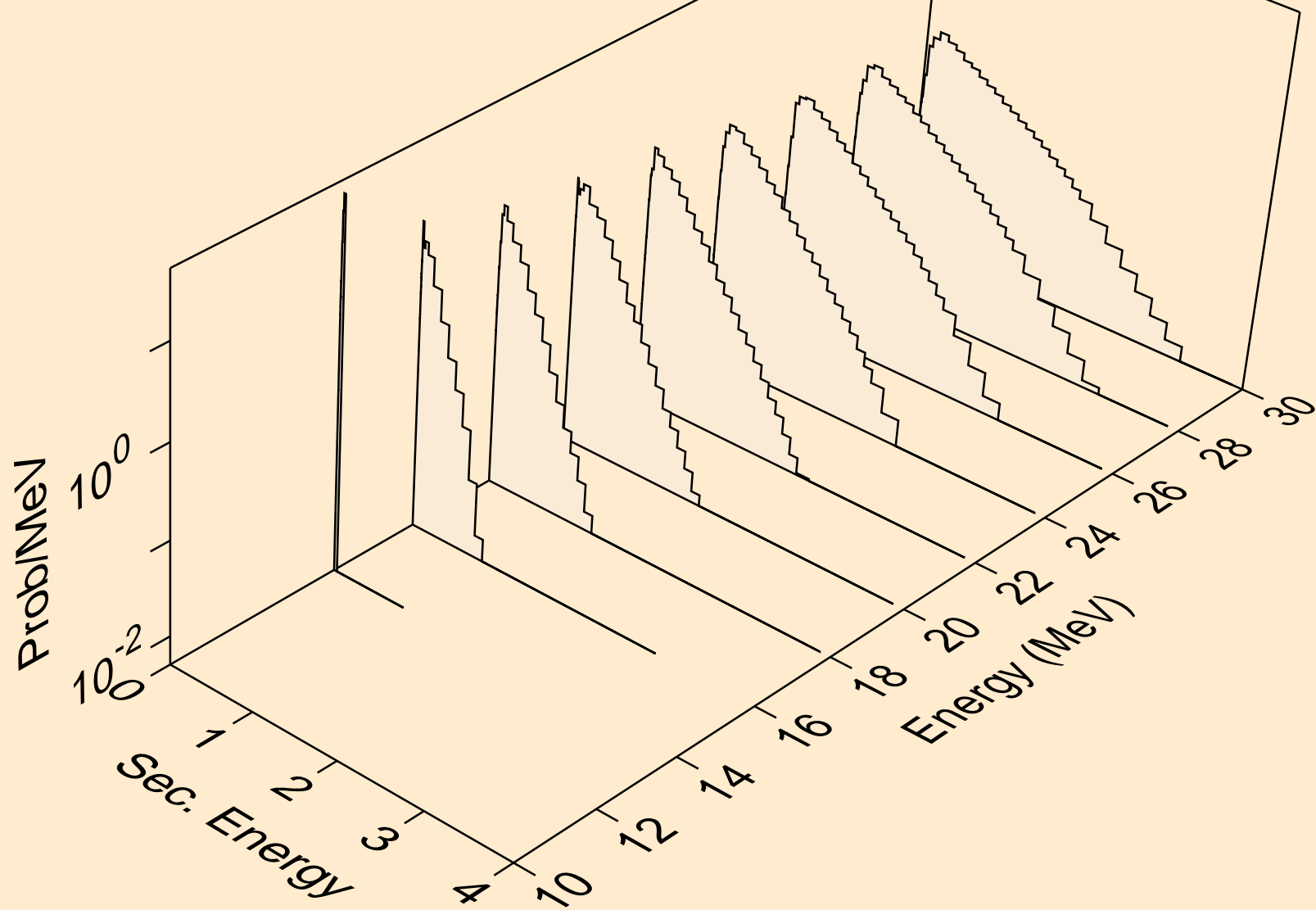

RN229 NEUTRON ACER TENDL-2024 LIBRARY; T=0.K
Neutron emission for (n,n*)t

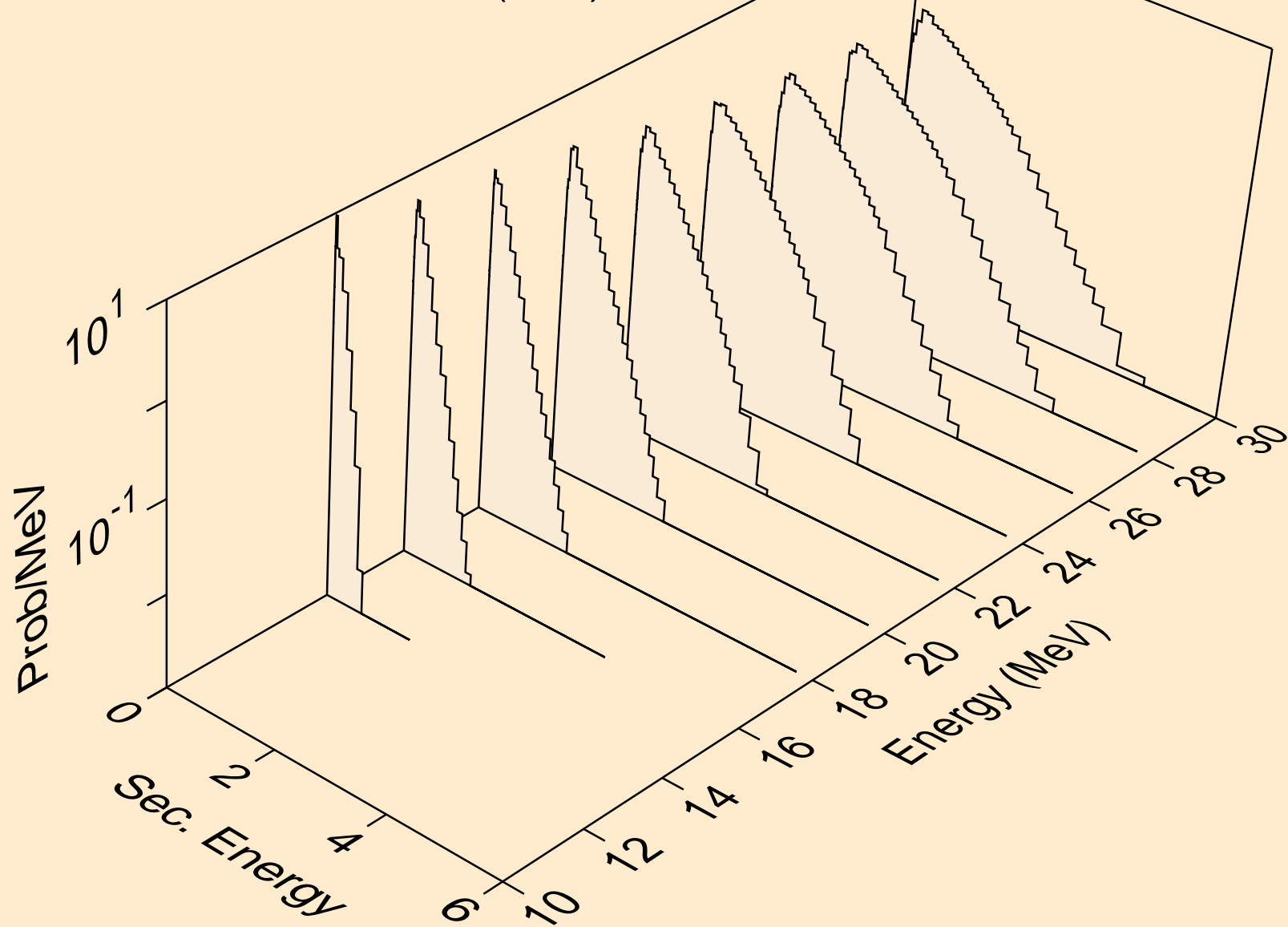

RN229 NEUTRON ACER TENDL-2024 LIBRARY; T=0.K
Neutron emission for (n,n*)he3

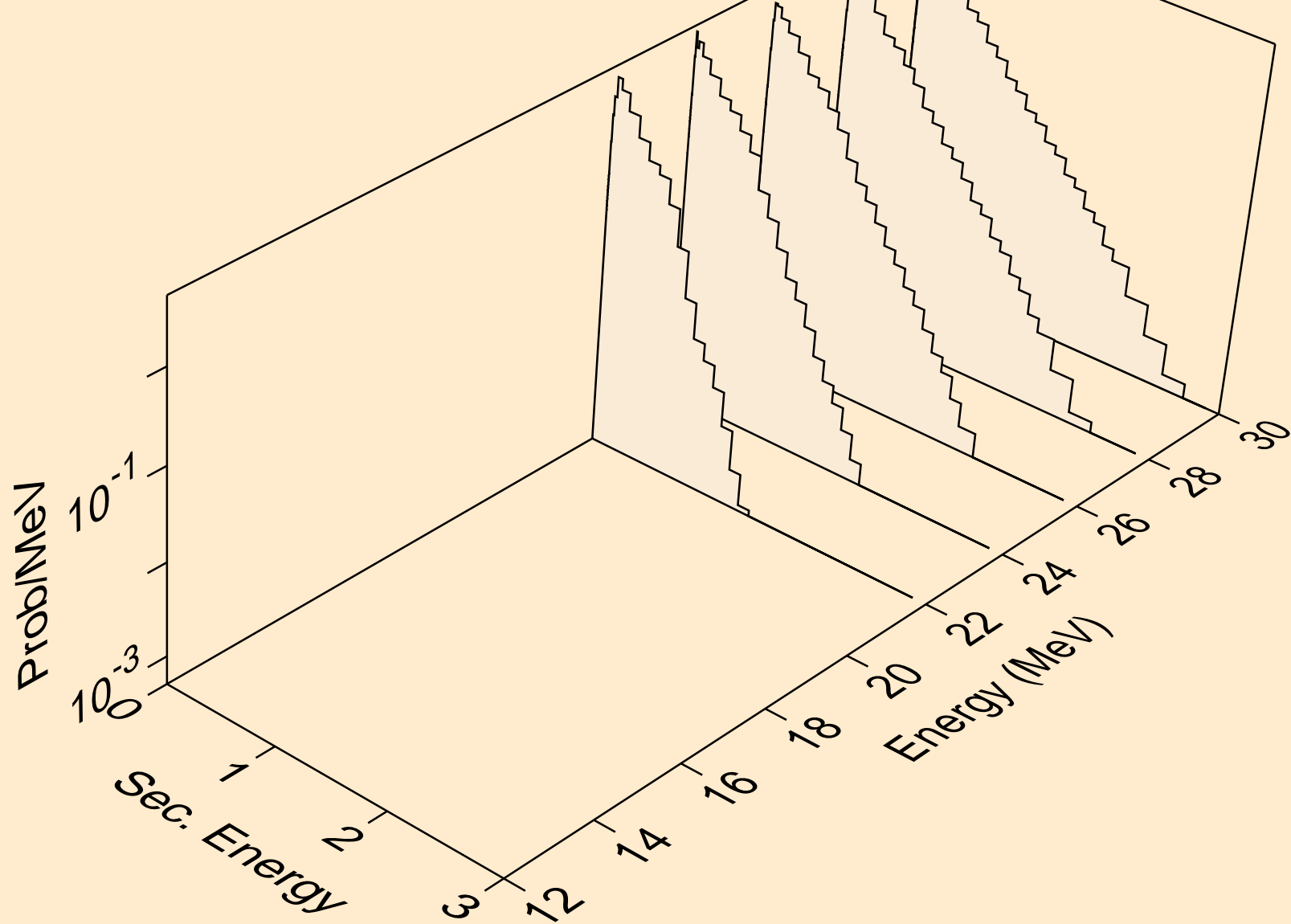

RN229 NEUTRON ACER TENDL-2024 LIBRARY; T=0.K
Neutron emission for (n,4n)

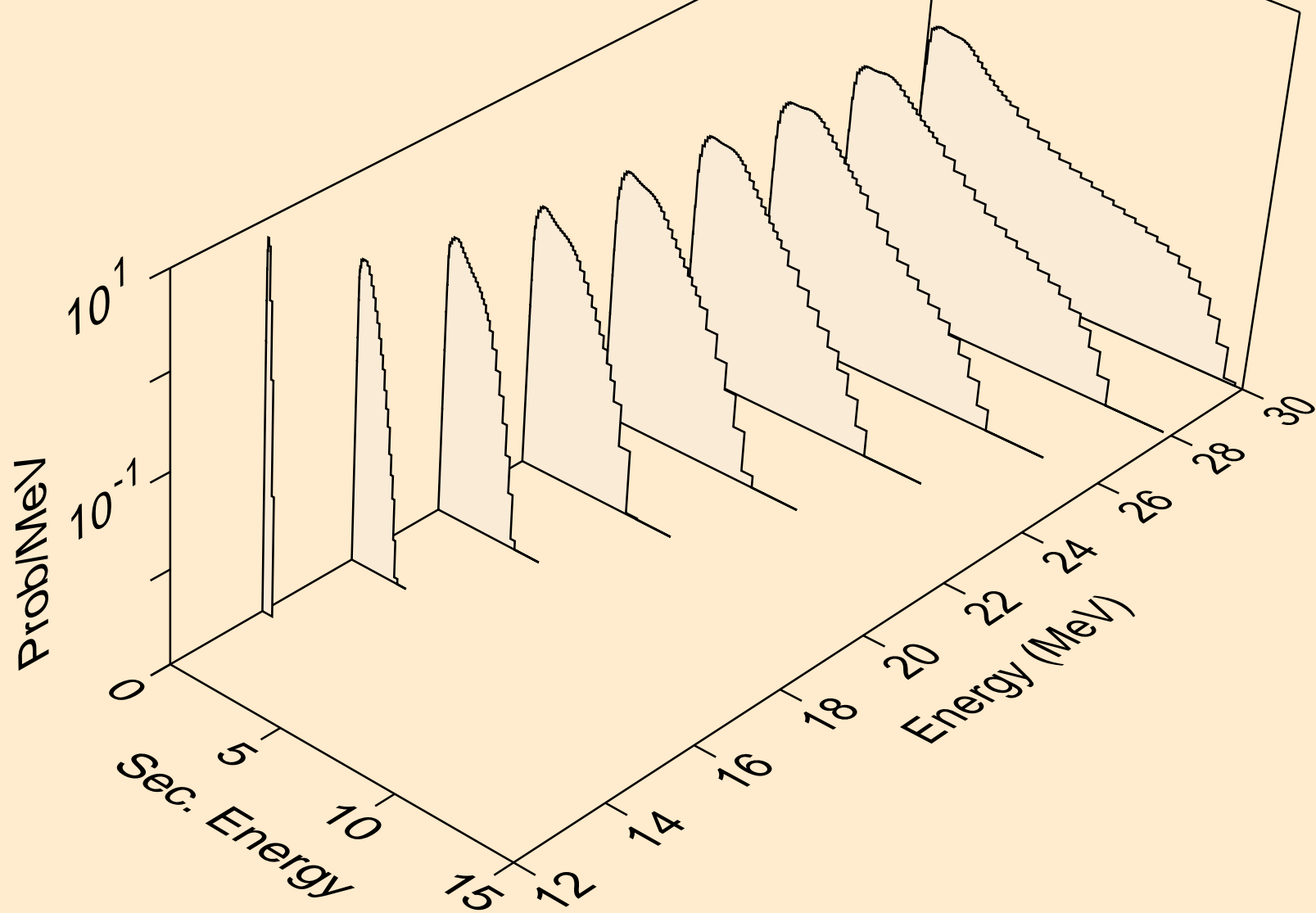

RN229 NEUTRON ACER TENDL-2024 LIBRARY; T=0.K
Neutron emission for (n,2np)

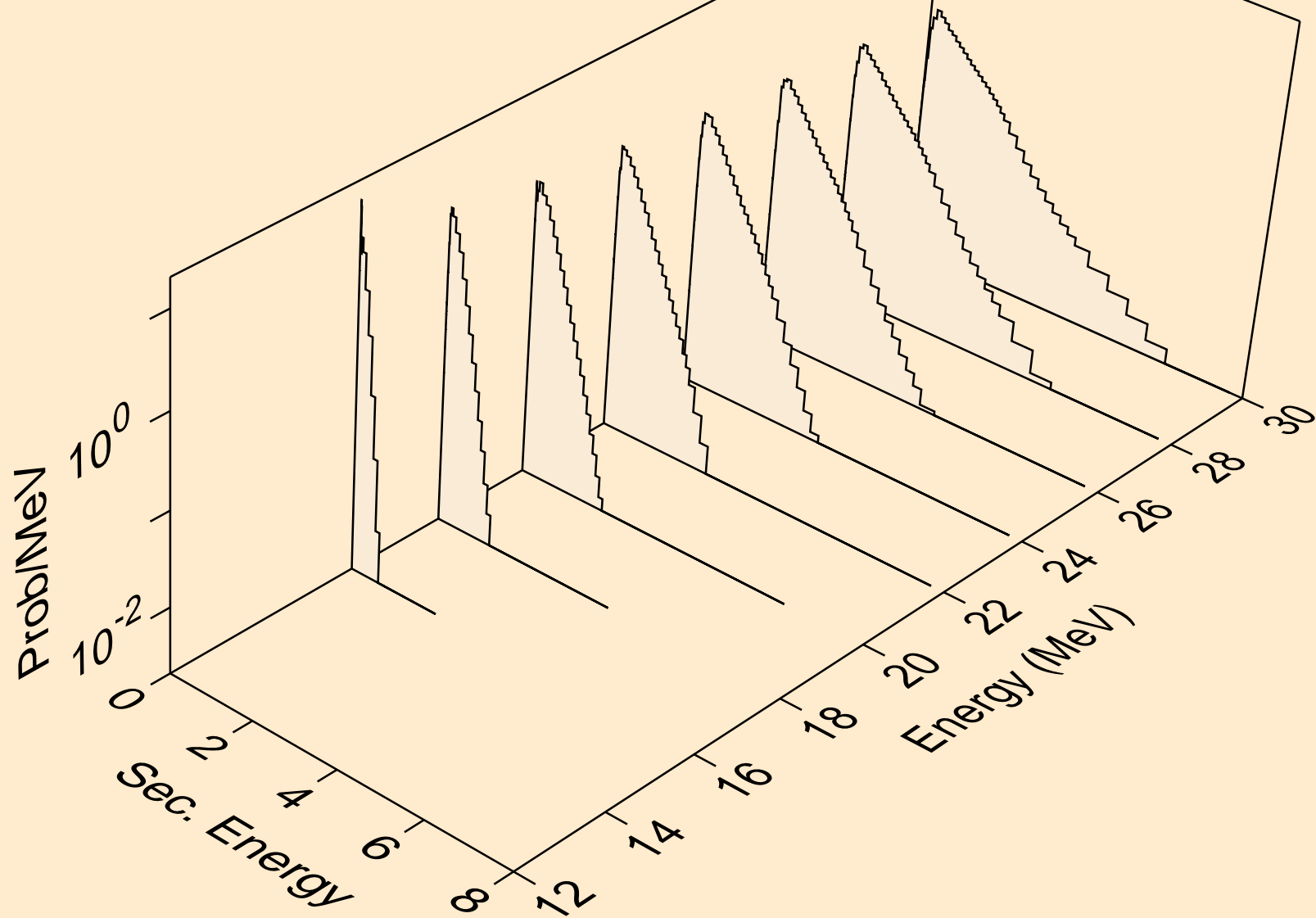

RN229 NEUTRON ACER TENDL-2024 LIBRARY; T=0.K
Neutron emission for (n,3np)

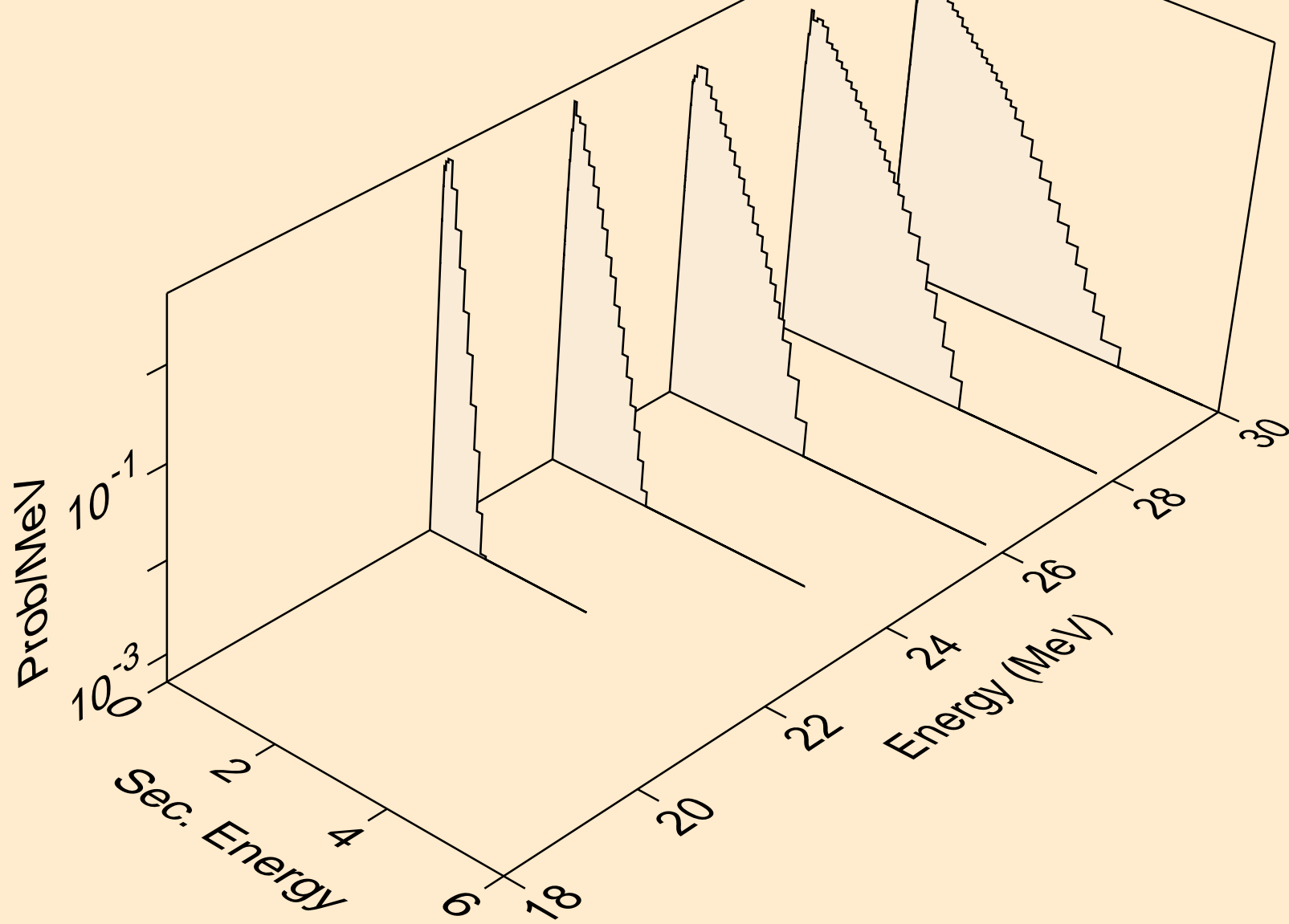

RN229 NEUTRON ACER TENDL-2024 LIBRARY; T=0.K
Neutron emission for (n,n*c)

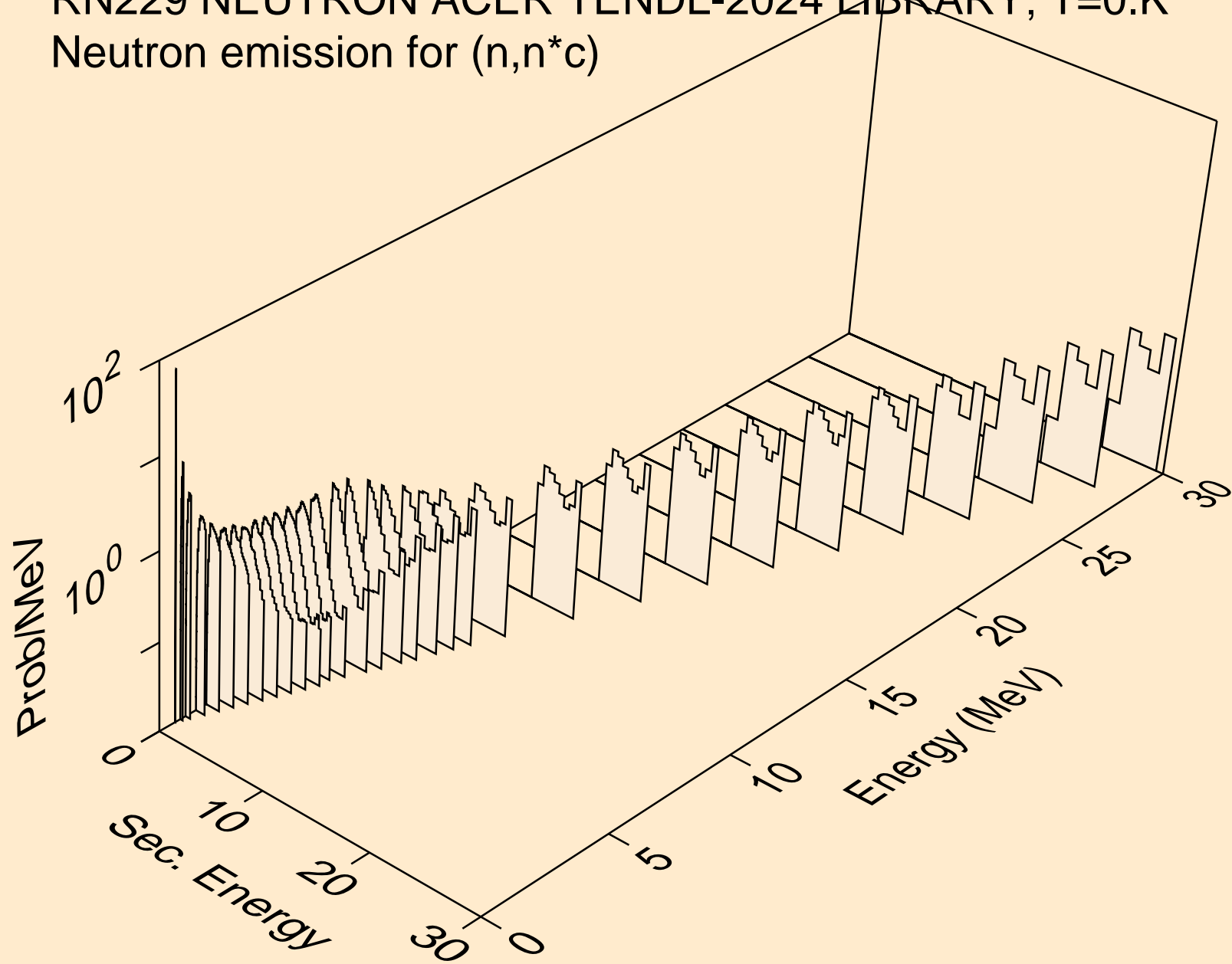

RN229 NEUTRON ACER TENDL-2024 LIBRARY; T=0.K

Delayed nubar

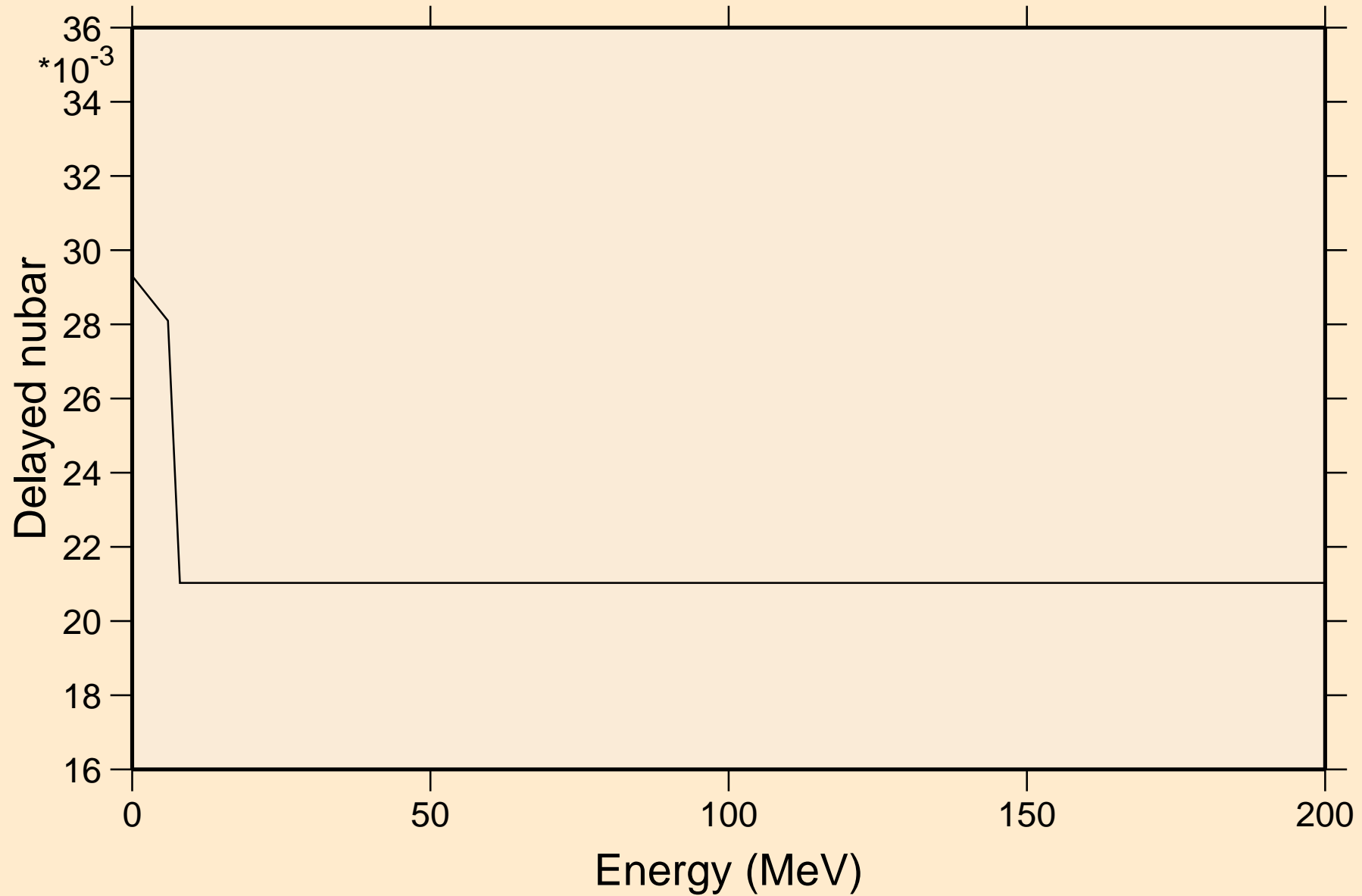

RN229 NEUTRON ACER TENDL-2024 LIBRARY; T=0.K

Delayed neutron spectra

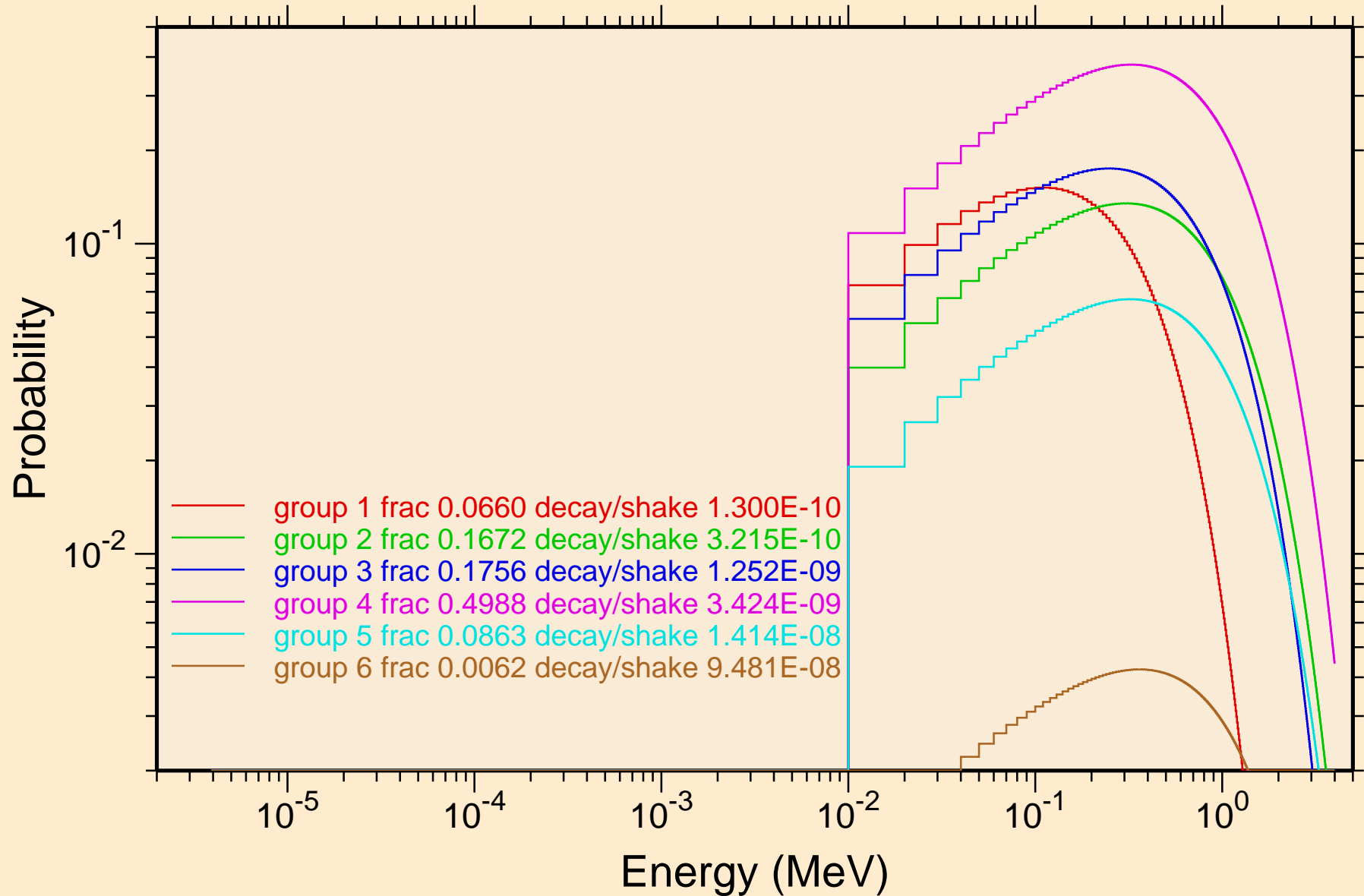

RN229 NEUTRON ACER TENDL-2024 LIBRARY; T=0.K
Photon emission for (n,x)

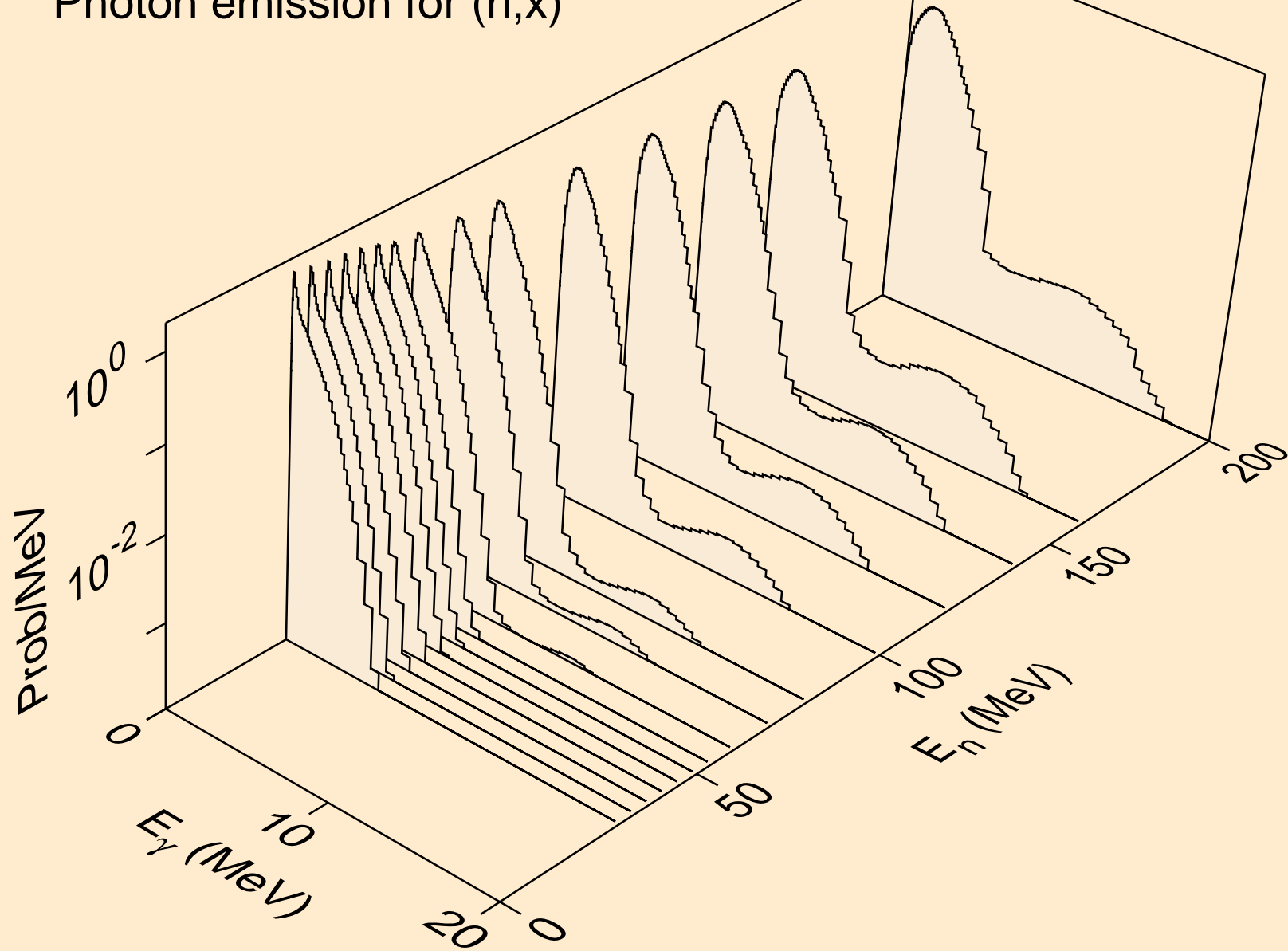

RN229 NEUTRON ACER TENDL-2024 LIBRARY; T=0.K
Photon emission for (n,2nd)

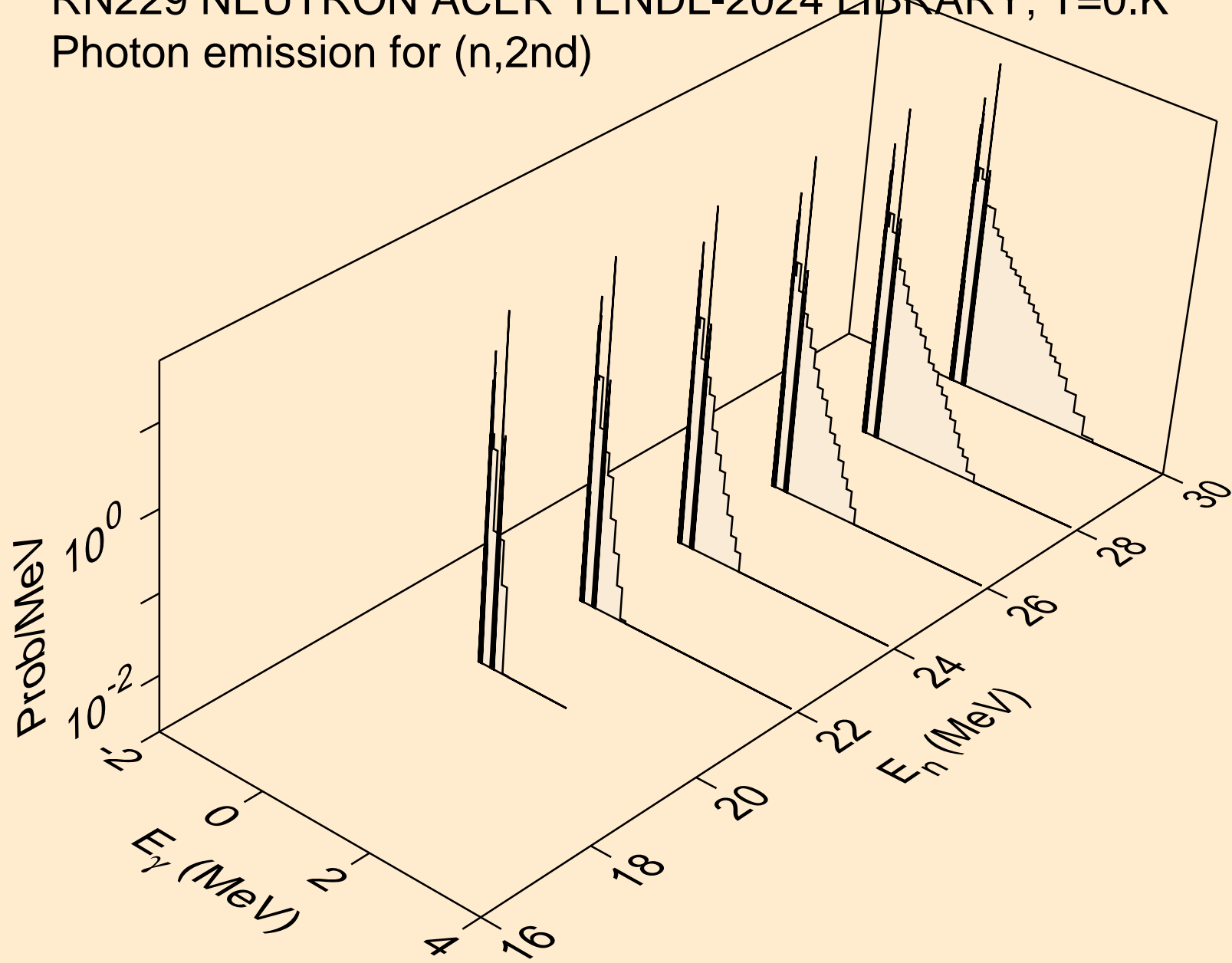

RN229 NEUTRON ACER TENDL-2024 LIBRARY; T=0.K
Photon emission for (n,2n)

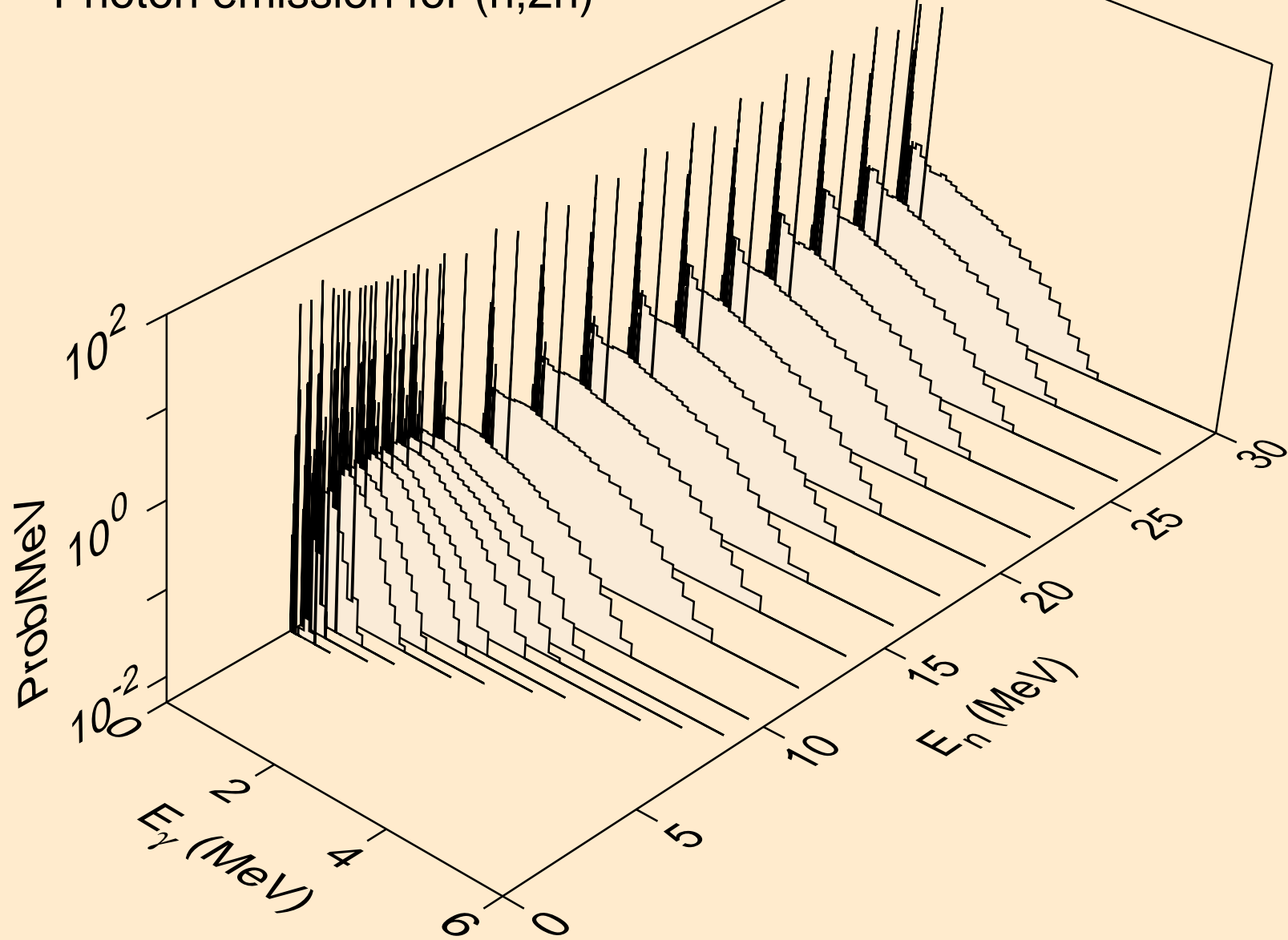

RN229 NEUTRON ACER TENDL-2024 LIBRARY; T=0.K
Photon emission for (n,3n)

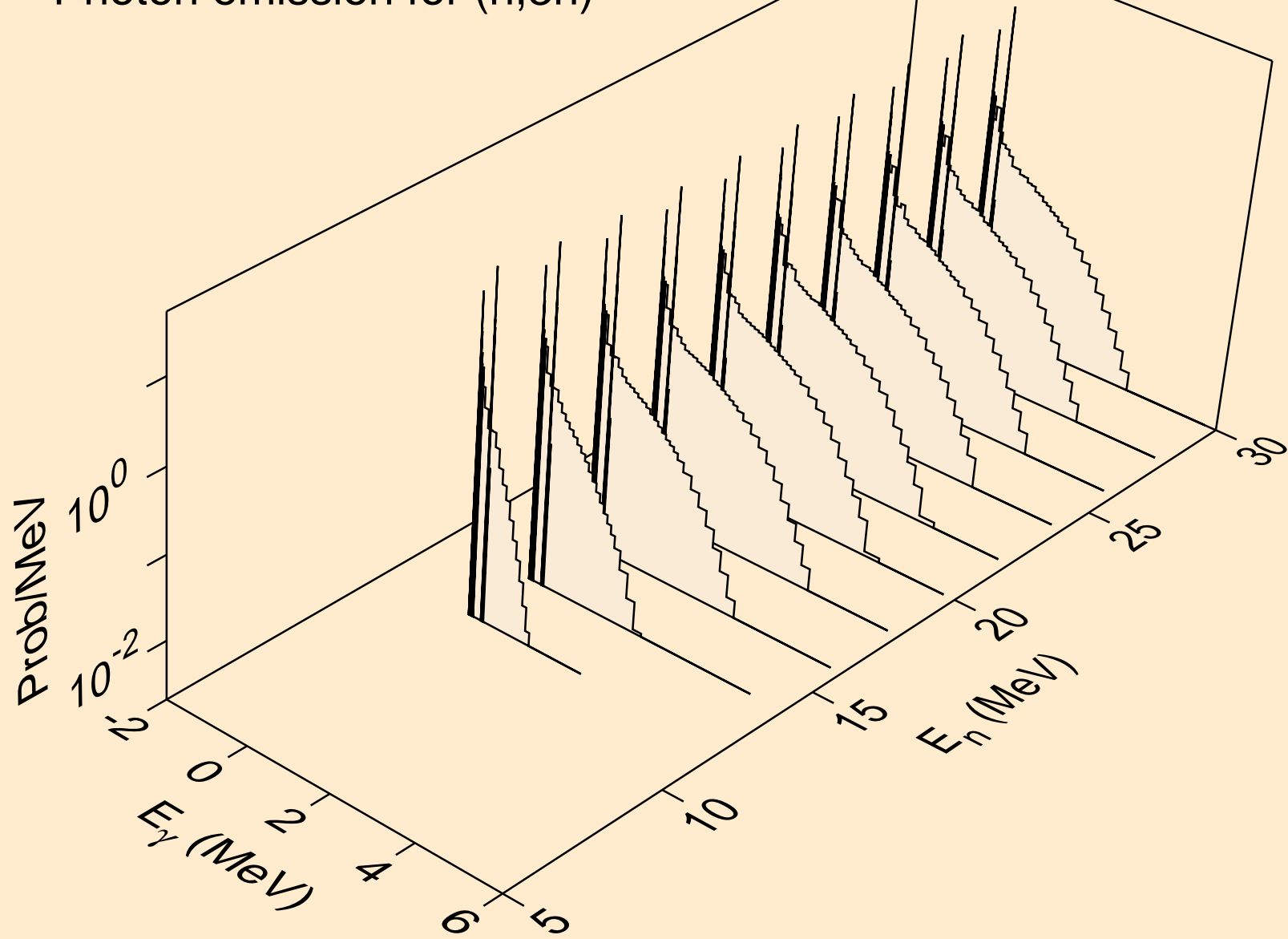

RN229 NEUTRON ACER TENDL-2024 LIBRARY; T=0.K
Photon emission for (n,n*)a

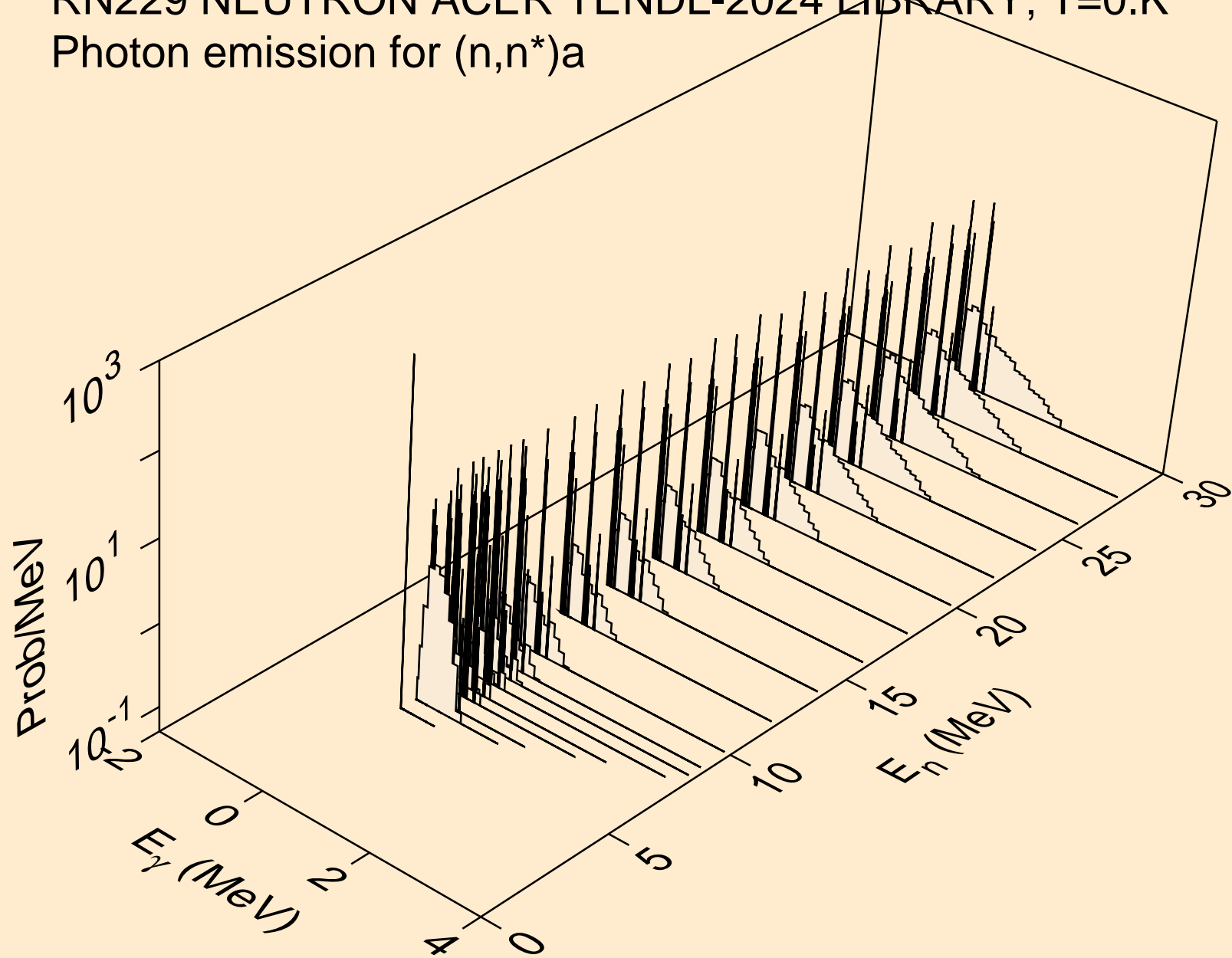

RN229 NEUTRON ACER TENDL-2024 LIBRARY; T=0.K
Photon emission for (n,2n)a

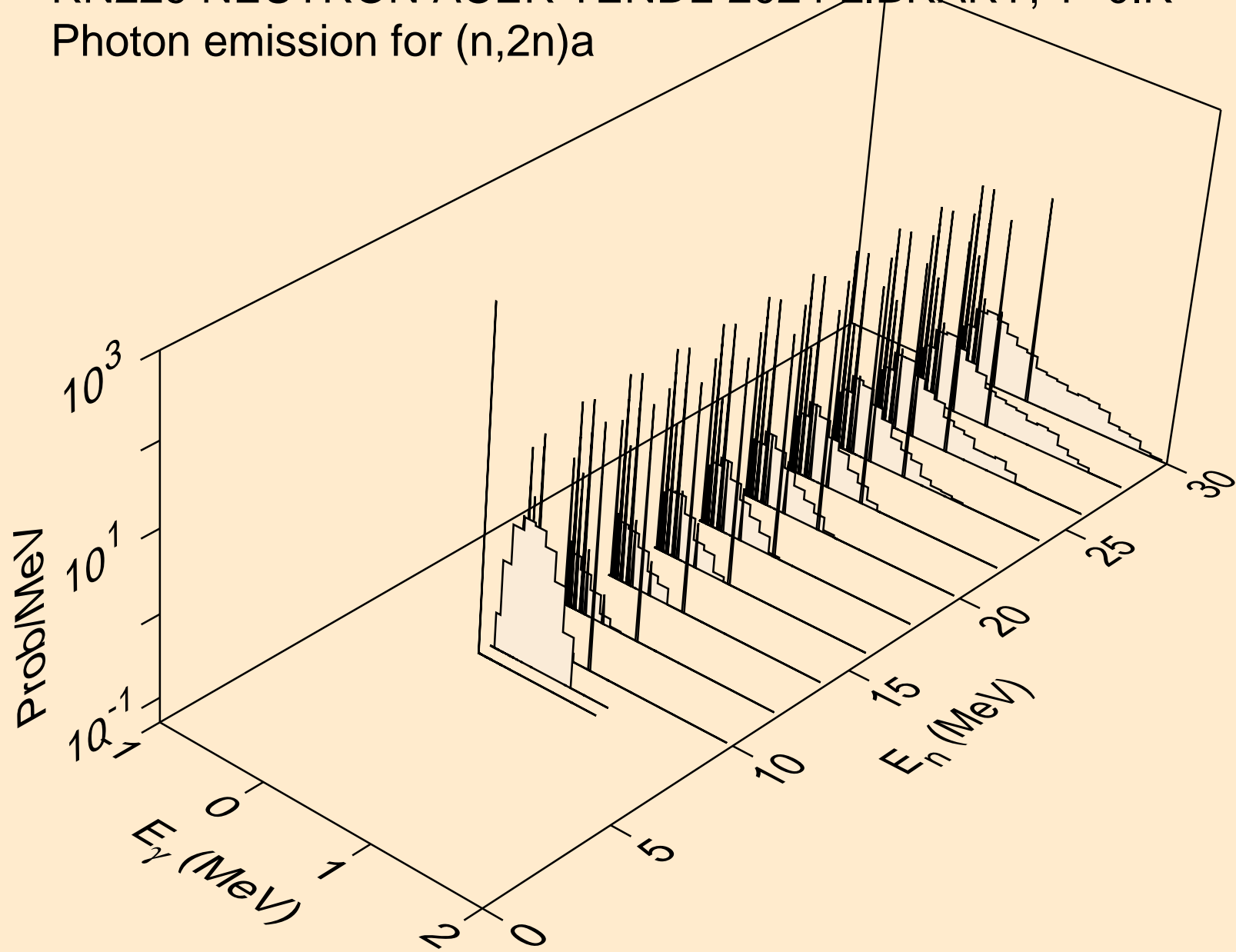

RN229 NEUTRON ACER TENDL-2024 LIBRARY; T=0.K
Photon emission for (n,3n)a

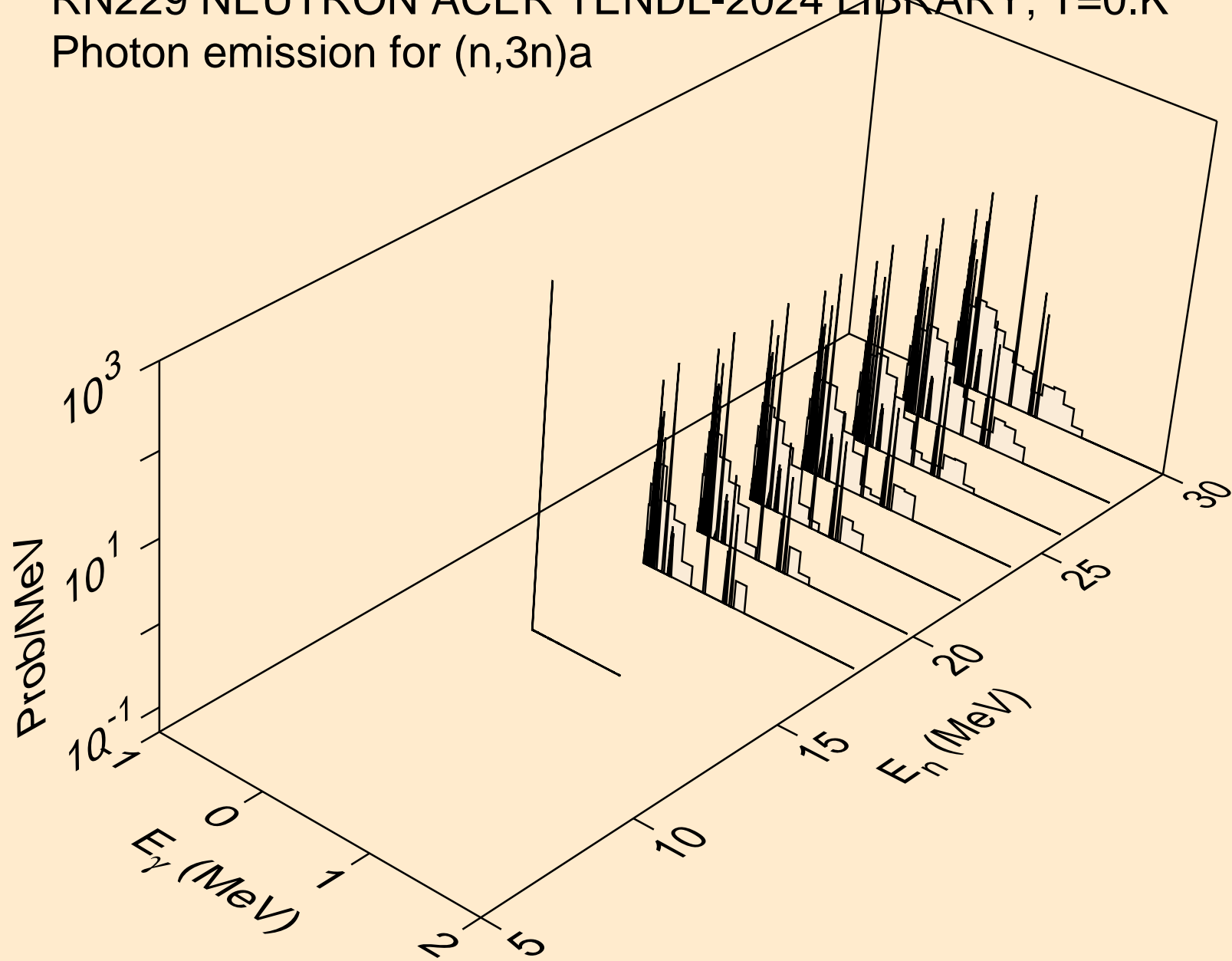

RN229 NEUTRON ACER TENDL-2024 LIBRARY; T=0.K
Photon emission for (n,n*)p

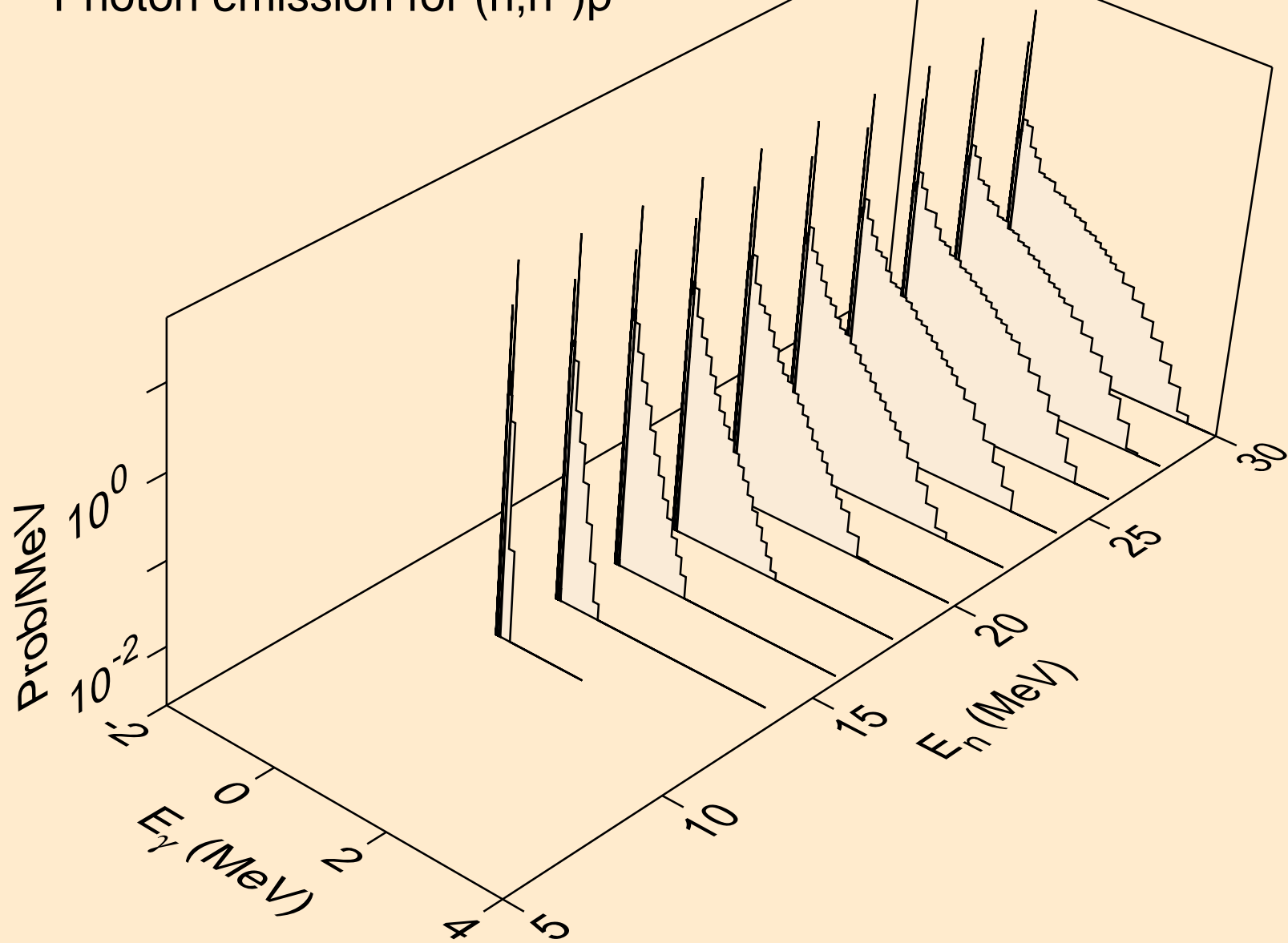

RN229 NEUTRON ACER TENDL-2024 LIBRARY; T=0.K
Photon emission for (n,n*)d

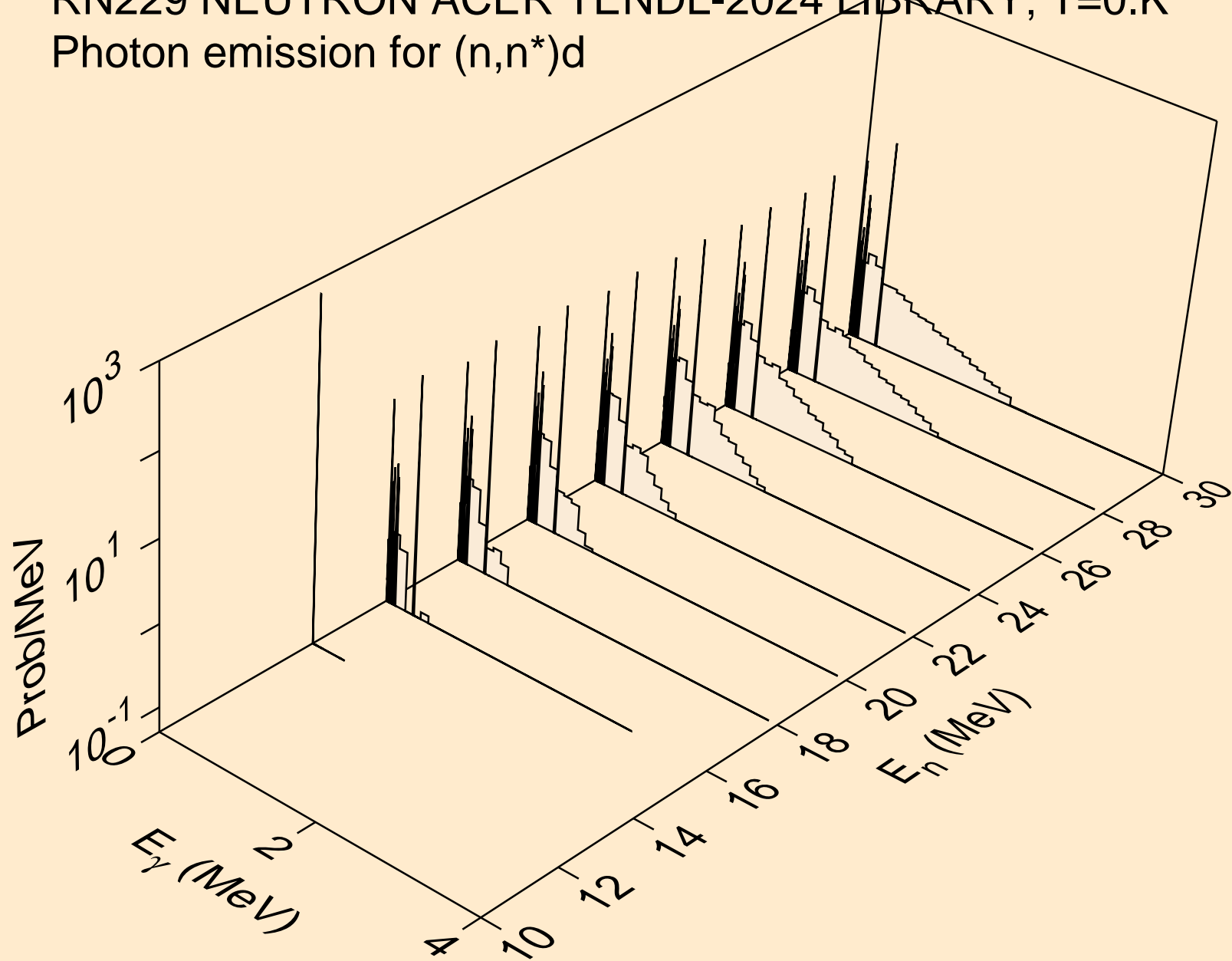

RN229 NEUTRON ACER TENDL-2024 LIBRARY; T=0.K
Photon emission for (n,n*)t

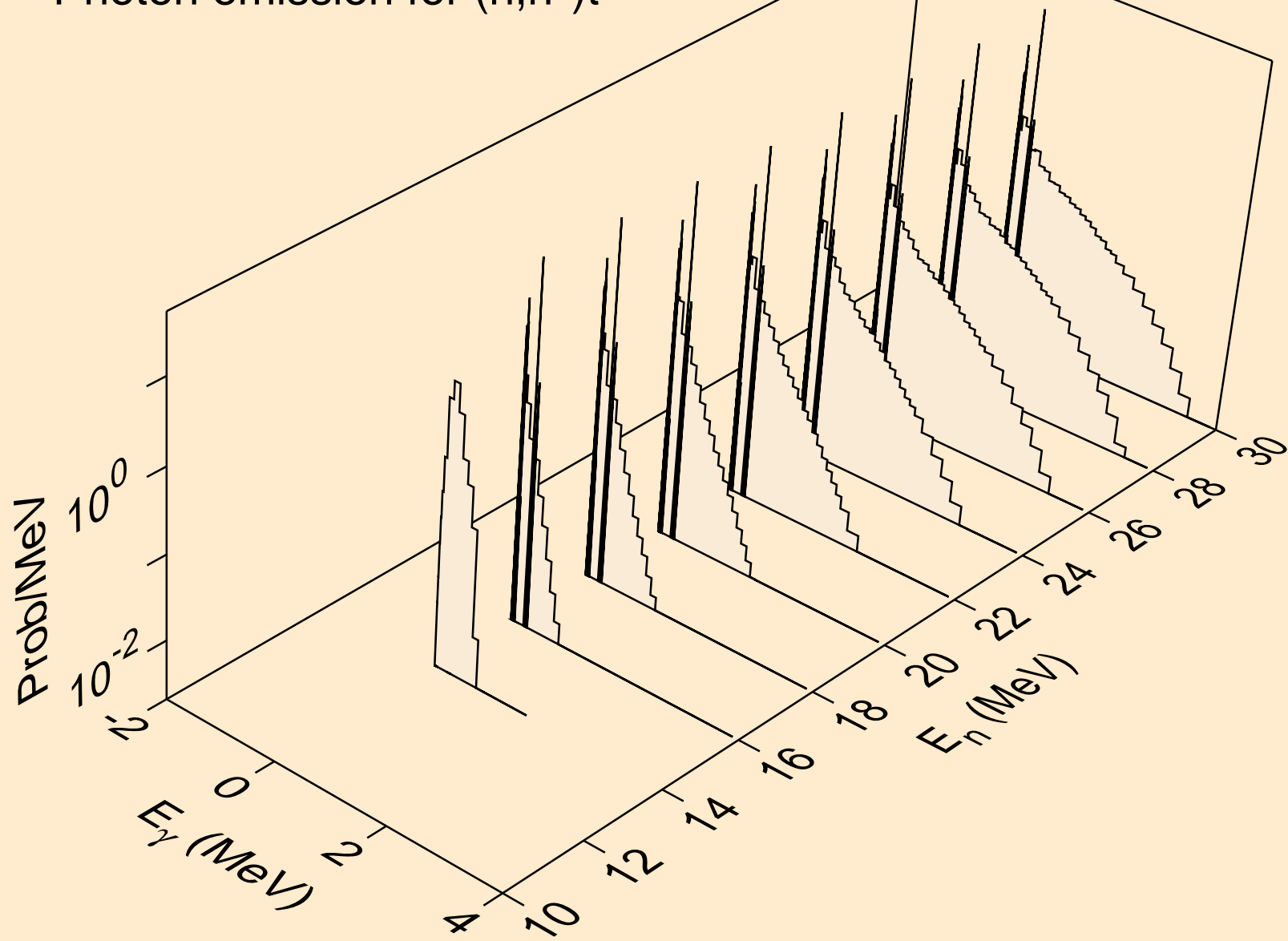

RN229 NEUTRON ACER TENDL-2024 LIBRARY; T=0.K
Photon emission for (n,n*)he3

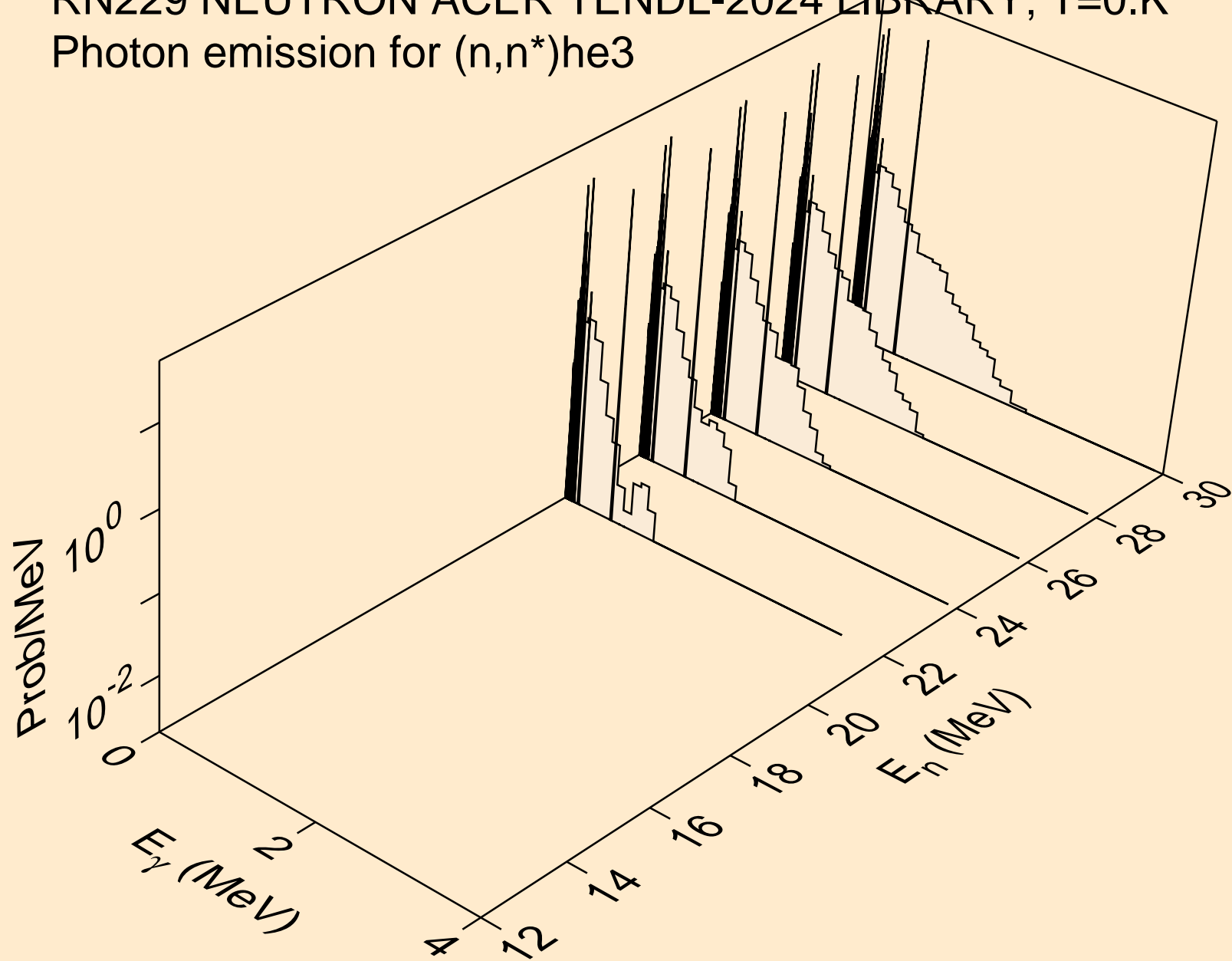

RN229 NEUTRON ACER TENDL-2024 LIBRARY; T=0.K
Photon emission for (n,4n)

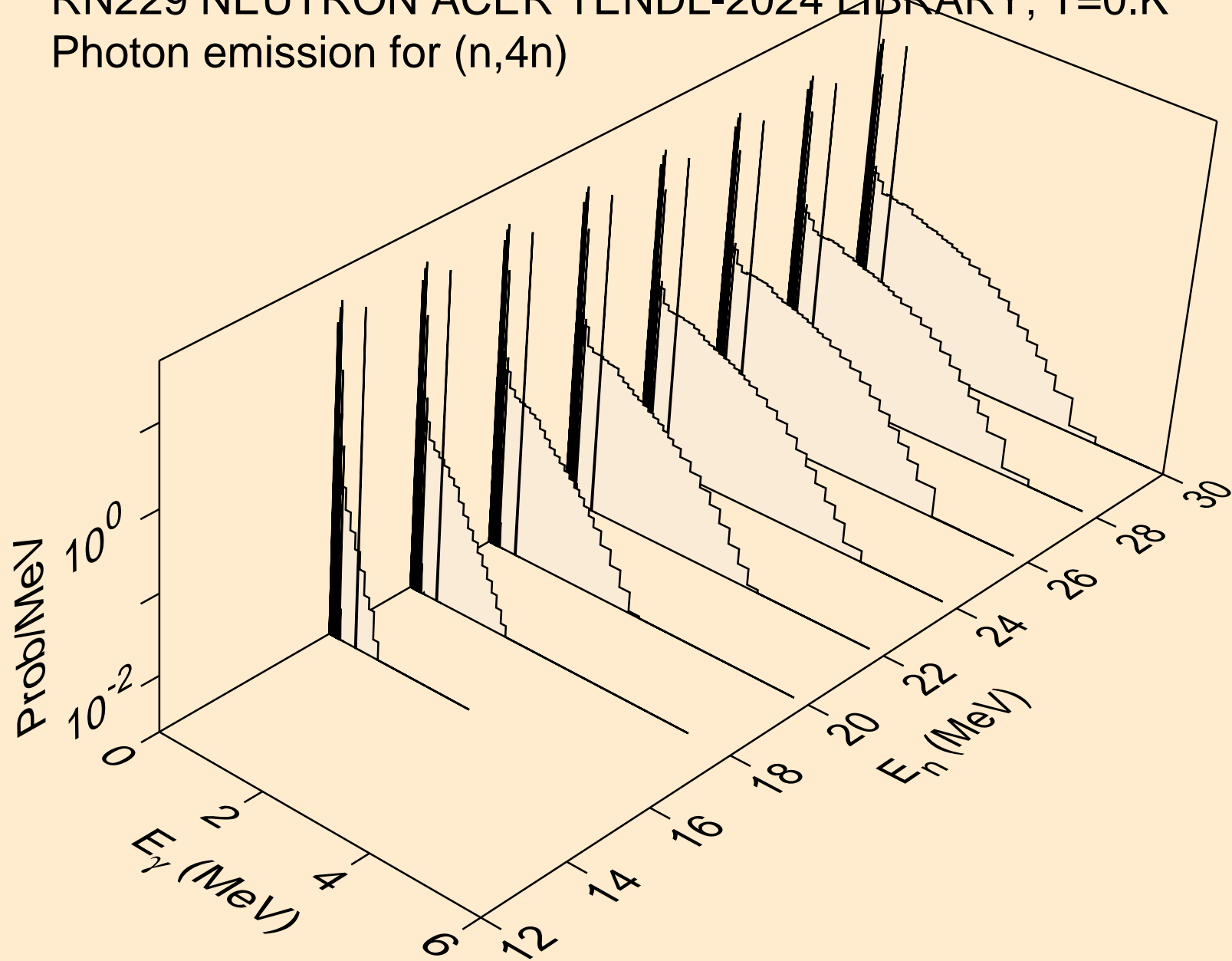

RN229 NEUTRON ACER TENDL-2024 LIBRARY; T=0.K
Photon emission for (n,2np)

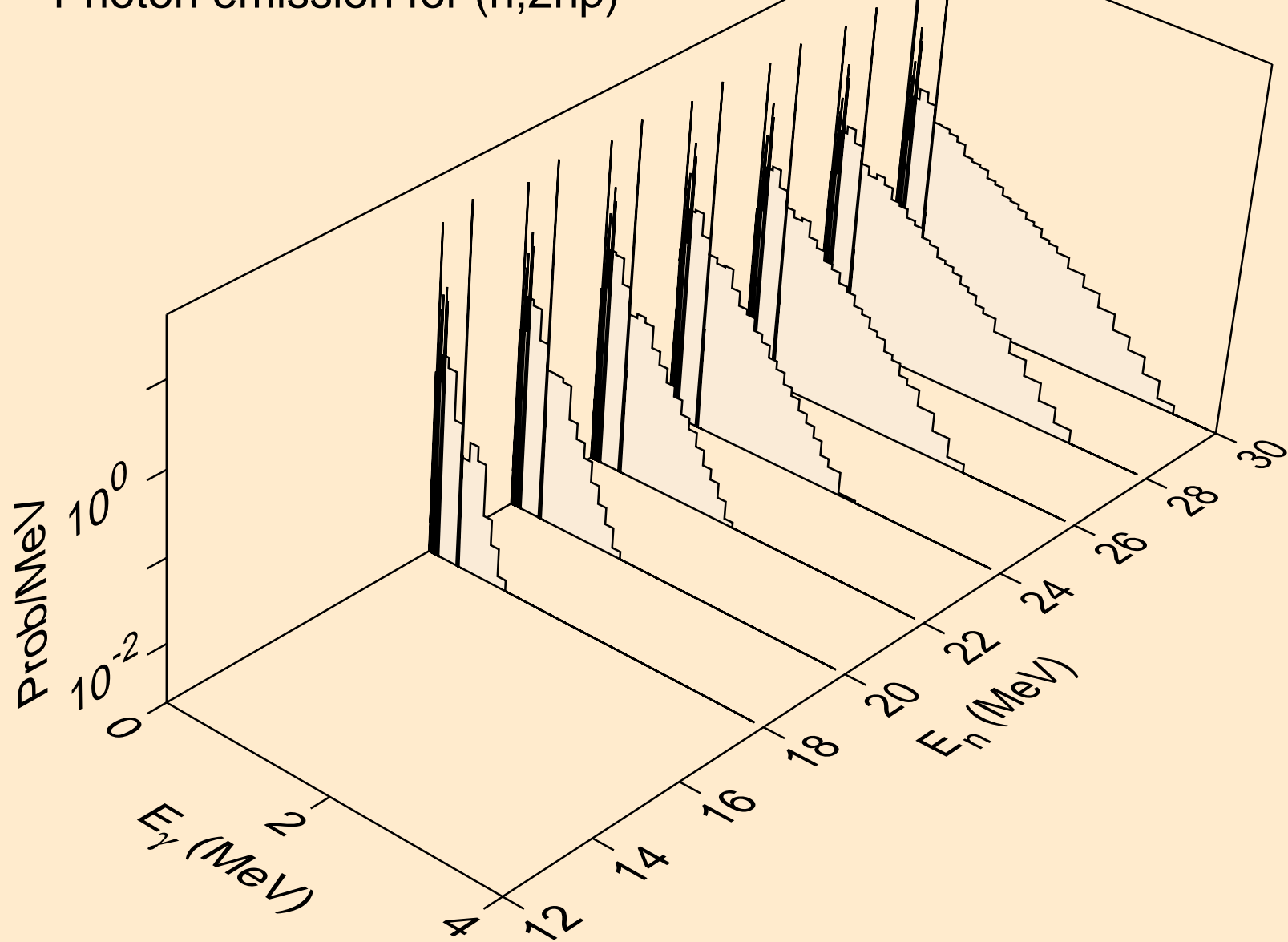

RN229 NEUTRON ACER TENDL-2024 LIBRARY; T=0.K
Photon emission for (n,3np)

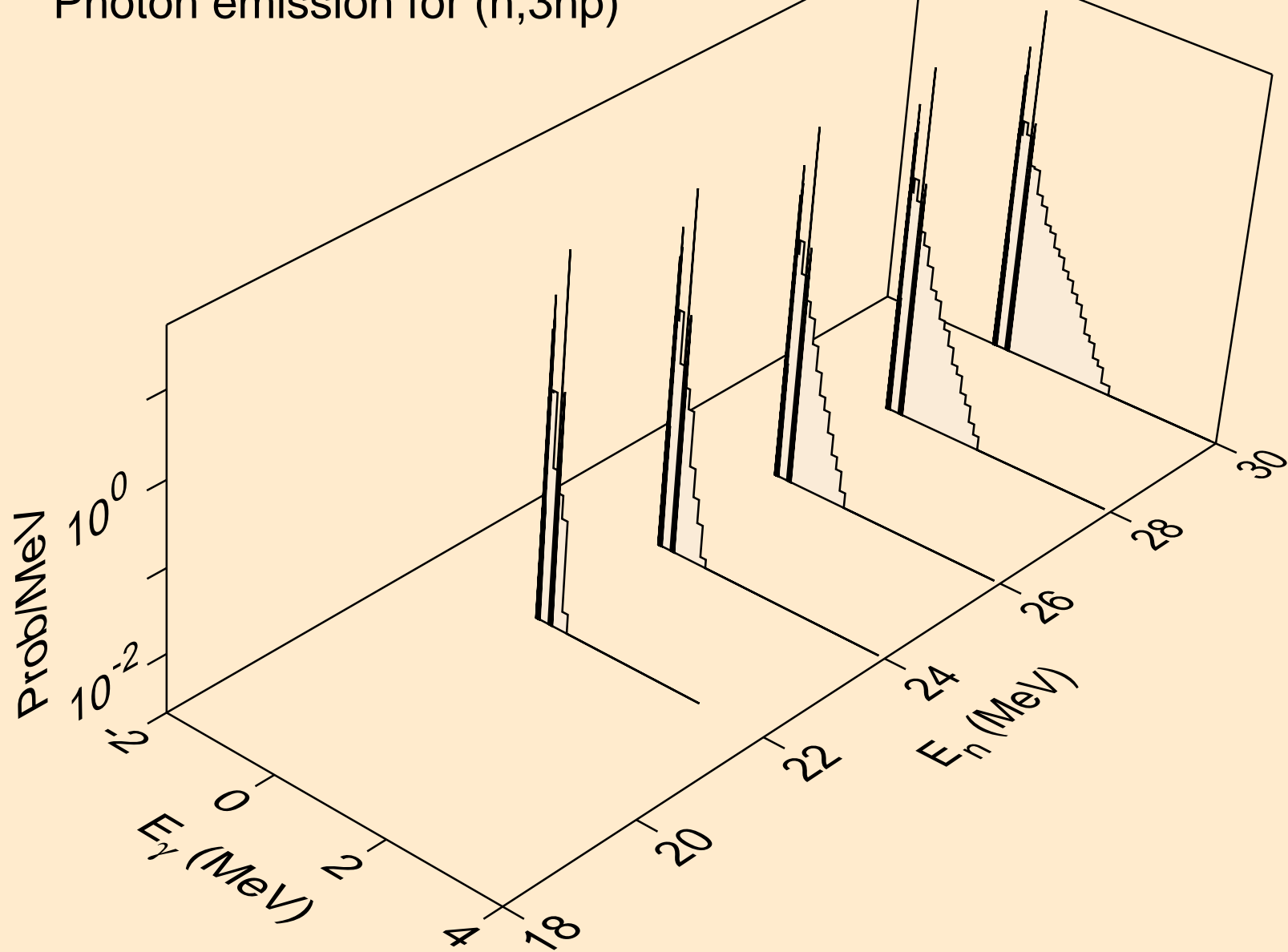

RN229 NEUTRON ACER TENDL-2024 LIBRARY; T=0.K
Photon emission for (n,n*c)

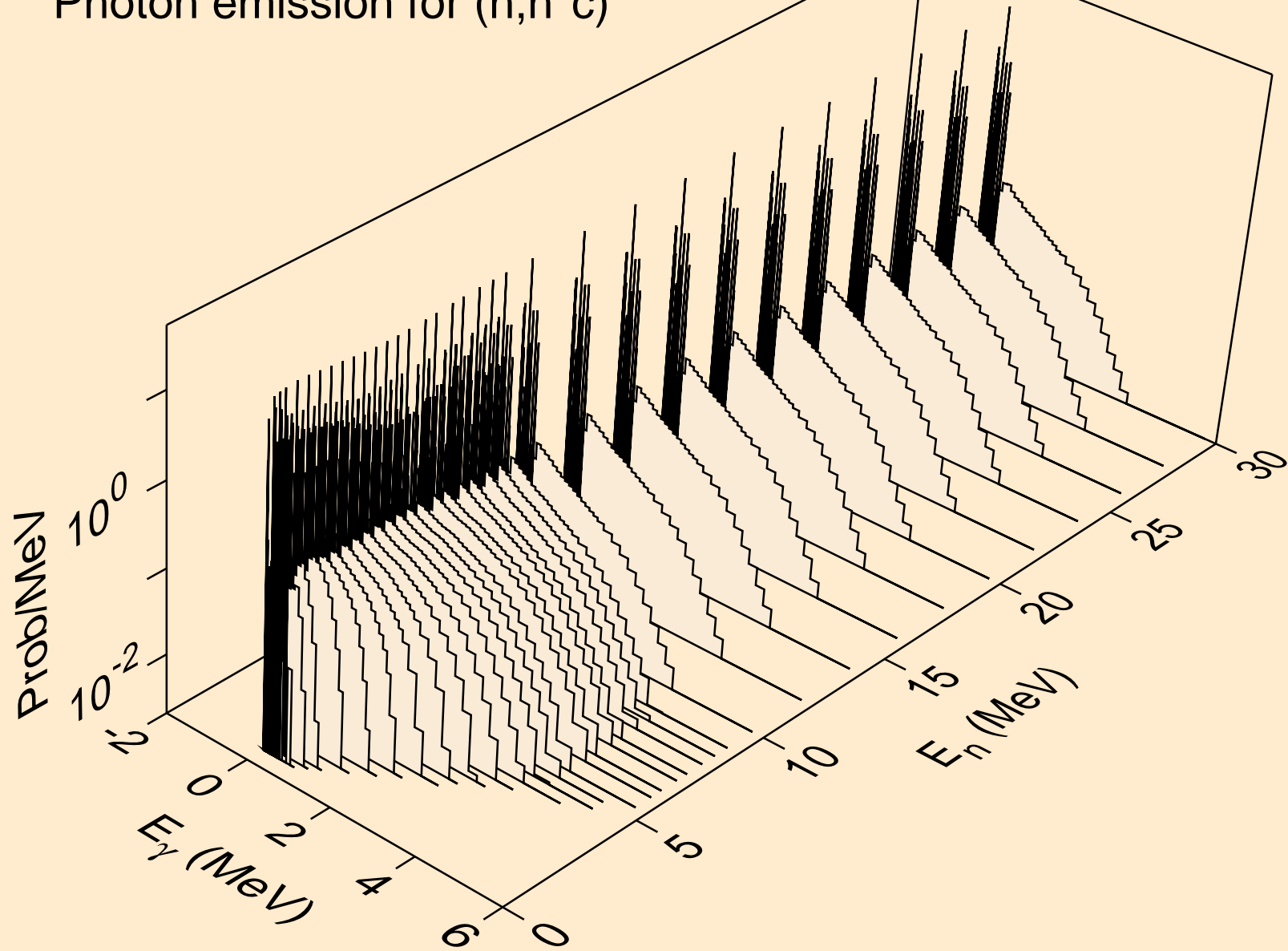

RN229 NEUTRON ACER TENDL-2024 LIBRARY; T=0.K
Photon emission for (n,gma)

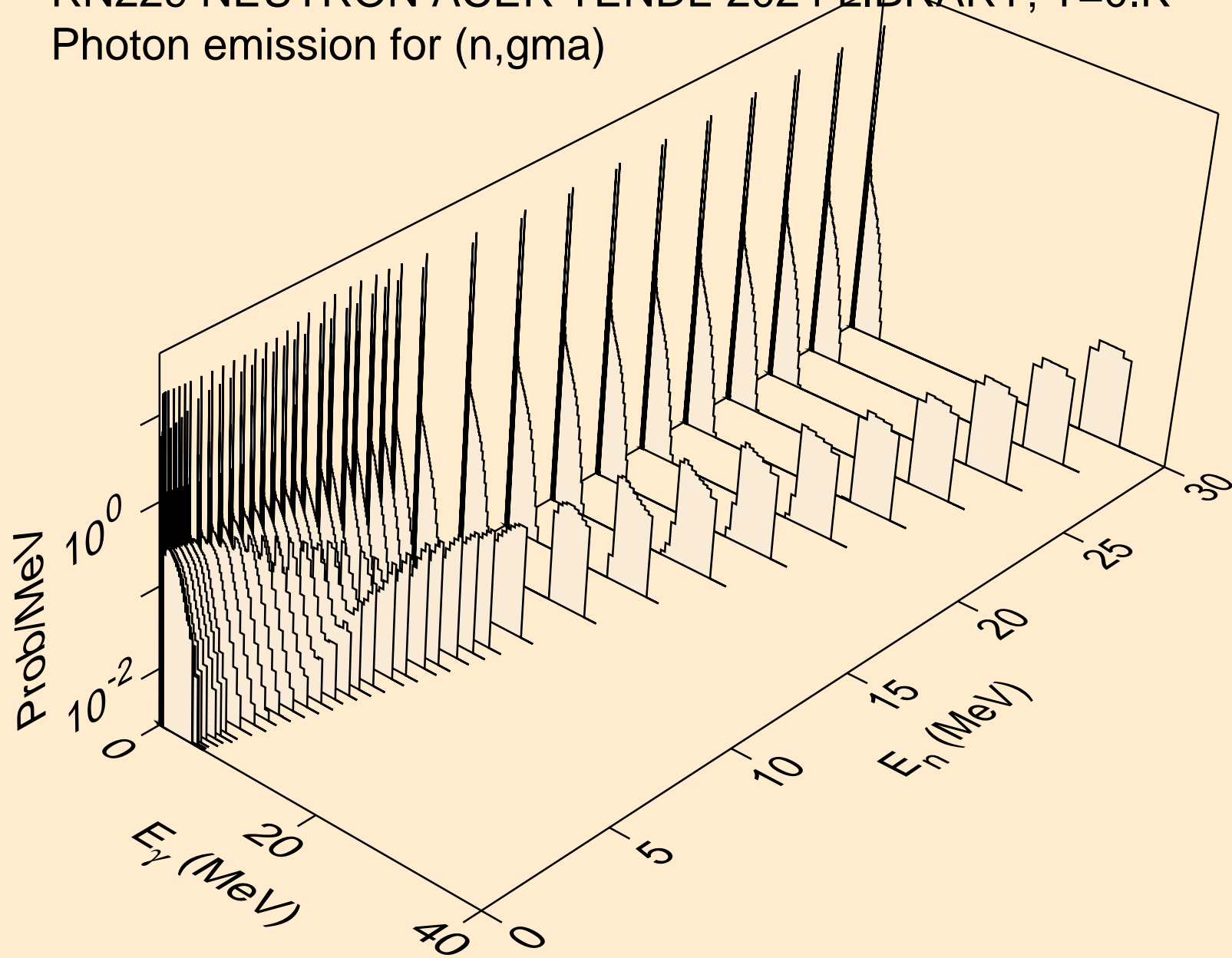

RN229 NEUTRON ACER TENDL-2024 LIBRARY; T=0.K
Photon emission for (n,p)

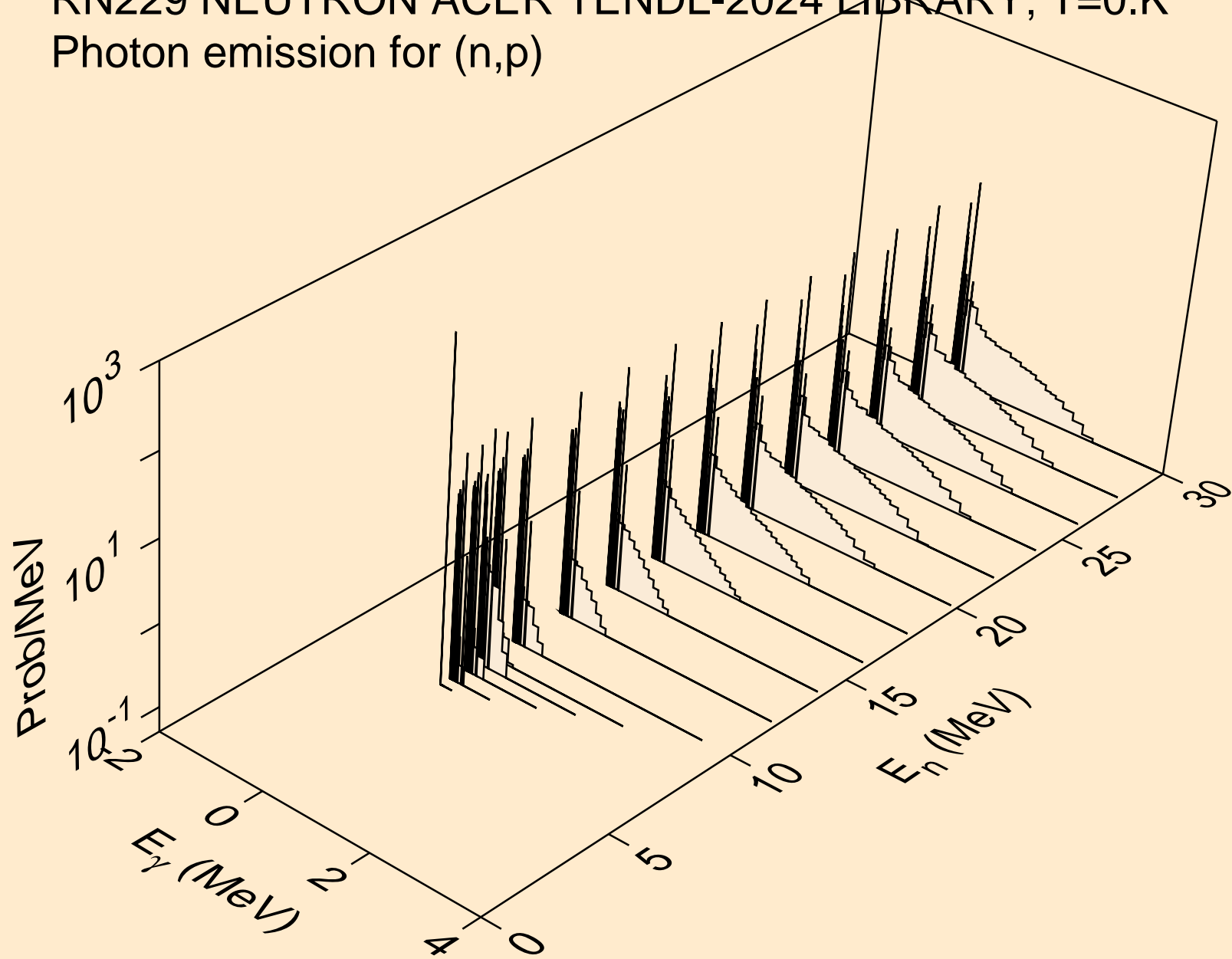

RN229 NEUTRON ACER TENDL-2024 LIBRARY; T=0.K
Photon emission for (n,d)

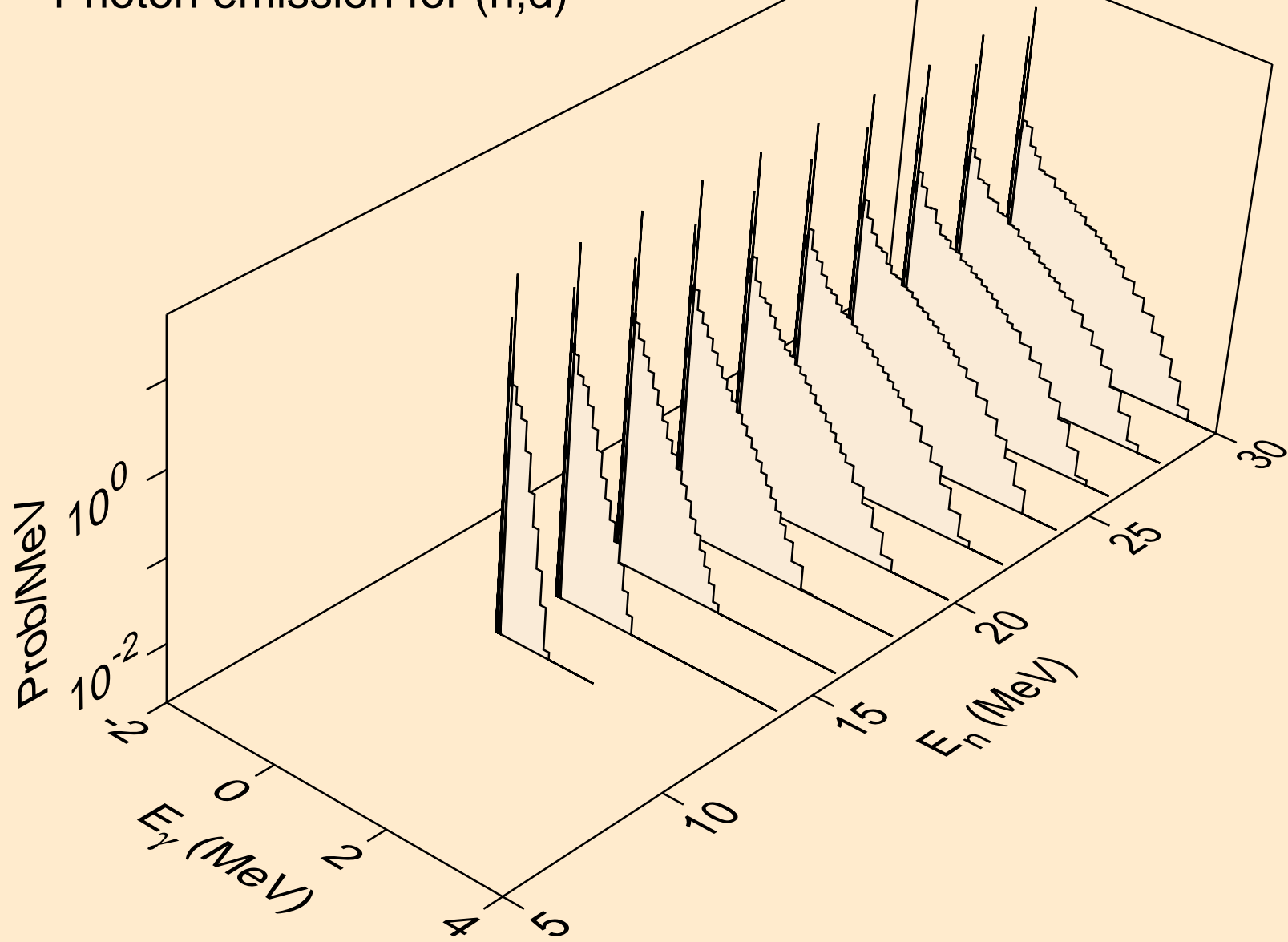

RN229 NEUTRON ACER TENDL-2024 LIBRARY; T=0.K
Photon emission for (n,t)

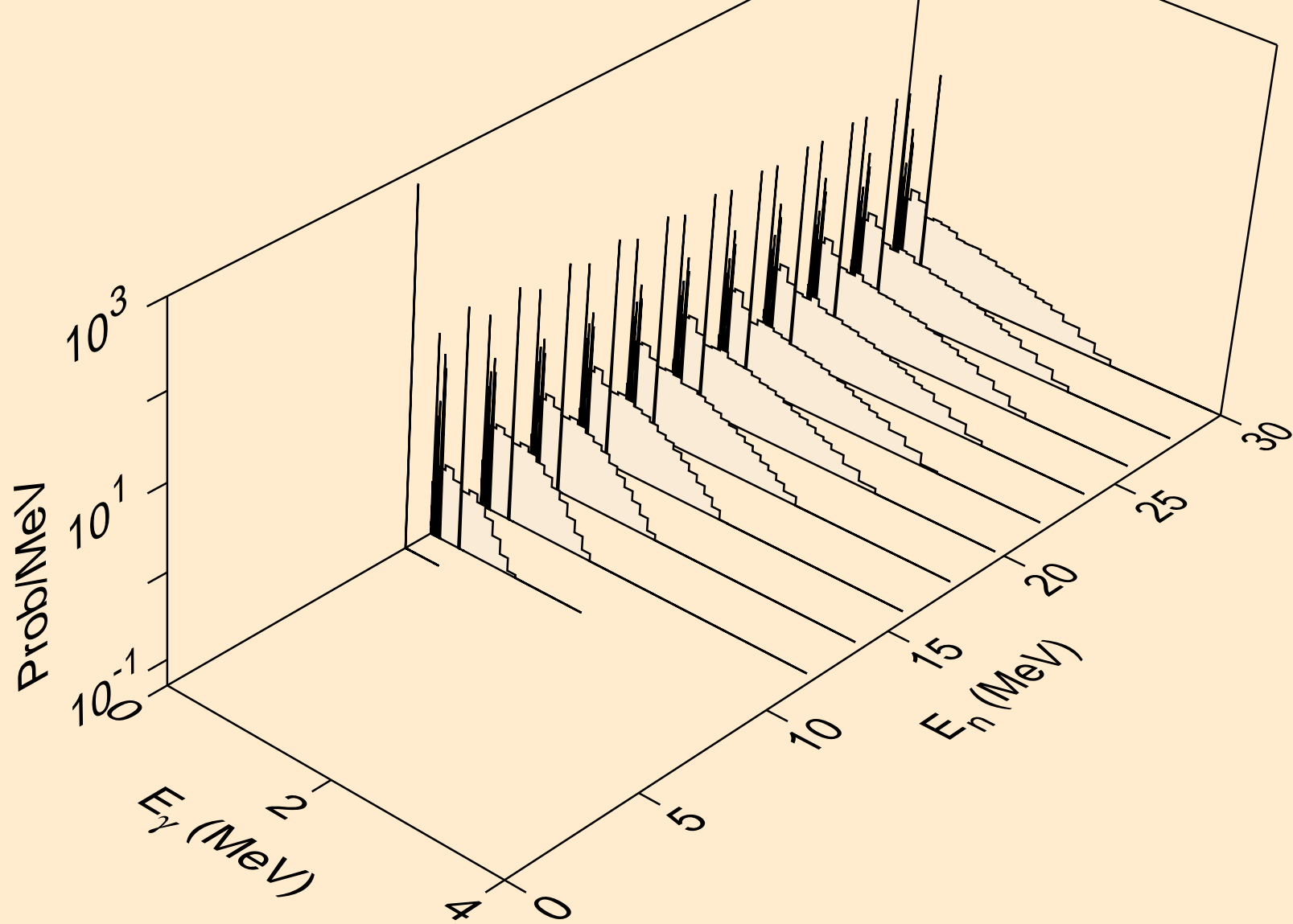

RN229 NEUTRON ACER TENDL-2024 LIBRARY; T=0.K
Photon emission for (n,he3)

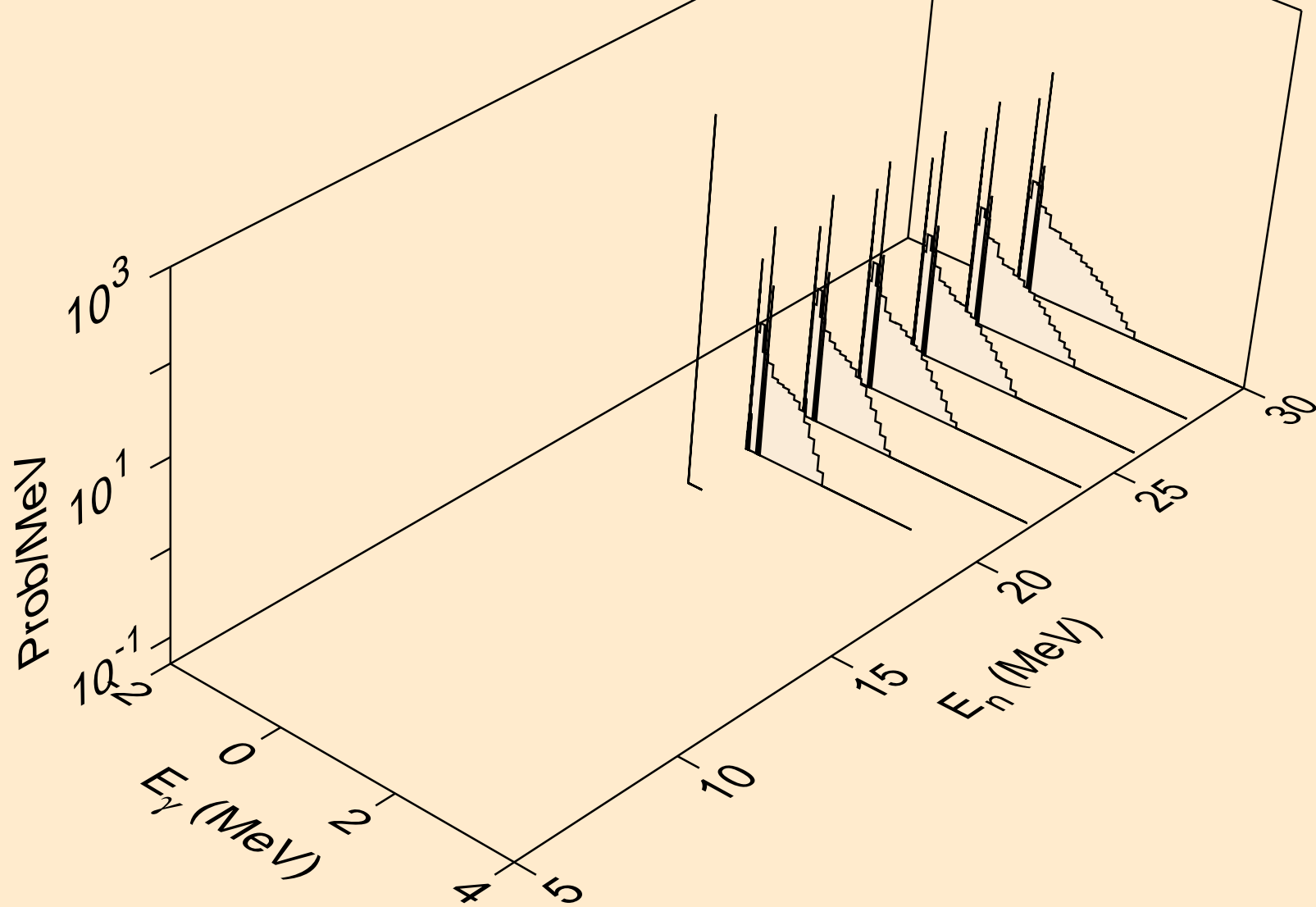

RN229 NEUTRON ACER TENDL-2024 LIBRARY; T=0.K
Photon emission for (n,a)

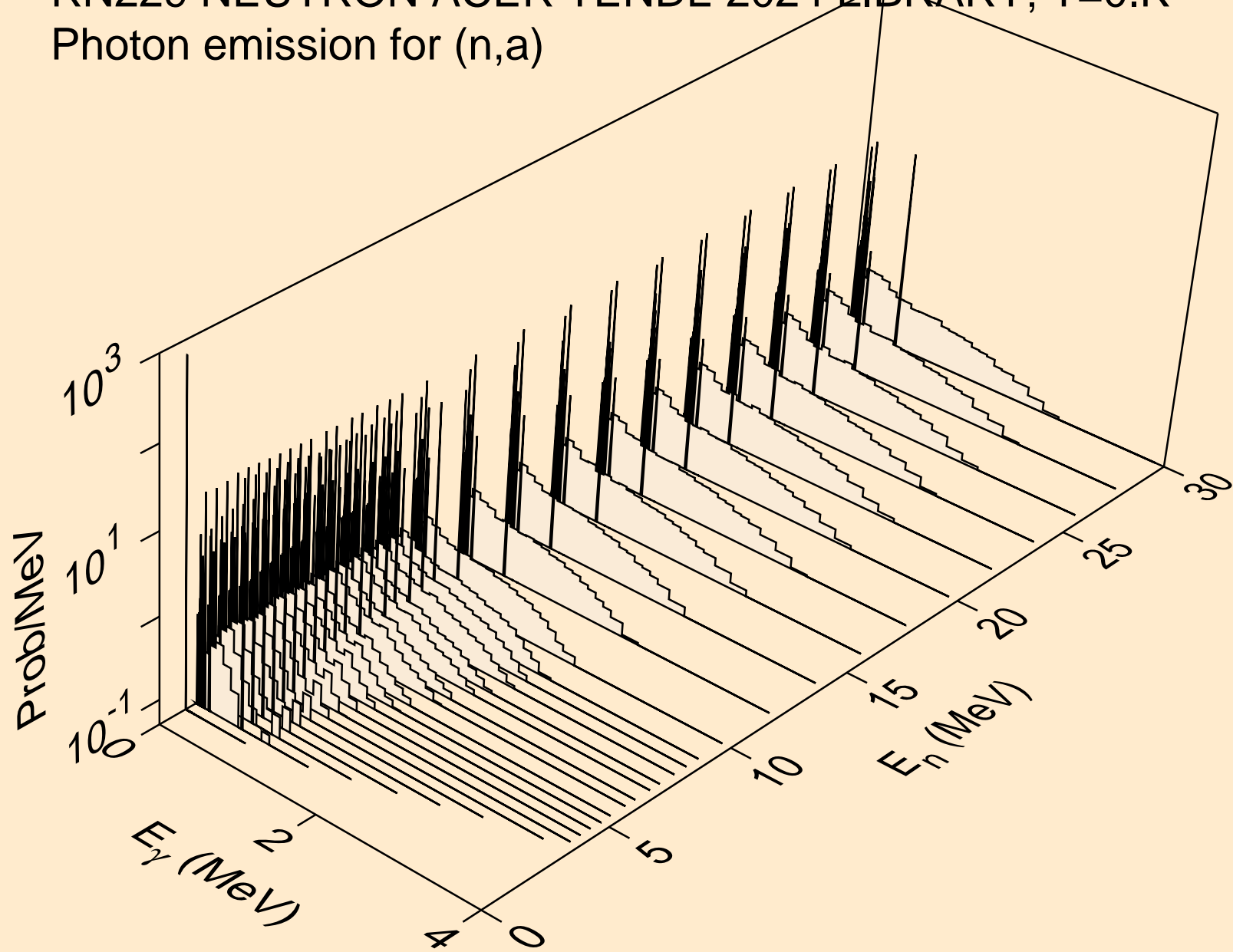

RN229 NEUTRON ACER TENDL-2024 LIBRARY; T=0.K
thermal capture photon spectrum

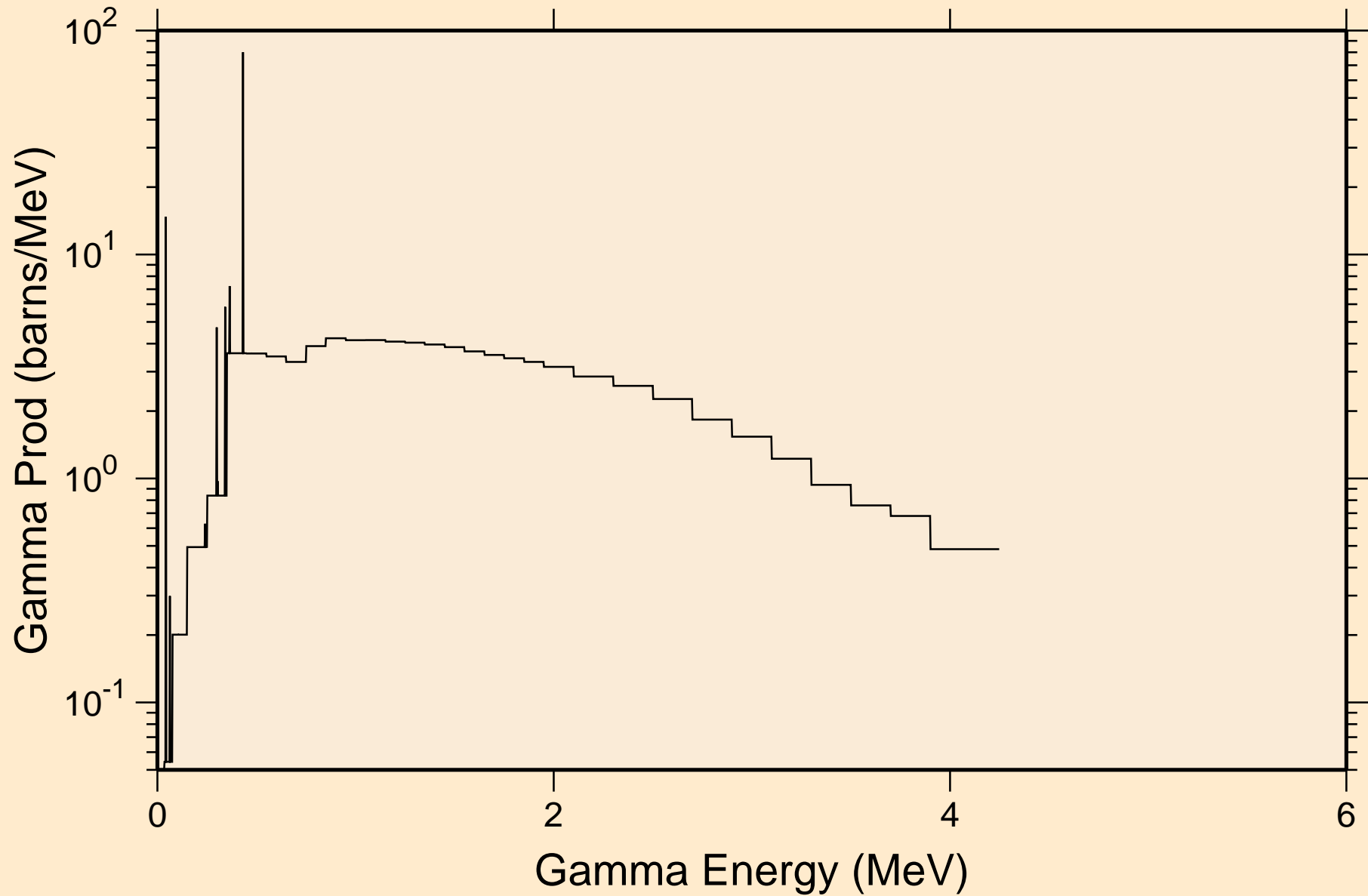

RN229 NEUTRON ACER TENDL-2024 LIBRARY; T=0.K
14 MeV photon spectrum

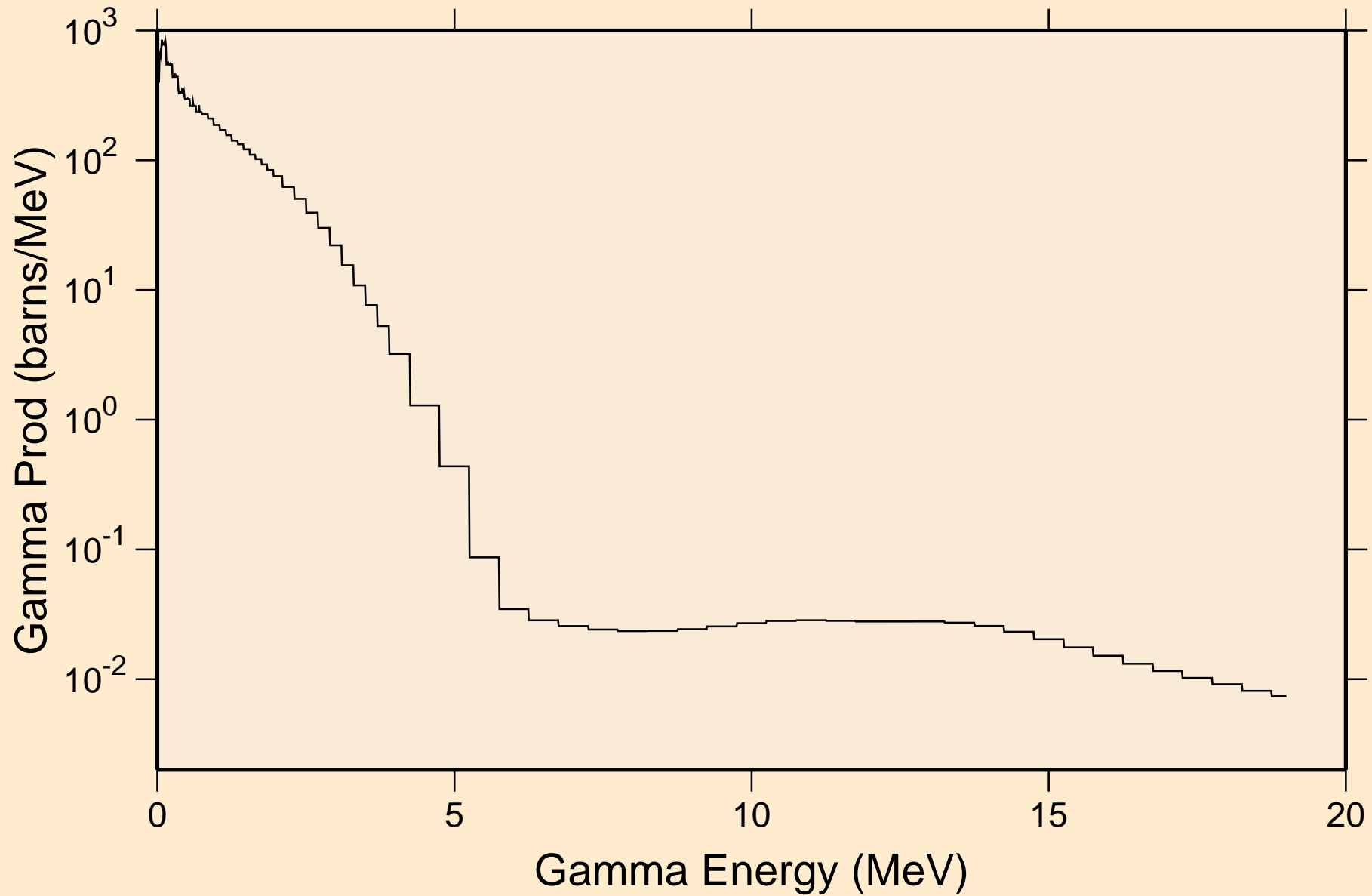

RN229 NEUTRON ACER TENDL-2024 LIBRARY; T=0.K
Particle heating contributions

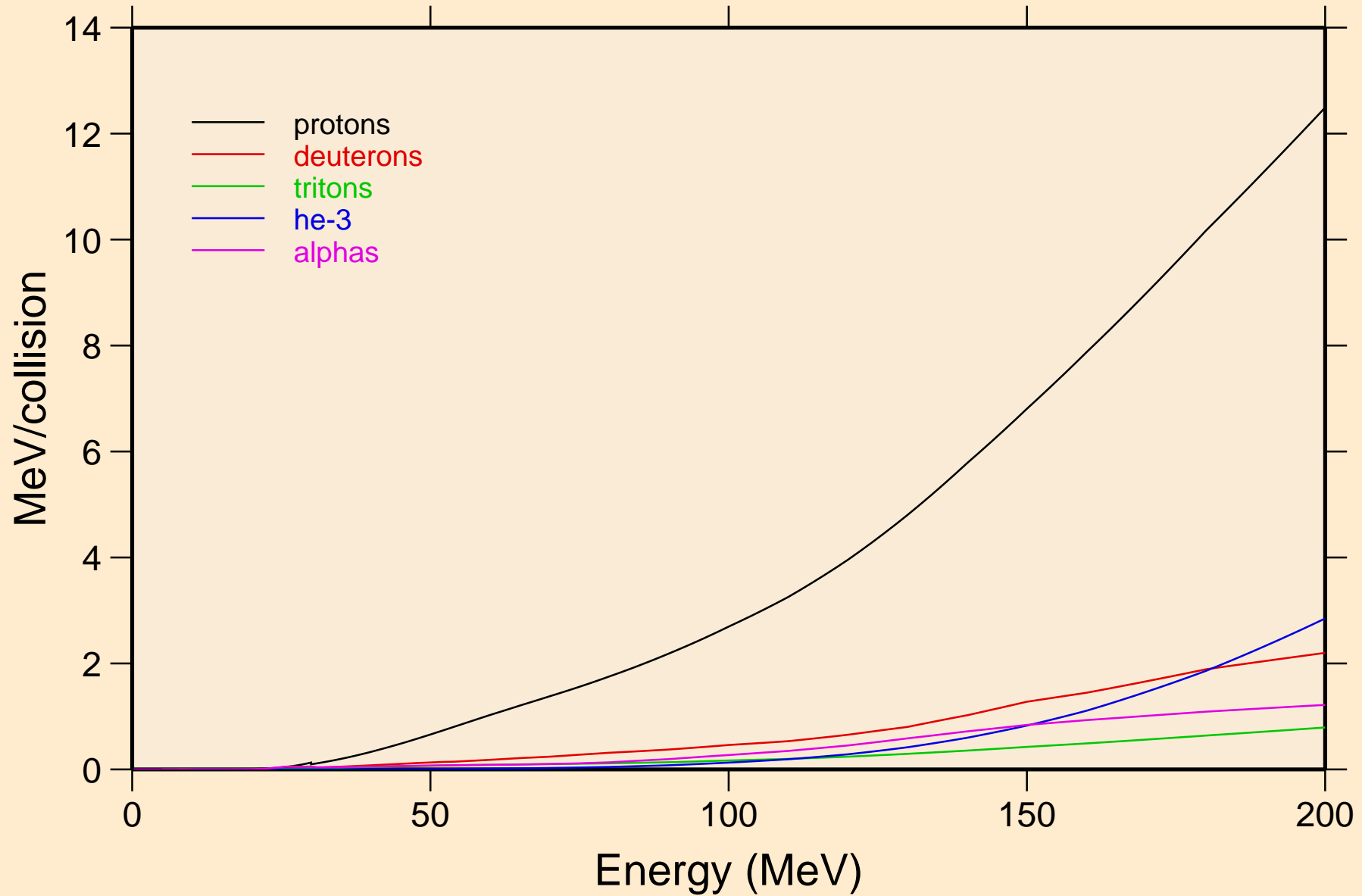

RN229 NEUTRON ACER TENDL-2024 LIBRARY; T=0.K
Recoil Heating

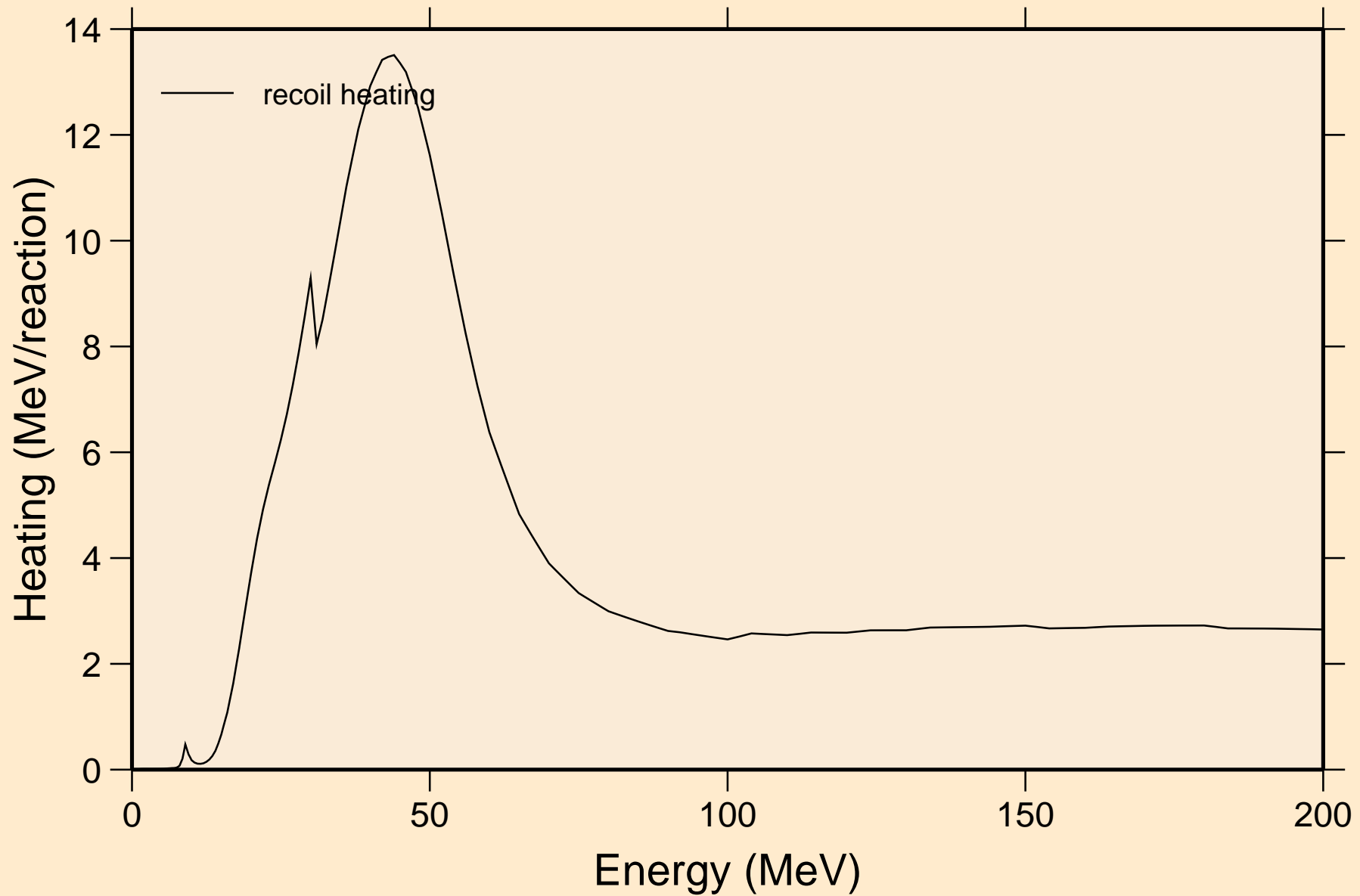

RN229 NEUTRON ACER TENDL-2024 LIBRARY; T=0.K
Particle production cross sections

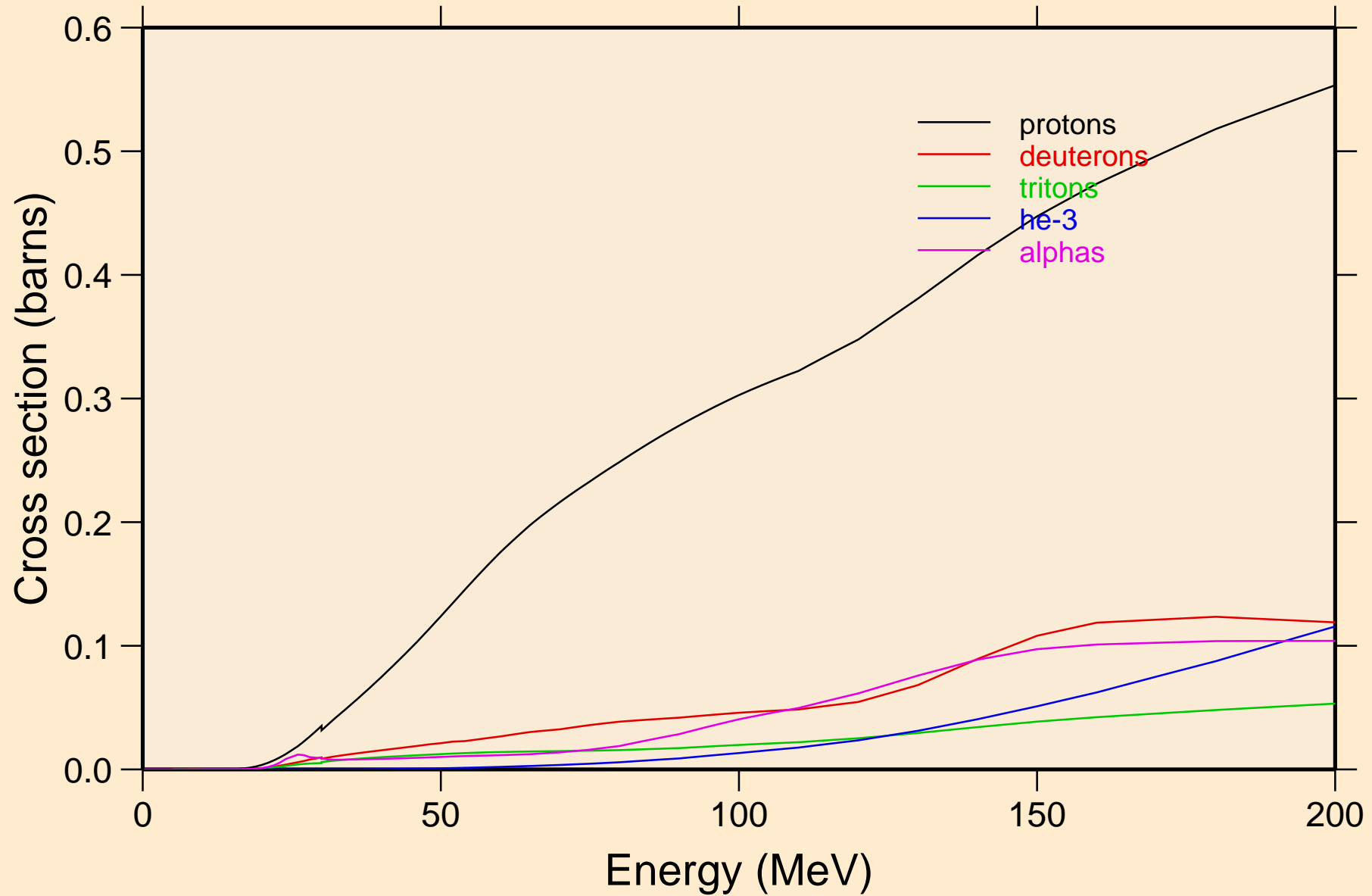

RN229 NEUTRON ACER TENDL-2024 LIBRARY; T=0.K
protons from (n,x)

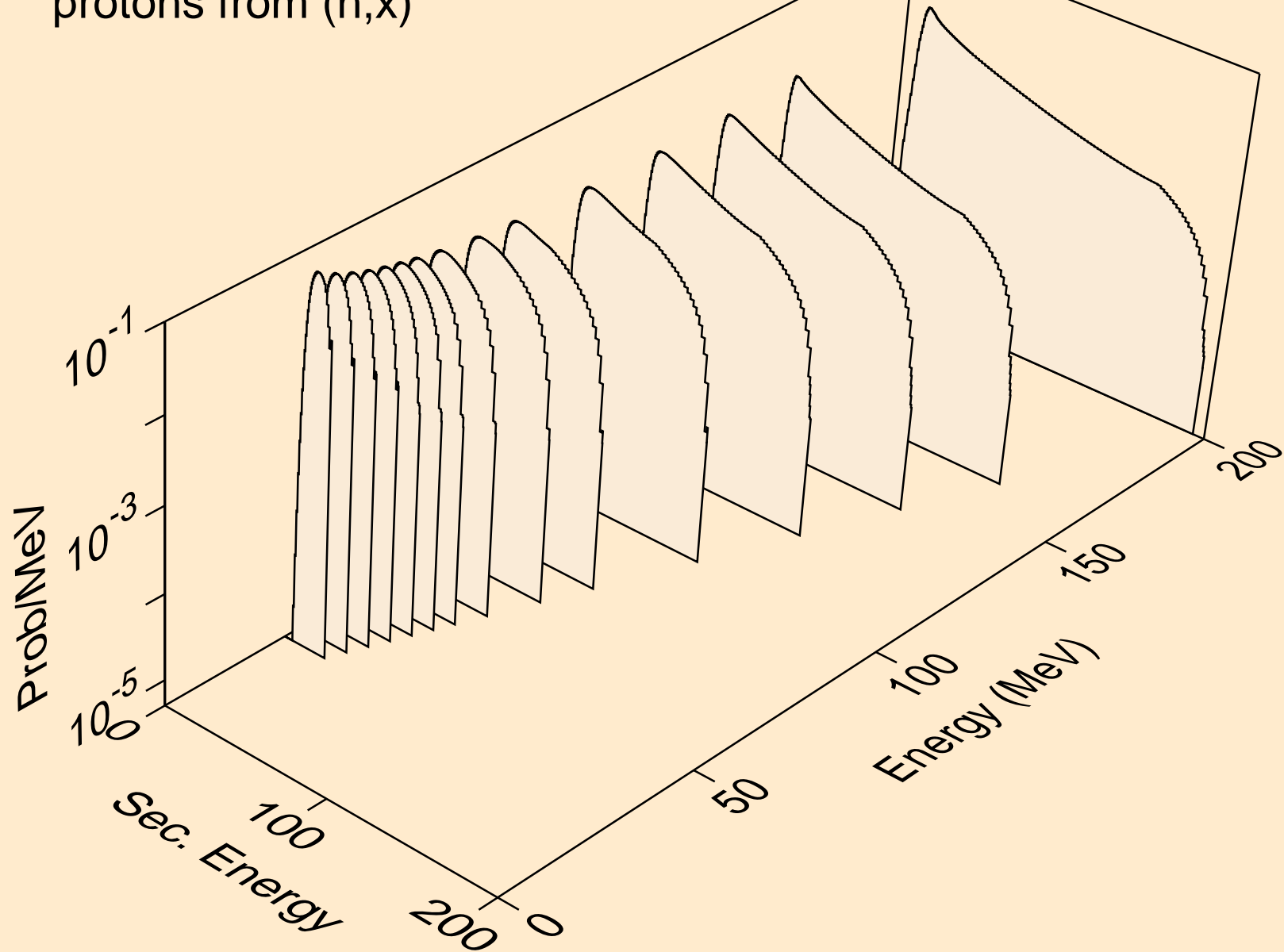

RN229 NEUTRON ACER TENDL-2024 LIBRARY; T=0.K
protons from (n,n*)p

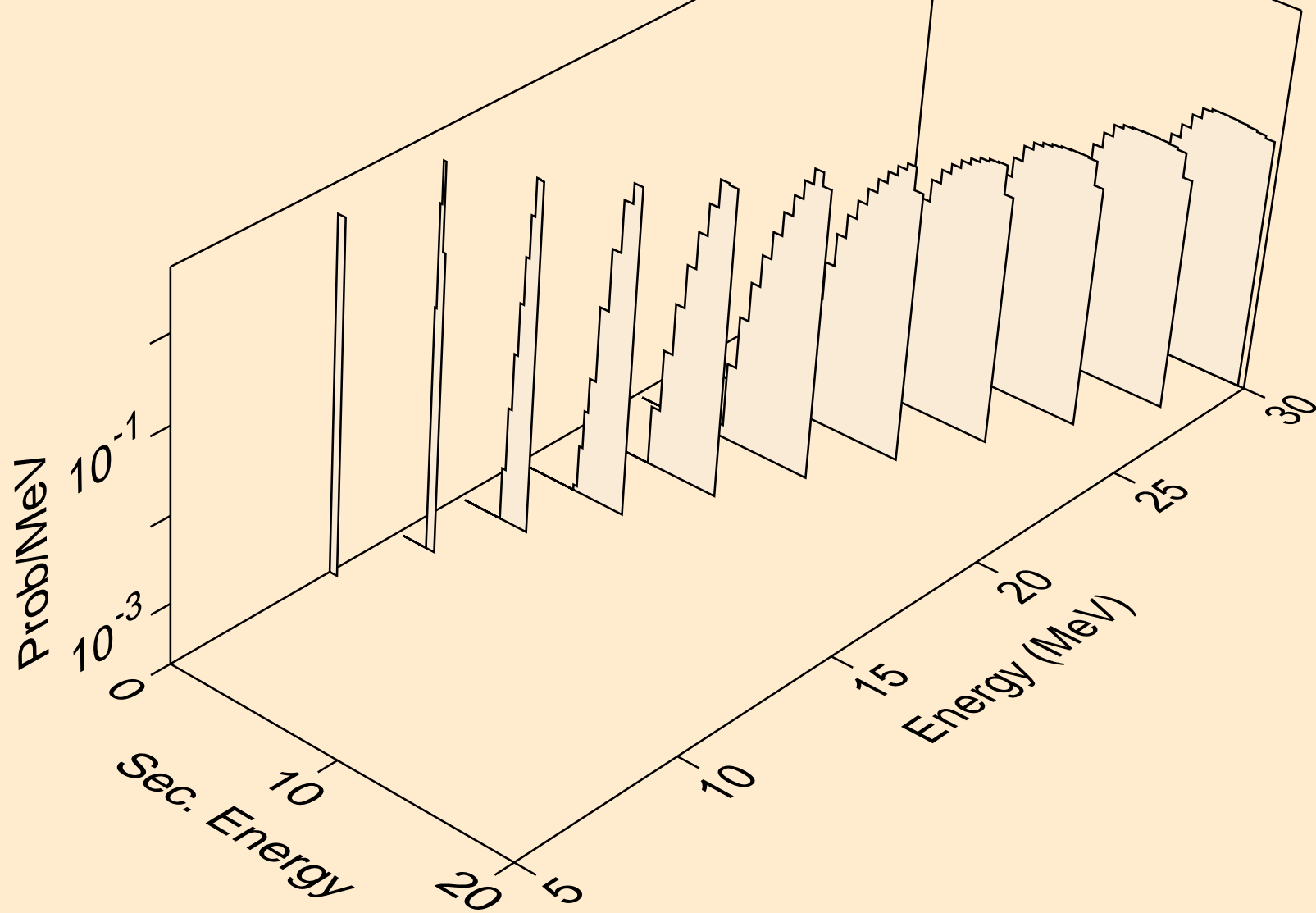

RN229 NEUTRON ACER TENDL-2024 LIBRARY; T=0.K
protons from (n,2np)

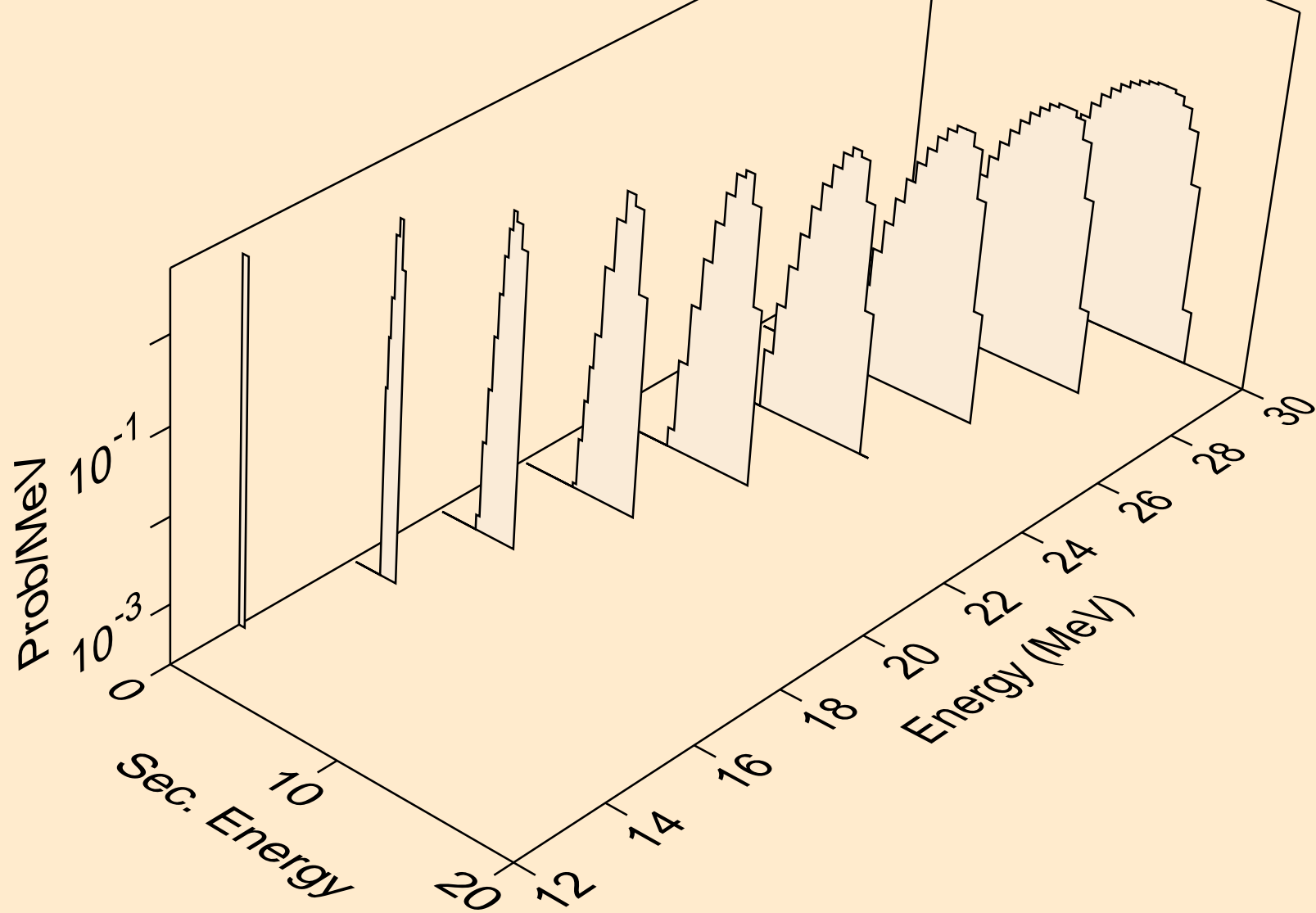

RN229 NEUTRON ACER TENDL-2024 LIBRARY; T=0.K
protons from (n,3np)

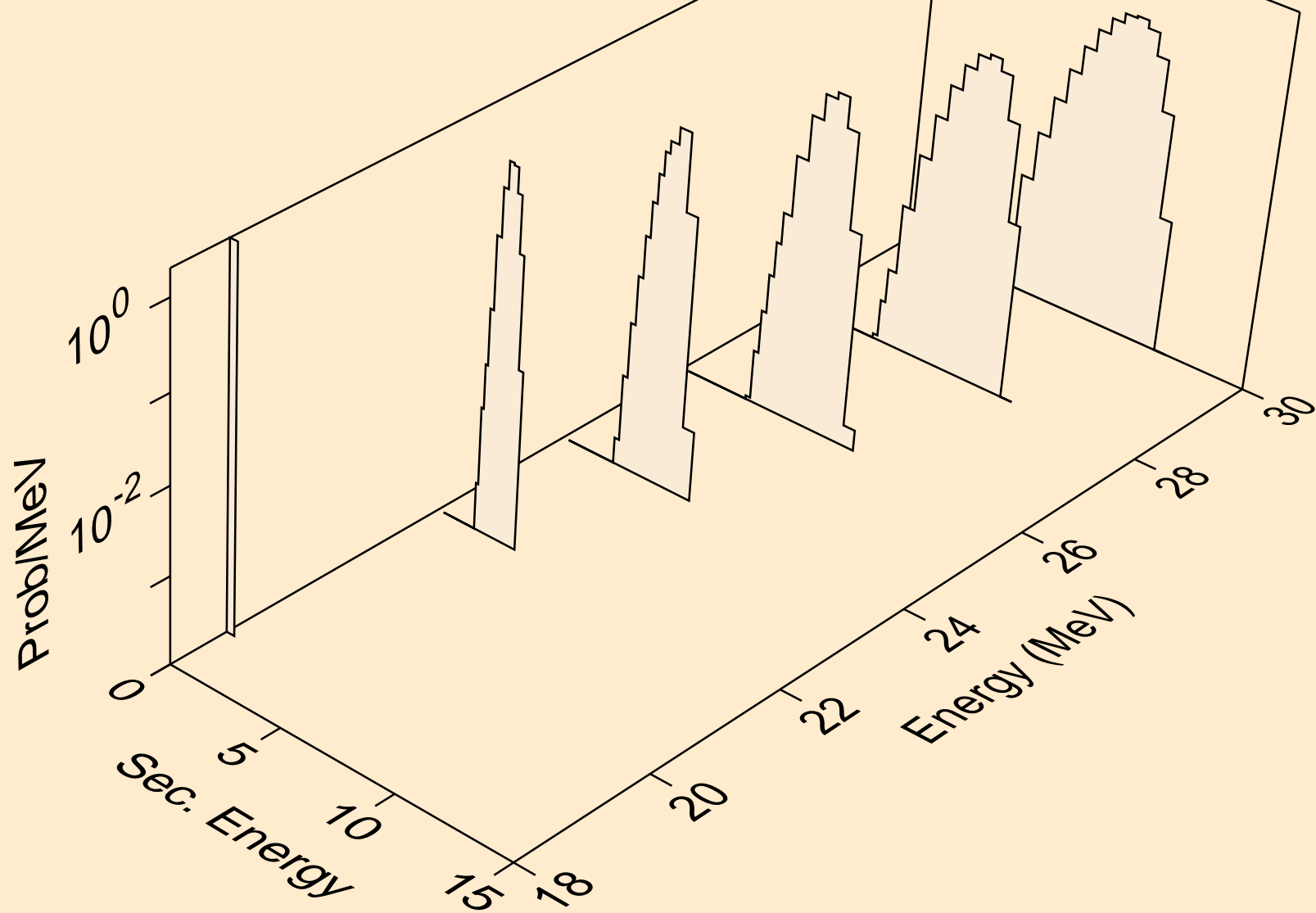

RN229 NEUTRON ACER TENDL-2024 LIBRARY; T=0.K
protons from (n,p)

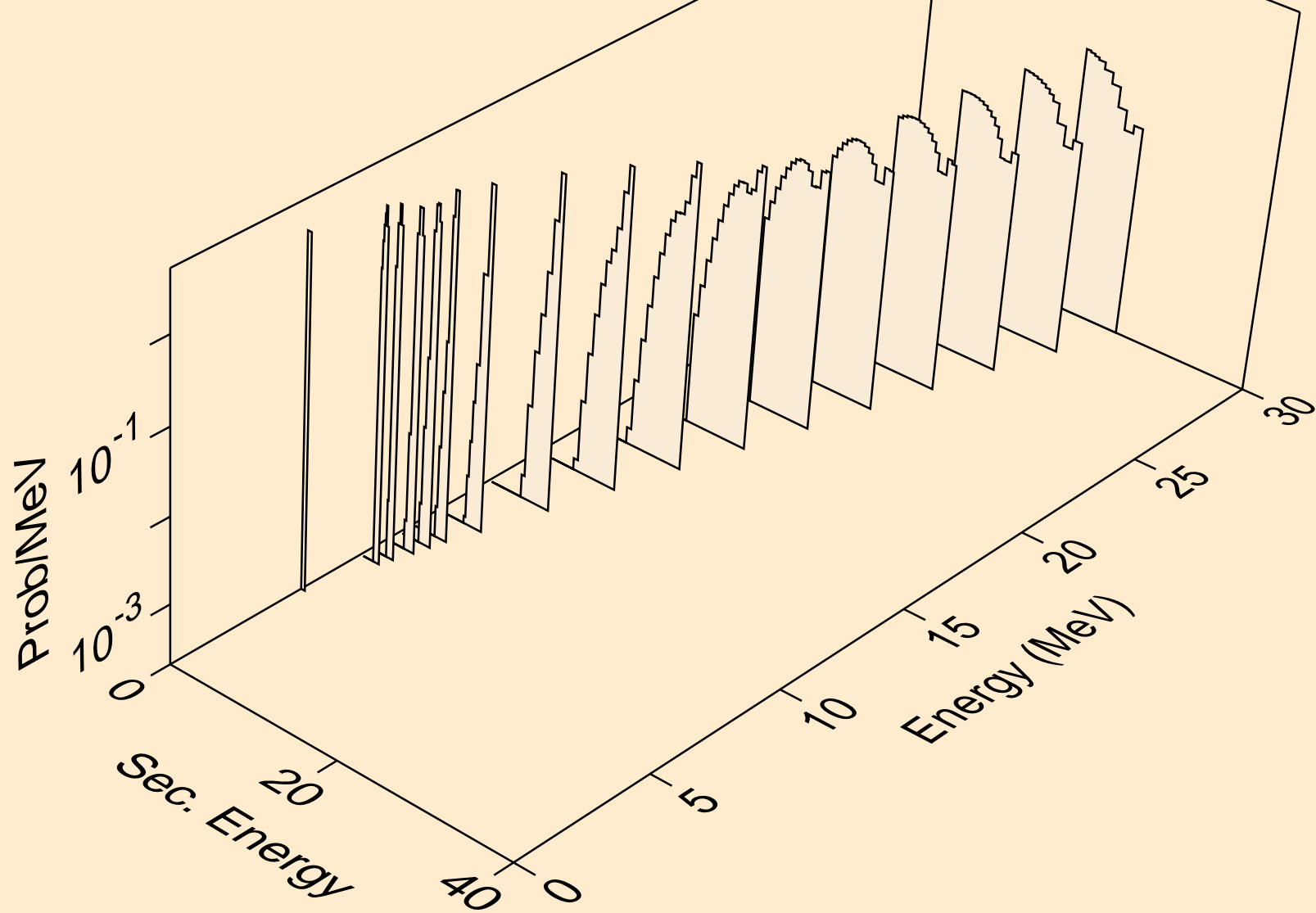

RN229 NEUTRON ACER TENDL-2024 LIBRARY; T=0.K
deuterons from (n,x)

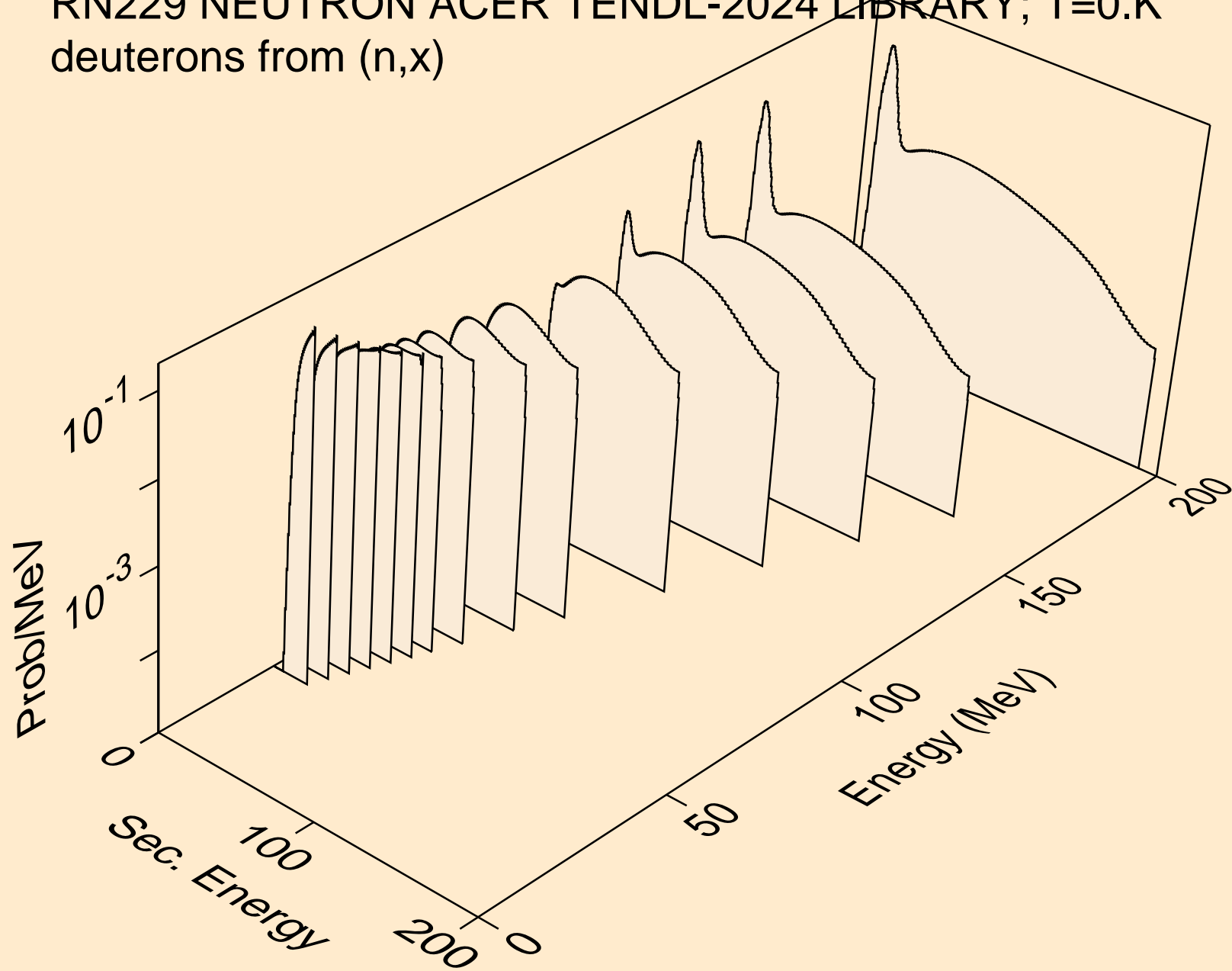

RN229 NEUTRON ACER TENDL-2024 LIBRARY; T=0.K
deuterons from (n,2nd)

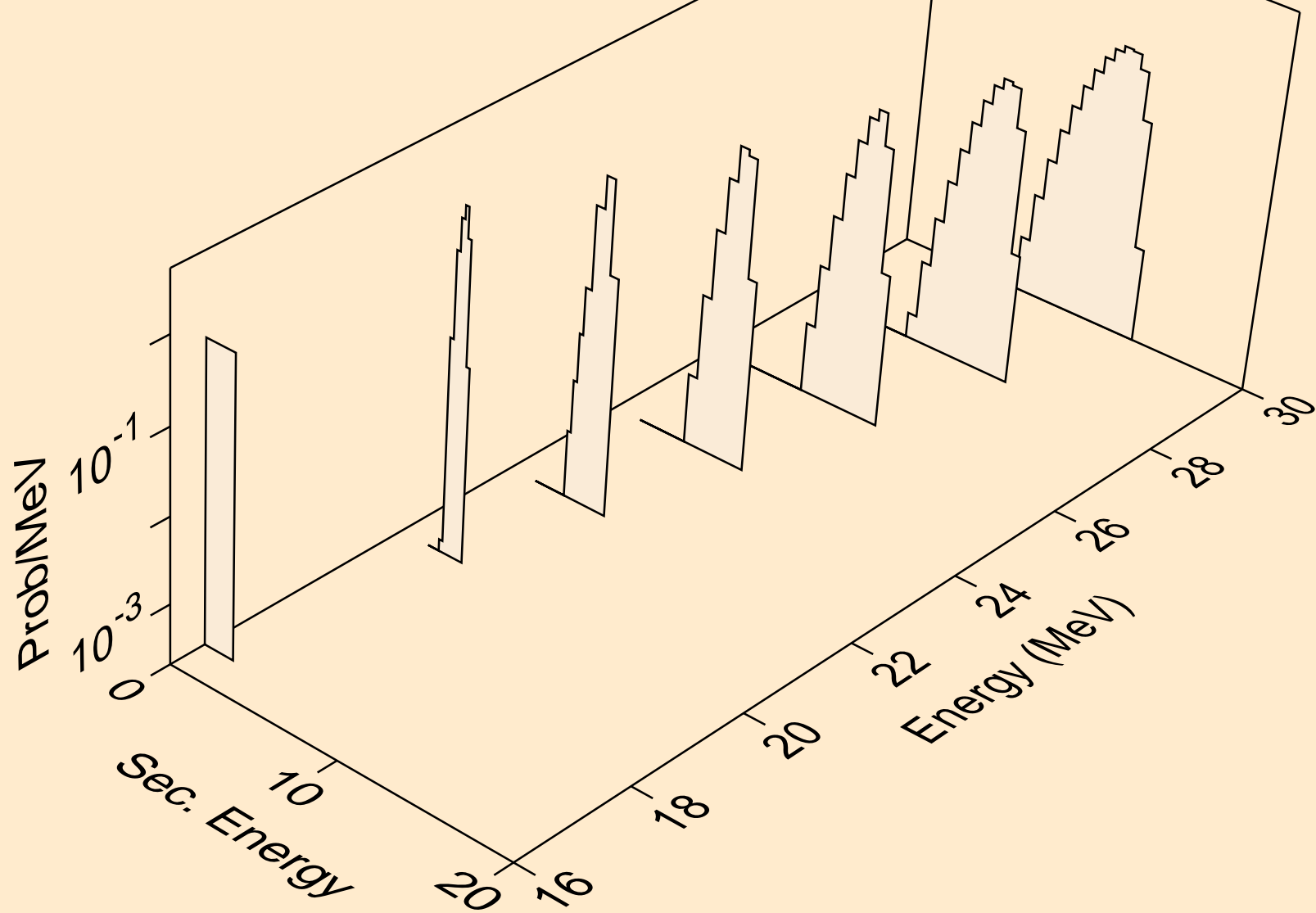

RN229 NEUTRON ACER TENDL-2024 LIBRARY; T=0.K
deuterons from (n,n*)d

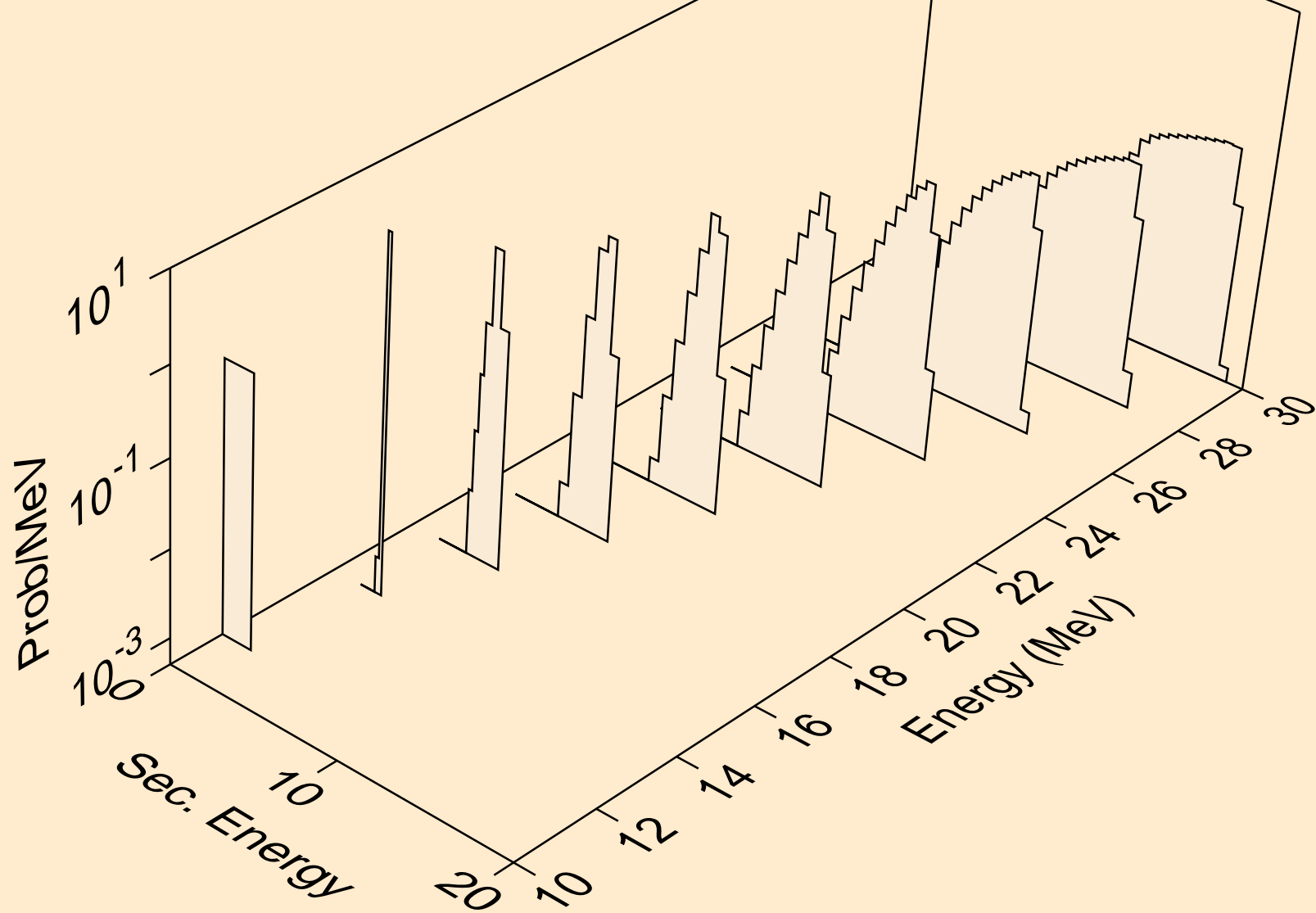

RN229 NEUTRON ACER TENDL-2024 LIBRARY; T=0.K
deuterons from (n,d)

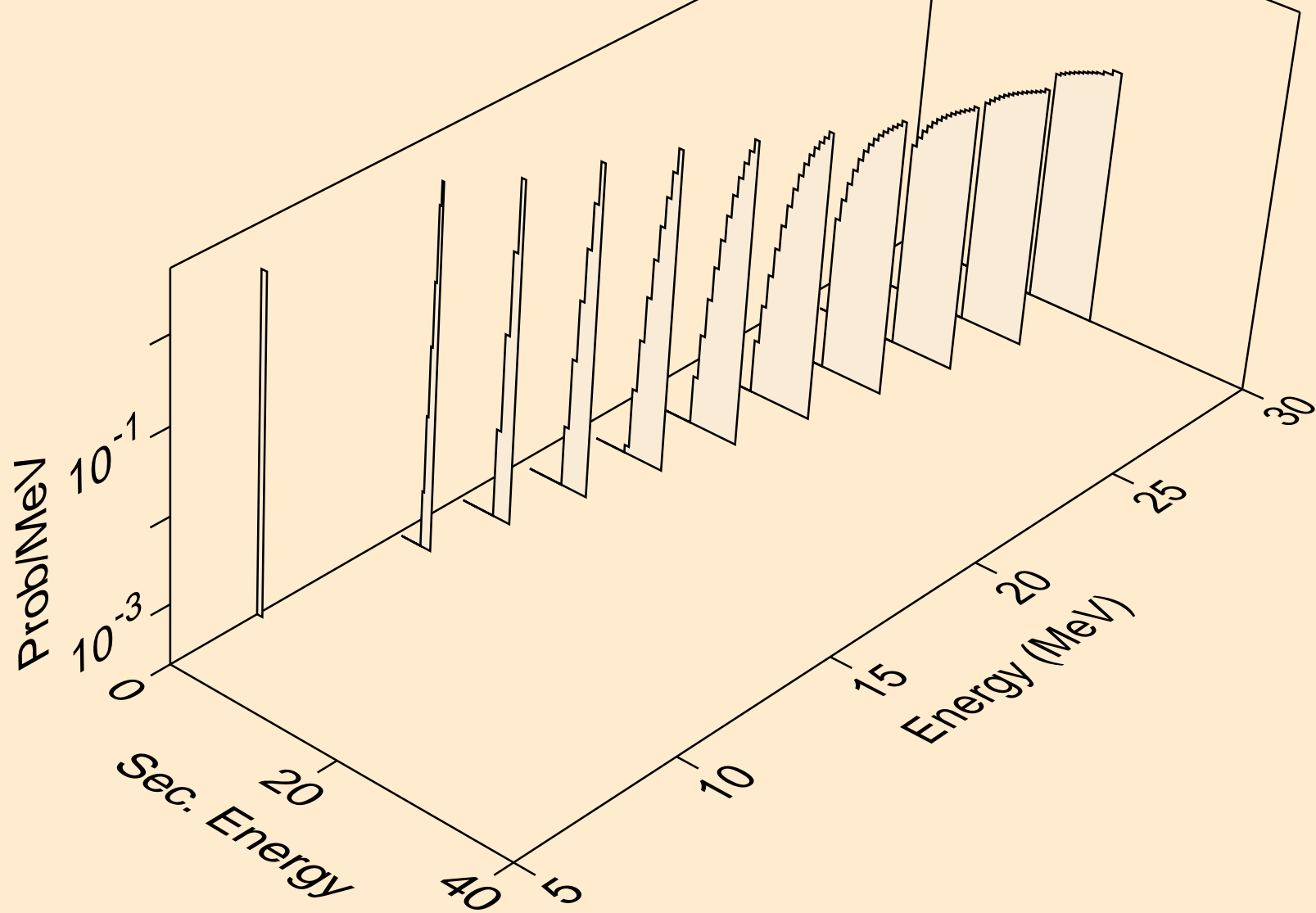

RN229 NEUTRON ACER TENDL-2024 LIBRARY; T=0.K
tritons from (n,x)

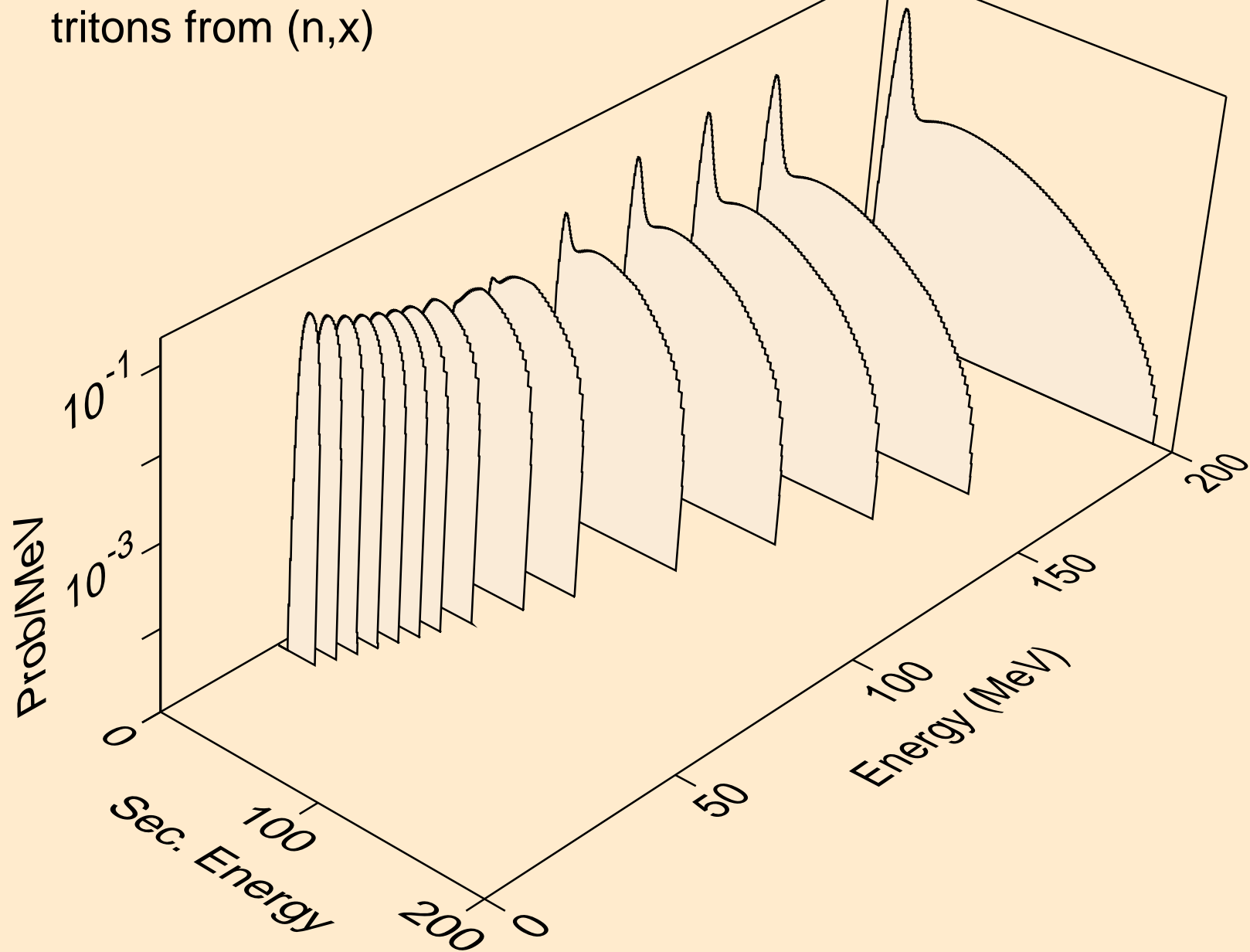

RN229 NEUTRON ACER TENDL-2024 LIBRARY; T=0.K
tritons from (n,n*)t

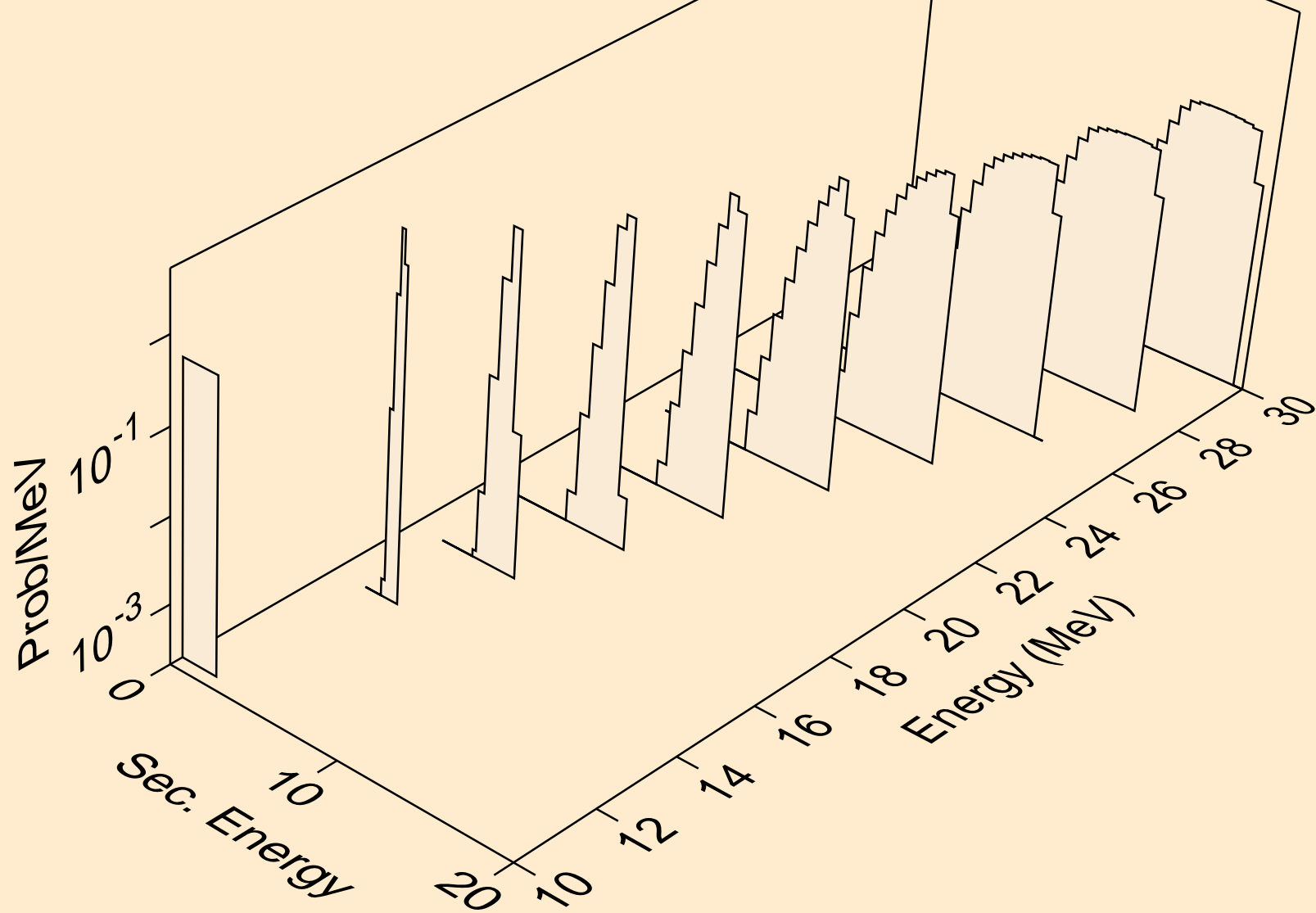

RN229 NEUTRON ACER TENDL-2024 LIBRARY; T=0.K
tritons from (n,t)

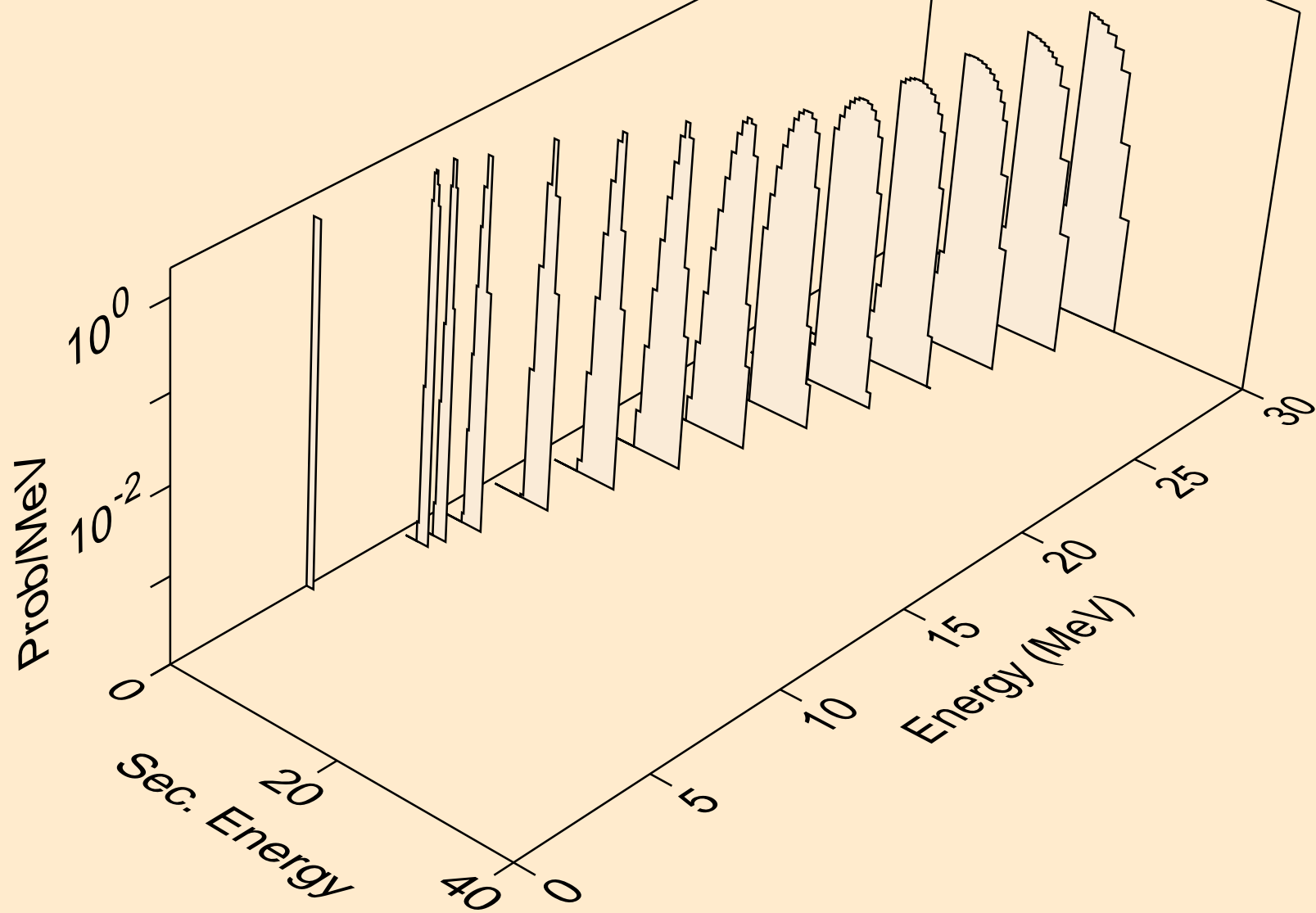

RN229 NEUTRON ACER TENDL-2024 LIBRARY; T=0.K
he3s from (n,x)

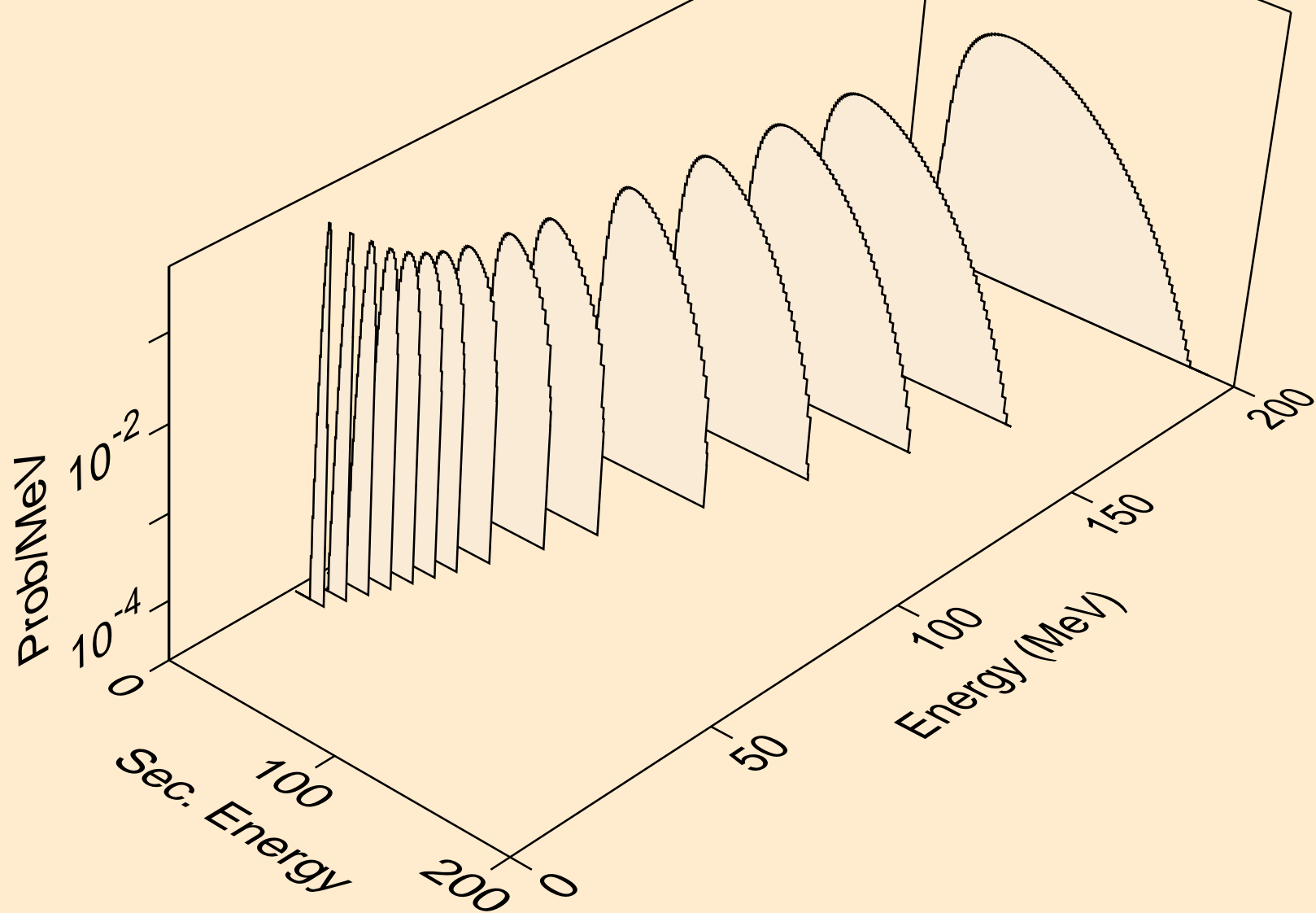

RN229 NEUTRON ACER TENDL-2024 LIBRARY; T=0.K
he3s from (n,n*)he3

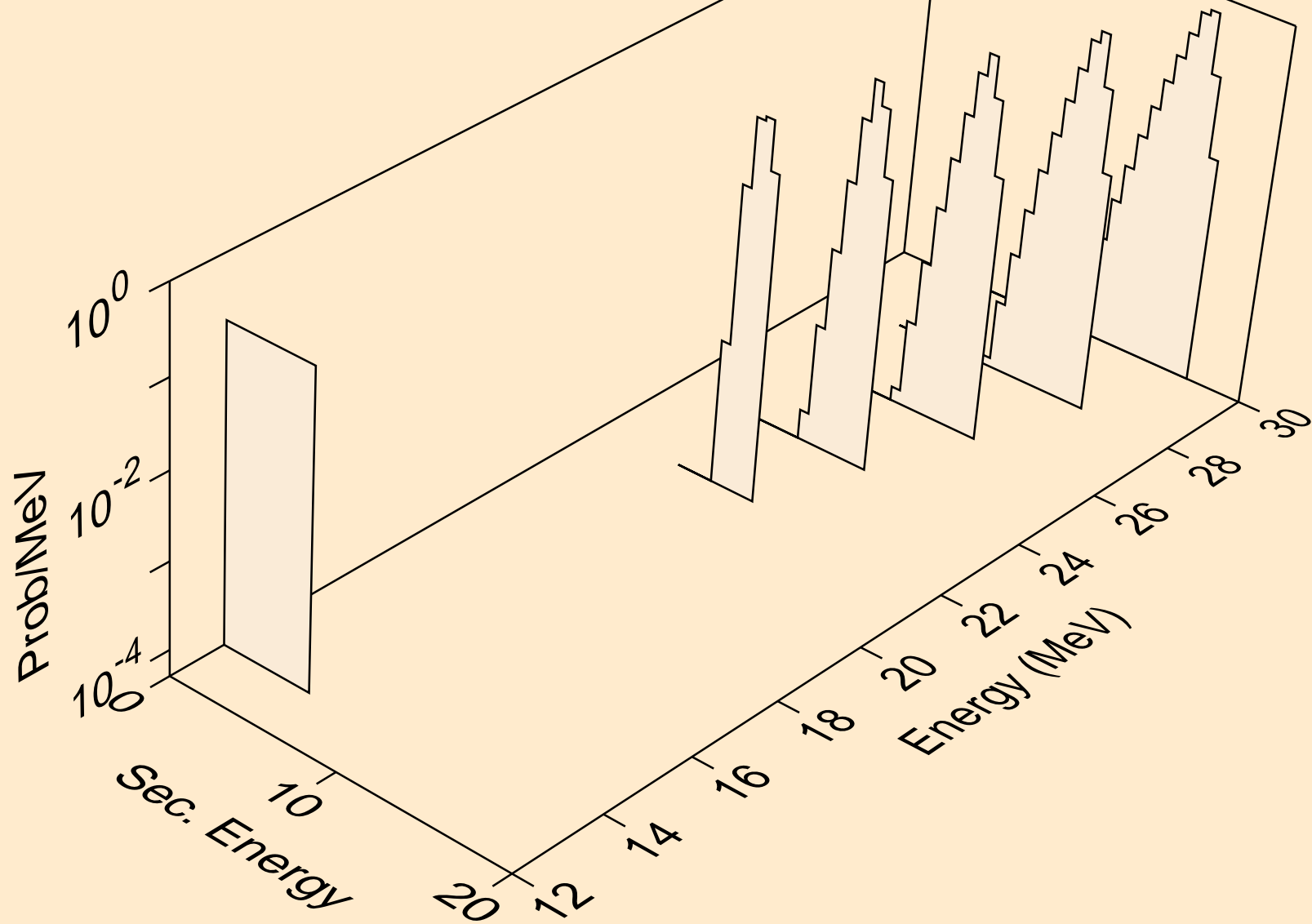

RN229 NEUTRON ACER TENDL-2024 LIBRARY; T=0.K
he3s from (n,he3)

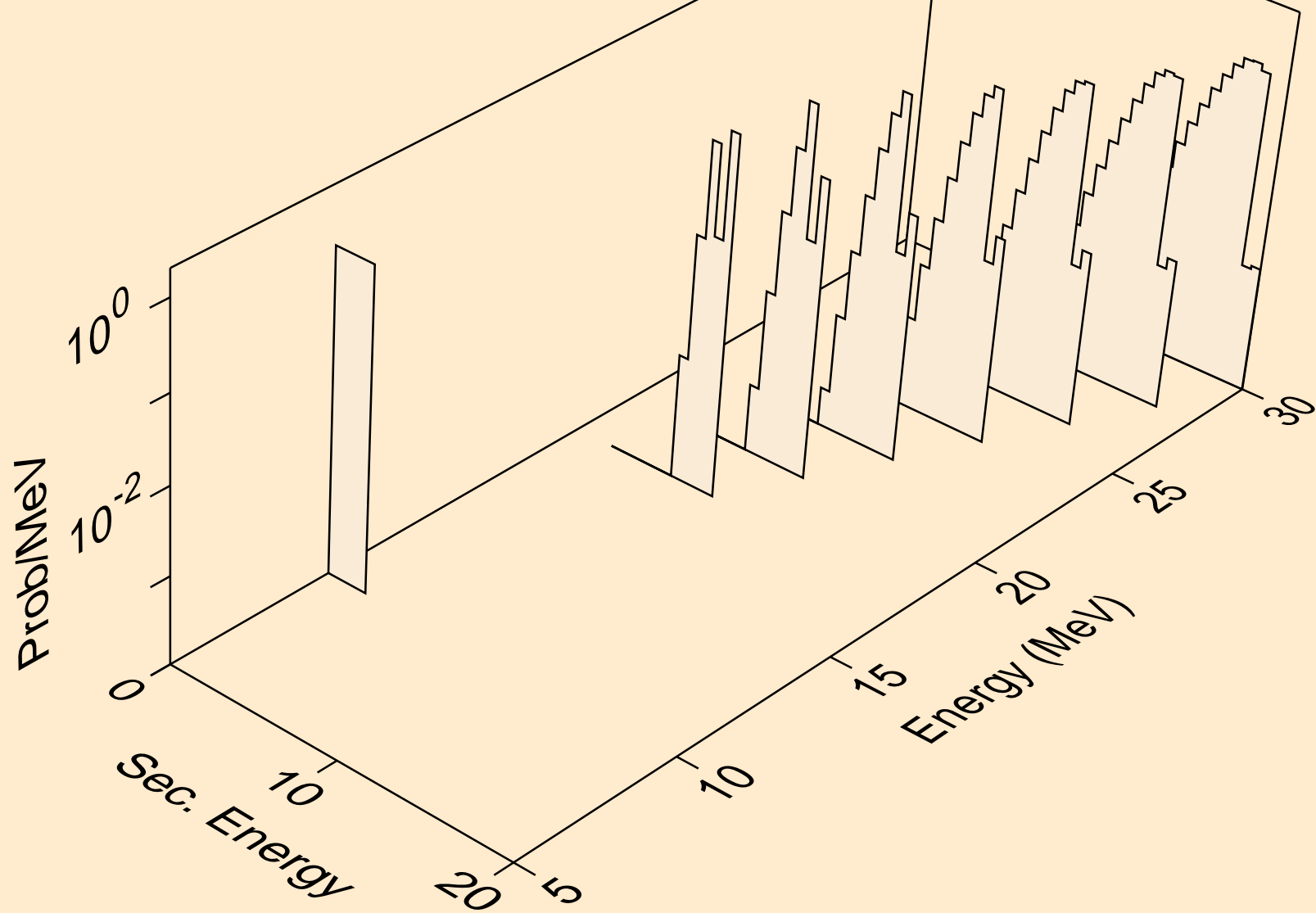

RN229 NEUTRON ACER TENDL-2024 LIBRARY; T=0.K
alphas from (n,x)

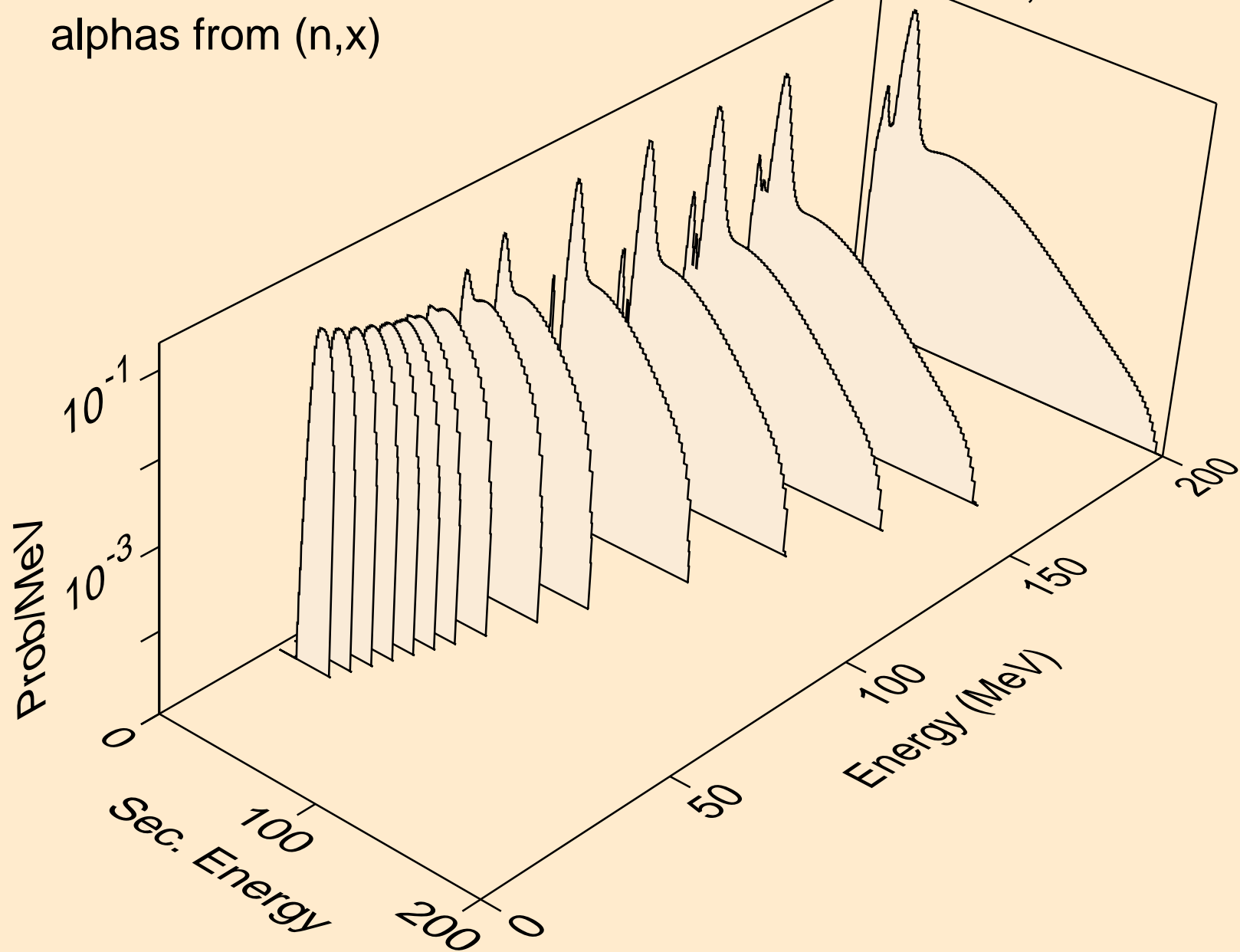

RN229 NEUTRON ACER TENDL-2024 LIBRARY; T=0.K
alphas from (n,n*)a

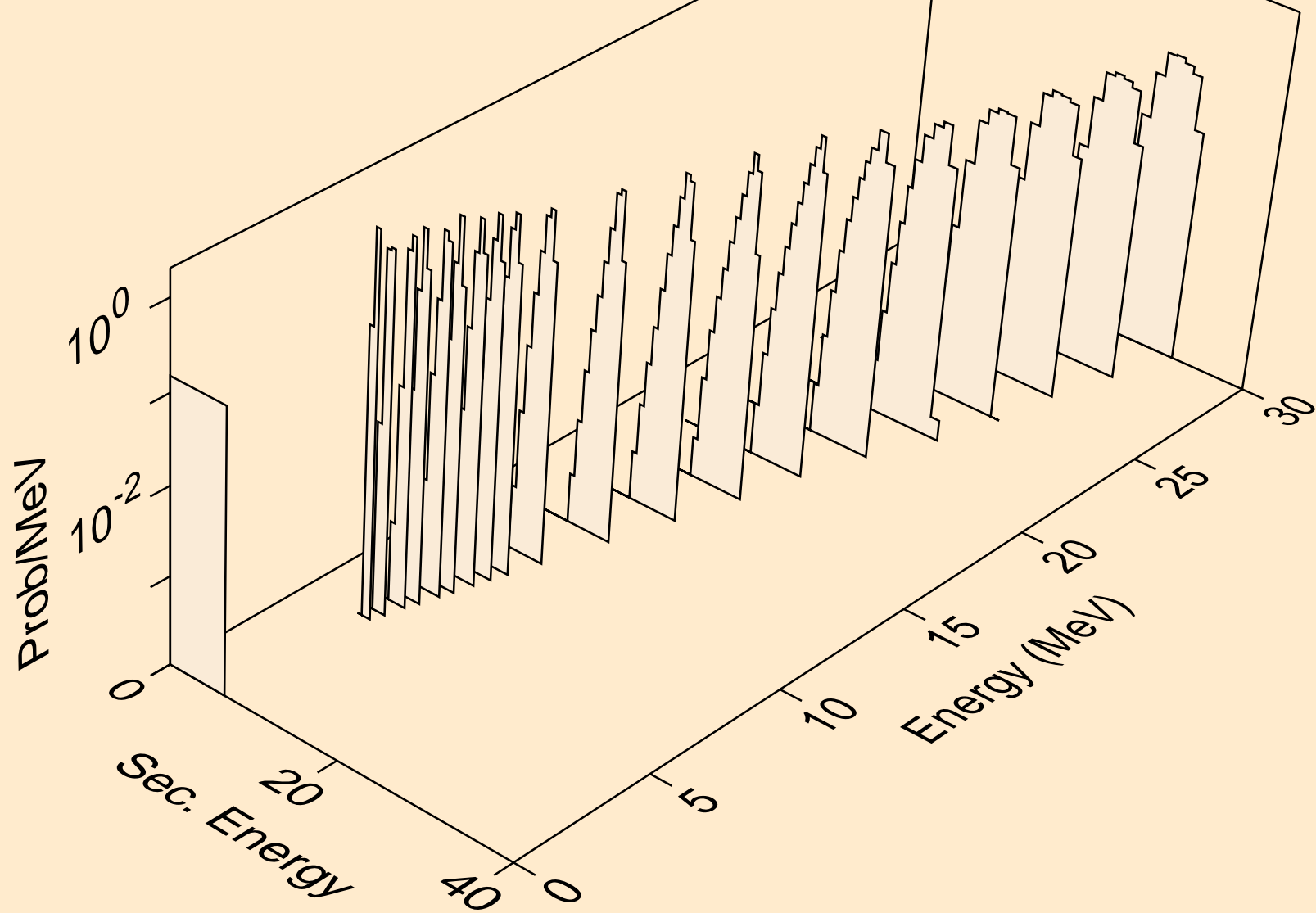

RN229 NEUTRON ACER TENDL-2024 LIBRARY; T=0.K
alphas from (n,2n)a

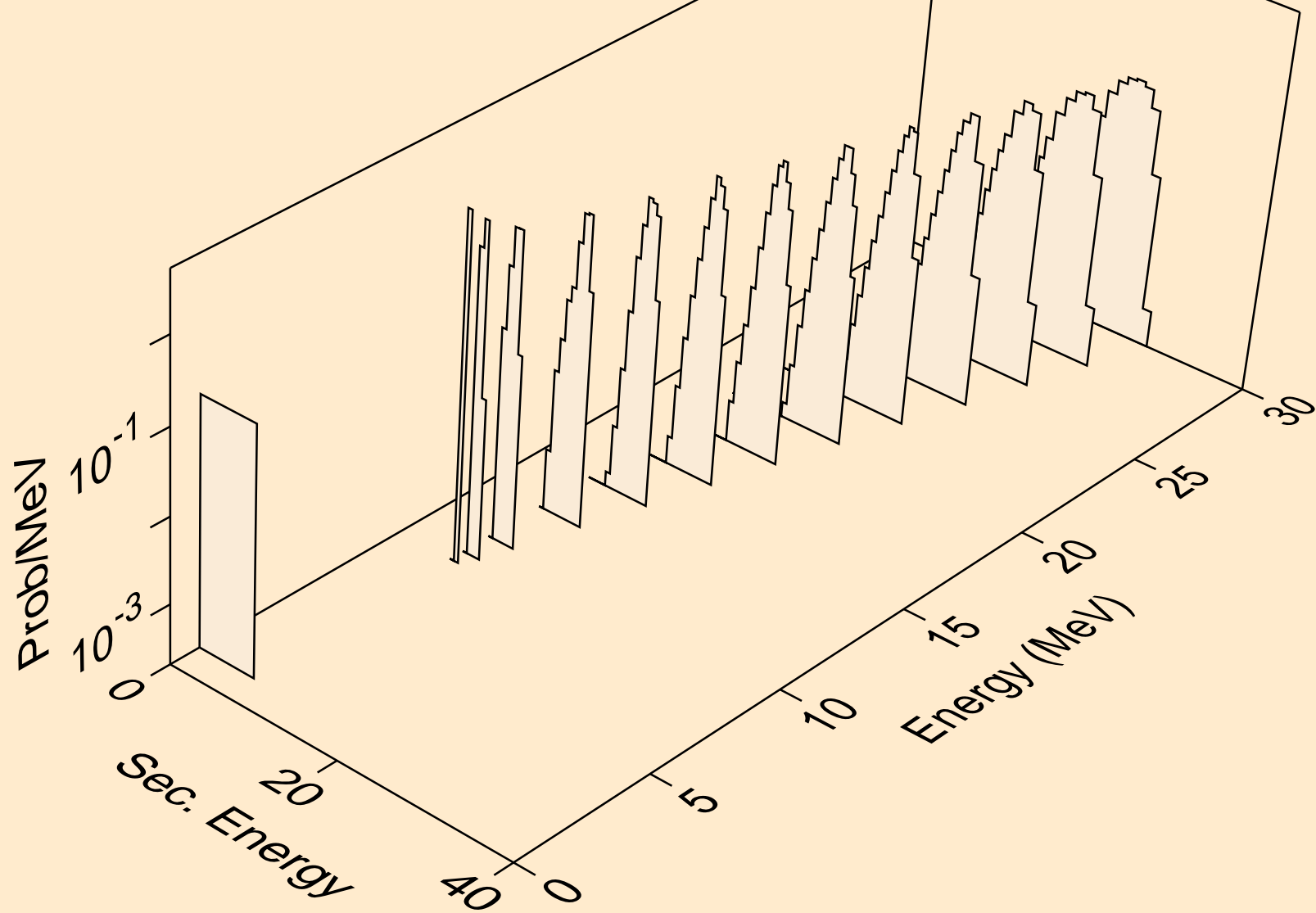

RN229 NEUTRON ACER TENDL-2024 LIBRARY; T=0.K
alphas from (n,3n)a

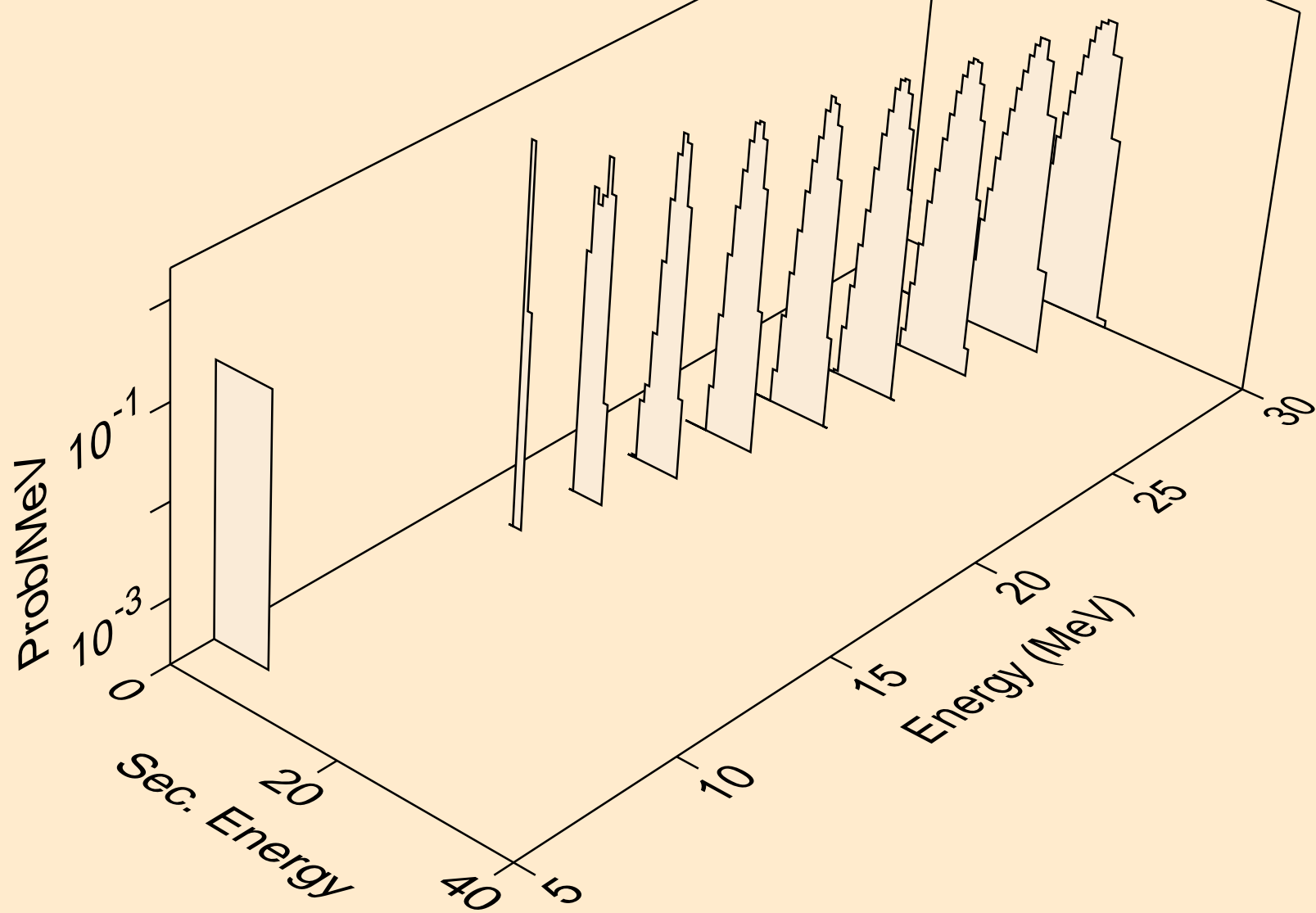

RN229 NEUTRON ACER TENDL-2024 LIBRARY; T=0.K
alphas from (n,a)

