

TH237 NEUTRON ACER TENDL-2024 LIBRARY; T=0.K
Principal cross sections

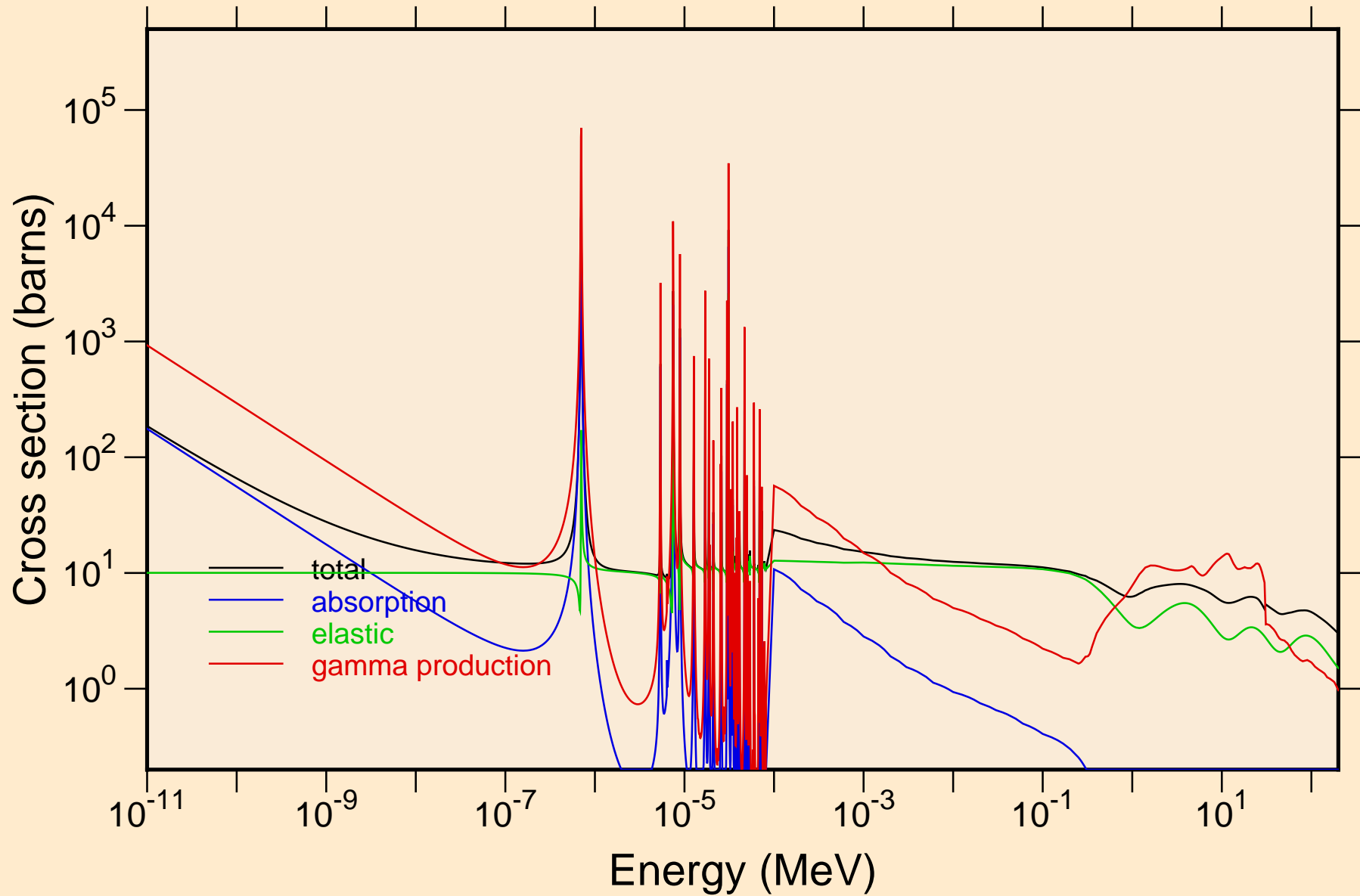

TH237 NEUTRON ACER TENDL-2024 LIBRARY; T=0.K
resonance total cross section

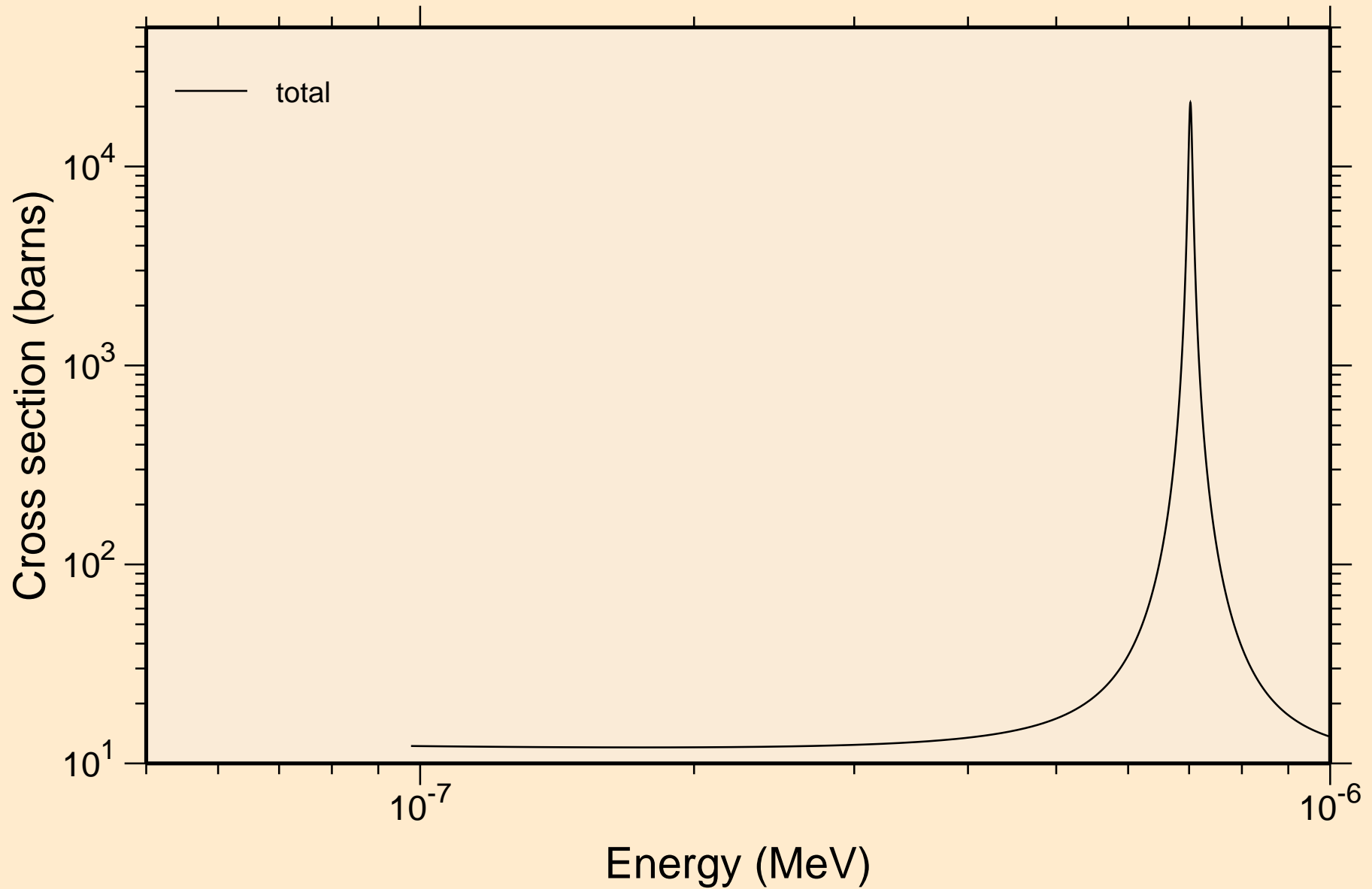

TH237 NEUTRON ACER TENDL-2024 LIBRARY; T=0.K
resonance total cross section

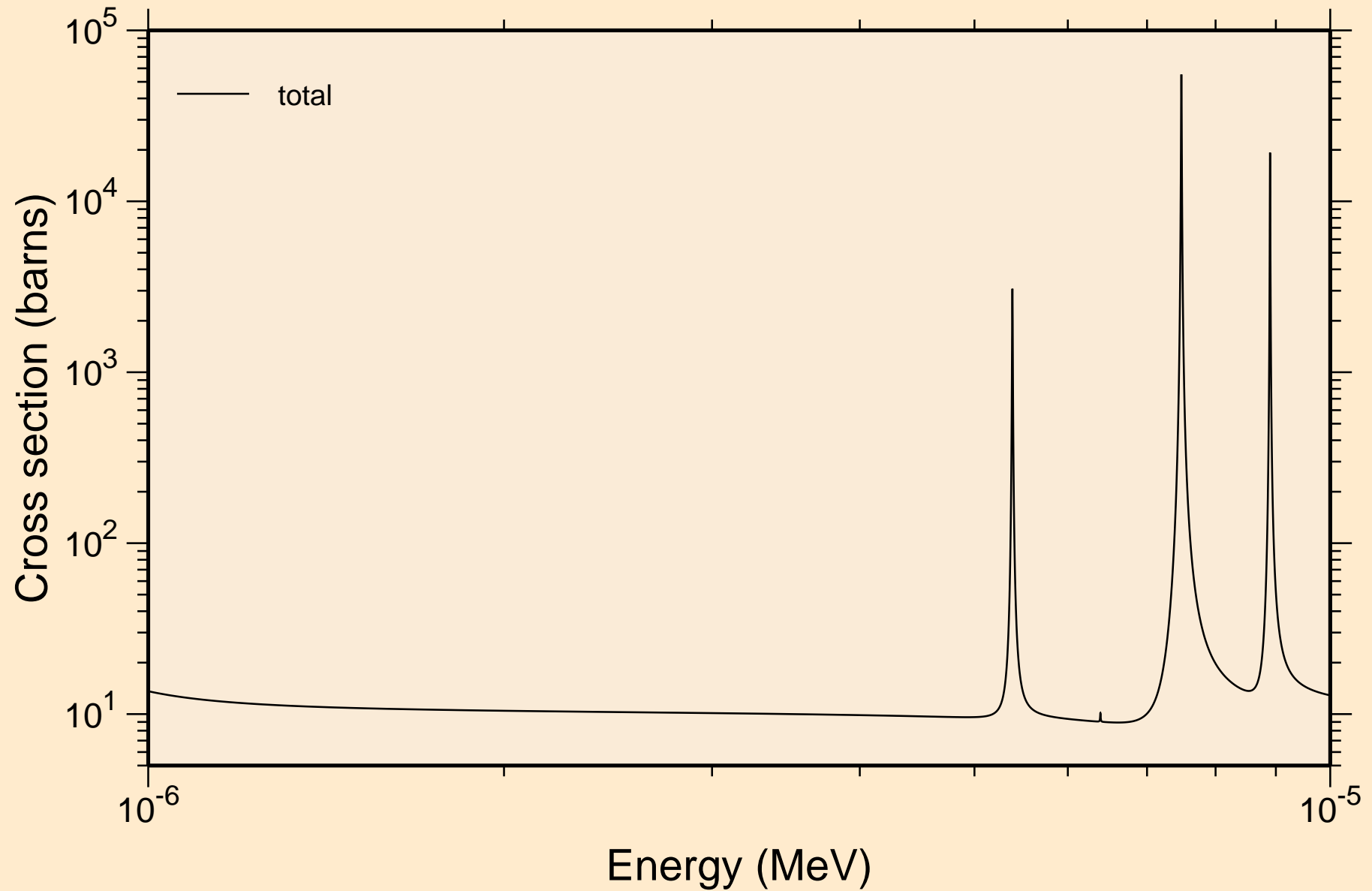

TH237 NEUTRON ACER TENDL-2024 LIBRARY; T=0.K
resonance total cross section

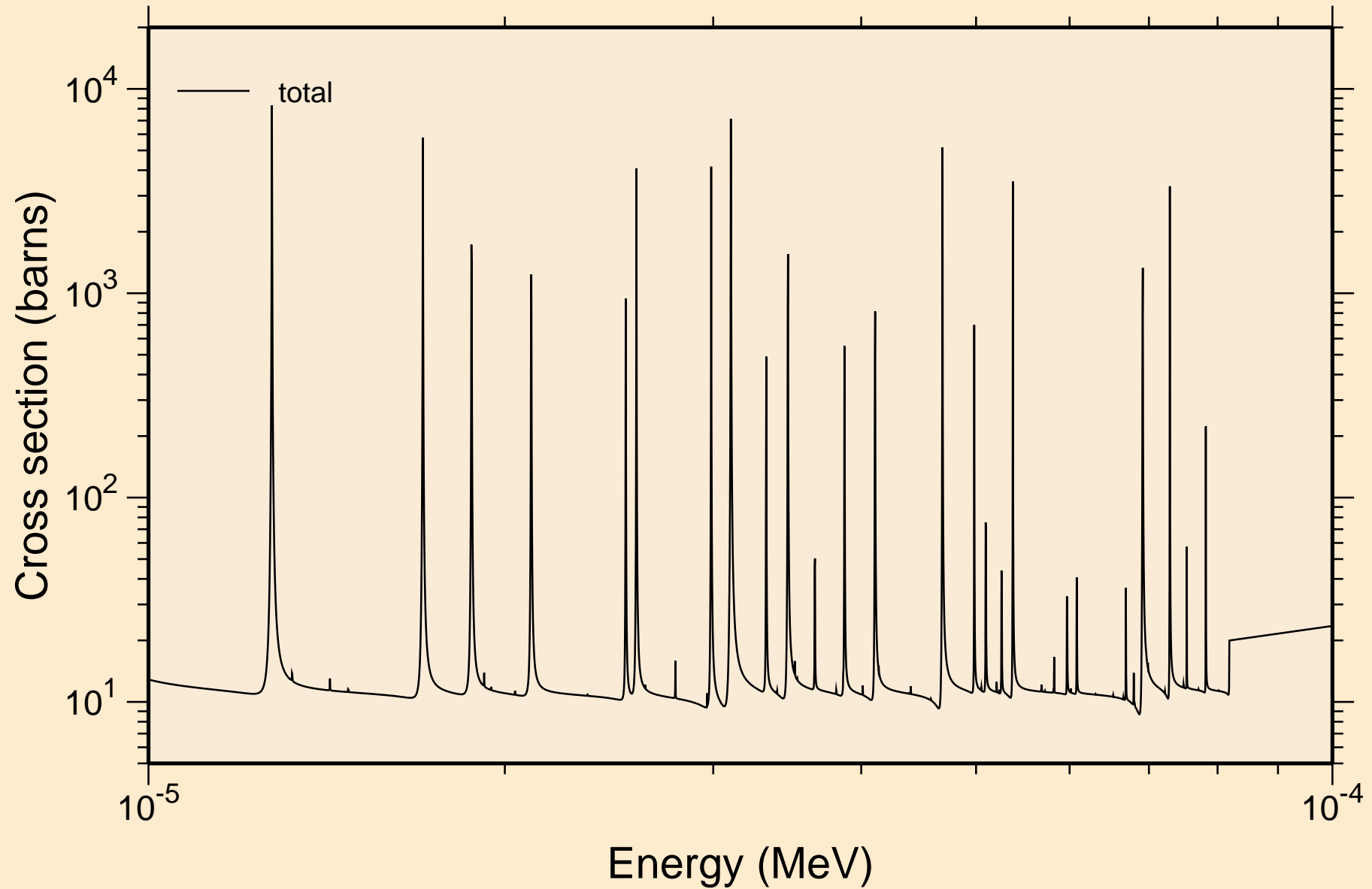

TH237 NEUTRON ACER TENDL-2024 LIBRARY; T=0.K
resonance total cross section

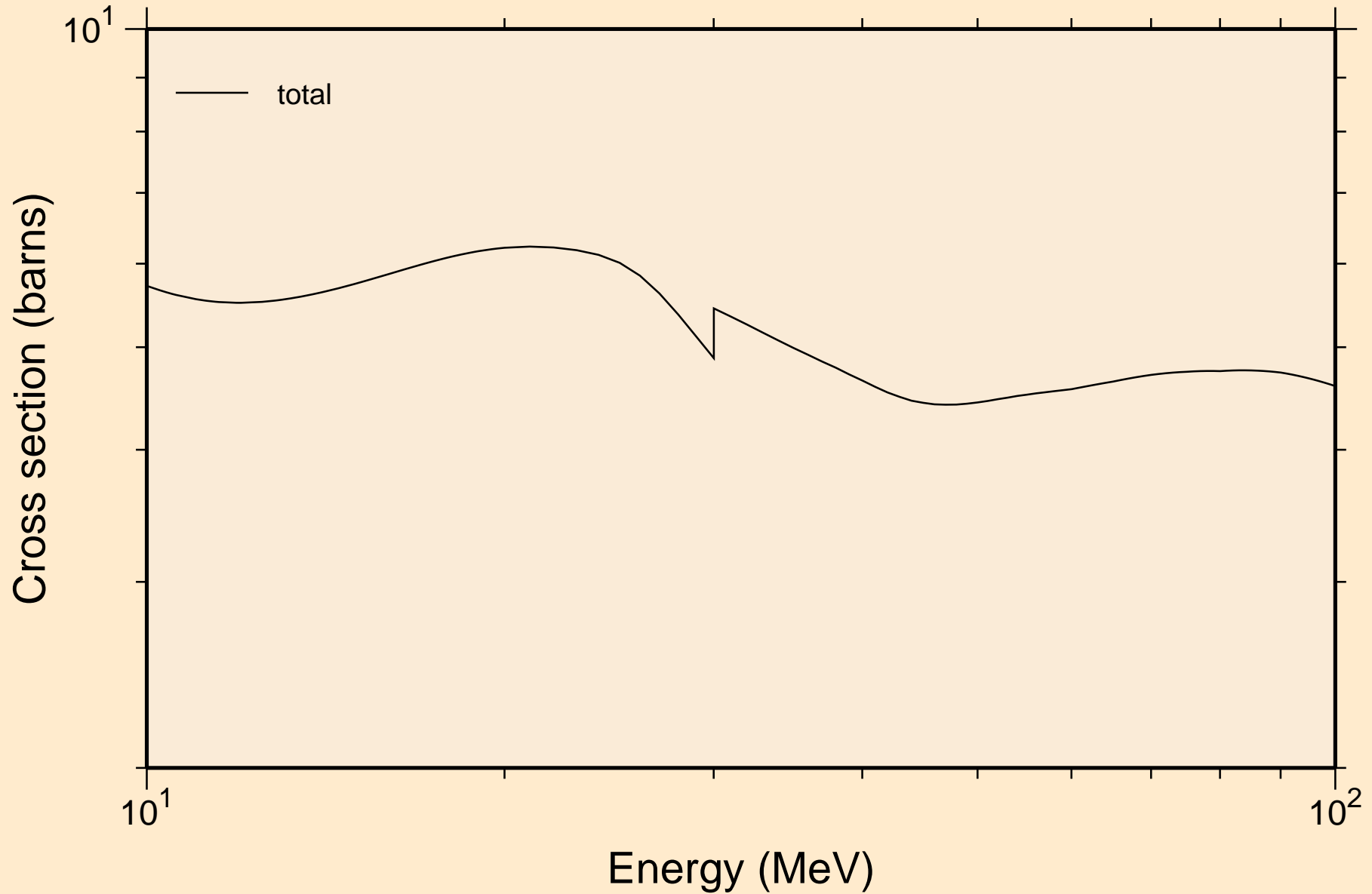

TH237 NEUTRON ACER TENDL-2024 LIBRARY; T=0.K
resonance absorption cross sections

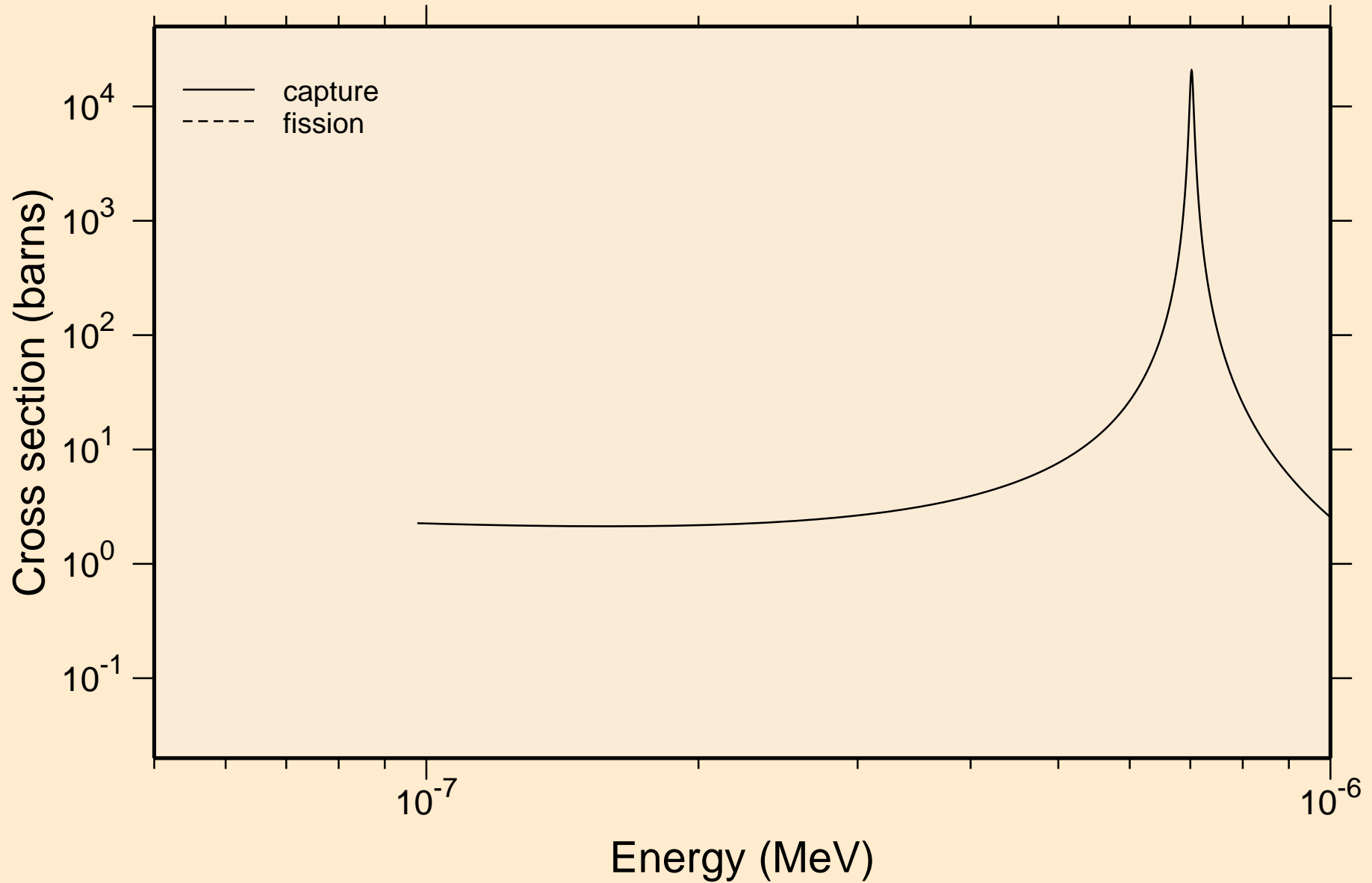

TH237 NEUTRON ACER TENDL-2024 LIBRARY; T=0.K
resonance absorption cross sections

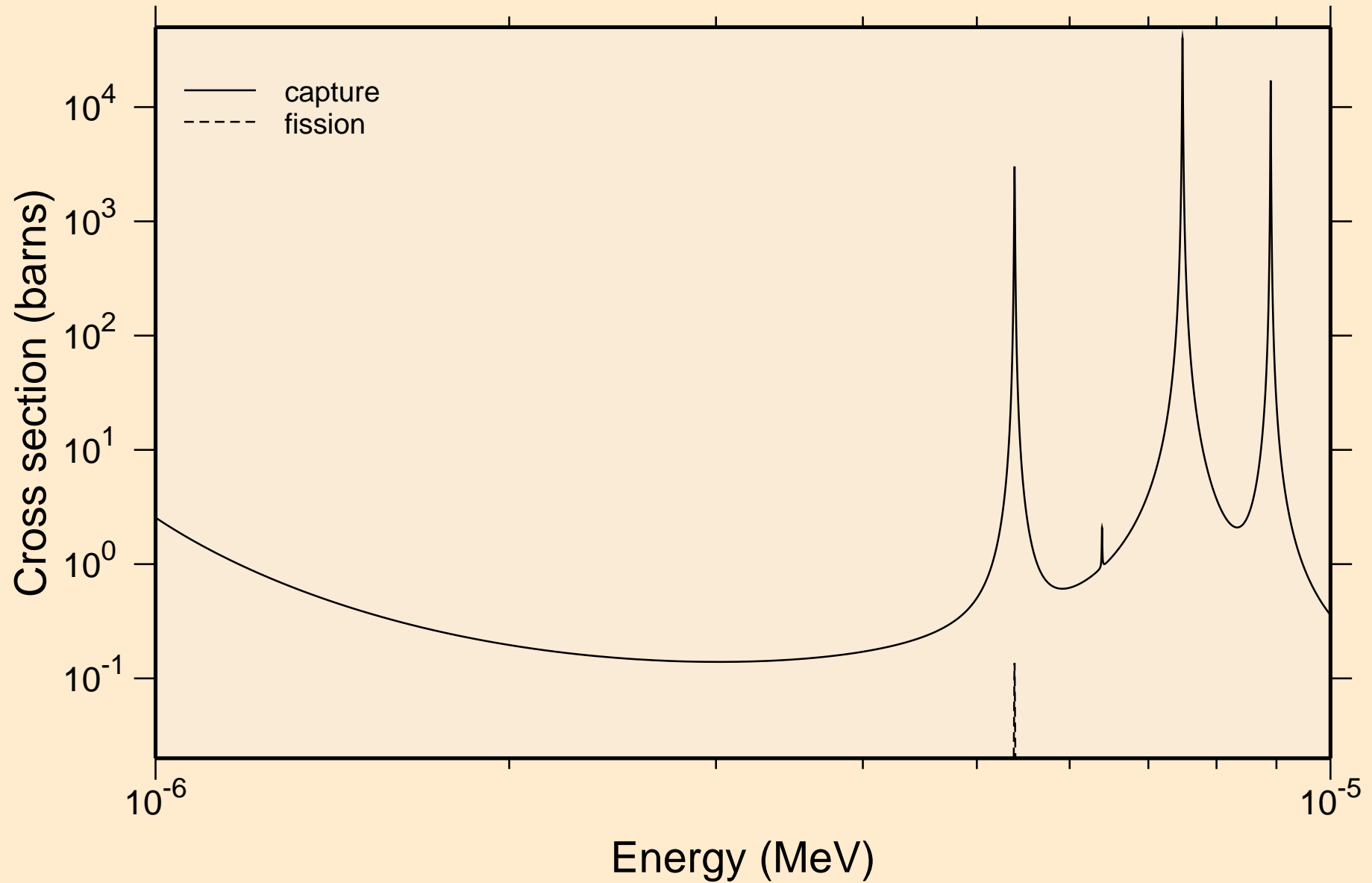

TH237 NEUTRON ACER TENDL-2024 LIBRARY; T=0.K

resonance absorption cross sections

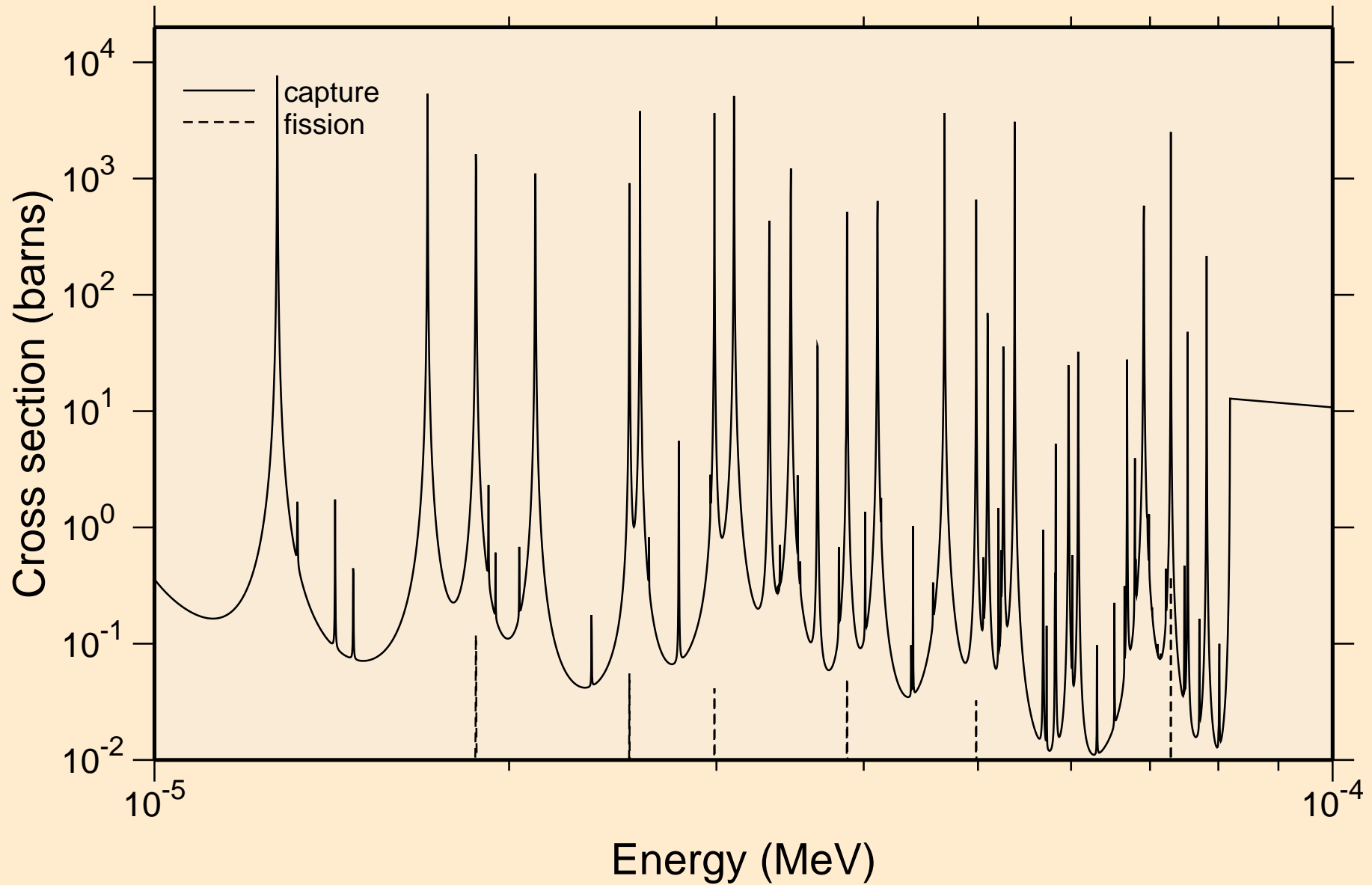

TH237 NEUTRON ACER TENDL-2024 LIBRARY; T=0.K
resonance absorption cross sections

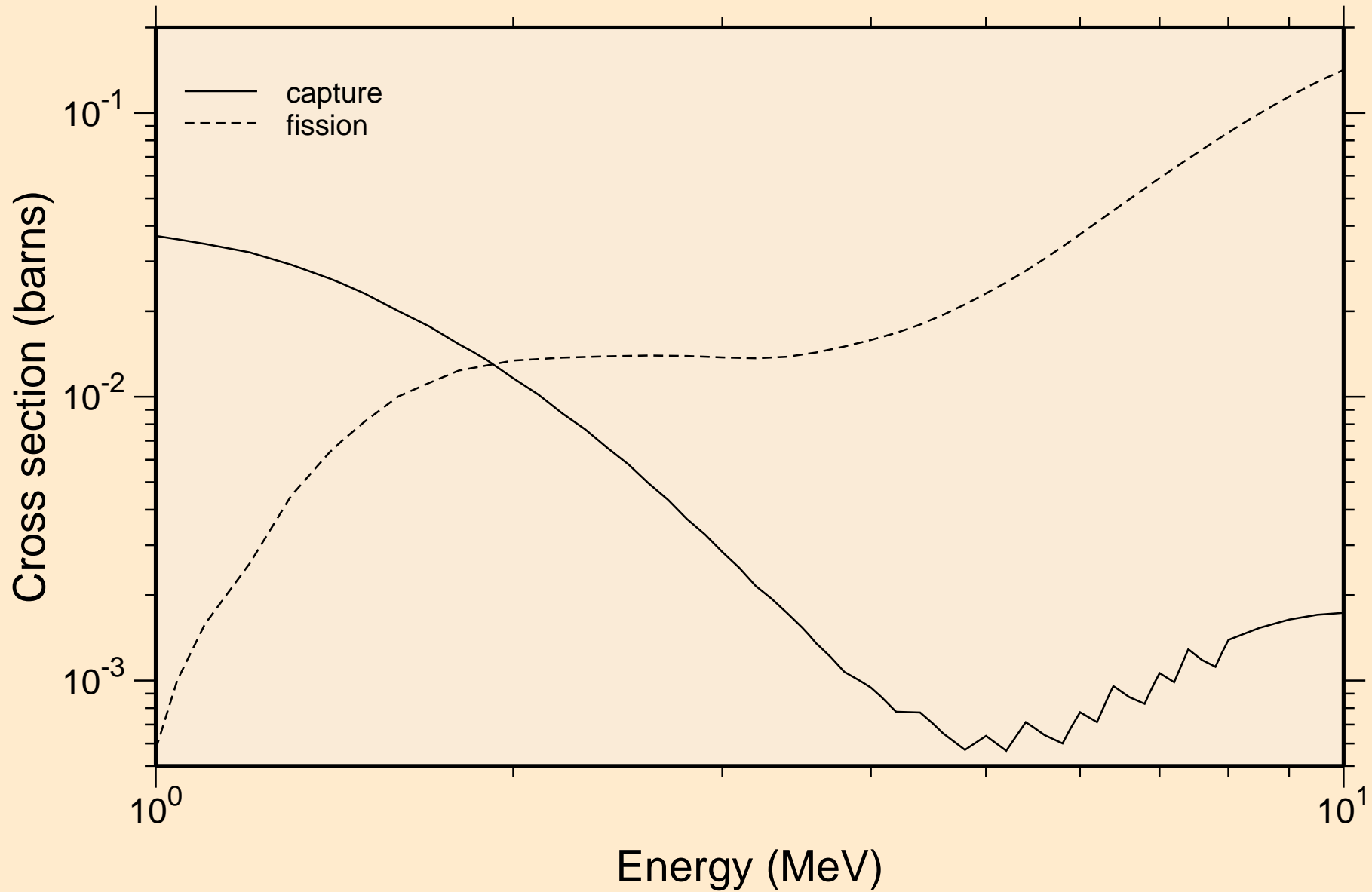

TH237 NEUTRON ACER TENDL-2024 LIBRARY; T=0.K

Heating

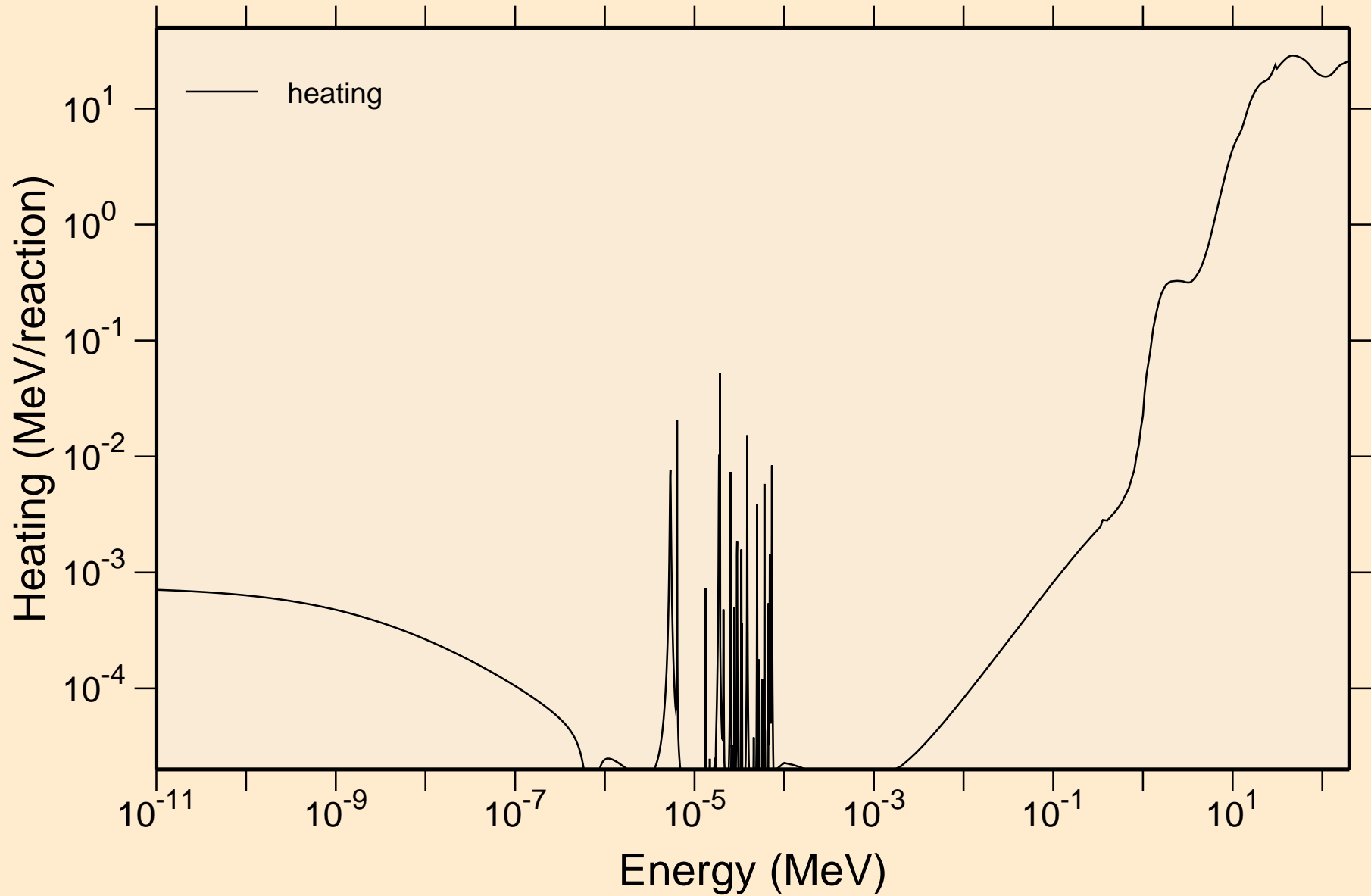

TH237 NEUTRON ACER TENDL-2024 LIBRARY; T=0.K
Damage

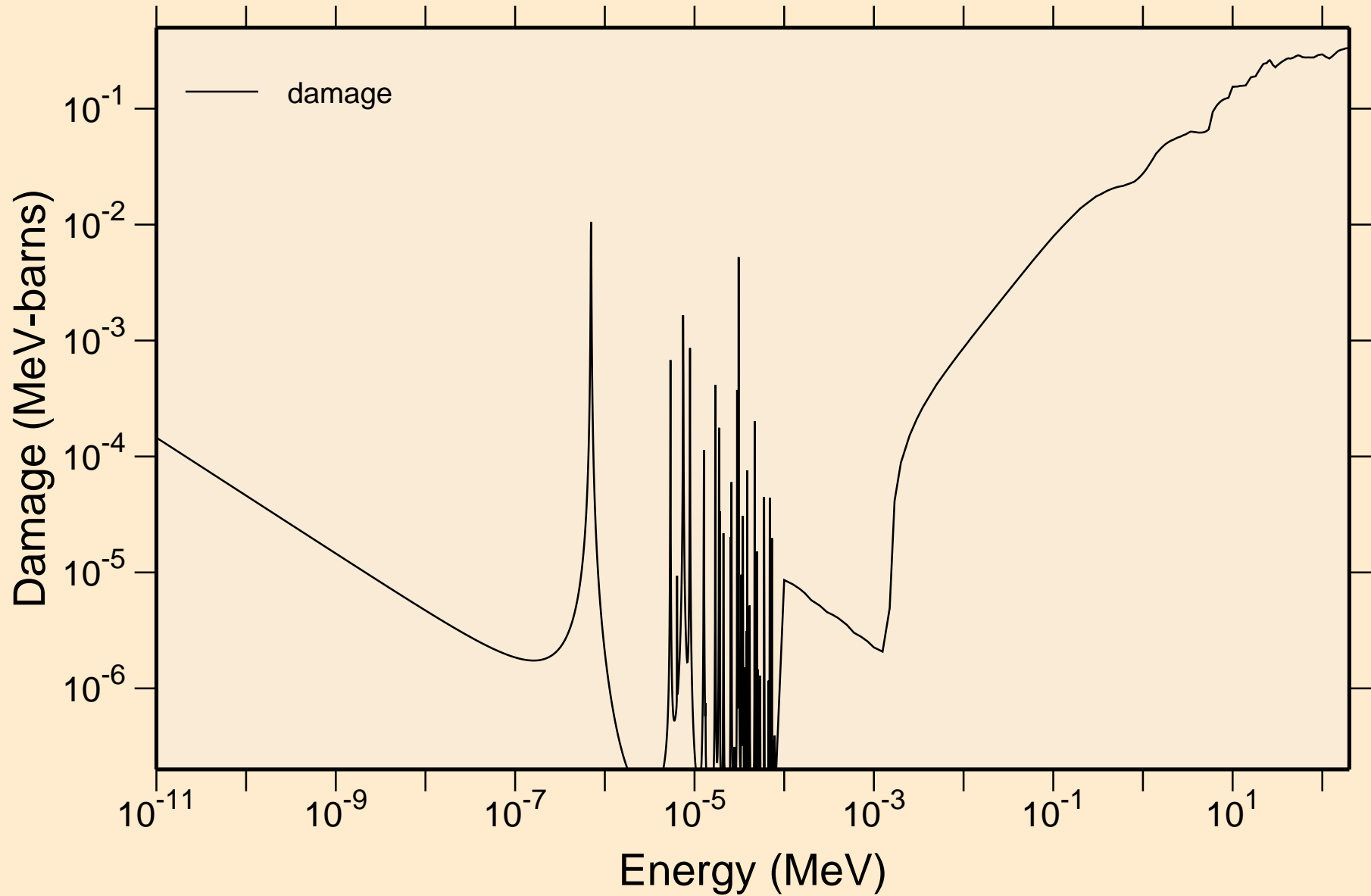

TH237 NEUTRON ACER TENDL-2024 LIBRARY; T=0.K

Non-threshold reactions

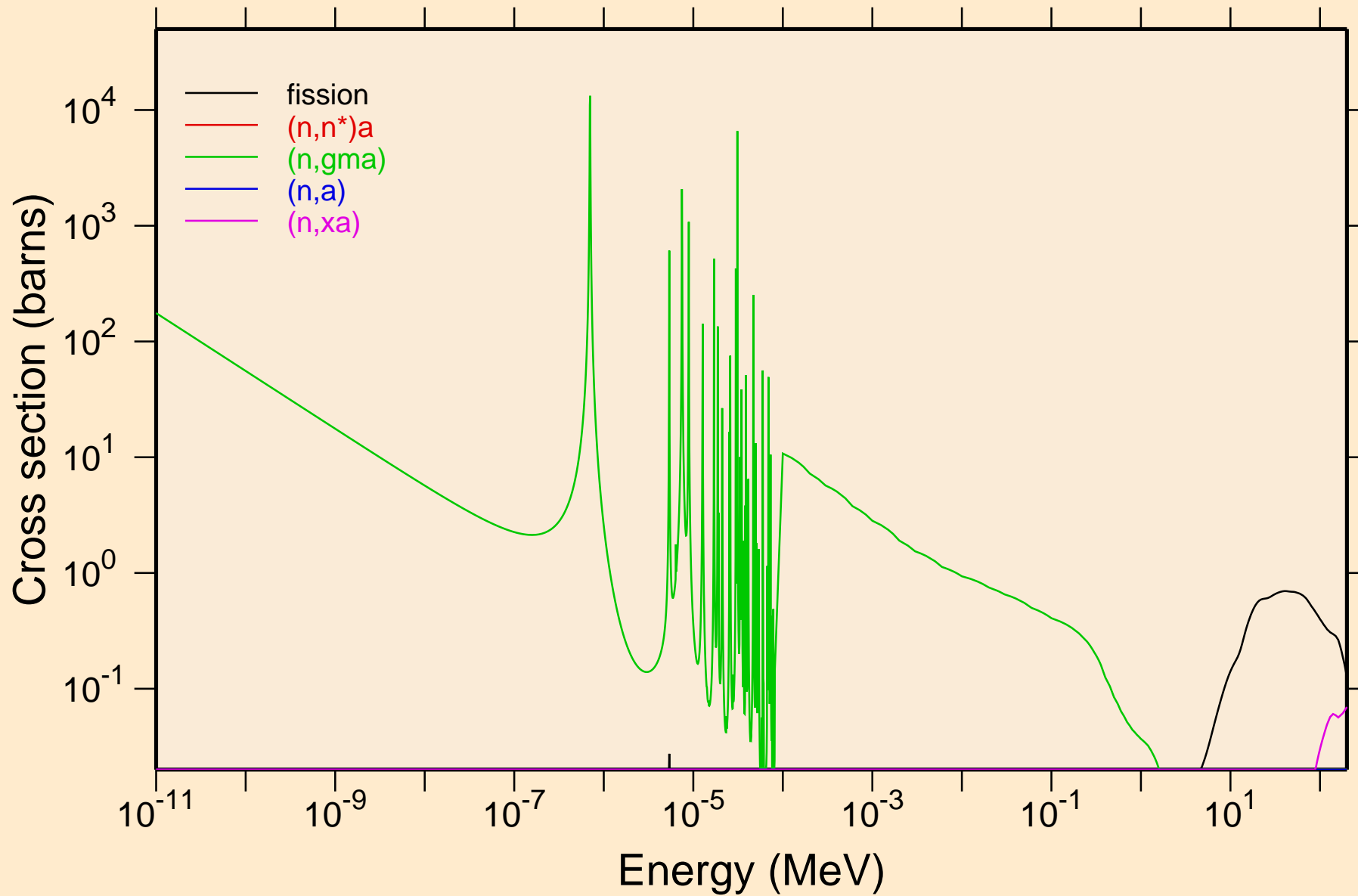

TH237 NEUTRON ACER TENDL-2024 LIBRARY; T=0.K

Principal cross sections

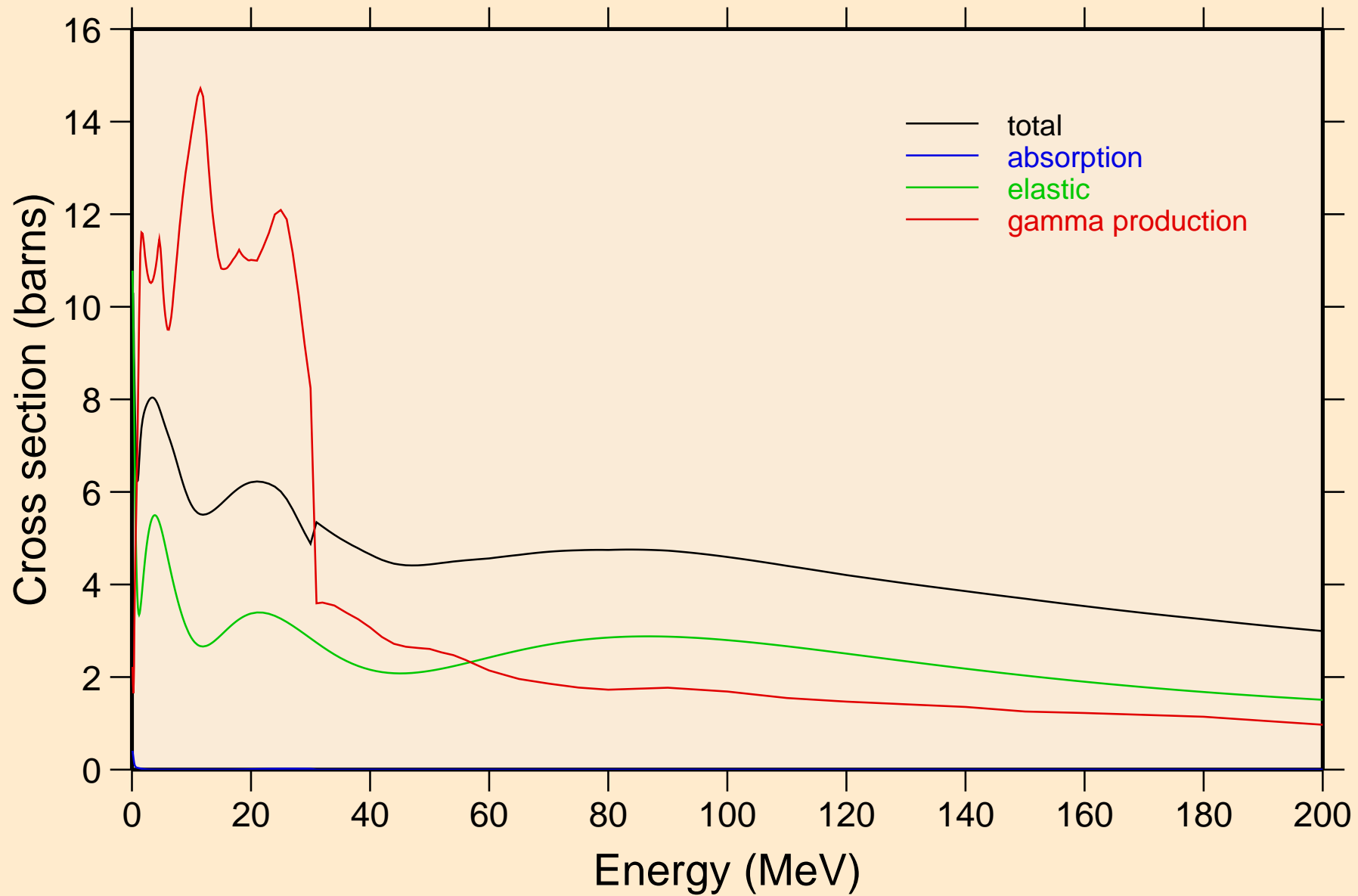

TH237 NEUTRON ACER TENDL-2024 LIBRARY; T=0.K

Heating

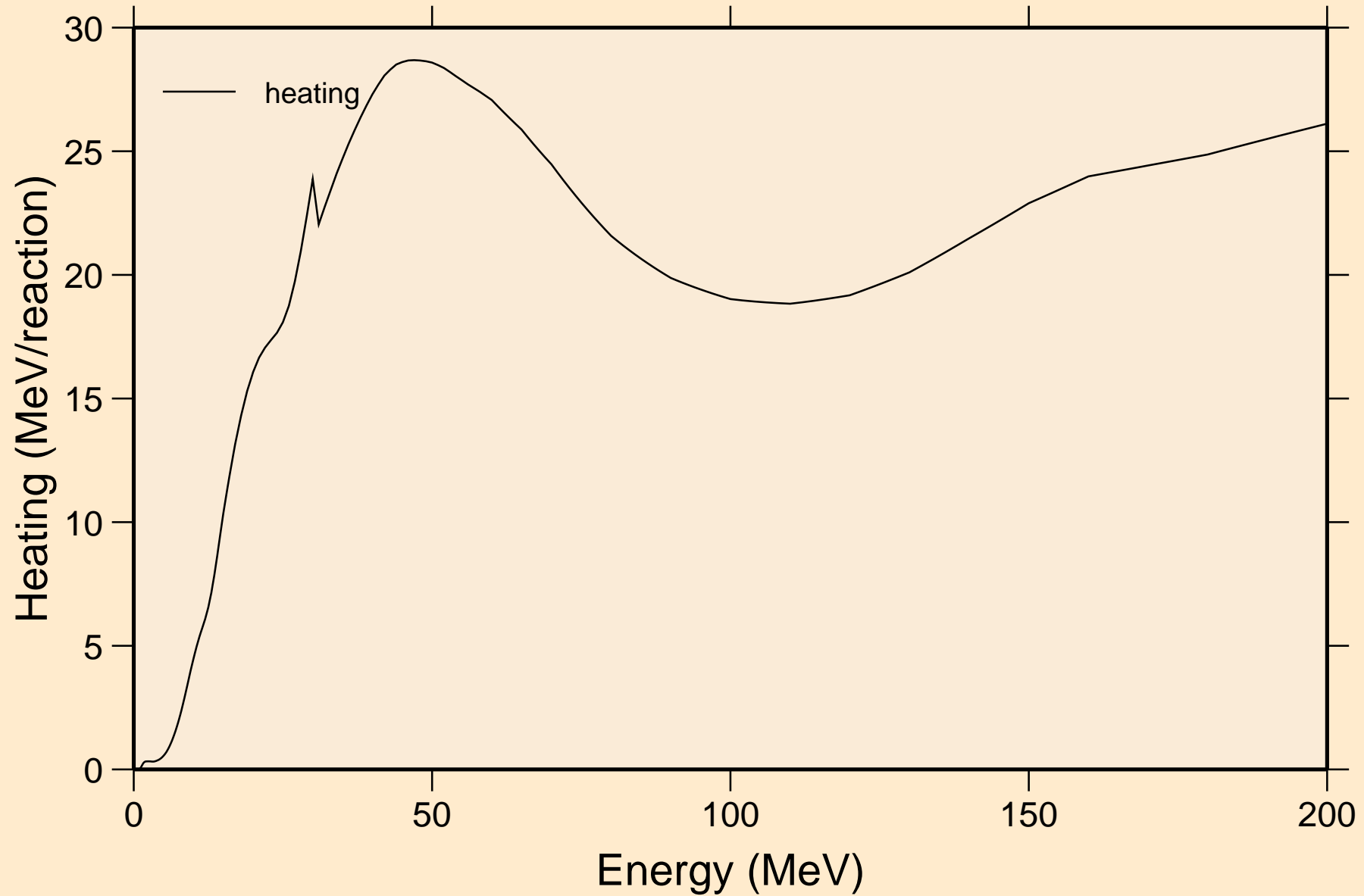

TH237 NEUTRON ACER TENDL-2024 LIBRARY; T=0.K

Damage

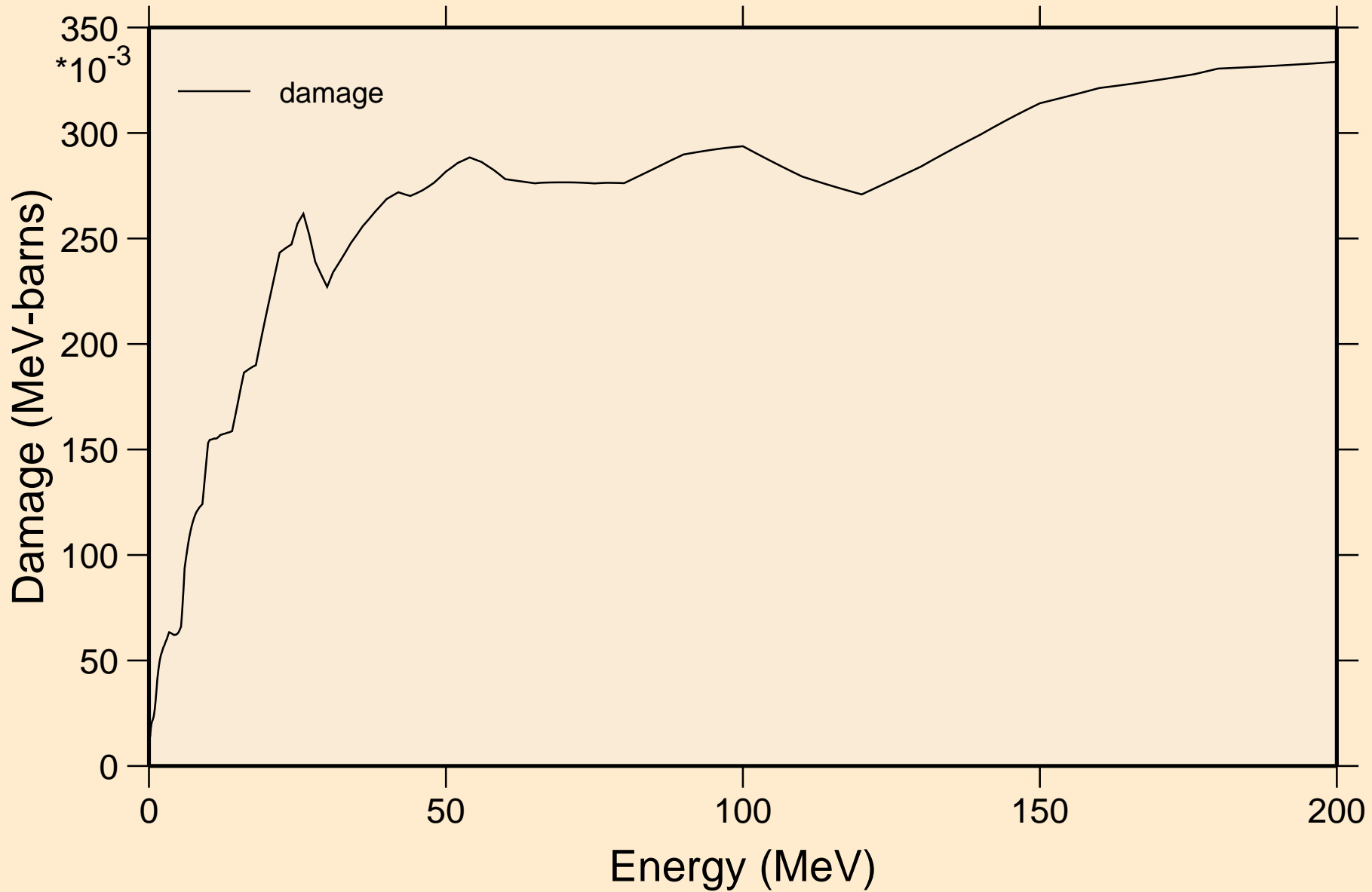

TH237 NEUTRON ACER TENDL-2024 LIBRARY; T=0.K

Non-threshold reactions

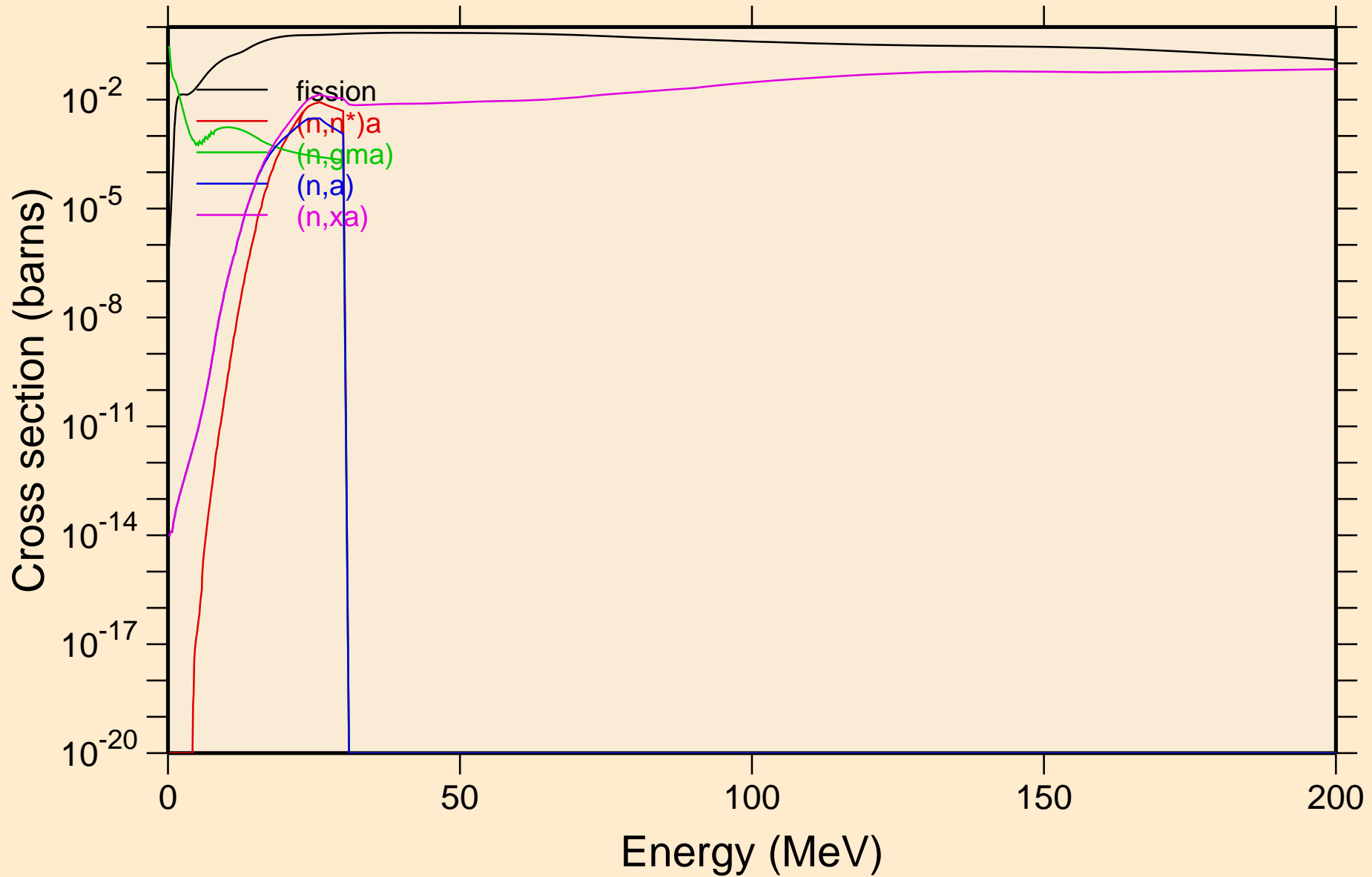

TH237 NEUTRON ACER TENDL-2024 LIBRARY; T=0.K

Inelastic levels

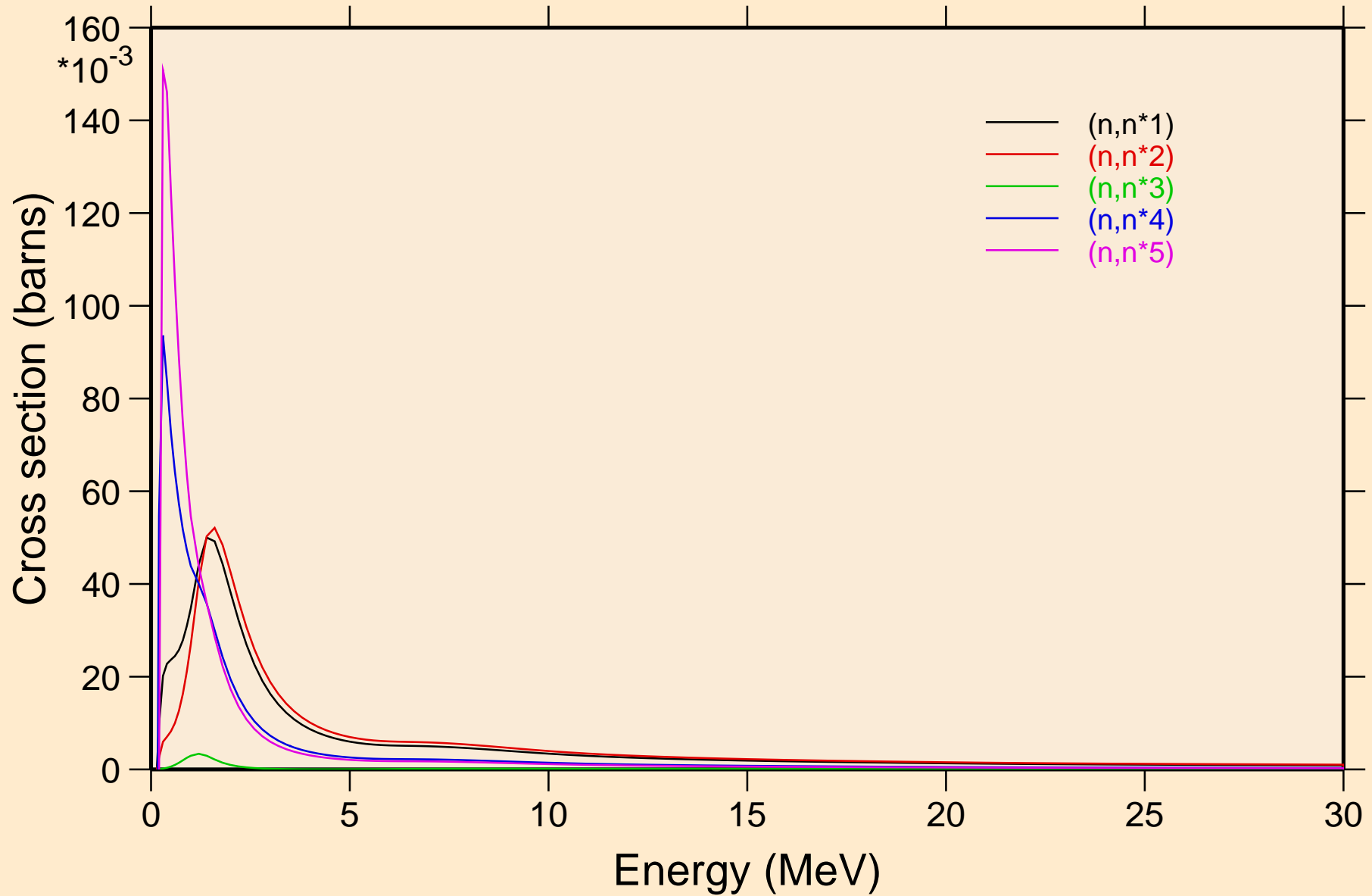

TH237 NEUTRON ACER TENDL-2024 LIBRARY; T=0.K

Inelastic levels

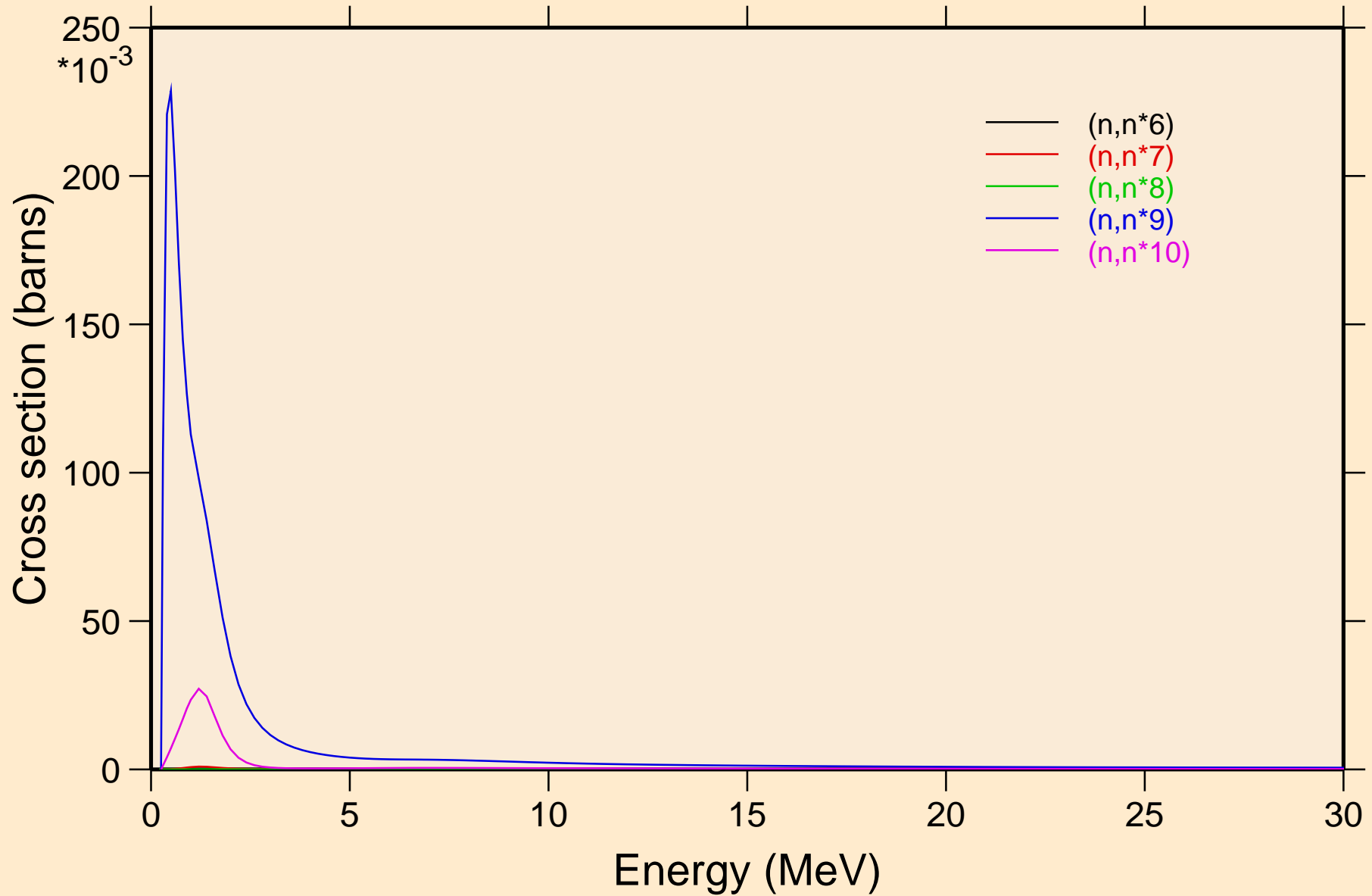

TH237 NEUTRON ACER TENDL-2024 LIBRARY; T=0.K
Inelastic levels

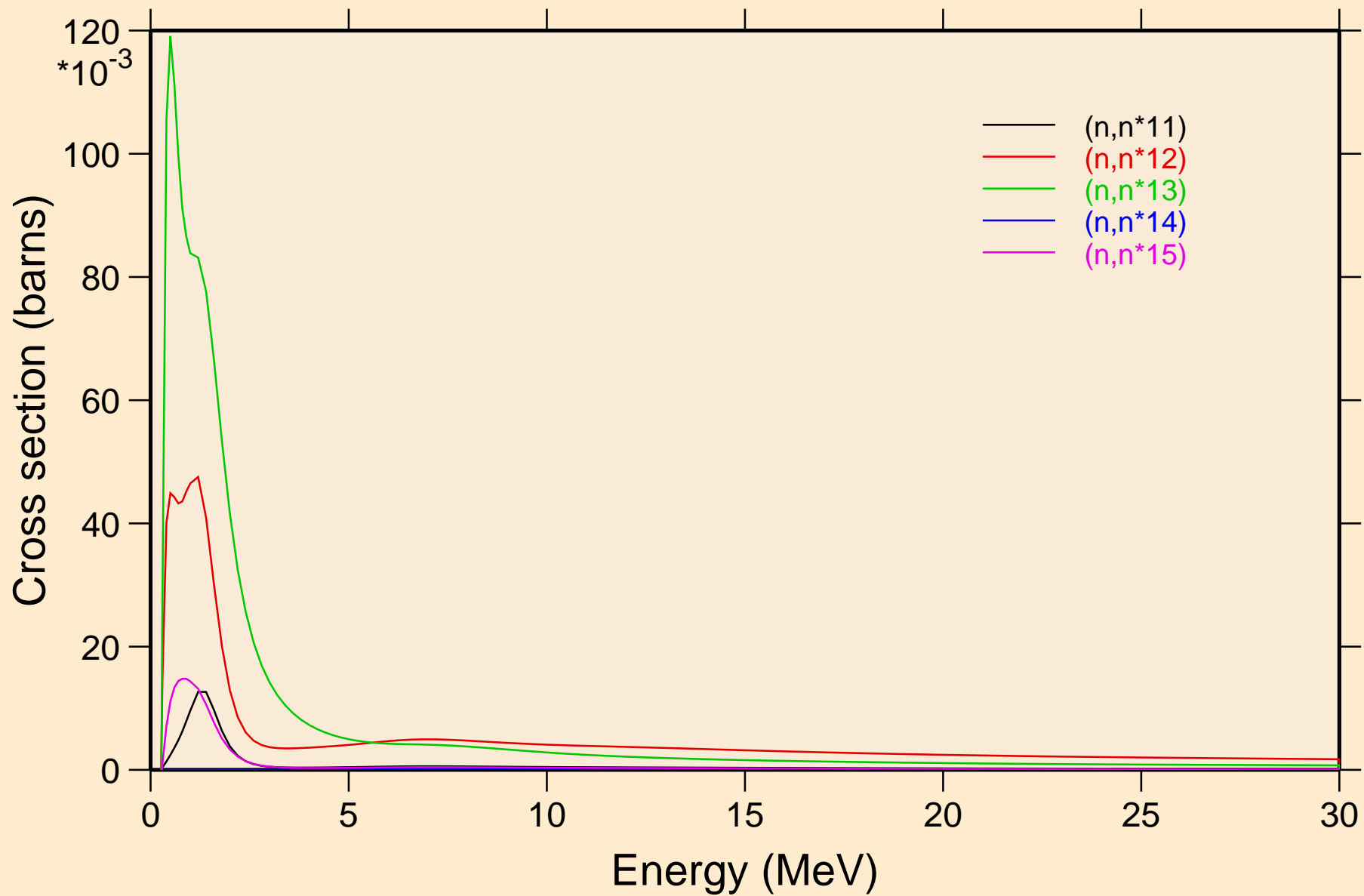

TH237 NEUTRON ACER TENDL-2024 LIBRARY; T=0.K
Inelastic levels

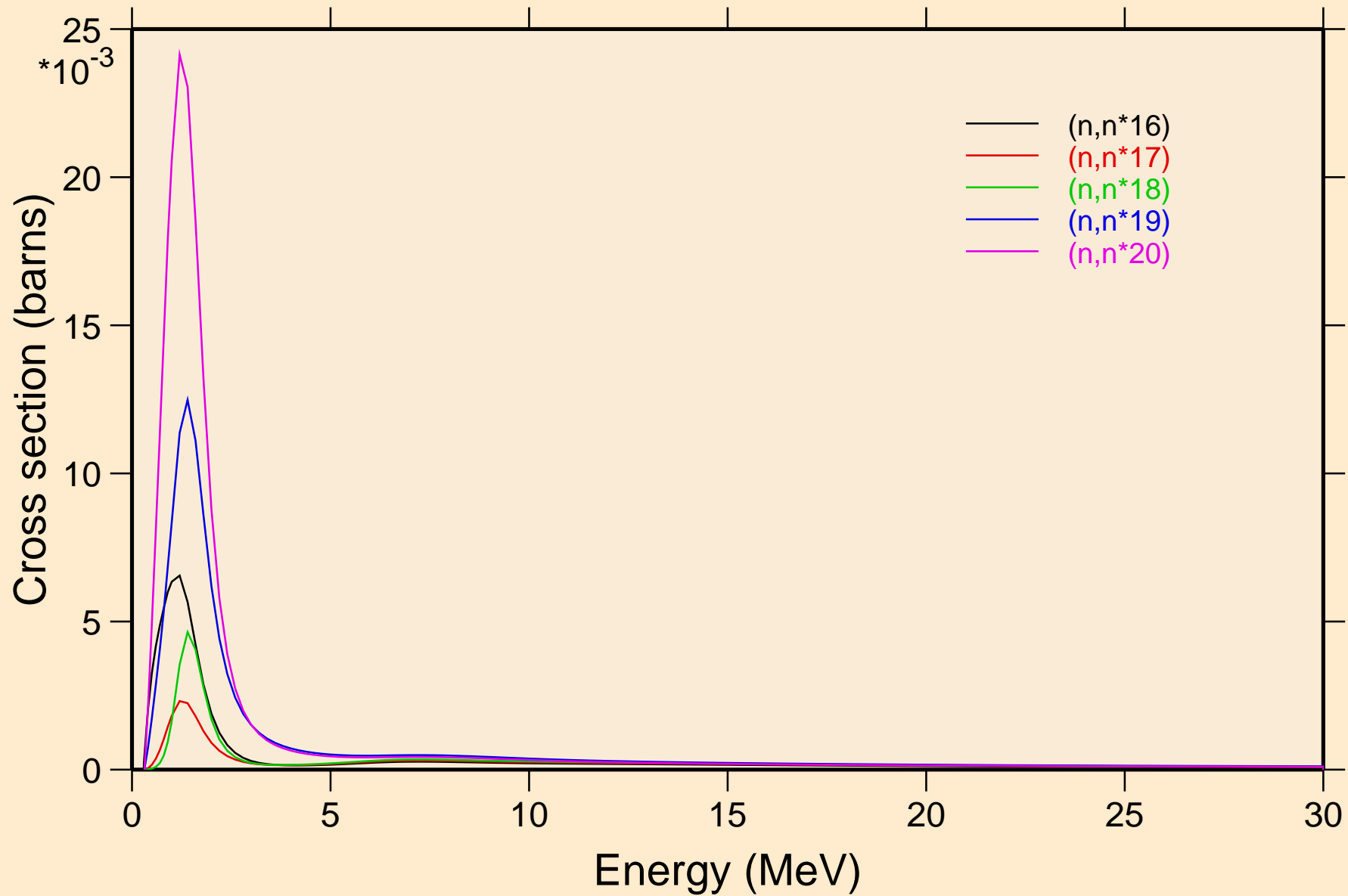

TH237 NEUTRON ACER TENDL-2024 LIBRARY; T=0.K
Inelastic levels

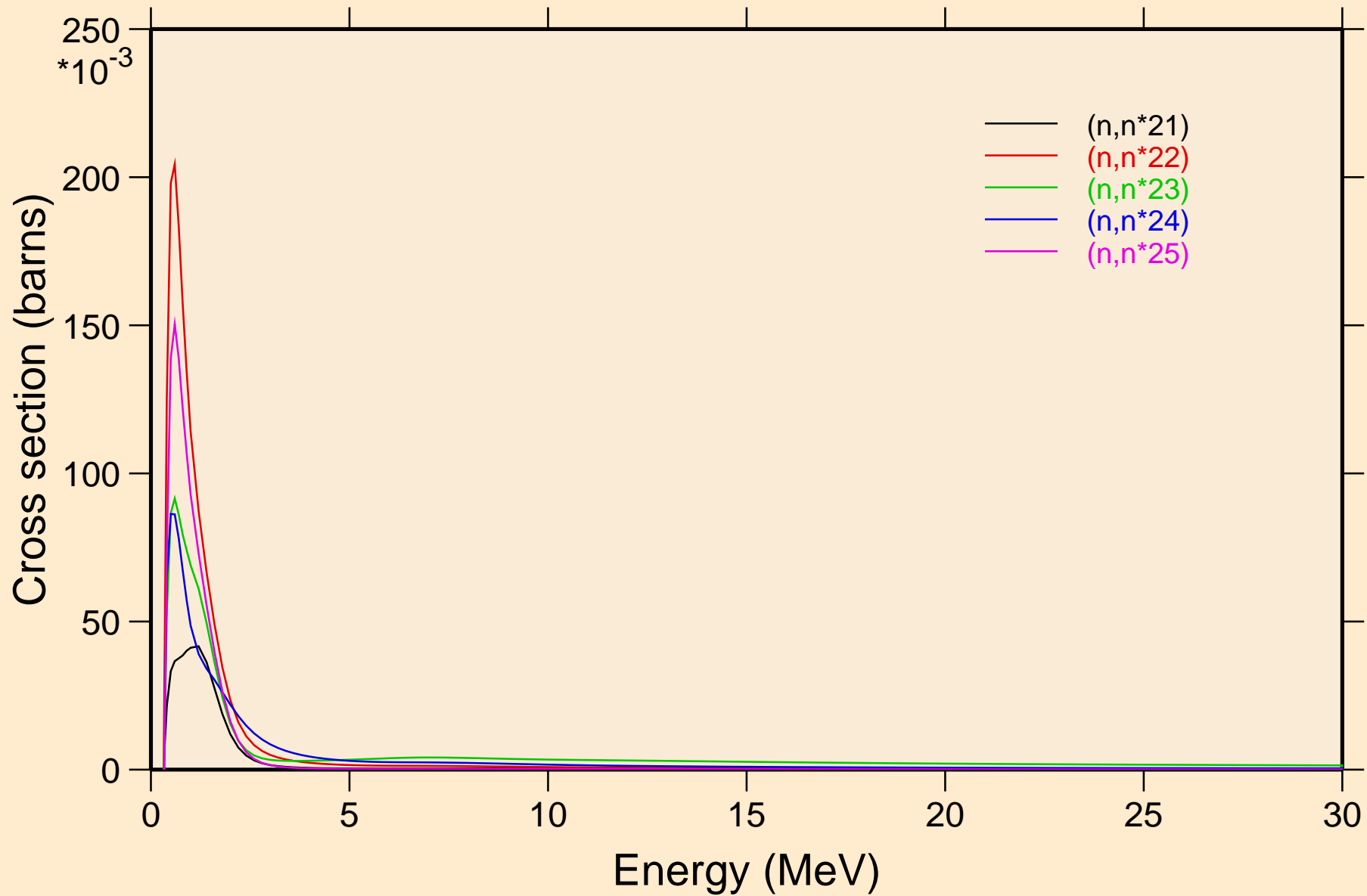

TH237 NEUTRON ACER TENDL-2024 LIBRARY; T=0.K
Inelastic levels

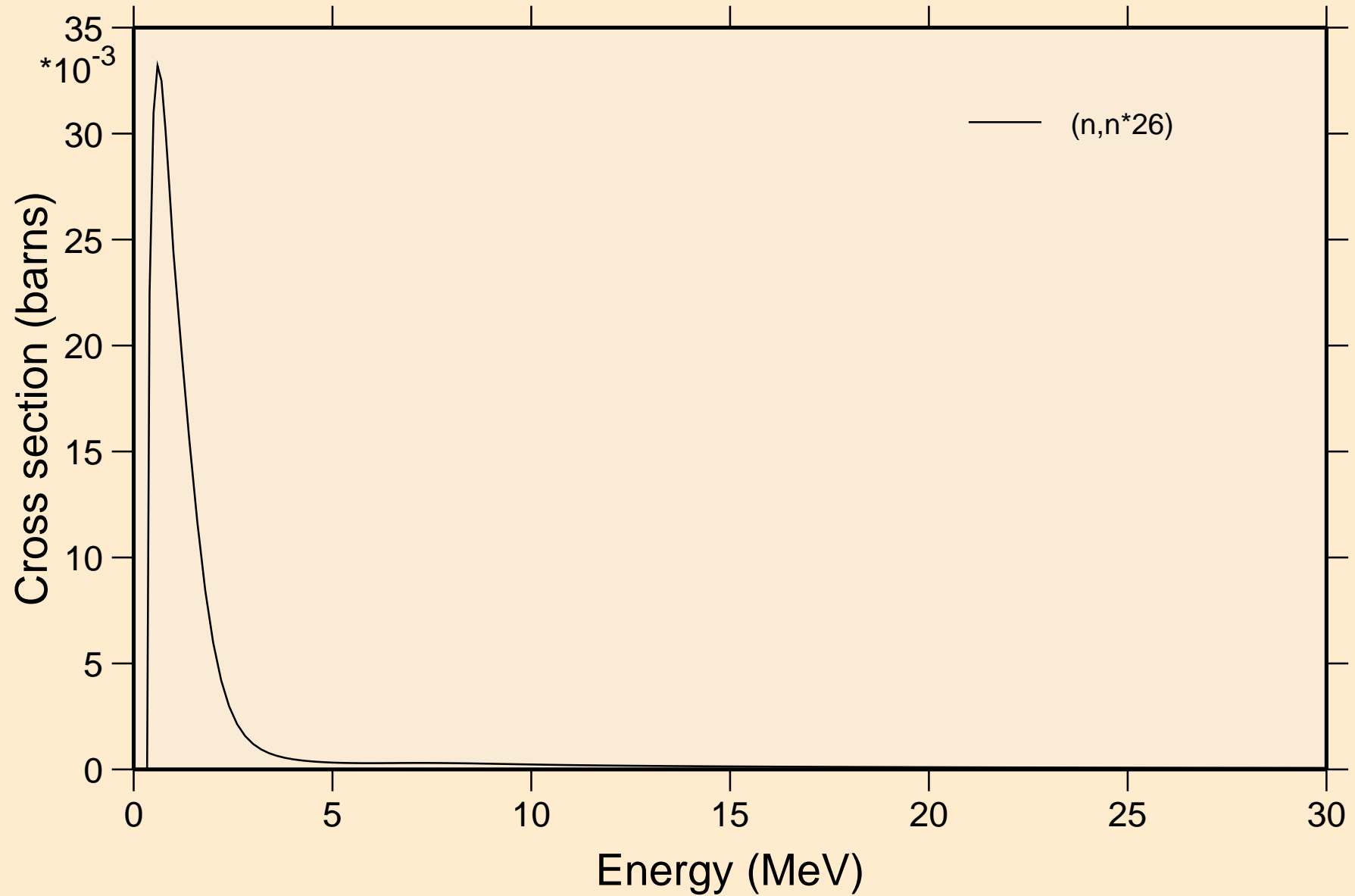

TH237 NEUTRON ACER TENDL-2024 LIBRARY; T=0.K

Threshold reactions

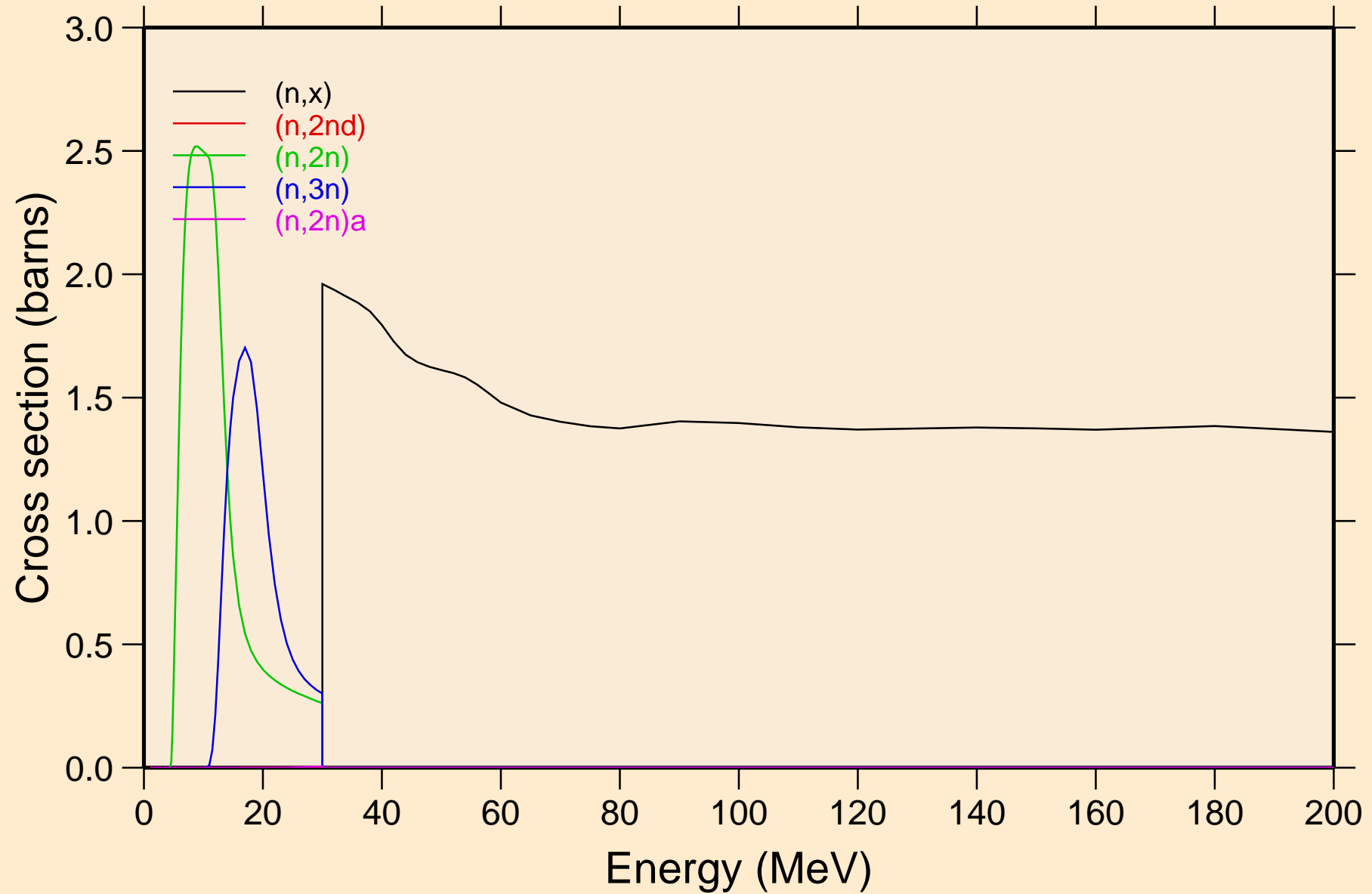

TH237 NEUTRON ACER TENDL-2024 LIBRARY; T=0.K
Threshold reactions

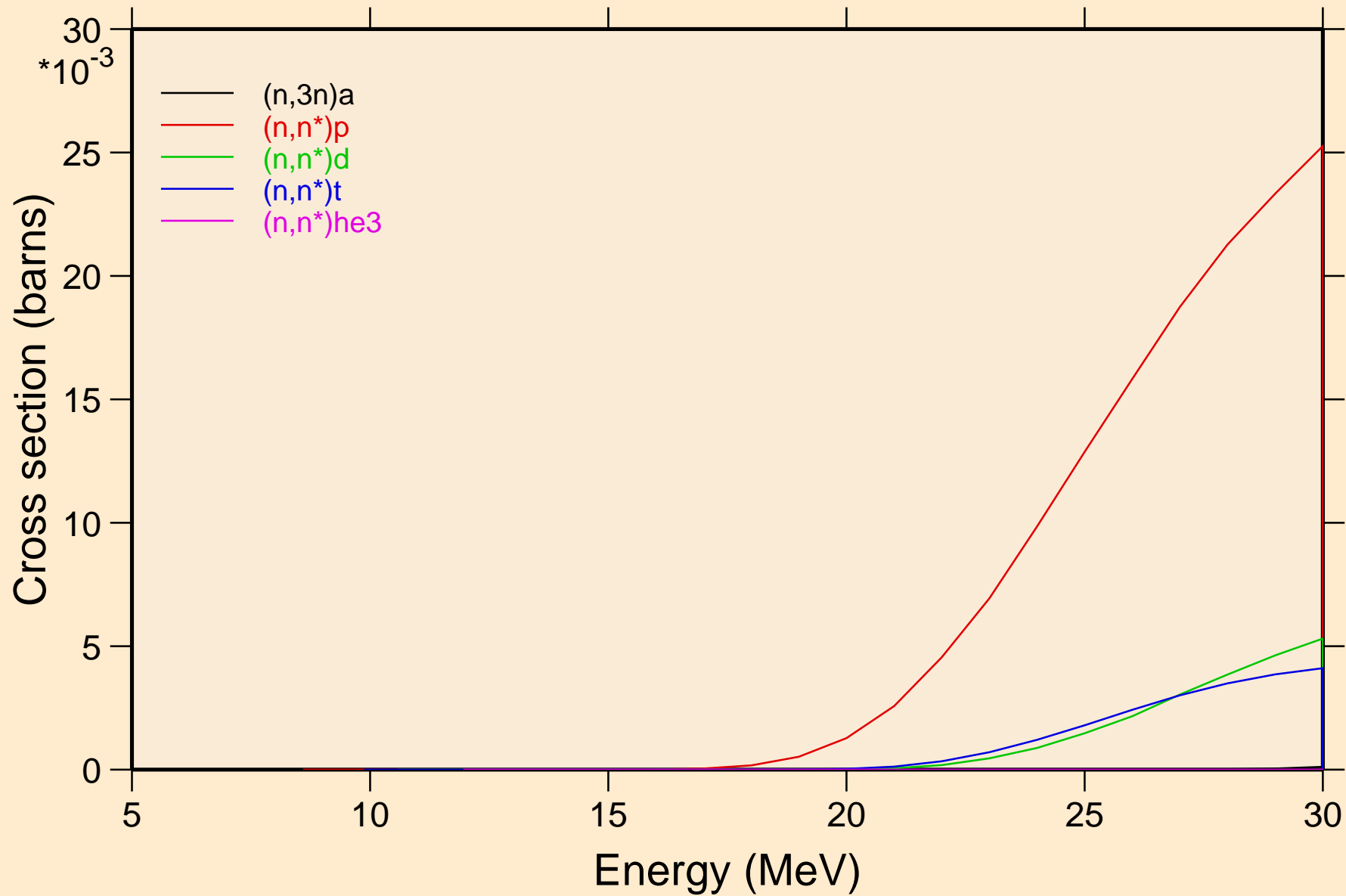

TH237 NEUTRON ACER TENDL-2024 LIBRARY; T=0.K
Threshold reactions

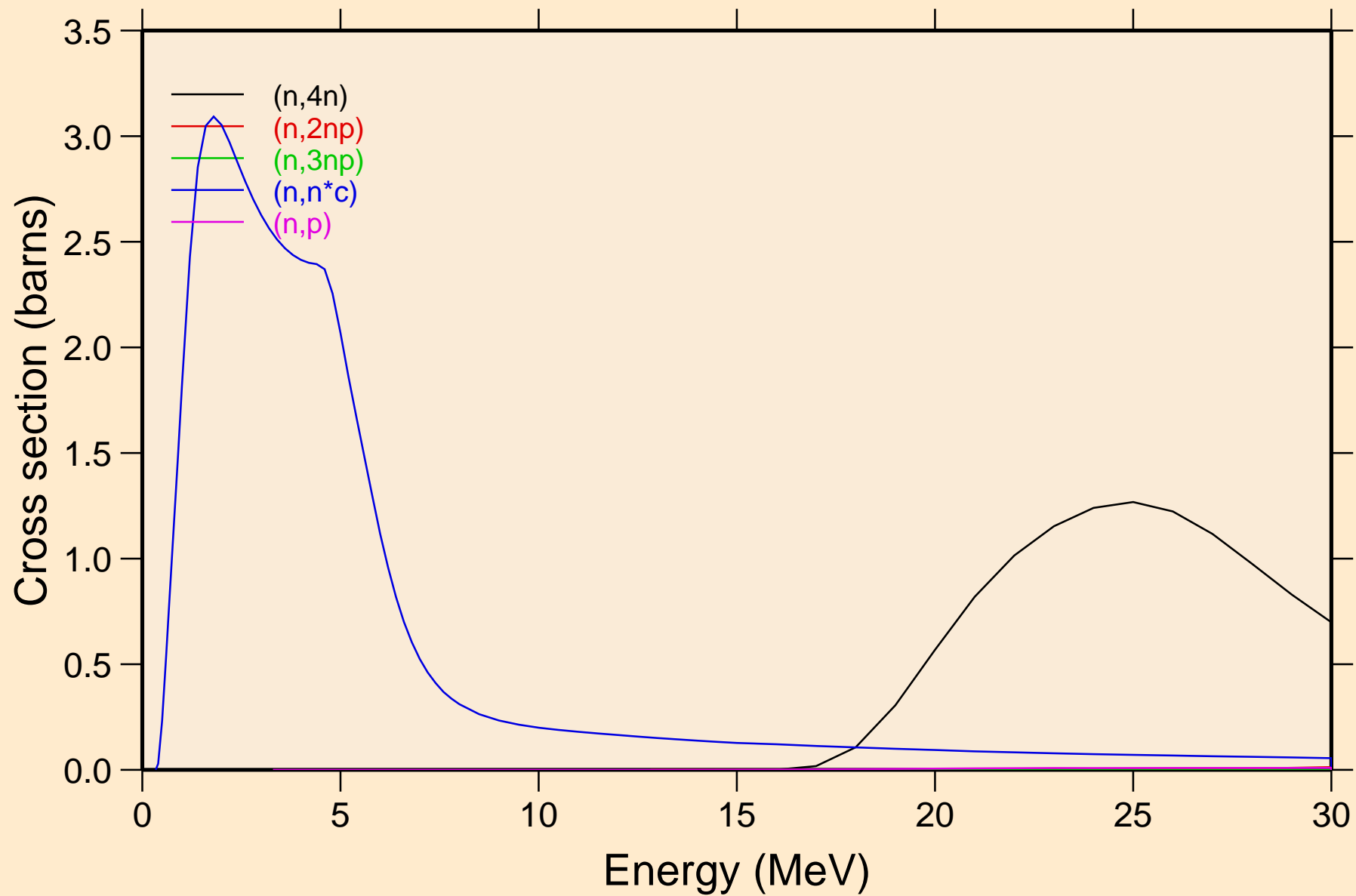

TH237 NEUTRON ACER TENDL-2024 LIBRARY; T=0.K
Threshold reactions

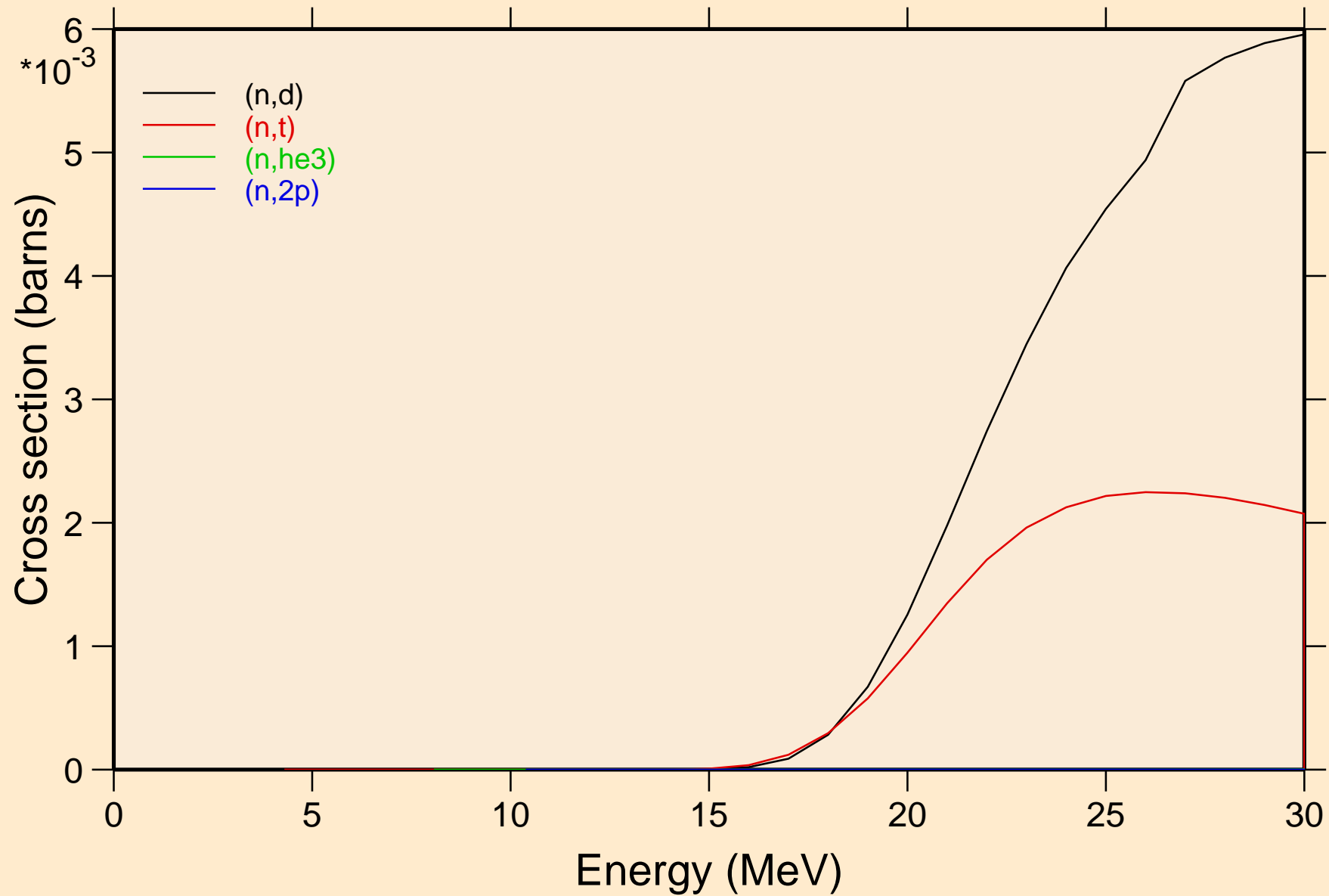

TH237 NEUTRON ACER TENDL-2024 LIBRARY; T=0.K

Threshold reactions

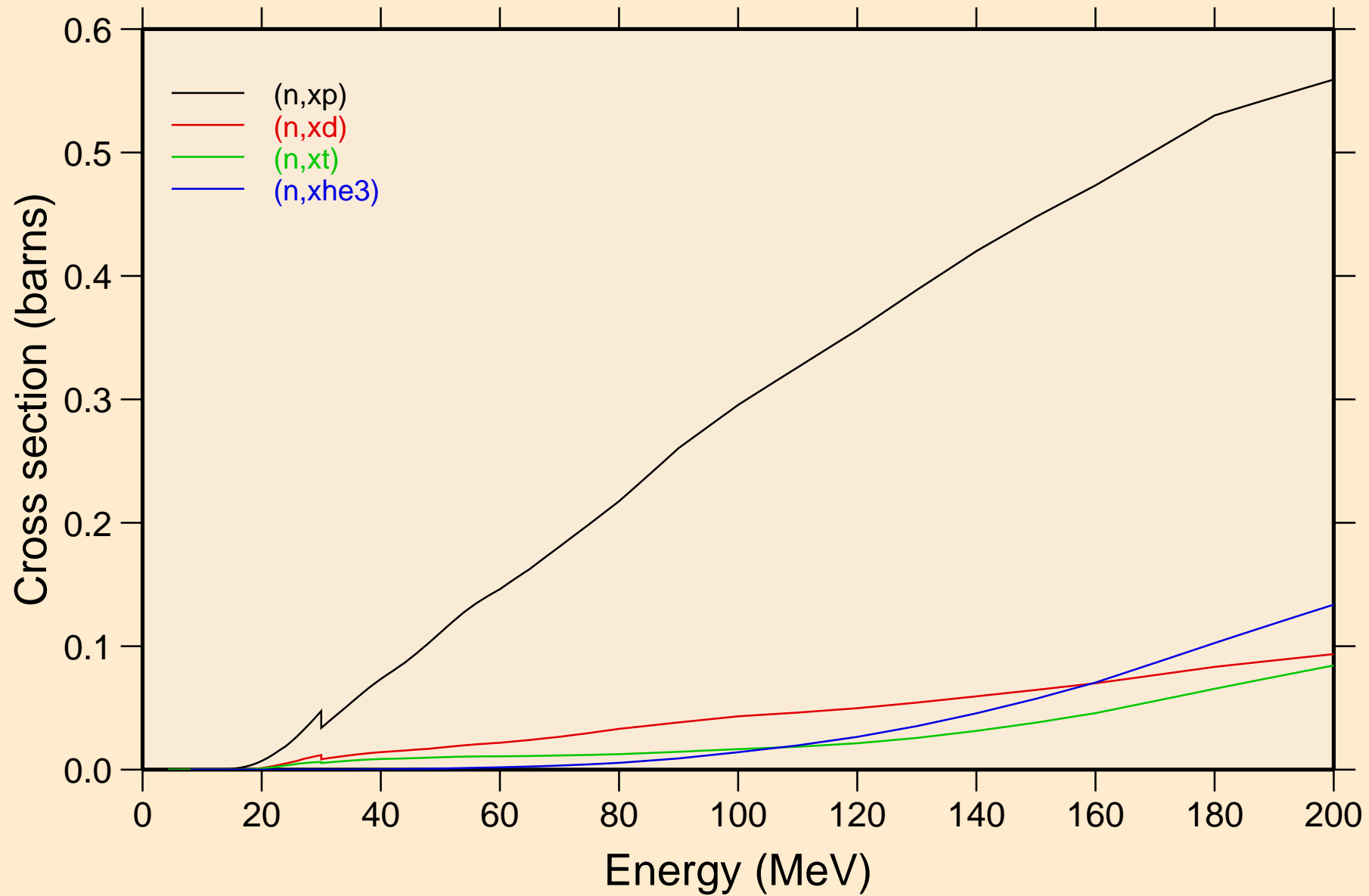

TH237 NEUTRON ACER TENDL-2024 LIBRARY; T=0.K
angular distribution for elastic

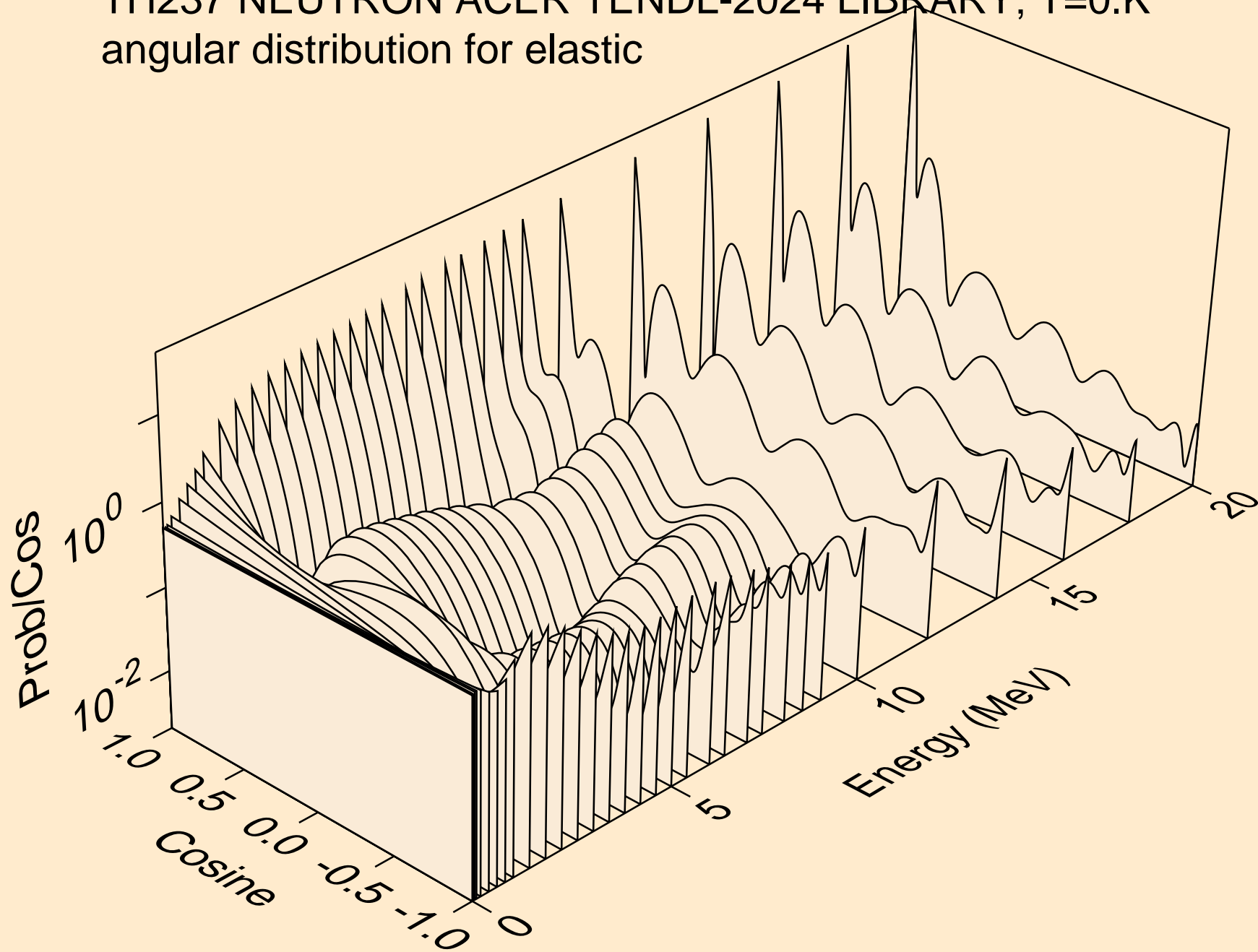

TH237 NEUTRON ACER TENDL-2024 LIBRARY; T=0.K
angular distribution for elastic

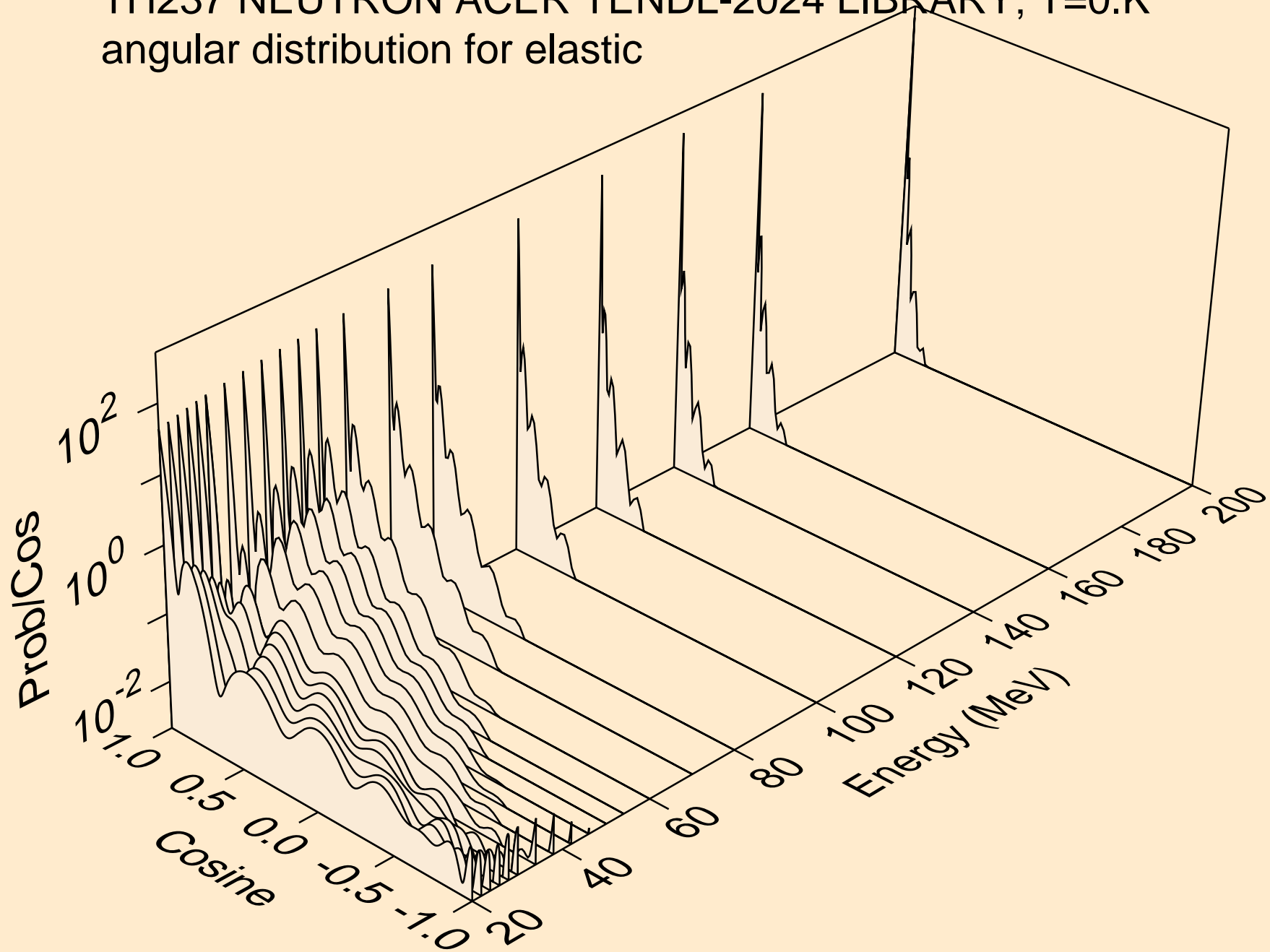

TH237 NEUTRON ACER TENDL-2024 LIBRARY; T=0.K
angular distribution for (n,n*1)

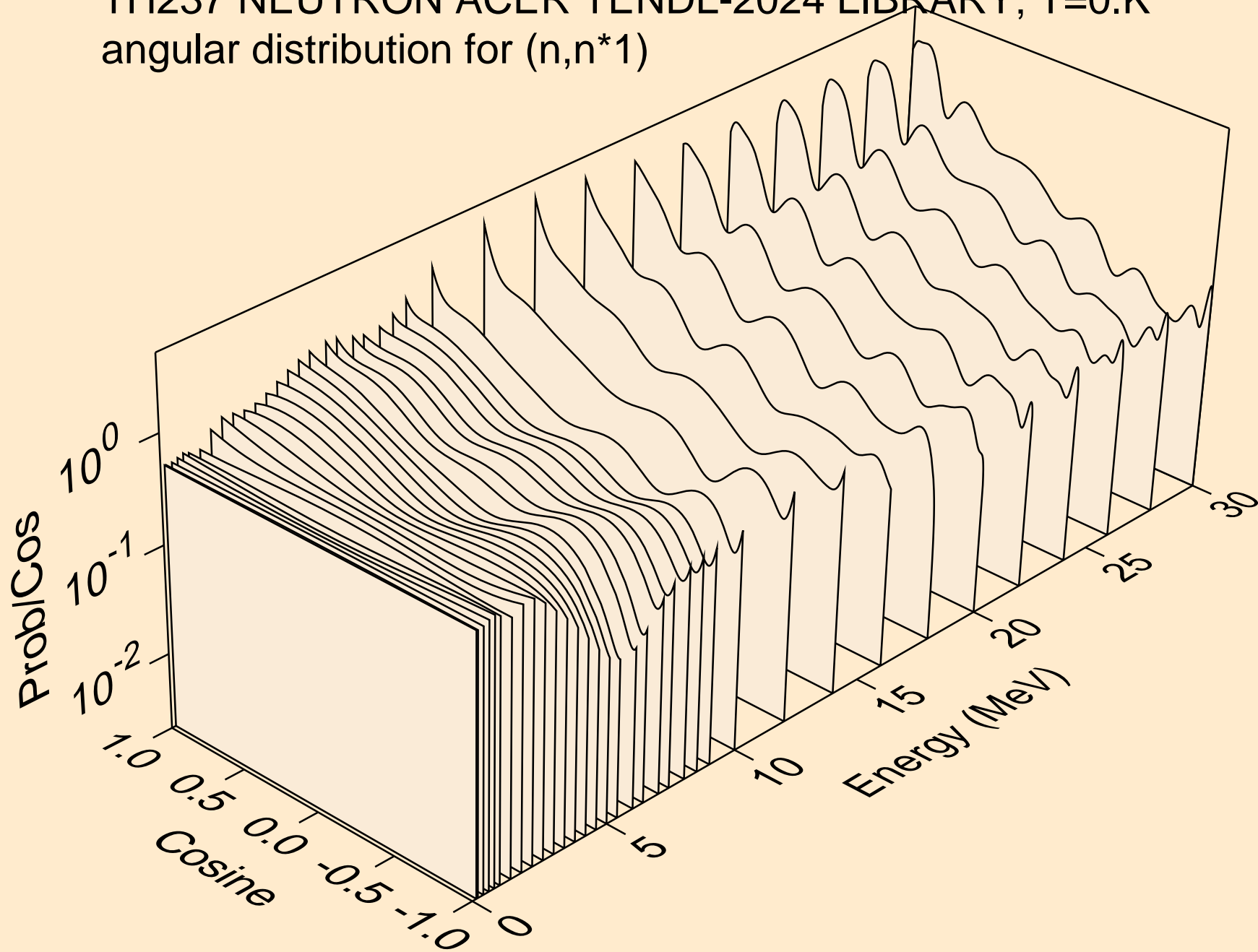

TH237 NEUTRON ACER TENDL-2024 LIBRARY; T=0.K
angular distribution for (n,n*2)

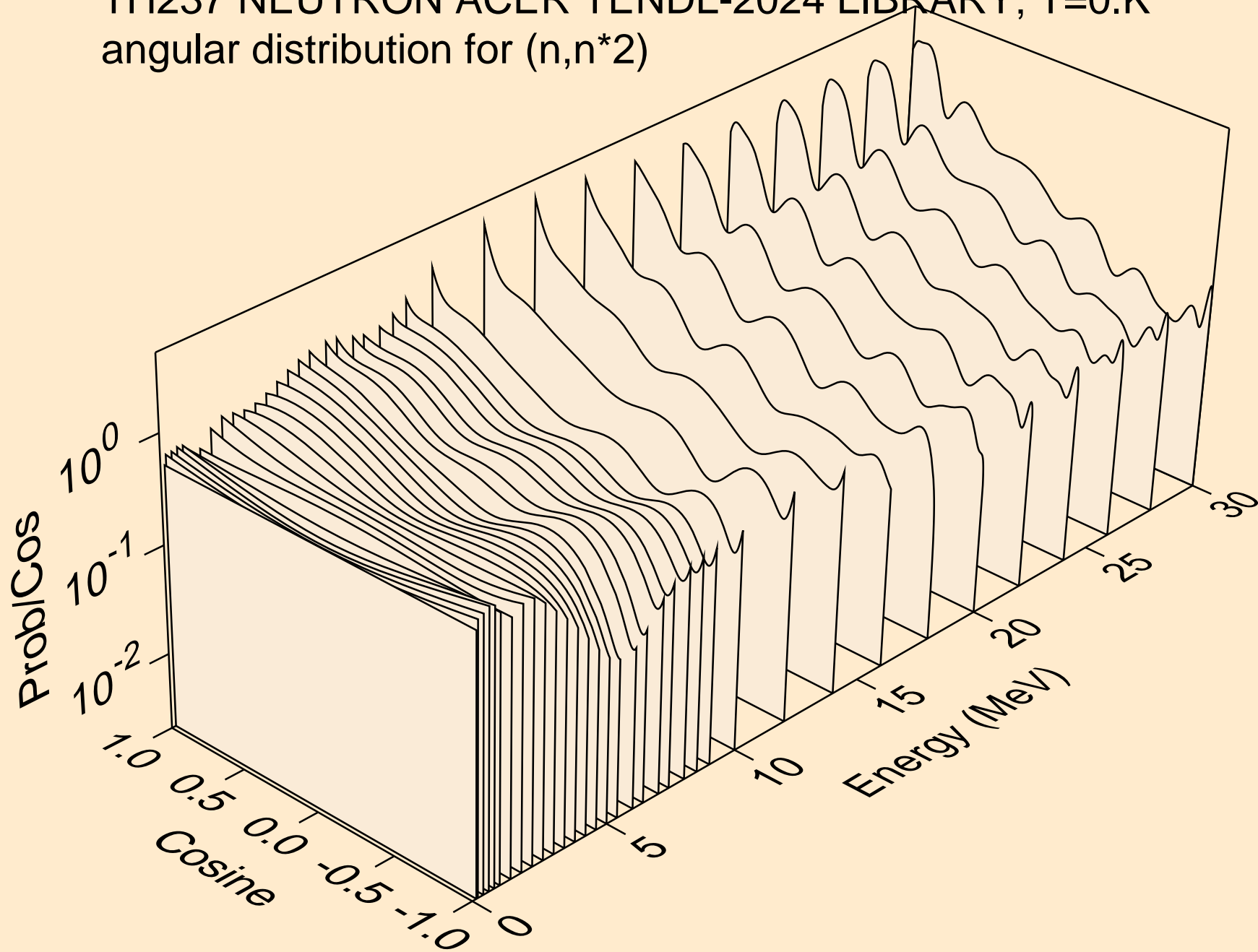

TH237 NEUTRON ACER TENDL-2024 LIBRARY; T=0.K
angular distribution for (n,n*3)

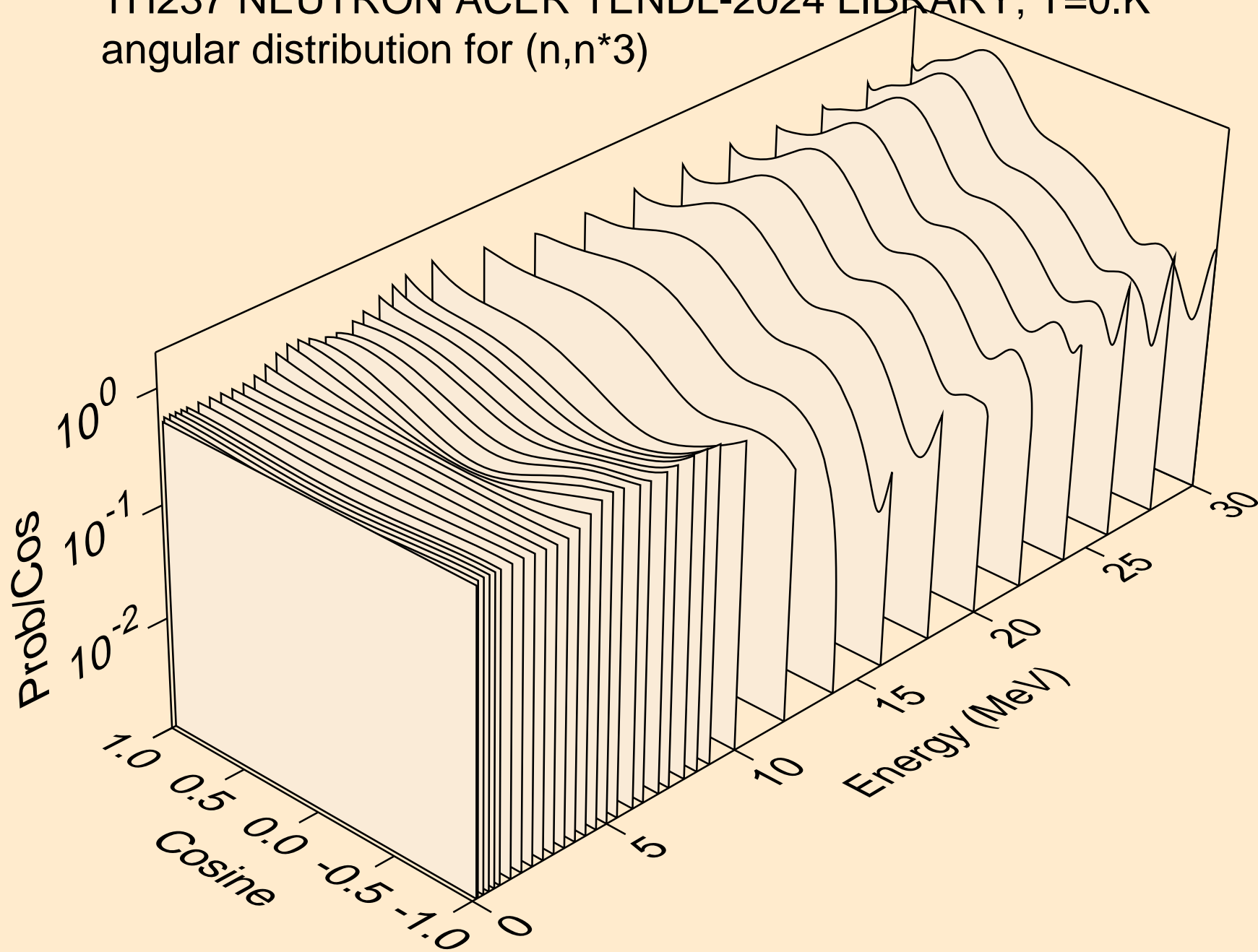

TH237 NEUTRON ACER TENDL-2024 LIBRARY; T=0.K
angular distribution for (n,n*4)

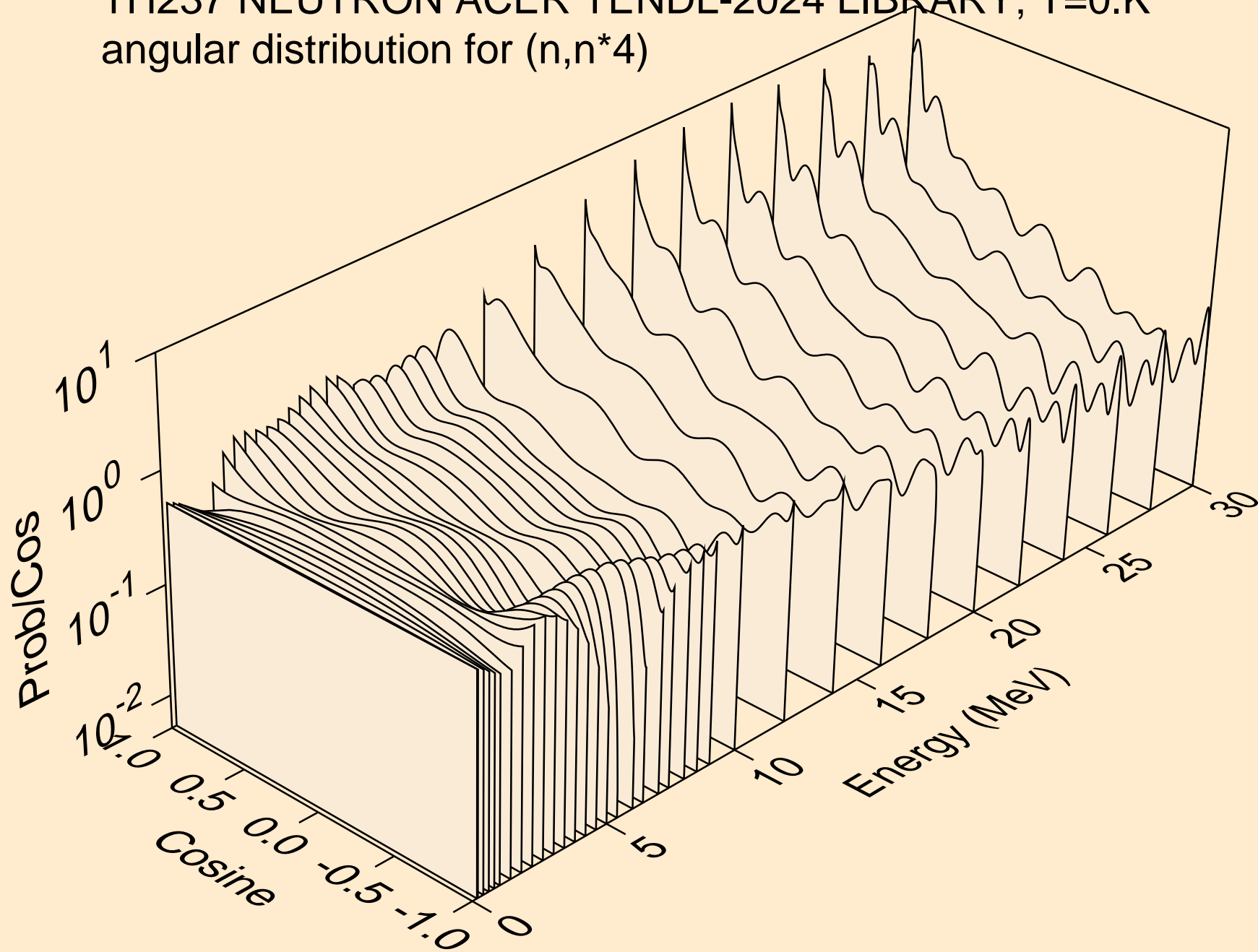

TH237 NEUTRON ACER TENDL-2024 LIBRARY; T=0.K
angular distribution for (n,n*5)

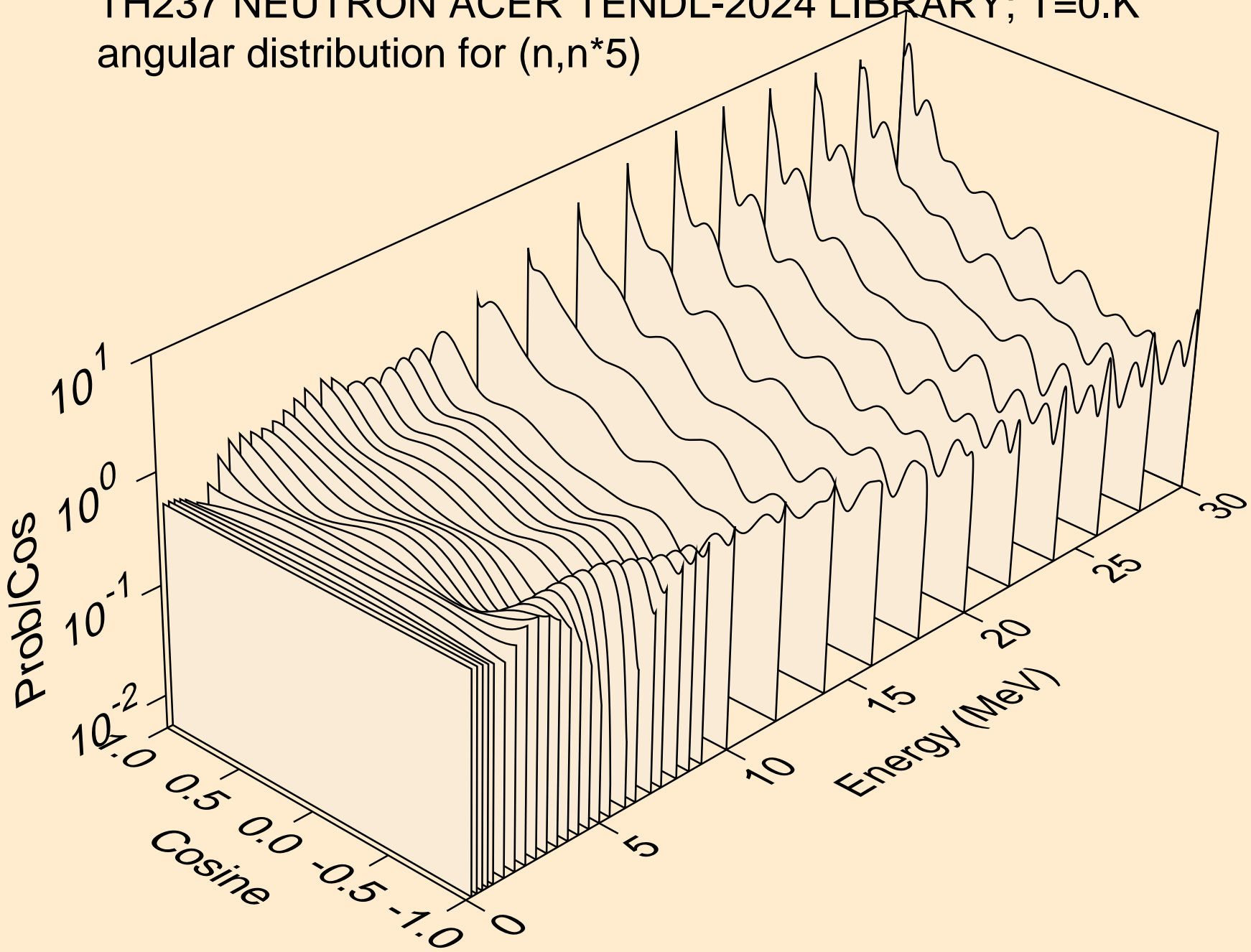

TH237 NEUTRON ACER TENDL-2024 LIBRARY; T=0.K
angular distribution for (n,n*6)

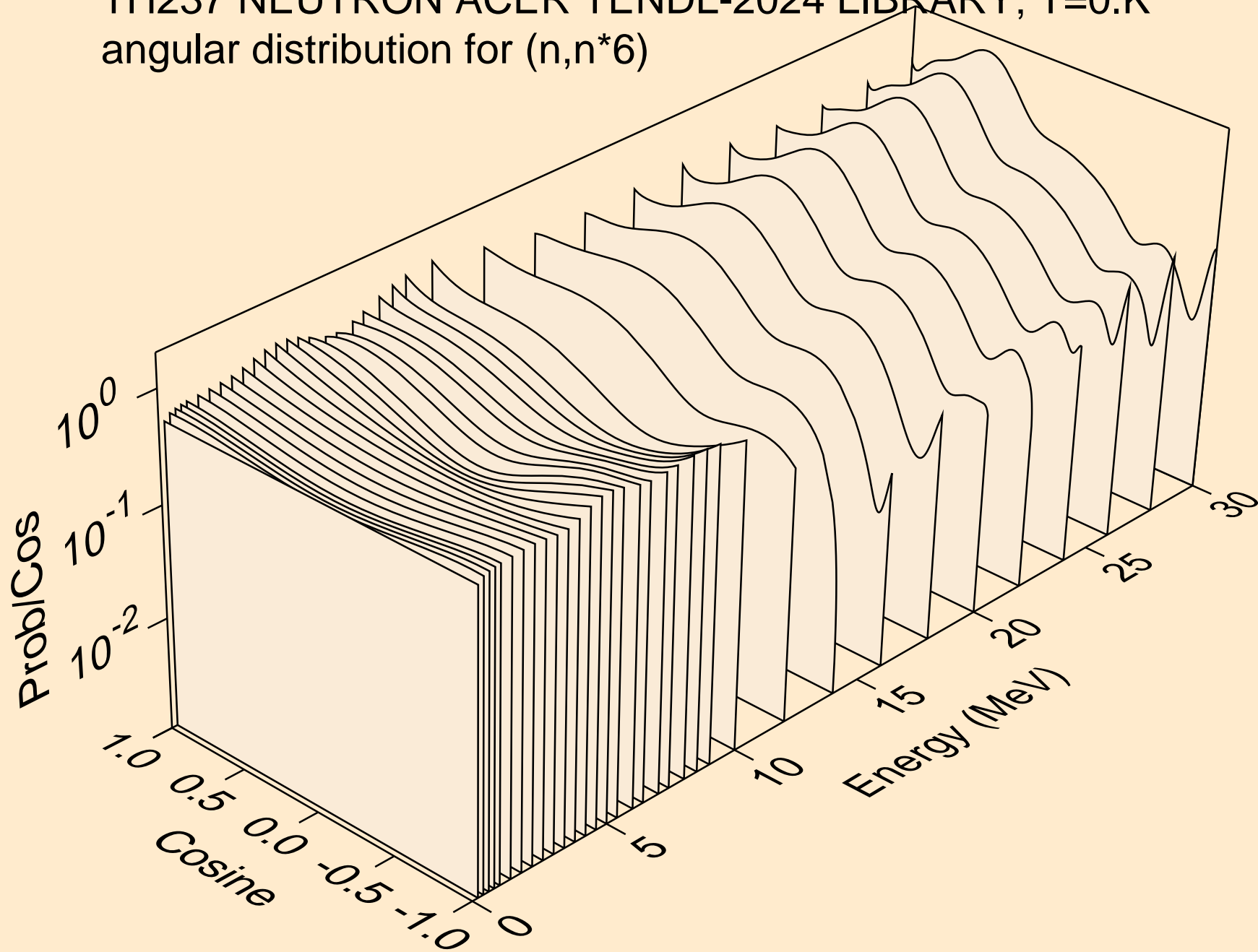

TH237 NEUTRON ACER TENDL-2024 LIBRARY; T=0.K
angular distribution for (n,n*7)

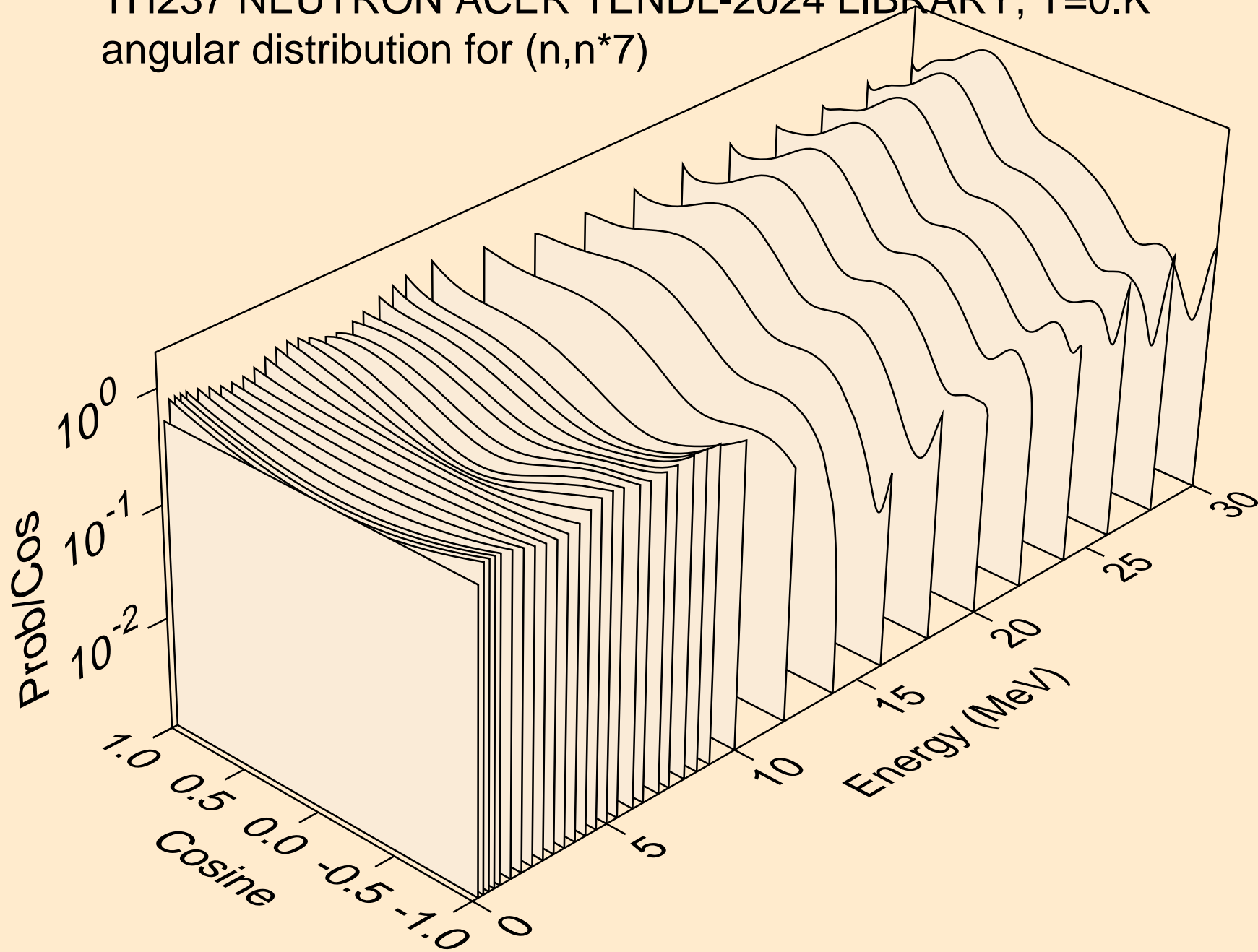

TH237 NEUTRON ACER TENDL-2024 LIBRARY; T=0.K
angular distribution for (n,n*8)

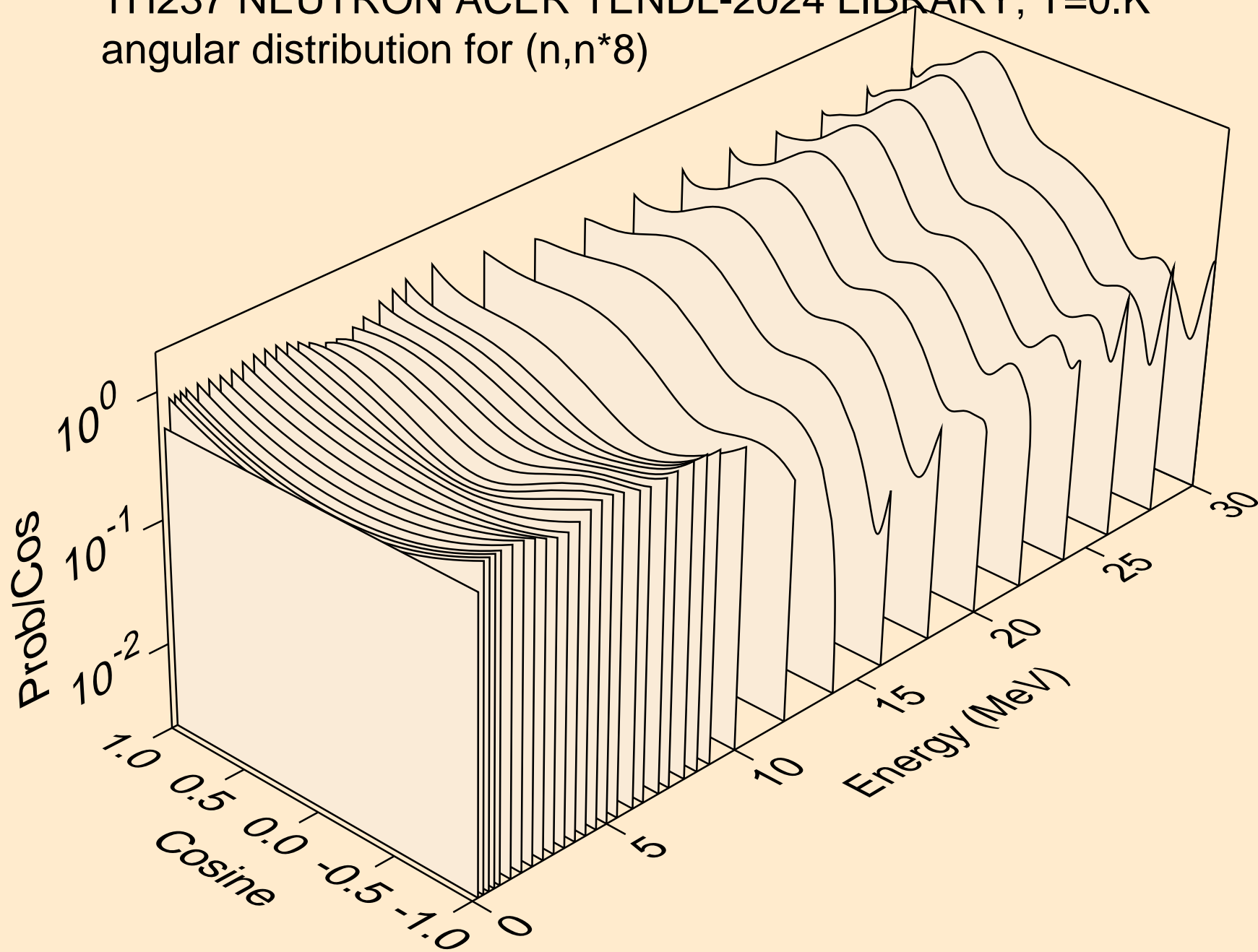

TH237 NEUTRON ACER TENDL-2024 LIBRARY; T=0.K
angular distribution for (n,n*9)

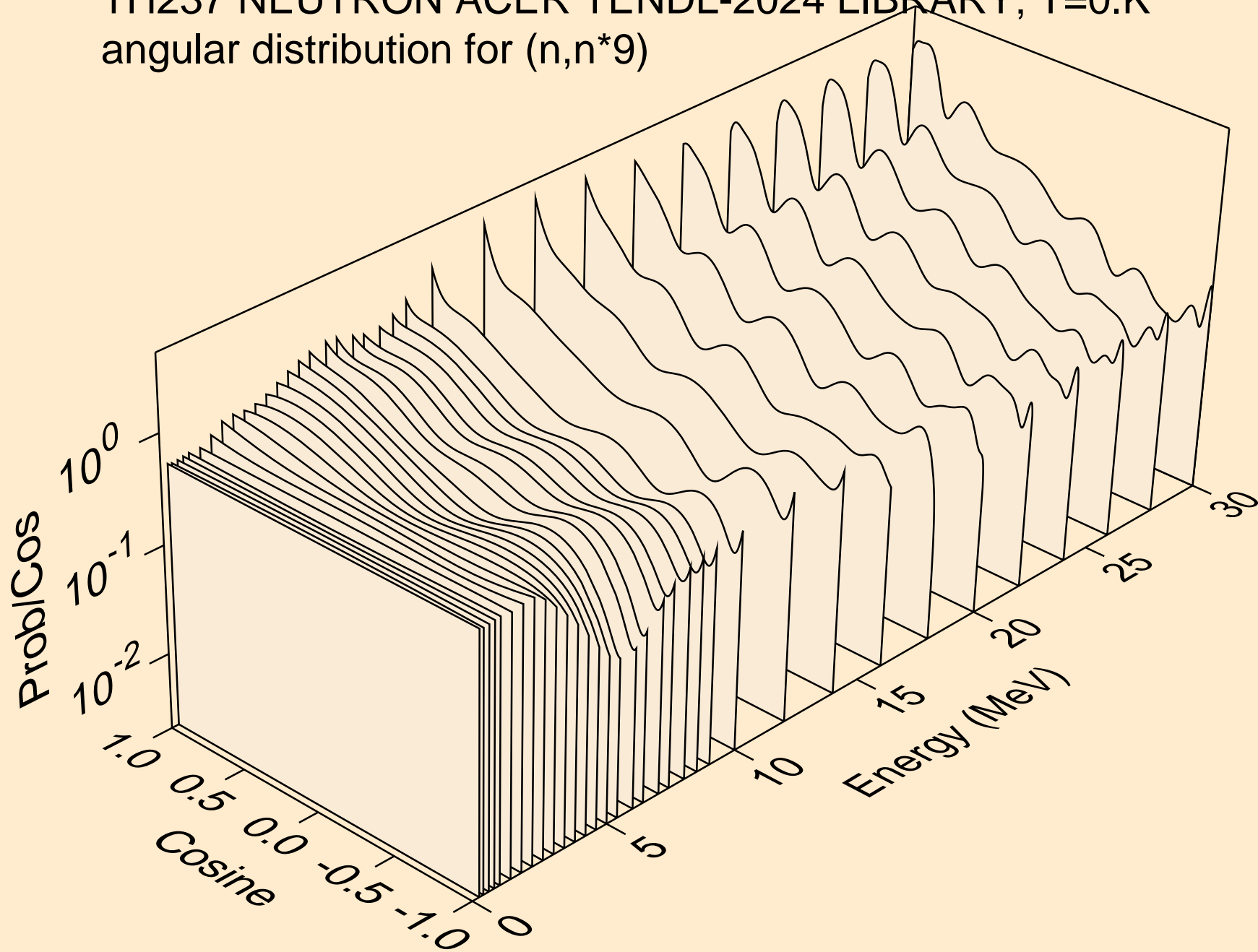

TH237 NEUTRON ACER TENDL-2024 LIBRARY; T=0.K
angular distribution for (n,n*10)

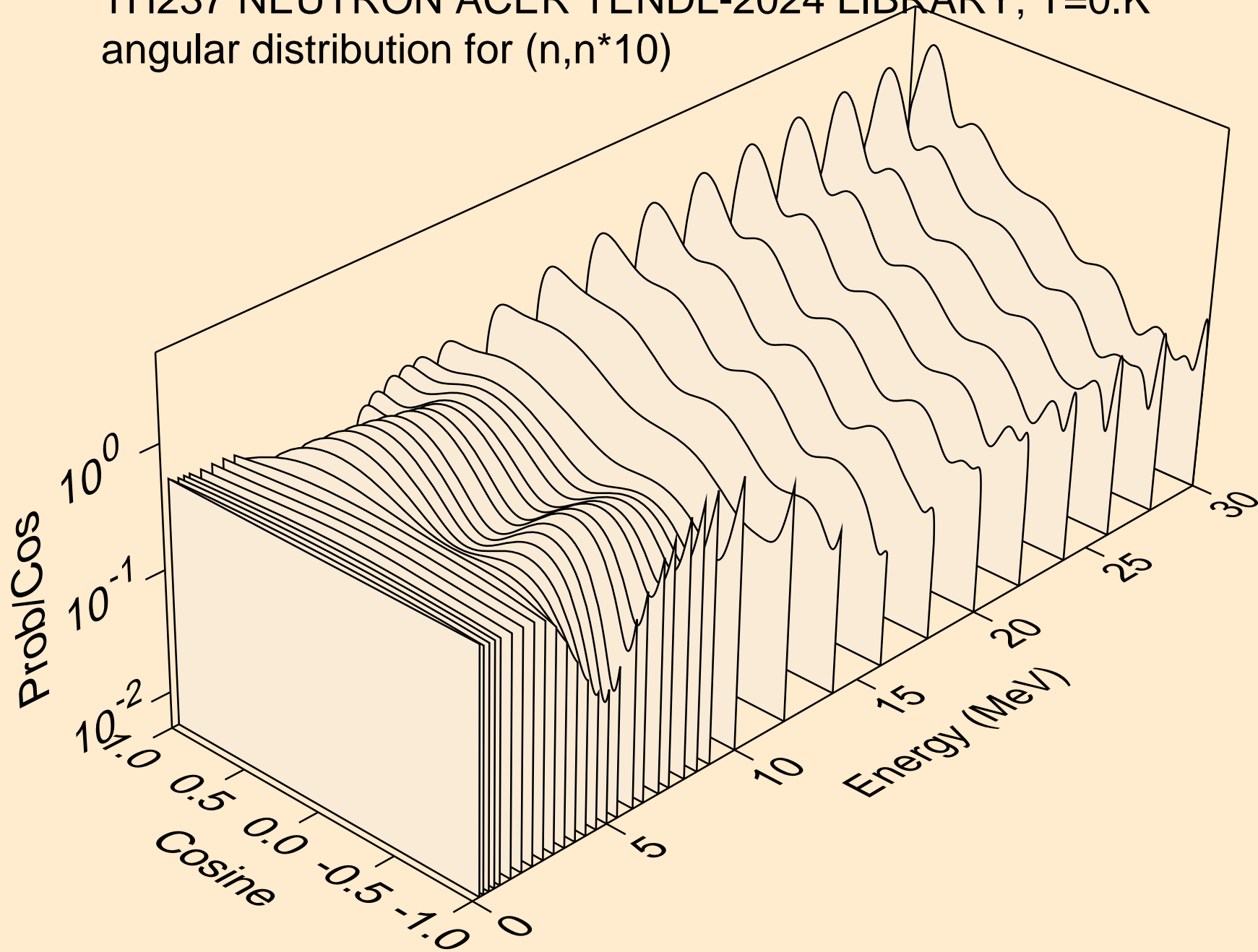

TH237 NEUTRON ACER TENDL-2024 LIBRARY; T=0.K
angular distribution for (n,n*11)

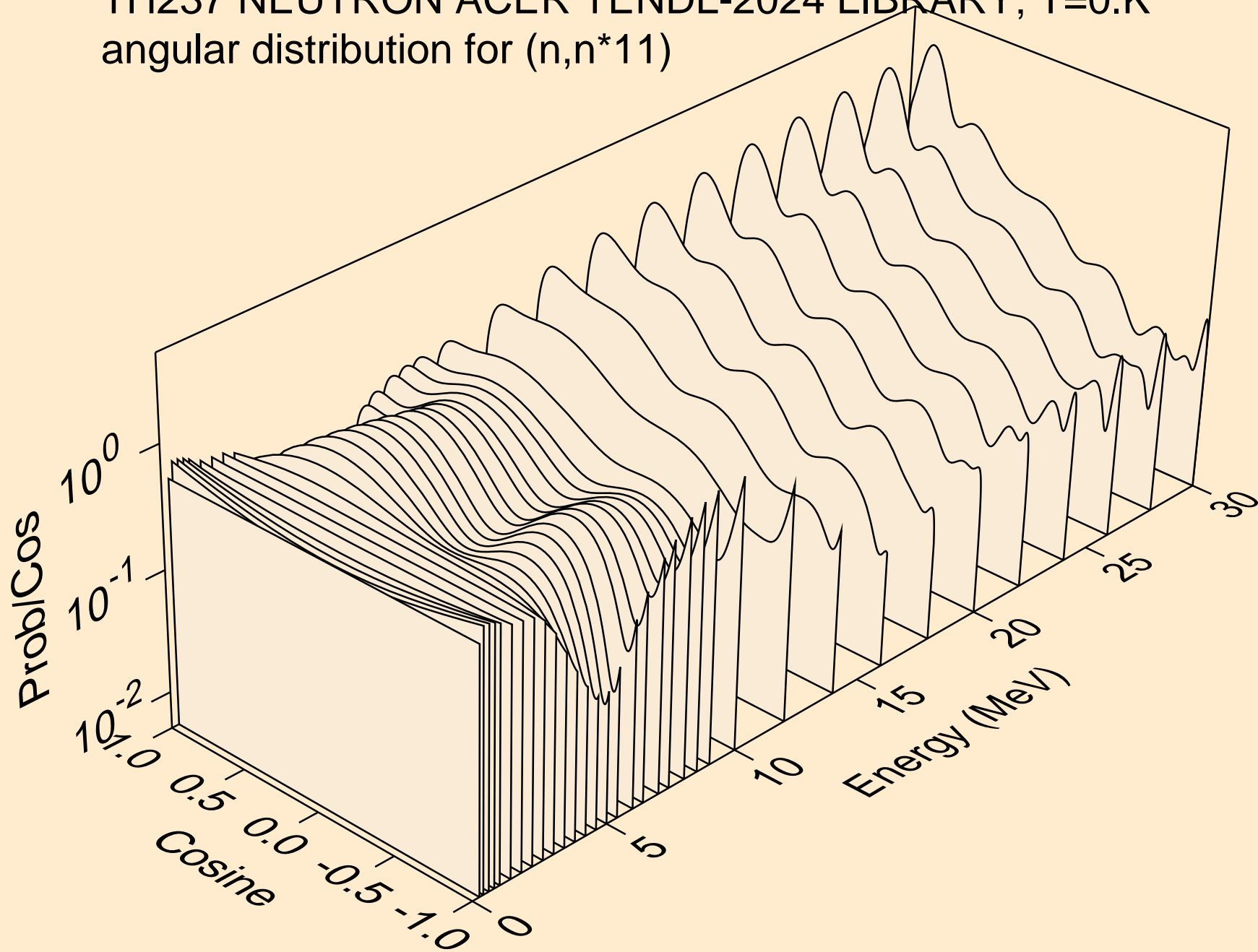

TH237 NEUTRON ACER TENDL-2024 LIBRARY; T=0.K
angular distribution for (n,n*12)

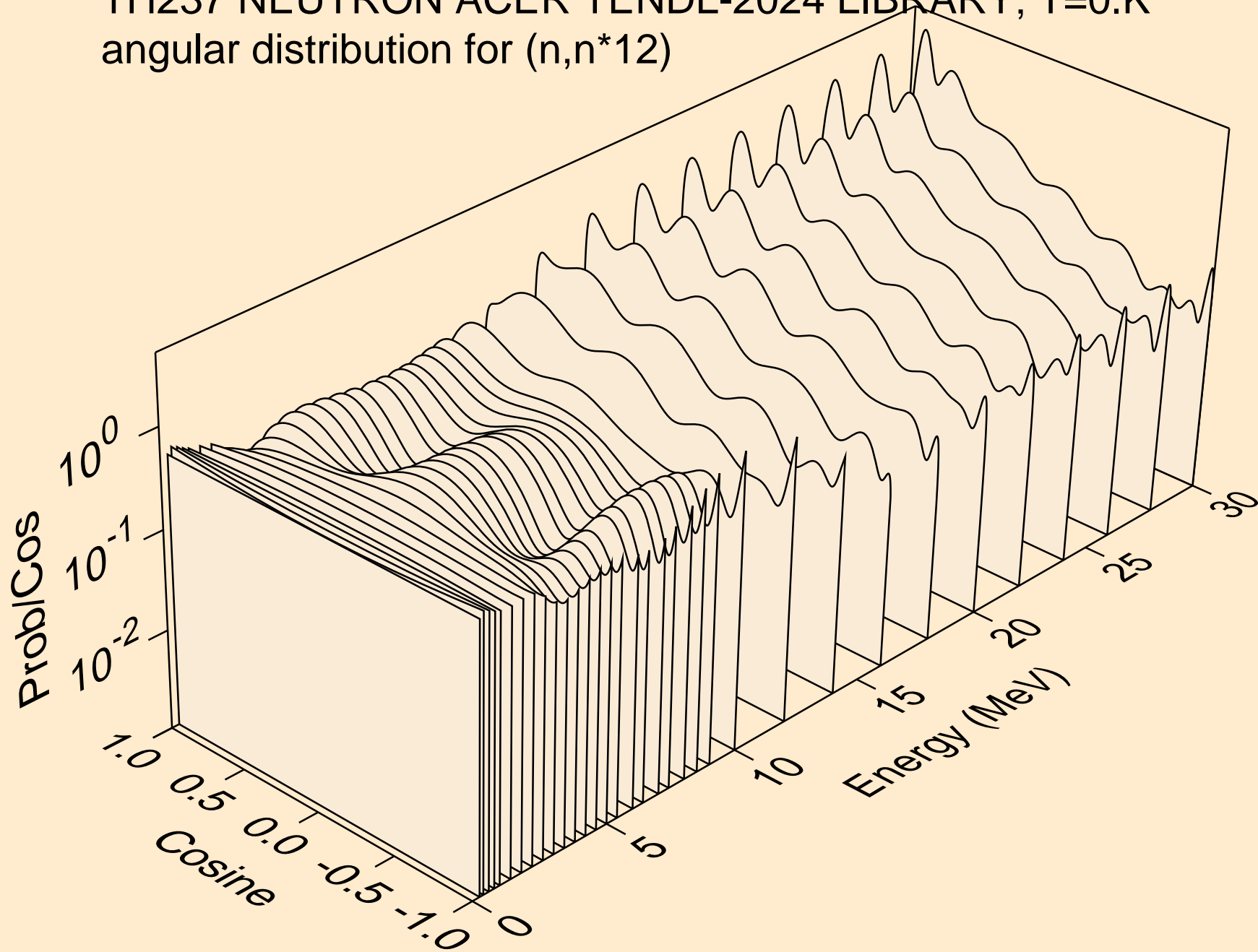

TH237 NEUTRON ACER TENDL-2024 LIBRARY; T=0.K
angular distribution for (n,n*13)

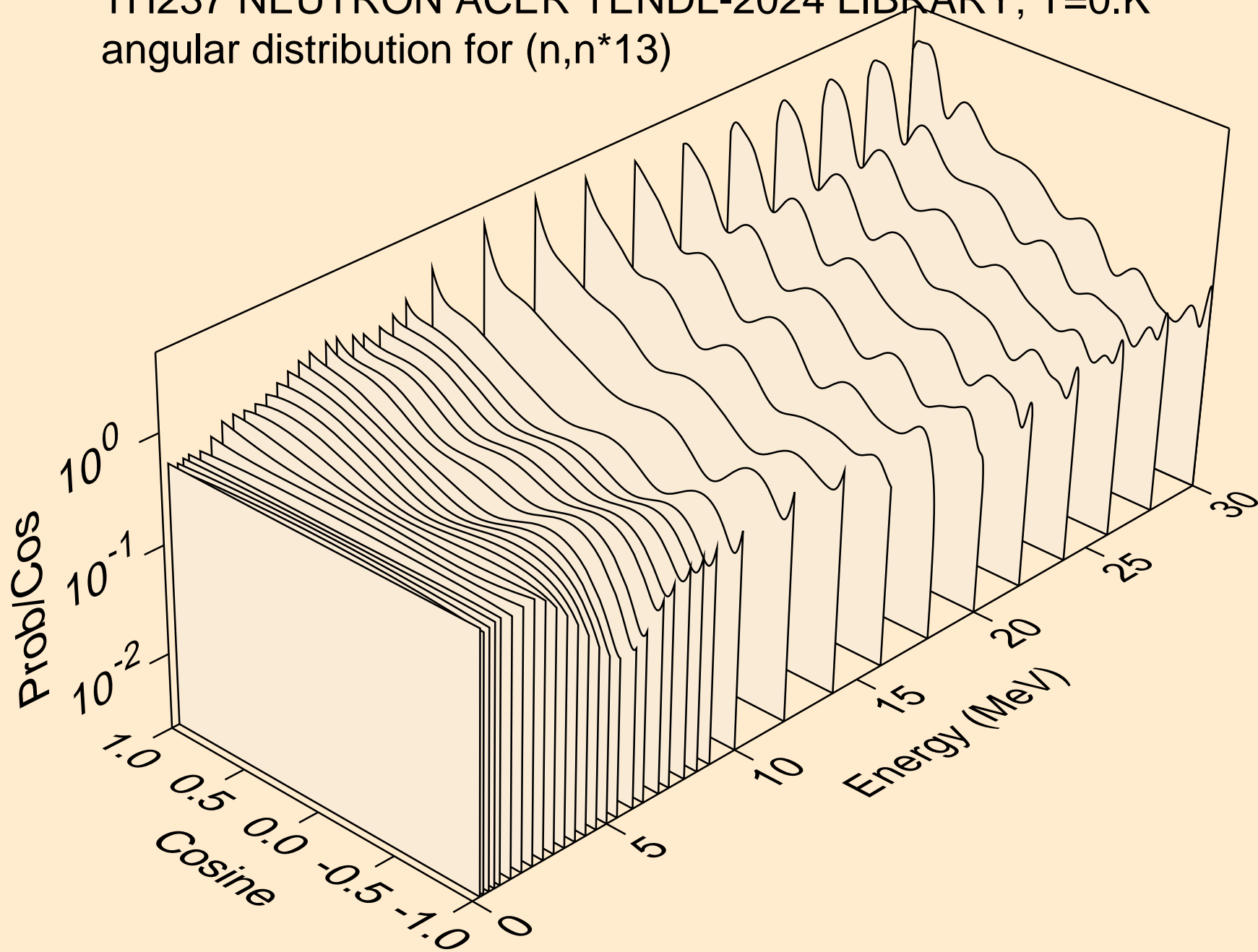

TH237 NEUTRON ACER TENDL-2024 LIBRARY; T=0.K
angular distribution for (n,n*14)

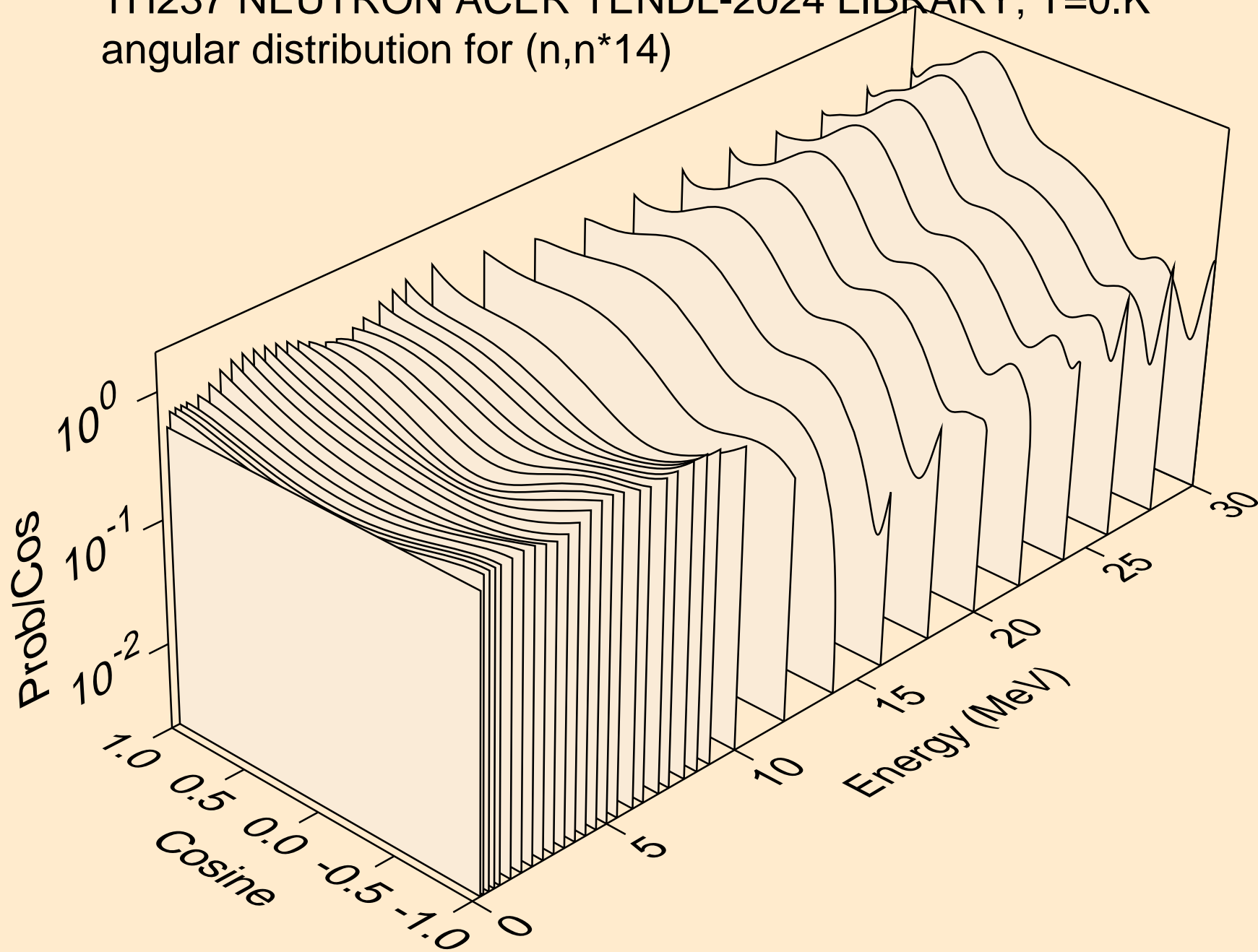

TH237 NEUTRON ACER TENDL-2024 LIBRARY; T=0.K
angular distribution for (n,n*15)

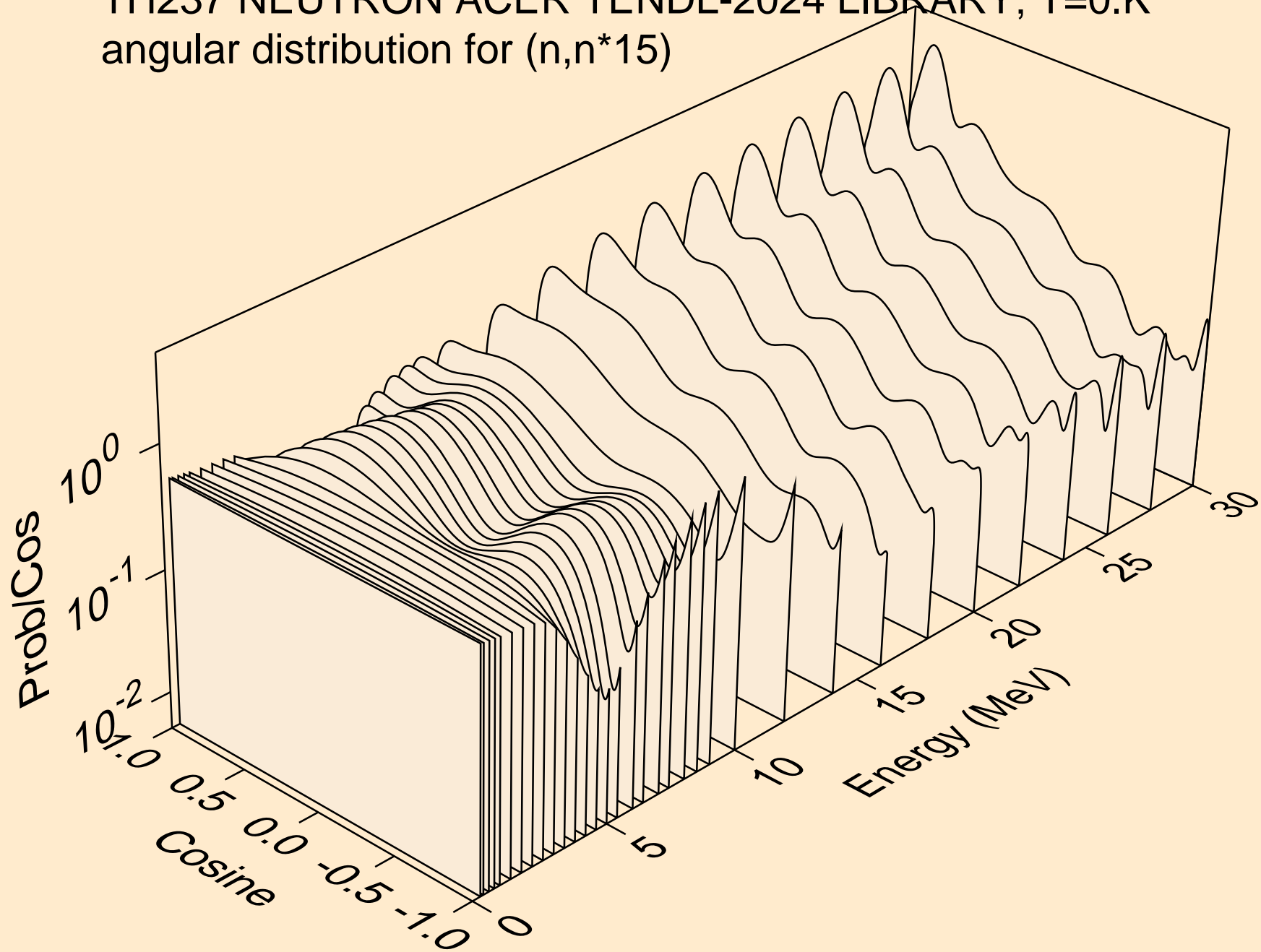

TH237 NEUTRON ACER TENDL-2024 LIBRARY; T=0.K
angular distribution for (n,n*16)

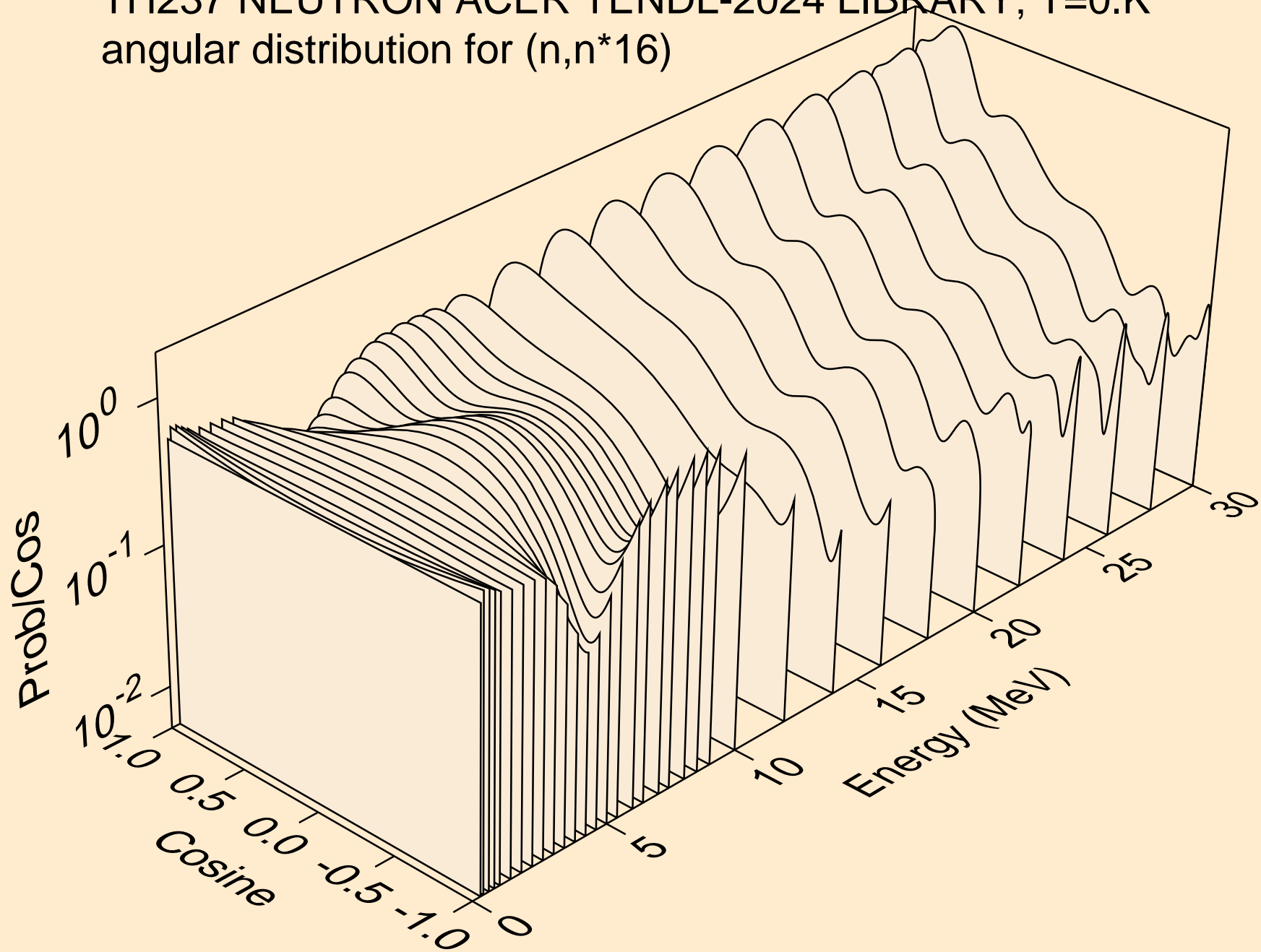

TH237 NEUTRON ACER TENDL-2024 LIBRARY; T=0.K
angular distribution for (n,n*17)

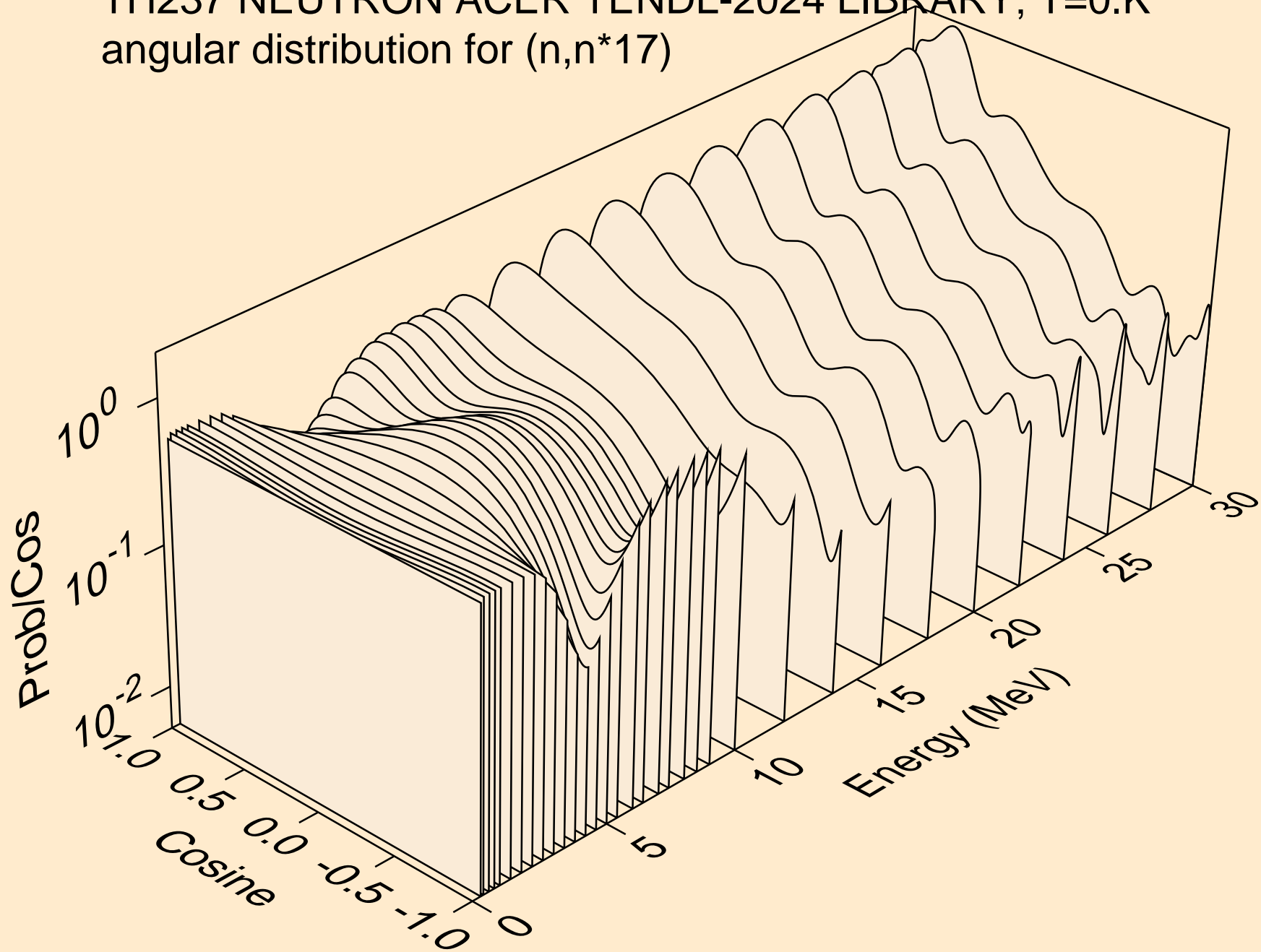

TH237 NEUTRON ACER TENDL-2024 LIBRARY; T=0.K
angular distribution for (n,n*18)

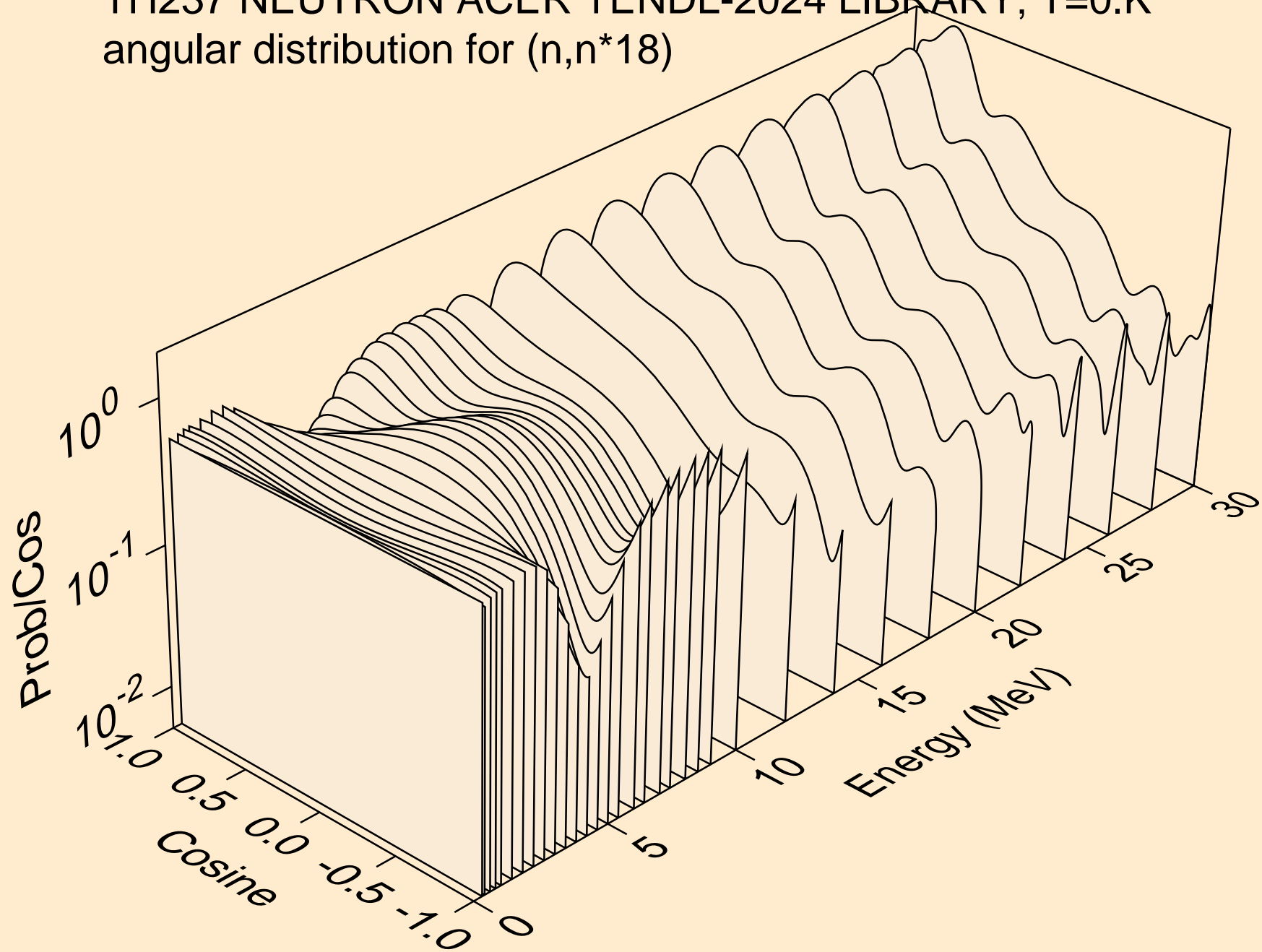

TH237 NEUTRON ACER TENDL-2024 LIBRARY; T=0.K
angular distribution for (n,n*19)

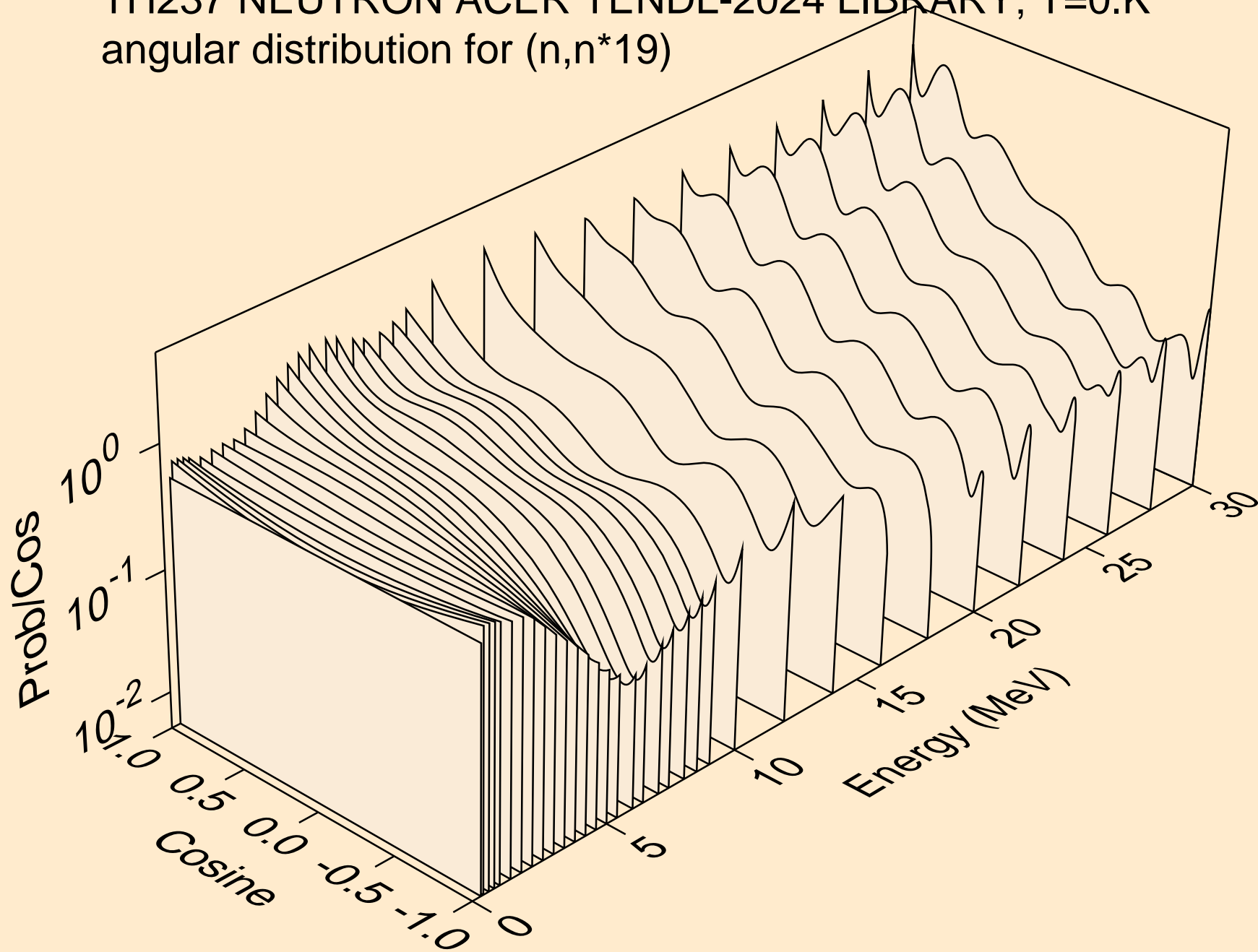

TH237 NEUTRON ACER TENDL-2024 LIBRARY; T=0.K
angular distribution for (n,n*20)

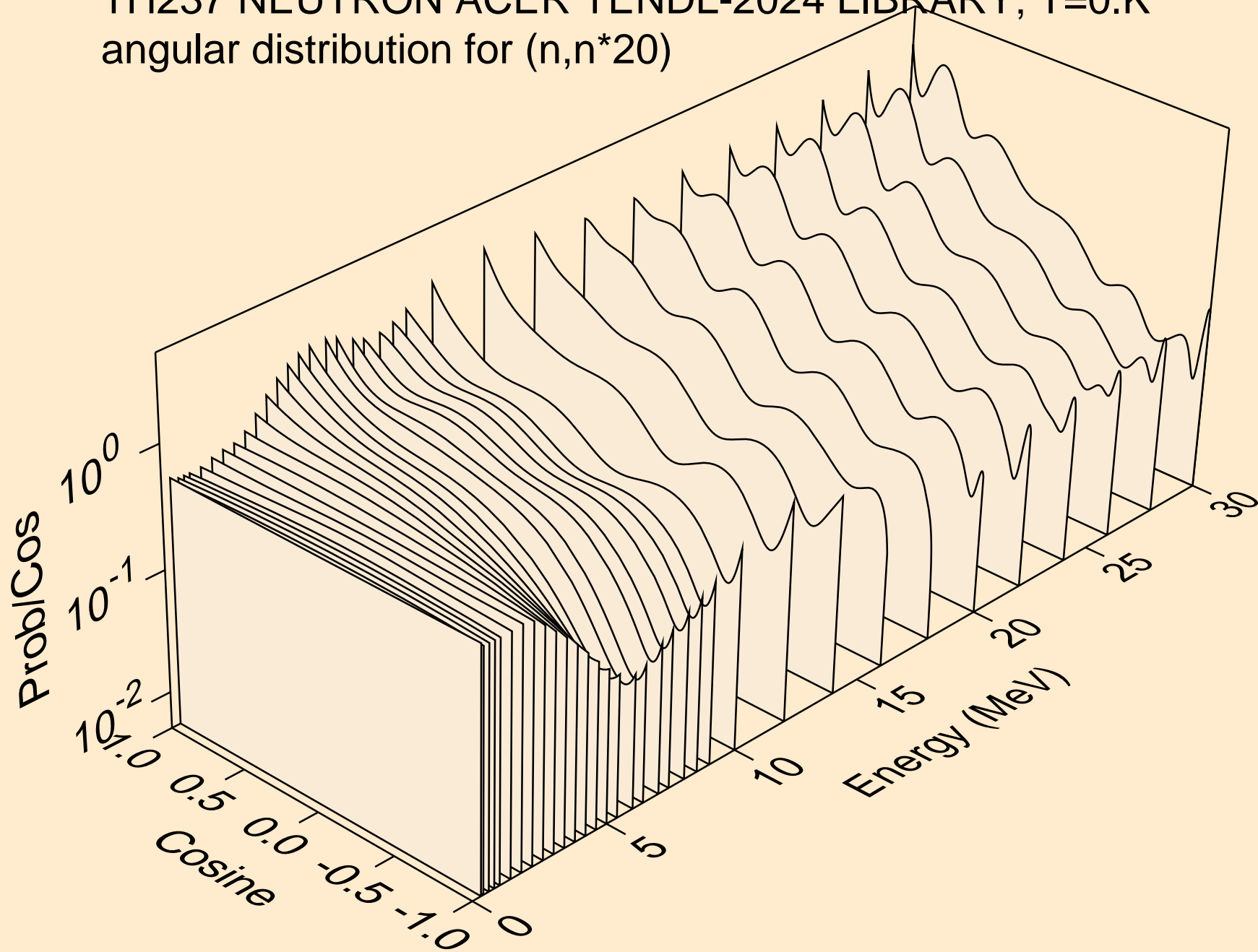

TH237 NEUTRON ACER TENDL-2024 LIBRARY; T=0.K
angular distribution for (n,n*21)

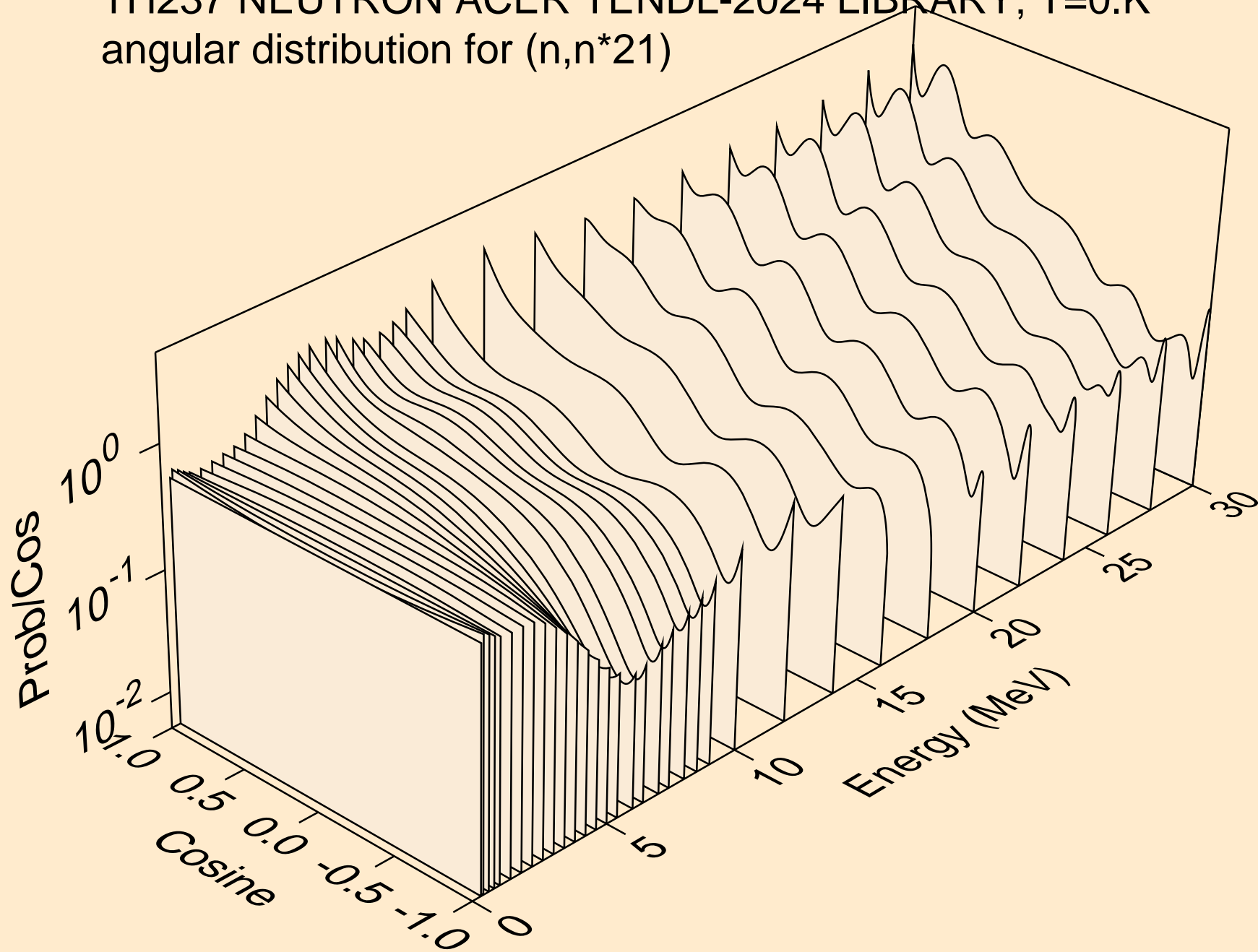

TH237 NEUTRON ACER TENDL-2024 LIBRARY; T=0.K
angular distribution for (n,n*22)

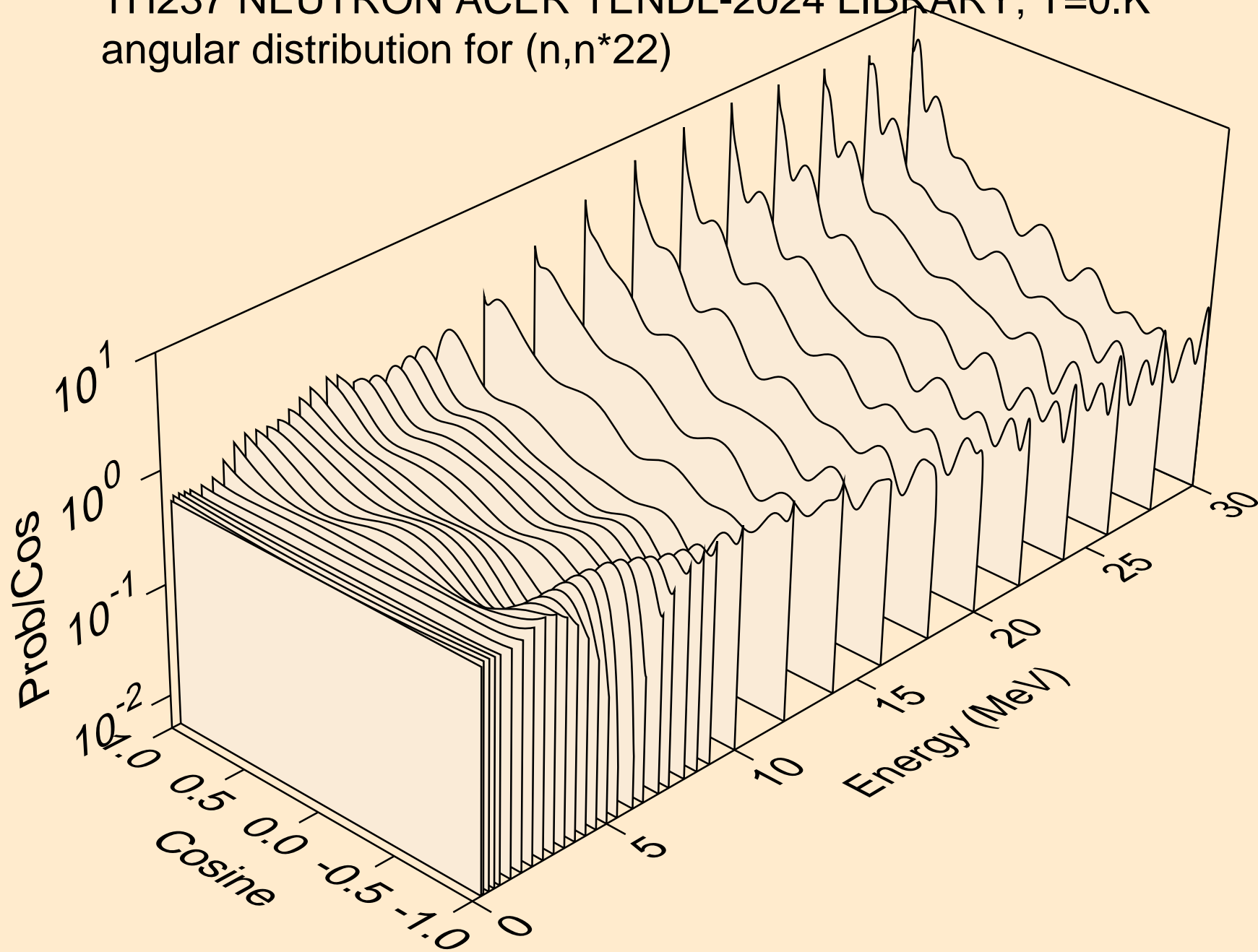

TH237 NEUTRON ACER TENDL-2024 LIBRARY; T=0.K
angular distribution for (n,n*23)

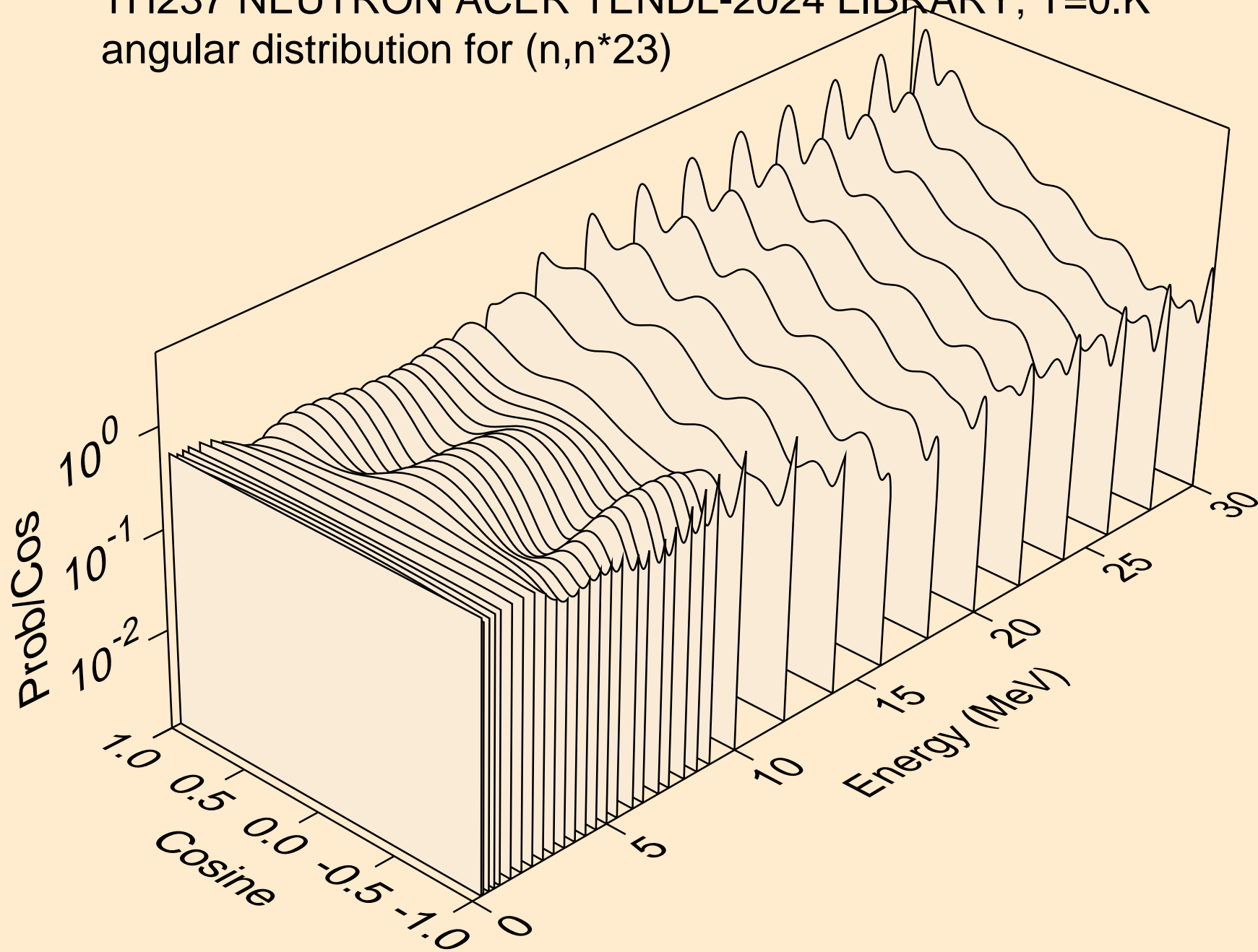

TH237 NEUTRON ACER TENDL-2024 LIBRARY; T=0.K
angular distribution for (n,n*24)

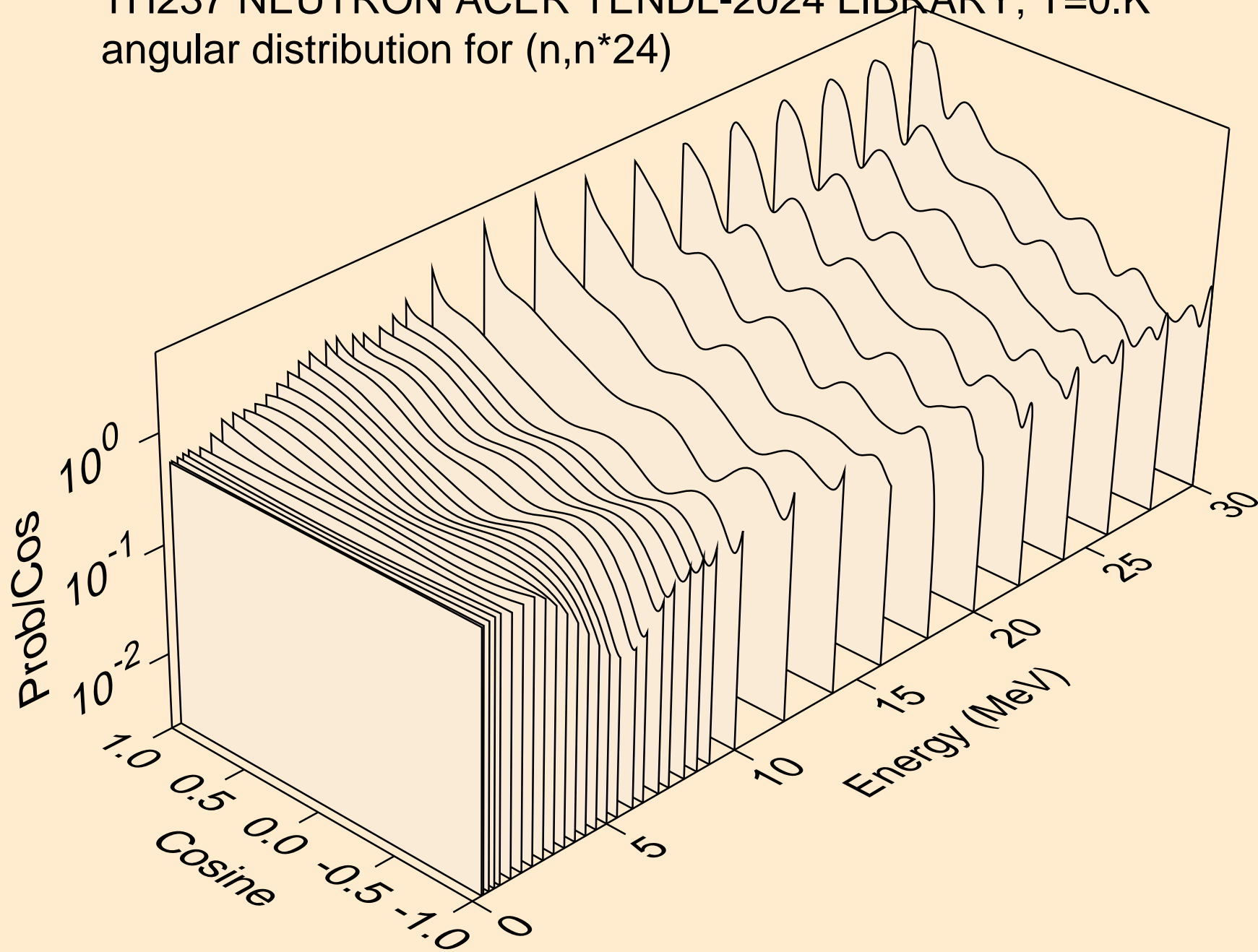

TH237 NEUTRON ACER TENDL-2024 LIBRARY; T=0.K
angular distribution for (n,n*25)

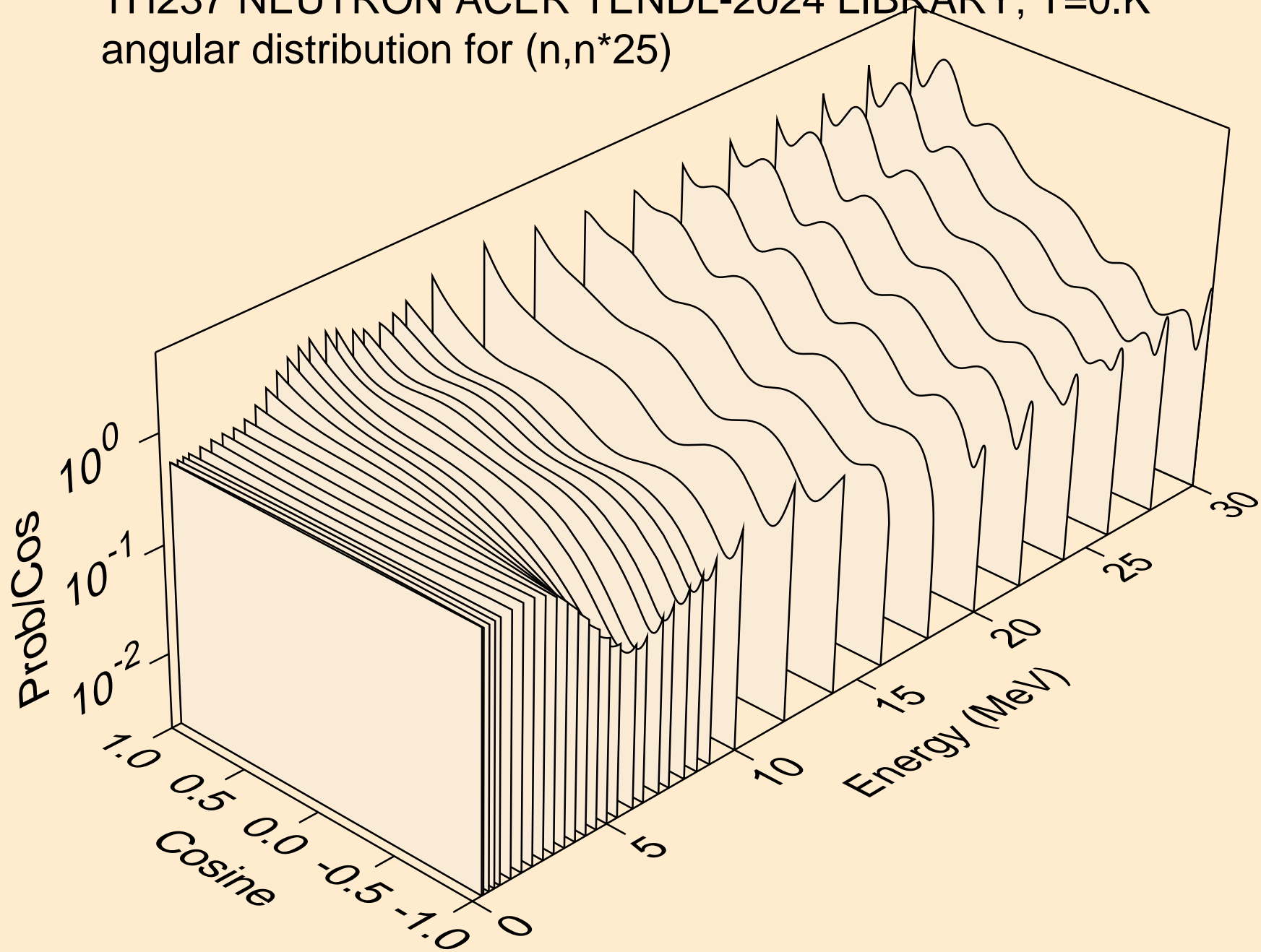

TH237 NEUTRON ACER TENDL-2024 LIBRARY; T=0.K
angular distribution for (n,n*26)

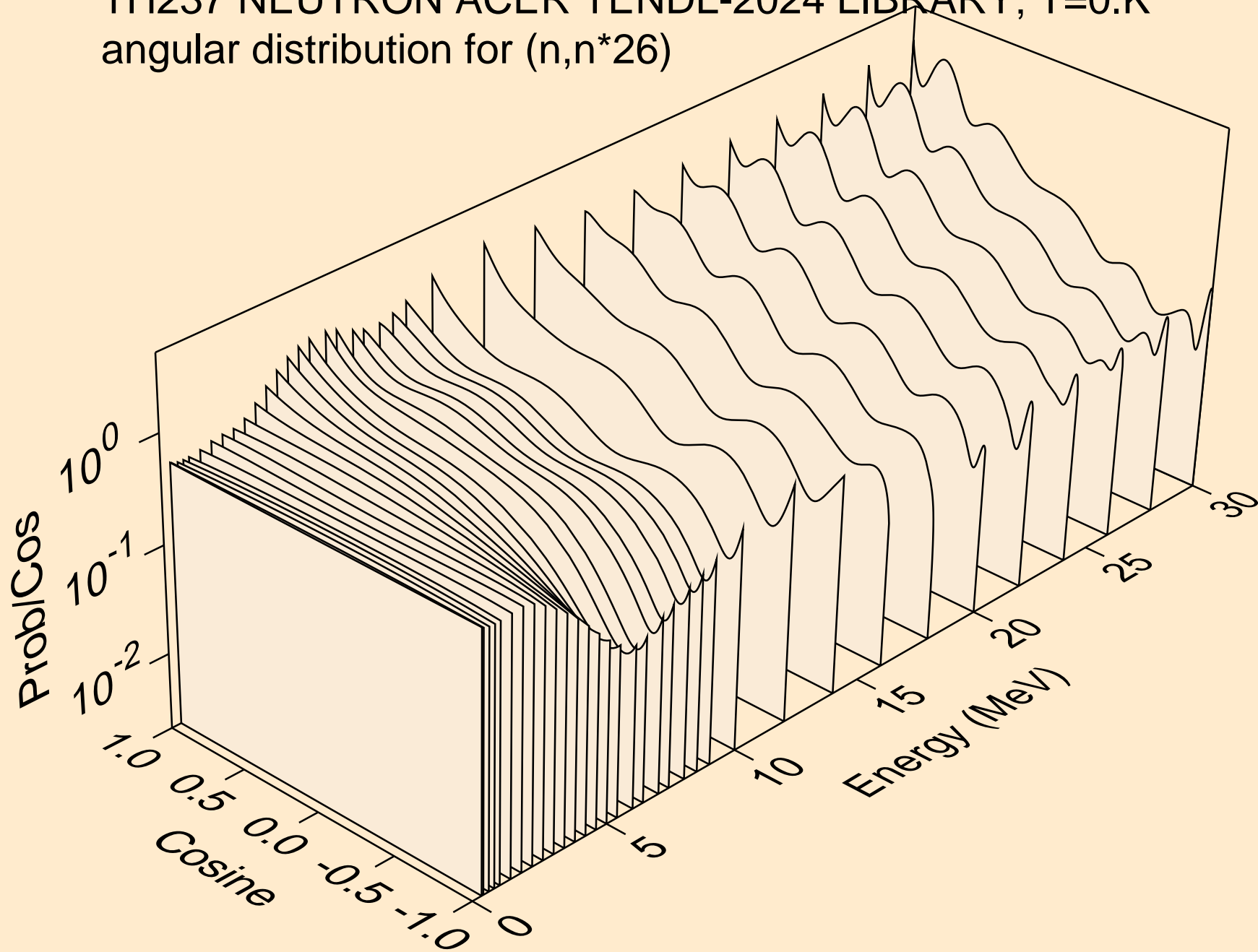

TH237 NEUTRON ACER TENDL-2024 LIBRARY; T=0.K

Total fission nubar

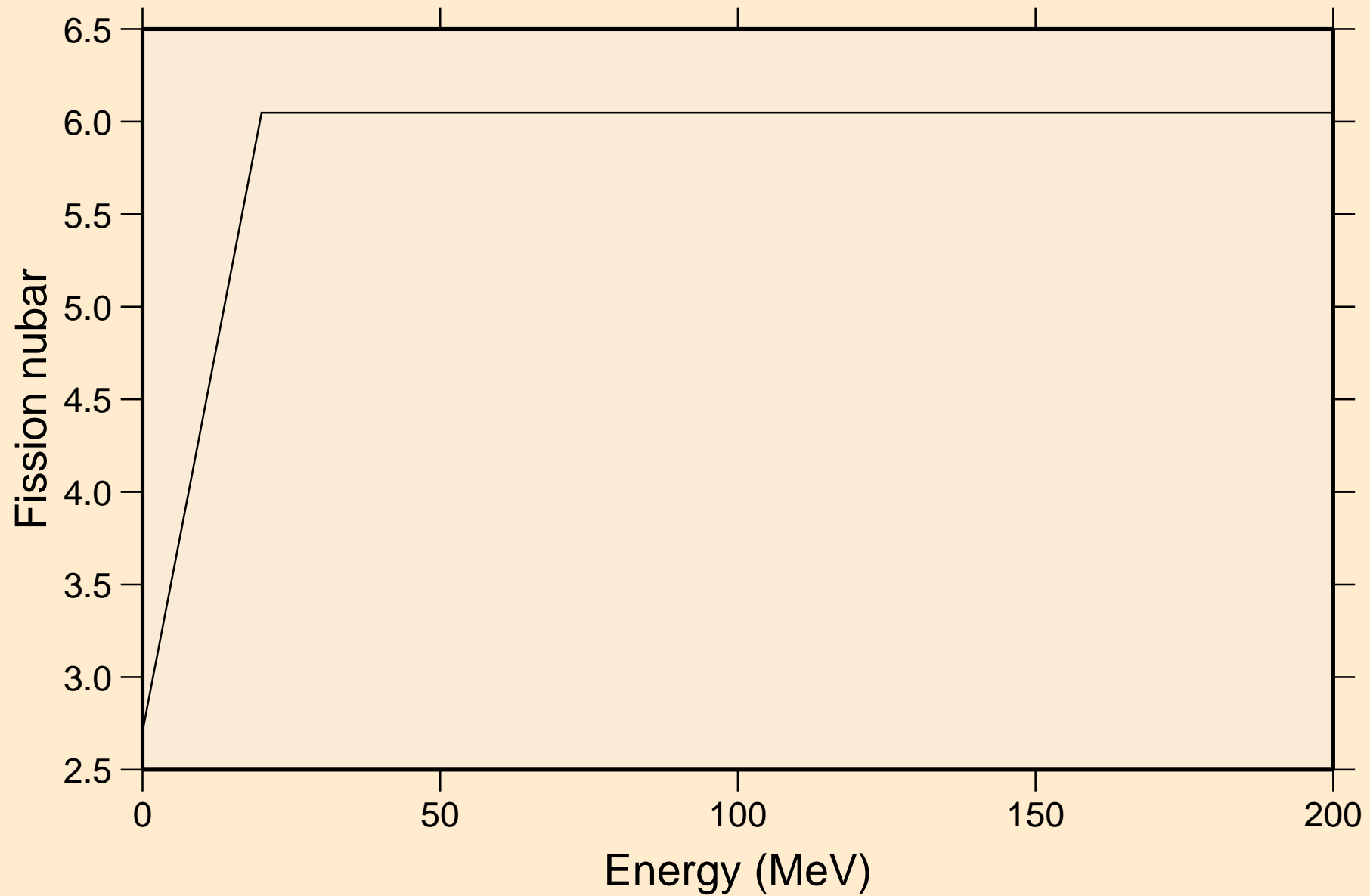

TH237 NEUTRON ACER TENDL-2024 LIBRARY; T=0.K
Neutron emission for (n,x)

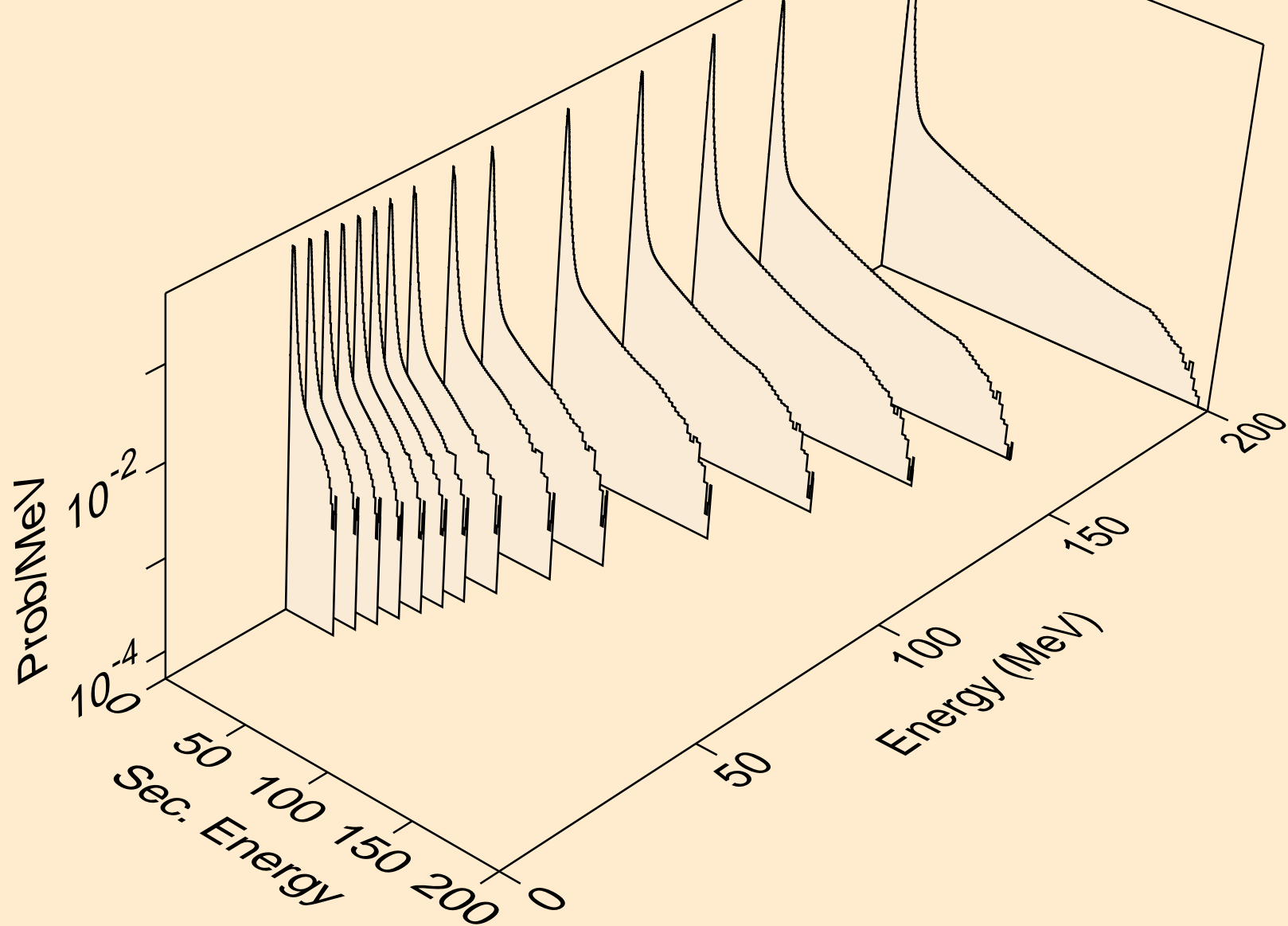

TH237 NEUTRON ACER TENDL-2024 LIBRARY; T=0.K
Neutron emission for (n,2nd)

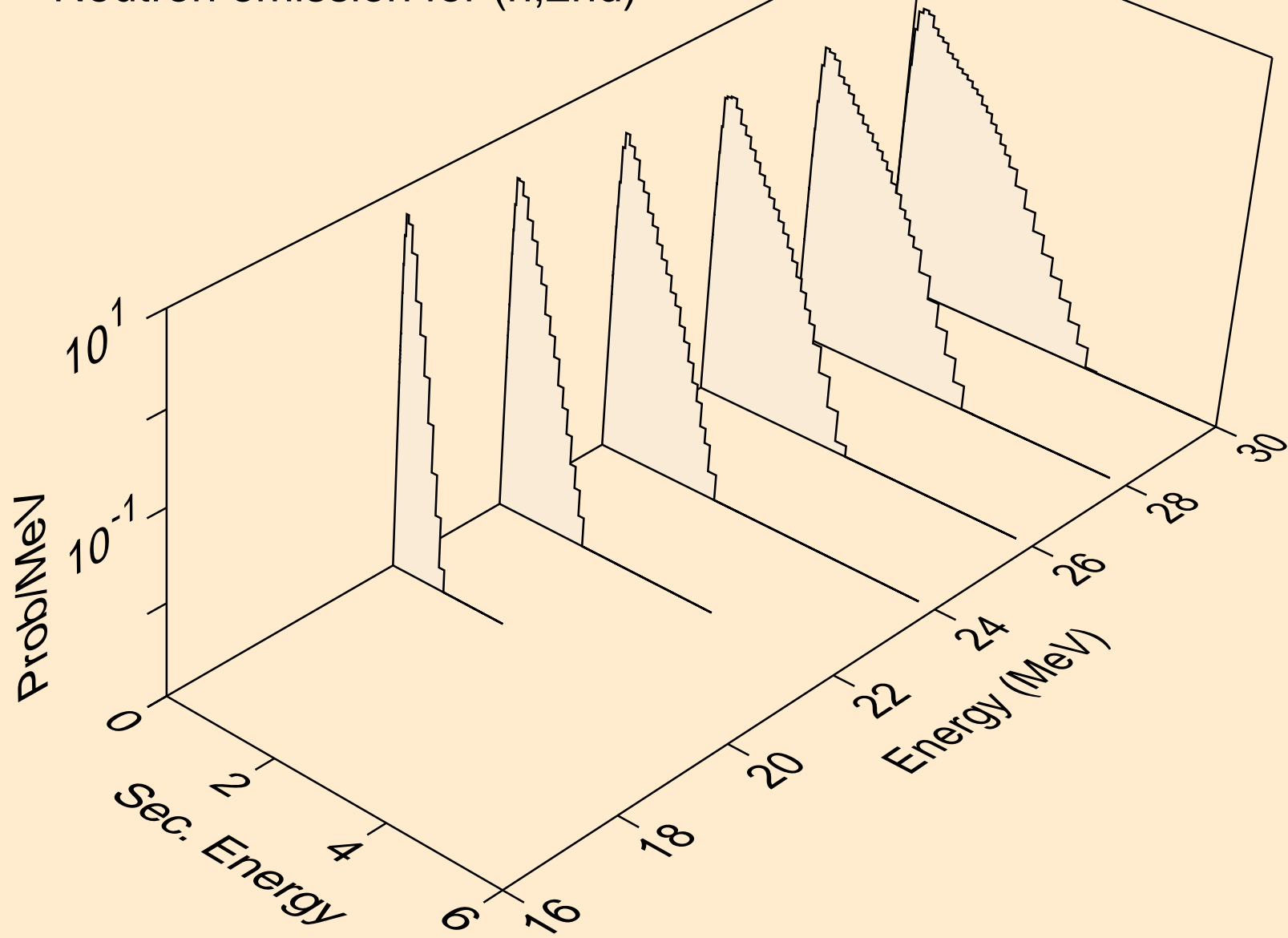

TH237 NEUTRON ACER TENDL-2024 LIBRARY; T=0.K
Neutron emission for (n,2n)

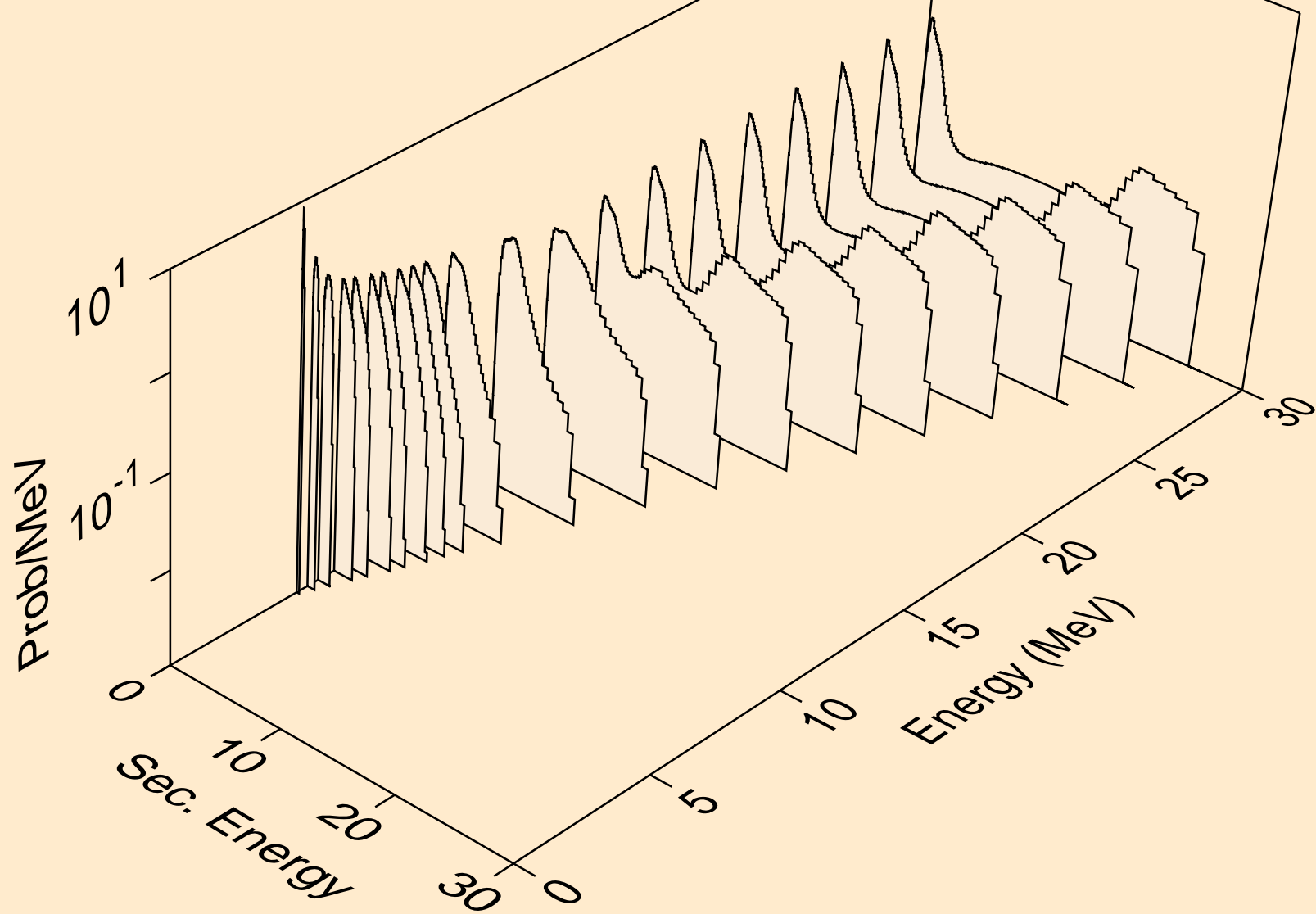

TH237 NEUTRON ACER TENDL-2024 LIBRARY; T=0.K
Neutron emission for (n,3n)

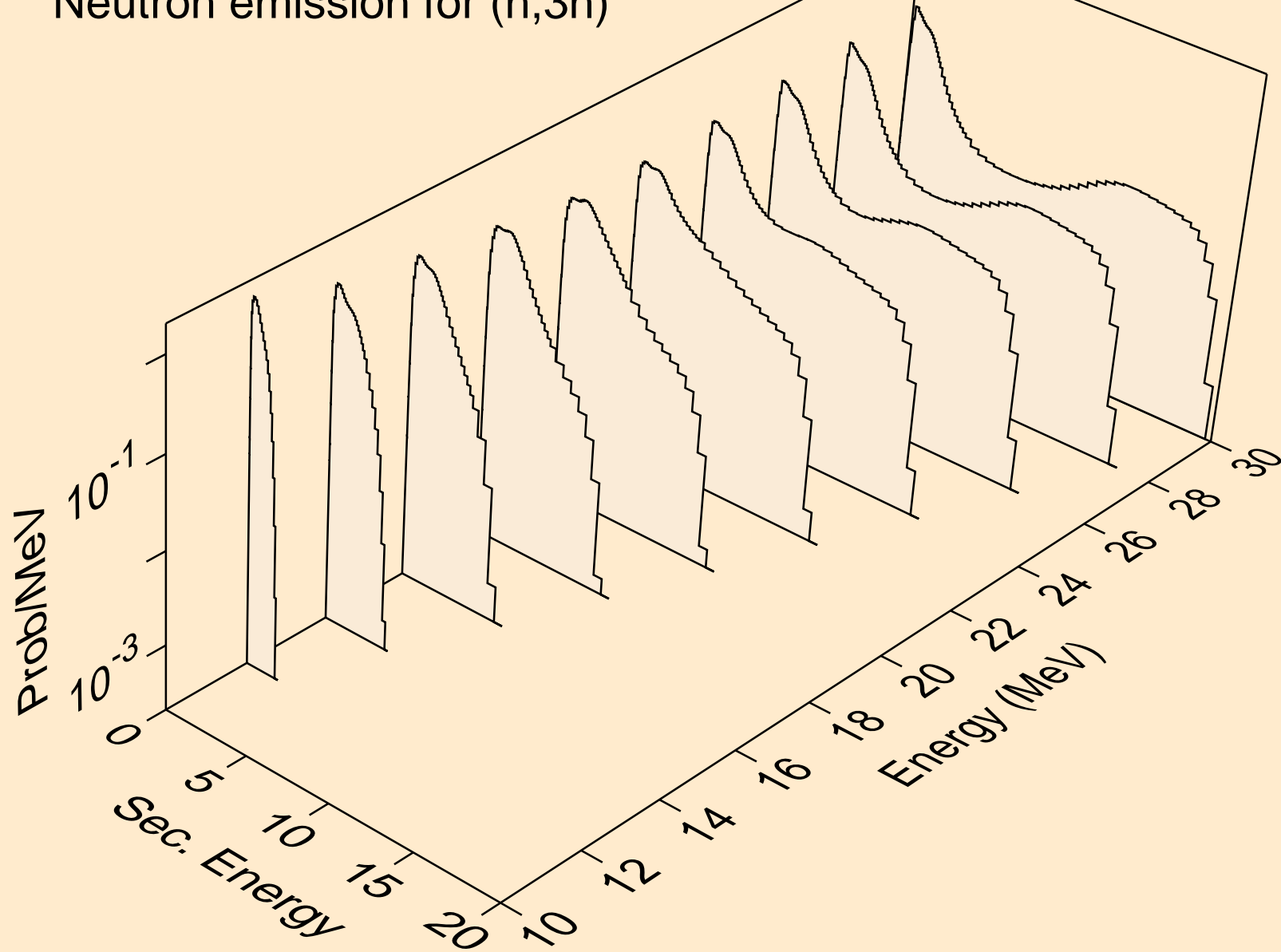

TH237 NEUTRON ACER TENDL-2024 LIBRARY; T=0.K
Neutron emission for fission

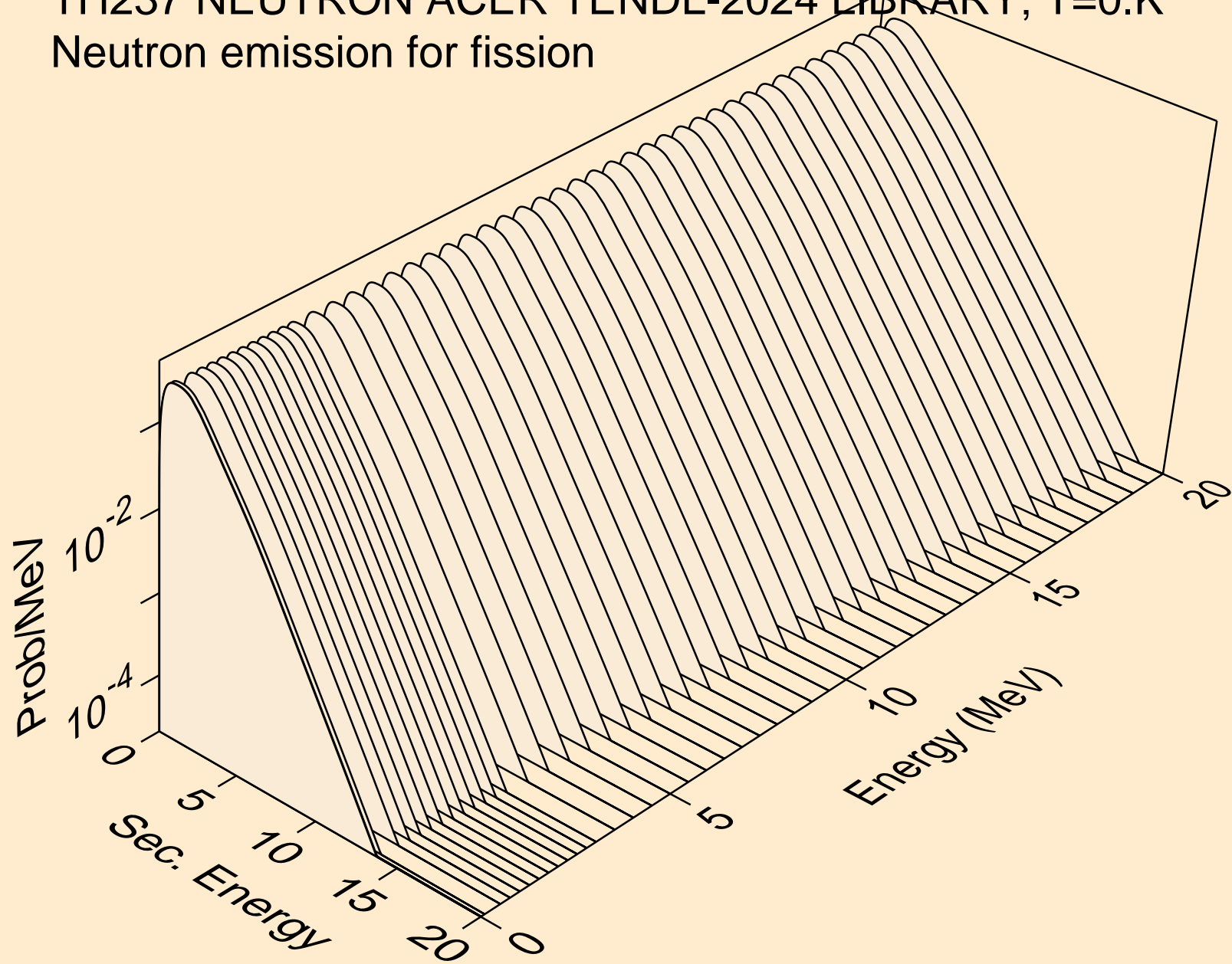

TH237 NEUTRON ACER TENDL-2024 LIBRARY; T=0.K
Neutron emission for (n,n*)a

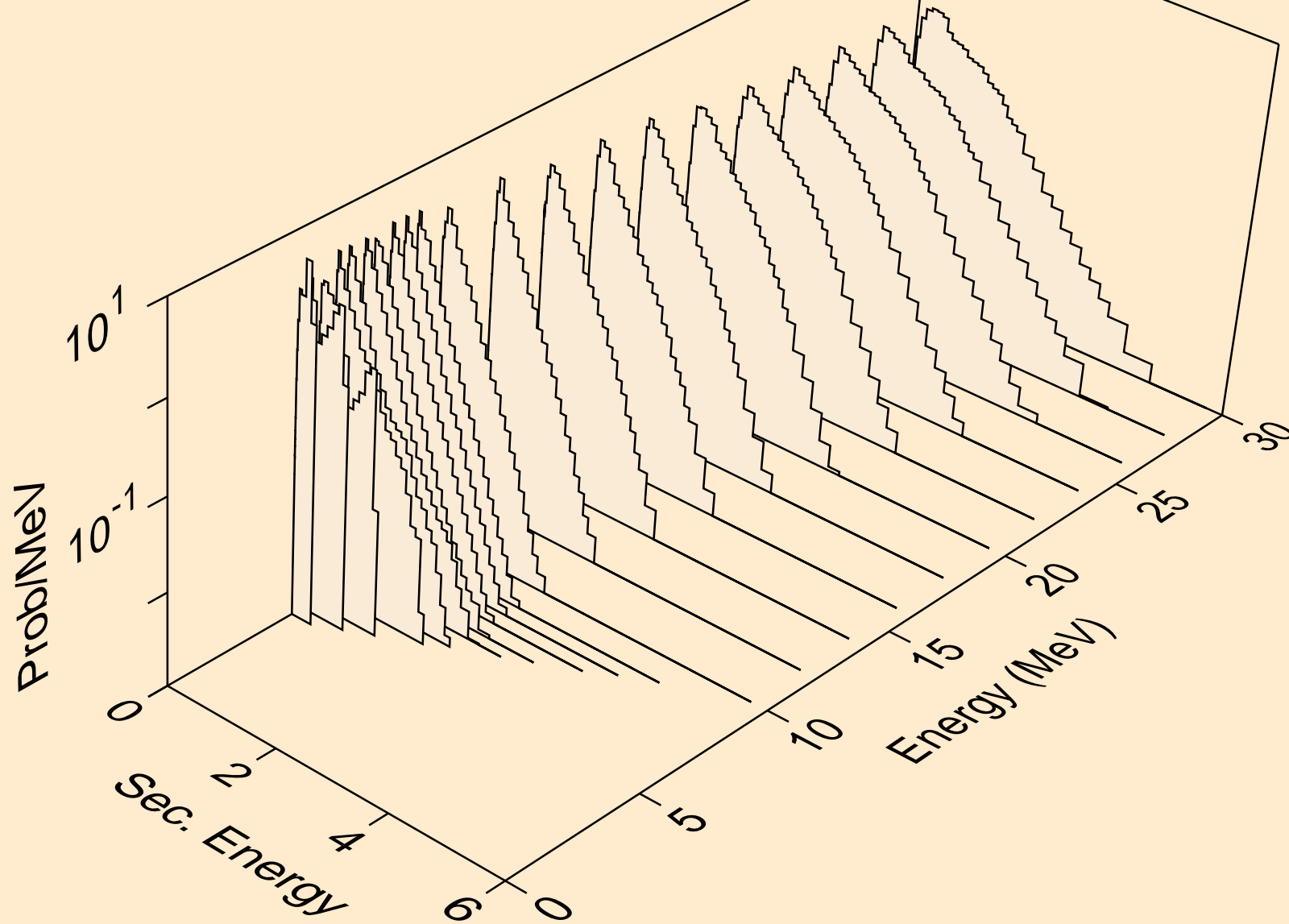

TH237 NEUTRON ACER TENDL-2024 LIBRARY; T=0.K
Neutron emission for (n,2n)a

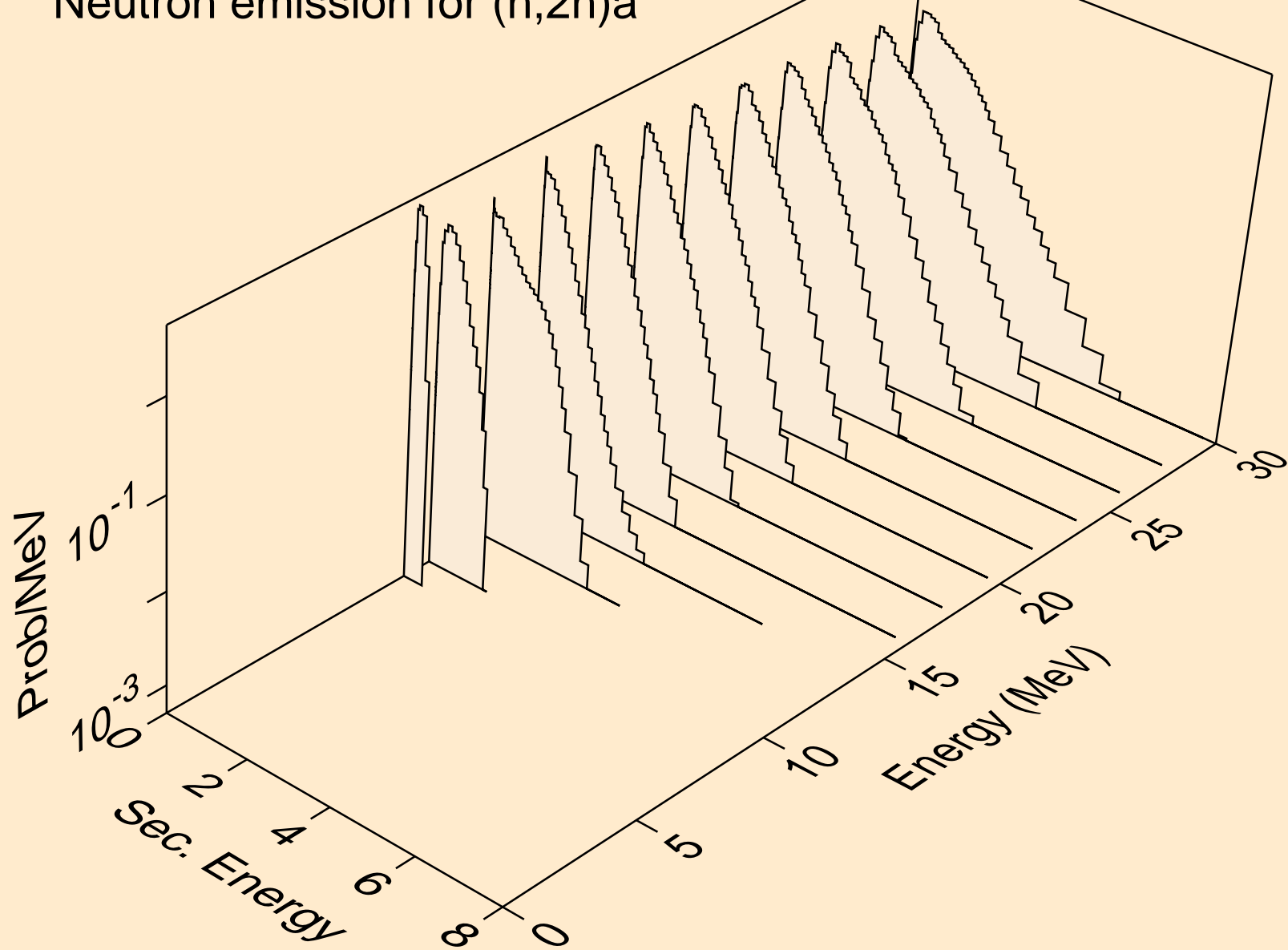

TH237 NEUTRON ACER TENDL-2024 LIBRARY; T=0.K
Neutron emission for (n,3n)a

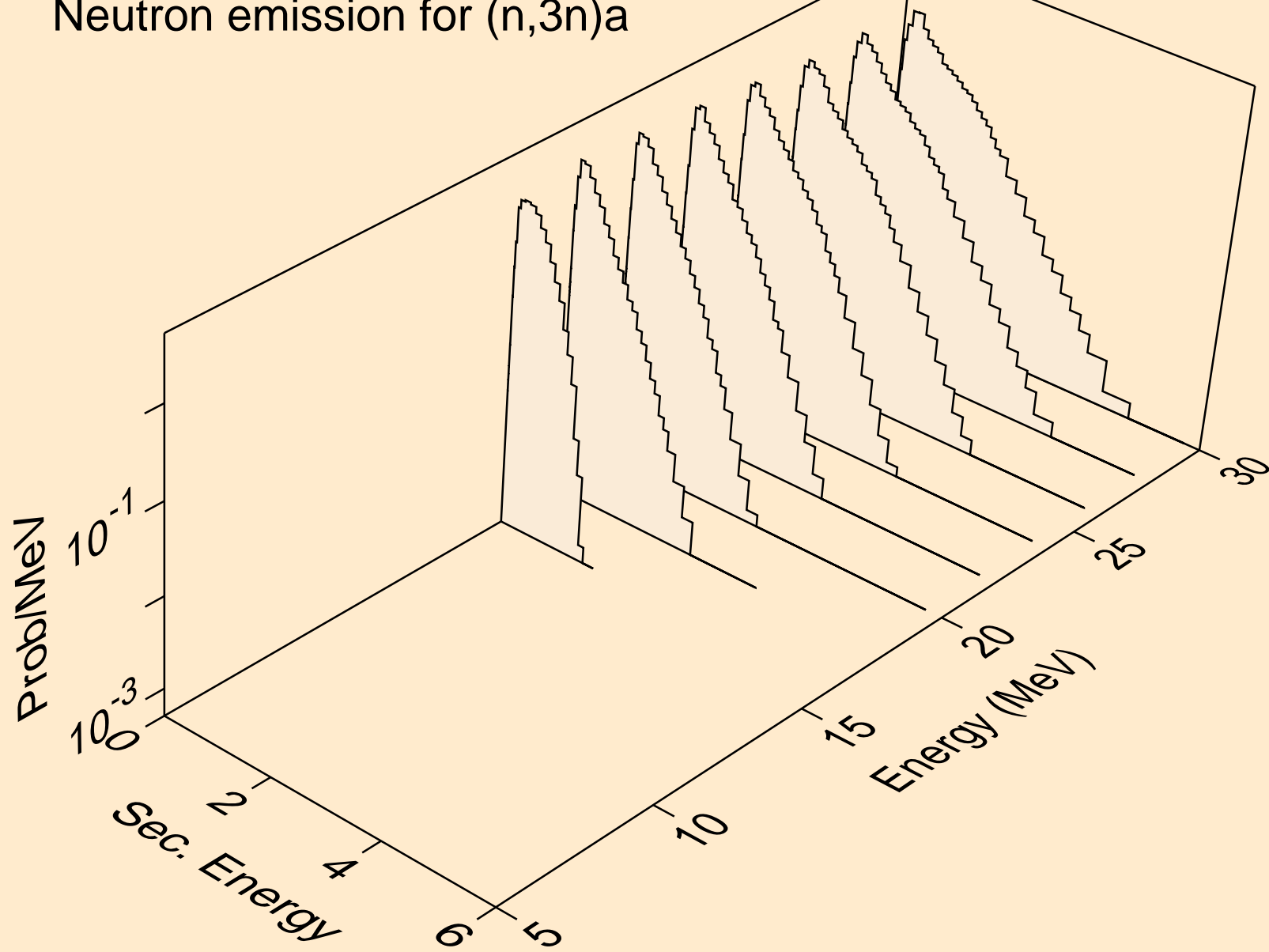

TH237 NEUTRON ACER TENDL-2024 LIBRARY; T=0.K
Neutron emission for (n,n*)p

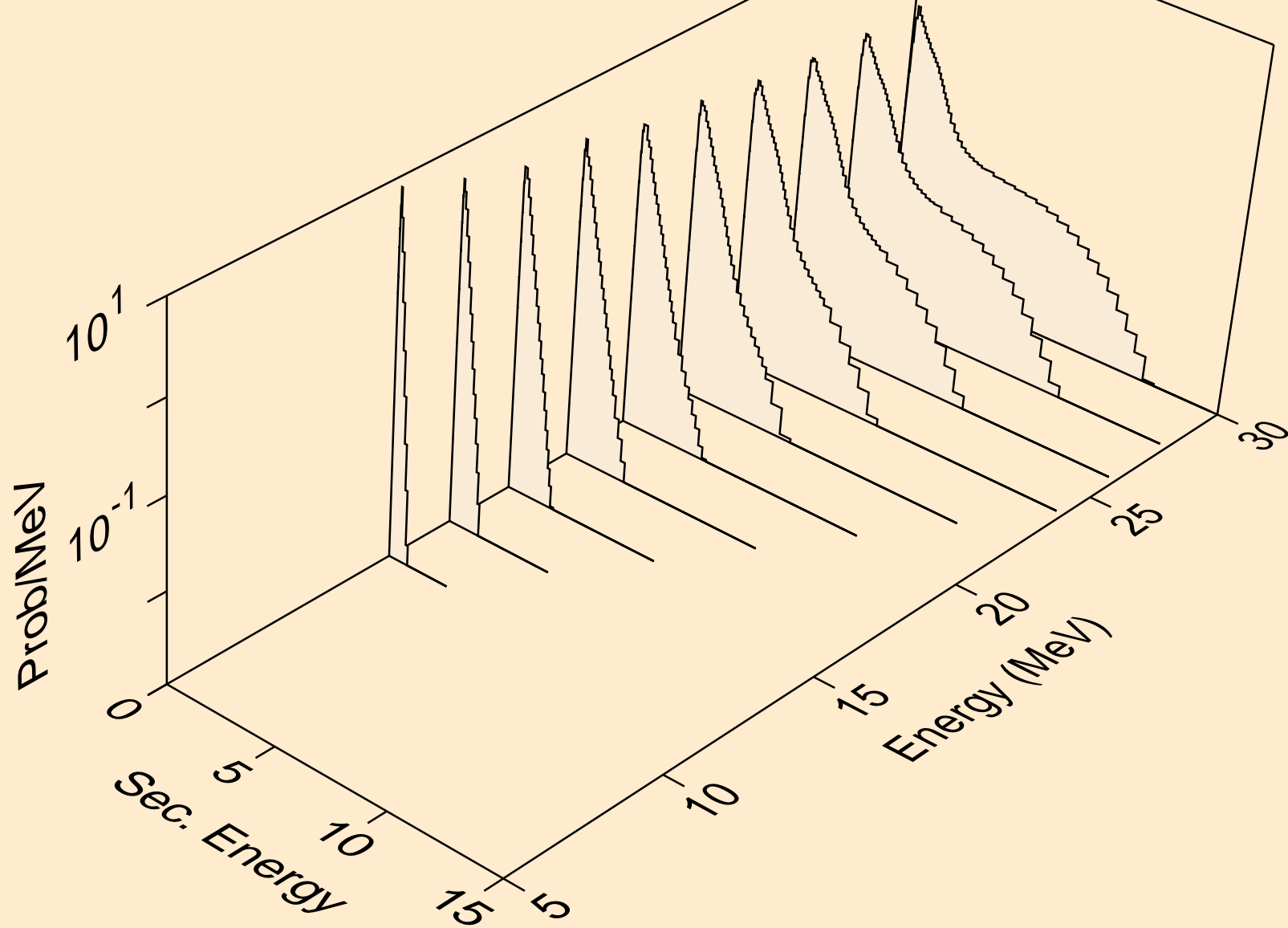

TH237 NEUTRON ACER TENDL-2024 LIBRARY; T=0.K
Neutron emission for (n,n*)d

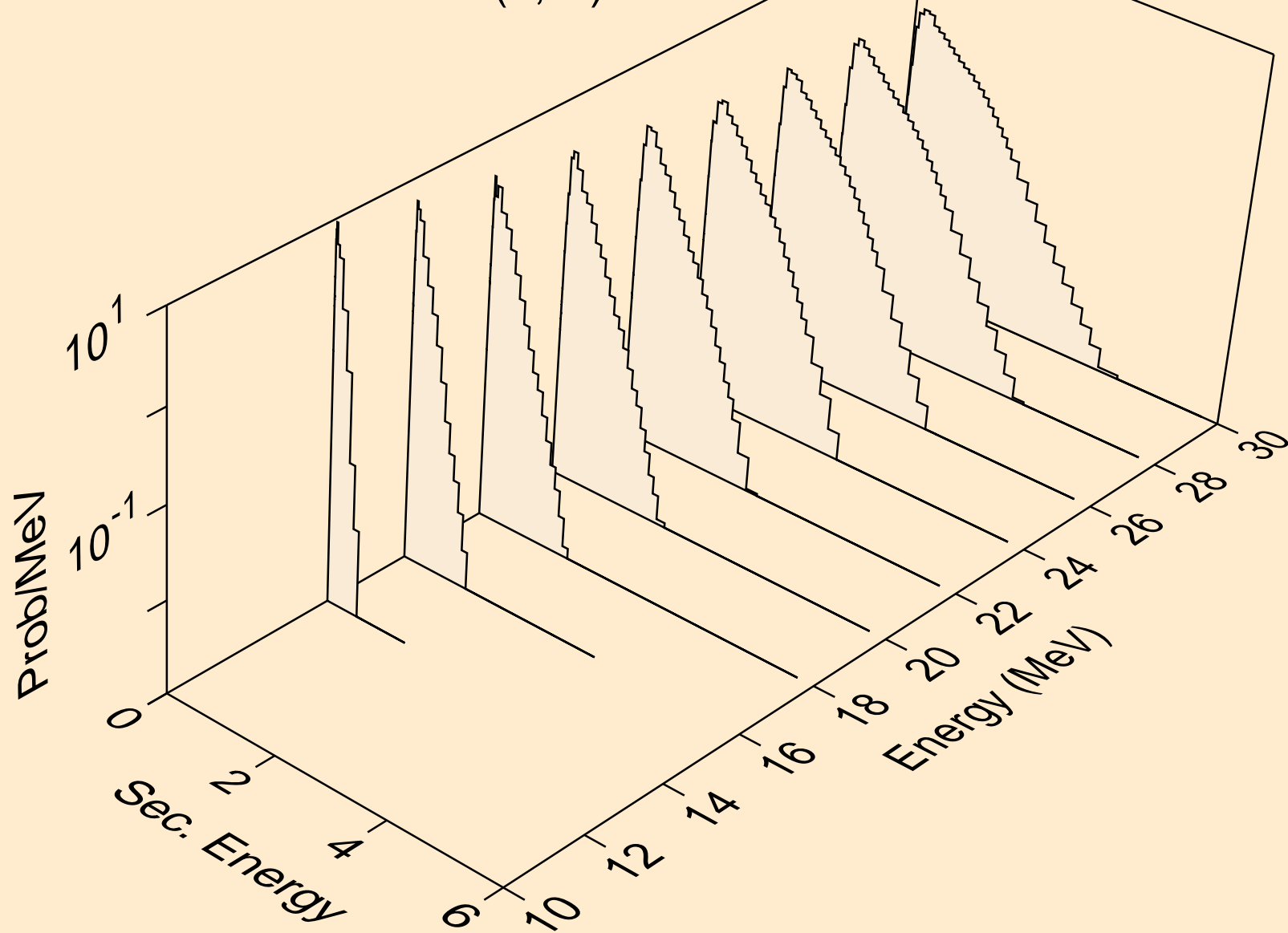

TH237 NEUTRON ACER TENDL-2024 LIBRARY; T=0.K
Neutron emission for (n,n*)t

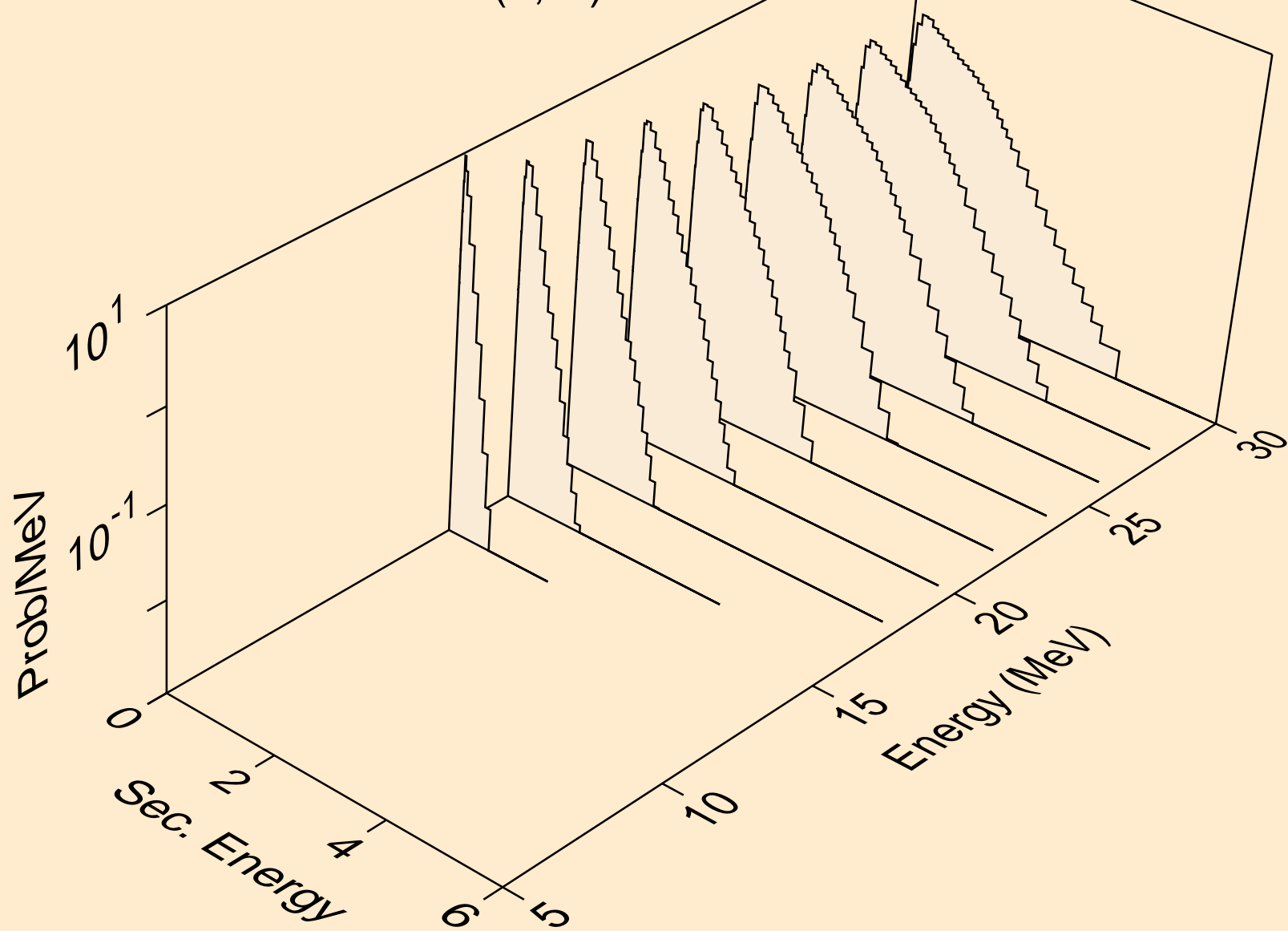

TH237 NEUTRON ACER TENDL-2024 LIBRARY; T=0.K
Neutron emission for (n,n*)he3

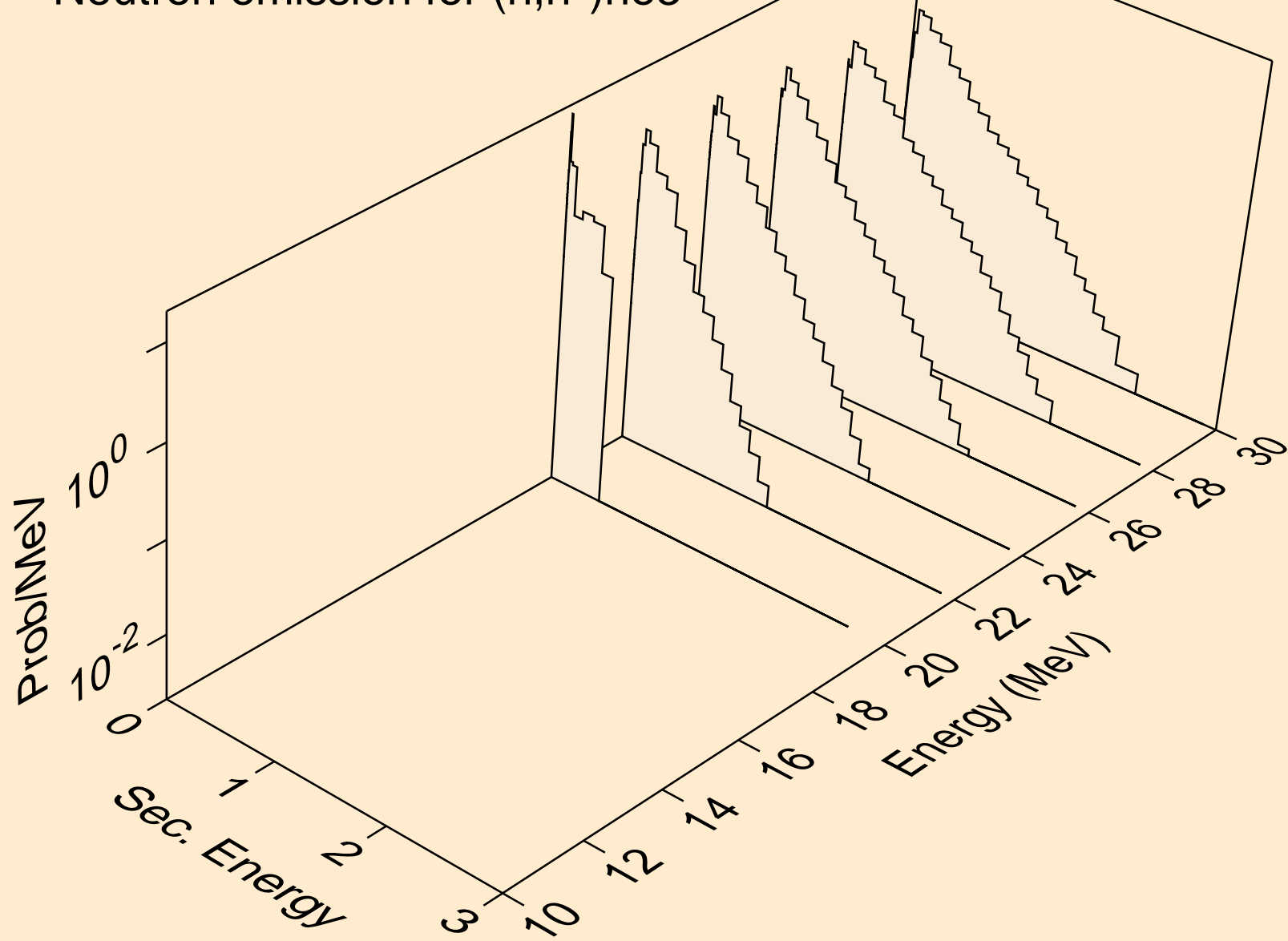

TH237 NEUTRON ACER TENDL-2024 LIBRARY; T=0.K
Neutron emission for (n,4n)

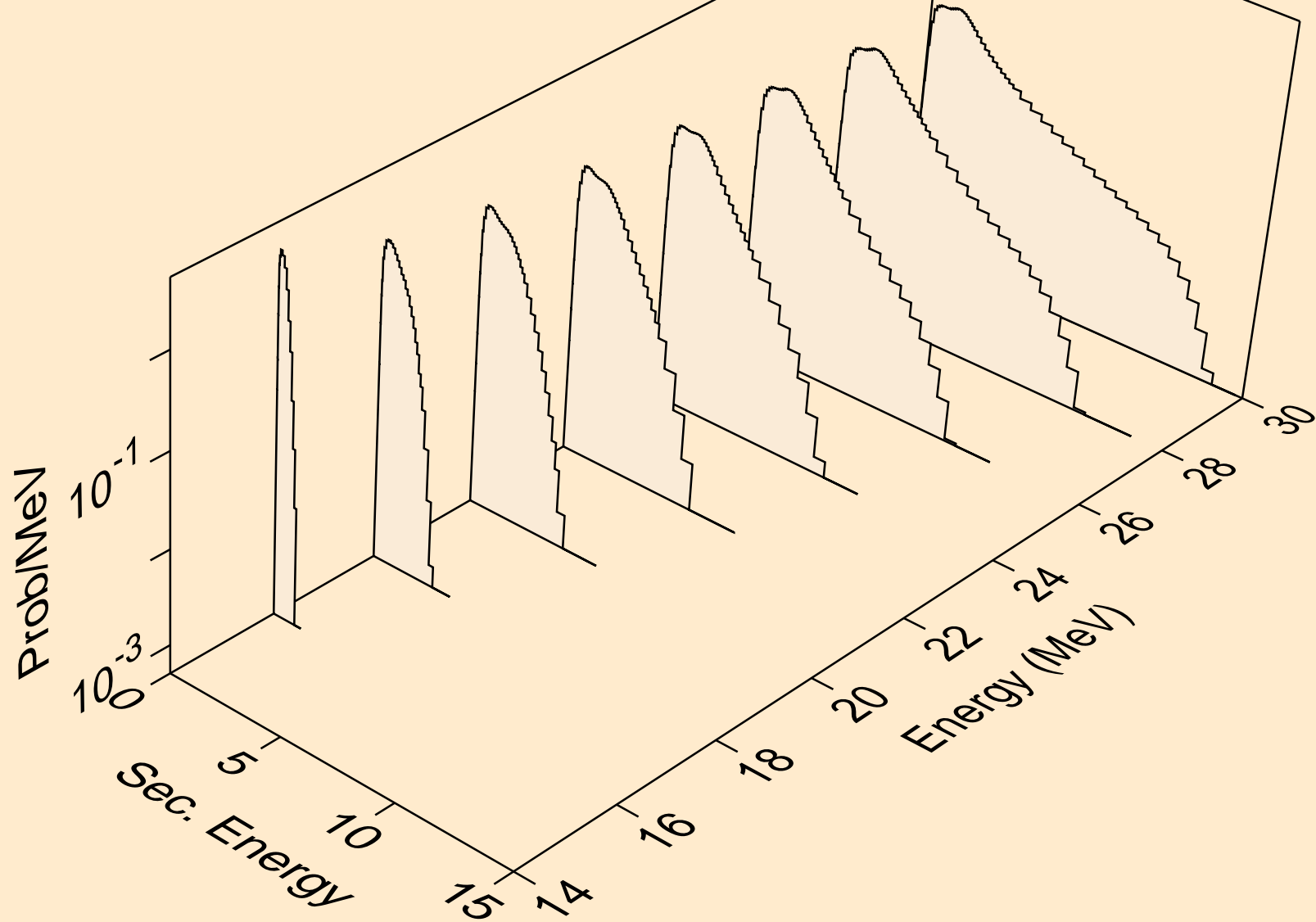

TH237 NEUTRON ACER TENDL-2024 LIBRARY; T=0.K
Neutron emission for (n,2np)

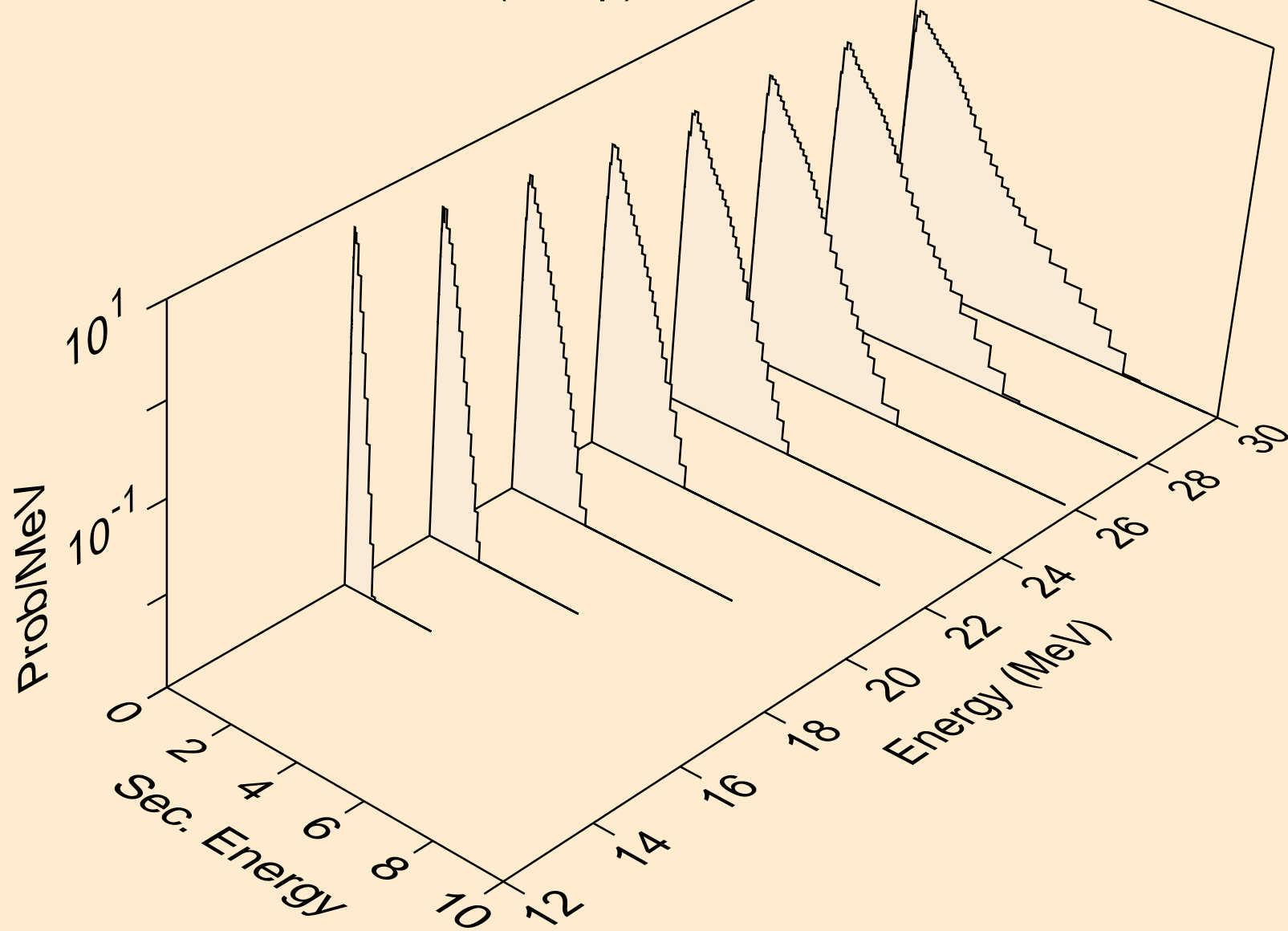

TH237 NEUTRON ACER TENDL-2024 LIBRARY; T=0.K
Neutron emission for (n,3np)

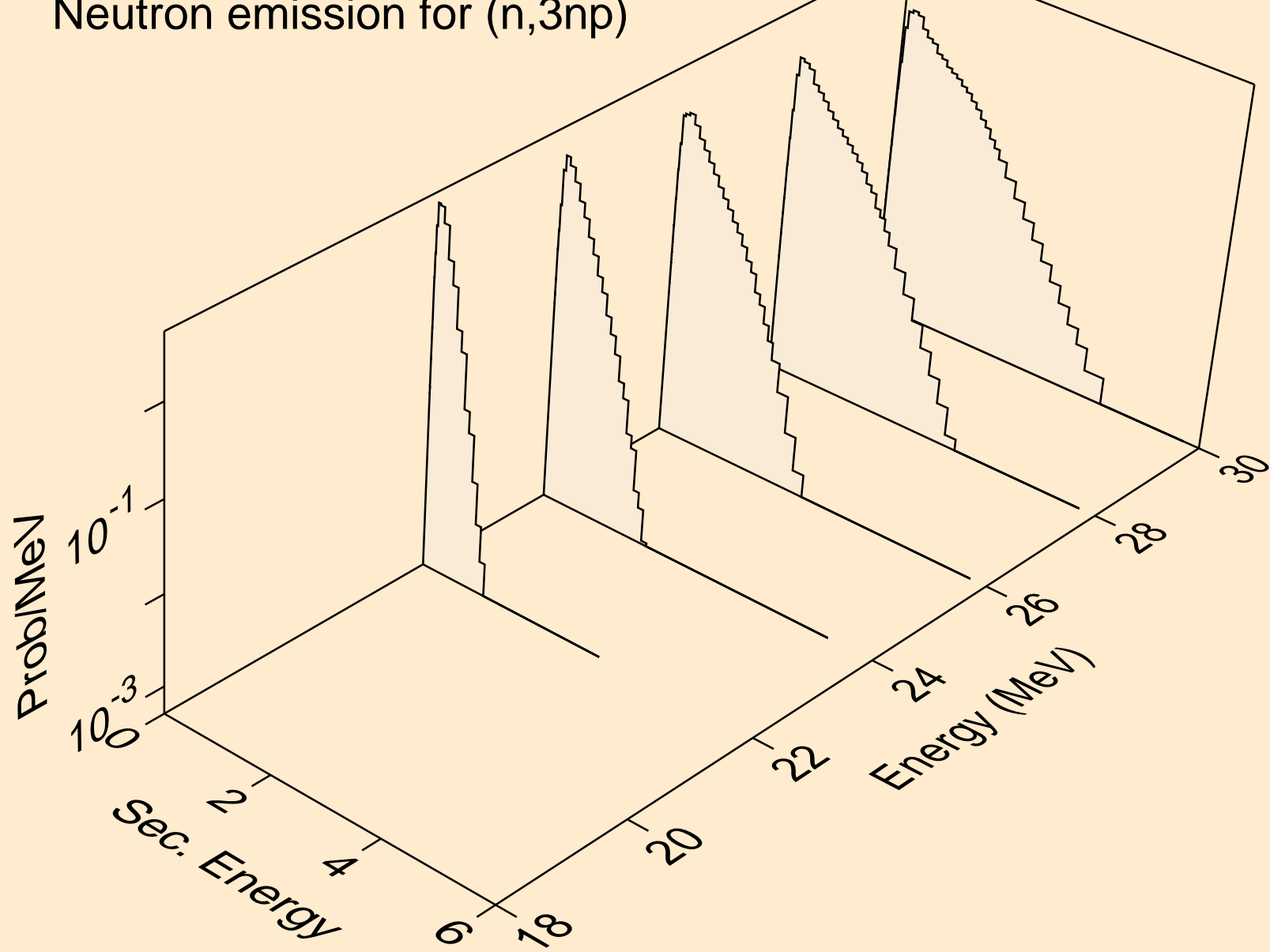

TH237 NEUTRON ACER TENDL-2024 LIBRARY; T=0.K
Neutron emission for (n,n*c)

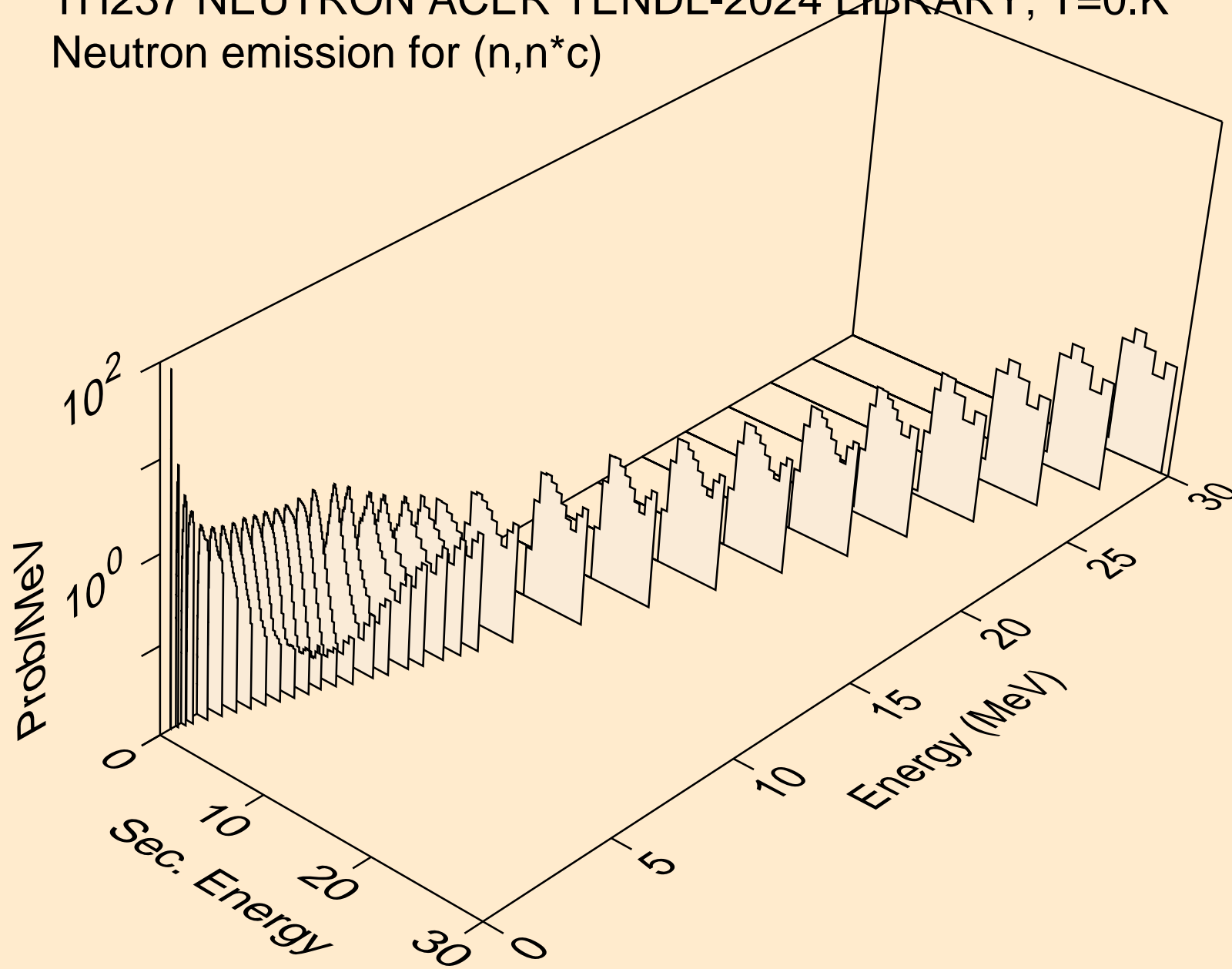

TH237 NEUTRON ACER TENDL-2024 LIBRARY; T=0.K

Delayed nubar

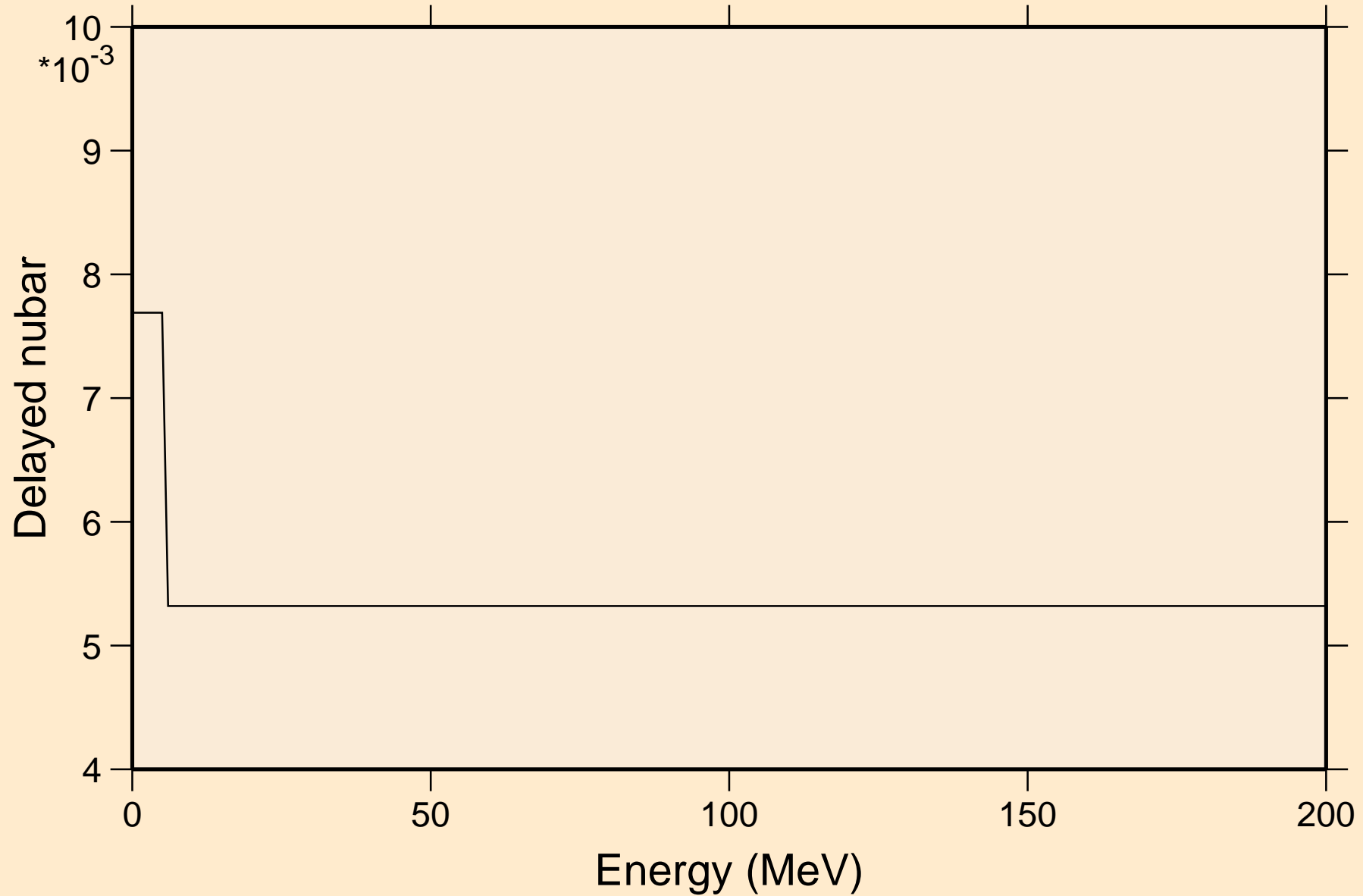

TH237 NEUTRON ACER TENDL-2024 LIBRARY; T=0.K

Delayed neutron spectra

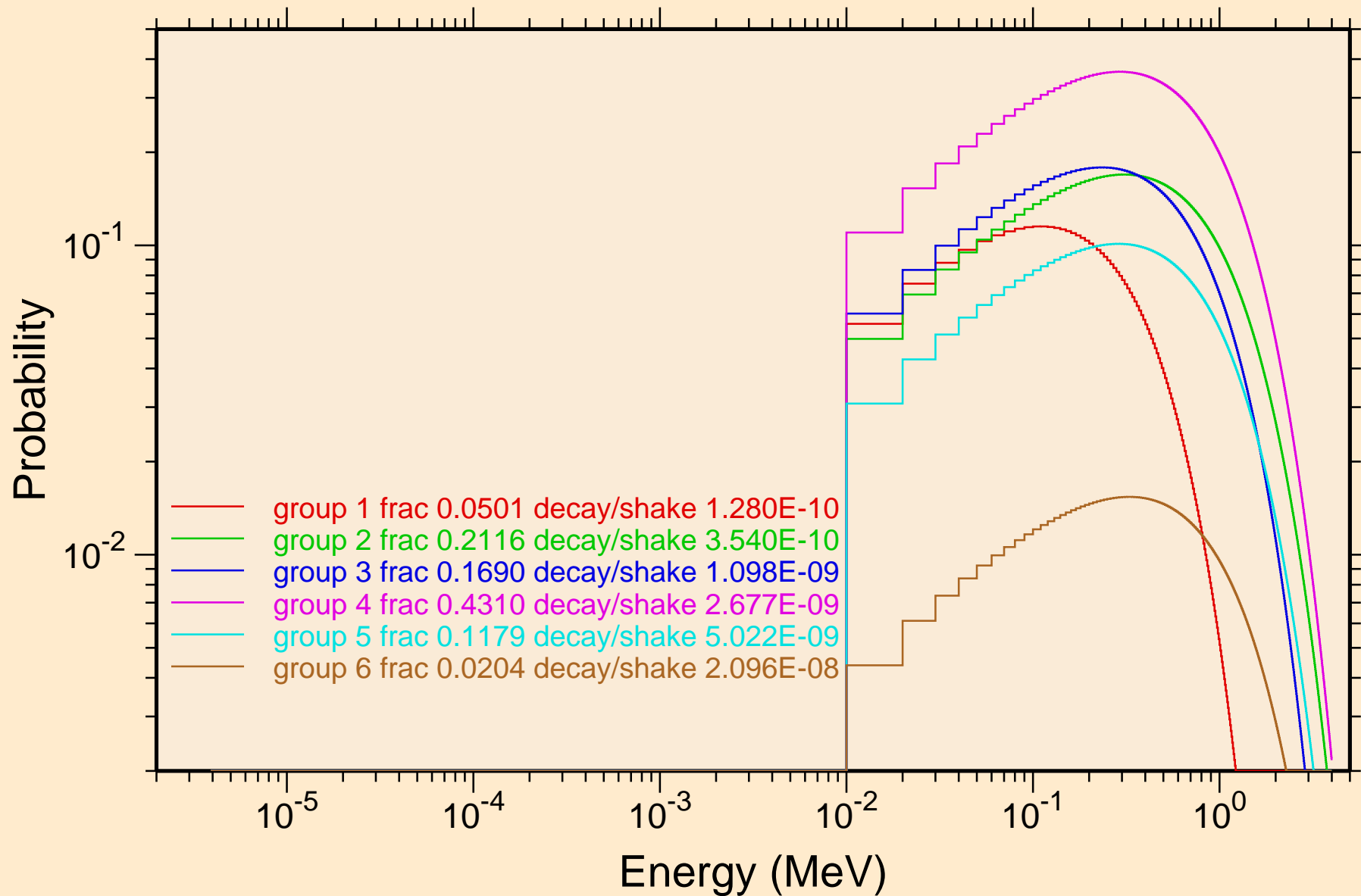

TH237 NEUTRON ACER TENDL-2024 LIBRARY; T=0.K
Photon emission for (n,x)

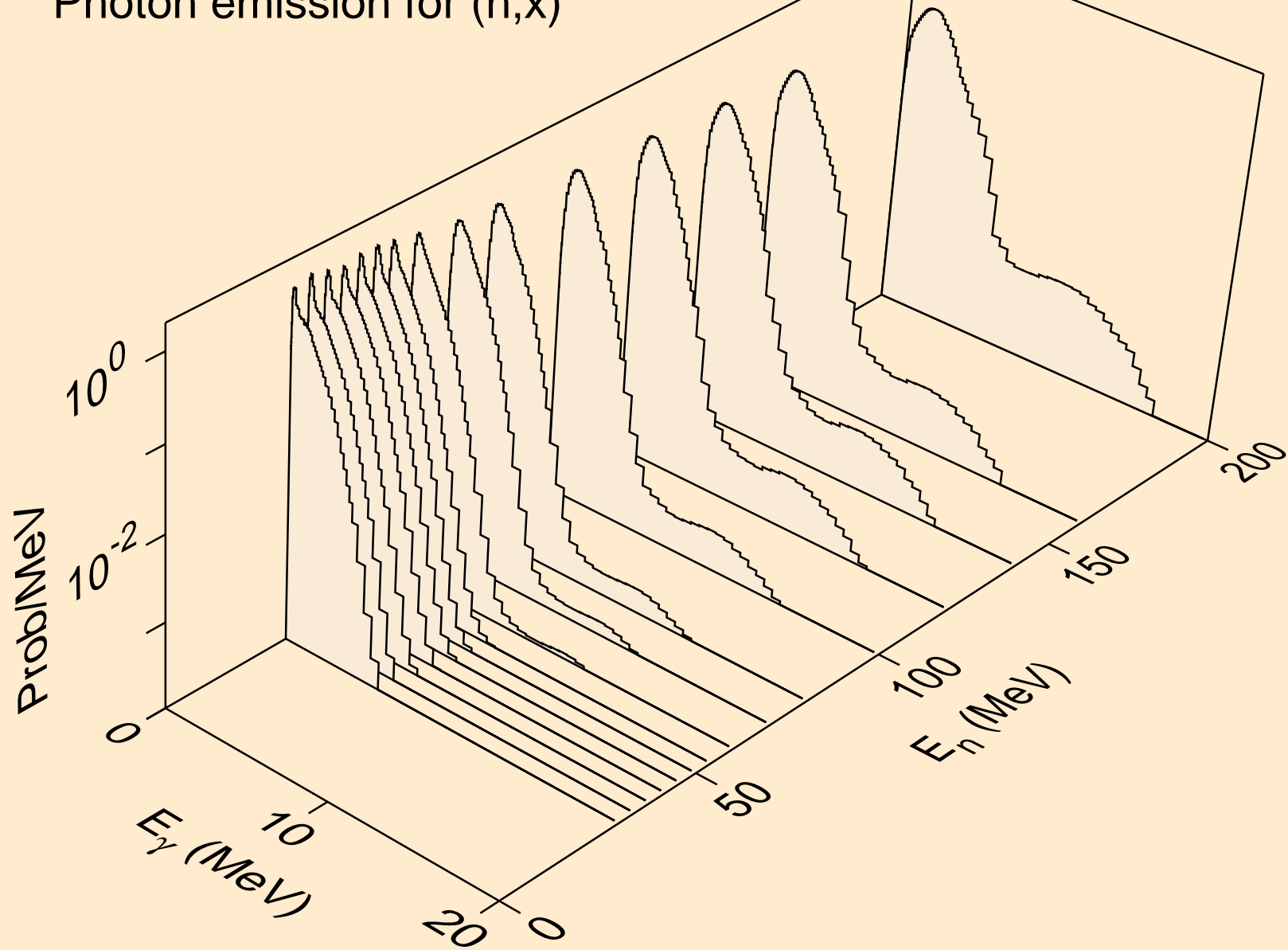

TH237 NEUTRON ACER TENDL-2024 LIBRARY; T=0.K
Photon emission for (n,2nd)

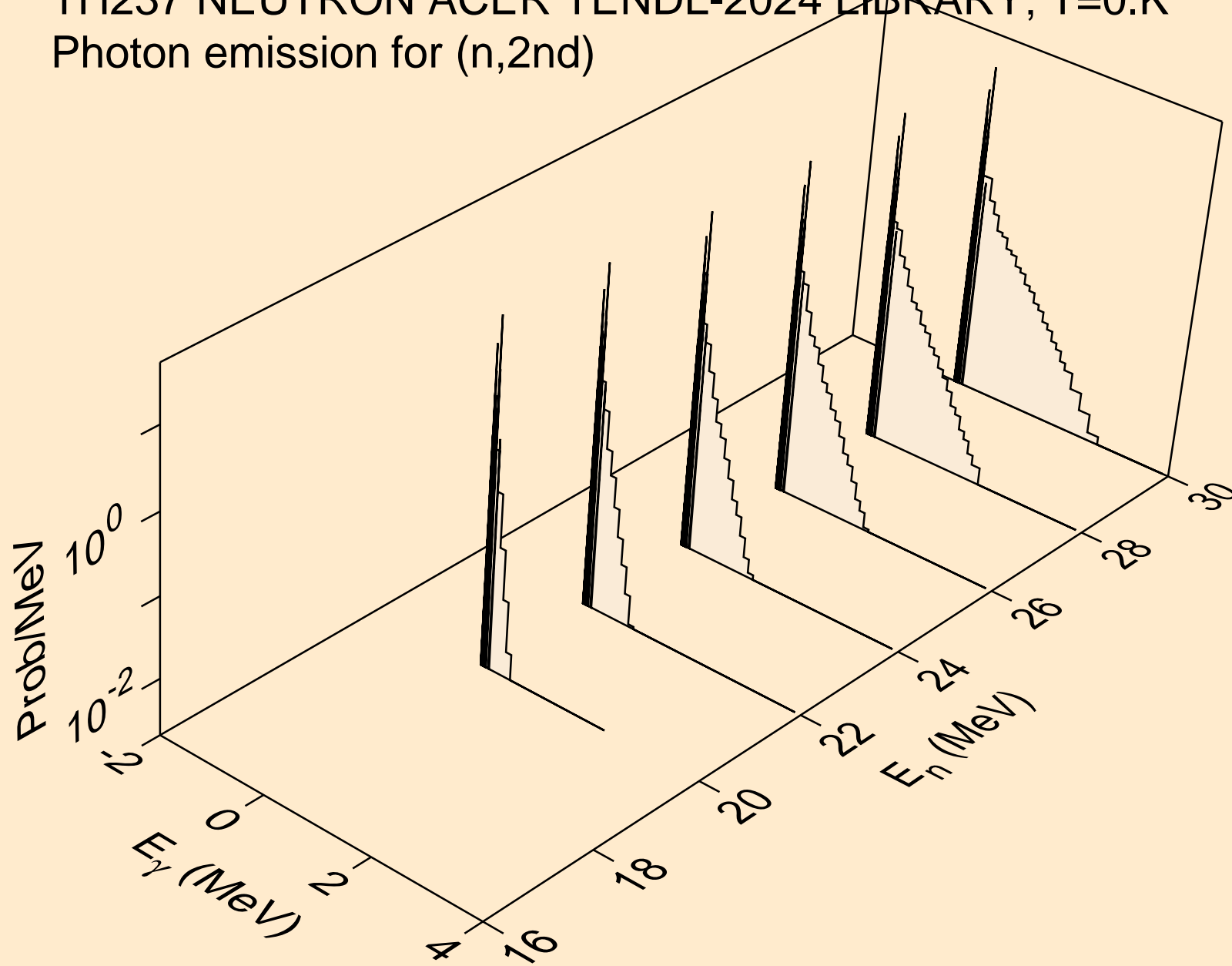

TH237 NEUTRON ACER TENDL-2024 LIBRARY; T=0.K
Photon emission for (n,2n)

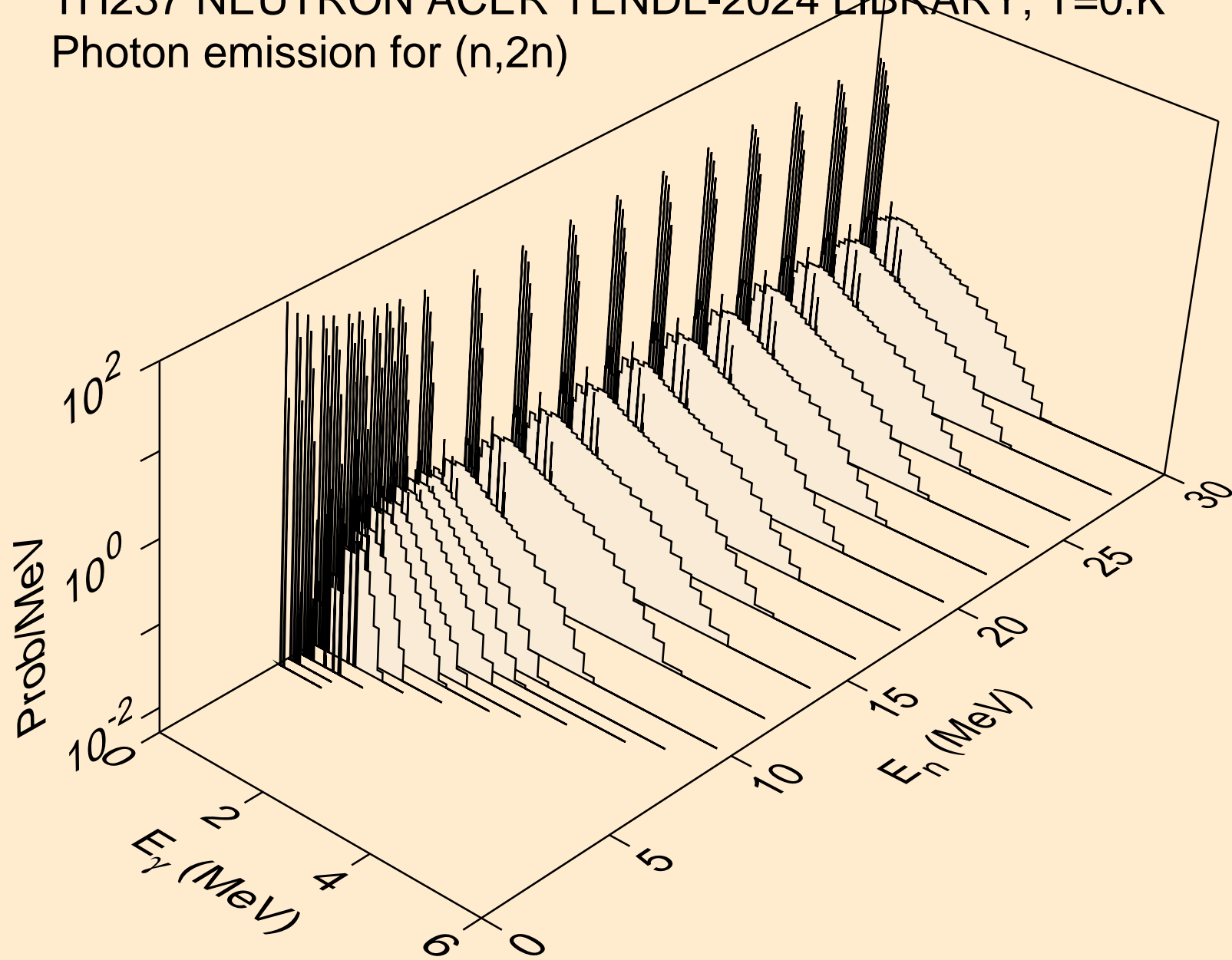

TH237 NEUTRON ACER TENDL-2024 LIBRARY; T=0.K
Photon emission for (n,3n)

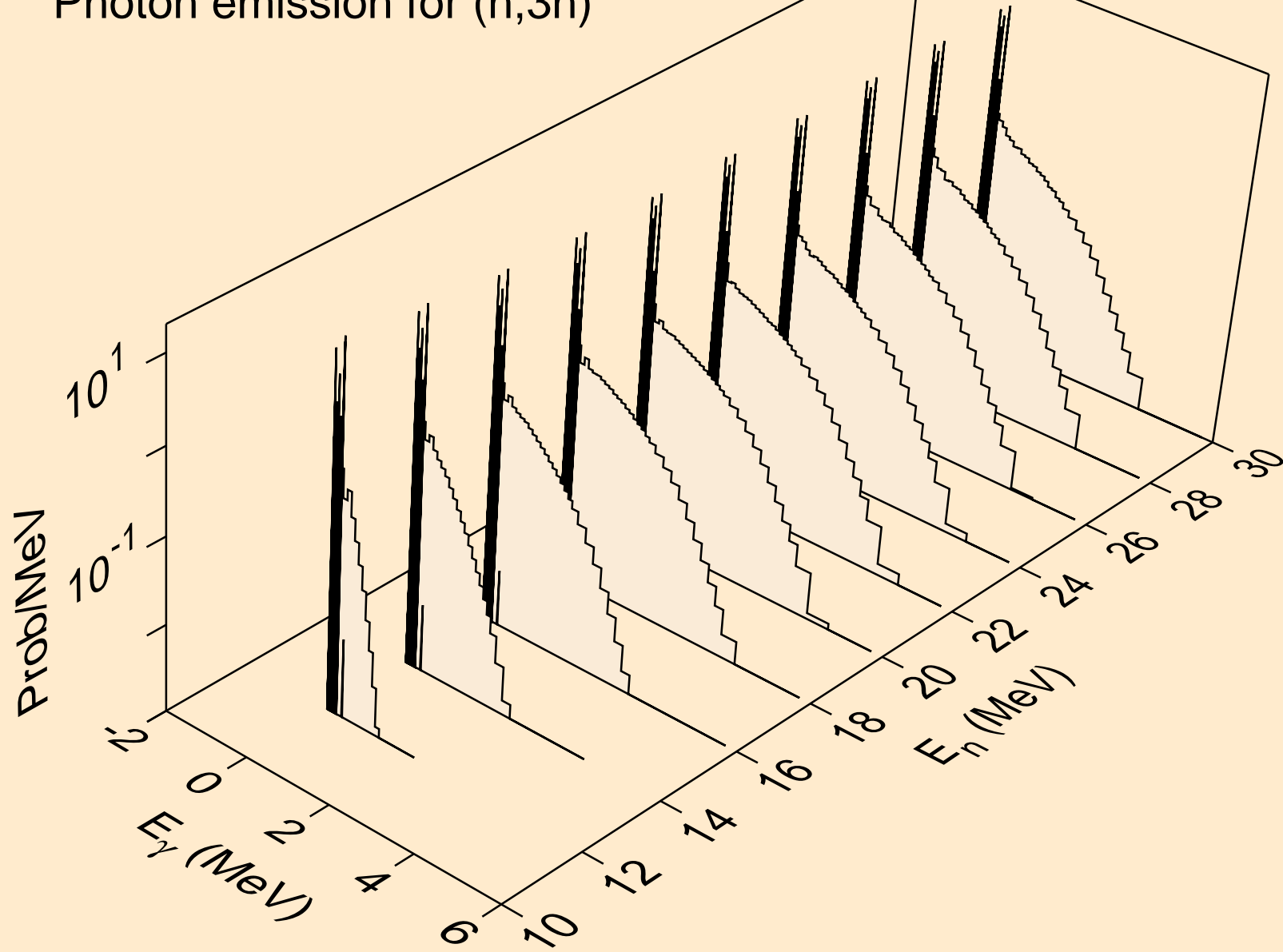

TH237 NEUTRON ACER TENDL-2024 LIBRARY; T=0.K
Photon emission for (n,n*)a

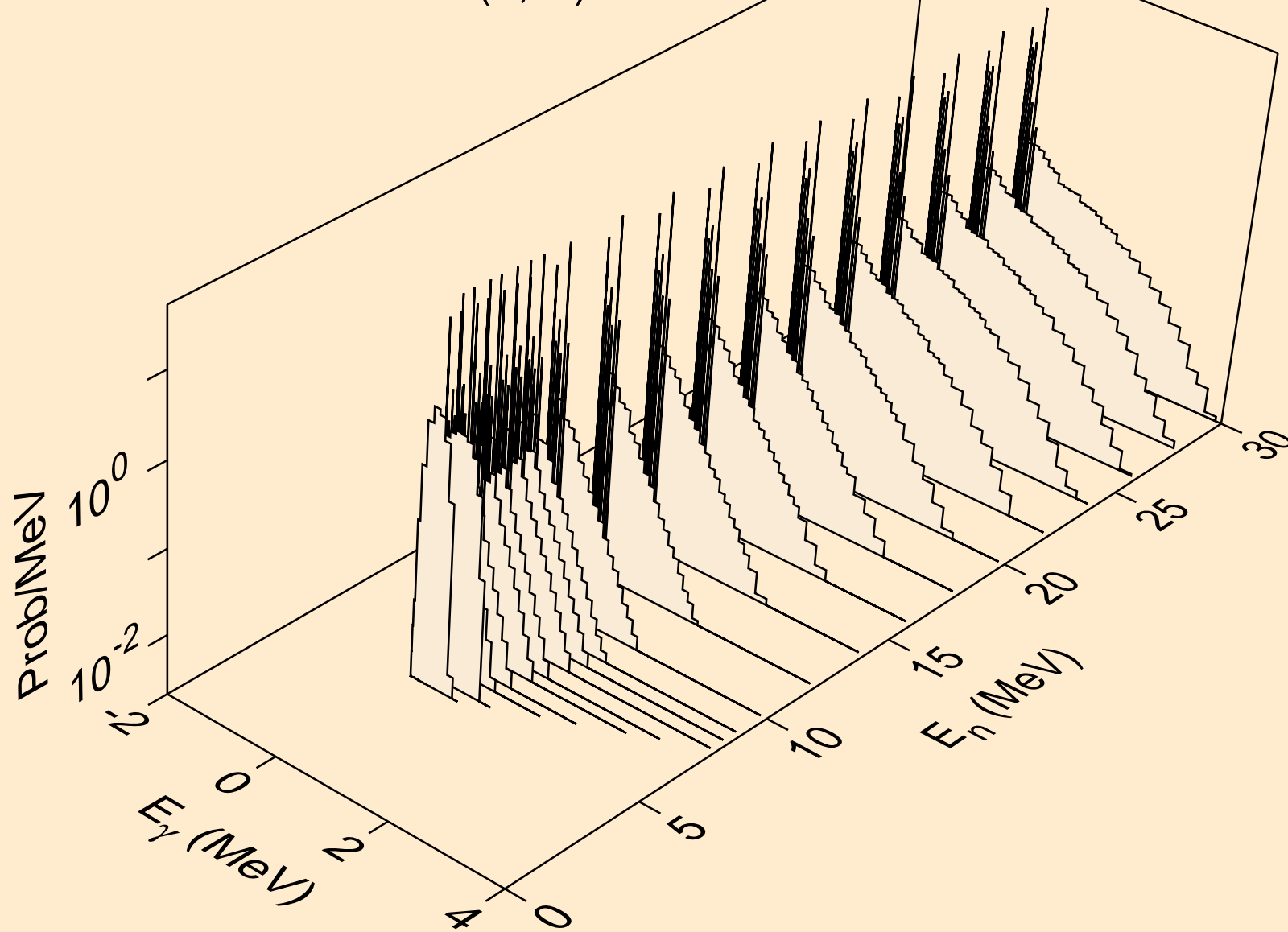

TH237 NEUTRON ACER TENDL-2024 LIBRARY; T=0.K
Photon emission for (n,2n)a

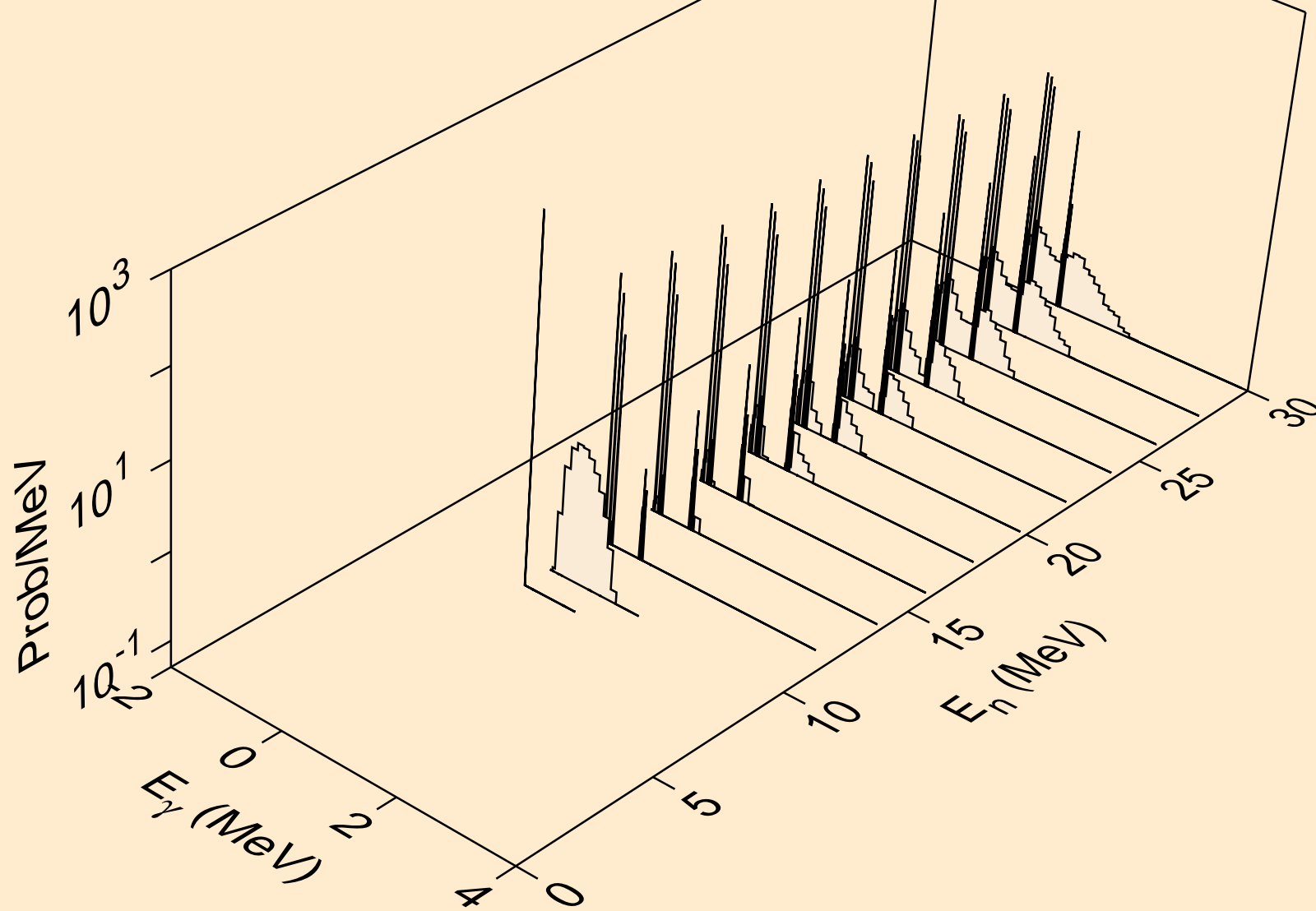

TH237 NEUTRON ACER TENDL-2024 LIBRARY; T=0.K
Photon emission for (n,3n)a

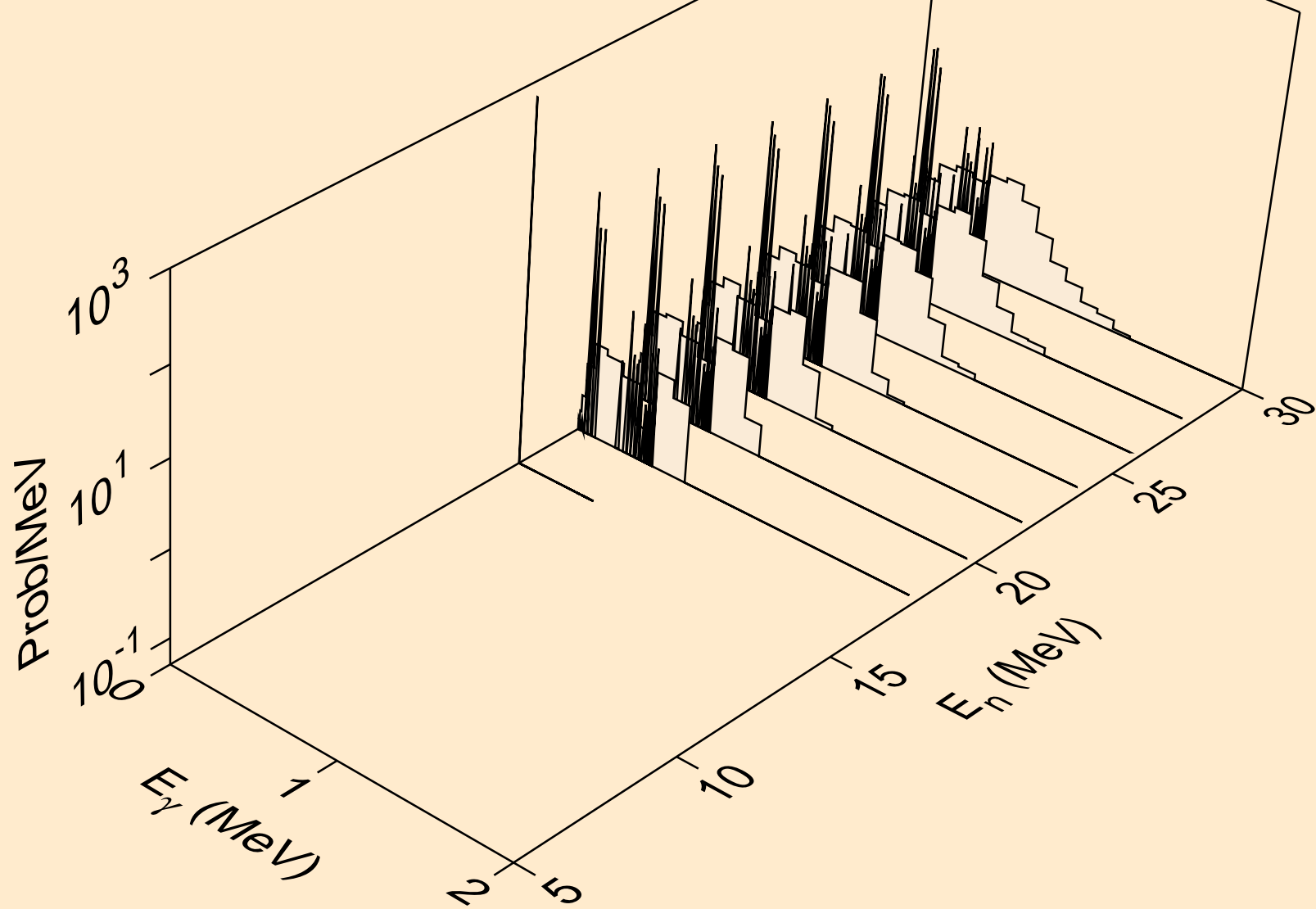

TH237 NEUTRON ACER TENDL-2024 LIBRARY; T=0.K
Photon emission for (n,n*)p

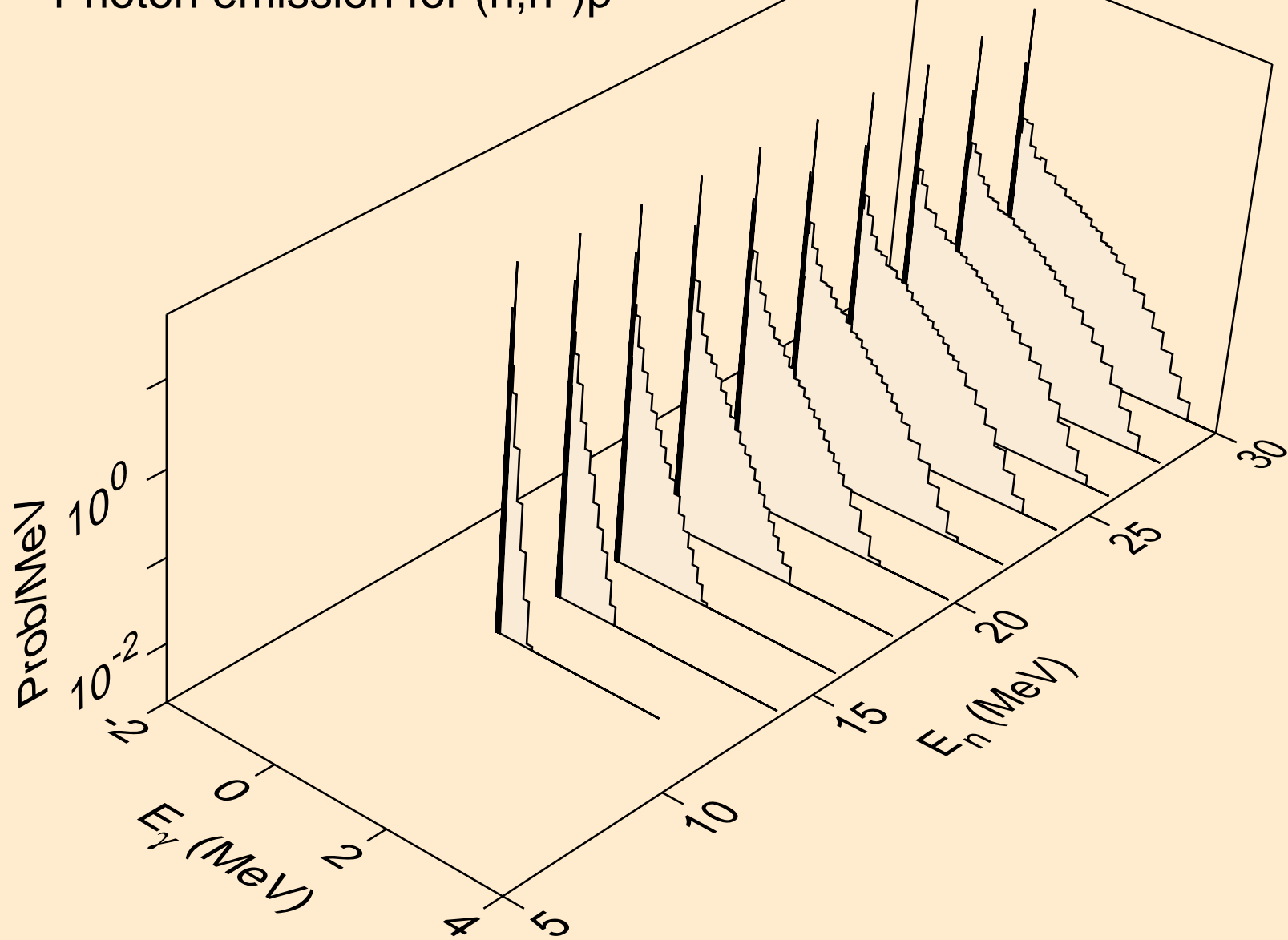

TH237 NEUTRON ACER TENDL-2024 LIBRARY; T=0.K
Photon emission for (n,n*)d

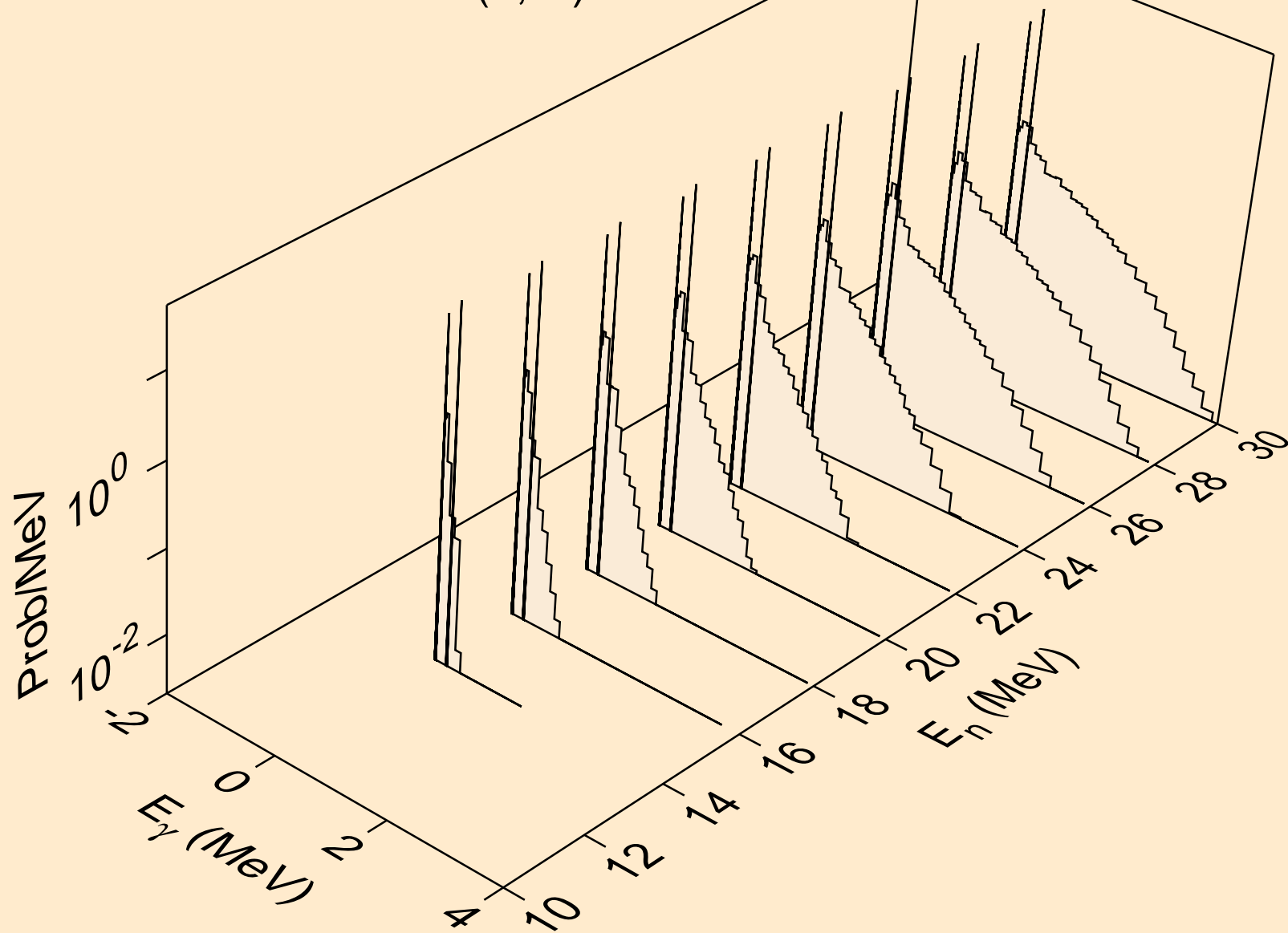

TH237 NEUTRON ACER TENDL-2024 LIBRARY; T=0.K
Photon emission for (n,n*)t

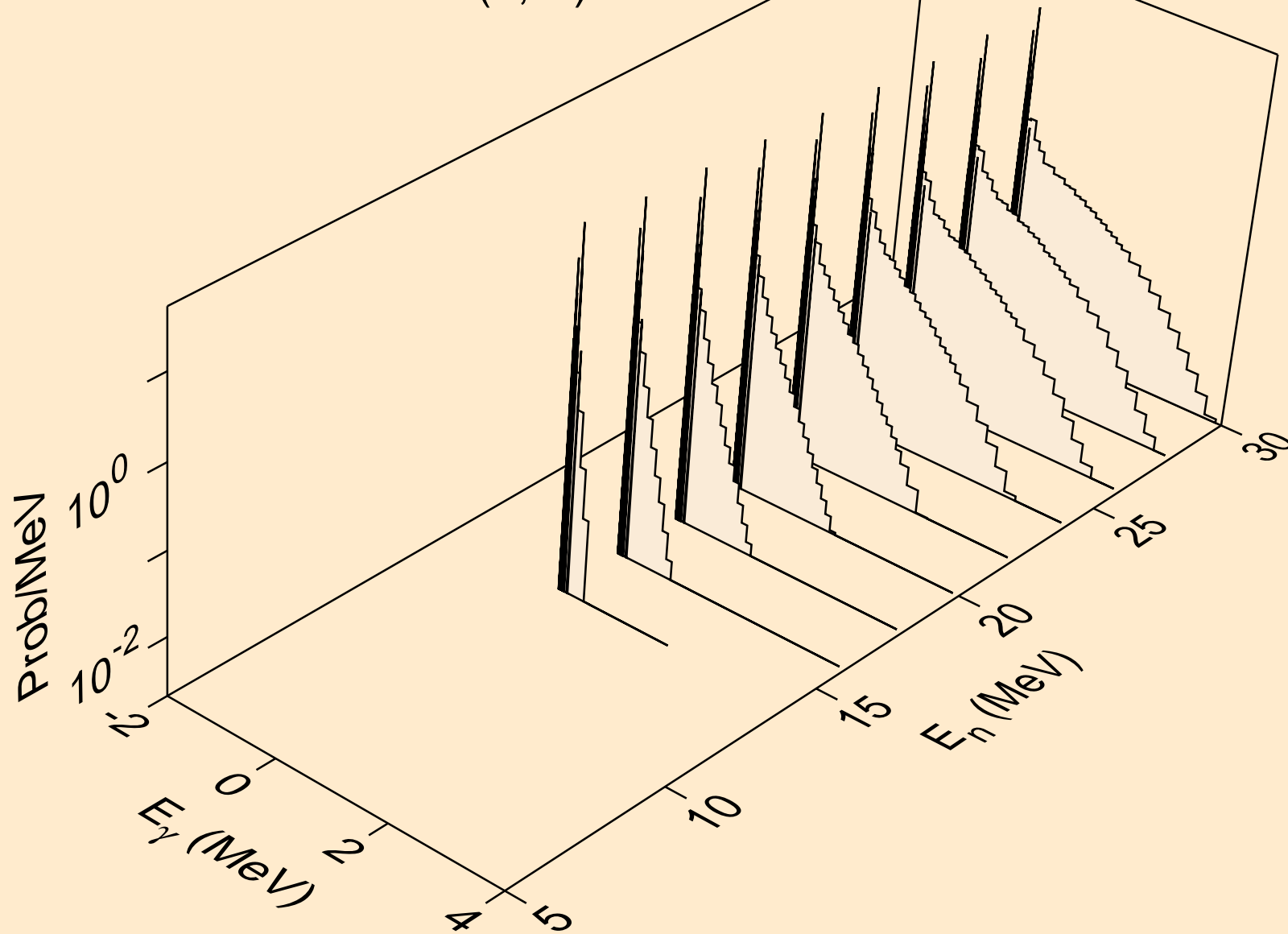

TH237 NEUTRON ACER TENDL-2024 LIBRARY; T=0.K
Photon emission for (n,n*)he3

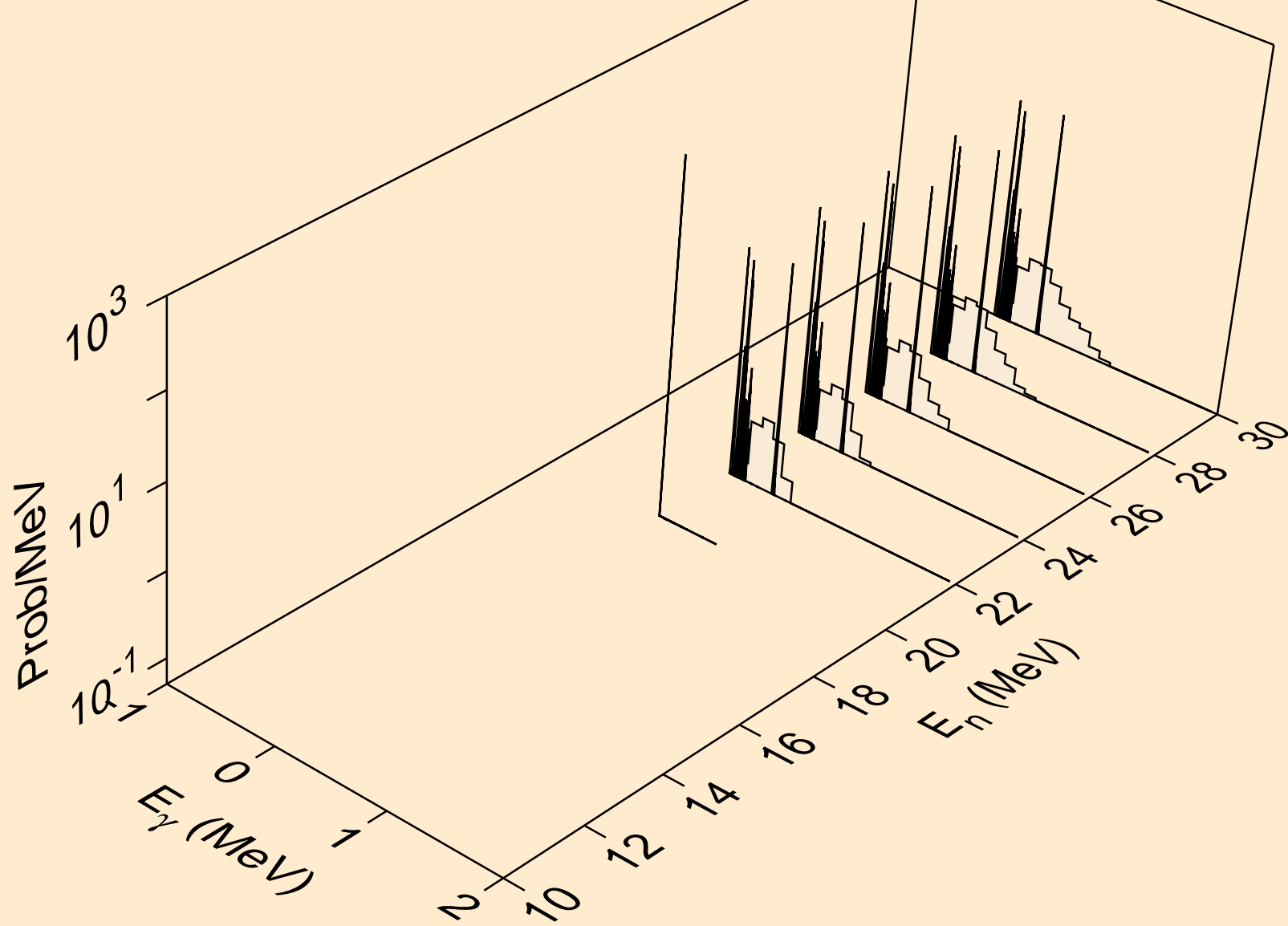

TH237 NEUTRON ACER TENDL-2024 LIBRARY; T=0.K
Photon emission for (n,4n)

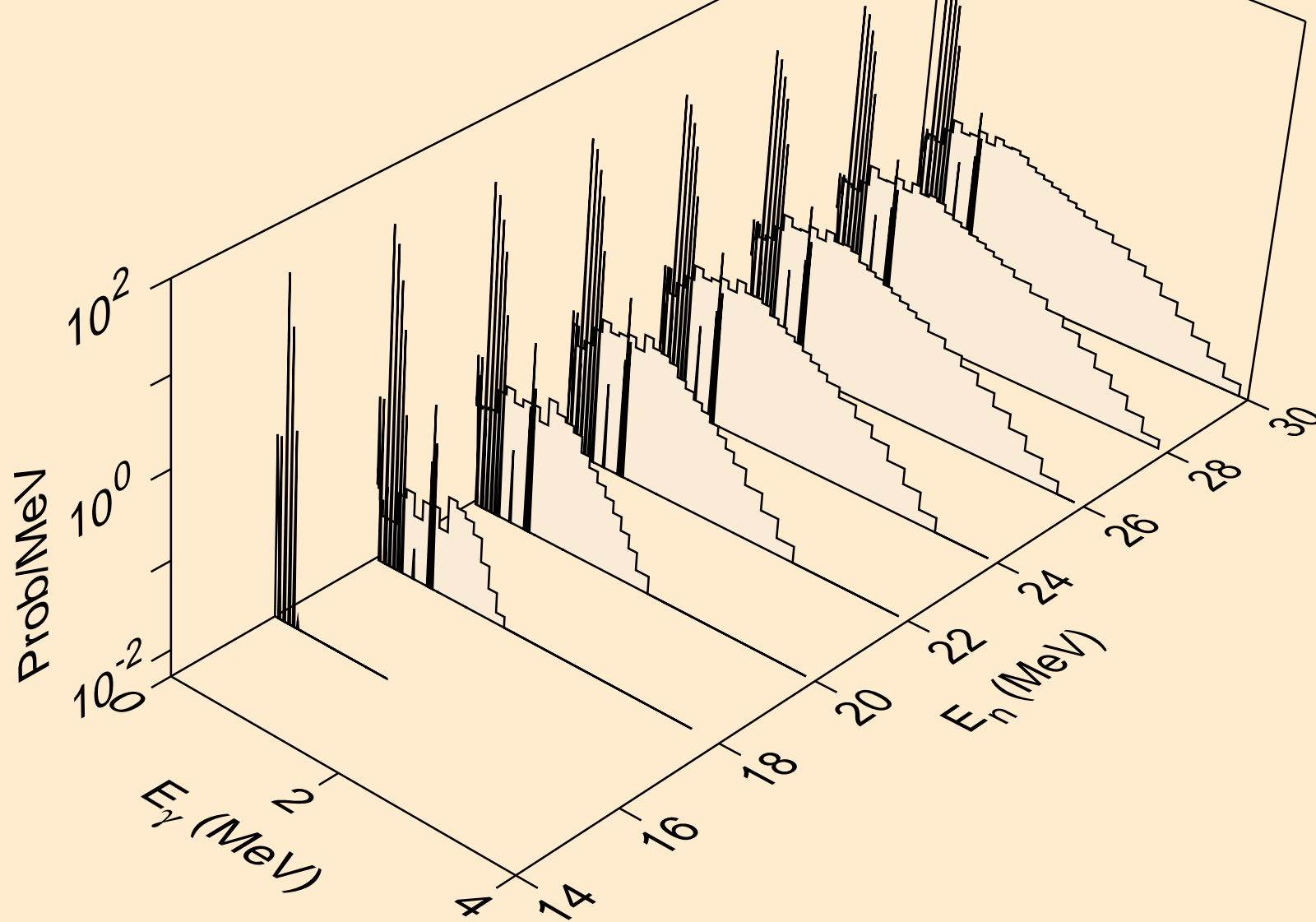

TH237 NEUTRON ACER TENDL-2024 LIBRARY; T=0.K
Photon emission for (n,2np)

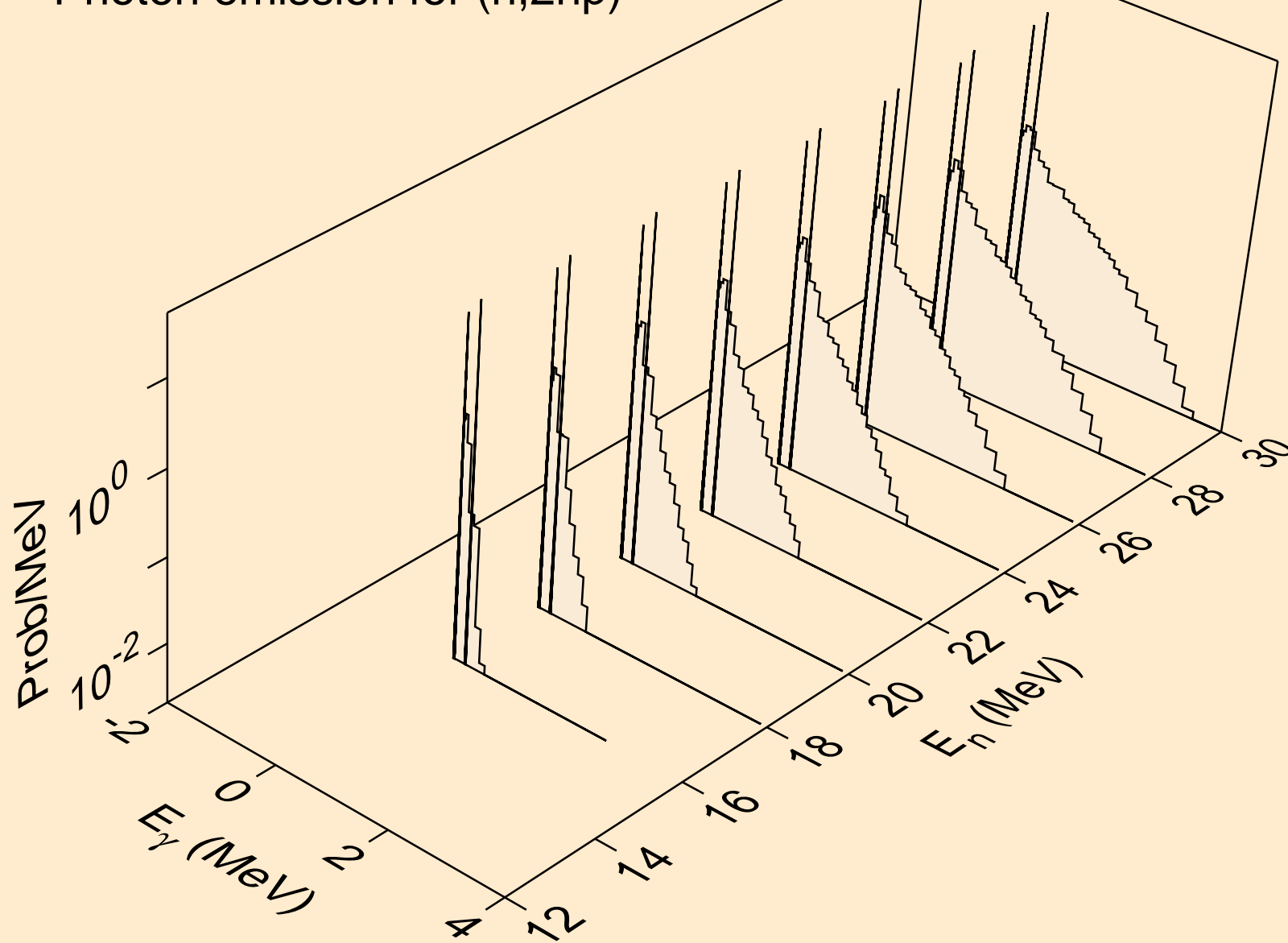

TH237 NEUTRON ACER TENDL-2024 LIBRARY; T=0.K
Photon emission for (n,3np)

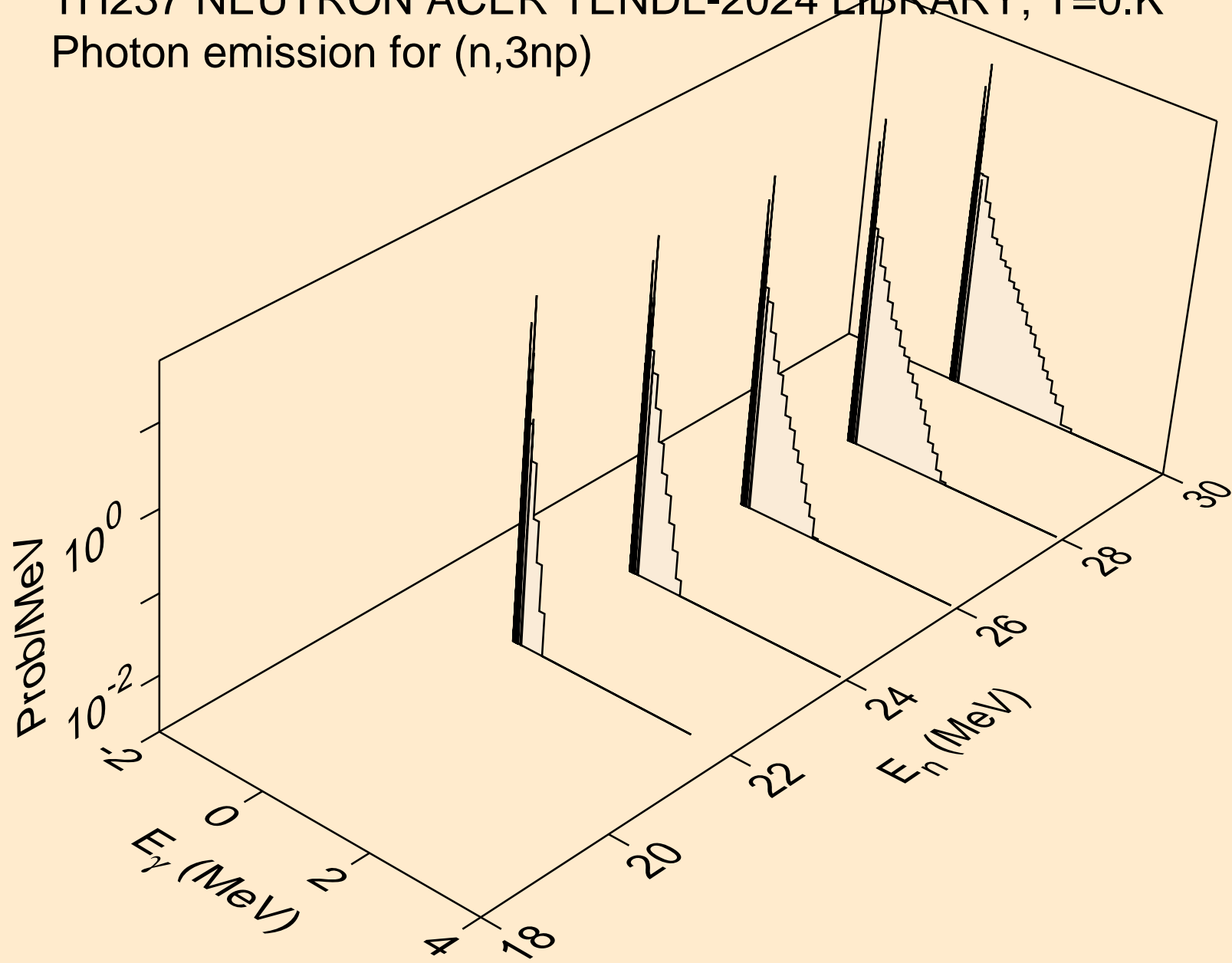

TH237 NEUTRON ACER TENDL-2024 LIBRARY; T=0.K
Photon emission for (n,n*c)

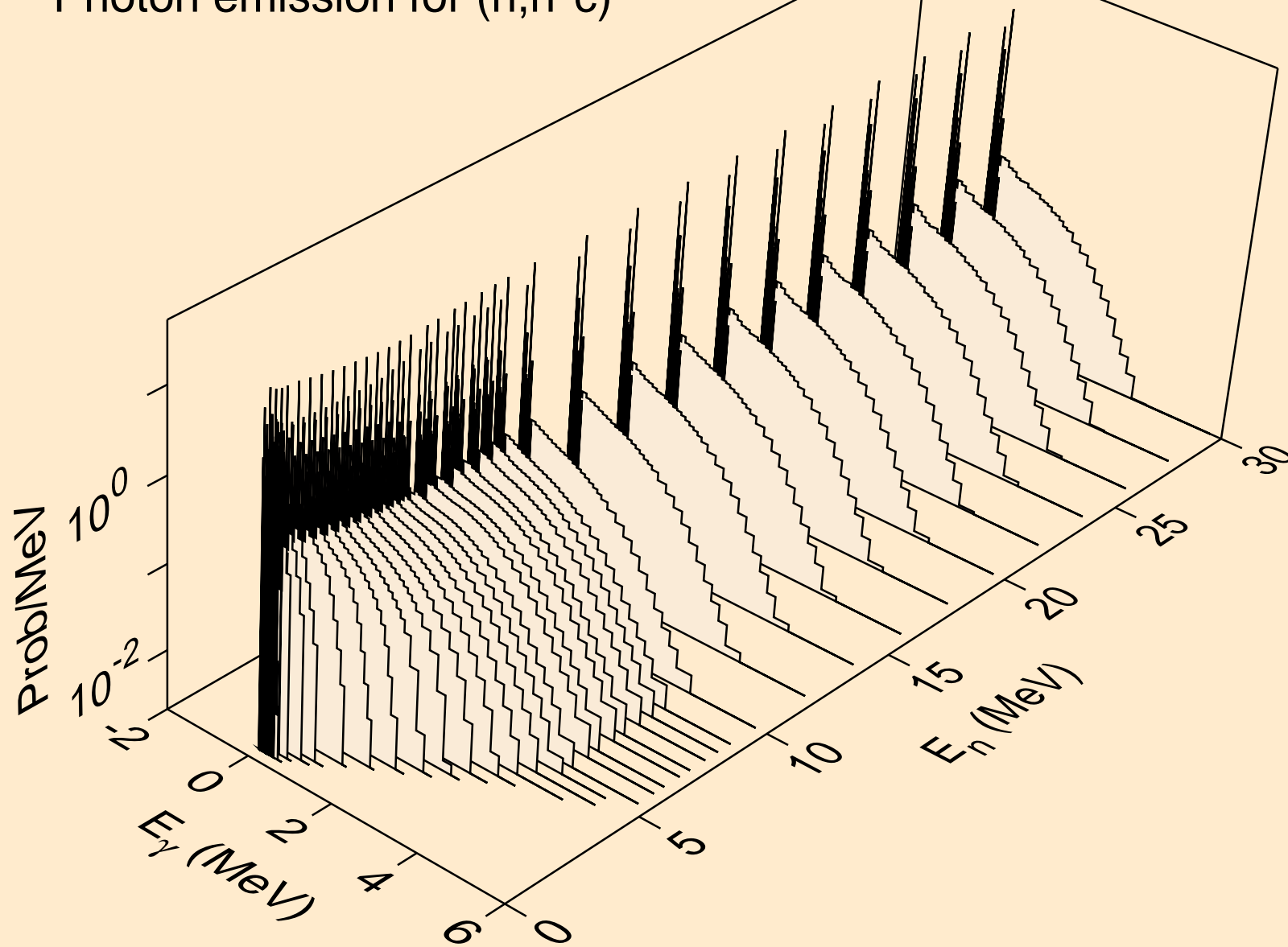

TH237 NEUTRON ACER TENDL-2024 LIBRARY; T=0.K
Photon emission for (n,gma)

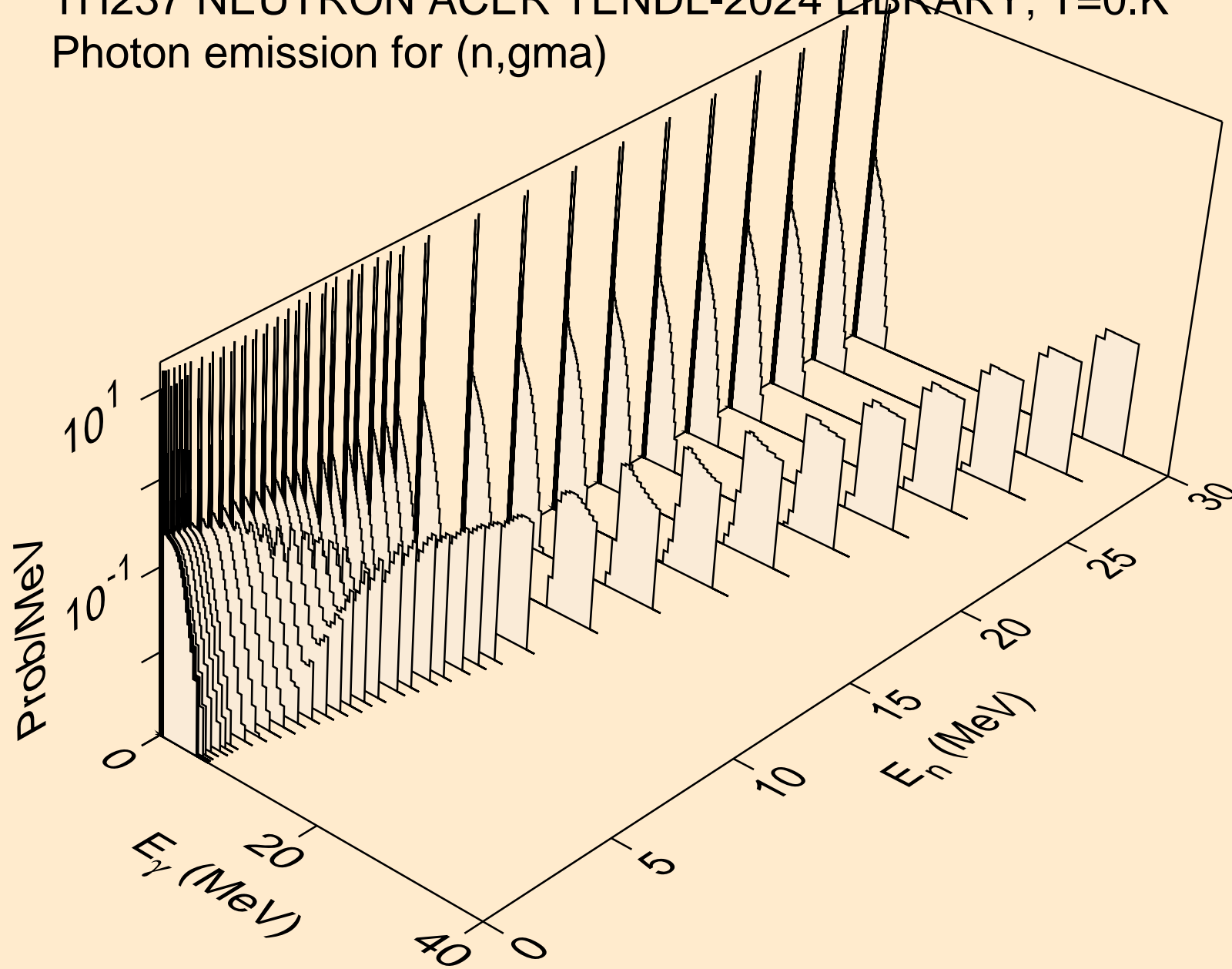

TH237 NEUTRON ACER TENDL-2024 LIBRARY; T=0.K
Photon emission for (n,p)

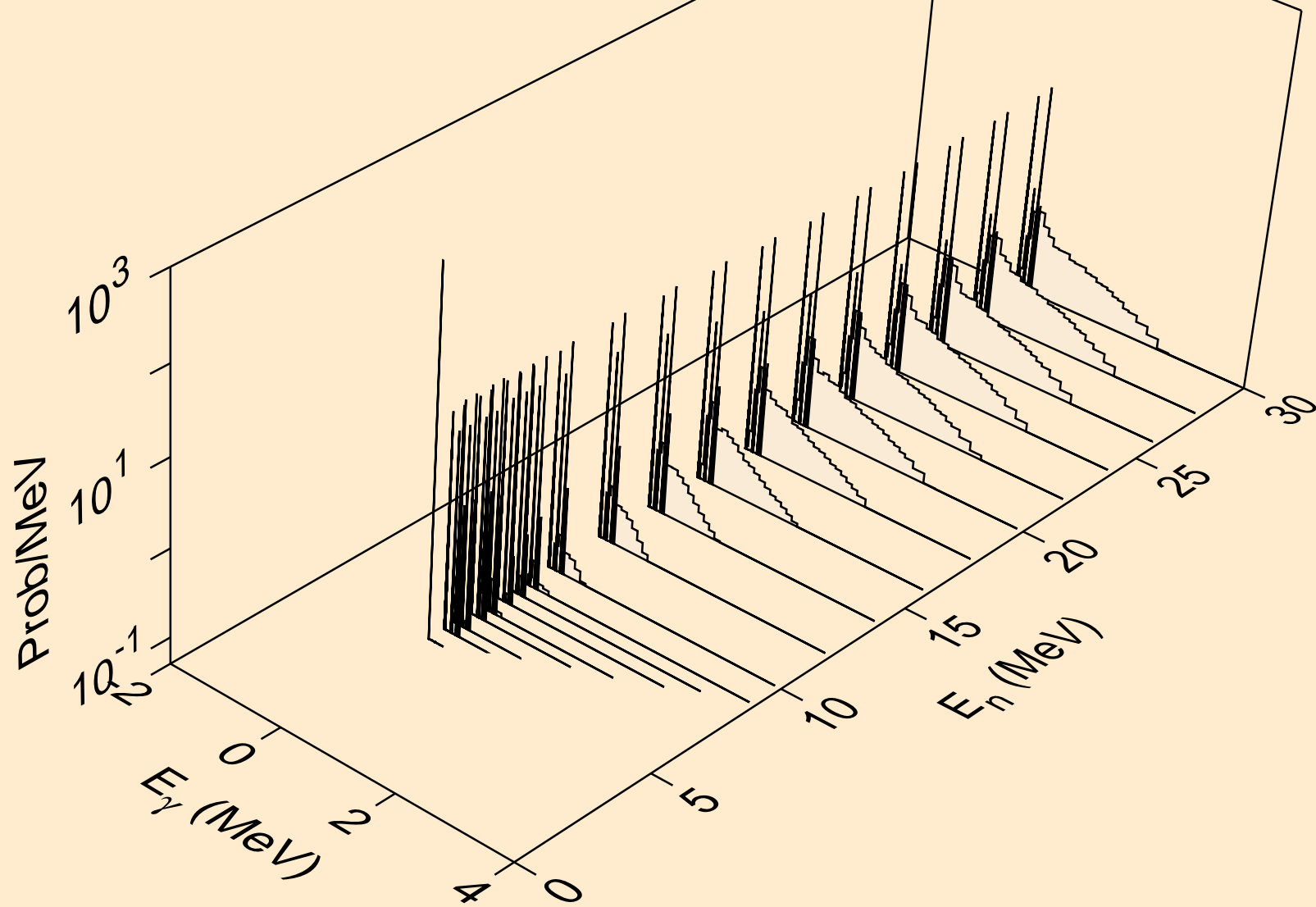

TH237 NEUTRON ACER TENDL-2024 LIBRARY; T=0.K
Photon emission for (n,d)

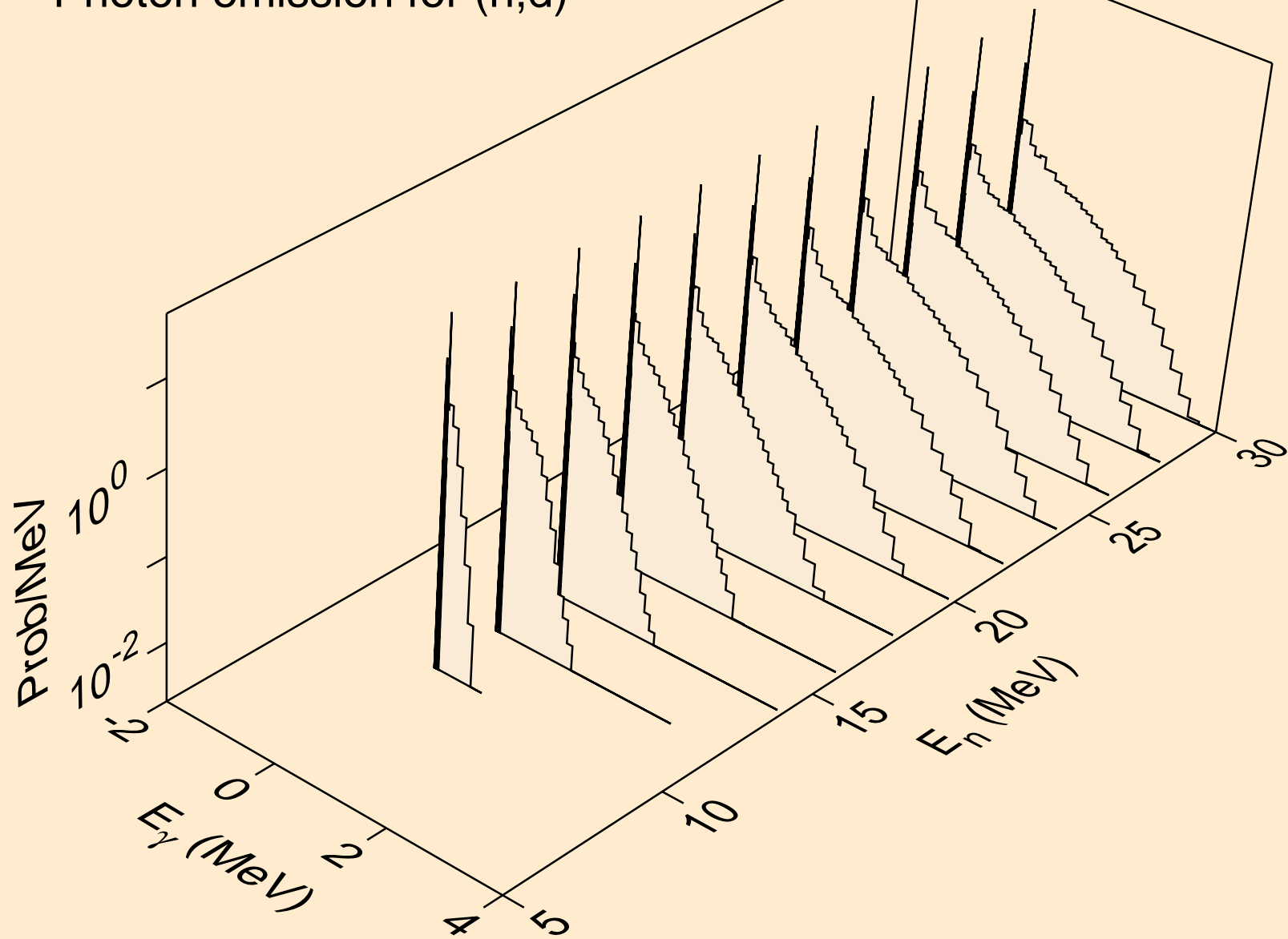

TH237 NEUTRON ACER TENDL-2024 LIBRARY; T=0.K
Photon emission for (n,t)

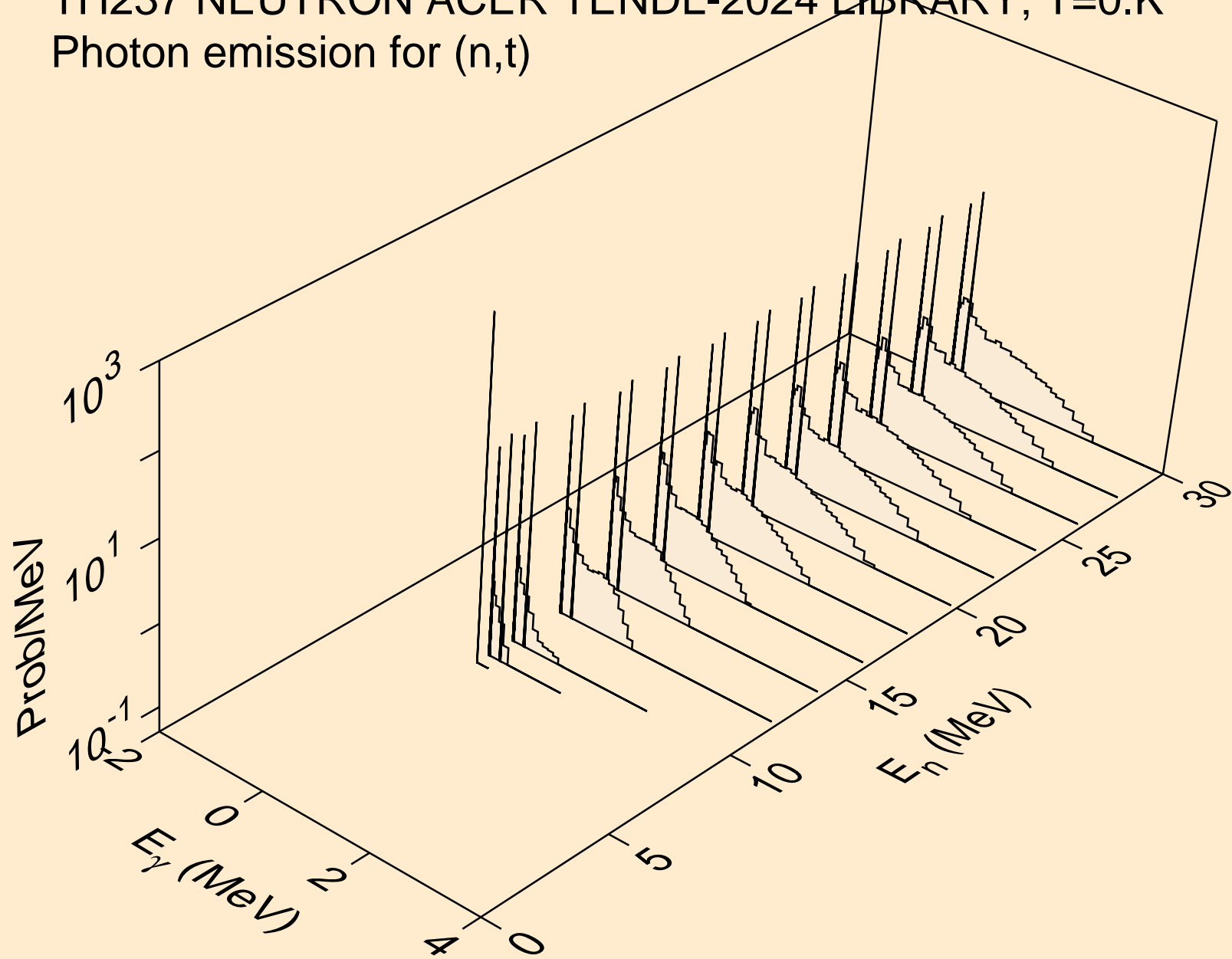

TH237 NEUTRON ACER TENDL-2024 LIBRARY; T=0.K
Photon emission for (n,he3)

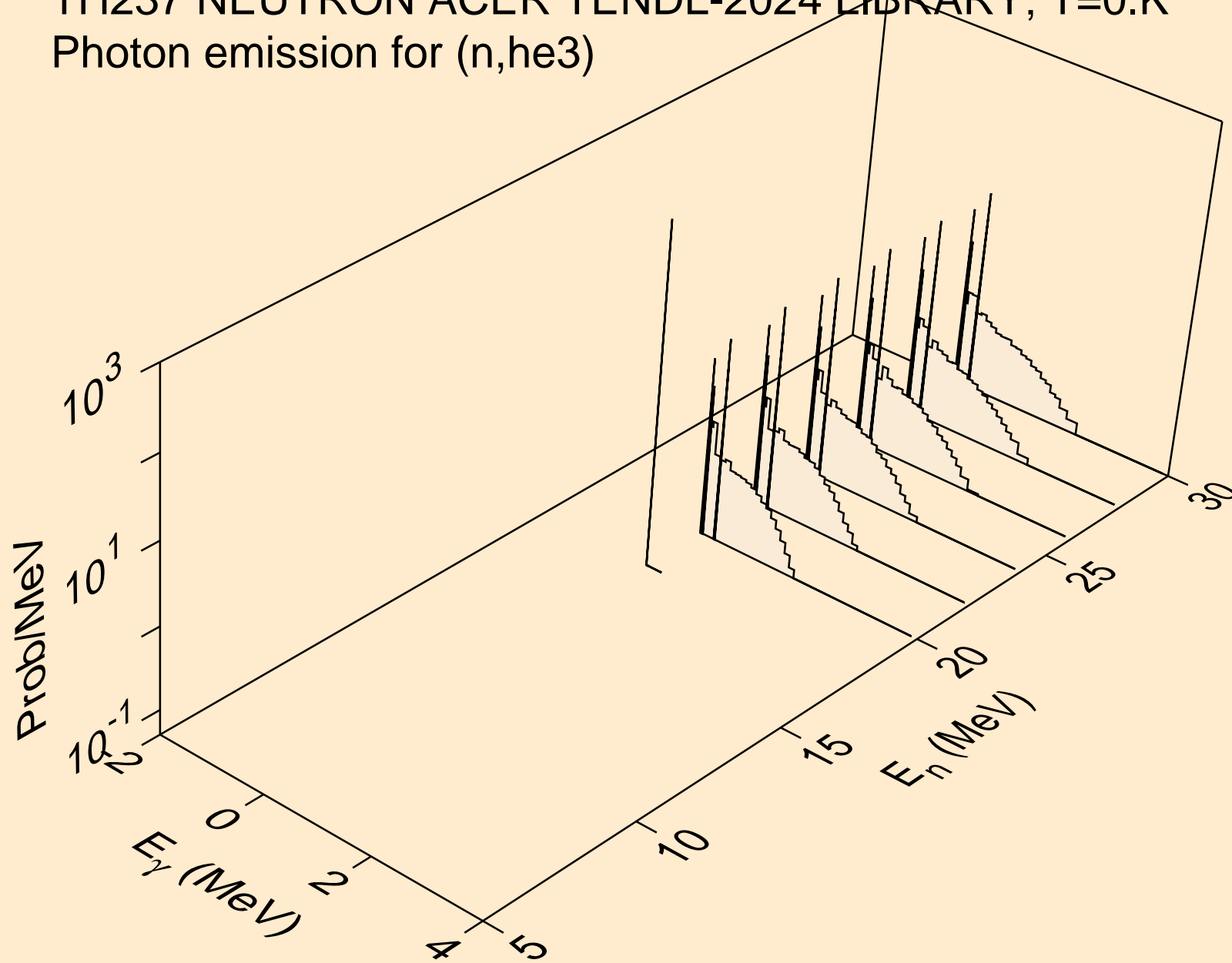

TH237 NEUTRON ACER TENDL-2024 LIBRARY; T=0.K
Photon emission for (n,a)

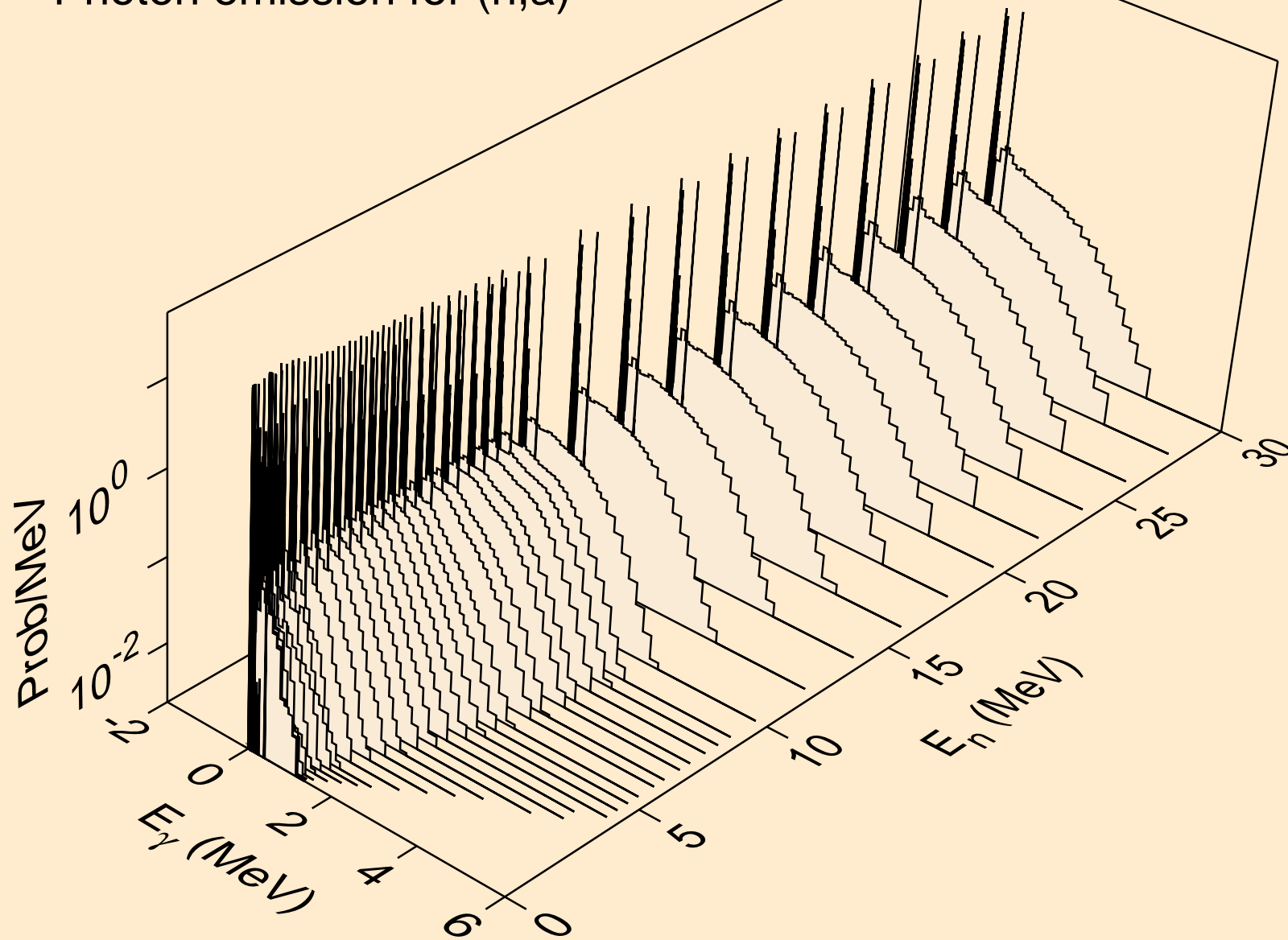

TH237 NEUTRON ACER TENDL-2024 LIBRARY; T=0.K
Photon emission for (n,2p)

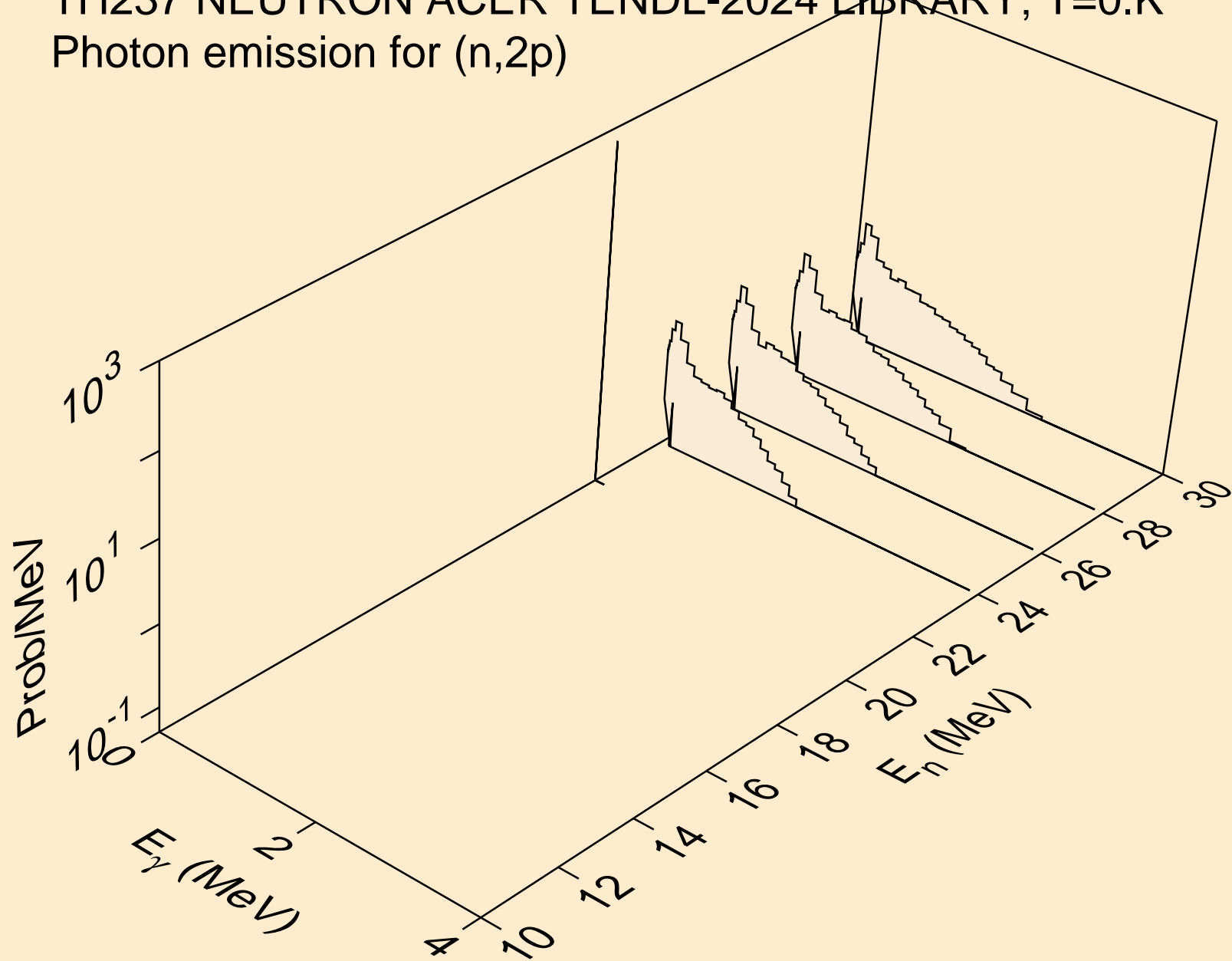

TH237 NEUTRON ACER TENDL-2024 LIBRARY; T=0.K
thermal capture photon spectrum

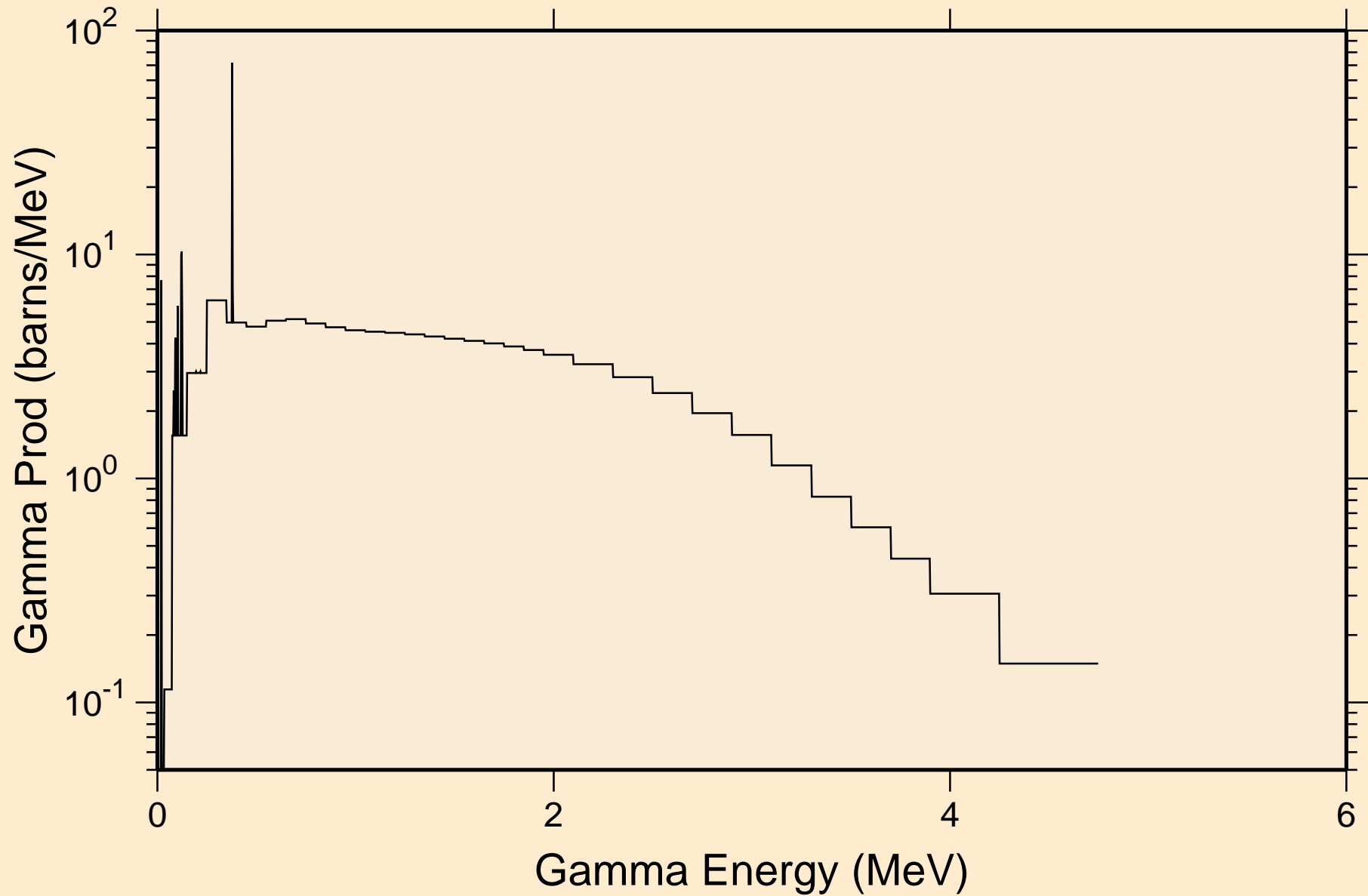

TH237 NEUTRON ACER TENDL-2024 LIBRARY; T=0.K
14 MeV photon spectrum

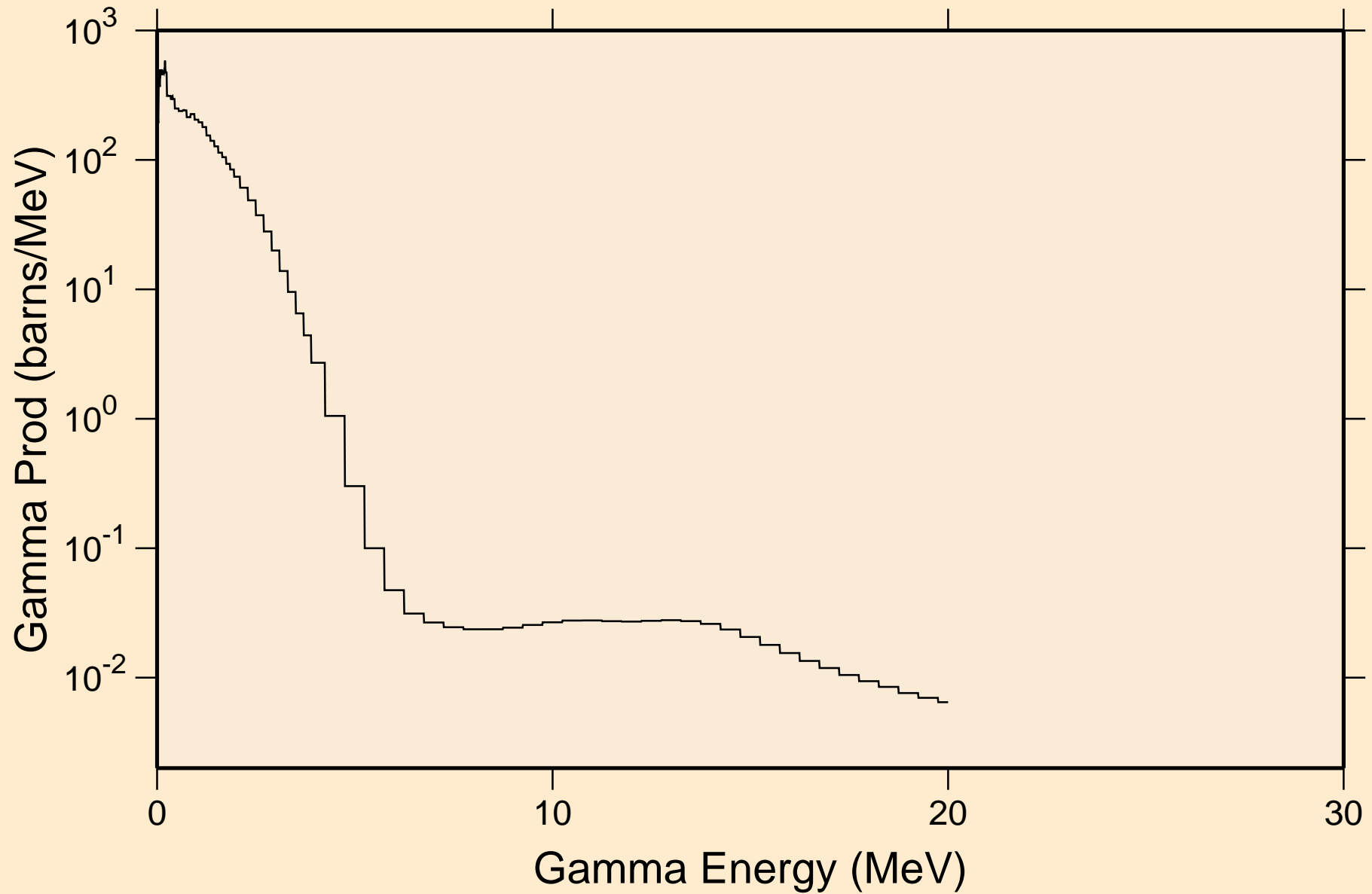

TH237 NEUTRON ACER TENDL-2024 LIBRARY; T=0.K
Particle heating contributions

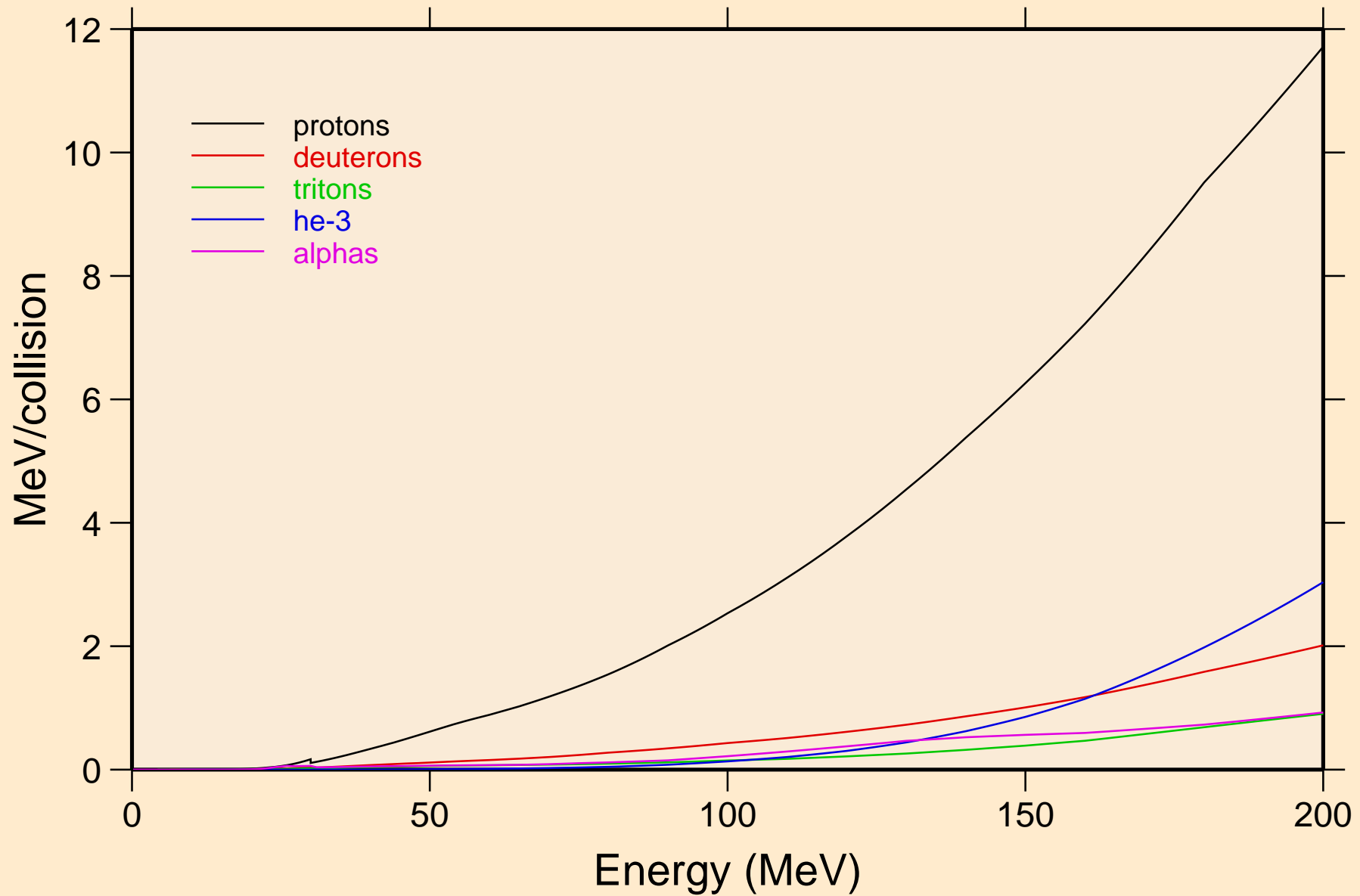

TH237 NEUTRON ACER TENDL-2024 LIBRARY; T=0.K
Recoil Heating

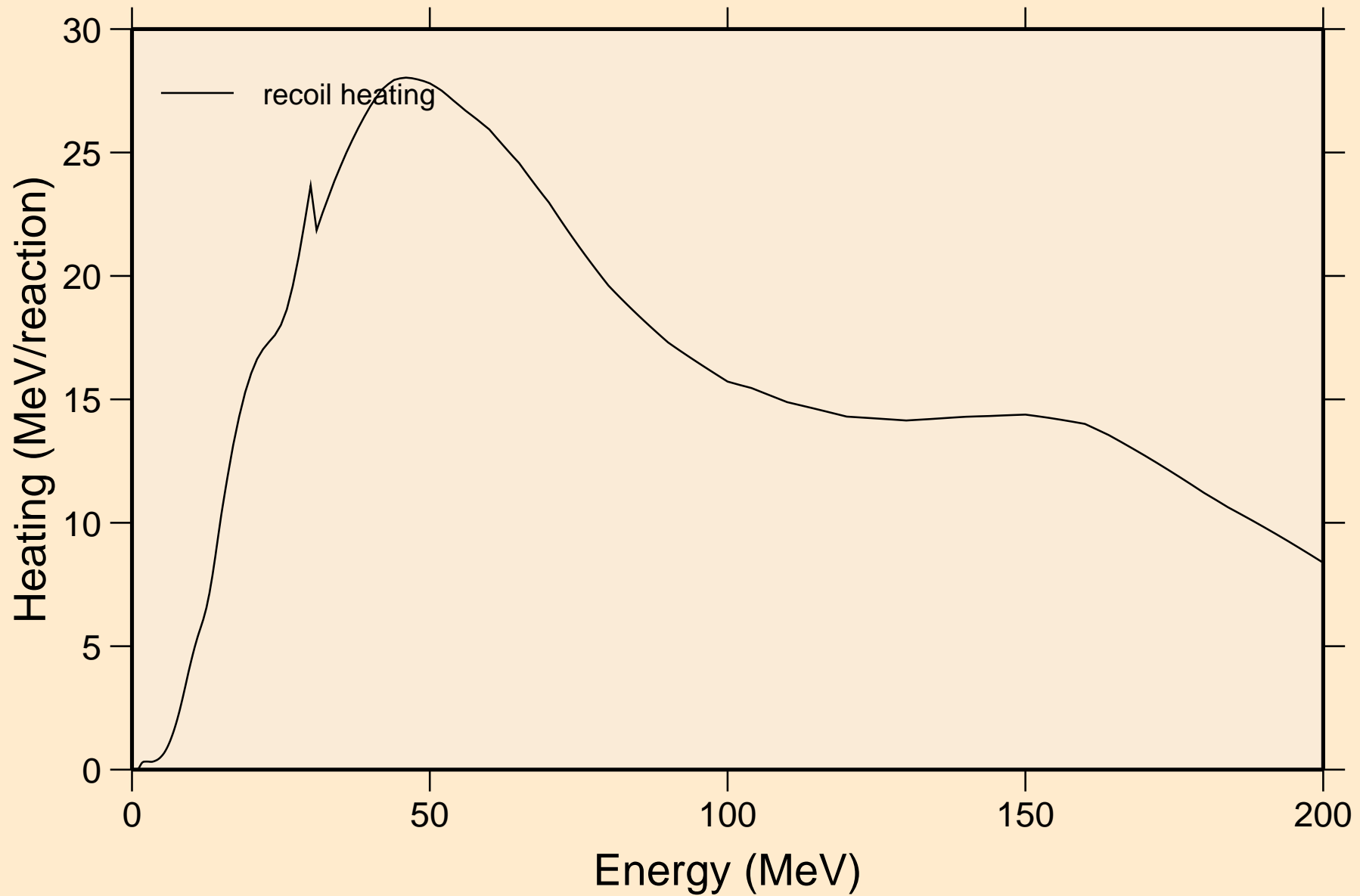

TH237 NEUTRON ACER TENDL-2024 LIBRARY; T=0.K
Particle production cross sections

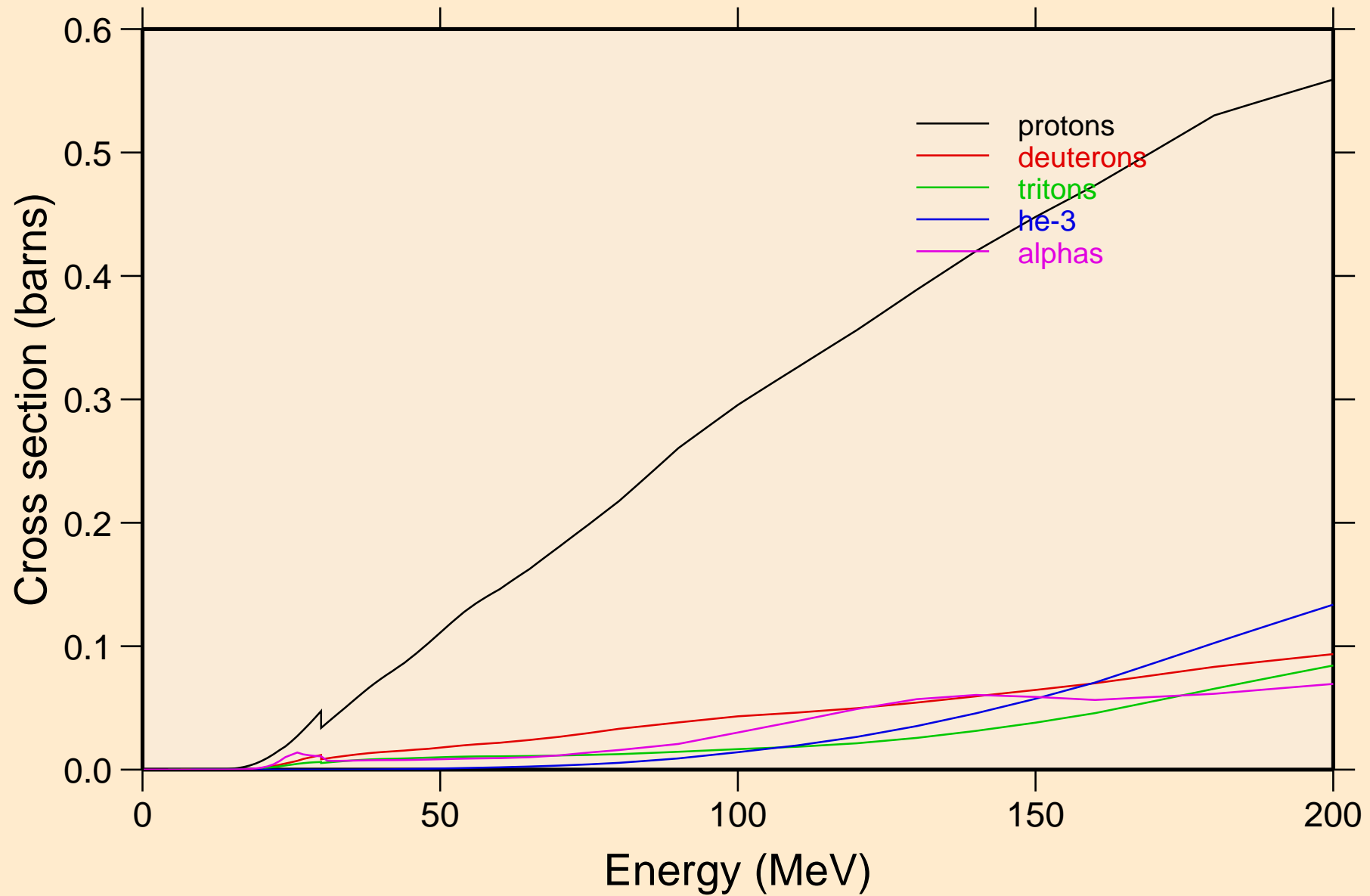

TH237 NEUTRON ACER TENDL-2024 LIBRARY; T=0.K
protons from (n,x)

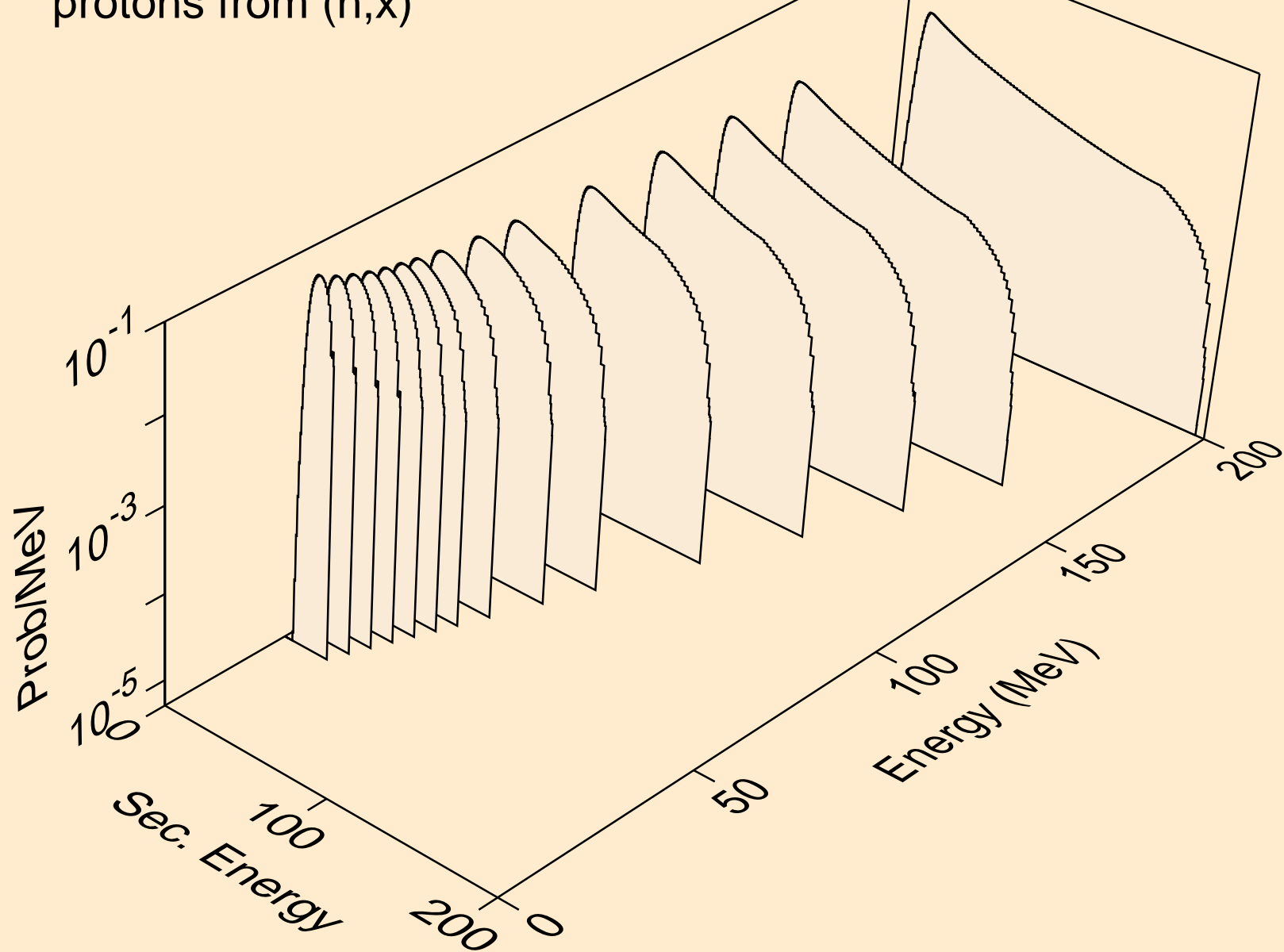

TH237 NEUTRON ACER TENDL-2024 LIBRARY; T=0.K
protons from (n,n*)p

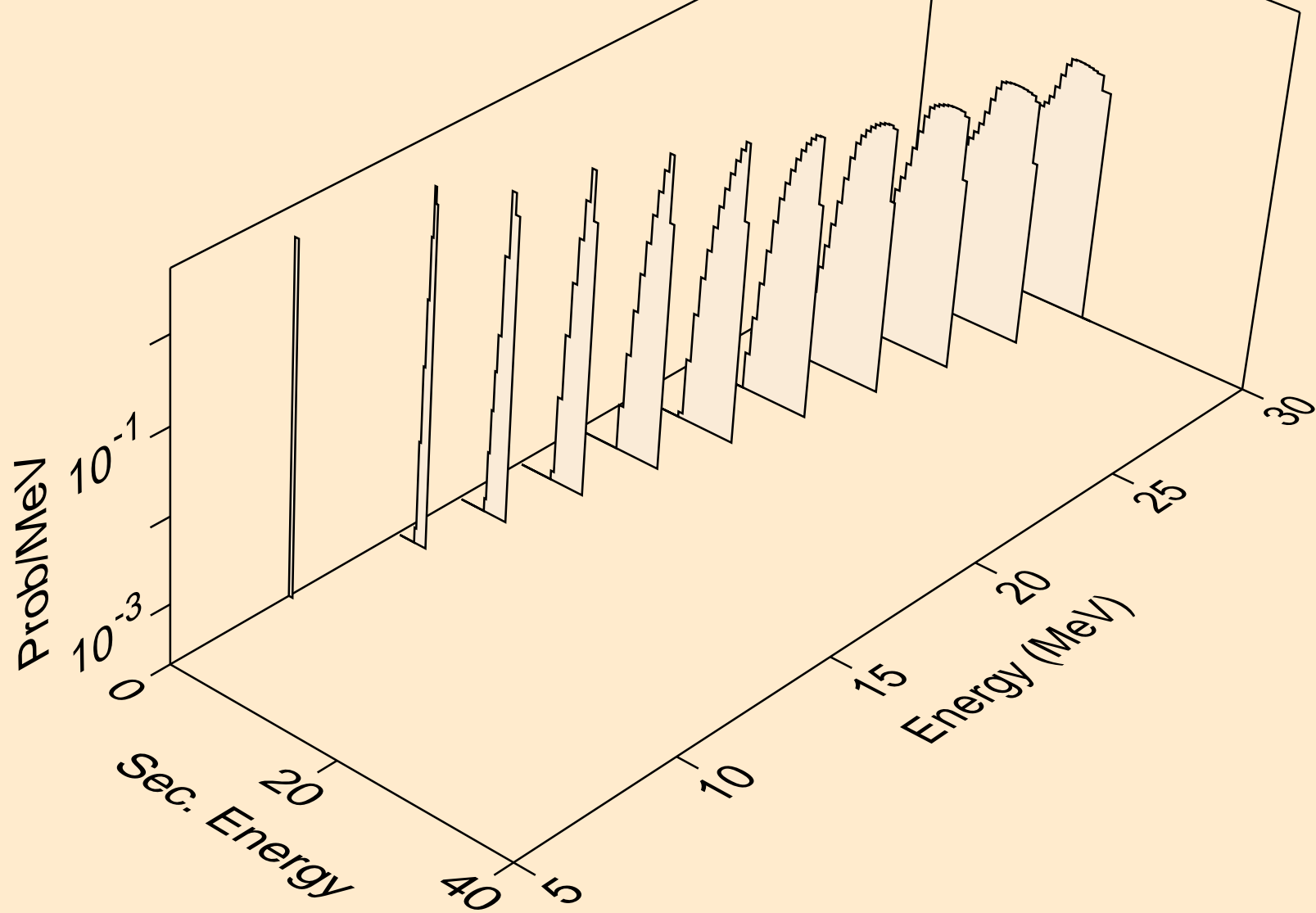

TH237 NEUTRON ACER TENDL-2024 LIBRARY; T=0.K
protons from (n,2np)

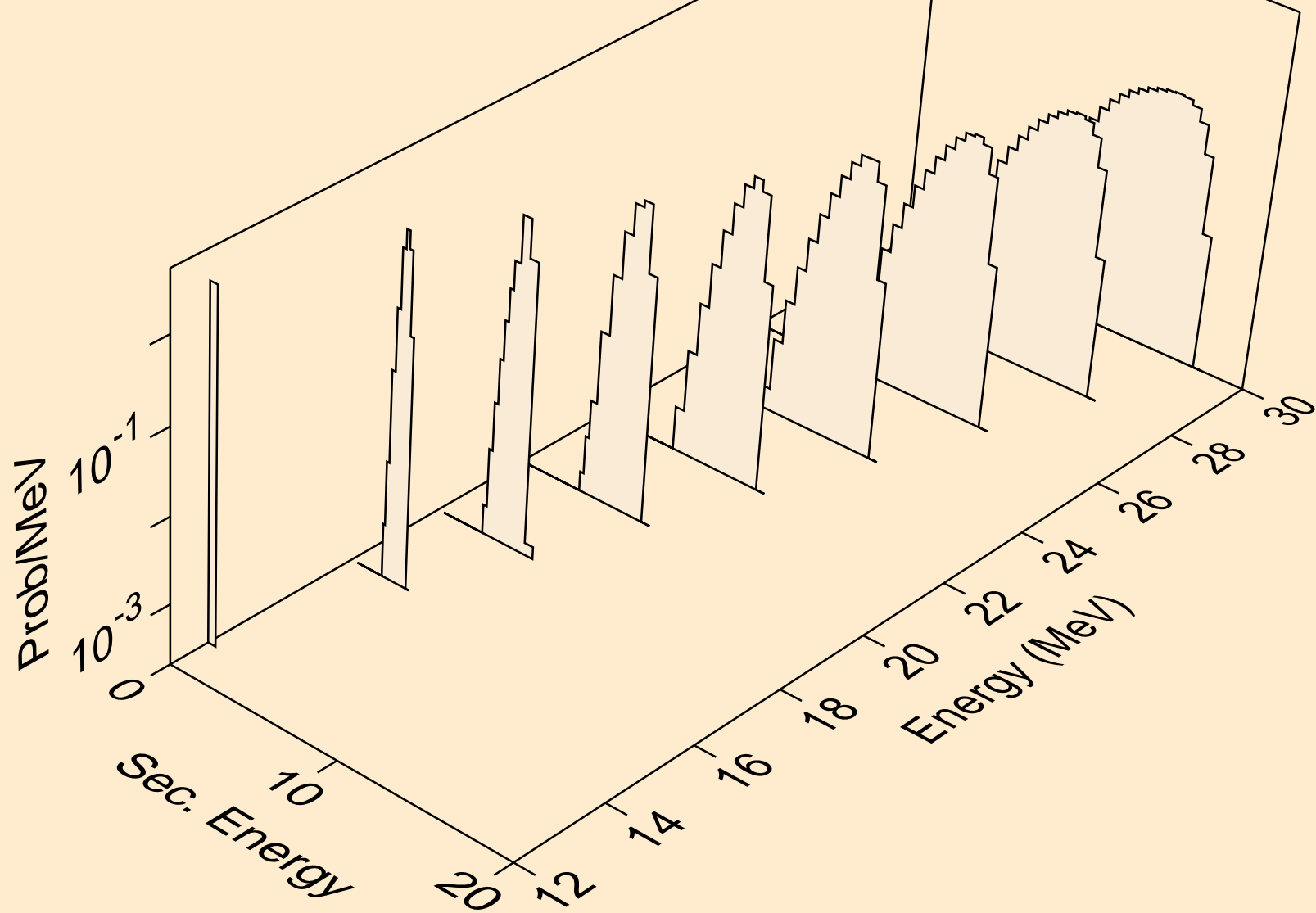

TH237 NEUTRON ACER TENDL-2024 LIBRARY; T=0.K
protons from (n,3np)

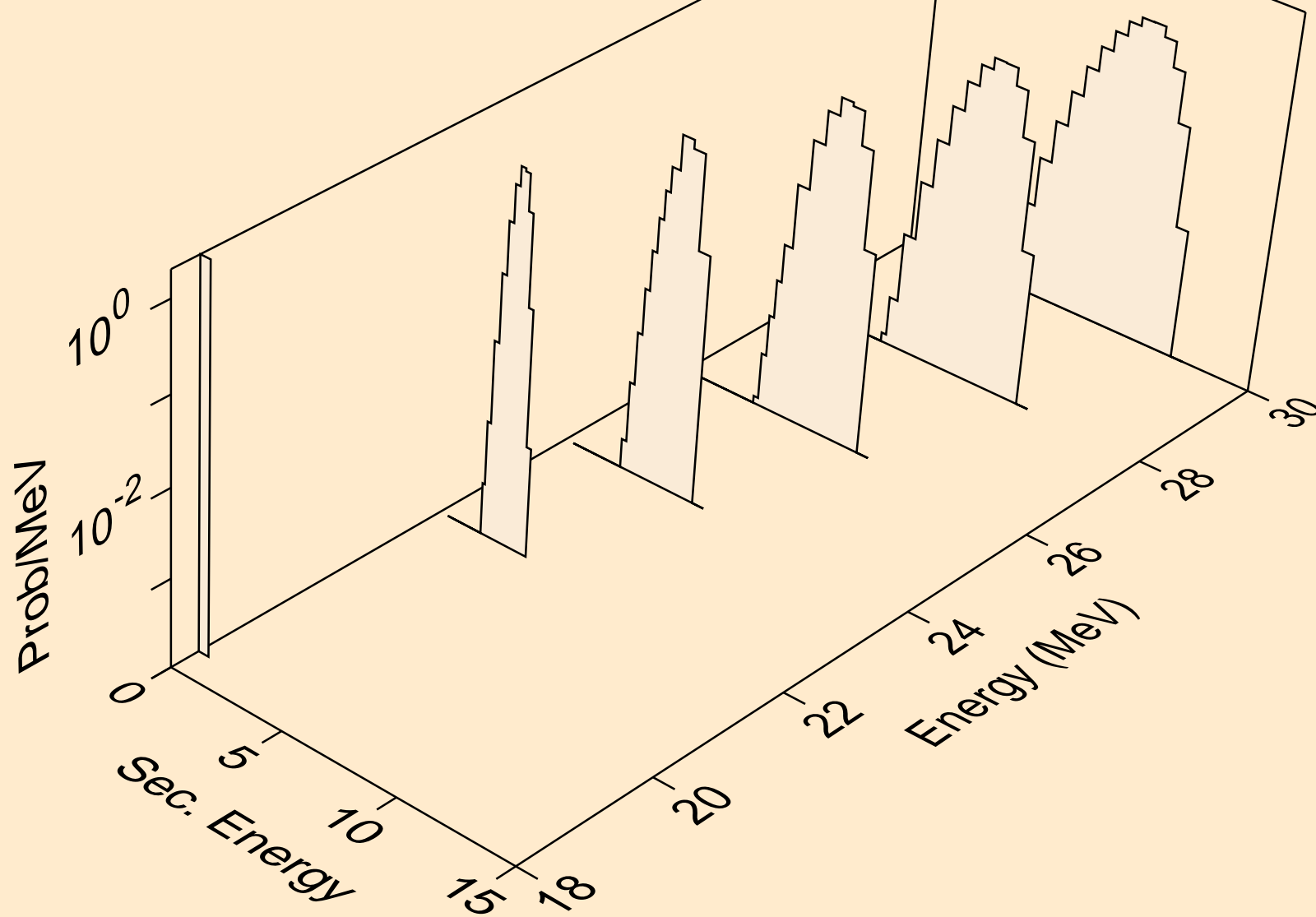

TH237 NEUTRON ACER TENDL-2024 LIBRARY; T=0.K
protons from (n,p)

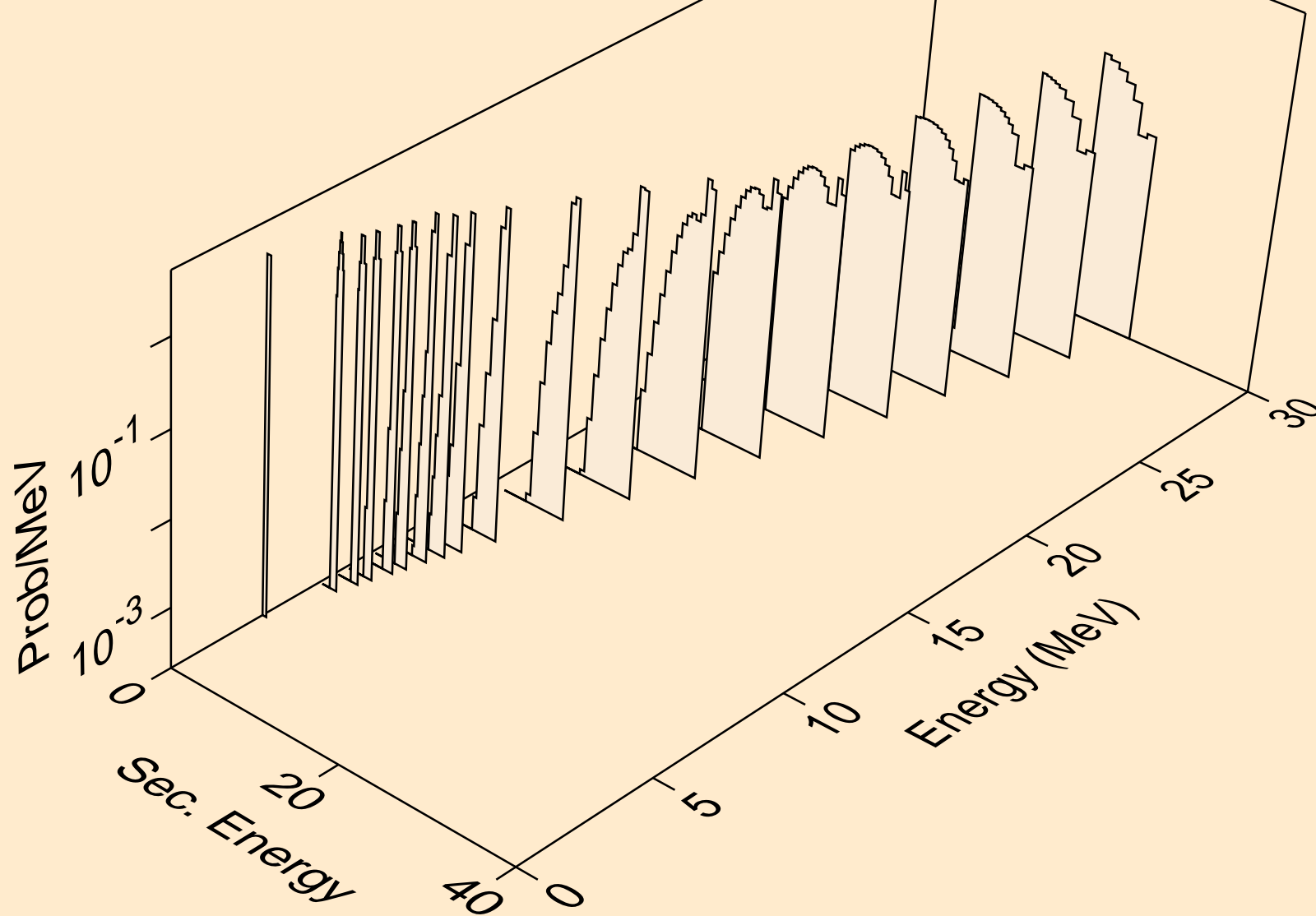

TH237 NEUTRON ACER TENDL-2024 LIBRARY; T=0.K
protons from (n,2p)

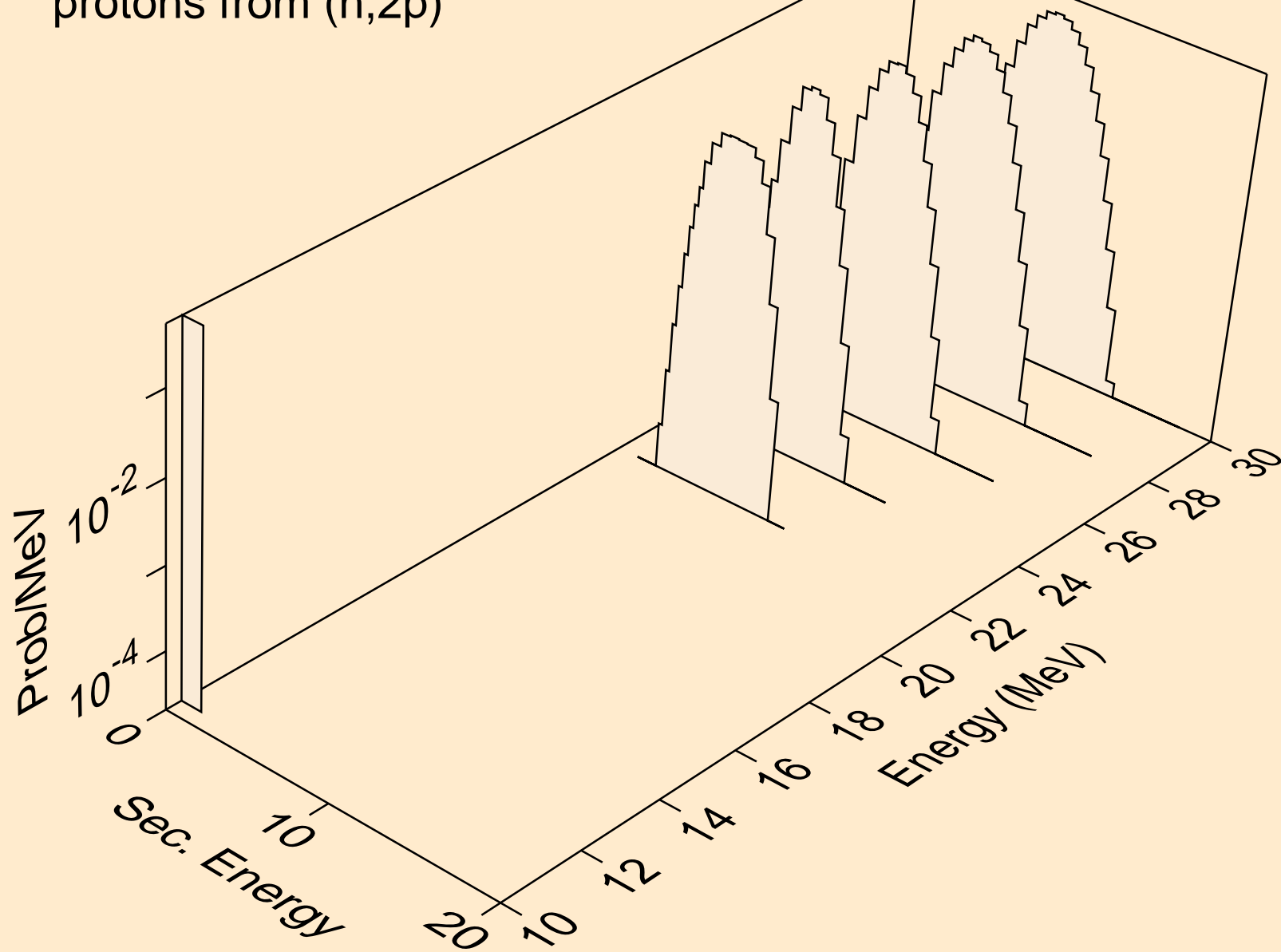

TH237 NEUTRON ACER TENDL-2024 LIBRARY; T=0.K
deuterons from (n,x)

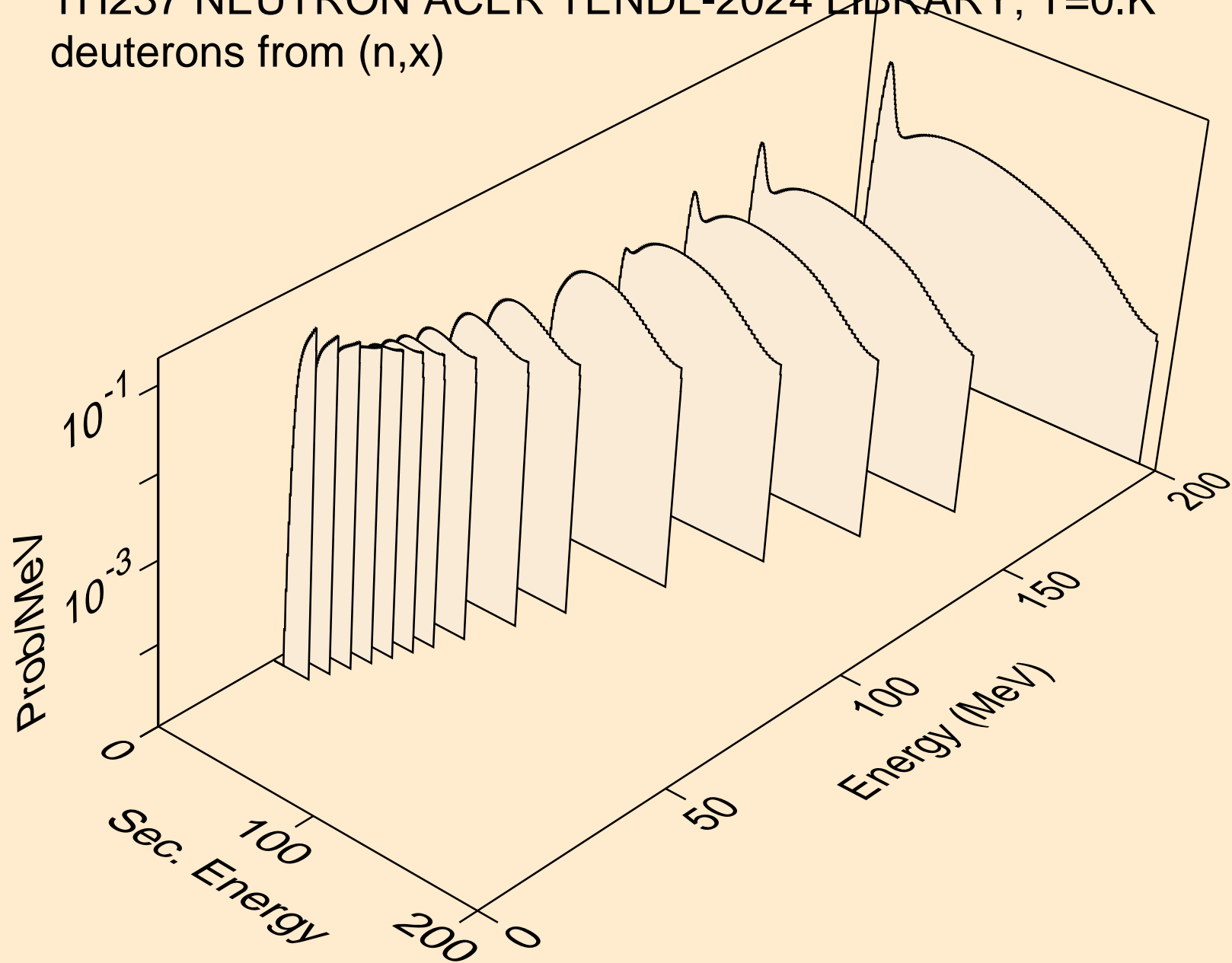

TH237 NEUTRON ACER TENDL-2024 LIBRARY; T=0.K
deuterons from (n,2nd)

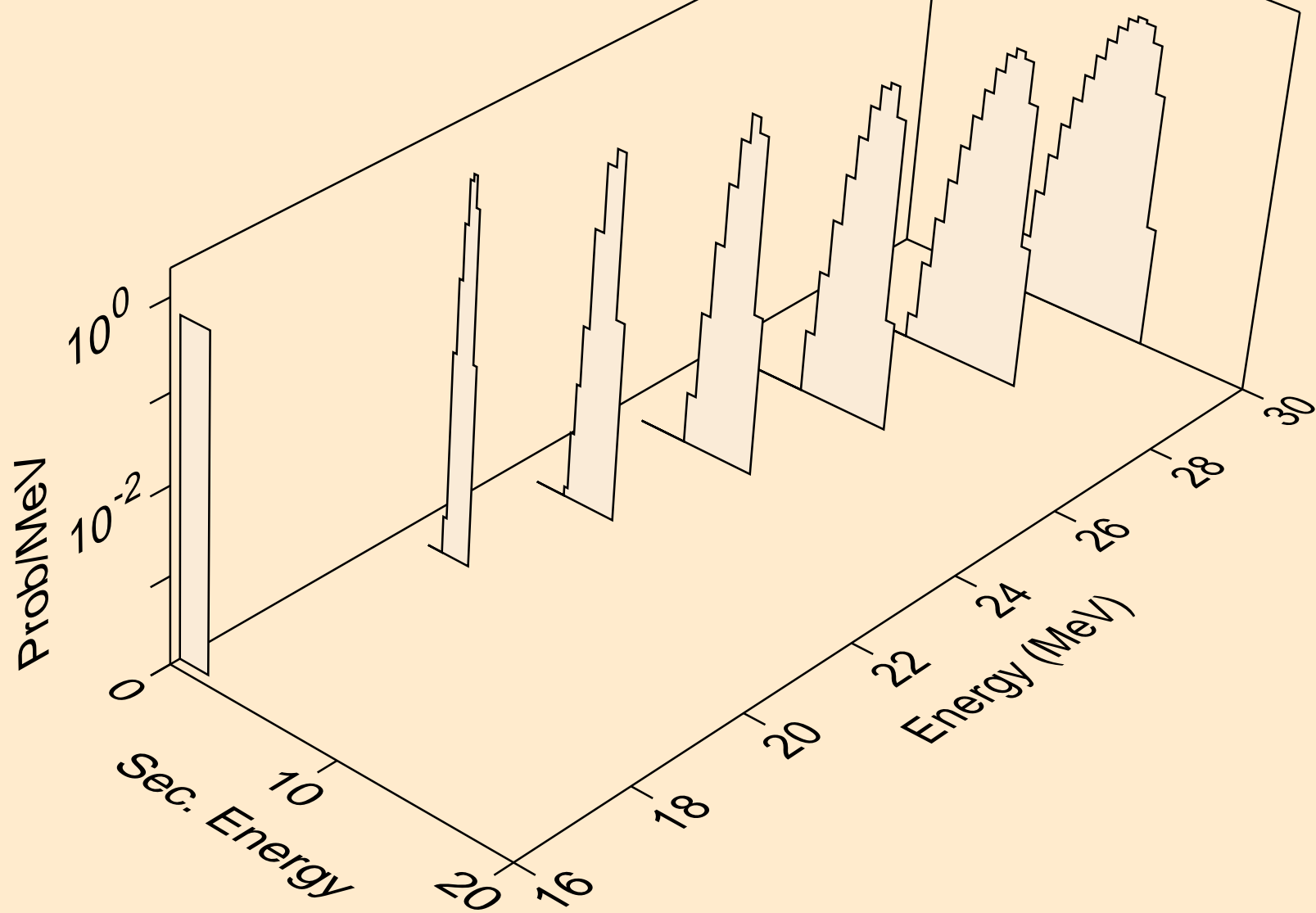

TH237 NEUTRON ACER TENDL-2024 LIBRARY; T=0.K
deuterons from (n,n*)d

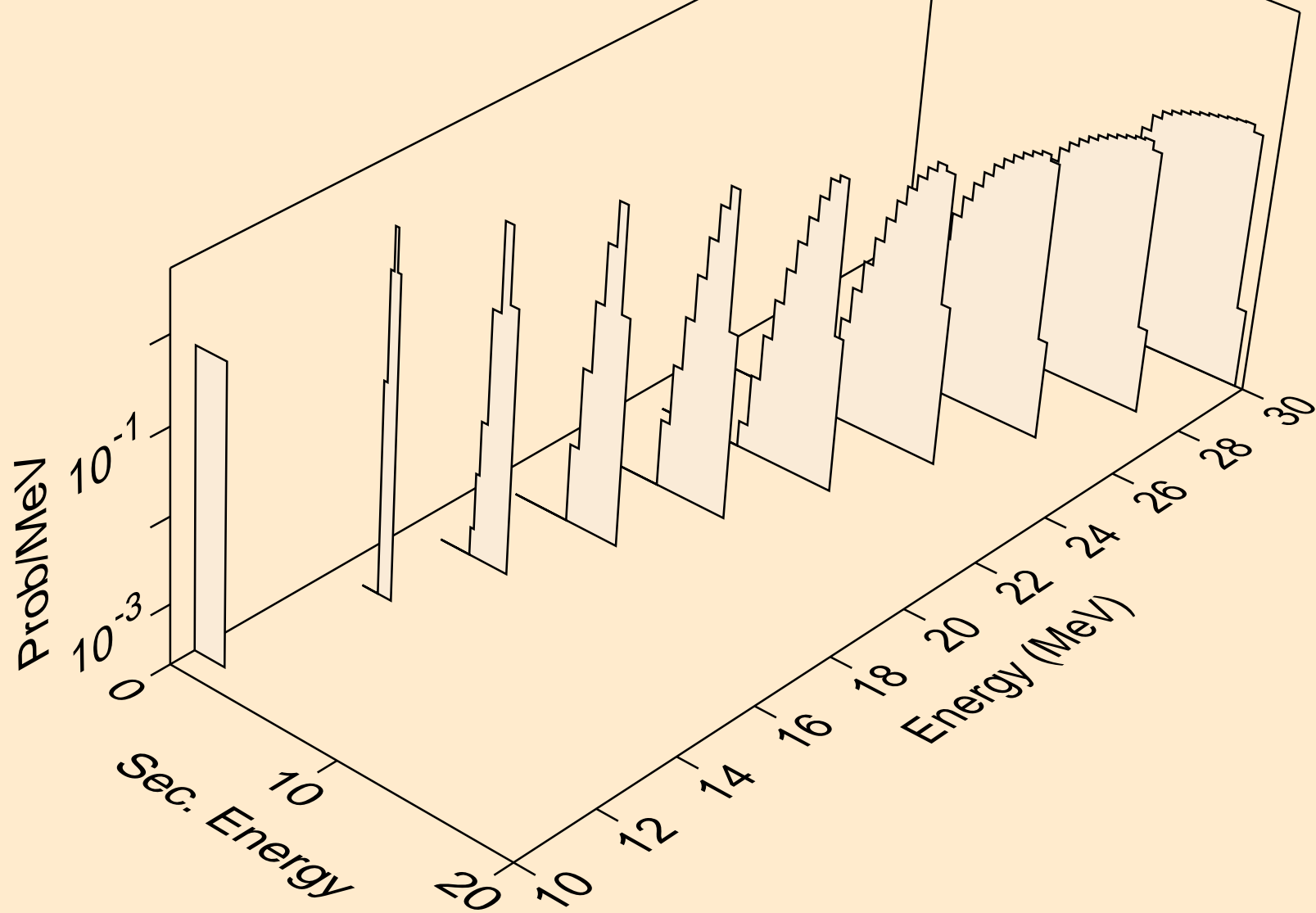

TH237 NEUTRON ACER TENDL-2024 LIBRARY; T=0.K
deuterons from (n,d)

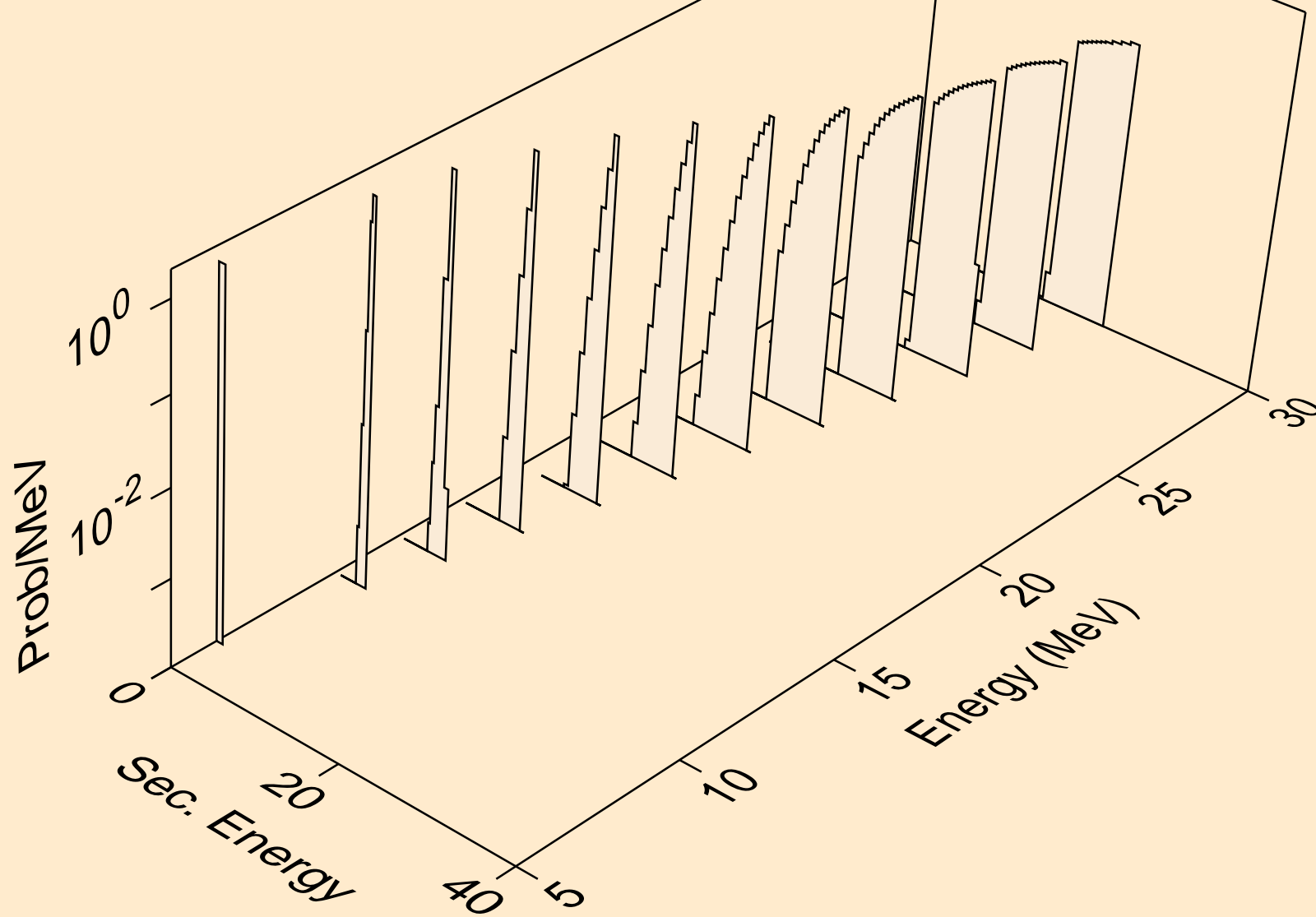

TH237 NEUTRON ACER TENDL-2024 LIBRARY; T=0.K
tritons from (n,x)

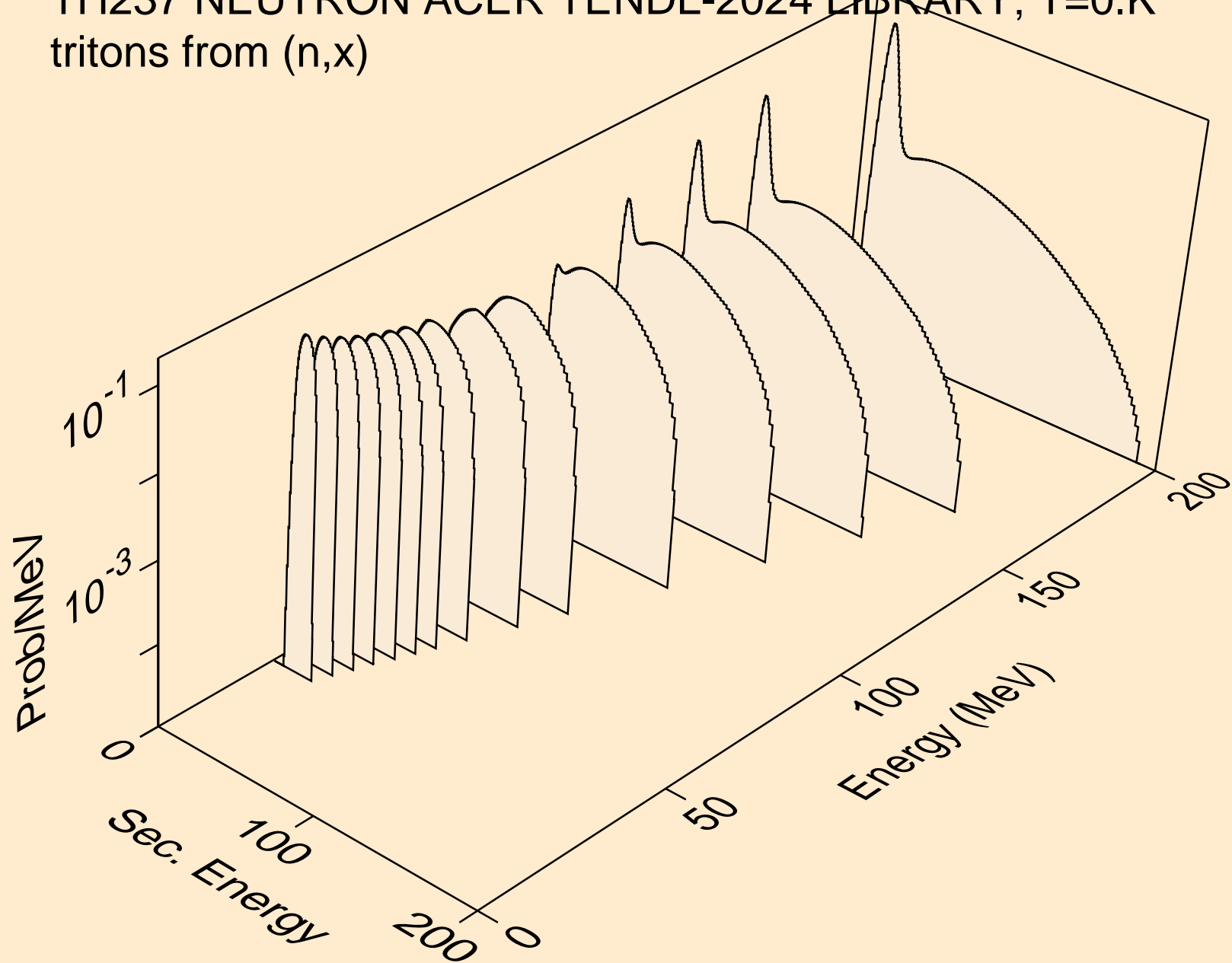

TH237 NEUTRON ACER TENDL-2024 LIBRARY; T=0.K
tritons from (n,n*)t

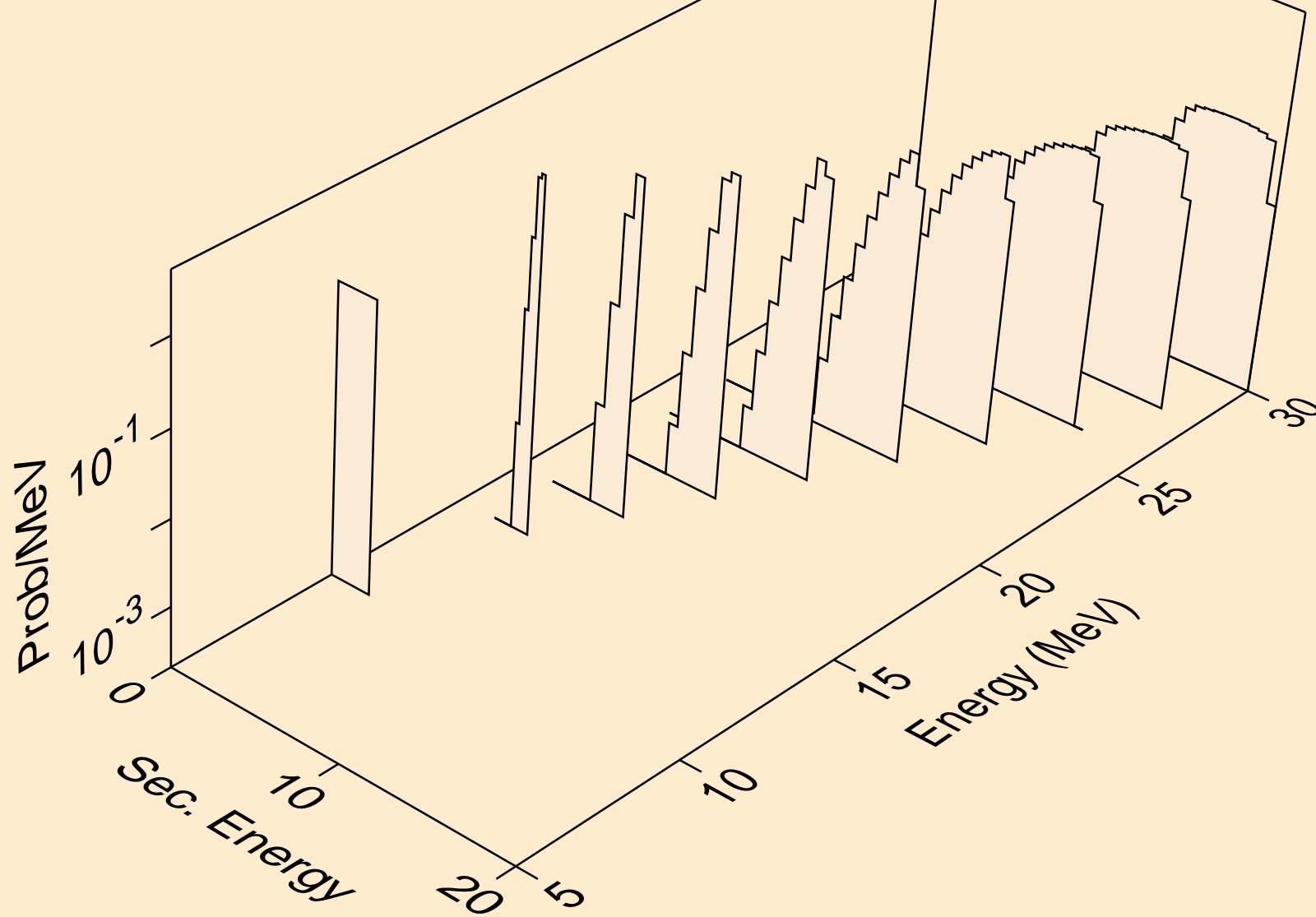

TH237 NEUTRON ACER TENDL-2024 LIBRARY; T=0.K
tritons from (n,t)

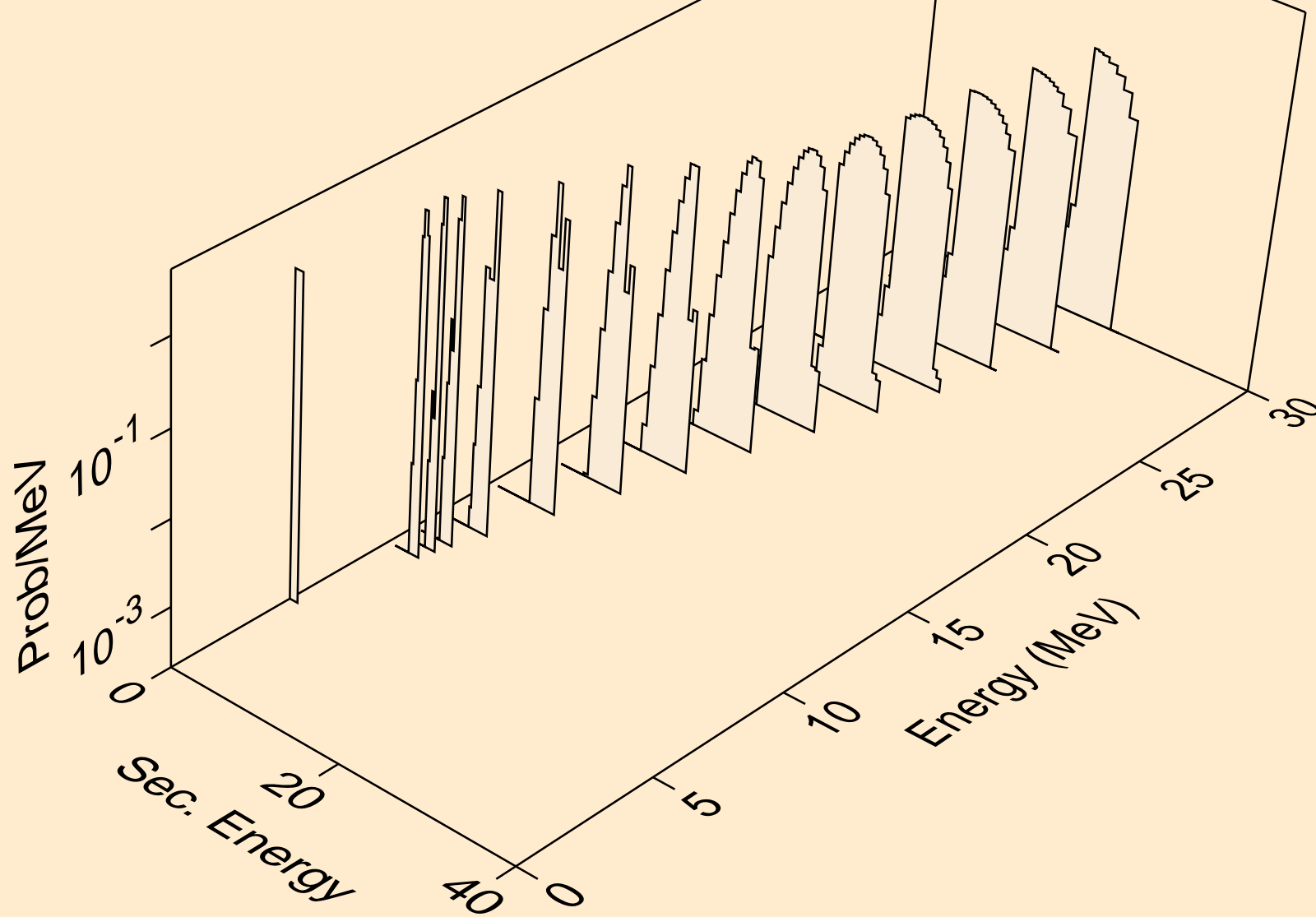

TH237 NEUTRON ACER TENDL-2024 LIBRARY; T=0.K
he3s from (n,x)

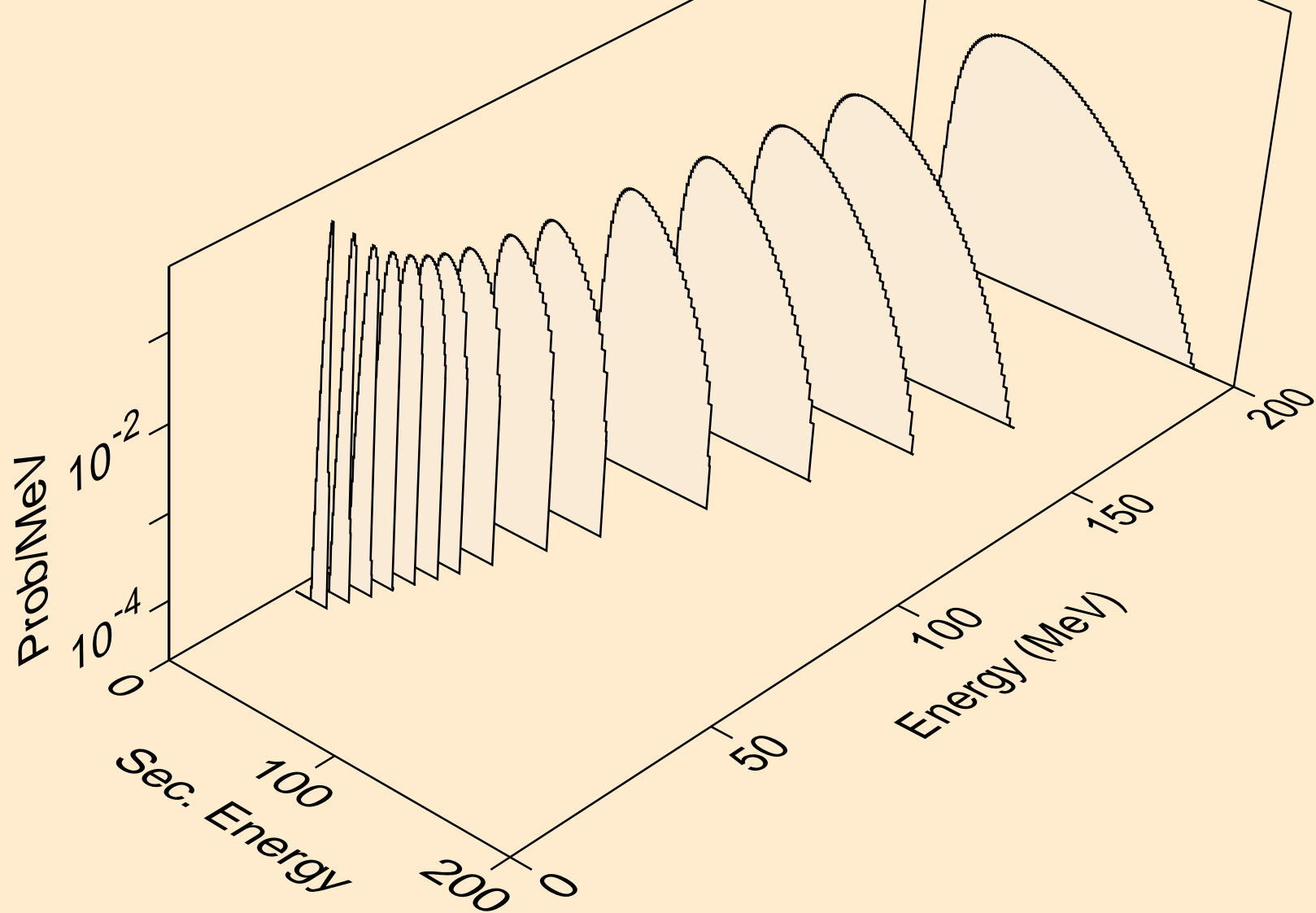

TH237 NEUTRON ACER TENDL-2024 LIBRARY; T=0.K
he3s from (n,n*)he3

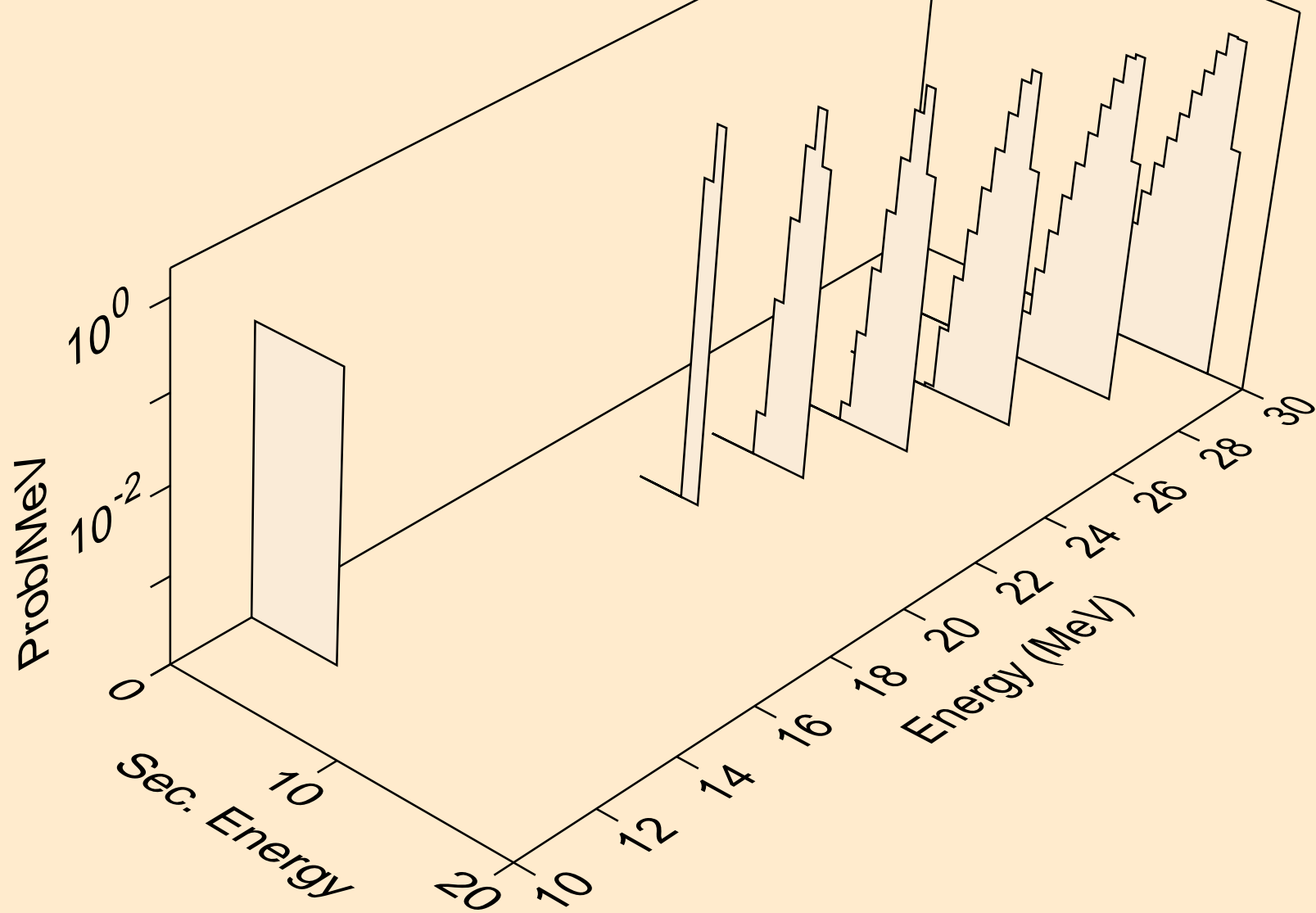

TH237 NEUTRON ACER TENDL-2024 LIBRARY; T=0.K
he3s from (n,he3)

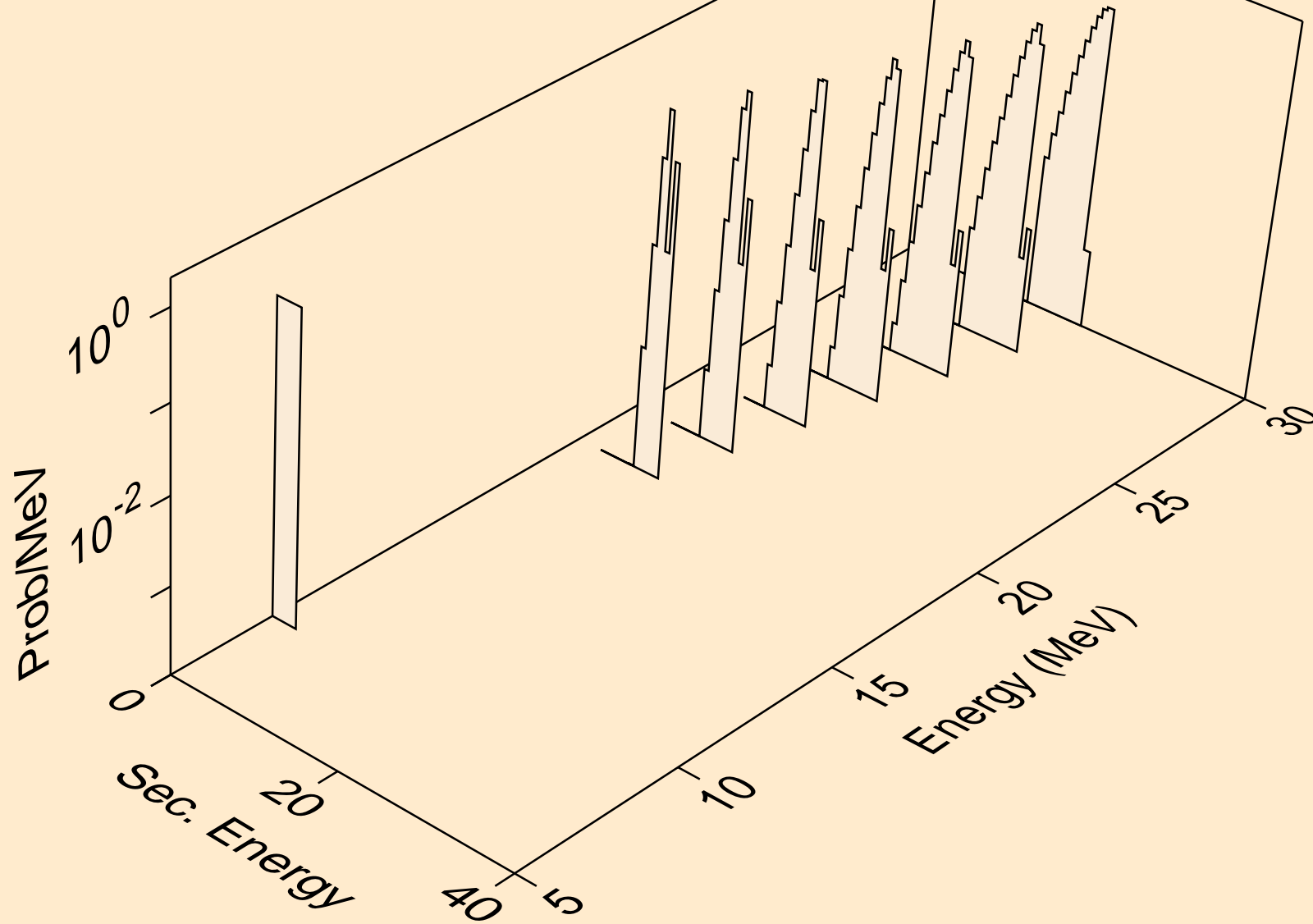

TH237 NEUTRON ACER TENDL-2024 LIBRARY; T=0.K
alphas from (n,x)

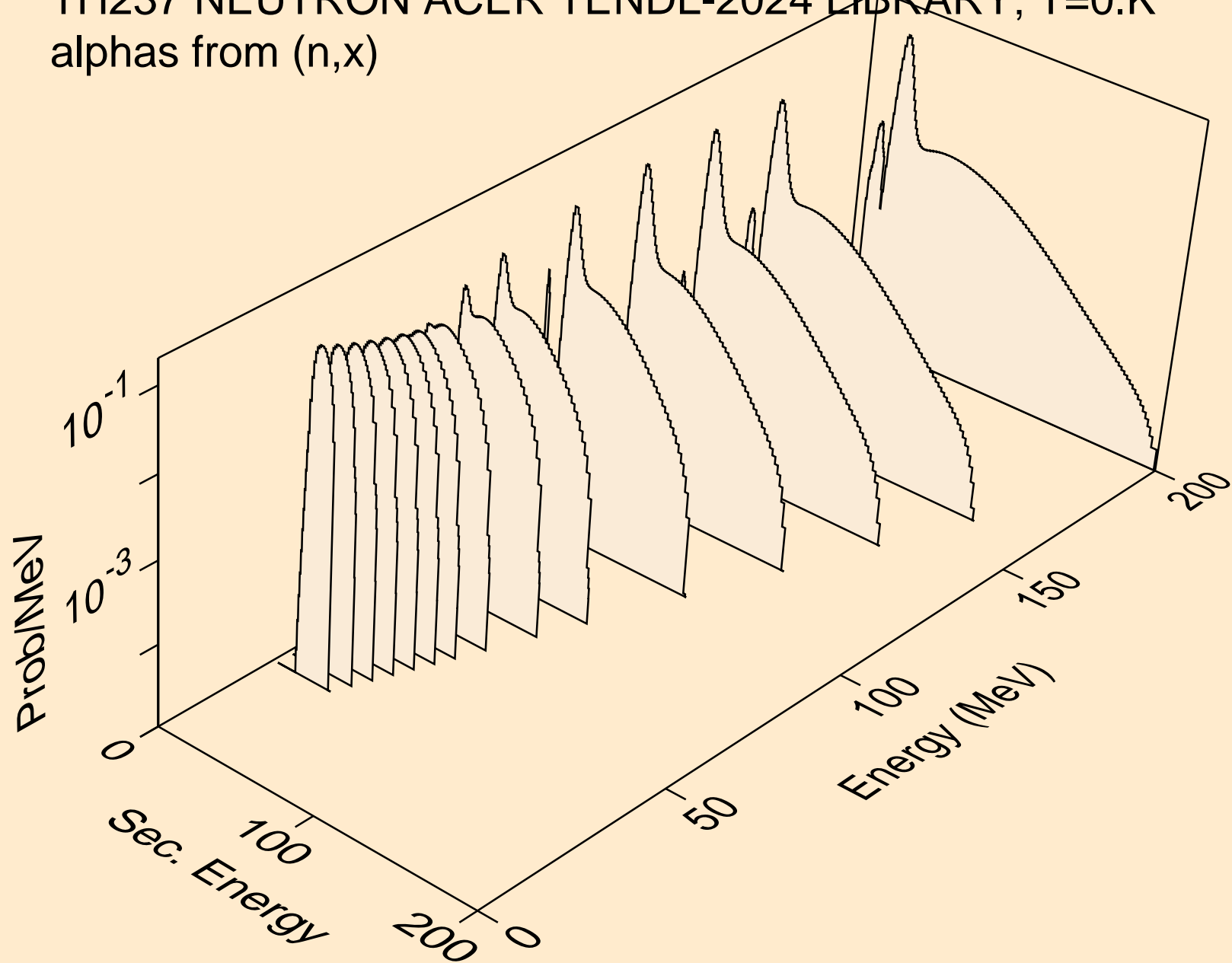

TH237 NEUTRON ACER TENDL-2024 LIBRARY; T=0.K
alphas from (n,n*)a

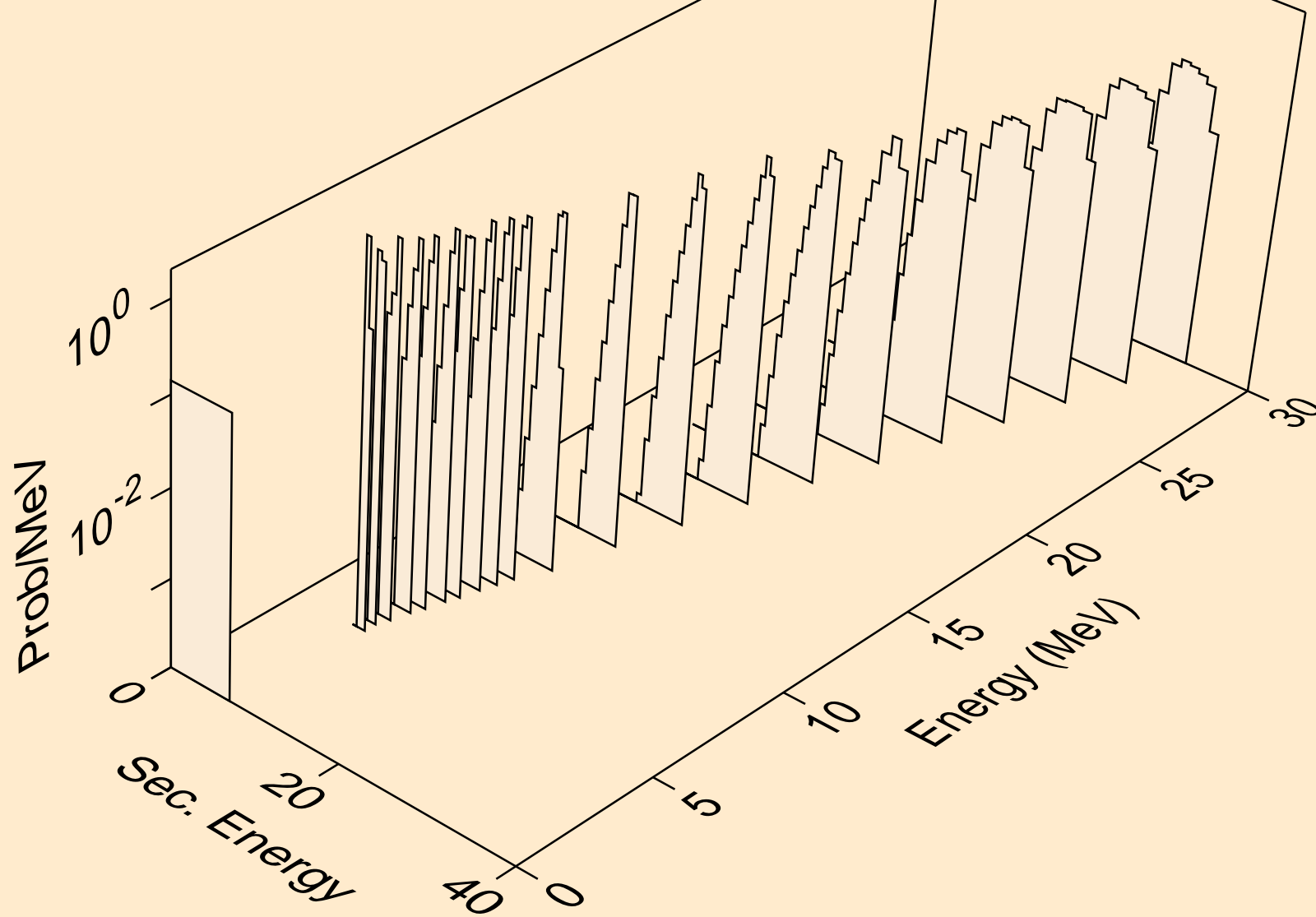

TH237 NEUTRON ACER TENDL-2024 LIBRARY; T=0.K
alphas from (n,2n)a

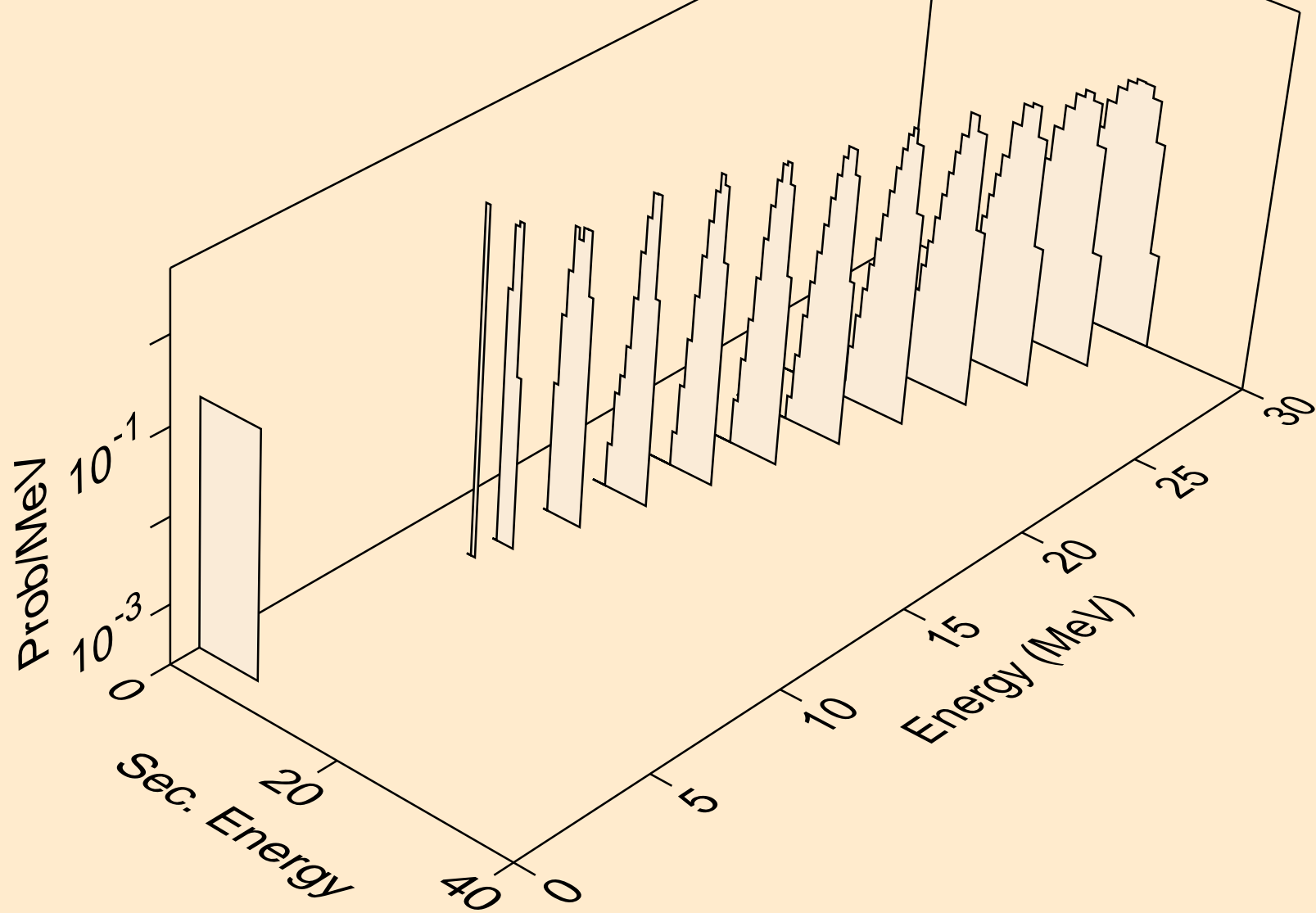

TH237 NEUTRON ACER TENDL-2024 LIBRARY; T=0.K
alphas from (n,3n)a

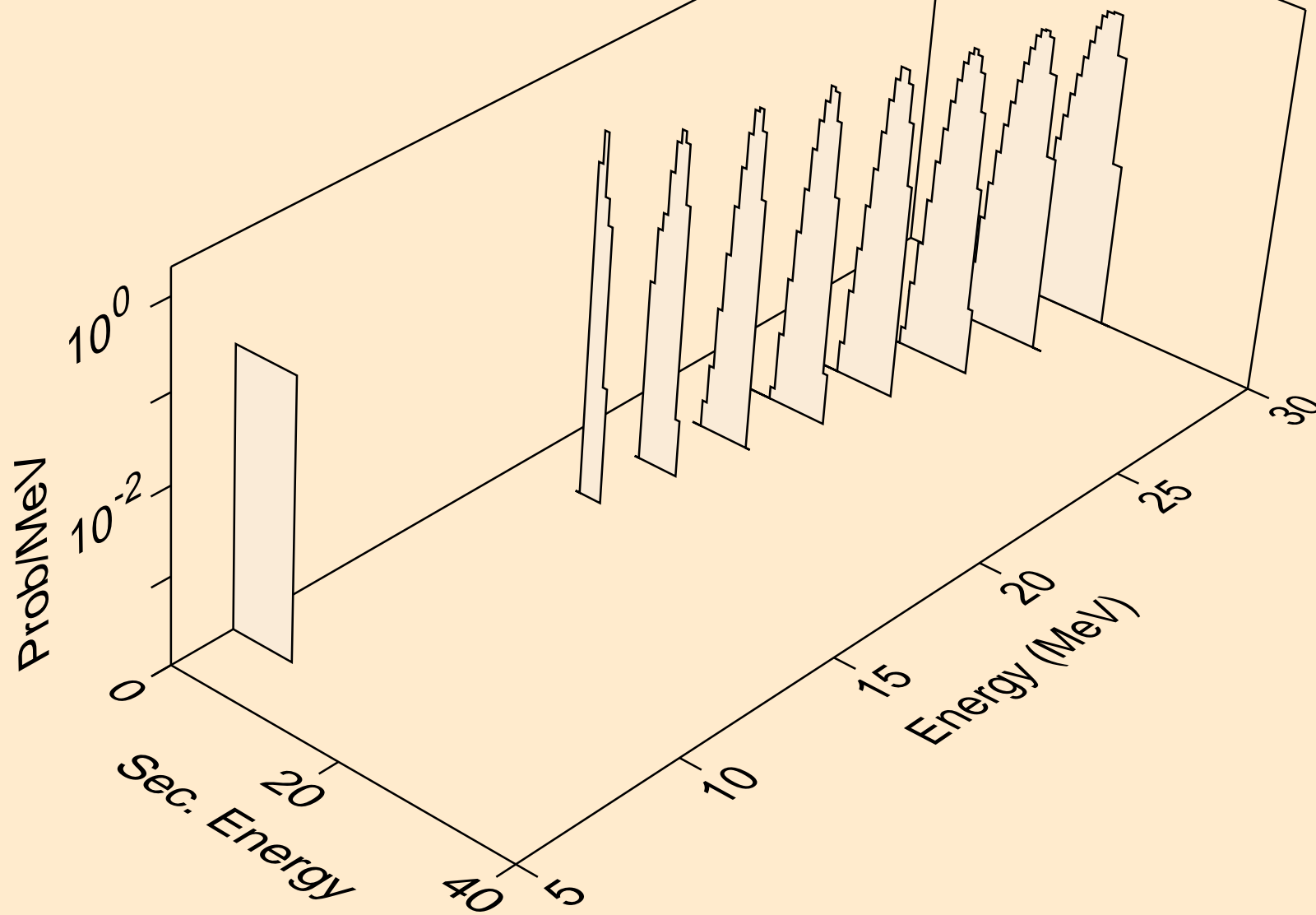

TH237 NEUTRON ACER TENDL-2024 LIBRARY; T=0.K
alphas from (n,a)

