

TI053 NEUTRON ACER TENDL-2024 LIBRARY; T=0.K

Principal cross sections

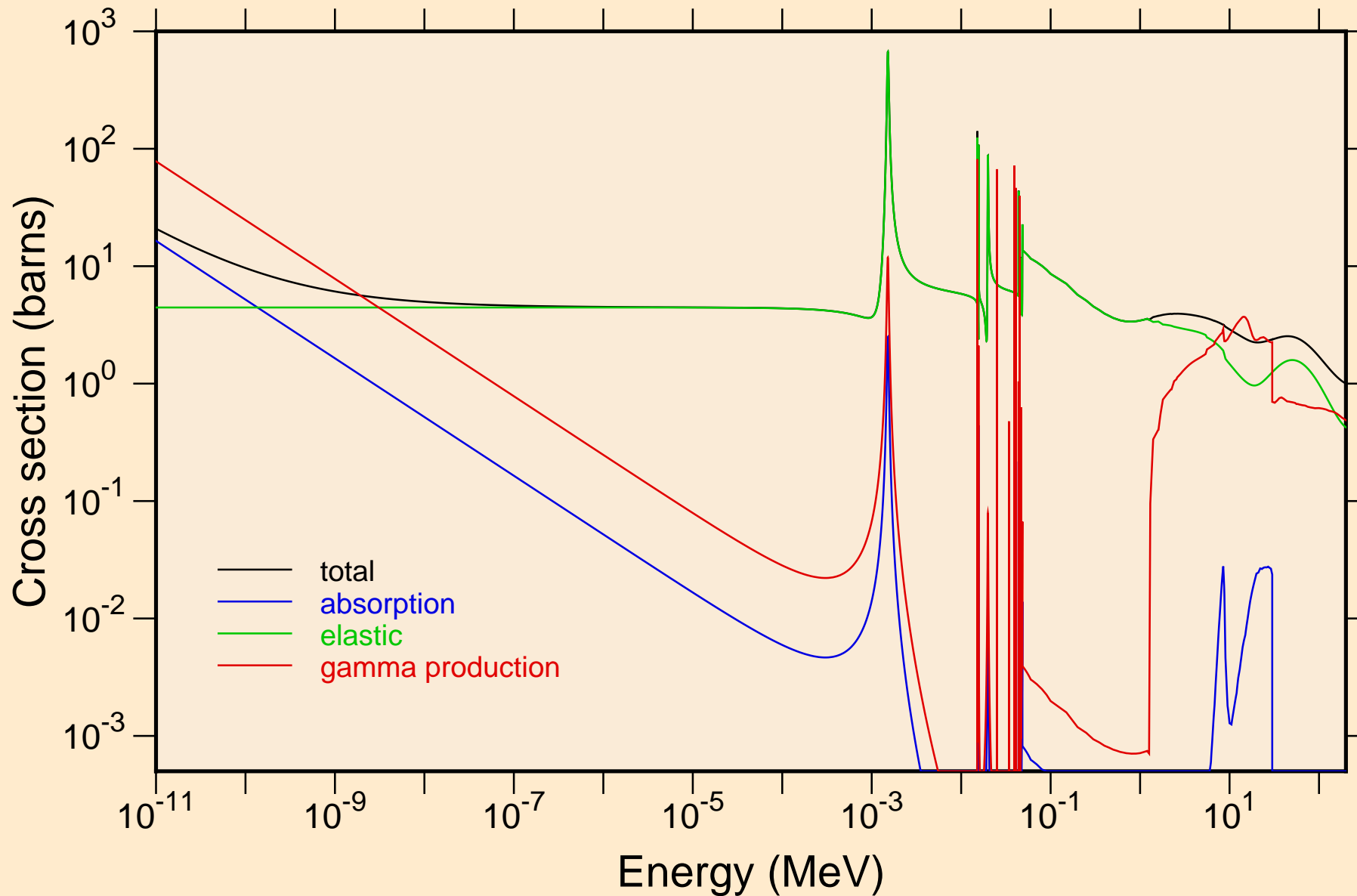

TI053 NEUTRON ACER TENDL-2024 LIBRARY; T=0.K
resonance total cross section

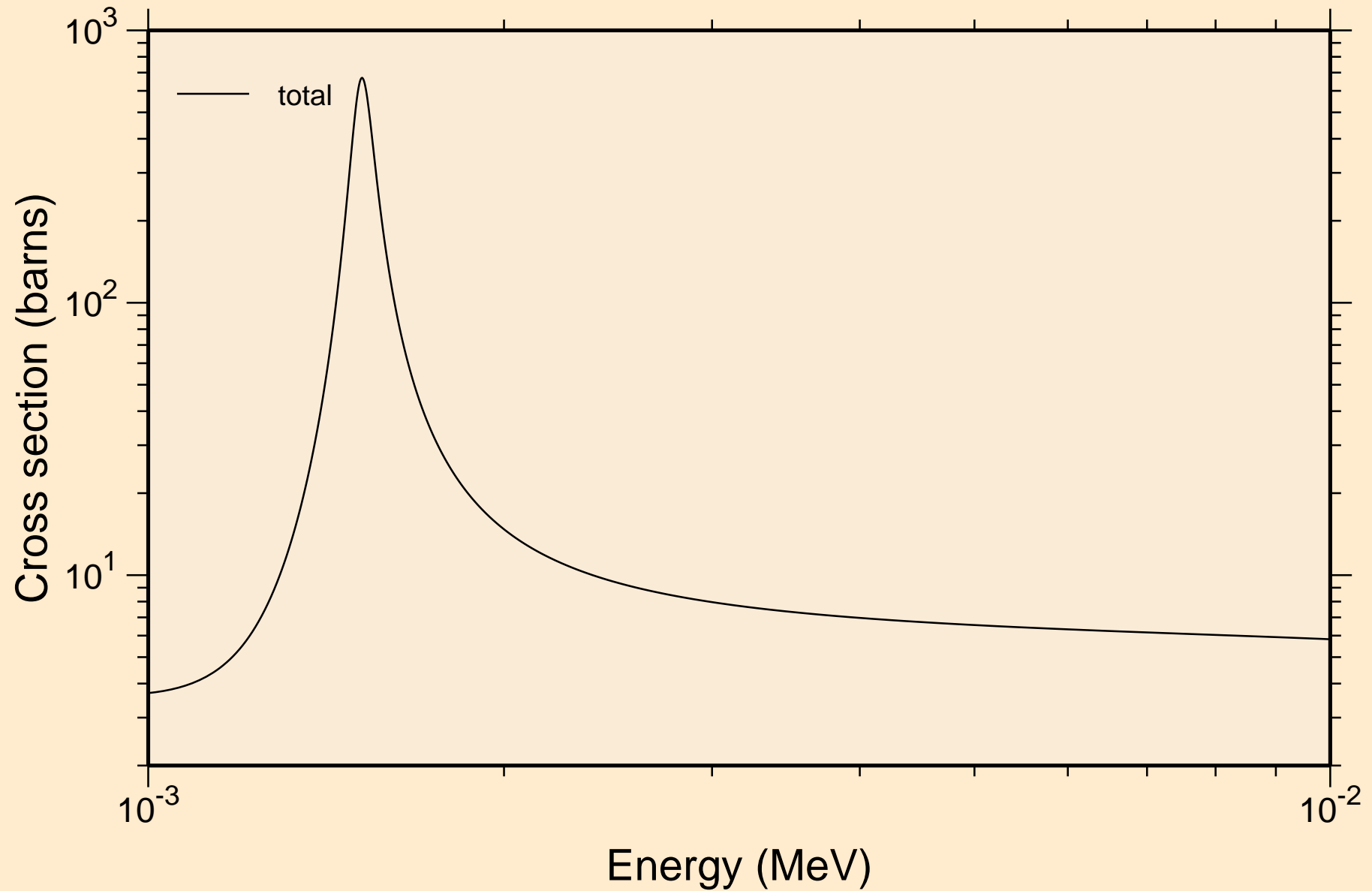

TI053 NEUTRON ACER TENDL-2024 LIBRARY; T=0.K
resonance total cross section

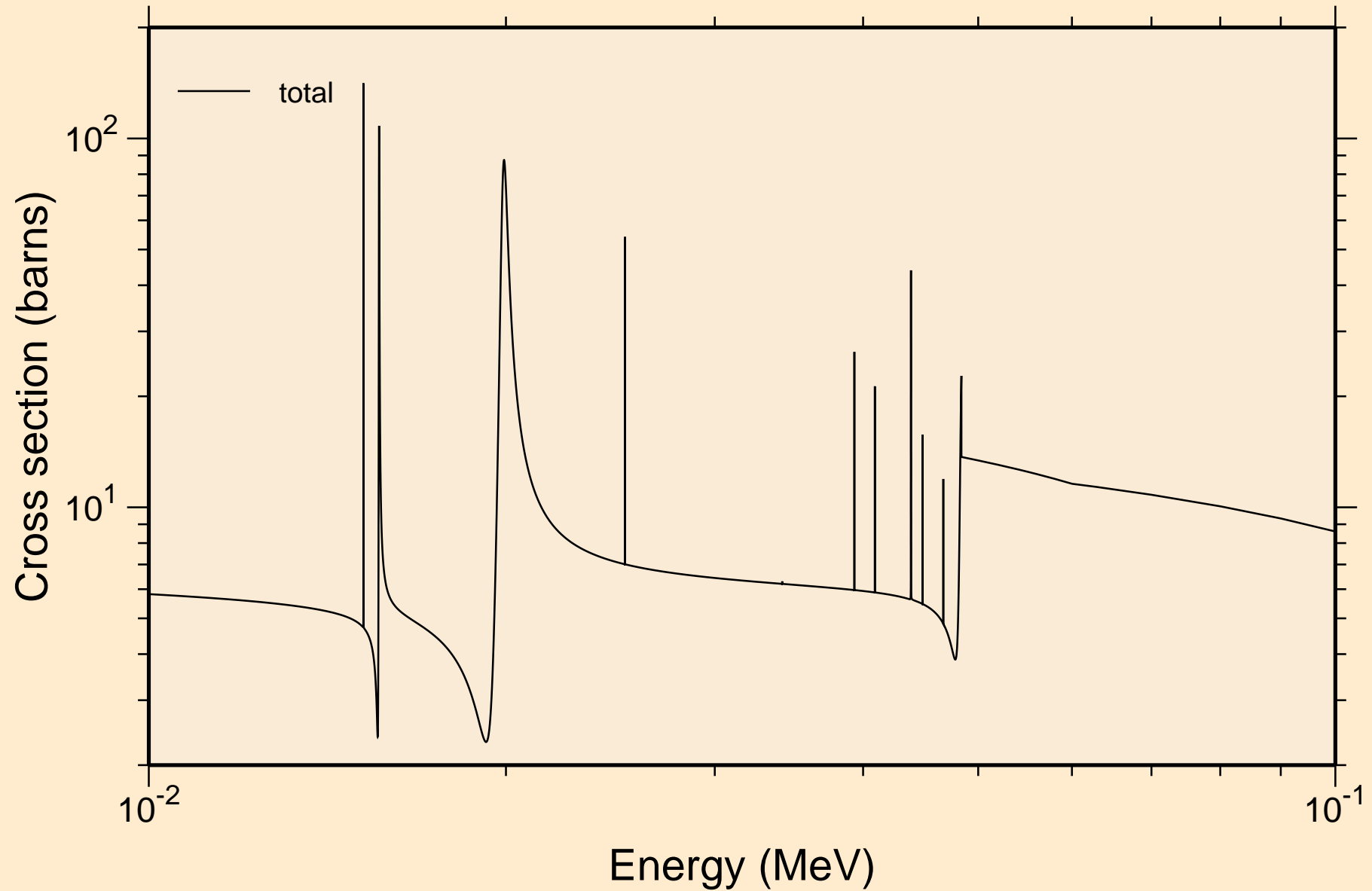

TI053 NEUTRON ACER TENDL-2024 LIBRARY; T=0.K
resonance total cross section

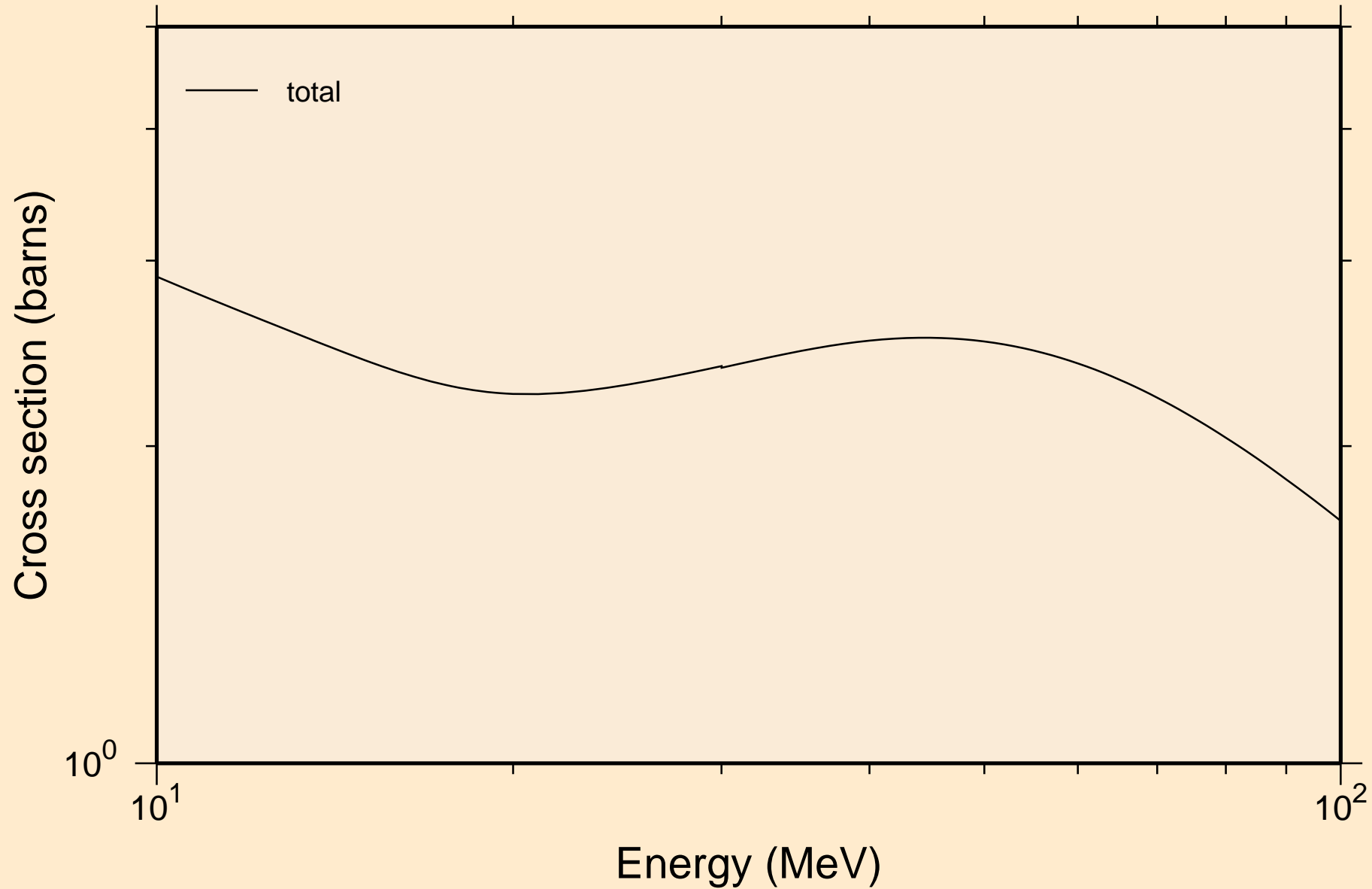

TI053 NEUTRON ACER TENDL-2024 LIBRARY; T=0.K
resonance absorption cross sections

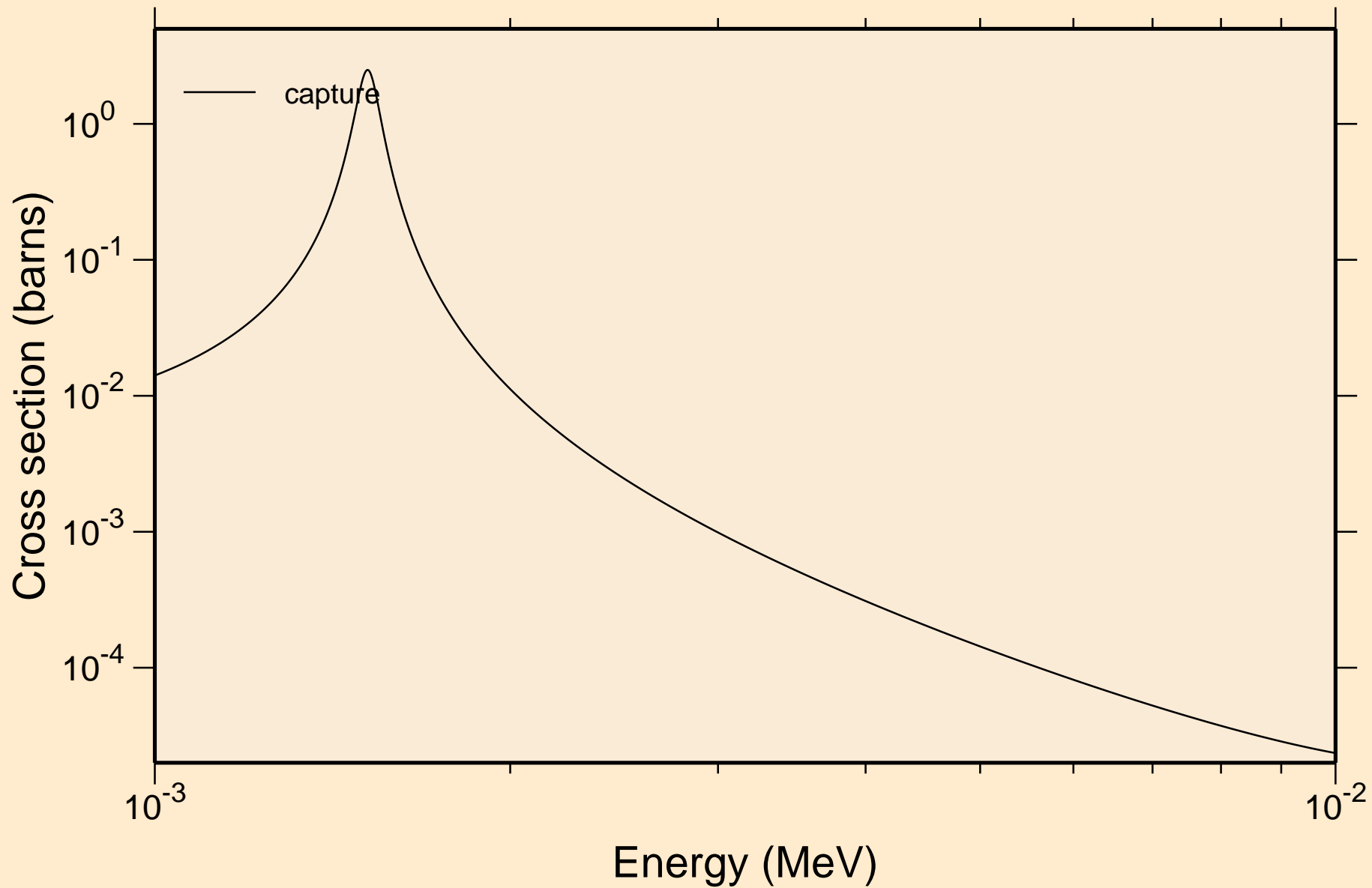

TI053 NEUTRON ACER TENDL-2024 LIBRARY; T=0.K
resonance absorption cross sections

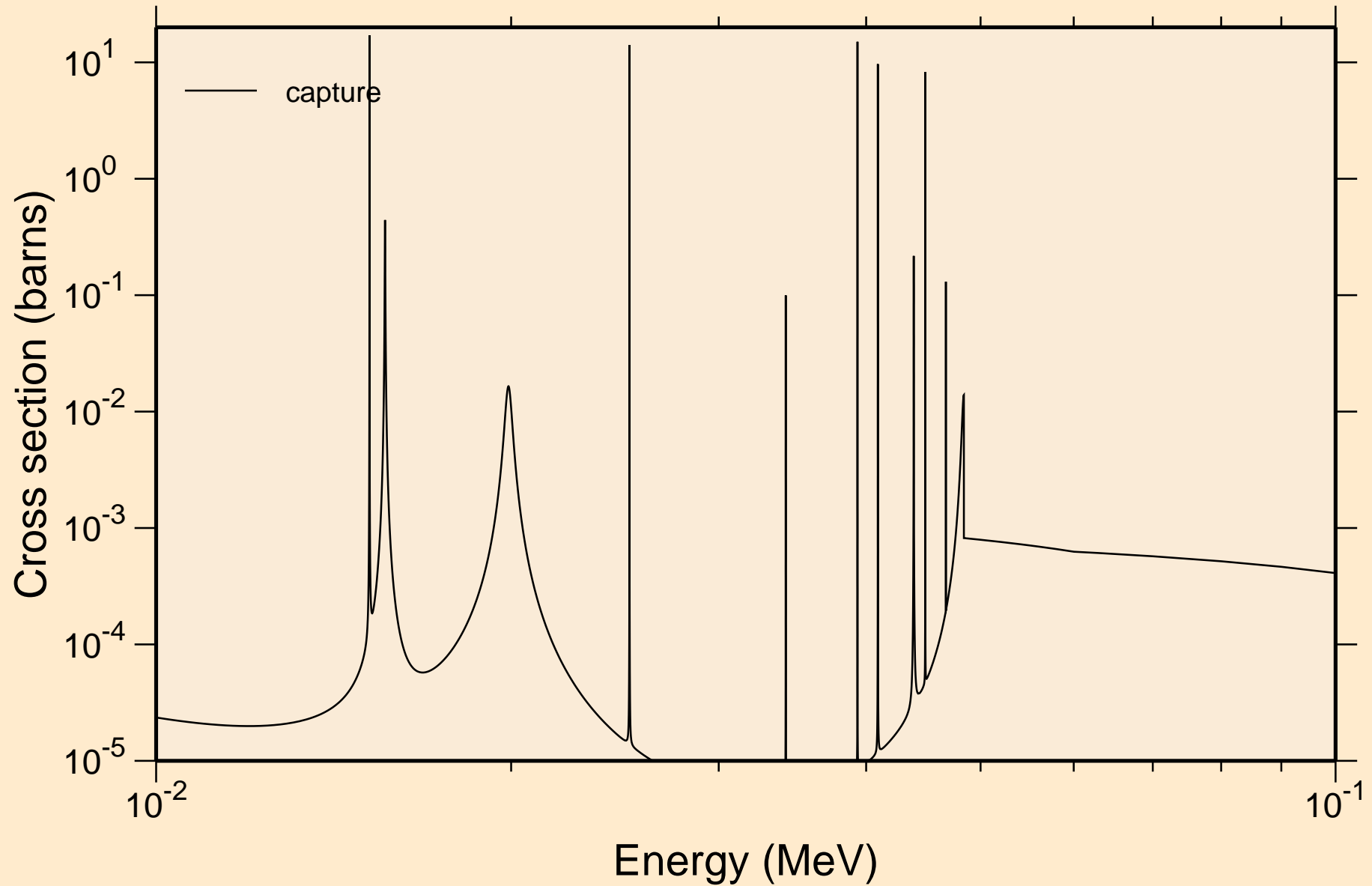

TI053 NEUTRON ACER TENDL-2024 LIBRARY; T=0.K
resonance absorption cross sections

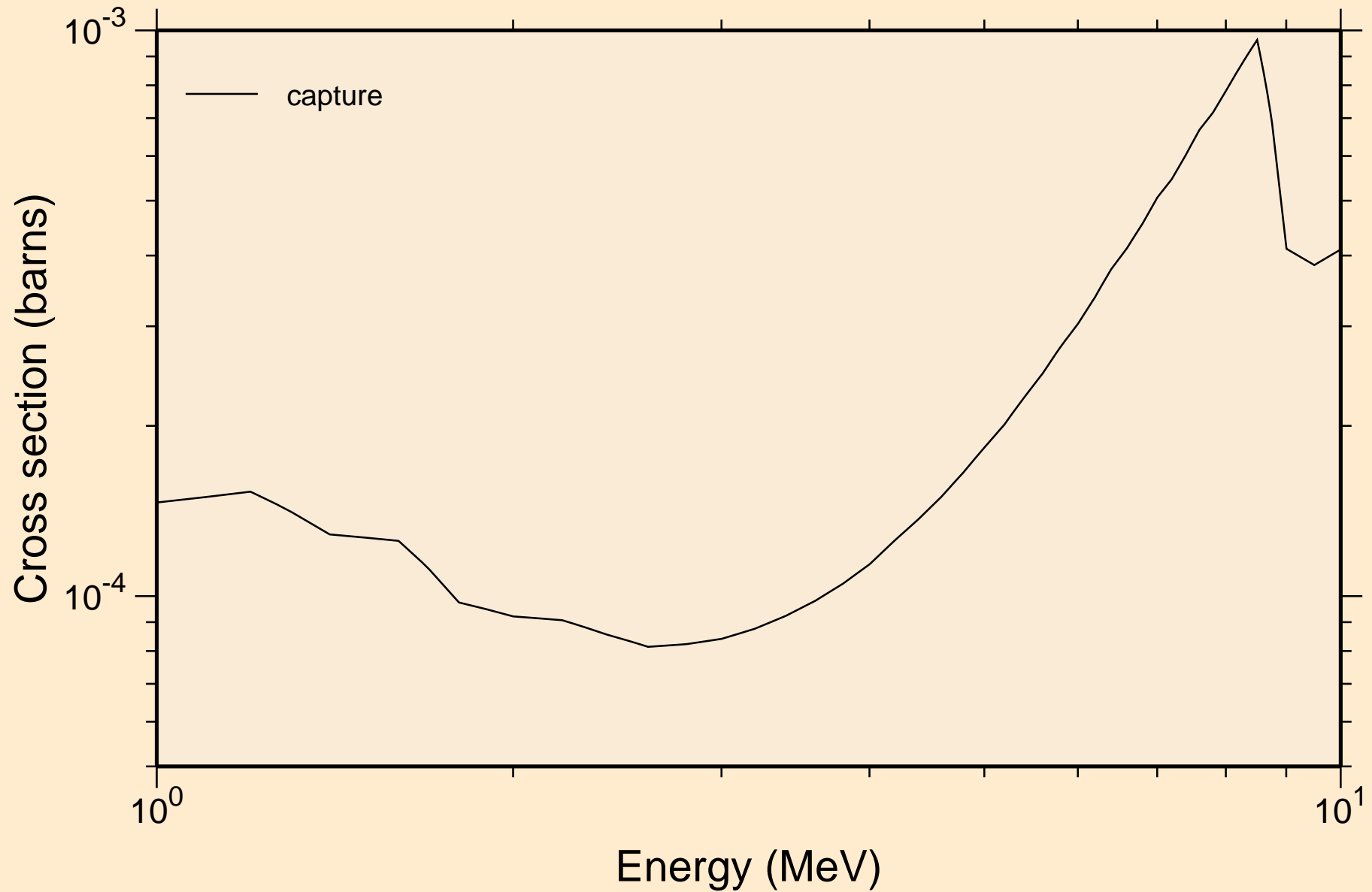

TI053 NEUTRON ACER TENDL-2024 LIBRARY; T=0.K
Heating

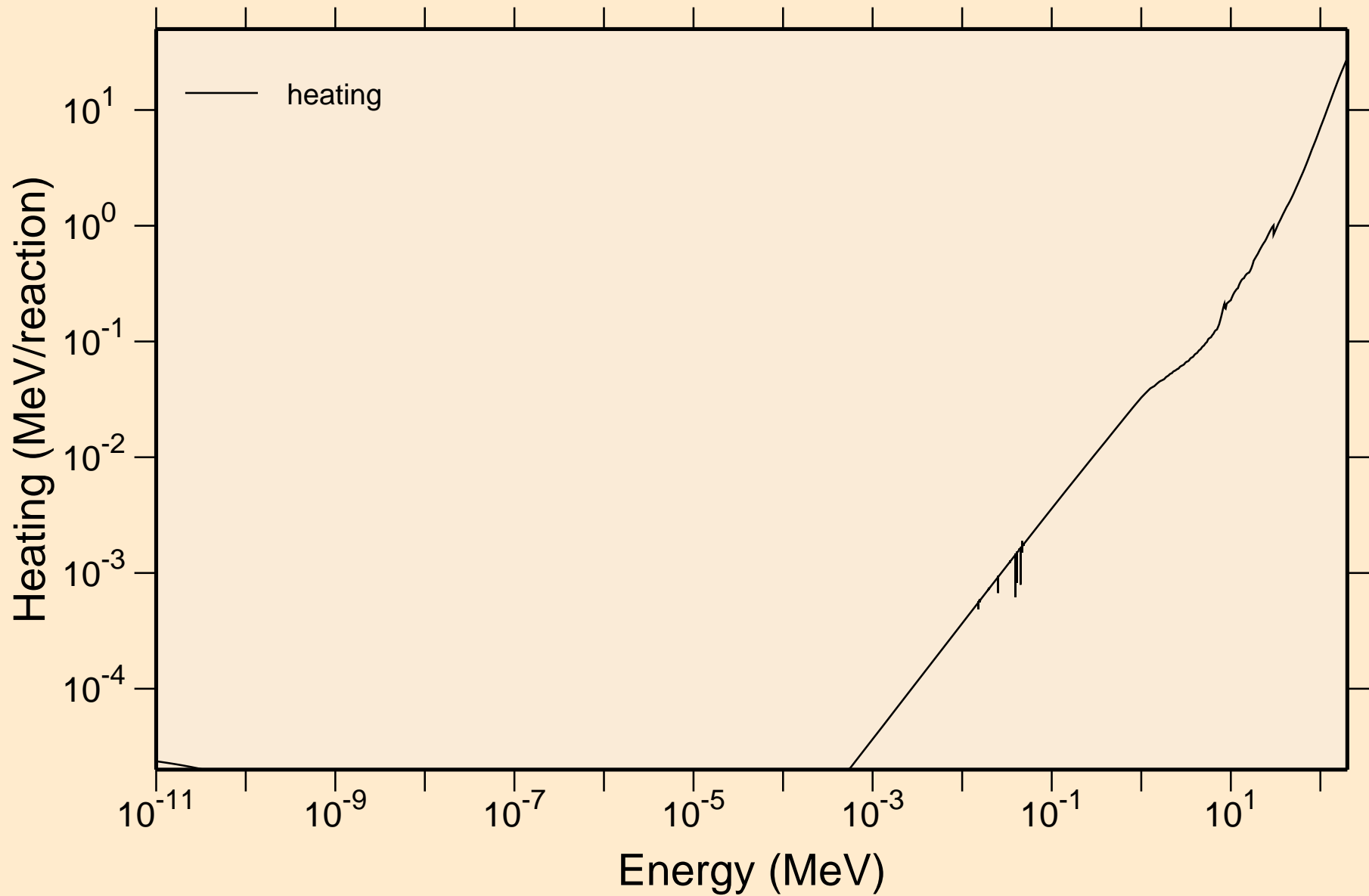

TI053 NEUTRON ACER TENDL-2024 LIBRARY; T=0.K
Damage

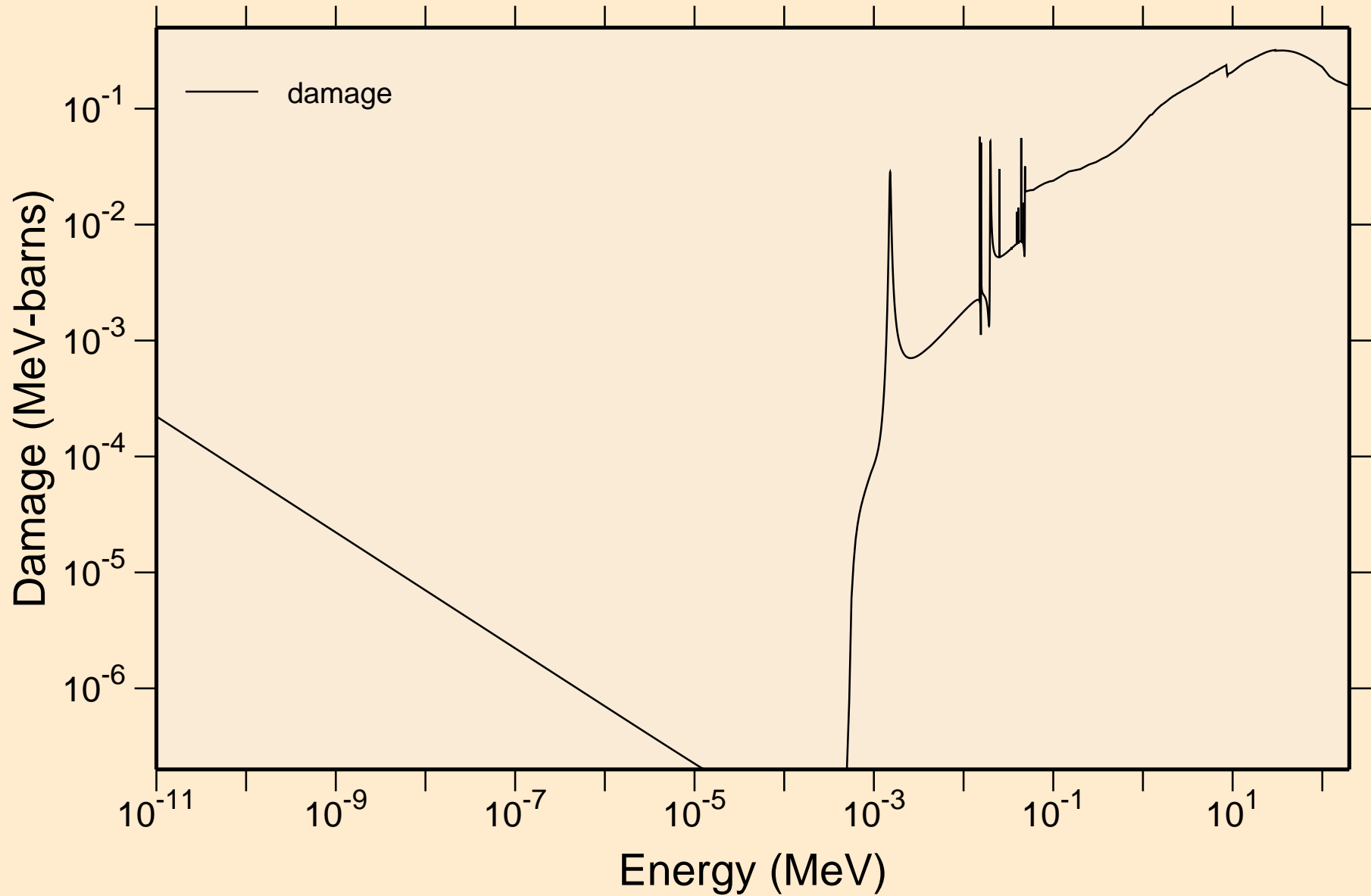

TI053 NEUTRON ACER TENDL-2024 LIBRARY; T=0.K
Non-threshold reactions

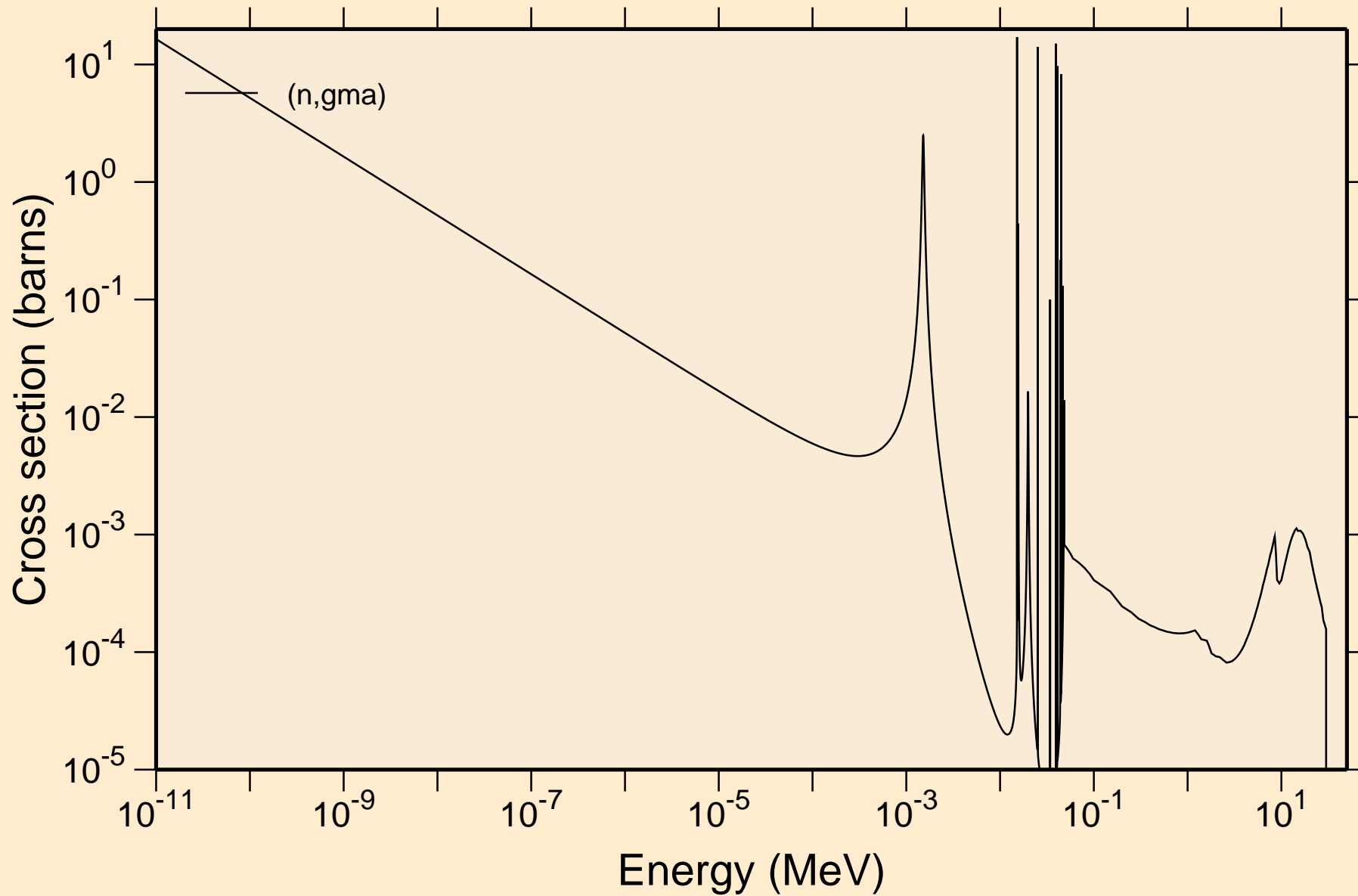

TI053 NEUTRON ACER TENDL-2024 LIBRARY; T=0.K

Principal cross sections

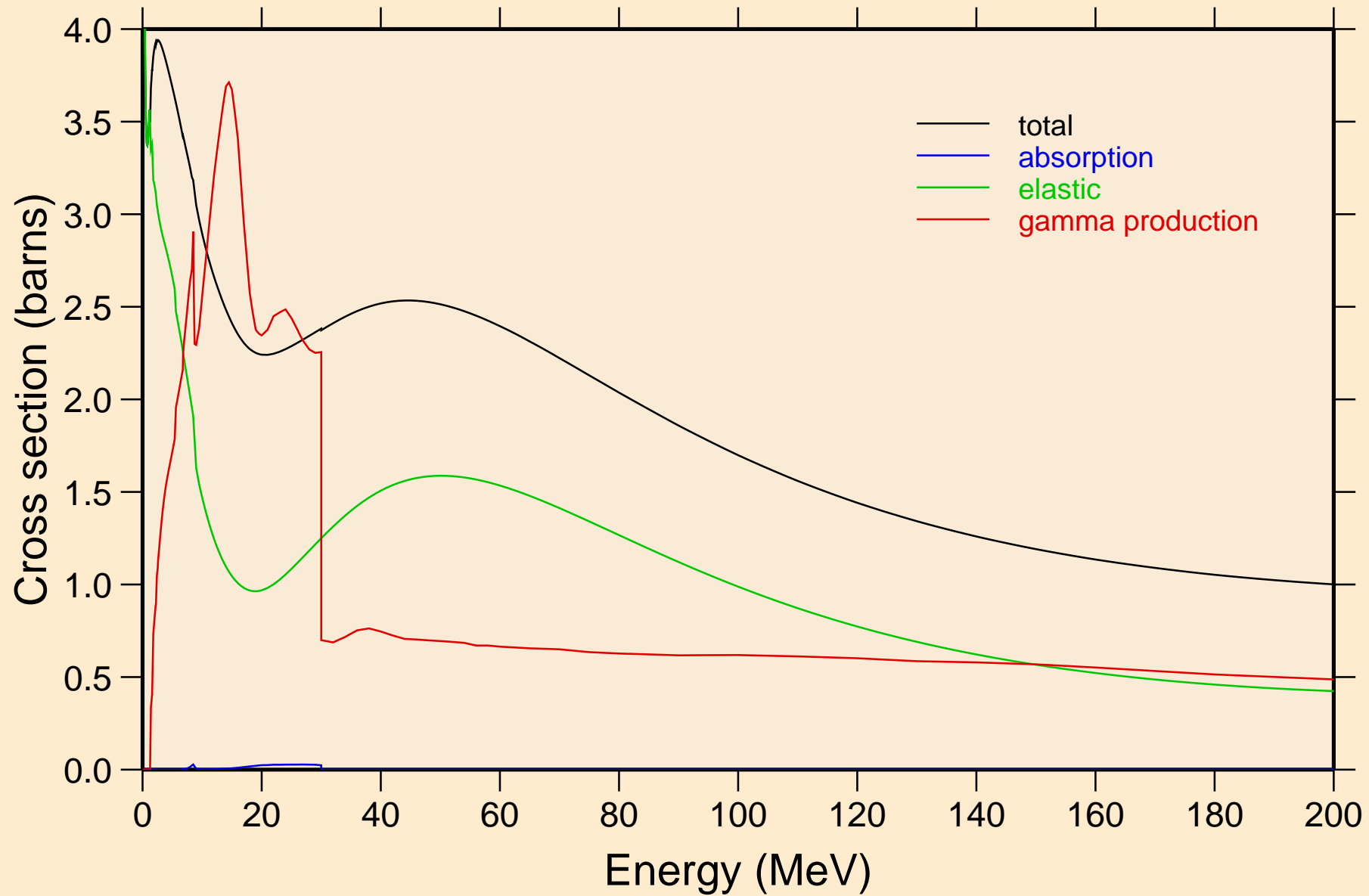

TI053 NEUTRON ACER TENDL-2024 LIBRARY; T=0.K

Heating

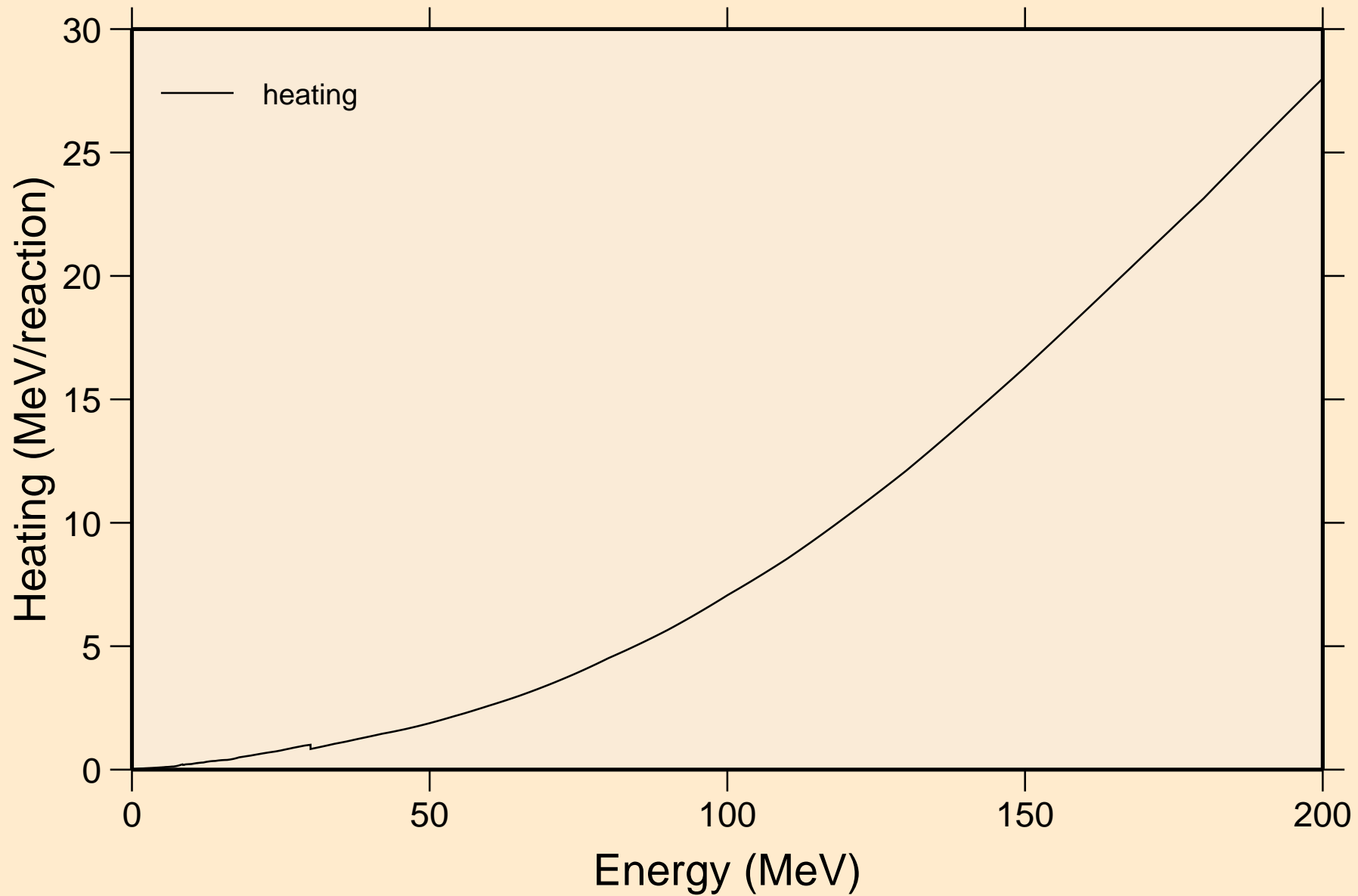

TI053 NEUTRON ACER TENDL-2024 LIBRARY; T=0.K
Damage

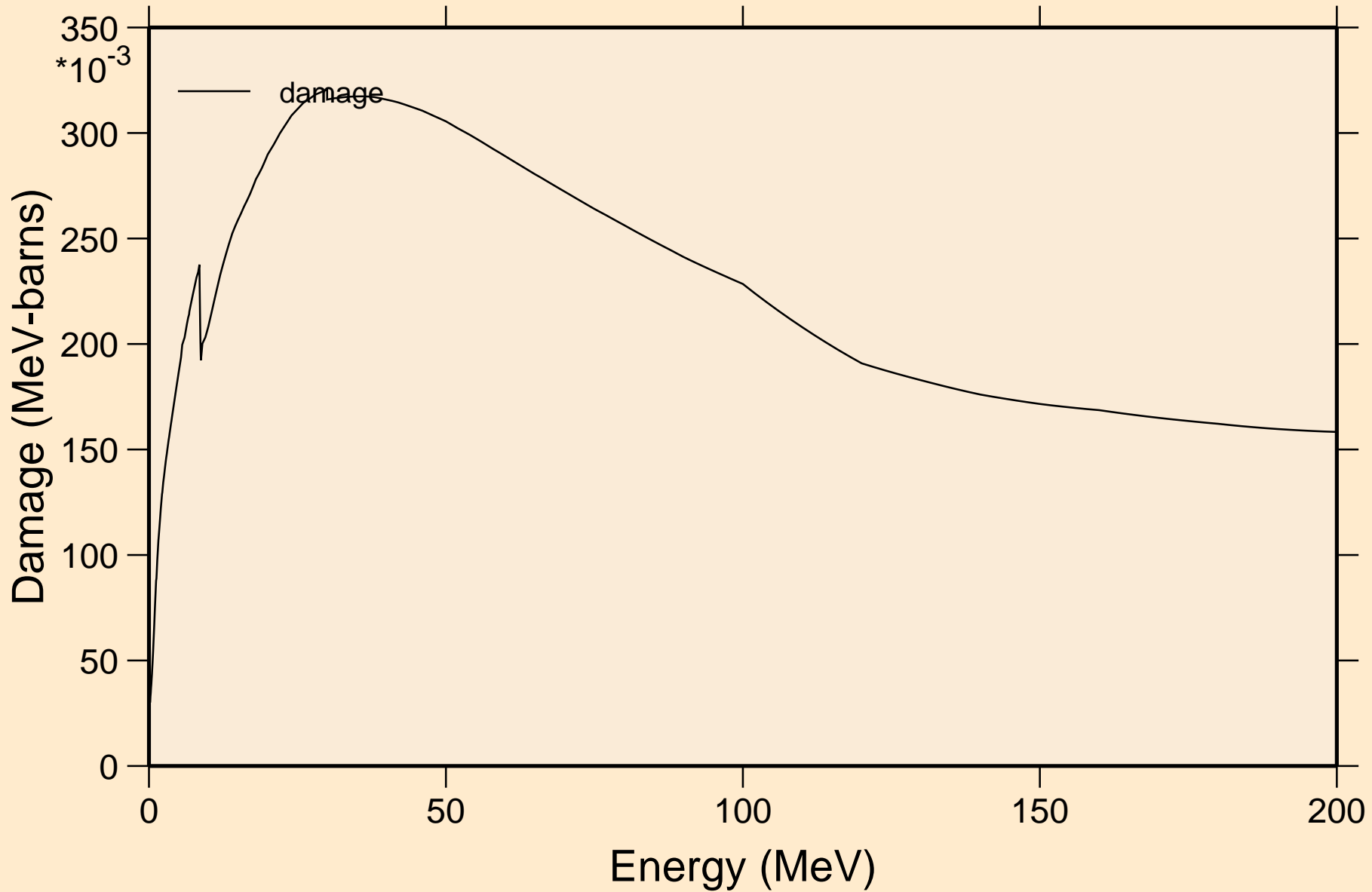

TI053 NEUTRON ACER TENDL-2024 LIBRARY; T=0.K
Non-threshold reactions

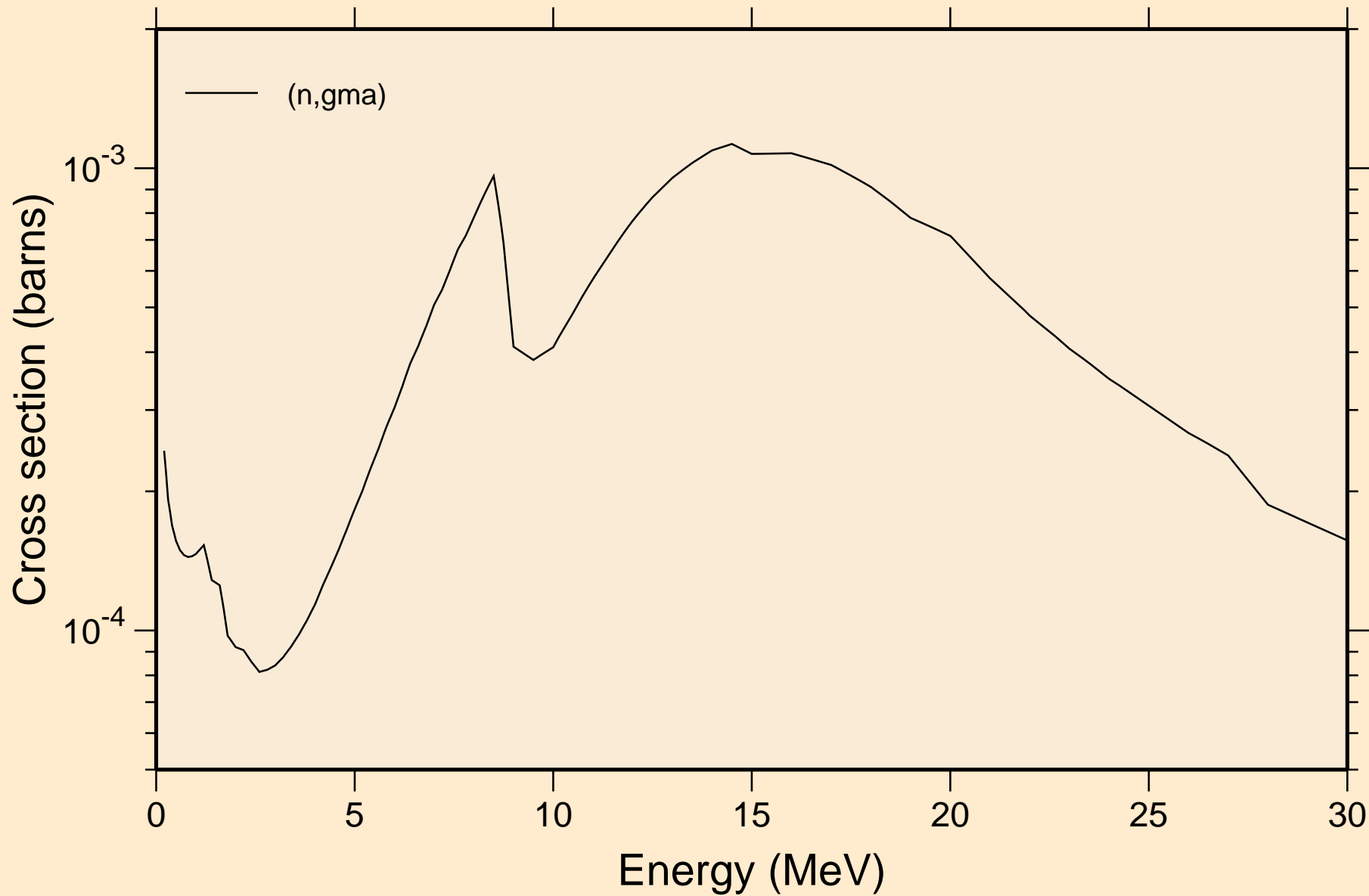

TI053 NEUTRON ACER TENDL-2024 LIBRARY; T=0.K
Inelastic levels

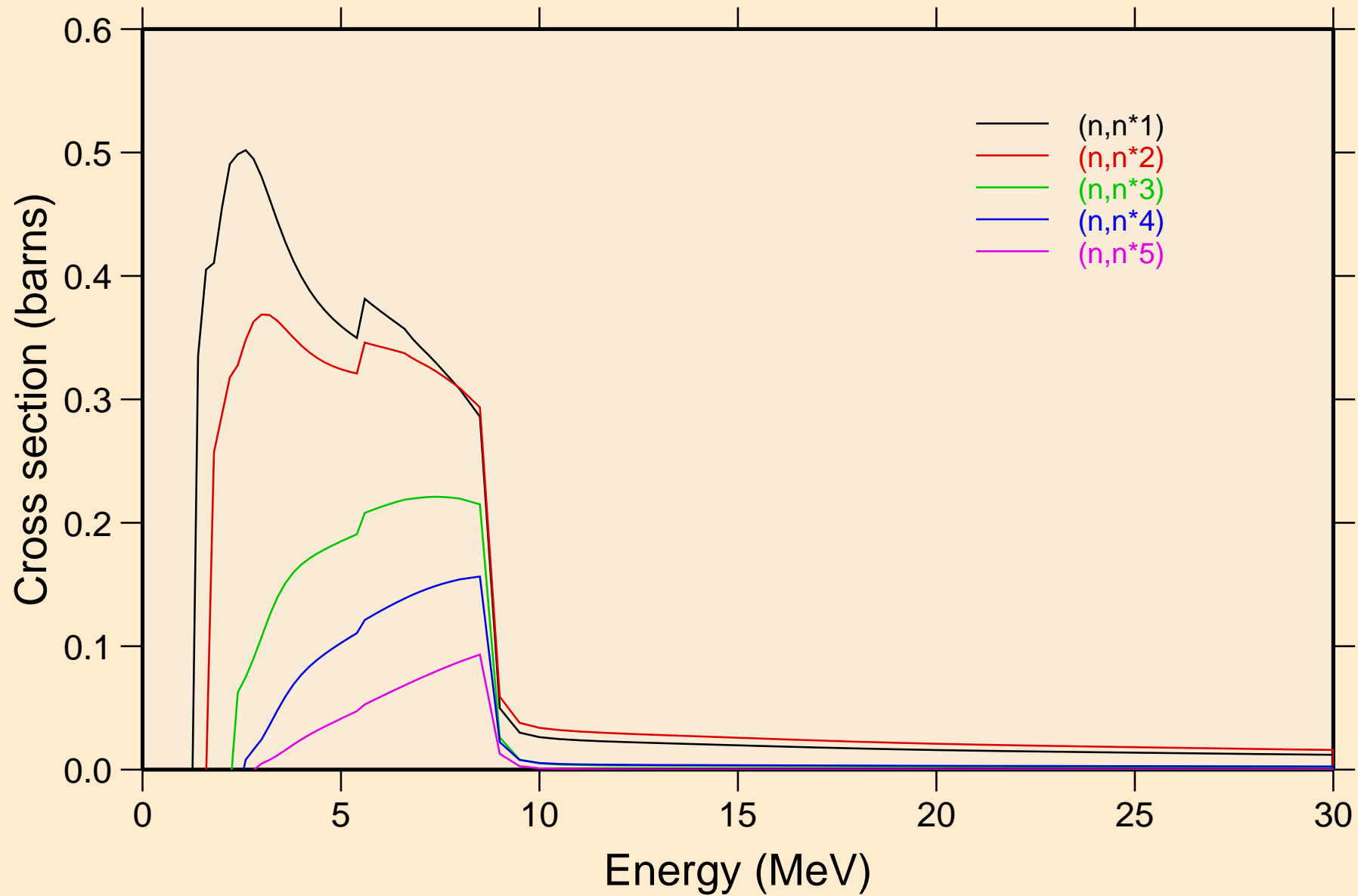

TI053 NEUTRON ACER TENDL-2024 LIBRARY; T=0.K
Inelastic levels

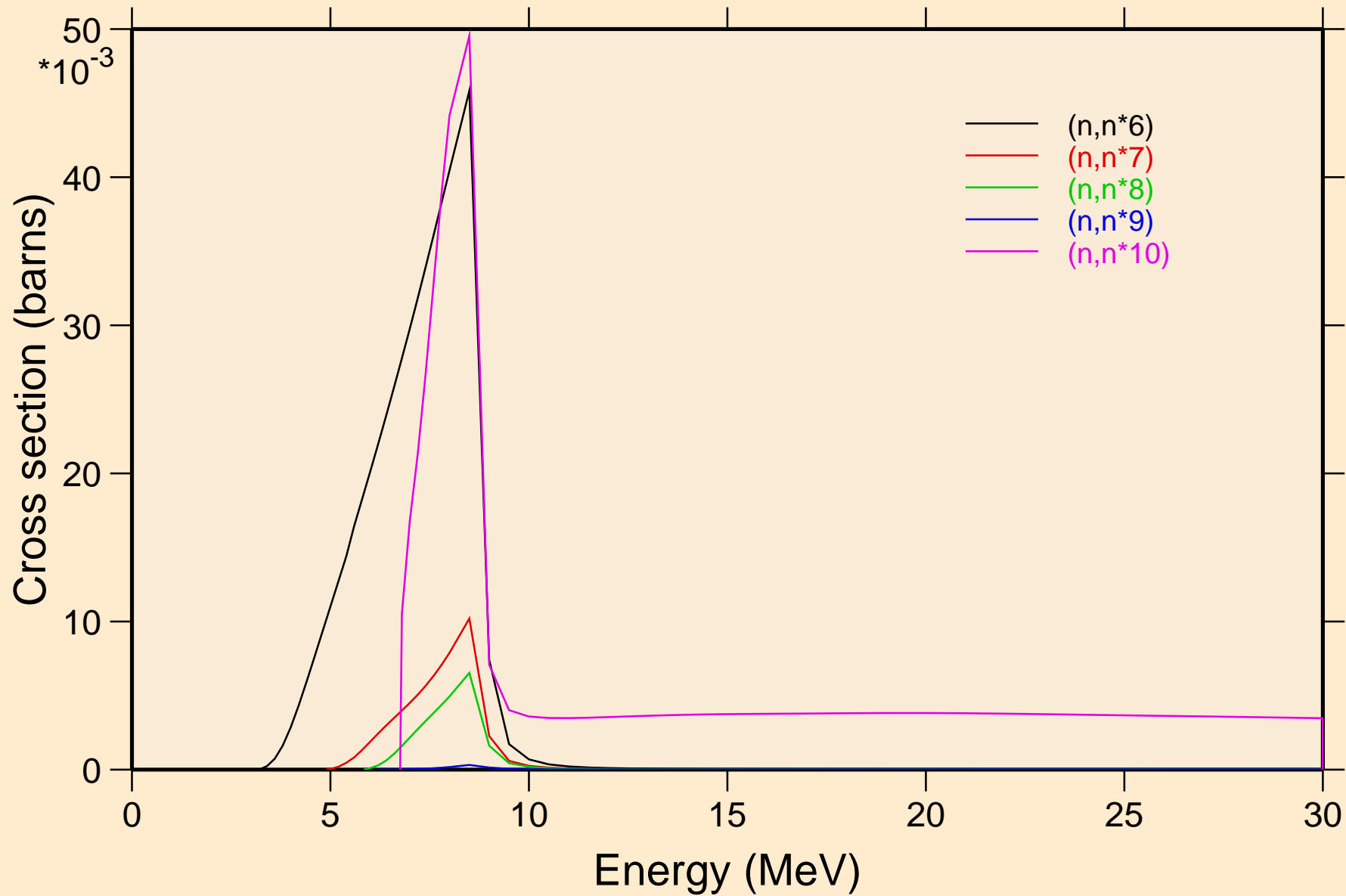

TI053 NEUTRON ACER TENDL-2024 LIBRARY; T=0.K
Inelastic levels

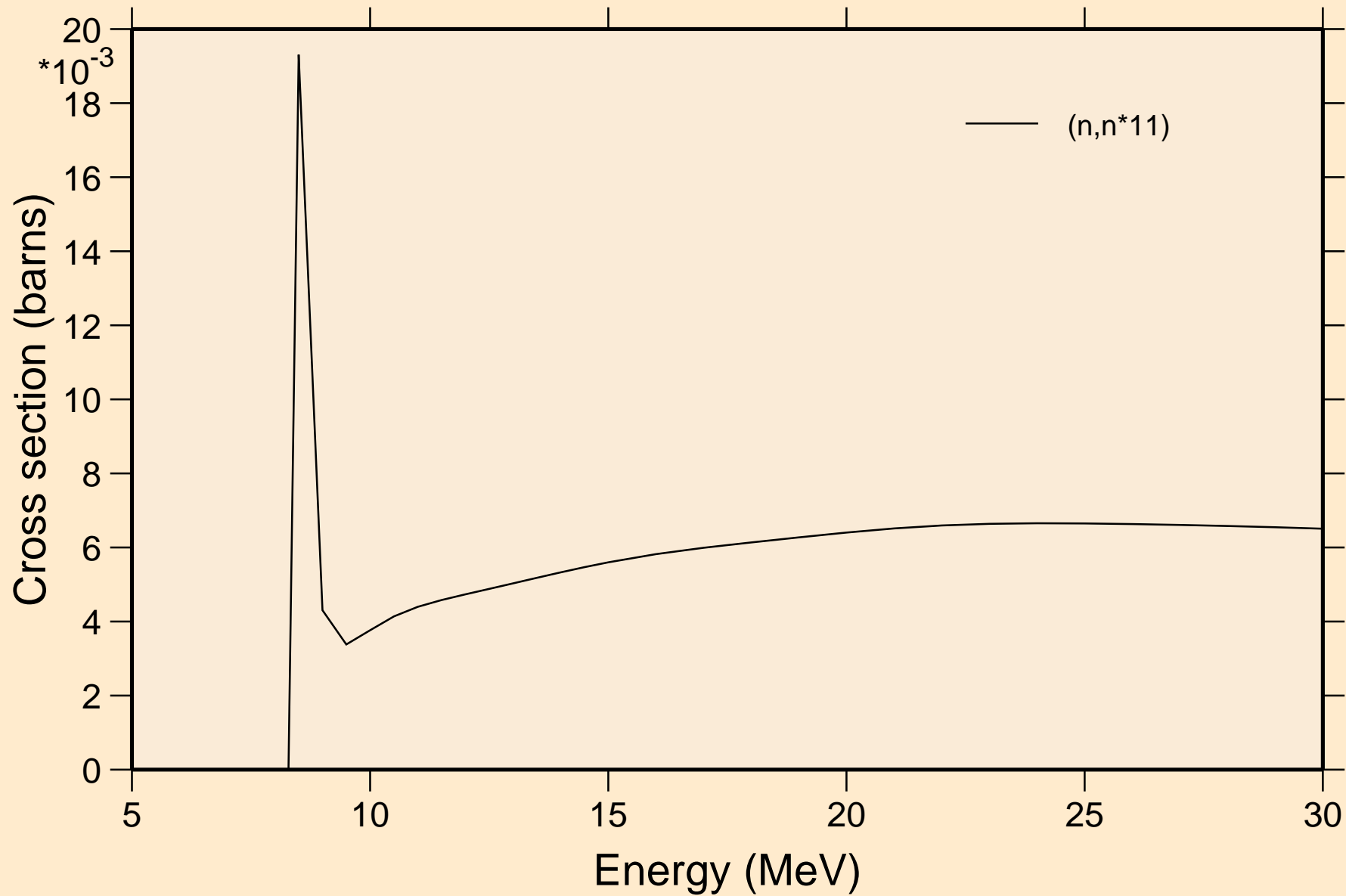

TI053 NEUTRON ACER TENDL-2024 LIBRARY; T=0.K
Threshold reactions

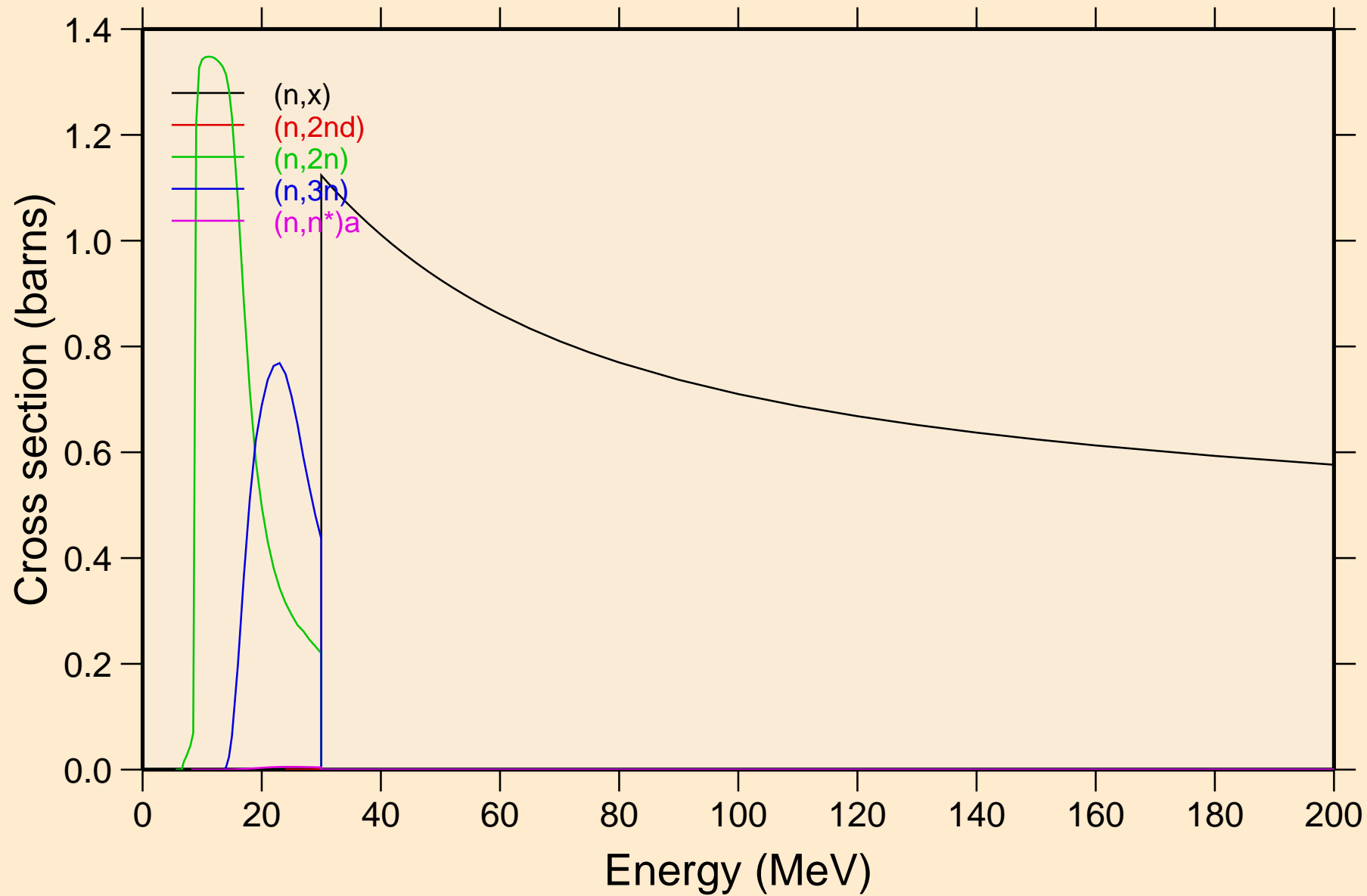

TI053 NEUTRON ACER TENDL-2024 LIBRARY; T=0.K
Threshold reactions

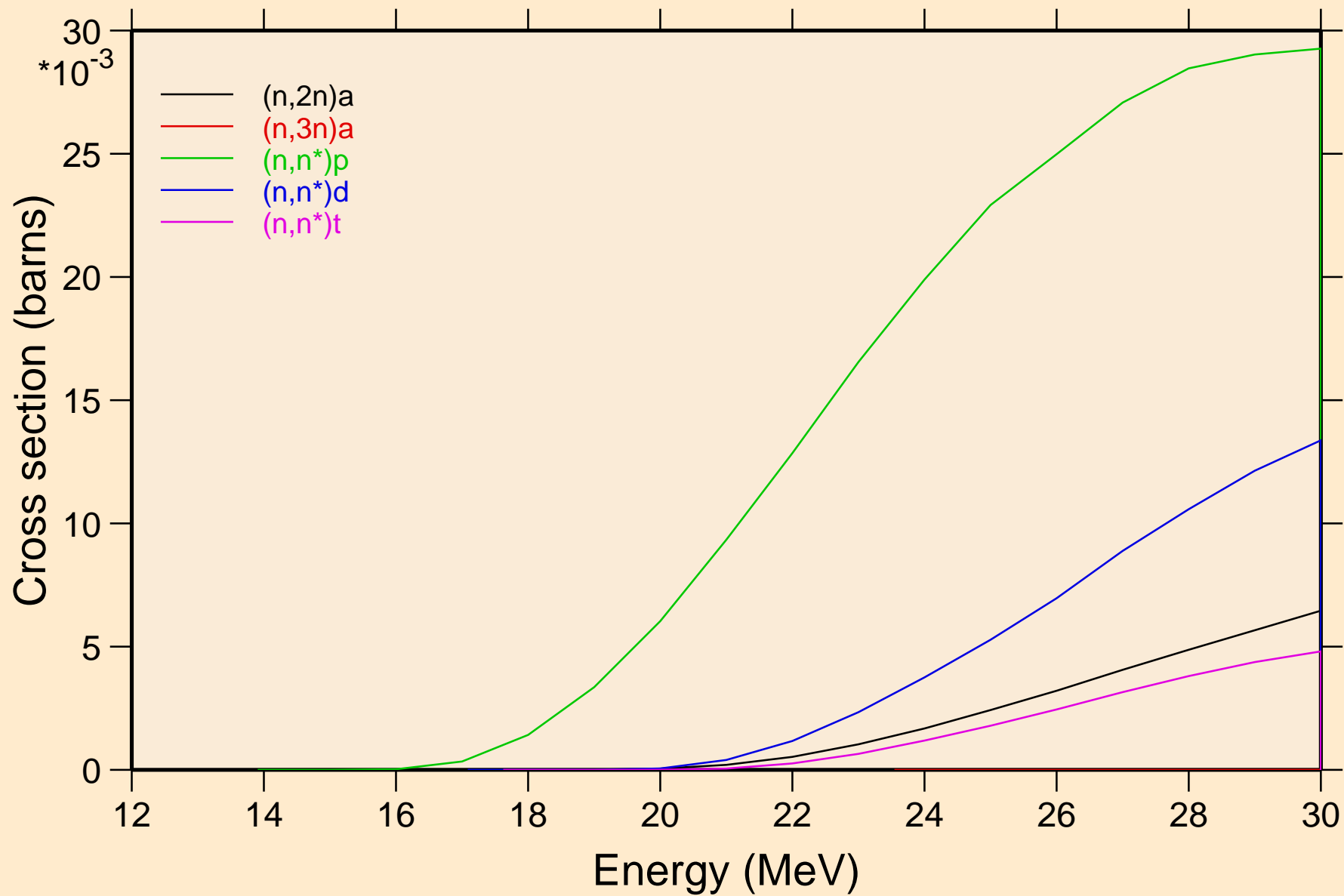

TI053 NEUTRON ACER TENDL-2024 LIBRARY; T=0.K

Threshold reactions

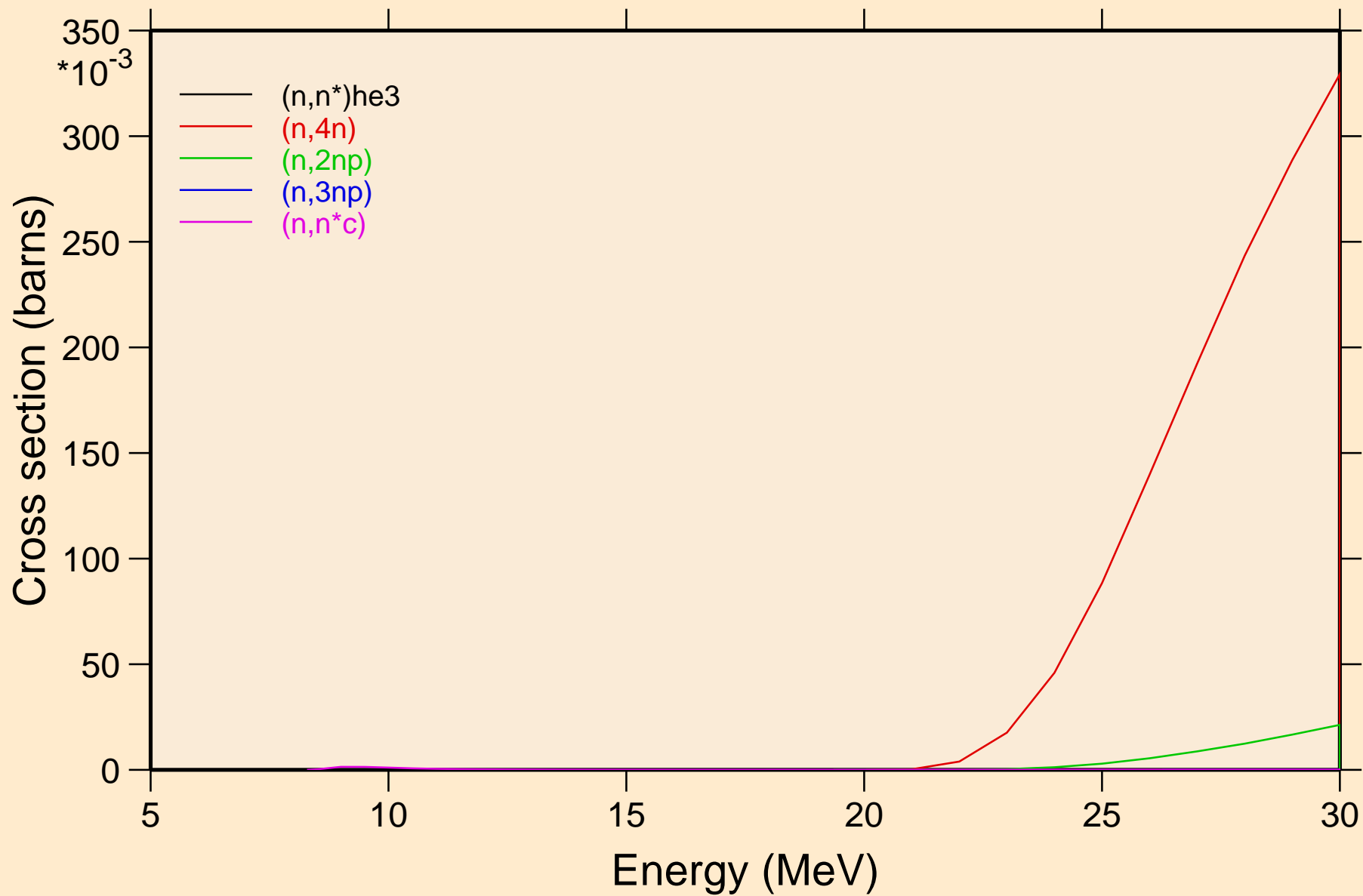

TI053 NEUTRON ACER TENDL-2024 LIBRARY; T=0.K
Threshold reactions

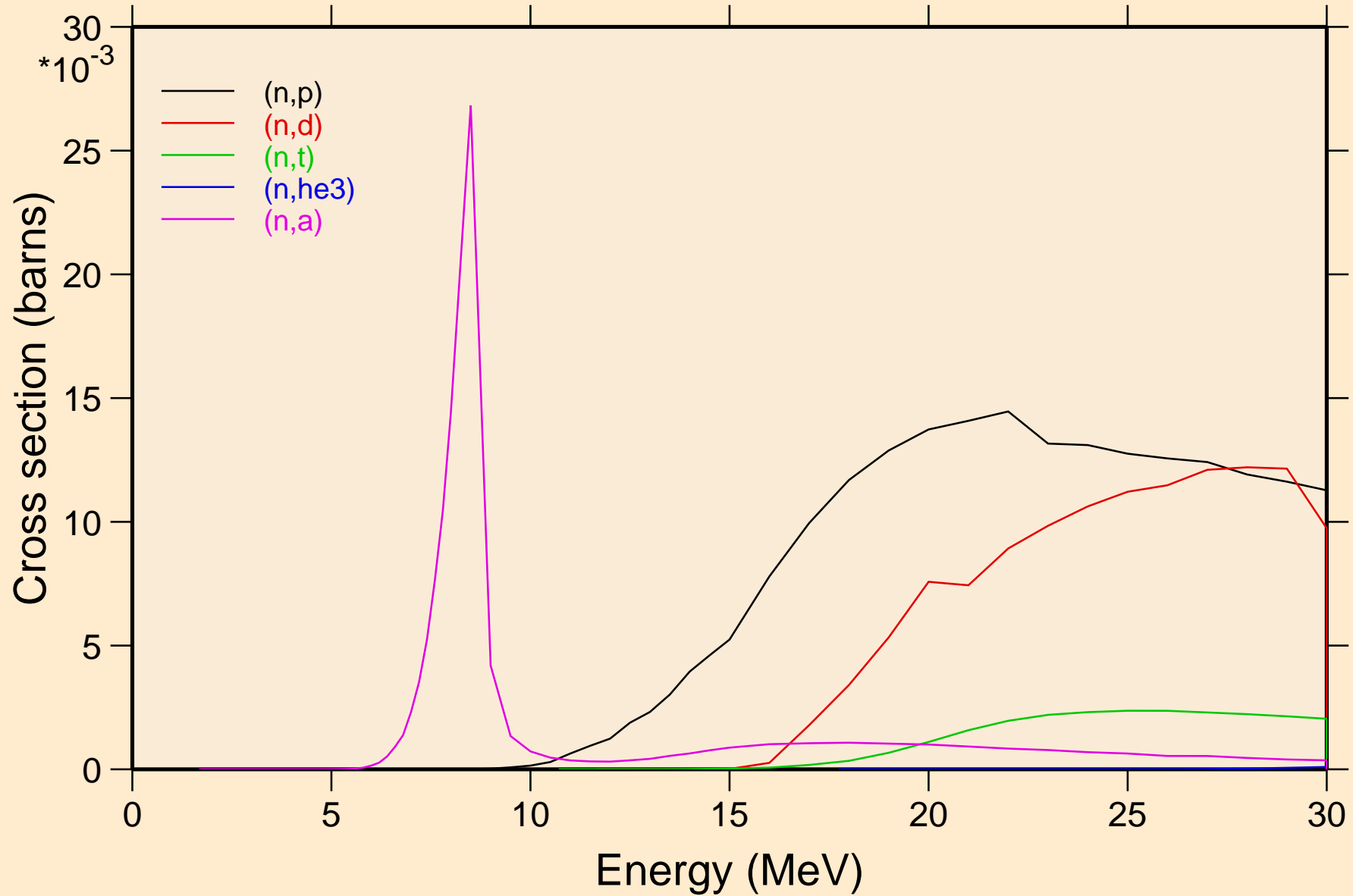

TI053 NEUTRON ACER TENDL-2024 LIBRARY; T=0.K

Threshold reactions

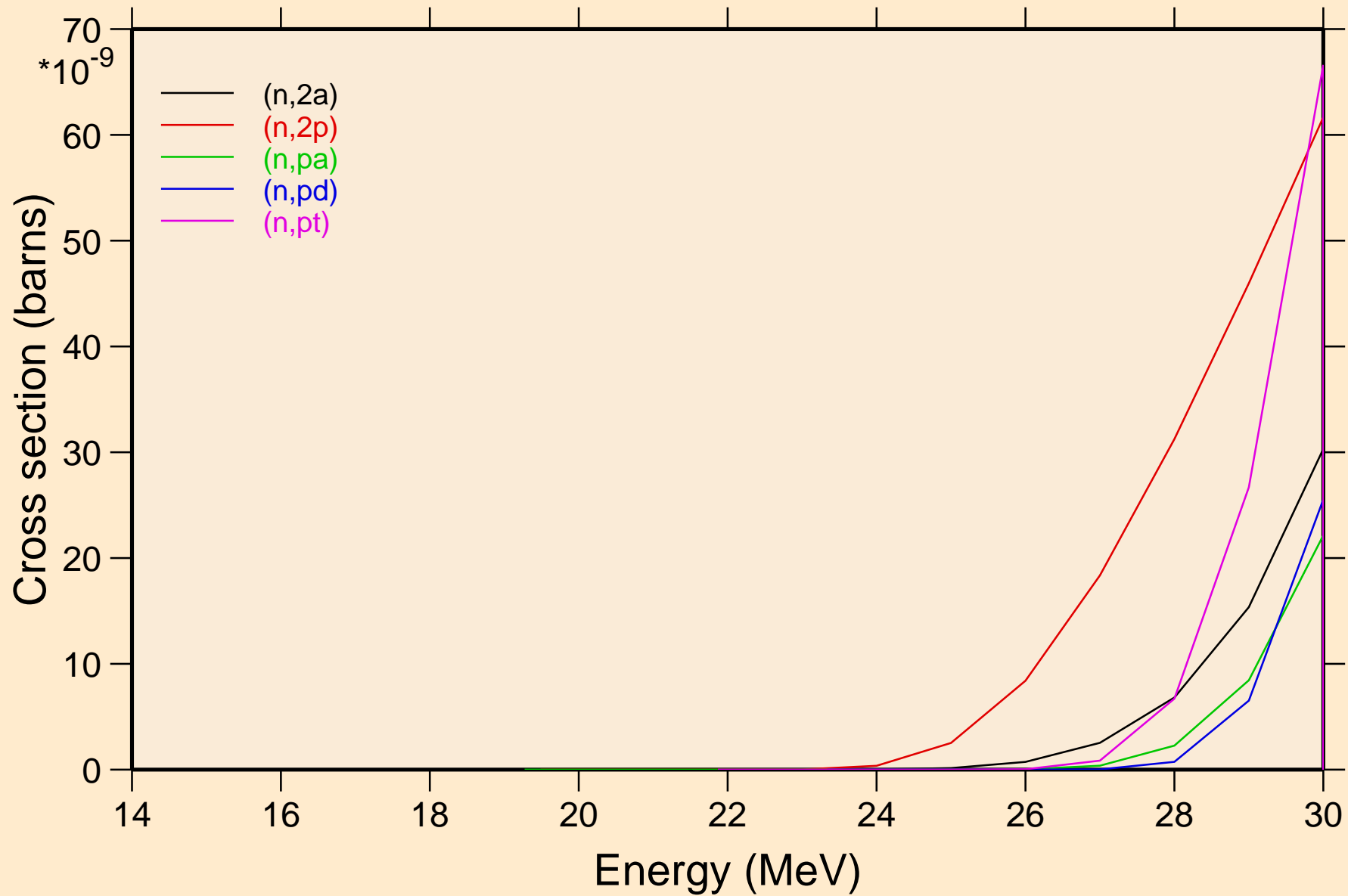

TI053 NEUTRON ACER TENDL-2024 LIBRARY; T=0.K
Threshold reactions

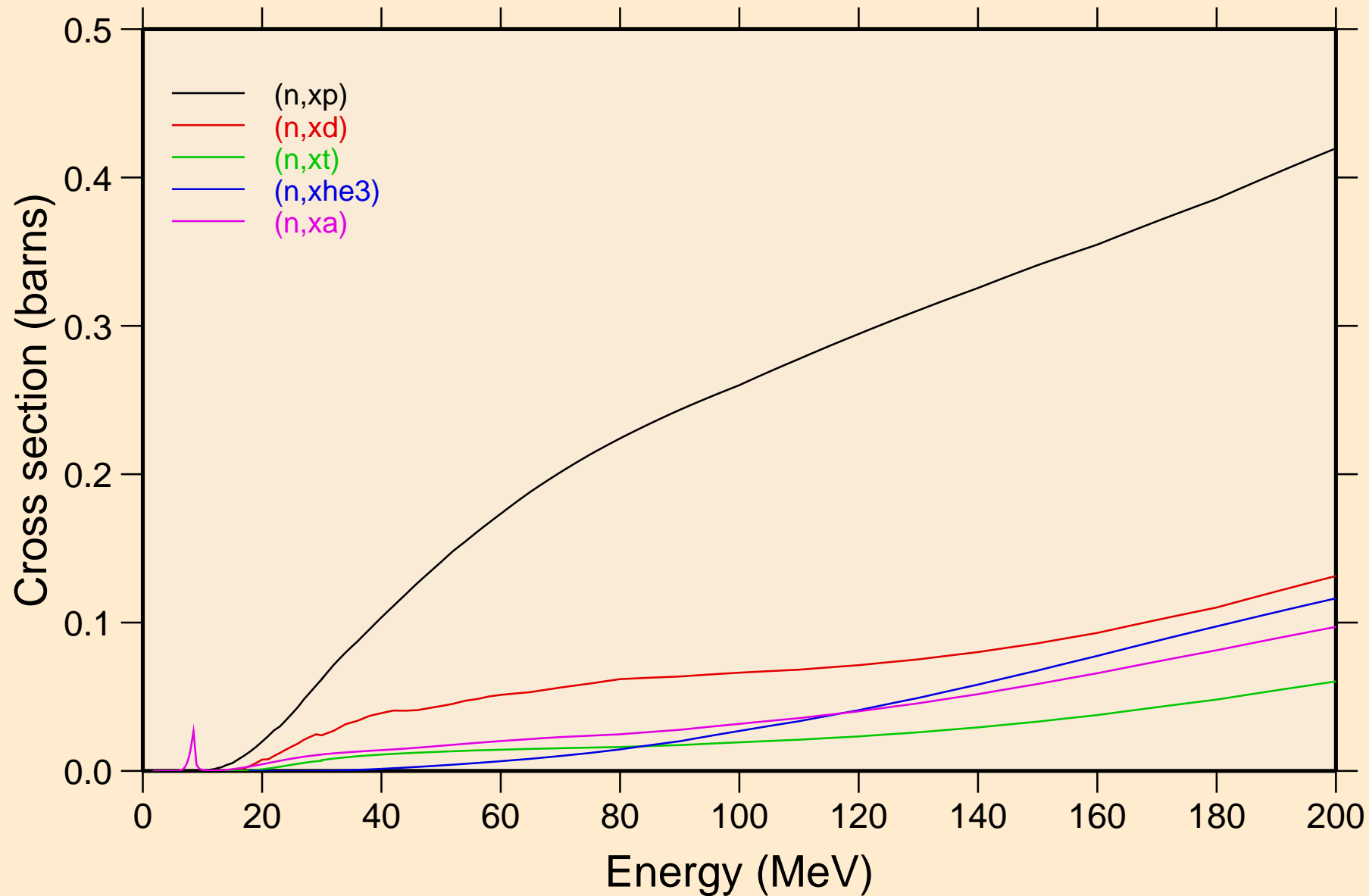

TI053 NEUTRON ACER TENDL-2024 LIBRARY; T=0.K
angular distribution for elastic

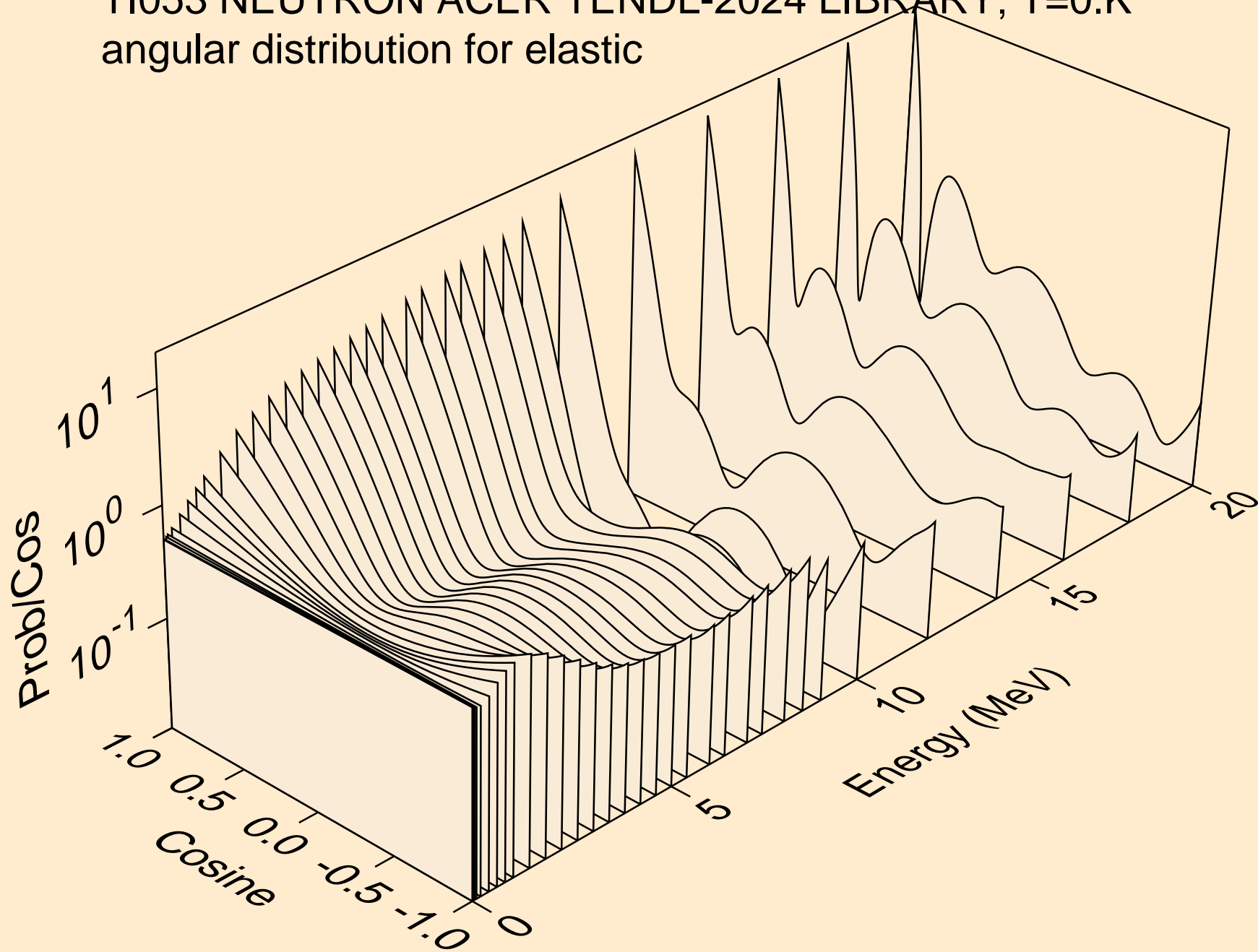

TI053 NEUTRON ACER TENDL-2024 LIBRARY; T=0.K
angular distribution for elastic

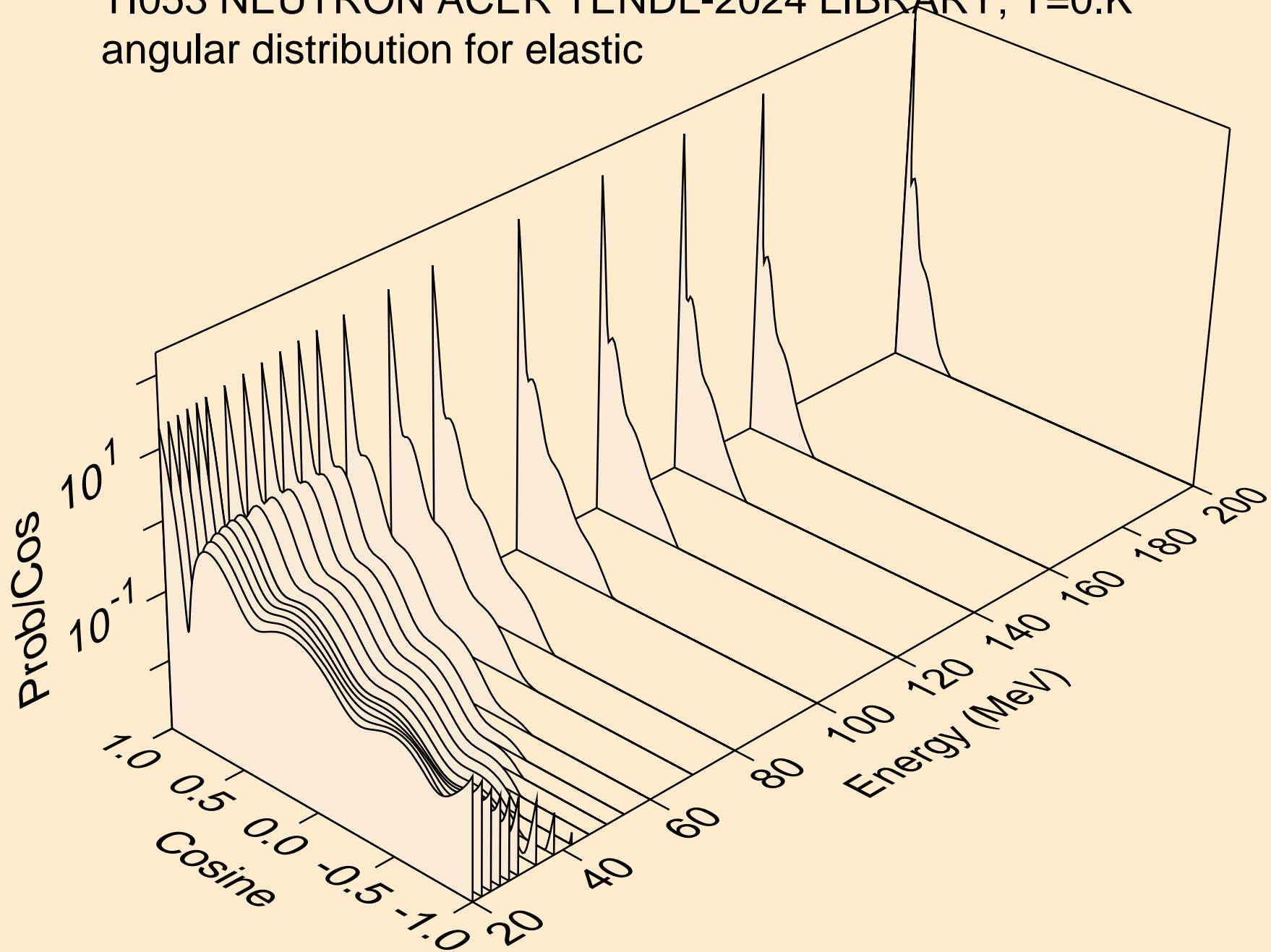

TI053 NEUTRON ACER TENDL-2024 LIBRARY; T=0.K
angular distribution for (n,n*1)

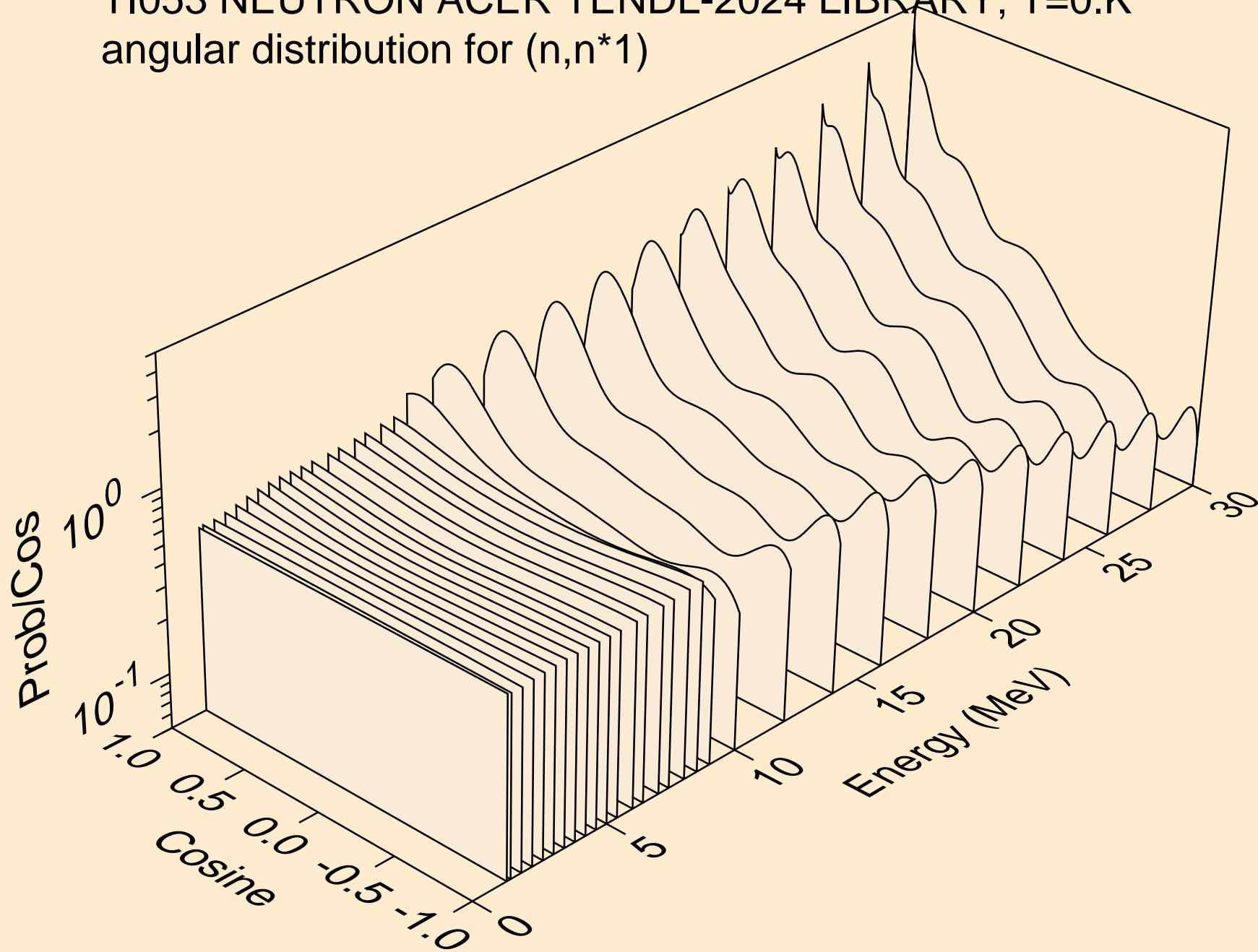

TI053 NEUTRON ACER TENDL-2024 LIBRARY; T=0.K
angular distribution for (n,n*2)

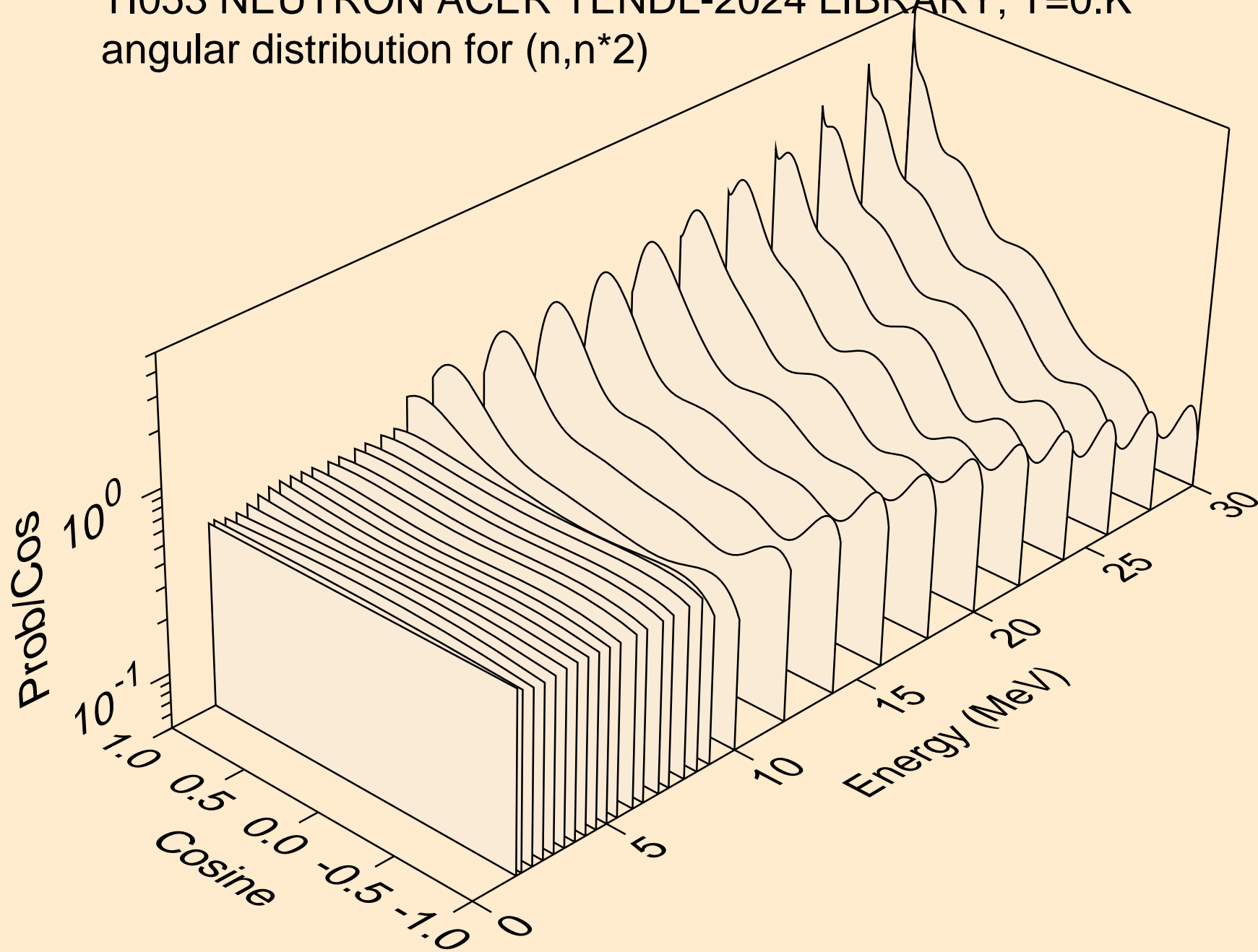

TI053 NEUTRON ACER TENDL-2024 LIBRARY; T=0.K
angular distribution for (n,n*3)

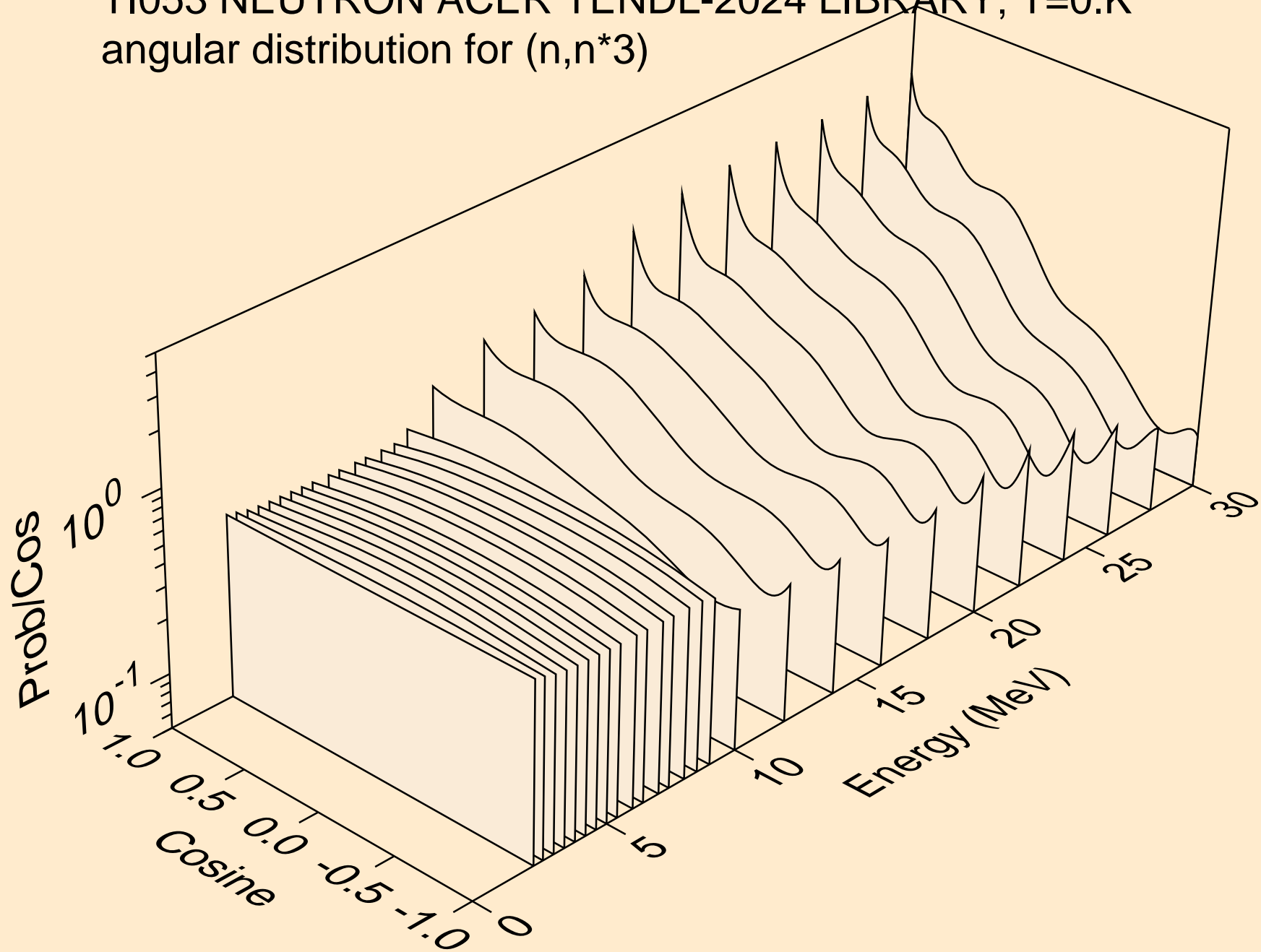

TI053 NEUTRON ACER TENDL-2024 LIBRARY; T=0.K
angular distribution for (n,n*4)

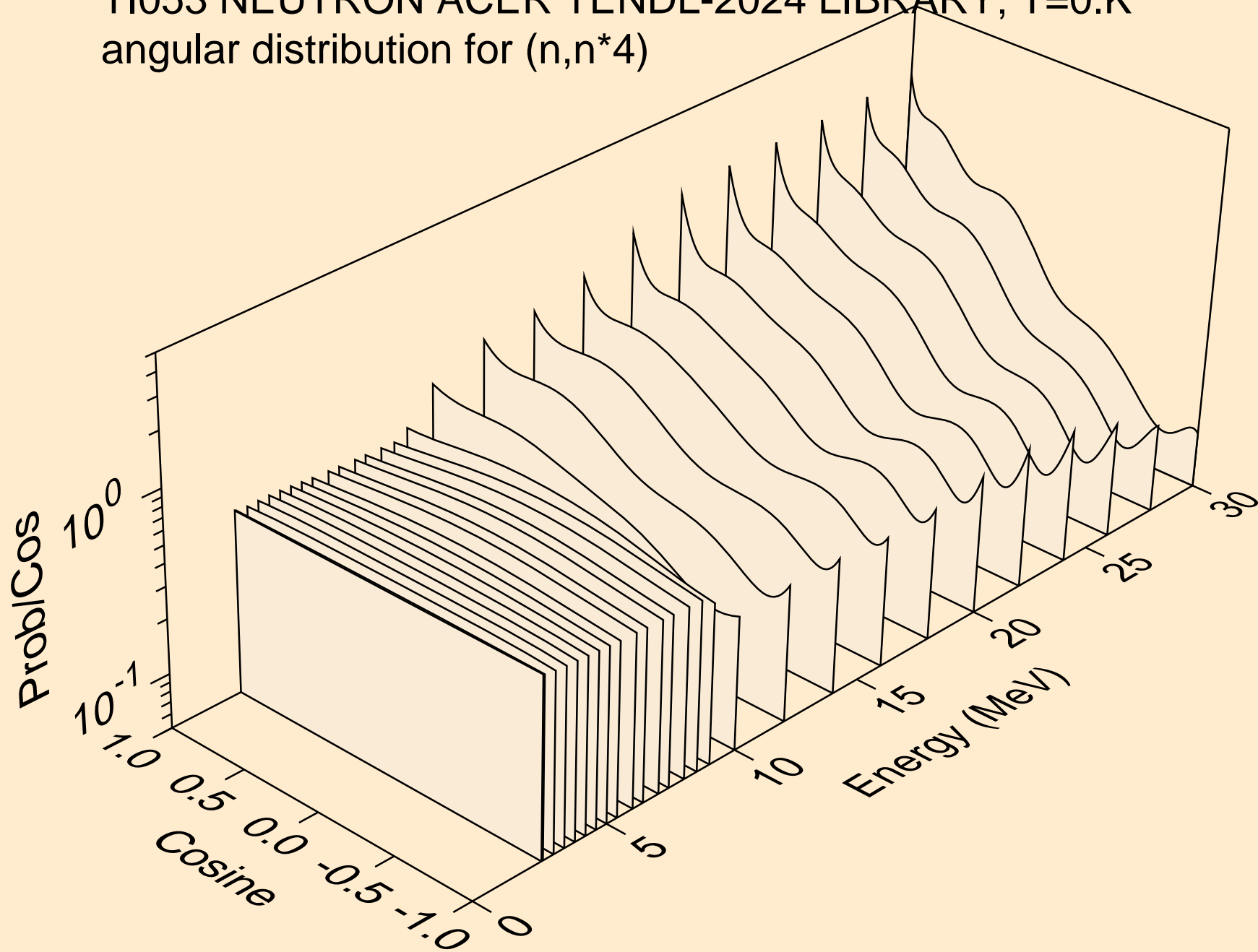

TI053 NEUTRON ACER TENDL-2024 LIBRARY; T=0.K
angular distribution for (n,n*5)

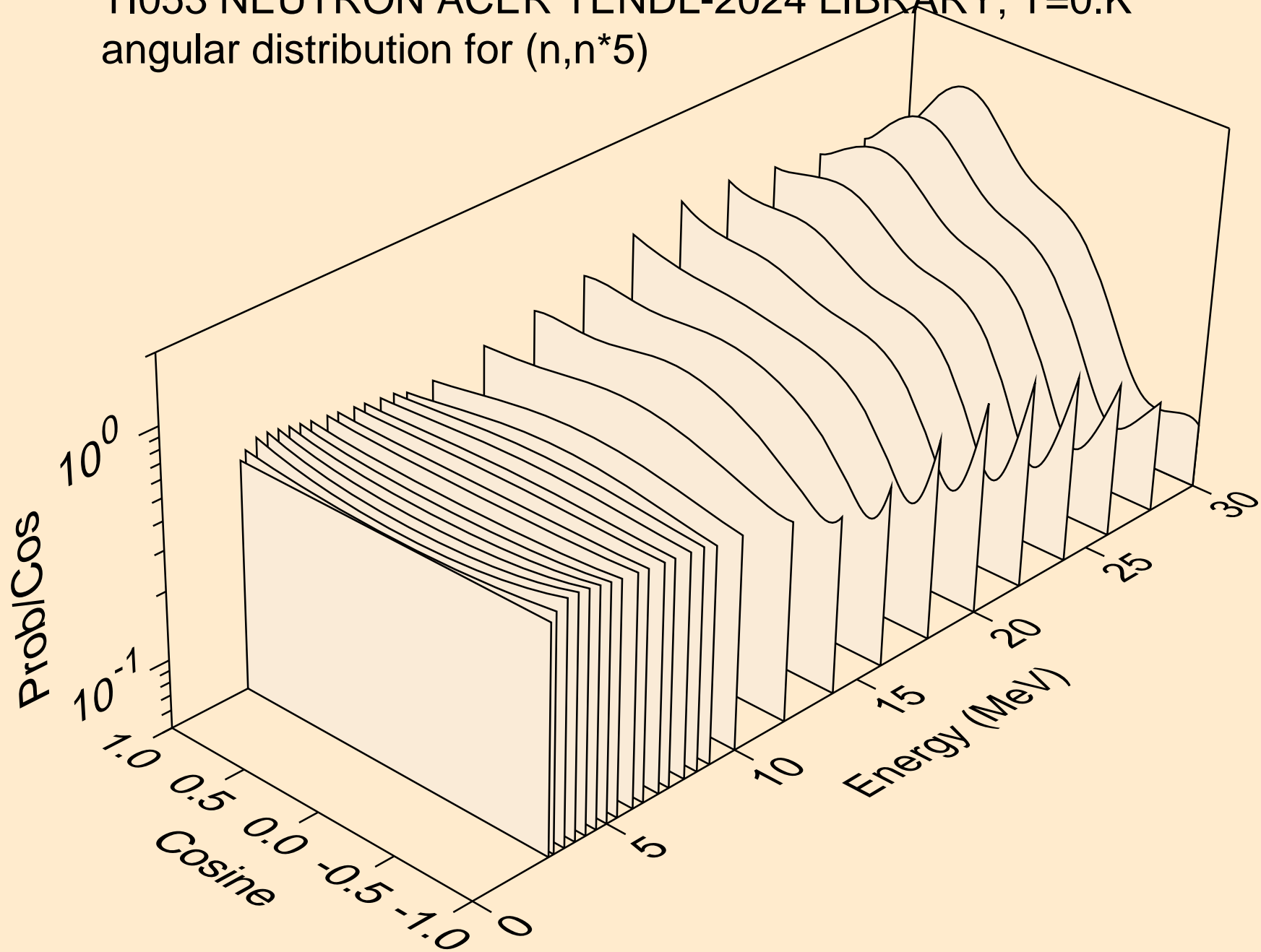

TI053 NEUTRON ACER TENDL-2024 LIBRARY; T=0.K
angular distribution for (n,n*6)

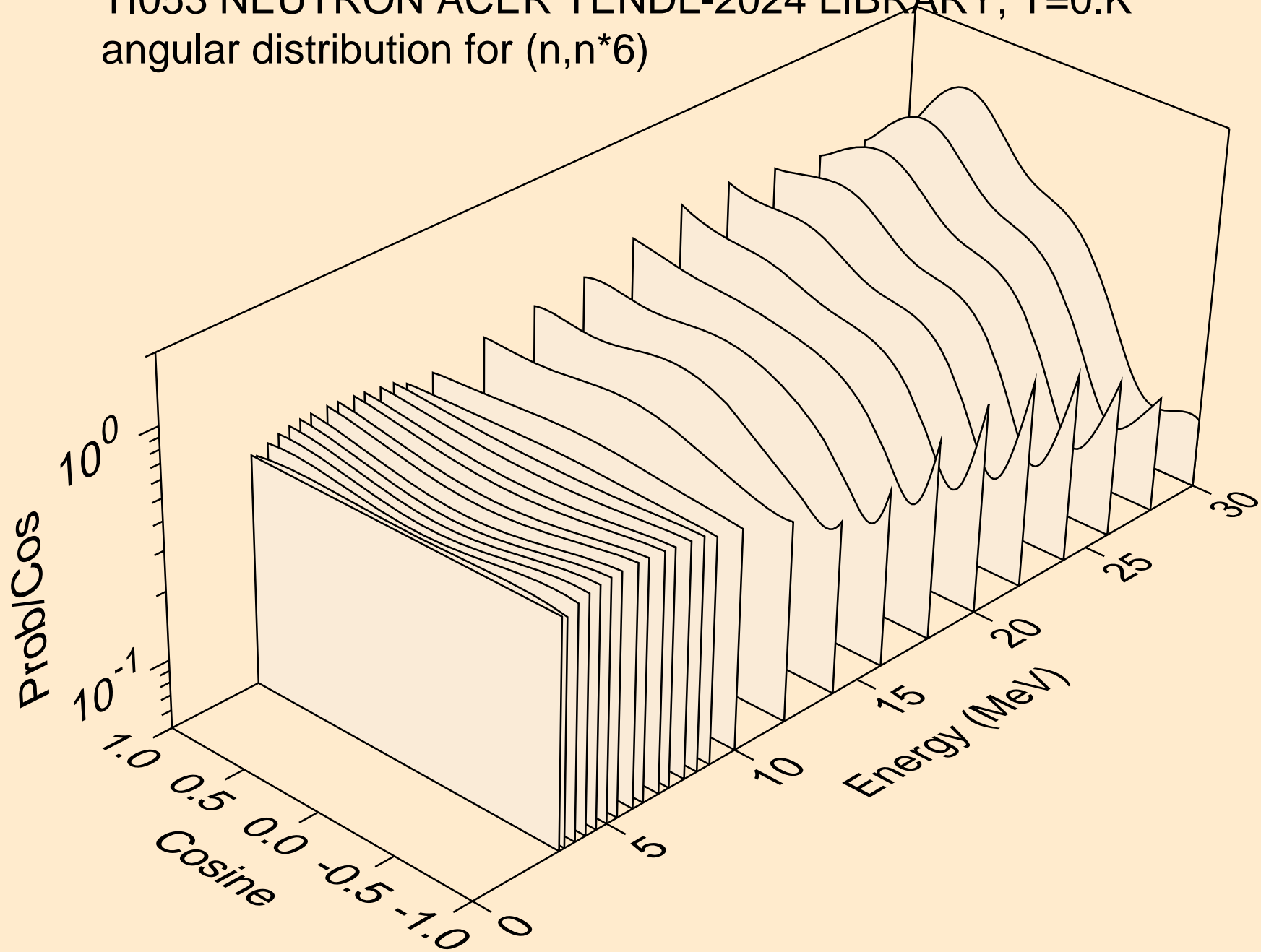

TI053 NEUTRON ACER TENDL-2024 LIBRARY; T=0.K
angular distribution for (n,n*7)

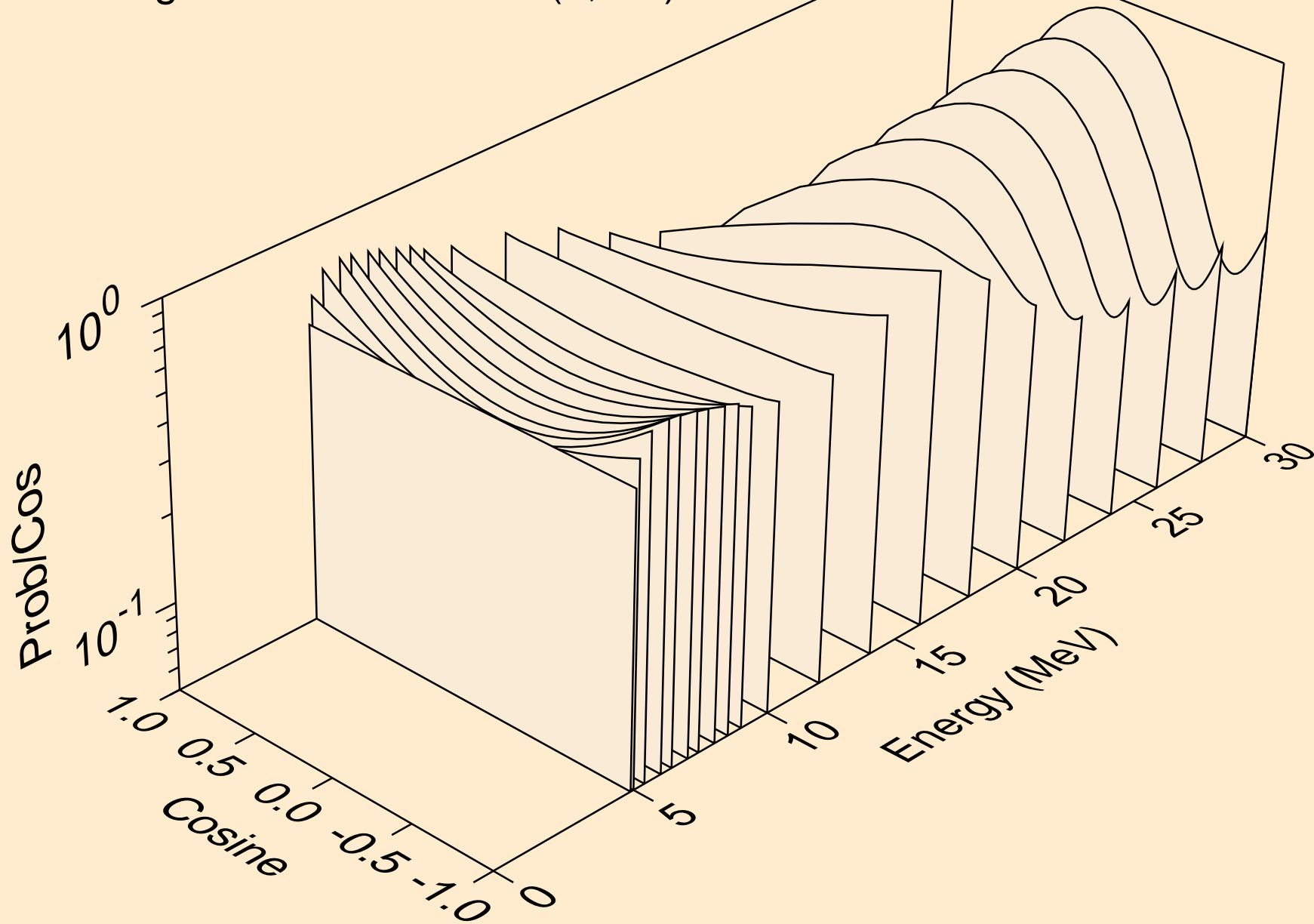

TI053 NEUTRON ACER TENDL-2024 LIBRARY; T=0.K
angular distribution for (n,n*8)

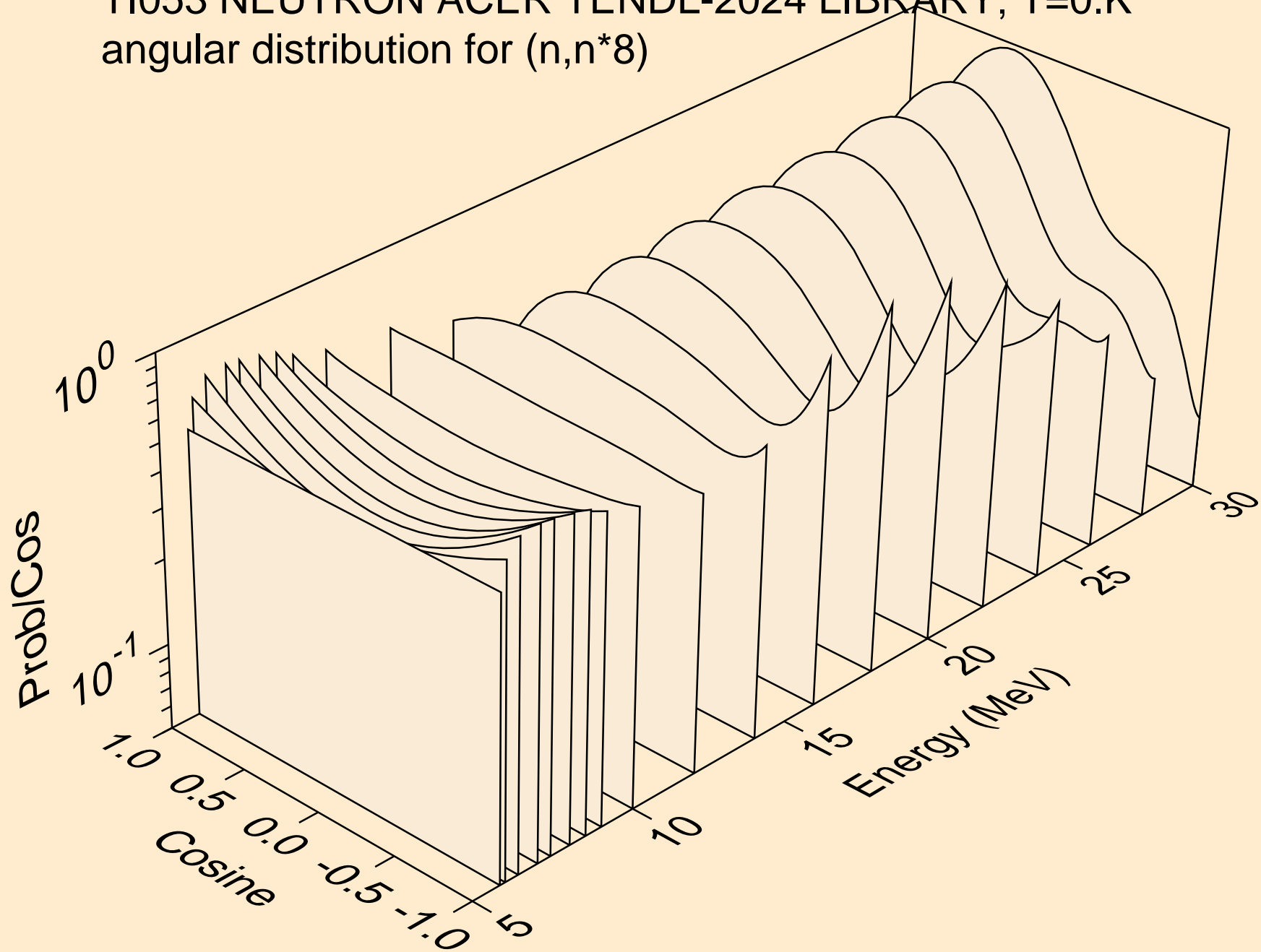

TI053 NEUTRON ACER TENDL-2024 LIBRARY; T=0.K
angular distribution for (n,n*9)

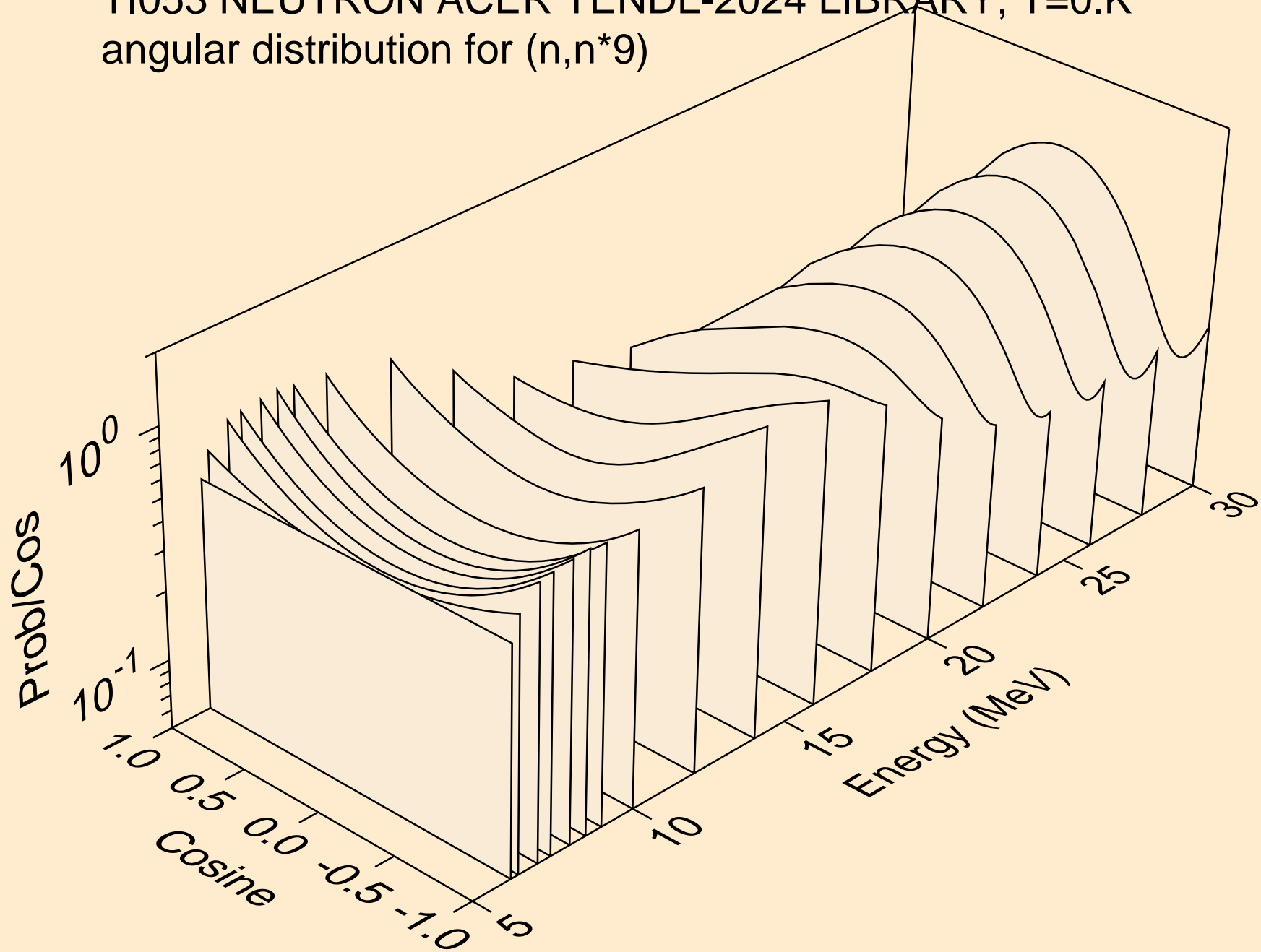

TI053 NEUTRON ACER TENDL-2024 LIBRARY; T=0.K
angular distribution for (n,n*10)

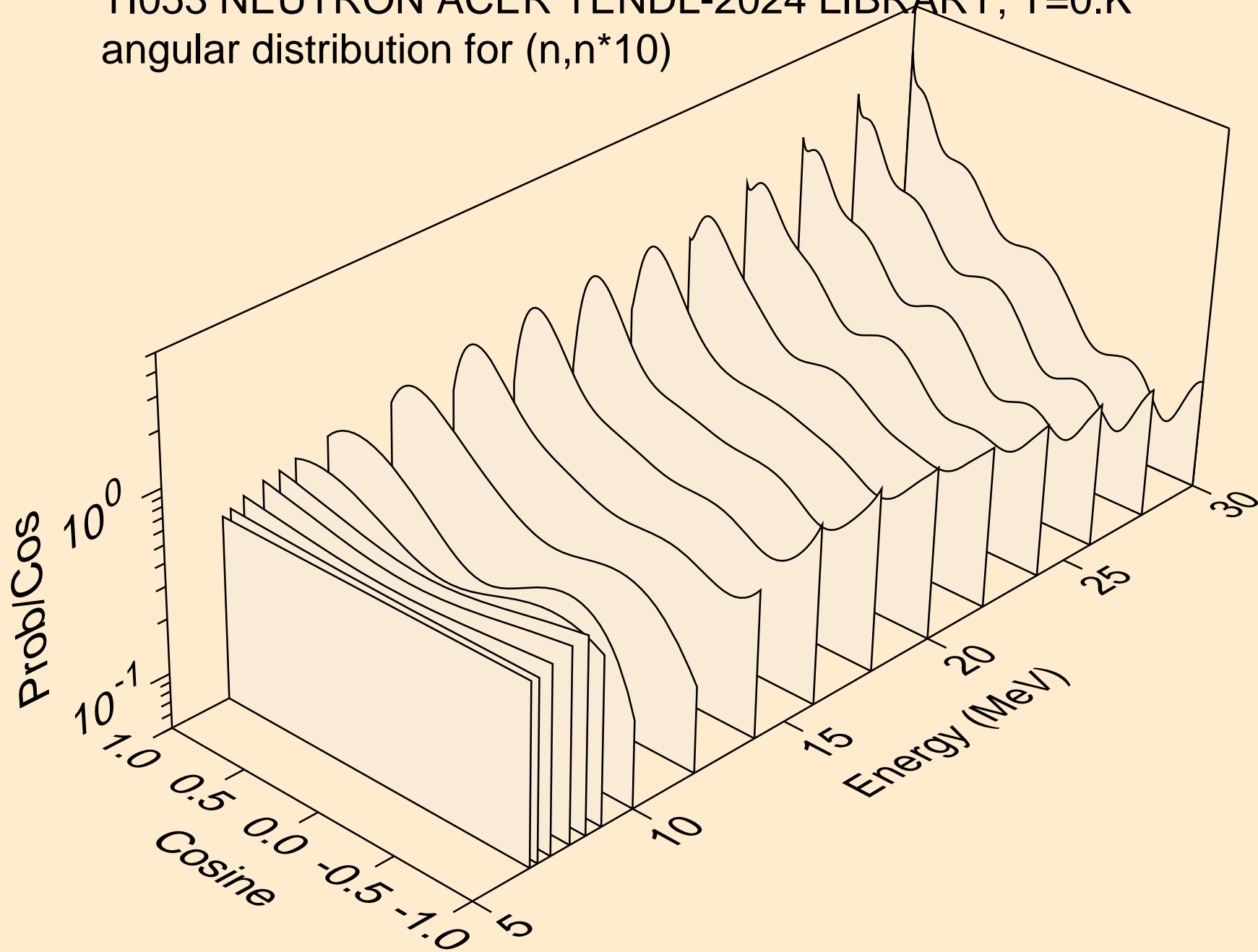

TI053 NEUTRON ACER TENDL-2024 LIBRARY; T=0.K
angular distribution for (n,n*11)

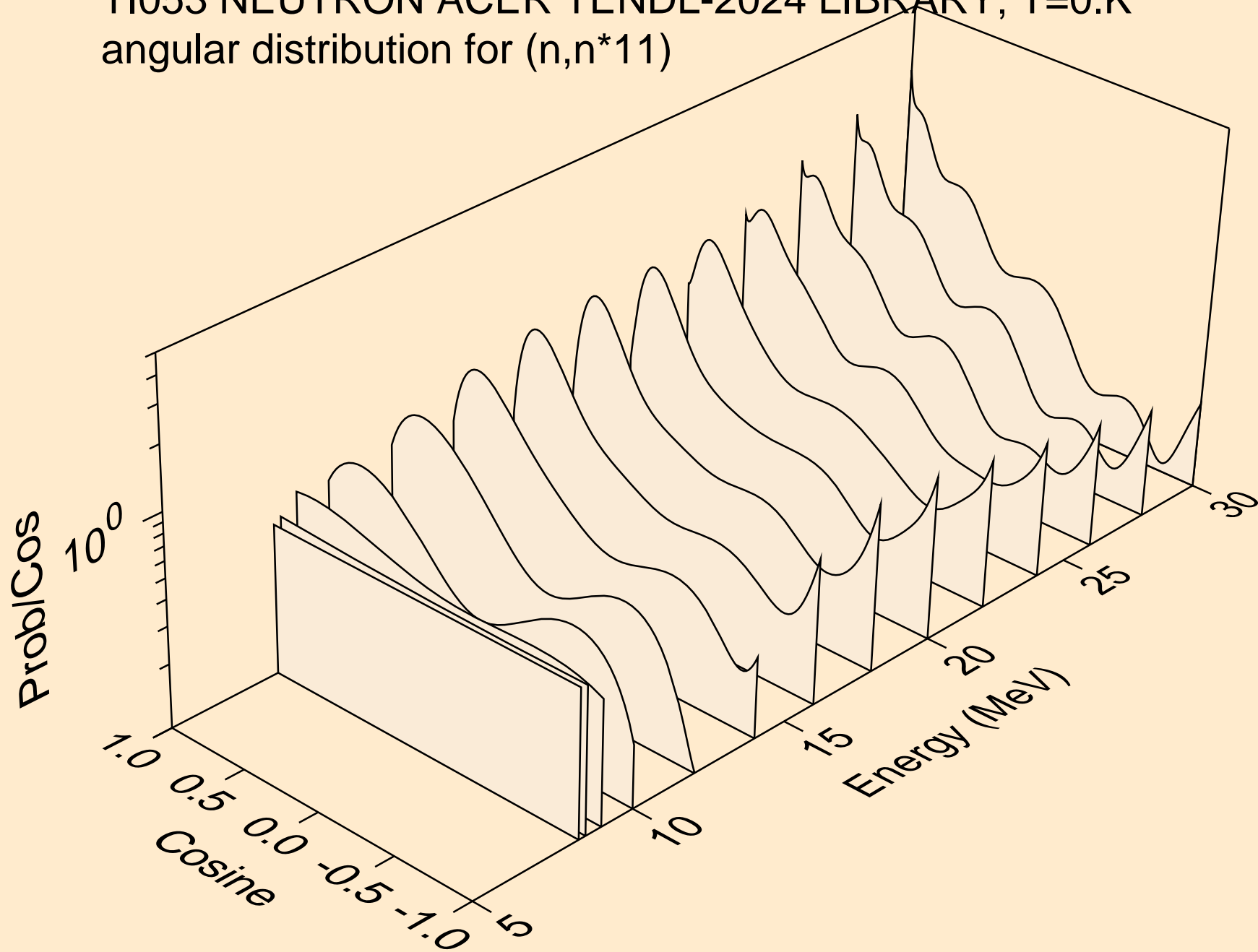

TI053 NEUTRON ACER TENDL-2024 LIBRARY; T=0.K
Neutron emission for (n,x)

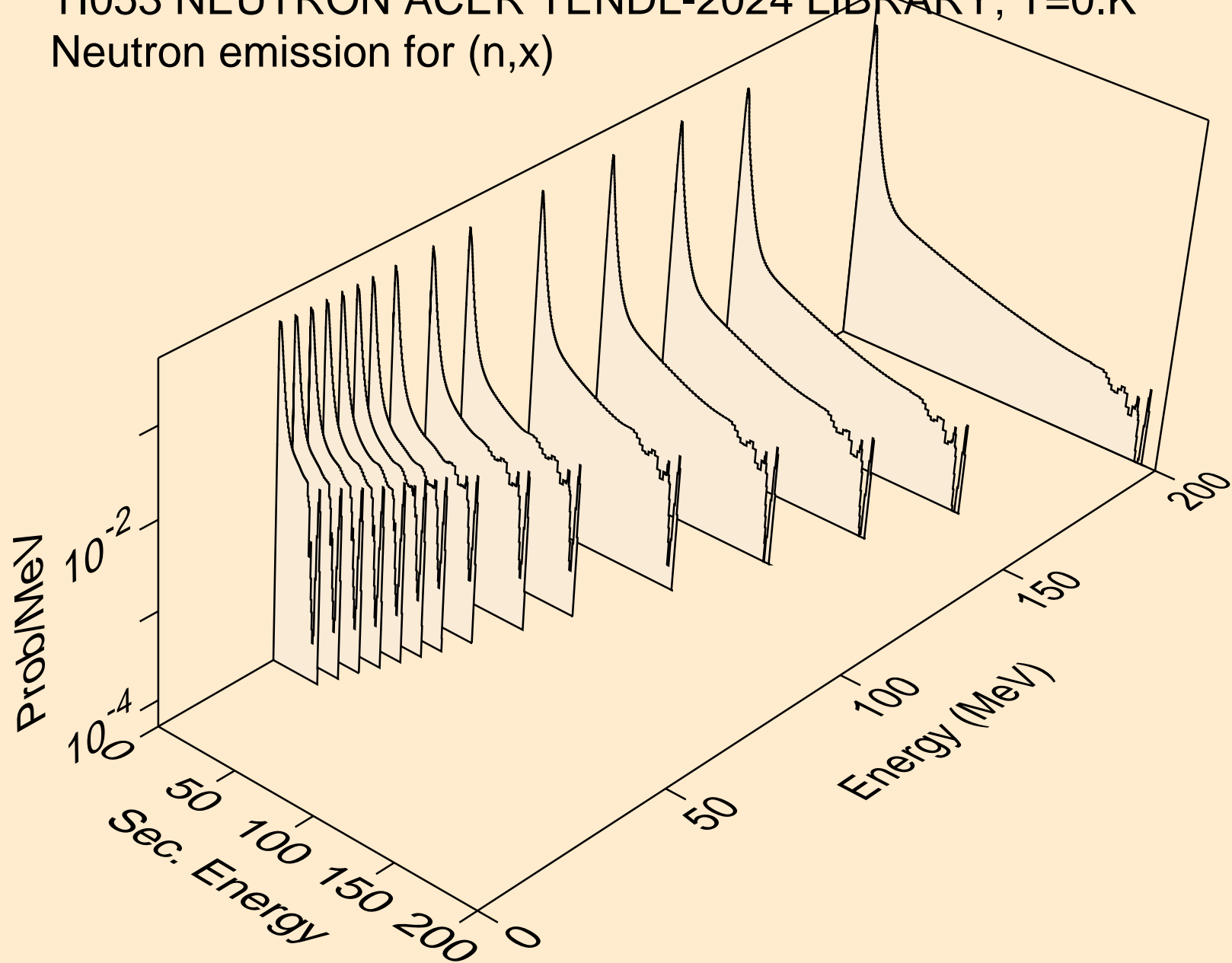

TI053 NEUTRON ACER TENDL-2024 LIBRARY; T=0.K
Neutron emission for (n,2nd)

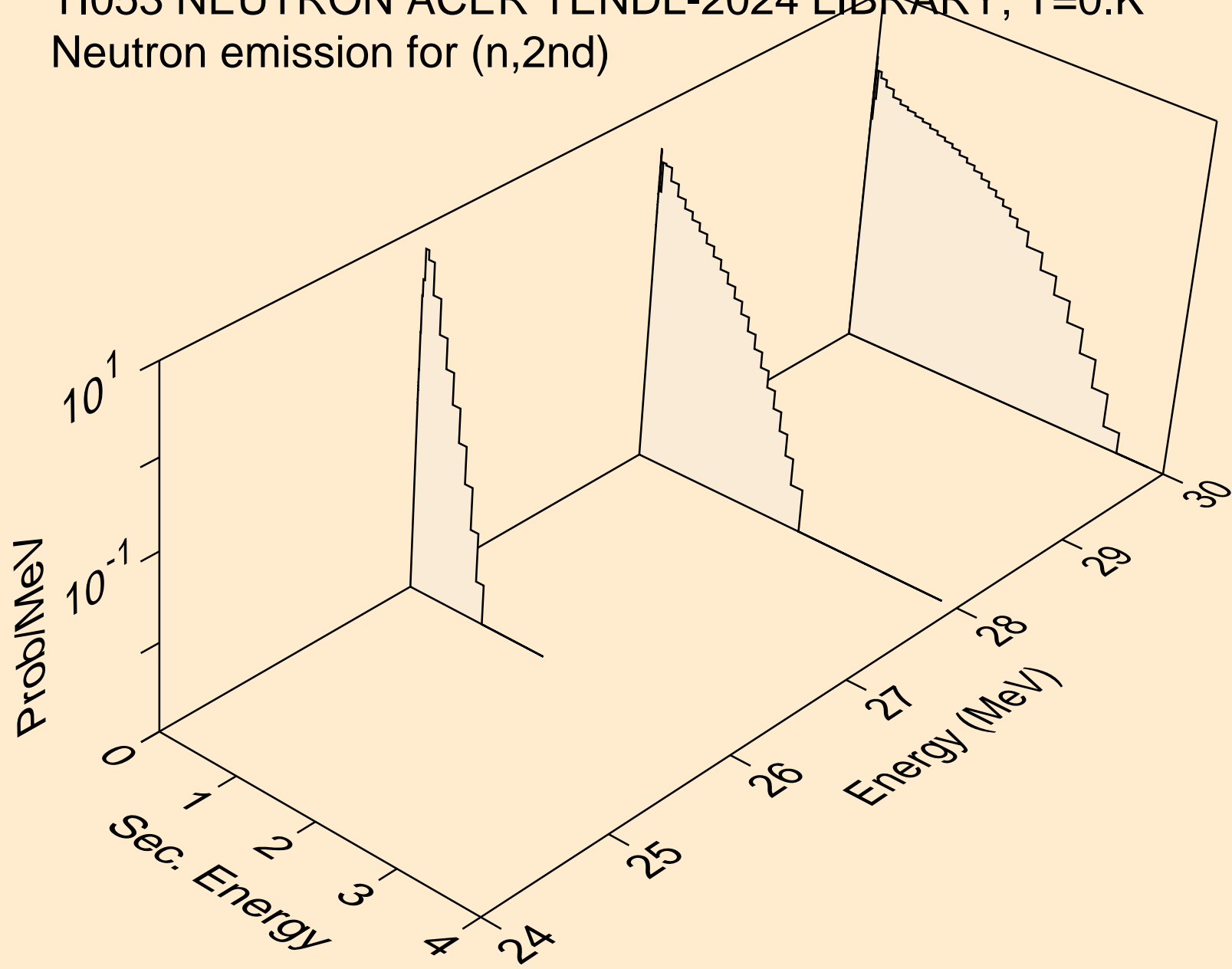

TI053 NEUTRON ACER TENDL-2024 LIBRARY; T=0.K
Neutron emission for (n,2n)

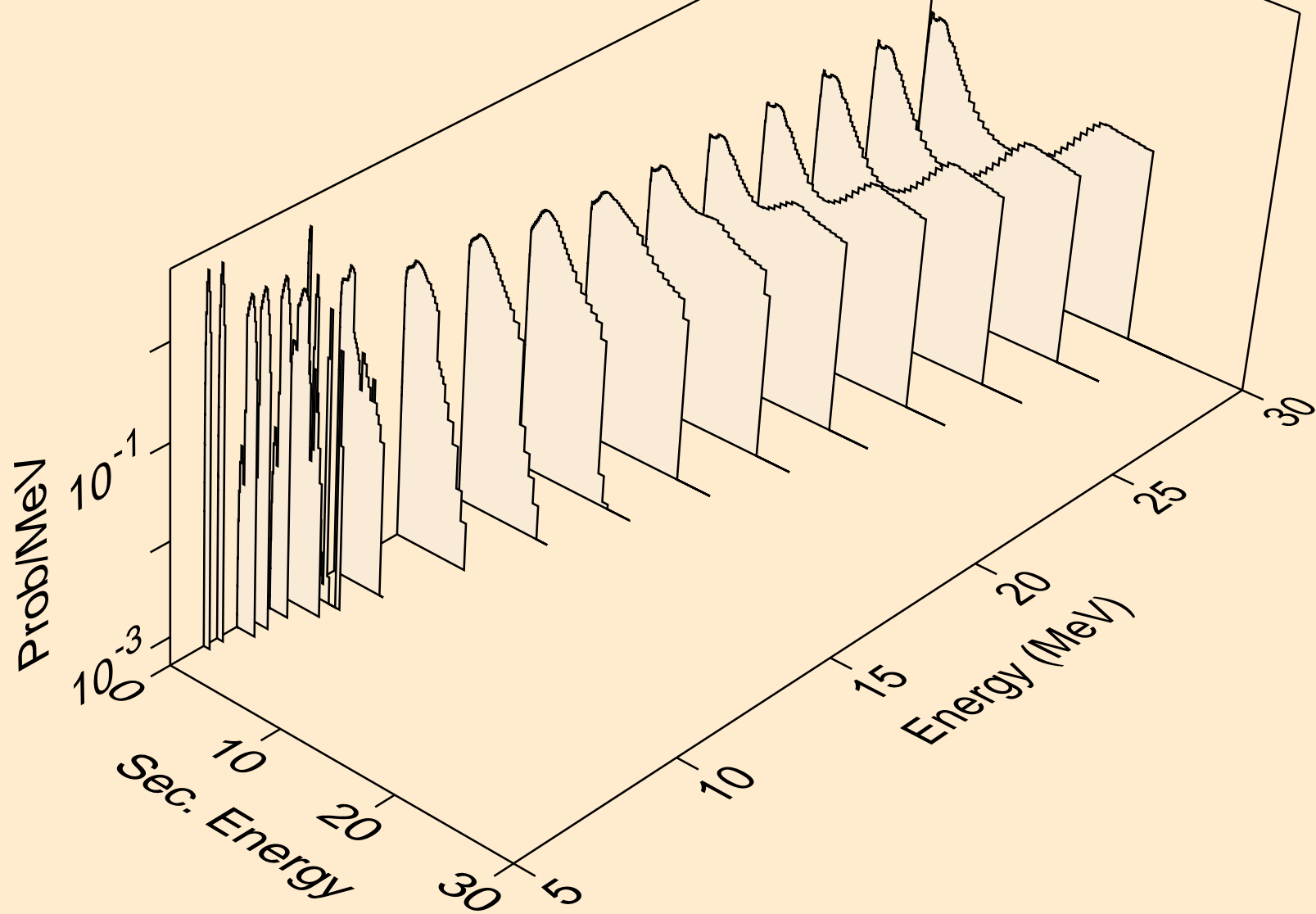

TI053 NEUTRON ACER TENDL-2024 LIBRARY; T=0.K
Neutron emission for (n,3n)

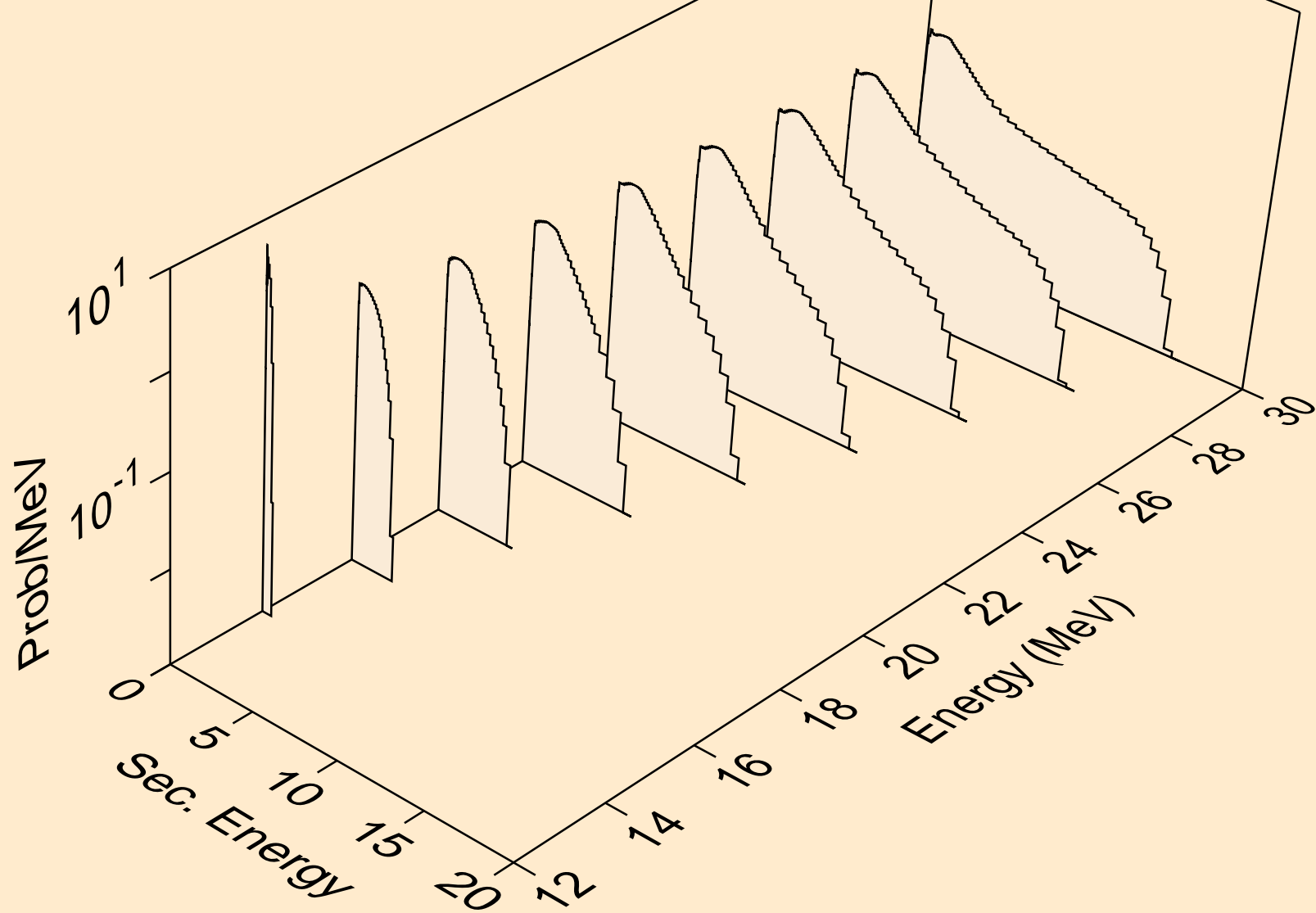

TI053 NEUTRON ACER TENDL-2024 LIBRARY; T=0.K
Neutron emission for (n,n*)a

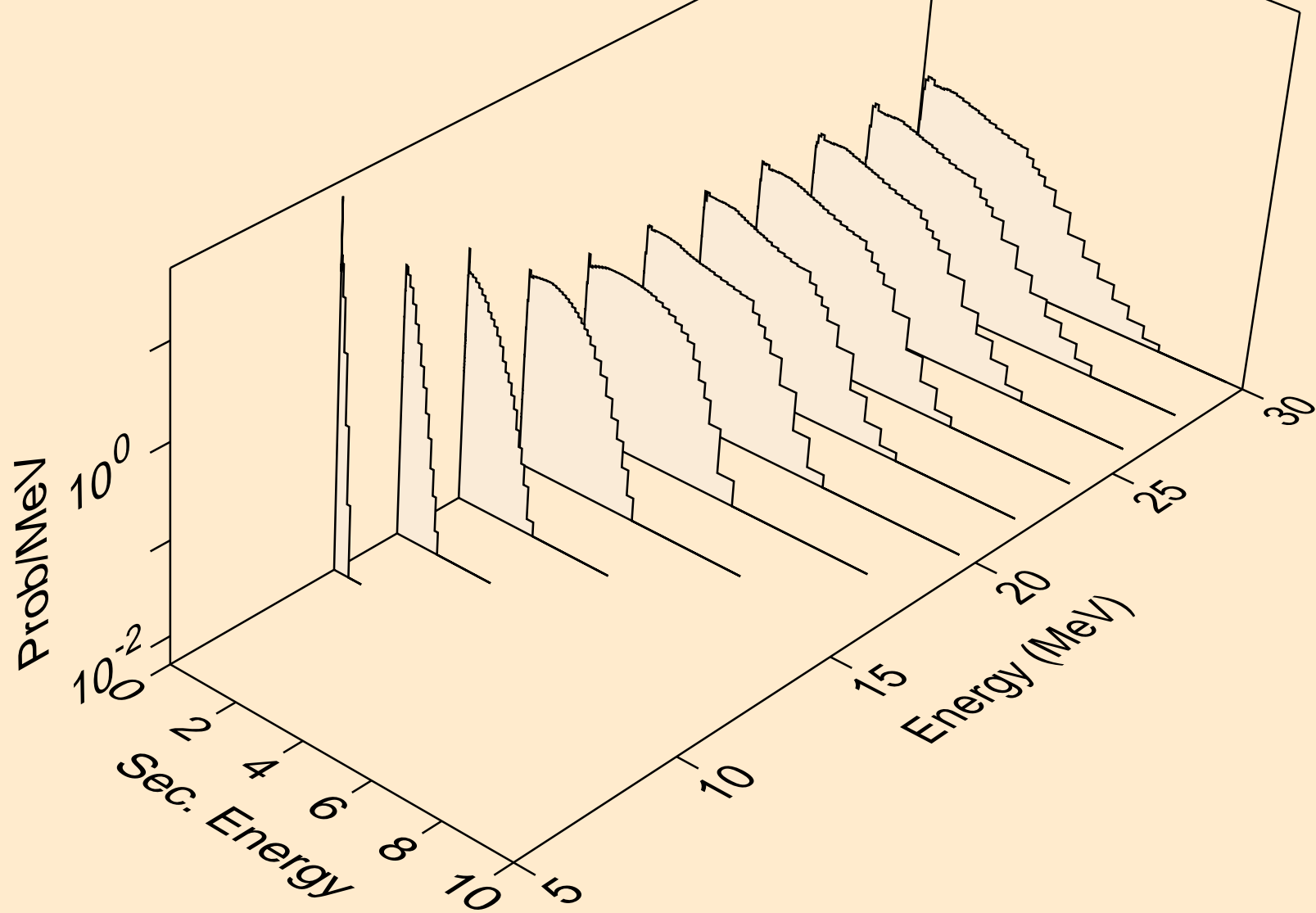

TI053 NEUTRON ACER TENDL-2024 LIBRARY; T=0.K
Neutron emission for (n,2n)a

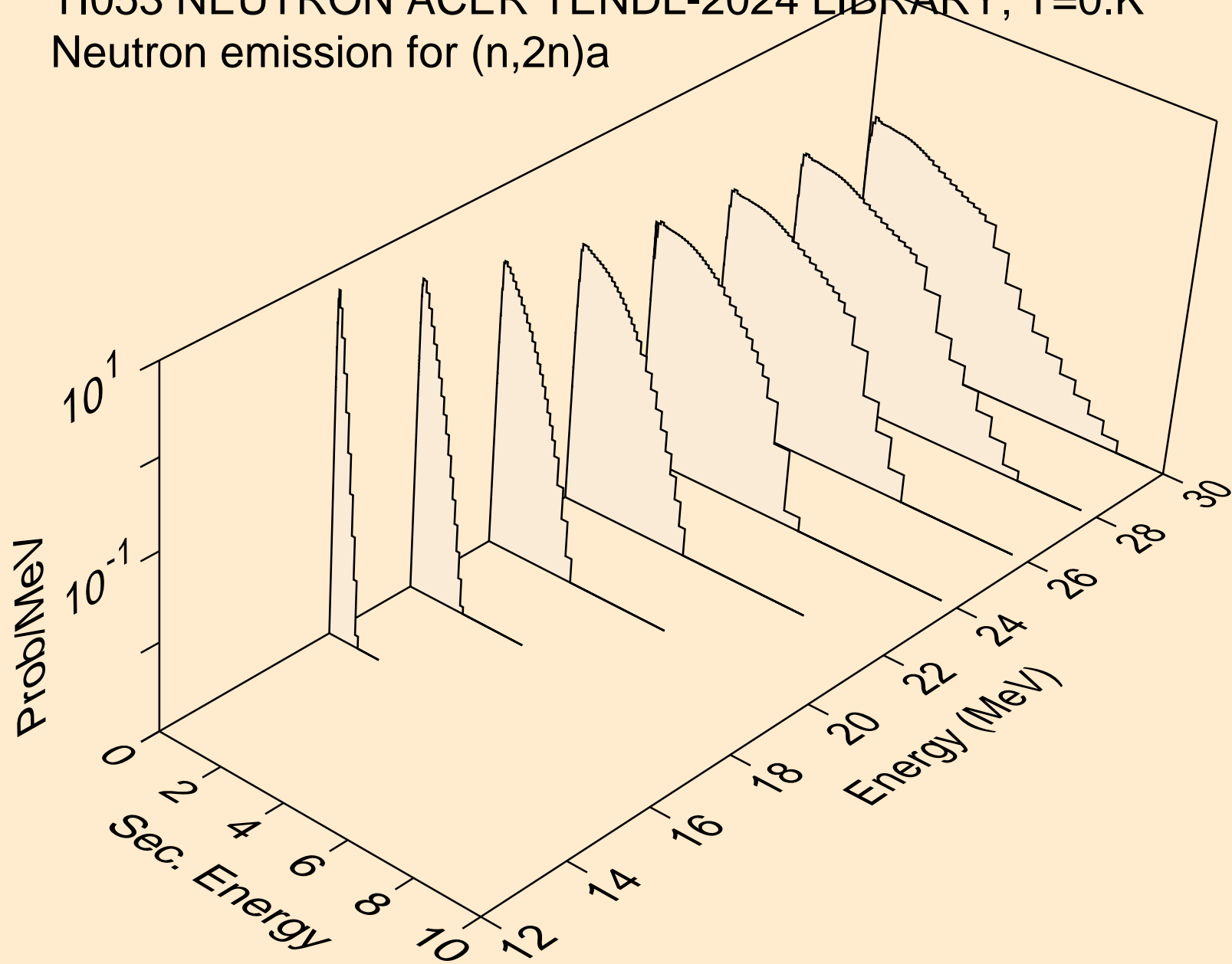

TI053 NEUTRON ACER TENDL-2024 LIBRARY; T=0.K
Neutron emission for (n,3n)a

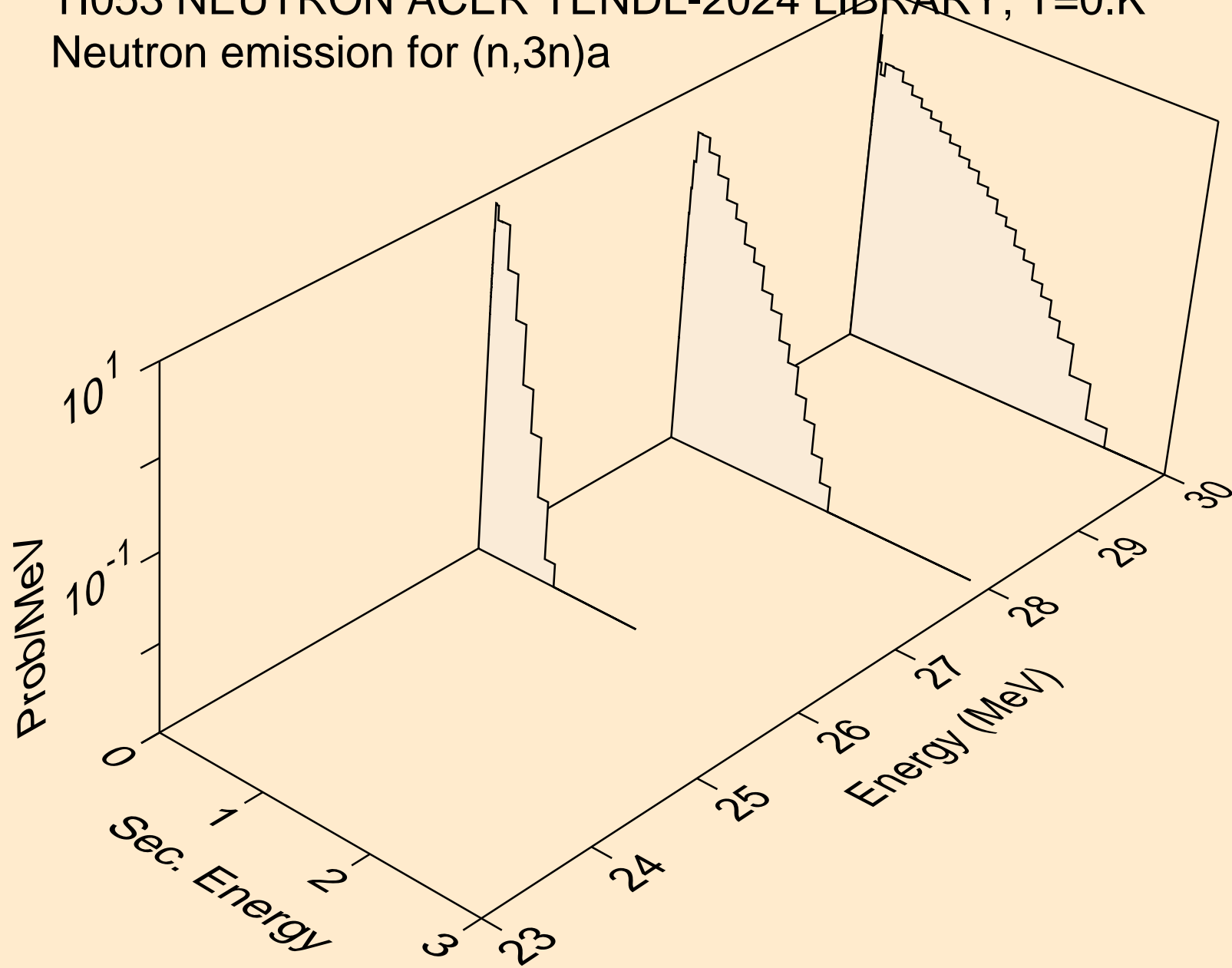

TI053 NEUTRON ACER TENDL-2024 LIBRARY; T=0.K
Neutron emission for (n,n*)p

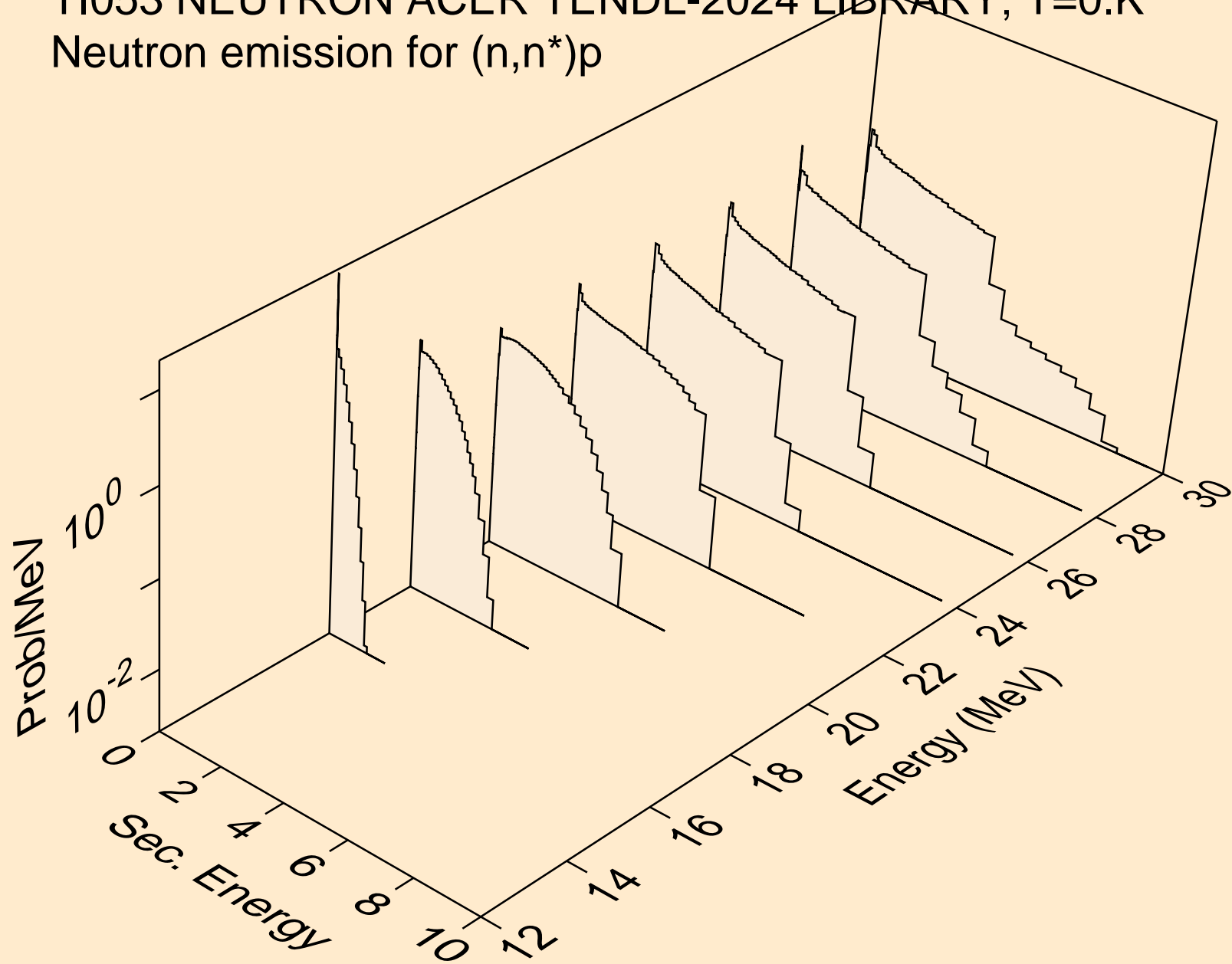

TI053 NEUTRON ACER TENDL-2024 LIBRARY; T=0.K
Neutron emission for (n,n*)d

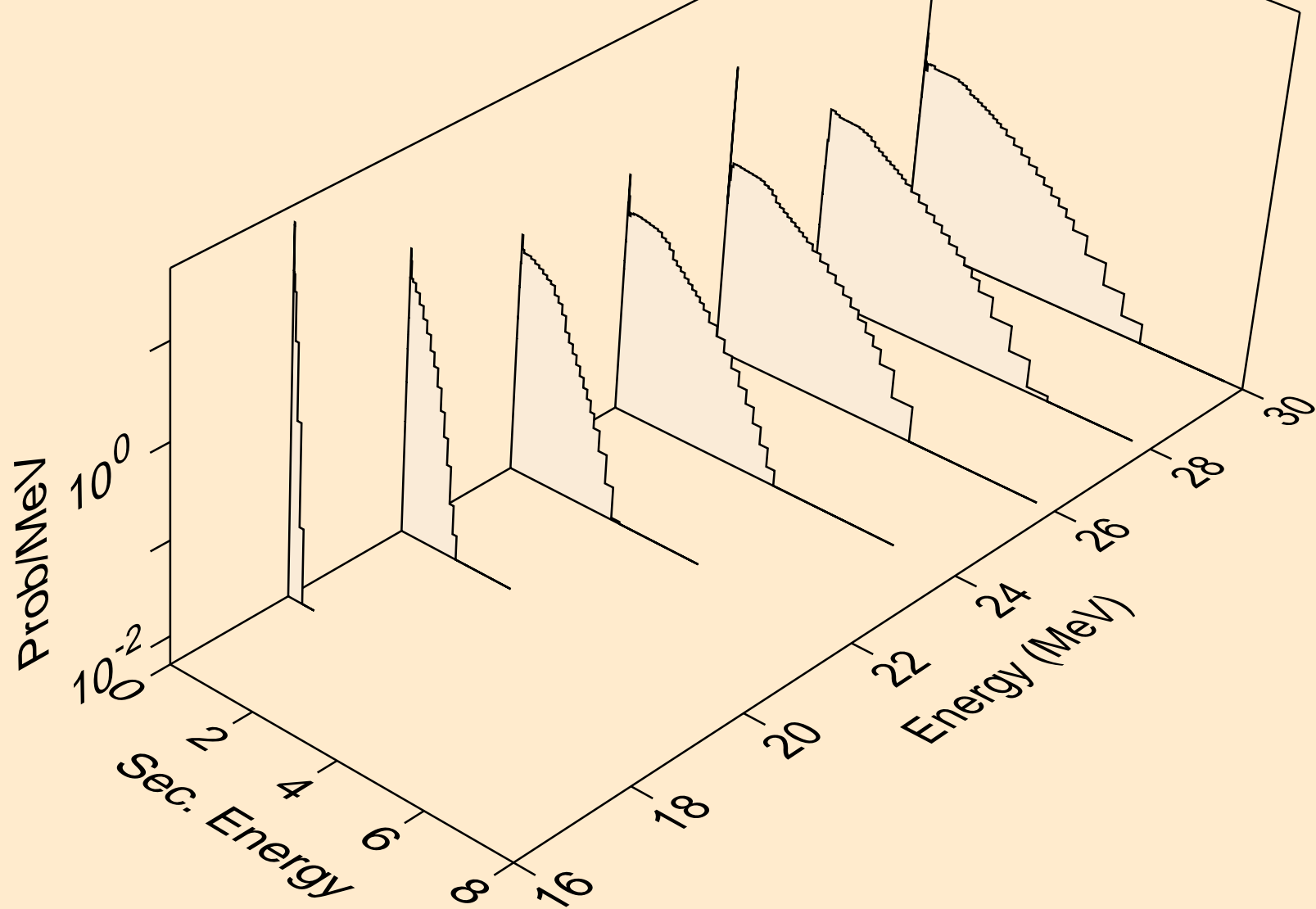

TI053 NEUTRON ACER TENDL-2024 LIBRARY; T=0.K
Neutron emission for (n,n*)t

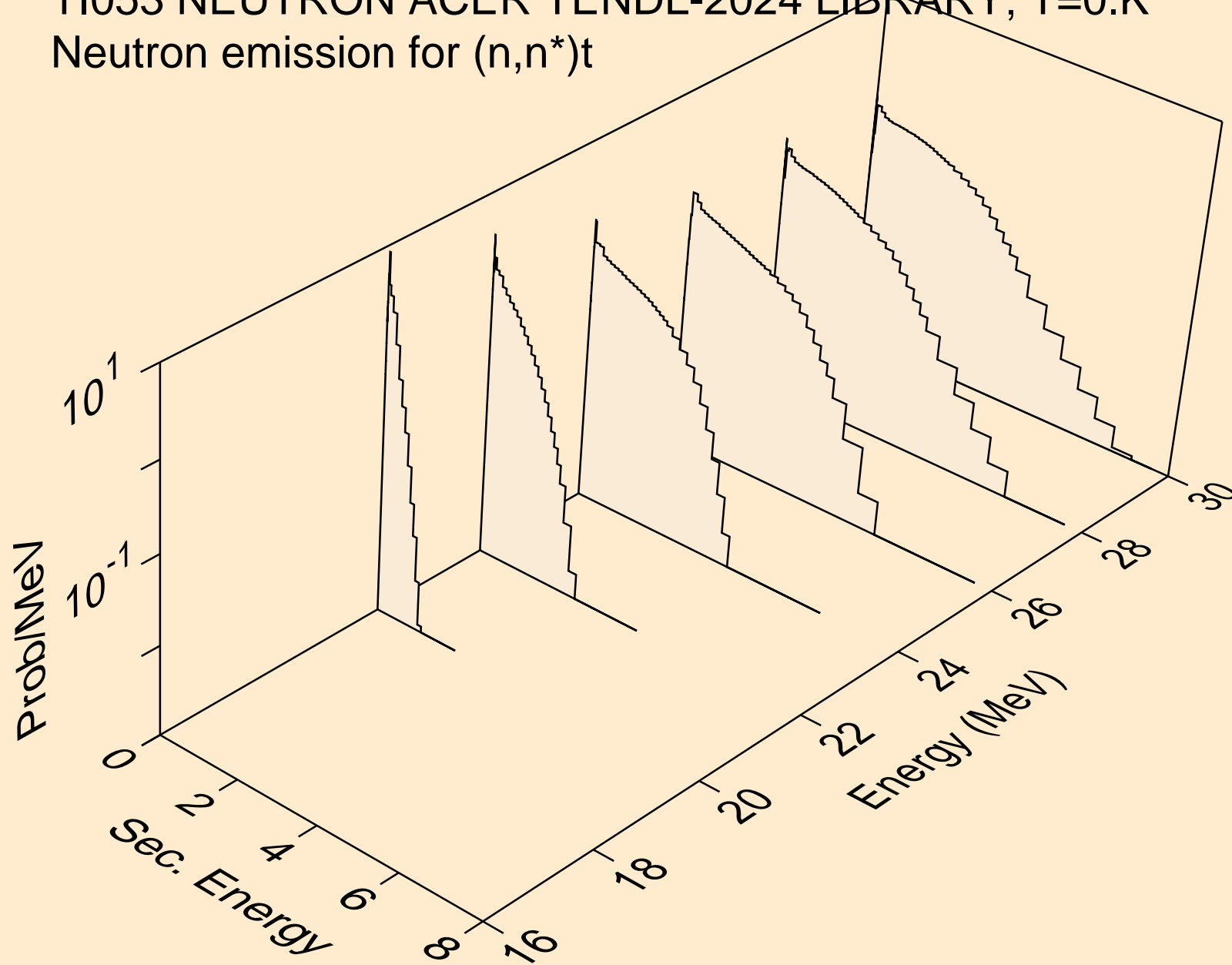

TI053 NEUTRON ACER TENDL-2024 LIBRARY; T=0.K
Neutron emission for (n,n*)he3

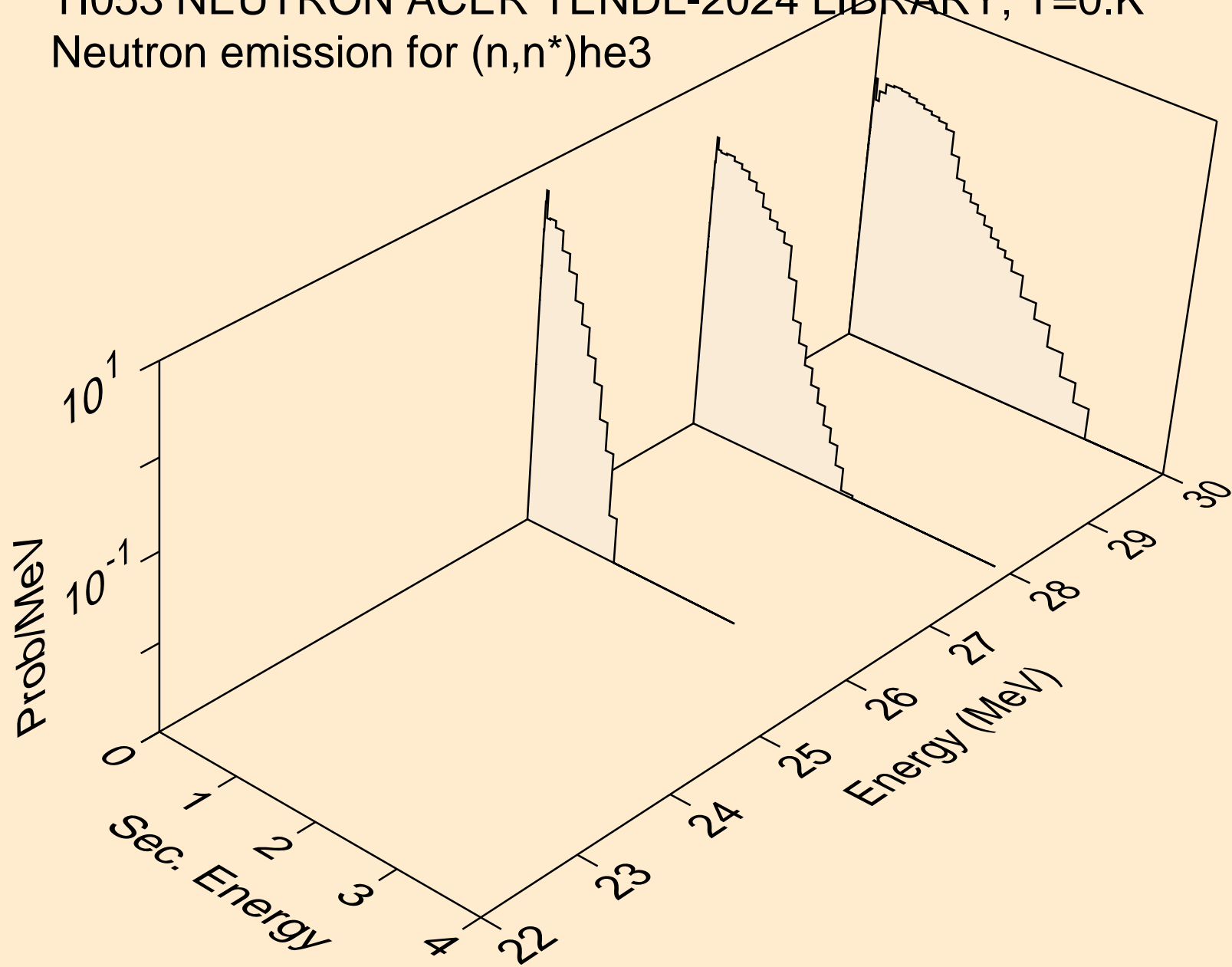

TI053 NEUTRON ACER TENDL-2024 LIBRARY; T=0.K
Neutron emission for (n,4n)

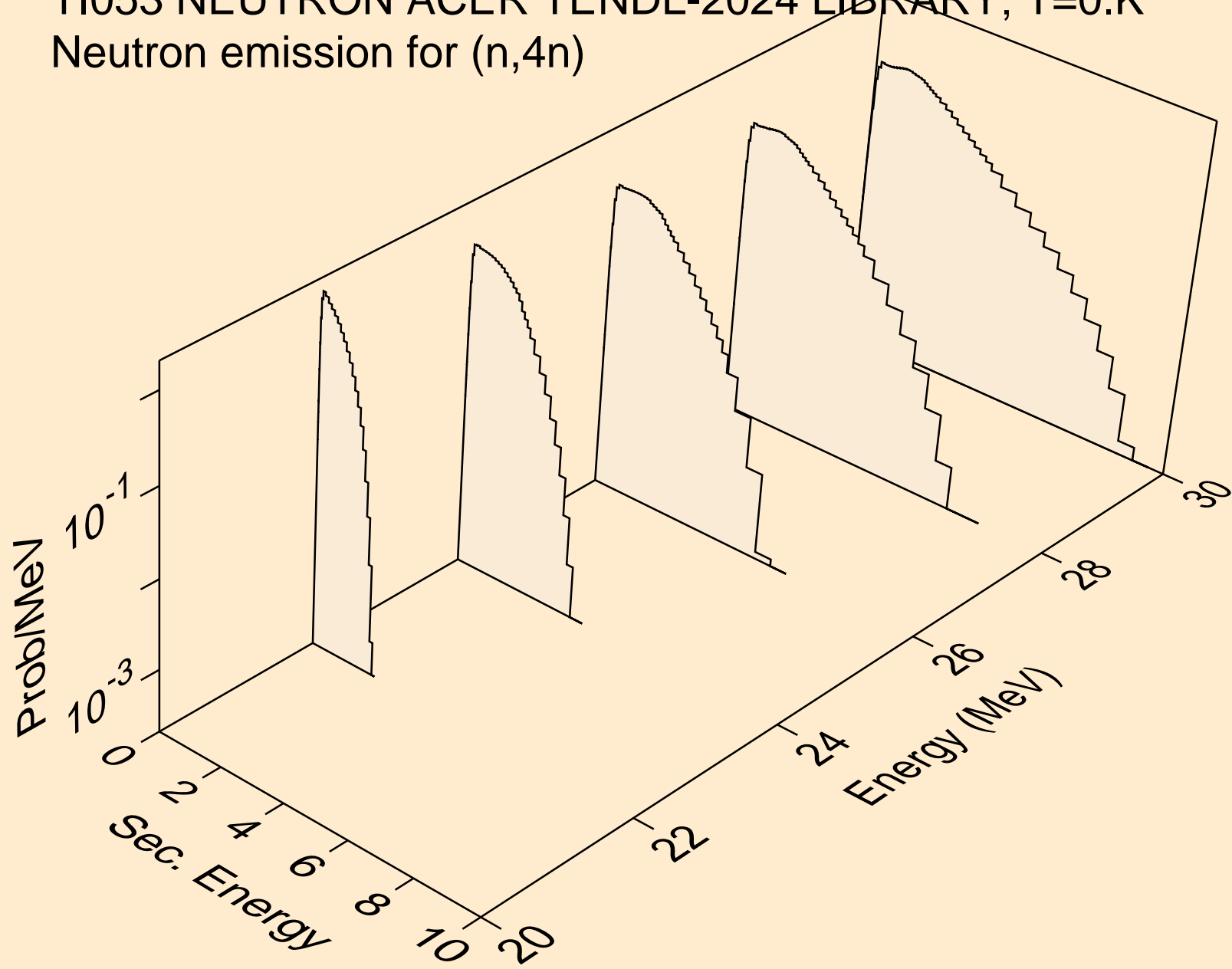

TI053 NEUTRON ACER TENDL-2024 LIBRARY; T=0.K
Neutron emission for (n,2np)

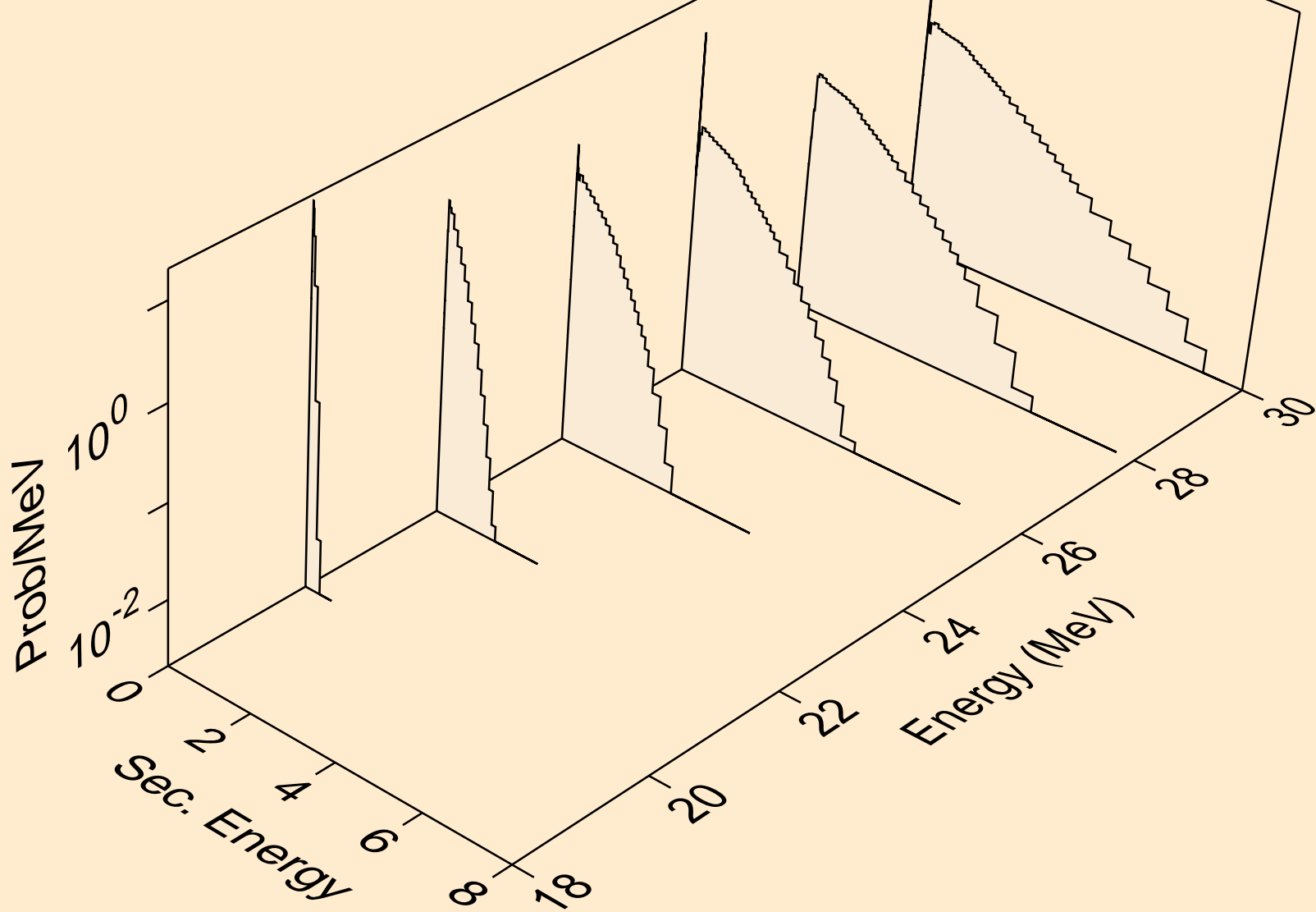

TI053 NEUTRON ACER TENDL-2024 LIBRARY; T=0.K
Neutron emission for (n,3np)

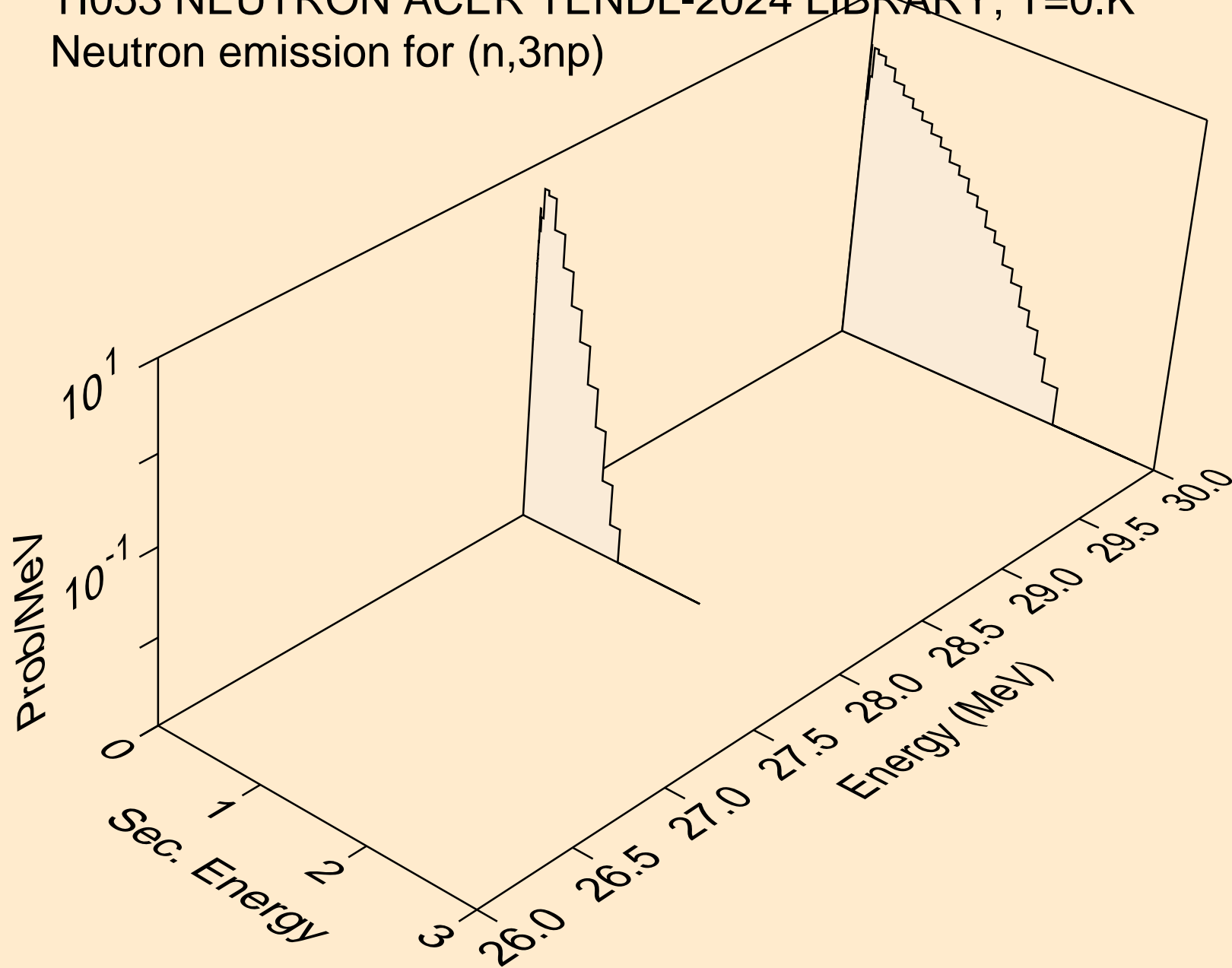

TI053 NEUTRON ACER TENDL-2024 LIBRARY; T=0.K
Photon emission for (n,x)

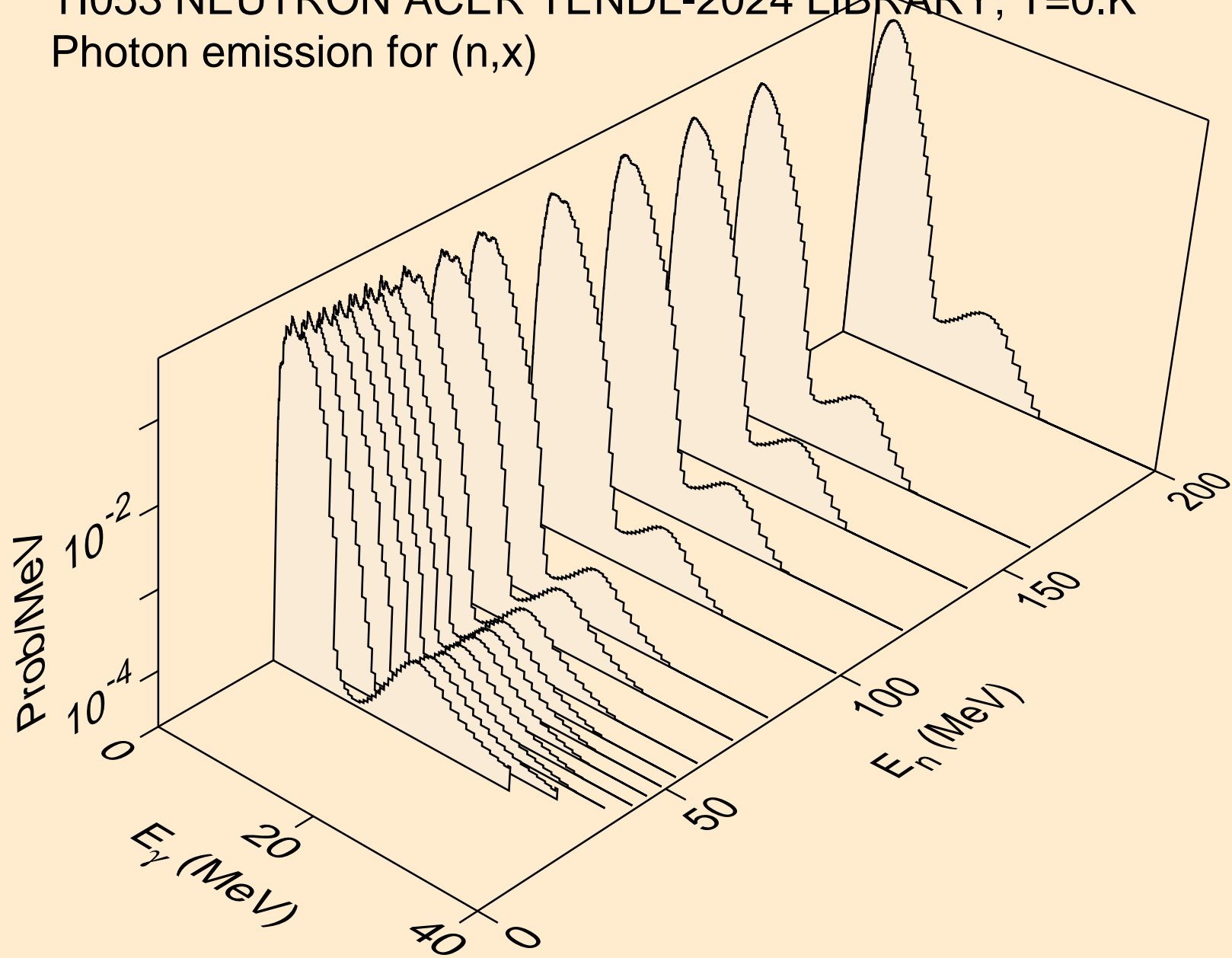

TI053 NEUTRON ACER TENDL-2024 LIBRARY; T=0.K
Photon emission for (n,2nd)

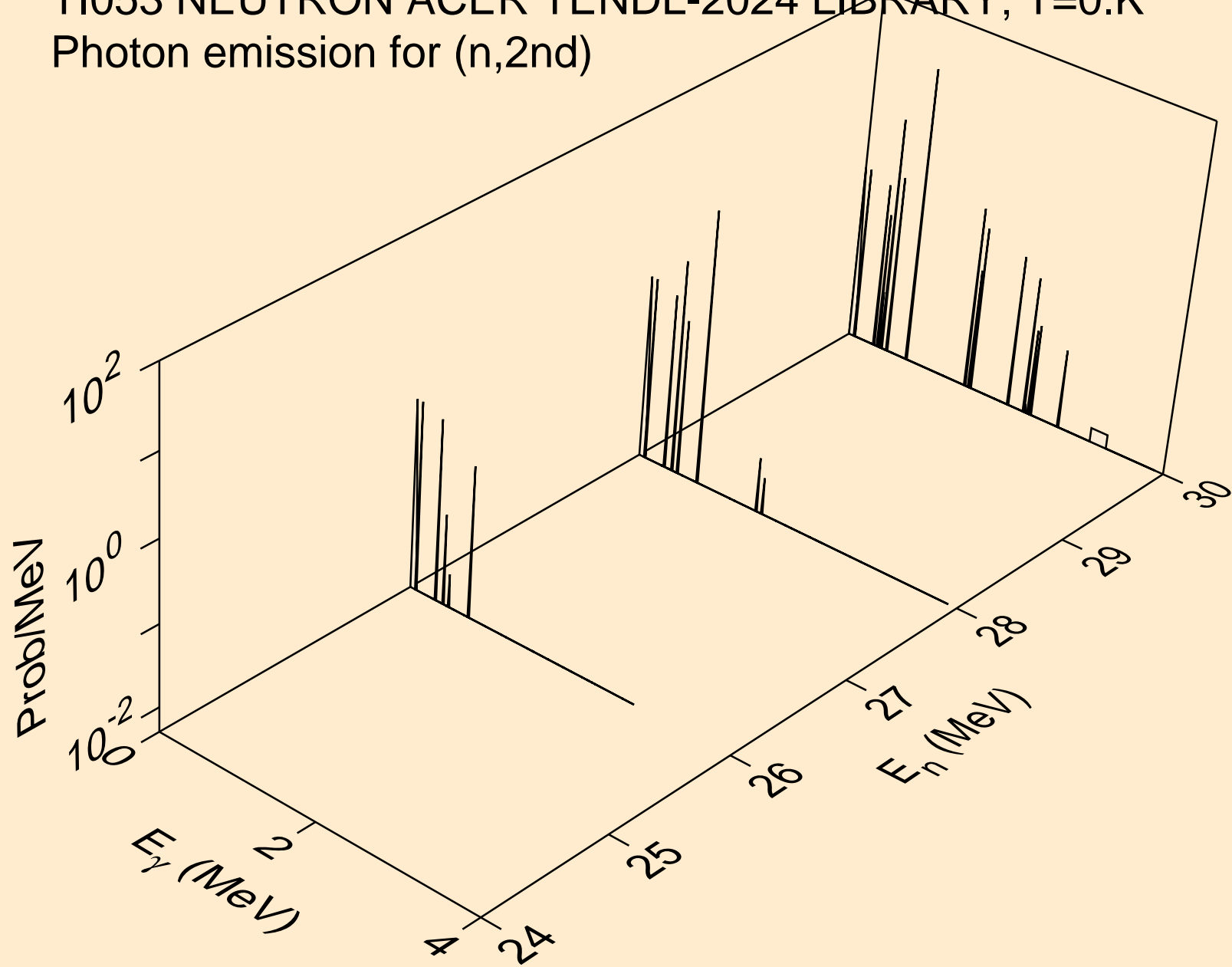

TI053 NEUTRON ACER TENDL-2024 LIBRARY; T=0.K
Photon emission for (n,2n)

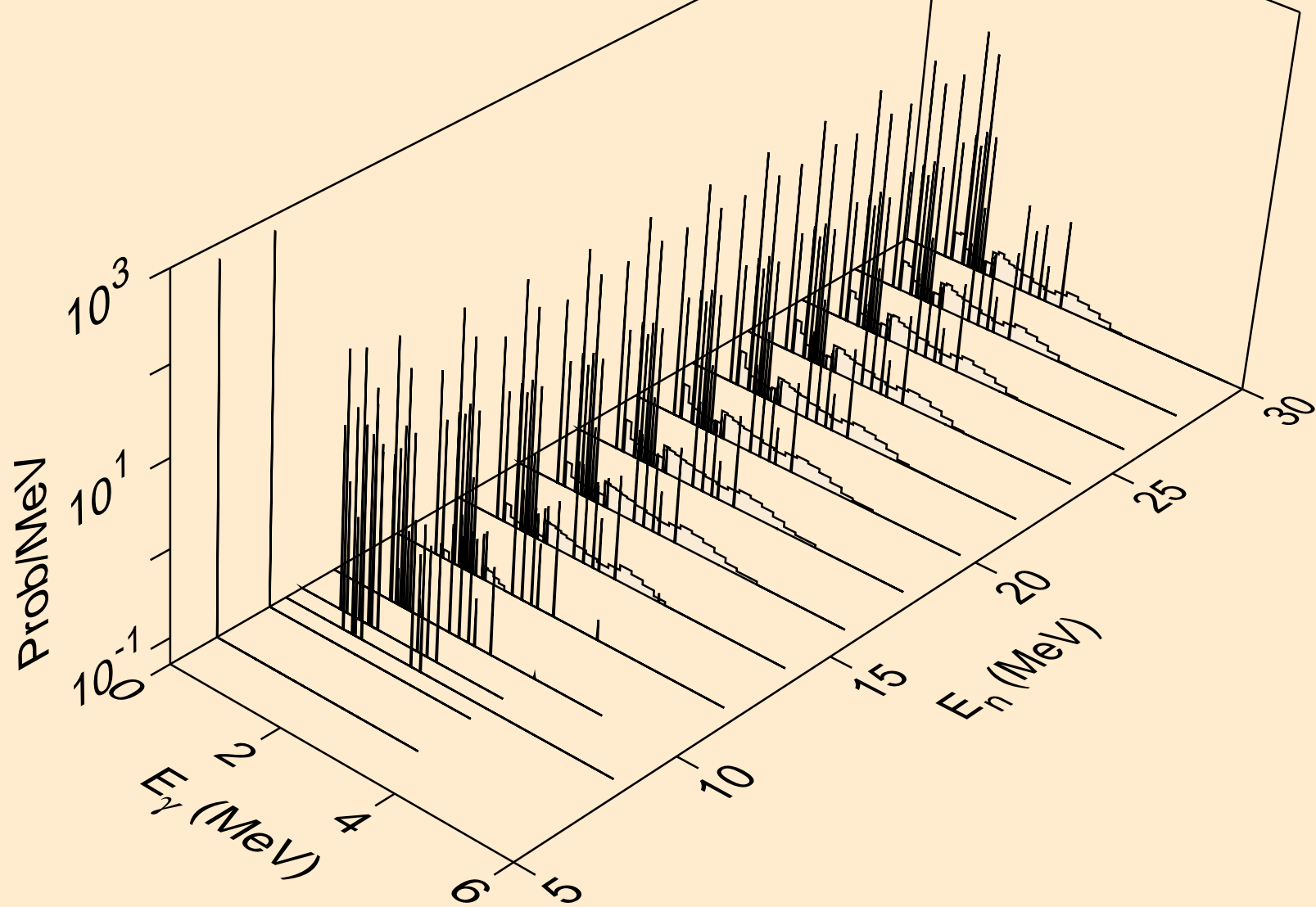

TI053 NEUTRON ACER TENDL-2024 LIBRARY; T=0.K
Photon emission for (n,3n)

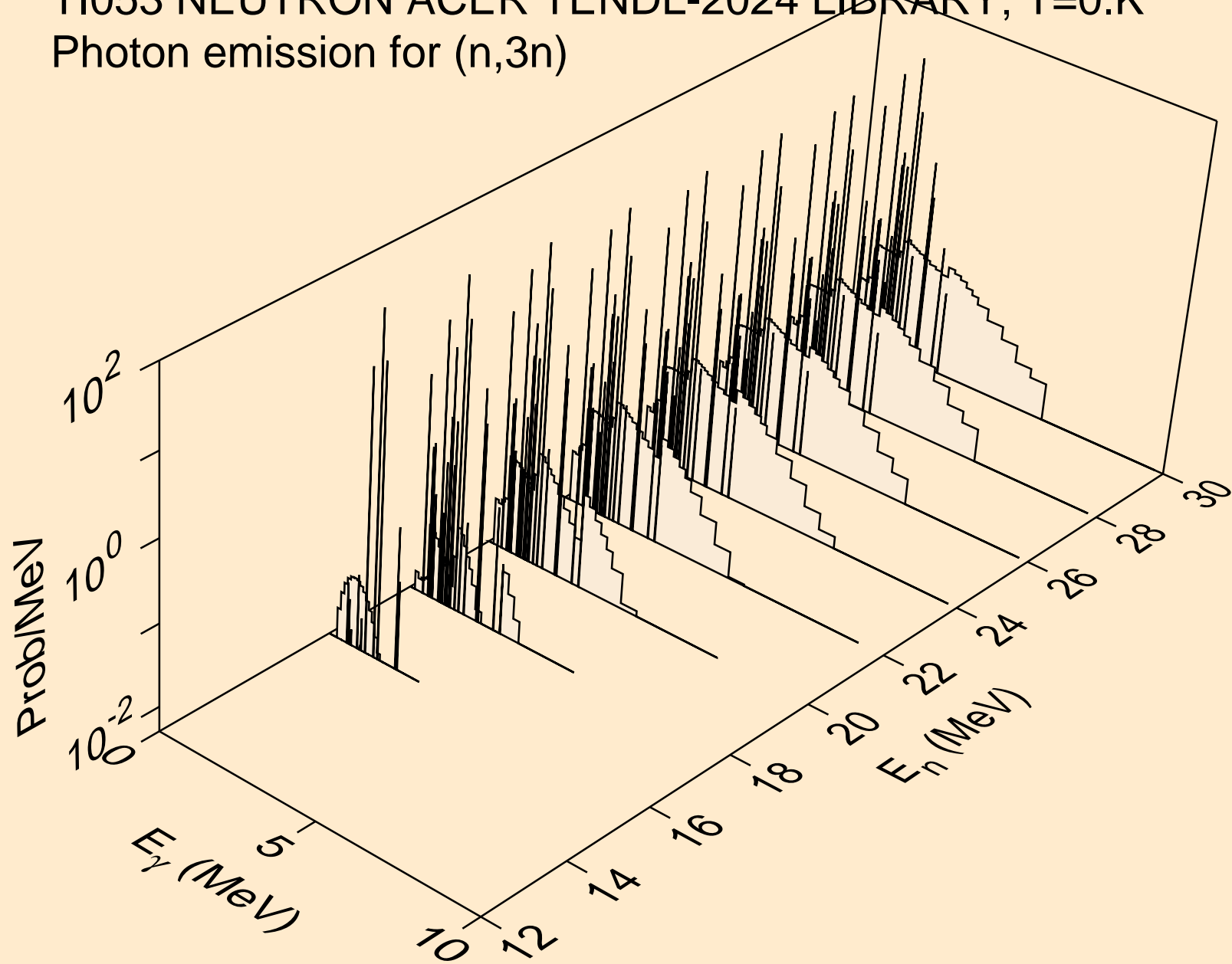

TI053 NEUTRON ACER TENDL-2024 LIBRARY; T=0.K
Photon emission for (n,n*)a

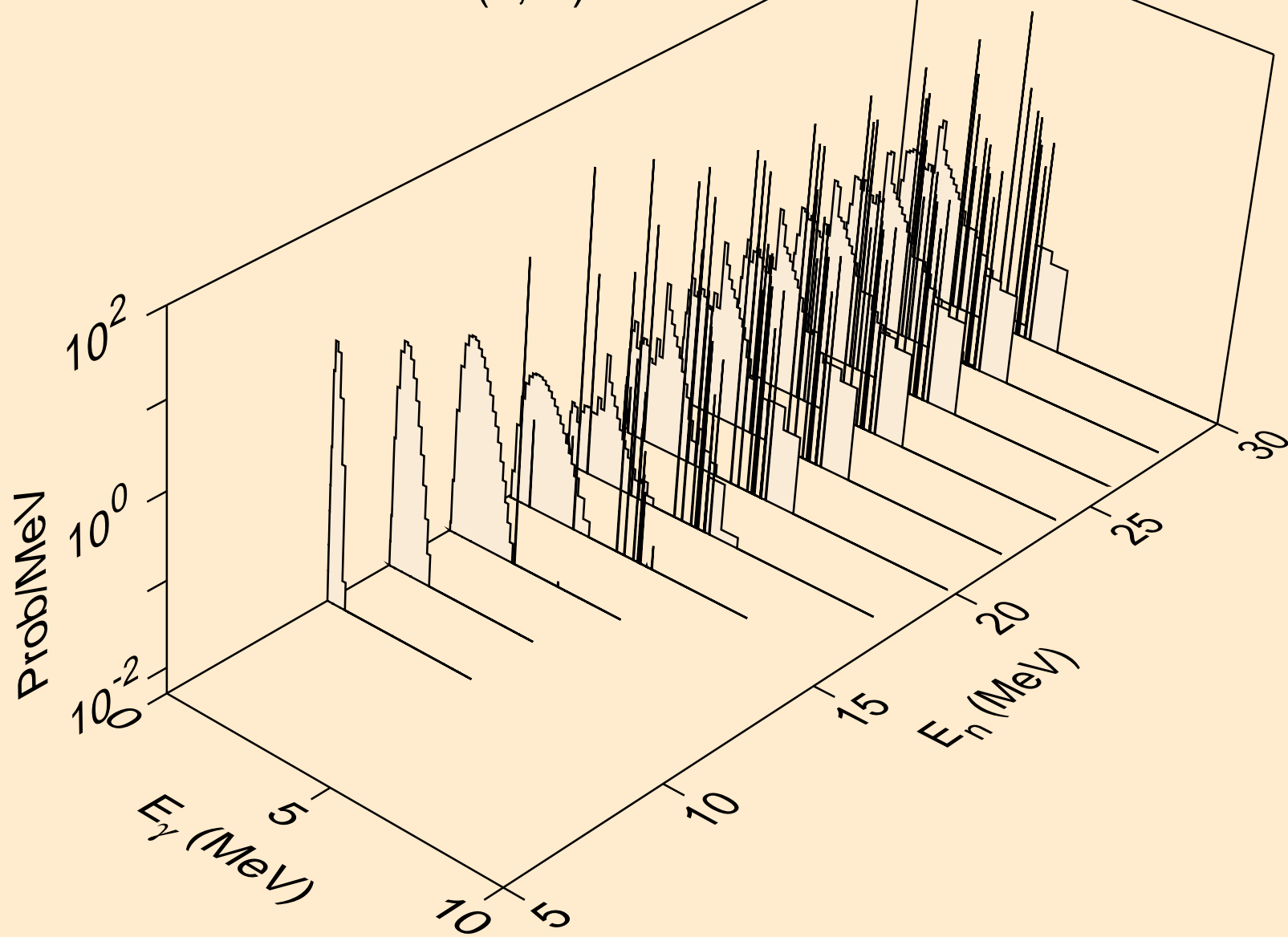

TI053 NEUTRON ACER TENDL-2024 LIBRARY; T=0.K
Photon emission for (n,2n)a

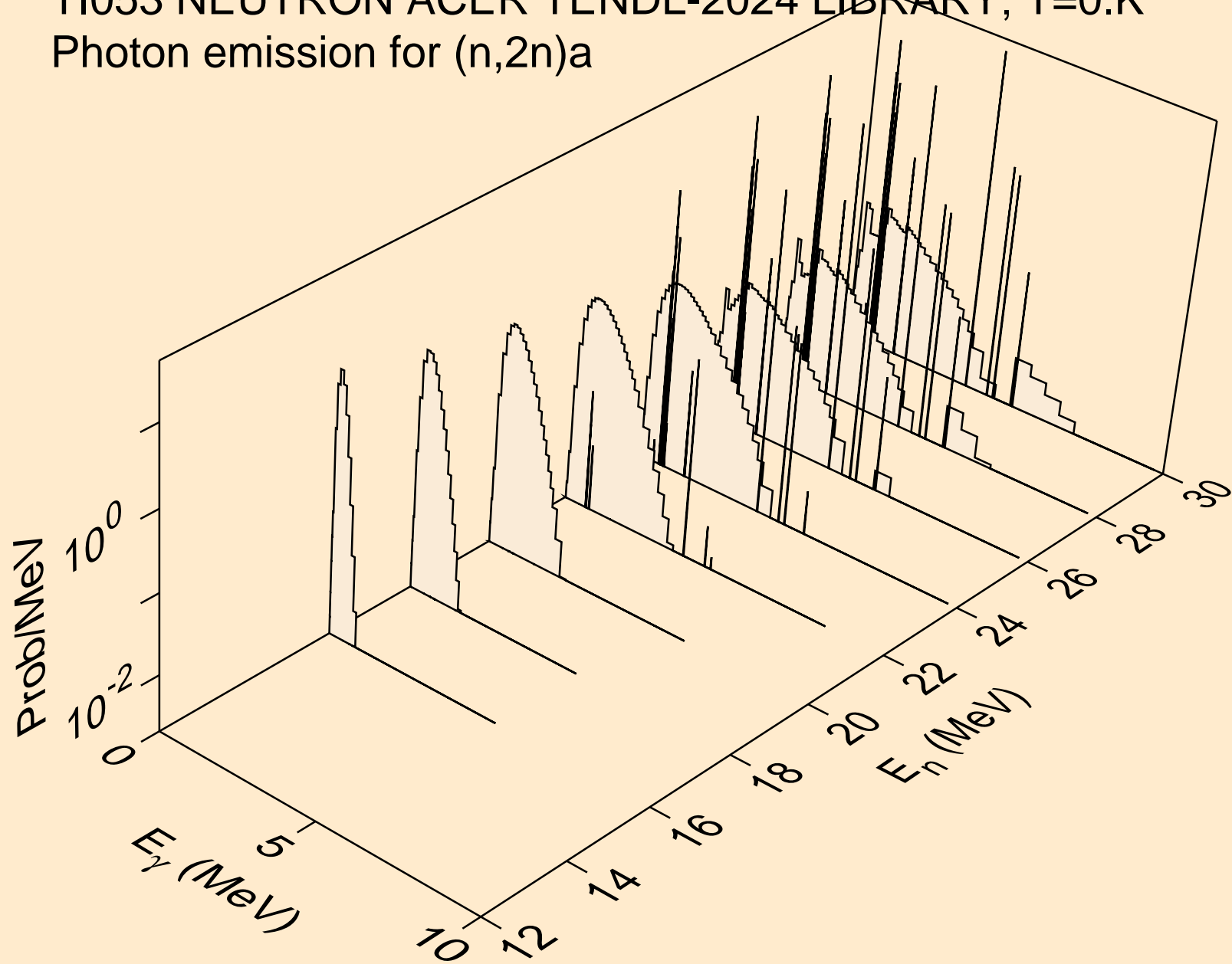

TI053 NEUTRON ACER TENDL-2024 LIBRARY; T=0.K
Photon emission for (n,3n)a

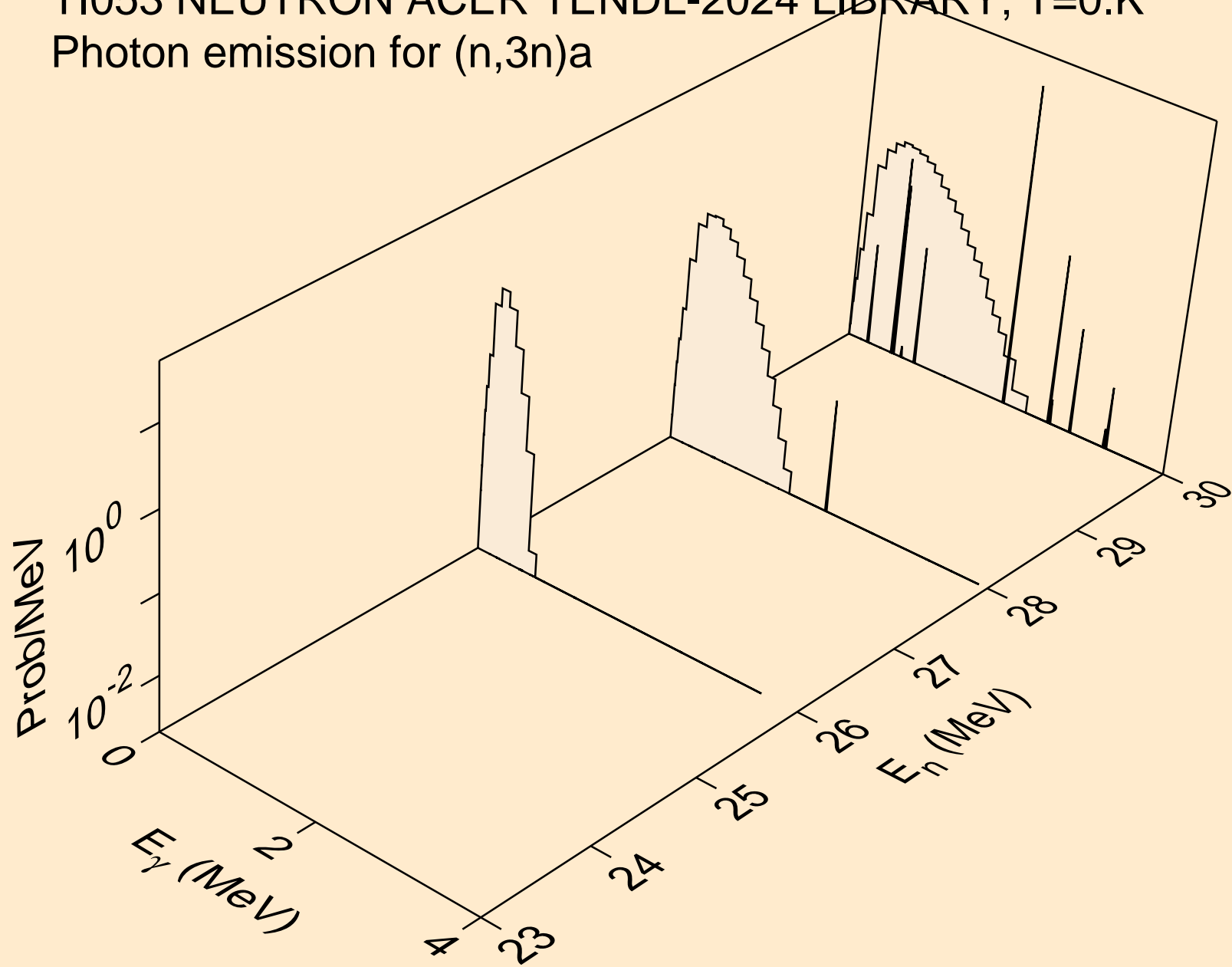

TI053 NEUTRON ACER TENDL-2024 LIBRARY; T=0.K
Photon emission for (n,n*)p

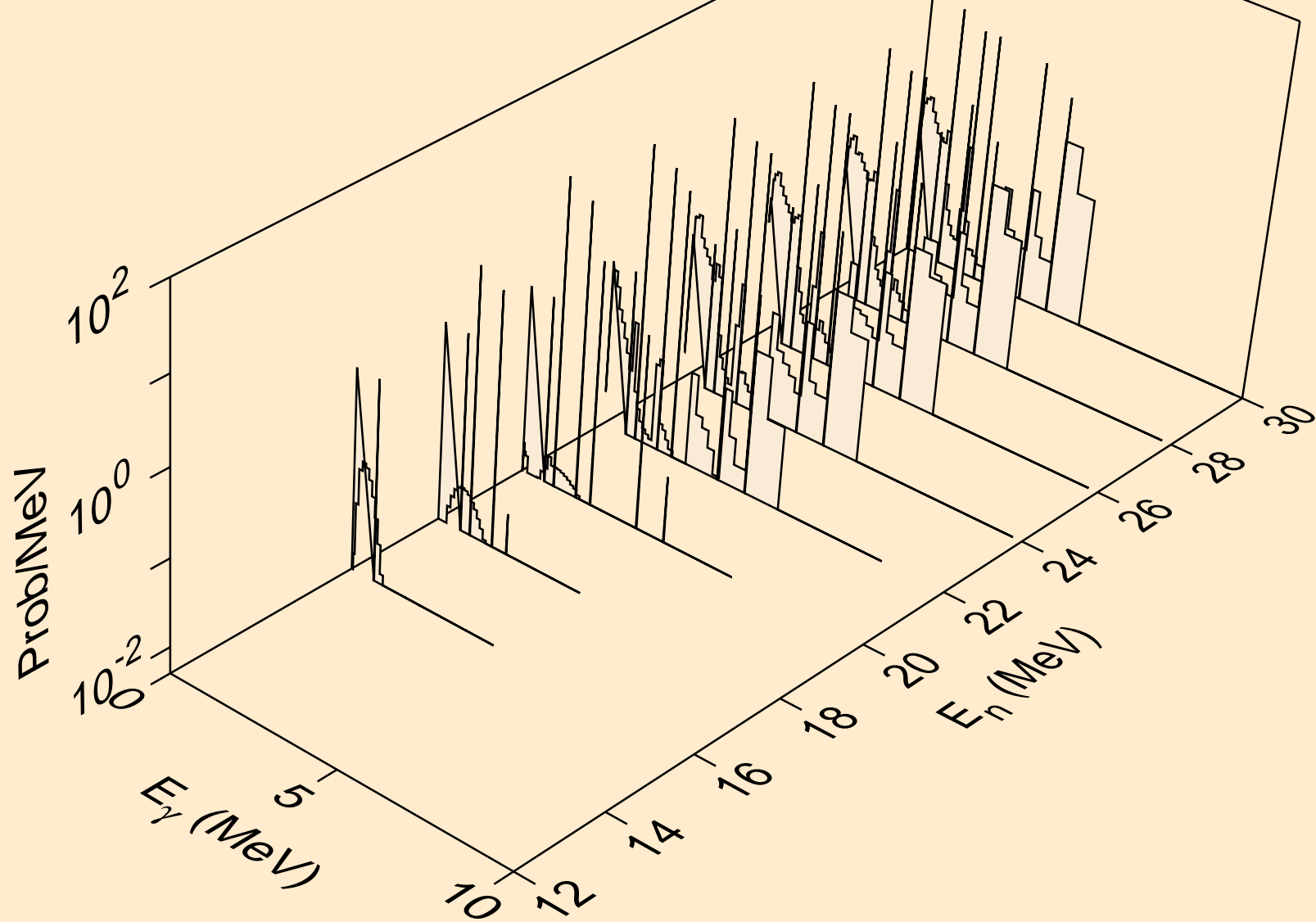

TI053 NEUTRON ACER TENDL-2024 LIBRARY; T=0.K
Photon emission for (n,n*)d

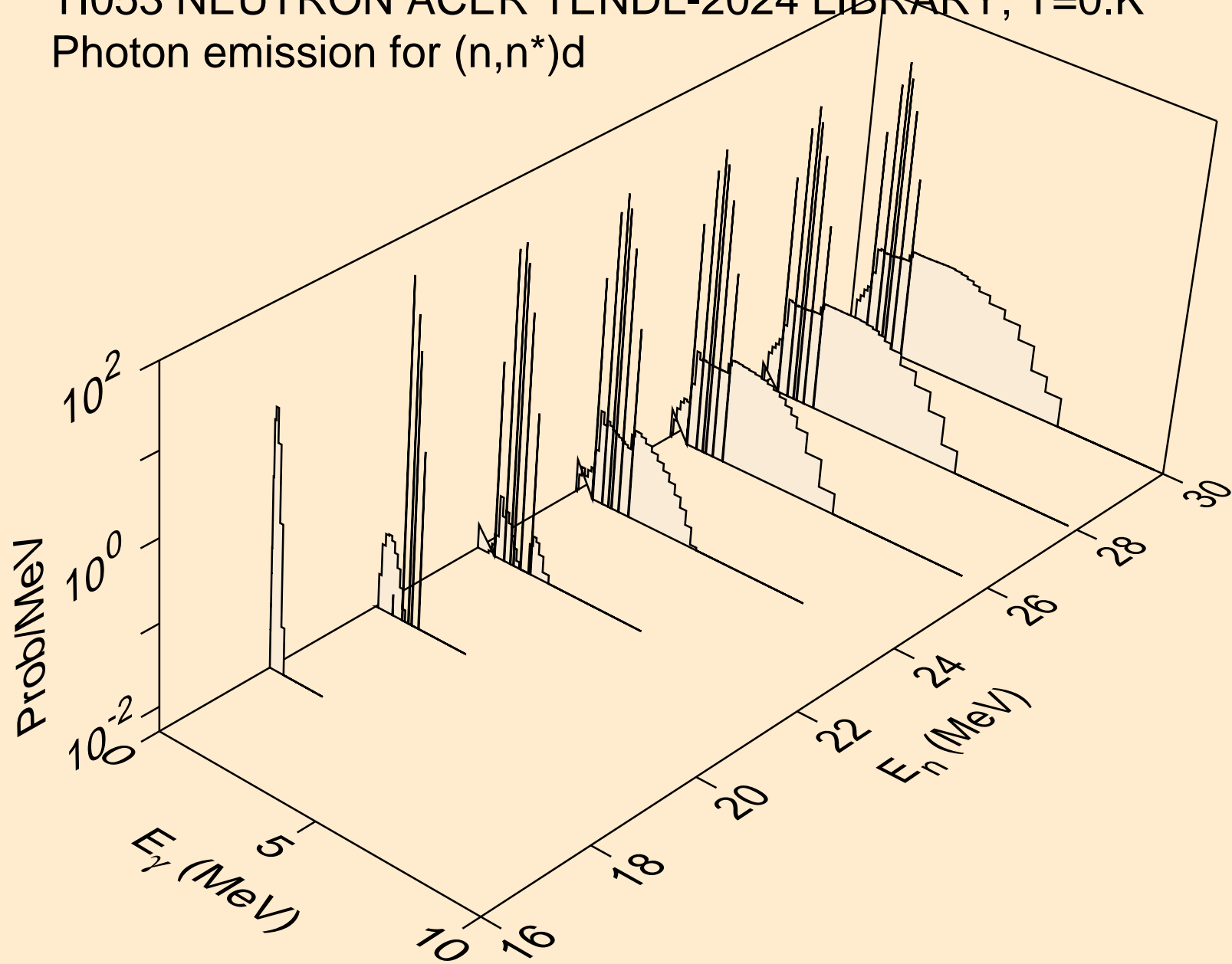

TI053 NEUTRON ACER TENDL-2024 LIBRARY; T=0.K
Photon emission for (n,n*)t

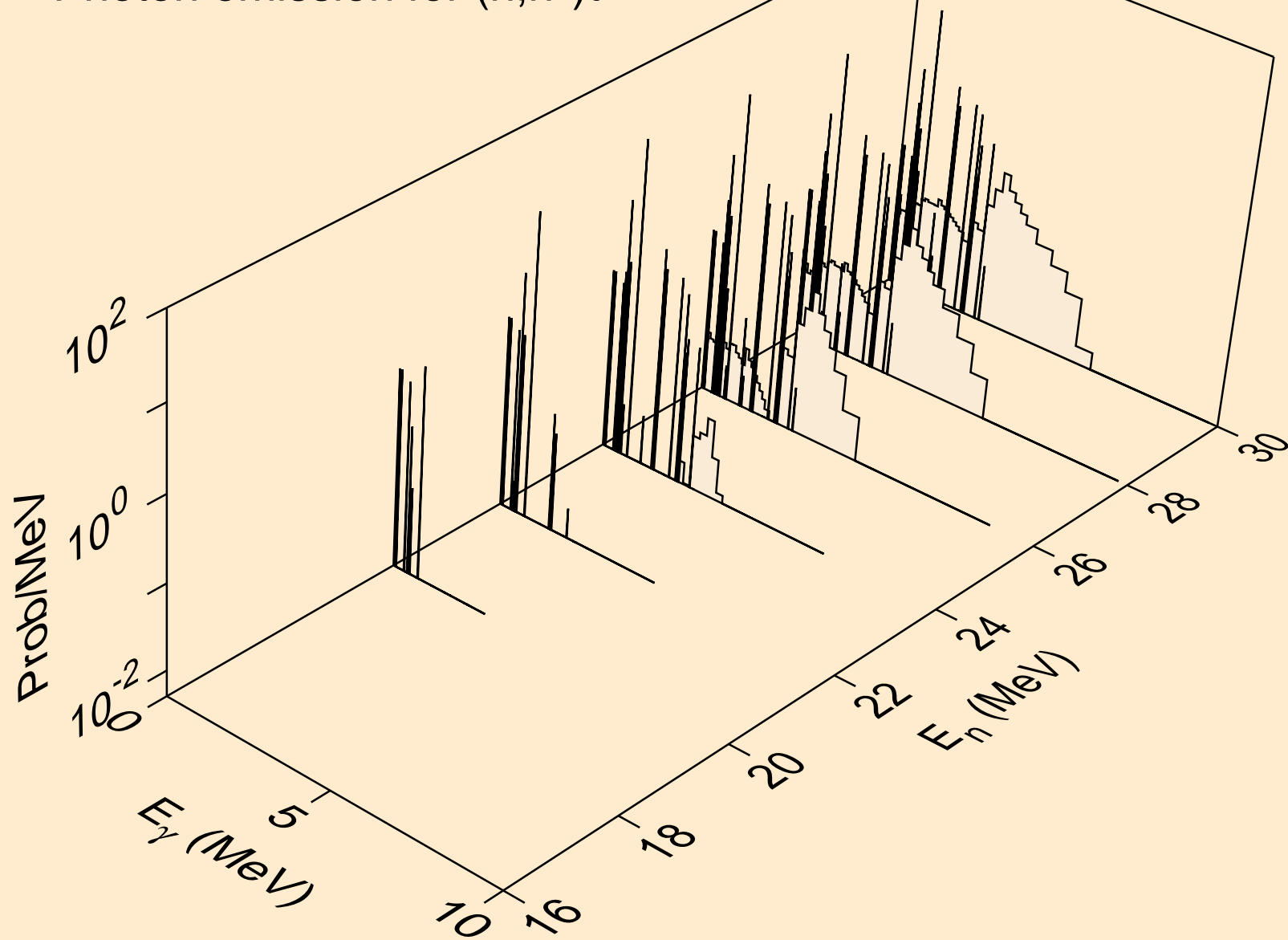

TI053 NEUTRON ACER TENDL-2024 LIBRARY; T=0.K
Photon emission for (n,n*)he3

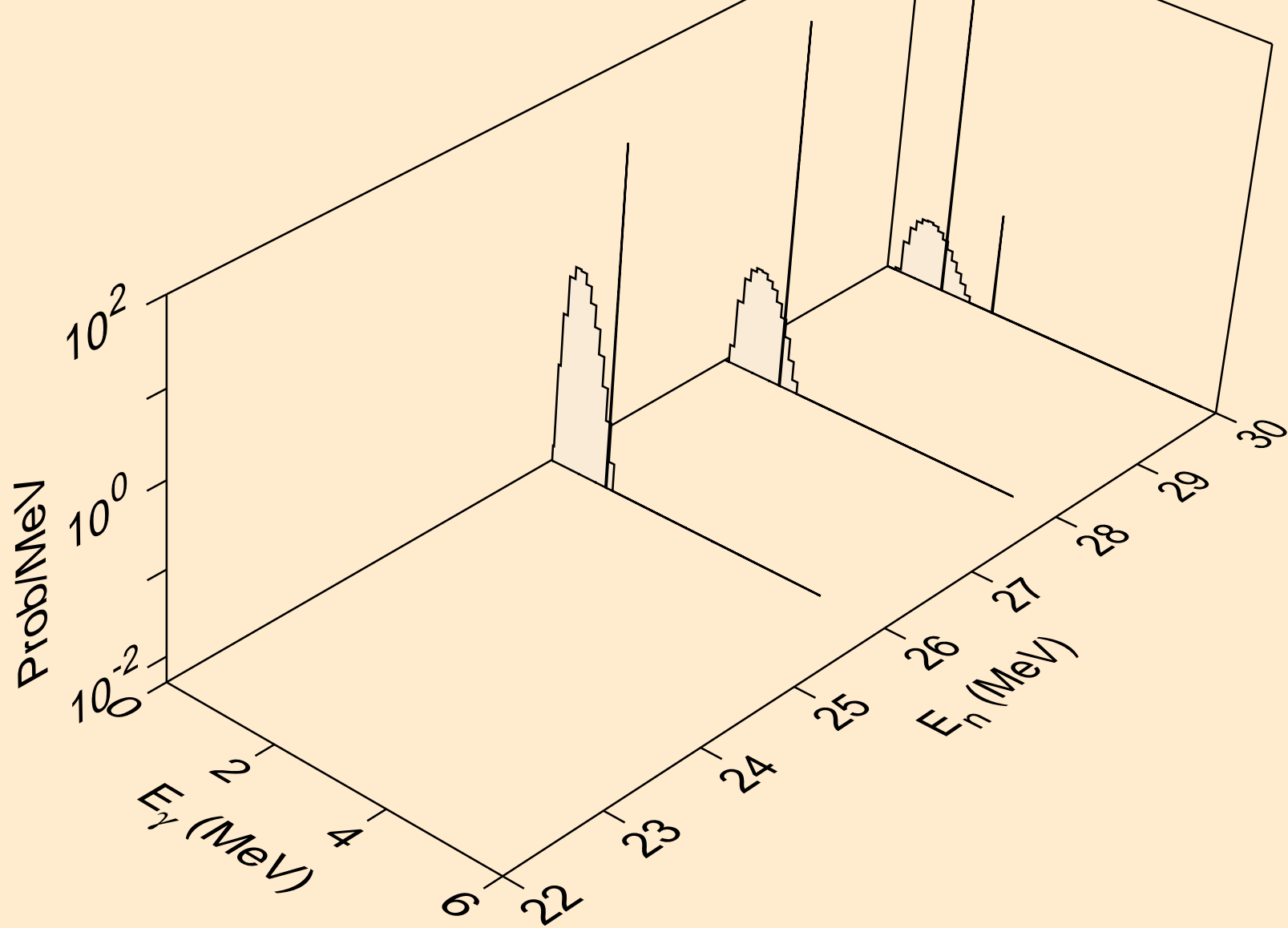

TI053 NEUTRON ACER TENDL-2024 LIBRARY; T=0.K
Photon emission for (n,4n)

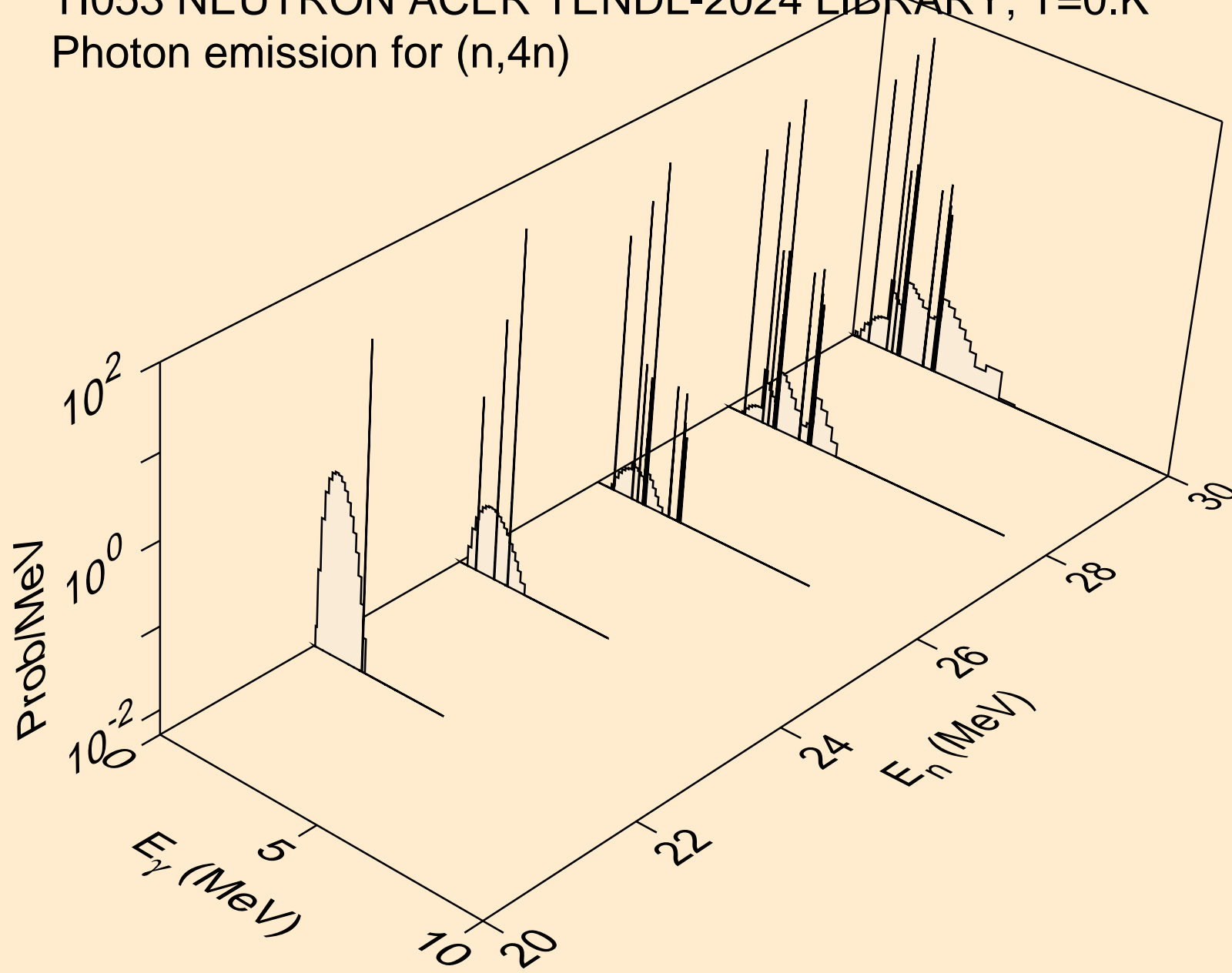

TI053 NEUTRON ACER TENDL-2024 LIBRARY; T=0.K
Photon emission for (n,2np)

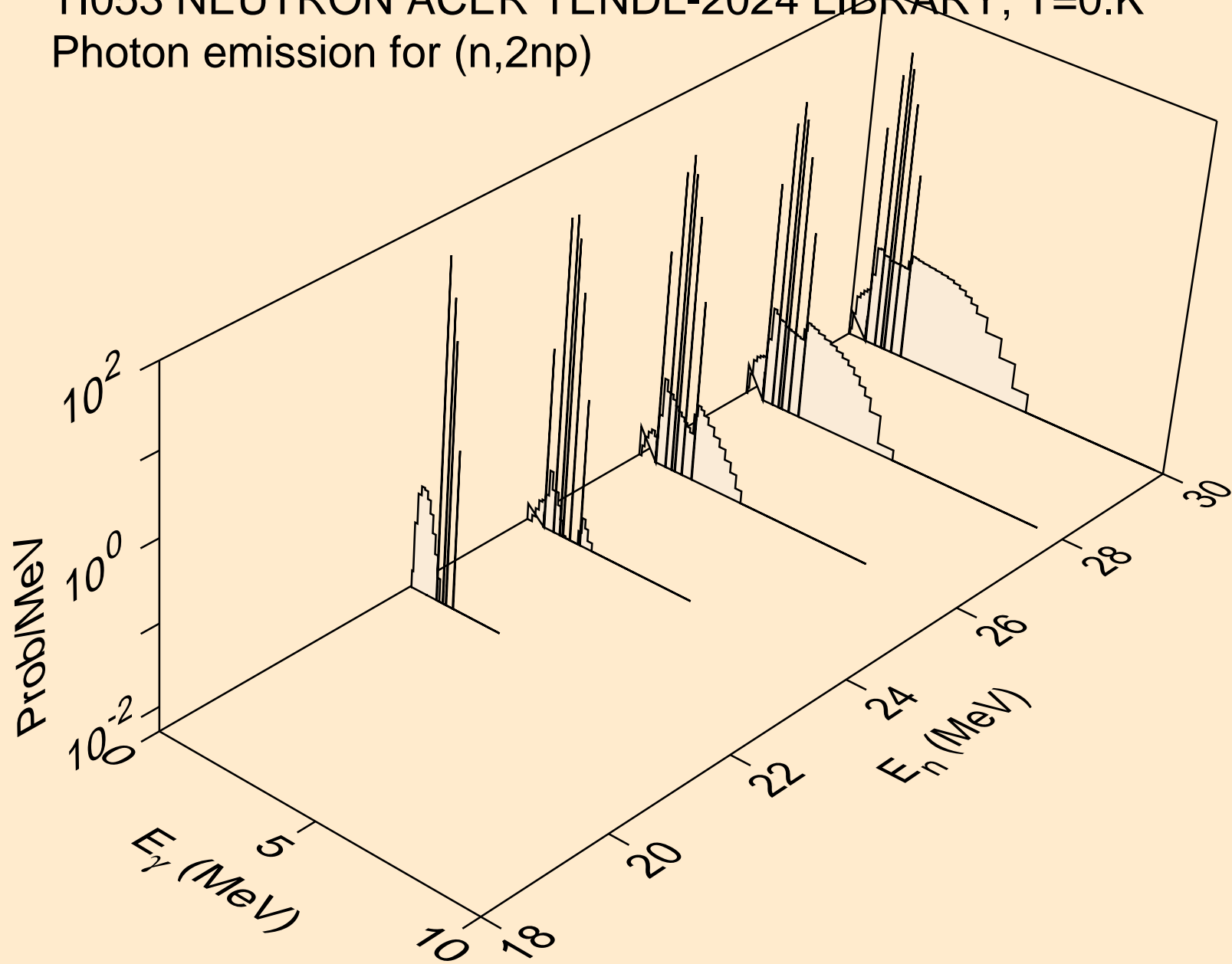

TI053 NEUTRON ACER TENDL-2024 LIBRARY; T=0.K
Photon emission for (n,3np)

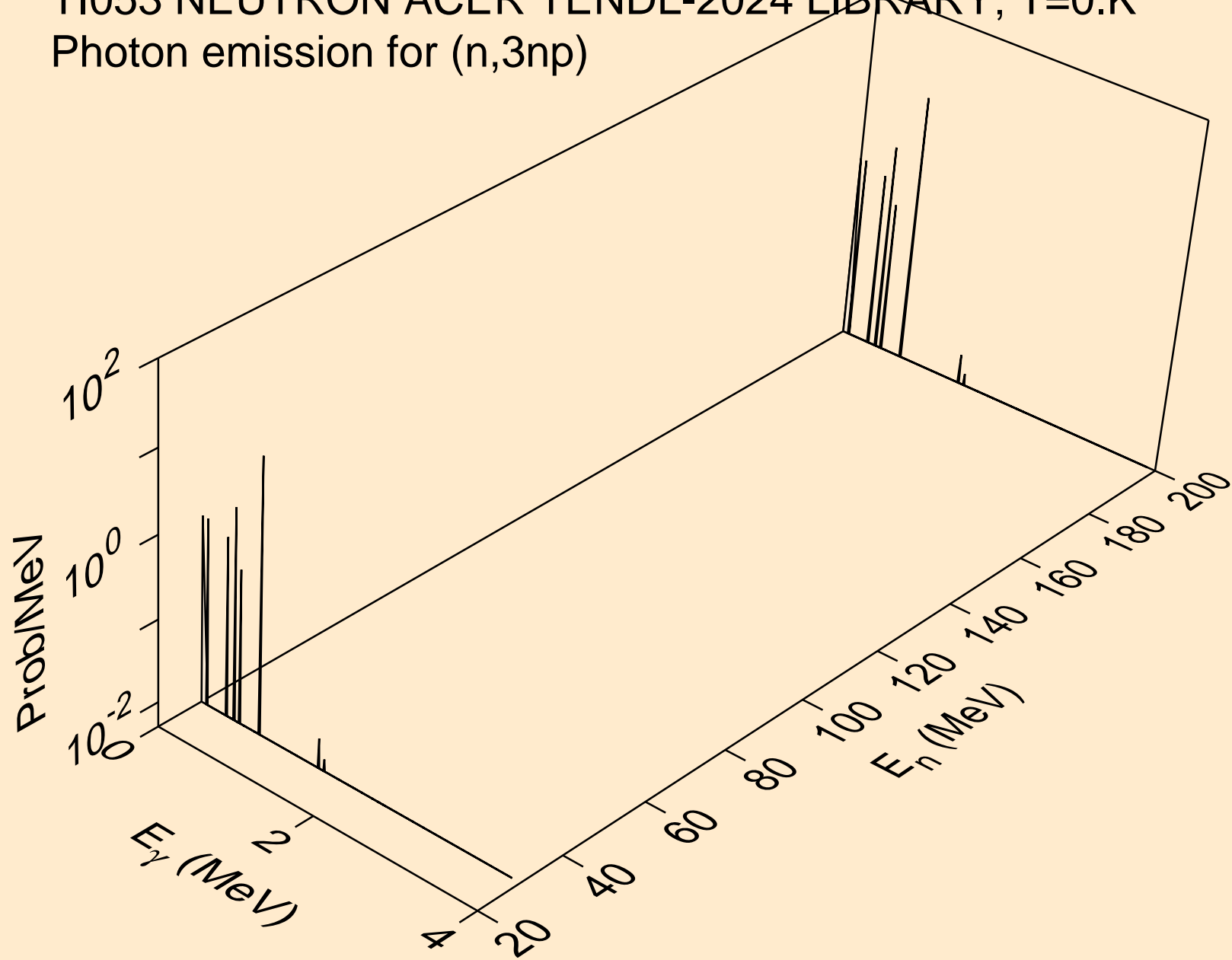

TI053 NEUTRON ACER TENDL-2024 LIBRARY; T=0.K
Photon emission for (n,n*c)

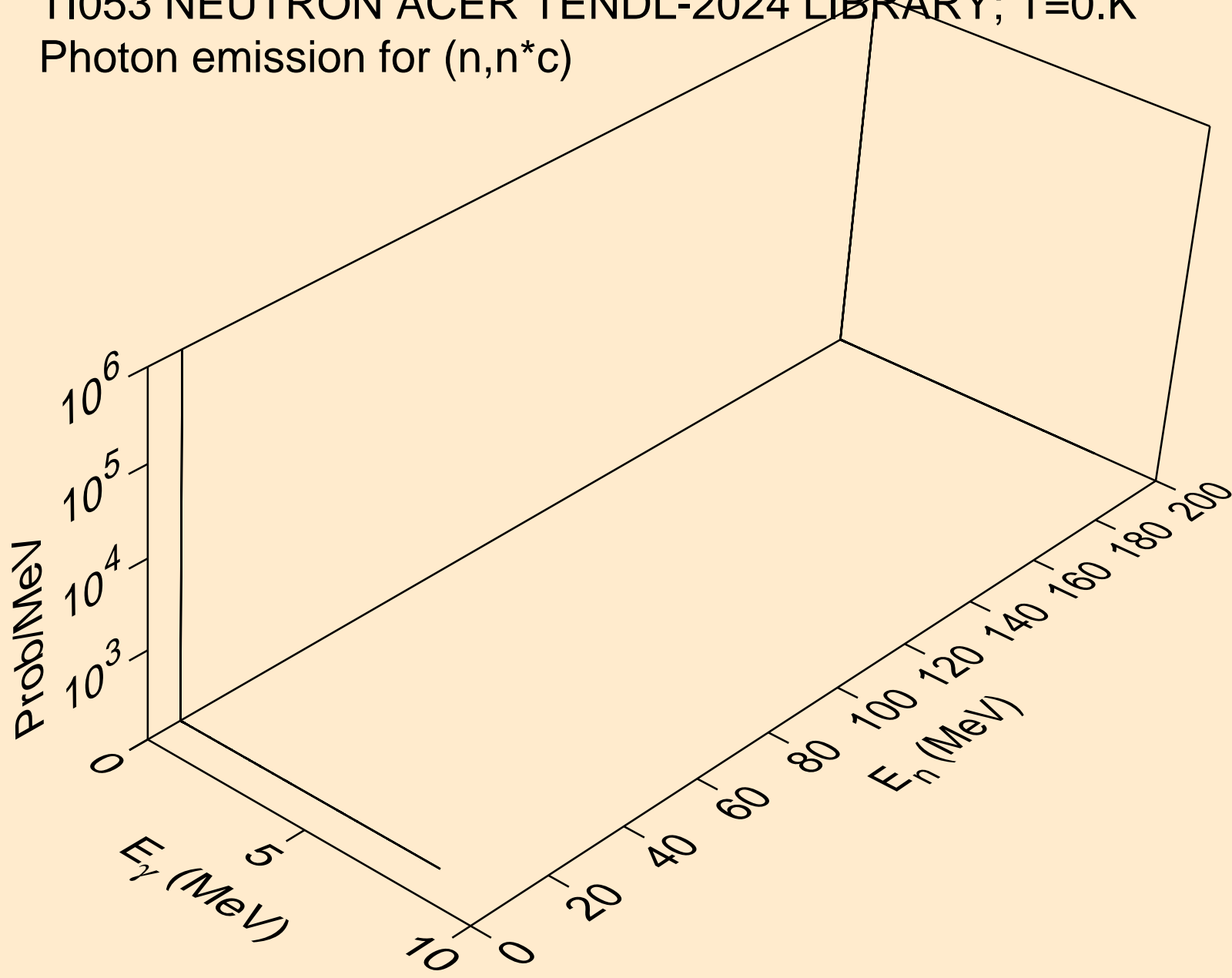

TI053 NEUTRON ACER TENDL-2024 LIBRARY; T=0.K
Photon emission for (n,gma)

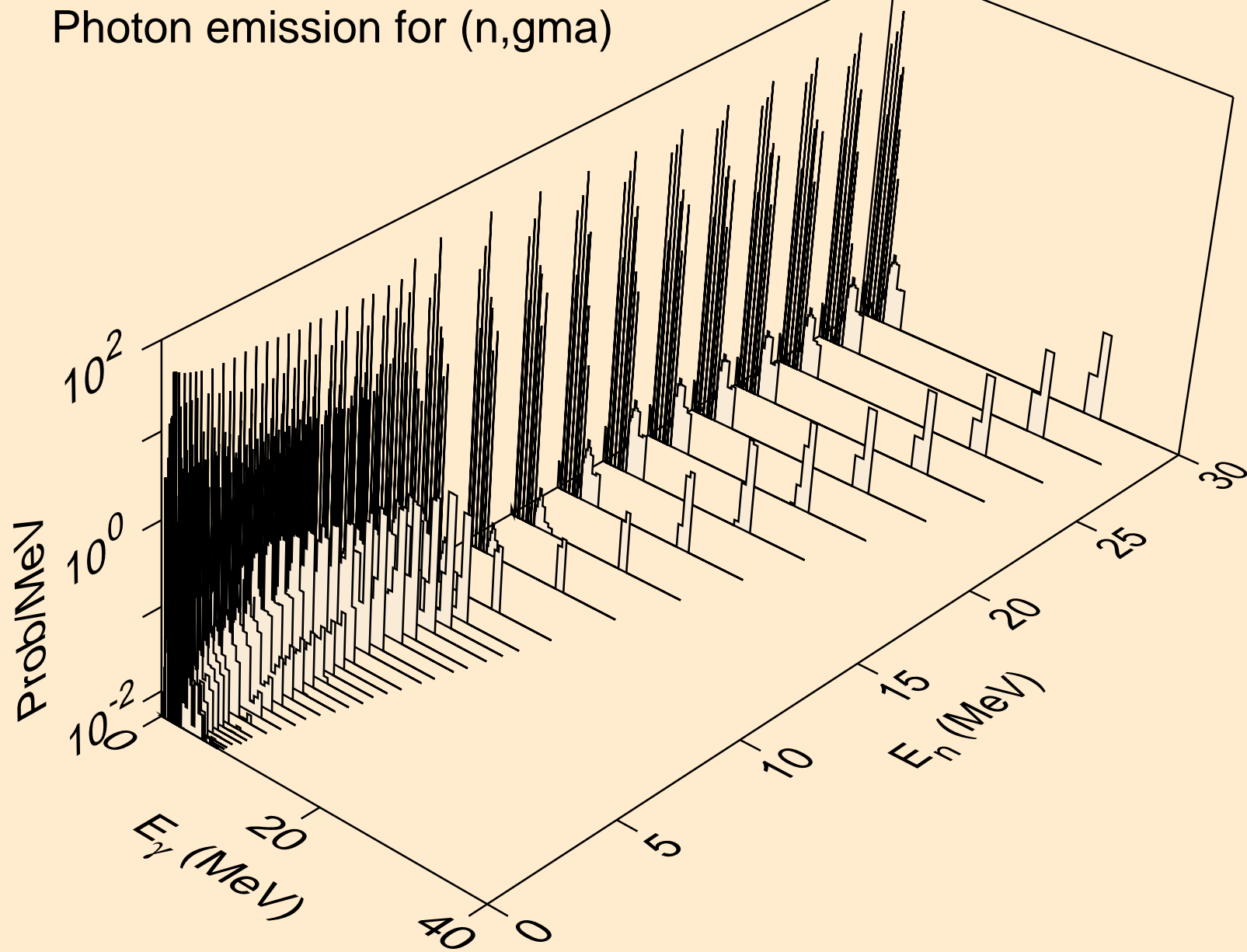

TI053 NEUTRON ACER TENDL-2024 LIBRARY; T=0.K
Photon emission for (n,p)

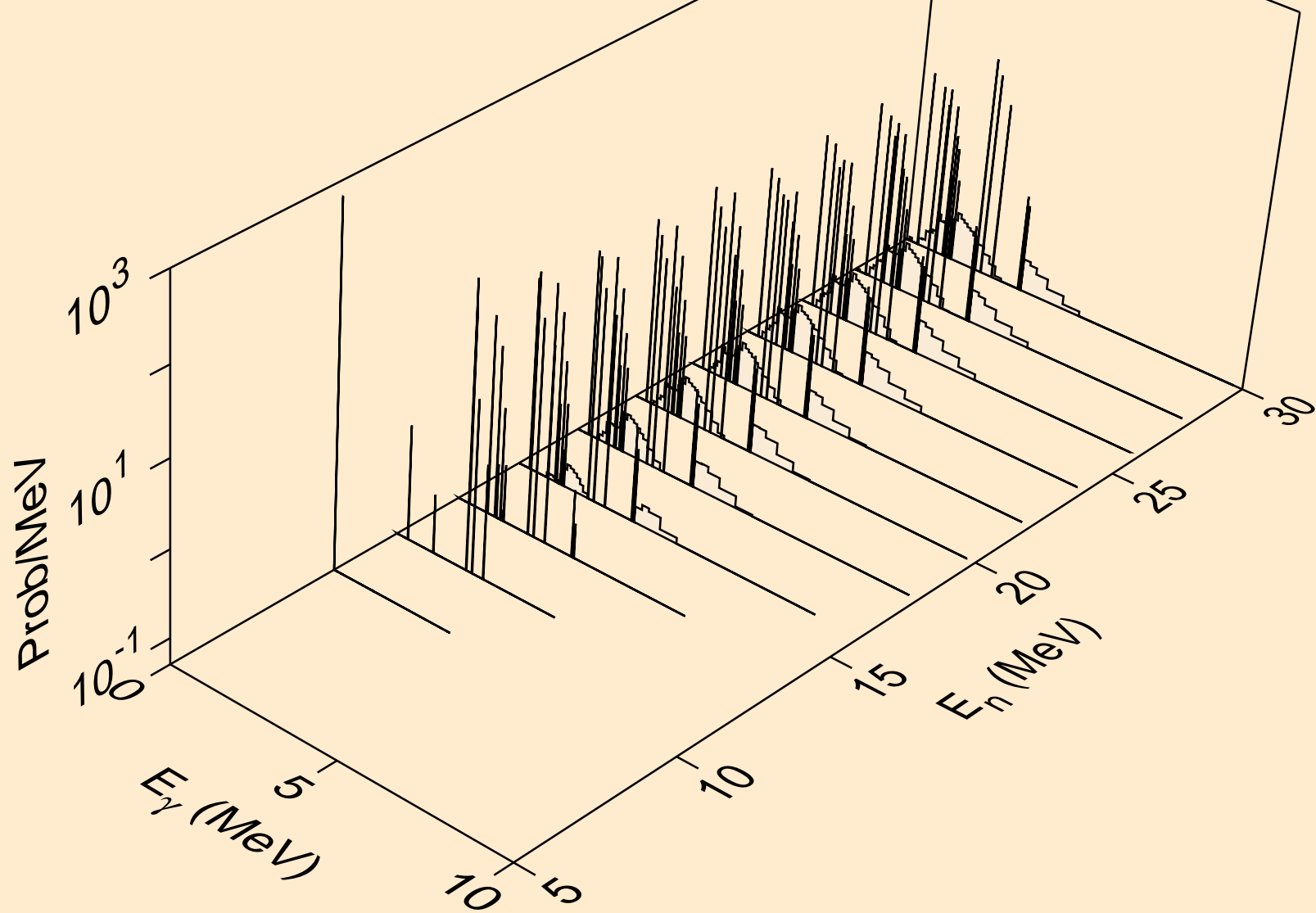

TI053 NEUTRON ACER TENDL-2024 LIBRARY; T=0.K
Photon emission for (n,d)

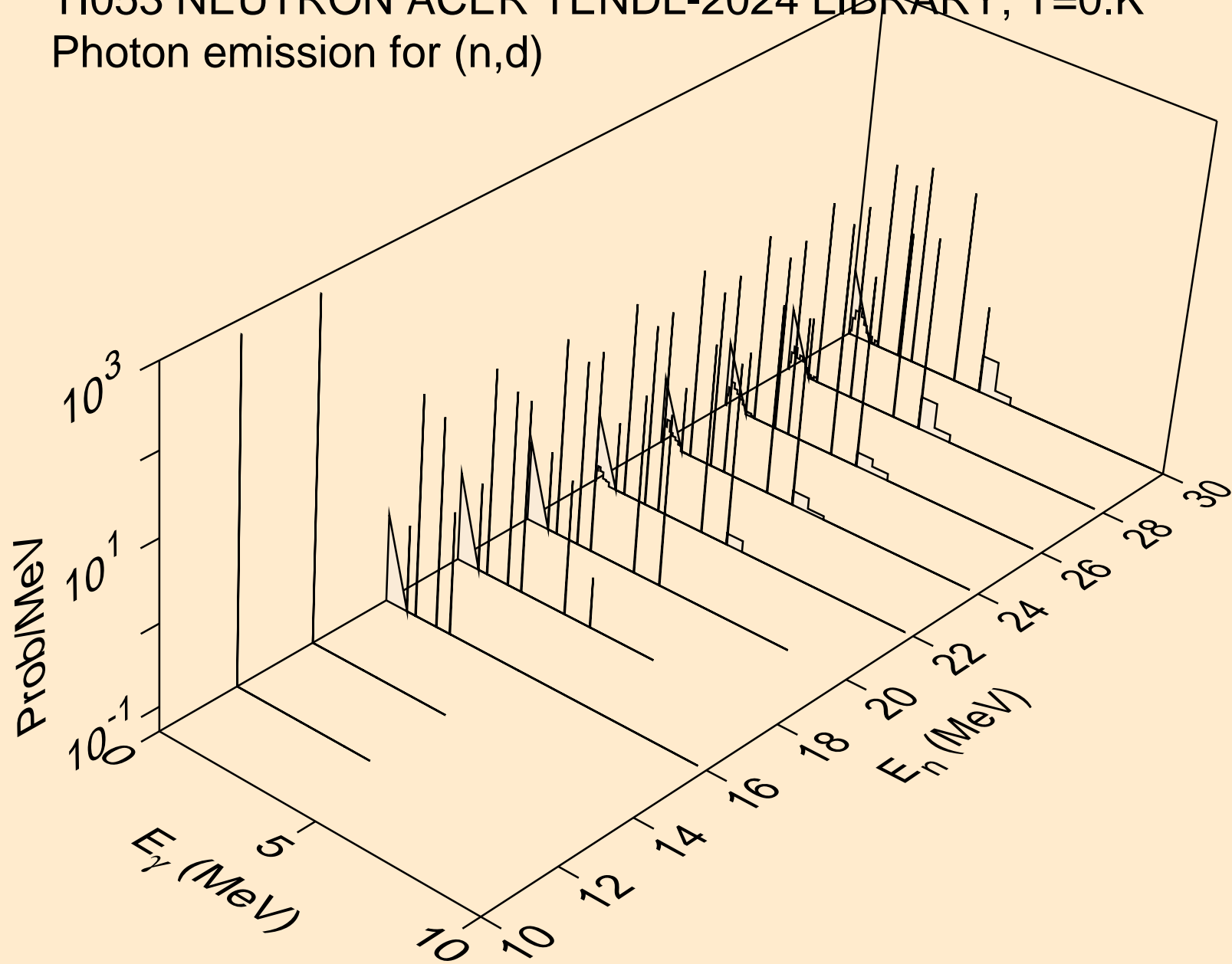

TI053 NEUTRON ACER TENDL-2024 LIBRARY; T=0.K
Photon emission for (n,t)

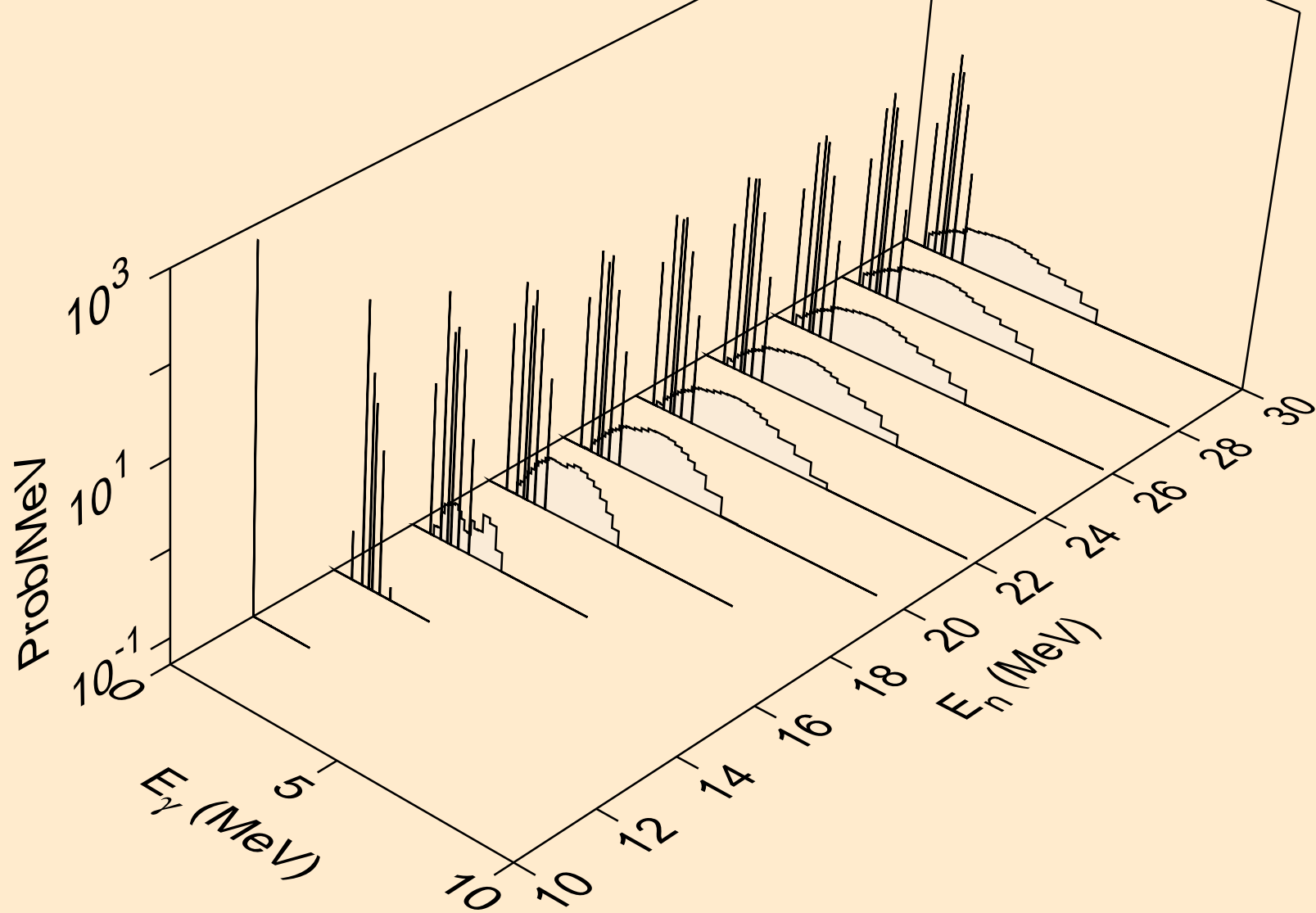

TI053 NEUTRON ACER TENDL-2024 LIBRARY; T=0.K
Photon emission for (n,he3)

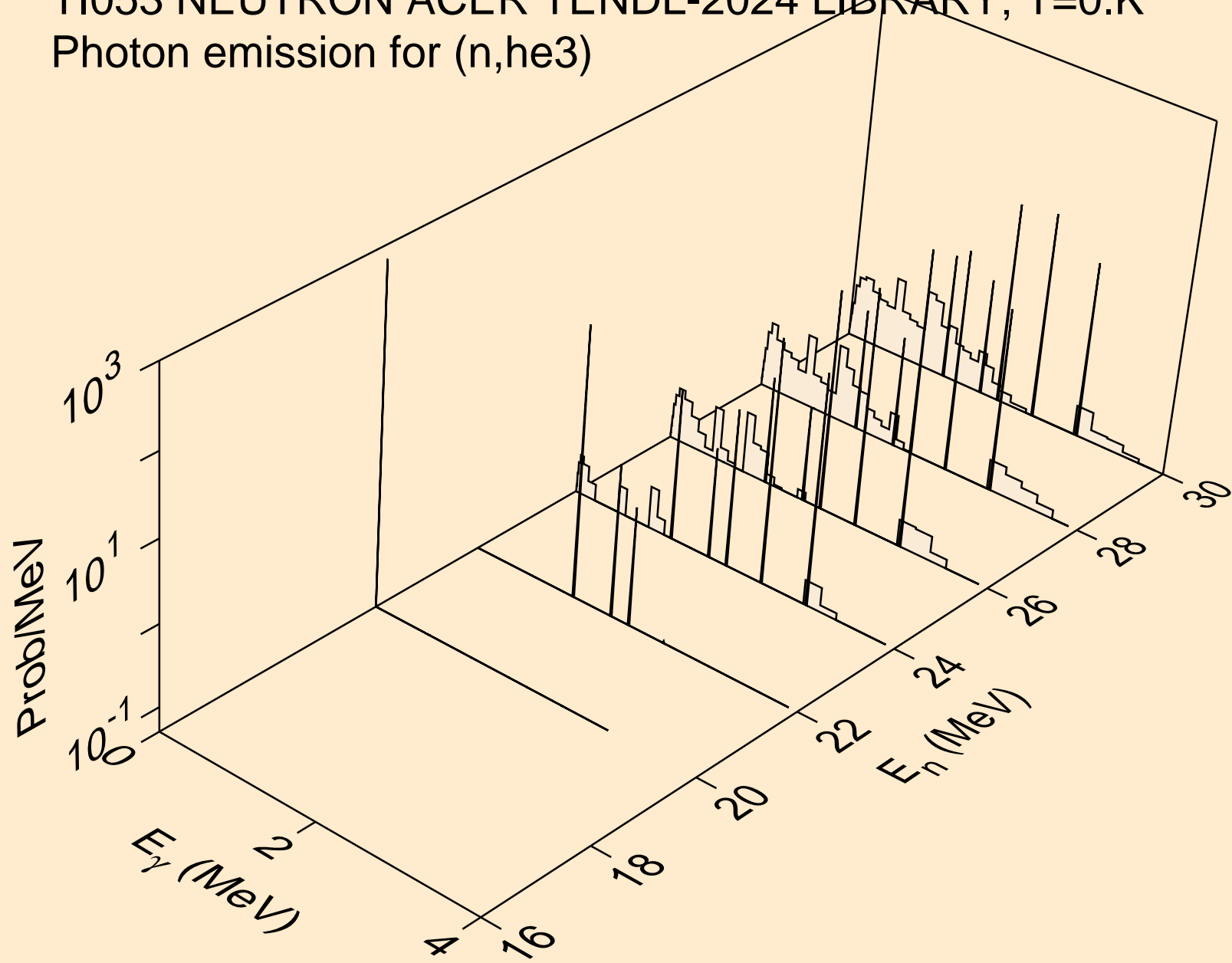

TI053 NEUTRON ACER TENDL-2024 LIBRARY; T=0.K
Photon emission for (n,a)

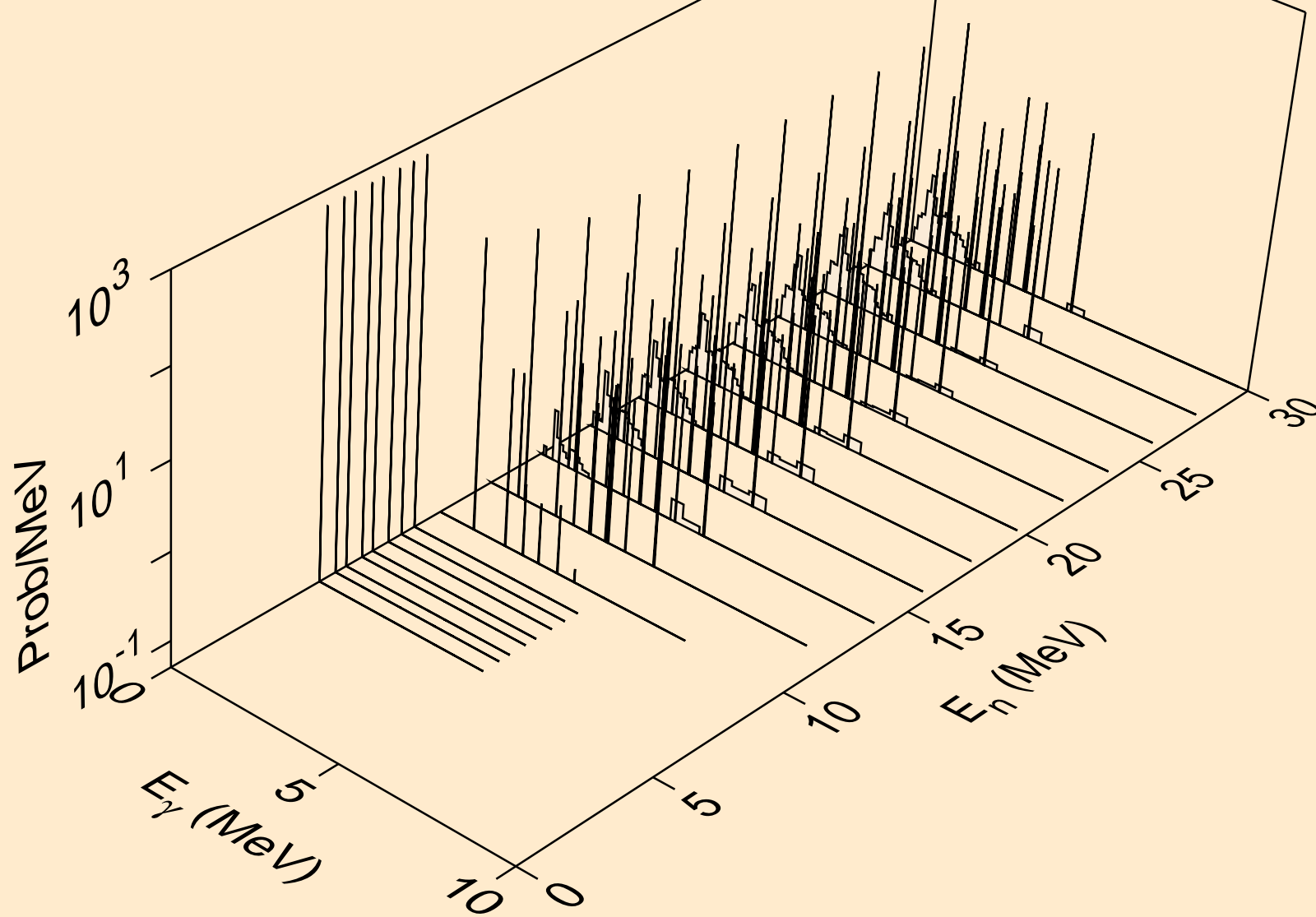

TI053 NEUTRON ACER TENDL-2024 LIBRARY; T=0.K
Photon emission for (n,2a)

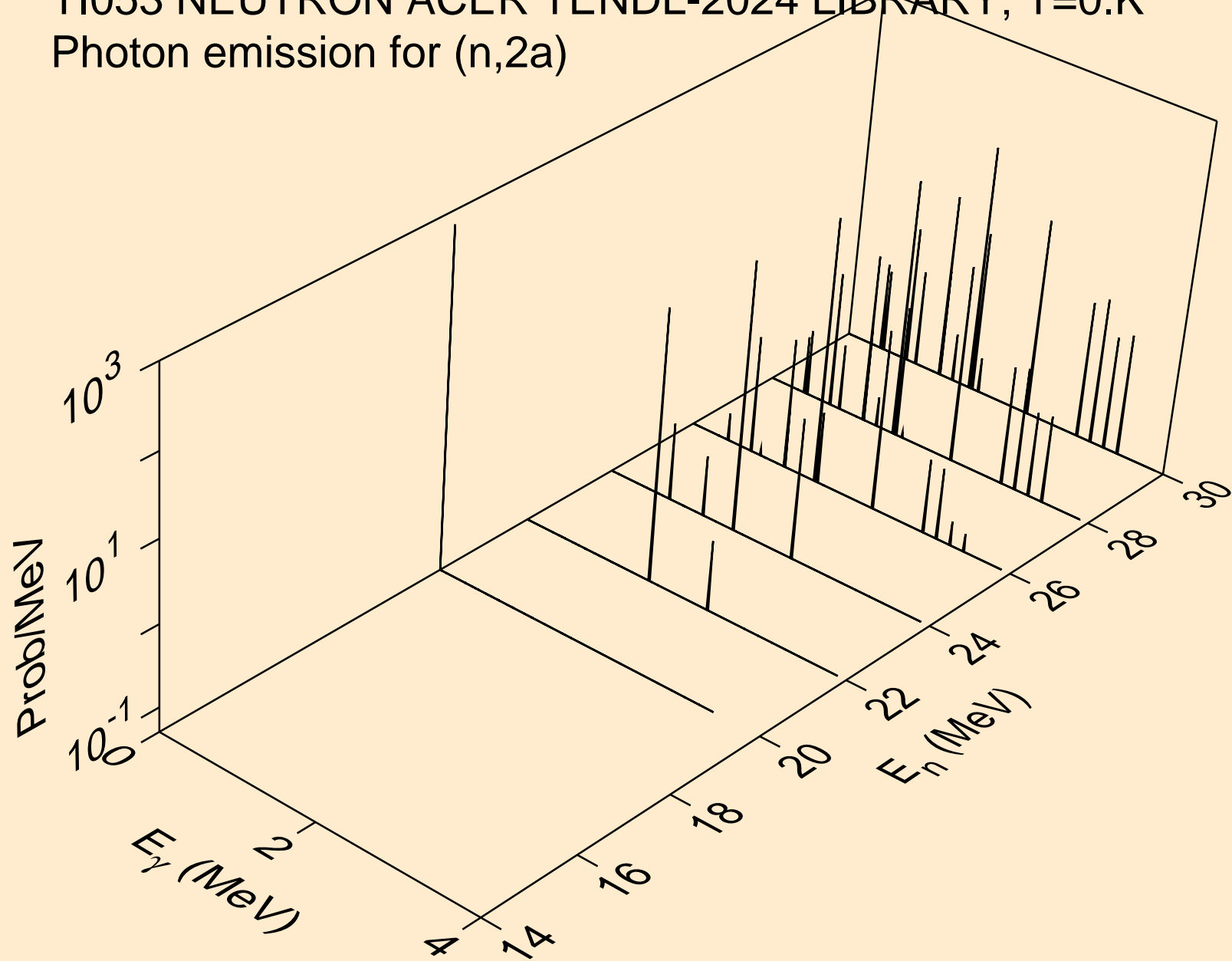

TI053 NEUTRON ACER TENDL-2024 LIBRARY; T=0.K
Photon emission for (n,2p)

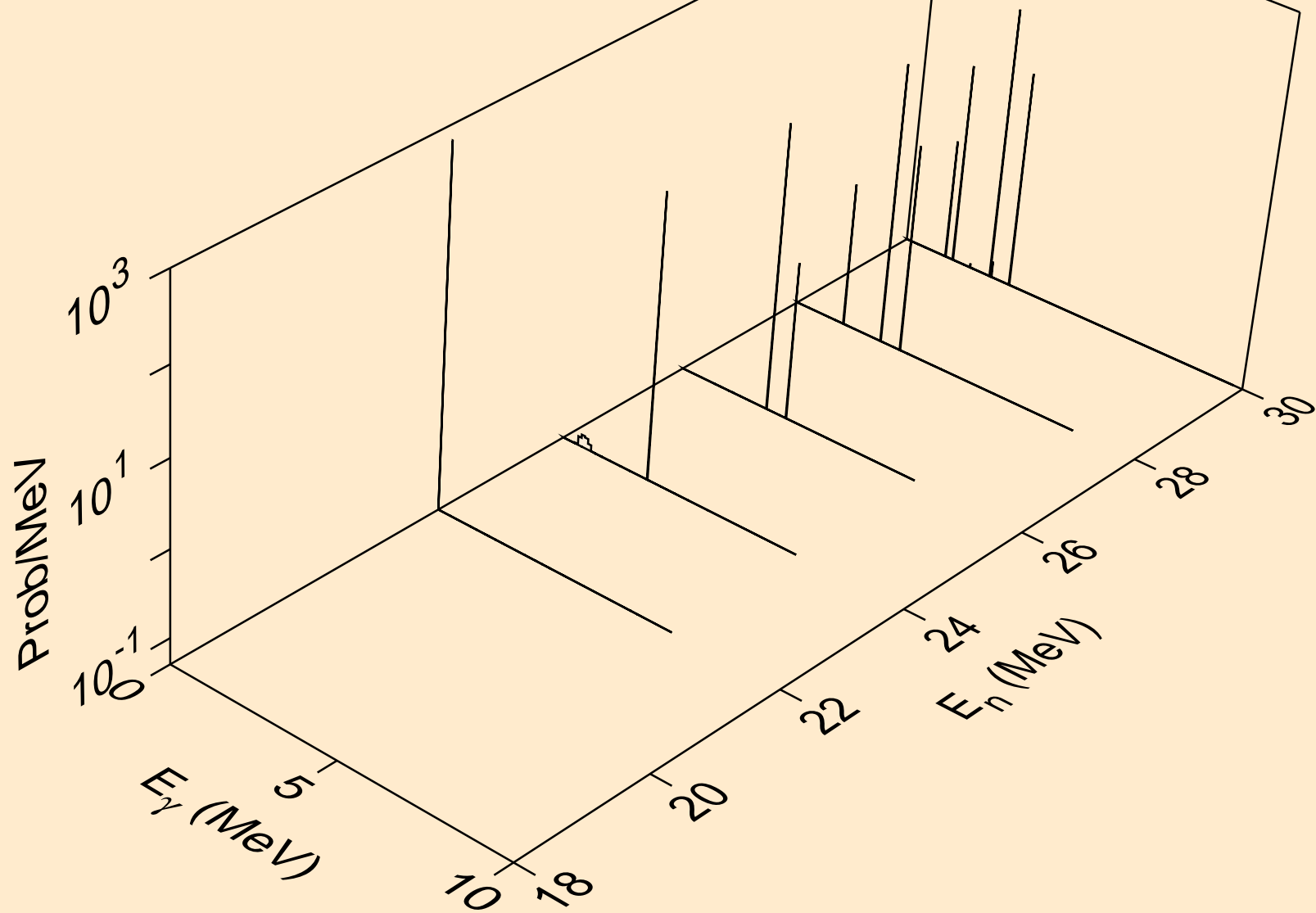

TI053 NEUTRON ACER TENDL-2024 LIBRARY; T=0.K
Photon emission for (n,p α)

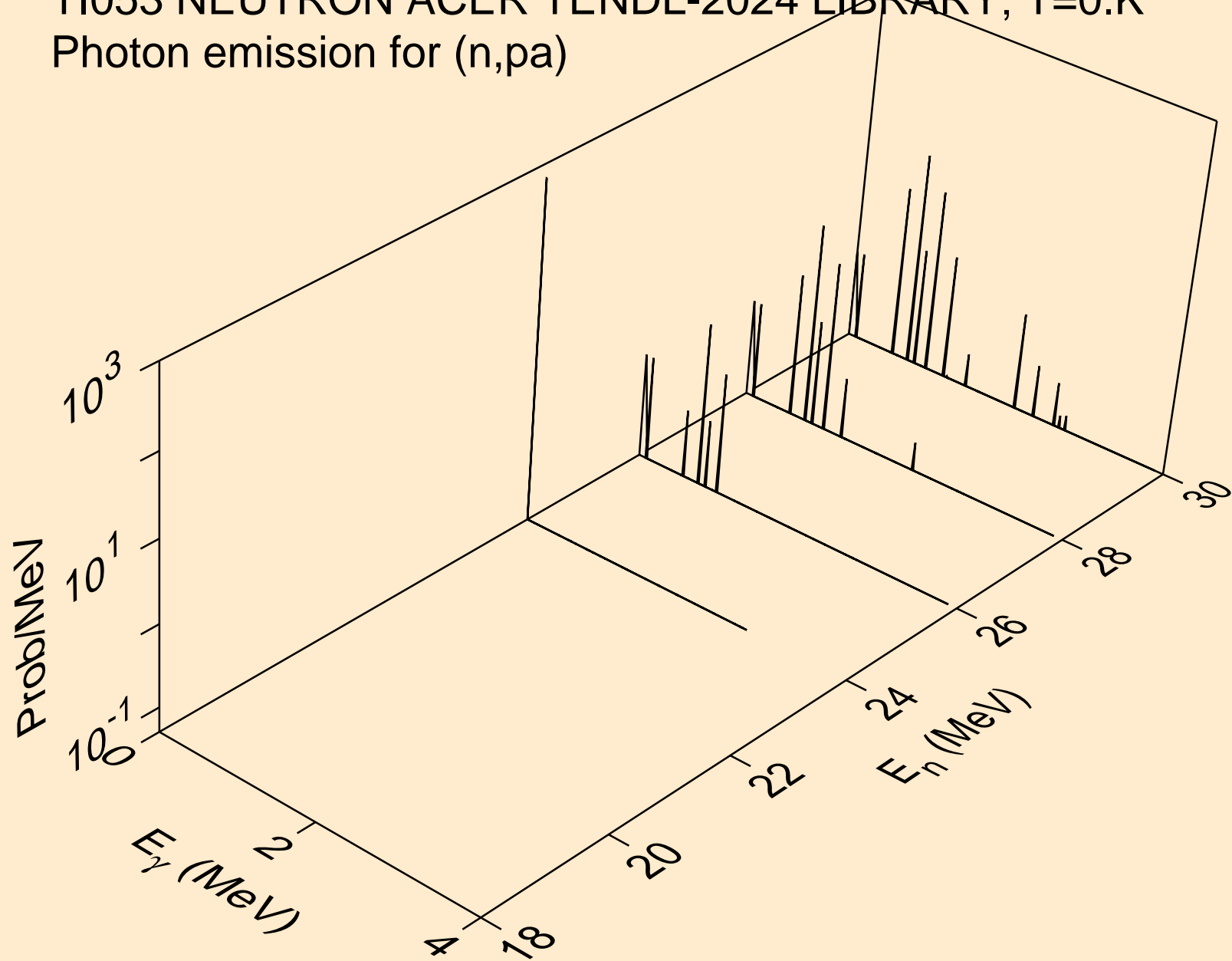

TI053 NEUTRON ACER TENDL-2024 LIBRARY; T=0.K
Photon emission for (n,pd)

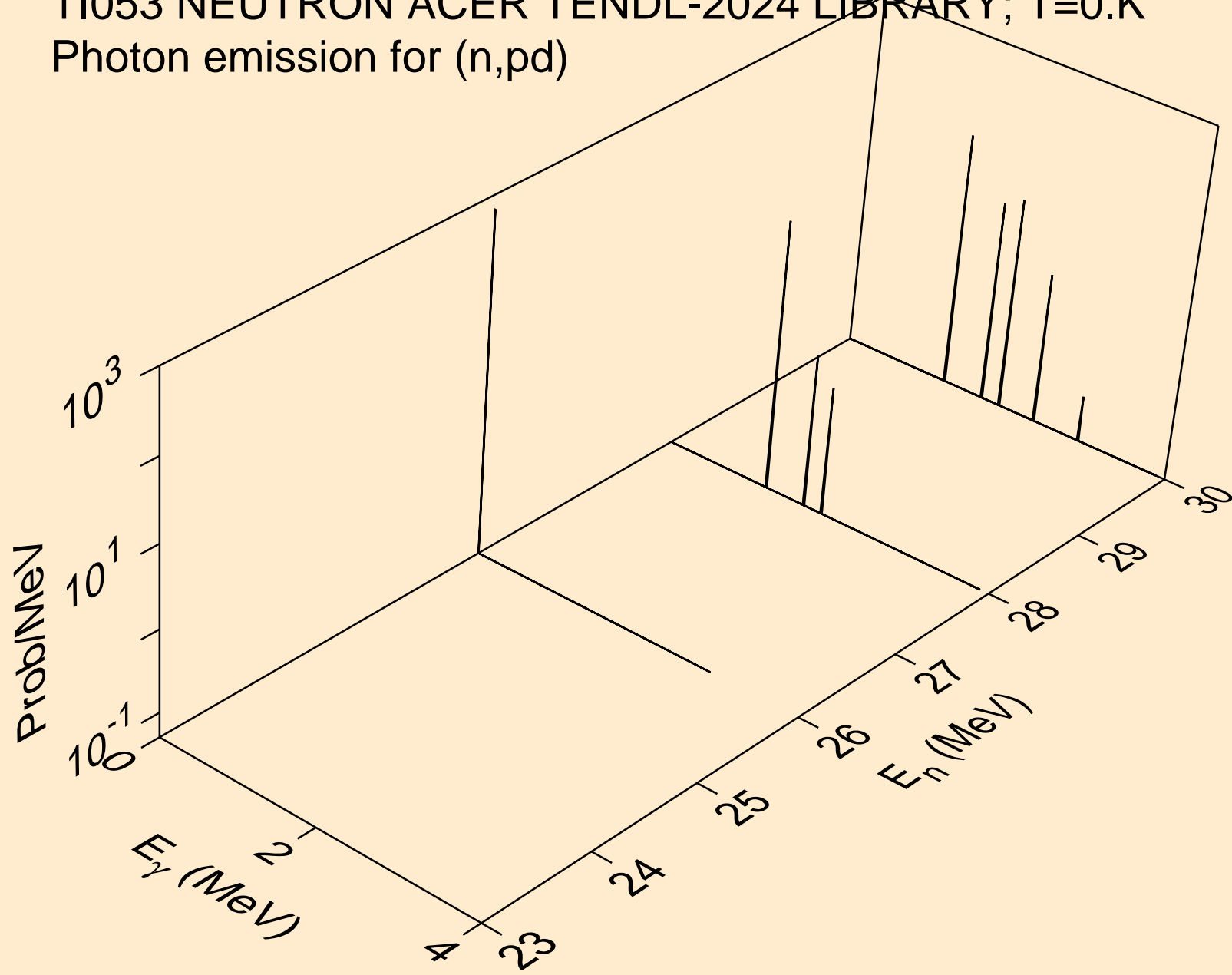

TI053 NEUTRON ACER TENDL-2024 LIBRARY; T=0.K
Photon emission for (n,pt)

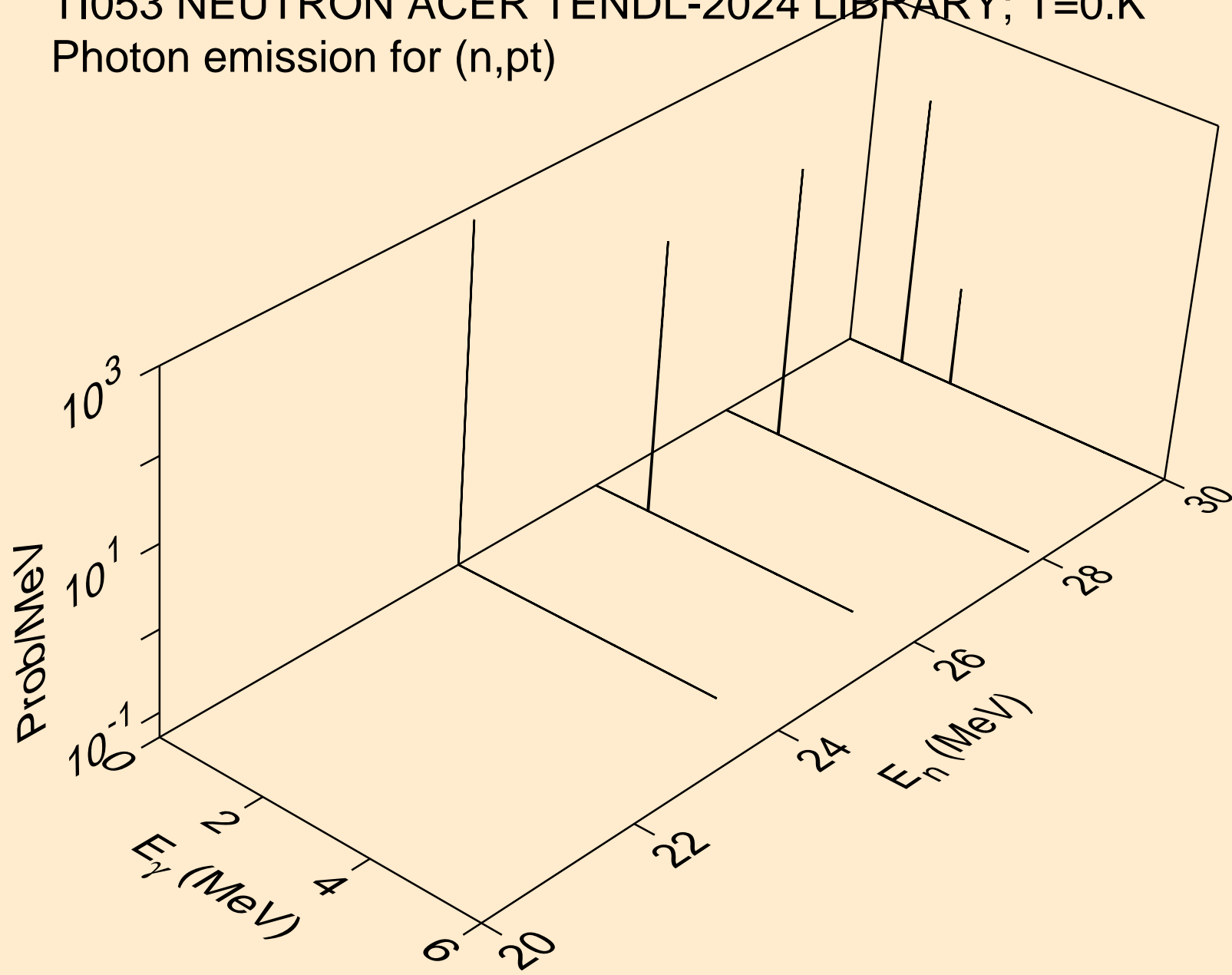

TI053 NEUTRON ACER TENDL-2024 LIBRARY; T=0.K
thermal capture photon spectrum

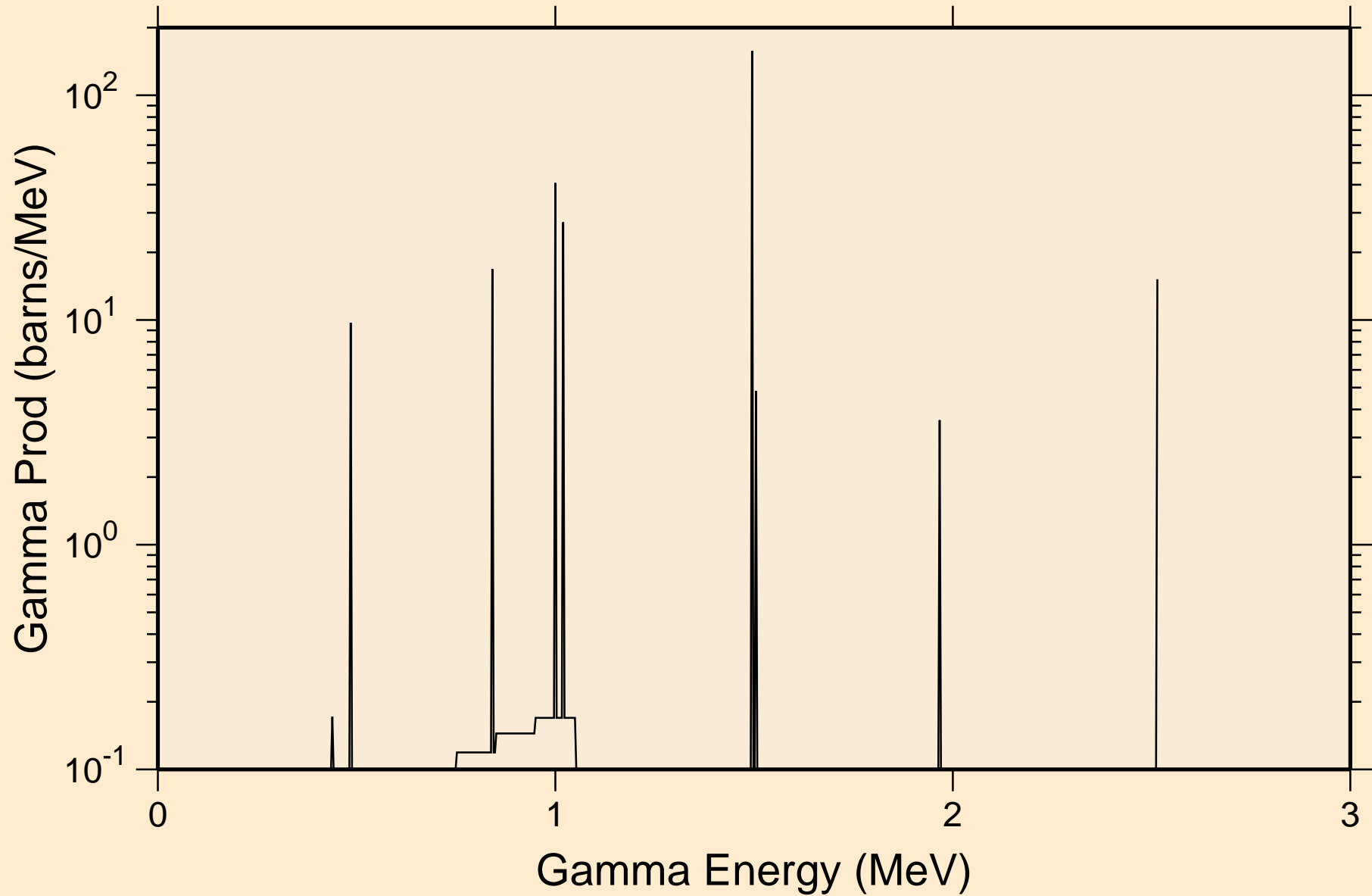

TI053 NEUTRON ACER TENDL-2024 LIBRARY; T=0.K
14 MeV photon spectrum

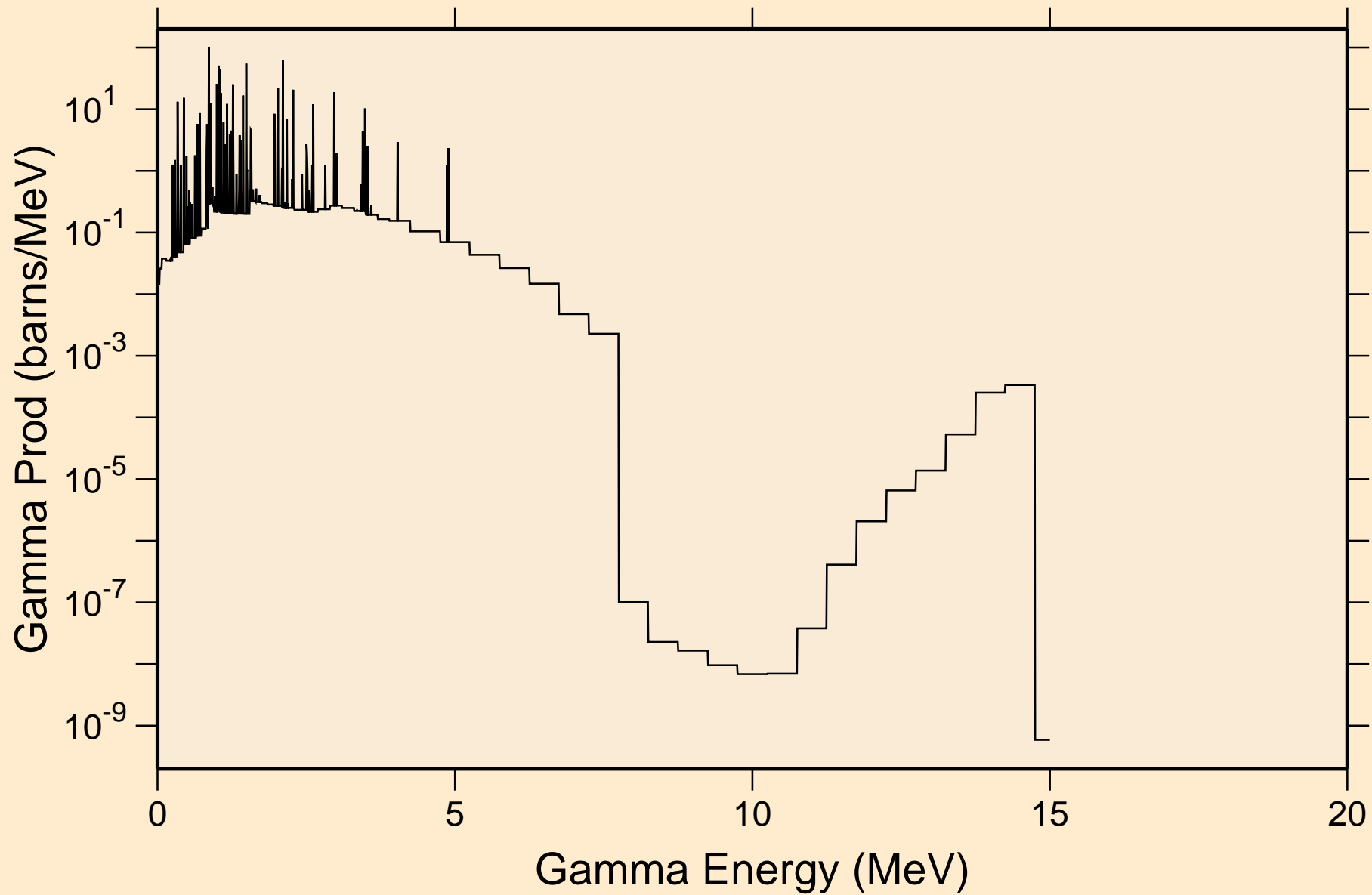

TI053 NEUTRON ACER TENDL-2024 LIBRARY; T=0.K
Particle heating contributions

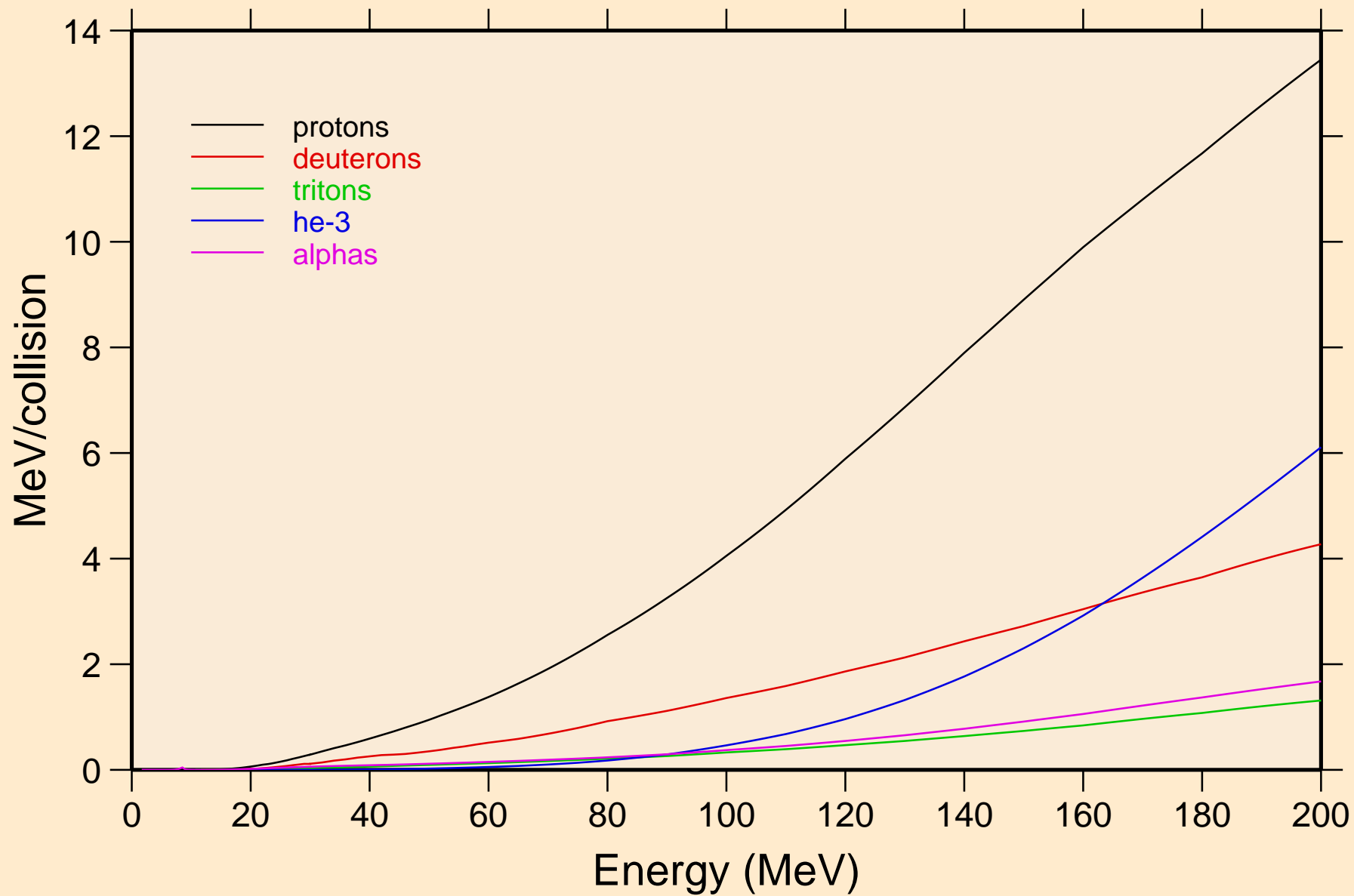

TI053 NEUTRON ACER TENDL-2024 LIBRARY; T=0.K
Recoil Heating

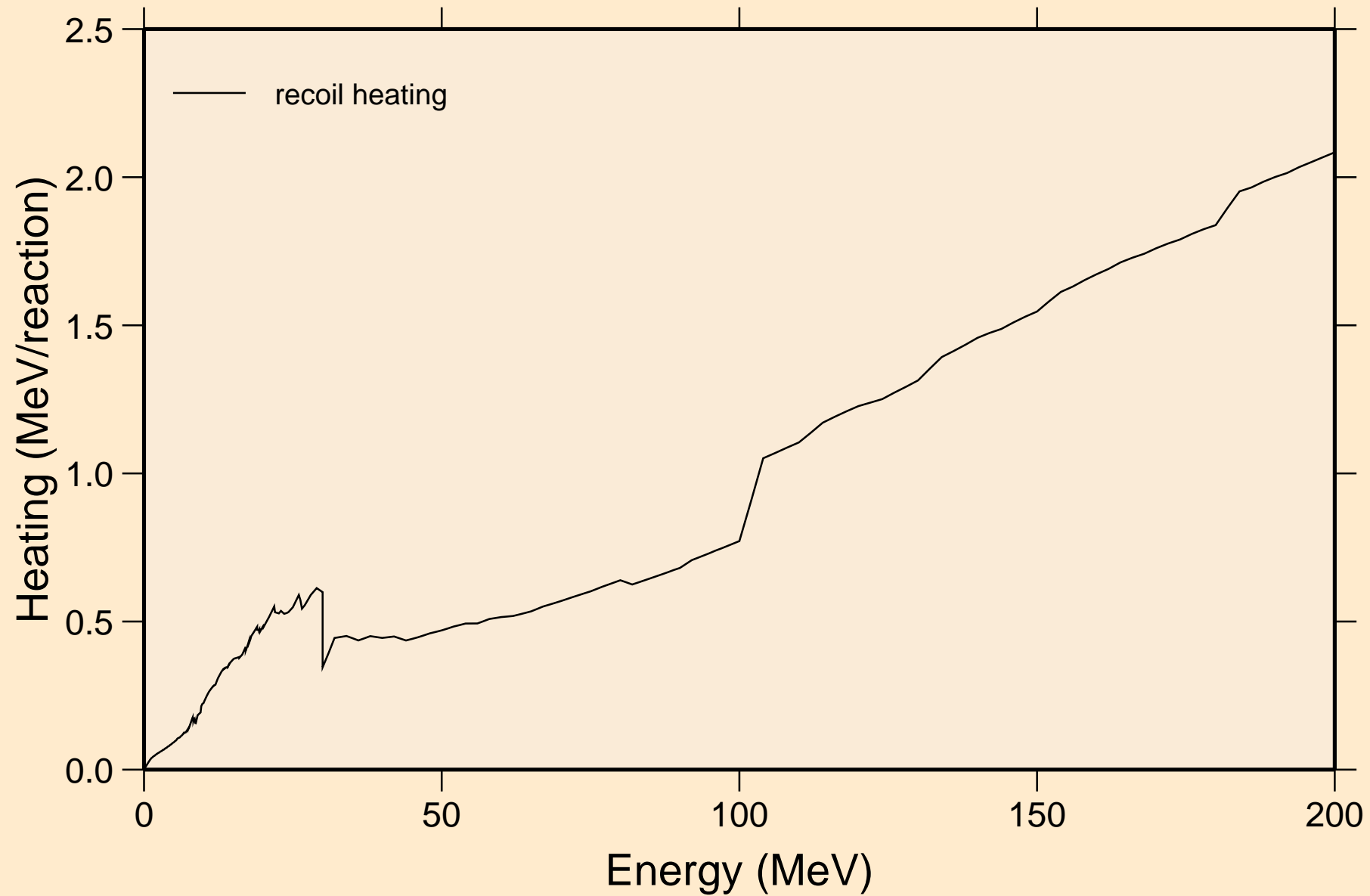

TI053 NEUTRON ACER TENDL-2024 LIBRARY; T=0.K

Particle production cross sections

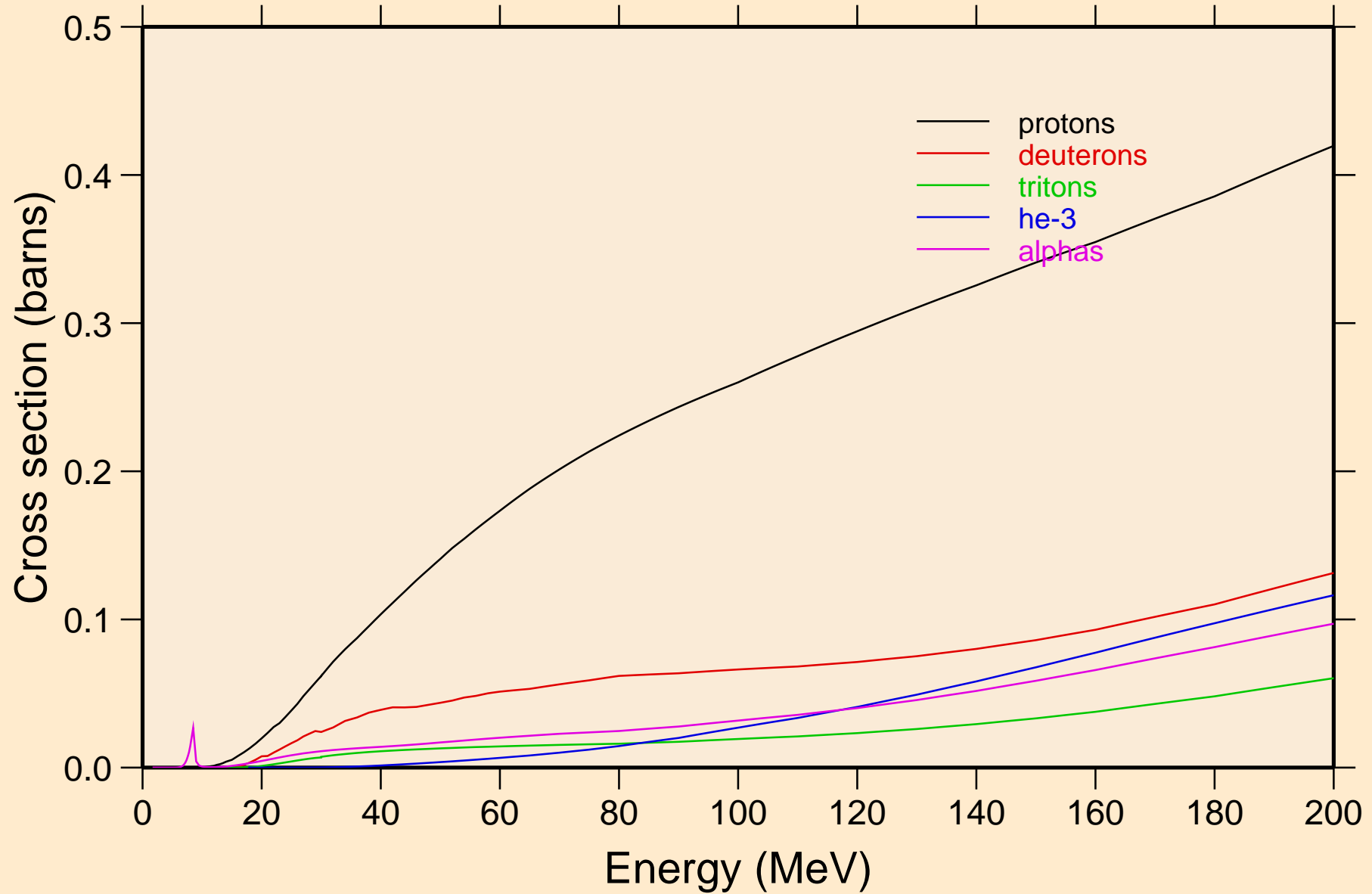

TI053 NEUTRON ACER TENDL-2024 LIBRARY; T=0.K
protons from (n,x)

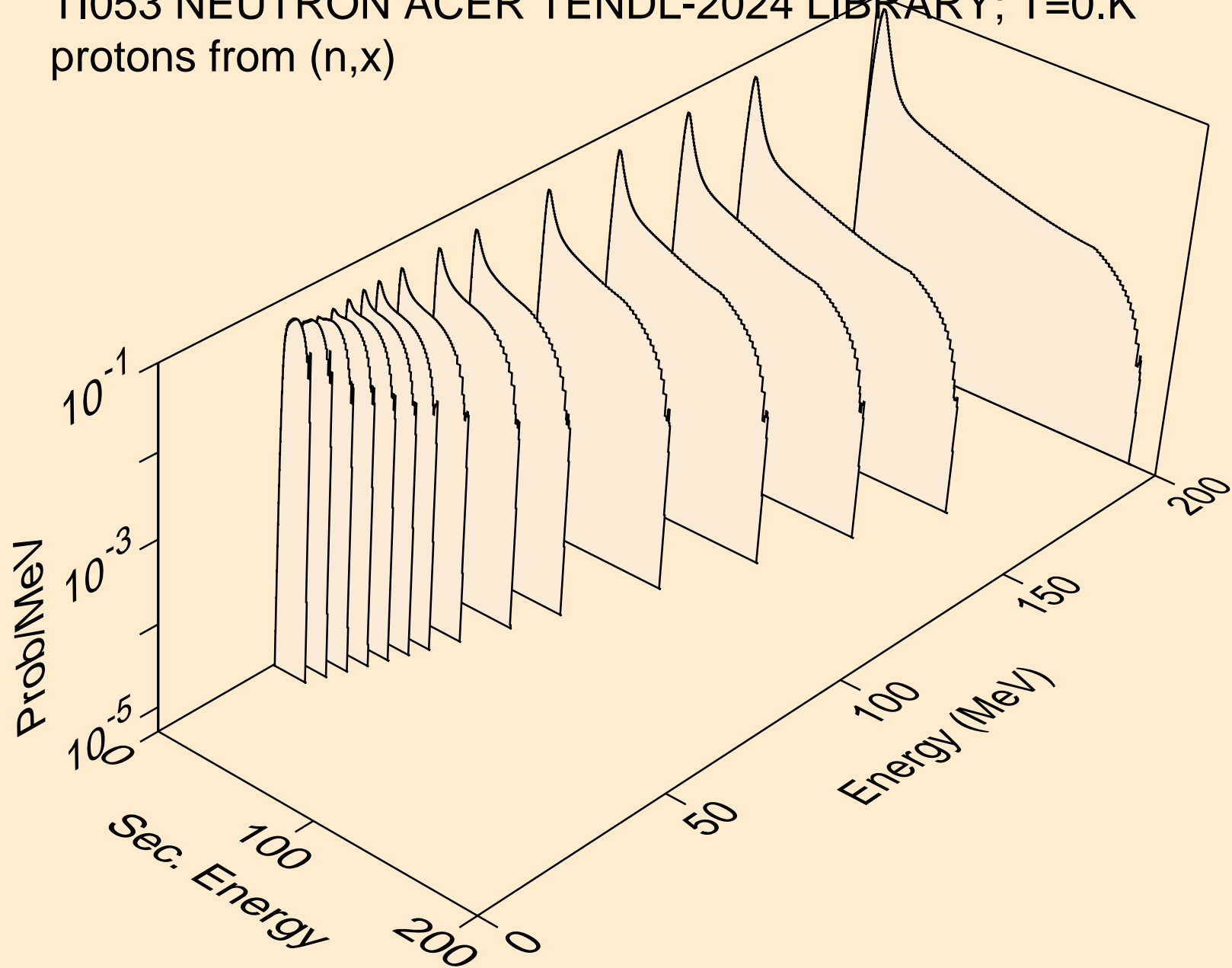

TI053 NEUTRON ACER TENDL-2024 LIBRARY; T=0.K
protons from (n,n*)p

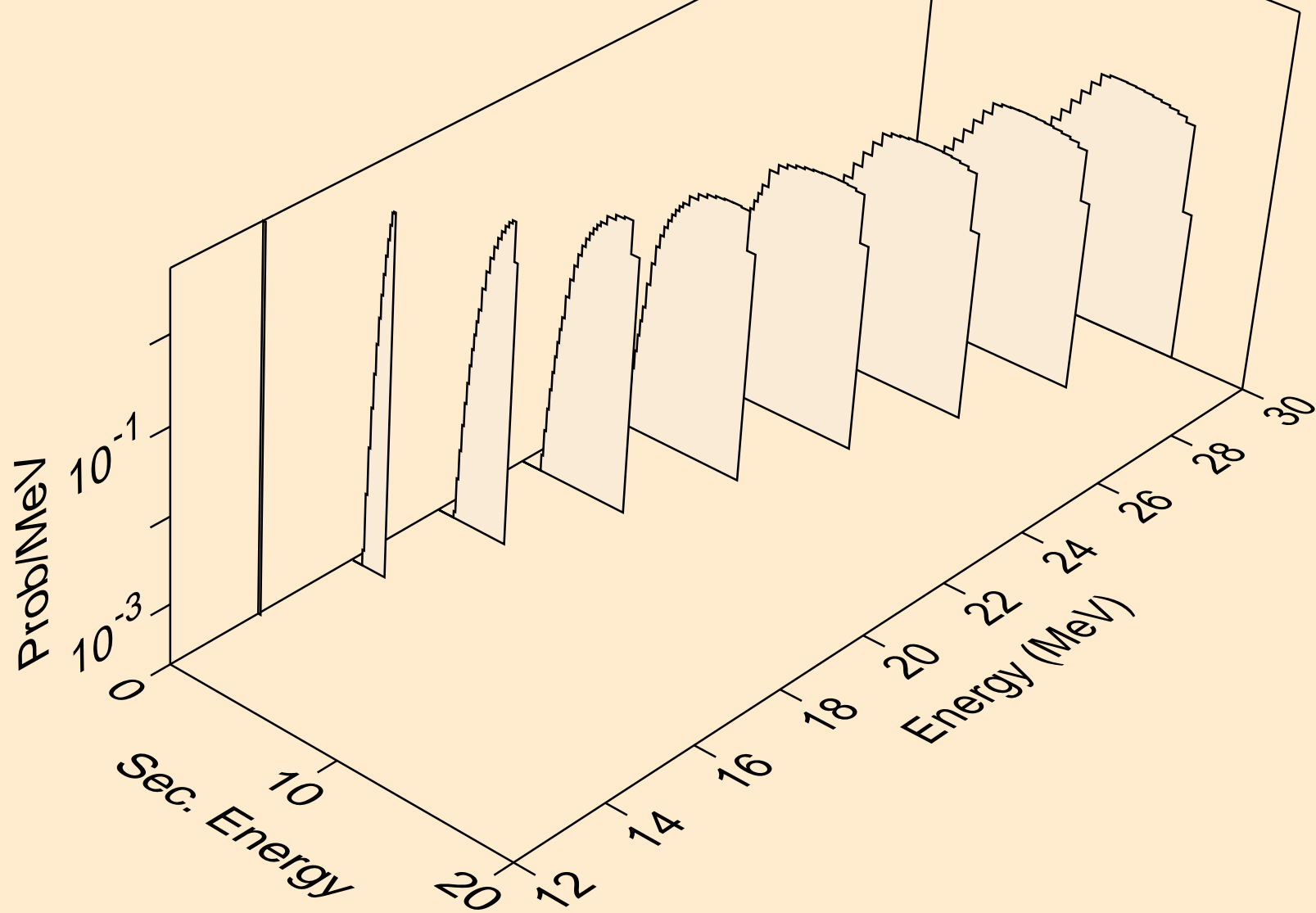

TI053 NEUTRON ACER TENDL-2024 LIBRARY; T=0.K
protons from (n,2np)

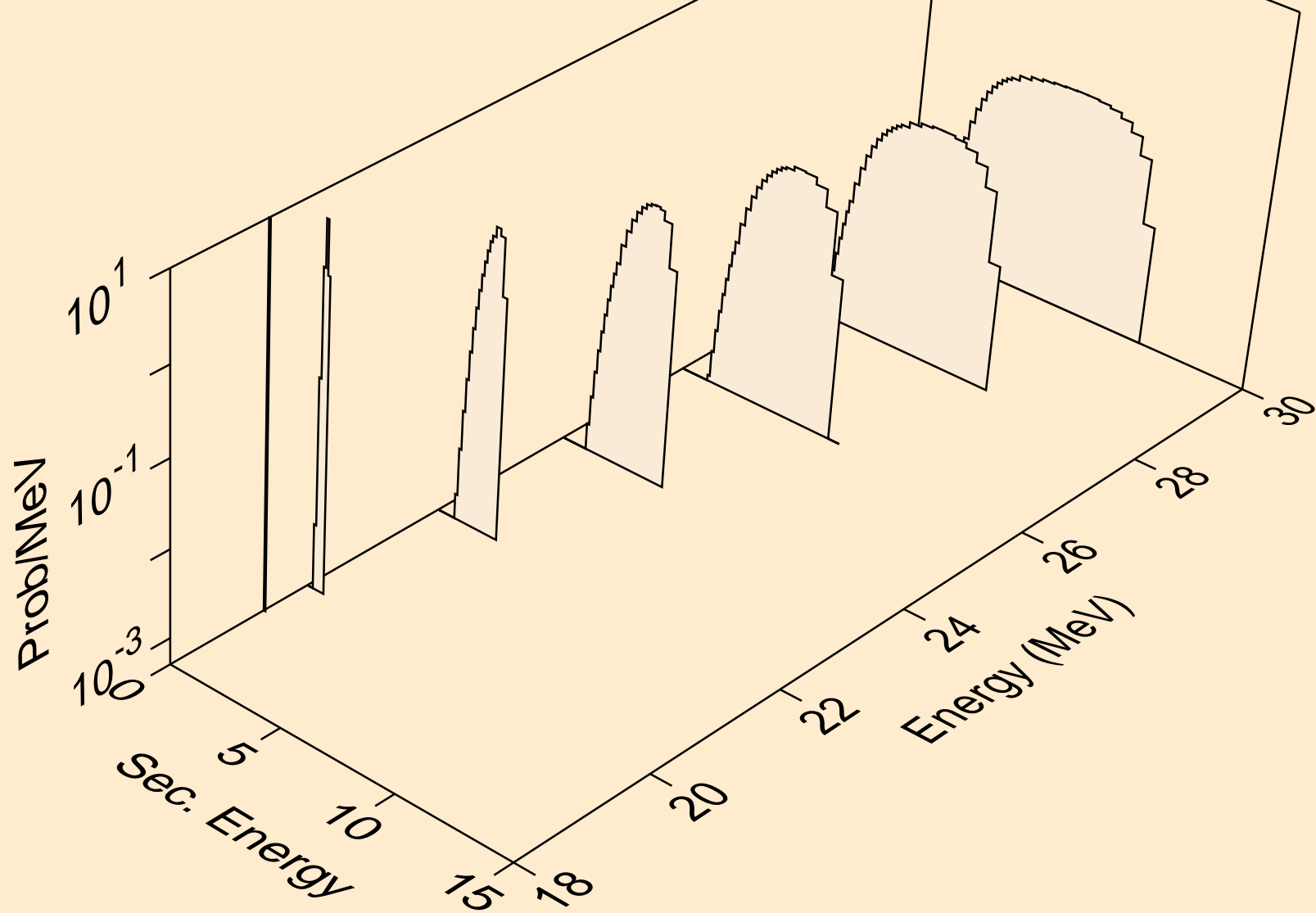

TI053 NEUTRON ACER TENDL-2024 LIBRARY; T=0.K
protons from (n,3np)

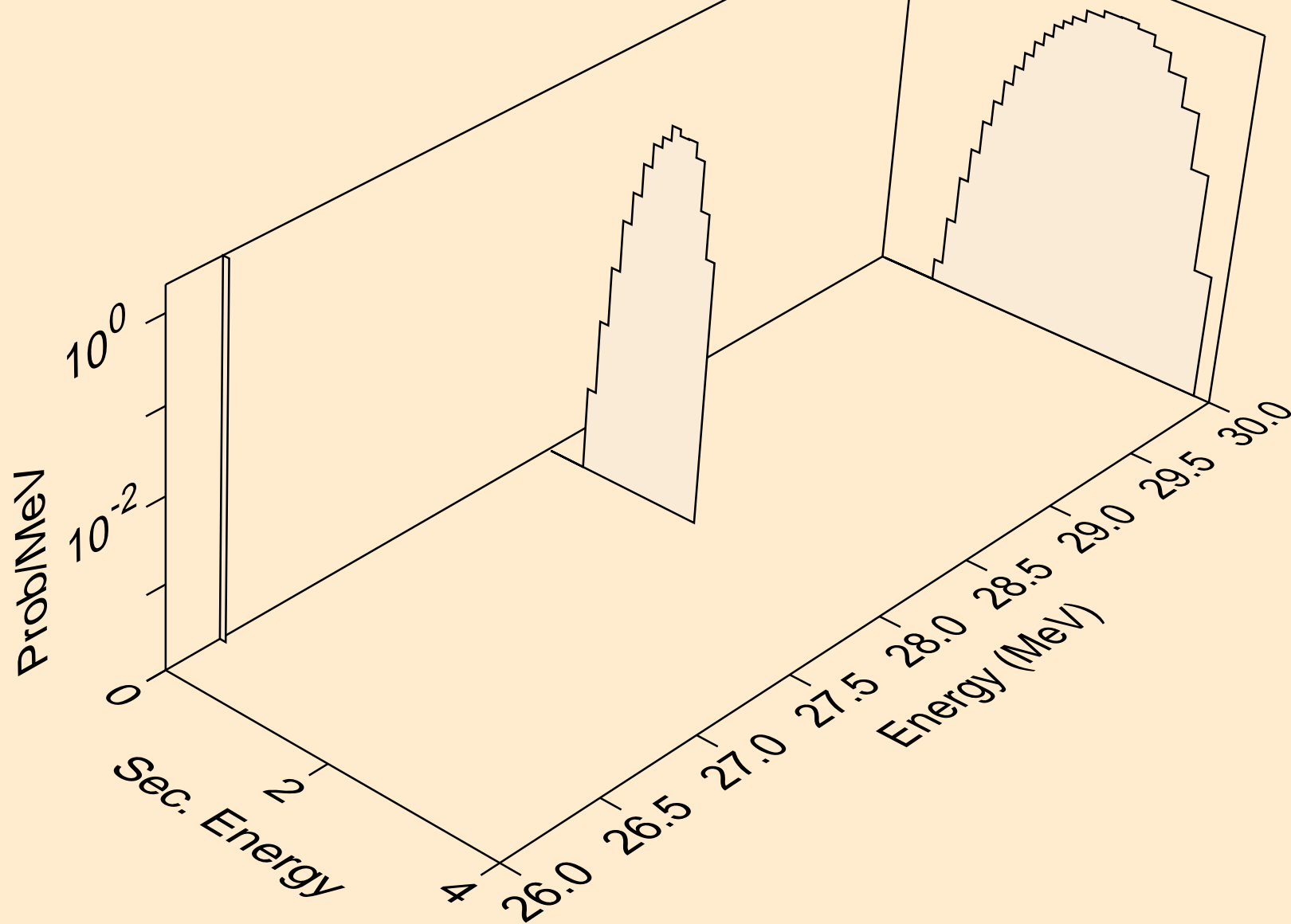

TI053 NEUTRON ACER TENDL-2024 LIBRARY; T=0.K
protons from (n,p)

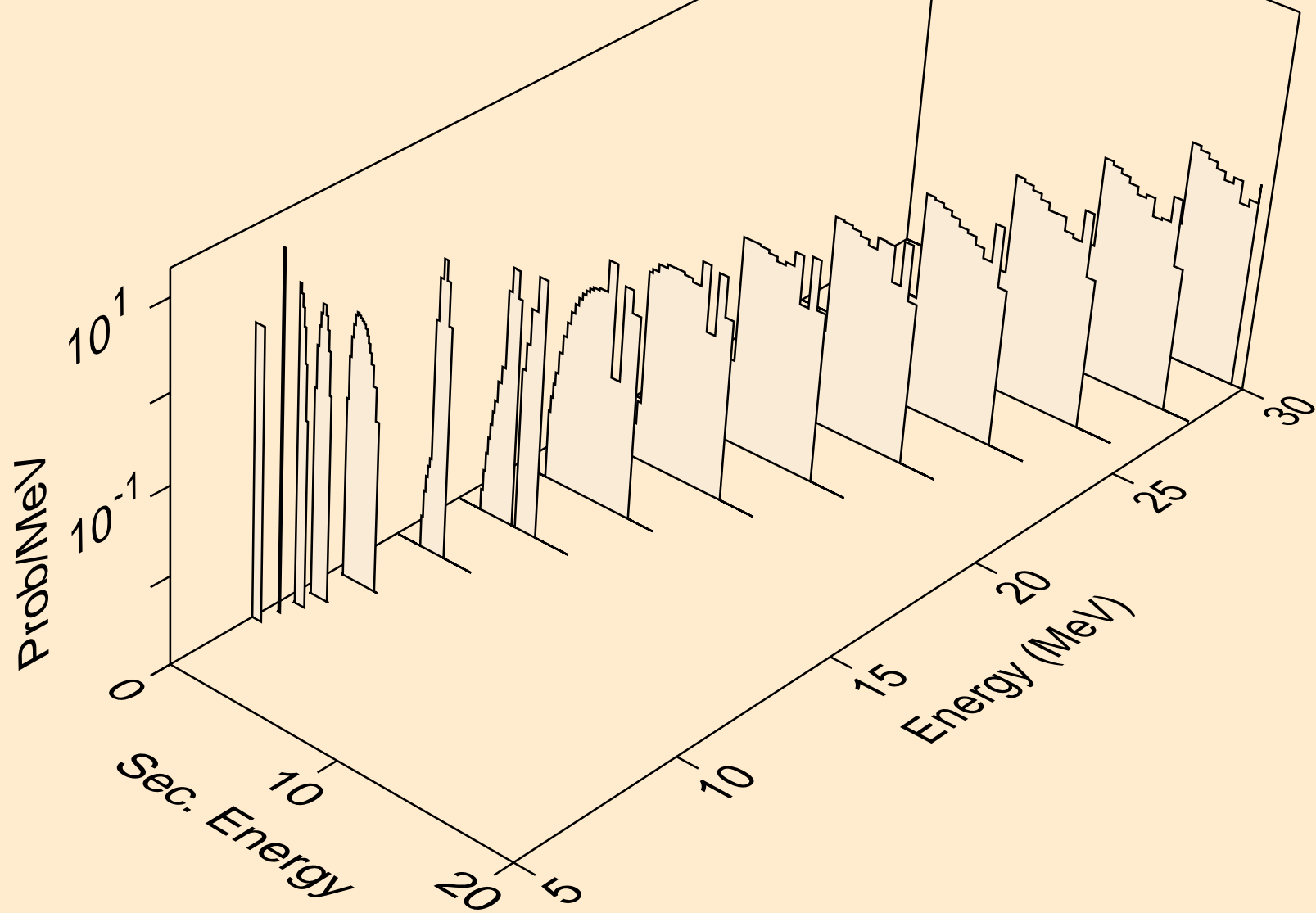

TI053 NEUTRON ACER TENDL-2024 LIBRARY; T=0.K
protons from (n,2p)

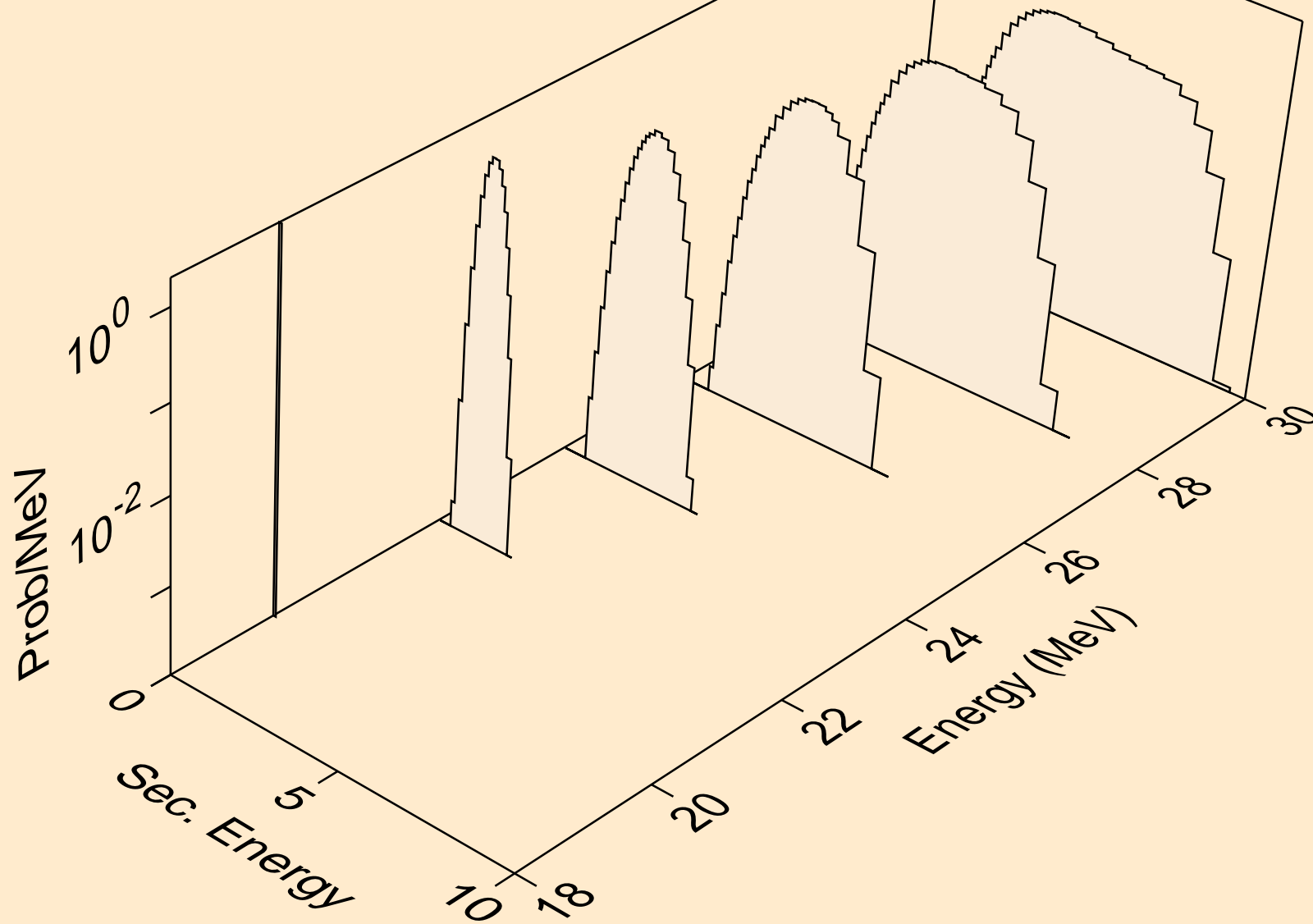

TI053 NEUTRON ACER TENDL-2024 LIBRARY; T=0.K
protons from (n,p)

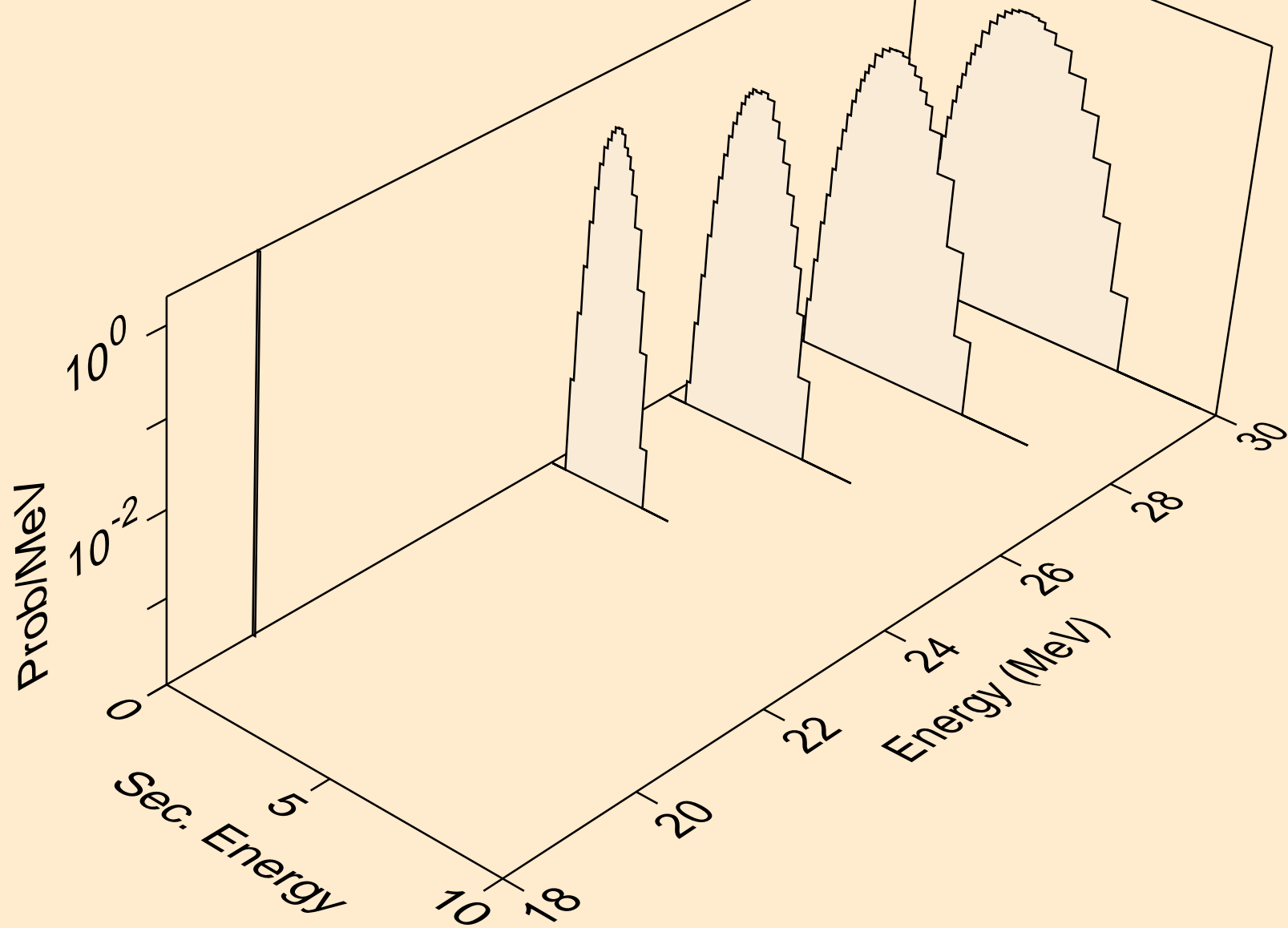

TI053 NEUTRON ACER TENDL-2024 LIBRARY; T=0.K
protons from (n,pd)

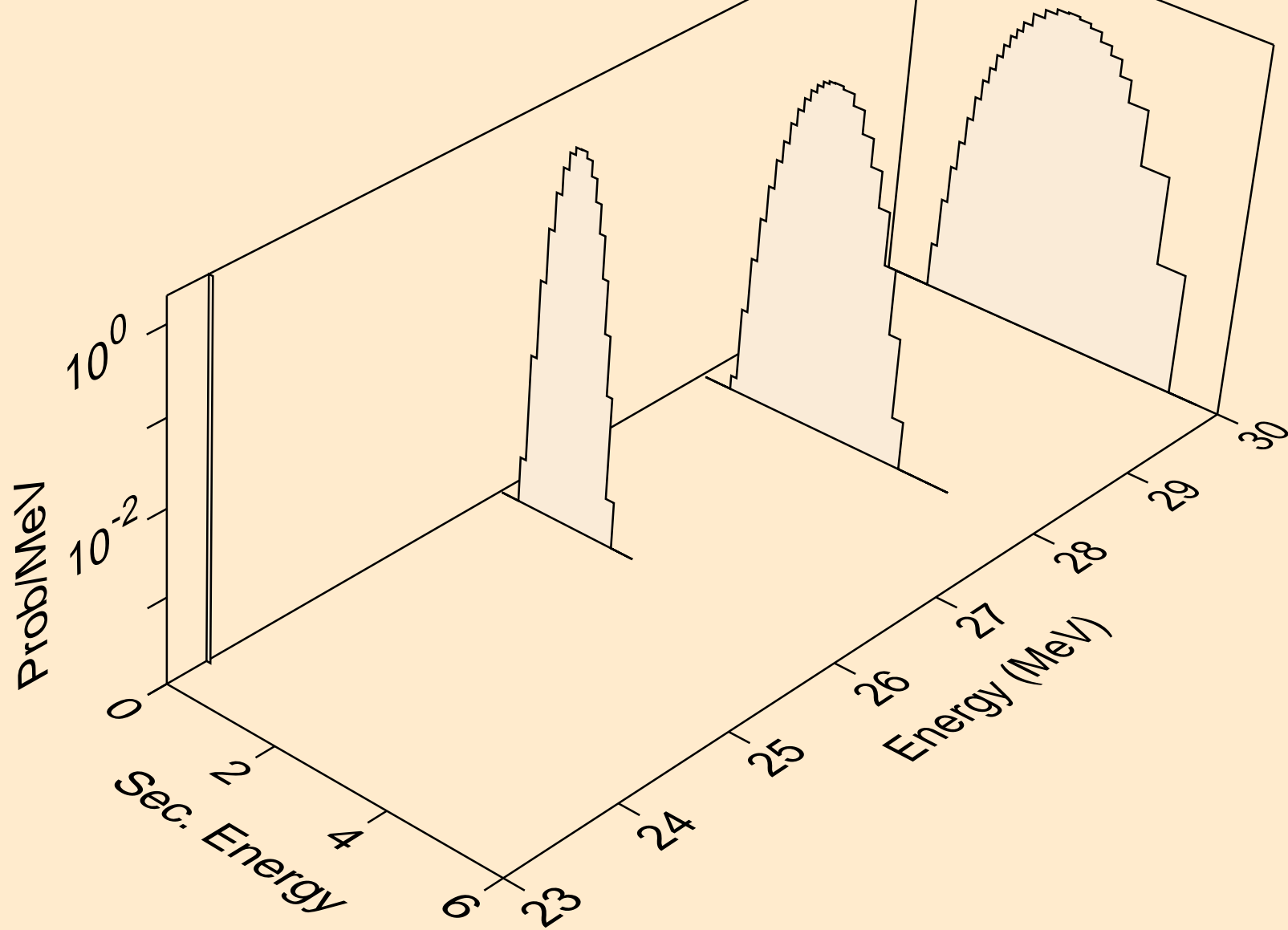

TI053 NEUTRON ACER TENDL-2024 LIBRARY; T=0.K
protons from (n,pt)

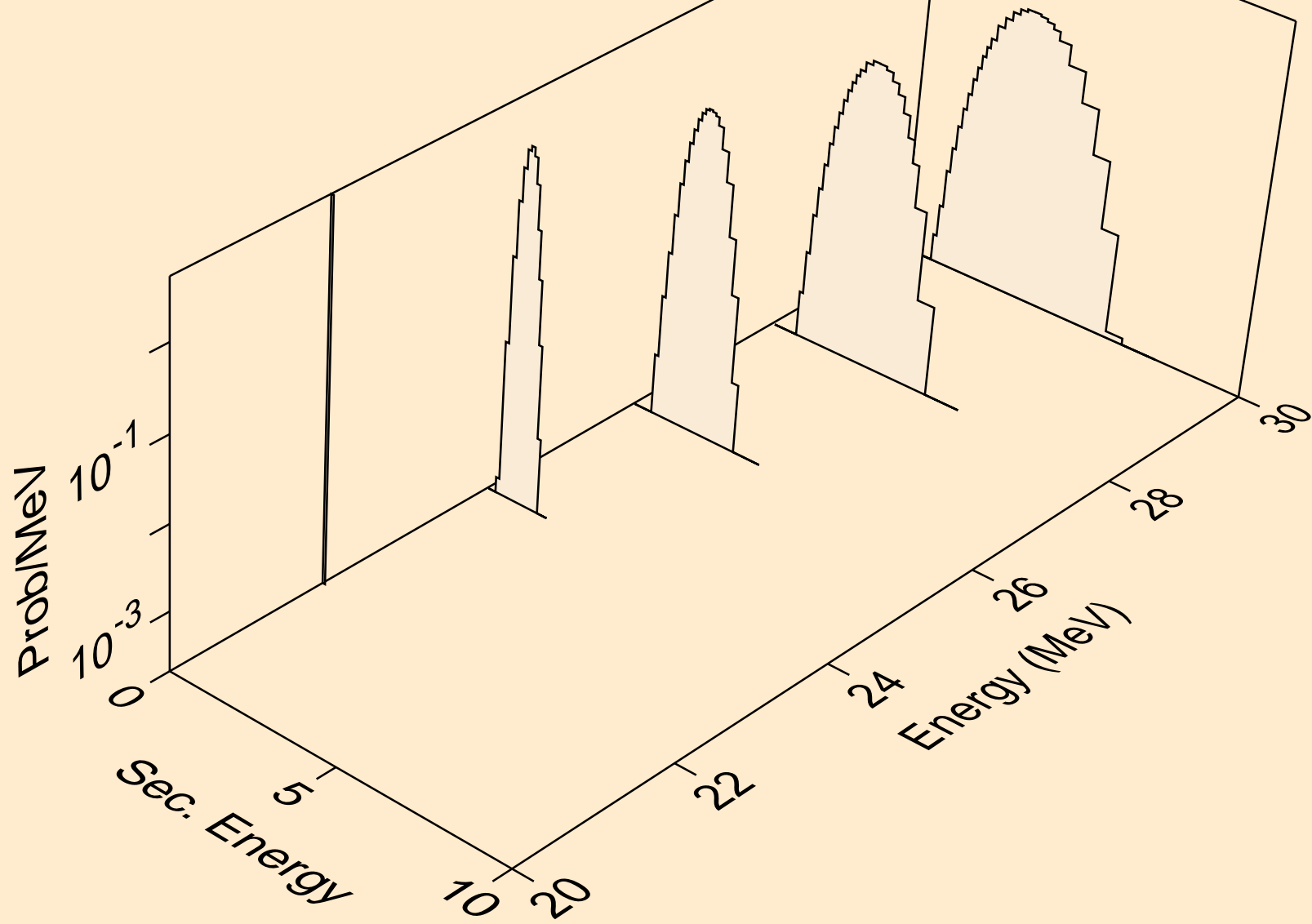

TI053 NEUTRON ACER TENDL-2024 LIBRARY; T=0.K
deuterons from (n,x)

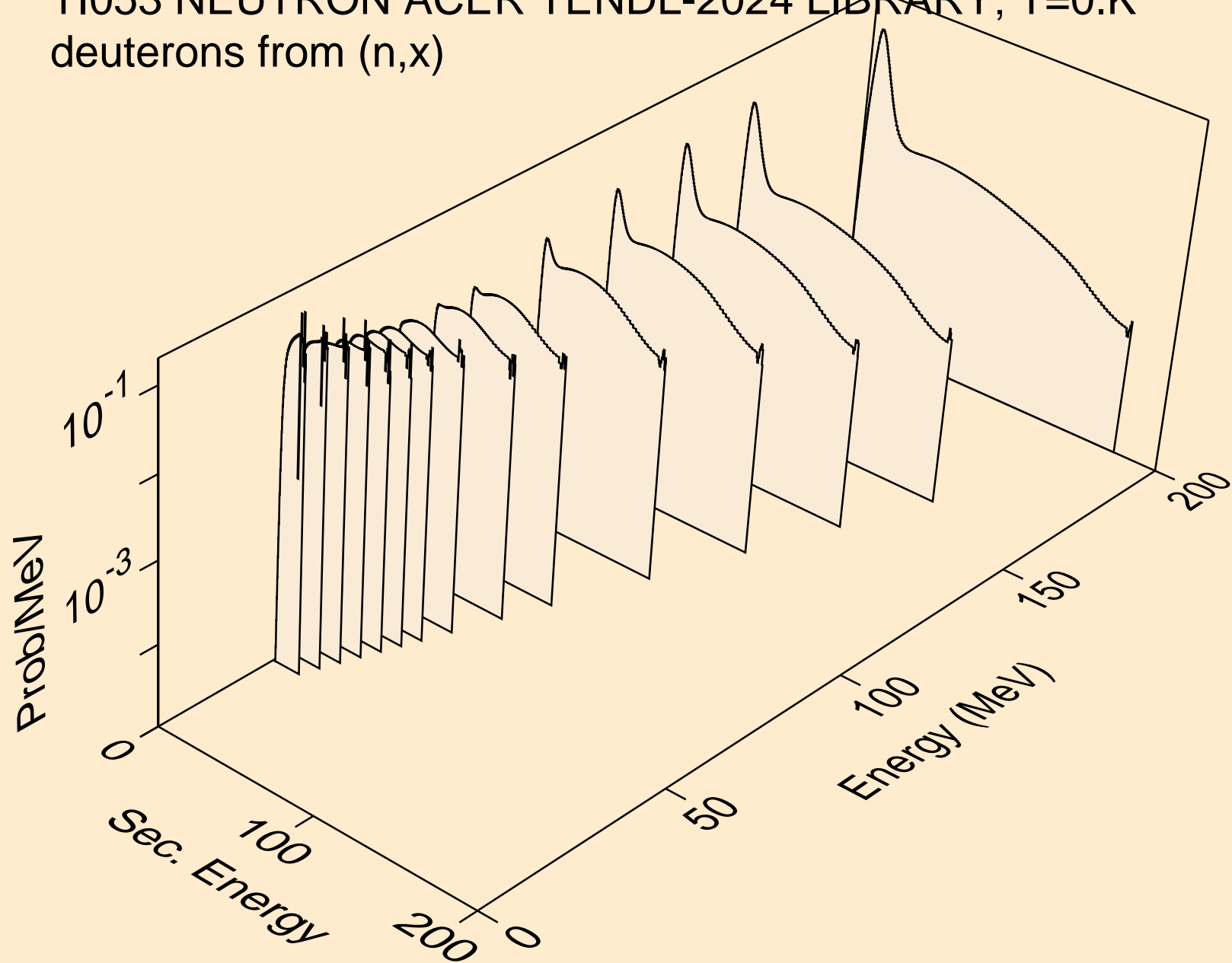

TI053 NEUTRON ACER TENDL-2024 LIBRARY; T=0.K
deuterons from (n,2nd)

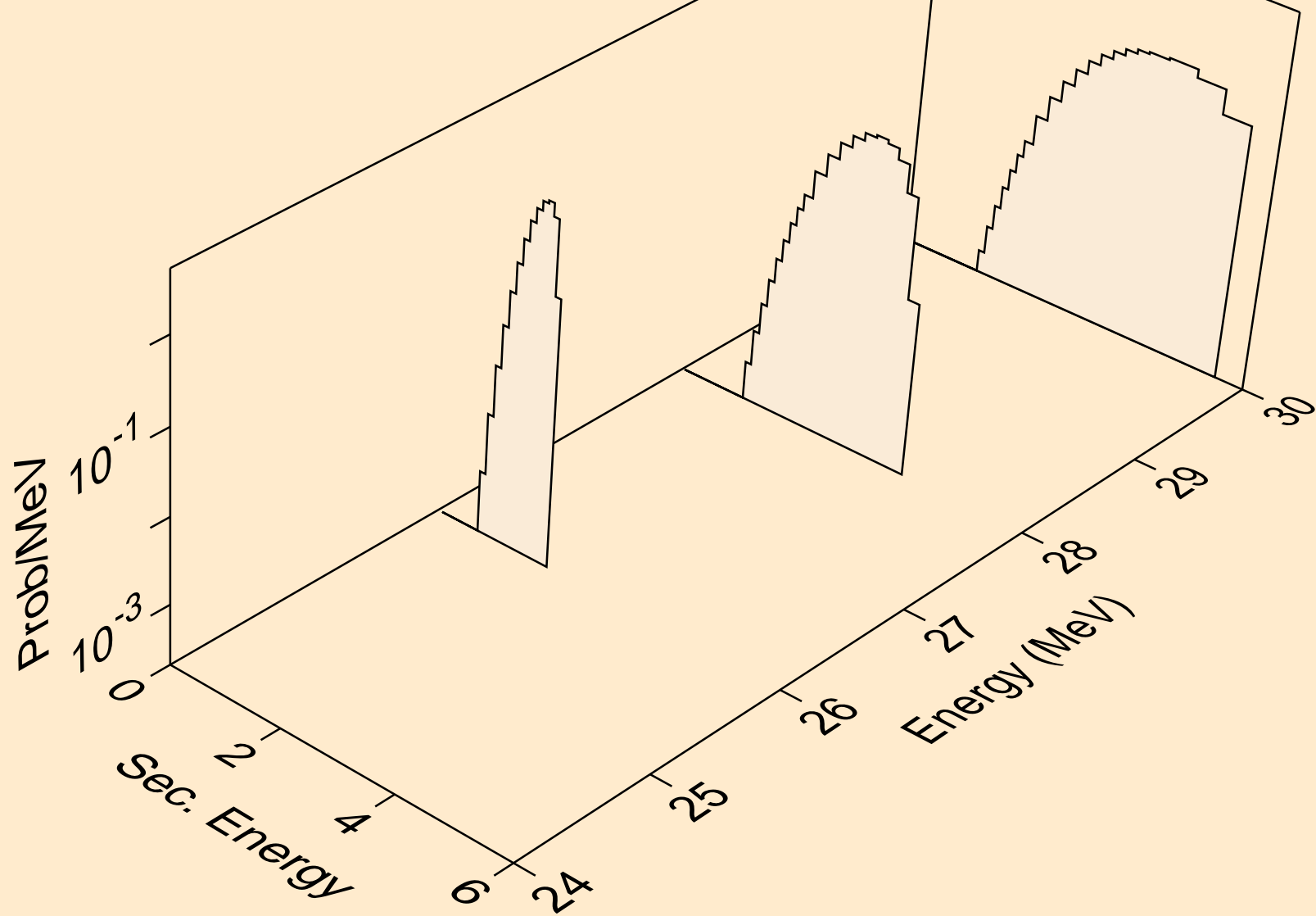

TI053 NEUTRON ACER TENDL-2024 LIBRARY; T=0.K
deuterons from (n,n*)d

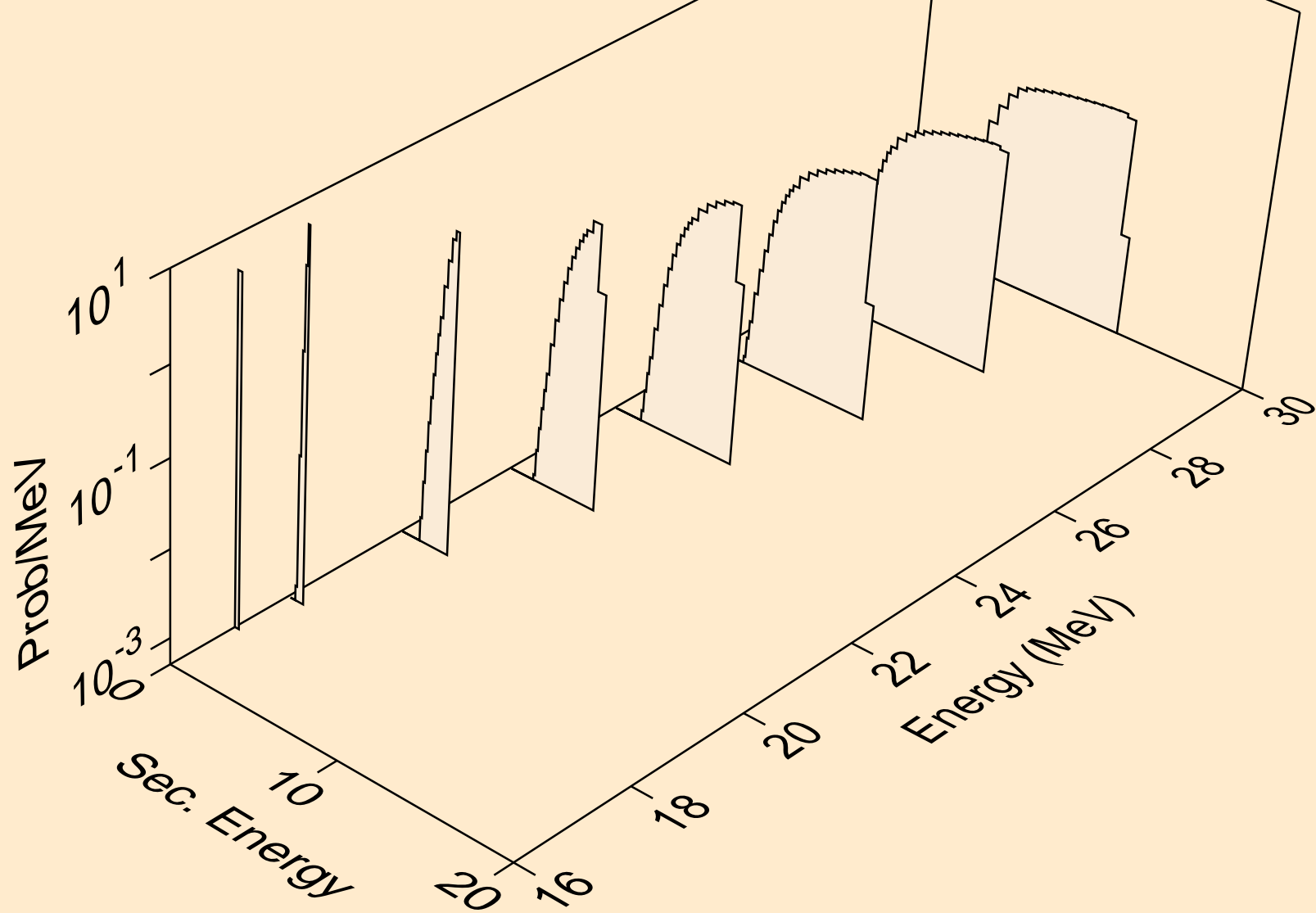

TI053 NEUTRON ACER TENDL-2024 LIBRARY; T=0.K
deuterons from (n,d)

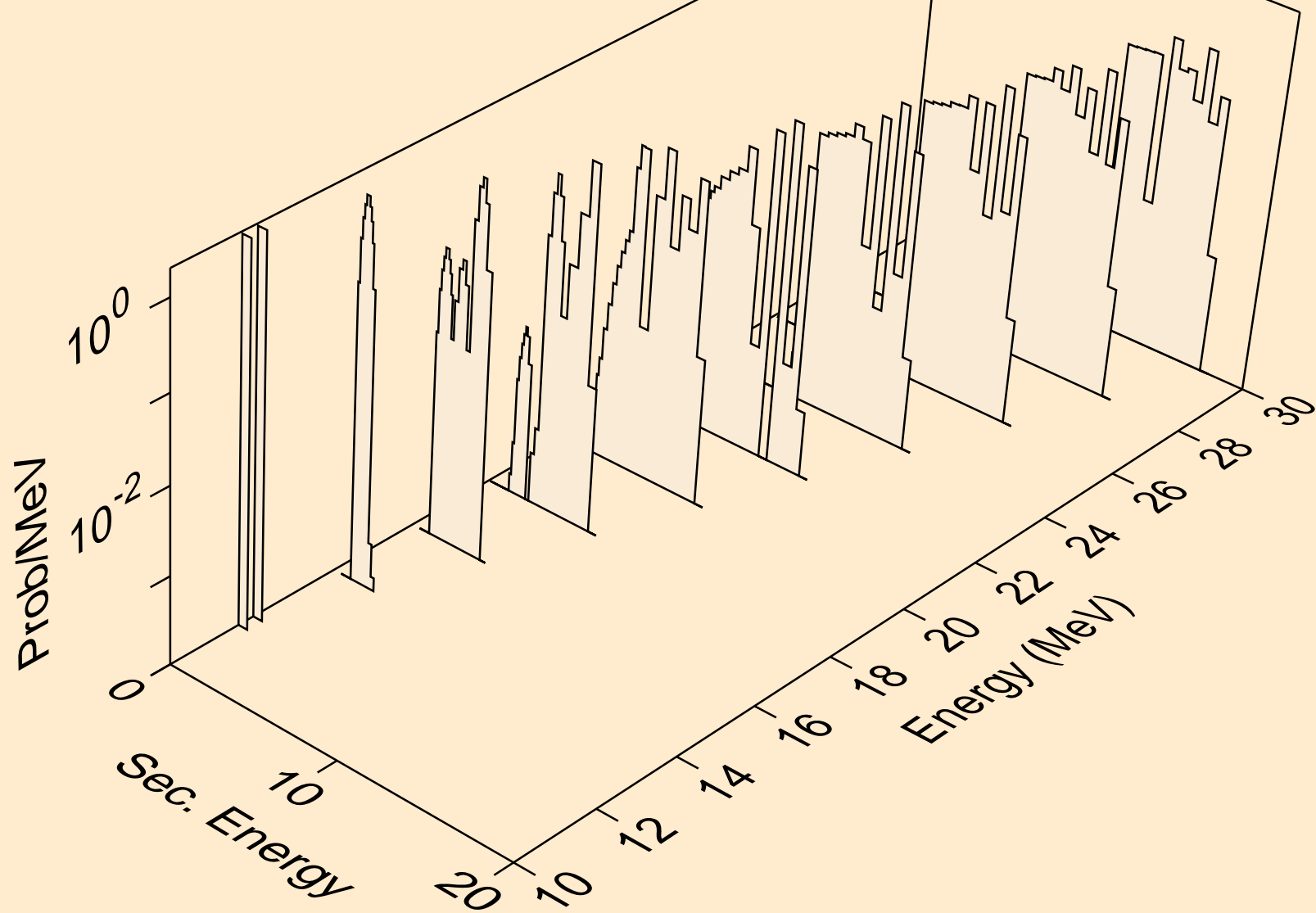

TI053 NEUTRON ACER TENDL-2024 LIBRARY; T=0.K
deuterons from (n,pd)

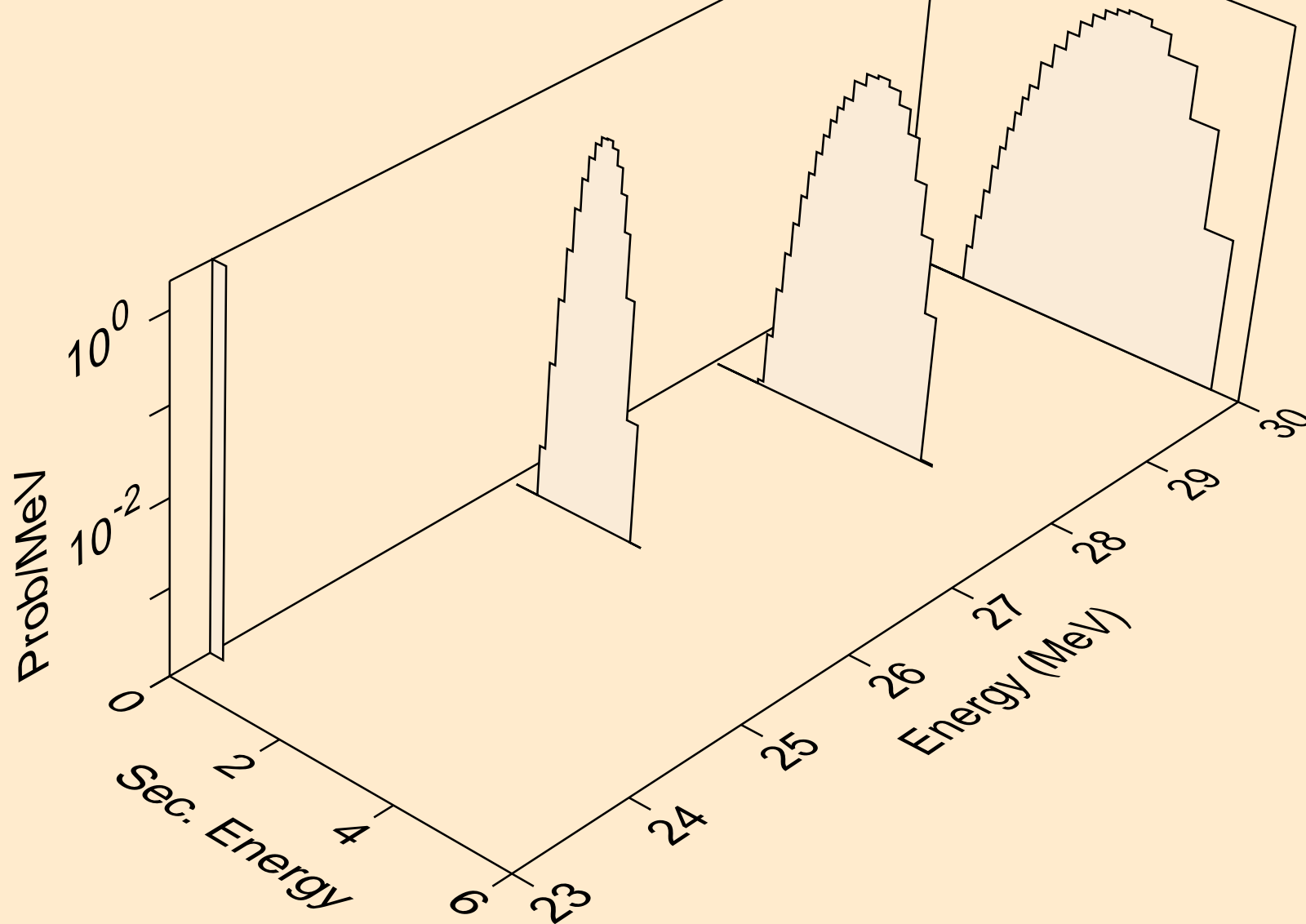

TI053 NEUTRON ACER TENDL-2024 LIBRARY; T=0.K
tritons from (n,x)

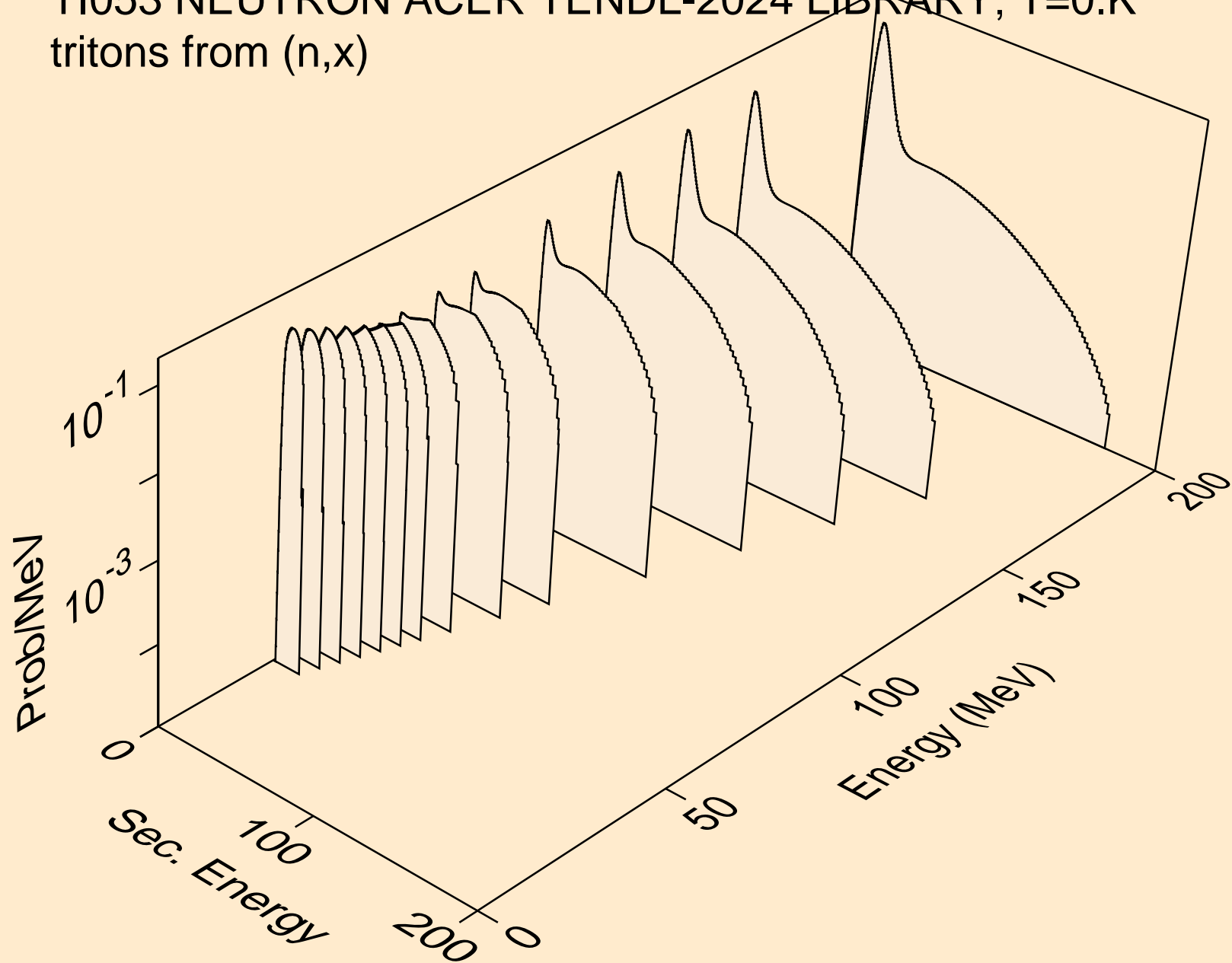

TI053 NEUTRON ACER TENDL-2024 LIBRARY; T=0.K
tritons from (n,n*)t

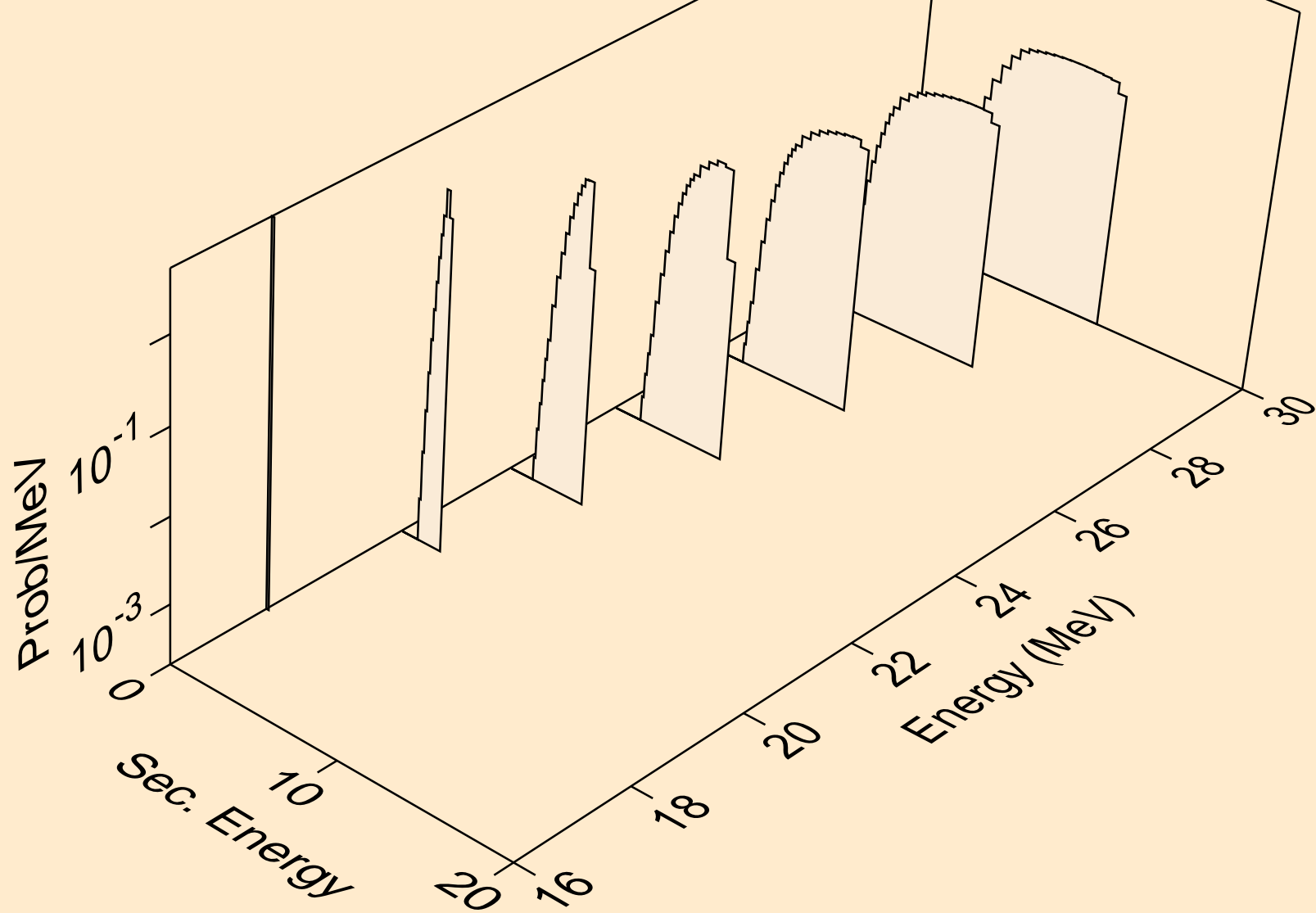

TI053 NEUTRON ACER TENDL-2024 LIBRARY; T=0.K
tritons from (n,t)

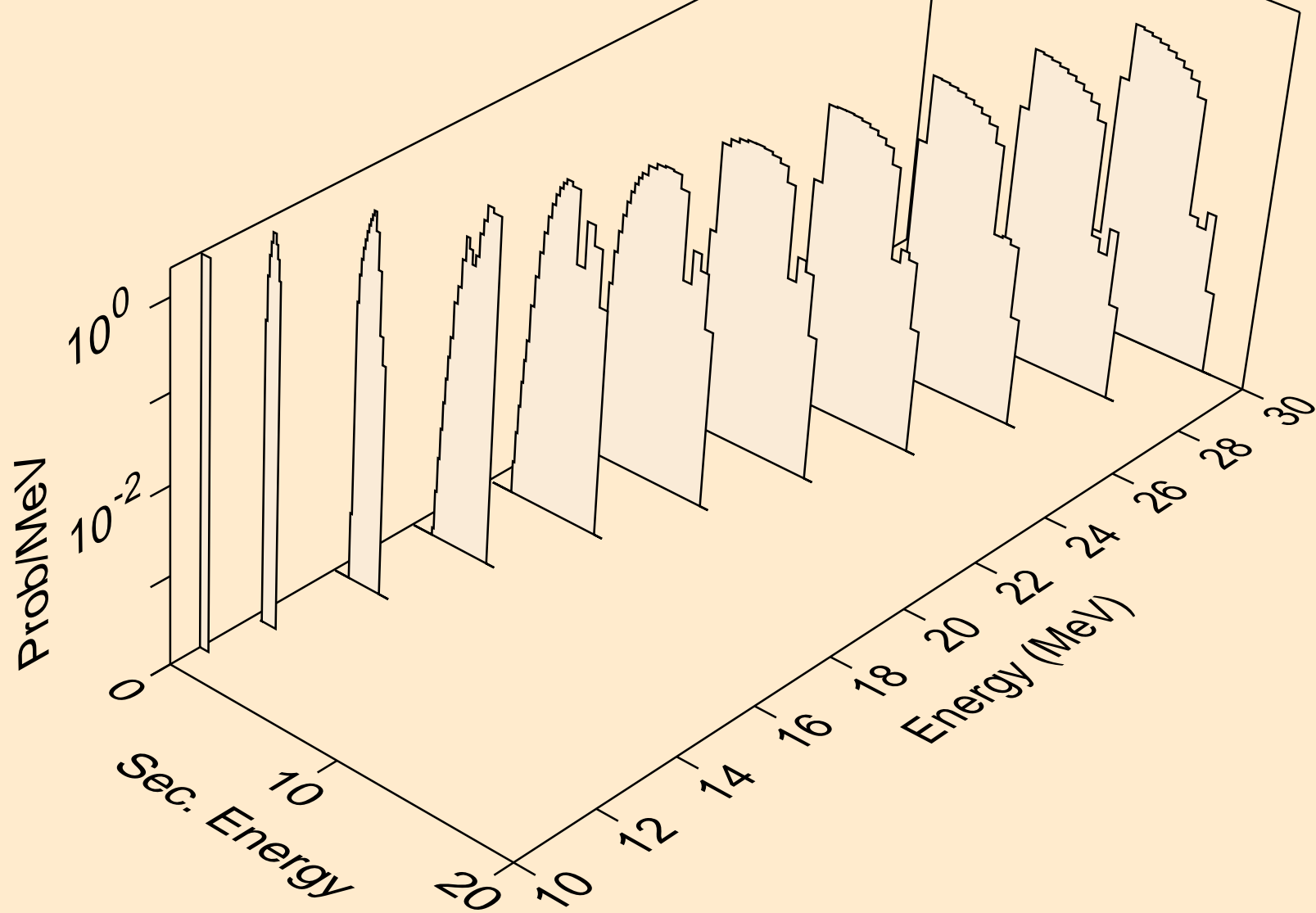

TI053 NEUTRON ACER TENDL-2024 LIBRARY; T=0.K
tritons from (n,pt)

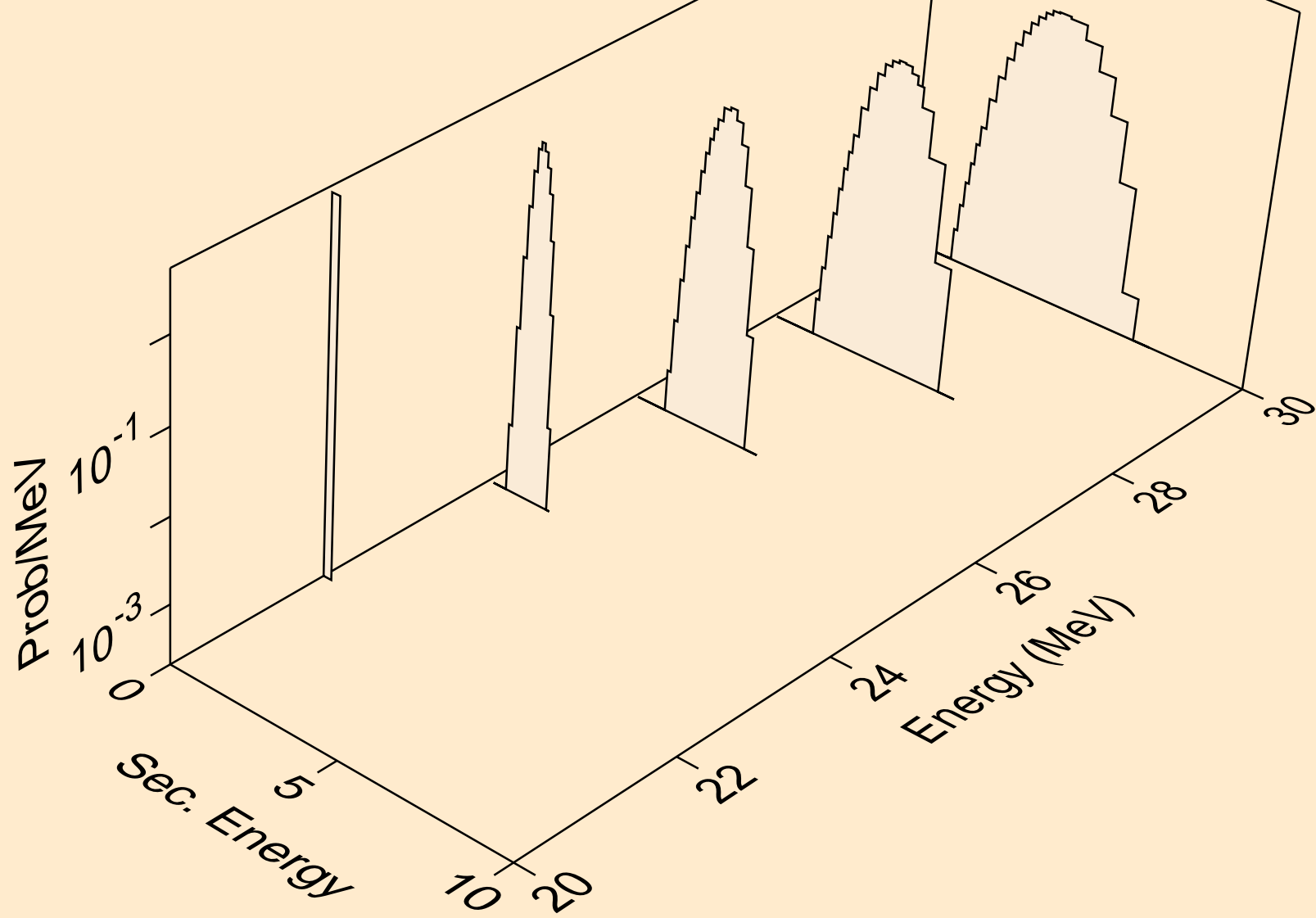

TI053 NEUTRON ACER TENDL-2024 LIBRARY; T=0.K
he3s from (n,x)

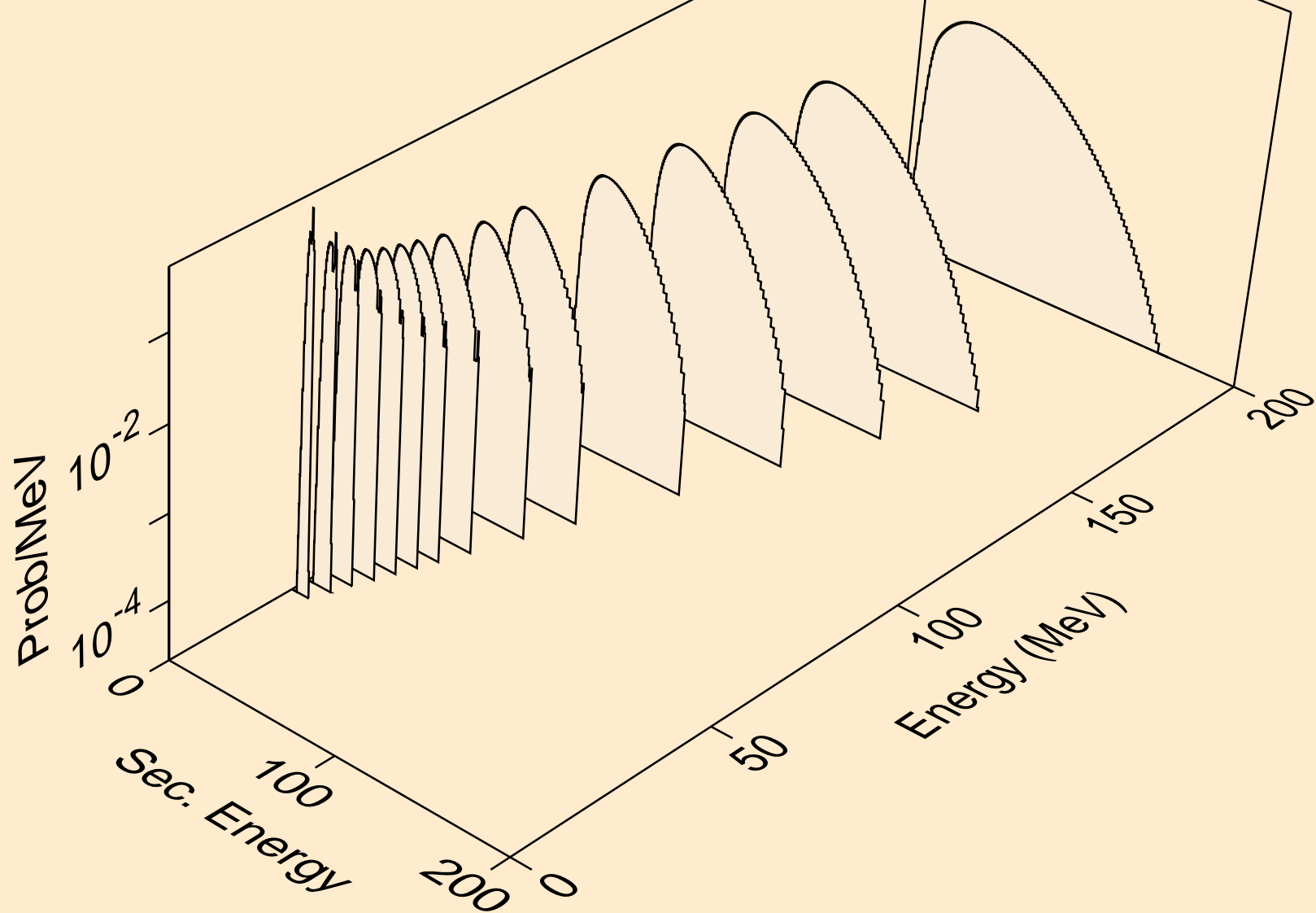

TI053 NEUTRON ACER TENDL-2024 LIBRARY; T=0.K
he3s from (n,n*)he3

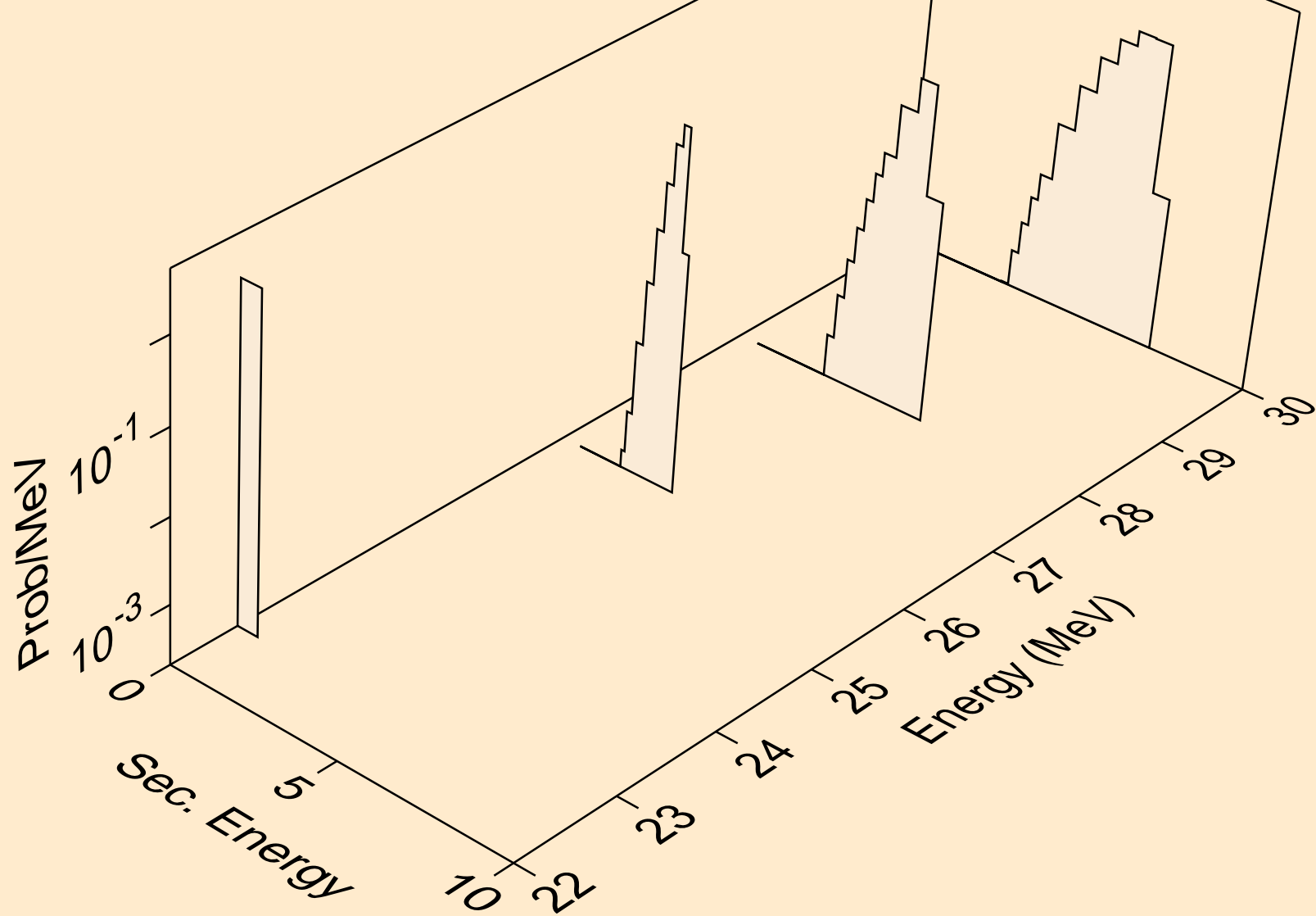

TI053 NEUTRON ACER TENDL-2024 LIBRARY; T=0.K
he3s from (n,he3)

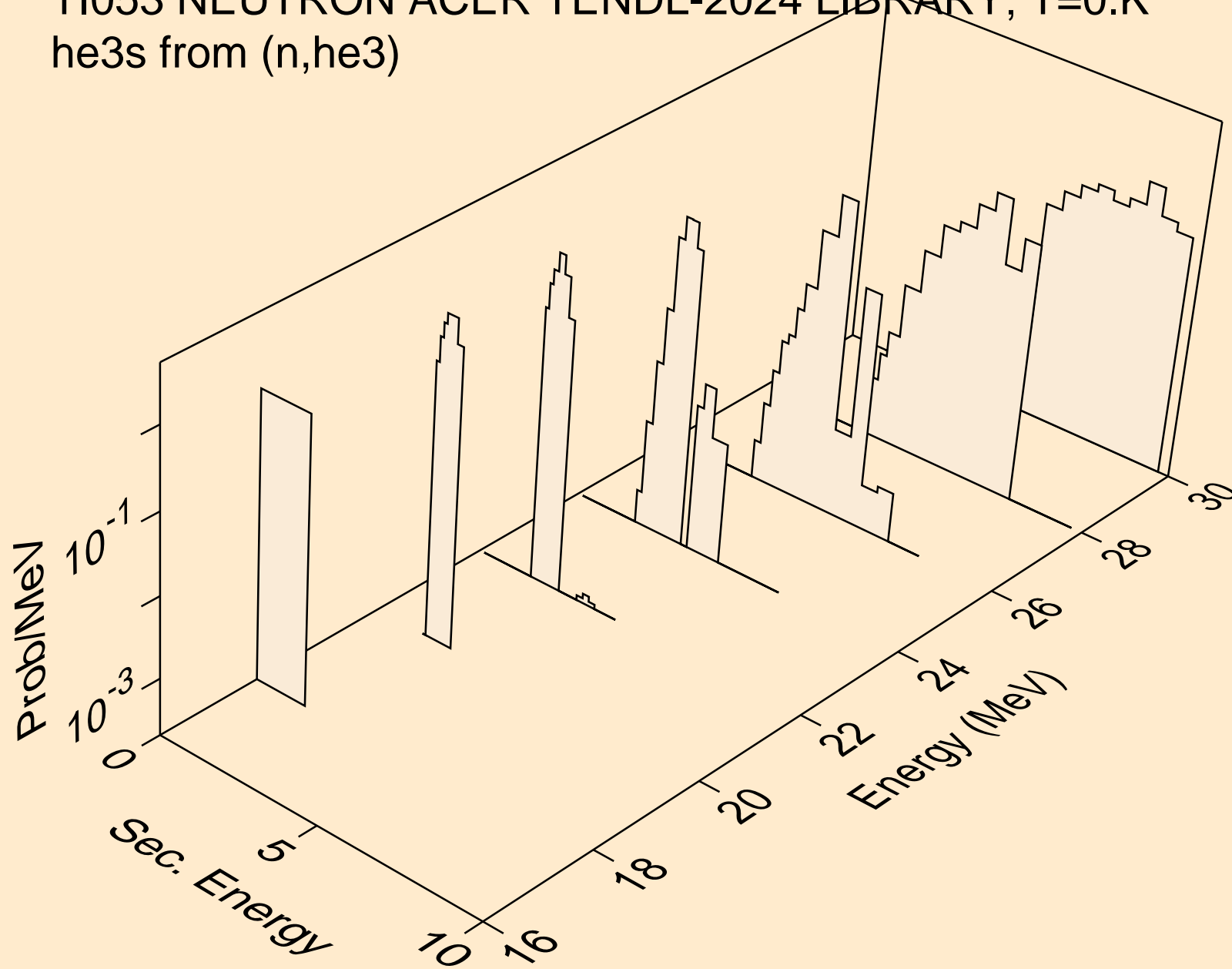

TI053 NEUTRON ACER TENDL-2024 LIBRARY; T=0.K
alphas from (n,x)

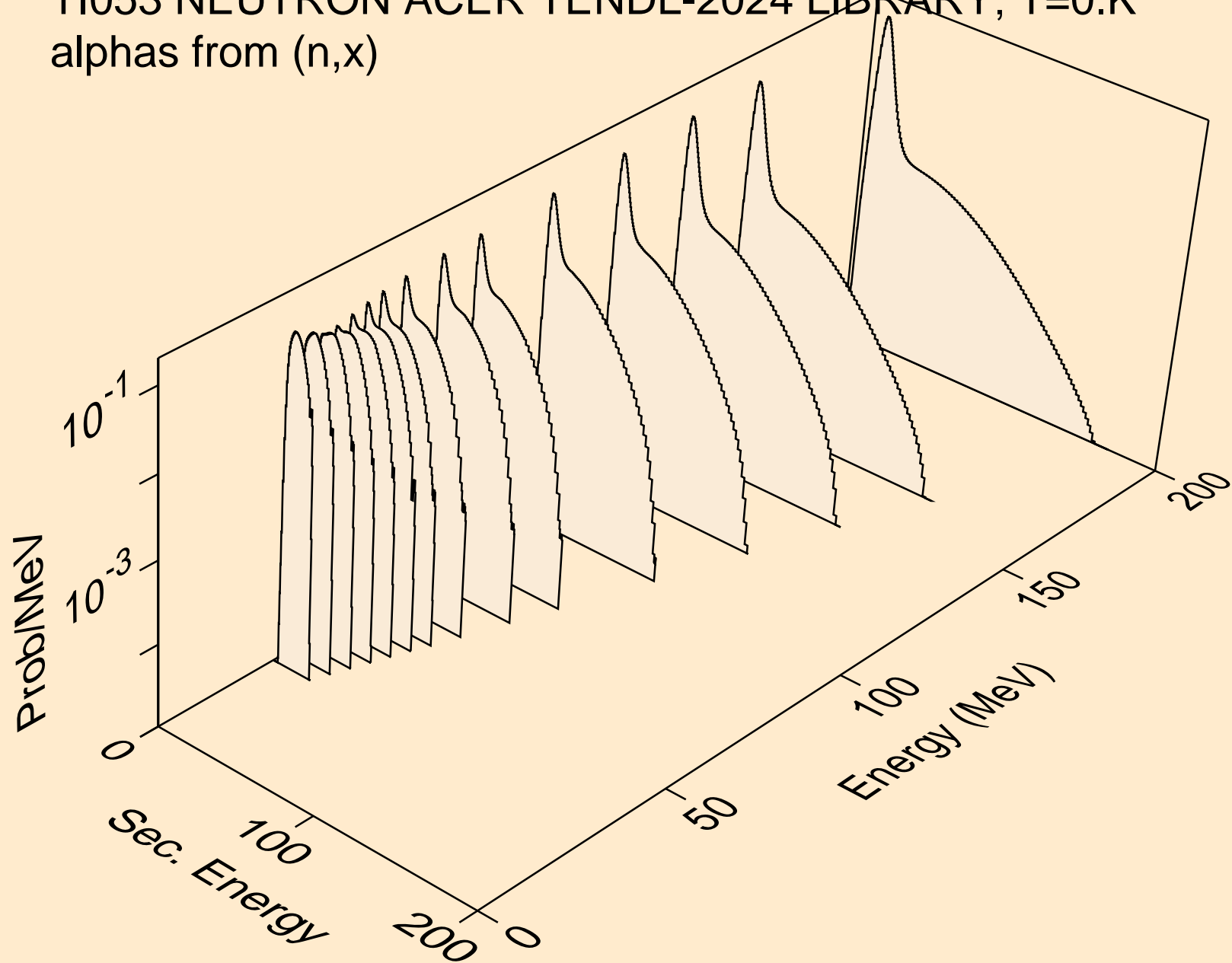

TI053 NEUTRON ACER TENDL-2024 LIBRARY; T=0.K
alphas from (n,n*)a

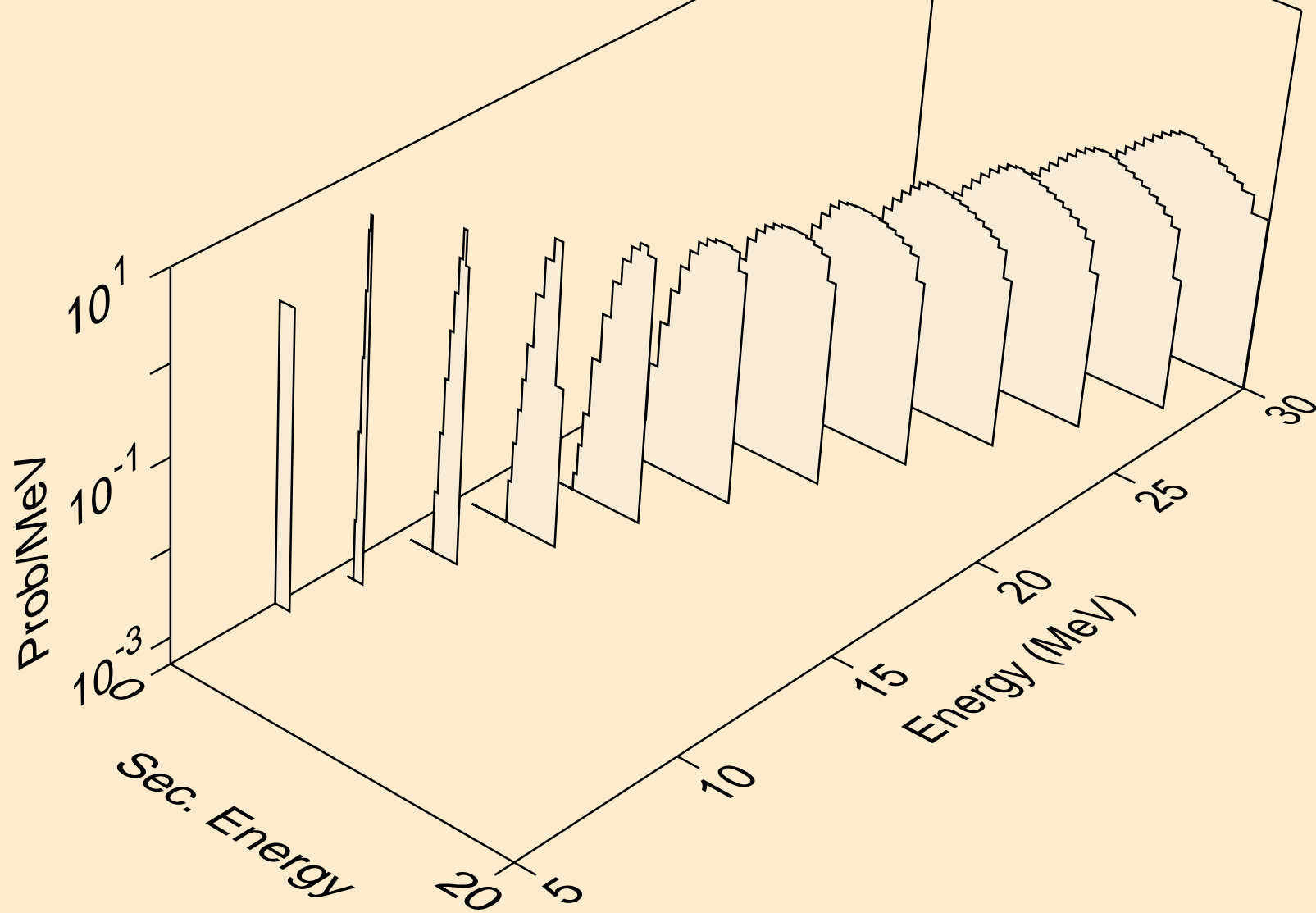

TI053 NEUTRON ACER TENDL-2024 LIBRARY; T=0.K
alphas from (n,2n)a

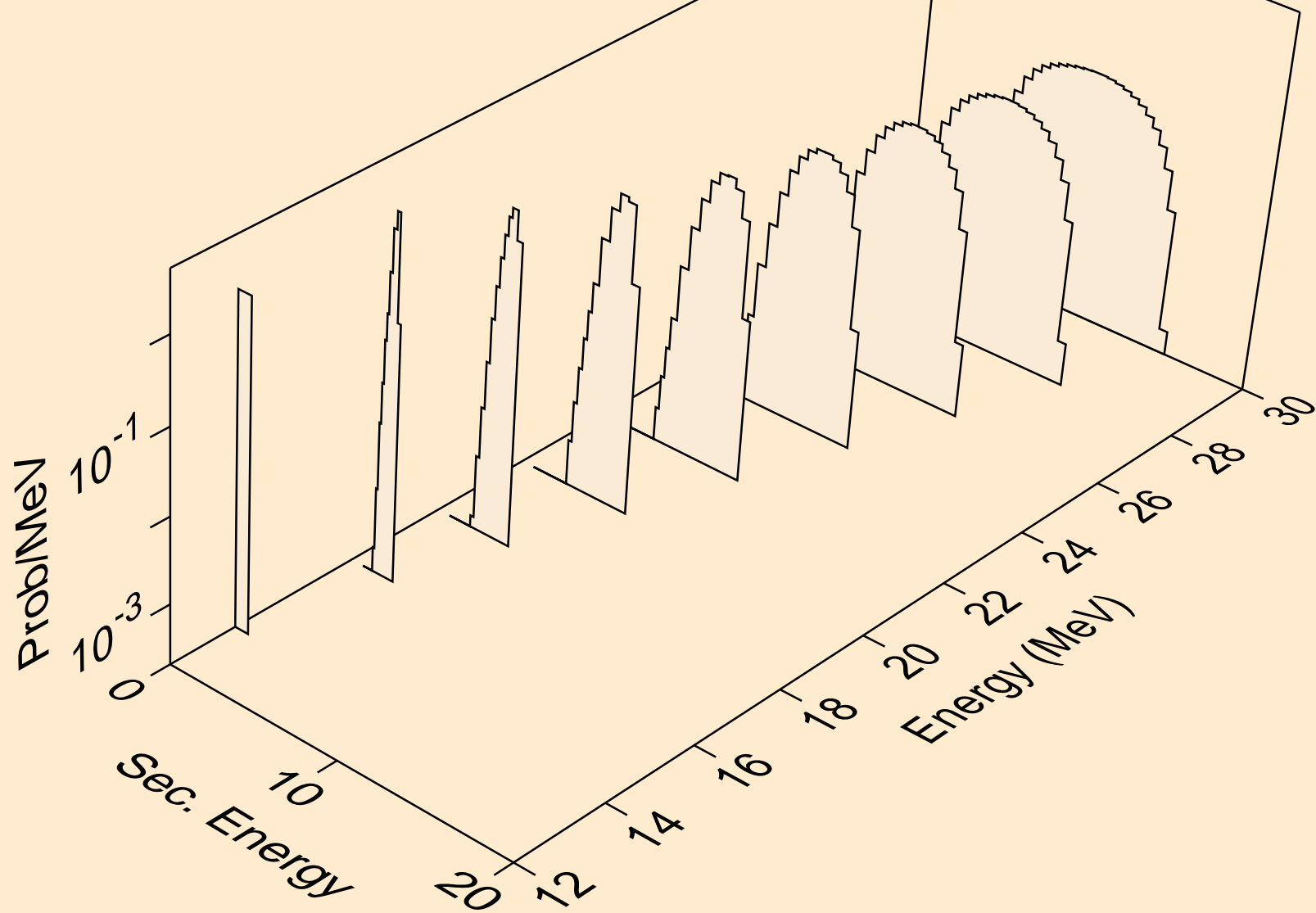

TI053 NEUTRON ACER TENDL-2024 LIBRARY; T=0.K
alphas from (n,3n)a

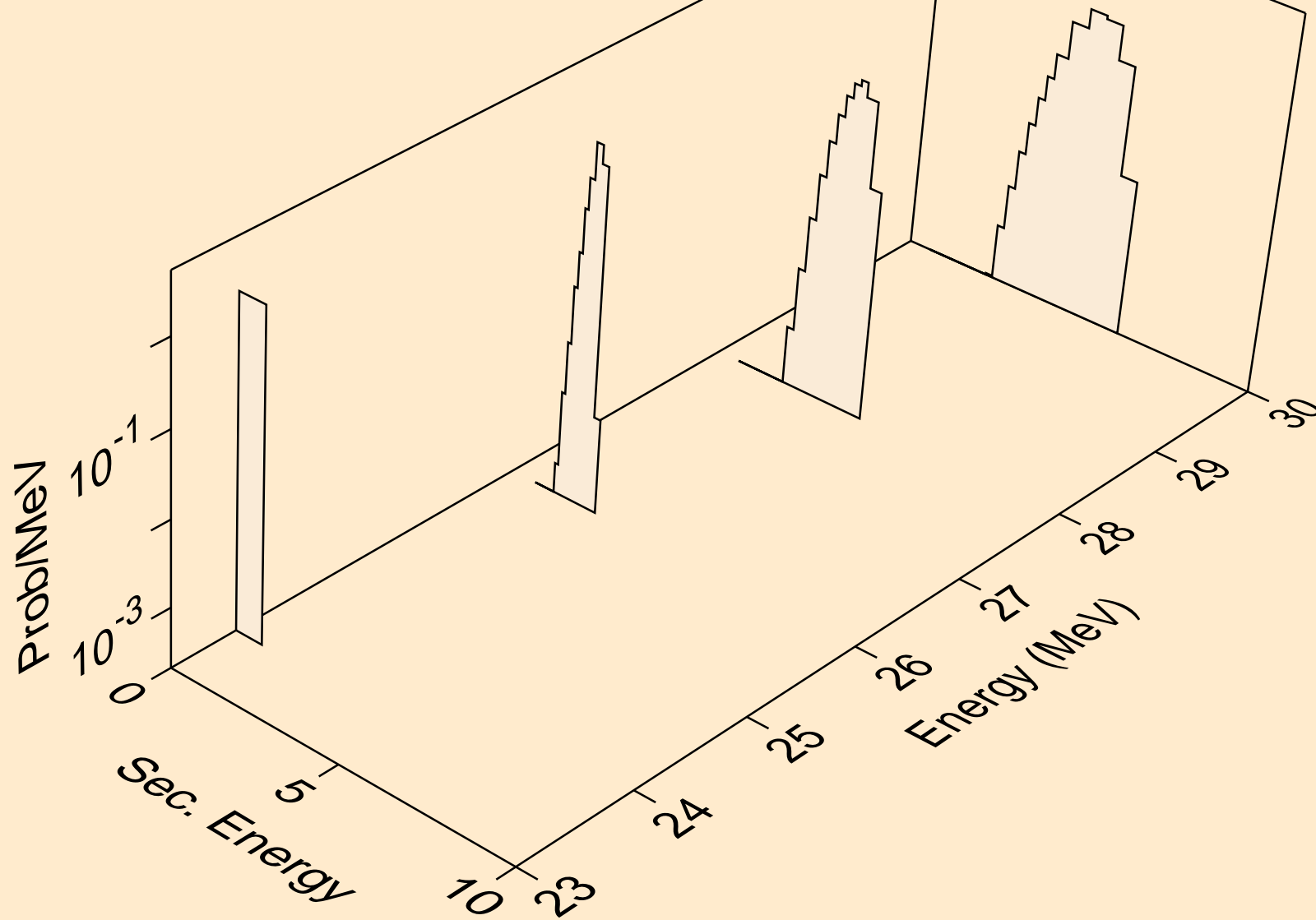

TI053 NEUTRON ACER TENDL-2024 LIBRARY; T=0.K
alphas from (n,a)

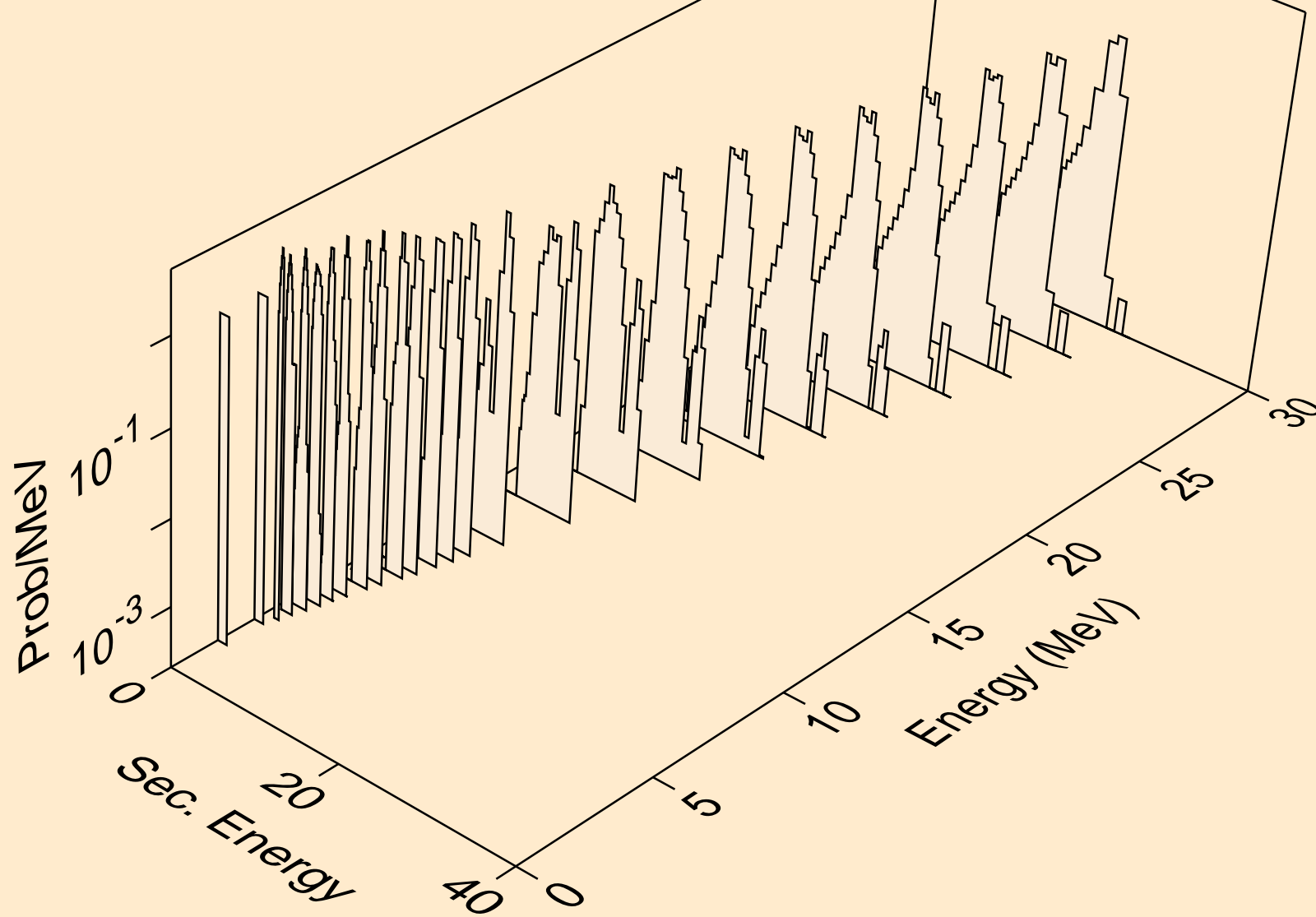

TI053 NEUTRON ACER TENDL-2024 LIBRARY; T=0.K
alphas from (n,2a)

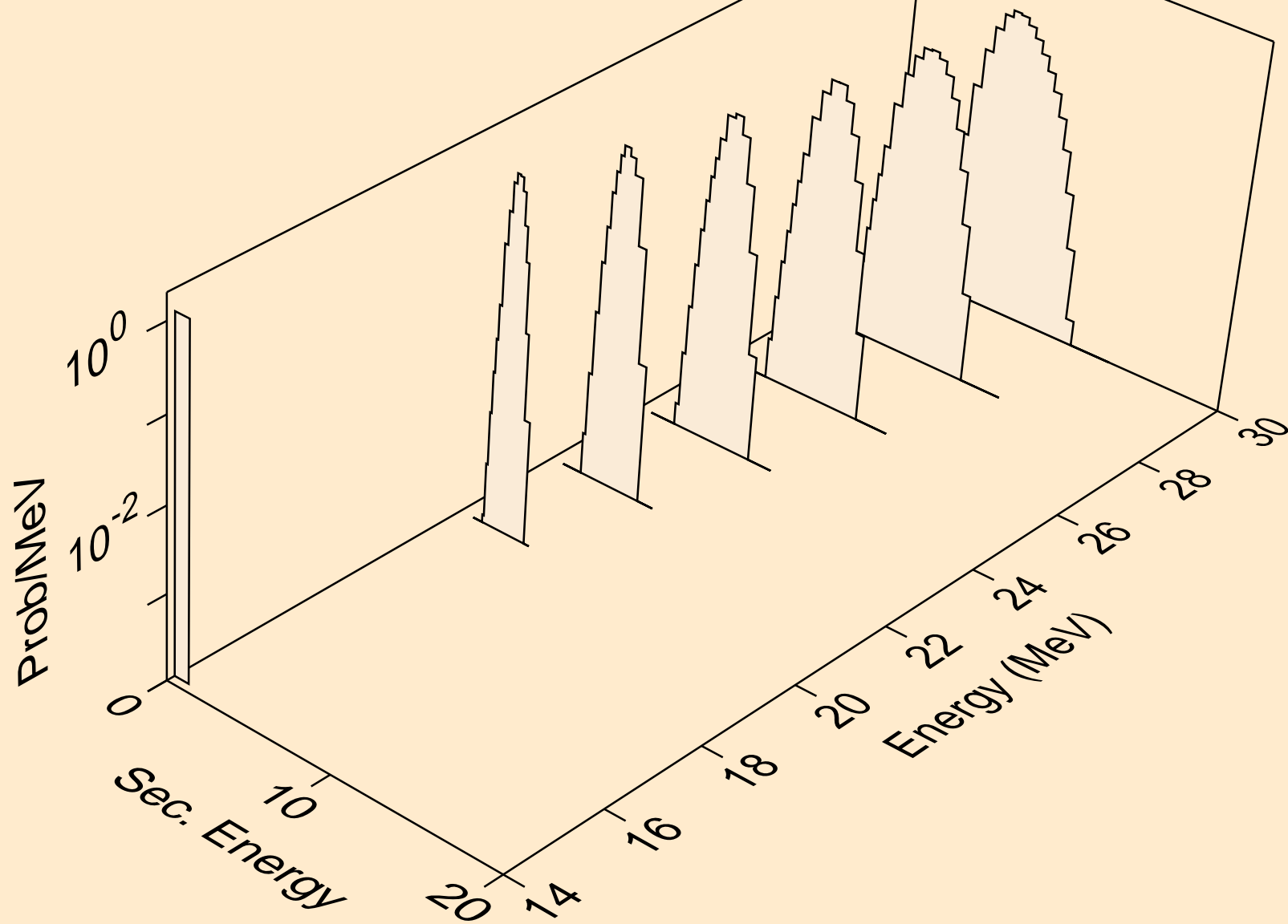

TI053 NEUTRON ACER TENDL-2024 LIBRARY; T=0.K
alphas from (n,pa)

