

W165 NEUTRON ACER TENDL-2024 LIBRARY; T=0.K

Principal cross sections

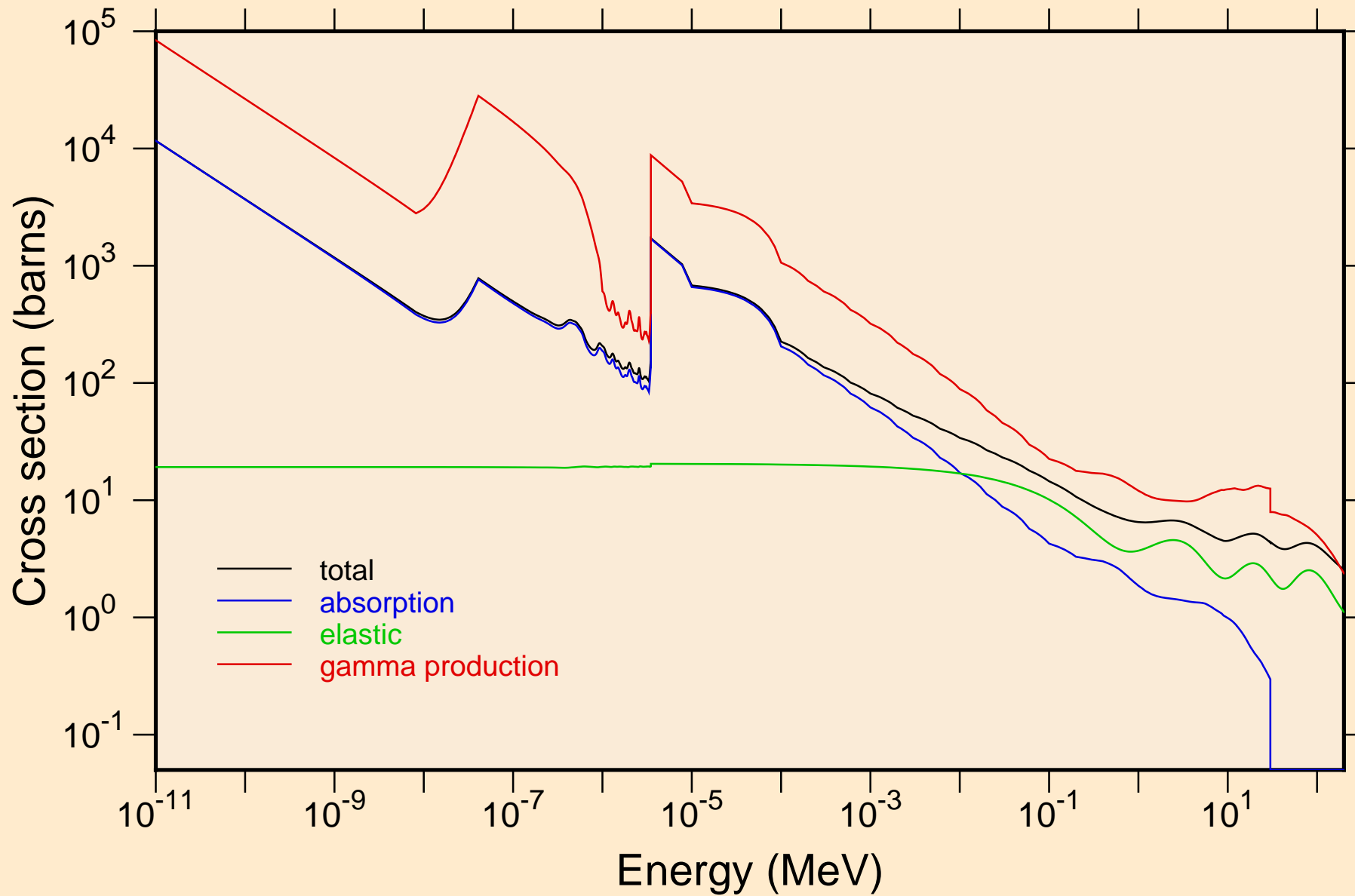

W165 NEUTRON ACER TENDL-2024 LIBRARY; T=0.K

Heating

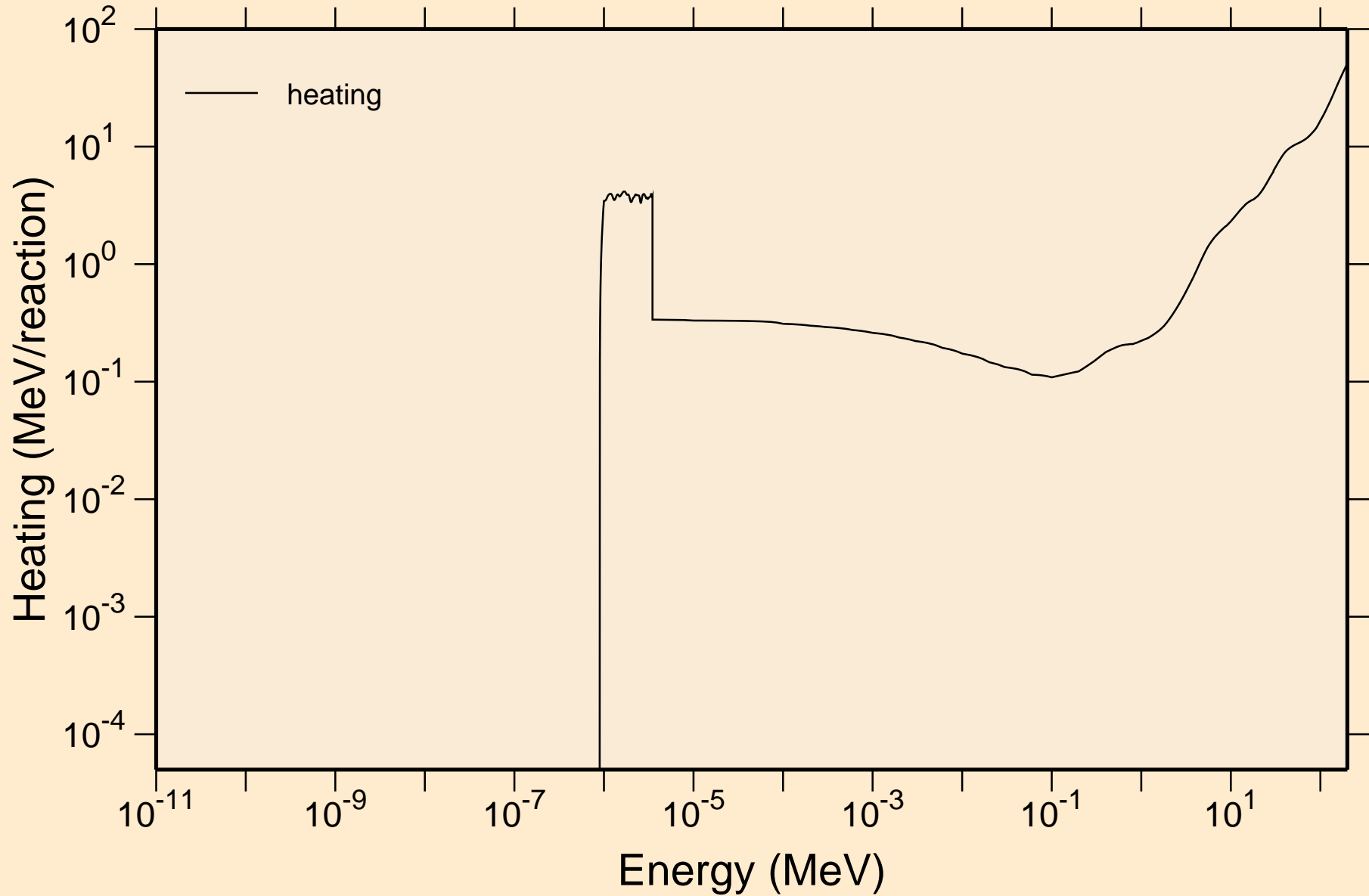

W165 NEUTRON ACER TENDL-2024 LIBRARY; T=0.K

Damage

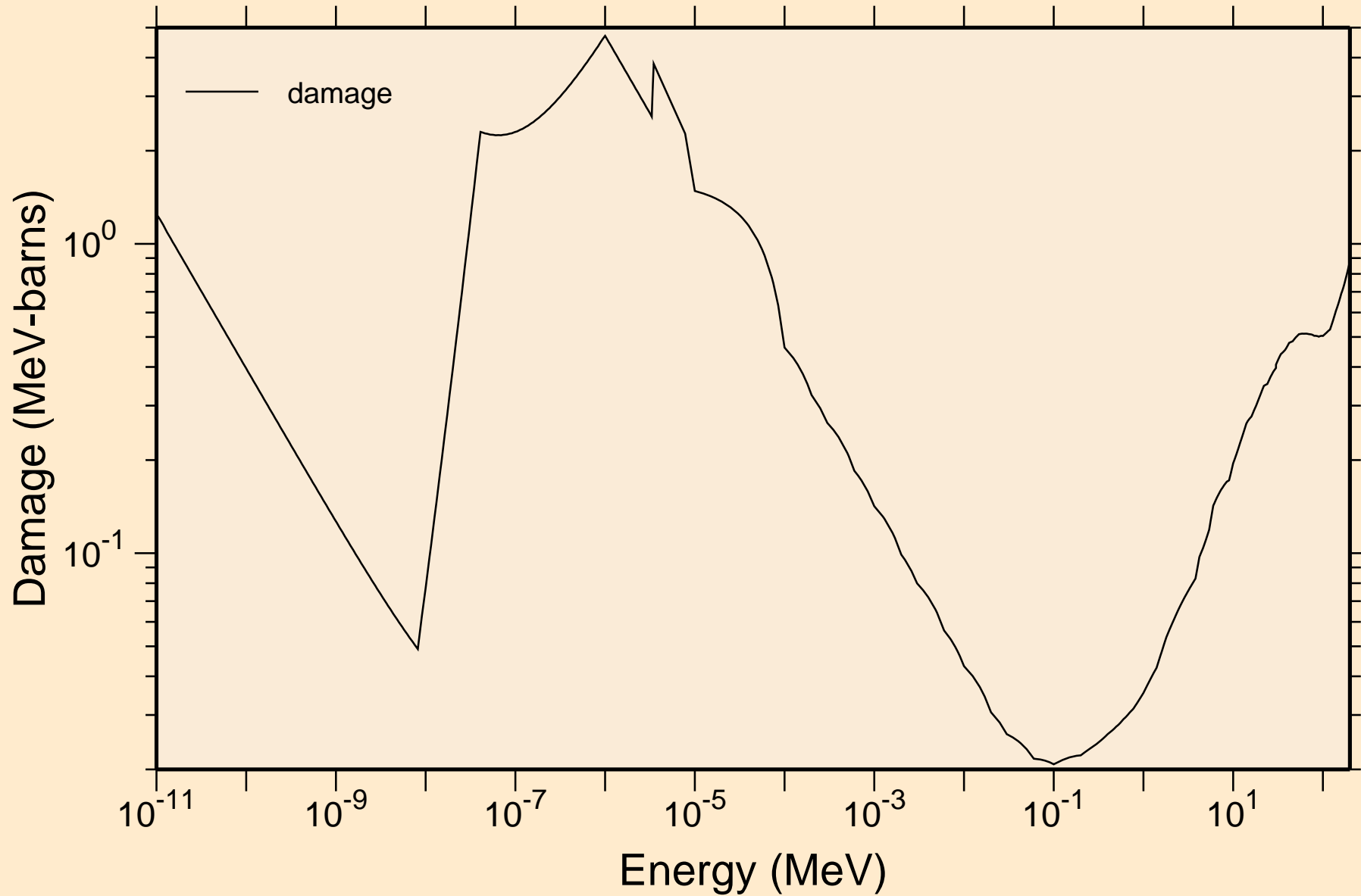

W165 NEUTRON ACER TENDL-2024 LIBRARY; T=0.K
Non-threshold reactions

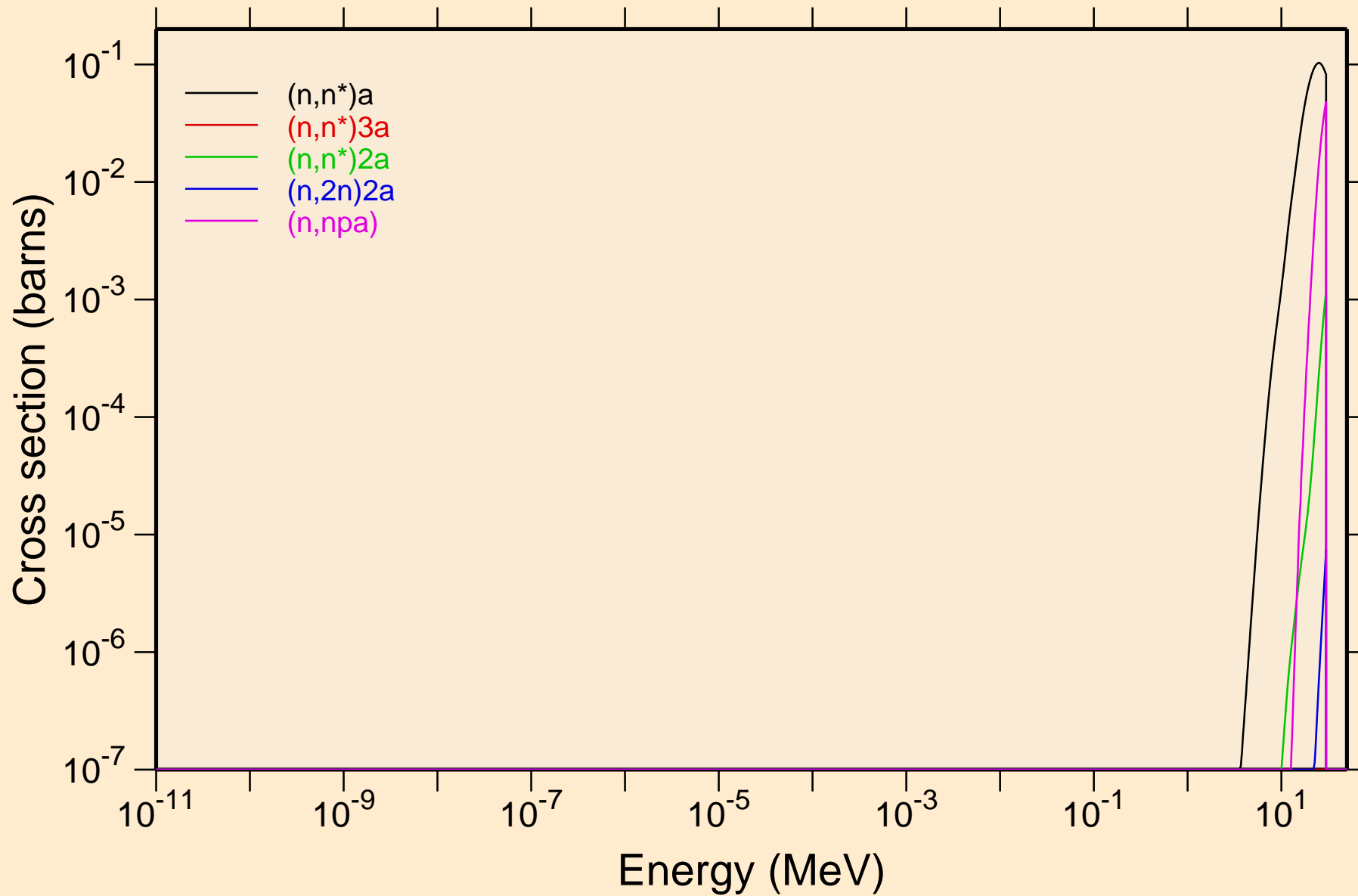

W165 NEUTRON ACER TENDL-2024 LIBRARY; T=0.K
Non-threshold reactions

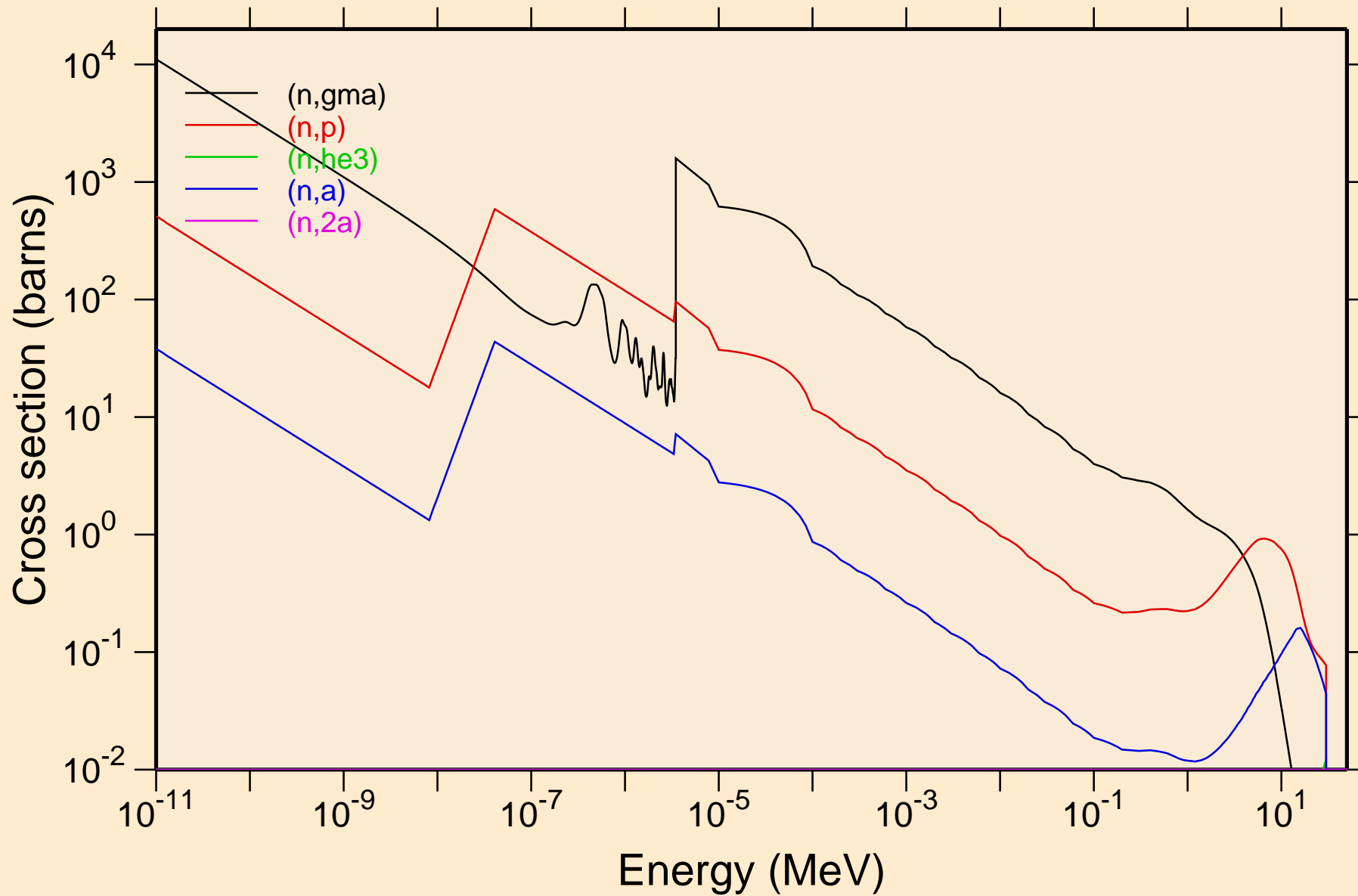

W165 NEUTRON ACER TENDL-2024 LIBRARY; T=0.K
Non-threshold reactions

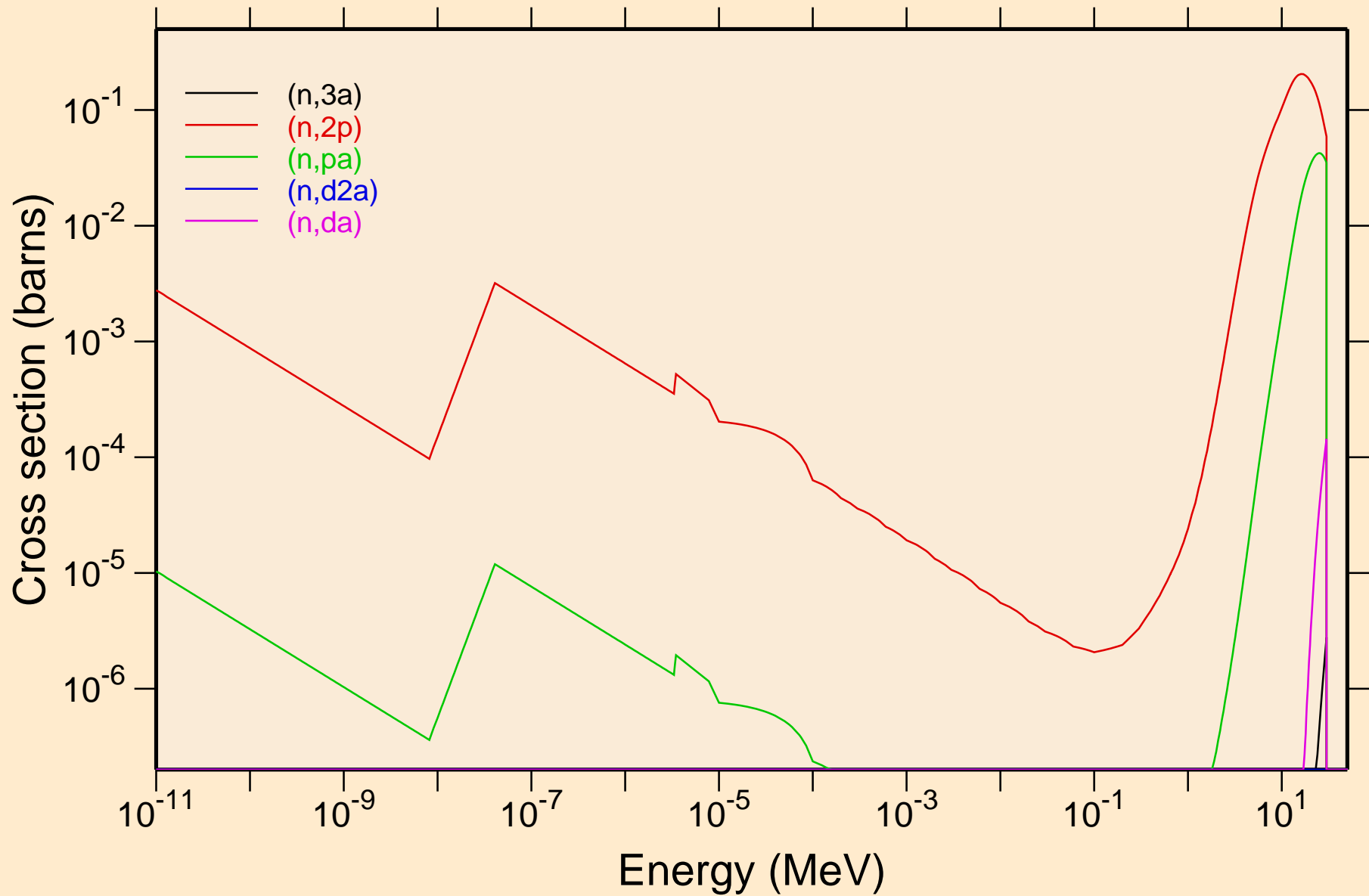

W165 NEUTRON ACER TENDL-2024 LIBRARY; T=0.K
Non-threshold reactions

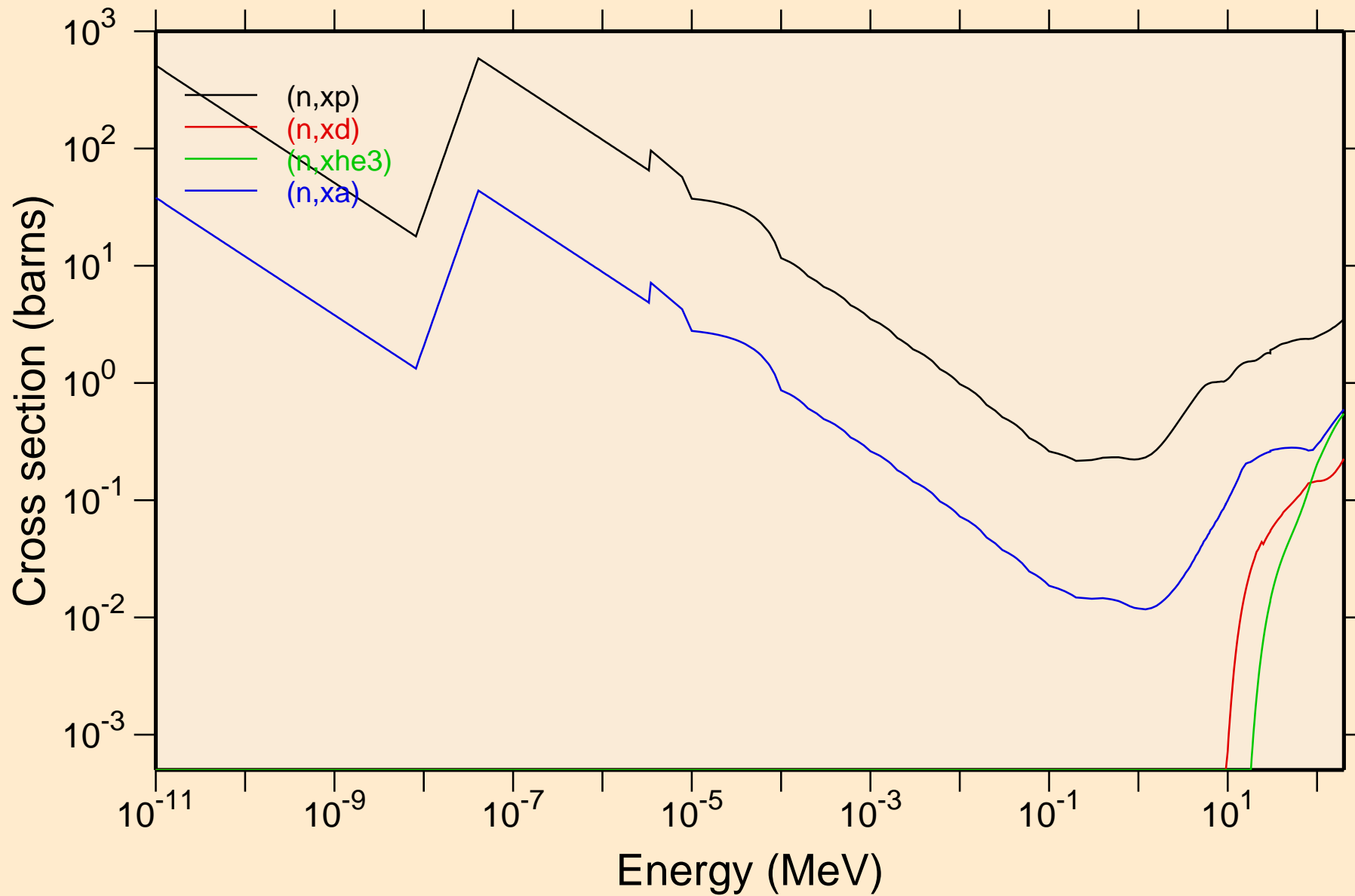

W165 NEUTRON ACER TENDL-2024 LIBRARY; T=0.K

Principal cross sections

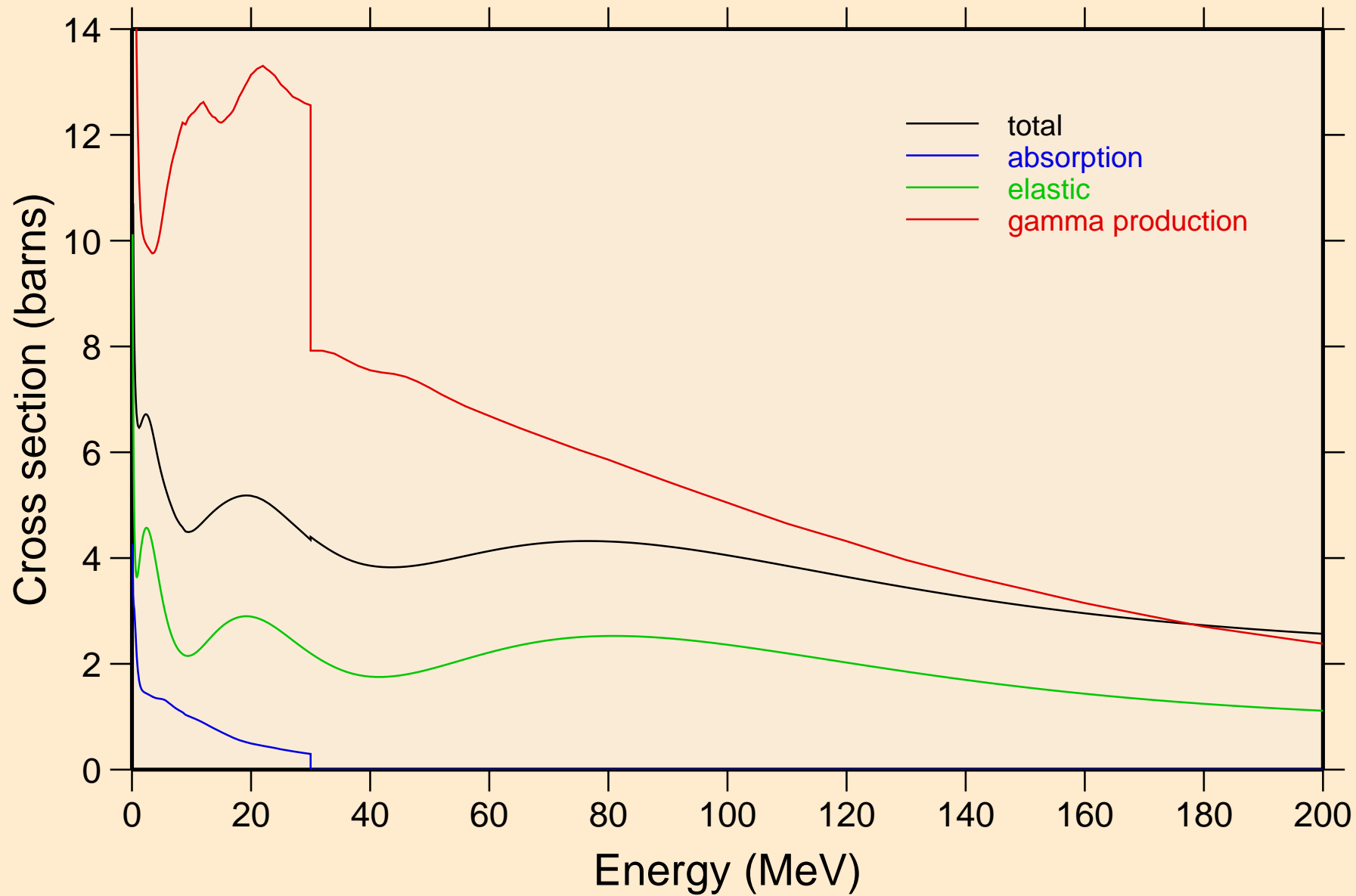

W165 NEUTRON ACER TENDL-2024 LIBRARY; T=0.K

Heating

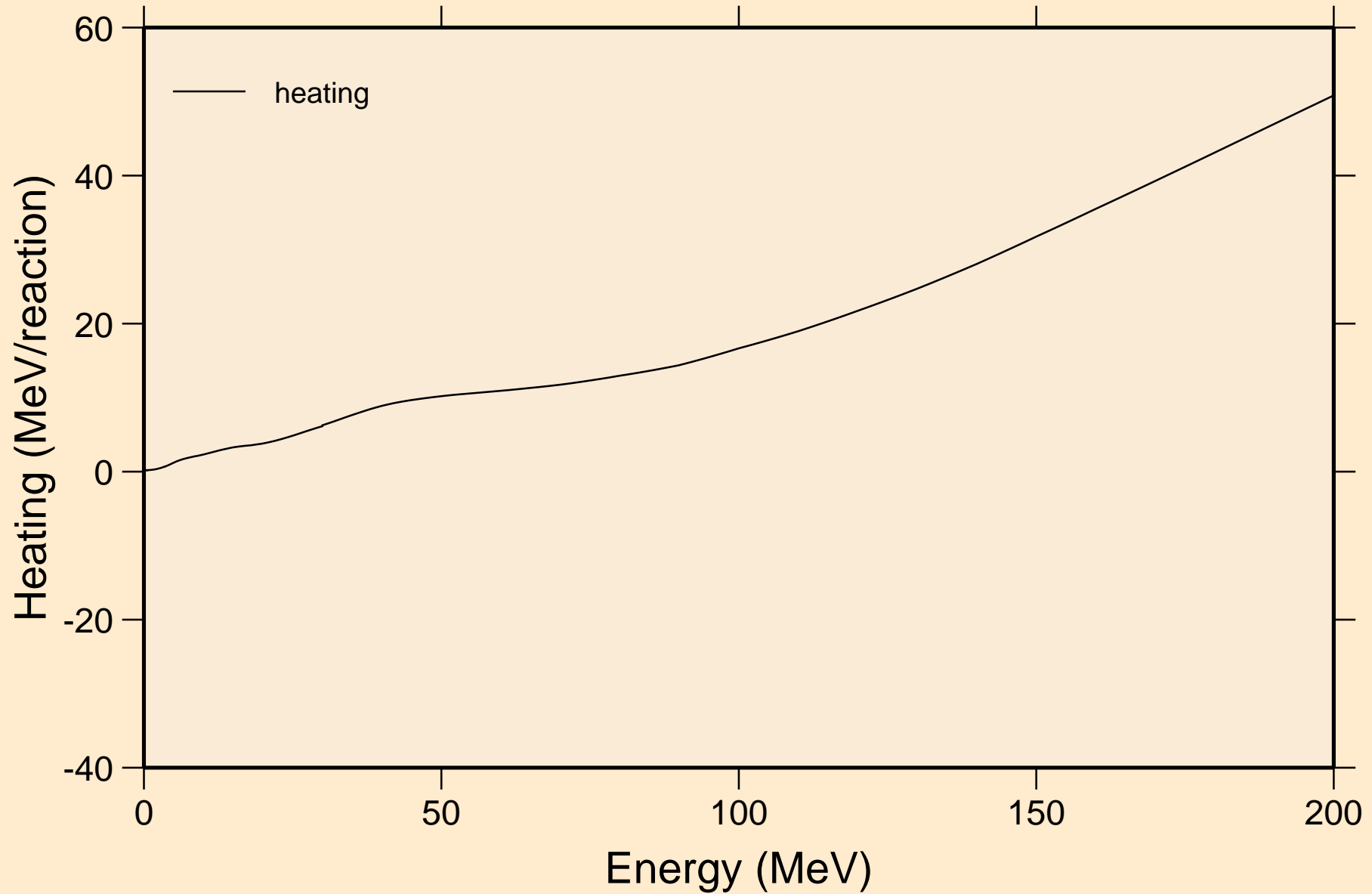

W165 NEUTRON ACER TENDL-2024 LIBRARY; T=0.K

Damage

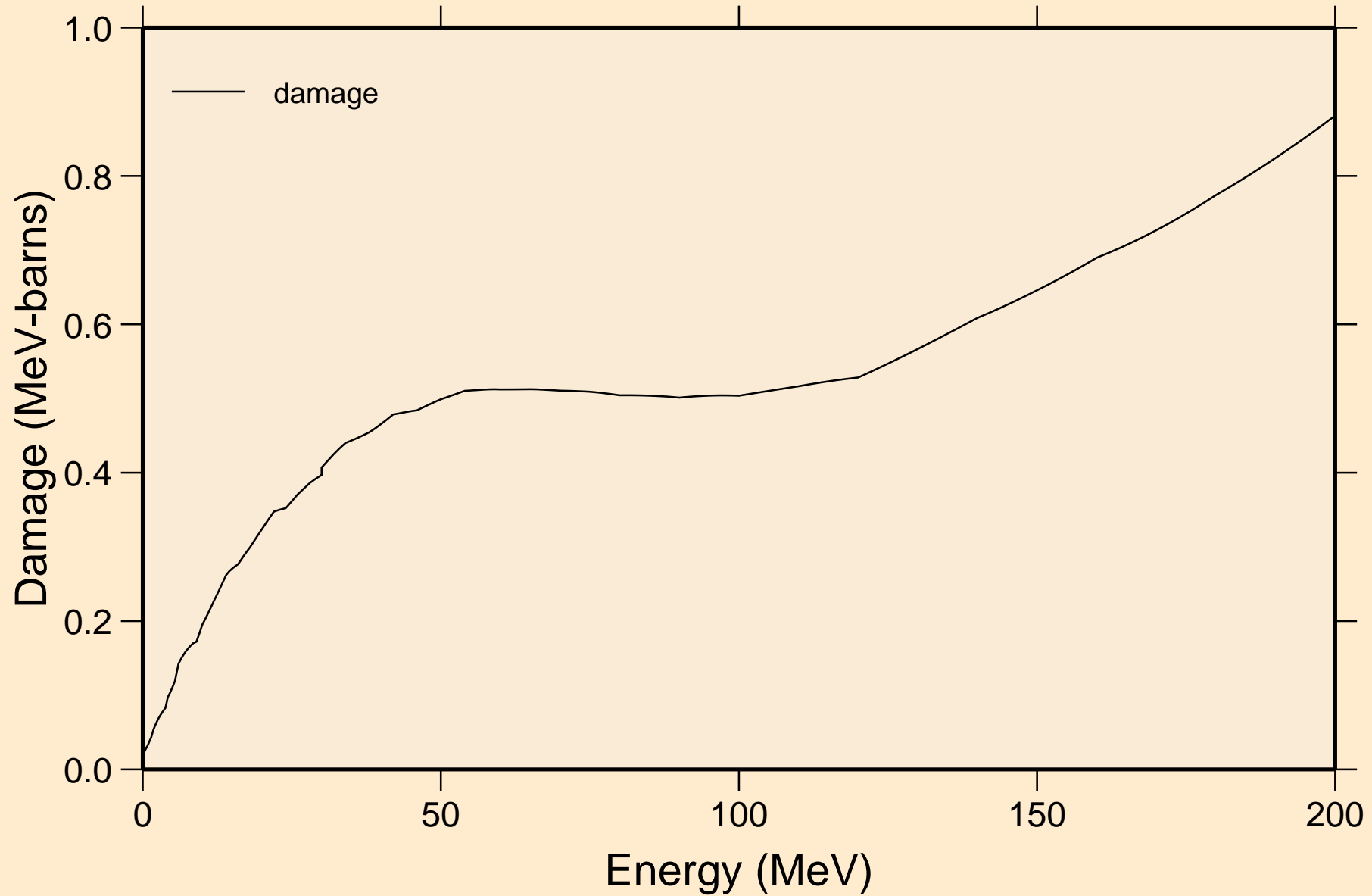

W165 NEUTRON ACER TENDL-2024 LIBRARY; T=0.K
Non-threshold reactions

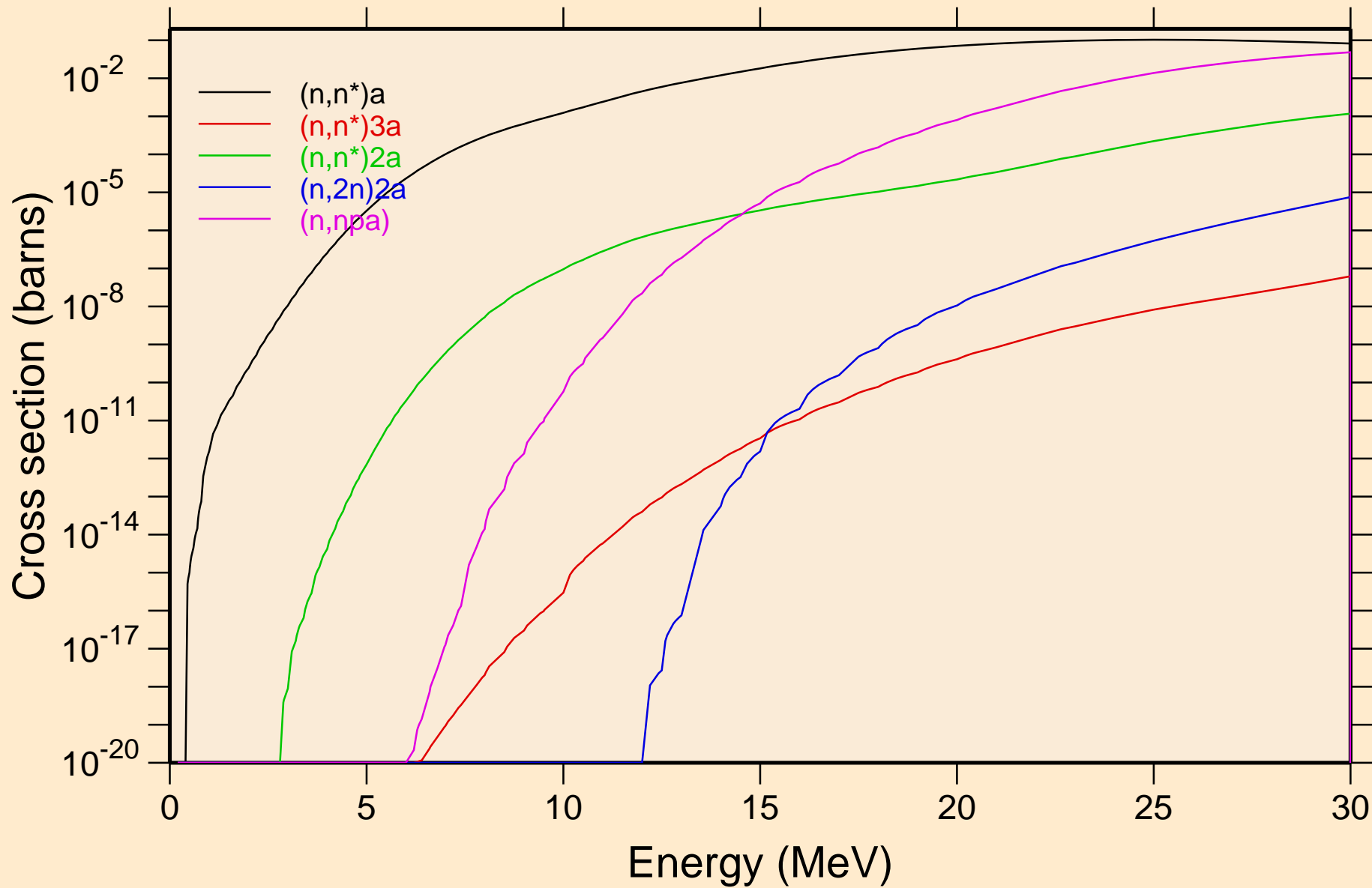

W165 NEUTRON ACER TENDL-2024 LIBRARY; T=0.K

Non-threshold reactions

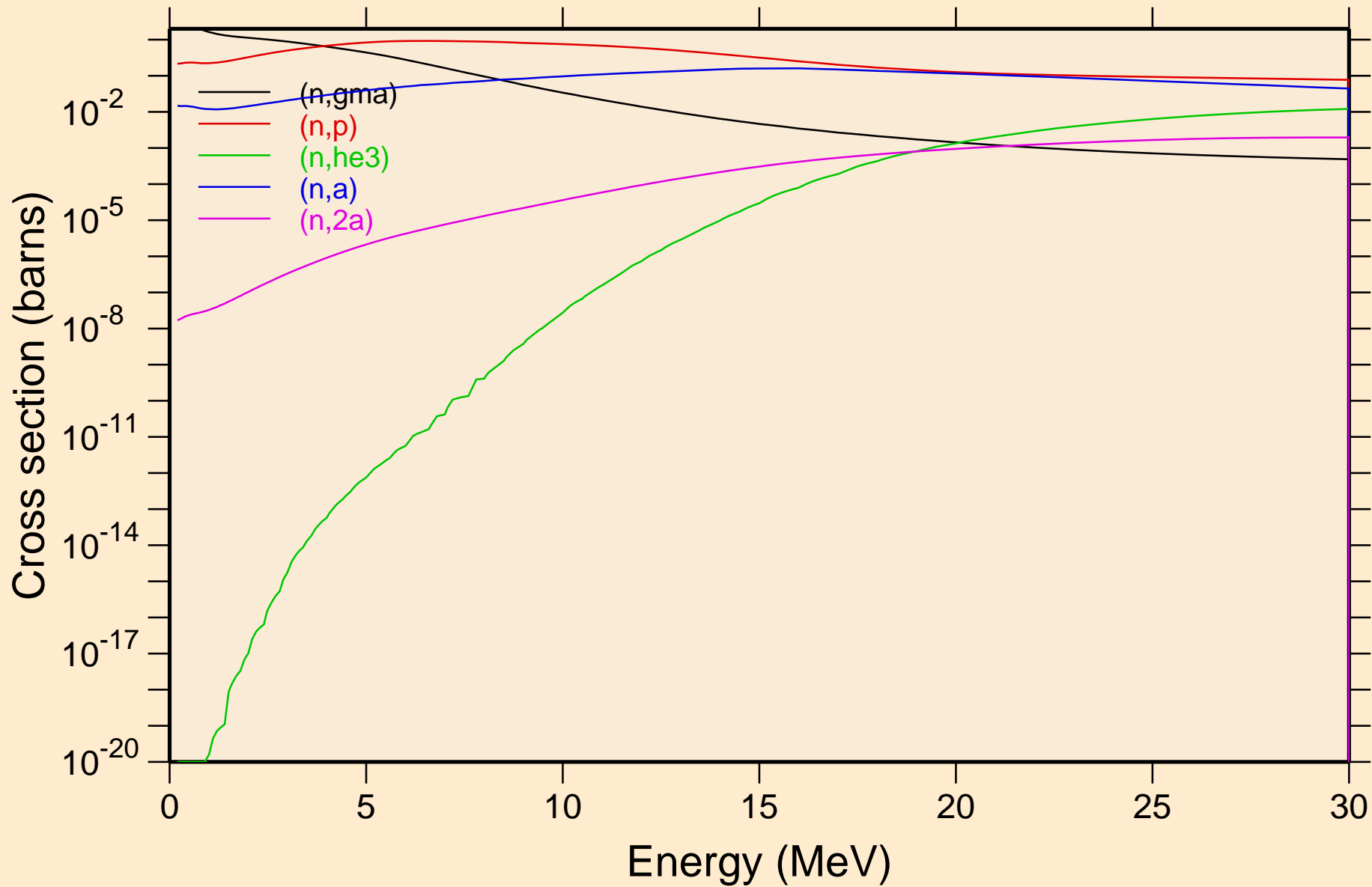

W165 NEUTRON ACER TENDL-2024 LIBRARY; T=0.K
Non-threshold reactions

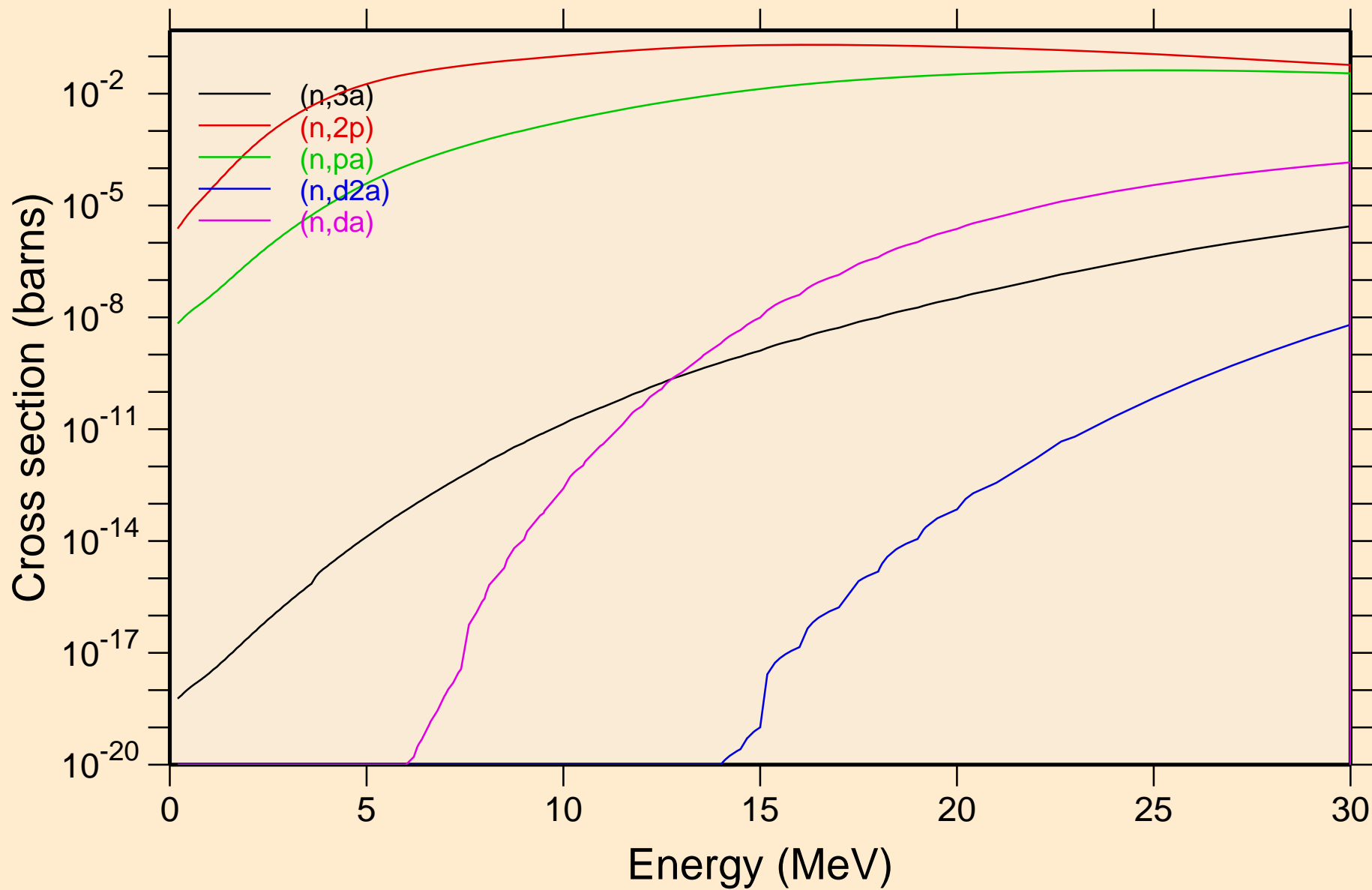

W165 NEUTRON ACER TENDL-2024 LIBRARY; T=0.K
Non-threshold reactions

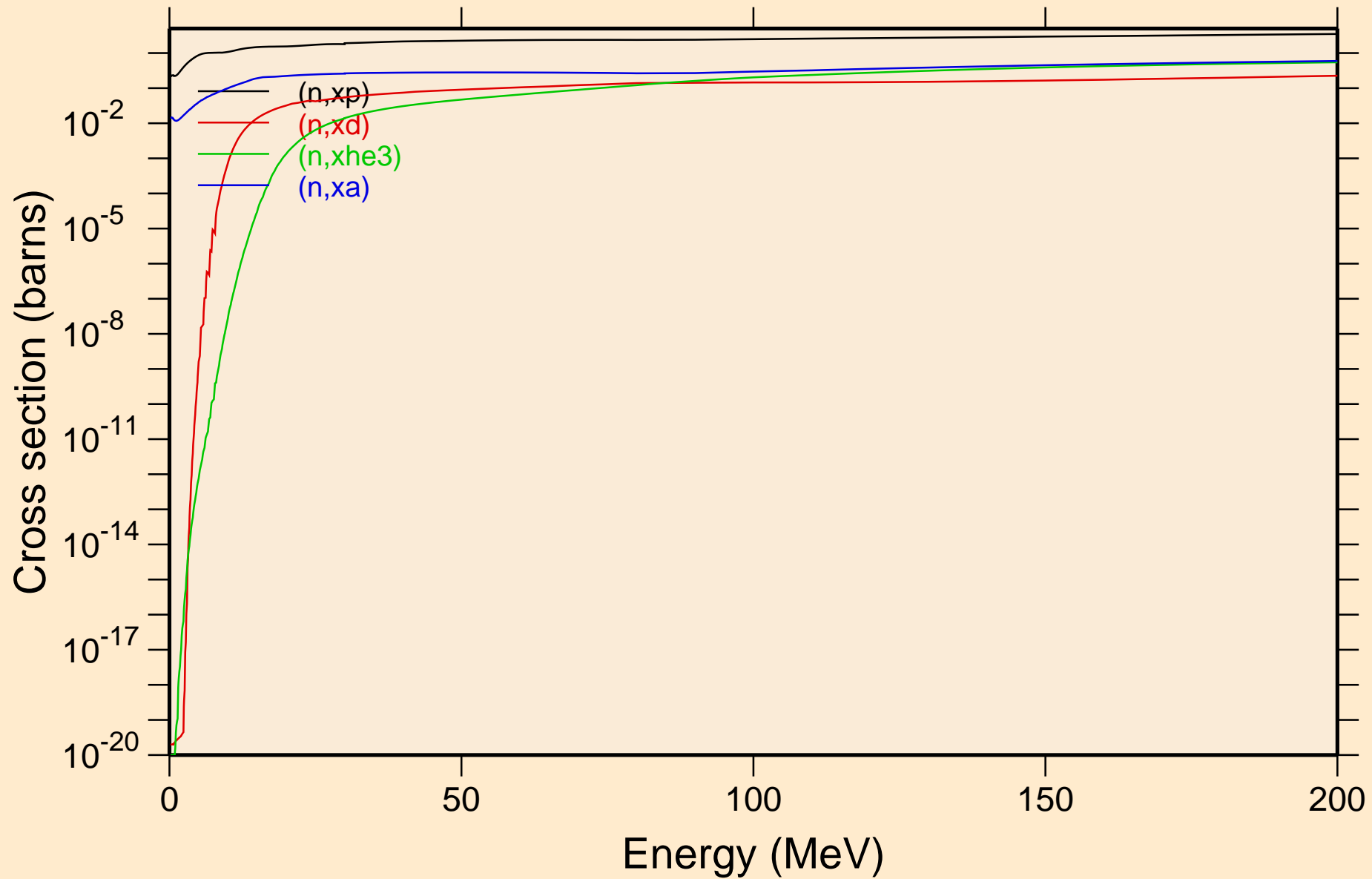

W165 NEUTRON ACER TENDL-2024 LIBRARY; T=0.K
Inelastic levels

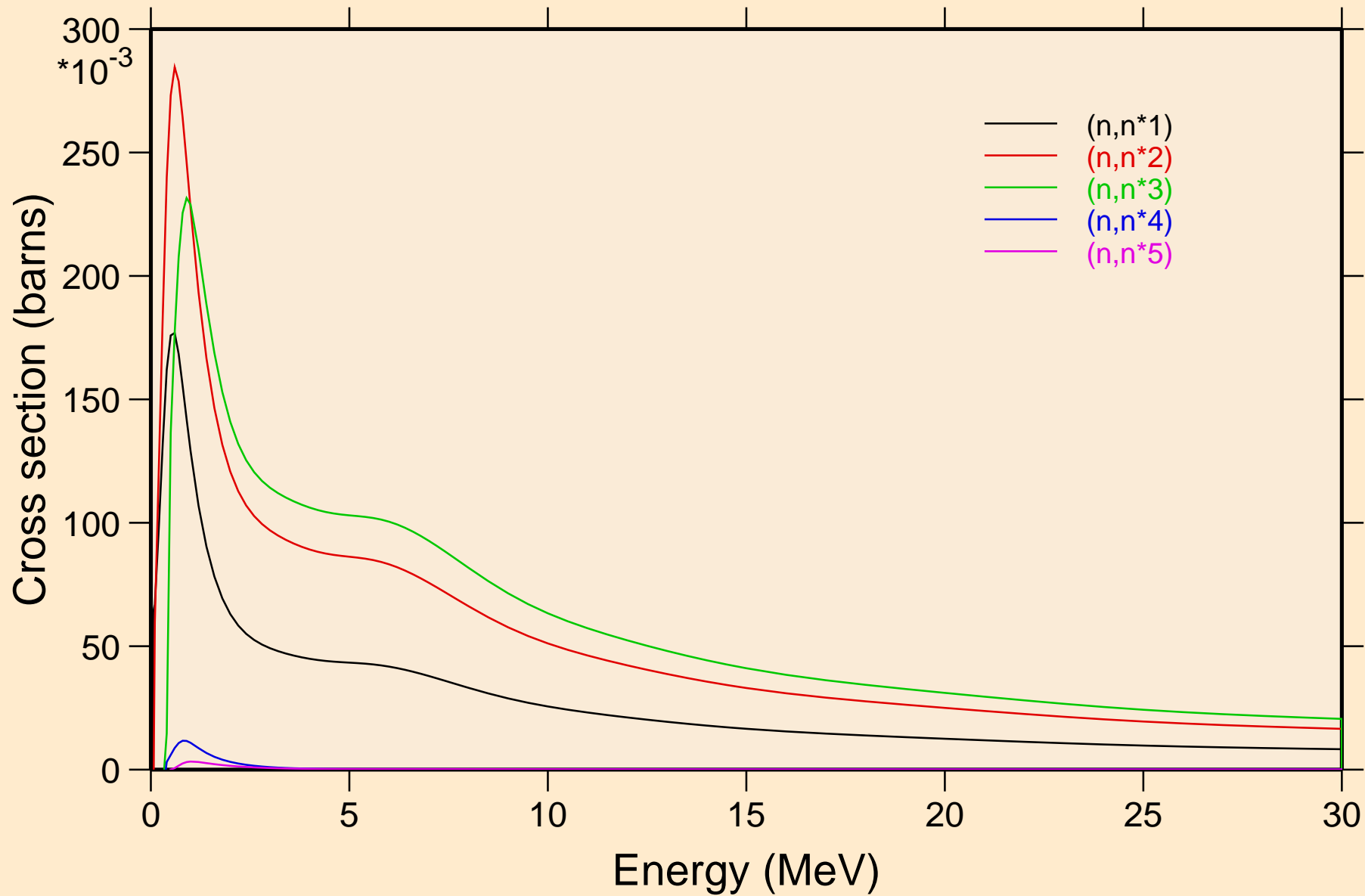

W165 NEUTRON ACER TENDL-2024 LIBRARY; T=0.K
Inelastic levels

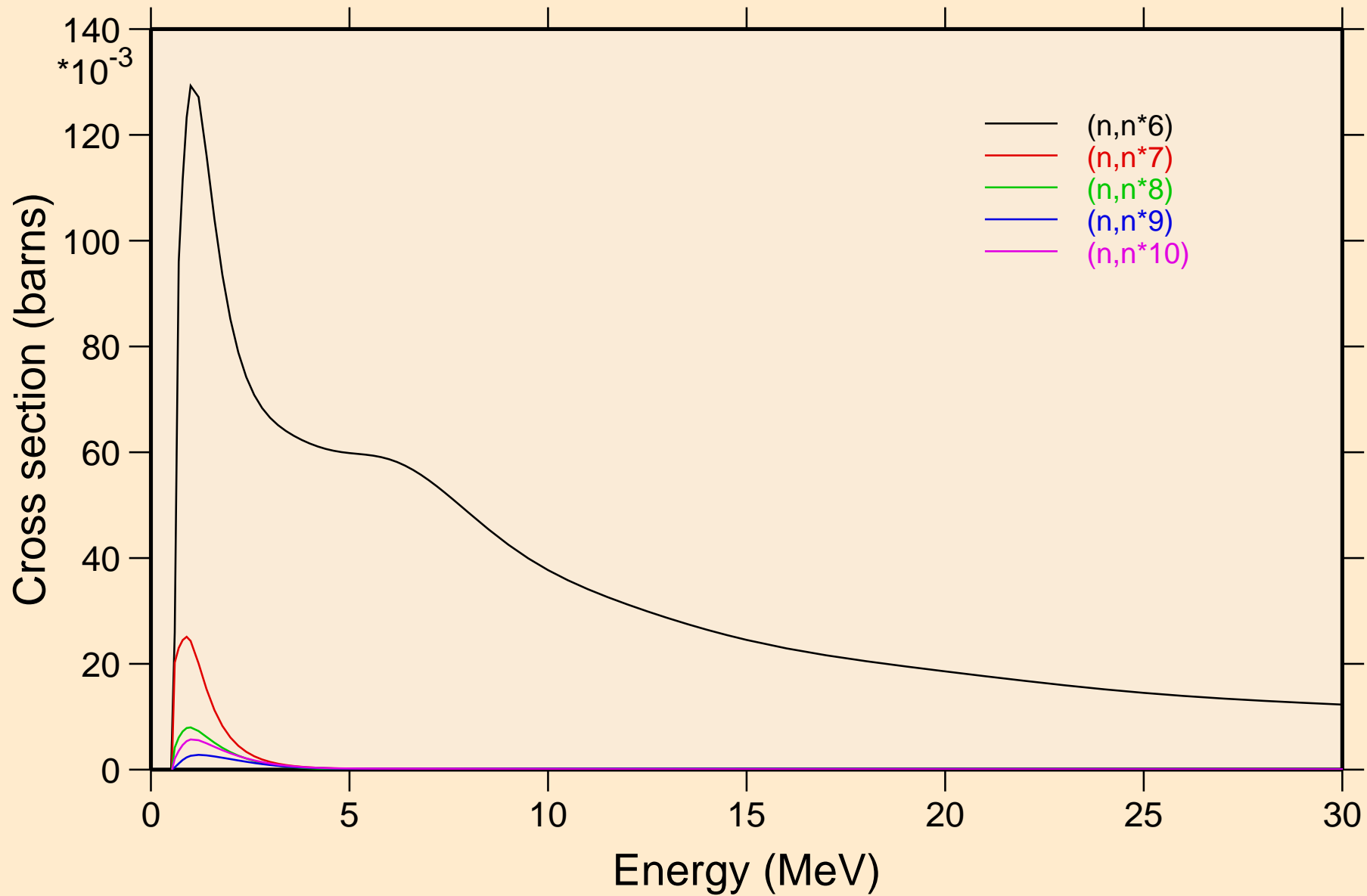

W165 NEUTRON ACER TENDL-2024 LIBRARY; T=0.K
Inelastic levels

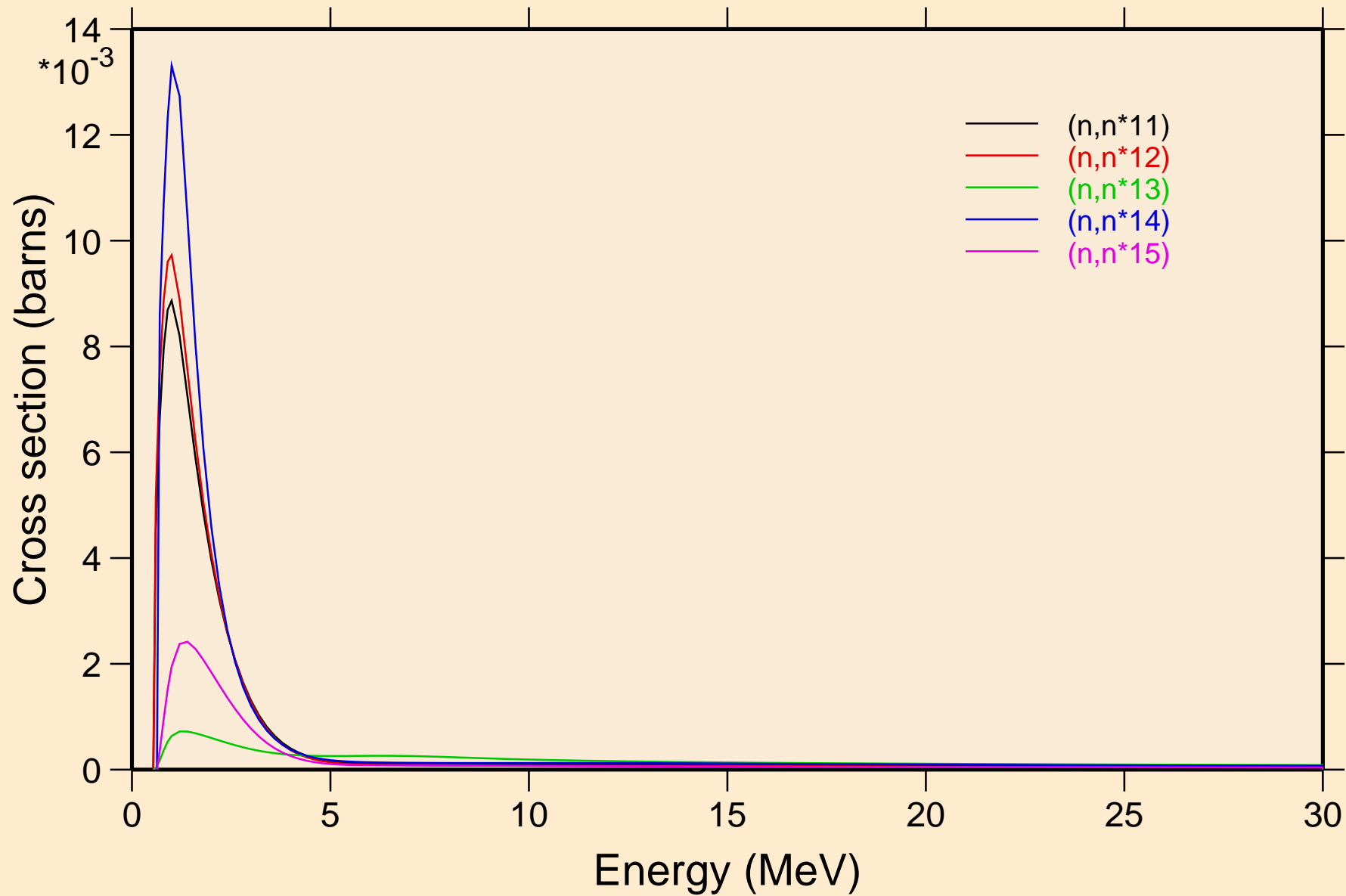

W165 NEUTRON ACER TENDL-2024 LIBRARY; T=0.K
Inelastic levels

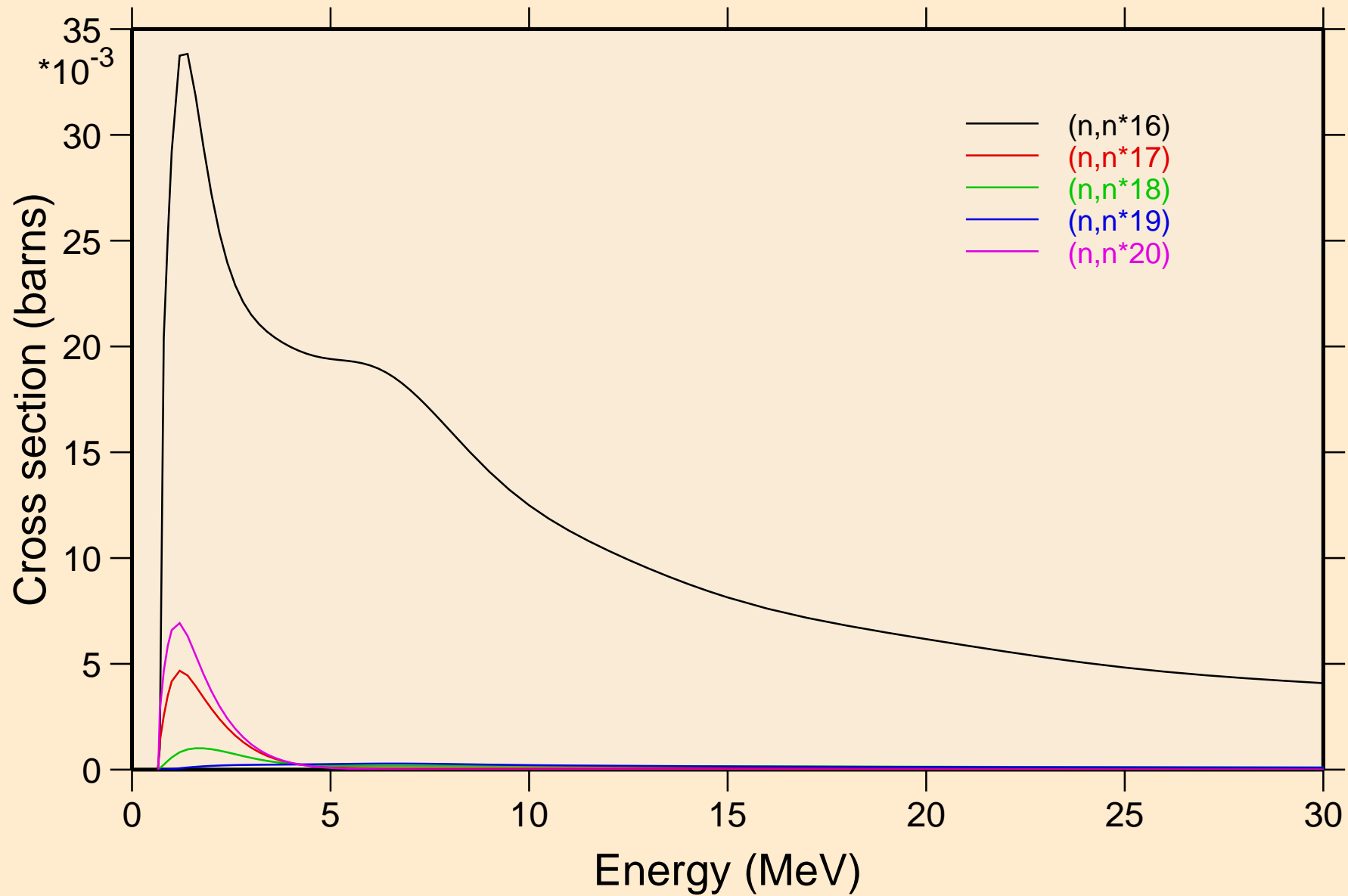

W165 NEUTRON ACER TENDL-2024 LIBRARY; T=0.K
Inelastic levels

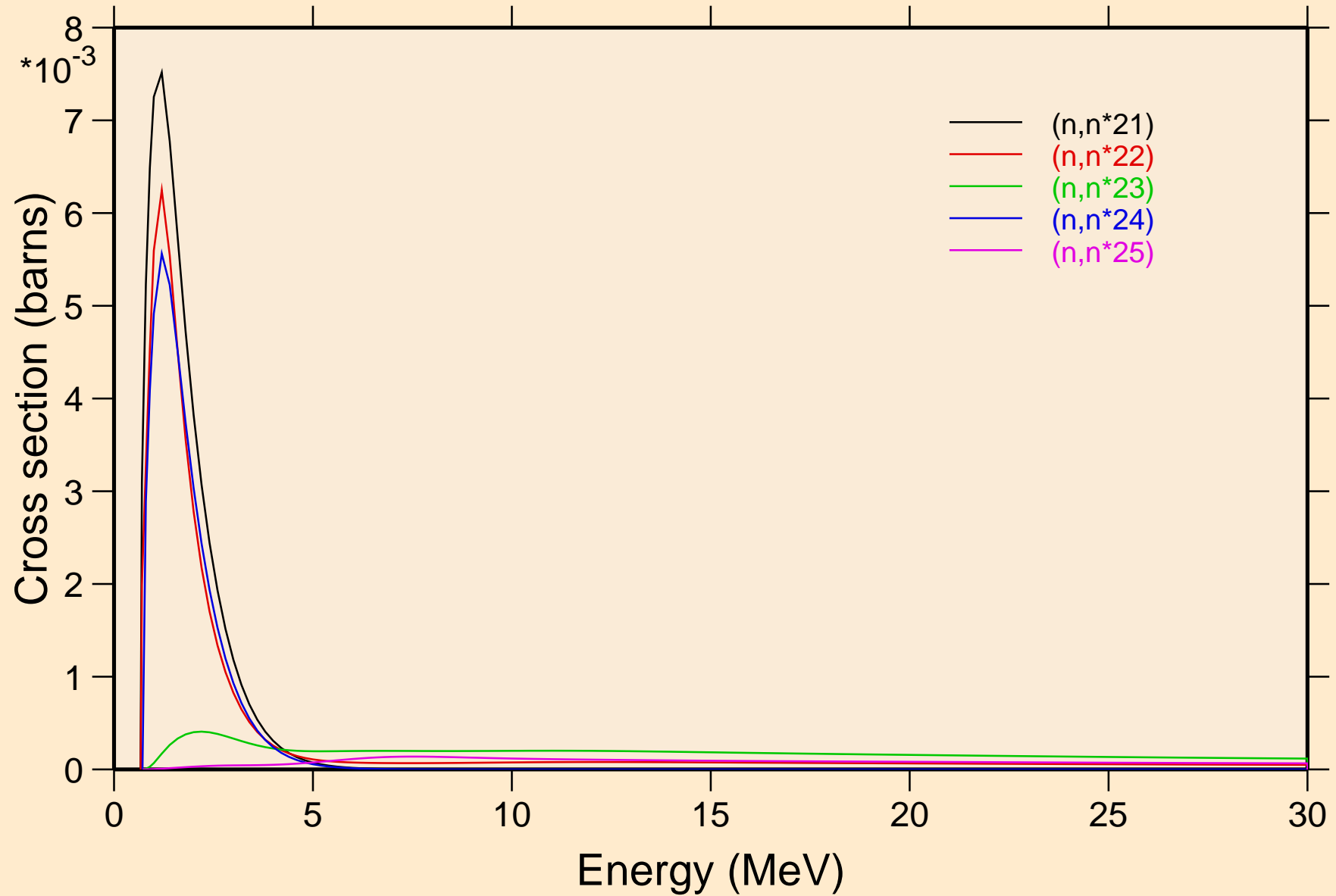

W165 NEUTRON ACER TENDL-2024 LIBRARY; T=0.K
Inelastic levels

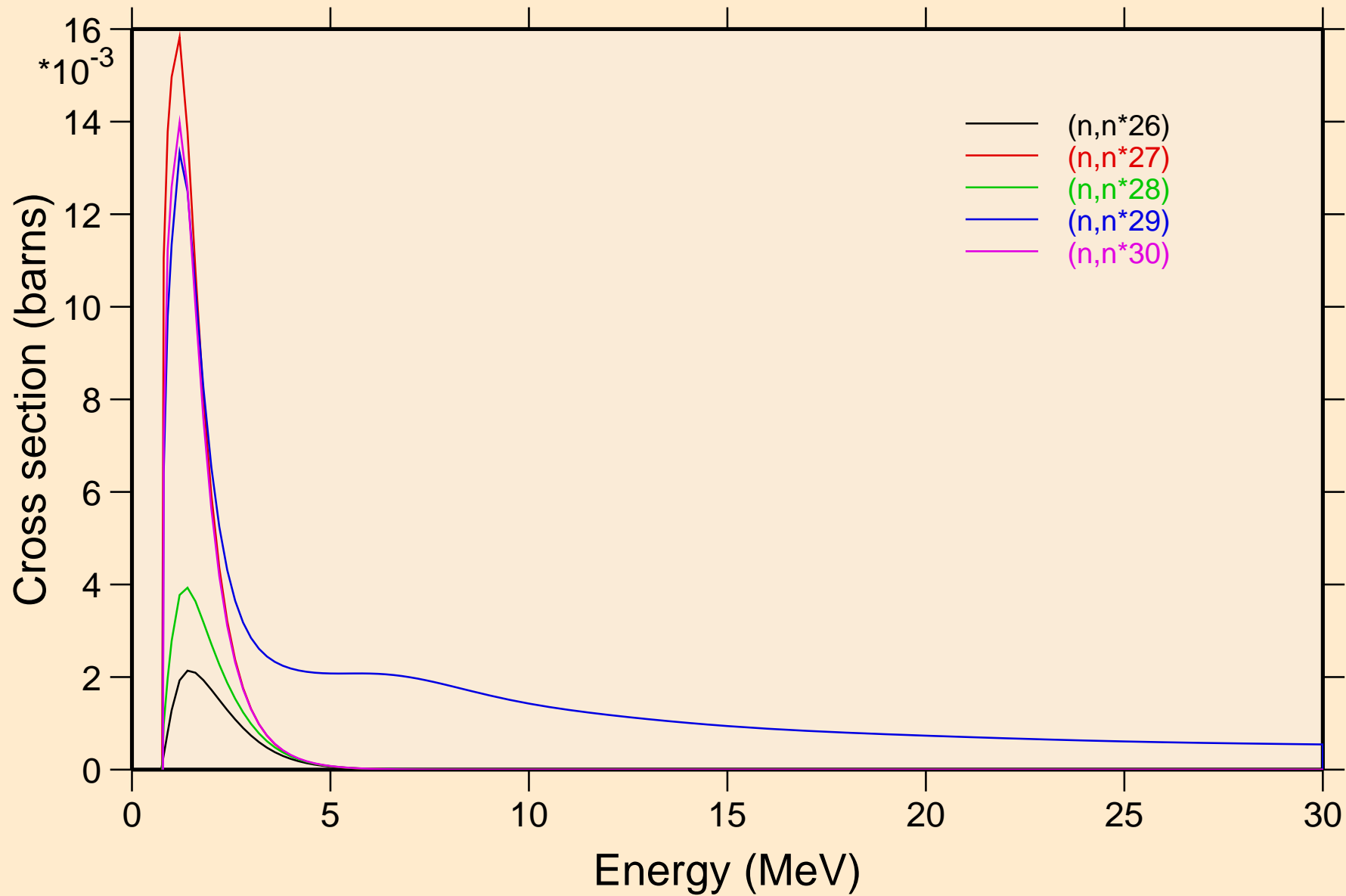

W165 NEUTRON ACER TENDL-2024 LIBRARY; T=0.K
Threshold reactions

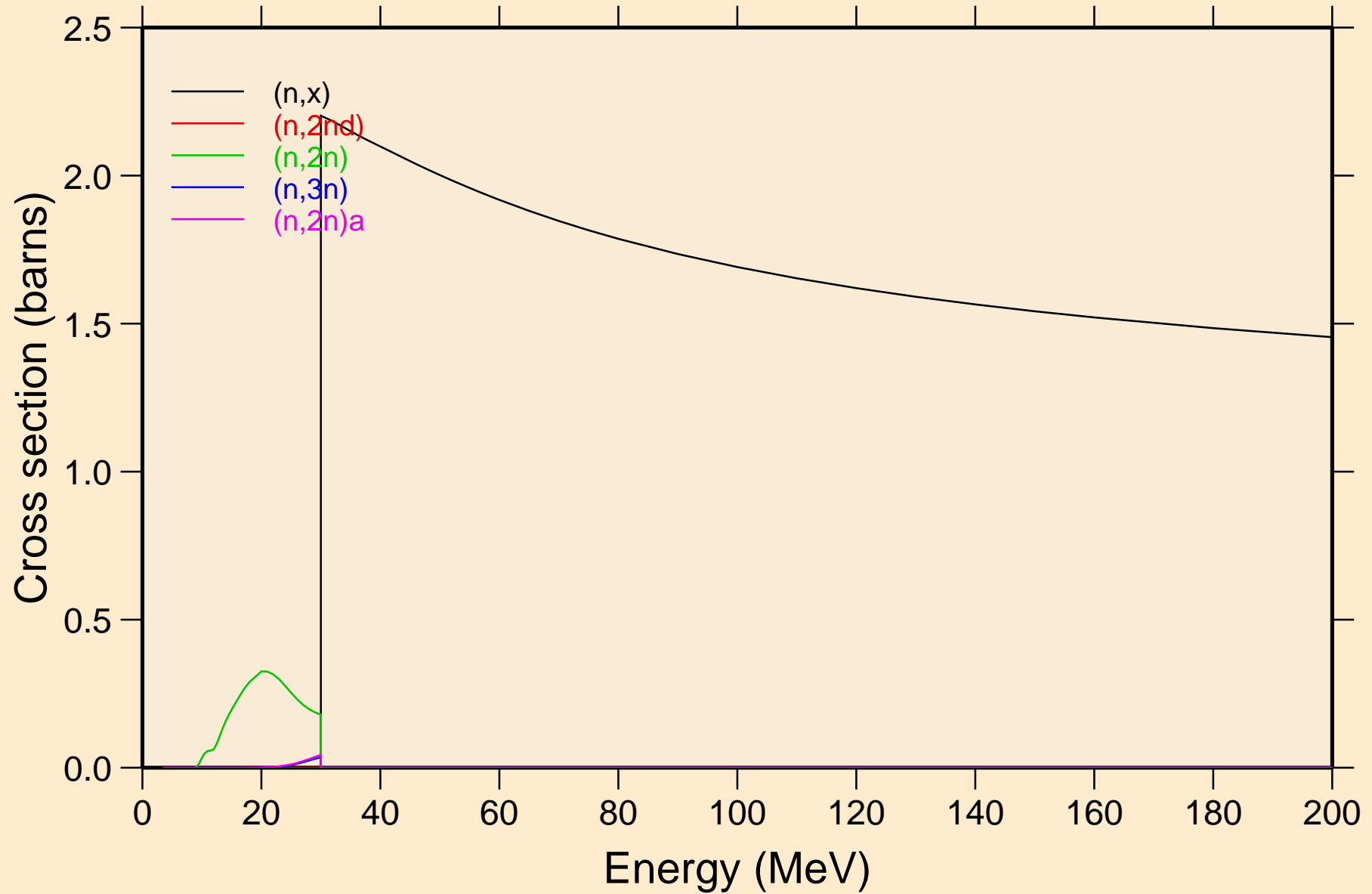

W165 NEUTRON ACER TENDL-2024 LIBRARY; T=0.K
Threshold reactions

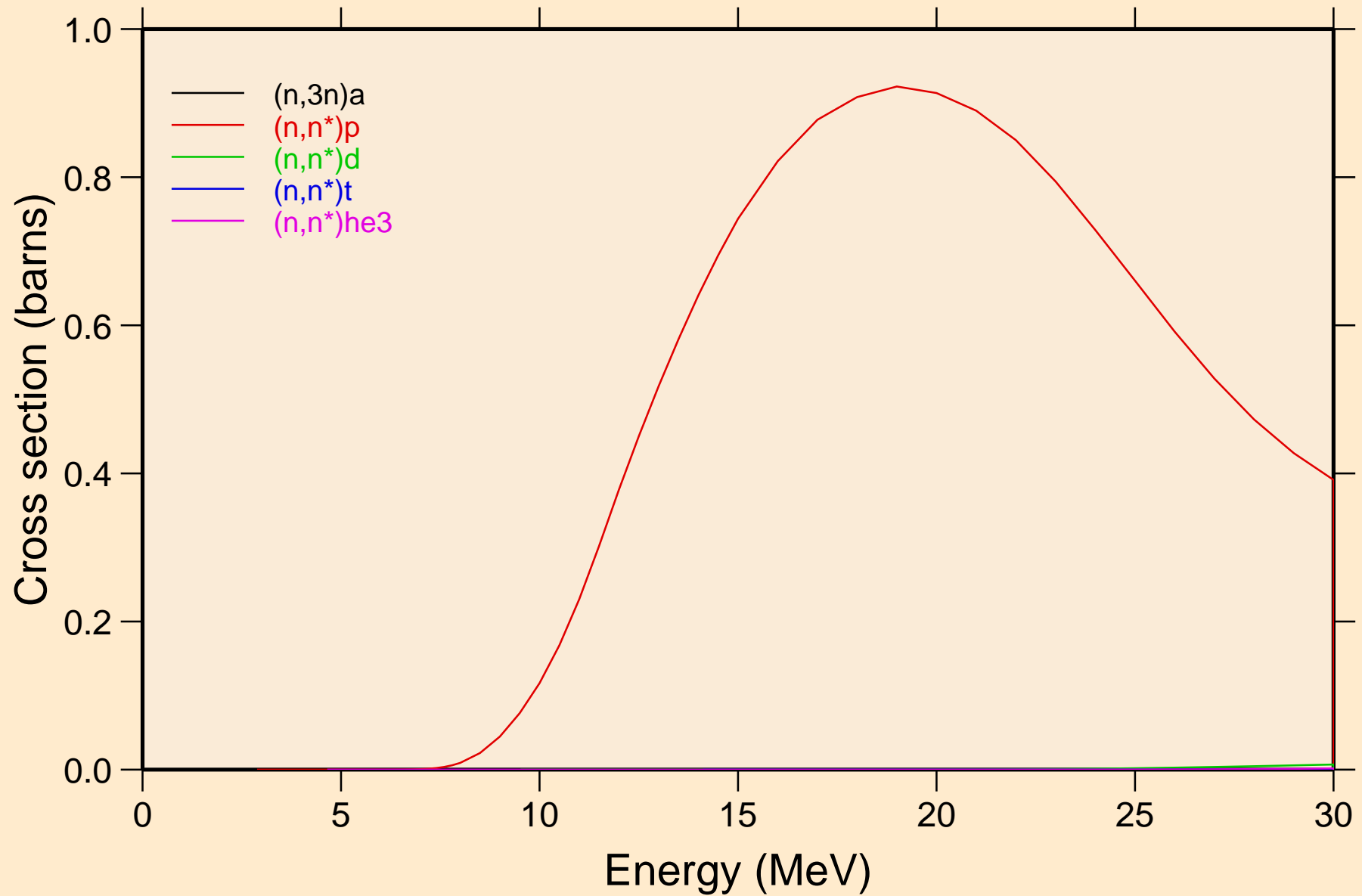

W165 NEUTRON ACER TENDL-2024 LIBRARY; T=0.K

Threshold reactions

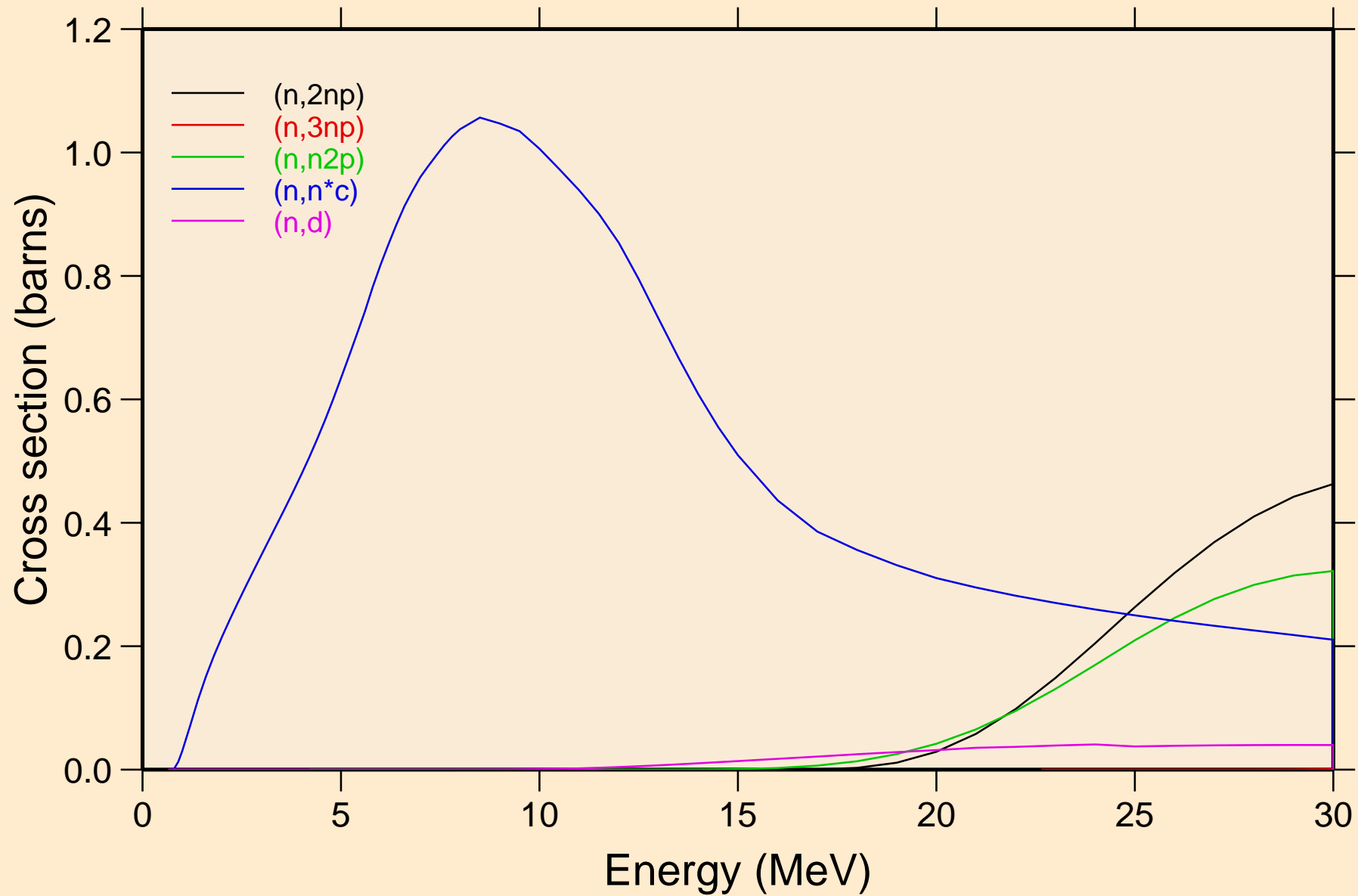

W165 NEUTRON ACER TENDL-2024 LIBRARY; T=0.K
Threshold reactions

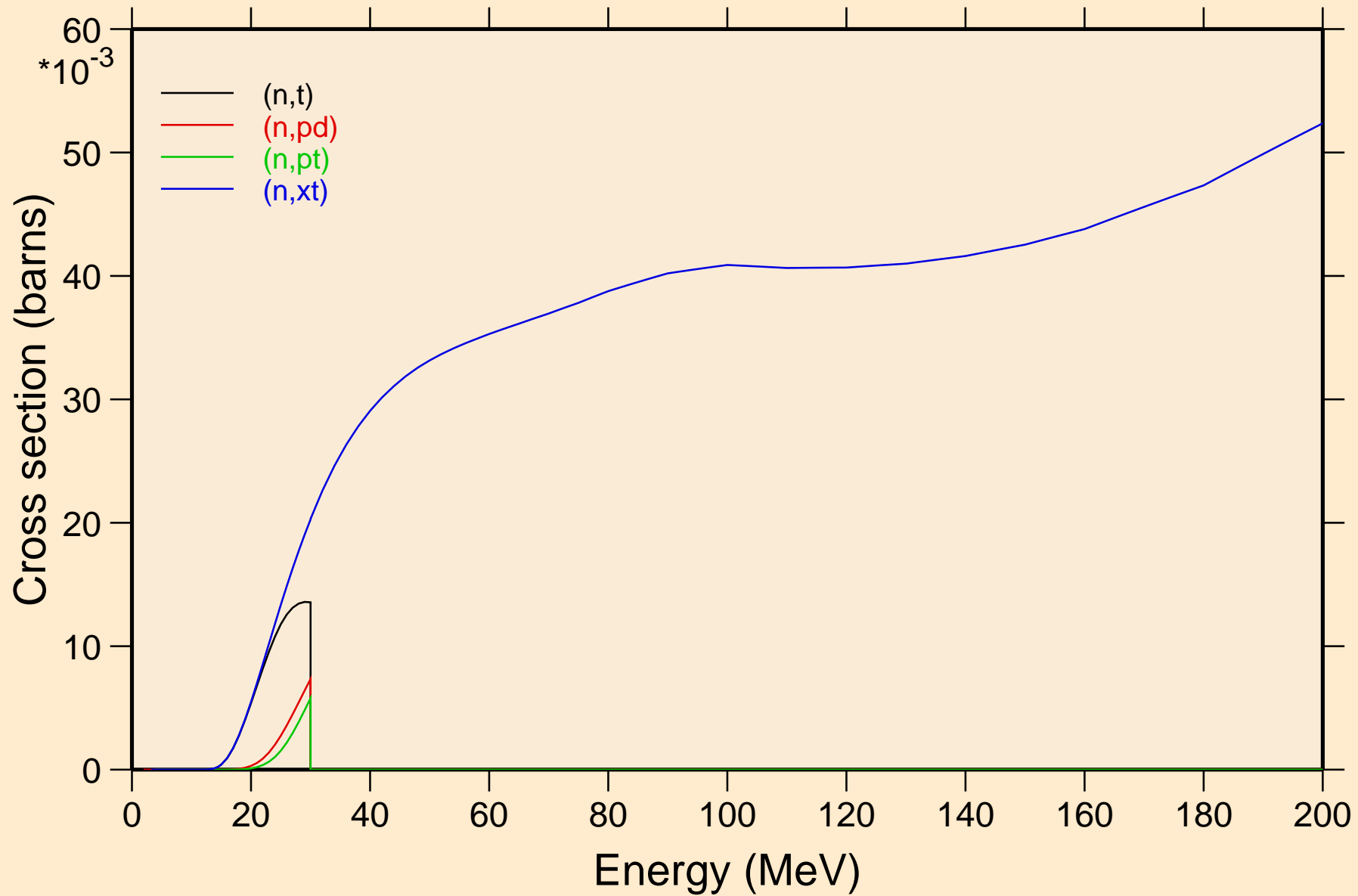

W165 NEUTRON ACER TENDL-2024 LIBRARY; T=0.K
angular distribution for elastic

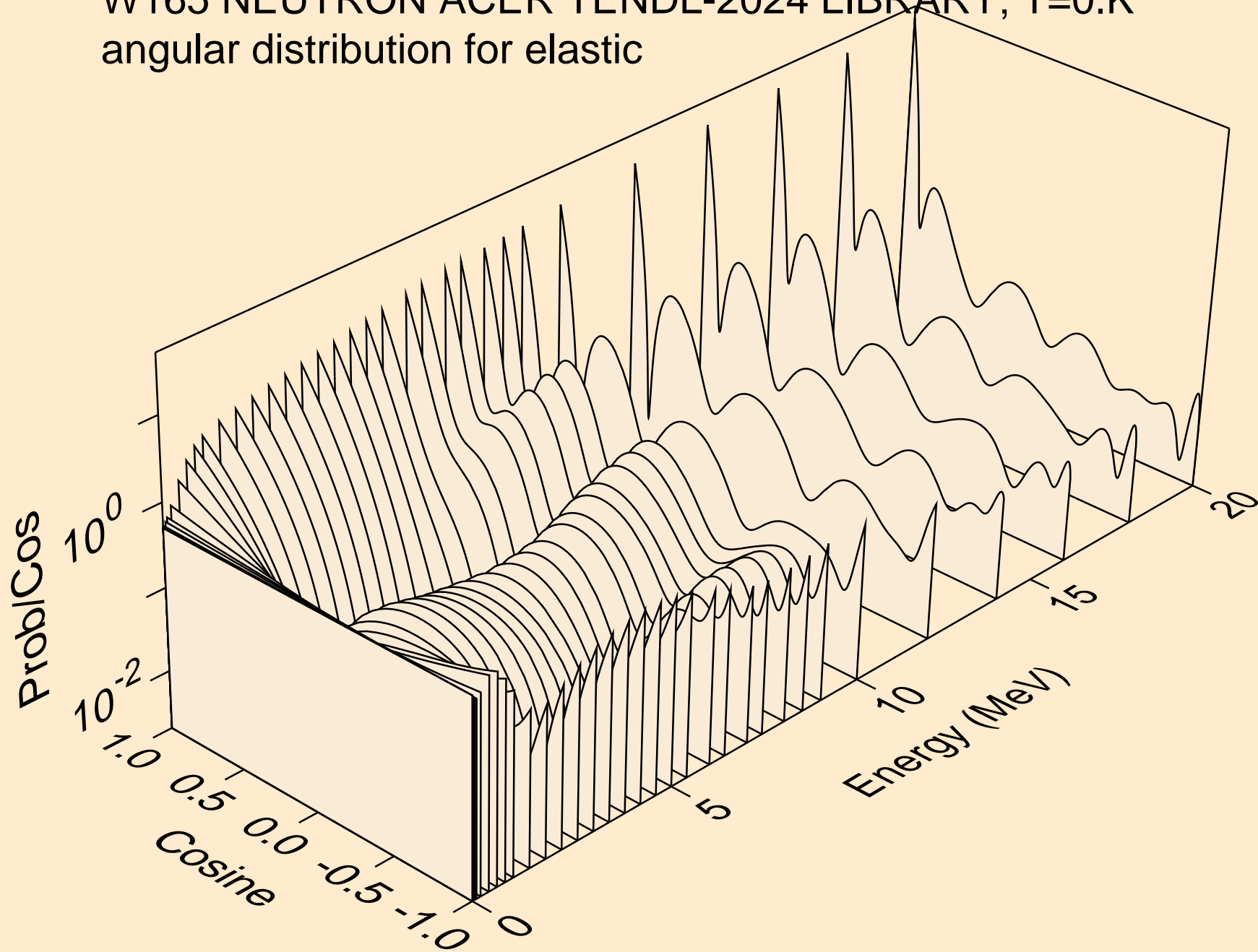

W165 NEUTRON ACER TENDL-2024 LIBRARY; T=0.K
angular distribution for elastic

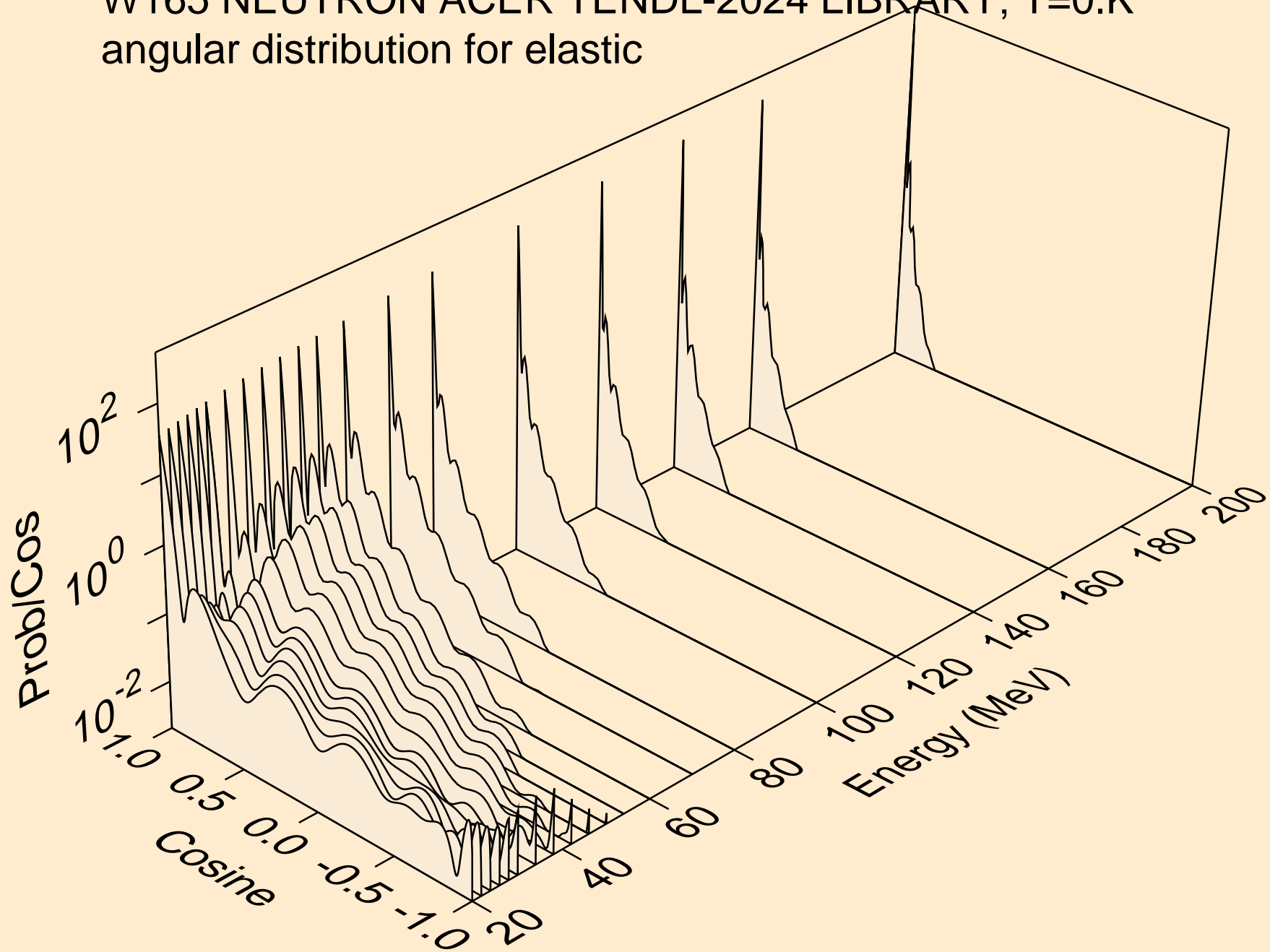

W165 NEUTRON ACER TENDL-2024 LIBRARY; T=0.K
angular distribution for (n,n*1)

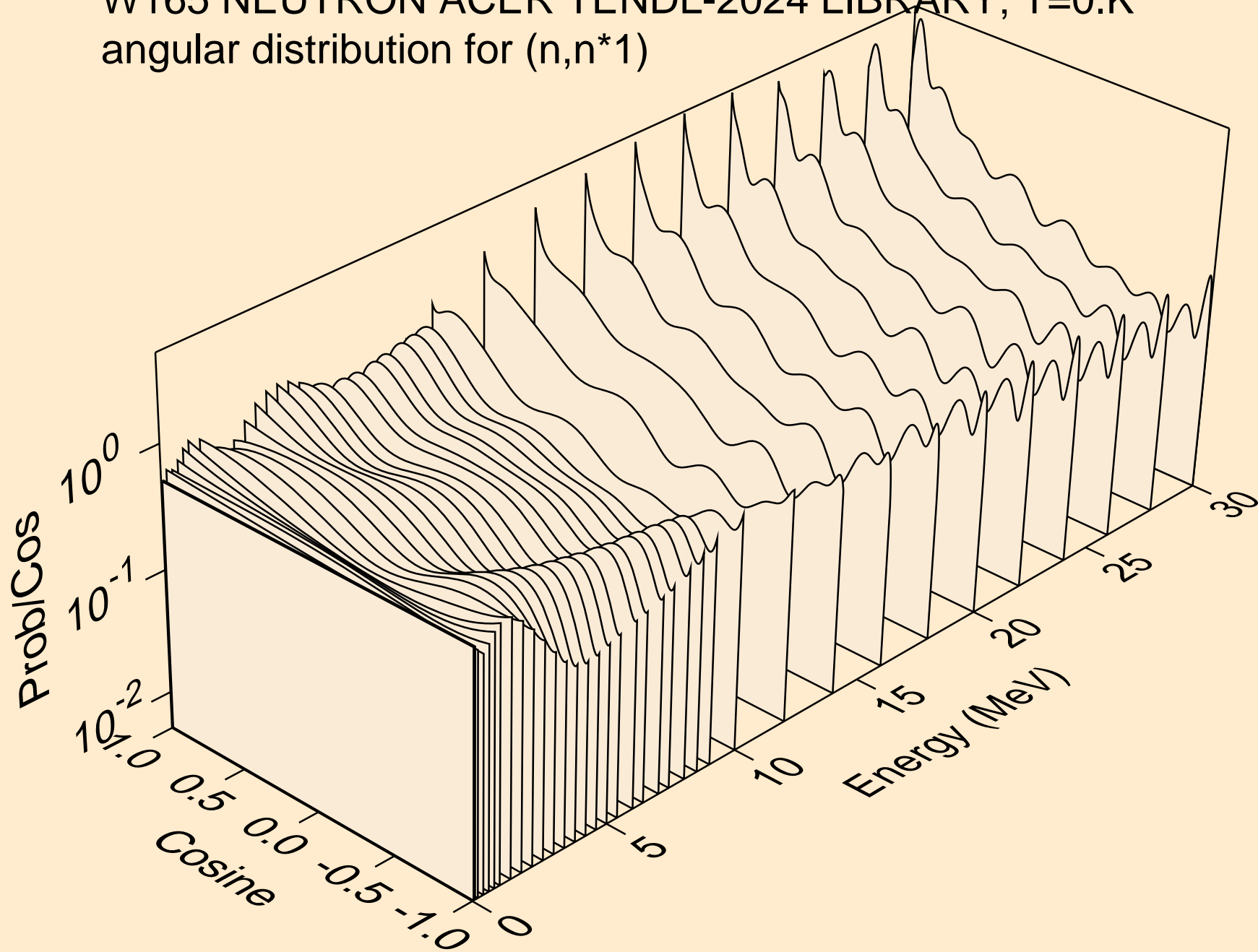

W165 NEUTRON ACER TENDL-2024 LIBRARY; T=0.K
angular distribution for (n,n*2)

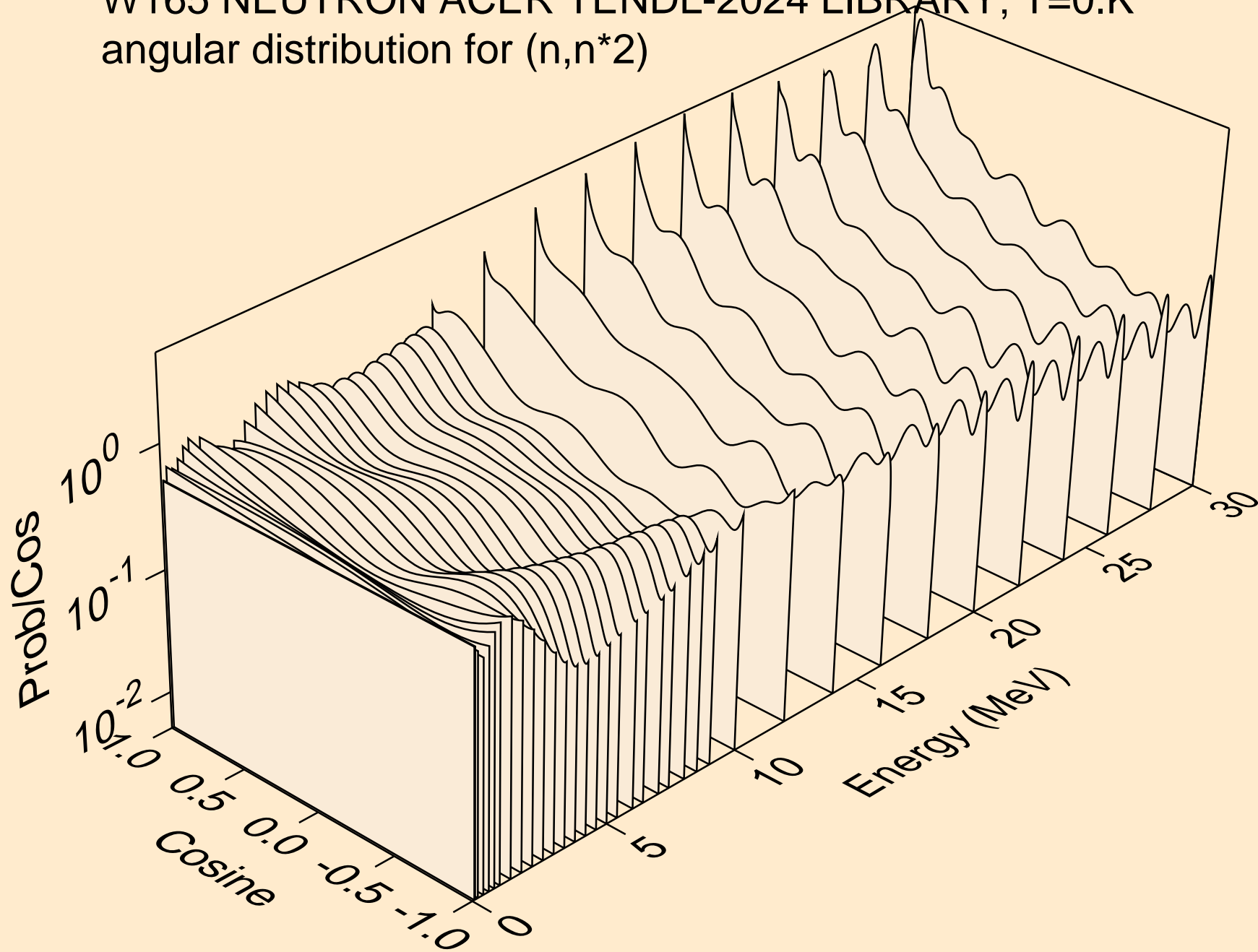

W165 NEUTRON ACER TENDL-2024 LIBRARY; T=0.K
angular distribution for (n,n*3)

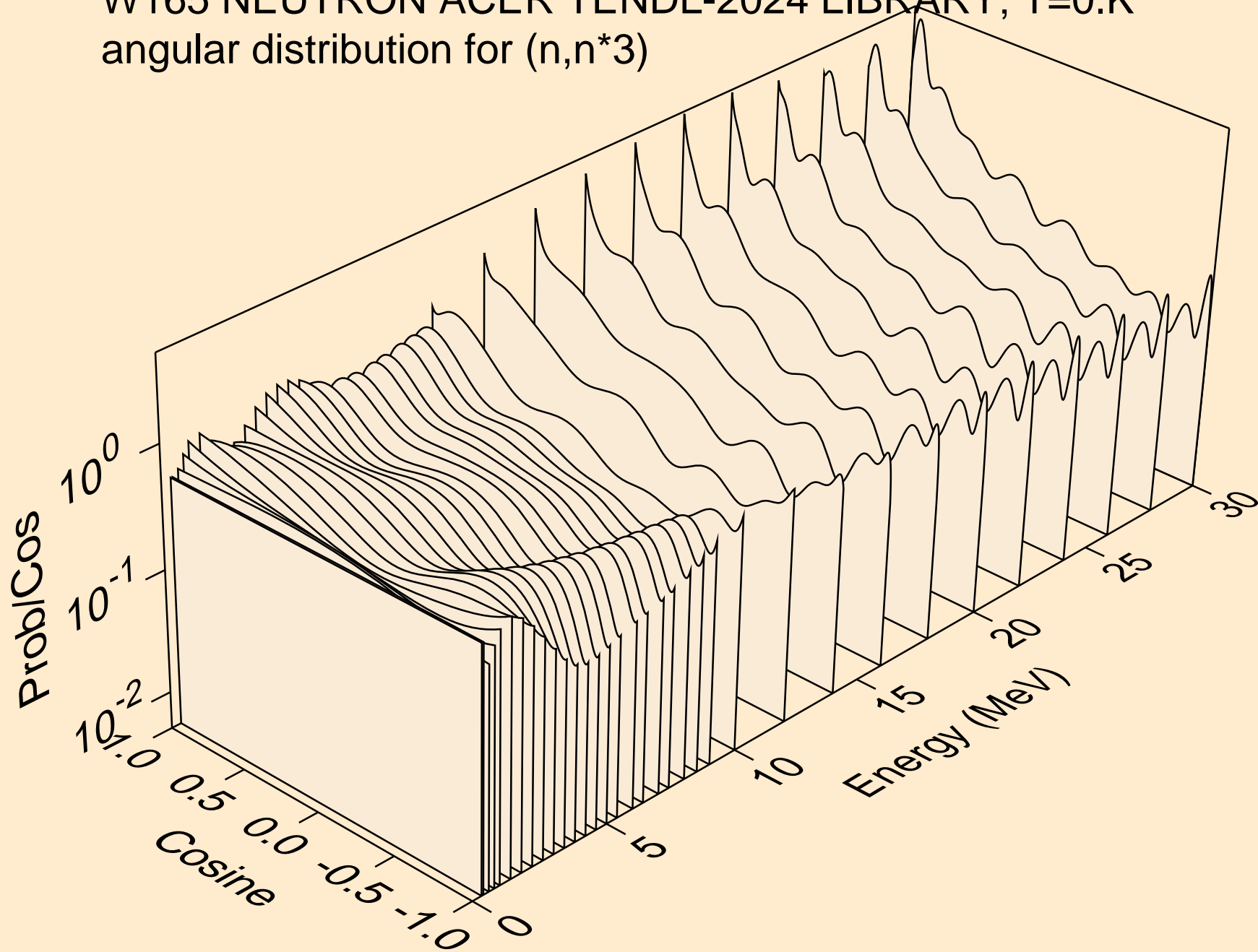

W165 NEUTRON ACER TENDL-2024 LIBRARY; T=0.K
angular distribution for (n,n*4)

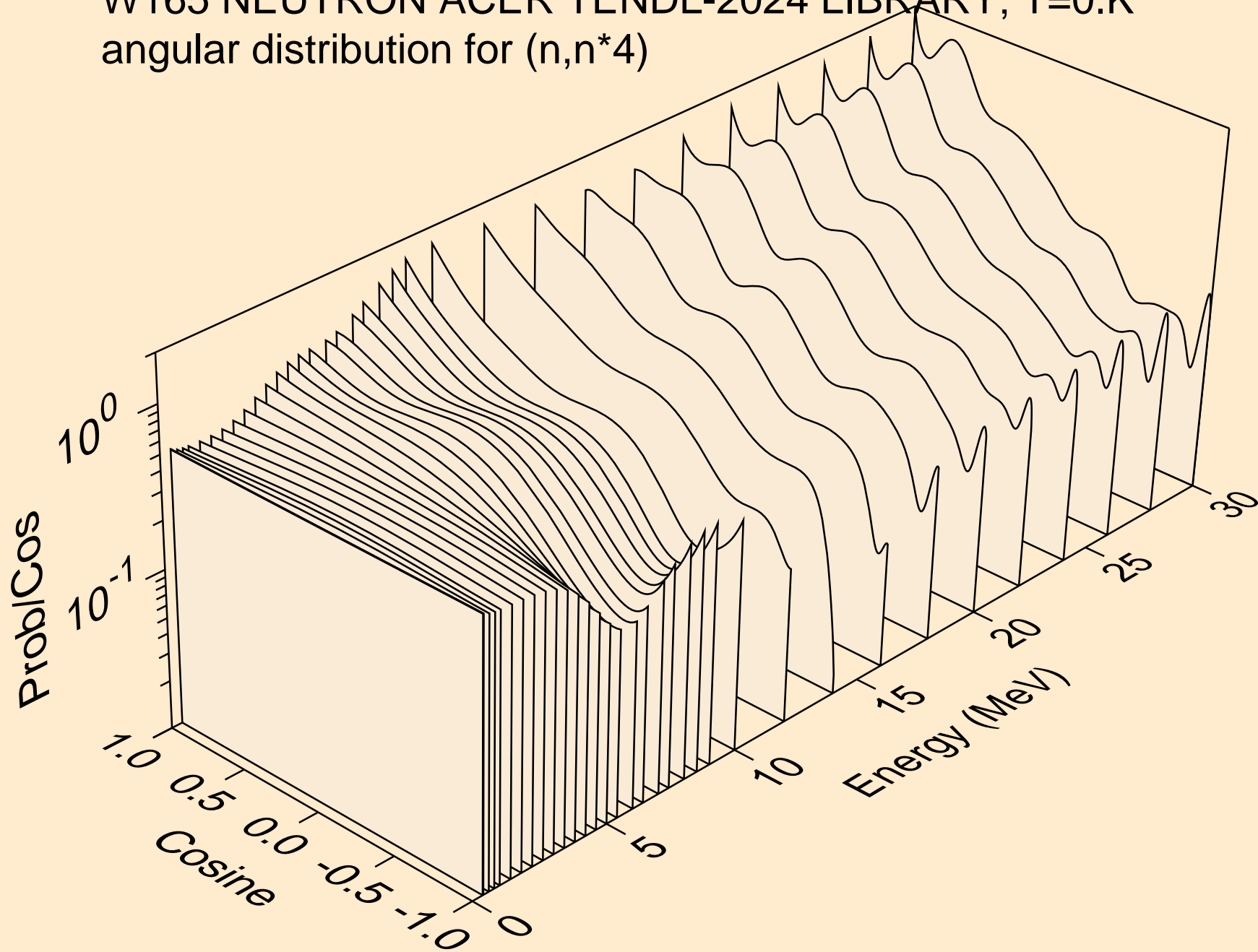

W165 NEUTRON ACER TENDL-2024 LIBRARY; T=0.K
angular distribution for (n,n*5)

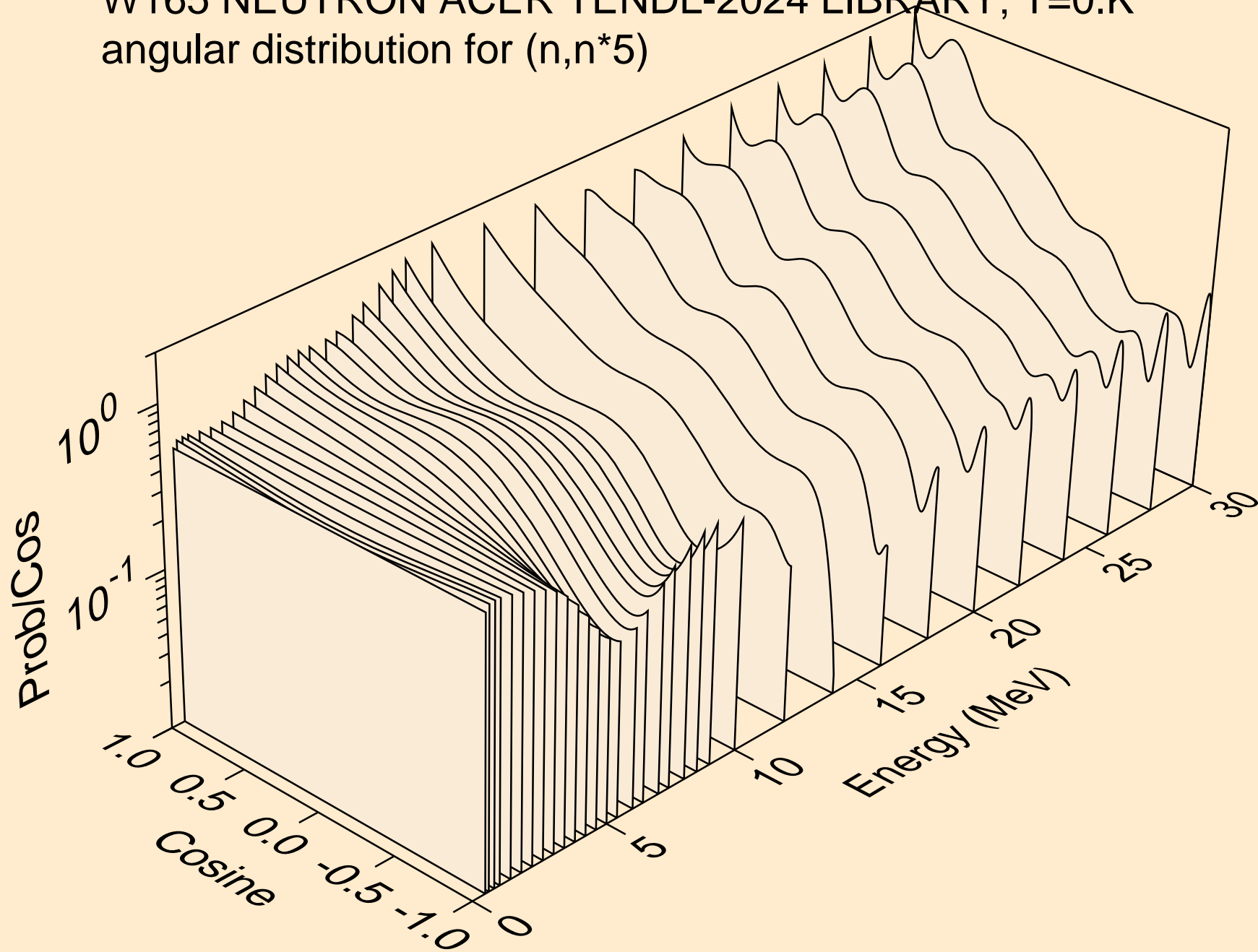

W165 NEUTRON ACER TENDL-2024 LIBRARY; T=0.K
angular distribution for (n,n*6)

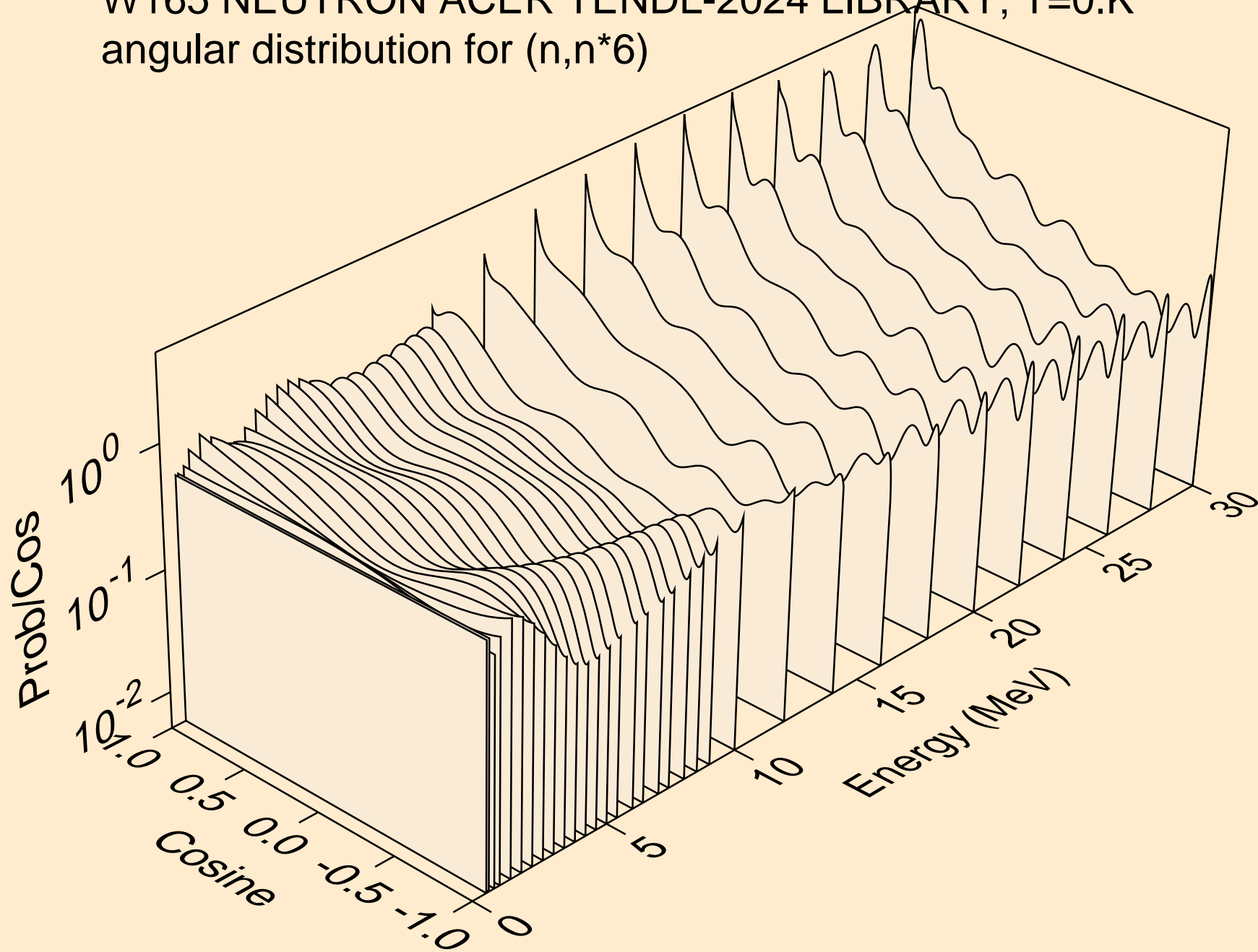

W165 NEUTRON ACER TENDL-2024 LIBRARY; T=0.K
angular distribution for (n,n*7)

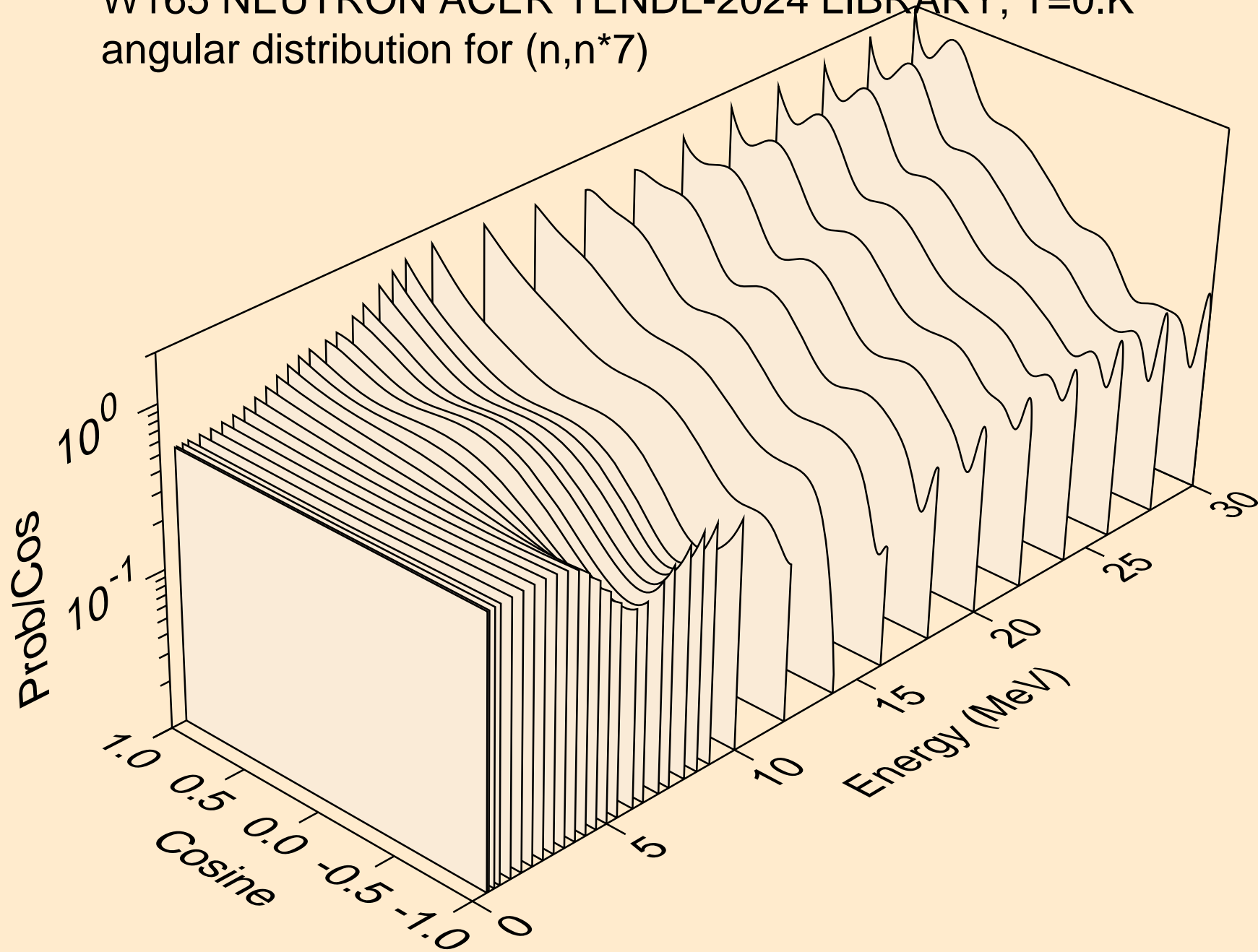

W165 NEUTRON ACER TENDL-2024 LIBRARY; T=0.K
angular distribution for (n,n*8)

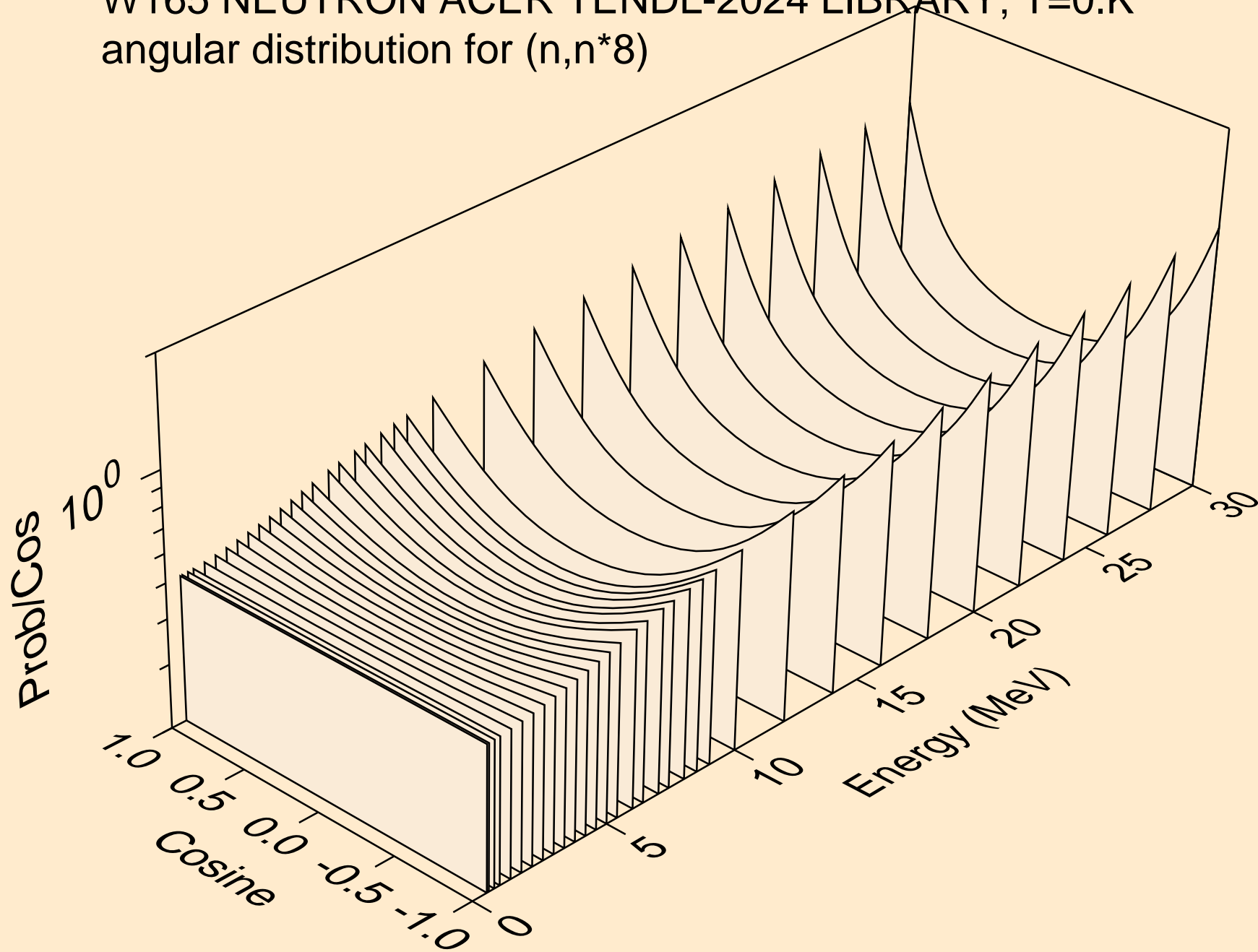

W165 NEUTRON ACER TENDL-2024 LIBRARY; T=0.K
angular distribution for (n,n*9)

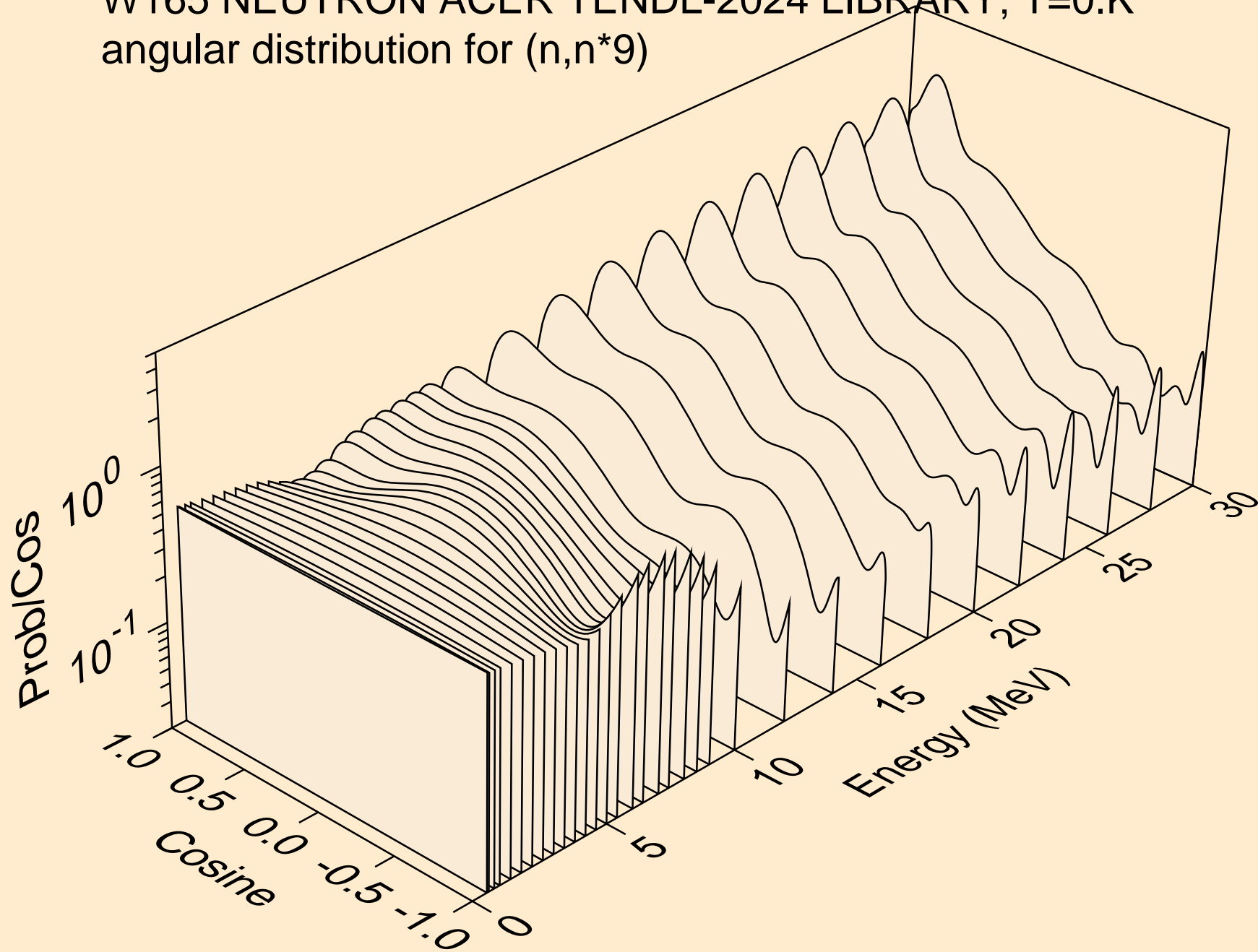

W165 NEUTRON ACER TENDL-2024 LIBRARY; T=0.K
angular distribution for (n,n*10)

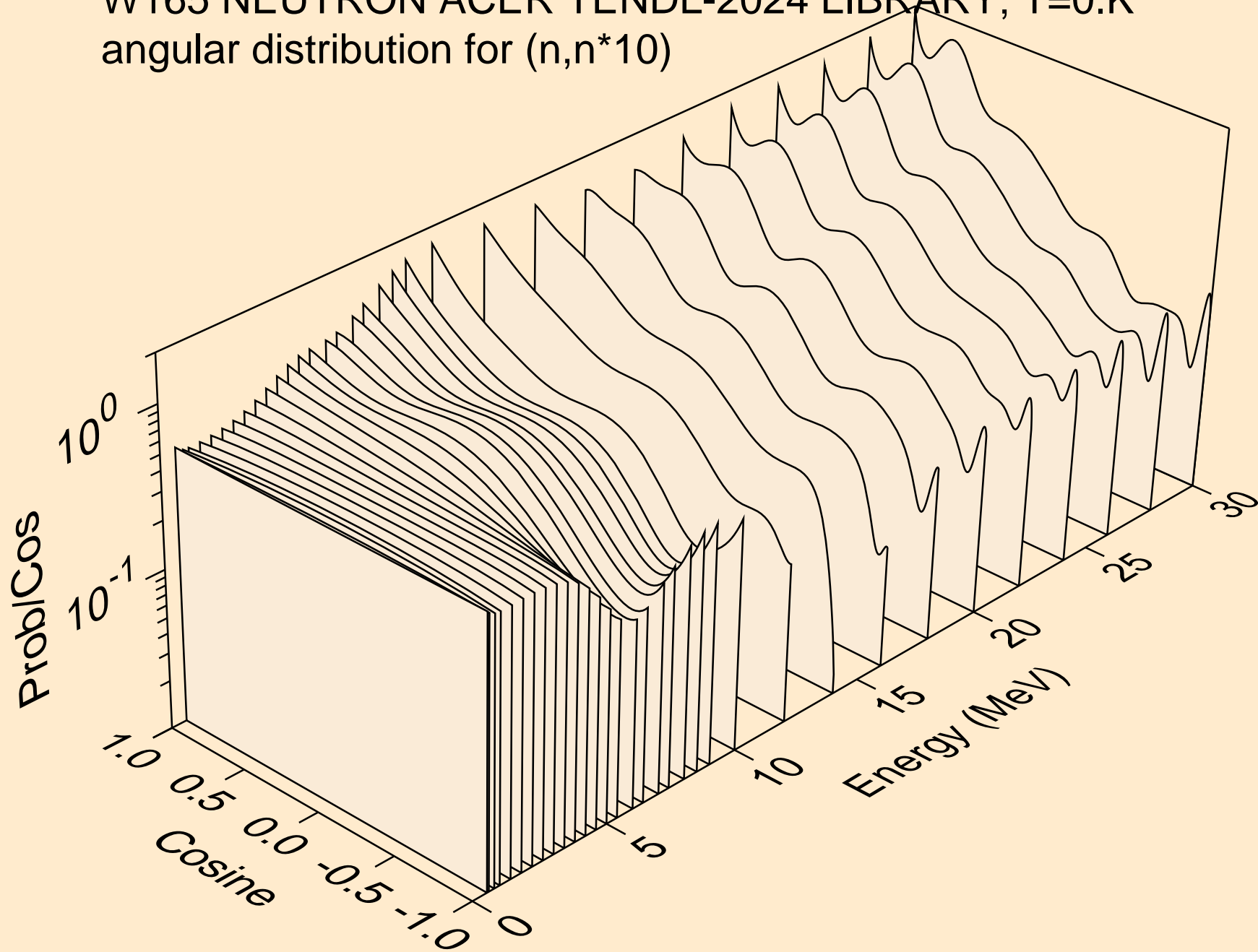

W165 NEUTRON ACER TENDL-2024 LIBRARY; T=0.K
angular distribution for (n,n*11)

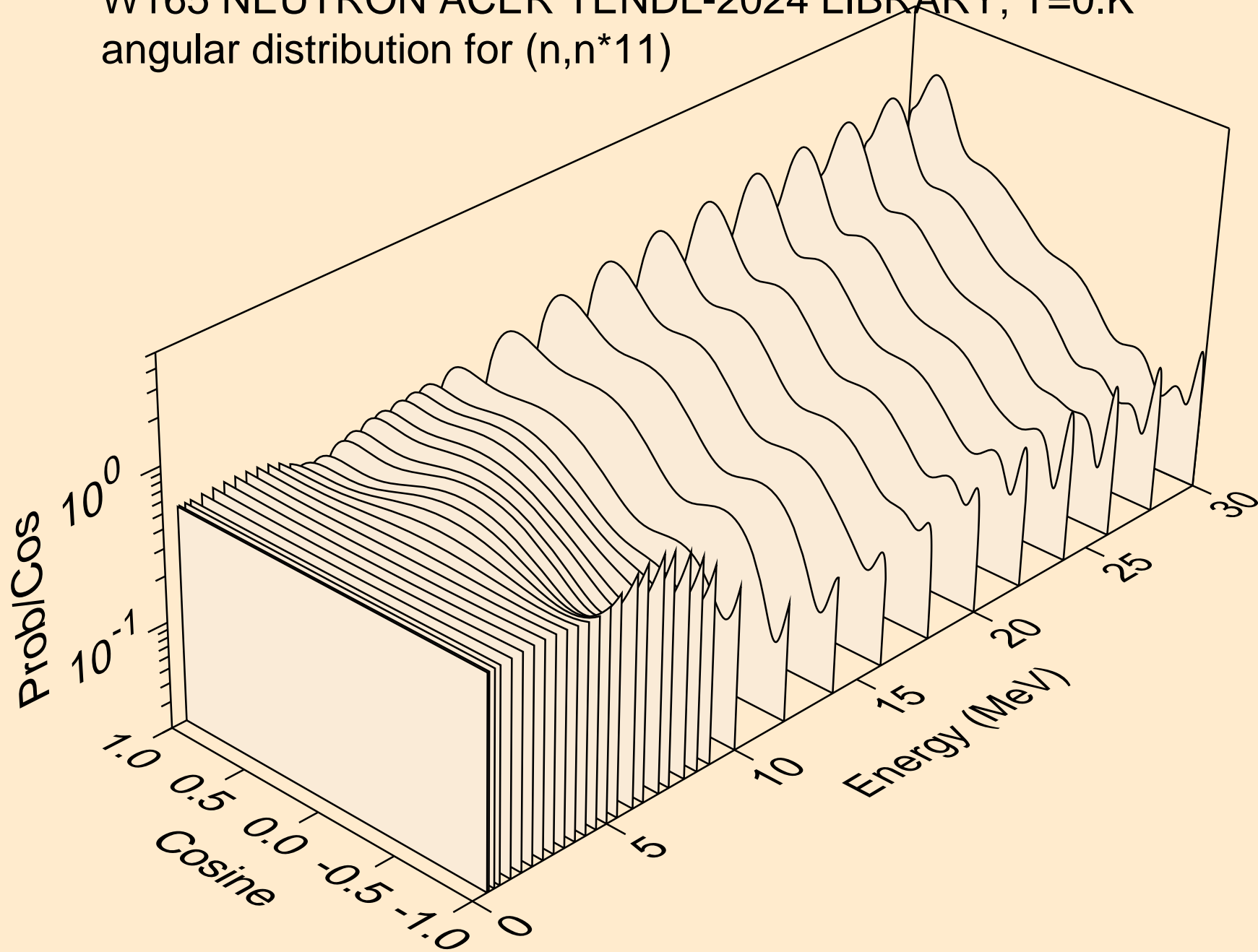

W165 NEUTRON ACER TENDL-2024 LIBRARY; T=0.K
angular distribution for (n,n*12)

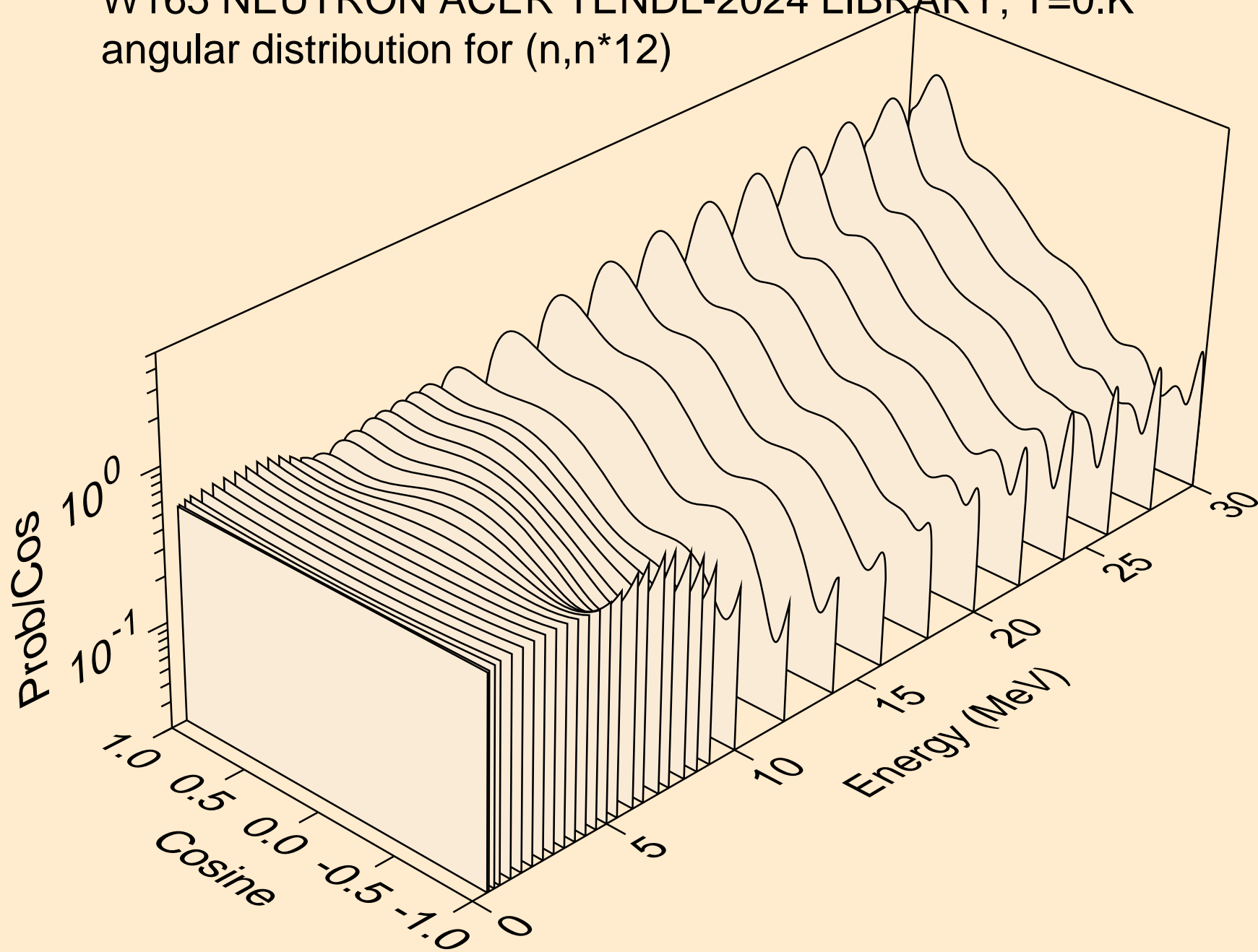

W165 NEUTRON ACER TENDL-2024 LIBRARY; T=0.K
angular distribution for (n,n*13)

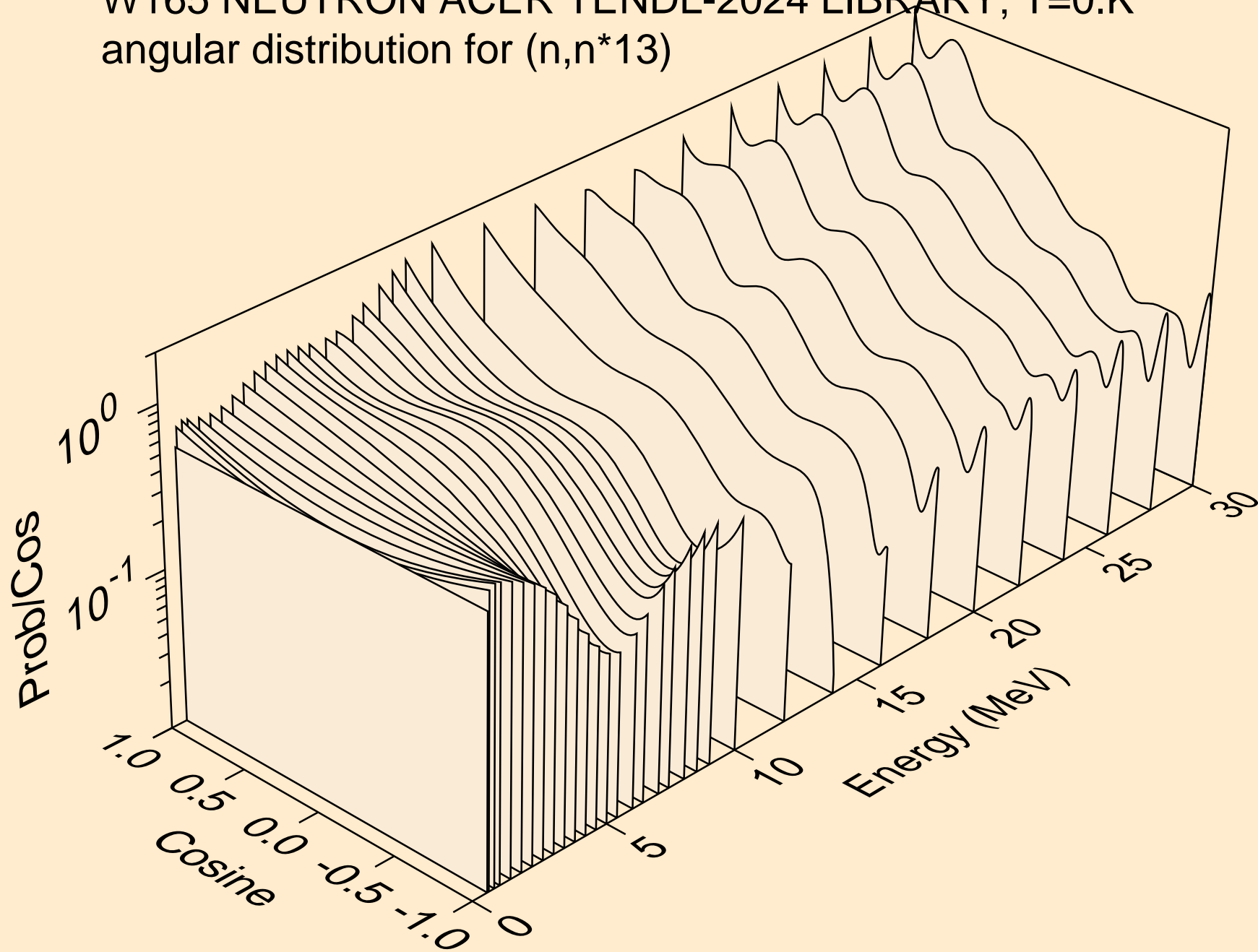

W165 NEUTRON ACER TENDL-2024 LIBRARY; T=0.K
angular distribution for (n,n*14)

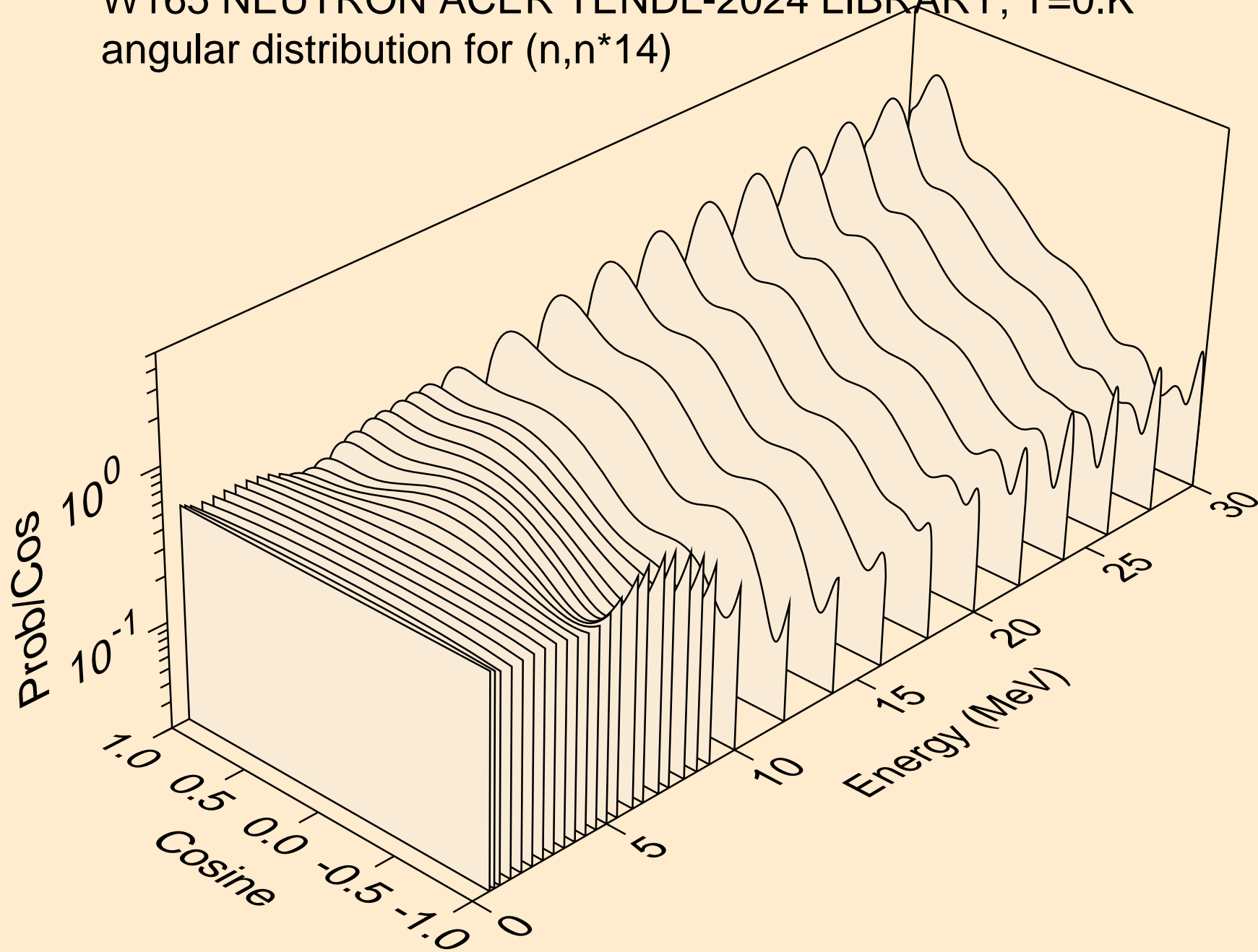

W165 NEUTRON ACER TENDL-2024 LIBRARY; T=0.K
angular distribution for (n,n*15)

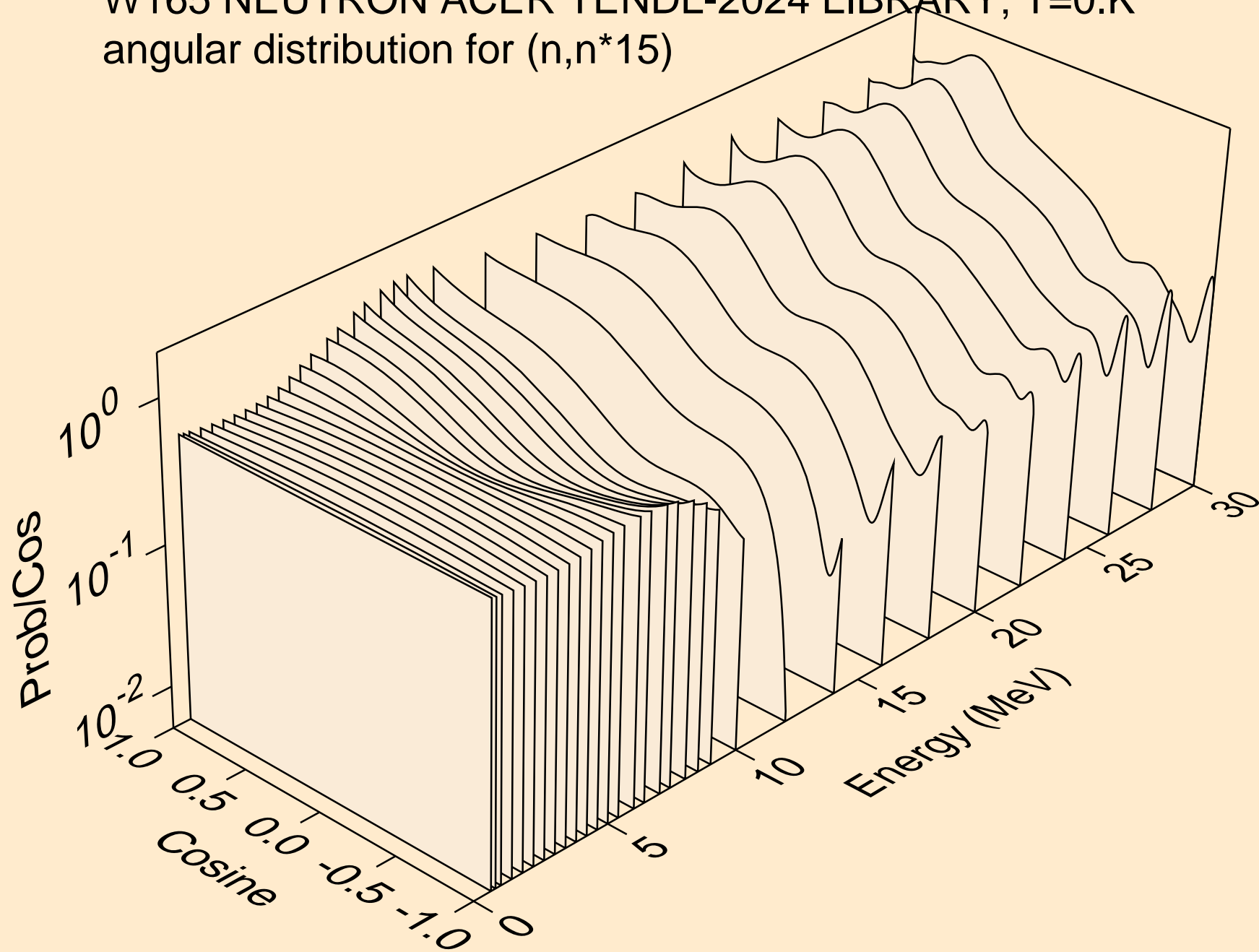

W165 NEUTRON ACER TENDL-2024 LIBRARY; T=0.K
angular distribution for (n,n*16)

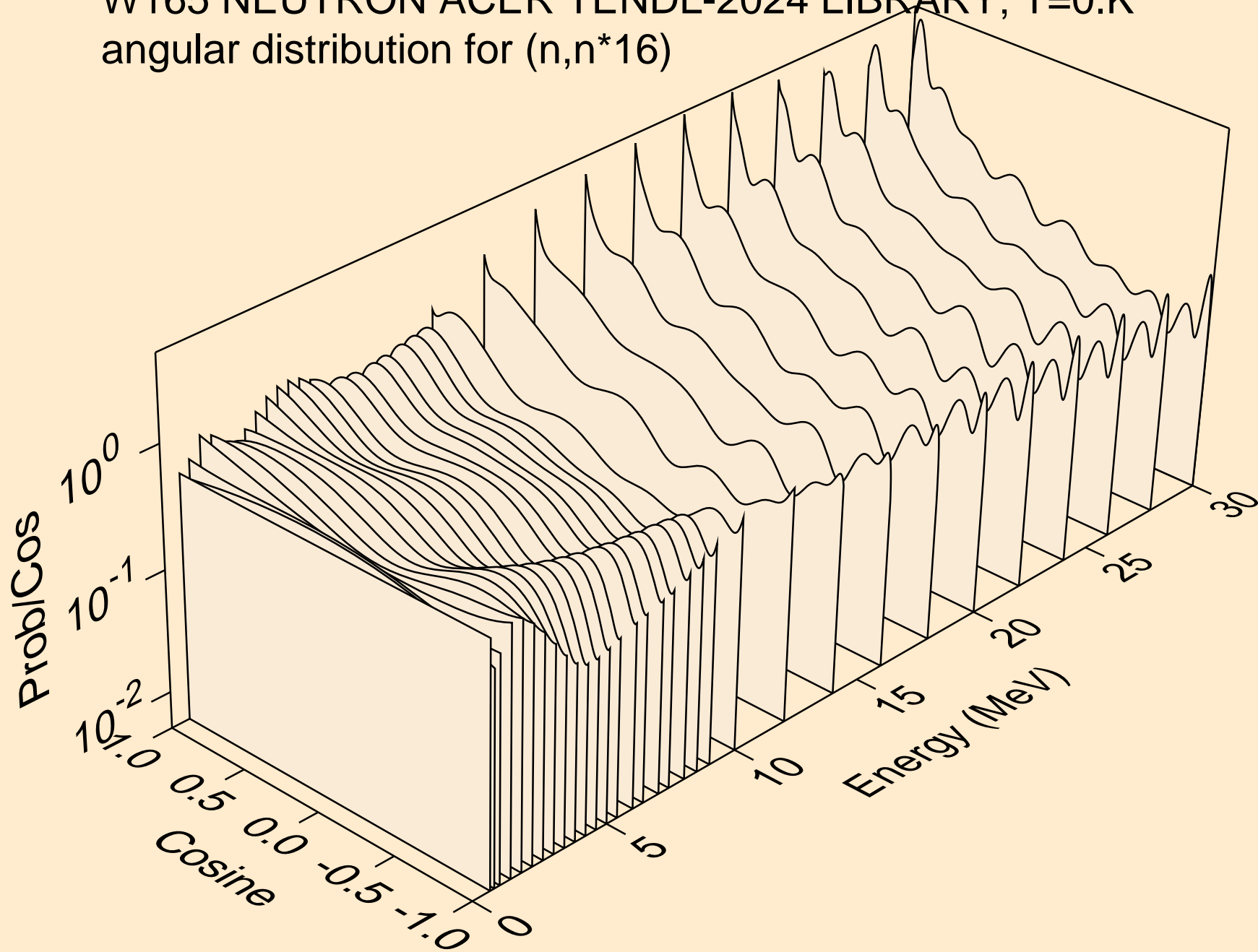

W165 NEUTRON ACER TENDL-2024 LIBRARY; T=0.K
angular distribution for (n,n*17)

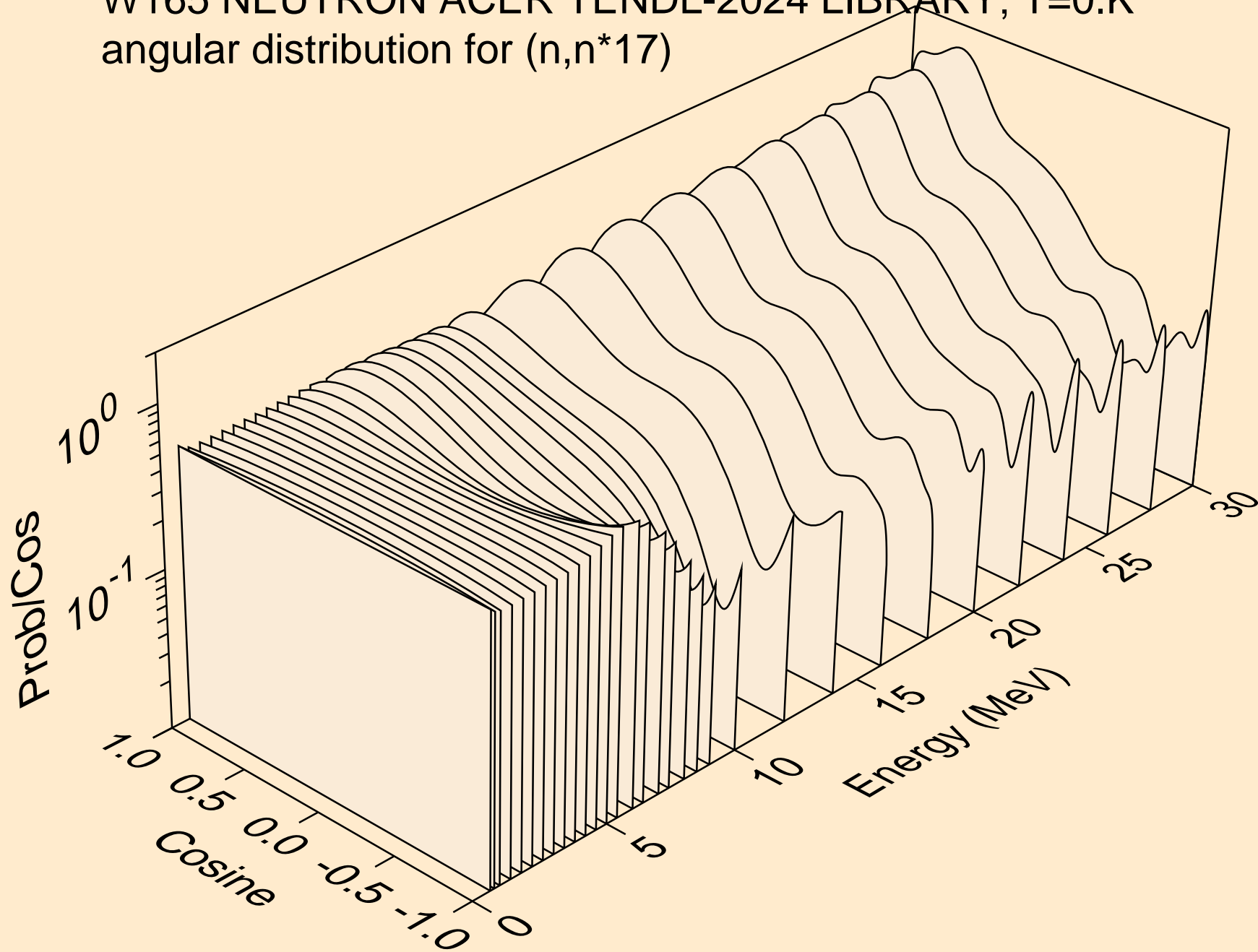

W165 NEUTRON ACER TENDL-2024 LIBRARY; T=0.K
angular distribution for (n,n*18)

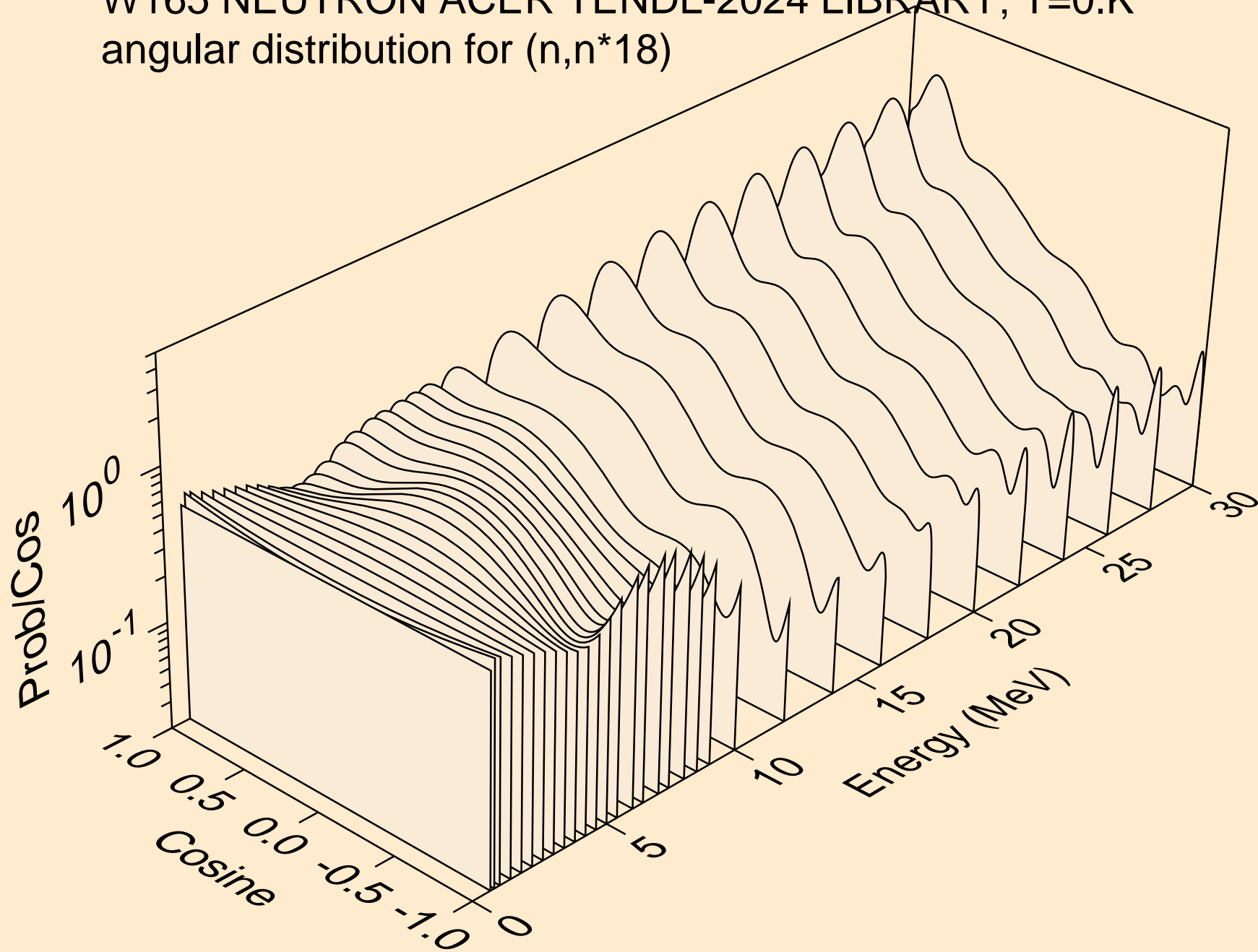

W165 NEUTRON ACER TENDL-2024 LIBRARY; T=0.K
angular distribution for (n,n*19)

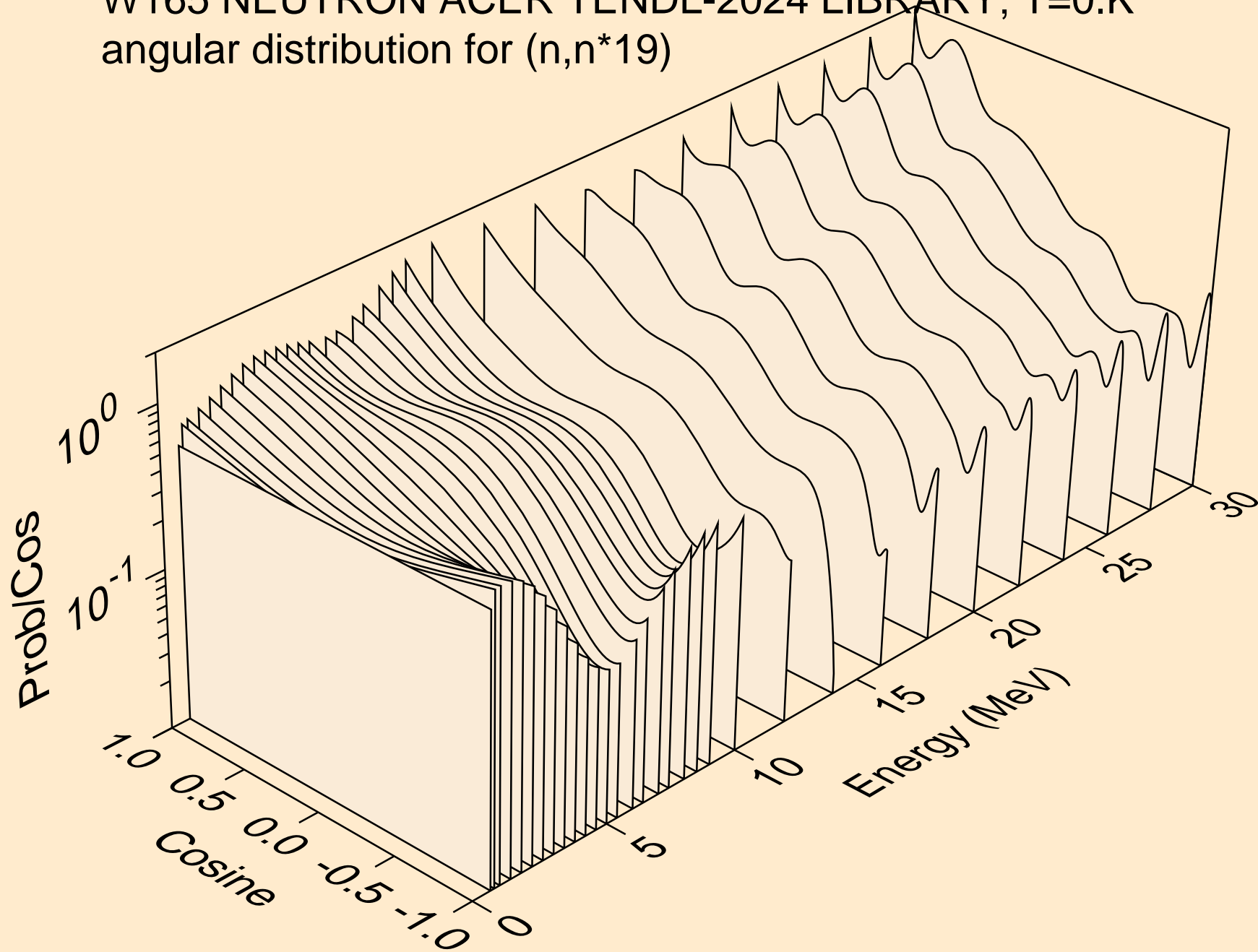

W165 NEUTRON ACER TENDL-2024 LIBRARY; T=0.K
angular distribution for (n,n*20)

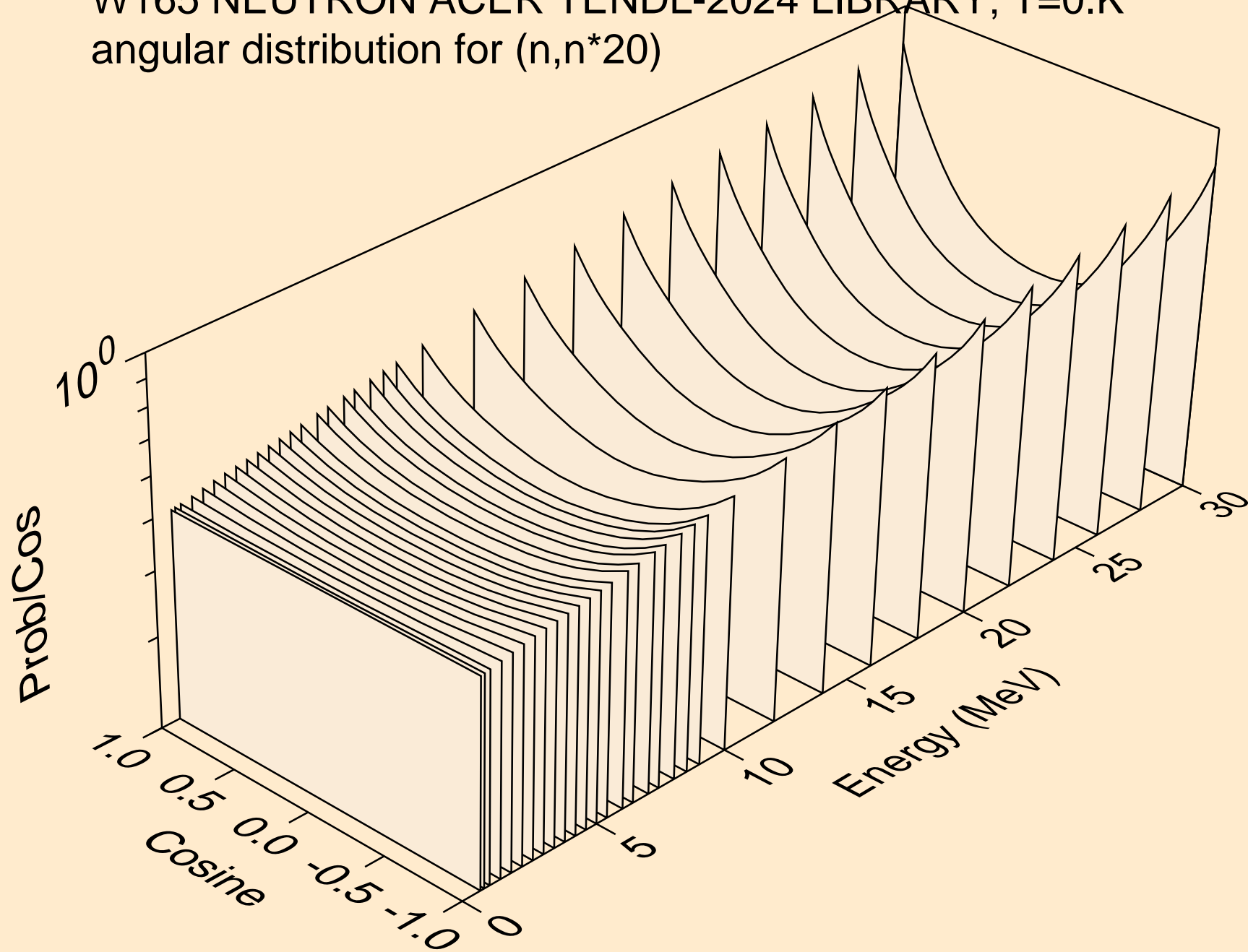

W165 NEUTRON ACER TENDL-2024 LIBRARY; T=0.K
angular distribution for (n,n*21)

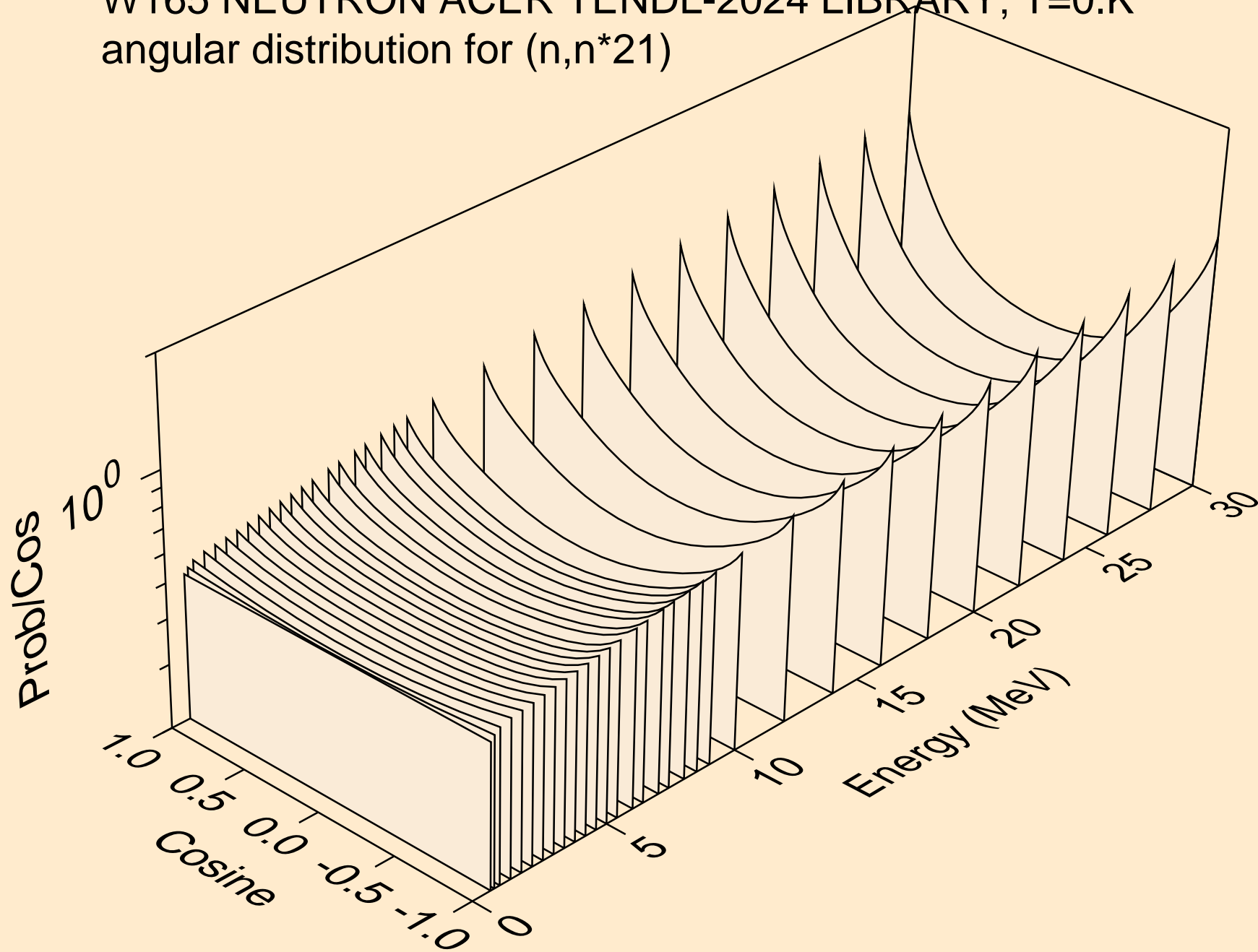

W165 NEUTRON ACER TENDL-2024 LIBRARY; T=0.K
angular distribution for (n,n*22)

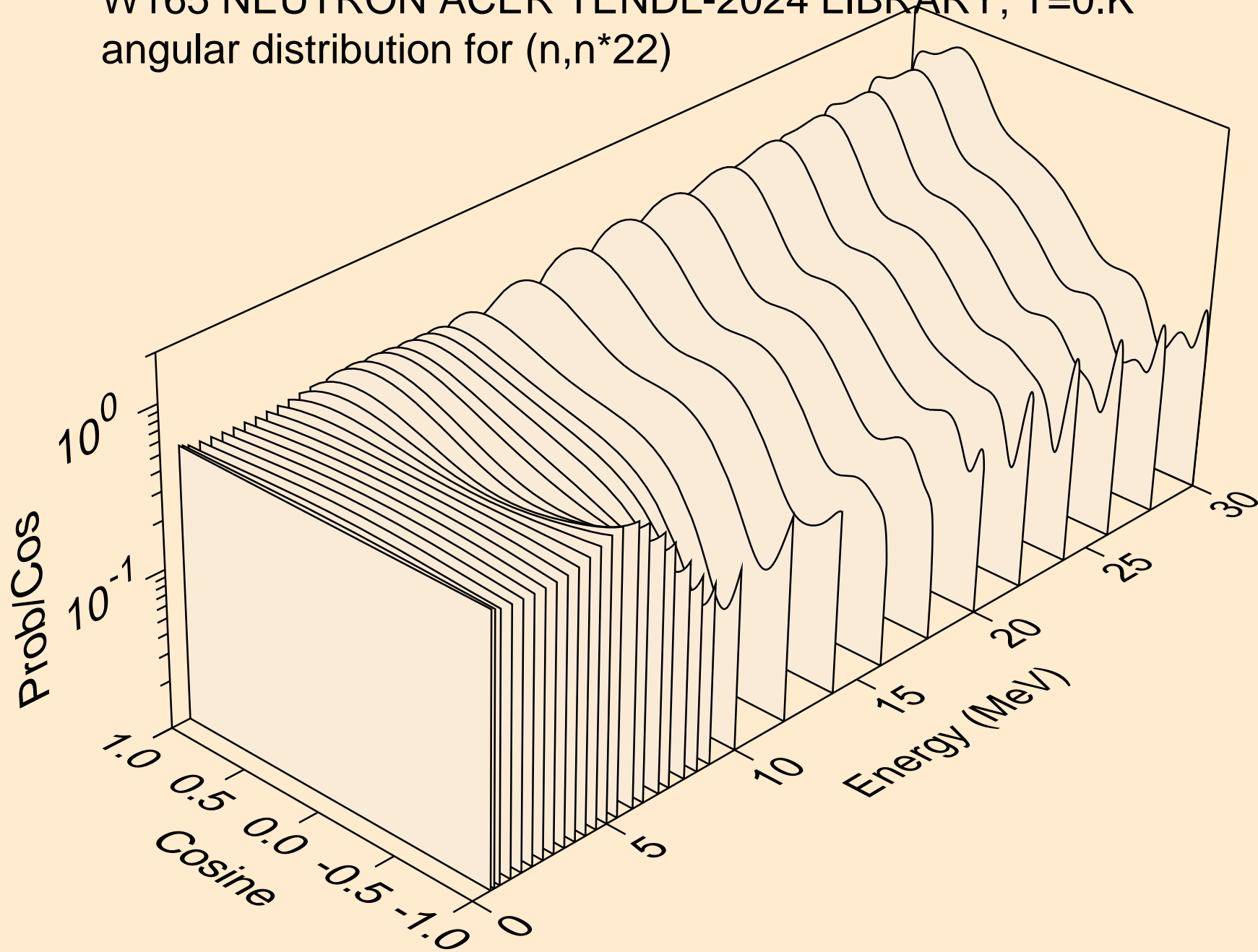

W165 NEUTRON ACER TENDL-2024 LIBRARY; T=0.K
angular distribution for (n,n*23)

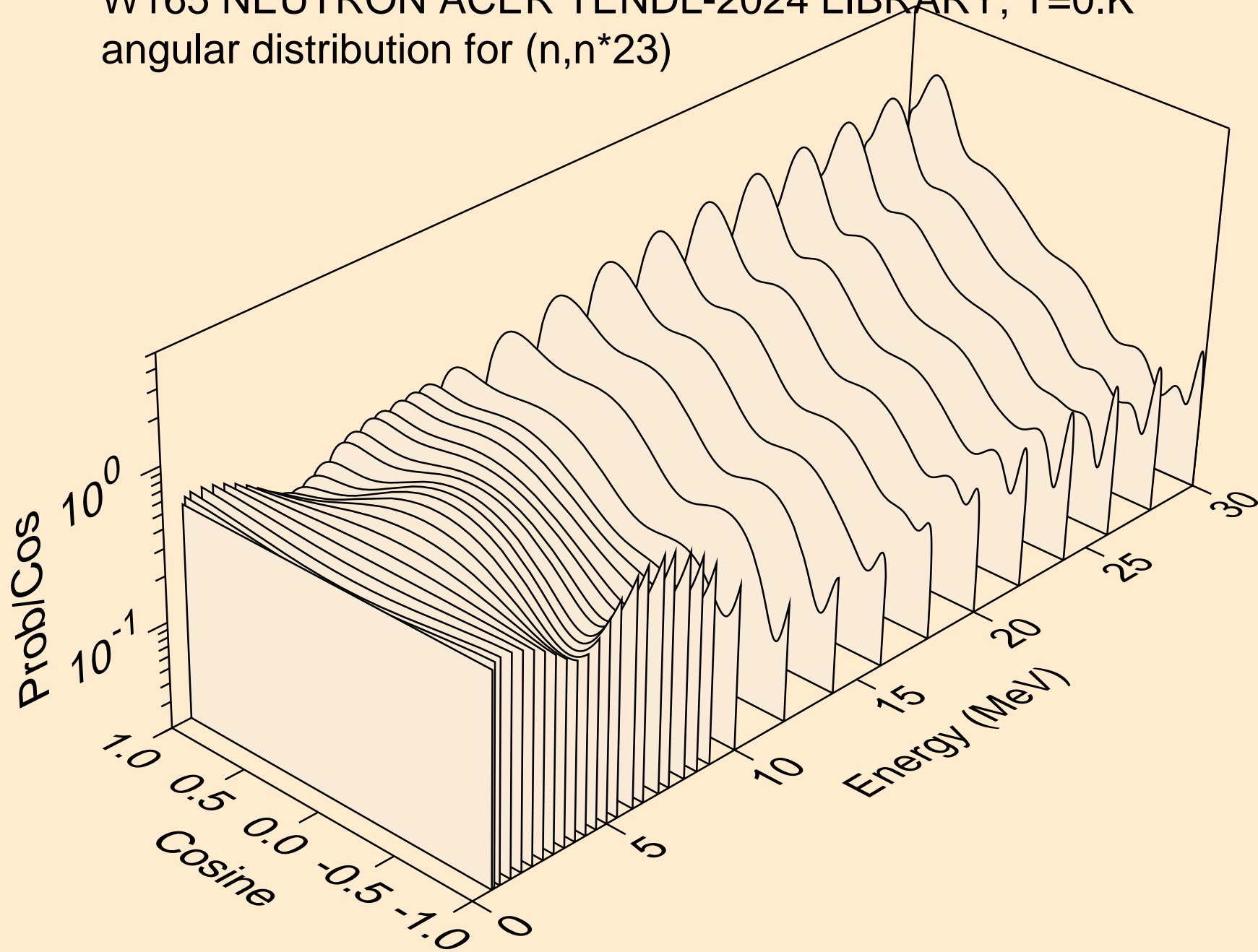

W165 NEUTRON ACER TENDL-2024 LIBRARY; T=0.K
angular distribution for (n,n*24)

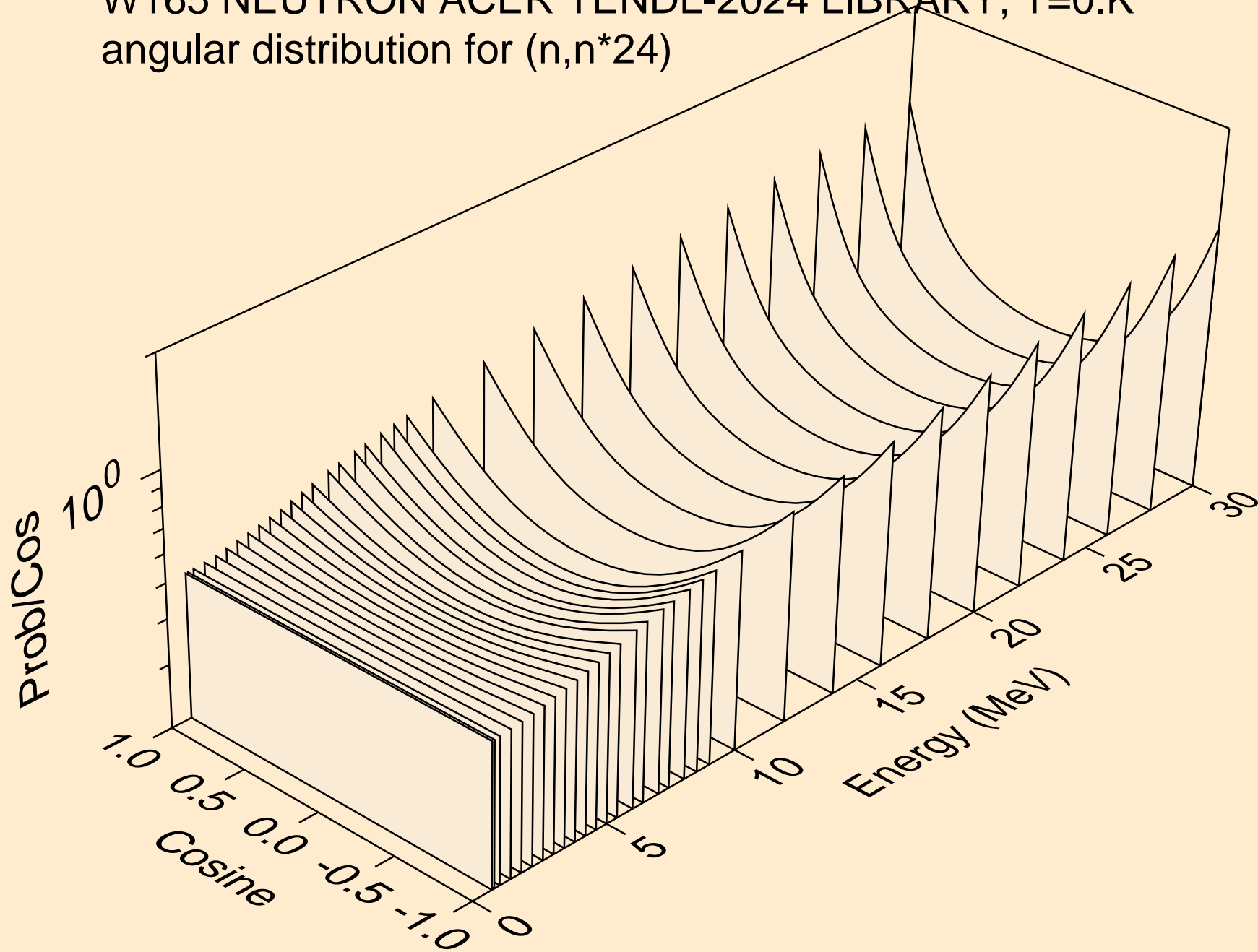

W165 NEUTRON ACER TENDL-2024 LIBRARY; T=0.K
angular distribution for (n,n*25)

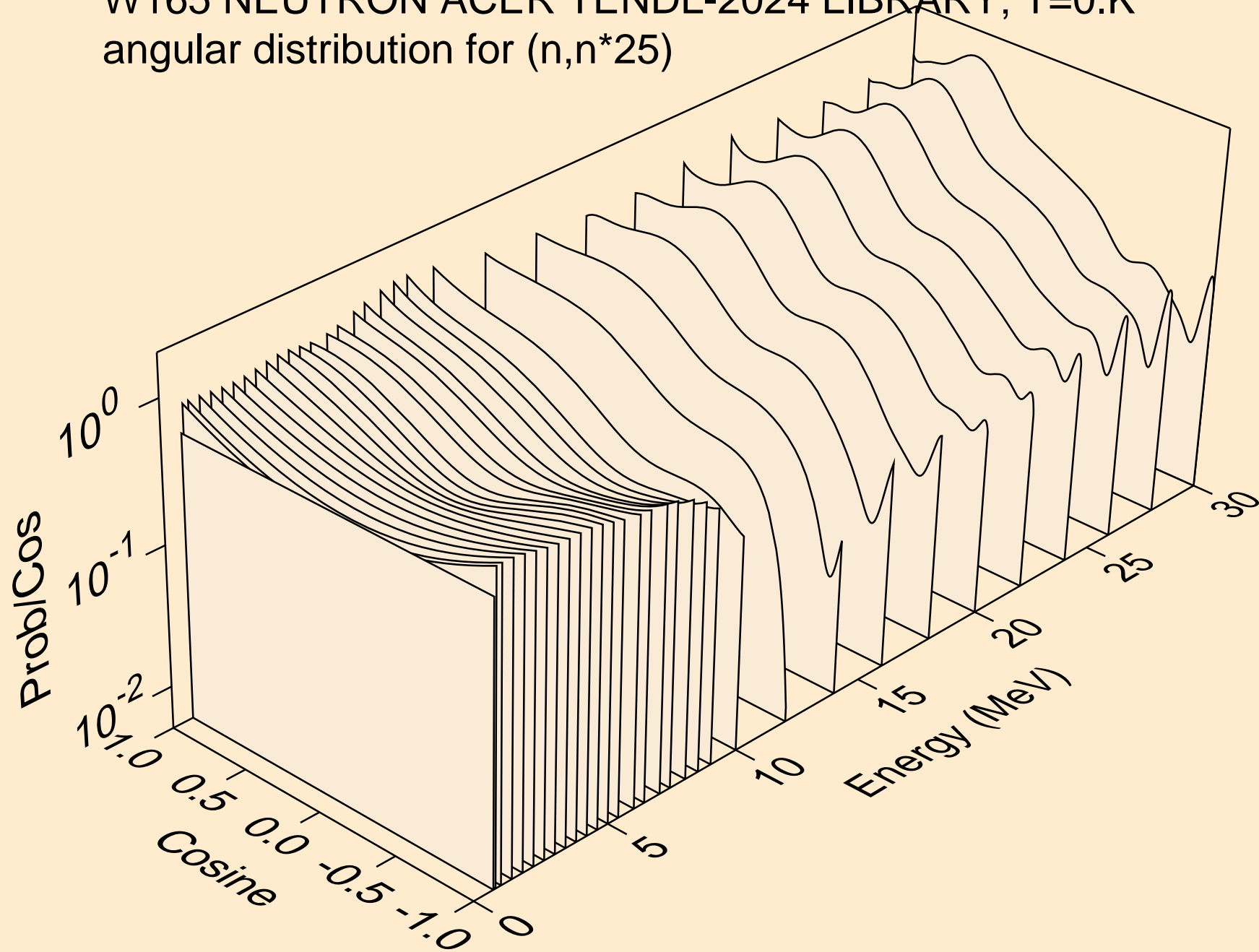

W165 NEUTRON ACER TENDL-2024 LIBRARY; T=0.K
angular distribution for (n,n*26)

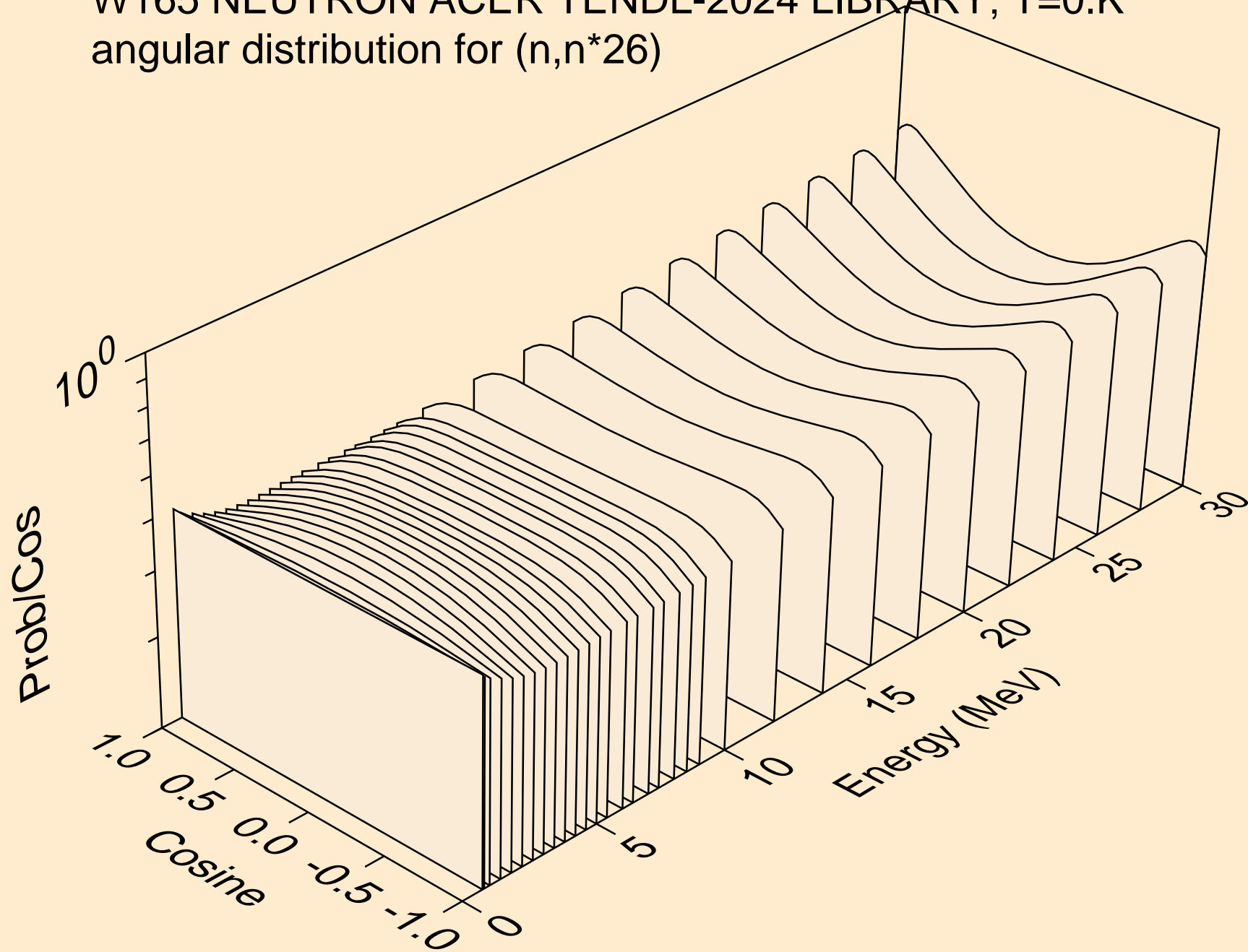

W165 NEUTRON ACER TENDL-2024 LIBRARY; T=0.K
angular distribution for (n,n*27)

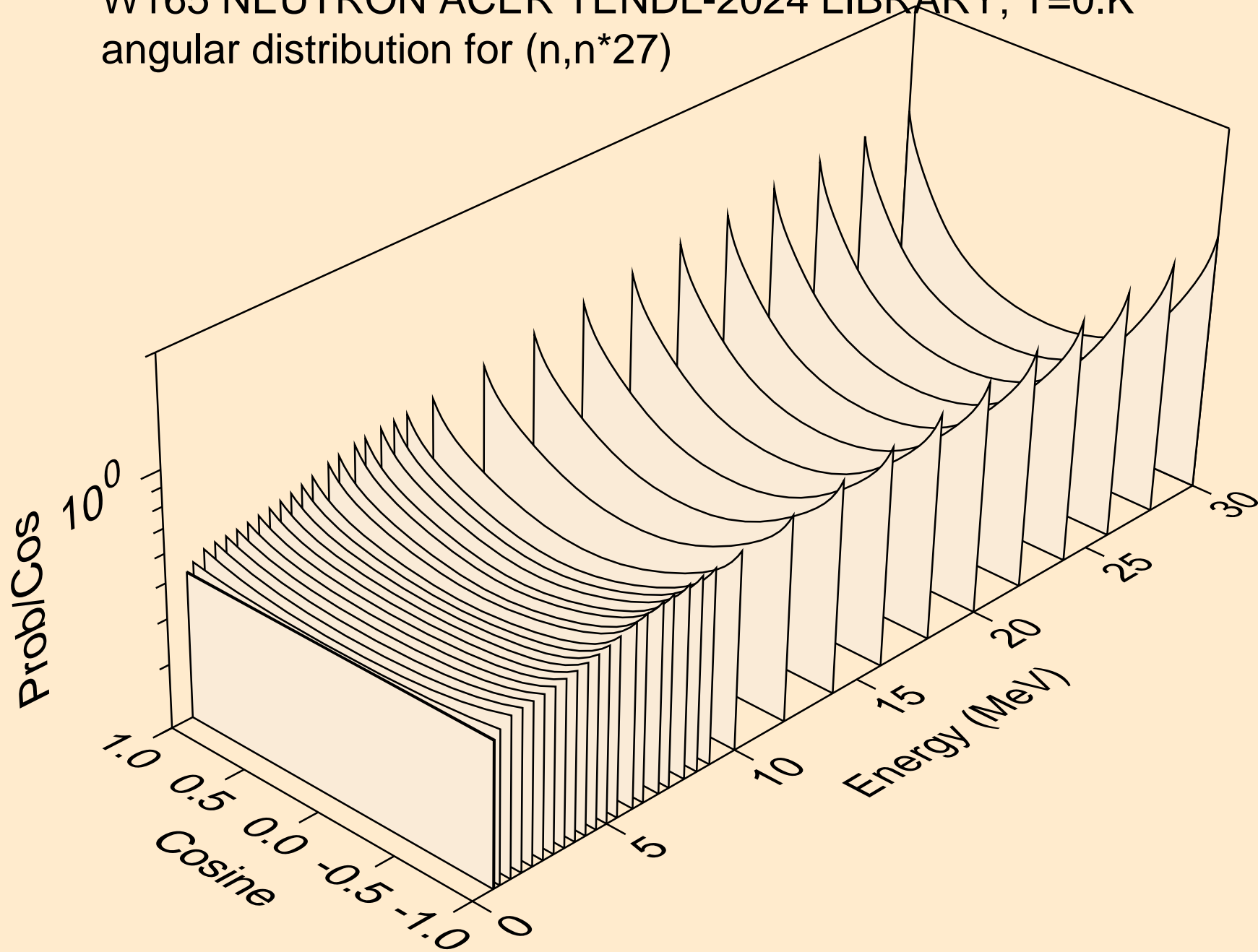

W165 NEUTRON ACER TENDL-2024 LIBRARY; T=0.K
angular distribution for (n,n*28)

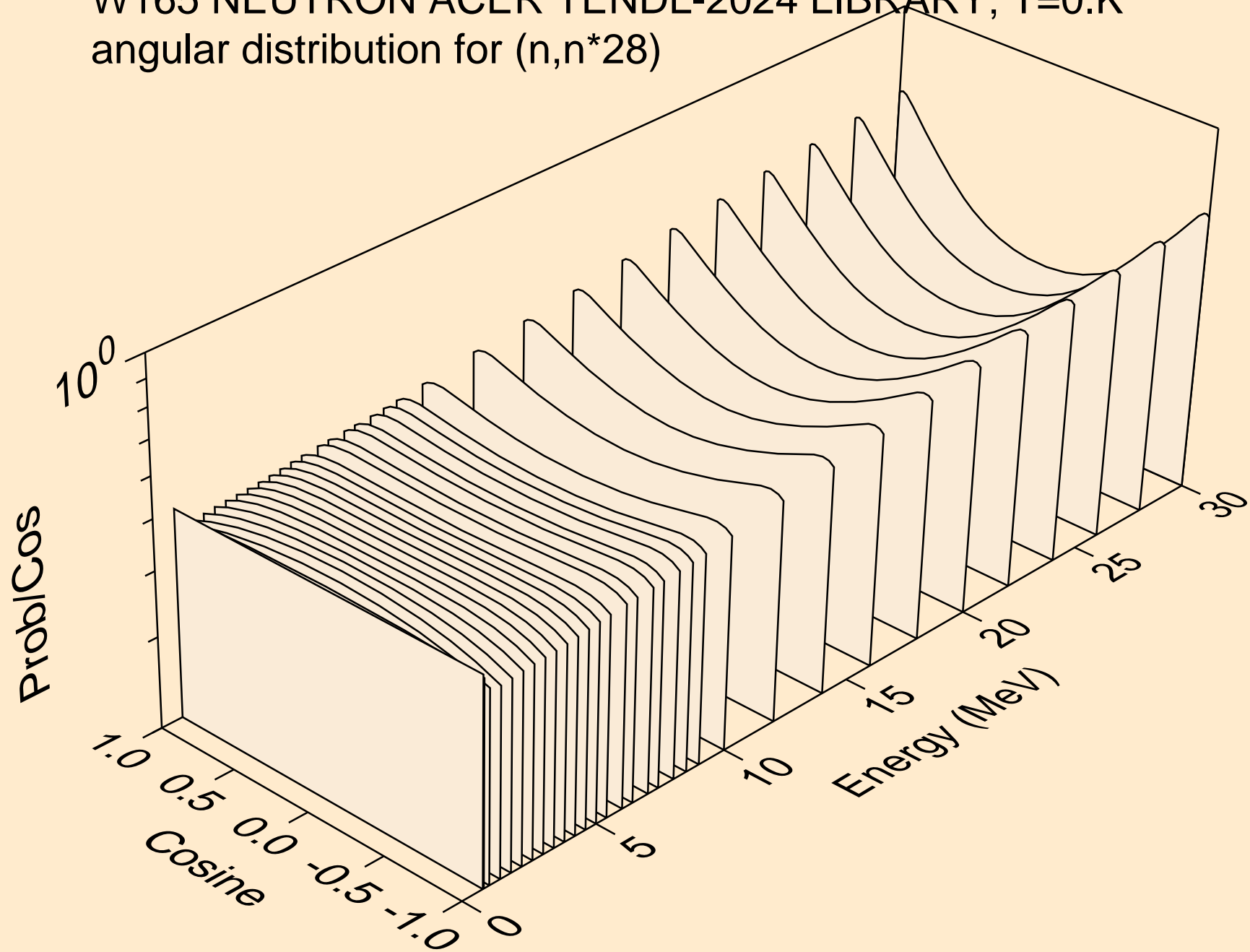

W165 NEUTRON ACER TENDL-2024 LIBRARY; T=0.K
angular distribution for (n,n*29)

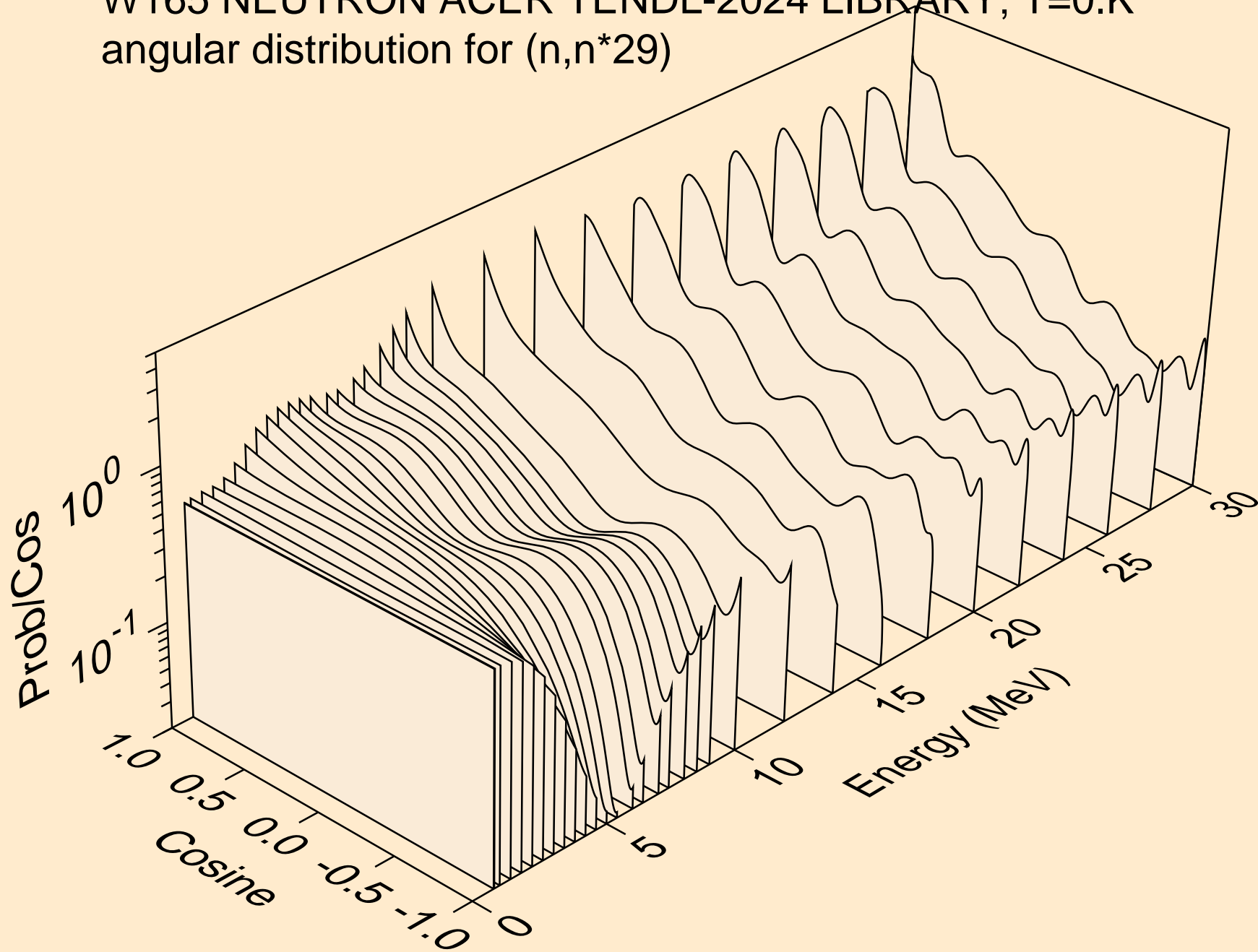

W165 NEUTRON ACER TENDL-2024 LIBRARY; T=0.K
angular distribution for (n,n*30)

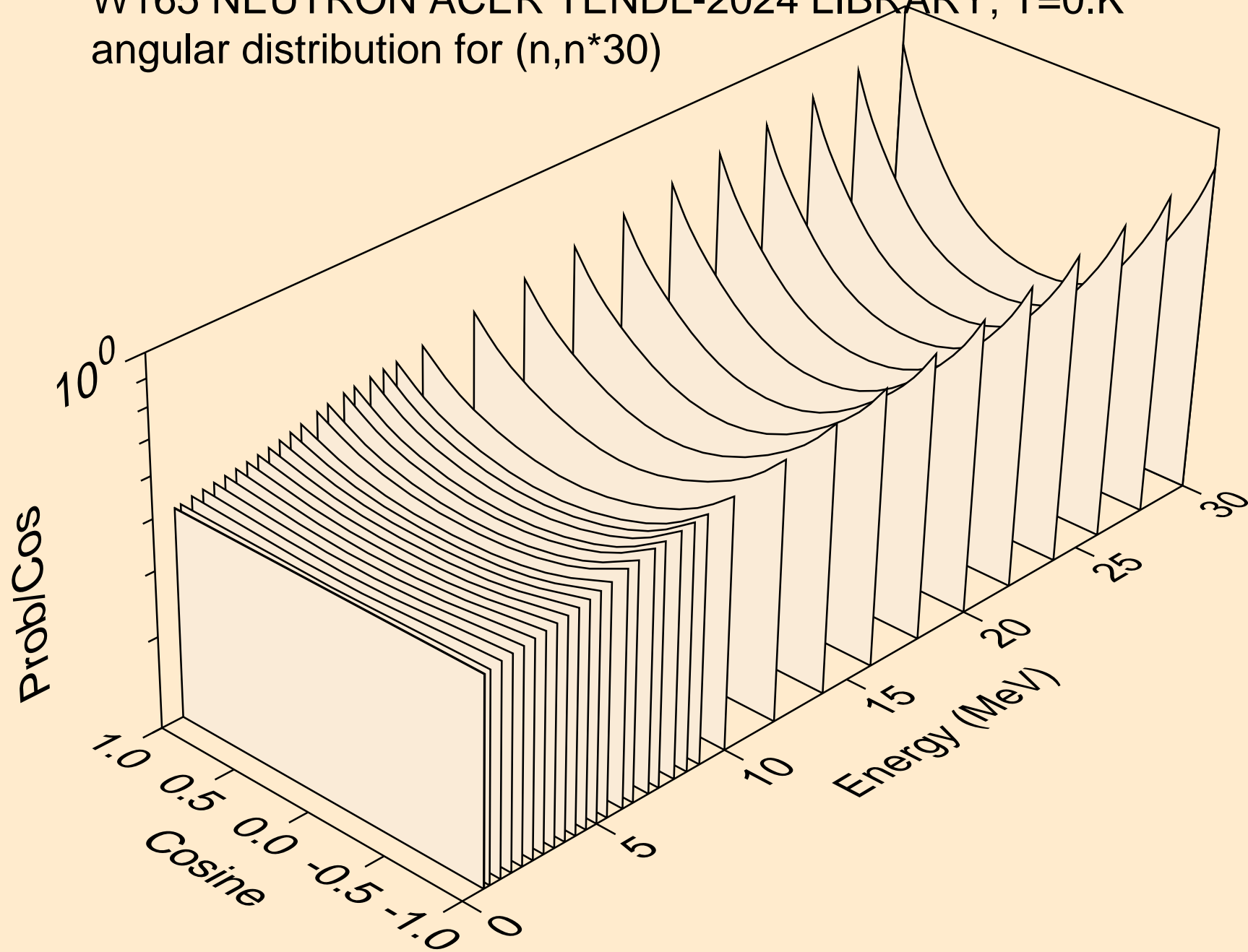

W165 NEUTRON ACER TENDL-2024 LIBRARY; T=0.K
Neutron emission for (n,x)

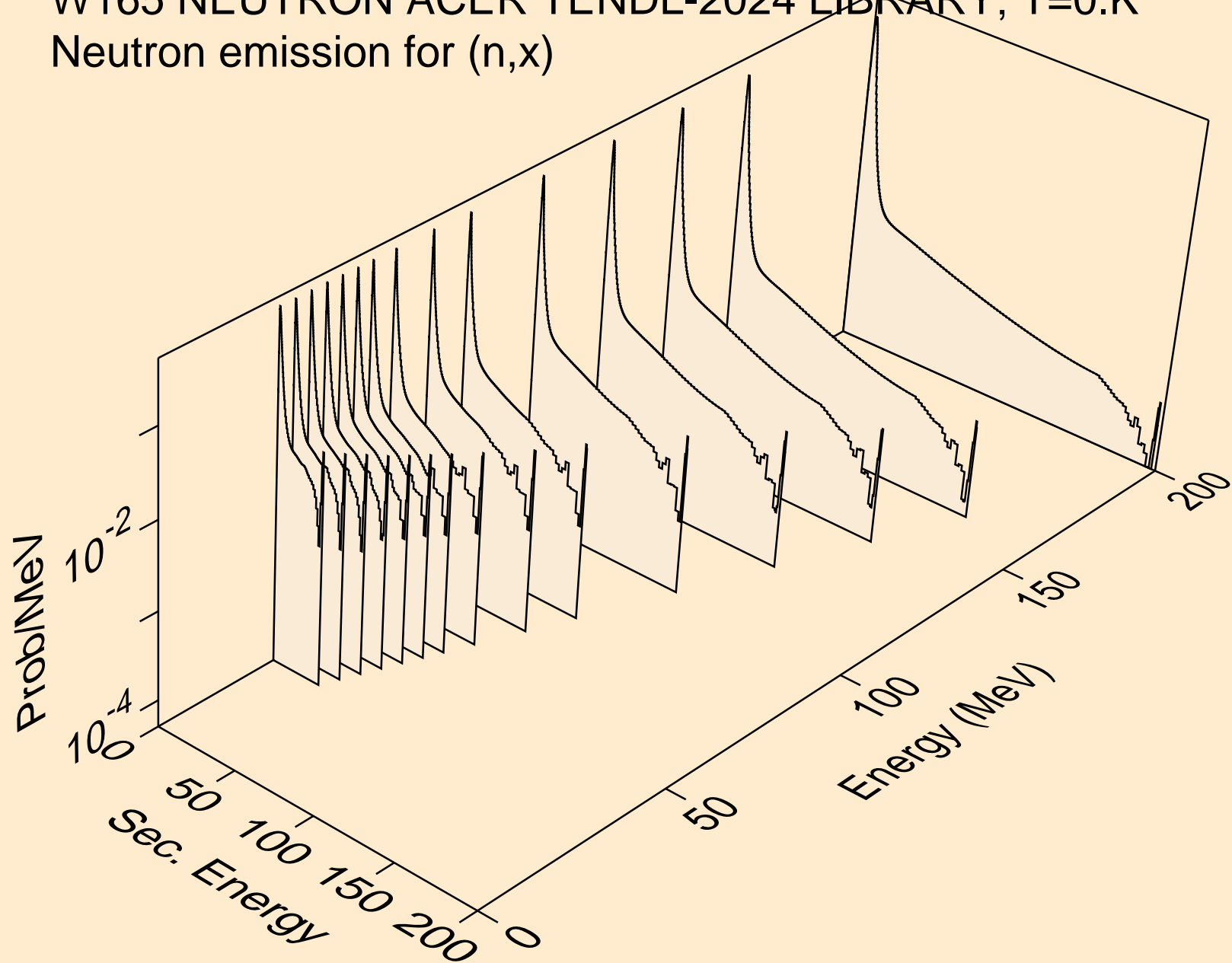

W165 NEUTRON ACER TENDL-2024 LIBRARY; T=0.K
Neutron emission for (n,2nd)

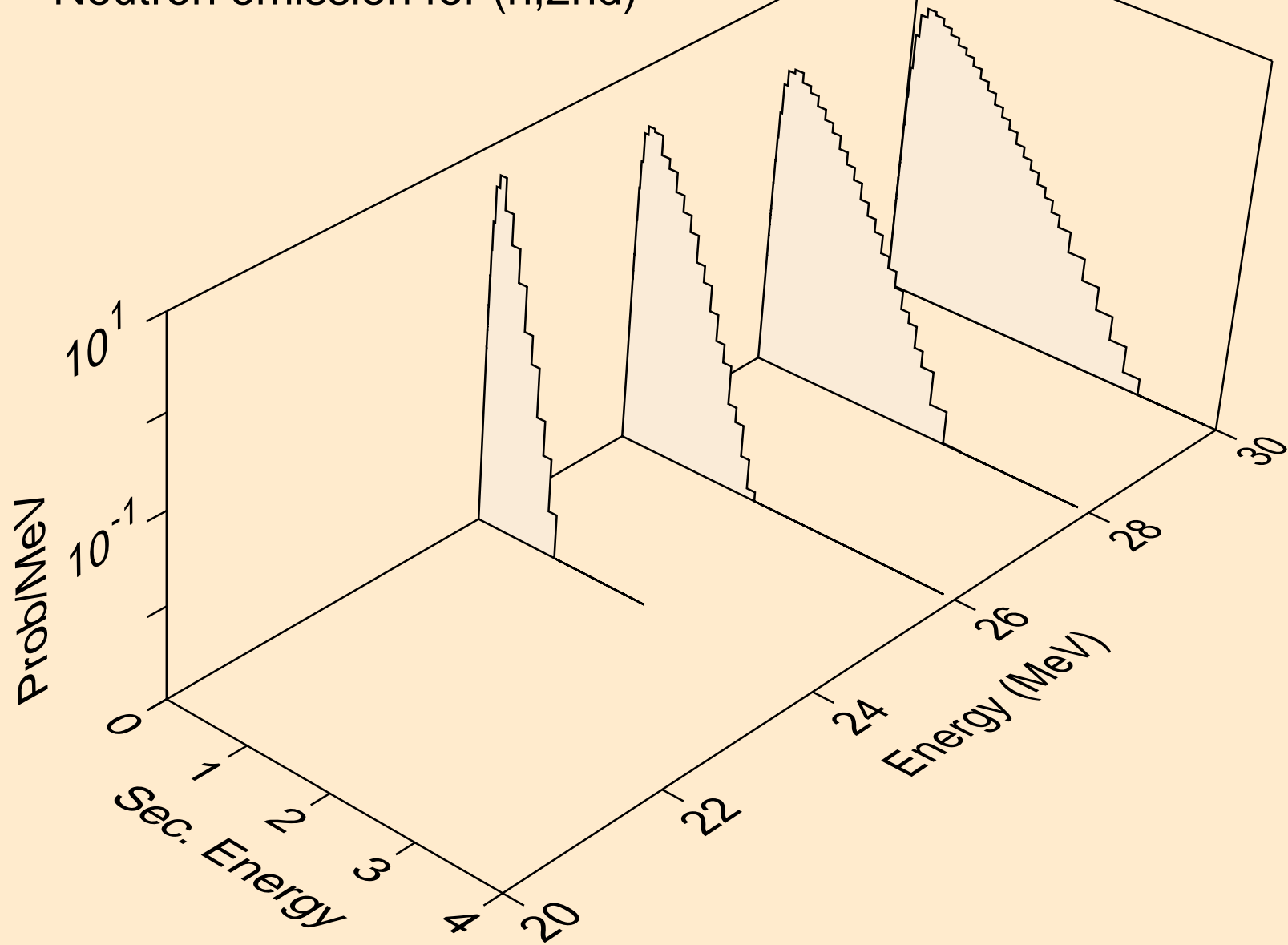

W165 NEUTRON ACER TENDL-2024 LIBRARY; T=0.K
Neutron emission for (n,2n)

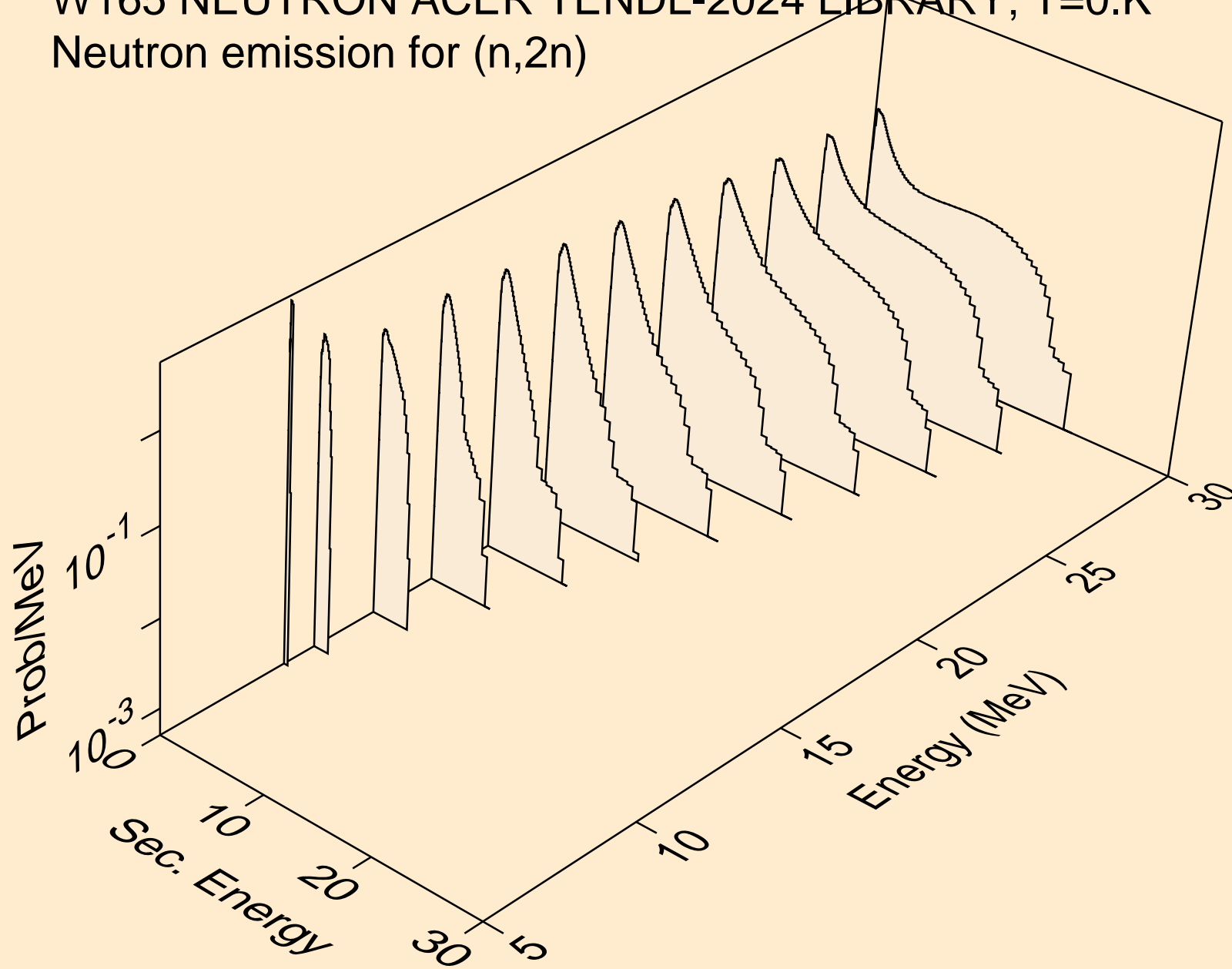

W165 NEUTRON ACER TENDL-2024 LIBRARY; T=0.K
Neutron emission for (n,3n)

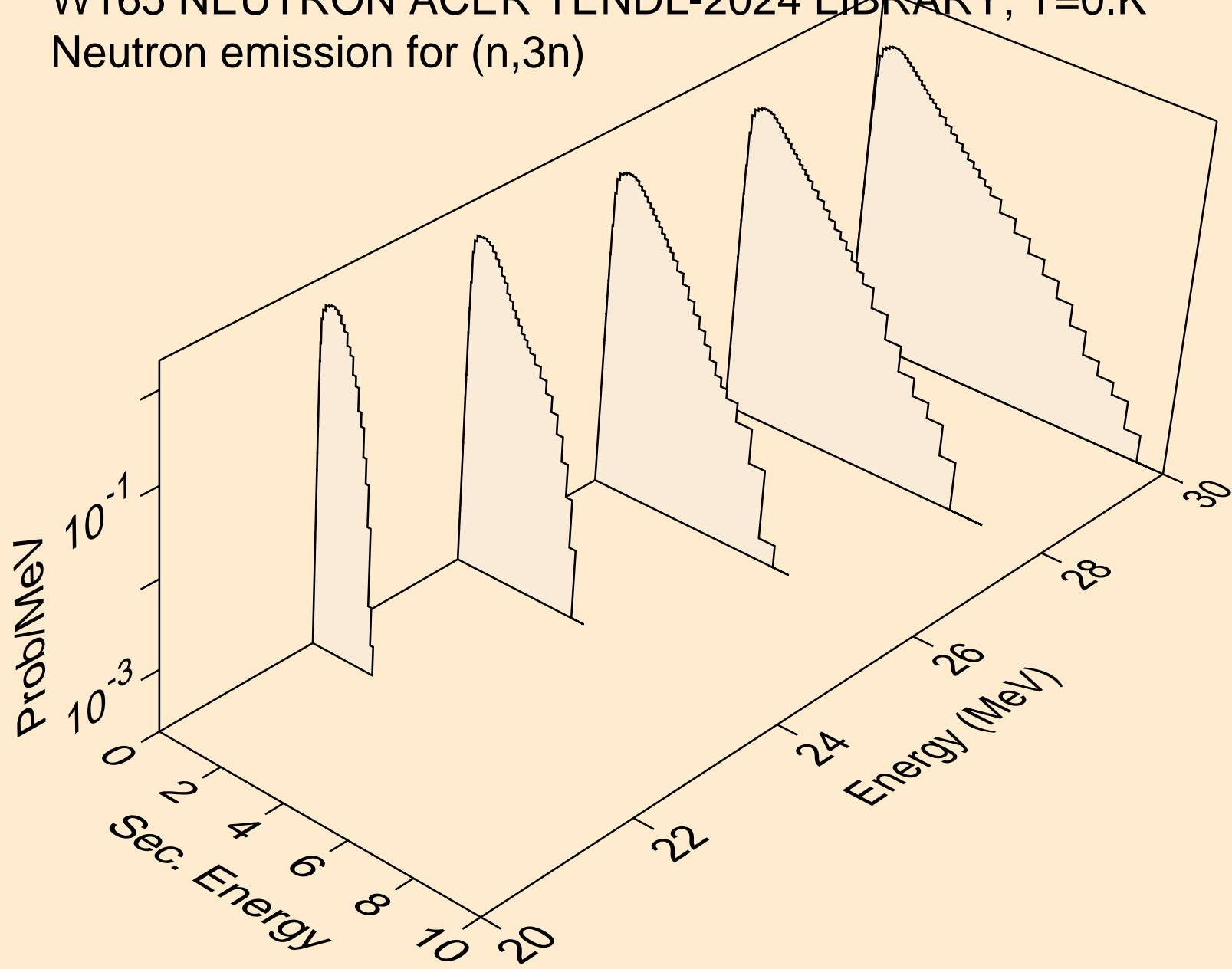

W165 NEUTRON ACER TENDL-2024 LIBRARY; T=0.K
Neutron emission for (n,n*)a

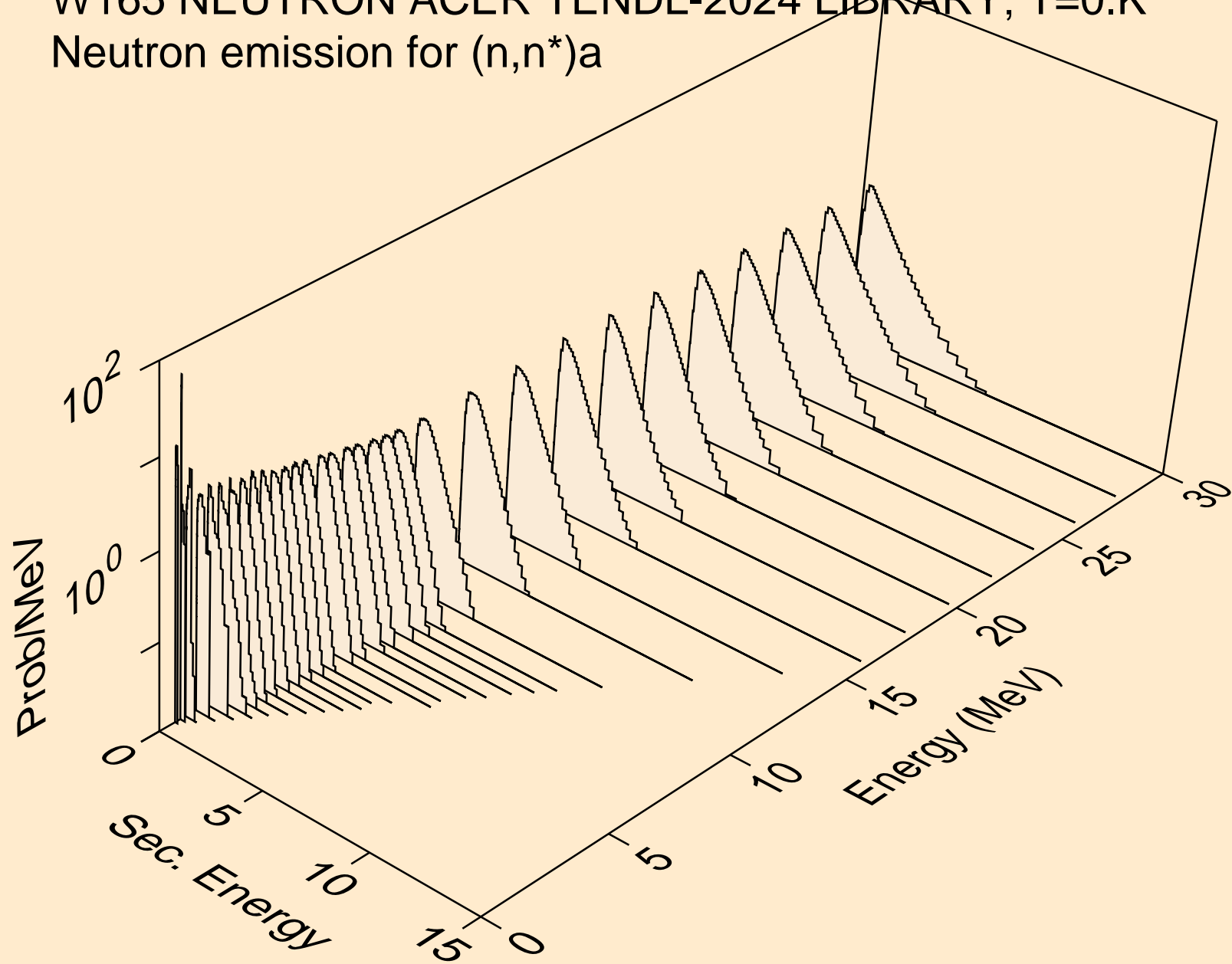

W165 NEUTRON ACER TENDL-2024 LIBRARY; T=0.K
Neutron emission for (n,n*)3a

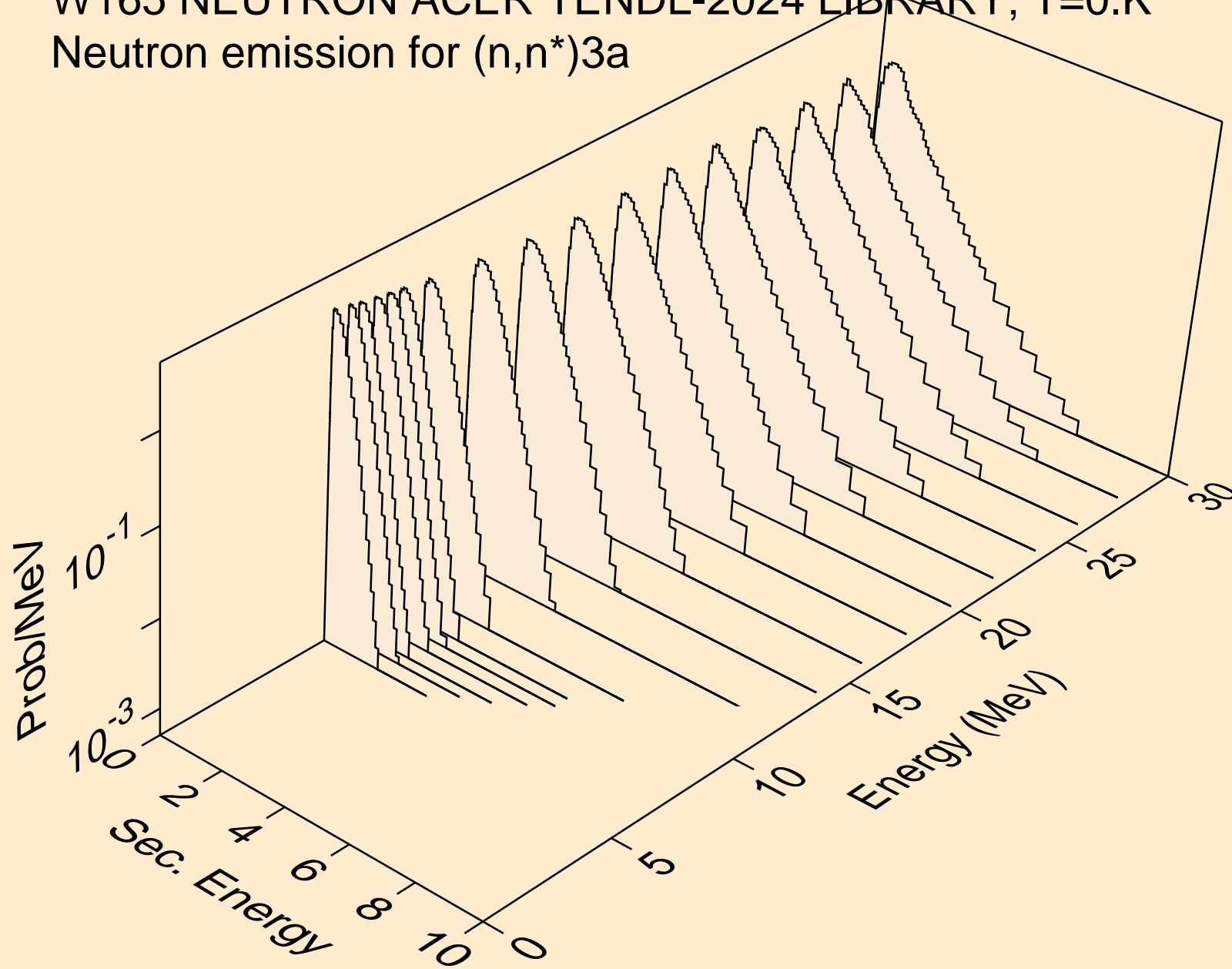

W165 NEUTRON ACER TENDL-2024 LIBRARY; T=0.K
Neutron emission for (n,2n)a

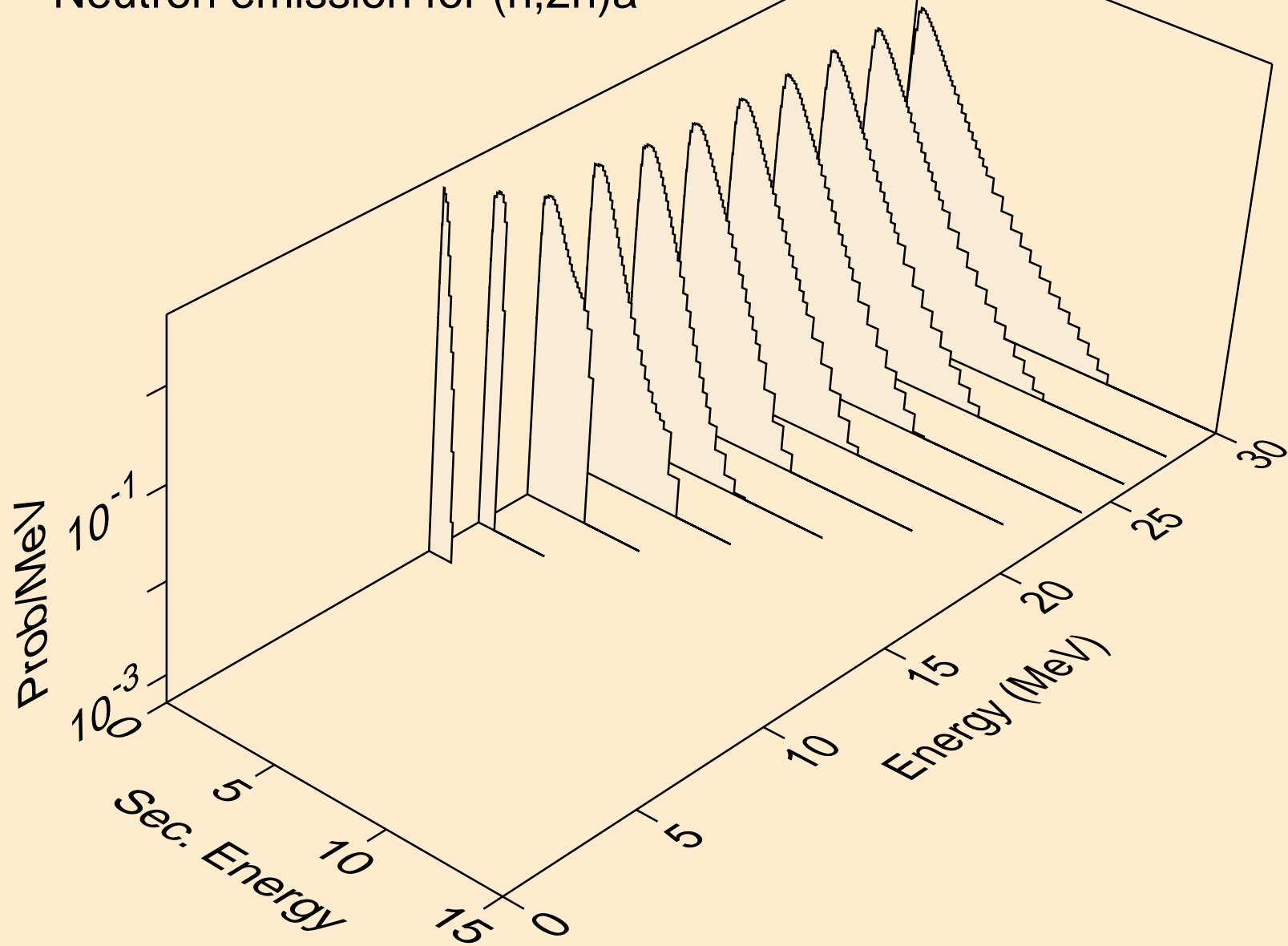

W165 NEUTRON ACER TENDL-2024 LIBRARY; T=0.K
Neutron emission for (n,3n)a

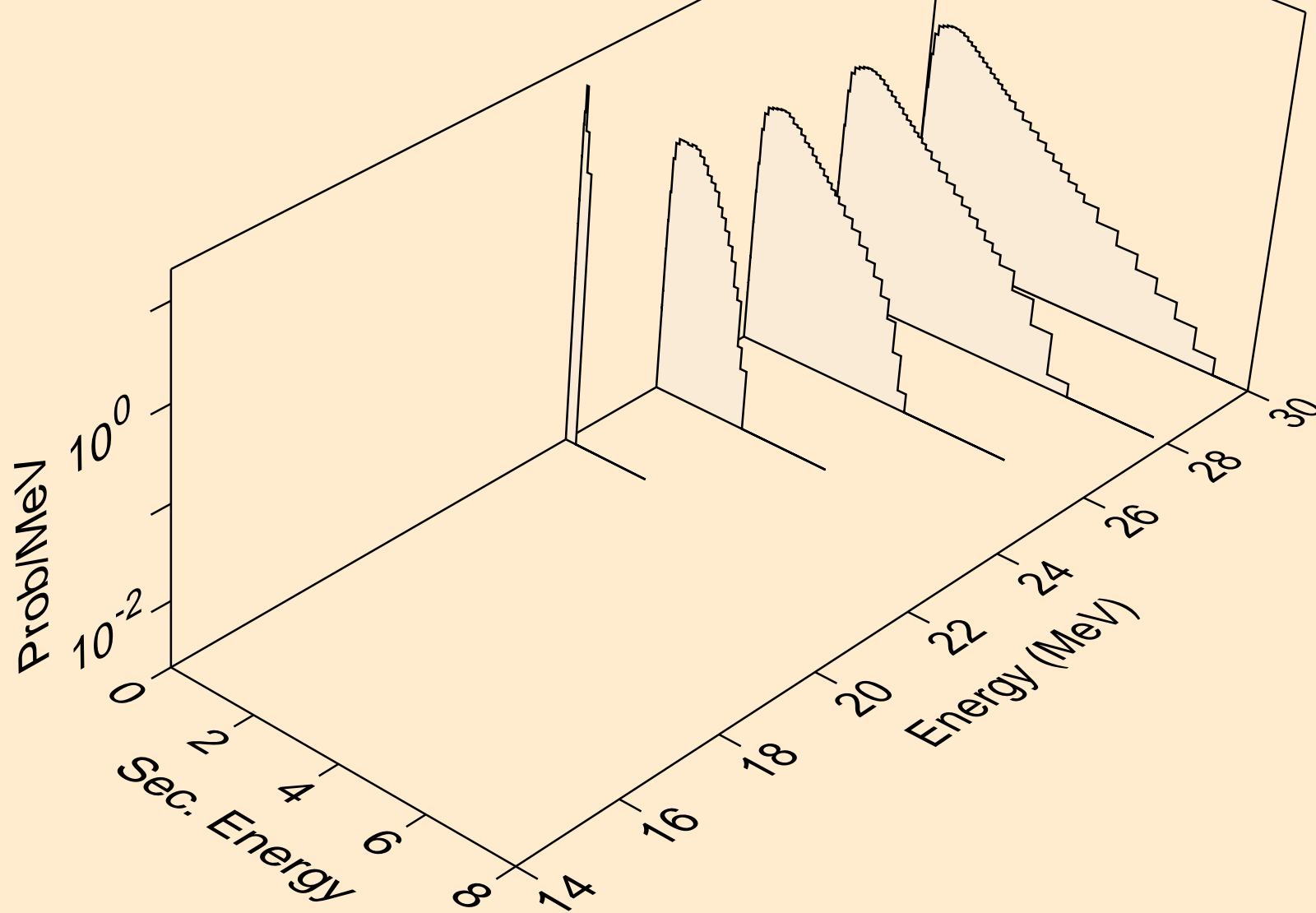

W165 NEUTRON ACER TENDL-2024 LIBRARY; T=0.K
Neutron emission for (n,n*)p

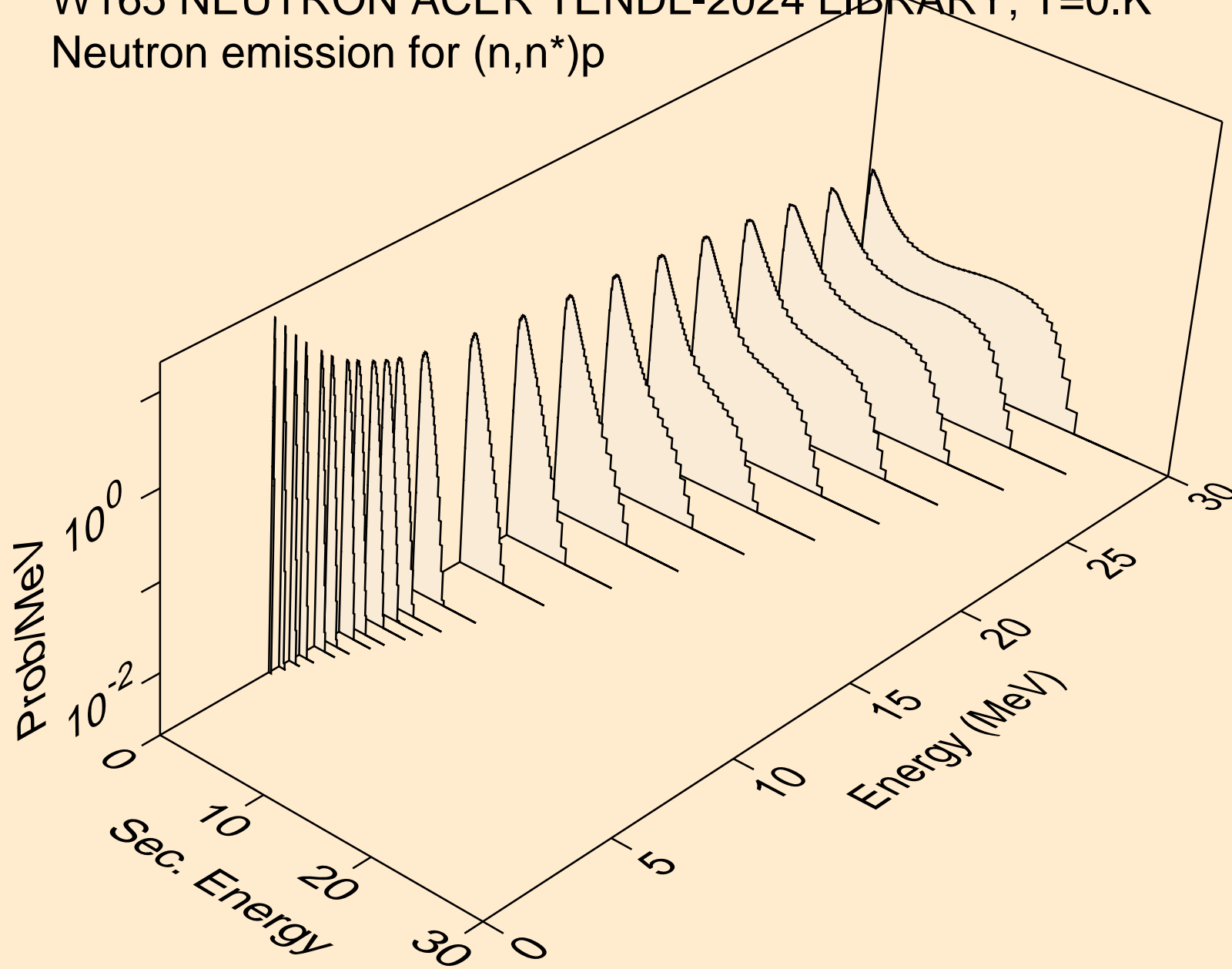

W165 NEUTRON ACER TENDL-2024 LIBRARY; T=0.K
Neutron emission for (n,n*)2a

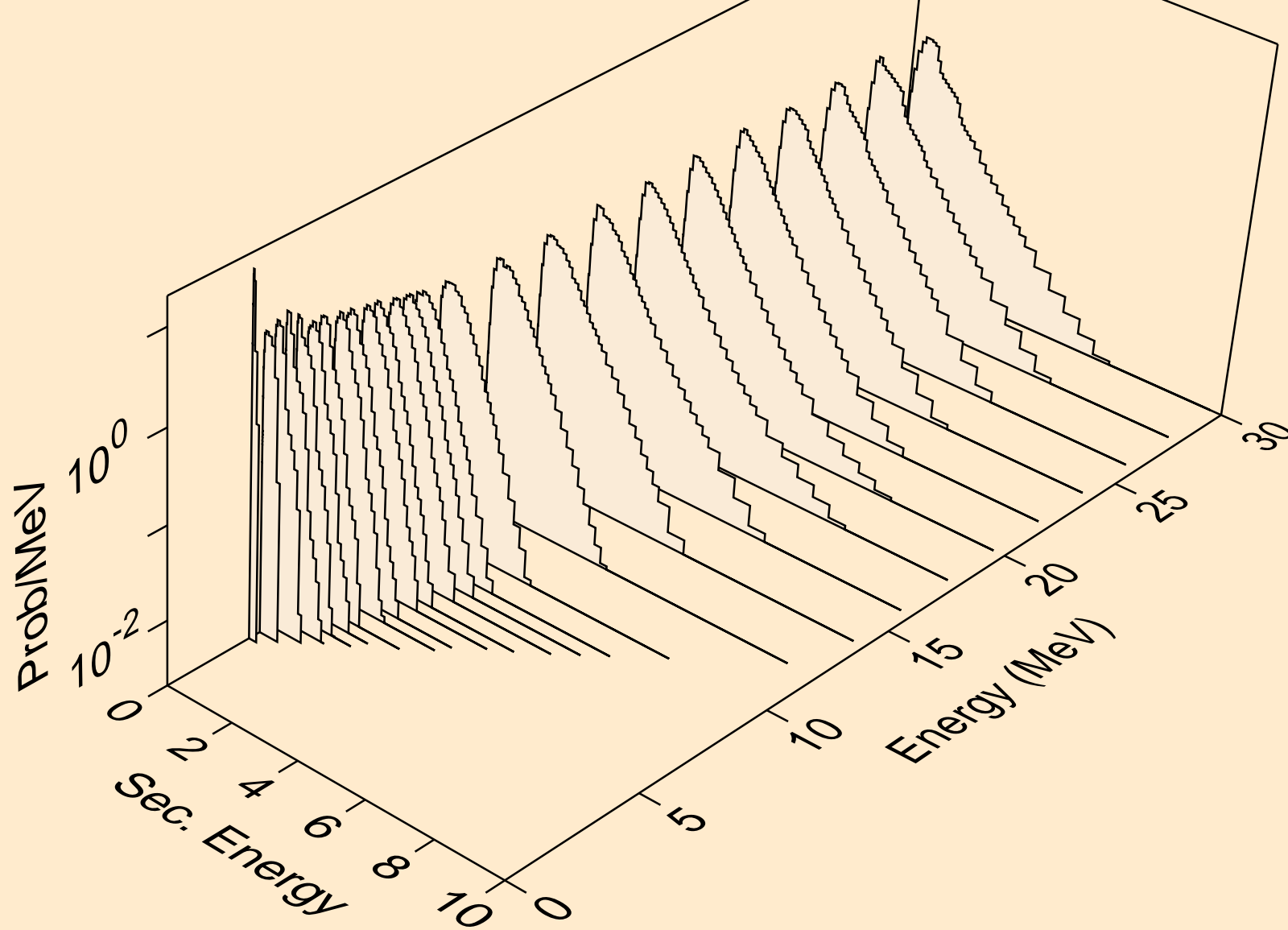

W165 NEUTRON ACER TENDL-2024 LIBRARY; T=0.K
Neutron emission for (n,2n)2a

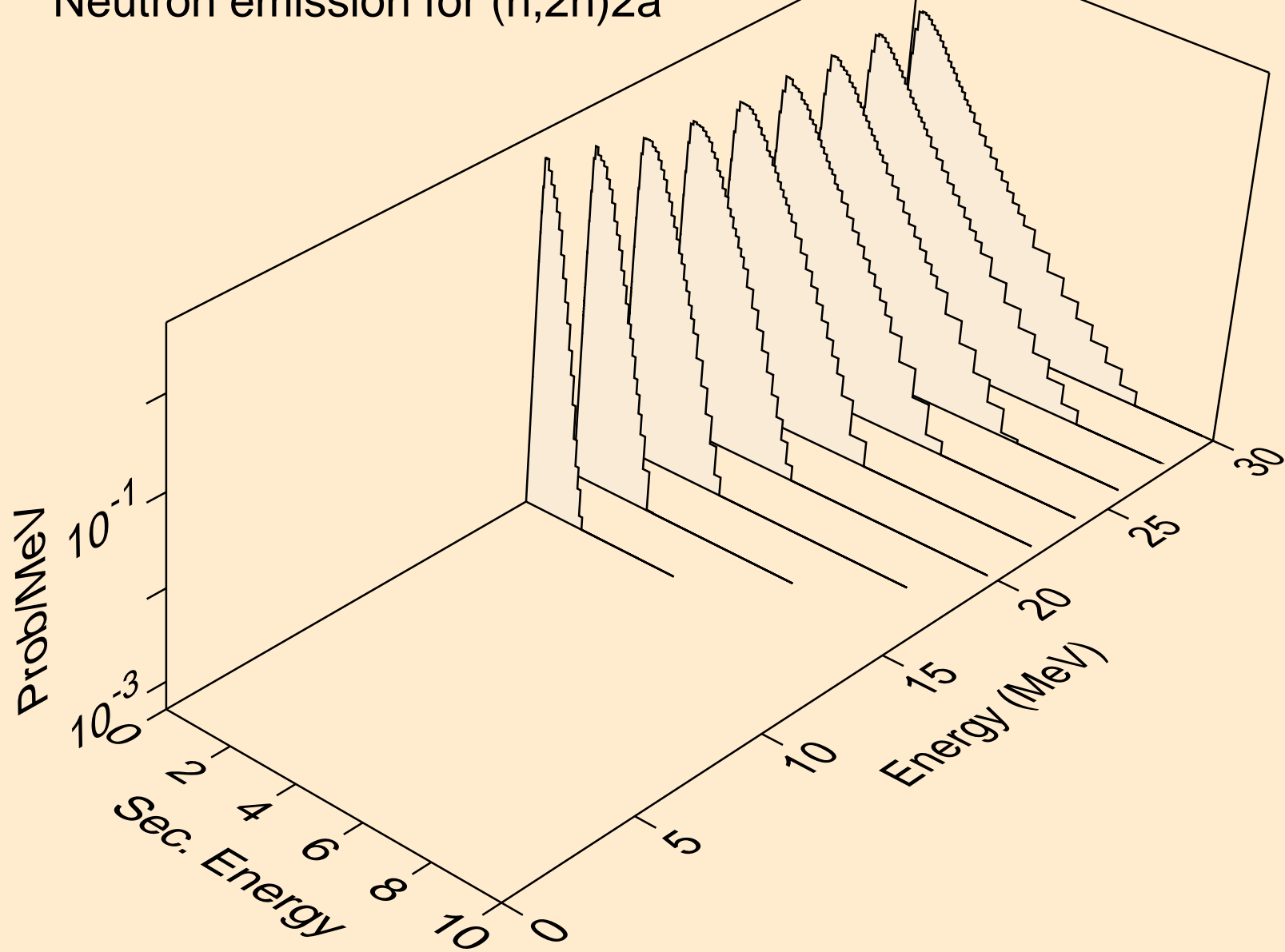

W165 NEUTRON ACER TENDL-2024 LIBRARY; T=0.K
Neutron emission for (n,n*)d

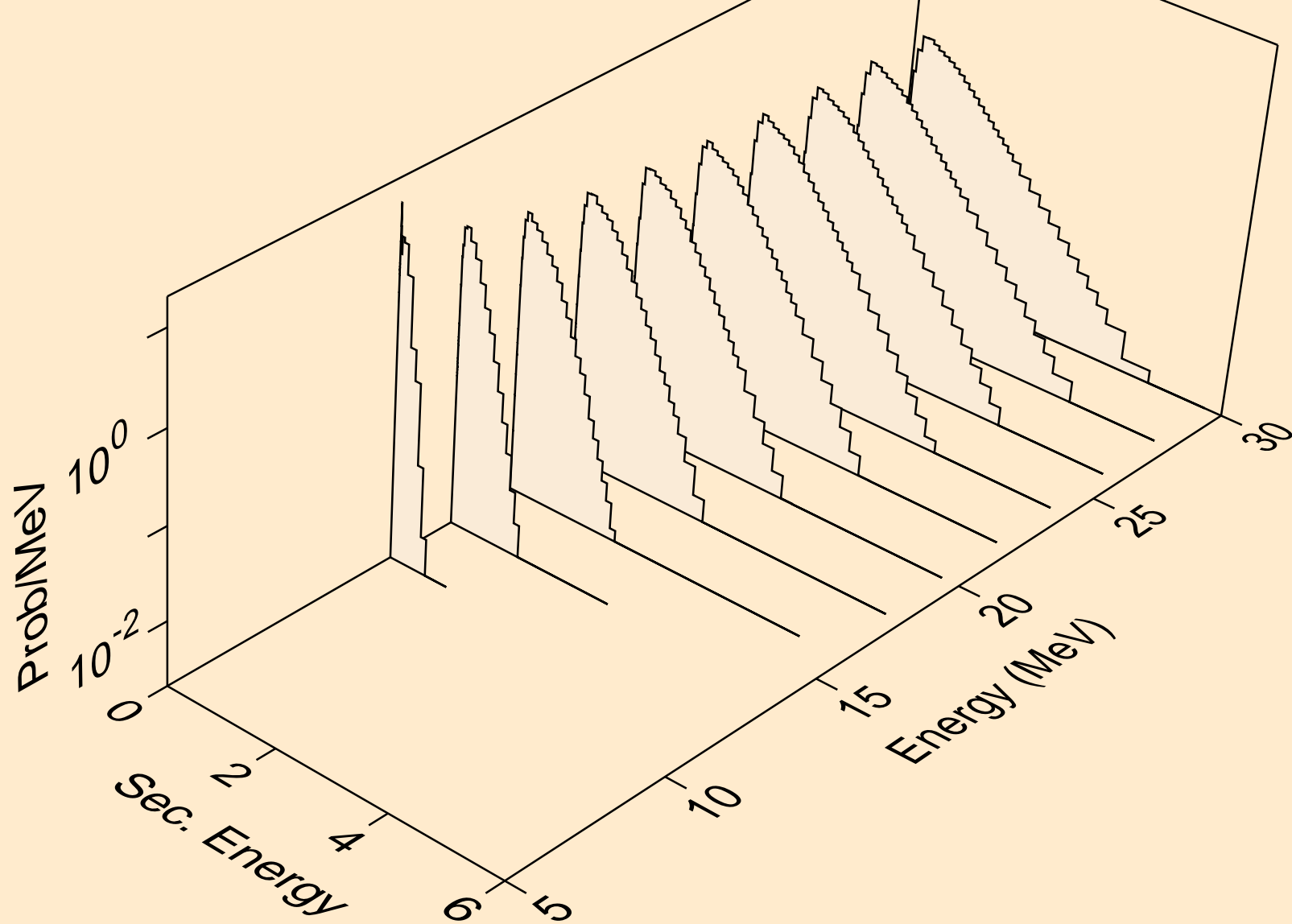

W165 NEUTRON ACER TENDL-2024 LIBRARY; T=0.K
Neutron emission for (n,n*)t

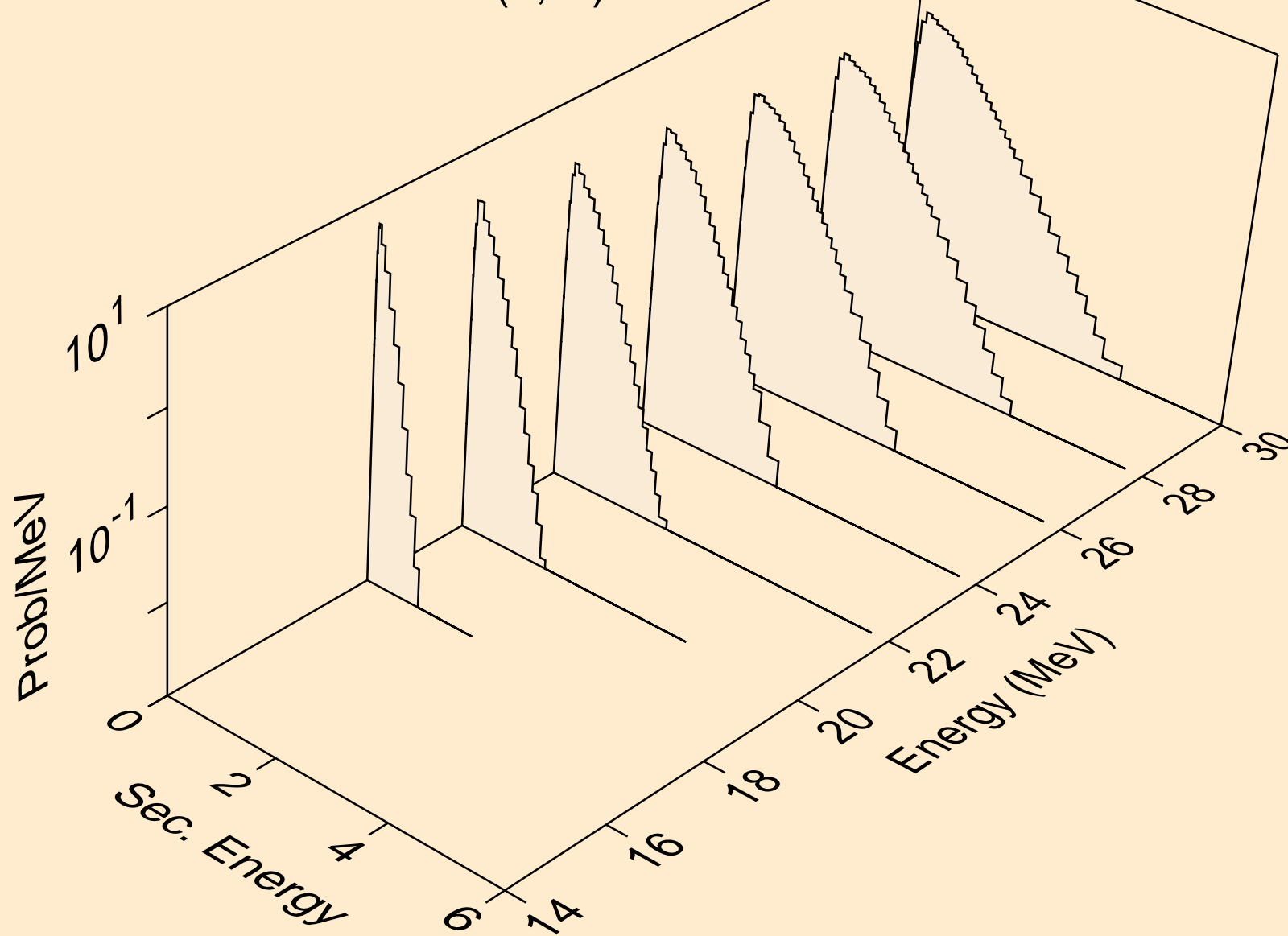

W165 NEUTRON ACER TENDL-2024 LIBRARY; T=0.K
Neutron emission for (n,n*)he3

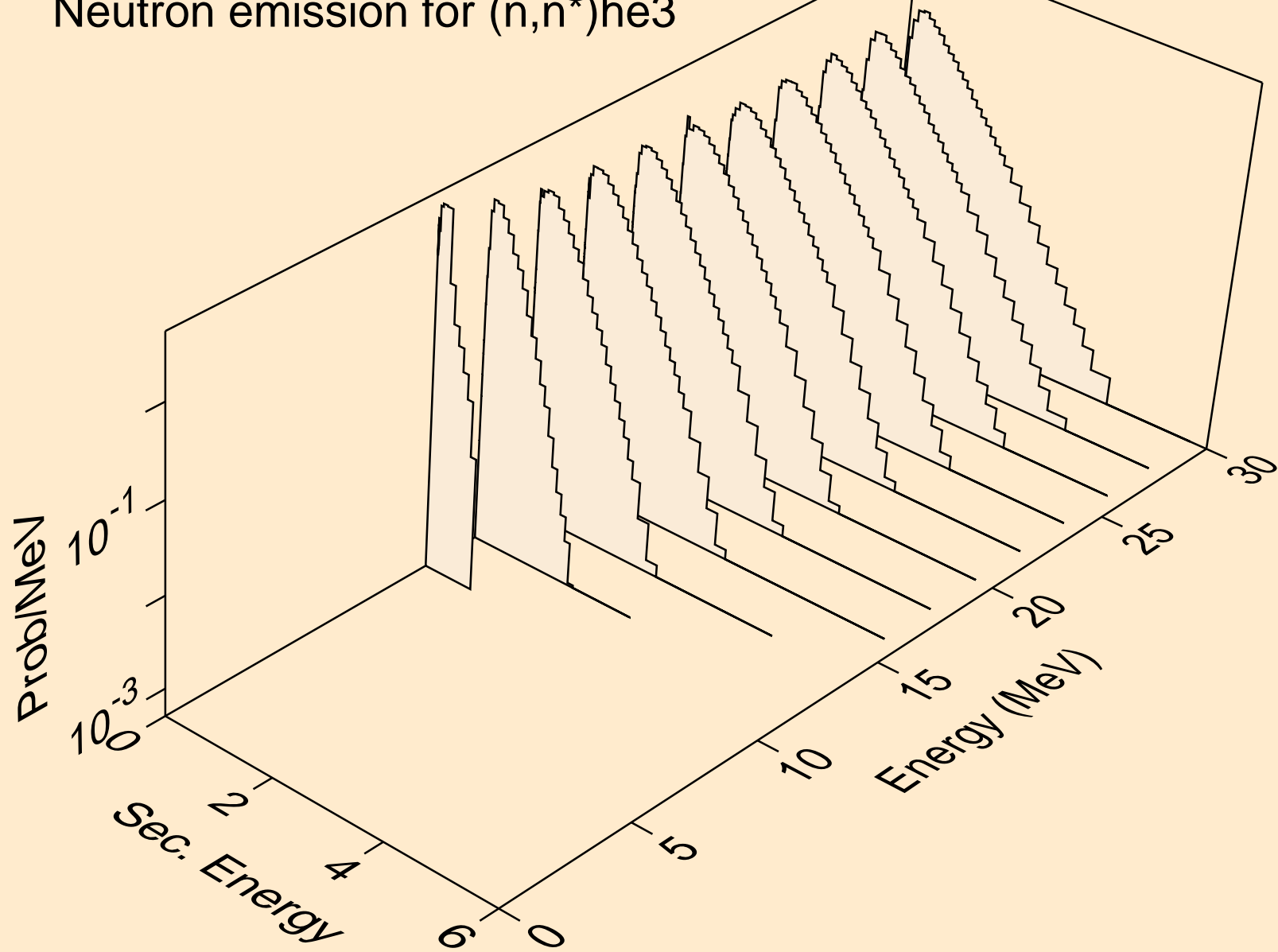

W165 NEUTRON ACER TENDL-2024 LIBRARY; T=0.K
Neutron emission for (n,2np)

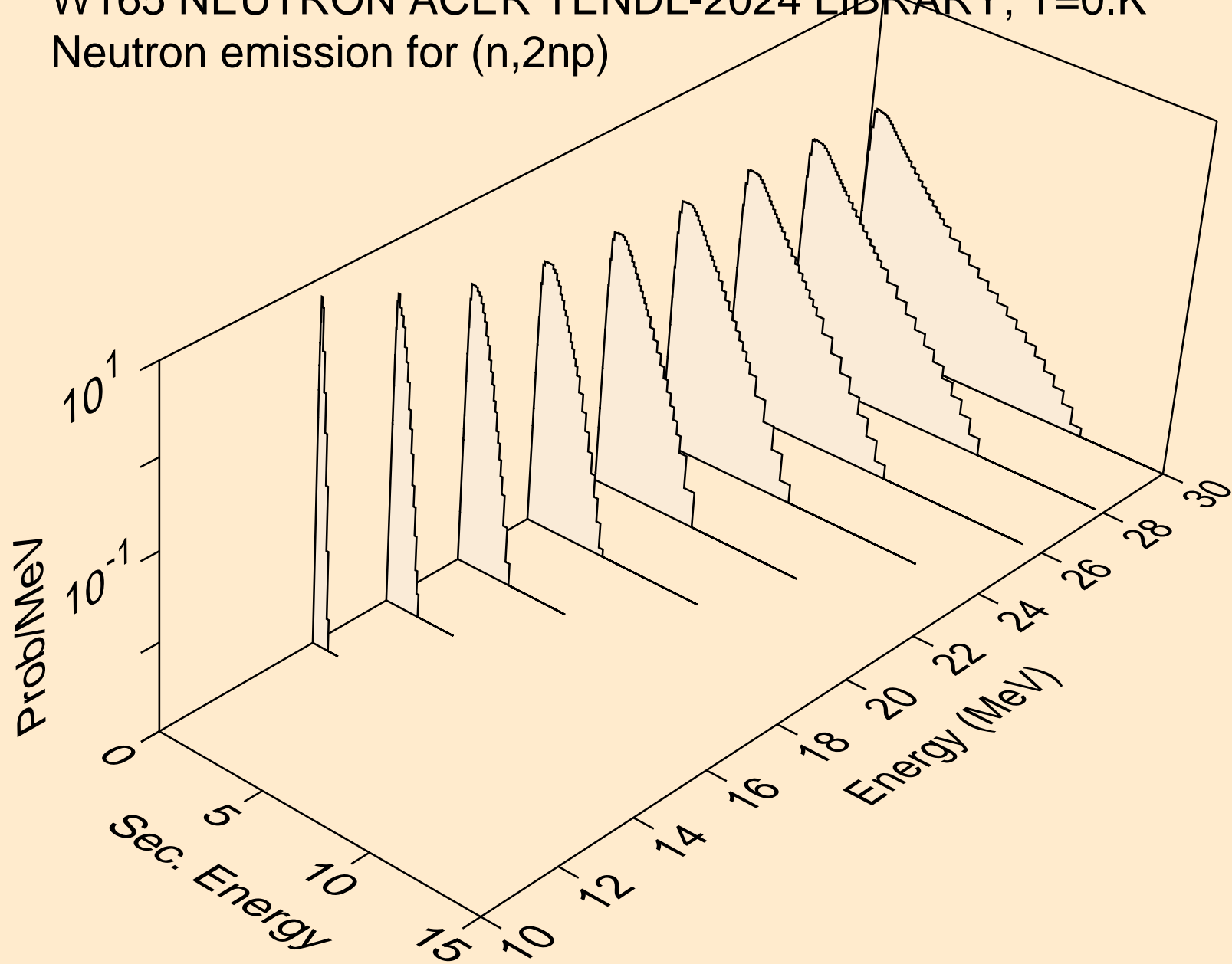

W165 NEUTRON ACER TENDL-2024 LIBRARY; T=0.K
Neutron emission for (n,3np)

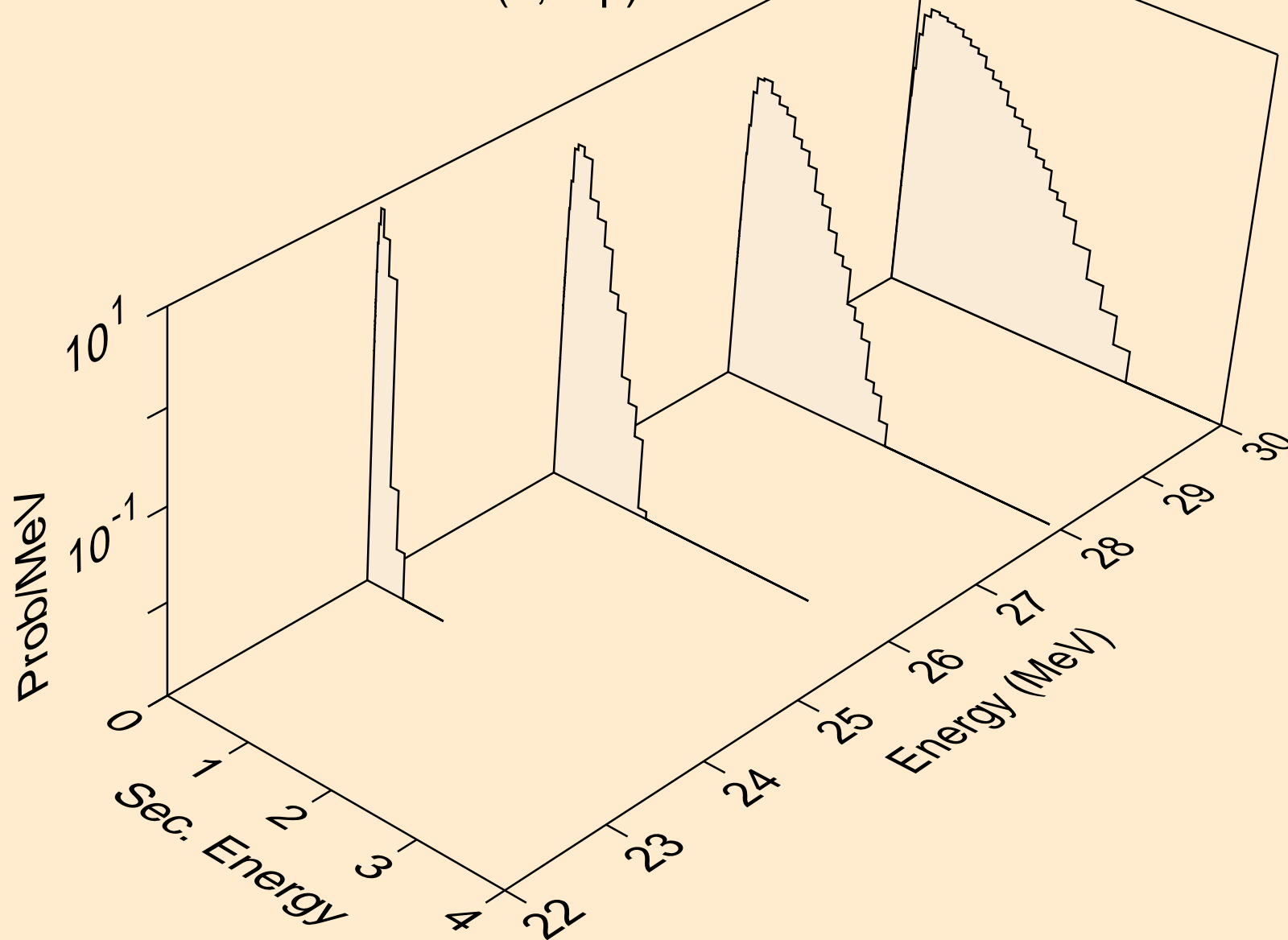

W165 NEUTRON ACER TENDL-2024 LIBRARY; T=0.K
Neutron emission for (n,n2p)

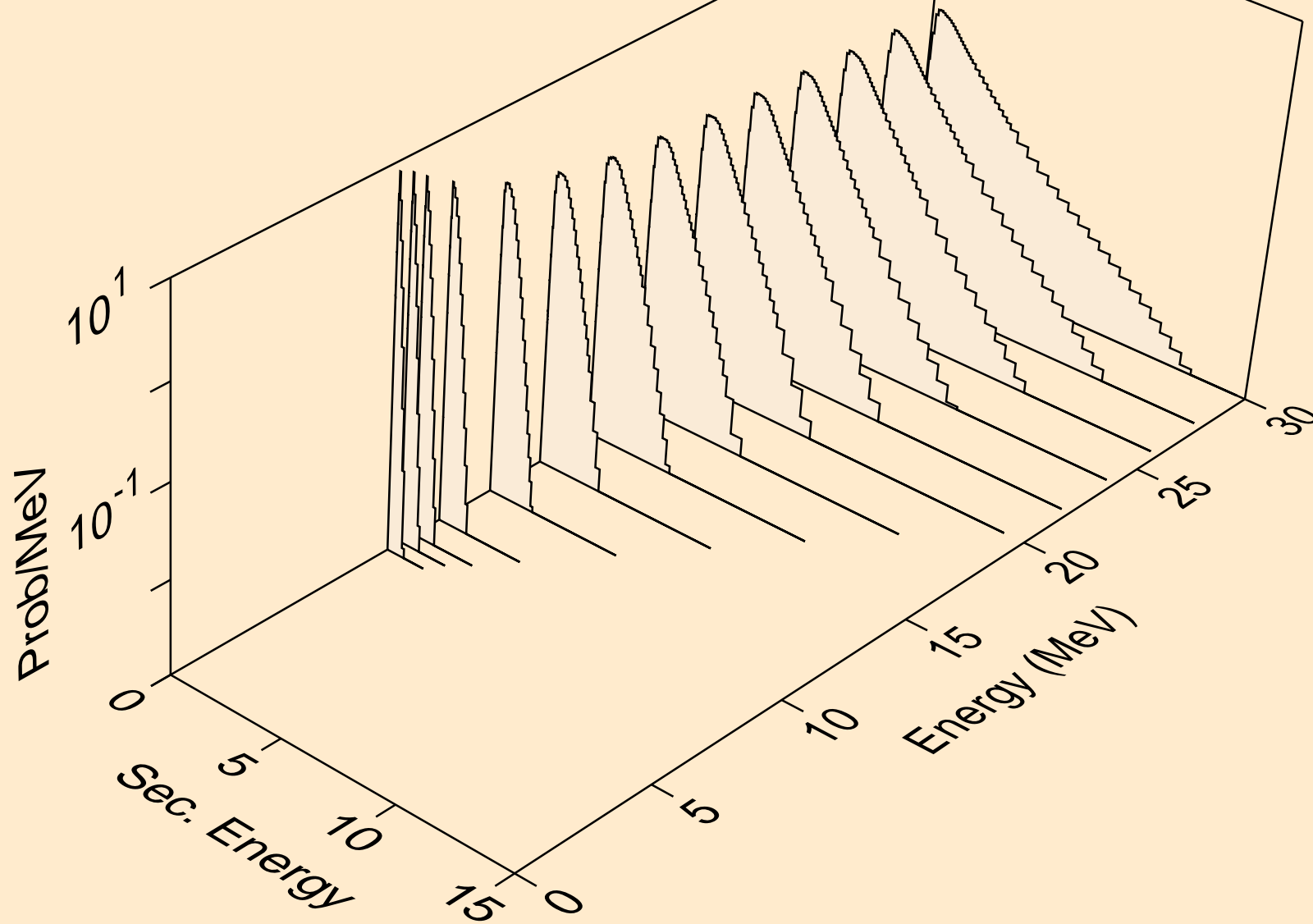

W165 NEUTRON ACER TENDL-2024 LIBRARY; T=0.K
Neutron emission for (n,npa)

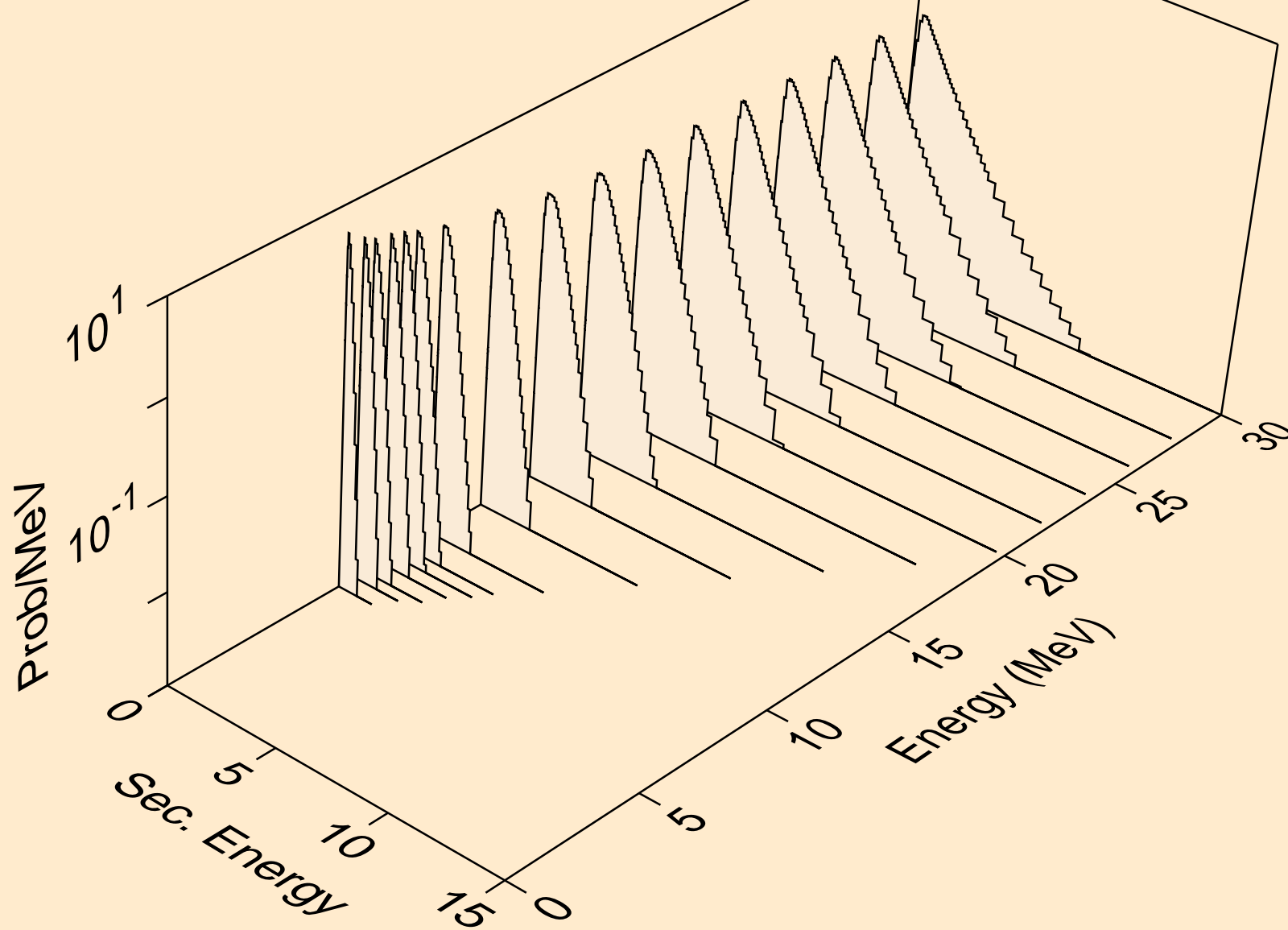

W165 NEUTRON ACER TENDL-2024 LIBRARY; T=0.K
Neutron emission for (n,n*c)

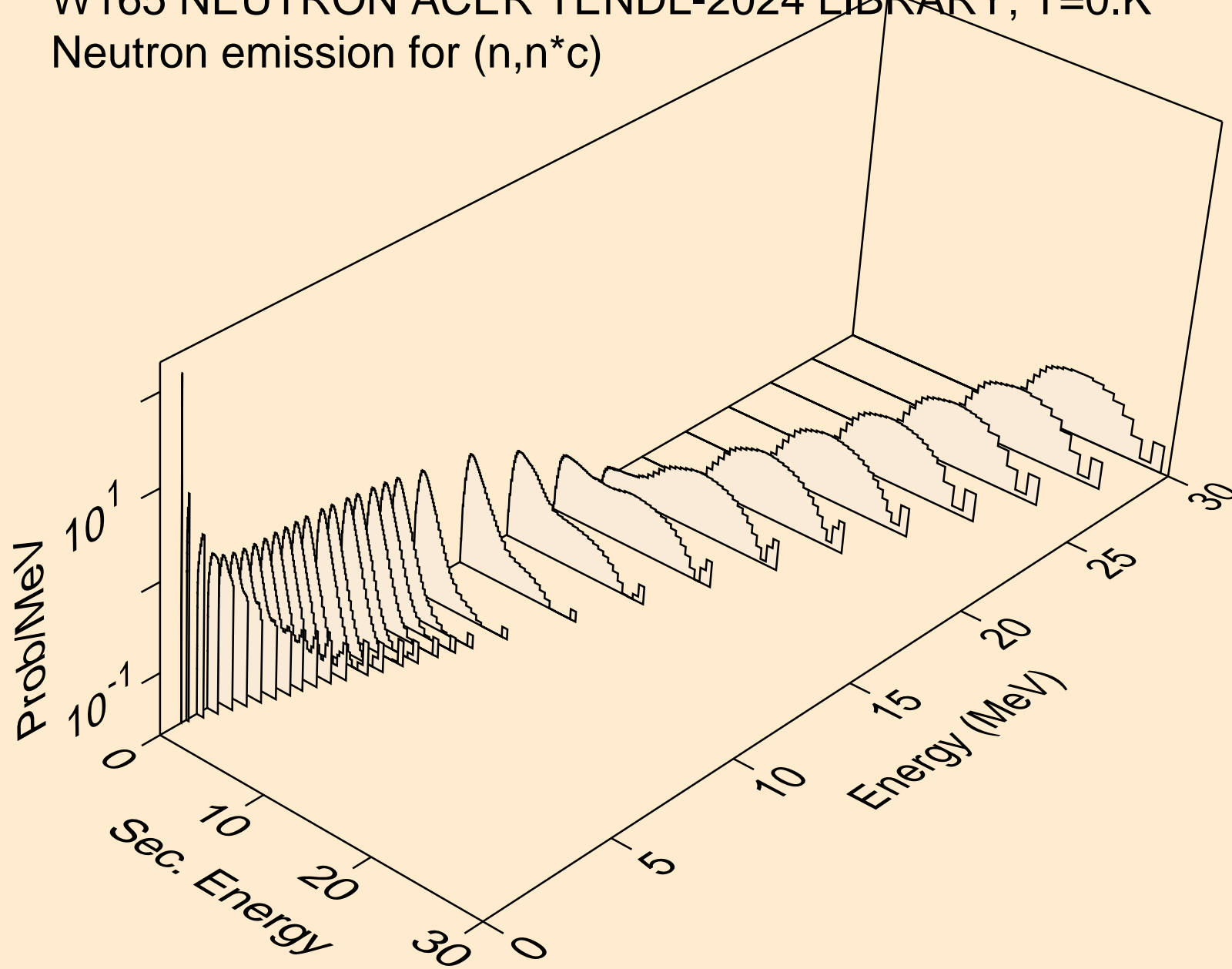

W165 NEUTRON ACER TENDL-2024 LIBRARY; T=0.K
Photon emission for (n,x)

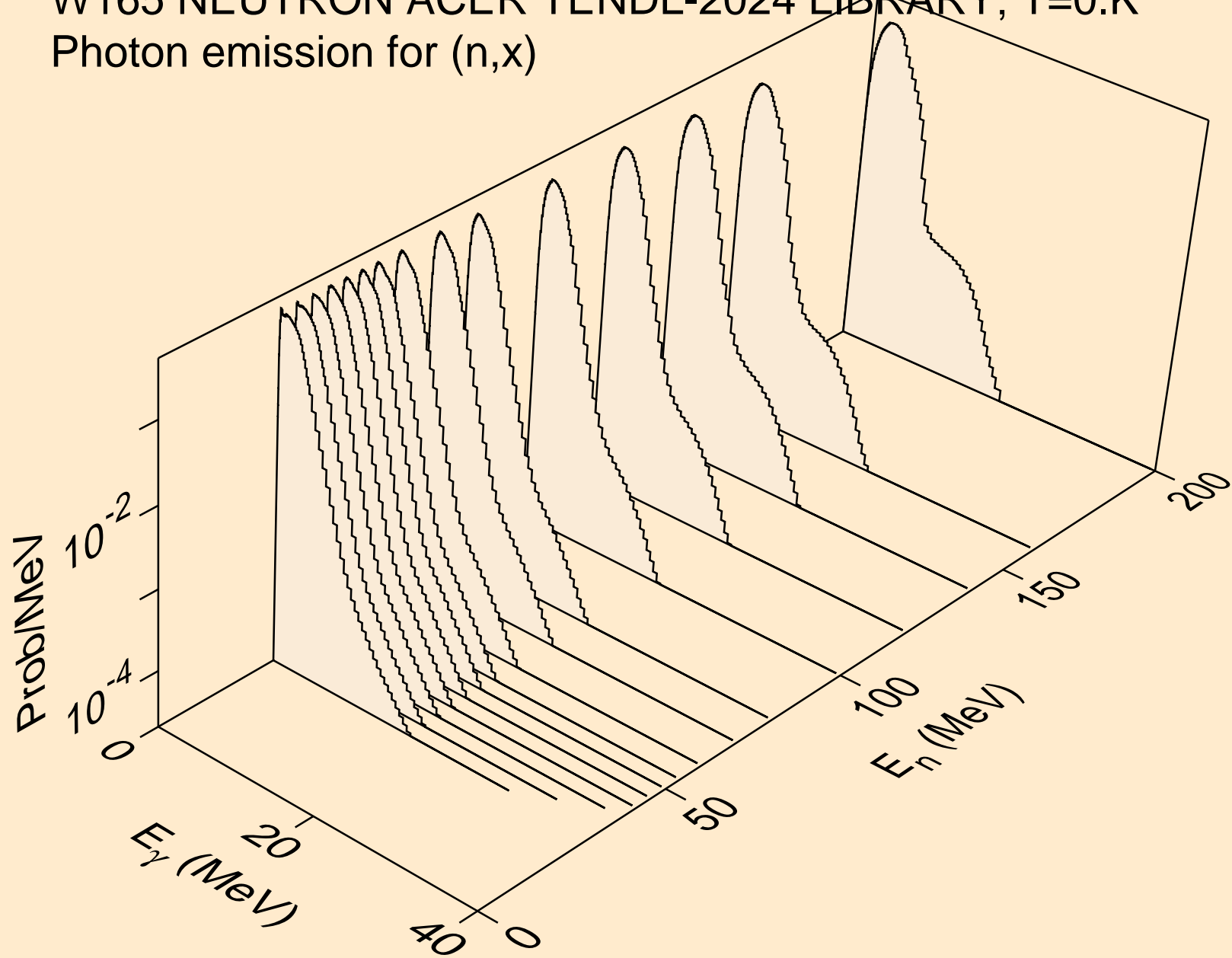

W165 NEUTRON ACER TENDL-2024 LIBRARY; T=0.K
Photon emission for (n,2nd)

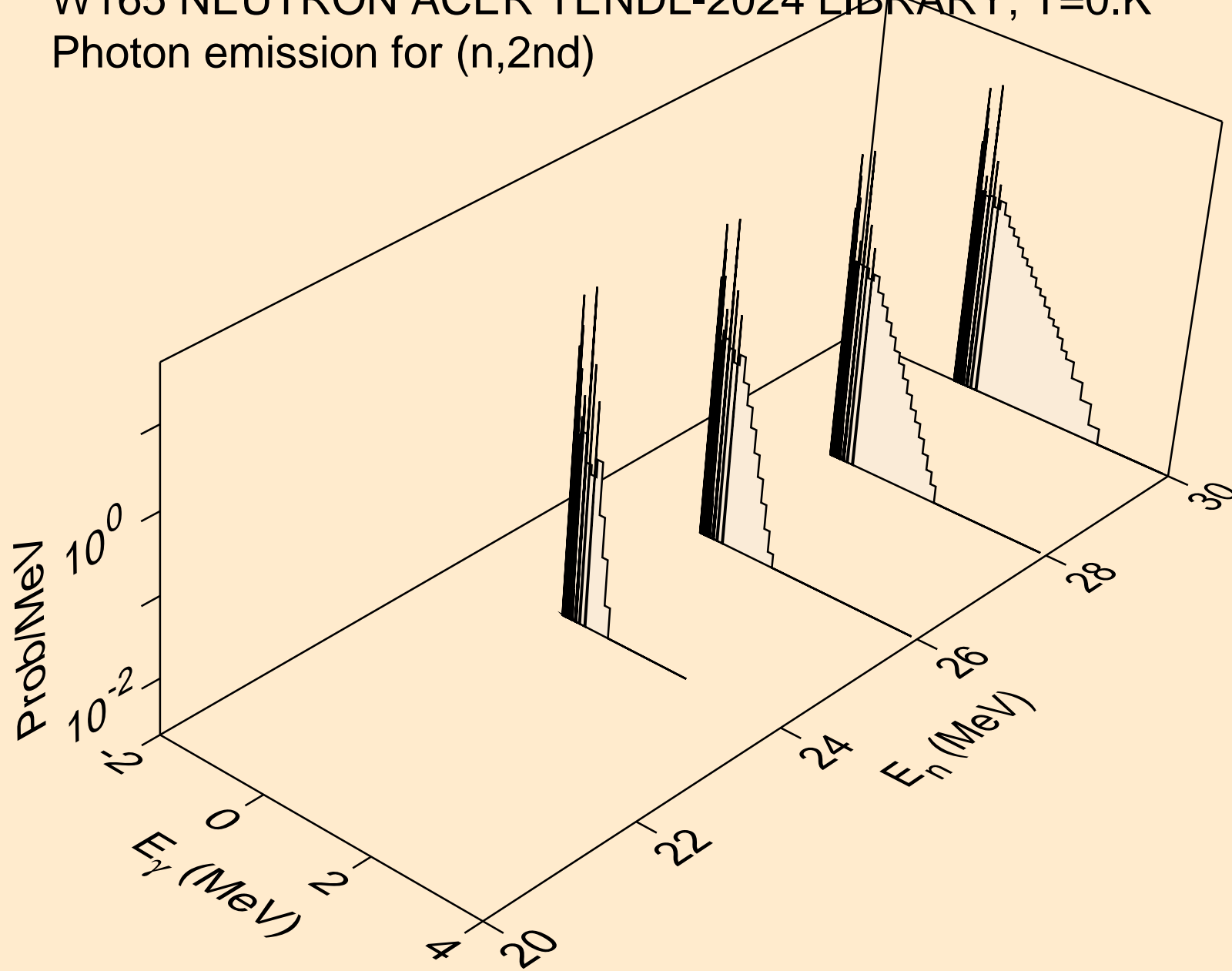

W165 NEUTRON ACER TENDL-2024 LIBRARY; T=0.K
Photon emission for (n,2n)

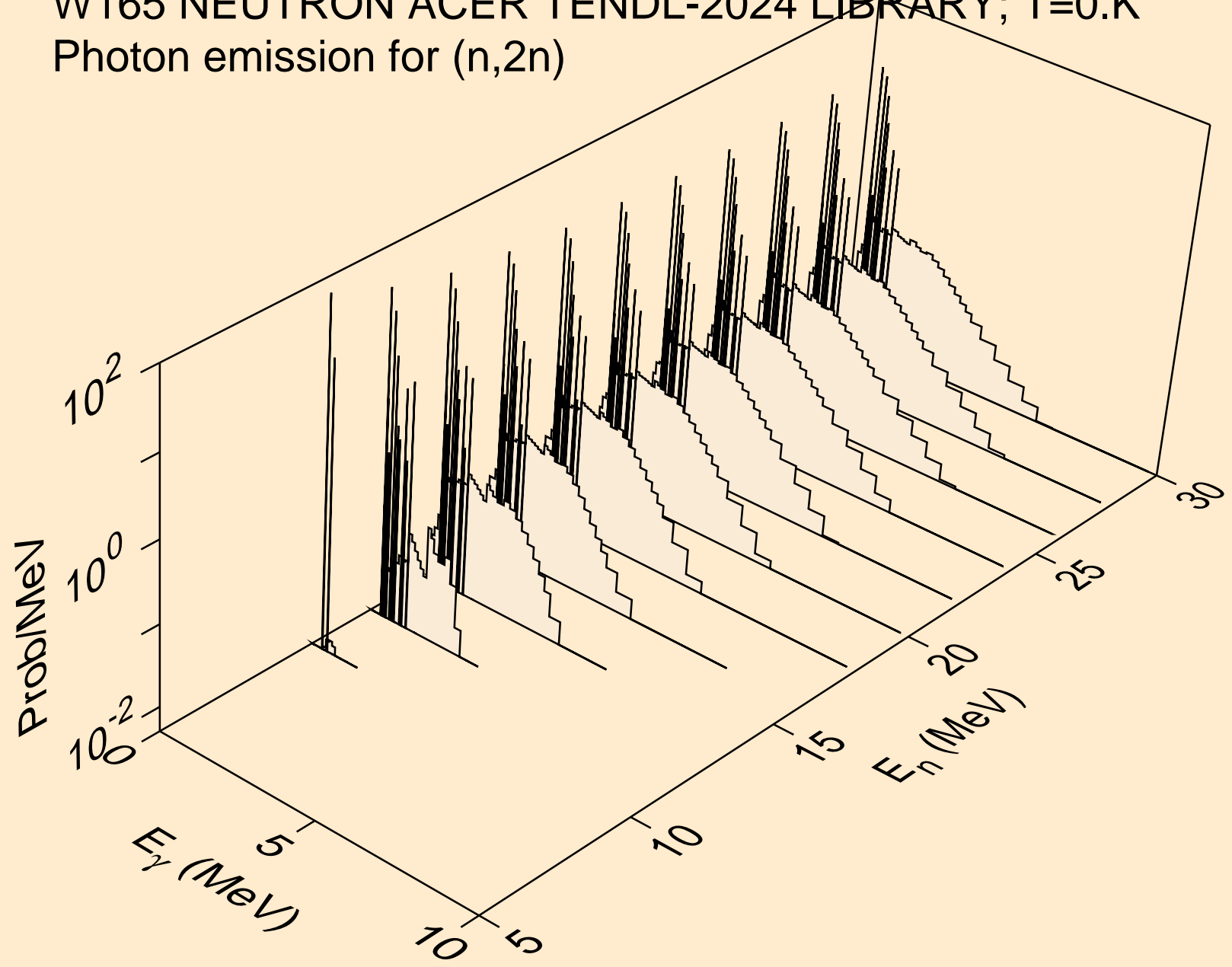

W165 NEUTRON ACER TENDL-2024 LIBRARY; T=0.K
Photon emission for (n,3n)

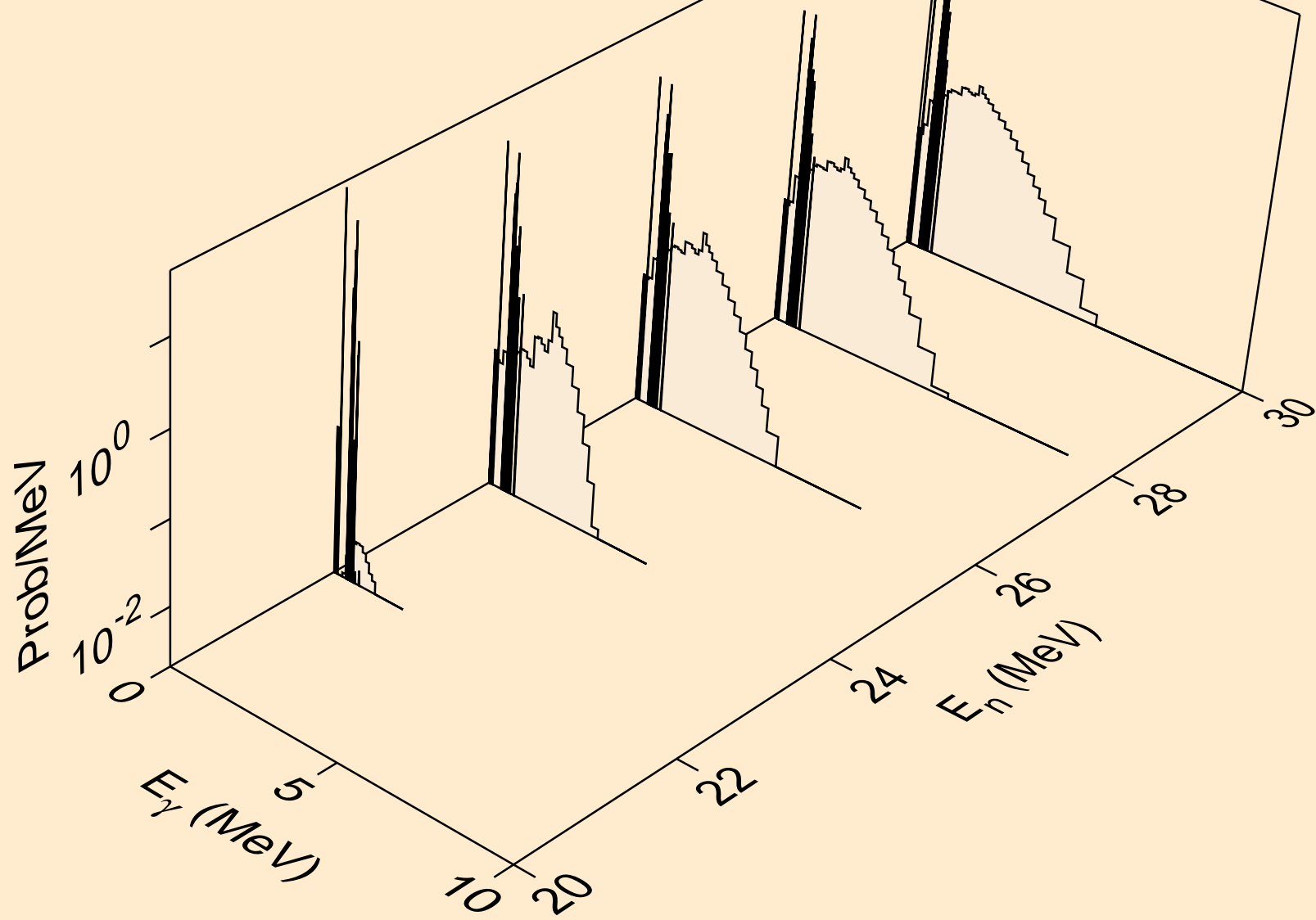

W165 NEUTRON ACER TENDL-2024 LIBRARY; T=0.K
Photon emission for (n,n*)a

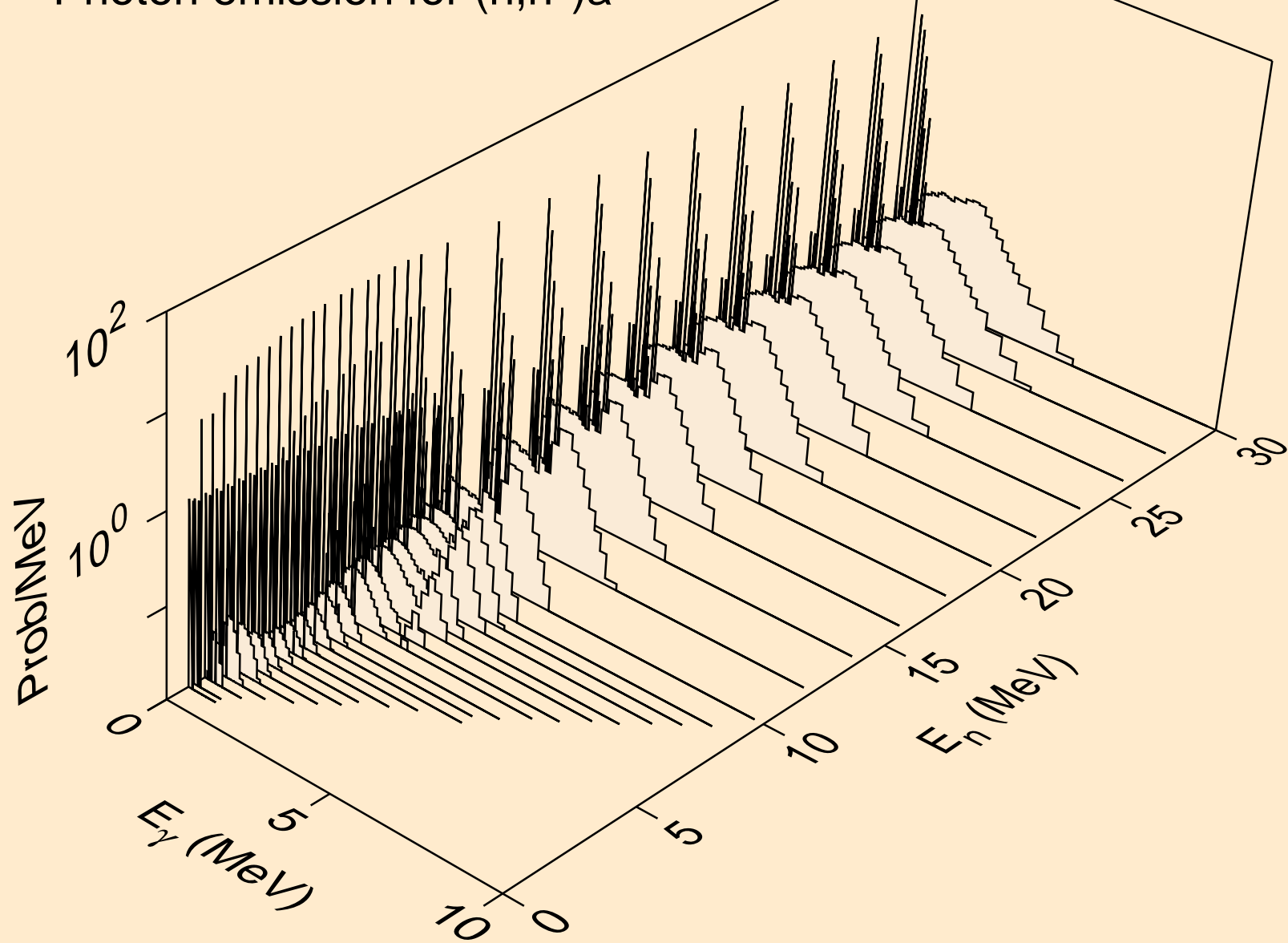

W165 NEUTRON ACER TENDL-2024 LIBRARY; T=0.K
Photon emission for (n,n*)3a

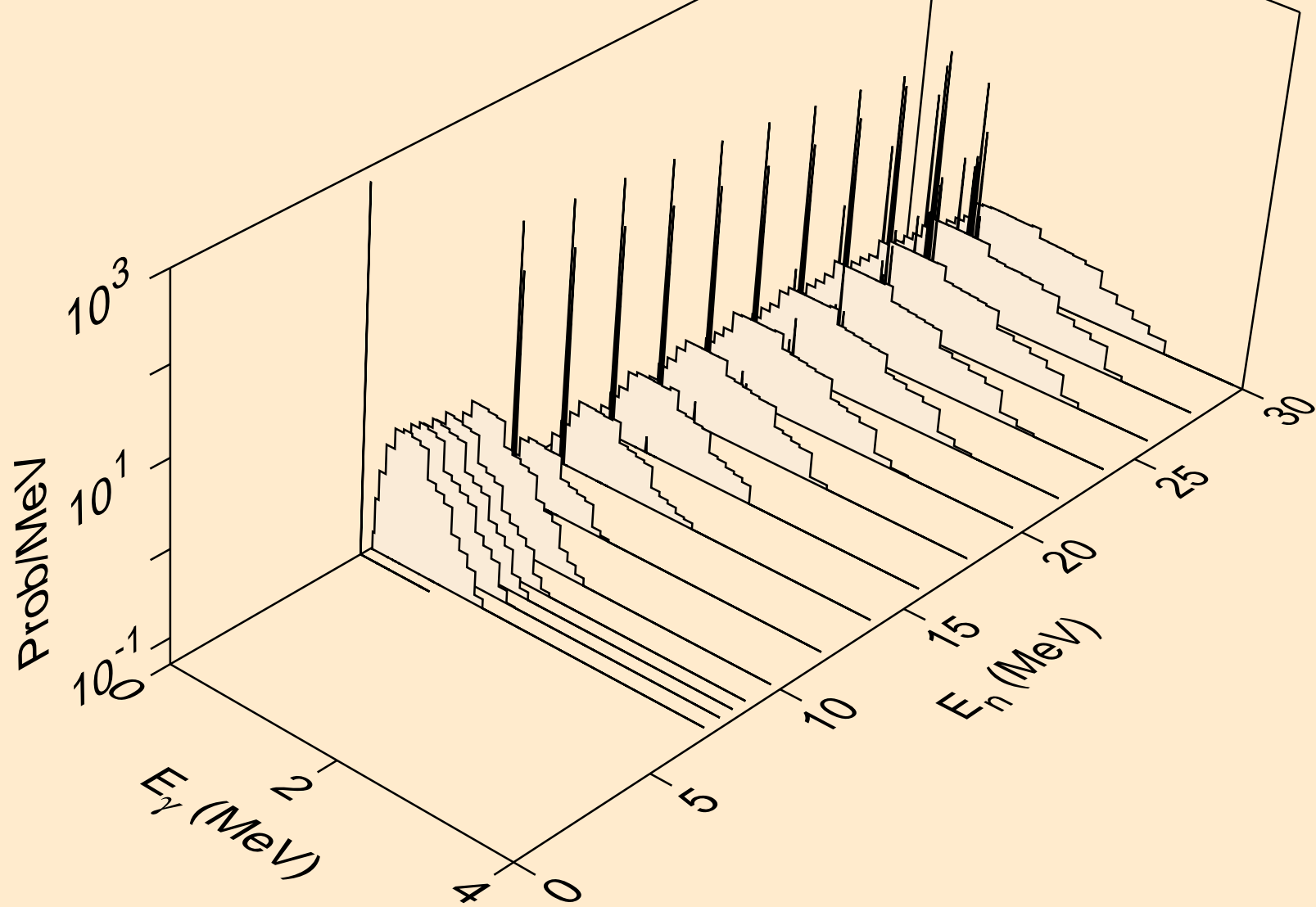

W165 NEUTRON ACER TENDL-2024 LIBRARY; T=0.K
Photon emission for (n,2n)a

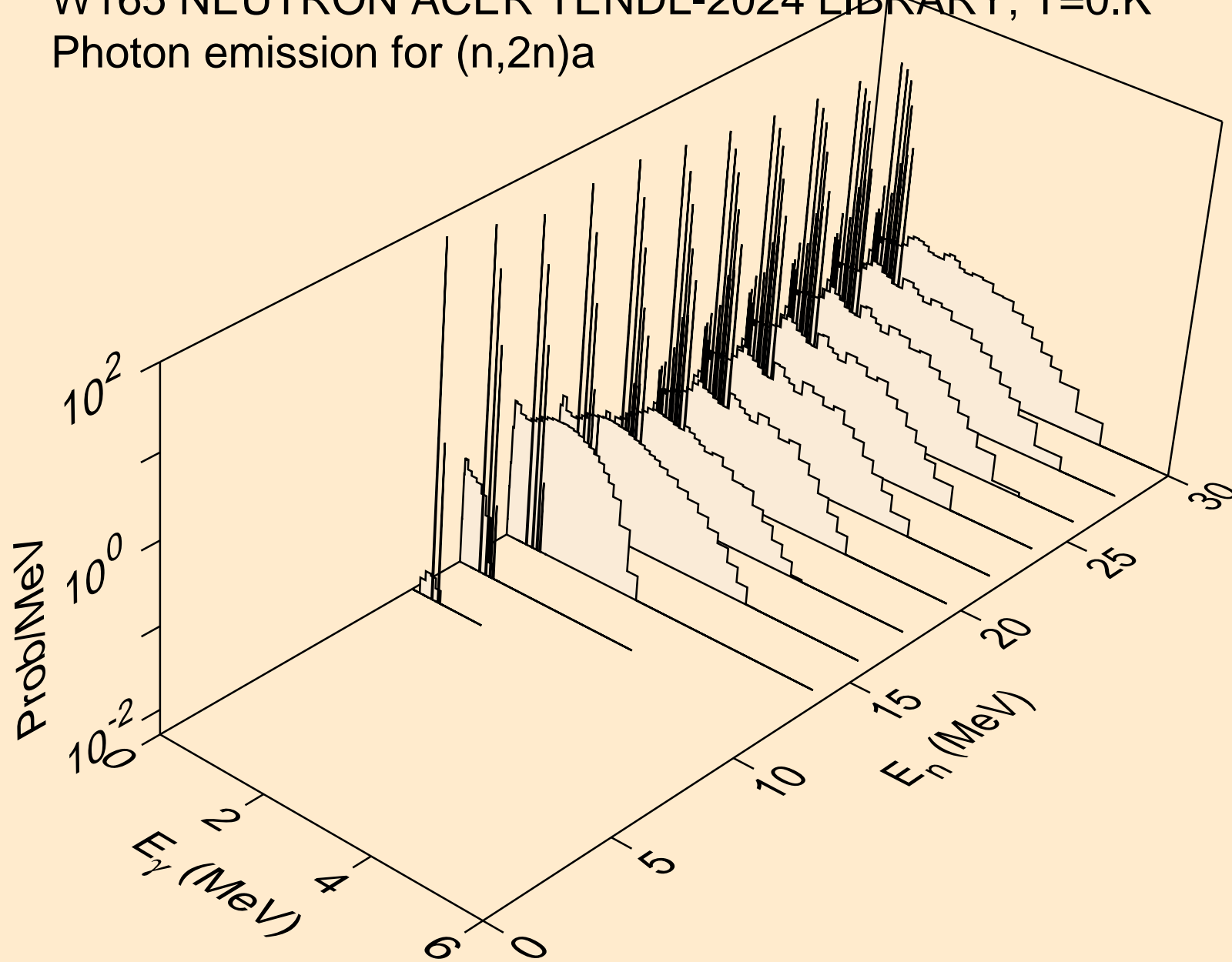

W165 NEUTRON ACER TENDL-2024 LIBRARY; T=0.K
Photon emission for (n,3n)a

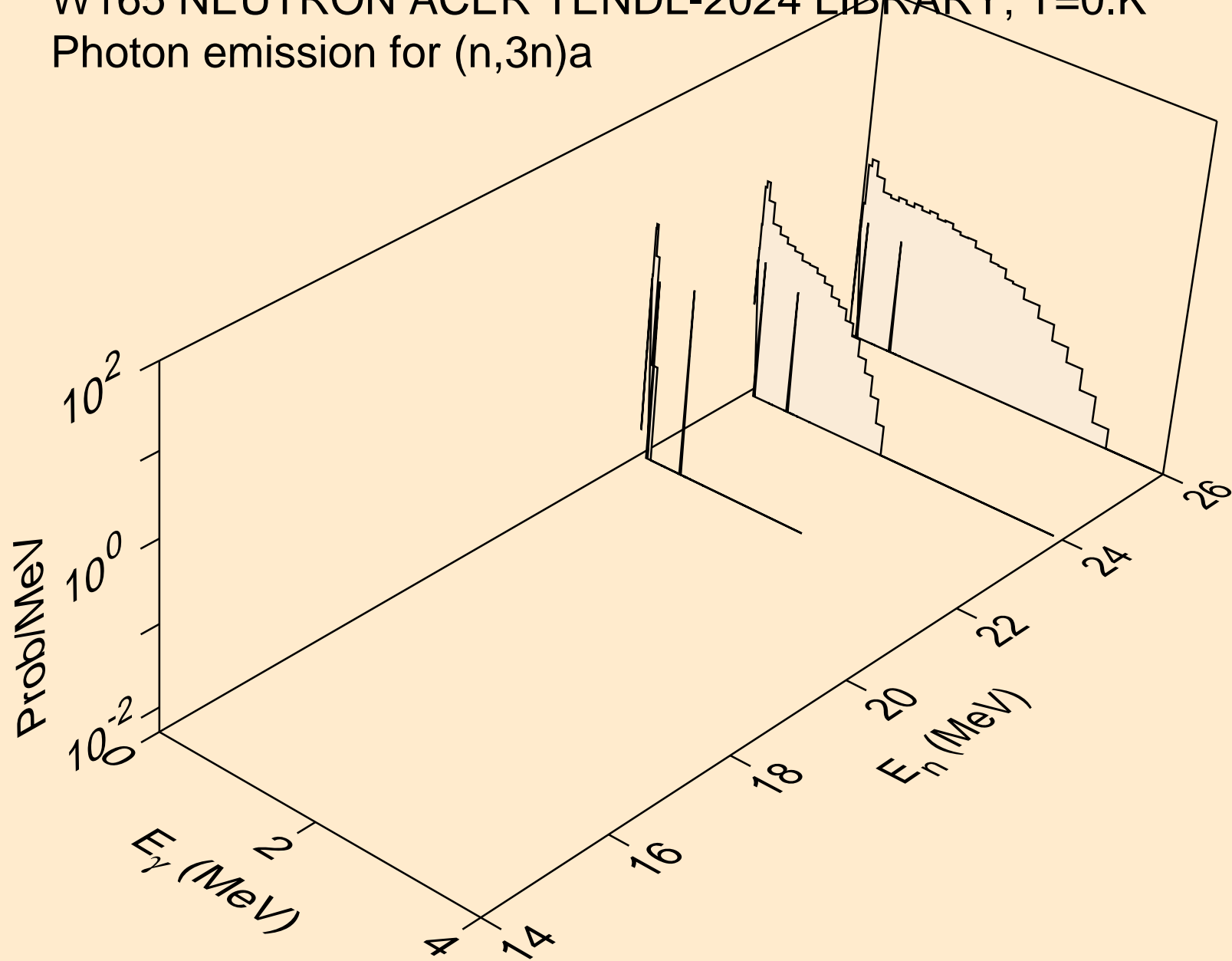

W165 NEUTRON ACER TENDL-2024 LIBRARY; T=0.K
Photon emission for (n,n*)p

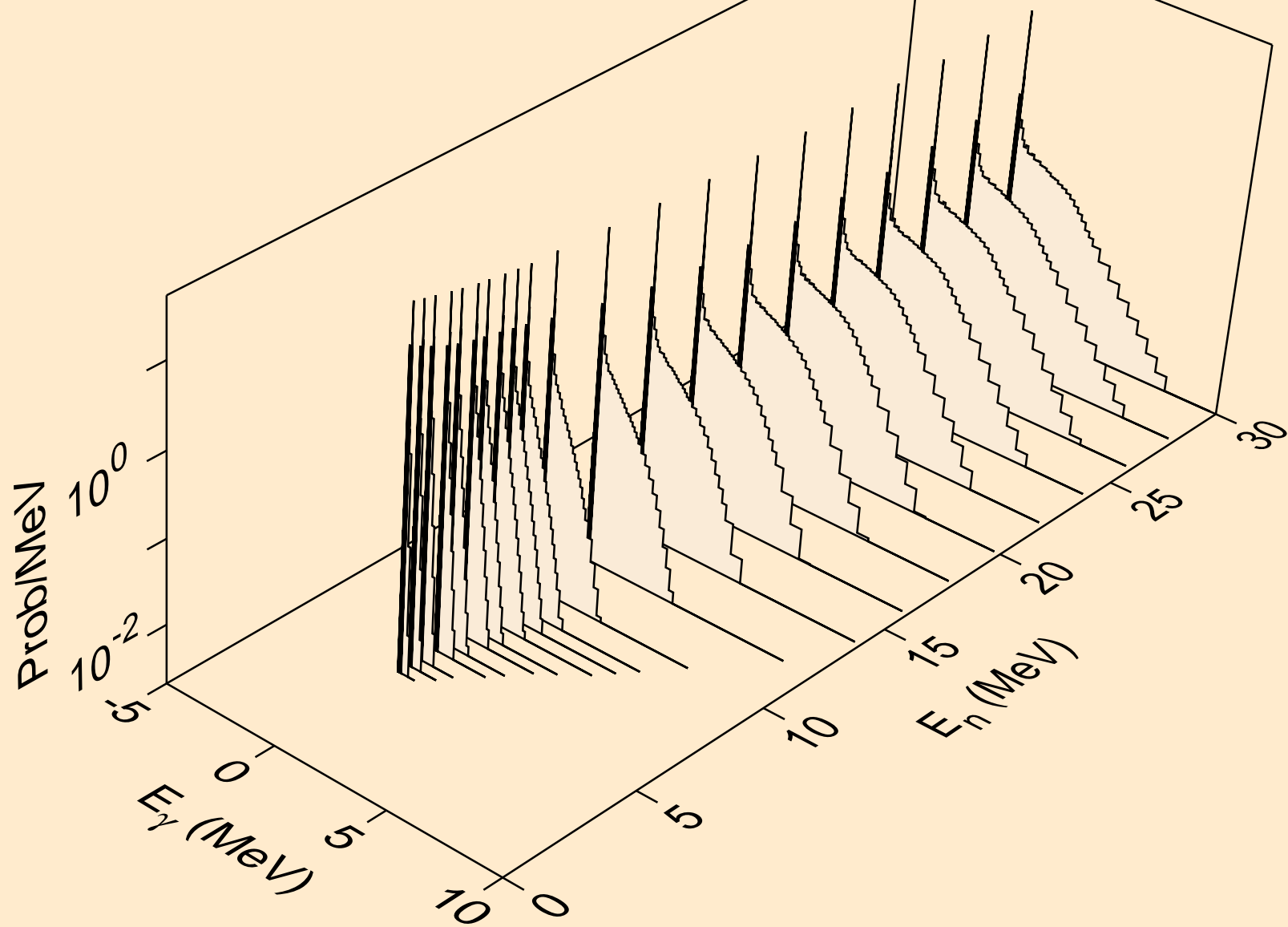

W165 NEUTRON ACER TENDL-2024 LIBRARY; T=0.K
Photon emission for (n,n*)2a

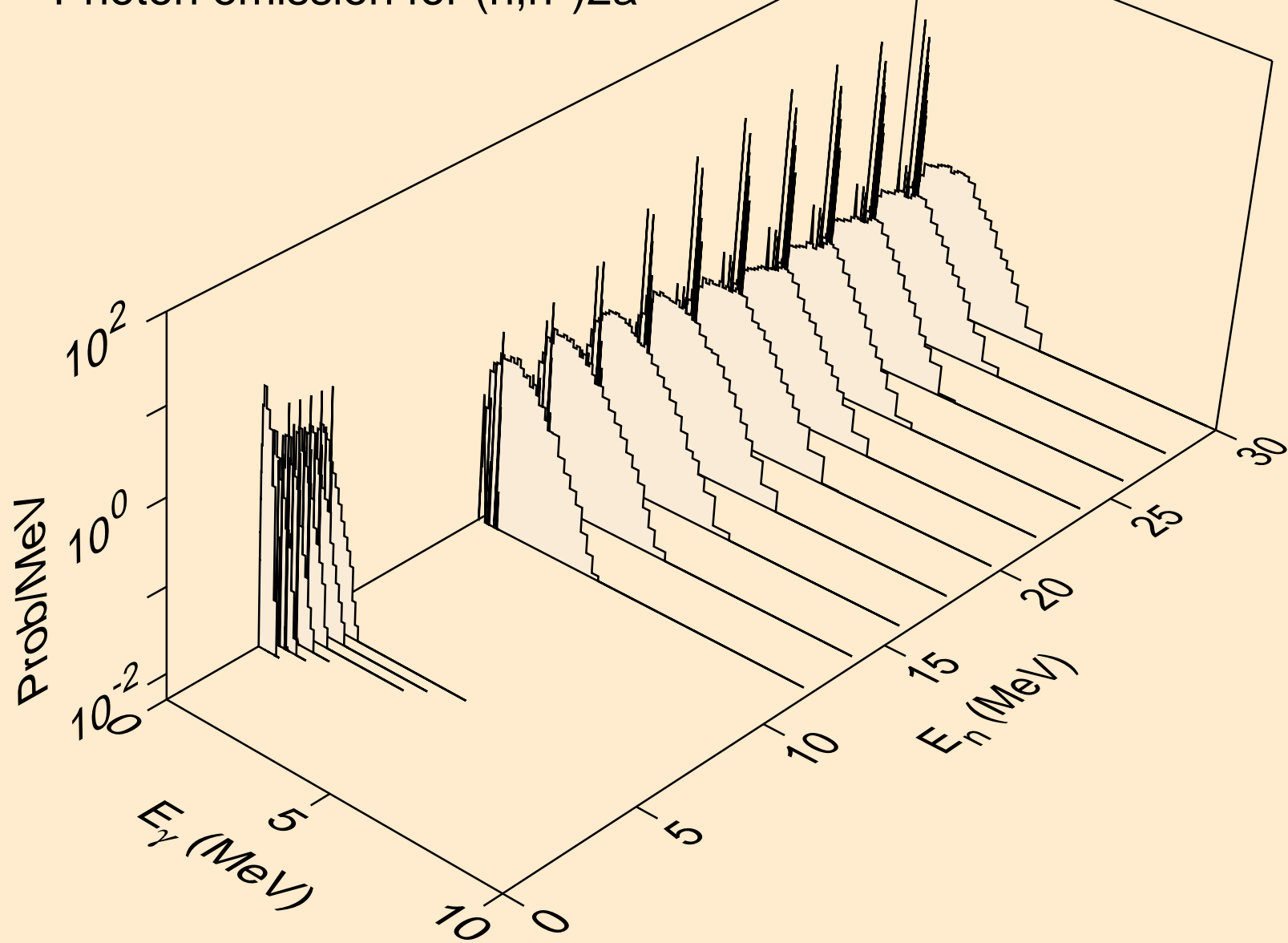

W165 NEUTRON ACER TENDL-2024 LIBRARY; T=0.K
Photon emission for (n,2n)2a

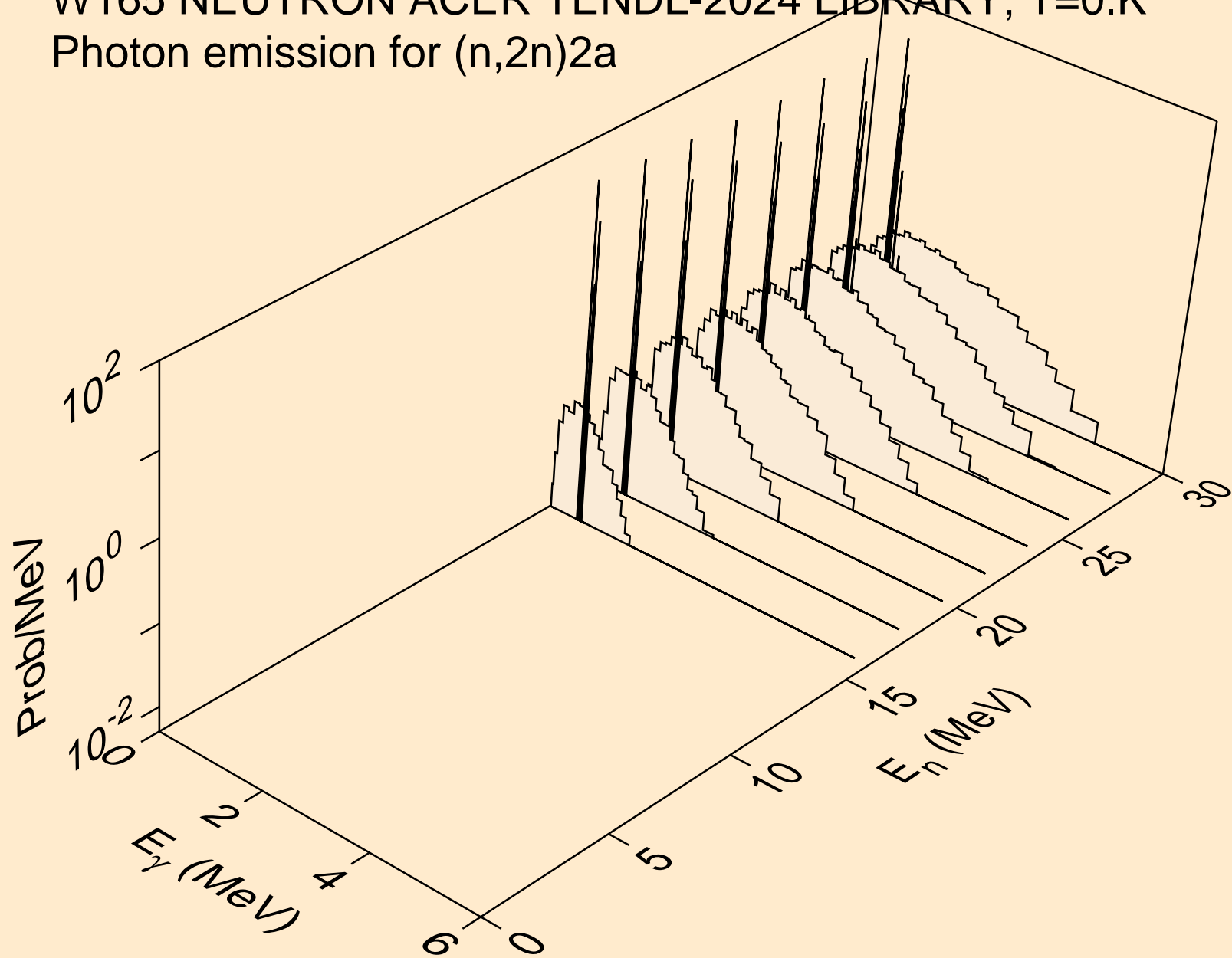

W165 NEUTRON ACER TENDL-2024 LIBRARY; T=0.K
Photon emission for (n,n*)d

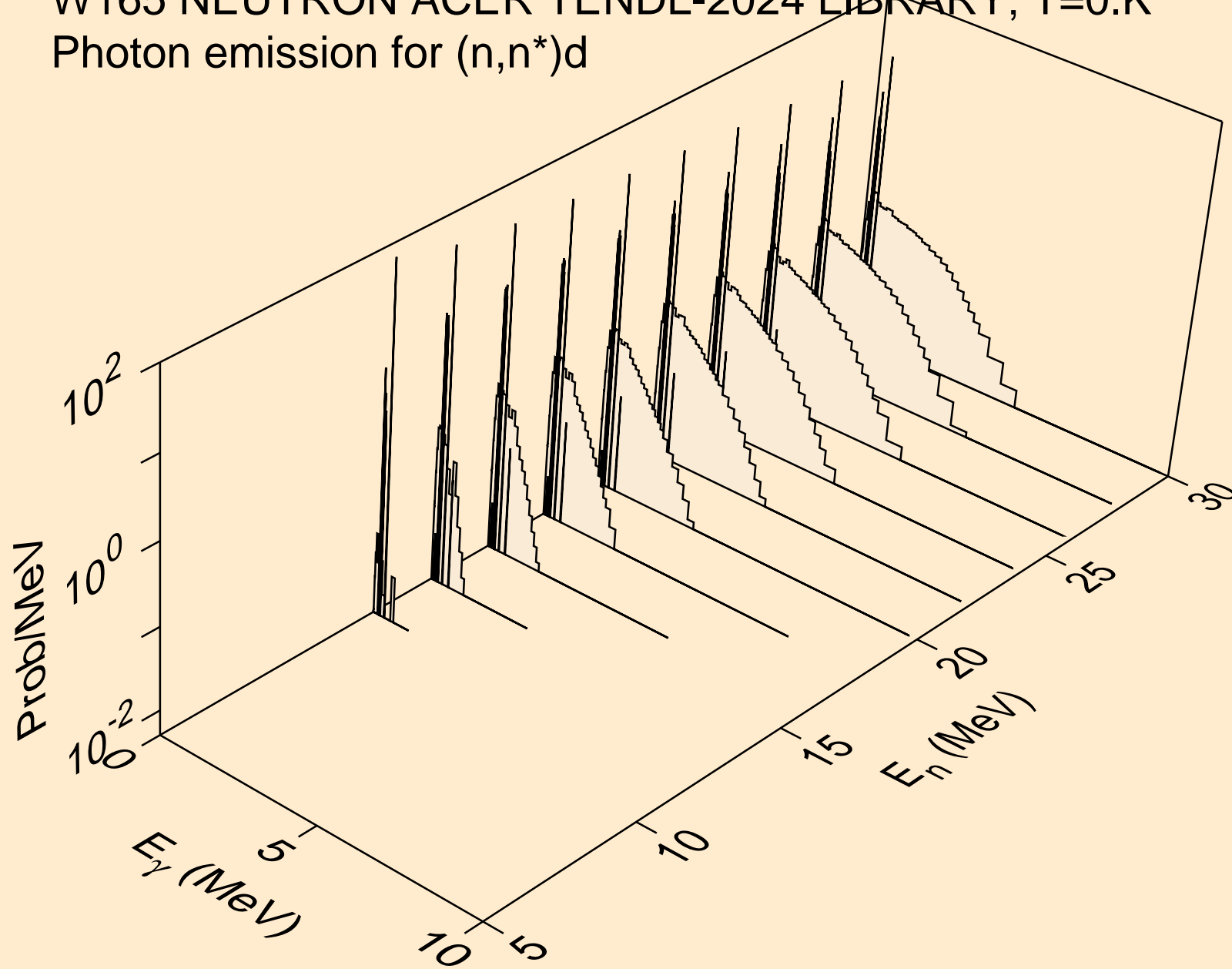

W165 NEUTRON ACER TENDL-2024 LIBRARY; T=0.K
Photon emission for (n,n*)t

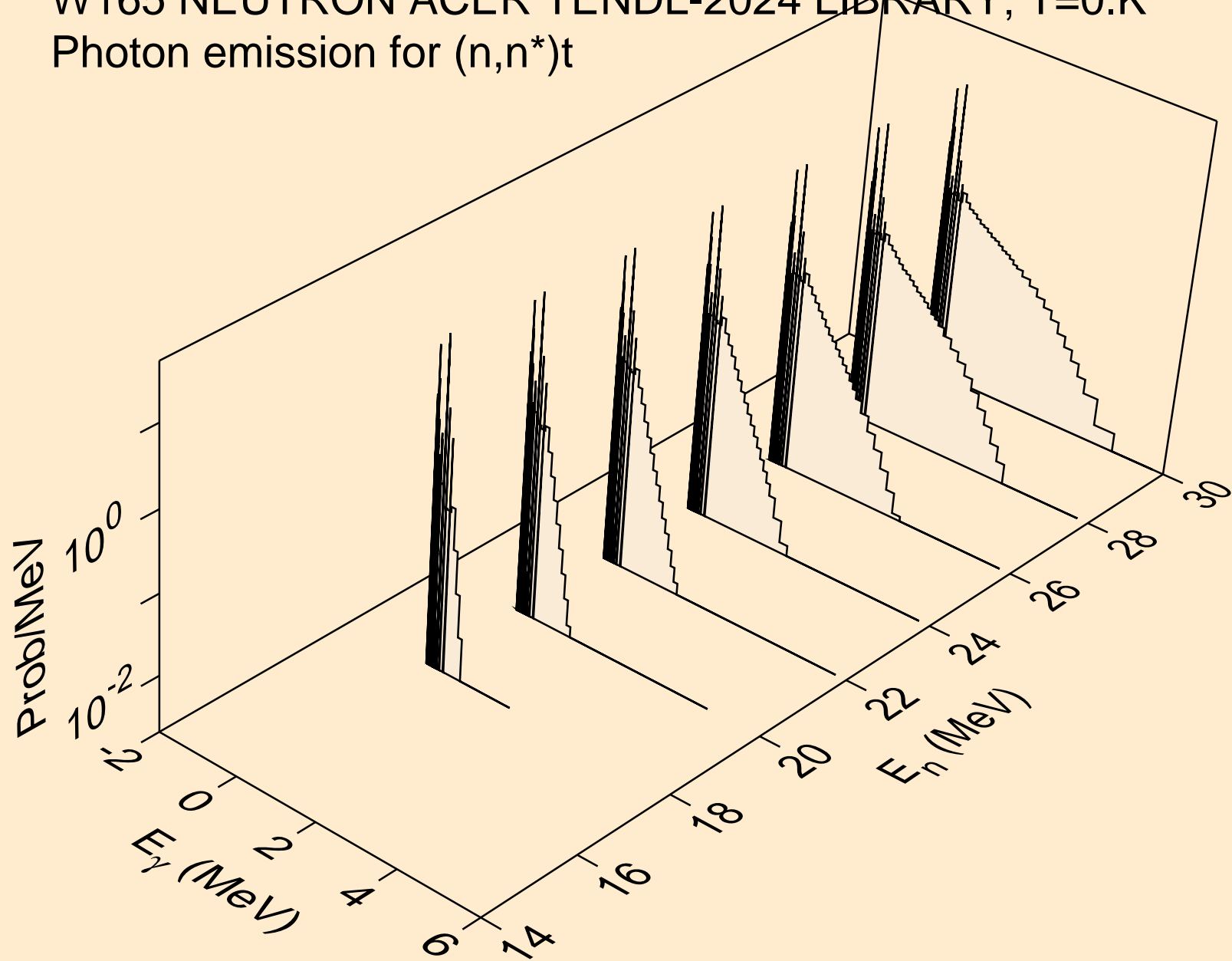

W165 NEUTRON ACER TENDL-2024 LIBRARY; T=0.K
Photon emission for (n,n*)he3

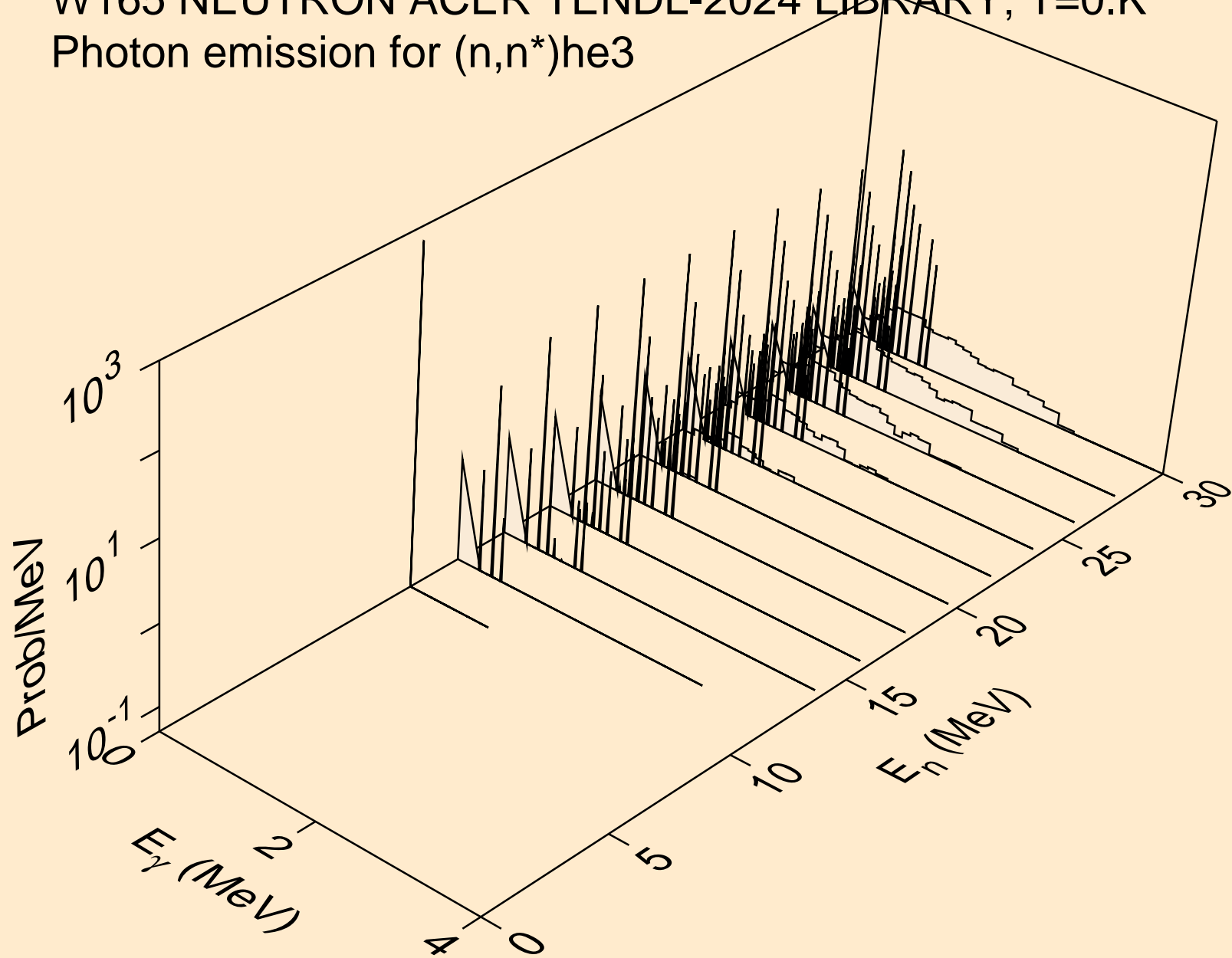

W165 NEUTRON ACER TENDL-2024 LIBRARY; T=0.K
Photon emission for (n,2np)

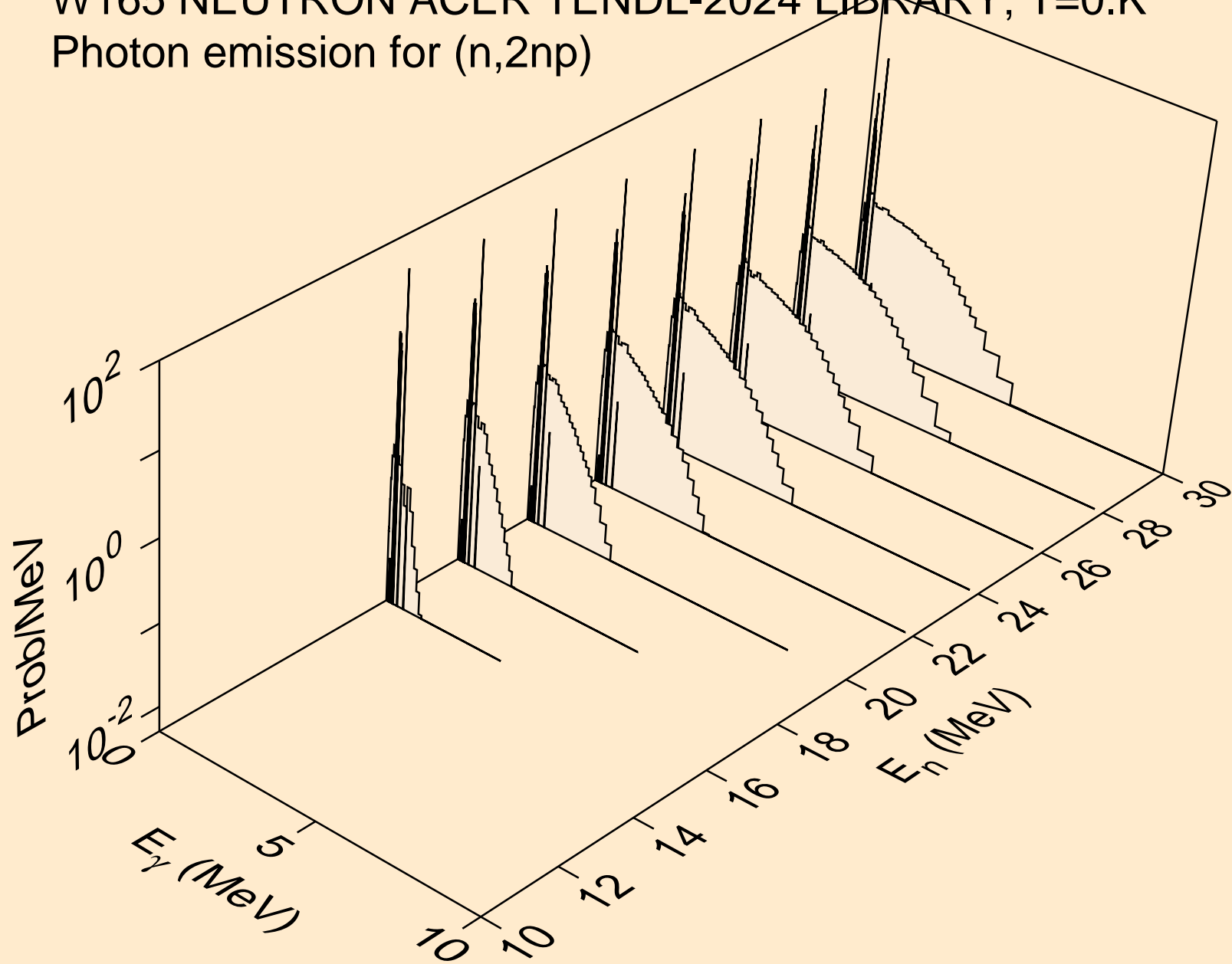

W165 NEUTRON ACER TENDL-2024 LIBRARY; T=0.K
Photon emission for (n,3np)

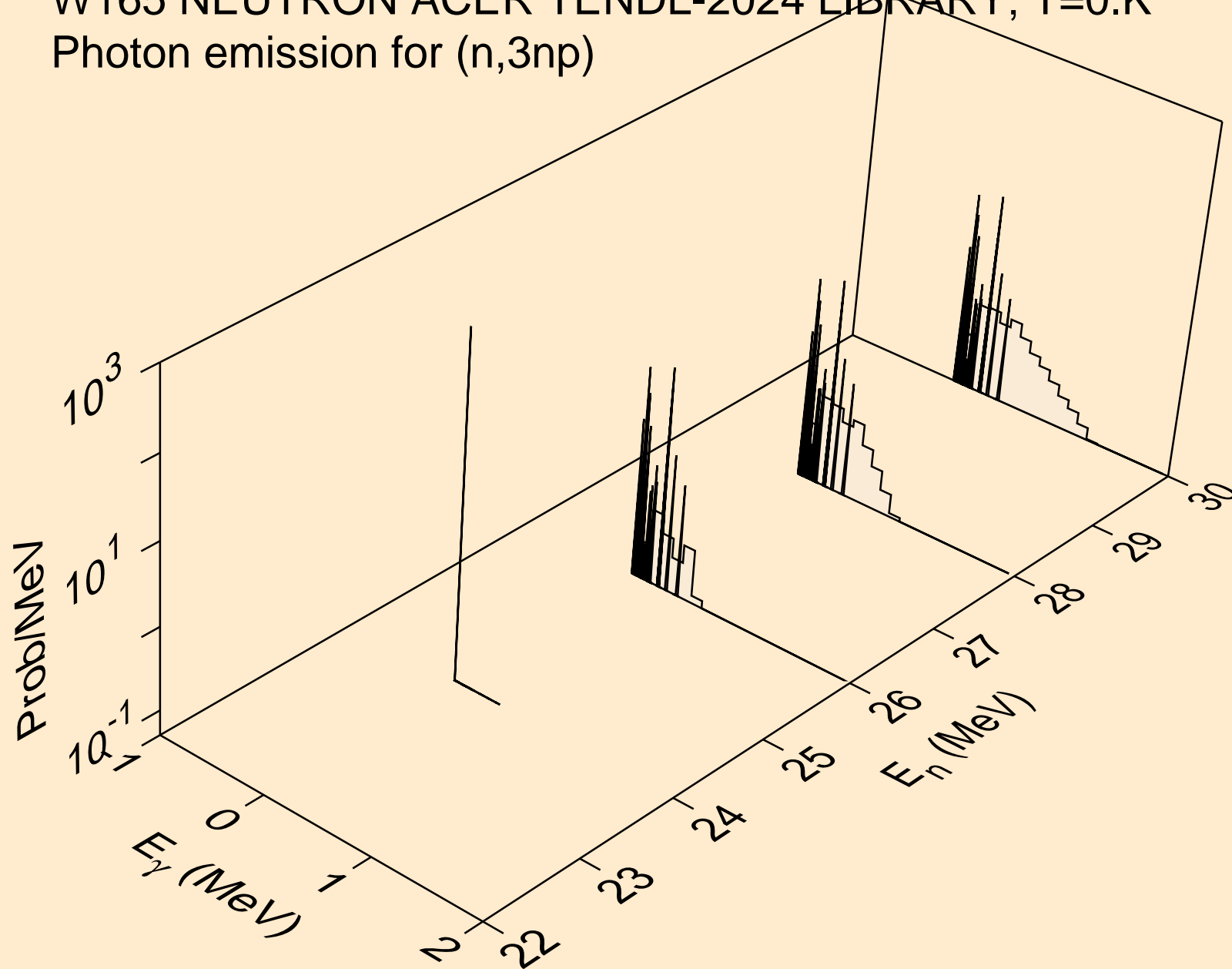

W165 NEUTRON ACER TENDL-2024 LIBRARY; T=0.K
Photon emission for (n,n2p)

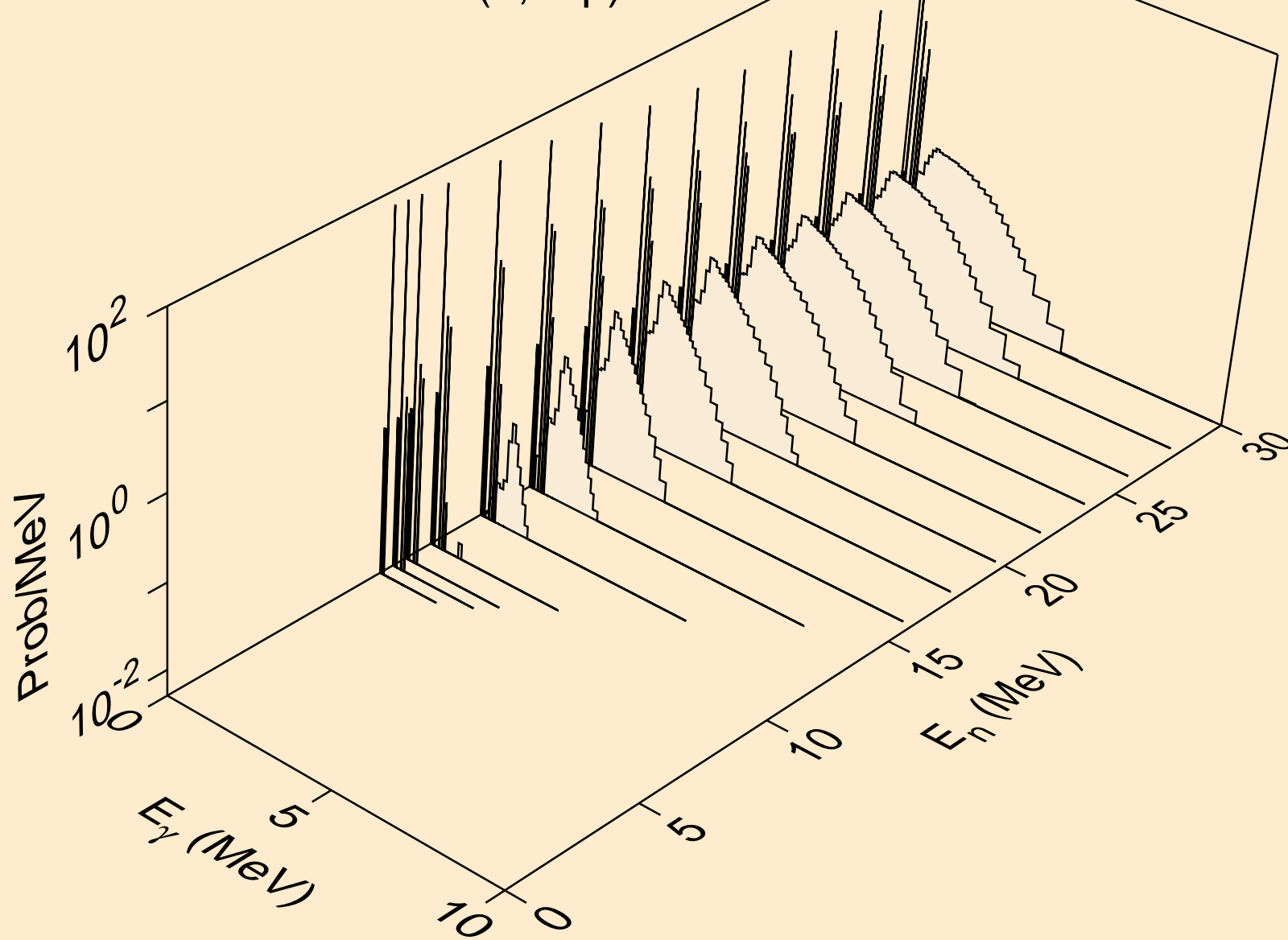

W165 NEUTRON ACER TENDL-2024 LIBRARY; T=0.K
Photon emission for (n,npa)

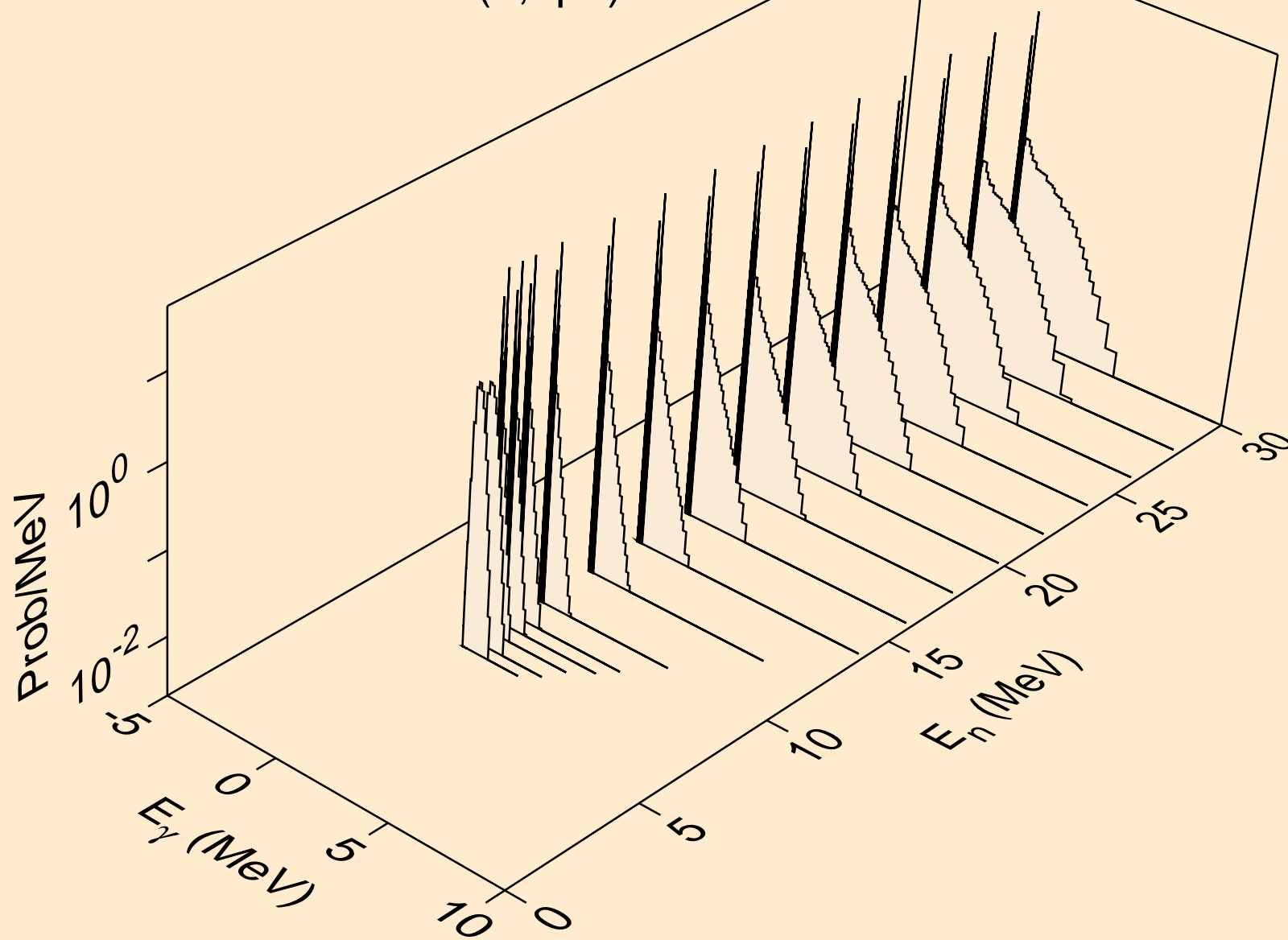

W165 NEUTRON ACER TENDL-2024 LIBRARY; T=0.K
Photon emission for (n,n*c)

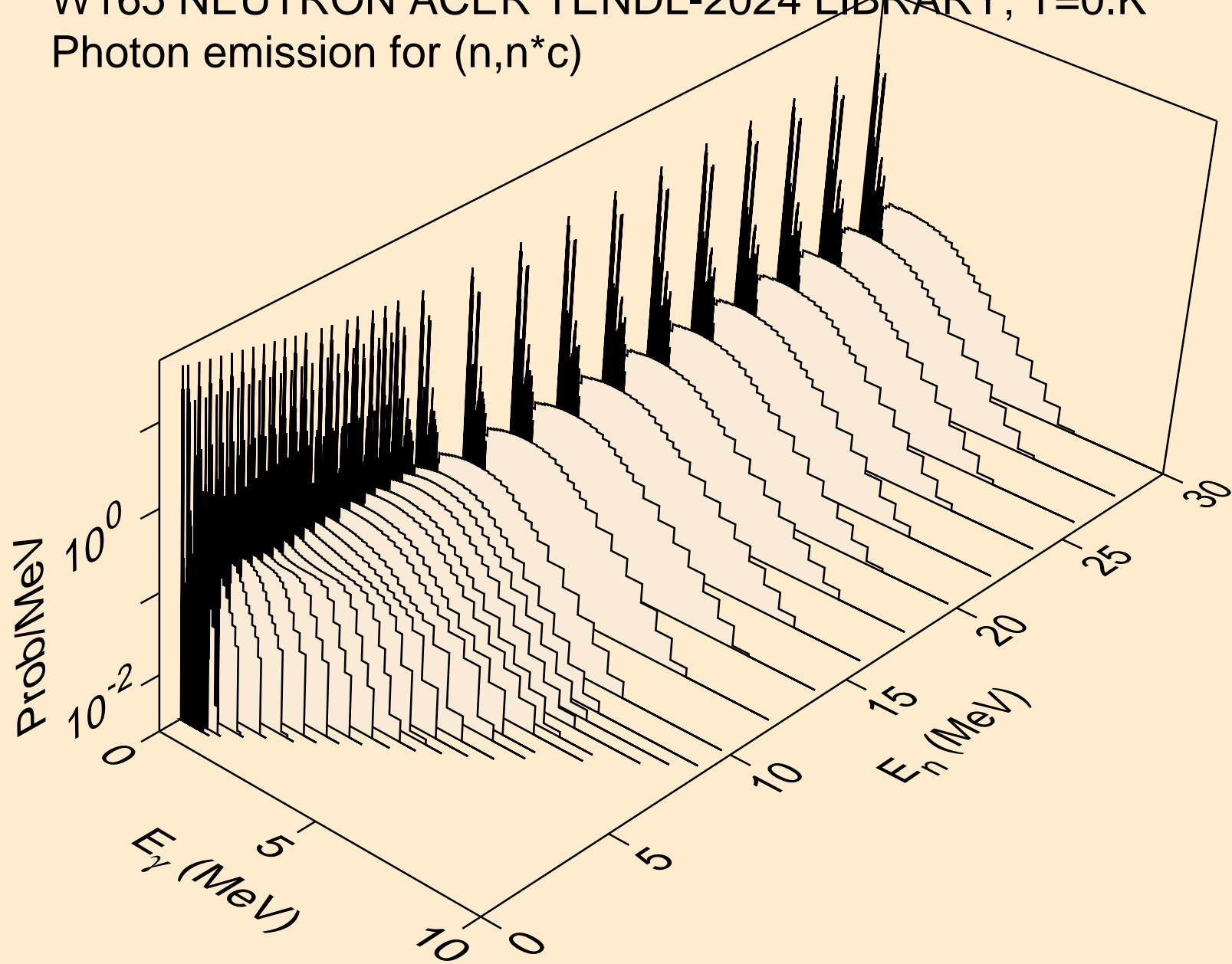

W165 NEUTRON ACER TENDL-2024 LIBRARY; T=0.K
Photon emission for (n,gma)

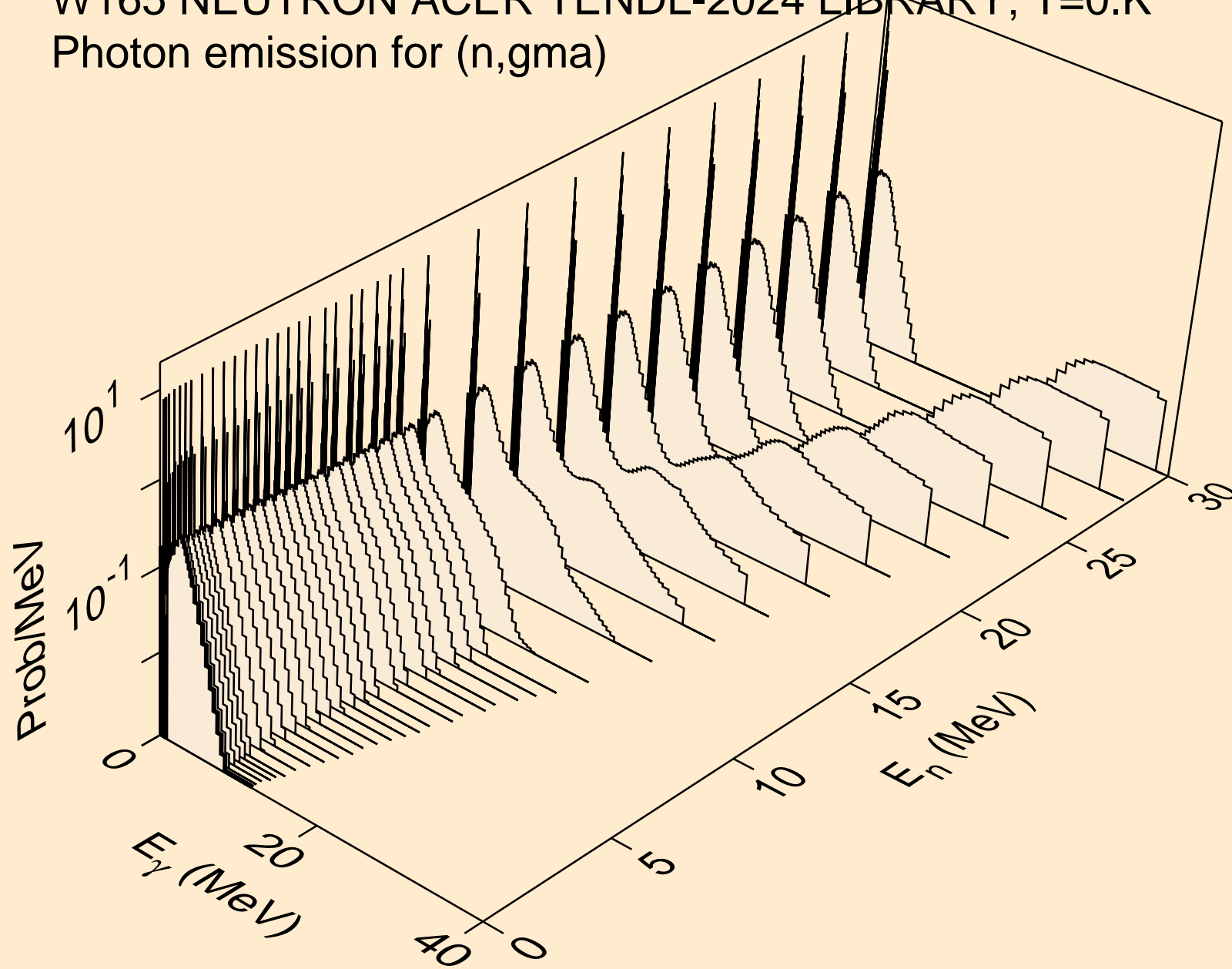

W165 NEUTRON ACER TENDL-2024 LIBRARY; T=0.K
Photon emission for (n,p)

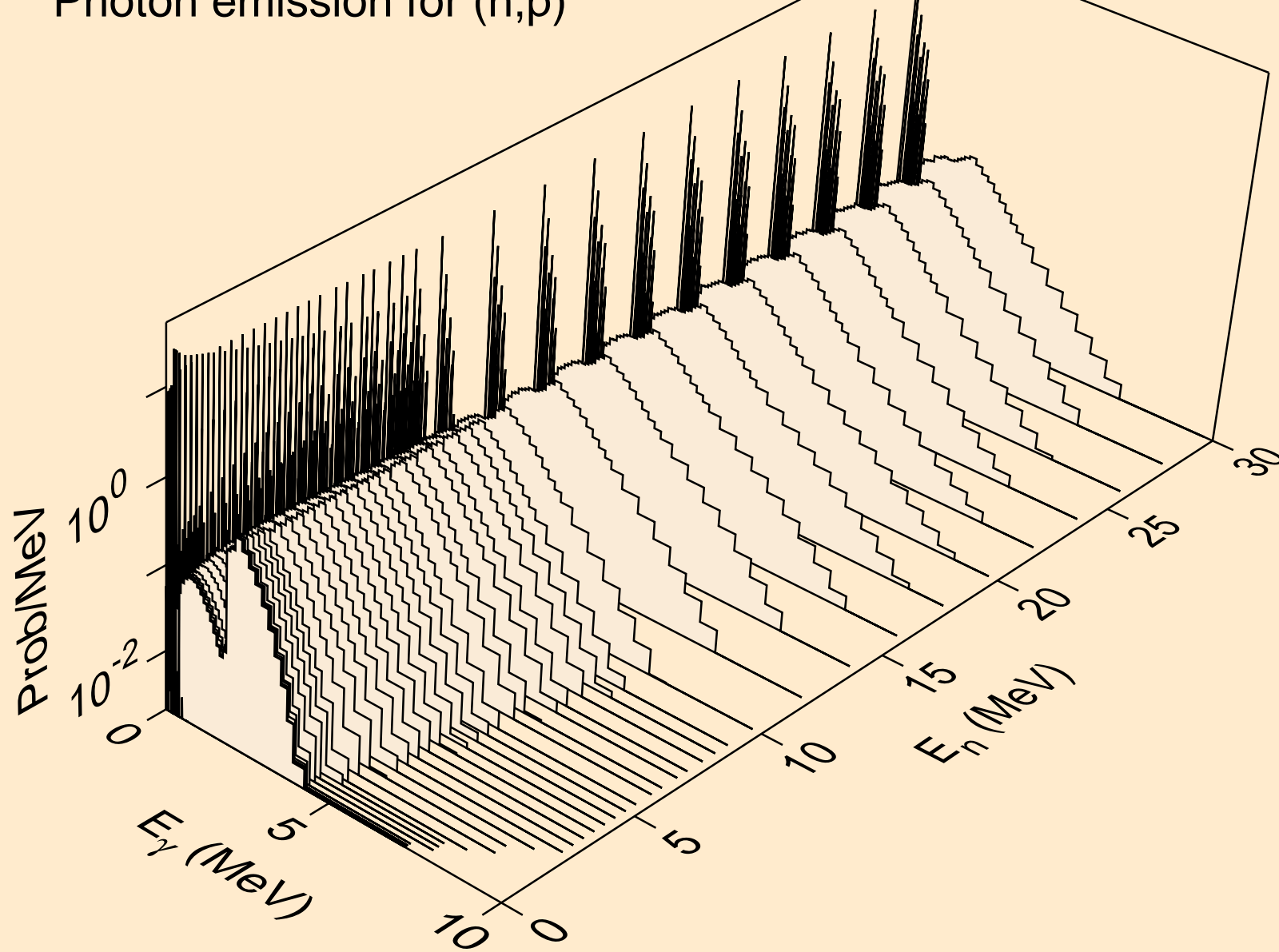

W165 NEUTRON ACER TENDL-2024 LIBRARY; T=0.K
Photon emission for (n,d)

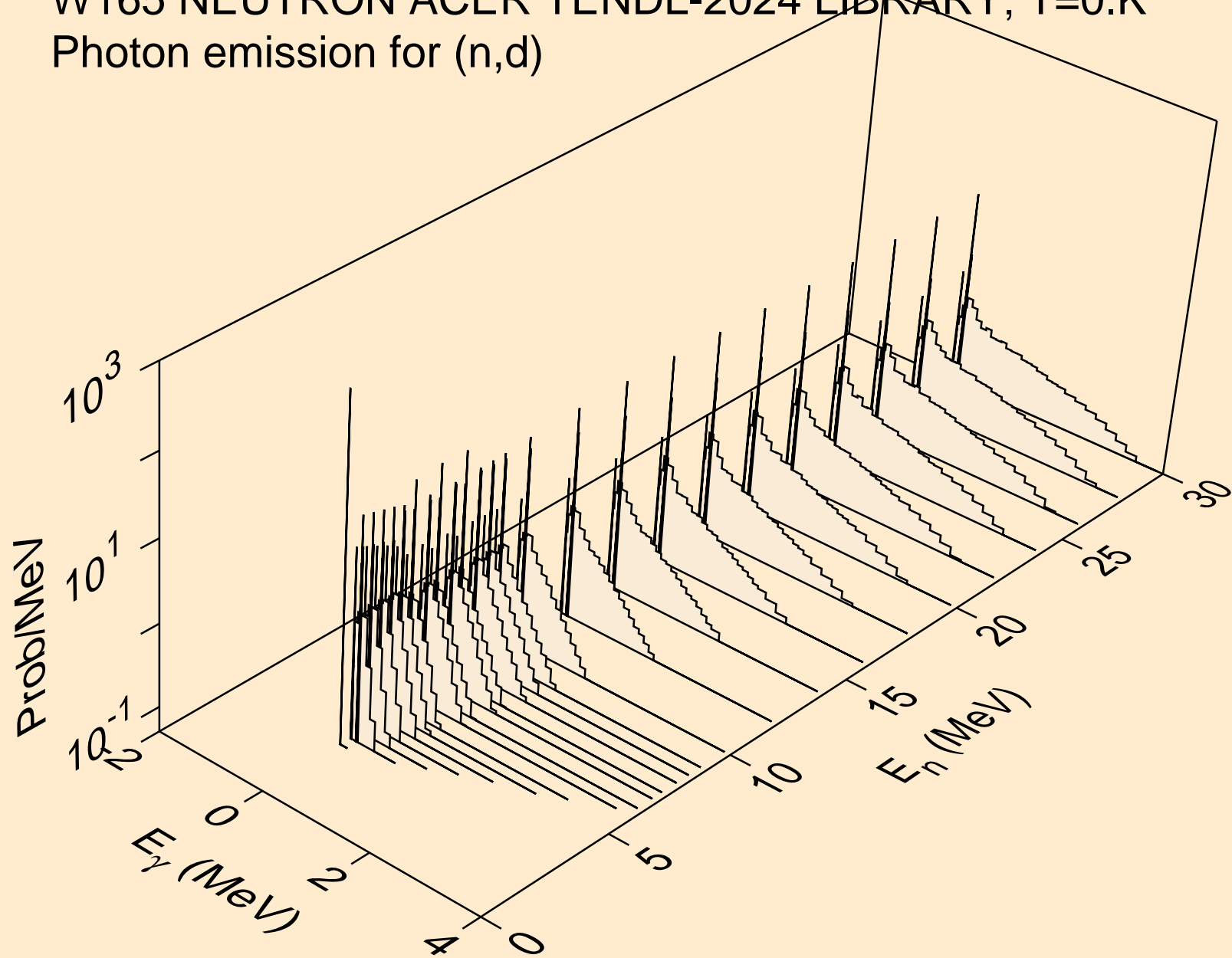

W165 NEUTRON ACER TENDL-2024 LIBRARY; T=0.K
Photon emission for (n,t)

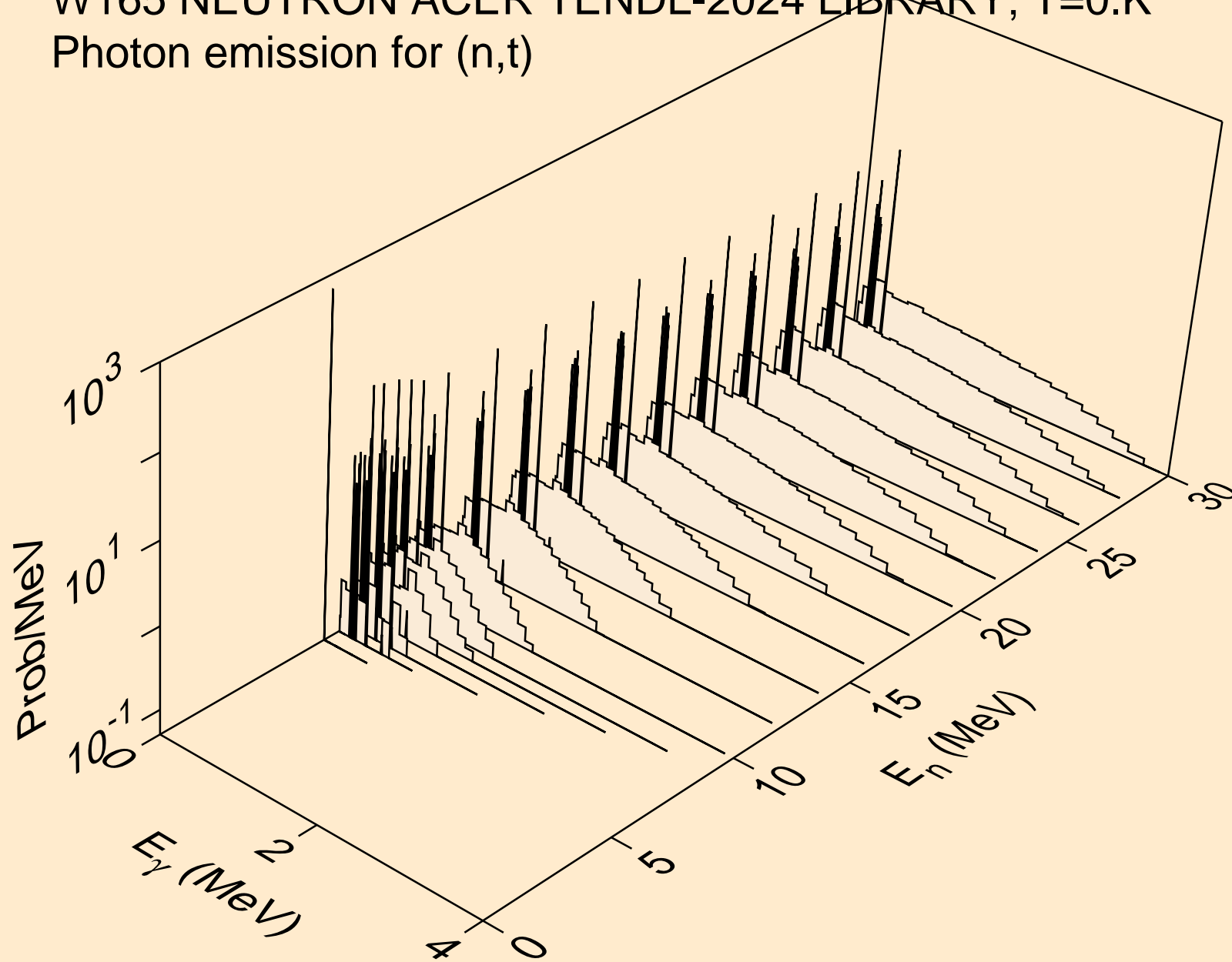

W165 NEUTRON ACER TENDL-2024 LIBRARY; T=0.K
Photon emission for (n,he3)

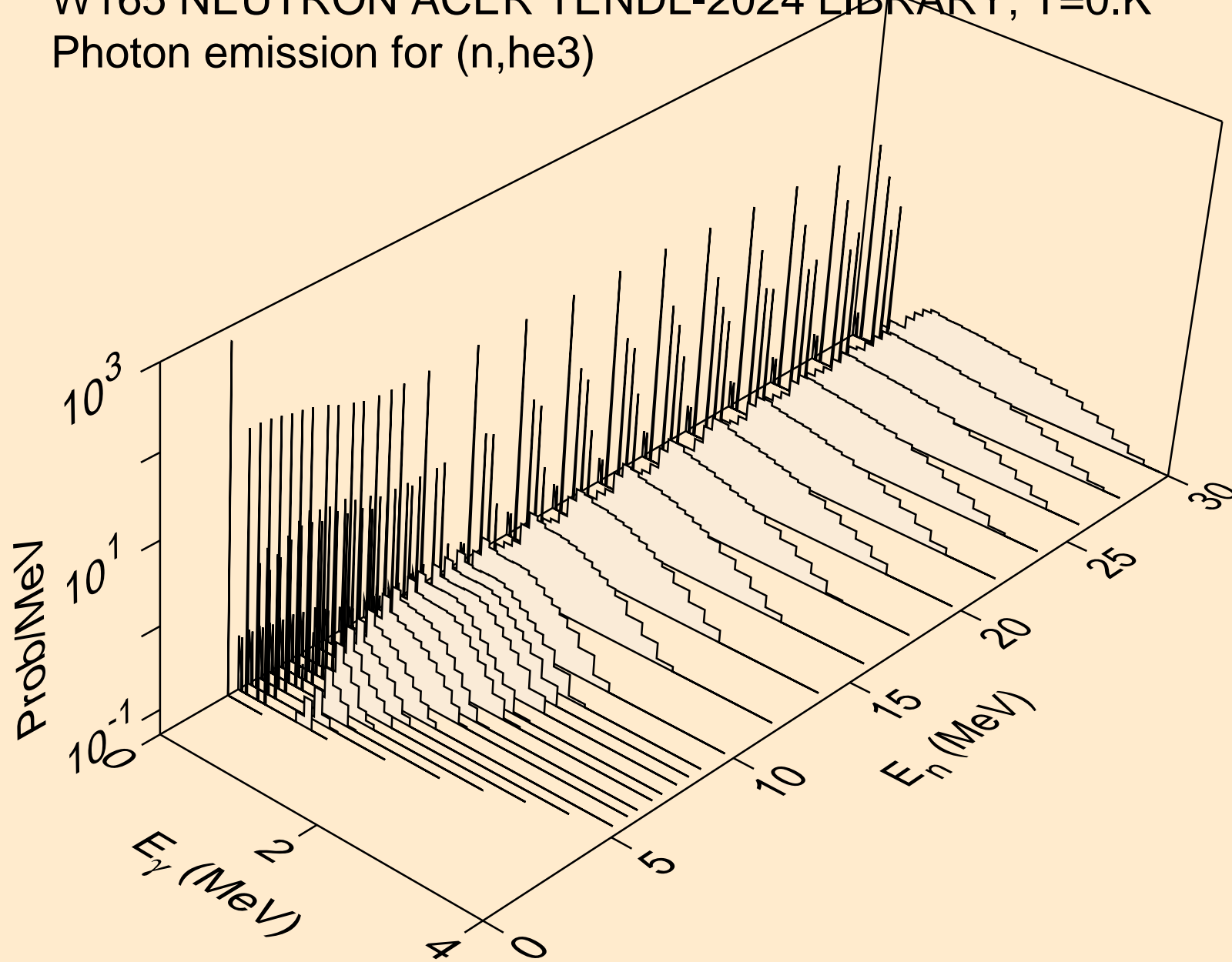

W165 NEUTRON ACER TENDL-2024 LIBRARY; T=0.K
Photon emission for (n,a)

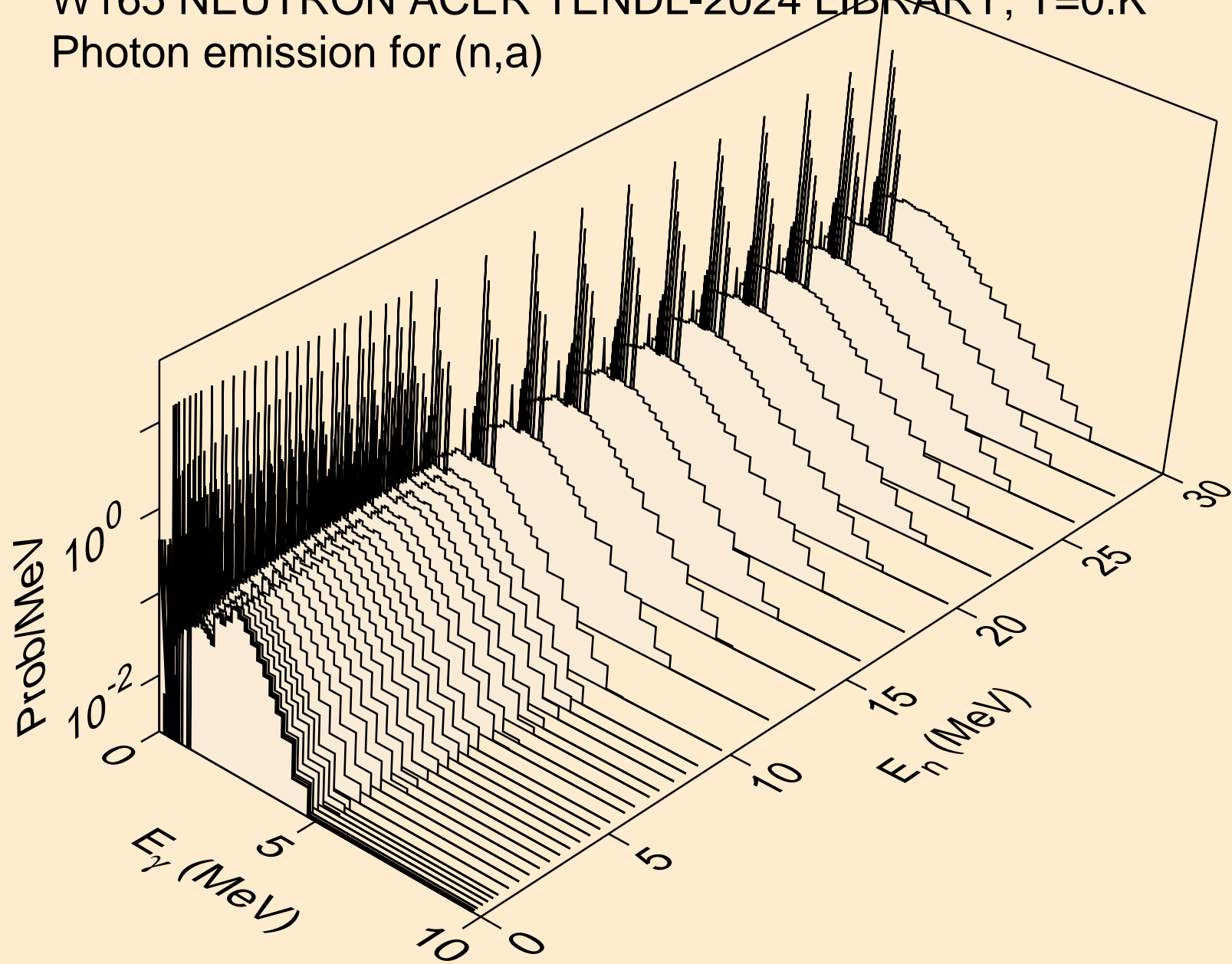

W165 NEUTRON ACER TENDL-2024 LIBRARY; T=0.K
Photon emission for (n,2a)

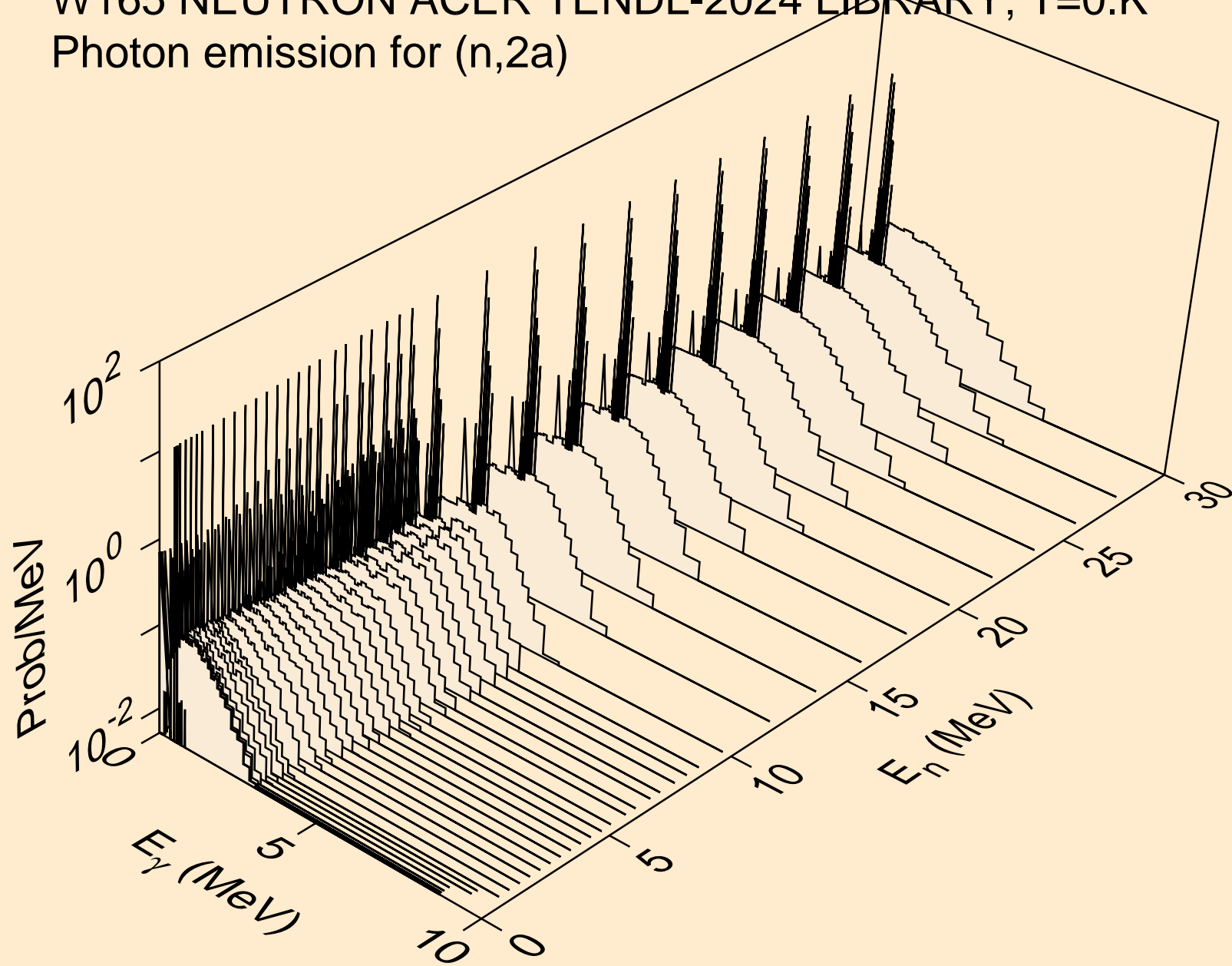

W165 NEUTRON ACER TENDL-2024 LIBRARY; T=0.K
Photon emission for (n,3a)

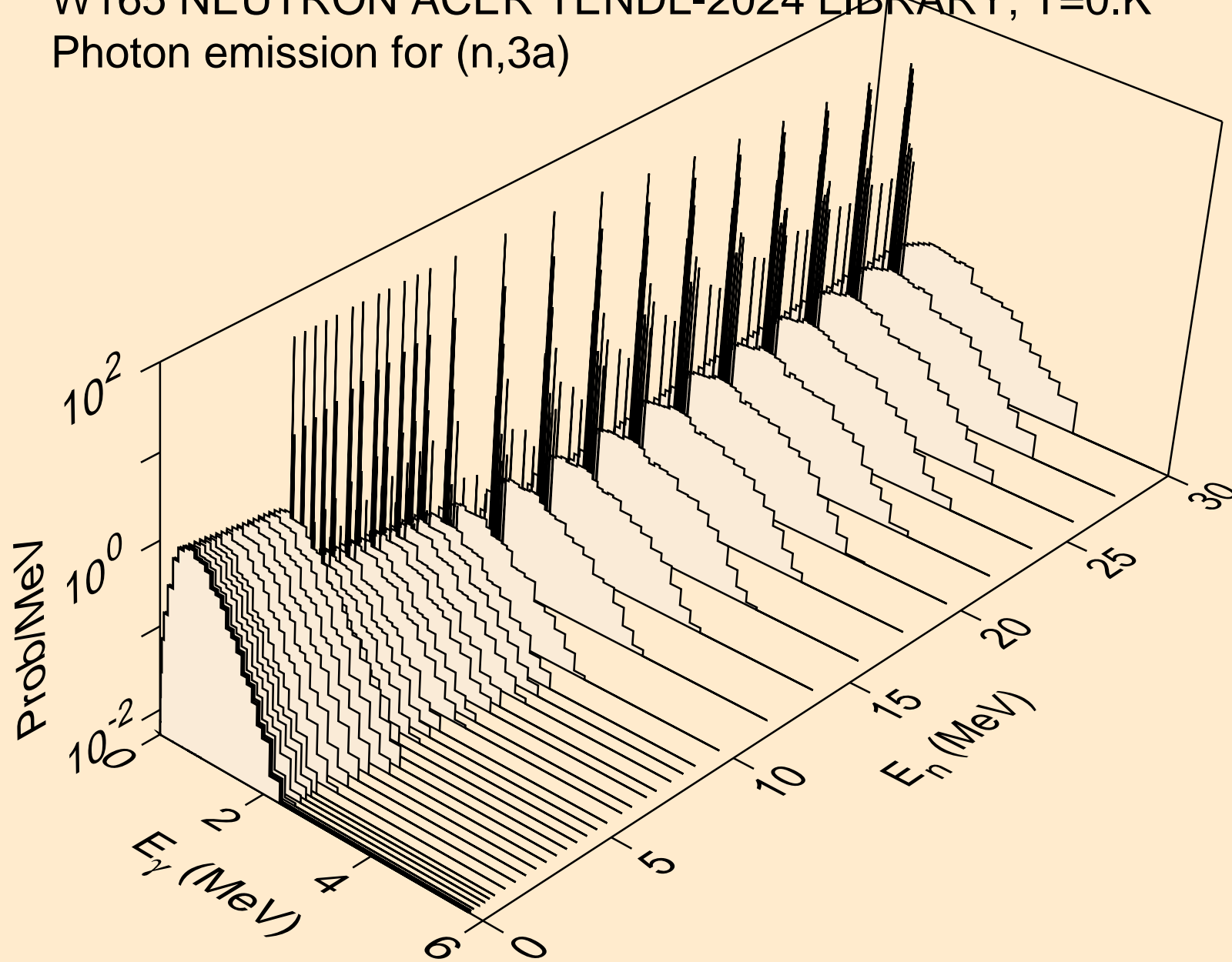

W165 NEUTRON ACER TENDL-2024 LIBRARY; T=0.K
Photon emission for (n,2p)

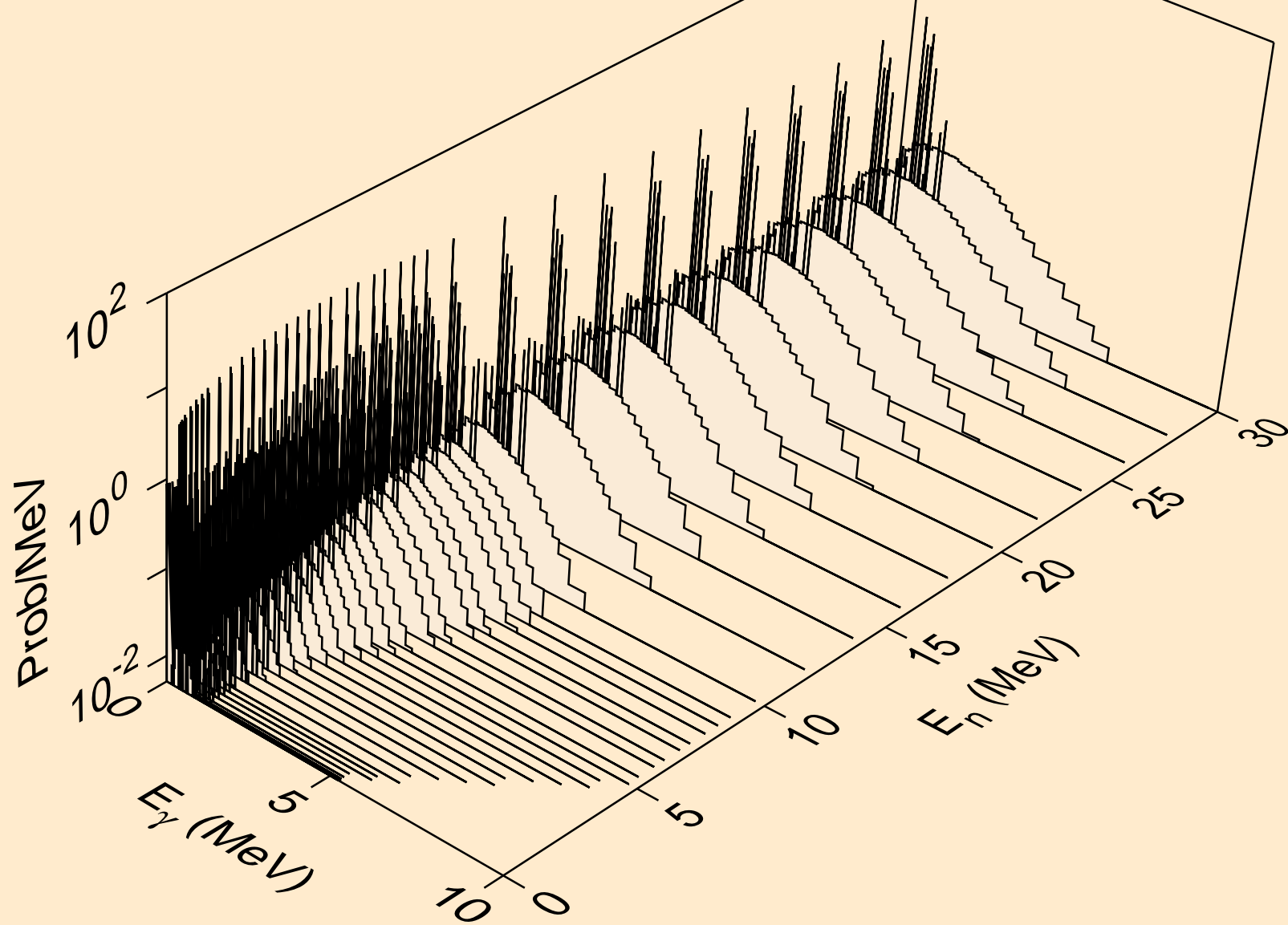

W165 NEUTRON ACER TENDL-2024 LIBRARY; T=0.K
Photon emission for (n,p α)

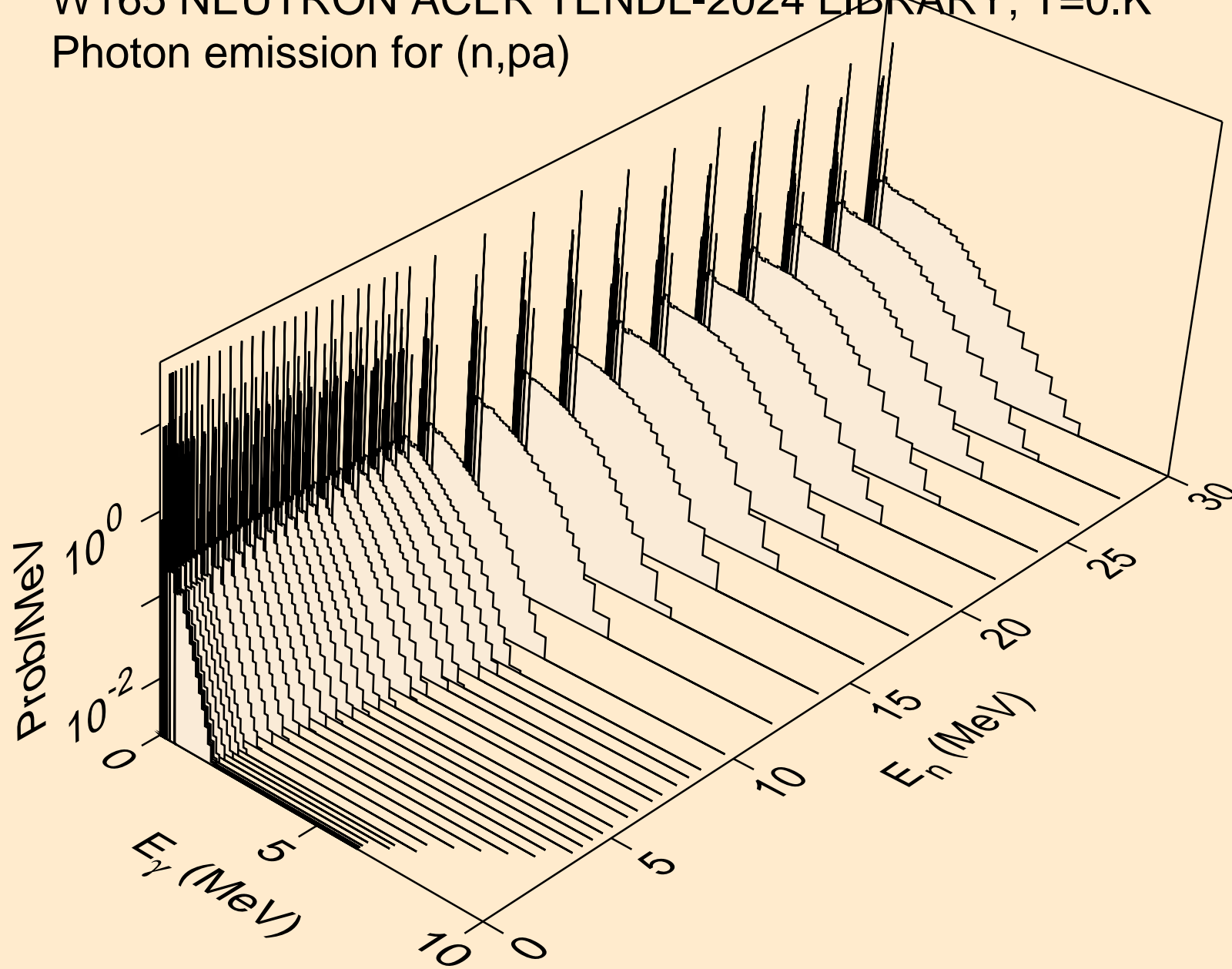

W165 NEUTRON ACER TENDL-2024 LIBRARY; T=0.K
Photon emission for (n,d2a)

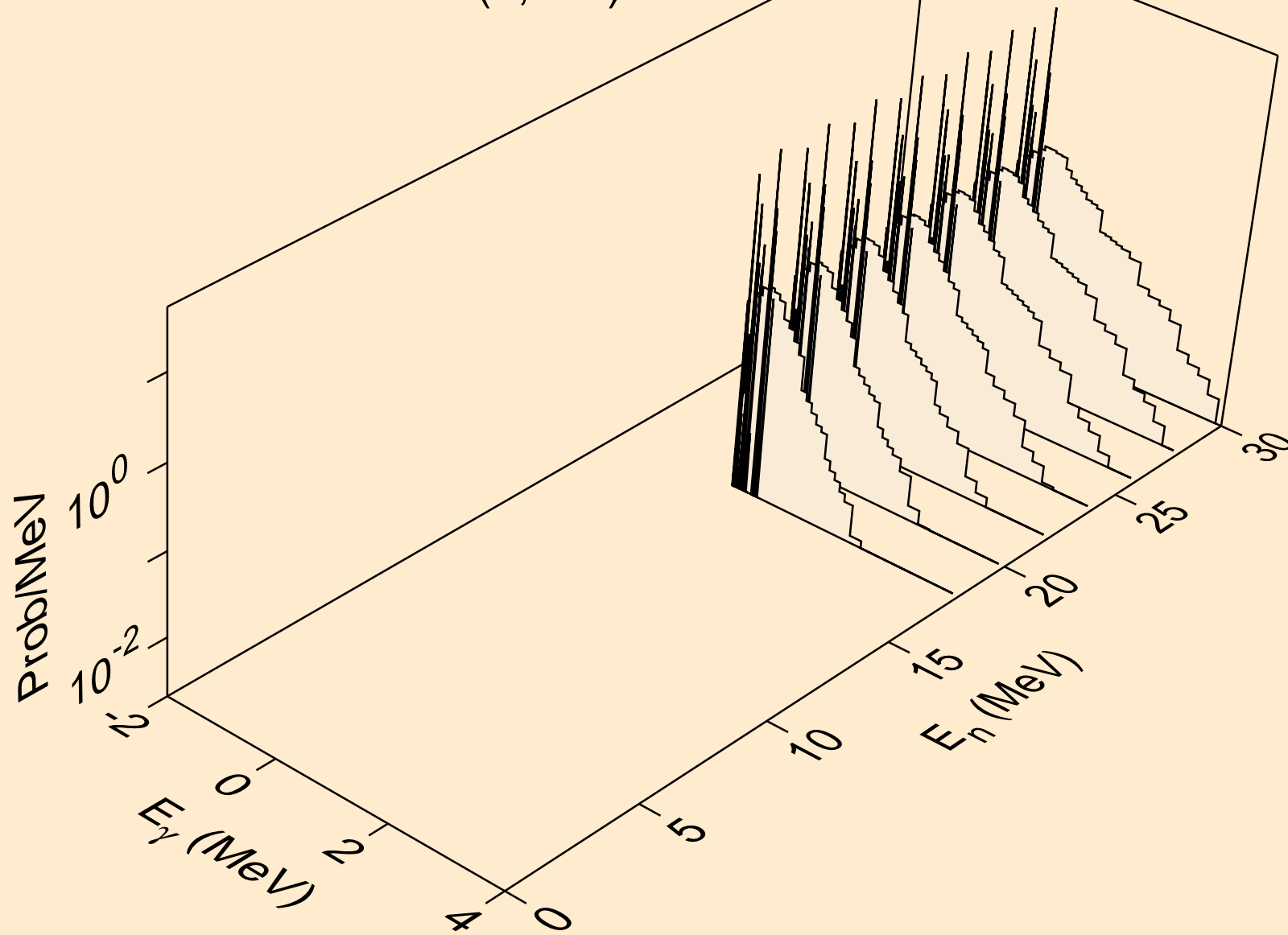

W165 NEUTRON ACER TENDL-2024 LIBRARY; T=0.K
Photon emission for (n,pd)

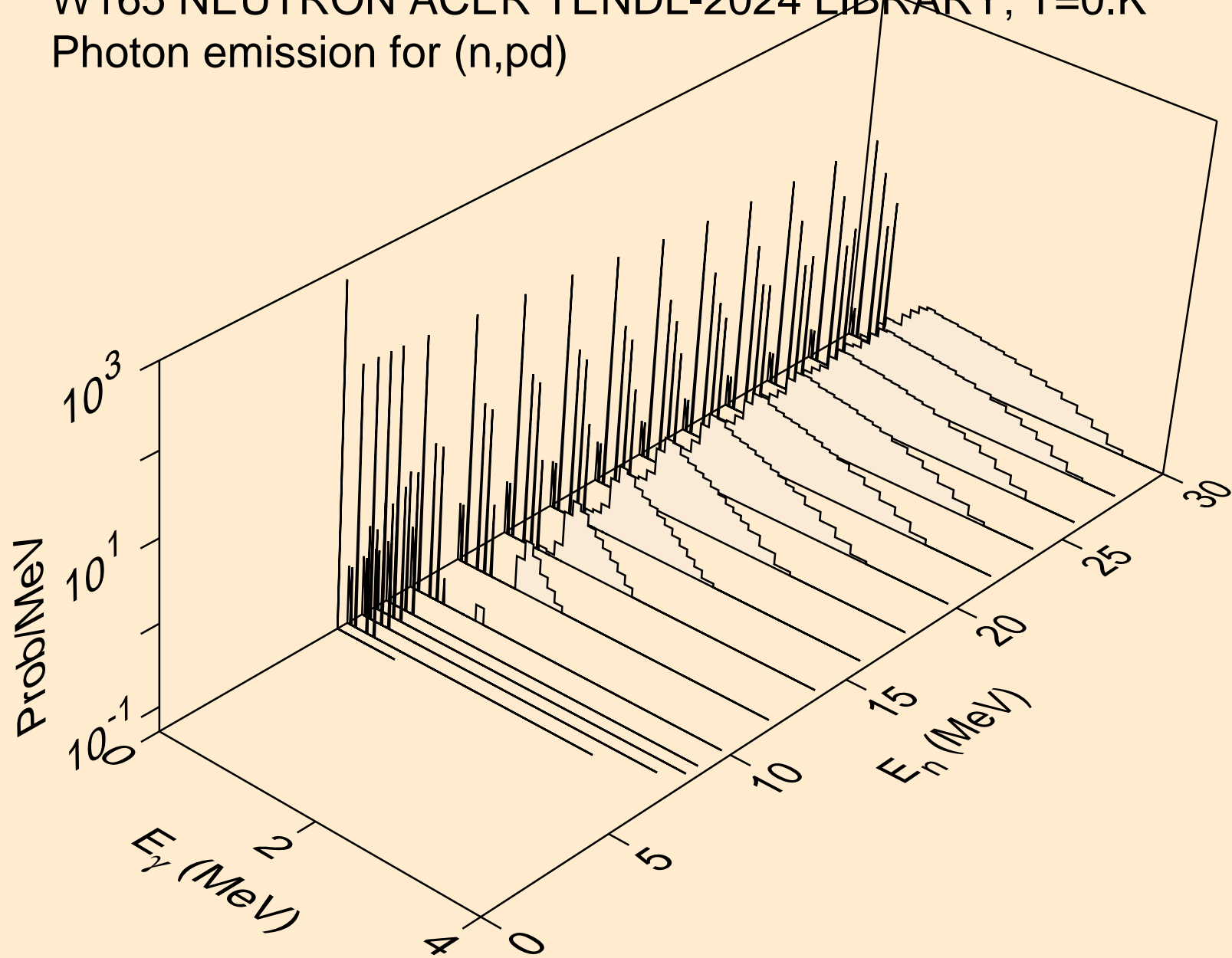

W165 NEUTRON ACER TENDL-2024 LIBRARY; T=0.K
Photon emission for (n,pt)

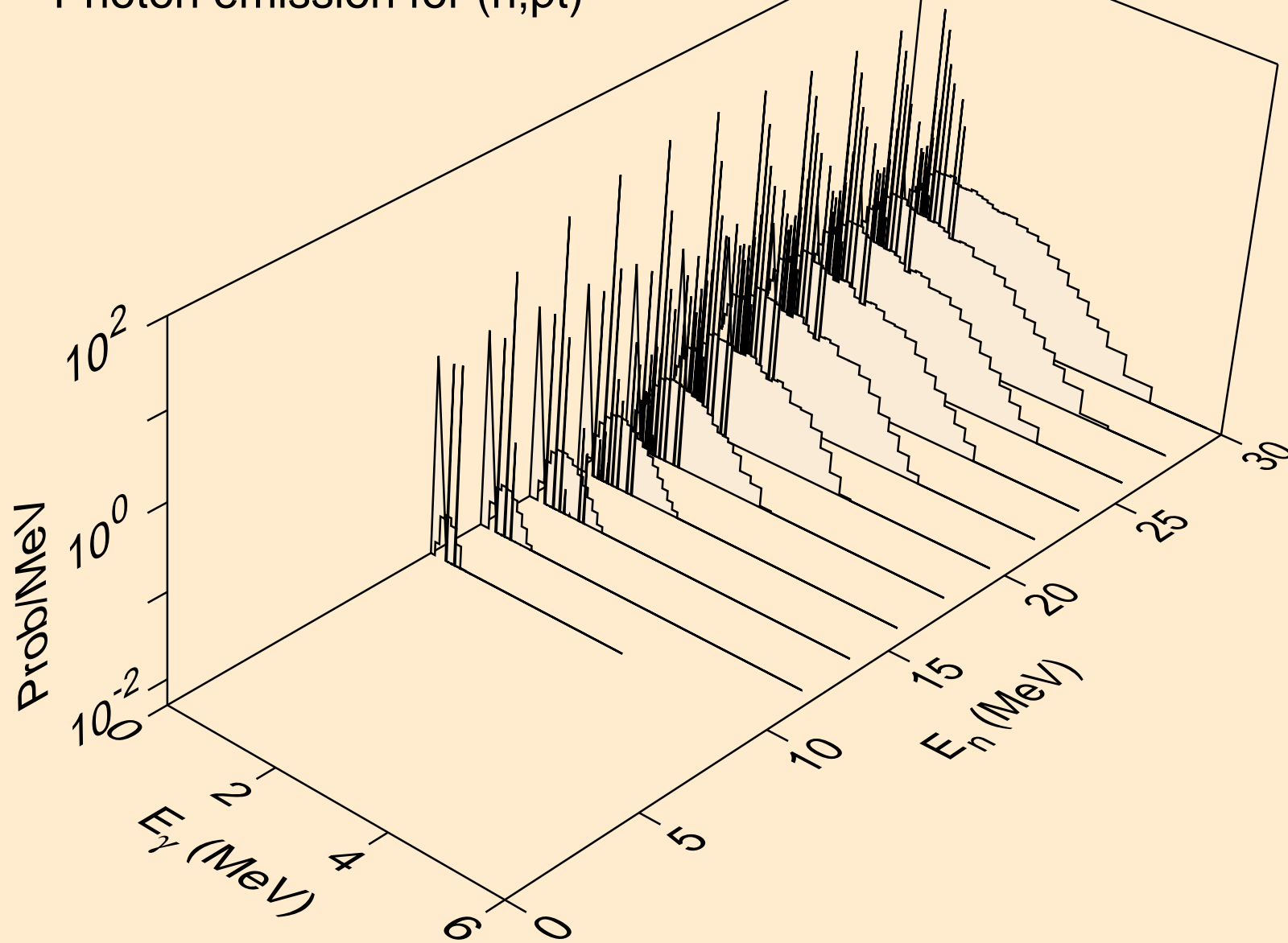

W165 NEUTRON ACER TENDL-2024 LIBRARY; T=0.K
Photon emission for (n,da)

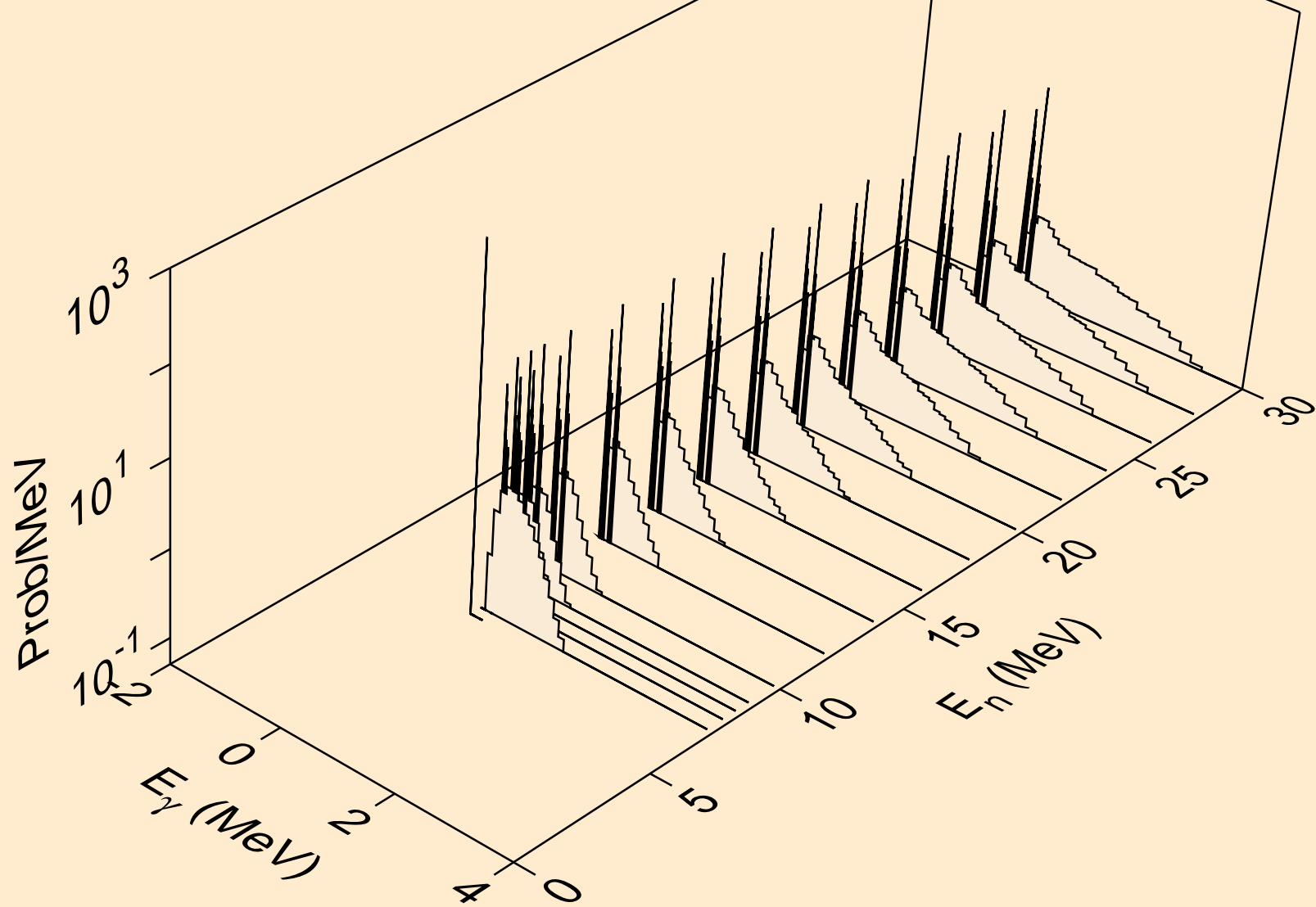

W165 NEUTRON ACER TENDL-2024 LIBRARY; T=0.K
thermal capture photon spectrum

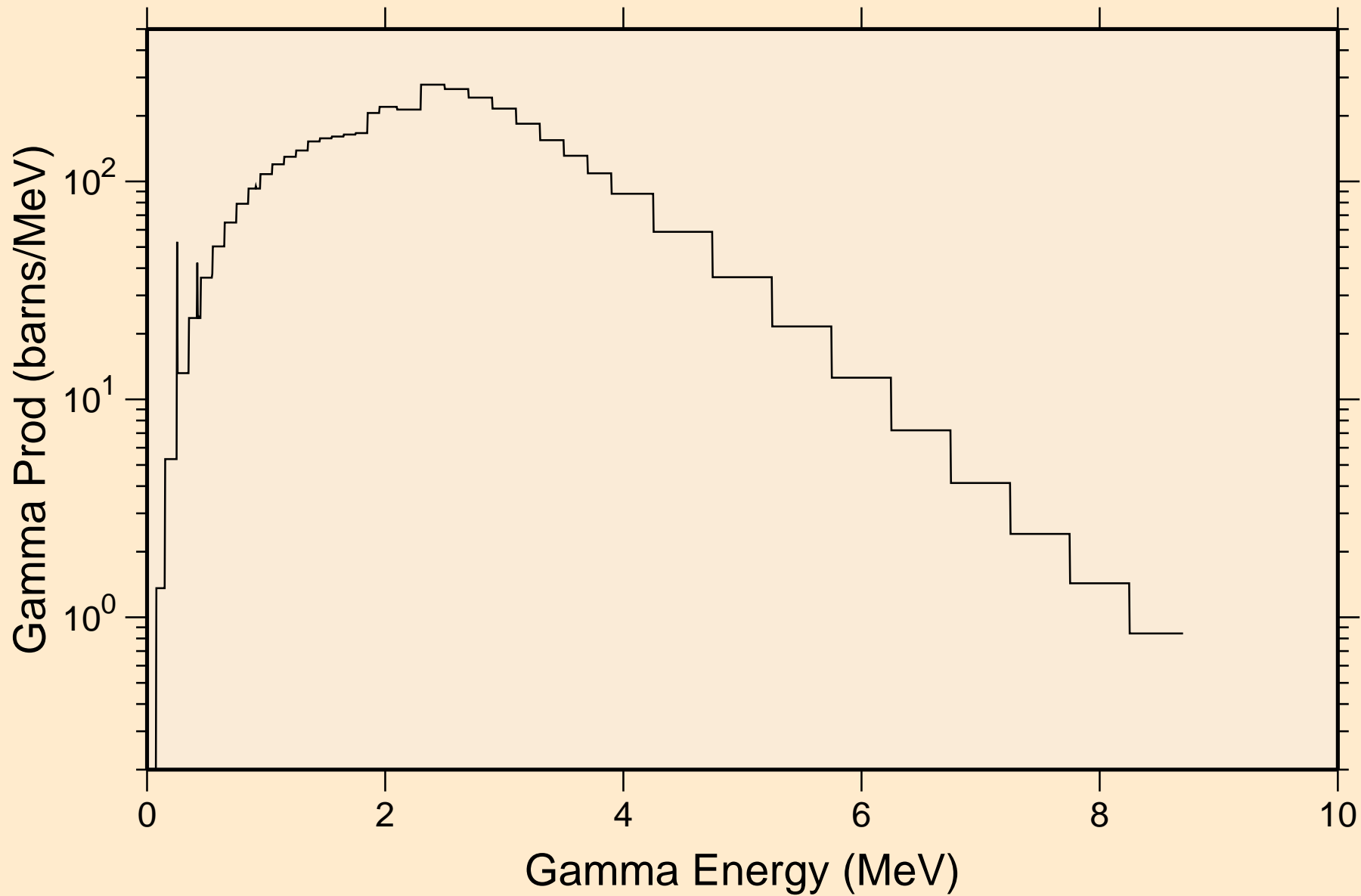

W165 NEUTRON ACER TENDL-2024 LIBRARY; T=0.K
14 MeV photon spectrum

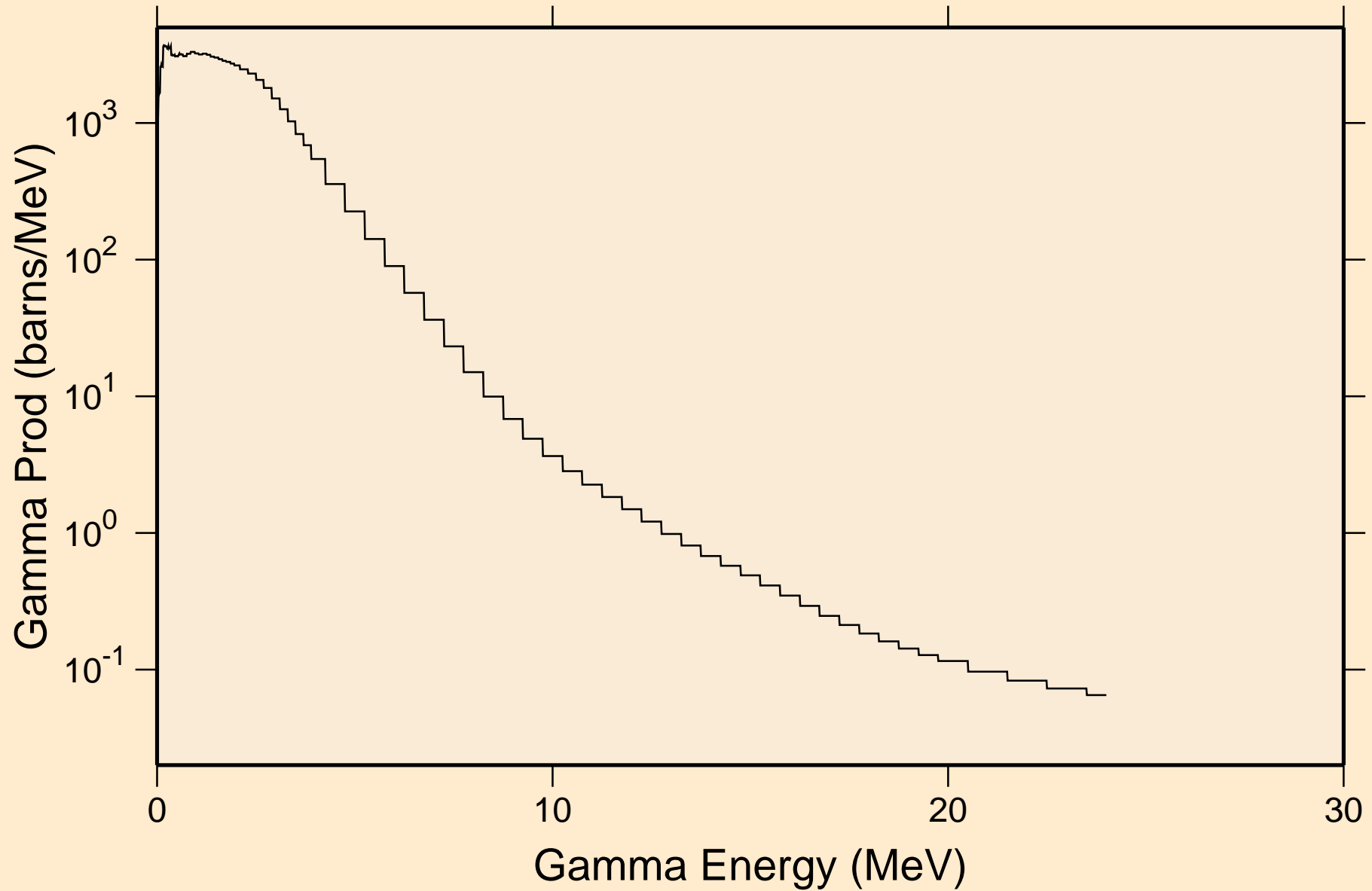

W165 NEUTRON ACER TENDL-2024 LIBRARY; T=0.K

Particle heating contributions

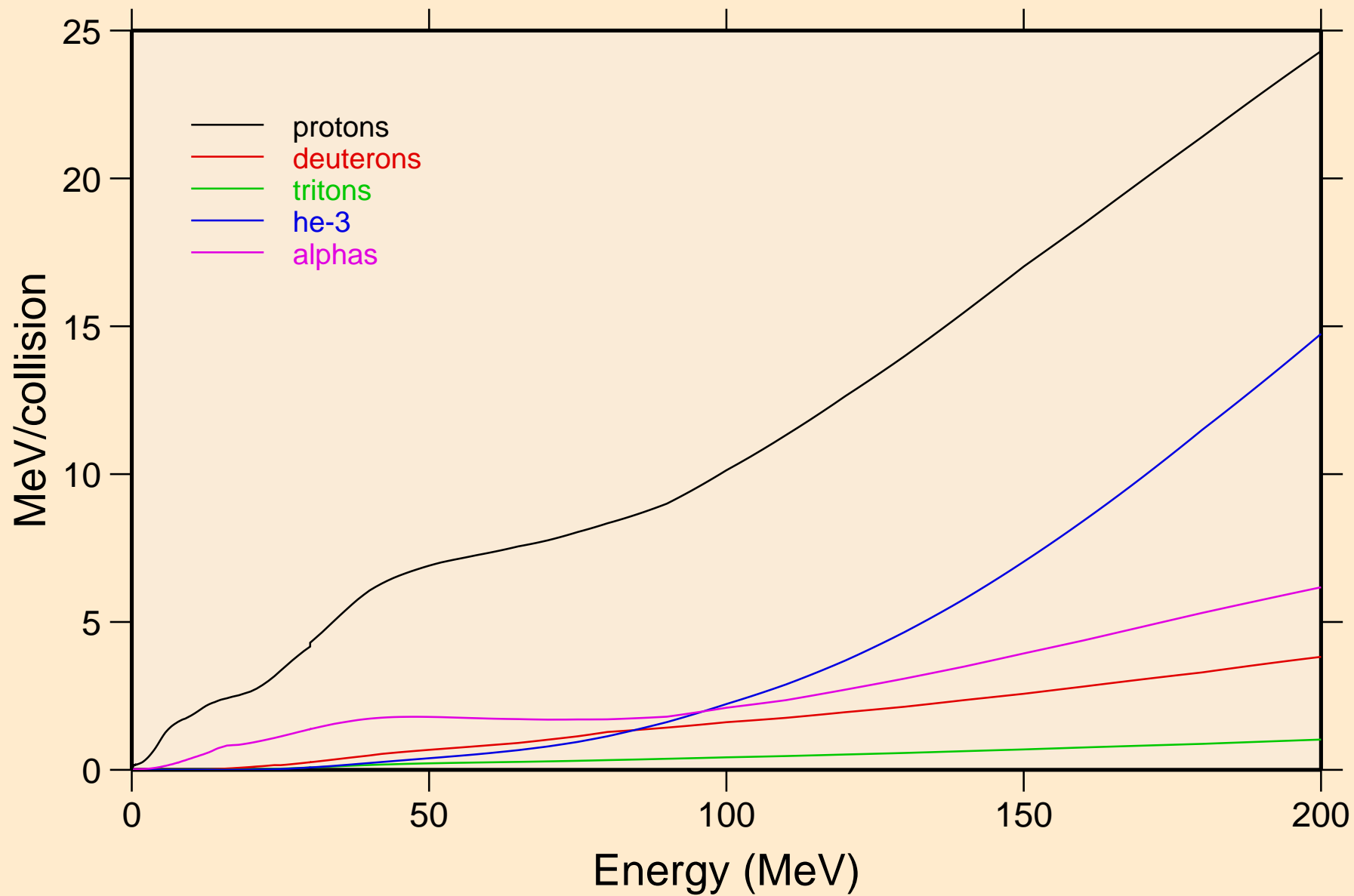

W165 NEUTRON ACER TENDL-2024 LIBRARY; T=0.K
Recoil Heating

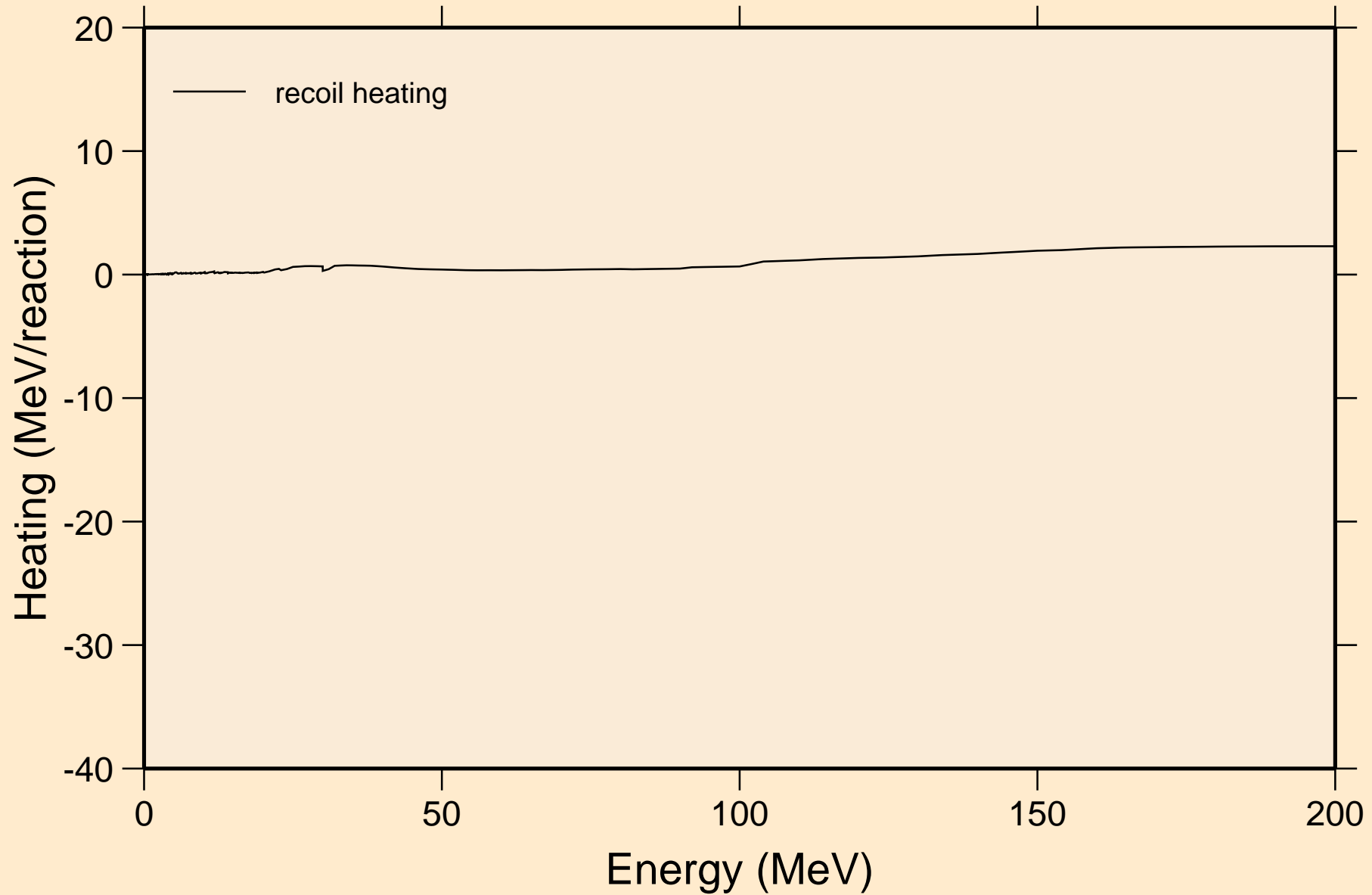

W165 NEUTRON ACER TENDL-2024 LIBRARY; T=0.K
Particle production cross sections

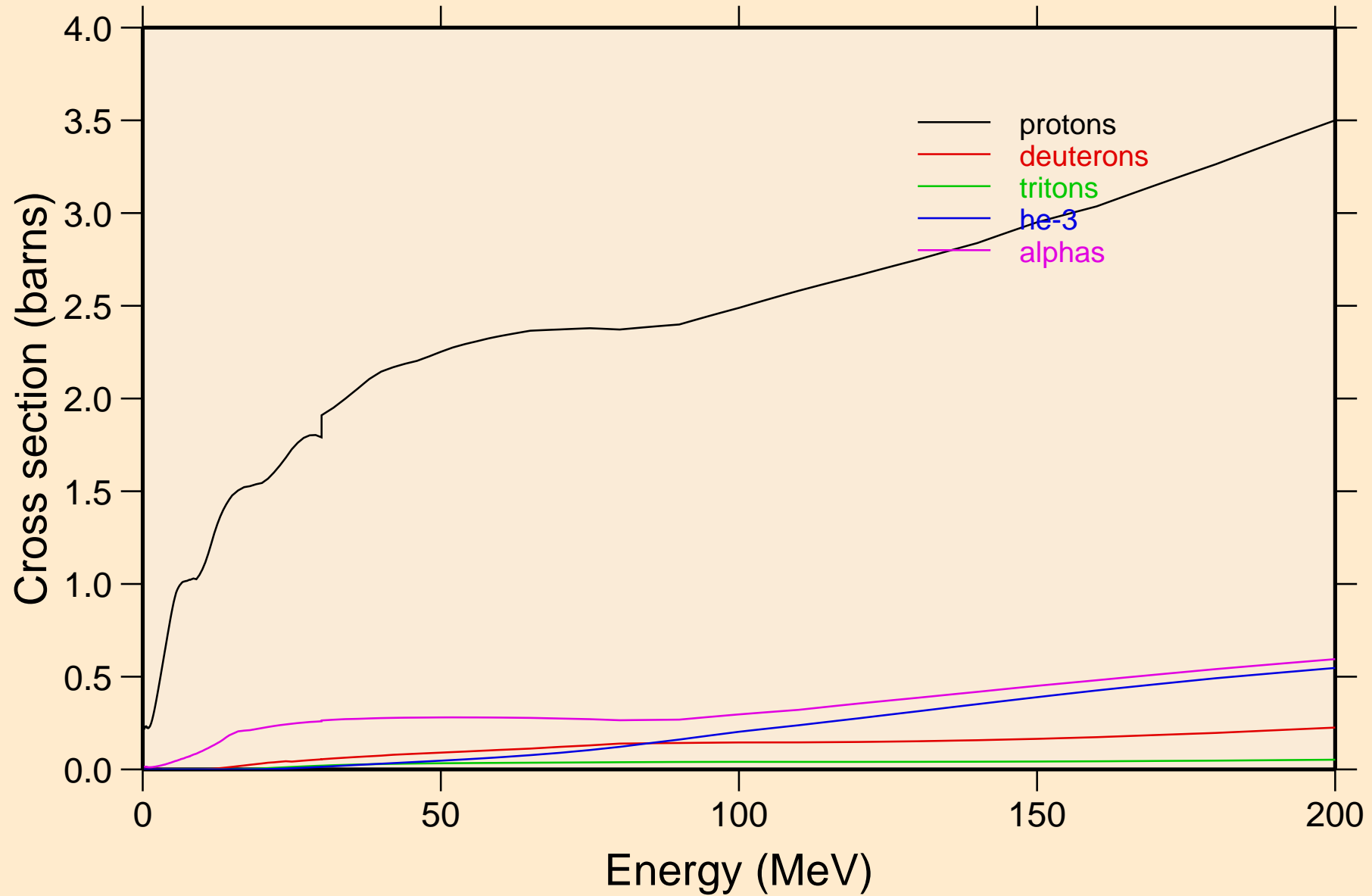

W165 NEUTRON ACER TENDL-2024 LIBRARY; T=0.K
protons from (n,x)

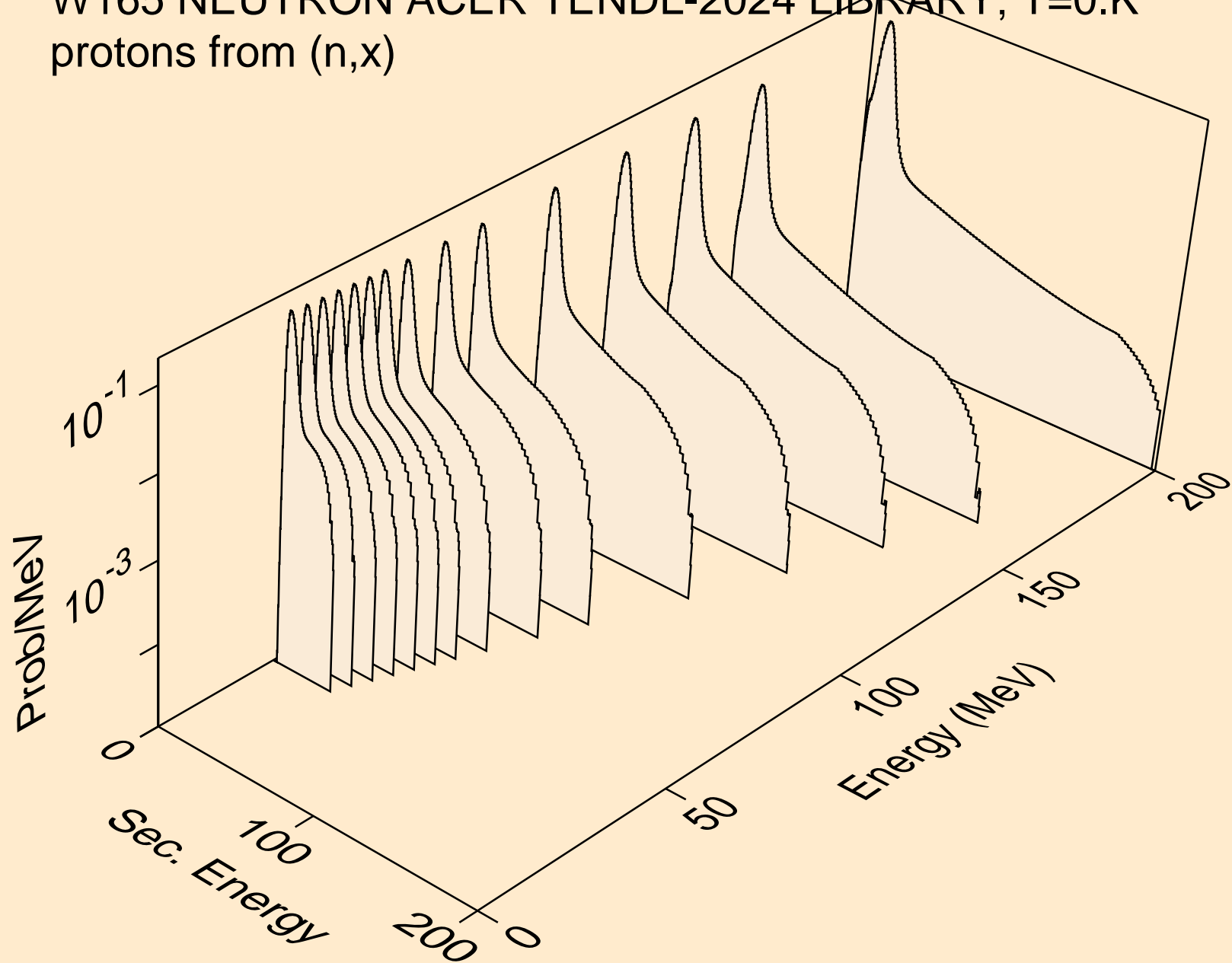

W165 NEUTRON ACER TENDL-2024 LIBRARY; T=0.K
protons from (n,n*)p

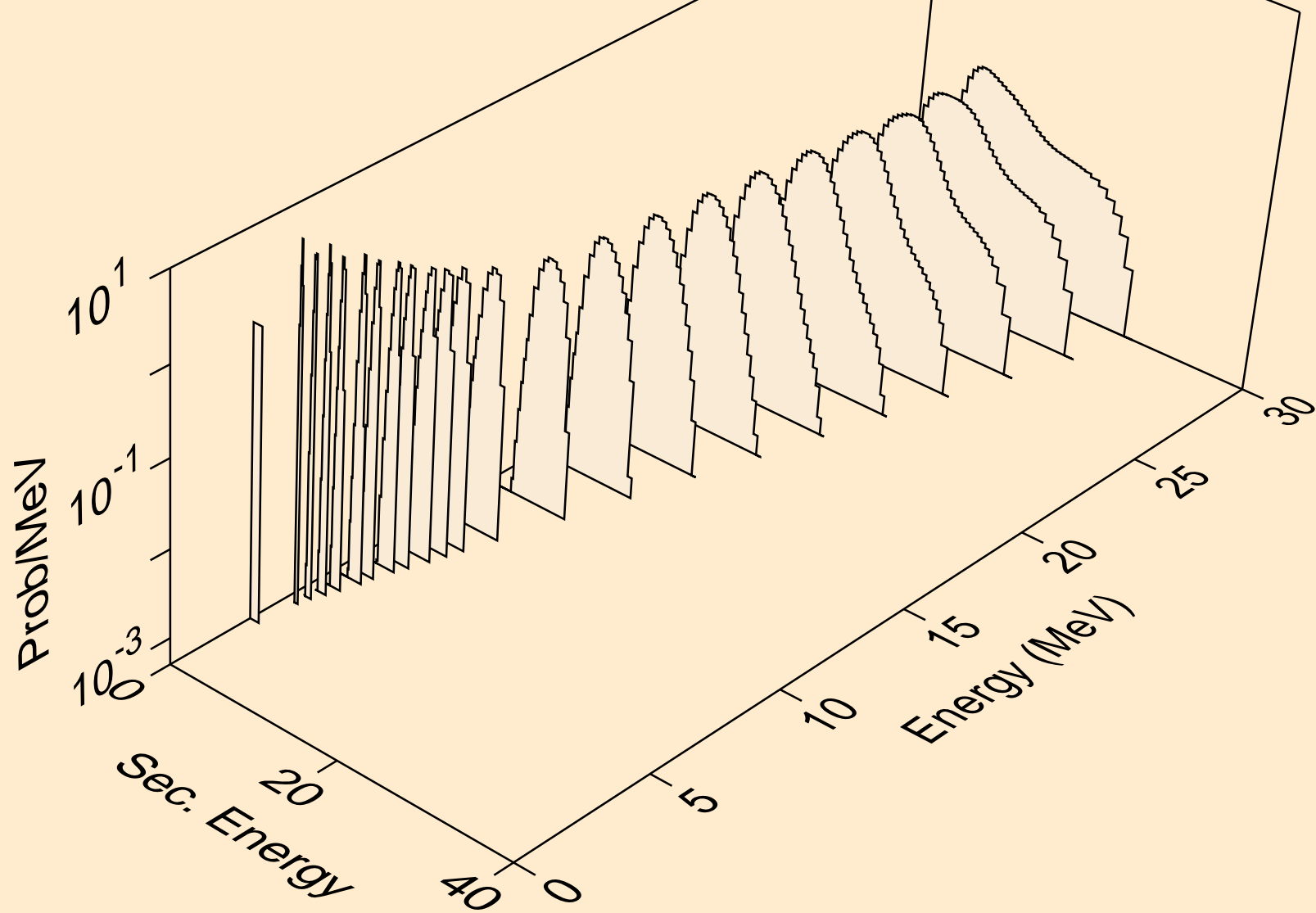

W165 NEUTRON ACER TENDL-2024 LIBRARY; T=0.K
protons from (n,2np)

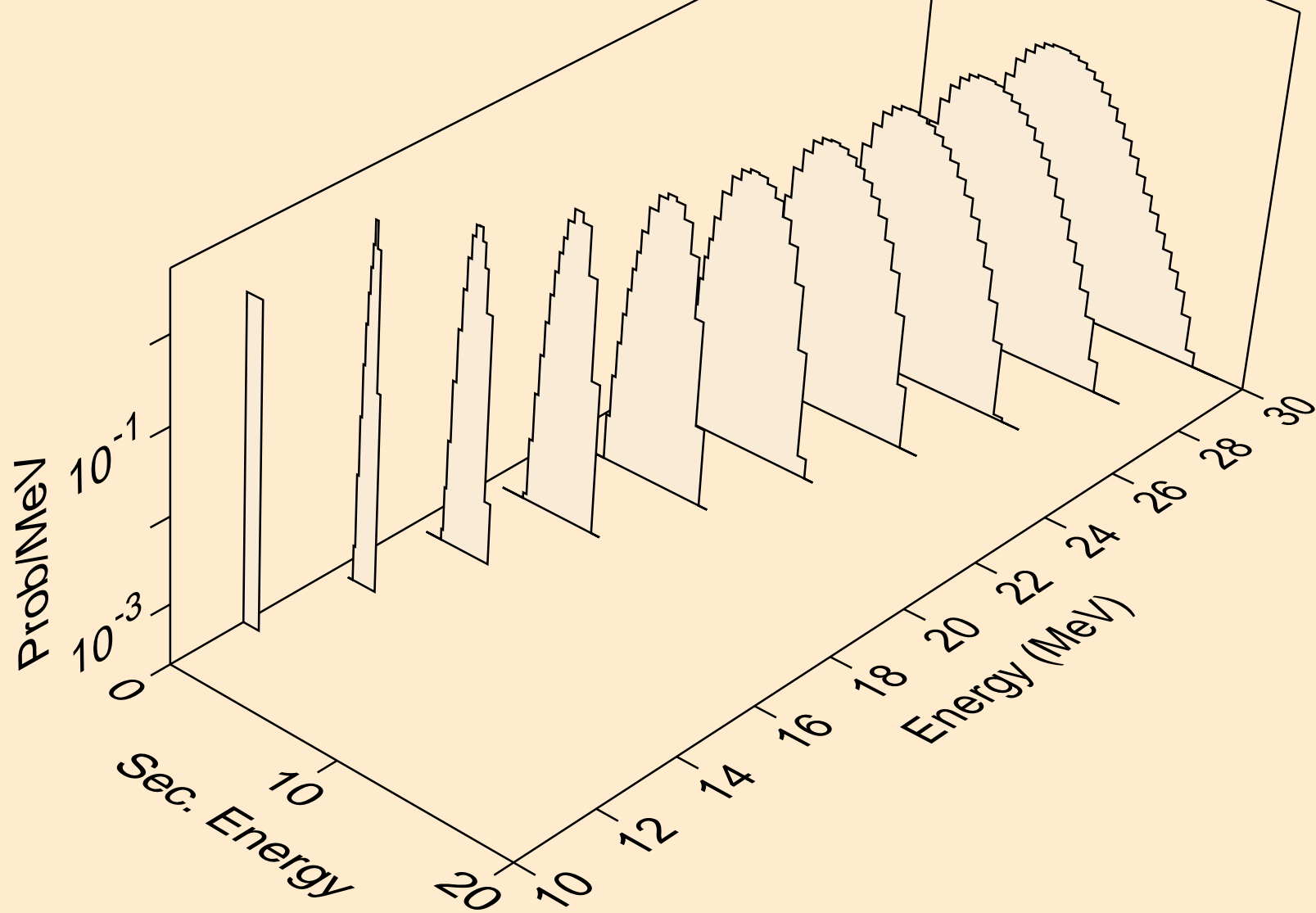

W165 NEUTRON ACER TENDL-2024 LIBRARY; T=0.K
protons from (n,3np)

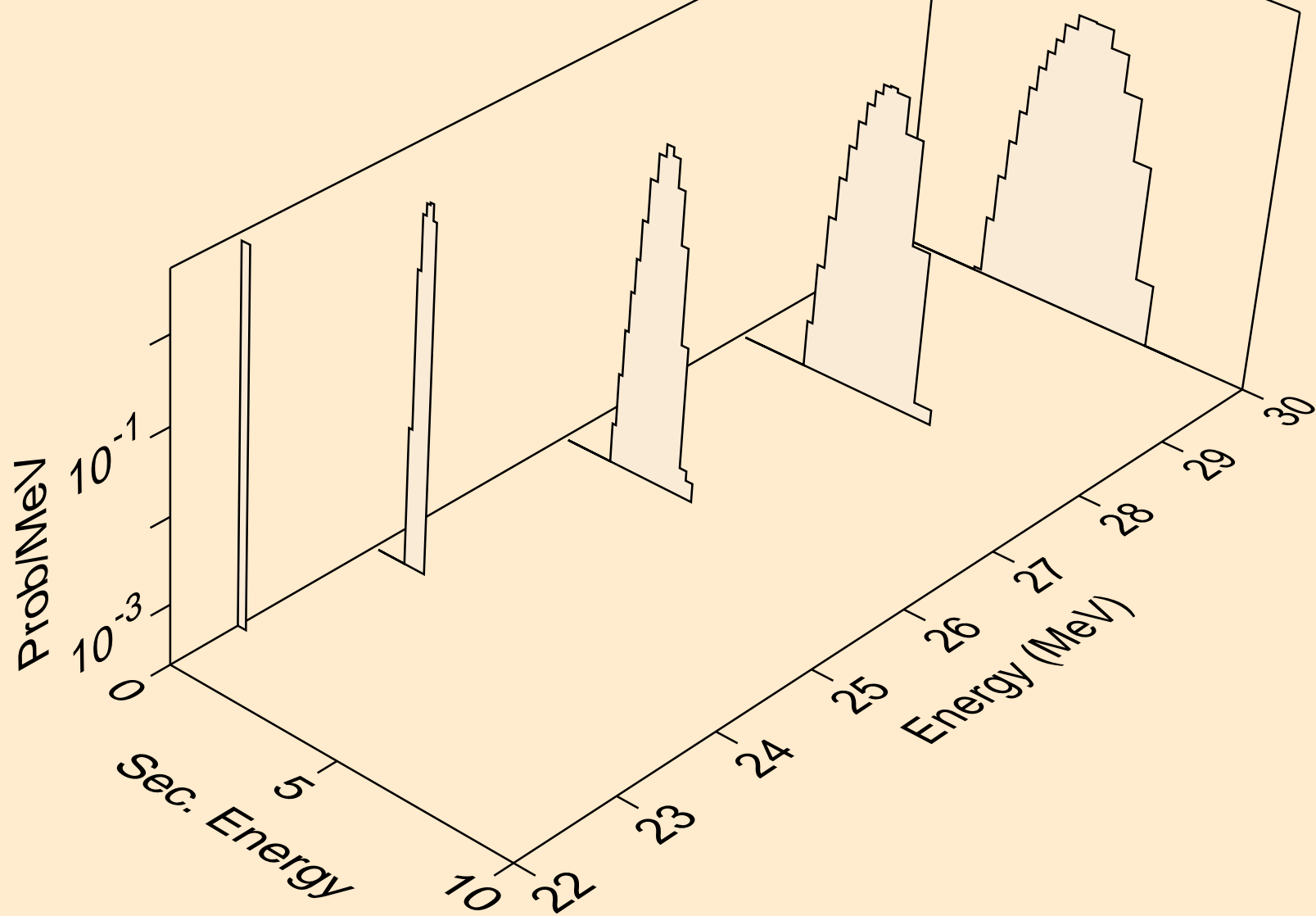

W165 NEUTRON ACER TENDL-2024 LIBRARY; T=0.K
protons from (n,n2p)

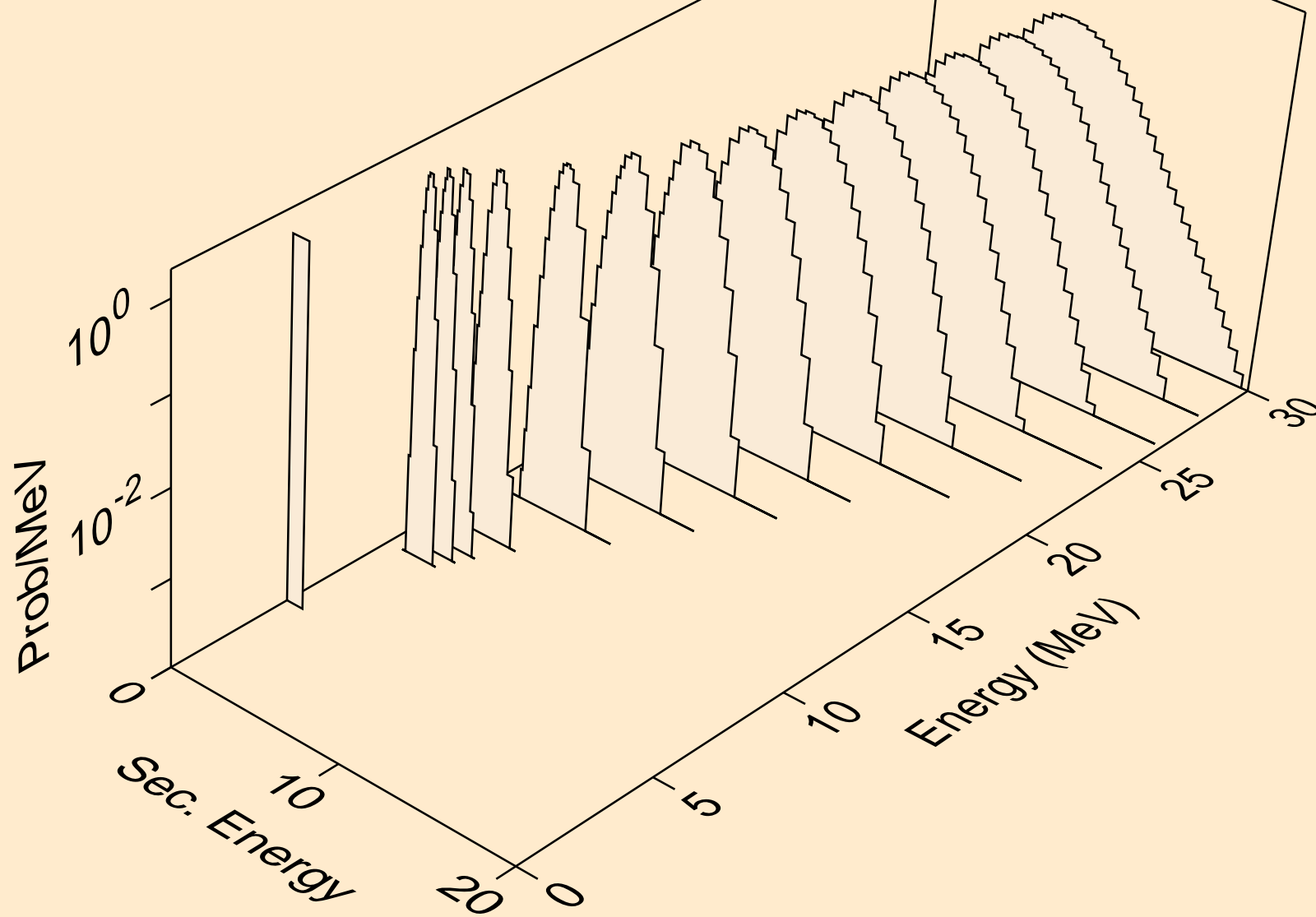

W165 NEUTRON ACER TENDL-2024 LIBRARY; T=0.K
protons from (n,npa)

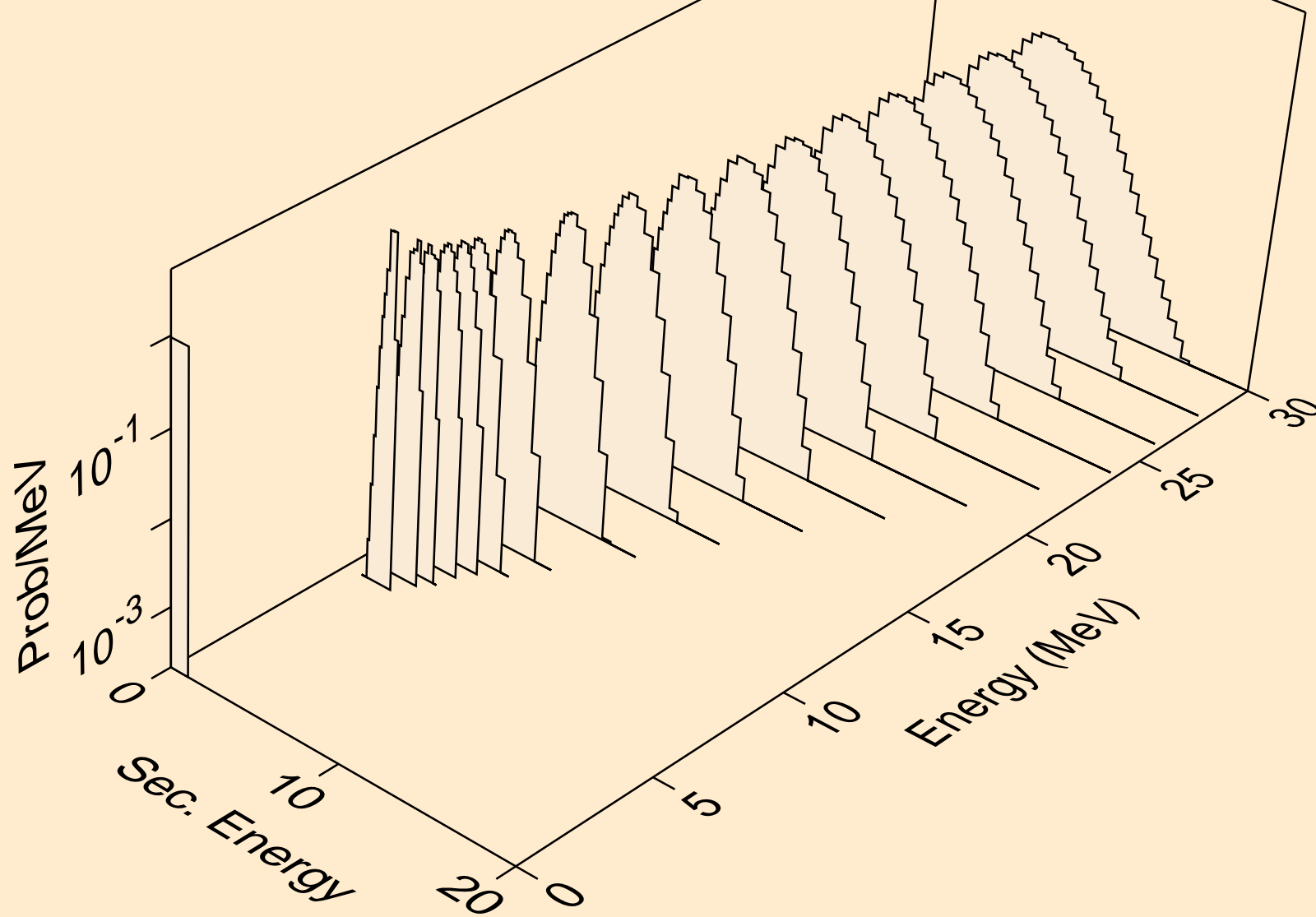

W165 NEUTRON ACER TENDL-2024 LIBRARY; T=0.K
protons from (n,p)

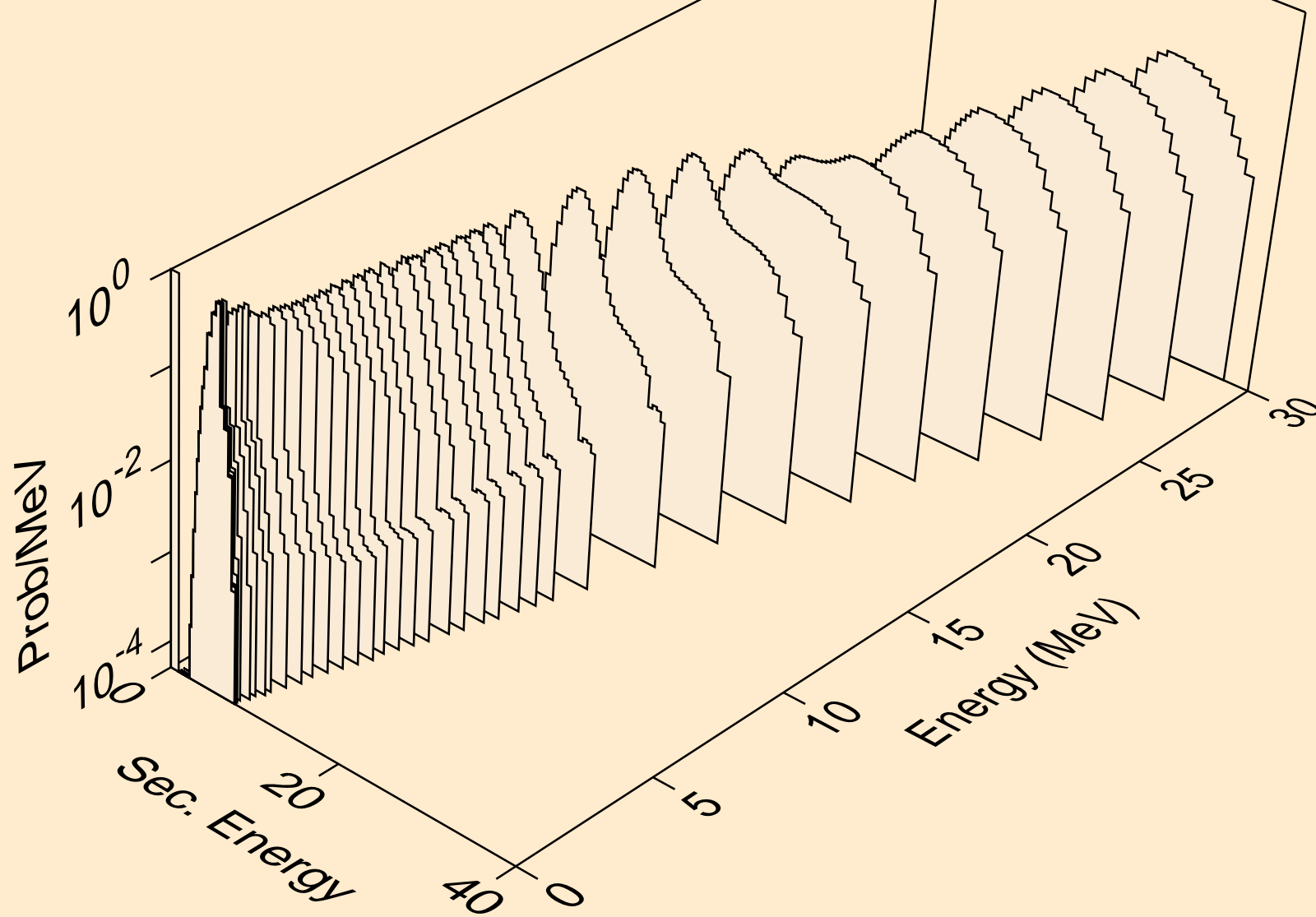

W165 NEUTRON ACER TENDL-2024 LIBRARY; T=0.K
protons from (n,2p)

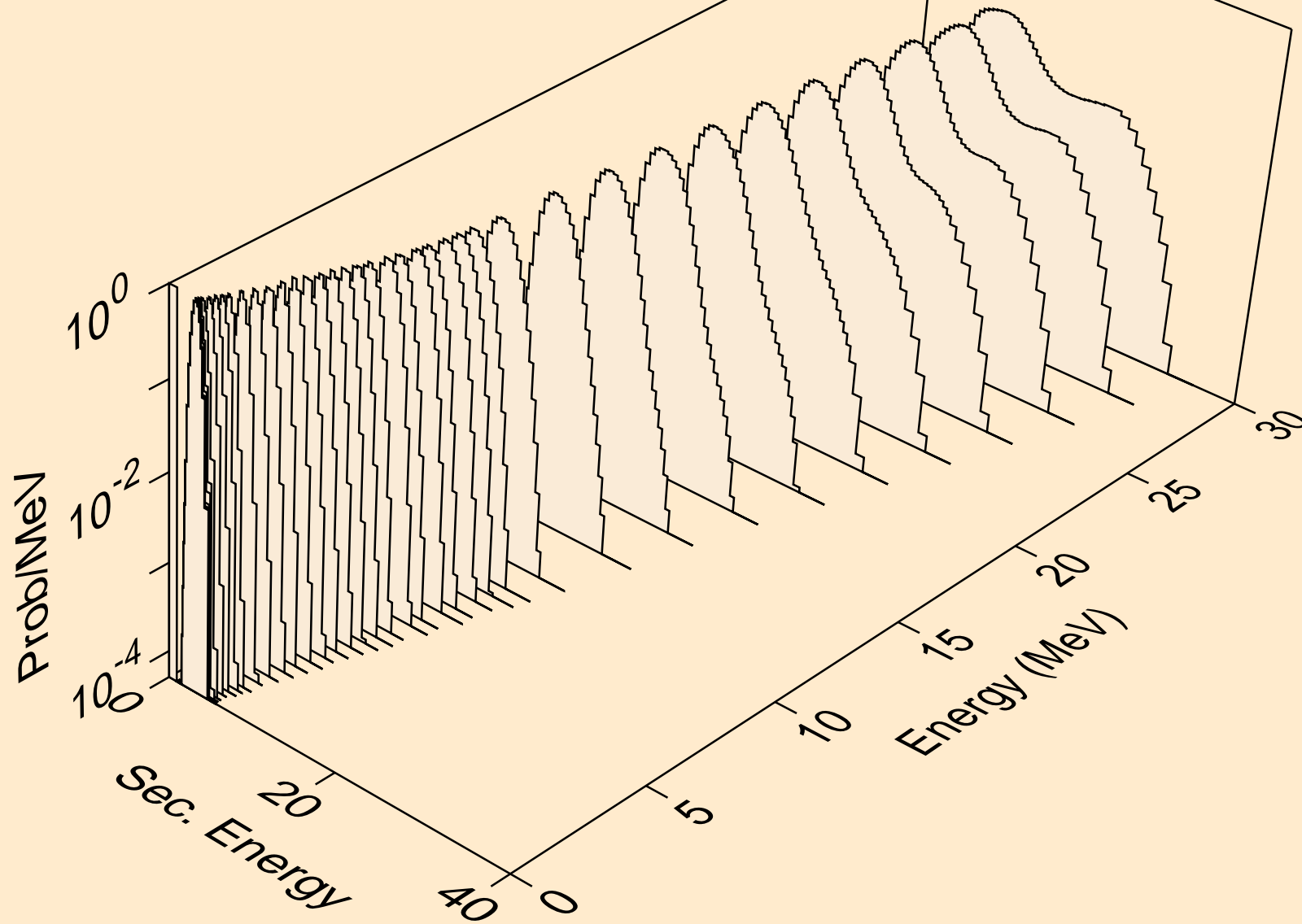

W165 NEUTRON ACER TENDL-2024 LIBRARY; T=0.K
protons from (n,p)

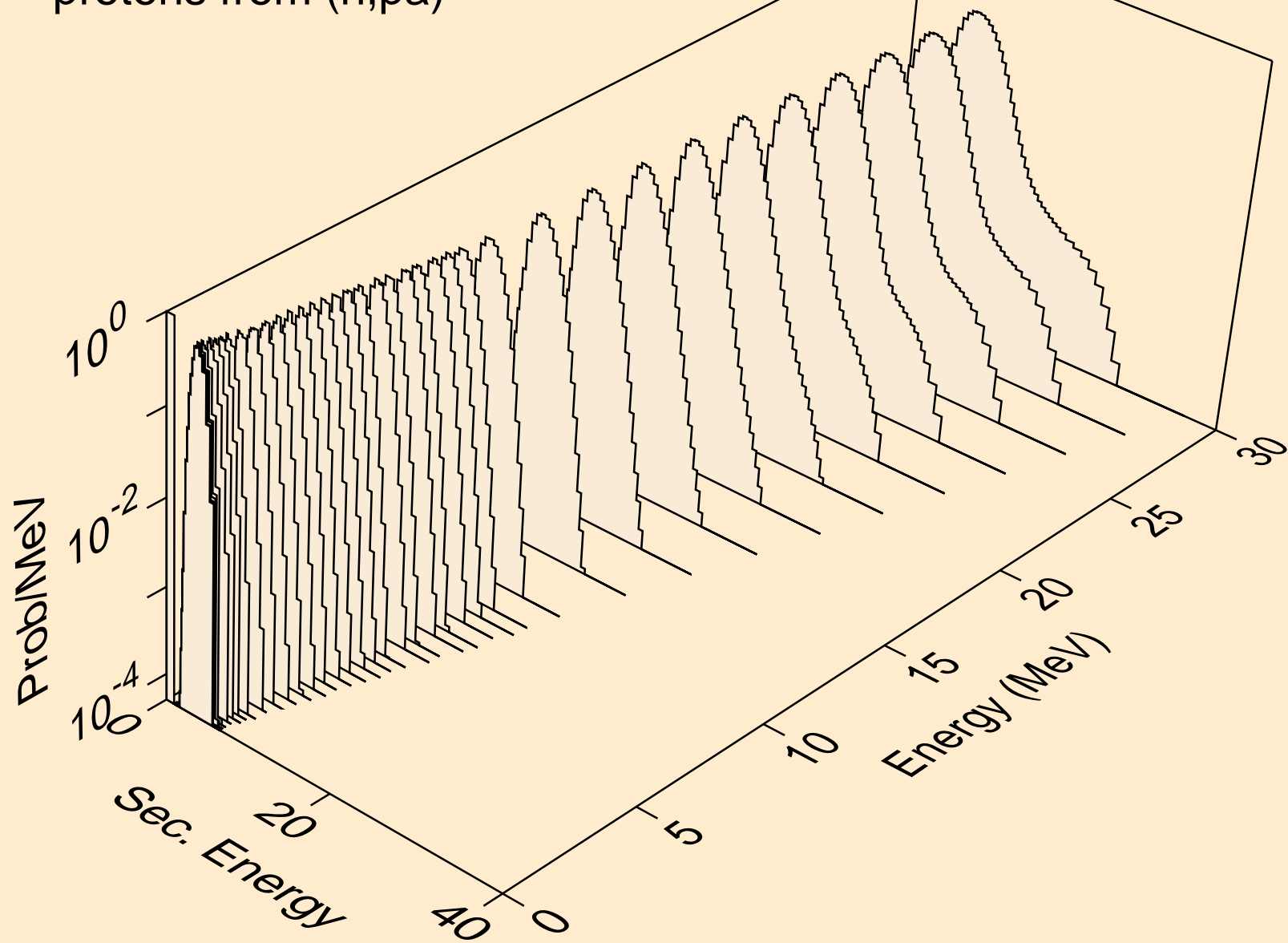

W165 NEUTRON ACER TENDL-2024 LIBRARY; T=0.K
protons from (n,pd)

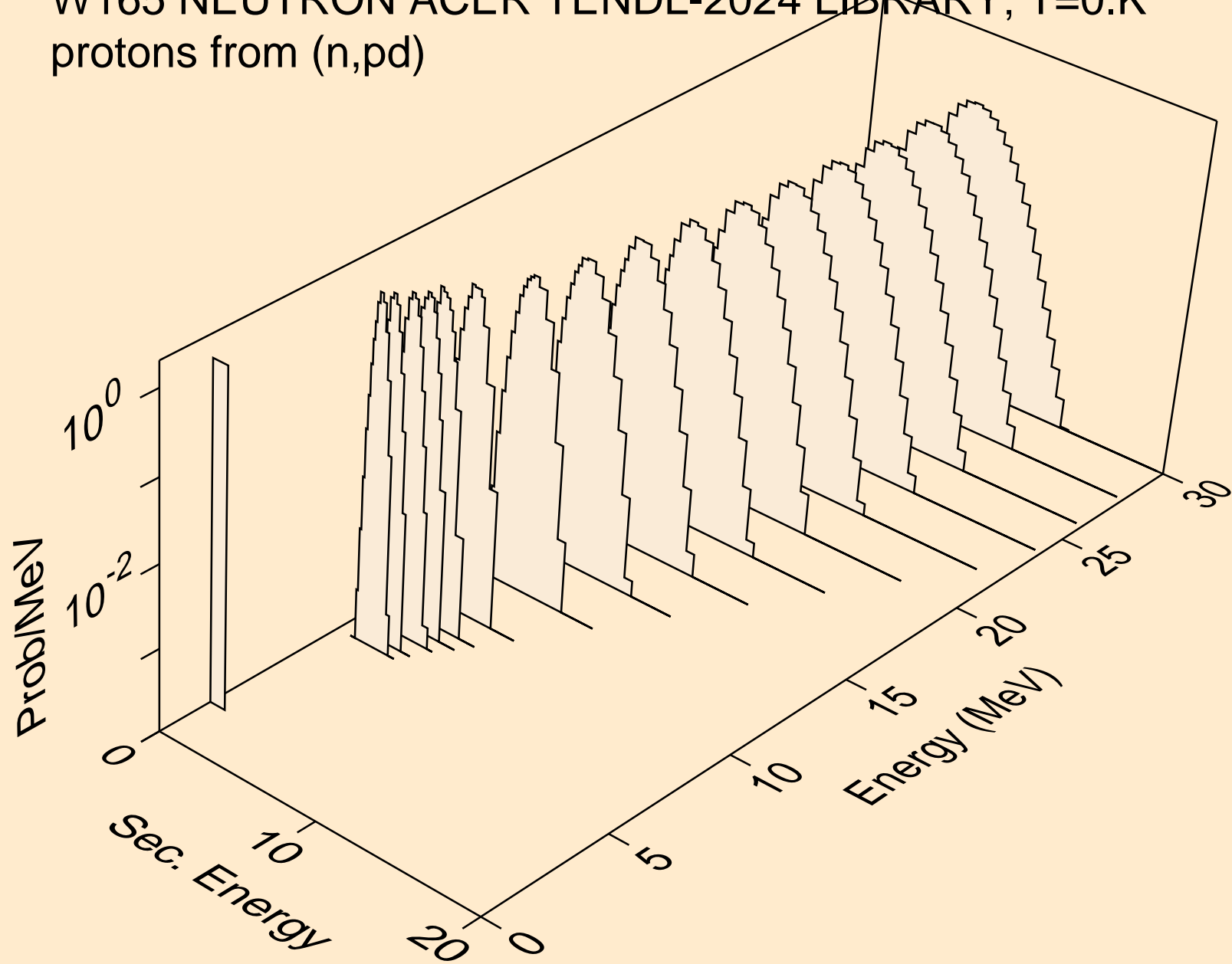

W165 NEUTRON ACER TENDL-2024 LIBRARY; T=0.K
protons from (n,pt)

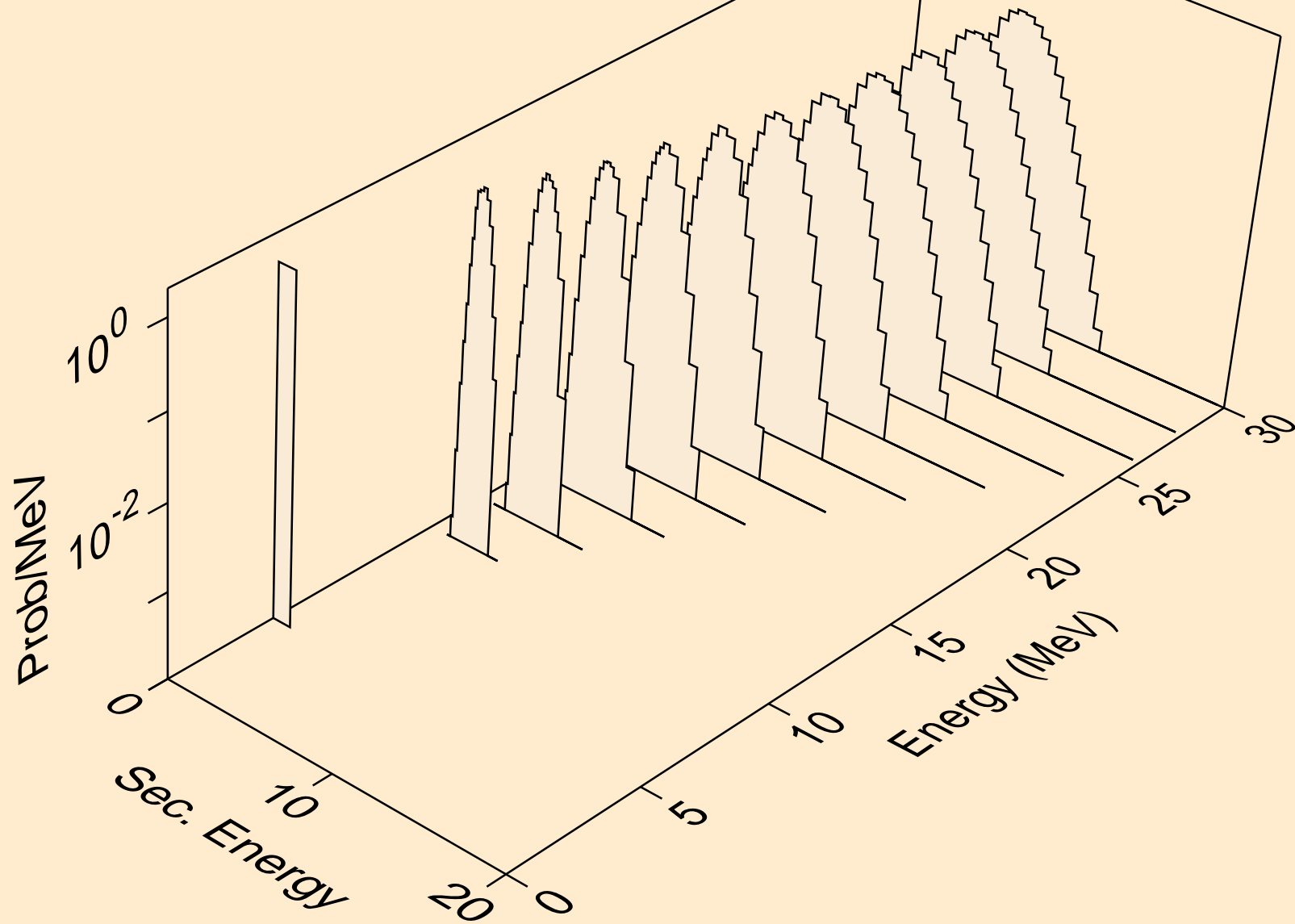

W165 NEUTRON ACER TENDL-2024 LIBRARY; T=0.K
deuterons from (n,x)

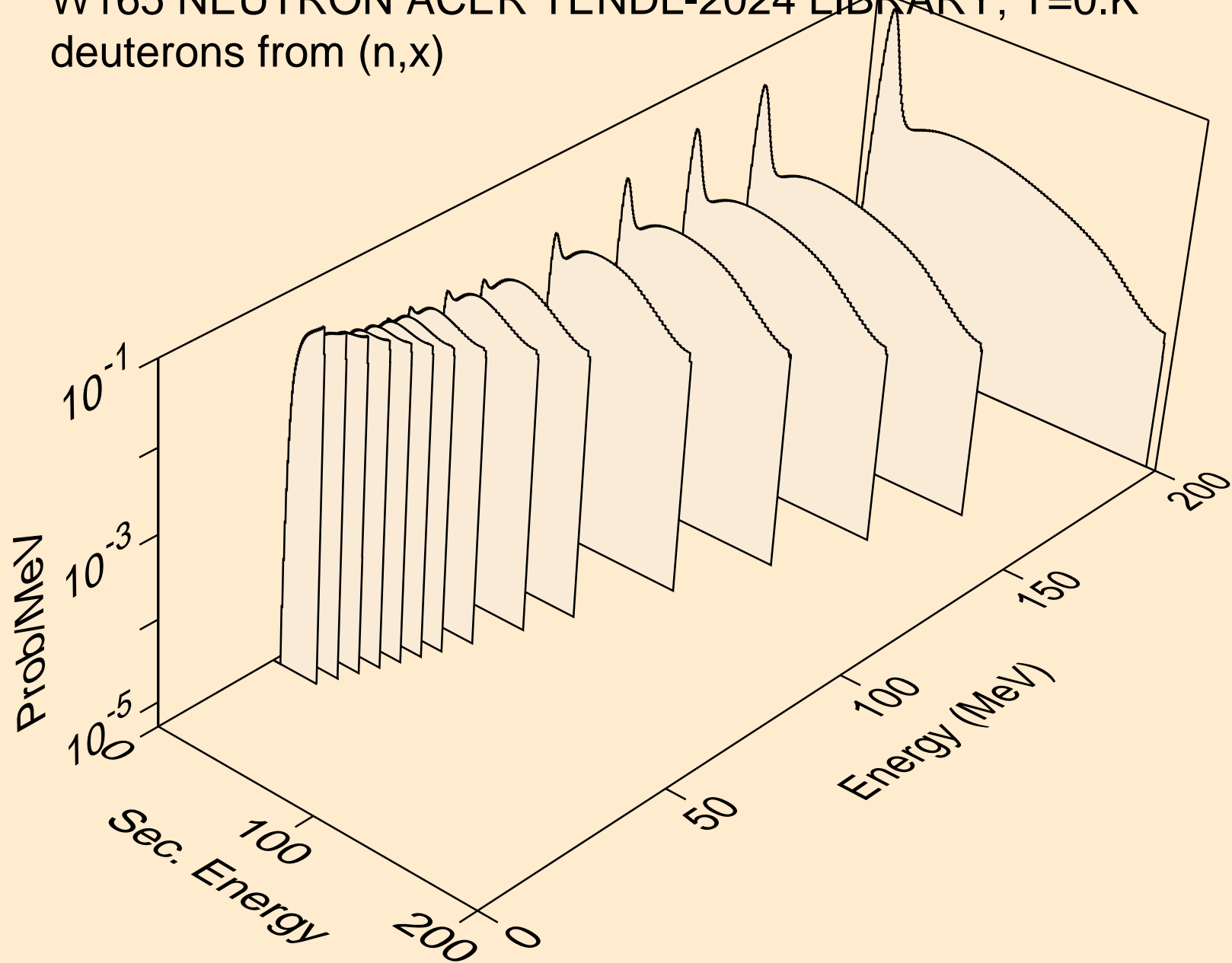

W165 NEUTRON ACER TENDL-2024 LIBRARY; T=0.K
deuterons from (n,2nd)

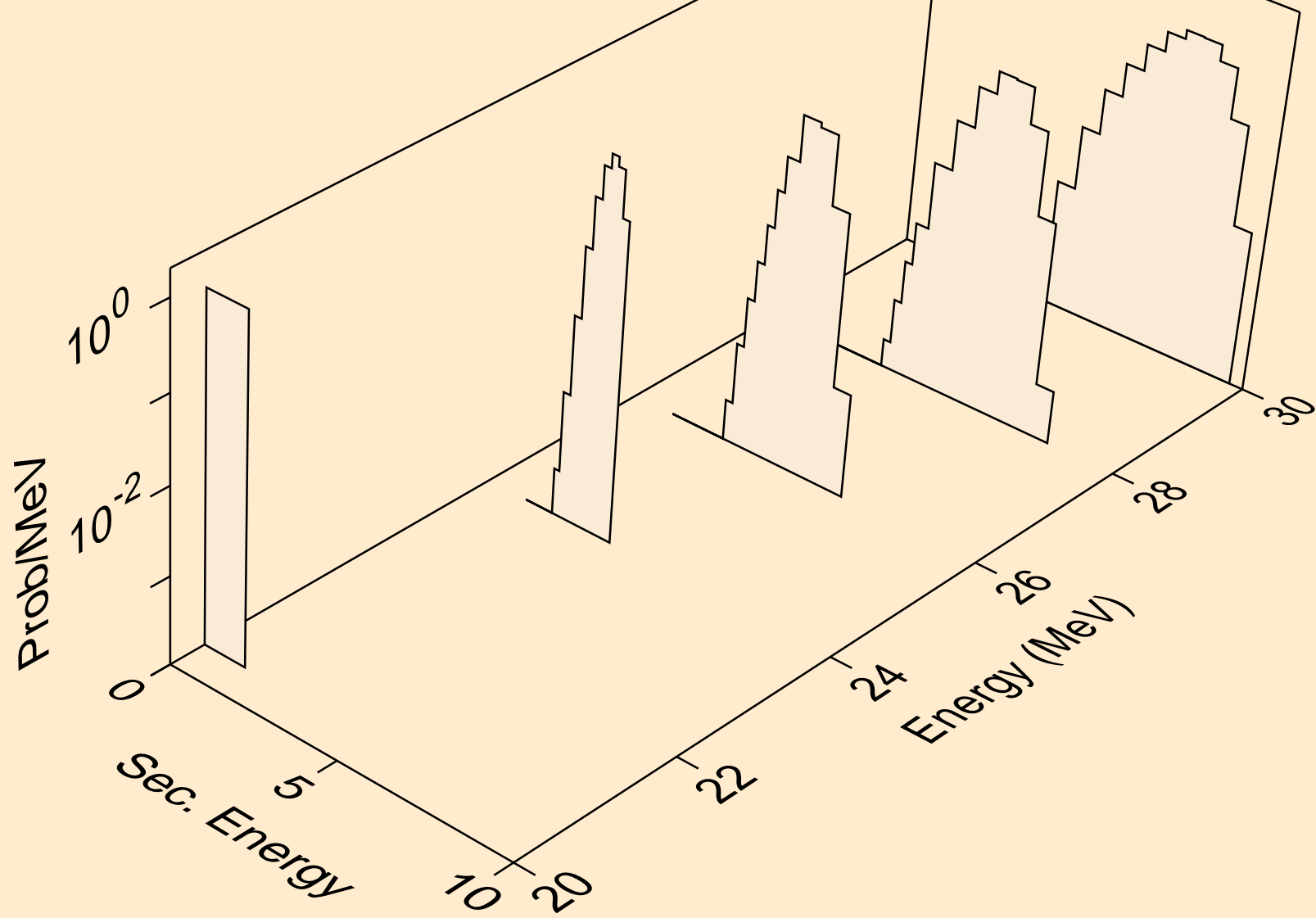

W165 NEUTRON ACER TENDL-2024 LIBRARY; T=0.K
deuterons from (n,n*)d

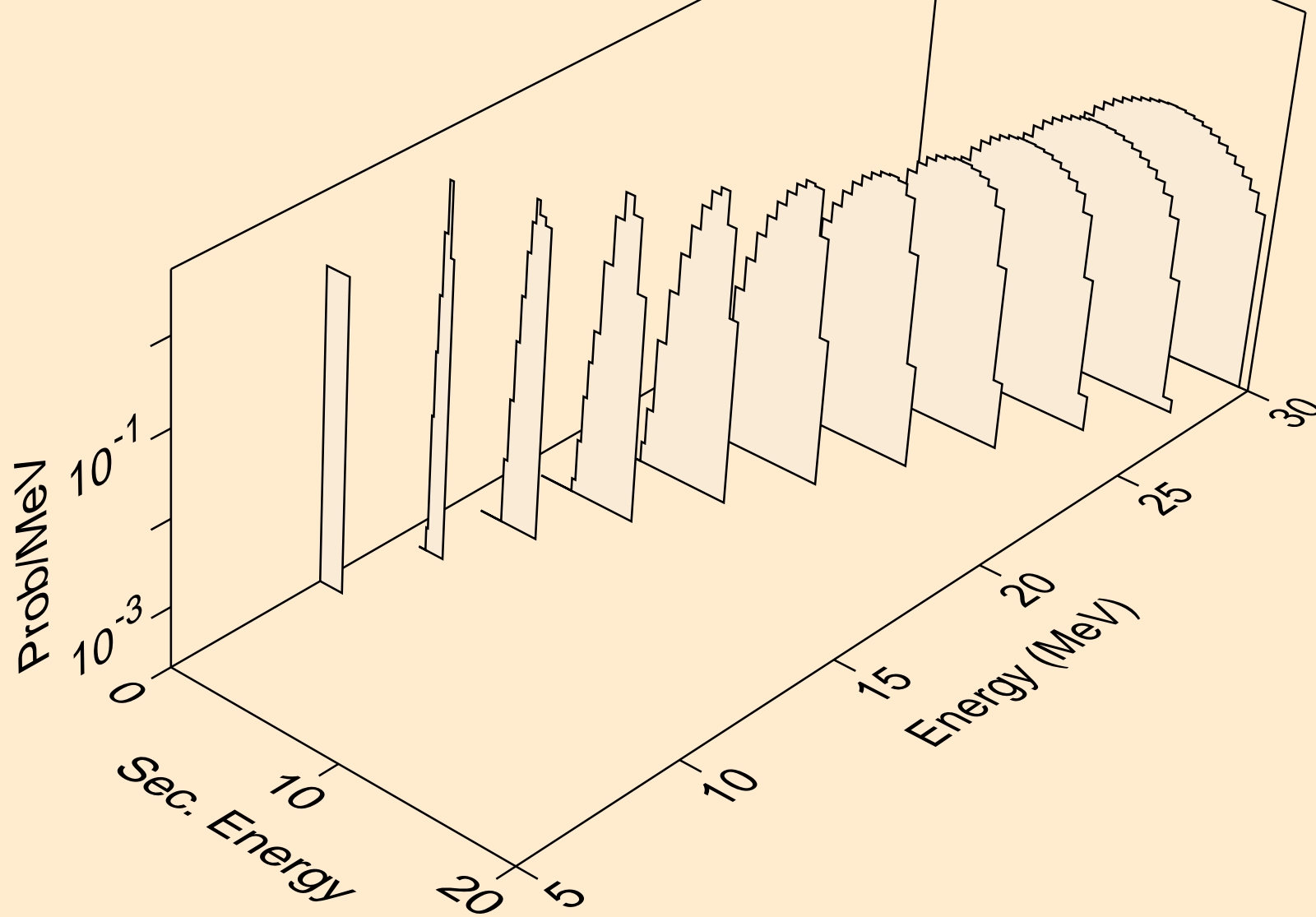

W165 NEUTRON ACER TENDL-2024 LIBRARY; T=0.K
deuterons from (n,d)

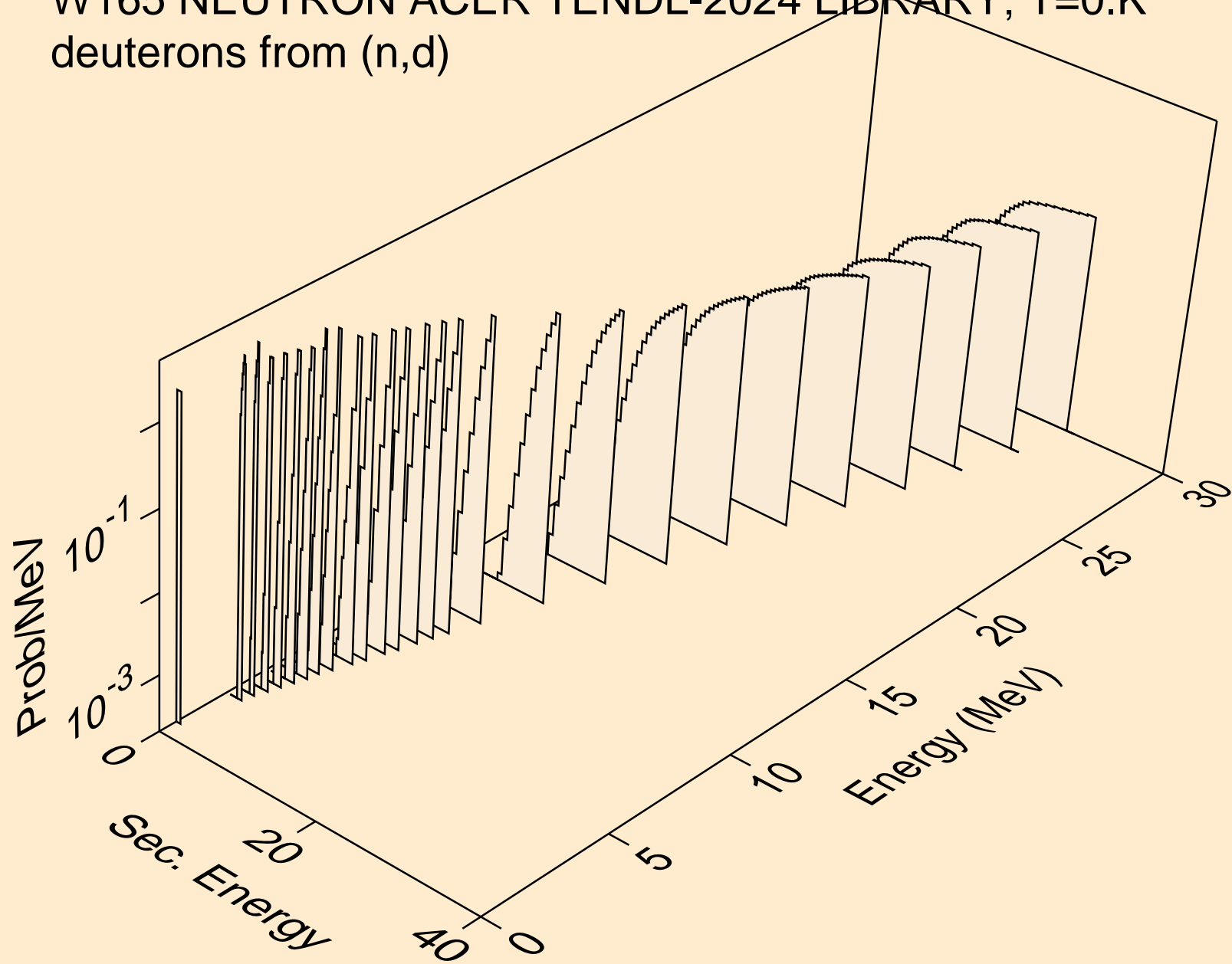

W165 NEUTRON ACER TENDL-2024 LIBRARY; T=0.K
deuterons from (n,d2a)

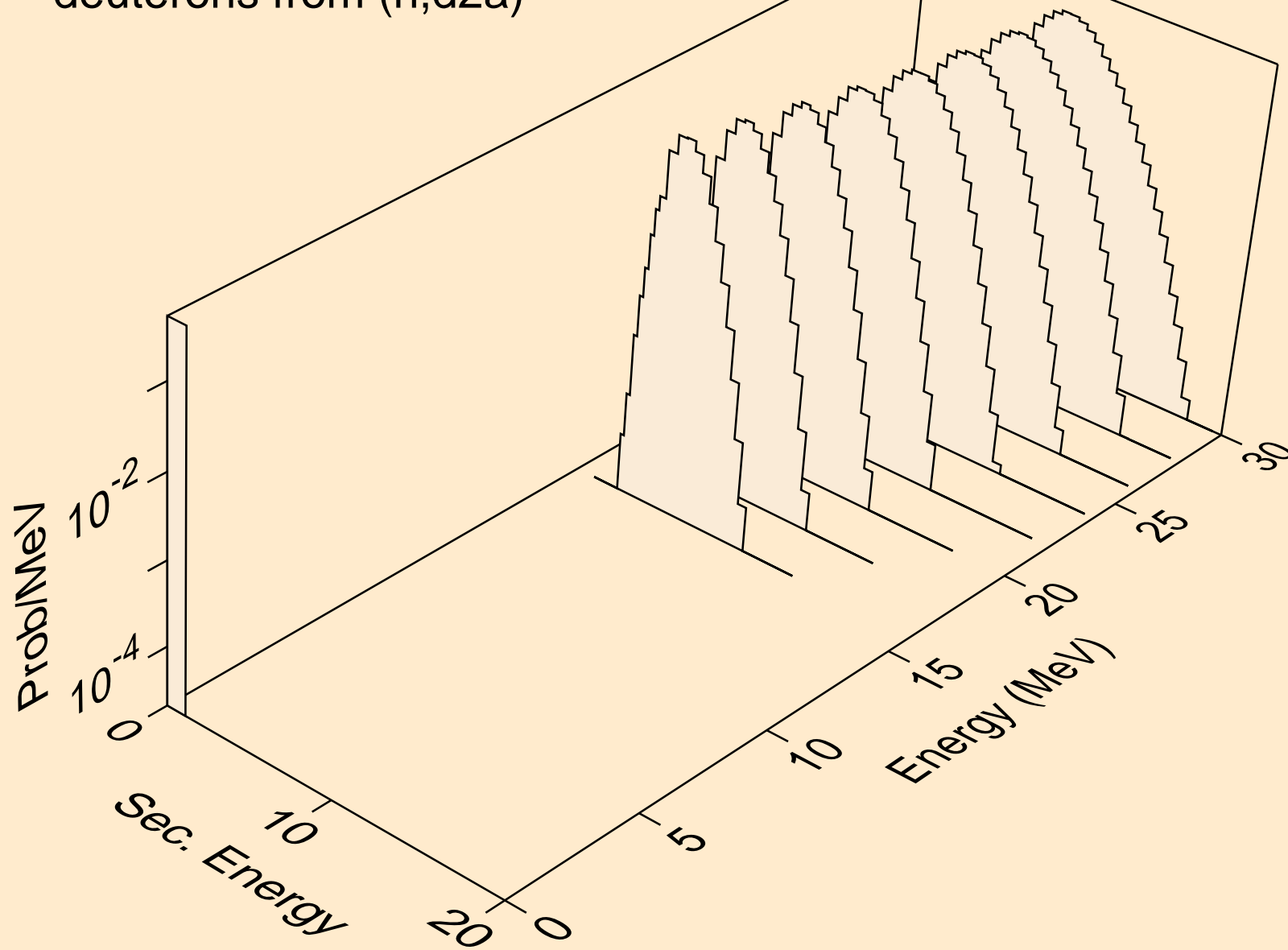

W165 NEUTRON ACER TENDL-2024 LIBRARY; T=0.K
deuterons from (n,pd)

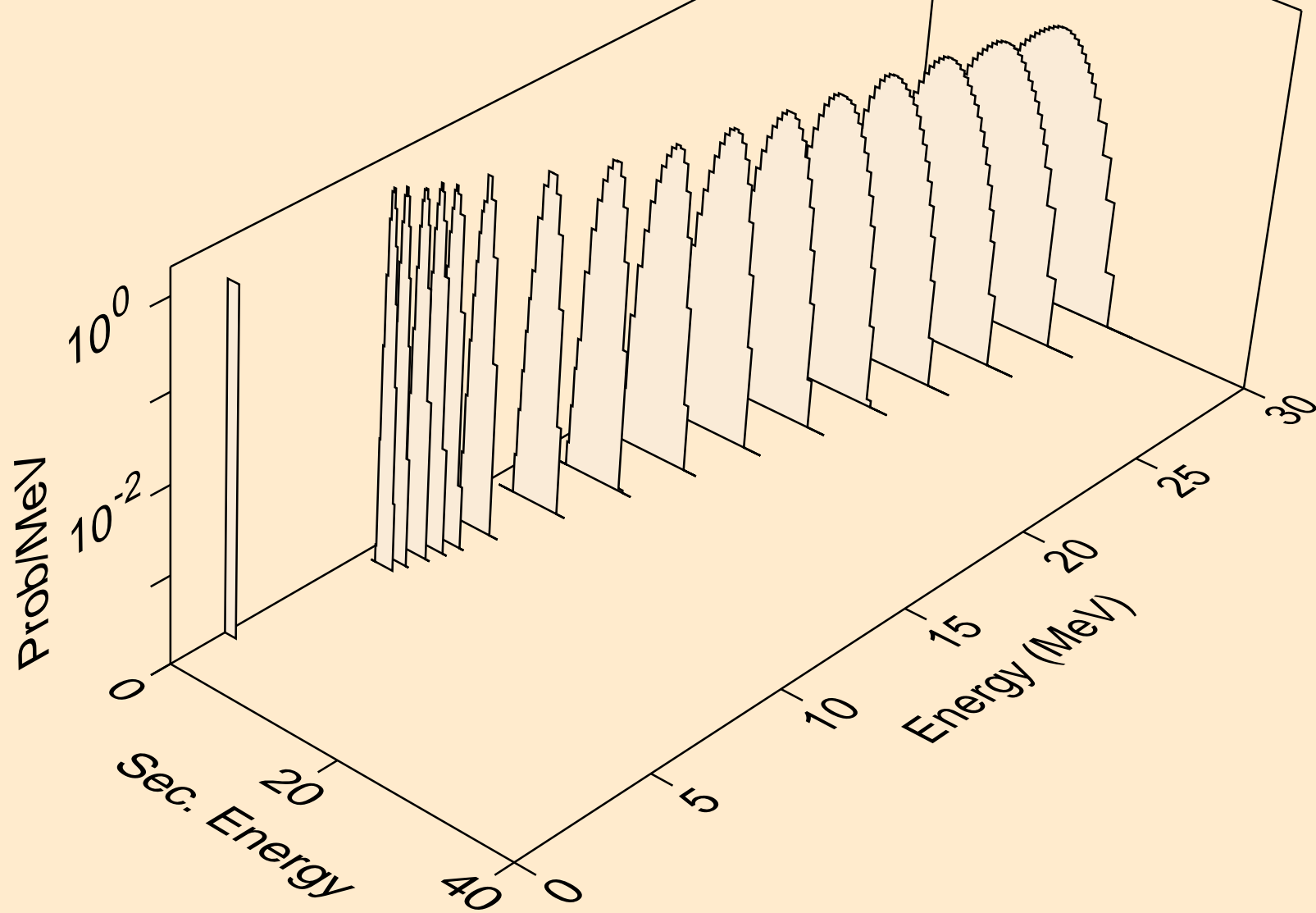

W165 NEUTRON ACER TENDL-2024 LIBRARY; T=0.K
deuterons from (n,da)

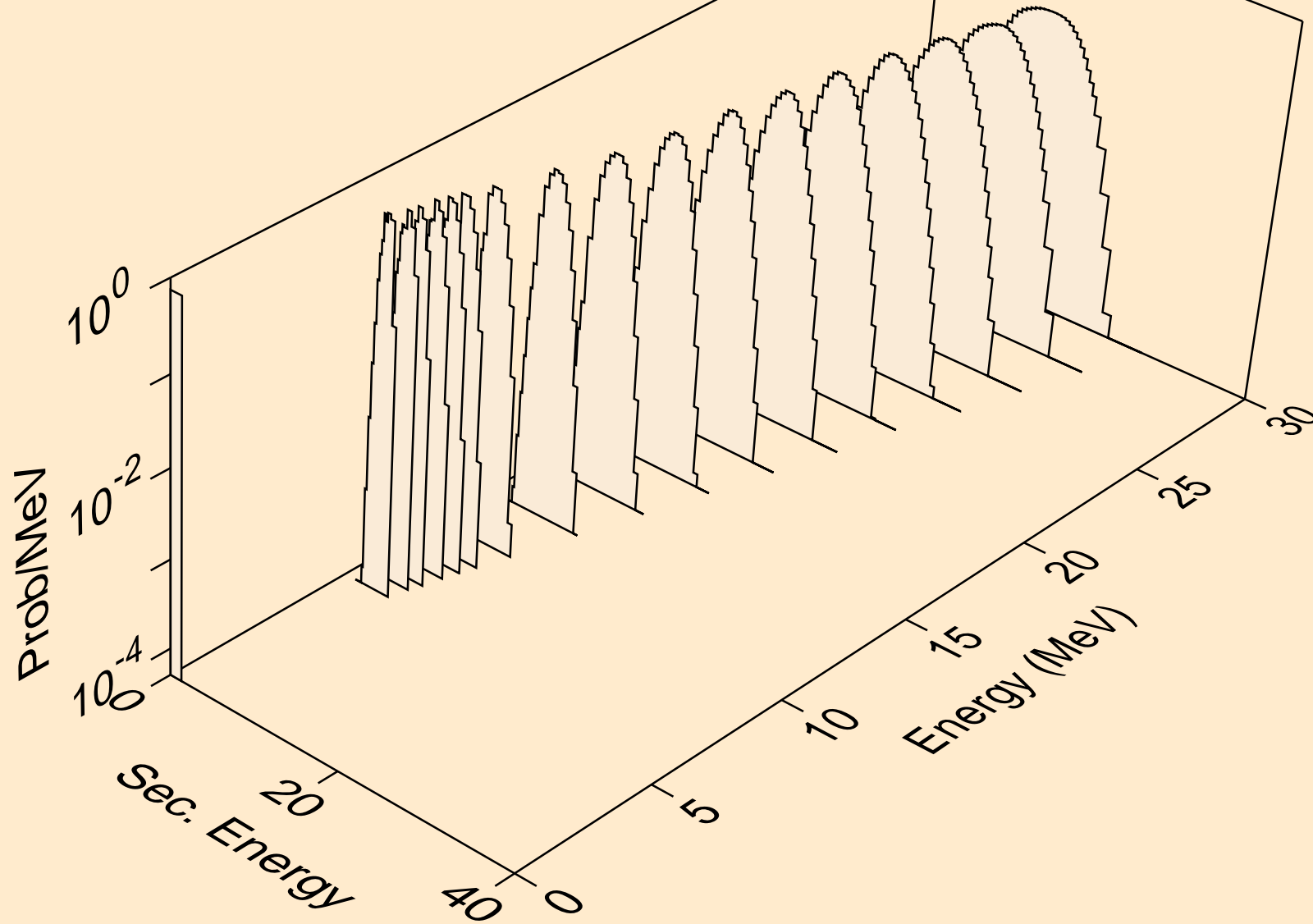

W165 NEUTRON ACER TENDL-2024 LIBRARY; T=0.K
tritons from (n,x)

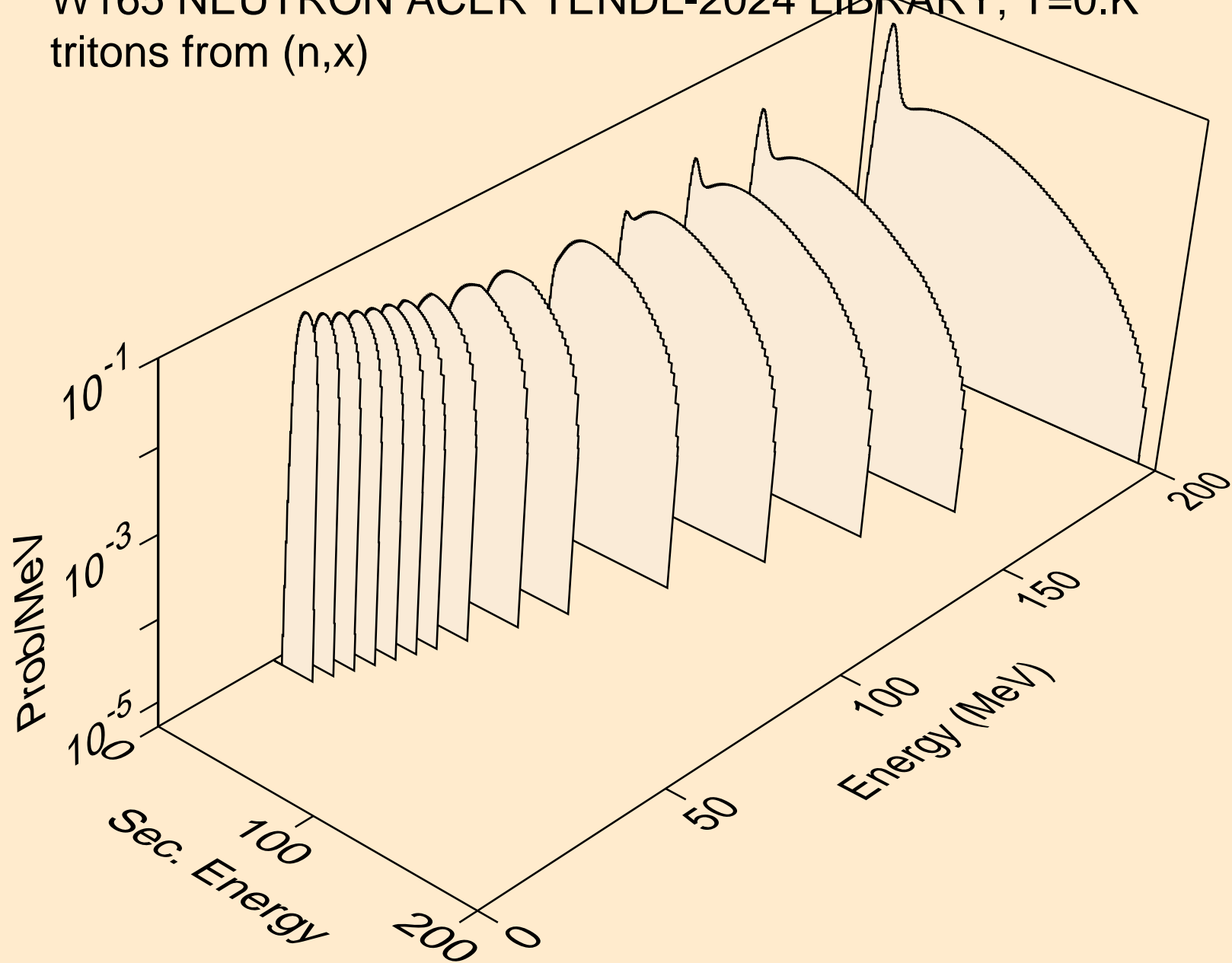

W165 NEUTRON ACER TENDL-2024 LIBRARY; T=0.K
tritons from (n,n*)t

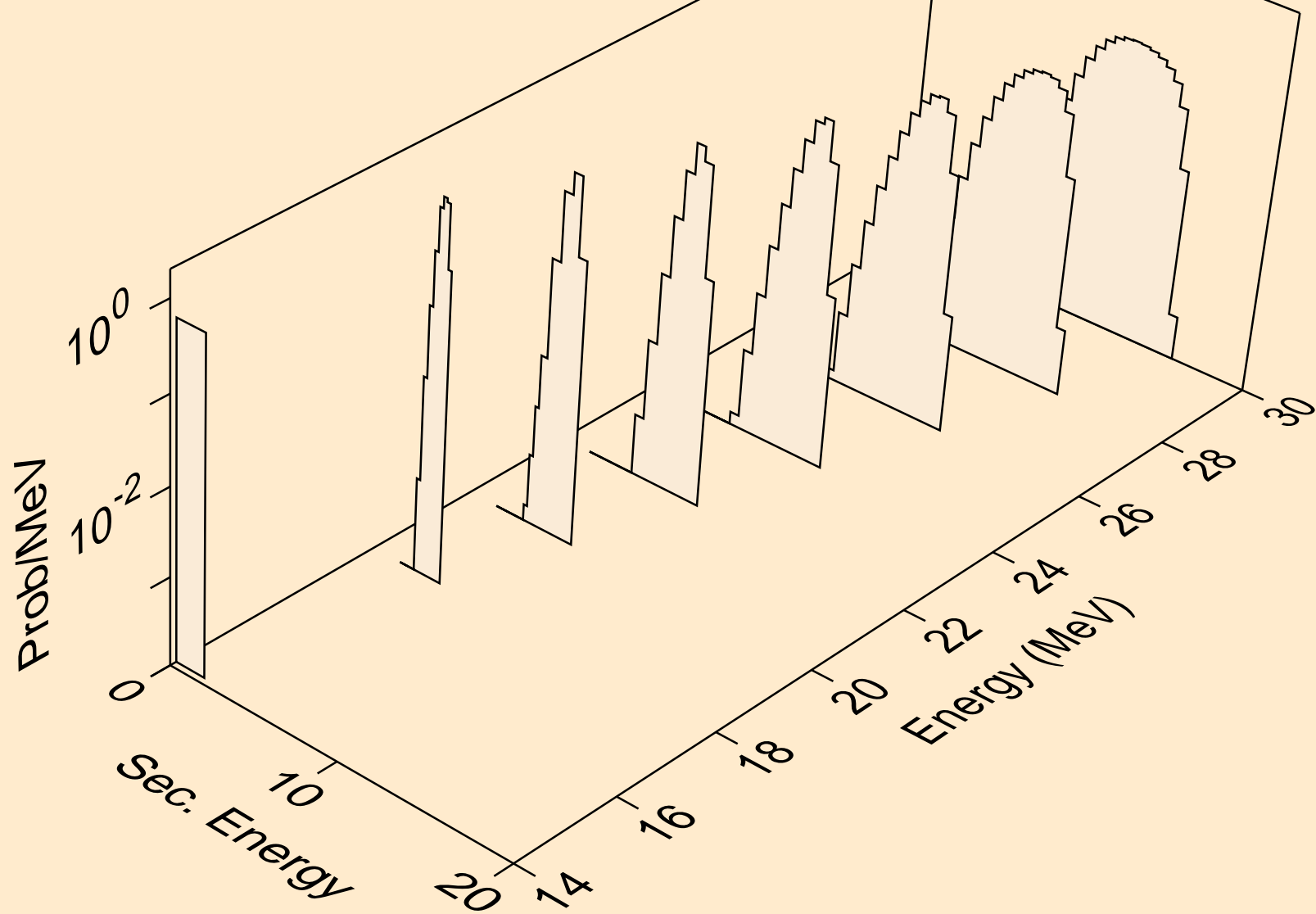

W165 NEUTRON ACER TENDL-2024 LIBRARY; T=0.K
tritons from (n,t)

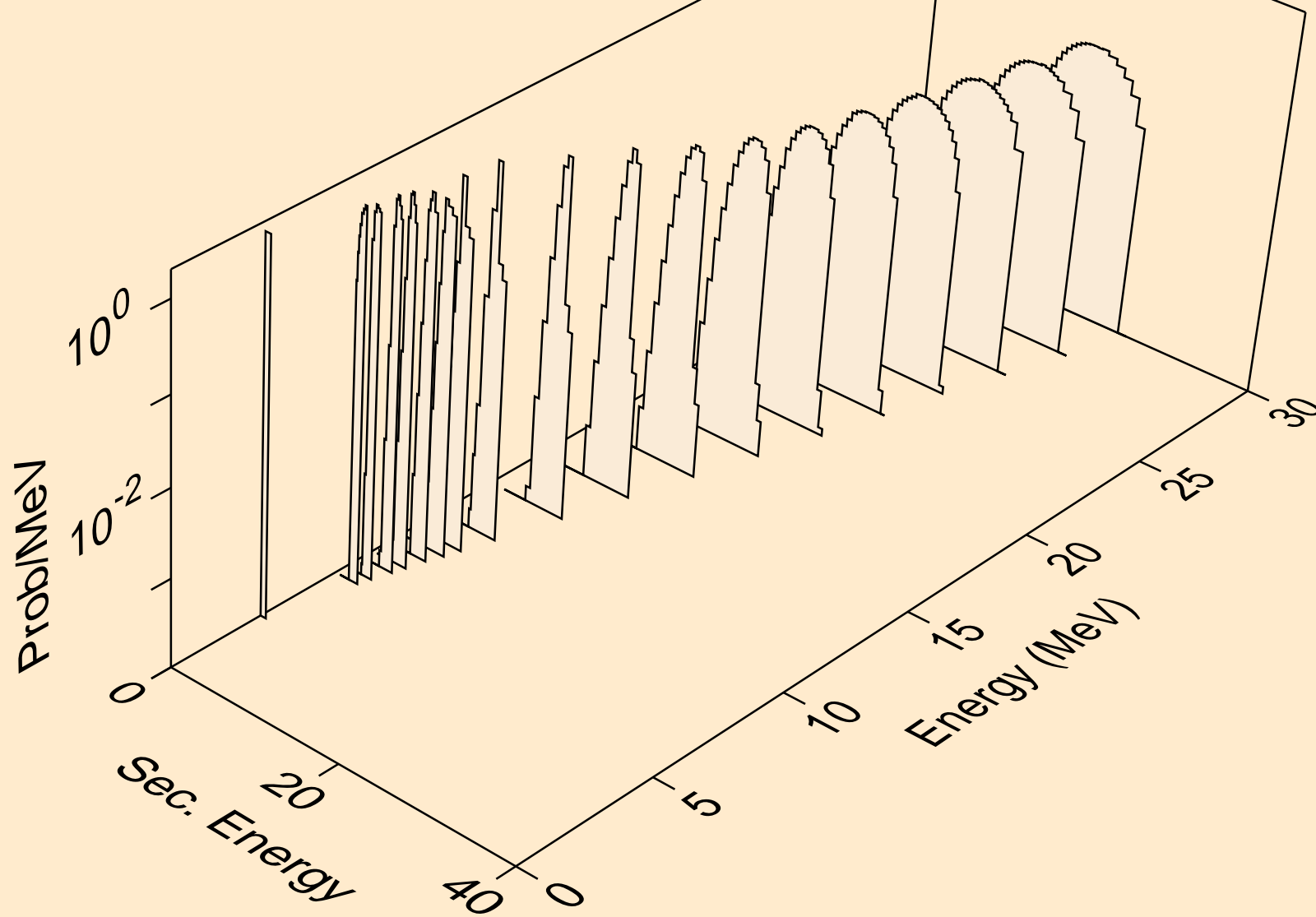

W165 NEUTRON ACER TENDL-2024 LIBRARY; T=0.K
tritons from (n,pt)

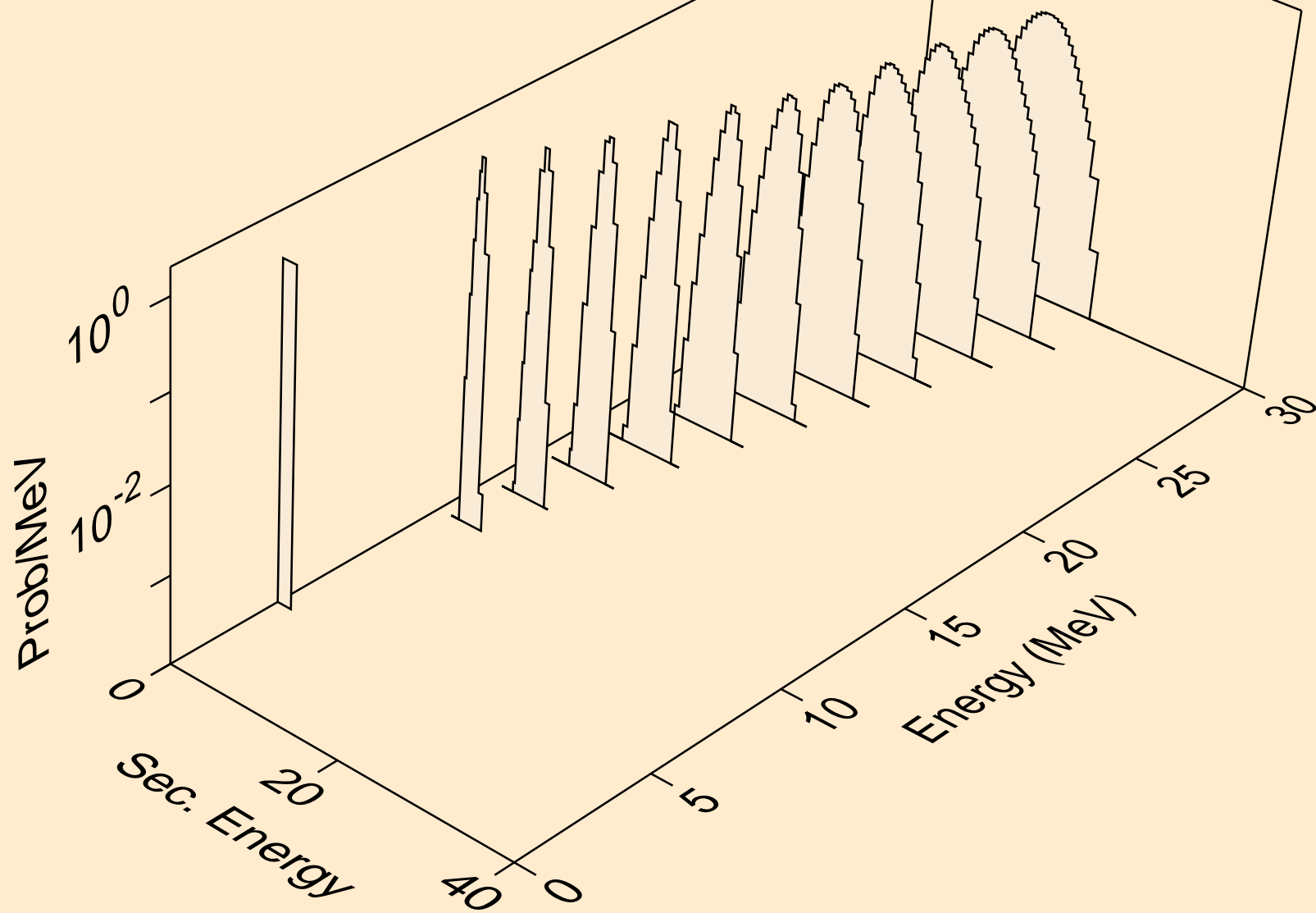

W165 NEUTRON ACER TENDL-2024 LIBRARY; T=0.K
he3s from (n,x)

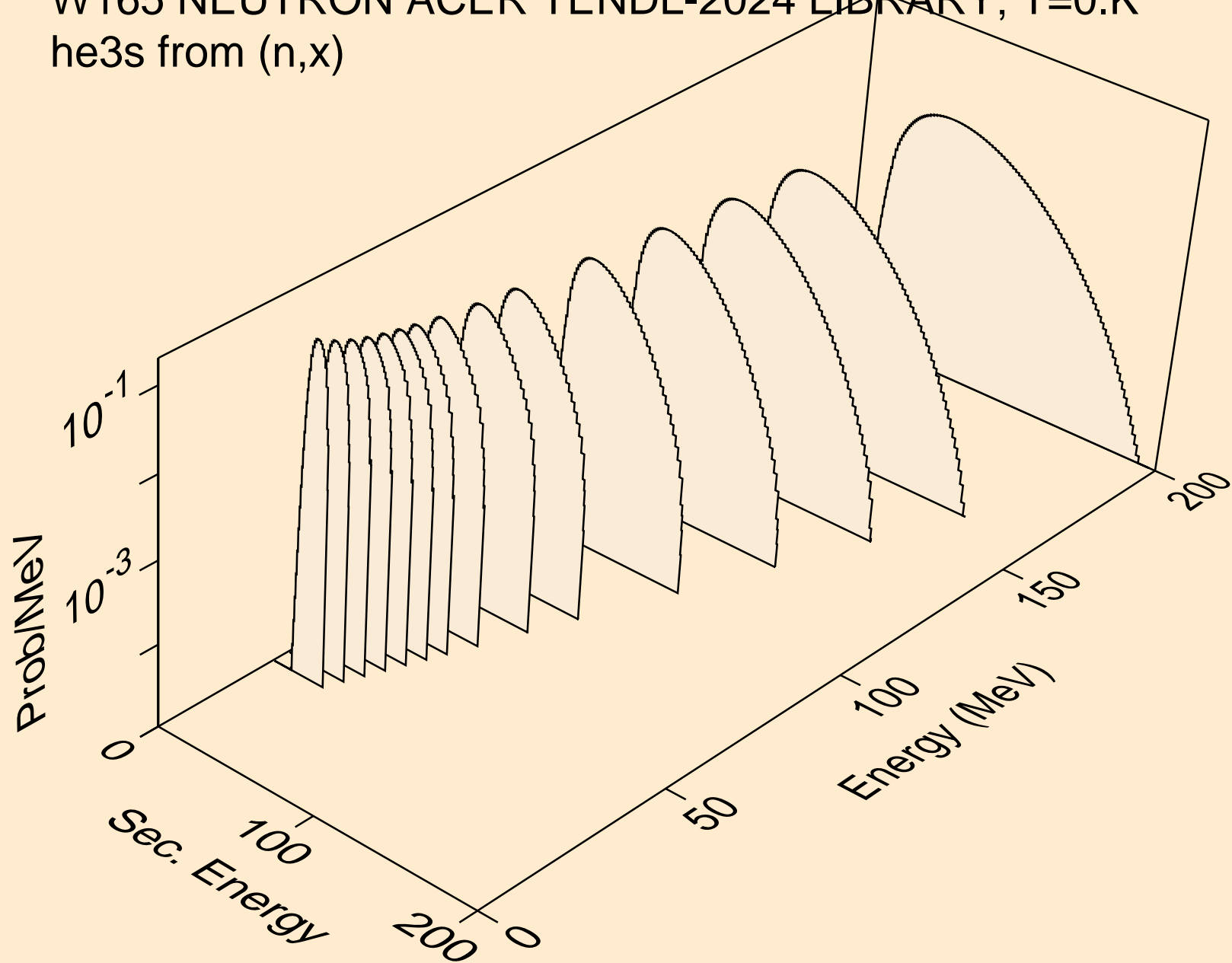

W165 NEUTRON ACER TENDL-2024 LIBRARY; T=0.K
he3s from (n,n*)he3

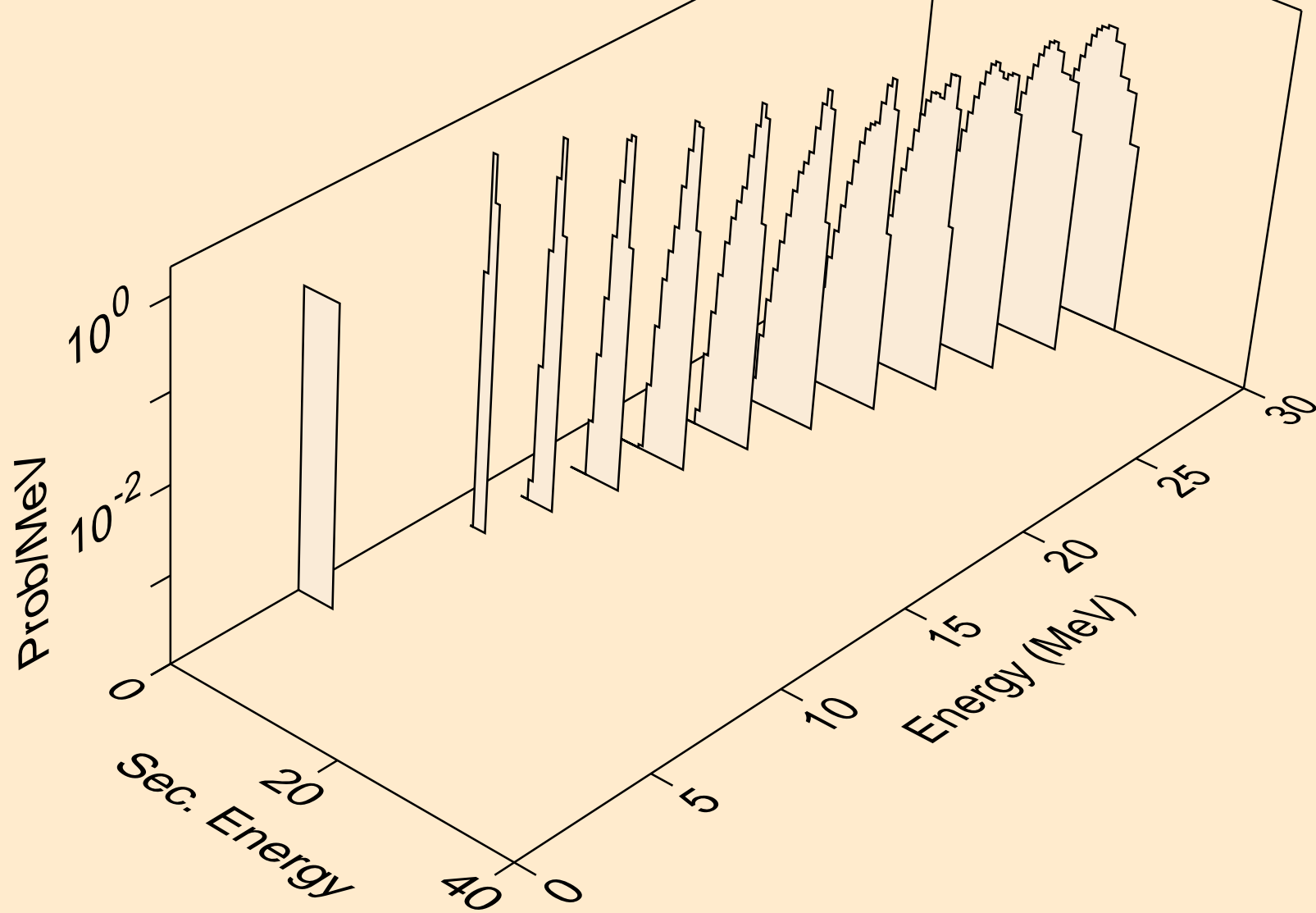

W165 NEUTRON ACER TENDL-2024 LIBRARY; T=0.K
he3s from (n,he3)

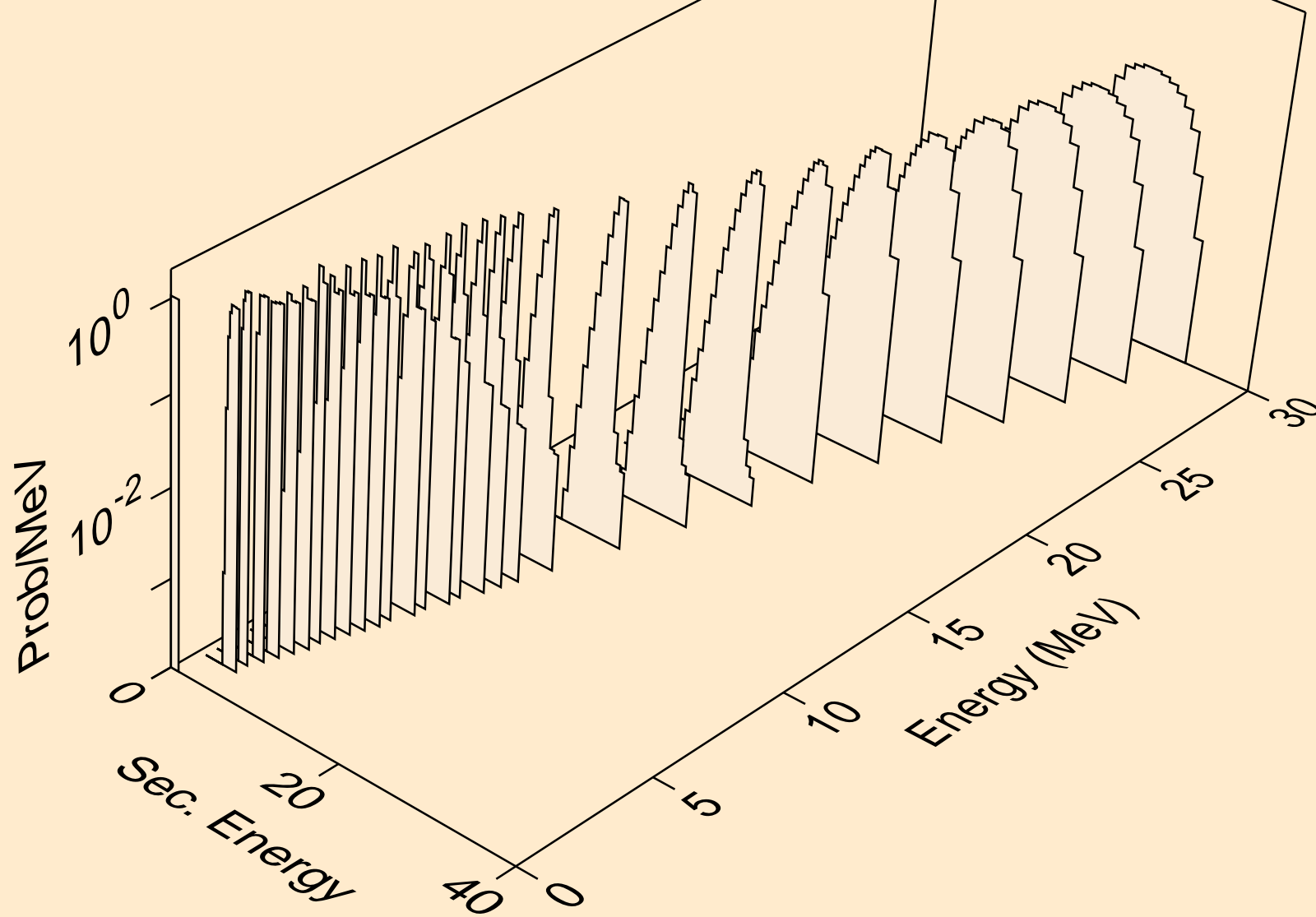

W165 NEUTRON ACER TENDL-2024 LIBRARY; T=0.K
alphas from (n,x)

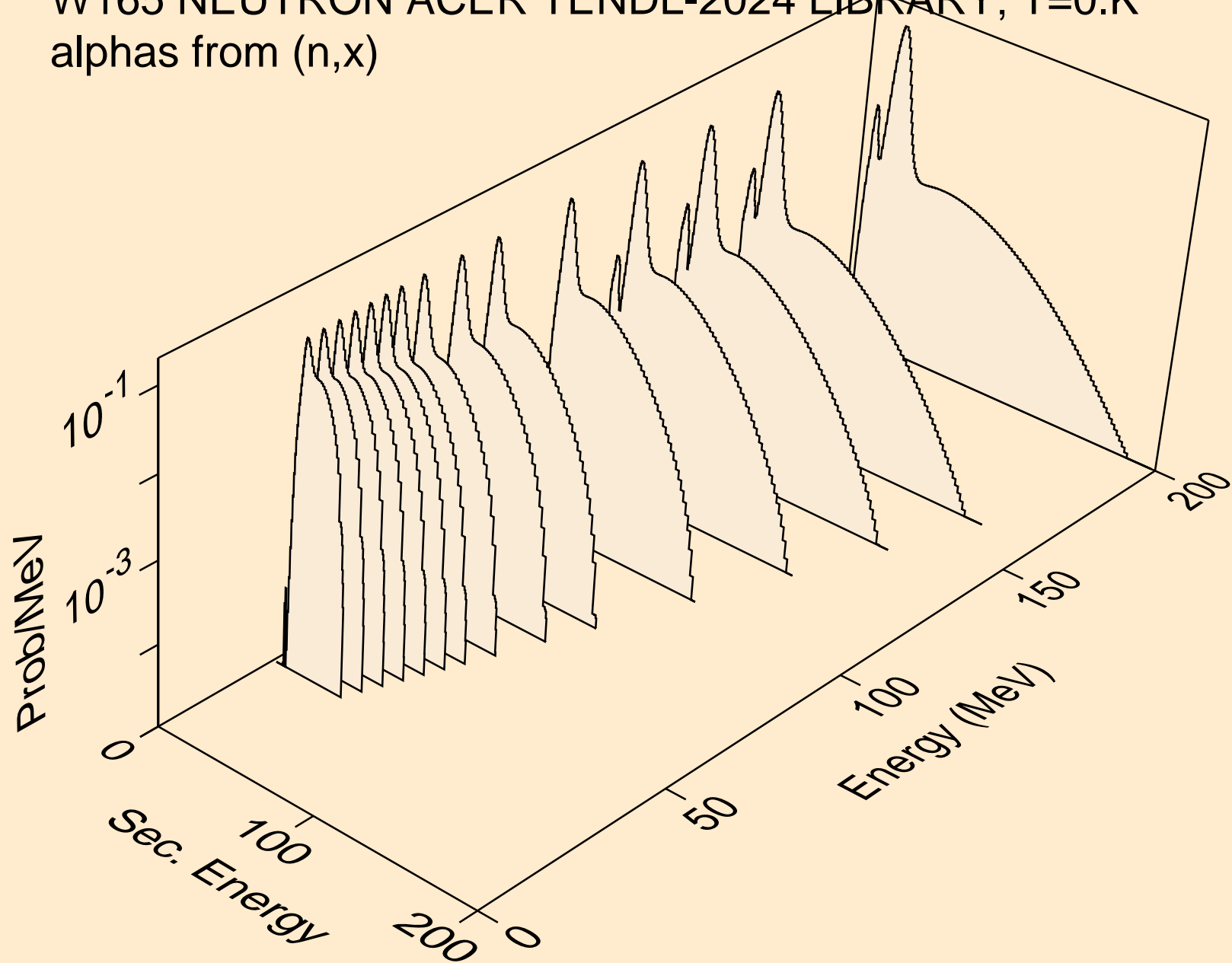

W165 NEUTRON ACER TENDL-2024 LIBRARY; T=0.K
alphas from (n,n*)a

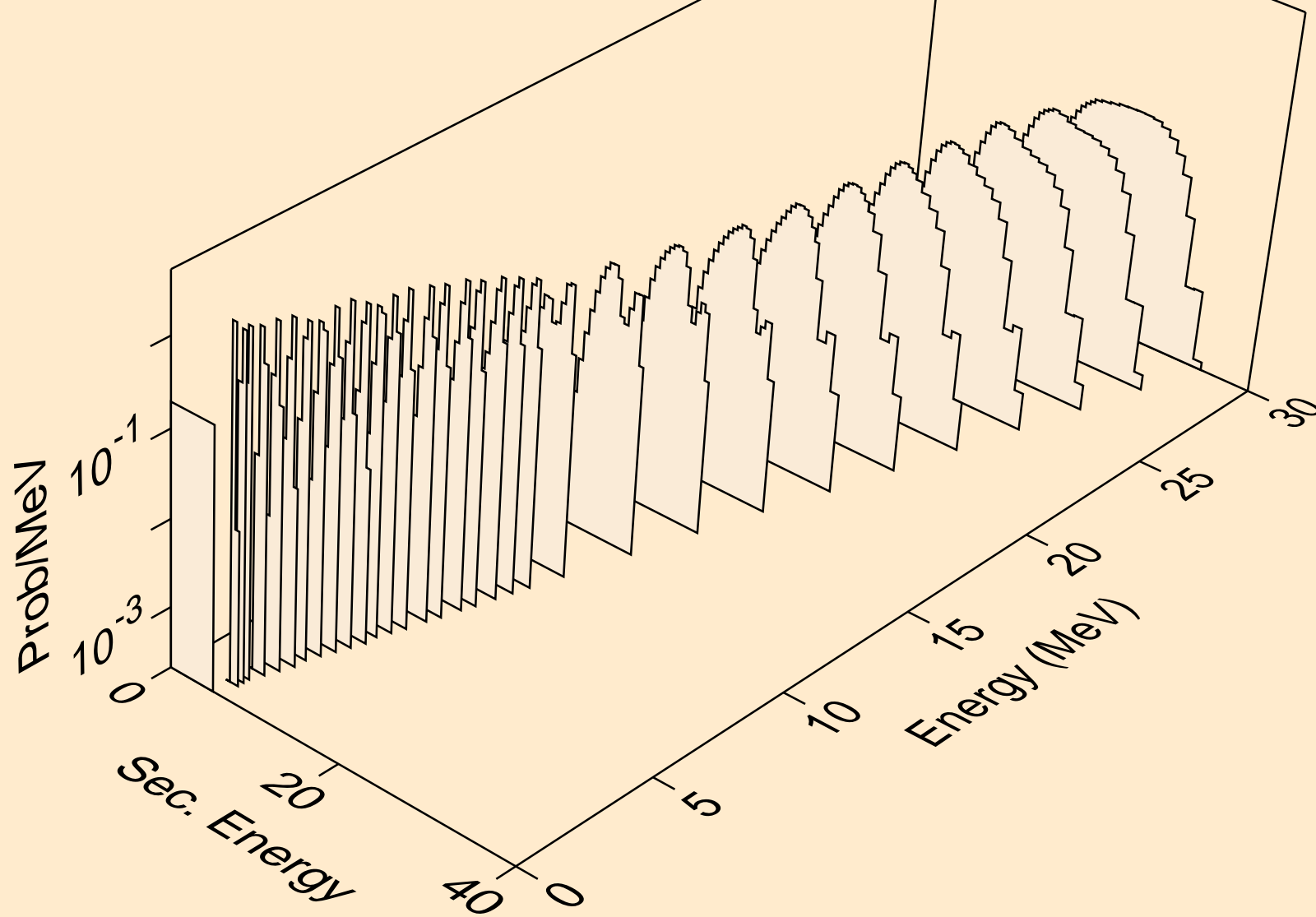

W165 NEUTRON ACER TENDL-2024 LIBRARY; T=0.K
alphas from (n,n*)3a

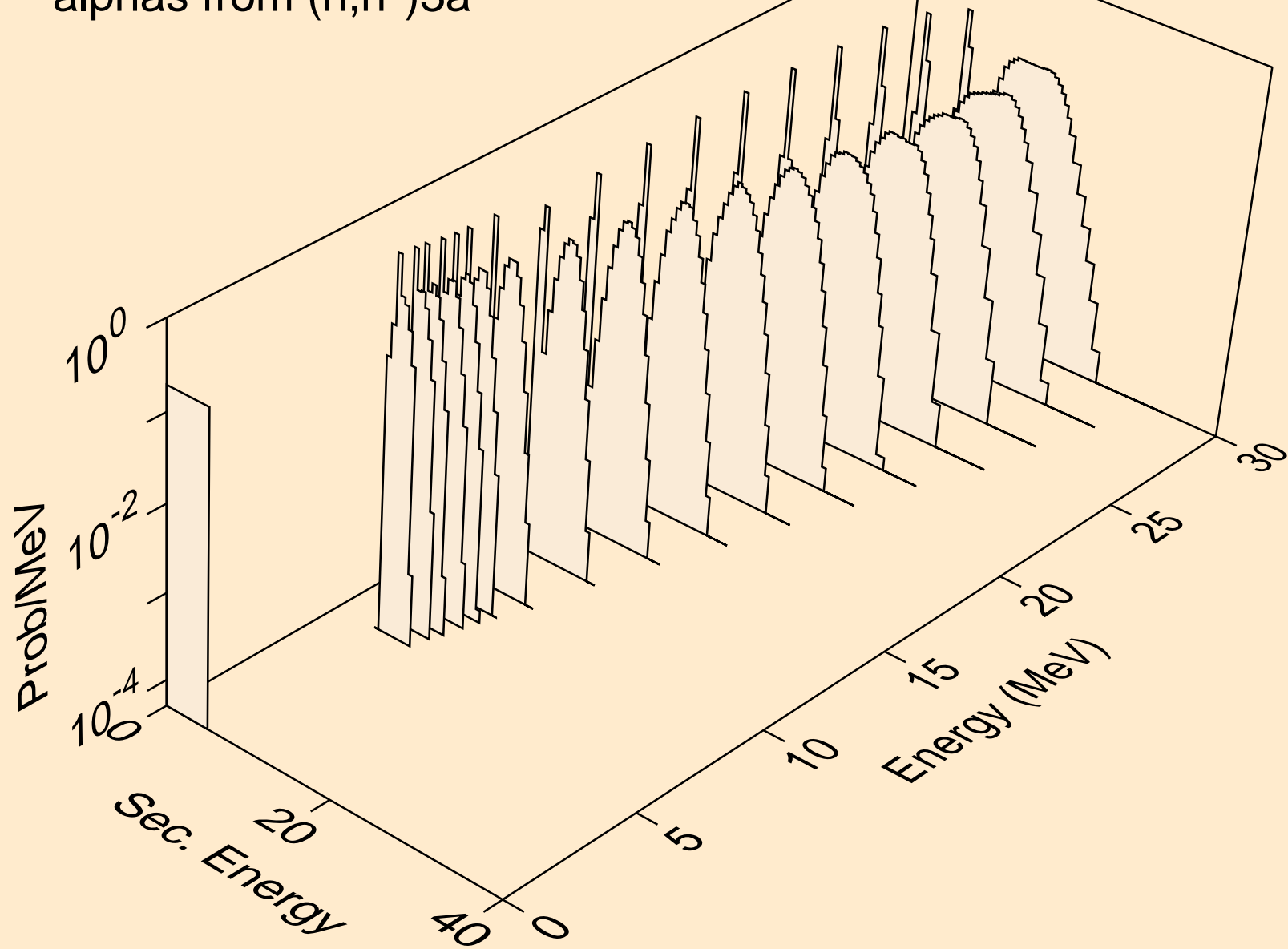

W165 NEUTRON ACER TENDL-2024 LIBRARY; T=0.K
alphas from (n,2n)a

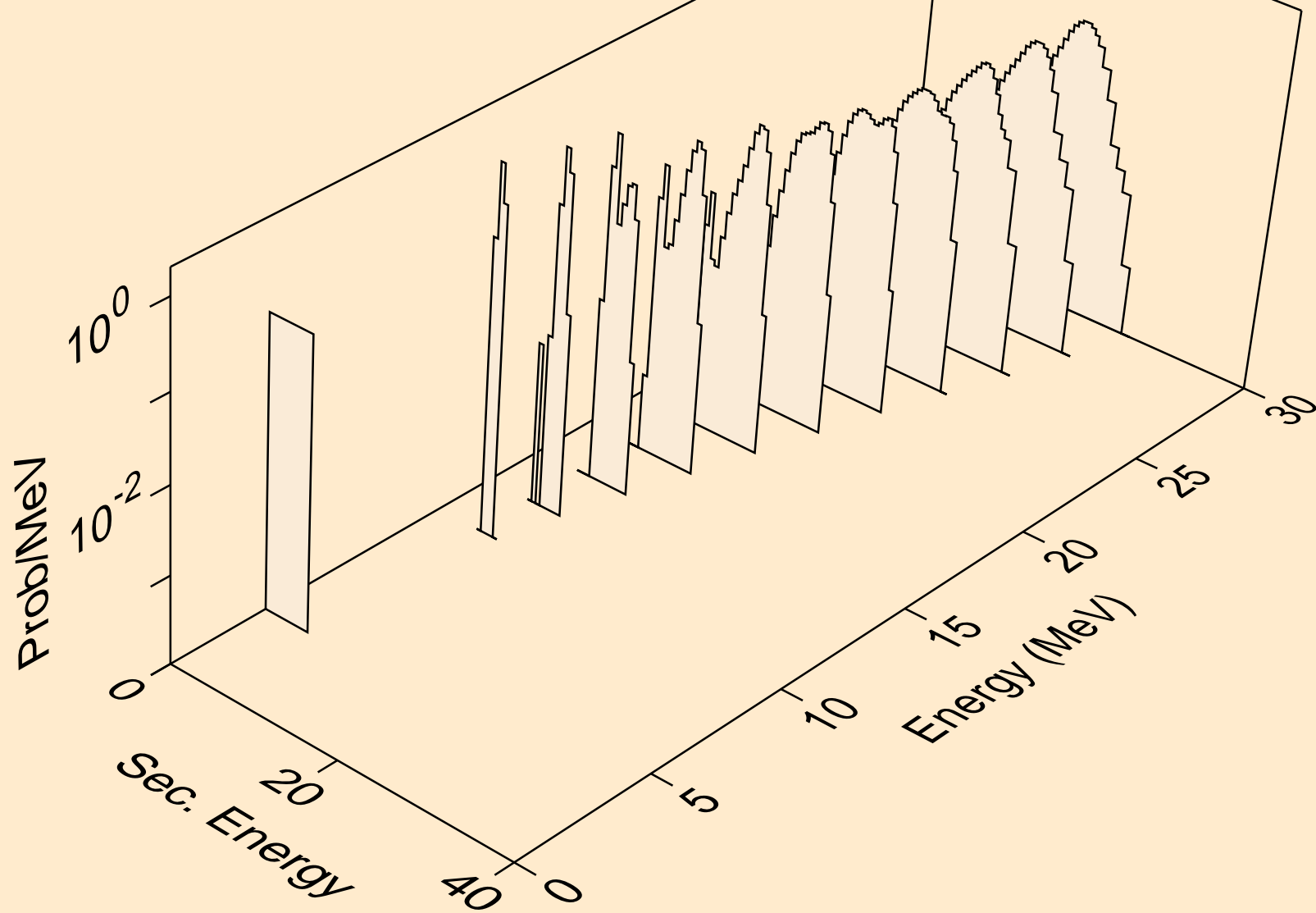

W165 NEUTRON ACER TENDL-2024 LIBRARY; T=0.K
alphas from (n,3n)a

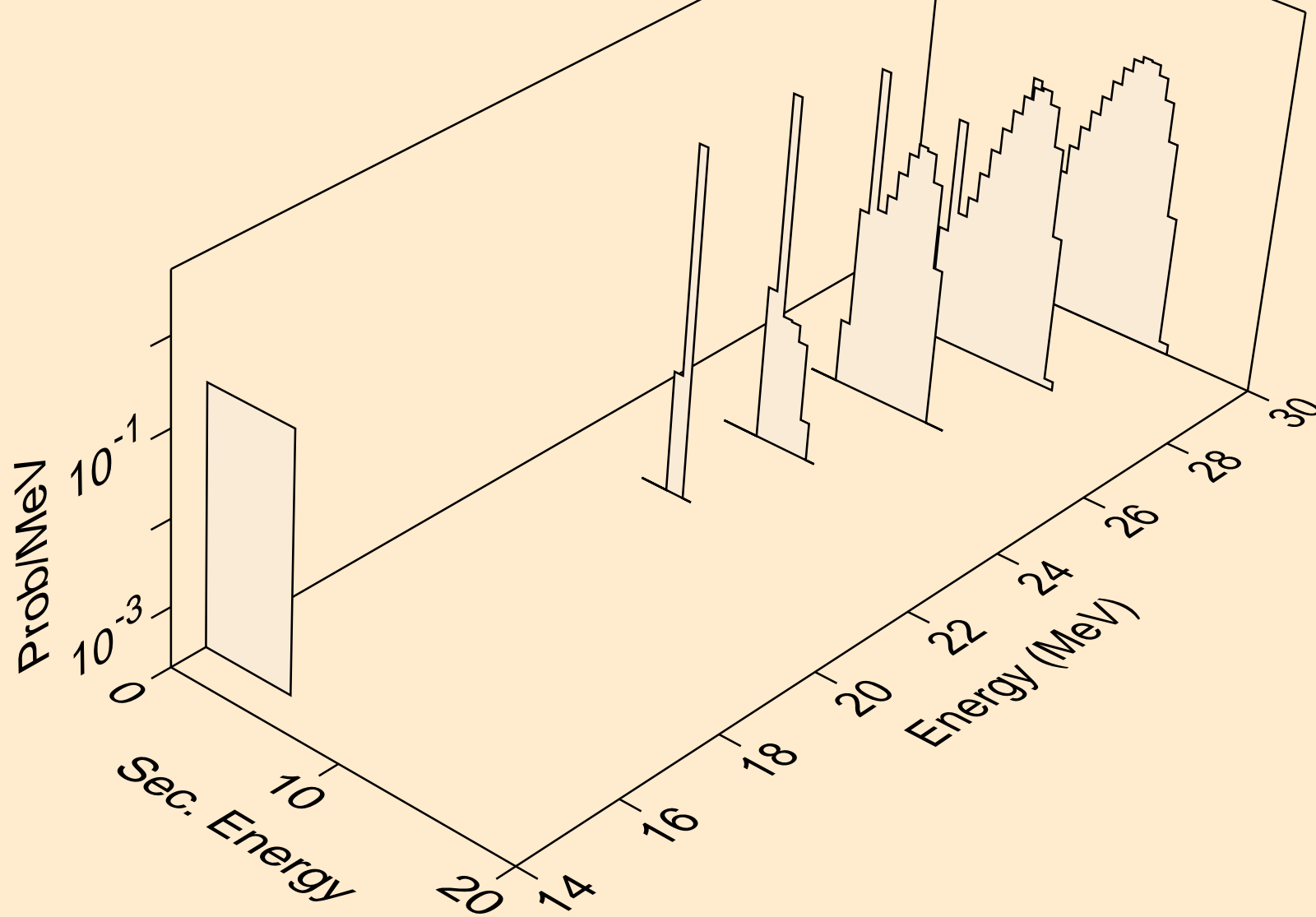

W165 NEUTRON ACER TENDL-2024 LIBRARY; T=0.K
alphas from (n,n*)2a

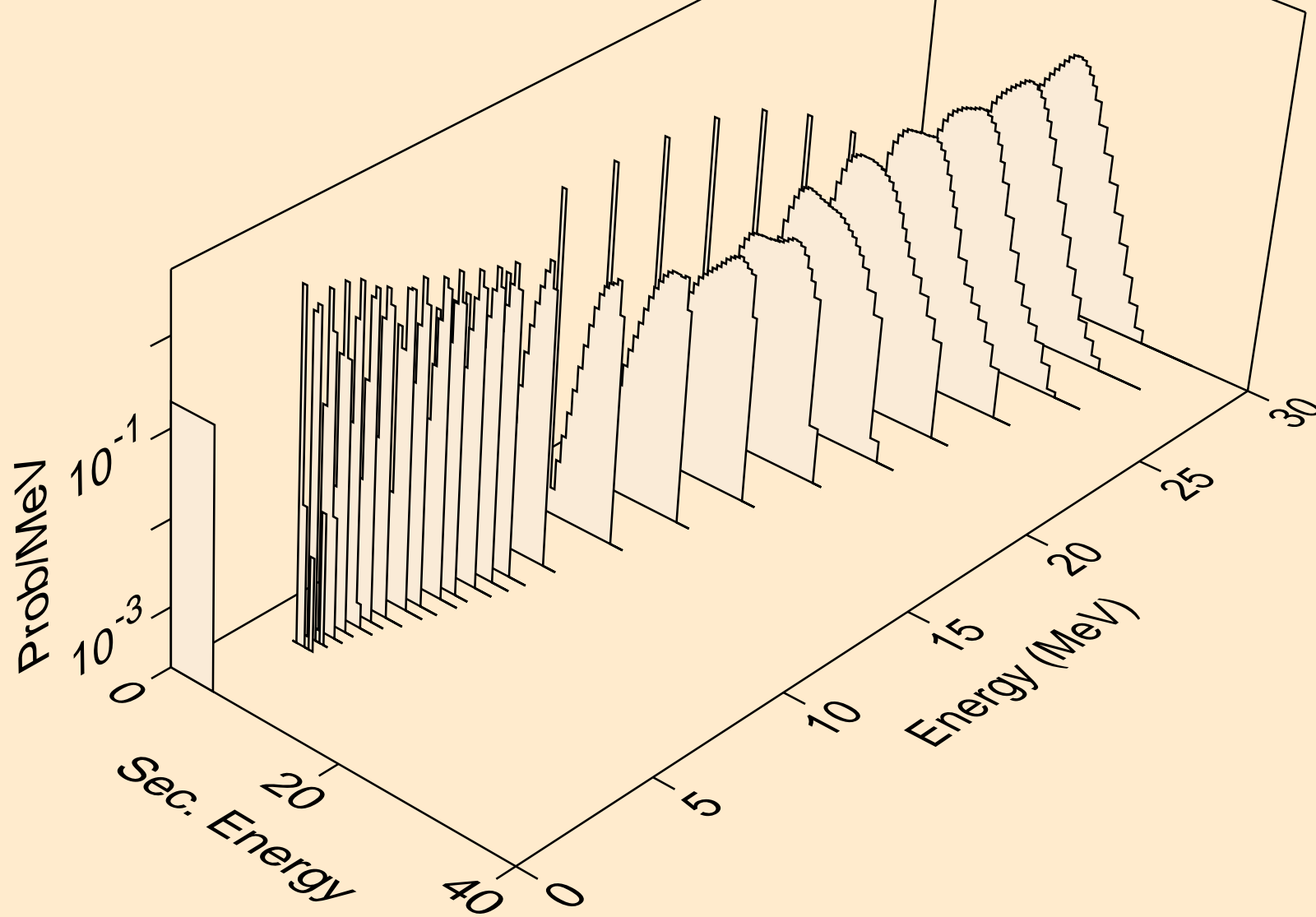

W165 NEUTRON ACER TENDL-2024 LIBRARY; T=0.K
alphas from (n,2n)2a

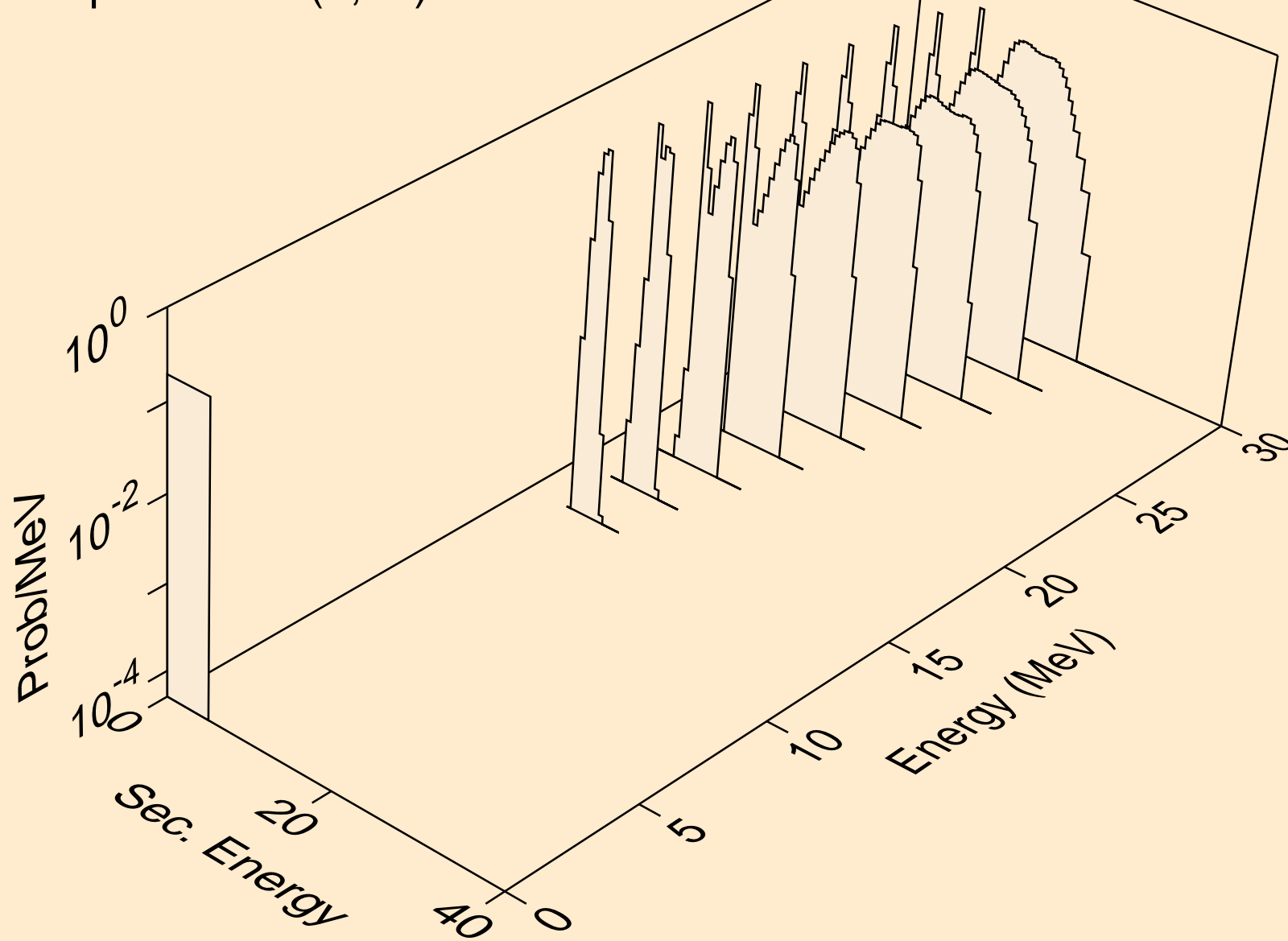

W165 NEUTRON ACER TENDL-2024 LIBRARY; T=0.K
alphas from (n,npa)

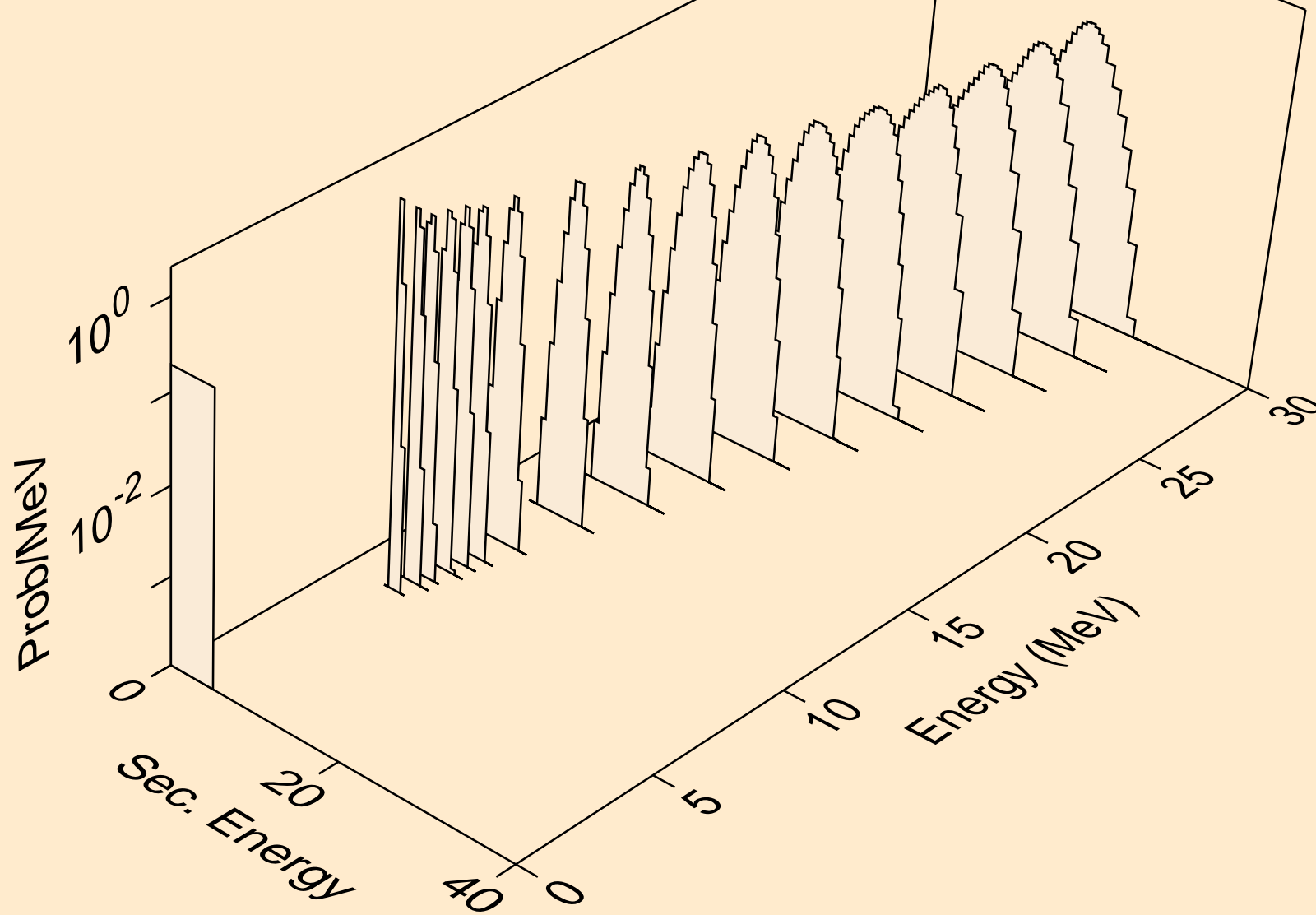

W165 NEUTRON ACER TENDL-2024 LIBRARY; T=0.K
alphas from (n,a)

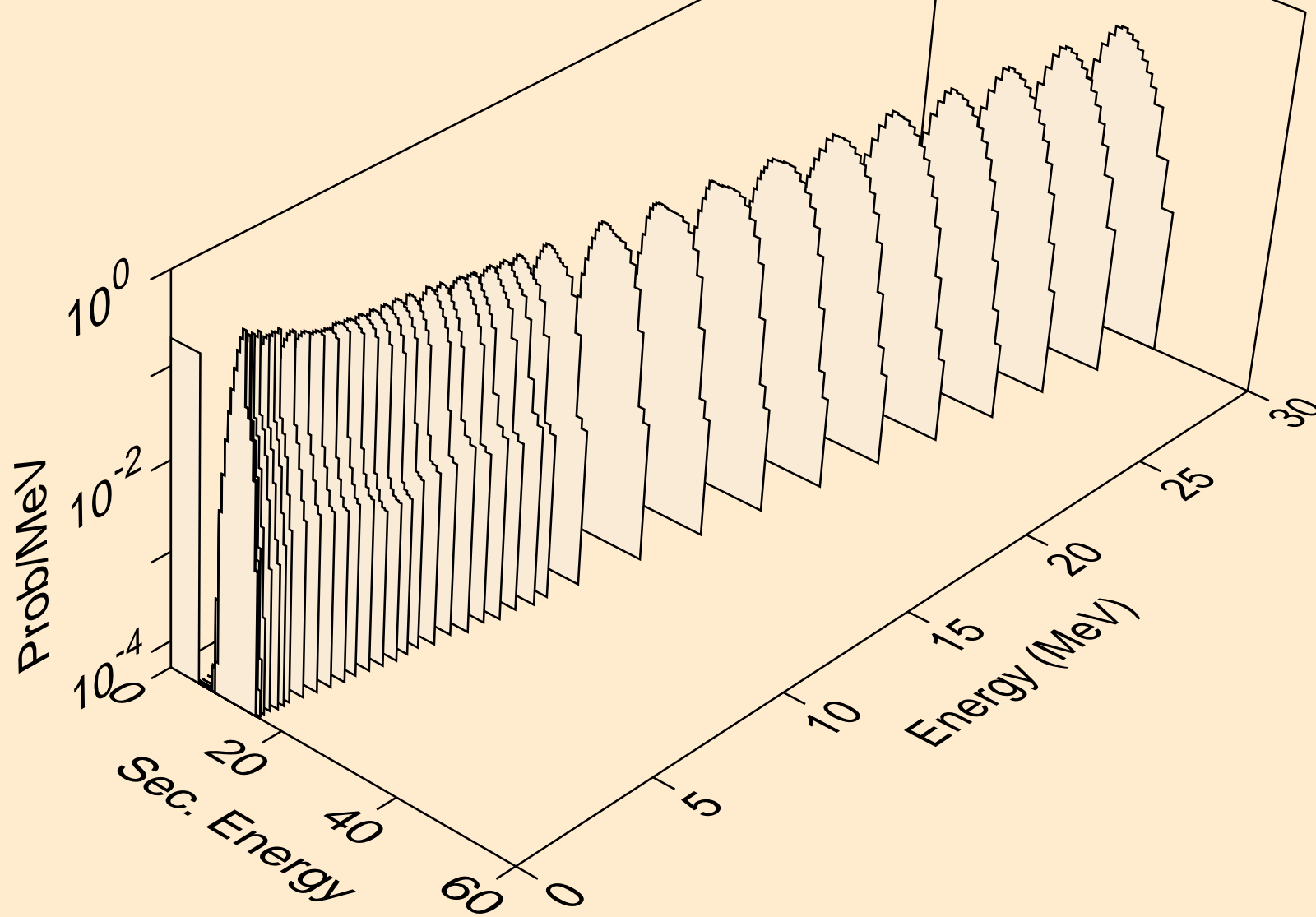

W165 NEUTRON ACER TENDL-2024 LIBRARY; T=0.K
alphas from (n,2a)

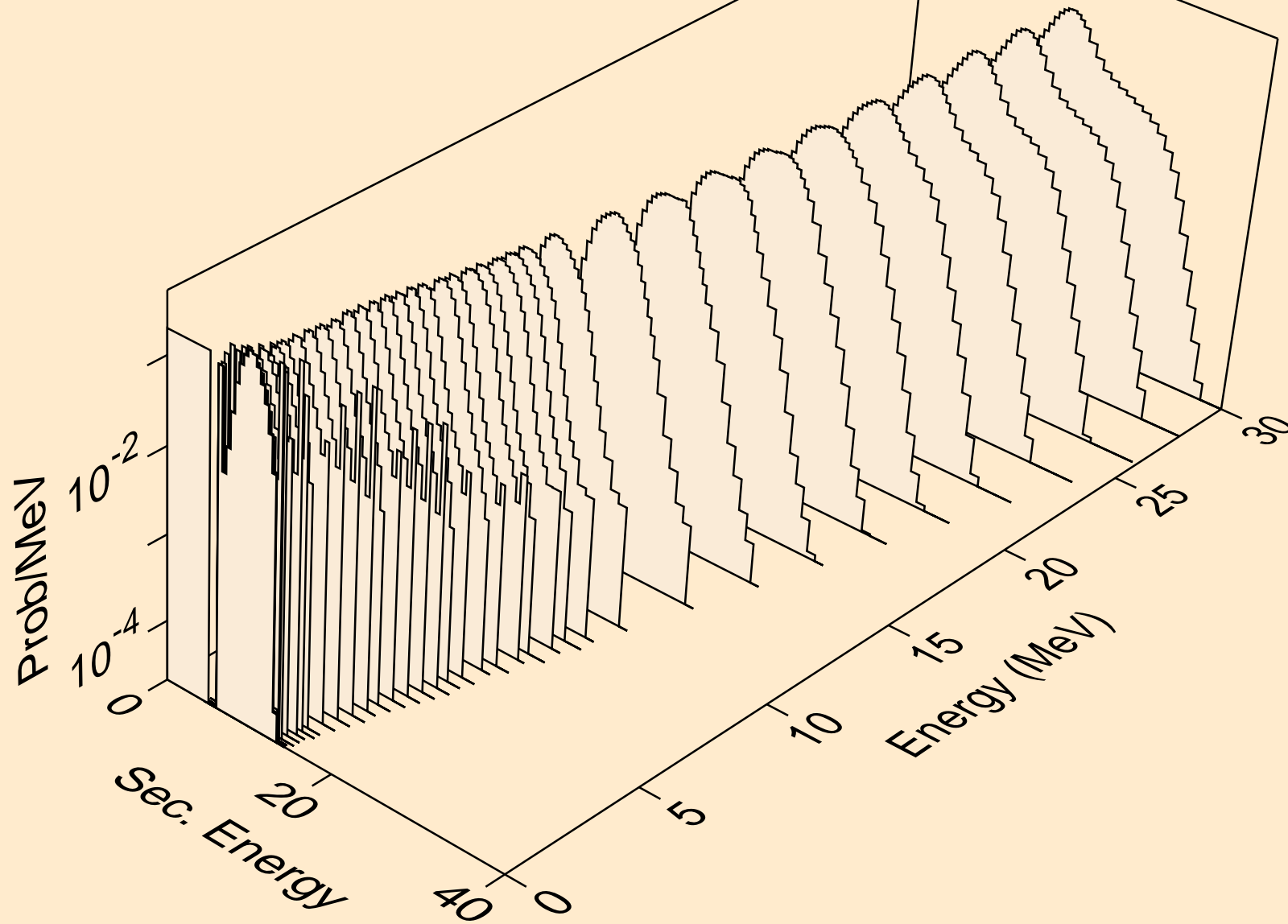

W165 NEUTRON ACER TENDL-2024 LIBRARY; T=0.K
alphas from (n,3a)

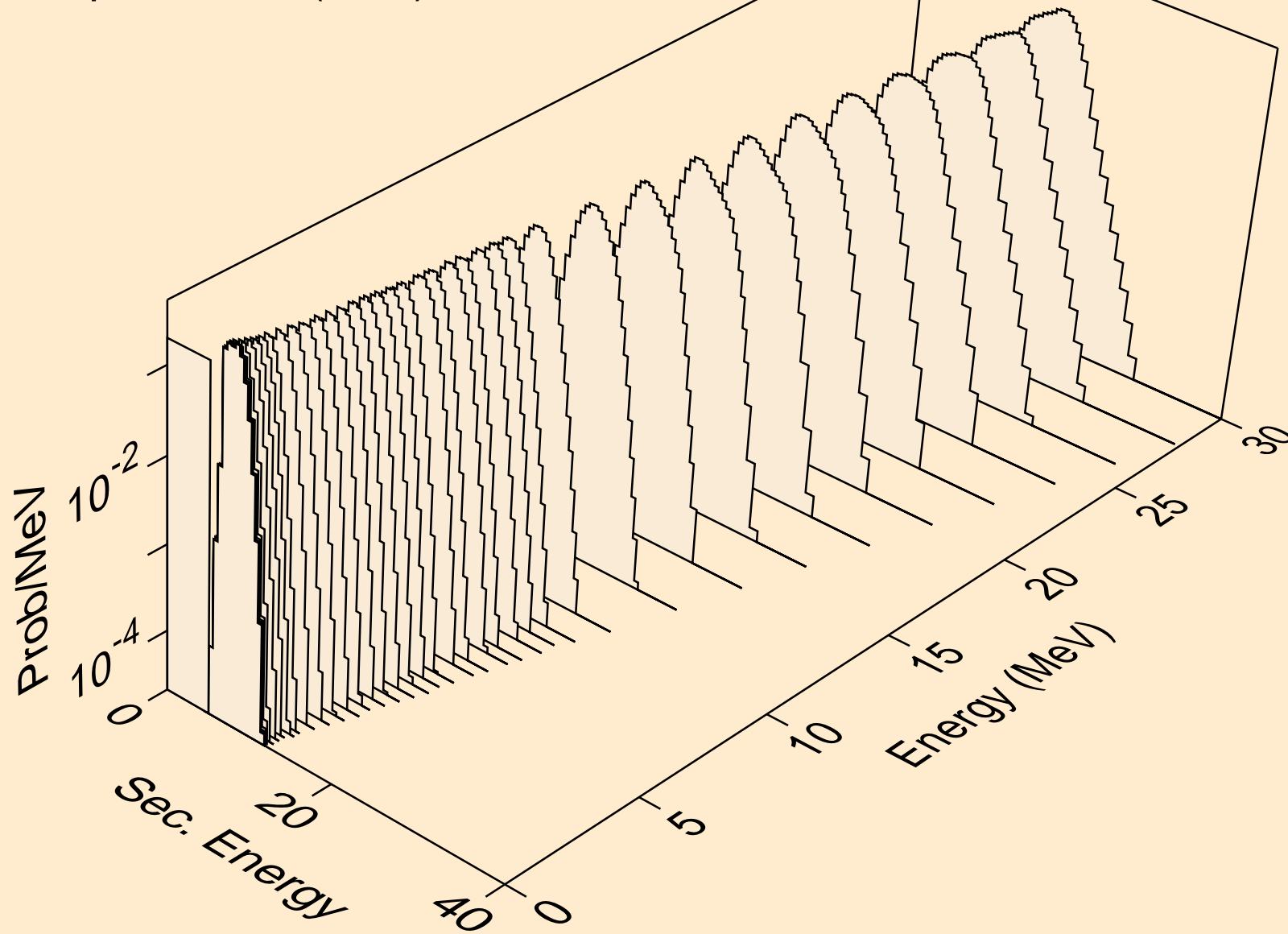

W165 NEUTRON ACER TENDL-2024 LIBRARY; T=0.K
alphas from (n,pa)

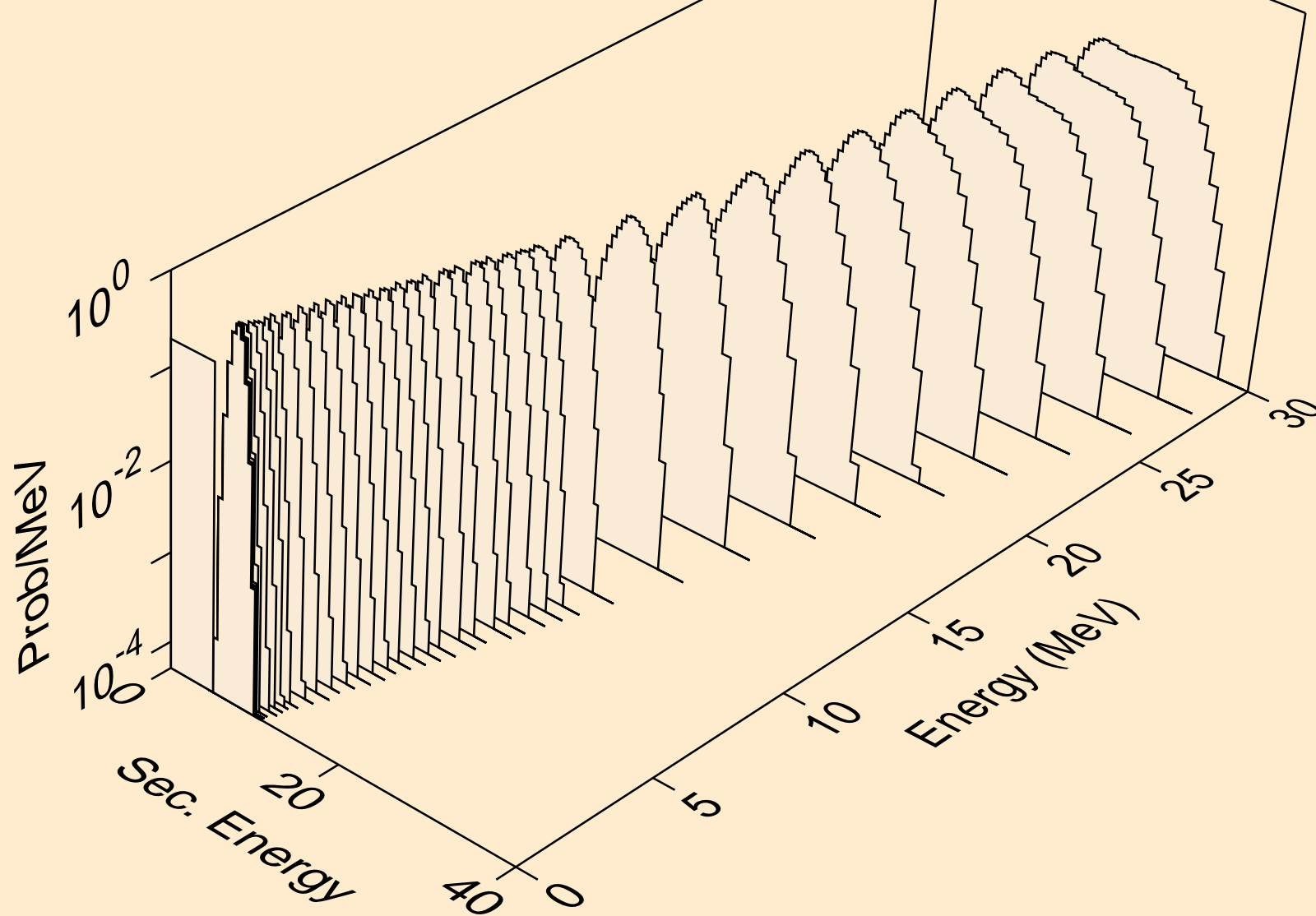

W165 NEUTRON ACER TENDL-2024 LIBRARY; T=0.K
alphas from (n,d2a)

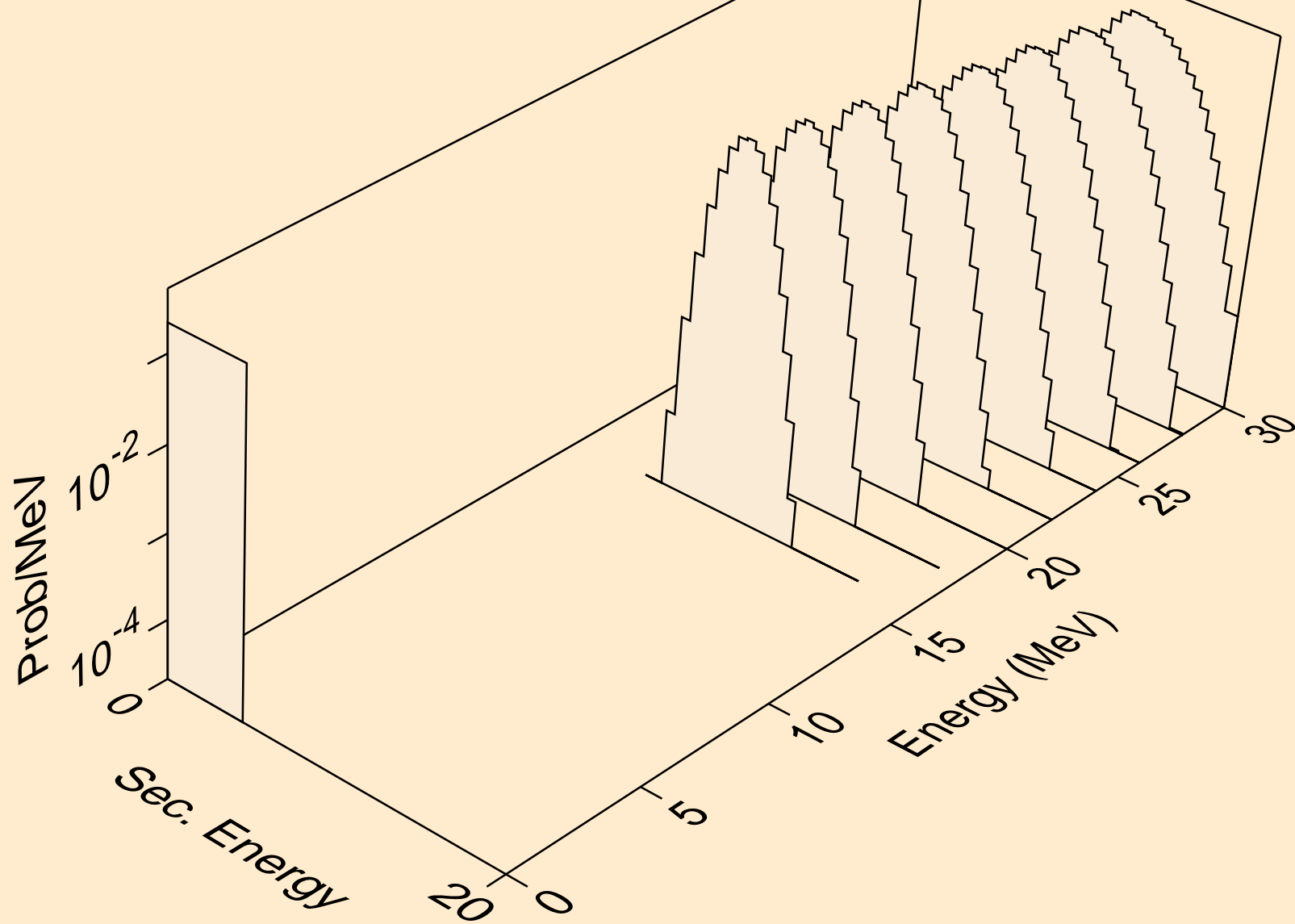

W165 NEUTRON ACER TENDL-2024 LIBRARY; T=0.K
alphas from (n,da)

