

# XE119 NEUTRON ACER TENDL-2024 LIBRARY; T=0.K

## Principal cross sections

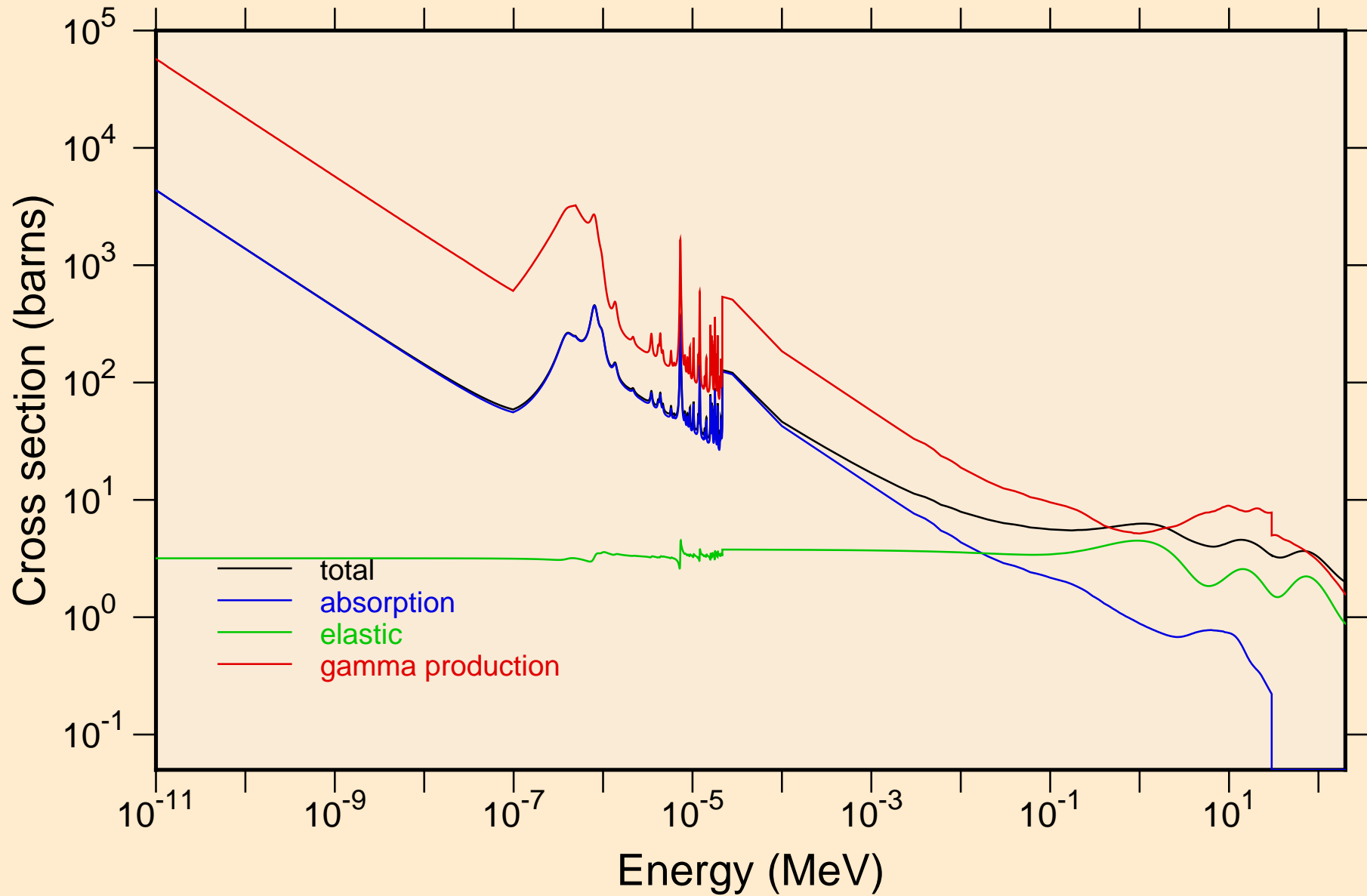

XE119 NEUTRON ACER TENDL-2024 LIBRARY; T=0.K  
resonance total cross section

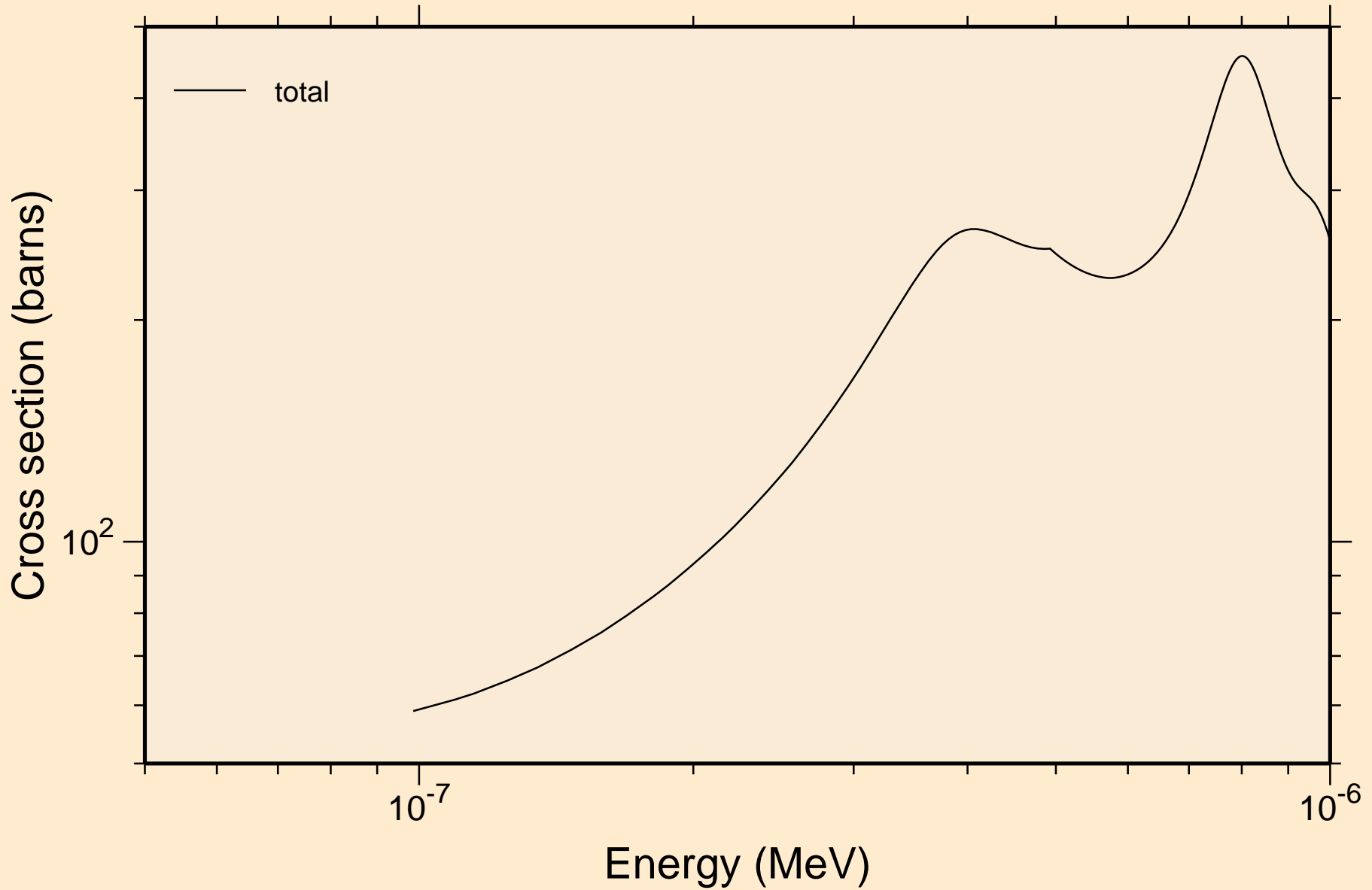

XE119 NEUTRON ACER TENDL-2024 LIBRARY; T=0.K  
resonance total cross section

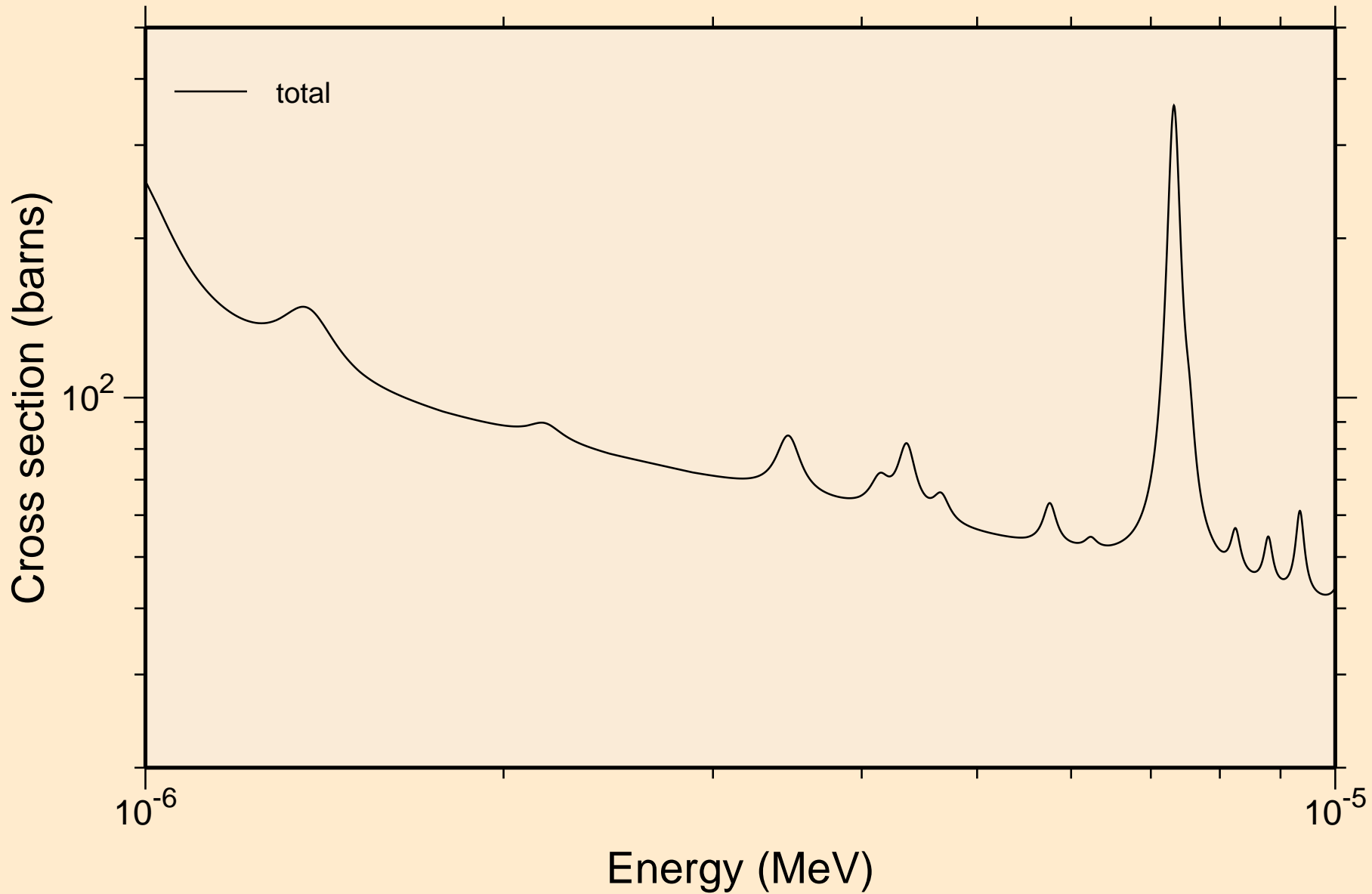

XE119 NEUTRON ACER TENDL-2024 LIBRARY; T=0.K  
resonance total cross section

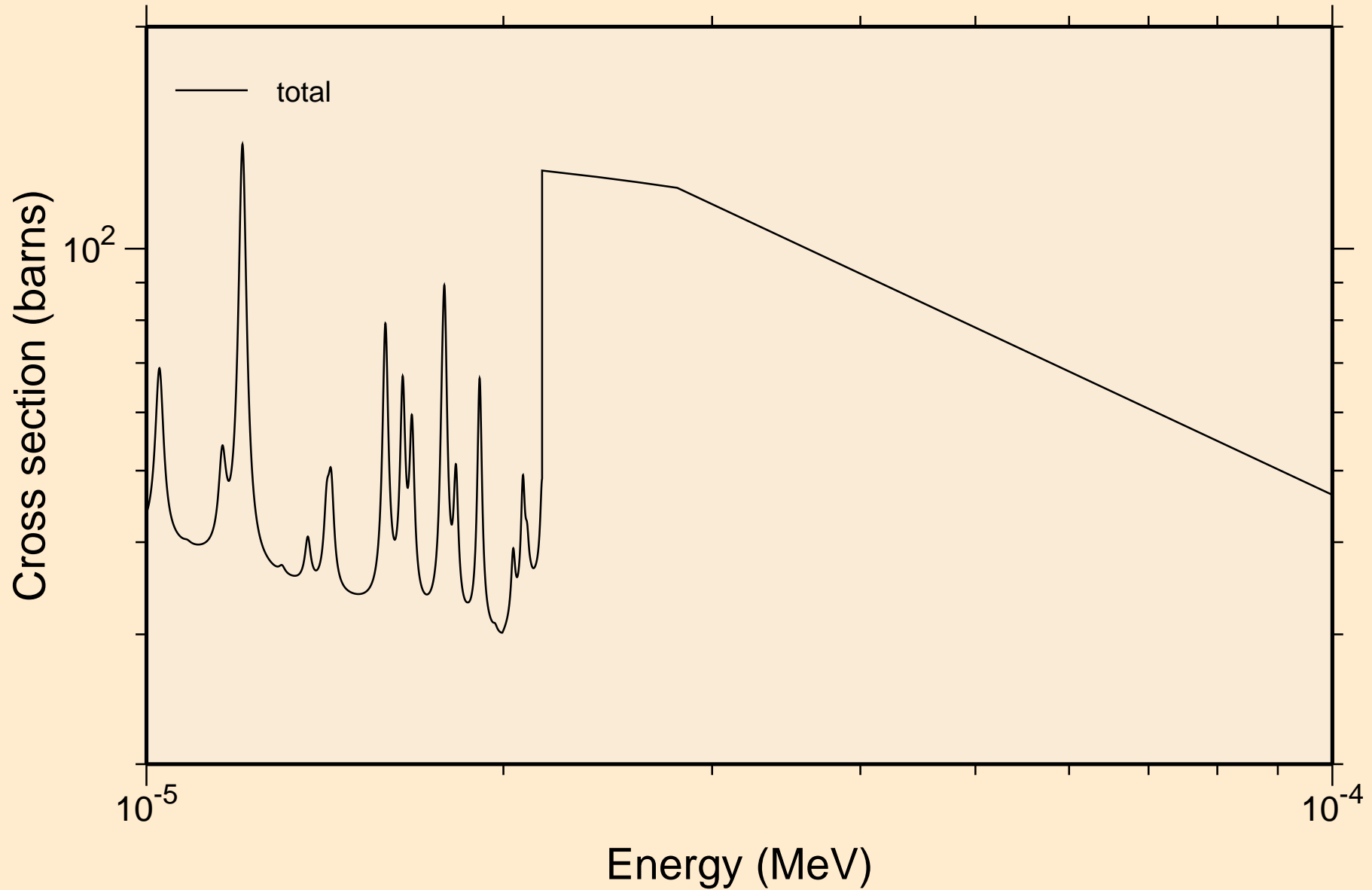

XE119 NEUTRON ACER TENDL-2024 LIBRARY; T=0.K  
resonance total cross section

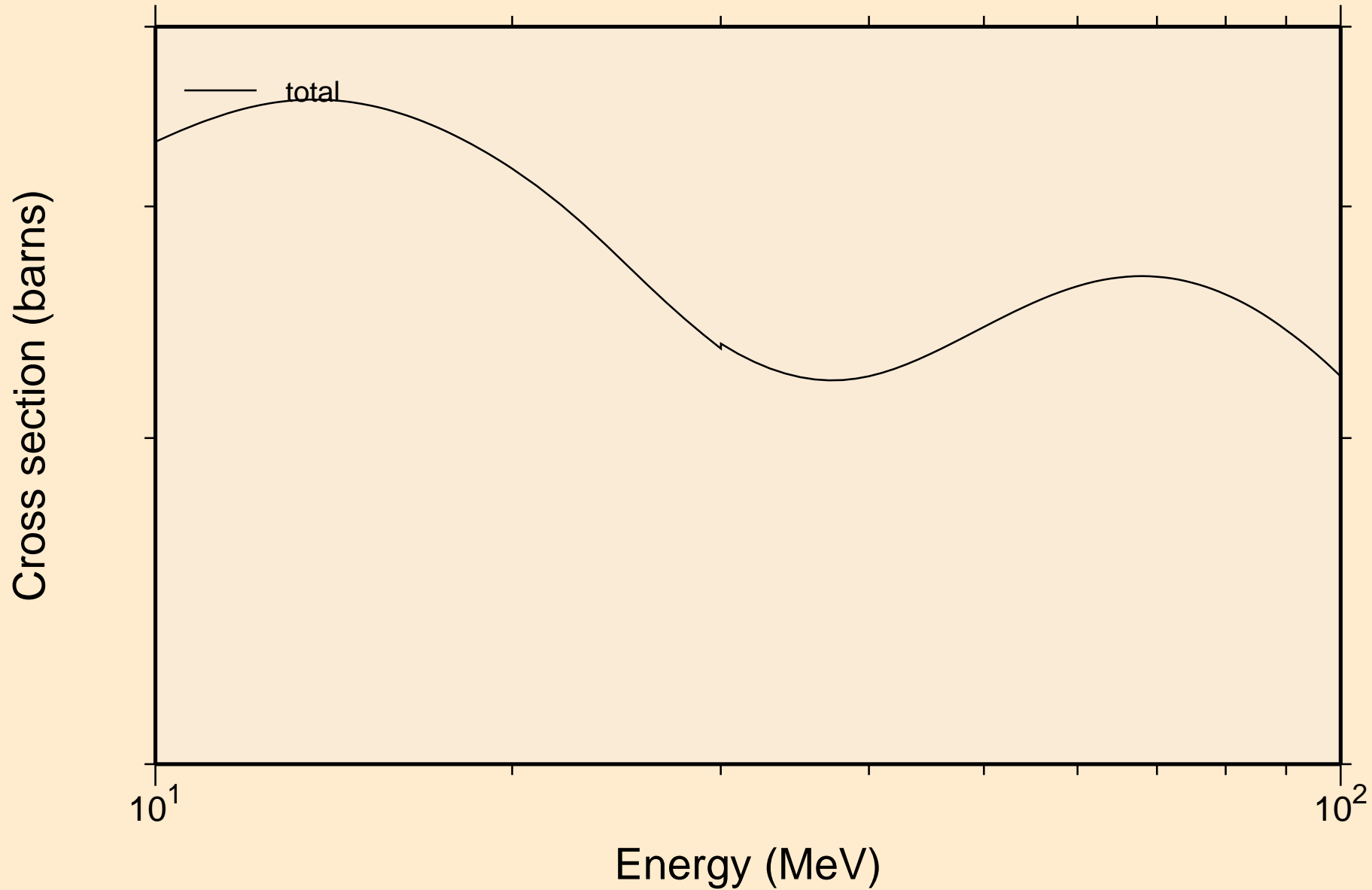

XE119 NEUTRON ACER TENDL-2024 LIBRARY; T=0.K  
resonance absorption cross sections

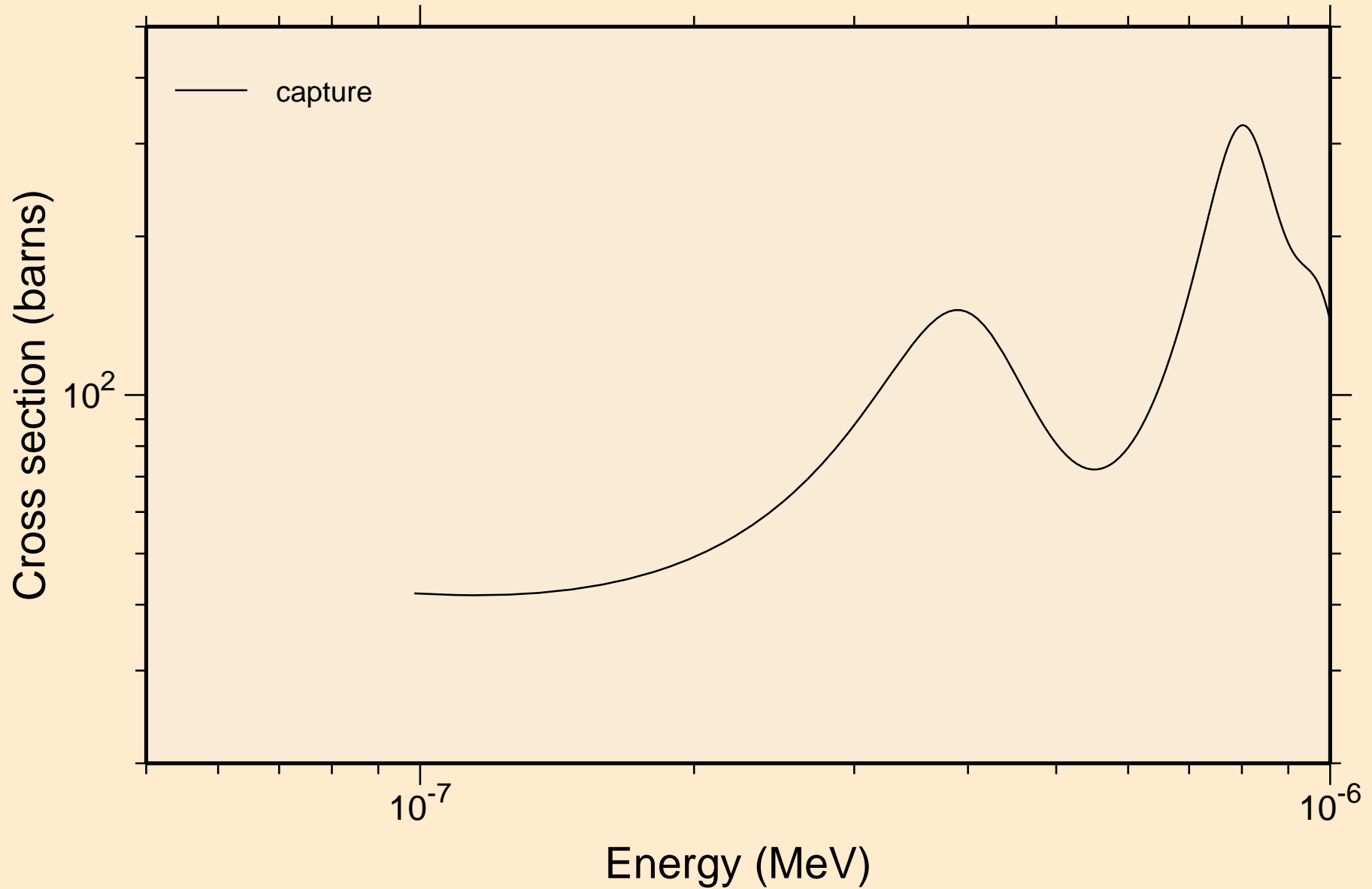

XE119 NEUTRON ACER TENDL-2024 LIBRARY; T=0.K  
resonance absorption cross sections

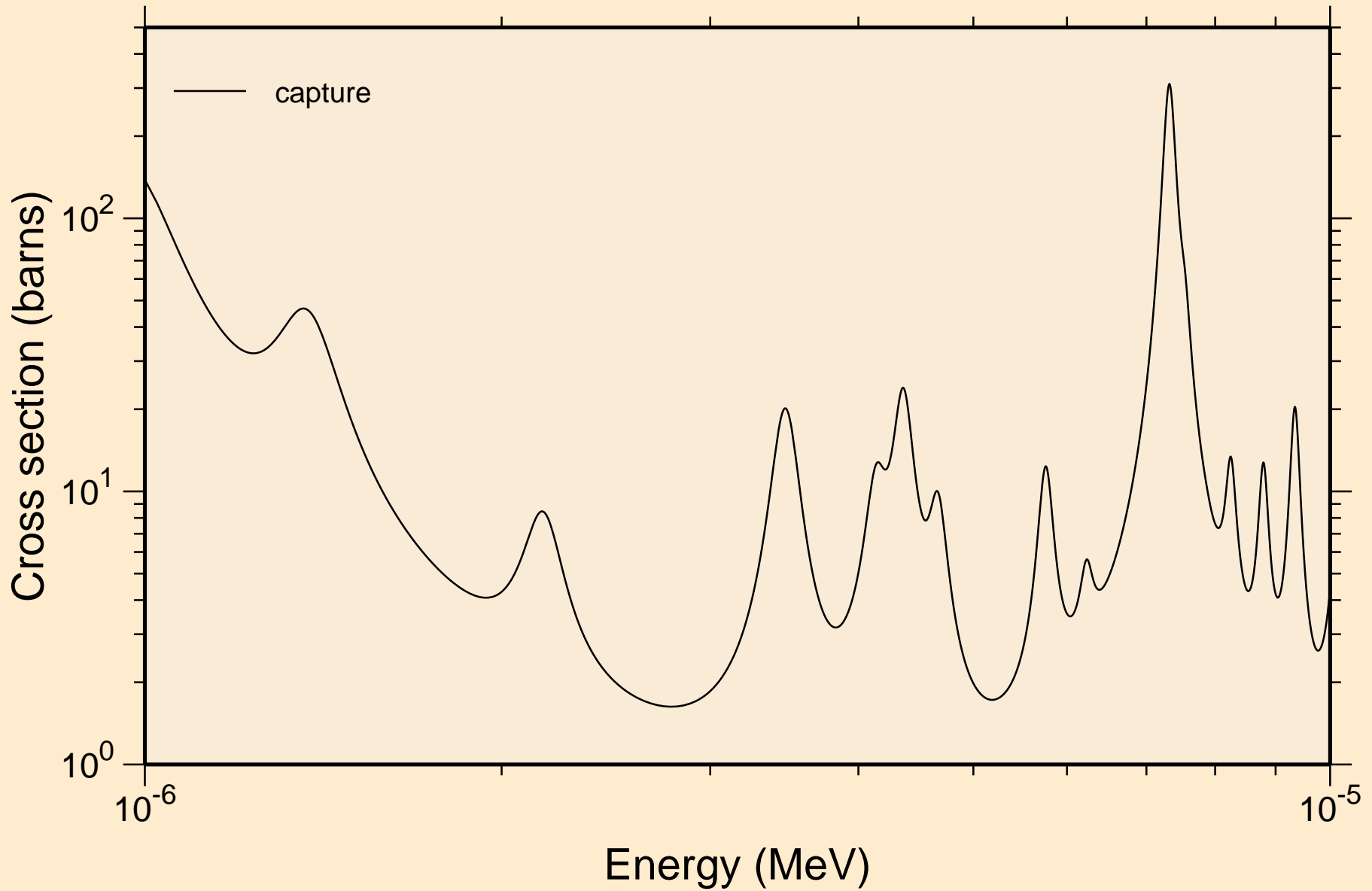

XE119 NEUTRON ACER TENDL-2024 LIBRARY; T=0.K  
resonance absorption cross sections

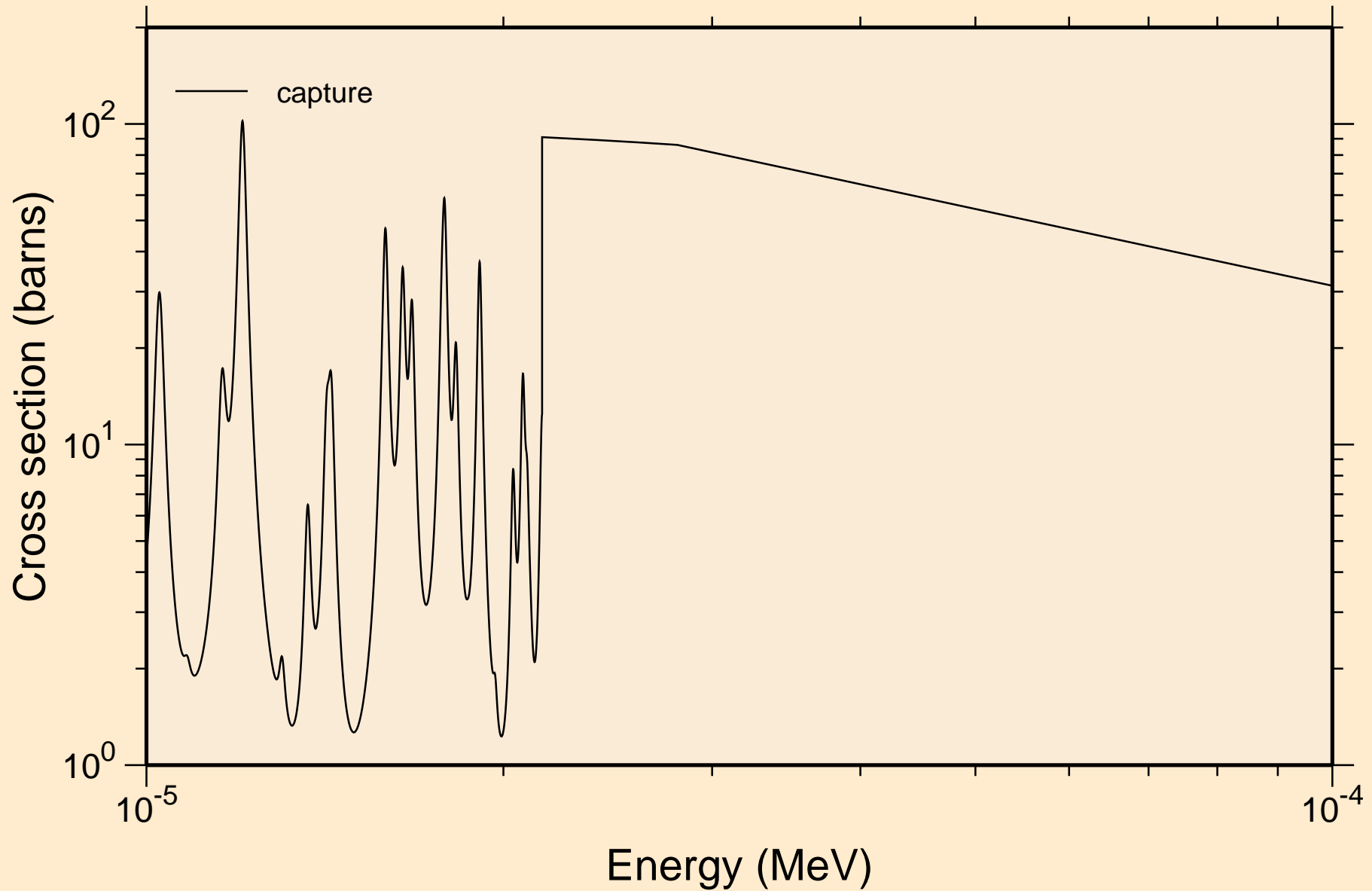

XE119 NEUTRON ACER TENDL-2024 LIBRARY; T=0.K  
resonance absorption cross sections

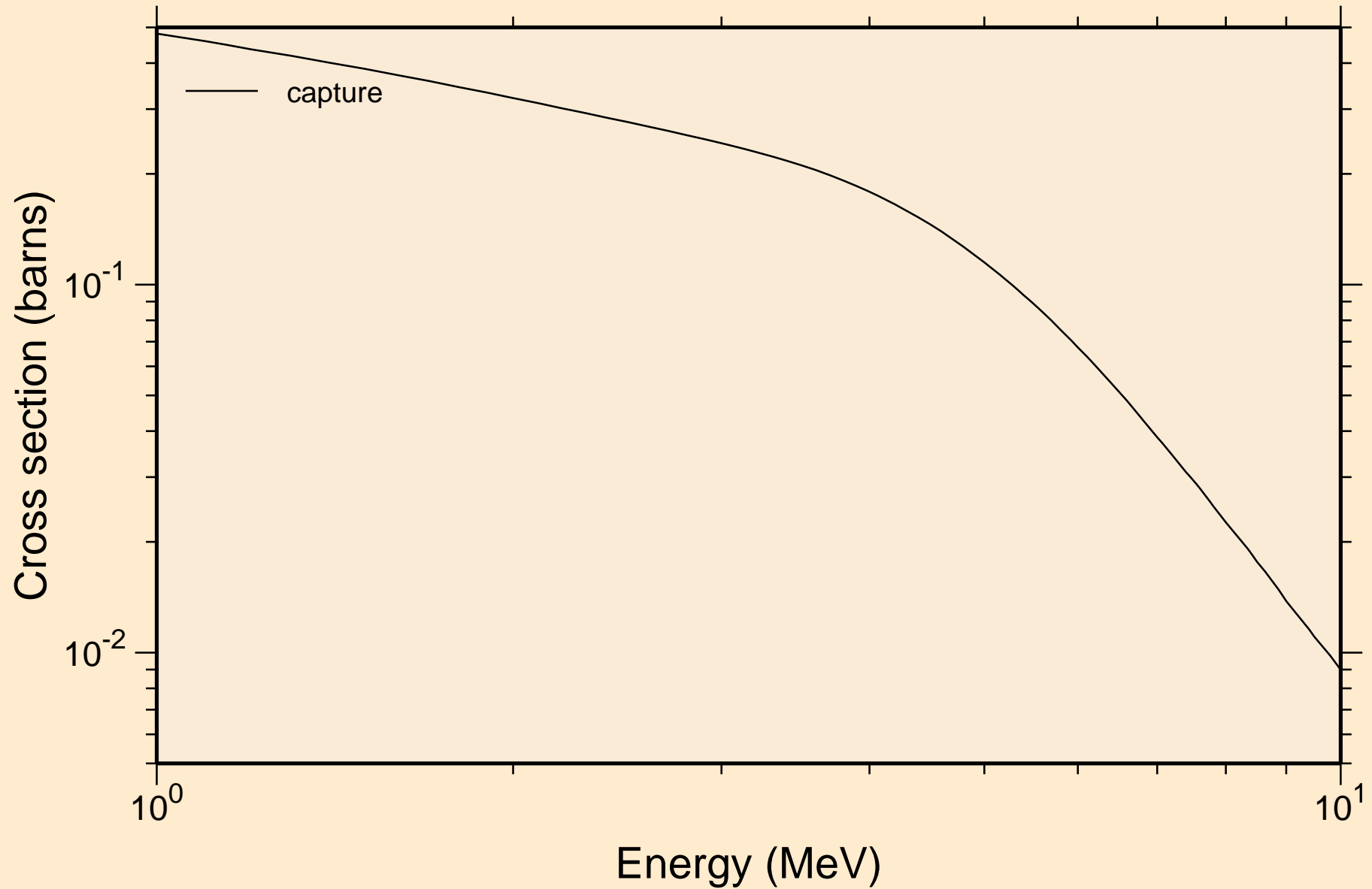

XE119 NEUTRON ACER TENDL-2024 LIBRARY; T=0.K  
Heating

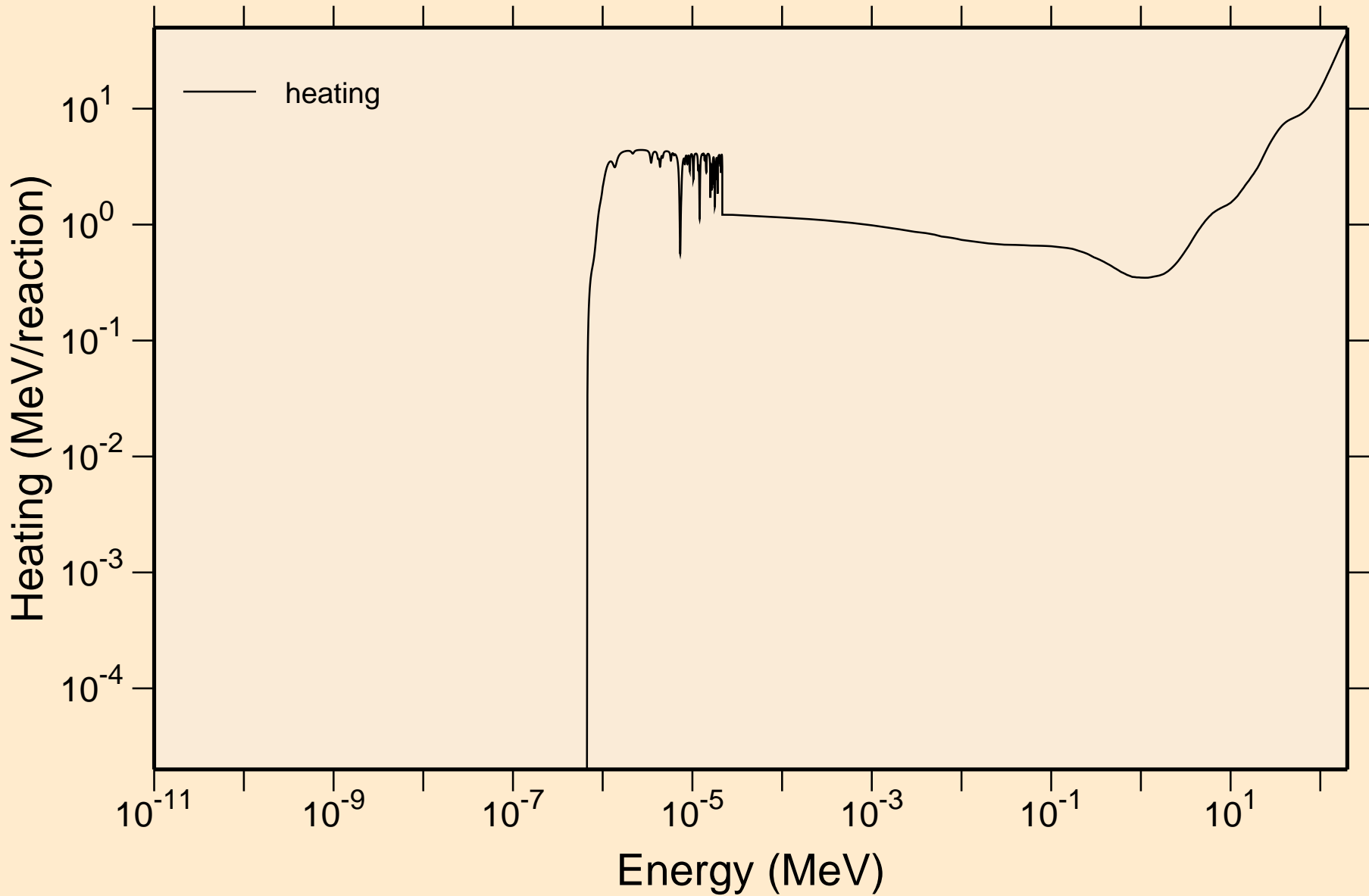

XE119 NEUTRON ACER TENDL-2024 LIBRARY; T=0.K  
Damage

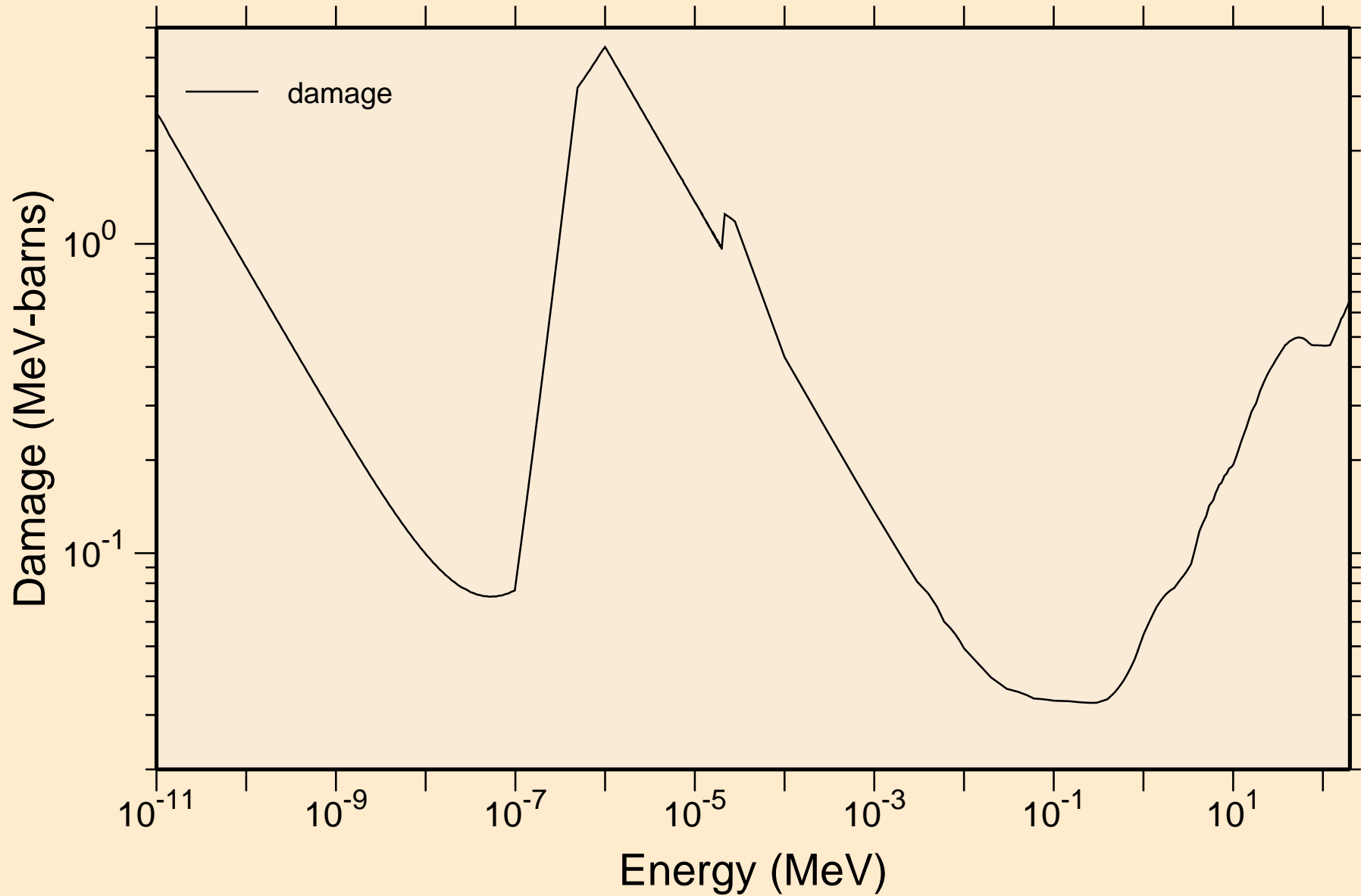

XE119 NEUTRON ACER TENDL-2024 LIBRARY; T=0.K  
Non-threshold reactions

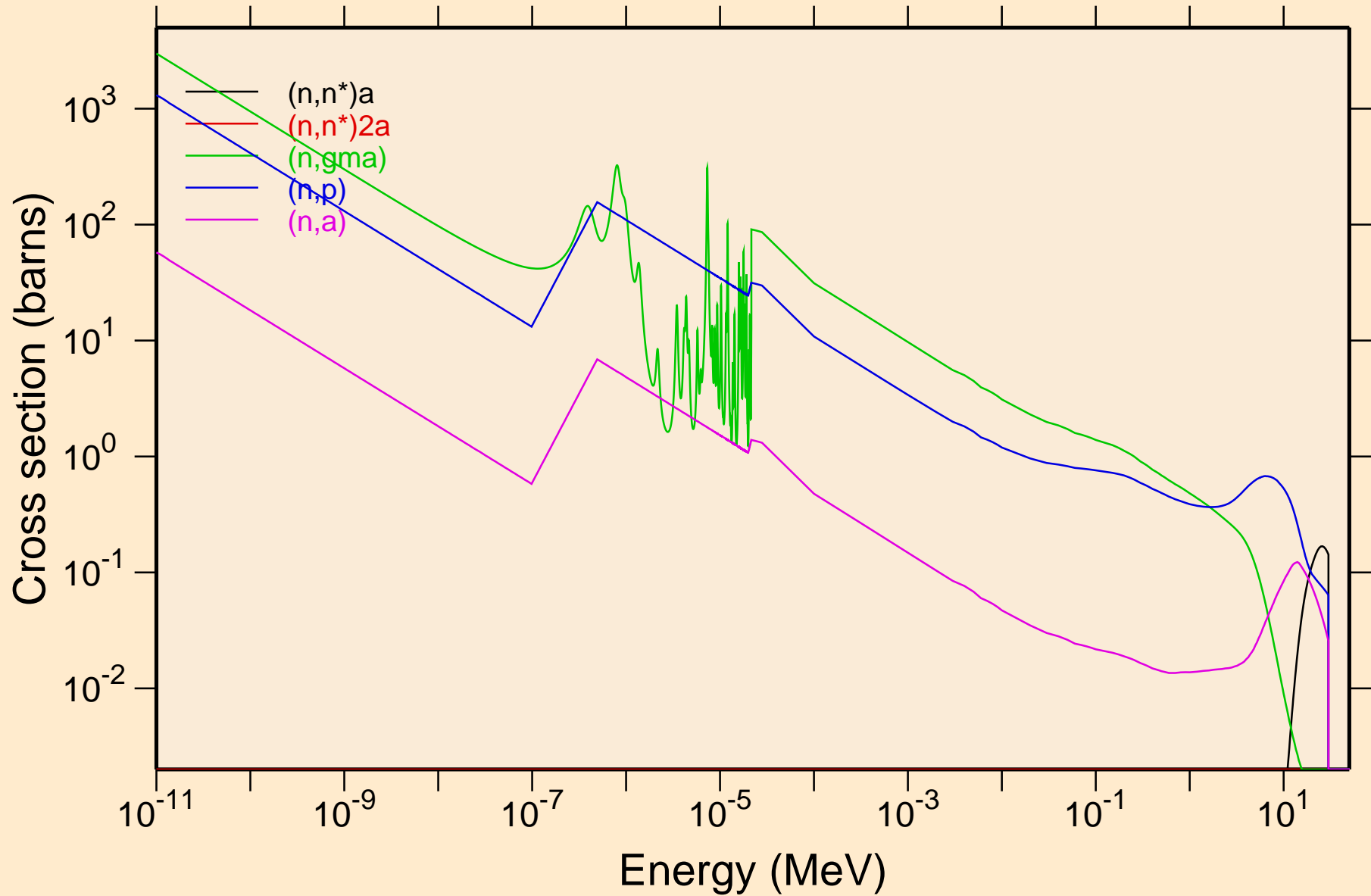

XE119 NEUTRON ACER TENDL-2024 LIBRARY; T=0.K  
Non-threshold reactions

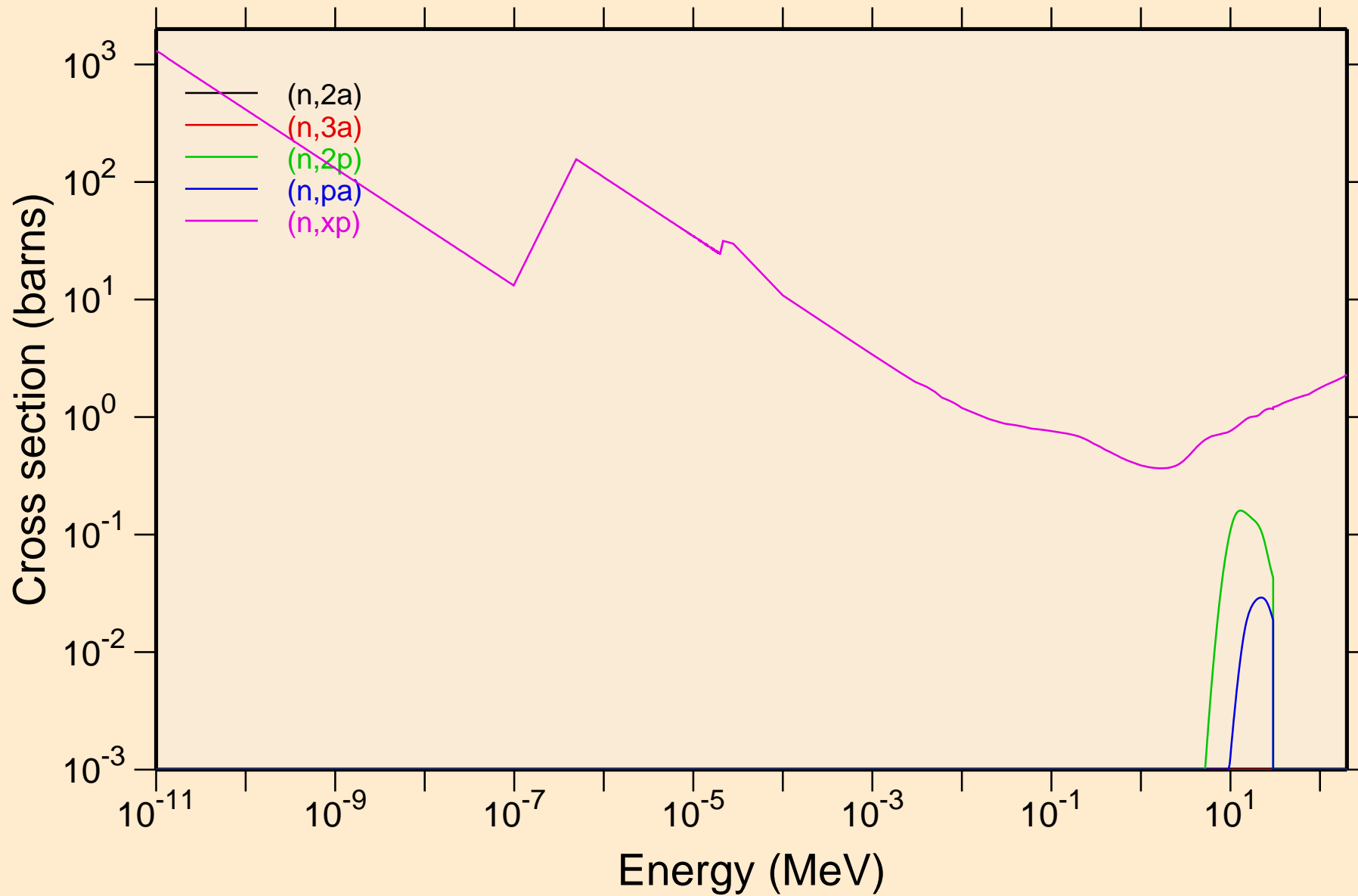

XE119 NEUTRON ACER TENDL-2024 LIBRARY; T=0.K  
Non-threshold reactions

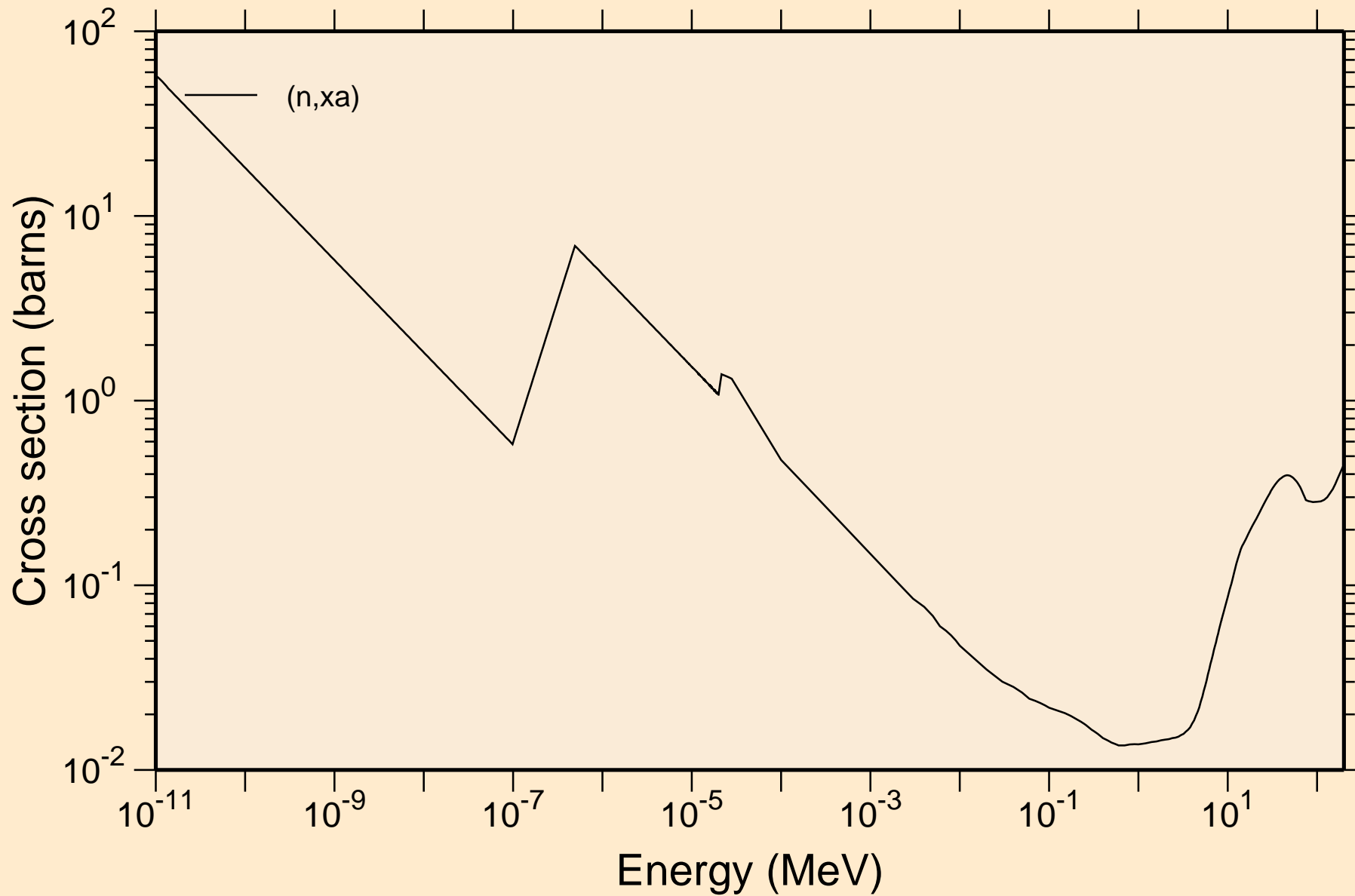

XE119 NEUTRON ACER TENDL-2024 LIBRARY; T=0.K  
Principal cross sections

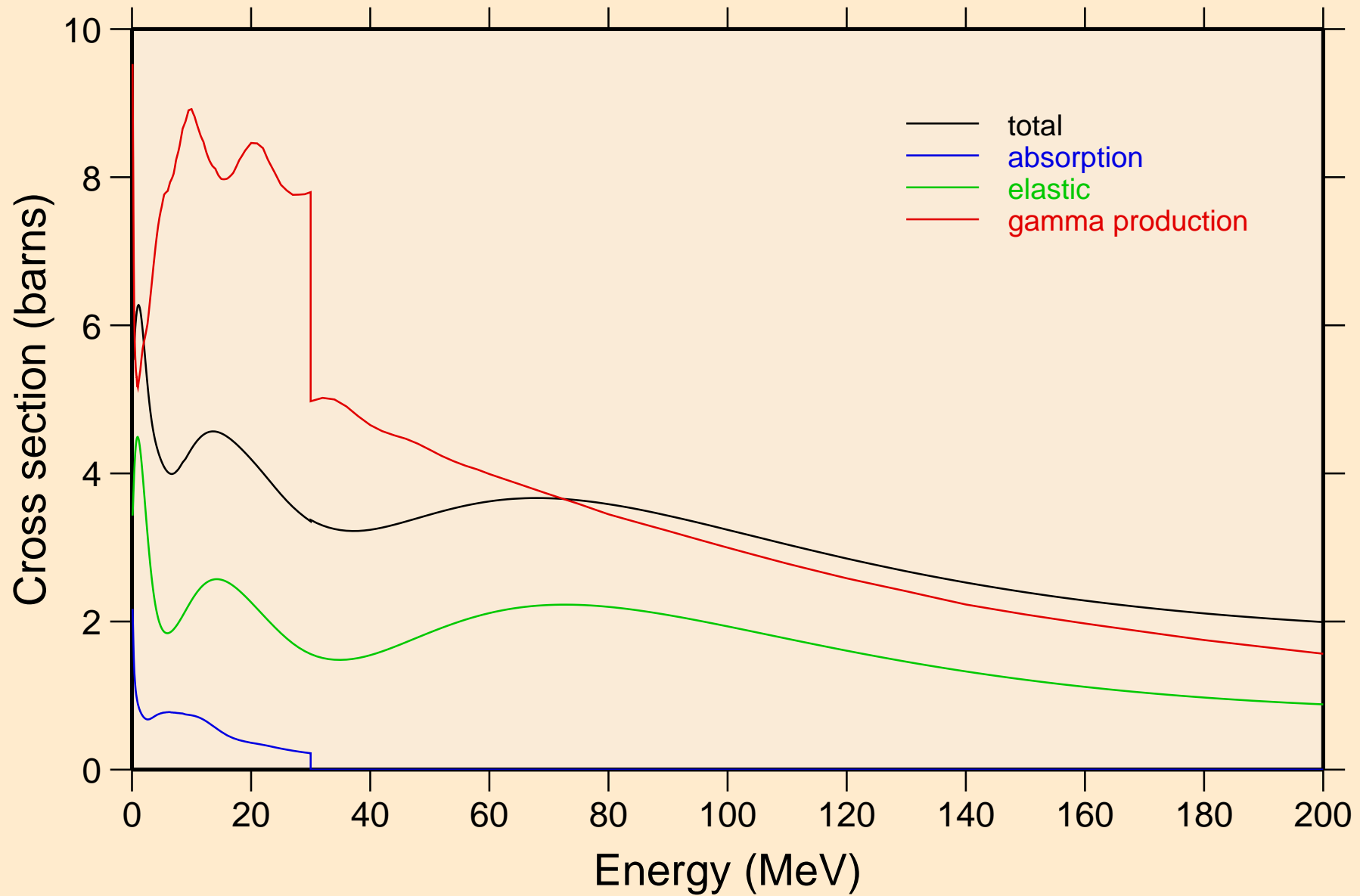

# XE119 NEUTRON ACER TENDL-2024 LIBRARY; T=0.K

## Heating

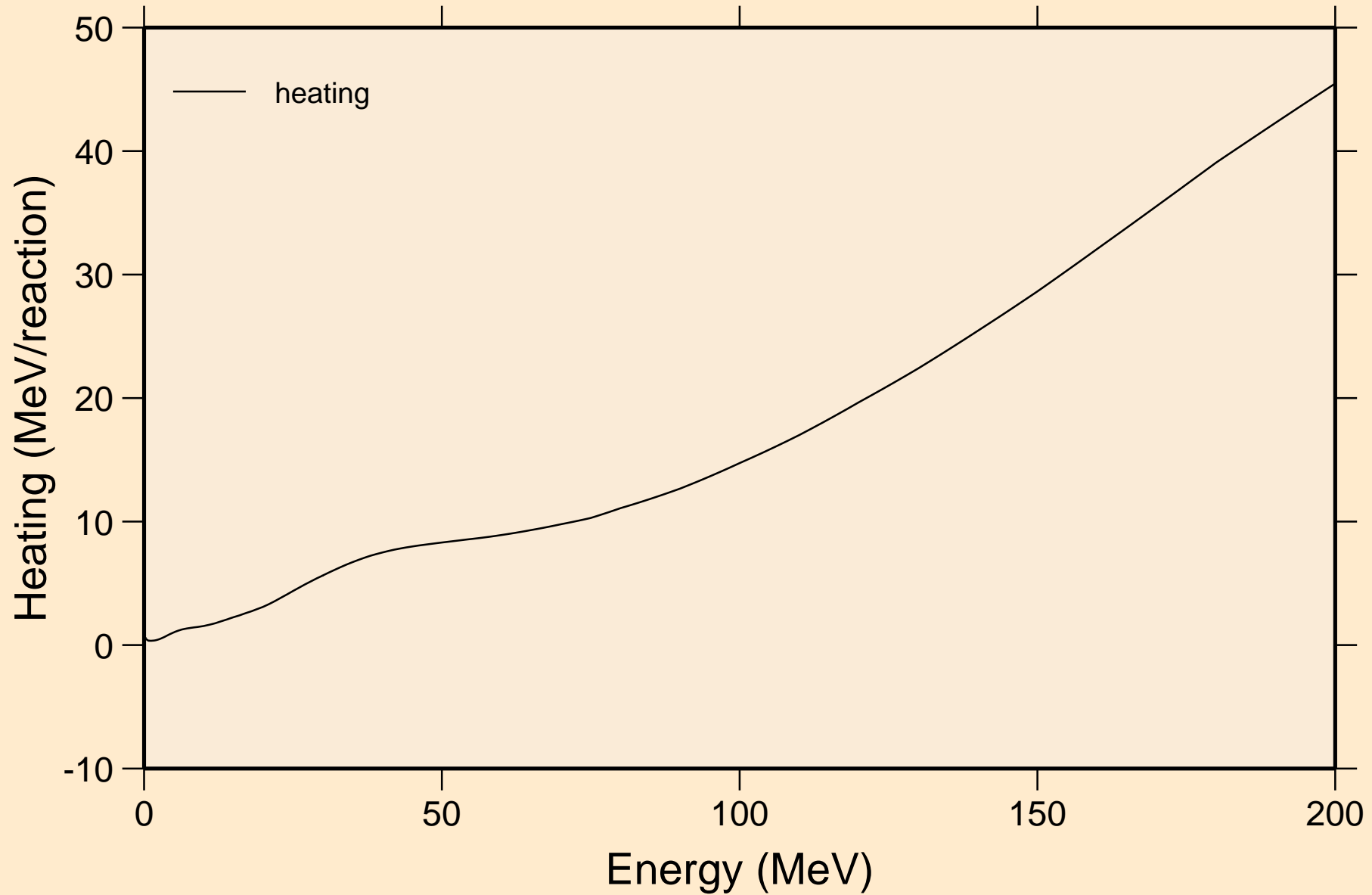

# XE119 NEUTRON ACER TENDL-2024 LIBRARY; T=0.K

## Damage

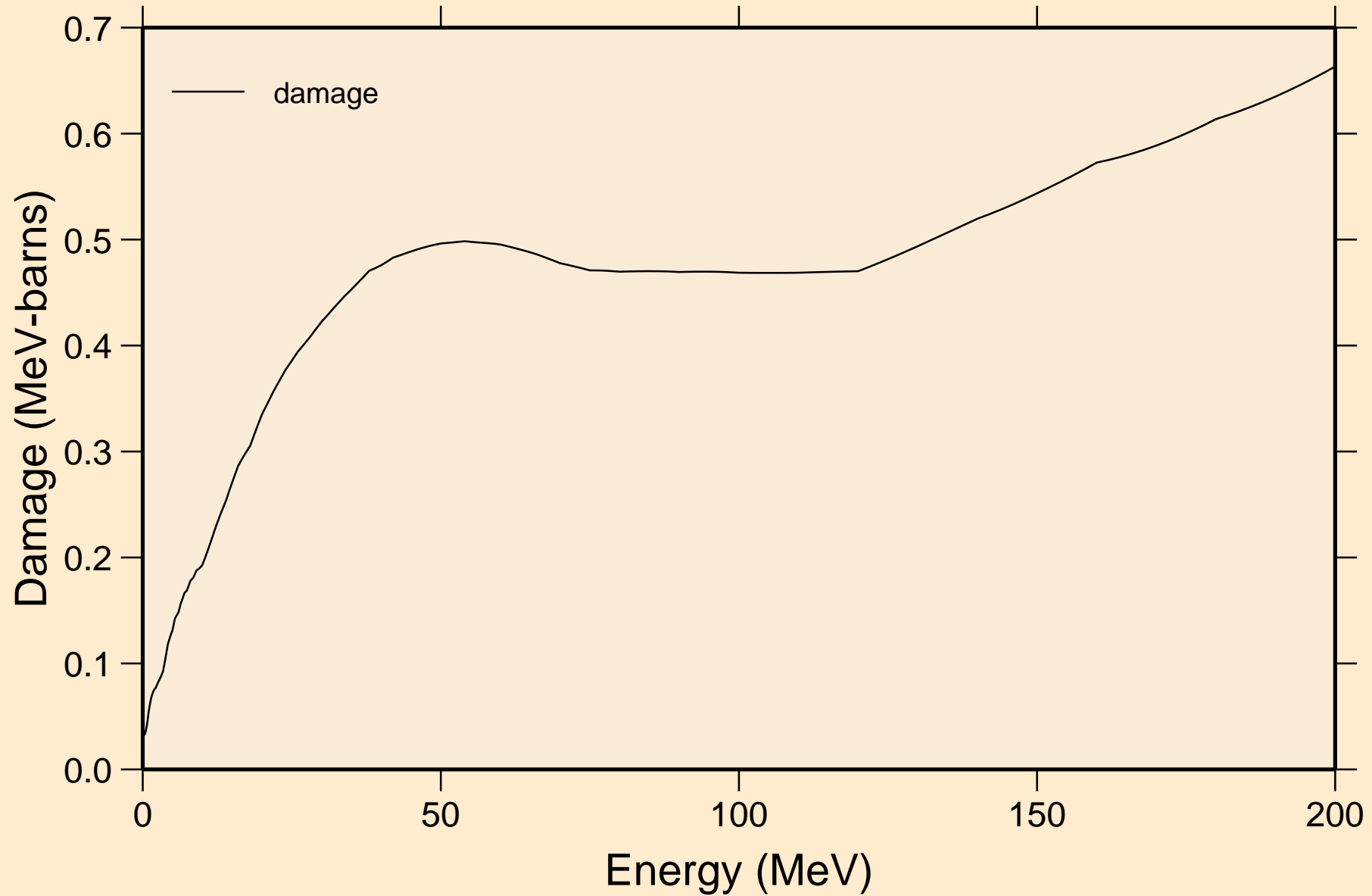

XE119 NEUTRON ACER TENDL-2024 LIBRARY; T=0.K  
Non-threshold reactions

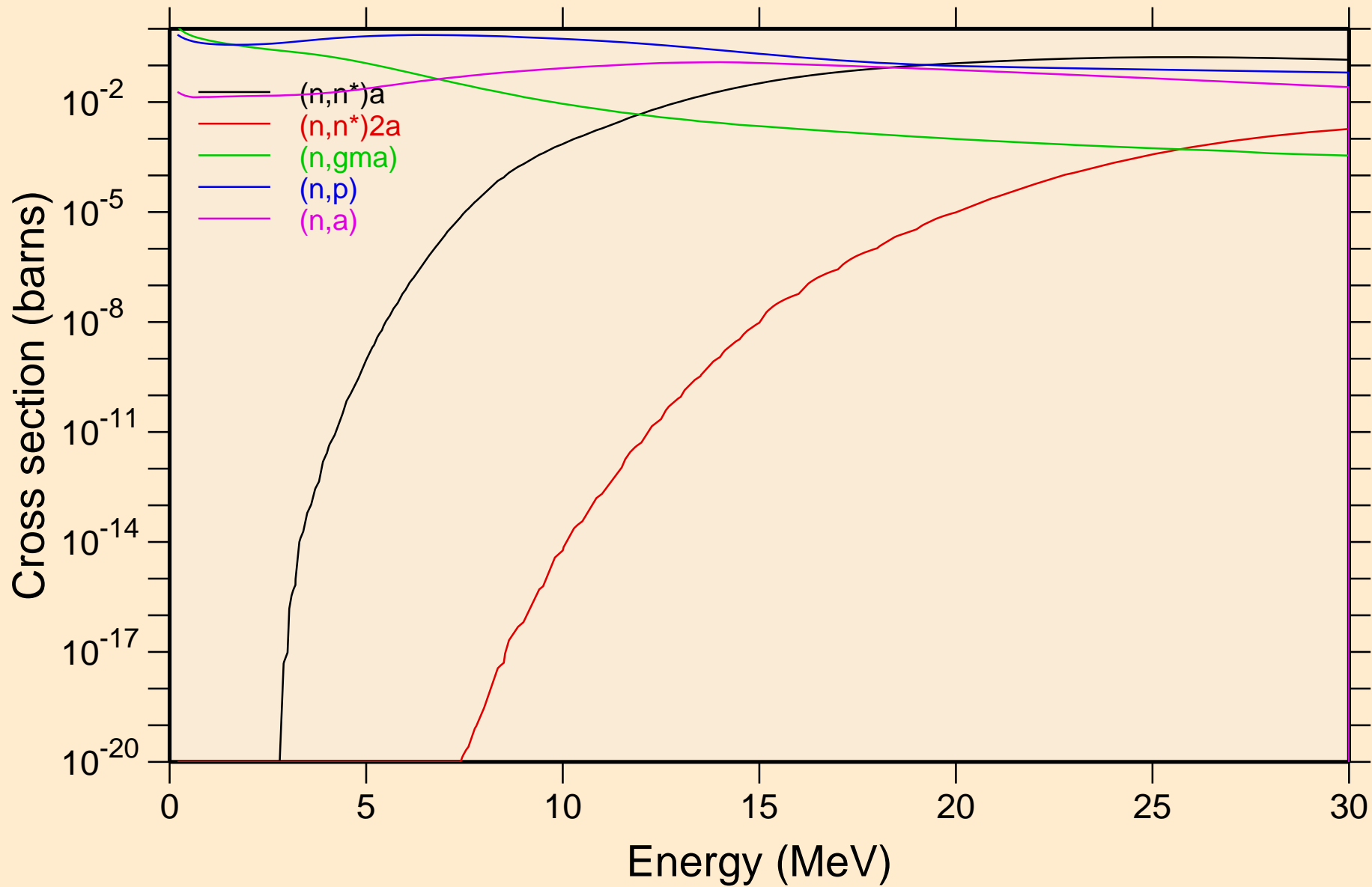

XE119 NEUTRON ACER TENDL-2024 LIBRARY; T=0.K  
Non-threshold reactions

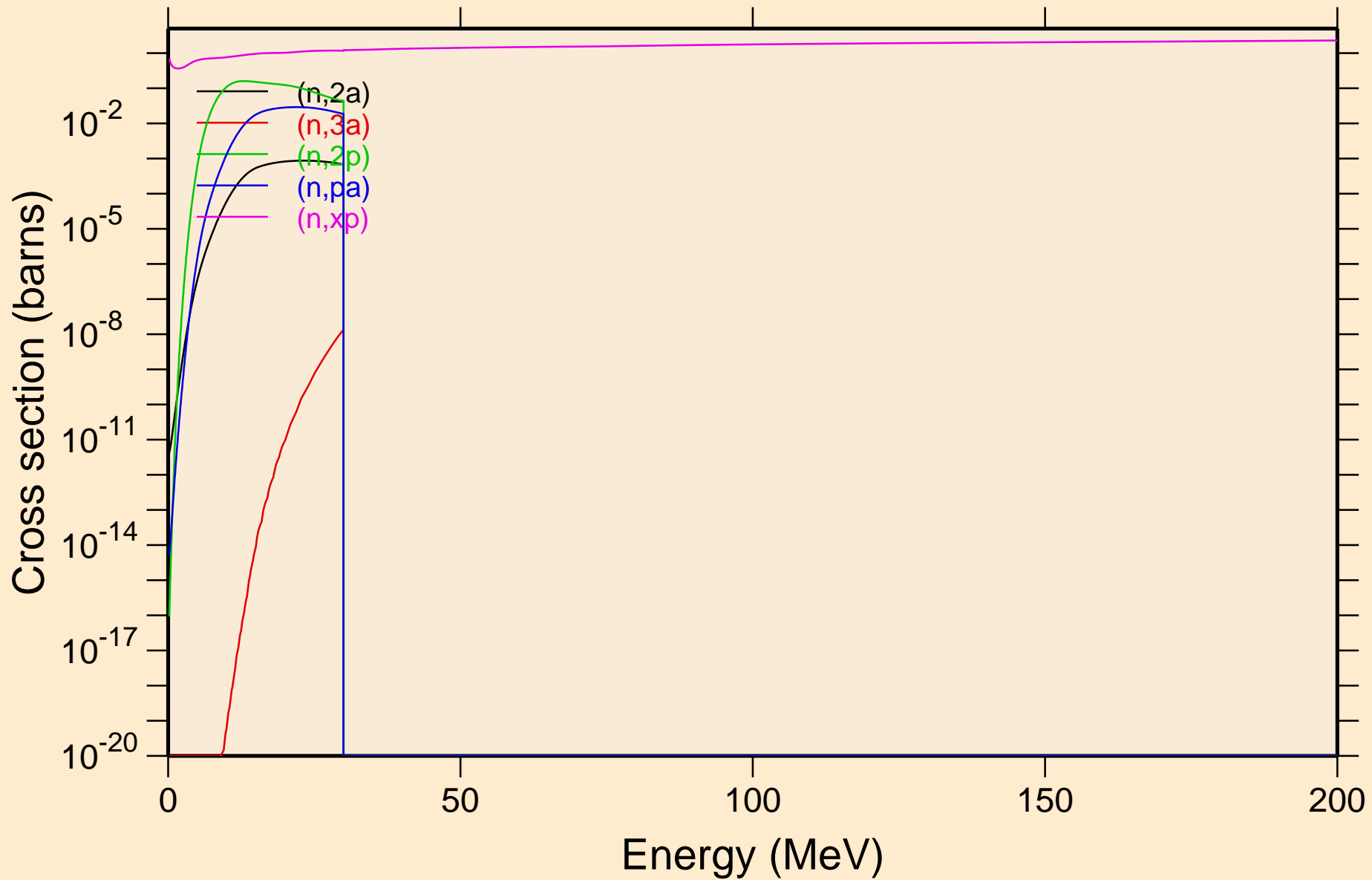

XE119 NEUTRON ACER TENDL-2024 LIBRARY; T=0.K  
Non-threshold reactions

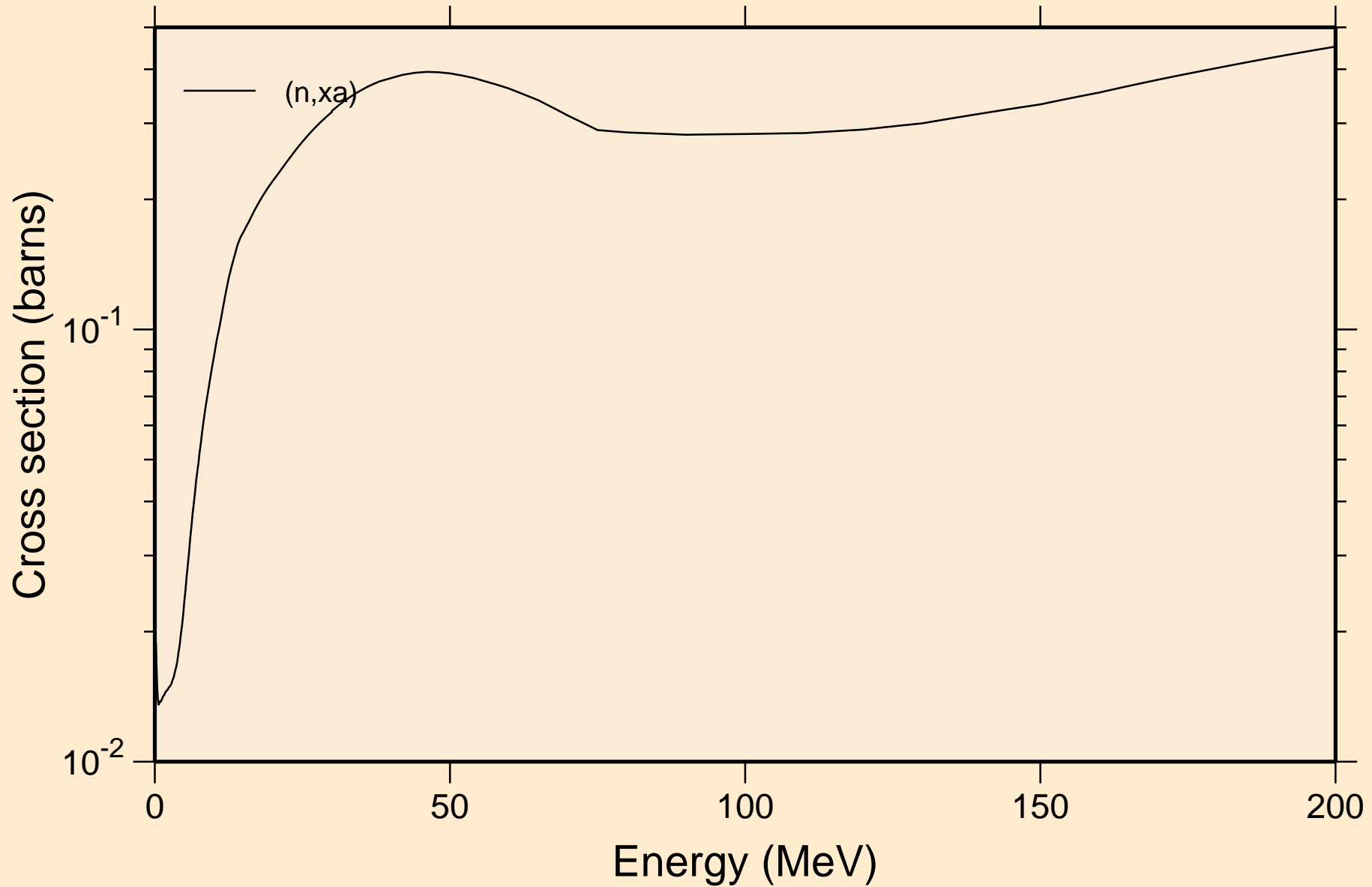

XE119 NEUTRON ACER TENDL-2024 LIBRARY; T=0.K  
Inelastic levels

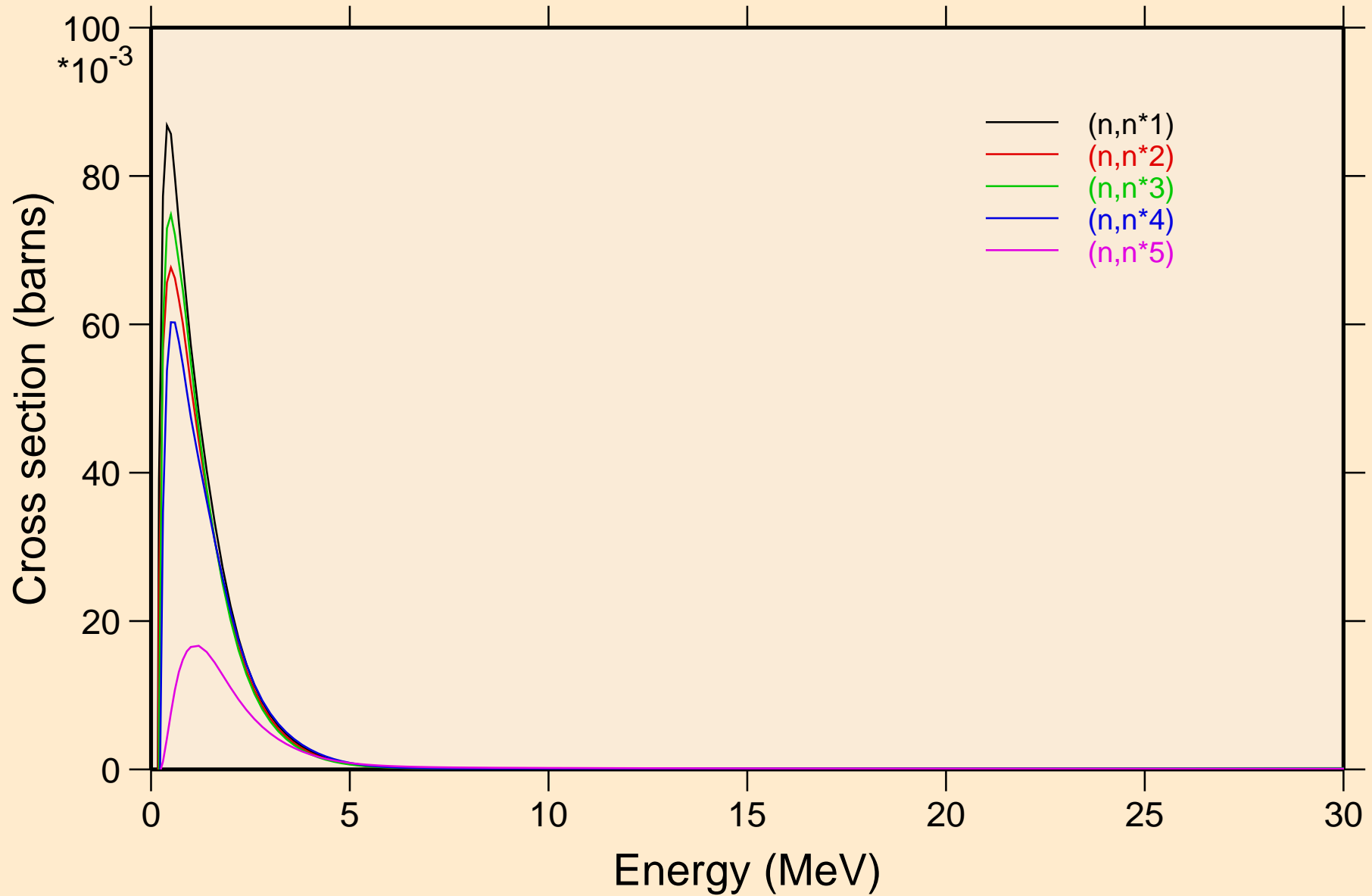

XE119 NEUTRON ACER TENDL-2024 LIBRARY; T=0.K  
Inelastic levels

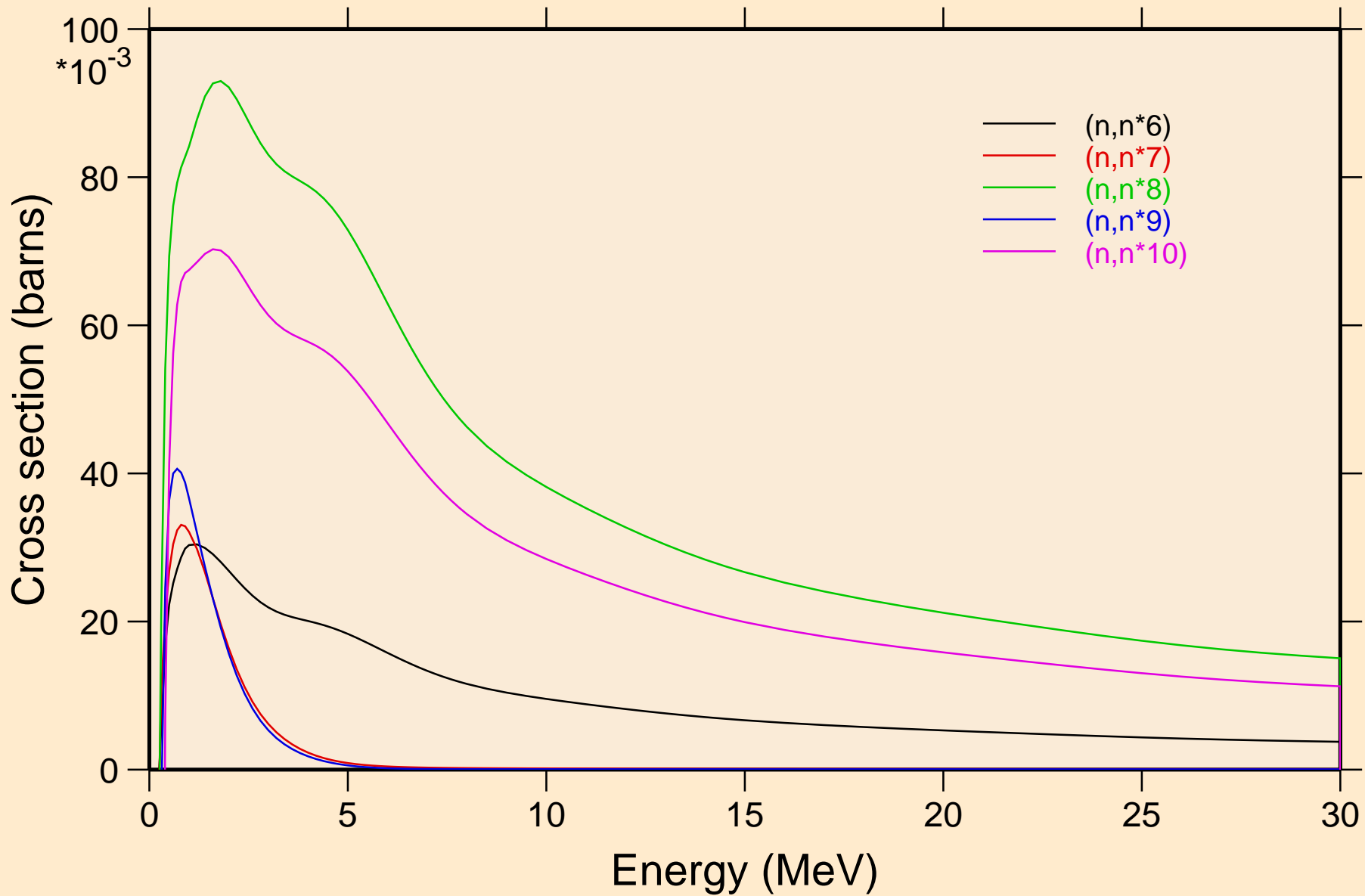

XE119 NEUTRON ACER TENDL-2024 LIBRARY; T=0.K  
Inelastic levels

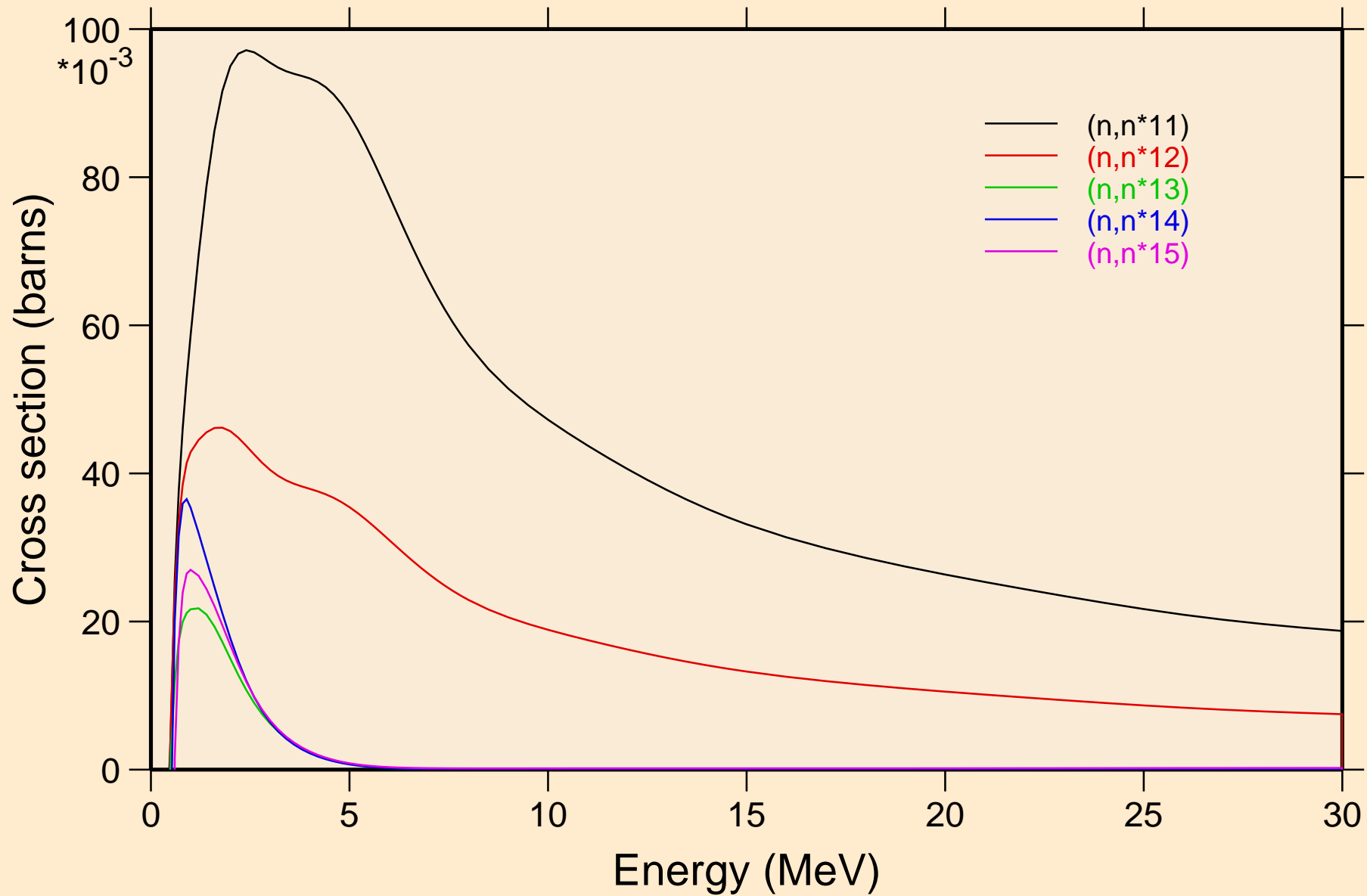

XE119 NEUTRON ACER TENDL-2024 LIBRARY; T=0.K  
Inelastic levels

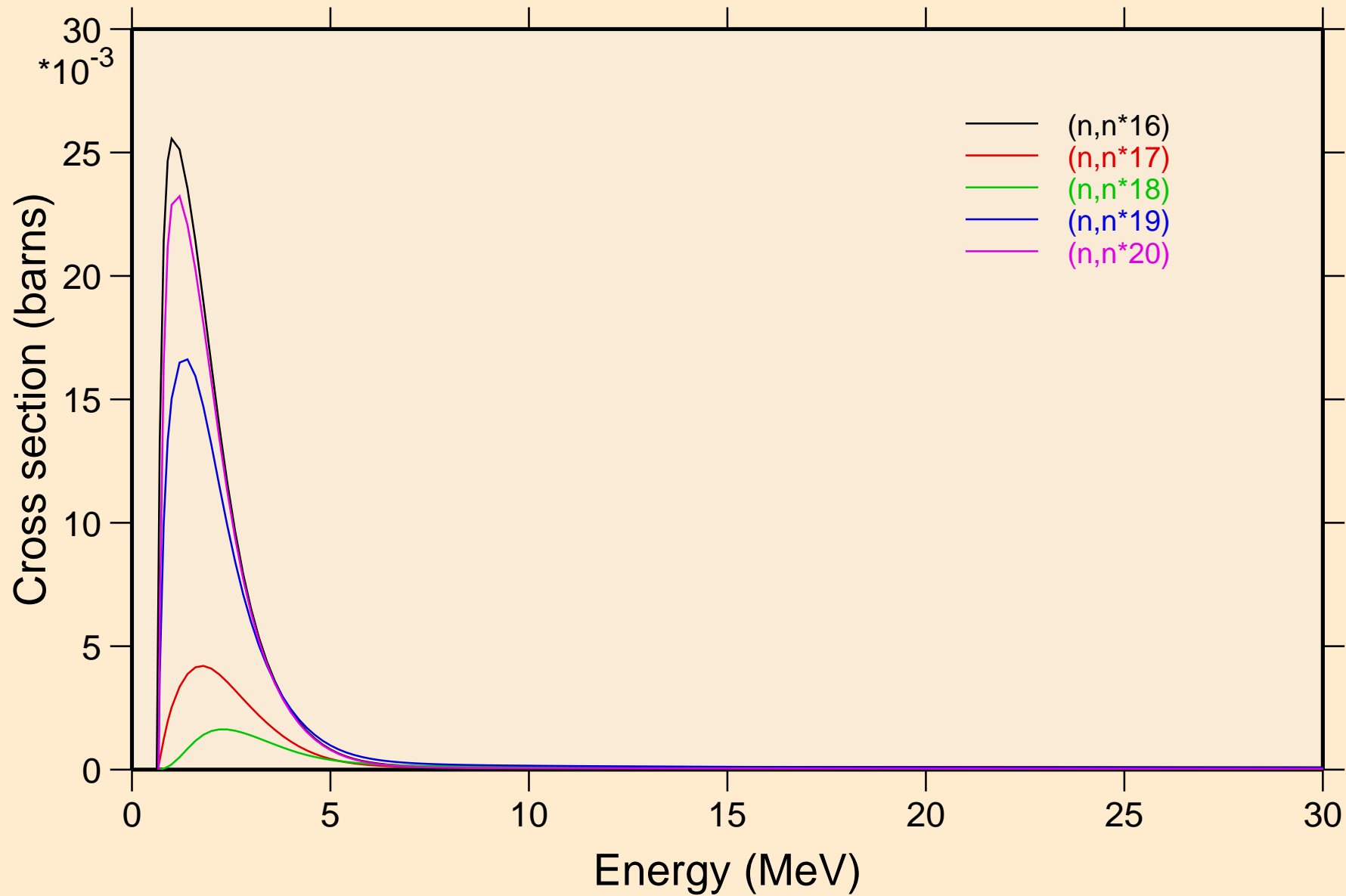

XE119 NEUTRON ACER TENDL-2024 LIBRARY; T=0.K  
Inelastic levels

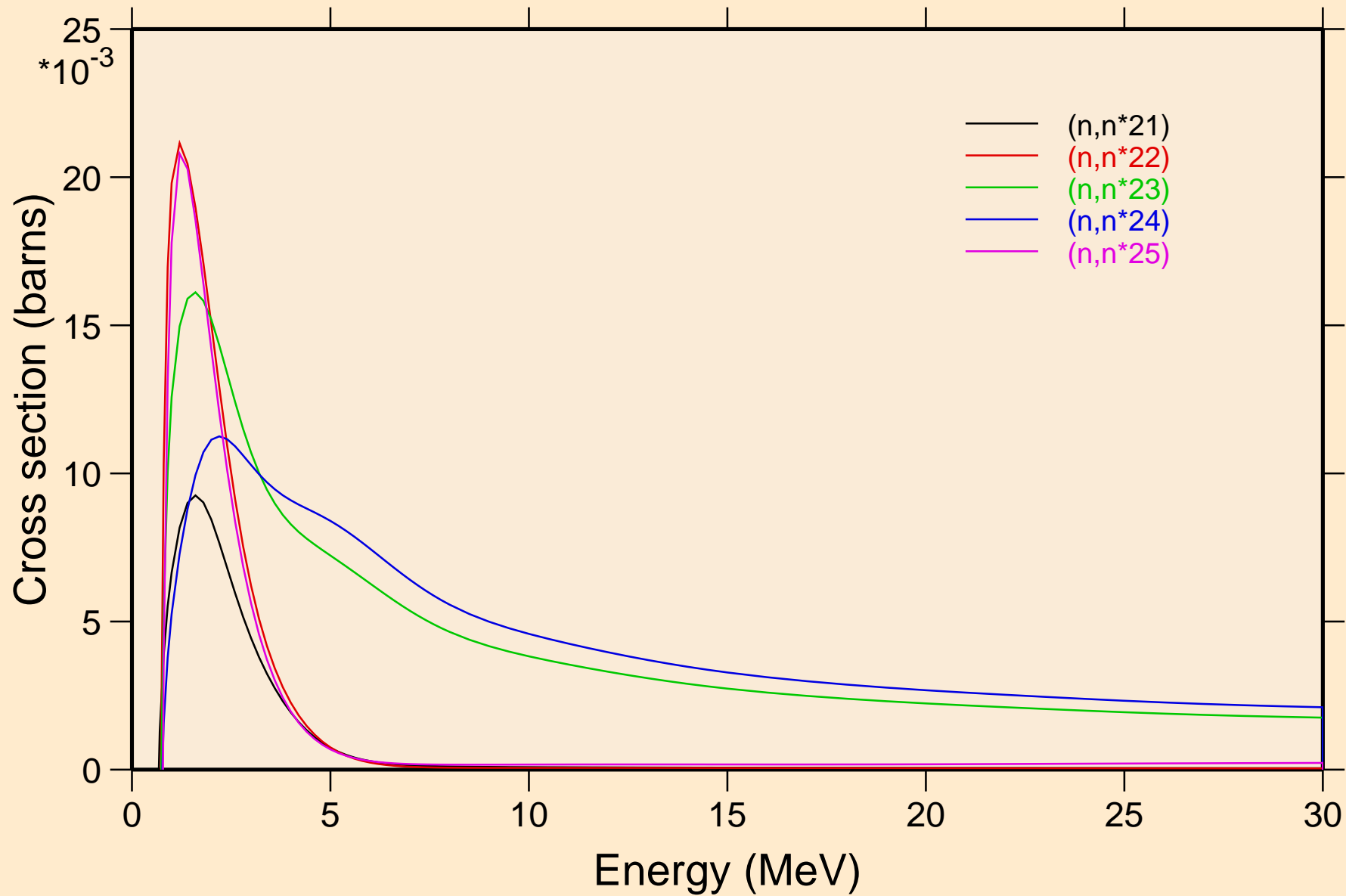

XE119 NEUTRON ACER TENDL-2024 LIBRARY; T=0.K  
Inelastic levels

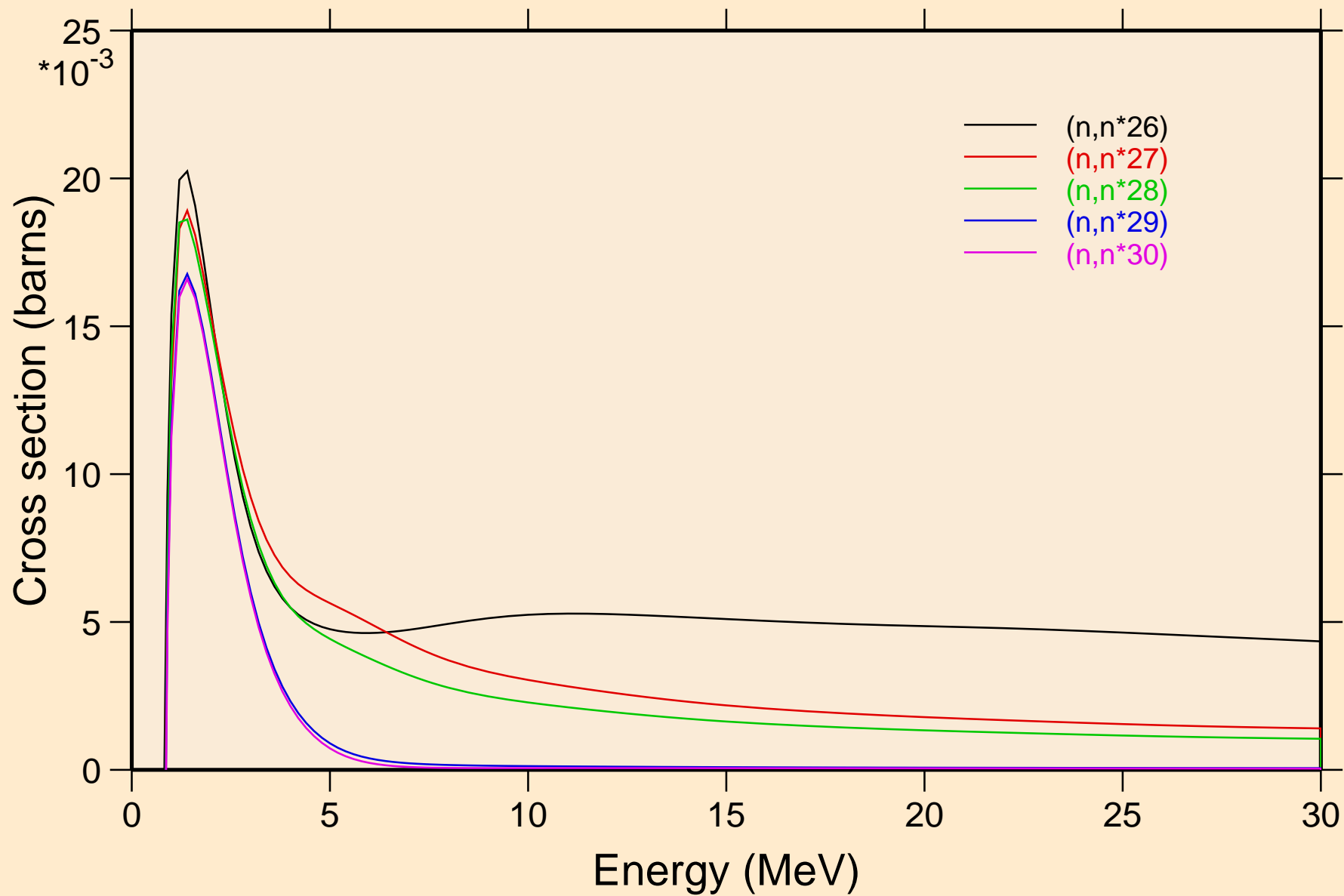

# XE119 NEUTRON ACER TENDL-2024 LIBRARY; T=0.K

## Threshold reactions

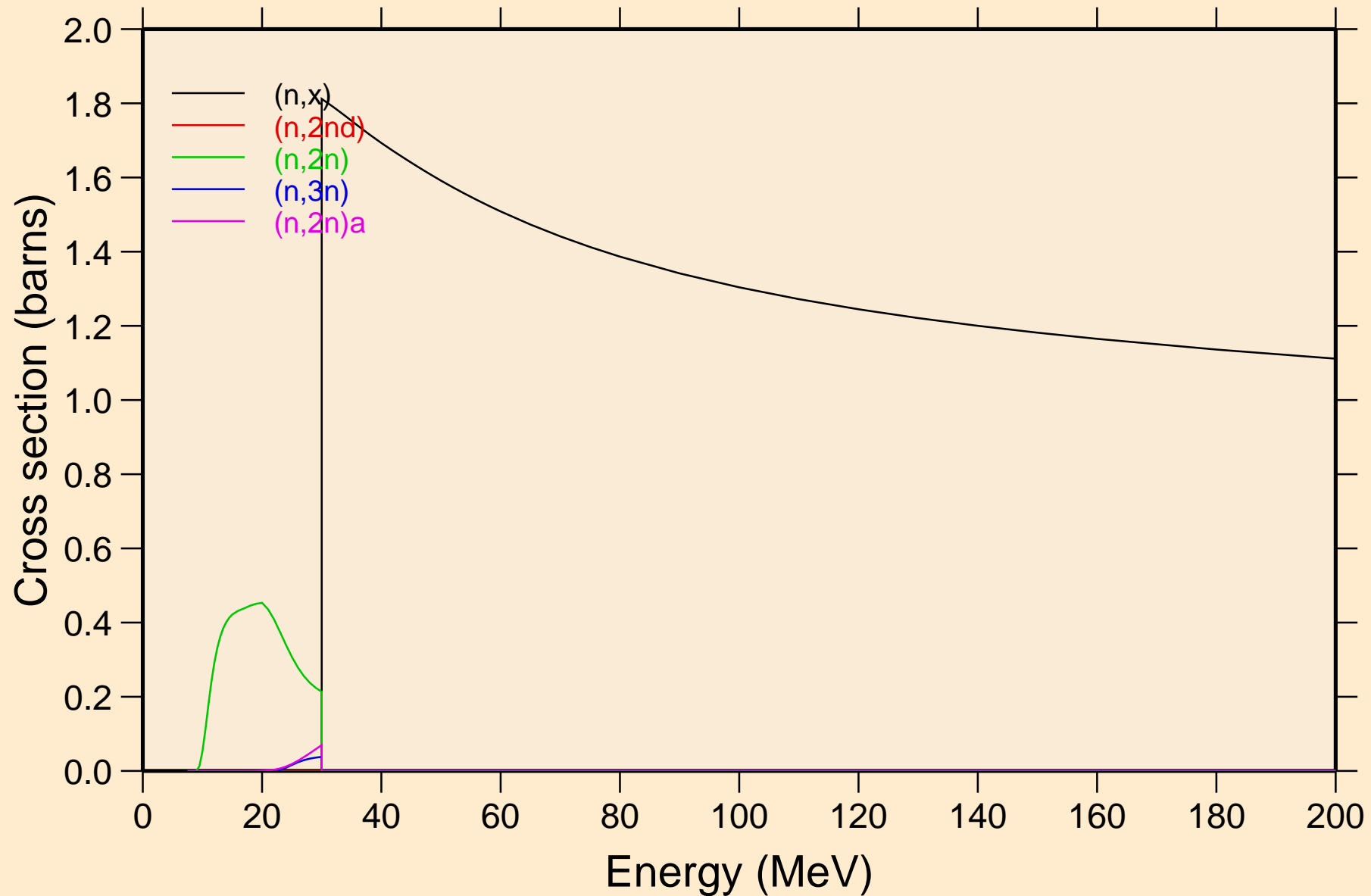

XE119 NEUTRON ACER TENDL-2024 LIBRARY; T=0.K  
Threshold reactions

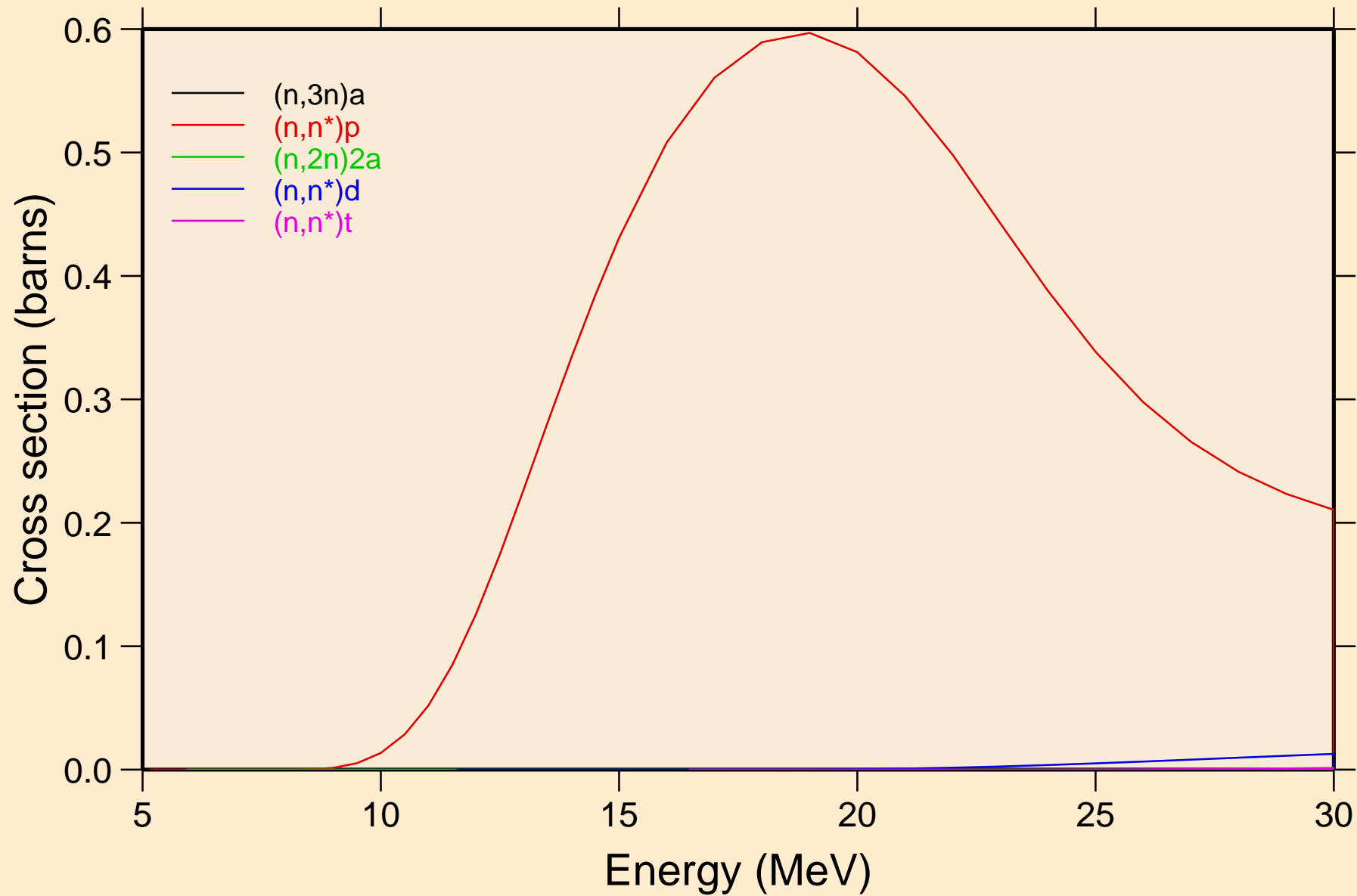

# XE119 NEUTRON ACER TENDL-2024 LIBRARY; T=0.K

## Threshold reactions

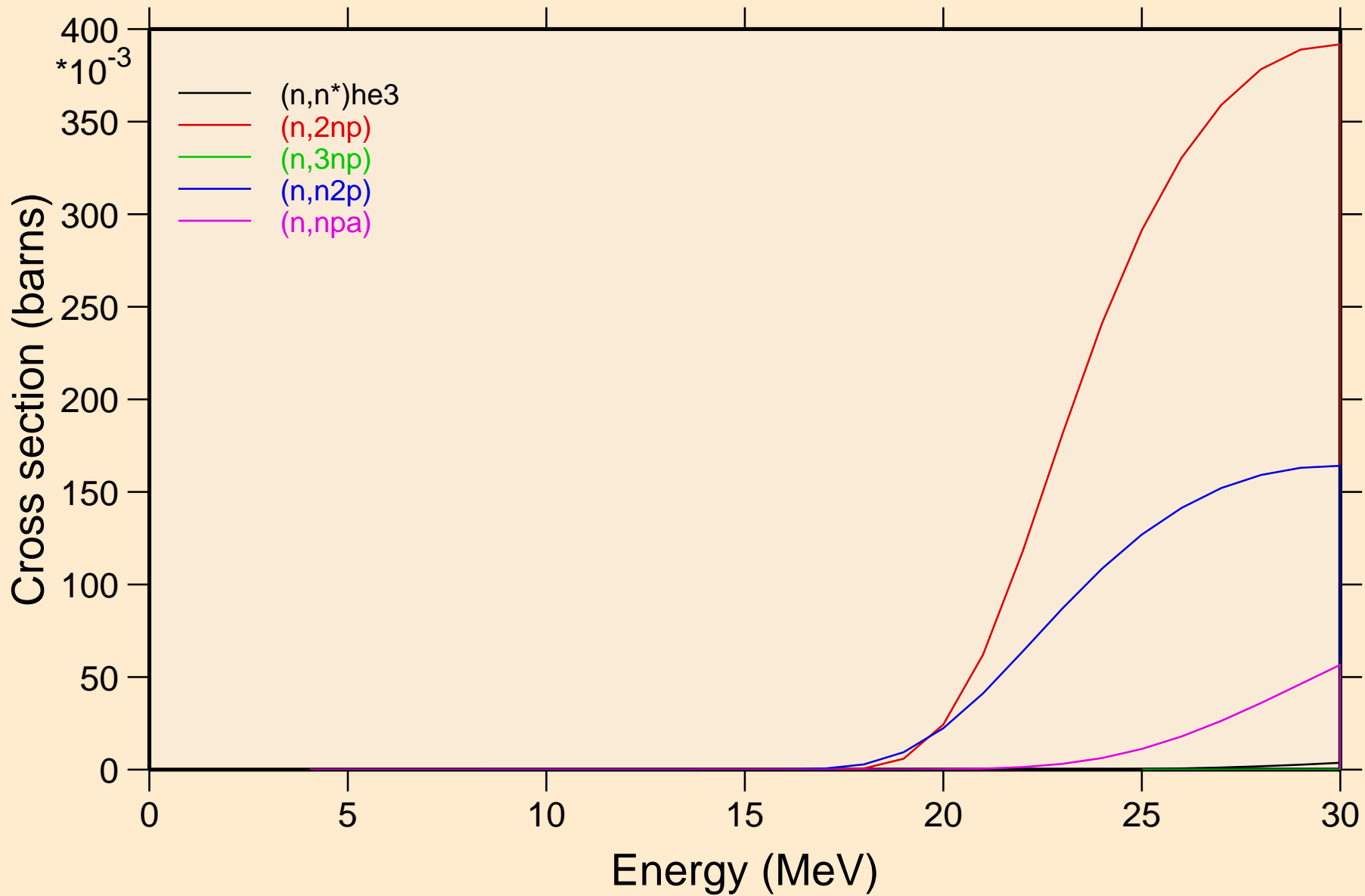

XE119 NEUTRON ACER TENDL-2024 LIBRARY; T=0.K  
Threshold reactions

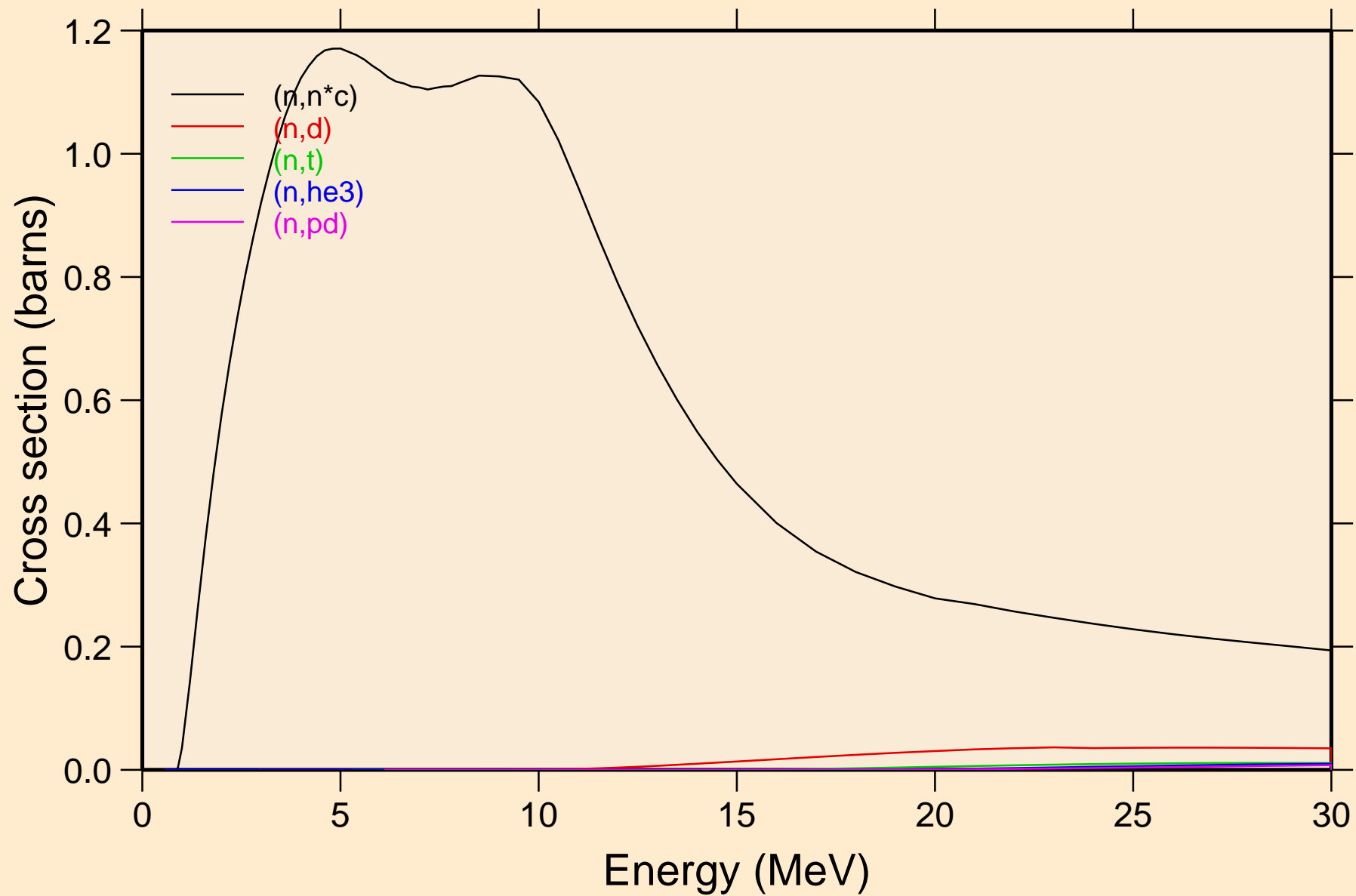

XE119 NEUTRON ACER TENDL-2024 LIBRARY; T=0.K  
Threshold reactions

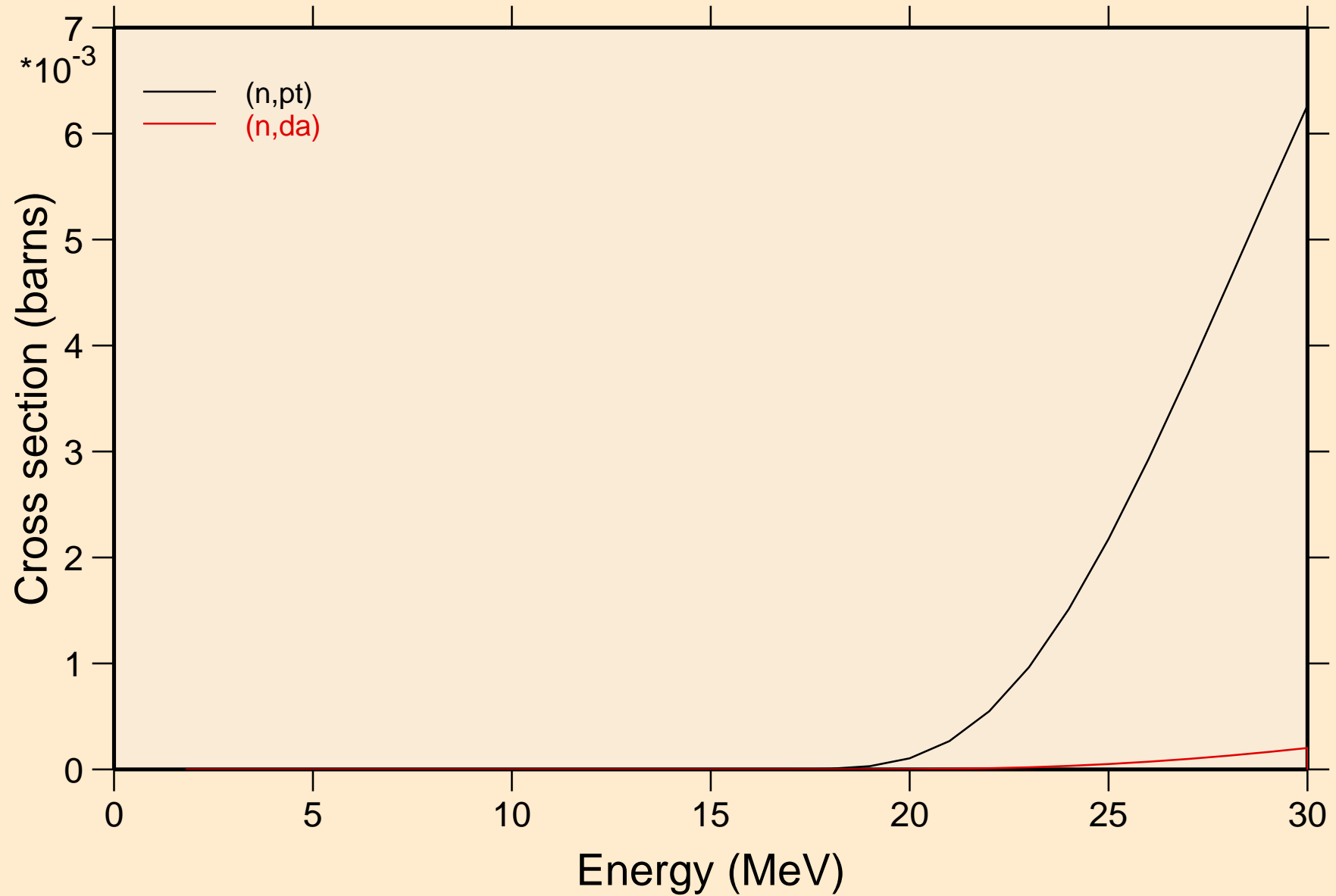

XE119 NEUTRON ACER TENDL-2024 LIBRARY; T=0.K  
Threshold reactions

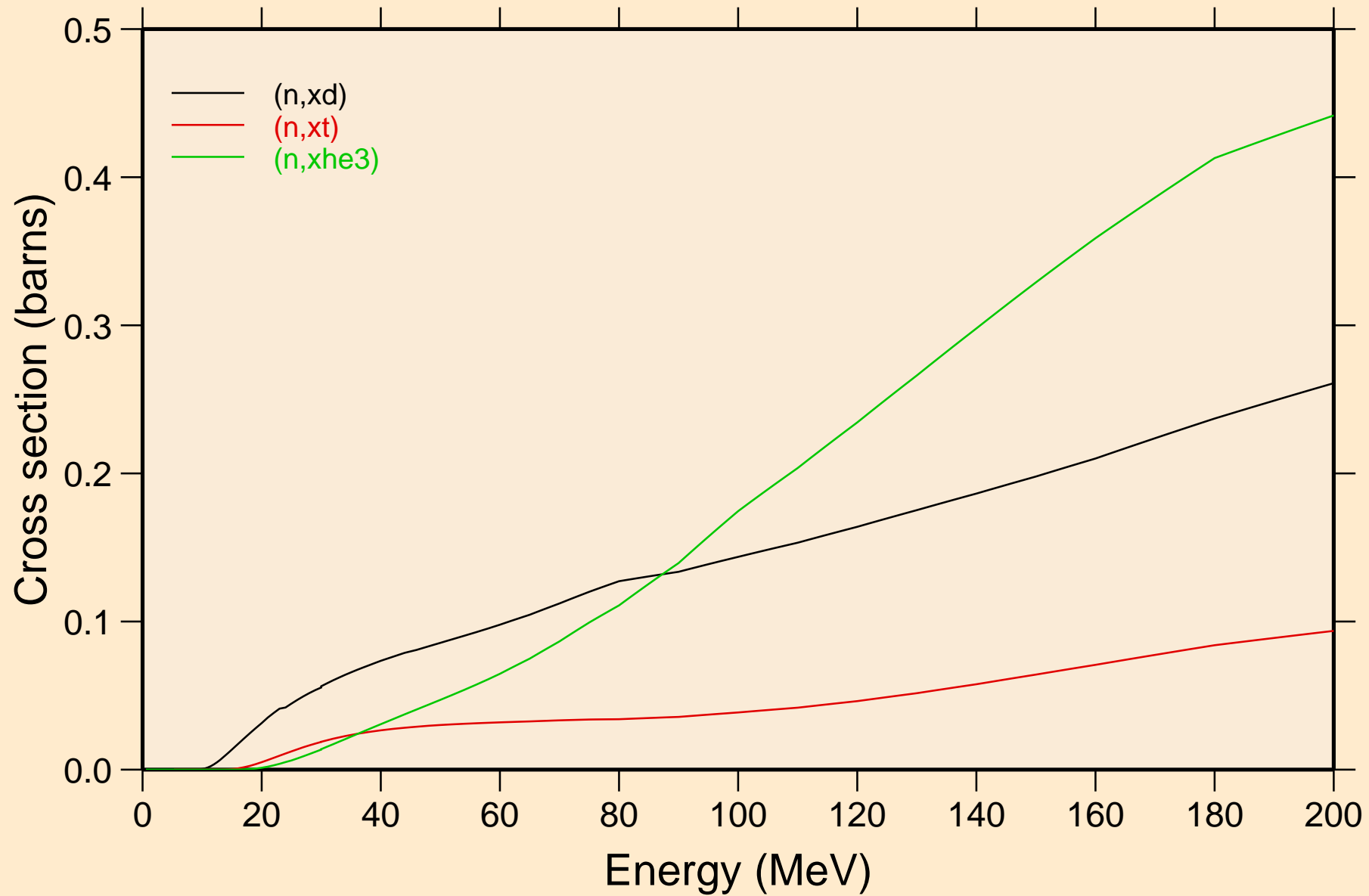

XE119 NEUTRON ACER TENDL-2024 LIBRARY; T=0.K  
angular distribution for elastic

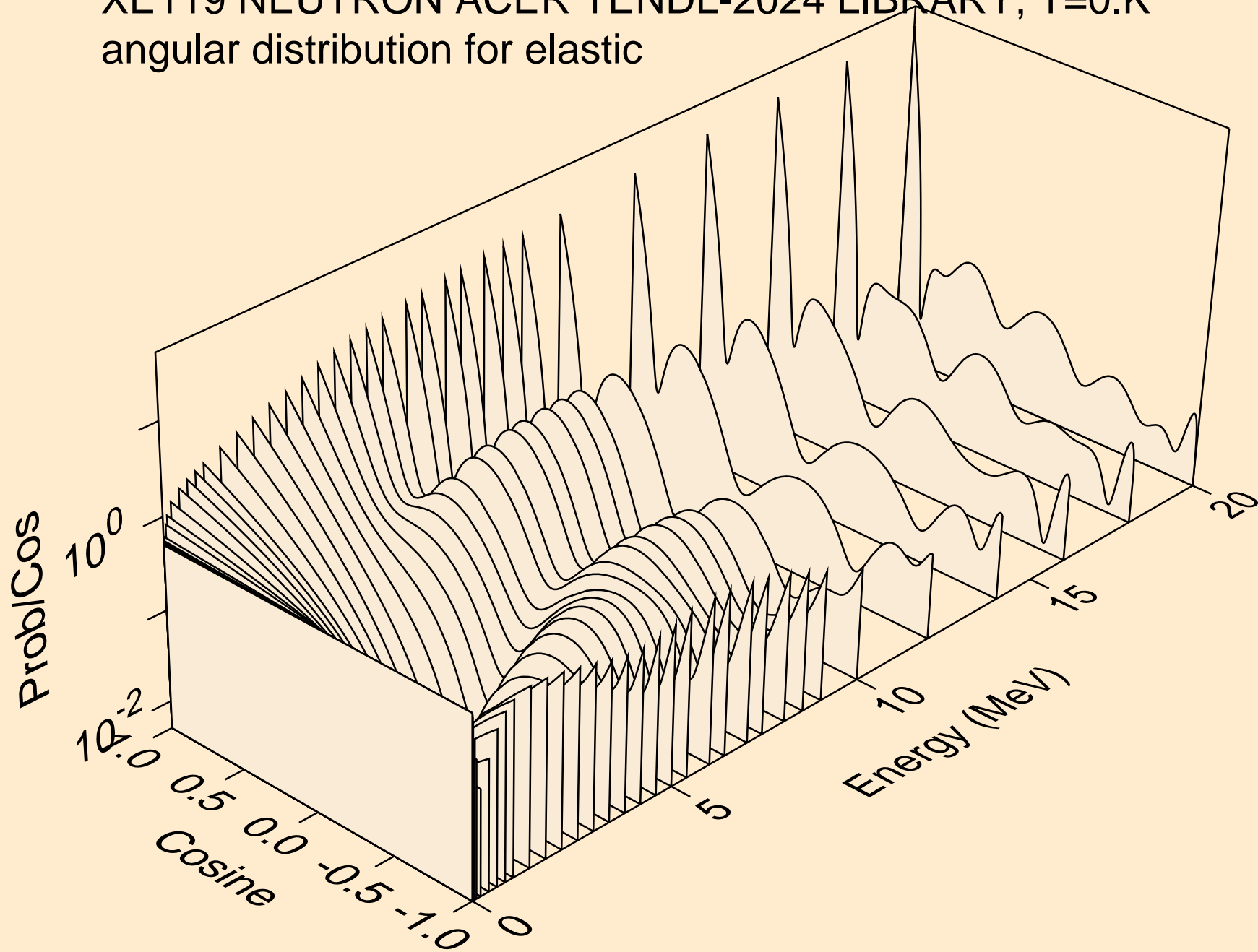

XE119 NEUTRON ACER TENDL-2024 LIBRARY; T=0.K  
angular distribution for elastic

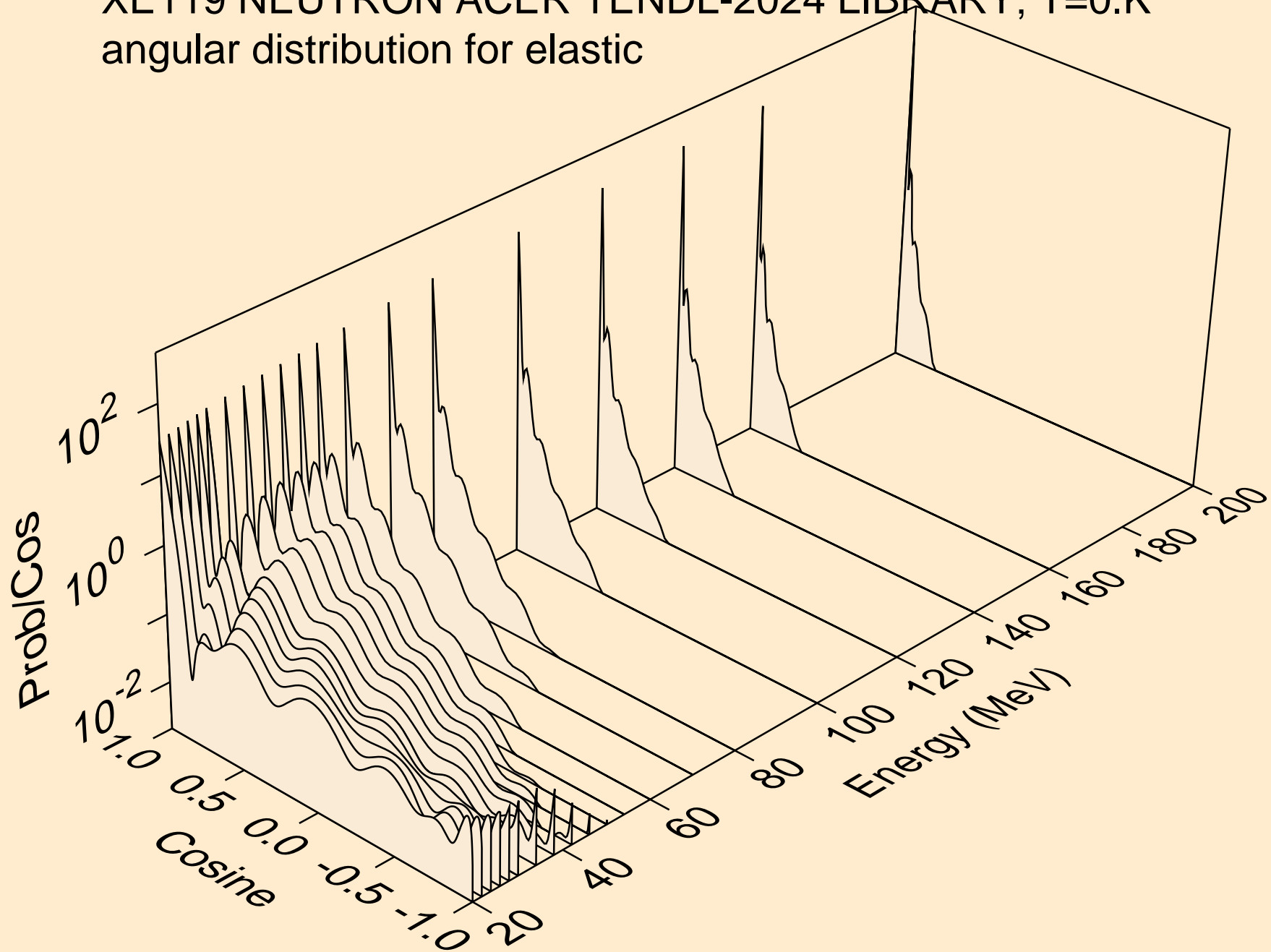

XE119 NEUTRON ACER TENDL-2024 LIBRARY; T=0.K  
angular distribution for (n,n\*1)

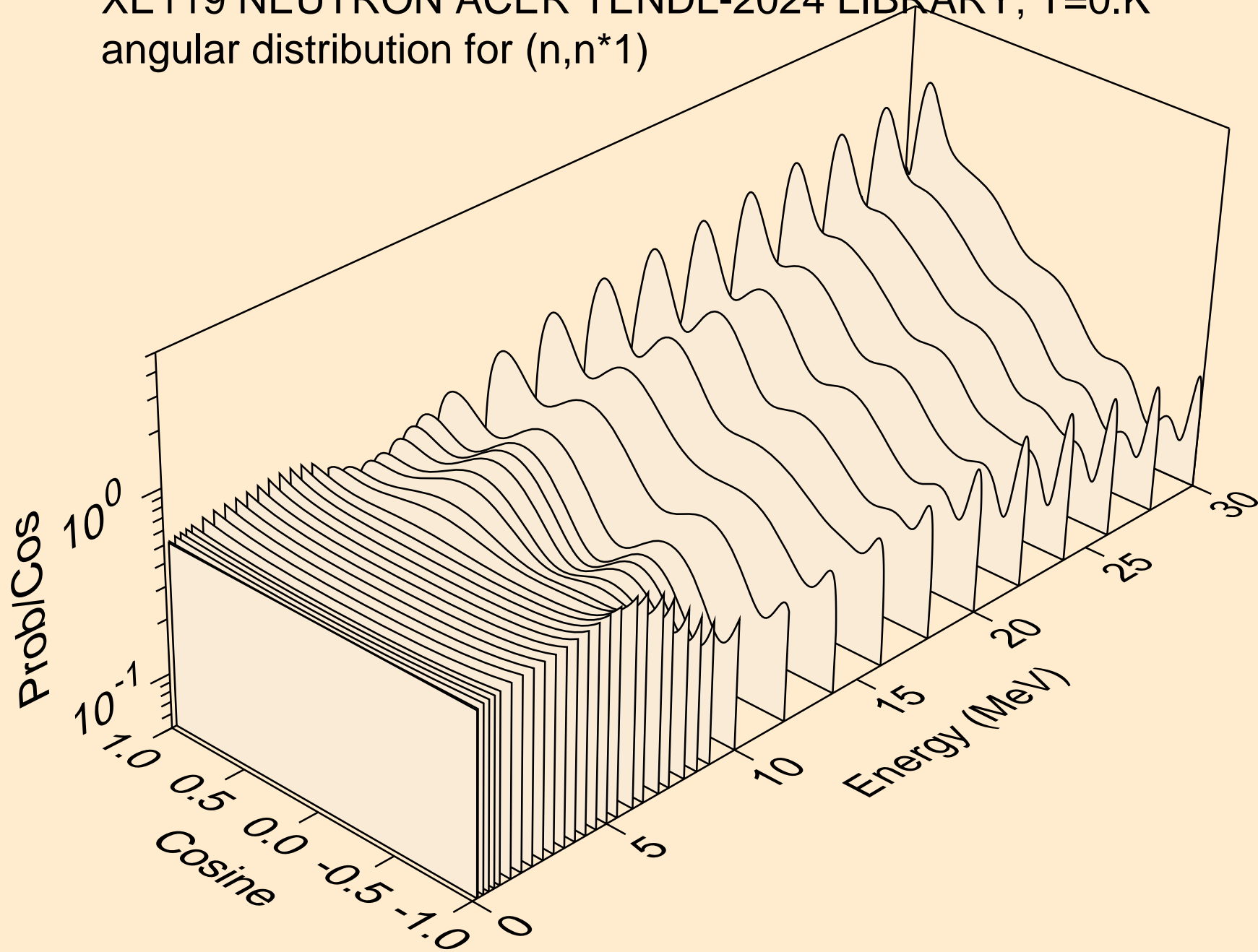

XE119 NEUTRON ACER TENDL-2024 LIBRARY; T=0.K  
angular distribution for (n,n\*2)

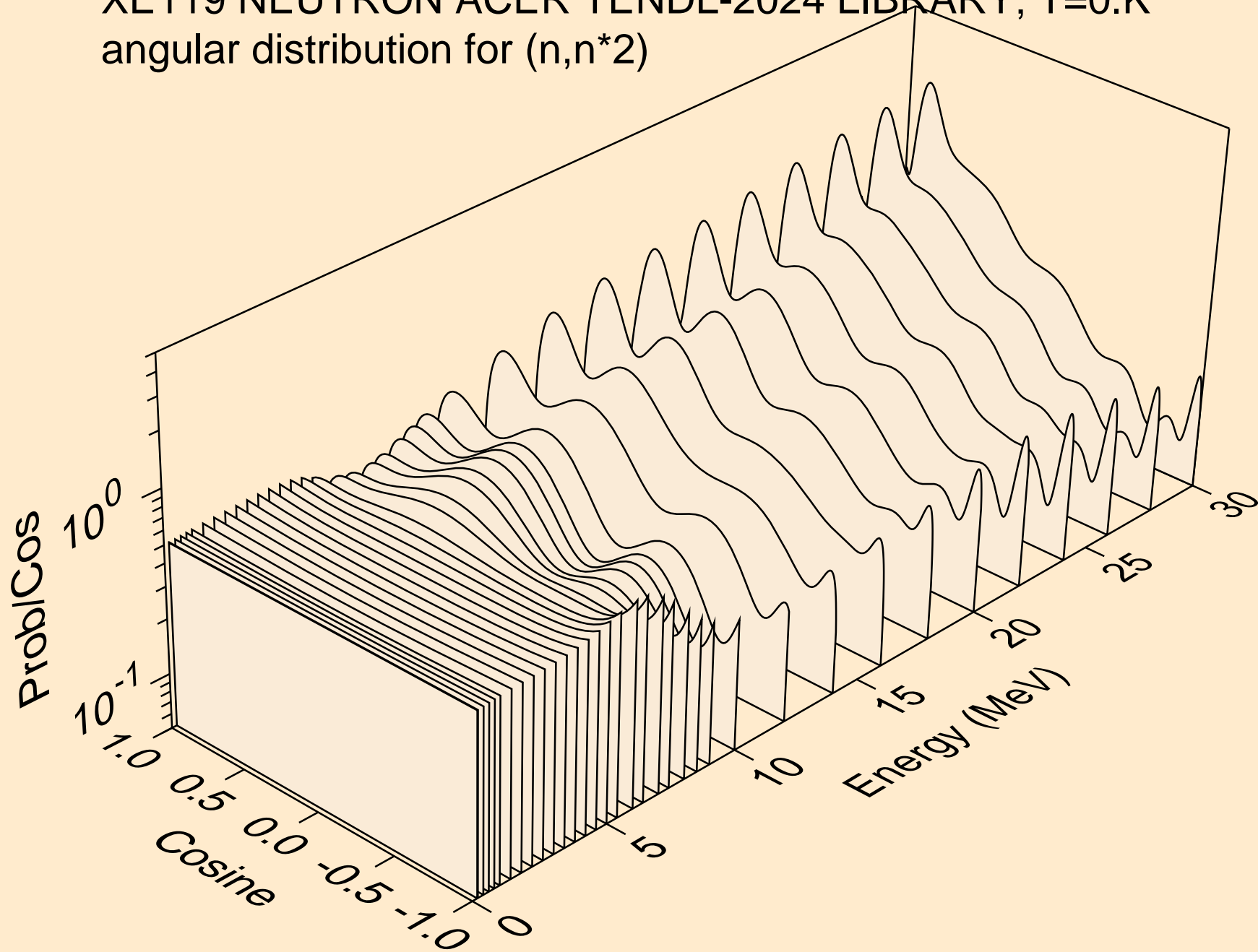

XE119 NEUTRON ACER TENDL-2024 LIBRARY; T=0.K  
angular distribution for (n,n\*3)

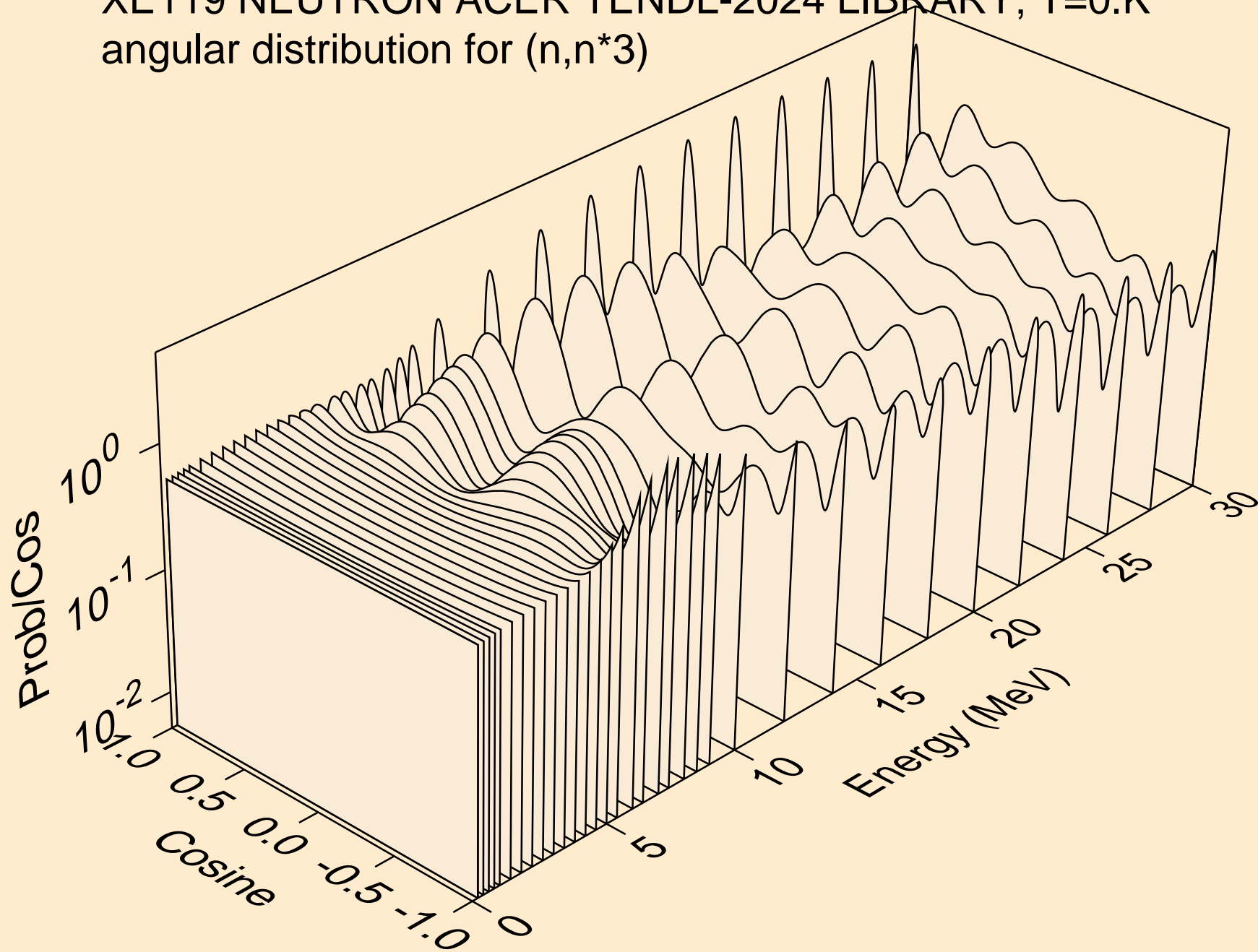

XE119 NEUTRON ACER TENDL-2024 LIBRARY; T=0.K  
angular distribution for (n,n\*4)

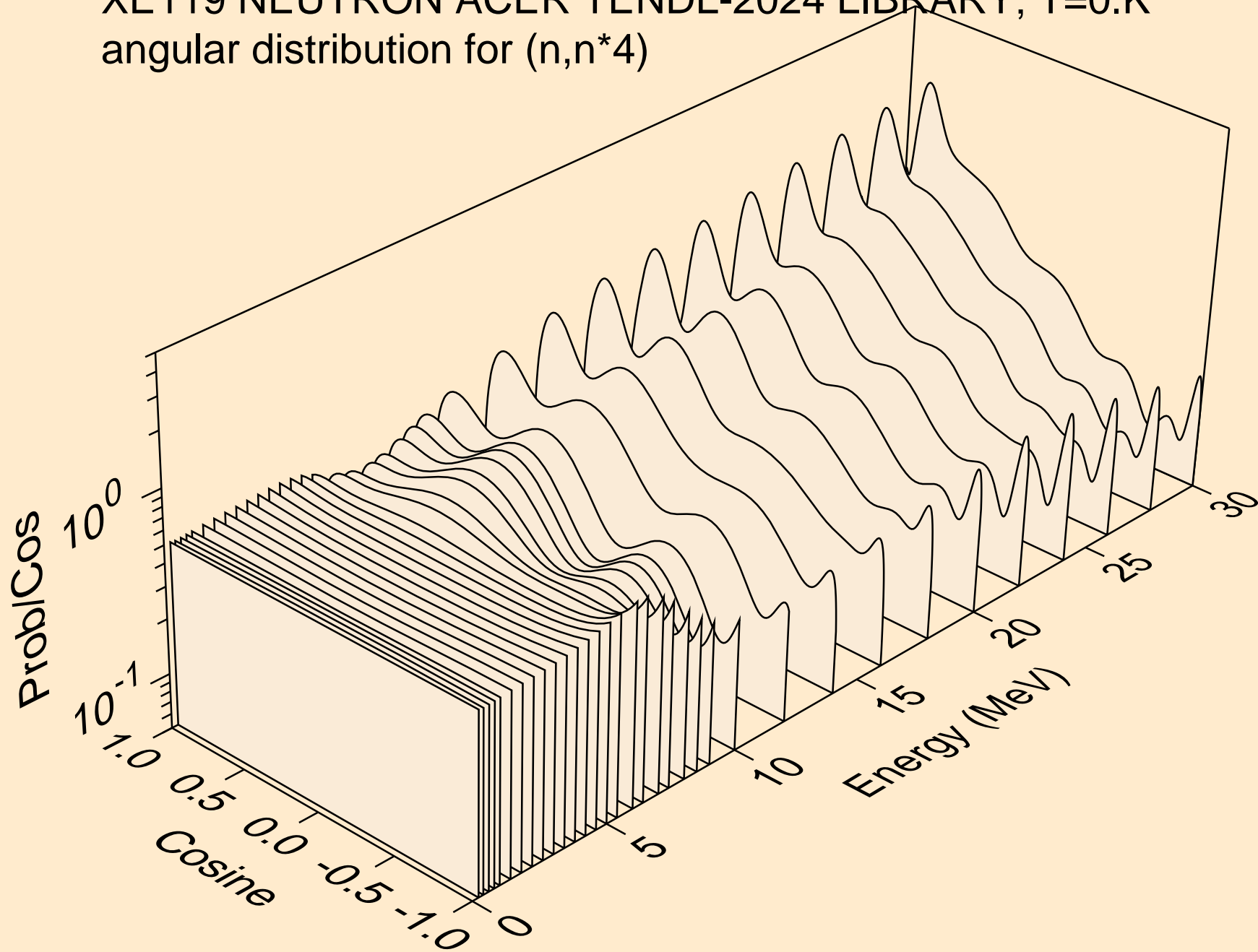

XE119 NEUTRON ACER TENDL-2024 LIBRARY; T=0.K  
angular distribution for (n,n\*5)

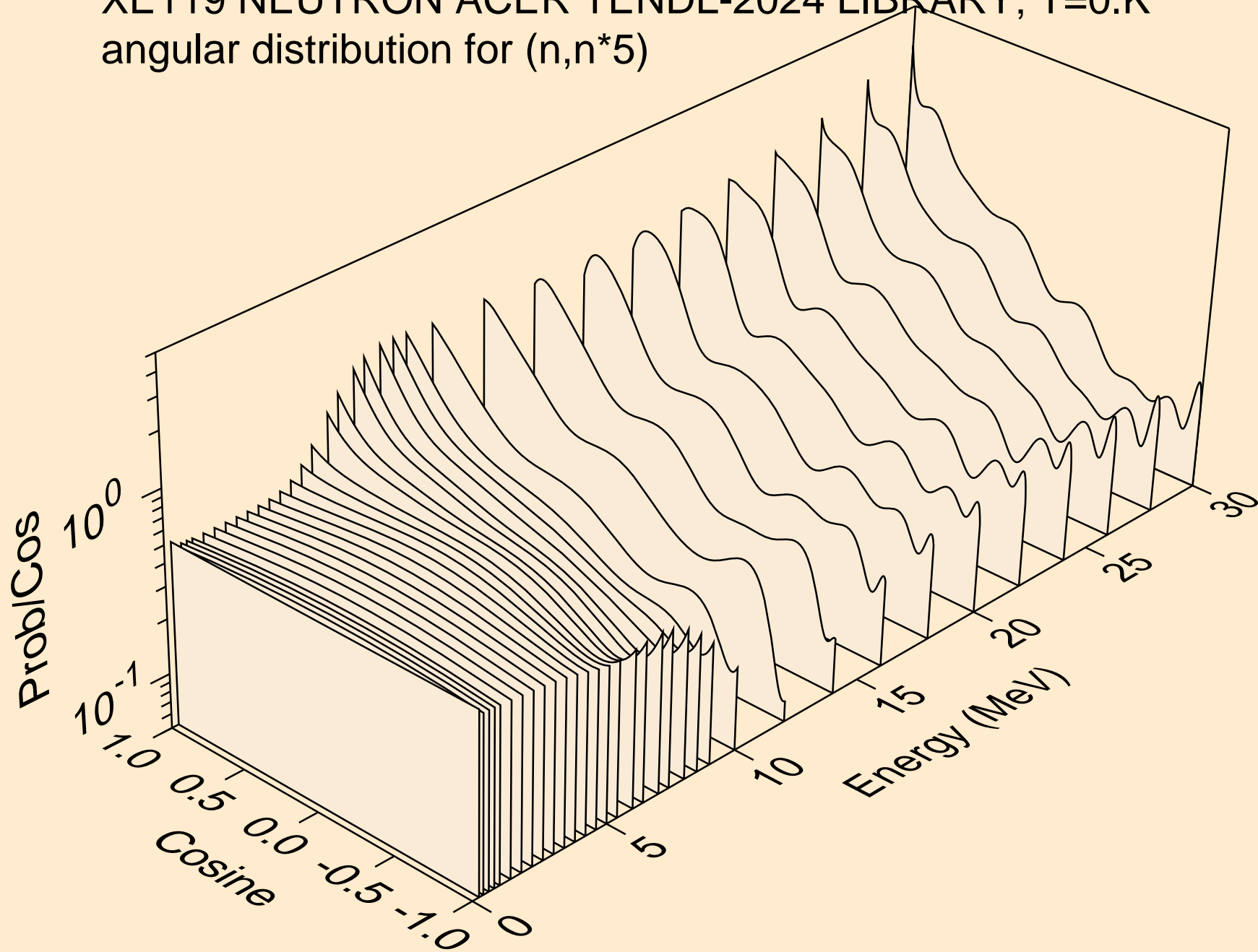

XE119 NEUTRON ACER TENDL-2024 LIBRARY; T=0.K  
angular distribution for (n,n\*6)

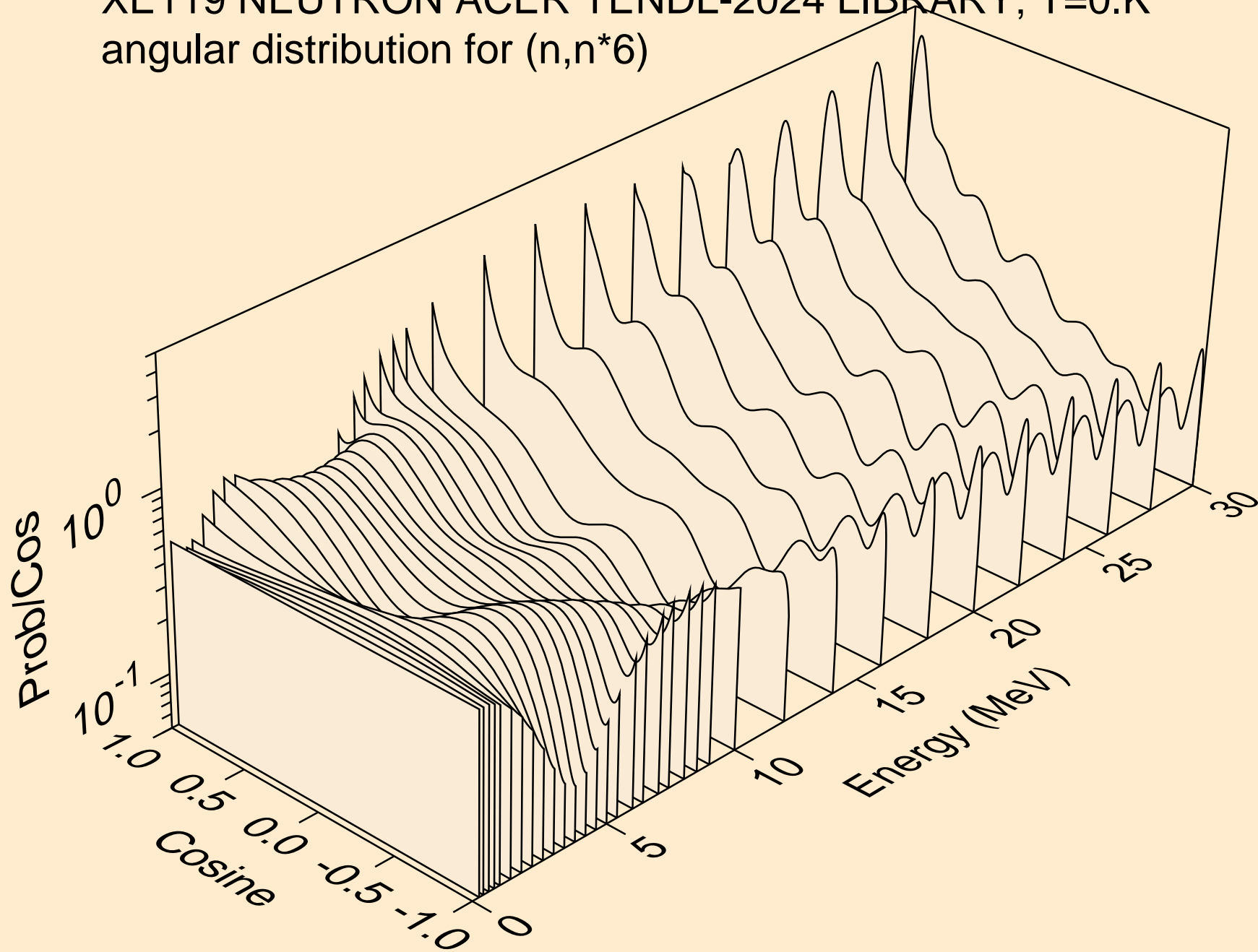

XE119 NEUTRON ACER TENDL-2024 LIBRARY; T=0.K  
angular distribution for (n,n\*7)

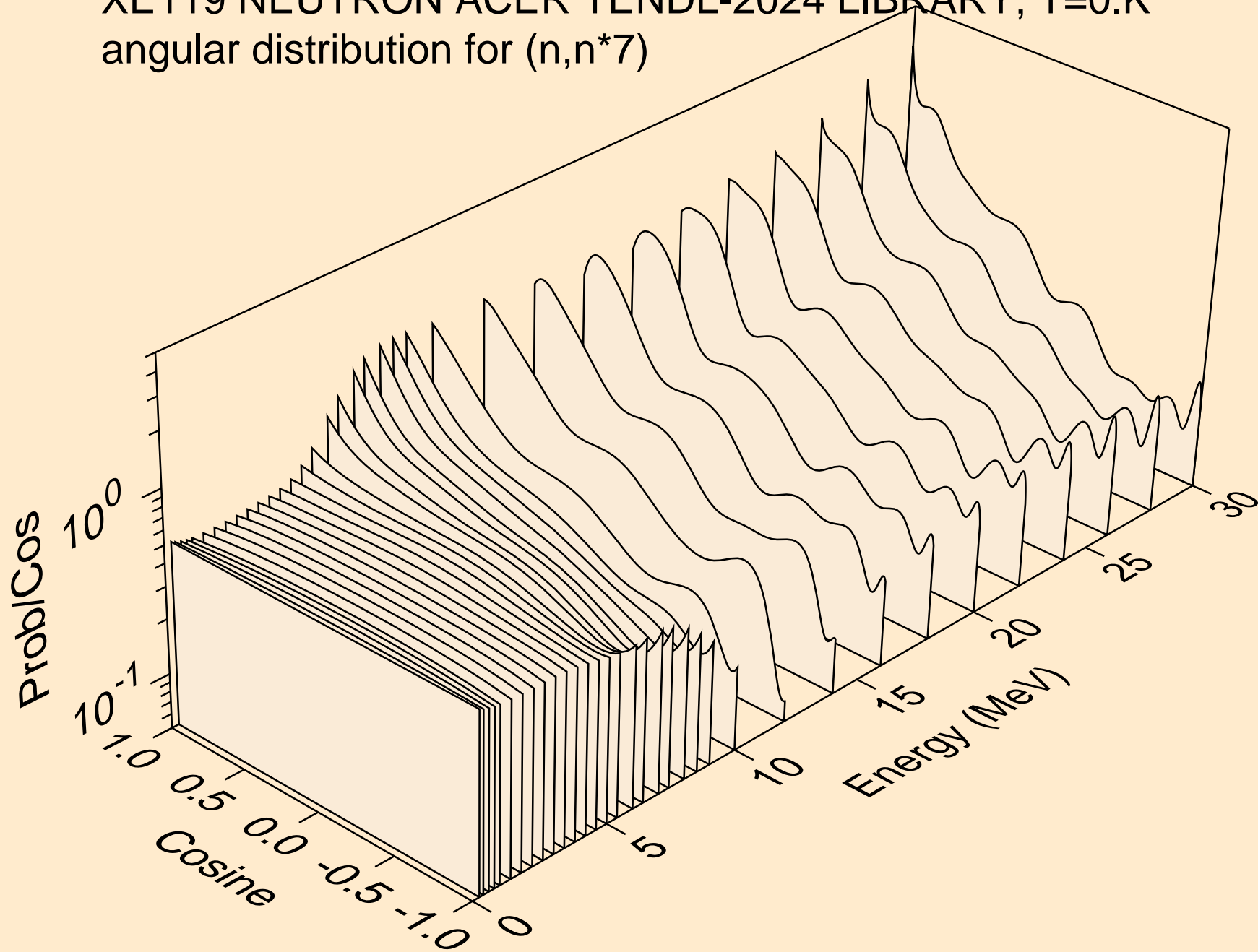

XE119 NEUTRON ACER TENDL-2024 LIBRARY; T=0.K  
angular distribution for (n,n\*8)

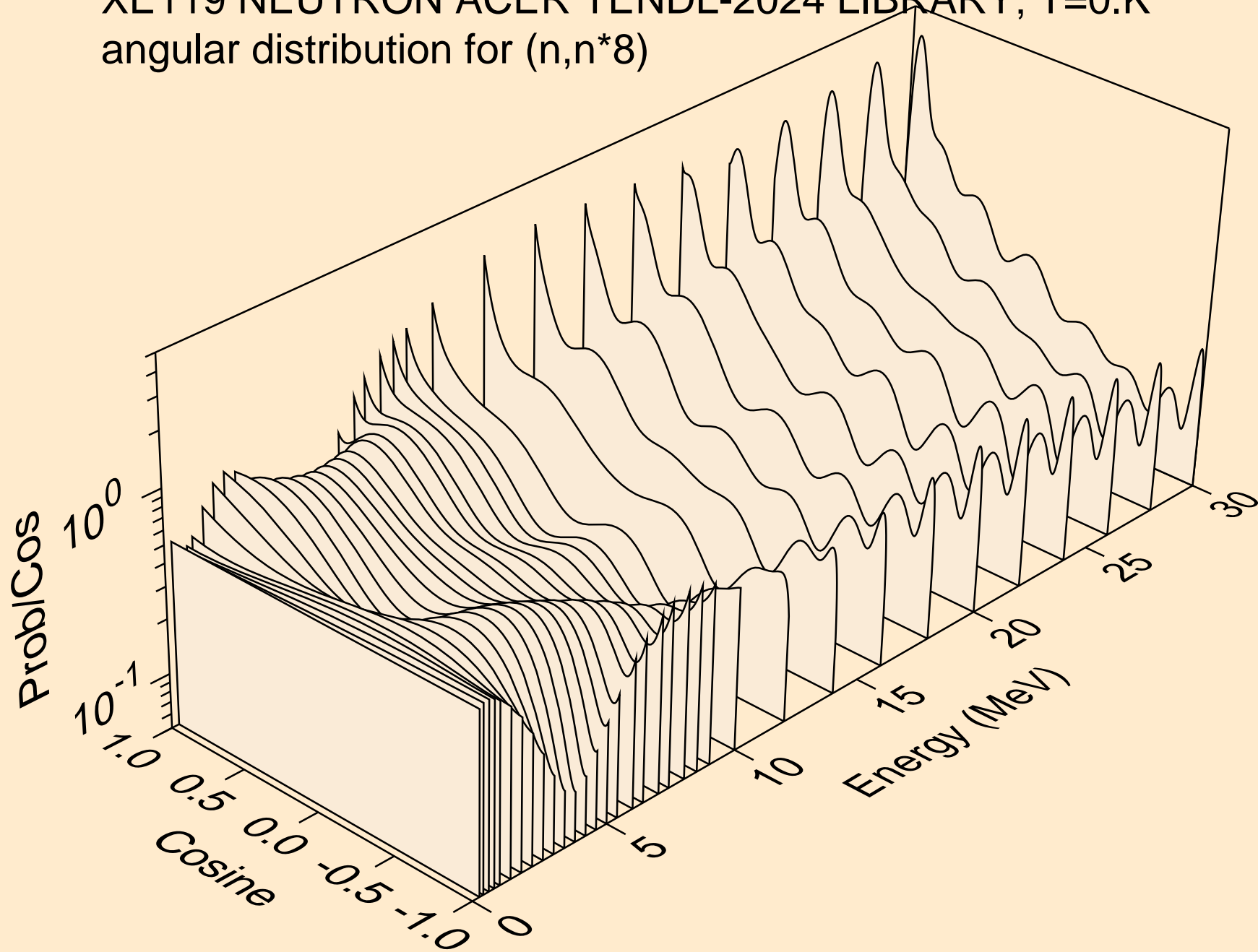

XE119 NEUTRON ACER TENDL-2024 LIBRARY; T=0.K  
angular distribution for (n,n\*9)

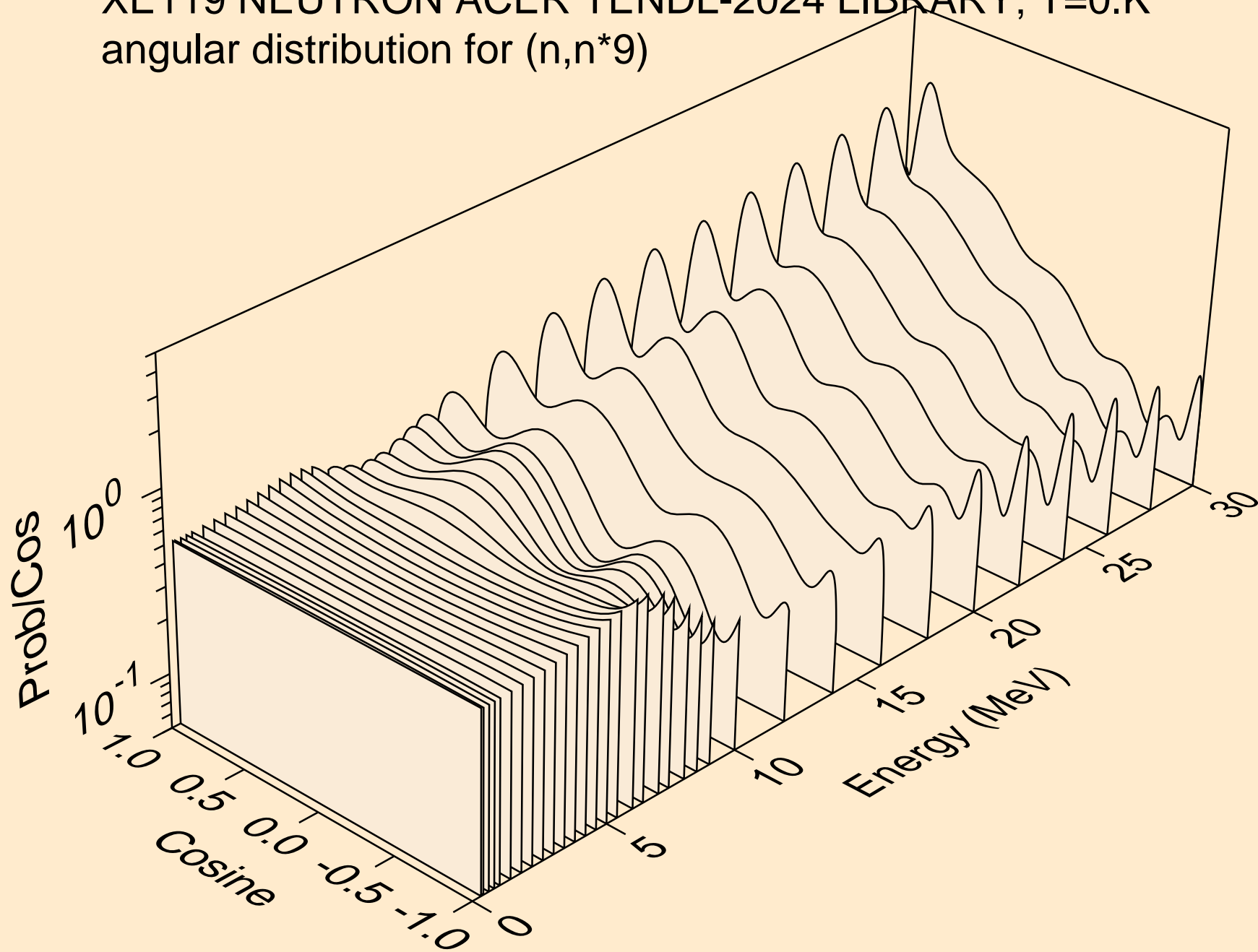

XE119 NEUTRON ACER TENDL-2024 LIBRARY; T=0.K  
angular distribution for (n,n\*10)

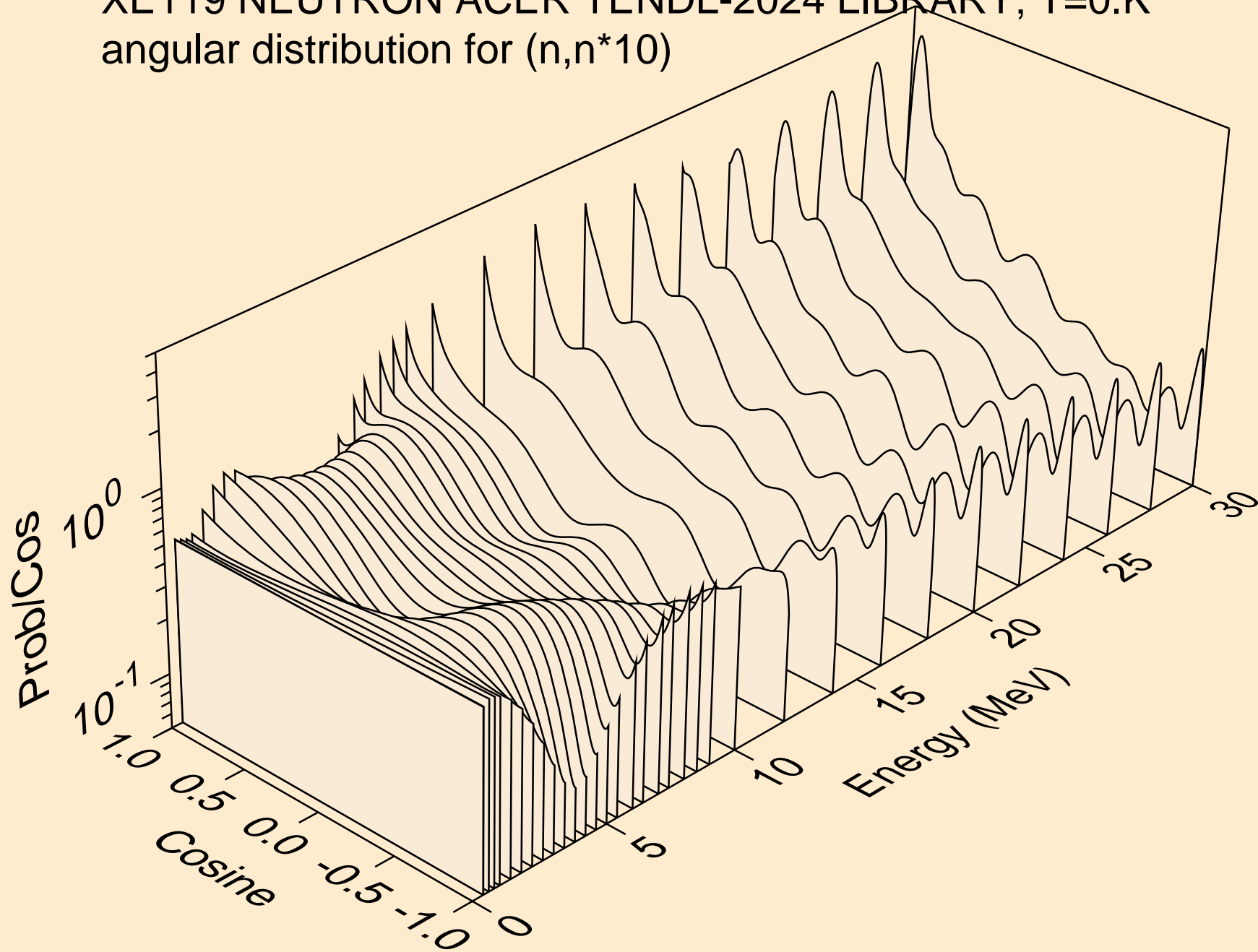

XE119 NEUTRON ACER TENDL-2024 LIBRARY; T=0.K  
angular distribution for (n,n\*11)

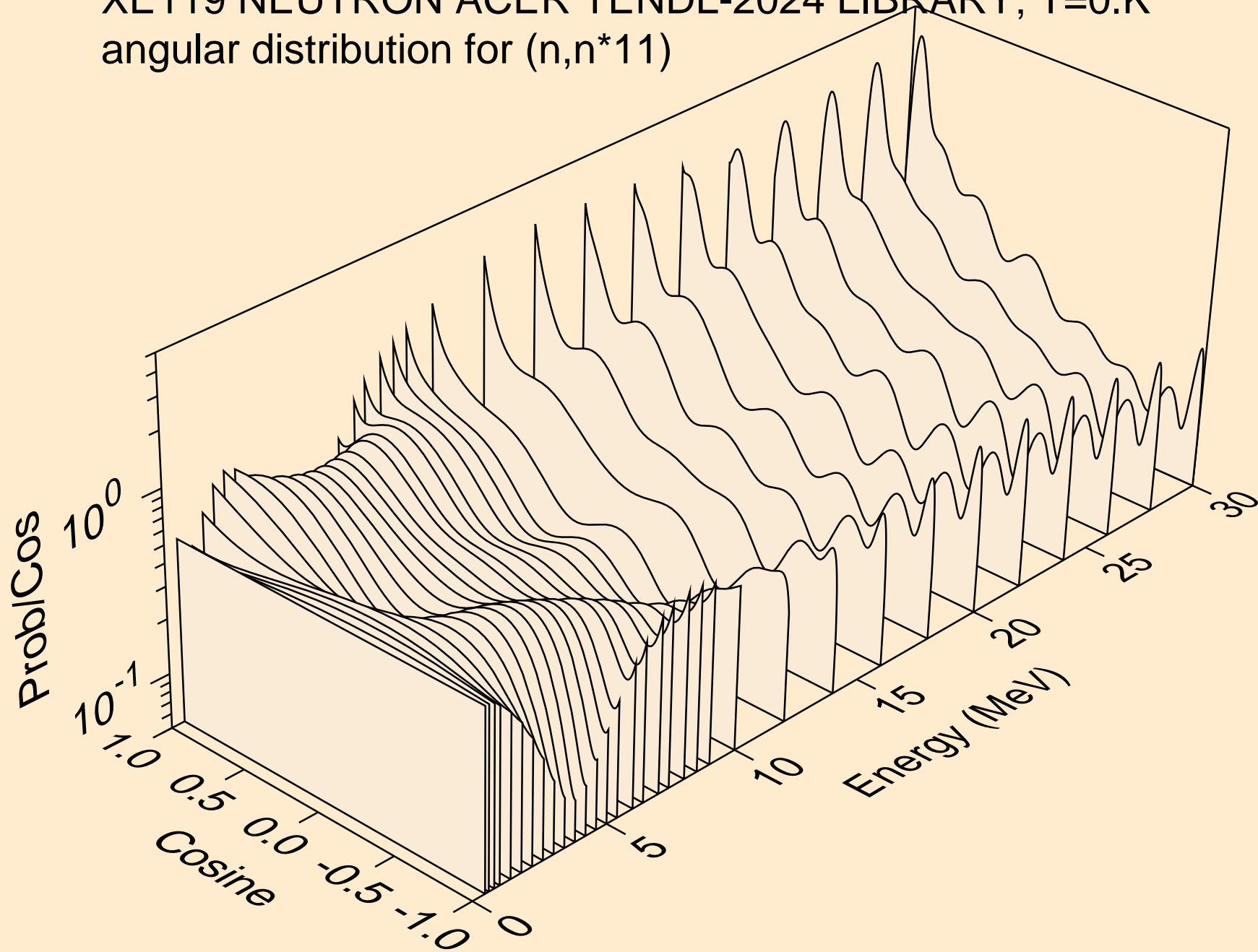

XE119 NEUTRON ACER TENDL-2024 LIBRARY; T=0.K  
angular distribution for (n,n\*12)

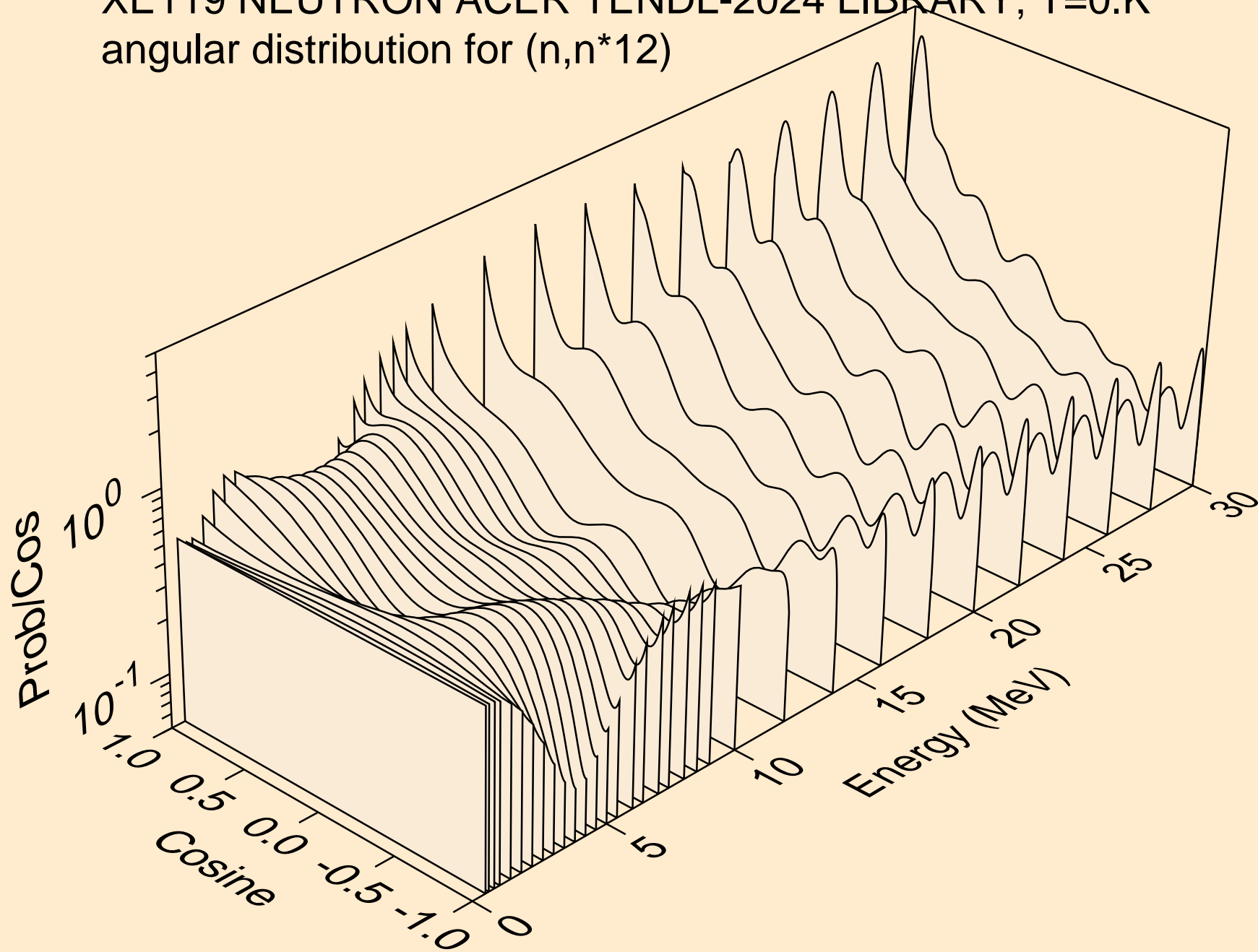

XE119 NEUTRON ACER TENDL-2024 LIBRARY; T=0.K  
angular distribution for (n,n\*13)

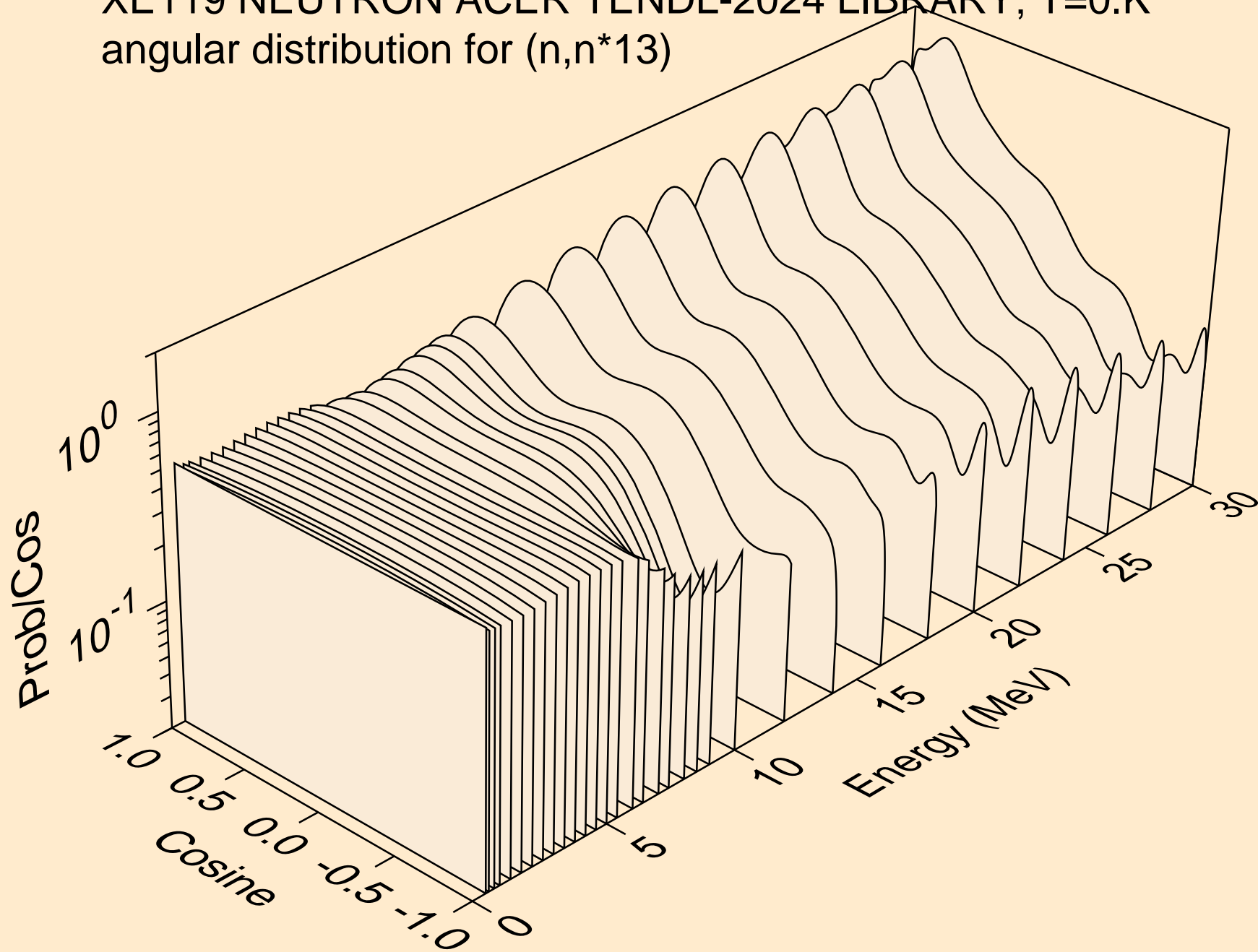

XE119 NEUTRON ACER TENDL-2024 LIBRARY; T=0.K  
angular distribution for (n,n\*14)

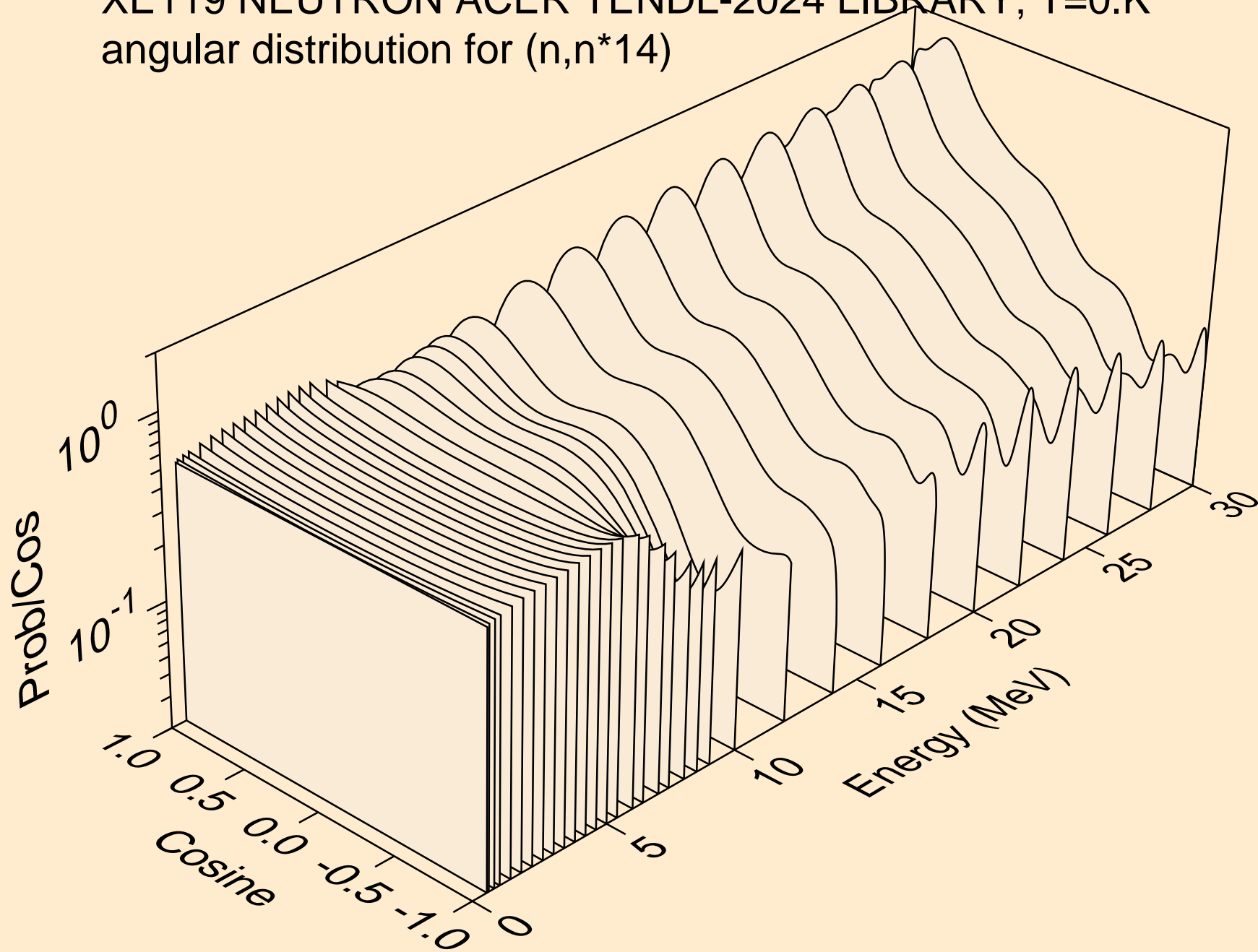

XE119 NEUTRON ACER TENDL-2024 LIBRARY; T=0.K  
angular distribution for (n,n\*15)

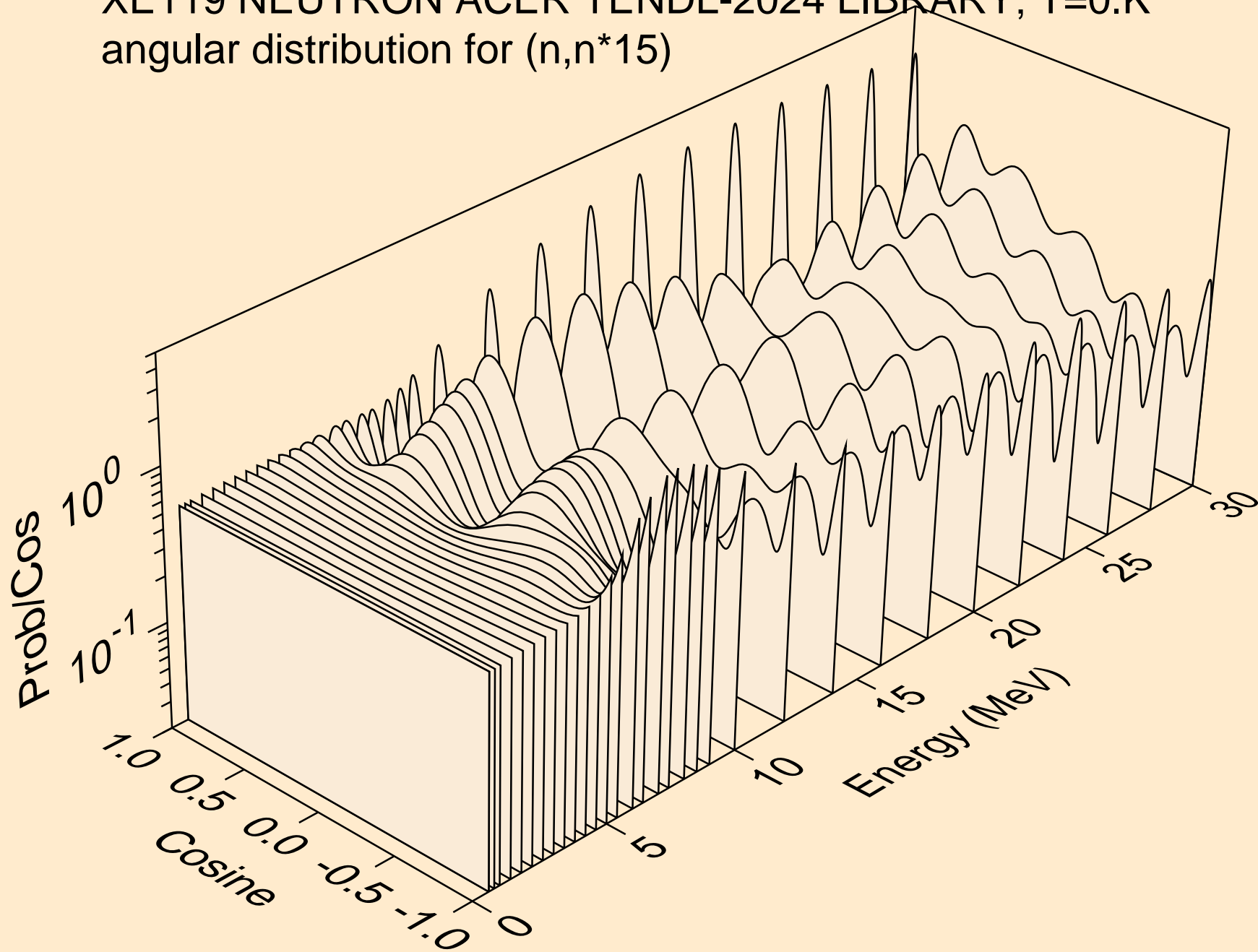

XE119 NEUTRON ACER TENDL-2024 LIBRARY; T=0.K  
angular distribution for (n,n\*16)

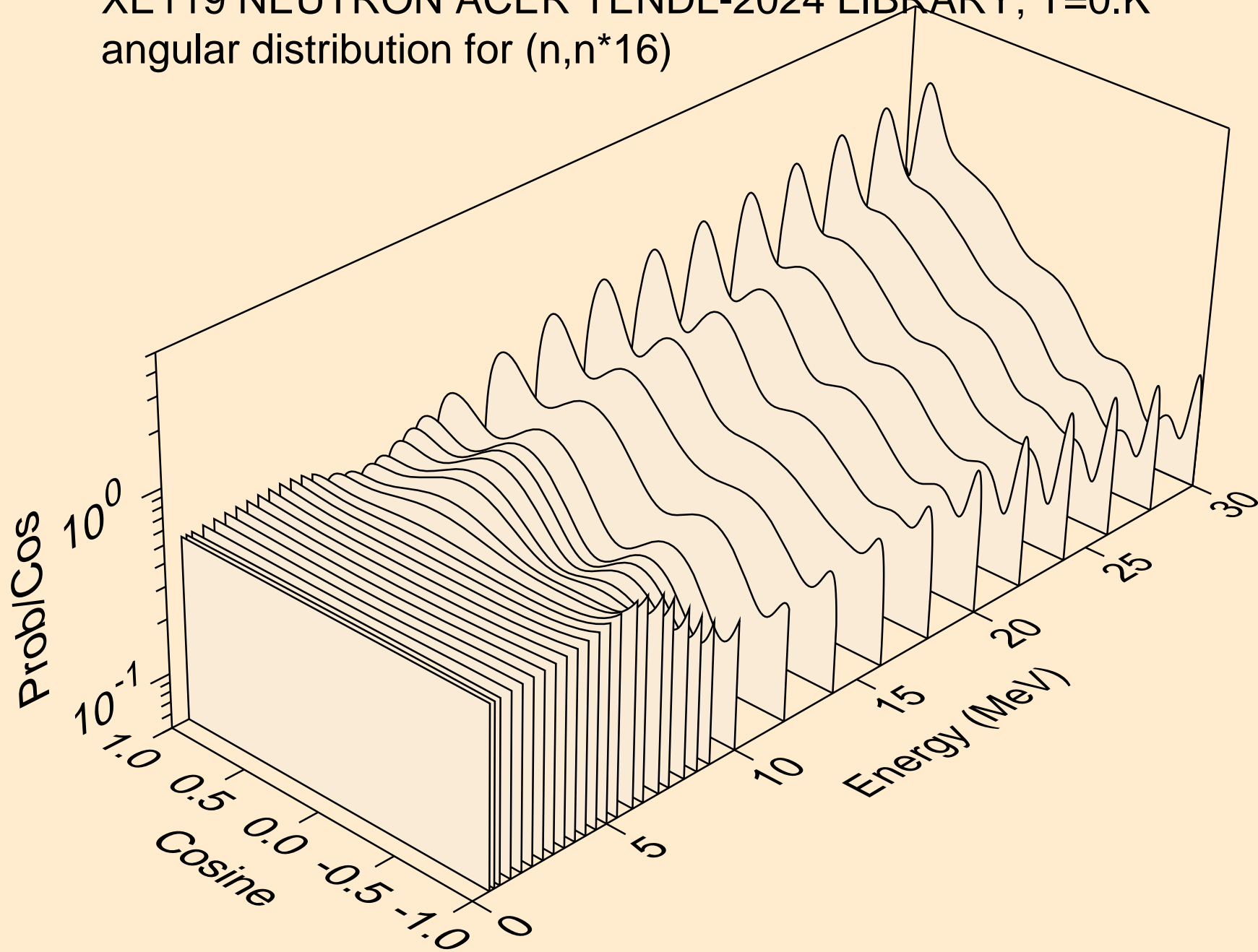

XE119 NEUTRON ACER TENDL-2024 LIBRARY; T=0.K  
angular distribution for (n,n\*17)

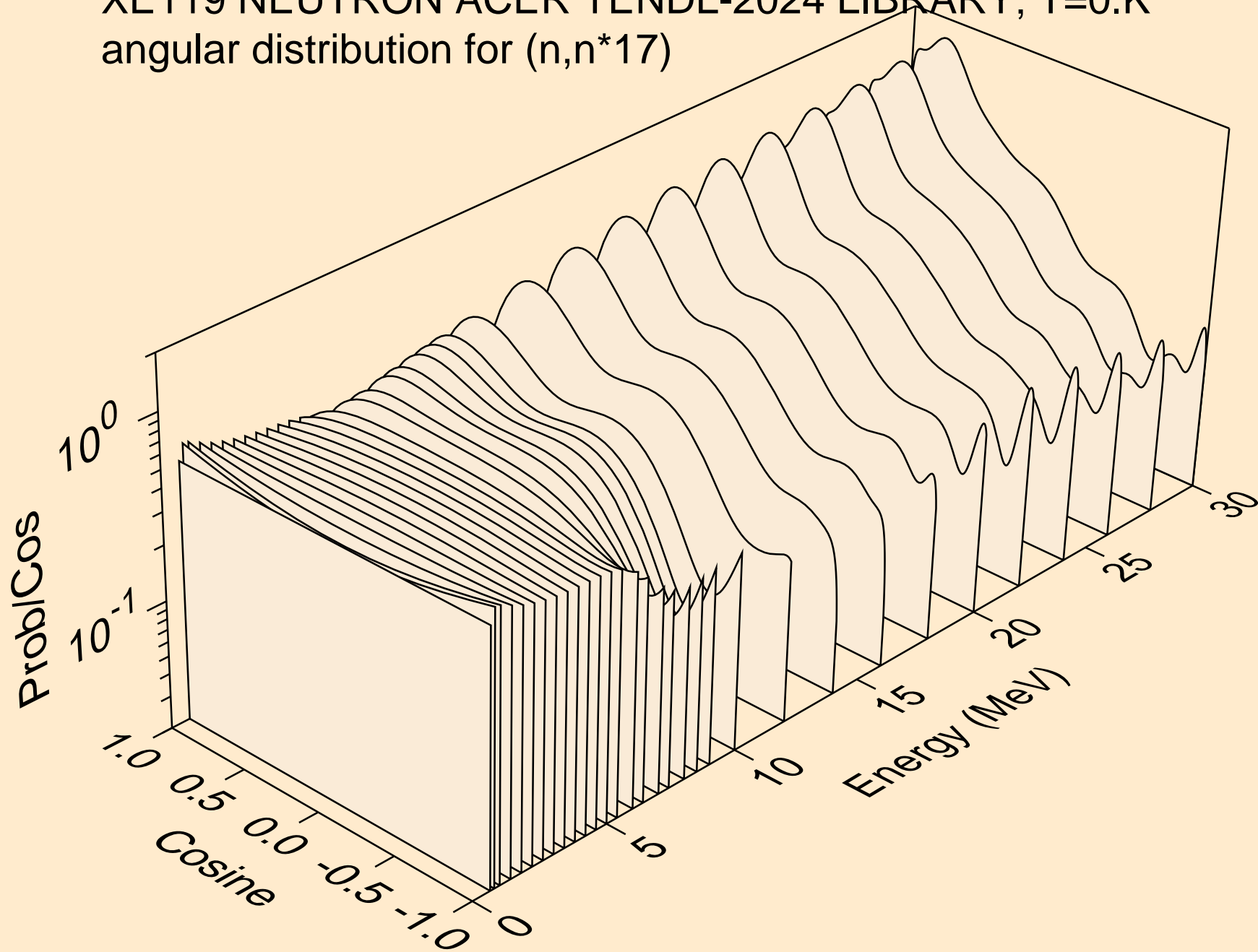

XE119 NEUTRON ACER TENDL-2024 LIBRARY; T=0.K  
angular distribution for (n,n\*18)

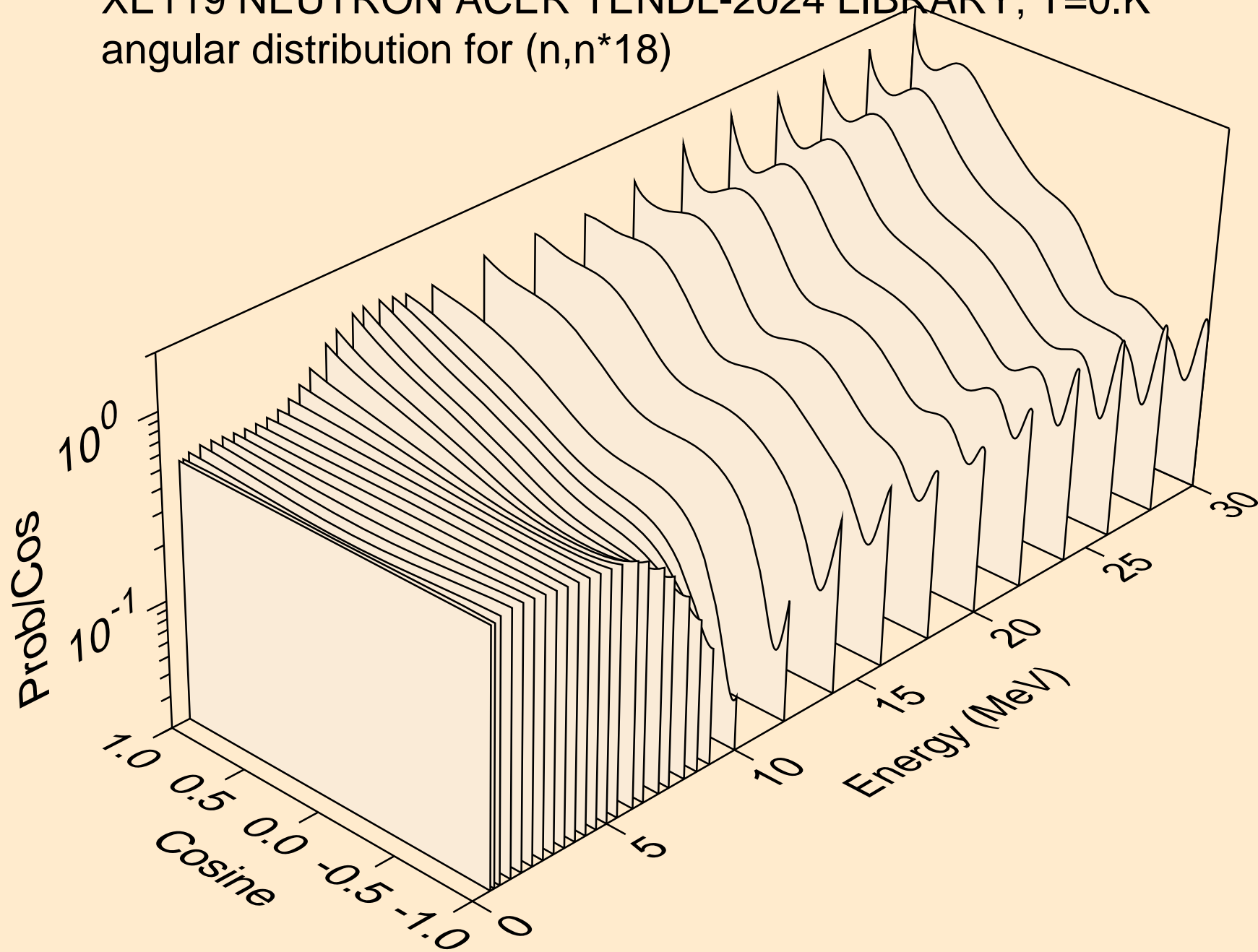

XE119 NEUTRON ACER TENDL-2024 LIBRARY; T=0.K  
angular distribution for (n,n\*19)

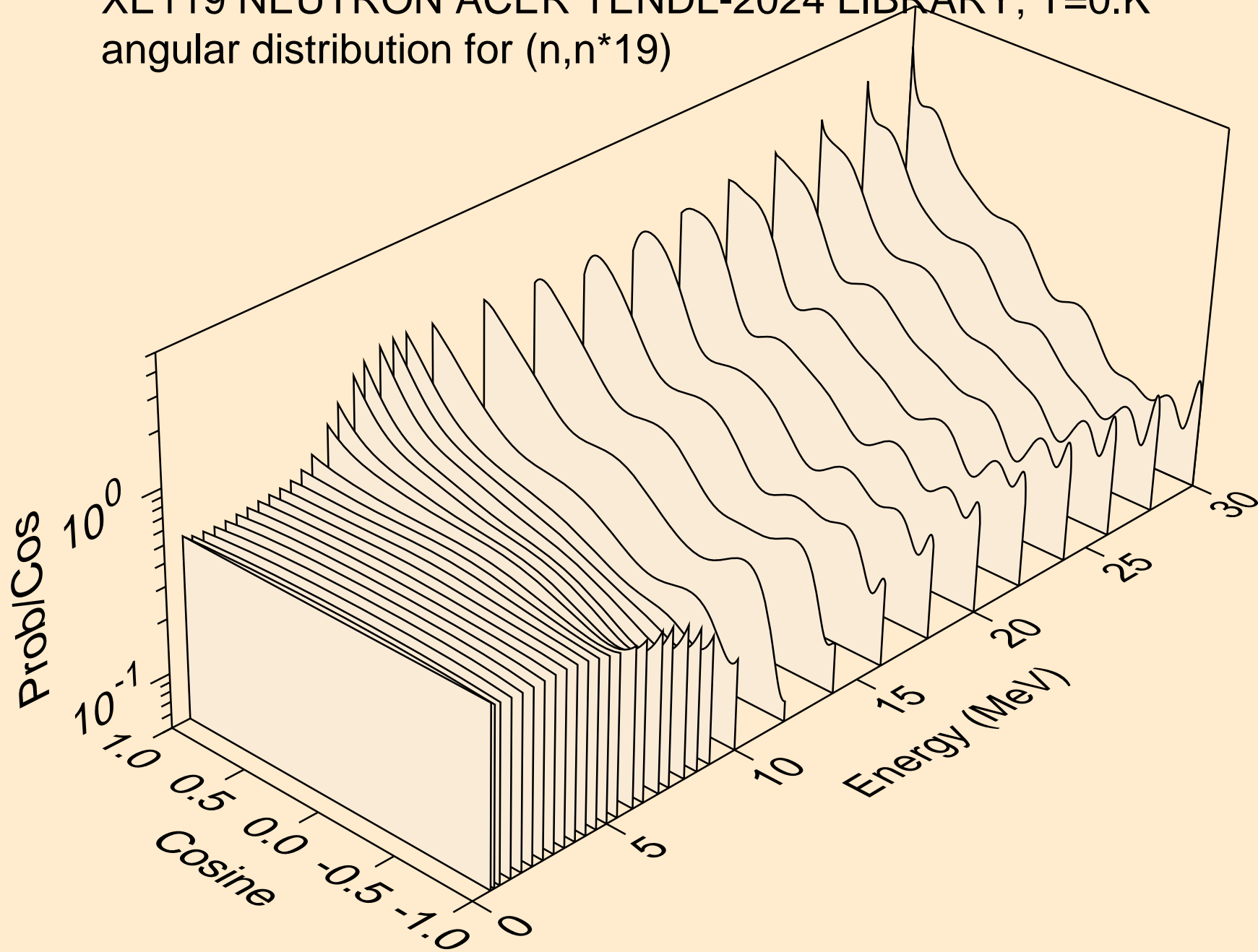

XE119 NEUTRON ACER TENDL-2024 LIBRARY; T=0.K  
angular distribution for (n,n\*20)

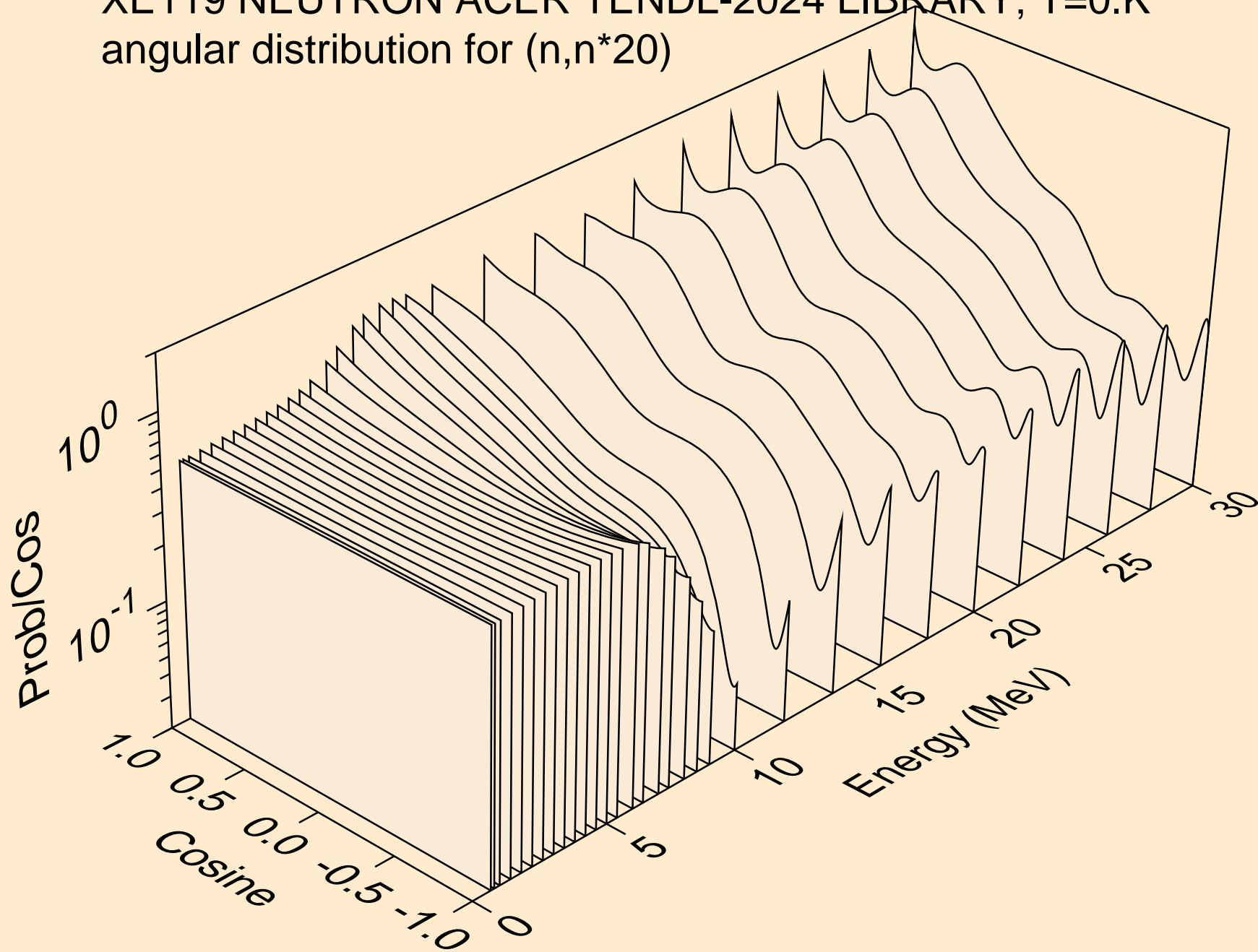

XE119 NEUTRON ACER TENDL-2024 LIBRARY; T=0.K  
angular distribution for (n,n\*21)

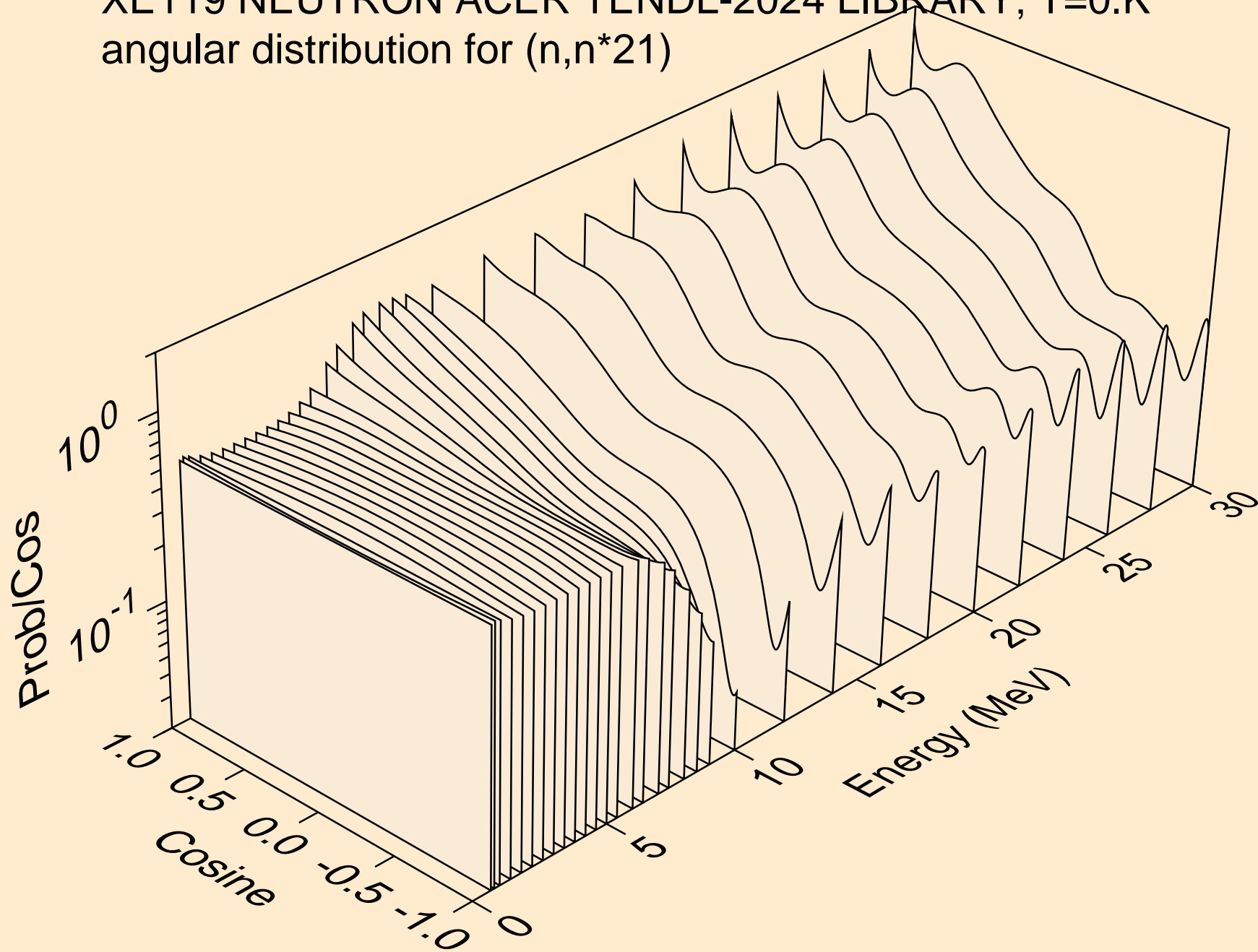

XE119 NEUTRON ACER TENDL-2024 LIBRARY; T=0.K  
angular distribution for (n,n\*22)

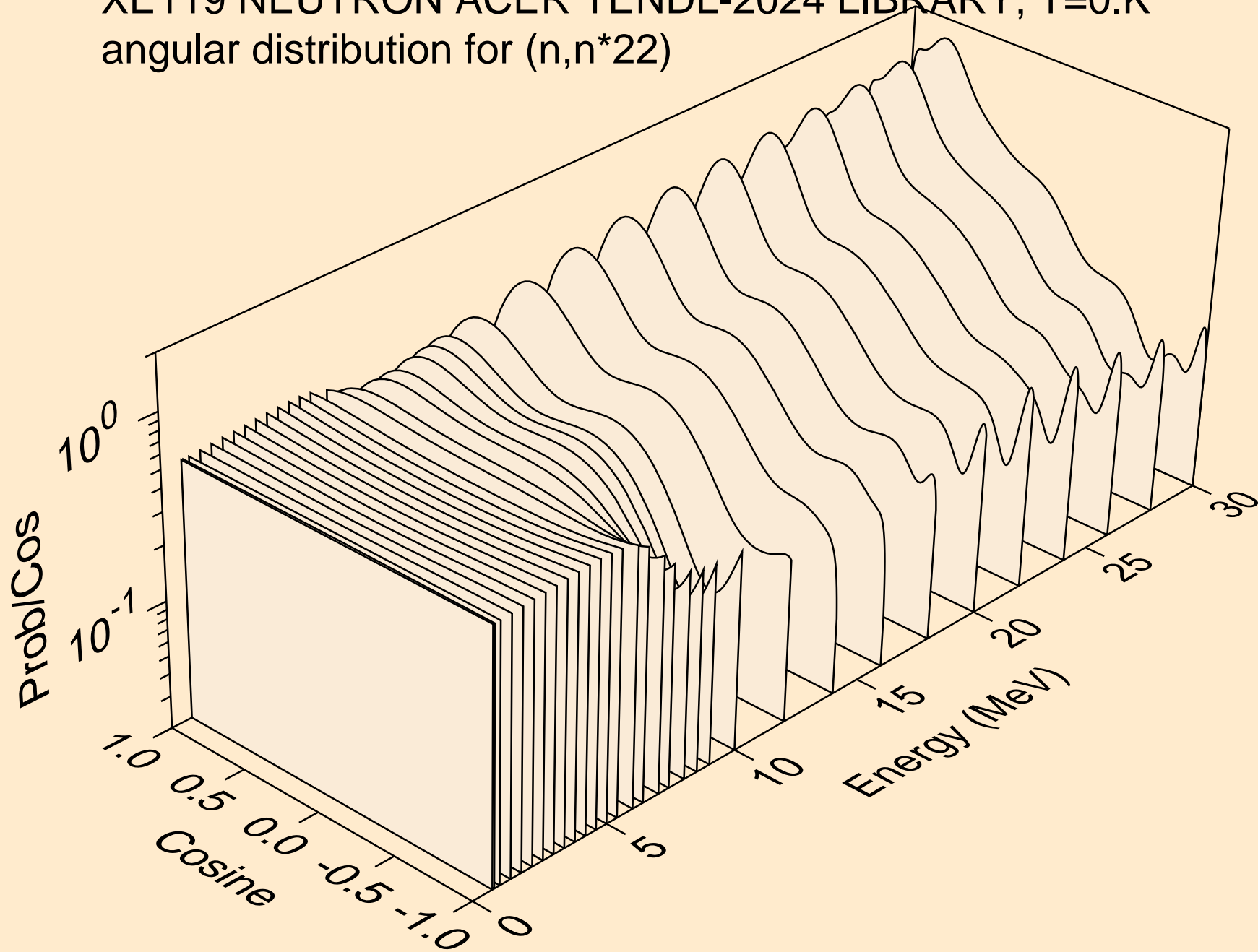

XE119 NEUTRON ACER TENDL-2024 LIBRARY; T=0.K  
angular distribution for (n,n\*23)

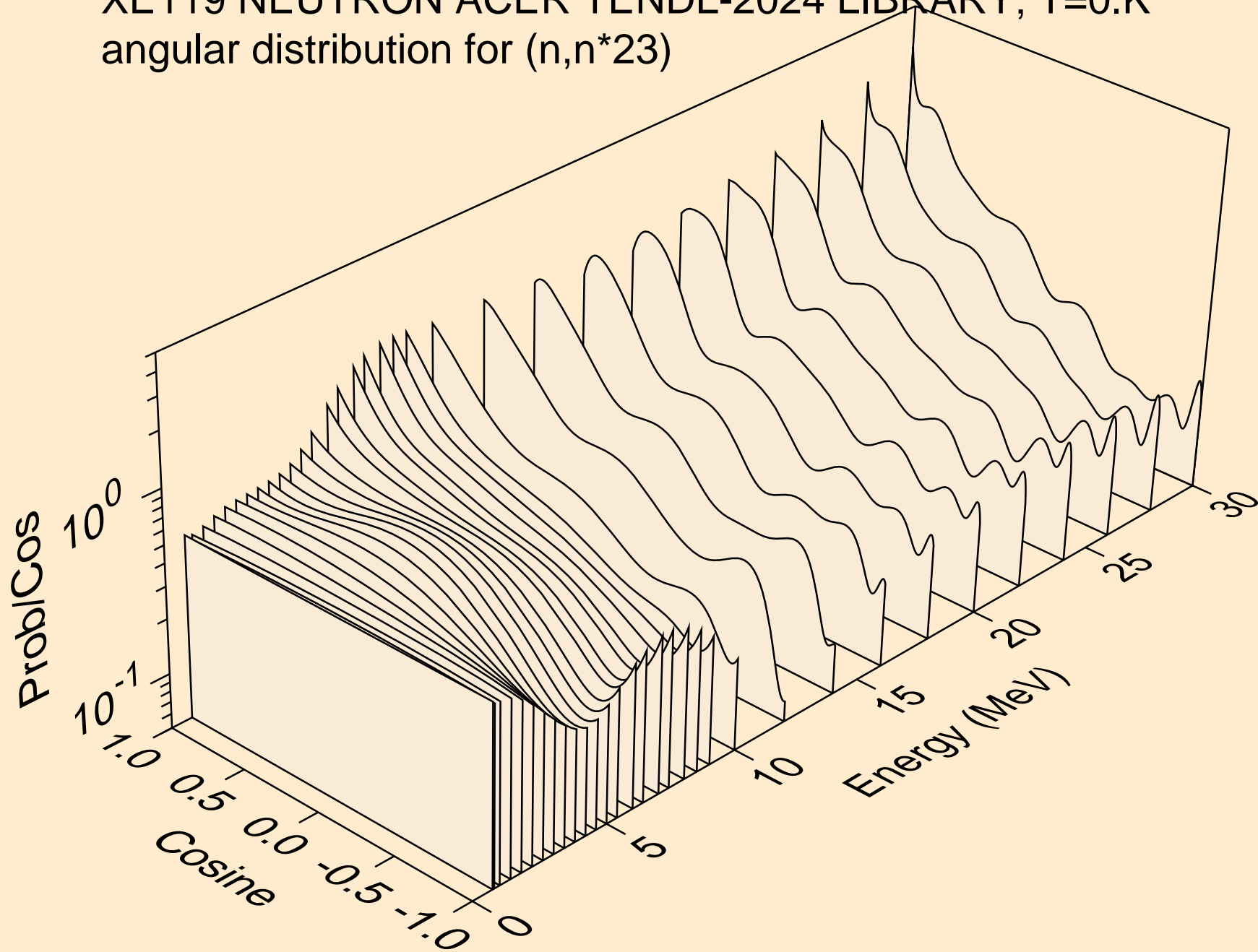

XE119 NEUTRON ACER TENDL-2024 LIBRARY; T=0.K  
angular distribution for (n,n\*24)

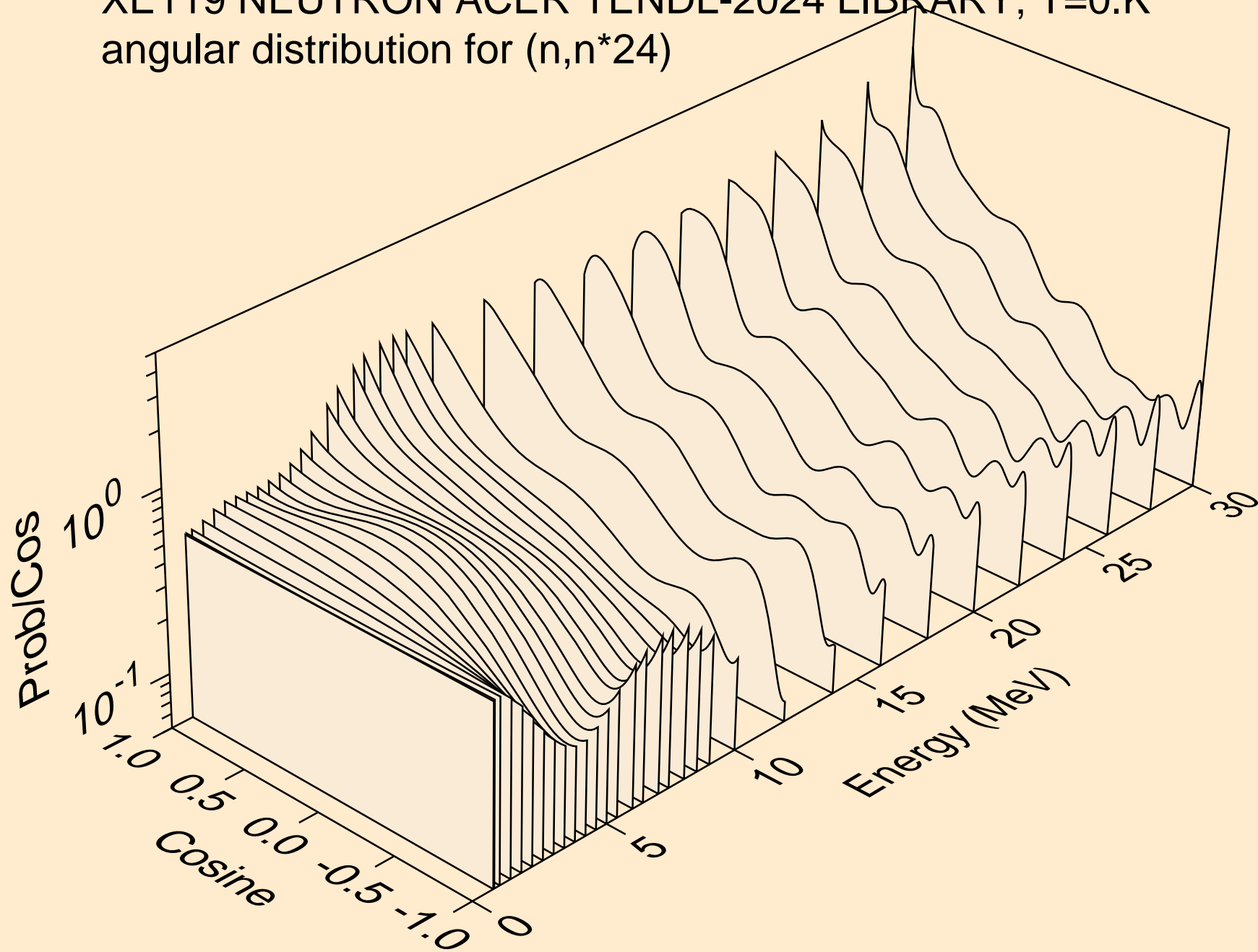

XE119 NEUTRON ACER TENDL-2024 LIBRARY; T=0.K  
angular distribution for (n,n\*25)

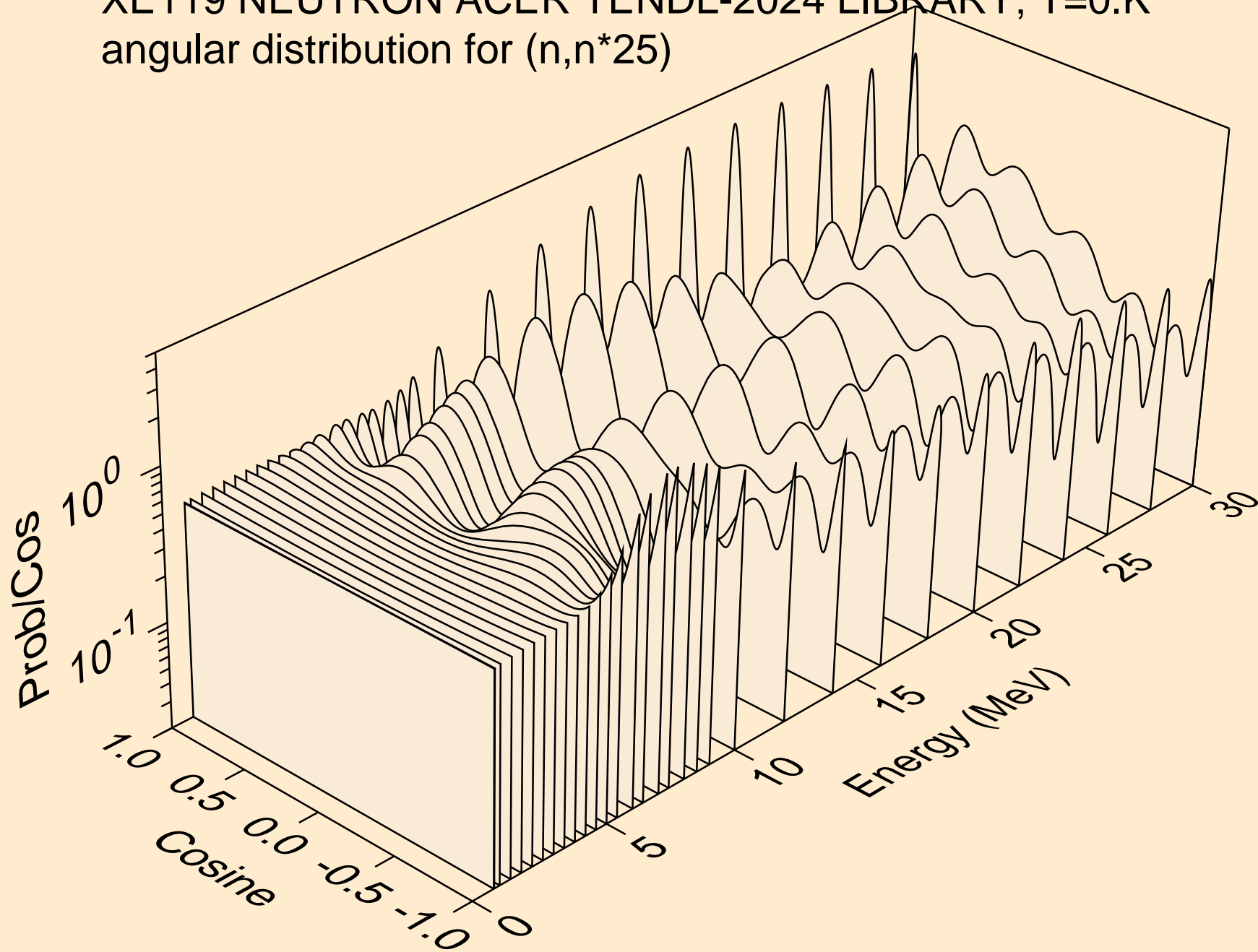

XE119 NEUTRON ACER TENDL-2024 LIBRARY; T=0.K  
angular distribution for (n,n\*26)

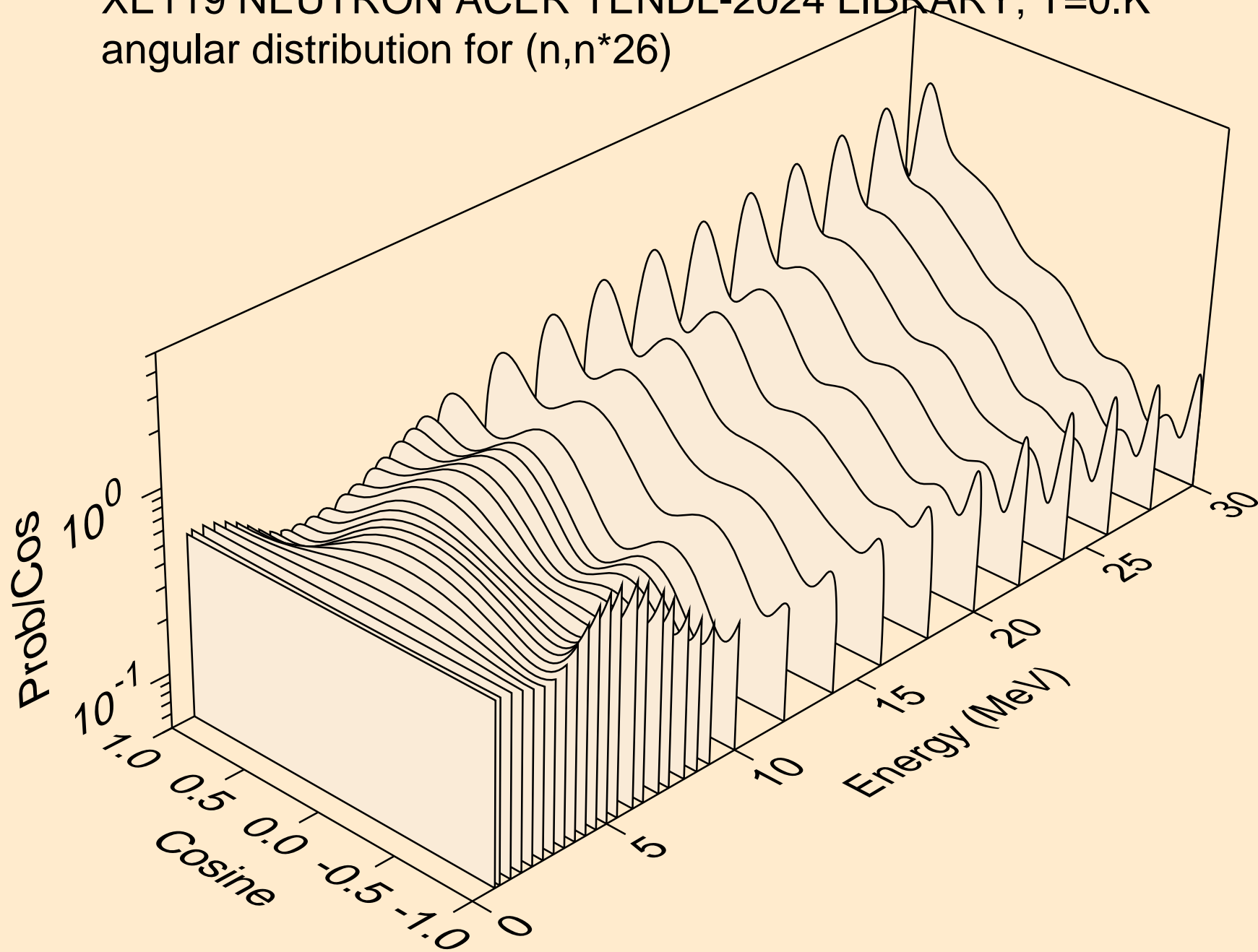

XE119 NEUTRON ACER TENDL-2024 LIBRARY; T=0.K  
angular distribution for (n,n\*27)

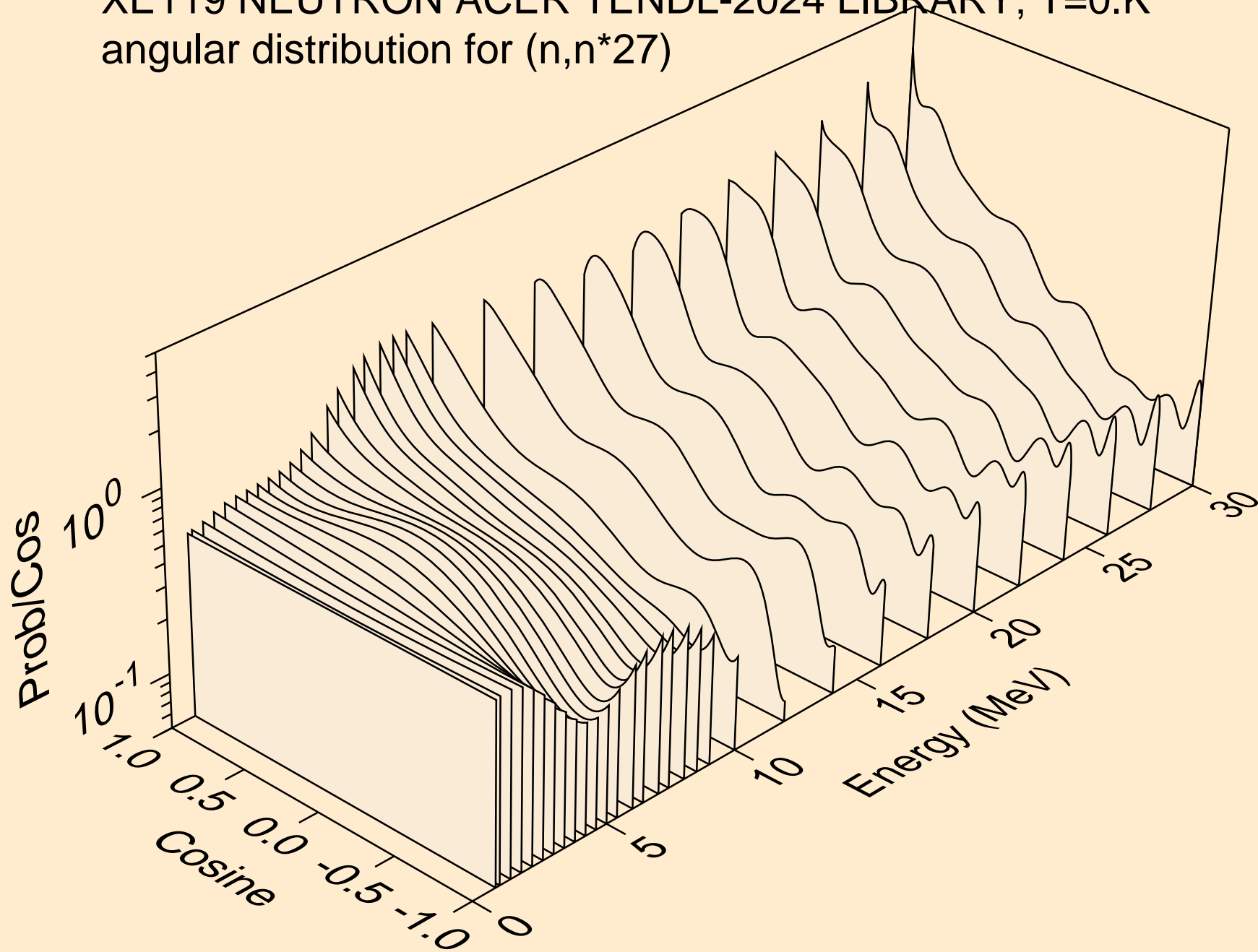

XE119 NEUTRON ACER TENDL-2024 LIBRARY; T=0.K  
angular distribution for (n,n\*28)

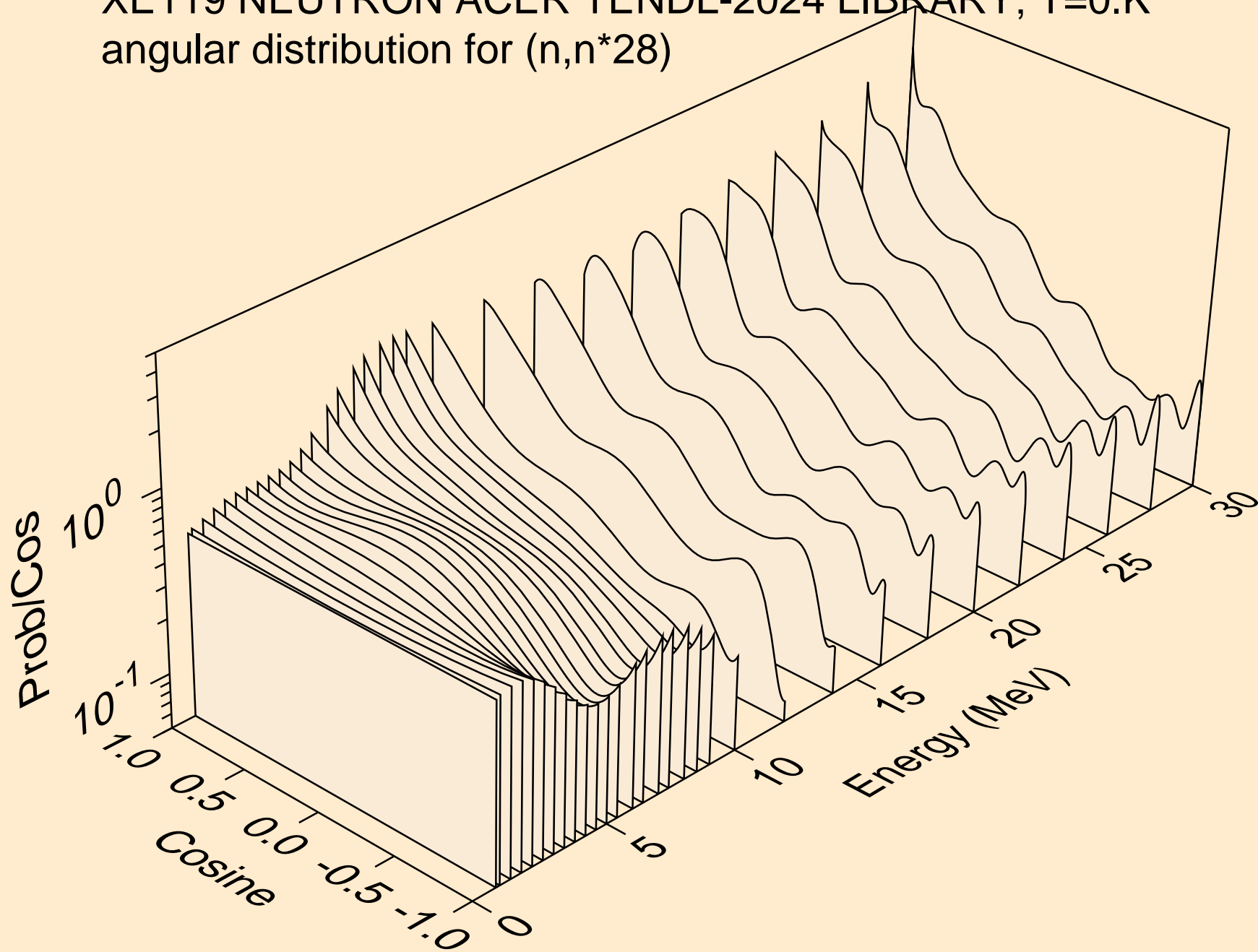

XE119 NEUTRON ACER TENDL-2024 LIBRARY; T=0.K  
angular distribution for (n,n\*29)

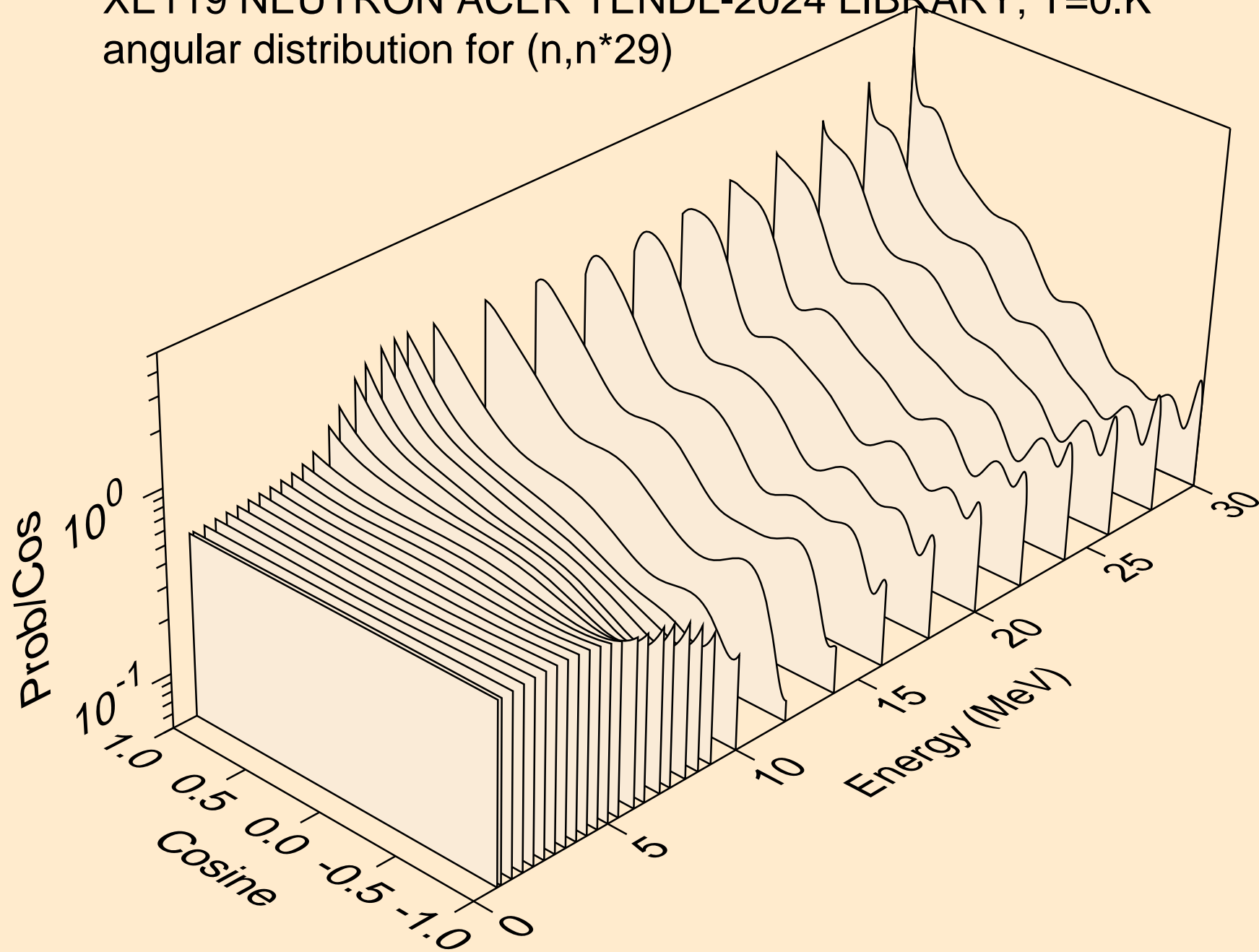

XE119 NEUTRON ACER TENDL-2024 LIBRARY; T=0.K  
angular distribution for (n,n\*30)

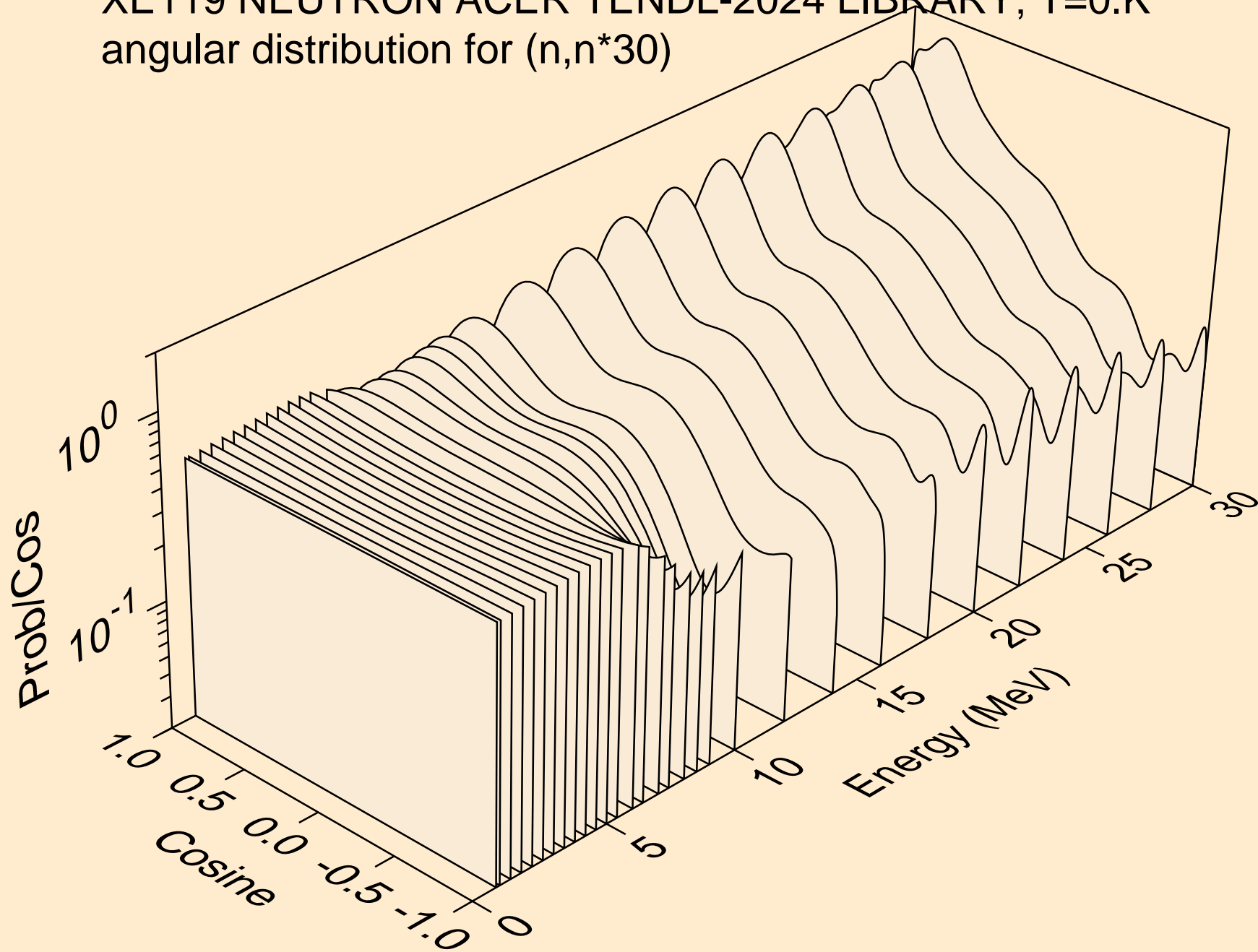

XE119 NEUTRON ACER TENDL-2024 LIBRARY; T=0.K  
Neutron emission for (n,x)

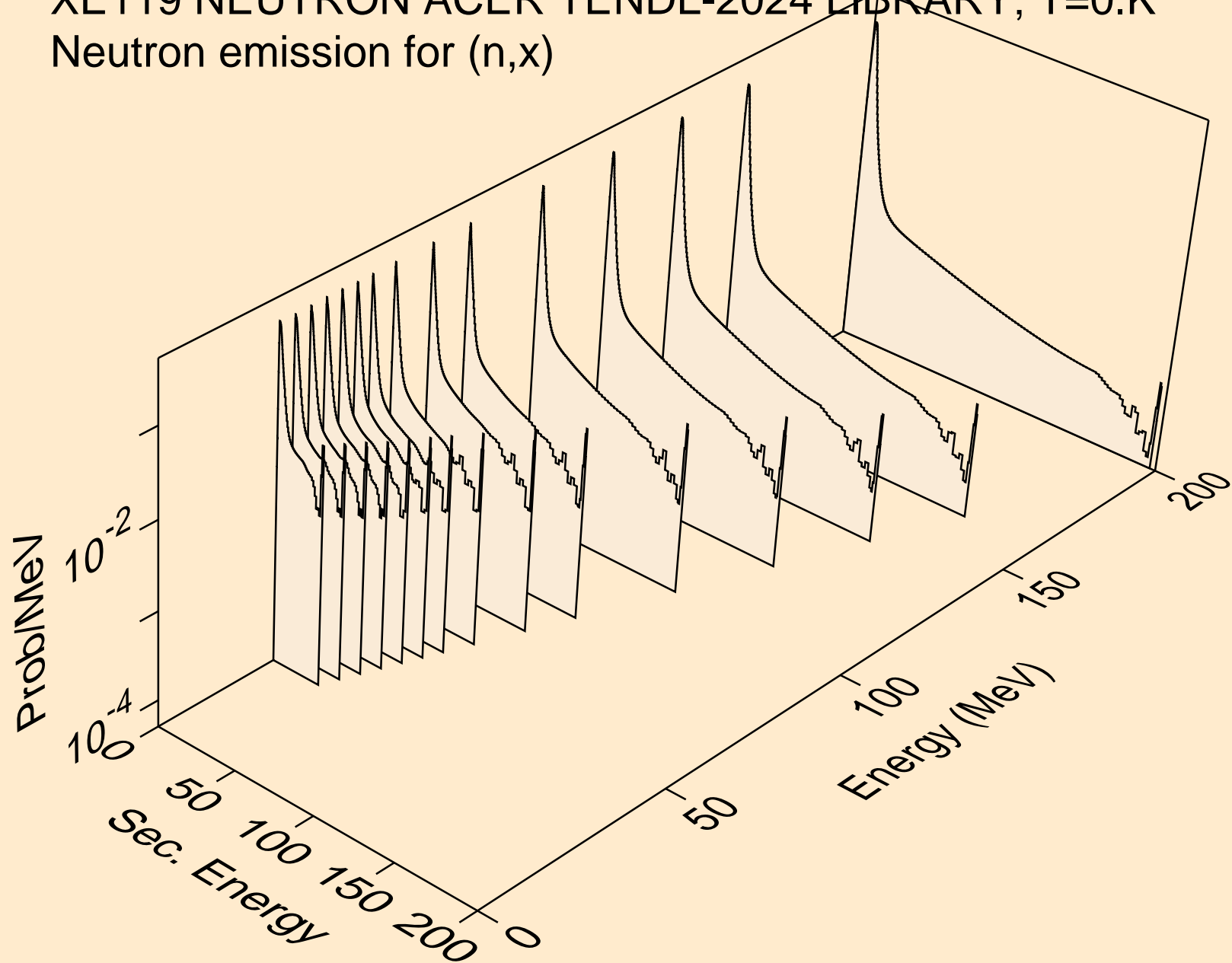

XE119 NEUTRON ACER TENDL-2024 LIBRARY; T=0.K  
Neutron emission for (n,2nd)

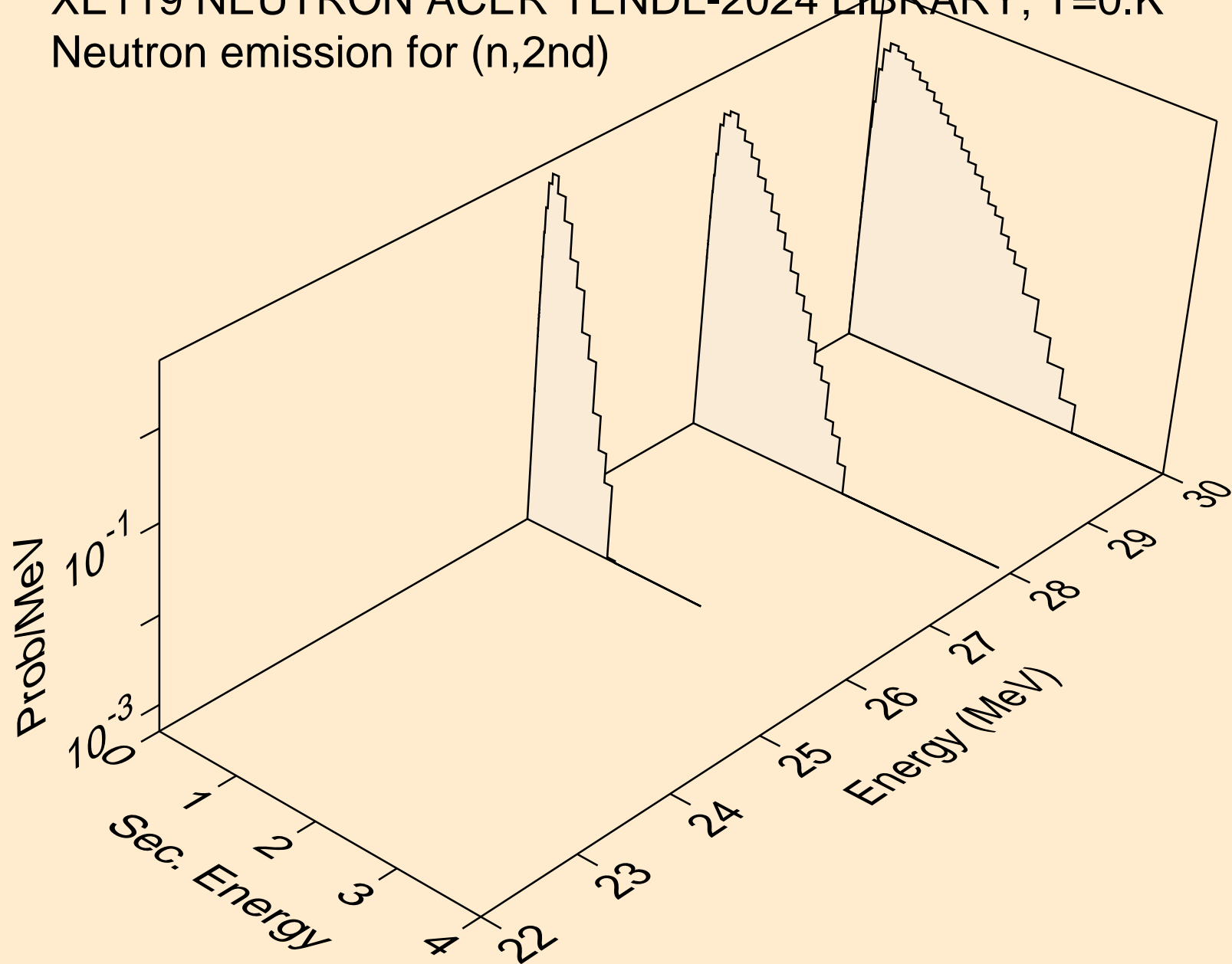

XE119 NEUTRON ACER TENDL-2024 LIBRARY; T=0.K  
Neutron emission for (n,2n)

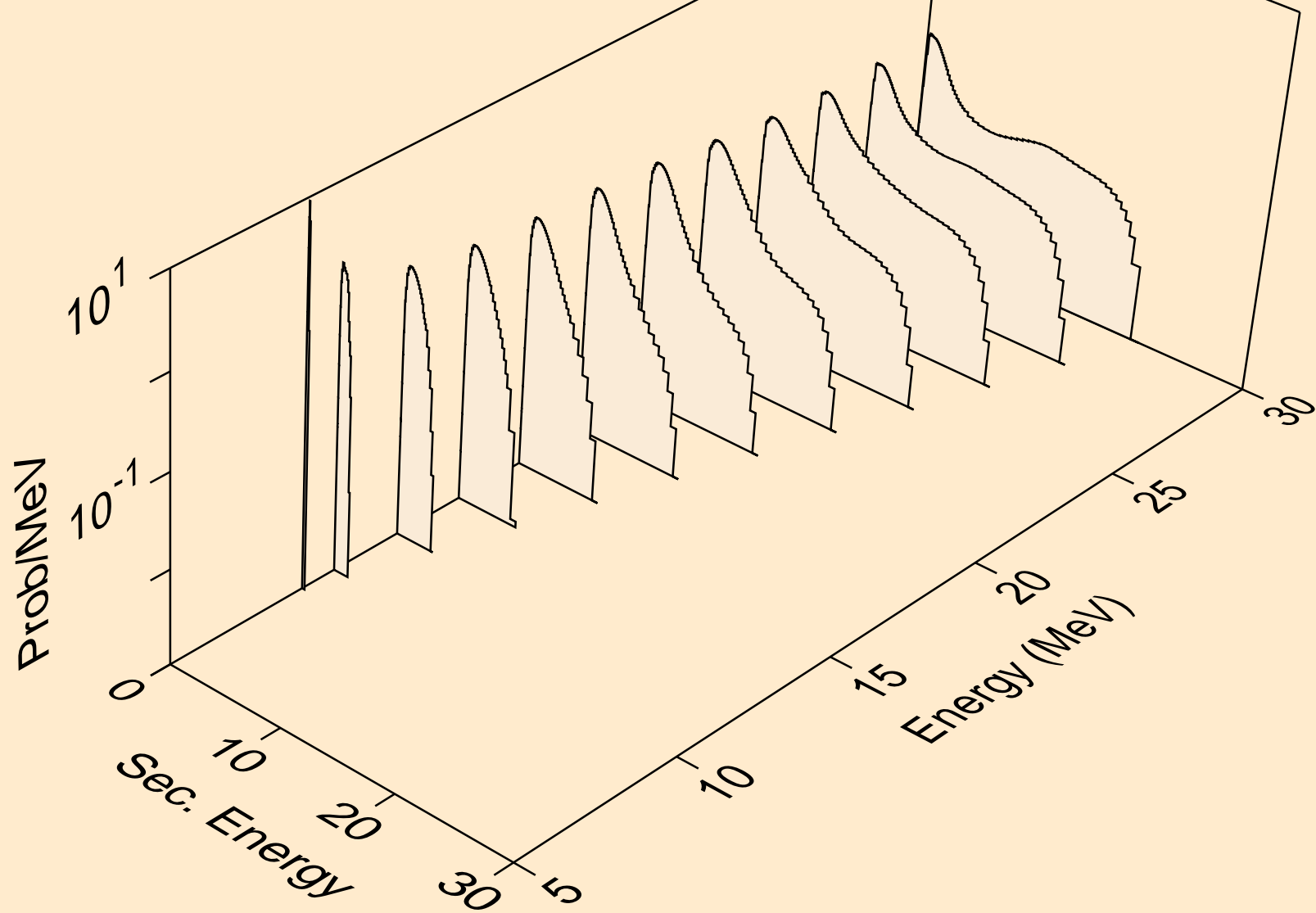

XE119 NEUTRON ACER TENDL-2024 LIBRARY; T=0.K  
Neutron emission for (n,3n)

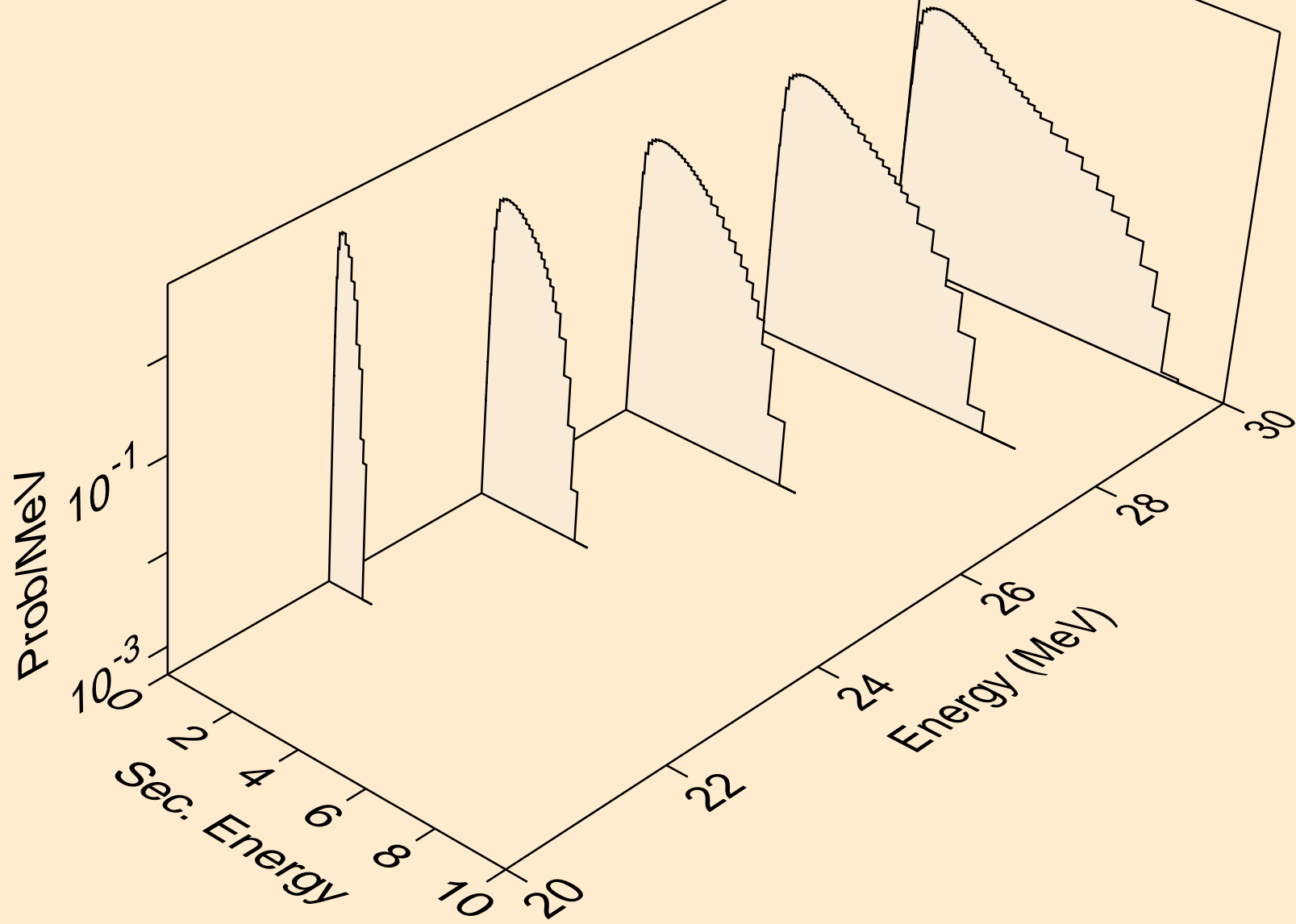

XE119 NEUTRON ACER TENDL-2024 LIBRARY; T=0.K  
Neutron emission for (n,n\*)a

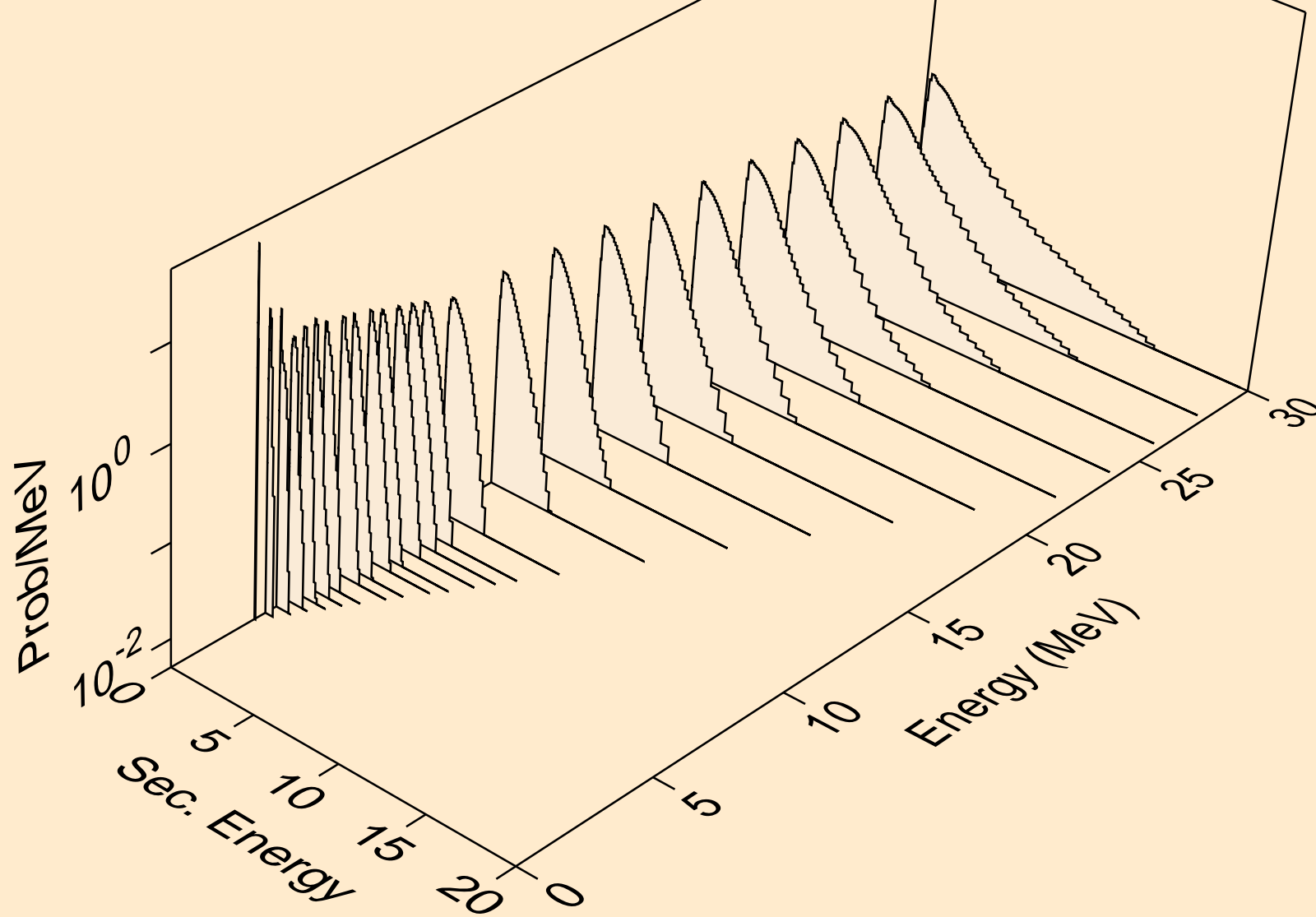

XE119 NEUTRON ACER TENDL-2024 LIBRARY; T=0.K  
Neutron emission for (n,2n)<sub>a</sub>

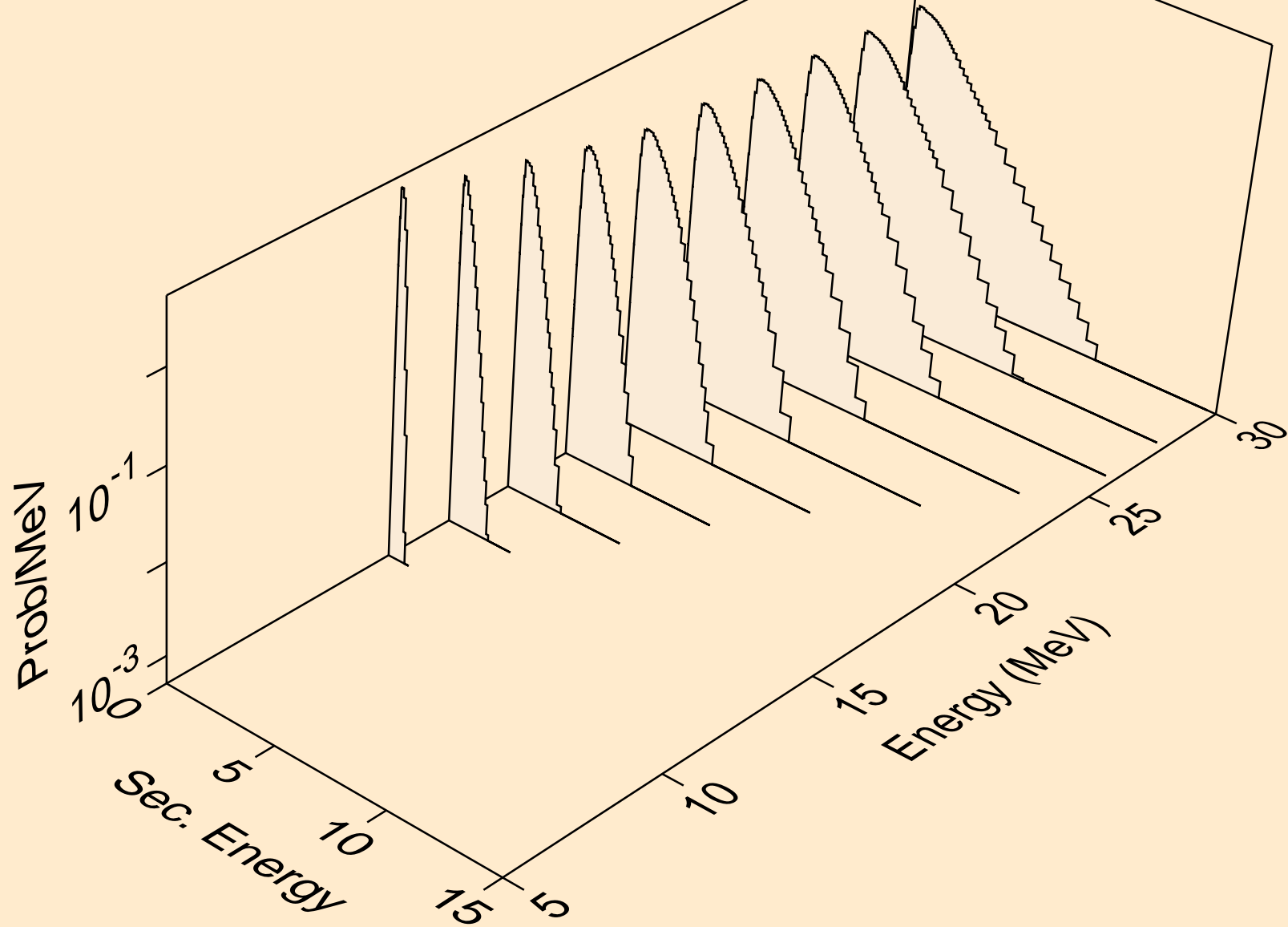

XE119 NEUTRON ACER TENDL-2024 LIBRARY; T=0.K  
Neutron emission for (n,3n)a

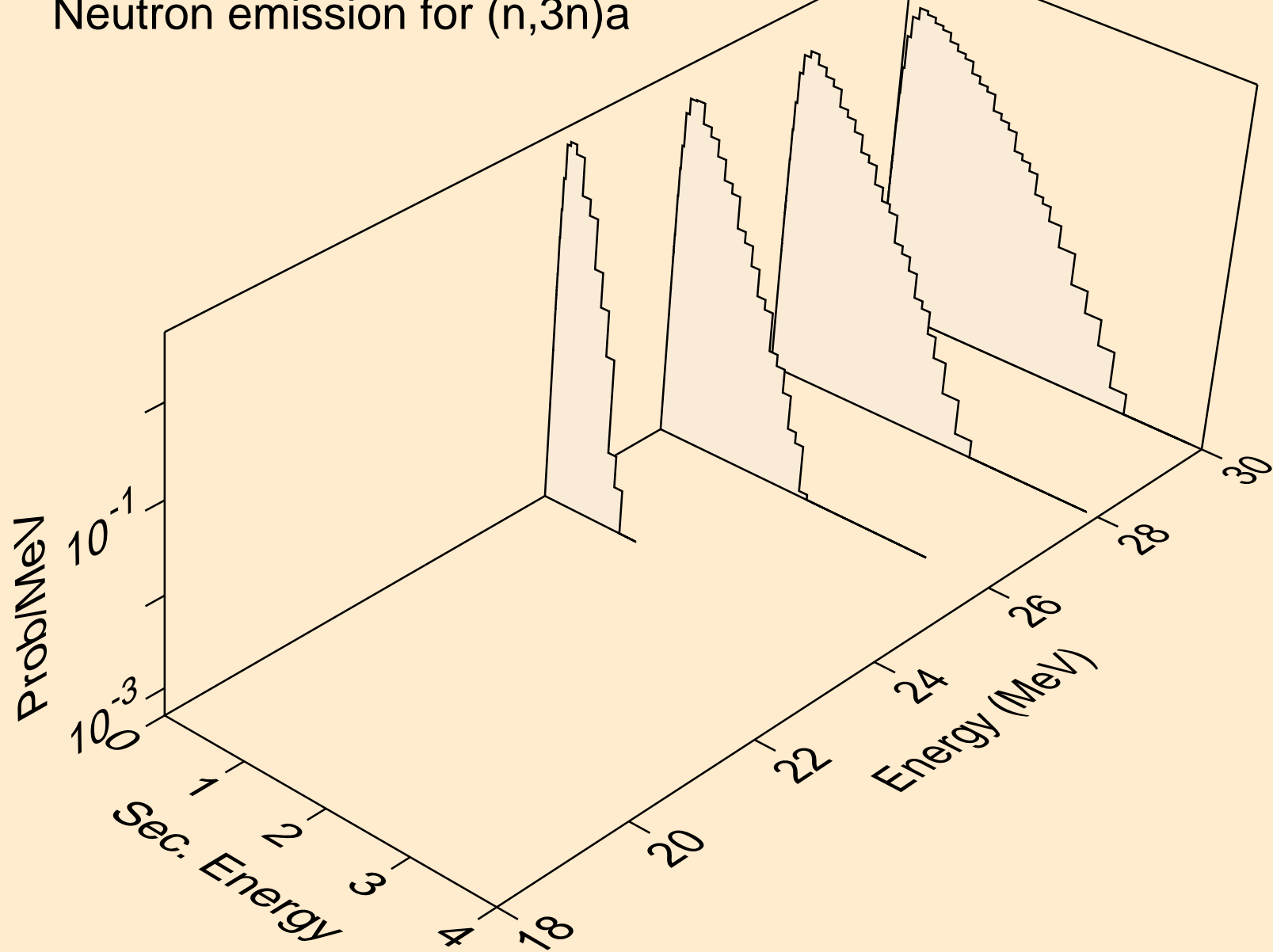

XE119 NEUTRON ACER TENDL-2024 LIBRARY; T=0.K  
Neutron emission for (n,n\*)p

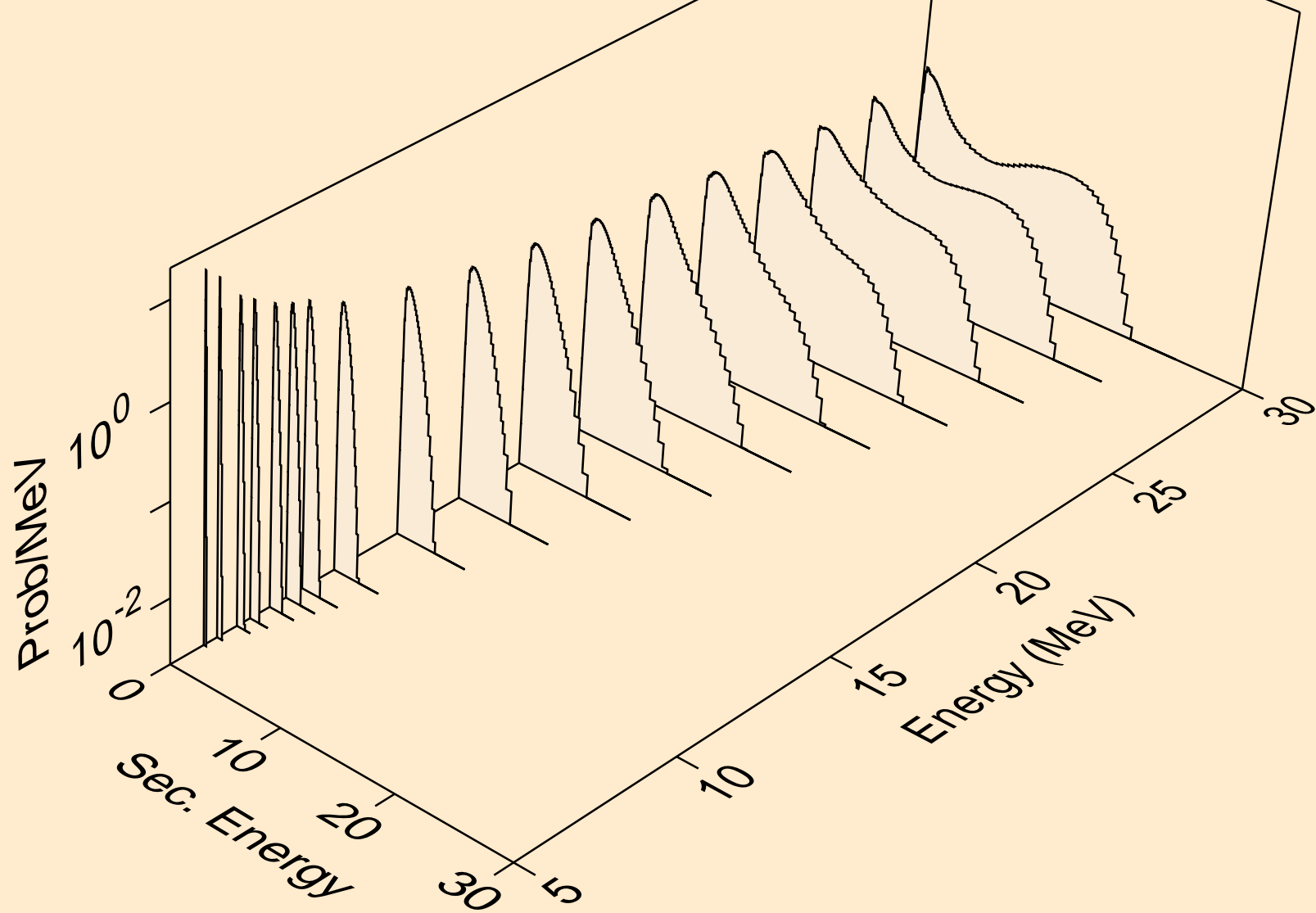

XE119 NEUTRON ACER TENDL-2024 LIBRARY; T=0.K  
Neutron emission for (n,n\*)2a

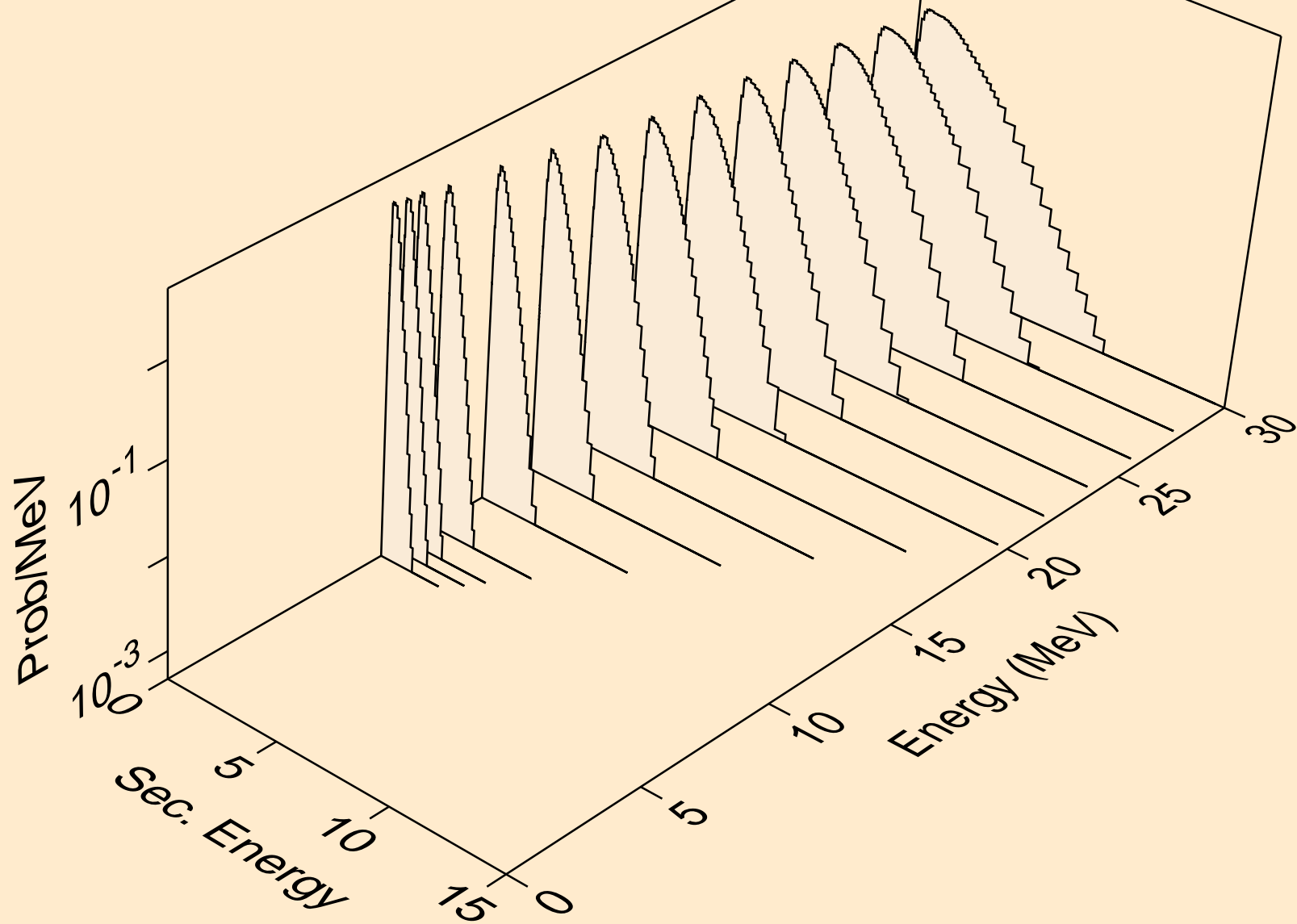

XE119 NEUTRON ACER TENDL-2024 LIBRARY; T=0.K  
Neutron emission for (n,2n)2a

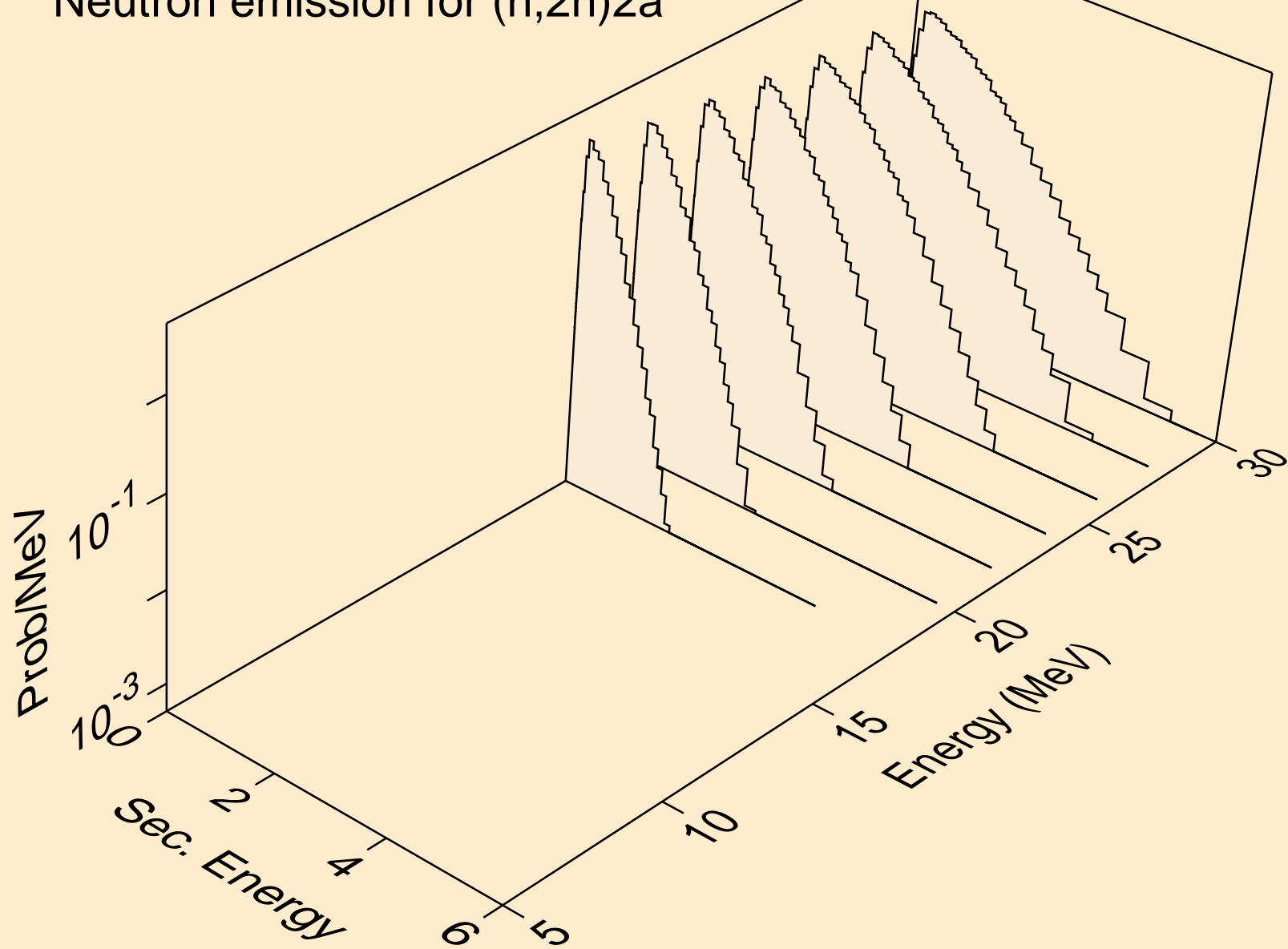

XE119 NEUTRON ACER TENDL-2024 LIBRARY; T=0.K  
Neutron emission for (n,n\*)d

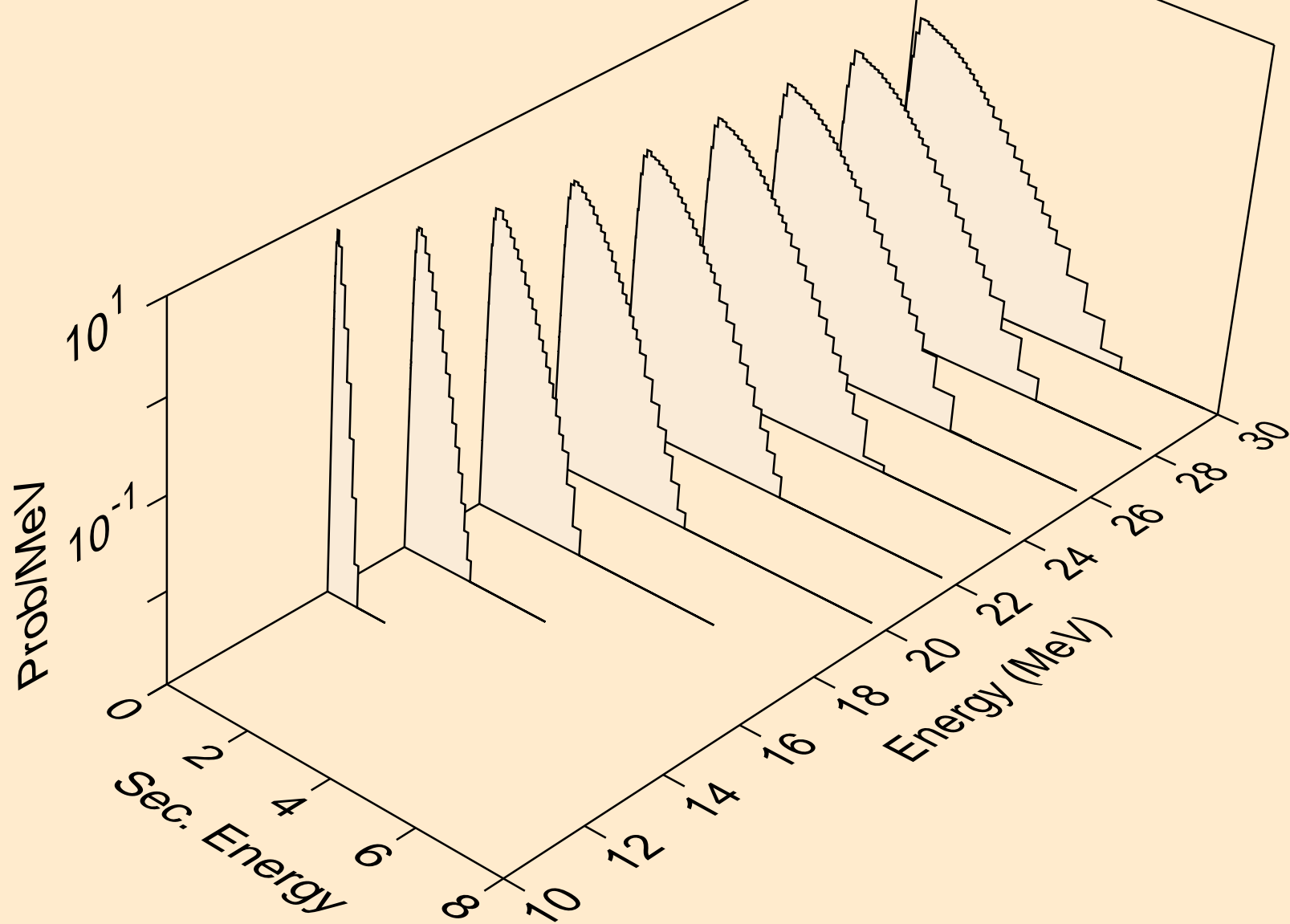

XE119 NEUTRON ACER TENDL-2024 LIBRARY; T=0.K  
Neutron emission for (n,n\*)t

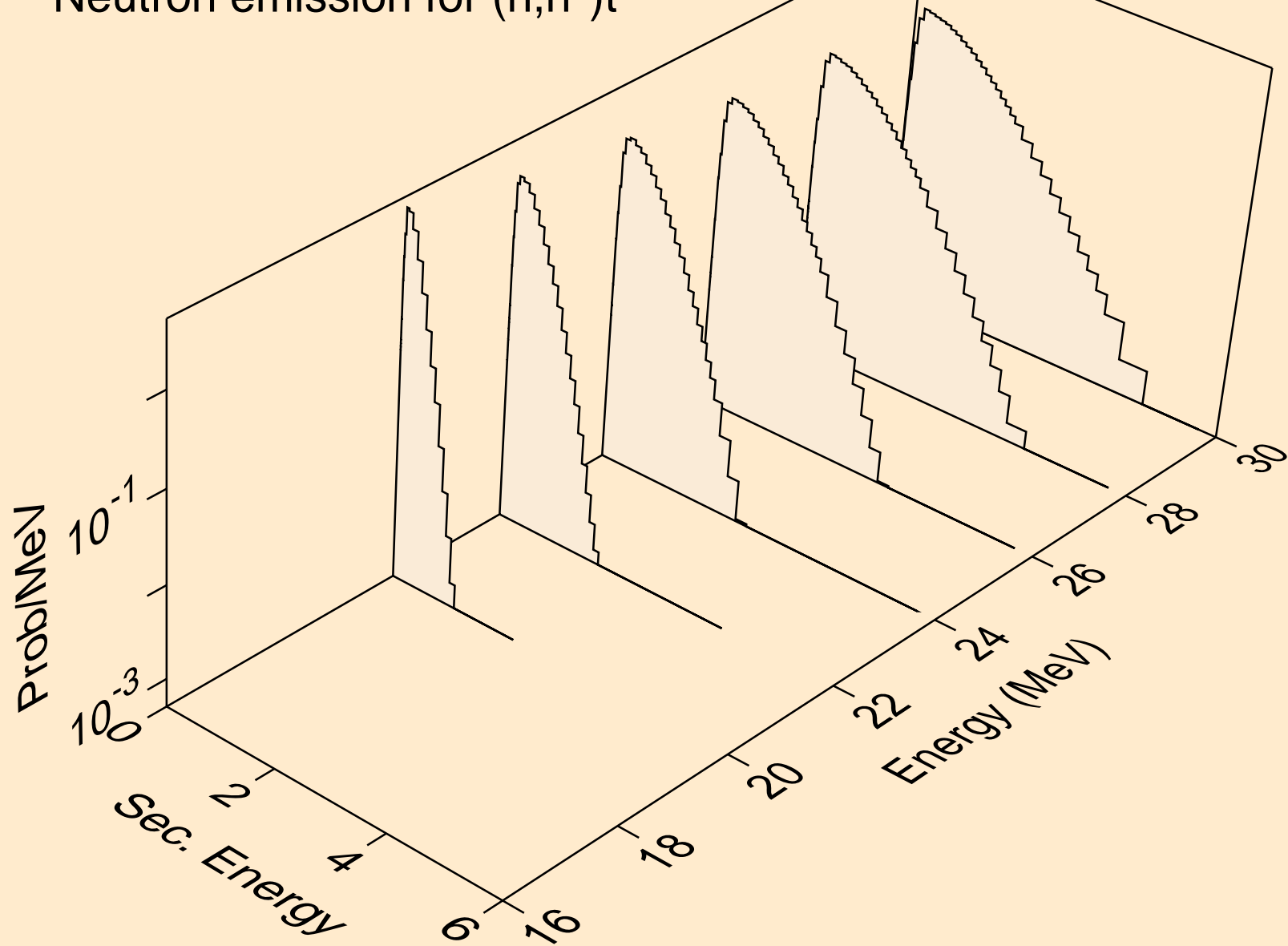

XE119 NEUTRON ACER TENDL-2024 LIBRARY; T=0.K  
Neutron emission for (n,n\*)he3

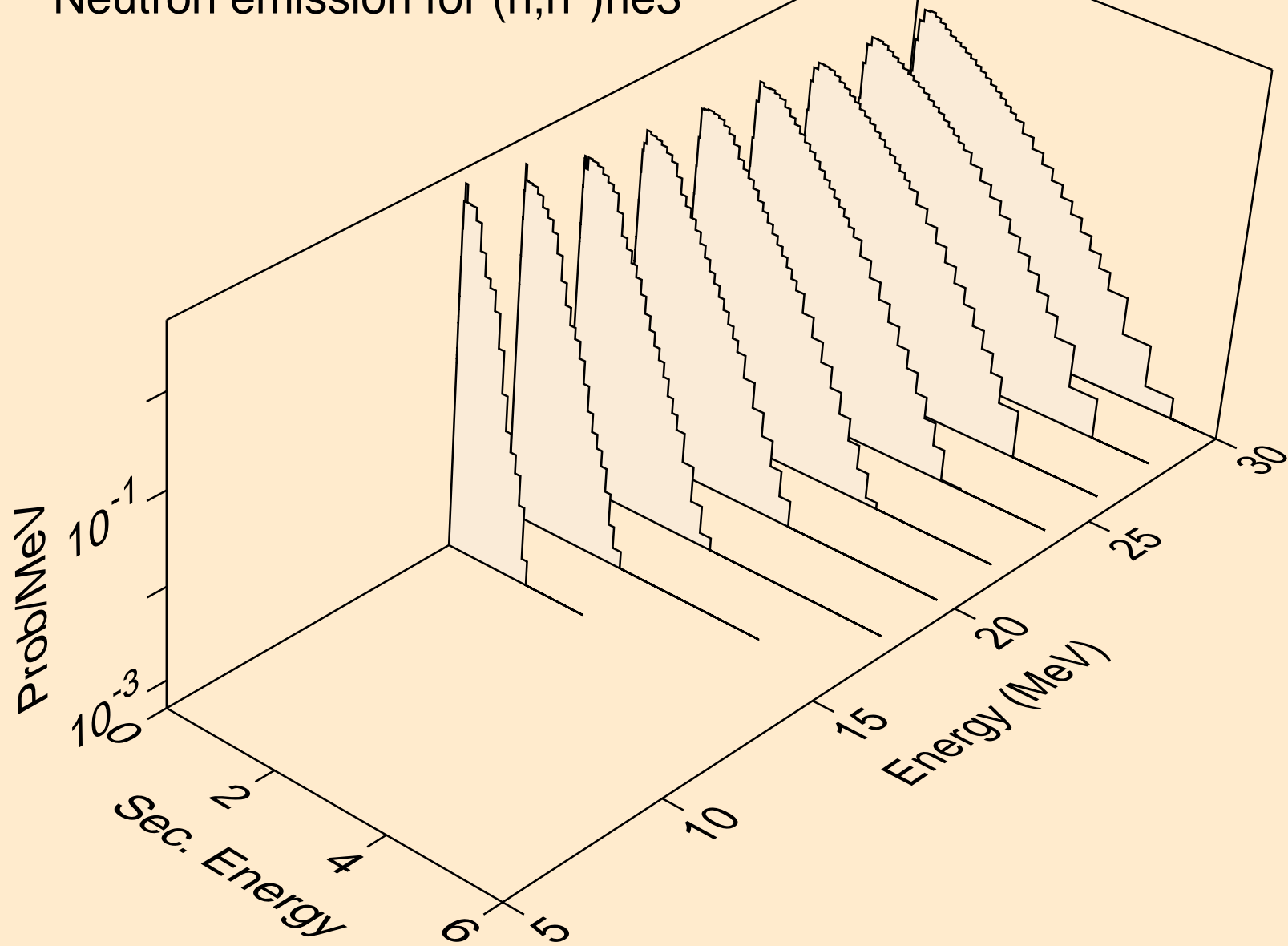

XE119 NEUTRON ACER TENDL-2024 LIBRARY; T=0.K  
Neutron emission for (n,2np)

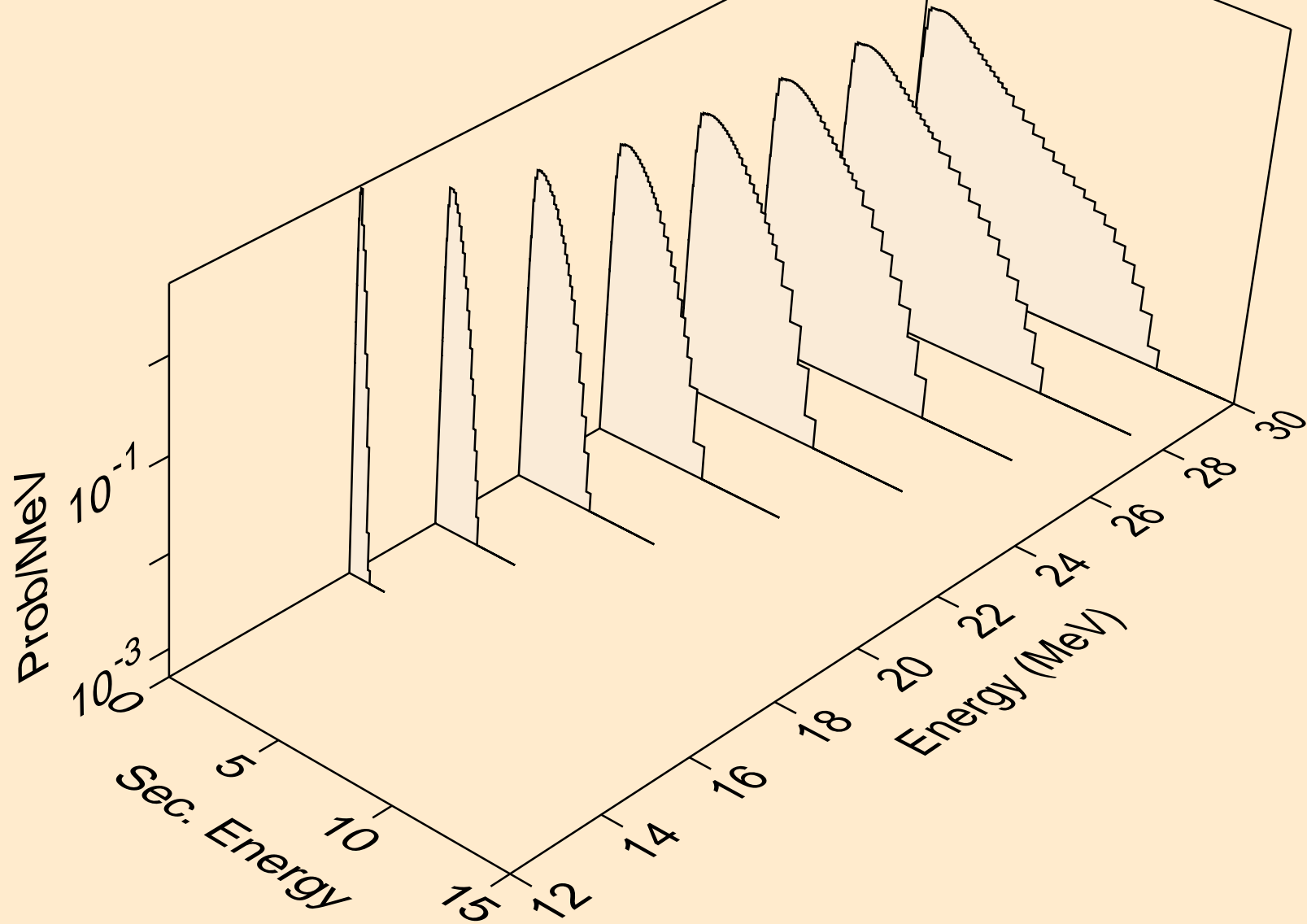

XE119 NEUTRON ACER TENDL-2024 LIBRARY; T=0.K  
Neutron emission for (n,3np)

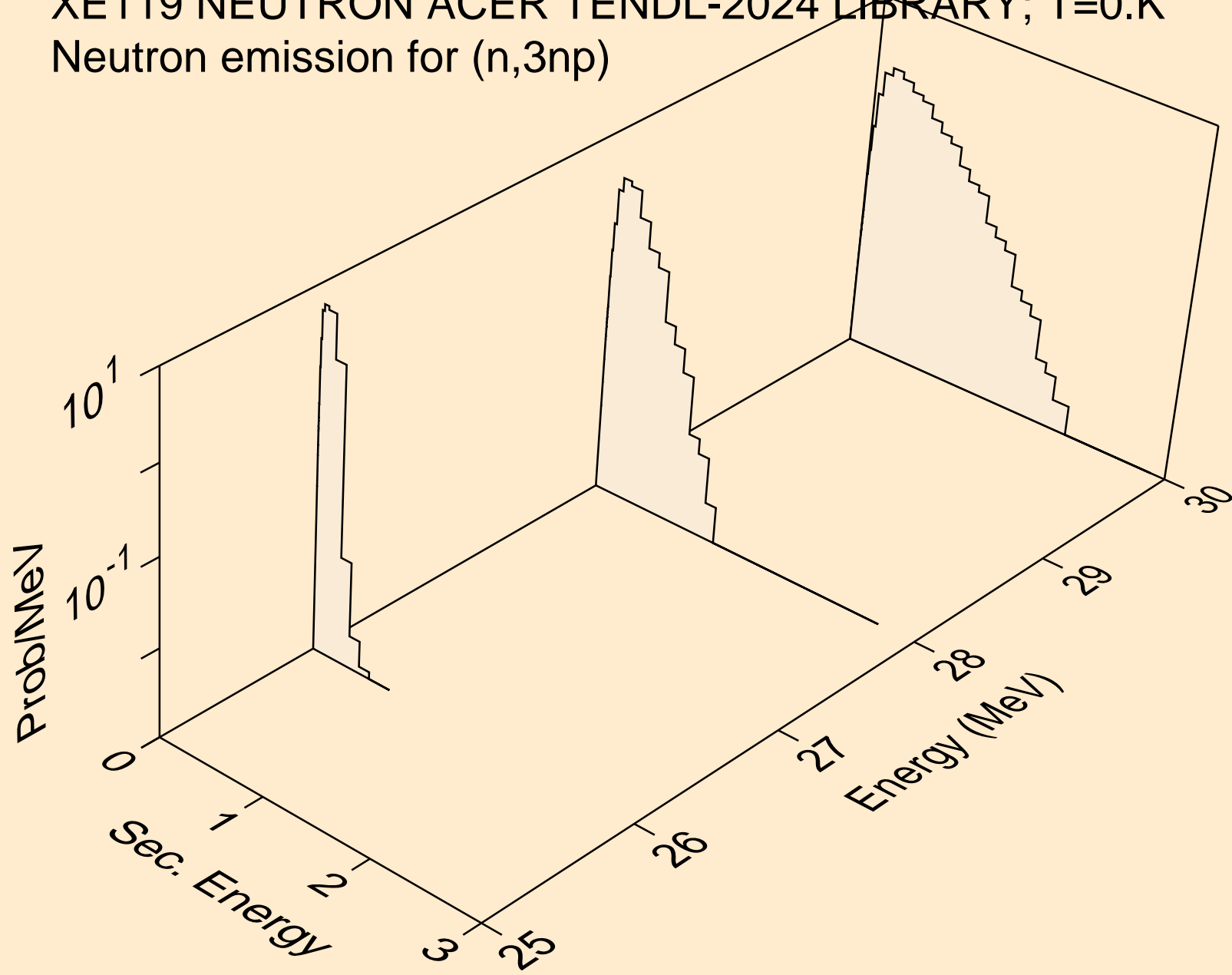

XE119 NEUTRON ACER TENDL-2024 LIBRARY; T=0.K  
Neutron emission for (n,n2p)

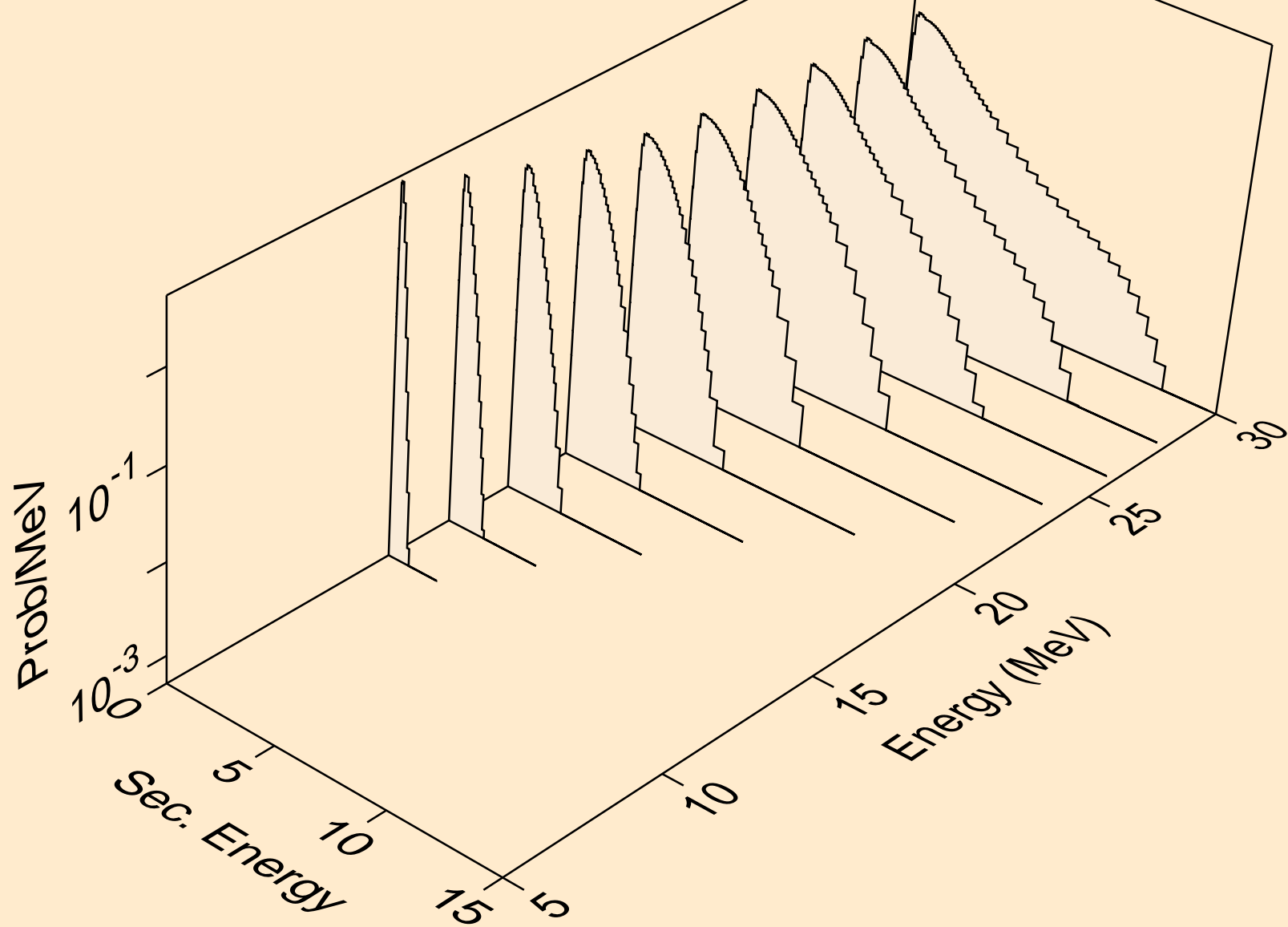

XE119 NEUTRON ACER TENDL-2024 LIBRARY; T=0.K  
Neutron emission for (n,npa)

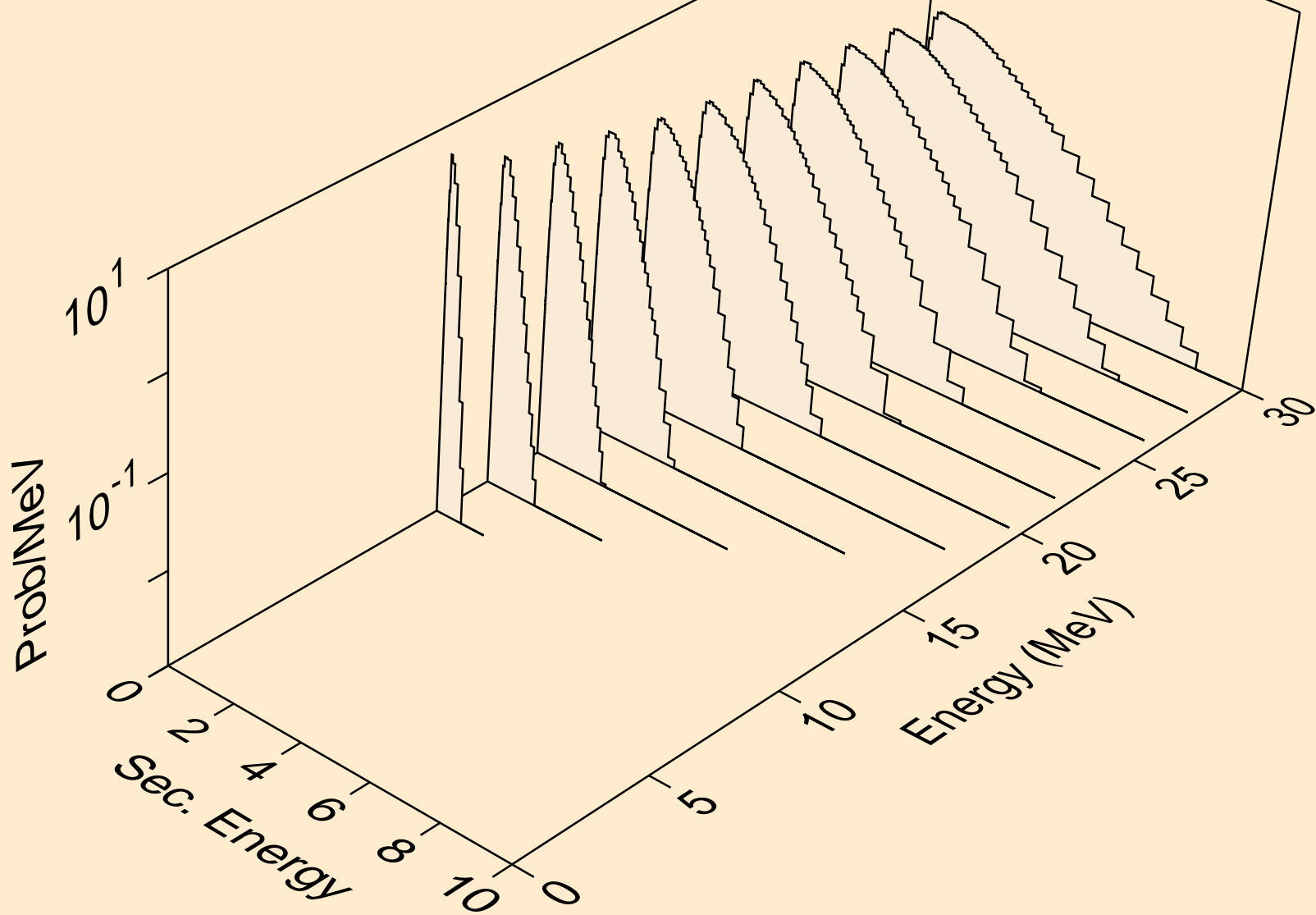

XE119 NEUTRON ACER TENDL-2024 LIBRARY; T=0.K  
Neutron emission for (n,n\*c)

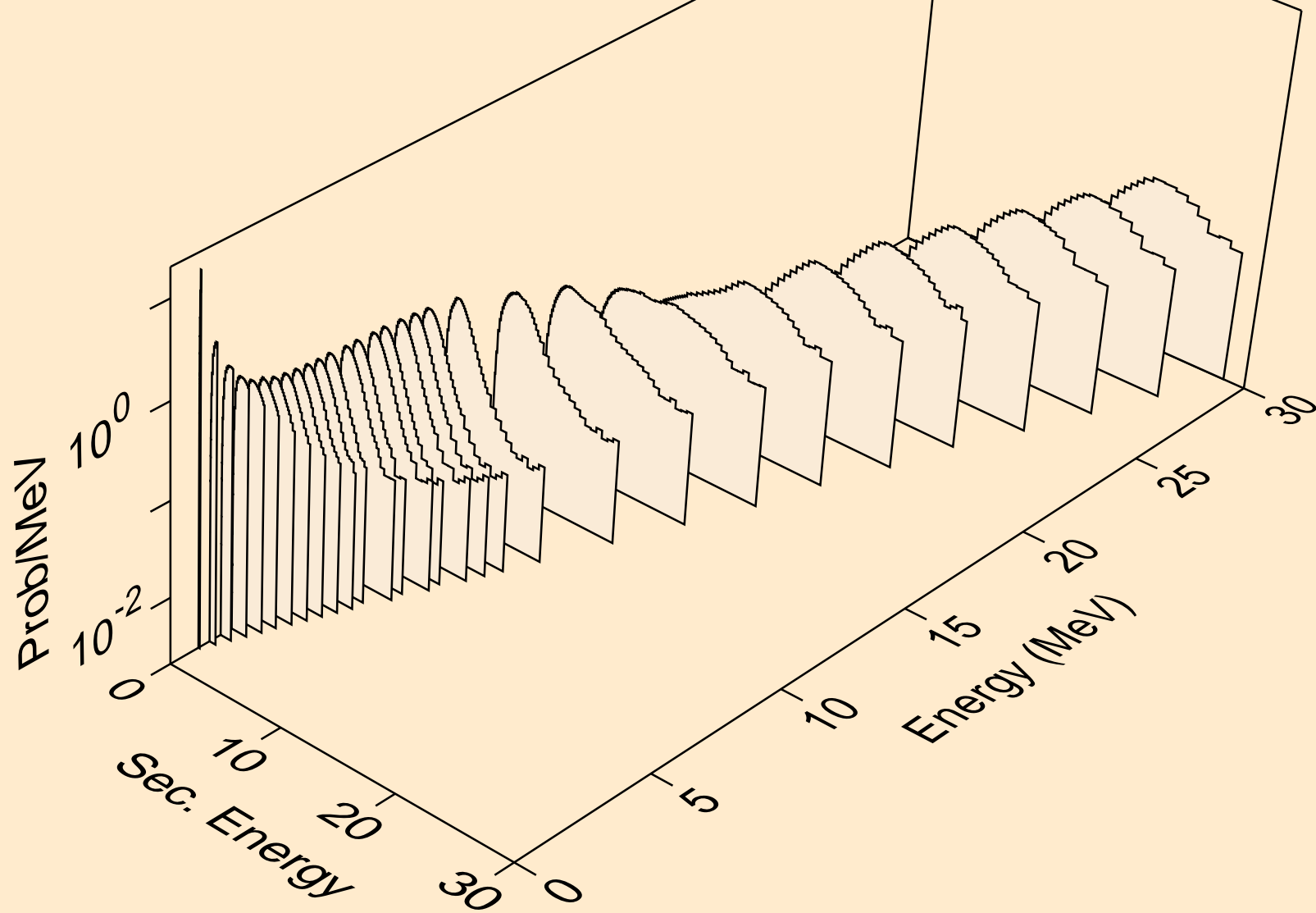

XE119 NEUTRON ACER TENDL-2024 LIBRARY; T=0.K  
Photon emission for (n,x)

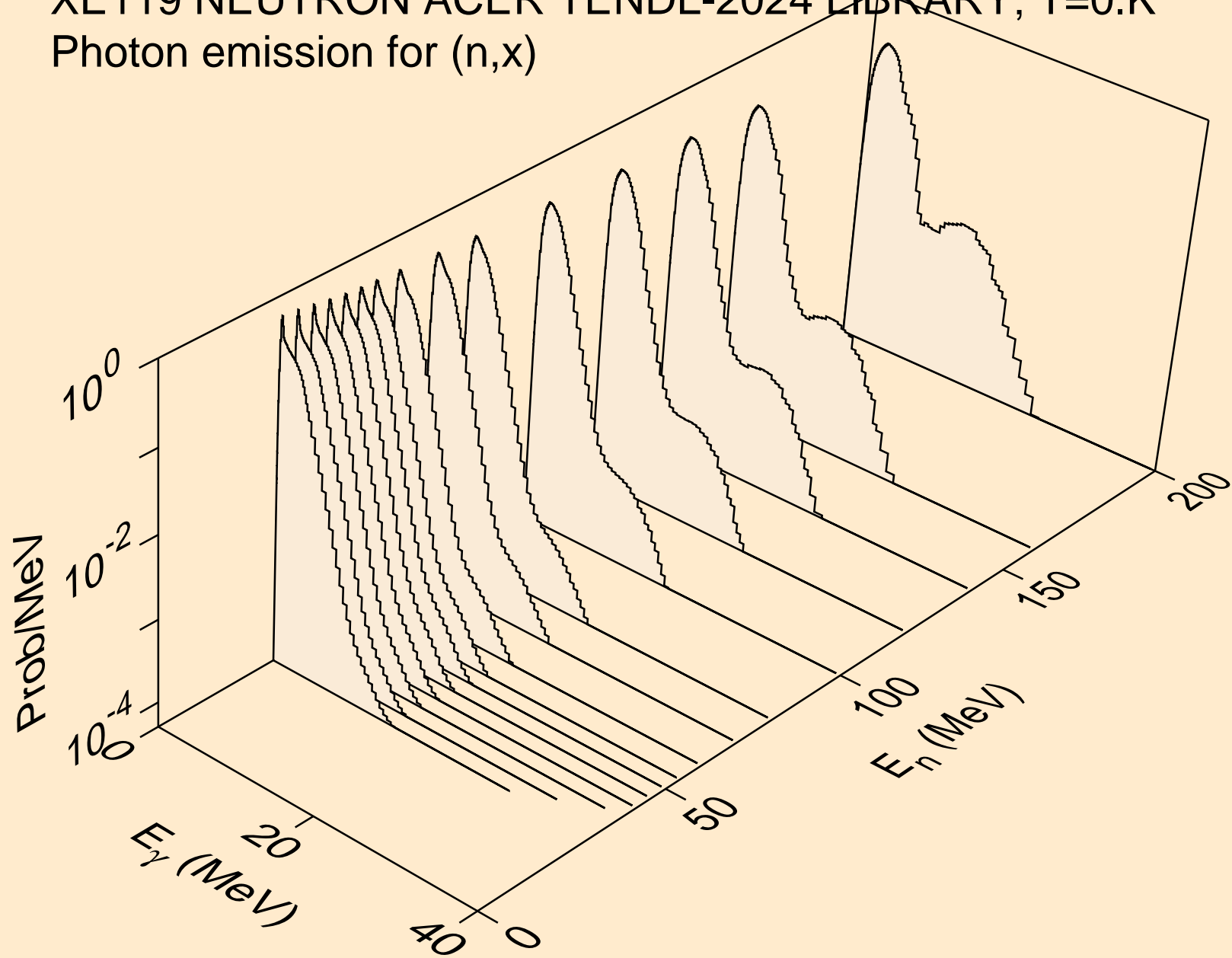

XE119 NEUTRON ACER TENDL-2024 LIBRARY; T=0.K  
Photon emission for (n,2nd)

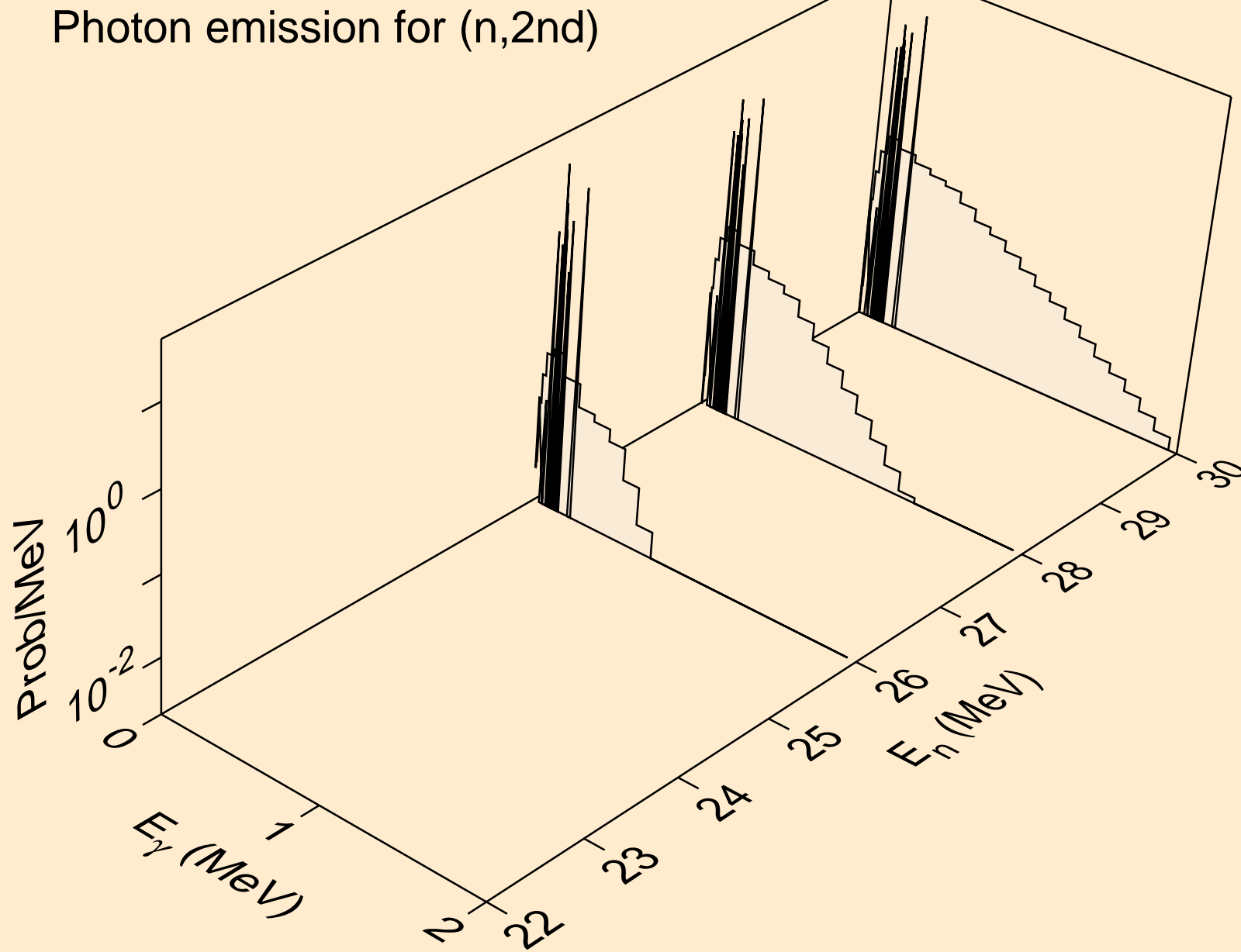

XE119 NEUTRON ACER TENDL-2024 LIBRARY; T=0.K  
Photon emission for (n,2n)

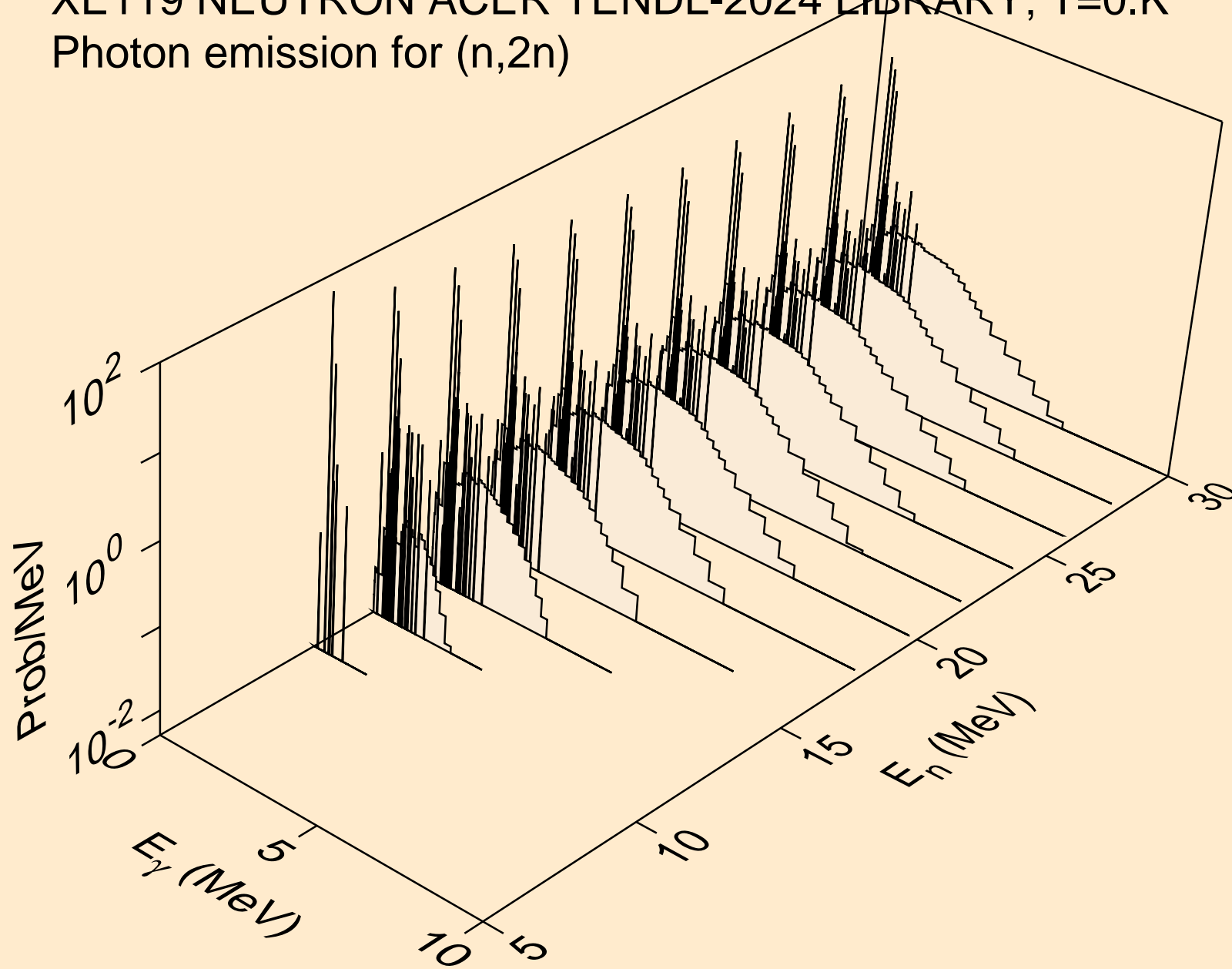

XE119 NEUTRON ACER TENDL-2024 LIBRARY; T=0.K  
Photon emission for (n,3n)

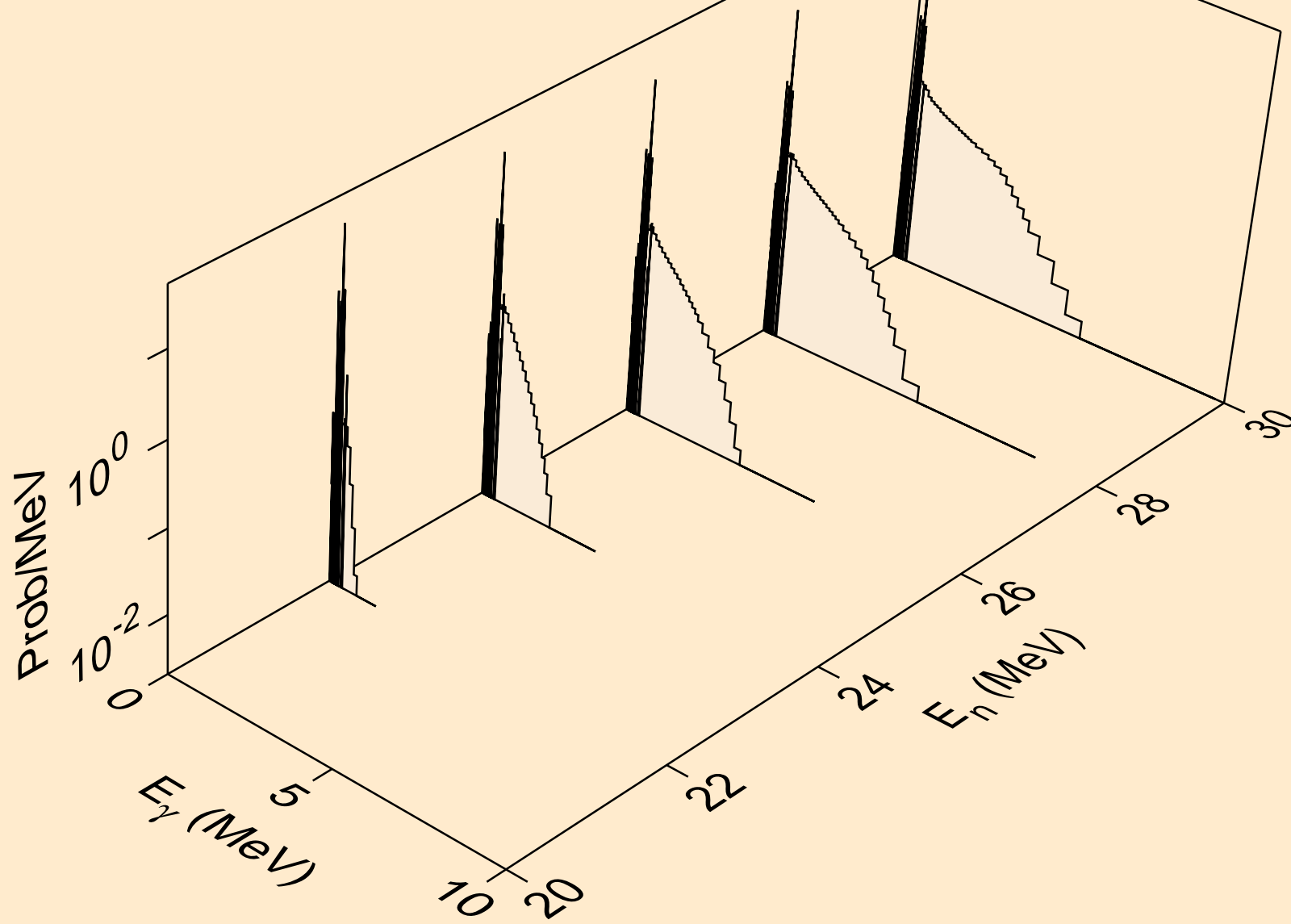

XE119 NEUTRON ACER TENDL-2024 LIBRARY; T=0.K  
Photon emission for (n,n\*)a

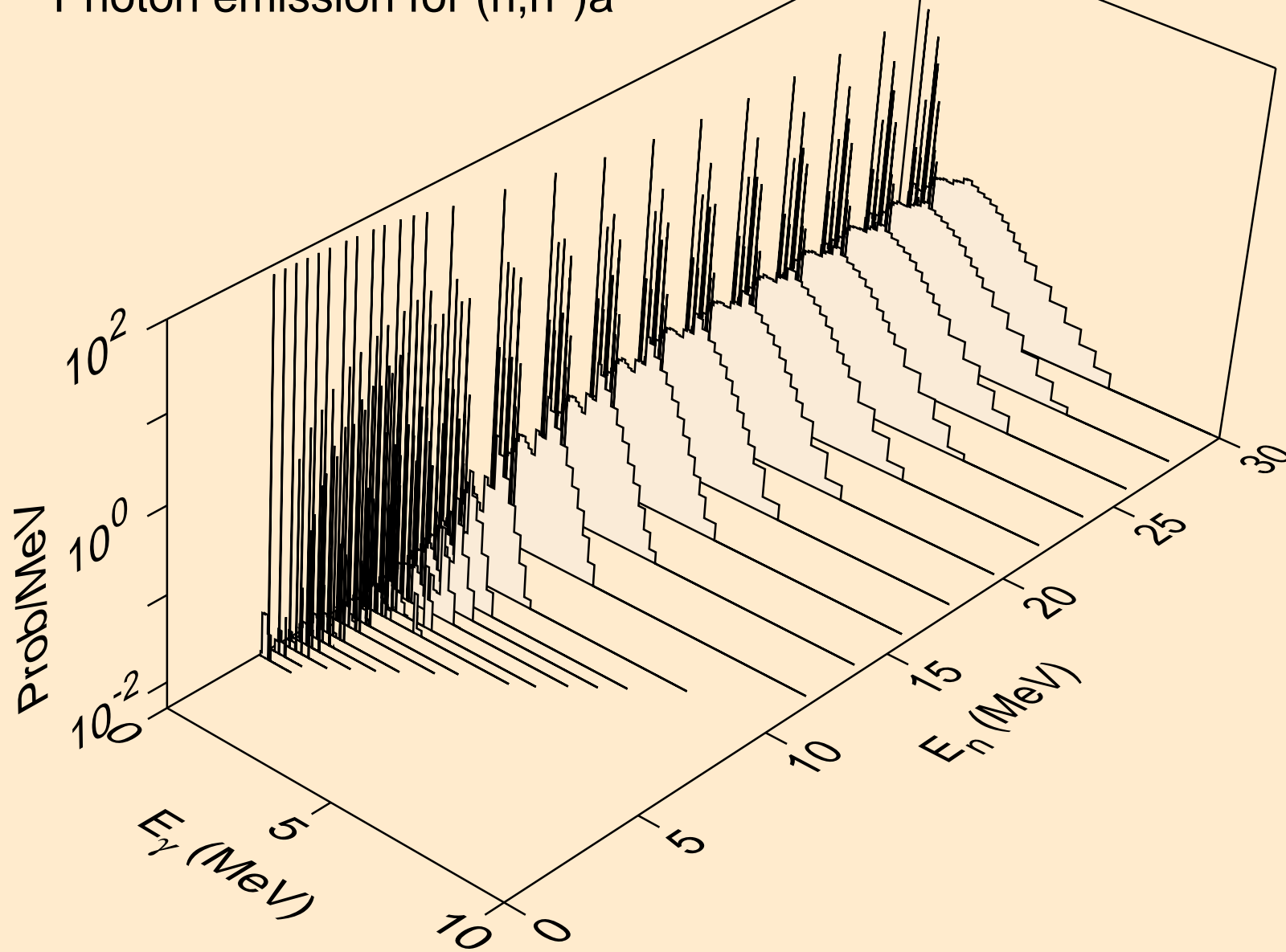

XE119 NEUTRON ACER TENDL-2024 LIBRARY; T=0.K  
Photon emission for (n,2n)a

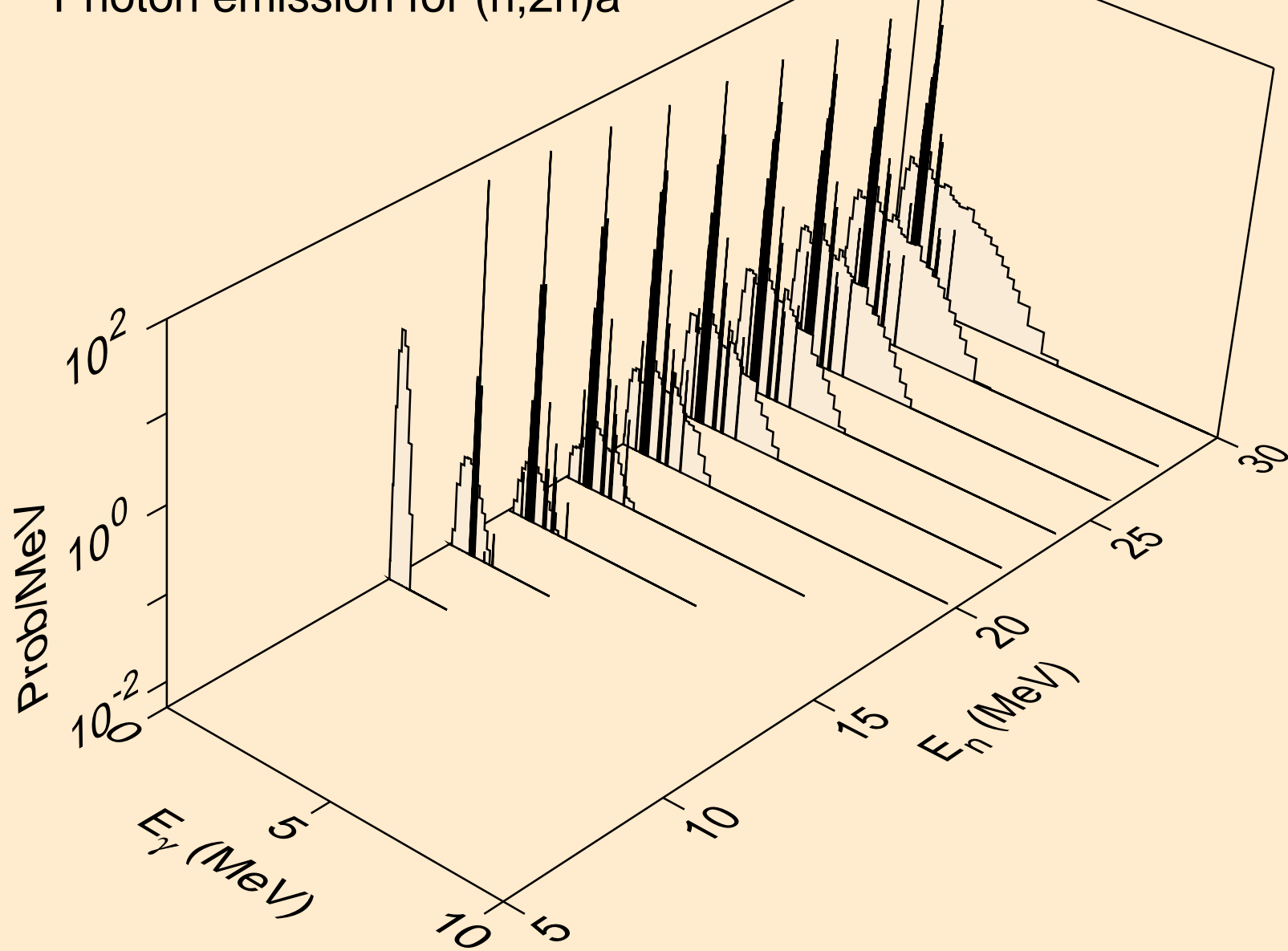

XE119 NEUTRON ACER TENDL-2024 LIBRARY; T=0.K  
Photon emission for (n,3n)a

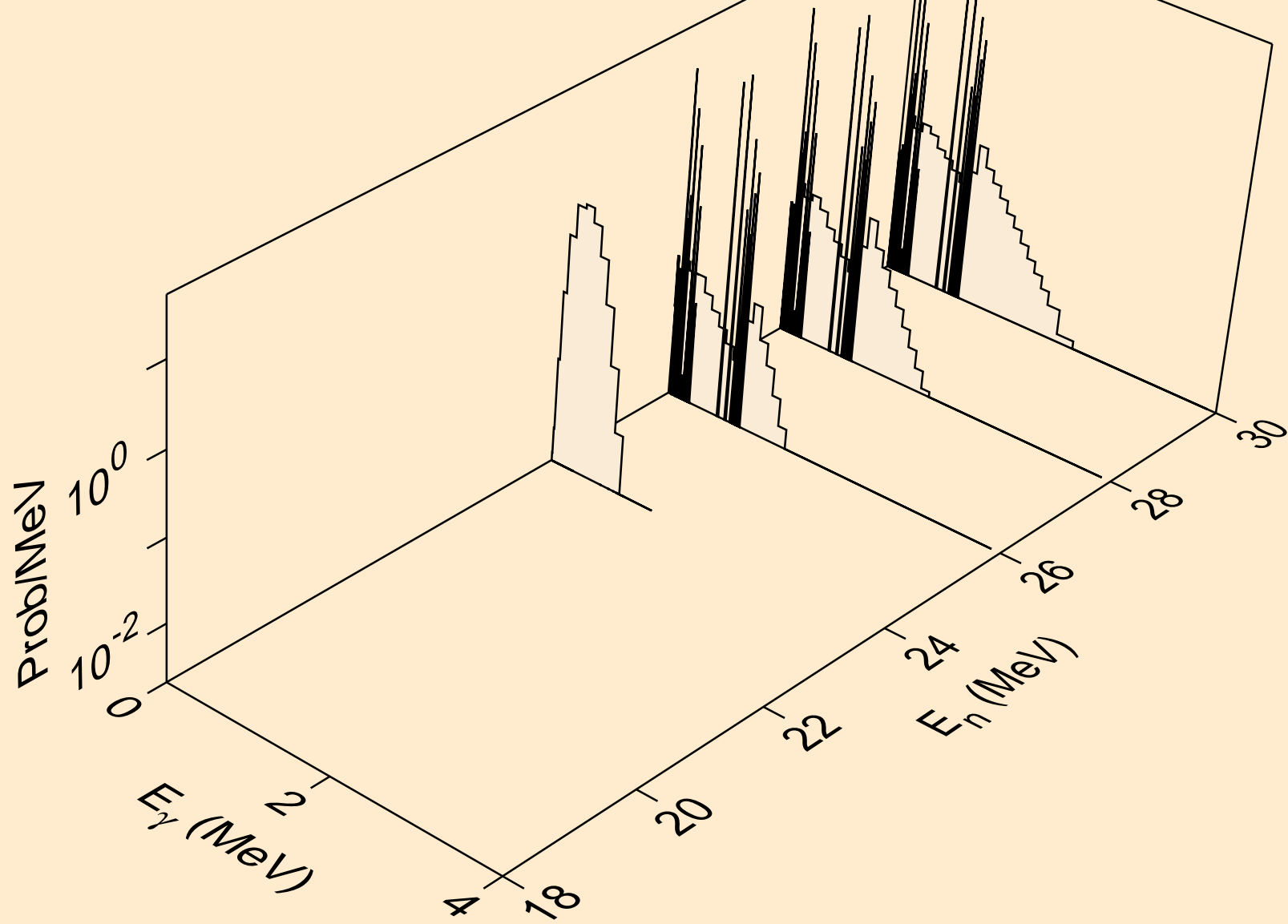

XE119 NEUTRON ACER TENDL-2024 LIBRARY; T=0.K  
Photon emission for (n,n\*)p

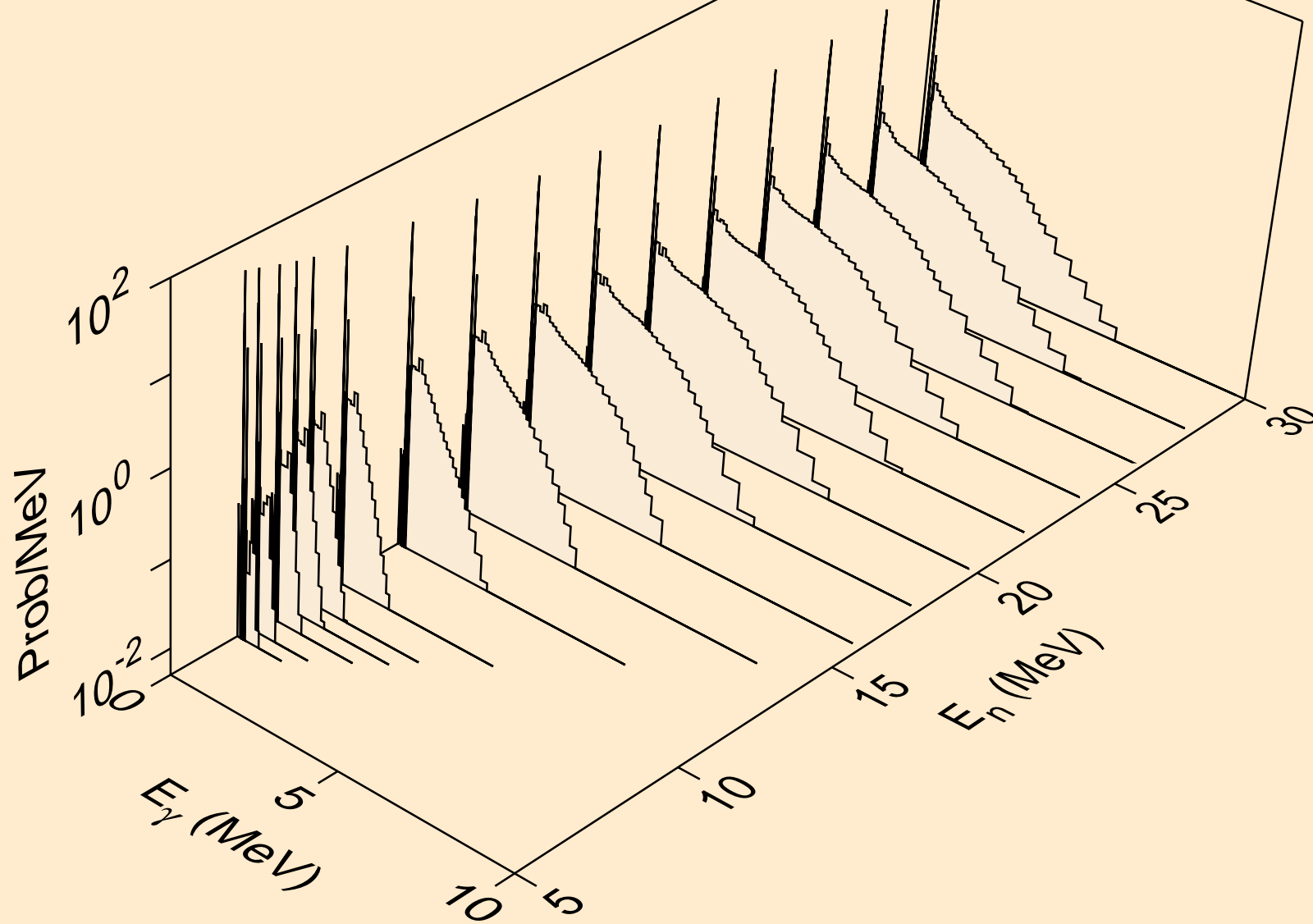

XE119 NEUTRON ACER TENDL-2024 LIBRARY; T=0.K  
Photon emission for (n,n\*)2a

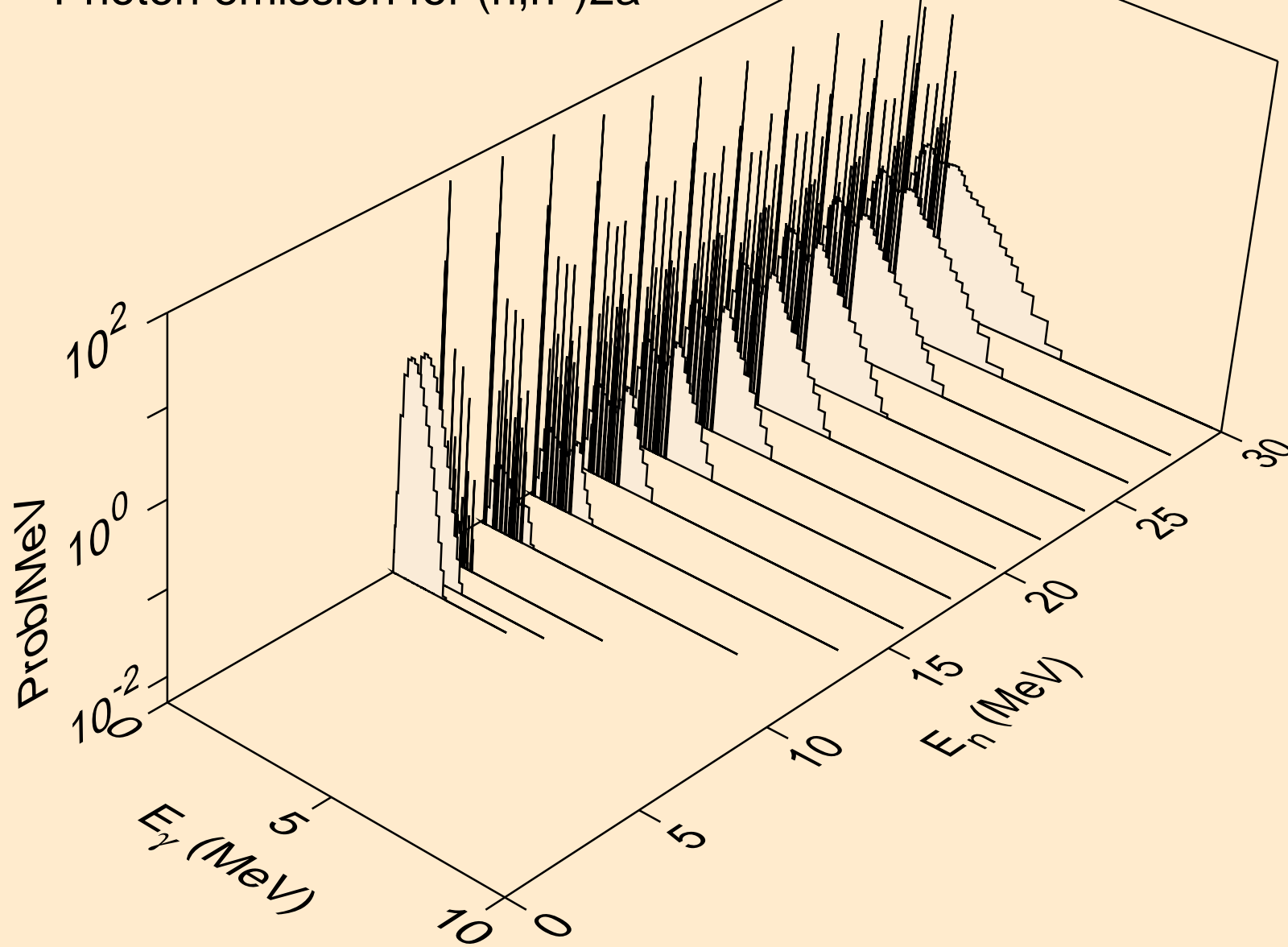

XE119 NEUTRON ACER TENDL-2024 LIBRARY; T=0.K  
Photon emission for (n,2n)2a

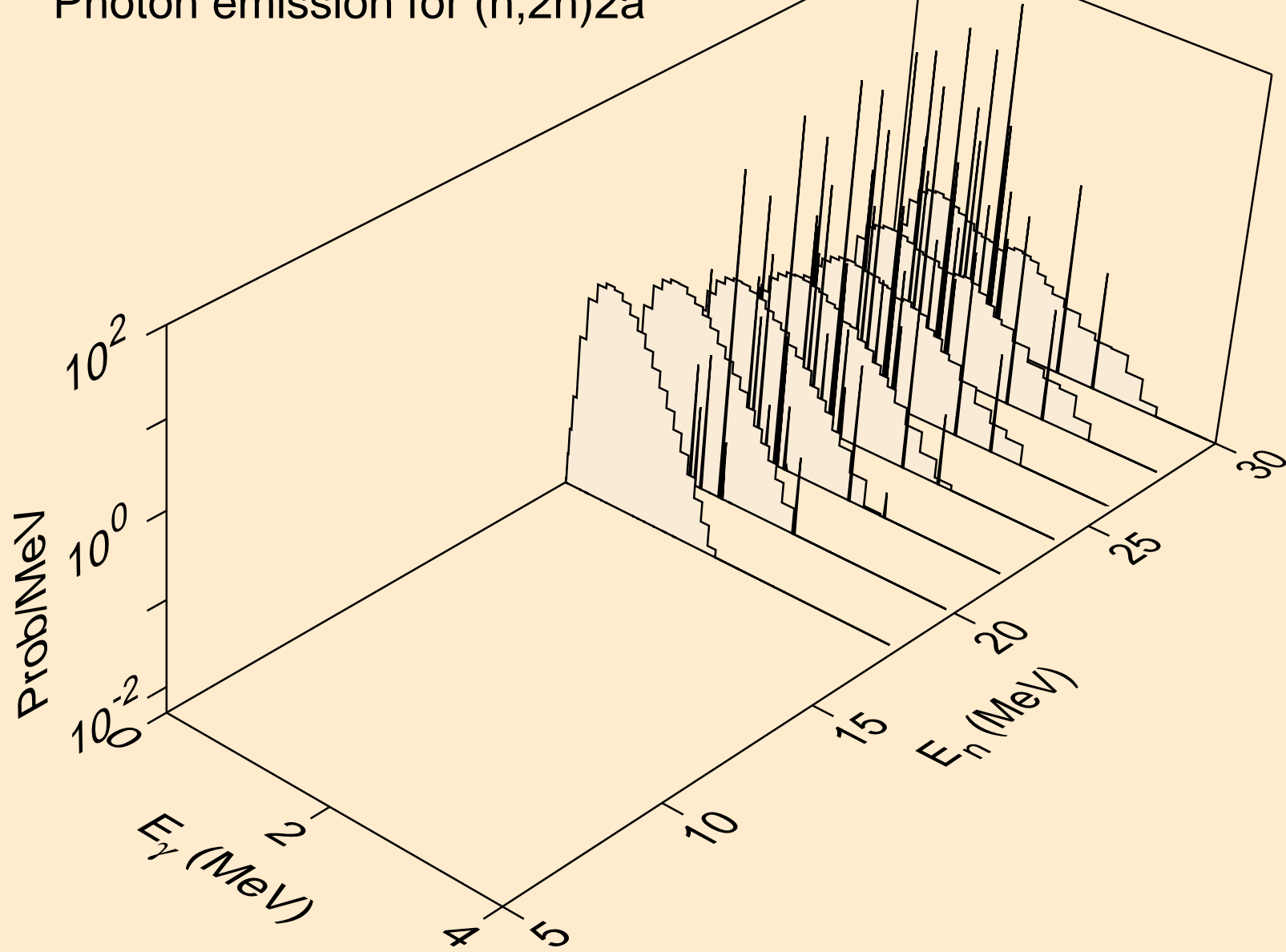

XE119 NEUTRON ACER TENDL-2024 LIBRARY; T=0.K  
Photon emission for (n,n\*)d

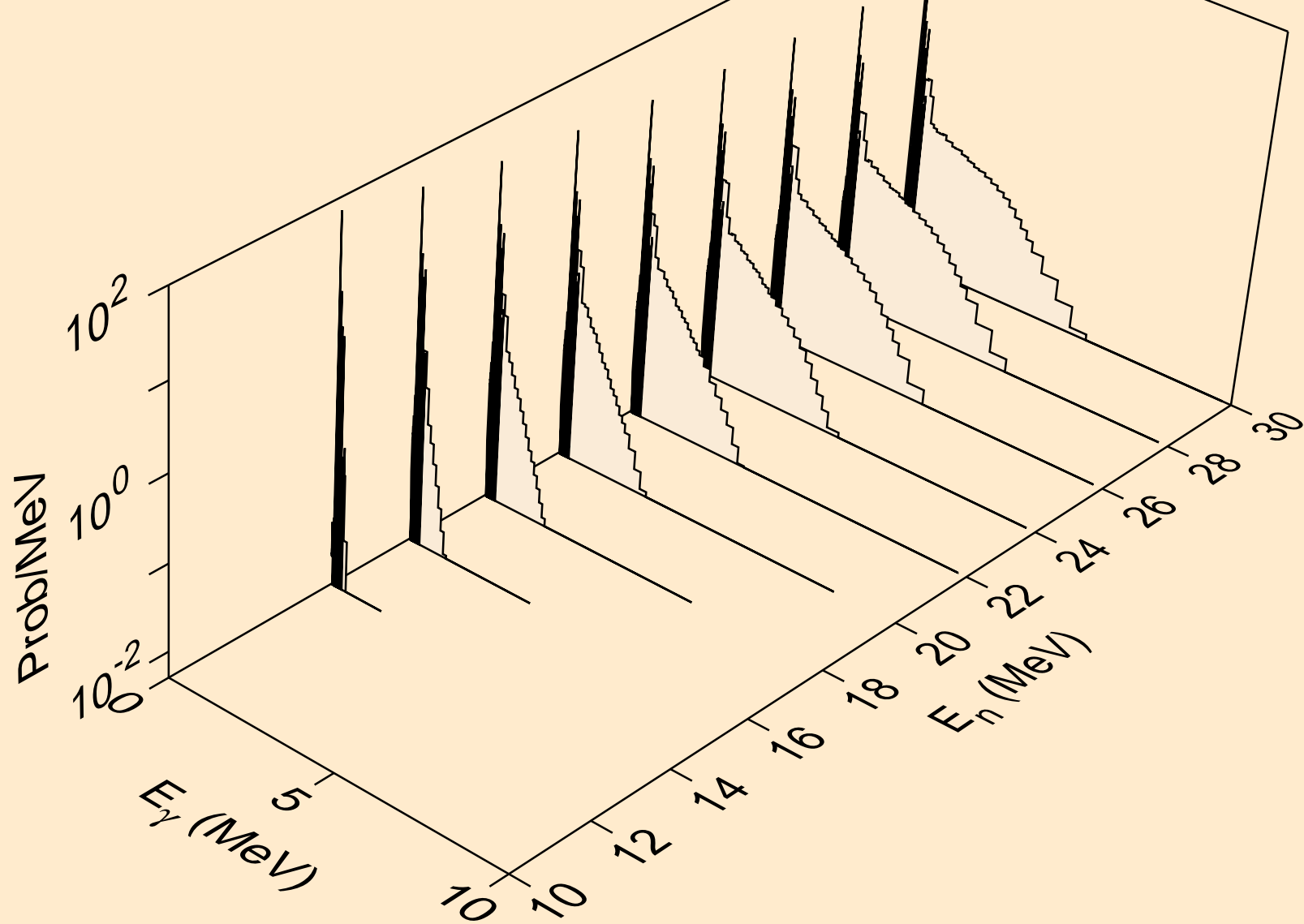

XE119 NEUTRON ACER TENDL-2024 LIBRARY; T=0.K  
Photon emission for (n,n\*)t

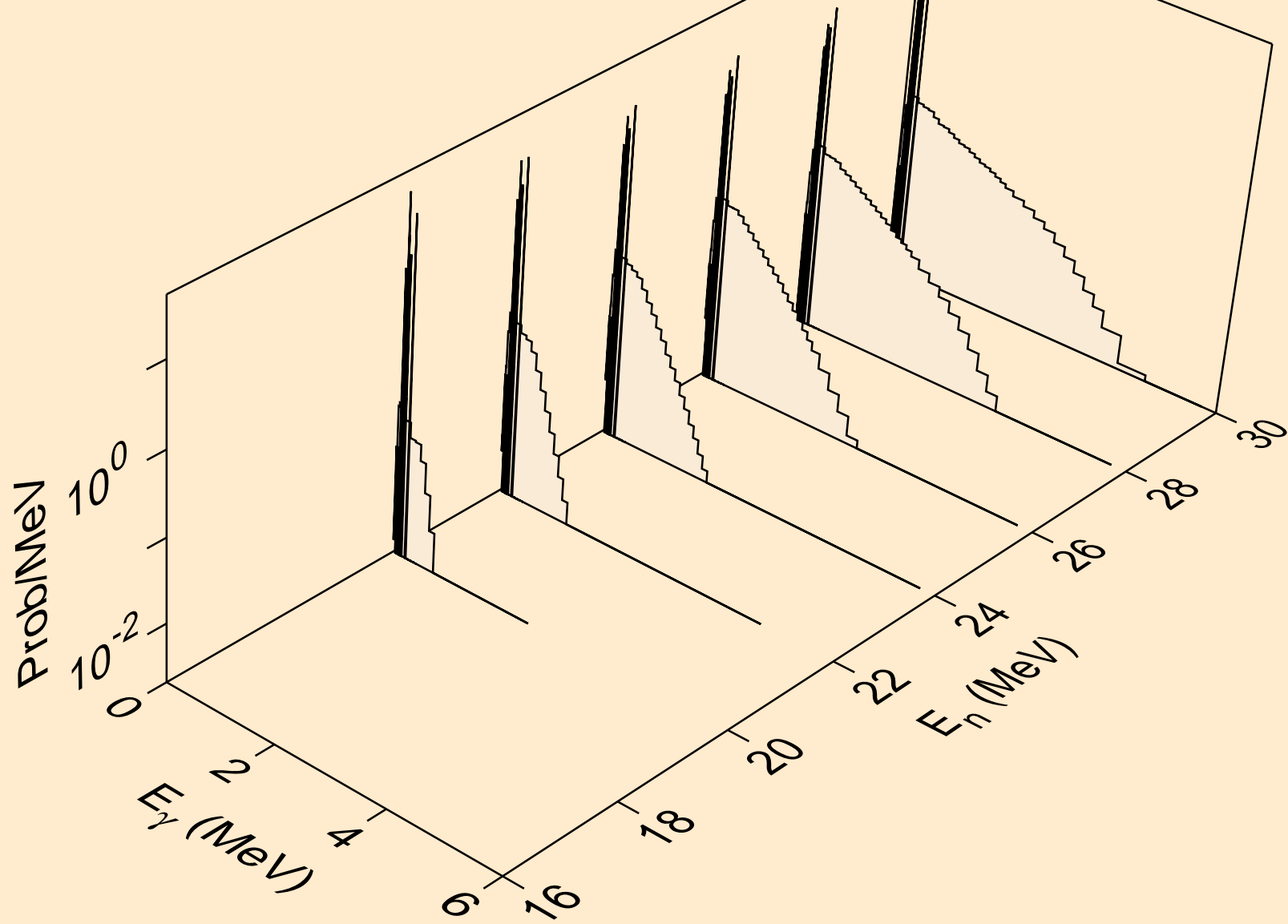

XE119 NEUTRON ACER TENDL-2024 LIBRARY; T=0.K  
Photon emission for (n,n\*)he3

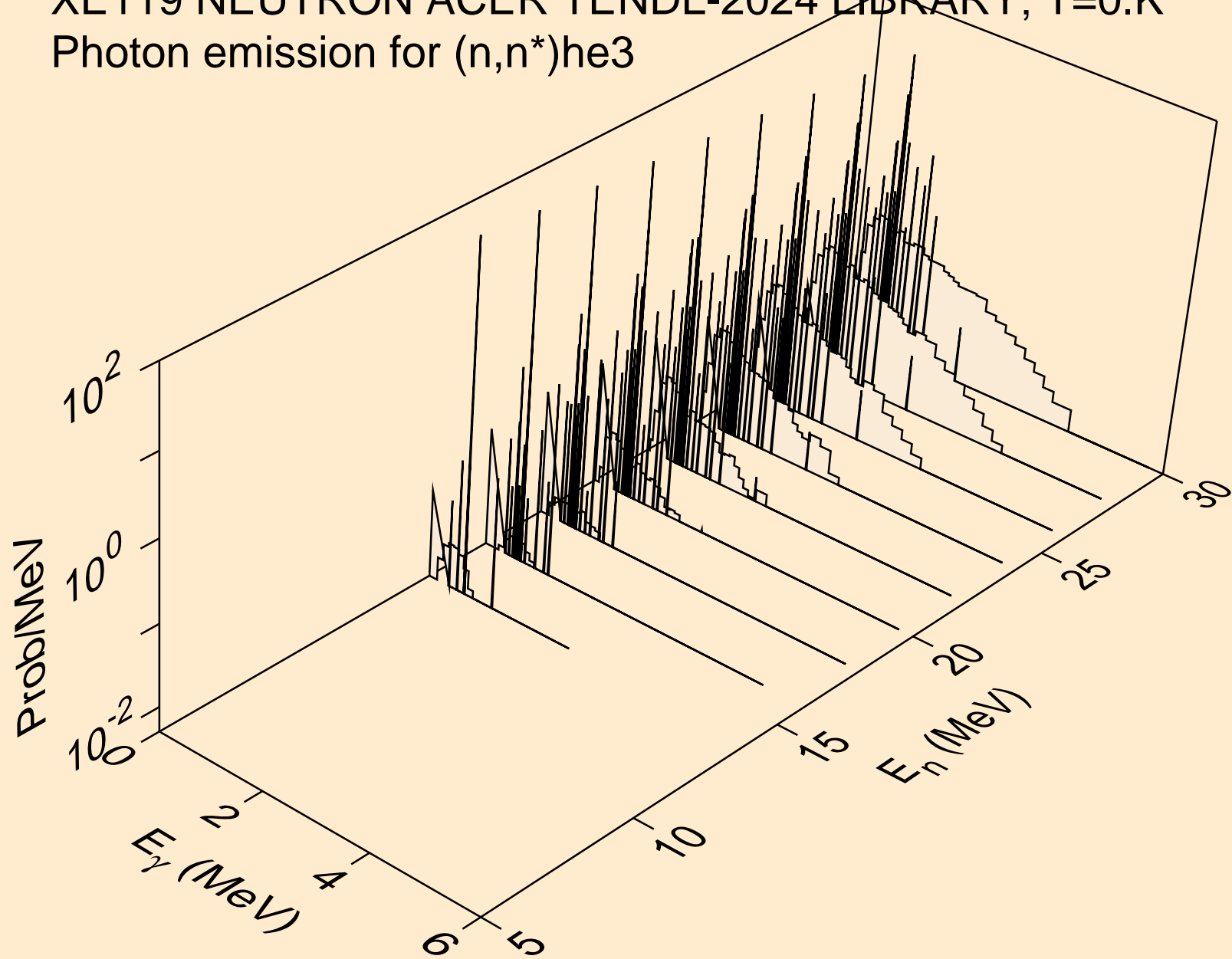

XE119 NEUTRON ACER TENDL-2024 LIBRARY; T=0.K  
Photon emission for (n,2np)

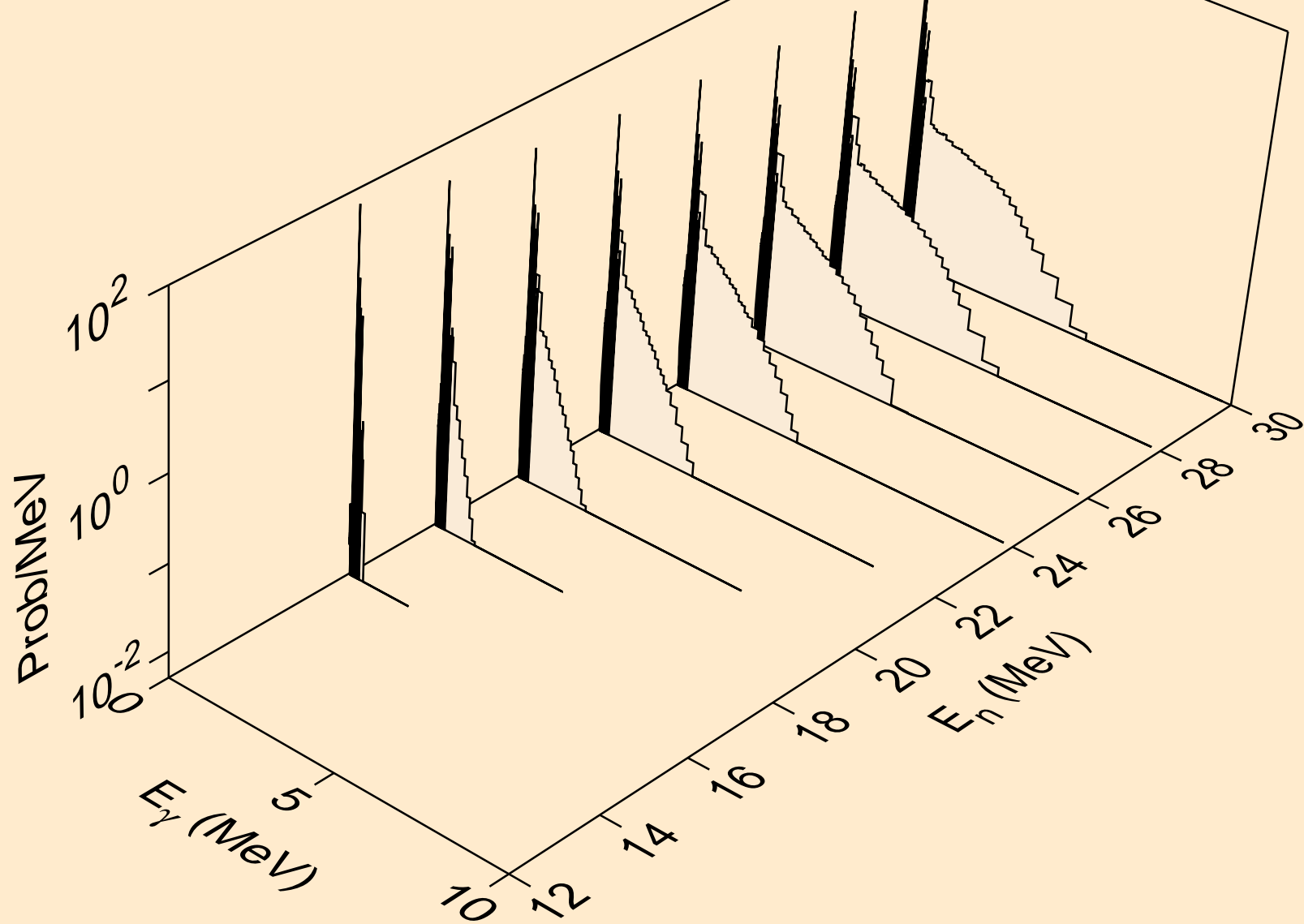

XE119 NEUTRON ACER TENDL-2024 LIBRARY; T=0.K  
Photon emission for (n,3np)

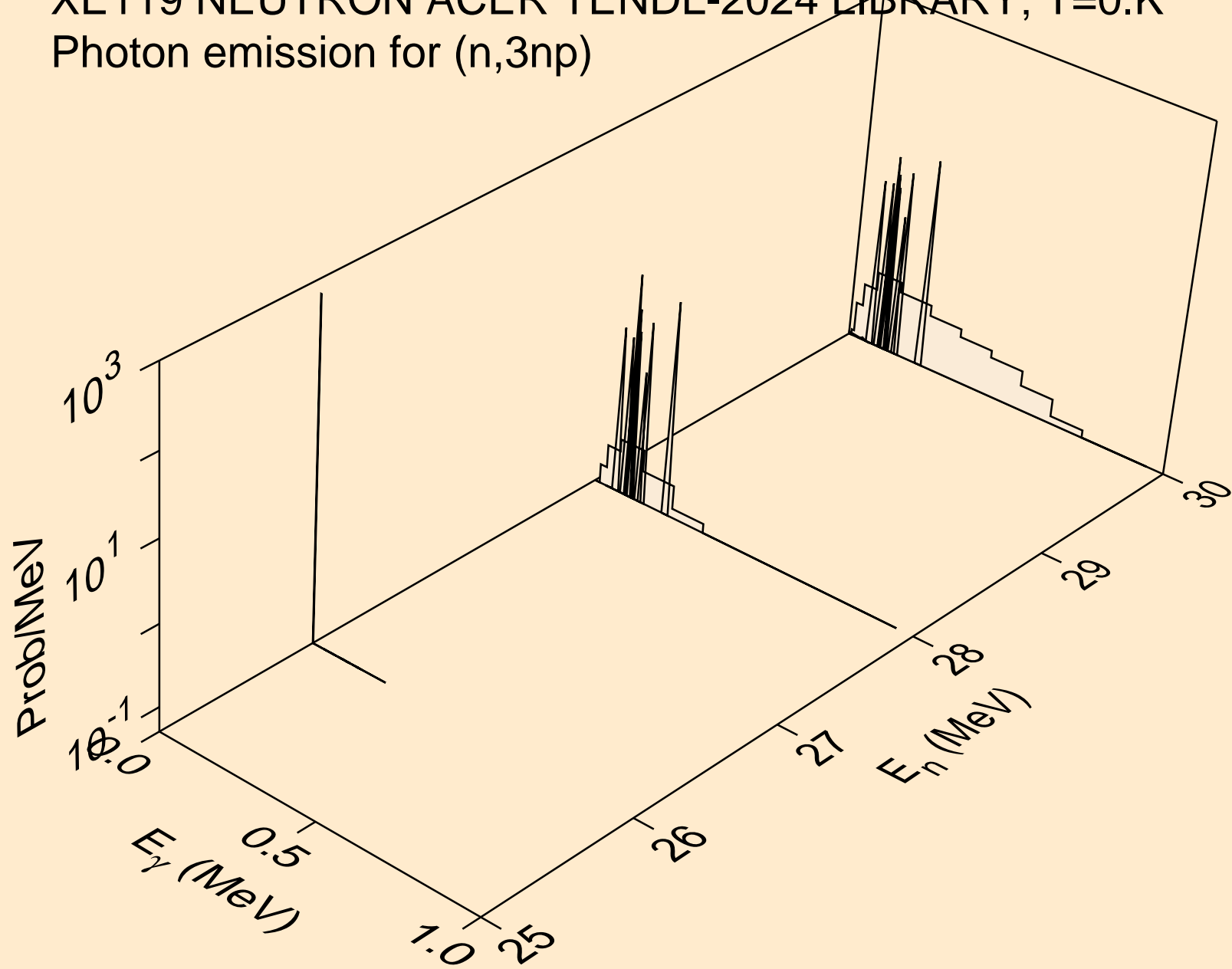

XE119 NEUTRON ACER TENDL-2024 LIBRARY; T=0.K  
Photon emission for (n,n2p)

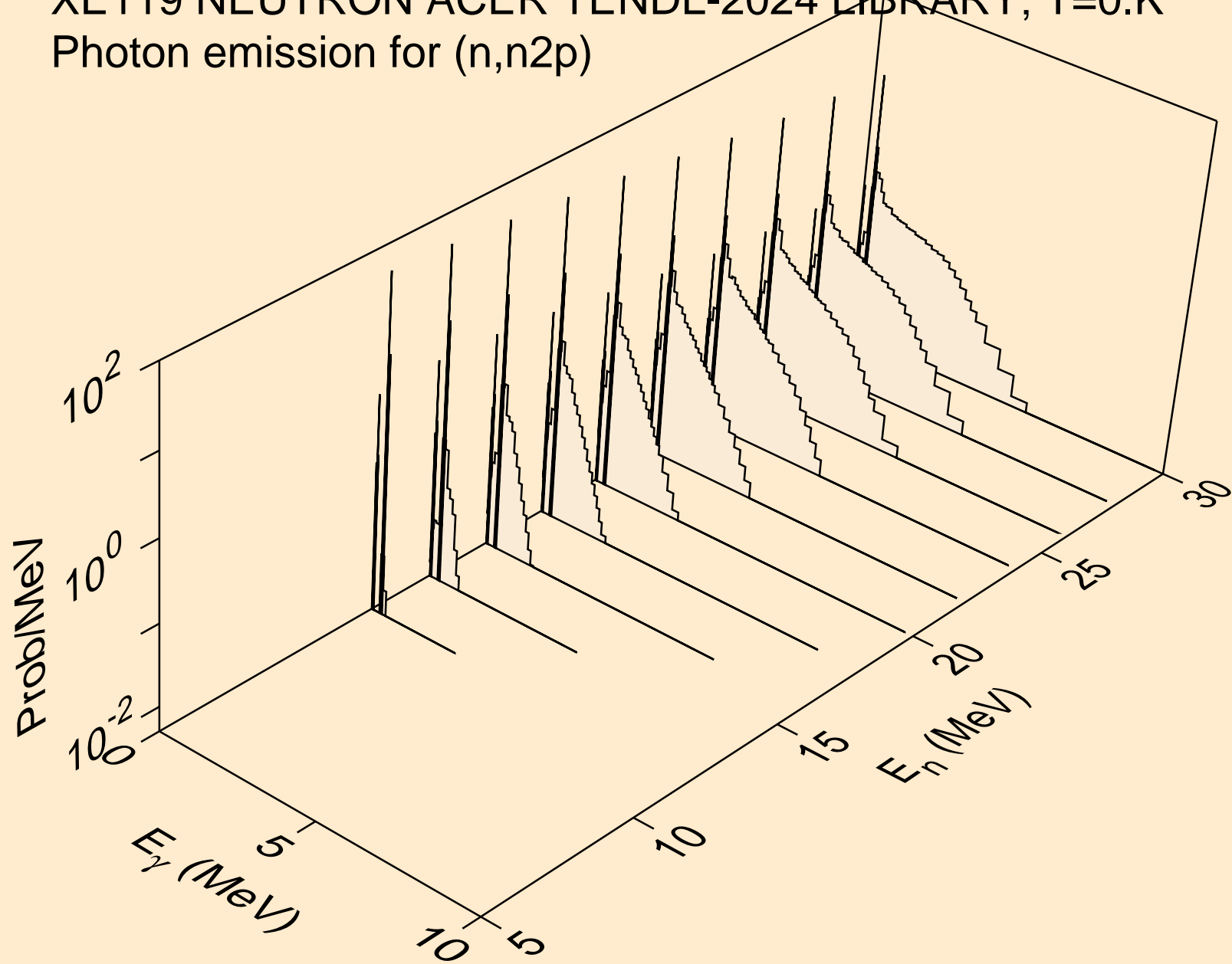

XE119 NEUTRON ACER TENDL-2024 LIBRARY; T=0.K  
Photon emission for (n,npa)

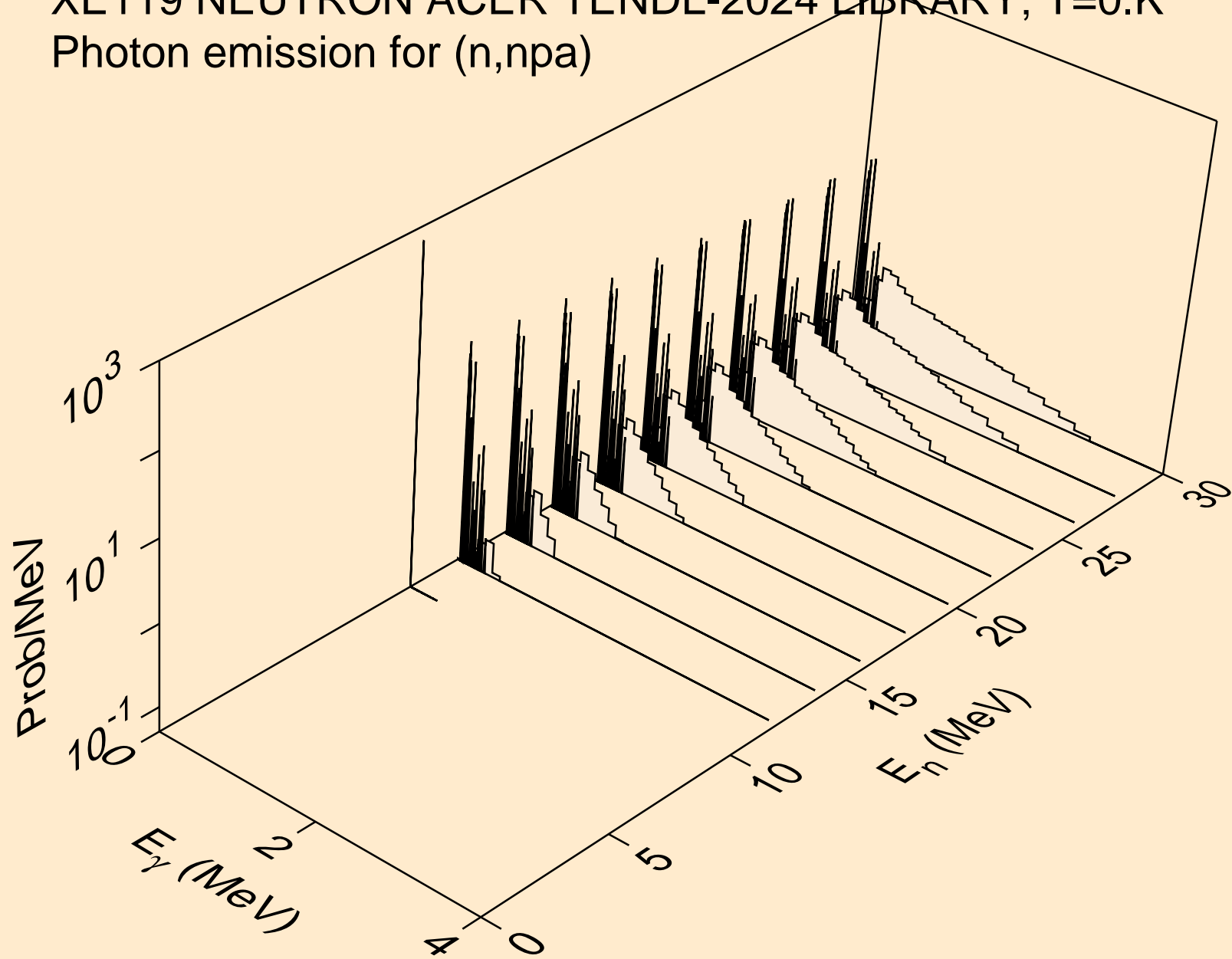

XE119 NEUTRON ACER TENDL-2024 LIBRARY; T=0.K  
Photon emission for (n,n\*c)

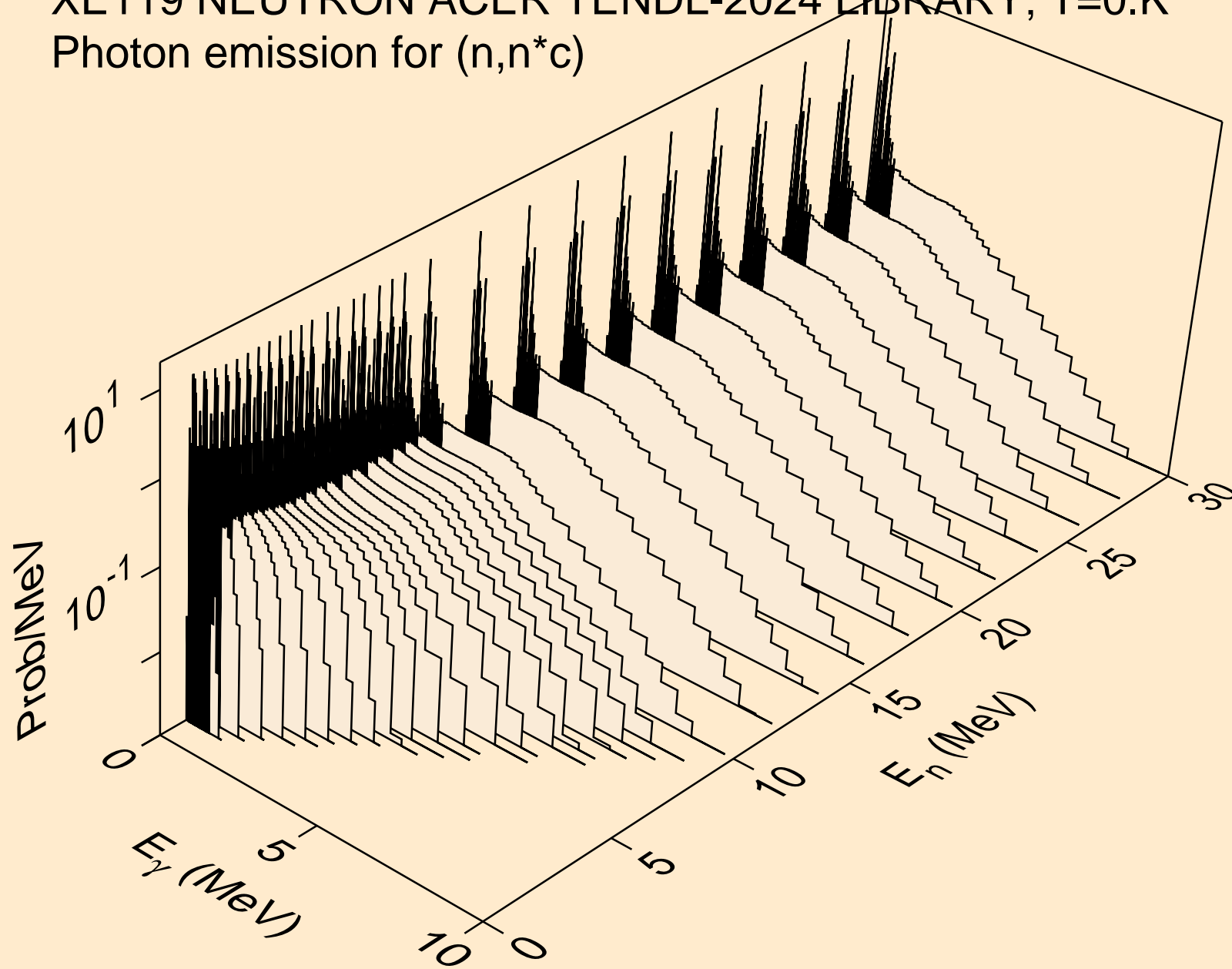

XE119 NEUTRON ACER TENDL-2024 LIBRARY; T=0.K  
Photon emission for (n,gma)

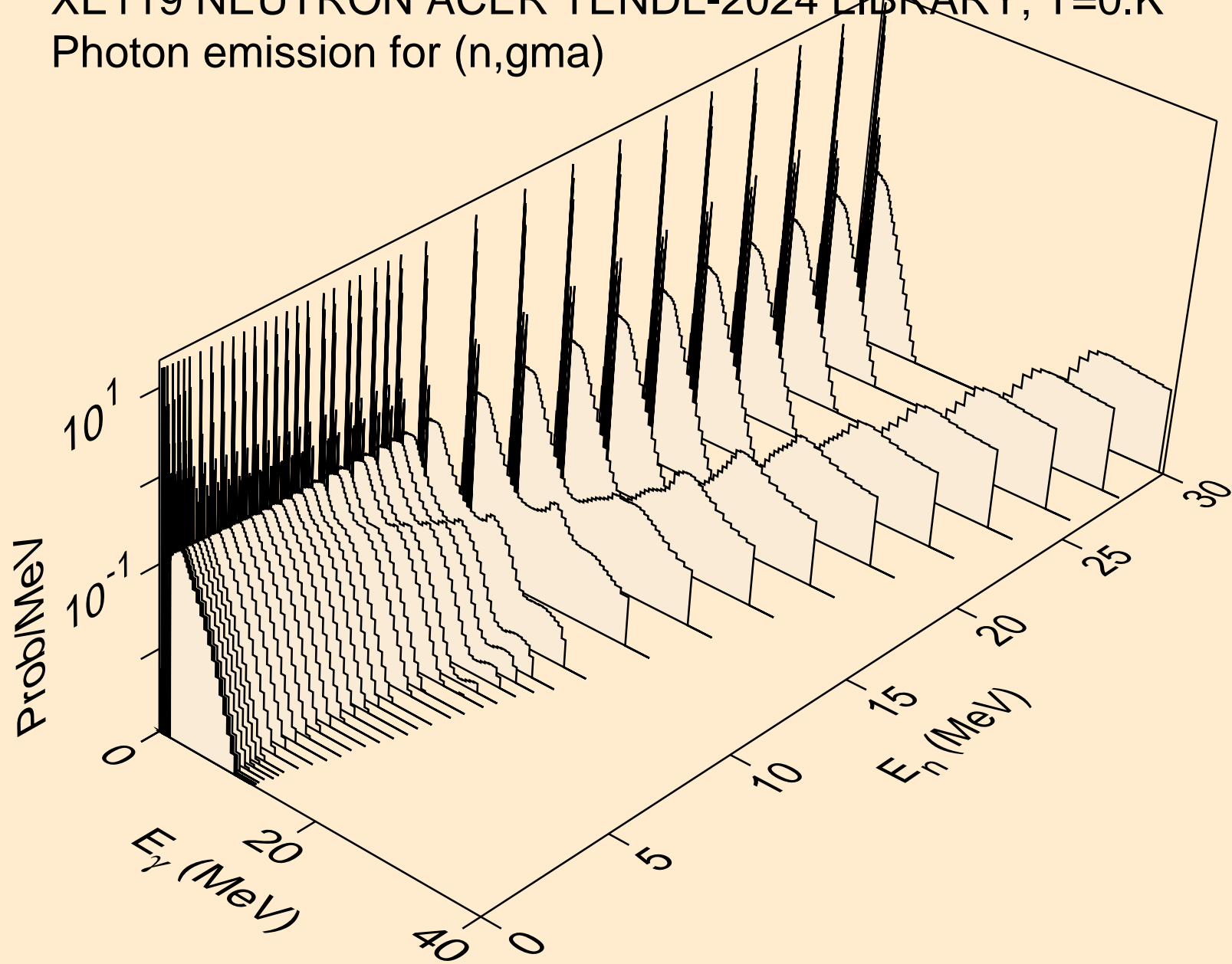

XE119 NEUTRON ACER TENDL-2024 LIBRARY; T=0.K  
Photon emission for (n,p)

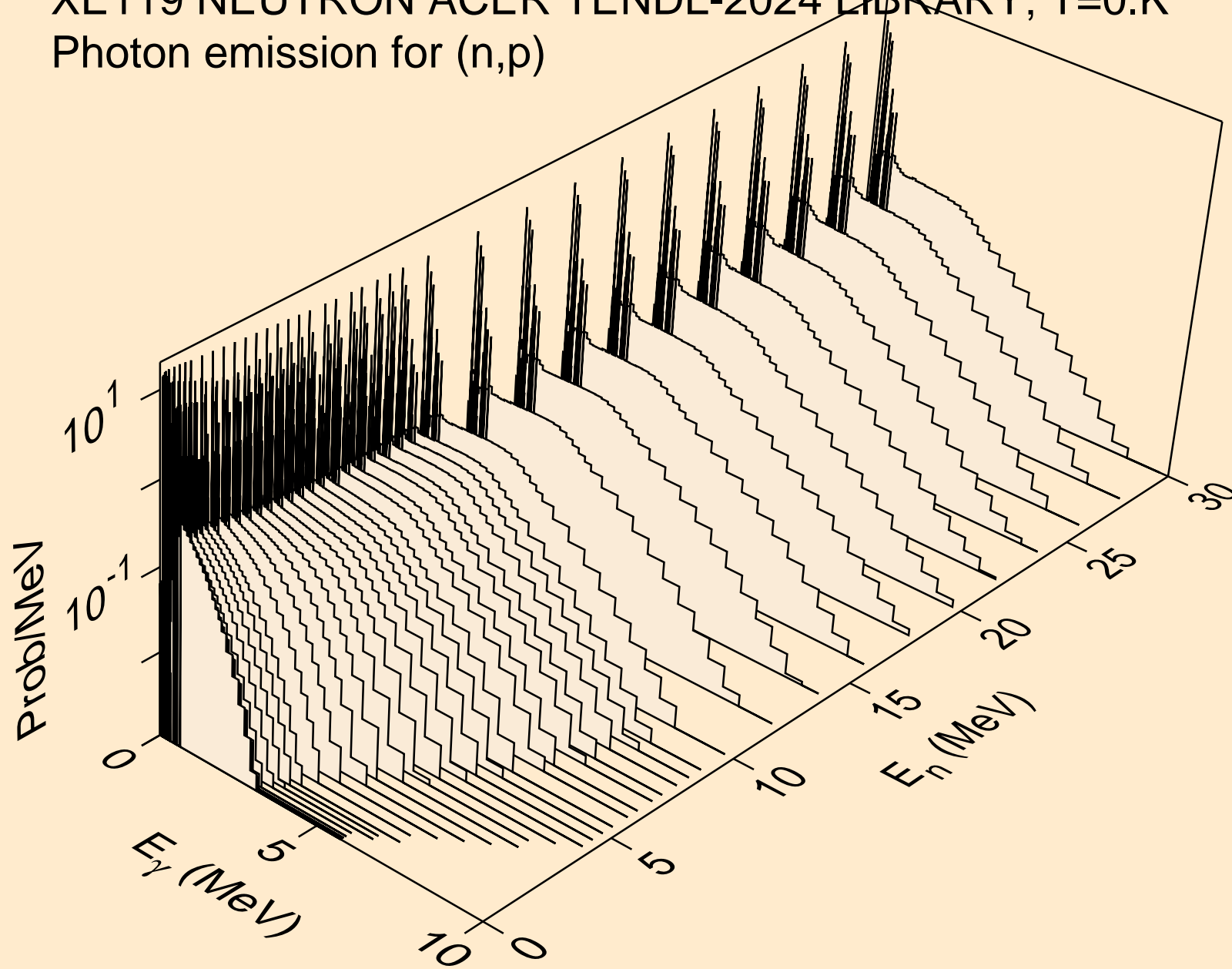

XE119 NEUTRON ACER TENDL-2024 LIBRARY; T=0.K  
Photon emission for (n,d)

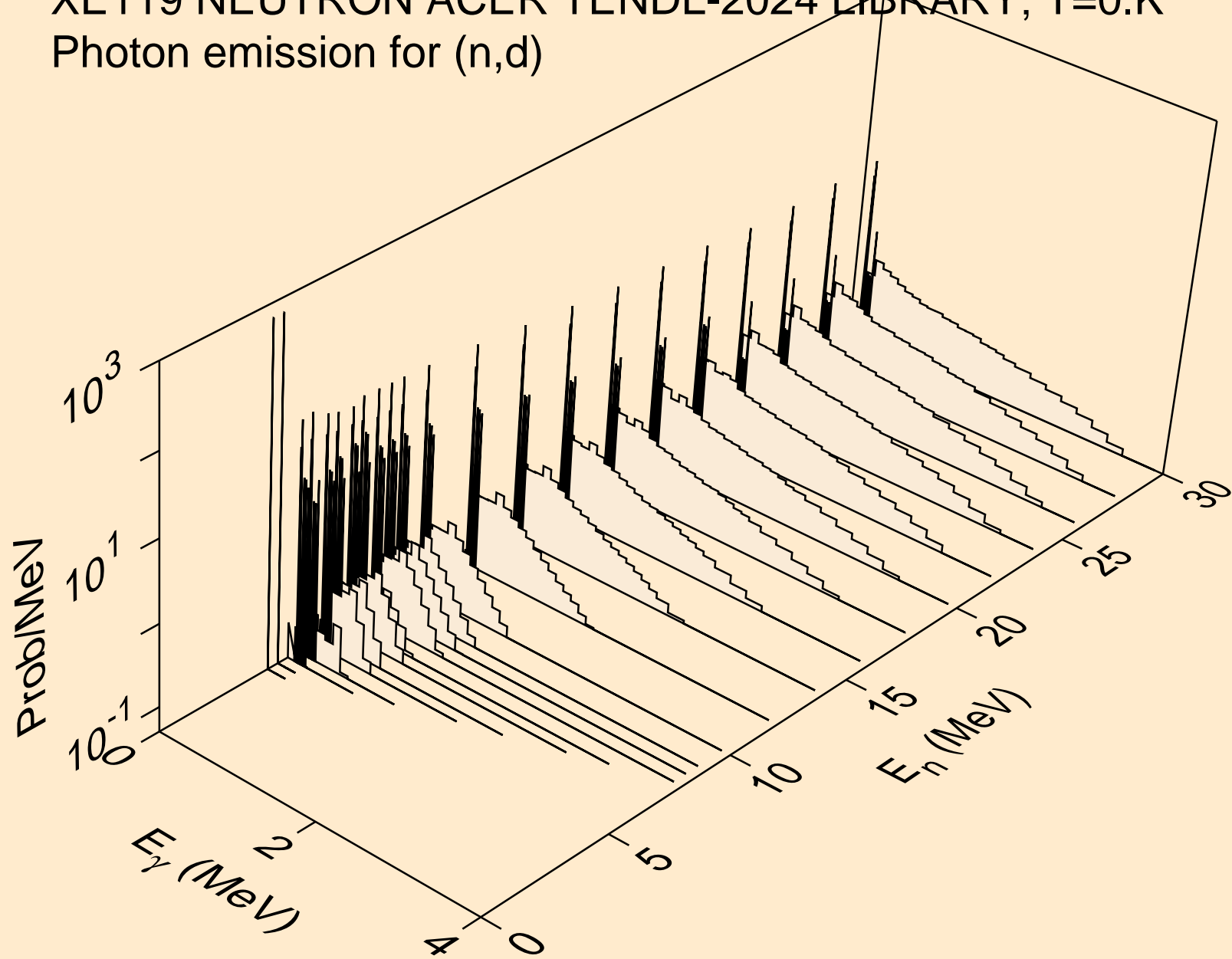

XE119 NEUTRON ACER TENDL-2024 LIBRARY; T=0.K  
Photon emission for (n,t)

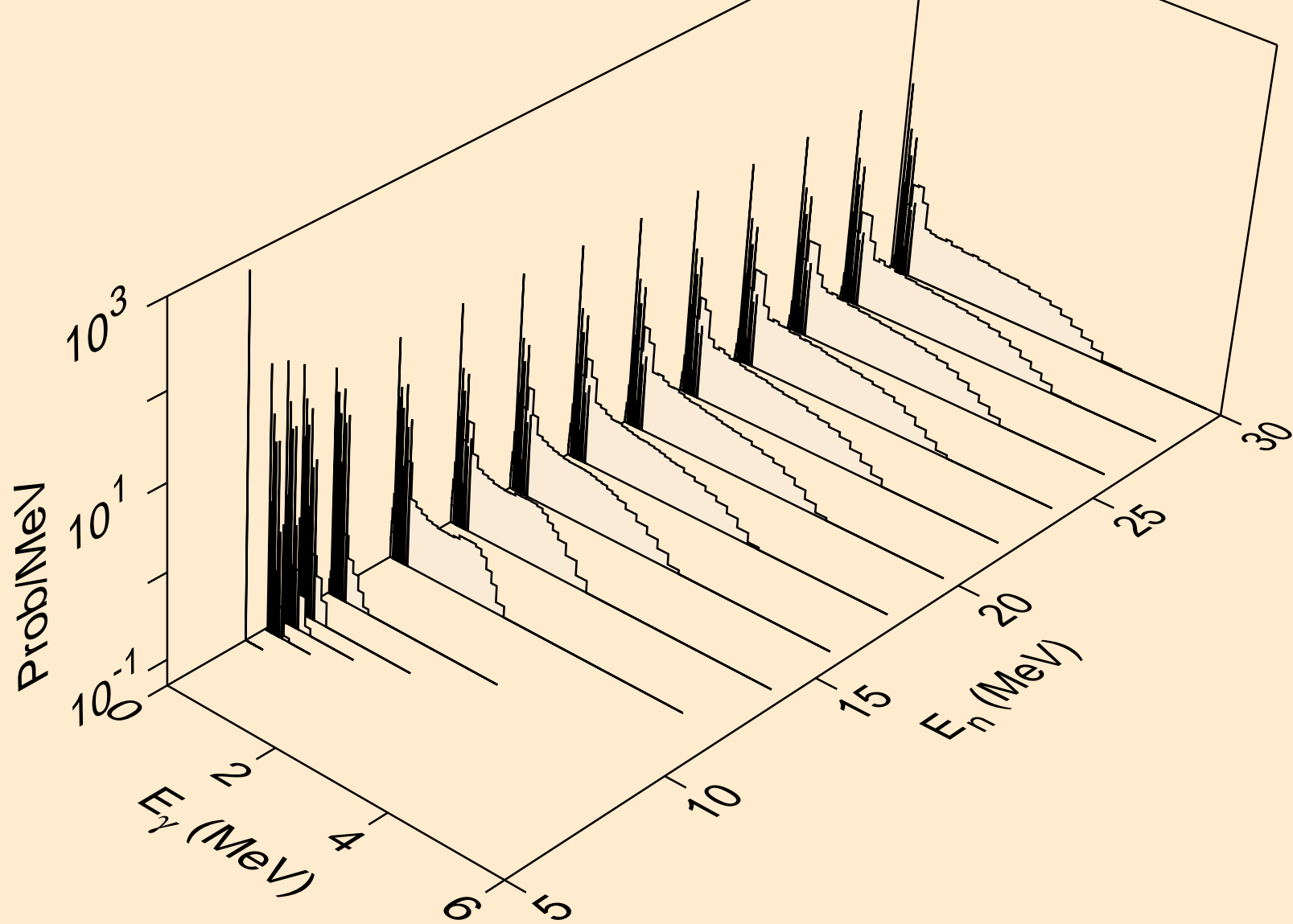

XE119 NEUTRON ACER TENDL-2024 LIBRARY; T=0.K  
Photon emission for (n,he3)

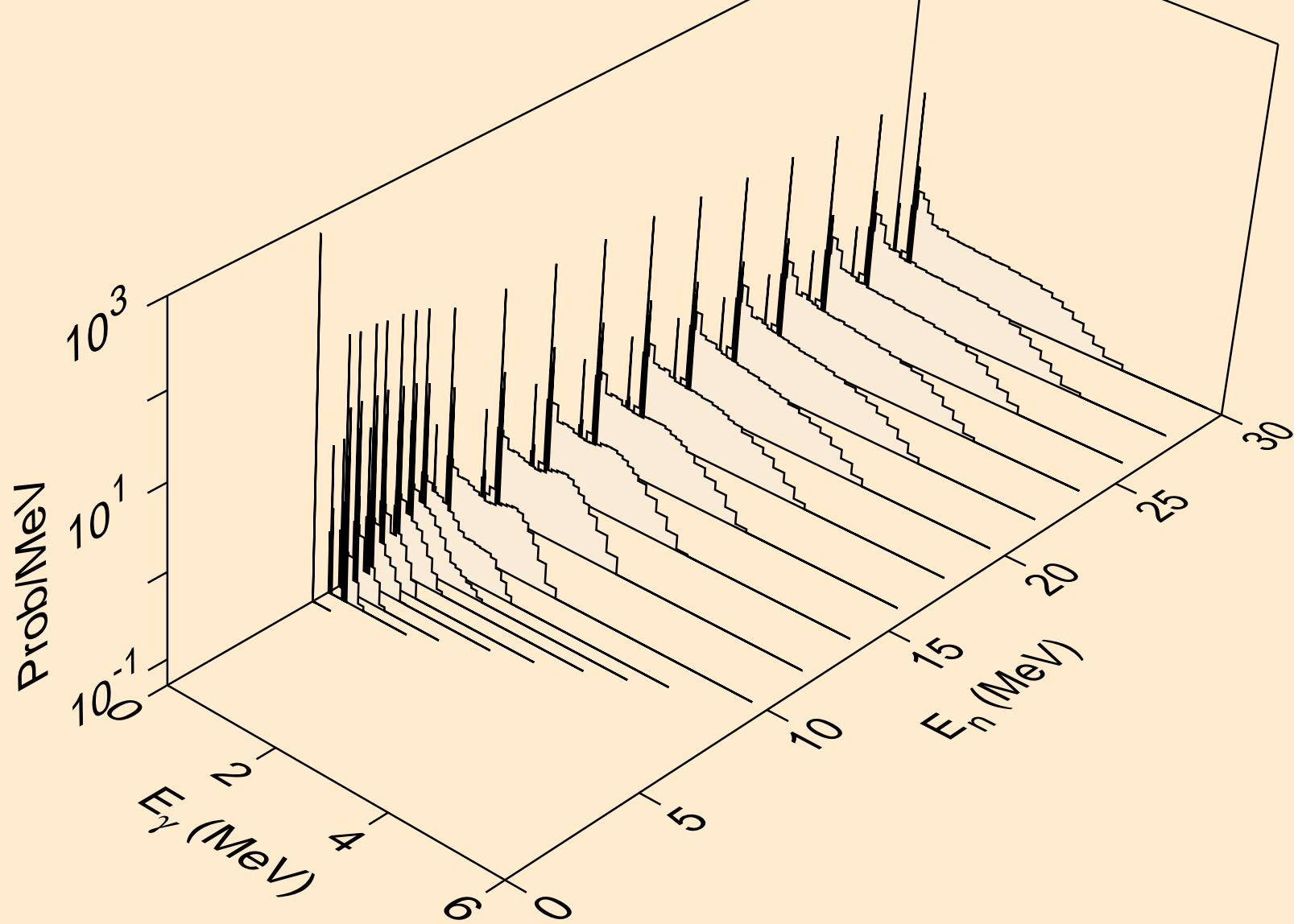

XE119 NEUTRON ACER TENDL-2024 LIBRARY; T=0.K  
Photon emission for (n,a)

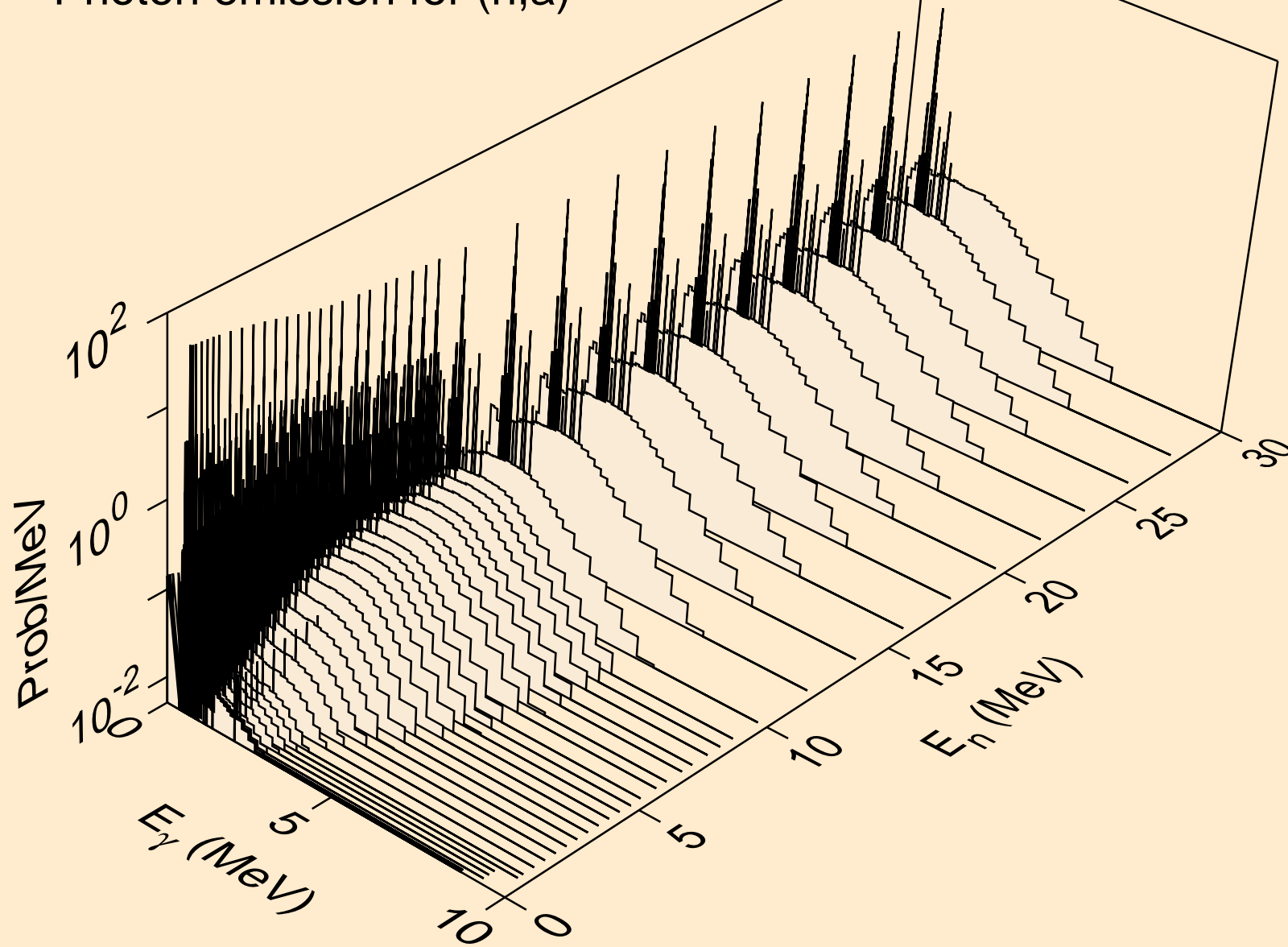

XE119 NEUTRON ACER TENDL-2024 LIBRARY; T=0.K  
Photon emission for (n,2a)

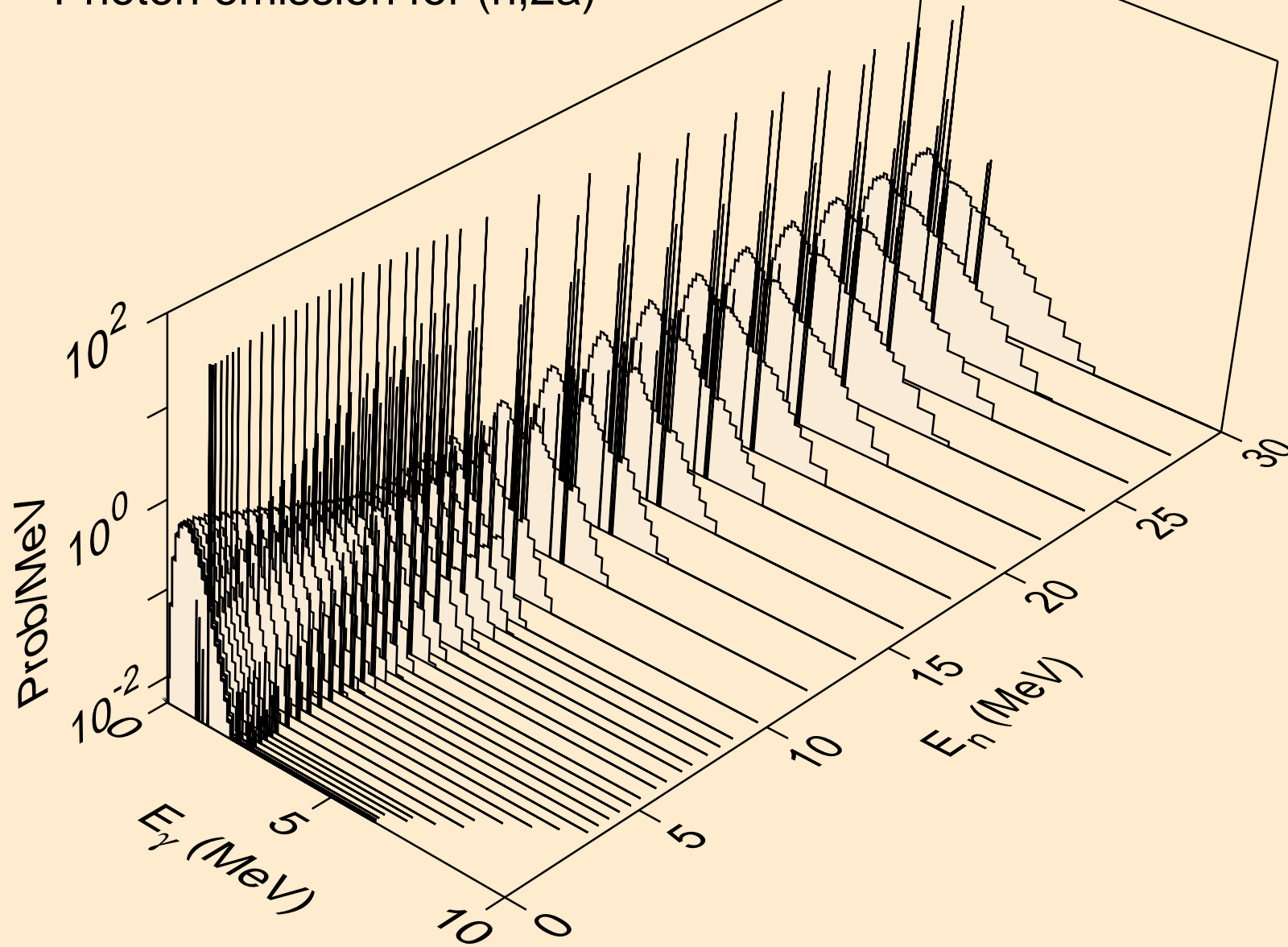

XE119 NEUTRON ACER TENDL-2024 LIBRARY; T=0.K  
Photon emission for (n,3a)

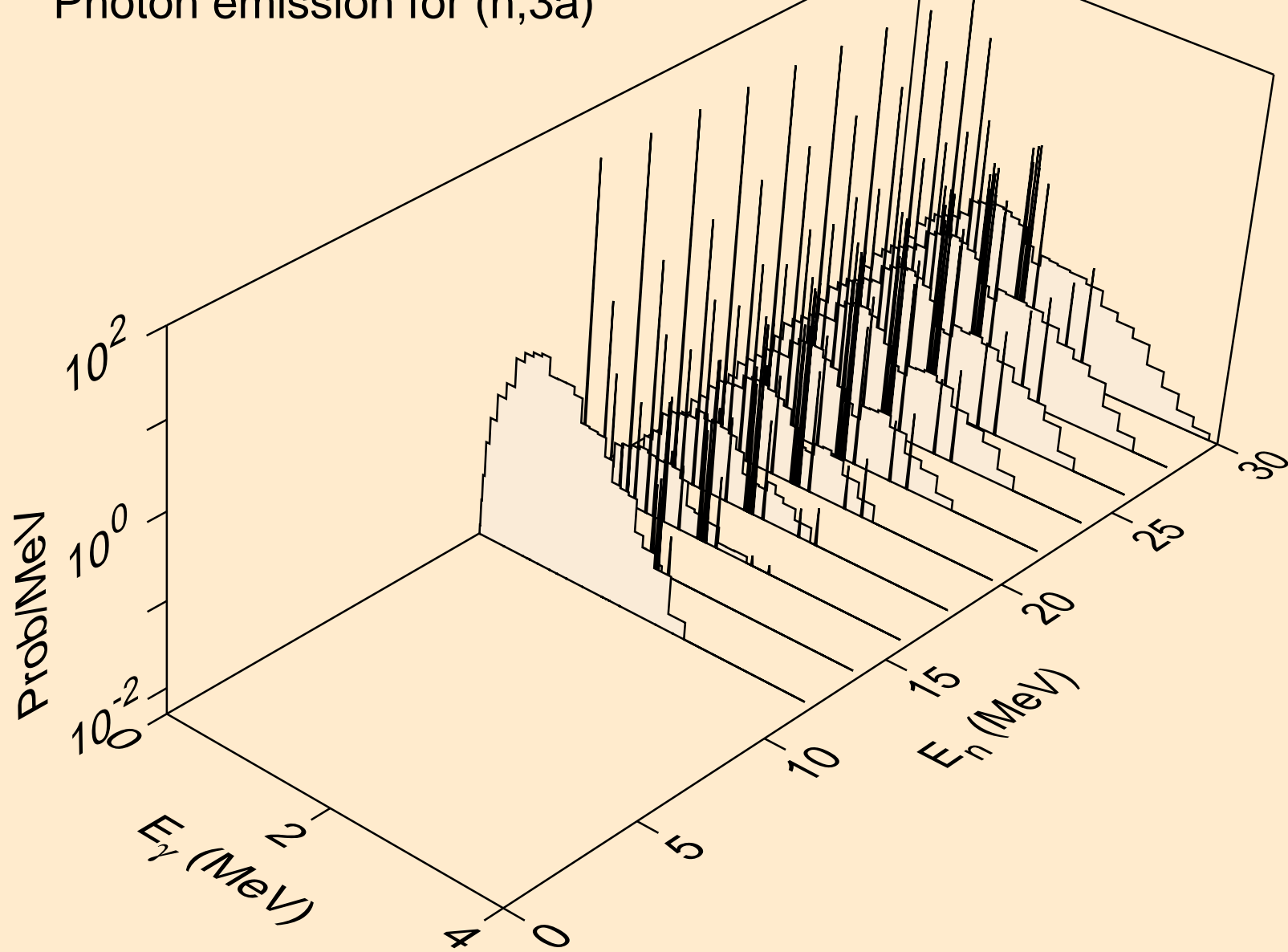

XE119 NEUTRON ACER TENDL-2024 LIBRARY; T=0.K  
Photon emission for (n,2p)

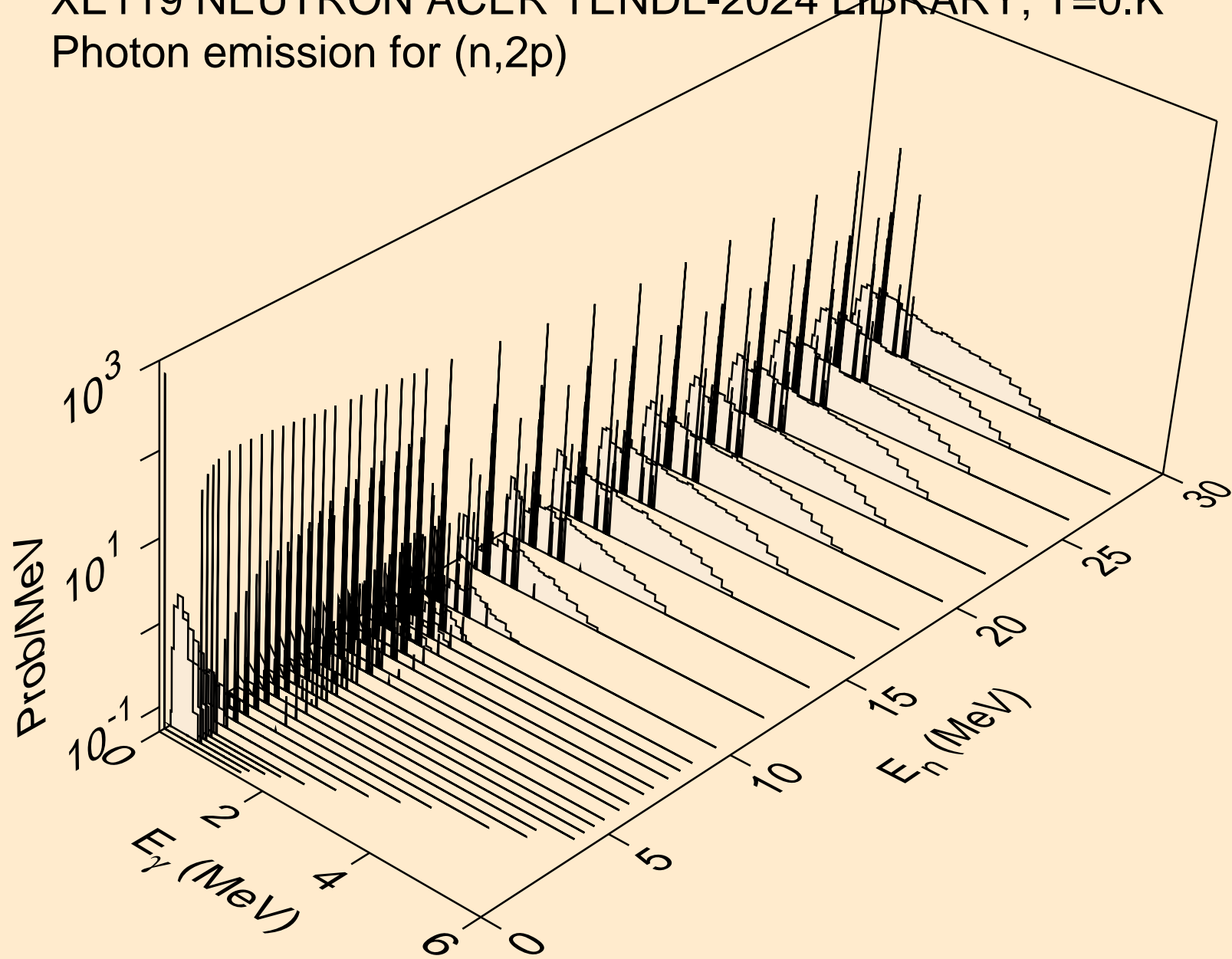

XE119 NEUTRON ACER TENDL-2024 LIBRARY; T=0.K  
Photon emission for (n,p $\alpha$ )

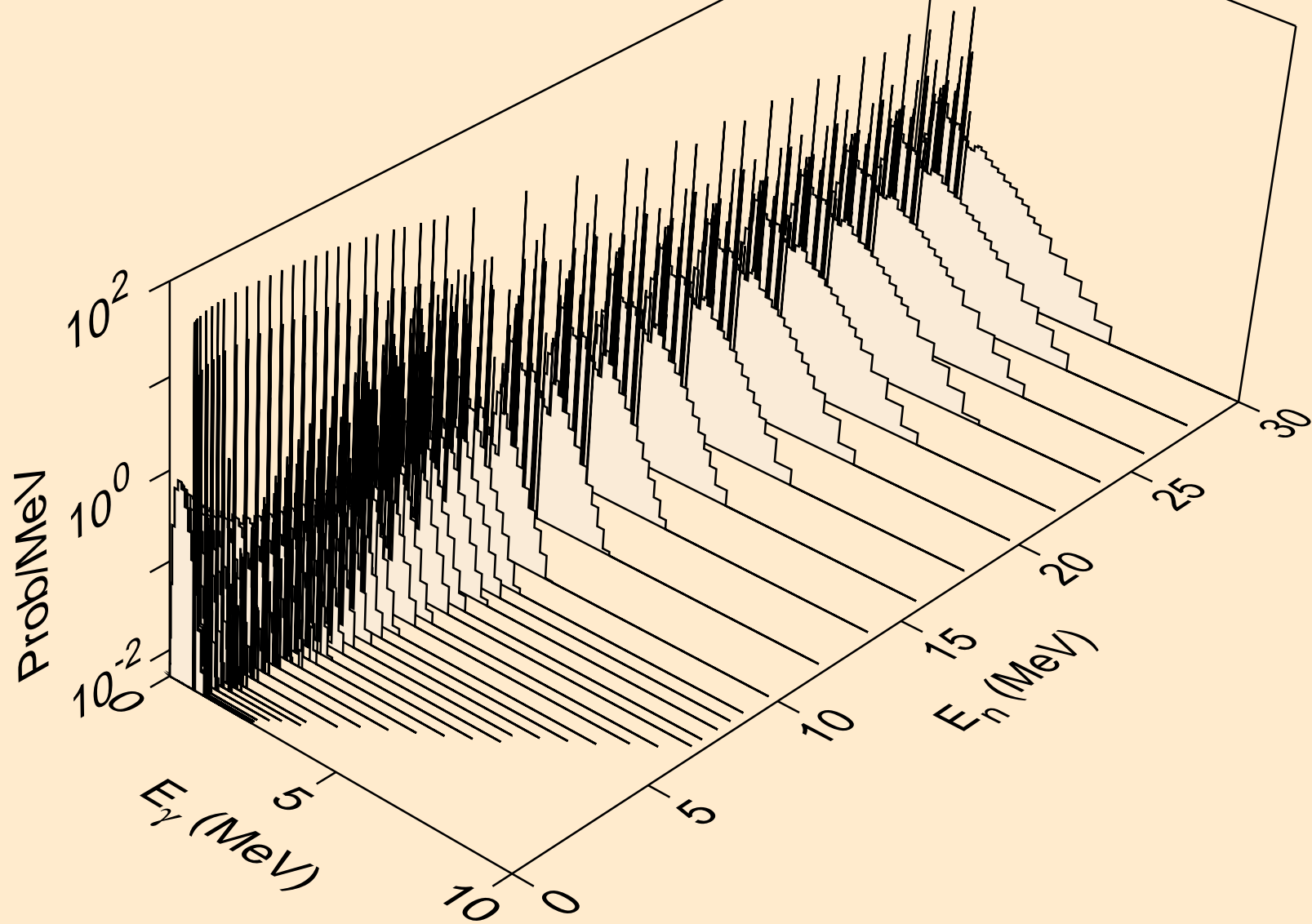

XE119 NEUTRON ACER TENDL-2024 LIBRARY; T=0.K  
Photon emission for (n,pd)

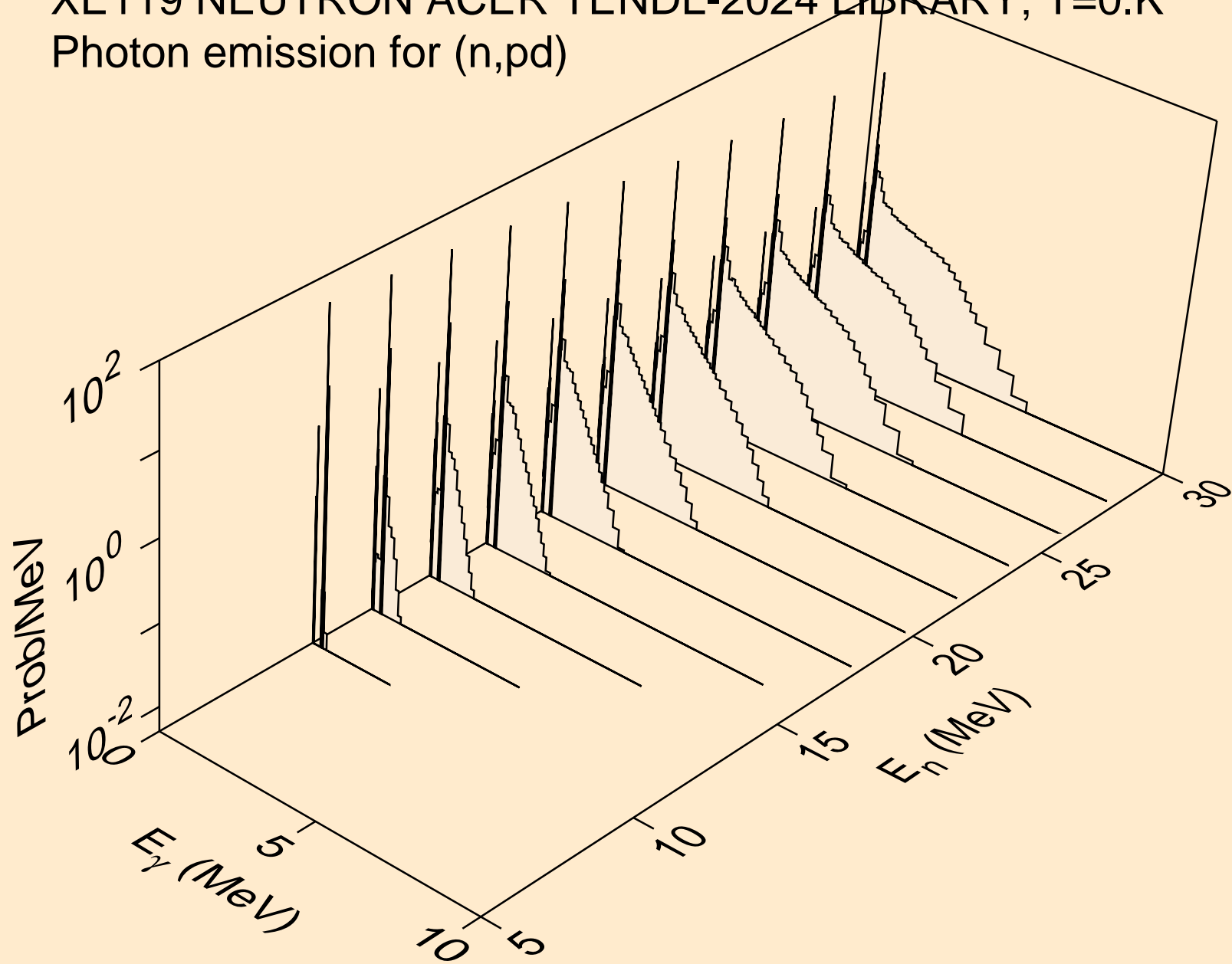

XE119 NEUTRON ACER TENDL-2024 LIBRARY; T=0.K  
Photon emission for (n,pt)

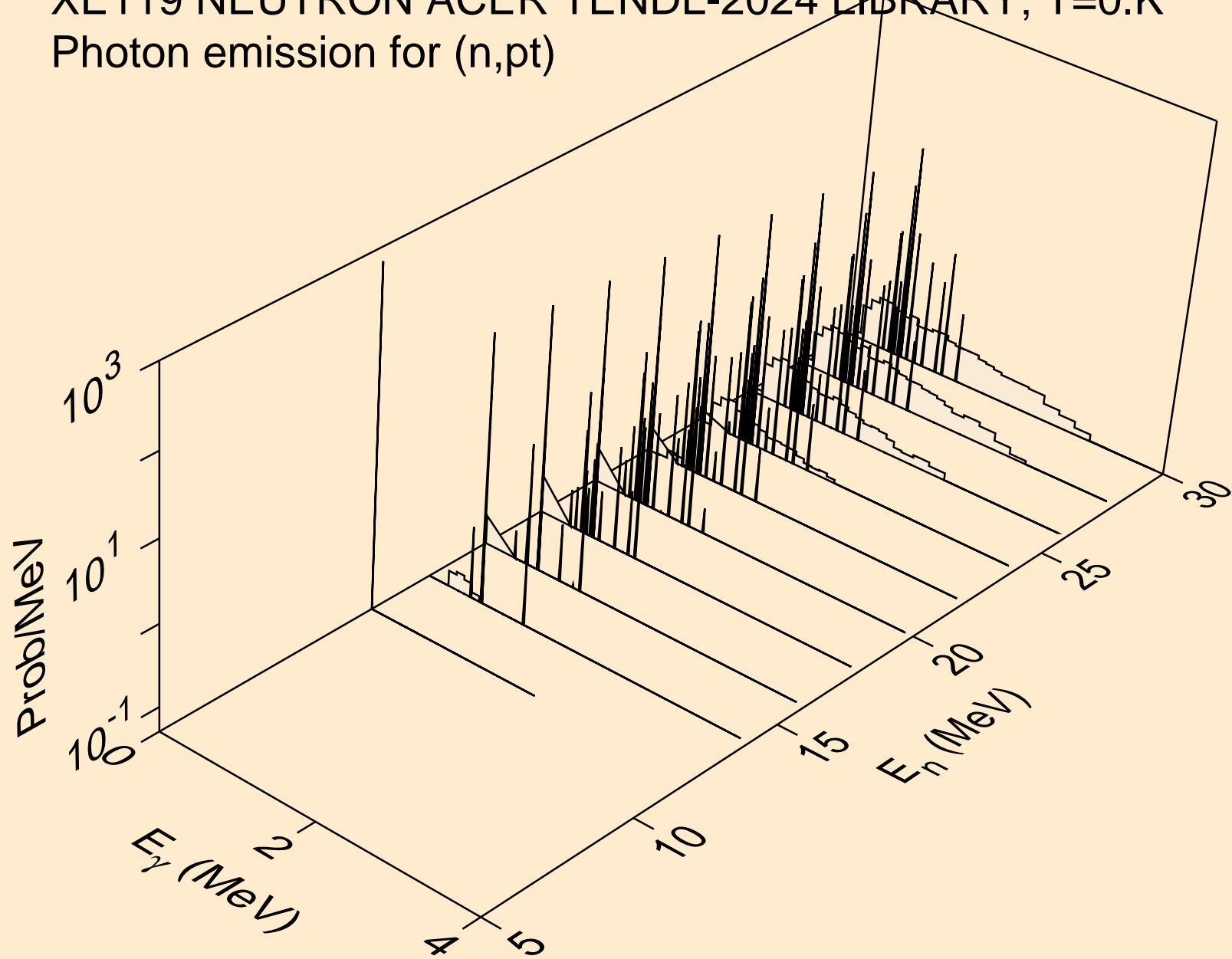

XE119 NEUTRON ACER TENDL-2024 LIBRARY; T=0.K  
Photon emission for (n,da)

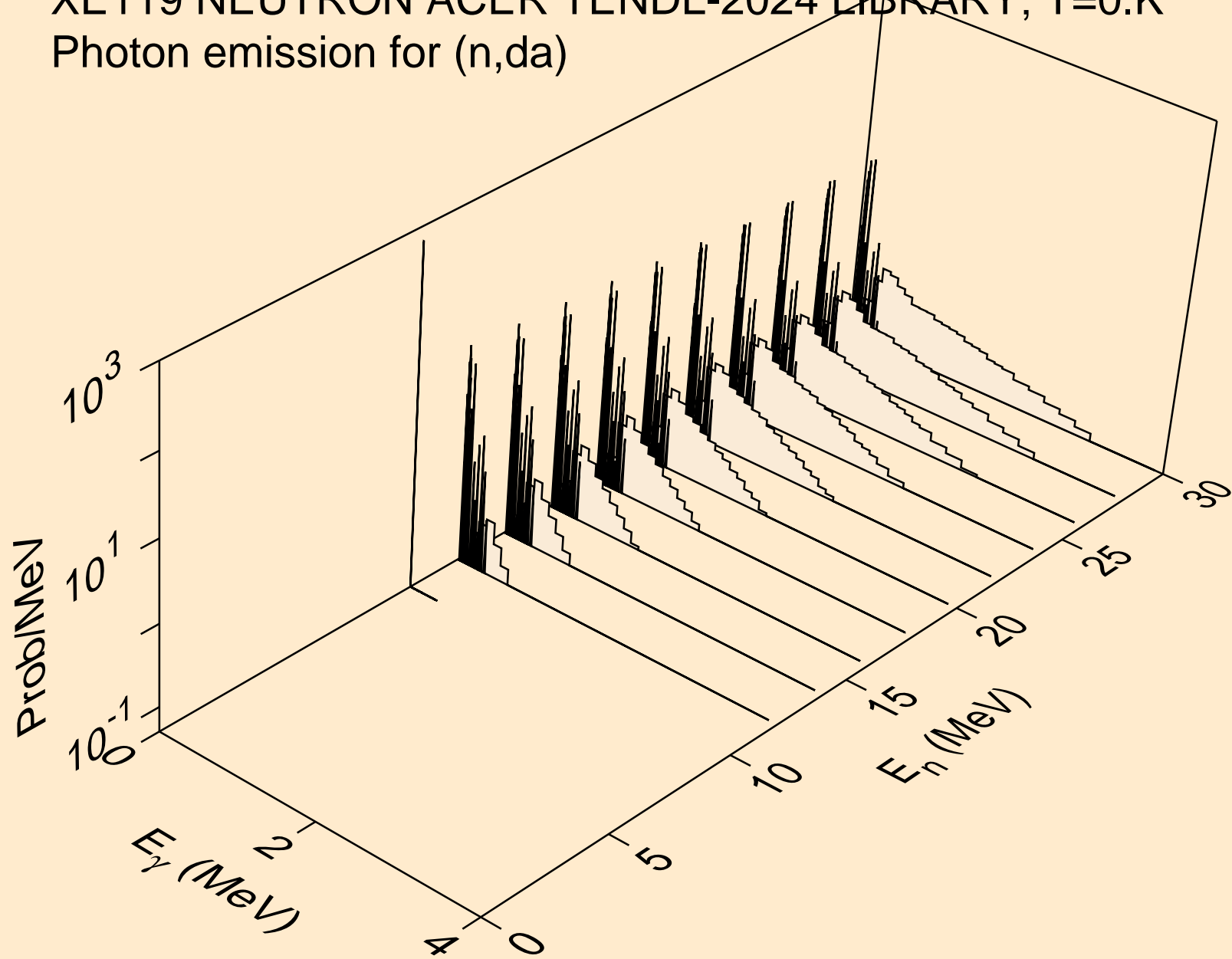

XE119 NEUTRON ACER TENDL-2024 LIBRARY; T=0.K  
thermal capture photon spectrum

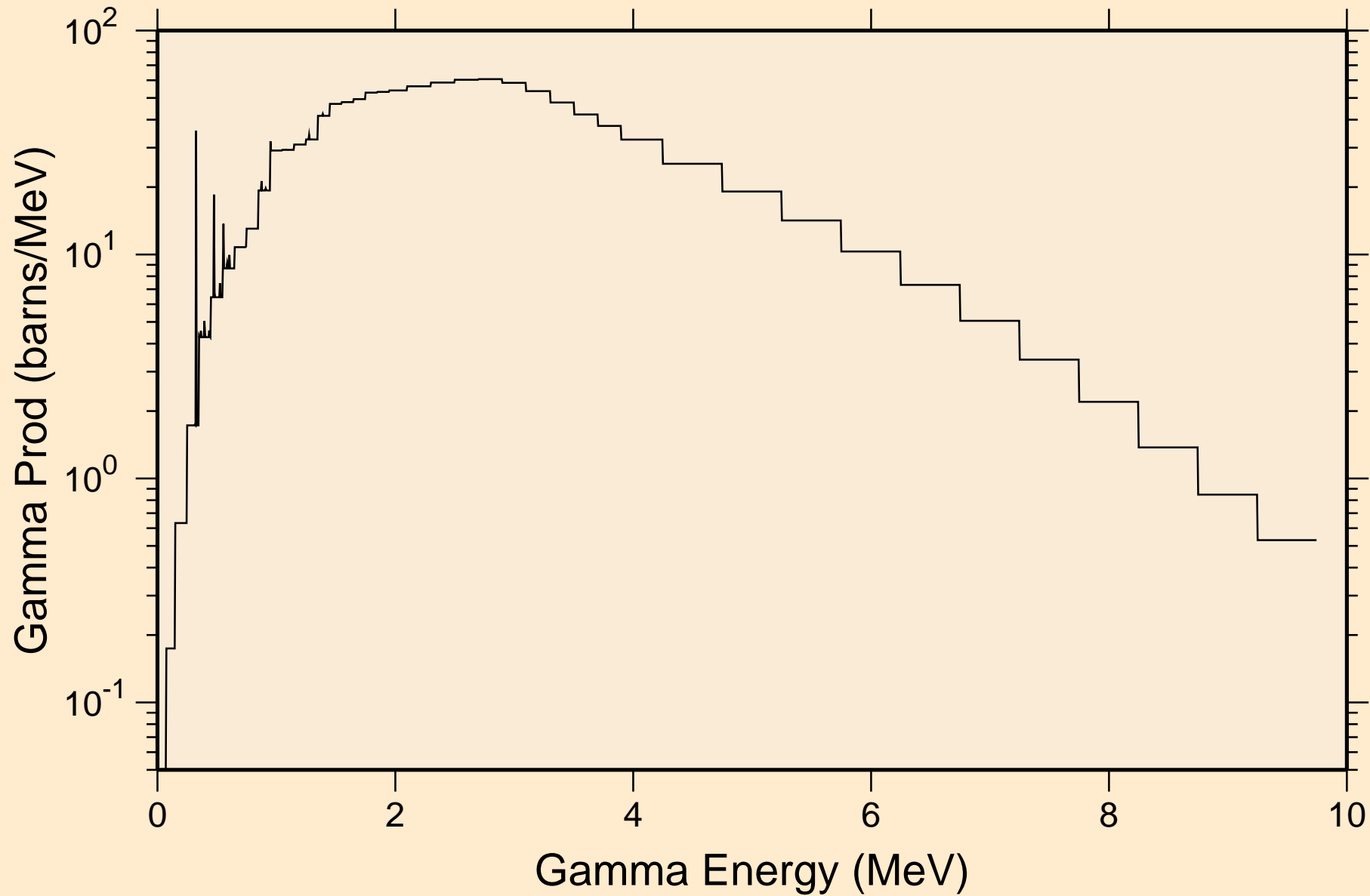

XE119 NEUTRON ACER TENDL-2024 LIBRARY; T=0.K  
14 MeV photon spectrum

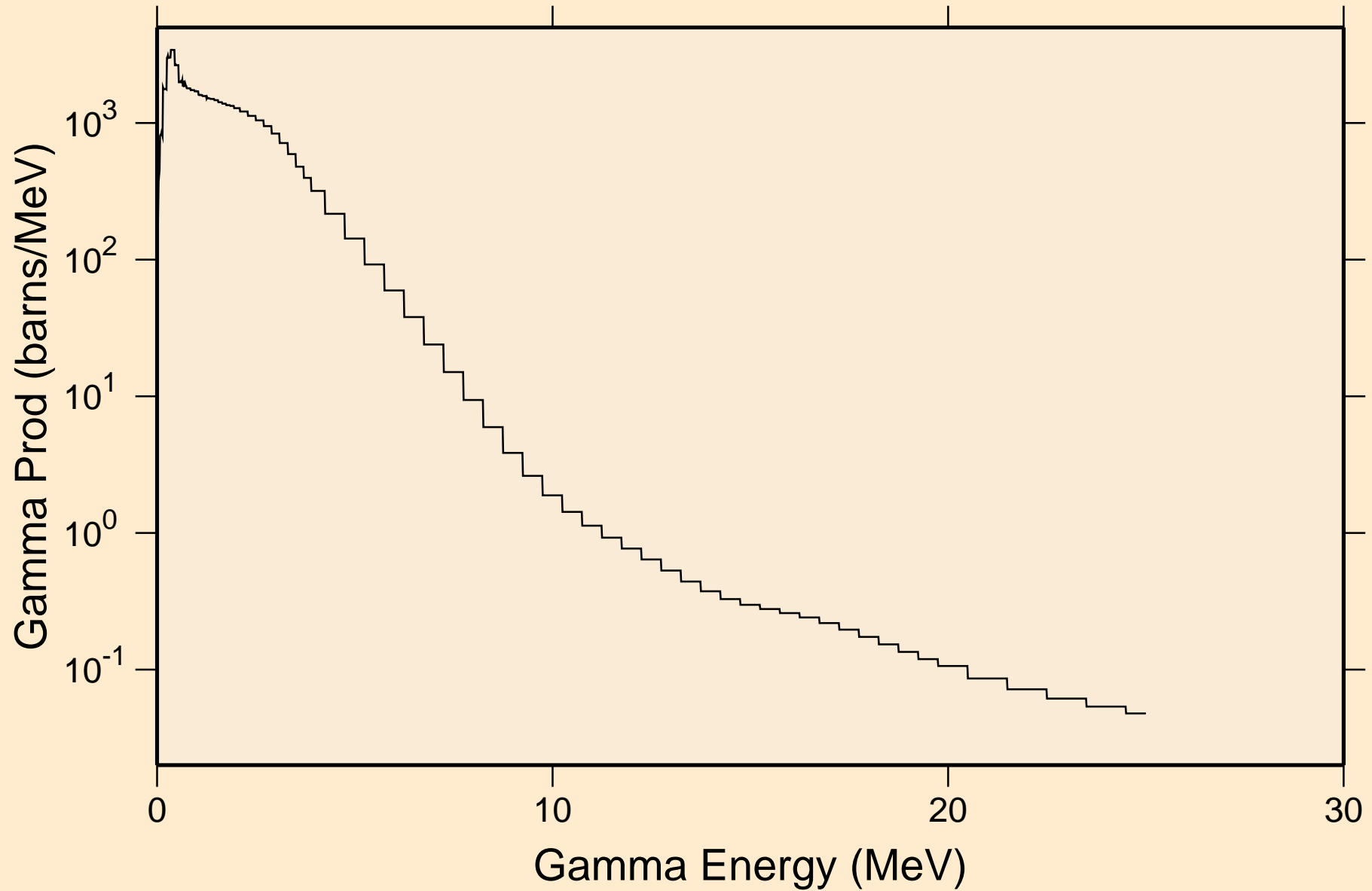

# XE119 NEUTRON ACER TENDL-2024 LIBRARY; T=0.K

## Particle heating contributions

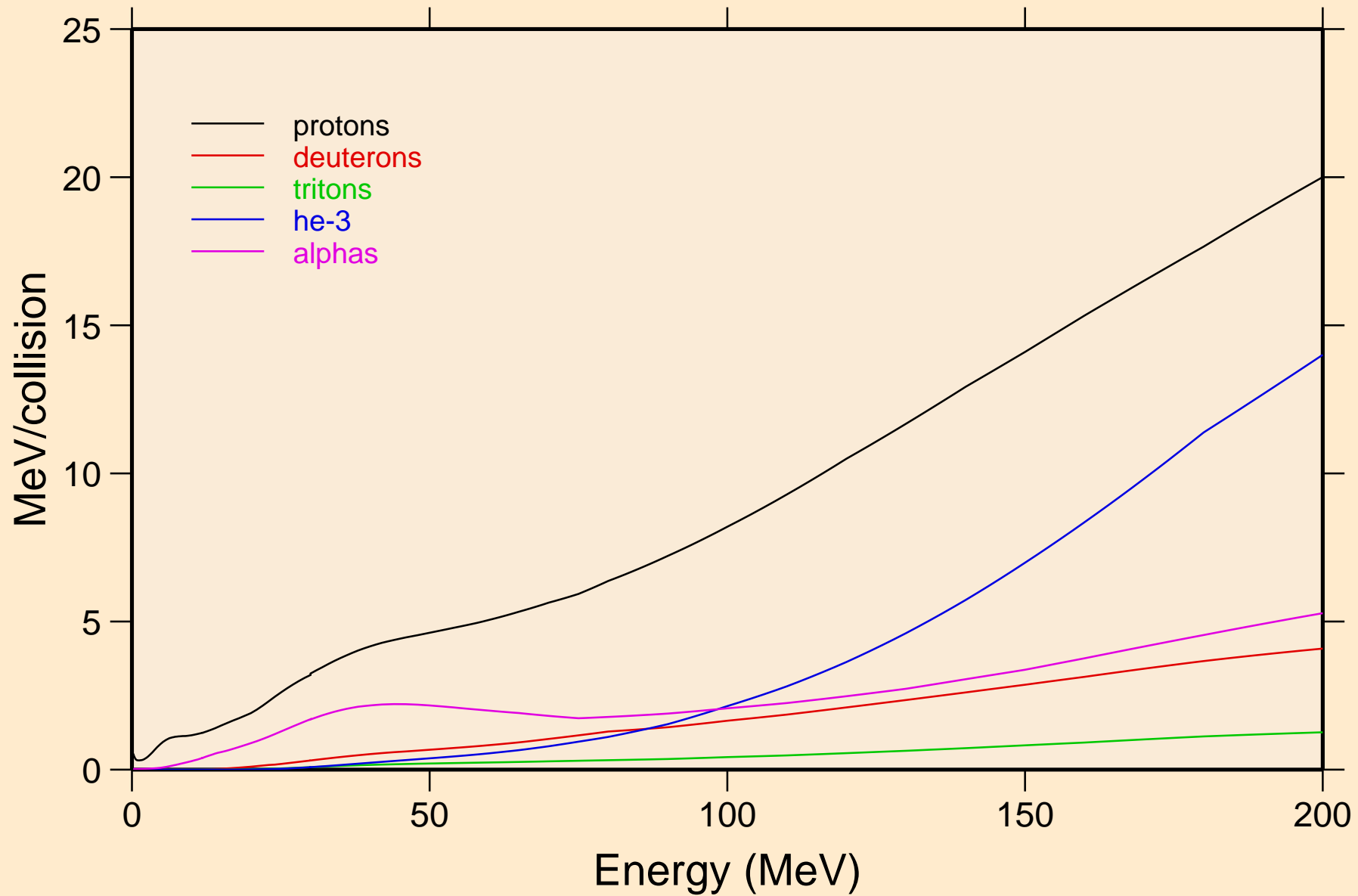

XE119 NEUTRON ACER TENDL-2024 LIBRARY; T=0.K  
Recoil Heating

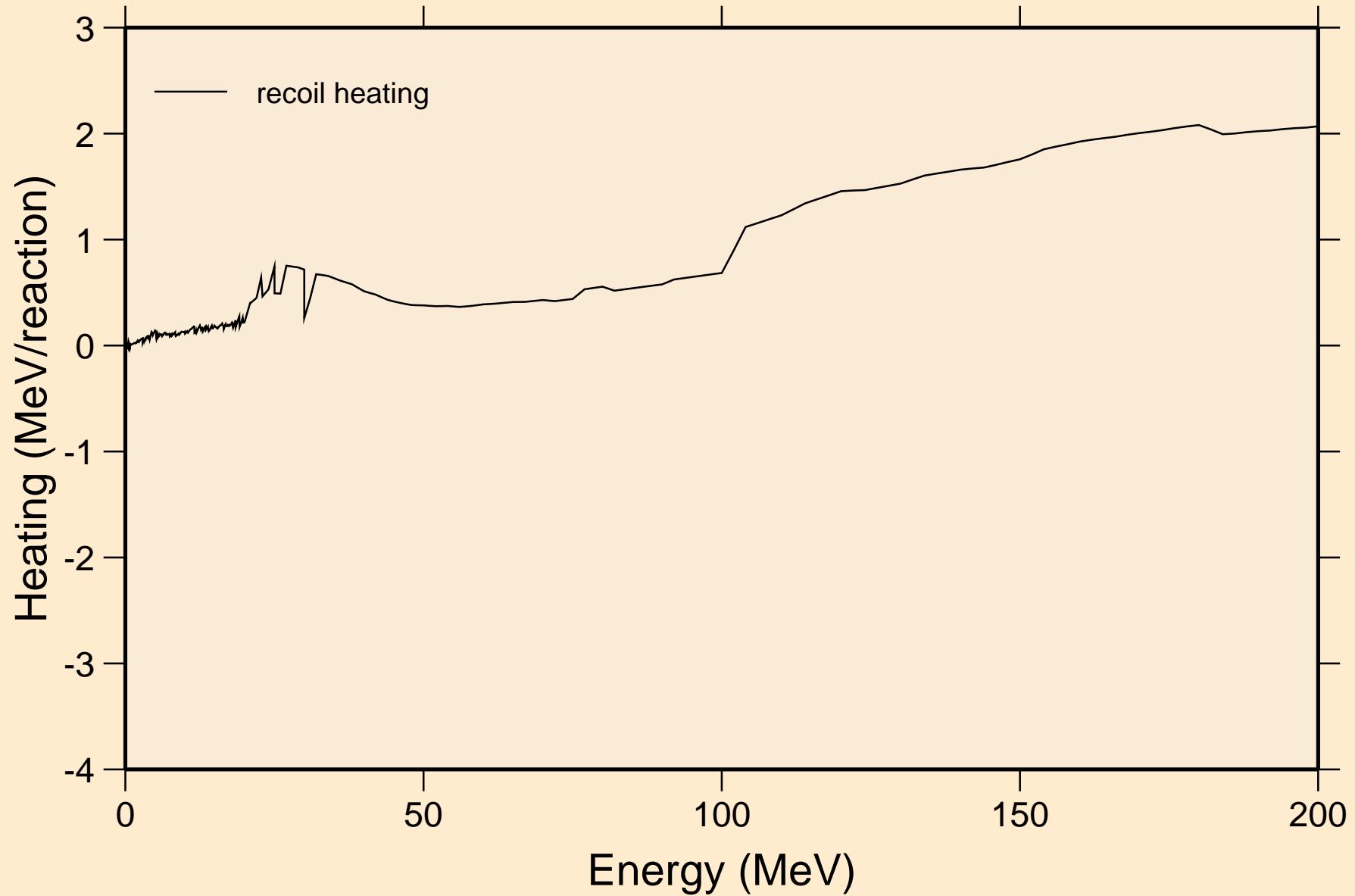

# XE119 NEUTRON ACER TENDL-2024 LIBRARY; T=0.K

## Particle production cross sections

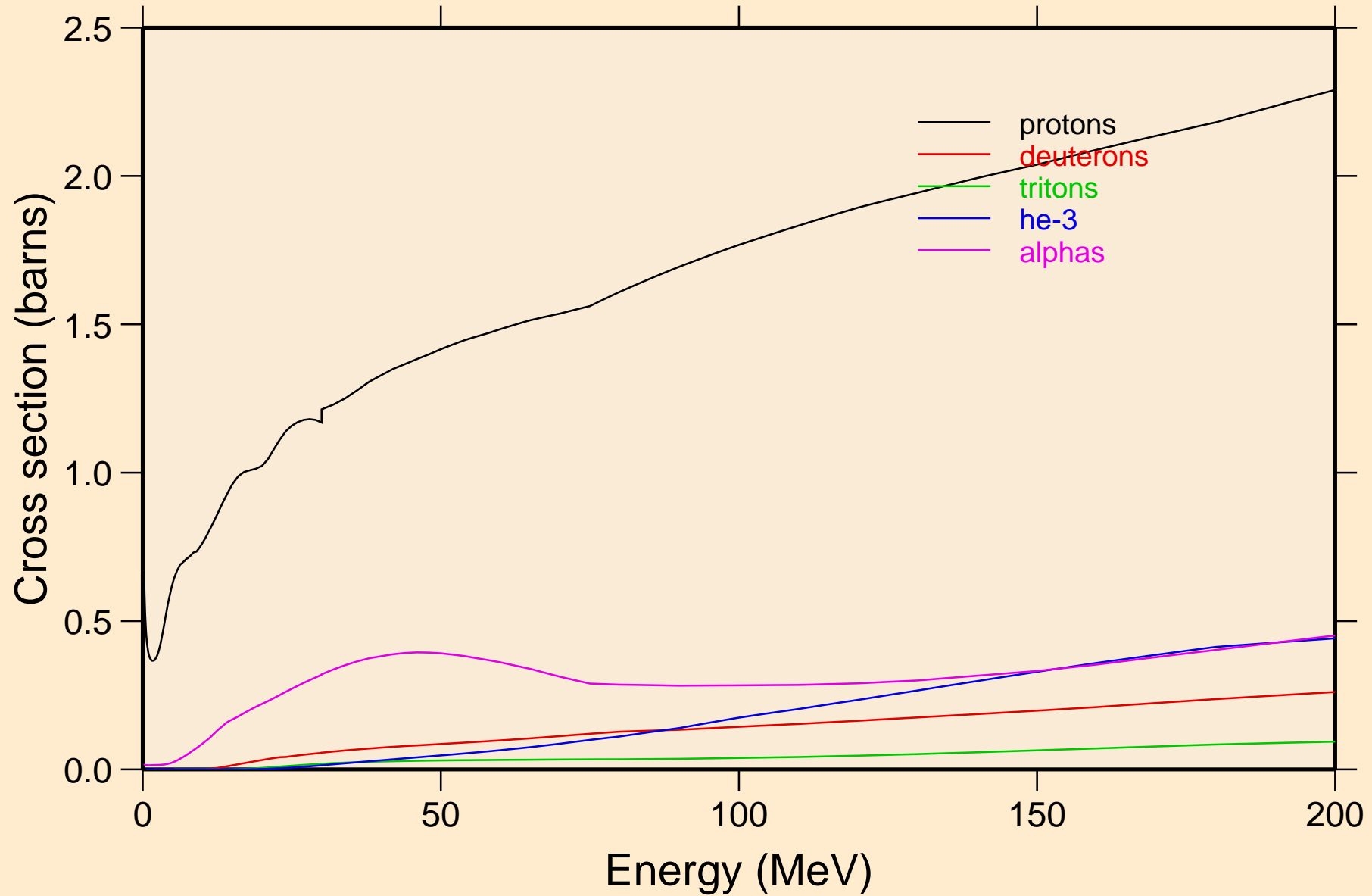

XE119 NEUTRON ACER TENDL-2024 LIBRARY; T=0.K  
protons from (n,x)

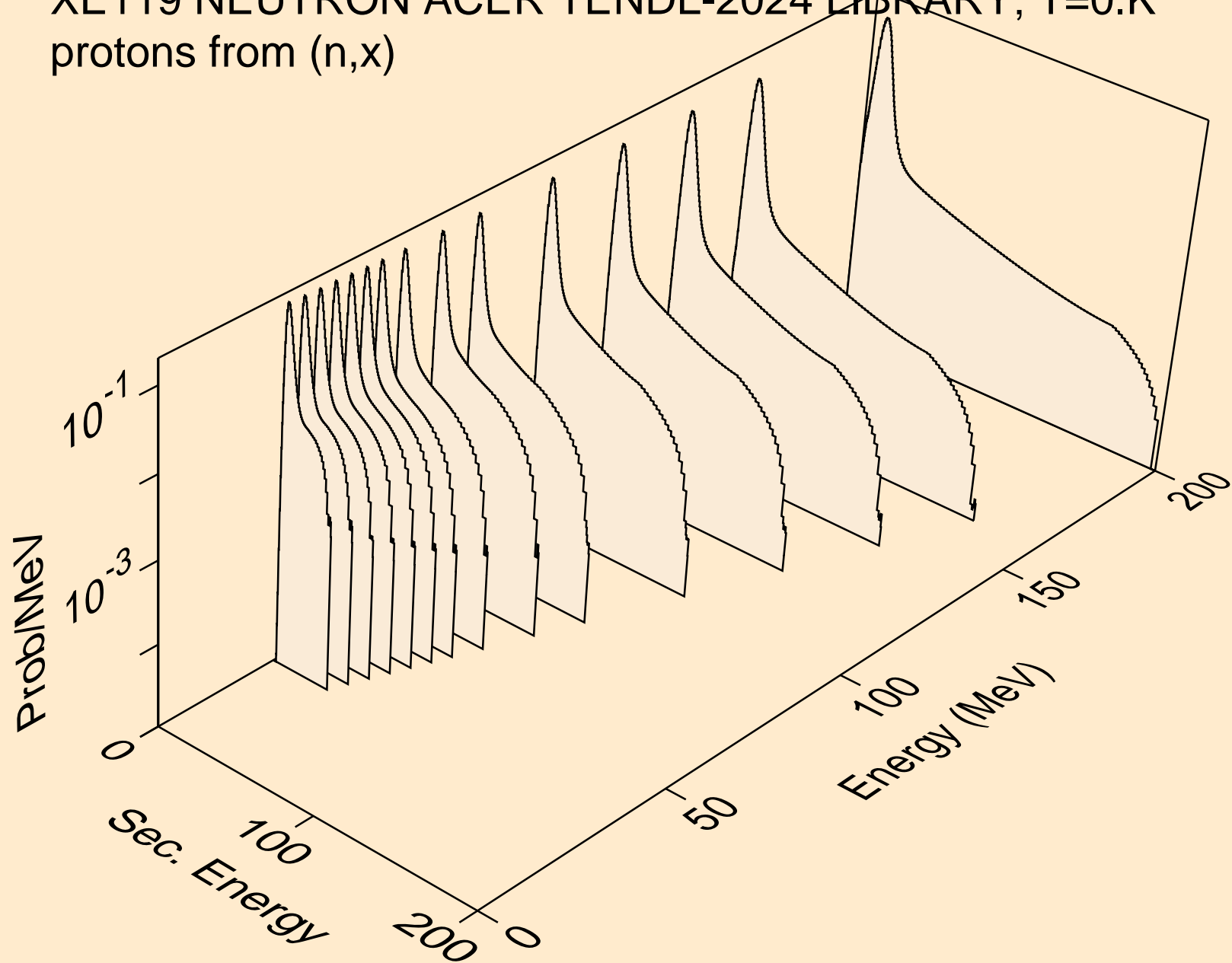

XE119 NEUTRON ACER TENDL-2024 LIBRARY; T=0.K  
protons from (n,n\*)p

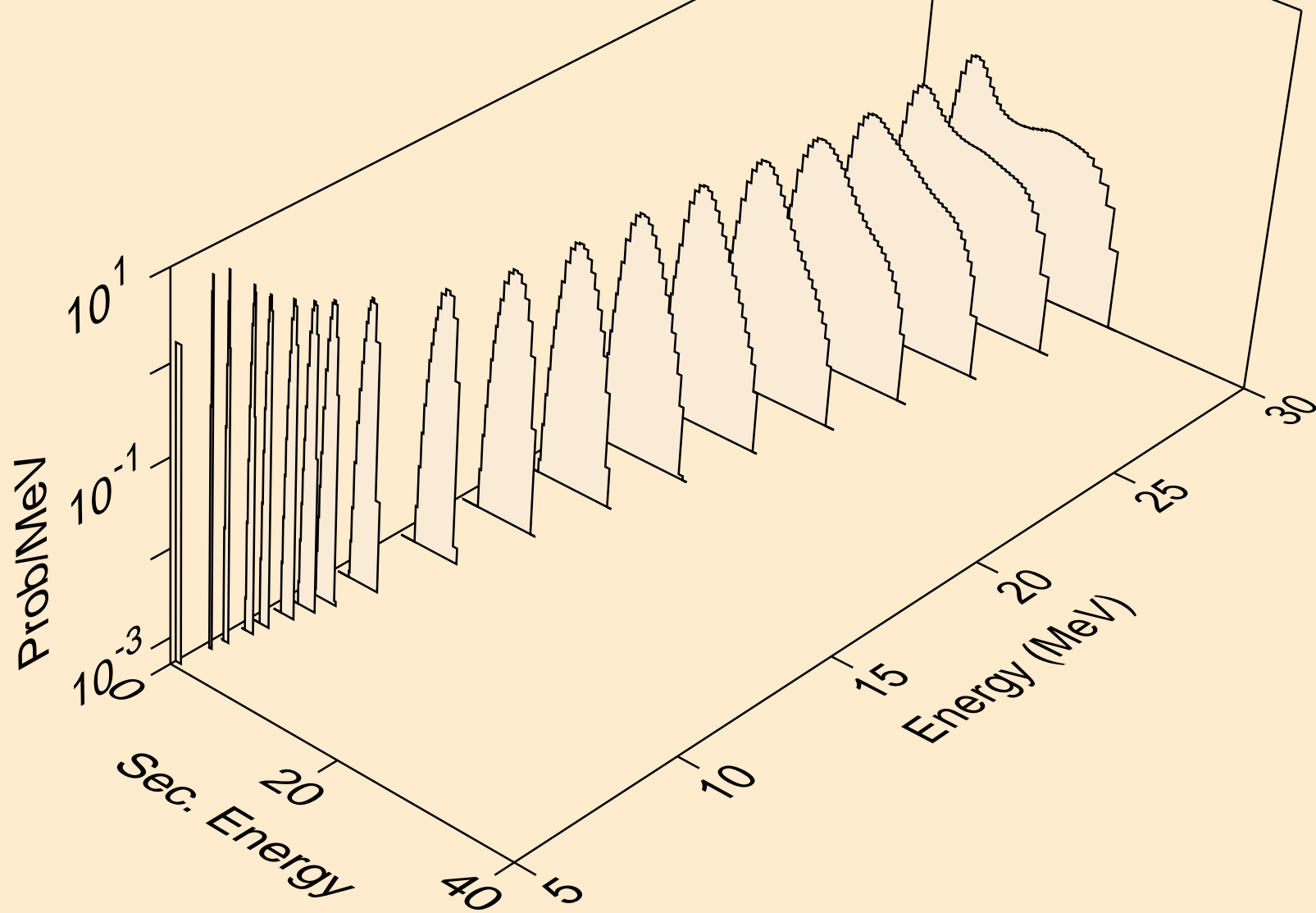

XE119 NEUTRON ACER TENDL-2024 LIBRARY; T=0.K  
protons from (n,2np)

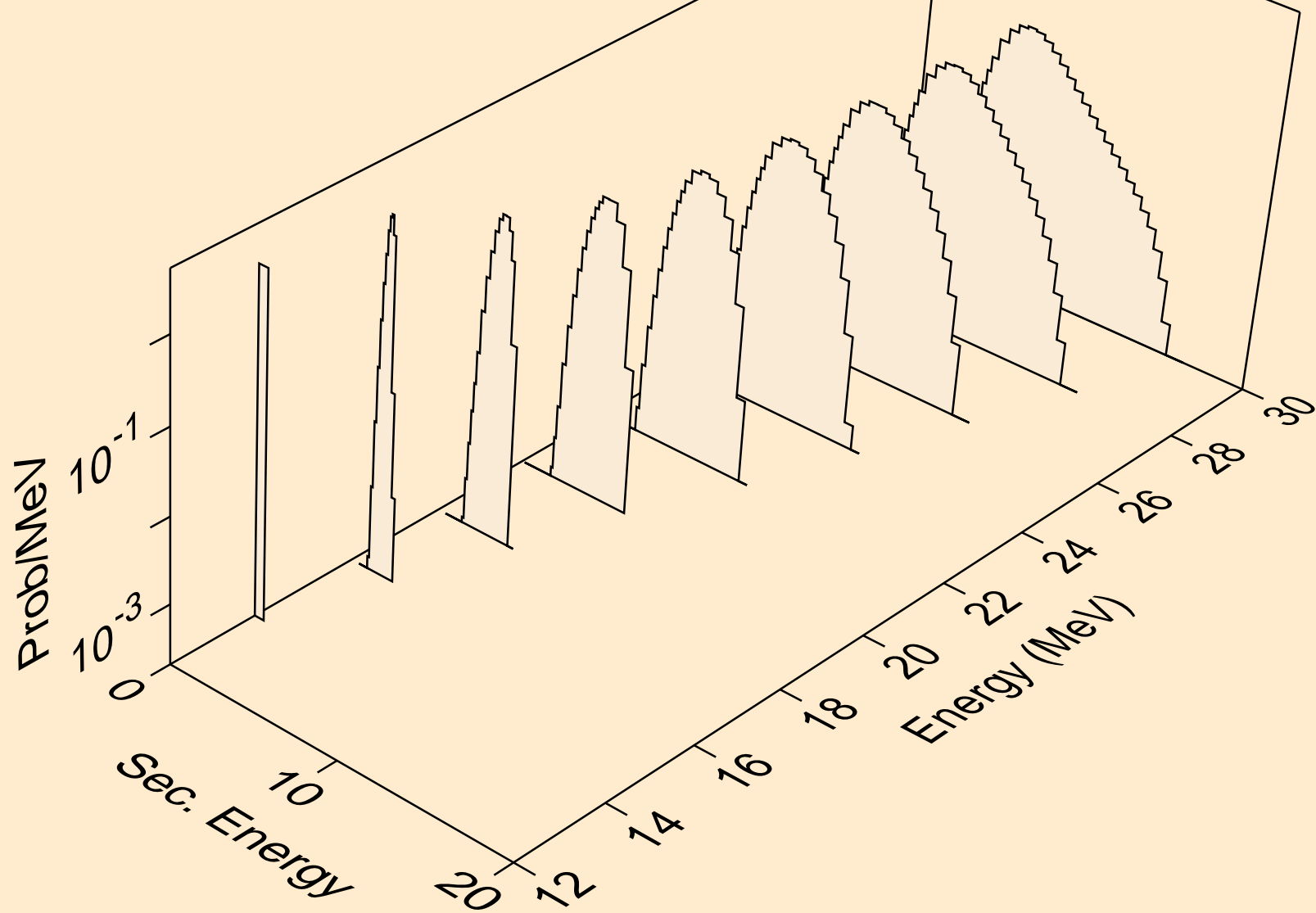

XE119 NEUTRON ACER TENDL-2024 LIBRARY; T=0.K  
protons from (n,3np)

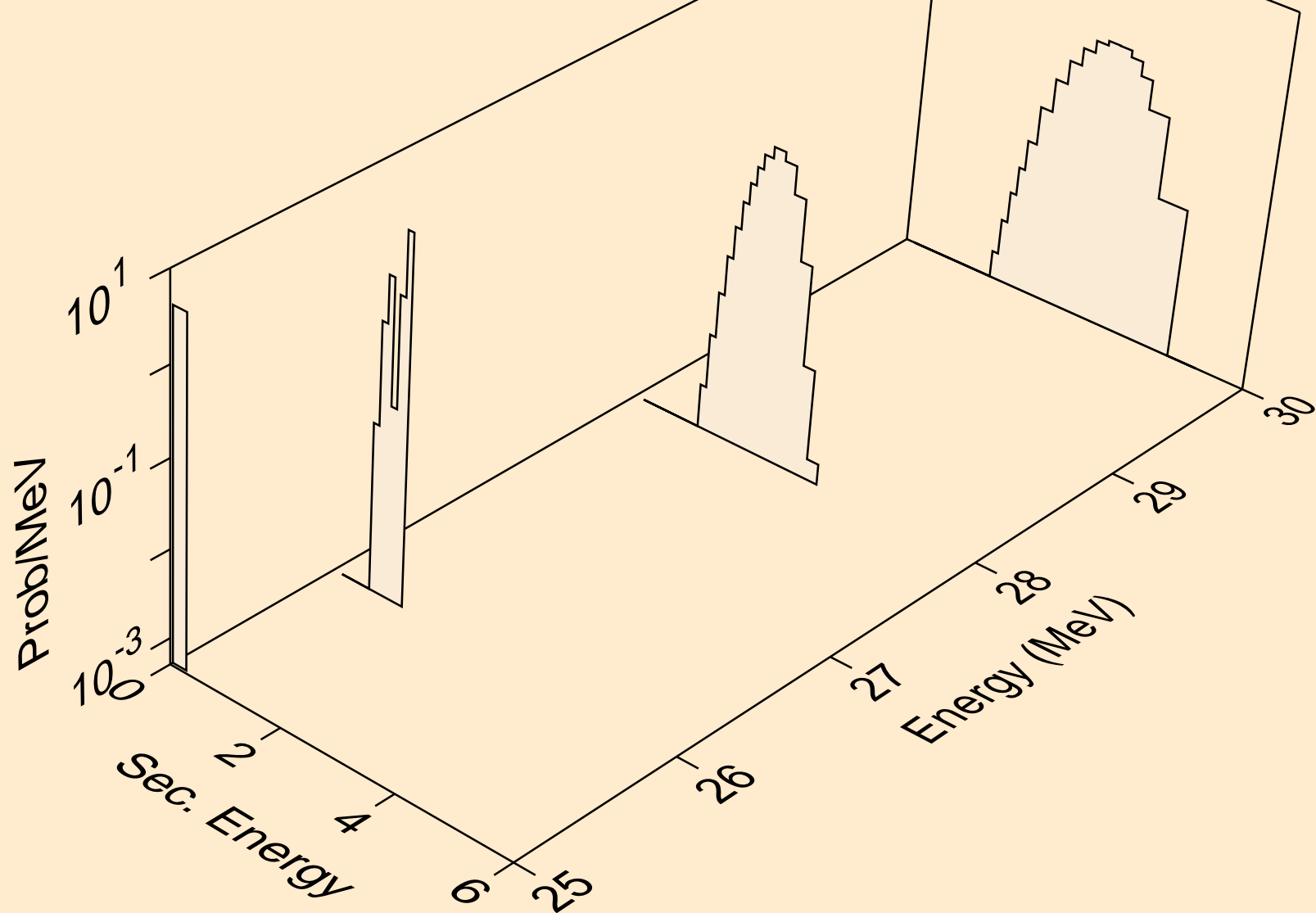

XE119 NEUTRON ACER TENDL-2024 LIBRARY; T=0.K  
protons from (n,n2p)

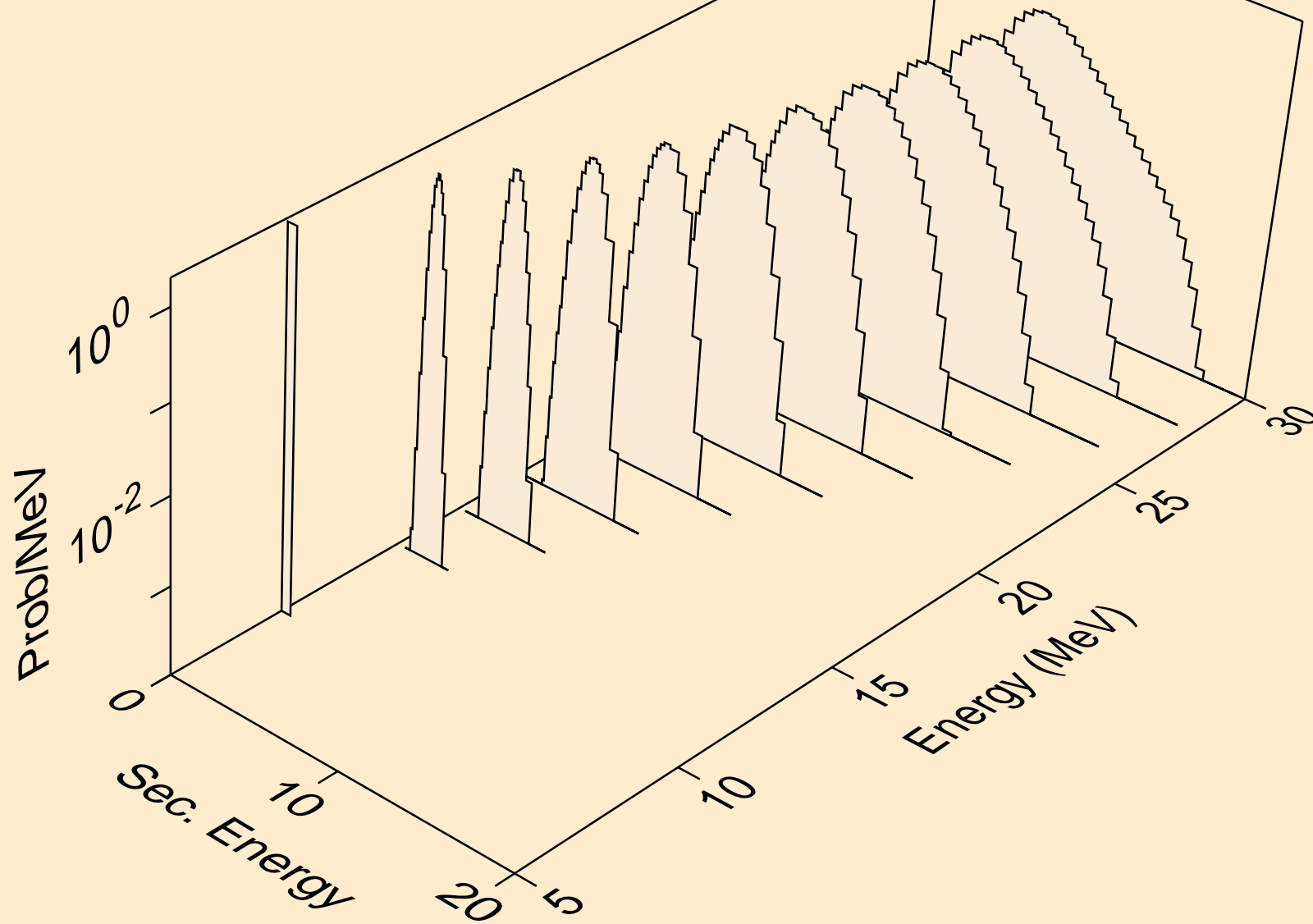

XE119 NEUTRON ACER TENDL-2024 LIBRARY; T=0.K  
protons from (n,npa)

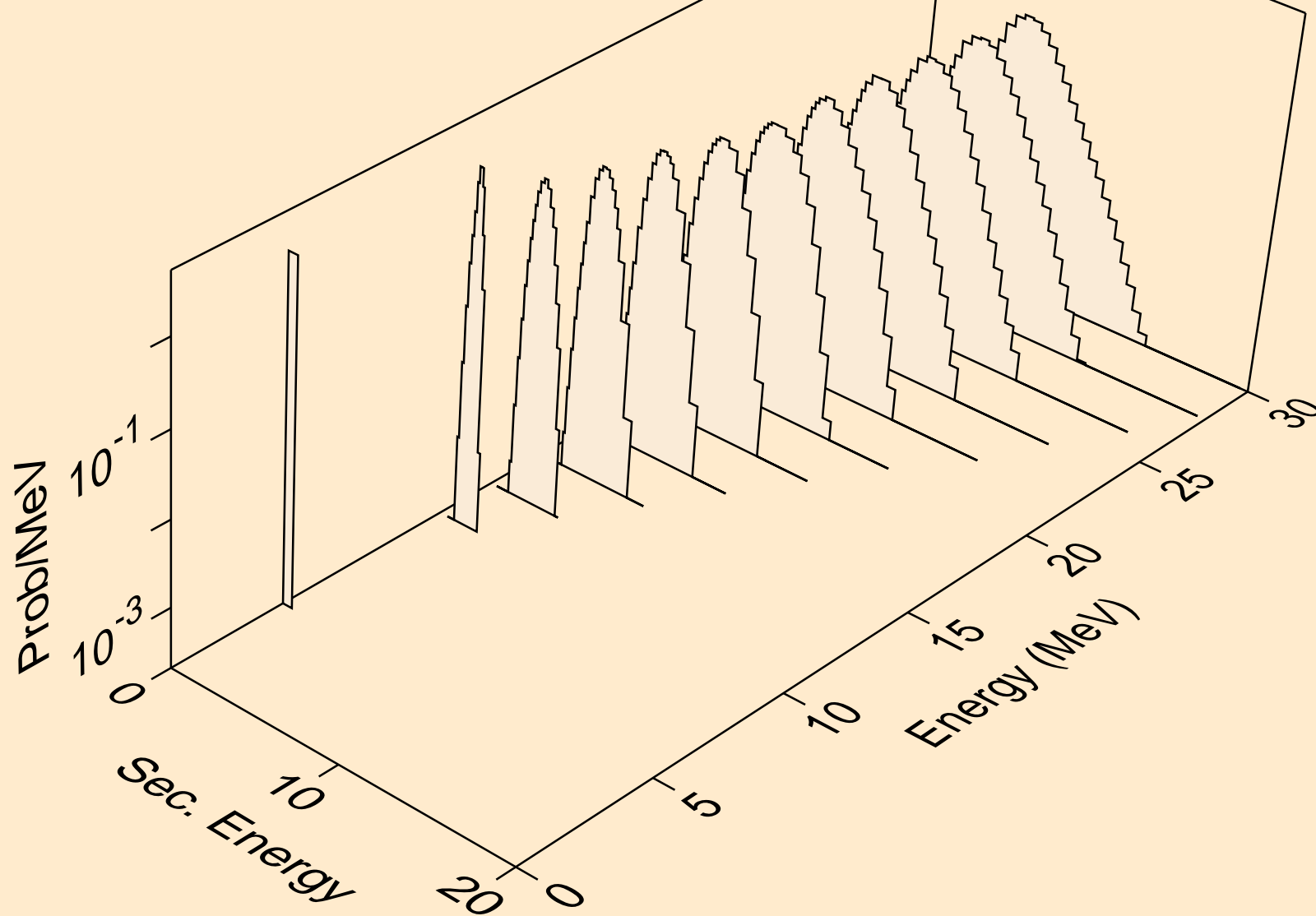

XE119 NEUTRON ACER TENDL-2024 LIBRARY; T=0.K  
protons from (n,p)

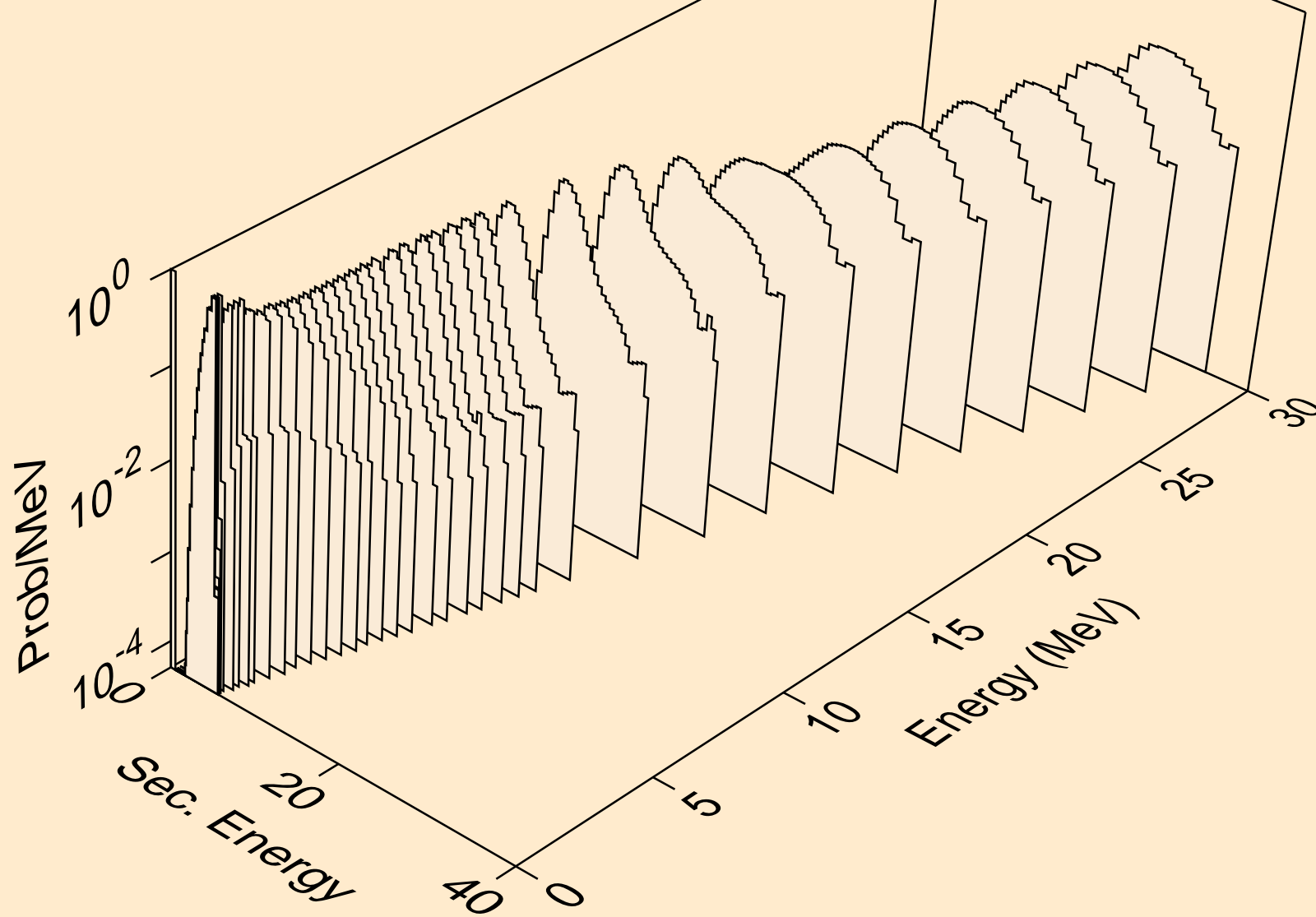

XE119 NEUTRON ACER TENDL-2024 LIBRARY; T=0.K  
protons from (n,2p)

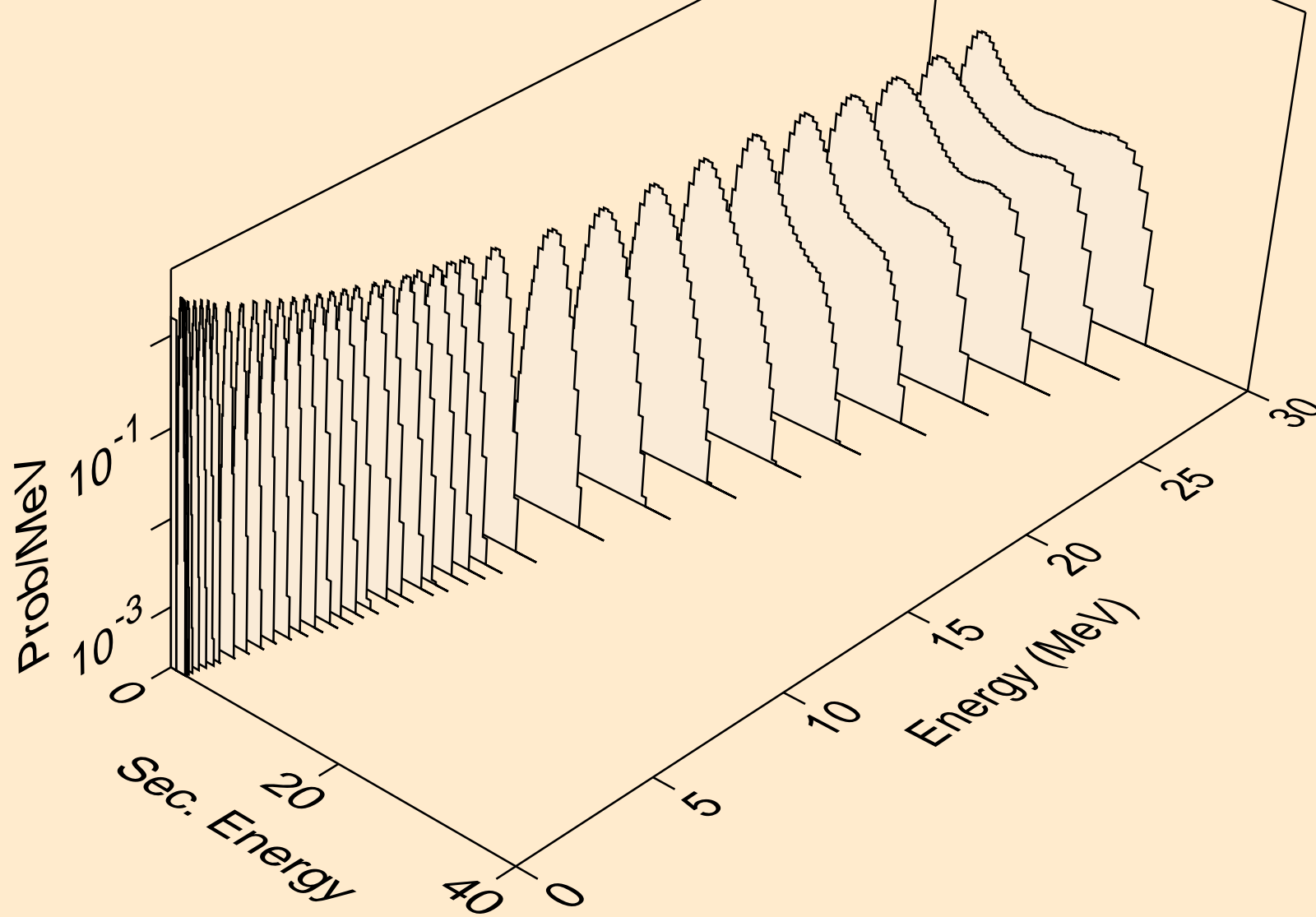

XE119 NEUTRON ACER TENDL-2024 LIBRARY; T=0.K  
protons from (n,p)

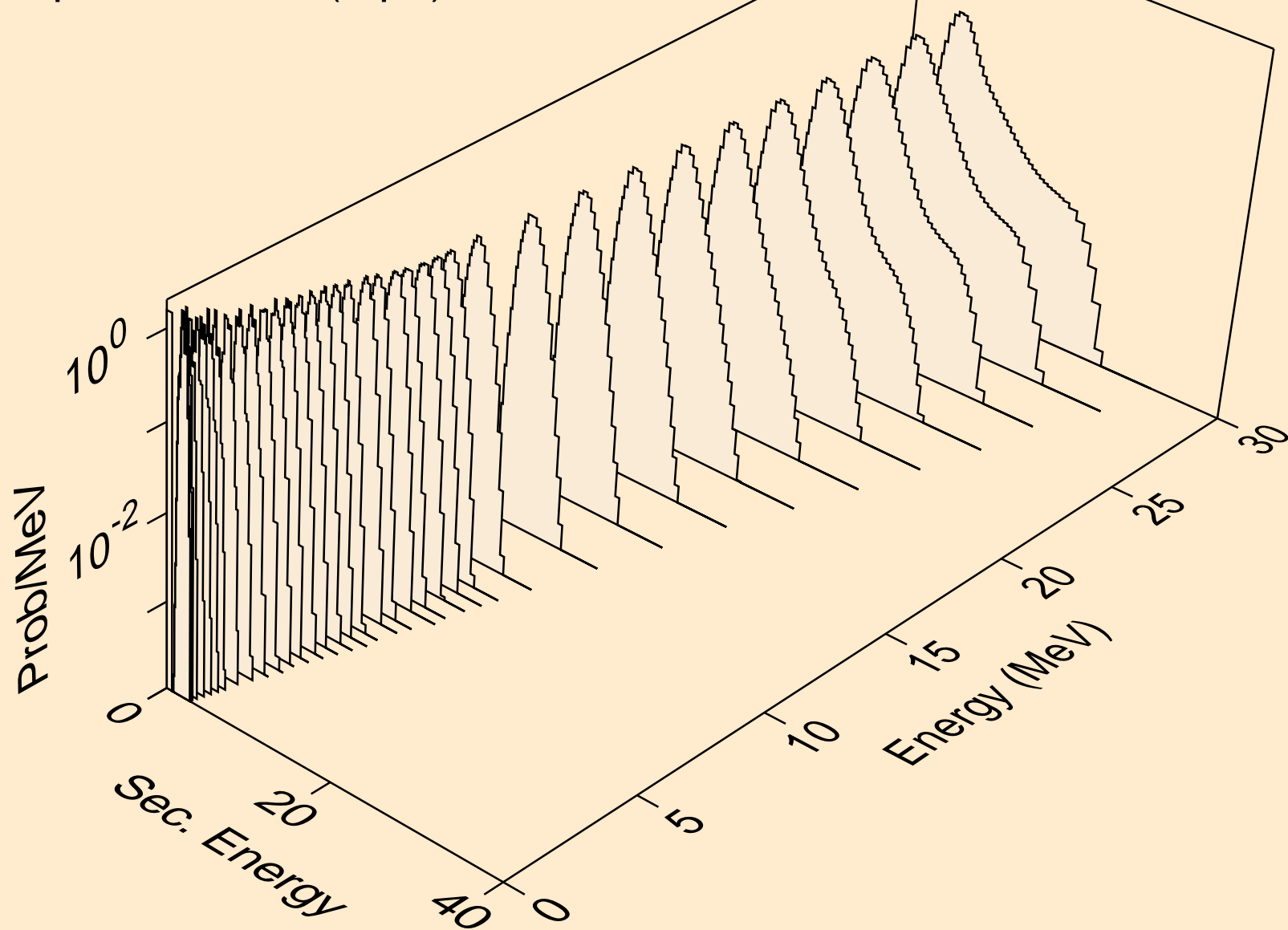

XE119 NEUTRON ACER TENDL-2024 LIBRARY; T=0.K  
protons from (n,pd)

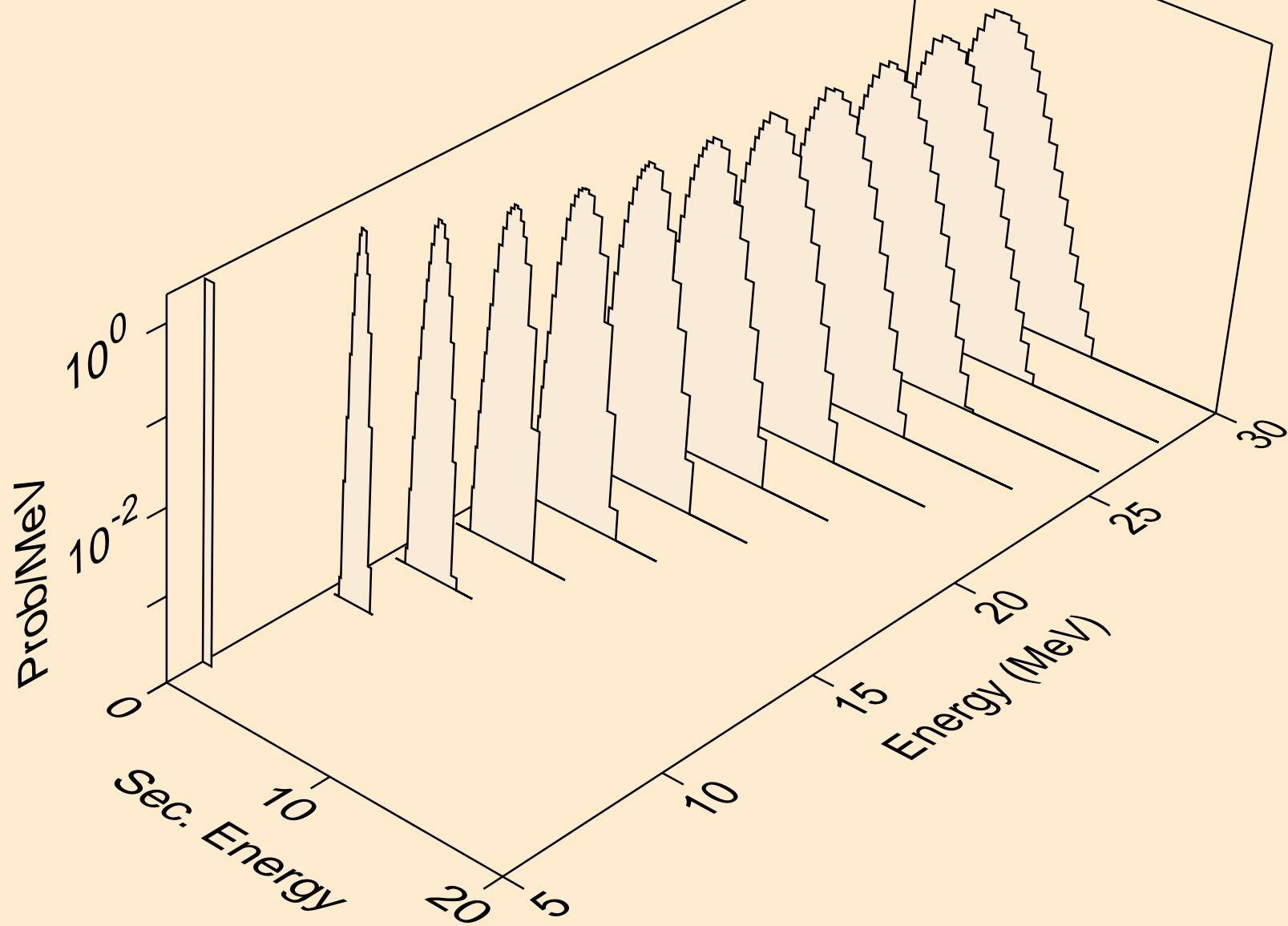

XE119 NEUTRON ACER TENDL-2024 LIBRARY; T=0.K  
protons from (n,pt)

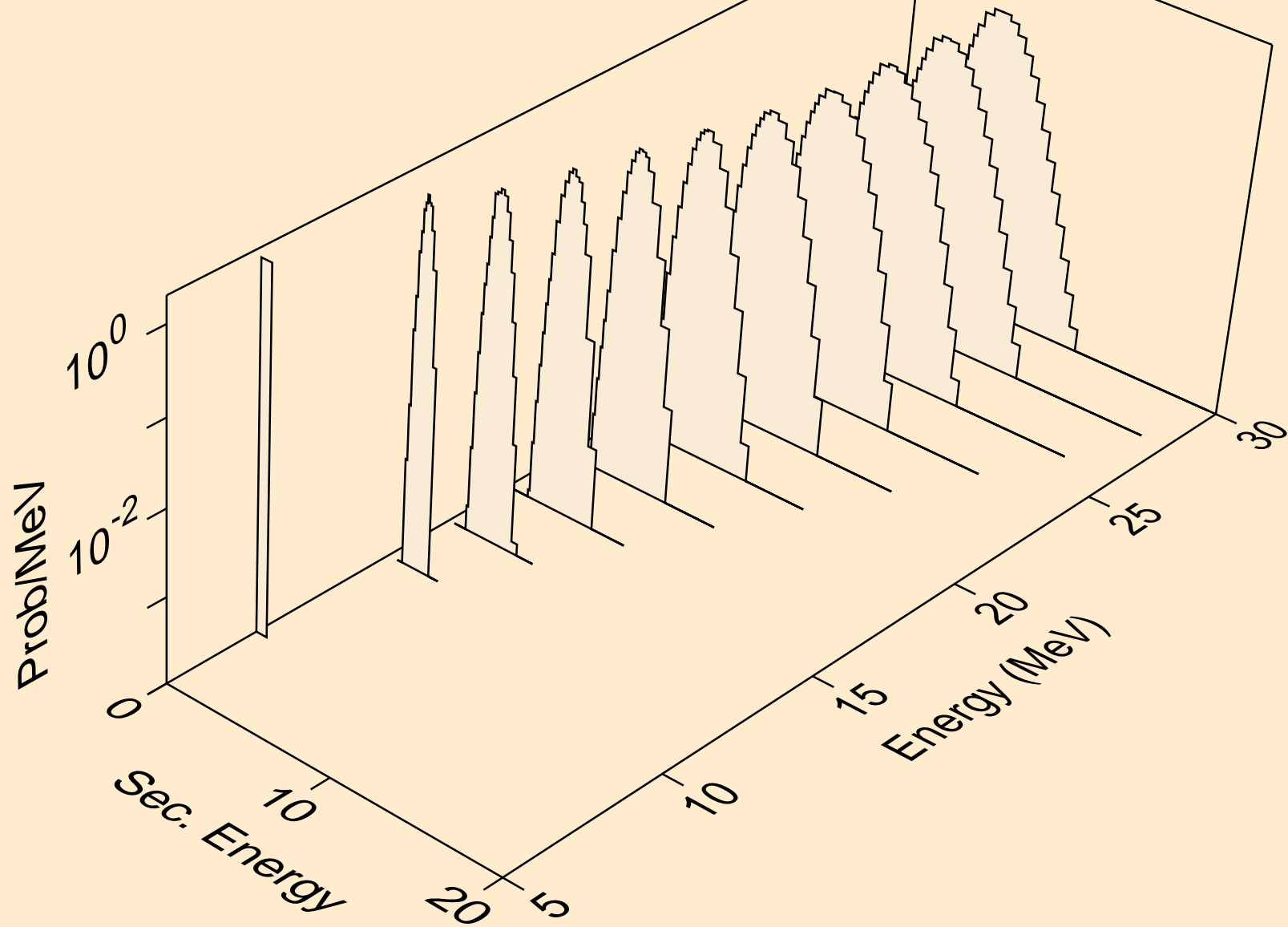

XE119 NEUTRON ACER TENDL-2024 LIBRARY; T=0.K  
deuterons from (n,x)

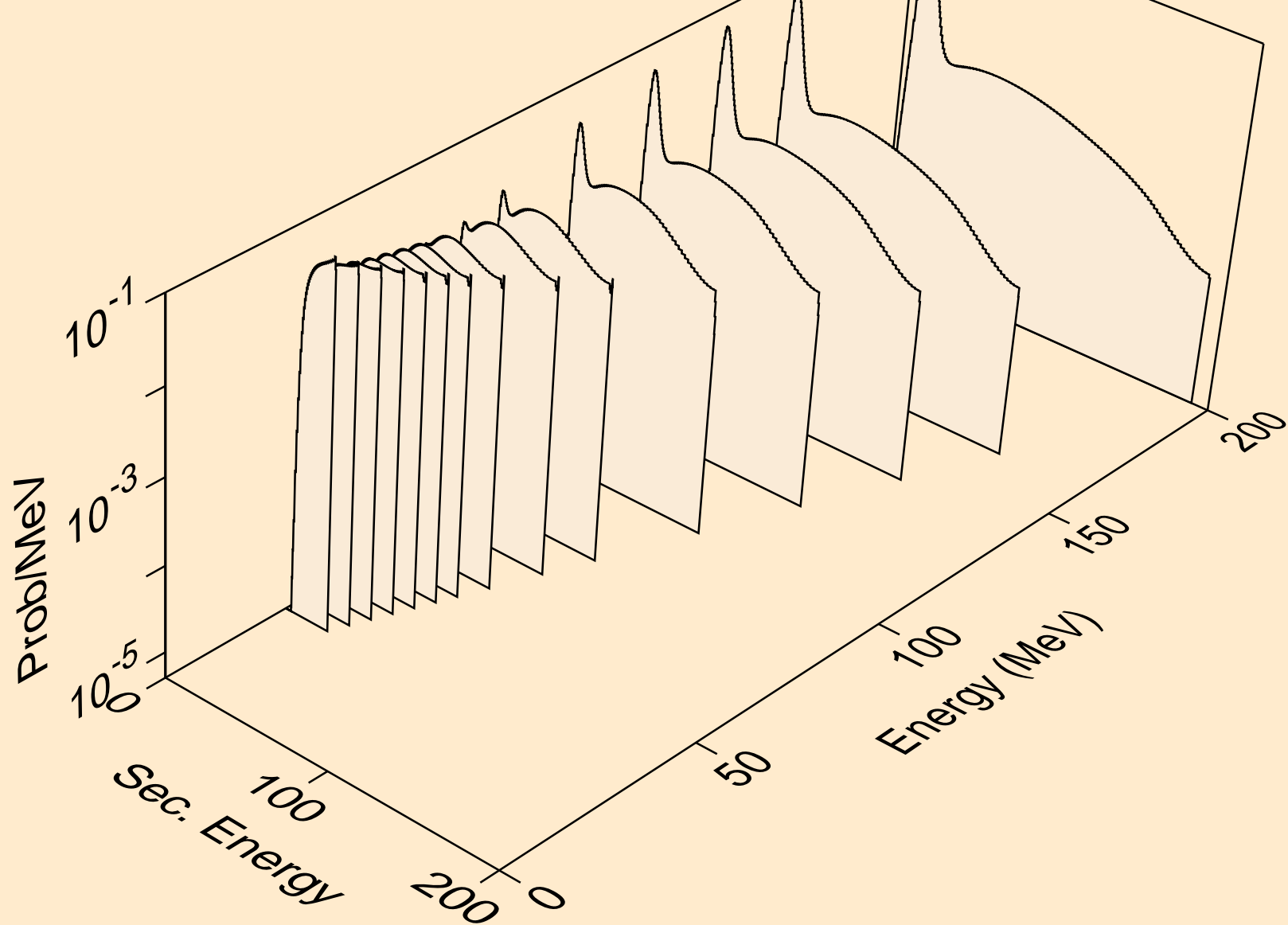

XE119 NEUTRON ACER TENDL-2024 LIBRARY; T=0.K  
deuterons from (n,2nd)

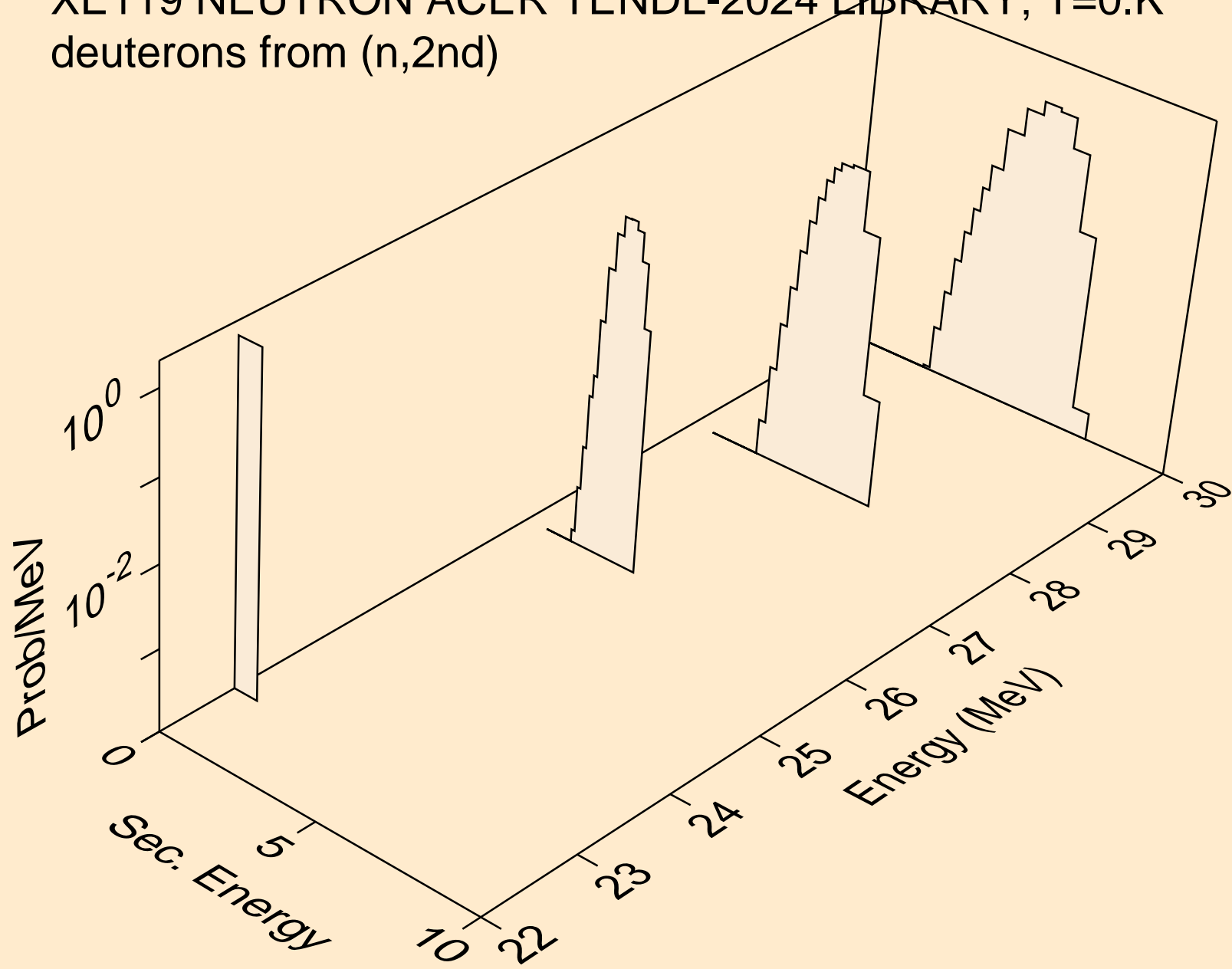

XE119 NEUTRON ACER TENDL-2024 LIBRARY; T=0.K  
deuterons from (n,n\*)d

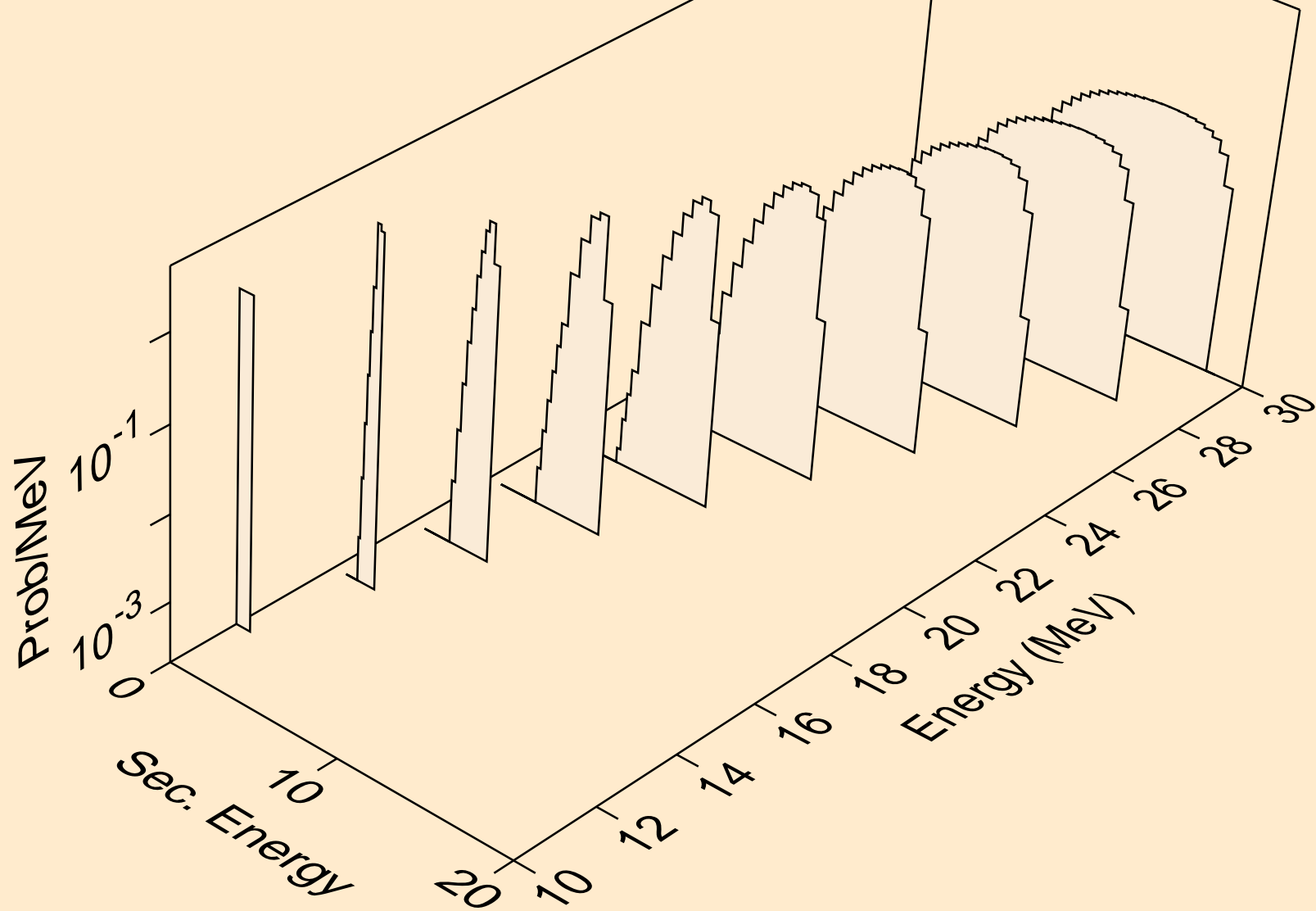

XE119 NEUTRON ACER TENDL-2024 LIBRARY; T=0.K  
deuterons from (n,d)

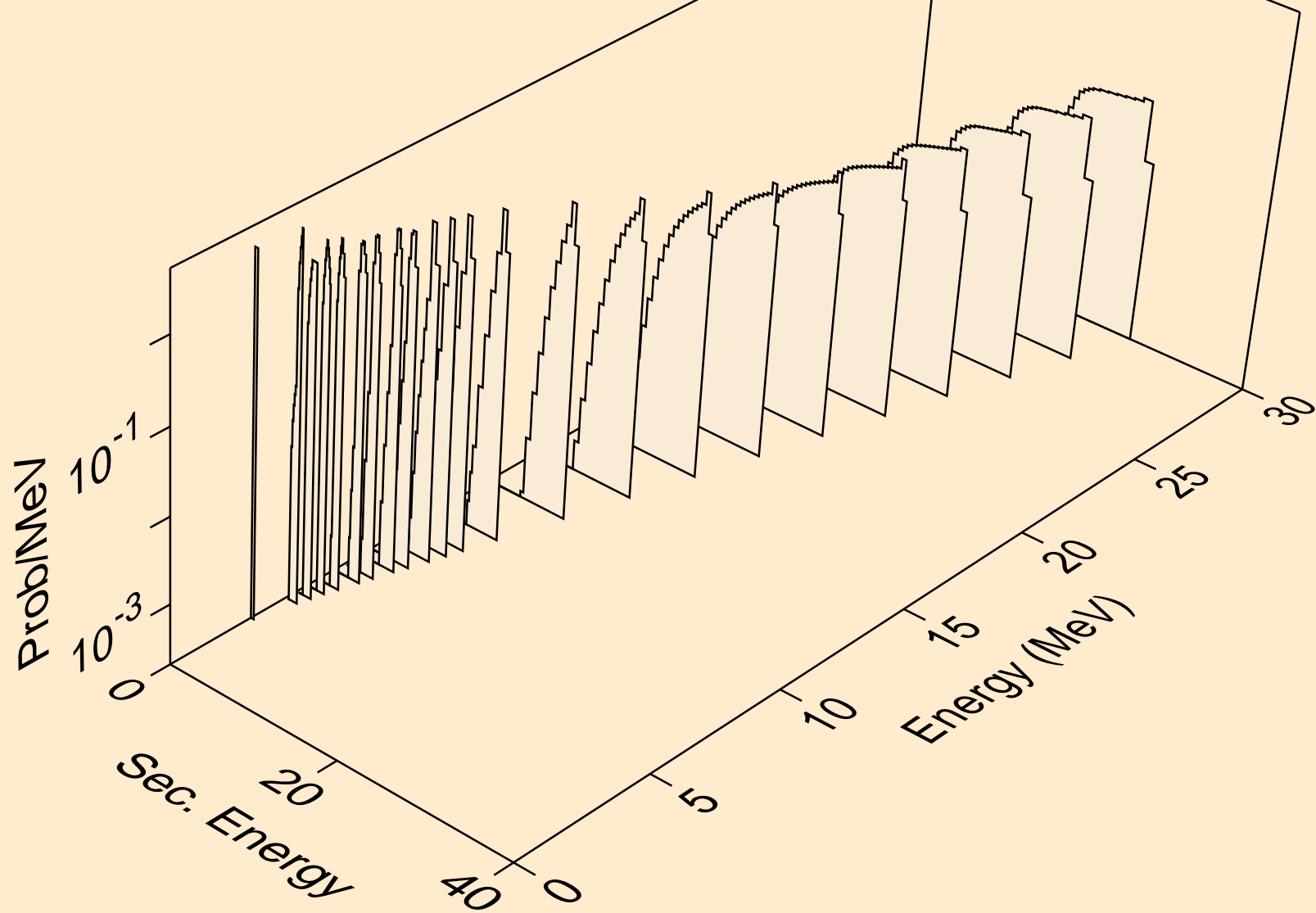

XE119 NEUTRON ACER TENDL-2024 LIBRARY; T=0.K  
deuterons from (n,pd)

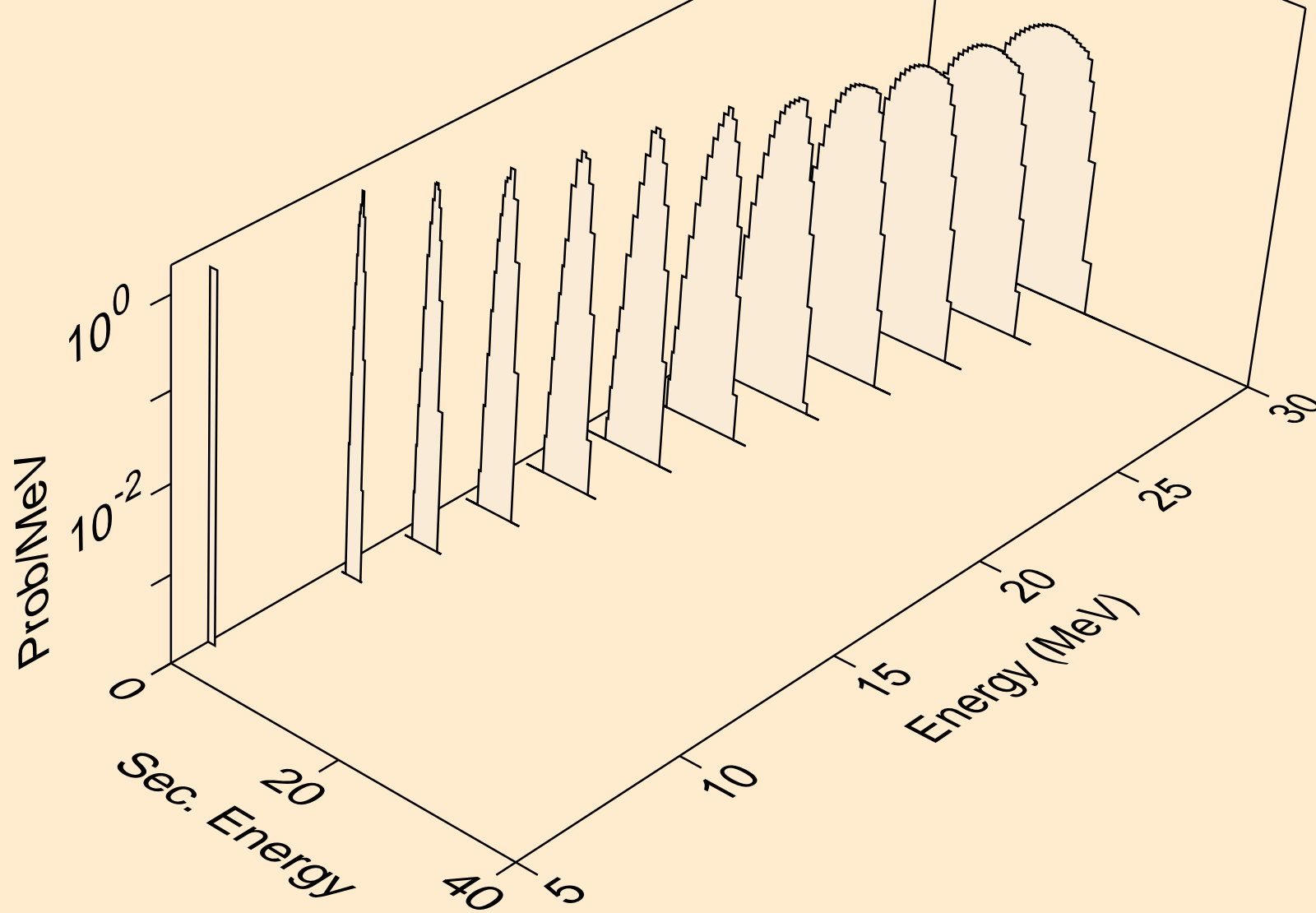

XE119 NEUTRON ACER TENDL-2024 LIBRARY; T=0.K  
deuterons from (n,da)

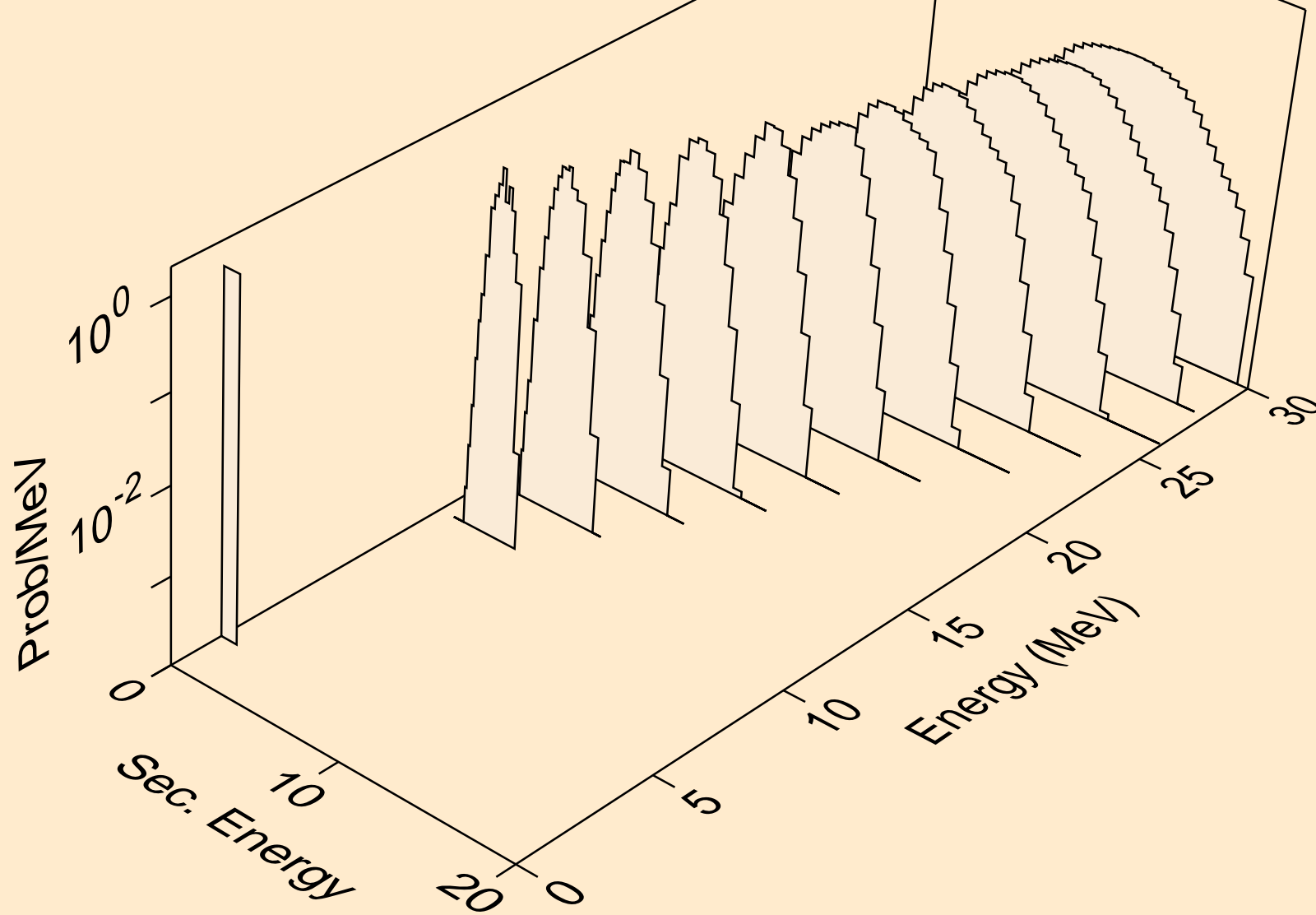

XE119 NEUTRON ACER TENDL-2024 LIBRARY; T=0.K  
tritons from (n,x)

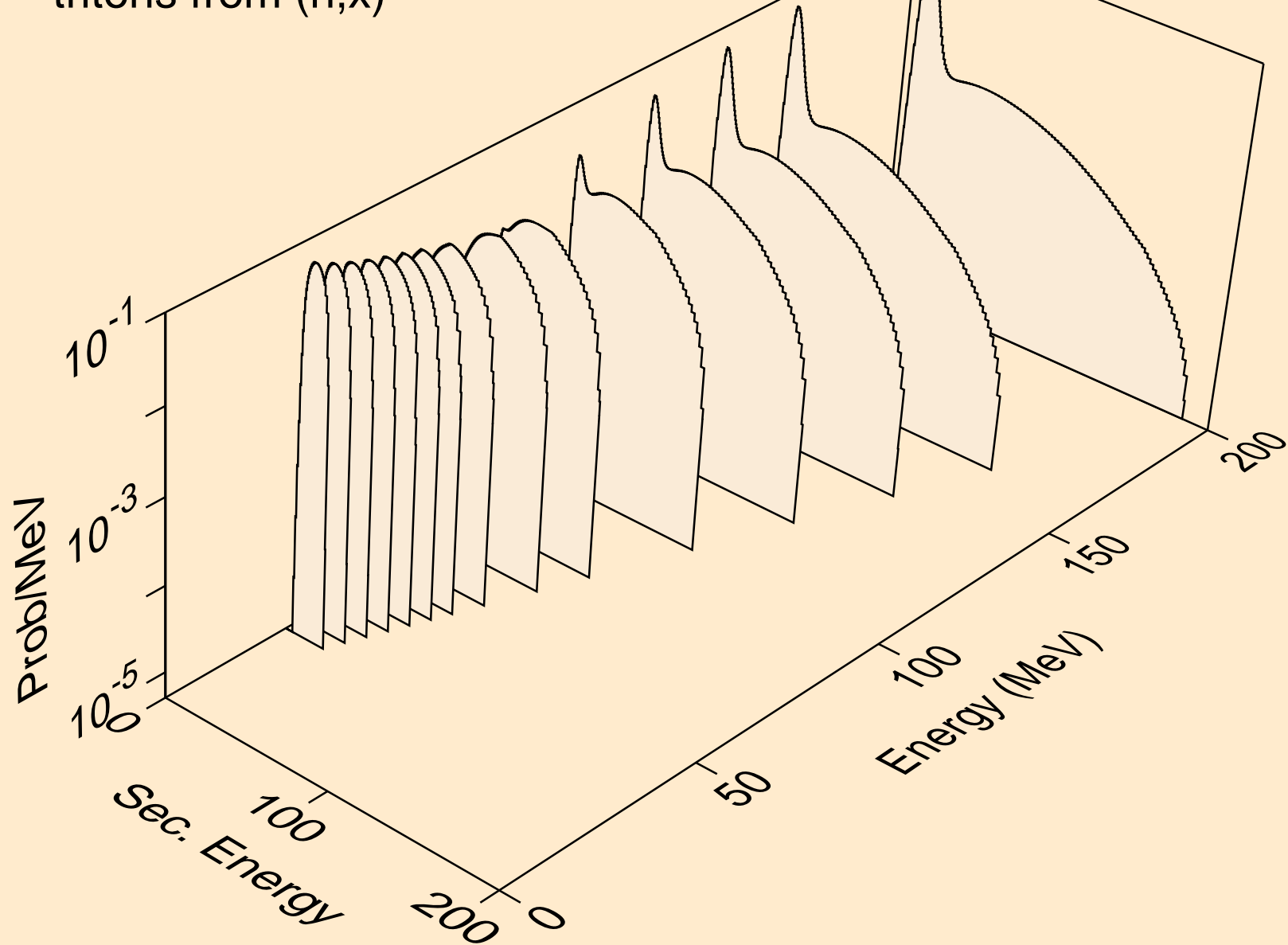

XE119 NEUTRON ACER TENDL-2024 LIBRARY; T=0.K  
tritons from (n,n\*)t

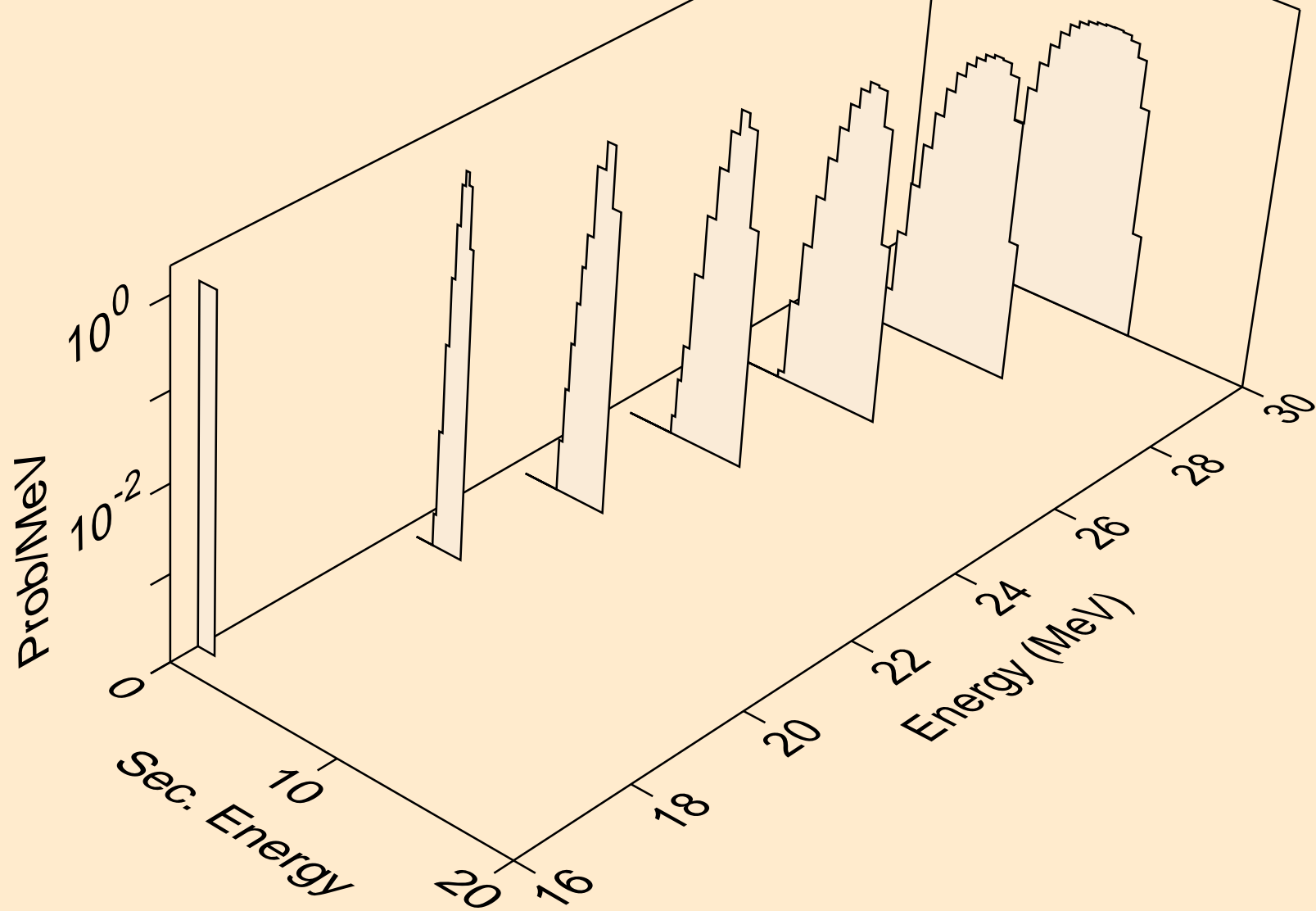

XE119 NEUTRON ACER TENDL-2024 LIBRARY; T=0.K  
tritons from (n,t)

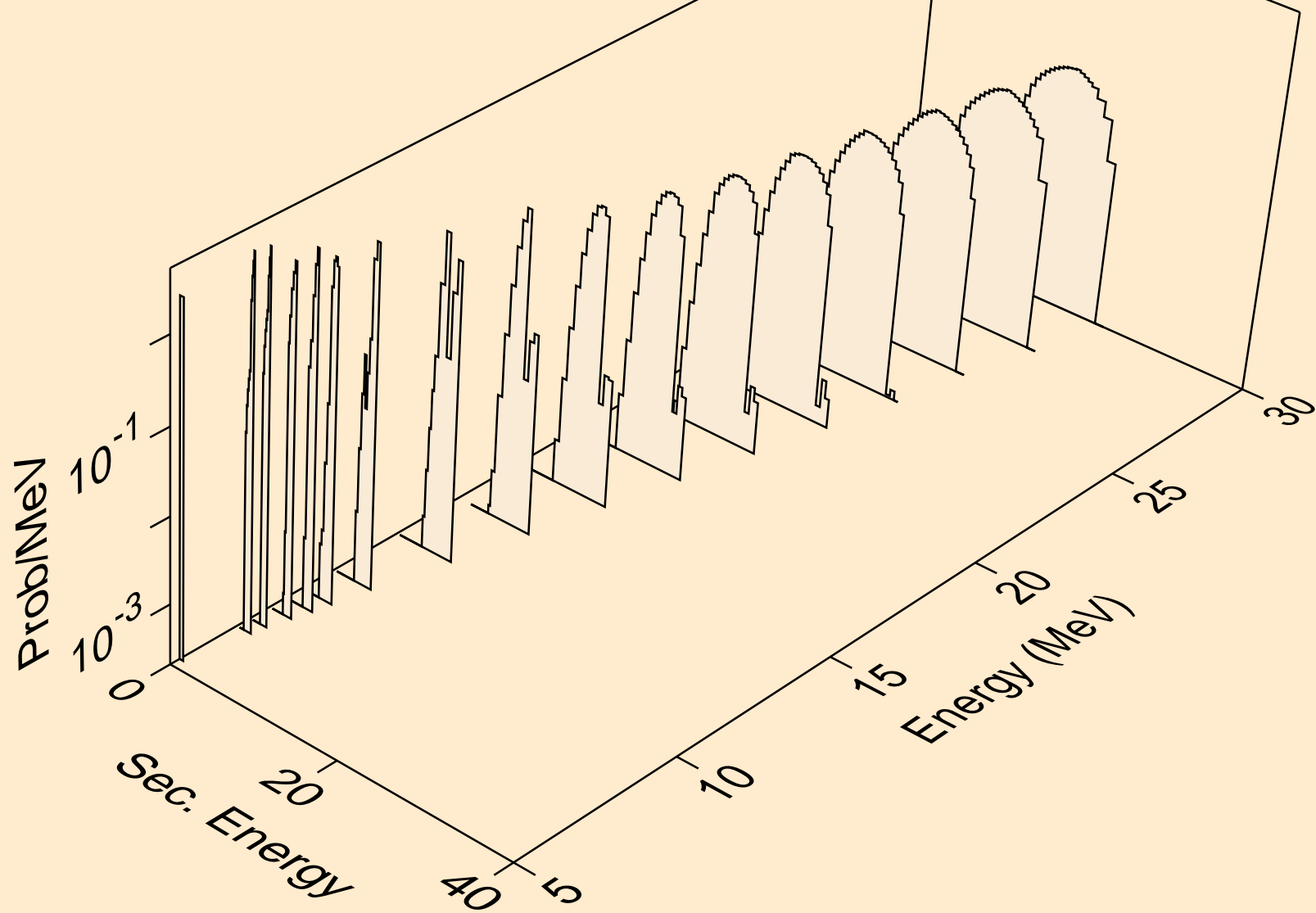

XE119 NEUTRON ACER TENDL-2024 LIBRARY; T=0.K  
tritons from (n,pt)

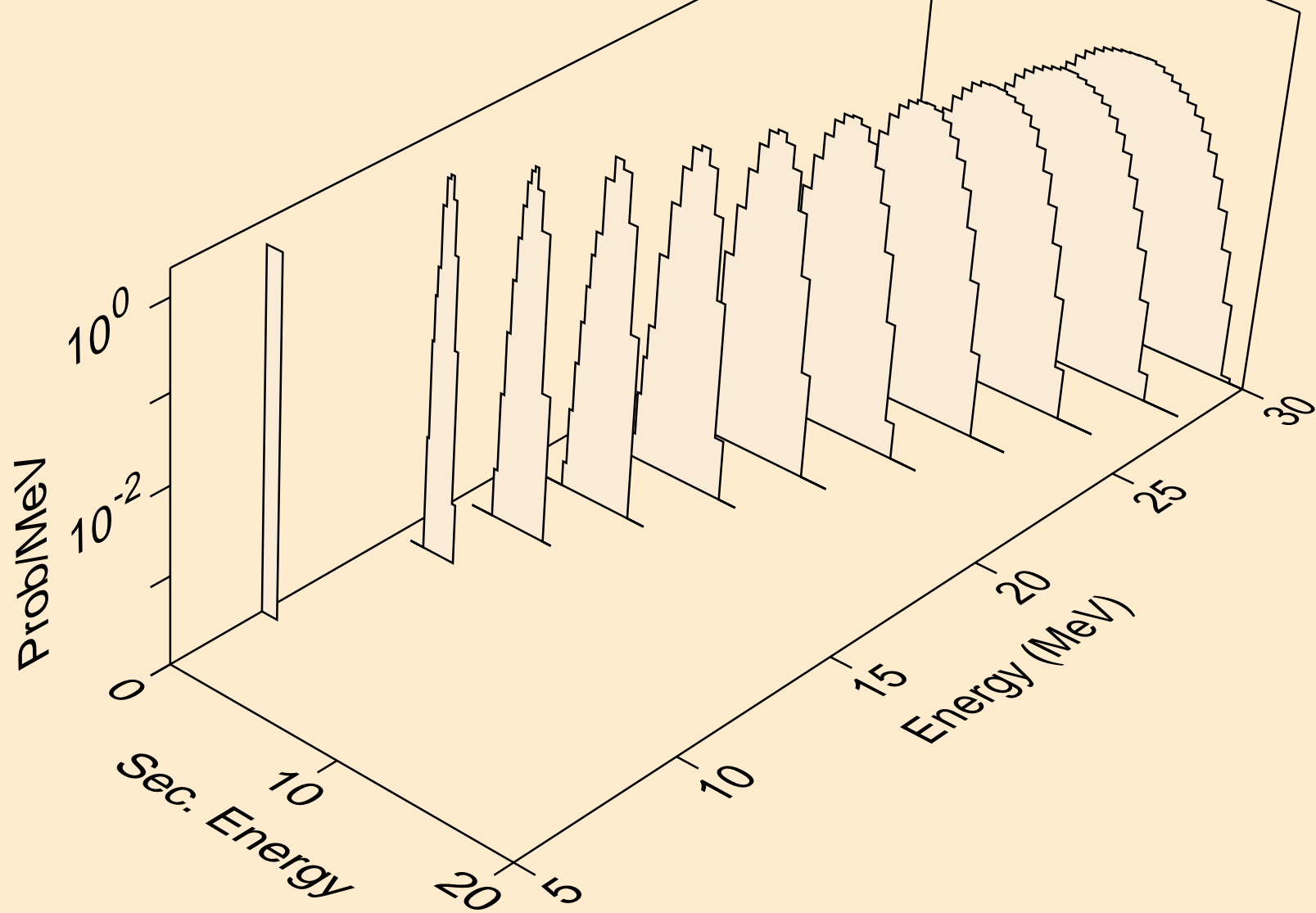

XE119 NEUTRON ACER TENDL-2024 LIBRARY; T=0.K  
he3s from (n,x)

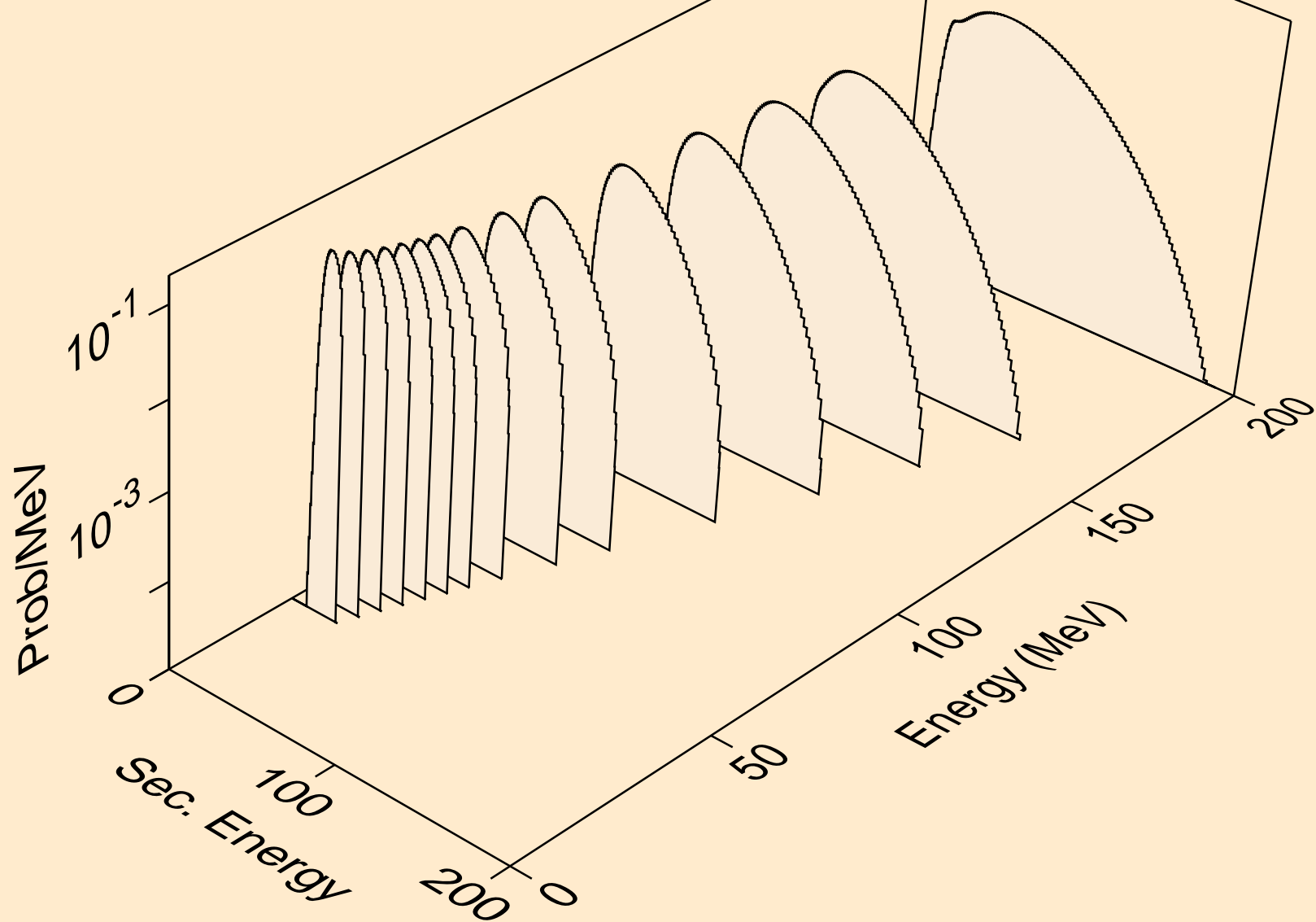

XE119 NEUTRON ACER TENDL-2024 LIBRARY; T=0.K  
he3s from (n,n\*)he3

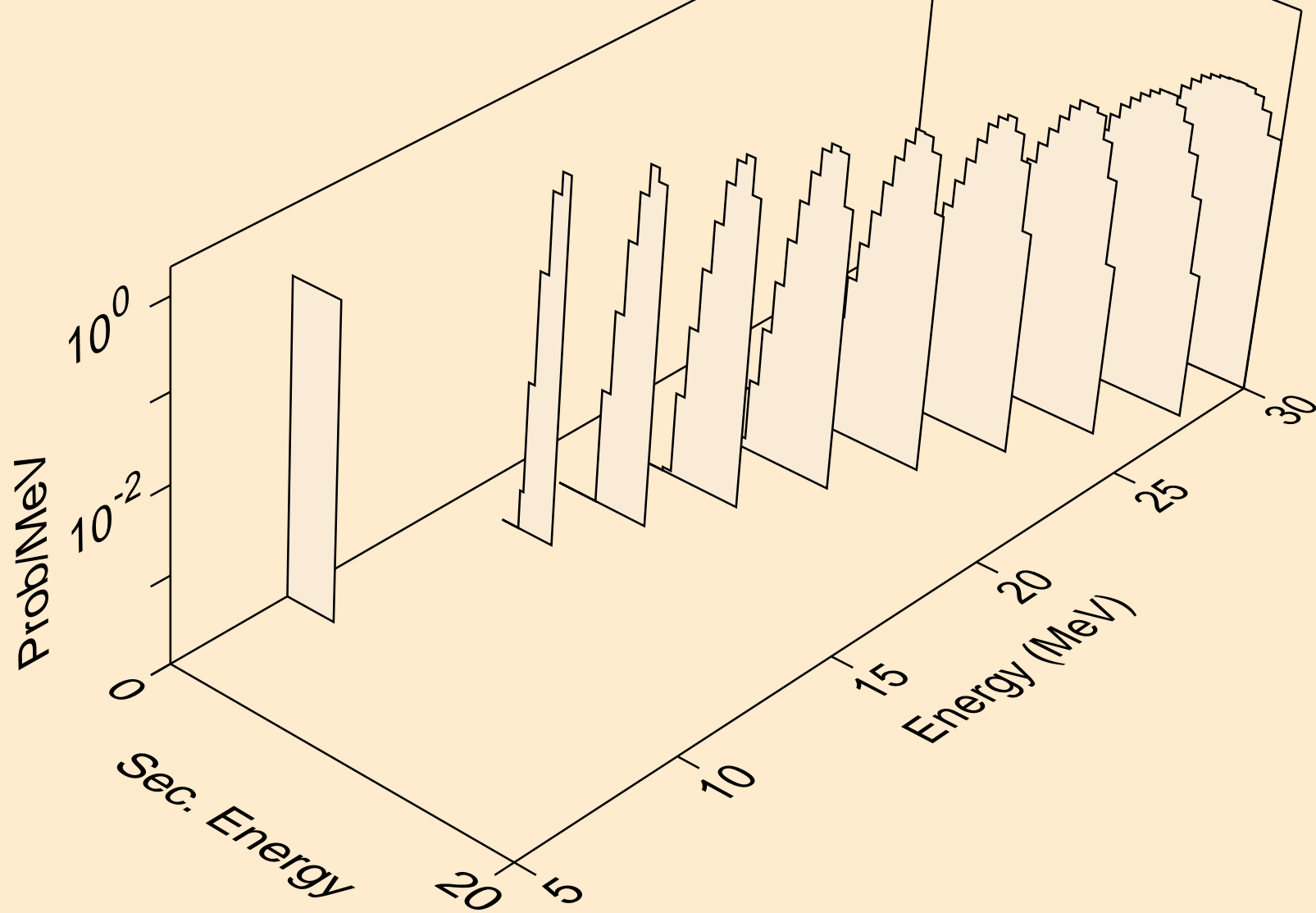

XE119 NEUTRON ACER TENDL-2024 LIBRARY; T=0.K  
he3s from (n,he3)

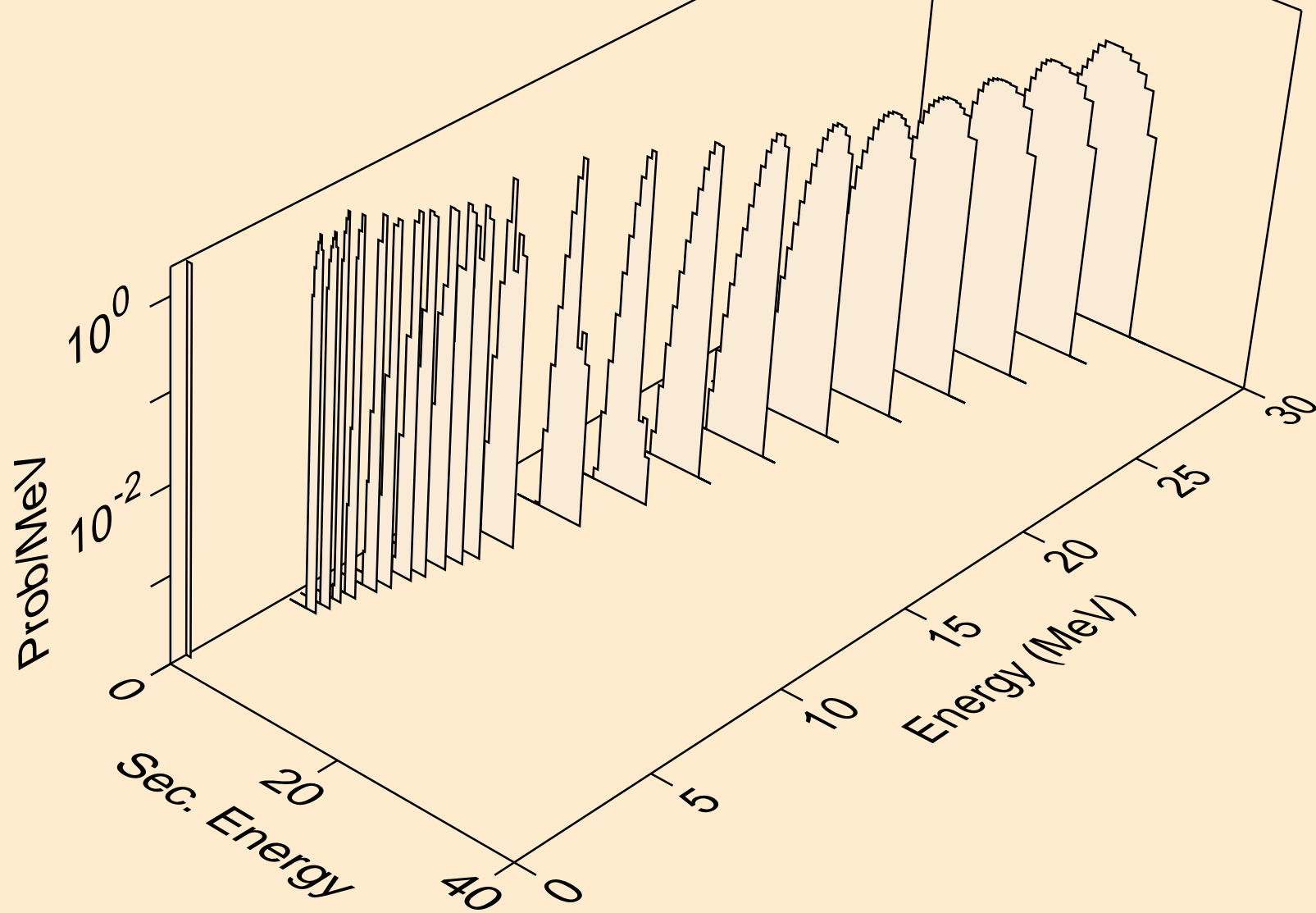

XE119 NEUTRON ACER TENDL-2024 LIBRARY; T=0.K  
alphas from (n,x)

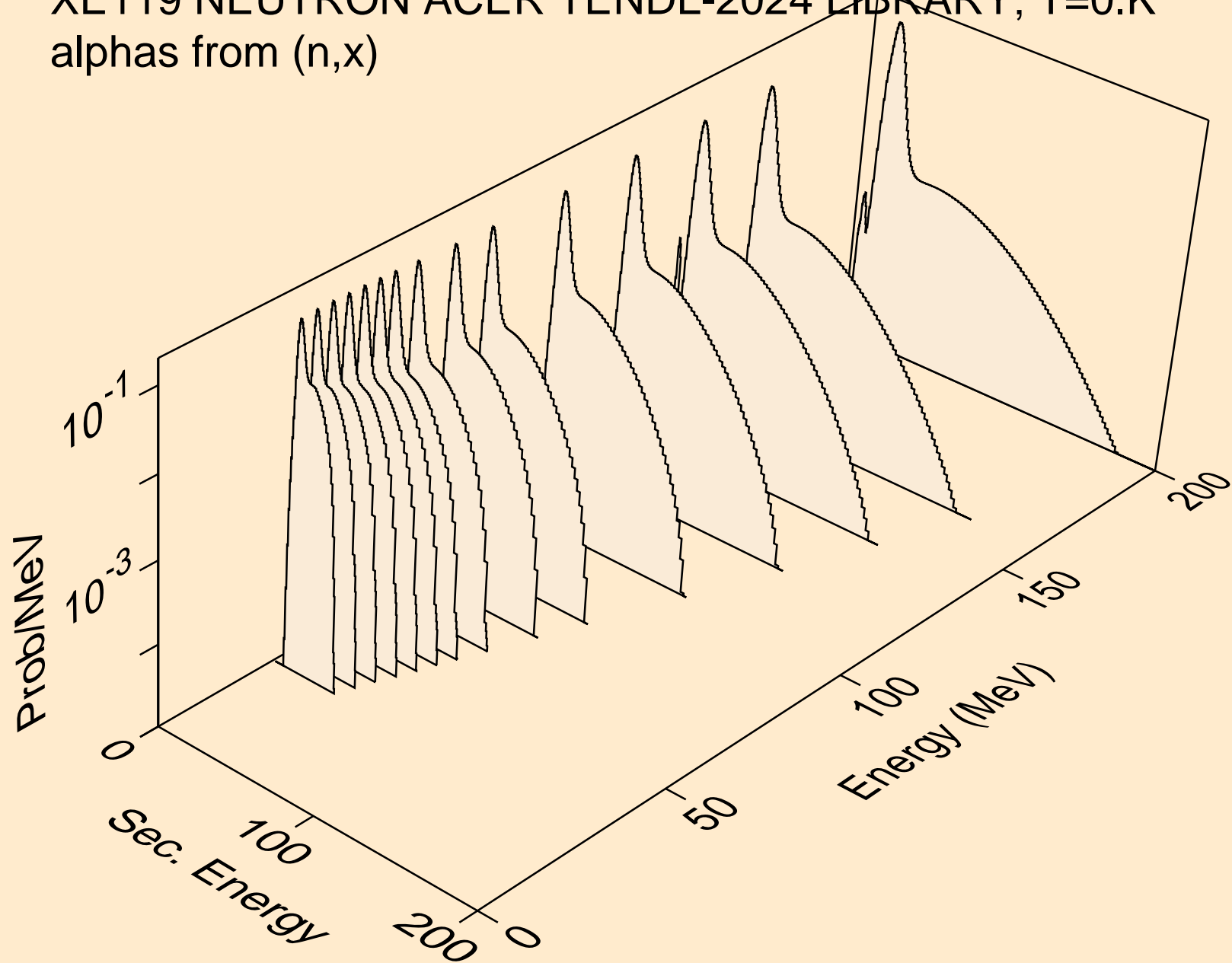

XE119 NEUTRON ACER TENDL-2024 LIBRARY; T=0.K  
alphas from (n,n\*)a

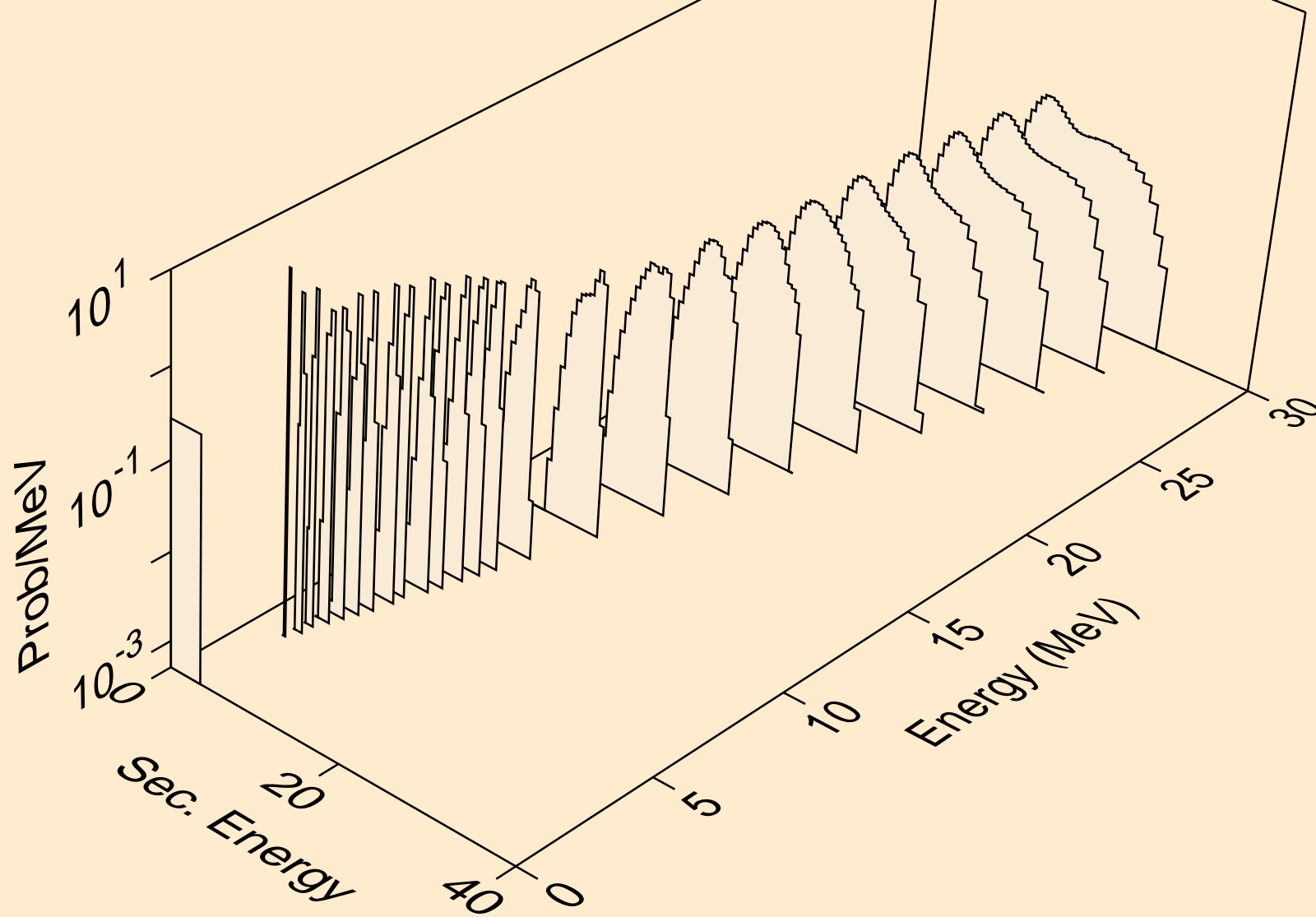

XE119 NEUTRON ACER TENDL-2024 LIBRARY; T=0.K  
alphas from (n,2n)a

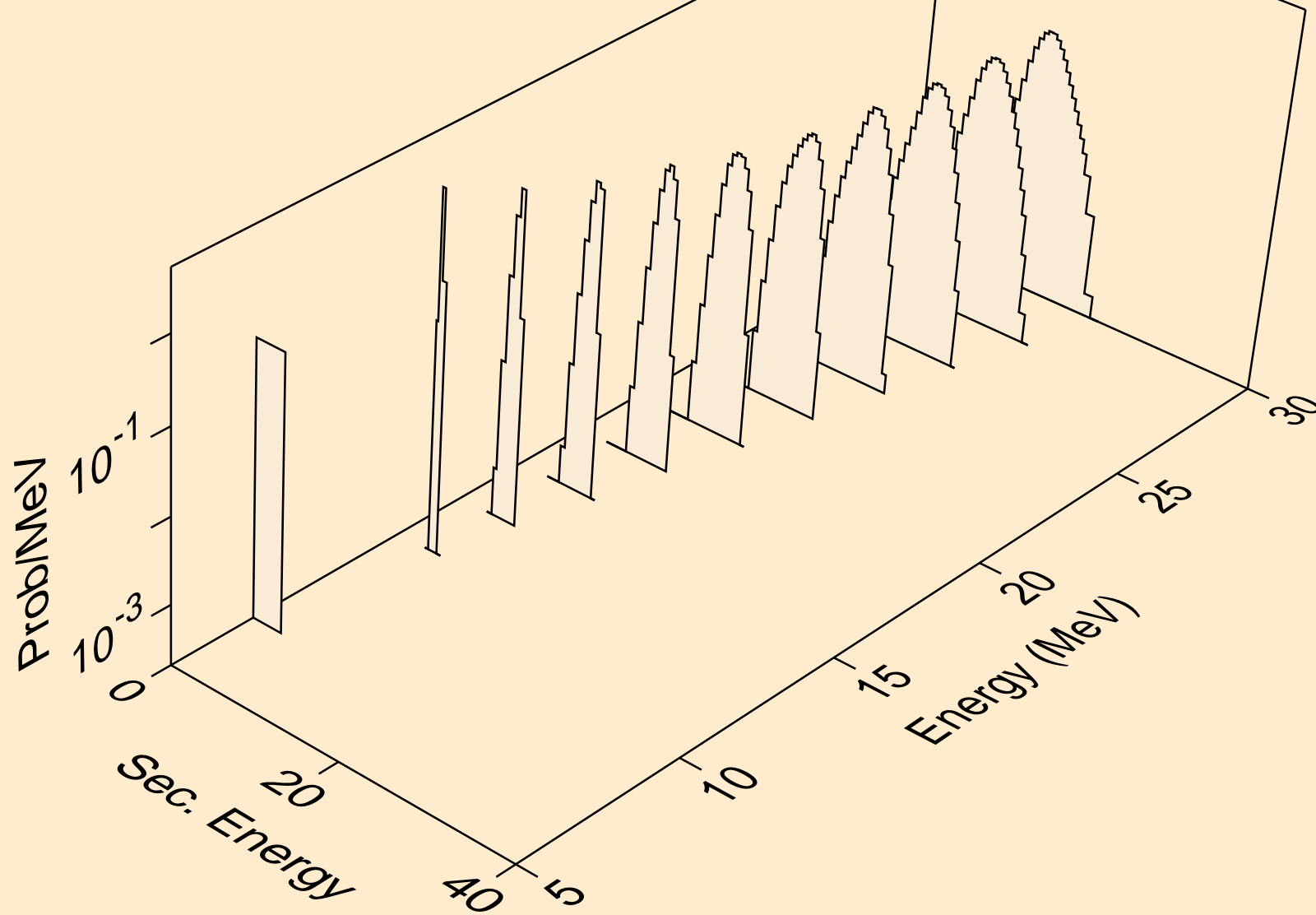

XE119 NEUTRON ACER TENDL-2024 LIBRARY; T=0.K  
alphas from (n,3n)a

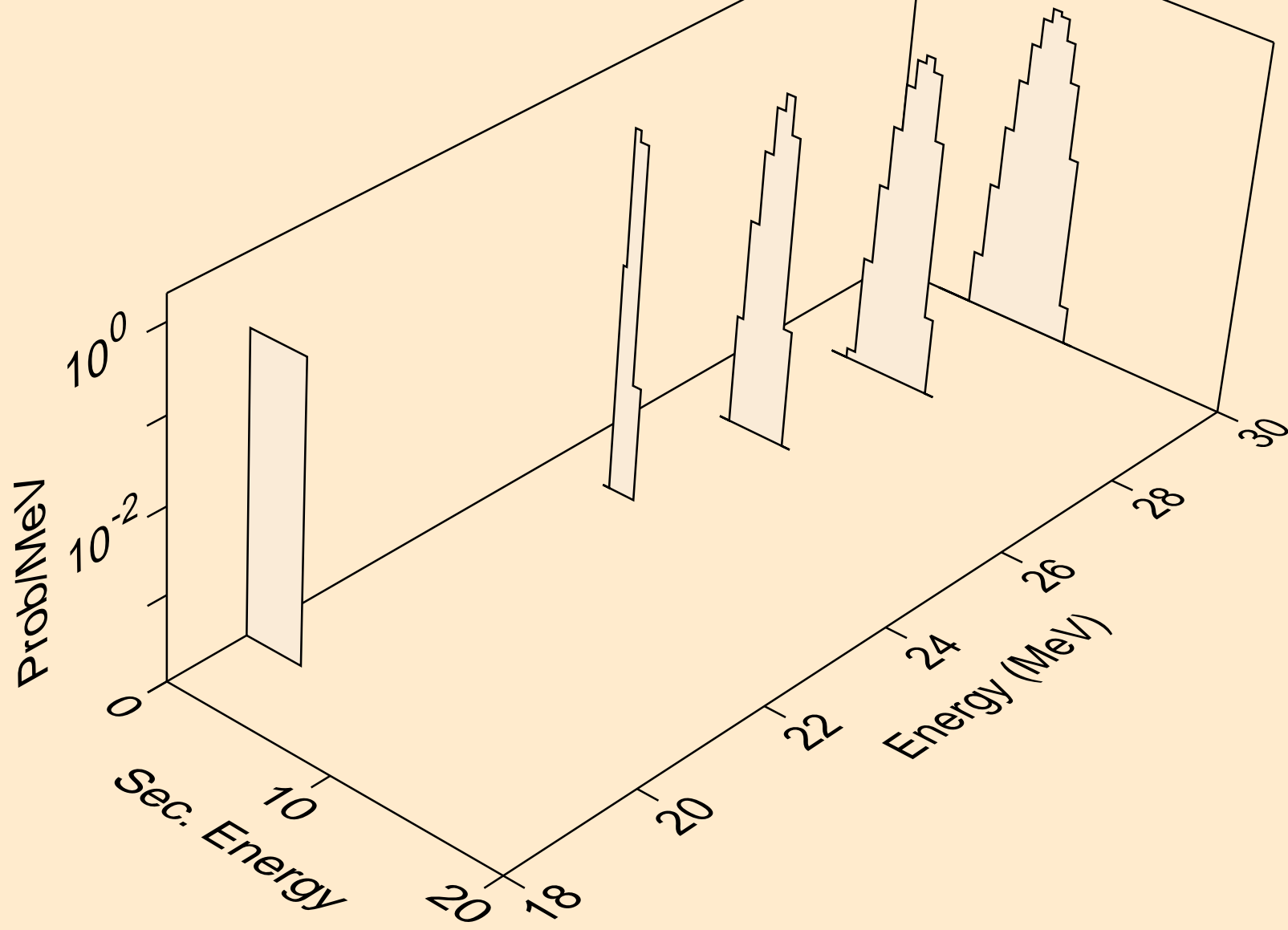

XE119 NEUTRON ACER TENDL-2024 LIBRARY; T=0.K  
alphas from (n,n\*)2a

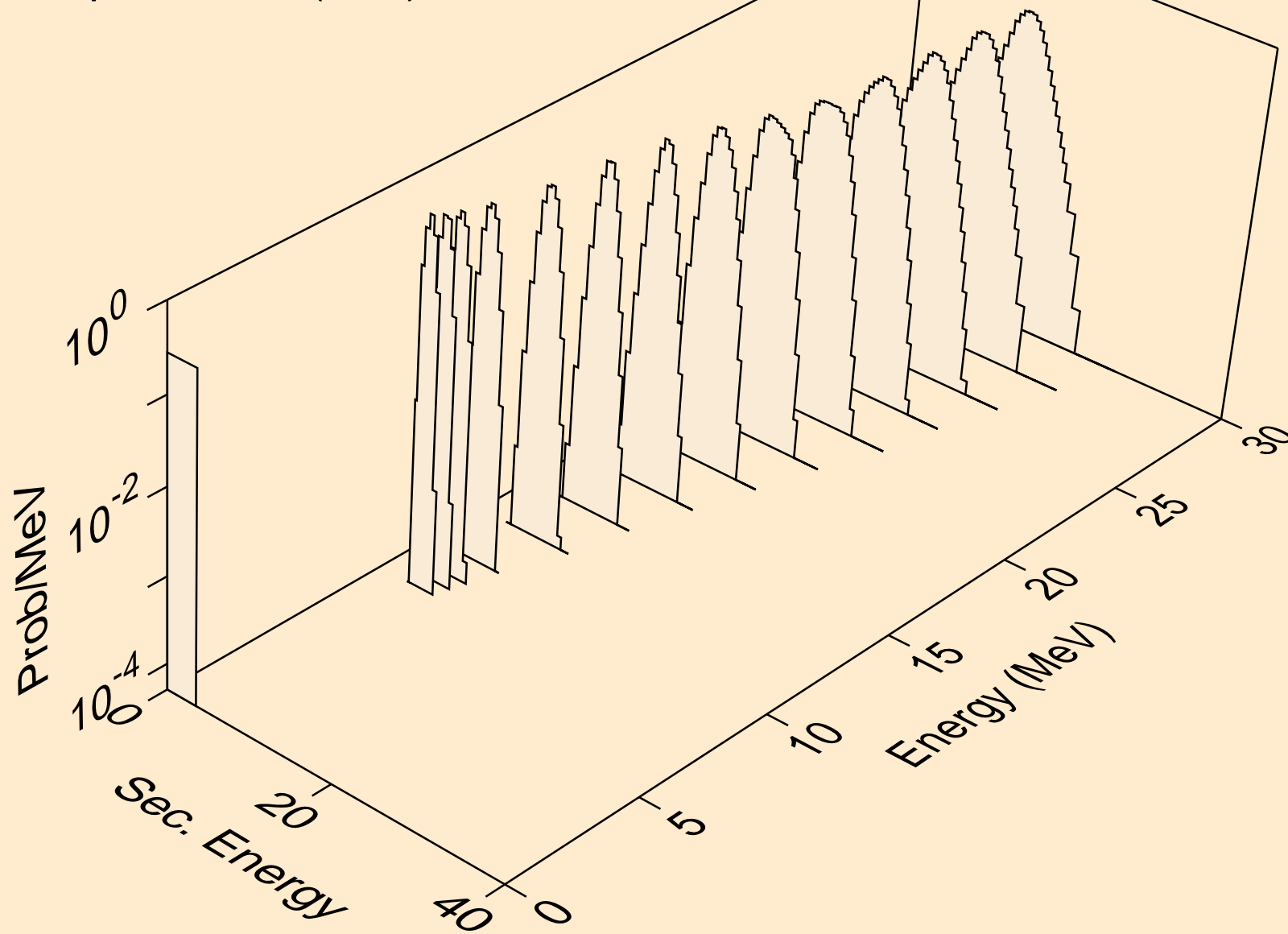

XE119 NEUTRON ACER TENDL-2024 LIBRARY; T=0.K  
alphas from (n,2n)2a

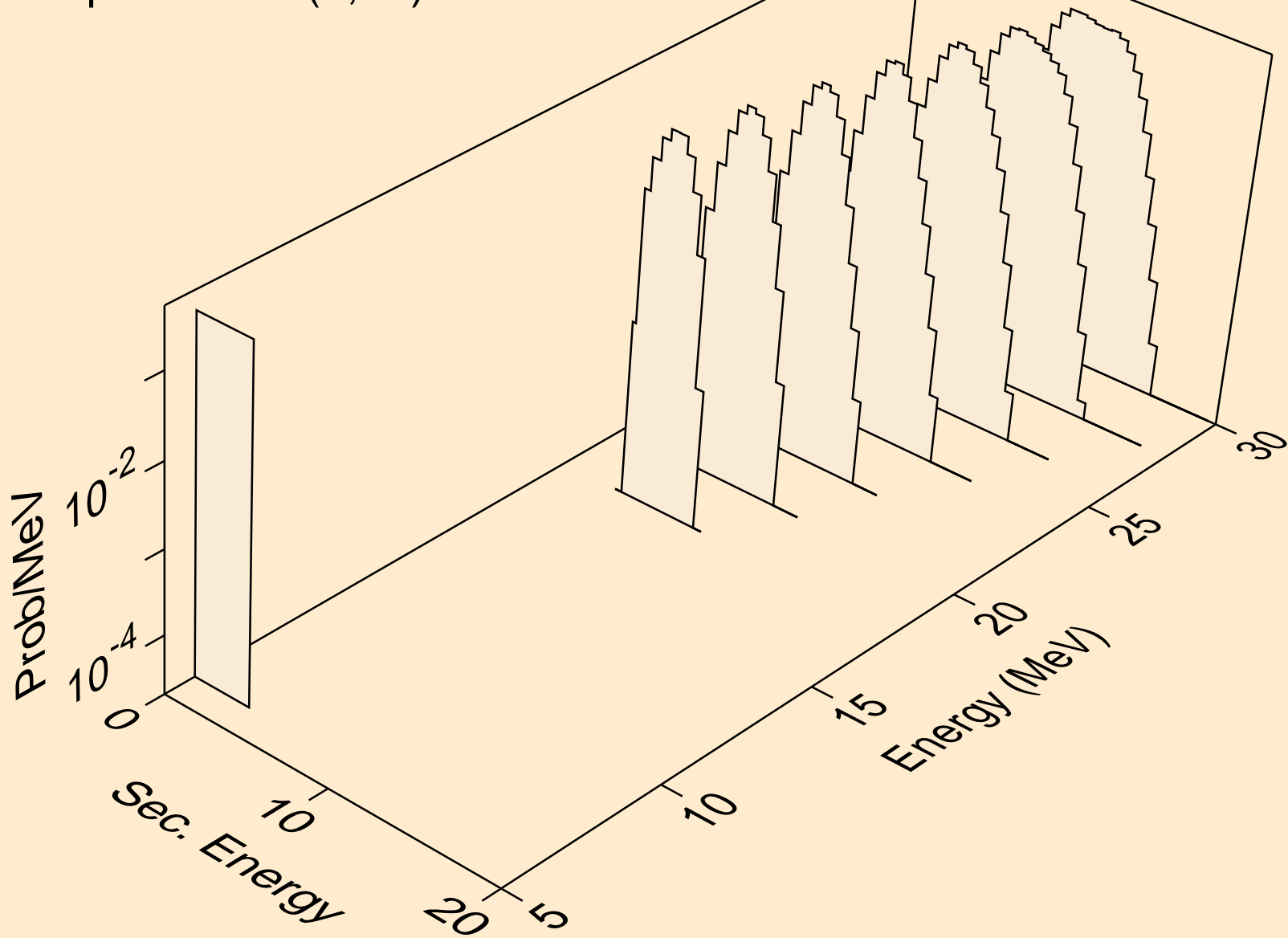

XE119 NEUTRON ACER TENDL-2024 LIBRARY; T=0.K  
alphas from (n,npa)

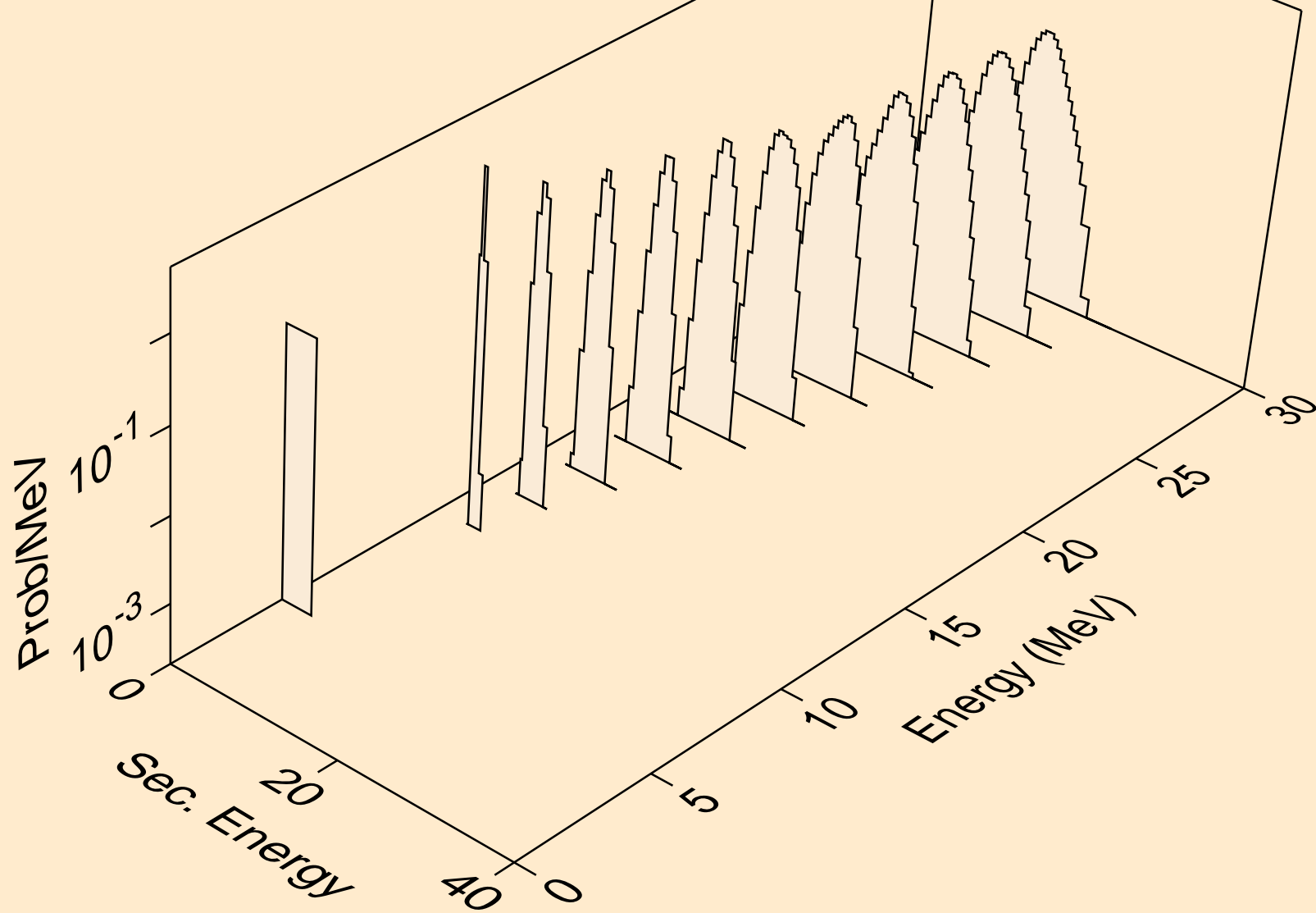

XE119 NEUTRON ACER TENDL-2024 LIBRARY; T=0.K  
alphas from (n,a)

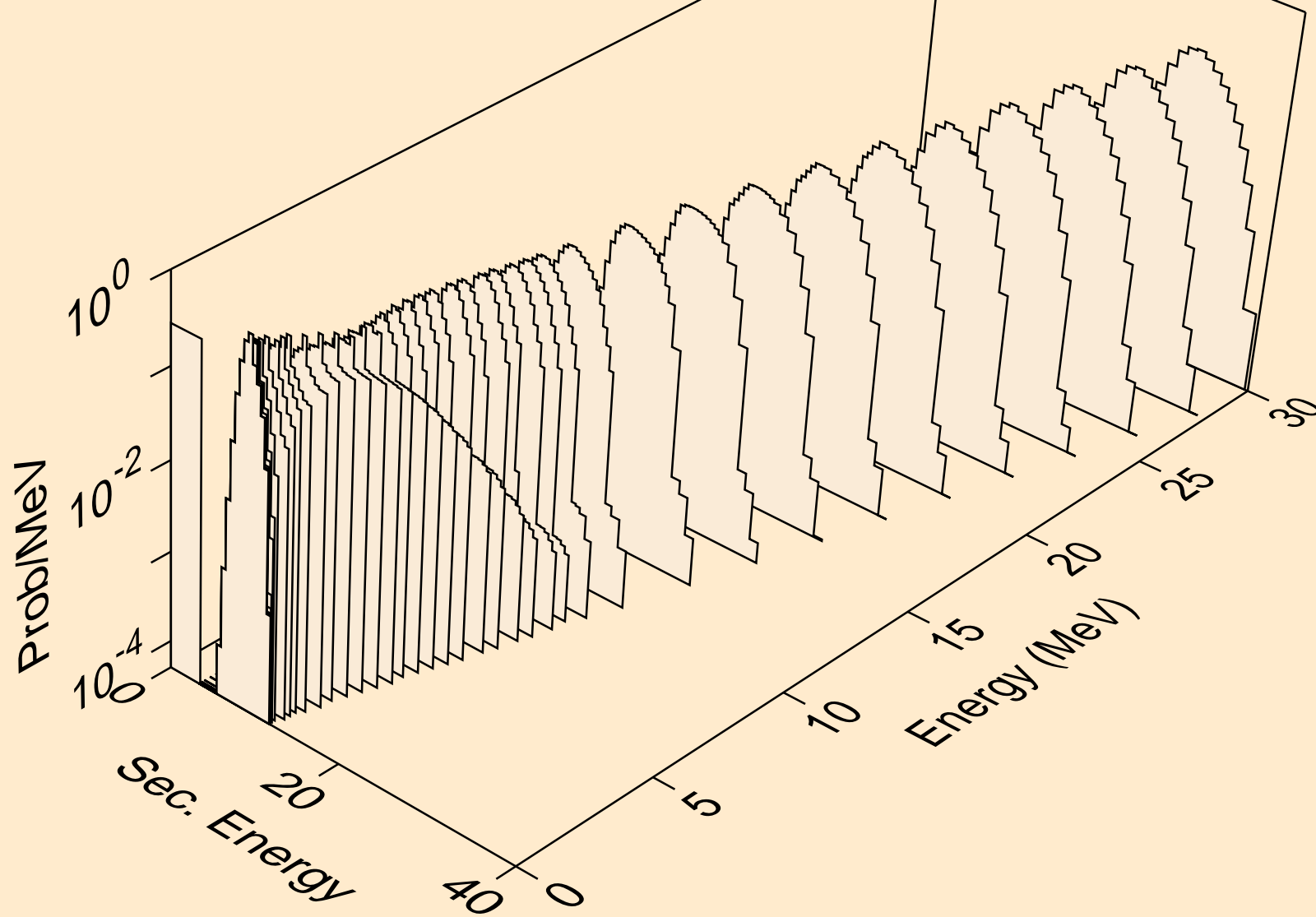

XE119 NEUTRON ACER TENDL-2024 LIBRARY; T=0.K  
alphas from (n,2a)

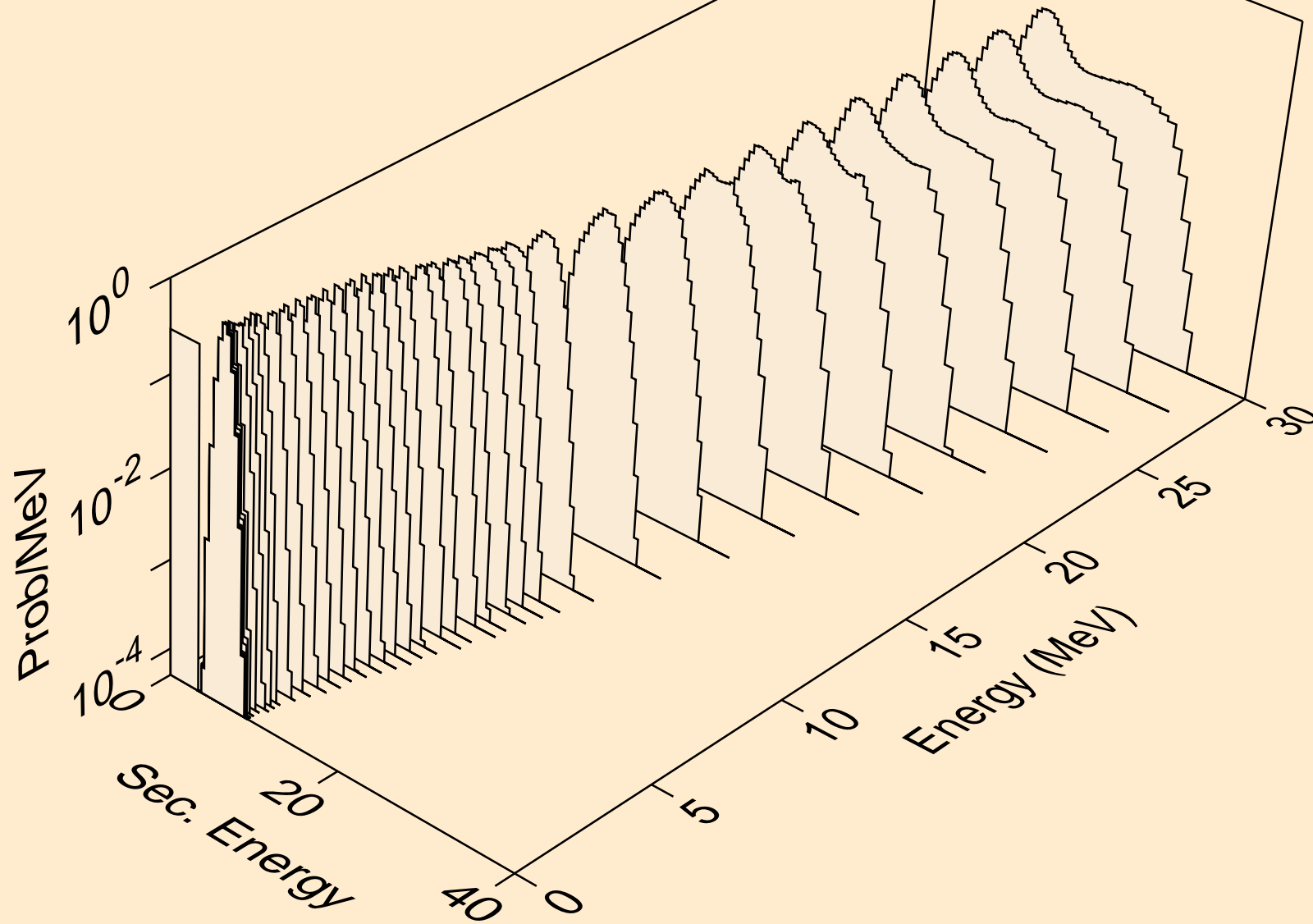

XE119 NEUTRON ACER TENDL-2024 LIBRARY; T=0.K  
alphas from (n,3a)

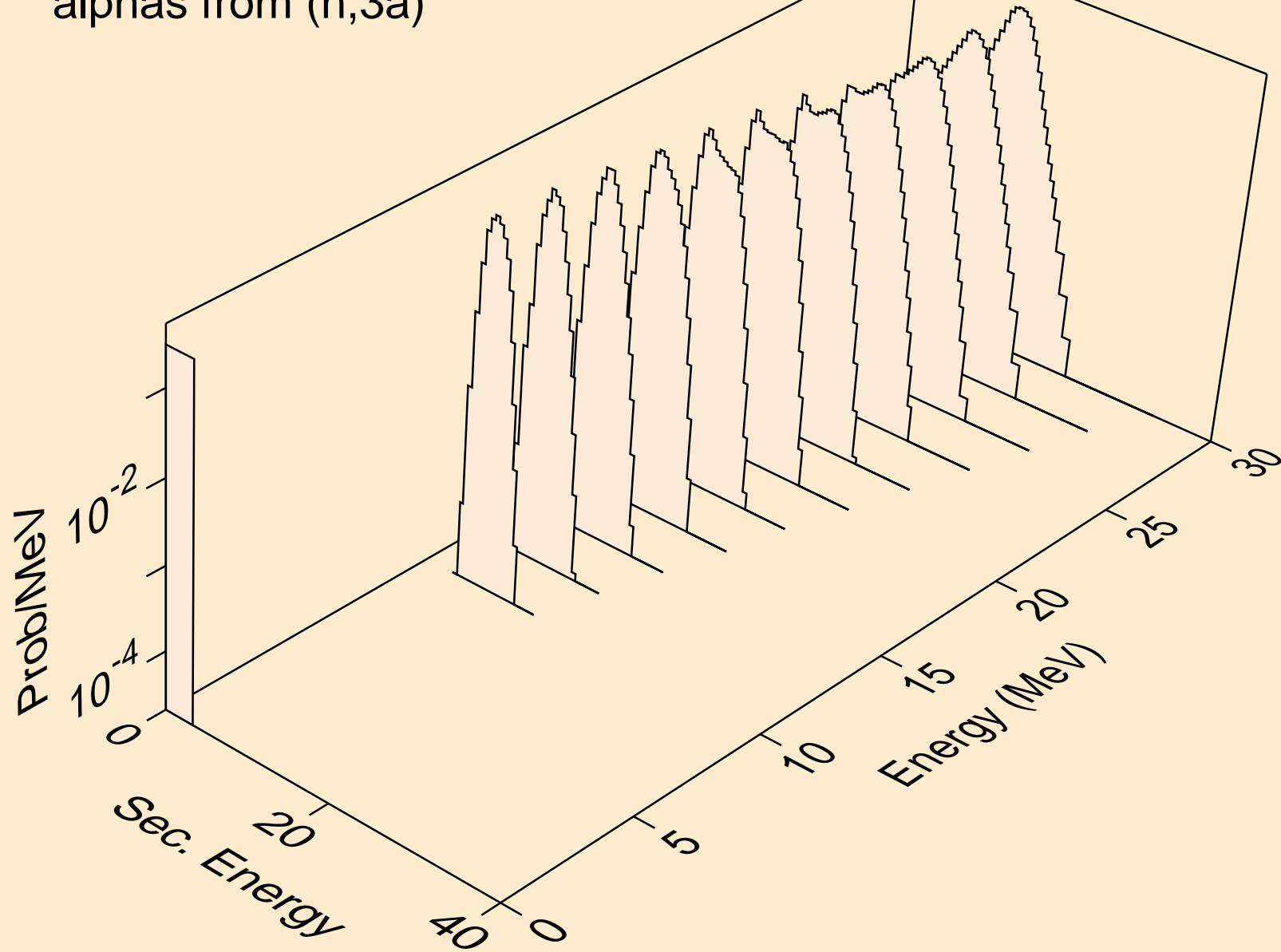

XE119 NEUTRON ACER TENDL-2024 LIBRARY; T=0.K  
alphas from (n,pa)

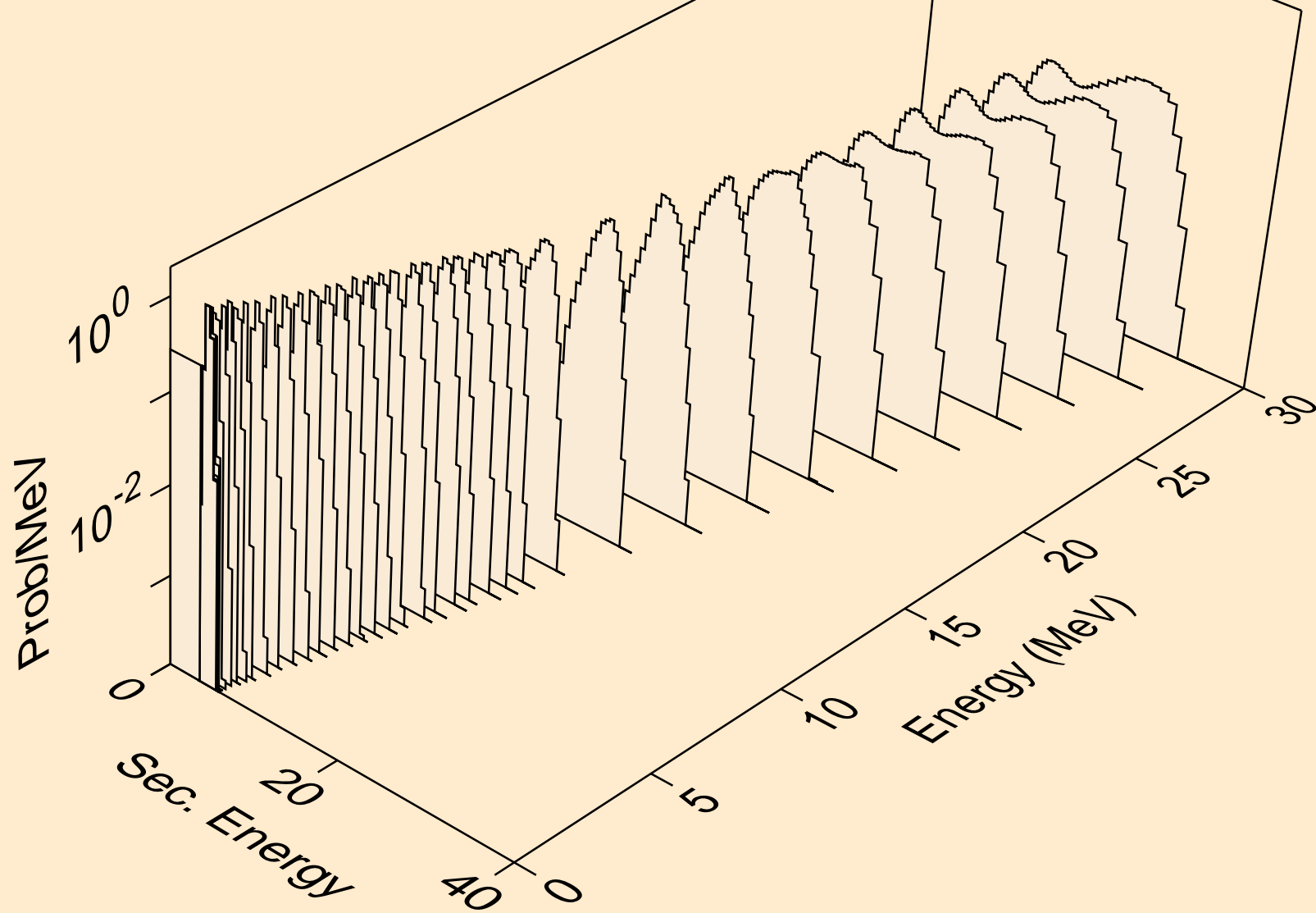

XE119 NEUTRON ACER TENDL-2024 LIBRARY; T=0.K  
alphas from (n,da)

