

XE140 NEUTRON ACER TENDL-2024 LIBRARY; T=0.K

Principal cross sections

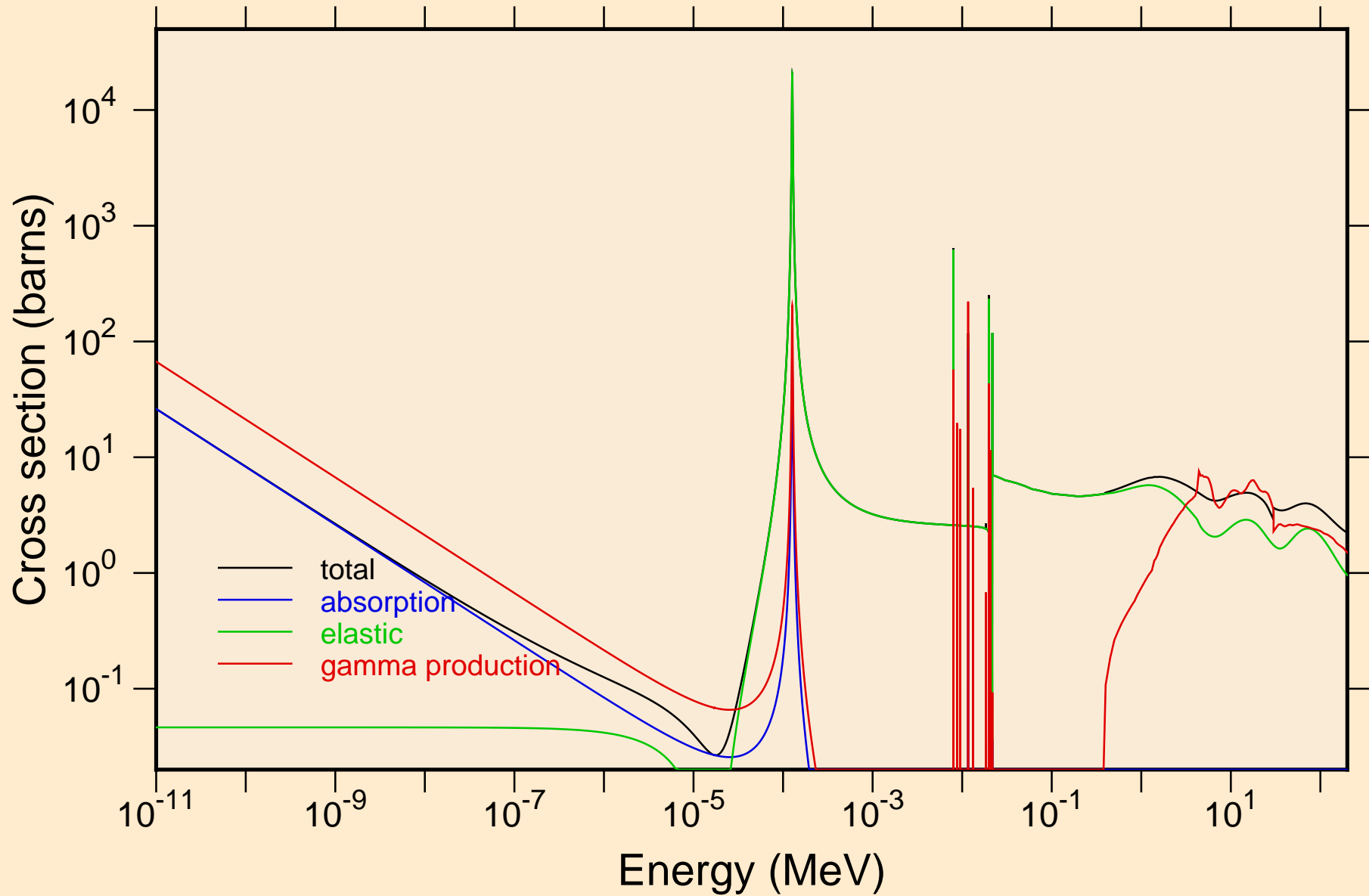

XE140 NEUTRON ACER TENDL-2024 LIBRARY; T=0.K
resonance total cross section

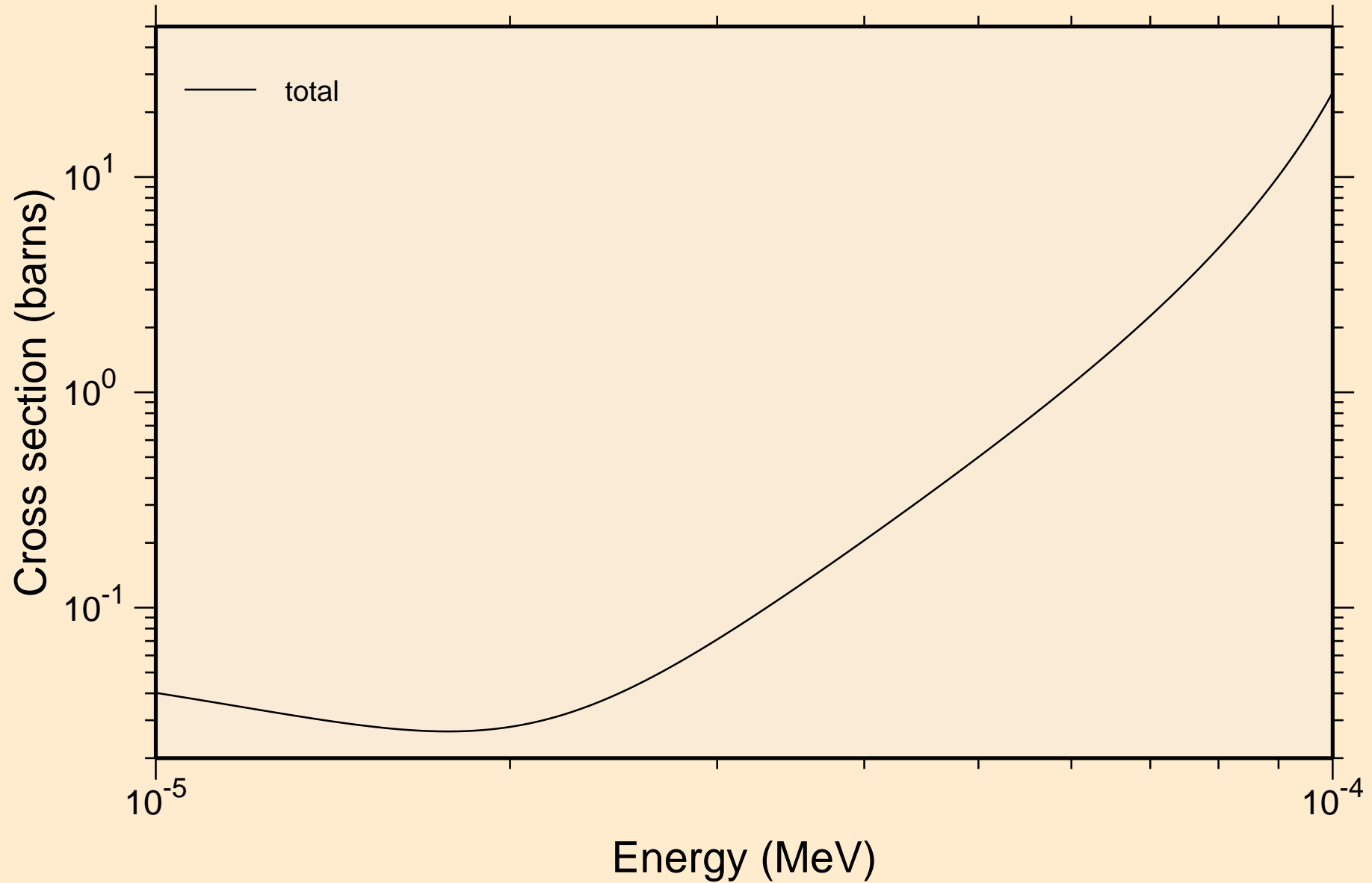

XE140 NEUTRON ACER TENDL-2024 LIBRARY; T=0.K
resonance total cross section

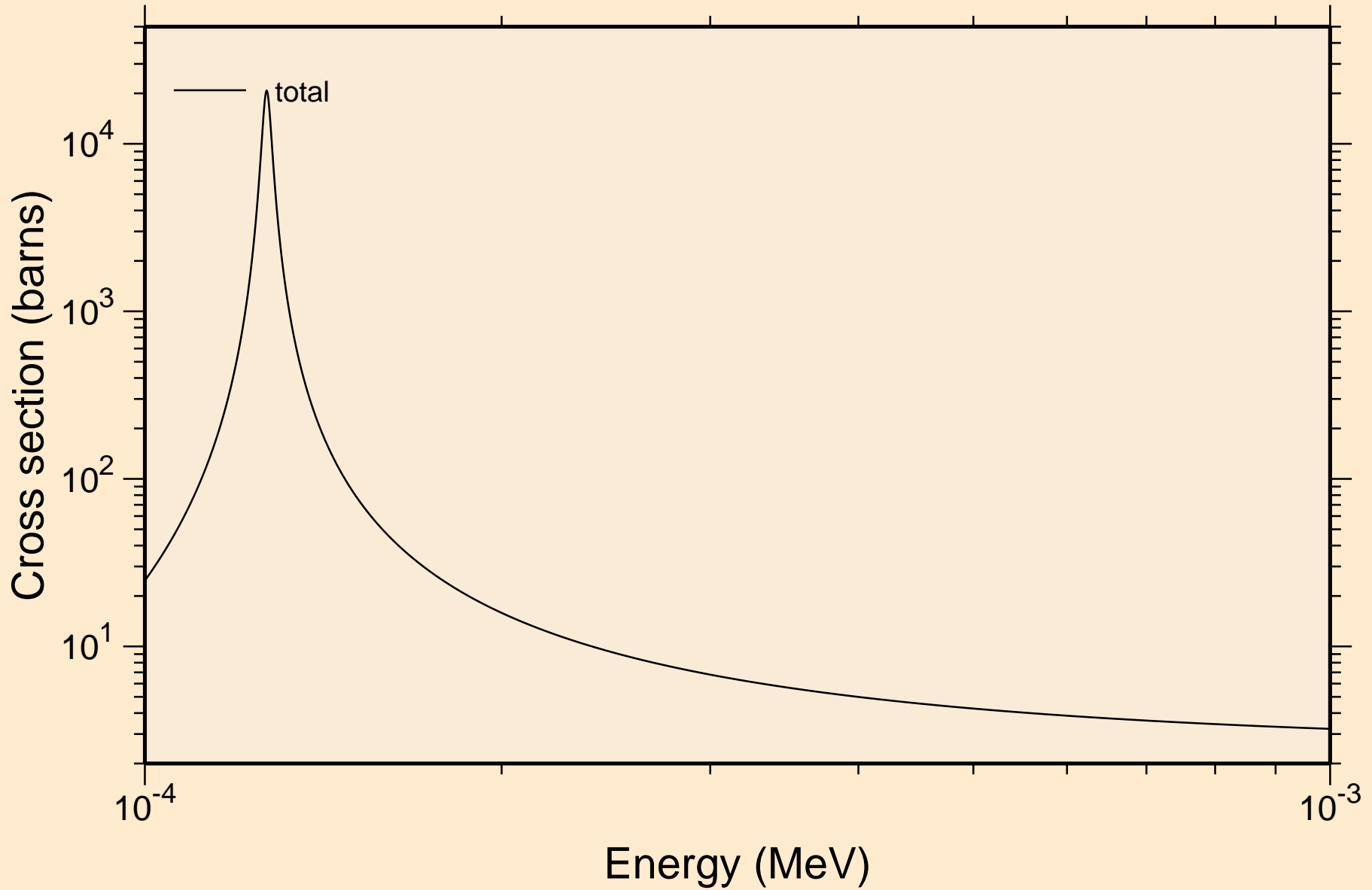

XE140 NEUTRON ACER TENDL-2024 LIBRARY; T=0.K
resonance total cross section

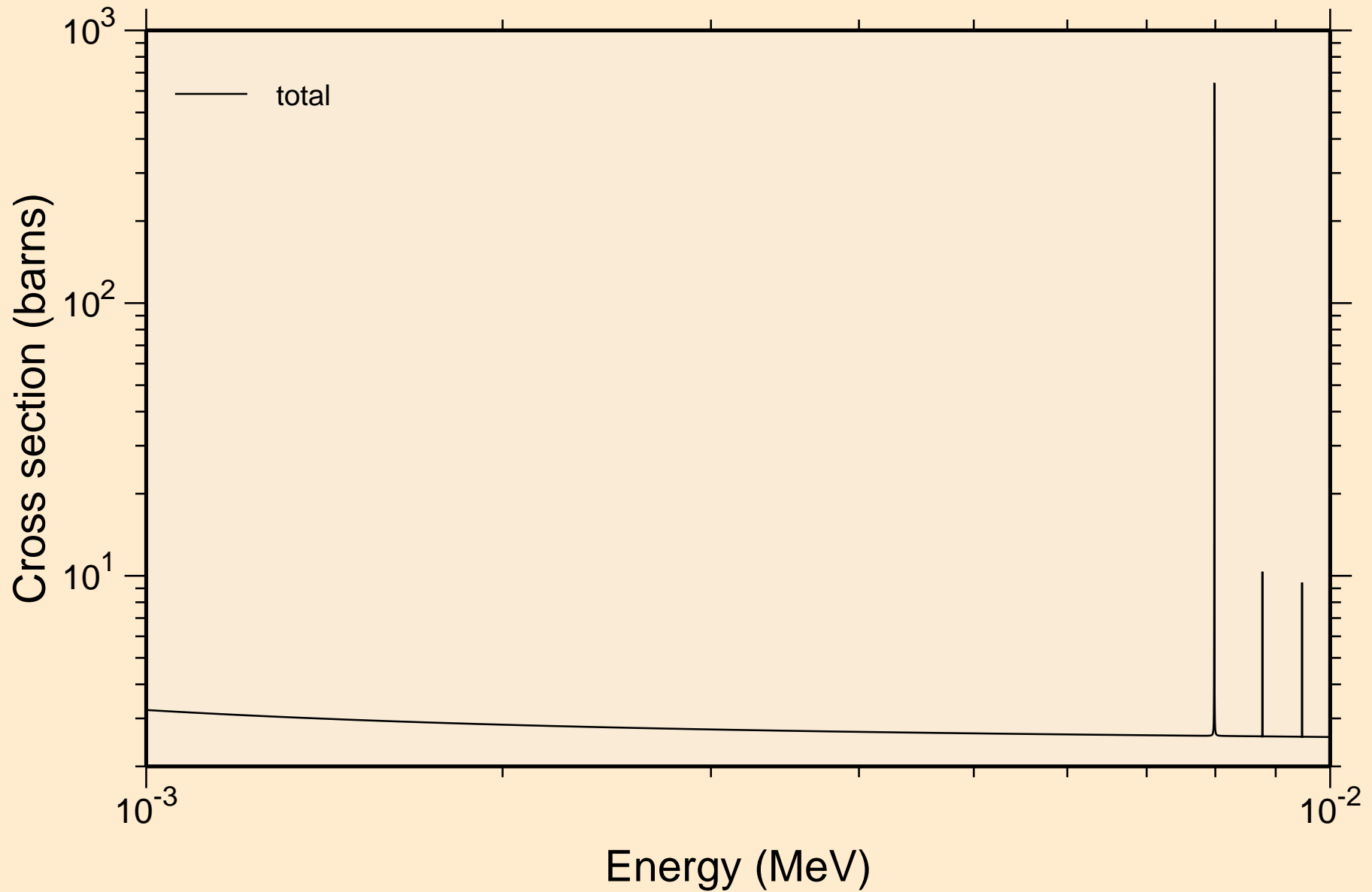

XE140 NEUTRON ACER TENDL-2024 LIBRARY; T=0.K
resonance total cross section

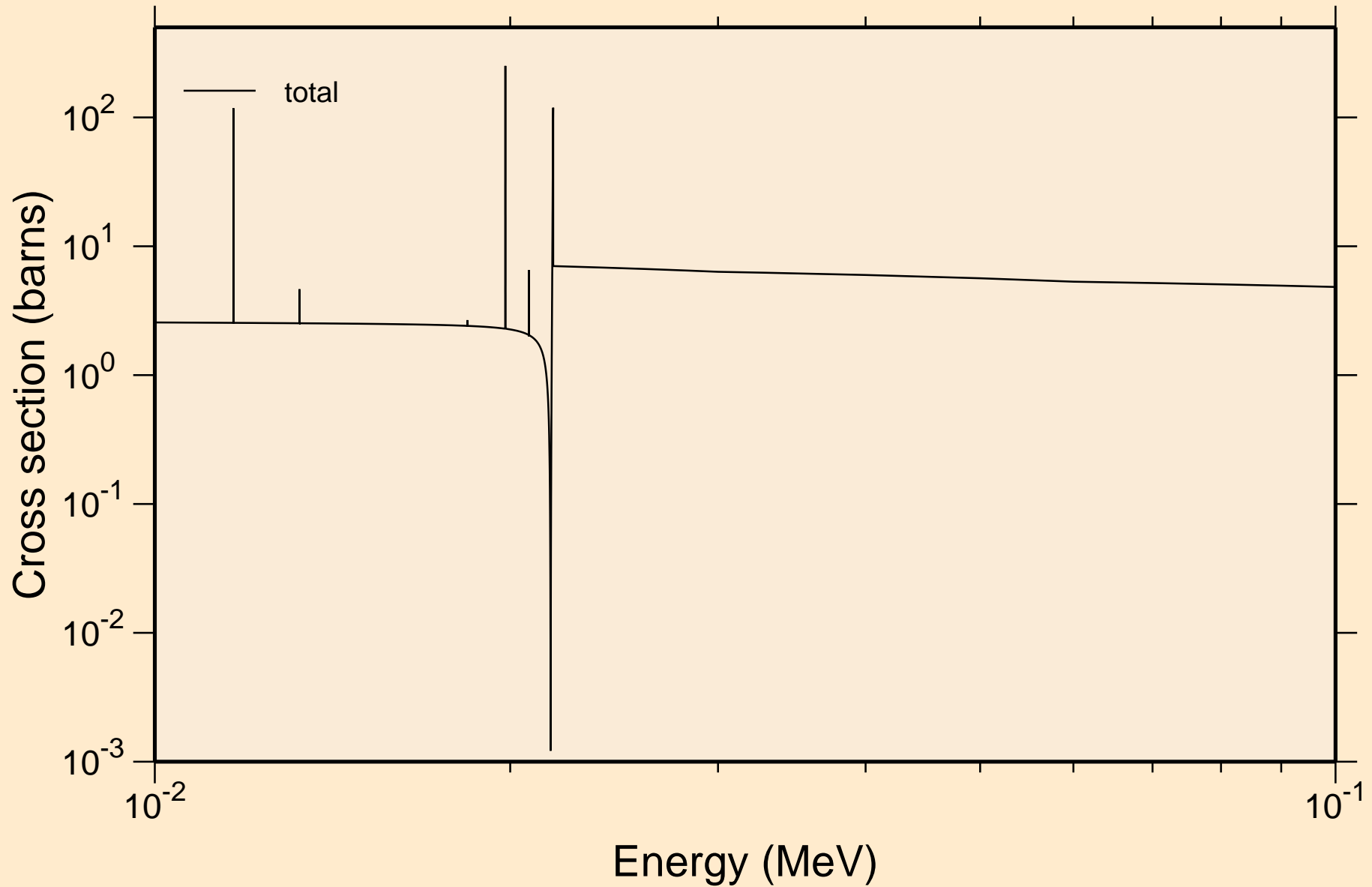

XE140 NEUTRON ACER TENDL-2024 LIBRARY; T=0.K
resonance total cross section

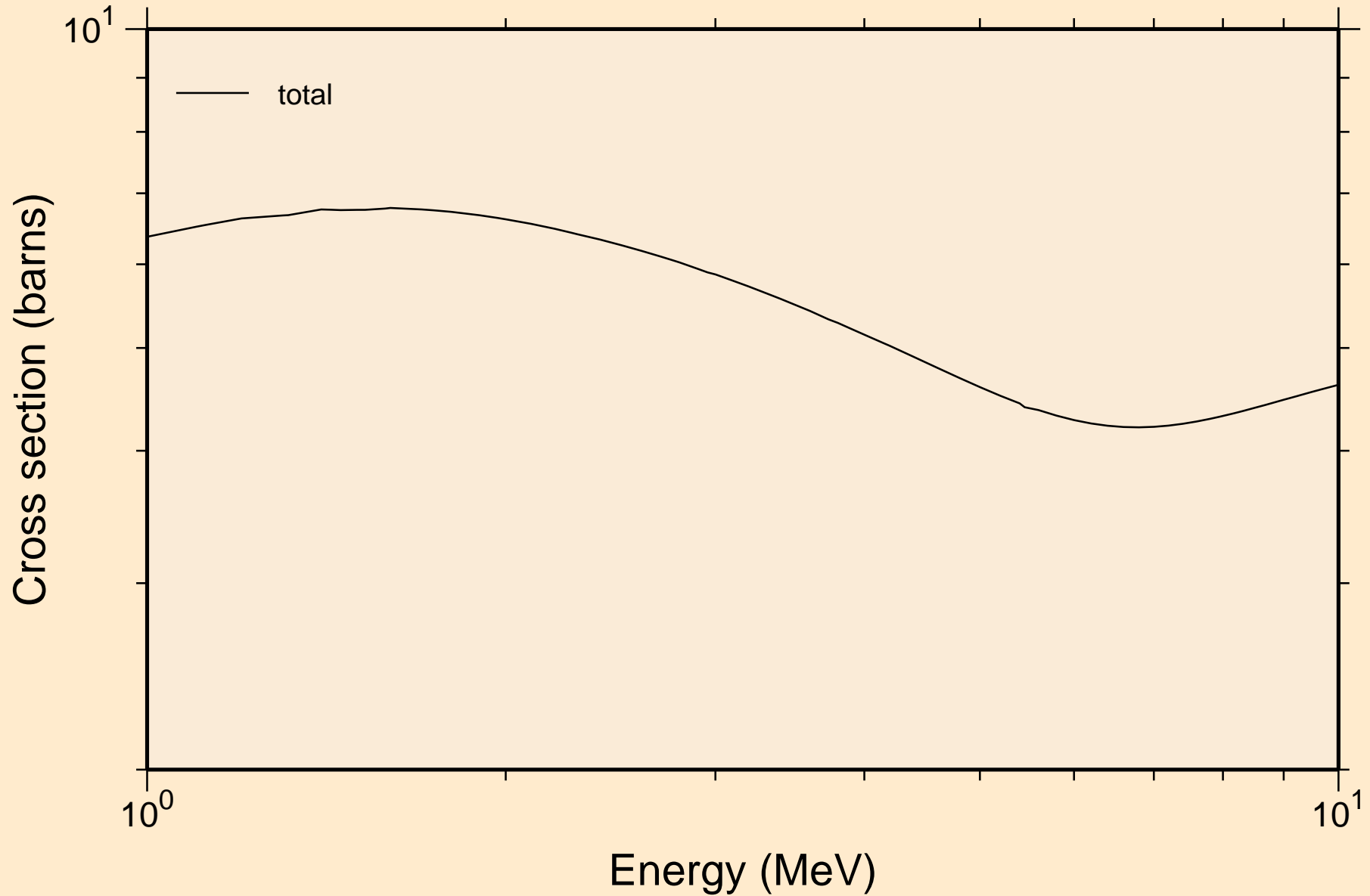

XE140 NEUTRON ACER TENDL-2024 LIBRARY; T=0.K
resonance absorption cross sections

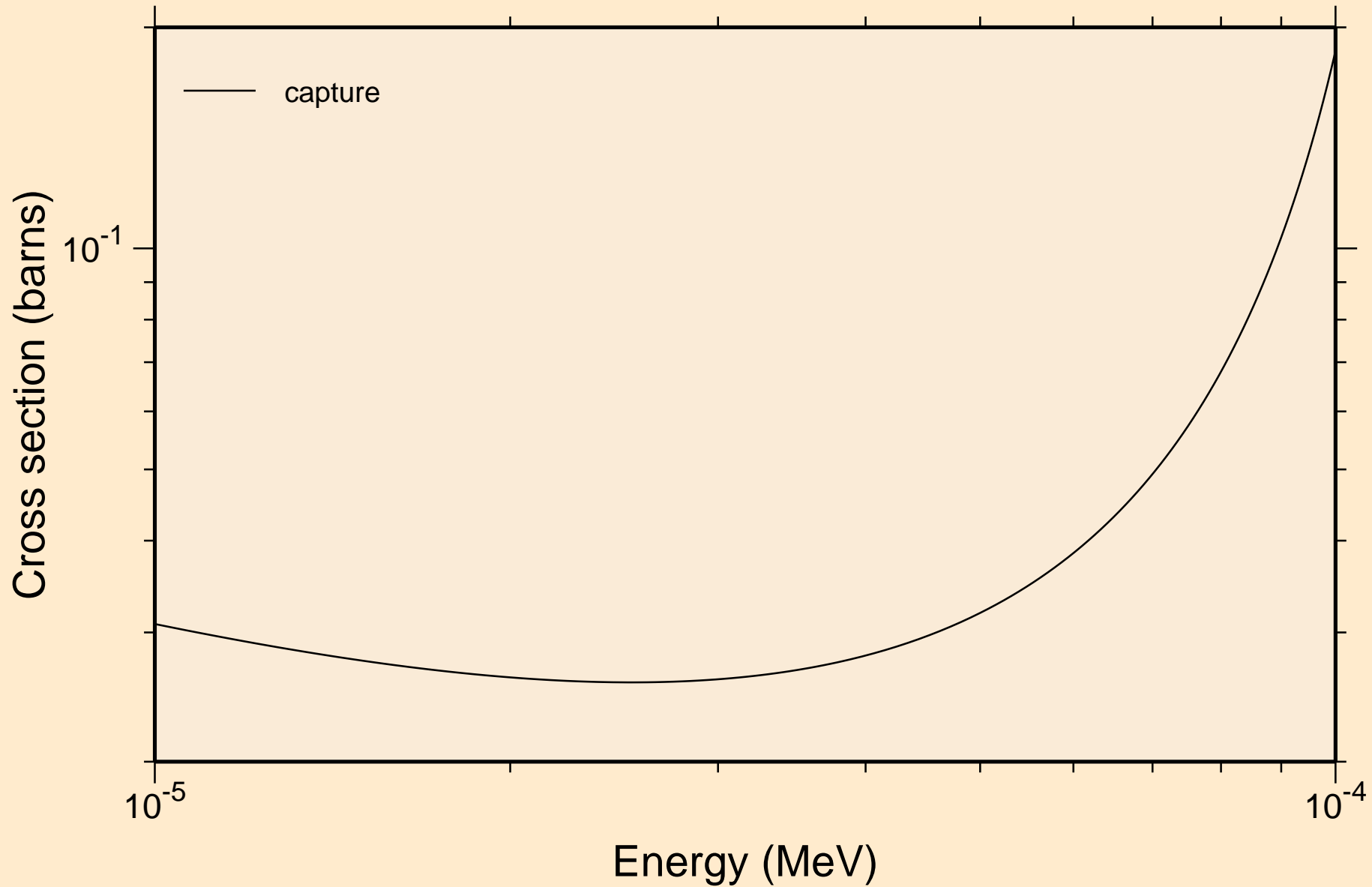

XE140 NEUTRON ACER TENDL-2024 LIBRARY; T=0.K
resonance absorption cross sections

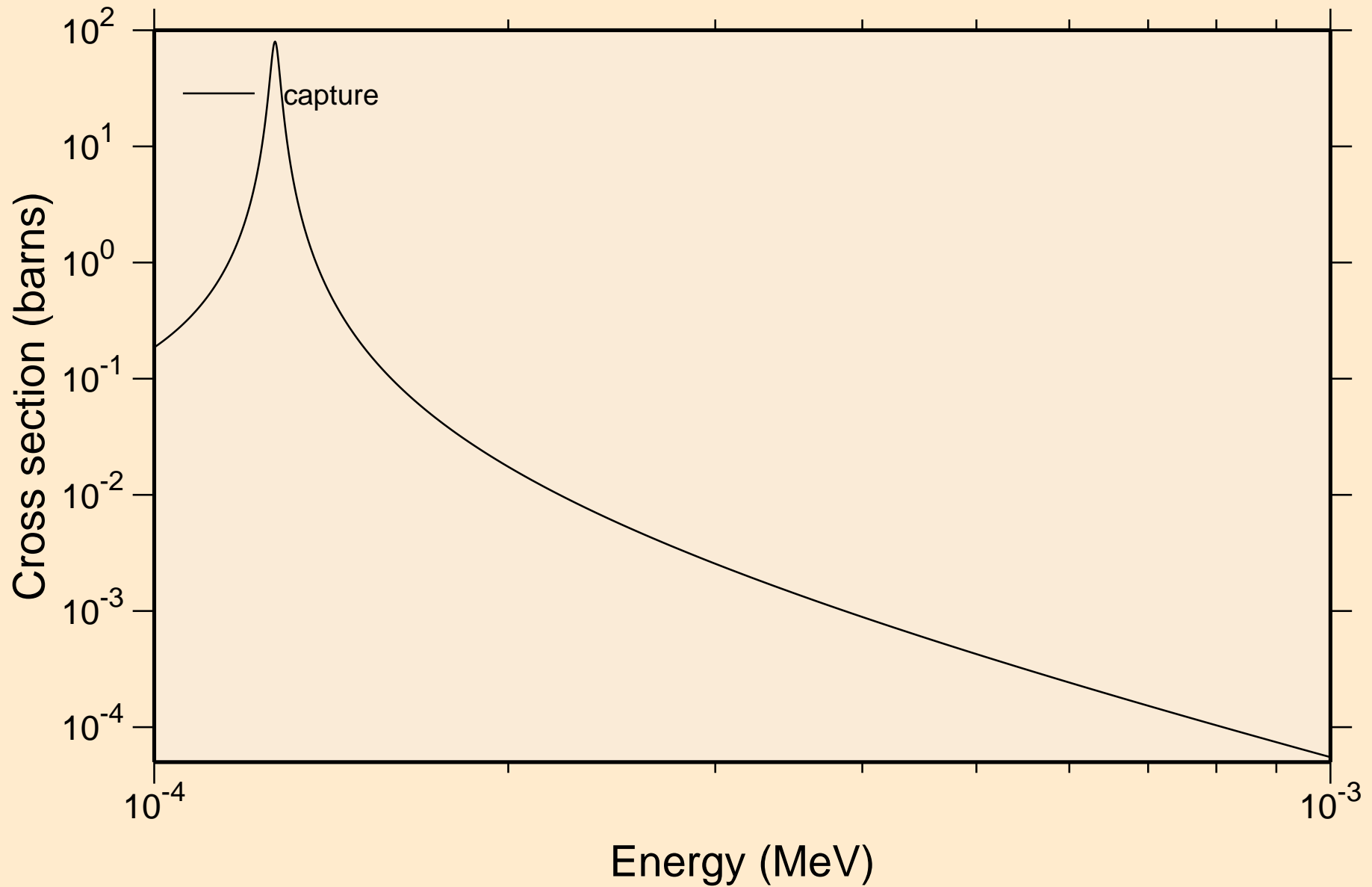

XE140 NEUTRON ACER TENDL-2024 LIBRARY; T=0.K
resonance absorption cross sections

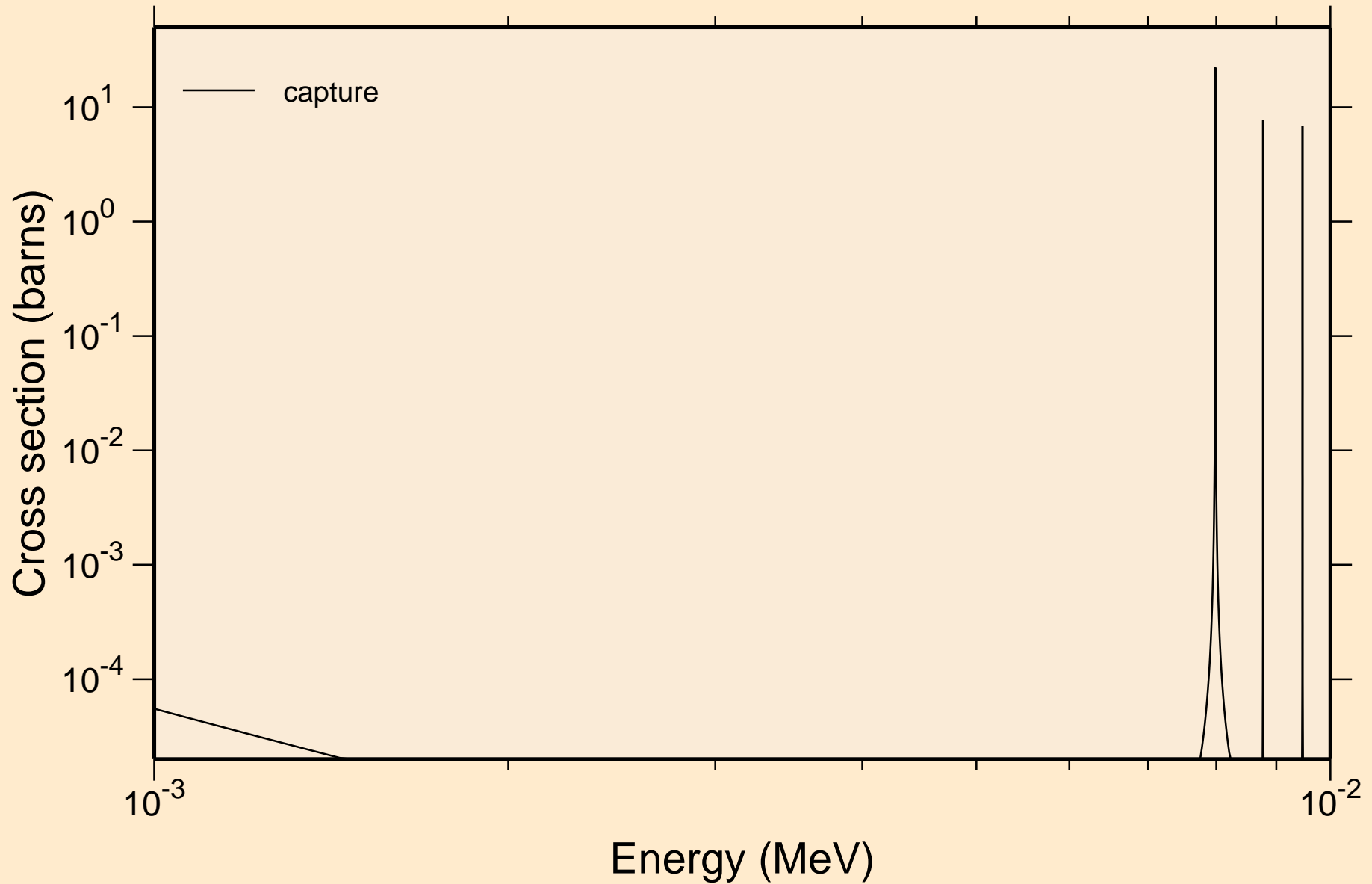

XE140 NEUTRON ACER TENDL-2024 LIBRARY; T=0.K
resonance absorption cross sections

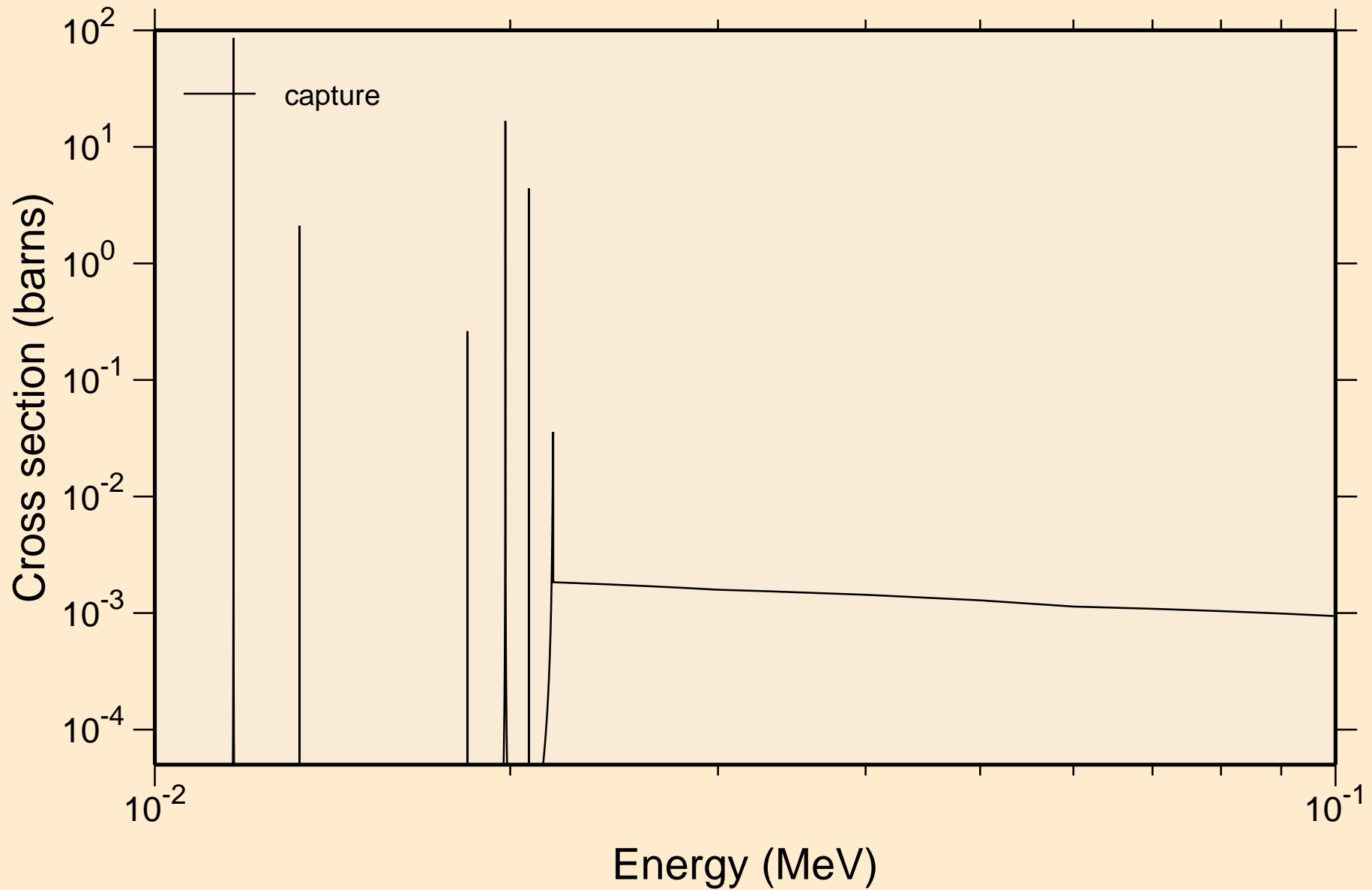

XE140 NEUTRON ACER TENDL-2024 LIBRARY; T=0.K
resonance absorption cross sections

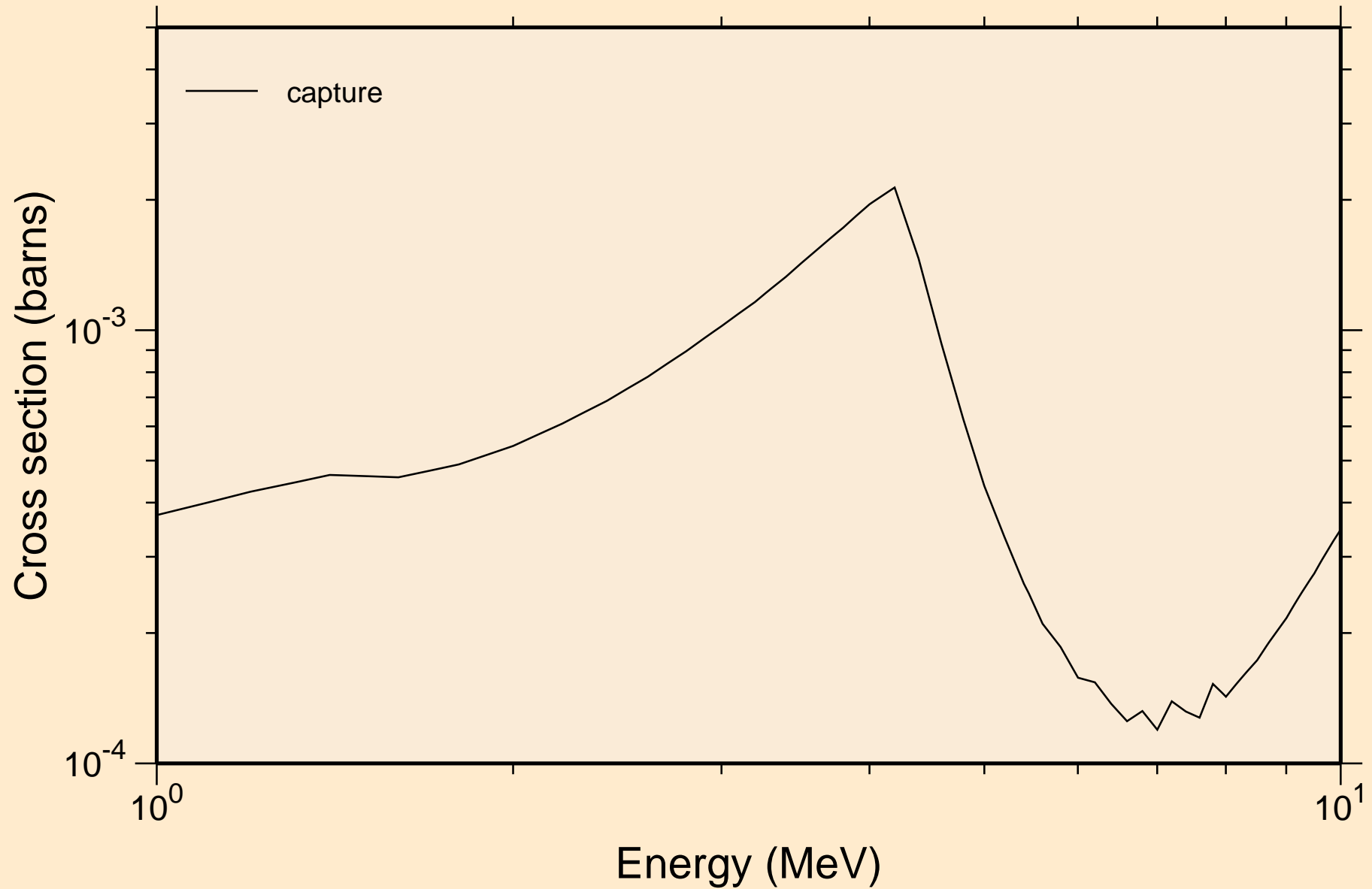

XE140 NEUTRON ACER TENDL-2024 LIBRARY; T=0.K

Heating

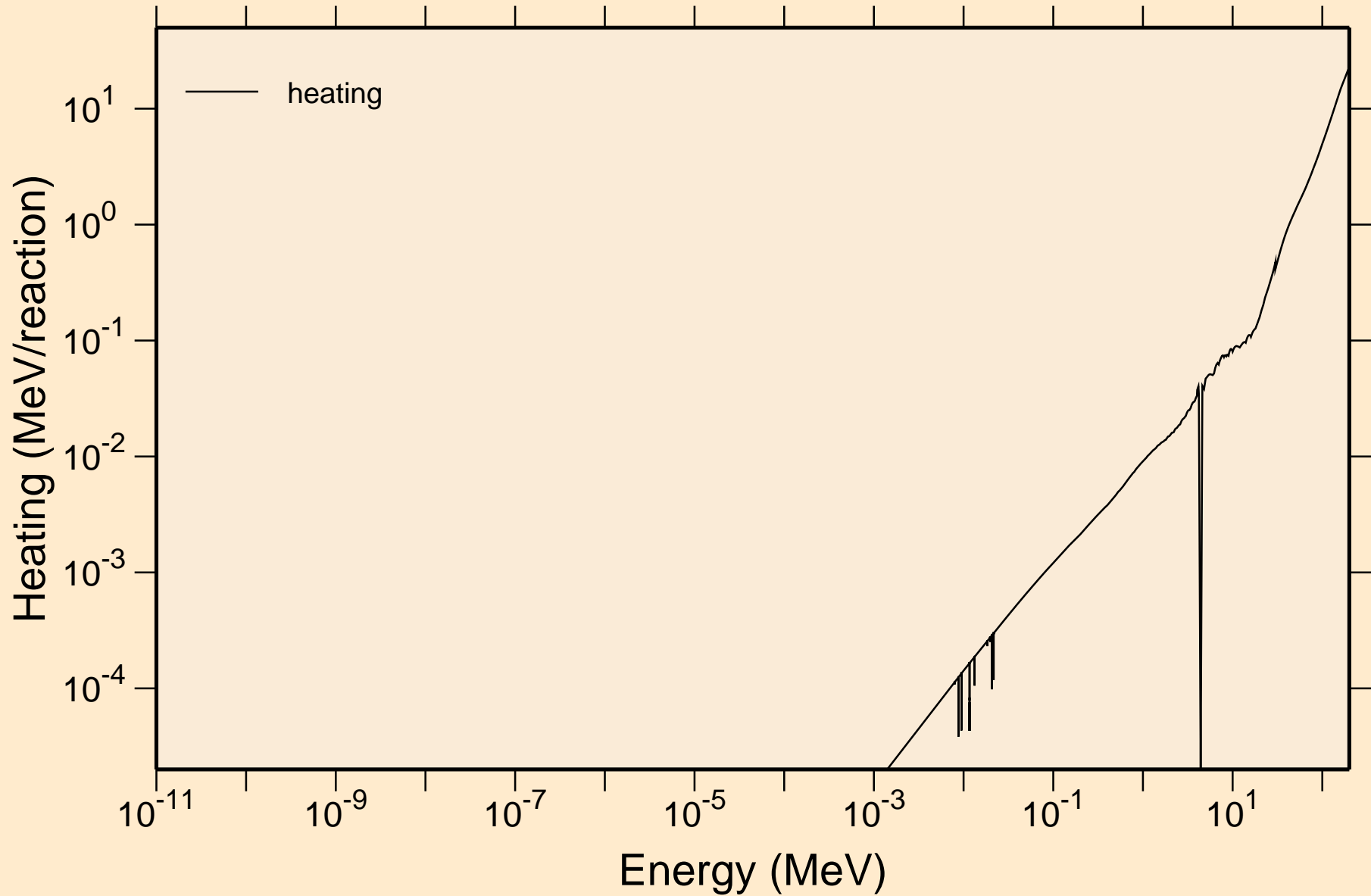

XE140 NEUTRON ACER TENDL-2024 LIBRARY; T=0.K

Damage

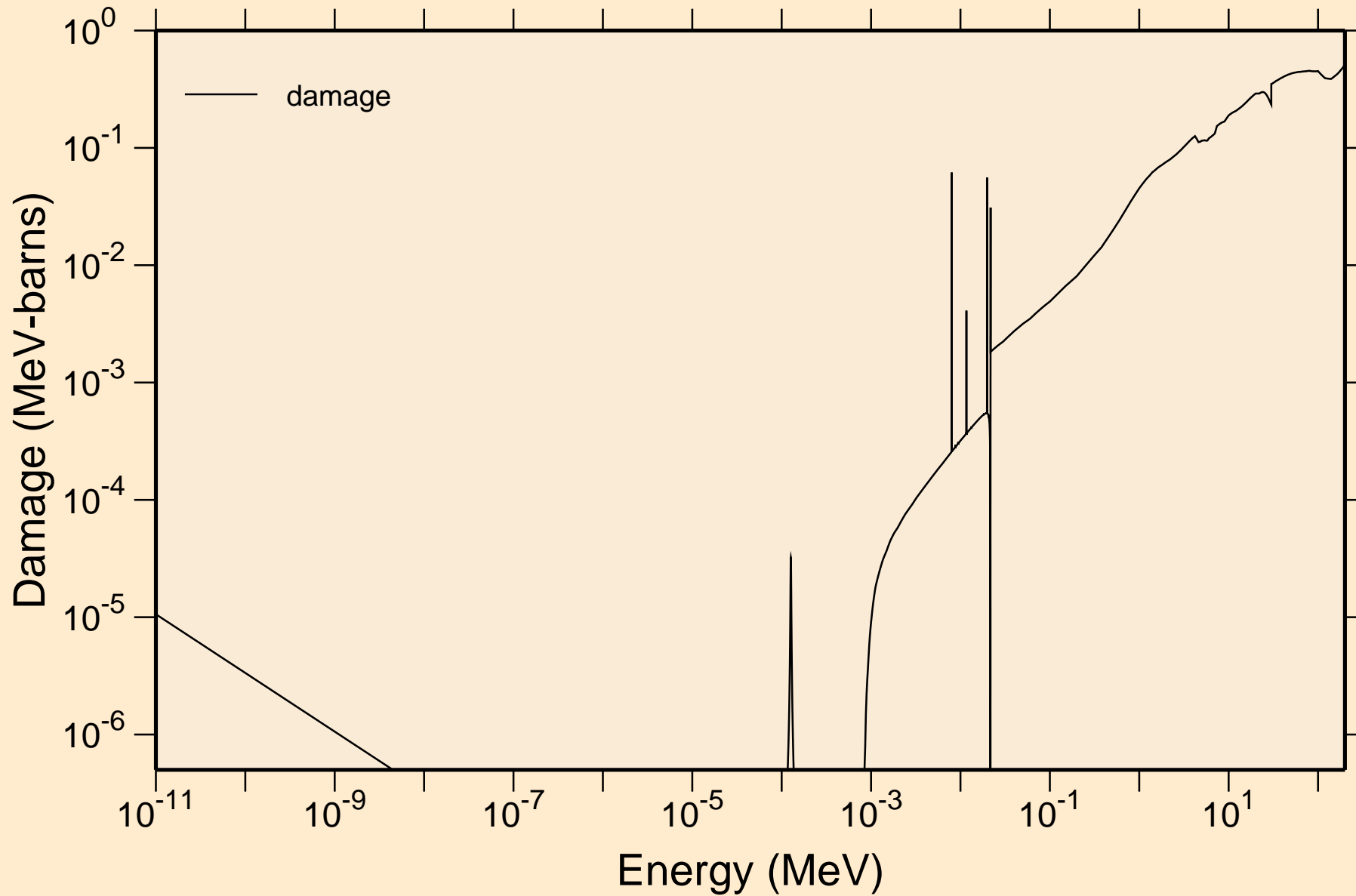

XE140 NEUTRON ACER TENDL-2024 LIBRARY; T=0.K

Non-threshold reactions

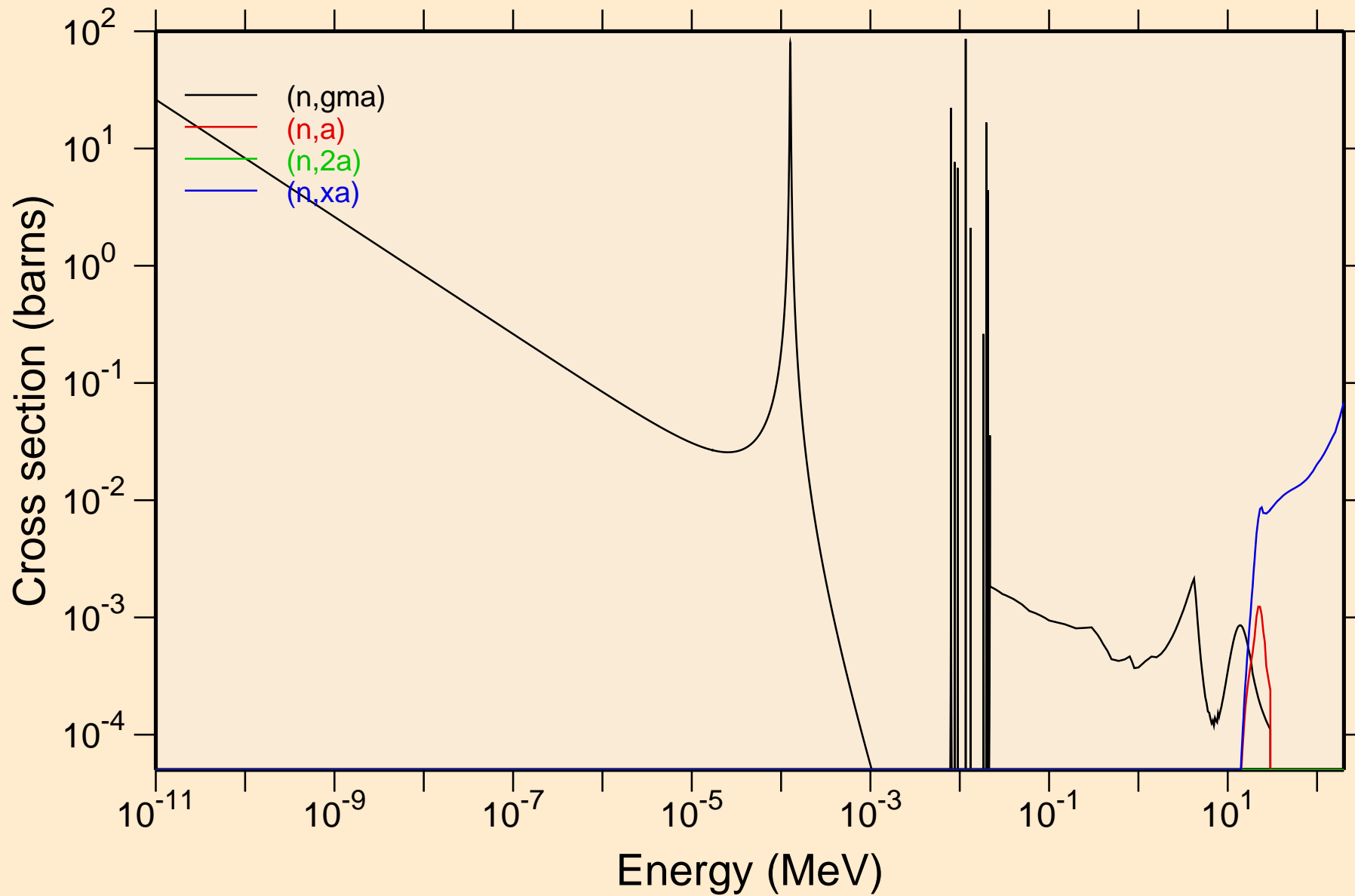

XE140 NEUTRON ACER TENDL-2024 LIBRARY; T=0.K
Principal cross sections

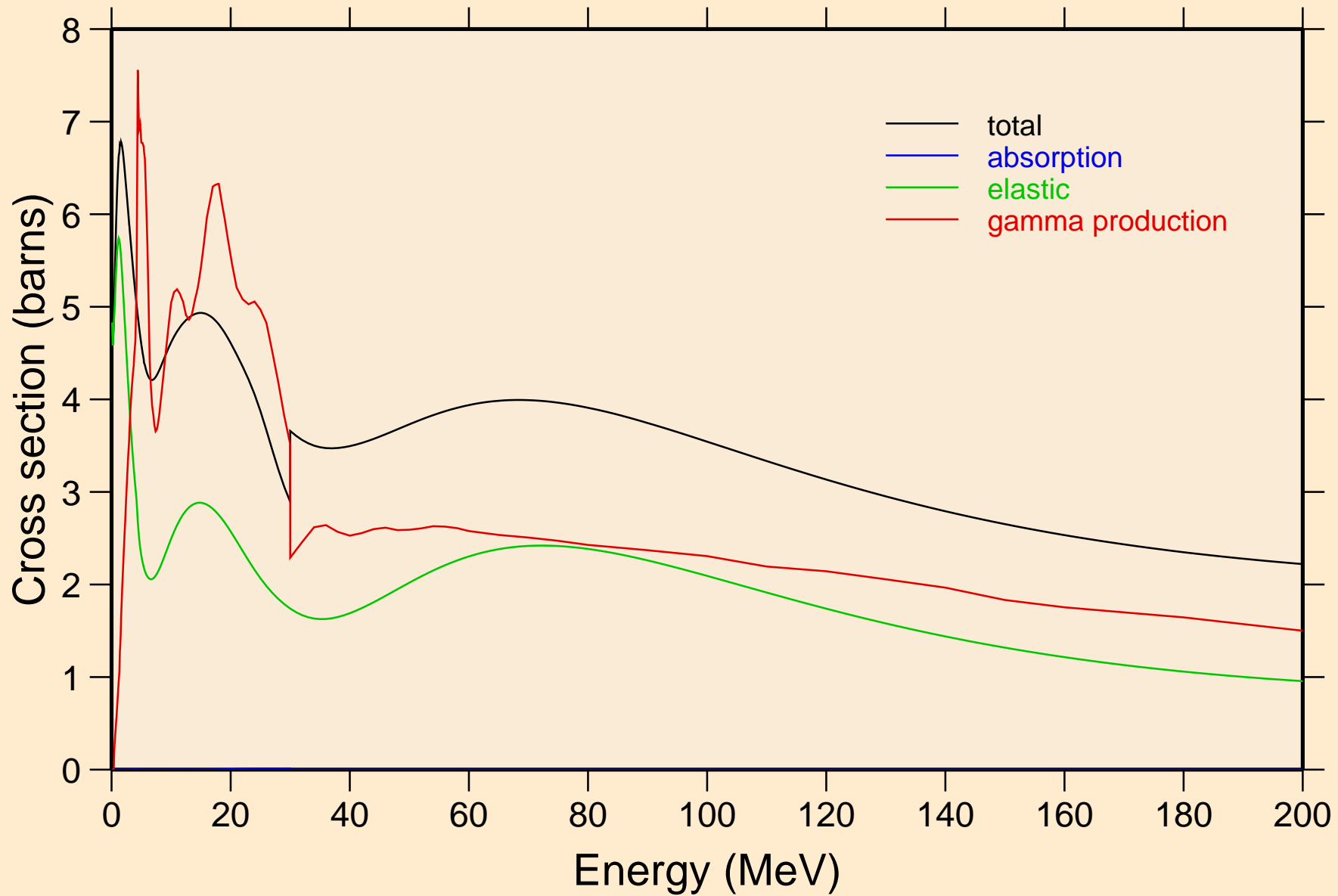

XE140 NEUTRON ACER TENDL-2024 LIBRARY; T=0.K

Heating

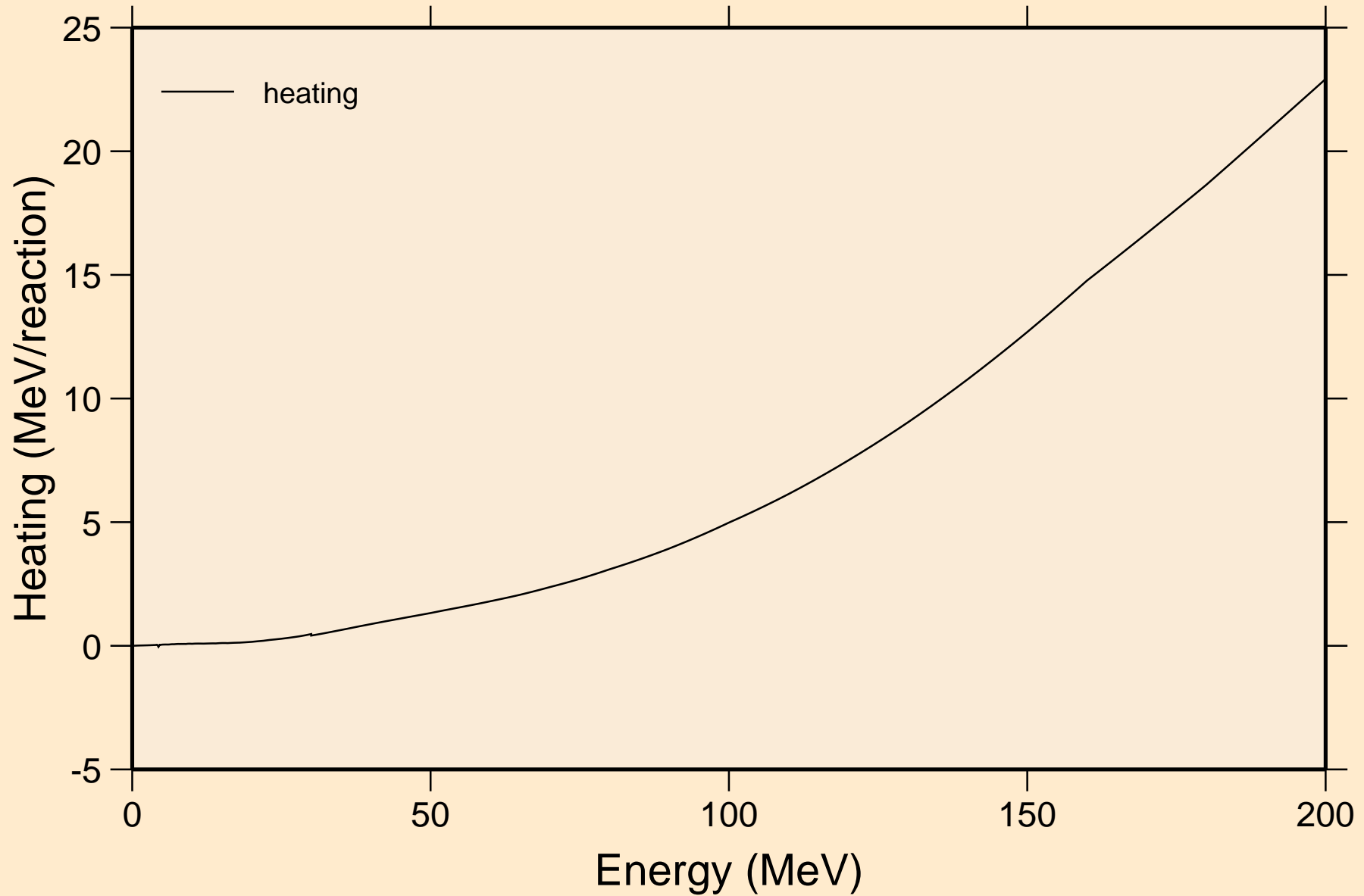

XE140 NEUTRON ACER TENDL-2024 LIBRARY; T=0.K
Damage

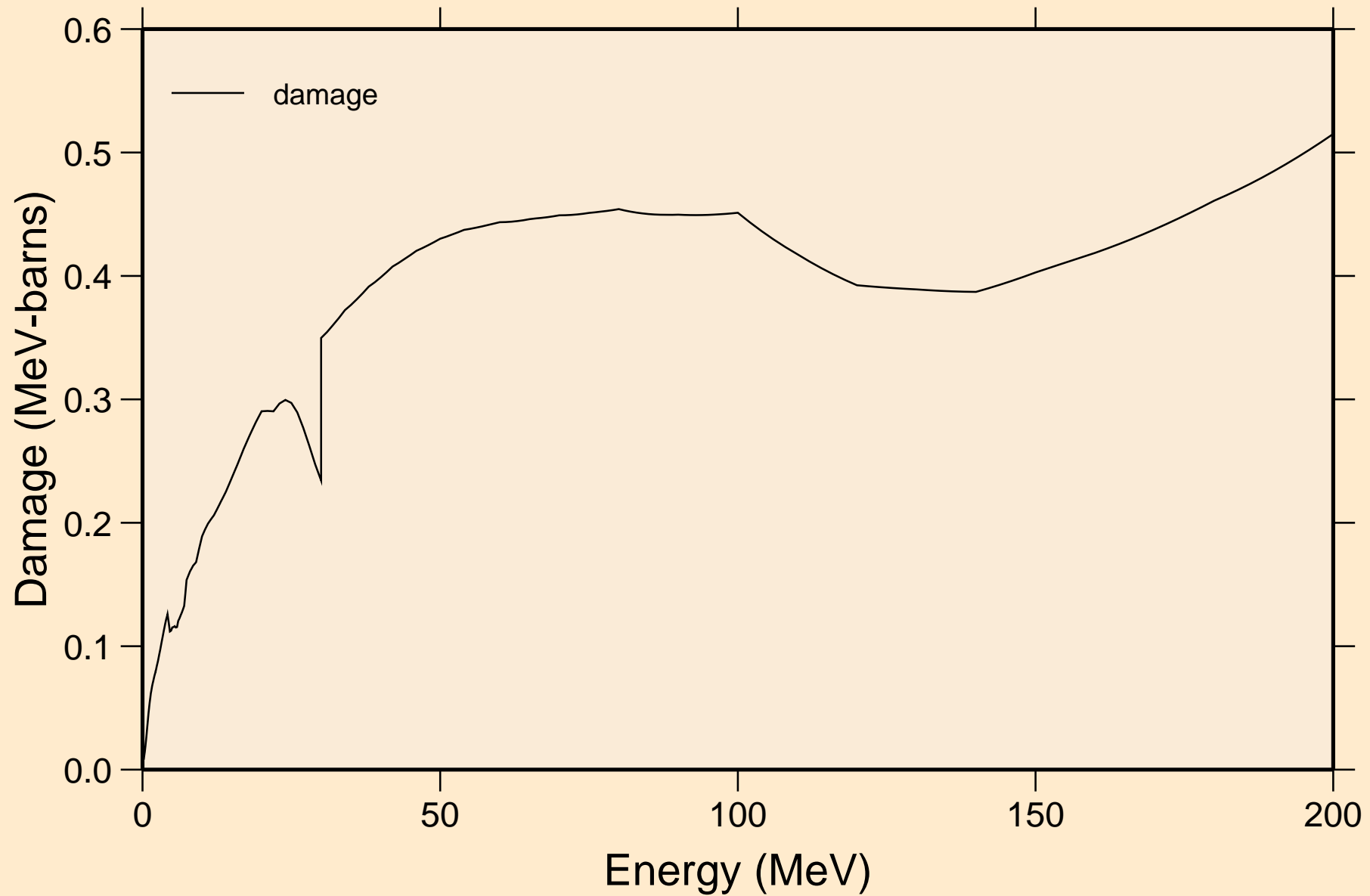

XE140 NEUTRON ACER TENDL-2024 LIBRARY; T=0.K

Non-threshold reactions

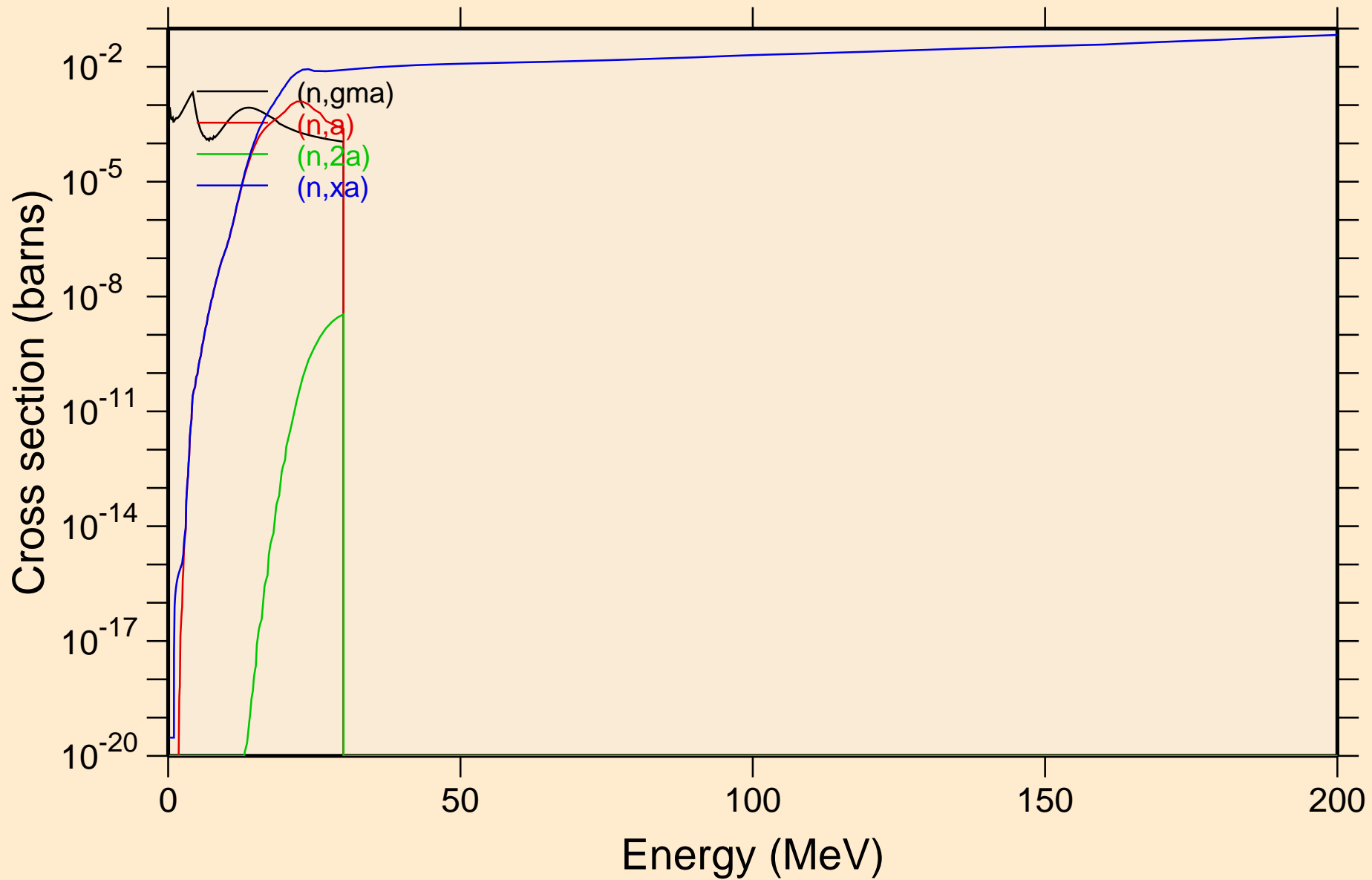

XE140 NEUTRON ACER TENDL-2024 LIBRARY; T=0.K
Inelastic levels

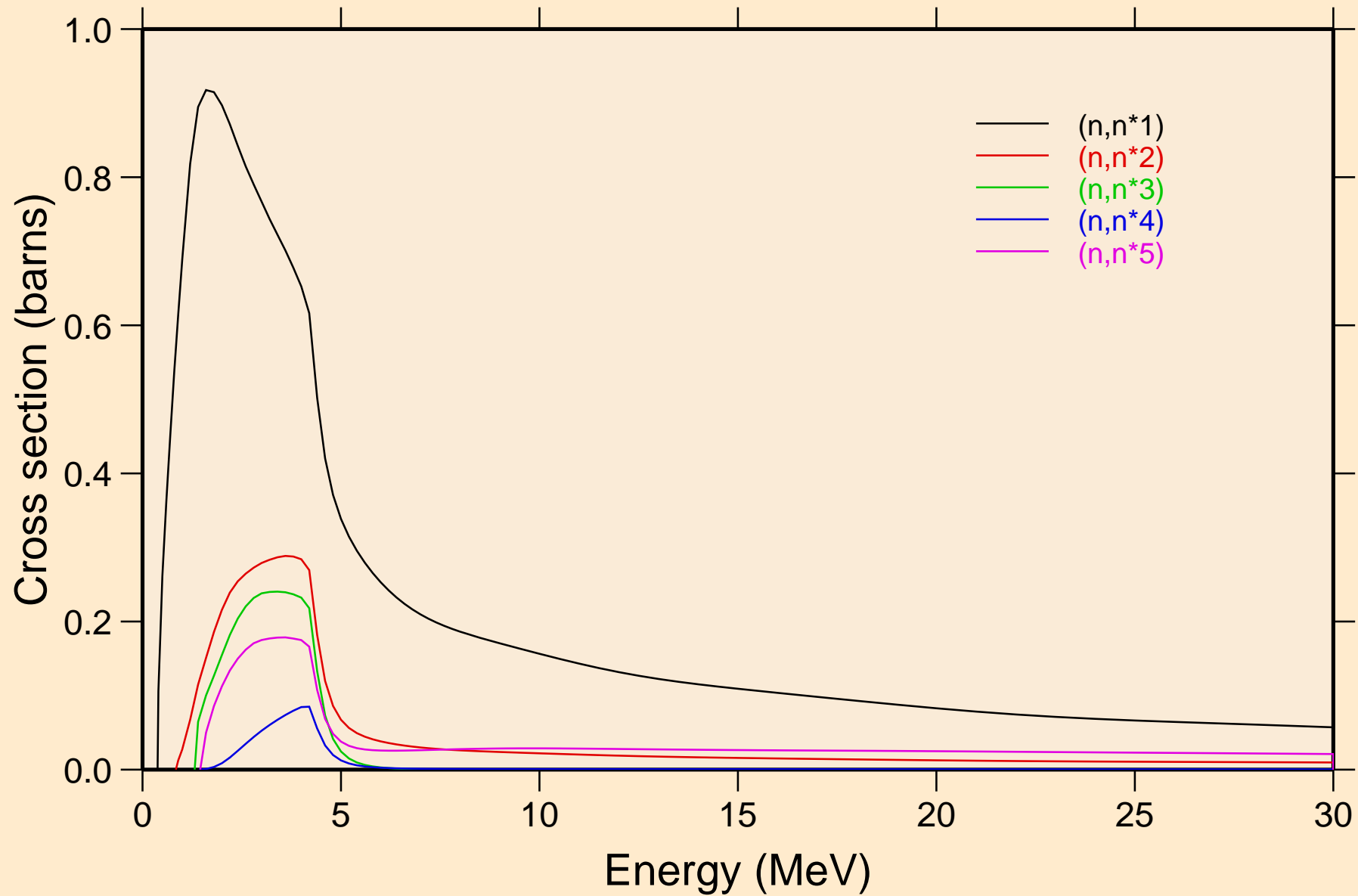

XE140 NEUTRON ACER TENDL-2024 LIBRARY; T=0.K
Inelastic levels

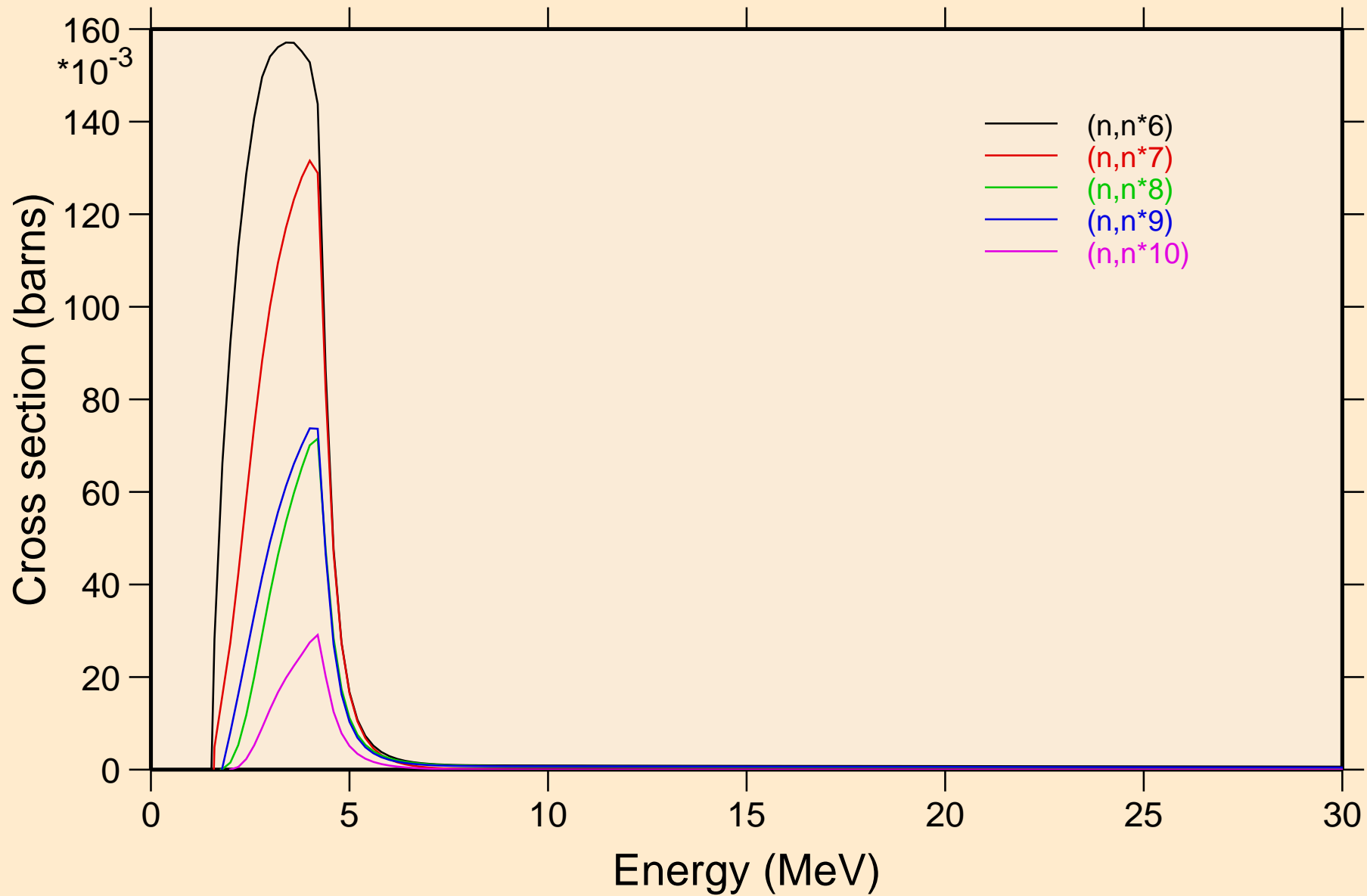

XE140 NEUTRON ACER TENDL-2024 LIBRARY; T=0.K
Inelastic levels

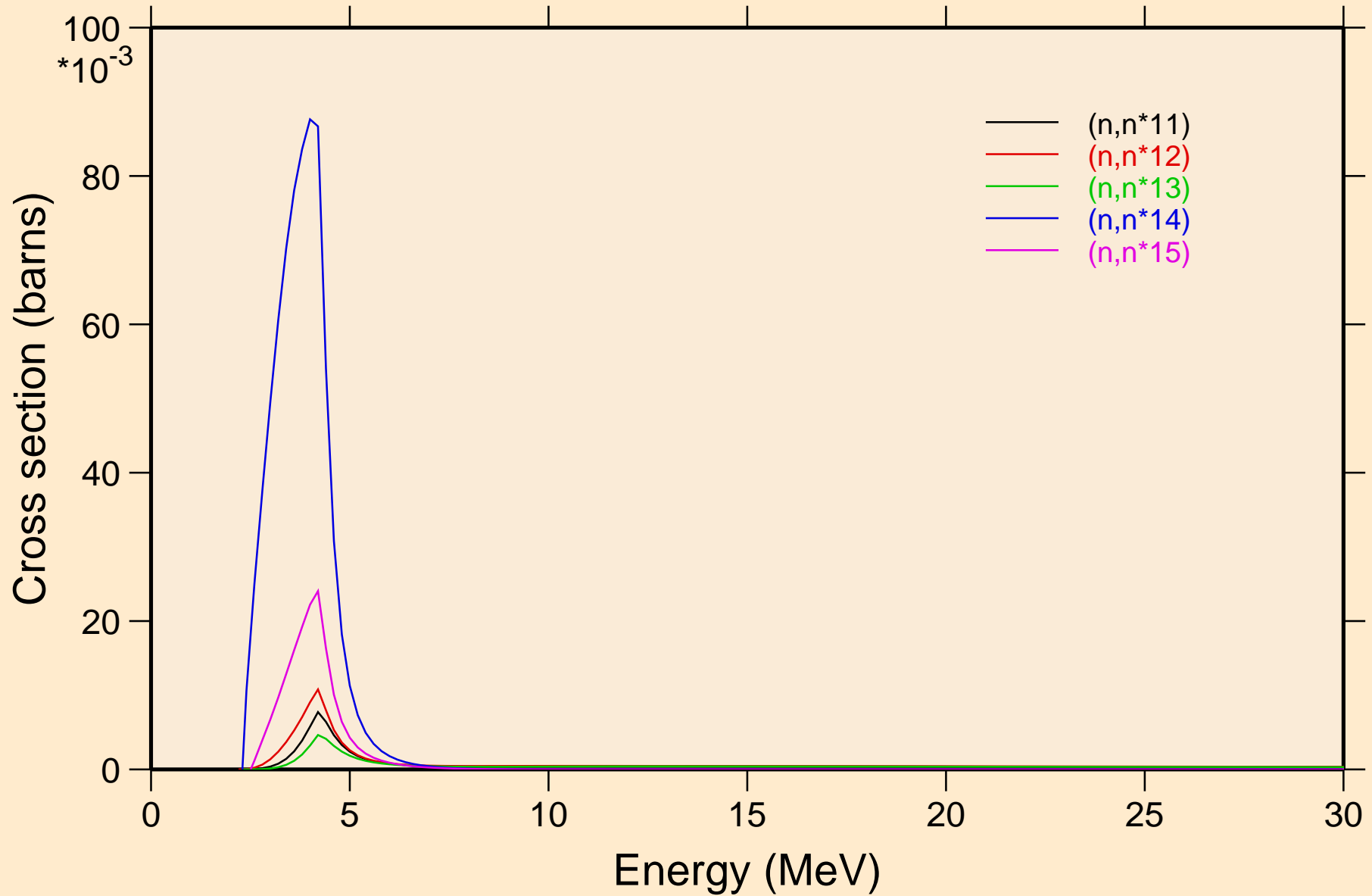

XE140 NEUTRON ACER TENDL-2024 LIBRARY; T=0.K
Inelastic levels

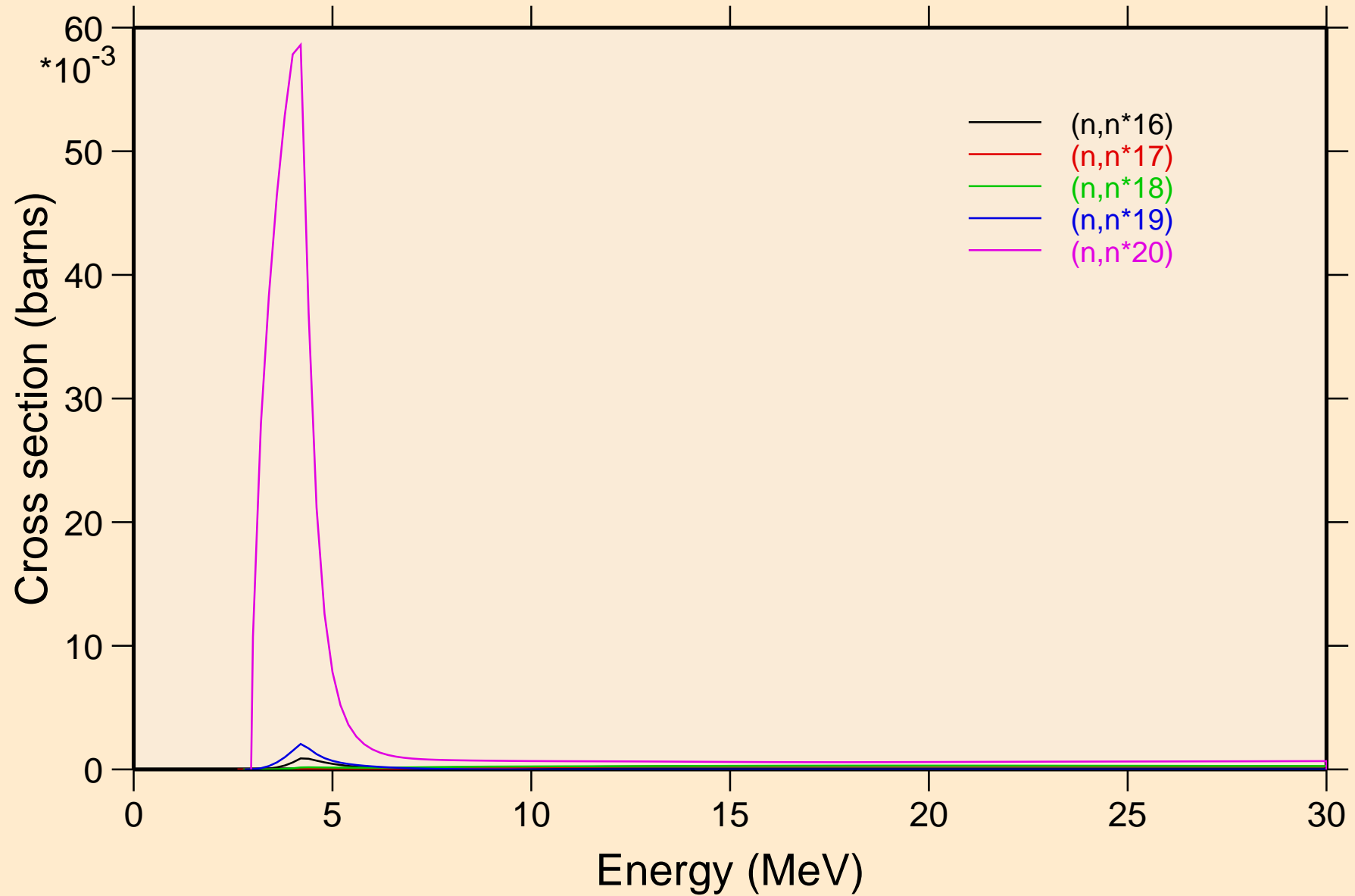

XE140 NEUTRON ACER TENDL-2024 LIBRARY; T=0.K
Inelastic levels

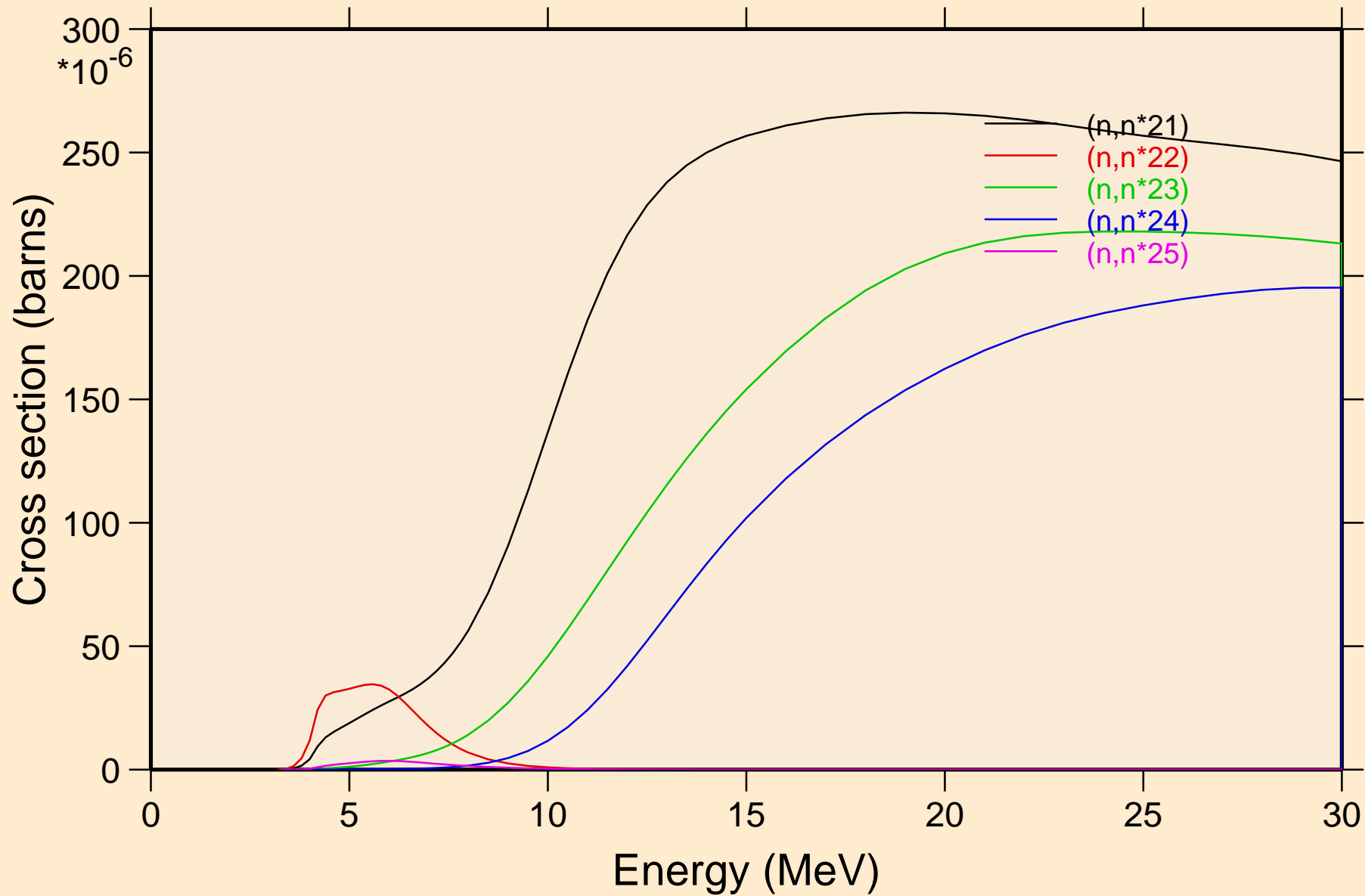

XE140 NEUTRON ACER TENDL-2024 LIBRARY; T=0.K
Inelastic levels

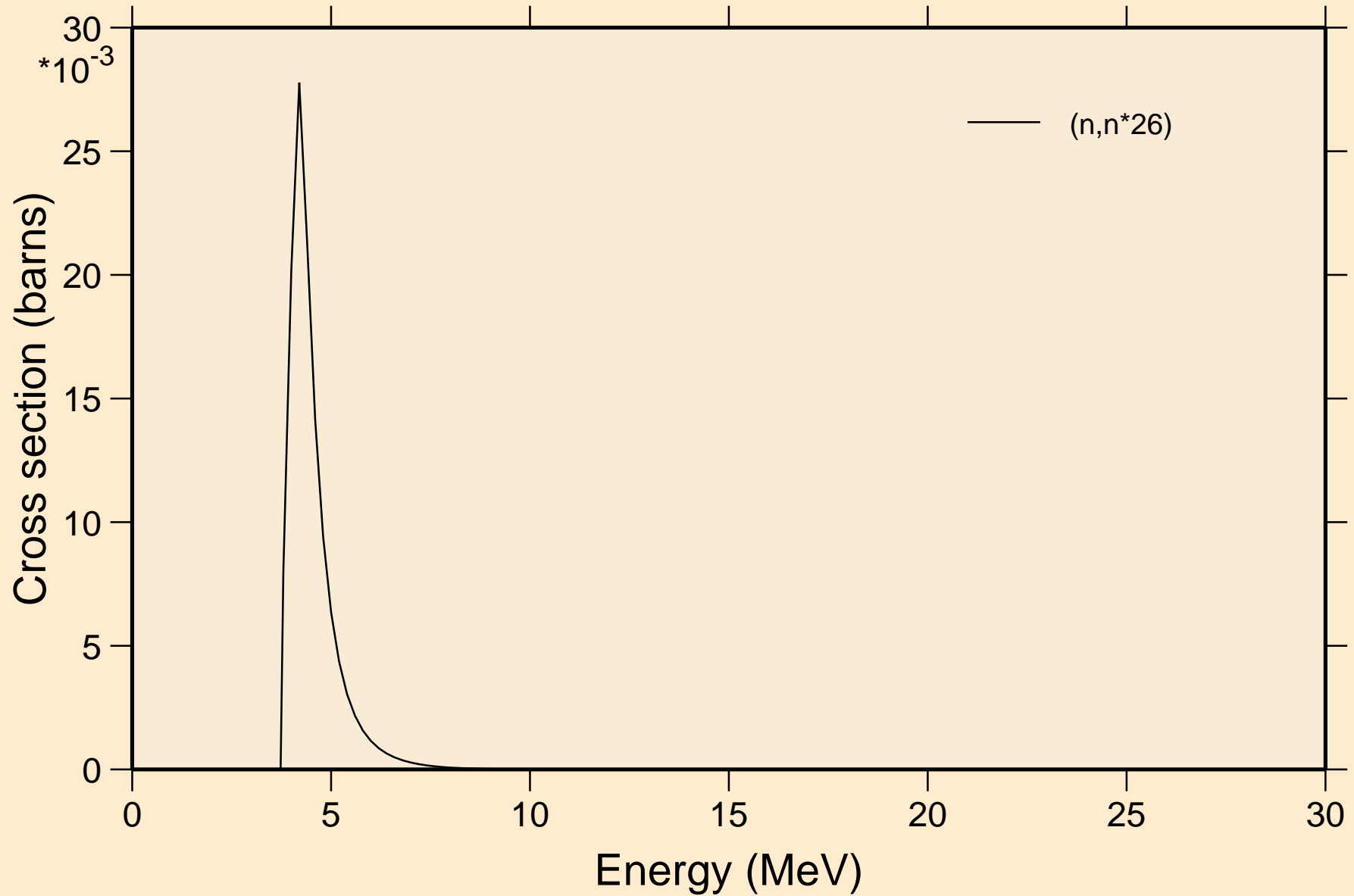

XE140 NEUTRON ACER TENDL-2024 LIBRARY; T=0.K

Threshold reactions

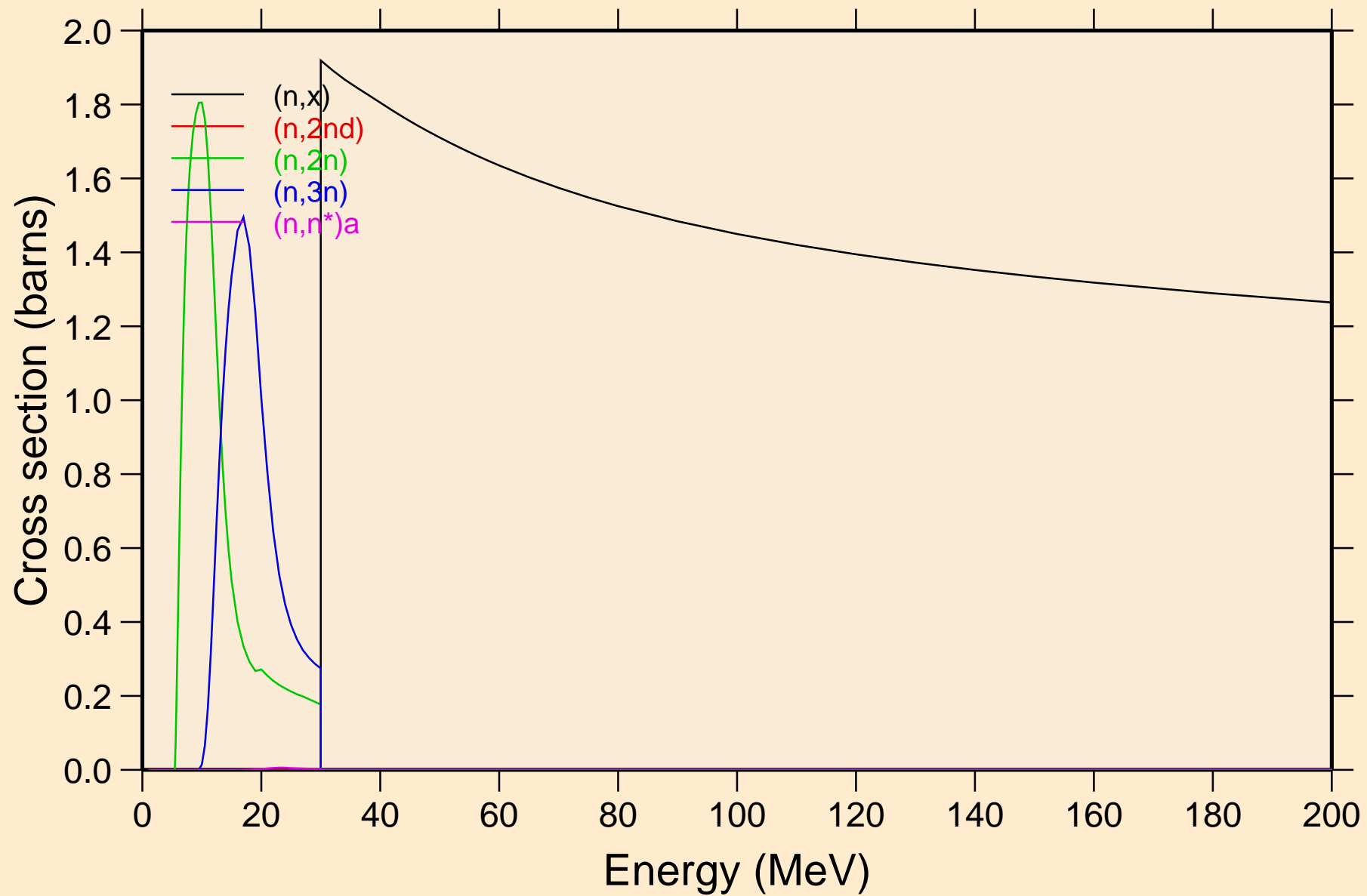

XE140 NEUTRON ACER TENDL-2024 LIBRARY; T=0.K

Threshold reactions

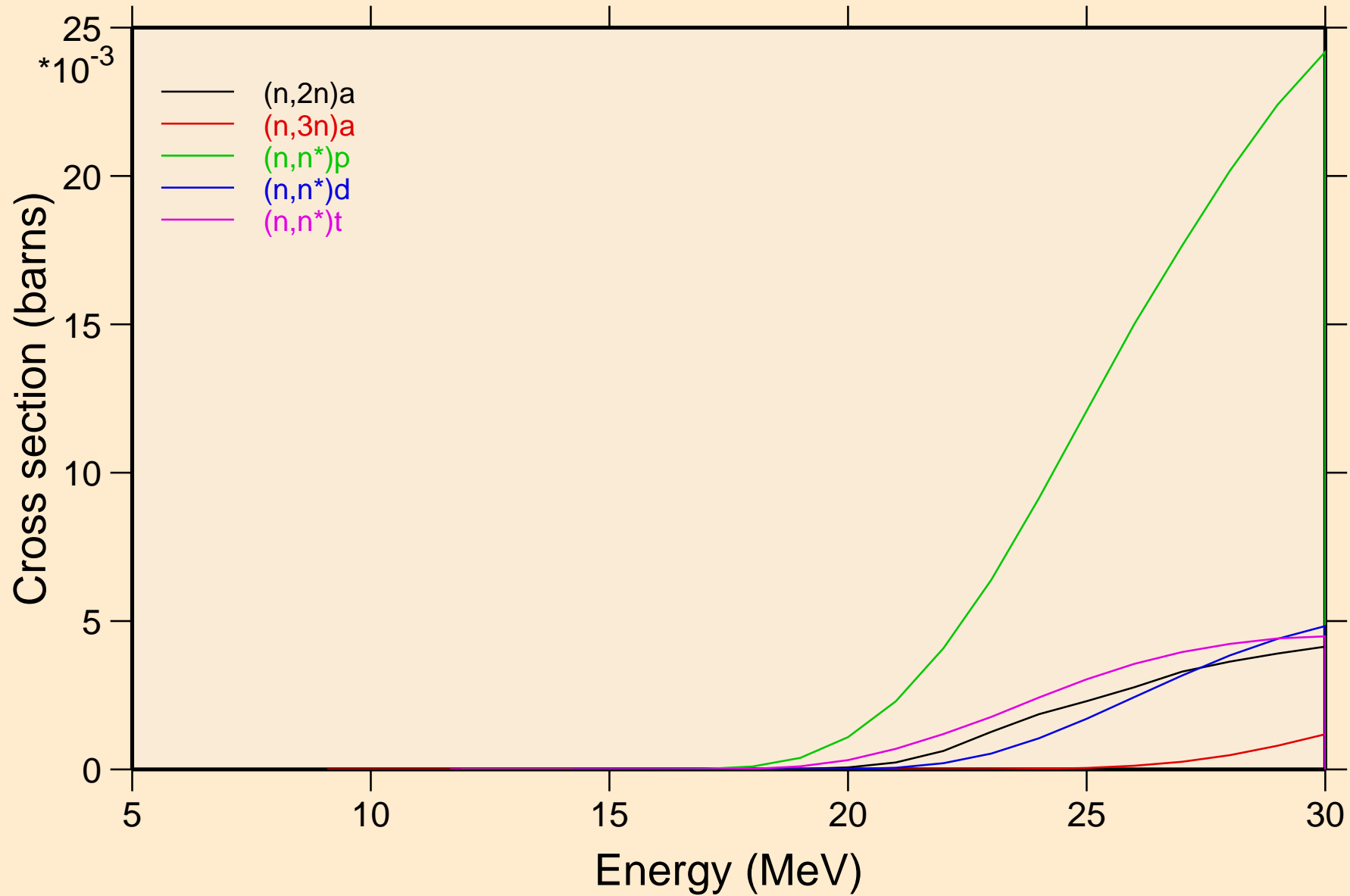

XE140 NEUTRON ACER TENDL-2024 LIBRARY; T=0.K
Threshold reactions

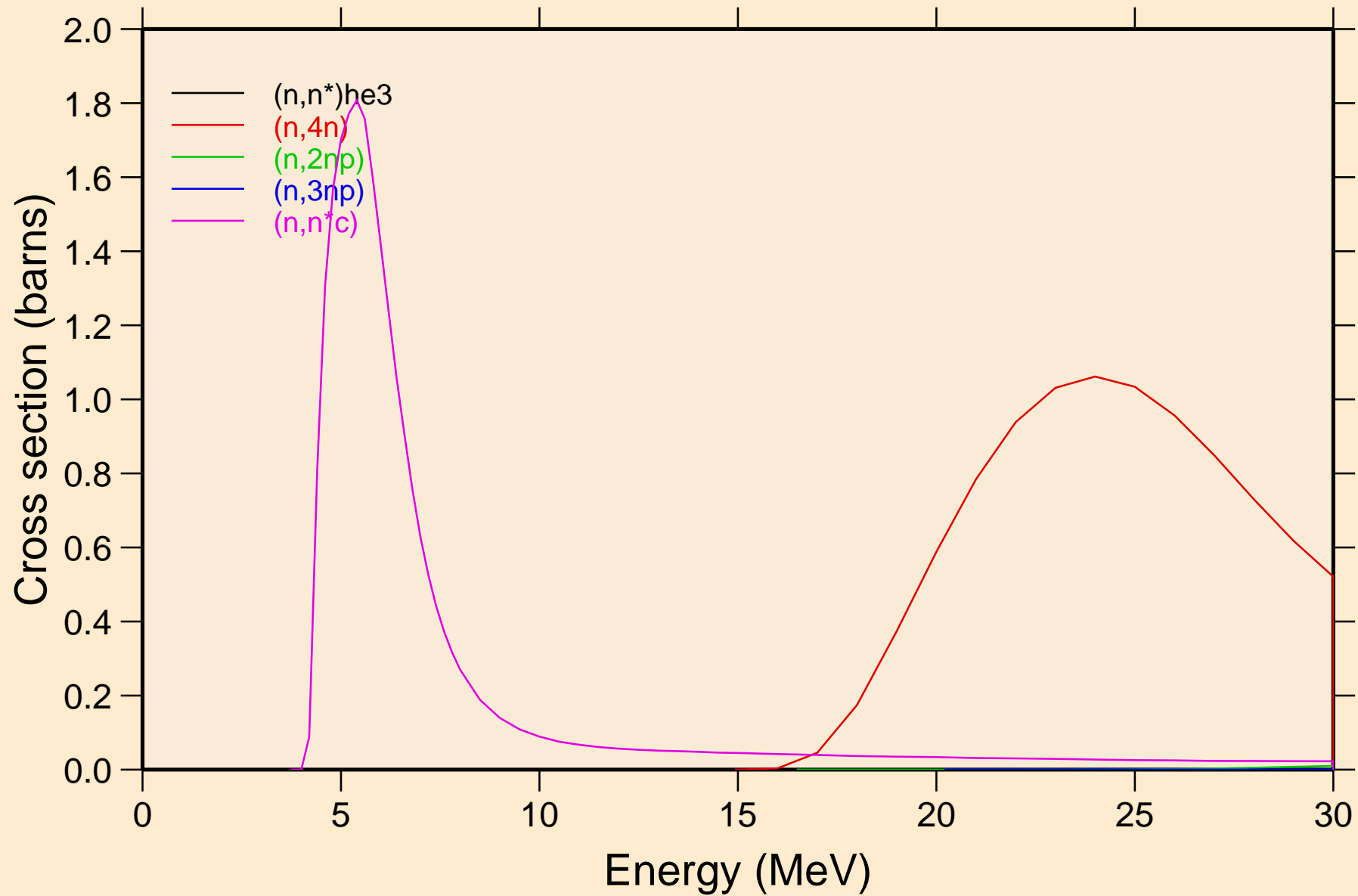

XE140 NEUTRON ACER TENDL-2024 LIBRARY; T=0.K

Threshold reactions

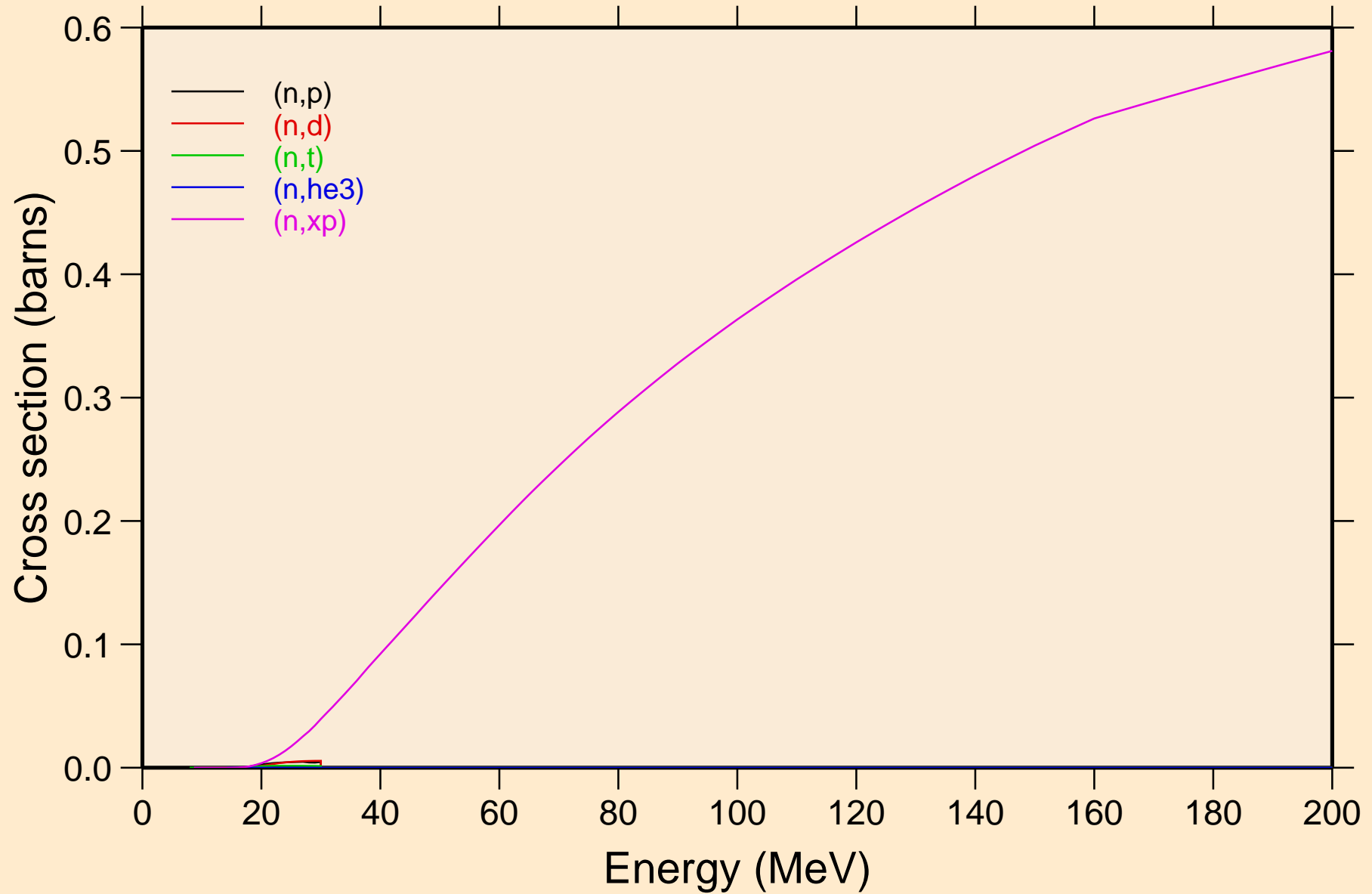

XE140 NEUTRON ACER TENDL-2024 LIBRARY; T=0.K

Threshold reactions

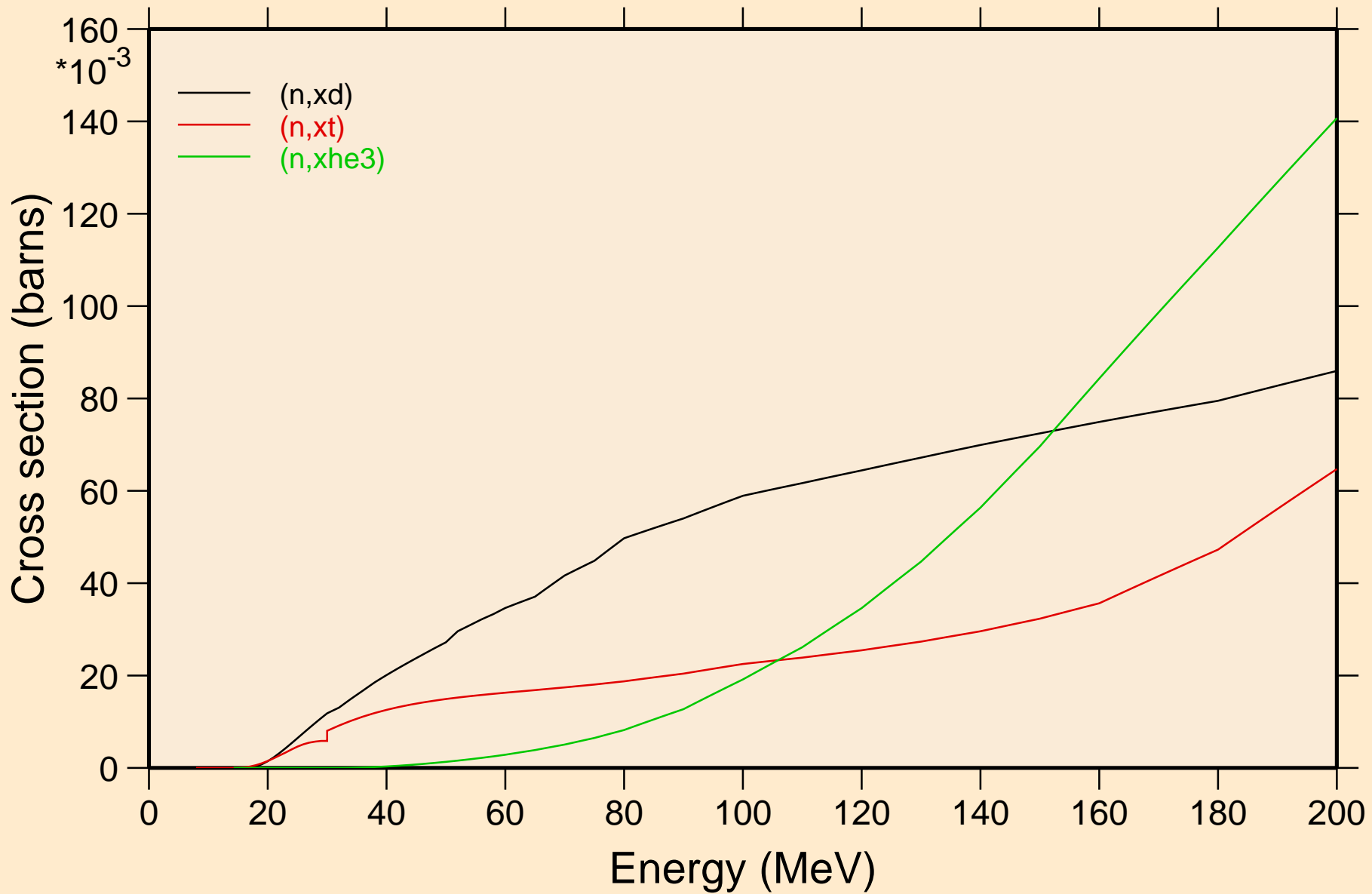

XE140 NEUTRON ACER TENDL-2024 LIBRARY; T=0.K
angular distribution for elastic

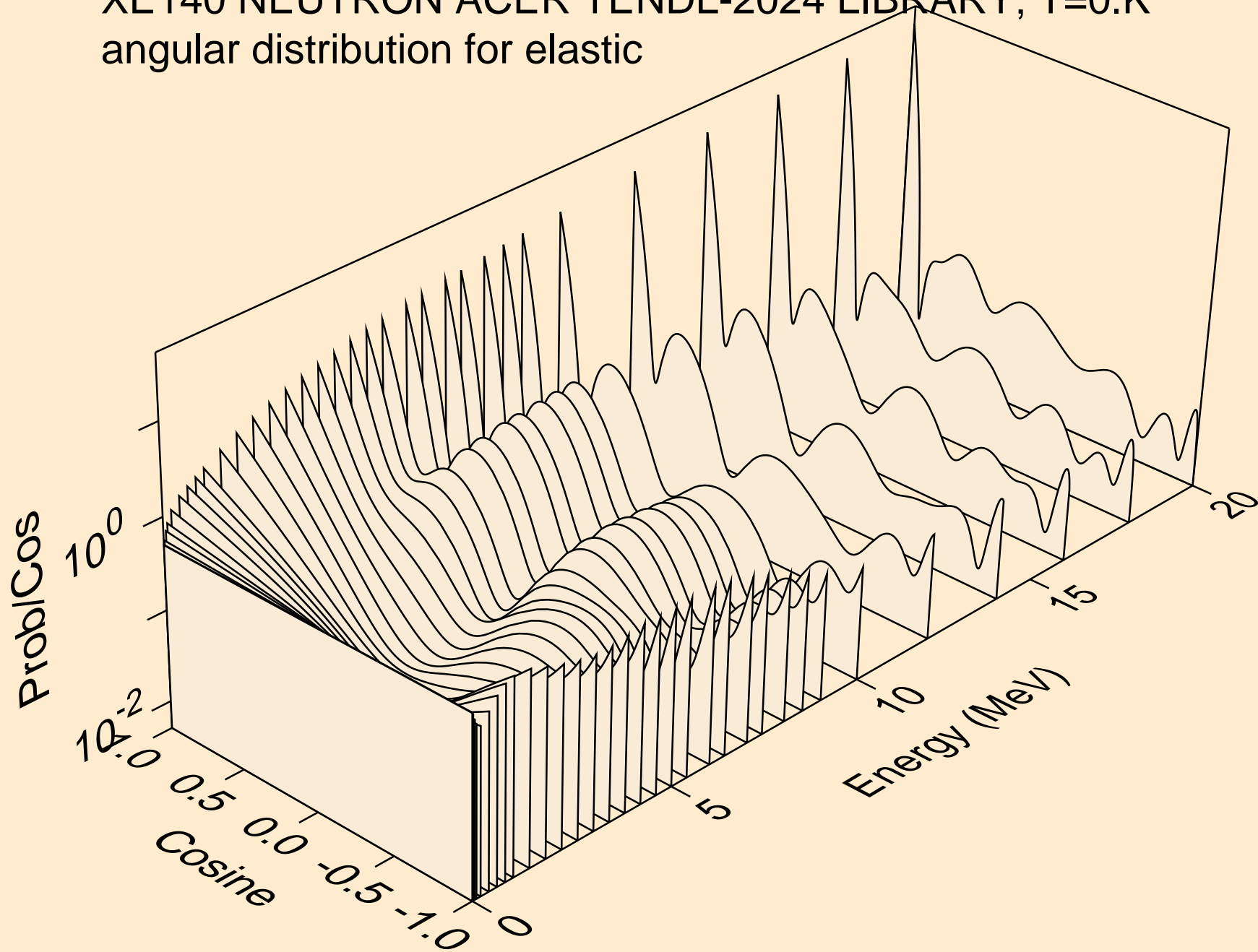

XE140 NEUTRON ACER TENDL-2024 LIBRARY; T=0.K
angular distribution for elastic

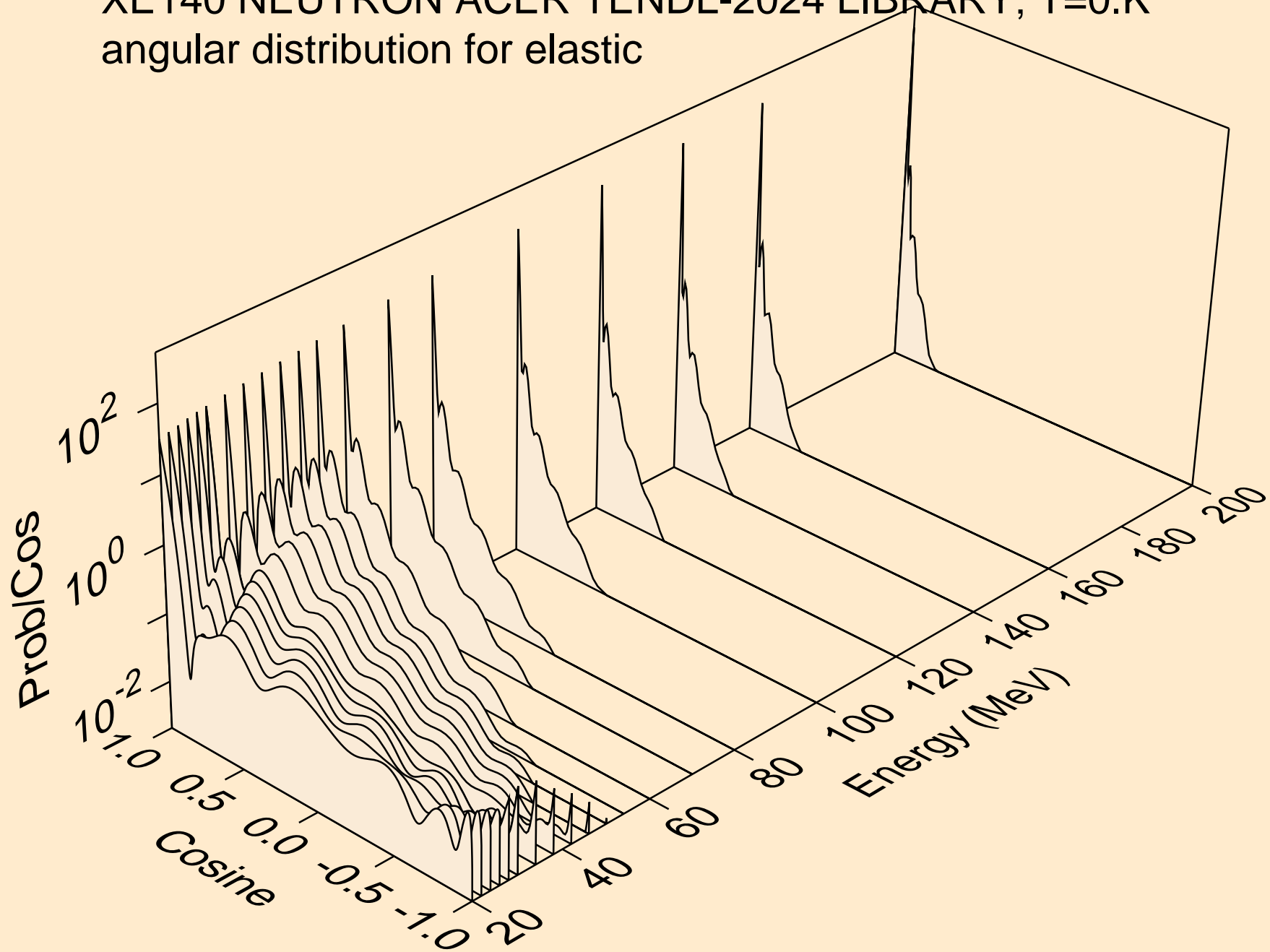

XE140 NEUTRON ACER TENDL-2024 LIBRARY; T=0.K
angular distribution for (n,n*1)

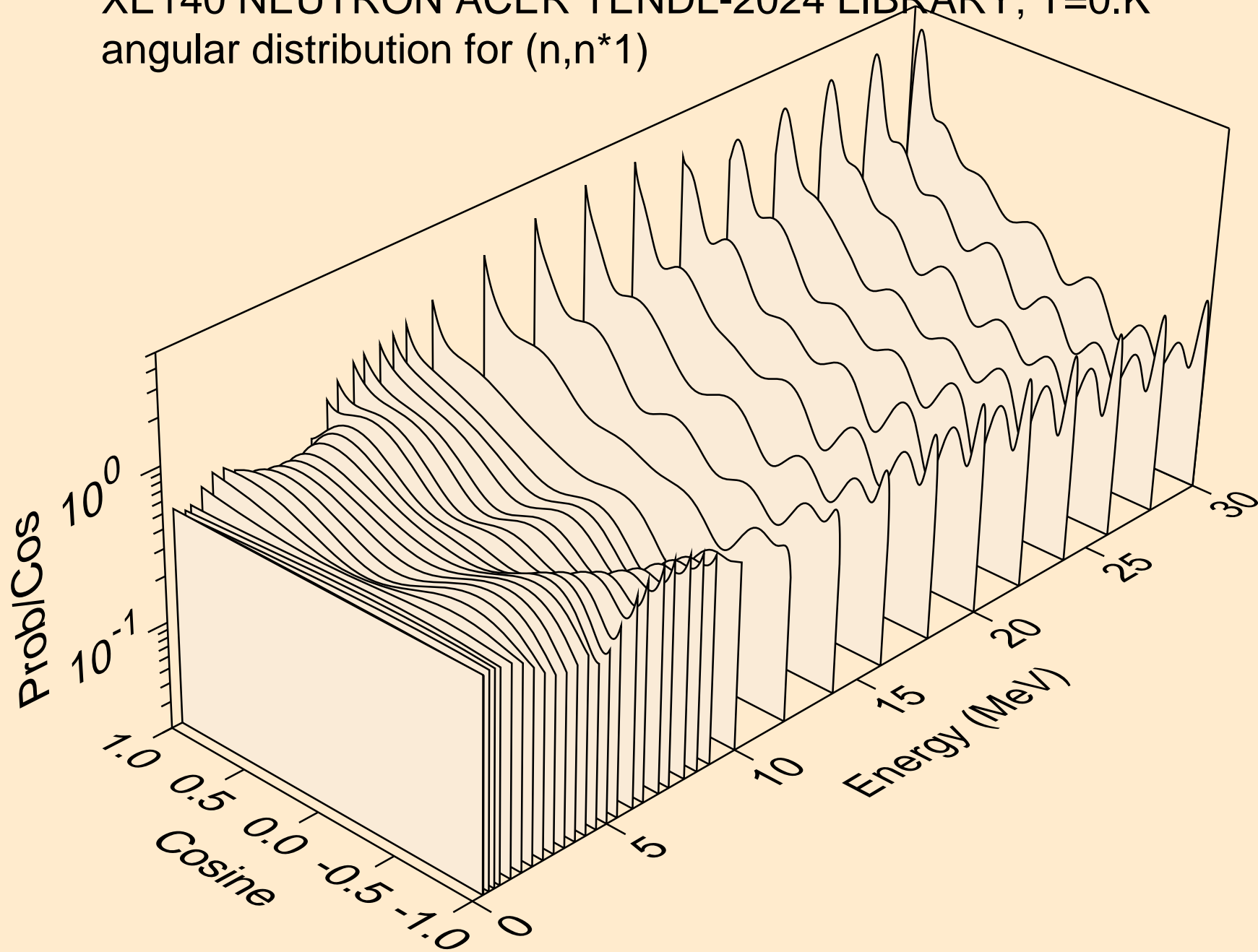

XE140 NEUTRON ACER TENDL-2024 LIBRARY; T=0.K
angular distribution for (n,n*2)

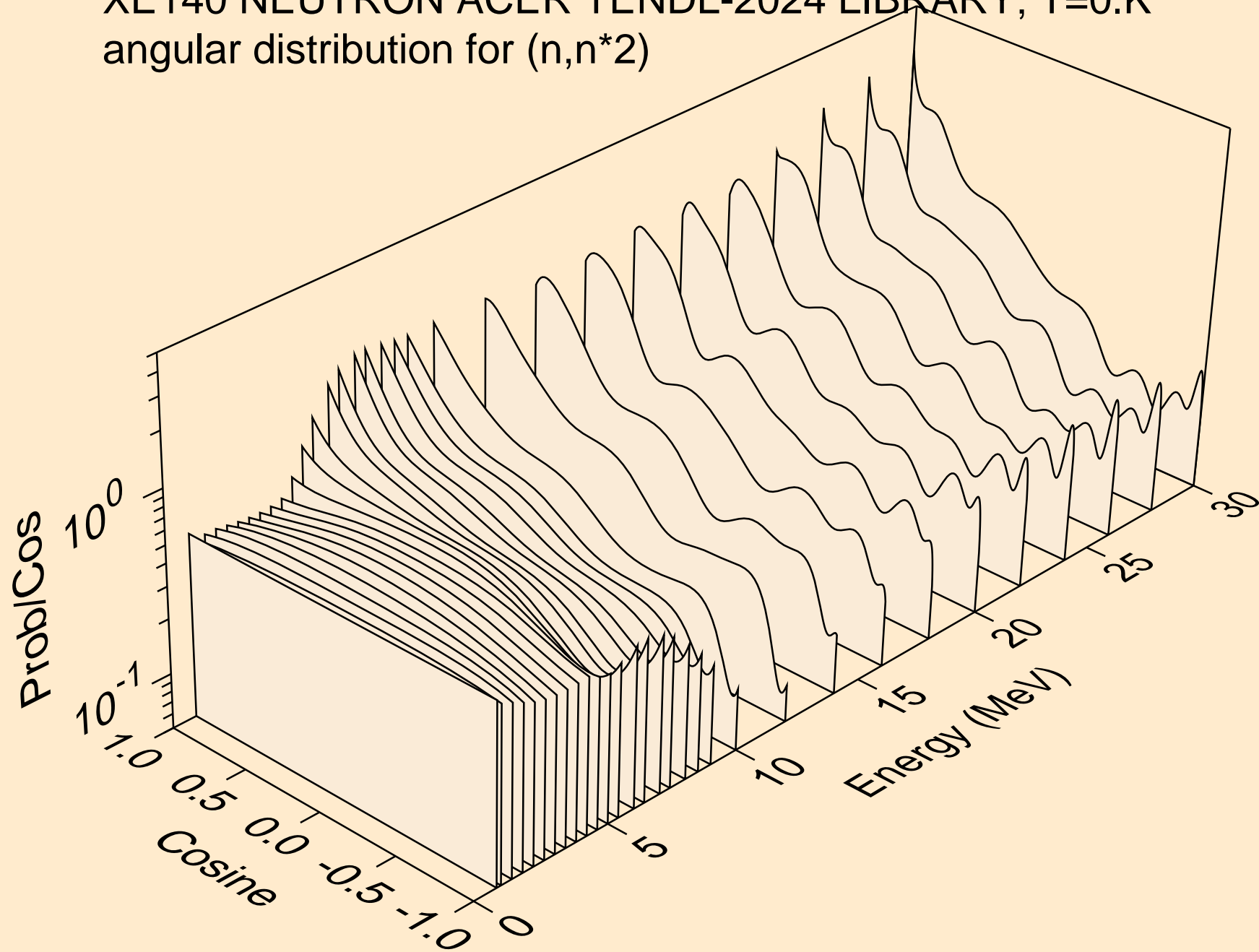

XE140 NEUTRON ACER TENDL-2024 LIBRARY; T=0.K
angular distribution for (n,n*3)

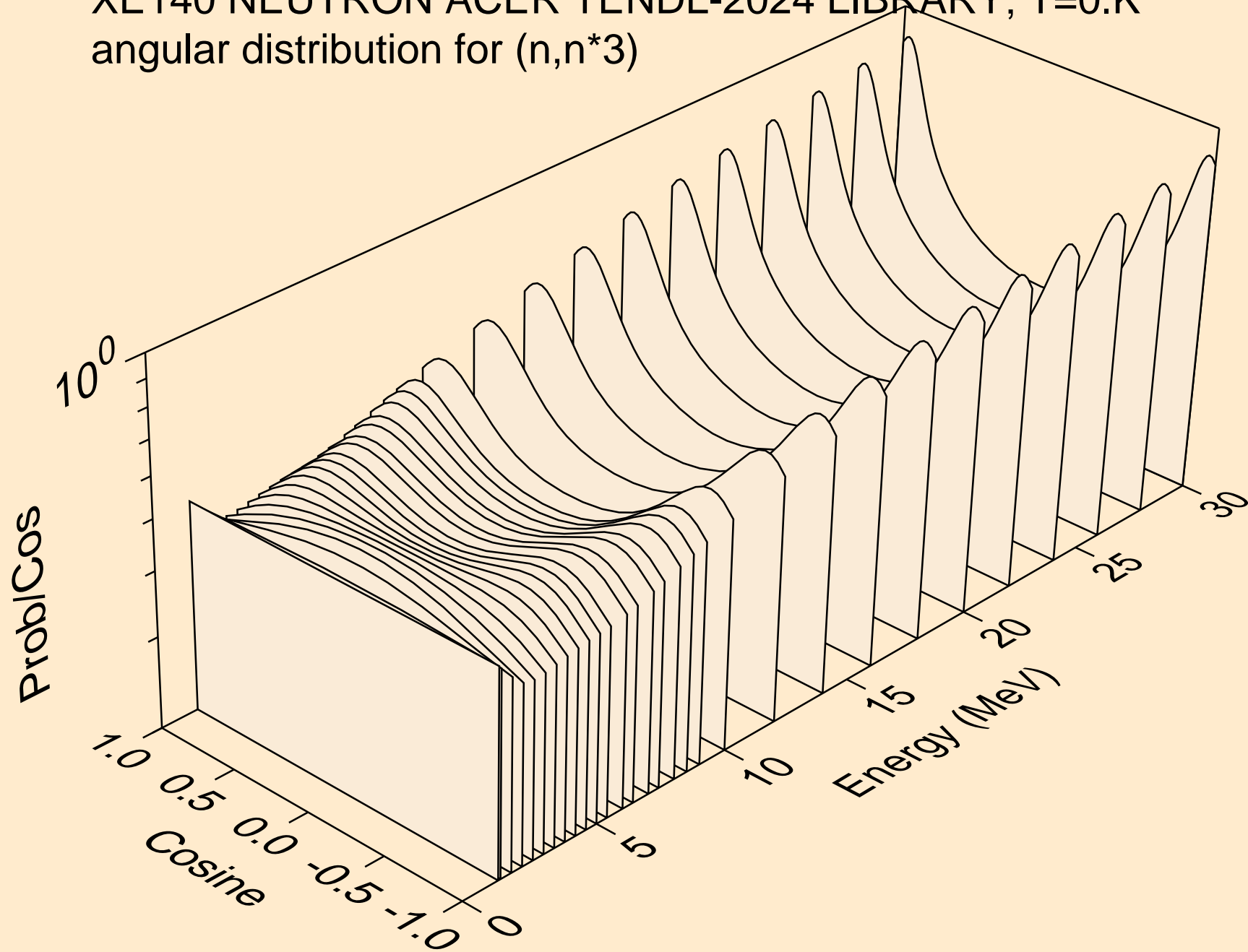

XE140 NEUTRON ACER TENDL-2024 LIBRARY; T=0.K
angular distribution for (n,n*4)

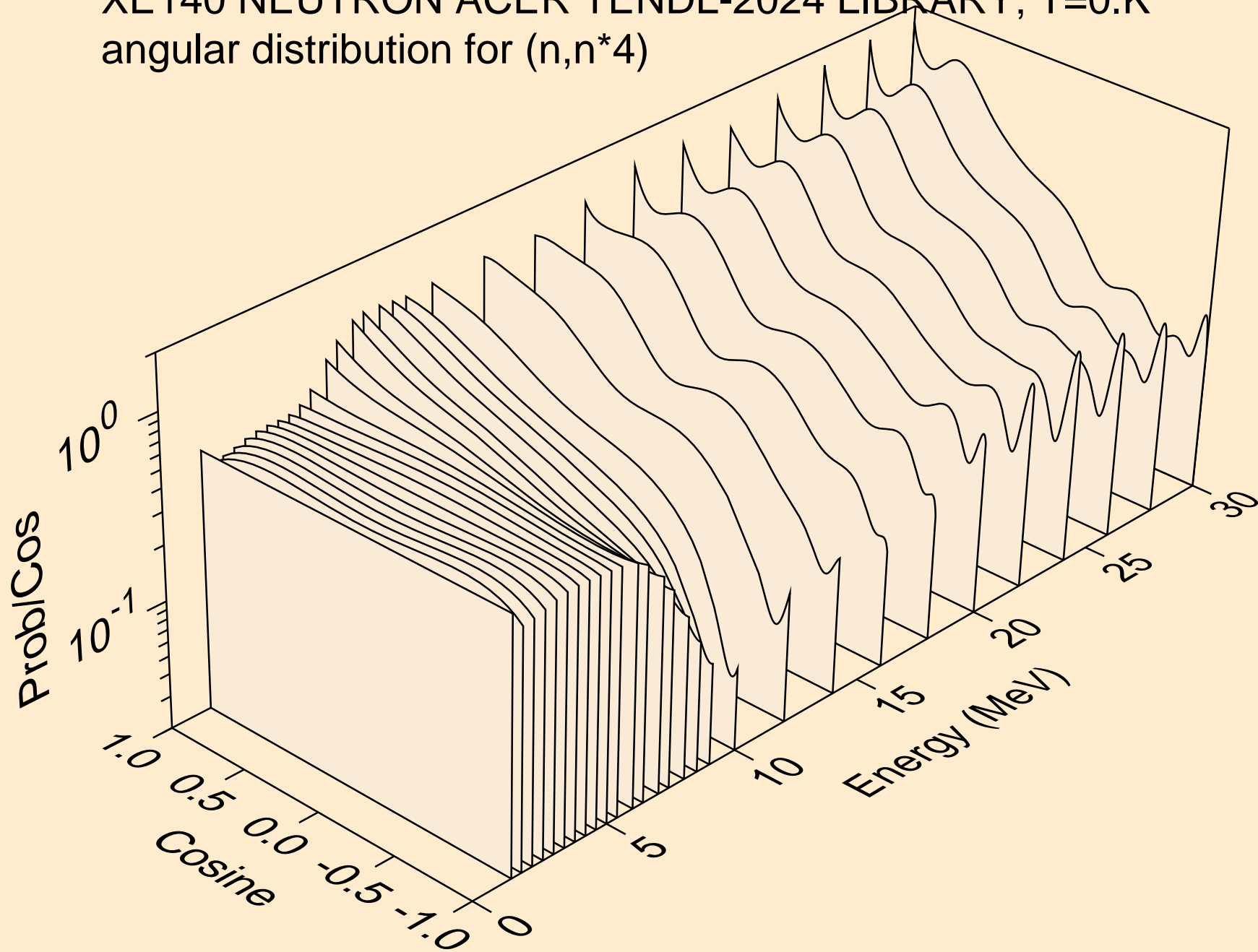

XE140 NEUTRON ACER TENDL-2024 LIBRARY; T=0.K
angular distribution for (n,n*5)

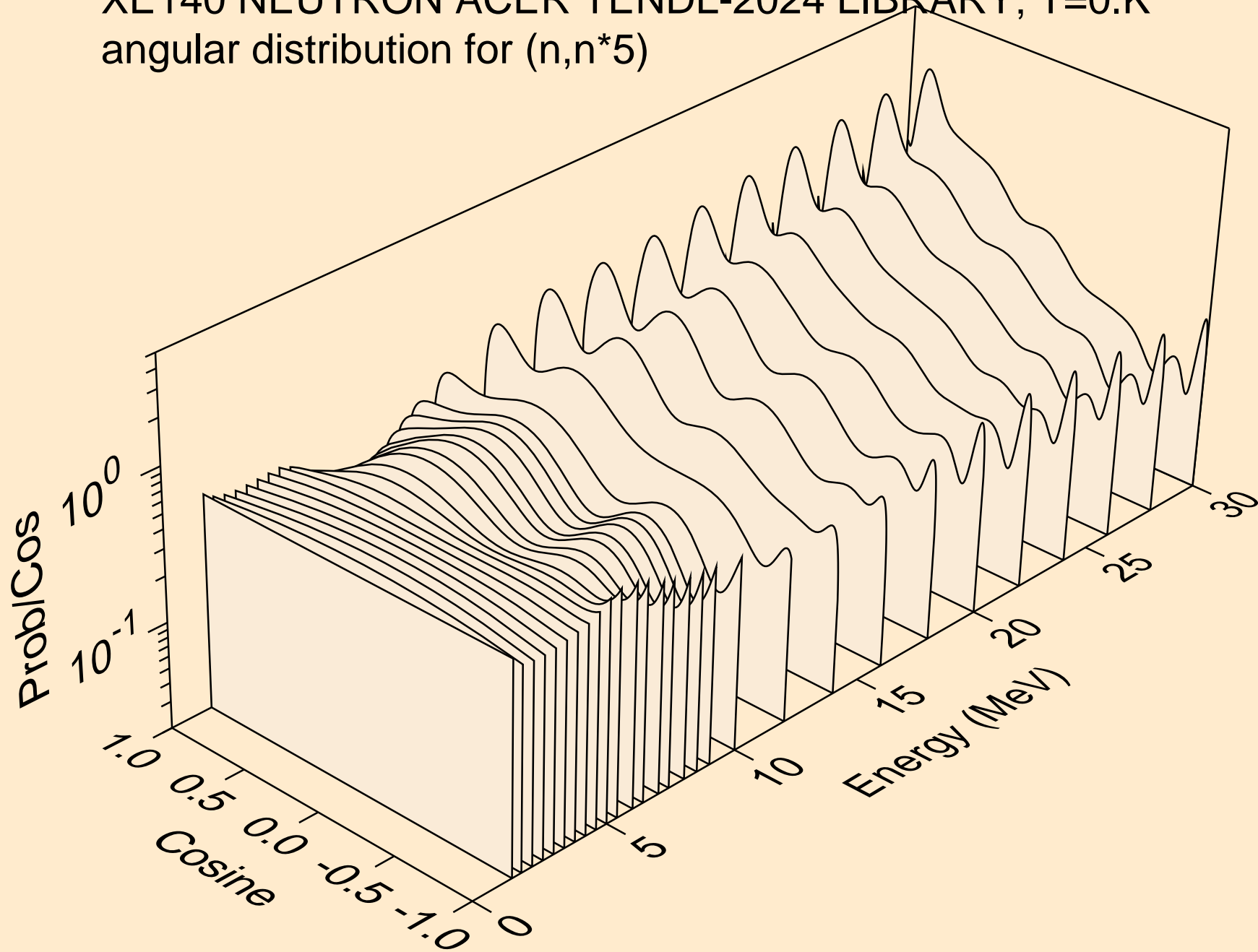

XE140 NEUTRON ACER TENDL-2024 LIBRARY; T=0.K
angular distribution for (n,n*6)

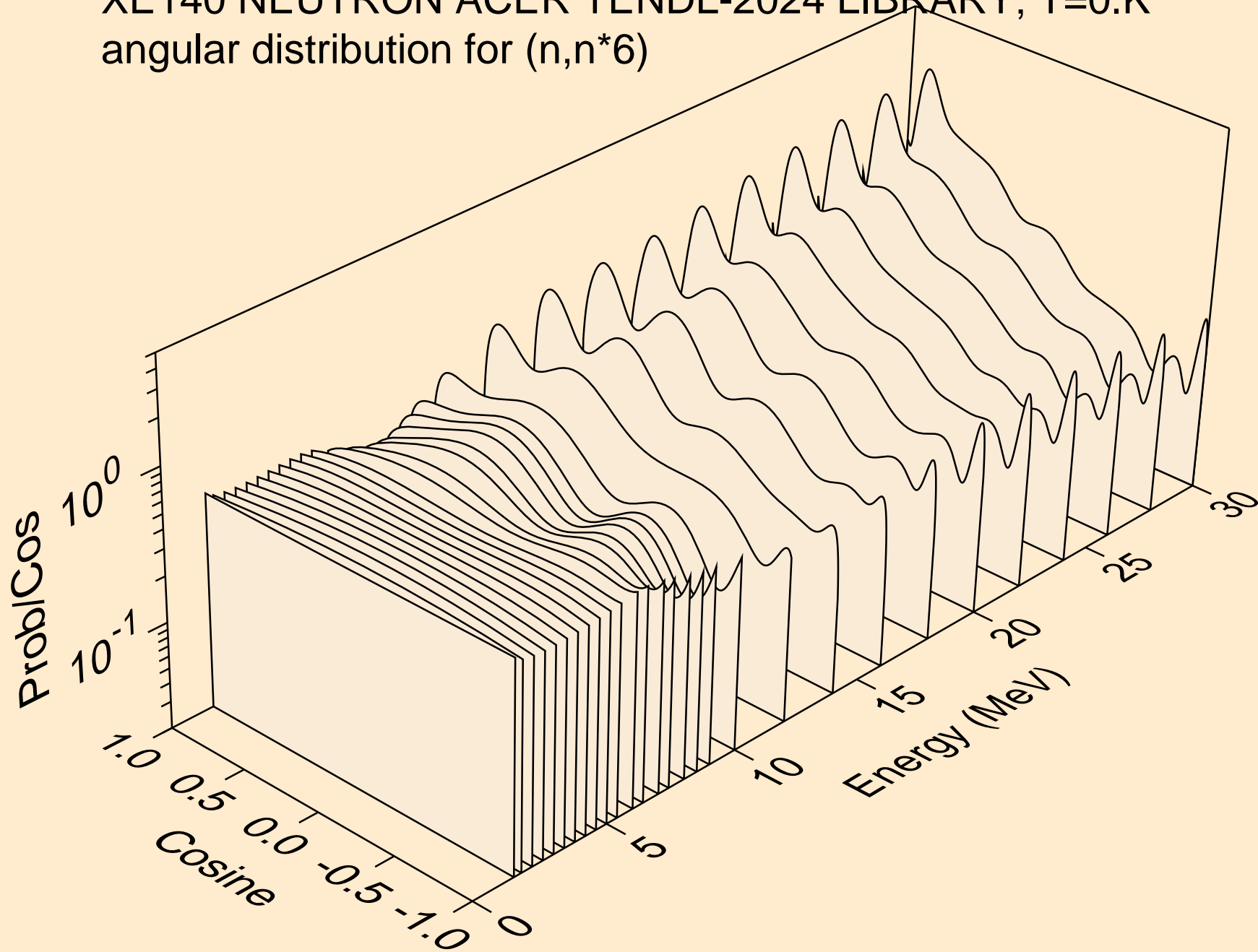

XE140 NEUTRON ACER TENDL-2024 LIBRARY; T=0.K
angular distribution for (n,n*7)

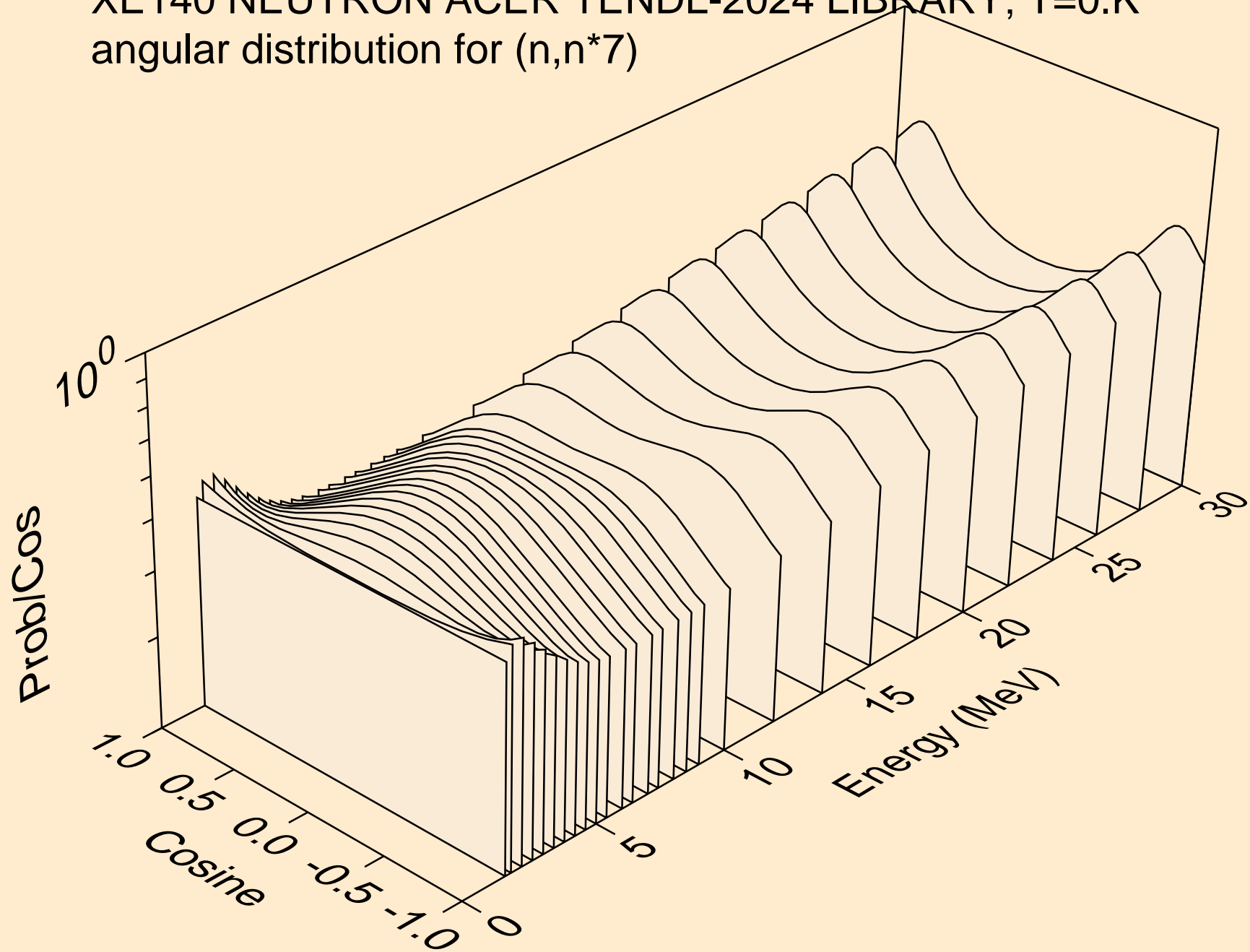

XE140 NEUTRON ACER TENDL-2024 LIBRARY; T=0.K
angular distribution for (n,n*8)

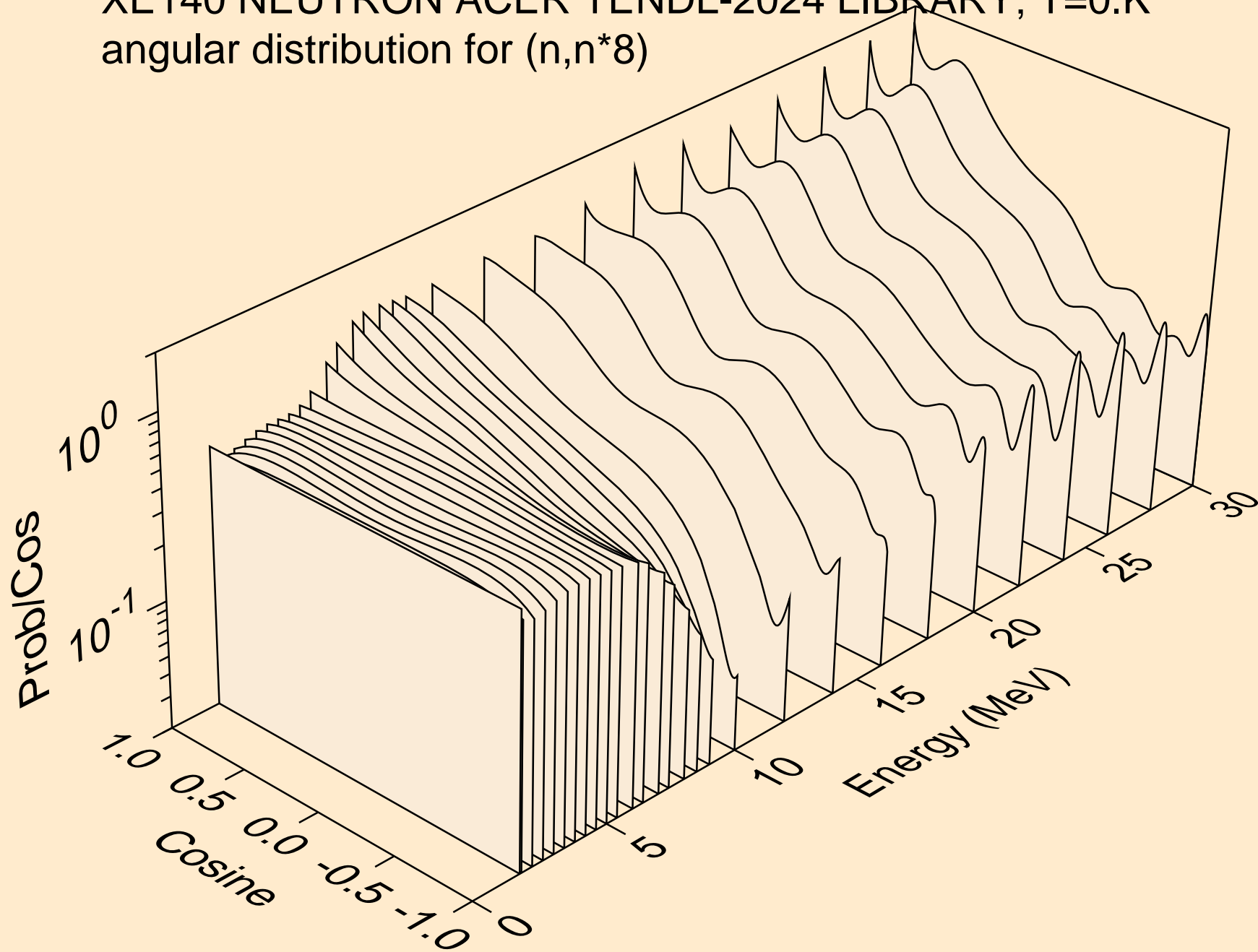

XE140 NEUTRON ACER TENDL-2024 LIBRARY; T=0.K
angular distribution for (n,n*9)

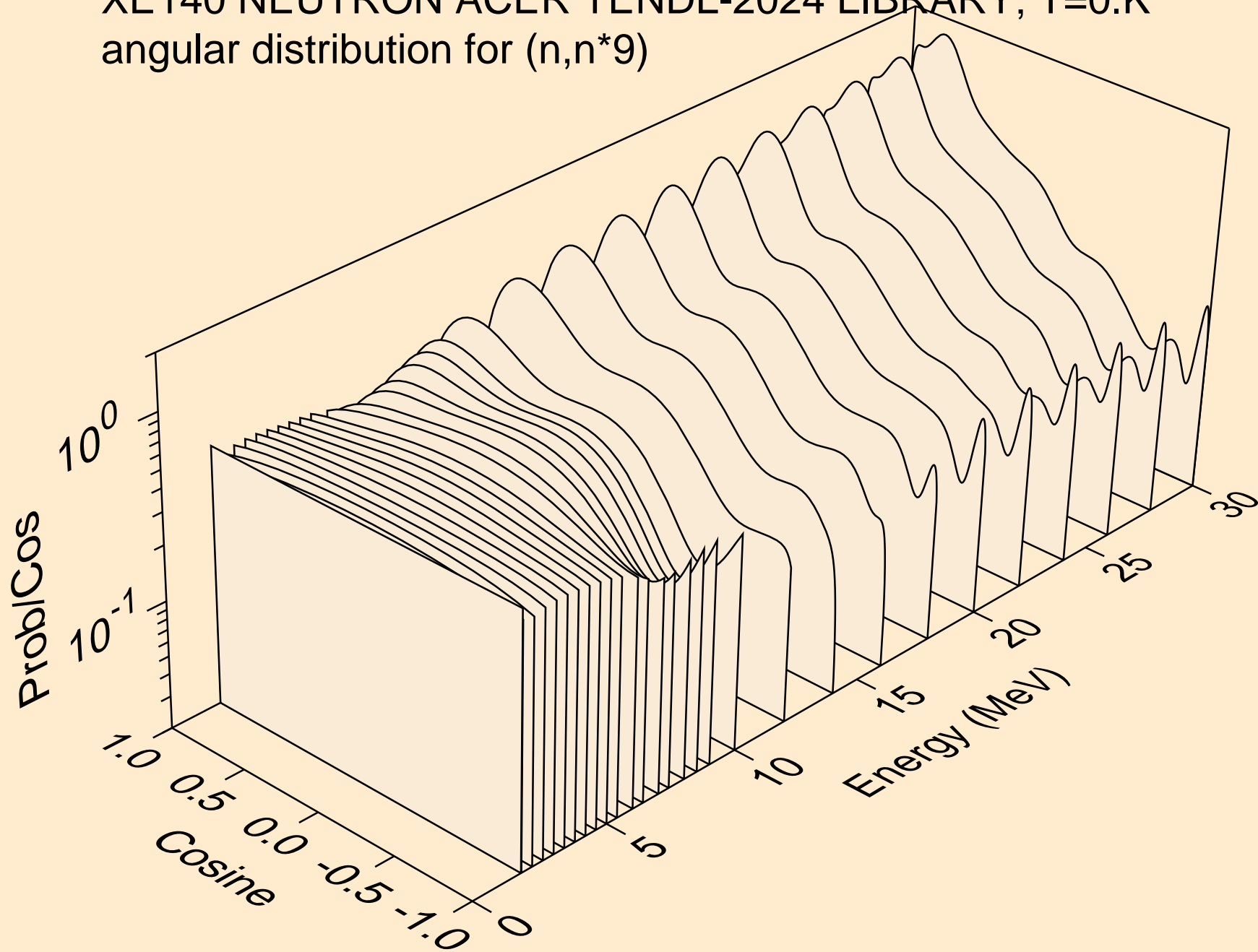

XE140 NEUTRON ACER TENDL-2024 LIBRARY; T=0.K
angular distribution for (n,n*10)

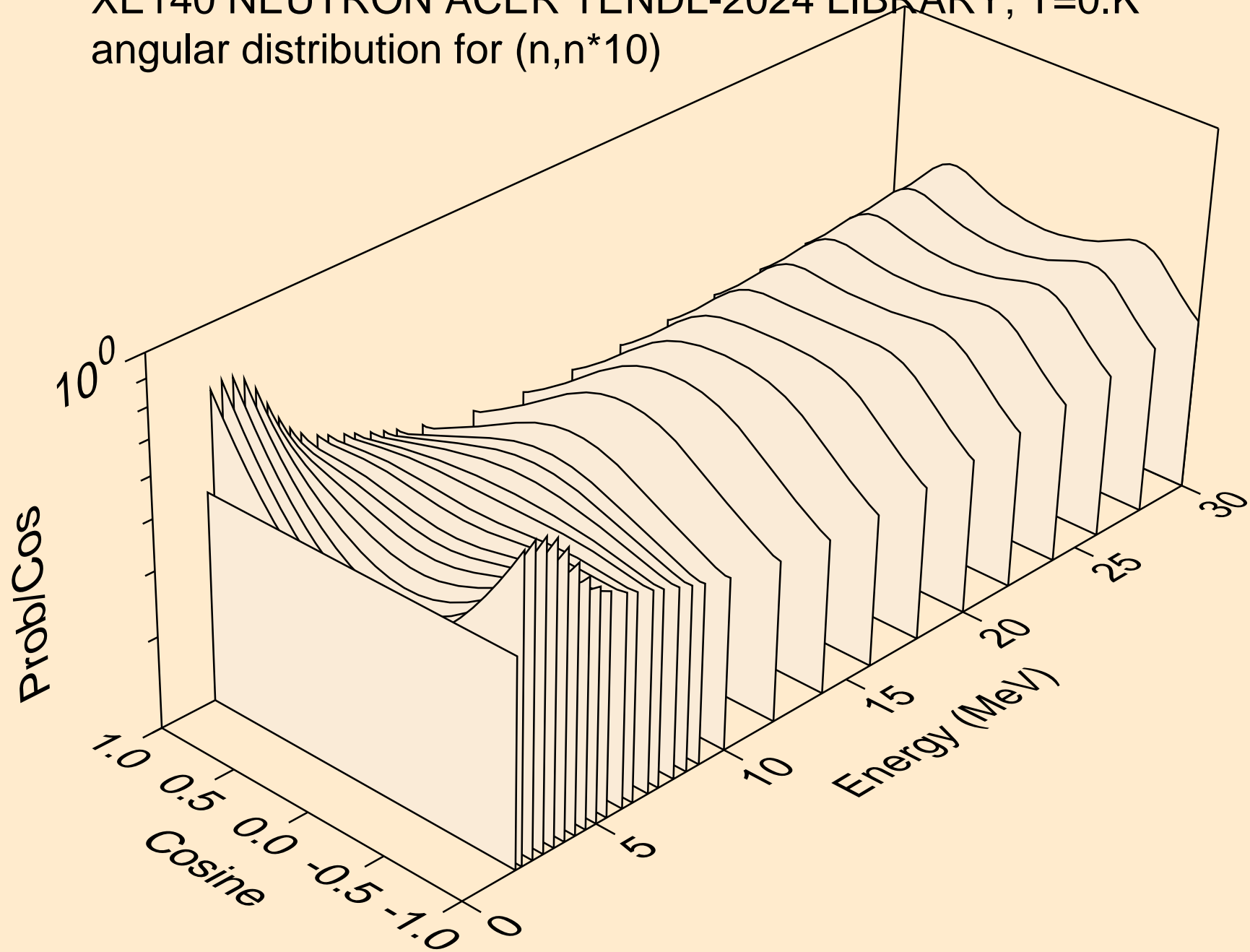

XE140 NEUTRON ACER TENDL-2024 LIBRARY; T=0.K
angular distribution for (n,n*11)

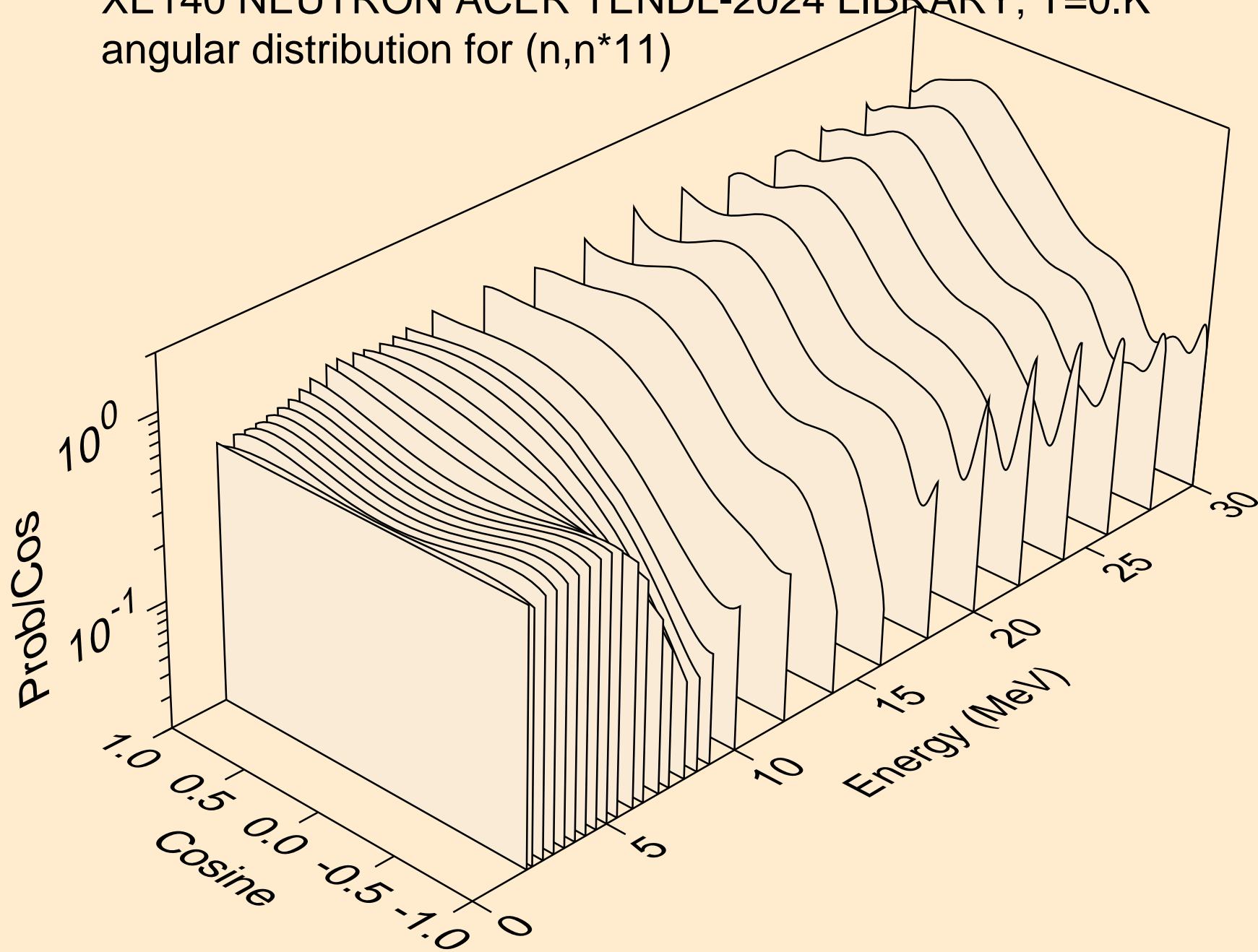

XE140 NEUTRON ACER TENDL-2024 LIBRARY; T=0.K
angular distribution for (n,n*12)

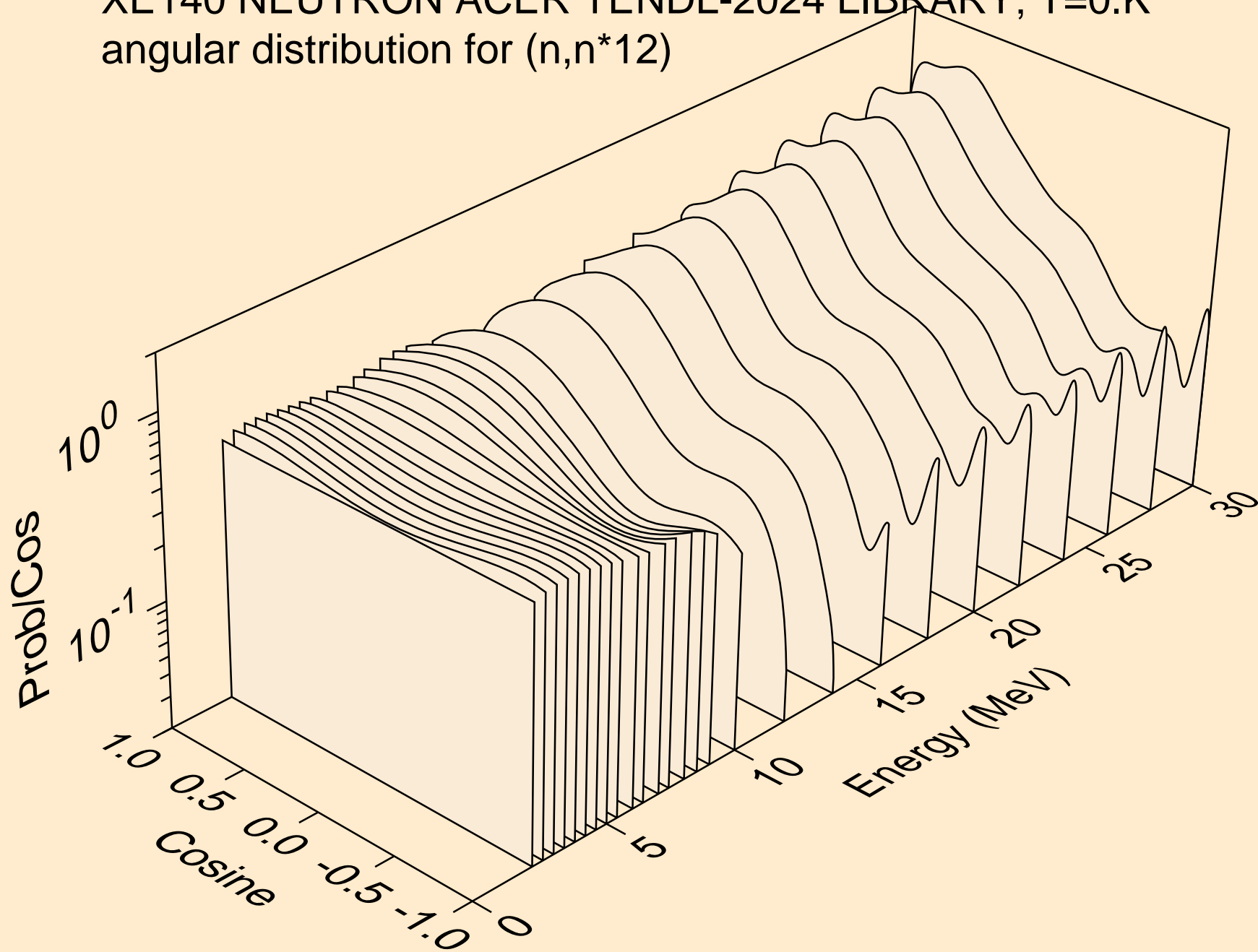

XE140 NEUTRON ACER TENDL-2024 LIBRARY; T=0.K
angular distribution for (n,n*13)

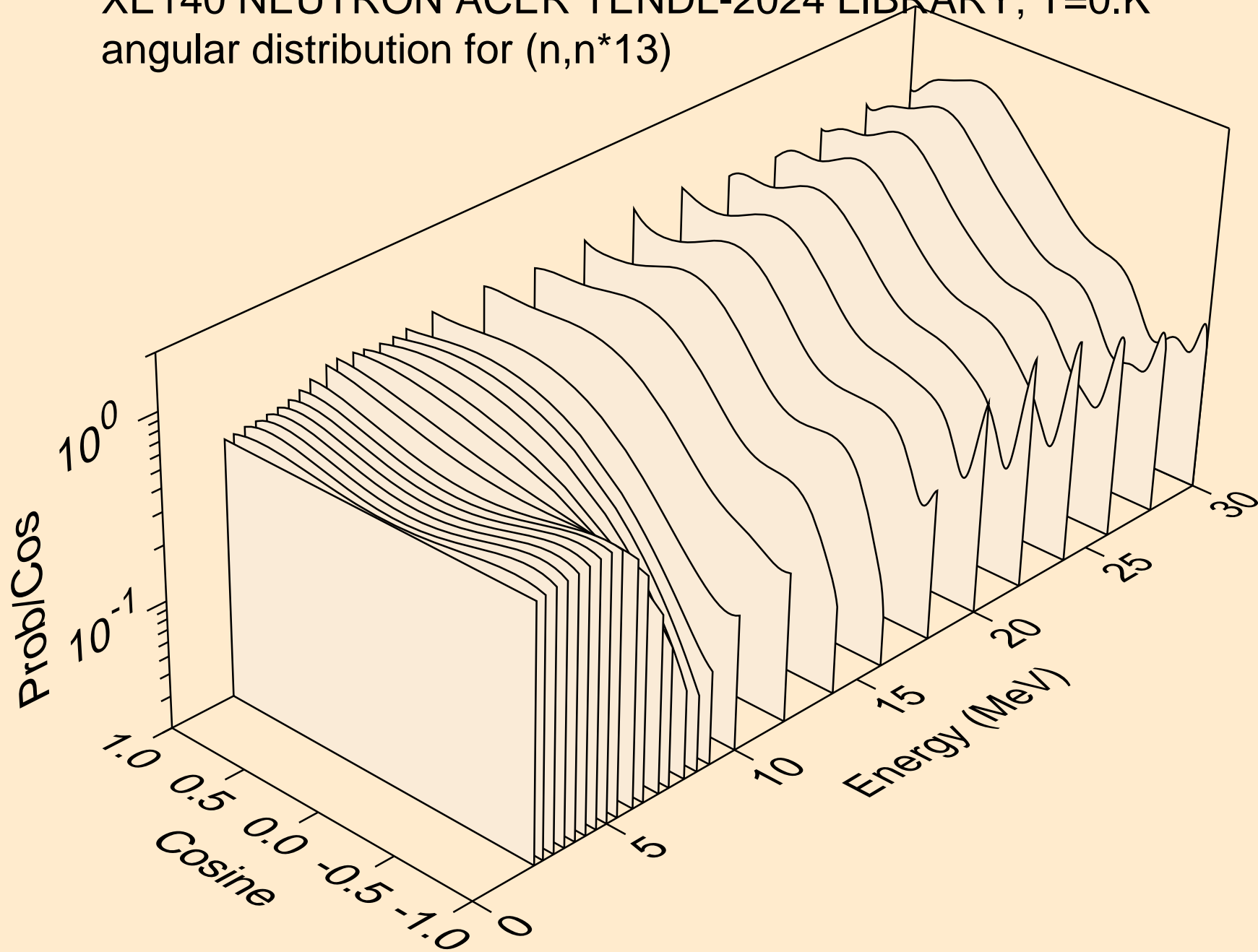

XE140 NEUTRON ACER TENDL-2024 LIBRARY; T=0.K
angular distribution for (n,n*14)

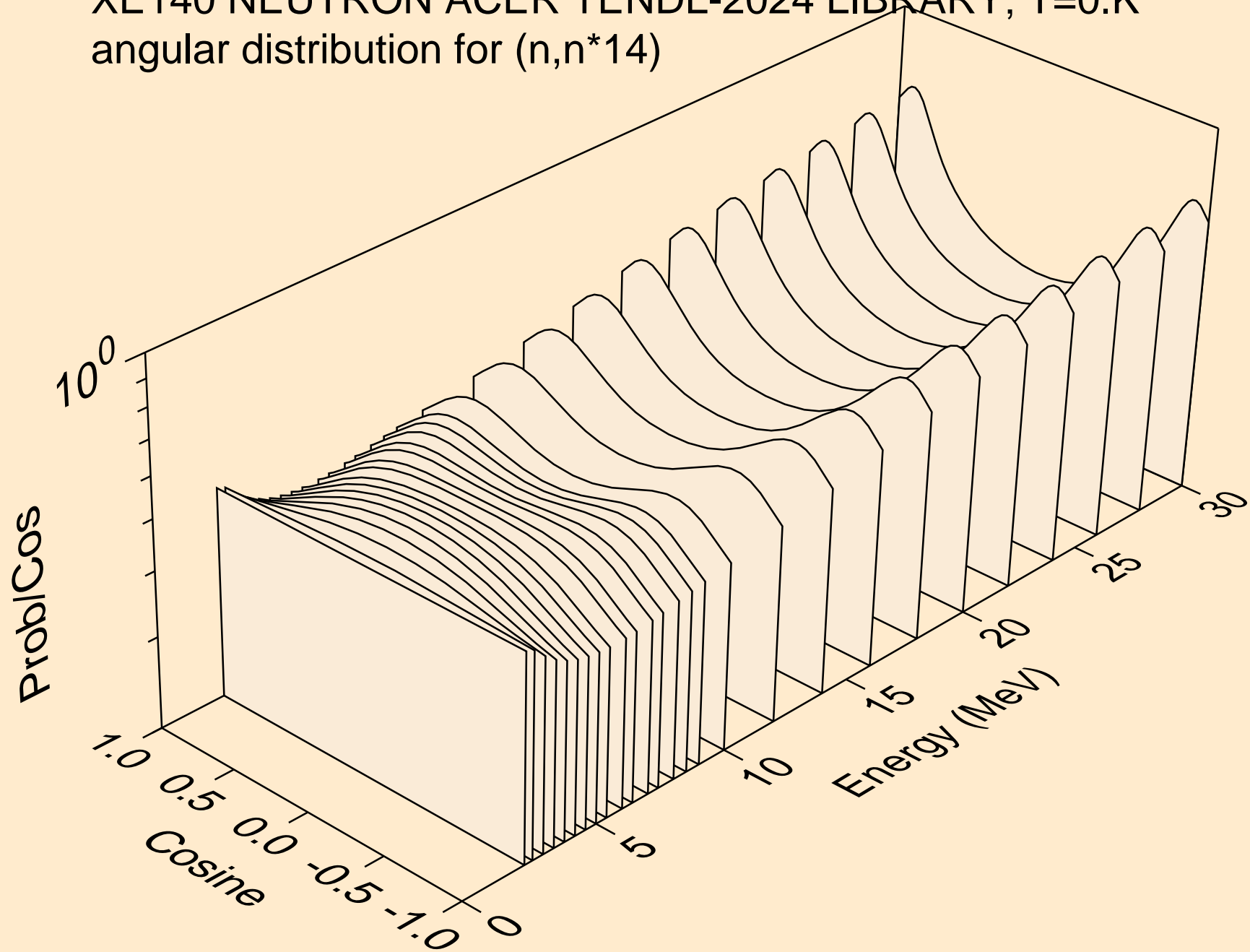

XE140 NEUTRON ACER TENDL-2024 LIBRARY; T=0.K
angular distribution for (n,n*15)

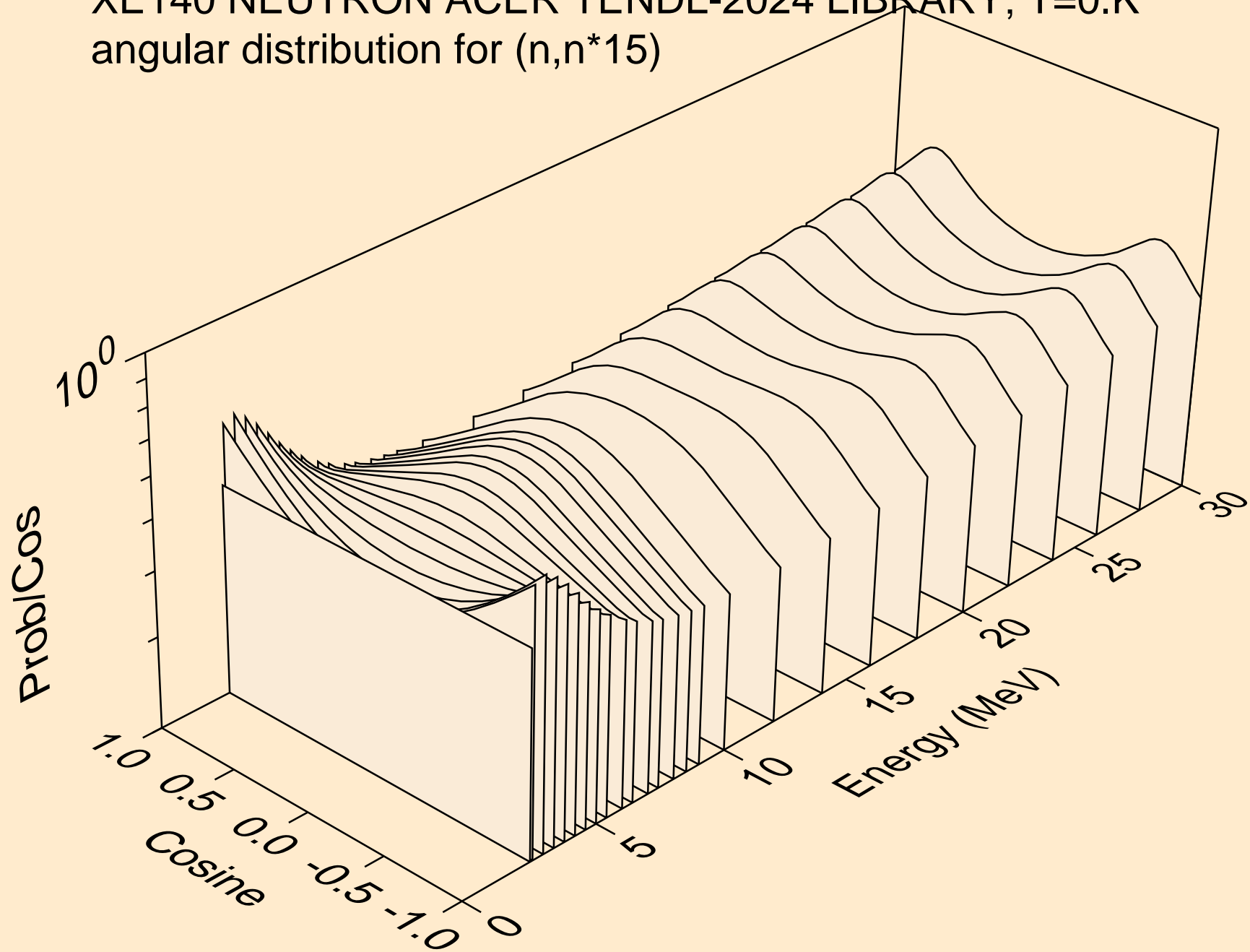

XE140 NEUTRON ACER TENDL-2024 LIBRARY; T=0.K
angular distribution for (n,n*16)

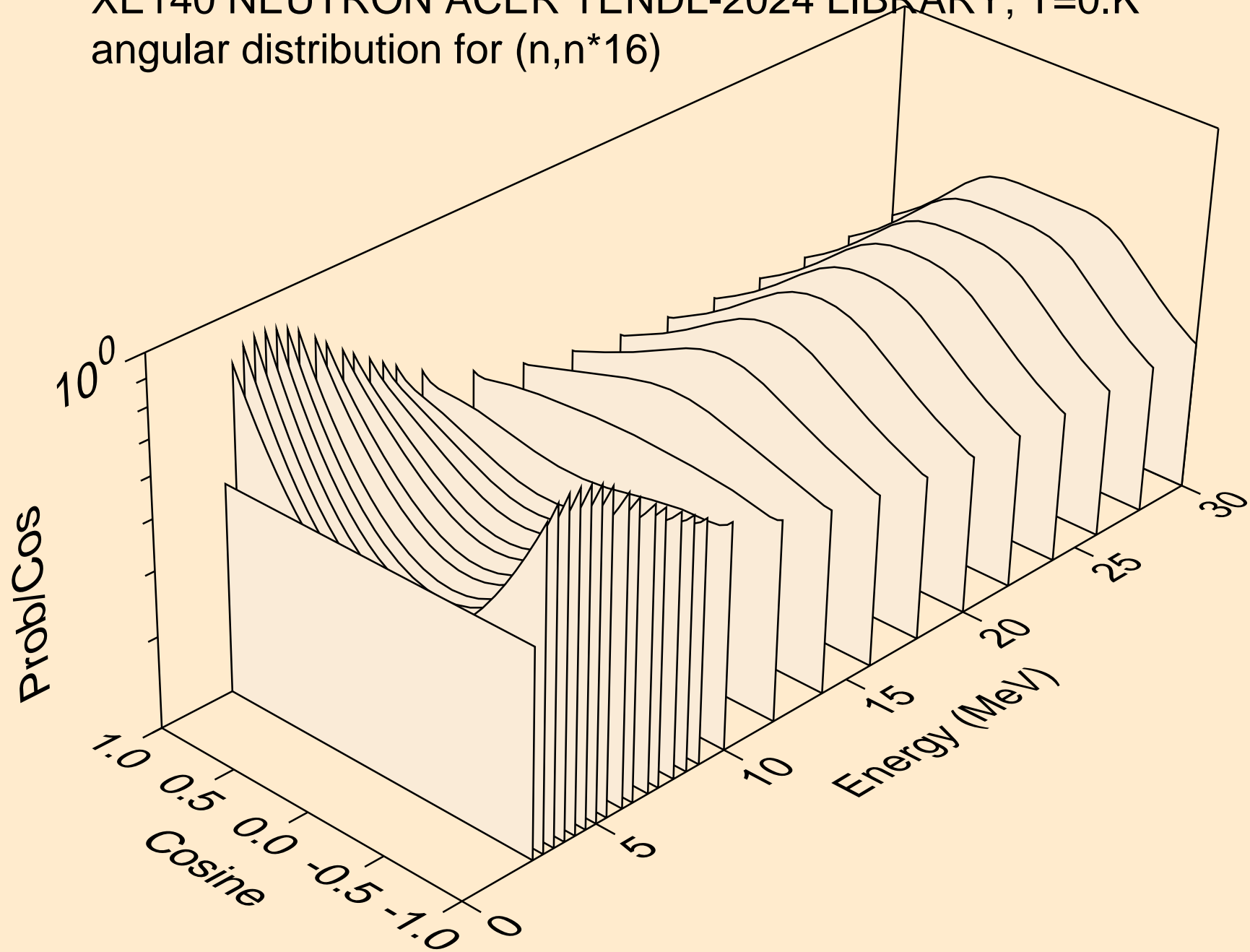

XE140 NEUTRON ACER TENDL-2024 LIBRARY; T=0.K
angular distribution for (n,n*17)

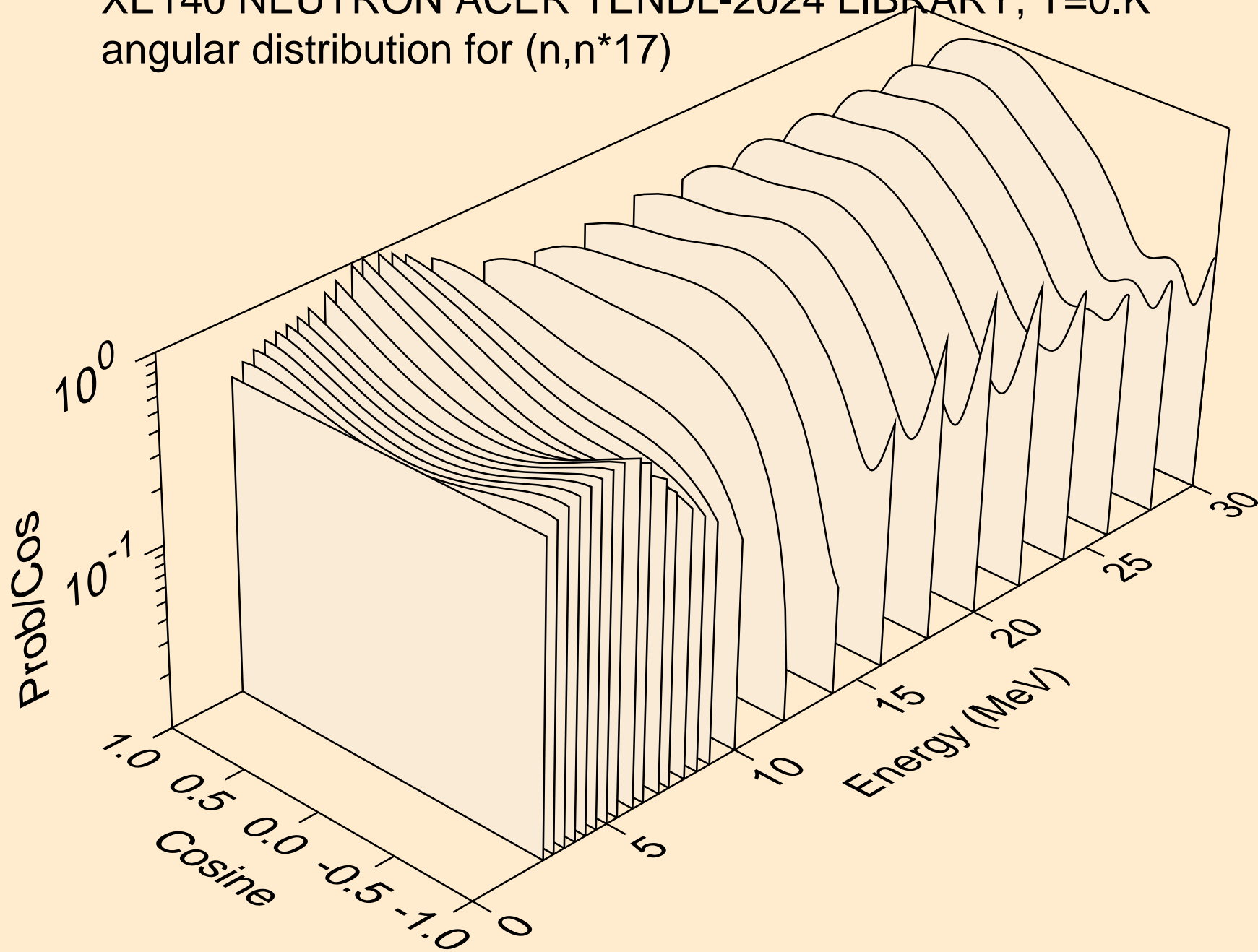

XE140 NEUTRON ACER TENDL-2024 LIBRARY; T=0.K
angular distribution for (n,n*18)

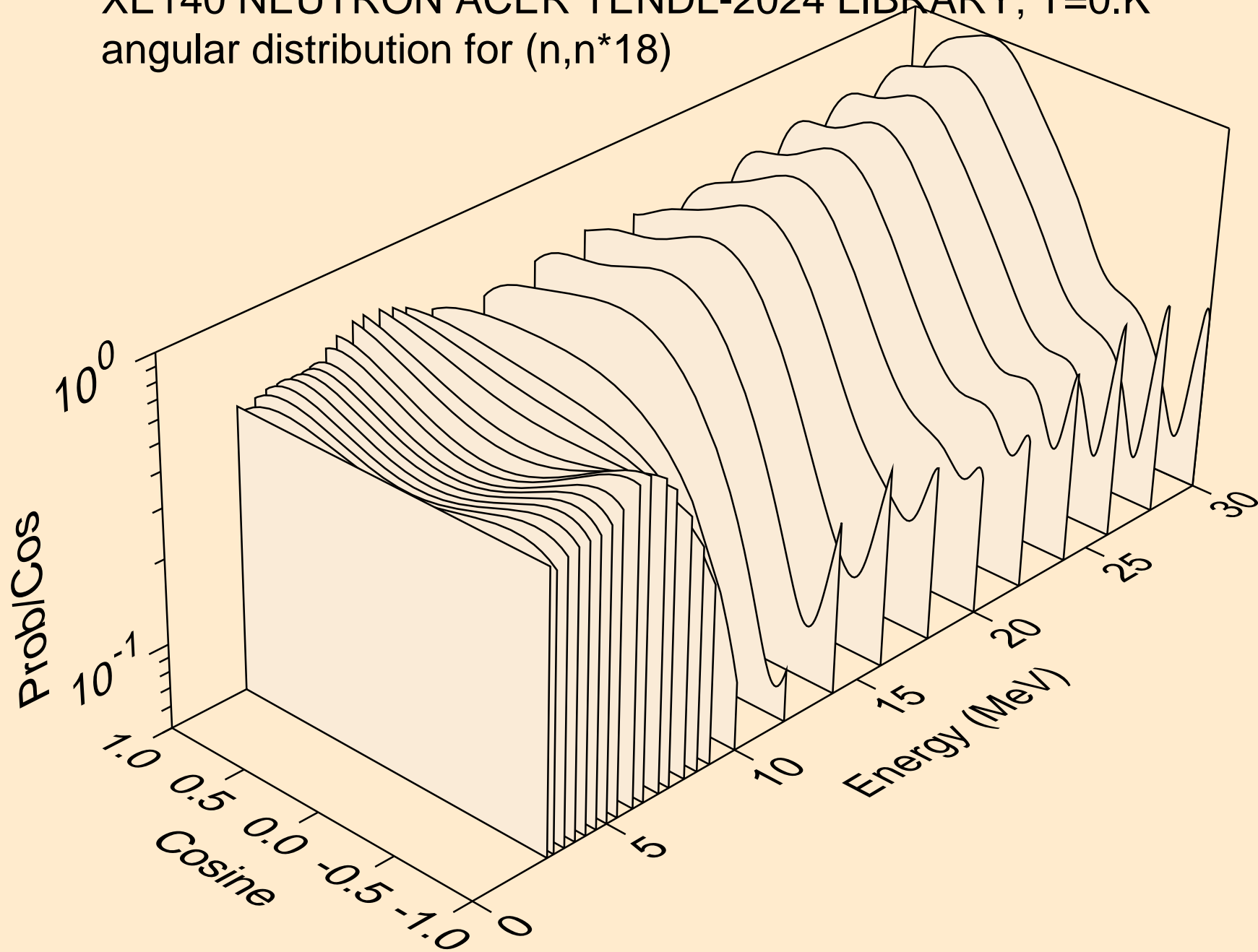

XE140 NEUTRON ACER TENDL-2024 LIBRARY; T=0.K
angular distribution for (n,n*19)

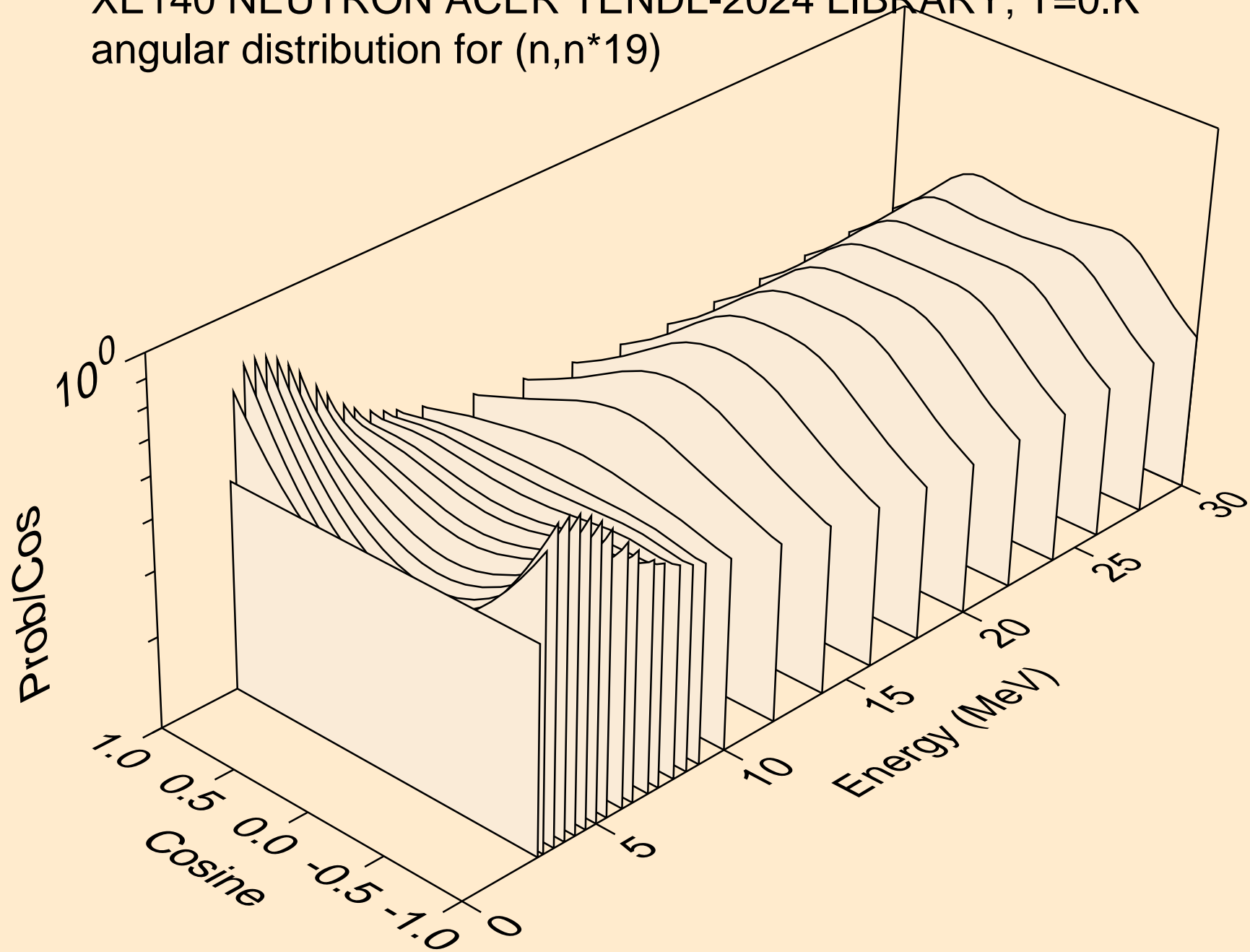

XE140 NEUTRON ACER TENDL-2024 LIBRARY; T=0.K
angular distribution for (n,n*20)

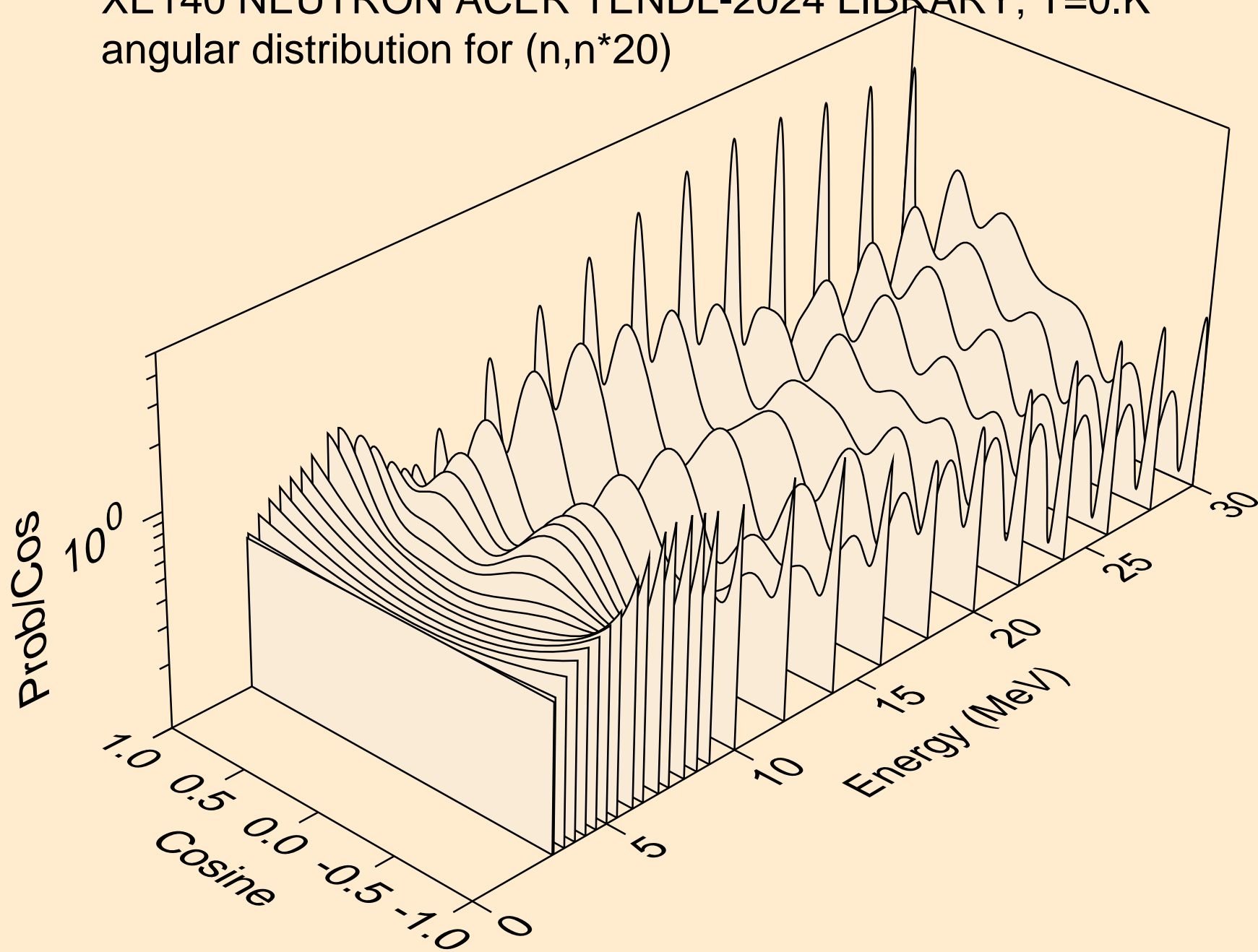

XE140 NEUTRON ACER TENDL-2024 LIBRARY; T=0.K
angular distribution for (n,n*21)

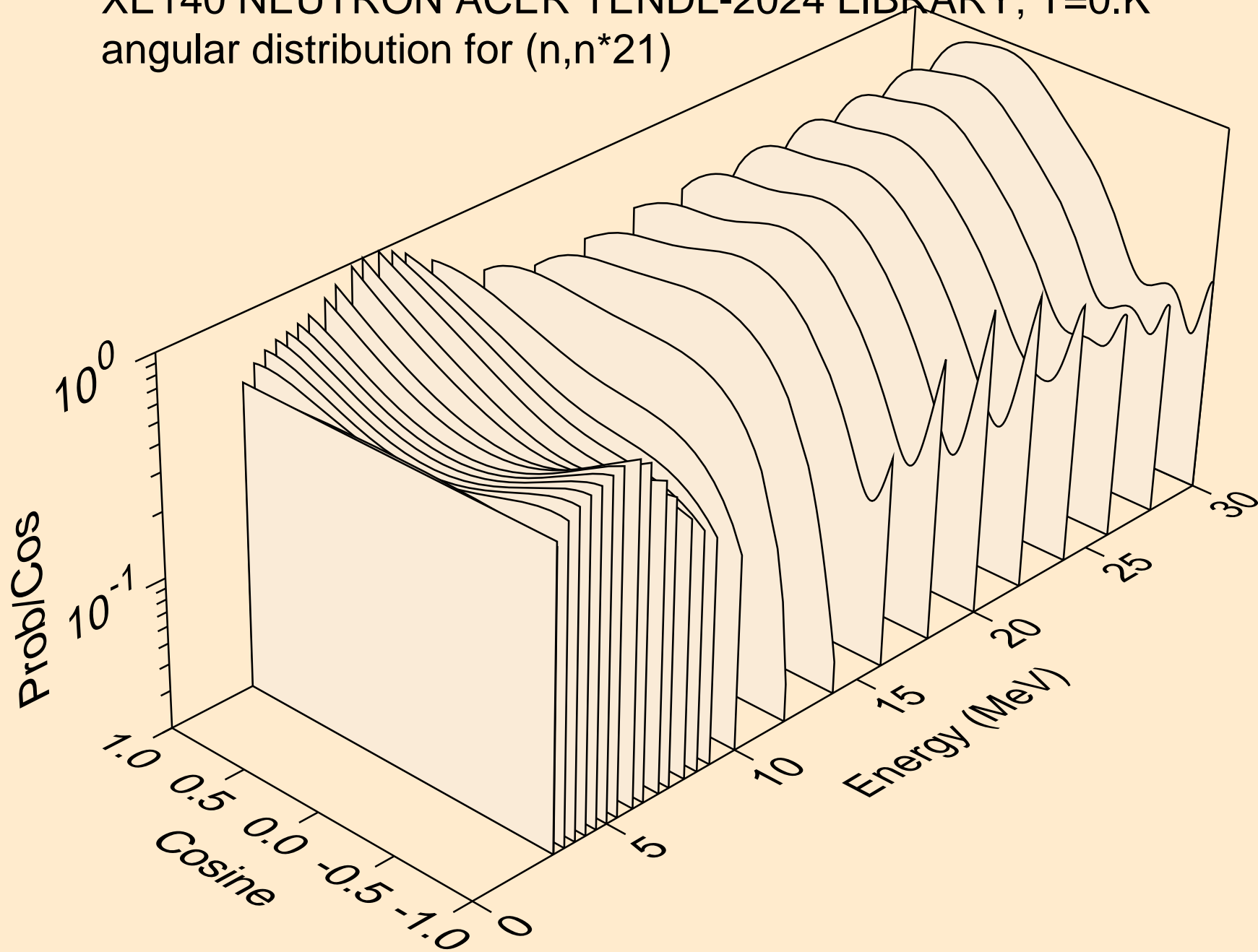

XE140 NEUTRON ACER TENDL-2024 LIBRARY; T=0.K
angular distribution for (n,n*22)

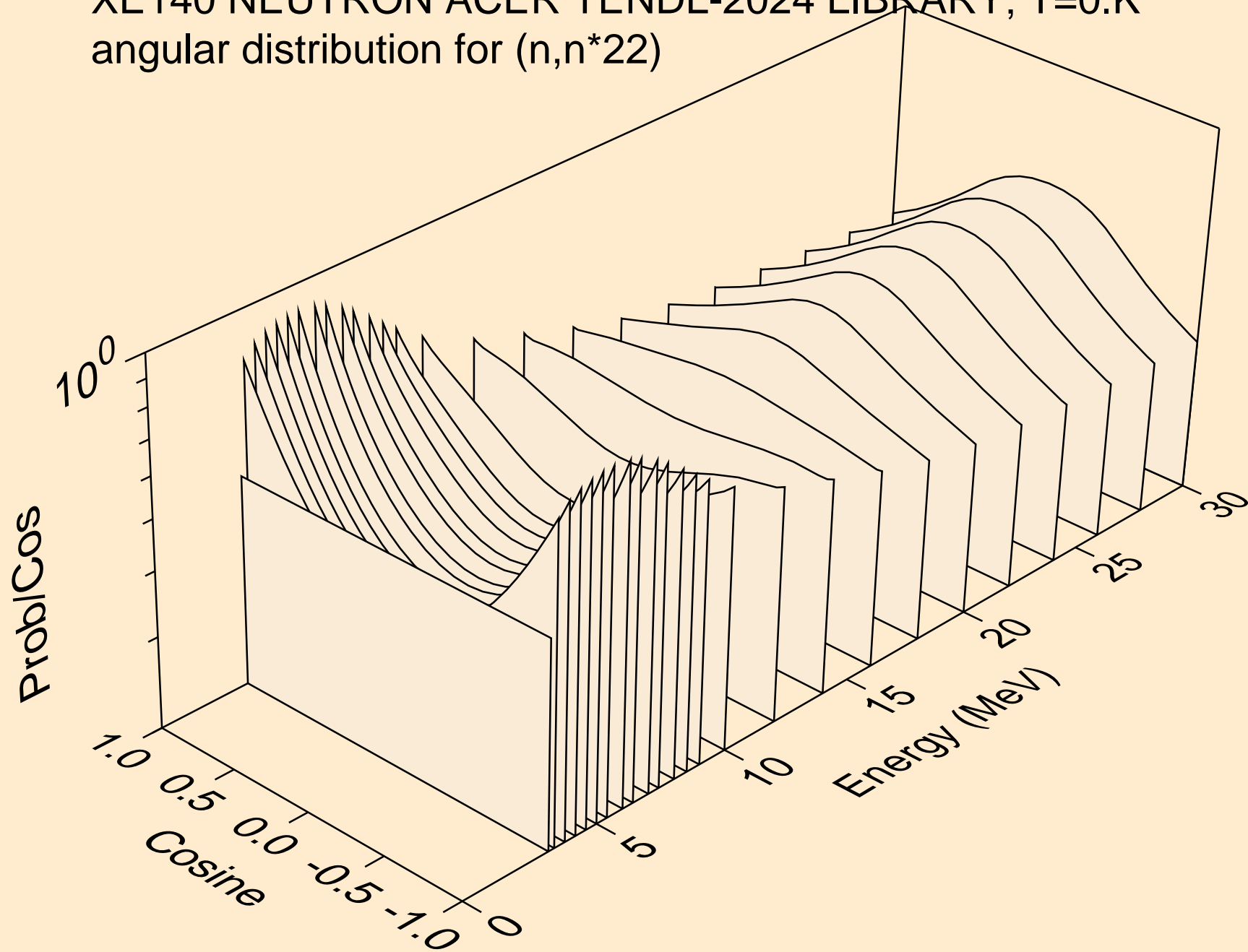

XE140 NEUTRON ACER TENDL-2024 LIBRARY; T=0.K
angular distribution for (n,n*23)

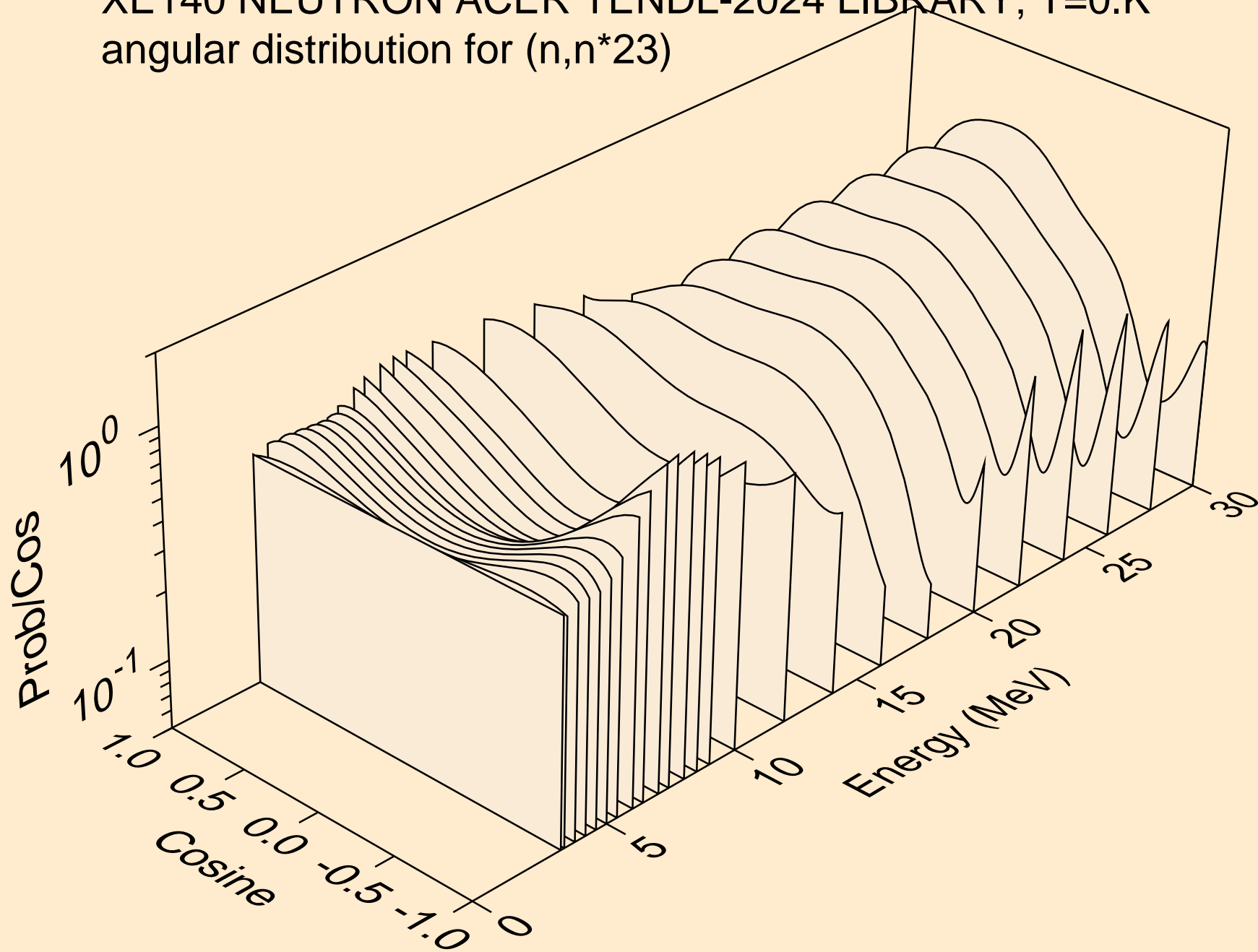

XE140 NEUTRON ACER TENDL-2024 LIBRARY; T=0.K
angular distribution for (n,n*24)

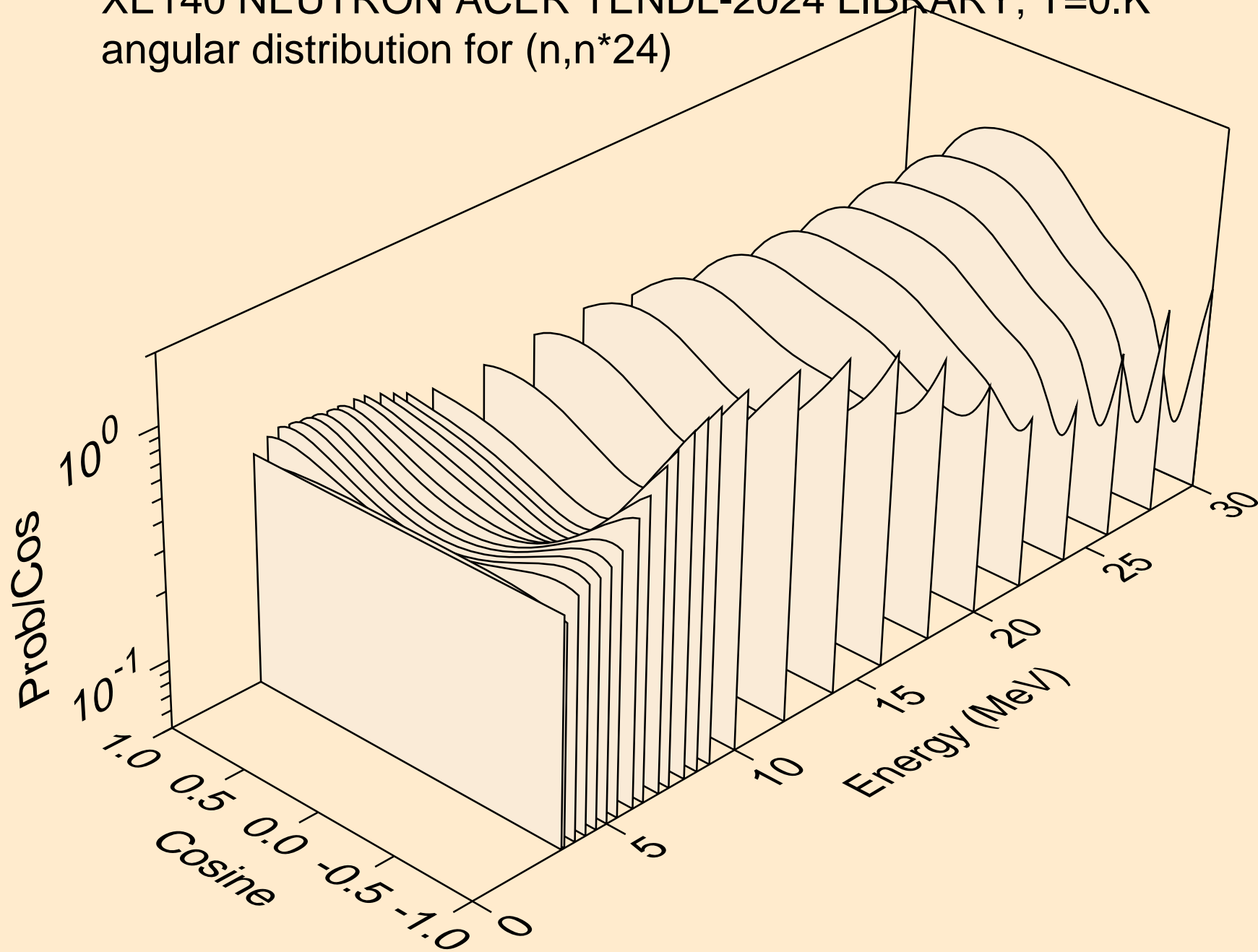

XE140 NEUTRON ACER TENDL-2024 LIBRARY; T=0.K
angular distribution for (n,n*25)

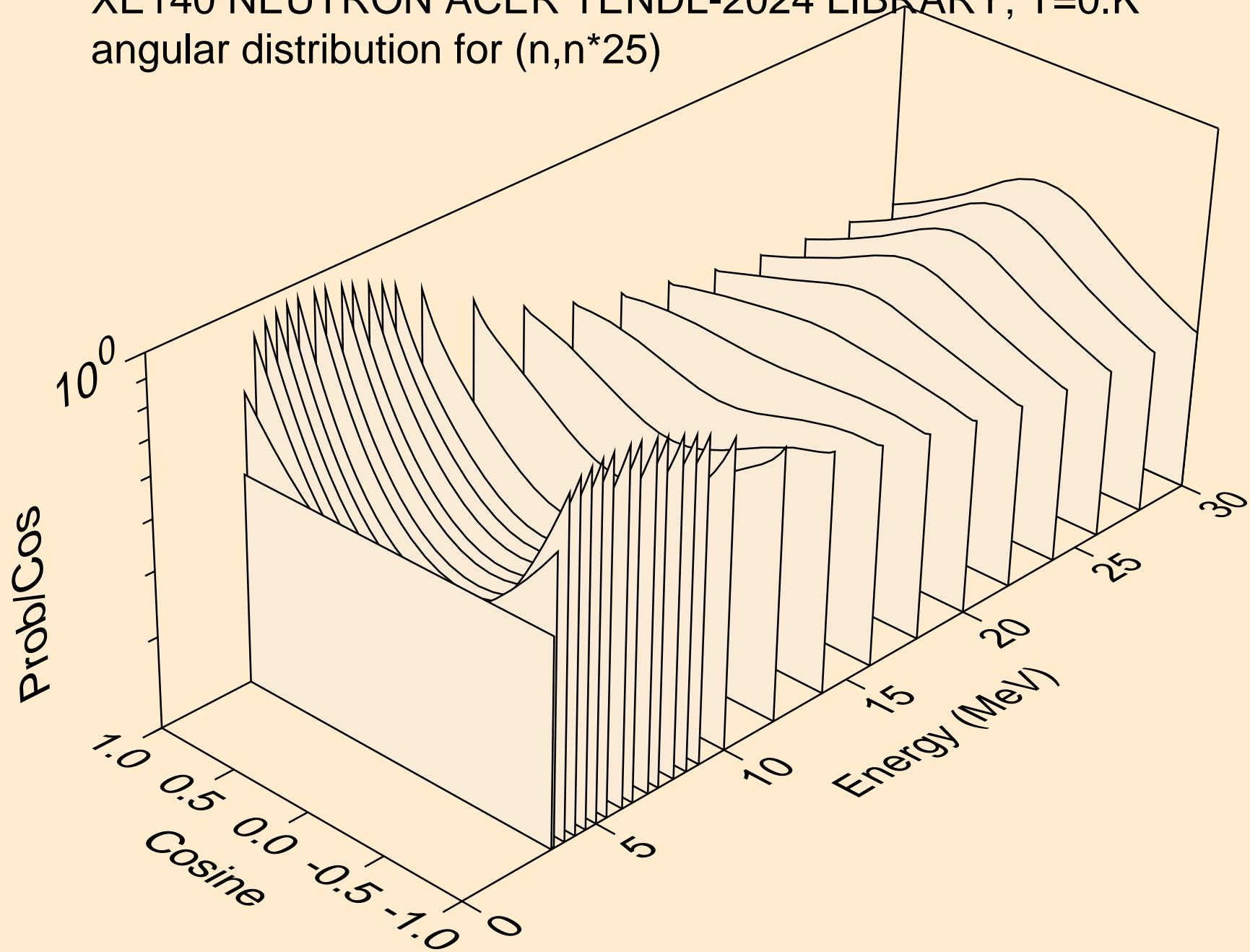

XE140 NEUTRON ACER TENDL-2024 LIBRARY; T=0.K
angular distribution for (n,n*26)

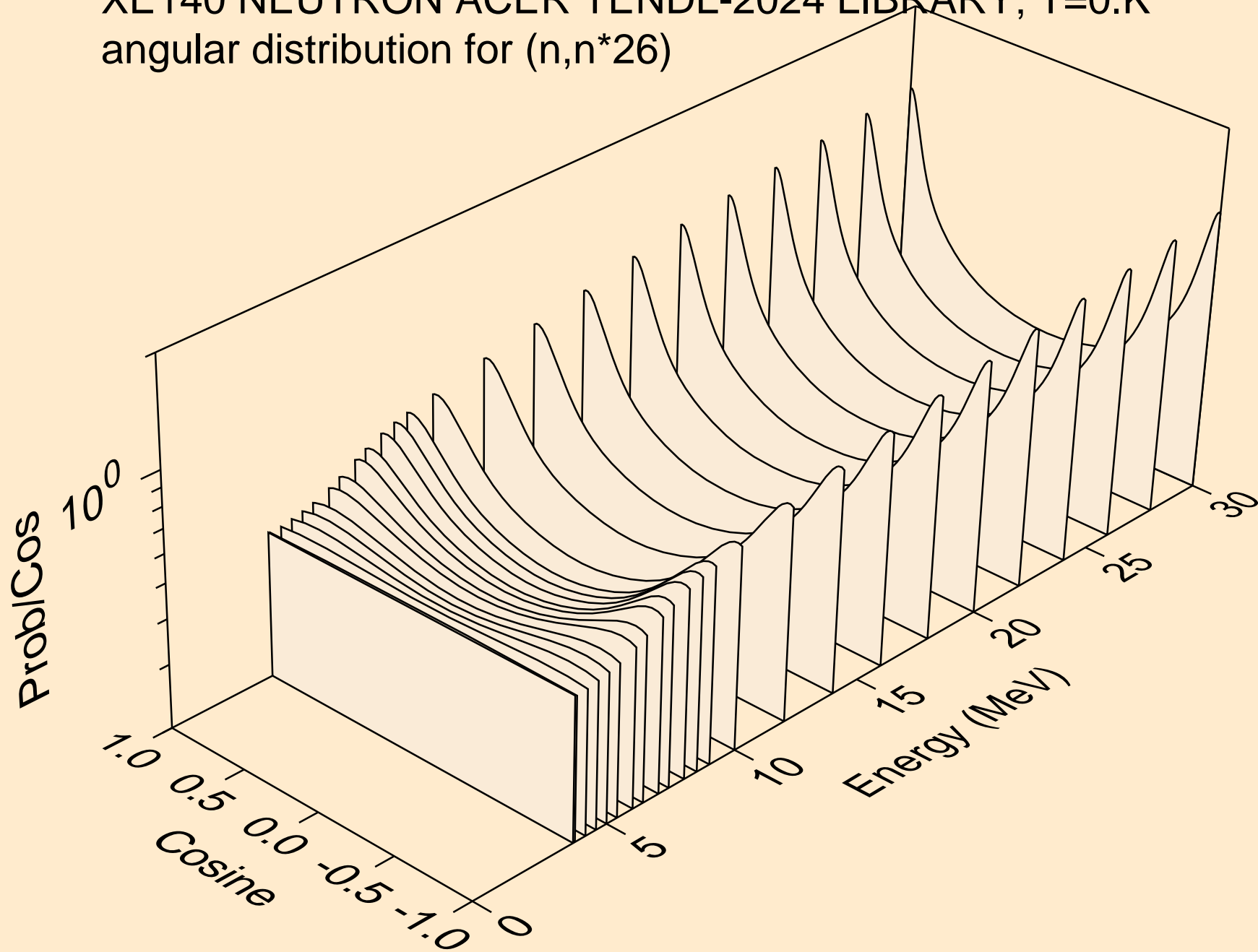

XE140 NEUTRON ACER TENDL-2024 LIBRARY; T=0.K
Neutron emission for (n,x)

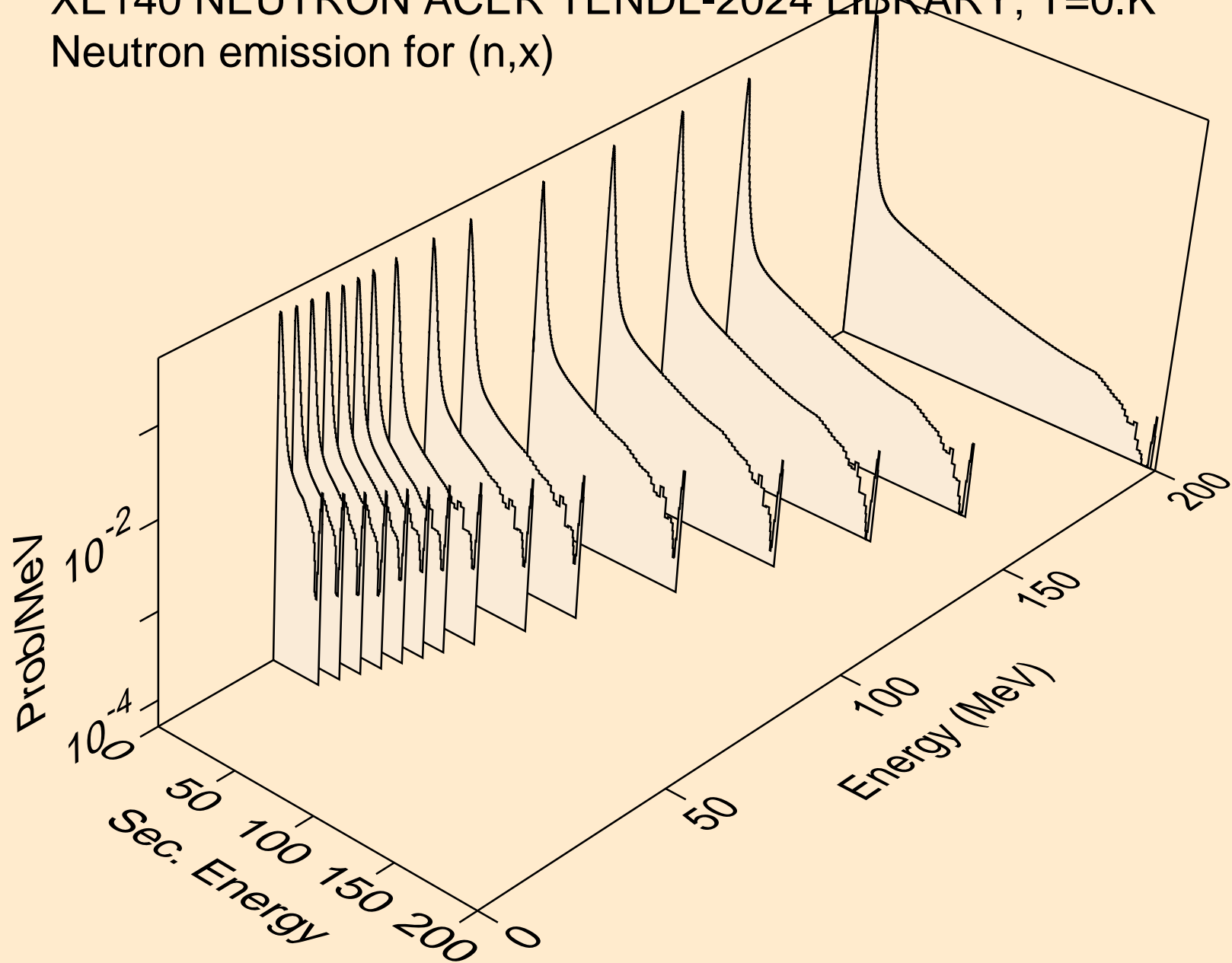

XE140 NEUTRON ACER TENDL-2024 LIBRARY; T=0.K
Neutron emission for (n,2nd)

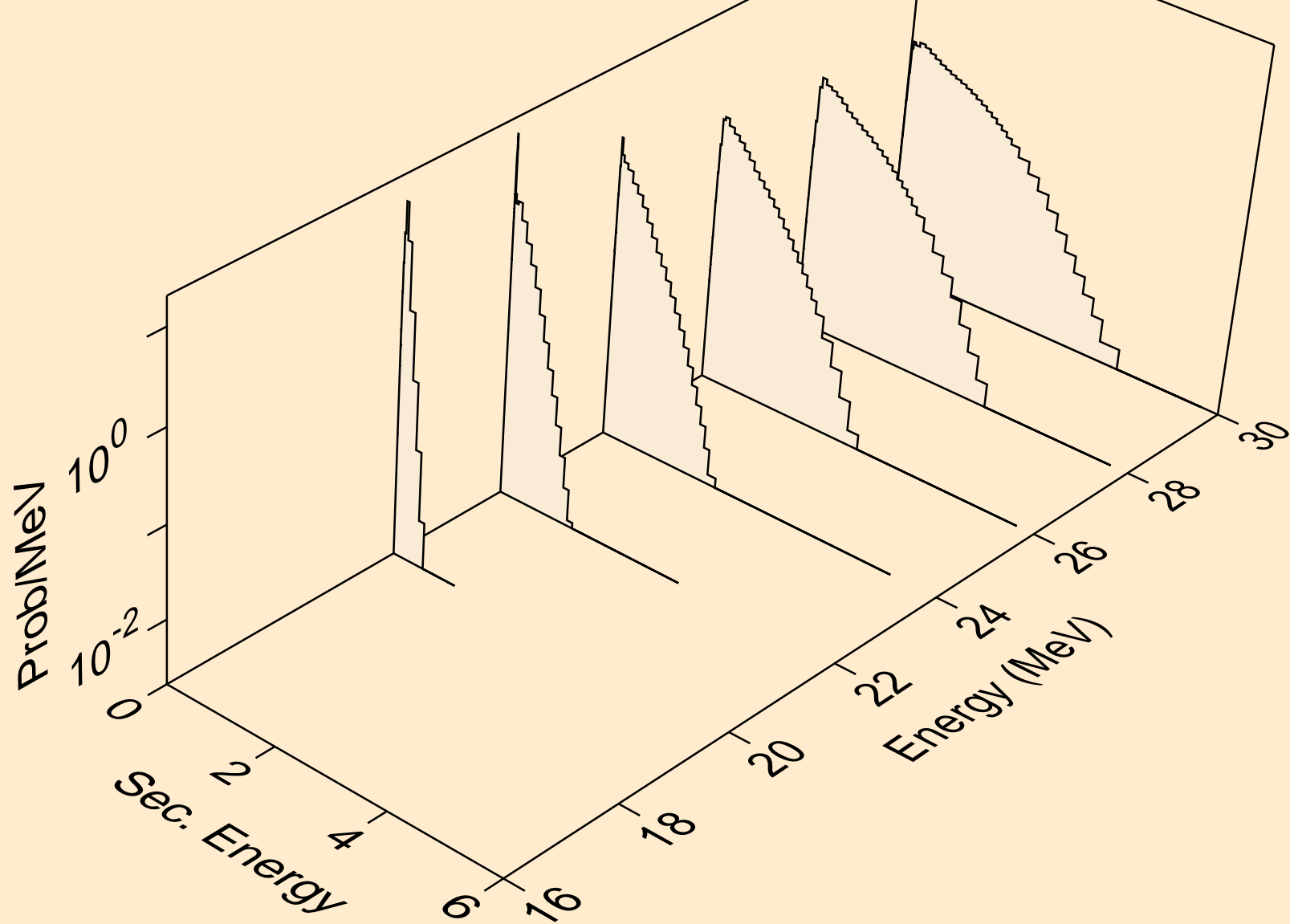

XE140 NEUTRON ACER TENDL-2024 LIBRARY; T=0.K
Neutron emission for (n,2n)

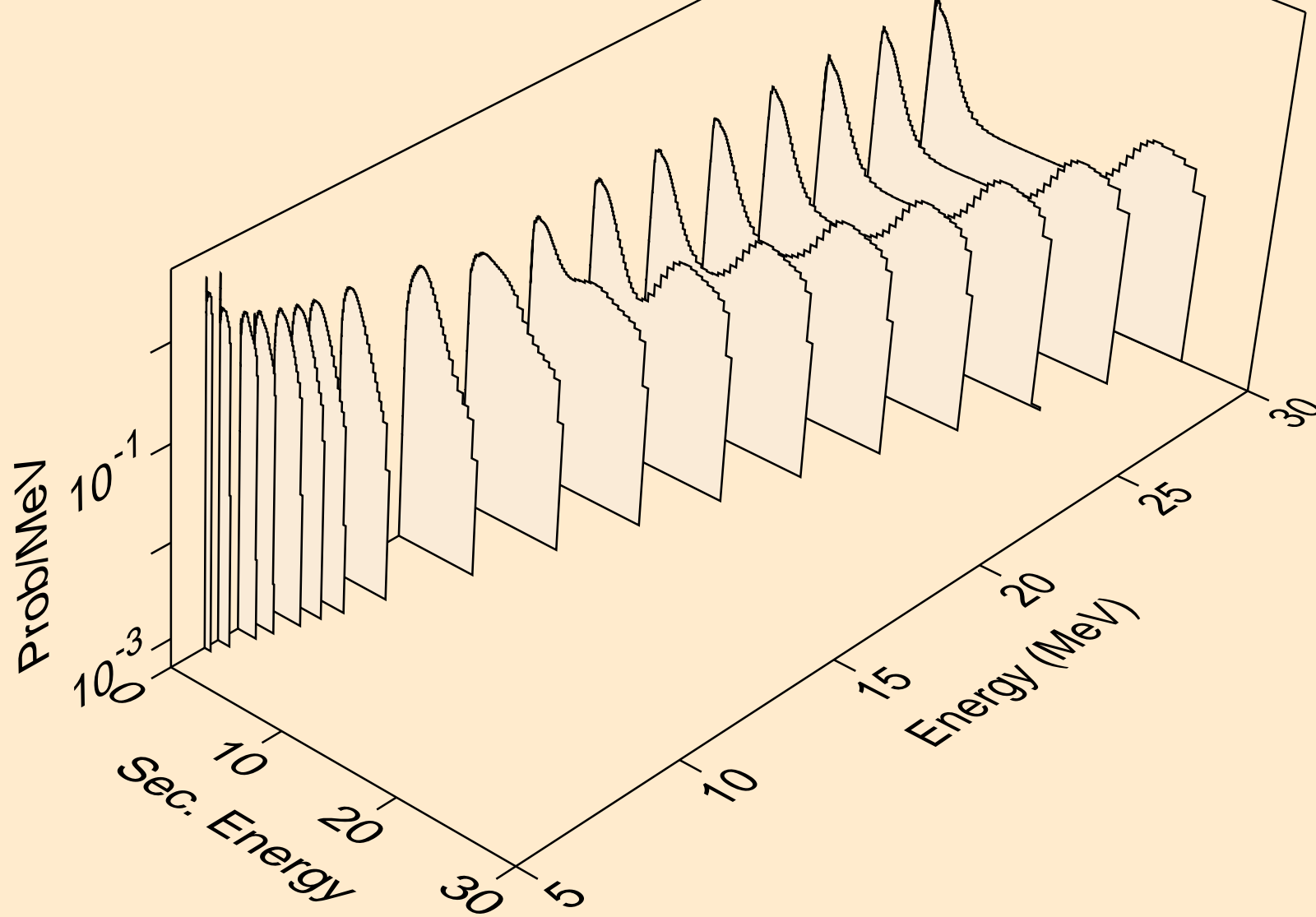

XE140 NEUTRON ACER TENDL-2024 LIBRARY; T=0.K
Neutron emission for (n,3n)

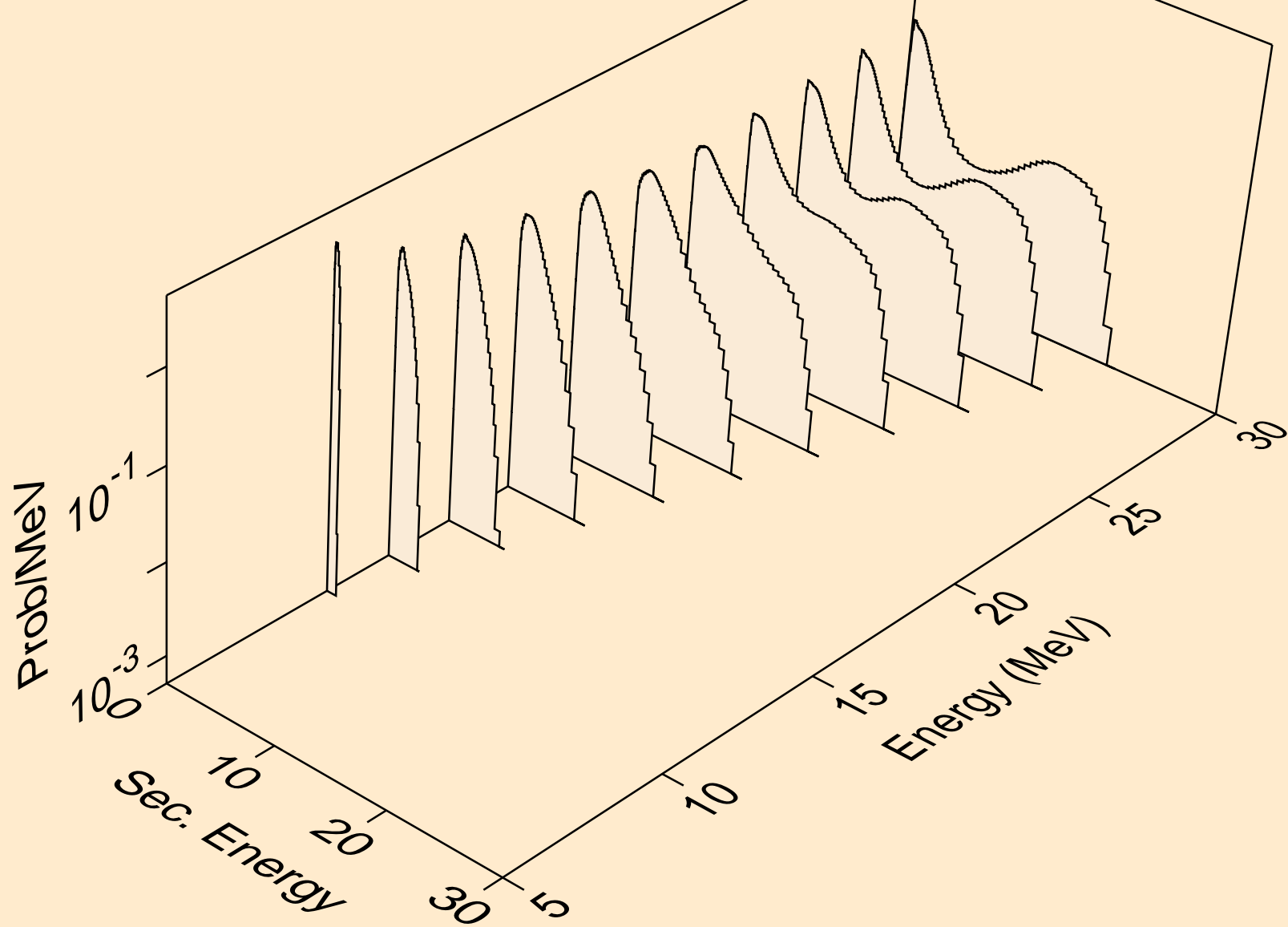

XE140 NEUTRON ACER TENDL-2024 LIBRARY; T=0.K
Neutron emission for (n,n*)a

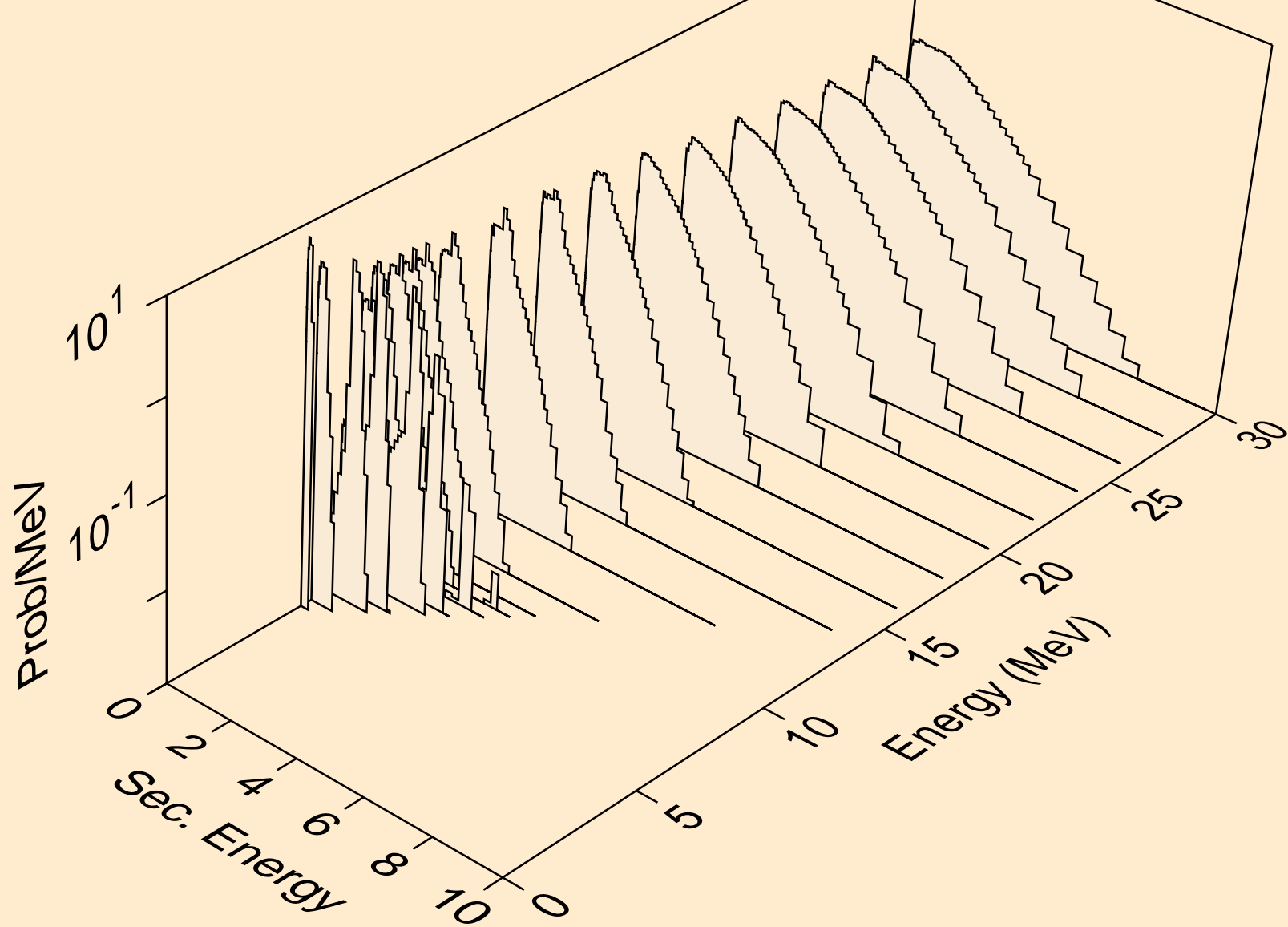

XE140 NEUTRON ACER TENDL-2024 LIBRARY; T=0.K
Neutron emission for (n,2n)_a

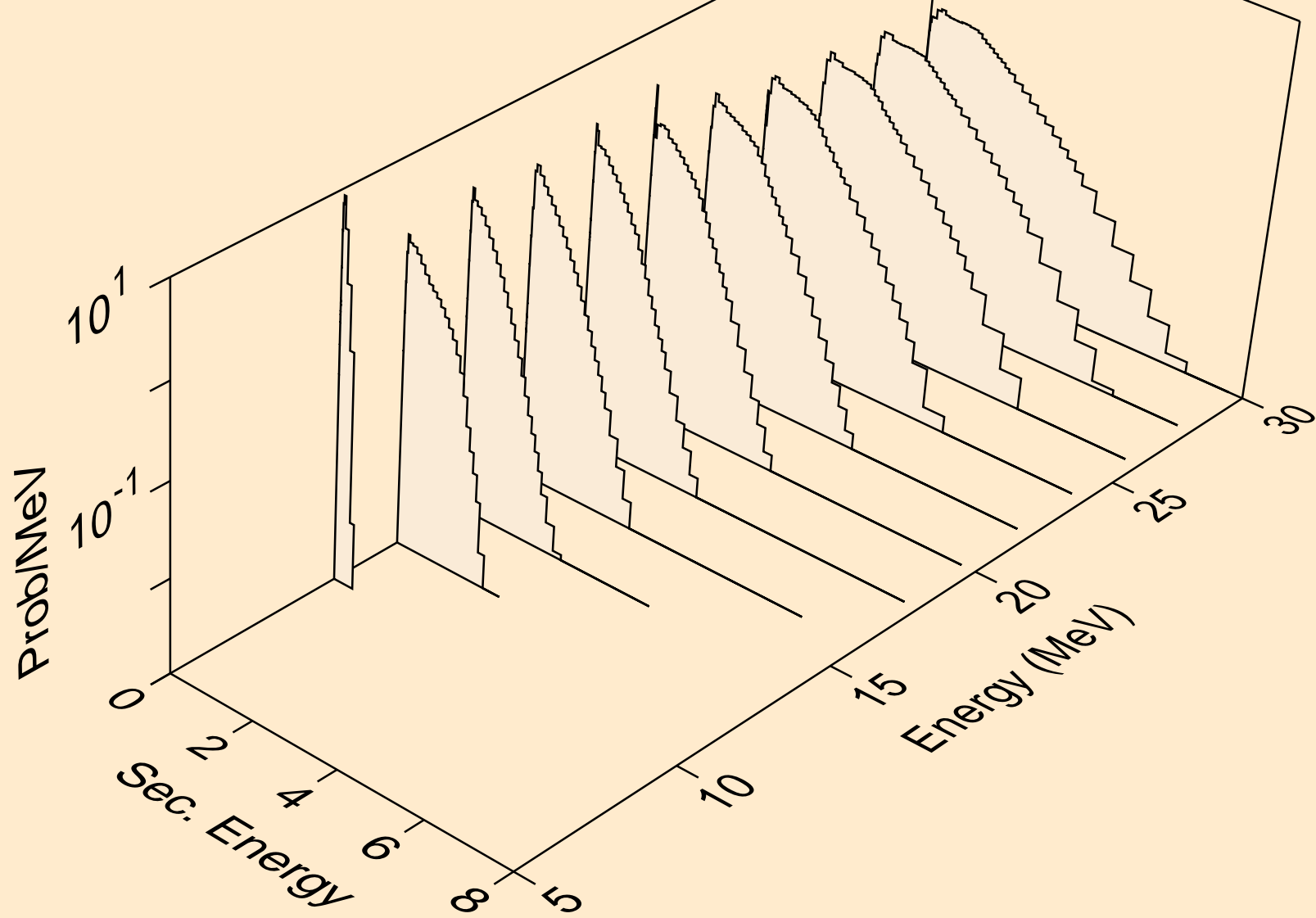

XE140 NEUTRON ACER TENDL-2024 LIBRARY; T=0.K
Neutron emission for (n,3n)a

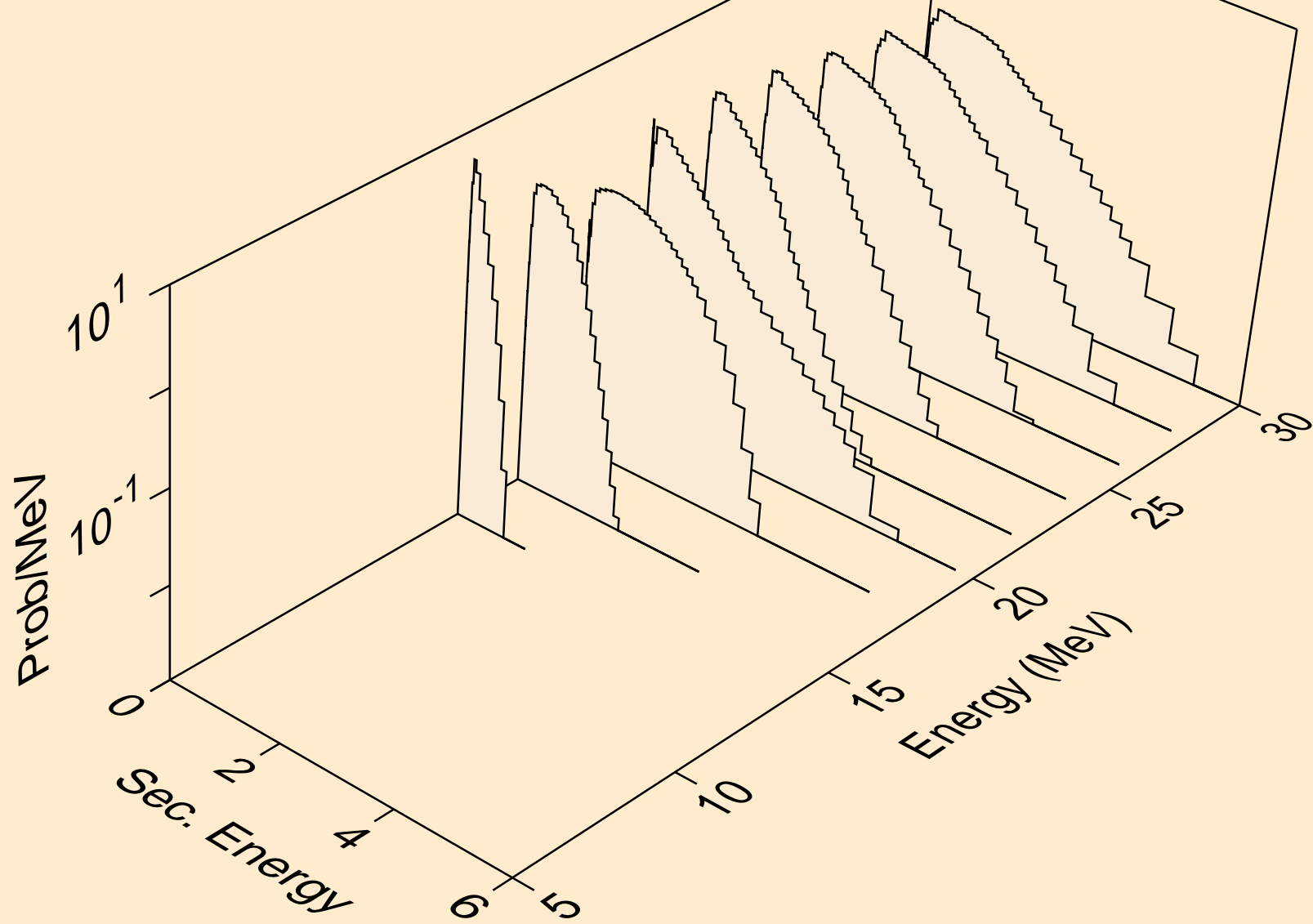

XE140 NEUTRON ACER TENDL-2024 LIBRARY; T=0.K
Neutron emission for (n,n*)p

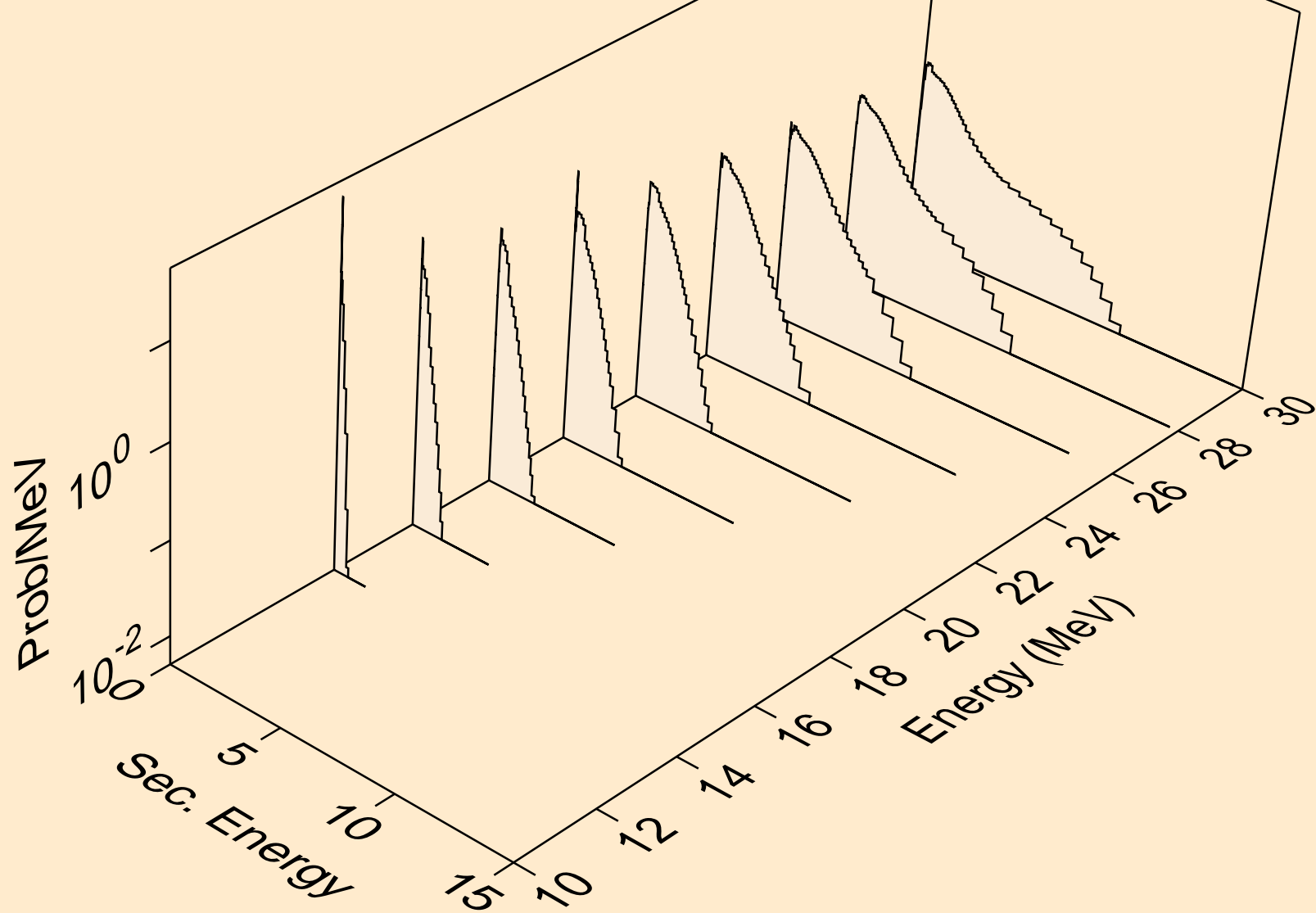

XE140 NEUTRON ACER TENDL-2024 LIBRARY; T=0.K
Neutron emission for (n,n*)d

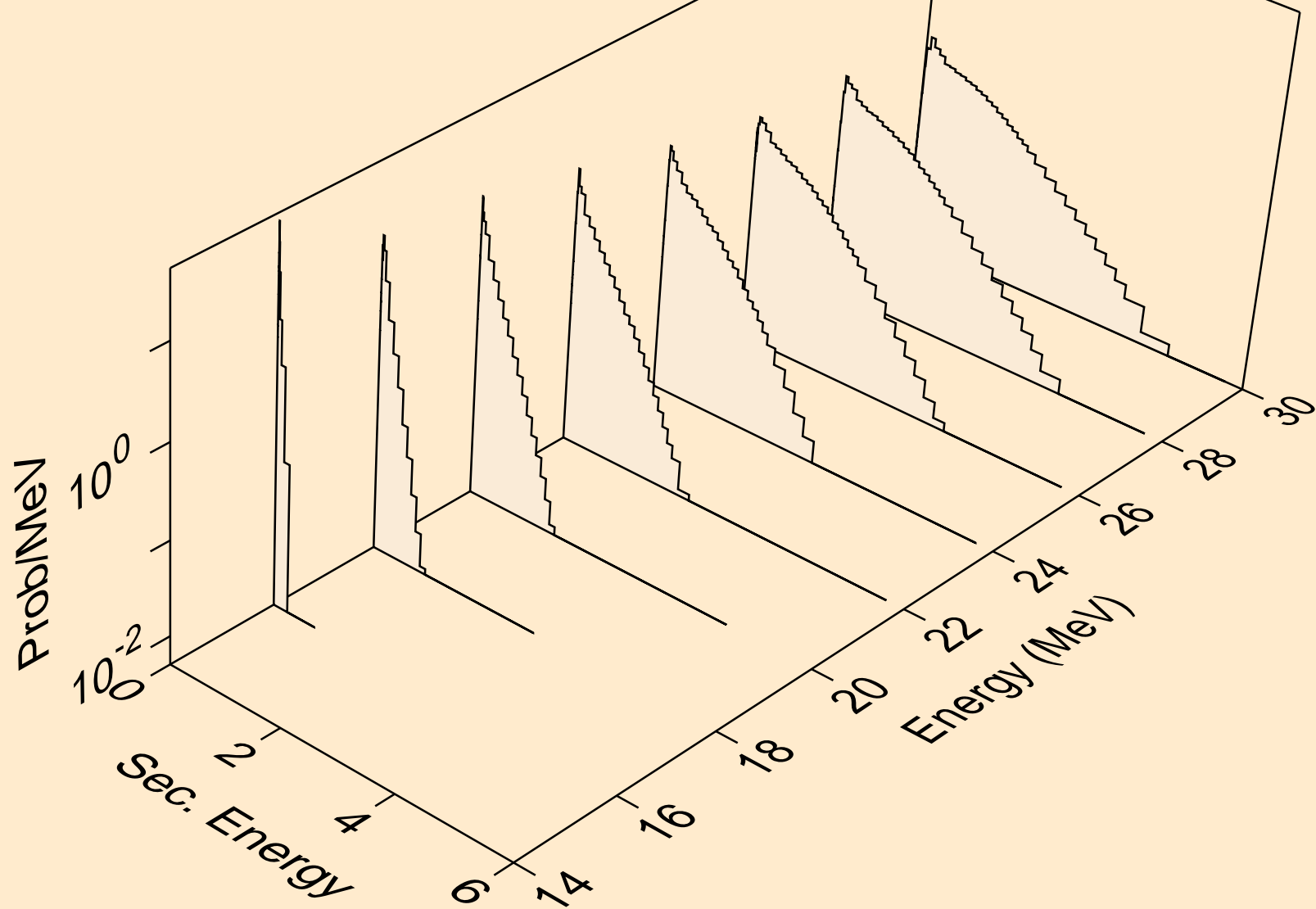

XE140 NEUTRON ACER TENDL-2024 LIBRARY; T=0.K
Neutron emission for (n,n*)t

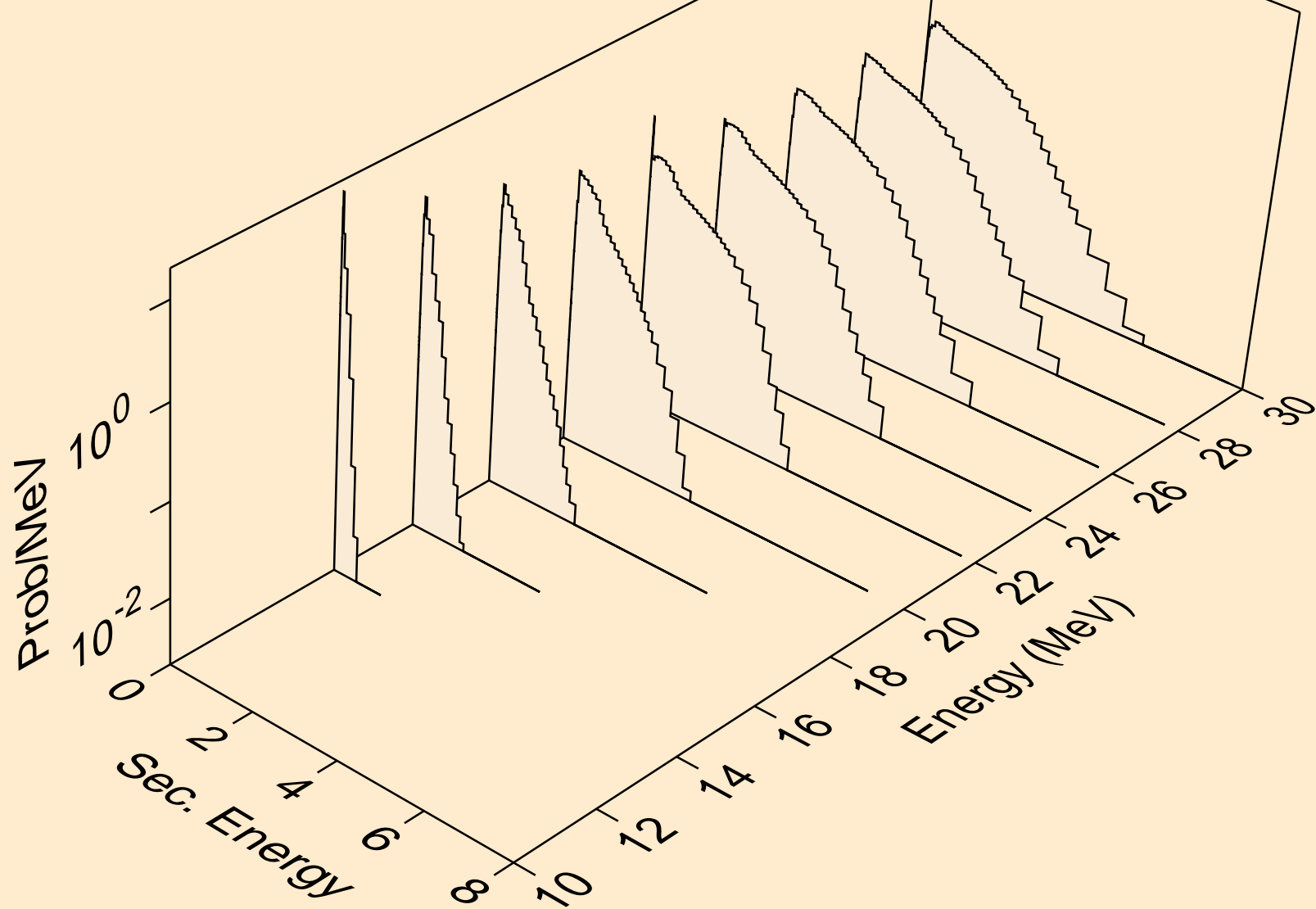

XE140 NEUTRON ACER TENDL-2024 LIBRARY; T=0.K
Neutron emission for (n,n*)he3

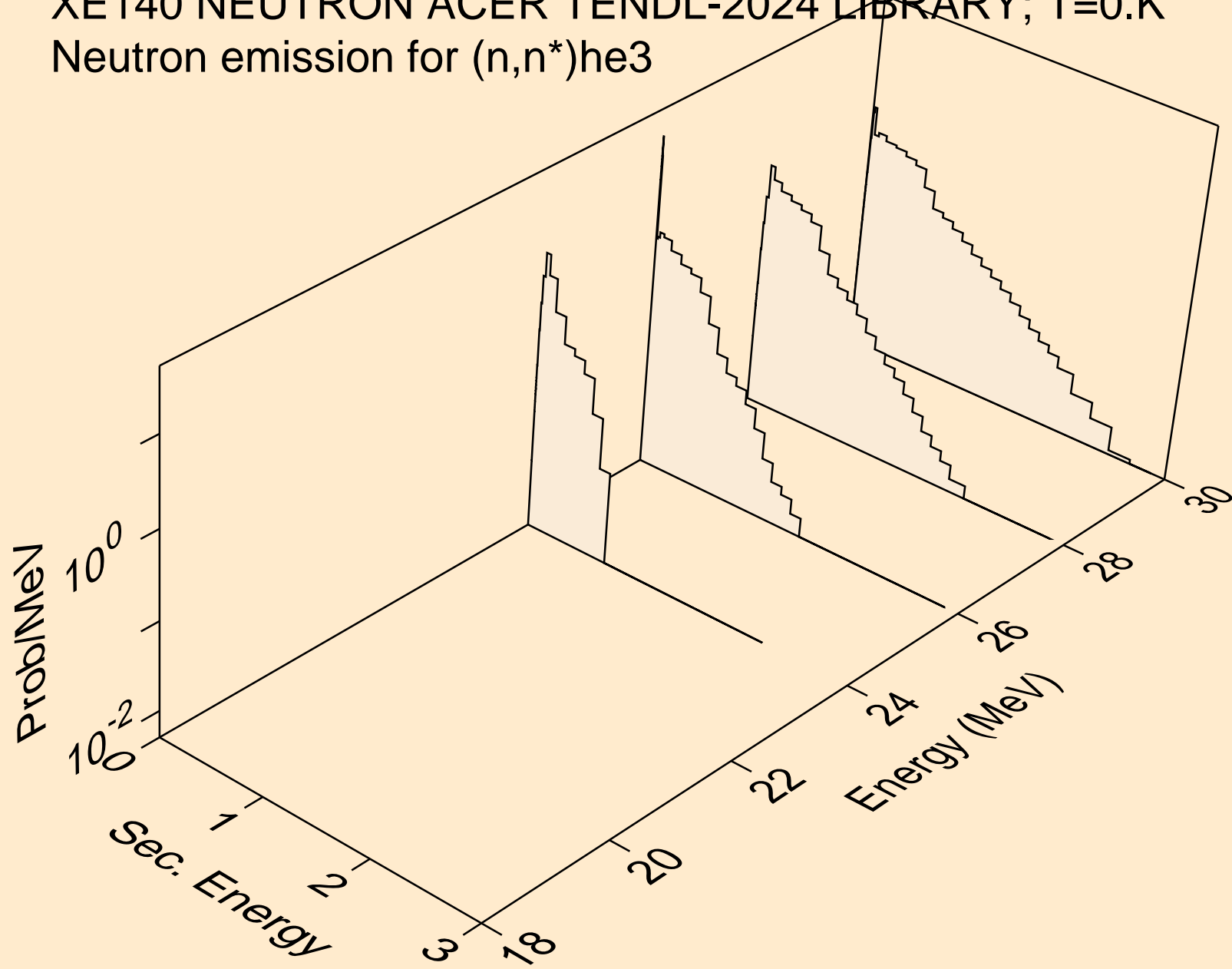

XE140 NEUTRON ACER TENDL-2024 LIBRARY; T=0.K
Neutron emission for (n,4n)

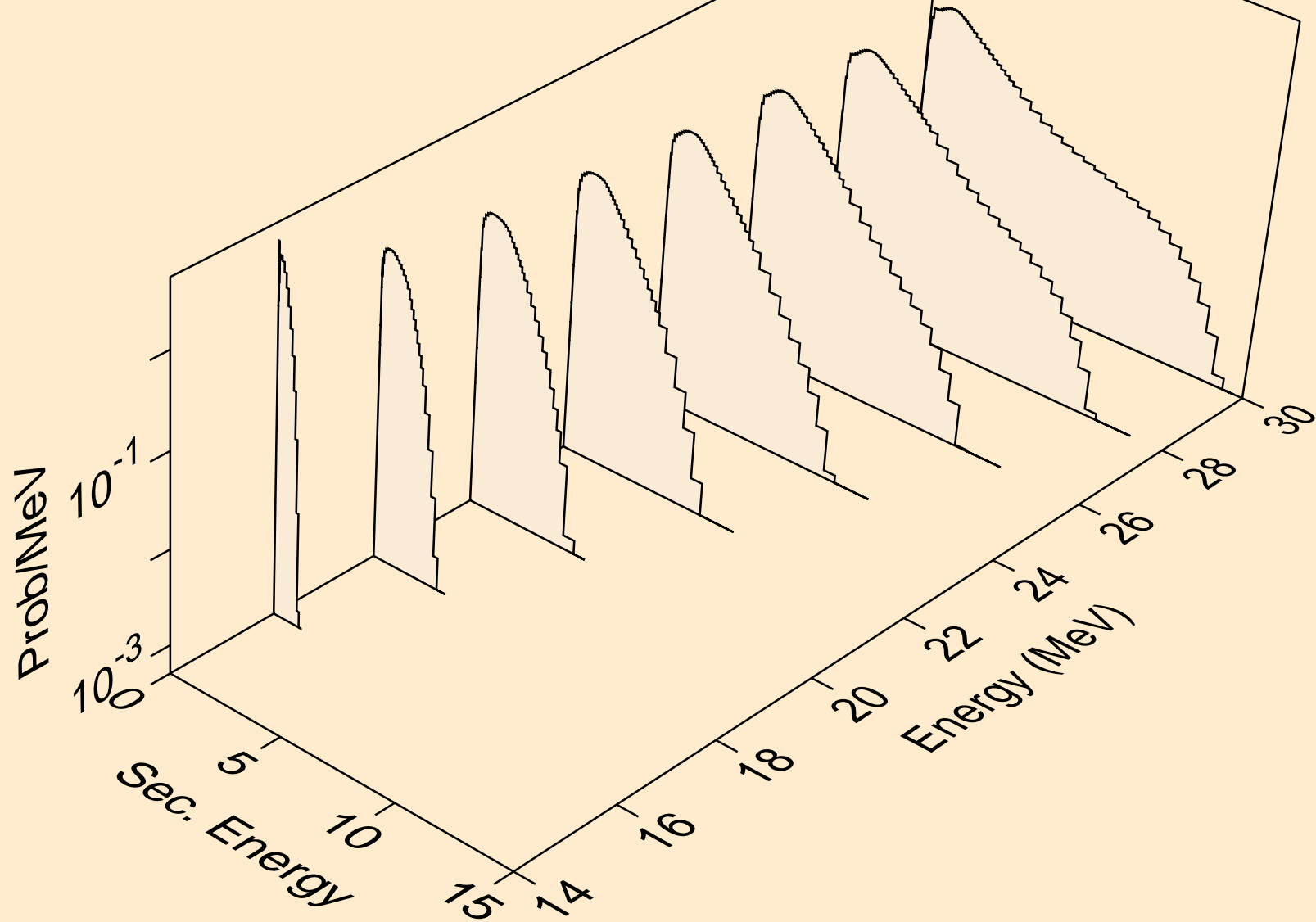

XE140 NEUTRON ACER TENDL-2024 LIBRARY; T=0.K
Neutron emission for (n,2np)

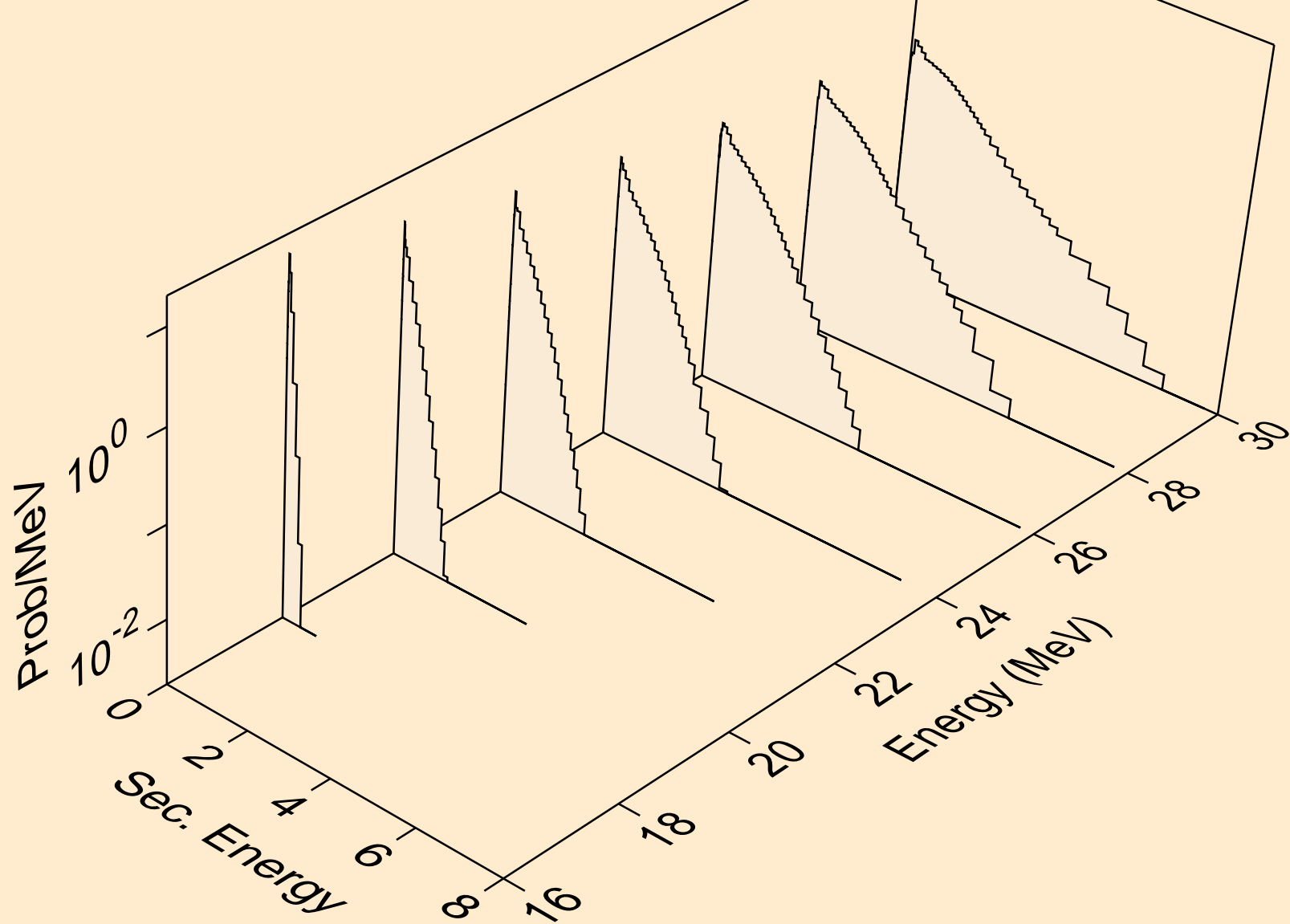

XE140 NEUTRON ACER TENDL-2024 LIBRARY; T=0.K
Neutron emission for (n,3np)

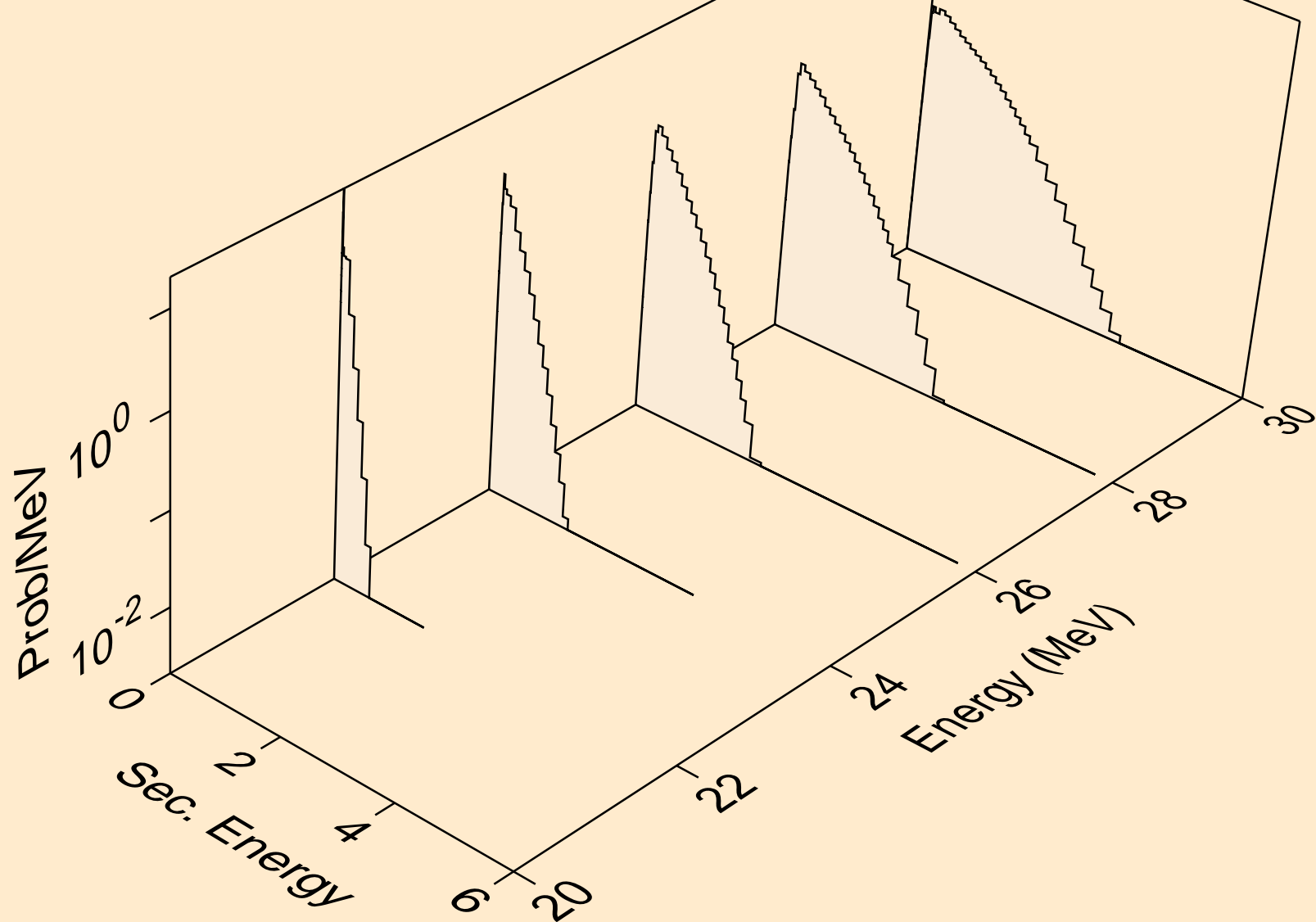

XE140 NEUTRON ACER TENDL-2024 LIBRARY; T=0.K
Neutron emission for (n,n*c)

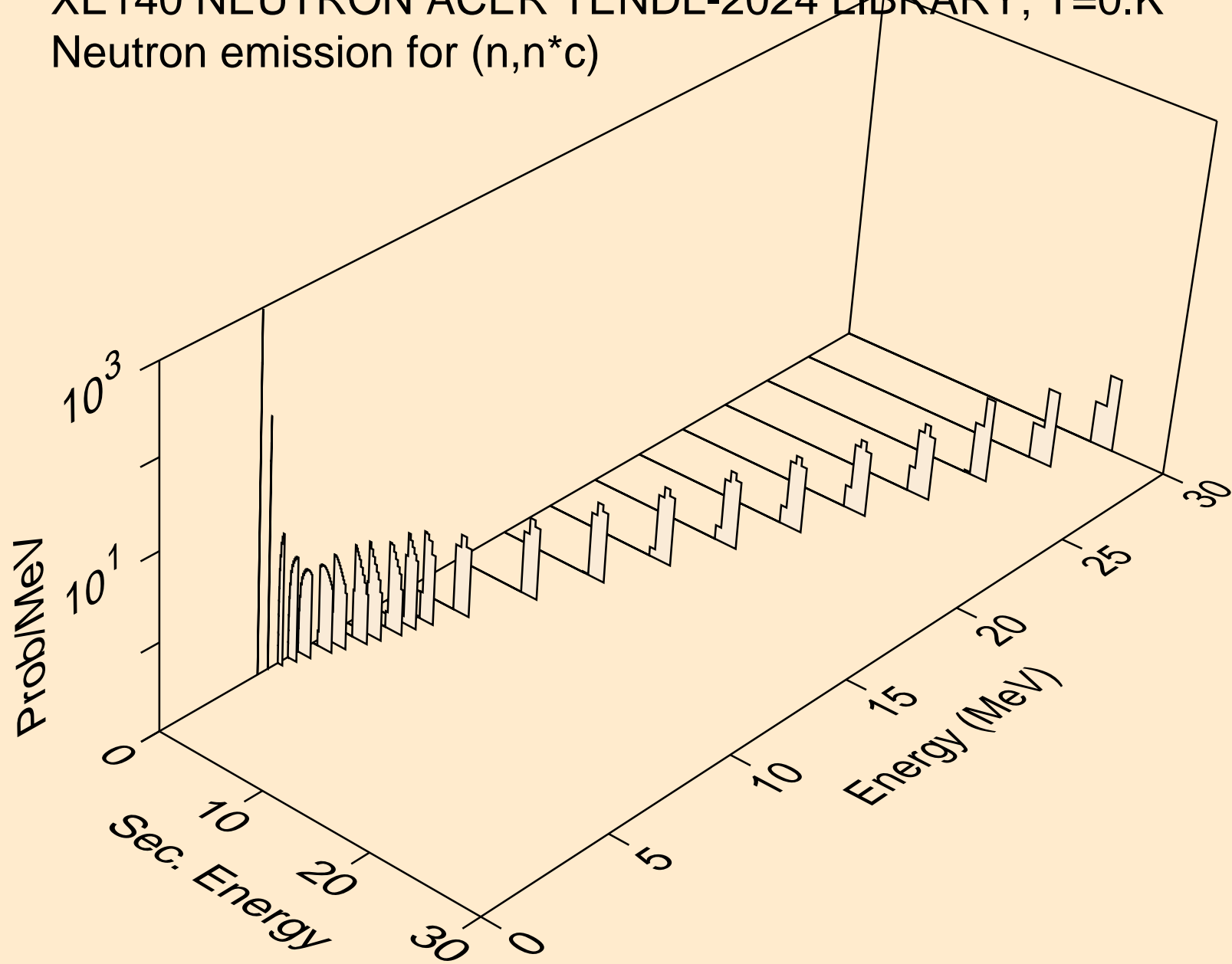

XE140 NEUTRON ACER TENDL-2024 LIBRARY; T=0.K
Photon emission for (n,x)

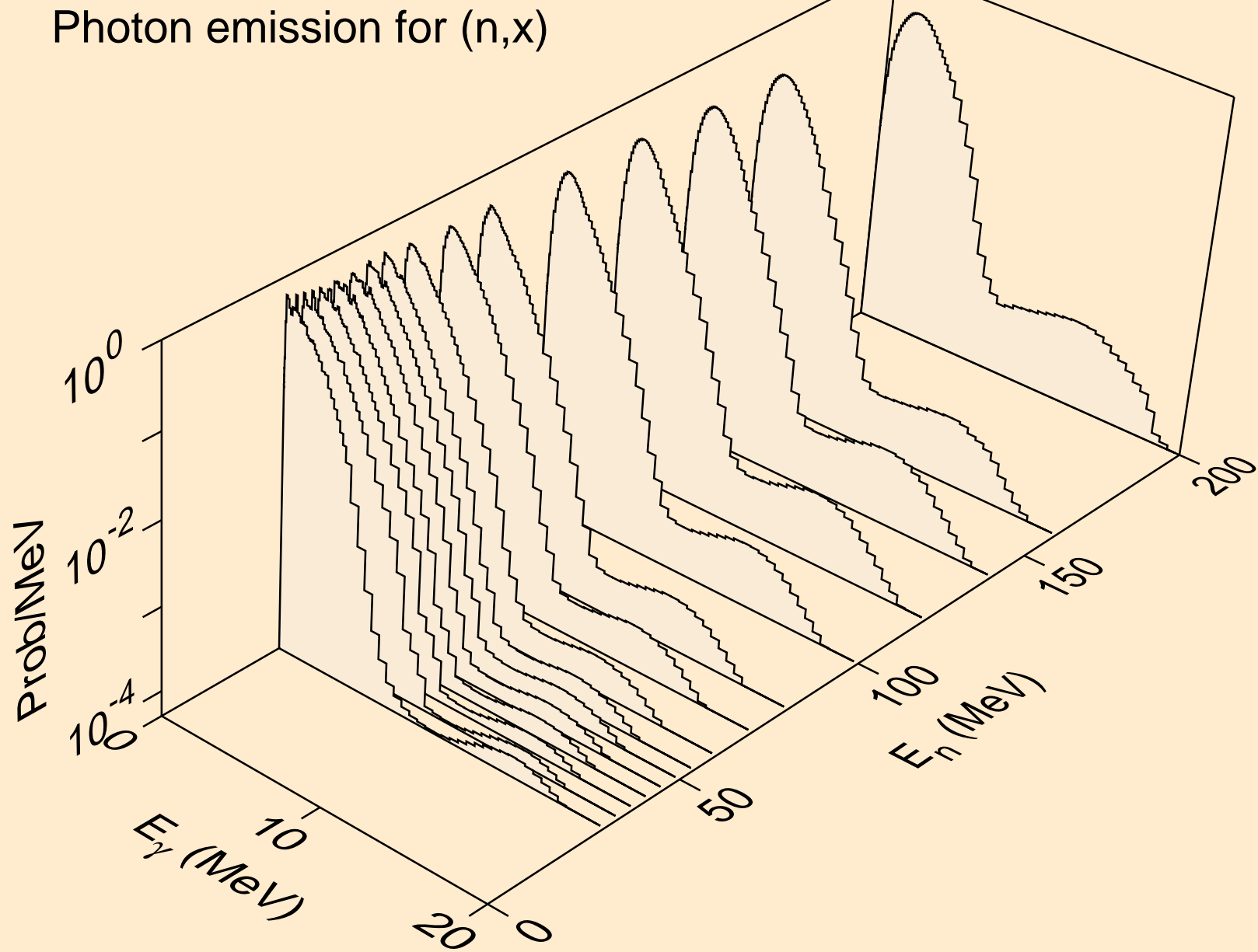

XE140 NEUTRON ACER TENDL-2024 LIBRARY; T=0.K
Photon emission for (n,2nd)

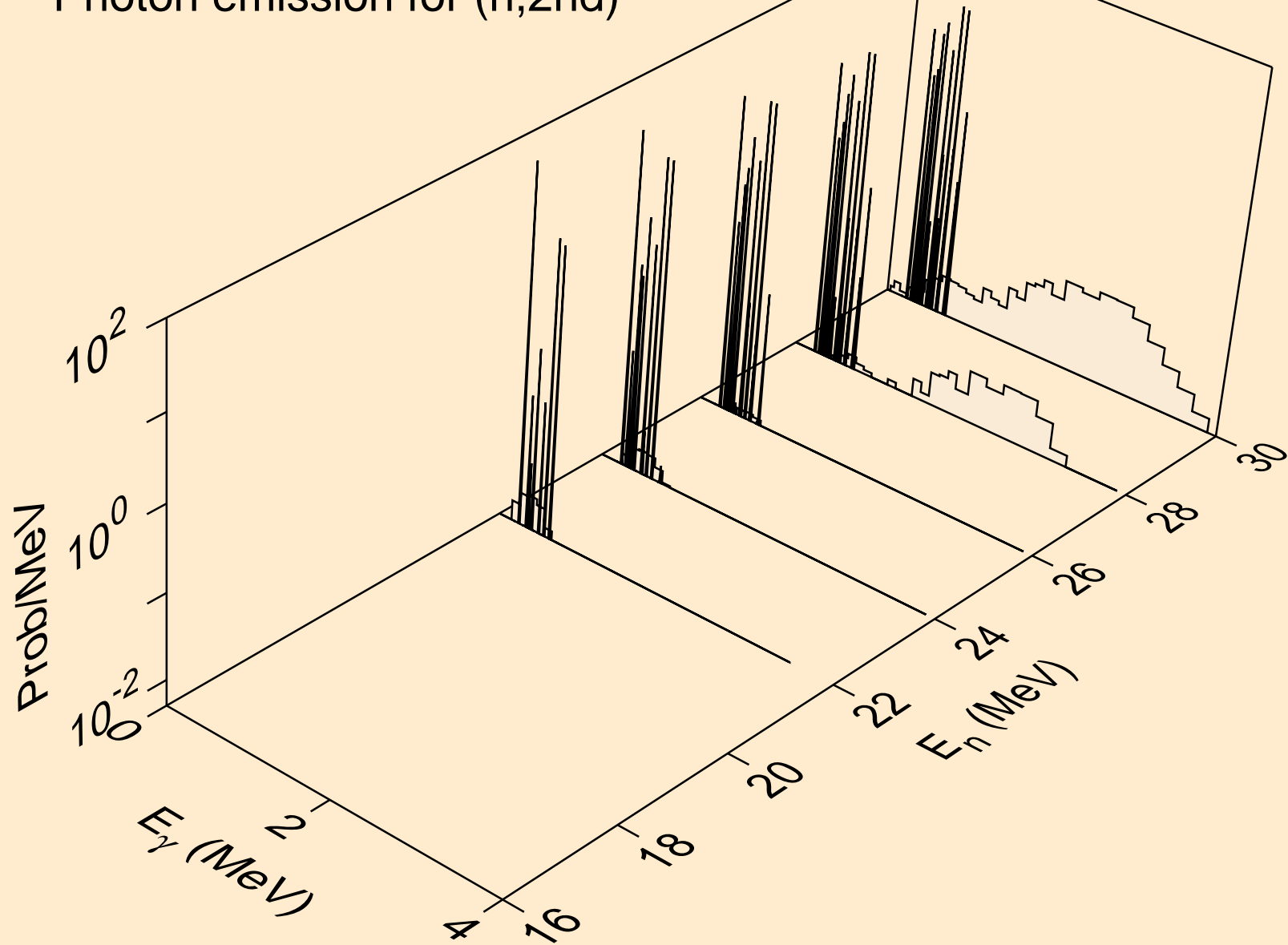

XE140 NEUTRON ACER TENDL-2024 LIBRARY; T=0.K
Photon emission for (n,2n)

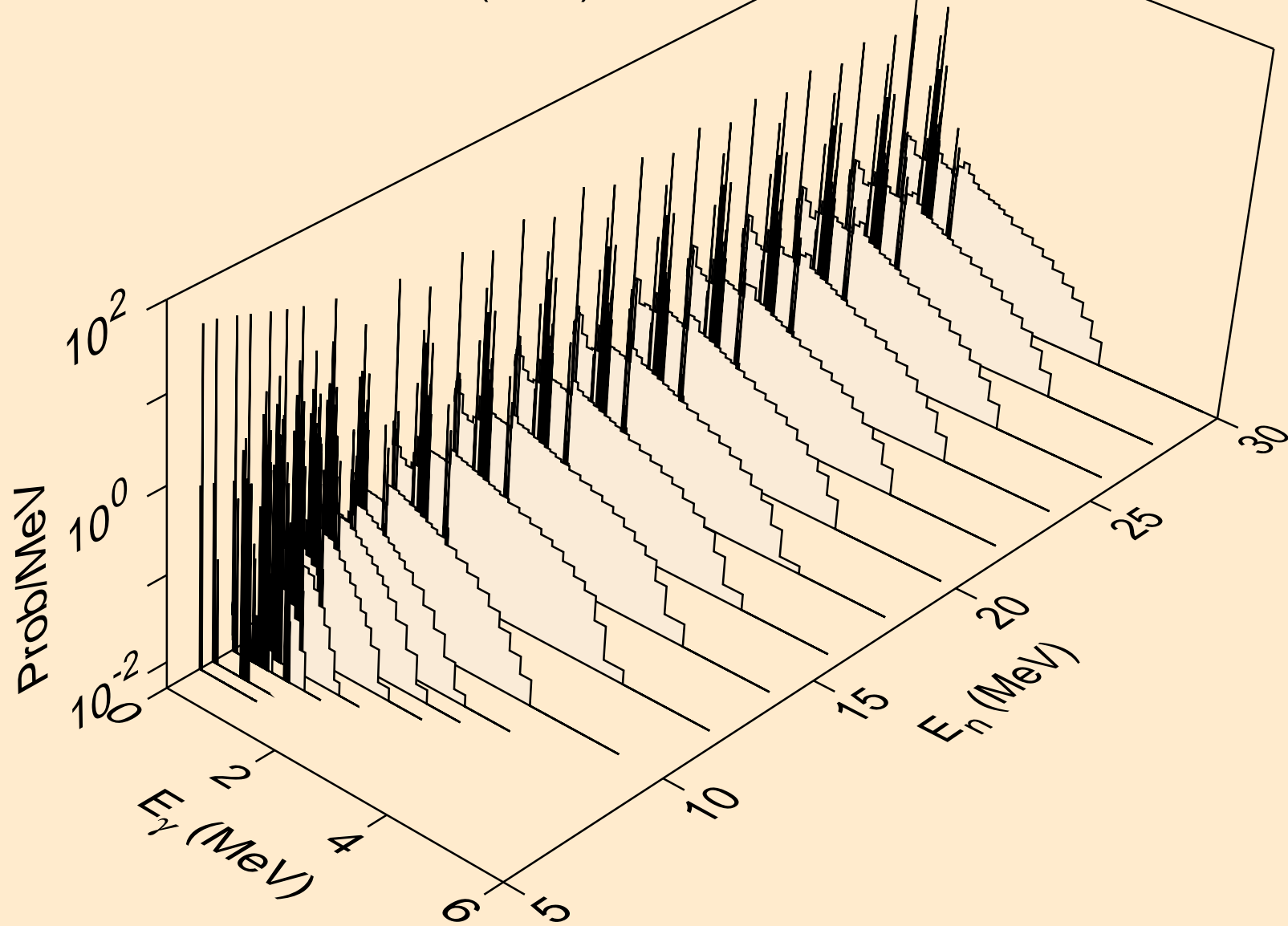

XE140 NEUTRON ACER TENDL-2024 LIBRARY; T=0.K
Photon emission for (n,3n)

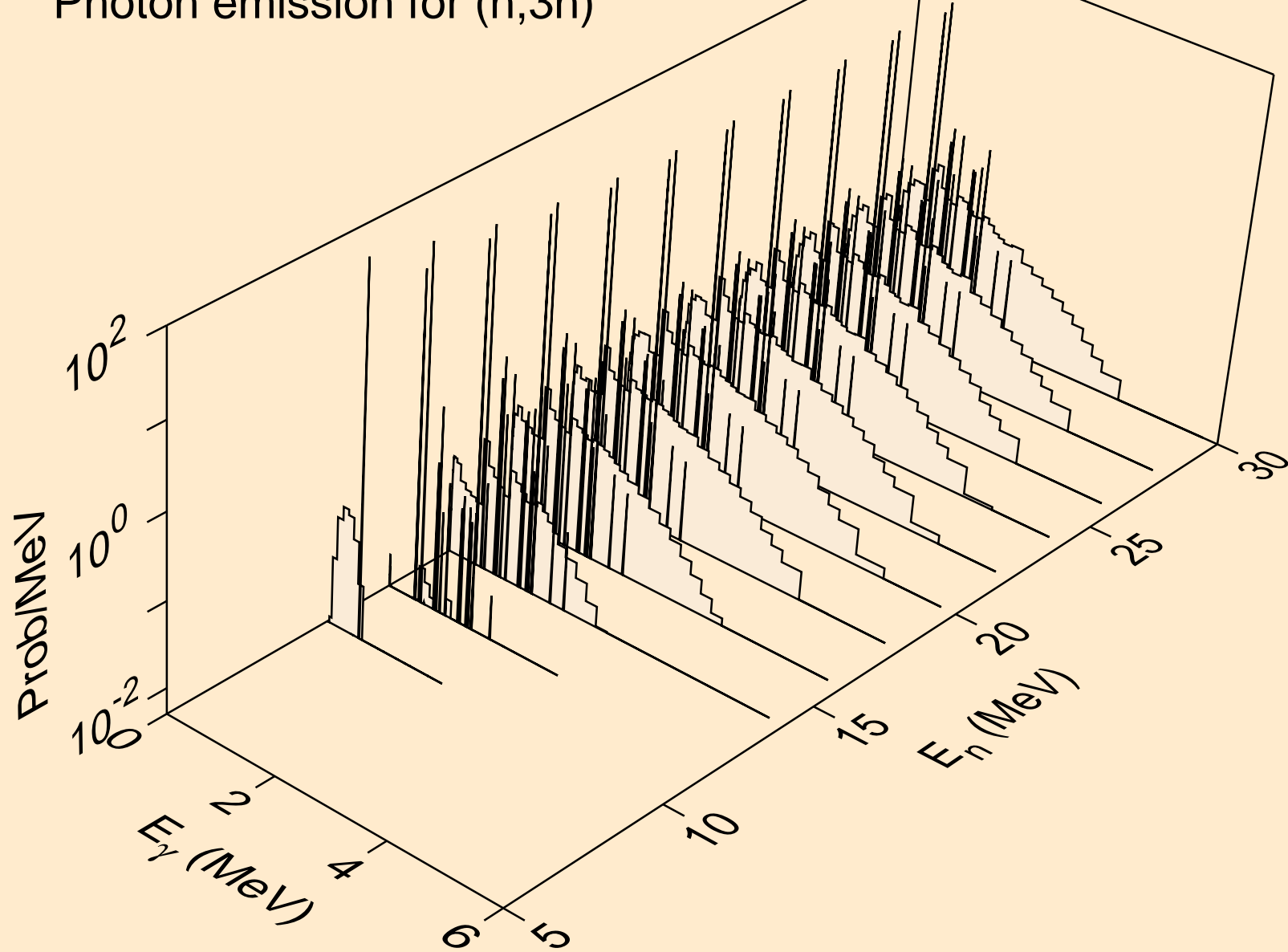

XE140 NEUTRON ACER TENDL-2024 LIBRARY; T=0.K
Photon emission for (n,n*)a

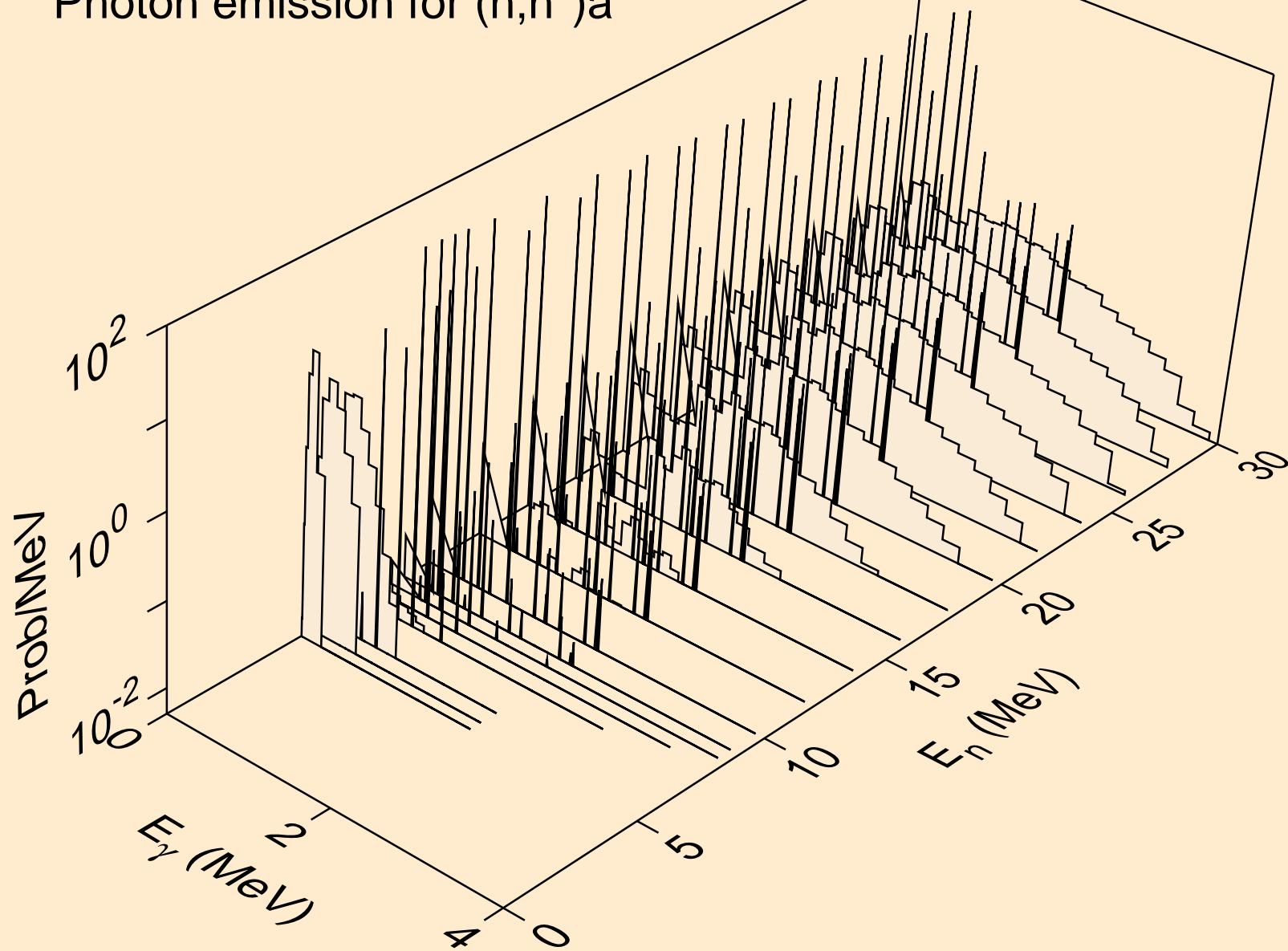

XE140 NEUTRON ACER TENDL-2024 LIBRARY; T=0.K
Photon emission for (n,2n)a

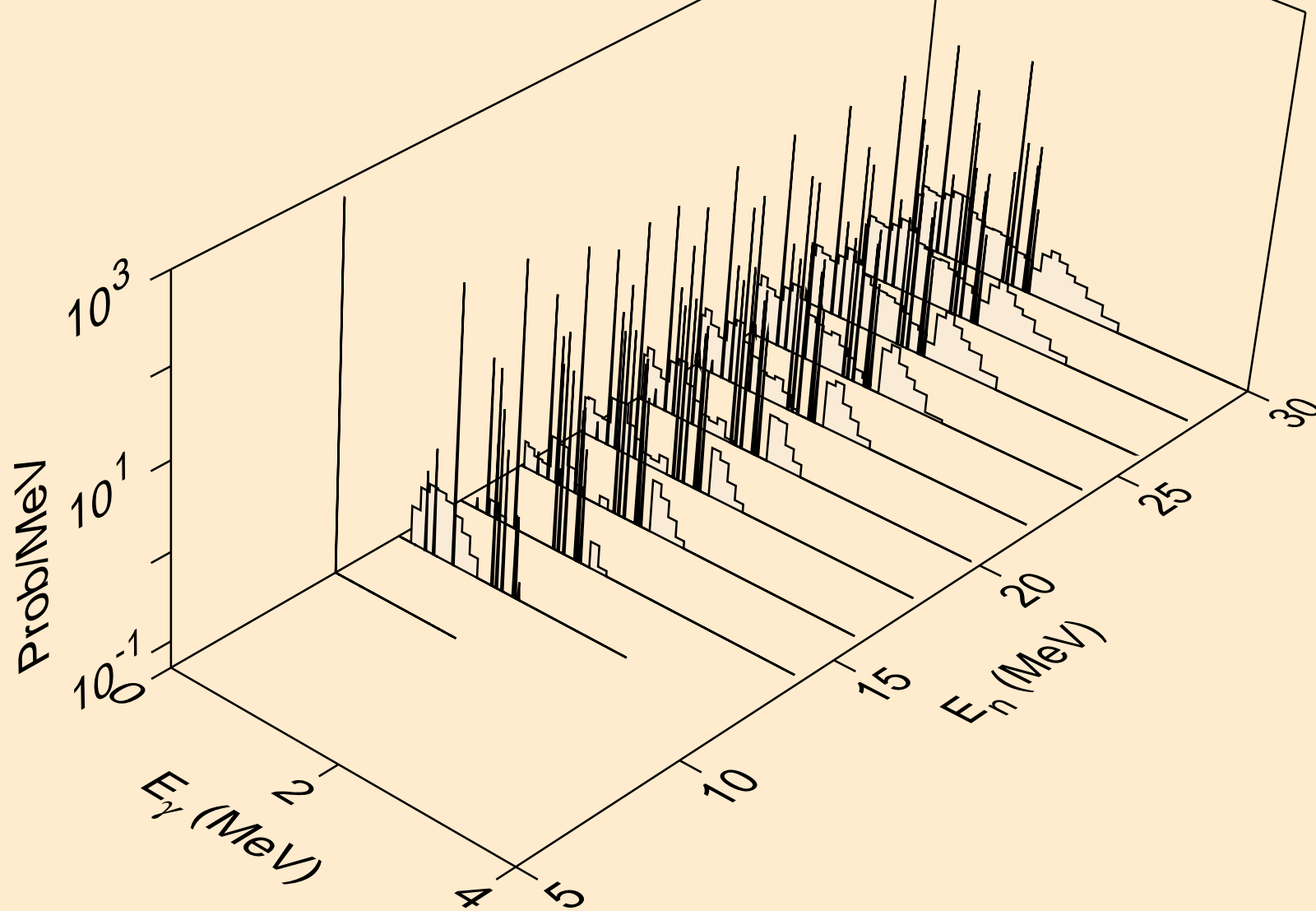

XE140 NEUTRON ACER TENDL-2024 LIBRARY; T=0.K
Photon emission for (n,3n)a

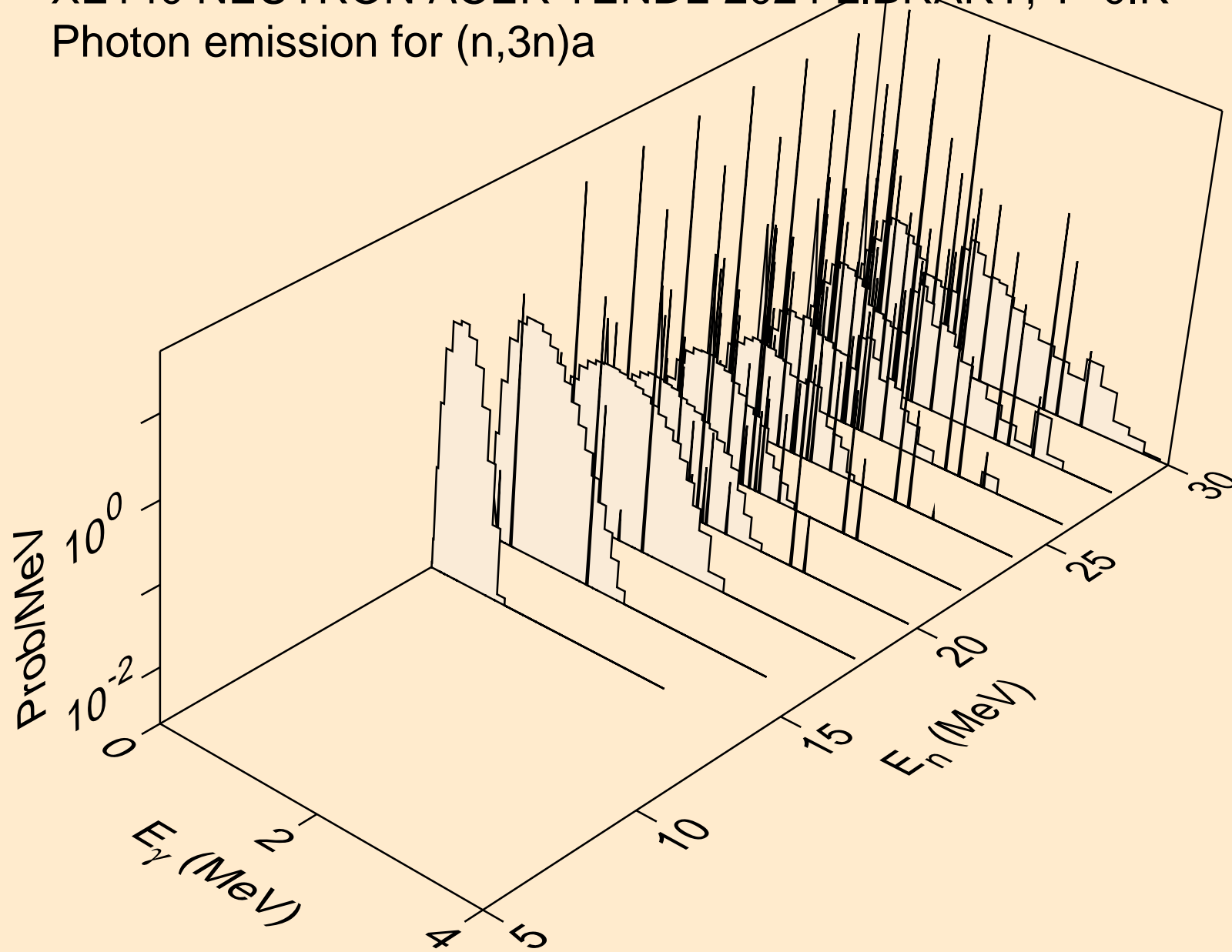

XE140 NEUTRON ACER TENDL-2024 LIBRARY; T=0.K
Photon emission for (n,n*)p

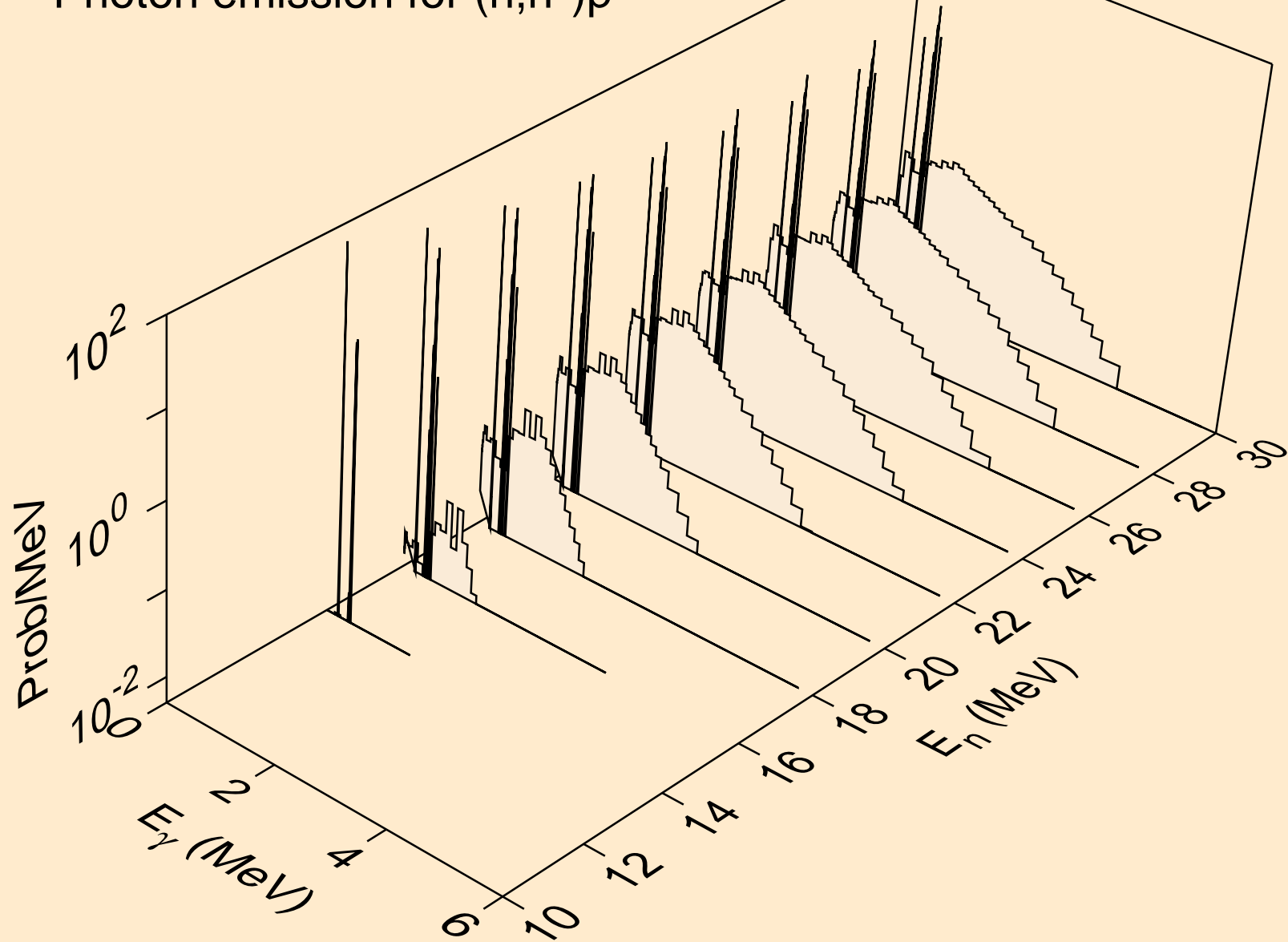

XE140 NEUTRON ACER TENDL-2024 LIBRARY; T=0.K
Photon emission for (n,n*)d

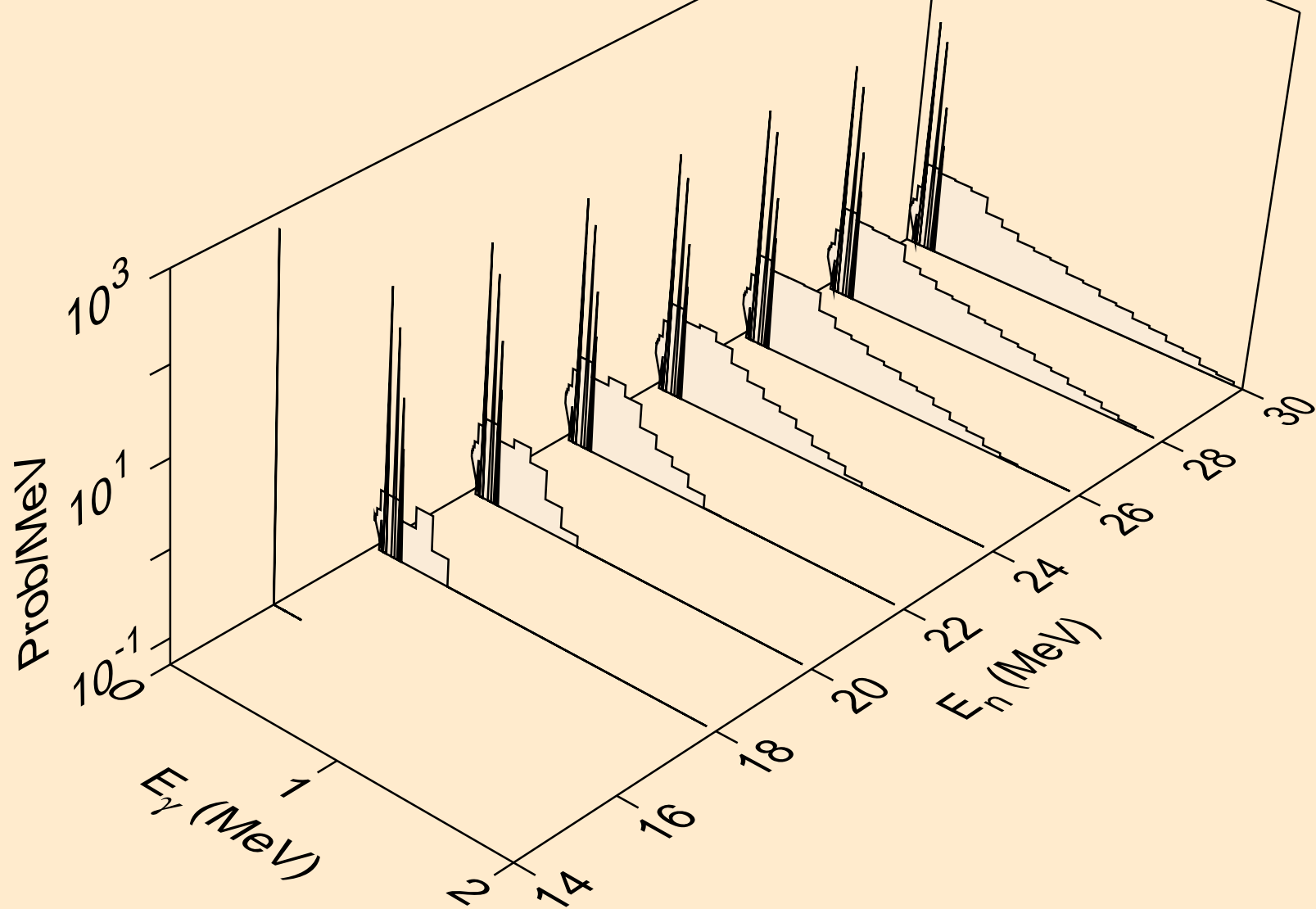

XE140 NEUTRON ACER TENDL-2024 LIBRARY; T=0.K
Photon emission for (n,n*)t

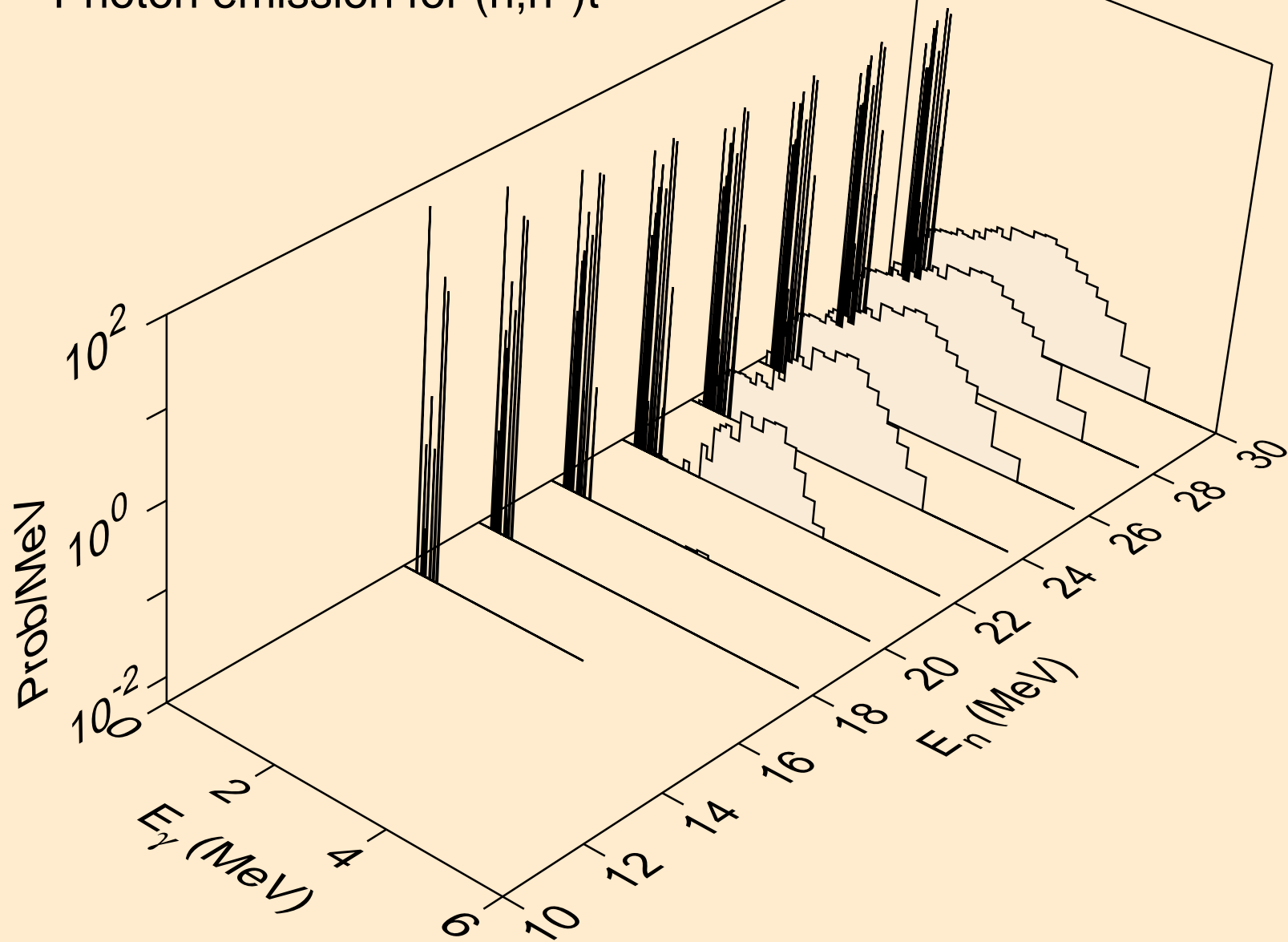

XE140 NEUTRON ACER TENDL-2024 LIBRARY; T=0.K
Photon emission for (n,n*)he3

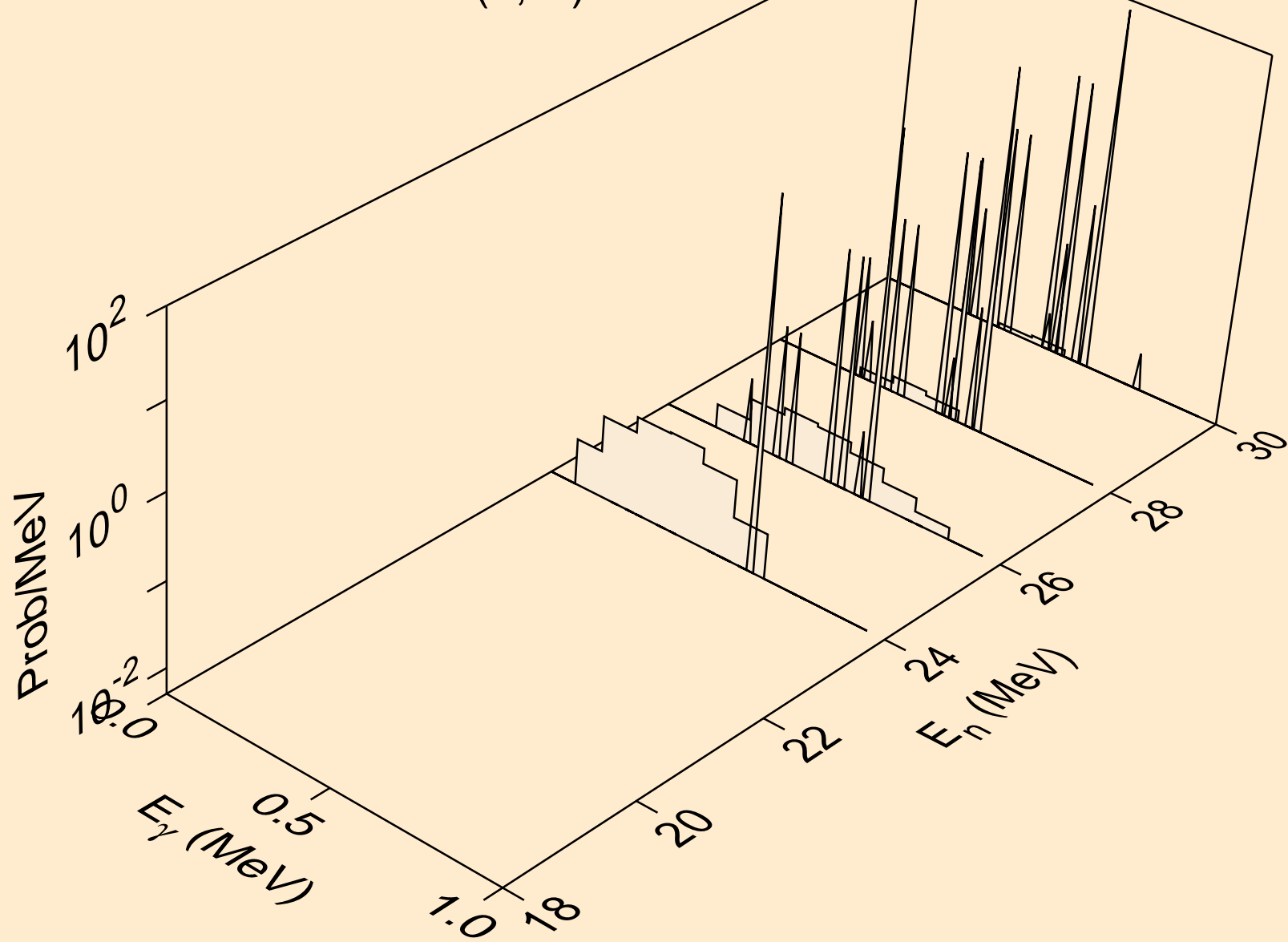

XE140 NEUTRON ACER TENDL-2024 LIBRARY; T=0.K
Photon emission for (n,4n)

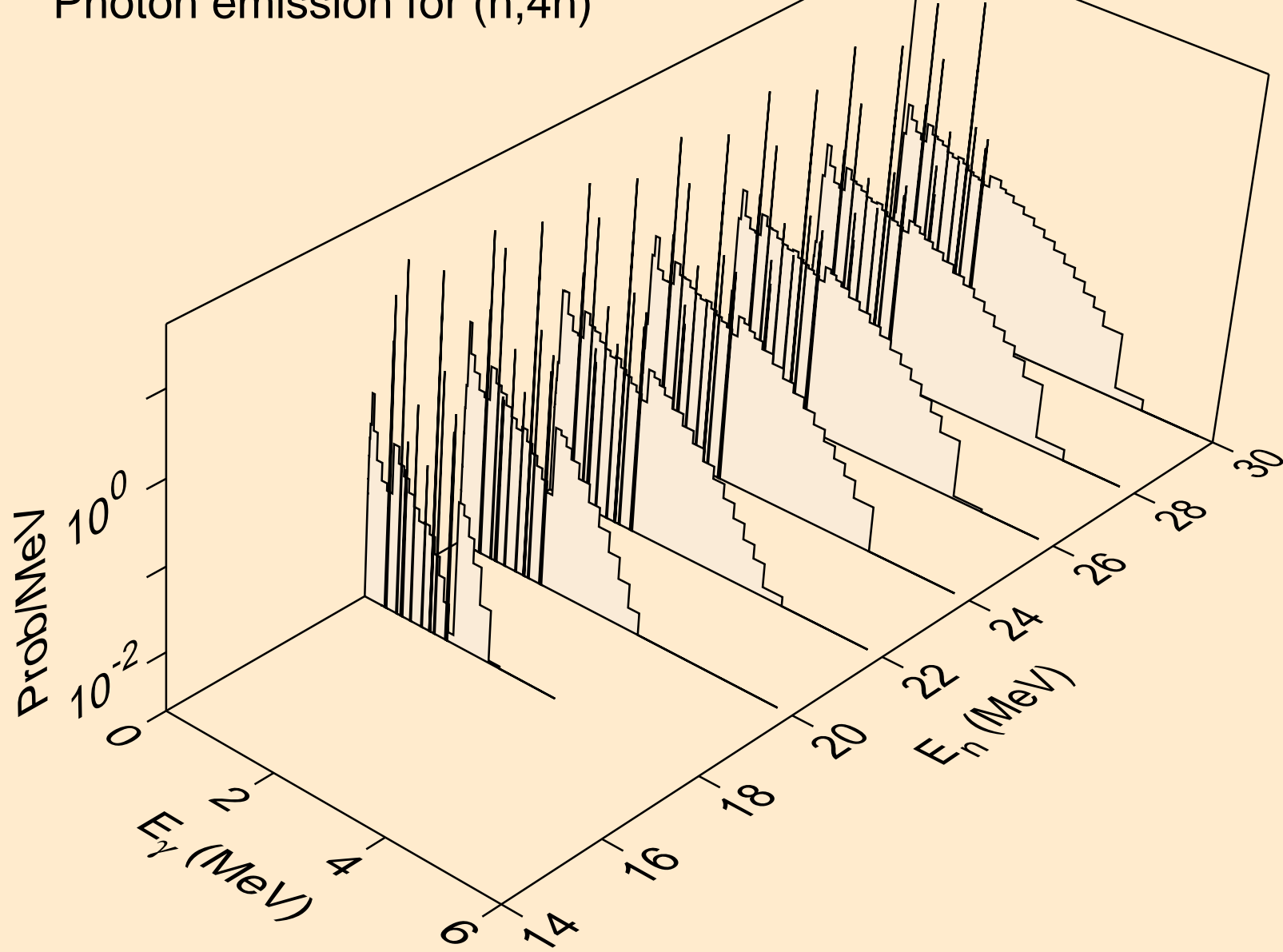

XE140 NEUTRON ACER TENDL-2024 LIBRARY; T=0.K
Photon emission for (n,2np)

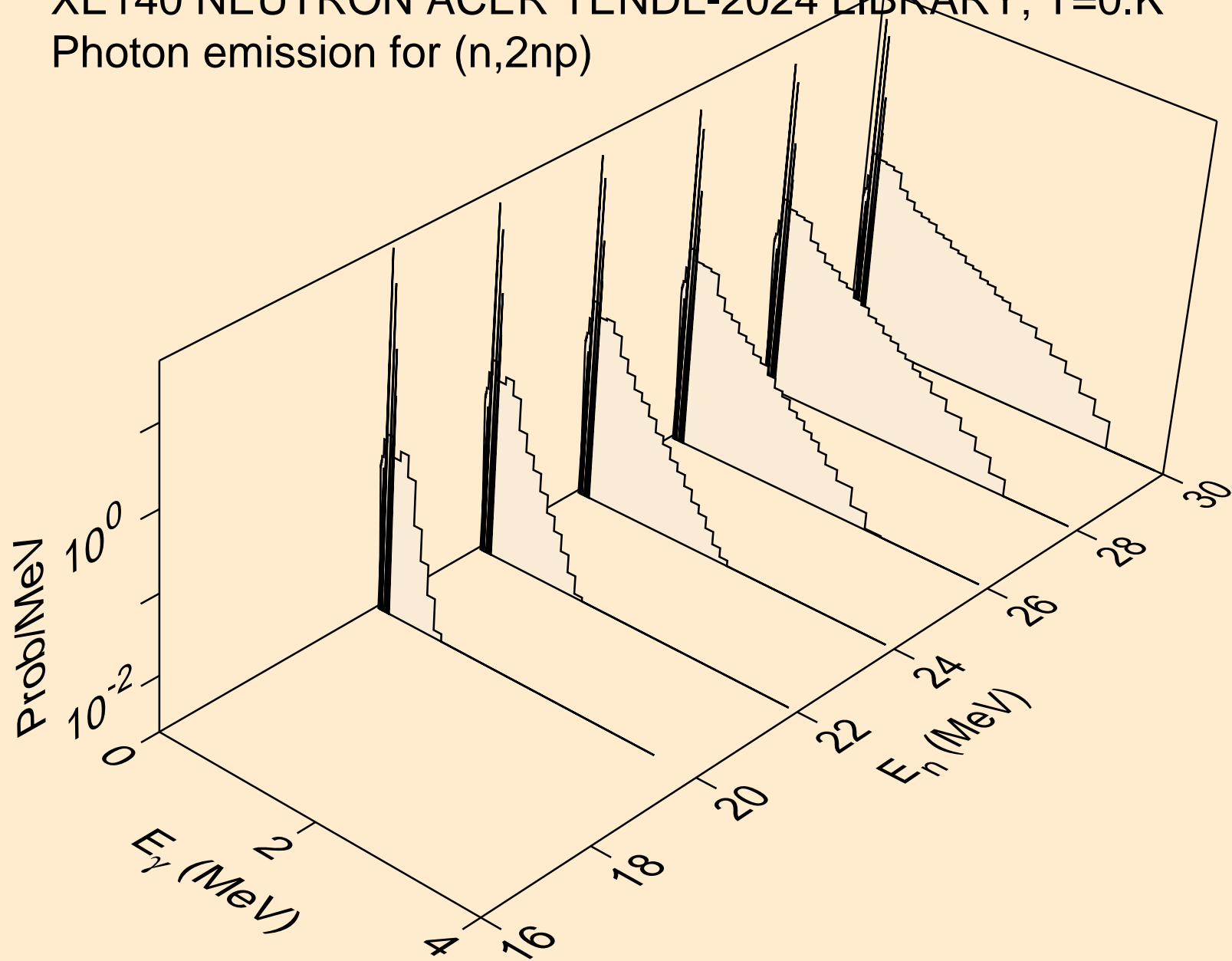

XE140 NEUTRON ACER TENDL-2024 LIBRARY; T=0.K
Photon emission for (n,3np)

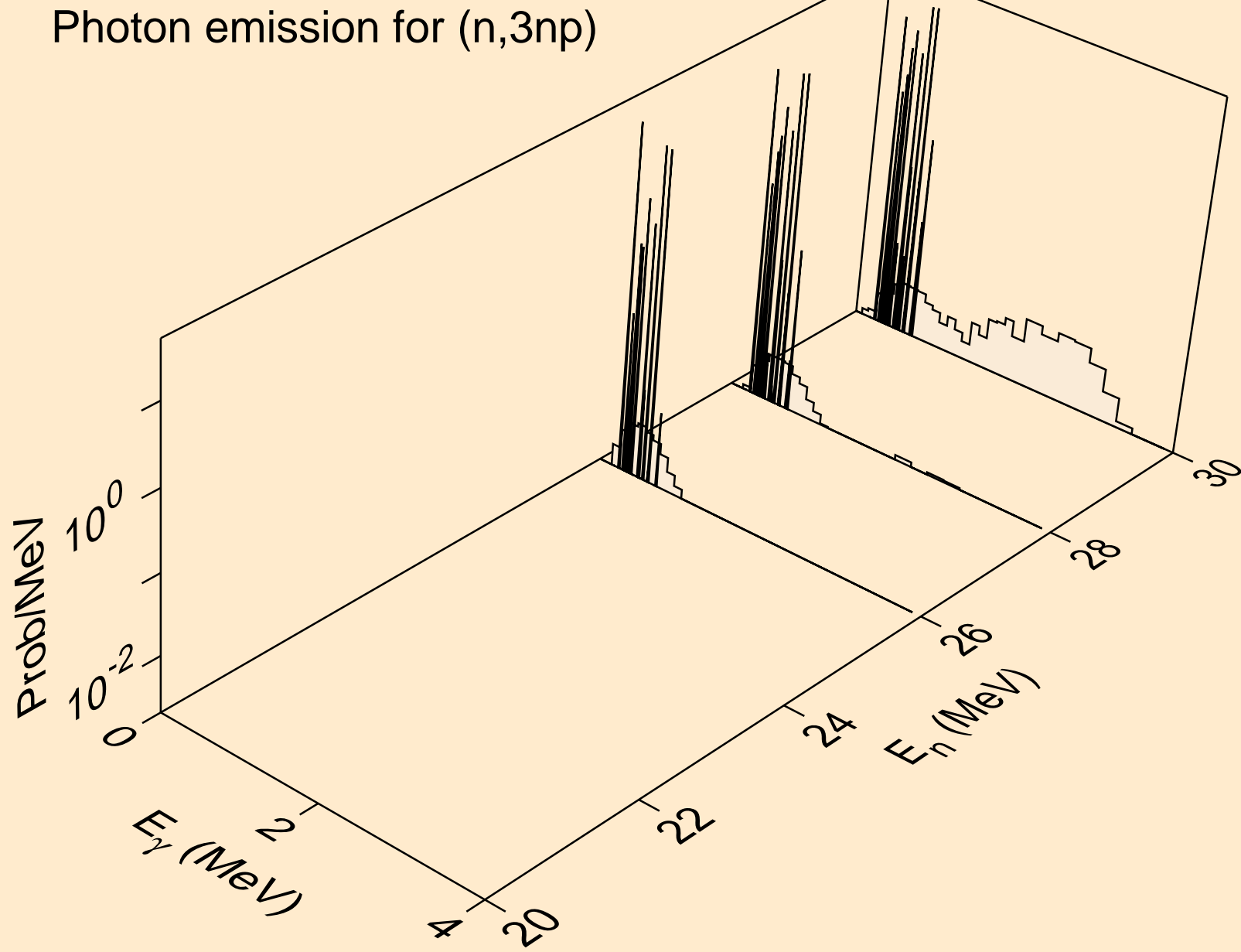

XE140 NEUTRON ACER TENDL-2024 LIBRARY; T=0.K
Photon emission for (n,n*c)

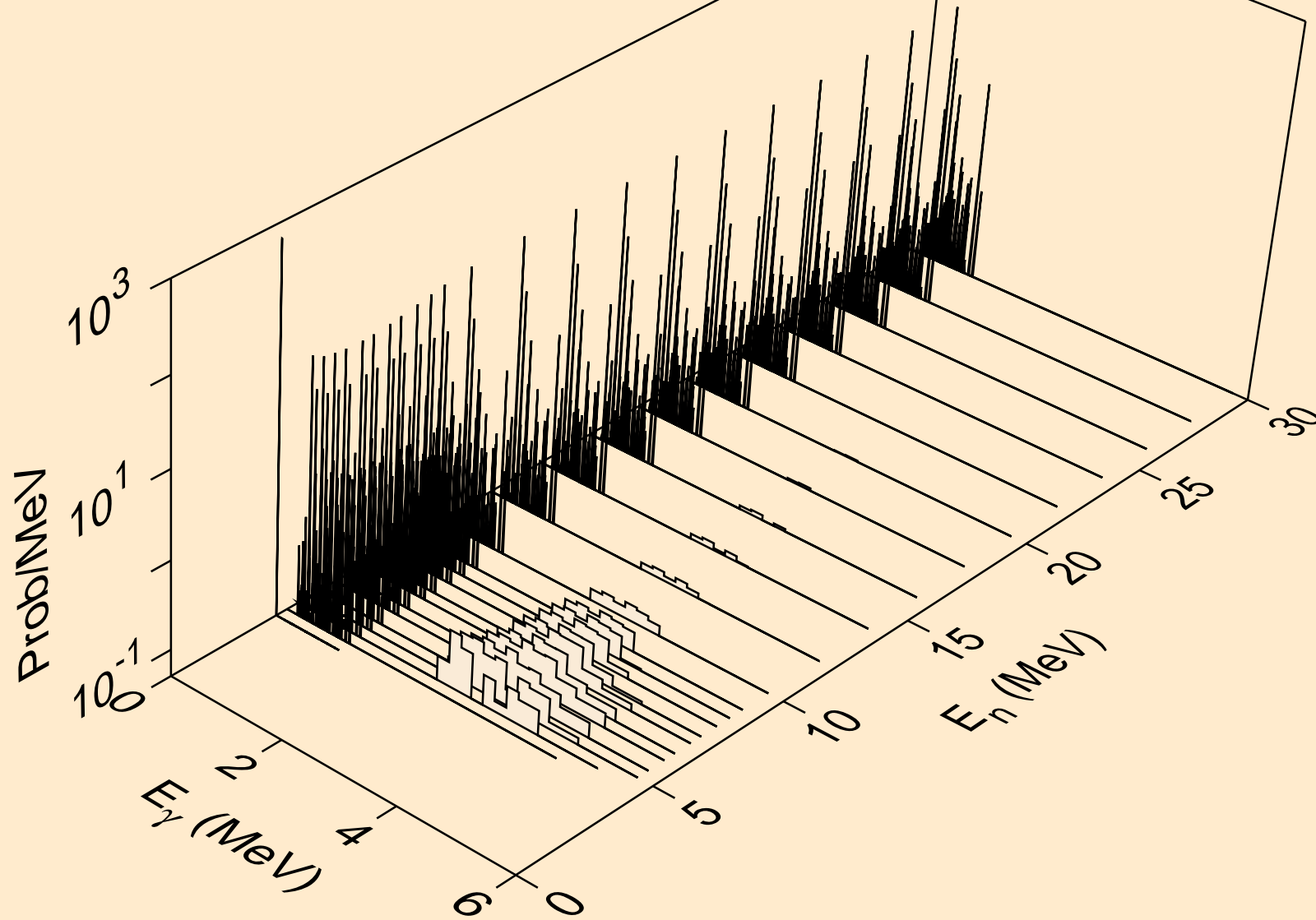

XE140 NEUTRON ACER TENDL-2024 LIBRARY; T=0.K
Photon emission for (n,gma)

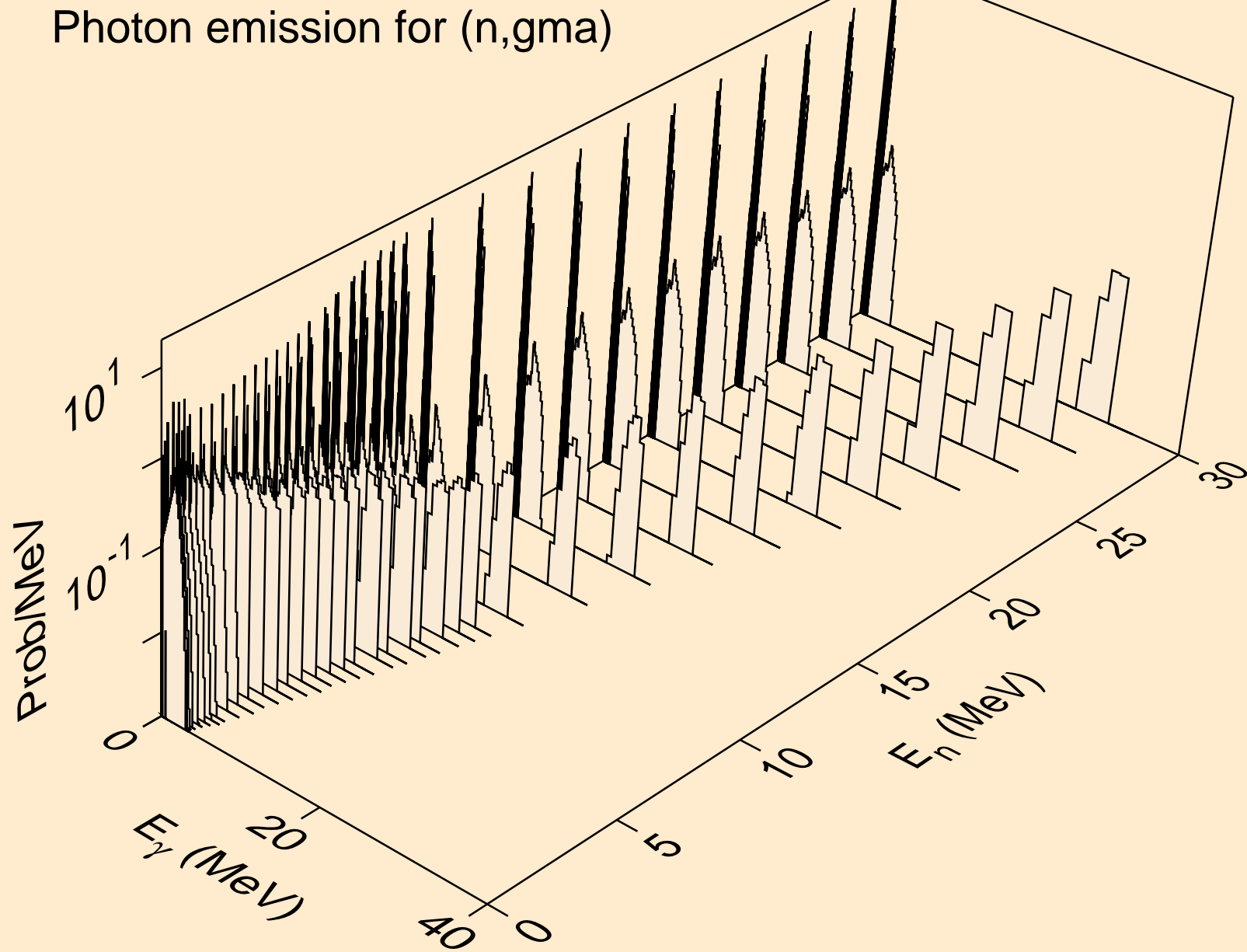

XE140 NEUTRON ACER TENDL-2024 LIBRARY; T=0.K
Photon emission for (n,p)

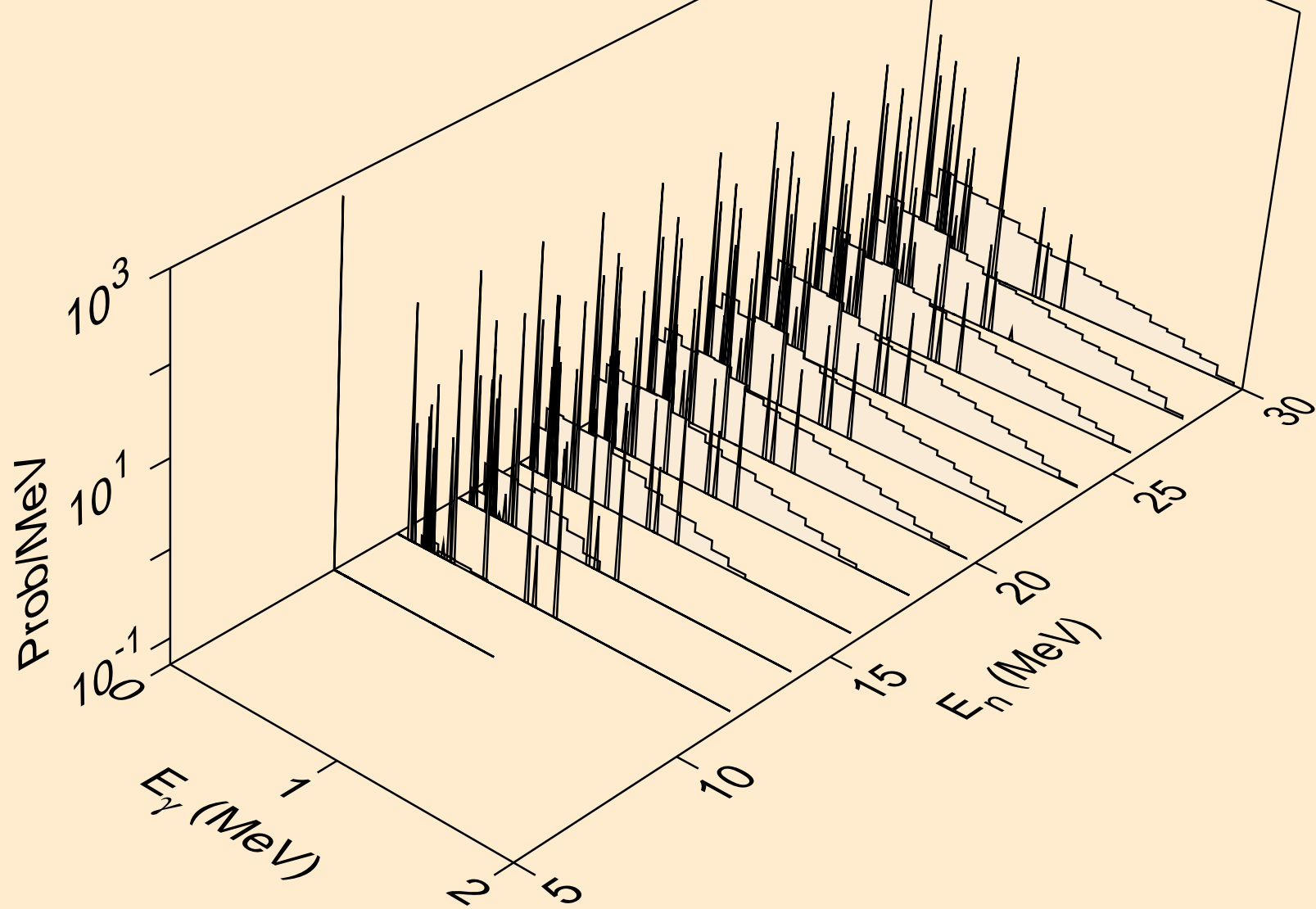

XE140 NEUTRON ACER TENDL-2024 LIBRARY; T=0.K
Photon emission for (n,d)

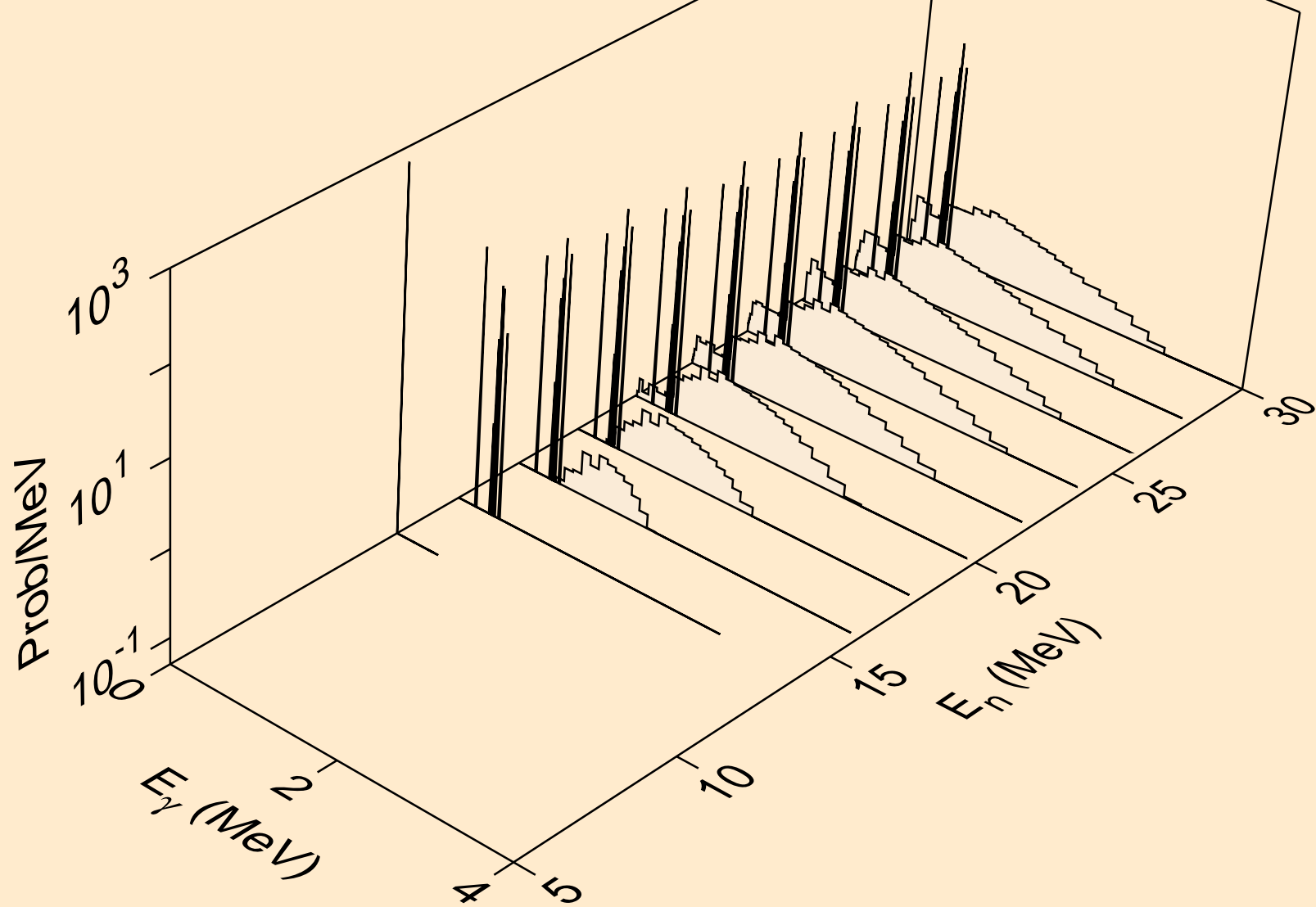

XE140 NEUTRON ACER TENDL-2024 LIBRARY; T=0.K
Photon emission for (n,t)

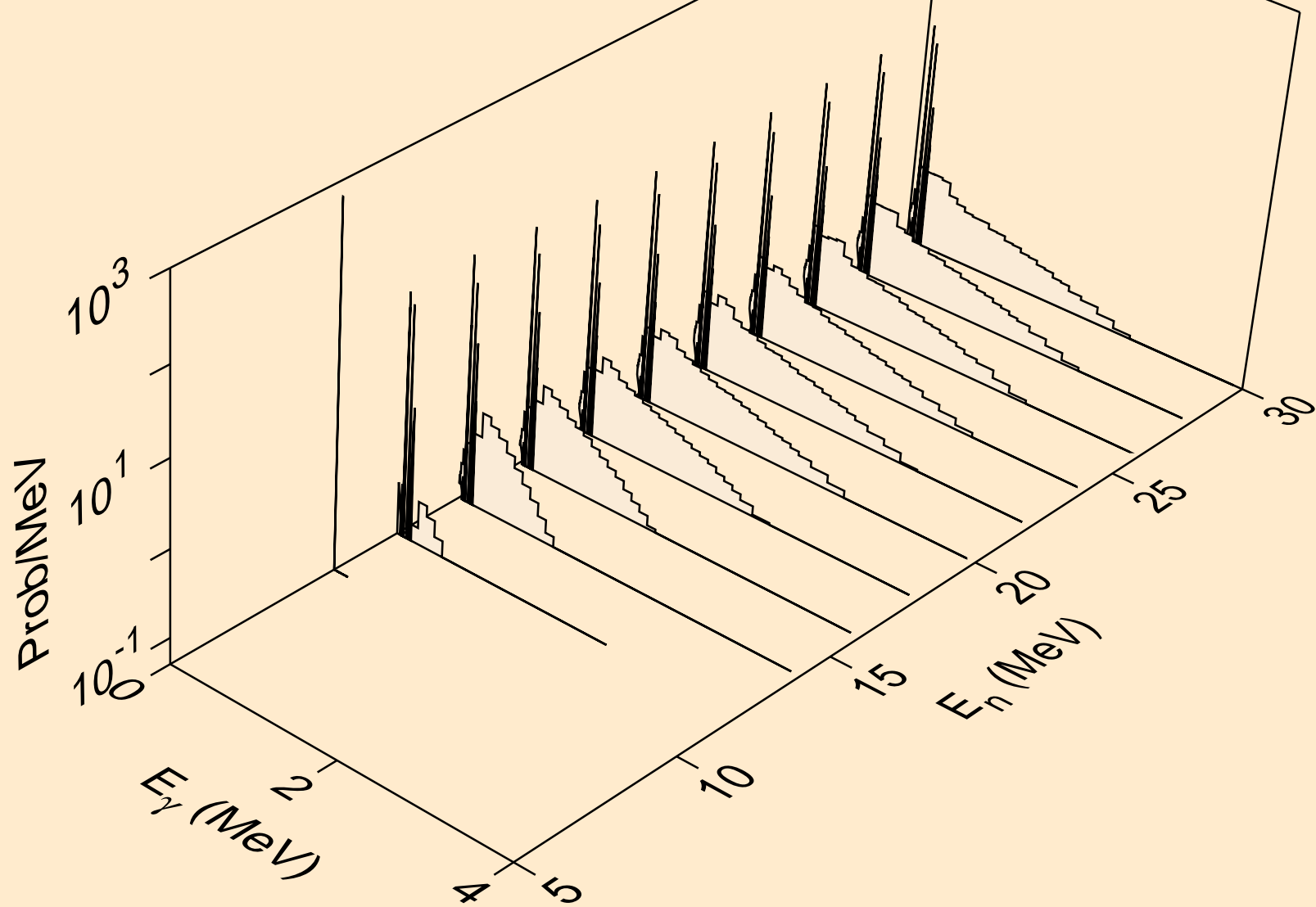

XE140 NEUTRON ACER TENDL-2024 LIBRARY; T=0.K
Photon emission for (n,he3)

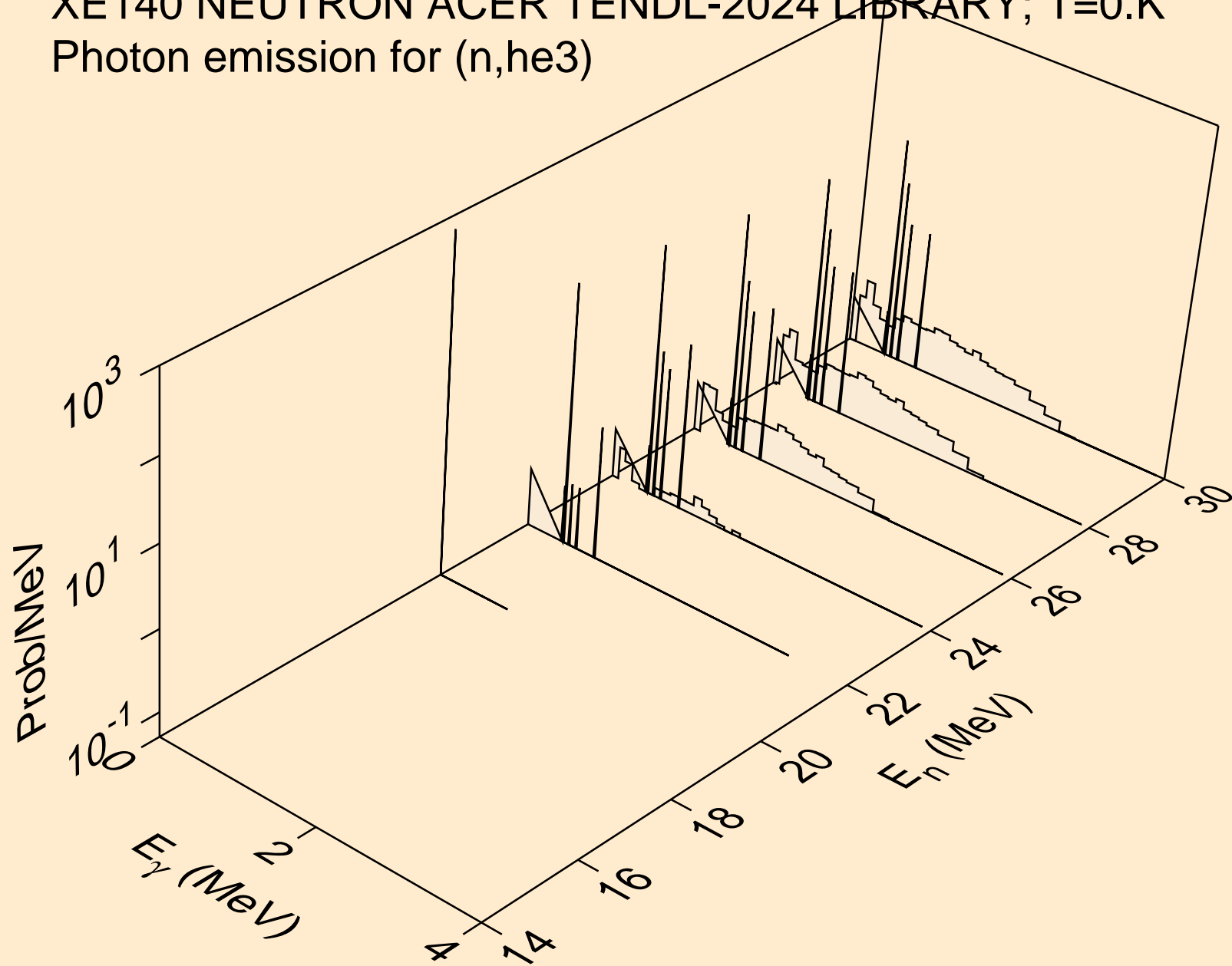

XE140 NEUTRON ACER TENDL-2024 LIBRARY; T=0.K
Photon emission for (n,a)

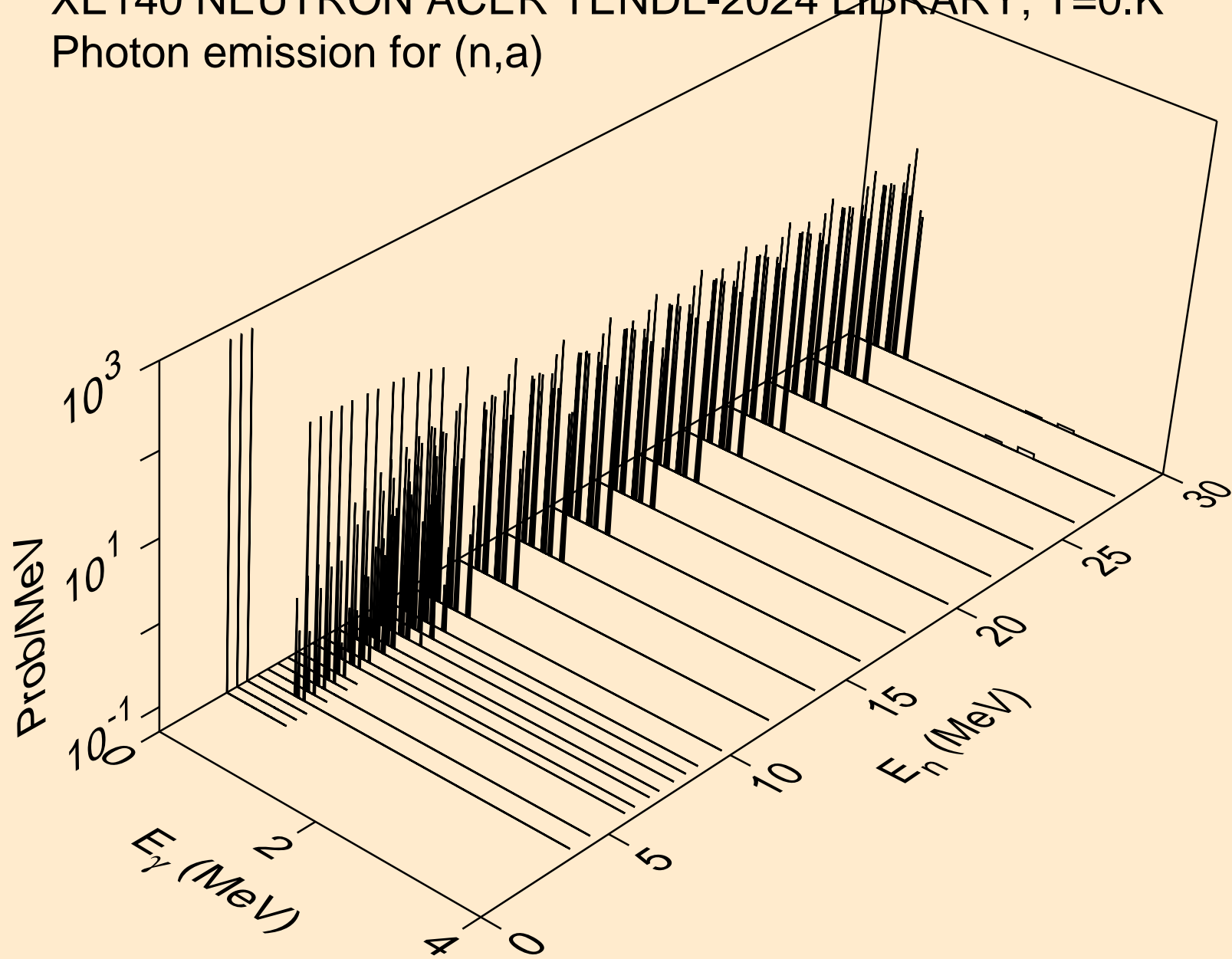

XE140 NEUTRON ACER TENDL-2024 LIBRARY; T=0.K
Photon emission for (n,2a)

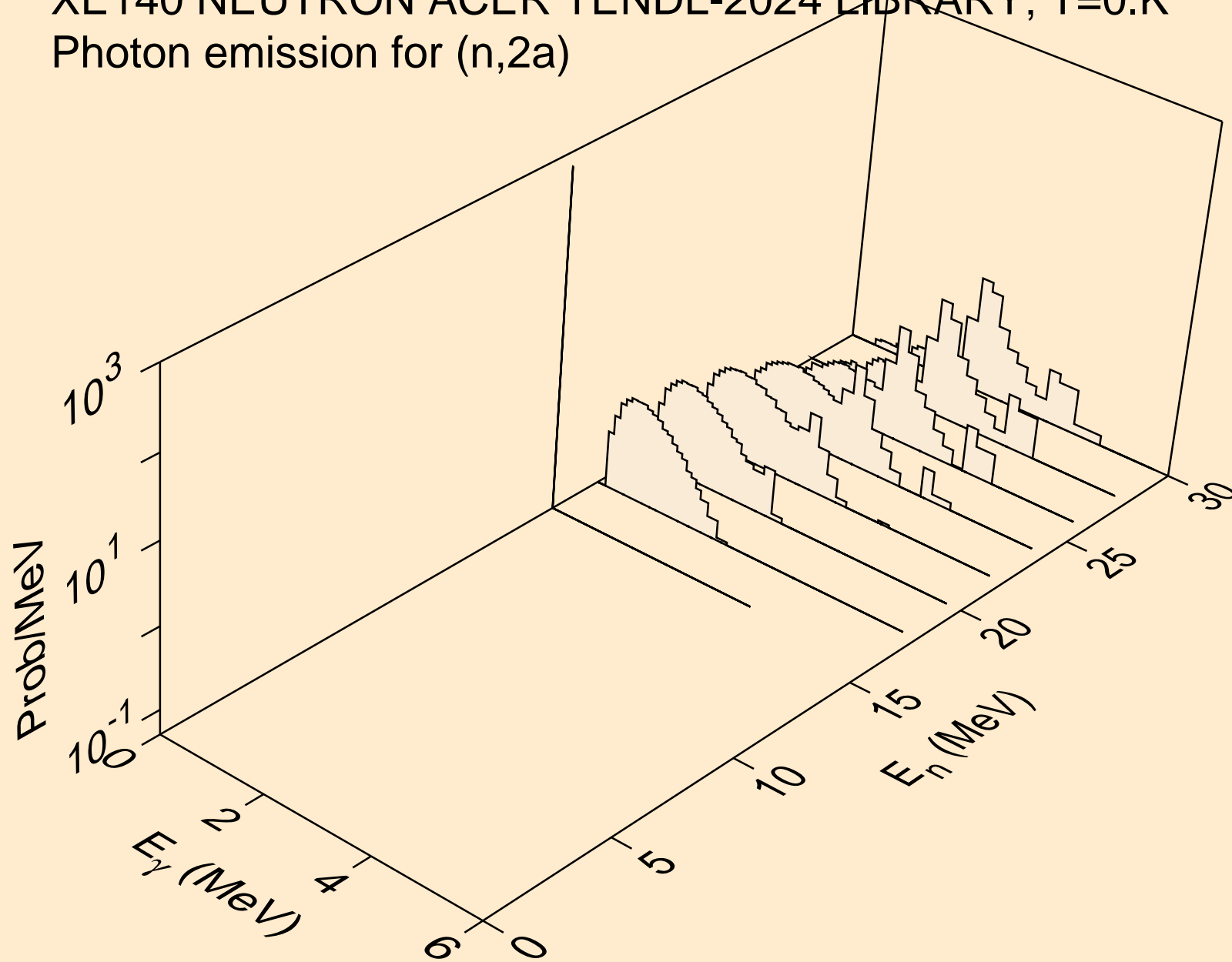

XE140 NEUTRON ACER TENDL-2024 LIBRARY; T=0.K
thermal capture photon spectrum

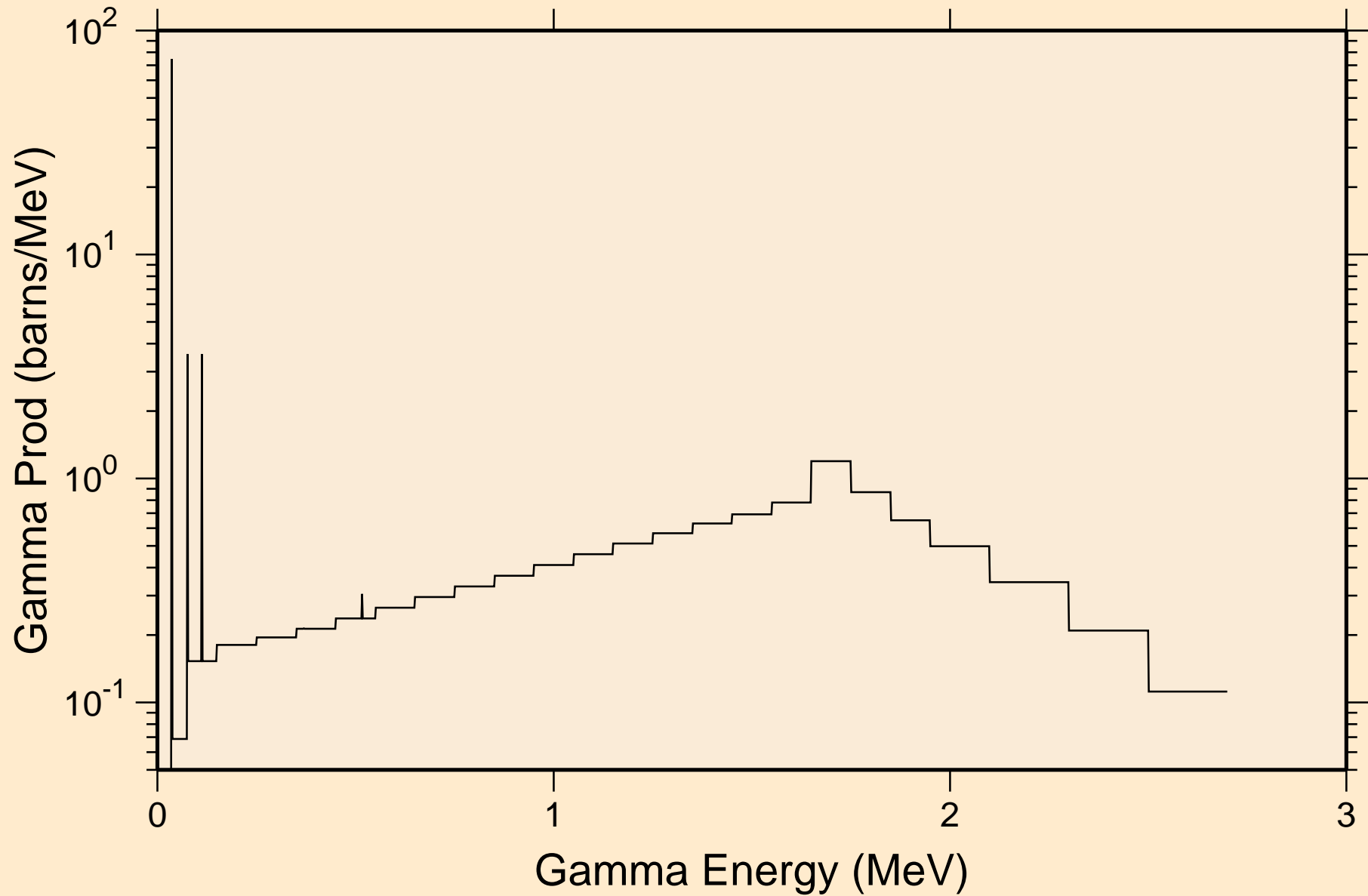

XE140 NEUTRON ACER TENDL-2024 LIBRARY; T=0.K
14 MeV photon spectrum

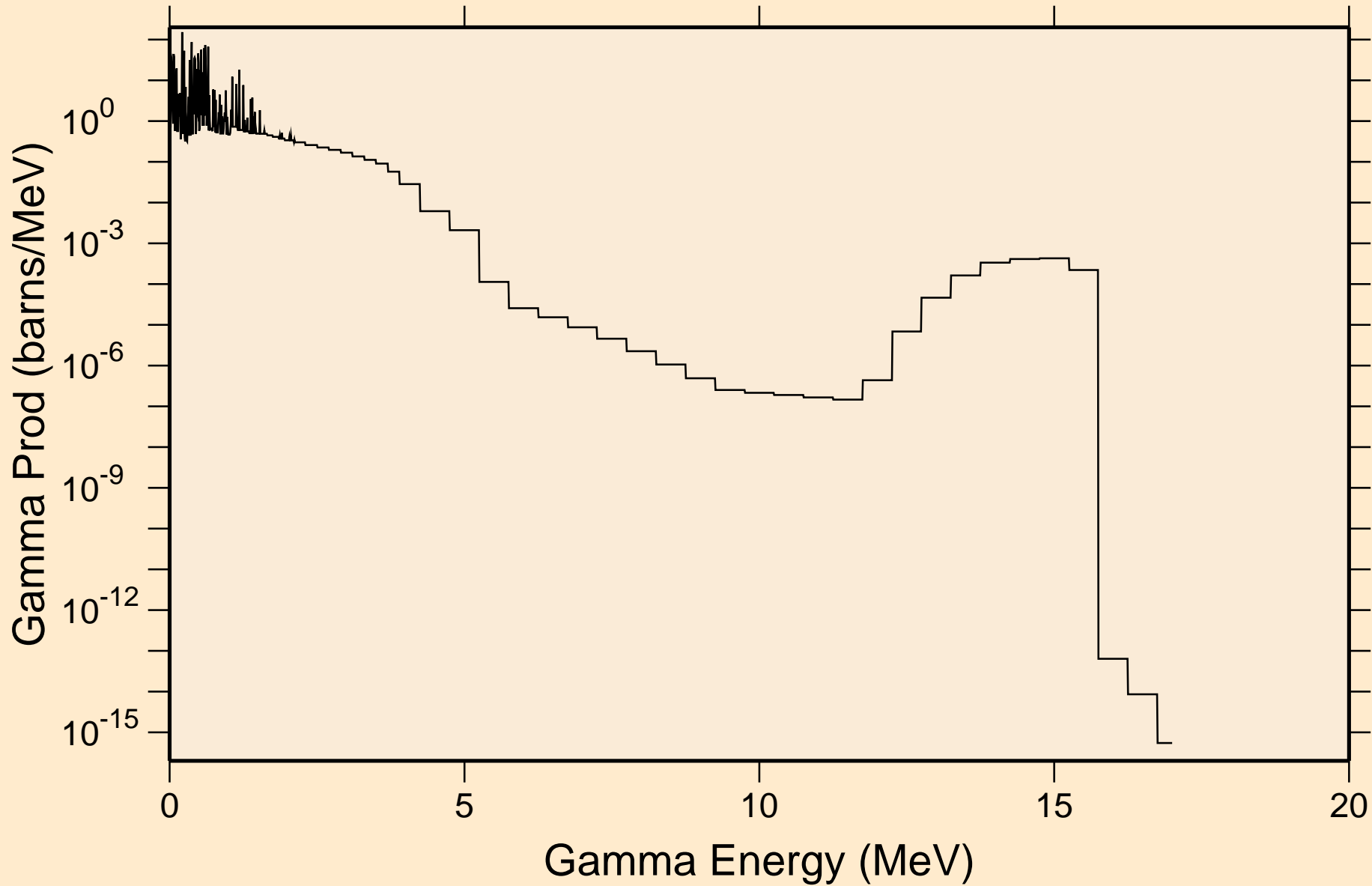

XE140 NEUTRON ACER TENDL-2024 LIBRARY; T=0.K

Particle heating contributions

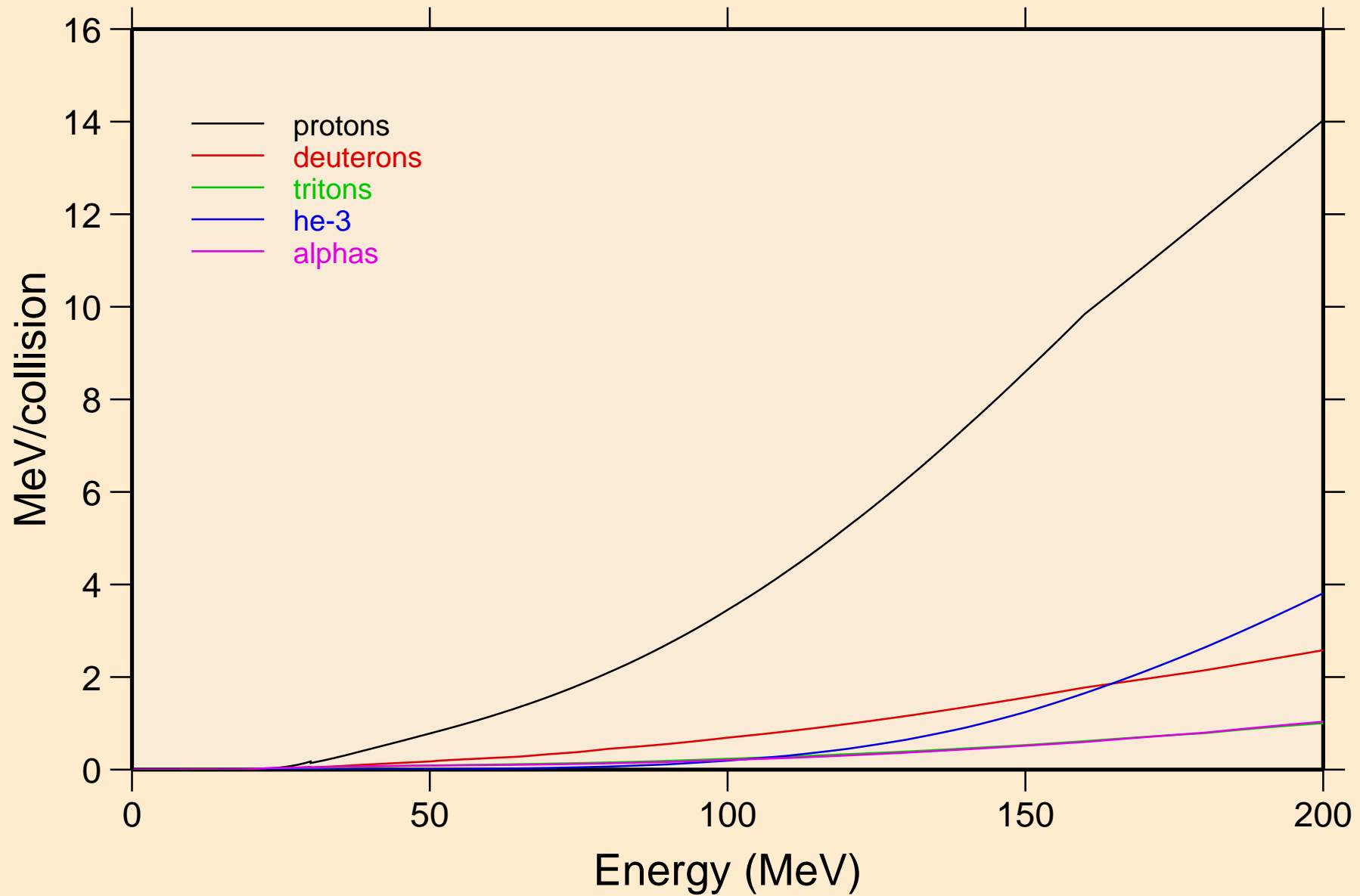

XE140 NEUTRON ACER TENDL-2024 LIBRARY; T=0.K
Recoil Heating

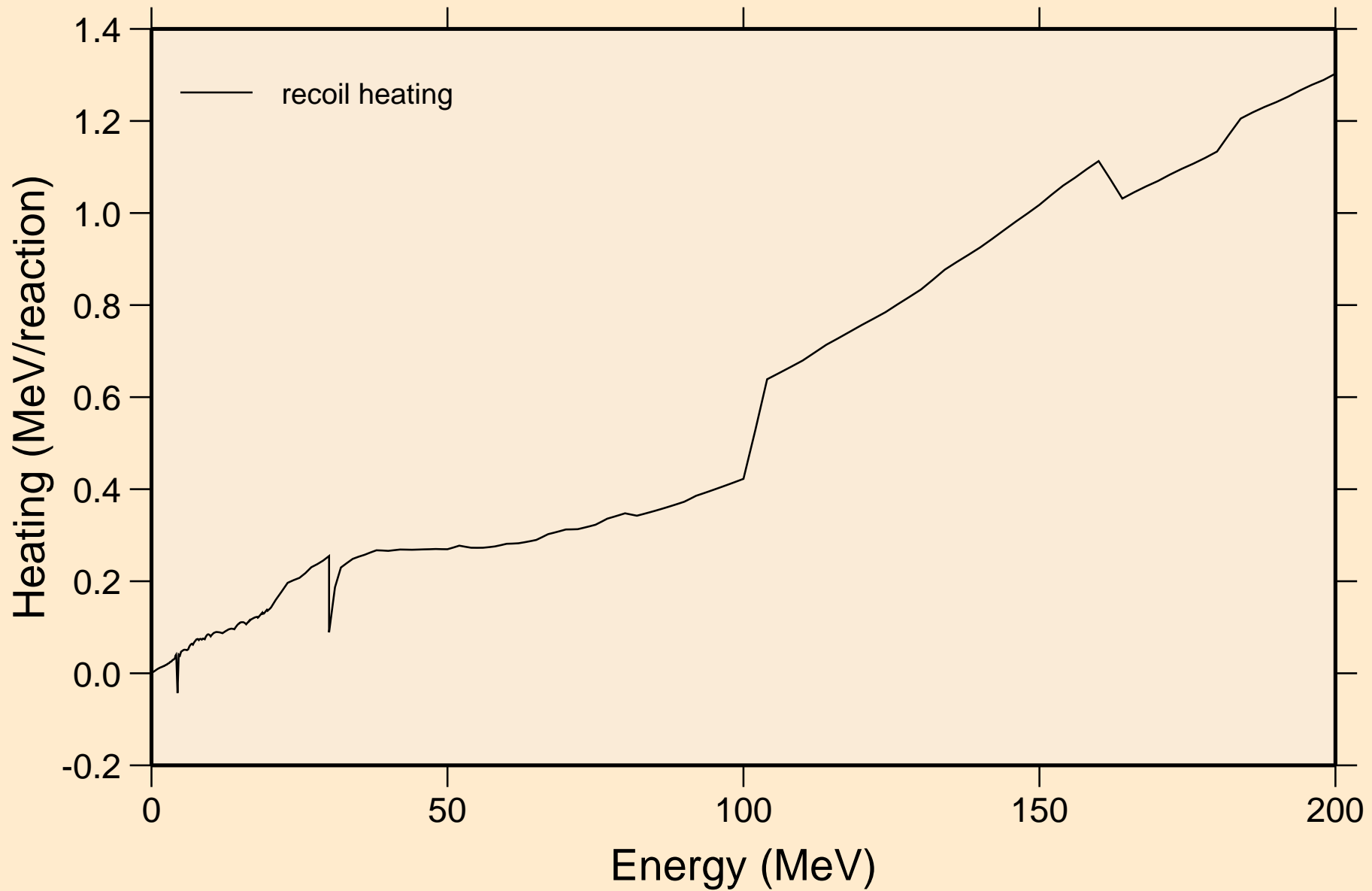

XE140 NEUTRON ACER TENDL-2024 LIBRARY; T=0.K
Particle production cross sections

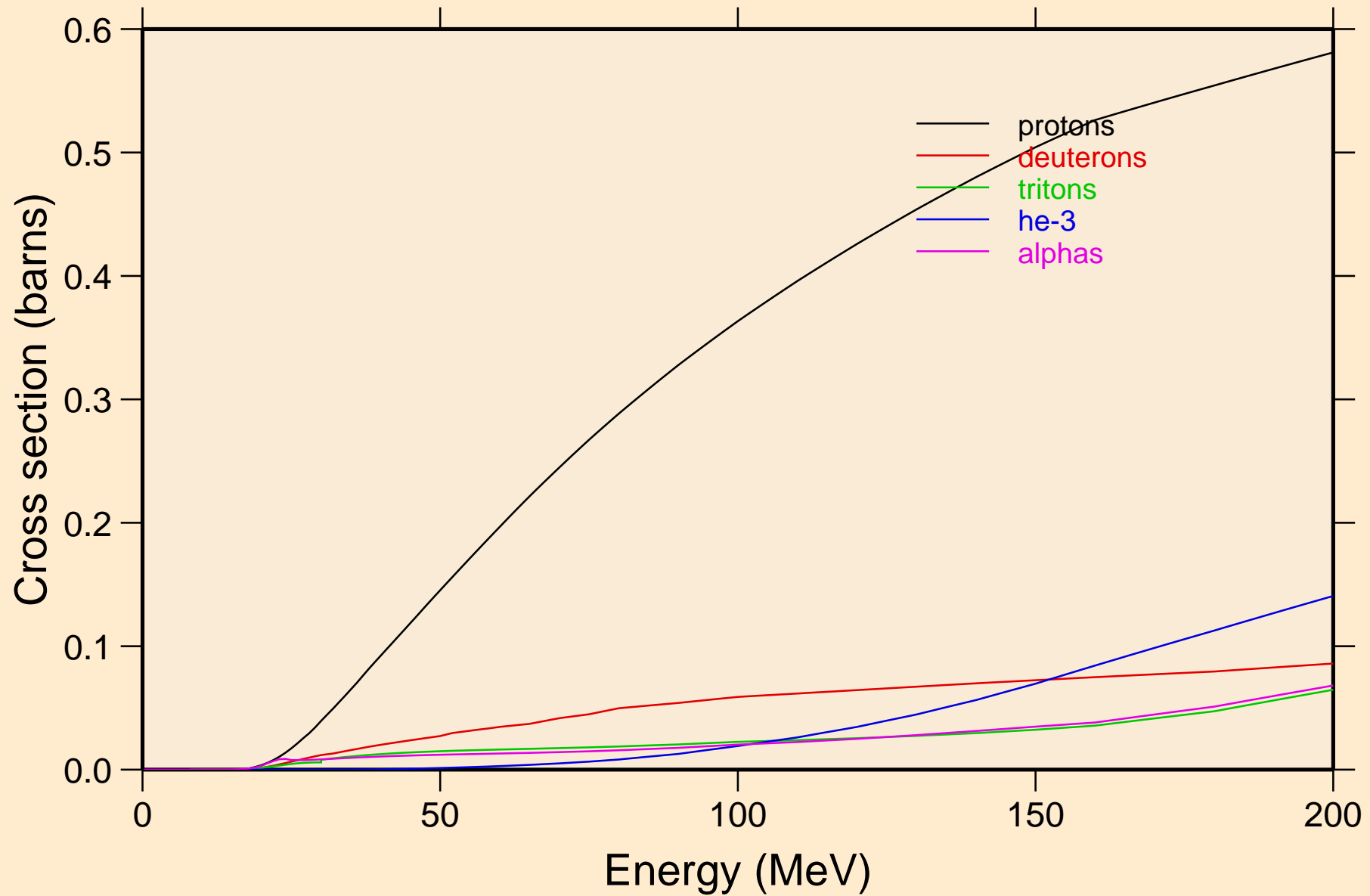

XE140 NEUTRON ACER TENDL-2024 LIBRARY; T=0.K
protons from (n,x)

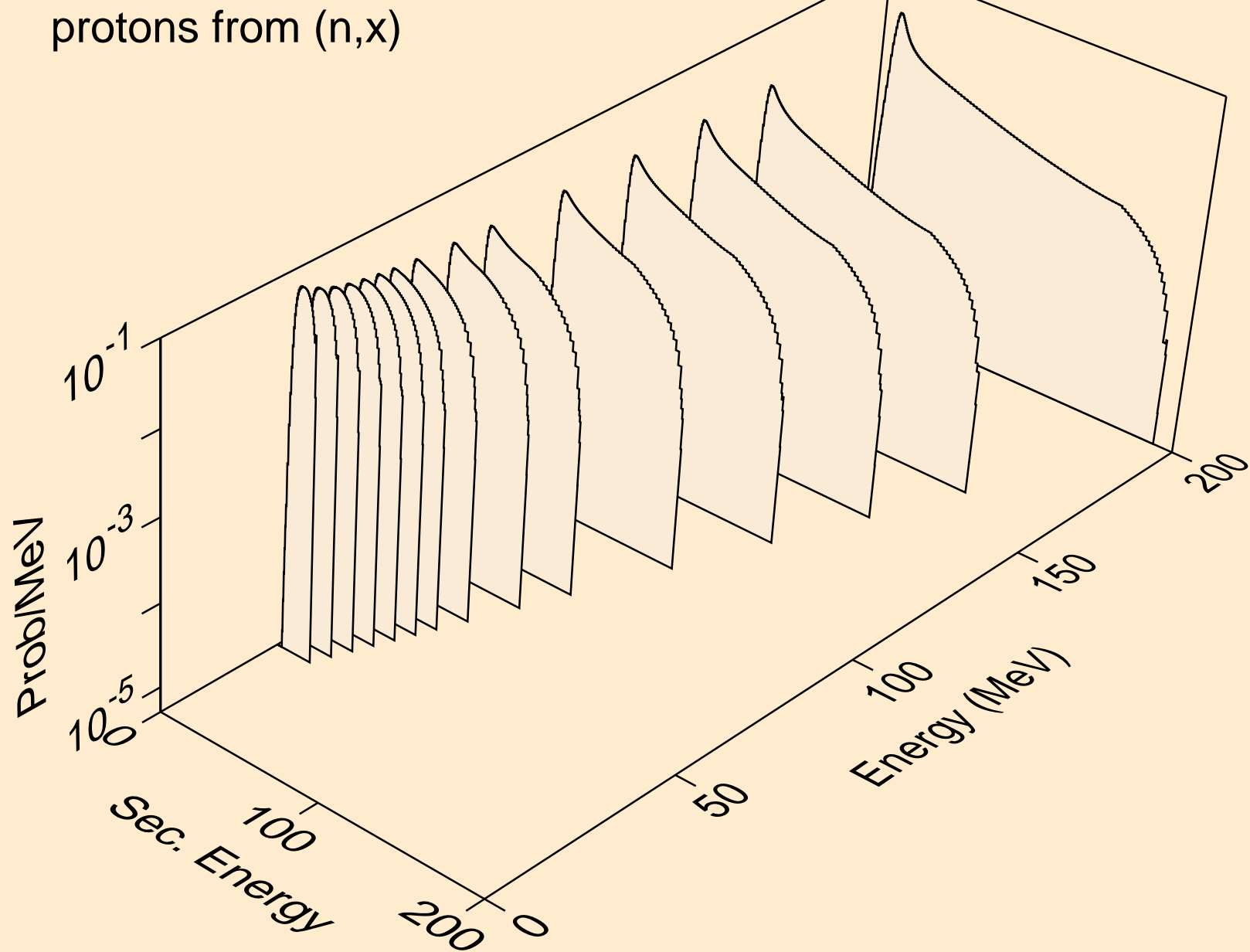

XE140 NEUTRON ACER TENDL-2024 LIBRARY; T=0.K
protons from (n,n*)p

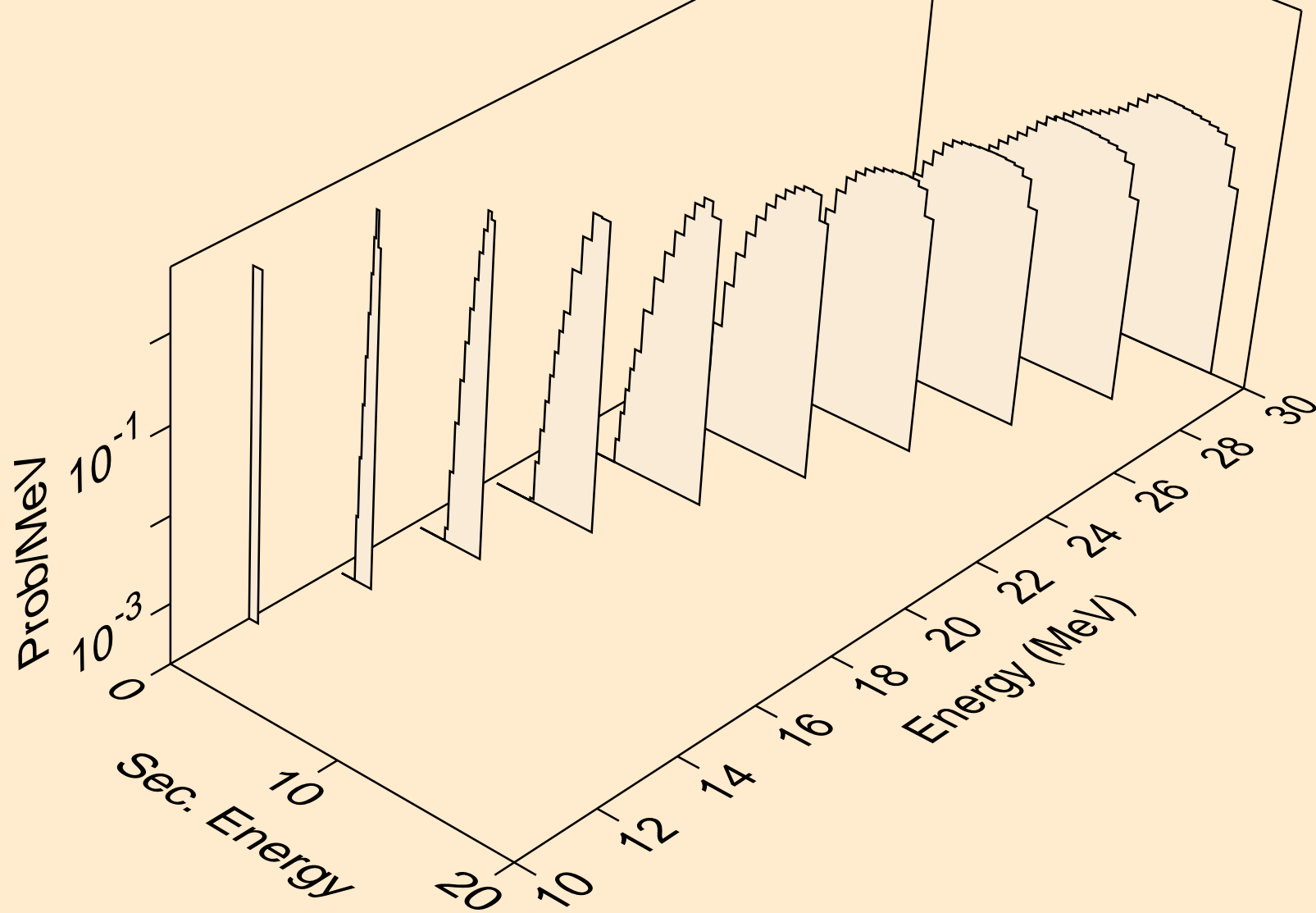

XE140 NEUTRON ACER TENDL-2024 LIBRARY; T=0.K
protons from (n,2np)

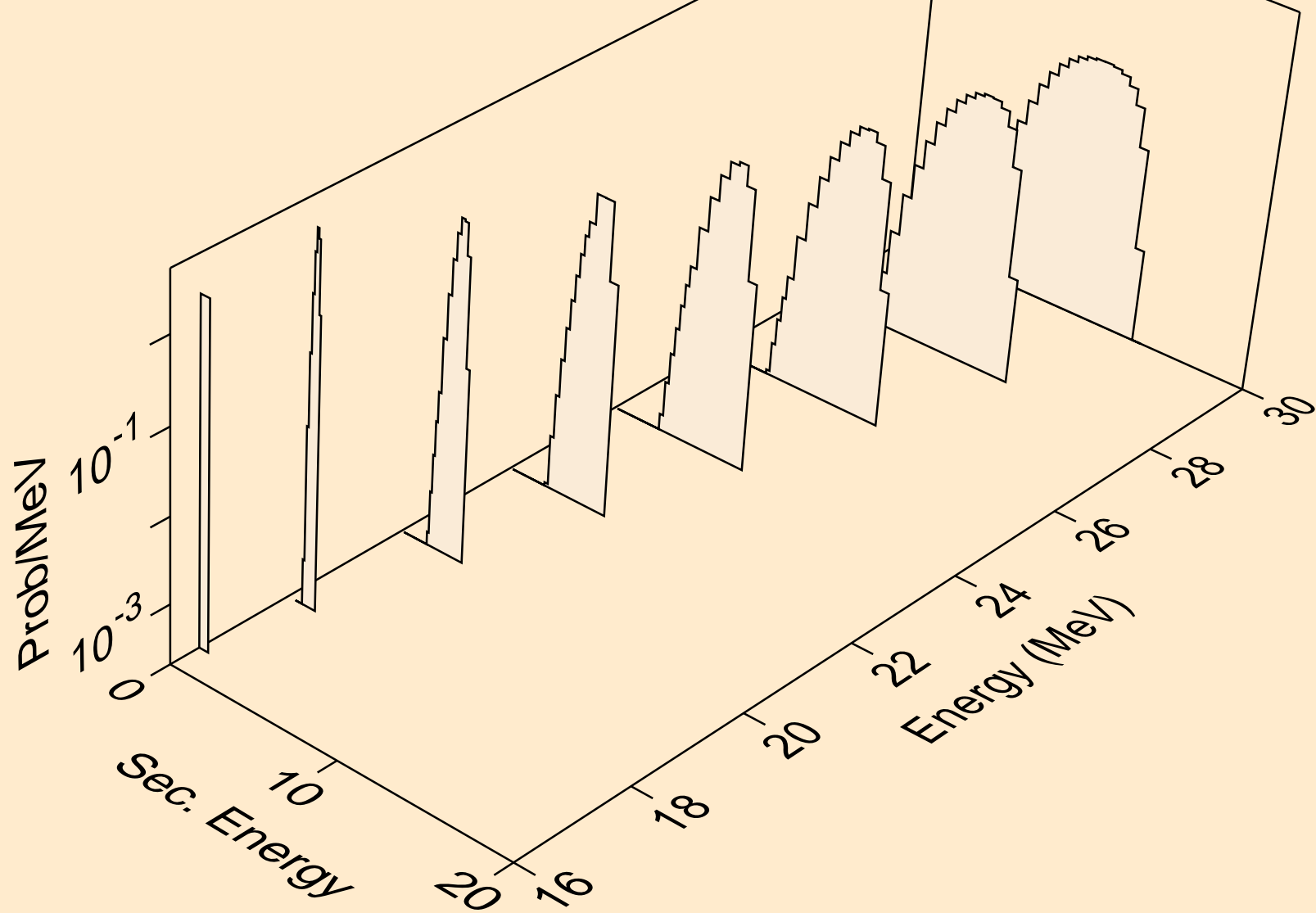

XE140 NEUTRON ACER TENDL-2024 LIBRARY; T=0.K
protons from (n,3np)

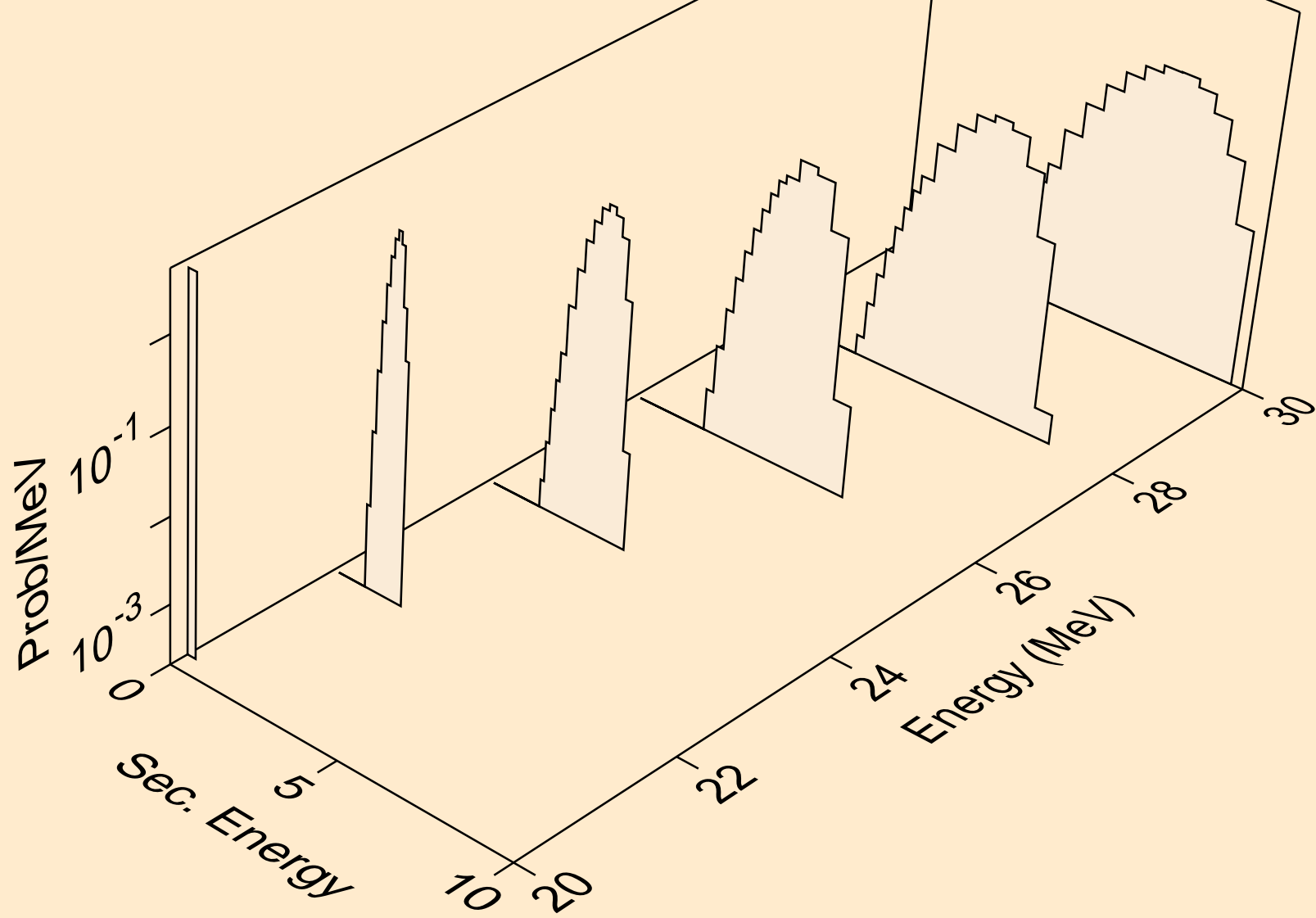

XE140 NEUTRON ACER TENDL-2024 LIBRARY; T=0.K
protons from (n,p)

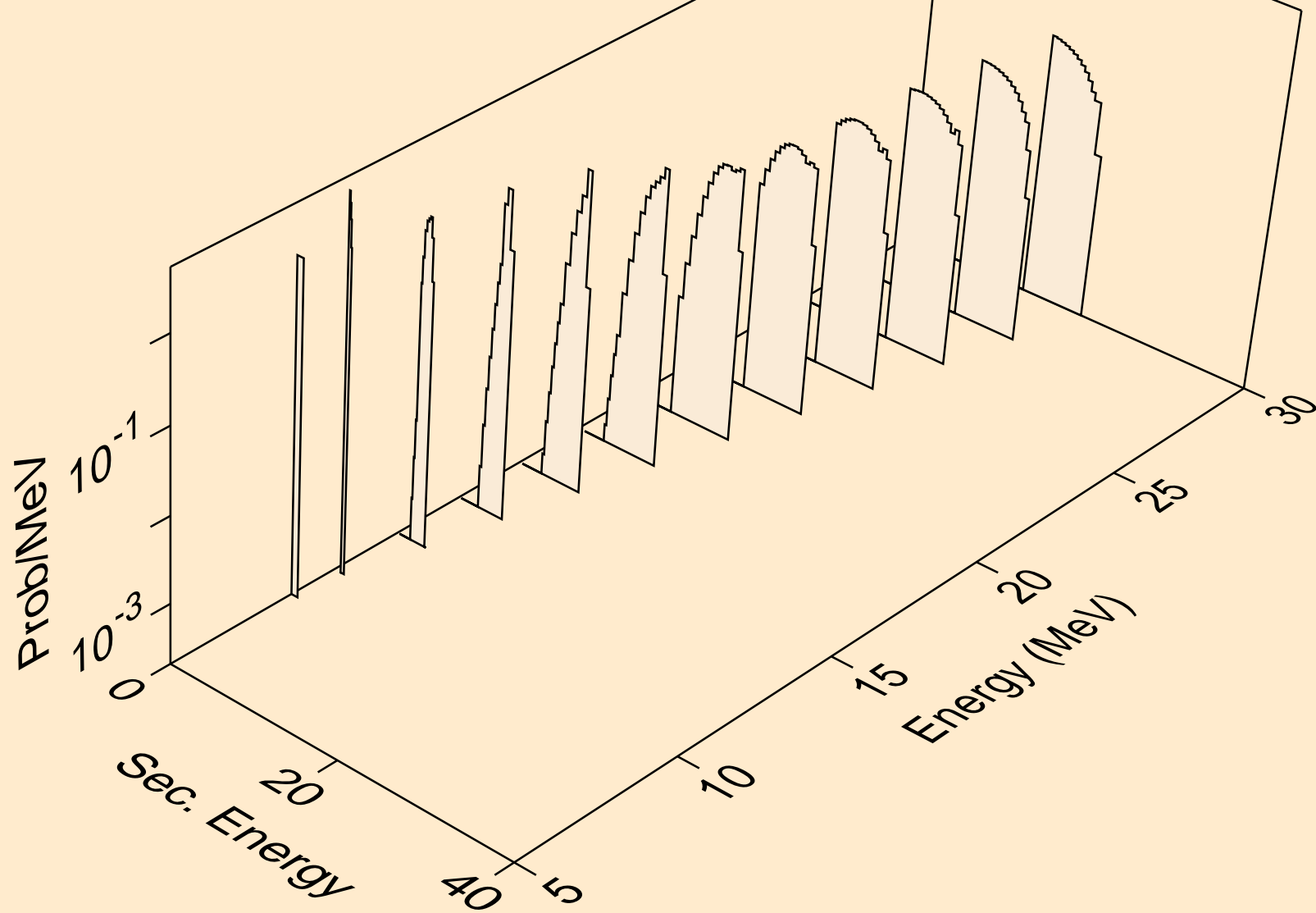

XE140 NEUTRON ACER TENDL-2024 LIBRARY; T=0.K
deuterons from (n,x)

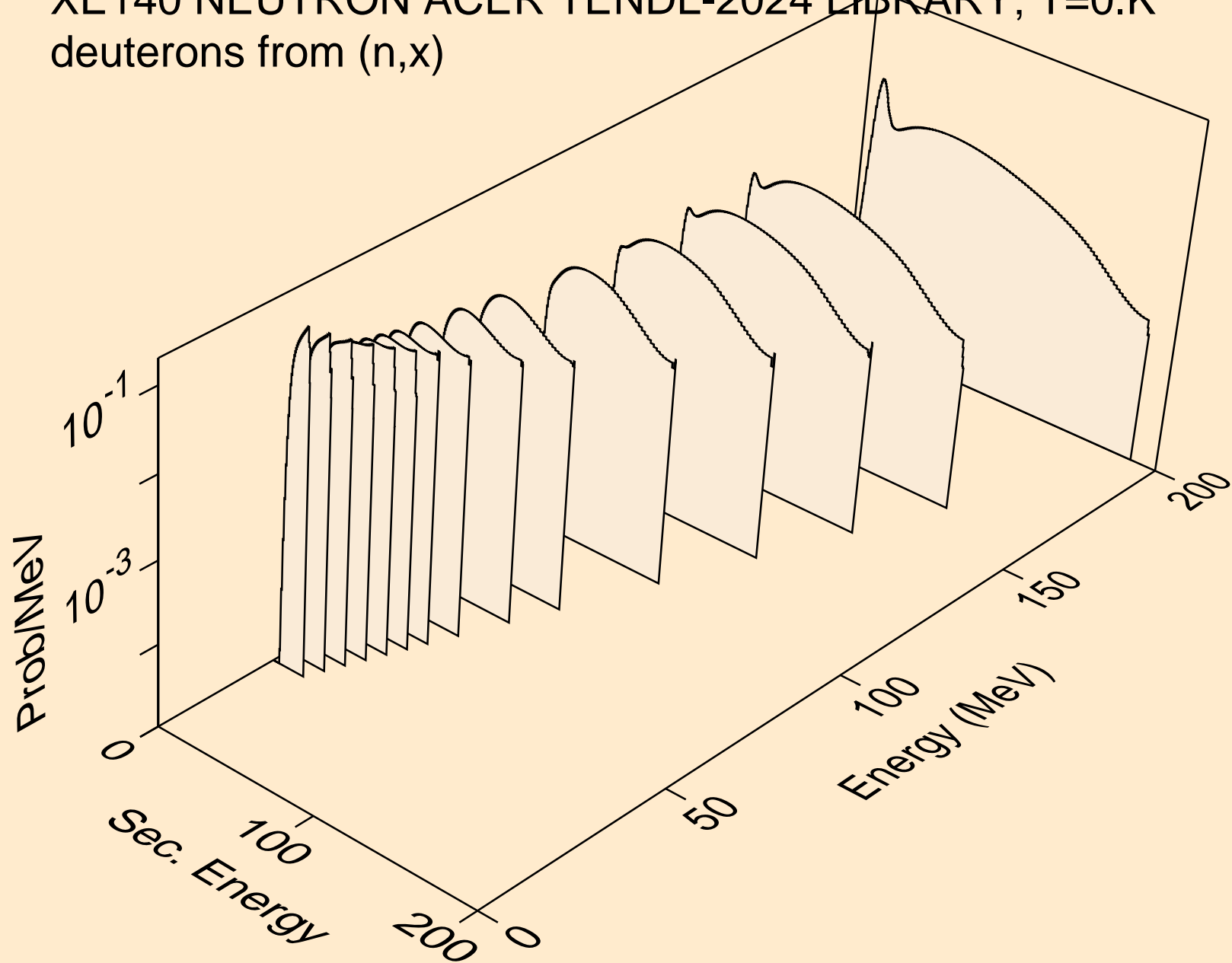

XE140 NEUTRON ACER TENDL-2024 LIBRARY; T=0.K
deuterons from (n,2nd)

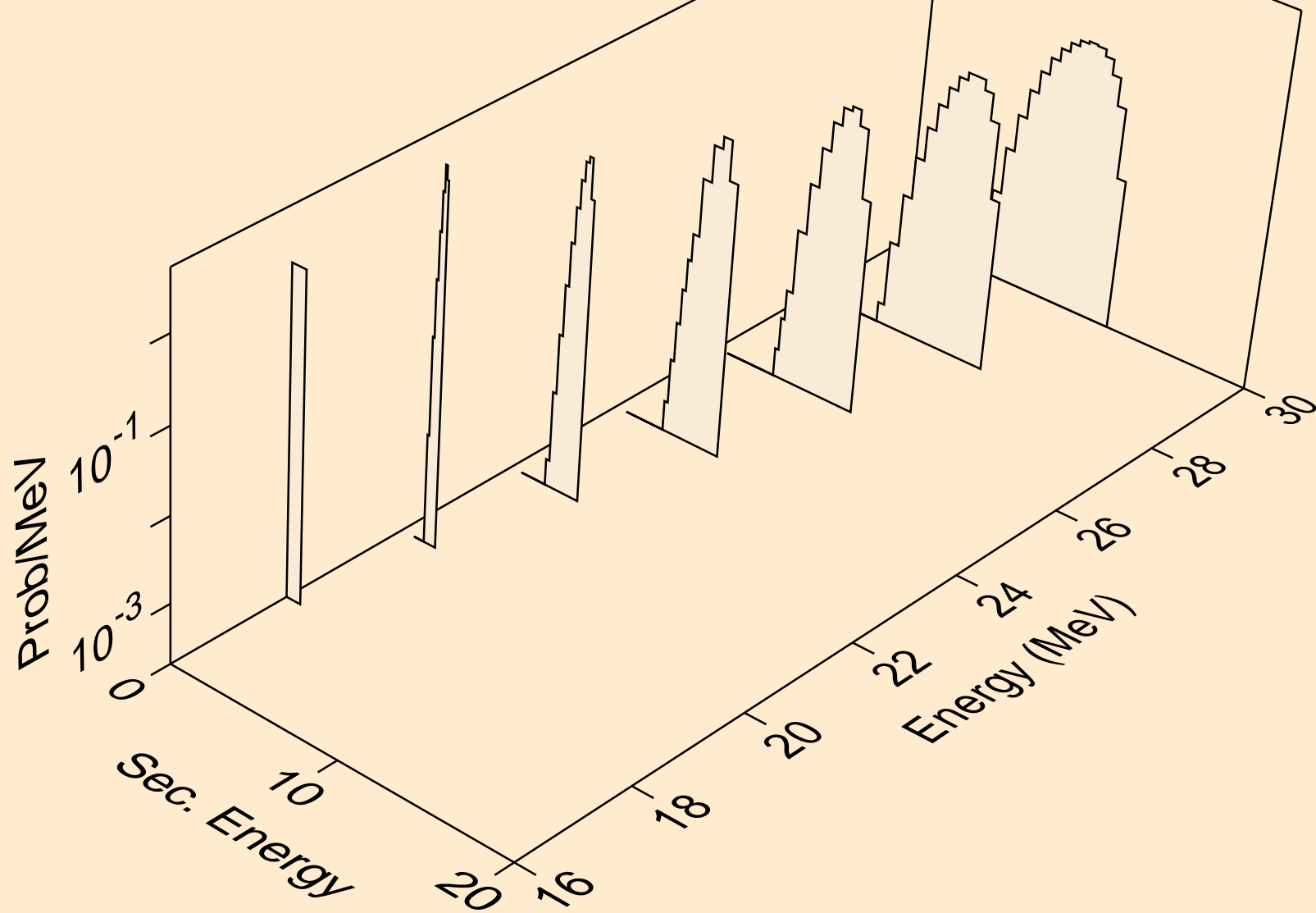

XE140 NEUTRON ACER TENDL-2024 LIBRARY; T=0.K
deuterons from (n,n*)d

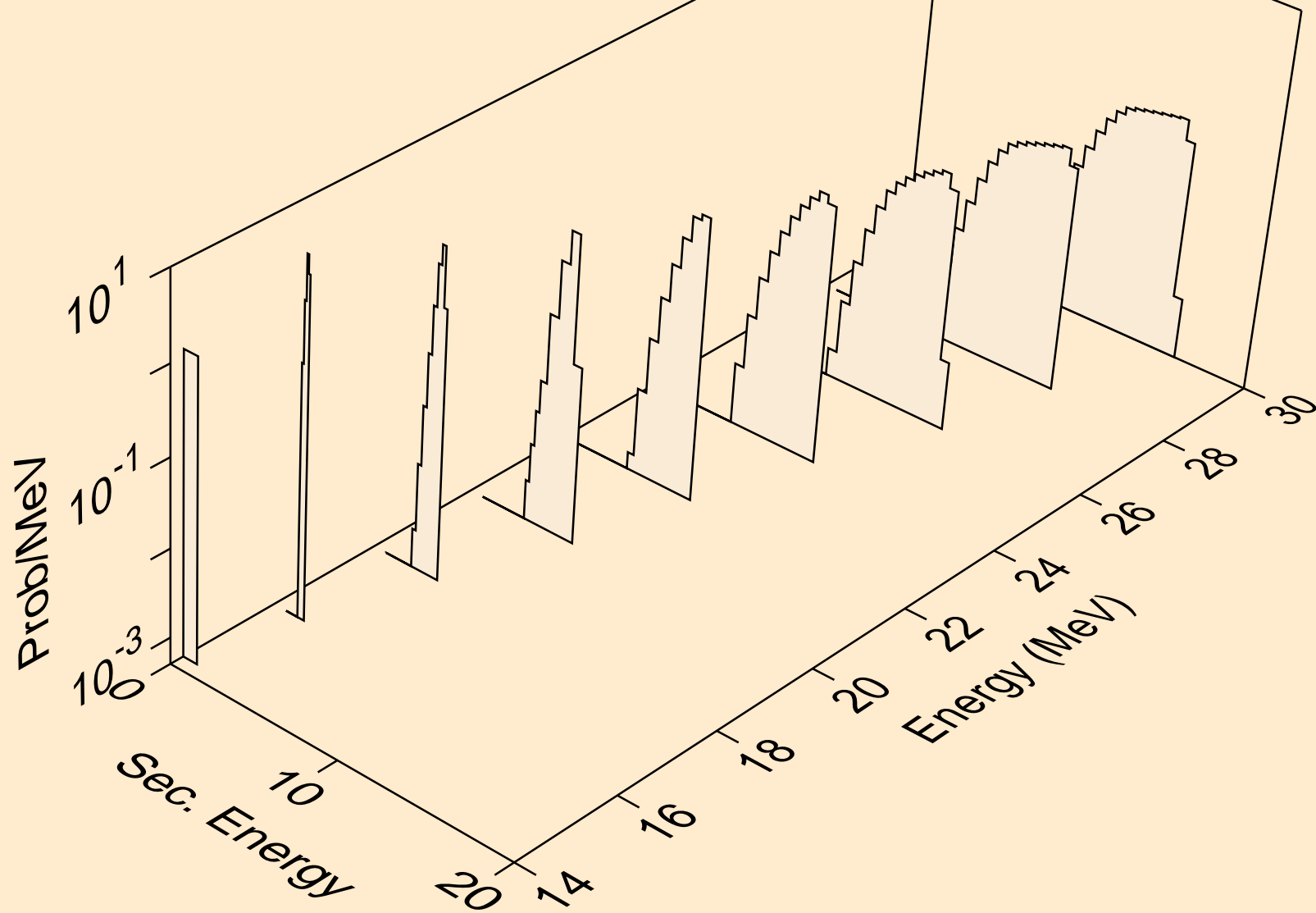

XE140 NEUTRON ACER TENDL-2024 LIBRARY; T=0.K
deuterons from (n,d)

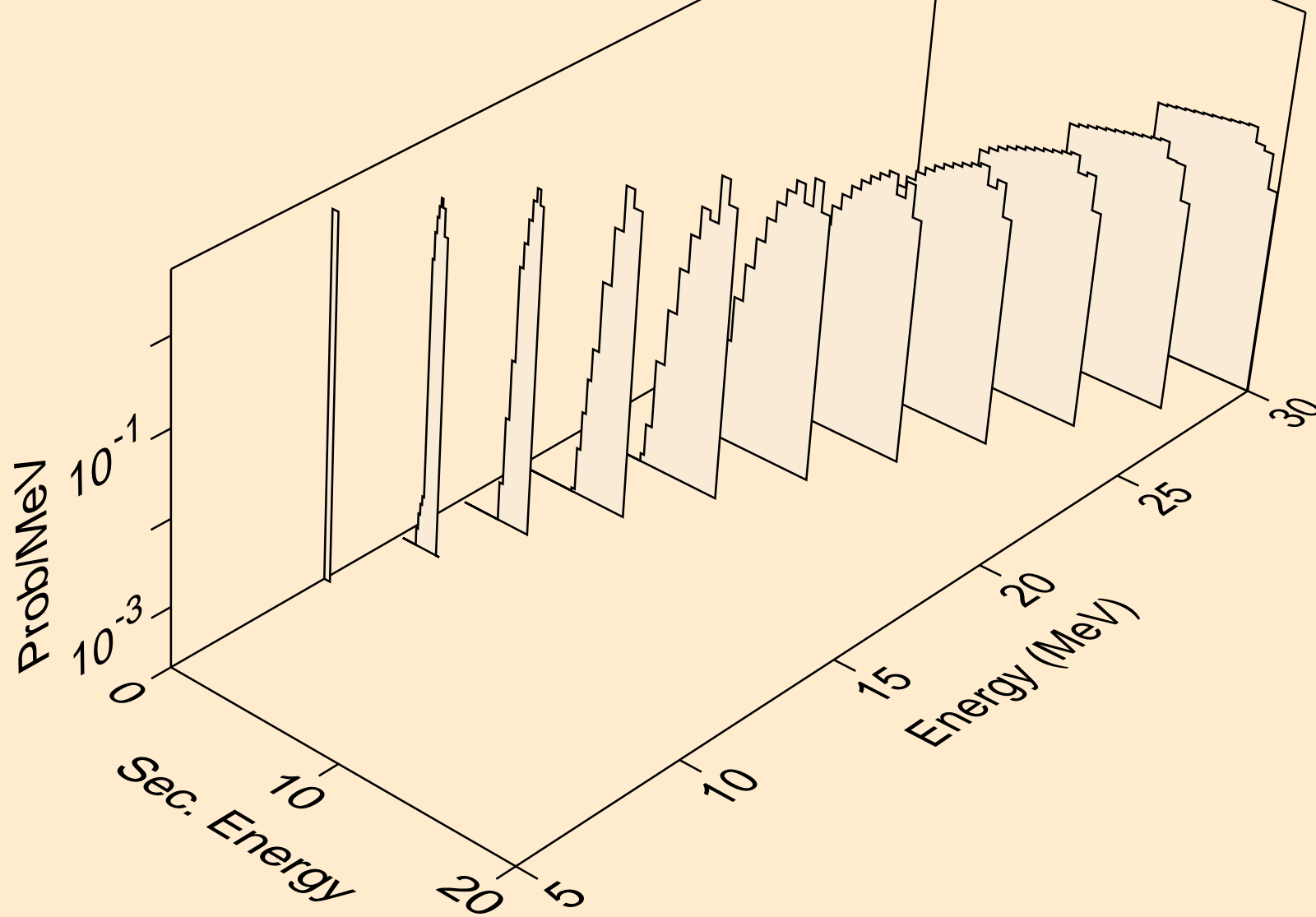

XE140 NEUTRON ACER TENDL-2024 LIBRARY; T=0.K
tritons from (n,x)

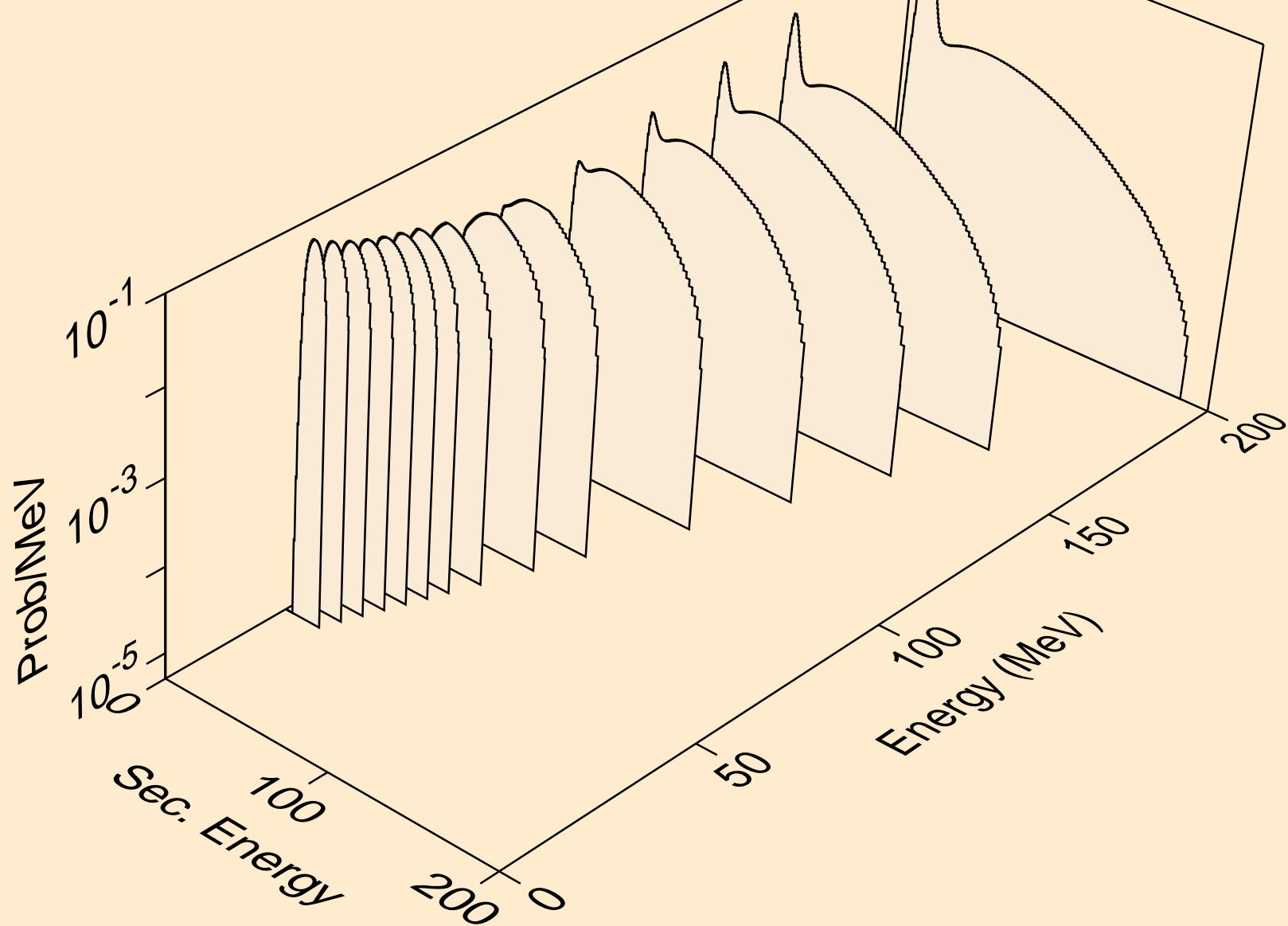

XE140 NEUTRON ACER TENDL-2024 LIBRARY; T=0.K
tritons from (n,n*)t

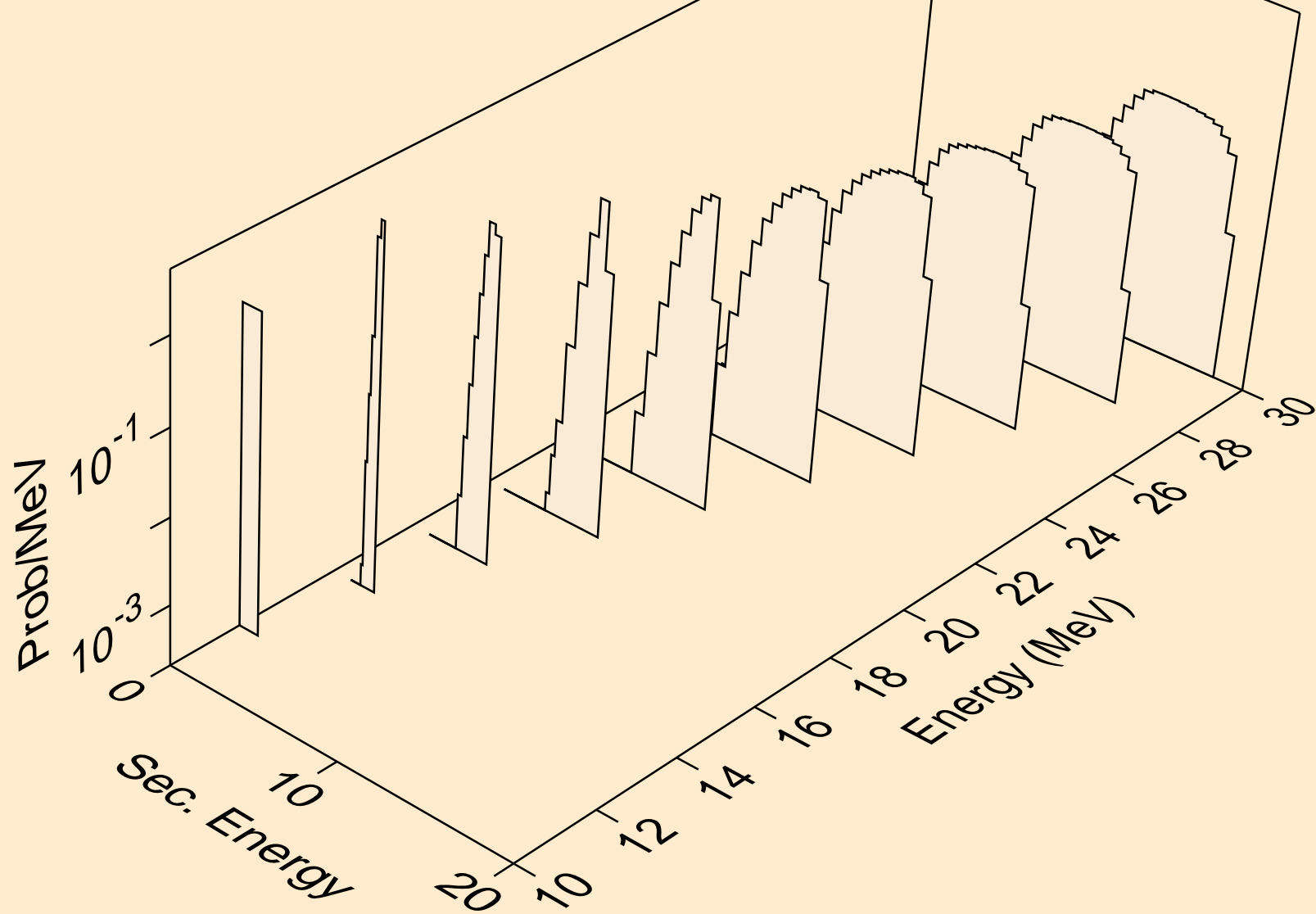

XE140 NEUTRON ACER TENDL-2024 LIBRARY; T=0.K
tritons from (n,t)

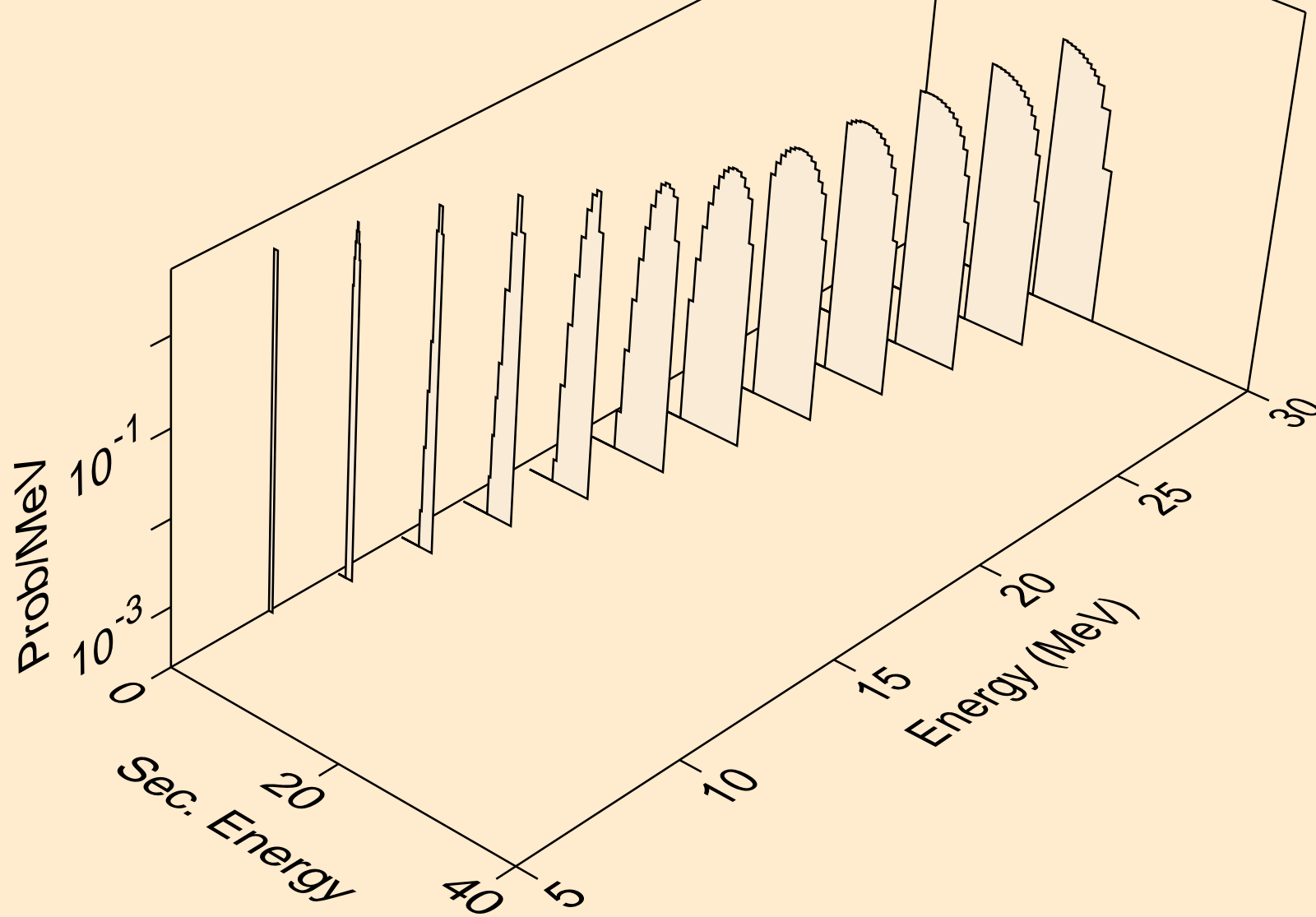

XE140 NEUTRON ACER TENDL-2024 LIBRARY; T=0.K
he3s from (n,x)

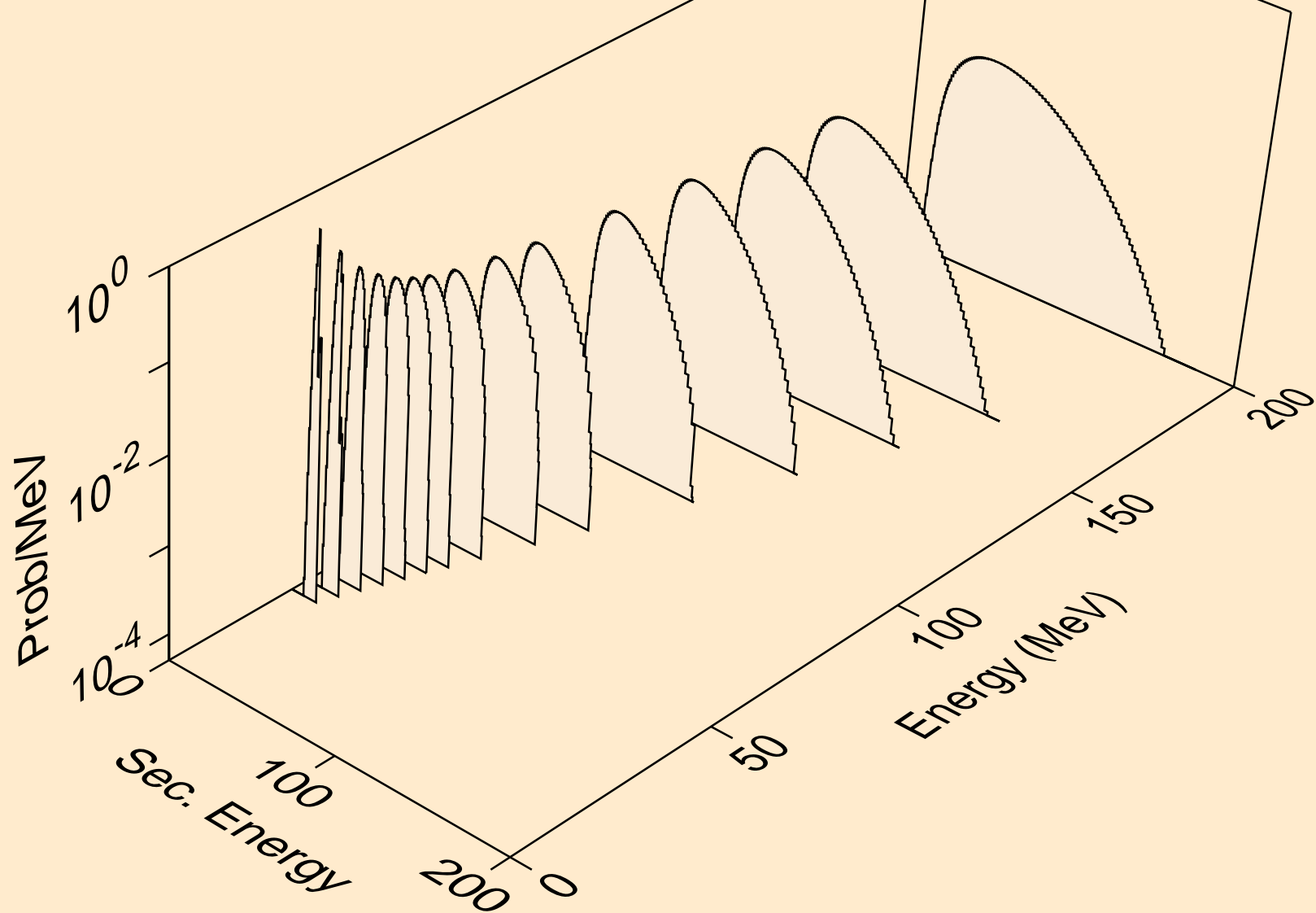

XE140 NEUTRON ACER TENDL-2024 LIBRARY; T=0.K
he3s from (n,n*)he3

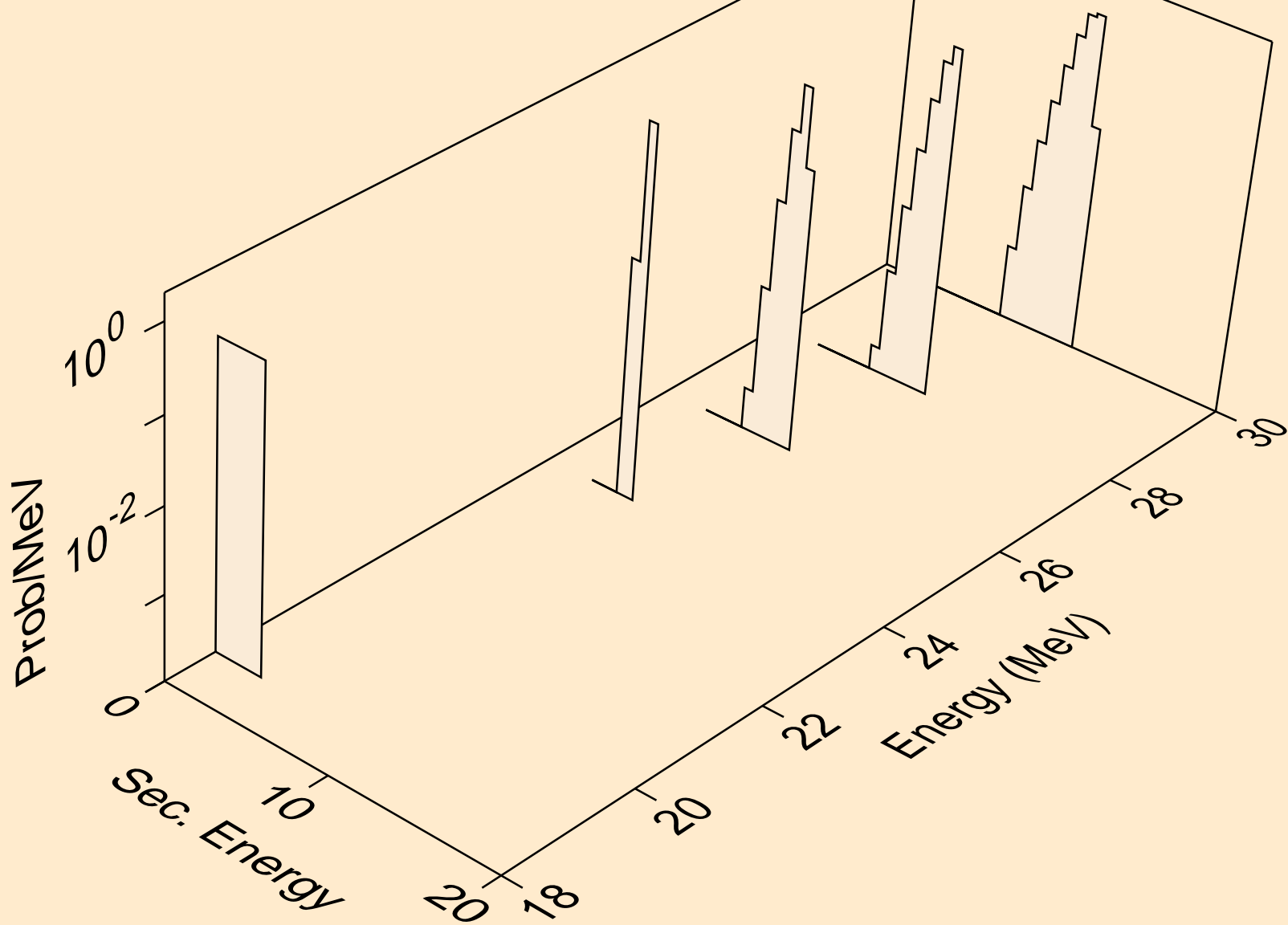

XE140 NEUTRON ACER TENDL-2024 LIBRARY; T=0.K
he3s from (n,he3)

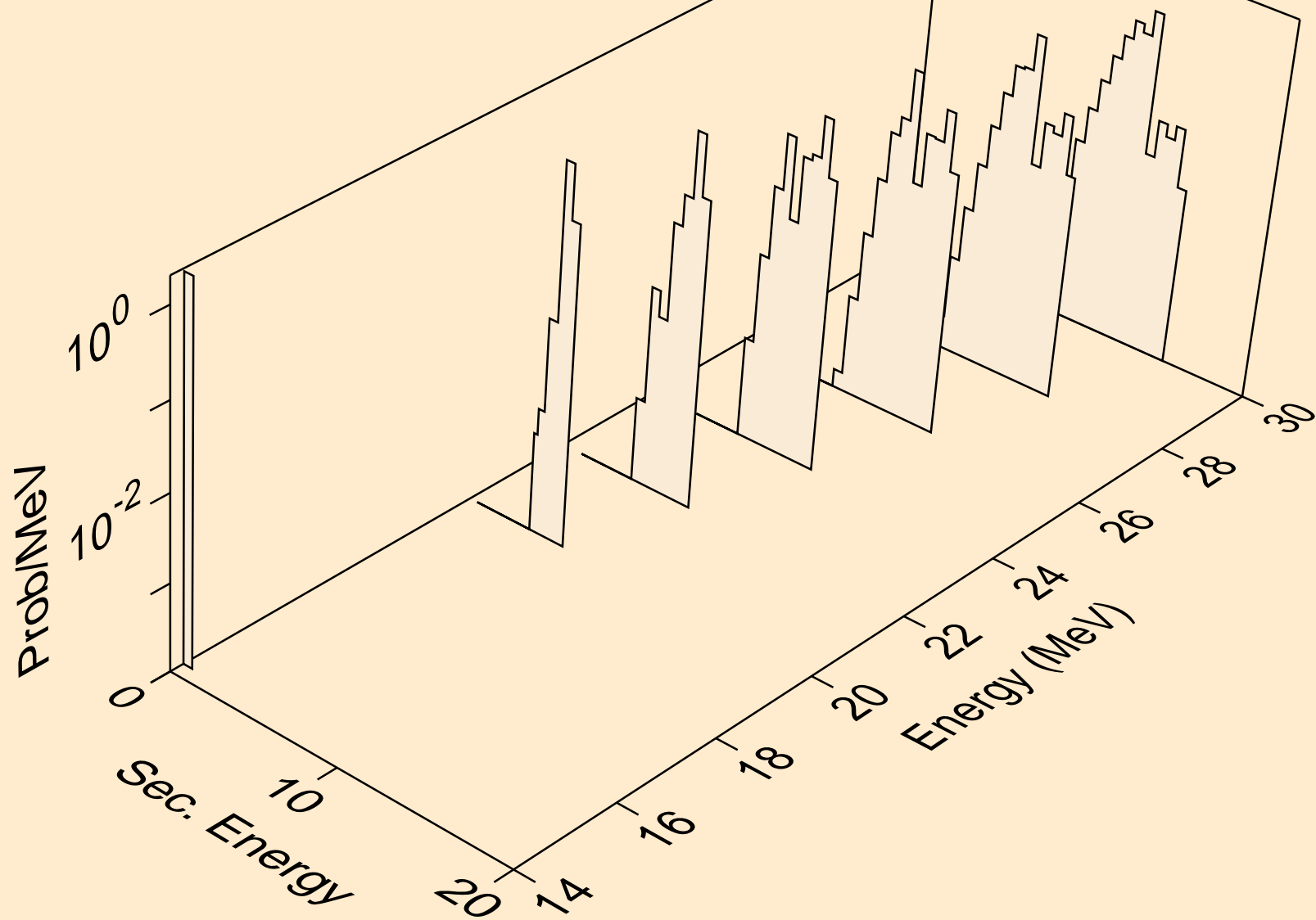

XE140 NEUTRON ACER TENDL-2024 LIBRARY; T=0.K
alphas from (n,x)

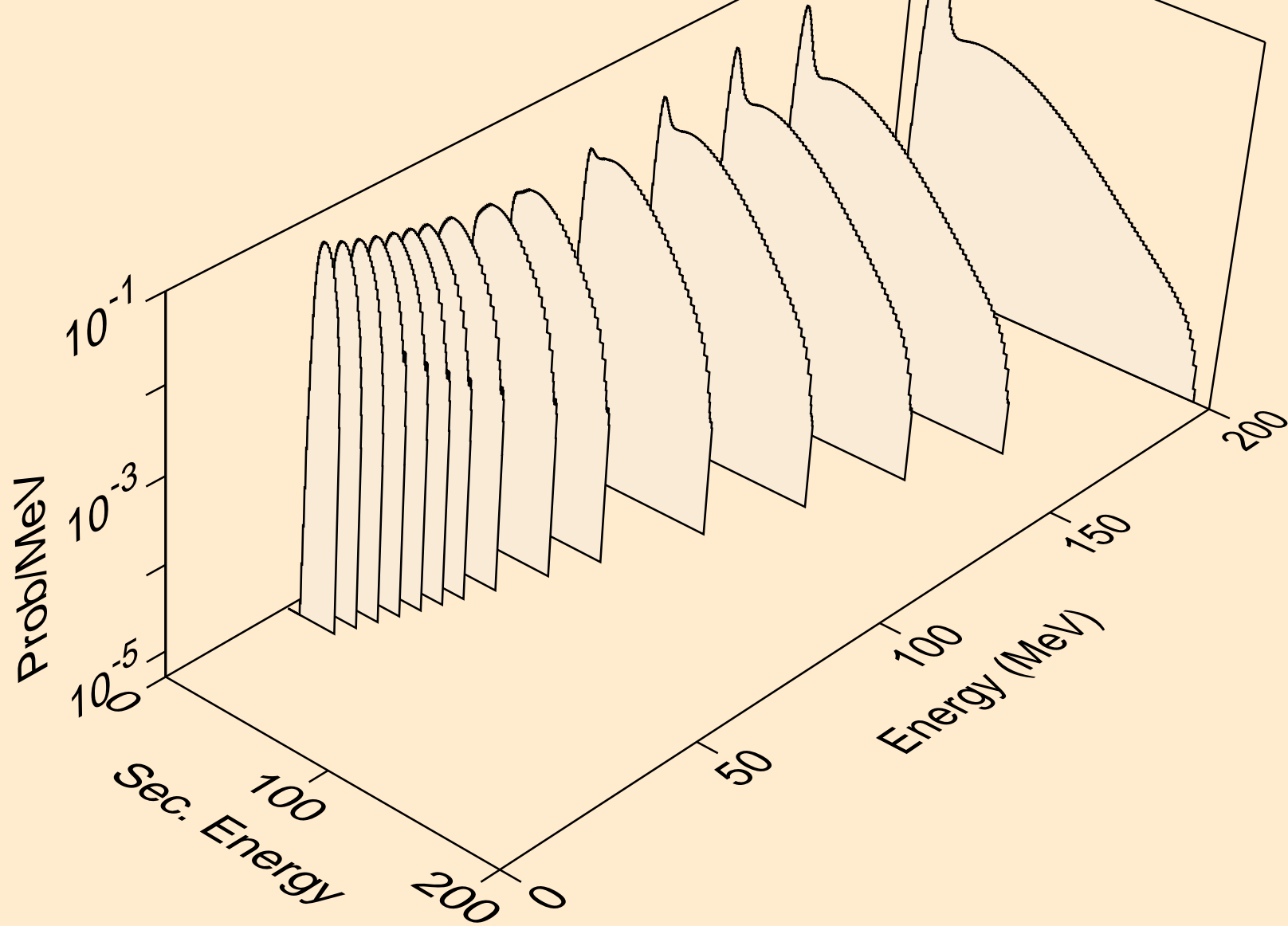

XE140 NEUTRON ACER TENDL-2024 LIBRARY; T=0.K
alphas from (n,n*)a

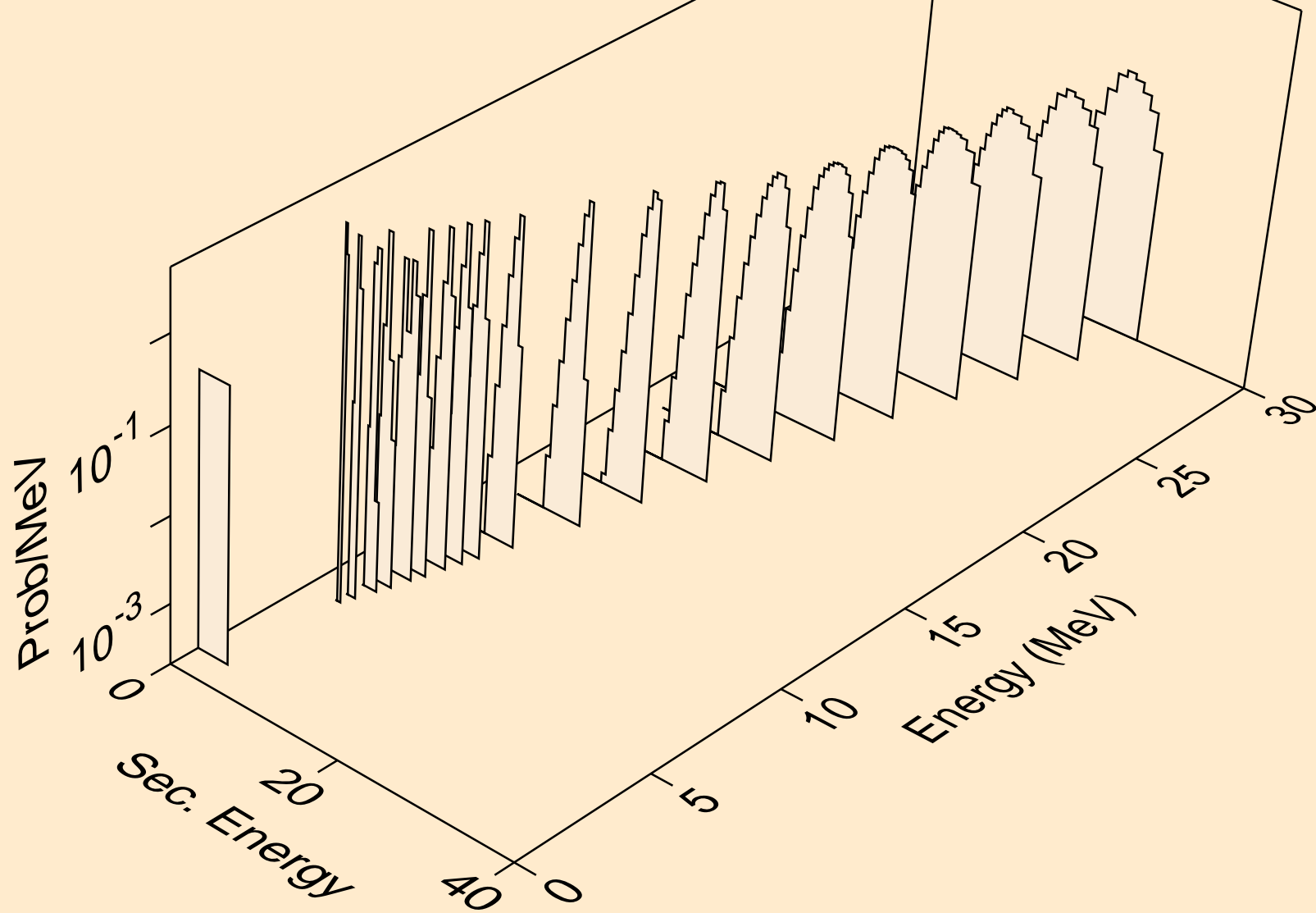

XE140 NEUTRON ACER TENDL-2024 LIBRARY; T=0.K
alphas from (n,2n)a

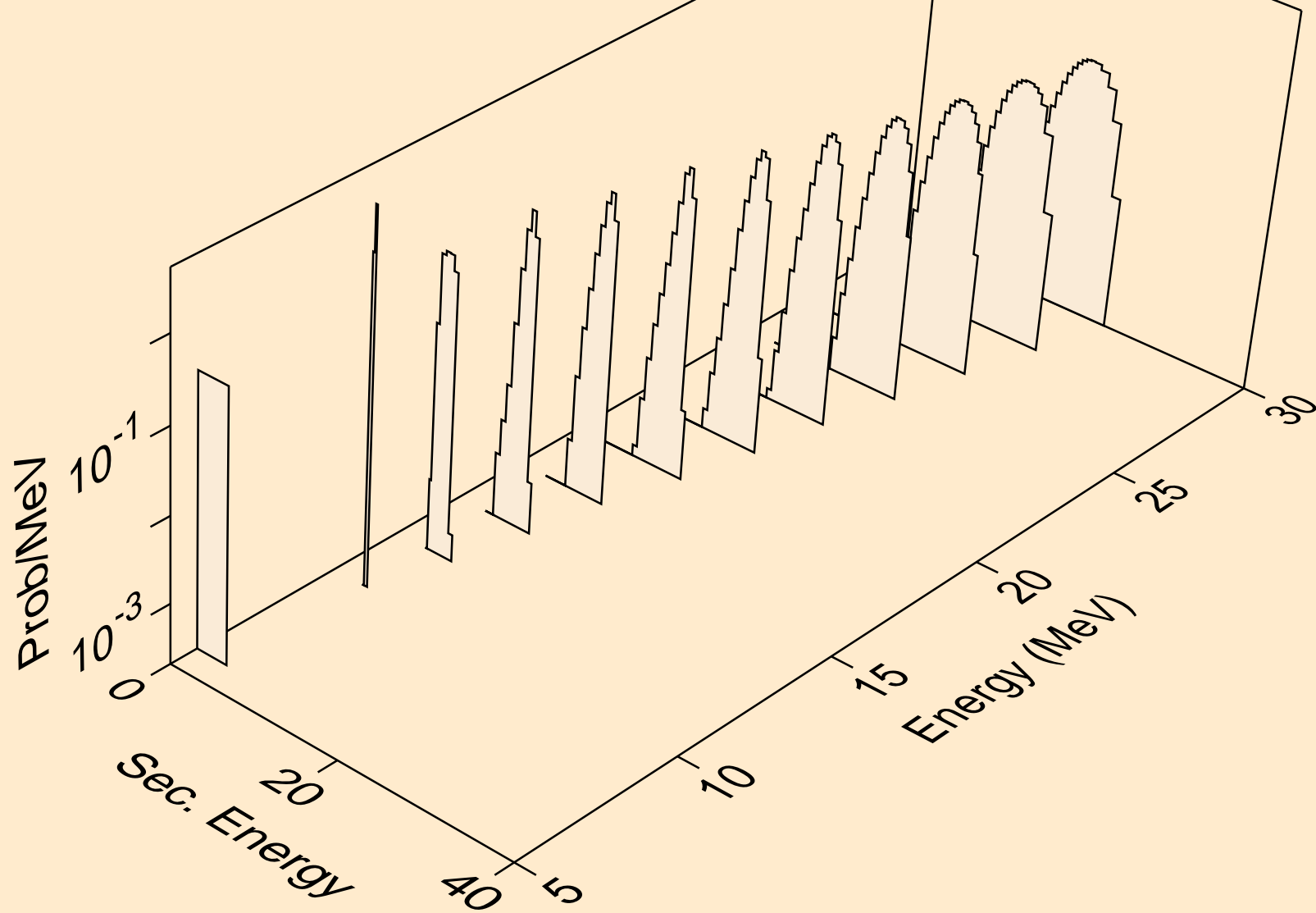

XE140 NEUTRON ACER TENDL-2024 LIBRARY; T=0.K
alphas from (n,3n)a

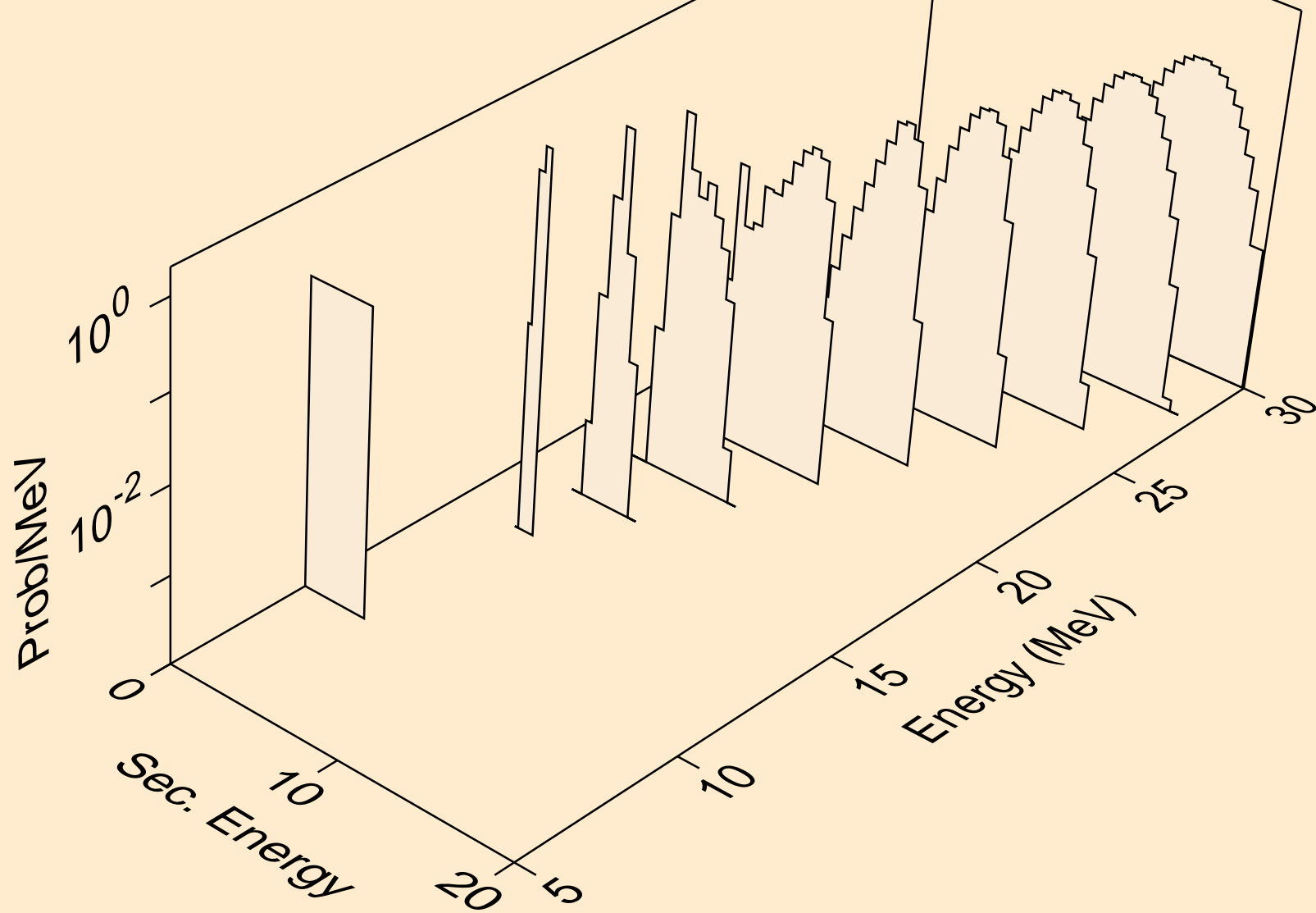

XE140 NEUTRON ACER TENDL-2024 LIBRARY; T=0.K
alphas from (n,a)

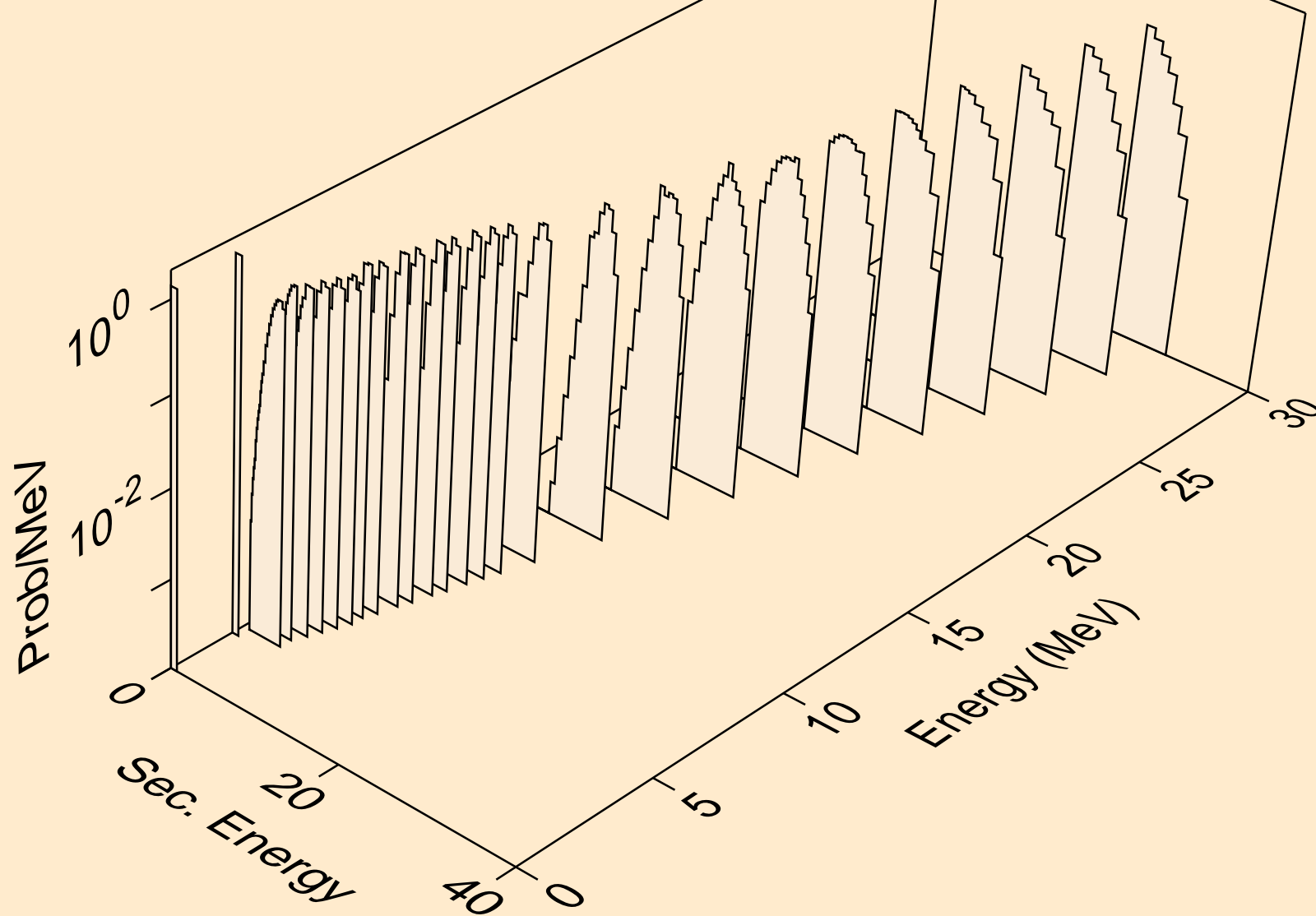

XE140 NEUTRON ACER TENDL-2024 LIBRARY; T=0.K
alphas from (n,2a)

