

# TB154 PROTON ACER TENDL-2023 LIBRARY; T=0.K

## Principal cross sections

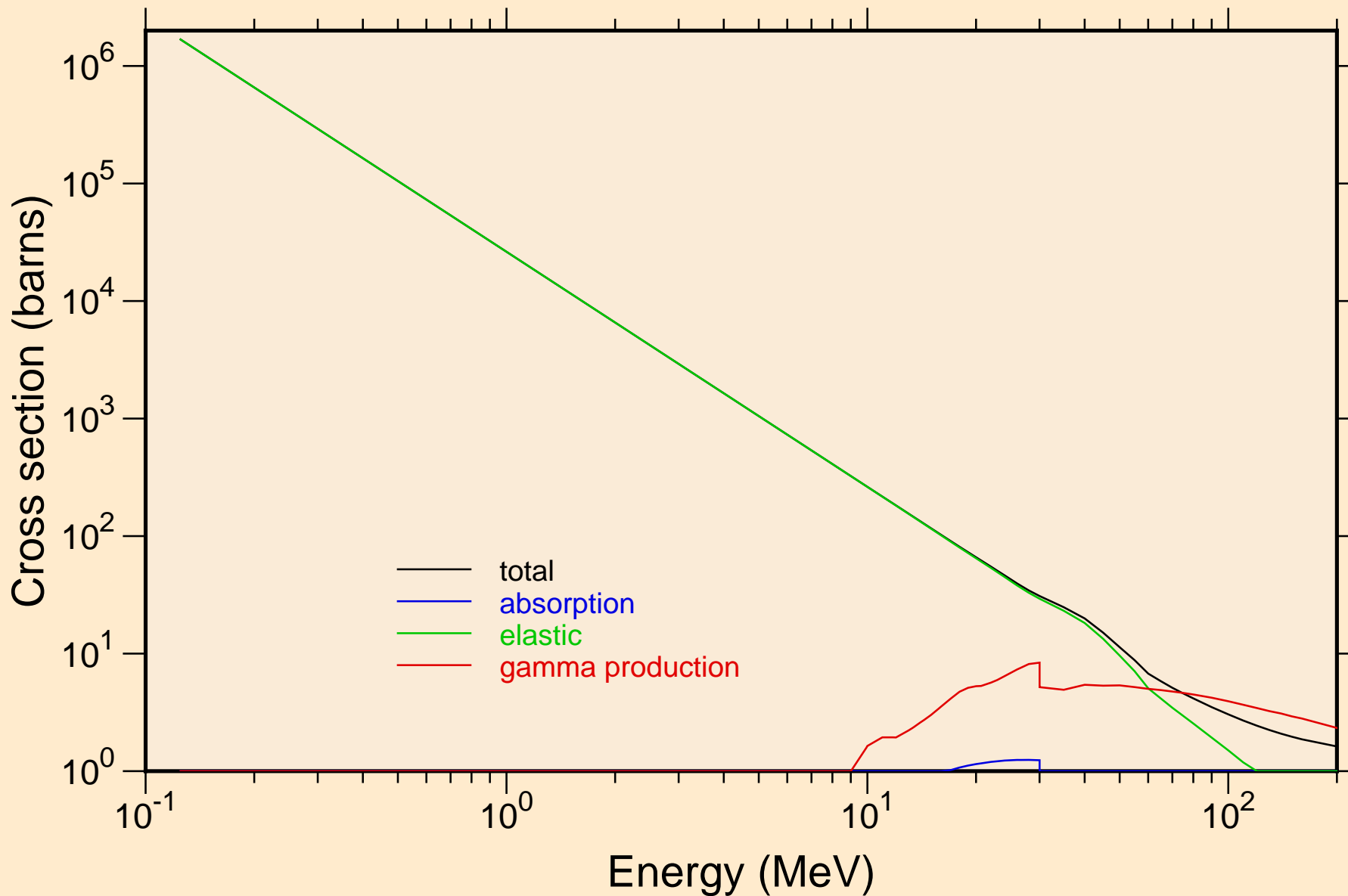

# TB154 PROTON ACER TENDL-2023 LIBRARY; T=0.K

## Heating

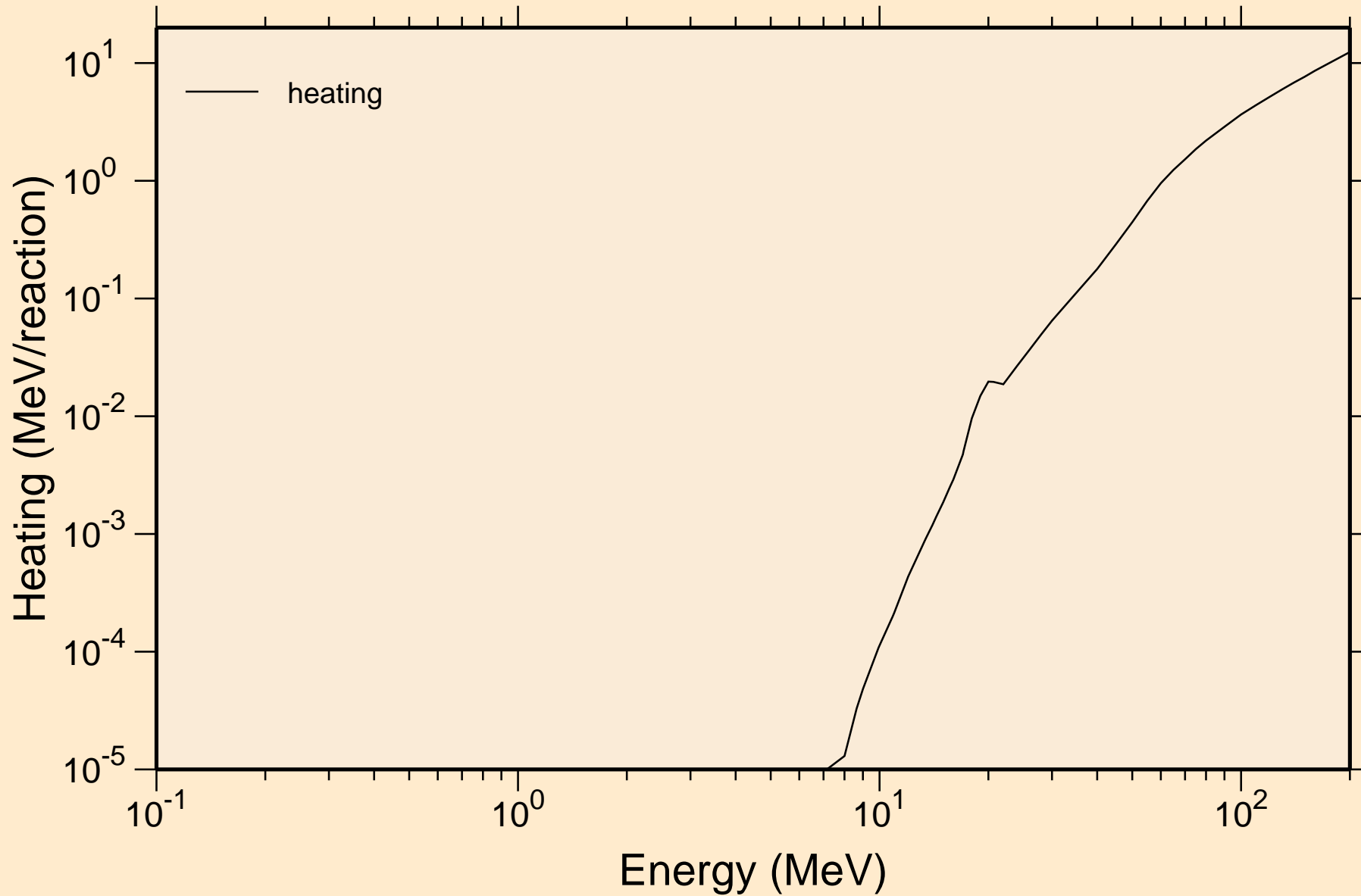

# TB154 PROTON ACER TENDL-2023 LIBRARY; T=0.K

## Principal cross sections

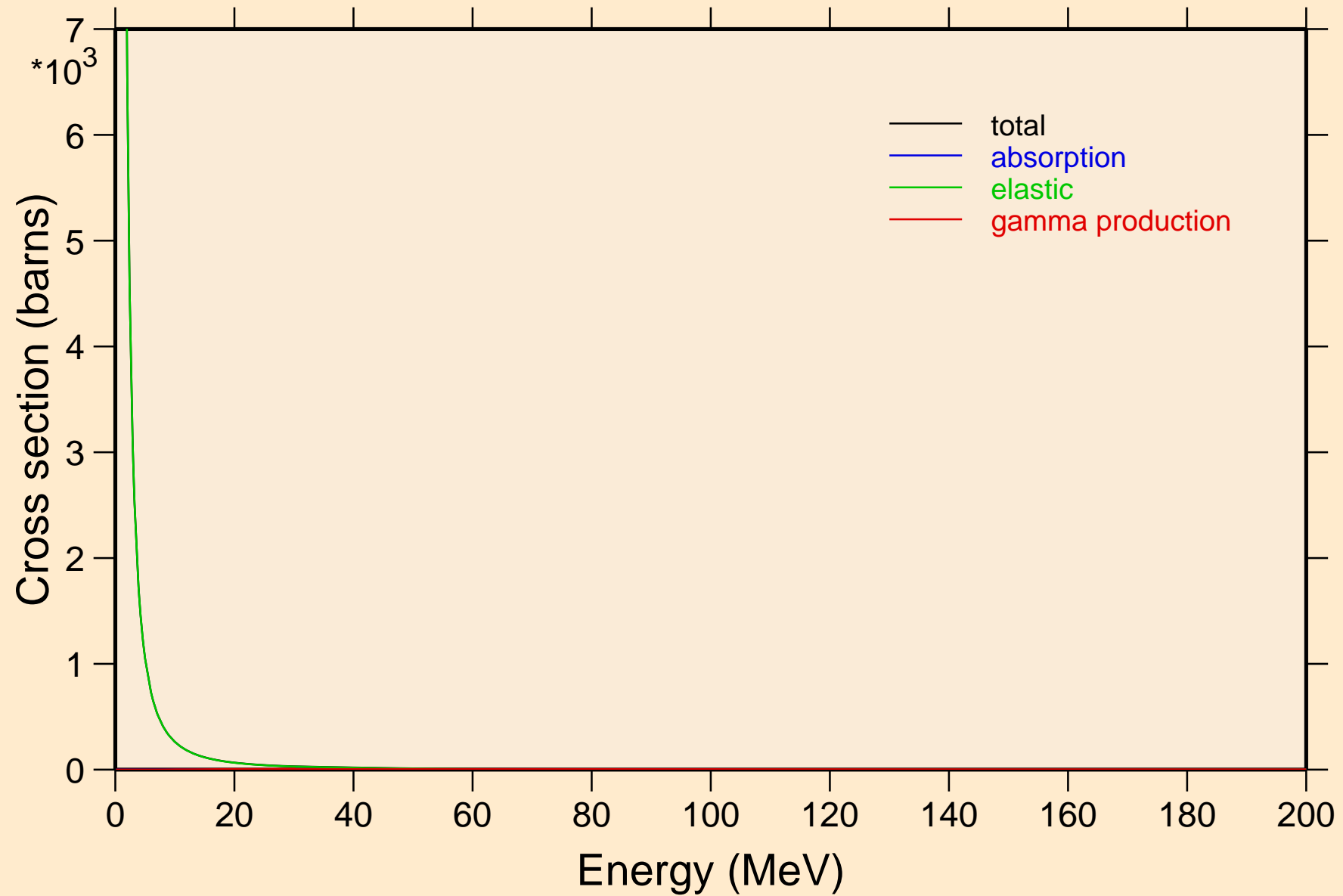

# TB154 PROTON ACER TENDL-2023 LIBRARY; T=0.K

## Heating

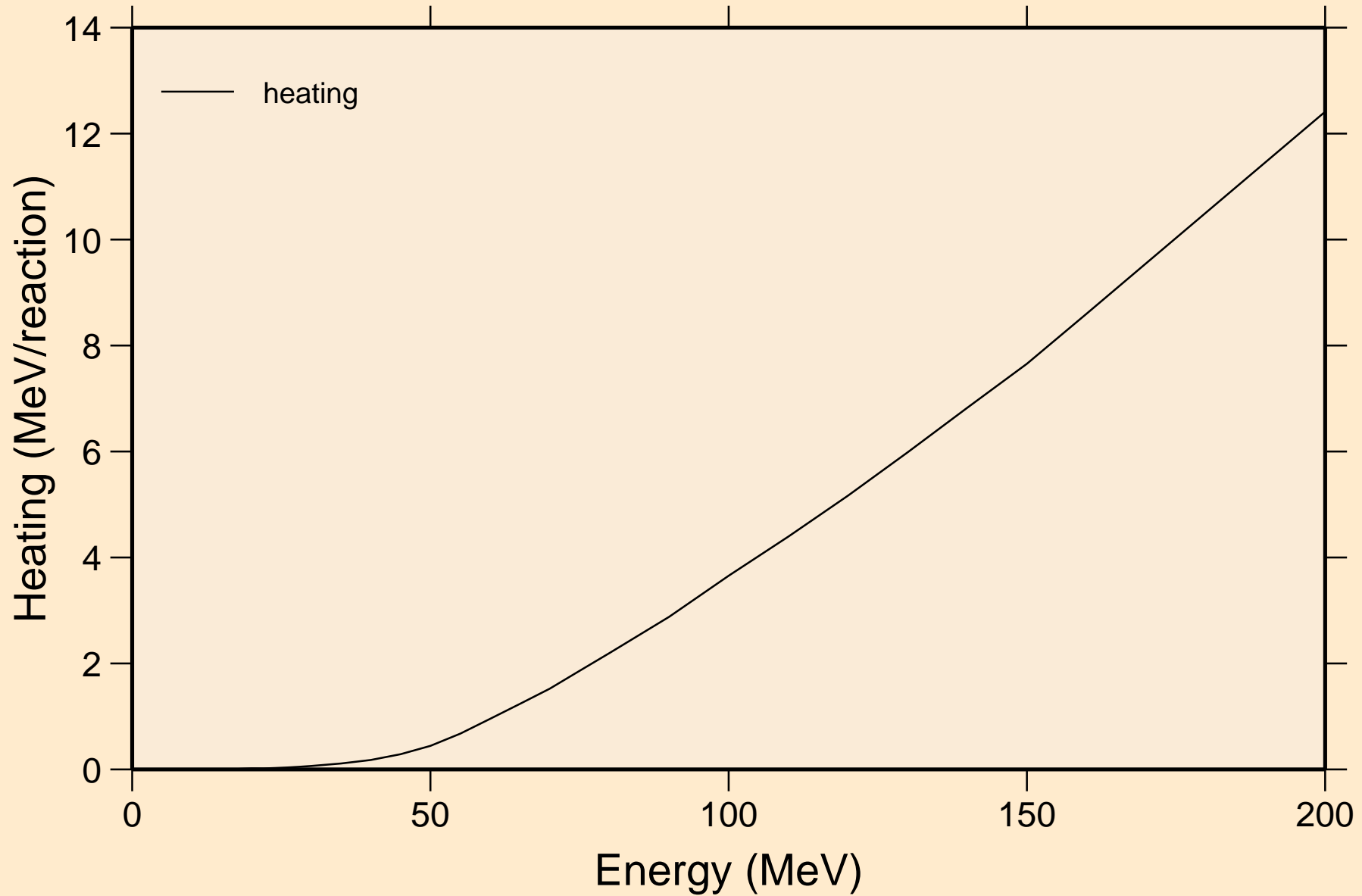

# TB154 PROTON ACER TENDL-2023 LIBRARY; T=0.K

## Threshold reactions

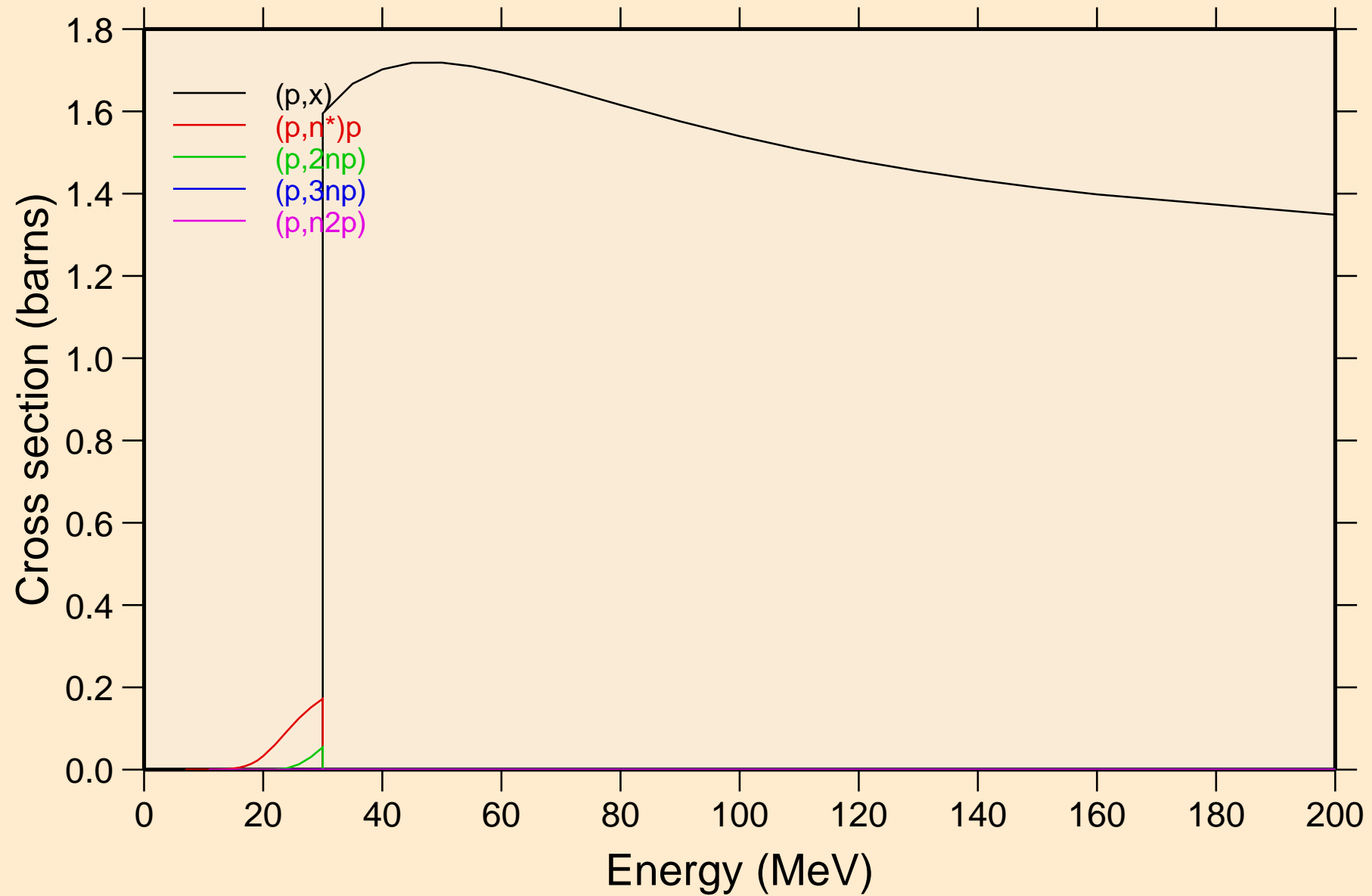

TB154 PROTON ACER TENDL-2023 LIBRARY; T=0.K  
Threshold reactions

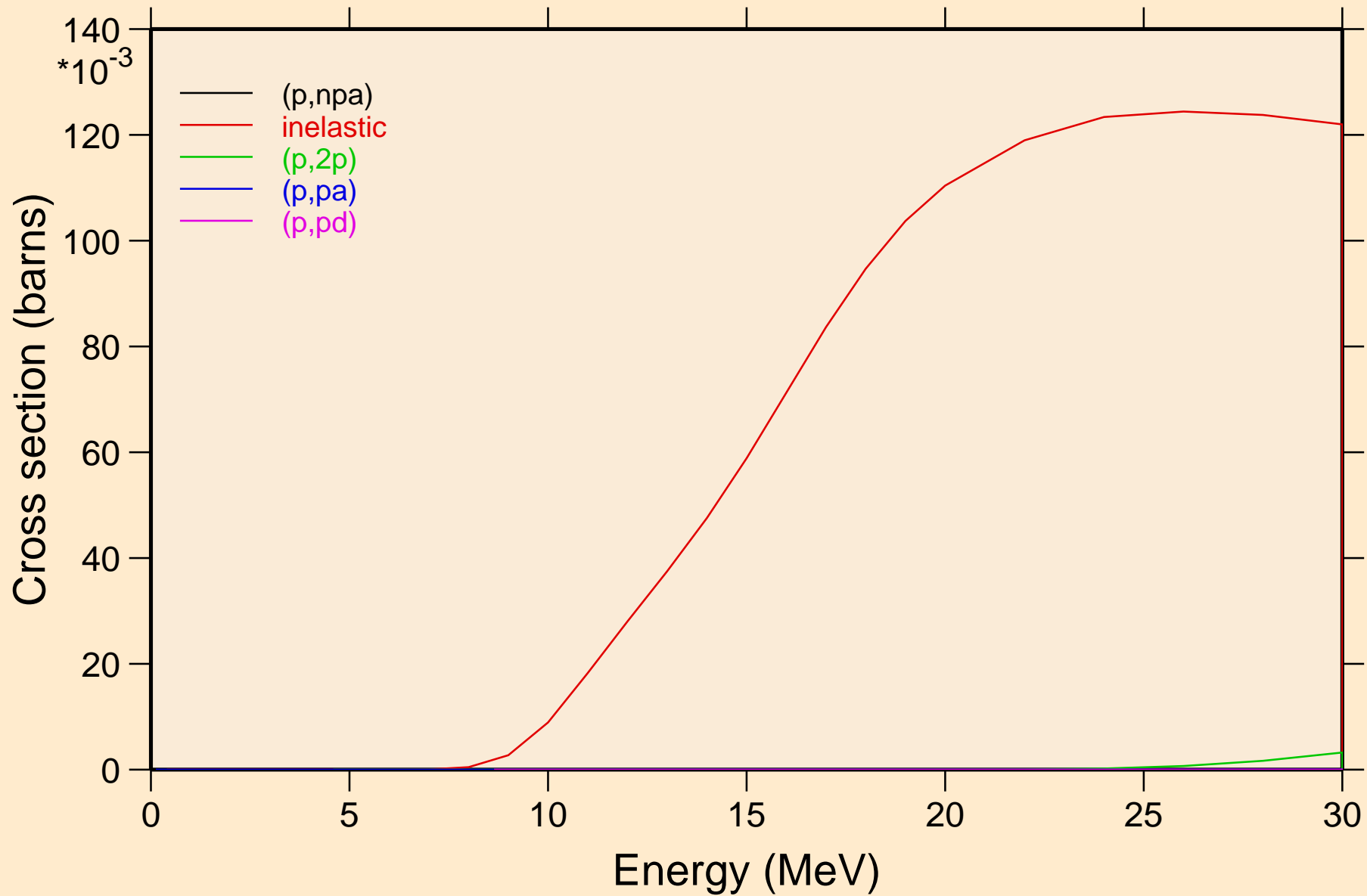

TB154 PROTON ACER TENDL-2023 LIBRARY; T=0.K  
Threshold reactions

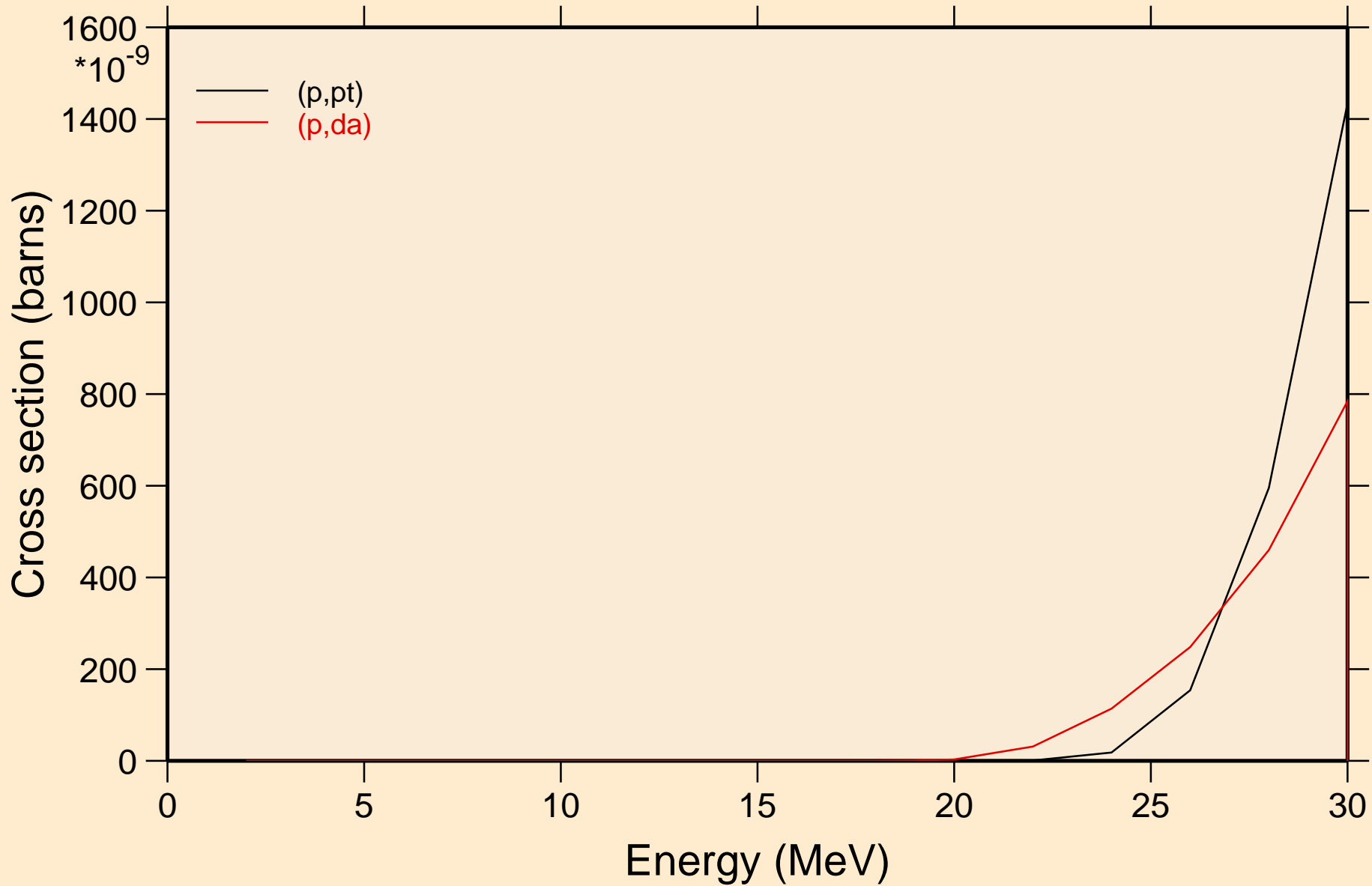

TB154 PROTON ACER TENDL-2023 LIBRARY; T=0.K  
angular distribution for elastic

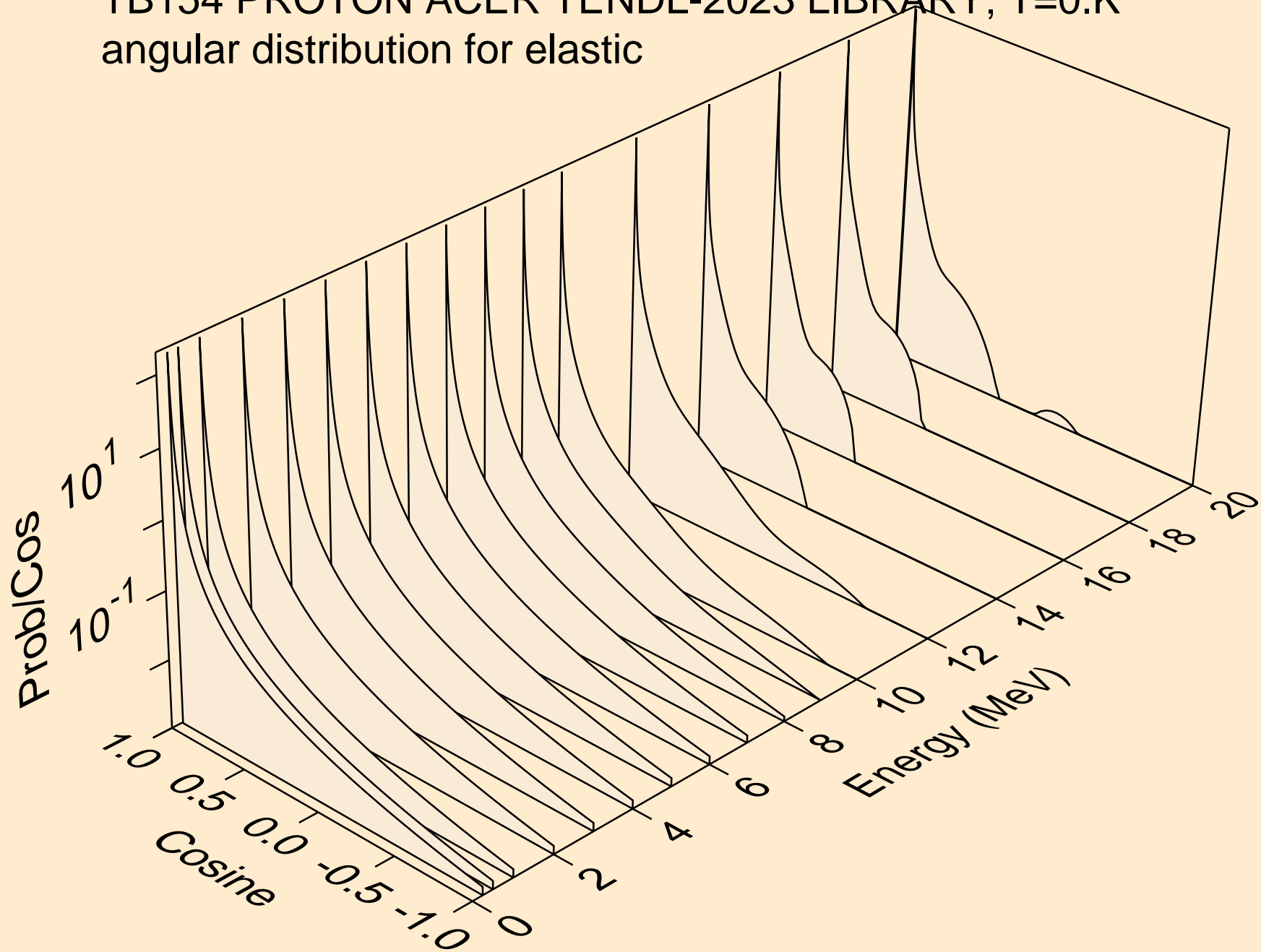

TB154 PROTON ACER TENDL-2023 LIBRARY; T=0.K  
angular distribution for elastic

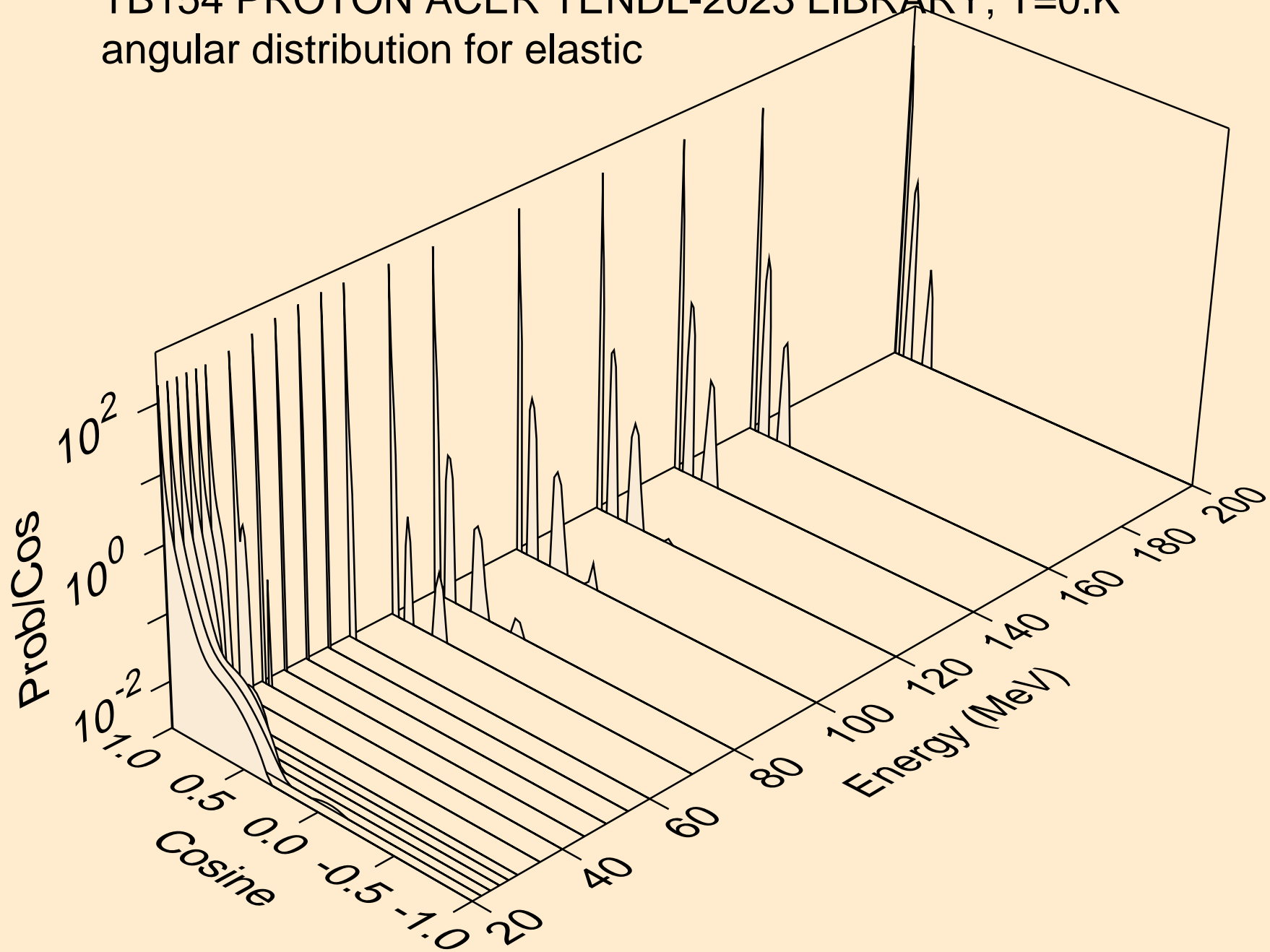

TB154 PROTON ACER TENDL-2023 LIBRARY; T=0.K  
Proton emission for (p,x)

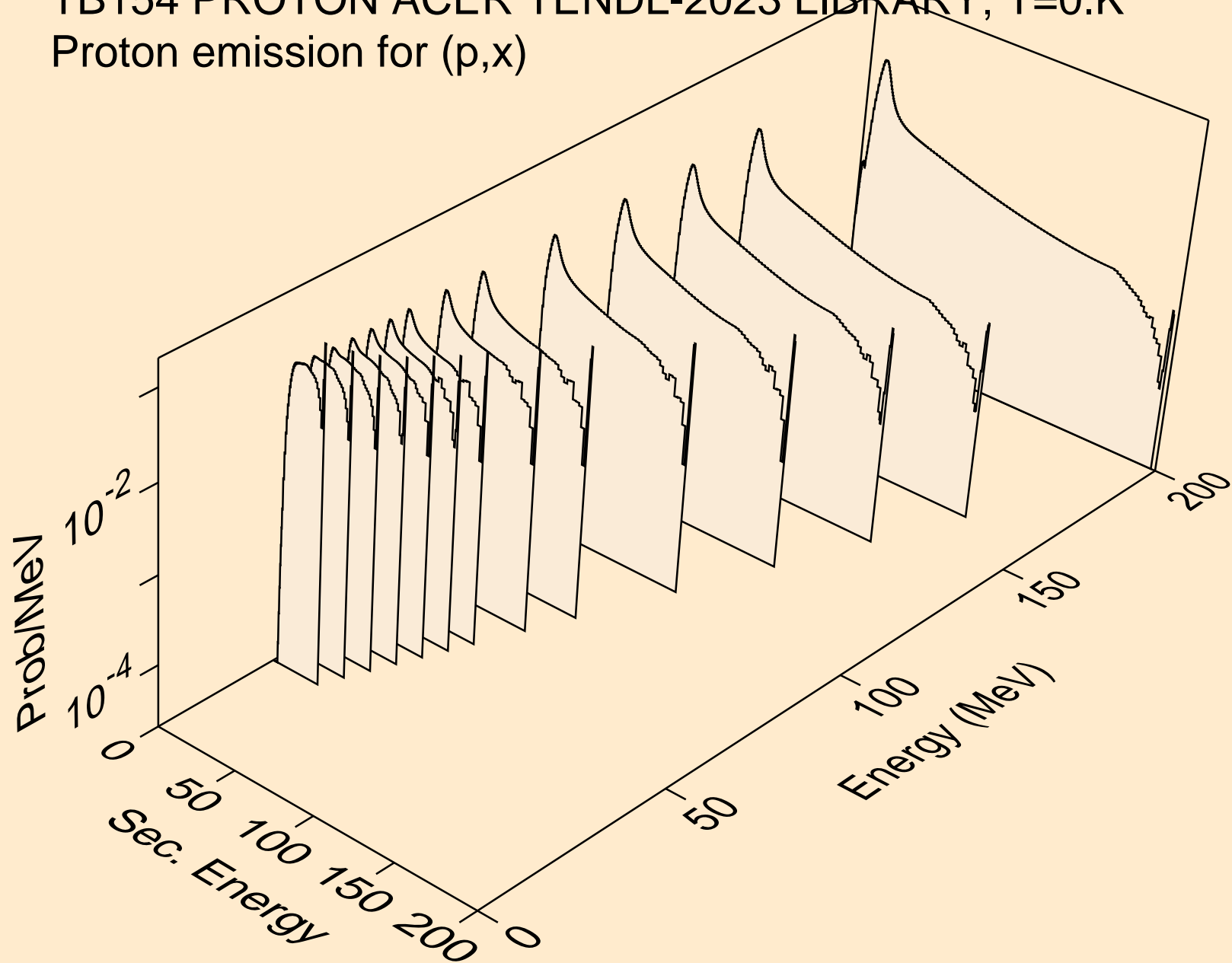

TB154 PROTON ACER TENDL-2023 LIBRARY; T=0.K  
Proton emission for (p,n\*)p

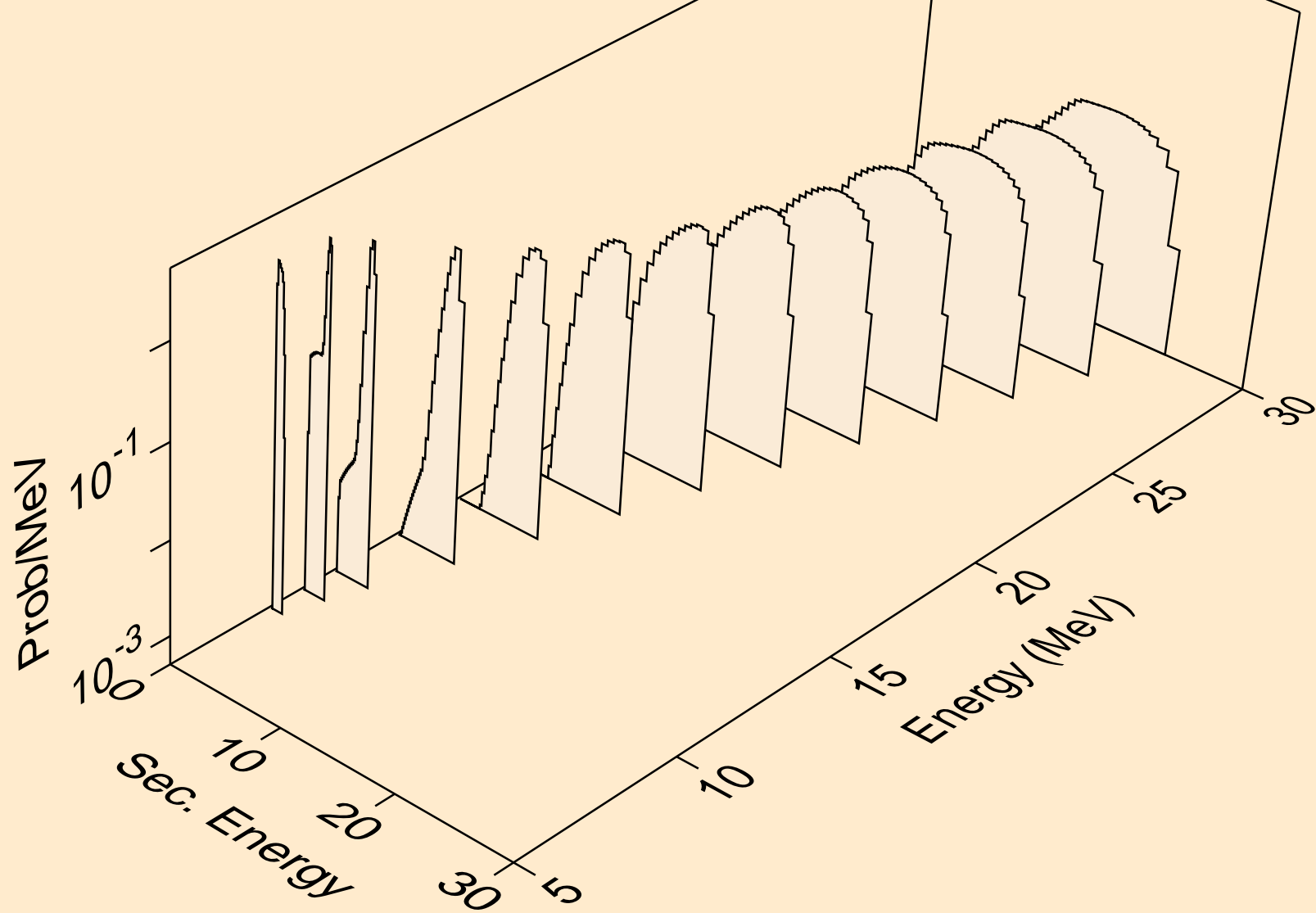

TB154 PROTON ACER TENDL-2023 LIBRARY; T=0.K  
Proton emission for (p,2np)

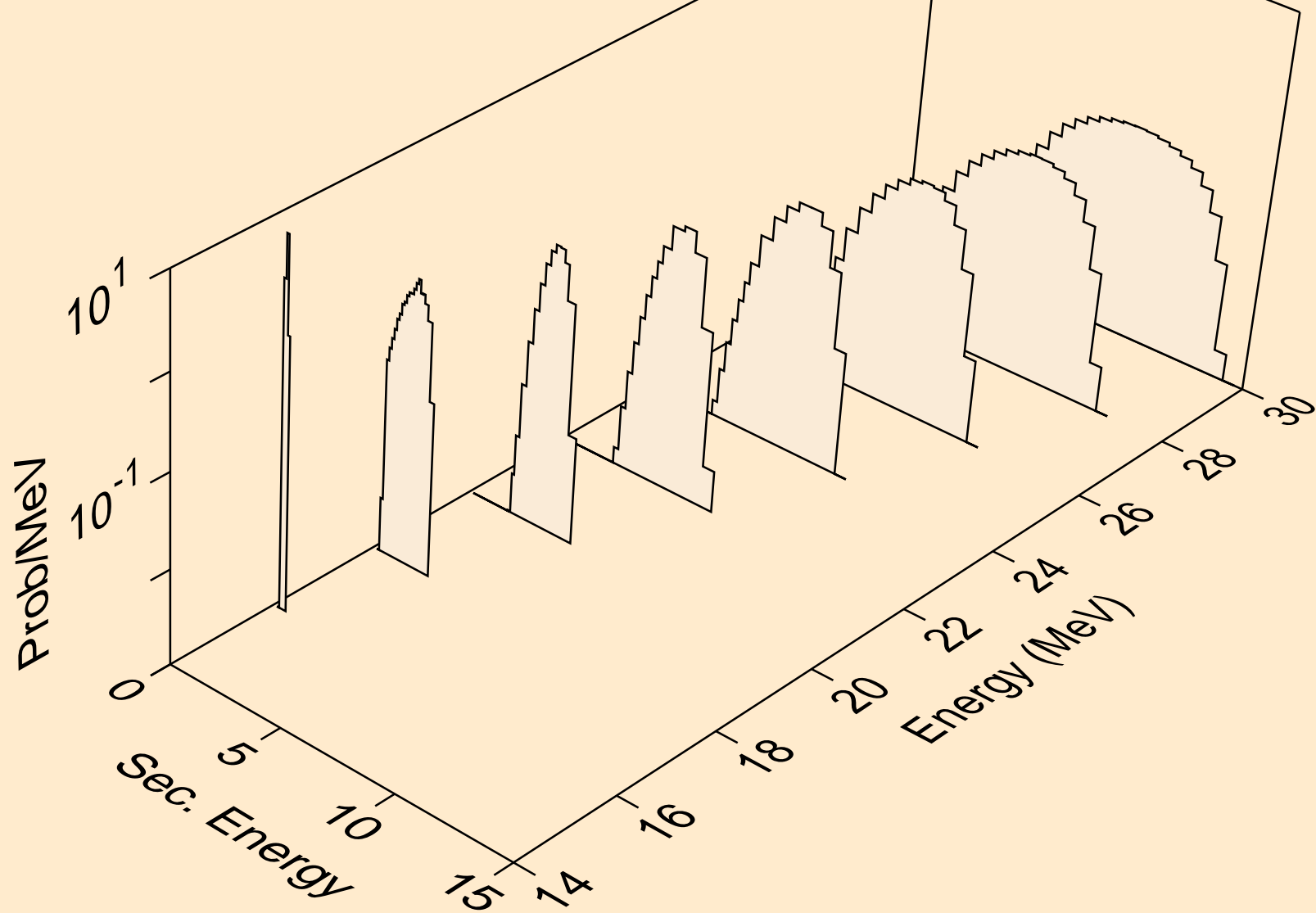

TB154 PROTON ACER TENDL-2023 LIBRARY; T=0.K  
Proton emission for (p,3np)

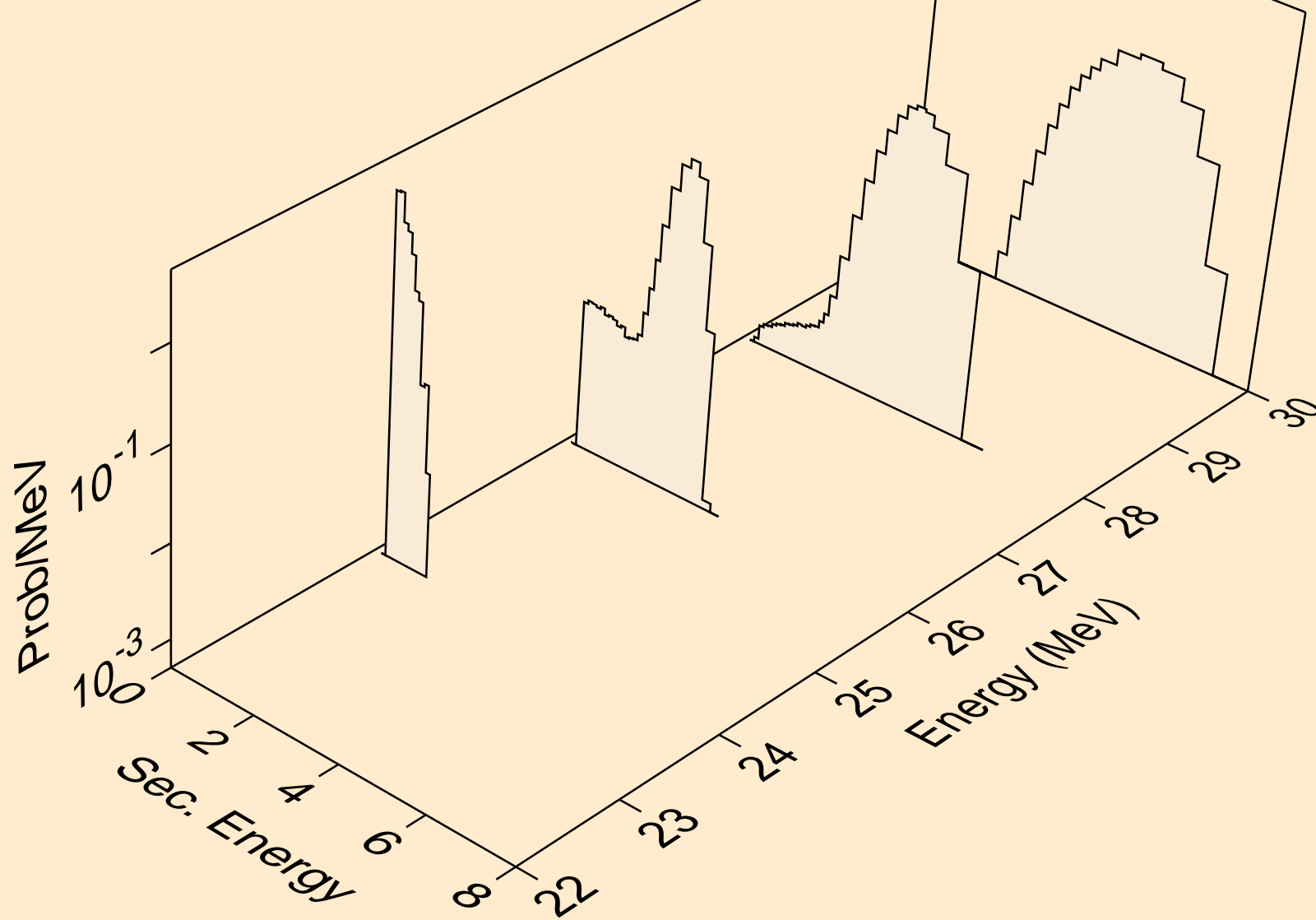

TB154 PROTON ACER TENDL-2023 LIBRARY; T=0.K  
Proton emission for (p,n2p)

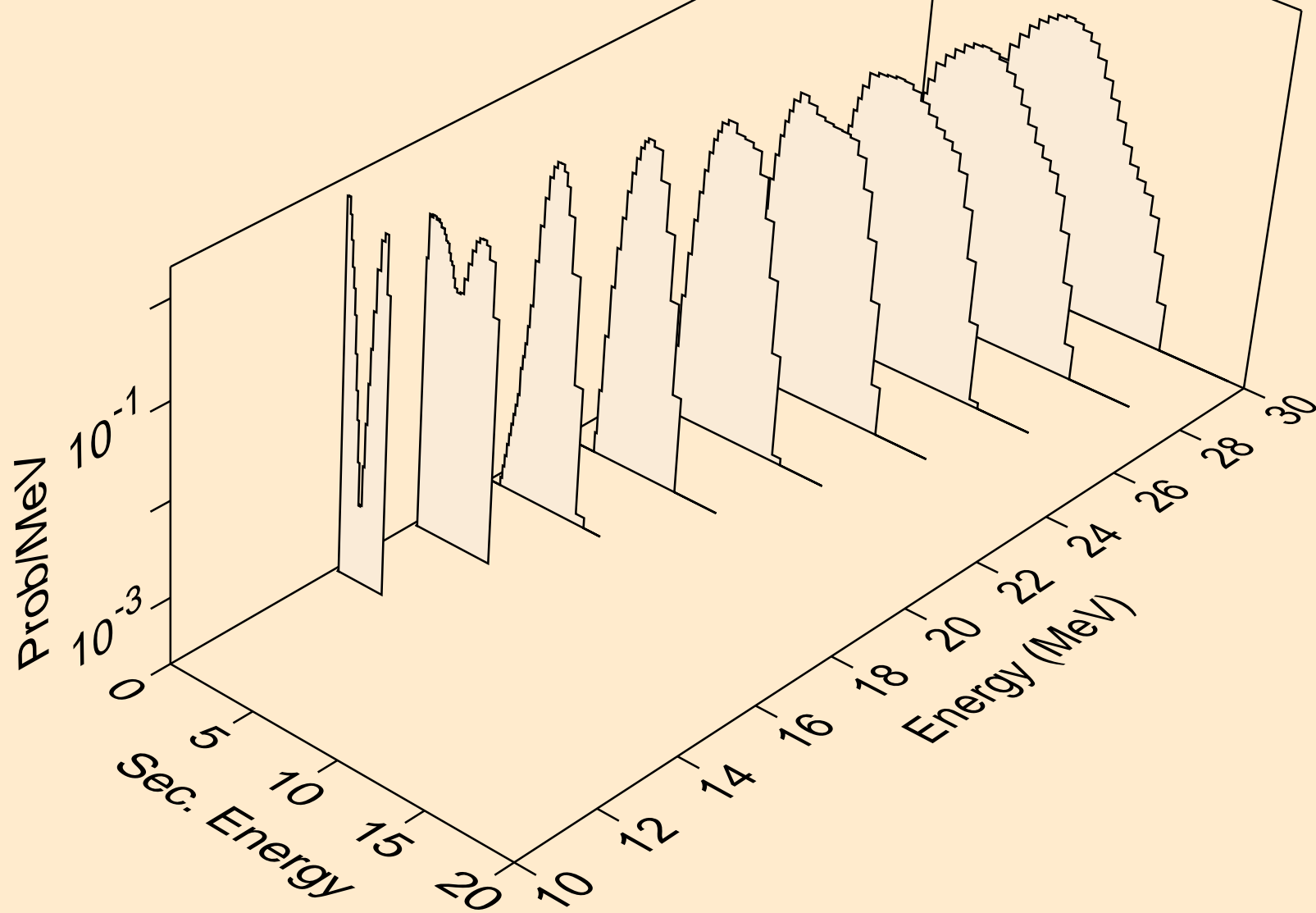

TB154 PROTON ACER TENDL-2023 LIBRARY; T=0.K  
Proton emission for (p,npa)

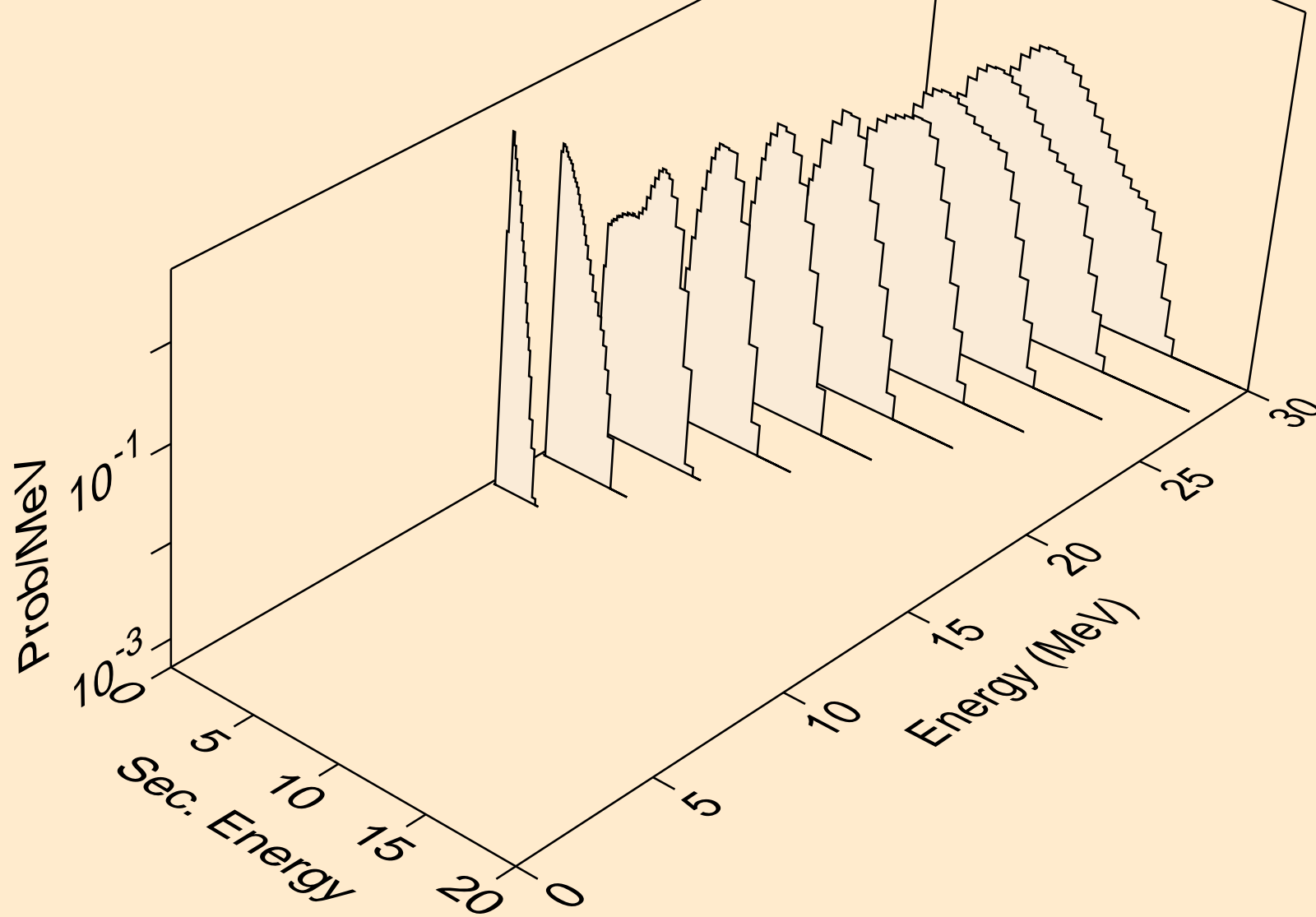

TB154 PROTON ACER TENDL-2023 LIBRARY; T=0.K  
Proton emission for inelastic

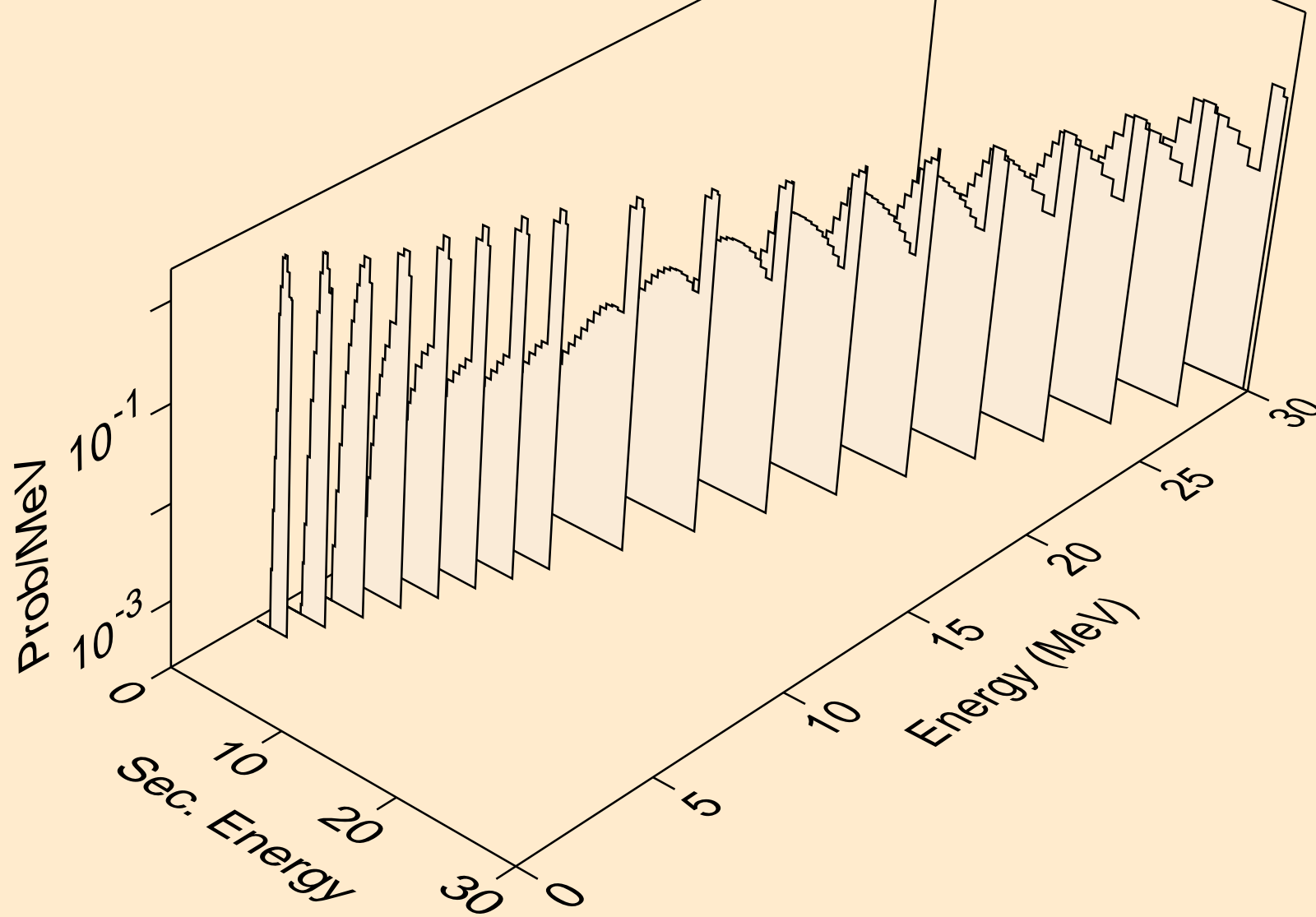

TB154 PROTON ACER TENDL-2023 LIBRARY; T=0.K  
Proton emission for (p,2p)

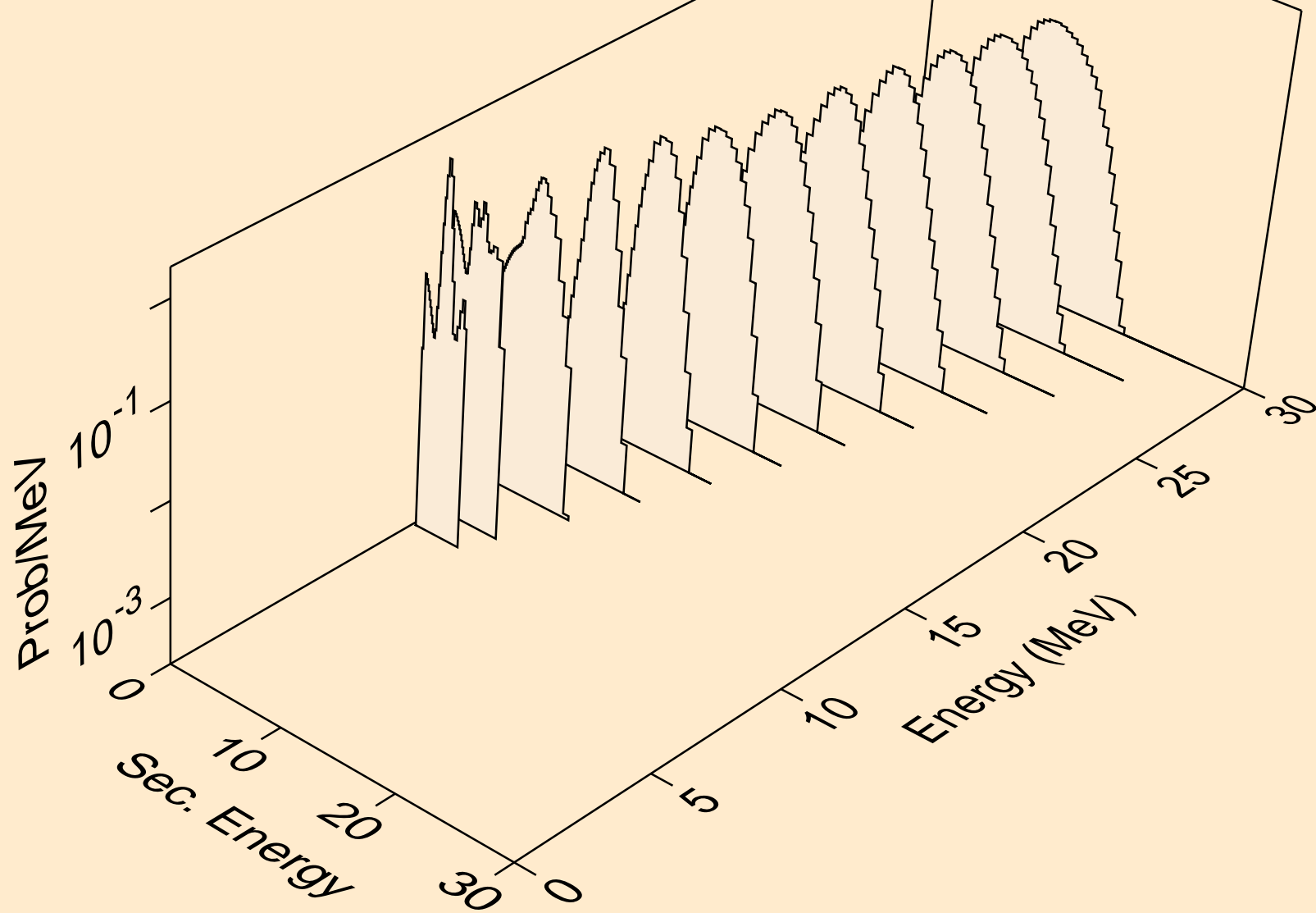

TB154 PROTON ACER TENDL-2023 LIBRARY; T=0.K  
Proton emission for (p,pa)

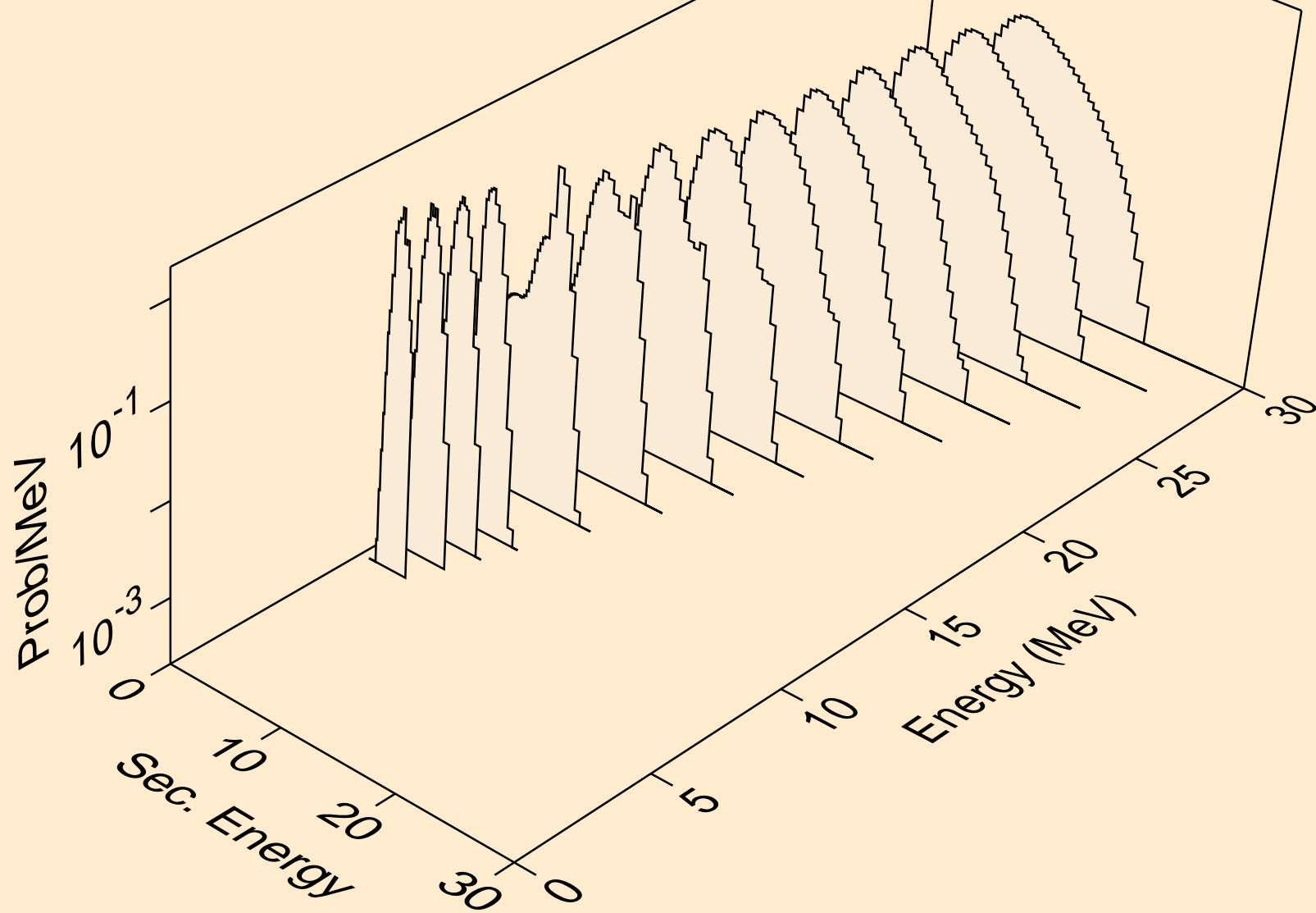

TB154 PROTON ACER TENDL-2023 LIBRARY; T=0.K  
Proton emission for (p,pd)

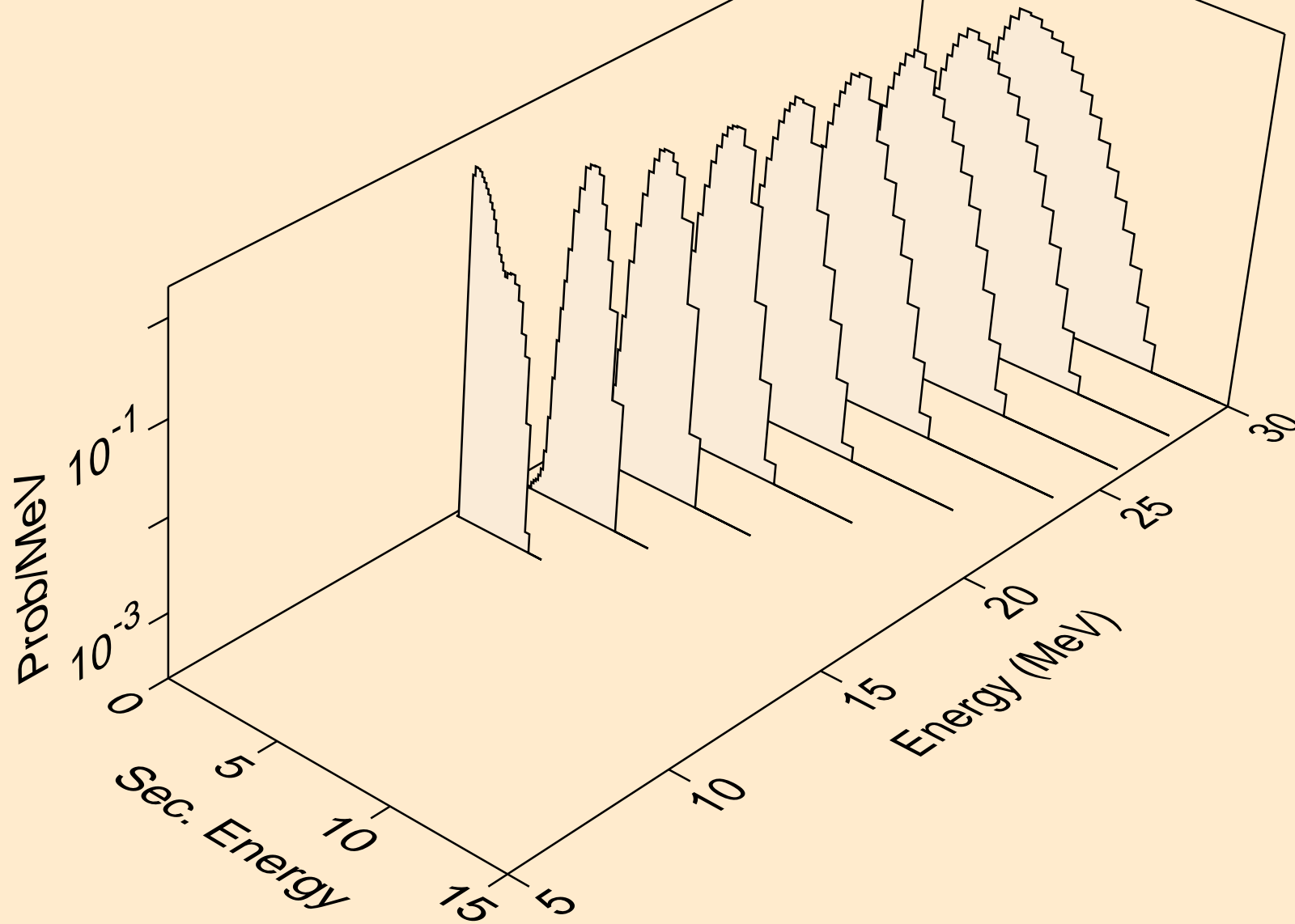

# TB154 PROTON ACER TENDL-2023 LIBRARY; T=0.K

Proton emission for (p,pt)

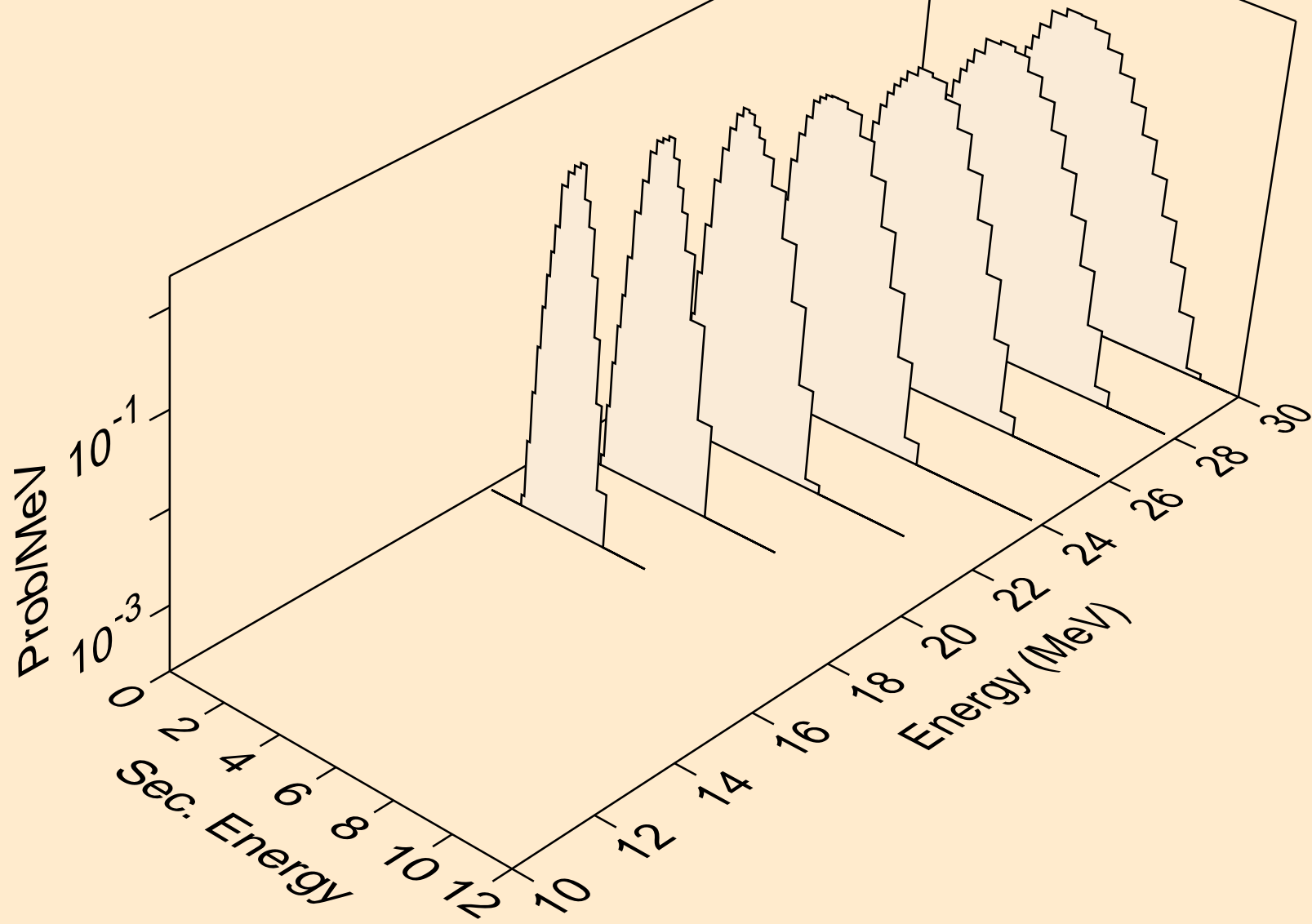

TB154 PROTON ACER TENDL-2023 LIBRARY; T=0.K  
Photon emission for (z,n)

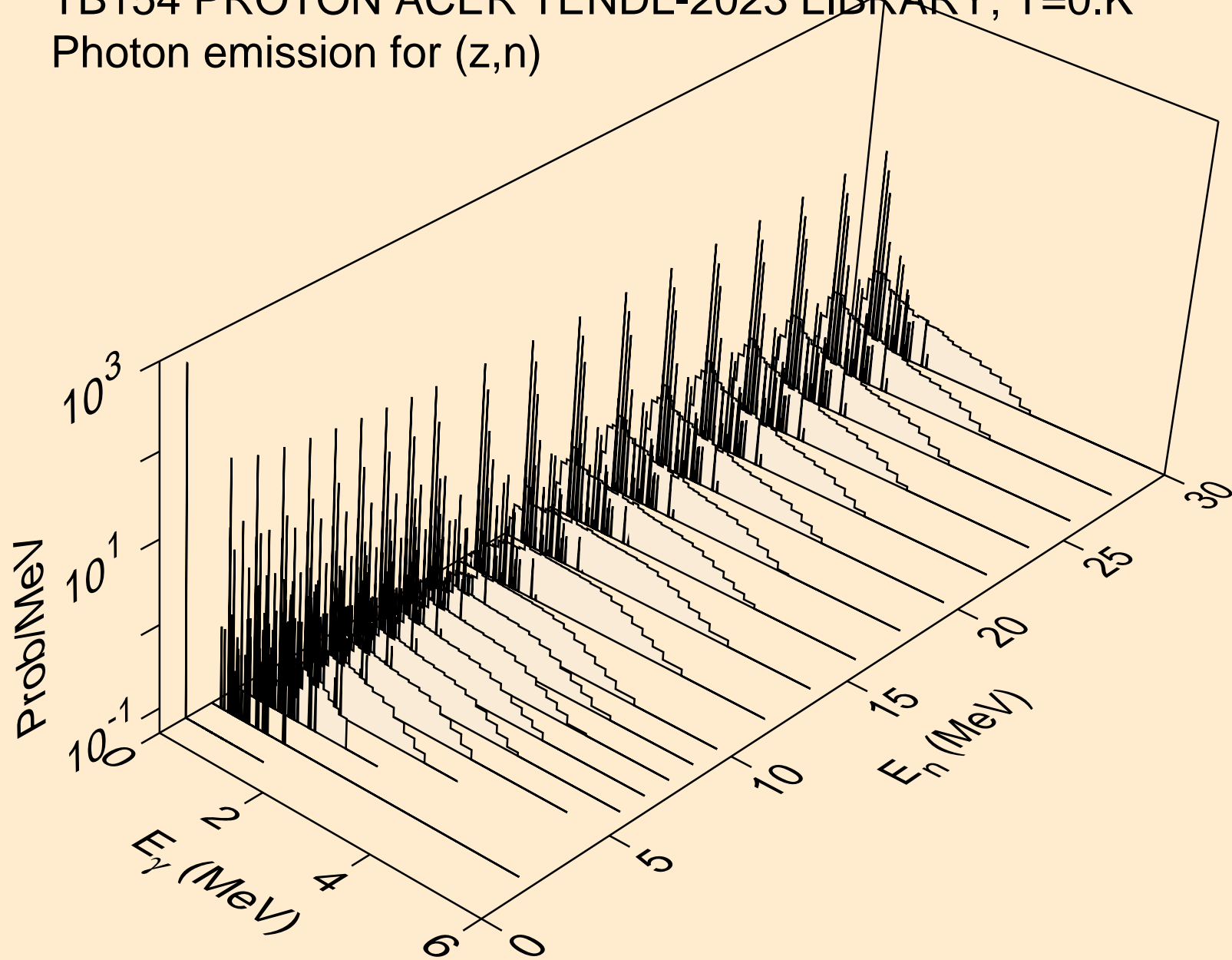

TB154 PROTON ACER TENDL-2023 LIBRARY; T=0.K

Photon emission for (z,x)

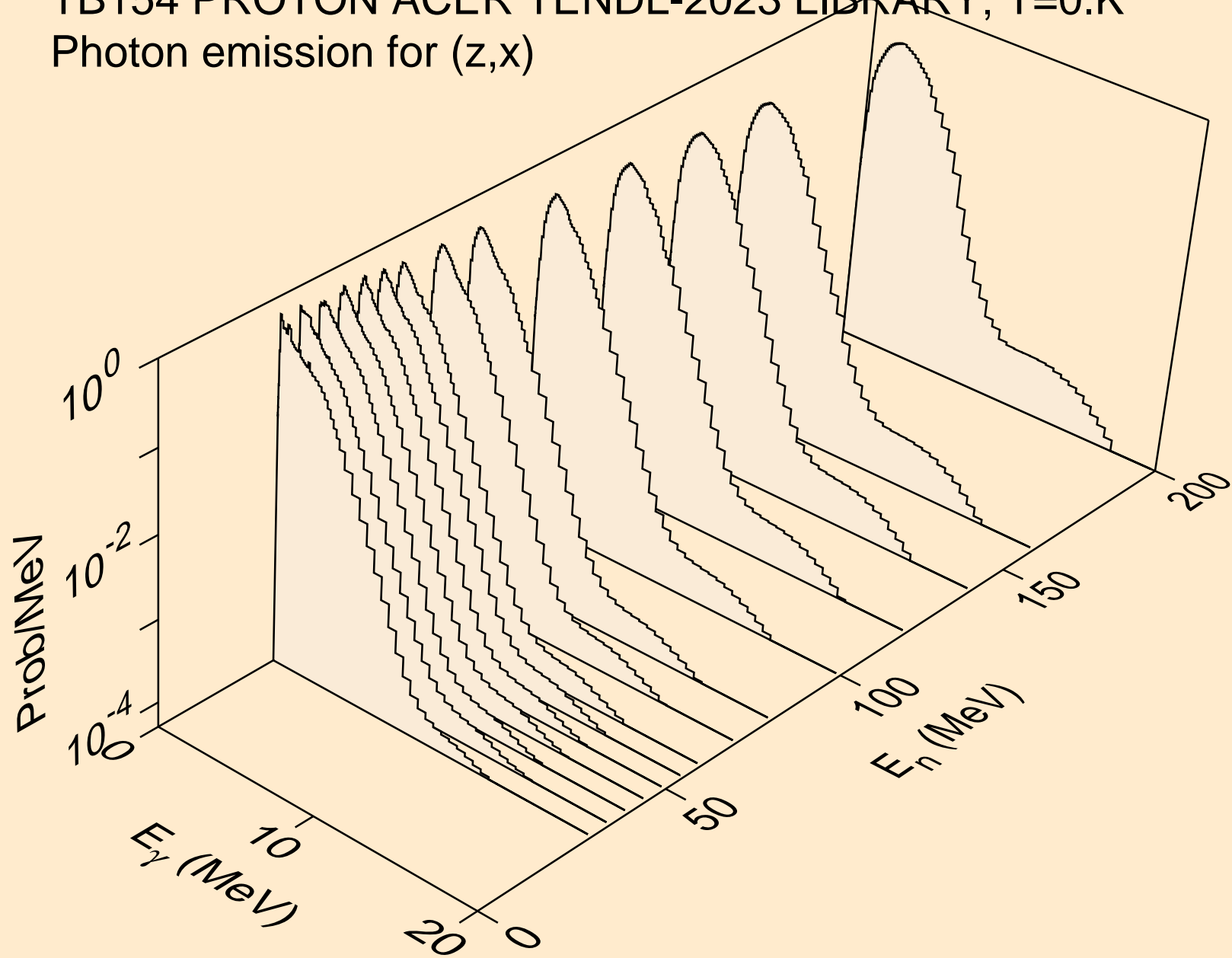

TB154 PROTON ACER TENDL-2023 LIBRARY; T=0.K  
Photon emission for (n,2nd)

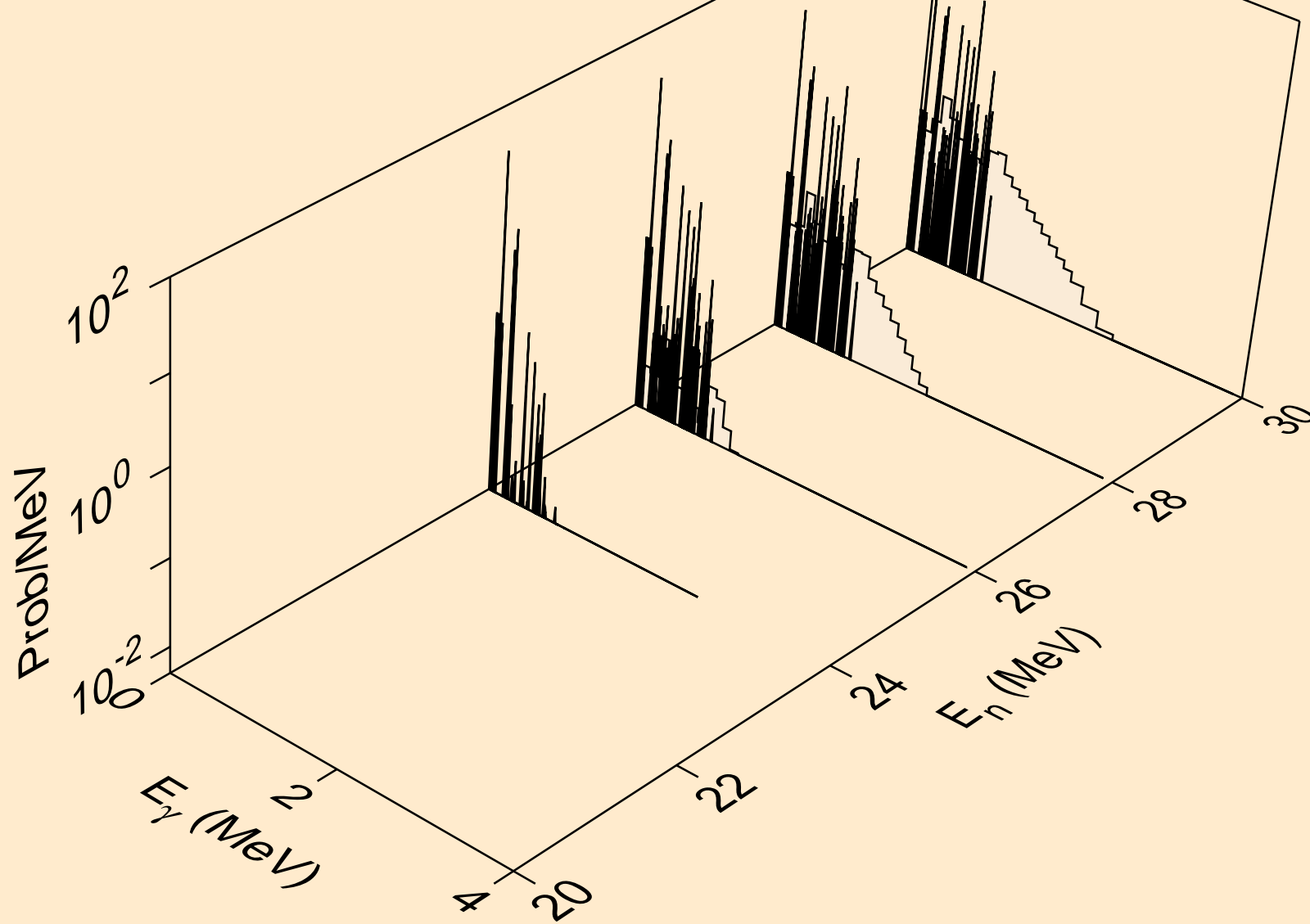

TB154 PROTON ACER TENDL-2023 LIBRARY; T=0.K  
Photon emission for (n,2n)

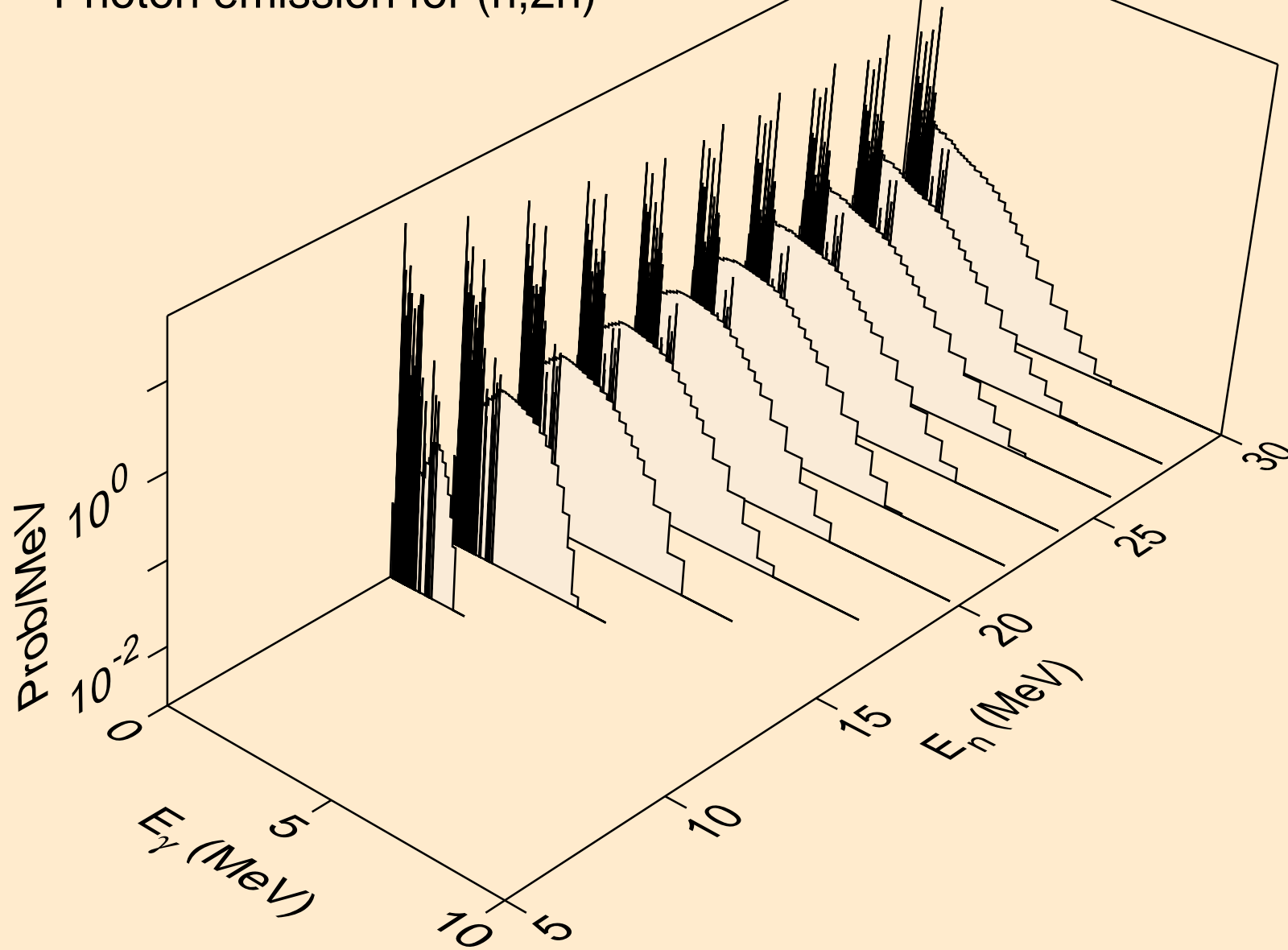

TB154 PROTON ACER TENDL-2023 LIBRARY; T=0.K  
Photon emission for (n,3n)

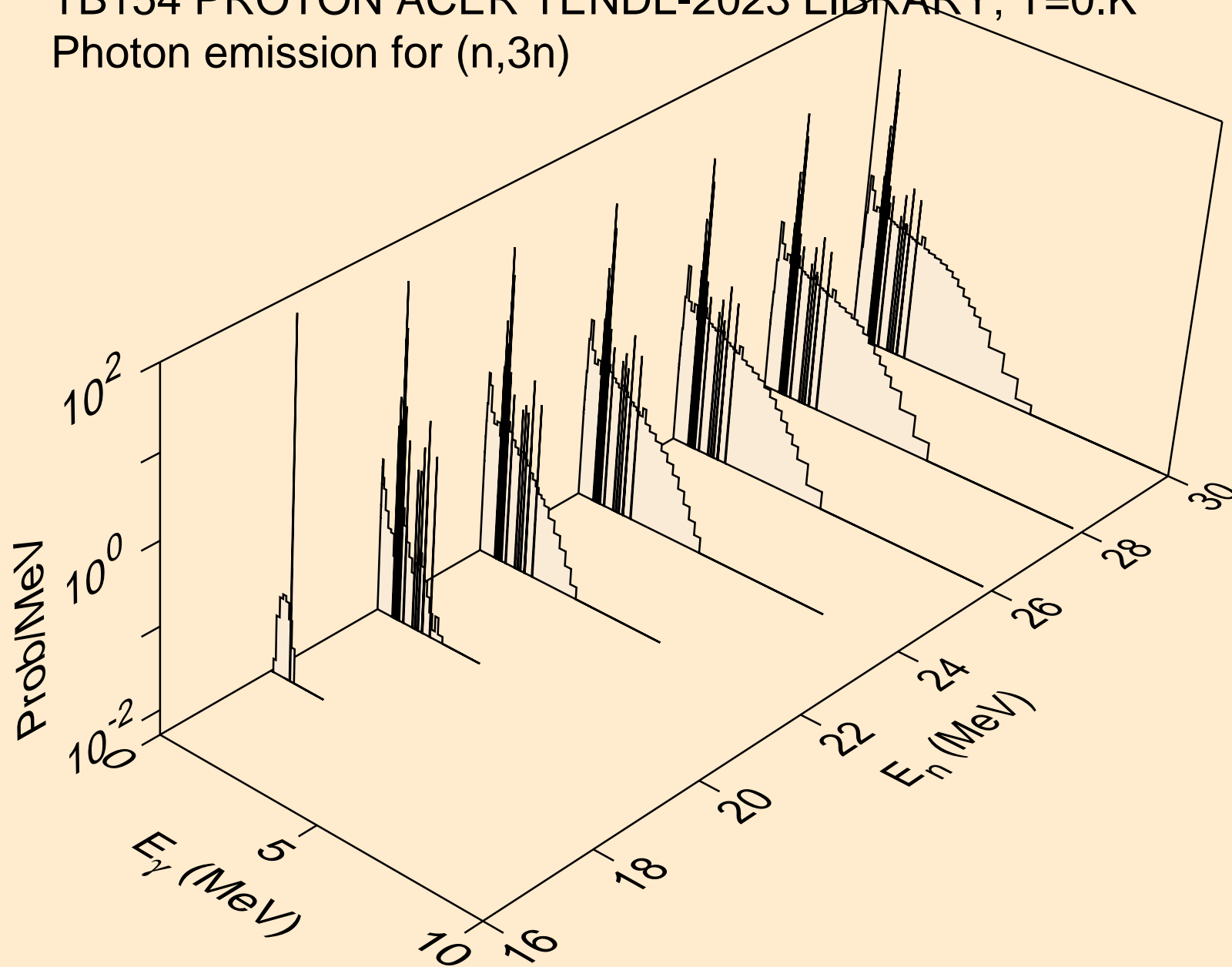

TB154 PROTON ACER TENDL-2023 LIBRARY; T=0.K  
Photon emission for (n,n\*)a

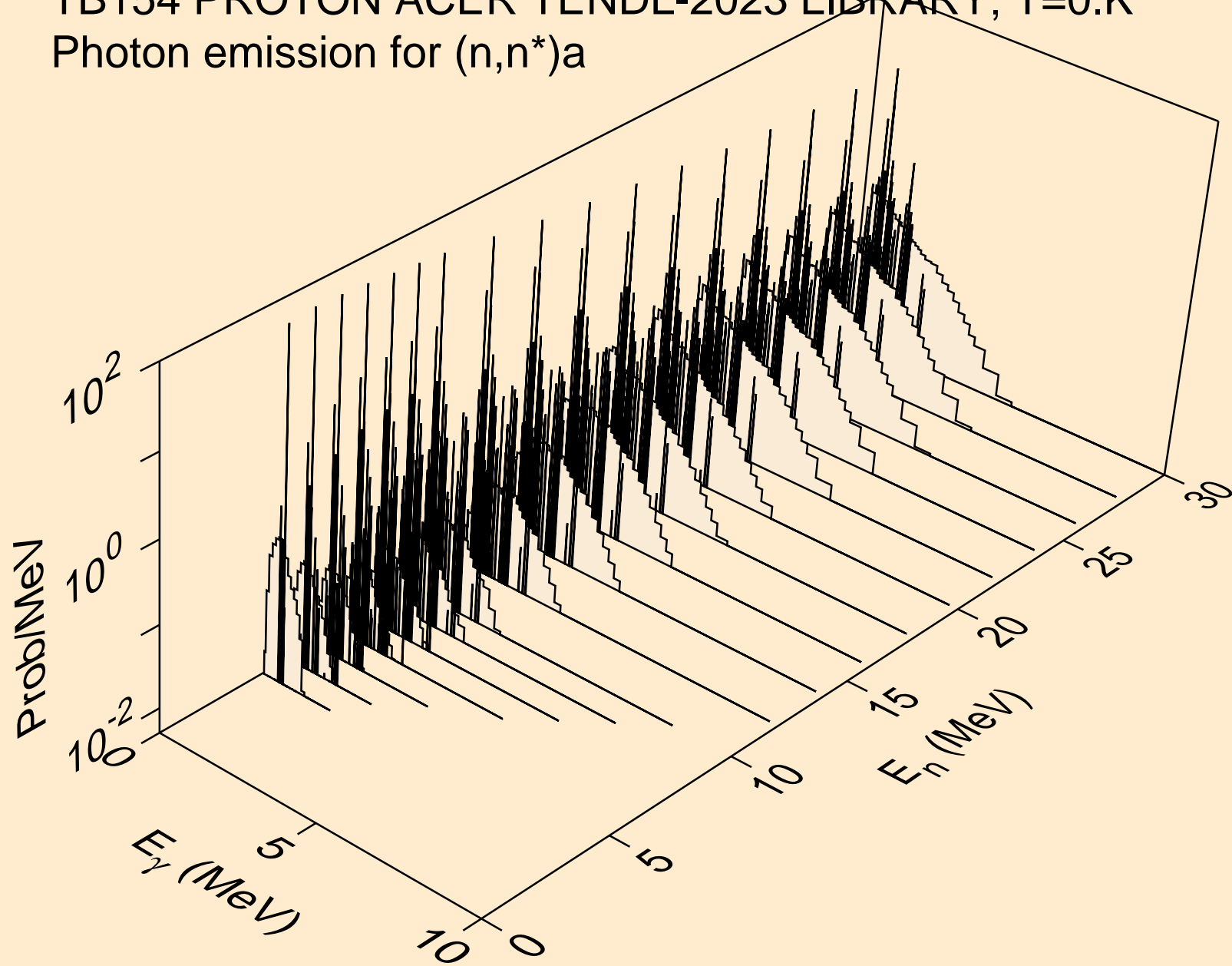

TB154 PROTON ACER TENDL-2023 LIBRARY; T=0.K  
Photon emission for (n,2n)a

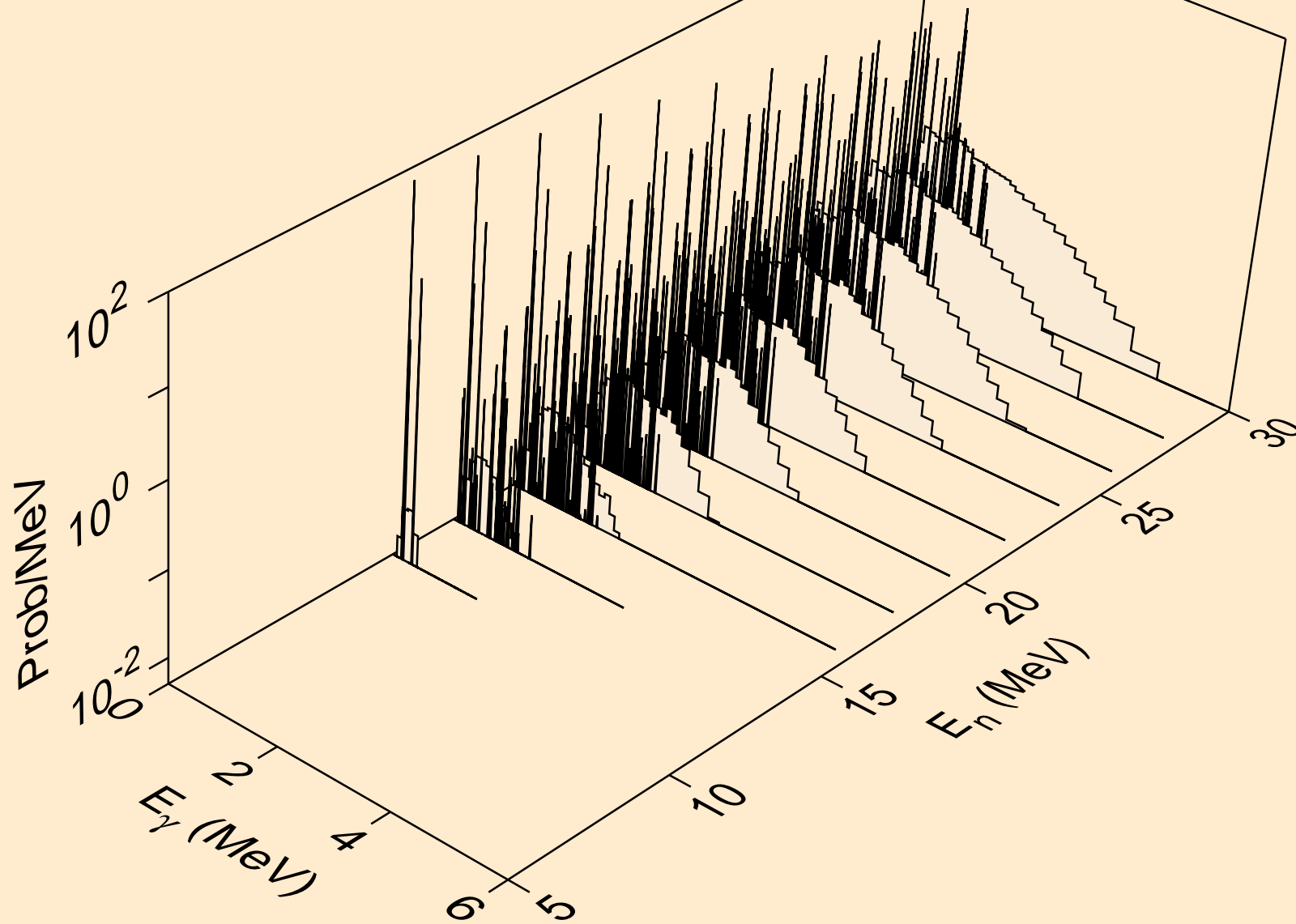

TB154 PROTON ACER TENDL-2023 LIBRARY; T=0.K  
Photon emission for (n,3n)a

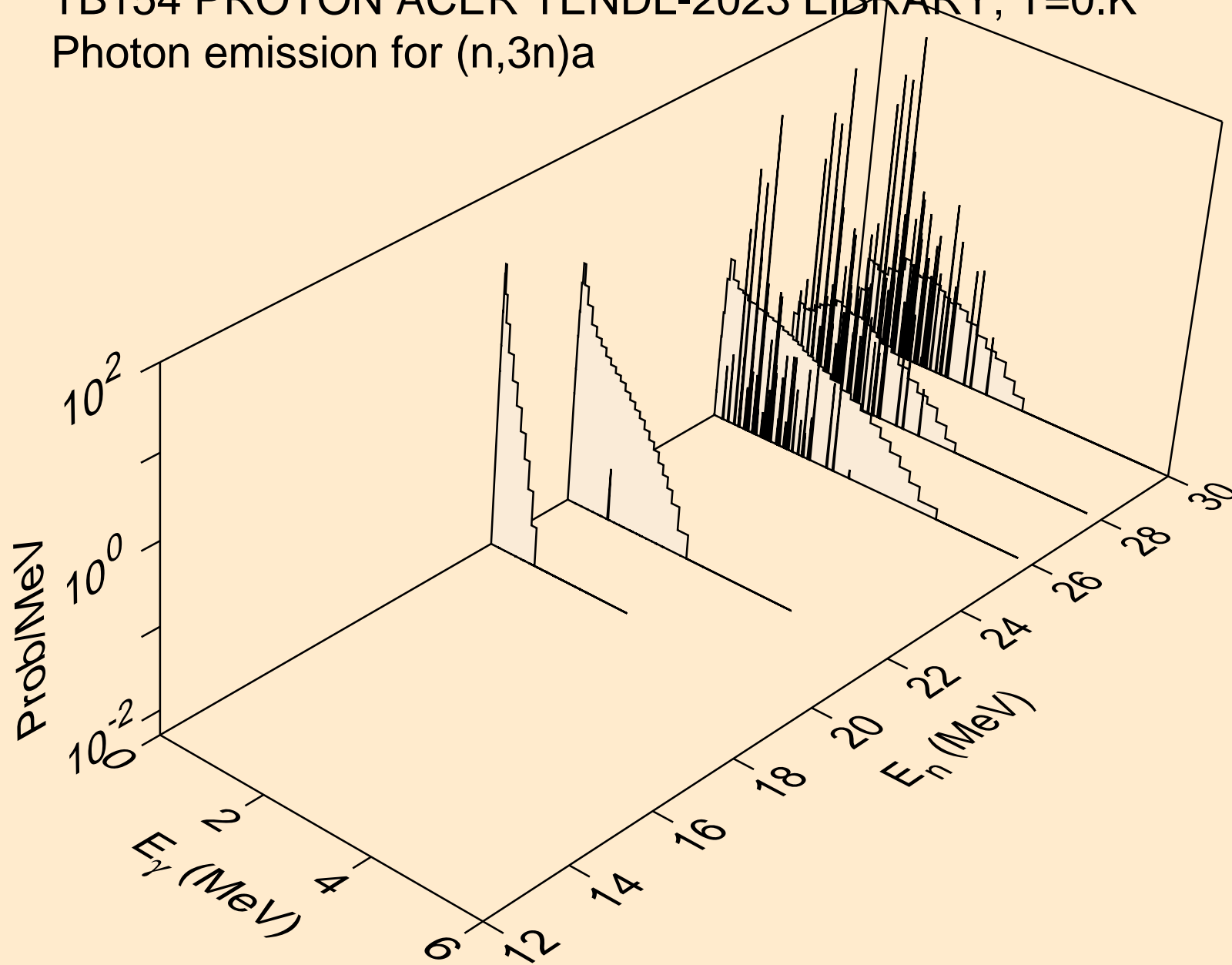

TB154 PROTON ACER TENDL-2023 LIBRARY; T=0.K  
Photon emission for (n,n\*)p

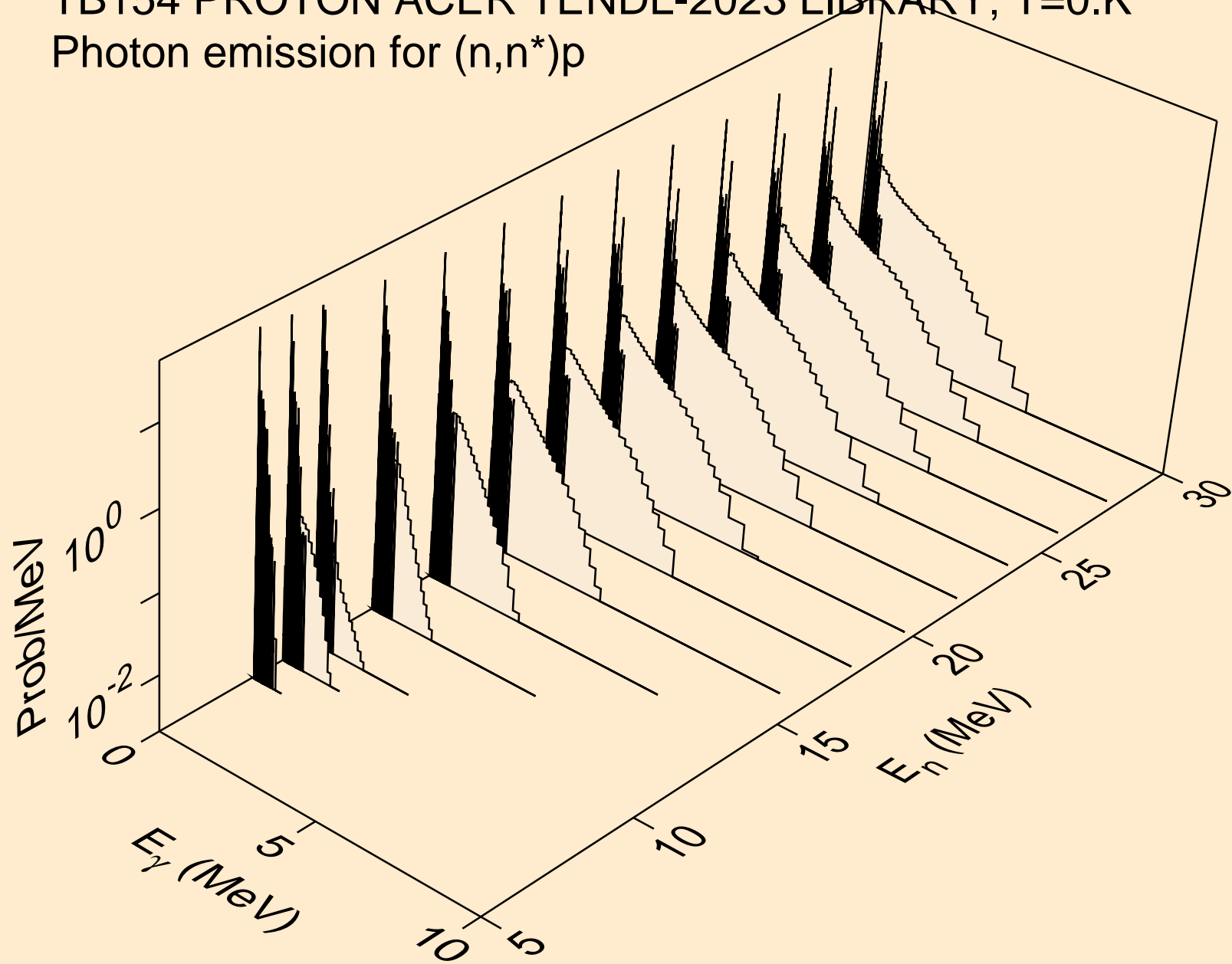

TB154 PROTON ACER TENDL-2023 LIBRARY; T=0.K  
Photon emission for (n,n\*)2a

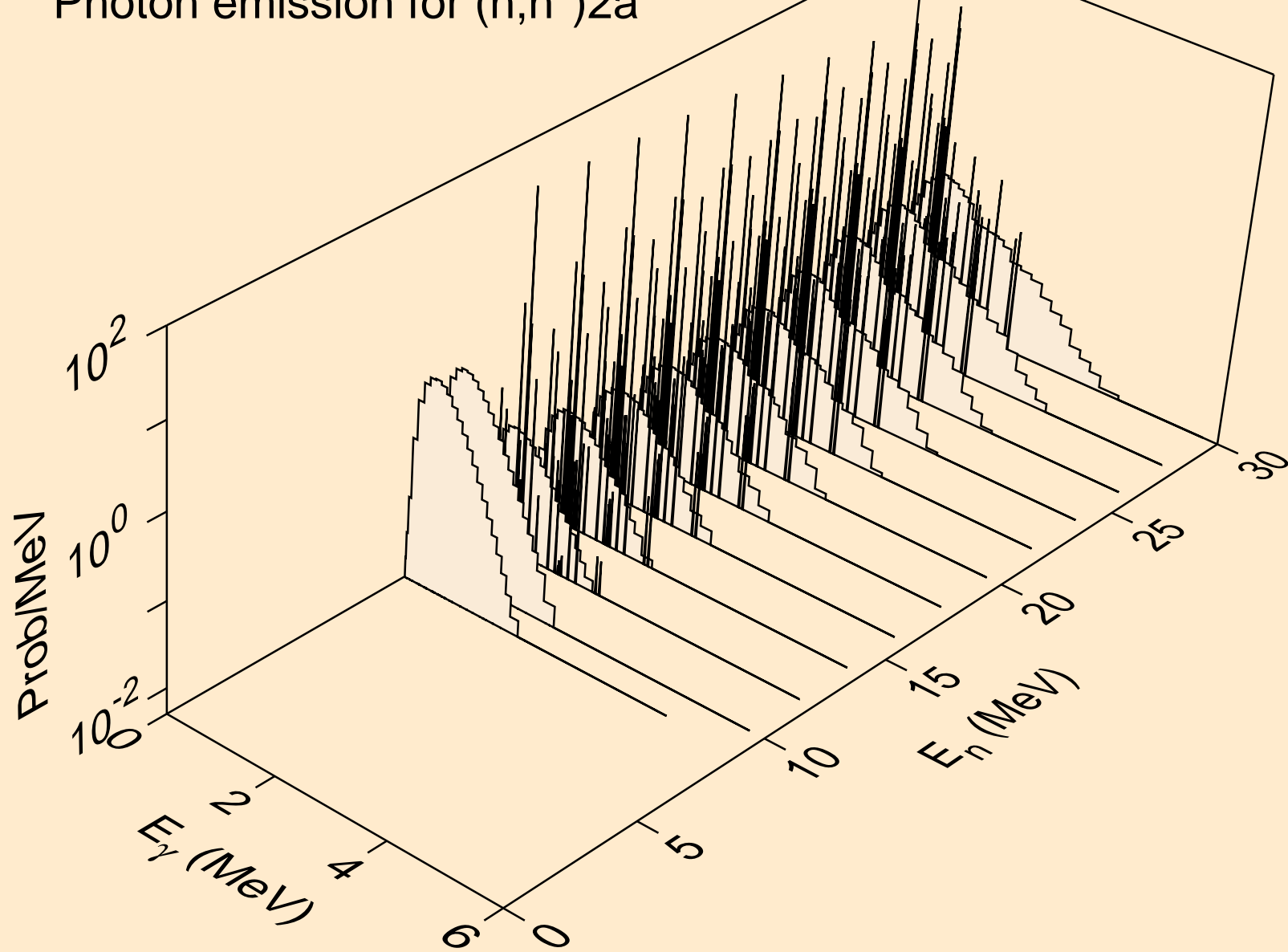

TB154 PROTON ACER TENDL-2023 LIBRARY; T=0.K  
Photon emission for (n,2n)2a

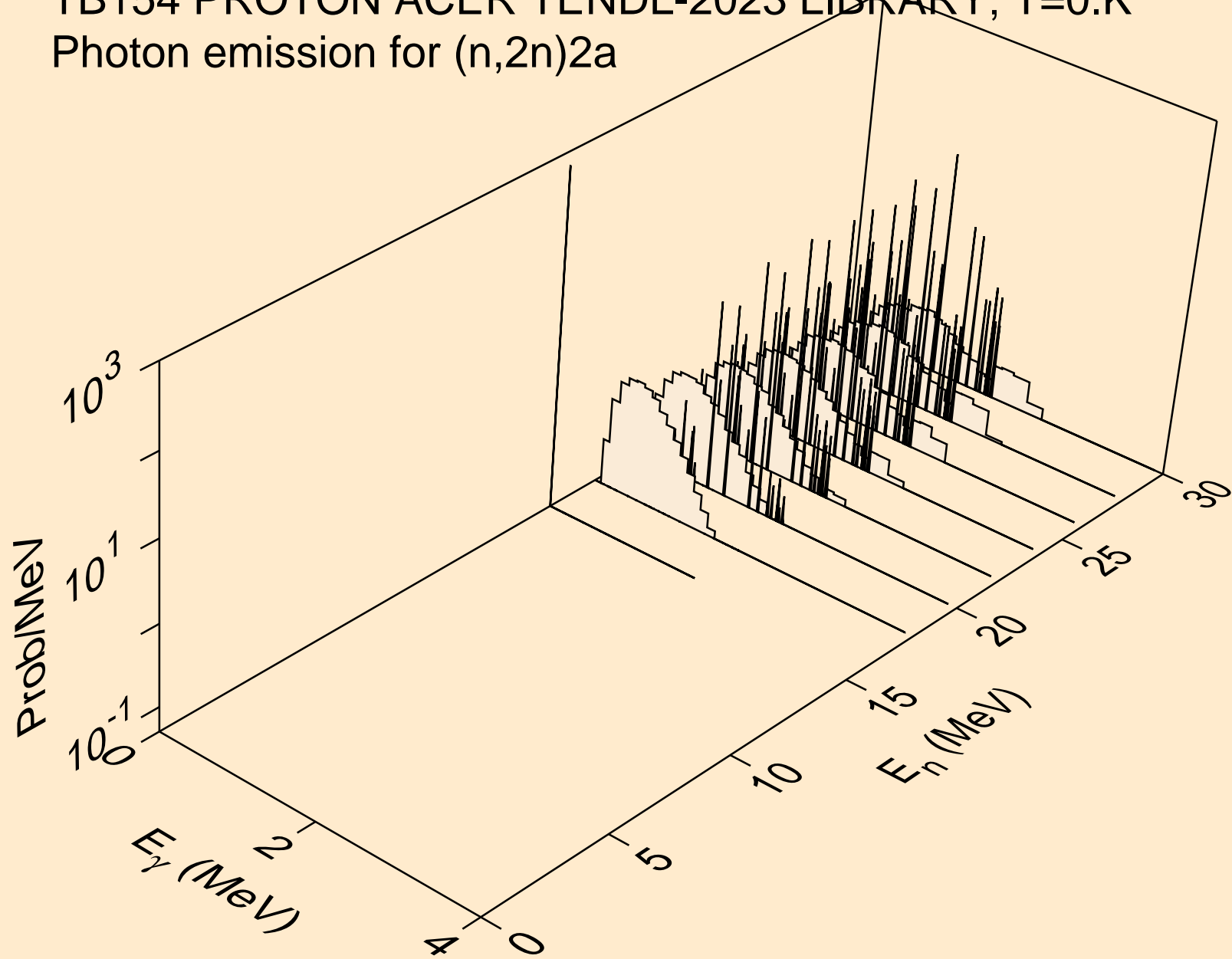

TB154 PROTON ACER TENDL-2023 LIBRARY; T=0.K  
Photon emission for (n,n\*)d

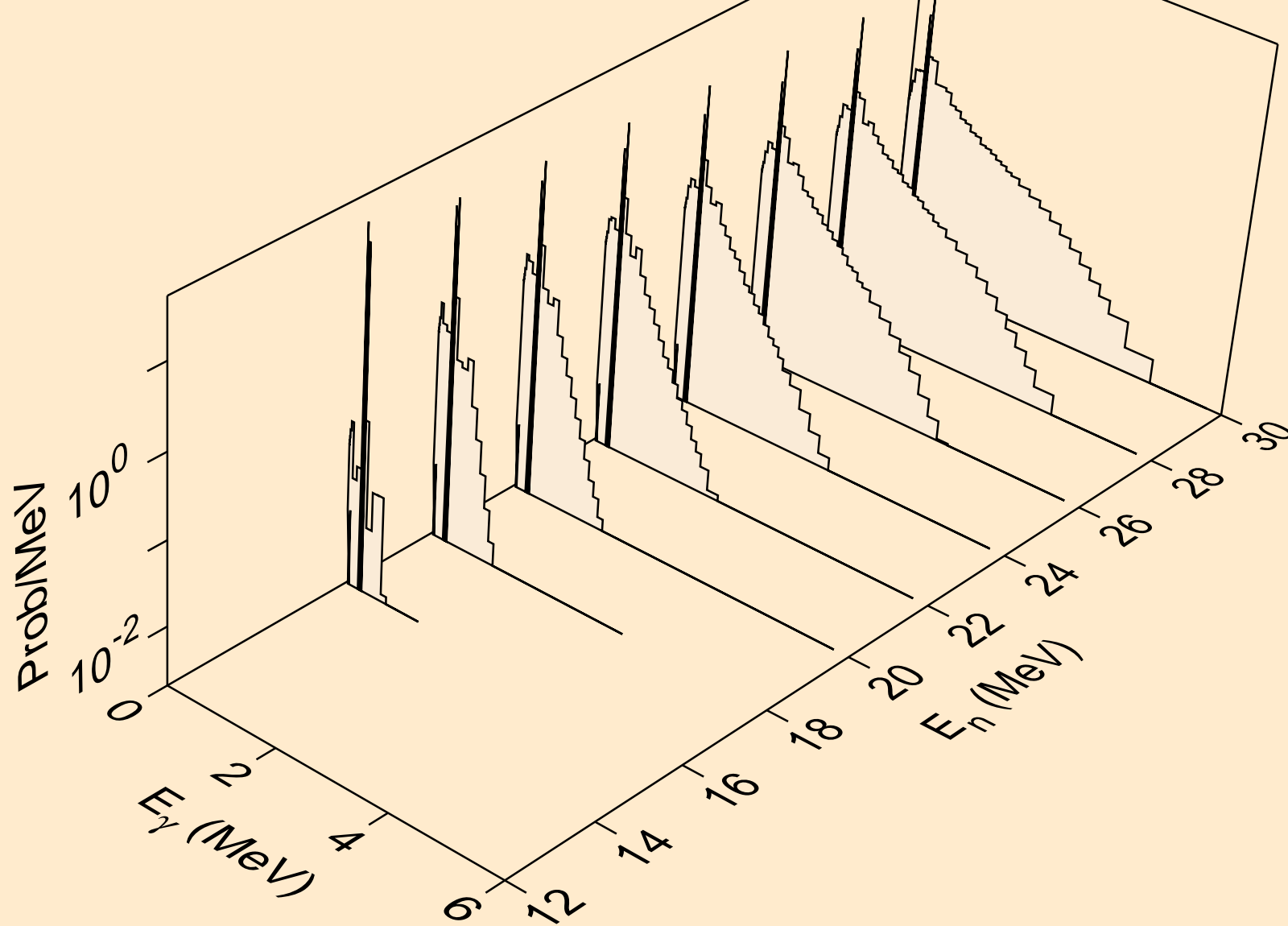

TB154 PROTON ACER TENDL-2023 LIBRARY; T=0.K  
Photon emission for (n,n\*)t

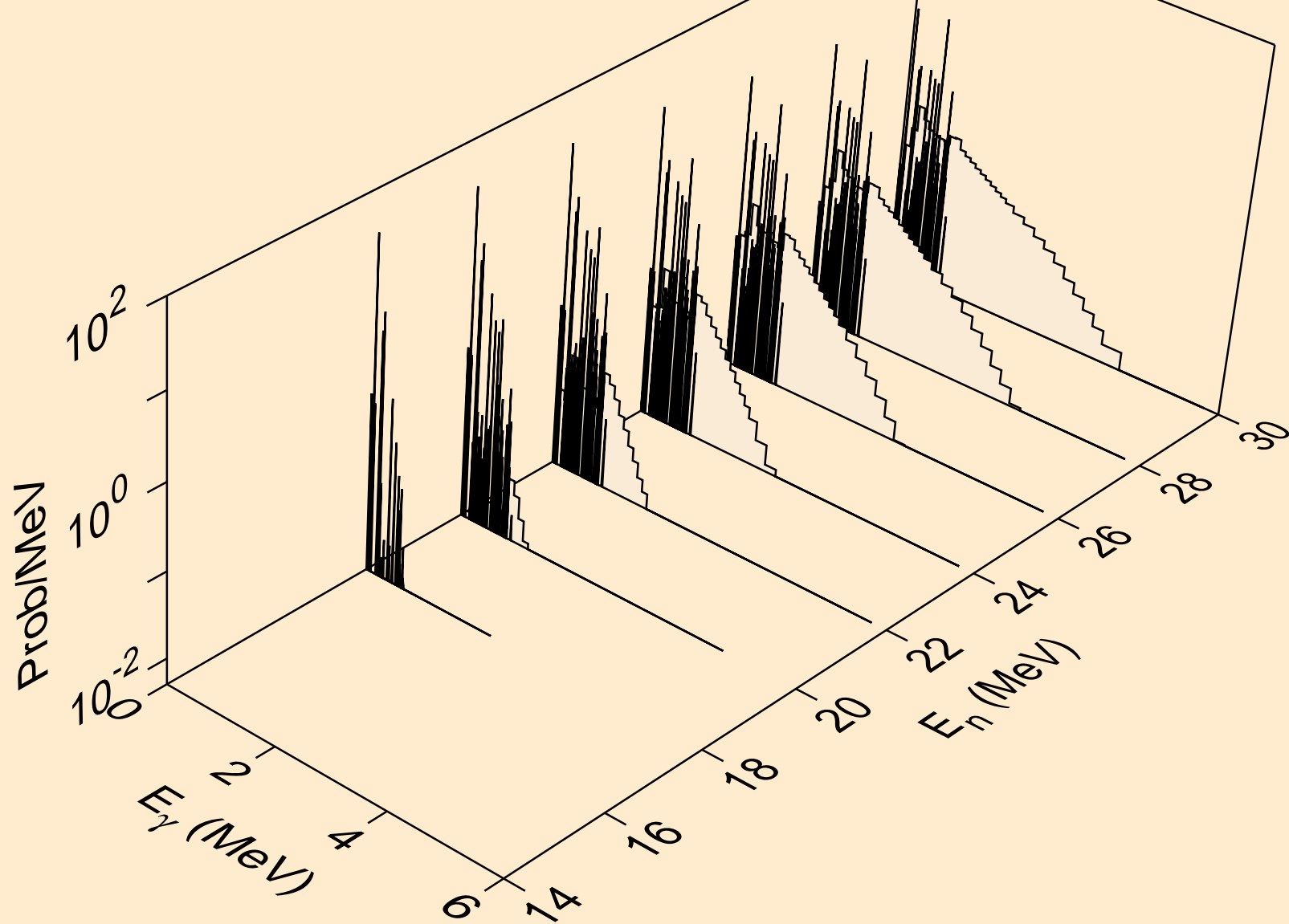

TB154 PROTON ACER TENDL-2023 LIBRARY; T=0.K  
Photon emission for (n,n\*)he3

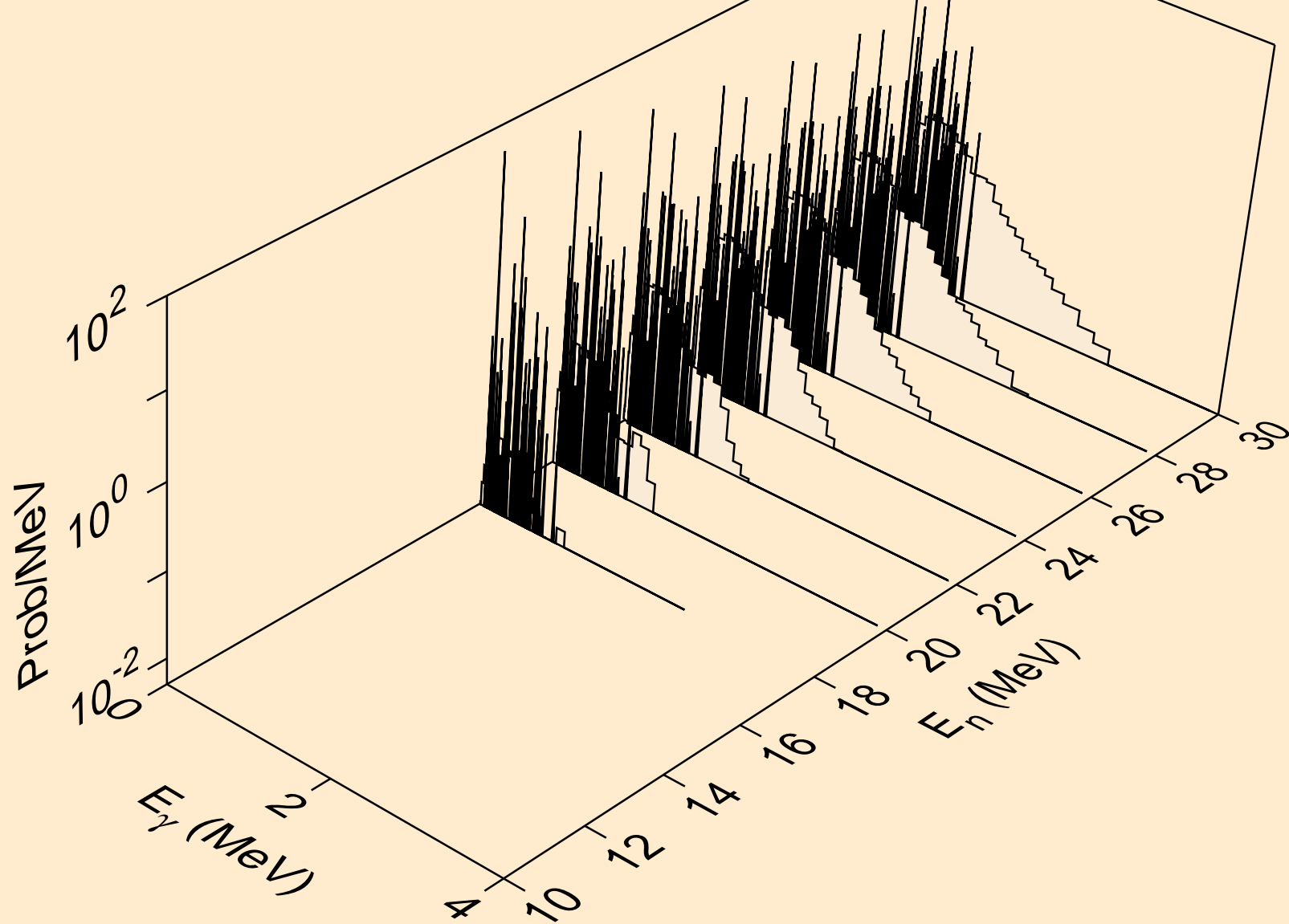

TB154 PROTON ACER TENDL-2023 LIBRARY; T=0.K  
Photon emission for (n,4n)

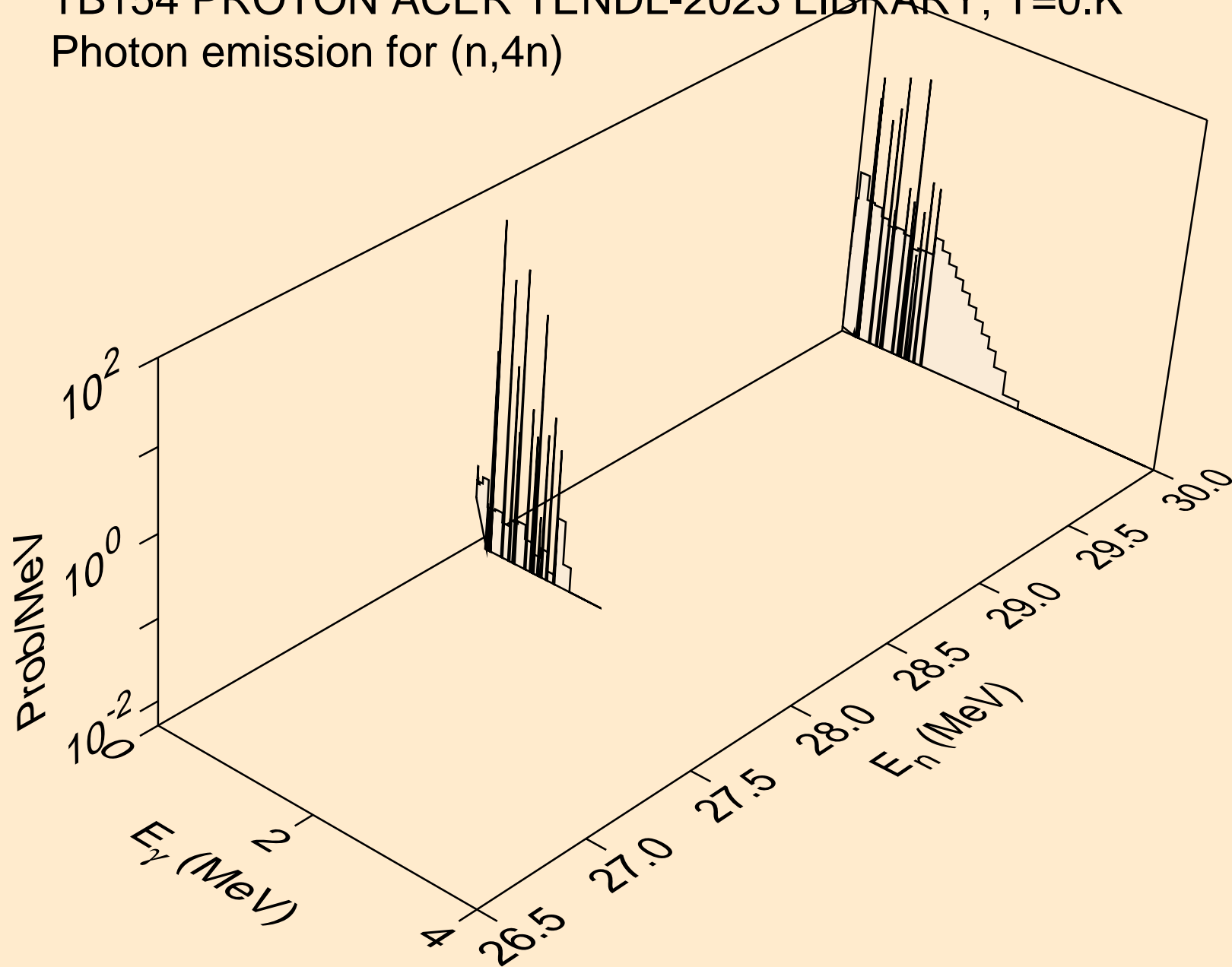

TB154 PROTON ACER TENDL-2023 LIBRARY; T=0.K  
Photon emission for (n,2np)

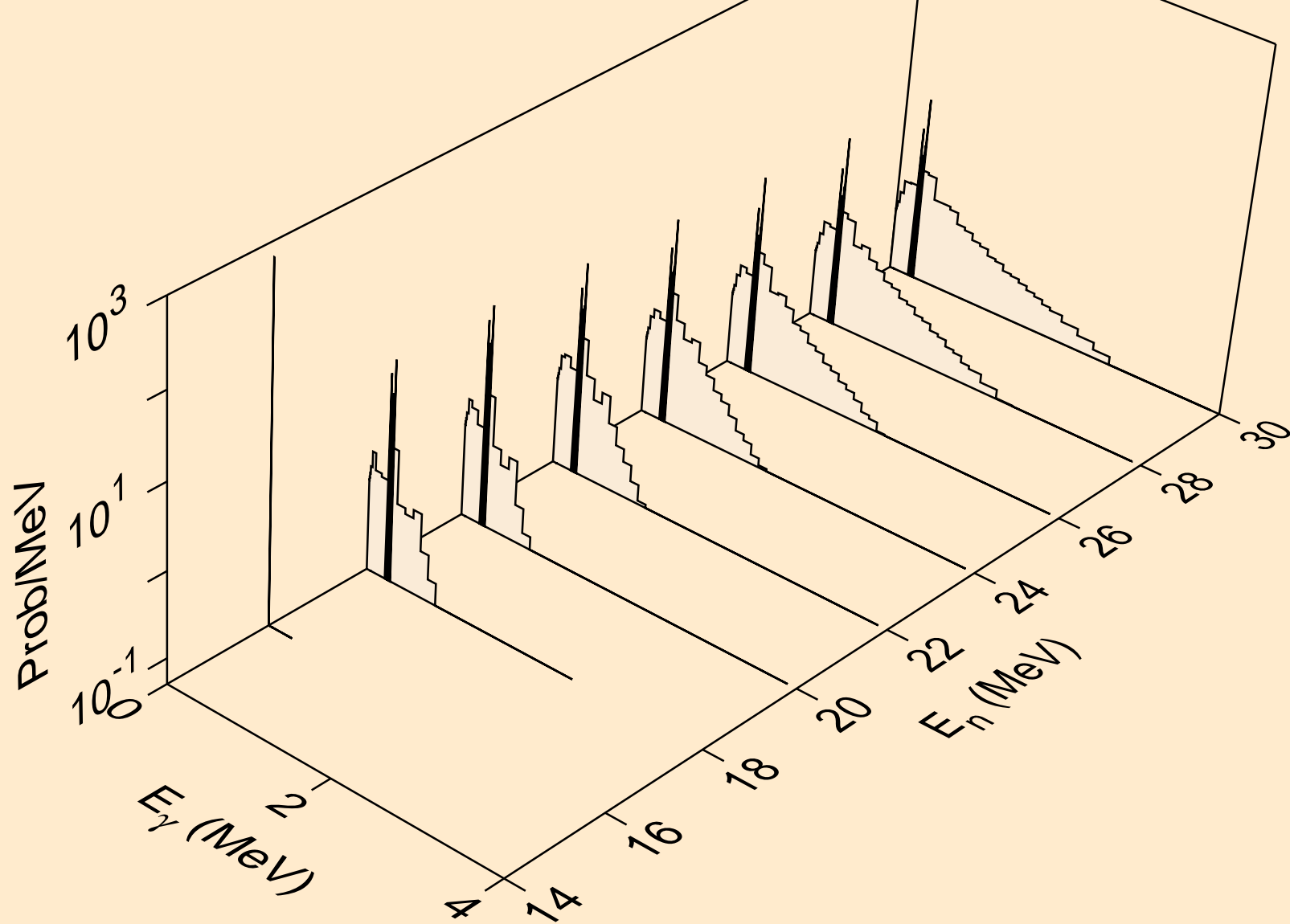

TB154 PROTON ACER TENDL-2023 LIBRARY; T=0.K  
Photon emission for (n,3np)

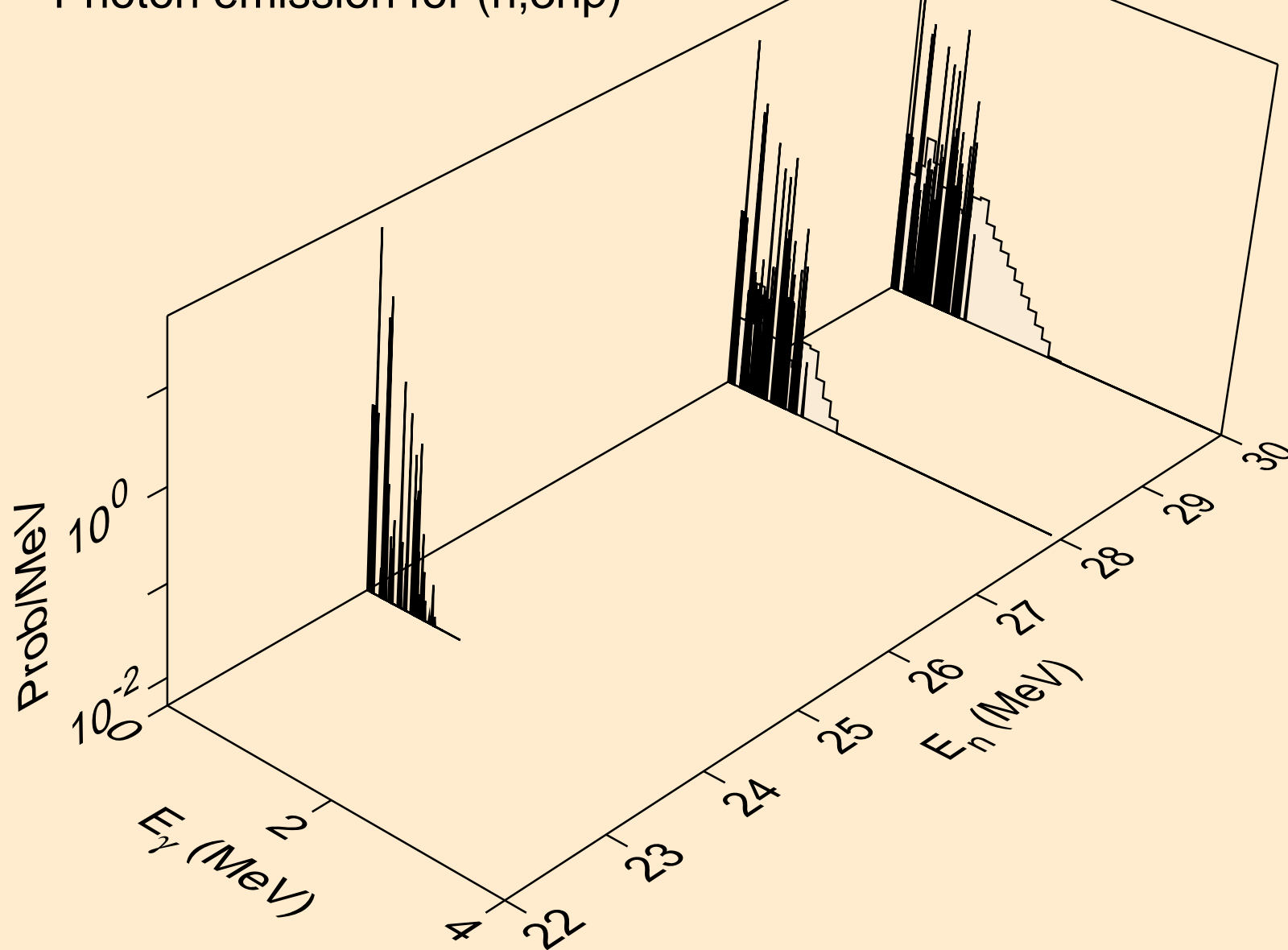

TB154 PROTON ACER TENDL-2023 LIBRARY; T=0.K  
Photon emission for (n,n2p)

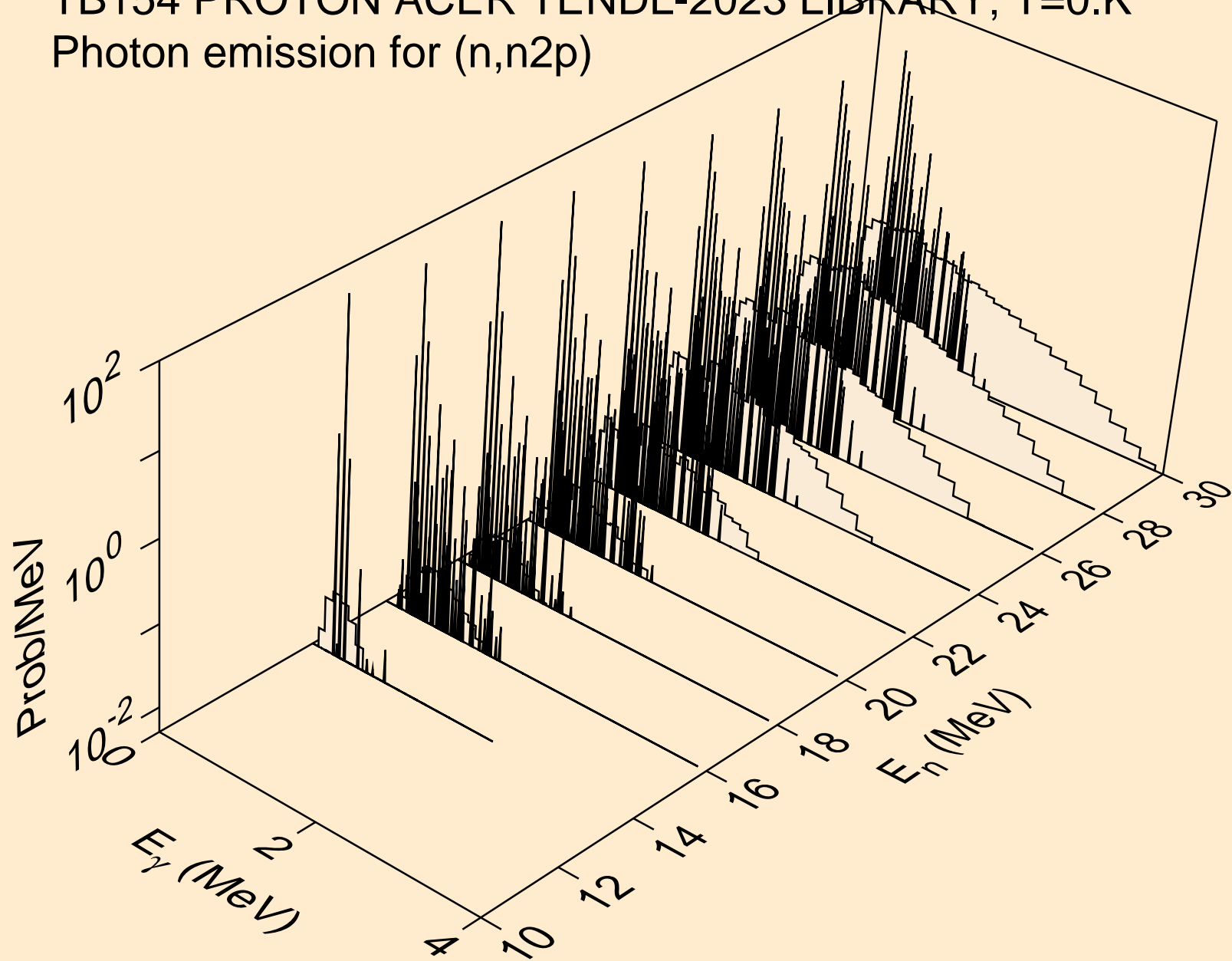

TB154 PROTON ACER TENDL-2023 LIBRARY; T=0.K  
Photon emission for (n,npa)

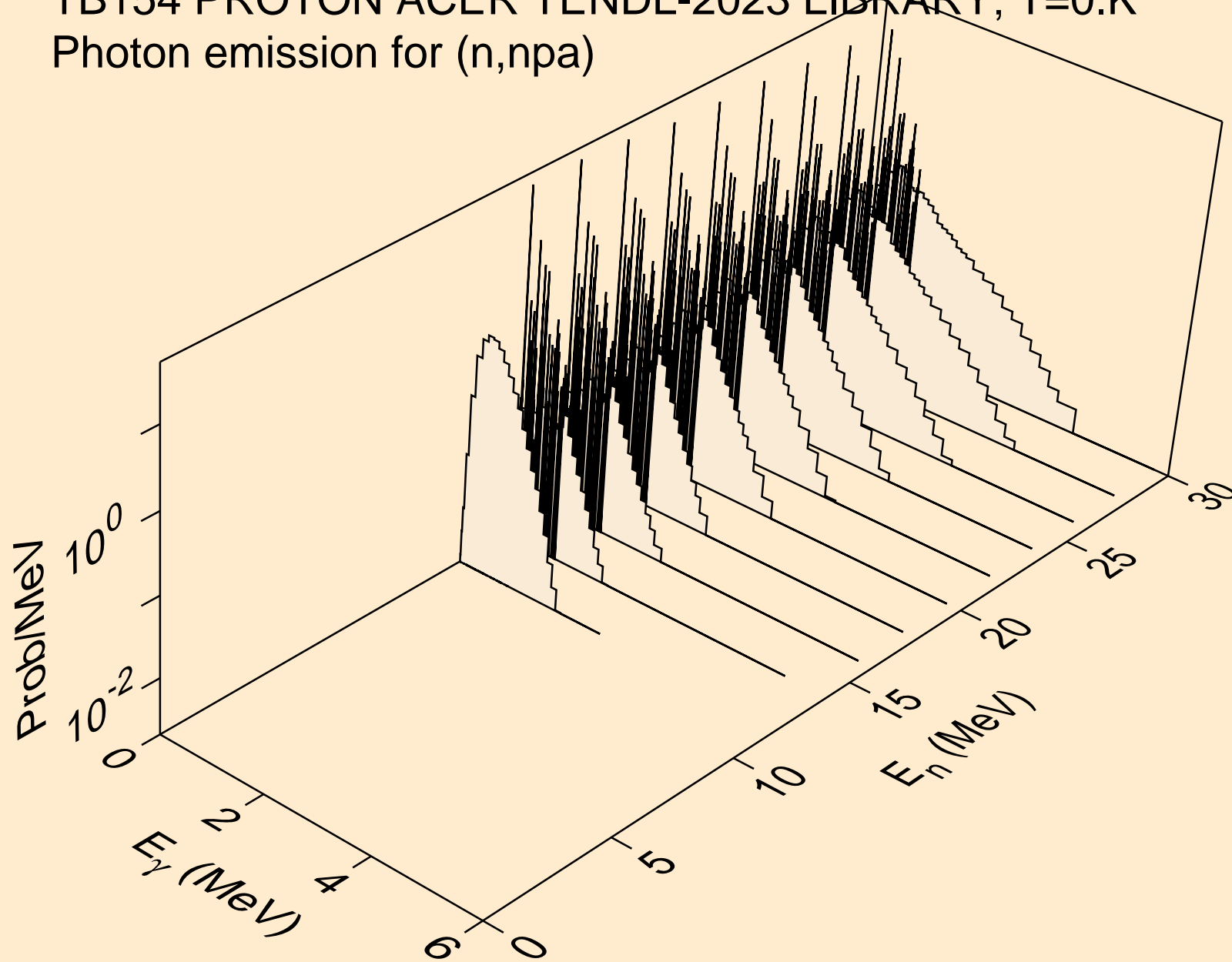

TB154 PROTON ACER TENDL-2023 LIBRARY; T=0.K  
Photon emission for (n,gma)

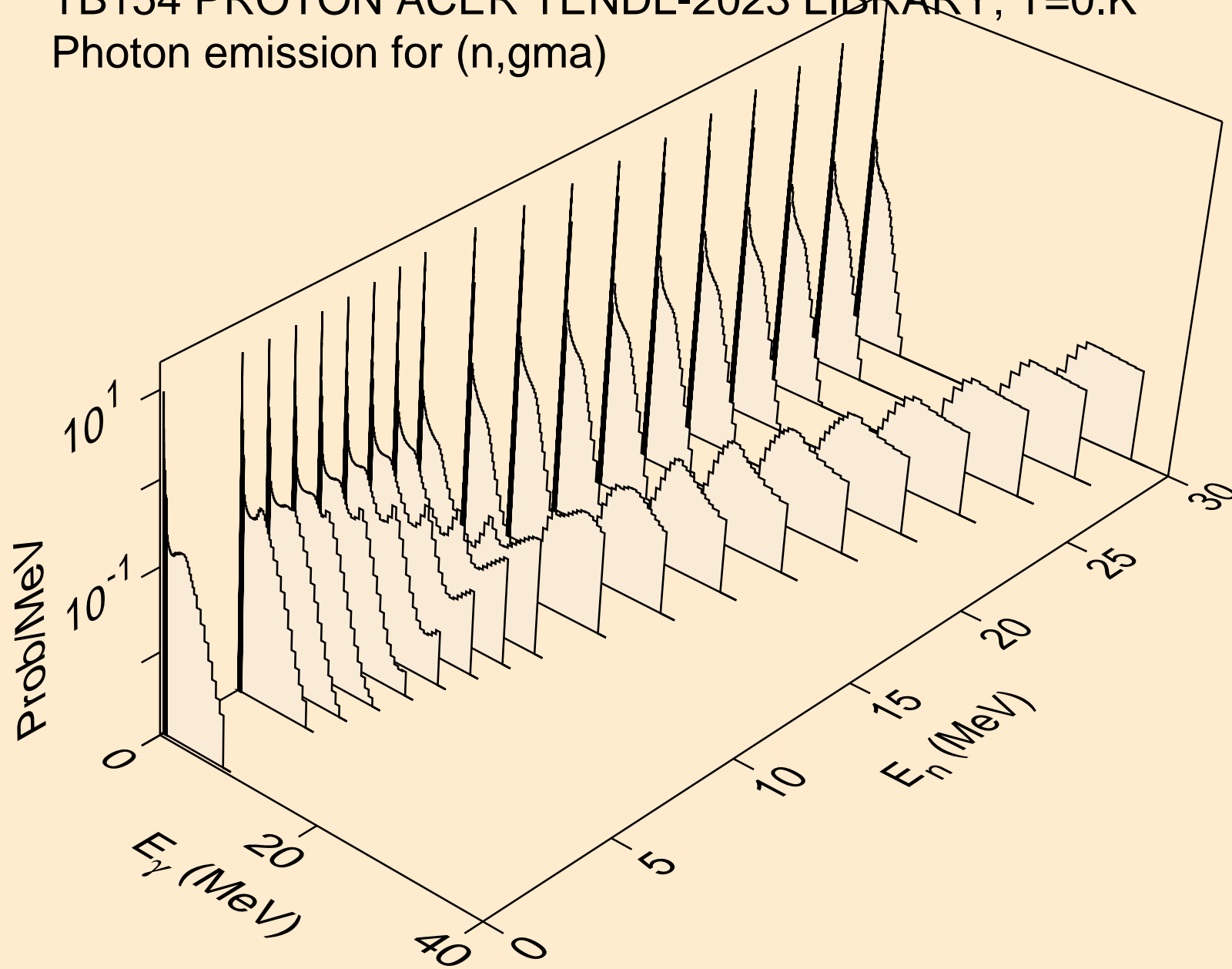

TB154 PROTON ACER TENDL-2023 LIBRARY; T=0.K  
Photon emission for inelastic

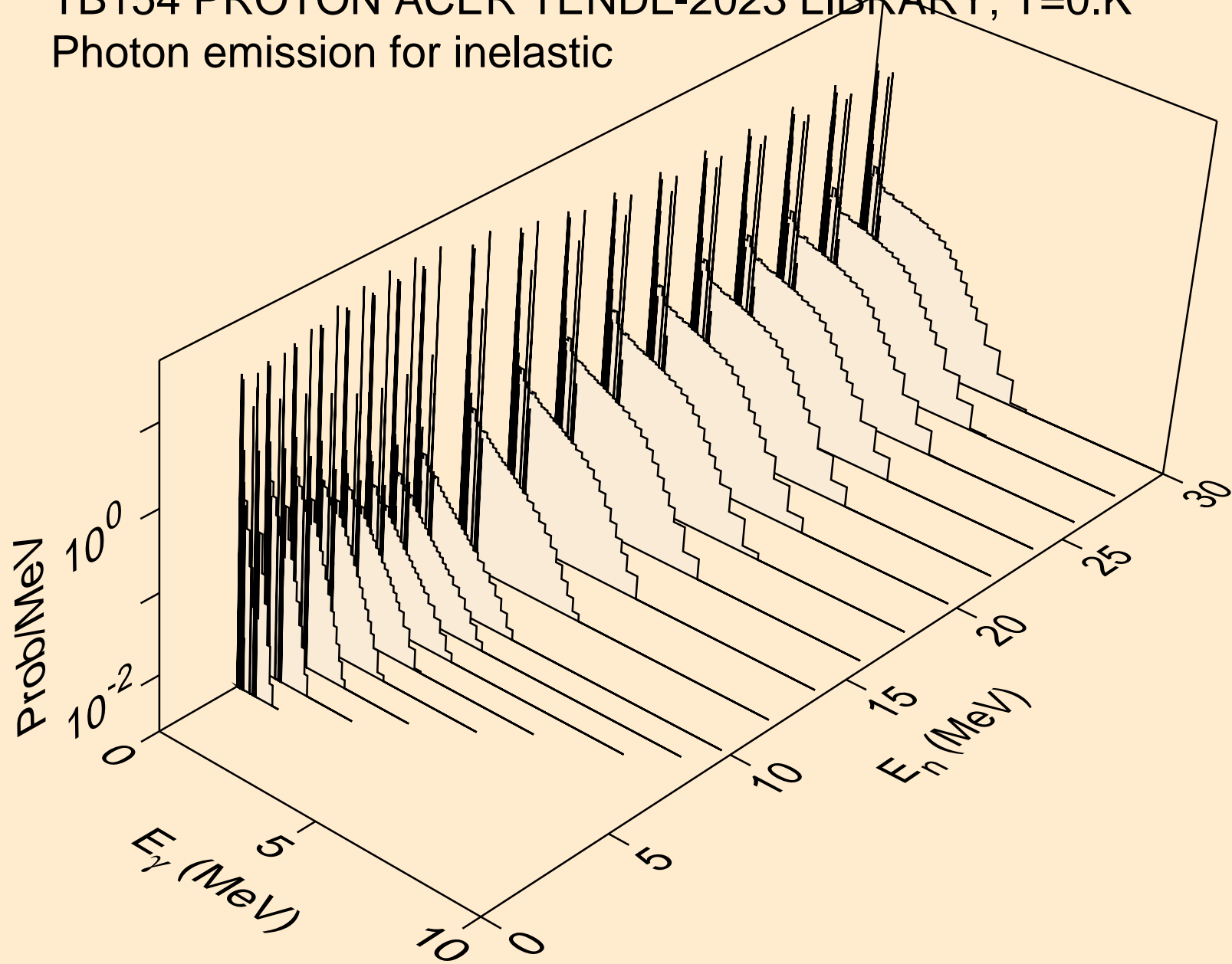

TB154 PROTON ACER TENDL-2023 LIBRARY; T=0.K  
Photon emission for (n,d)

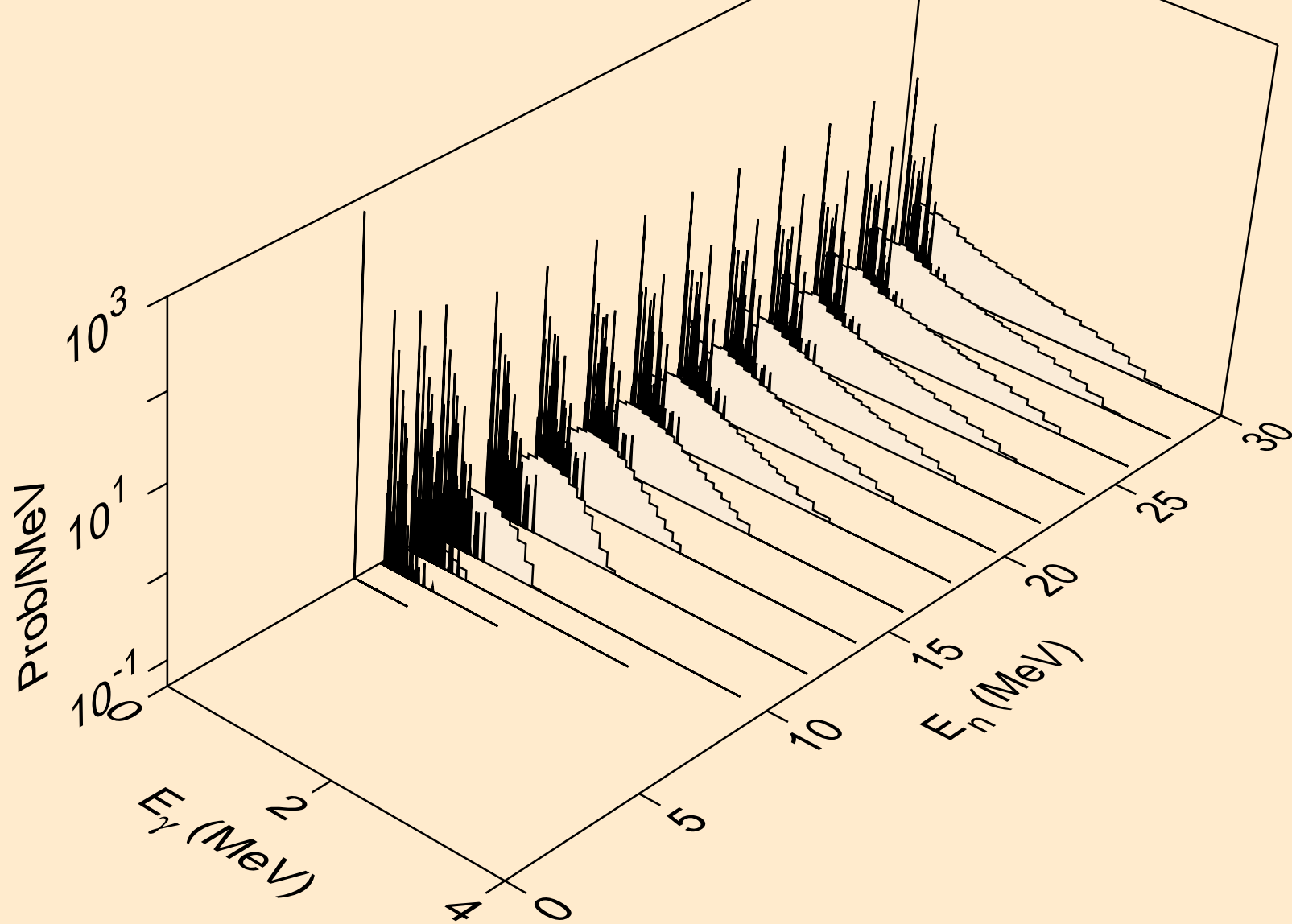

TB154 PROTON ACER TENDL-2023 LIBRARY; T=0.K  
Photon emission for (n,t)

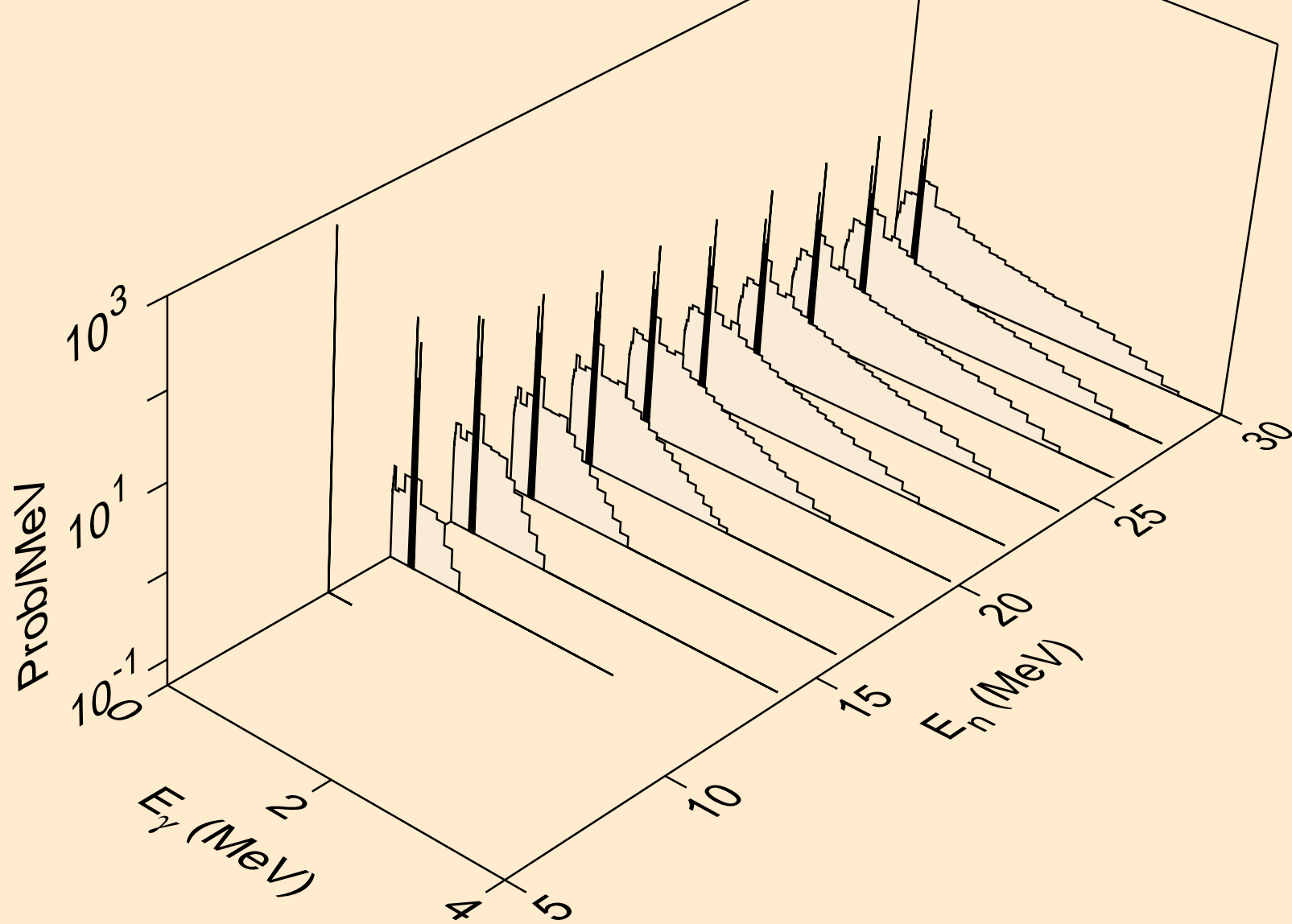

TB154 PROTON ACER TENDL-2023 LIBRARY; T=0.K  
Photon emission for (n,he3)

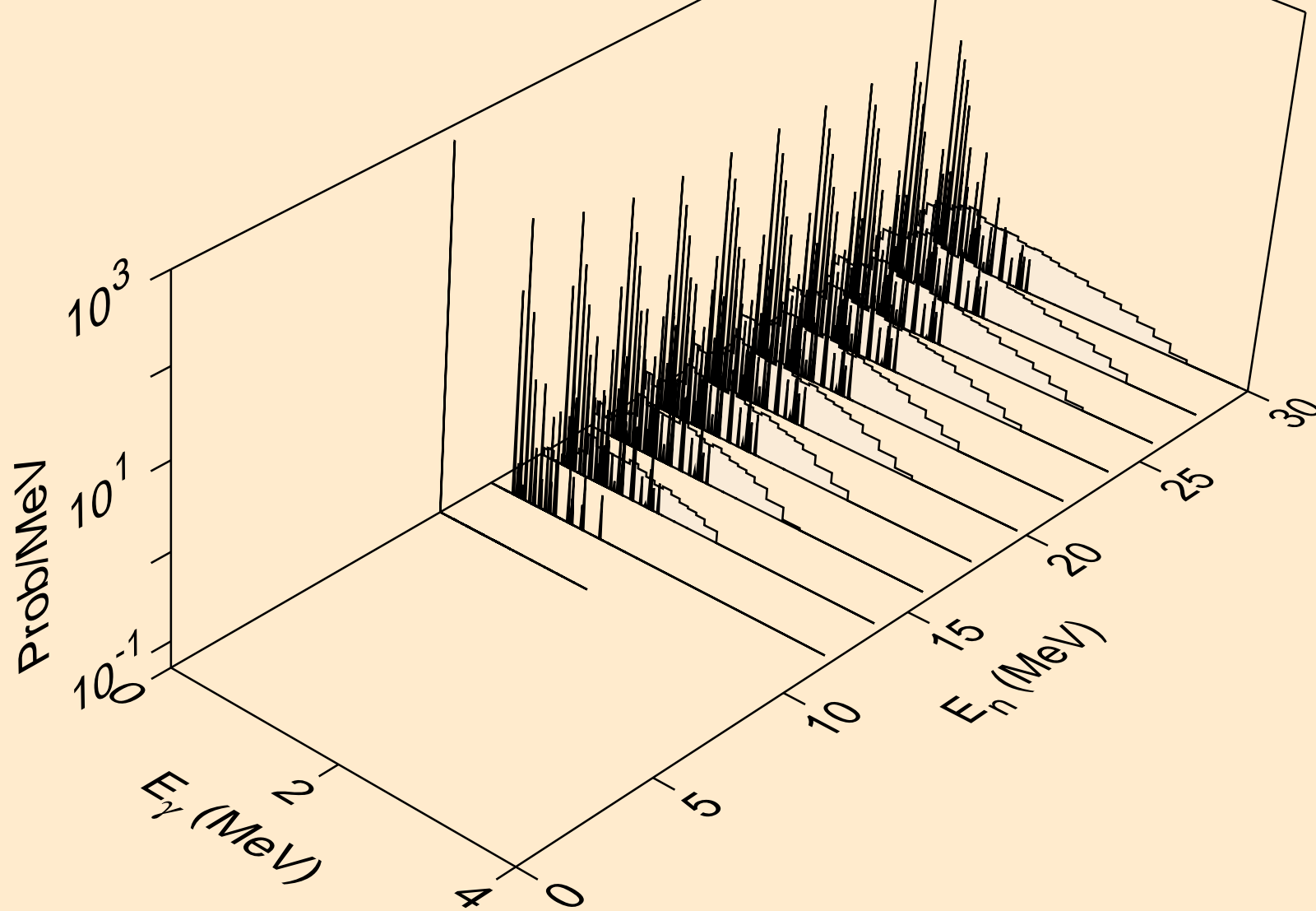

TB154 PROTON ACER TENDL-2023 LIBRARY; T=0.K  
Photon emission for (n,a)

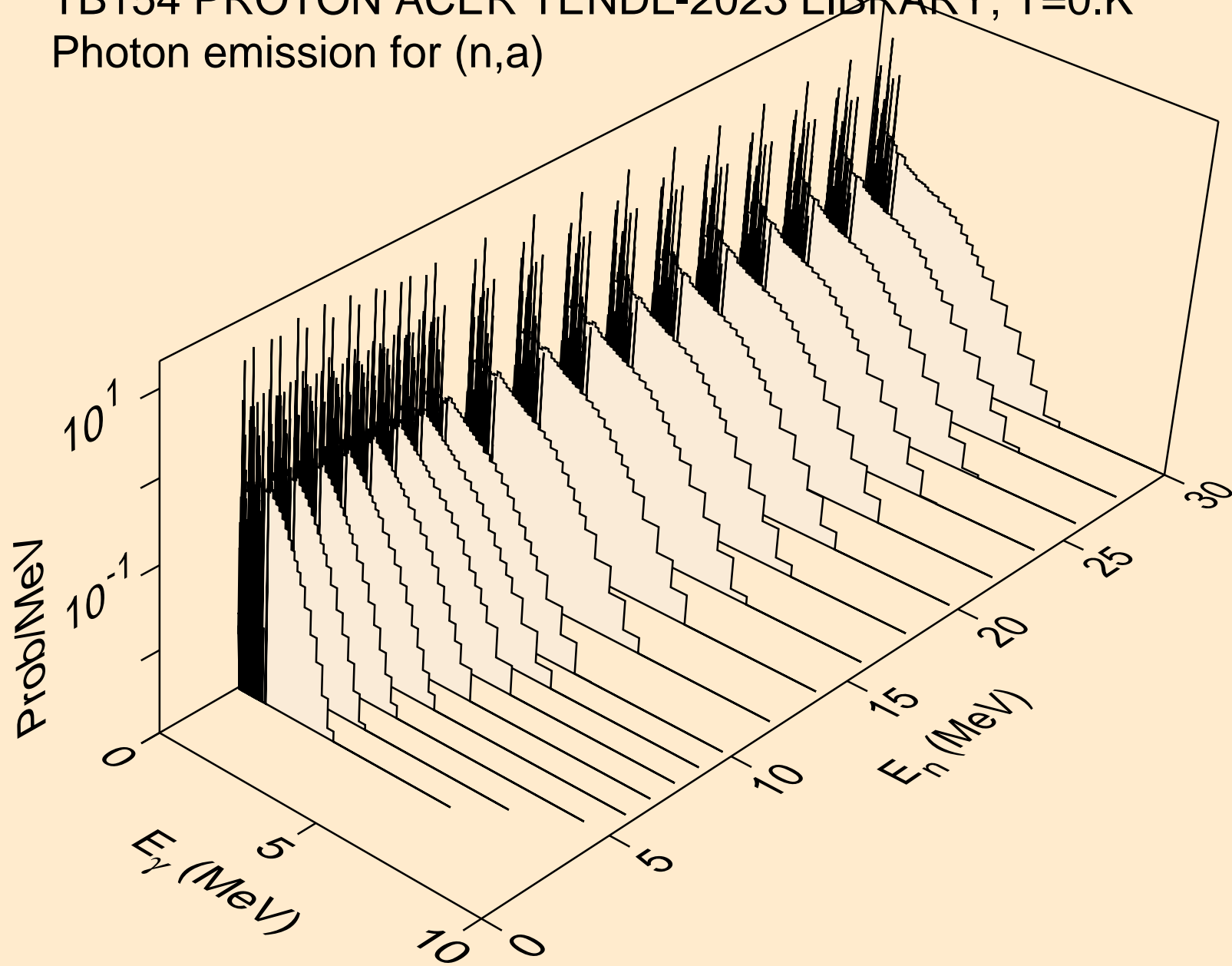

TB154 PROTON ACER TENDL-2023 LIBRARY; T=0.K  
Photon emission for (n,2a)

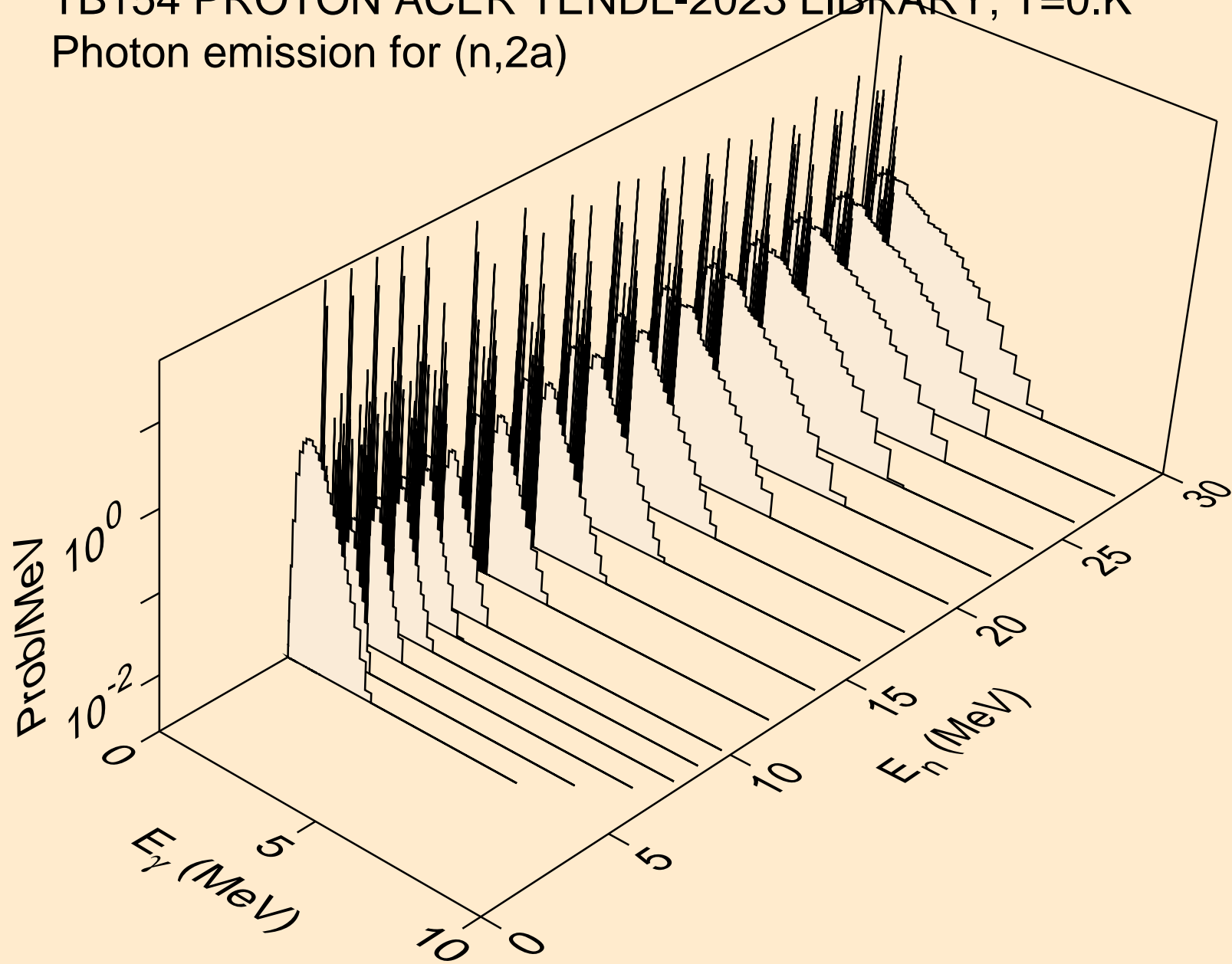

TB154 PROTON ACER TENDL-2023 LIBRARY; T=0.K  
Photon emission for (n,2p)

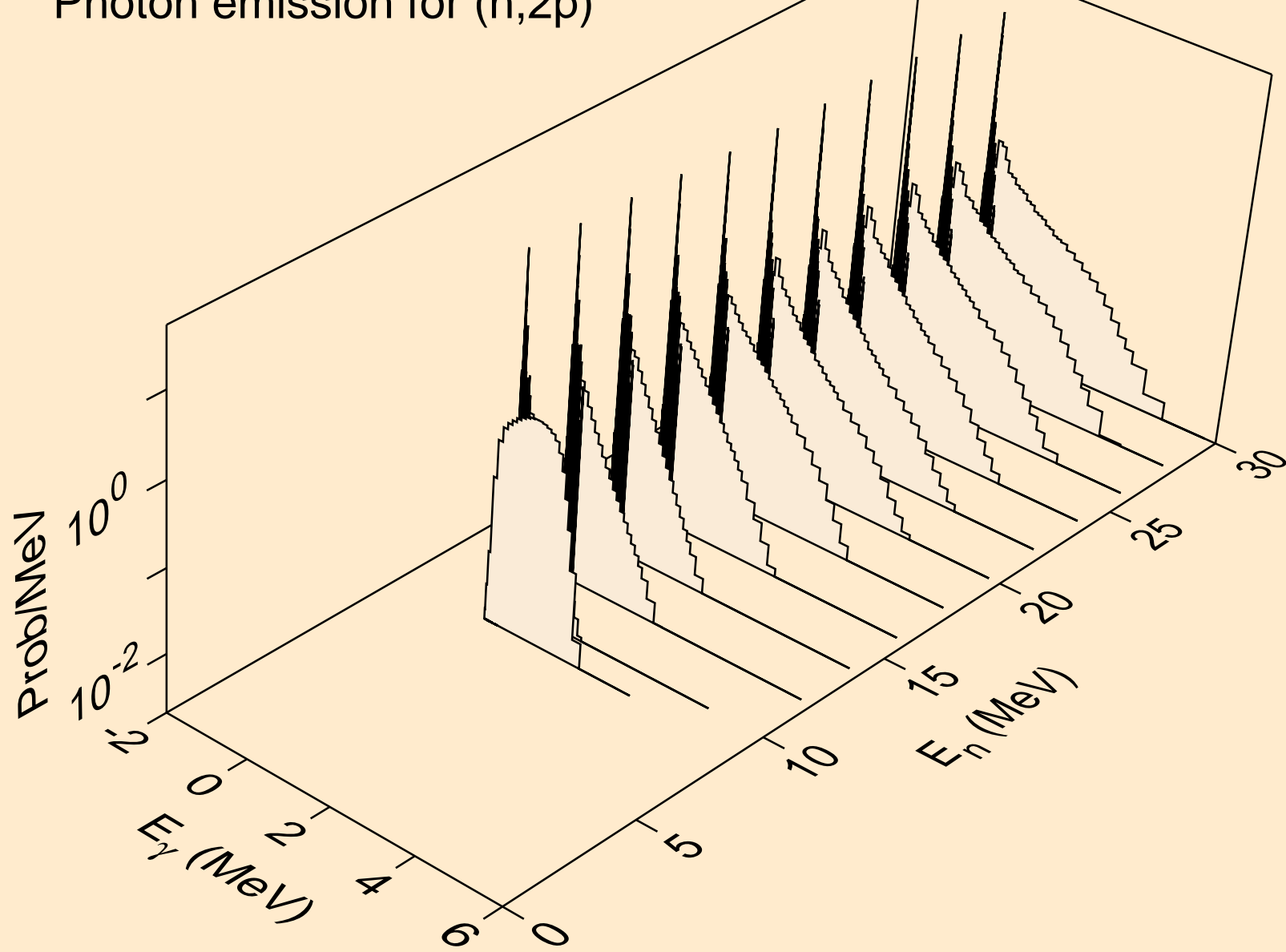

TB154 PROTON ACER TENDL-2023 LIBRARY; T=0.K  
Photon emission for (n,p)

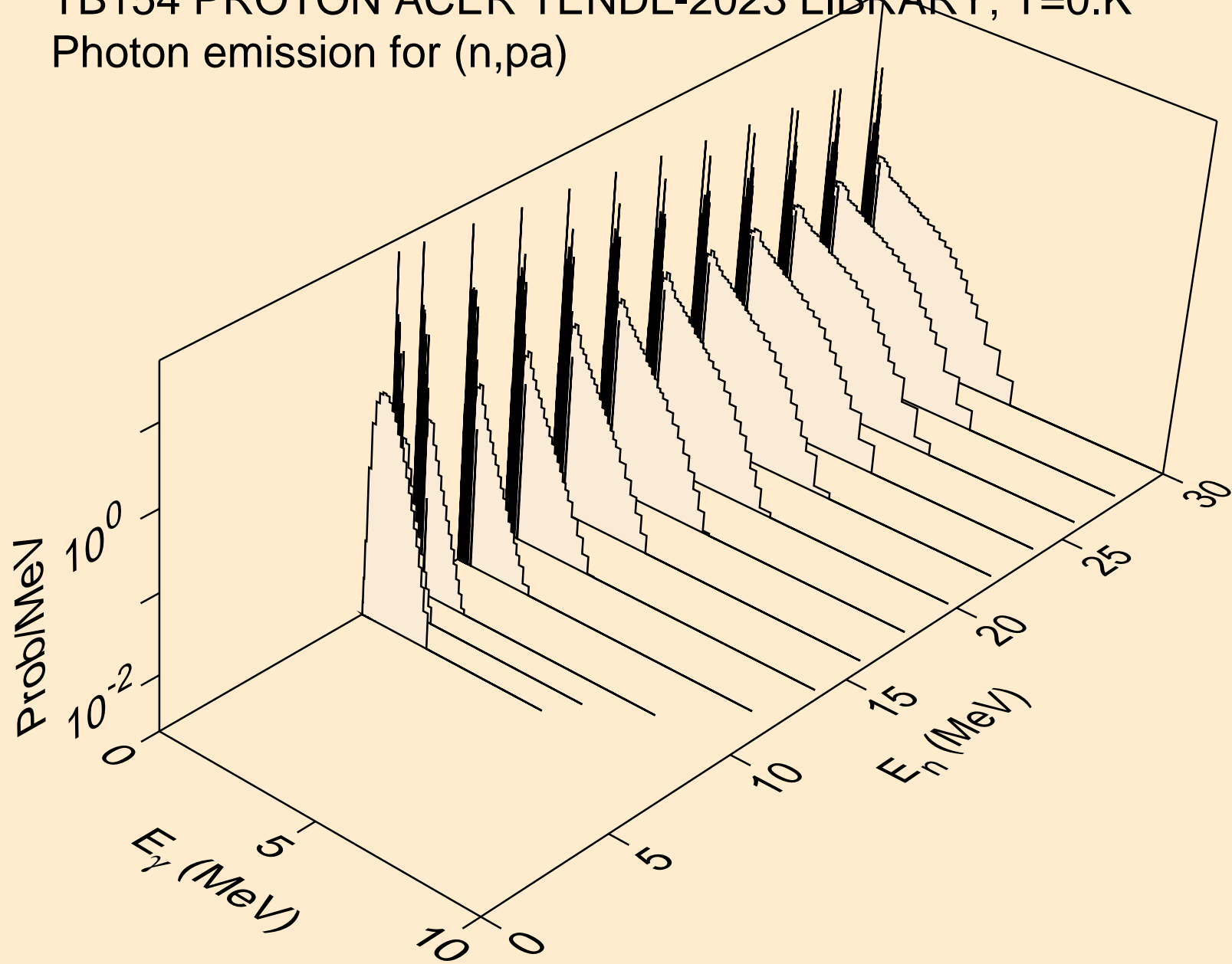

TB154 PROTON ACER TENDL-2023 LIBRARY; T=0.K  
Photon emission for (n,pd)

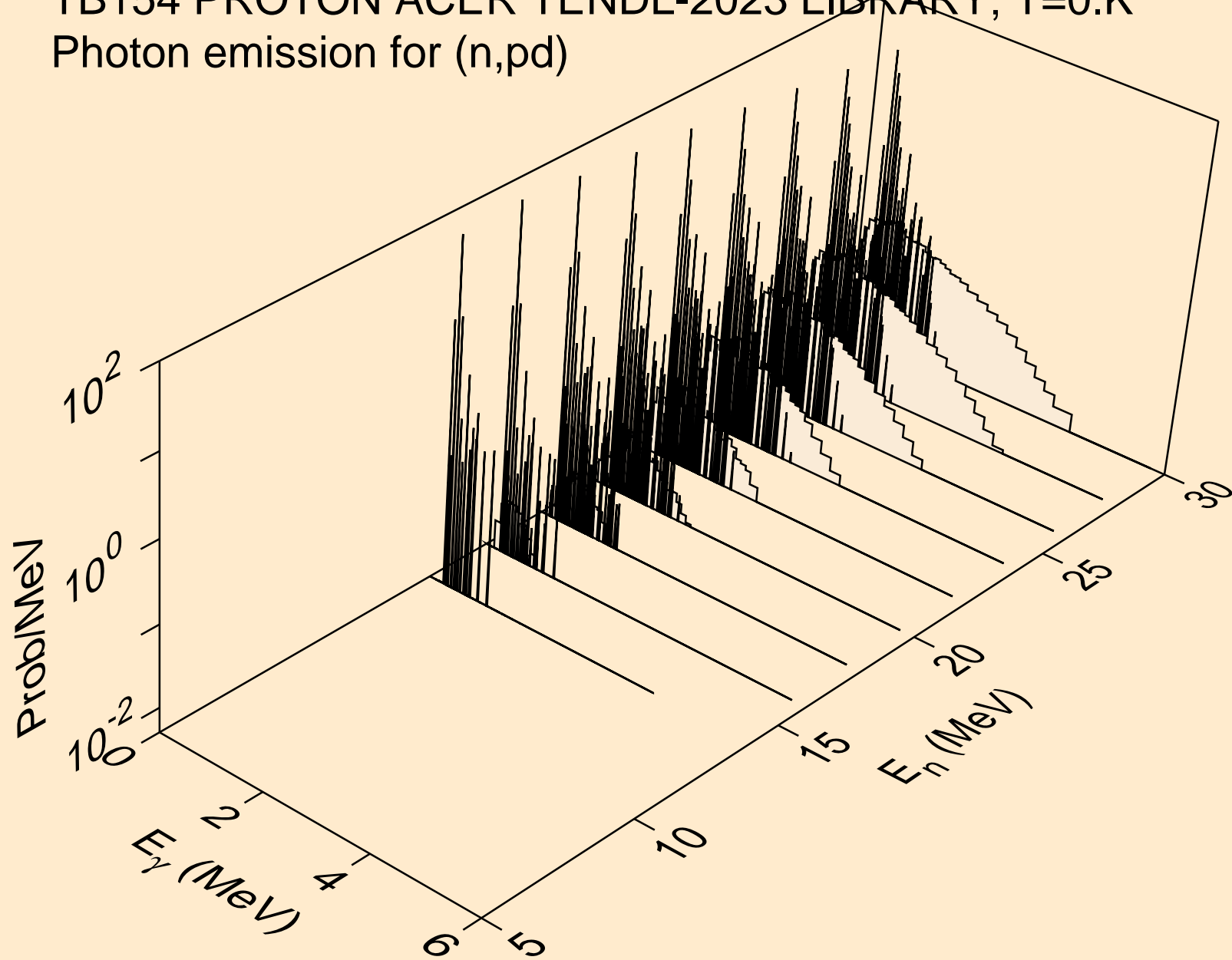

TB154 PROTON ACER TENDL-2023 LIBRARY; T=0.K  
Photon emission for (n,pt)

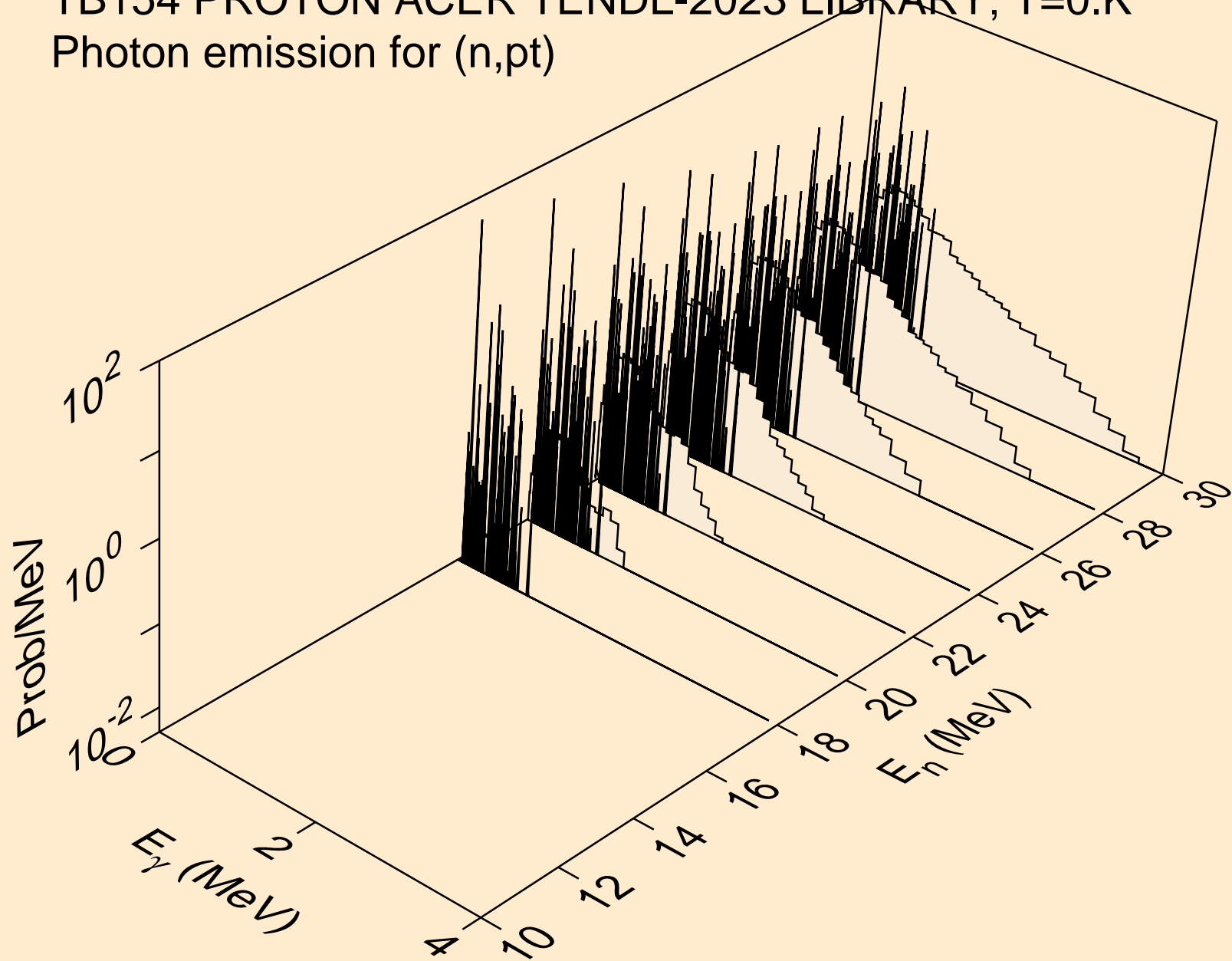

TB154 PROTON ACER TENDL-2023 LIBRARY; T=0.K  
Photon emission for (n,da)

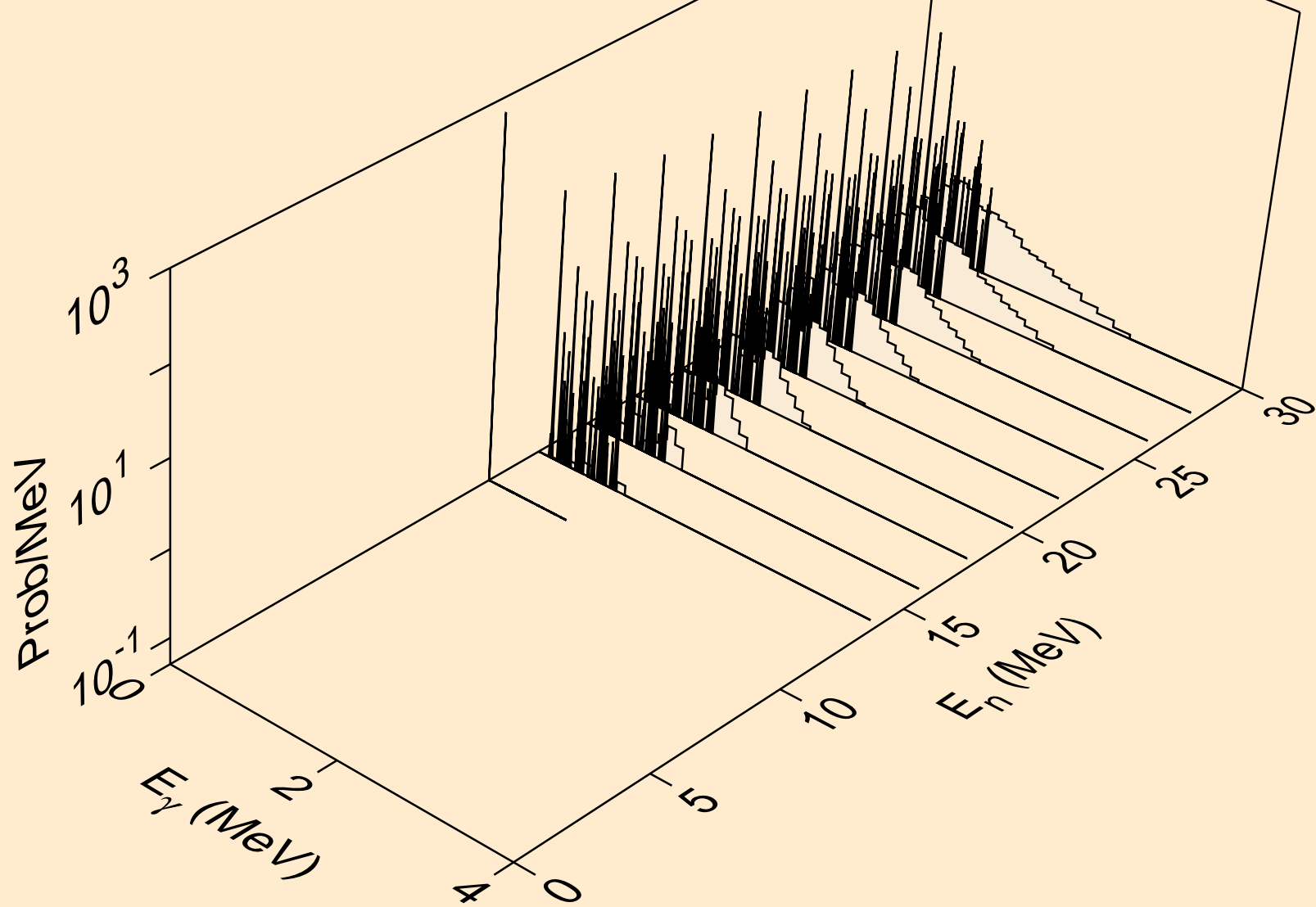

TB154 PROTON ACER TENDL-2023 LIBRARY; T=0.K  
Particle heating contributions

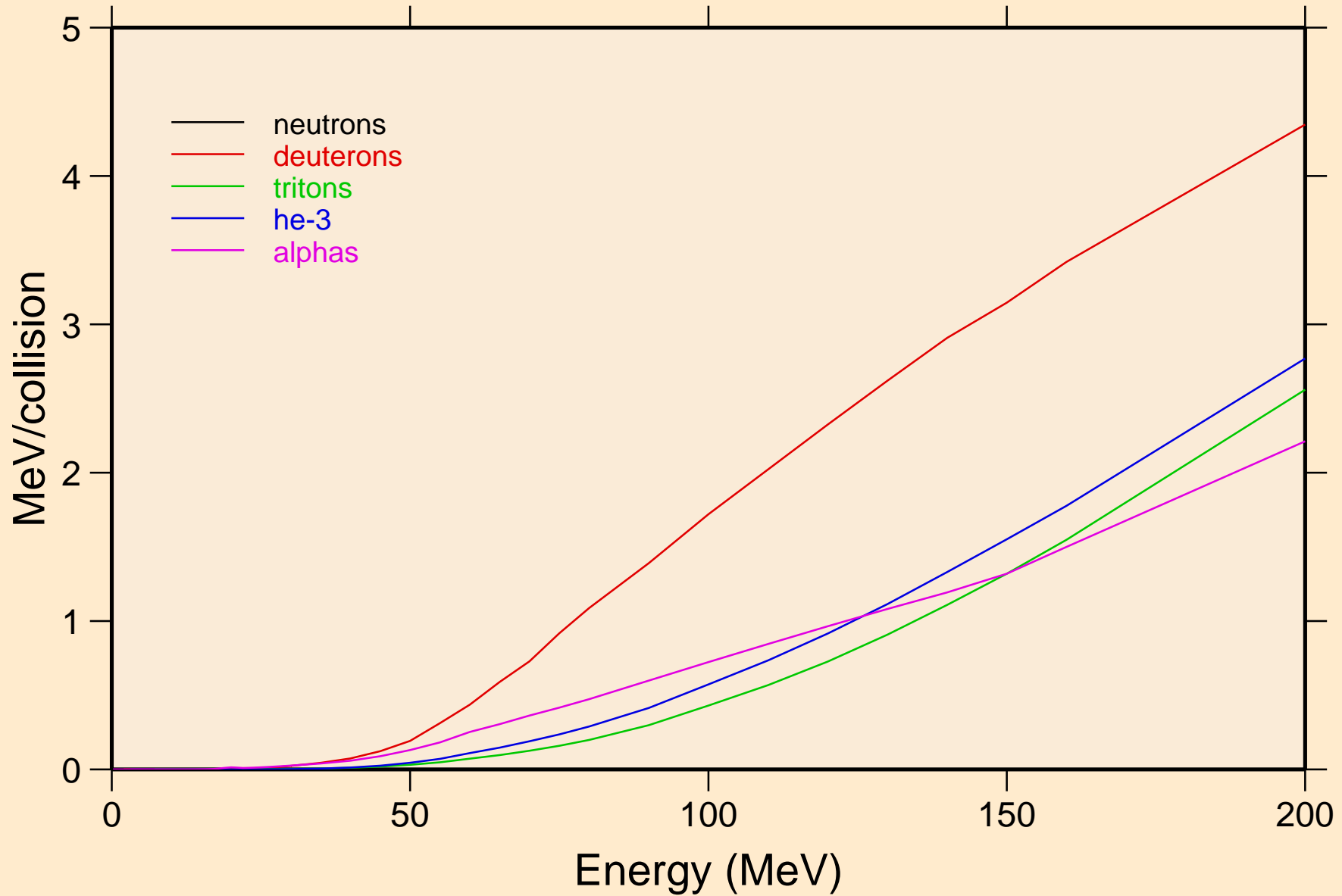

# TB154 PROTON ACER TENDL-2023 LIBRARY; T=0.K

## Recoil Heating

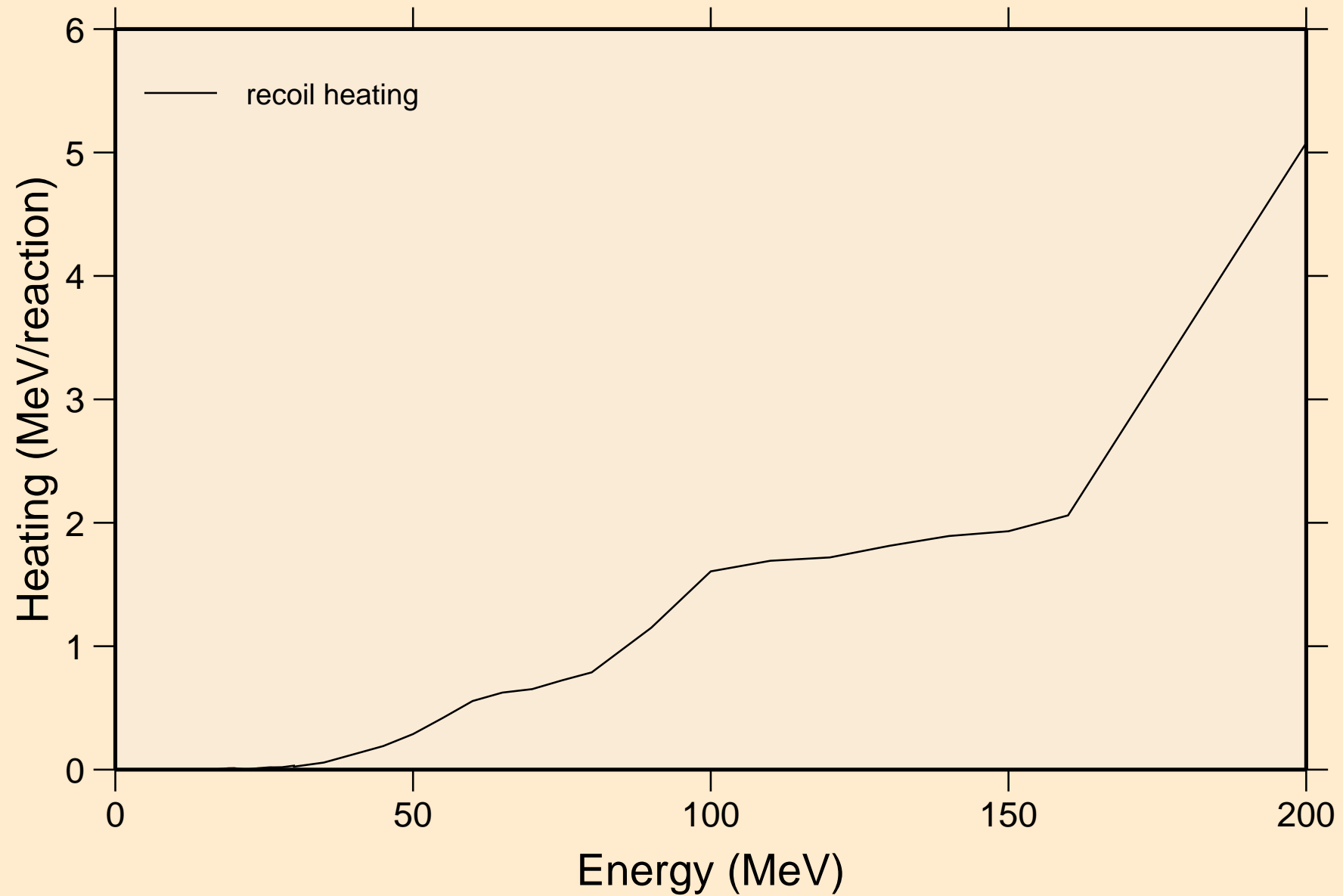

# TB154 PROTON ACER TENDL-2023 LIBRARY; T=0.K

## Particle production cross sections

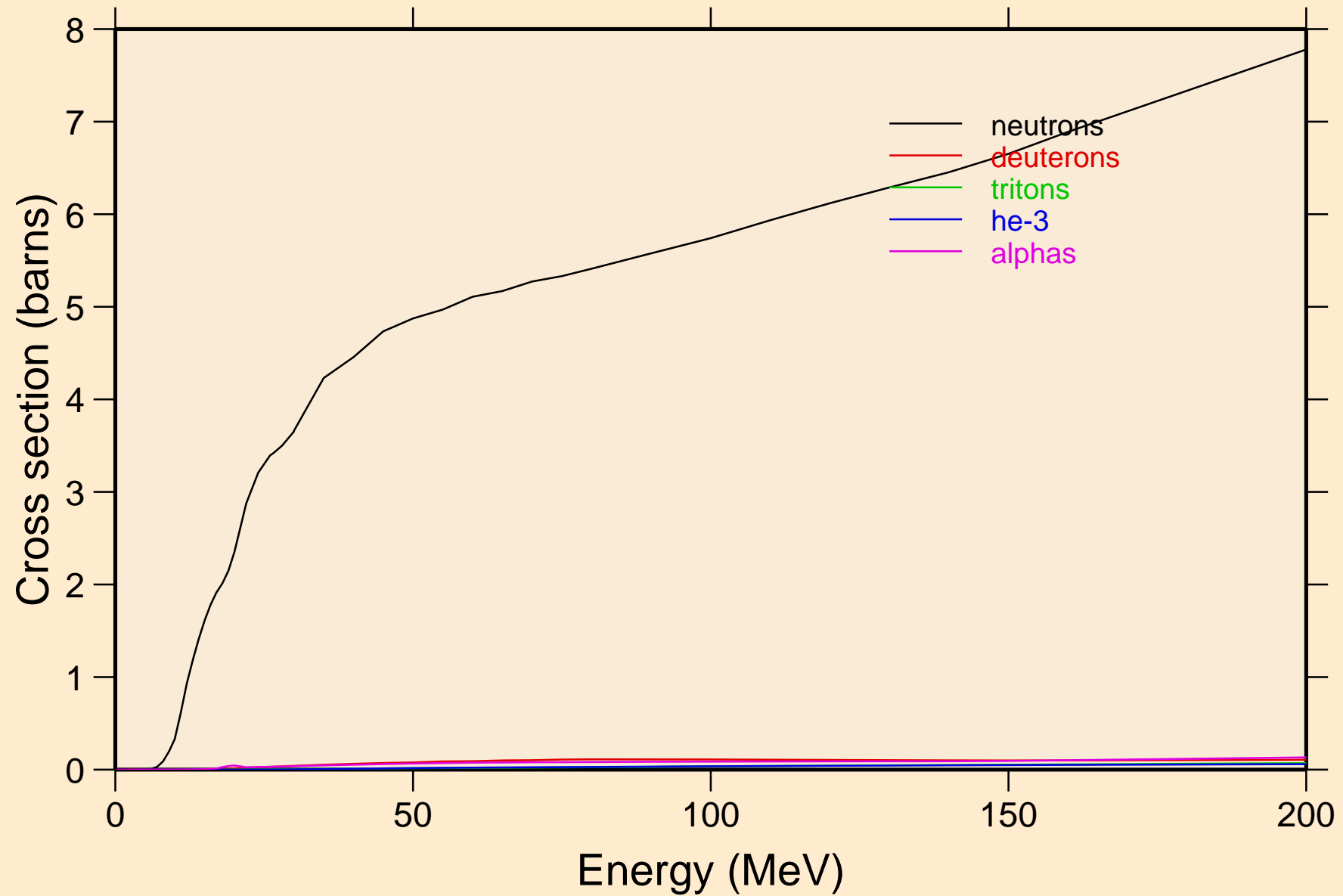

TB154 PROTON ACER TENDL-2023 LIBRARY; T=0.K  
neutrons from (p,n)

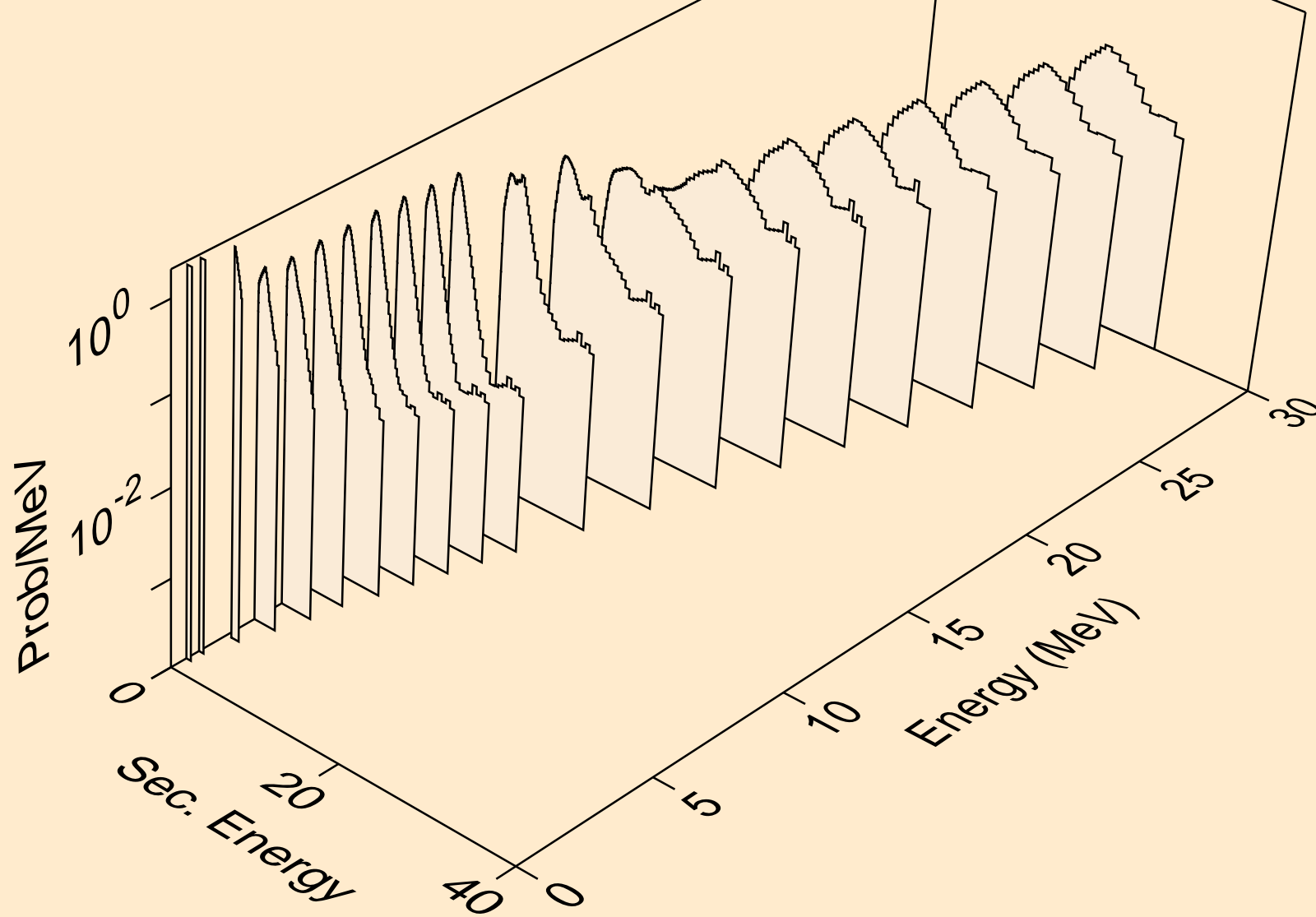

TB154 PROTON ACER TENDL-2023 LIBRARY; T=0.K  
neutrons from (p,x)

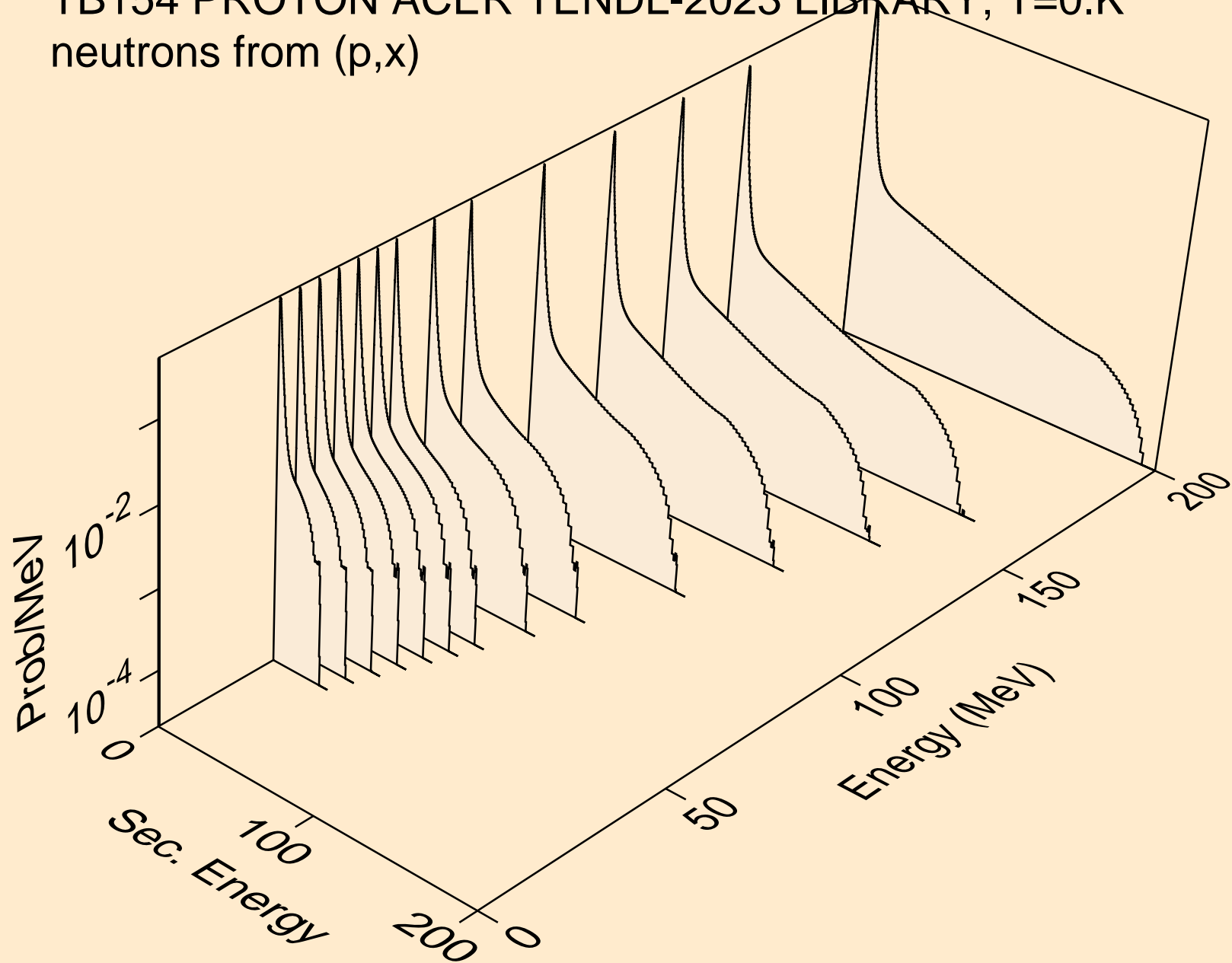

TB154 PROTON ACER TENDL-2023 LIBRARY; T=0.K  
neutrons from (p,2nd)

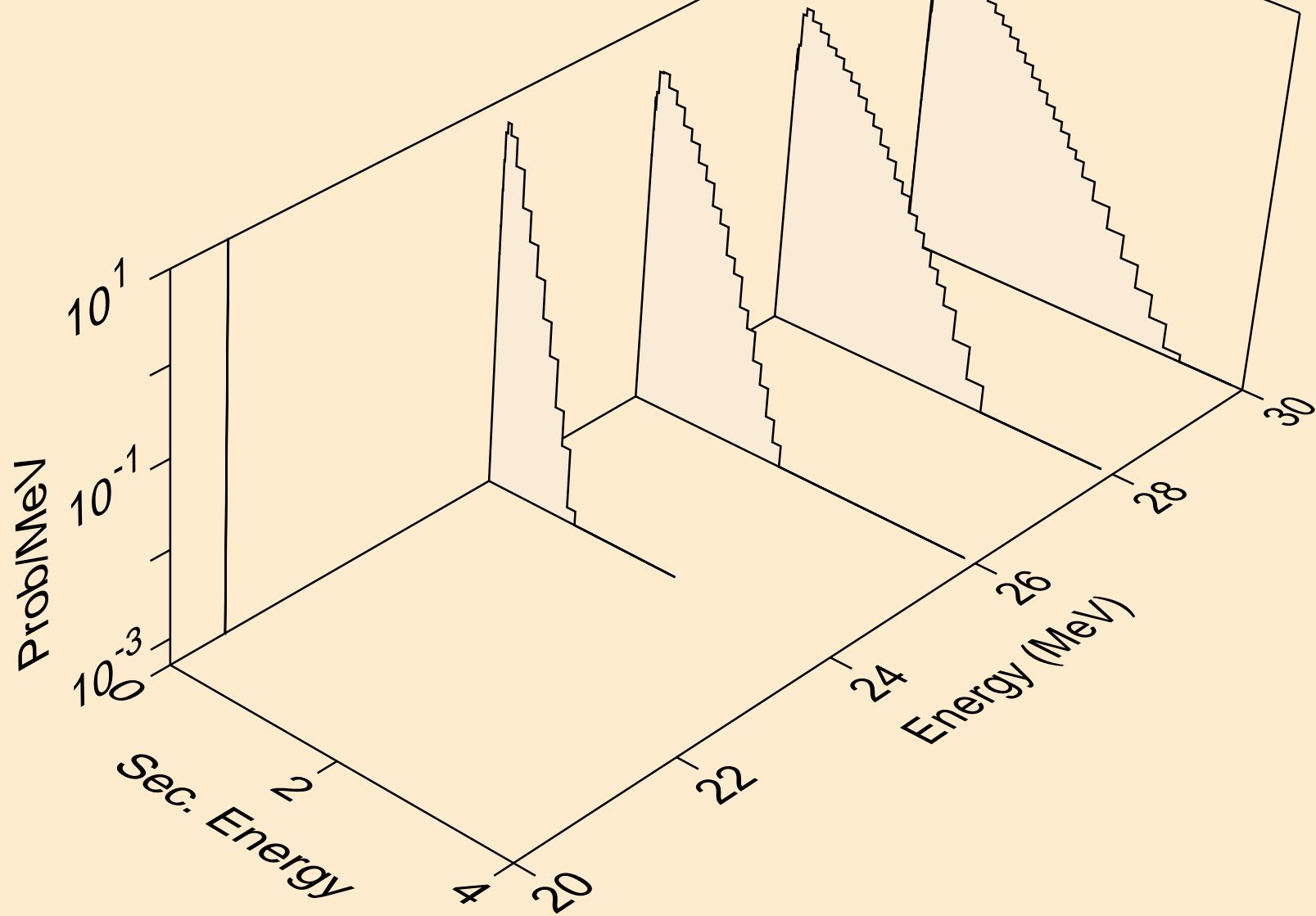

TB154 PROTON ACER TENDL-2023 LIBRARY; T=0.K  
neutrons from (p,2n)

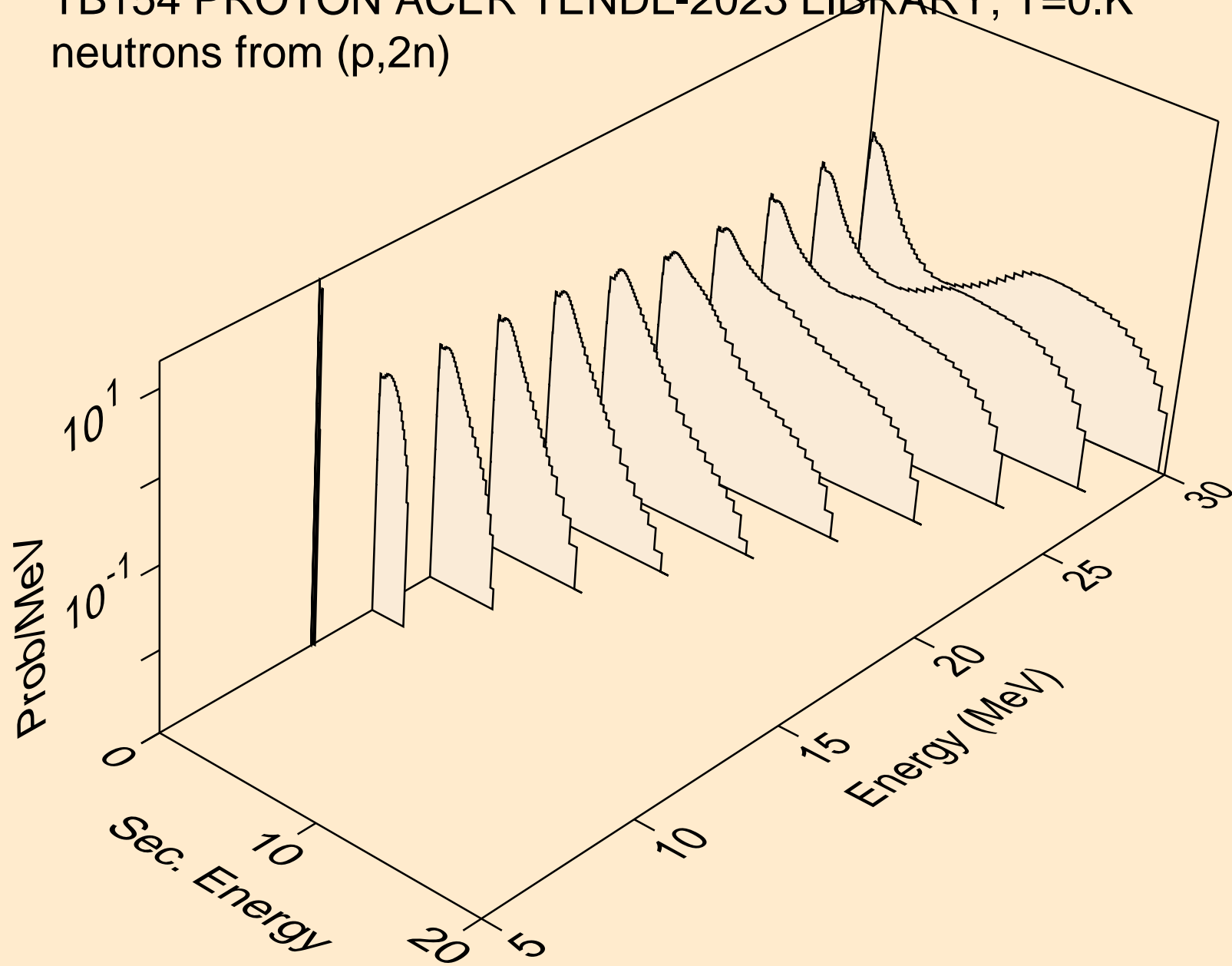

TB154 PROTON ACER TENDL-2023 LIBRARY; T=0.K  
neutrons from (p,3n)

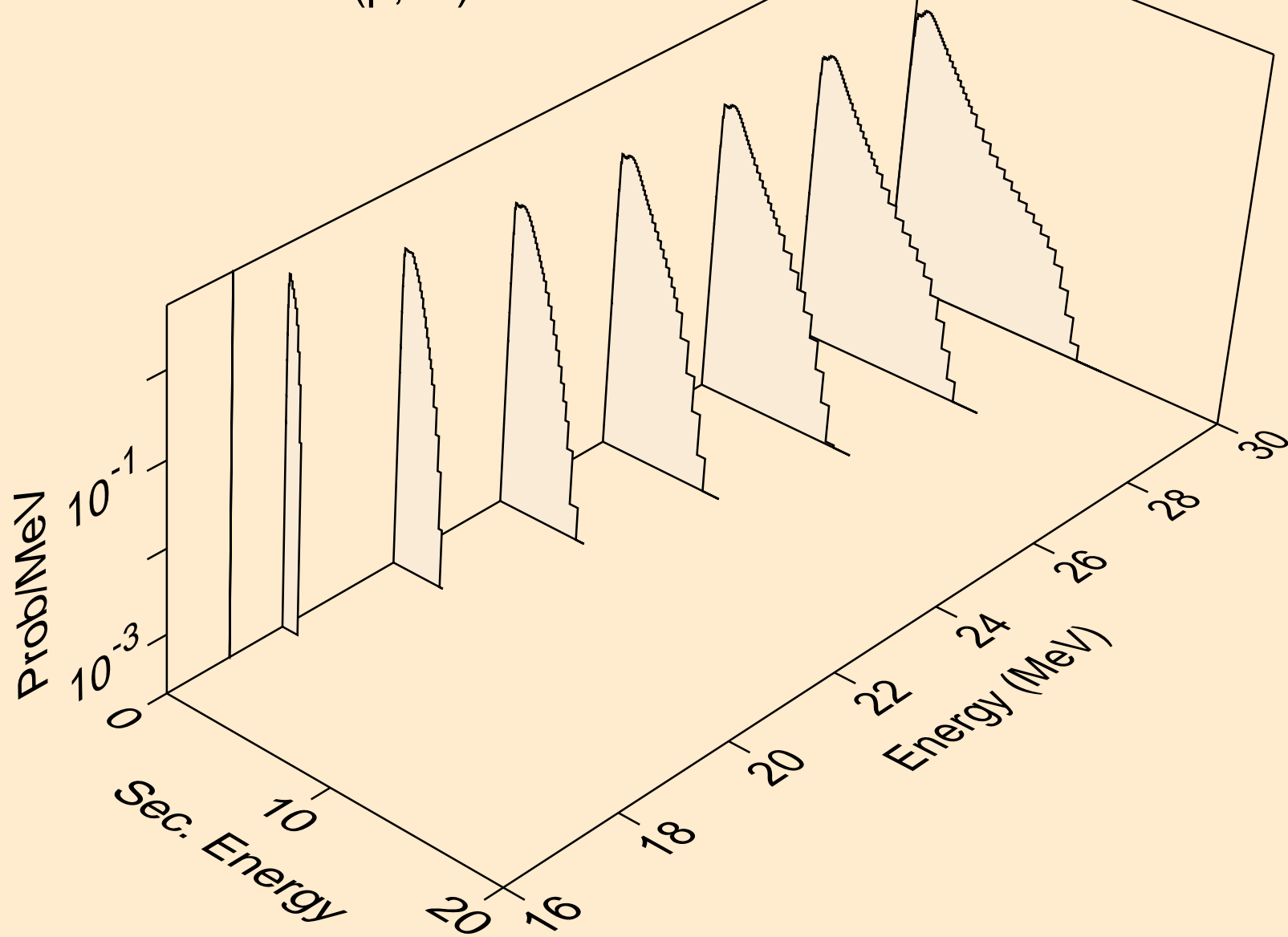

TB154 PROTON ACER TENDL-2023 LIBRARY; T=0.K  
neutrons from (p,n\*)a

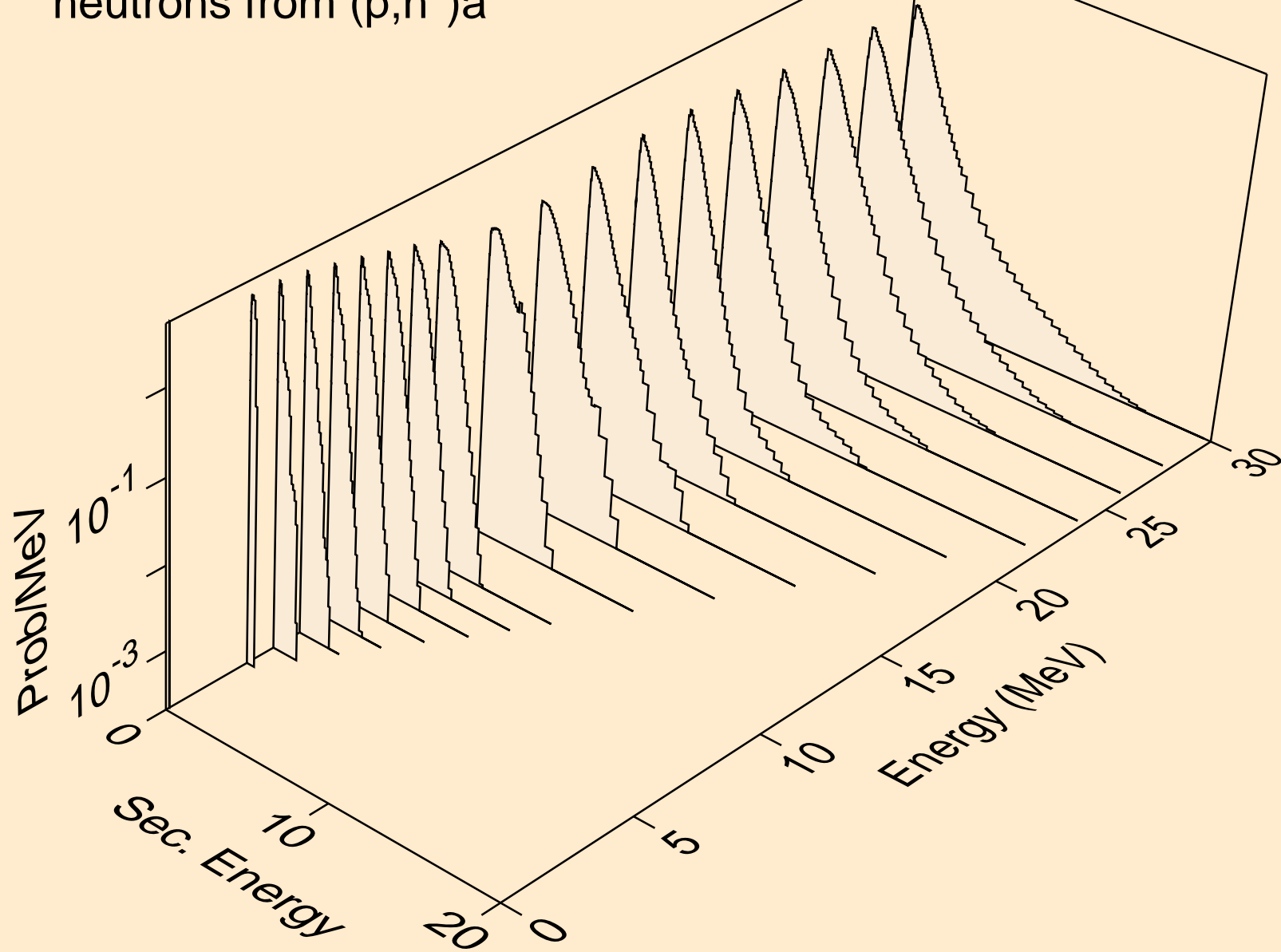

TB154 PROTON ACER TENDL-2023 LIBRARY; T=0.K  
neutrons from (p,2n)a

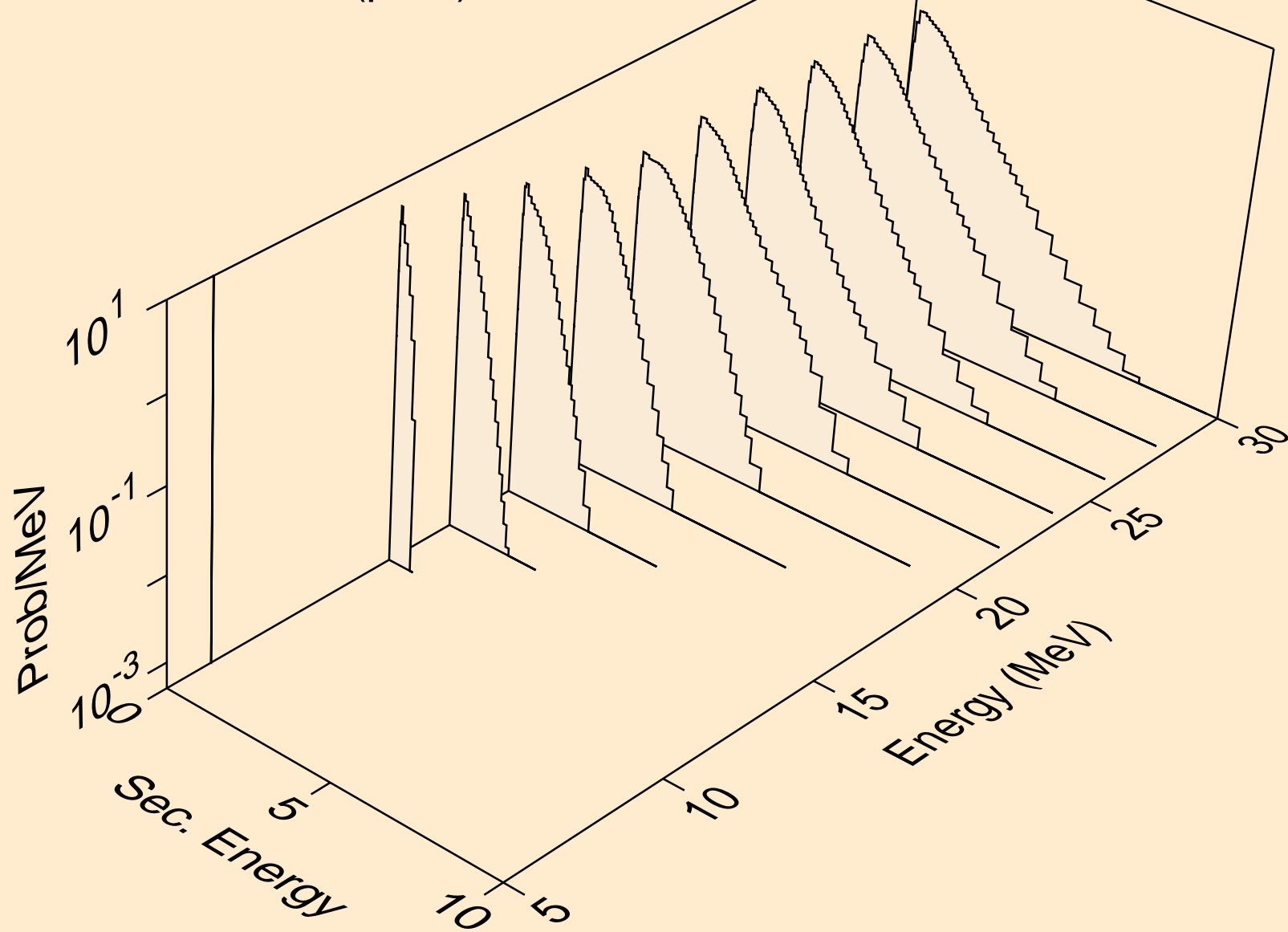

TB154 PROTON ACER TENDL-2023 LIBRARY; T=0.K  
neutrons from (p,3n)a

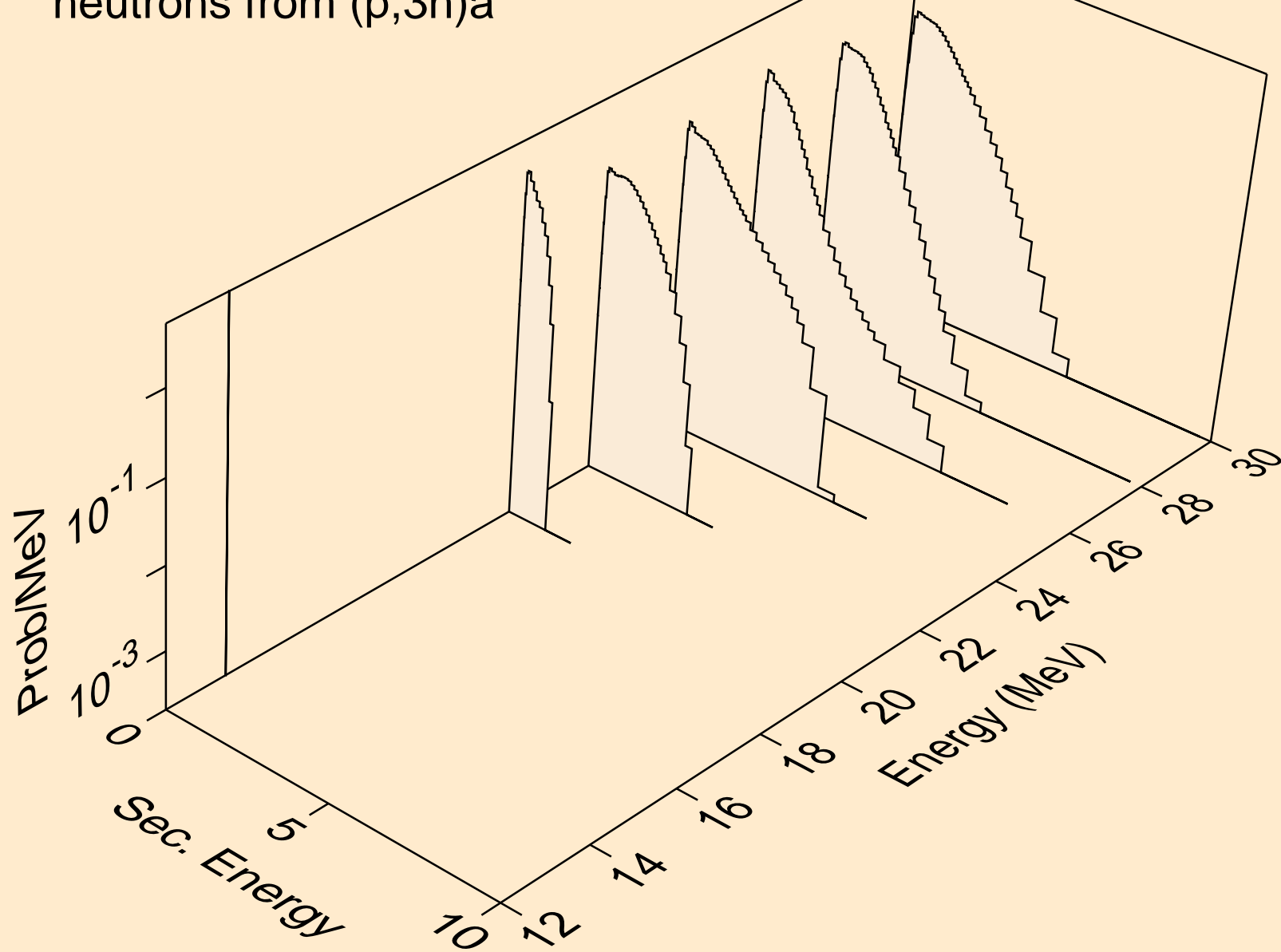

TB154 PROTON ACER TENDL-2023 LIBRARY; T=0.K  
neutrons from (p,n\*)p

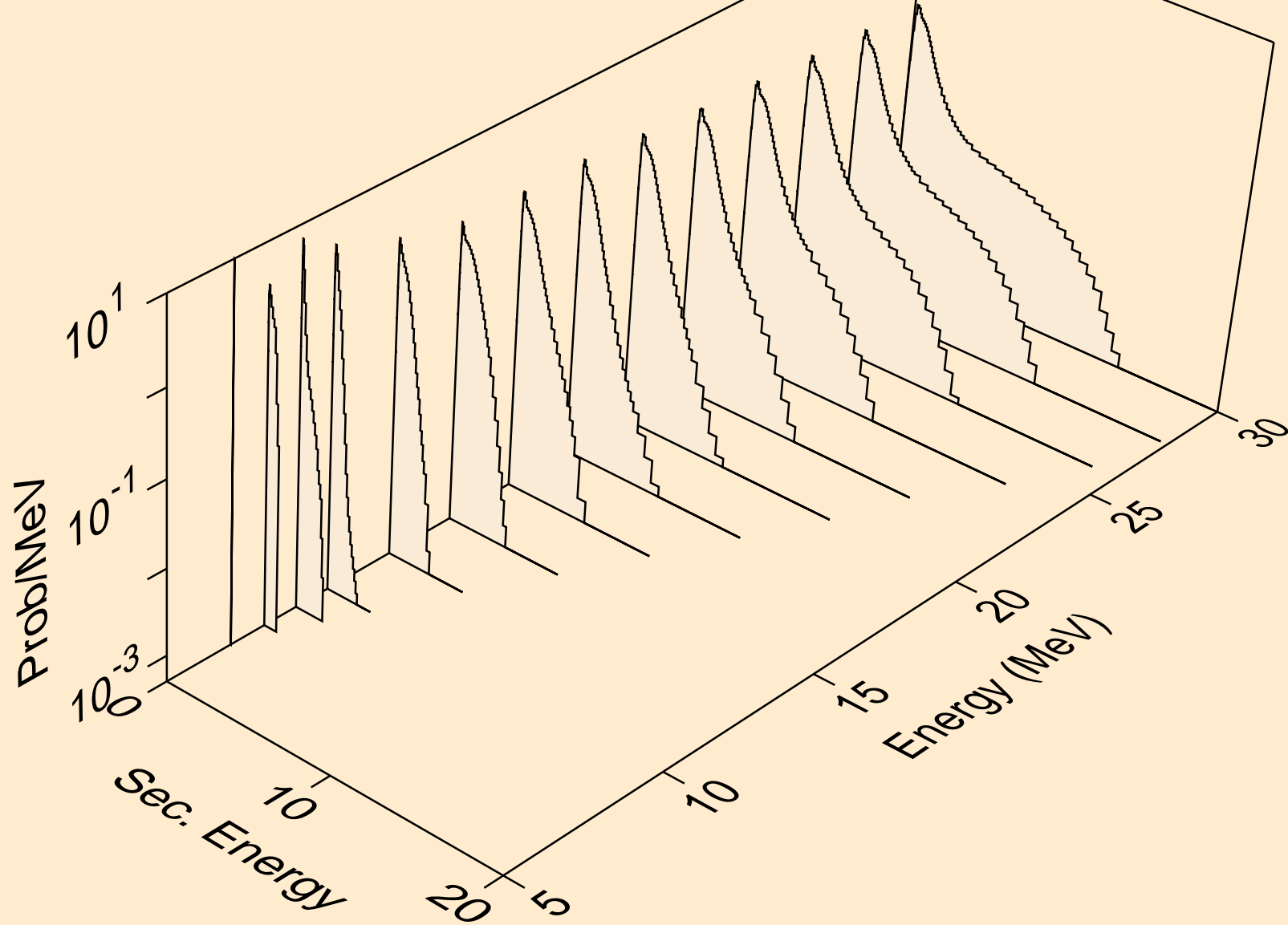

TB154 PROTON ACER TENDL-2023 LIBRARY; T=0.K  
neutrons from (p,n\*)2a

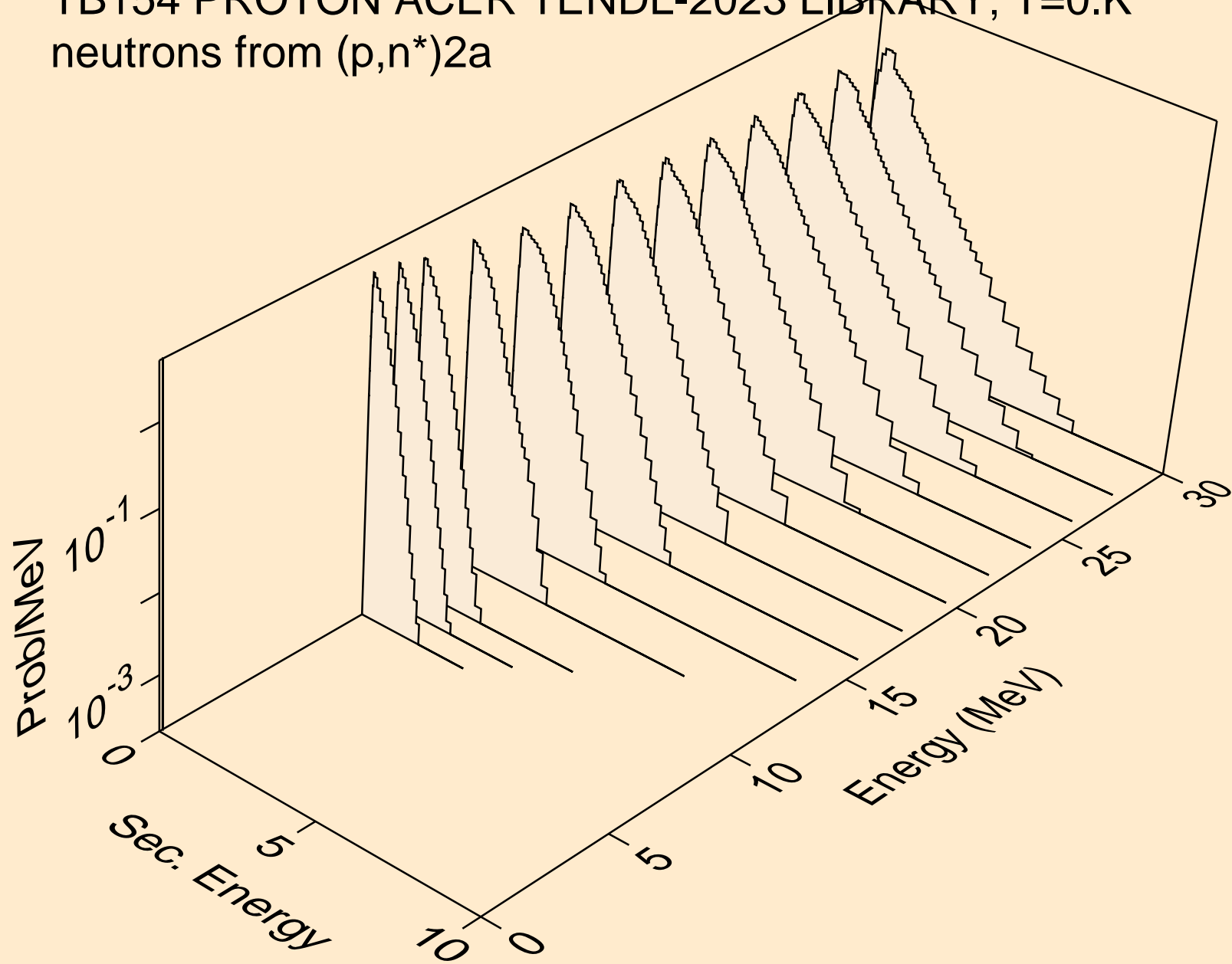

TB154 PROTON ACER TENDL-2023 LIBRARY; T=0.K  
neutrons from (p,2n)2a

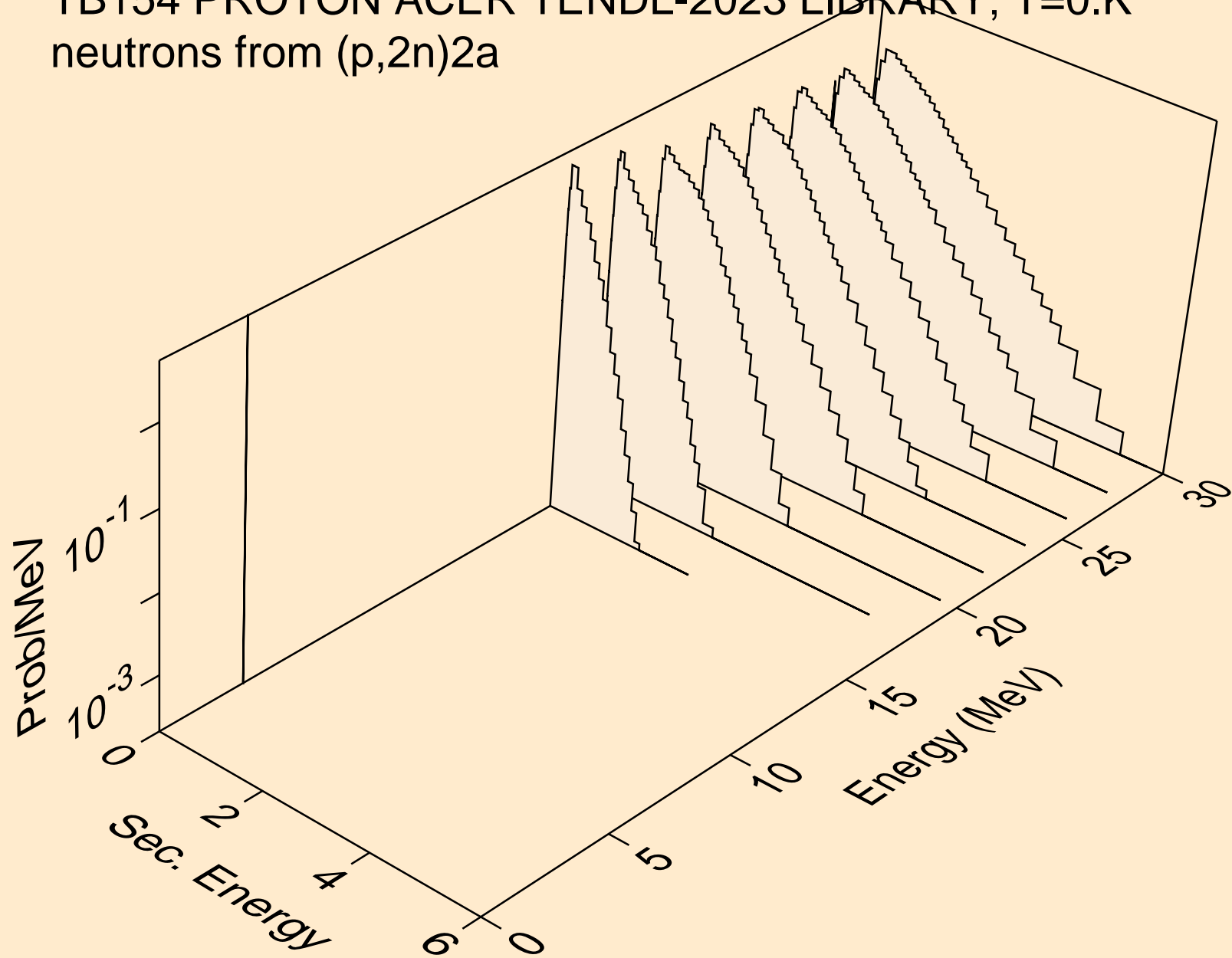

TB154 PROTON ACER TENDL-2023 LIBRARY; T=0.K  
neutrons from (p,n\*)d

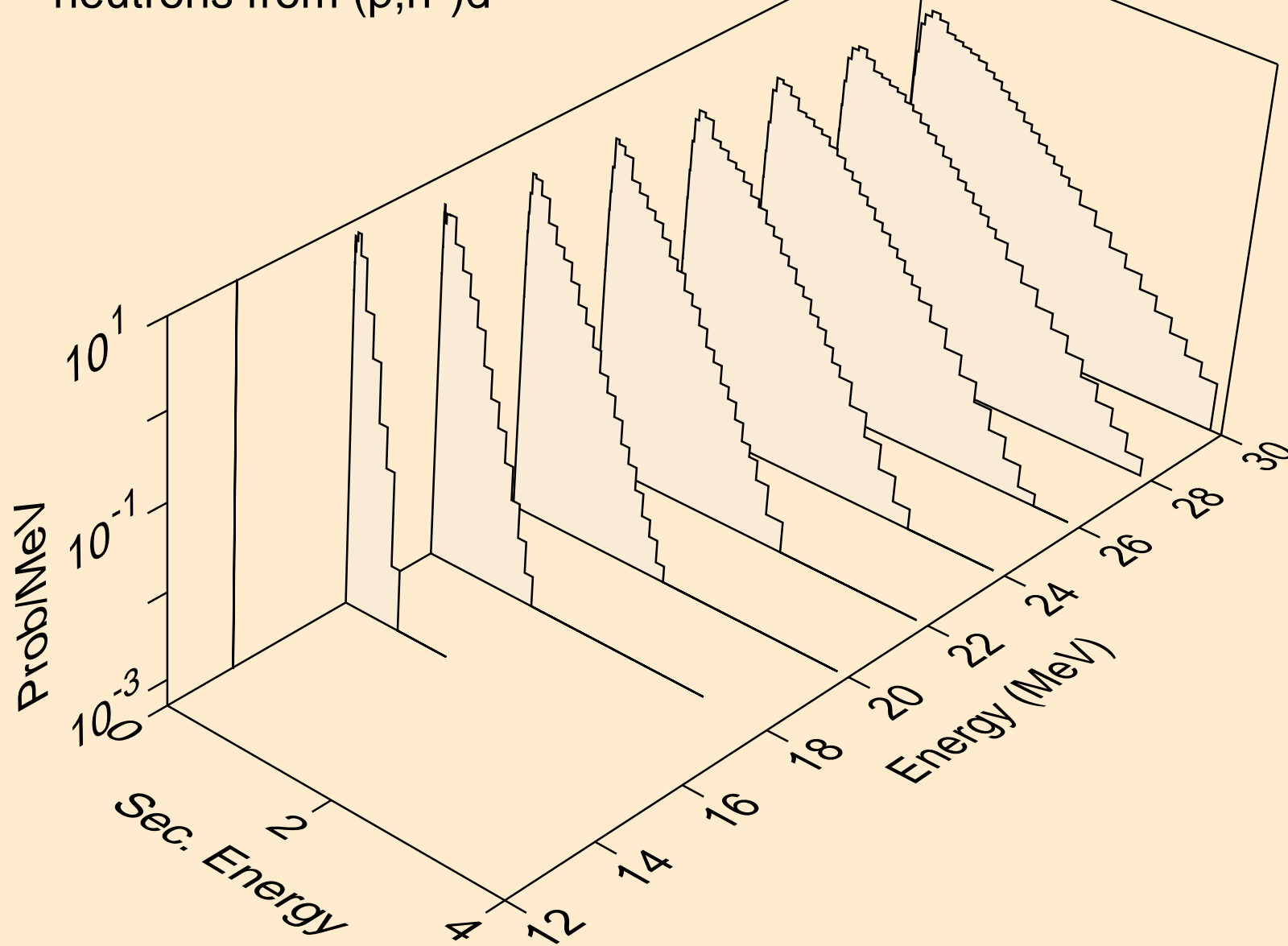

TB154 PROTON ACER TENDL-2023 LIBRARY; T=0.K  
neutrons from (p,n\*)t

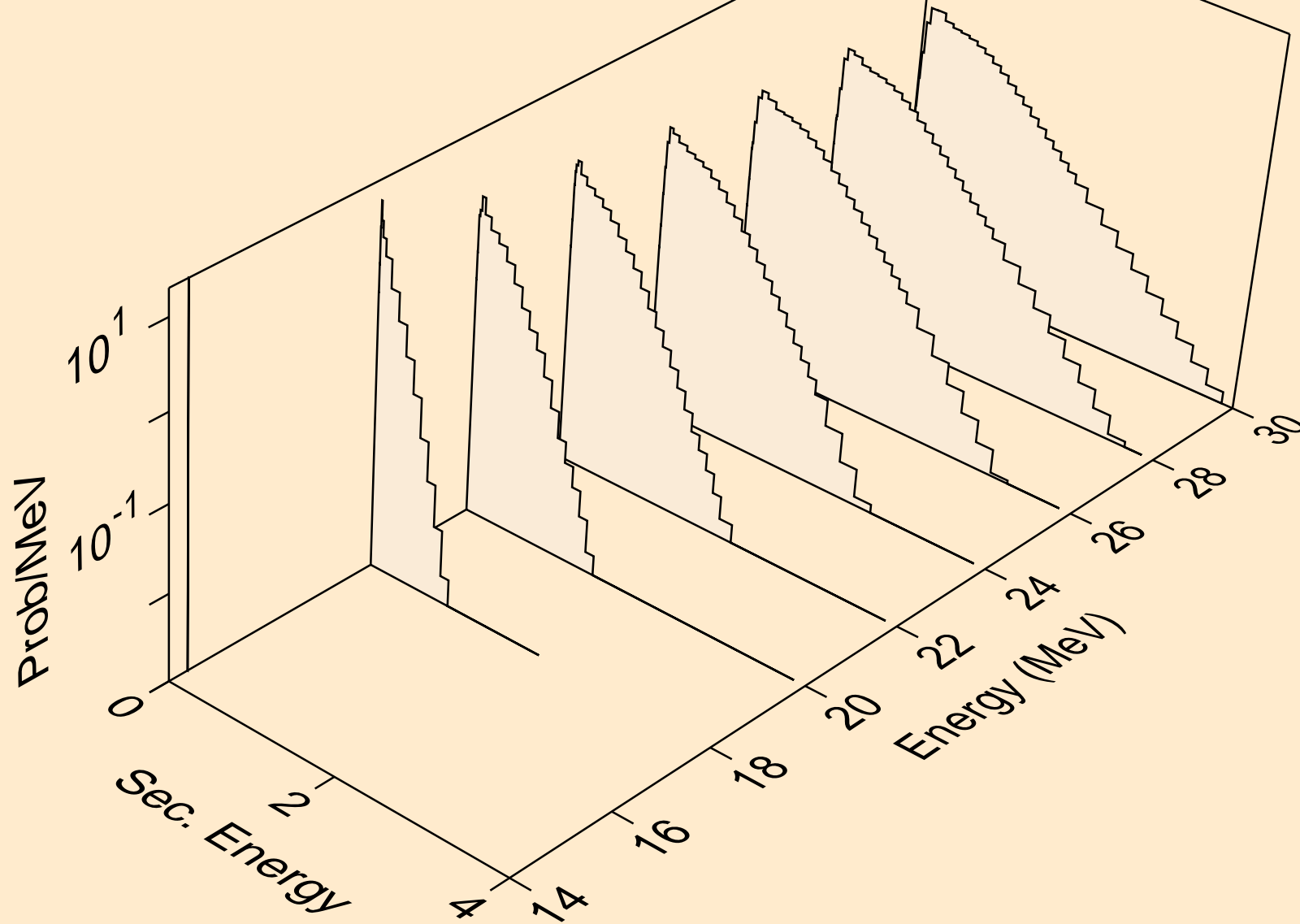

TB154 PROTON ACER TENDL-2023 LIBRARY; T=0.K  
neutrons from (p,n\*)he3

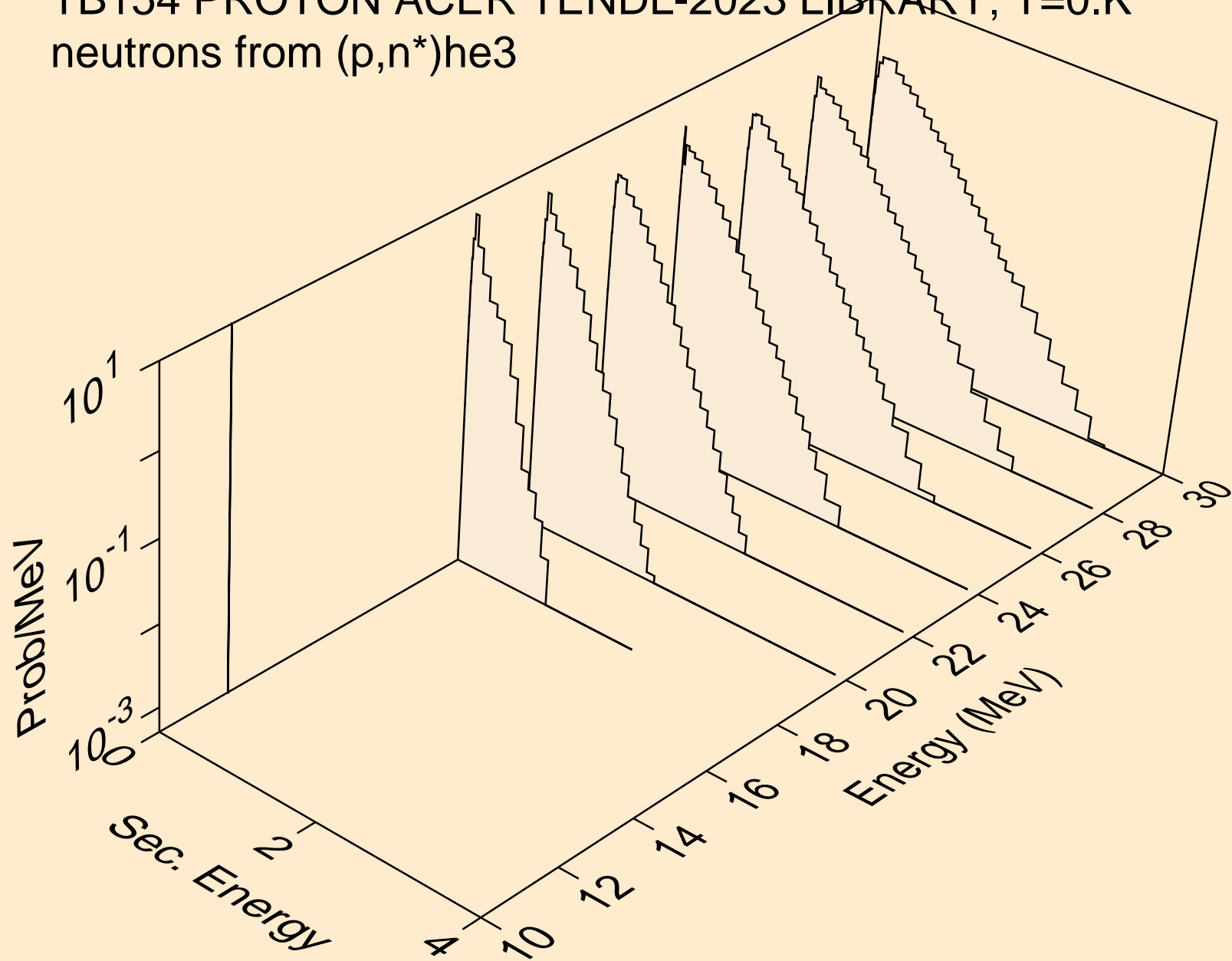

TB154 PROTON ACER TENDL-2023 LIBRARY; T=0.K  
neutrons from (p,4n)

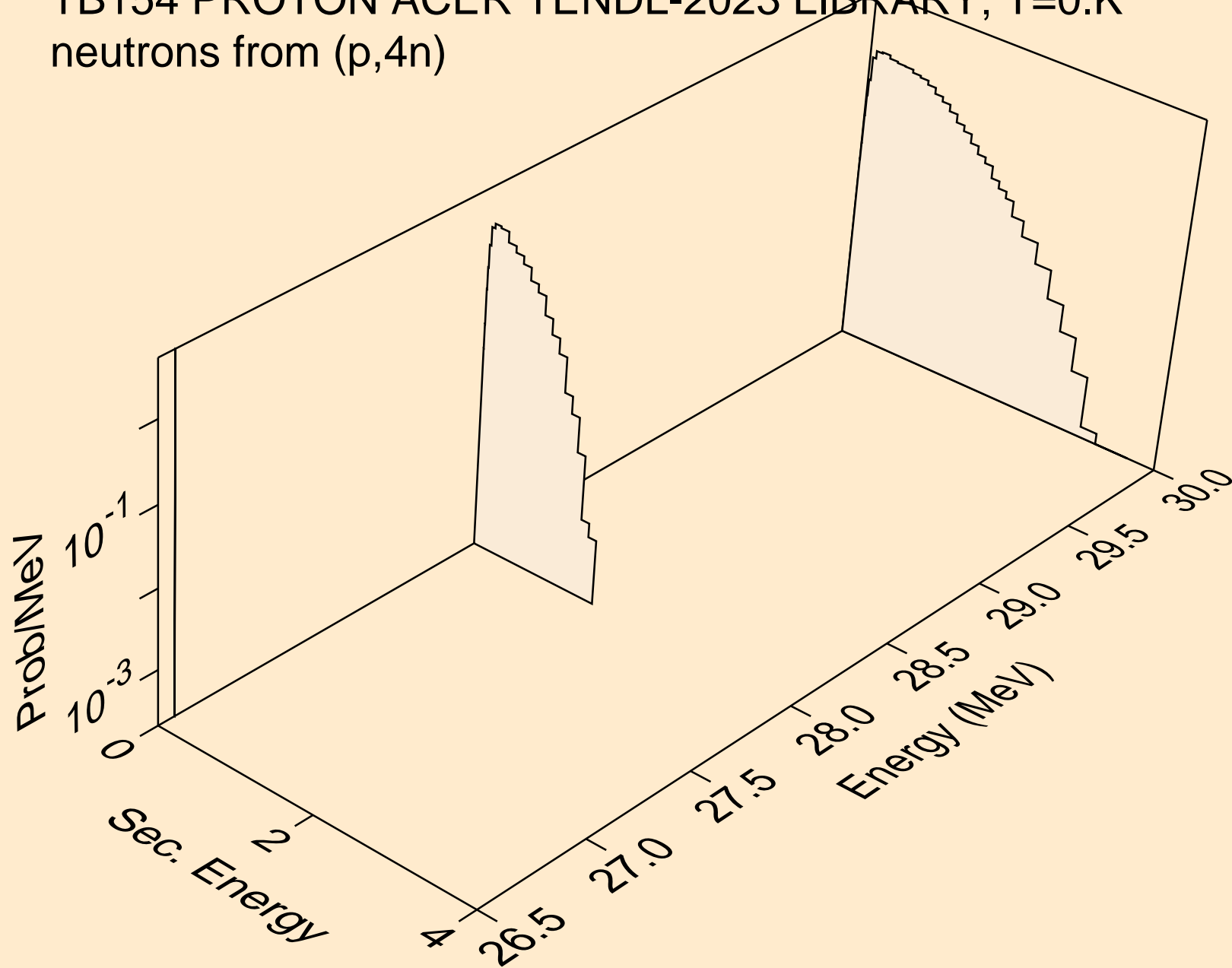

TB154 PROTON ACER TENDL-2023 LIBRARY; T=0.K  
neutrons from (p,2np)

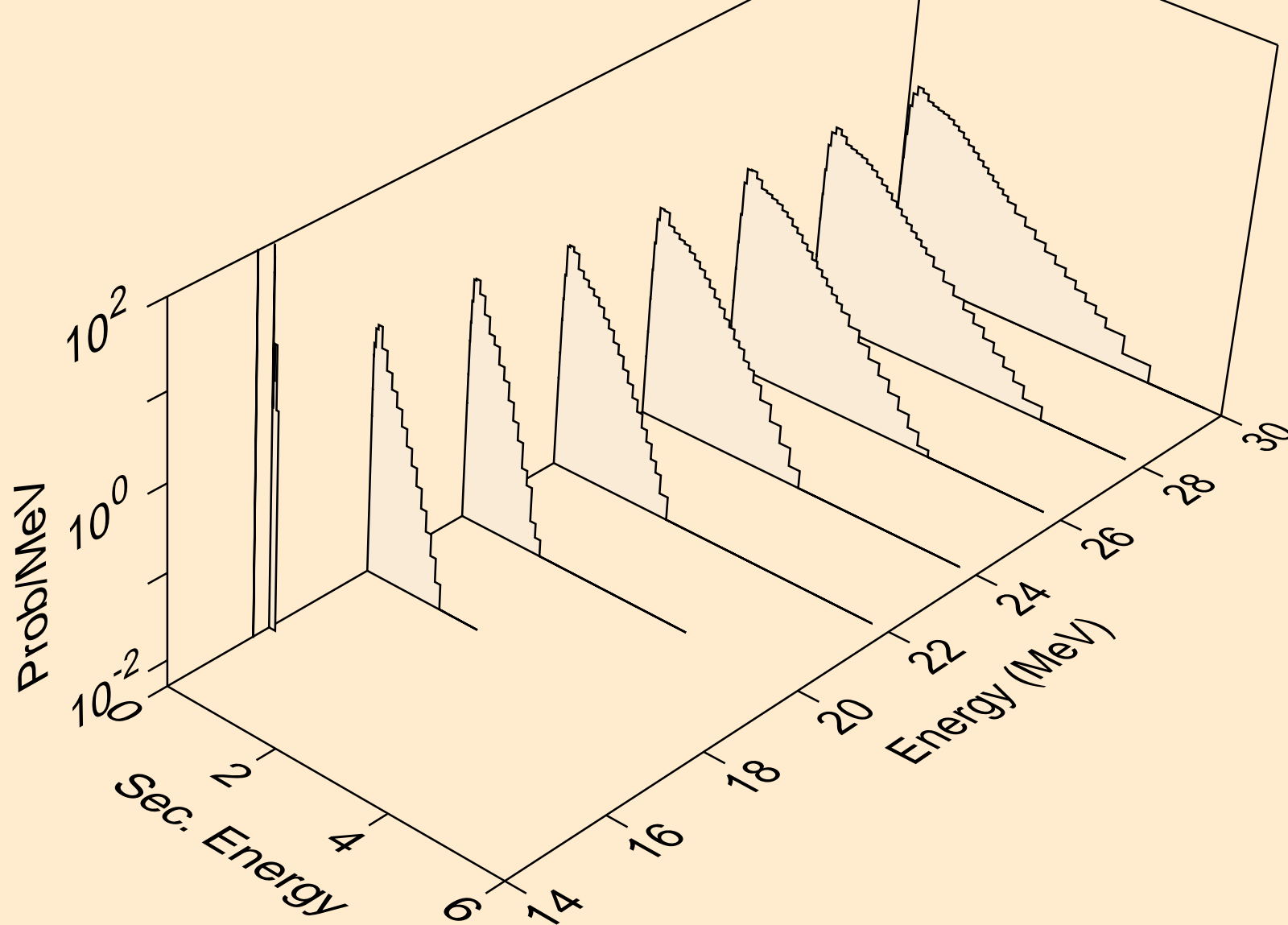

TB154 PROTON ACER TENDL-2023 LIBRARY; T=0.K  
neutrons from (p,3np)

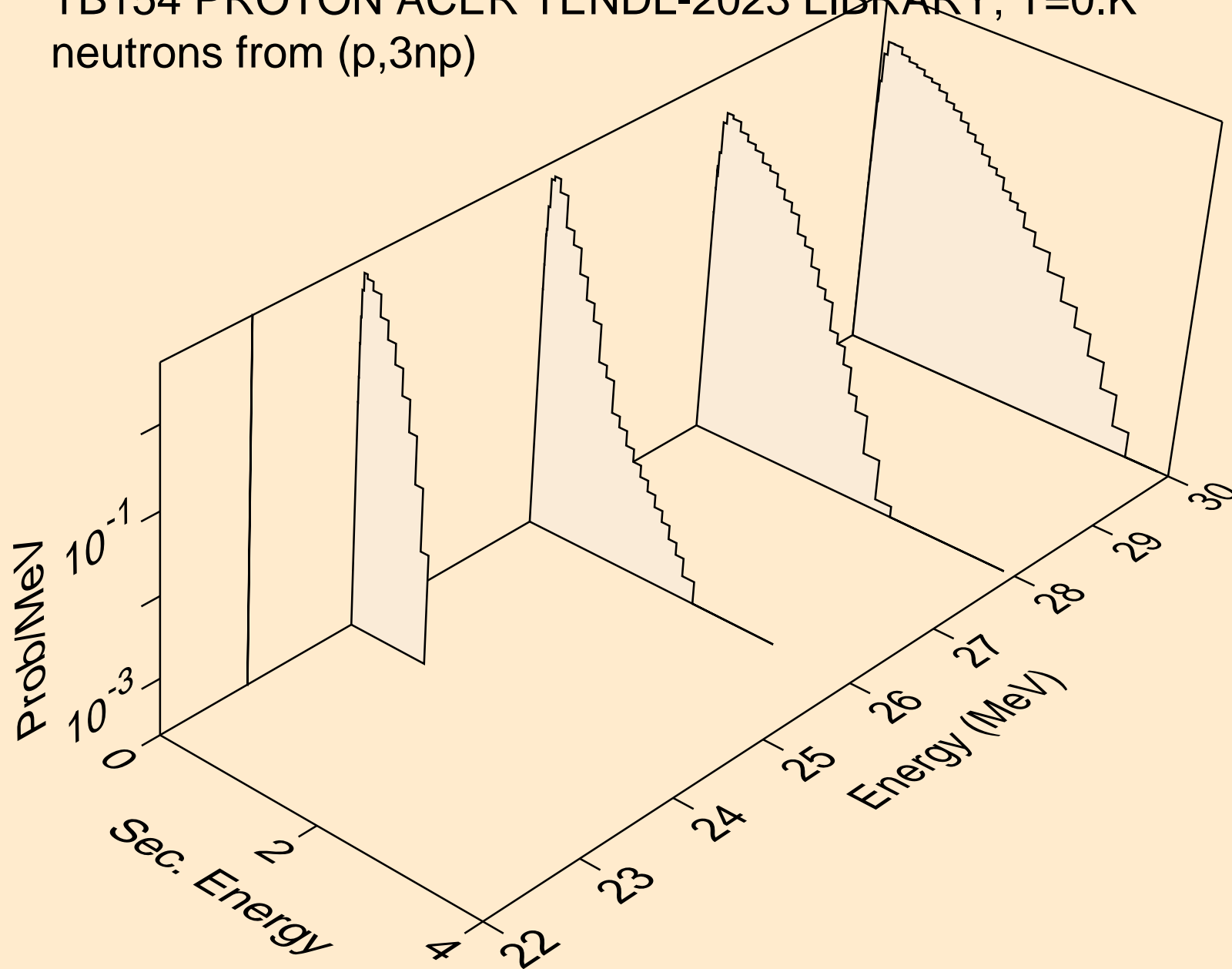

TB154 PROTON ACER TENDL-2023 LIBRARY; T=0.K  
neutrons from (p,n2p)

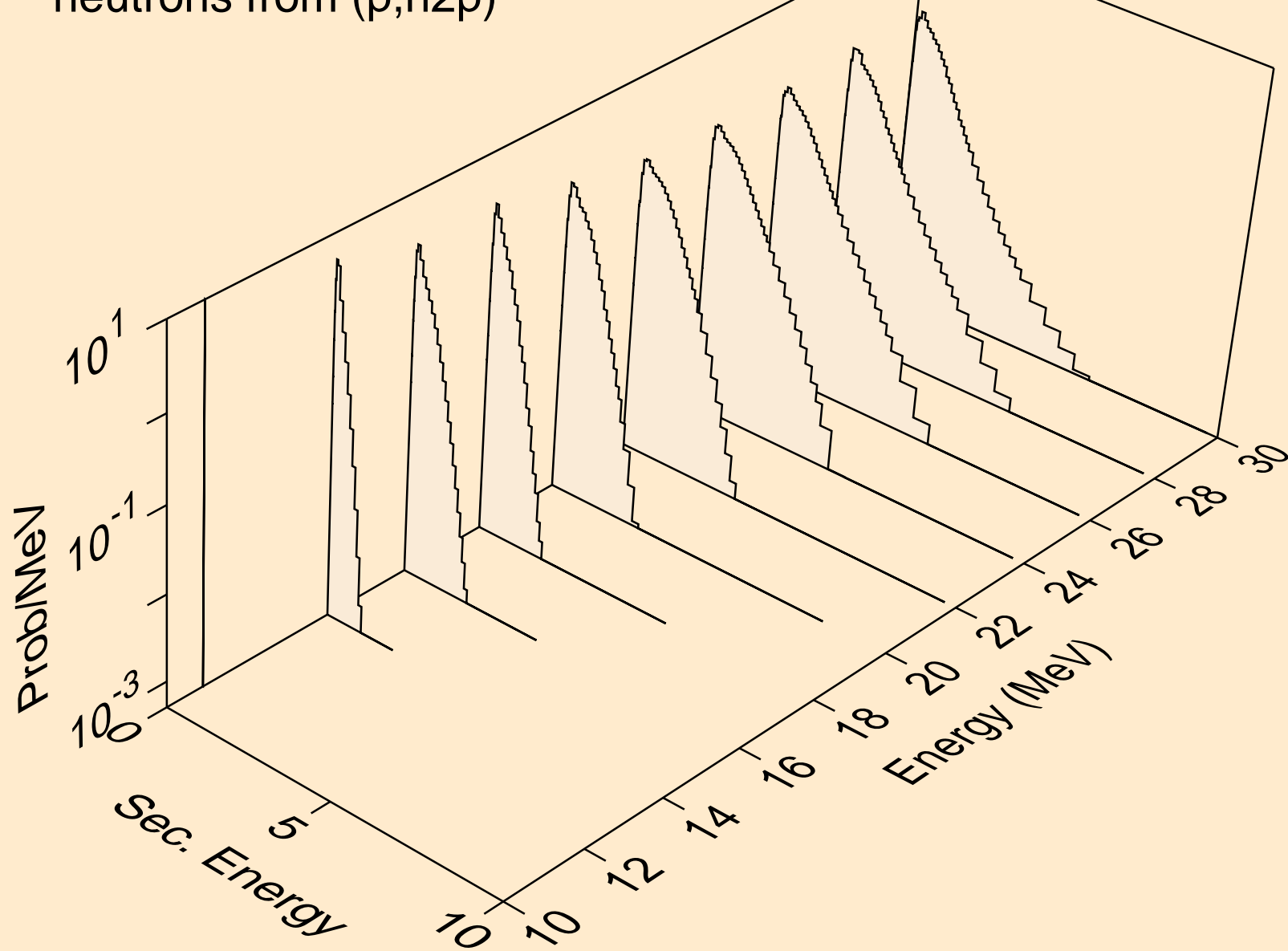

TB154 PROTON ACER TENDL-2023 LIBRARY; T=0.K  
neutrons from (p,npa)

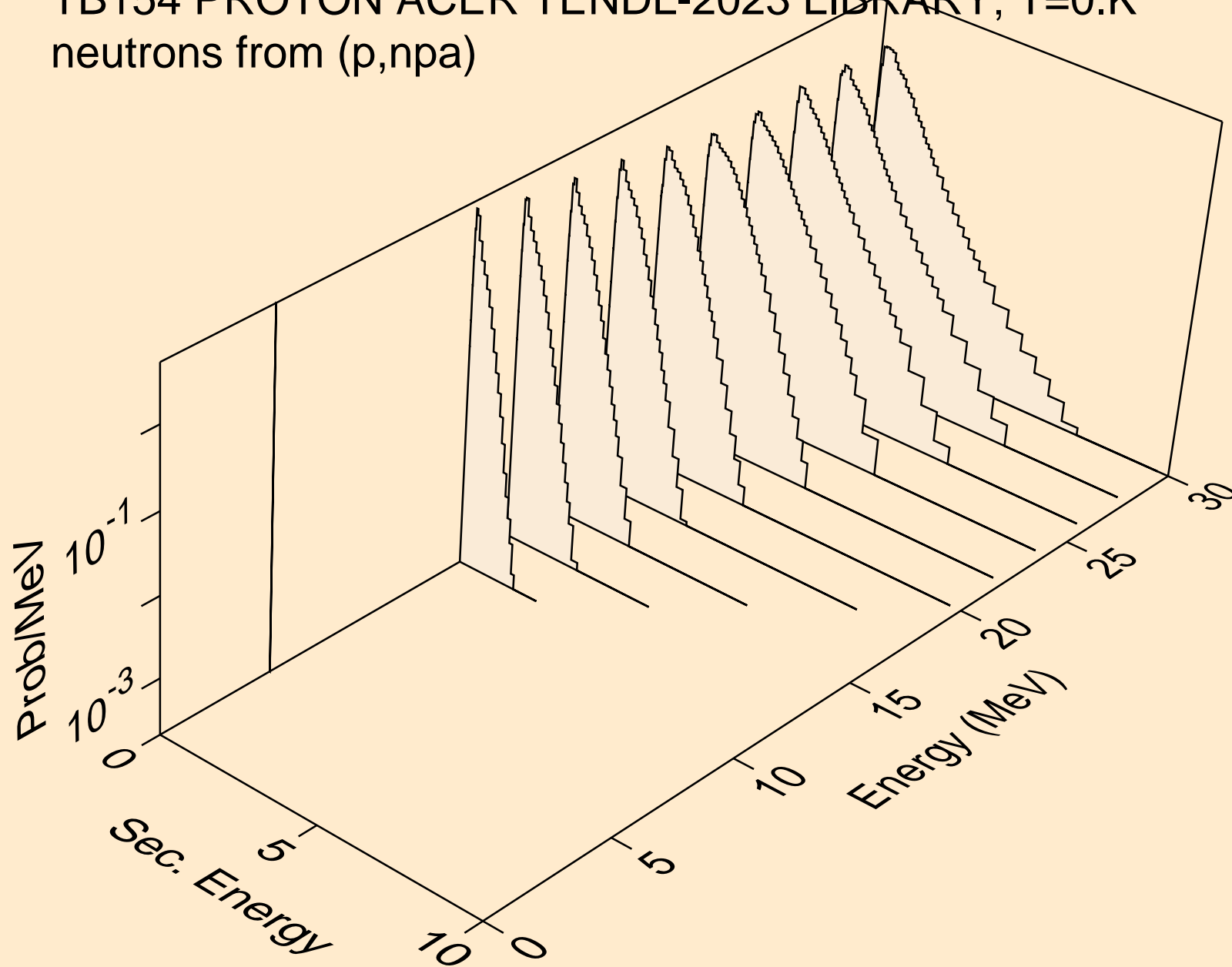

TB154 PROTON ACER TENDL-2023 LIBRARY; T=0.K  
deuterons from (p,x)

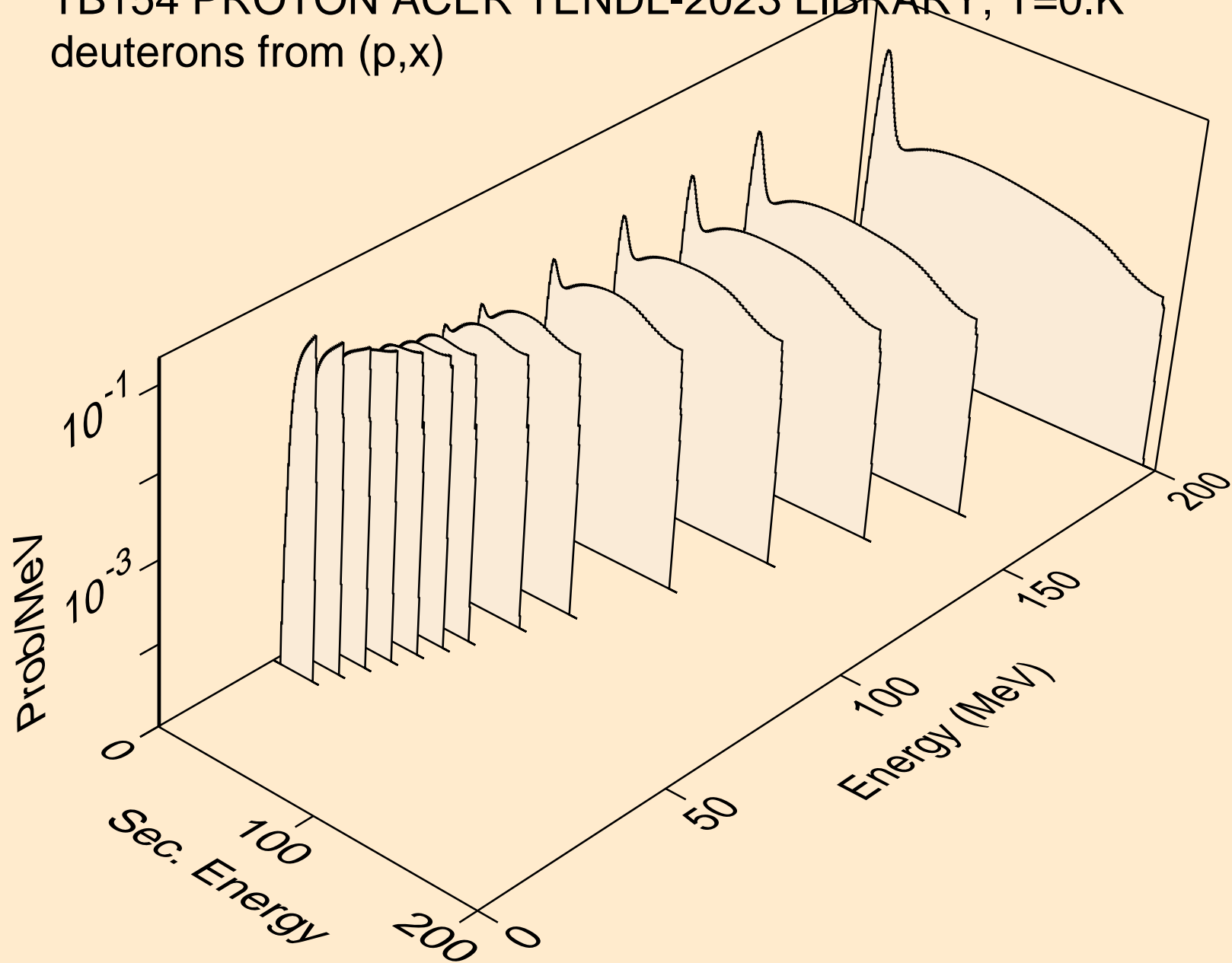

TB154 PROTON ACER TENDL-2023 LIBRARY; T=0.K  
deuterons from (p,2nd)

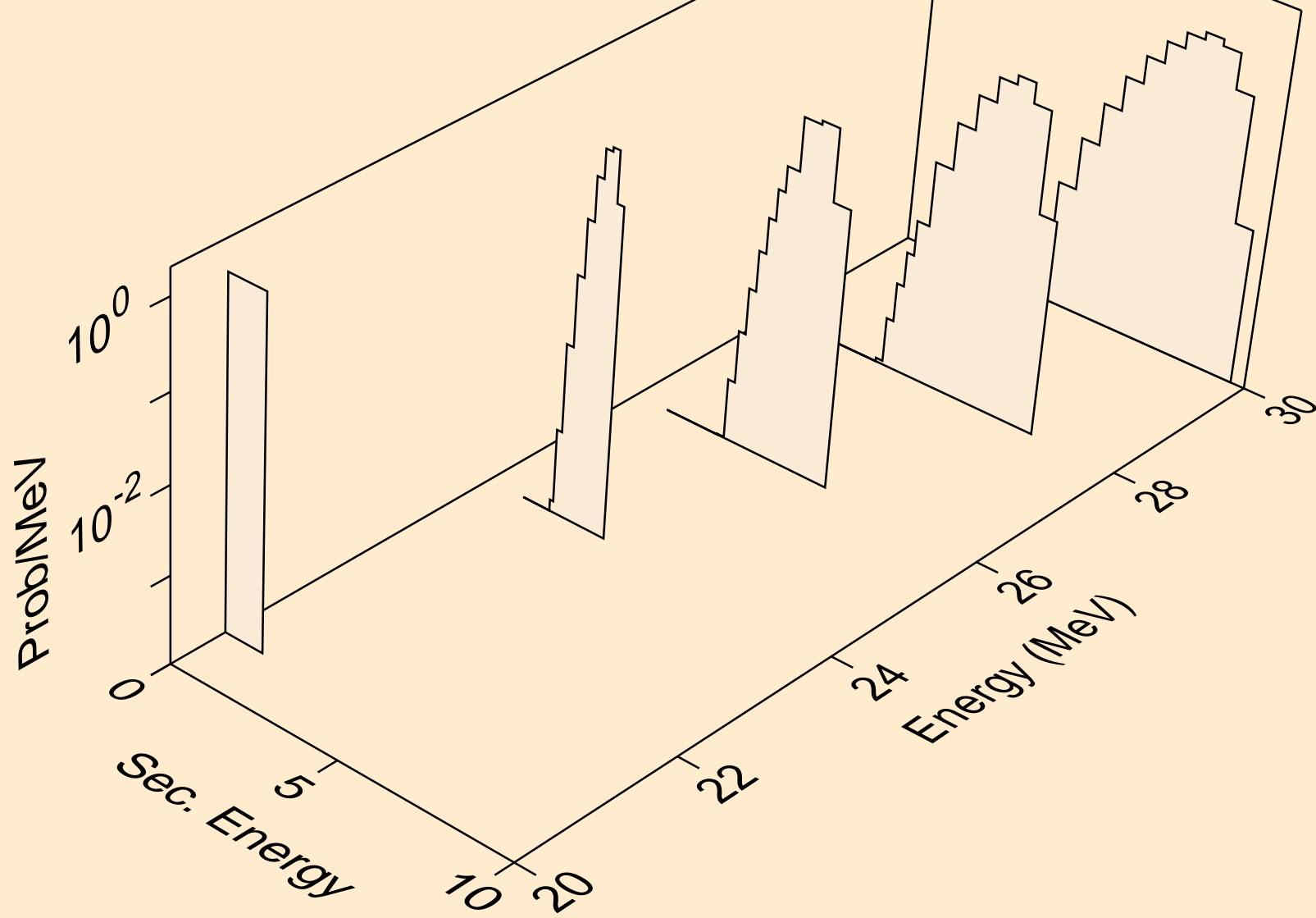

TB154 PROTON ACER TENDL-2023 LIBRARY; T=0.K  
deuterons from (p,n\*)d

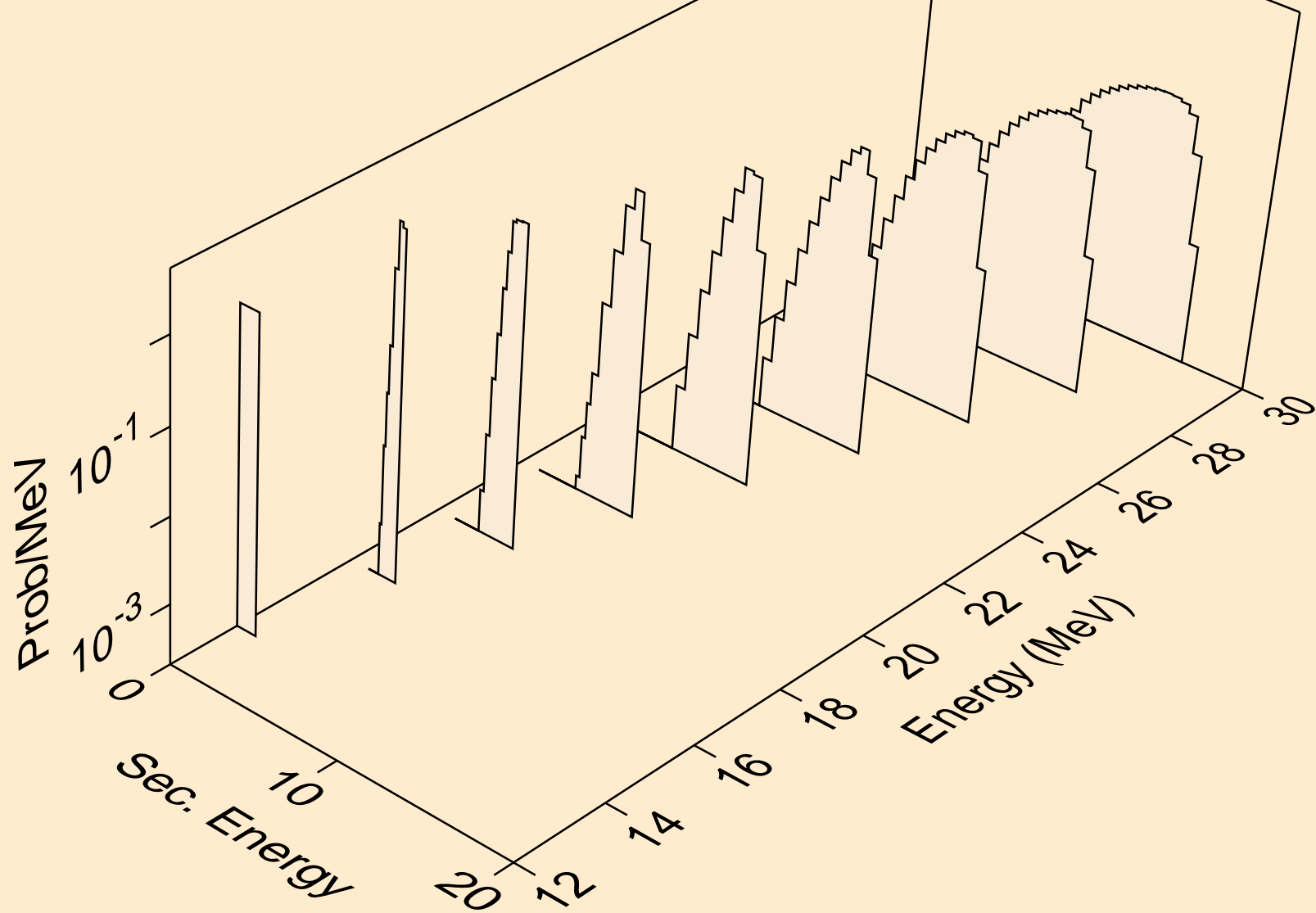

TB154 PROTON ACER TENDL-2023 LIBRARY; T=0.K  
deuterons from (p,d)

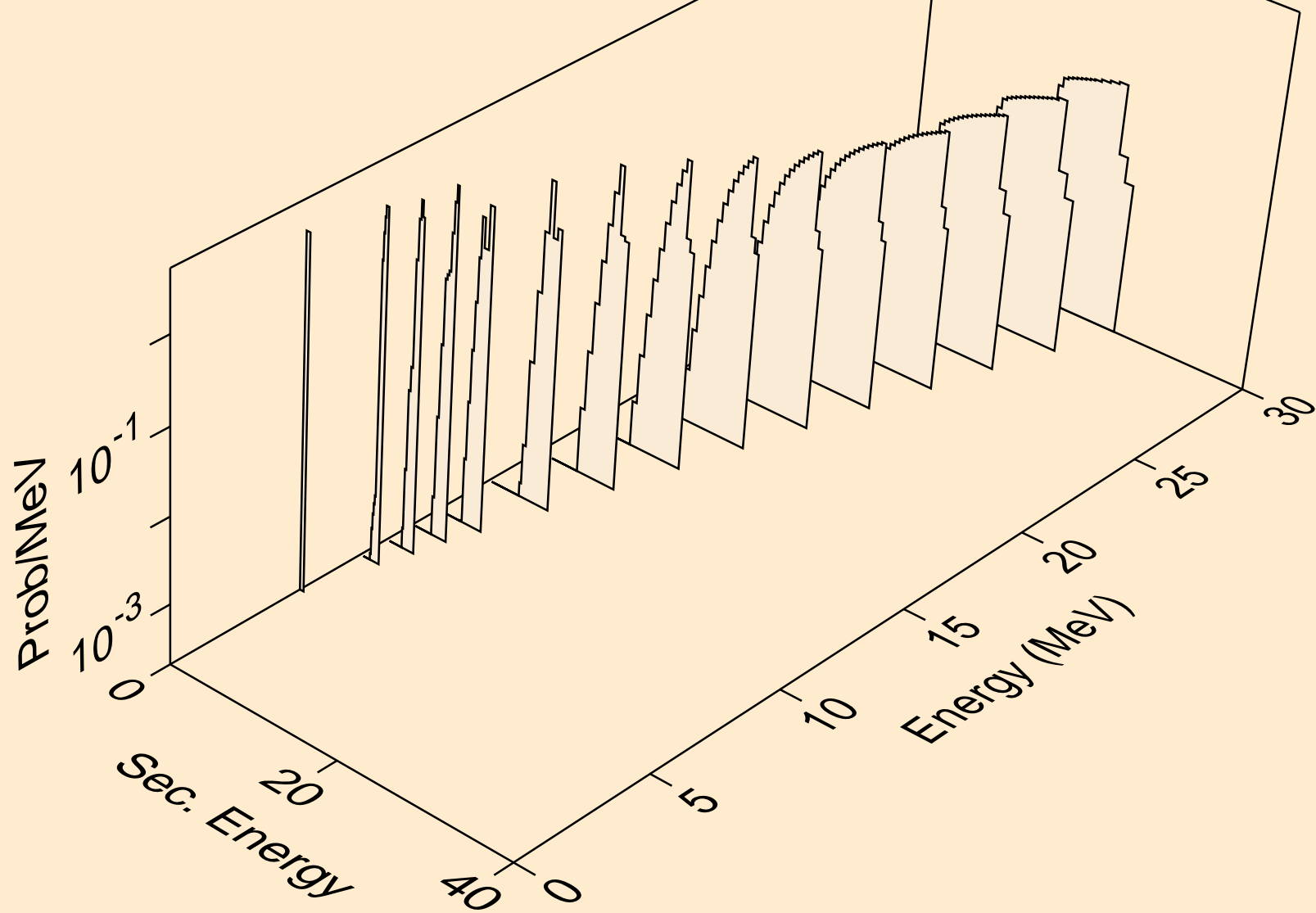

TB154 PROTON ACER TENDL-2023 LIBRARY; T=0.K  
deuterons from (p,pd)

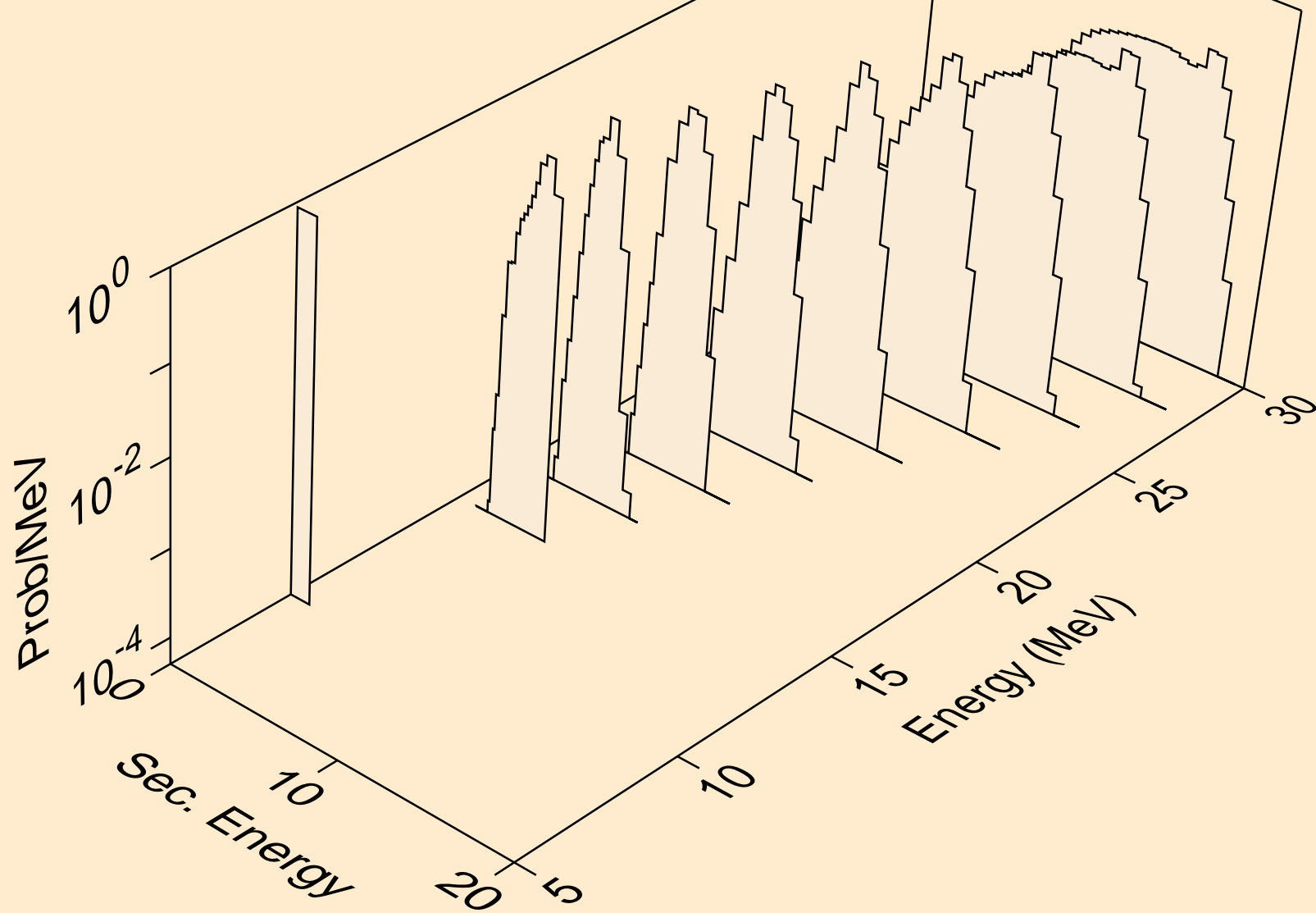

TB154 PROTON ACER TENDL-2023 LIBRARY; T=0.K  
deuterons from (p,da)

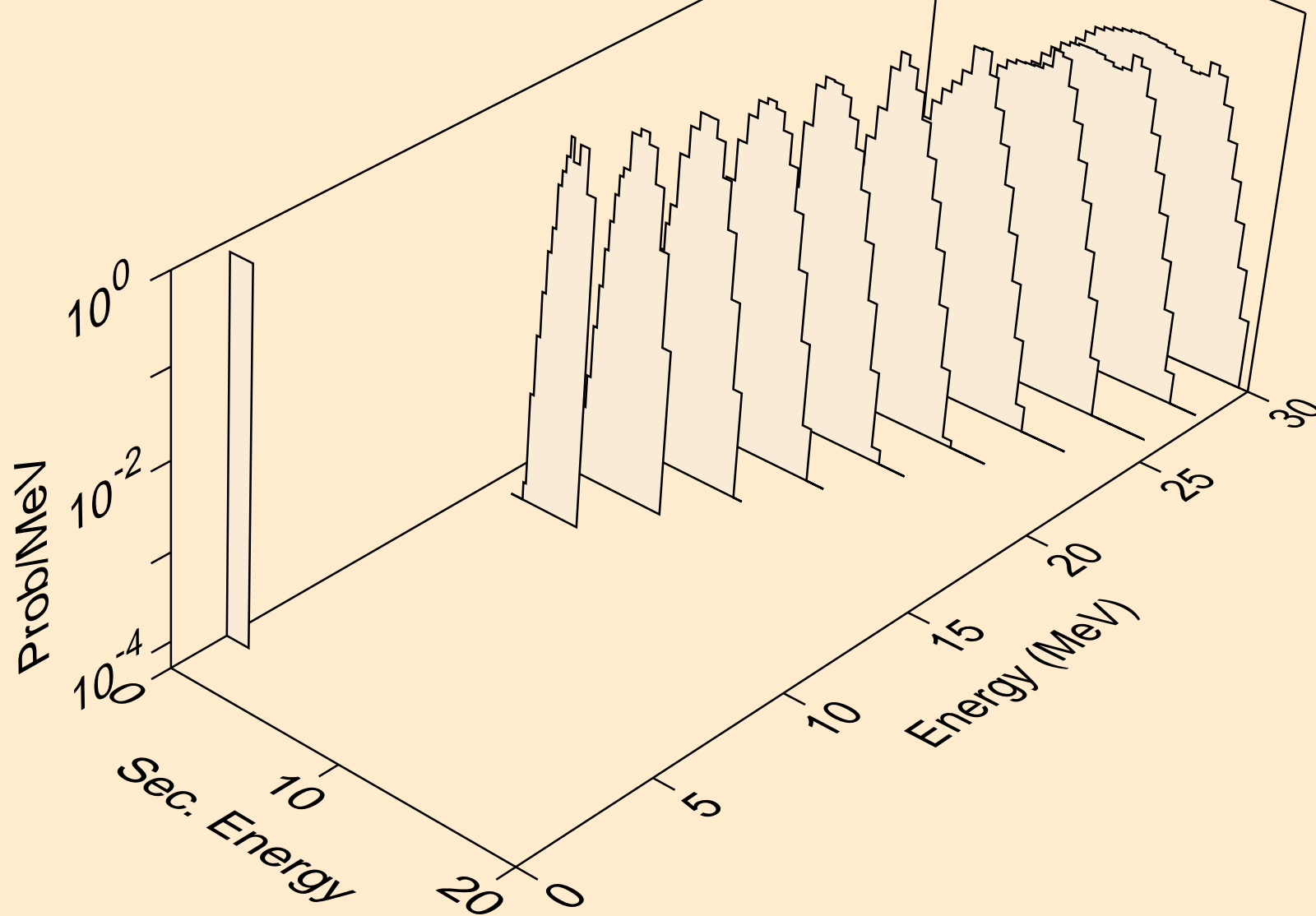

TB154 PROTON ACER TENDL-2023 LIBRARY; T=0.K  
tritons from (p,x)

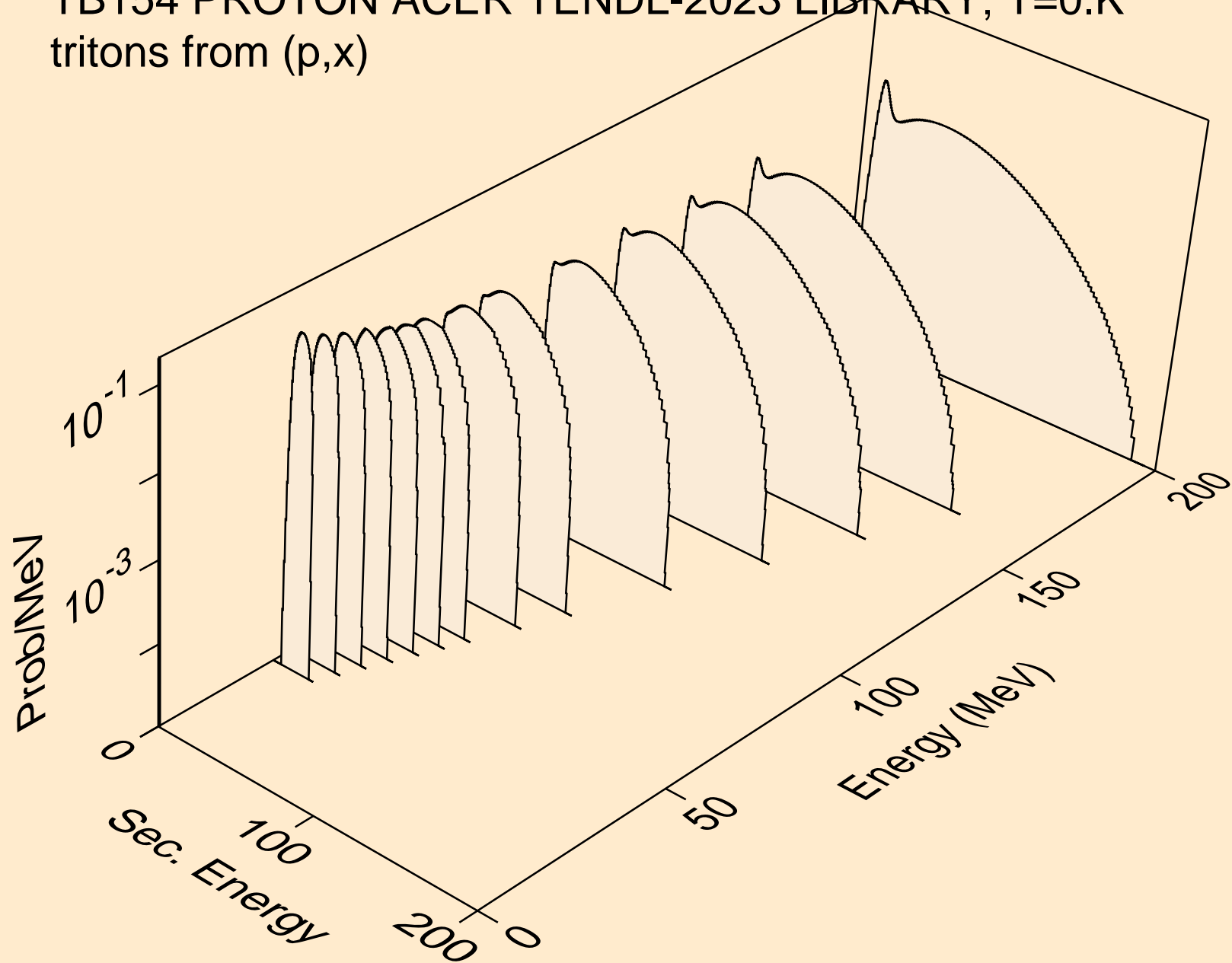

TB154 PROTON ACER TENDL-2023 LIBRARY; T=0.K  
tritons from (p,n\*)t

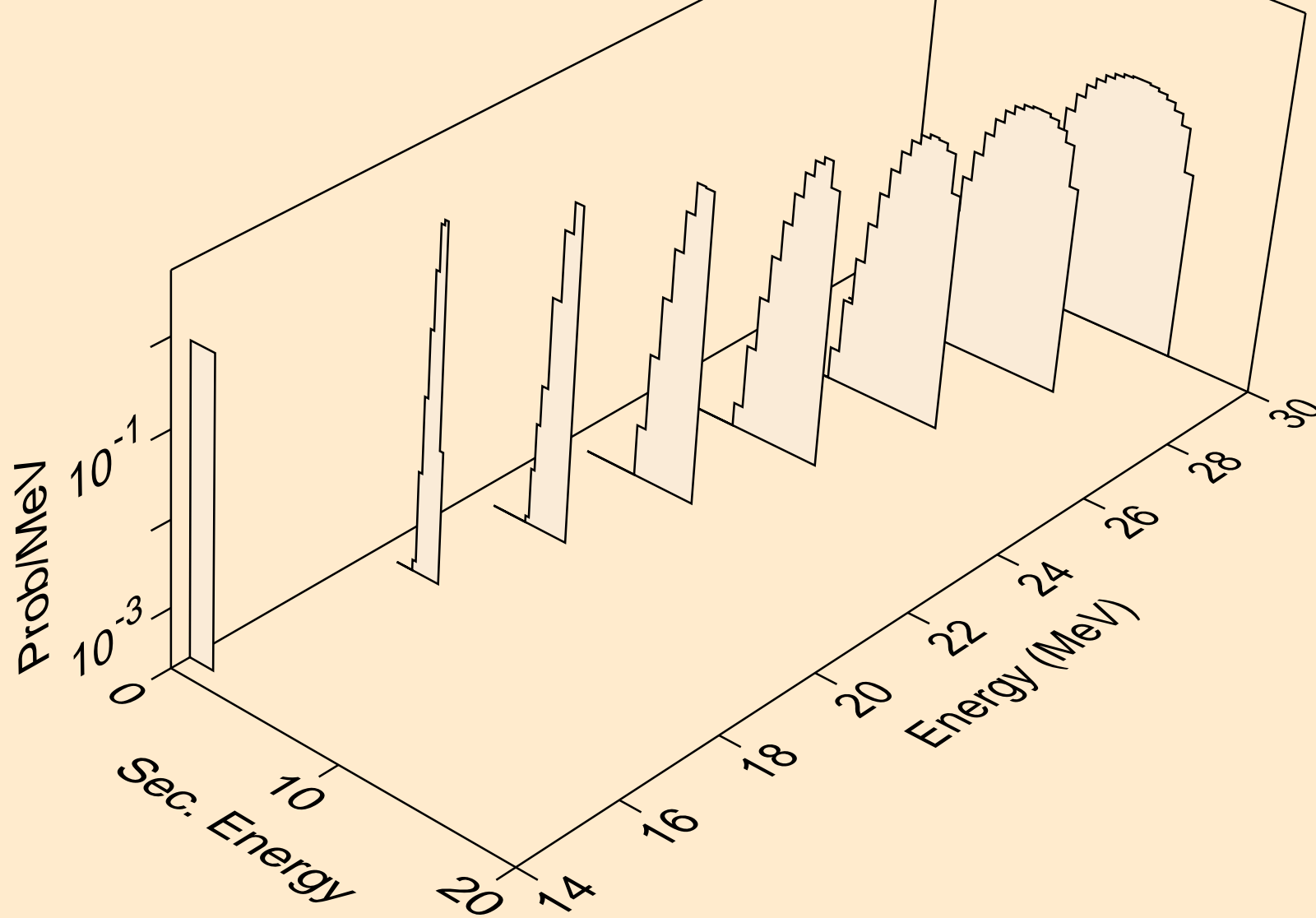

TB154 PROTON ACER TENDL-2023 LIBRARY; T=0.K  
tritons from (p,t)

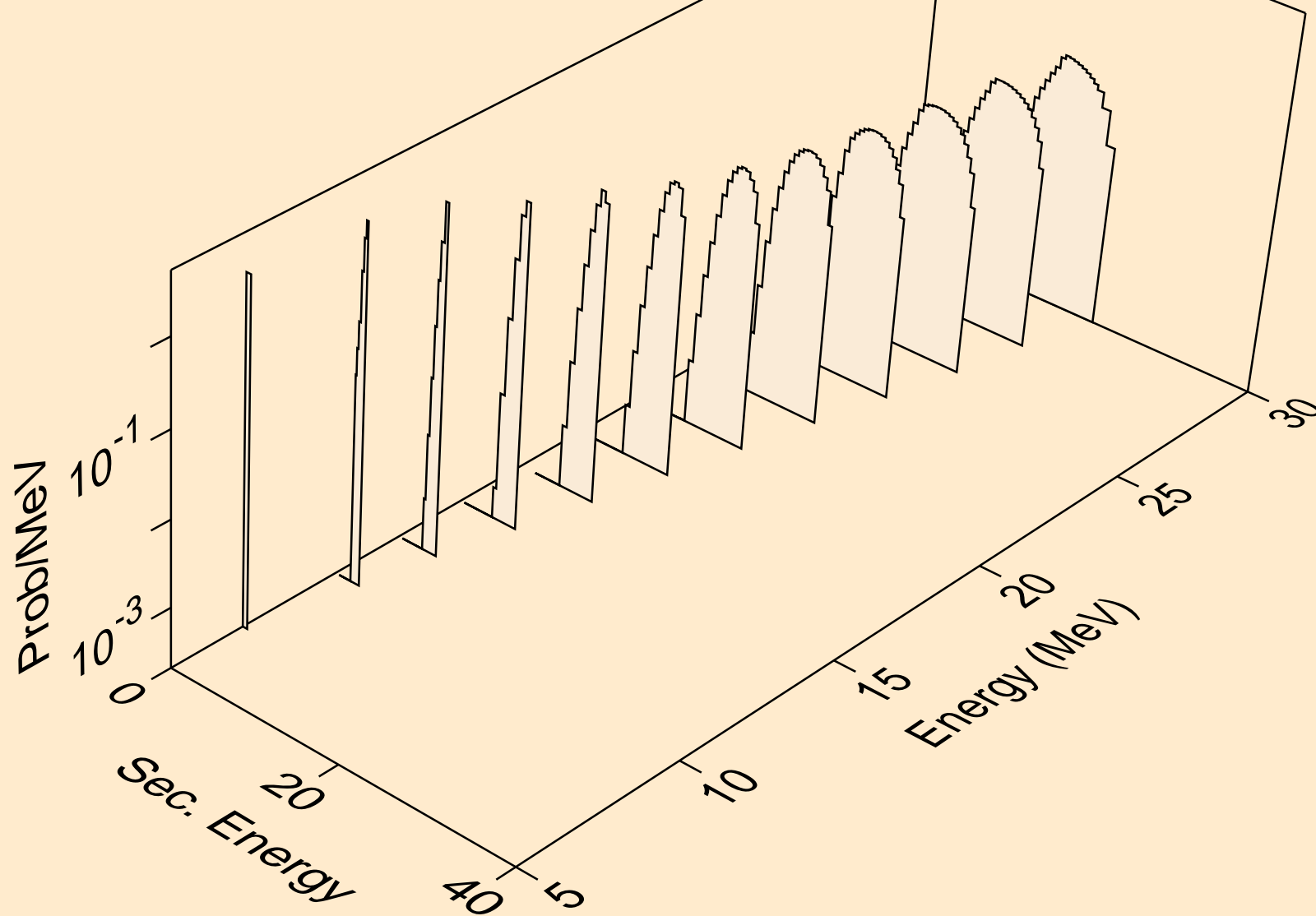

TB154 PROTON ACER TENDL-2023 LIBRARY; T=0.K  
tritons from (p,pt)

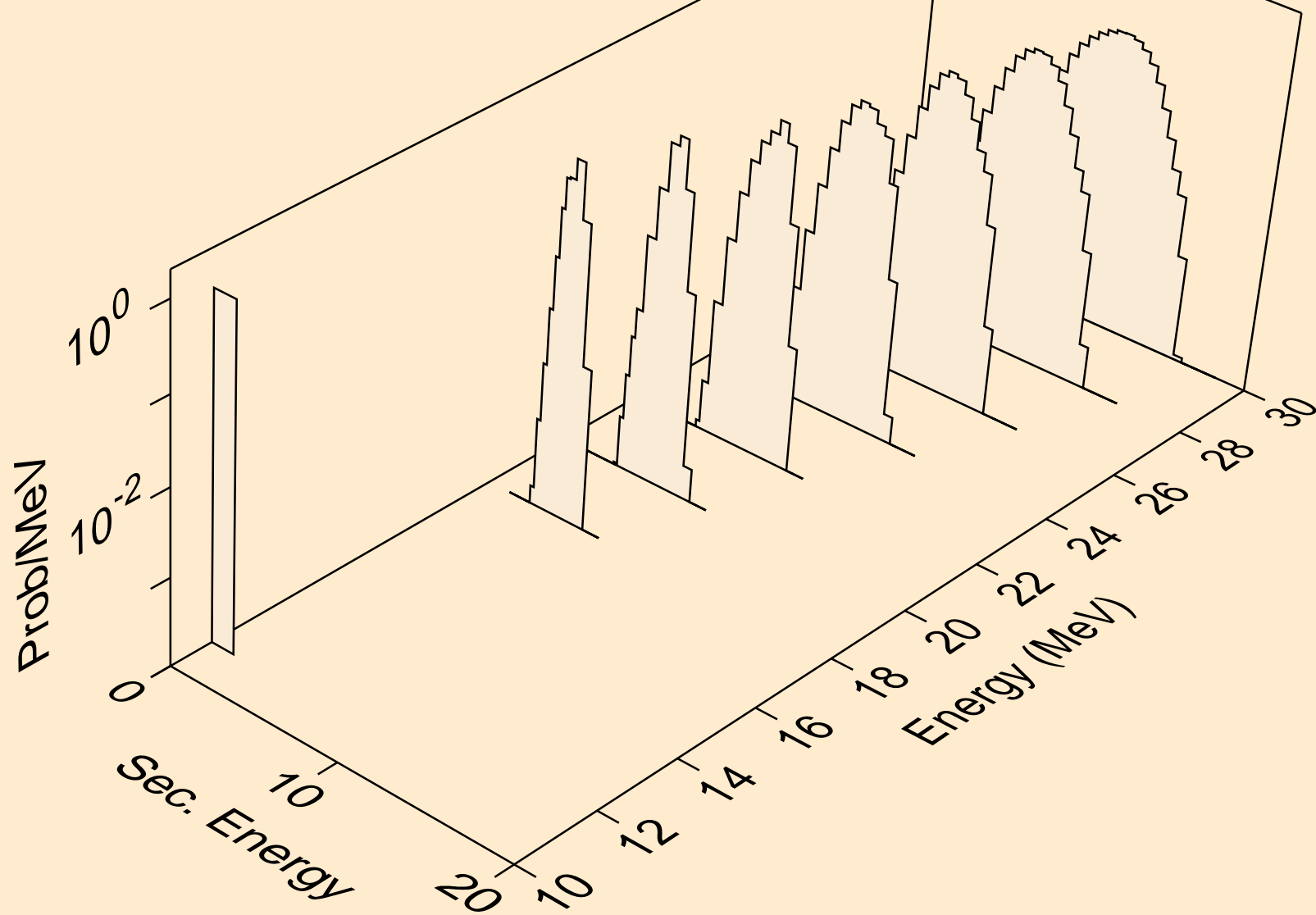

TB154 PROTON ACER TENDL-2023 LIBRARY; T=0.K  
he3s from (p,x)

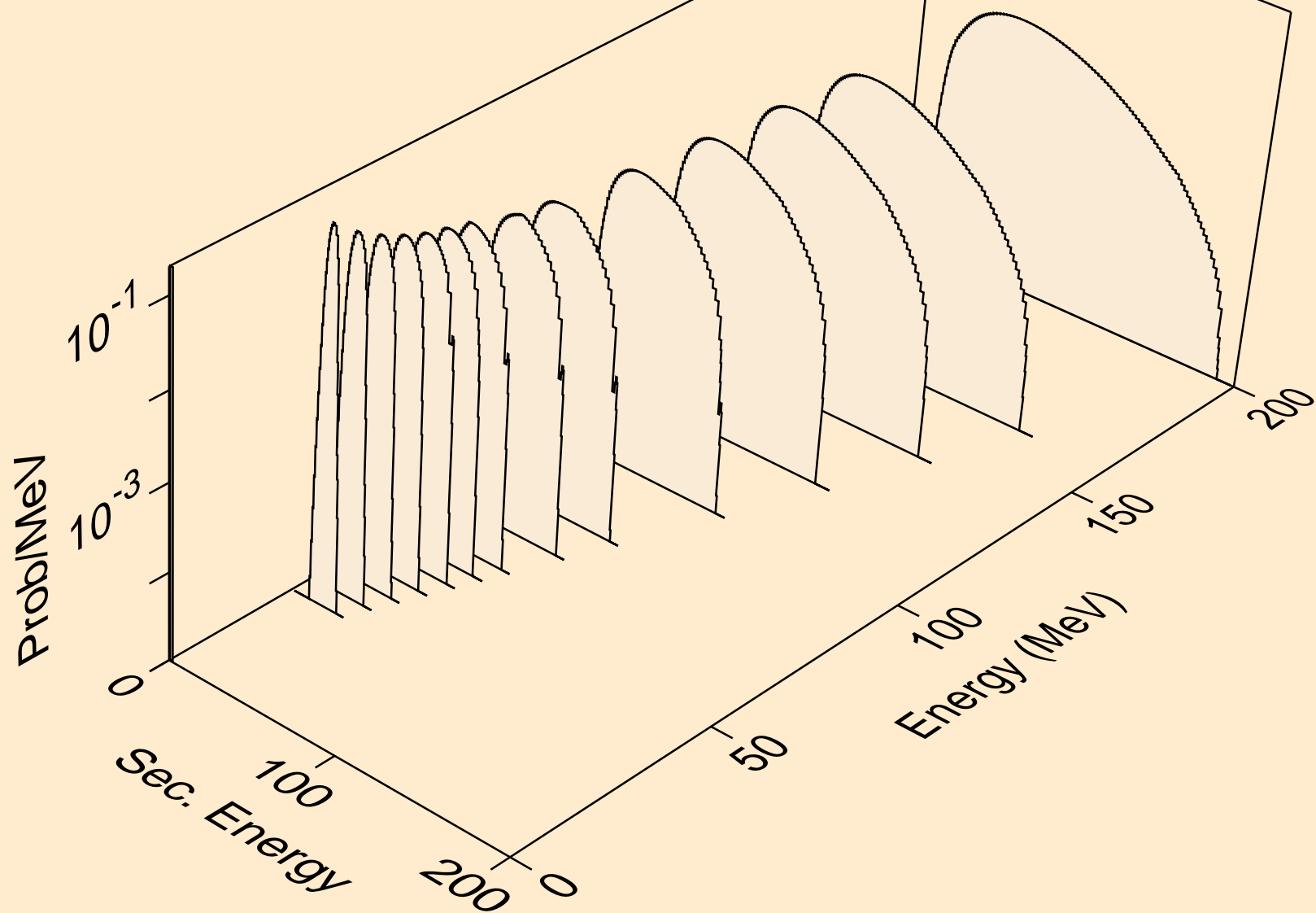

TB154 PROTON ACER TENDL-2023 LIBRARY; T=0.K  
he3s from (p,n\*)he3

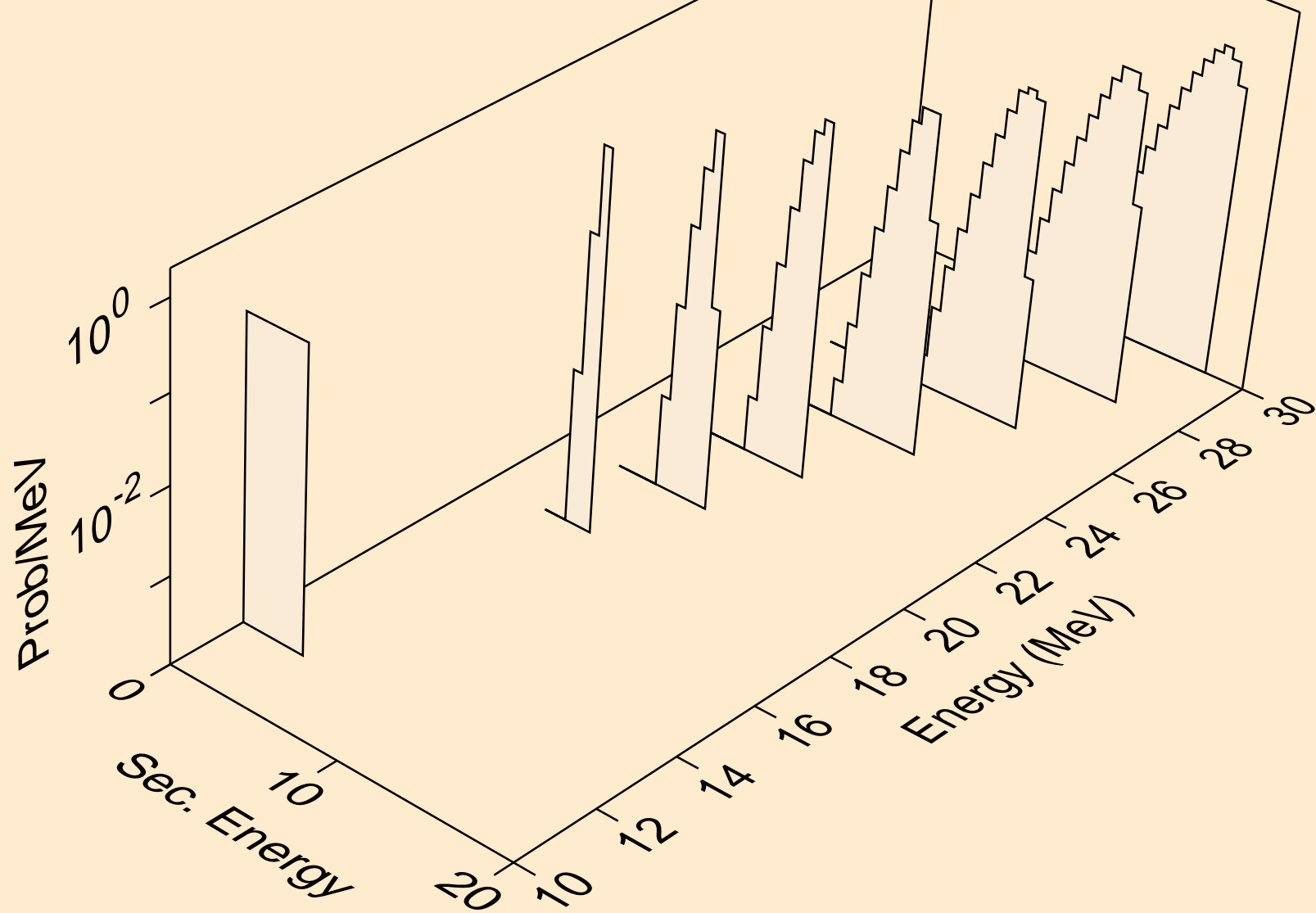

TB154 PROTON ACER TENDL-2023 LIBRARY; T=0.K  
he3s from (p,he3)

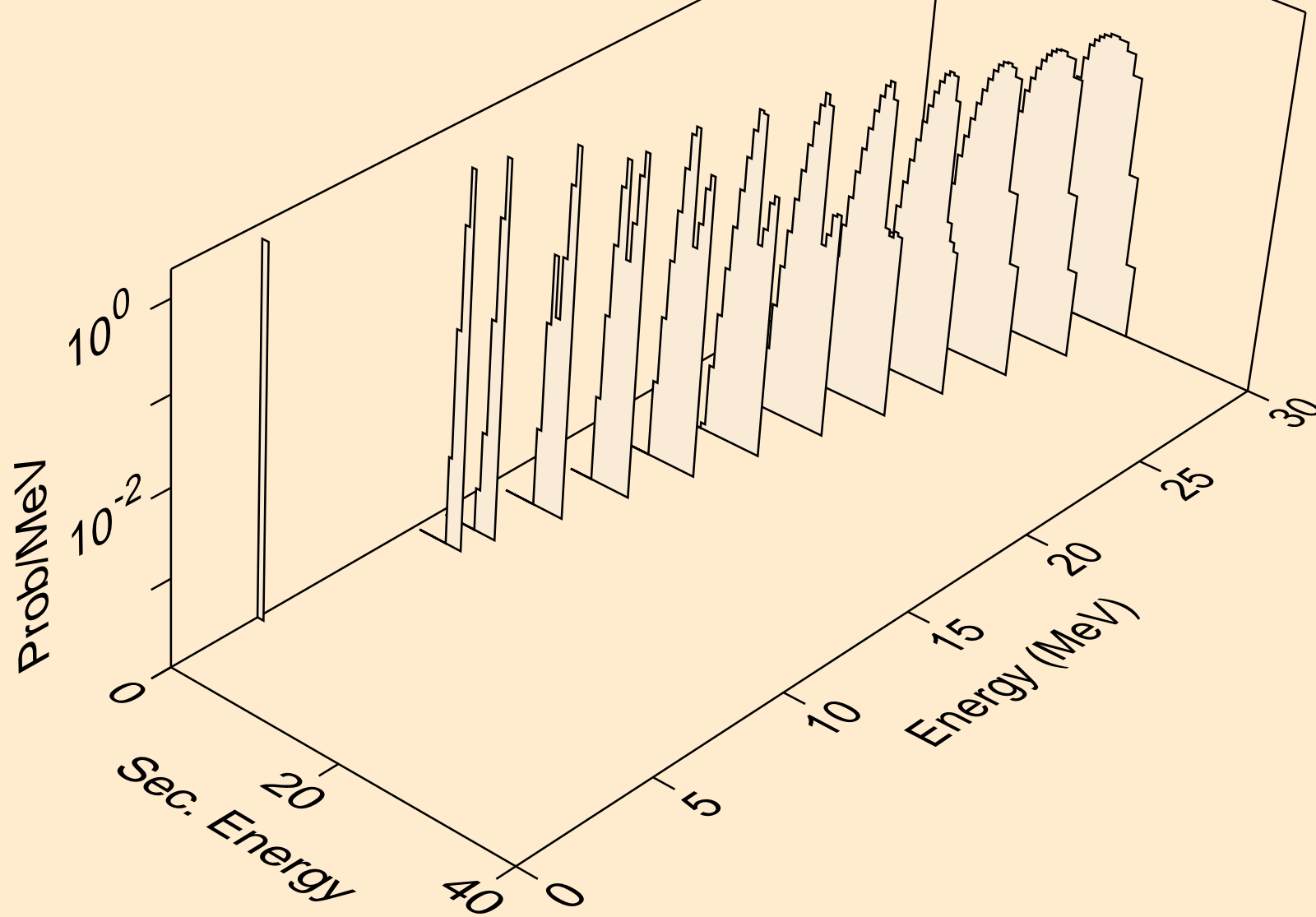

TB154 PROTON ACER TENDL-2023 LIBRARY; T=0.K  
alphas from (p,x)

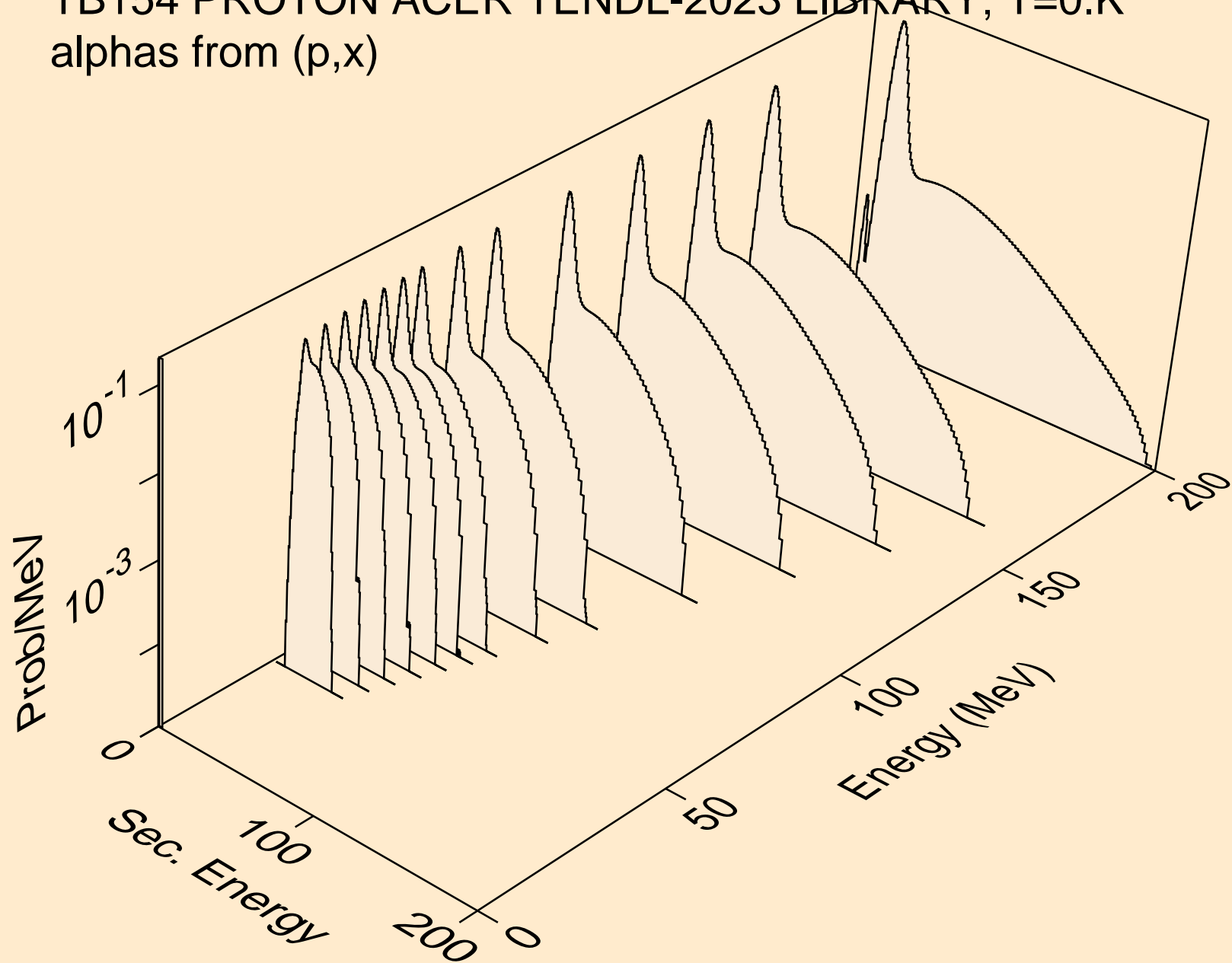

TB154 PROTON ACER TENDL-2023 LIBRARY; T=0.K  
alphas from (p,n\*)a

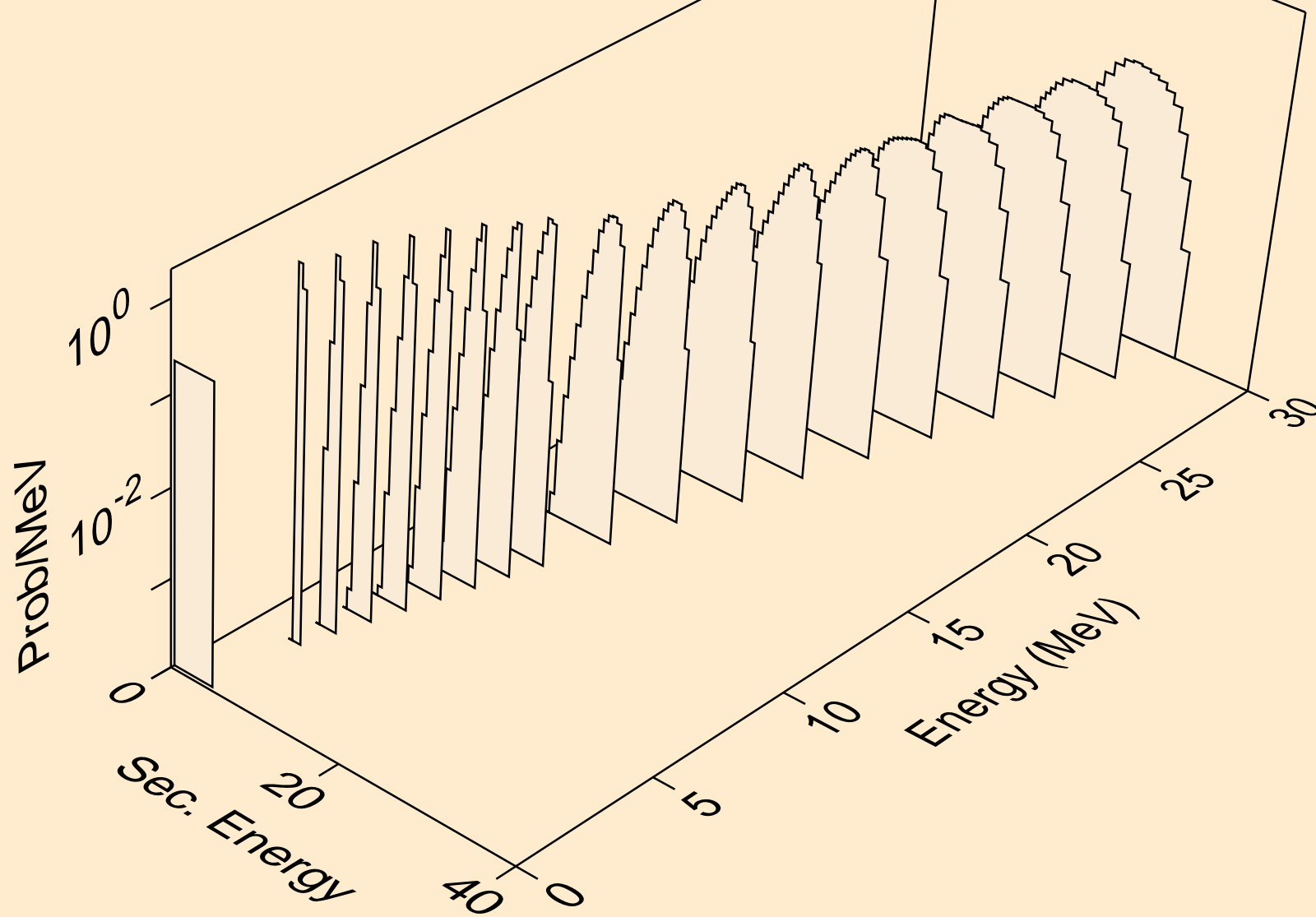

TB154 PROTON ACER TENDL-2023 LIBRARY; T=0.K  
alphas from (p,2n)a

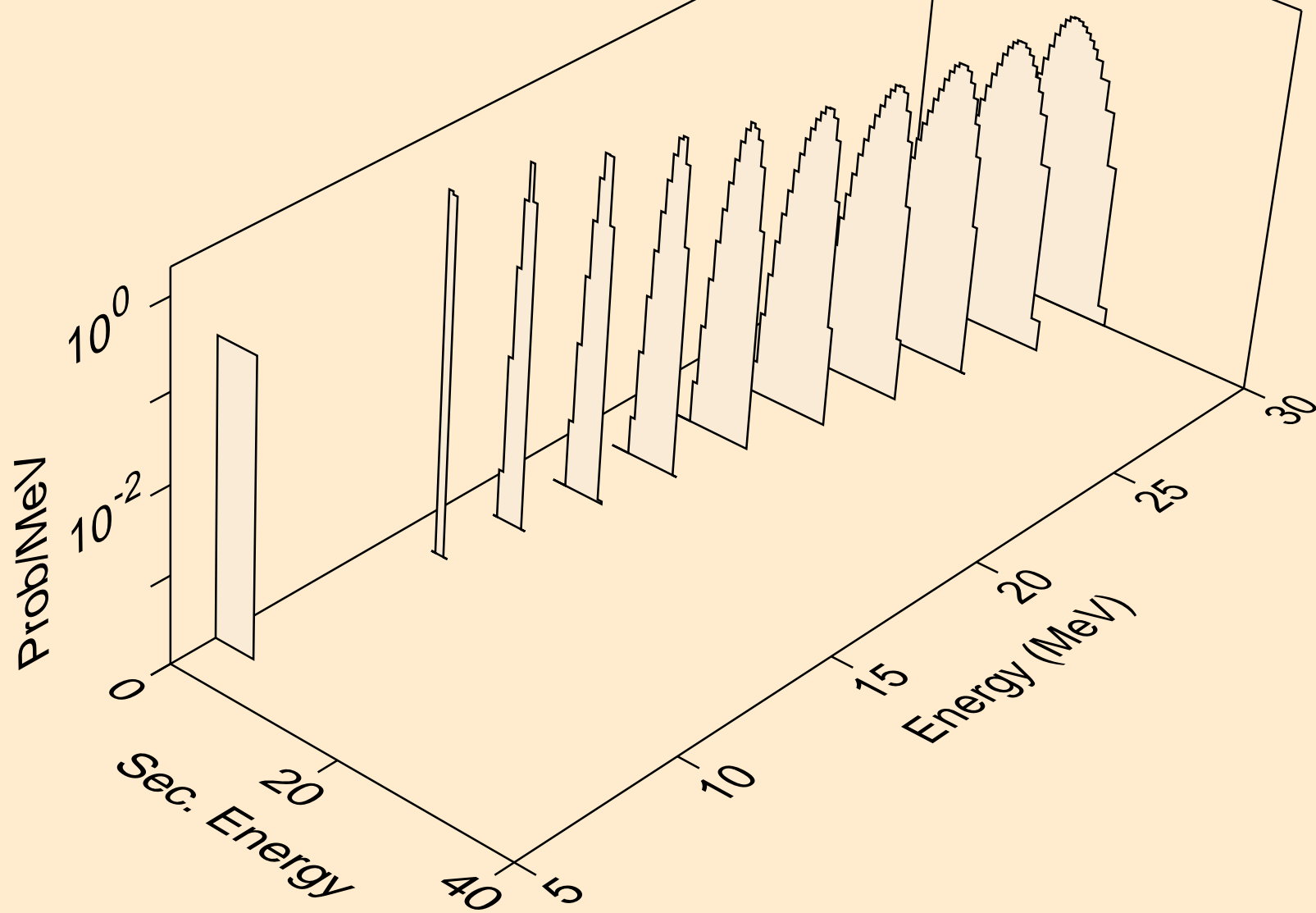

TB154 PROTON ACER TENDL-2023 LIBRARY; T=0.K  
alphas from (p,3n)a

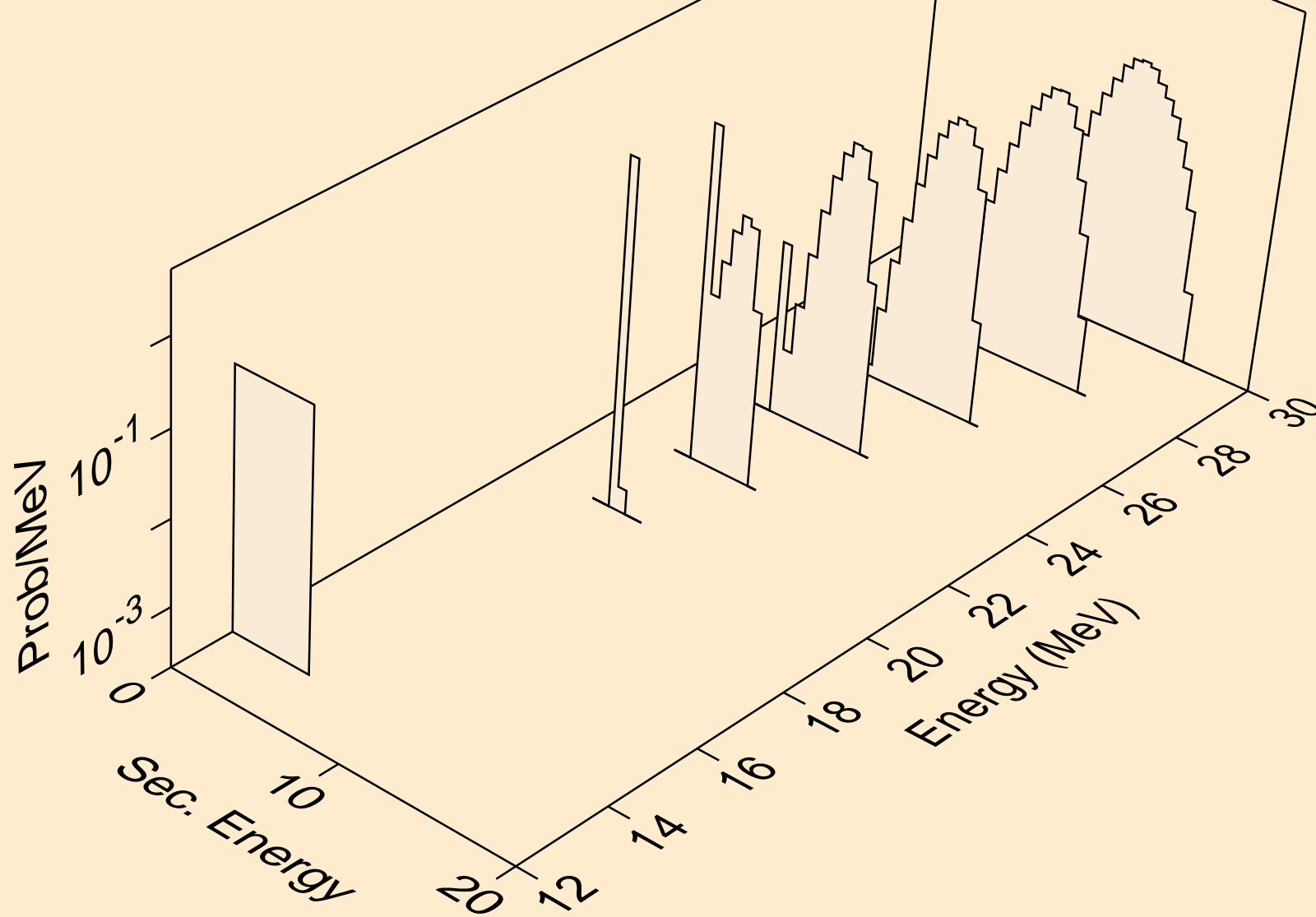

TB154 PROTON ACER TENDL-2023 LIBRARY; T=0.K  
alphas from (p,n\*)2a

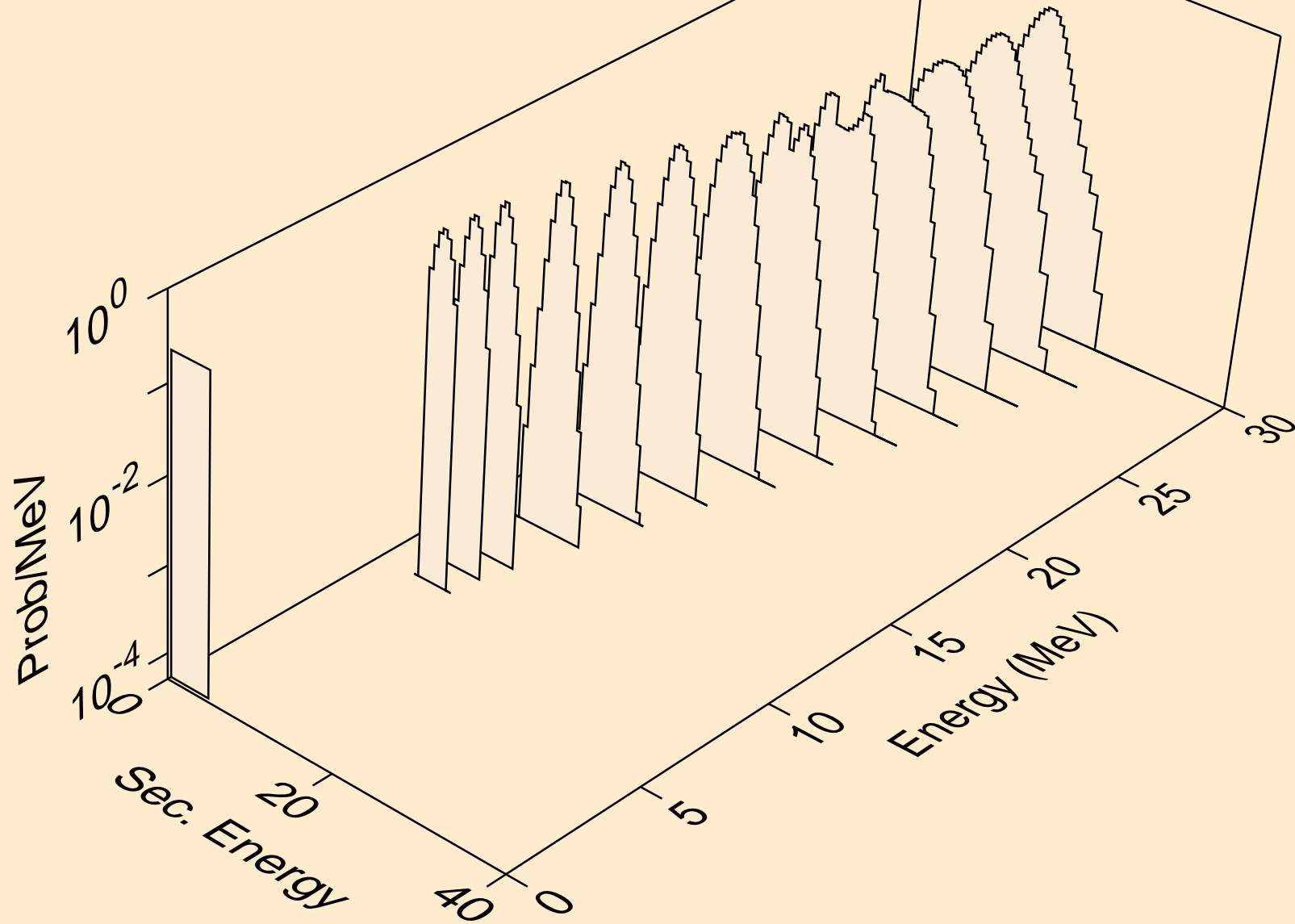

TB154 PROTON ACER TENDL-2023 LIBRARY; T=0.K  
alphas from (p,2n)2a

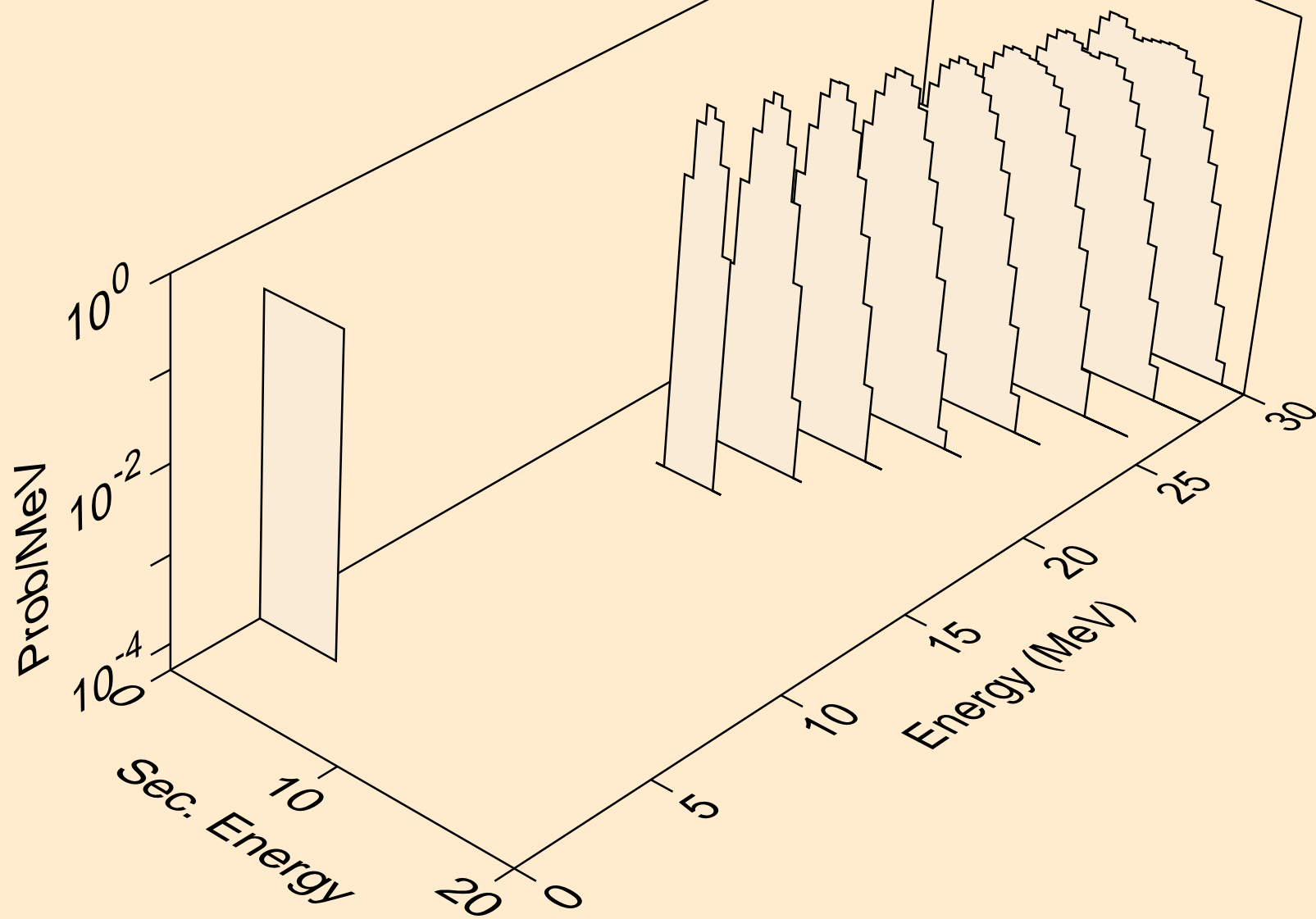

TB154 PROTON ACER TENDL-2023 LIBRARY; T=0.K  
alphas from (p,npa)

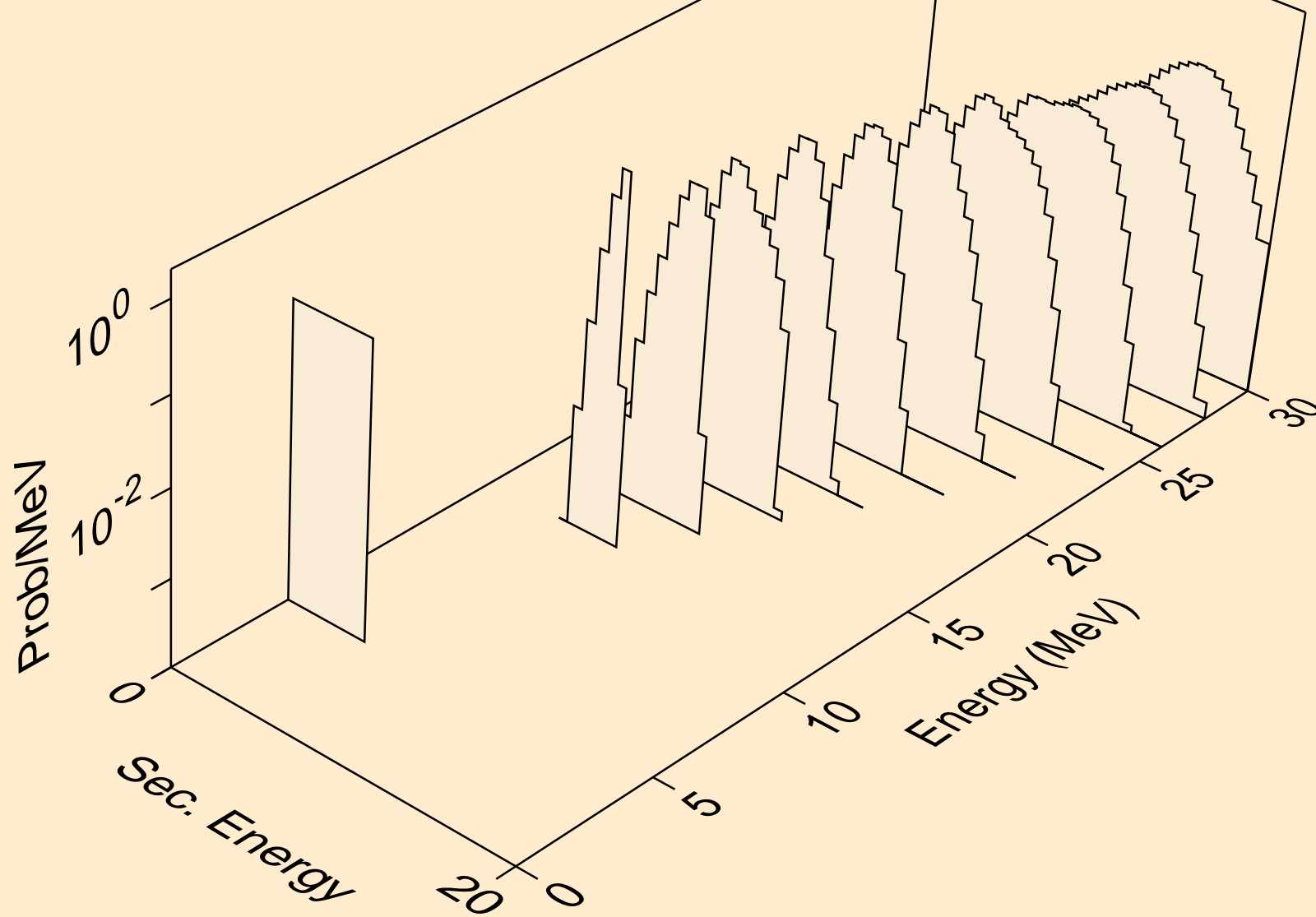

TB154 PROTON ACER TENDL-2023 LIBRARY; T=0.K  
alphas from (p,a)

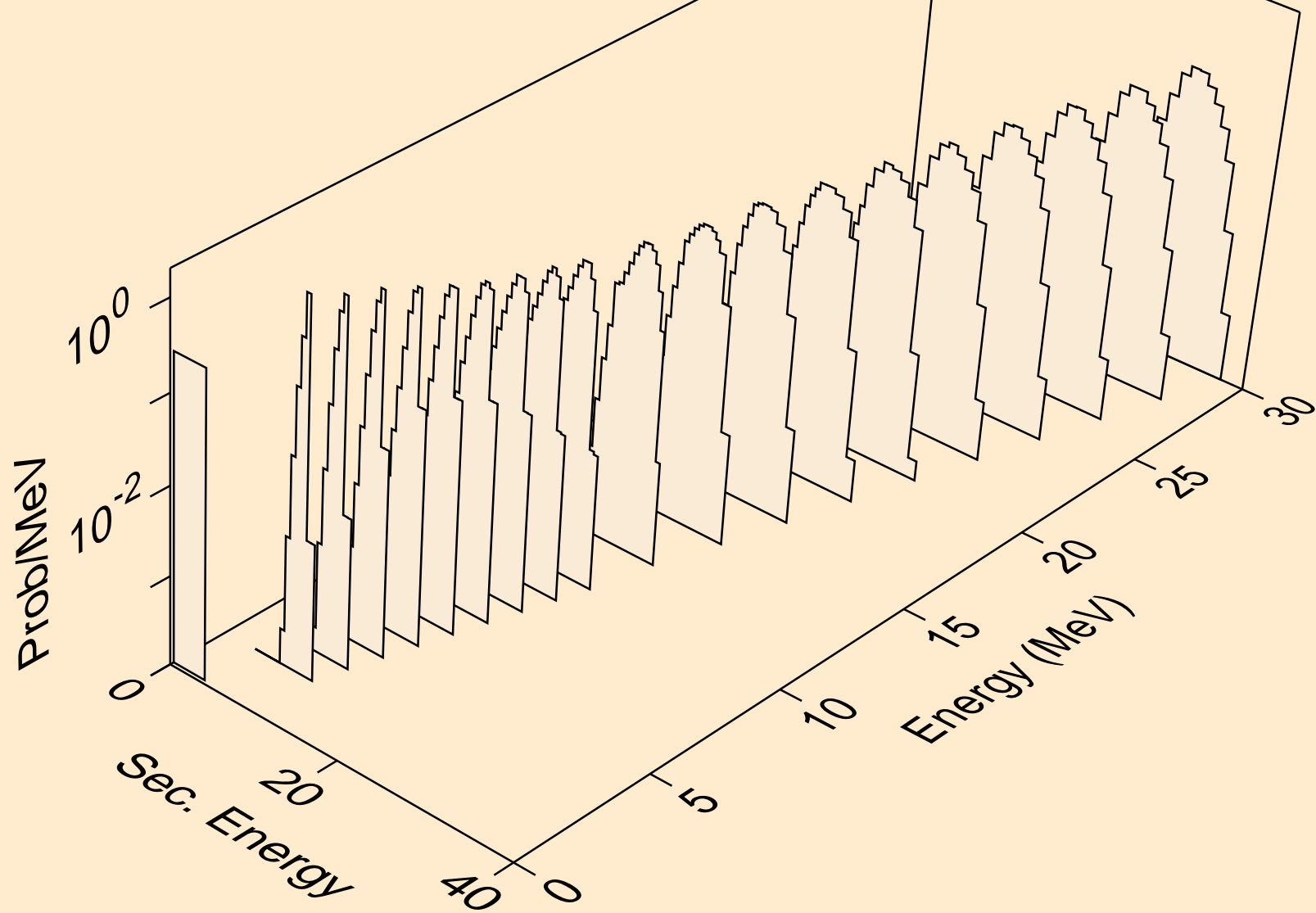

TB154 PROTON ACER TENDL-2023 LIBRARY; T=0.K  
alphas from (p,2a)

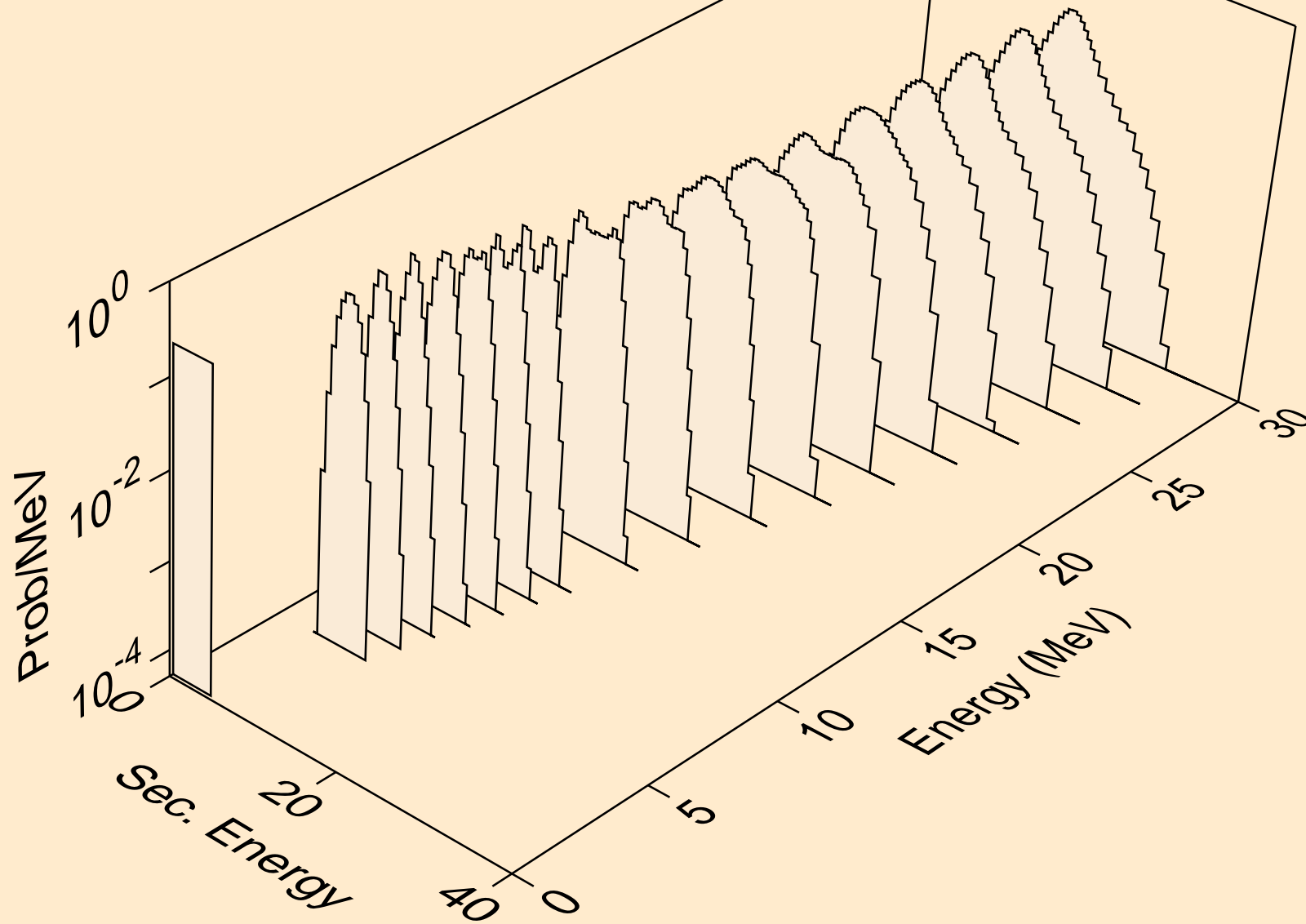

TB154 PROTON ACER TENDL-2023 LIBRARY; T=0.K  
alphas from (p,pa)

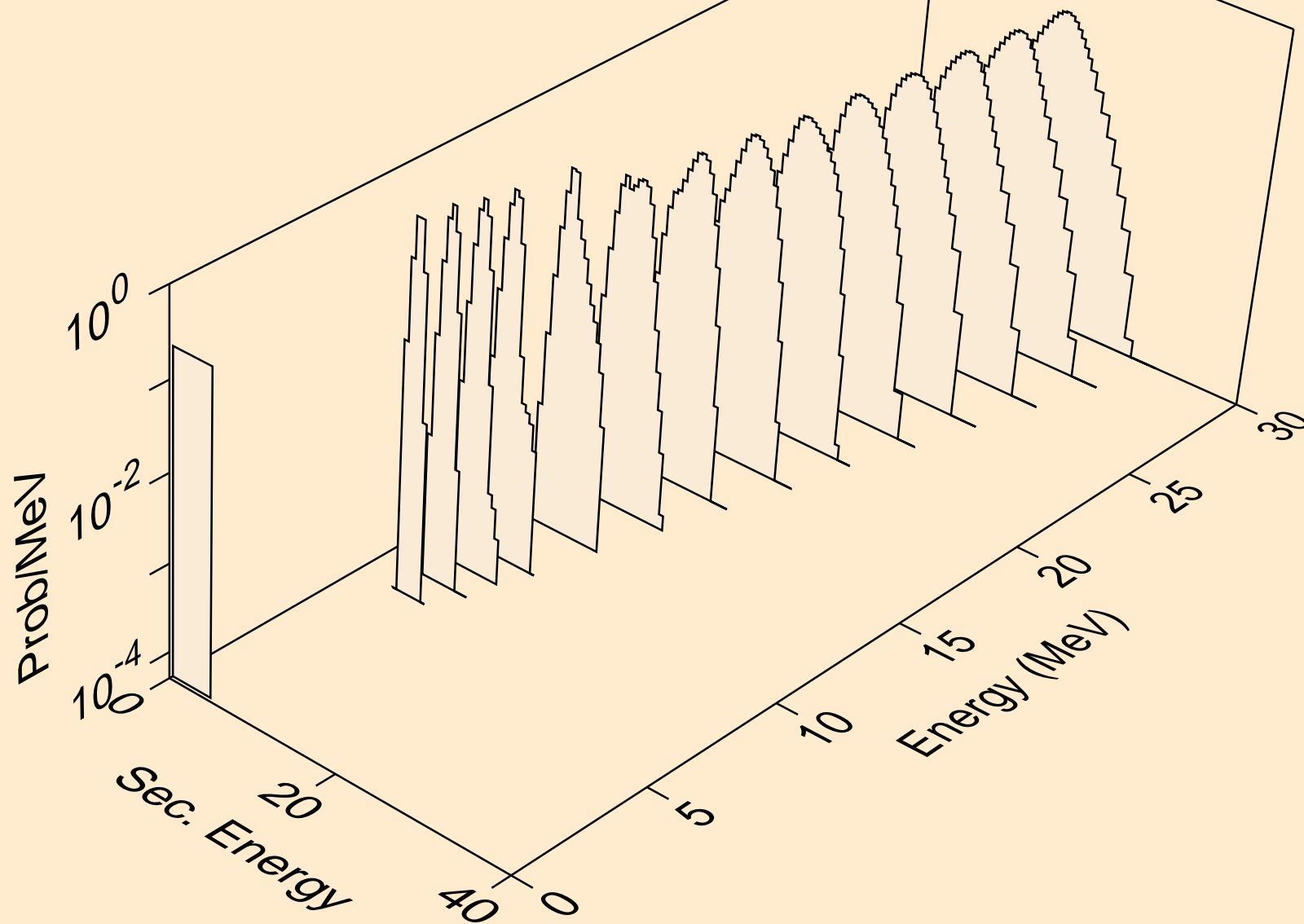

TB154 PROTON ACER TENDL-2023 LIBRARY; T=0.K  
alphas from (p,da)

