

BI210M TRITON ACER TENDL-2023 LIBRARY; T=0.K
Principal cross sections

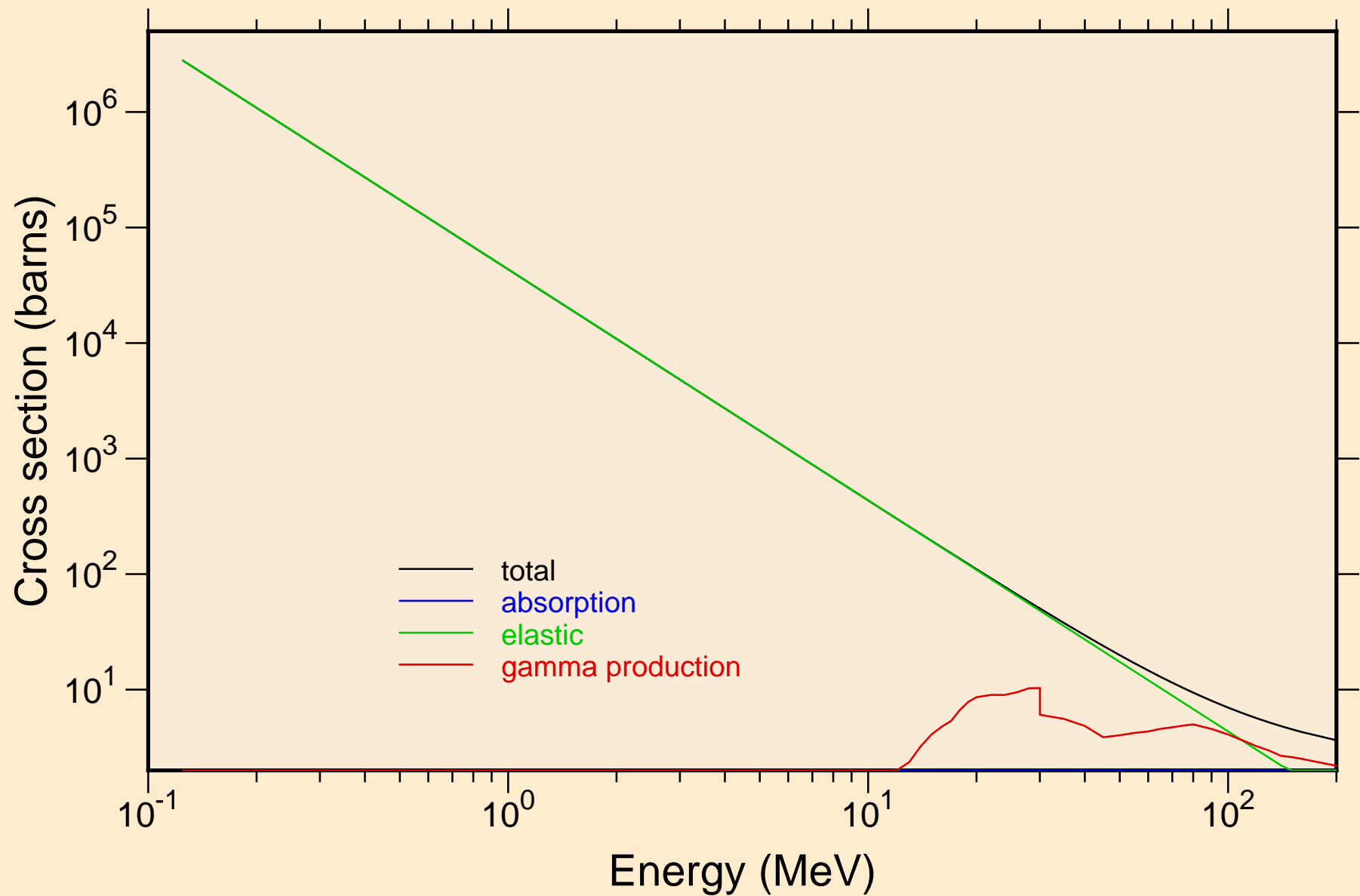

BI210M TRITON ACER TENDL-2023 LIBRARY; T=0.K

Heating

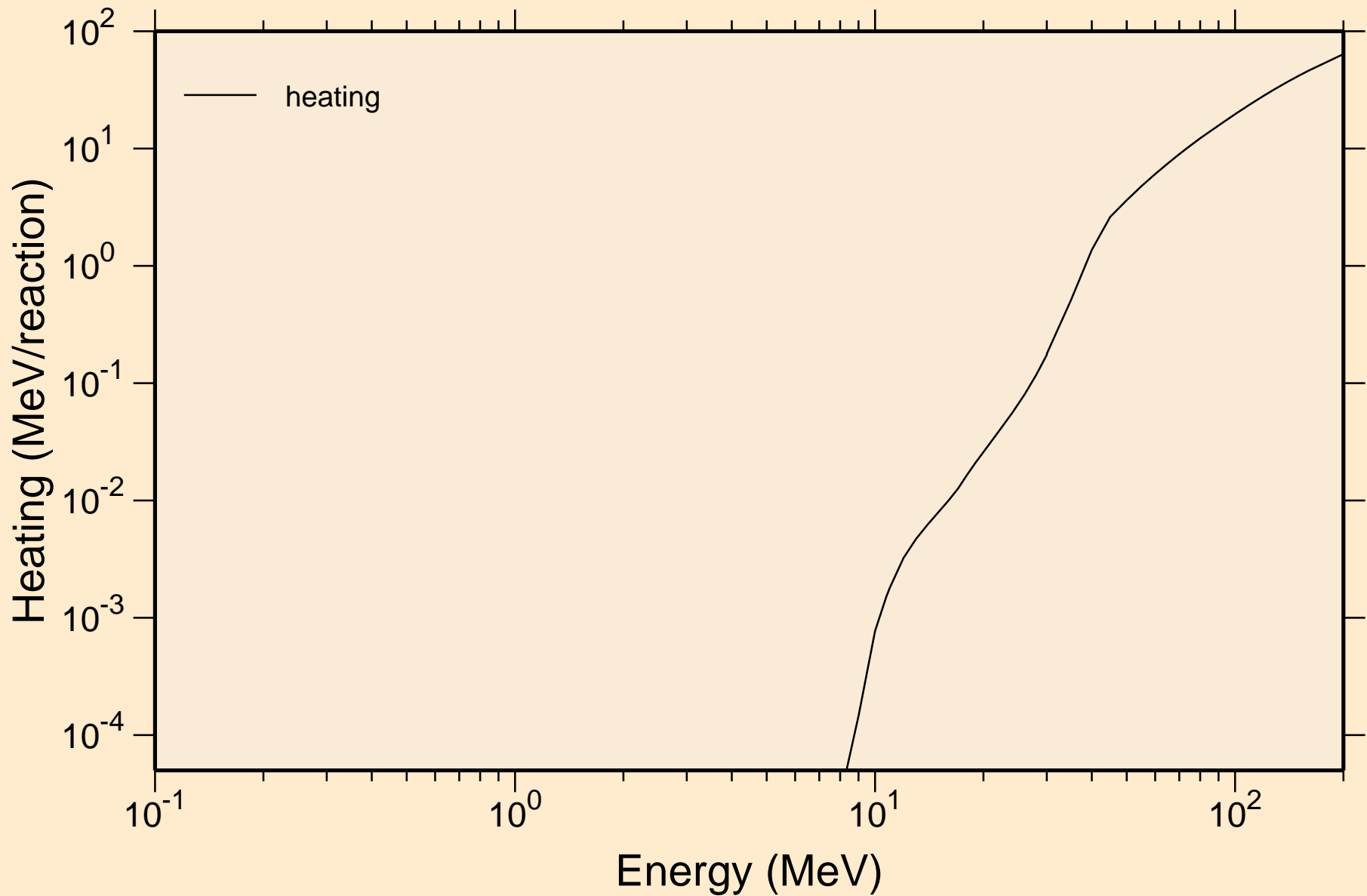

BI210M TRITON ACER TENDL-2023 LIBRARY; T=0.K

Principal cross sections

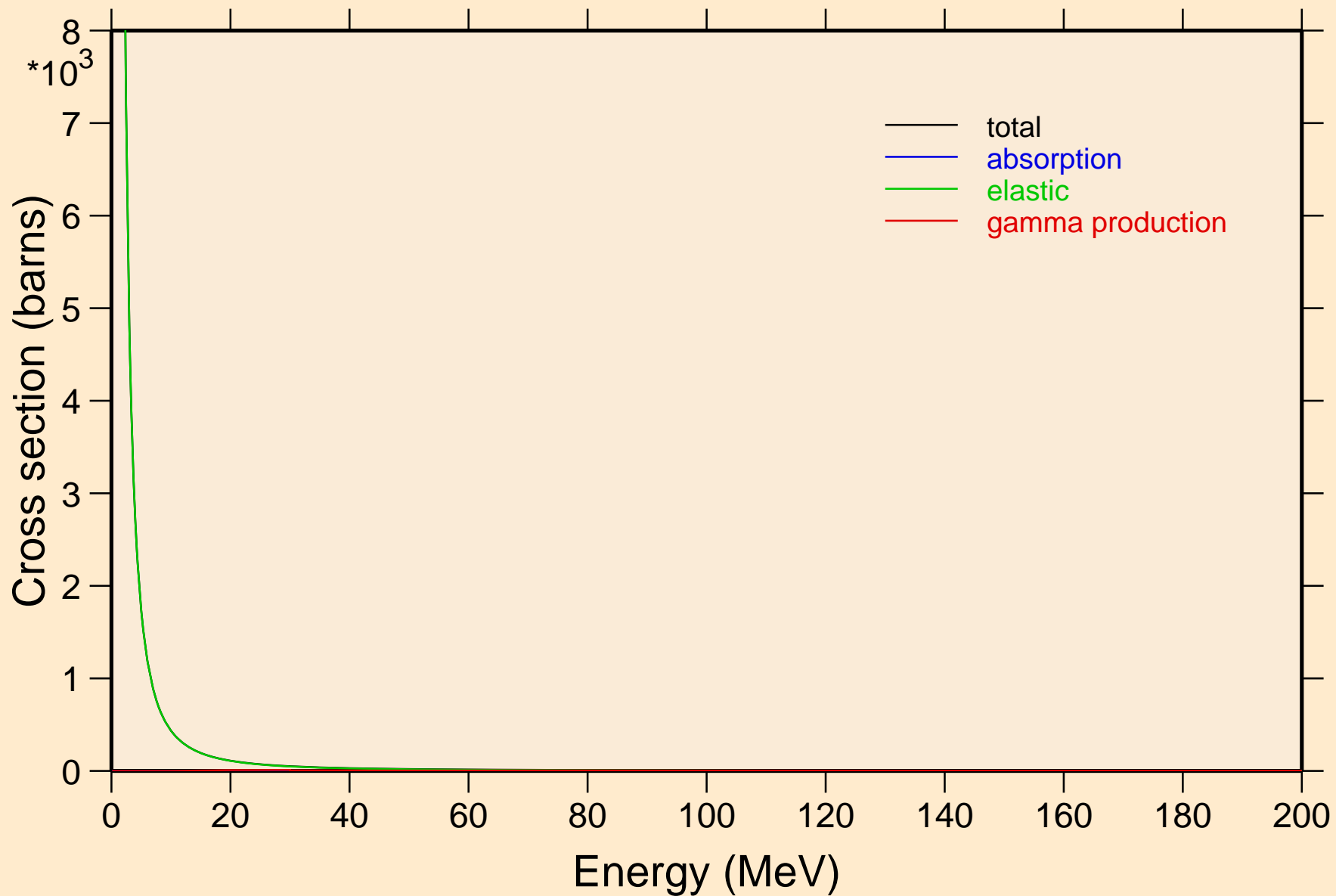

BI210M TRITON ACER TENDL-2023 LIBRARY; T=0.K

Heating

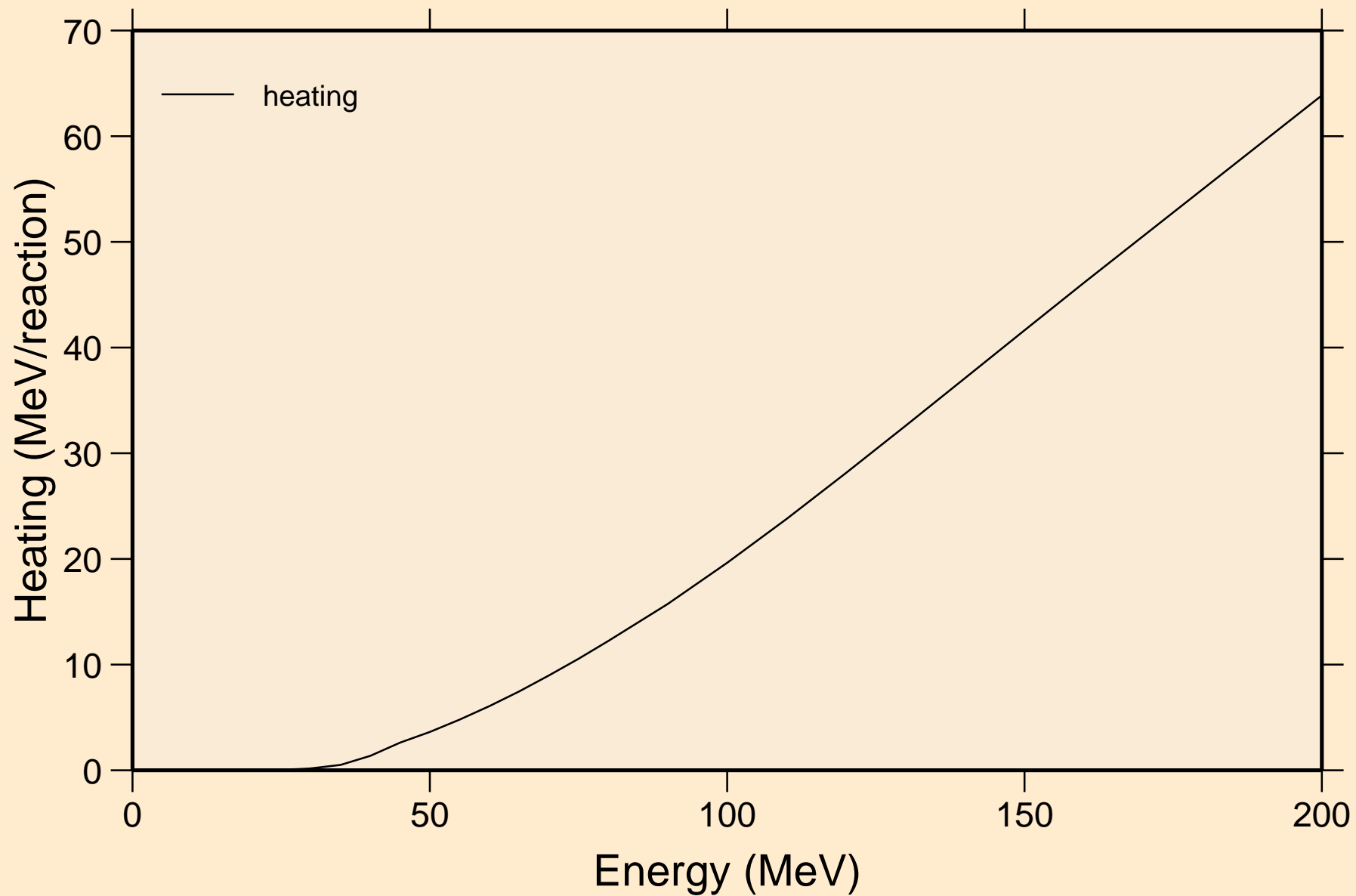

BI210M TRITON ACER TENDL-2023 LIBRARY; T=0.K

Threshold reactions

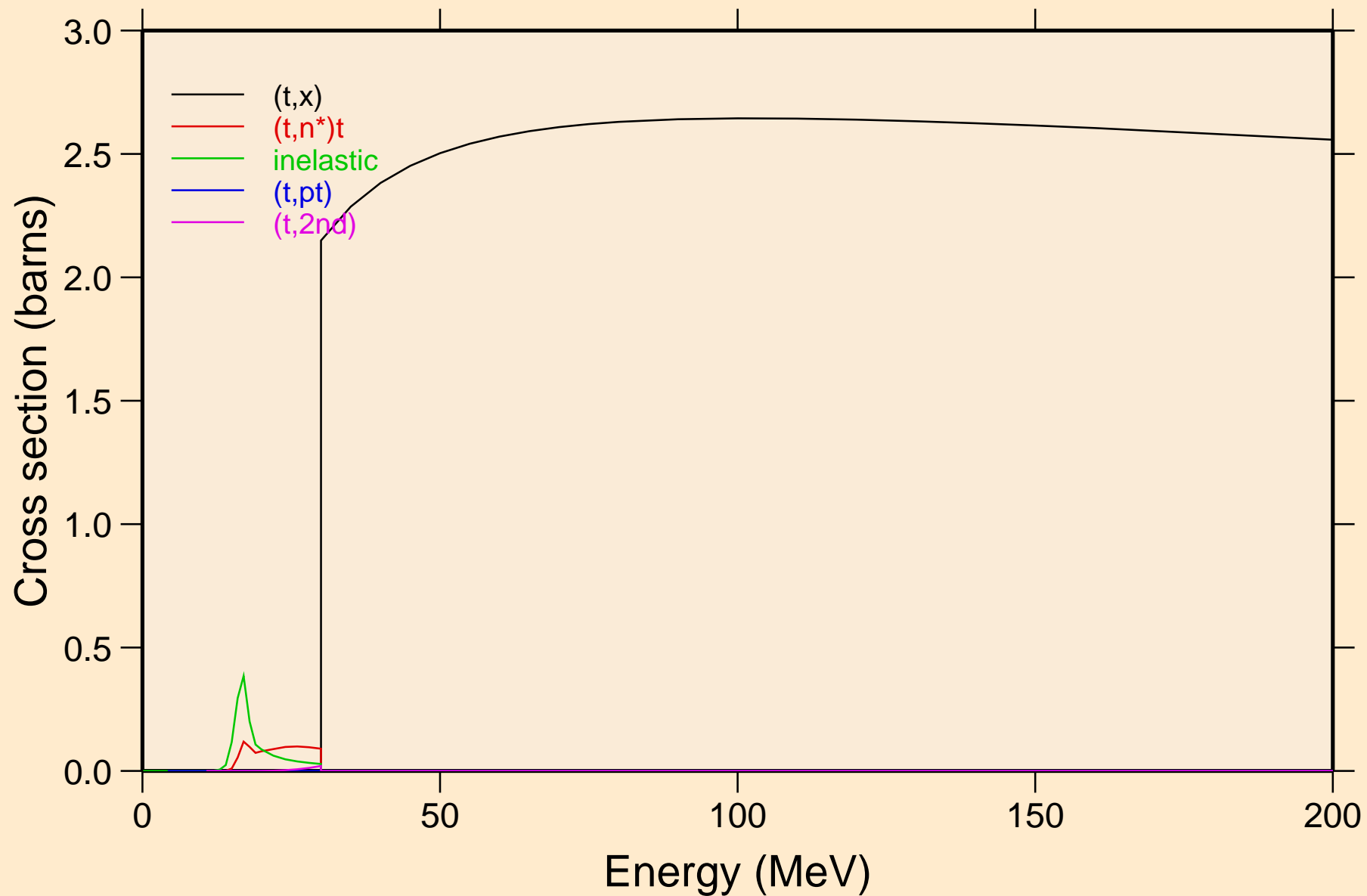

BI210M TRITON ACER TENDL-2023 LIBRARY; T=0.K
Threshold reactions

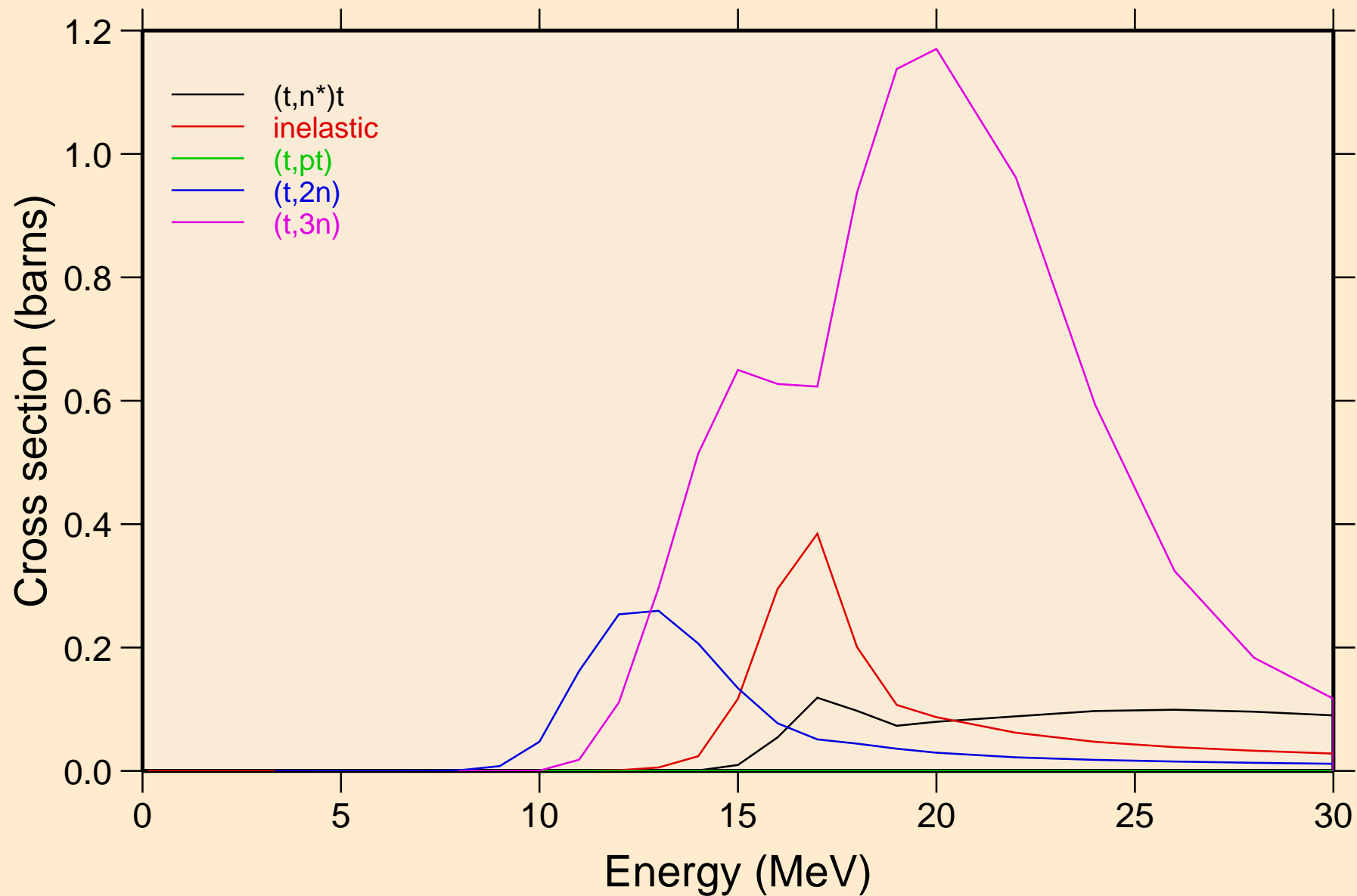

BI210M TRITON ACER TENDL-2023 LIBRARY; T=0.K
Threshold reactions

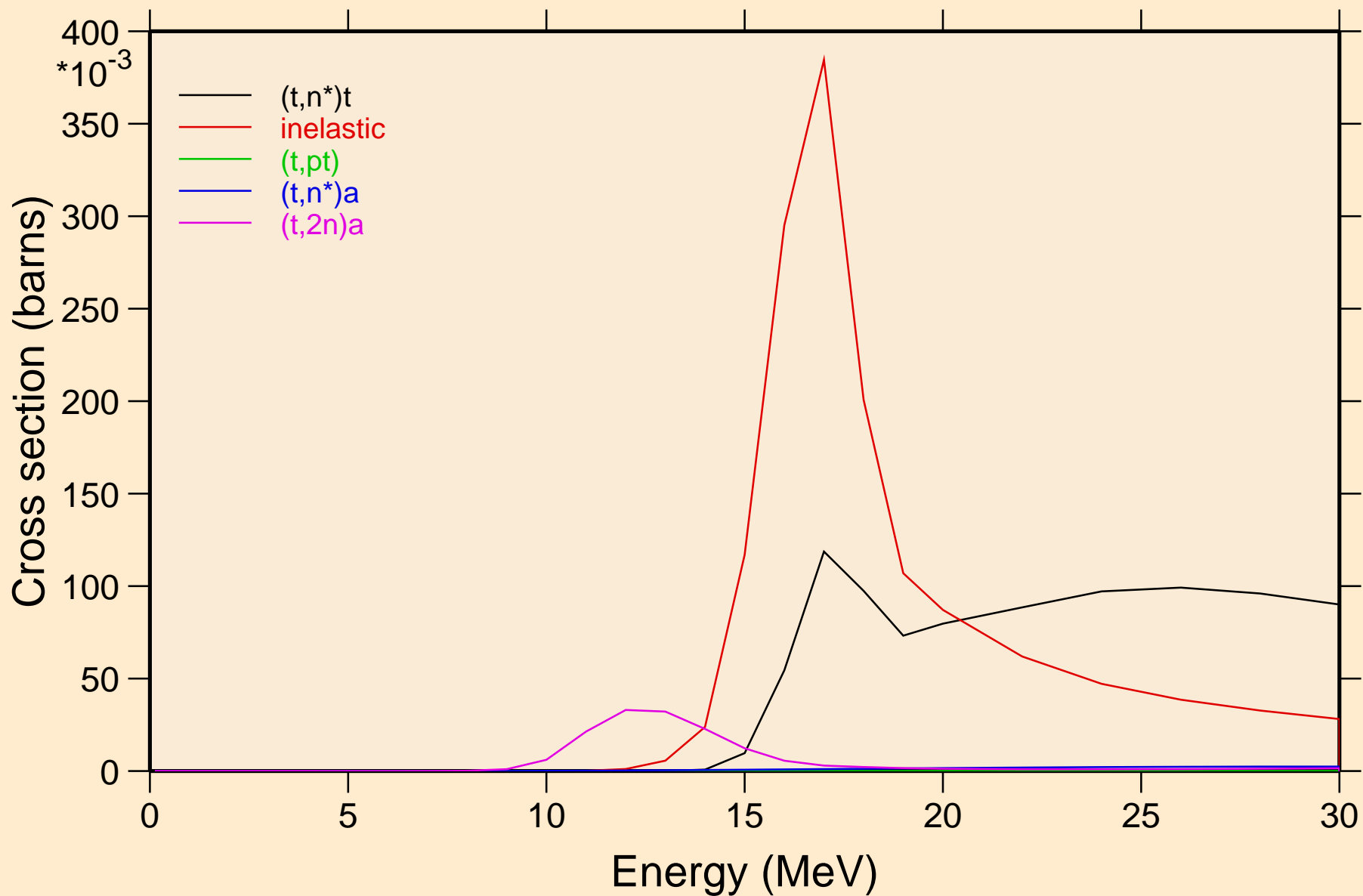

BI210M TRITON ACER TENDL-2023 LIBRARY; T=0.K
Threshold reactions

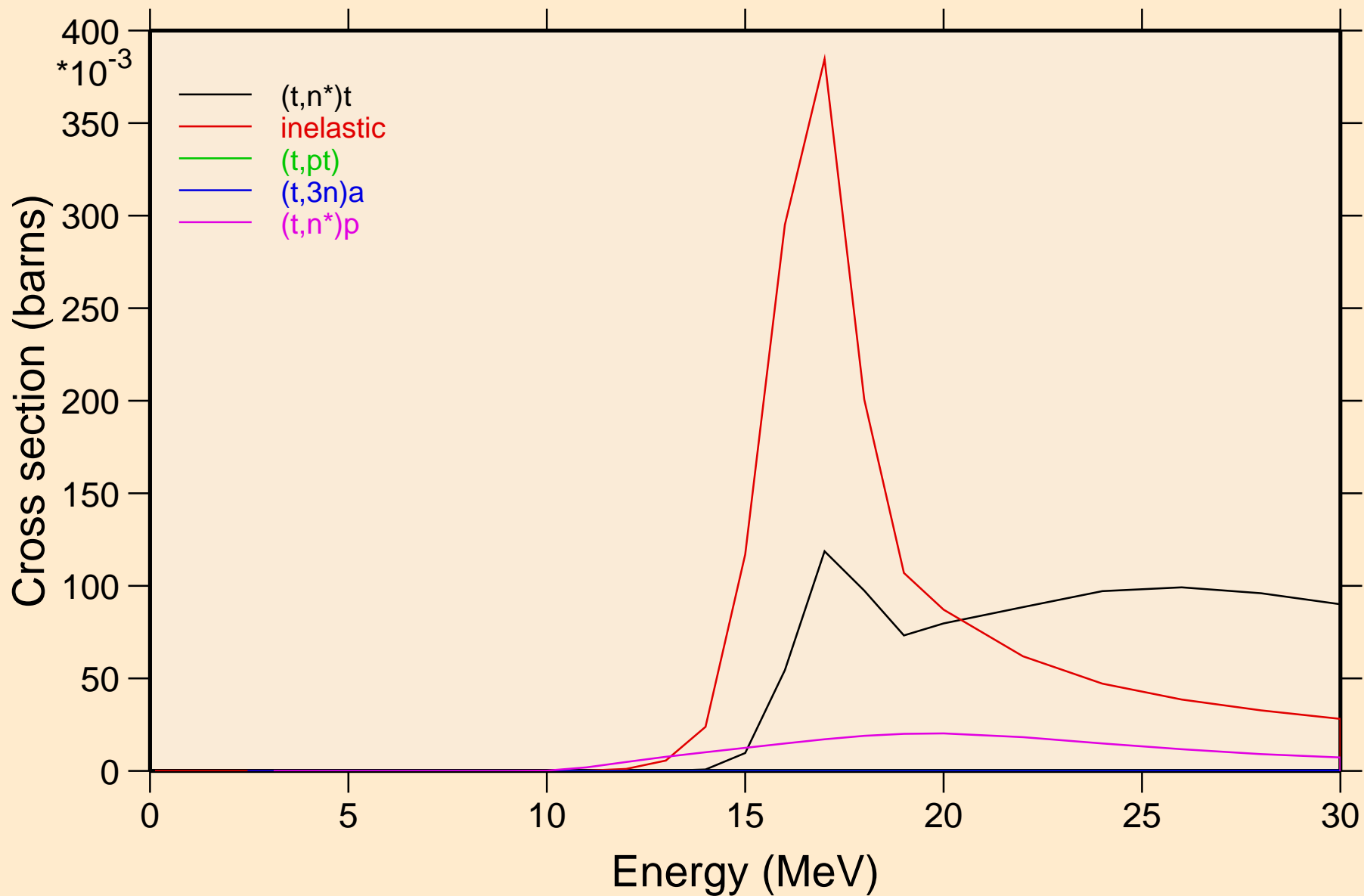

BI210M TRITON ACER TENDL-2023 LIBRARY; T=0.K
Threshold reactions

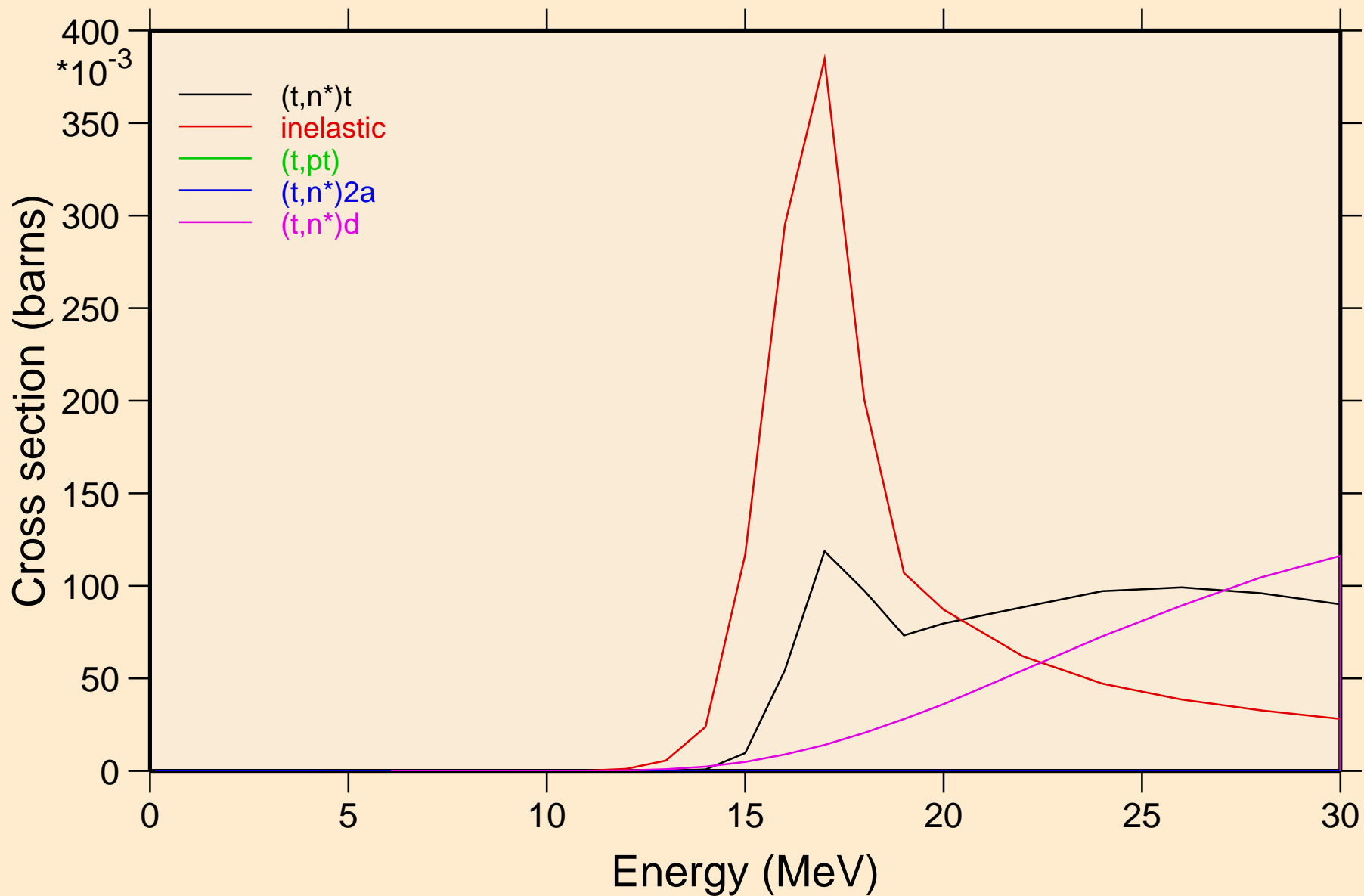

BI210M TRITON ACER TENDL-2023 LIBRARY; T=0.K
Threshold reactions

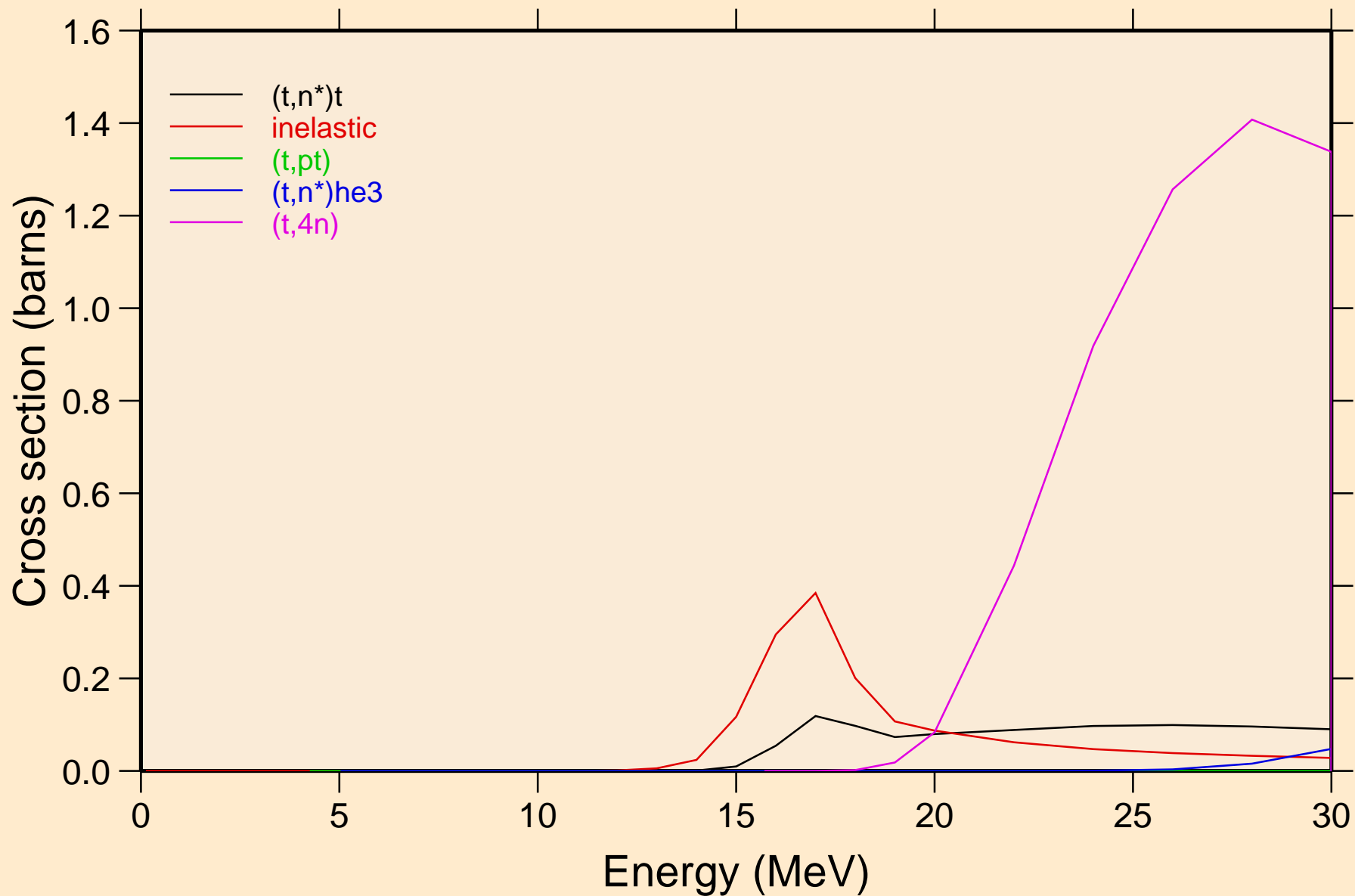

BI210M TRITON ACER TENDL-2023 LIBRARY; T=0.K
Threshold reactions

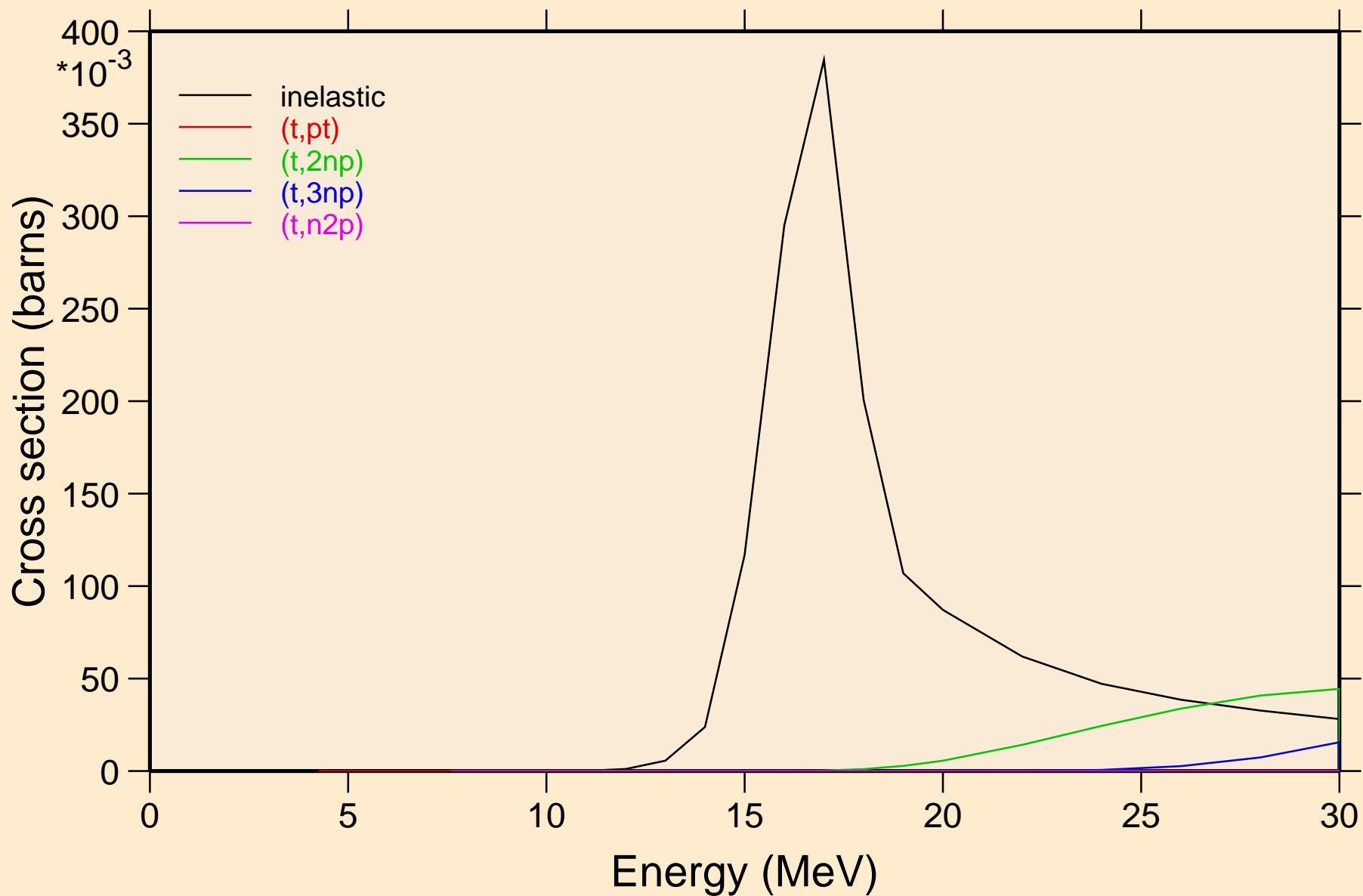

BI210M TRITON ACER TENDL-2023 LIBRARY; T=0.K
Threshold reactions

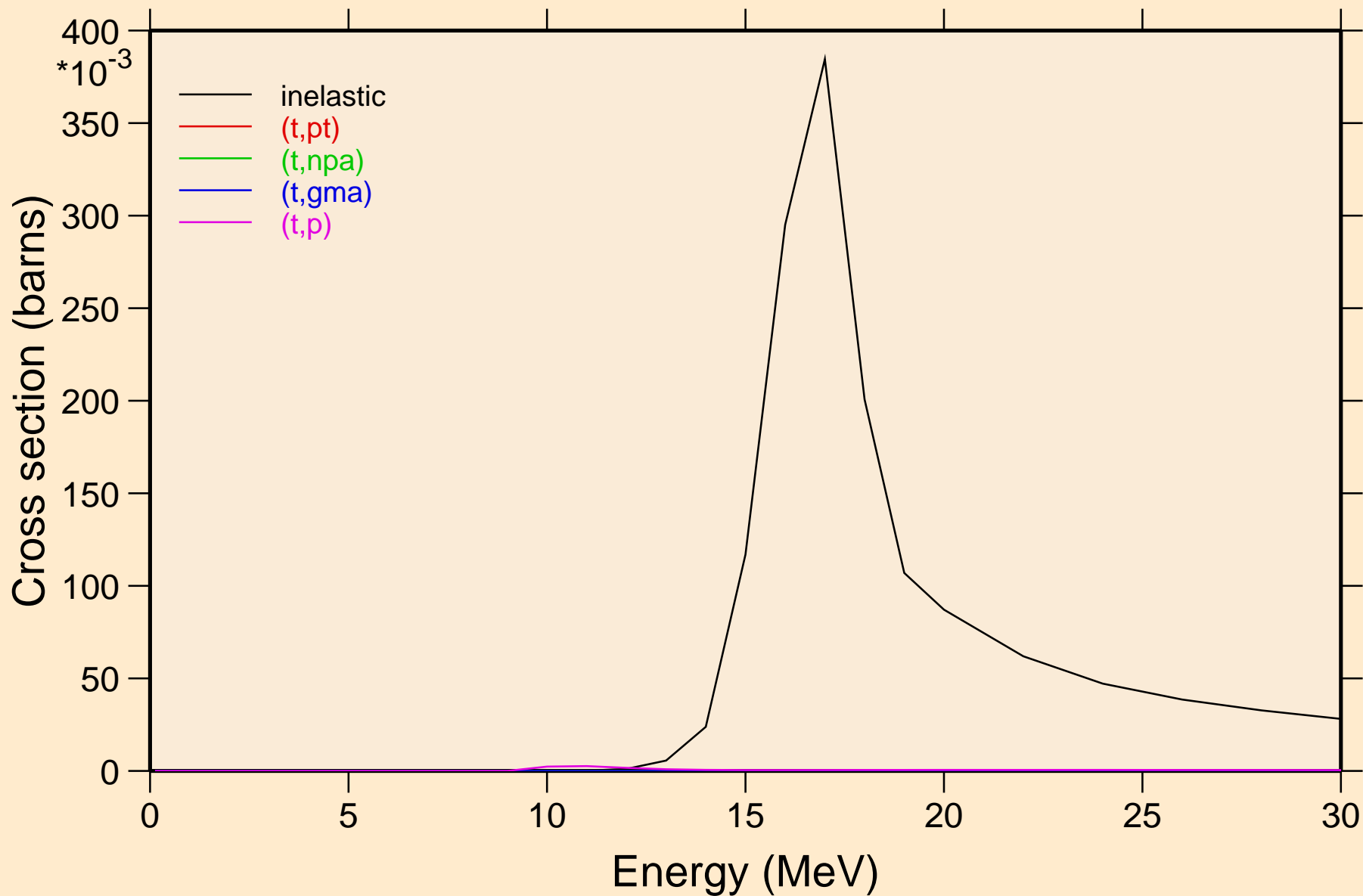

BI210M TRITON ACER TENDL-2023 LIBRARY; T=0.K
Threshold reactions

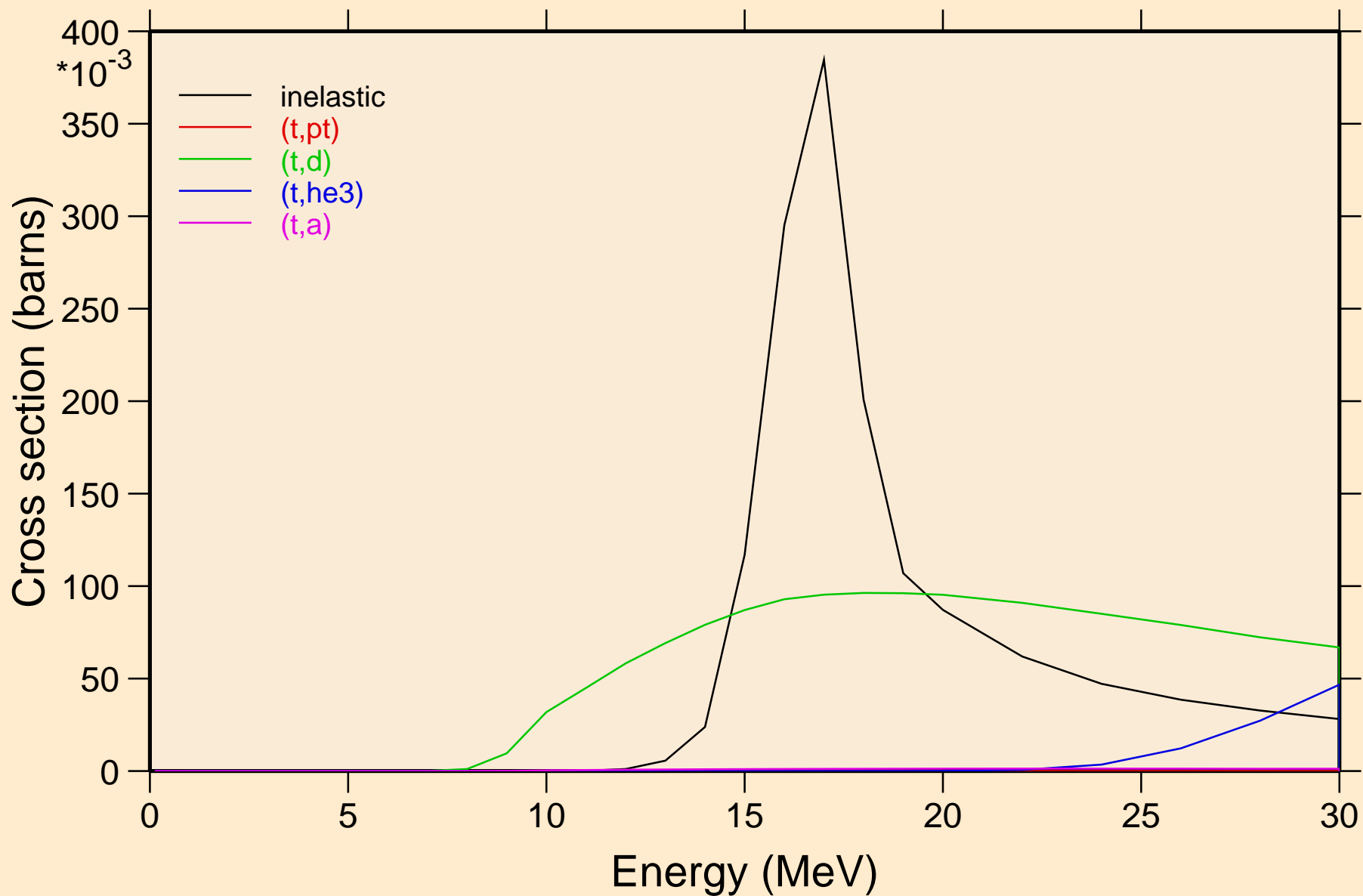

BI210M TRITON ACER TENDL-2023 LIBRARY; T=0.K
Threshold reactions

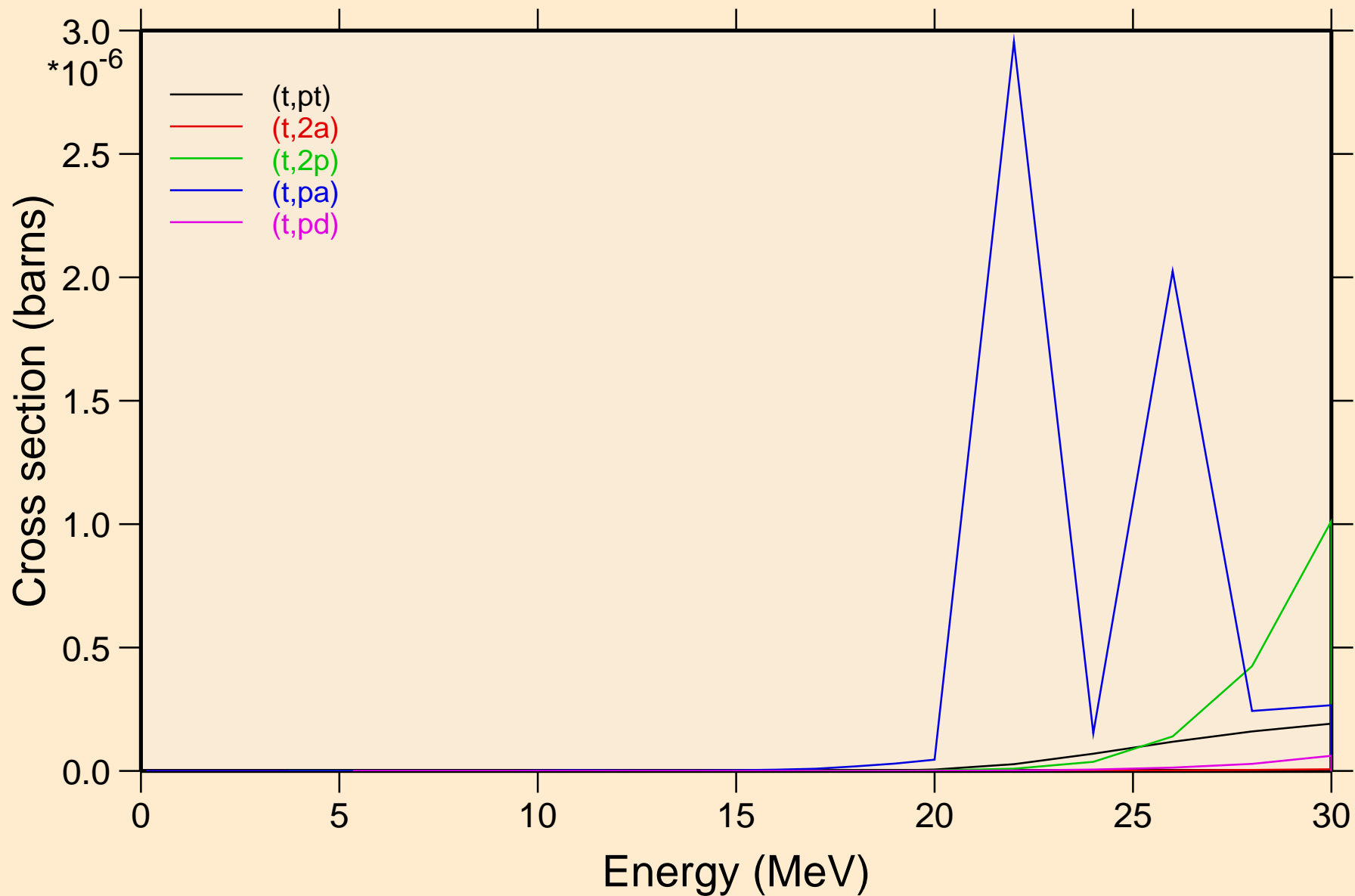

BI210M TRITON ACER TENDL-2023 LIBRARY; T=0.K
Threshold reactions

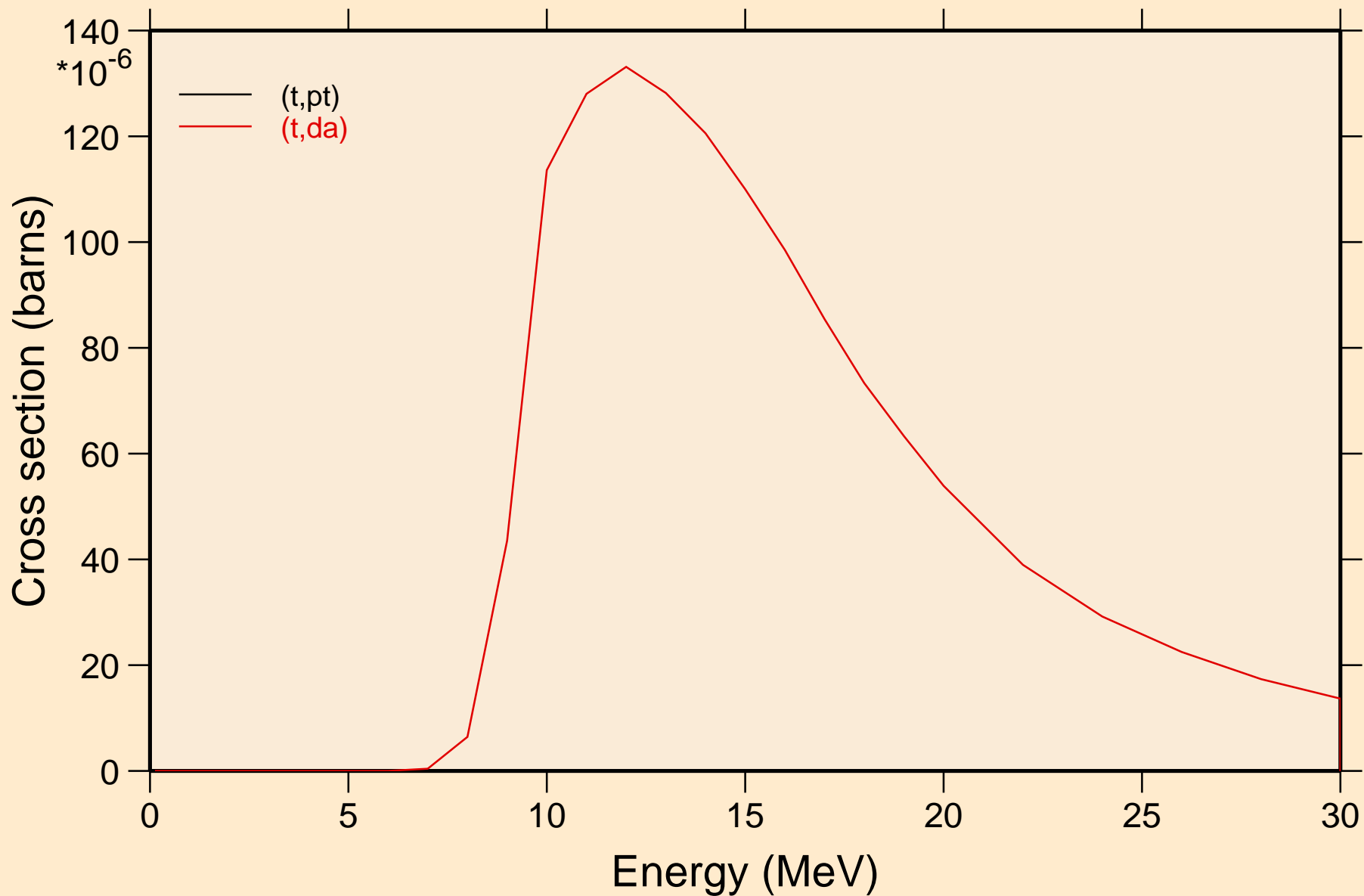

BI210M TRITON ACER TENDL-2023 LIBRARY; T=0.K
angular distribution for elastic

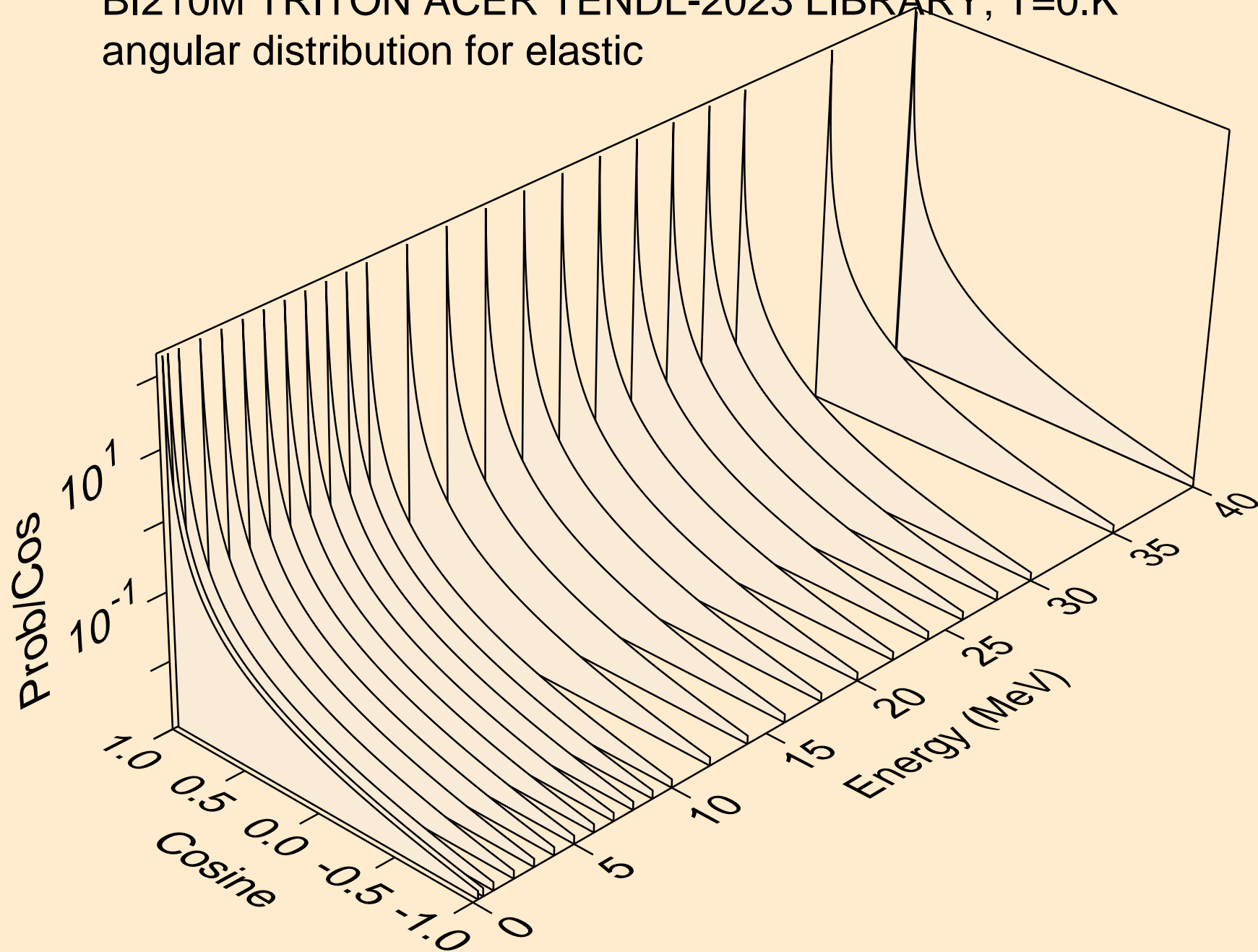

BI210M TRITON ACER TENDL-2023 LIBRARY; T=0.K
Triton emission for (t,x)

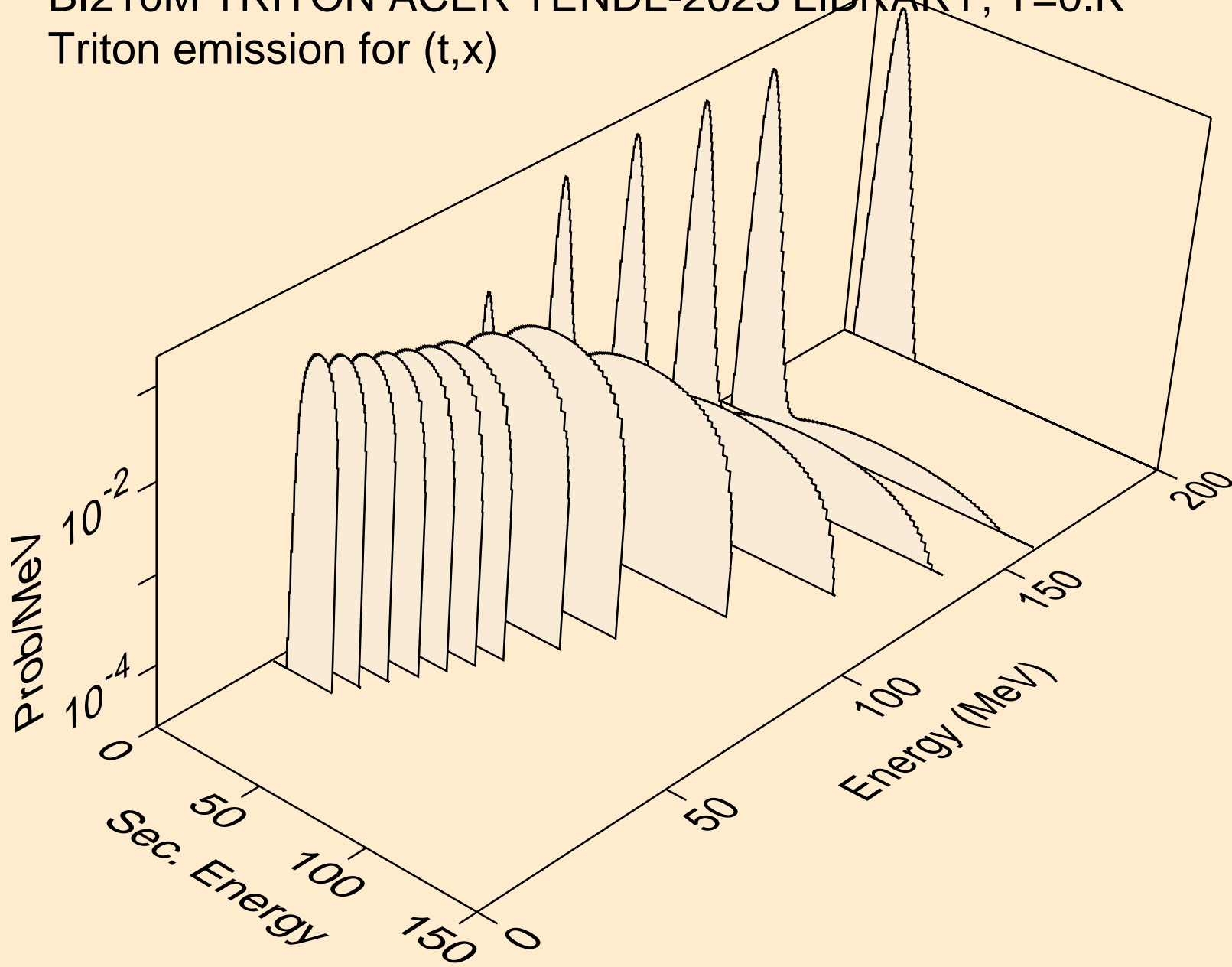

BI210M TRITON ACER TENDL-2023 LIBRARY; T=0.K
Triton emission for (t,n*)t

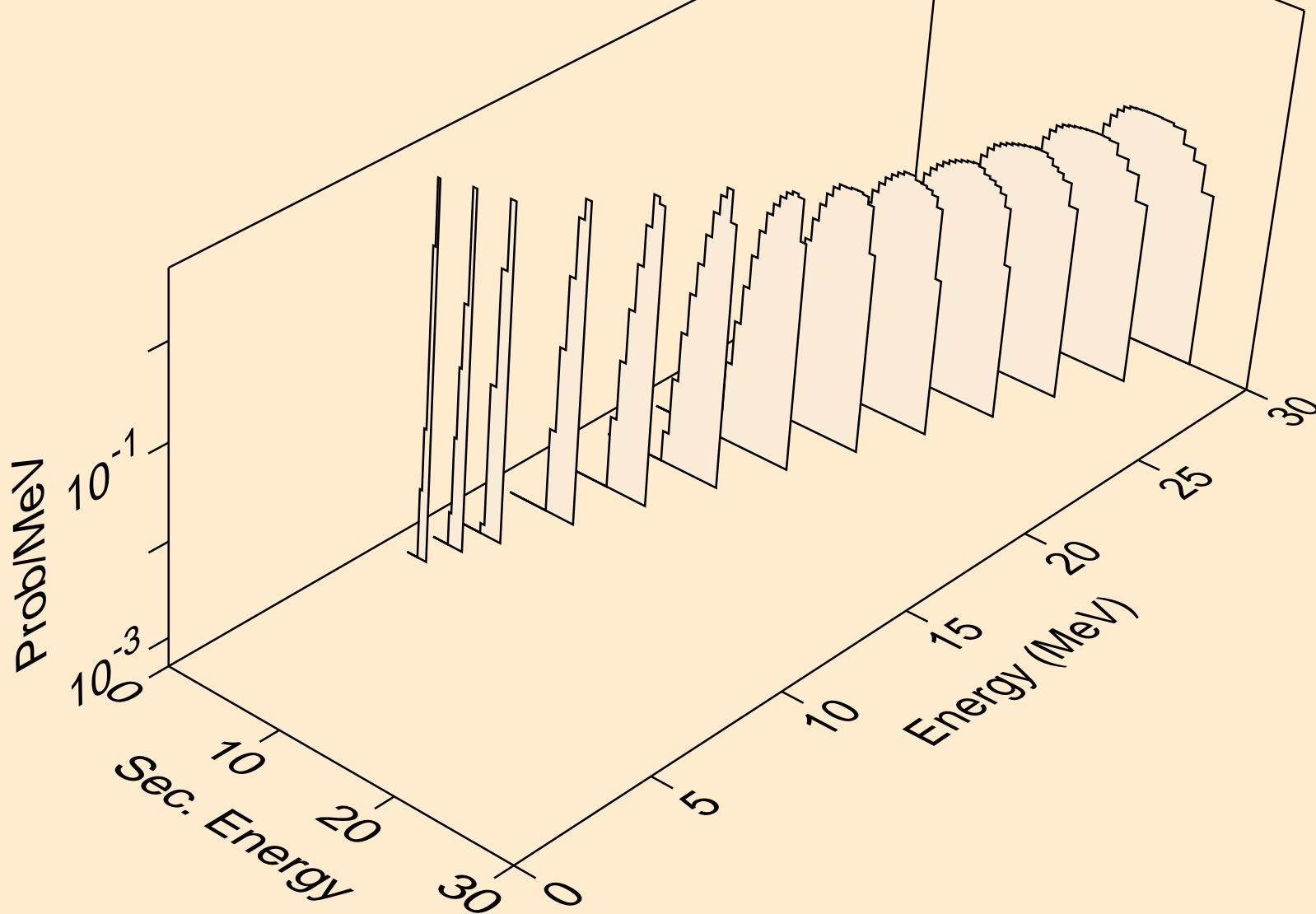

BI210M TRITON ACER TENDL-2023 LIBRARY; T=0.K
Triton emission for inelastic

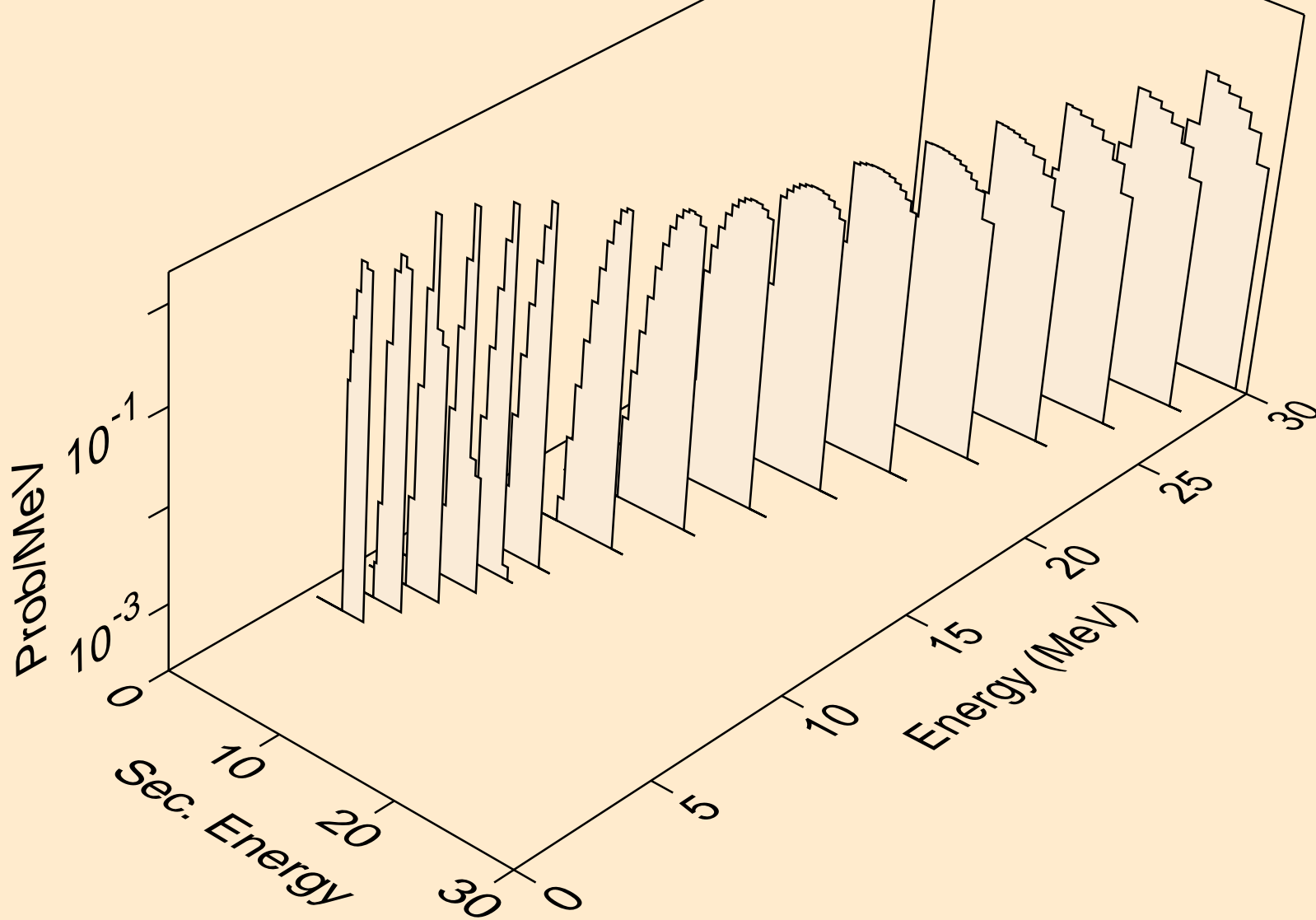

BI210M TRITON ACER TENDL-2023 LIBRARY; T=0.K
Triton emission for (t,pt)

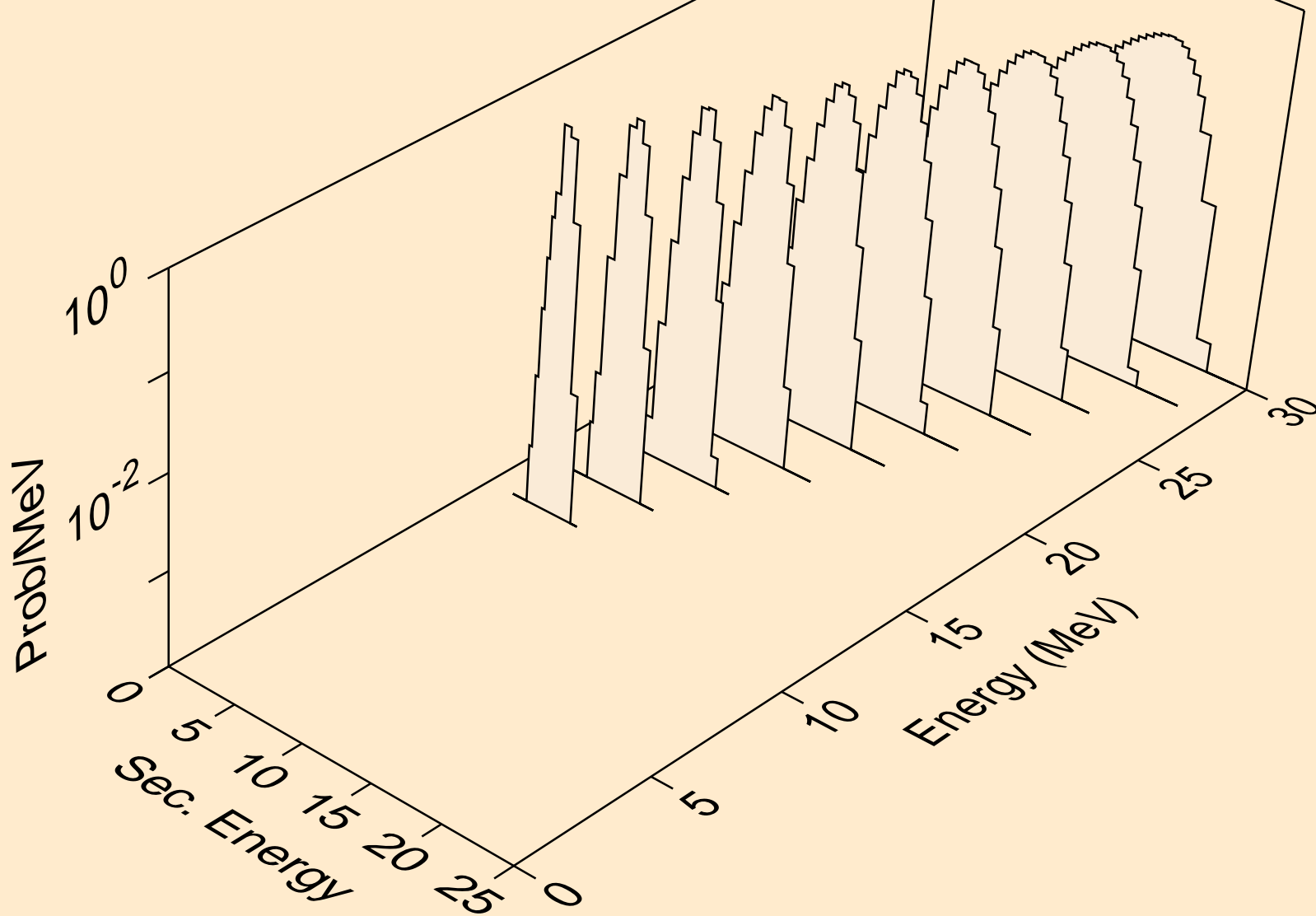

BI210M TRITON ACER TENDL-2023 LIBRARY; T=0.K
Photon emission for (z,n)

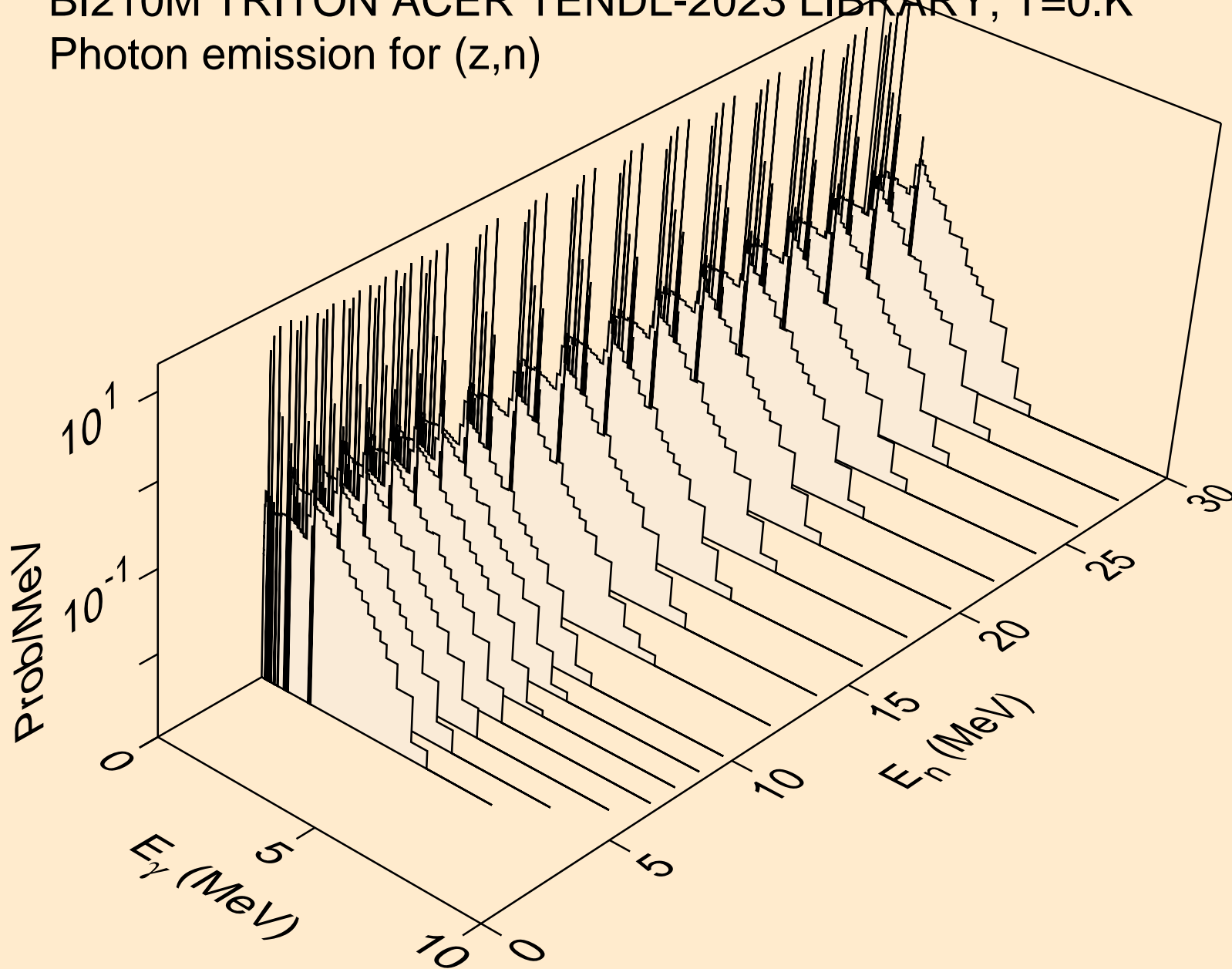

BI210M TRITON ACER TENDL-2023 LIBRARY; T=0.K
Photon emission for (z,x)

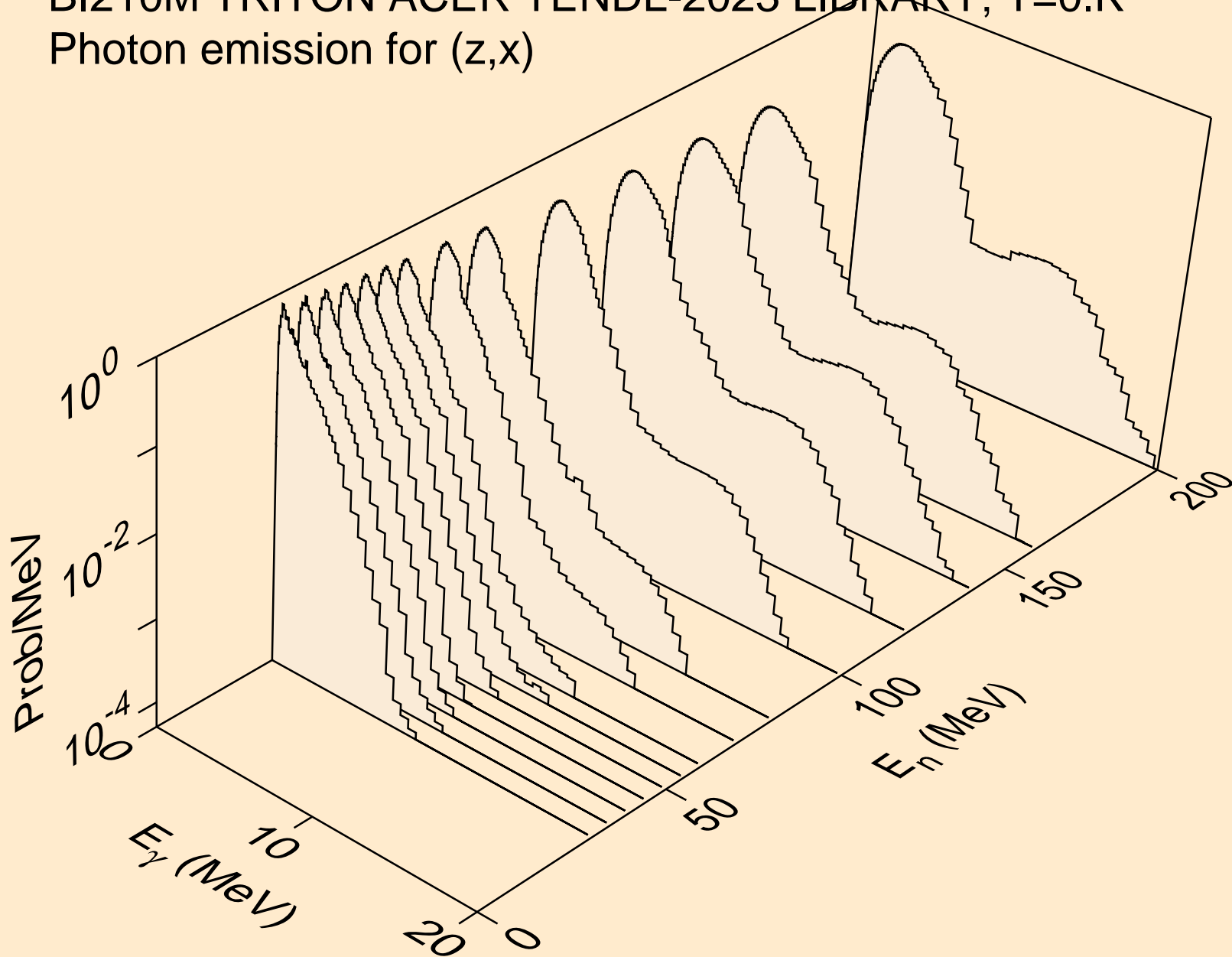

BI210M TRITON ACER TENDL-2023 LIBRARY; T=0.K
Photon emission for (n,2nd)

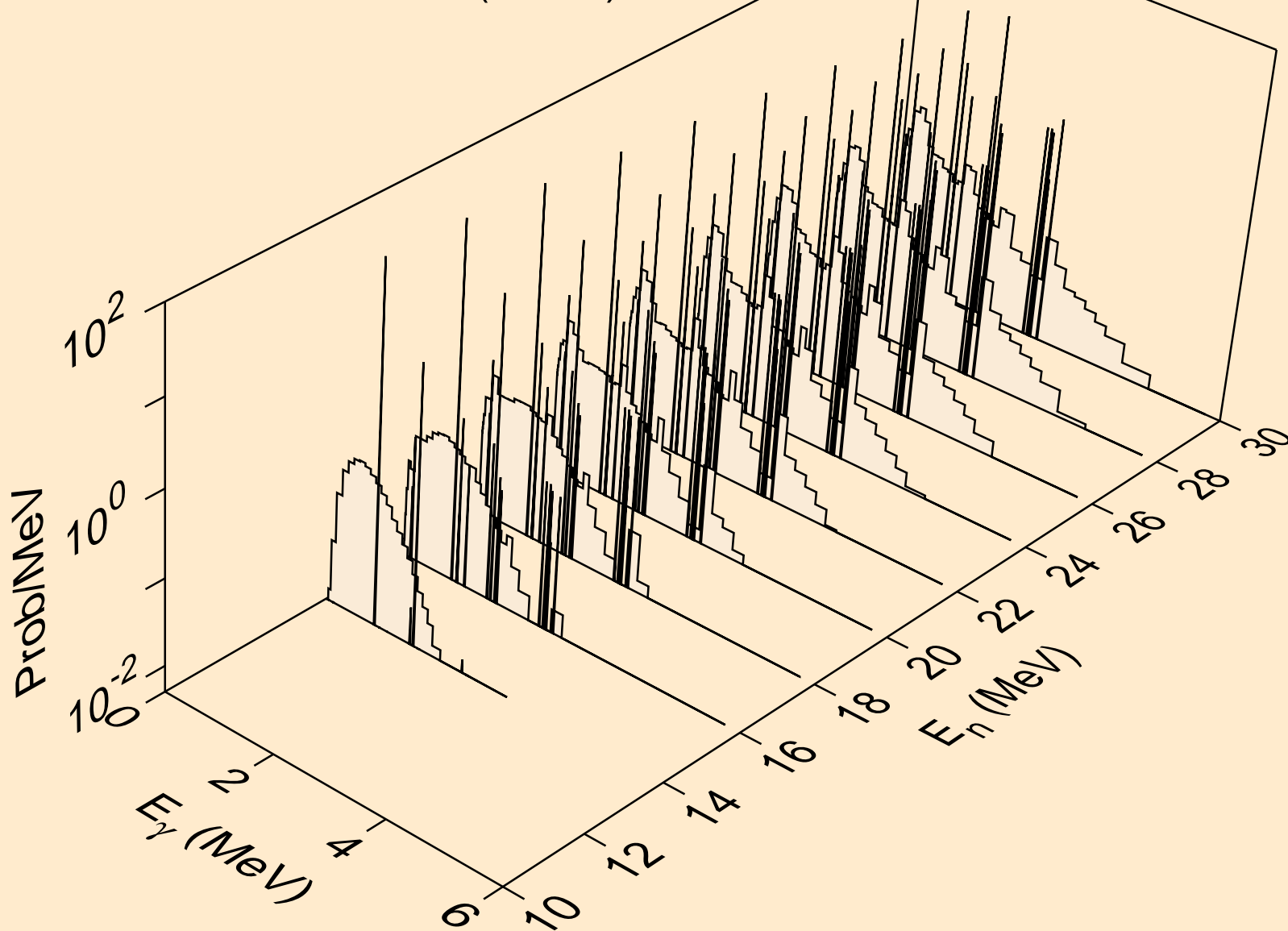

BI210M TRITON ACER TENDL-2023 LIBRARY; T=0.K
Photon emission for (n,2n)

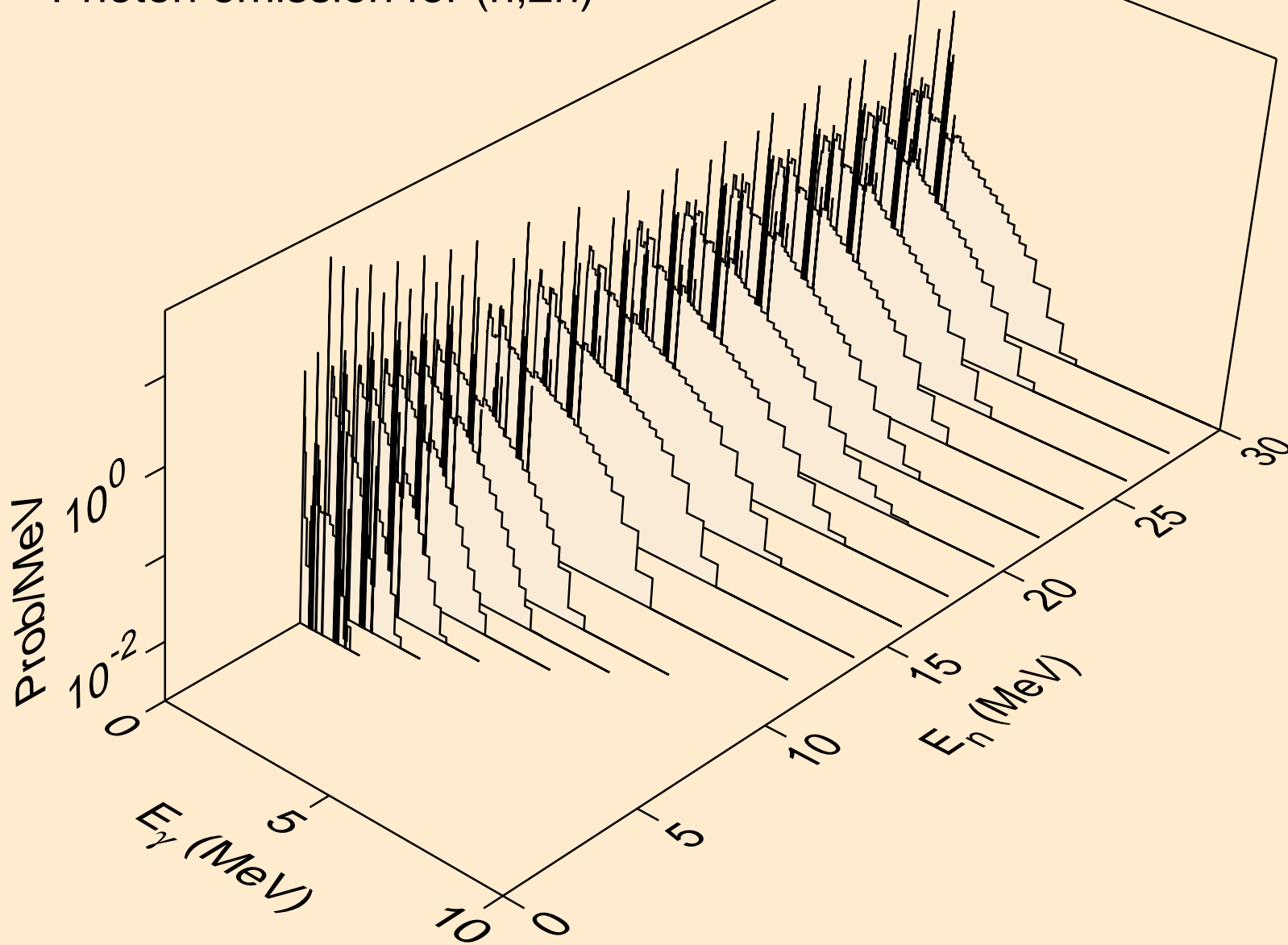

BI210M TRITON ACER TENDL-2023 LIBRARY; T=0.K
Photon emission for (n,3n)

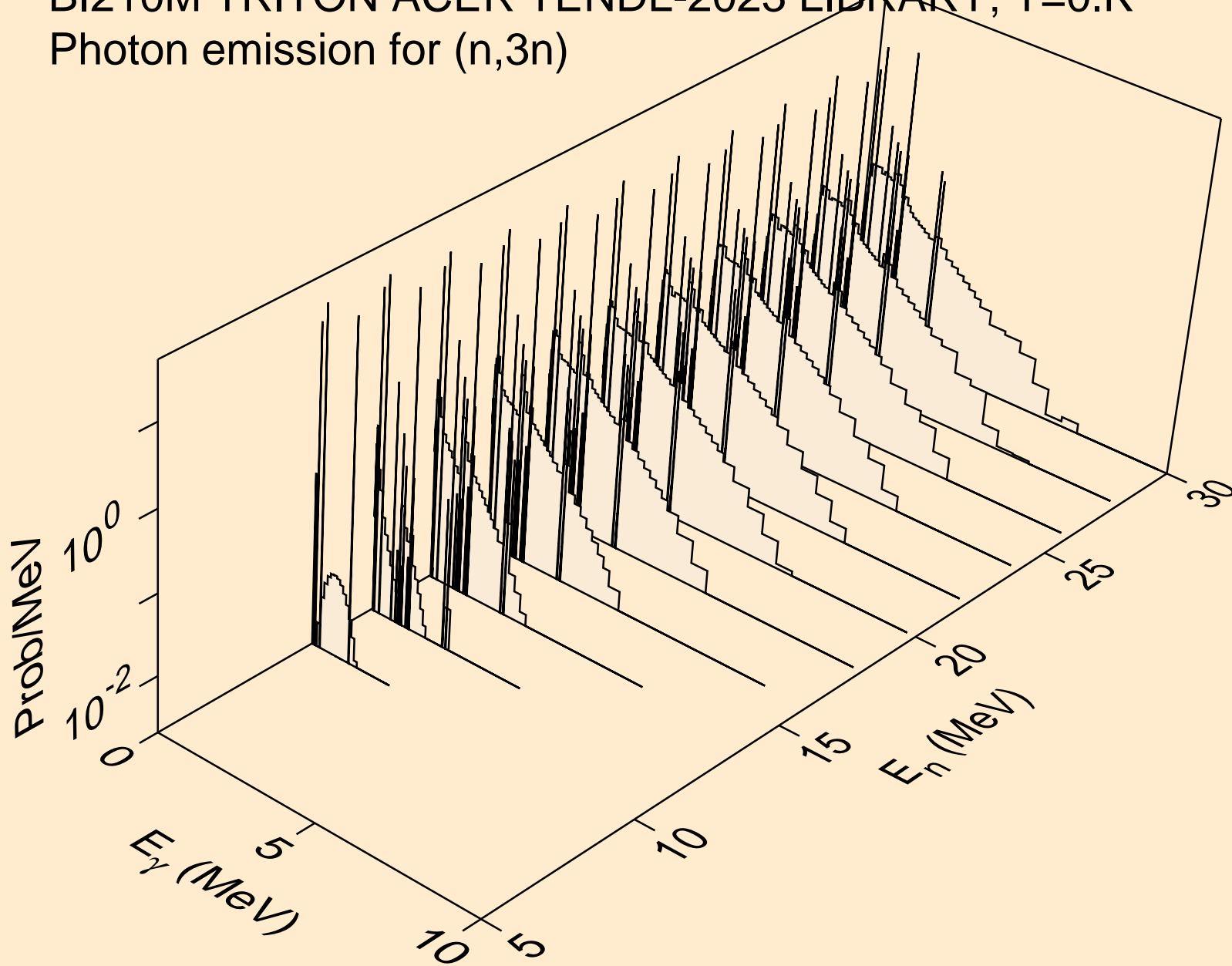

BI210M TRITON ACER TENDL-2023 LIBRARY; T=0.K
Photon emission for (n,n*)a

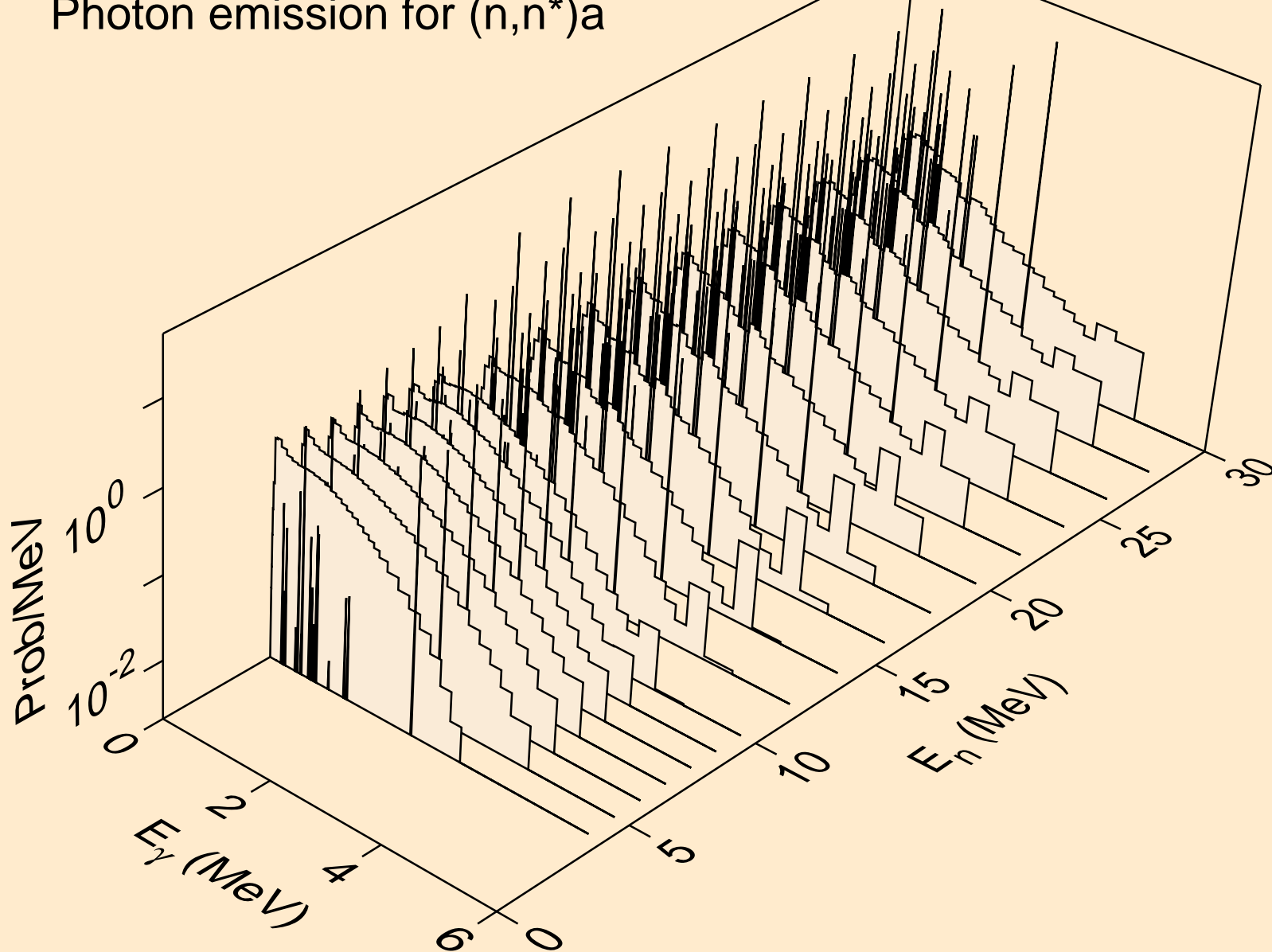

BI210M TRITON ACER TENDL-2023 LIBRARY; T=0.K
Photon emission for (n,2n)a

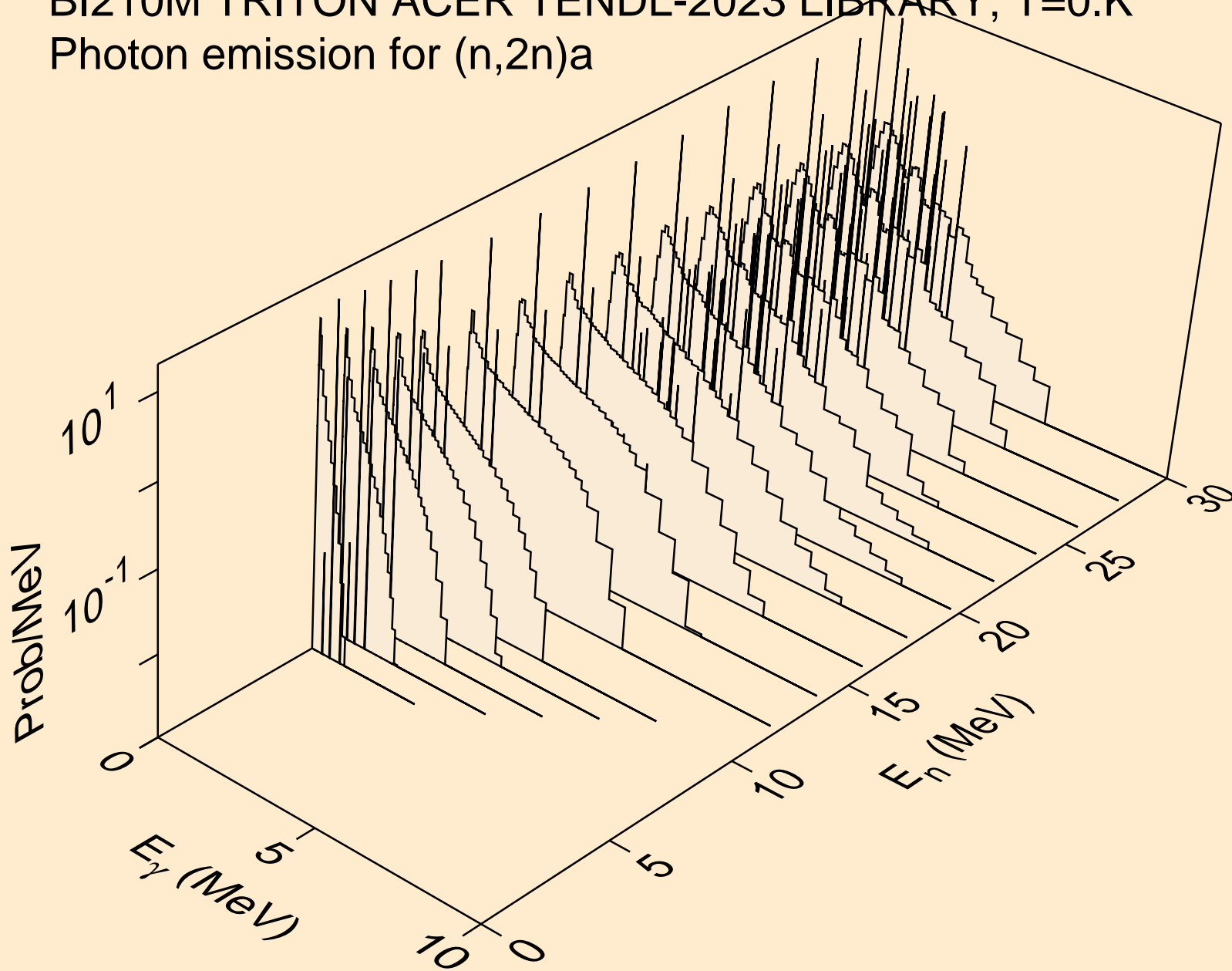

BI210M TRITON ACER TENDL-2023 LIBRARY; T=0.K
Photon emission for (n,3n)a

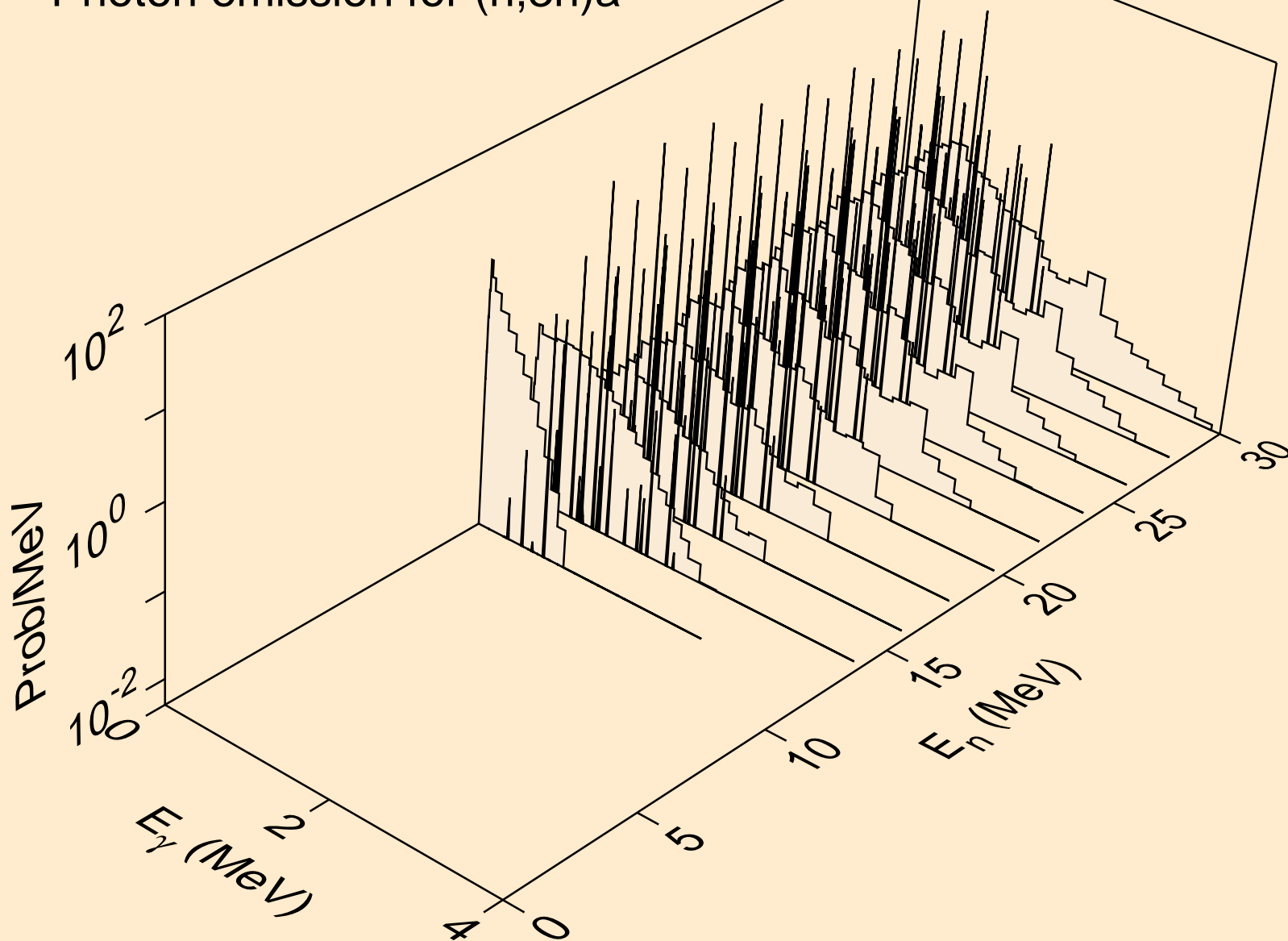

BI210M TRITON ACER TENDL-2023 LIBRARY; T=0.K
Photon emission for (n,n*)p

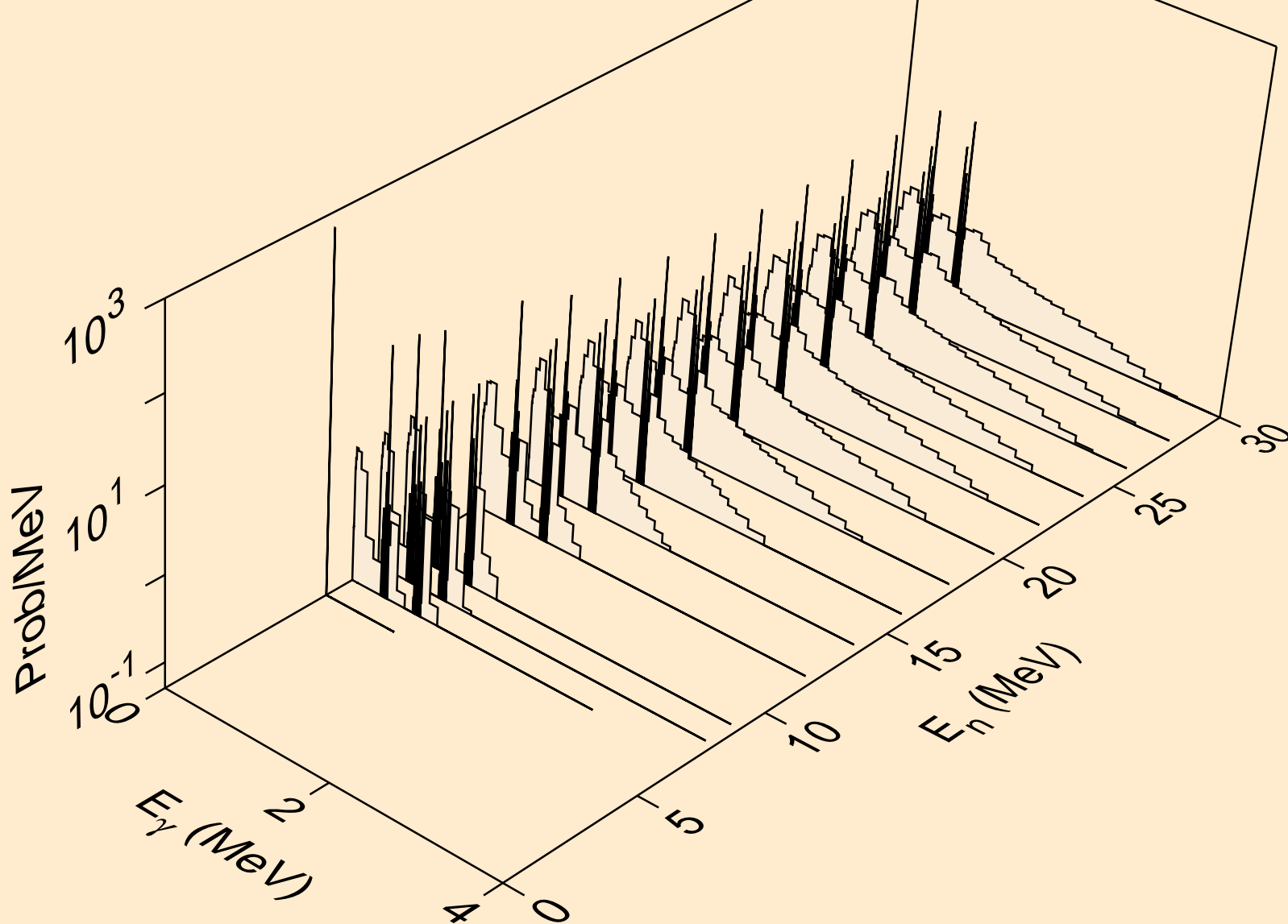

BI210M TRITON ACER TENDL-2023 LIBRARY; T=0.K
Photon emission for (n,n*)2a

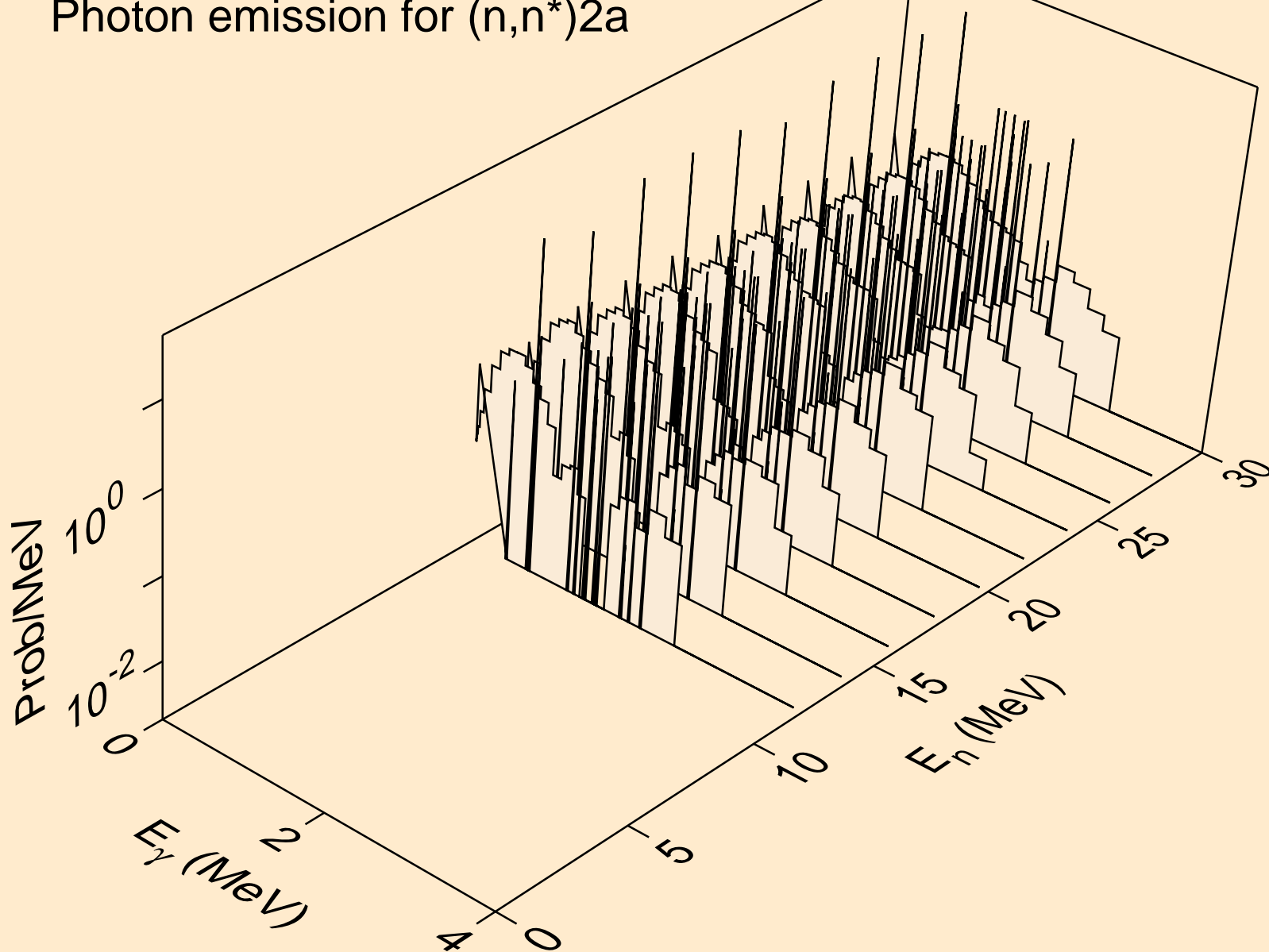

BI210M TRITON ACER TENDL-2023 LIBRARY; T=0.K
Photon emission for (n,n*)d

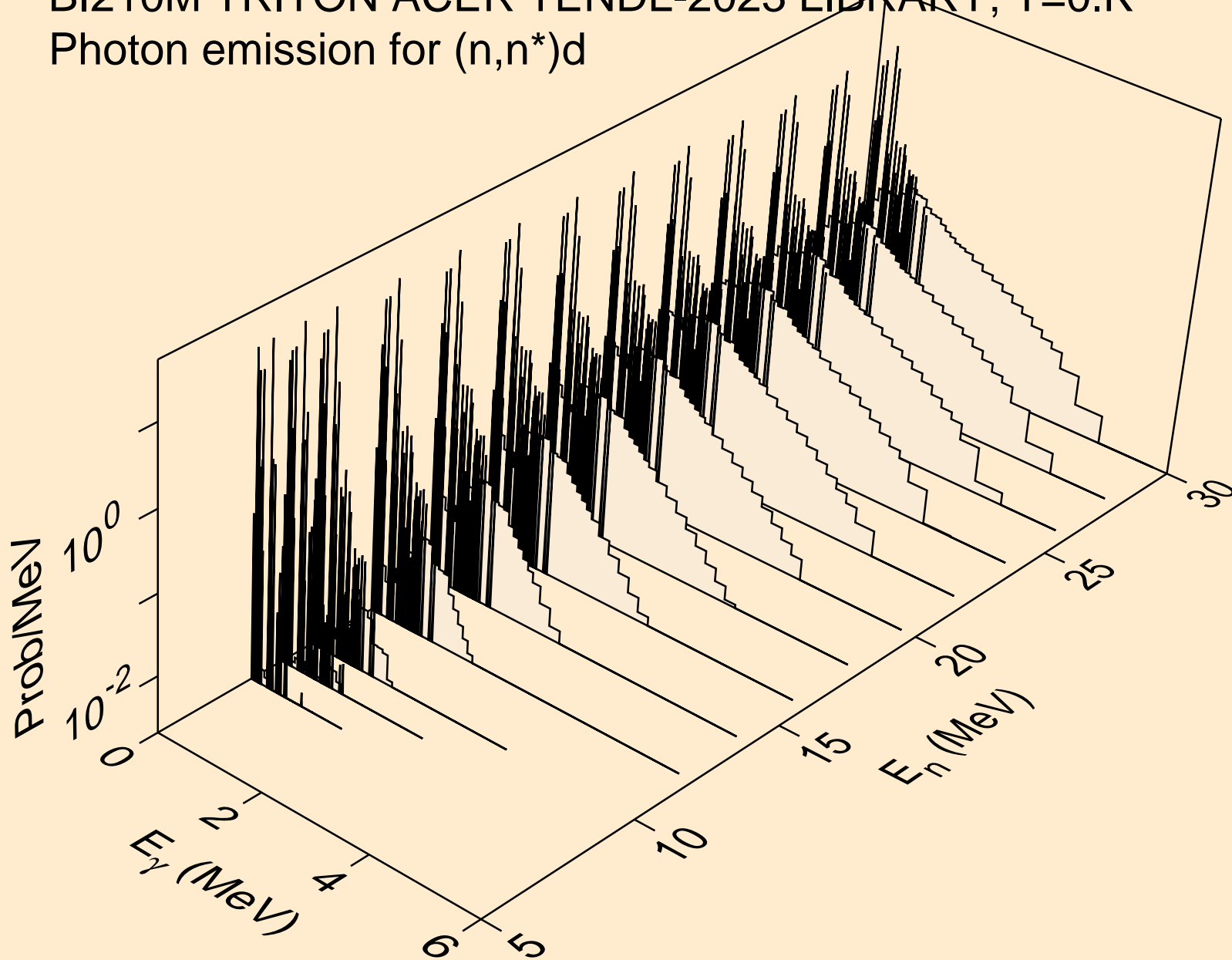

BI210M TRITON ACER TENDL-2023 LIBRARY; T=0.K
Photon emission for (n,n*)t

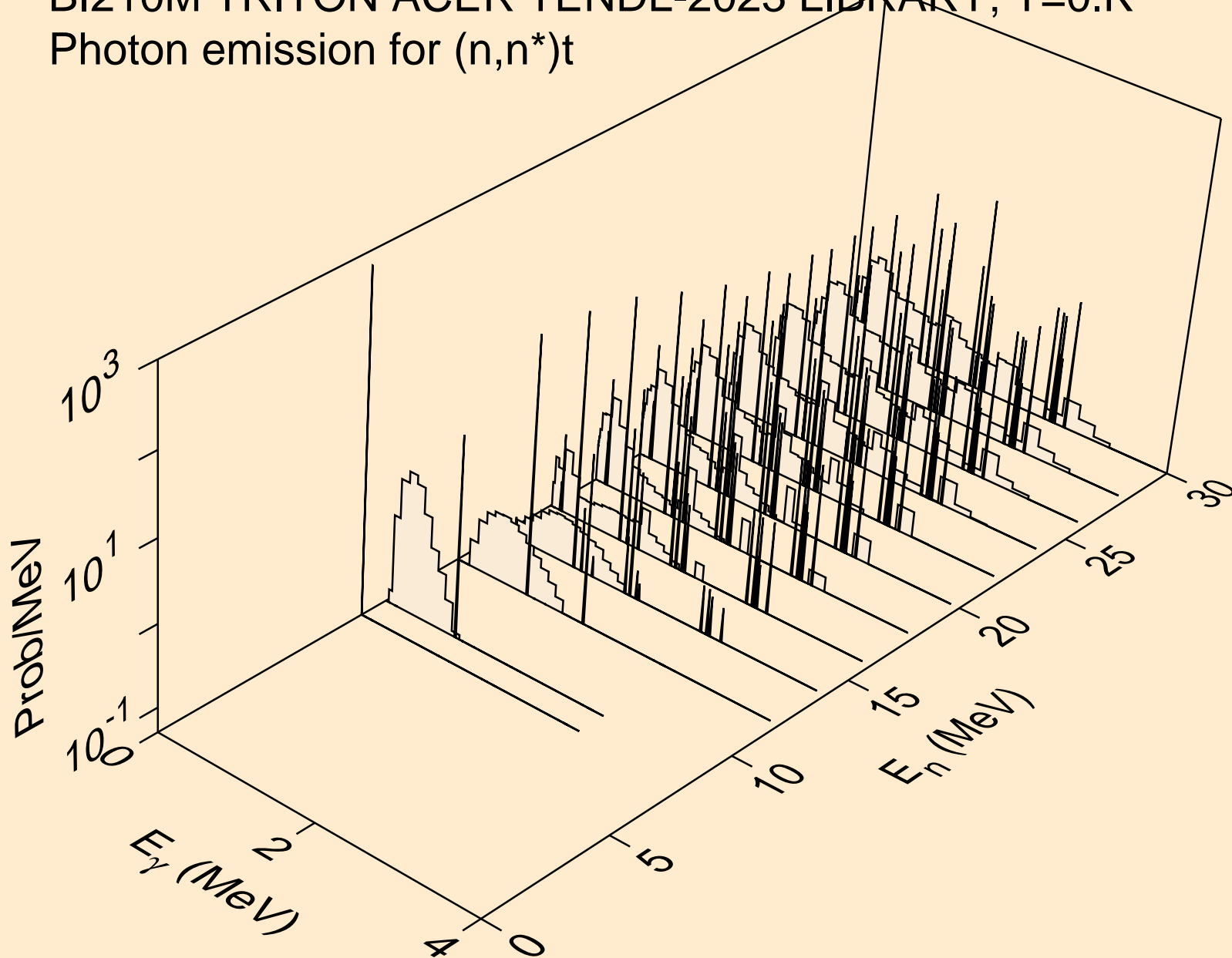

BI210M TRITON ACER TENDL-2023 LIBRARY; T=0.K
Photon emission for (n,n*)he3

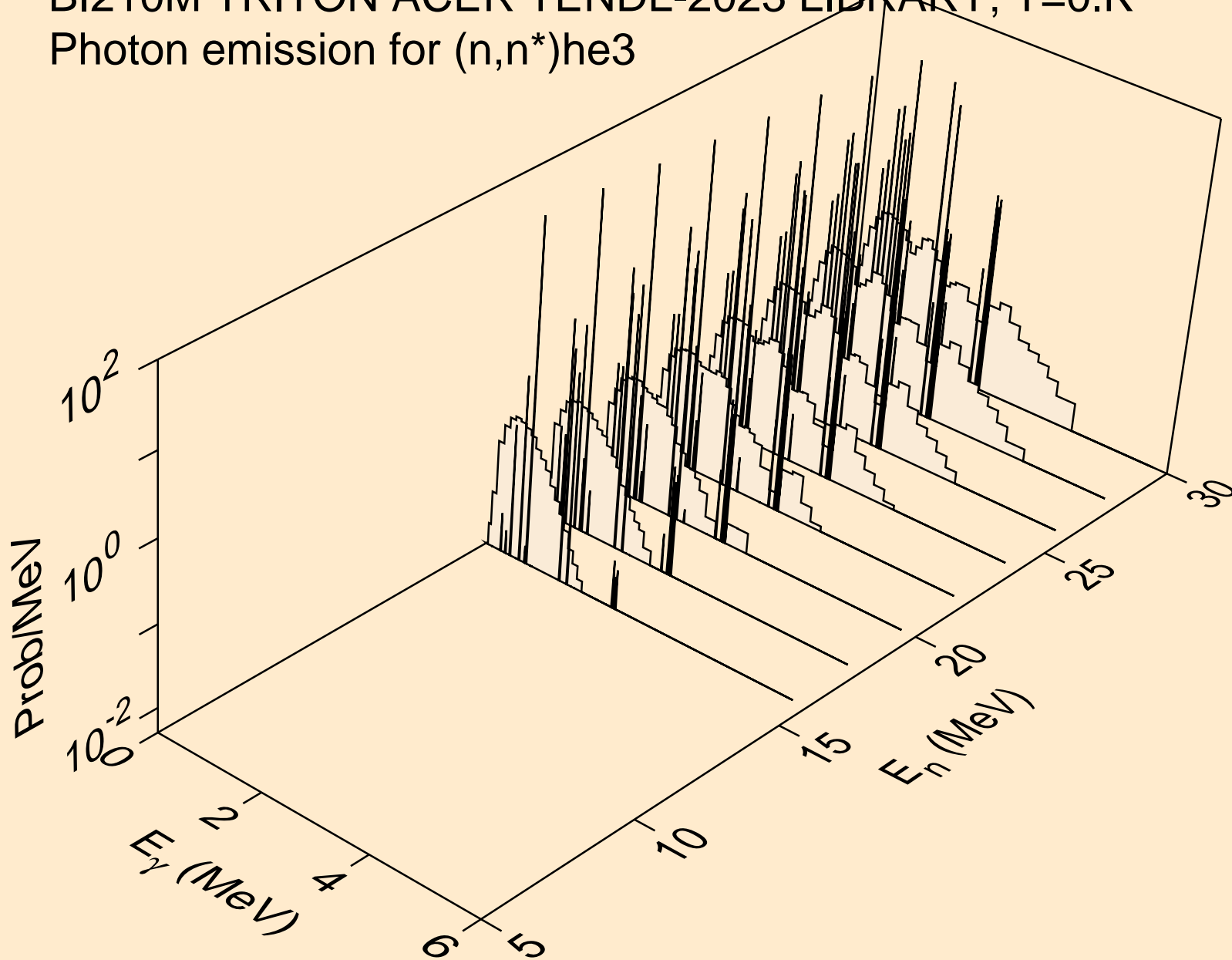

BI210M TRITON ACER TENDL-2023 LIBRARY; T=0.K
Photon emission for (n,4n)

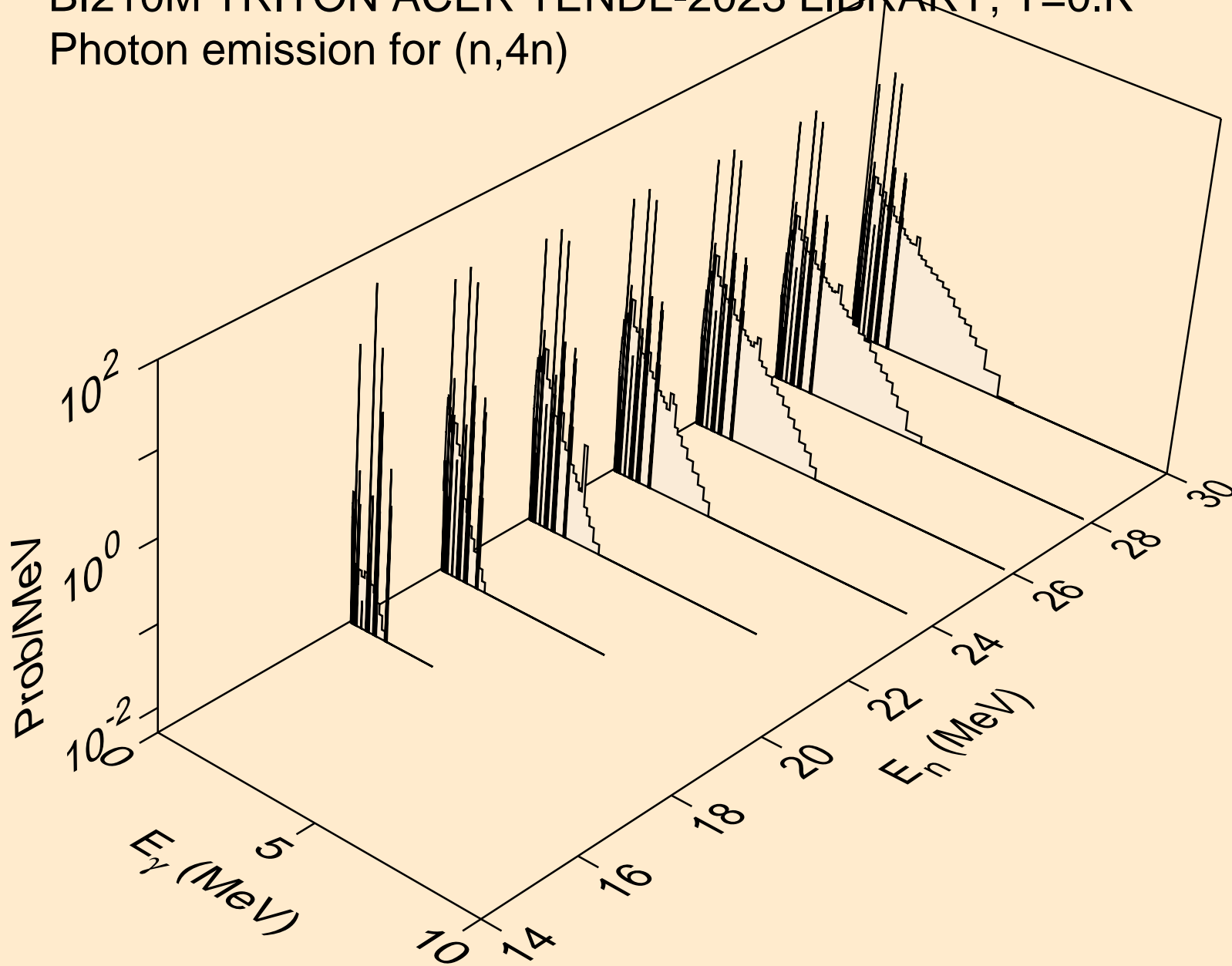

BI210M TRITON ACER TENDL-2023 LIBRARY; T=0.K
Photon emission for (n,2np)

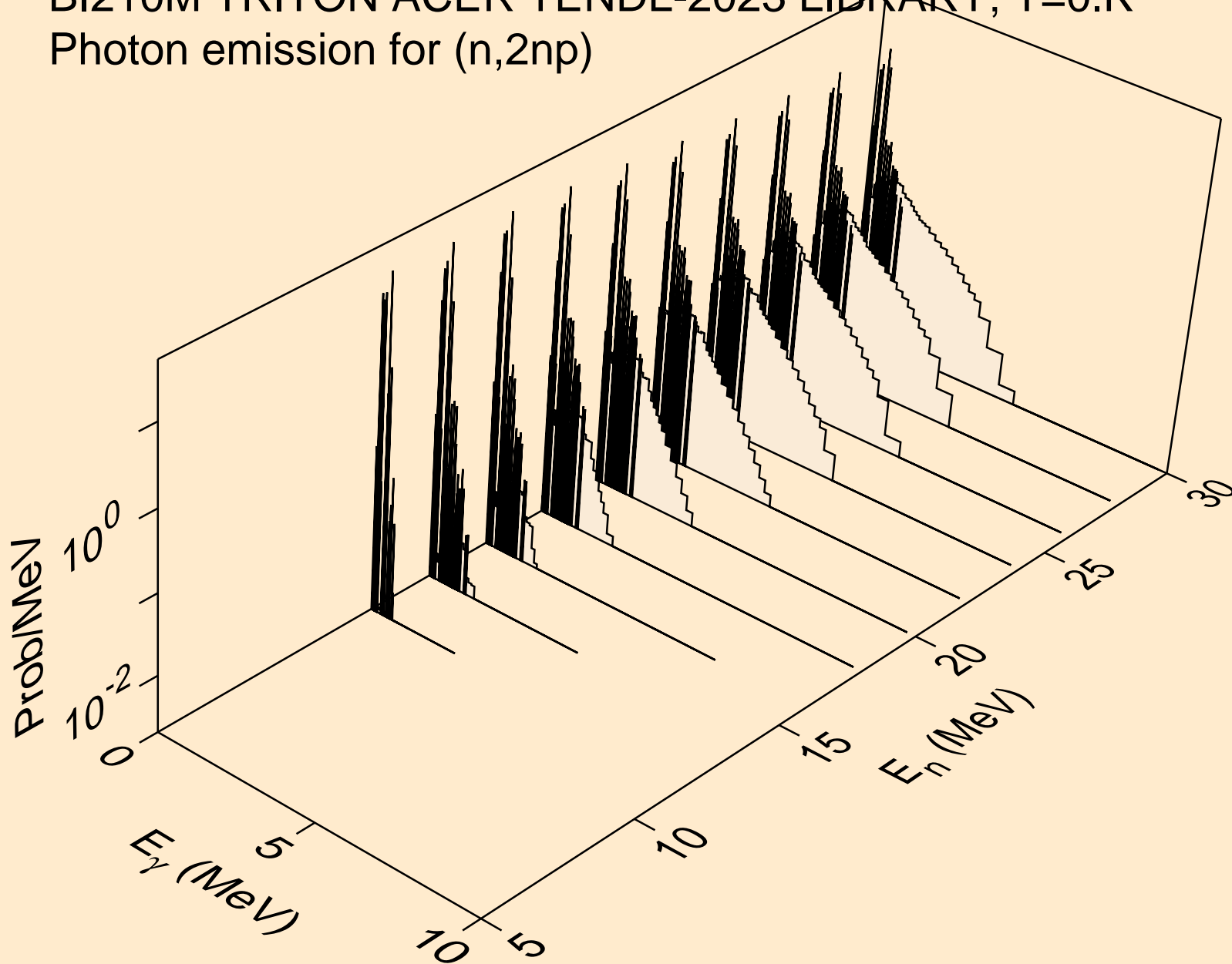

BI210M TRITON ACER TENDL-2023 LIBRARY; T=0.K
Photon emission for (n,3np)

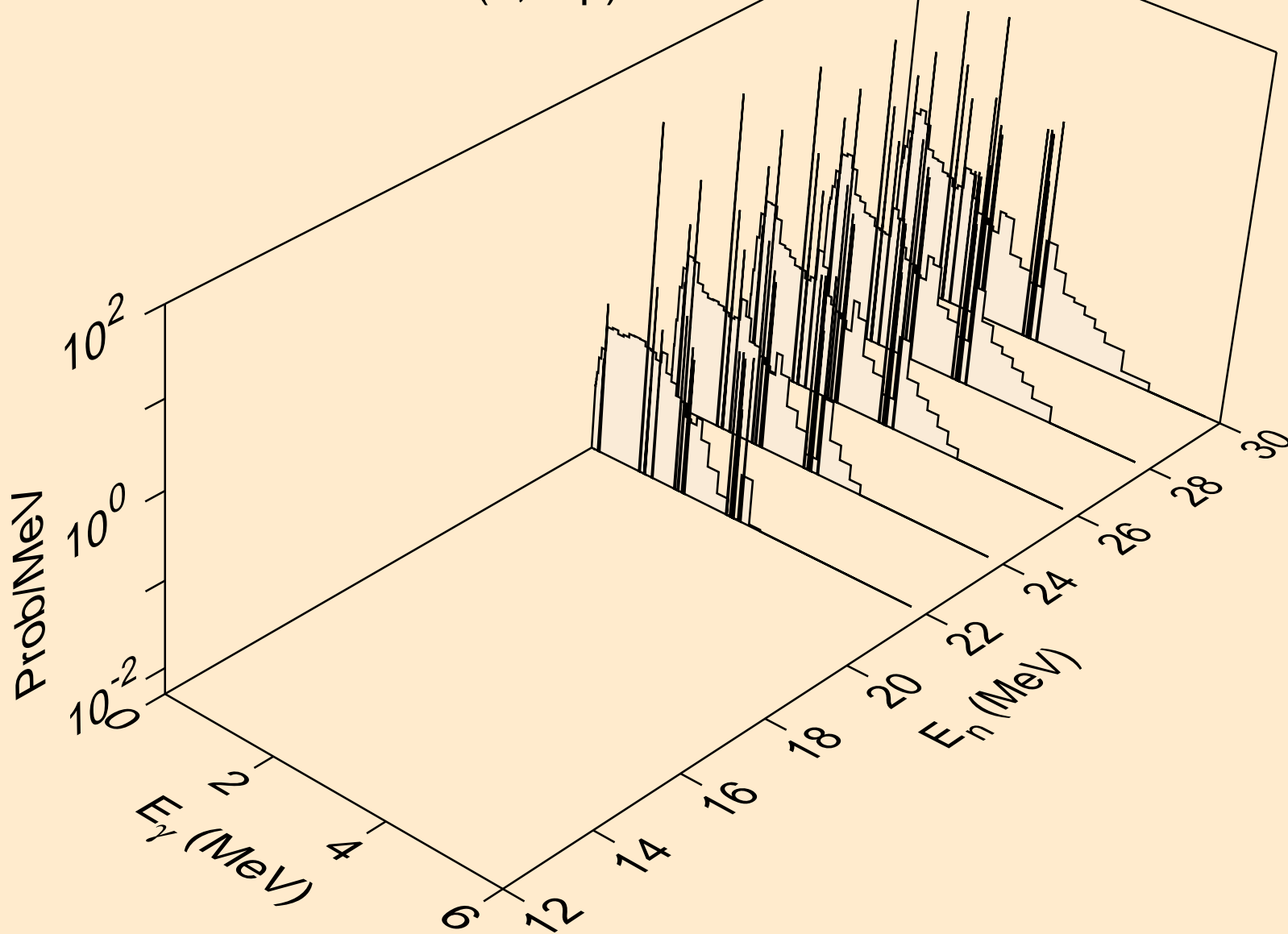

BI210M TRITON ACER TENDL-2023 LIBRARY; T=0.K
Photon emission for (n,n2p)

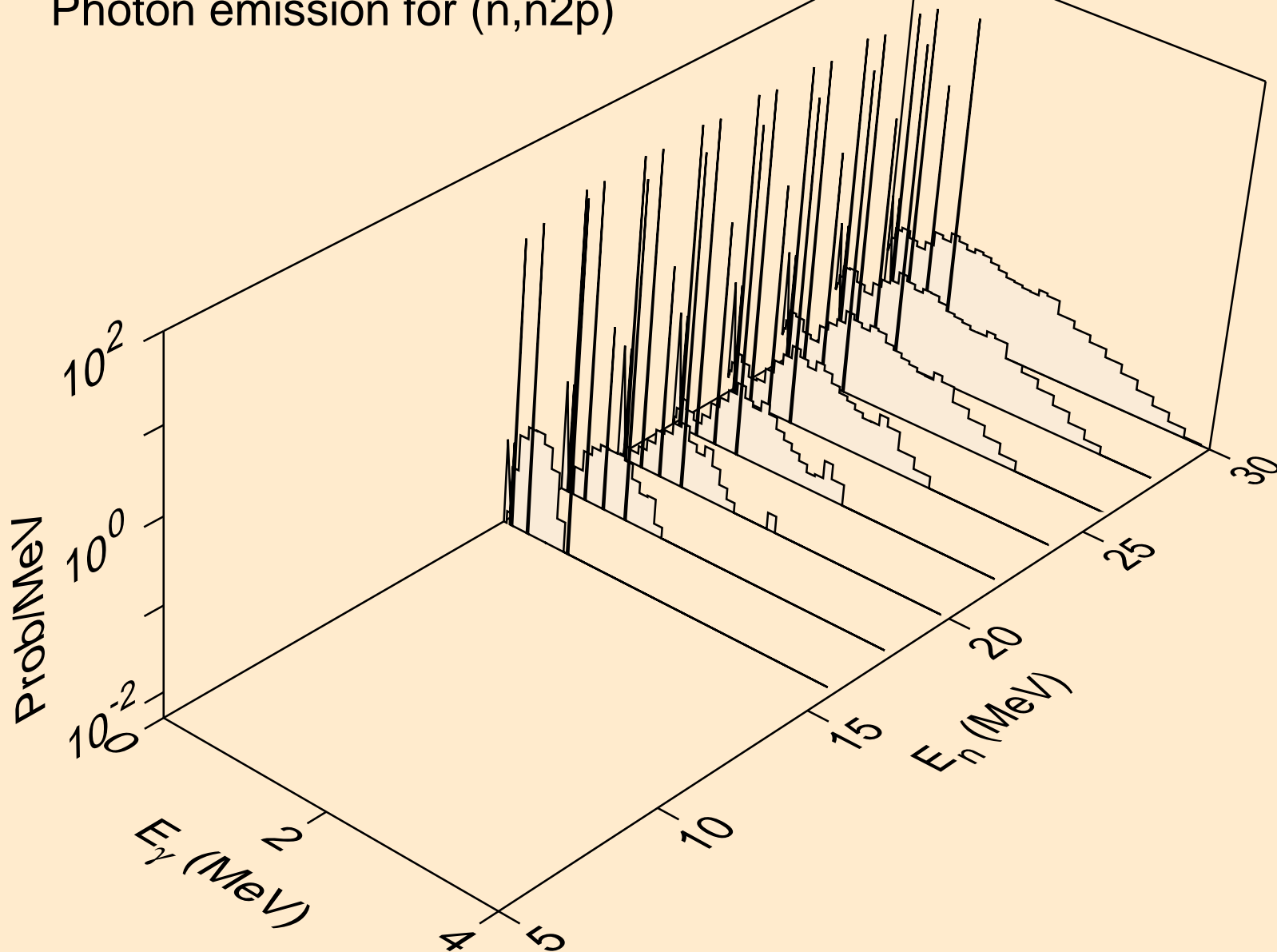

BI210M TRITON ACER TENDL-2023 LIBRARY; T=0.K
Photon emission for (n,npa)

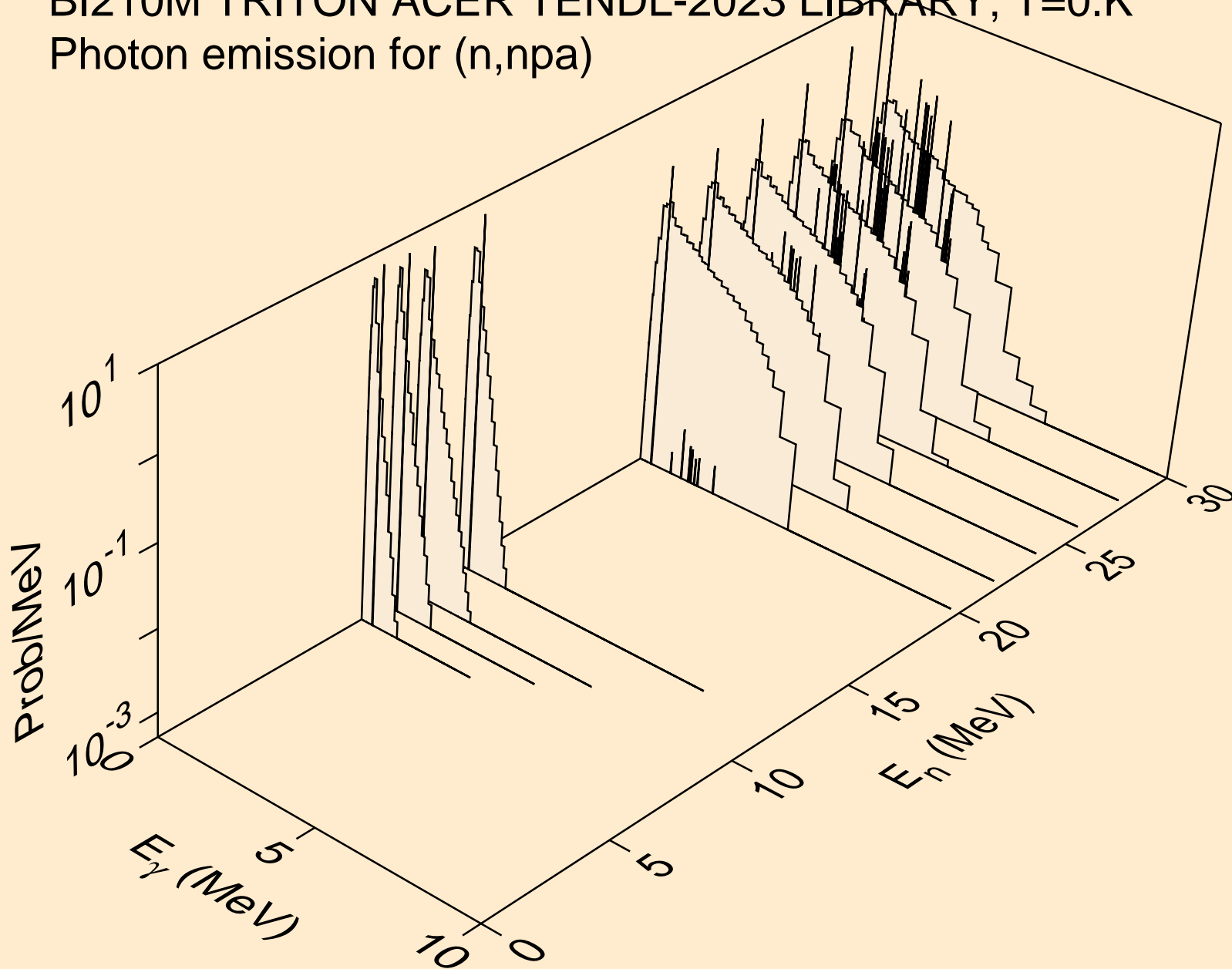

BI210M TRITON ACER TENDL-2023 LIBRARY; T=0.K
Photon emission for (n,gma)

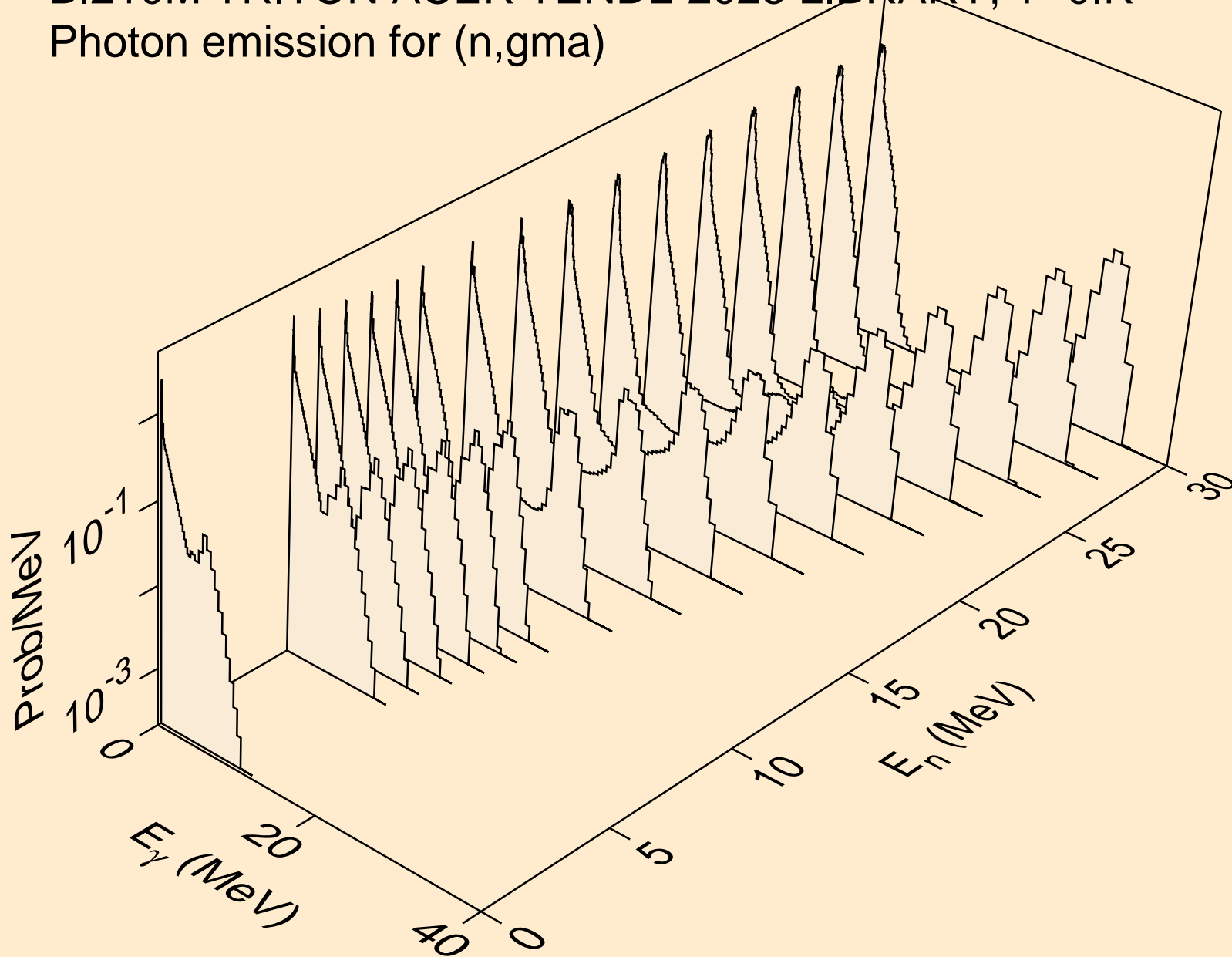

BI210M TRITON ACER TENDL-2023 LIBRARY; T=0.K
Photon emission for (n,p)

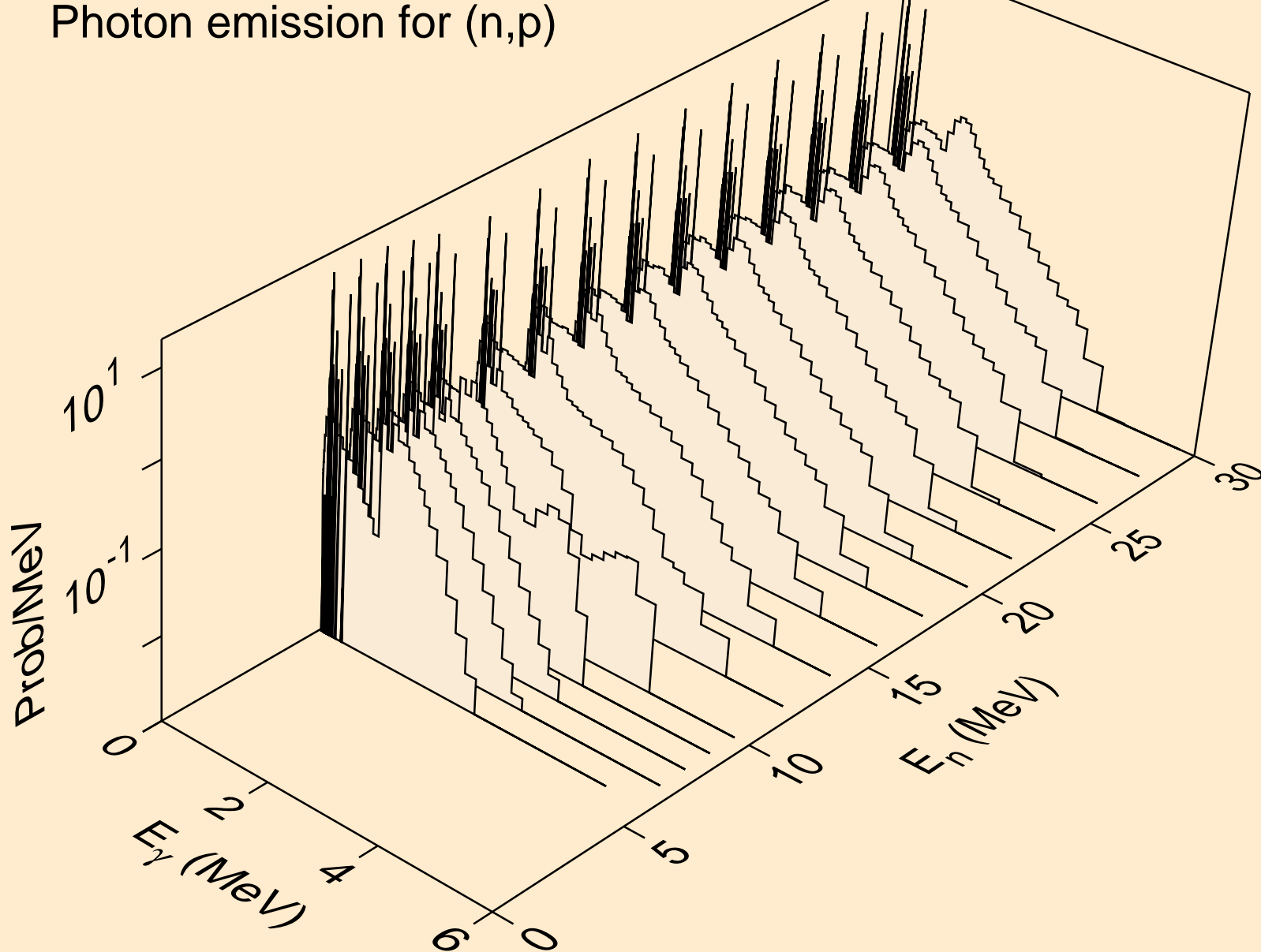

BI210M TRITON ACER TENDL-2023 LIBRARY; T=0.K
Photon emission for (n,d)

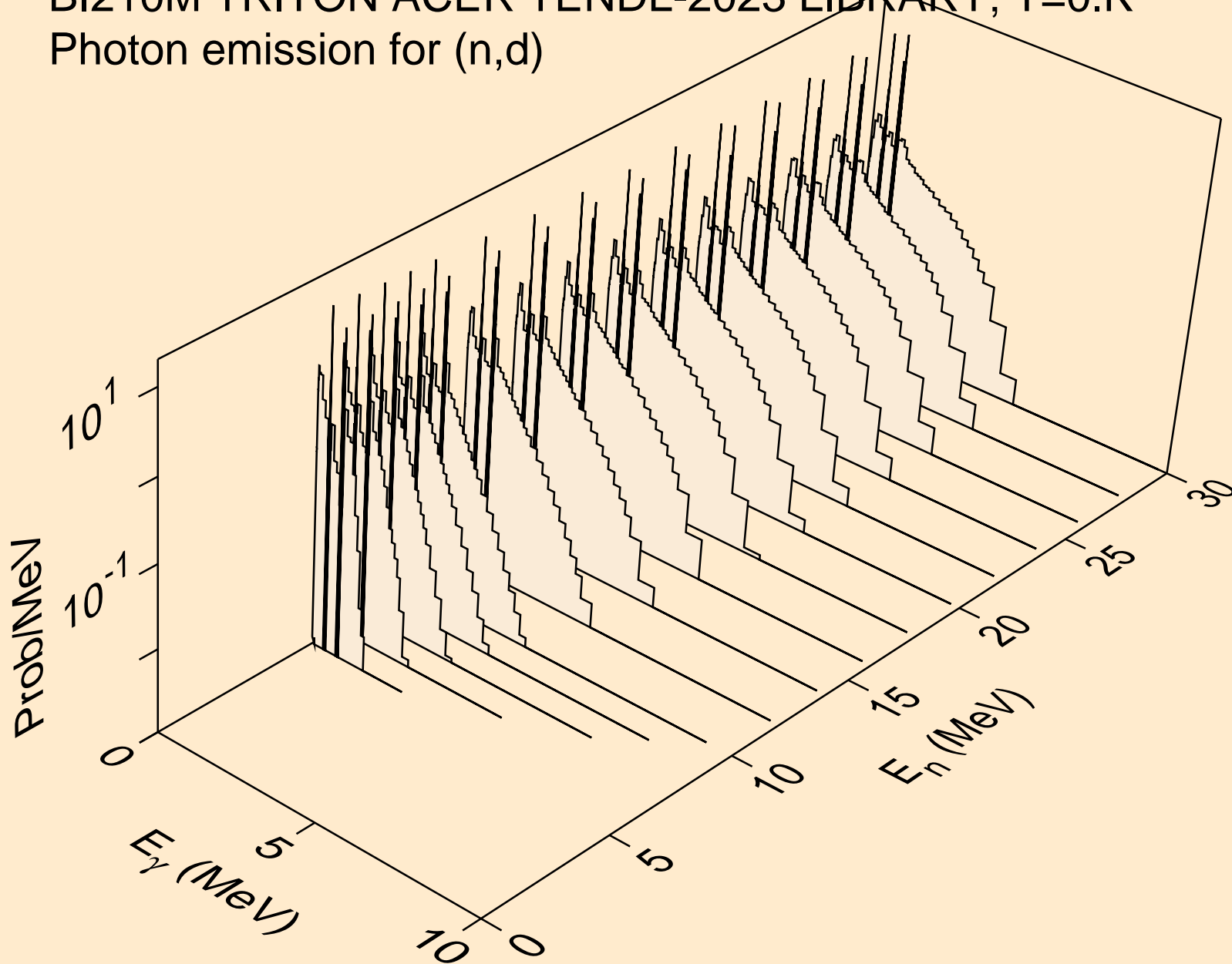

BI210M TRITON ACER TENDL-2023 LIBRARY; T=0.K
Photon emission for inelastic

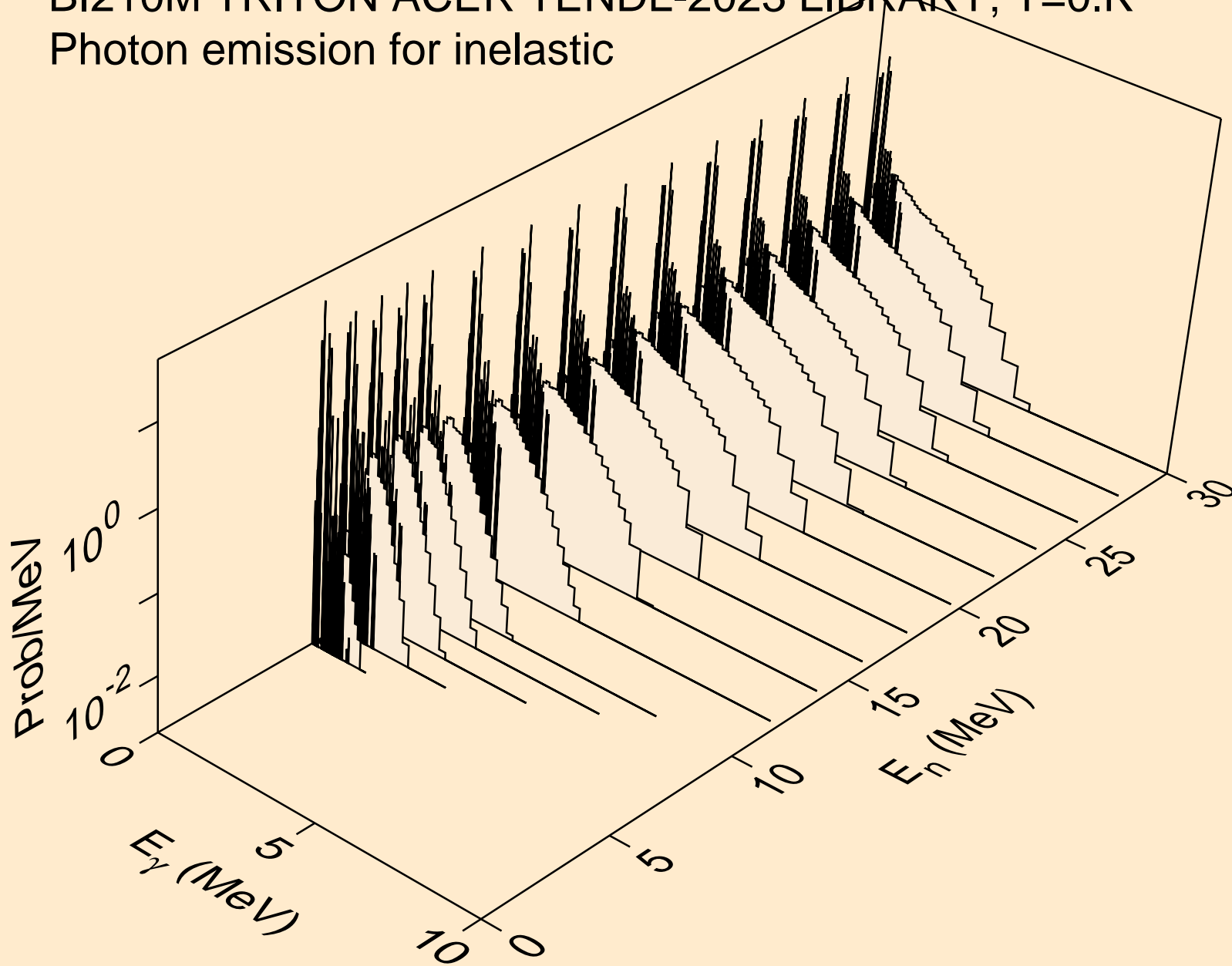

BI210M TRITON ACER TENDL-2023 LIBRARY; T=0.K
Photon emission for (n,he3)

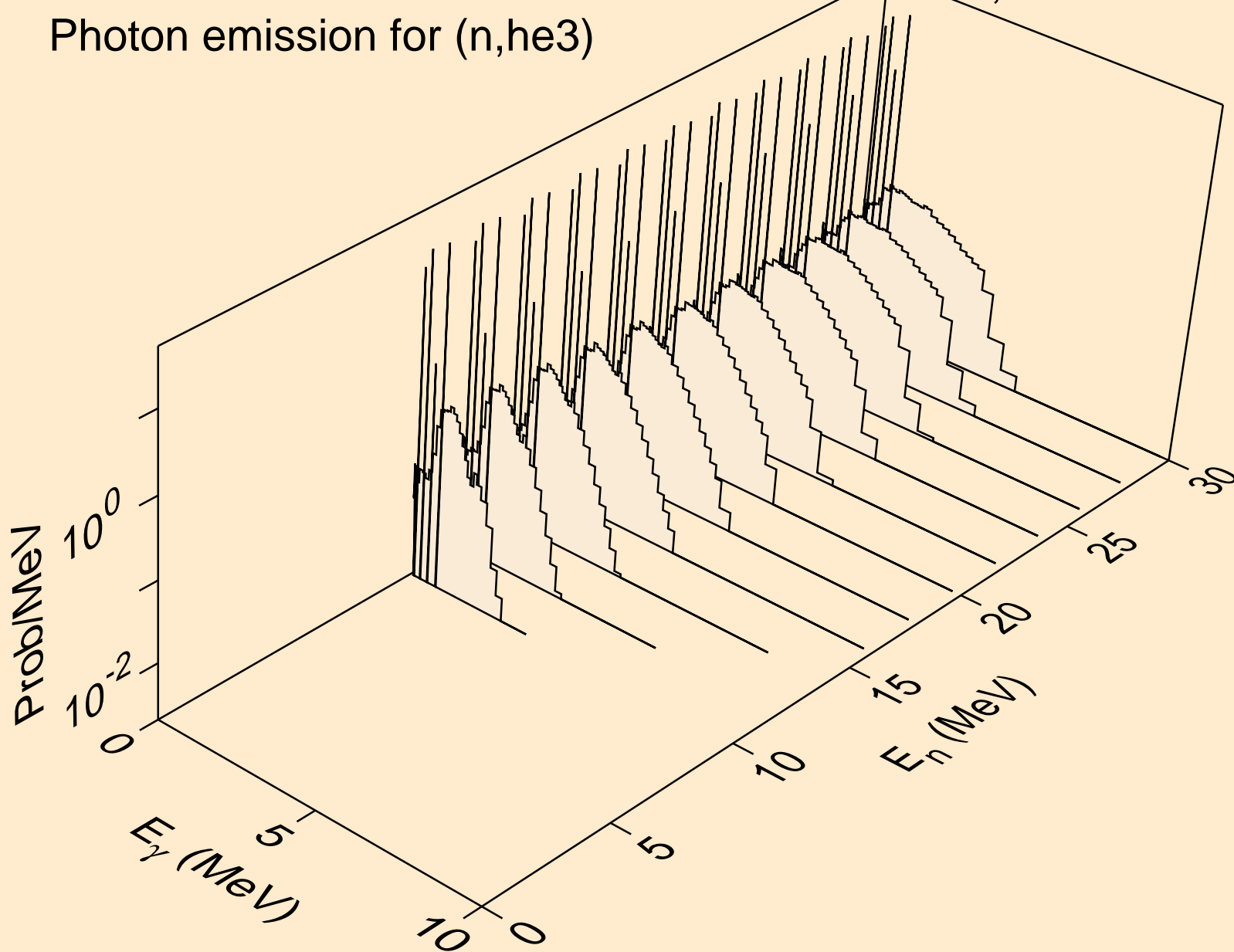

BI210M TRITON ACER TENDL-2023 LIBRARY; T=0.K
Photon emission for (n,a)

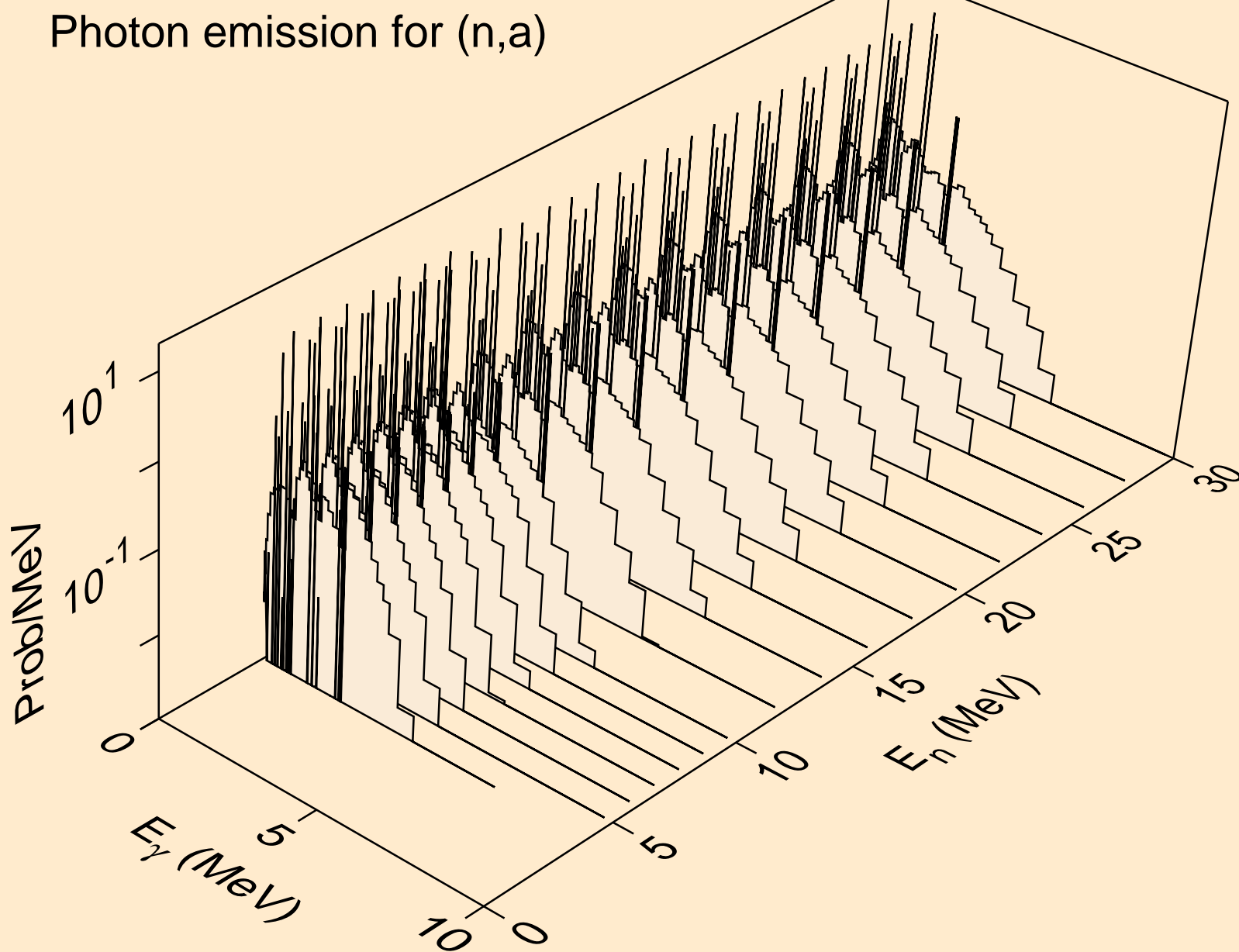

BI210M TRITON ACER TENDL-2023 LIBRARY; T=0.K
Photon emission for (n,2a)

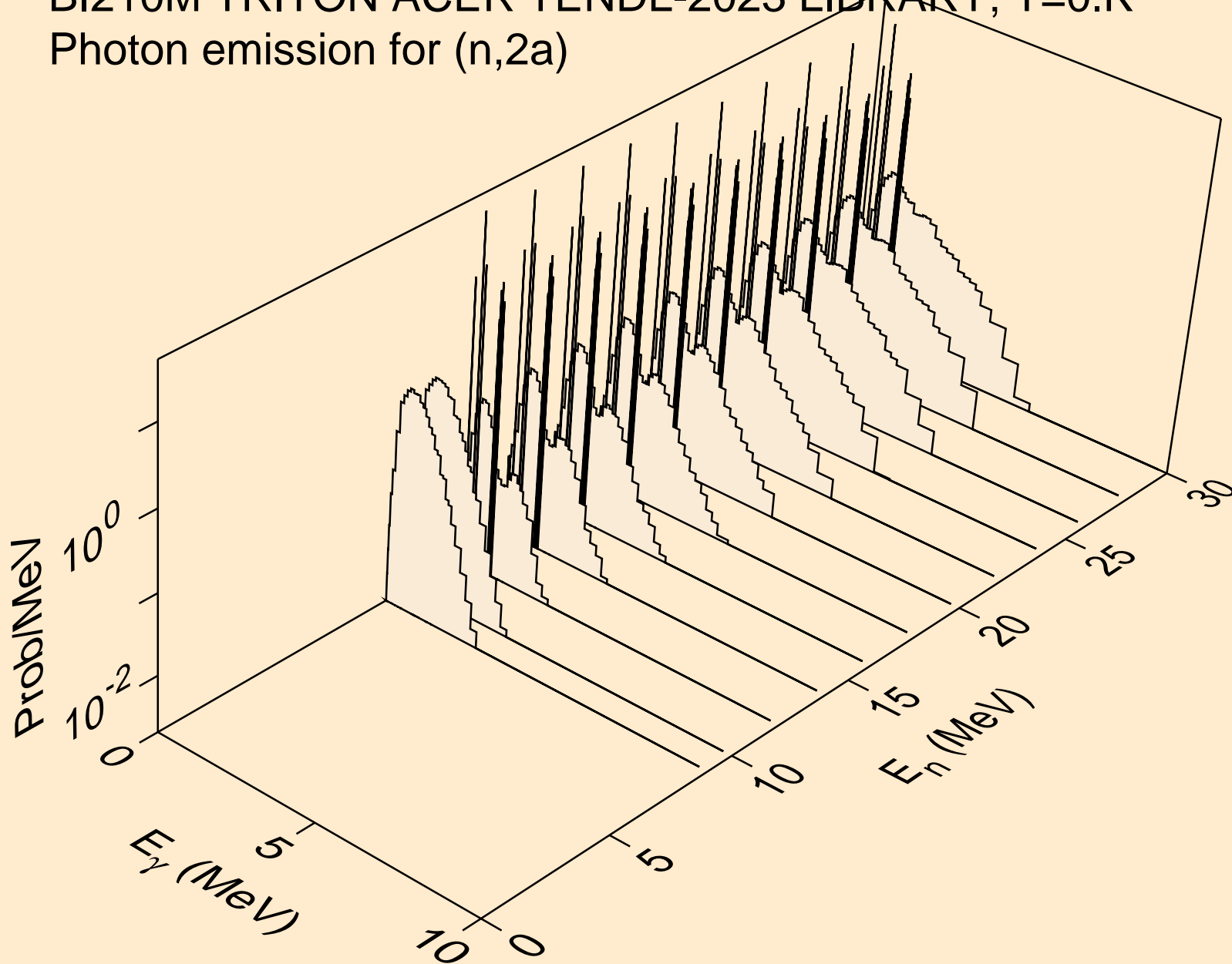

BI210M TRITON ACER TENDL-2023 LIBRARY; T=0.K
Photon emission for (n,2p)

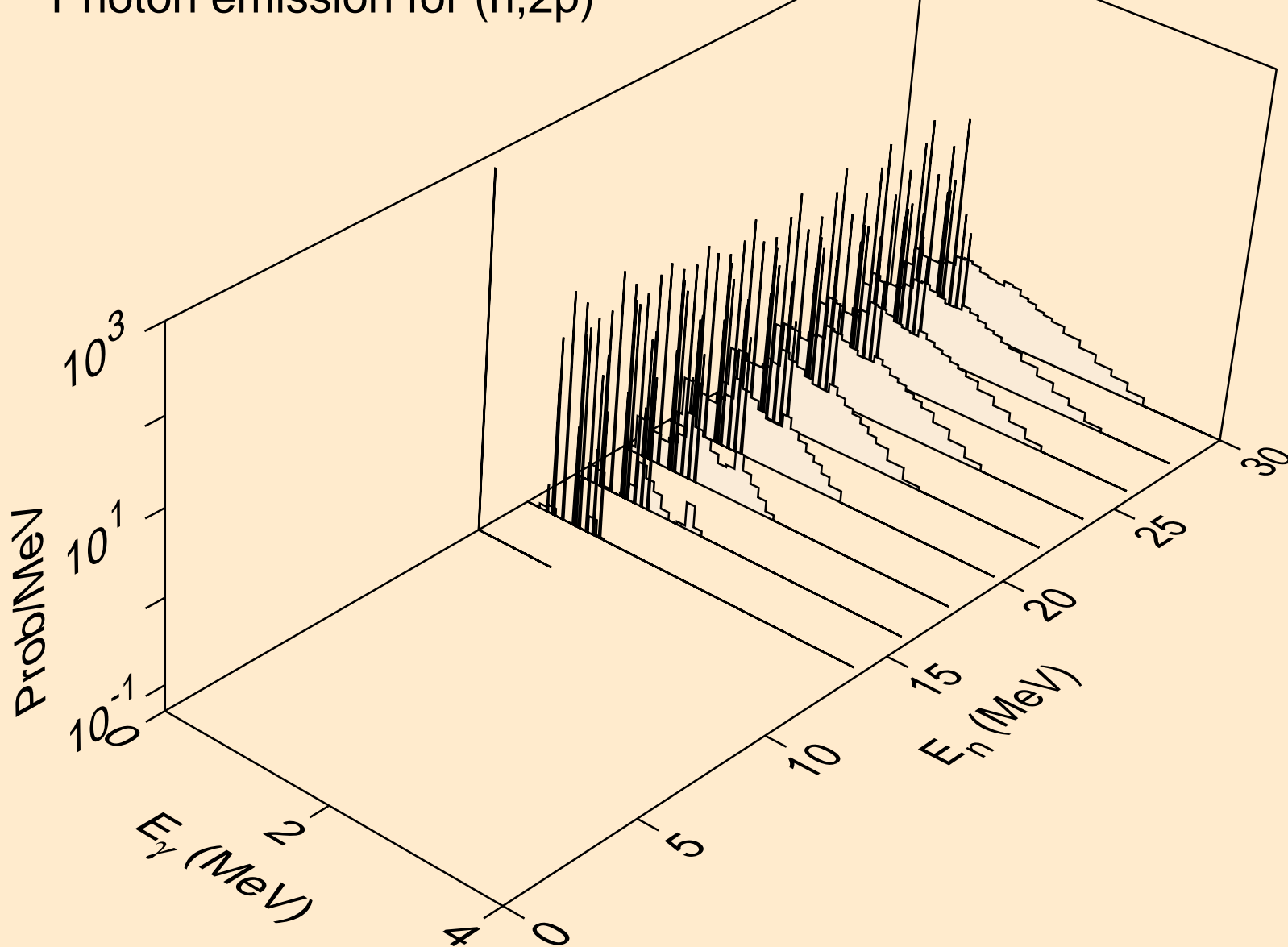

BI210M TRITON ACER TENDL-2023 LIBRARY; T=0.K
Photon emission for (n,pa)

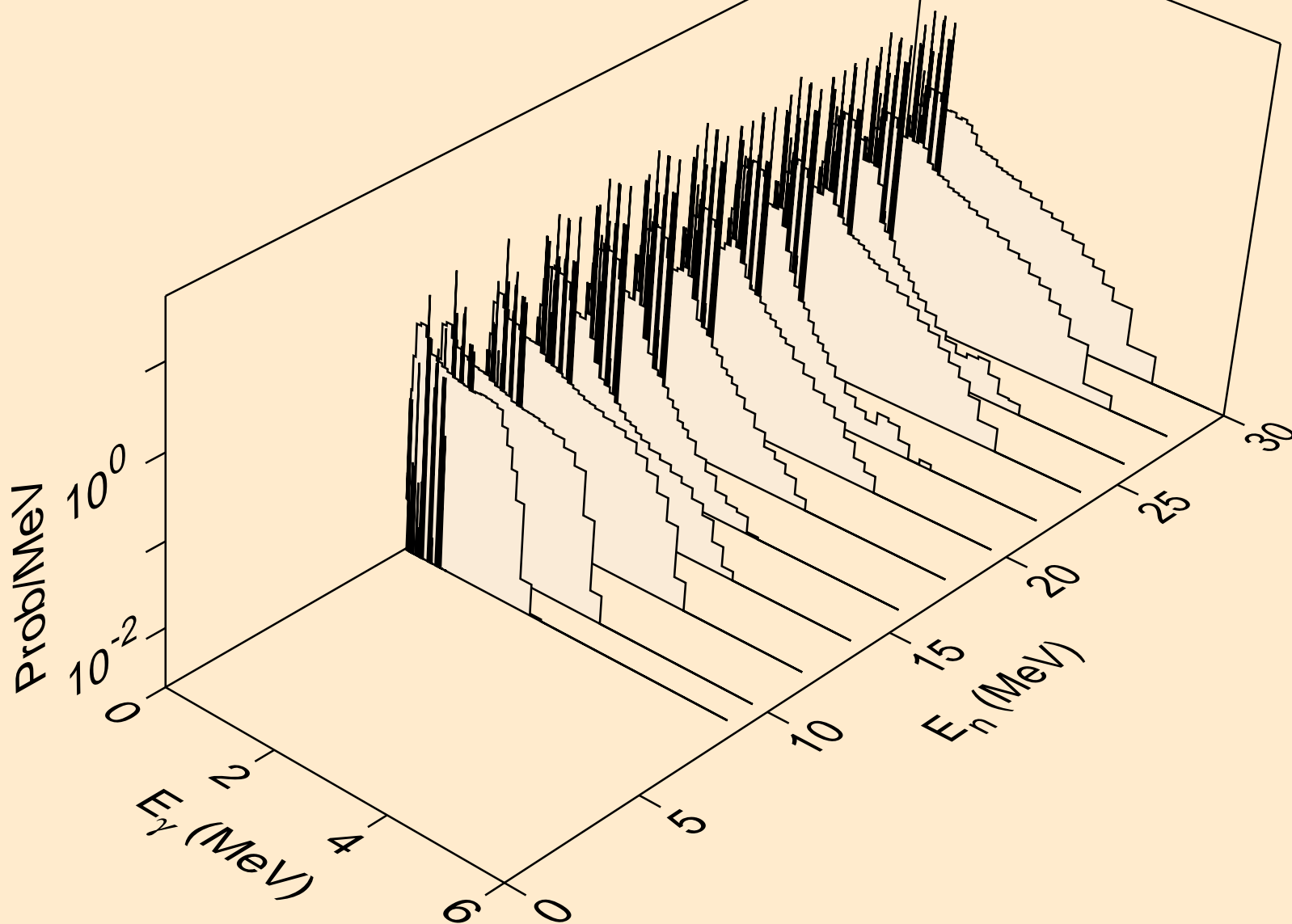

BI210M TRITON ACER TENDL-2023 LIBRARY; T=0.K
Photon emission for (n,pd)

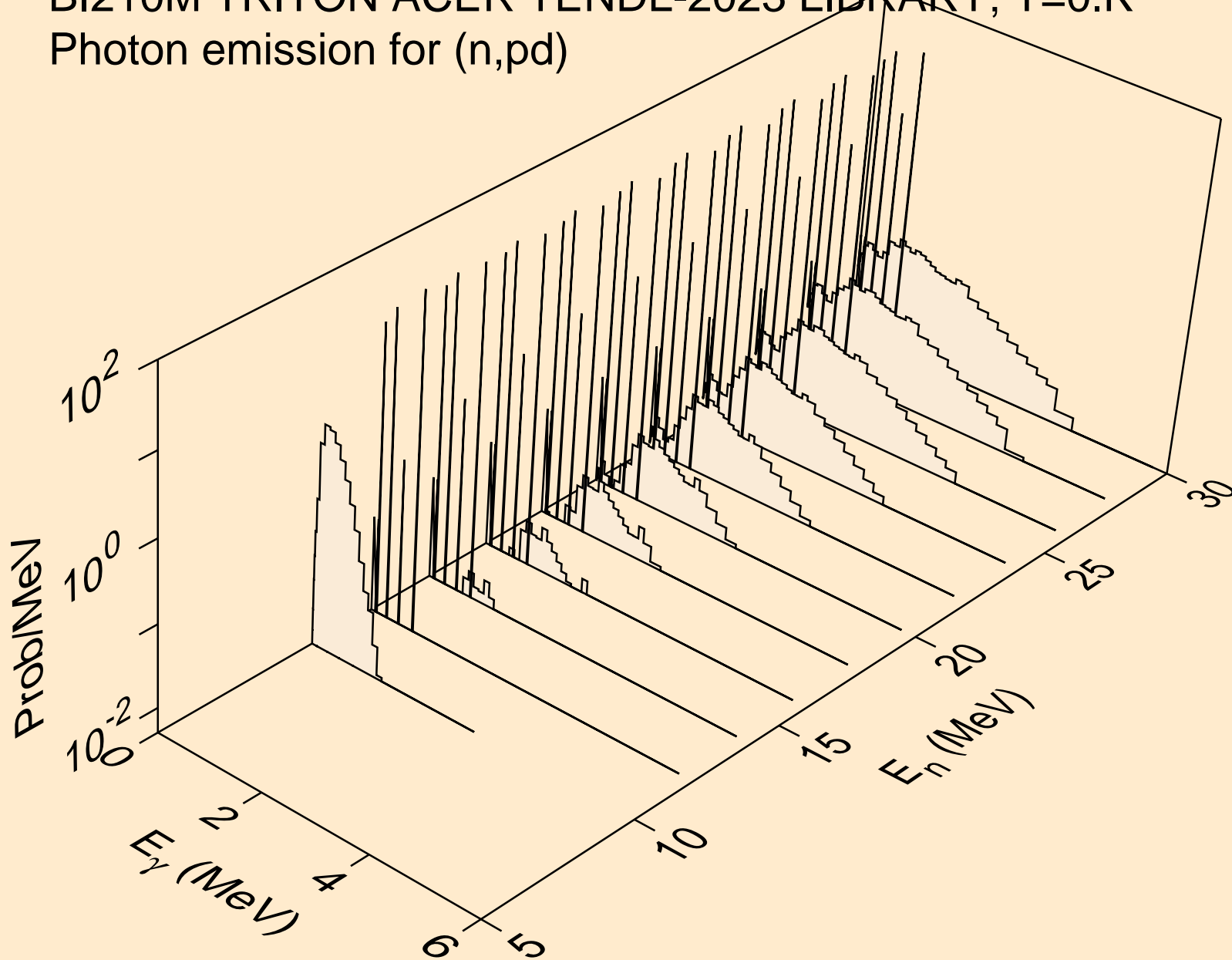

BI210M TRITON ACER TENDL-2023 LIBRARY; T=0.K
Photon emission for (n,pt)

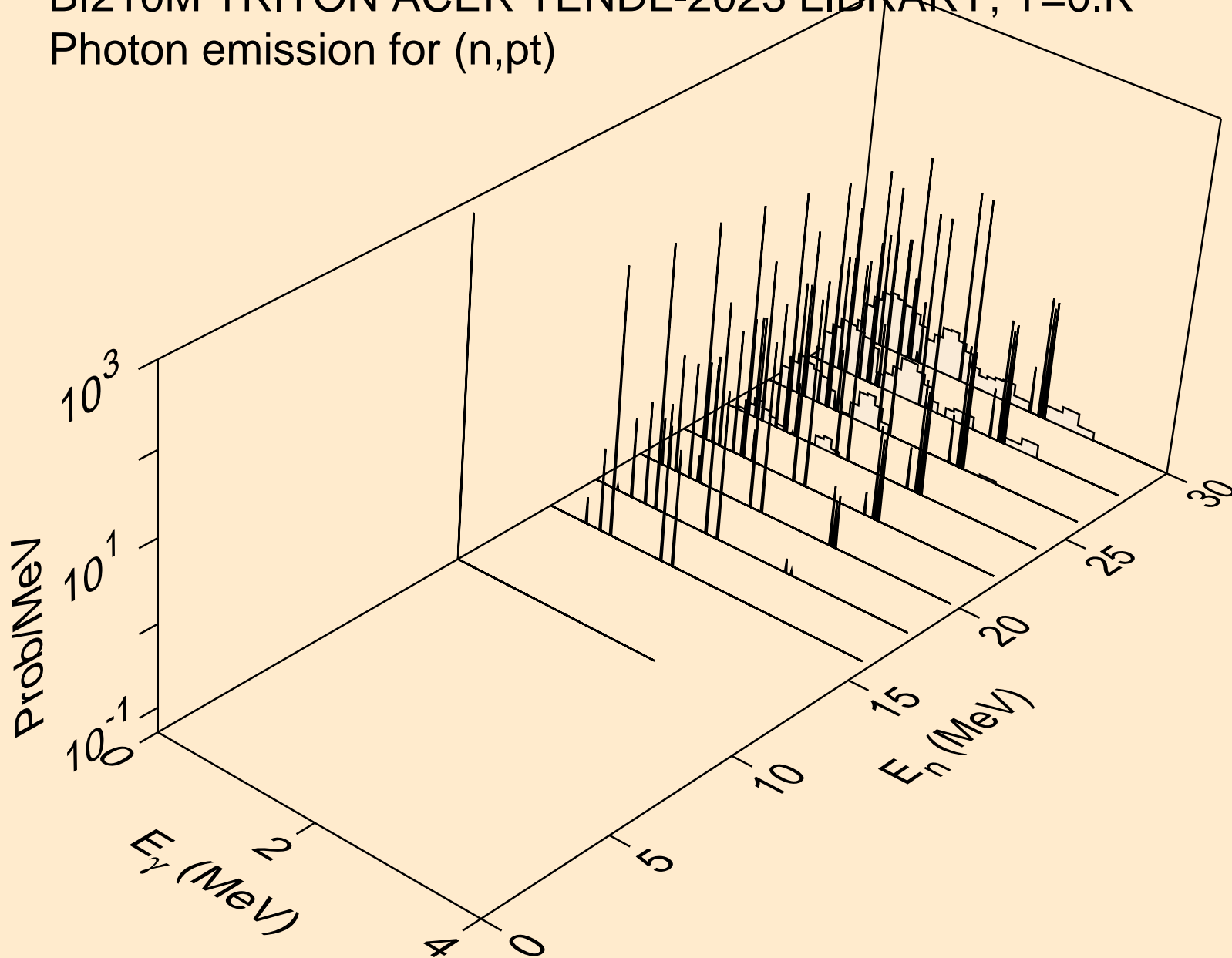

BI210M TRITON ACER TENDL-2023 LIBRARY; T=0.K
Photon emission for (n,da)

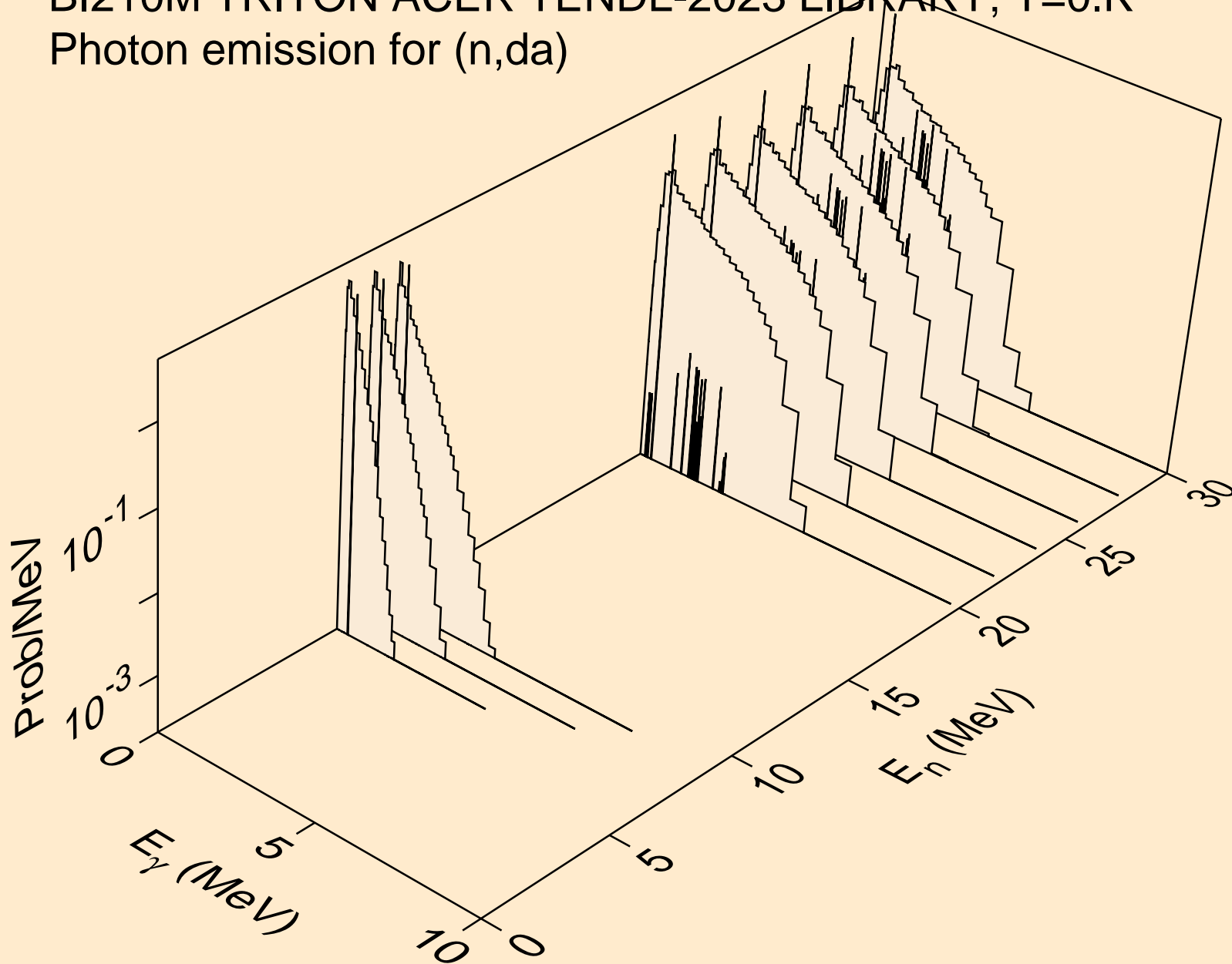

BI210M TRITON ACER TENDL-2023 LIBRARY; T=0.K
Particle heating contributions

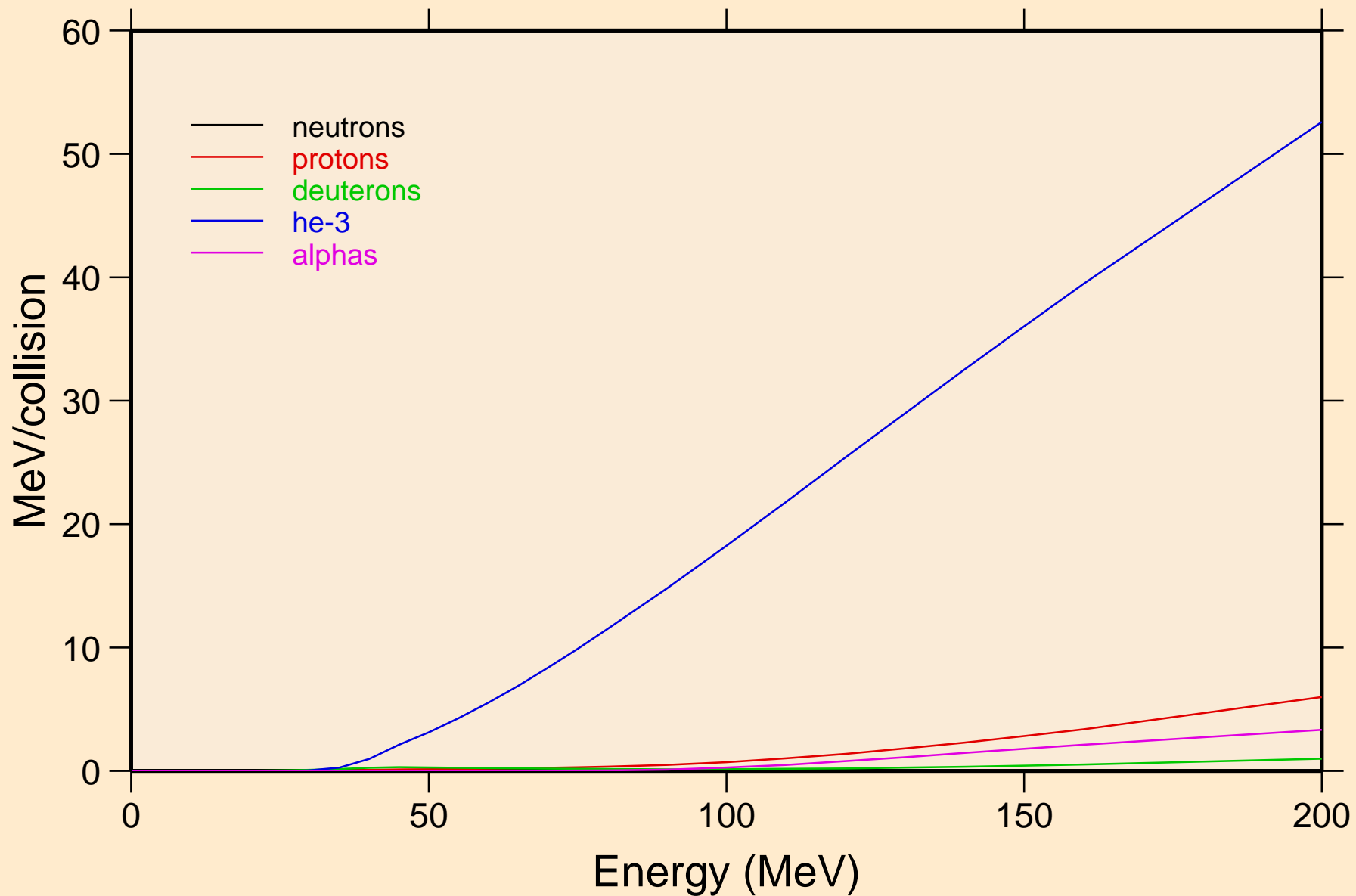

BI210M TRITON ACER TENDL-2023 LIBRARY; T=0.K
Recoil Heating

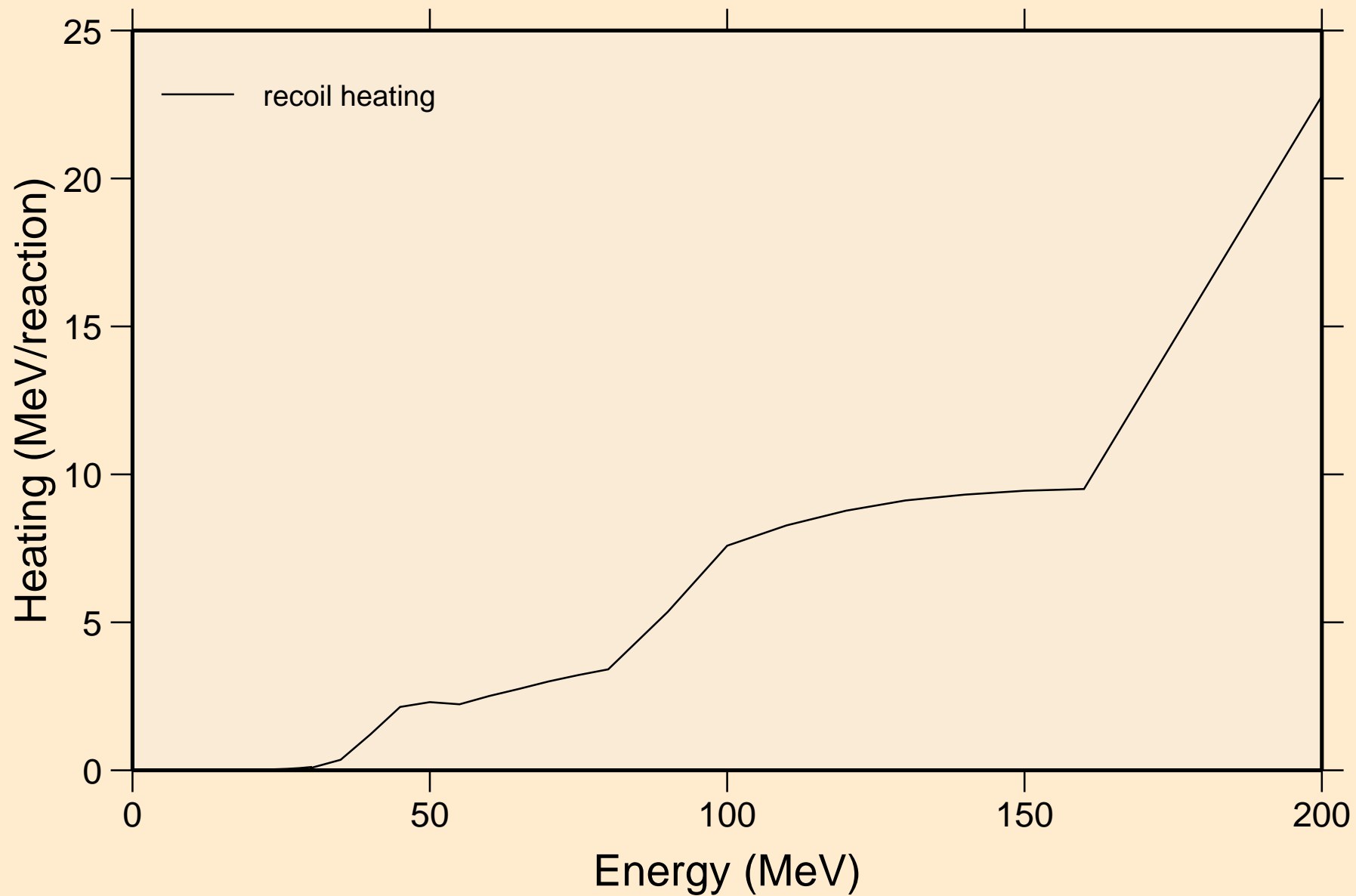

BI210M TRITON ACER TENDL-2023 LIBRARY; T=0.K
Particle production cross sections

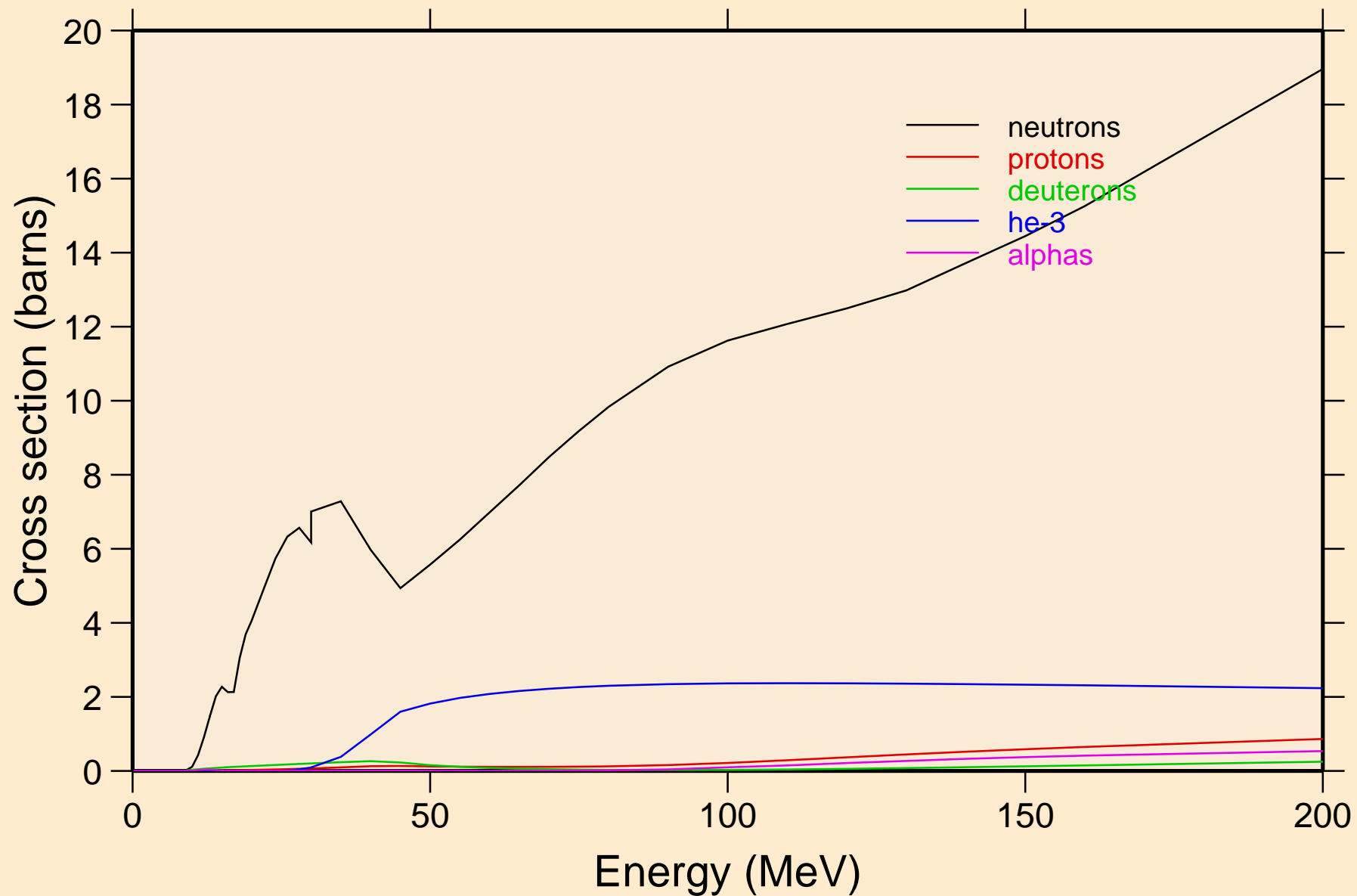

BI210M TRITON ACER TENDL-2023 LIBRARY; T=0.K
neutrons from (t,n)

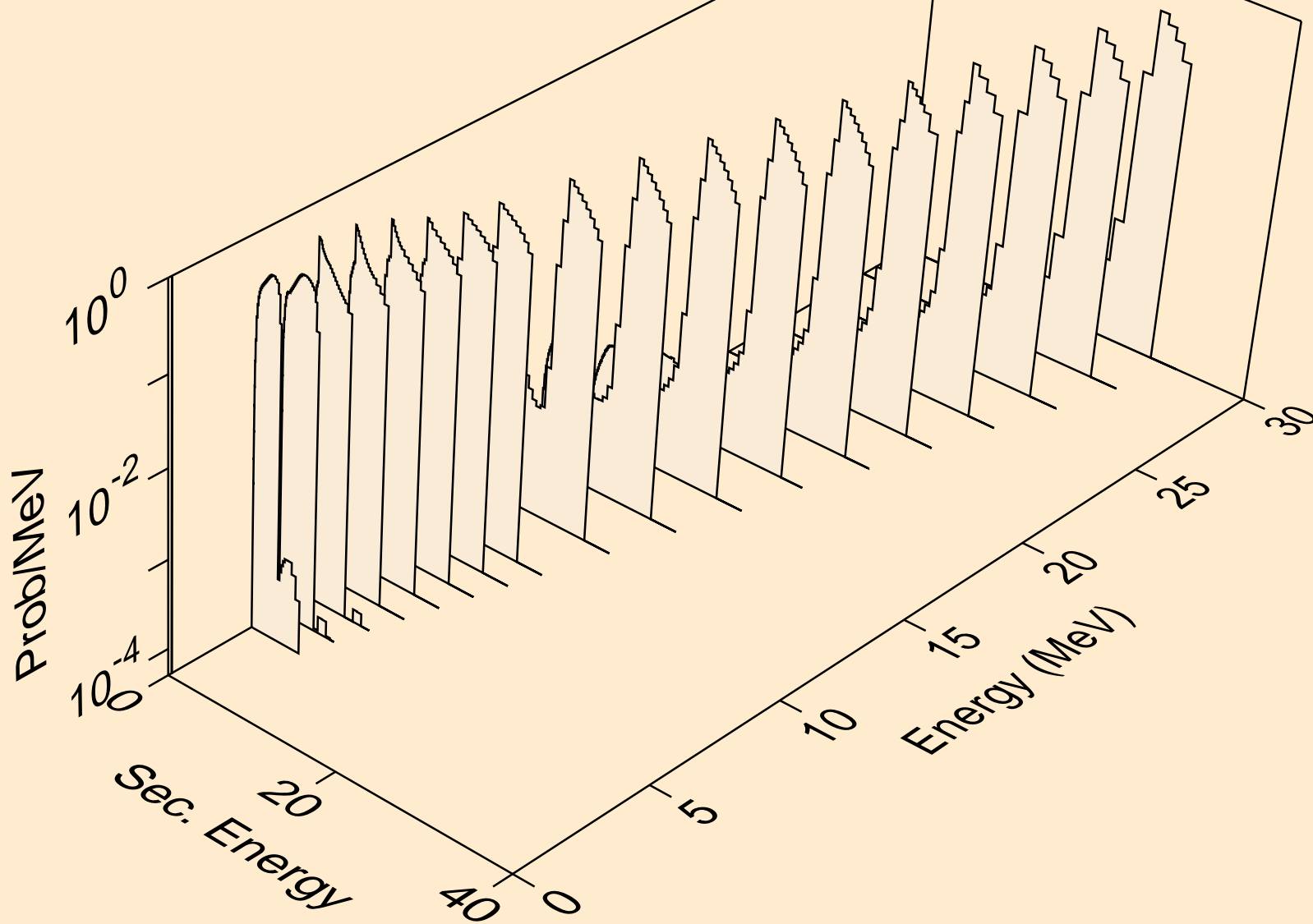

BI210M TRITON ACER TENDL-2023 LIBRARY; T=0.K
neutrons from (t,x)

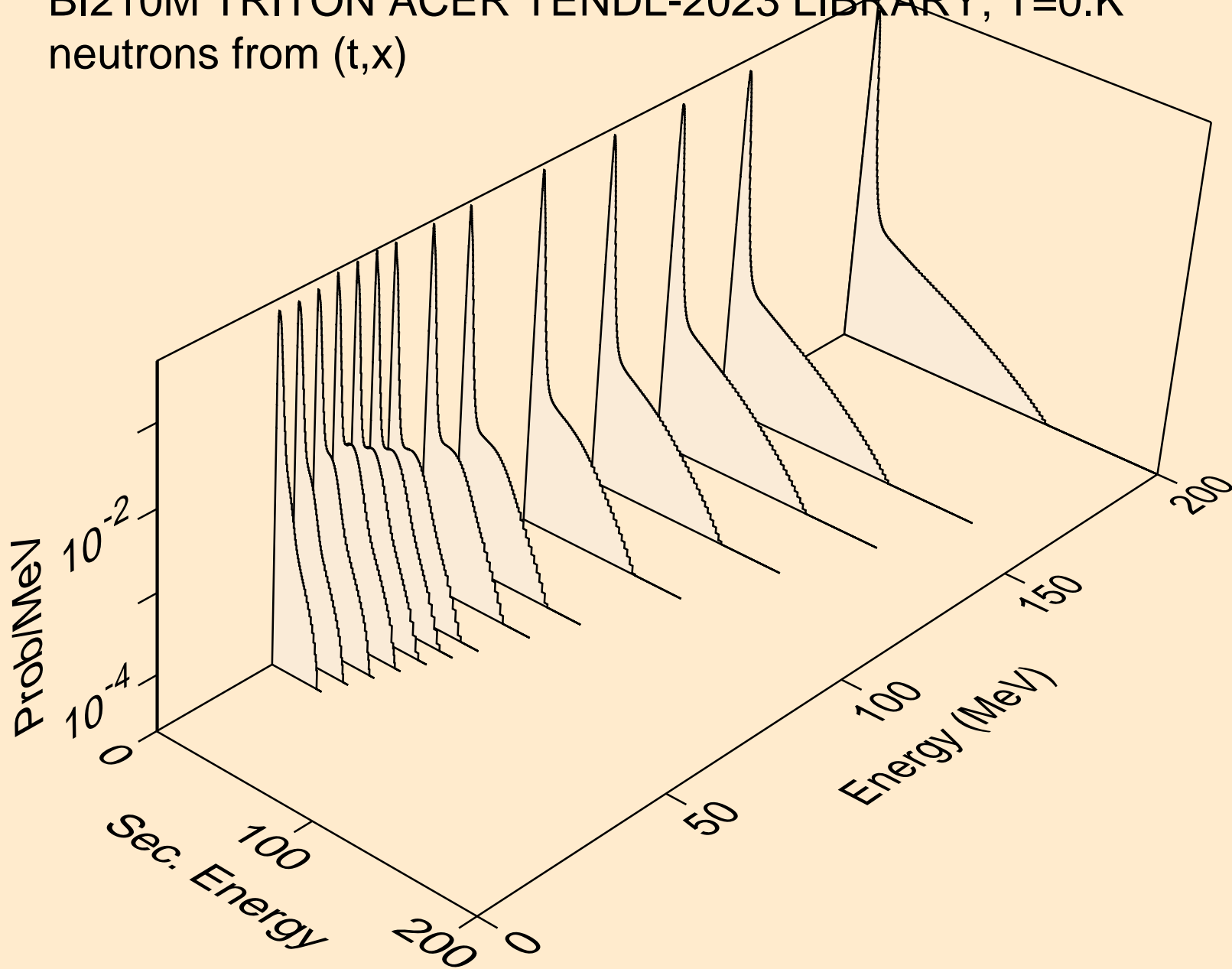

BI210M TRITON ACER TENDL-2023 LIBRARY; T=0.K
neutrons from (t,2nd)

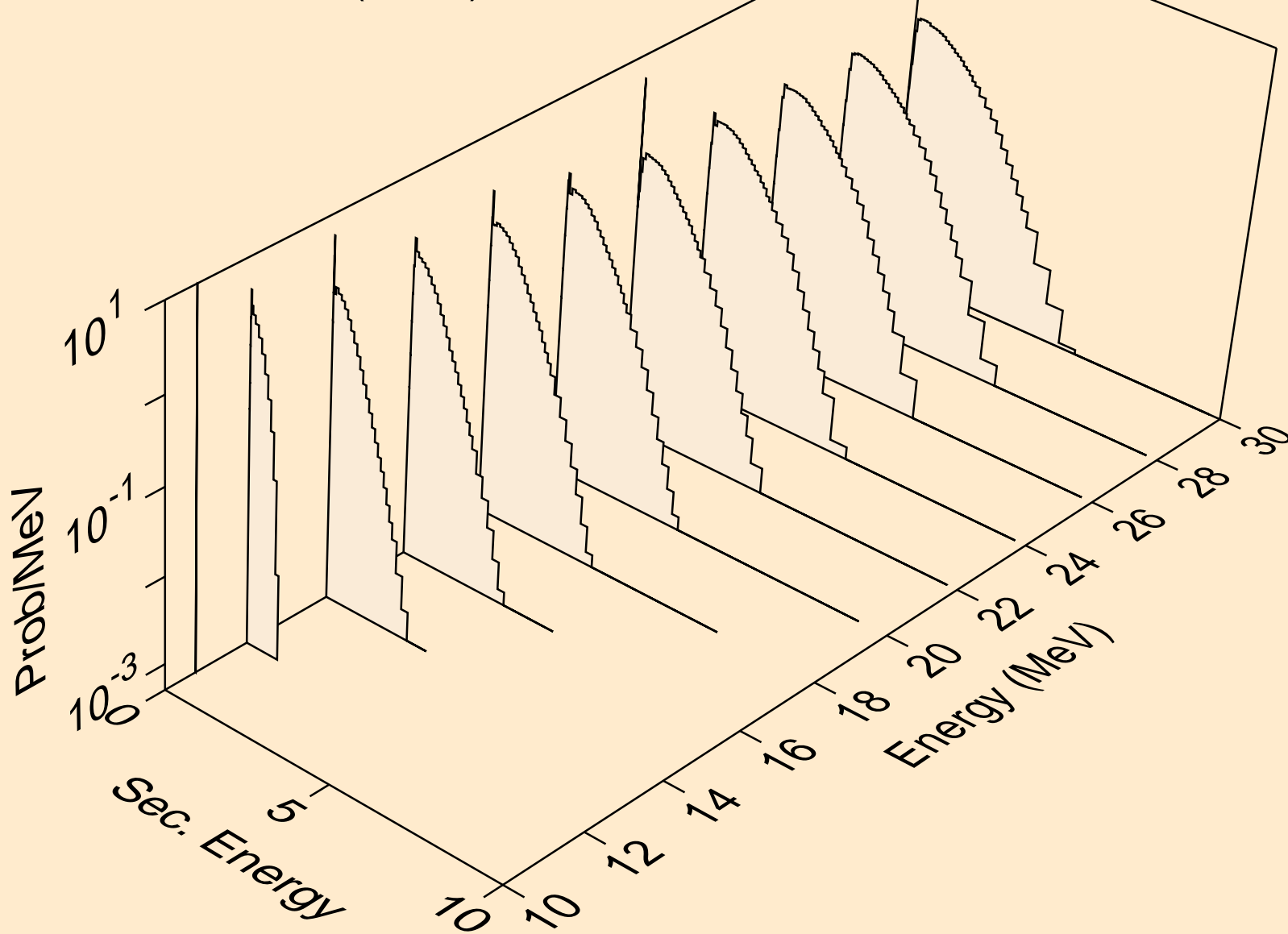

BI210M TRITON ACER TENDL-2023 LIBRARY; T=0.K
neutrons from (t,2n)

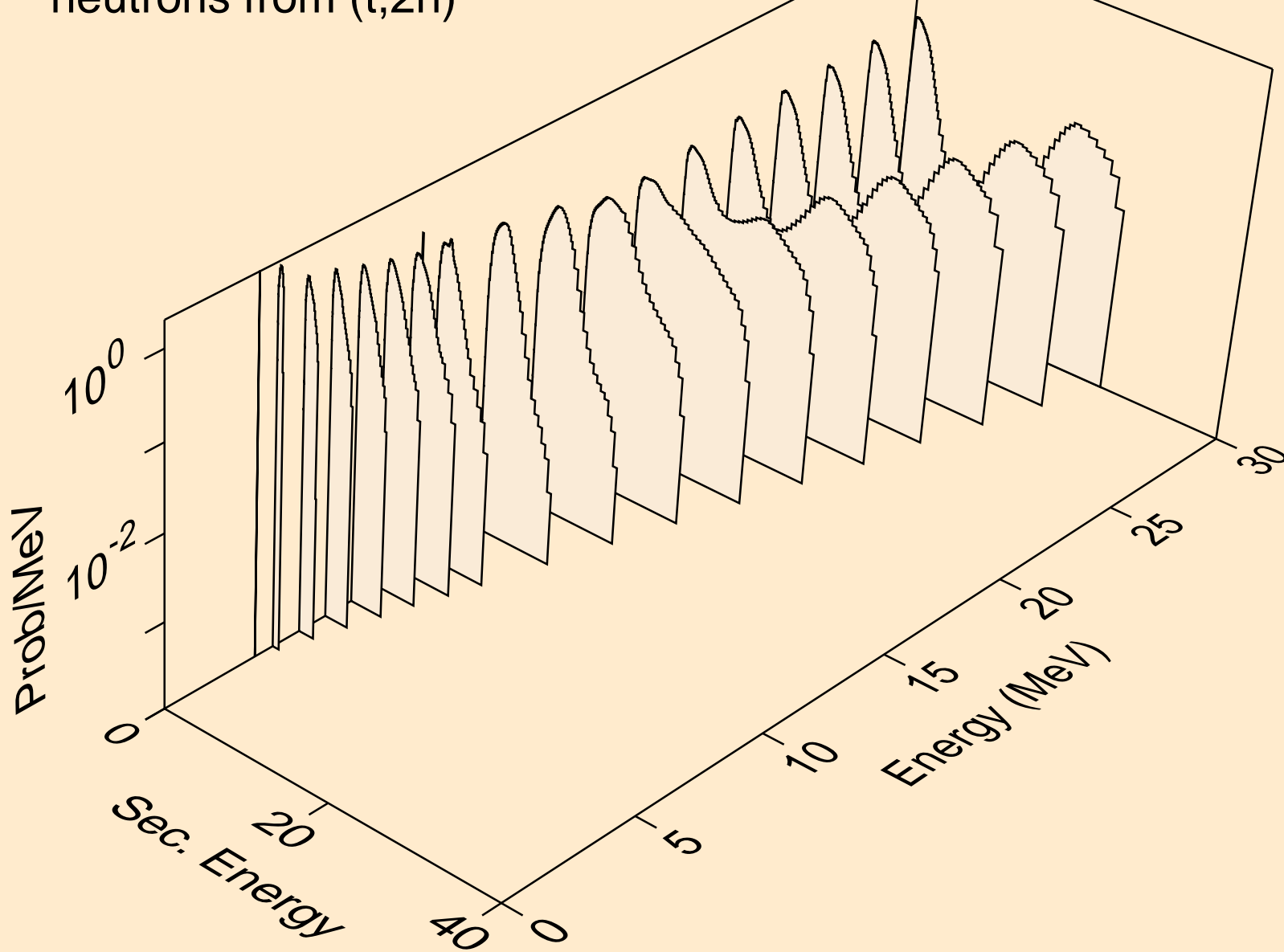

BI210M TRITON ACER TENDL-2023 LIBRARY; T=0.K
neutrons from (t,3n)

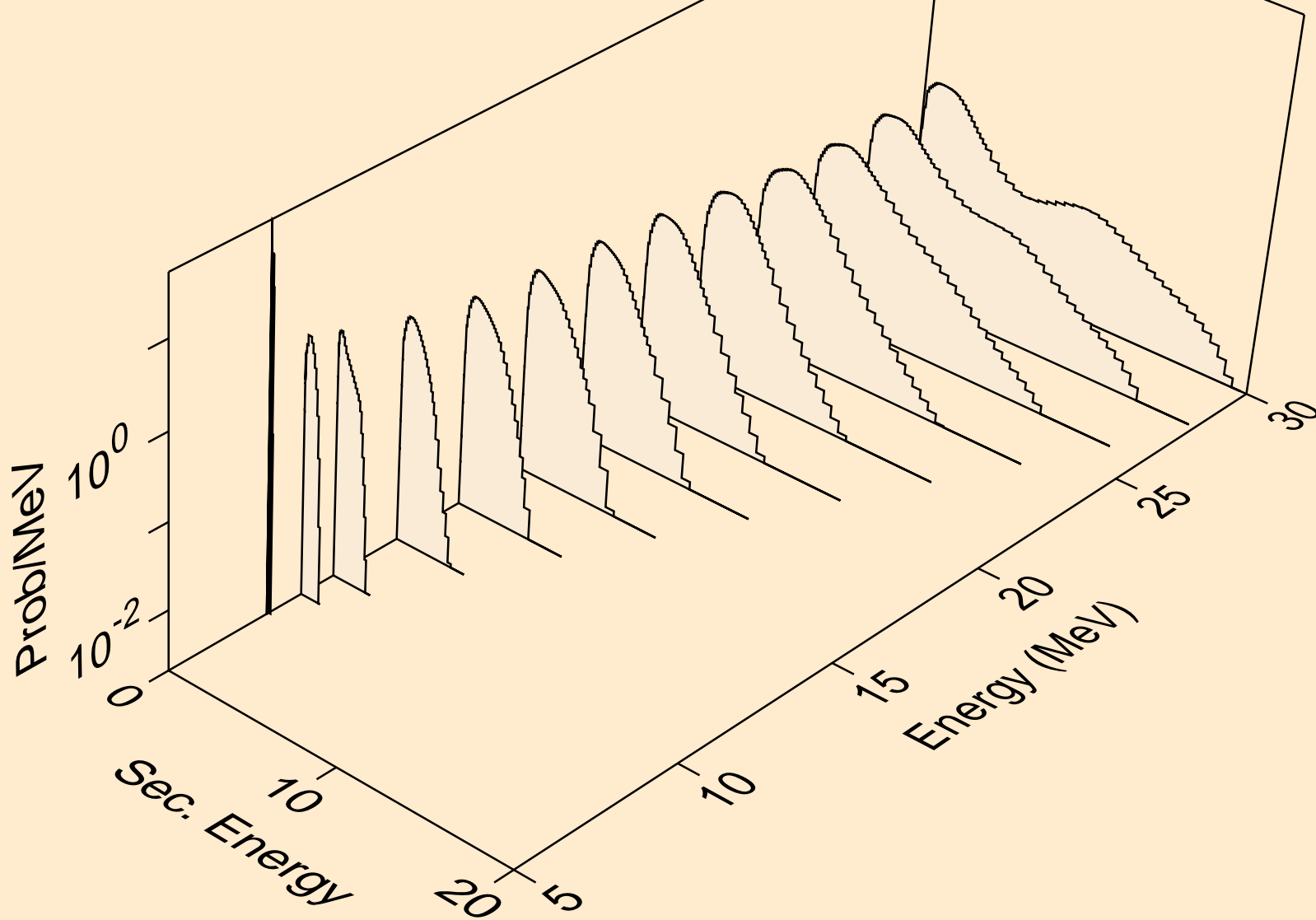

BI210M TRITON ACER TENDL-2023 LIBRARY; T=0.K
neutrons from (t,n*)a

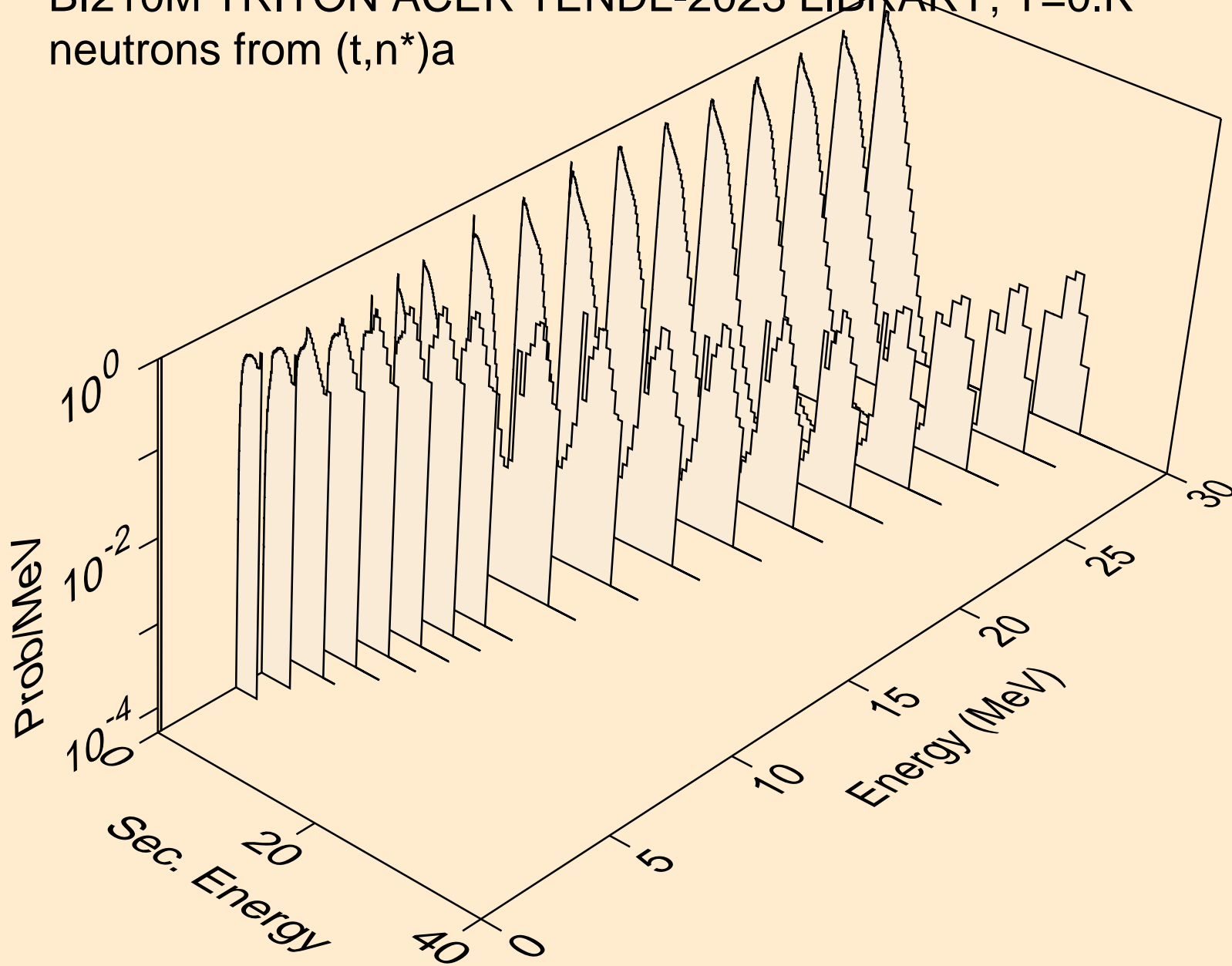

BI210M TRITON ACER TENDL-2023 LIBRARY; T=0.K
neutrons from (t,2n)a

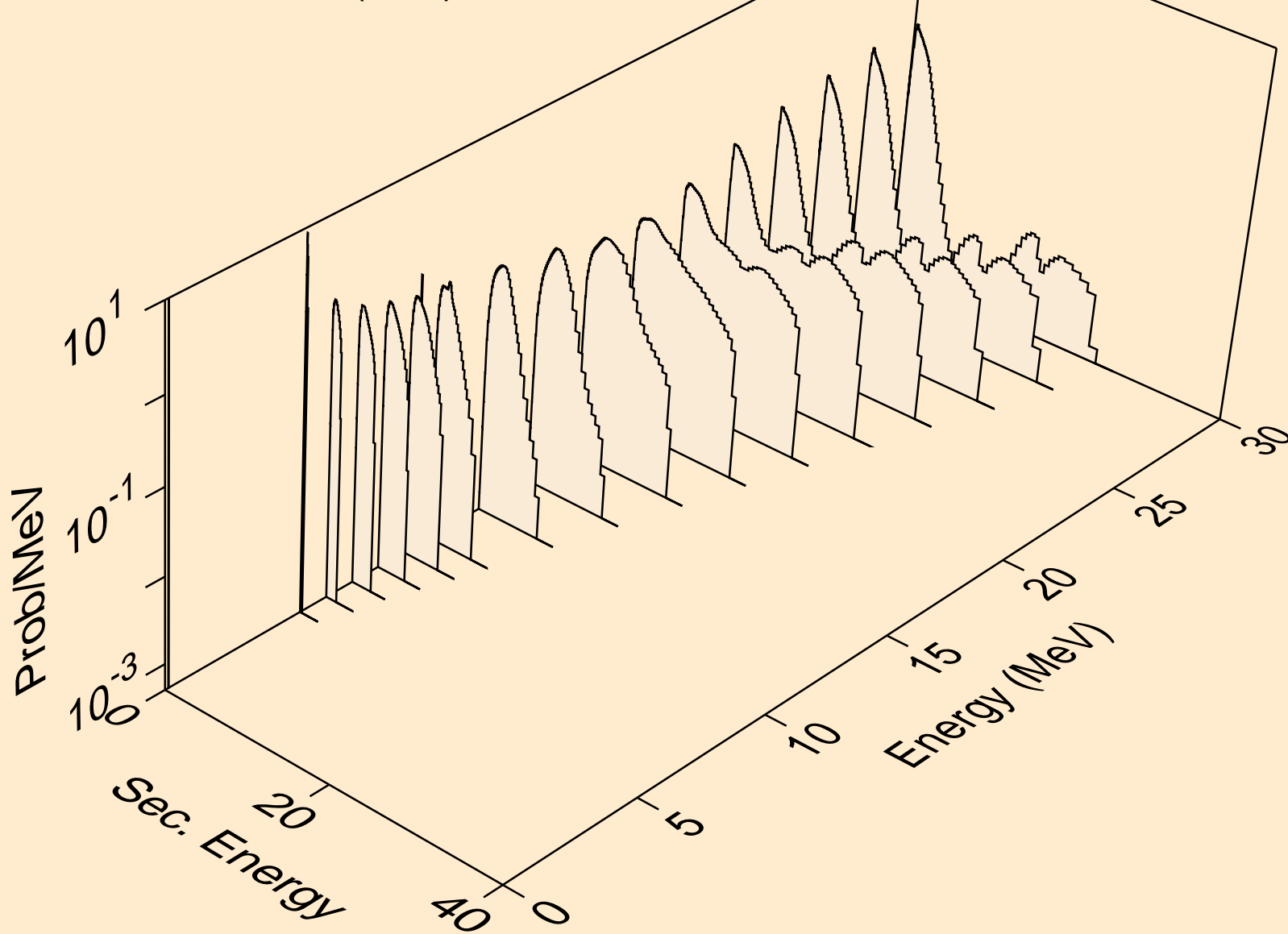

BI210M TRITON ACER TENDL-2023 LIBRARY; T=0.K
neutrons from (t,3n)a

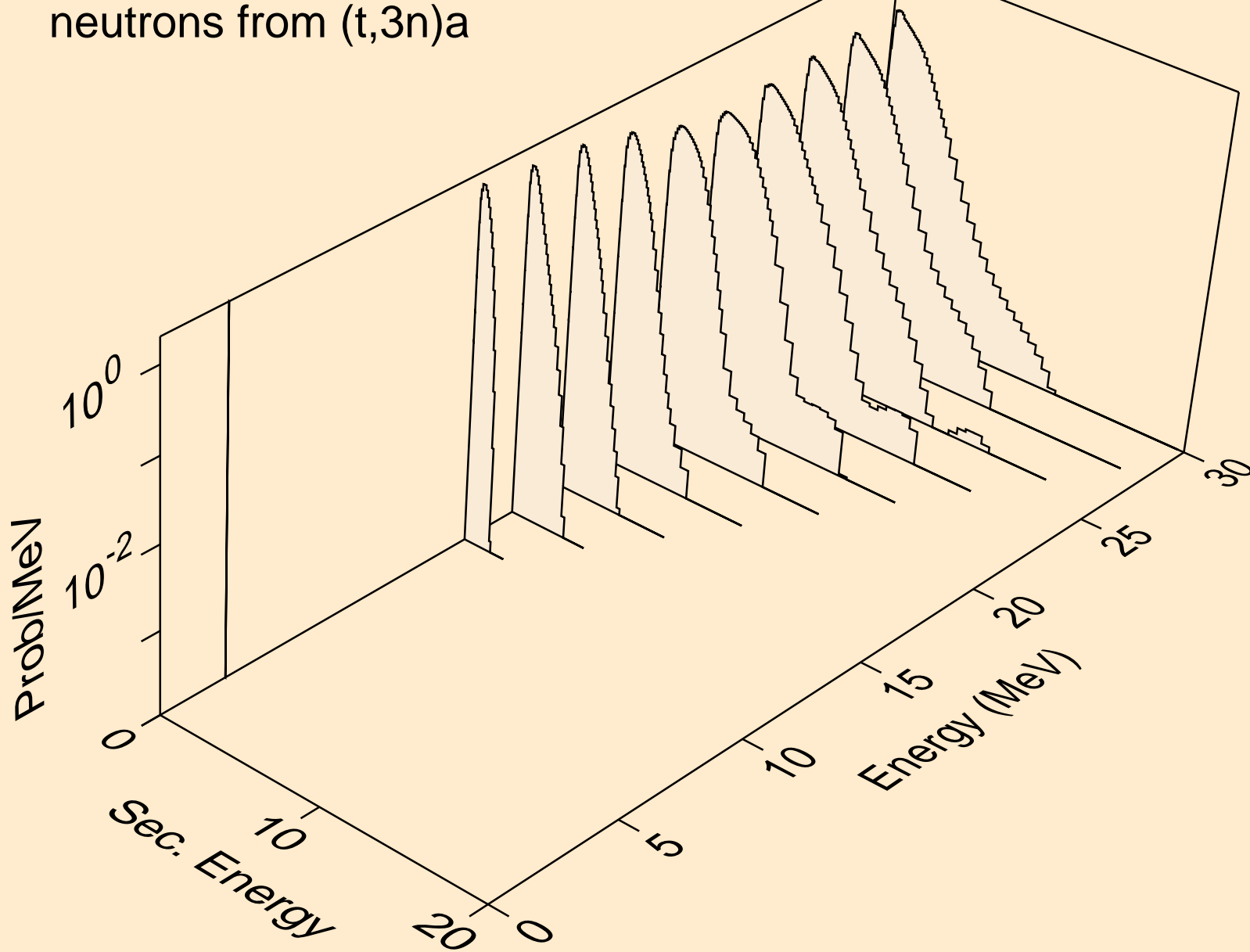

BI210M TRITON ACER TENDL-2023 LIBRARY; T=0.K
neutrons from (t,n*)p

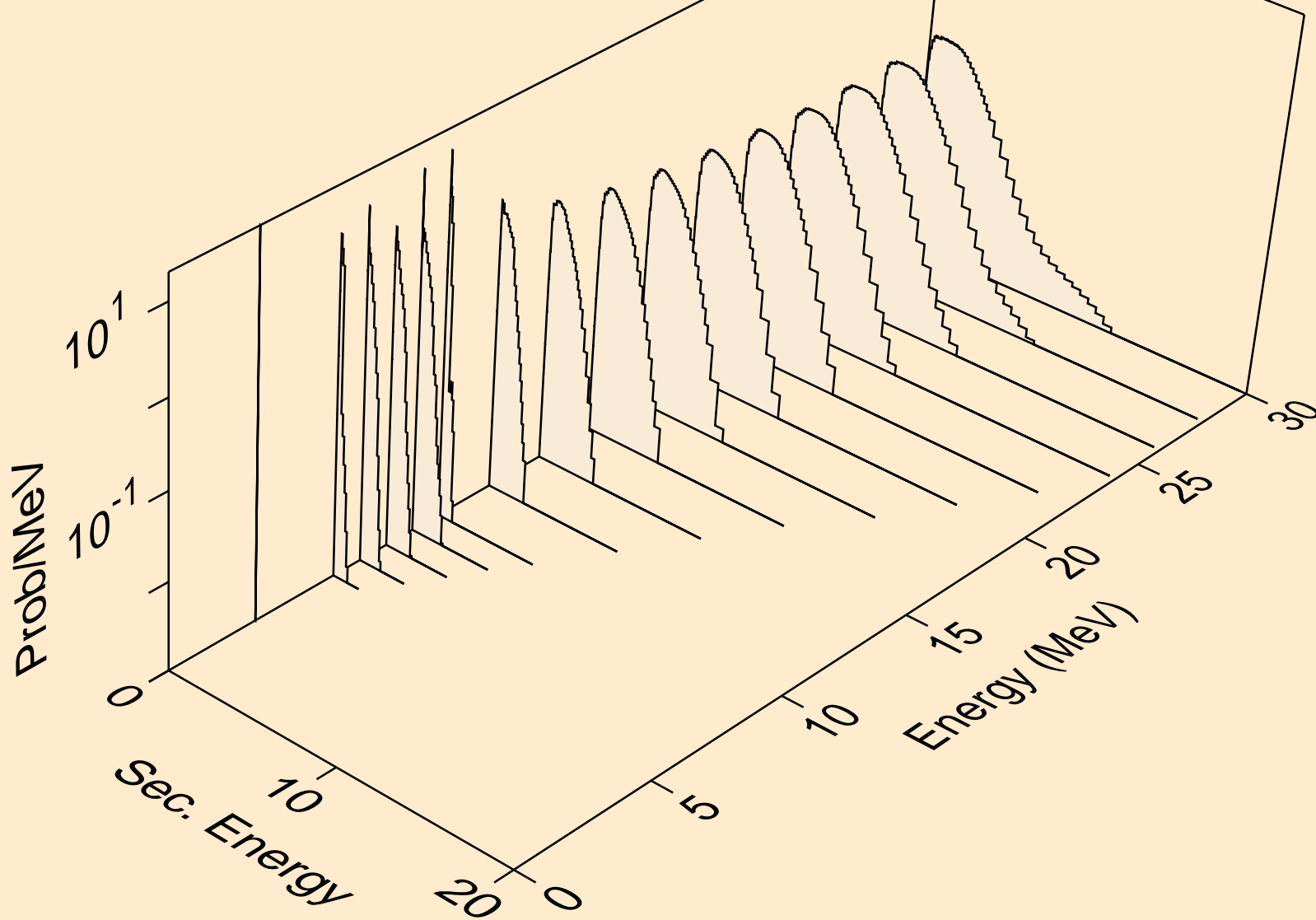

BI210M TRITON ACER TENDL-2023 LIBRARY; T=0.K
neutrons from (t,n*)2a

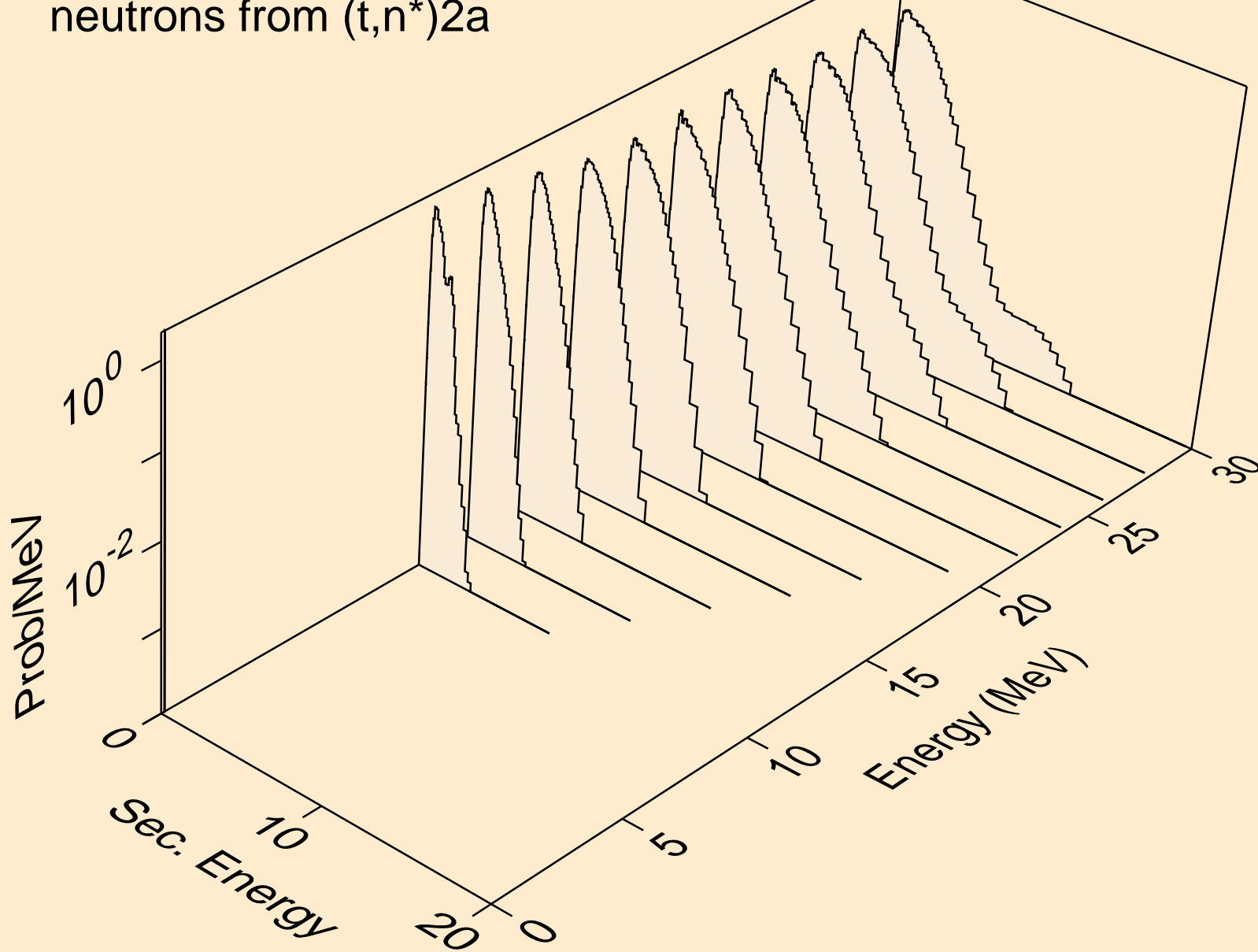

BI210M TRITON ACER TENDL-2023 LIBRARY; T=0.K
neutrons from (t,n*)d

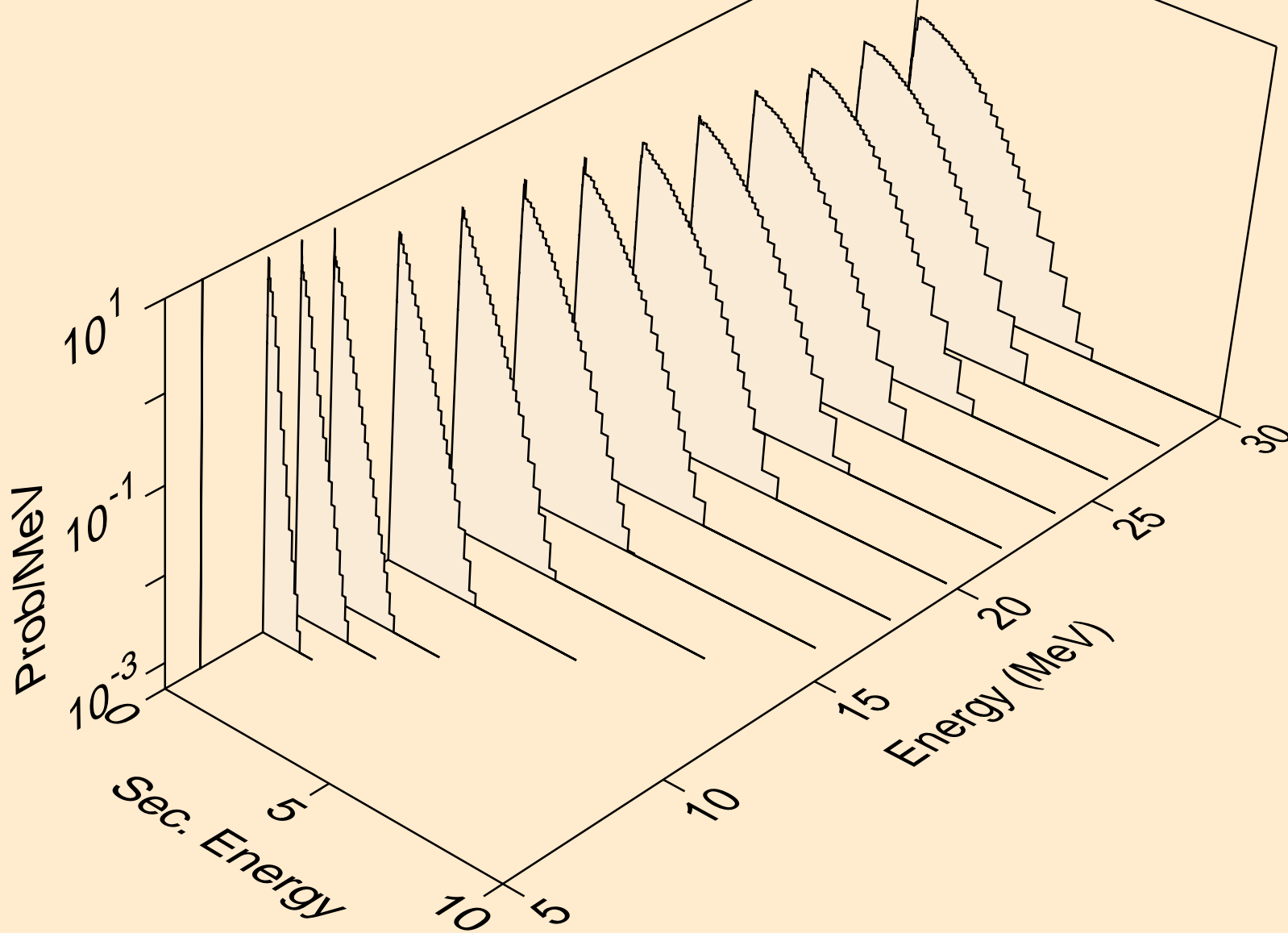

BI210M TRITON ACER TENDL-2023 LIBRARY; T=0.K
neutrons from (t,n*)t

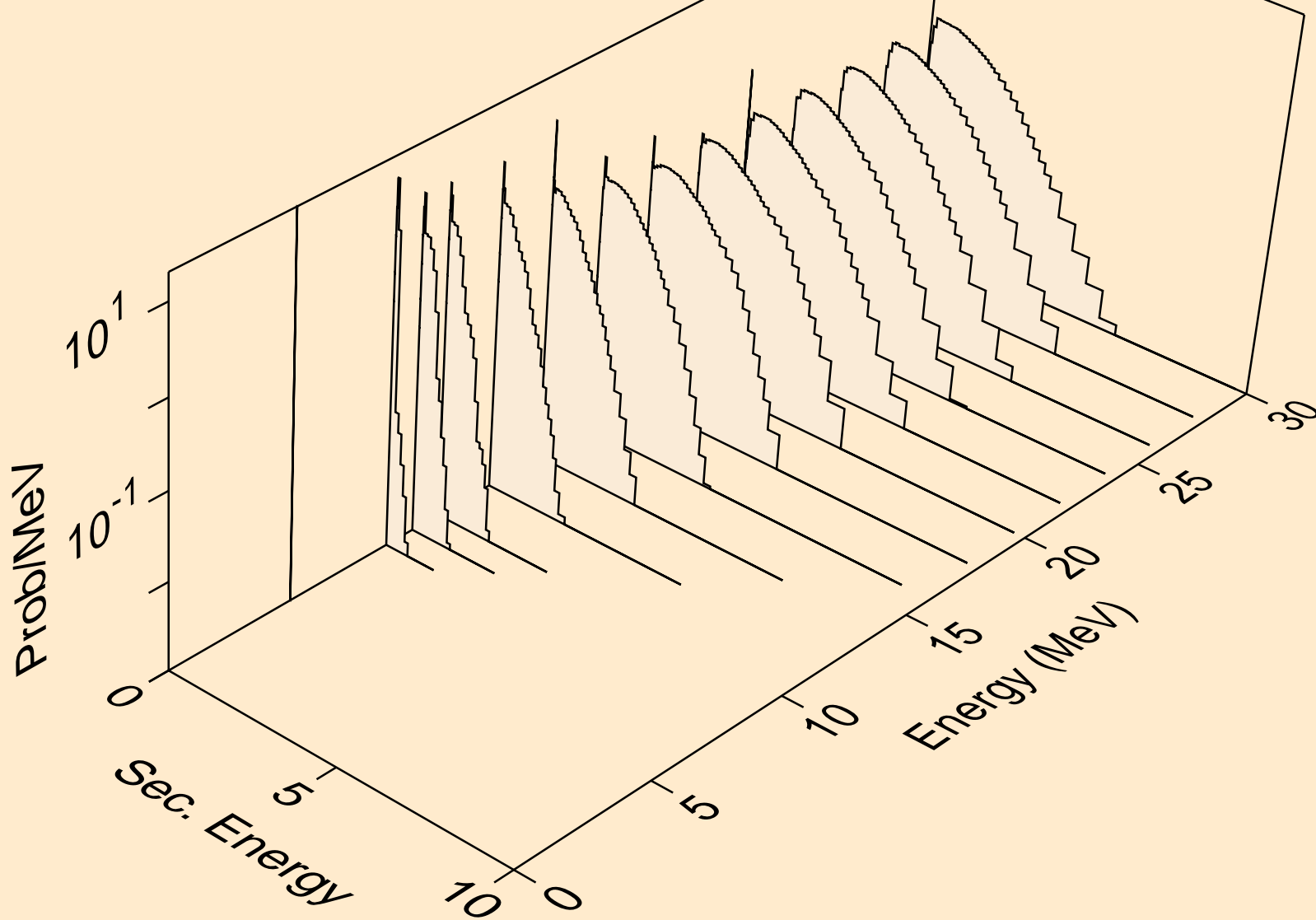

BI210M TRITON ACER TENDL-2023 LIBRARY; T=0.K
neutrons from (t,n*)he3

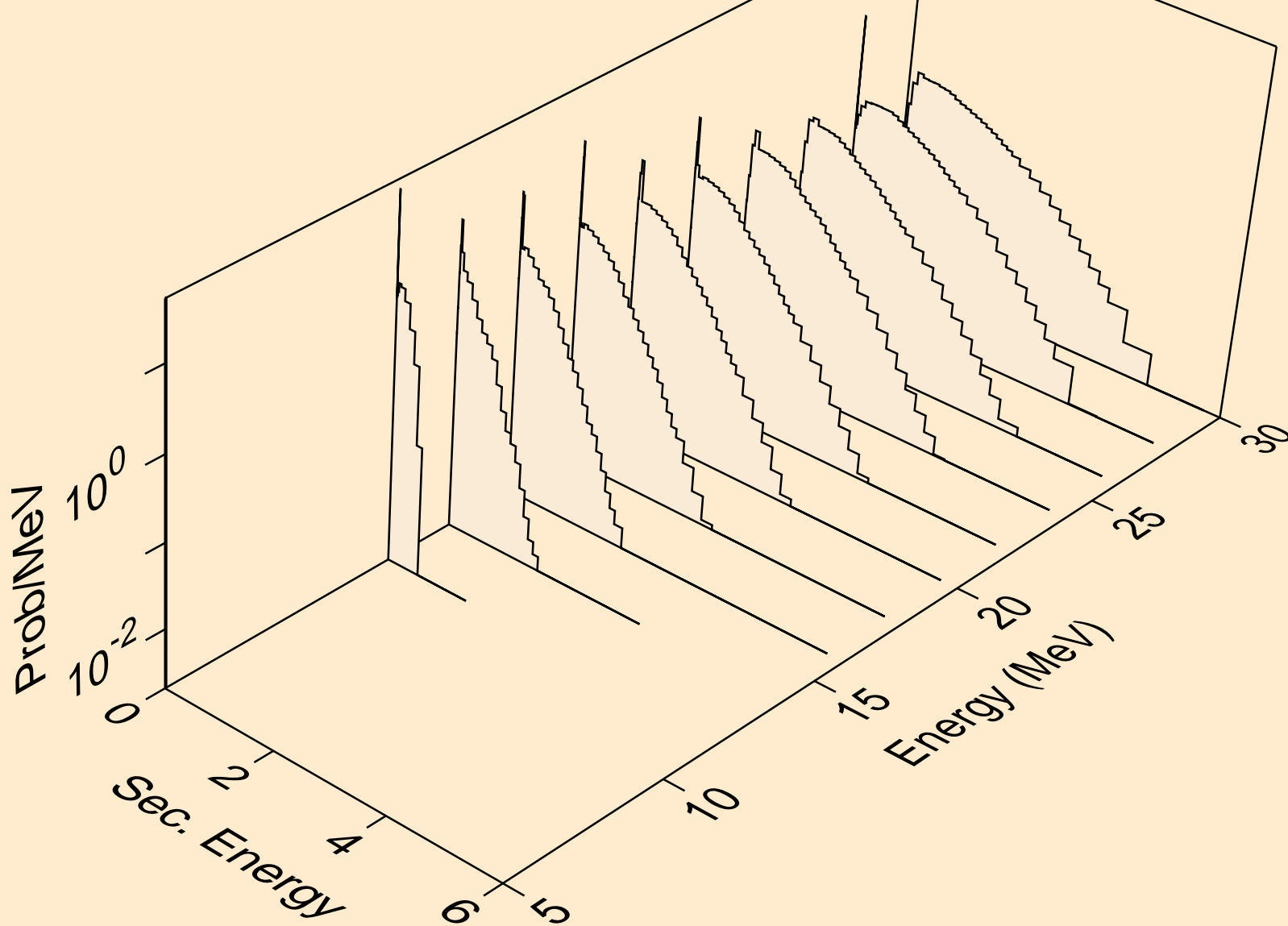

BI210M TRITON ACER TENDL-2023 LIBRARY; T=0.K
neutrons from (t,4n)

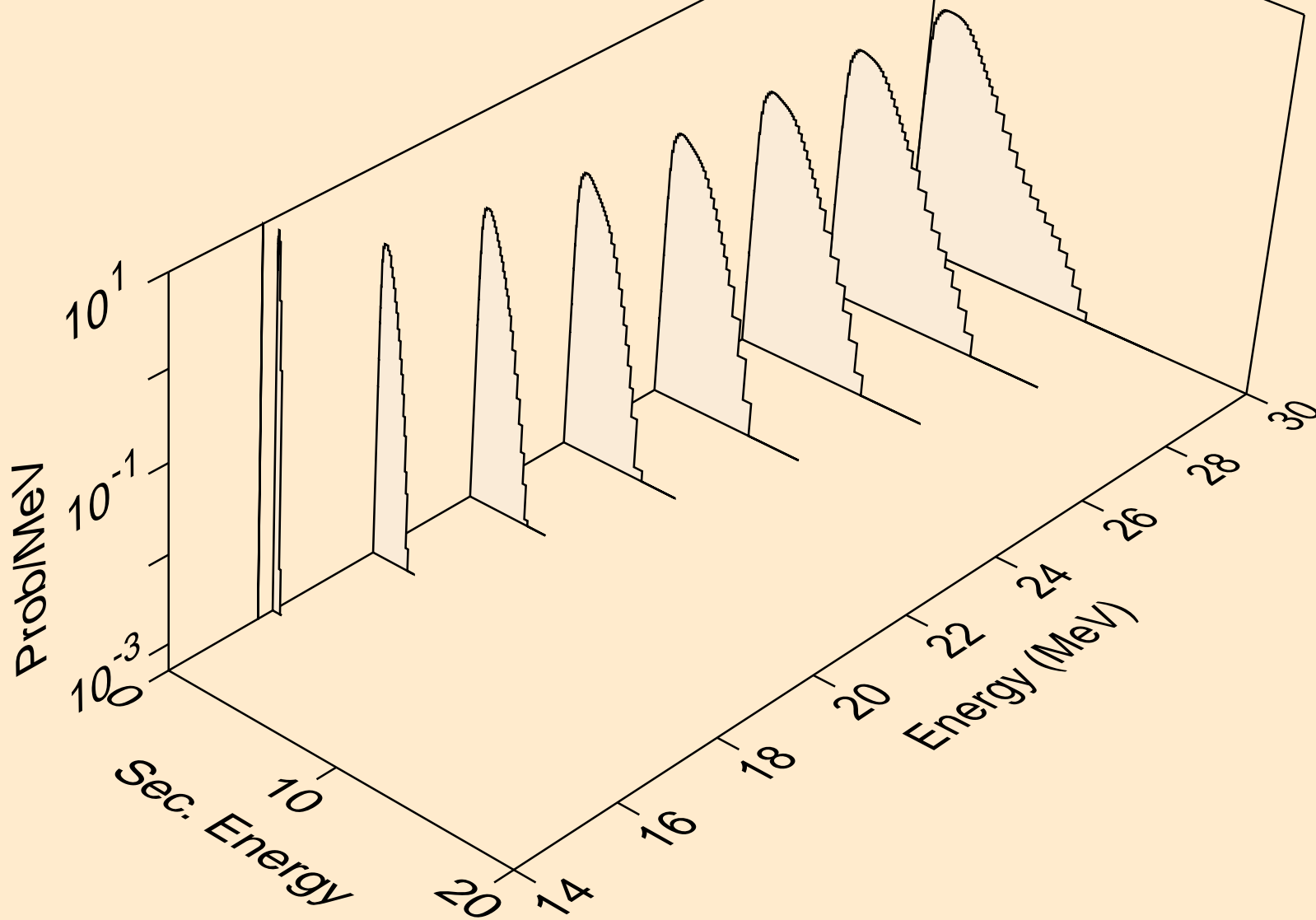

BI210M TRITON ACER TENDL-2023 LIBRARY; T=0.K
neutrons from (t,2np)

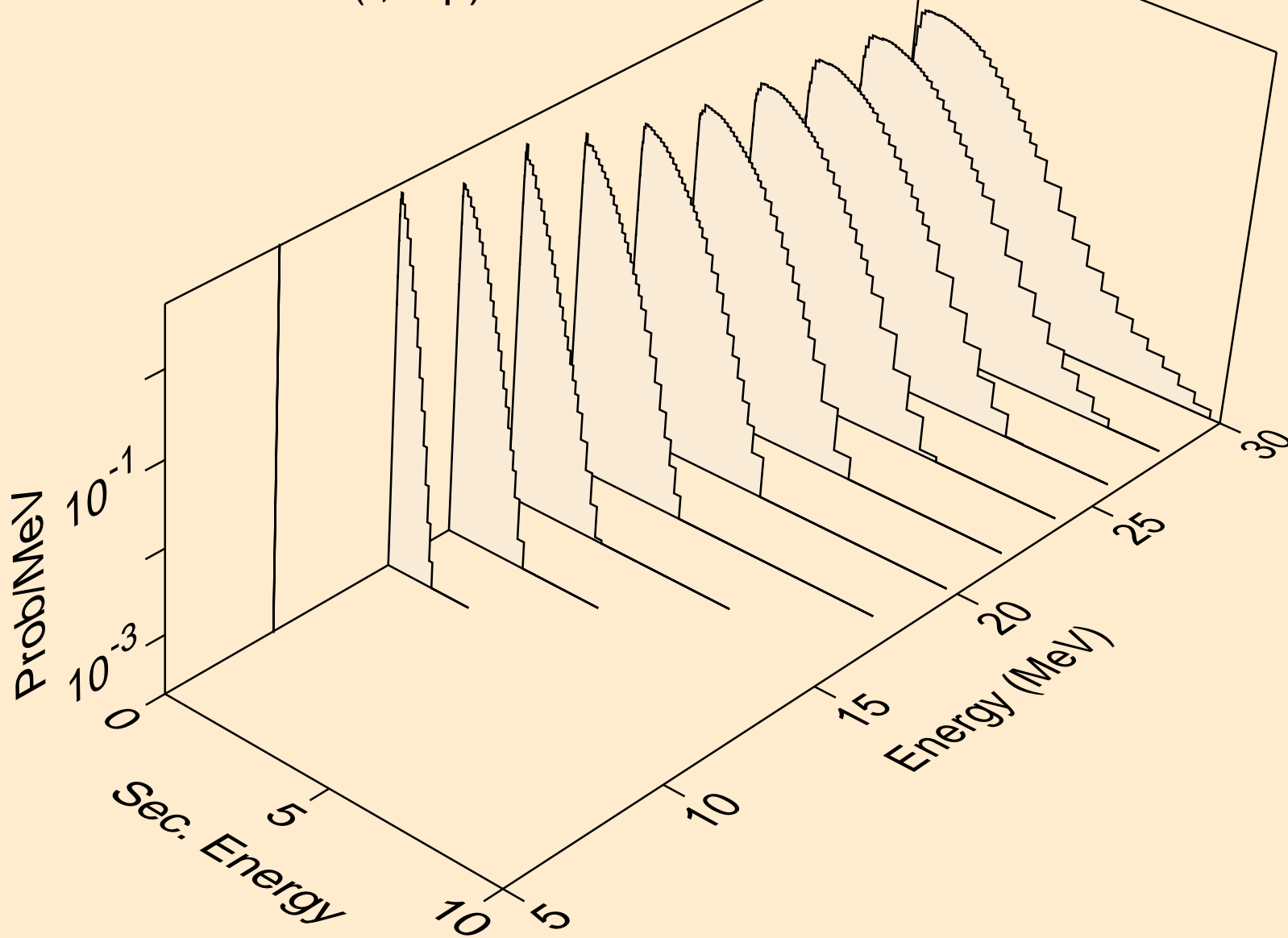

BI210M TRITON ACER TENDL-2023 LIBRARY; T=0.K
neutrons from (t,3np)

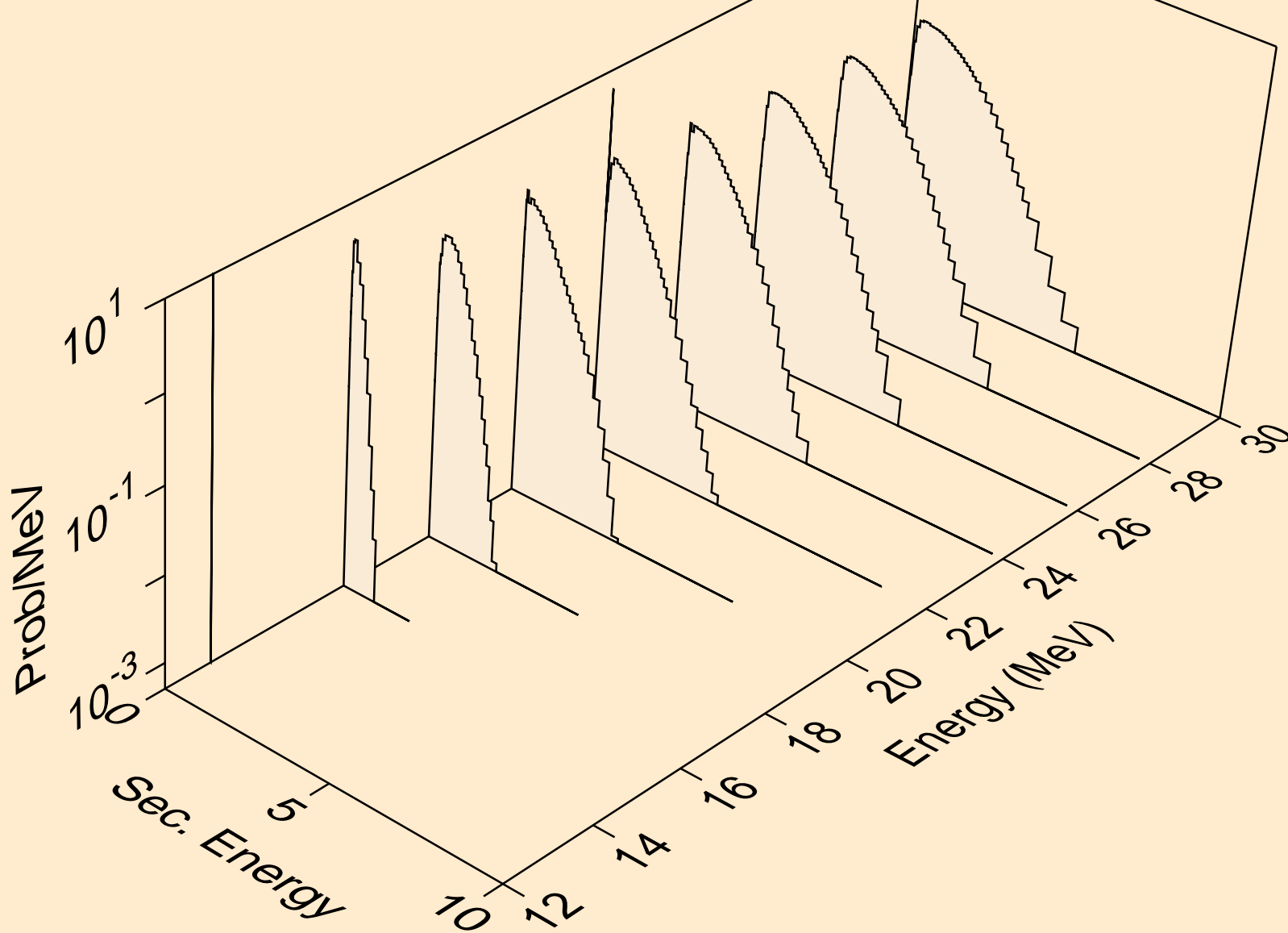

BI210M TRITON ACER TENDL-2023 LIBRARY; T=0.K
neutrons from (t,n2p)

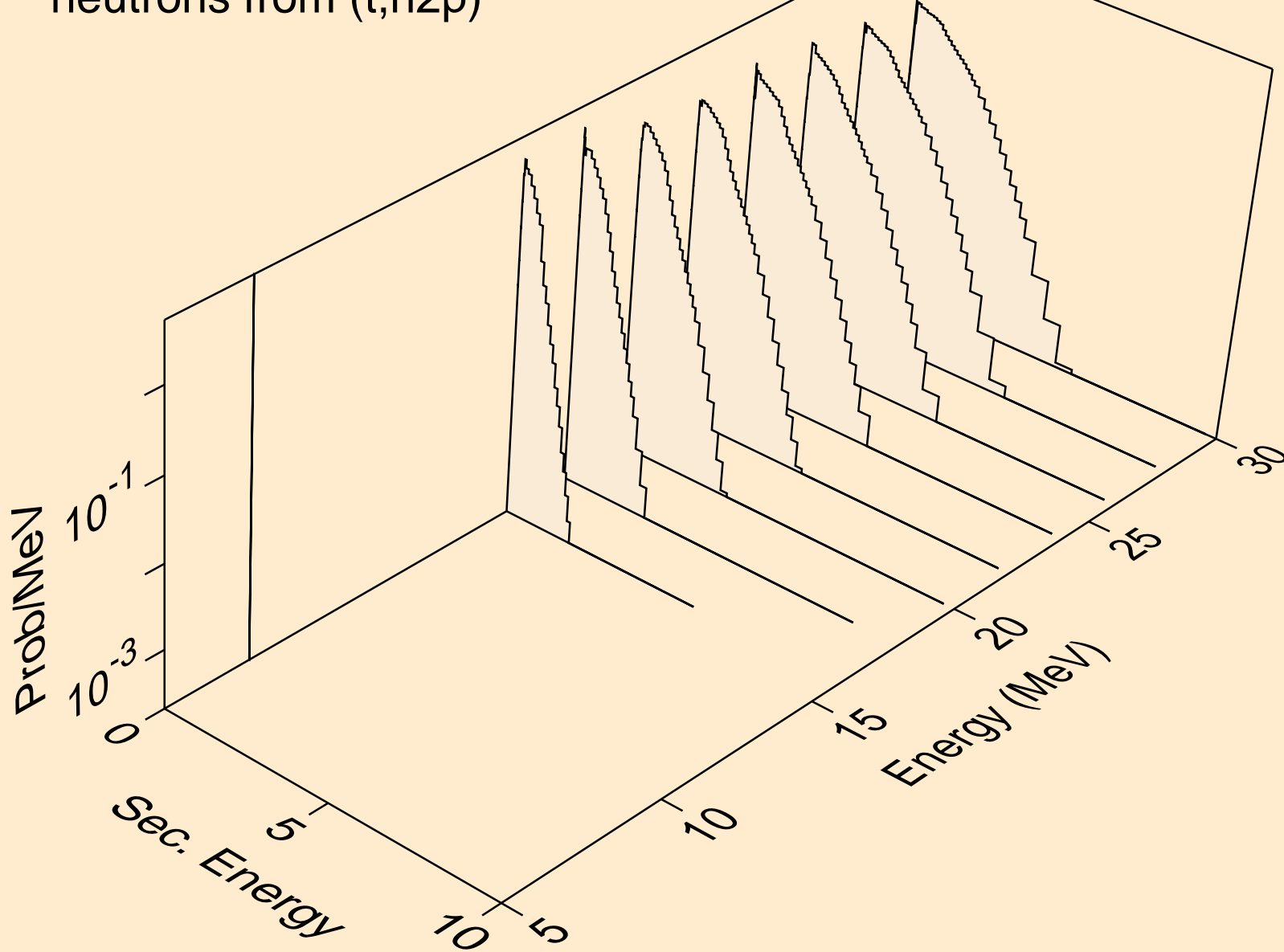

BI210M TRITON ACER TENDL-2023 LIBRARY; T=0.K
neutrons from (t,npa)

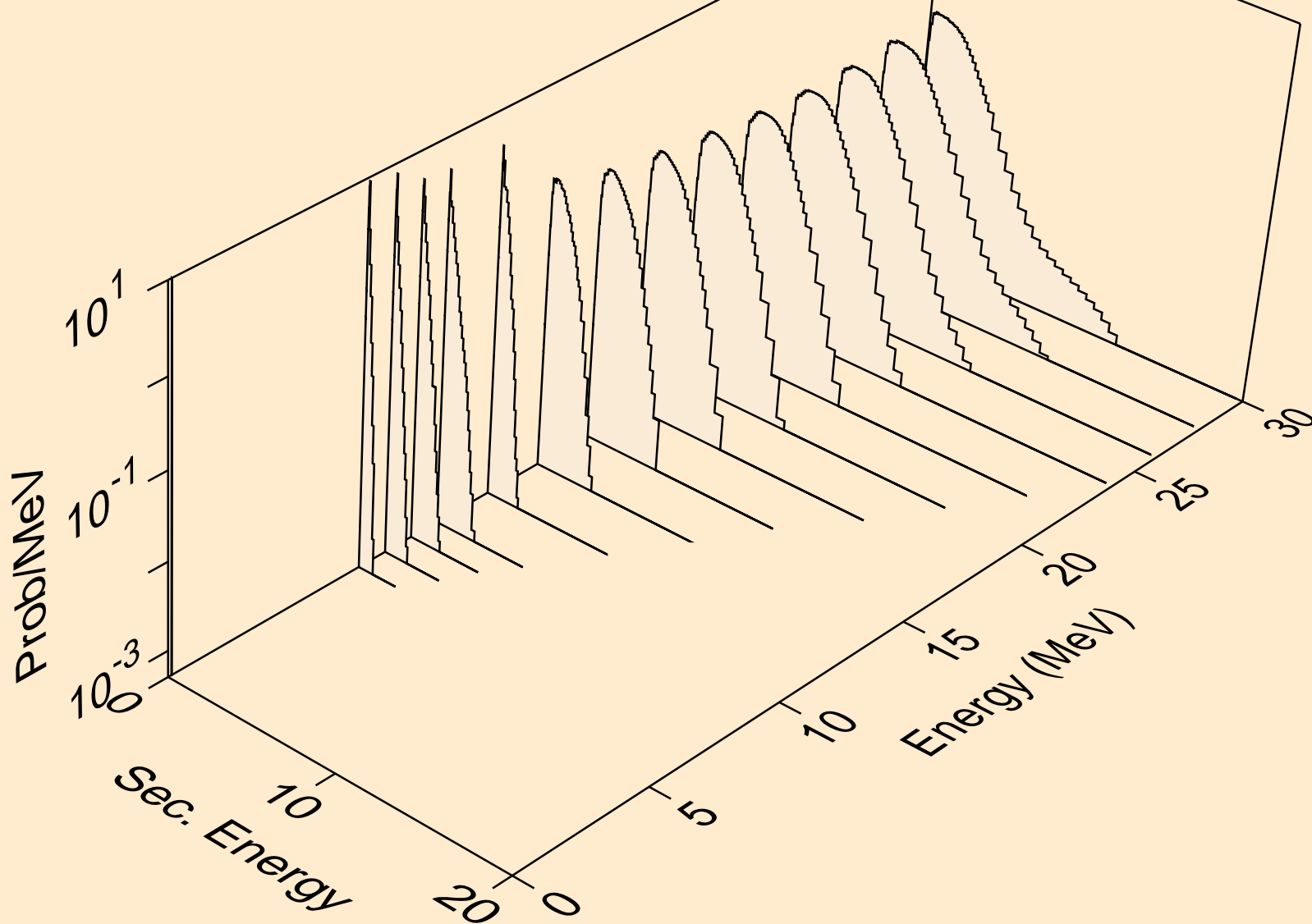

BI210M TRITON ACER TENDL-2023 LIBRARY; T=0.K
protons from (t,x)

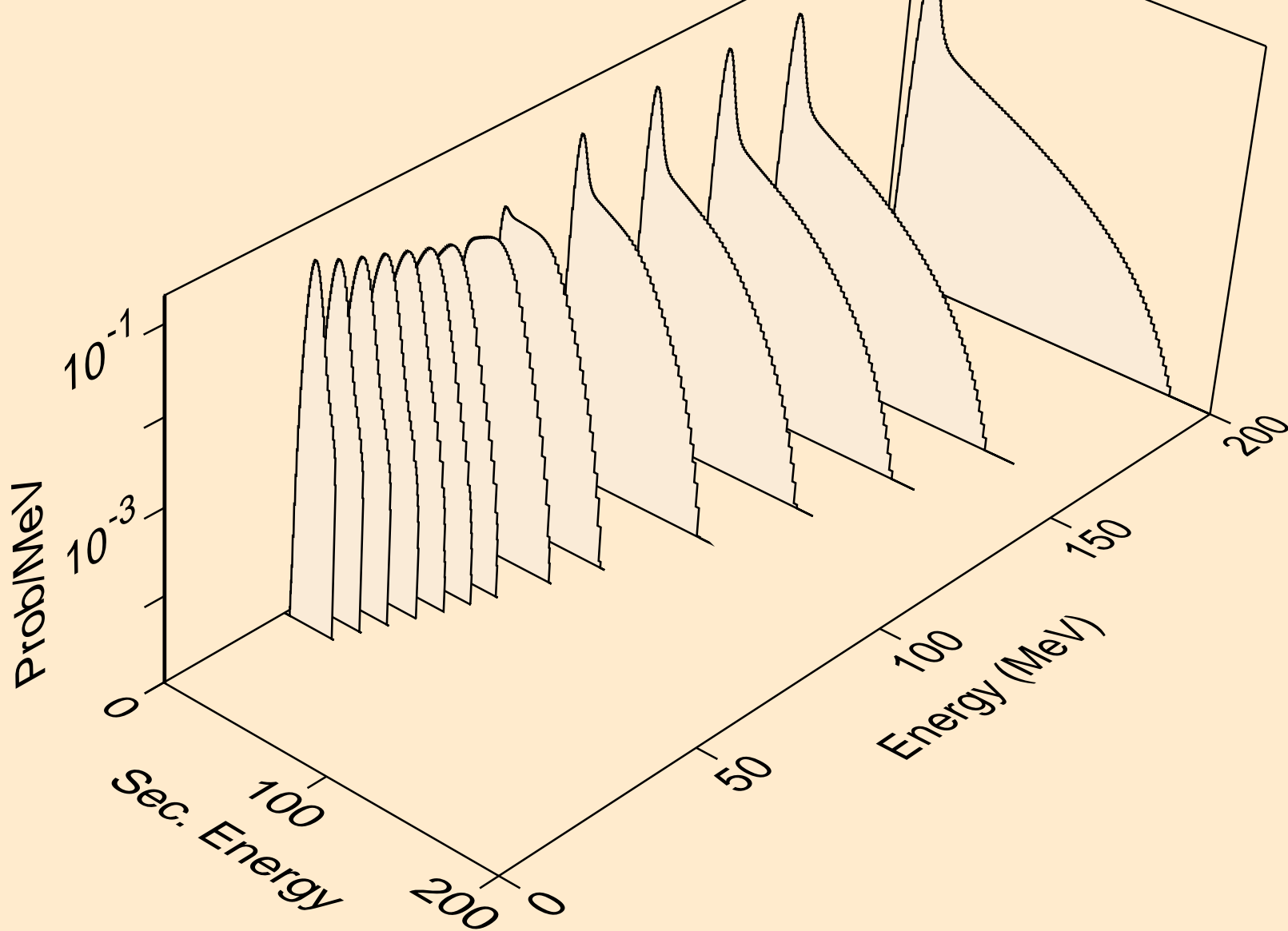

BI210M TRITON ACER TENDL-2023 LIBRARY; T=0.K
protons from (t,n*)p

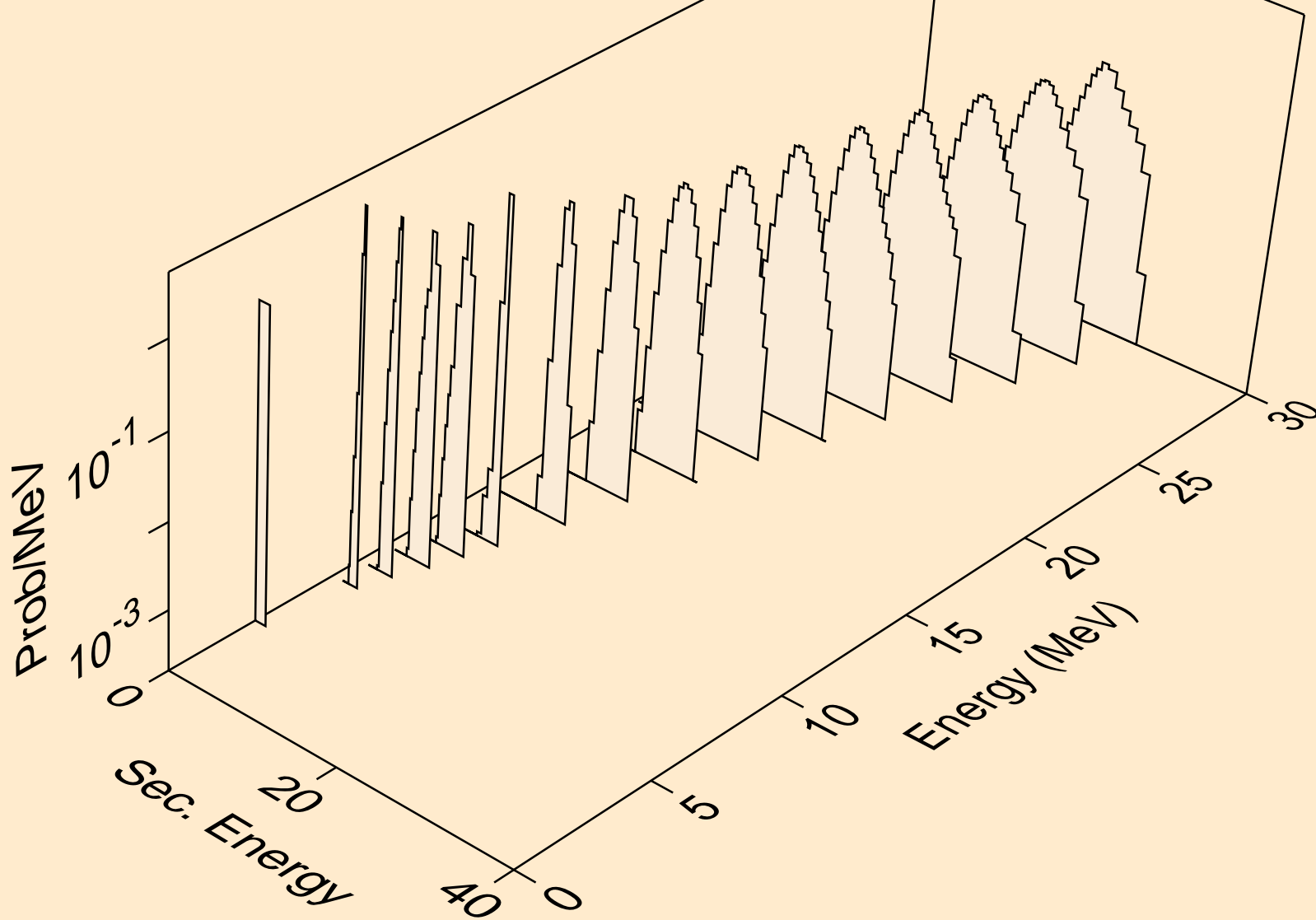

BI210M TRITON ACER TENDL-2023 LIBRARY; T=0.K
protons from (t,2np)

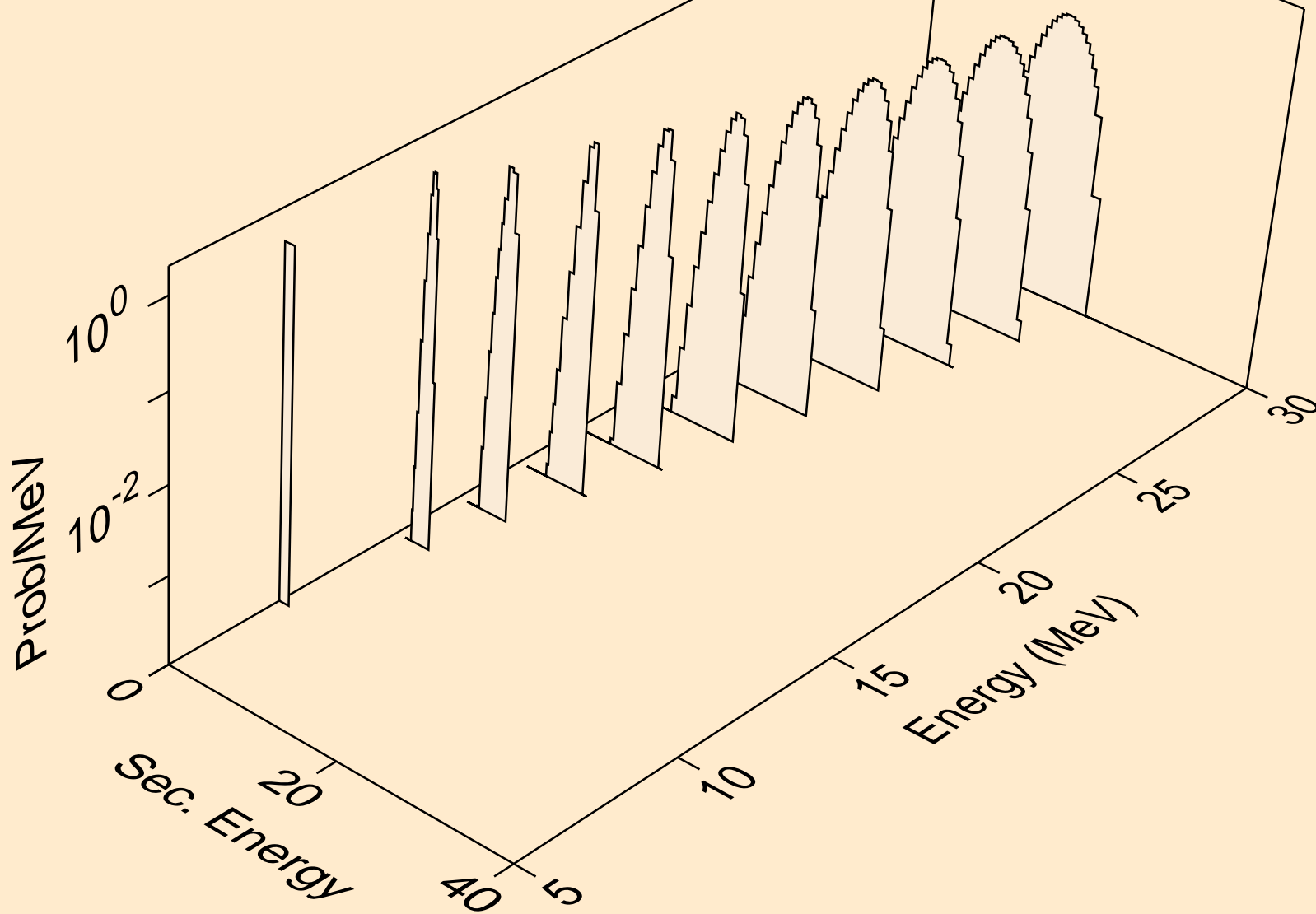

BI210M TRITON ACER TENDL-2023 LIBRARY; T=0.K
protons from (t,3np)

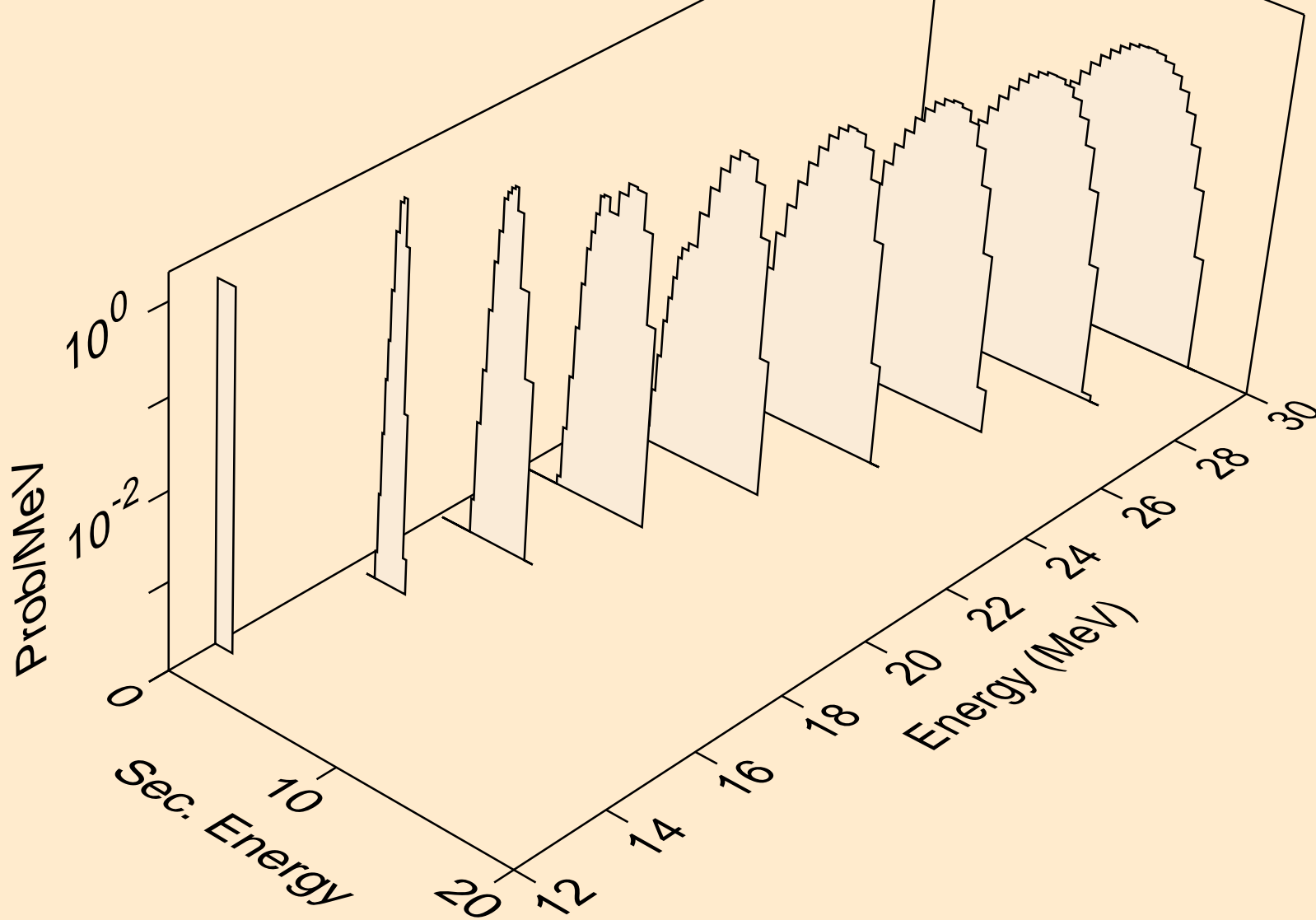

BI210M TRITON ACER TENDL-2023 LIBRARY; T=0.K
protons from (t,n2p)

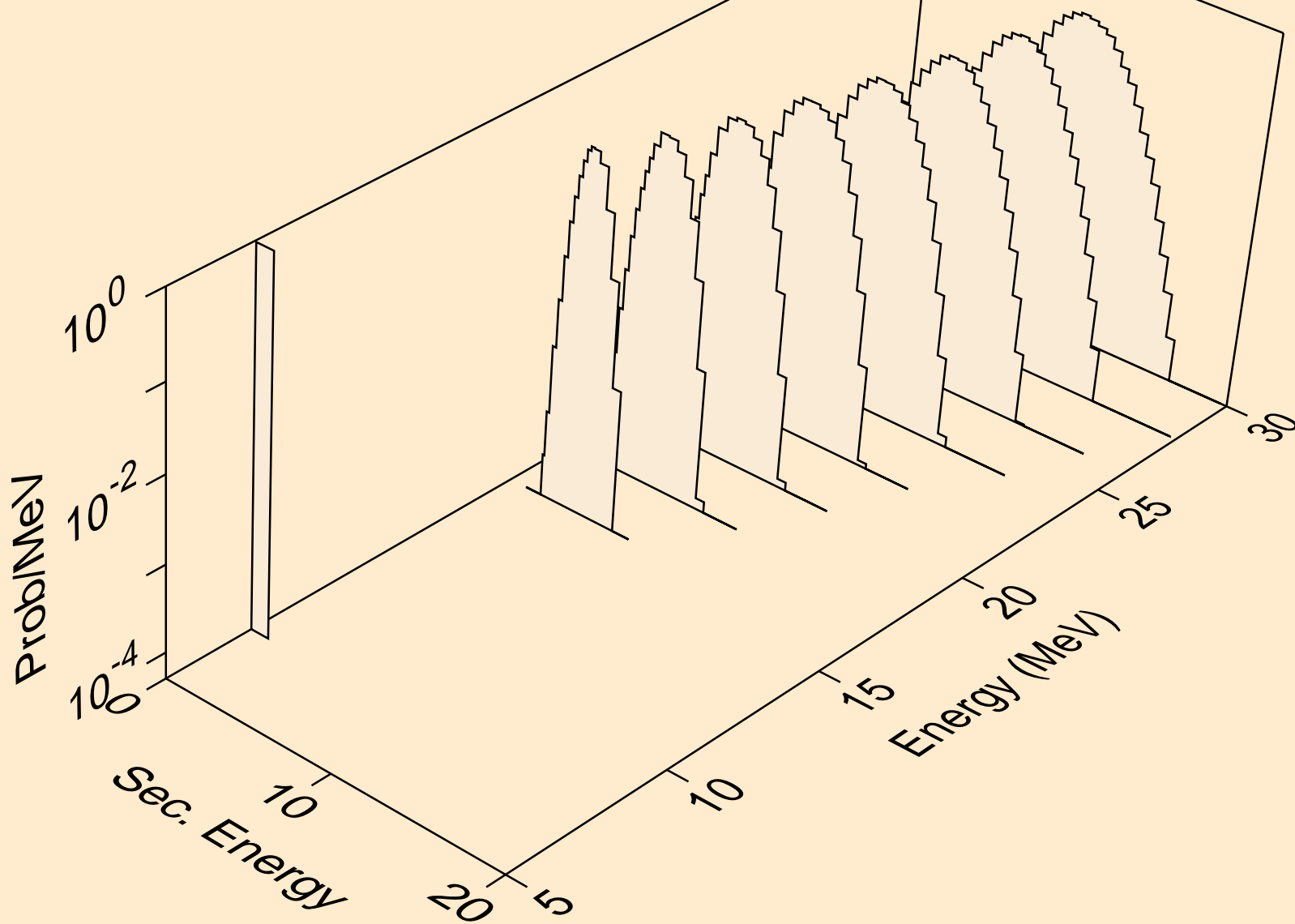

BI210M TRITON ACER TENDL-2023 LIBRARY; T=0.K
protons from (t,npa)

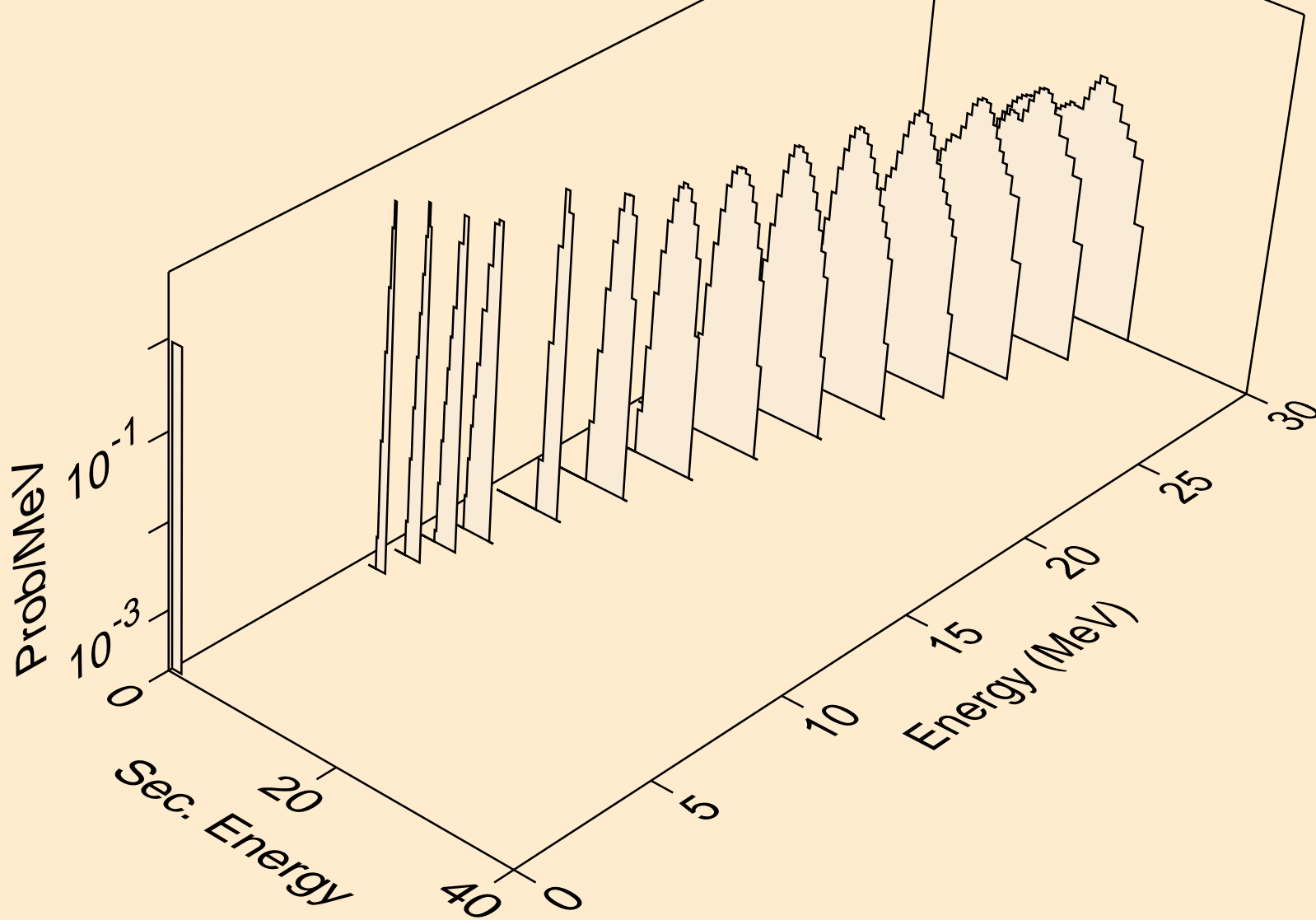

BI210M TRITON ACER TENDL-2023 LIBRARY; T=0.K
protons from (t,p)

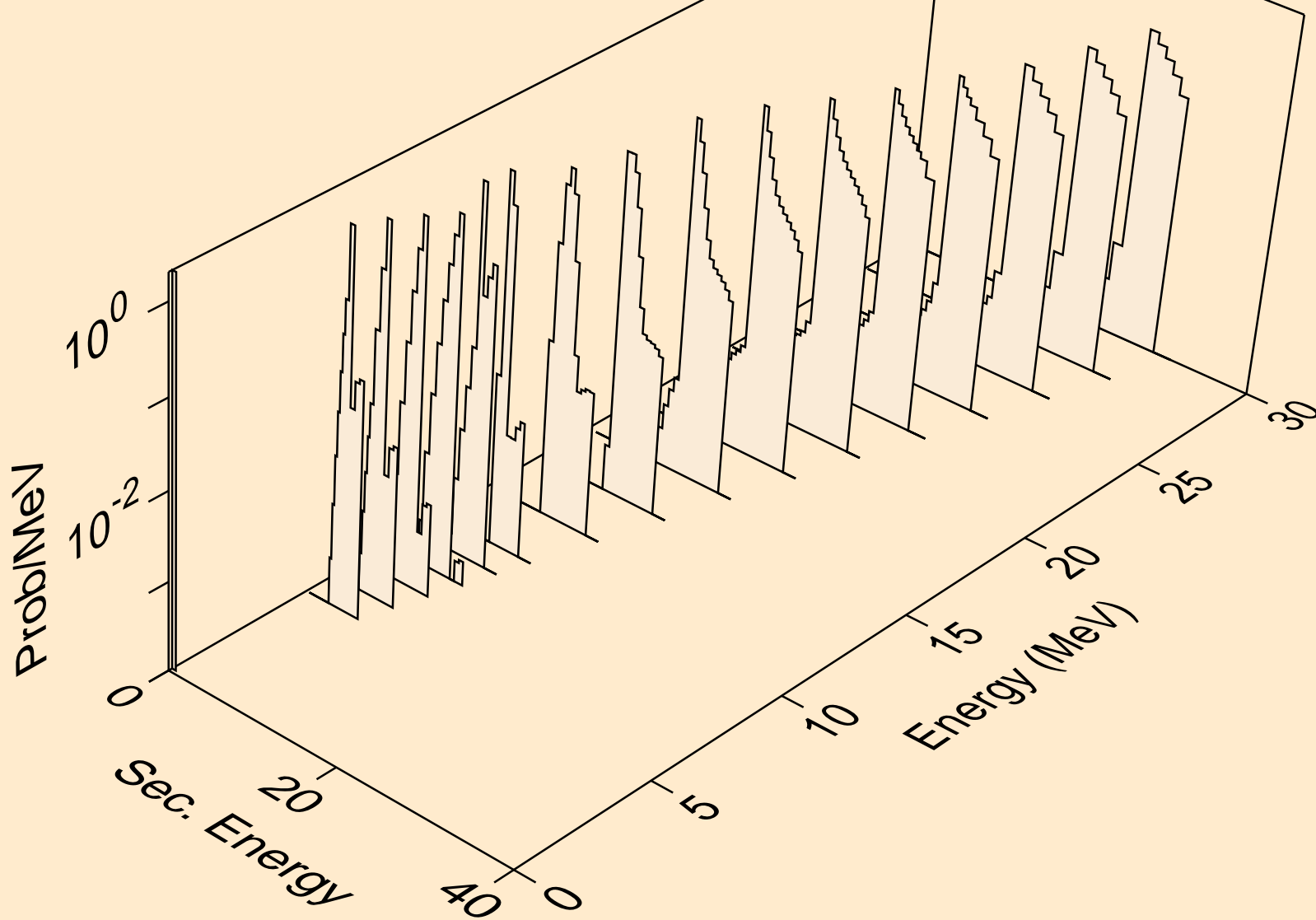

BI210M TRITON ACER TENDL-2023 LIBRARY; T=0.K
protons from (t,2p)

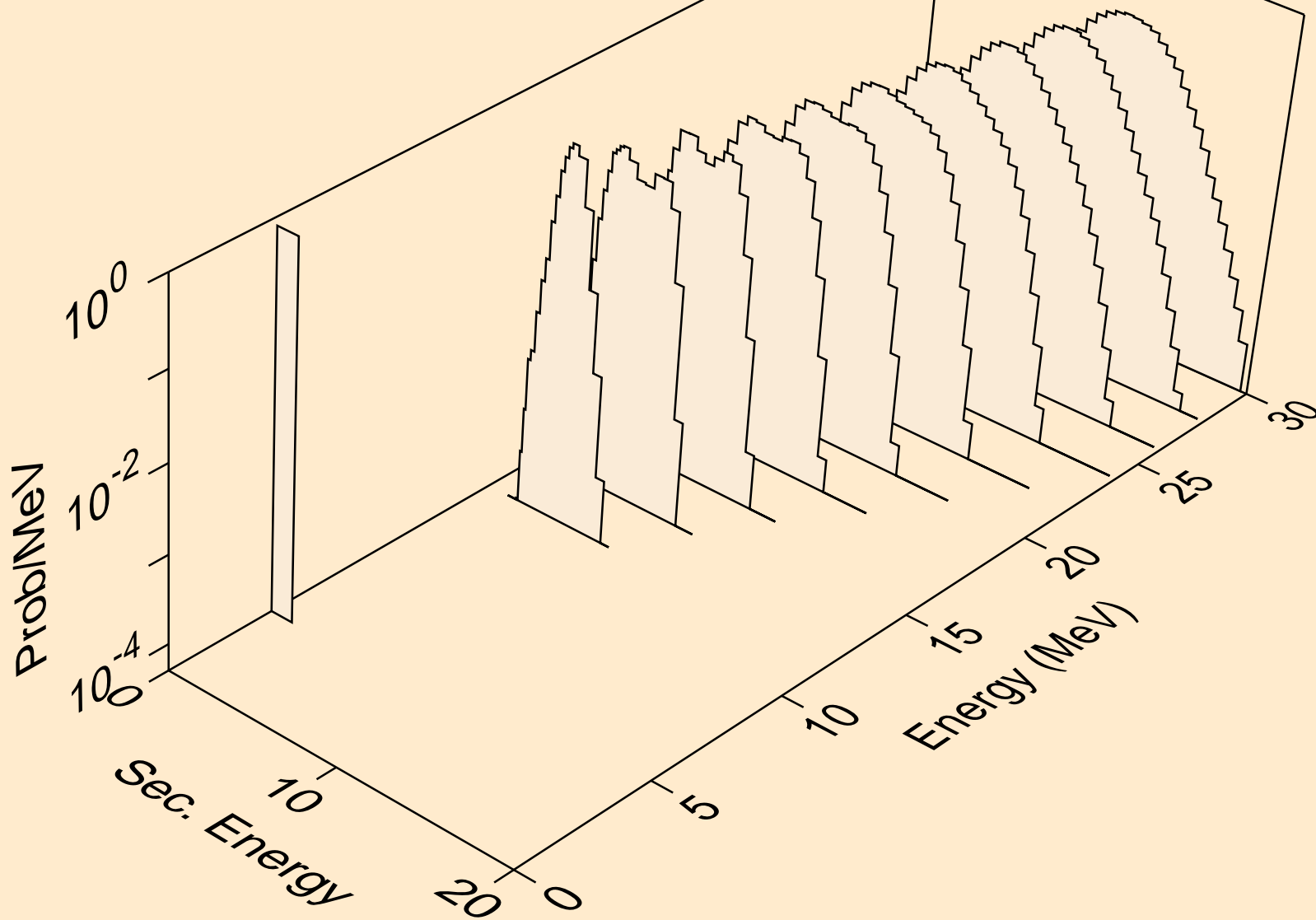

BI210M TRITON ACER TENDL-2023 LIBRARY; T=0.K
protons from (t,pa)

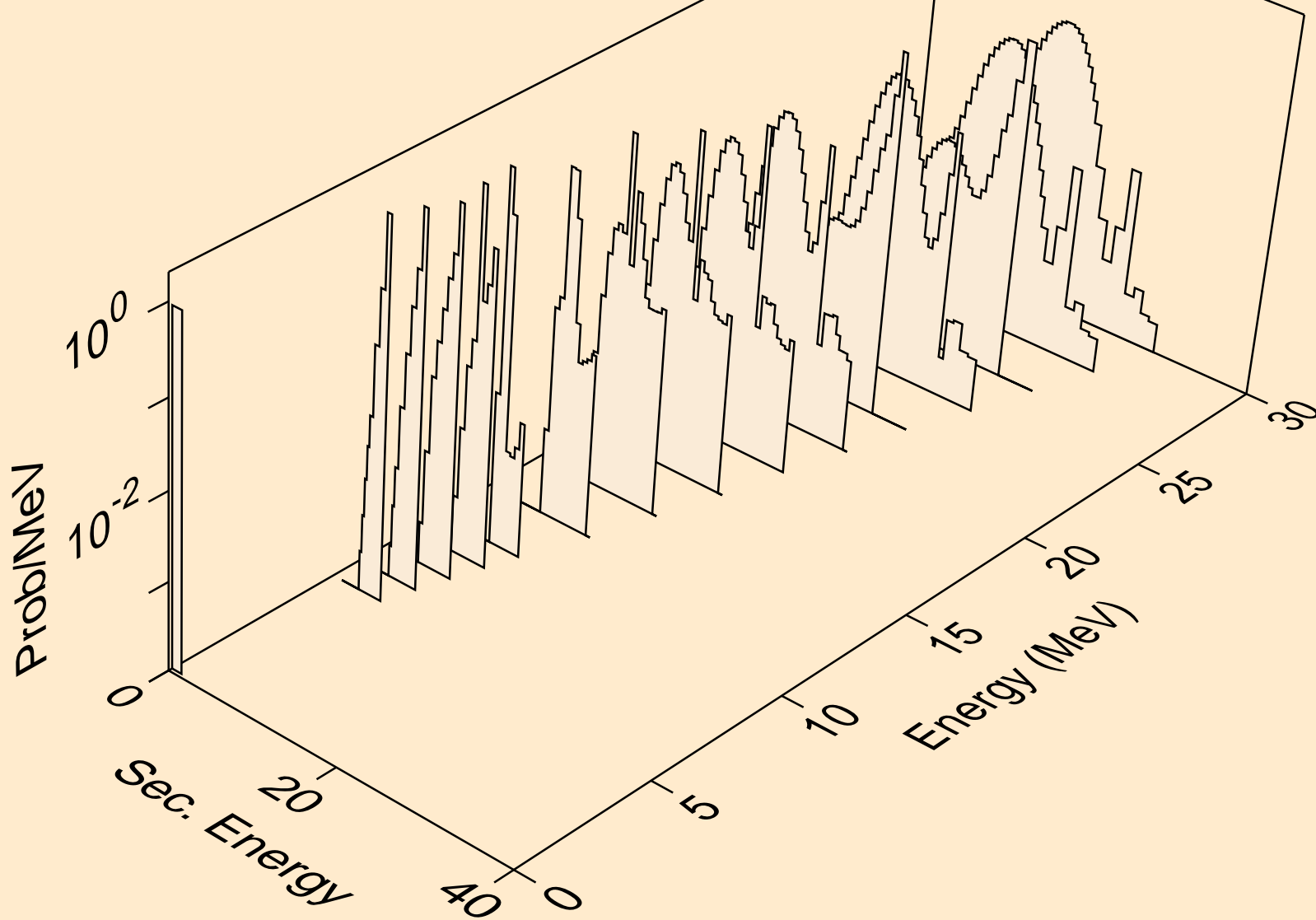

BI210M TRITON ACER TENDL-2023 LIBRARY; T=0.K
protons from (t,pd)

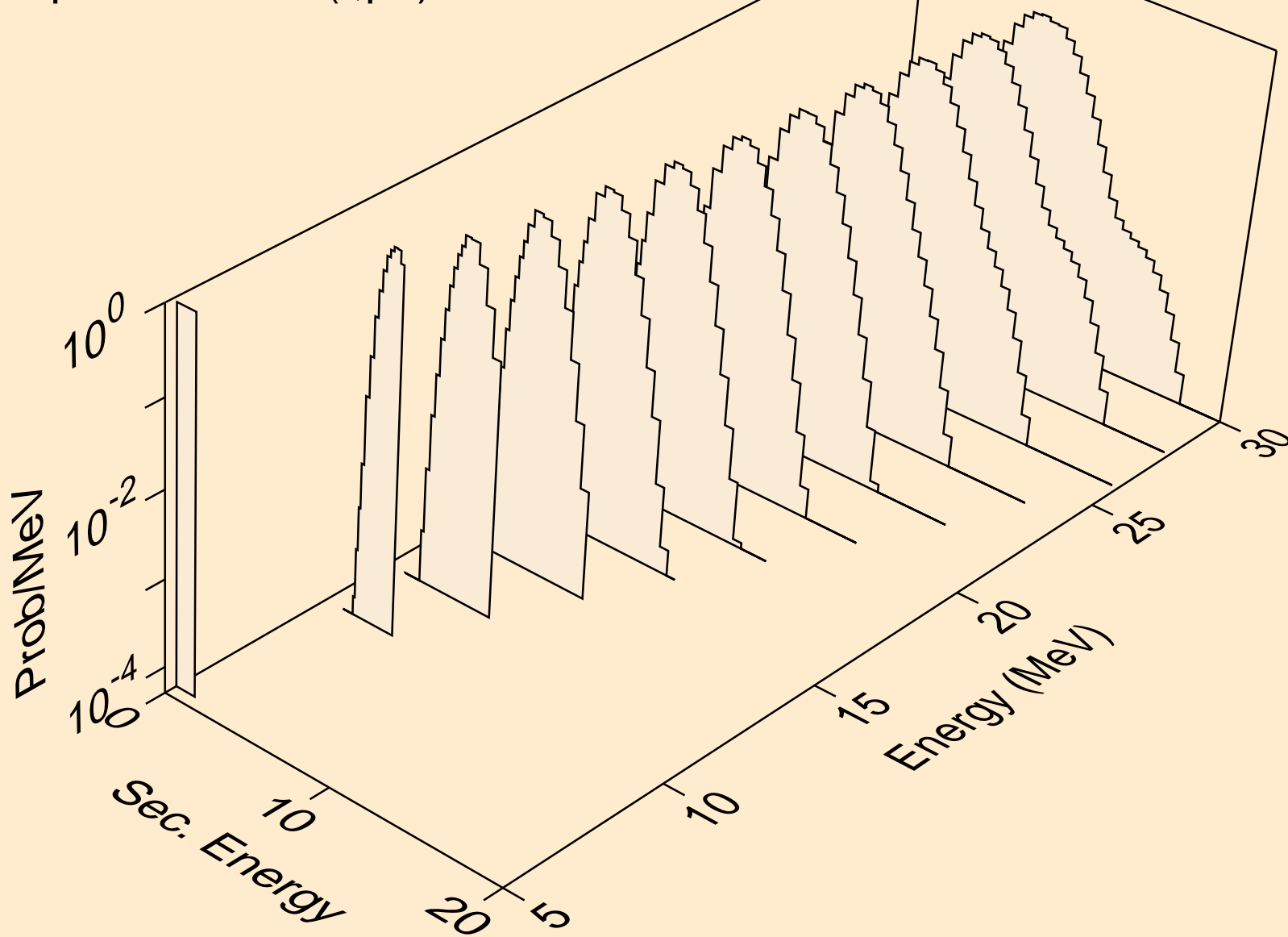

BI210M TRITON ACER TENDL-2023 LIBRARY; T=0.K
protons from (t,pt)

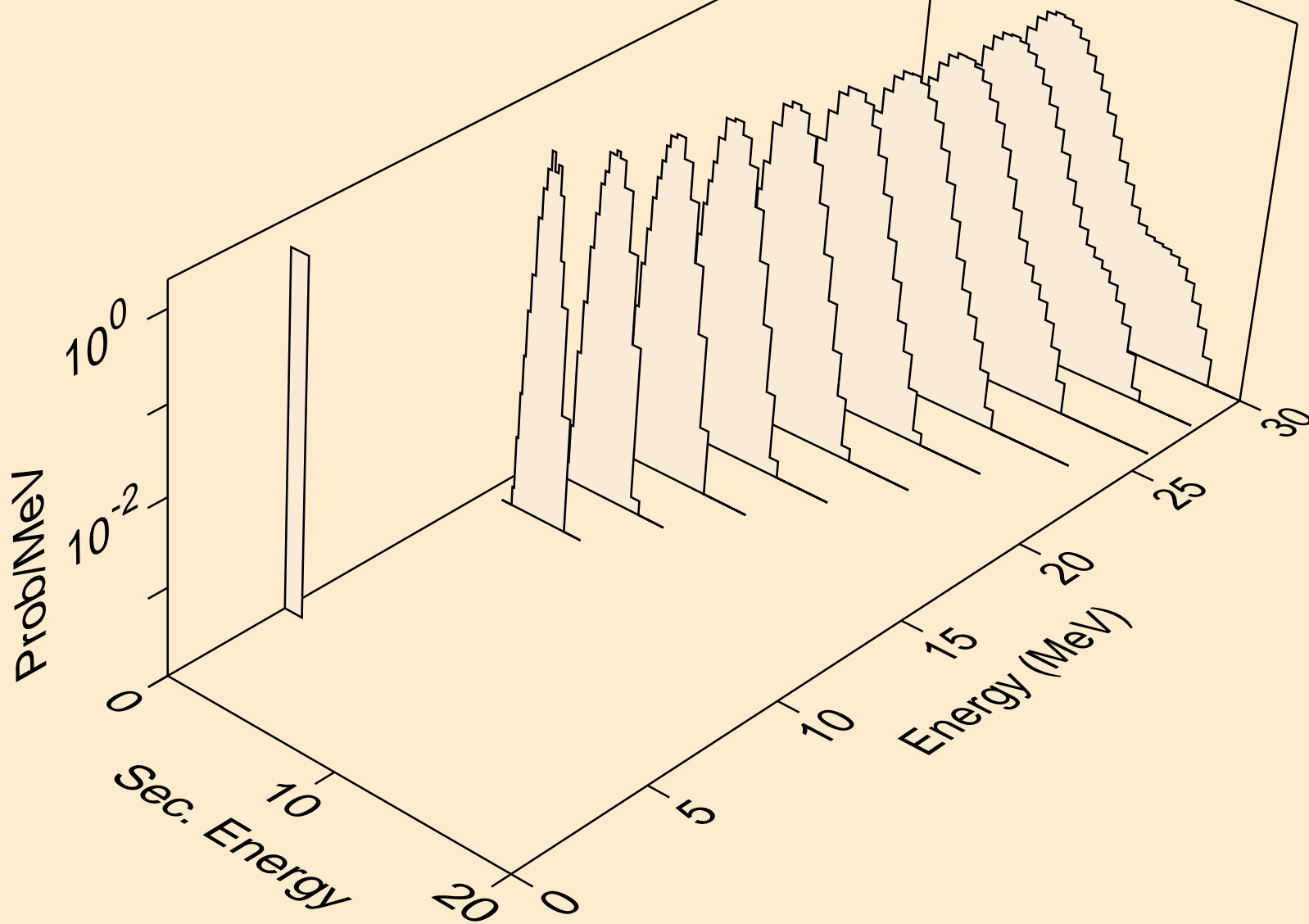

BI210M TRITON ACER TENDL-2023 LIBRARY; T=0.K
deuterons from (t,x)

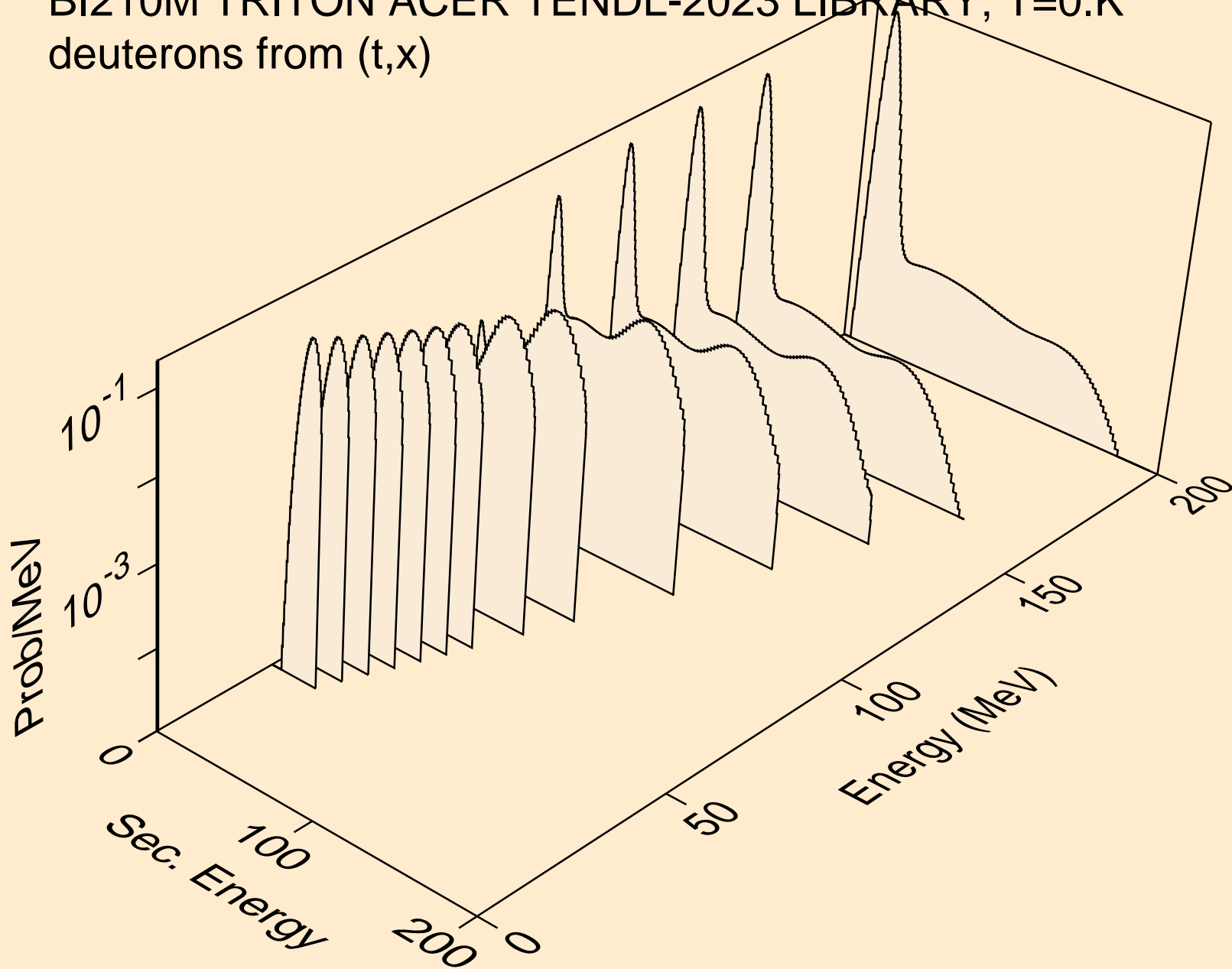

BI210M TRITON ACER TENDL-2023 LIBRARY; T=0.K
deuterons from (t,2nd)

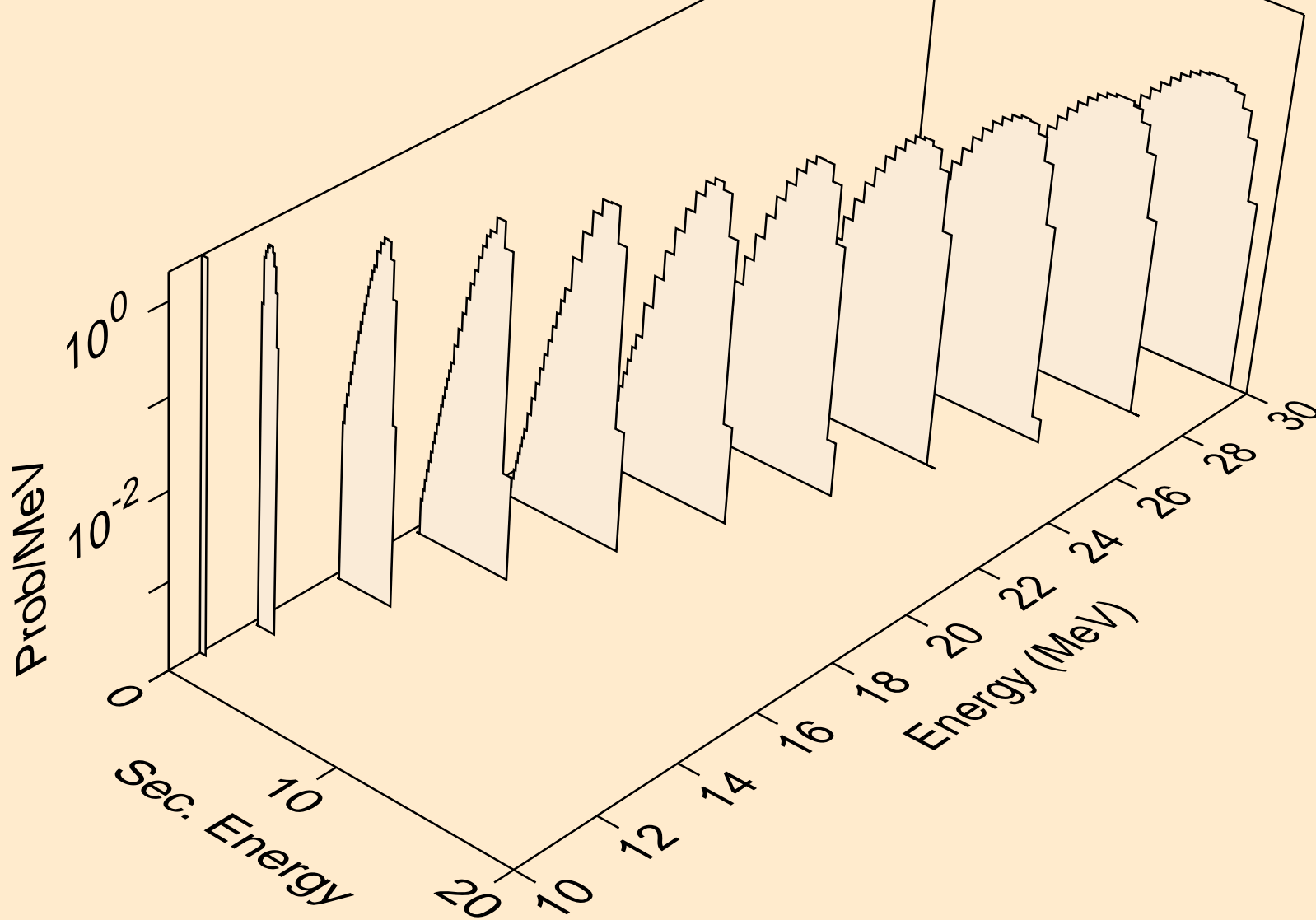

BI210M TRITON ACER TENDL-2023 LIBRARY; T=0.K
deuterons from (t,n*)d

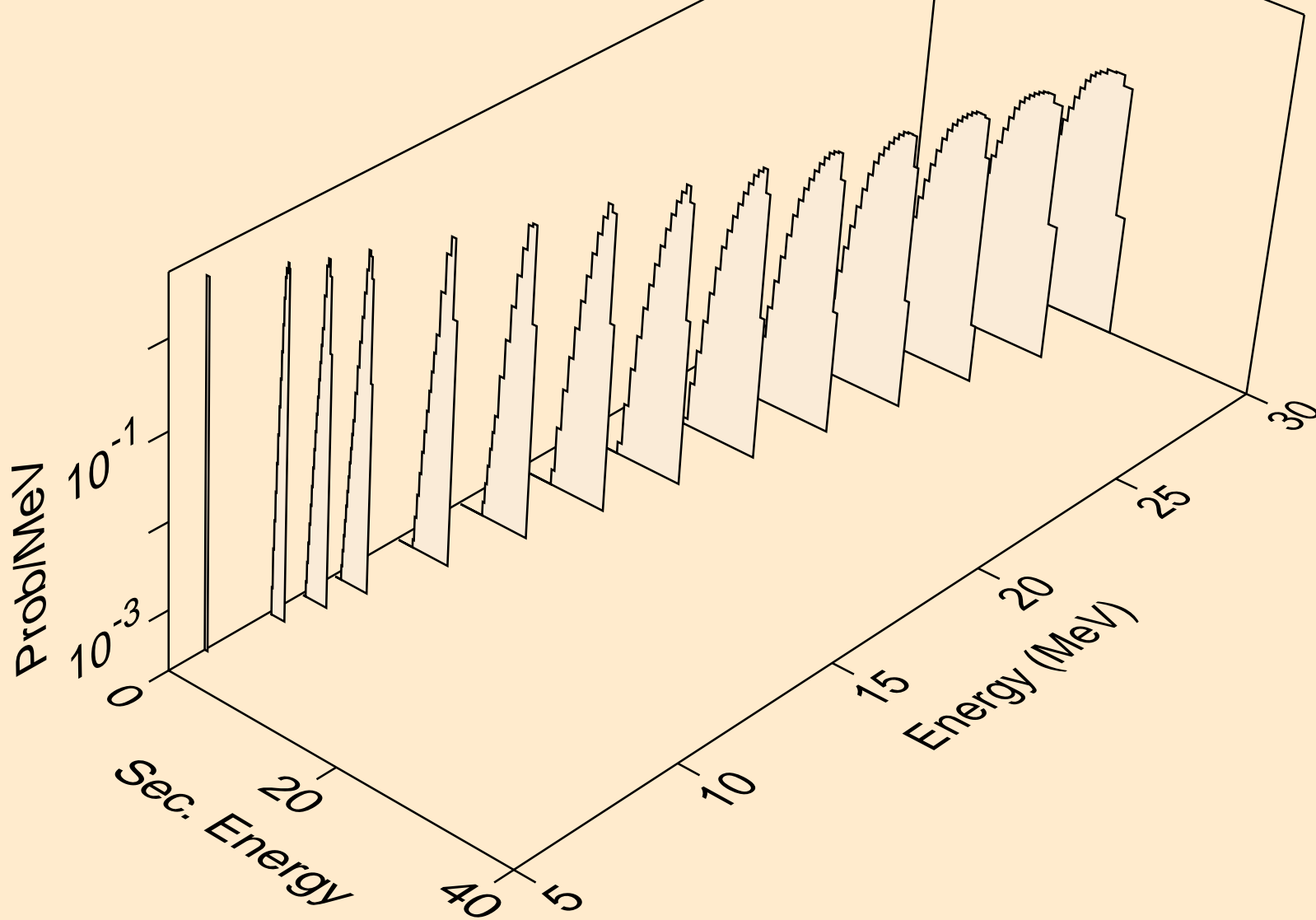

BI210M TRITON ACER TENDL-2023 LIBRARY; T=0.K
deuterons from (t,d)

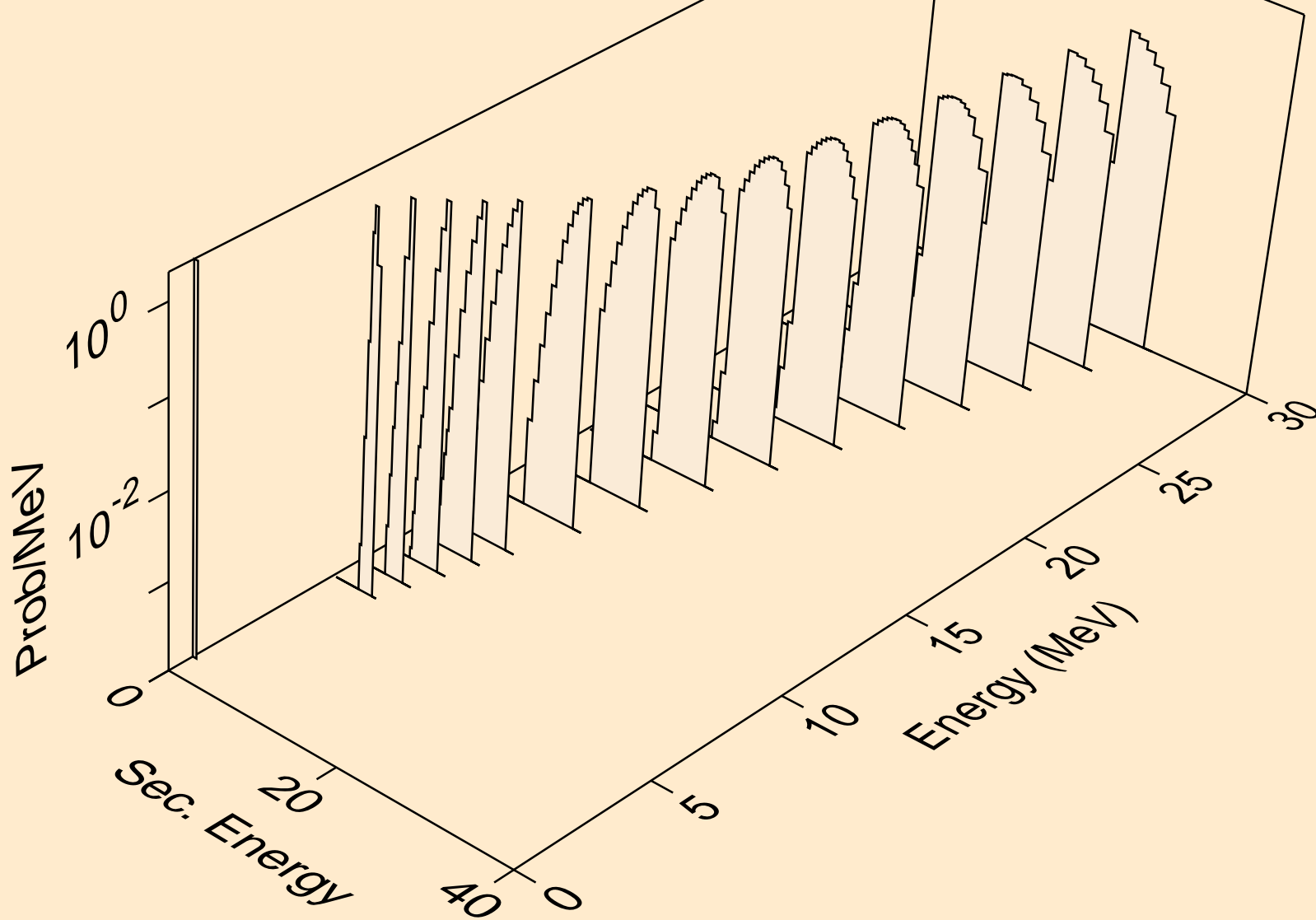

BI210M TRITON ACER TENDL-2023 LIBRARY; T=0.K
deuterons from (t,pd)

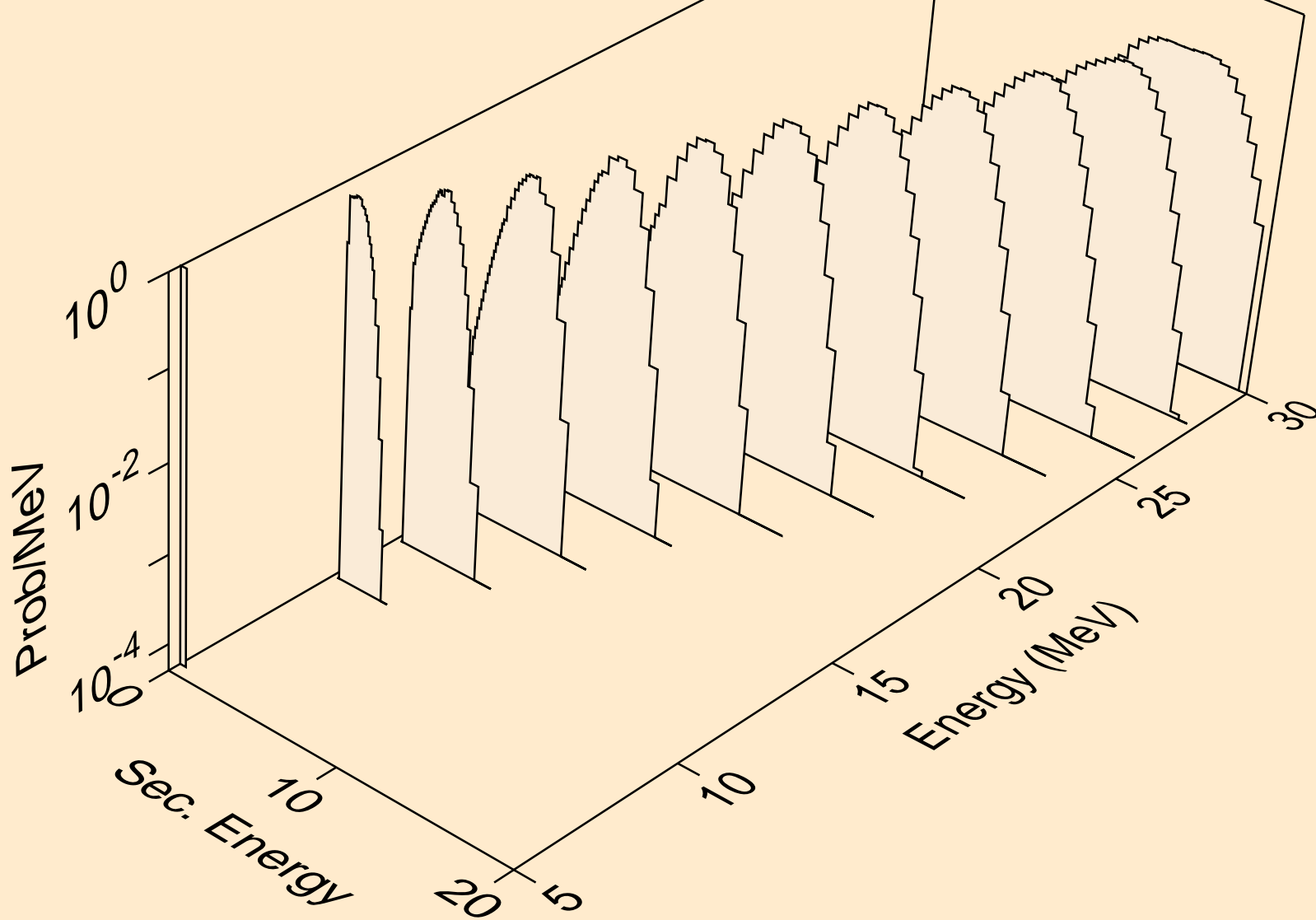

BI210M TRITON ACER TENDL-2023 LIBRARY; T=0.K
deuterons from (t,da)

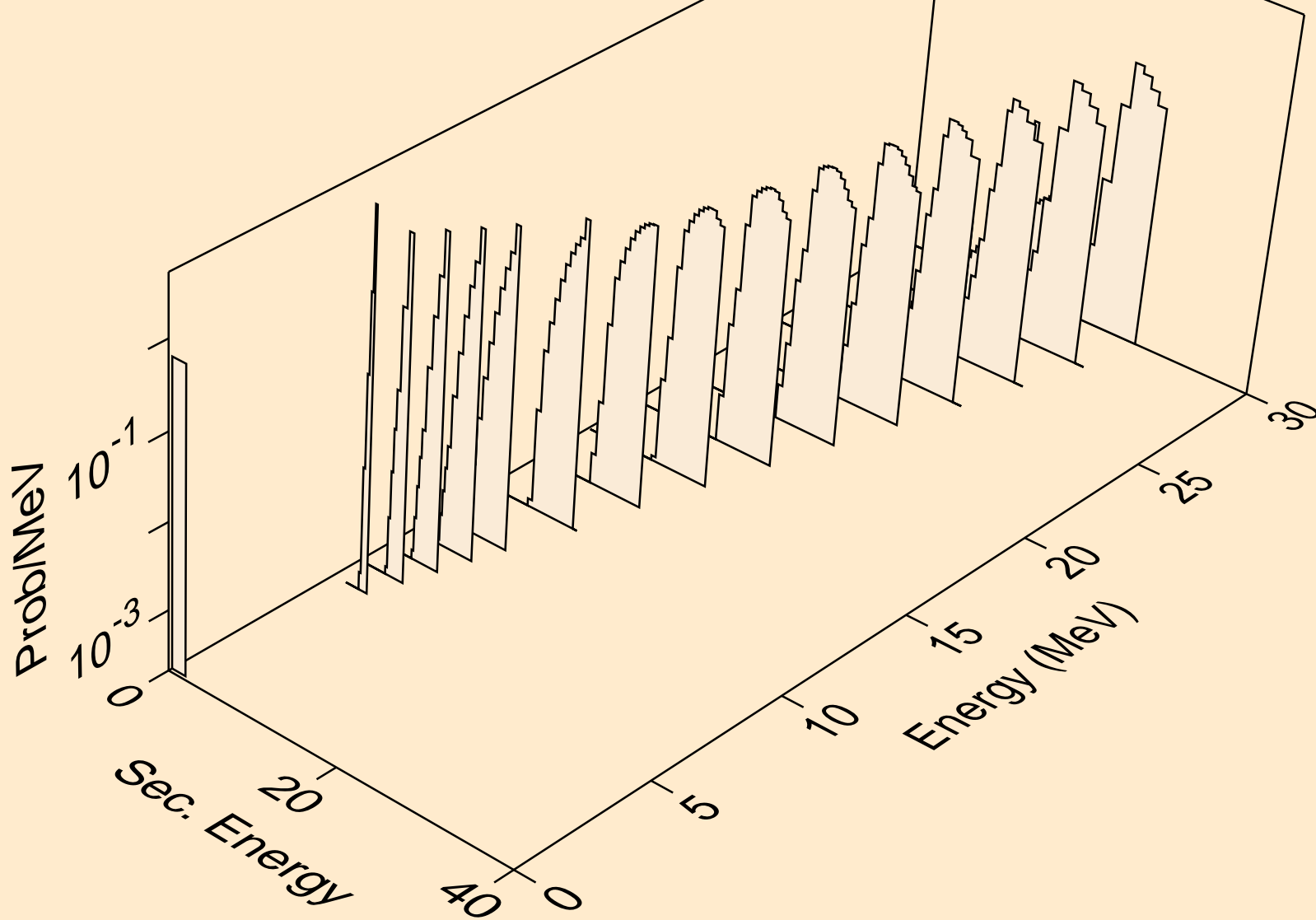

BI210M TRITON ACER TENDL-2023 LIBRARY; T=0.K
he3s from (t,x)

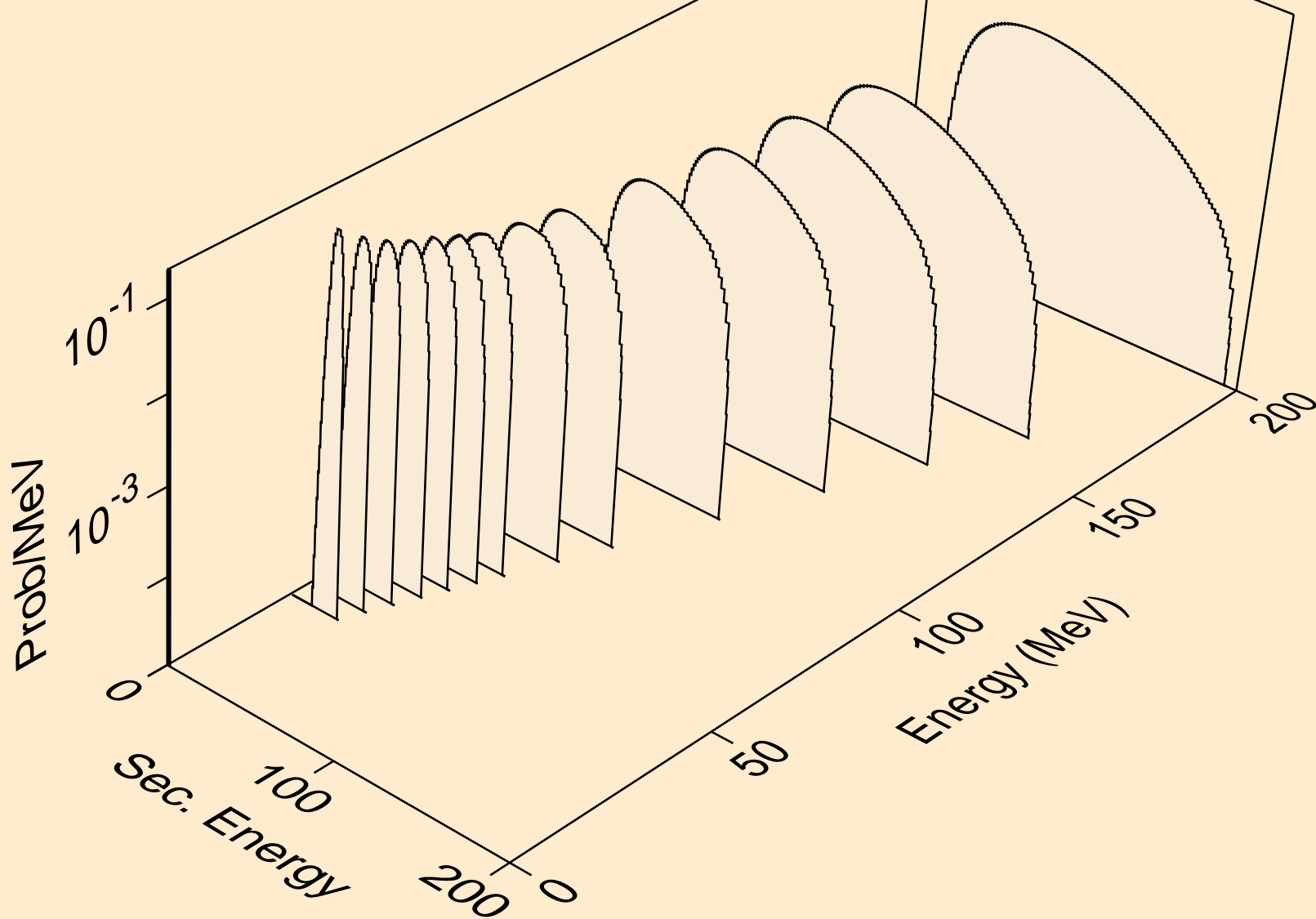

BI210M TRITON ACER TENDL-2023 LIBRARY; T=0.K
he3s from (t,n*)he3

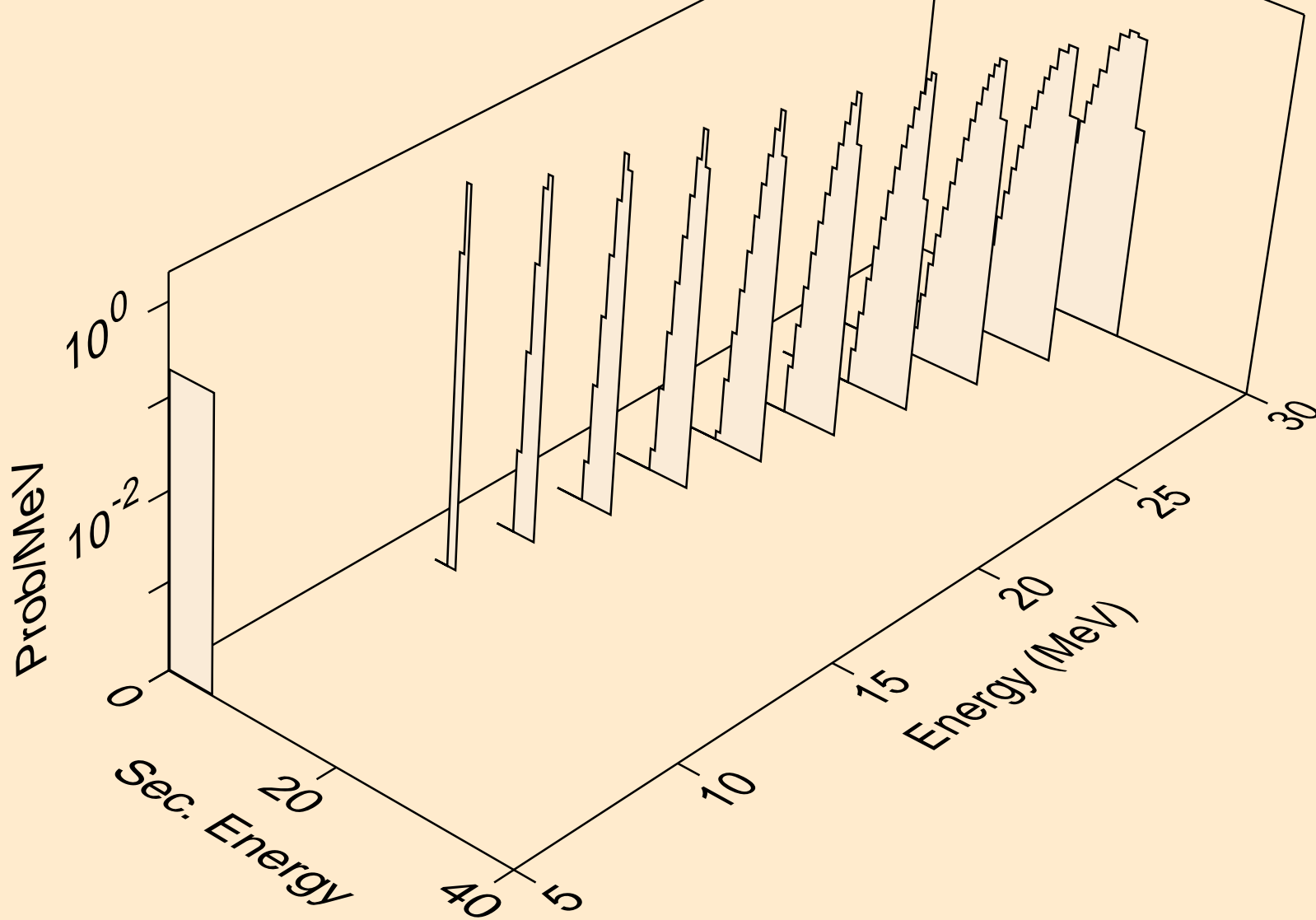

BI210M TRITON ACER TENDL-2023 LIBRARY; T=0.K
he3s from (t,he3)

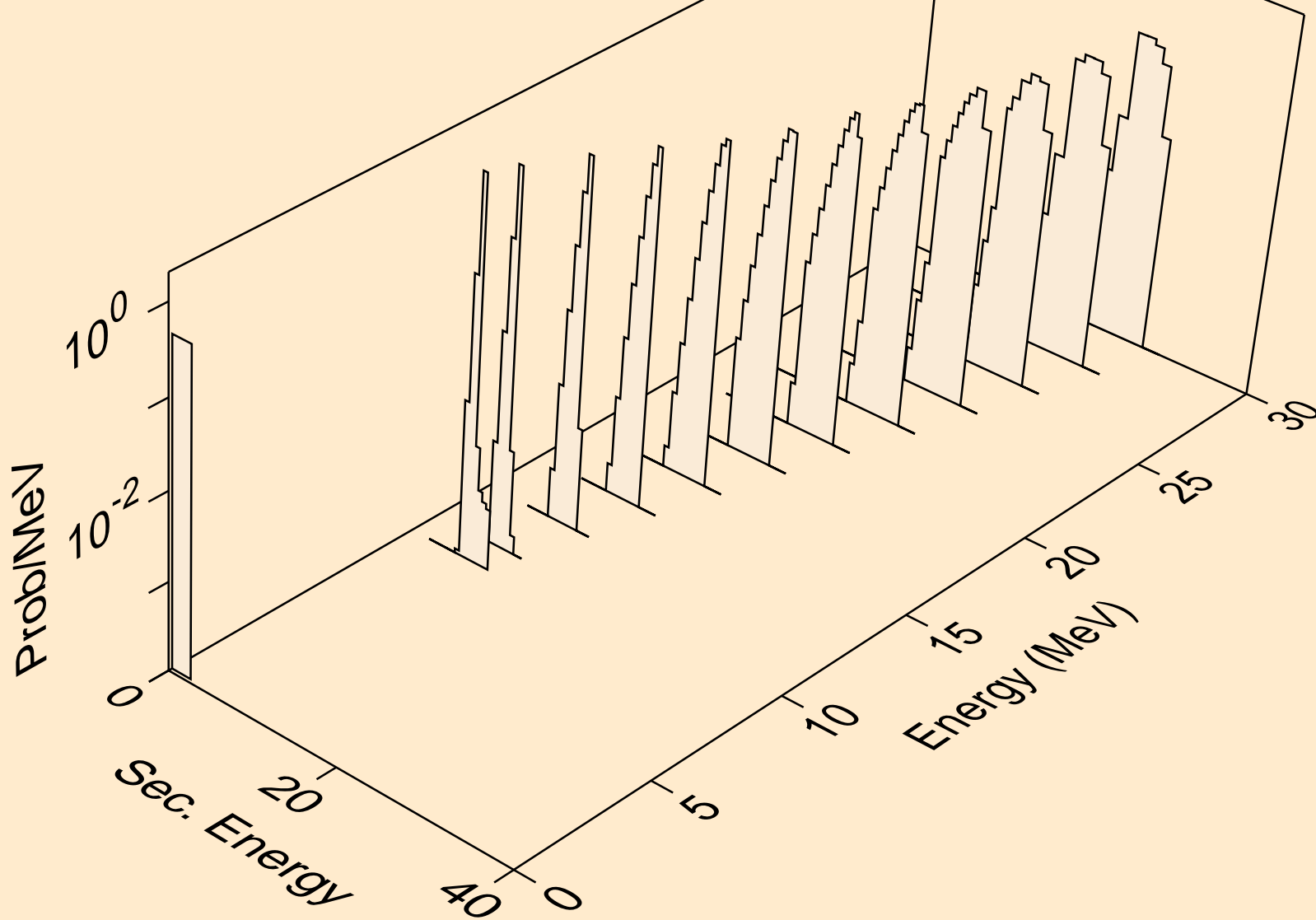

BI210M TRITON ACER TENDL-2023 LIBRARY; T=0.K
alphas from (t,x)

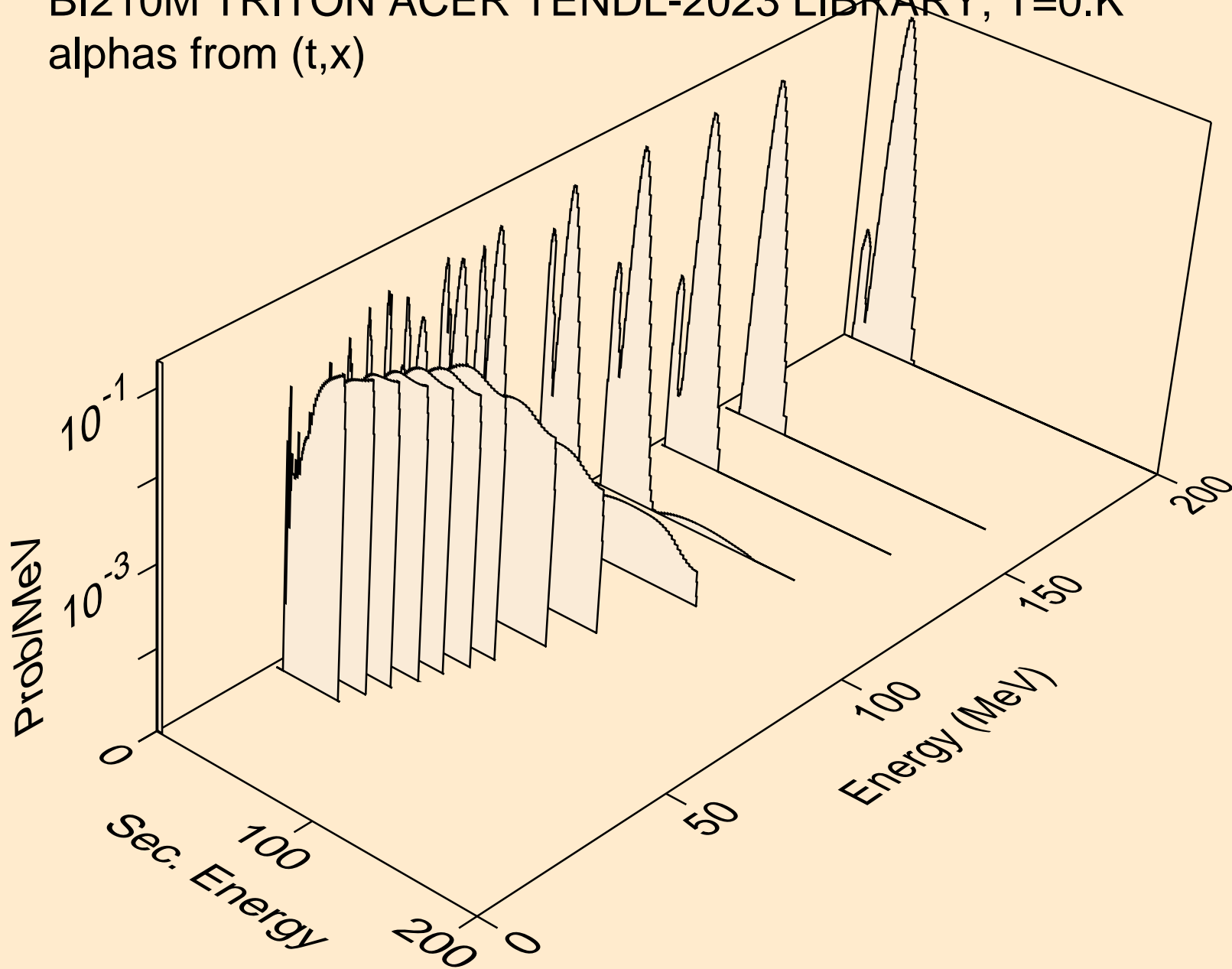

BI210M TRITON ACER TENDL-2023 LIBRARY; T=0.K
alphas from (t,n*)a

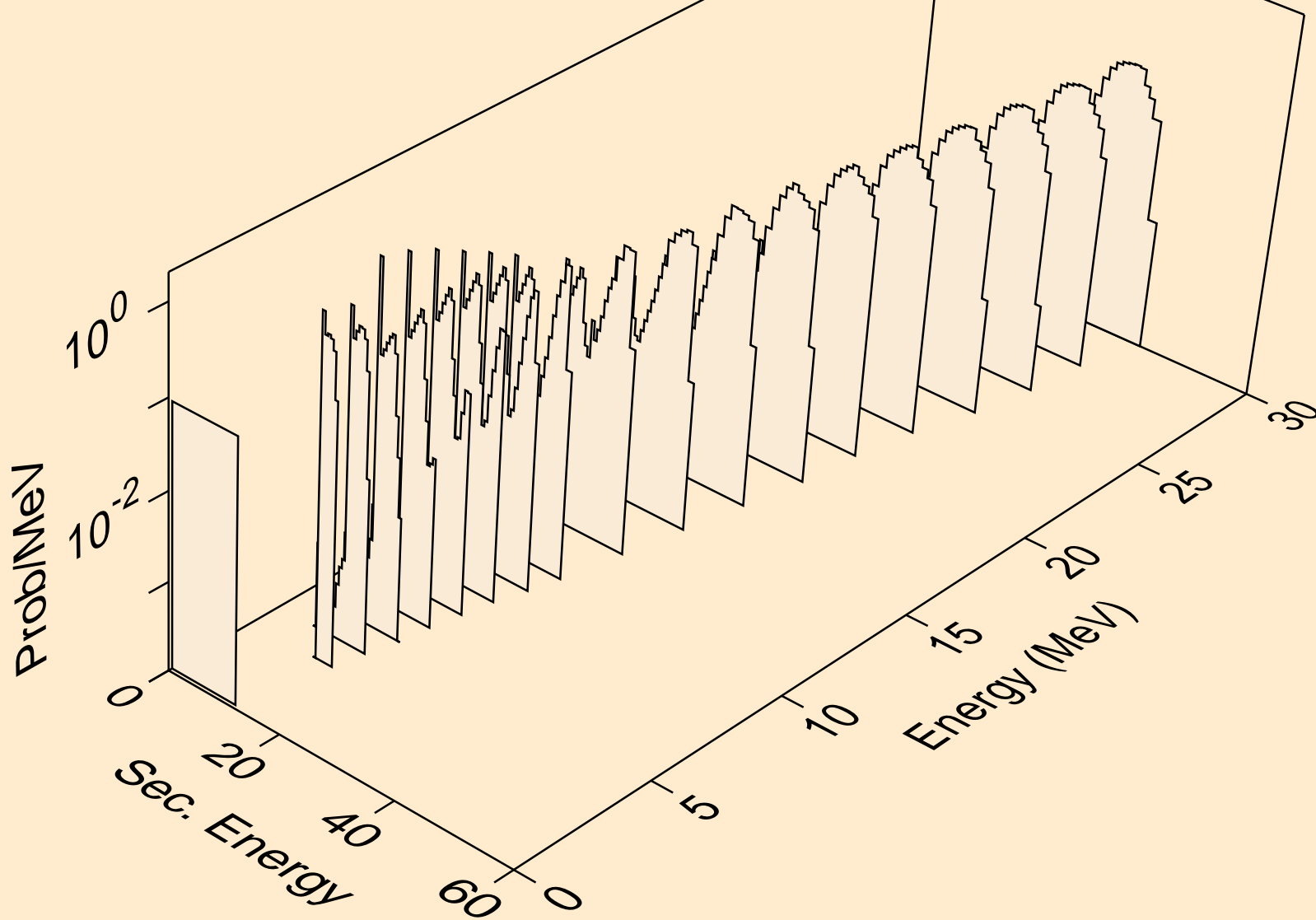

BI210M TRITON ACER TENDL-2023 LIBRARY; T=0.K
alphas from (t,2n)a

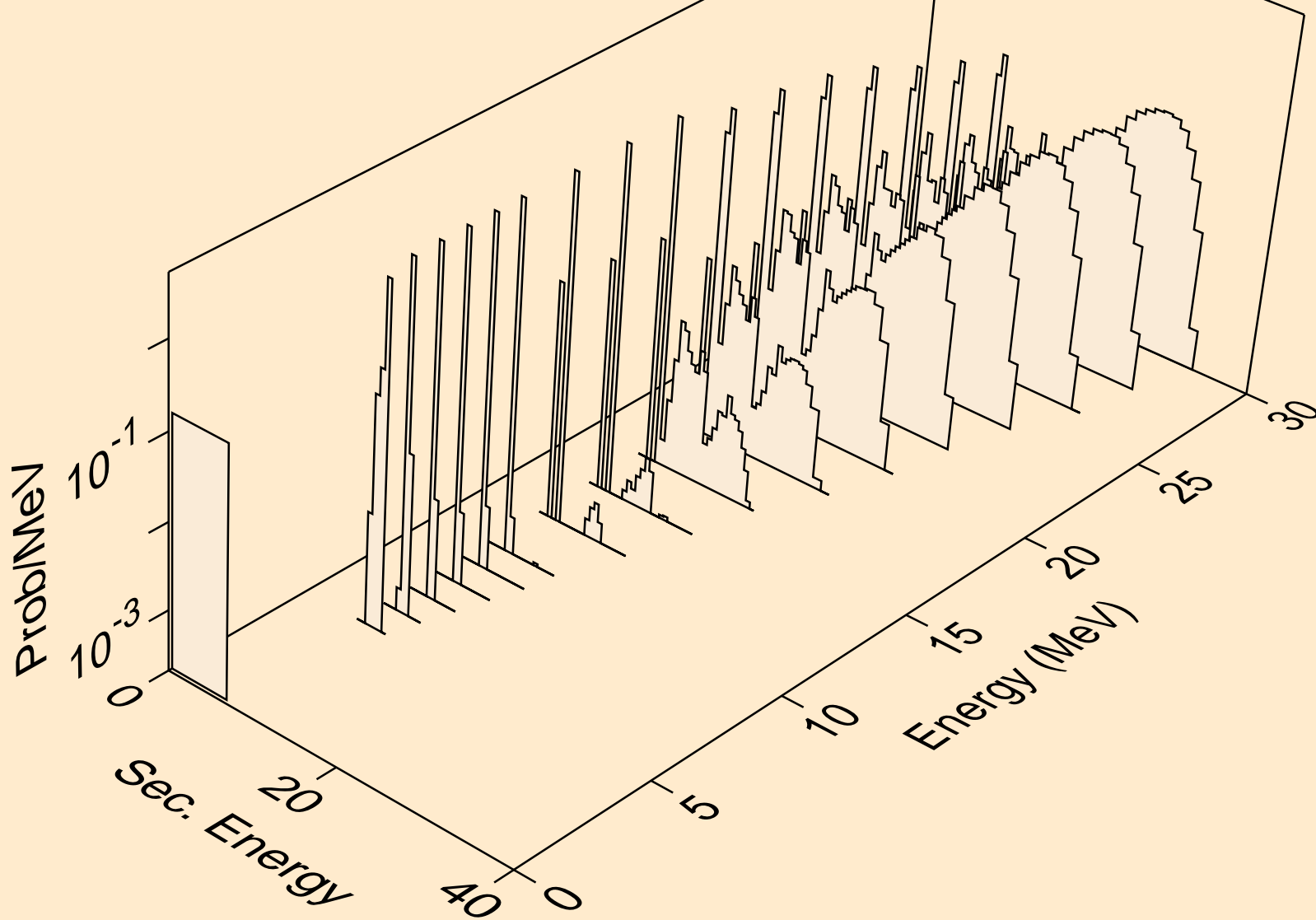

BI210M TRITON ACER TENDL-2023 LIBRARY; T=0.K
alphas from (t,3n)a

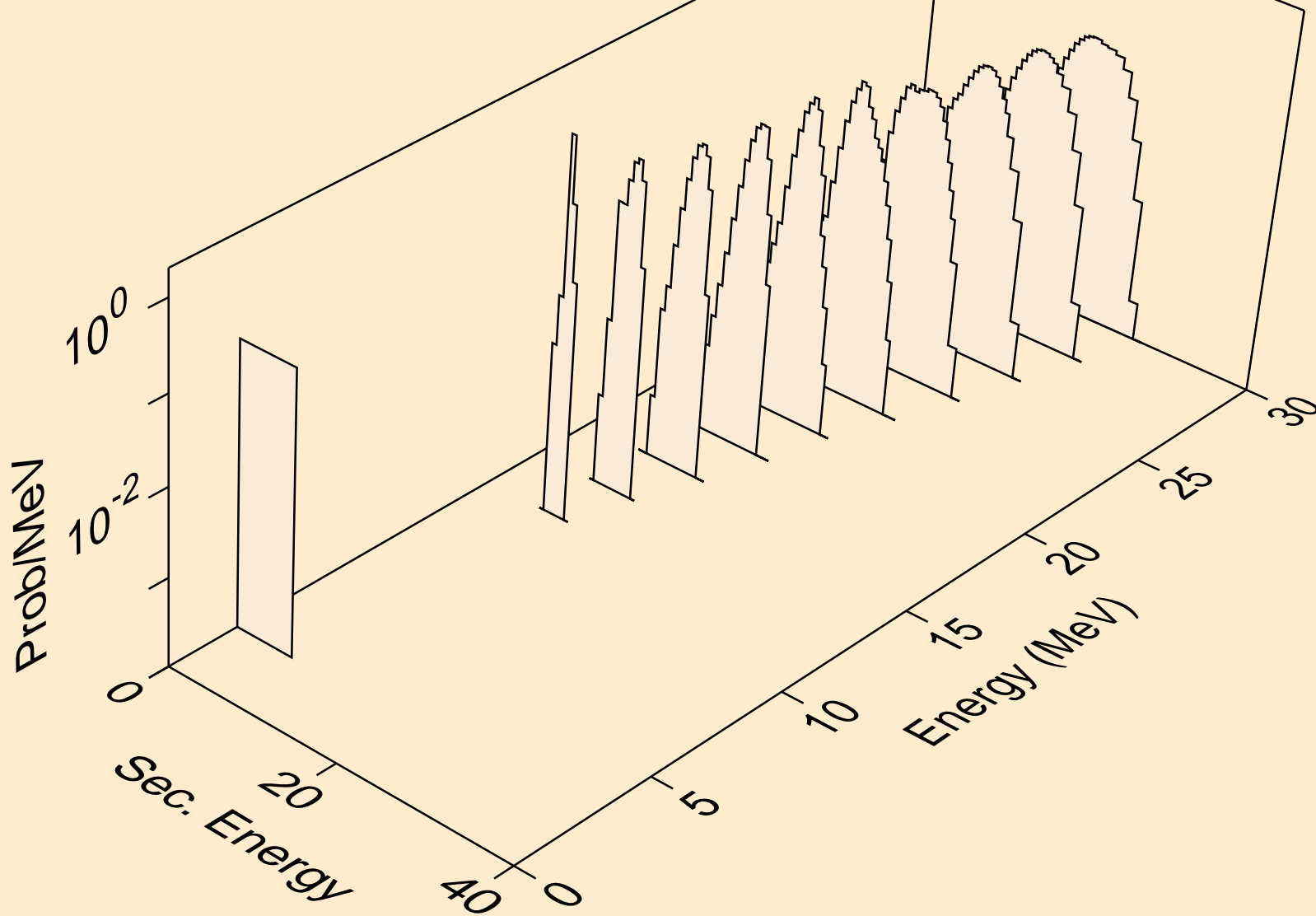

BI210M TRITON ACER TENDL-2023 LIBRARY; T=0.K
alphas from (t,n*)2a

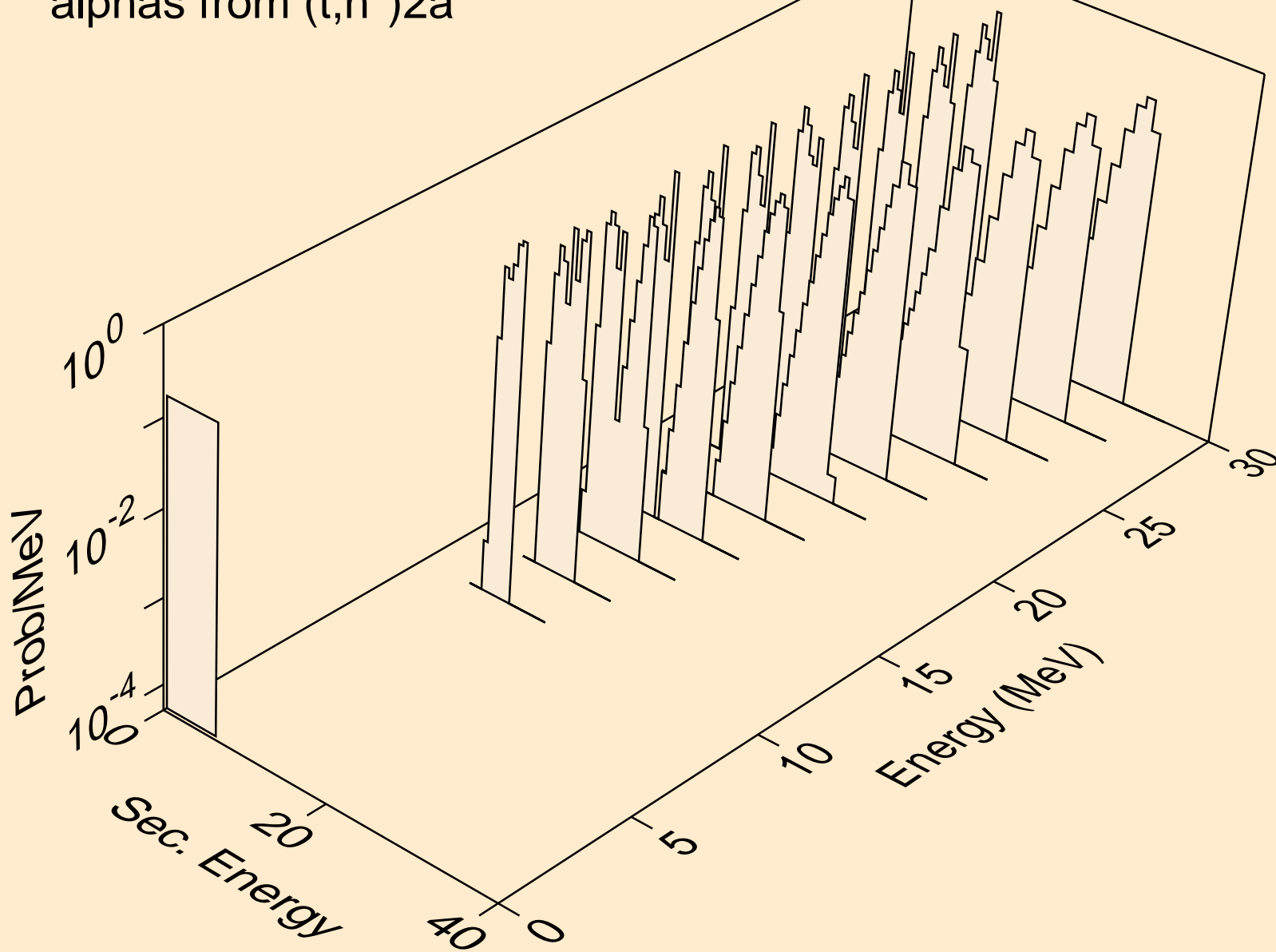

BI210M TRITON ACER TENDL-2023 LIBRARY; T=0.K
alphas from (t,npa)

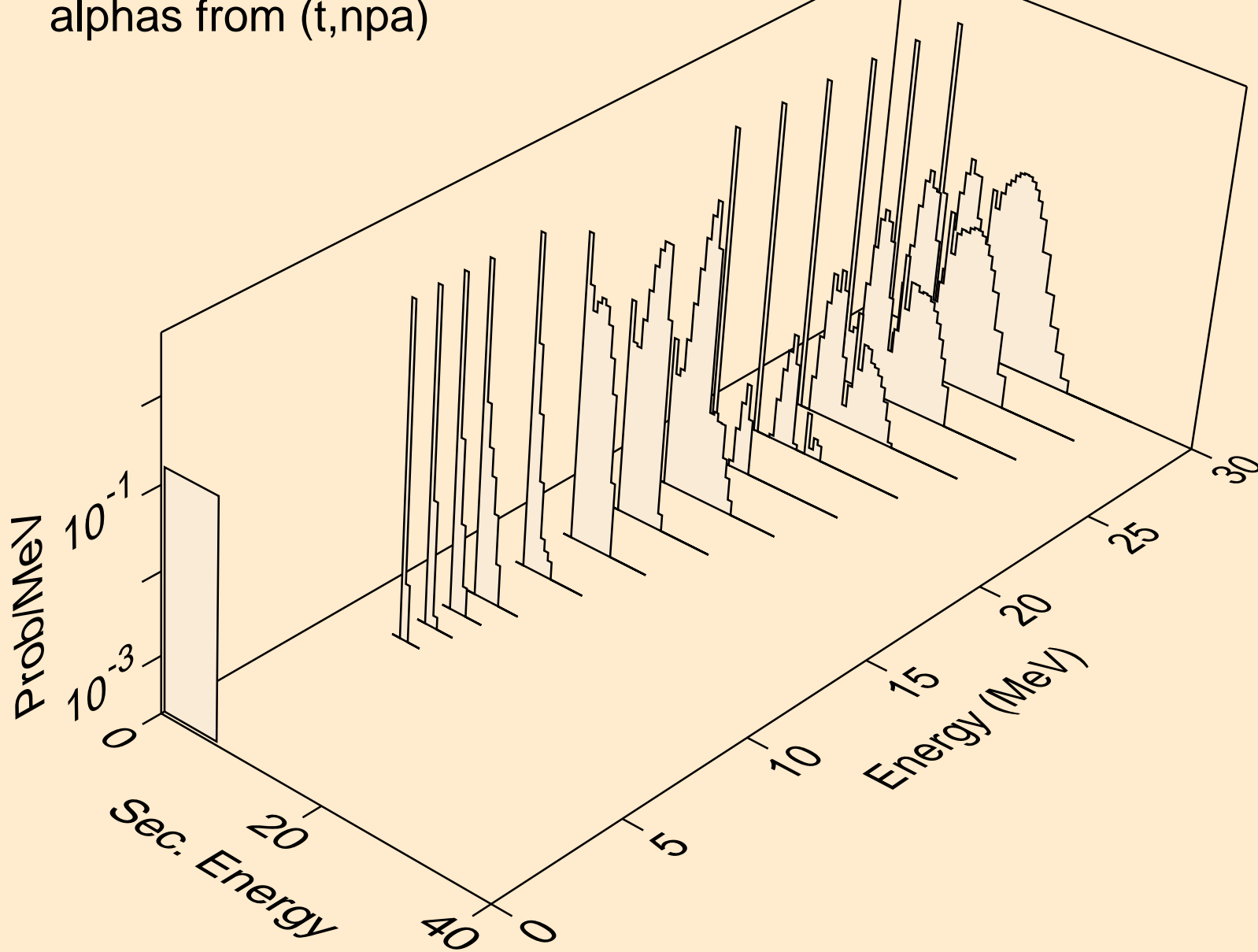

BI210M TRITON ACER TENDL-2023 LIBRARY; T=0.K
alphas from (t,a)

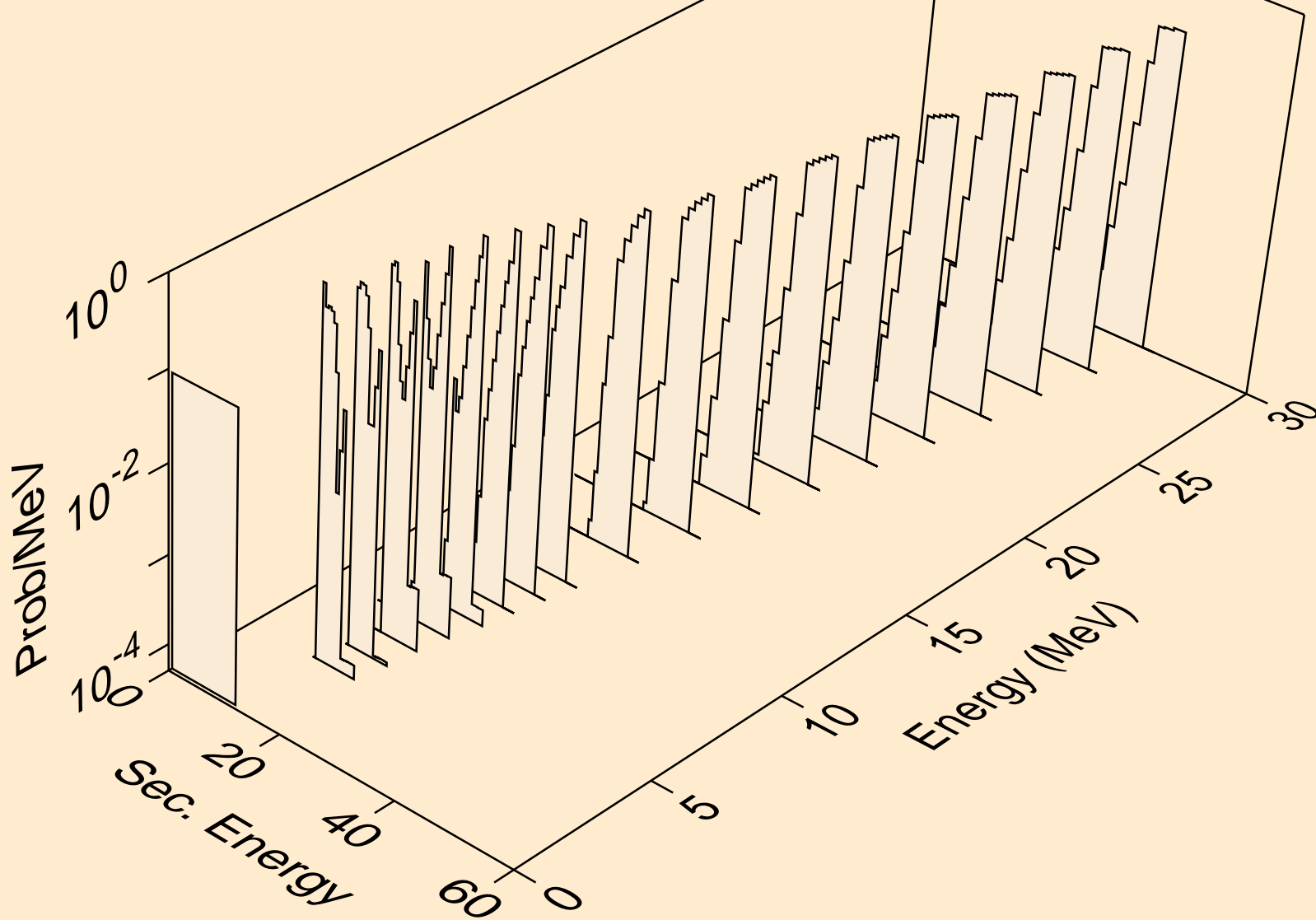

BI210M TRITON ACER TENDL-2023 LIBRARY; T=0.K
alphas from (t,2a)

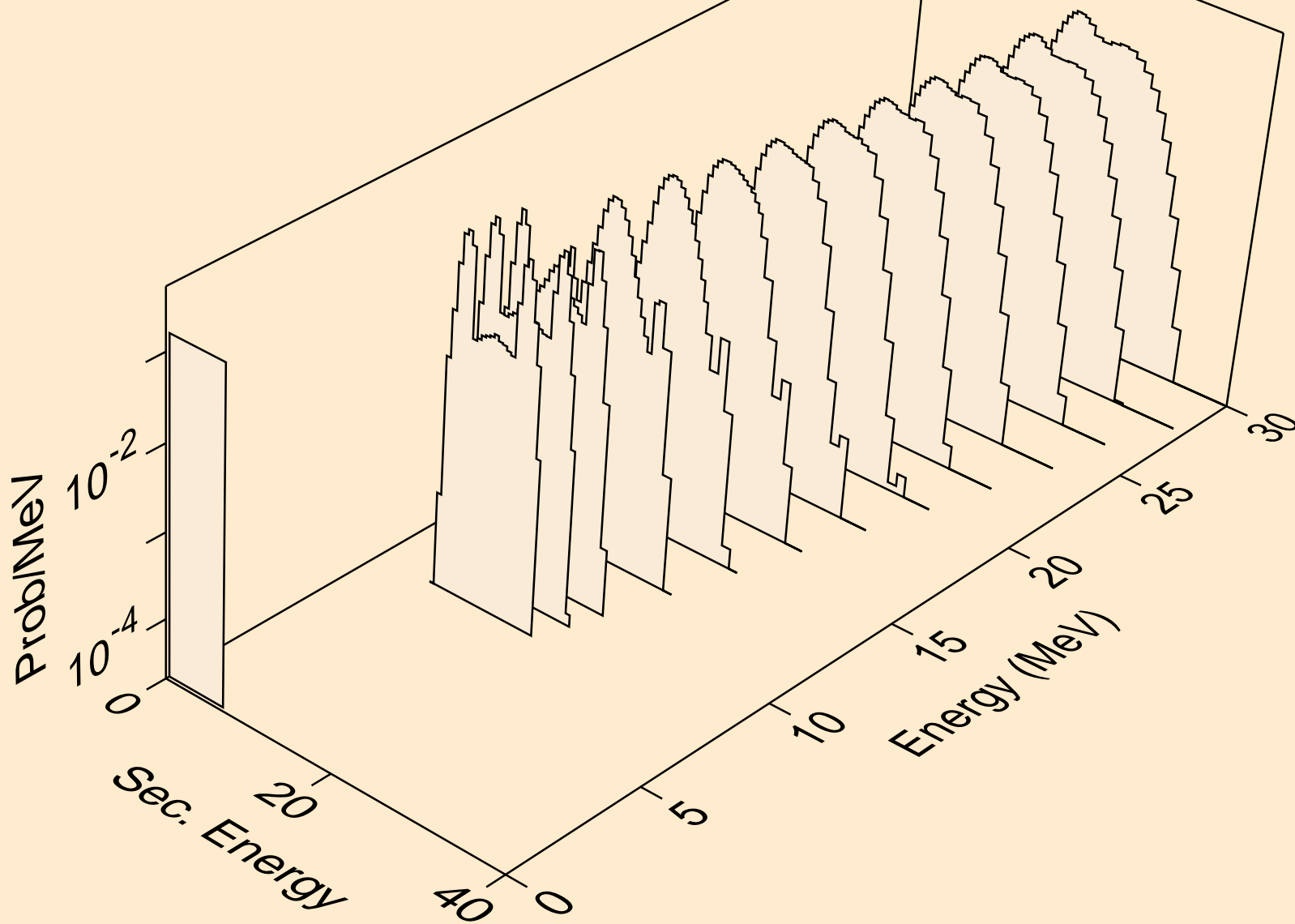

BI210M TRITON ACER TENDL-2023 LIBRARY; T=0.K
alphas from (t,pa)

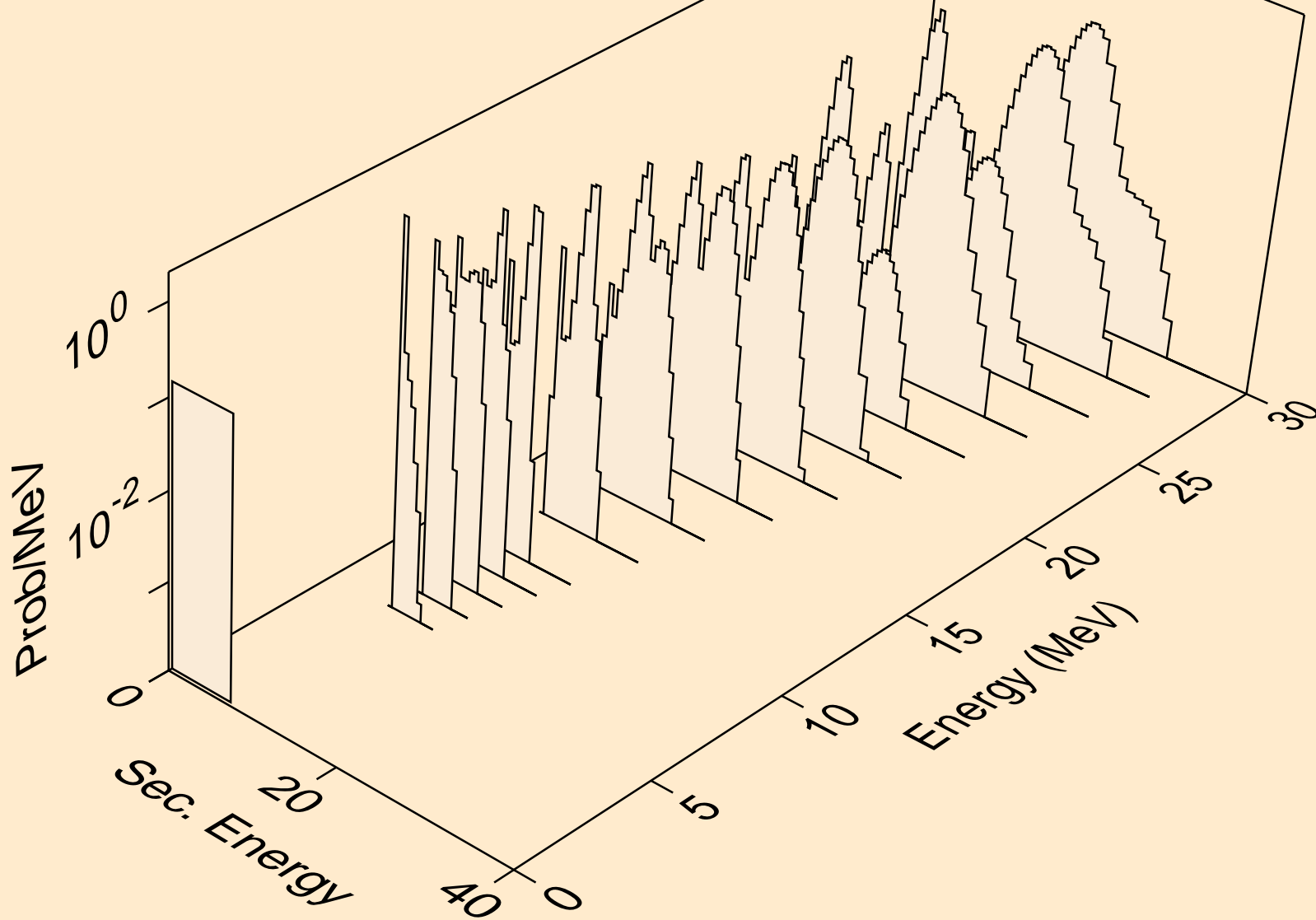

BI210M TRITON ACER TENDL-2023 LIBRARY; T=0.K
alphas from (t,da)

