

LU186 TRITON ACER TENDL-2023 LIBRARY; T=0.K  
Principal cross sections

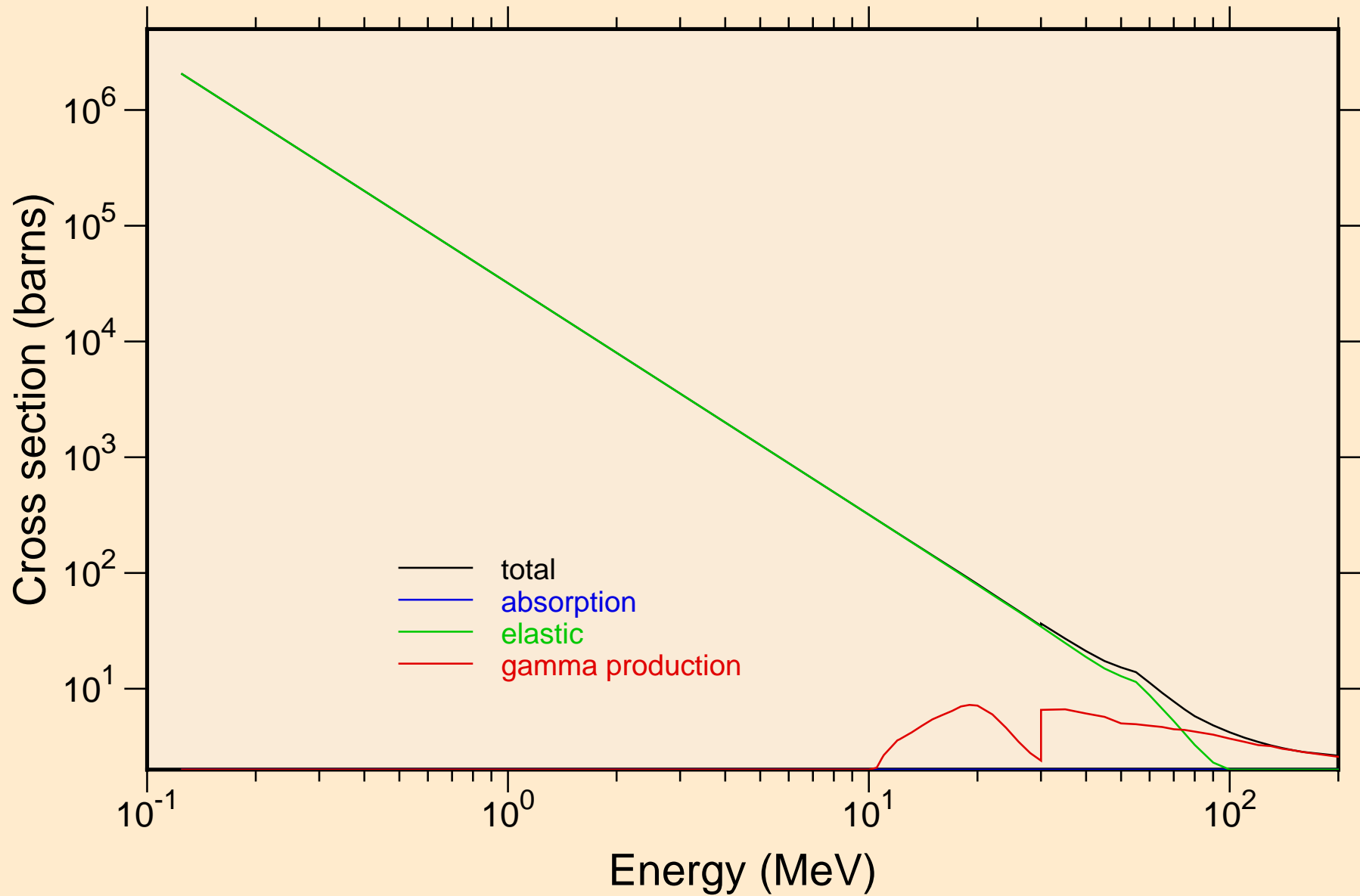

LU186 TRITON ACER TENDL-2023 LIBRARY; T=0.K

Heating

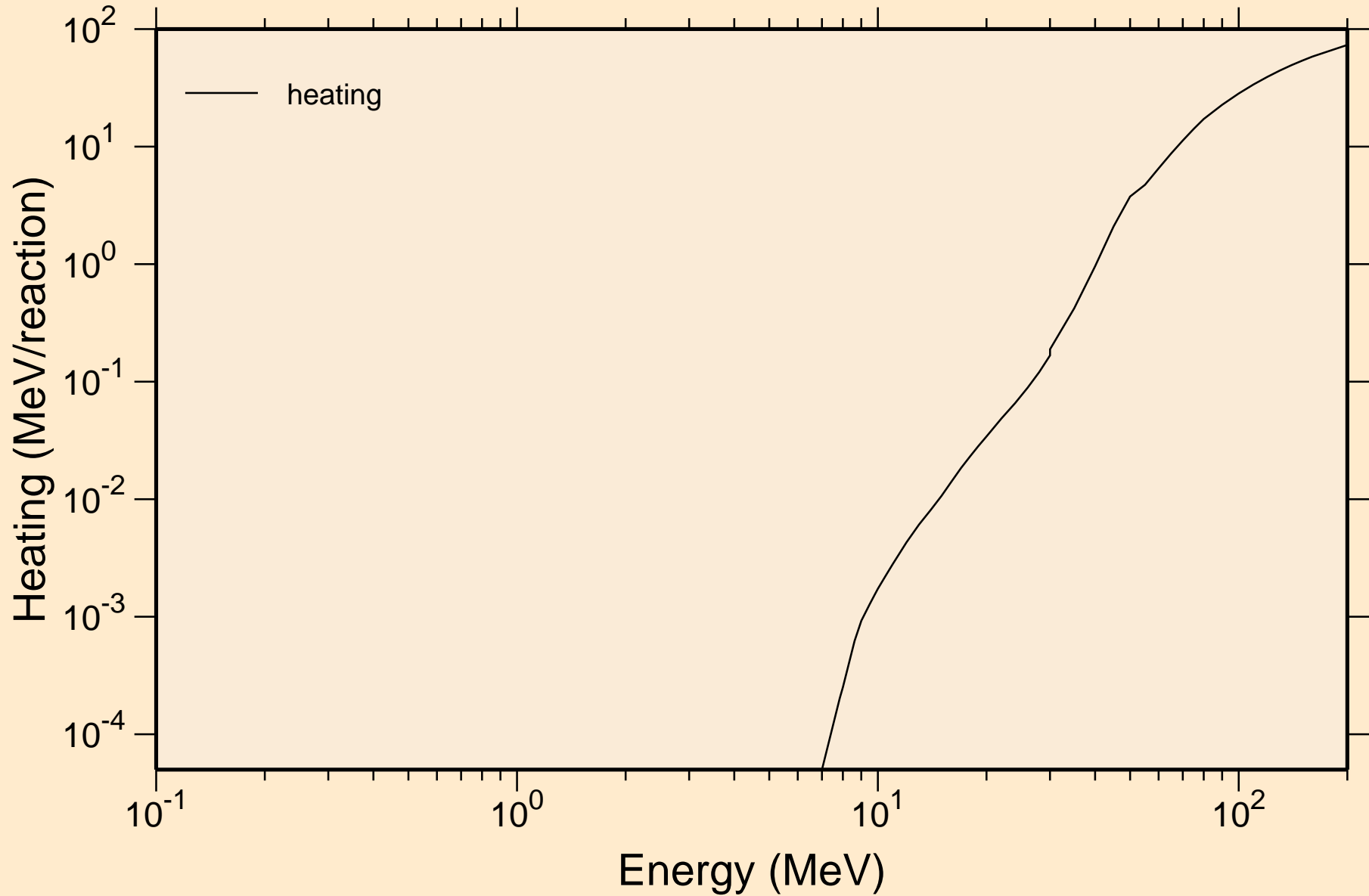

# LU186 TRITON ACER TENDL-2023 LIBRARY; T=0.K

## Principal cross sections

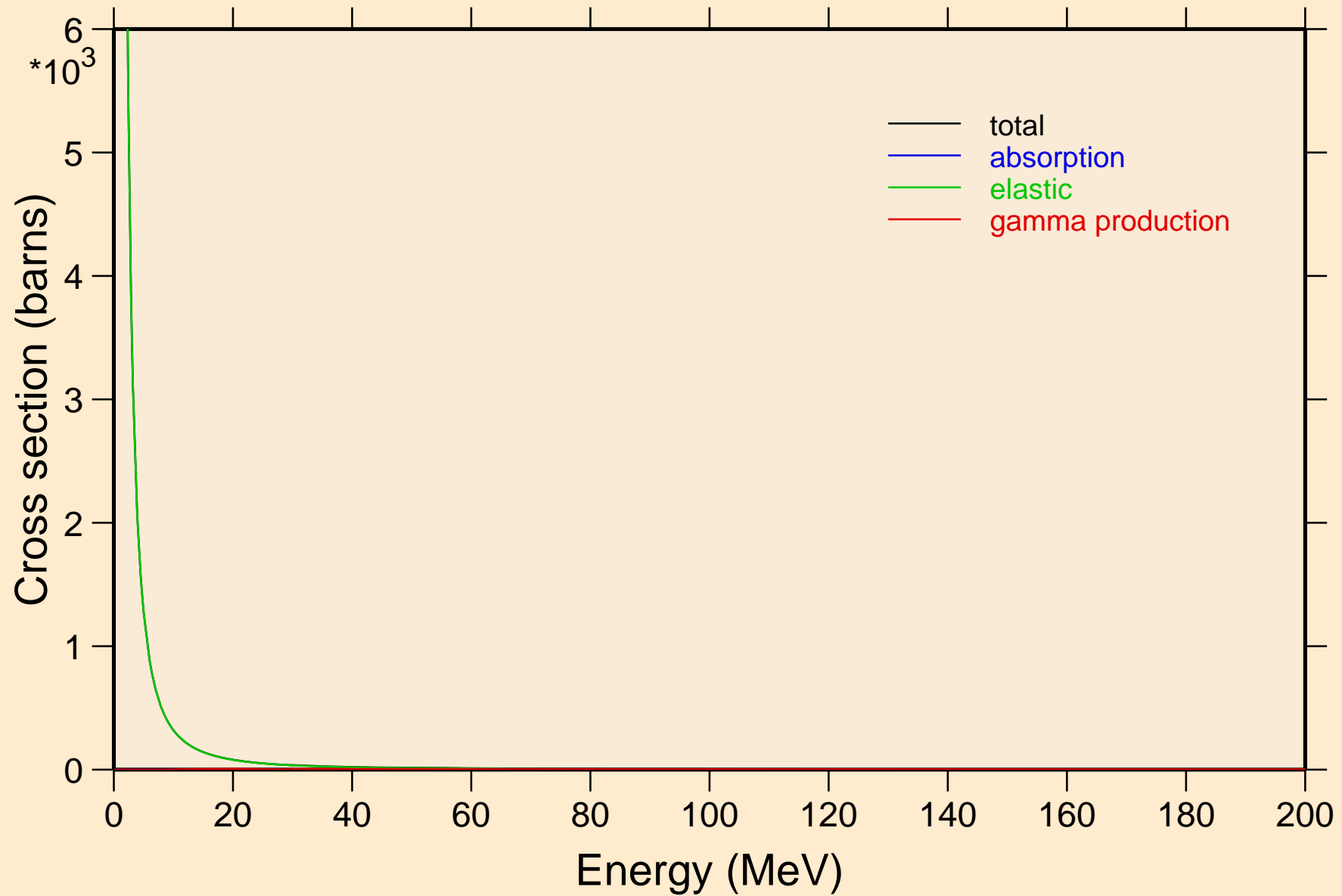

LU186 TRITON ACER TENDL-2023 LIBRARY; T=0.K

Heating

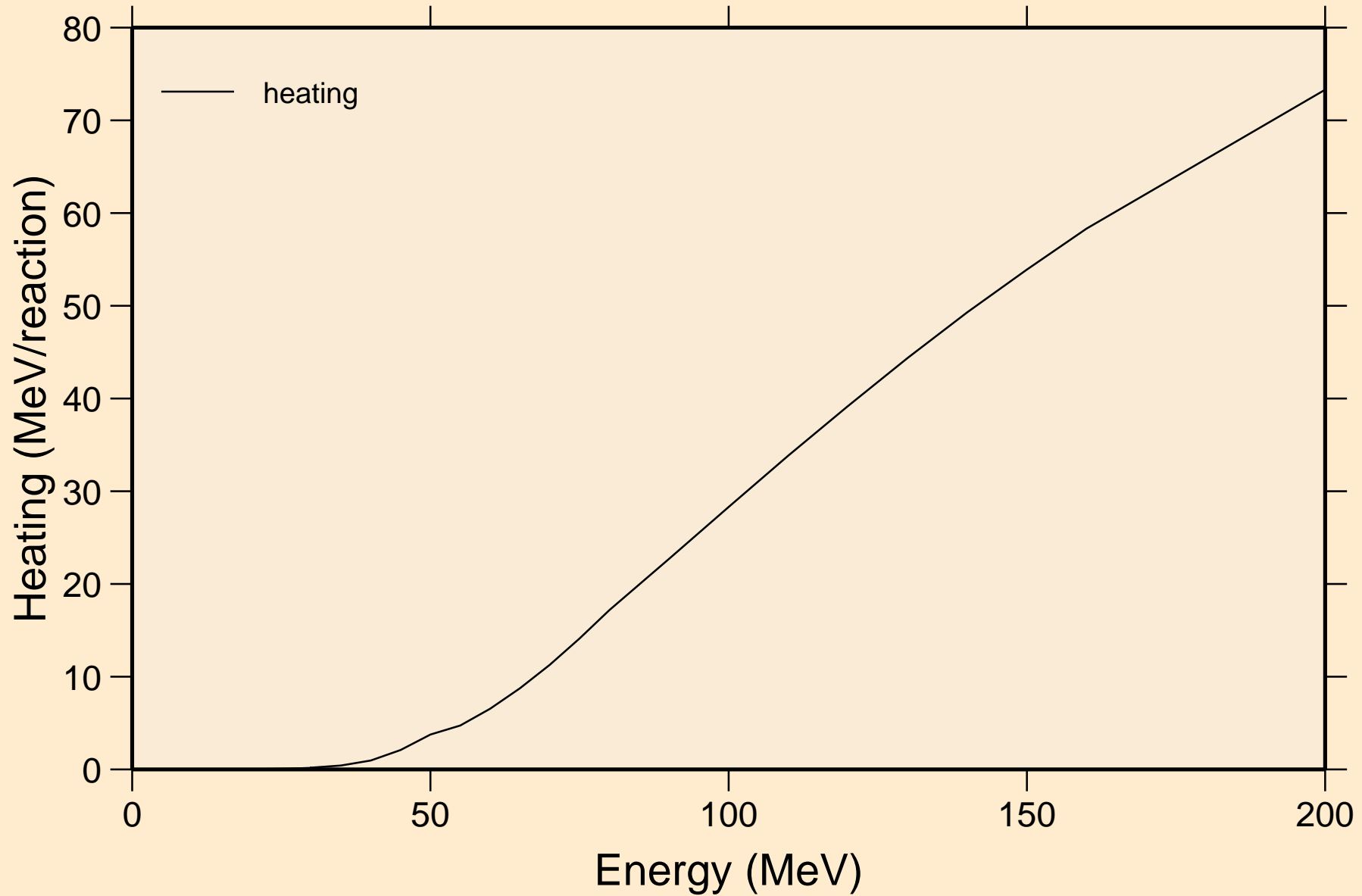

LU186 TRITON ACER TENDL-2023 LIBRARY; T=0.K  
Threshold reactions

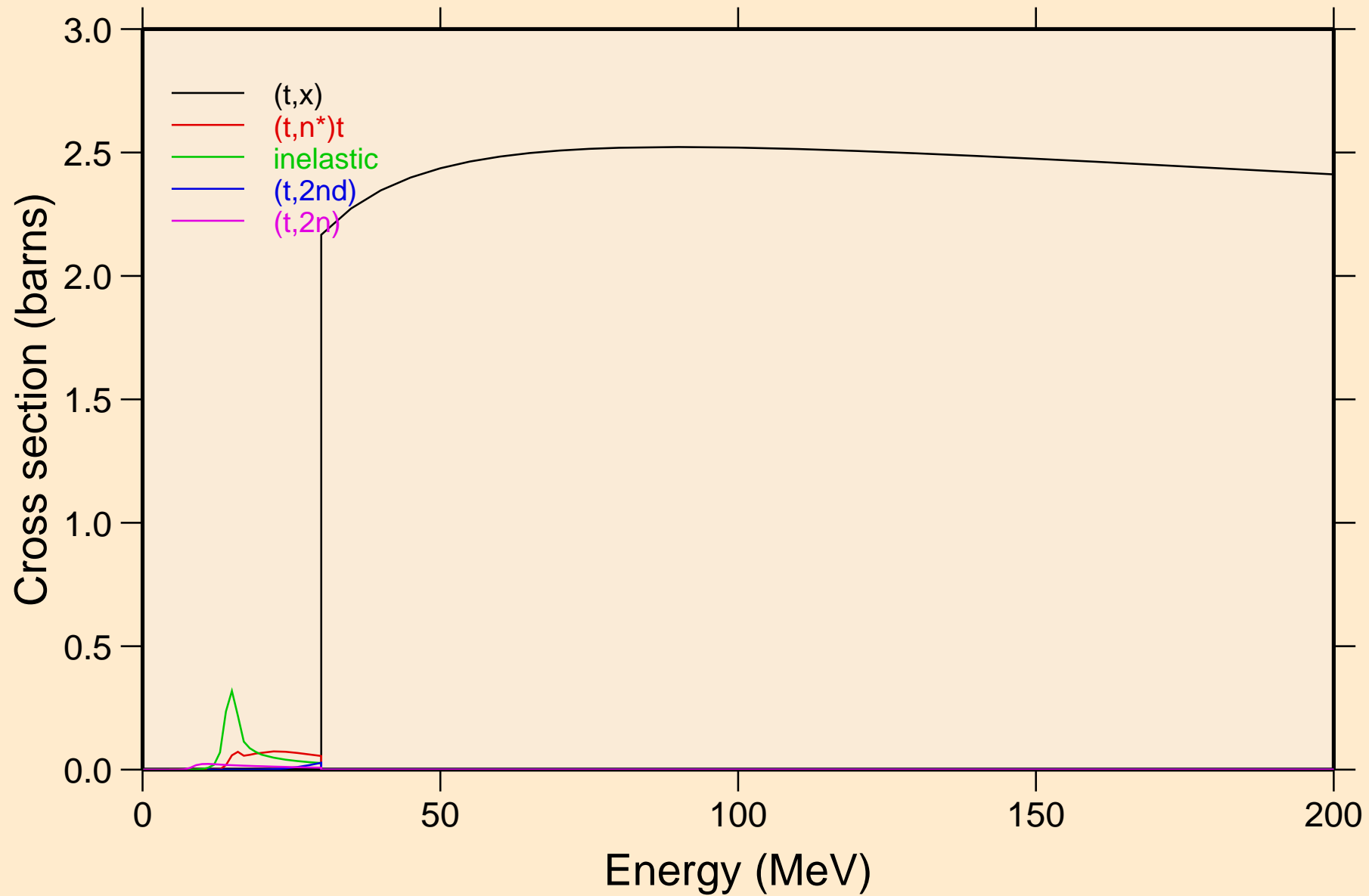

LU186 TRITON ACER TENDL-2023 LIBRARY; T=0.K  
Threshold reactions

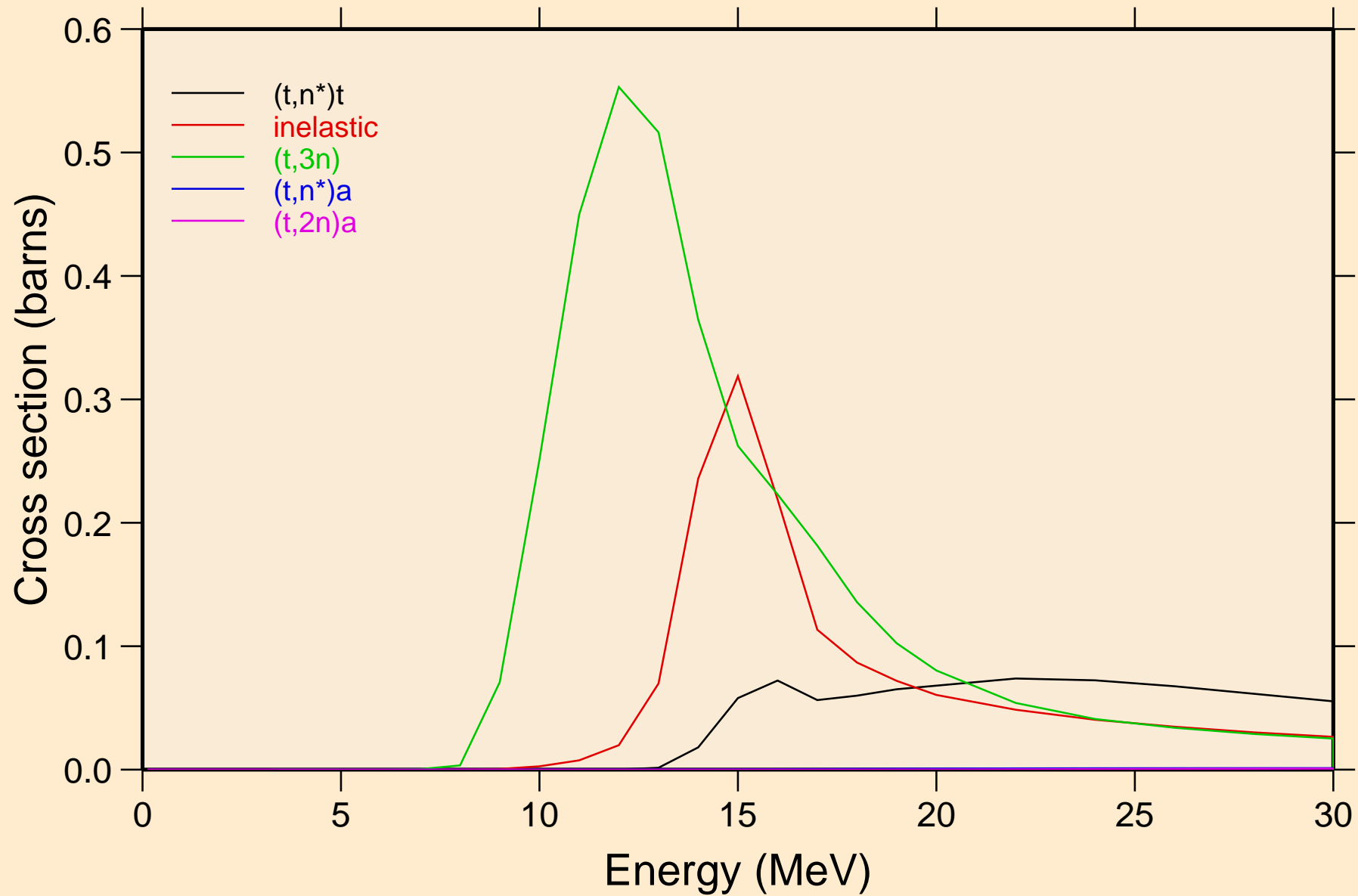

LU186 TRITON ACER TENDL-2023 LIBRARY; T=0.K  
Threshold reactions

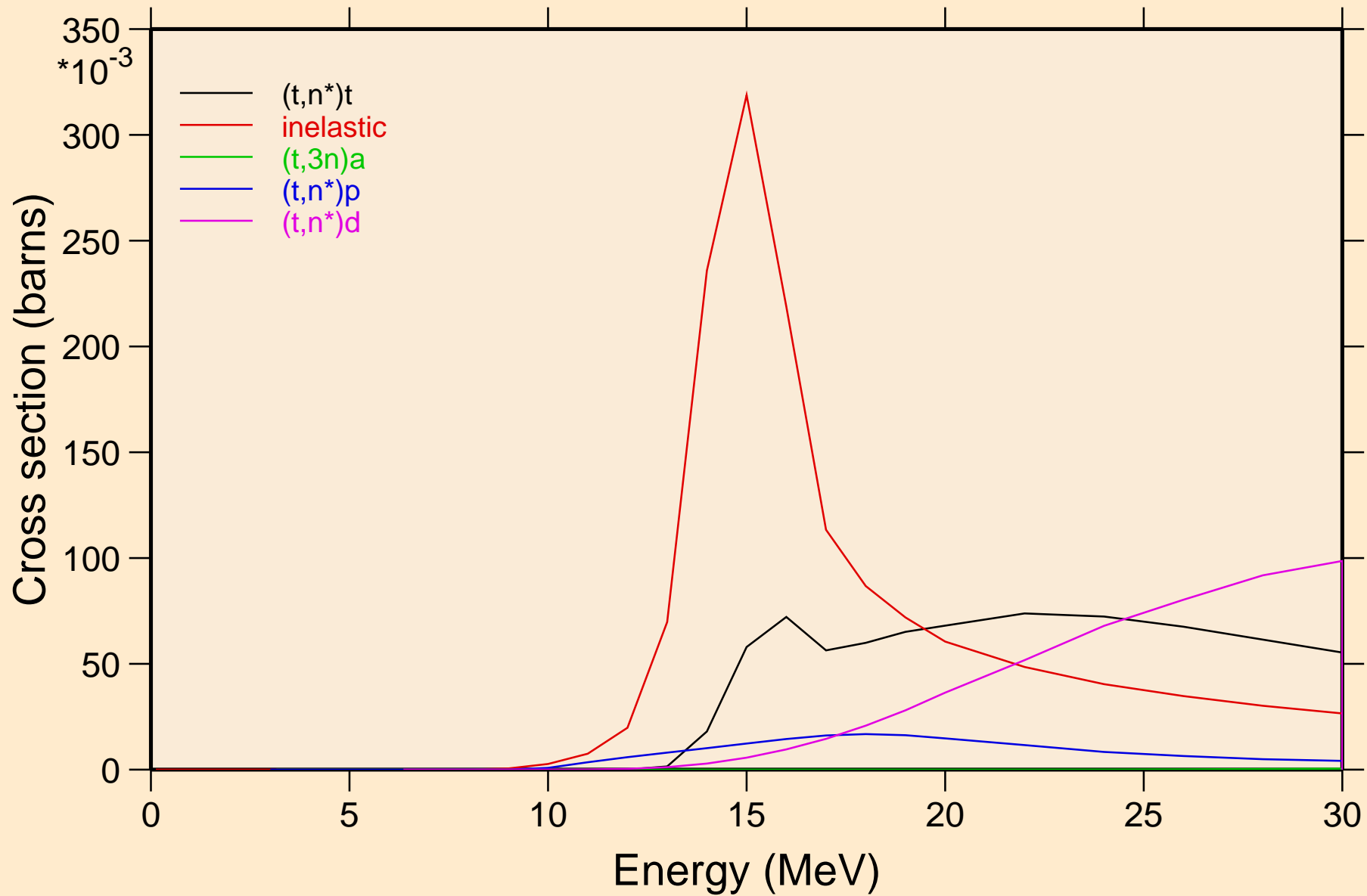

LU186 TRITON ACER TENDL-2023 LIBRARY; T=0.K  
Threshold reactions

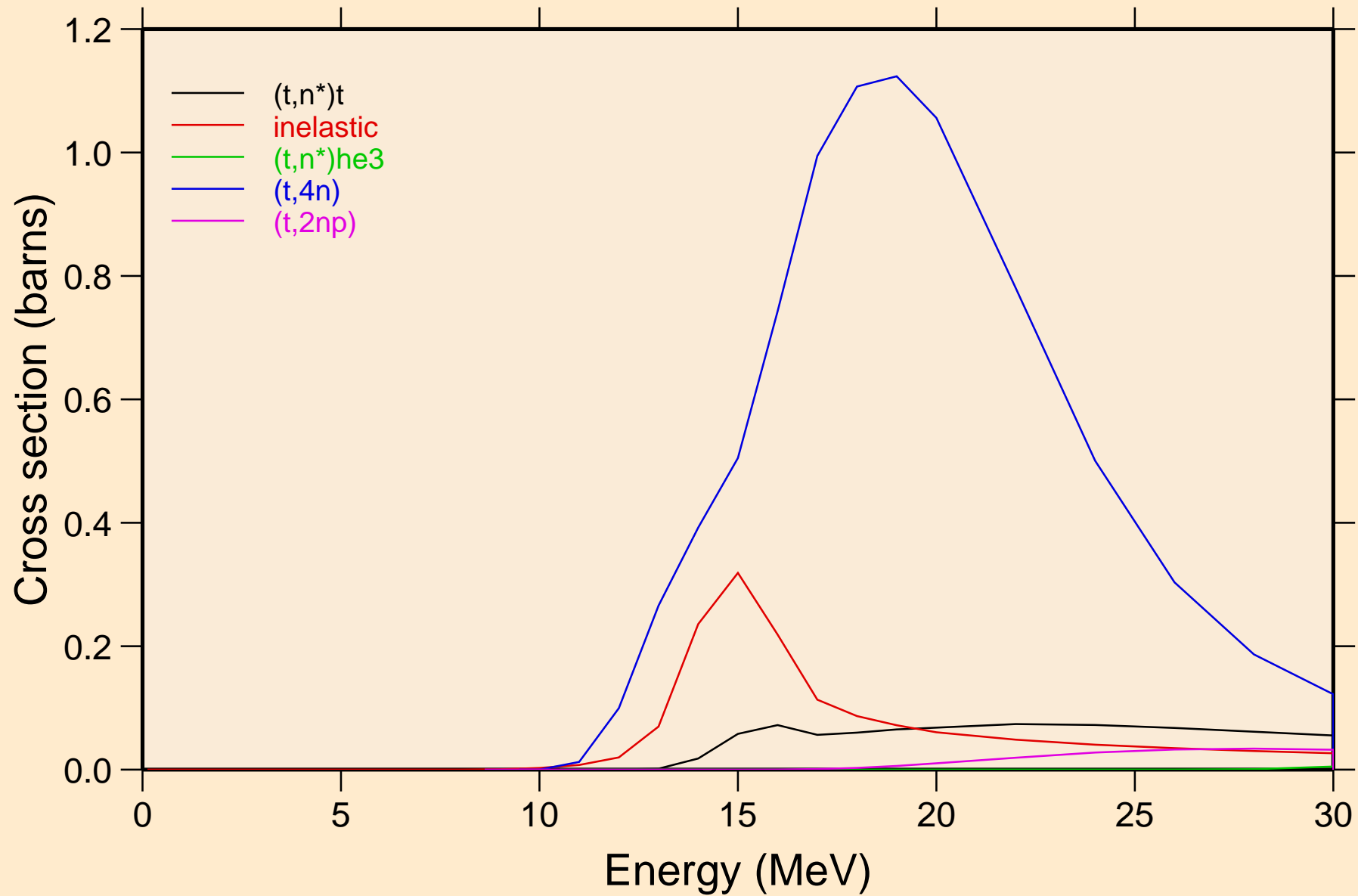

LU186 TRITON ACER TENDL-2023 LIBRARY; T=0.K  
Threshold reactions

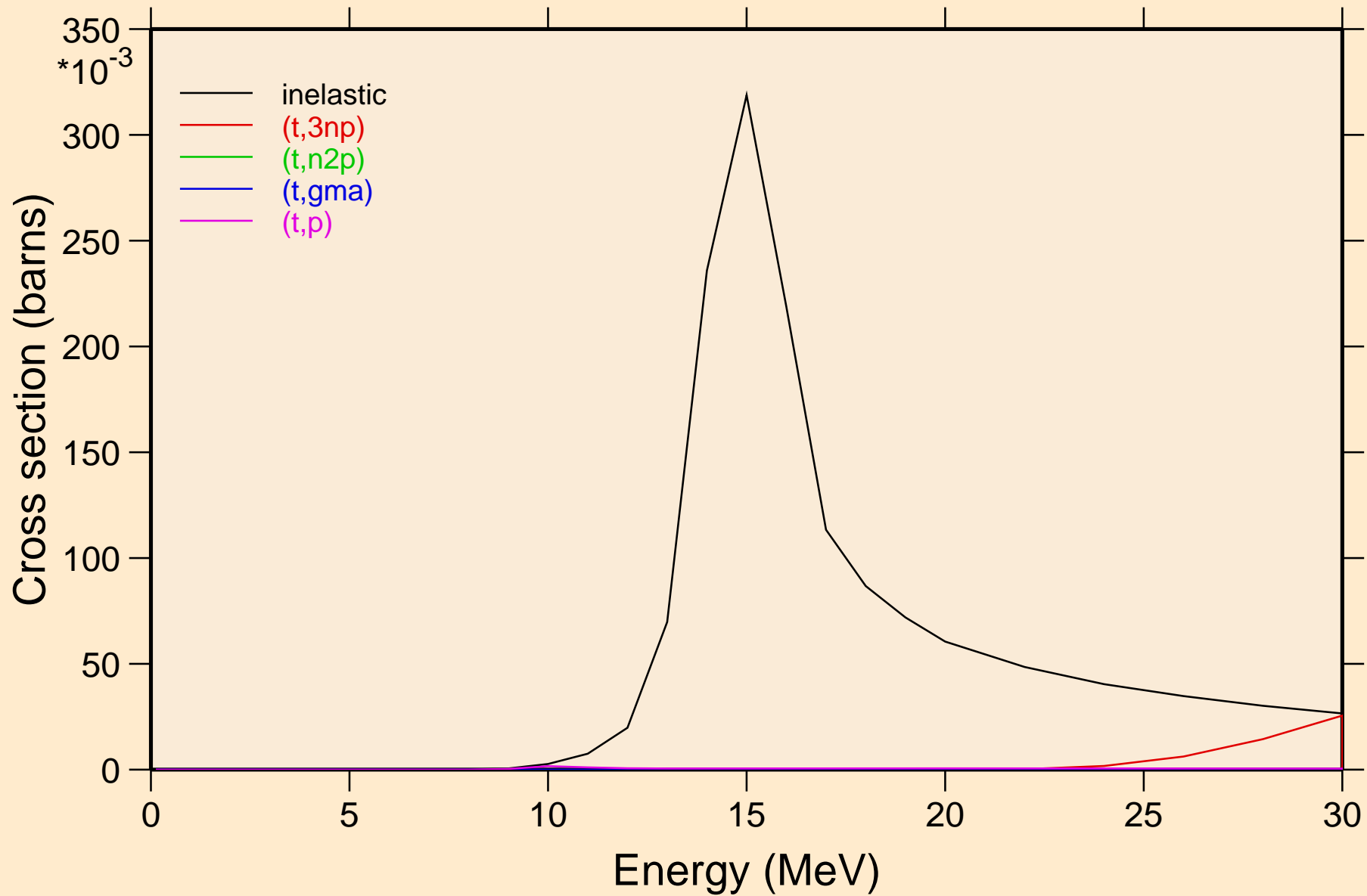

LU186 TRITON ACER TENDL-2023 LIBRARY; T=0.K  
Threshold reactions

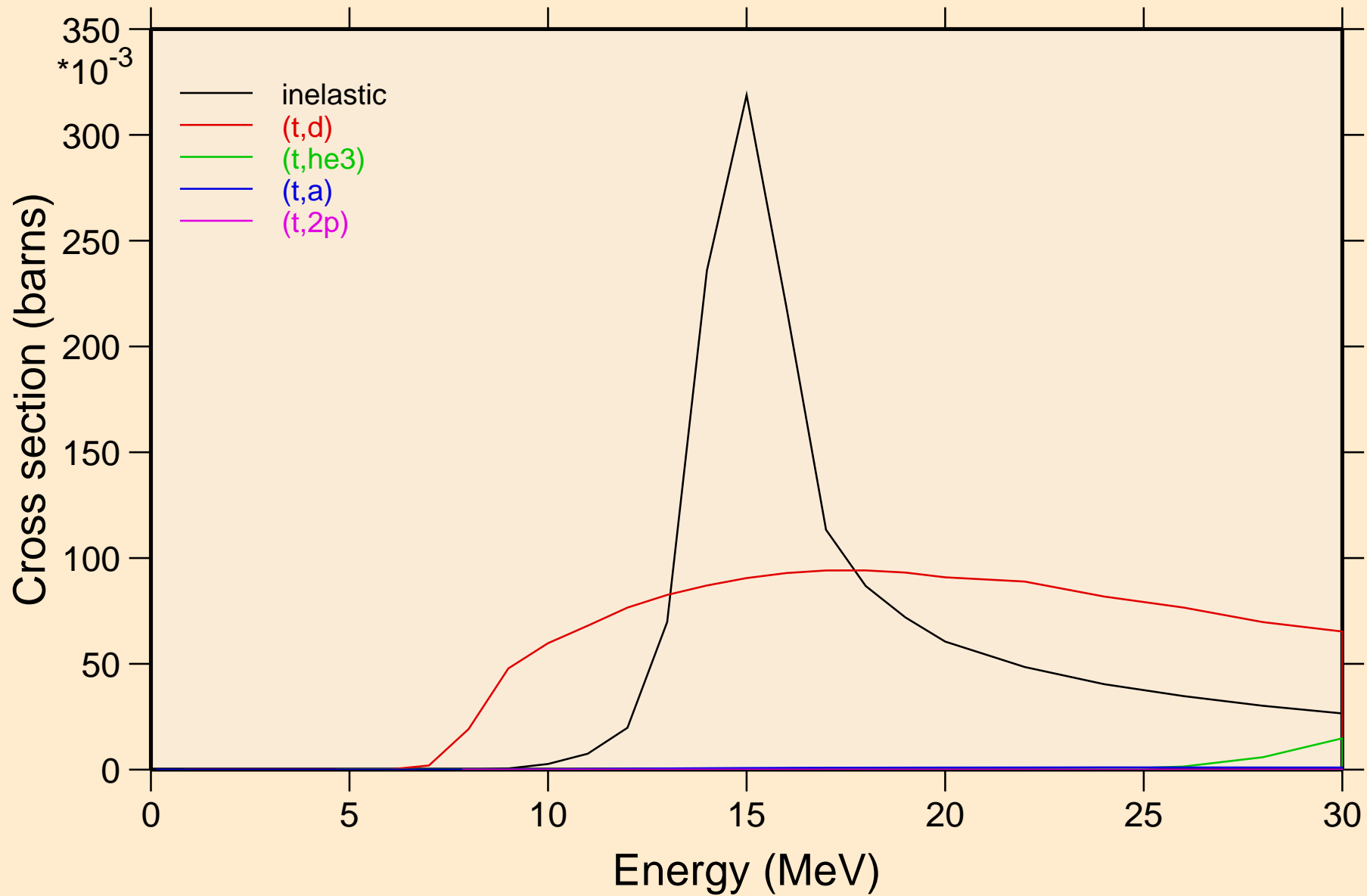

LU186 TRITON ACER TENDL-2023 LIBRARY; T=0.K  
Threshold reactions

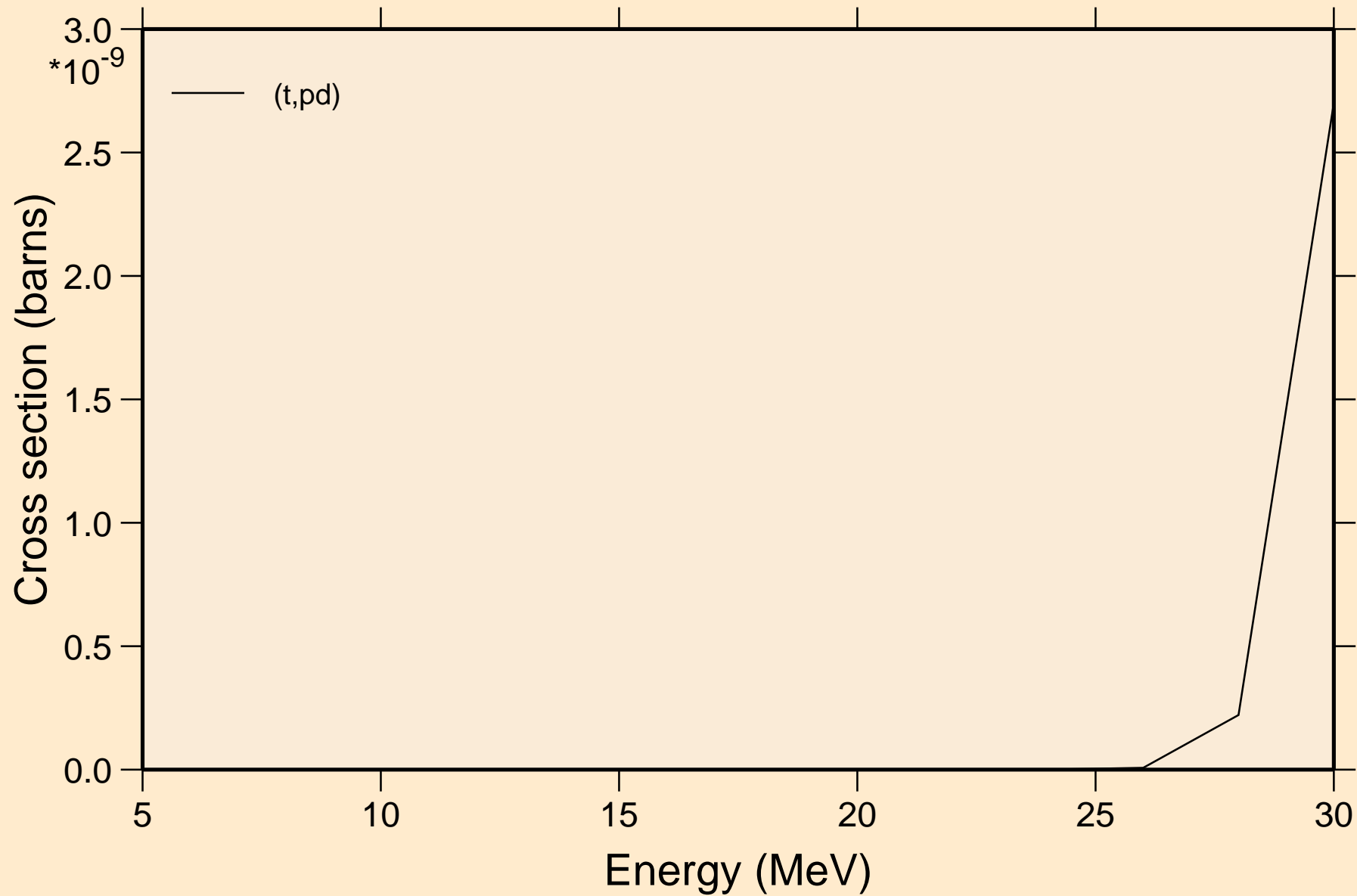

LU186 TRITON ACER TENDL-2023 LIBRARY; T=0.K  
angular distribution for elastic

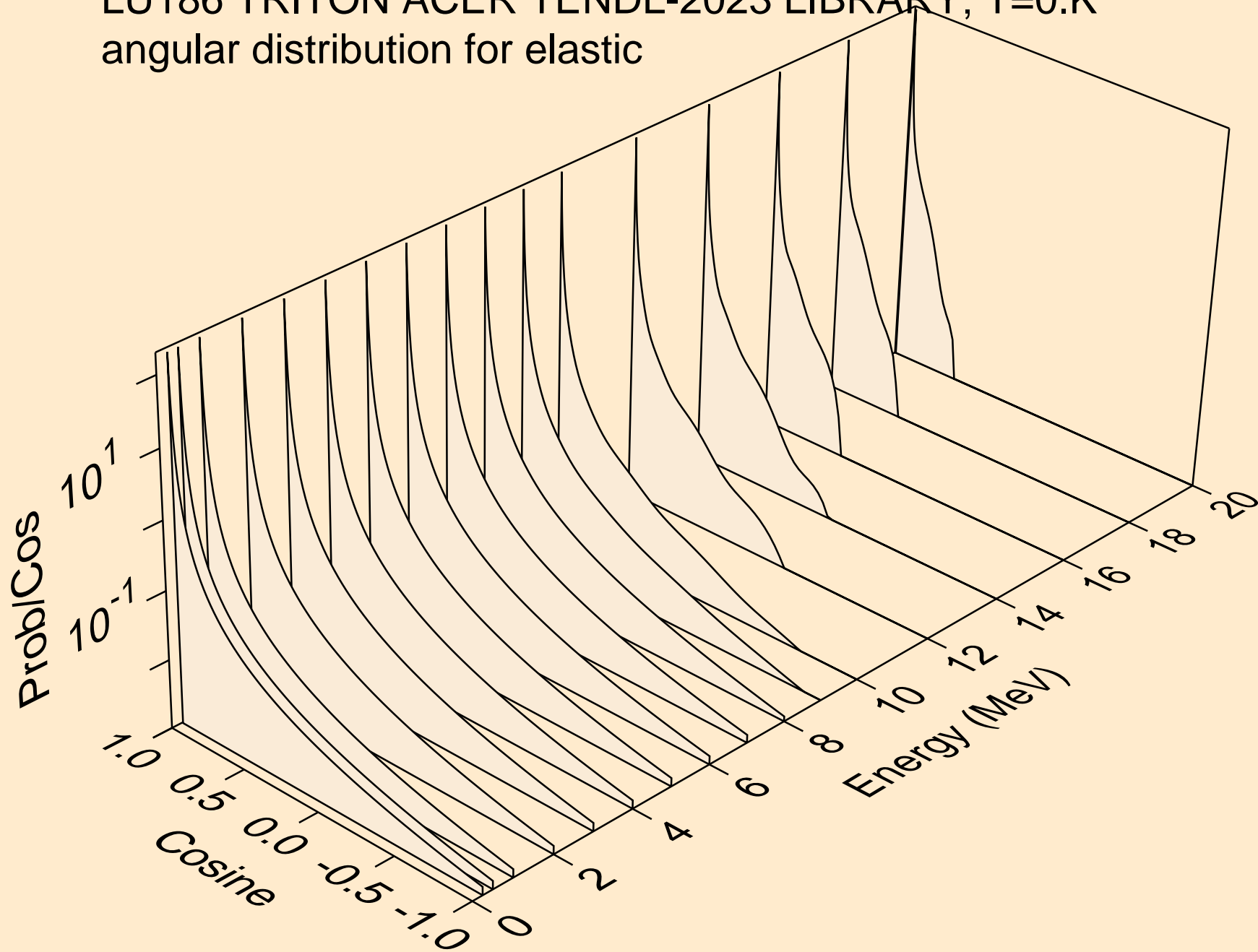

LU186 TRITON ACER TENDL-2023 LIBRARY; T=0.K  
angular distribution for elastic

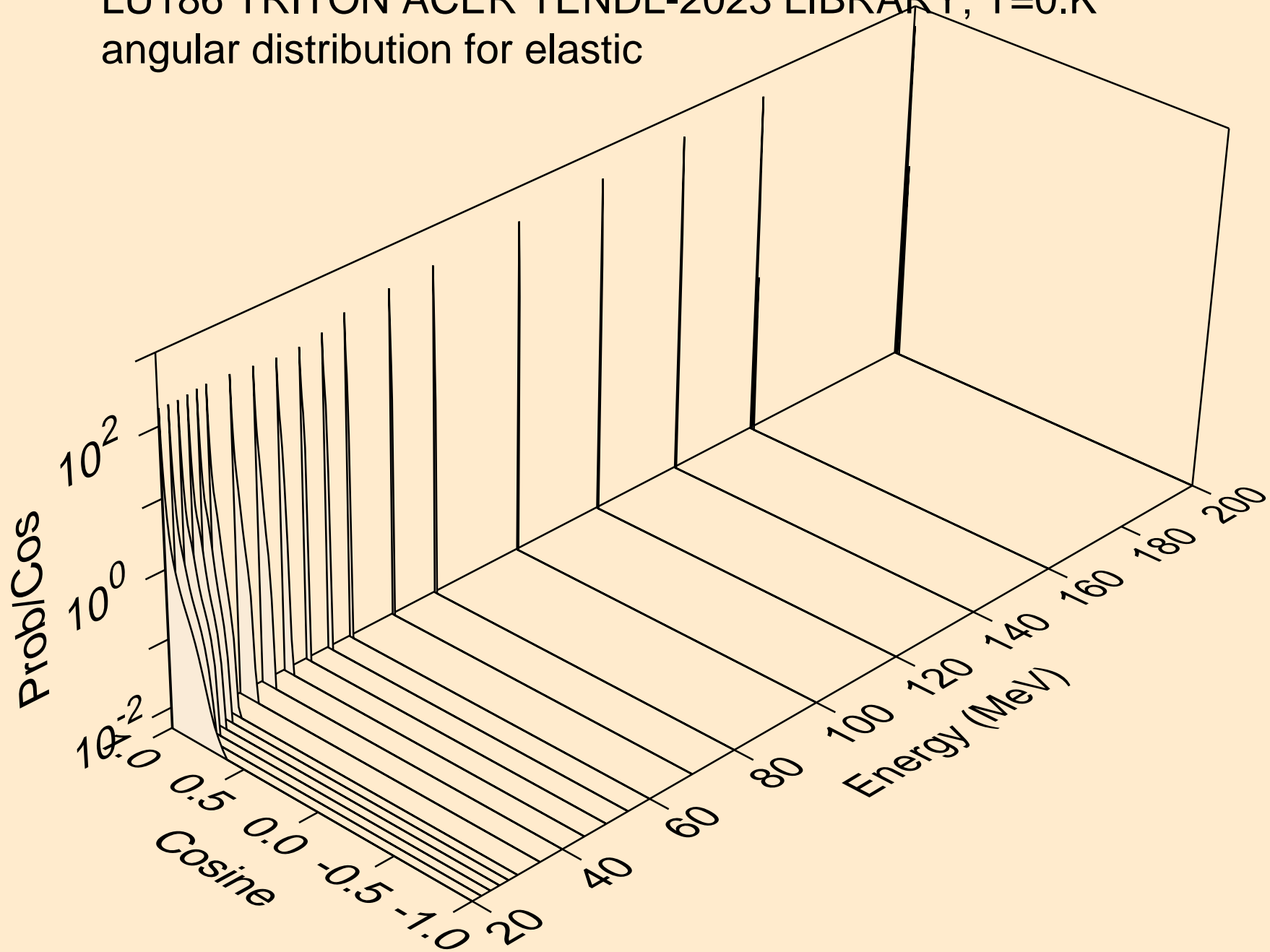

LU186 TRITON ACER TENDL-2023 LIBRARY; T=0.K  
Triton emission for (t,x)

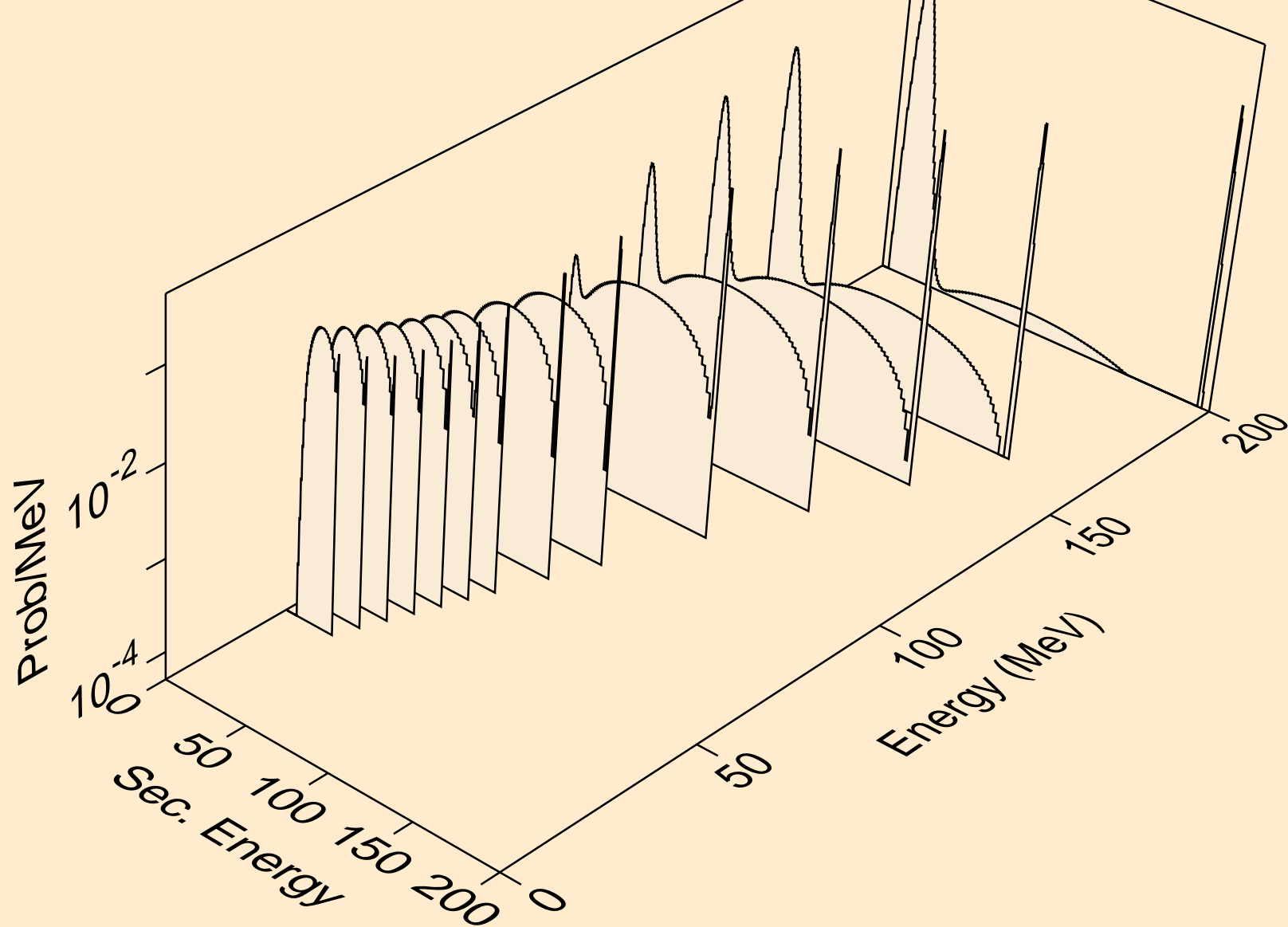

LU186 TRITON ACER TENDL-2023 LIBRARY; T=0.K  
Triton emission for (t,n\*)t

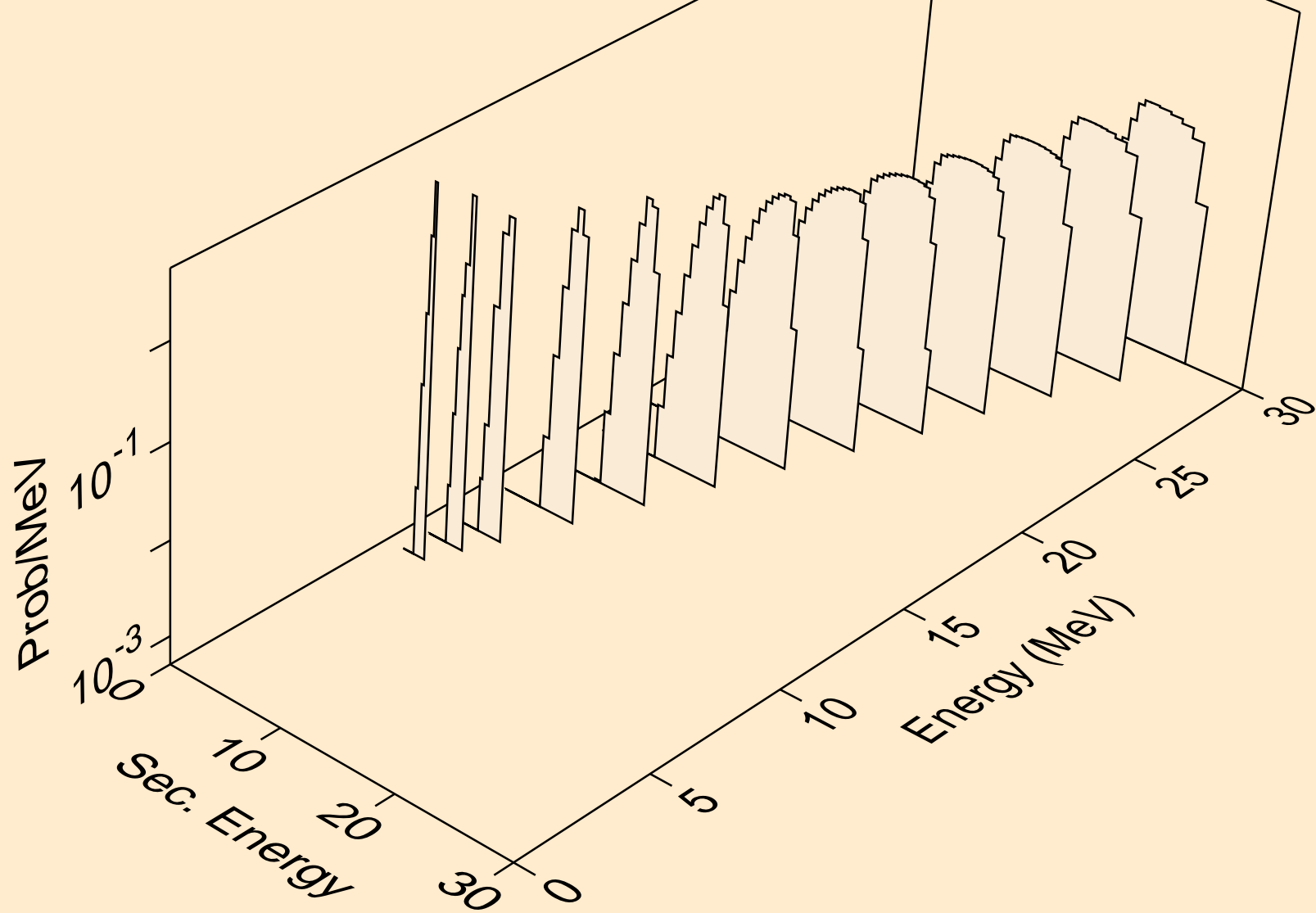

LU186 TRITON ACER TENDL-2023 LIBRARY; T=0.K  
Triton emission for inelastic

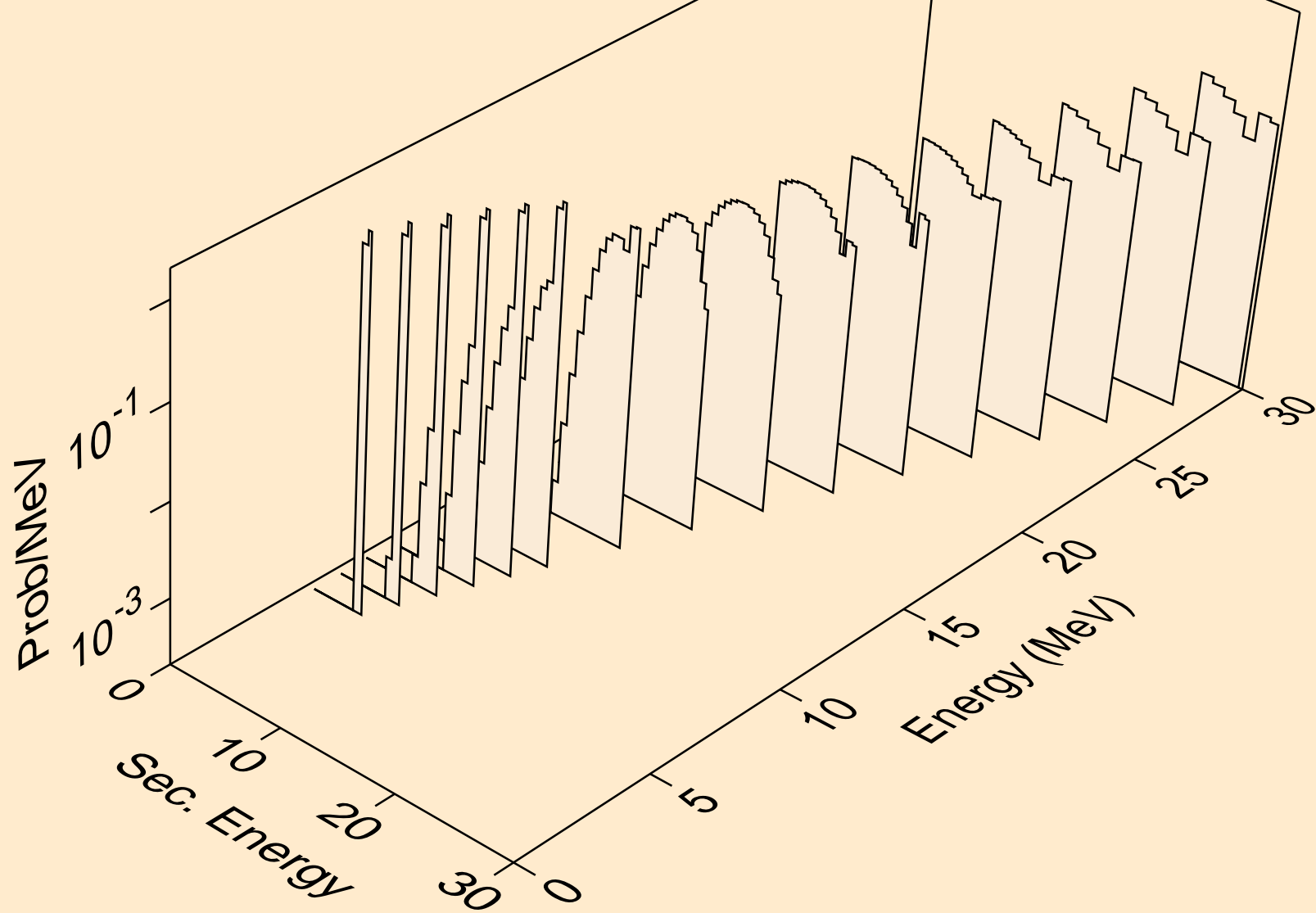

LU186 TRITON ACER TENDL-2023 LIBRARY; T=0.K  
Photon emission for (z,n)

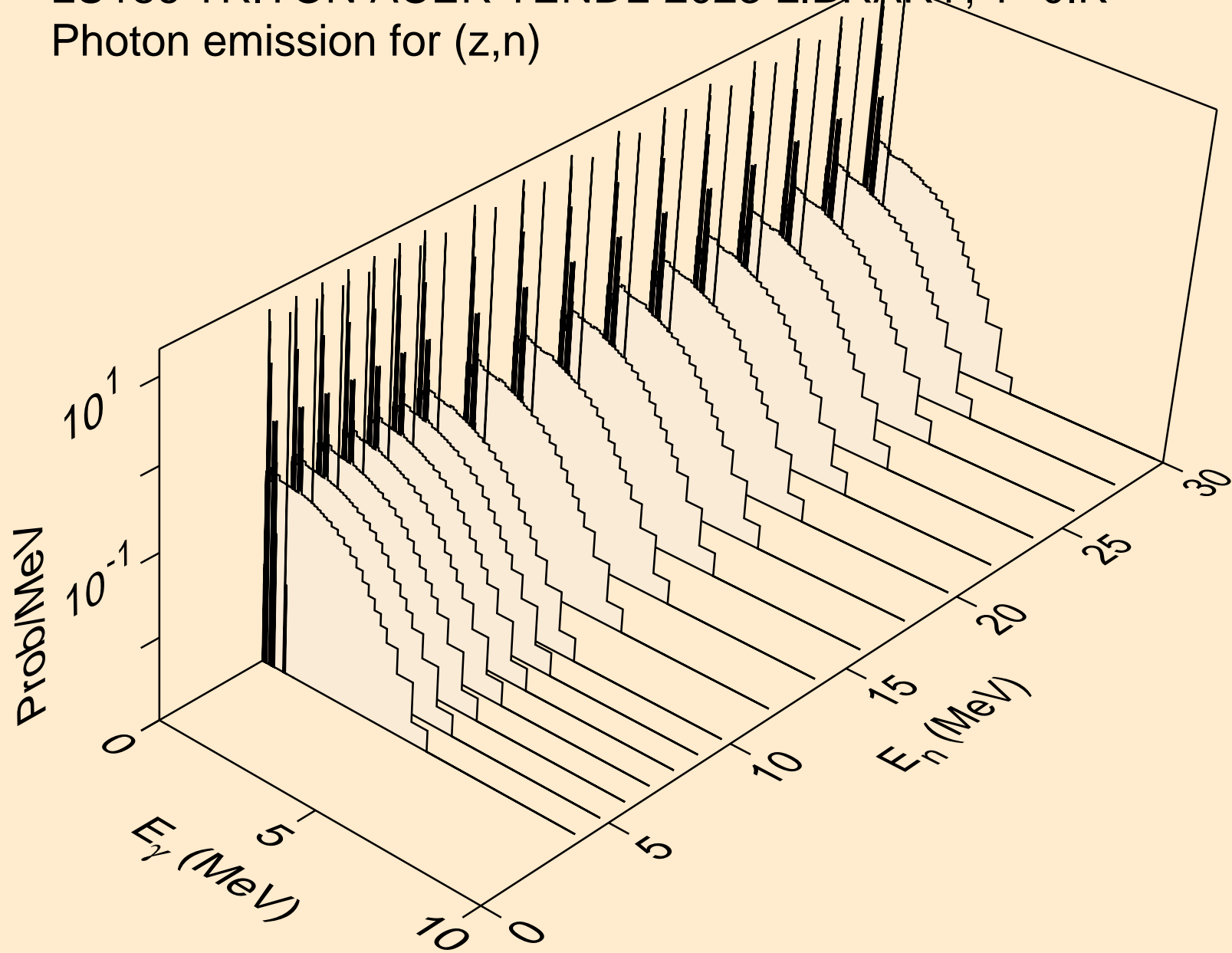

LU186 TRITON ACER TENDL-2023 LIBRARY; T=0.K  
Photon emission for (z,x)

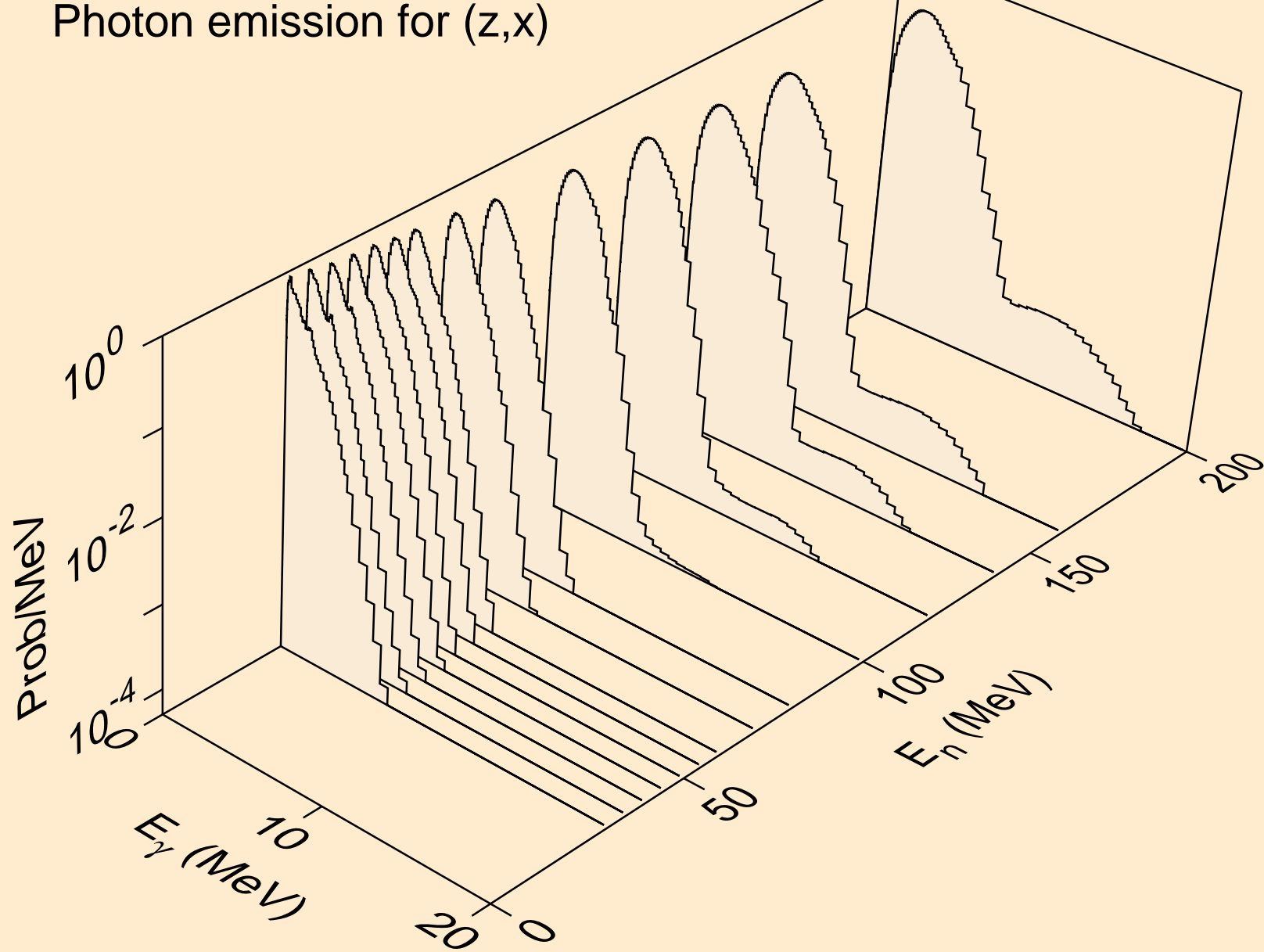

LU186 TRITON ACER TENDL-2023 LIBRARY; T=0.K  
Photon emission for (n,2nd)

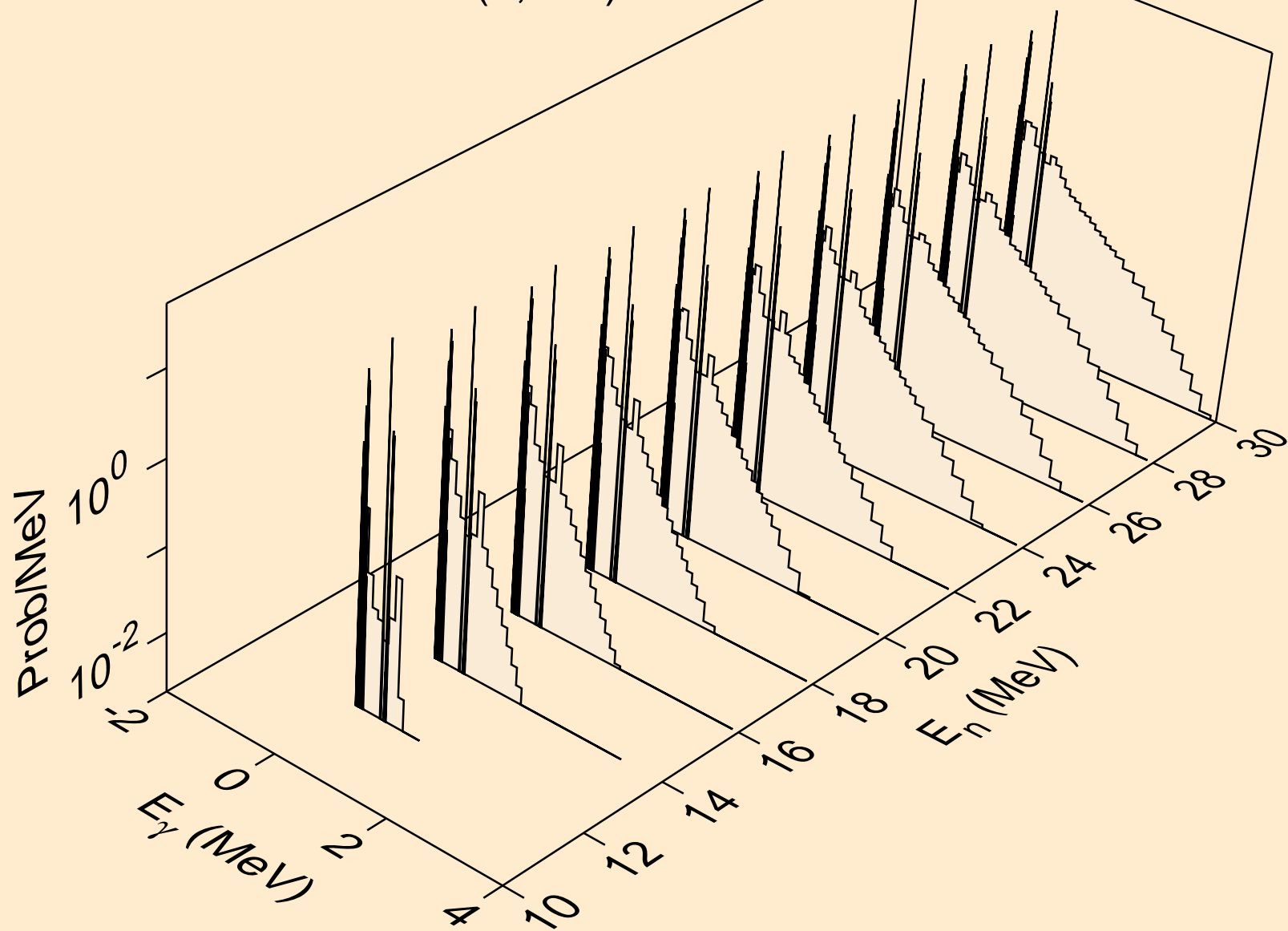

LU186 TRITON ACER TENDL-2023 LIBRARY; T=0.K  
Photon emission for (n,2n)

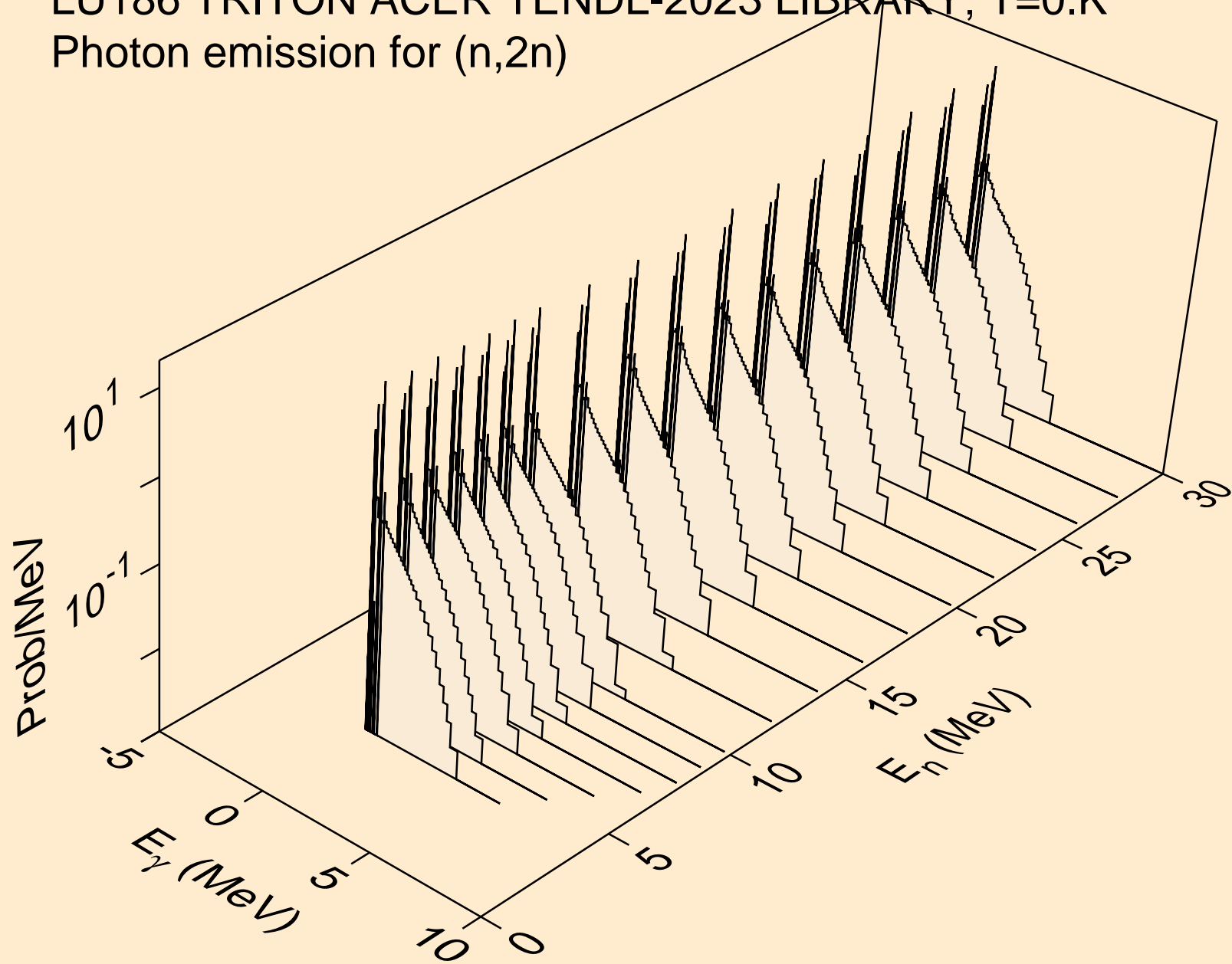

LU186 TRITON ACER TENDL-2023 LIBRARY; T=0.K  
Photon emission for (n,3n)

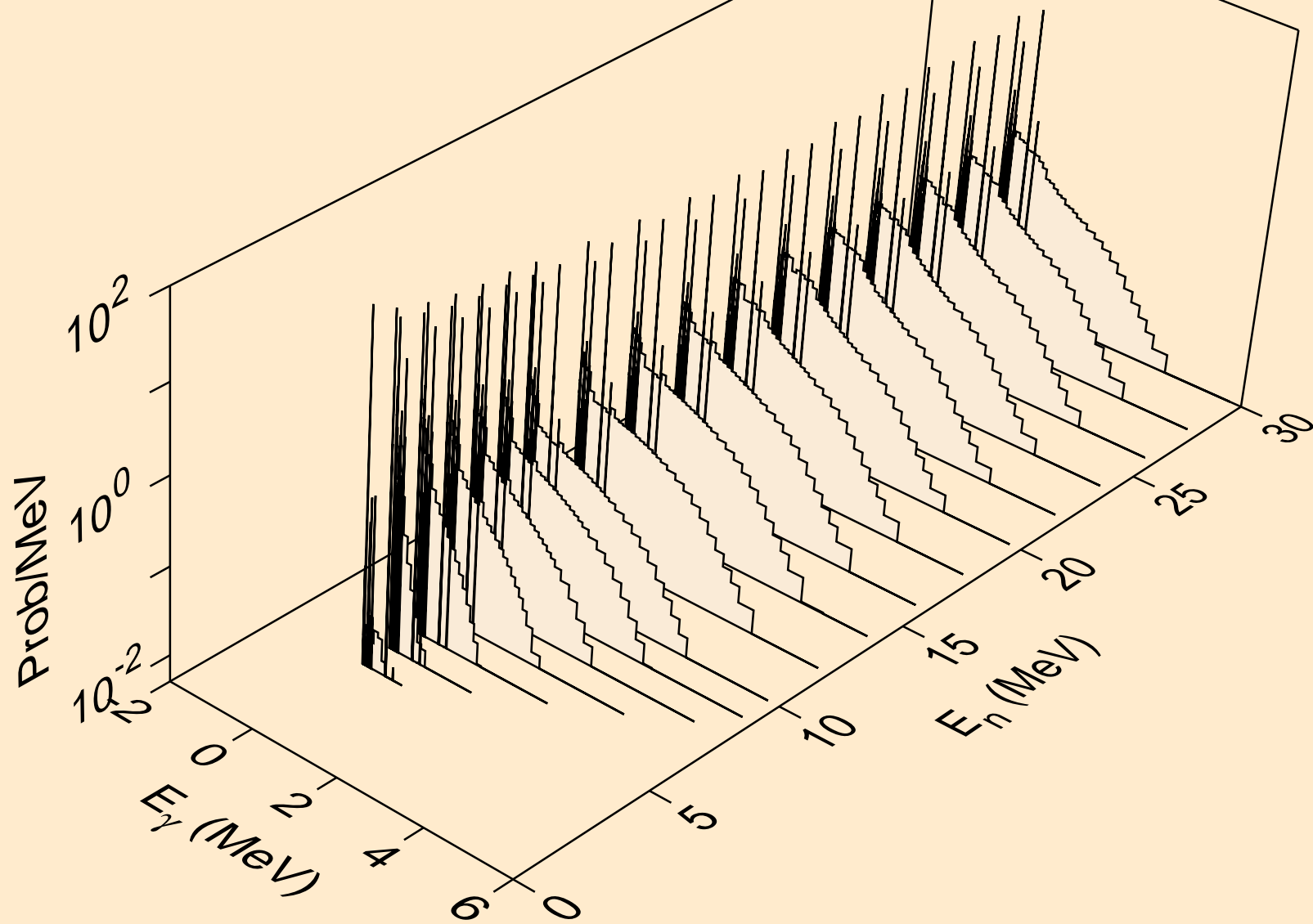

LU186 TRITON ACER TENDL-2023 LIBRARY; T=0.K  
Photon emission for (n,n\*)a

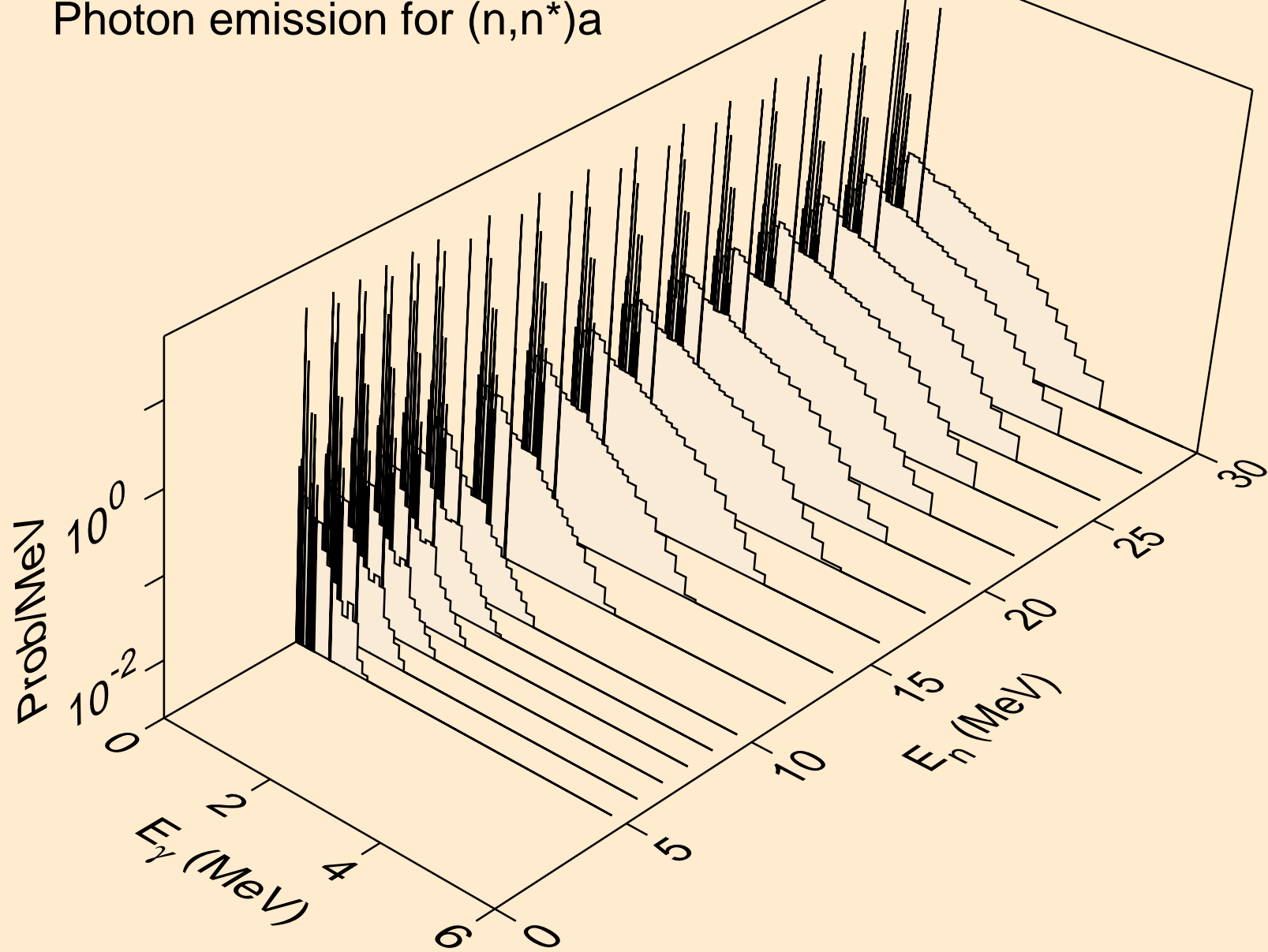

LU186 TRITON ACER TENDL-2023 LIBRARY; T=0.K  
Photon emission for (n,2n)a

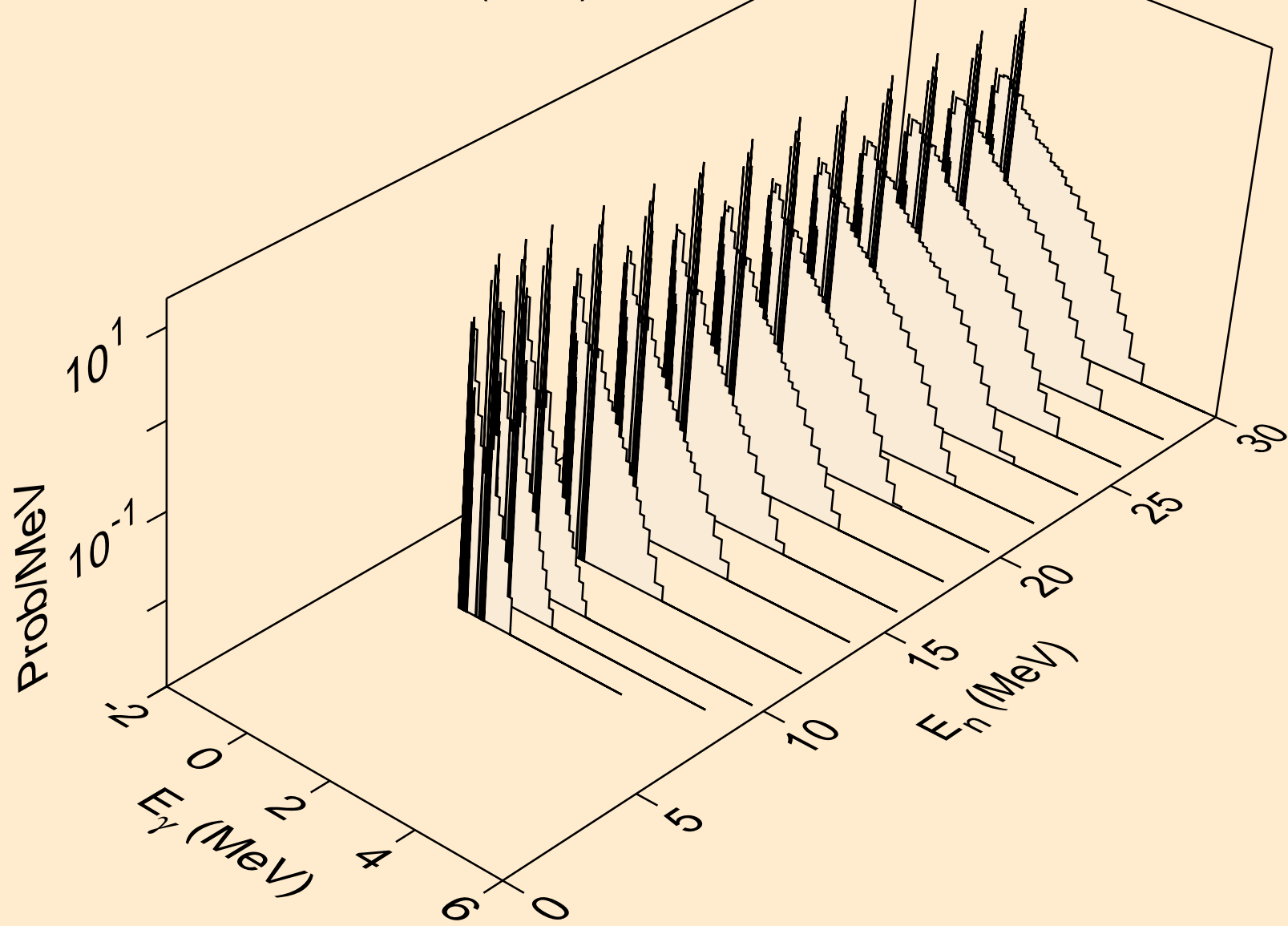

LU186 TRITON ACER TENDL-2023 LIBRARY; T=0.K  
Photon emission for (n,3n)a

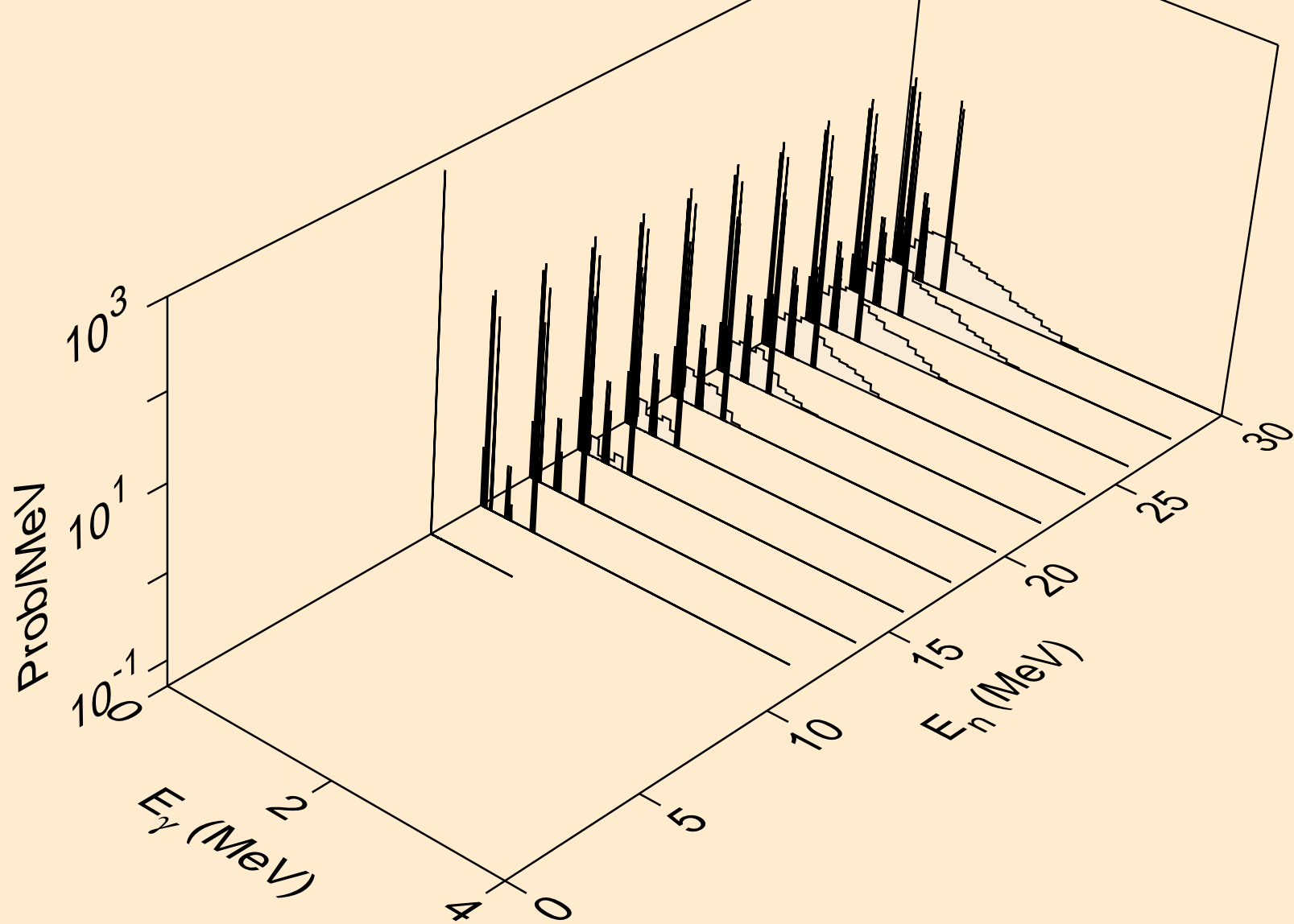

LU186 TRITON ACER TENDL-2023 LIBRARY; T=0.K  
Photon emission for (n,n\*)p

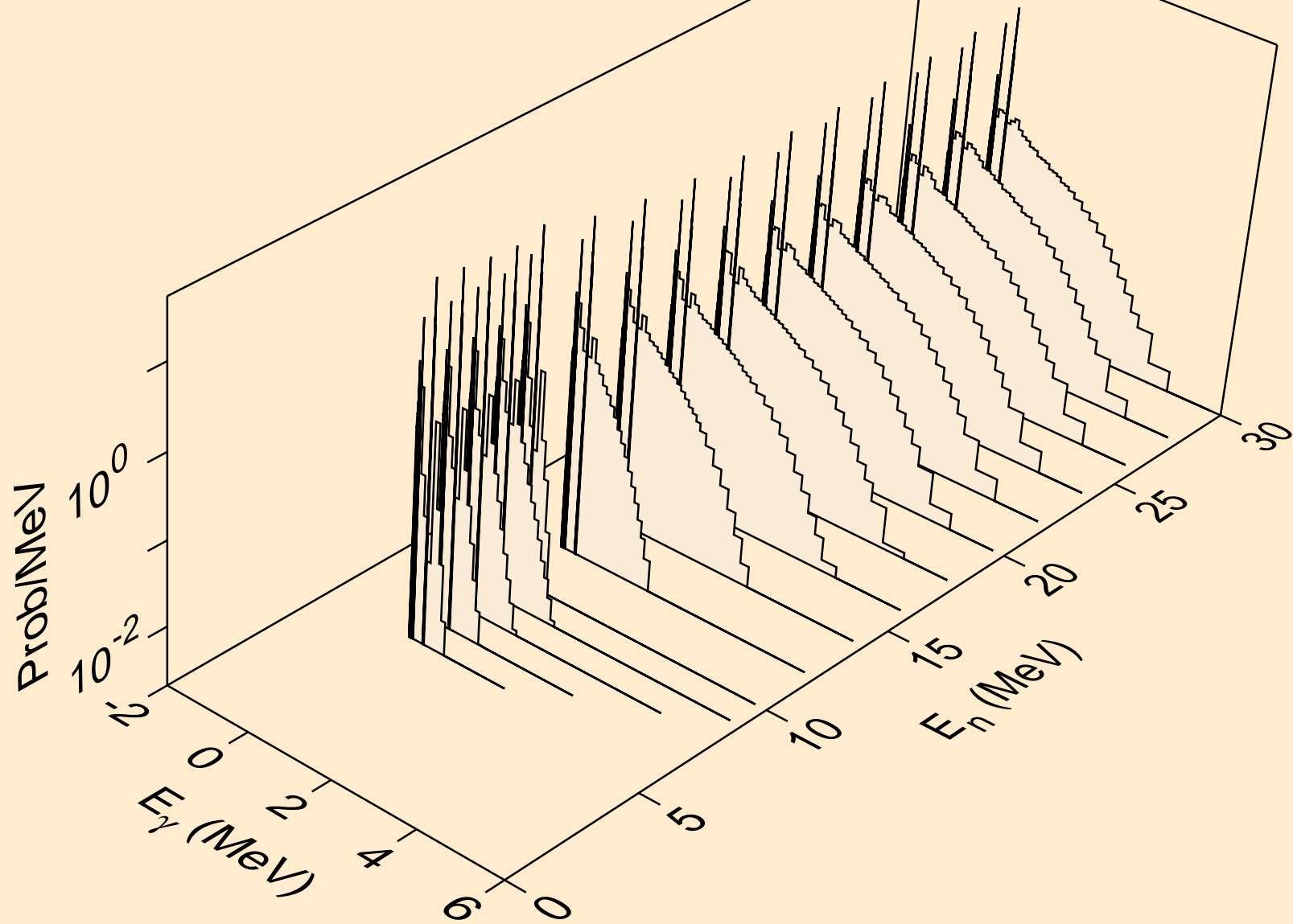

LU186 TRITON ACER TENDL-2023 LIBRARY; T=0.K  
Photon emission for (n,n\*)d

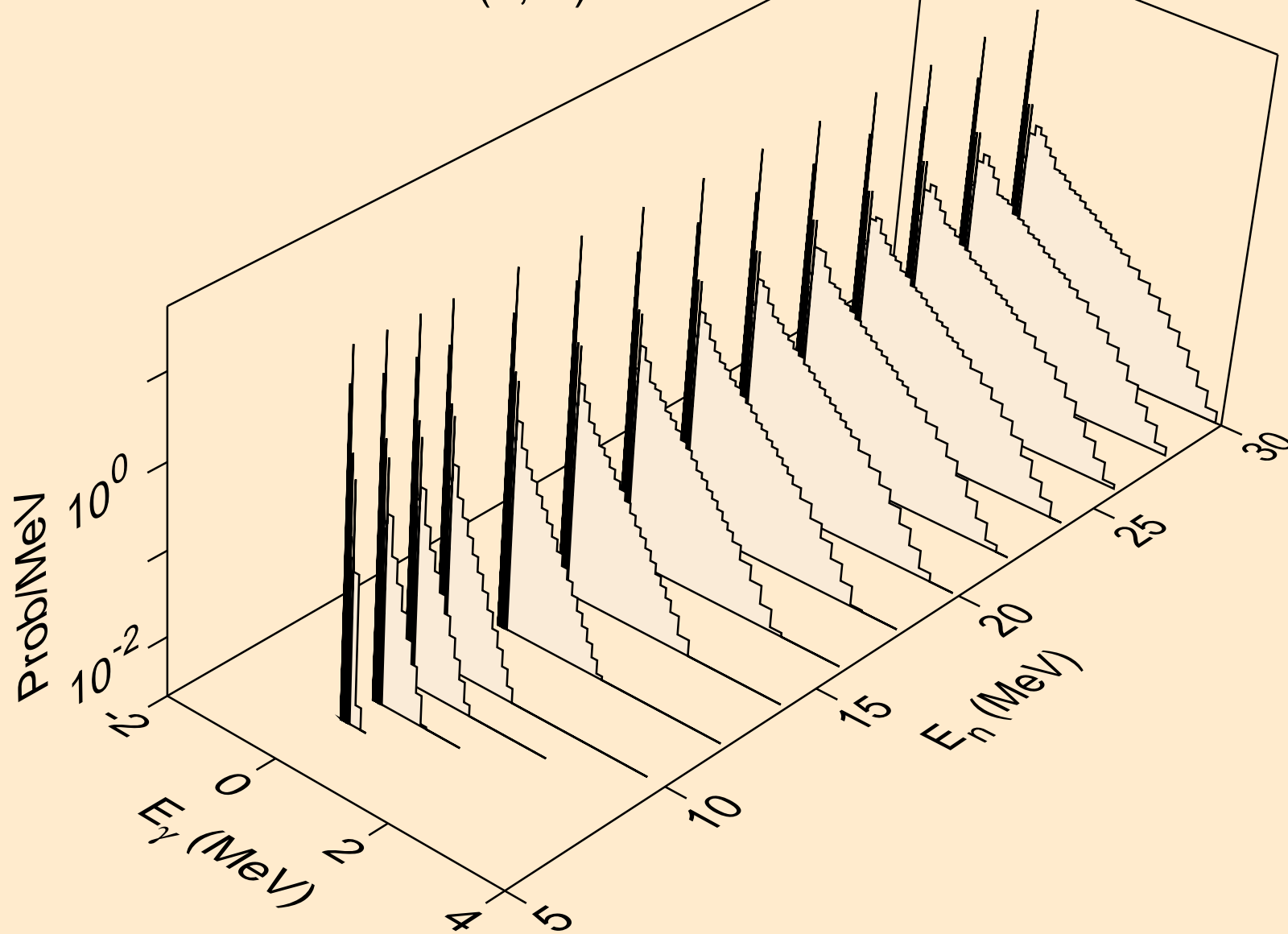

LU186 TRITON ACER TENDL-2023 LIBRARY; T=0.K  
Photon emission for (n,n\*)t

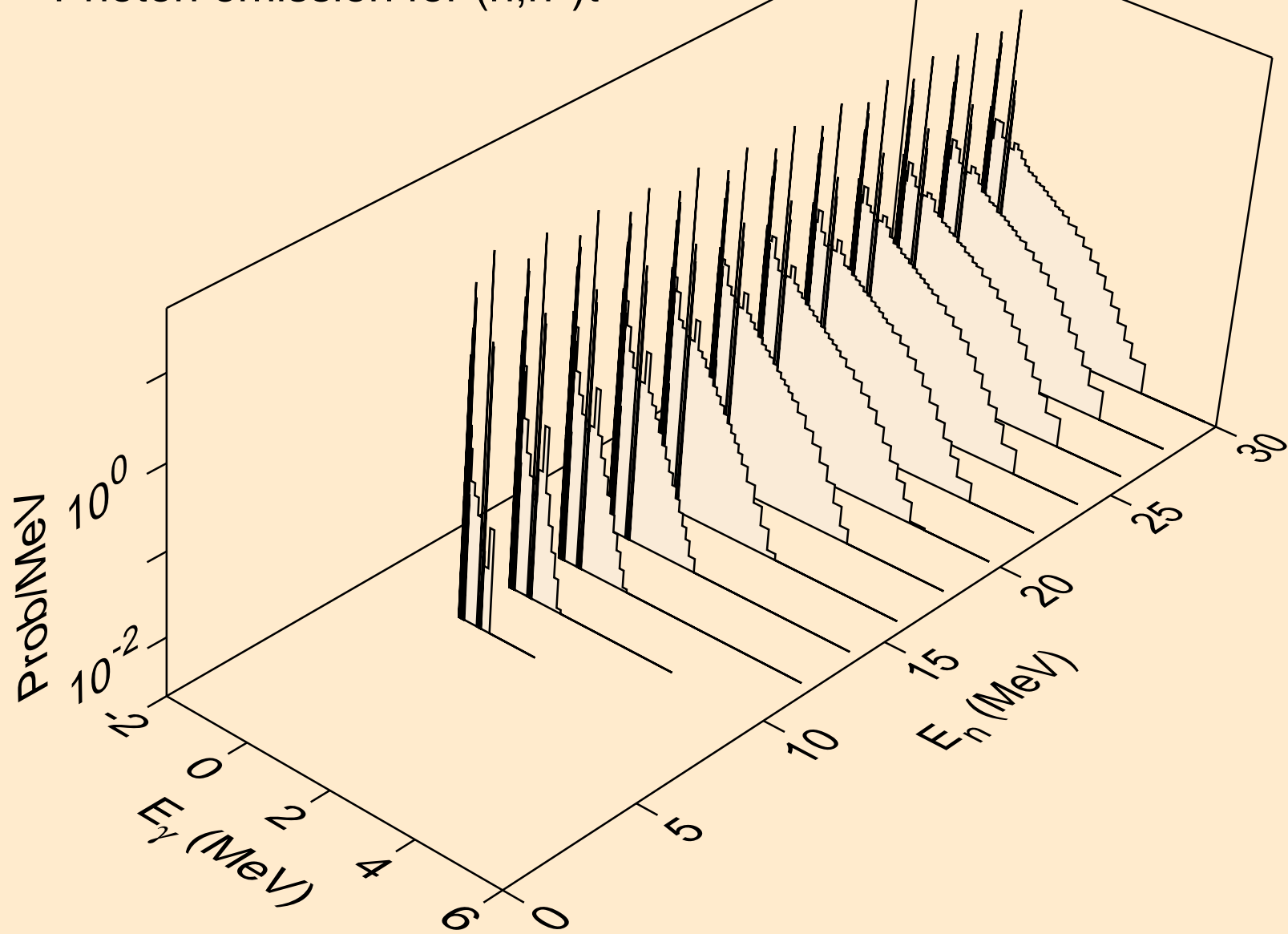

LU186 TRITON ACER TENDL-2023 LIBRARY; T=0.K  
Photon emission for (n,n\*)he3

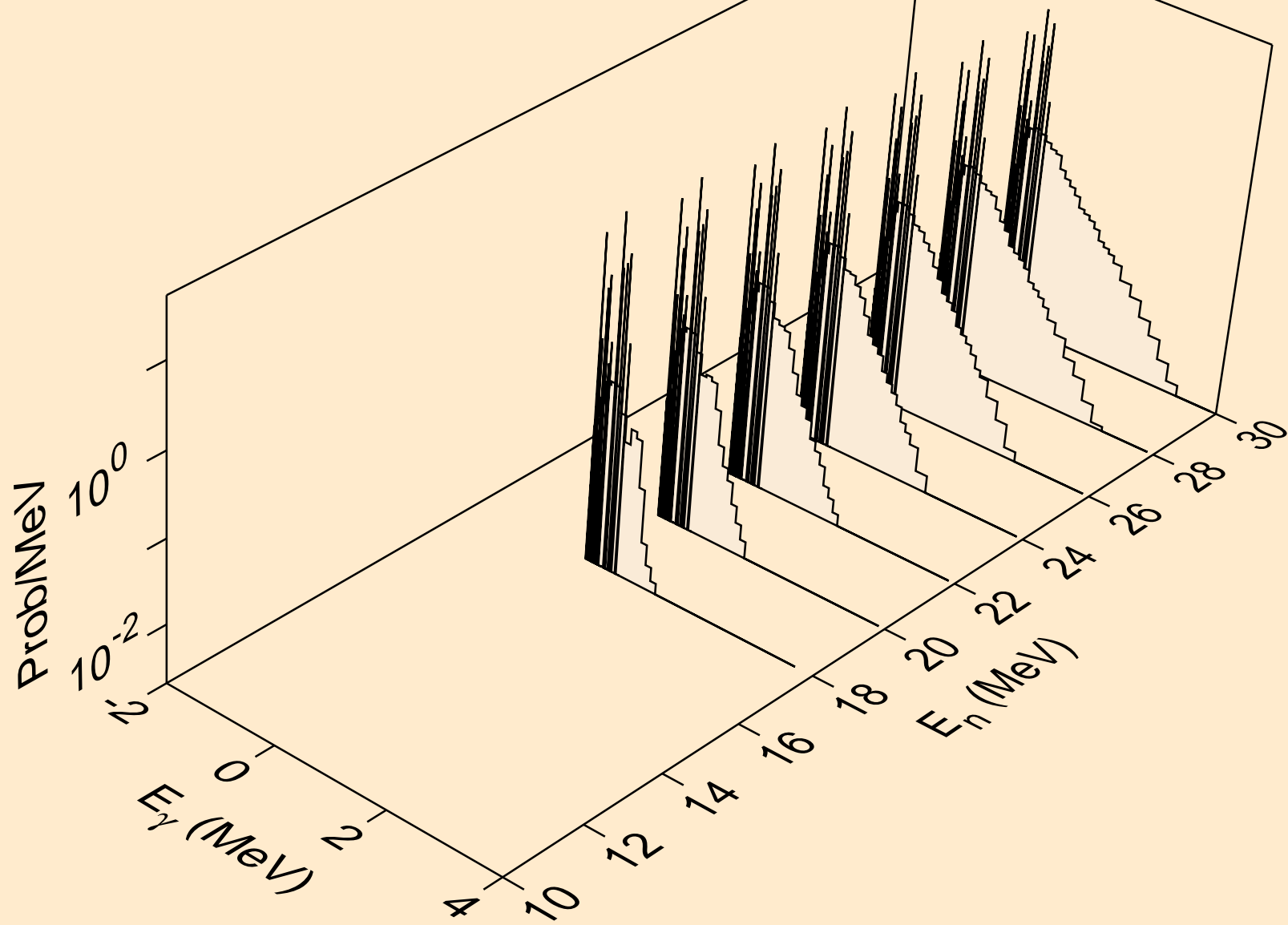

LU186 TRITON ACER TENDL-2023 LIBRARY; T=0.K  
Photon emission for (n,4n)

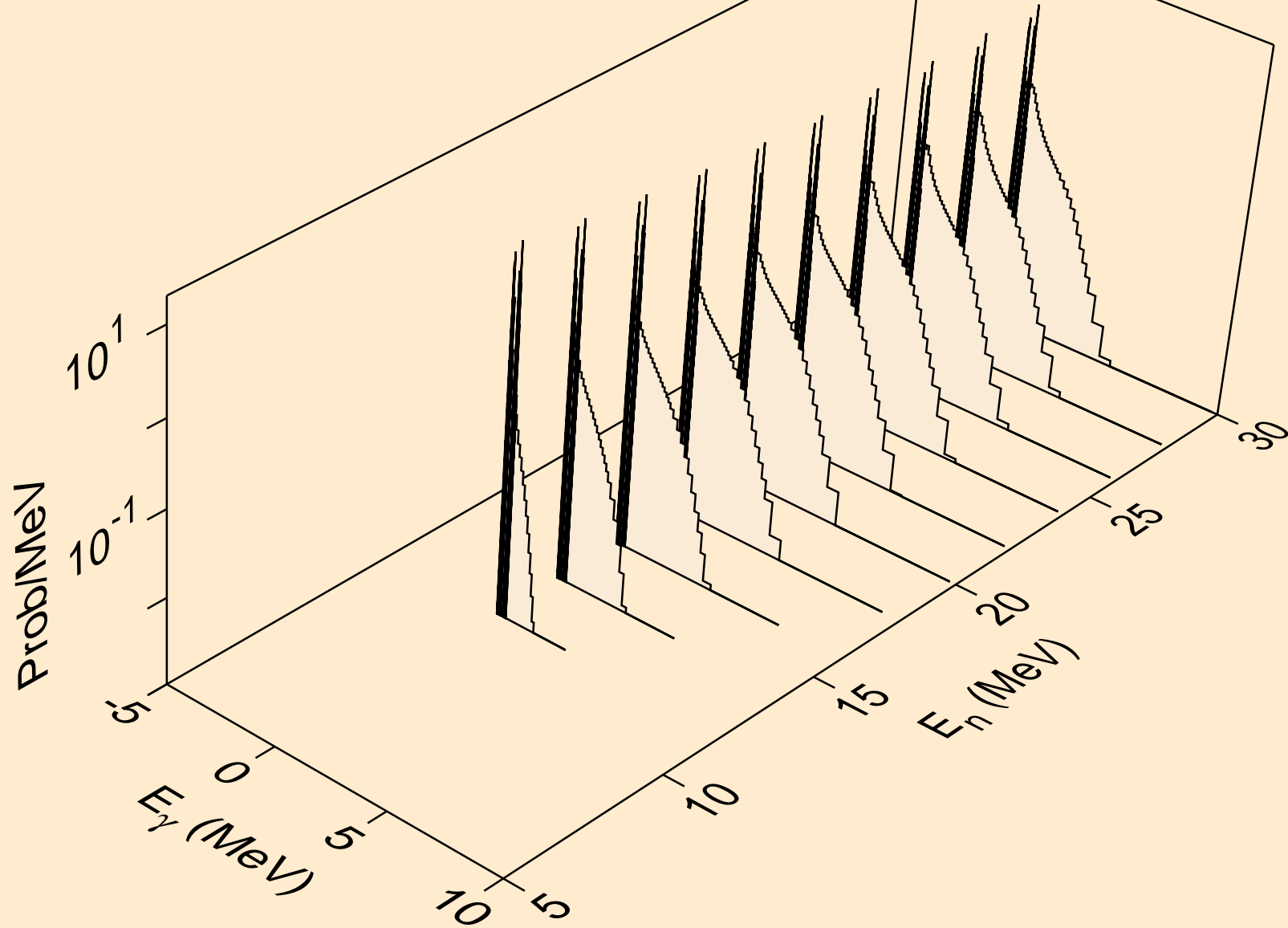

LU186 TRITON ACER TENDL-2023 LIBRARY; T=0.K  
Photon emission for (n,2np)

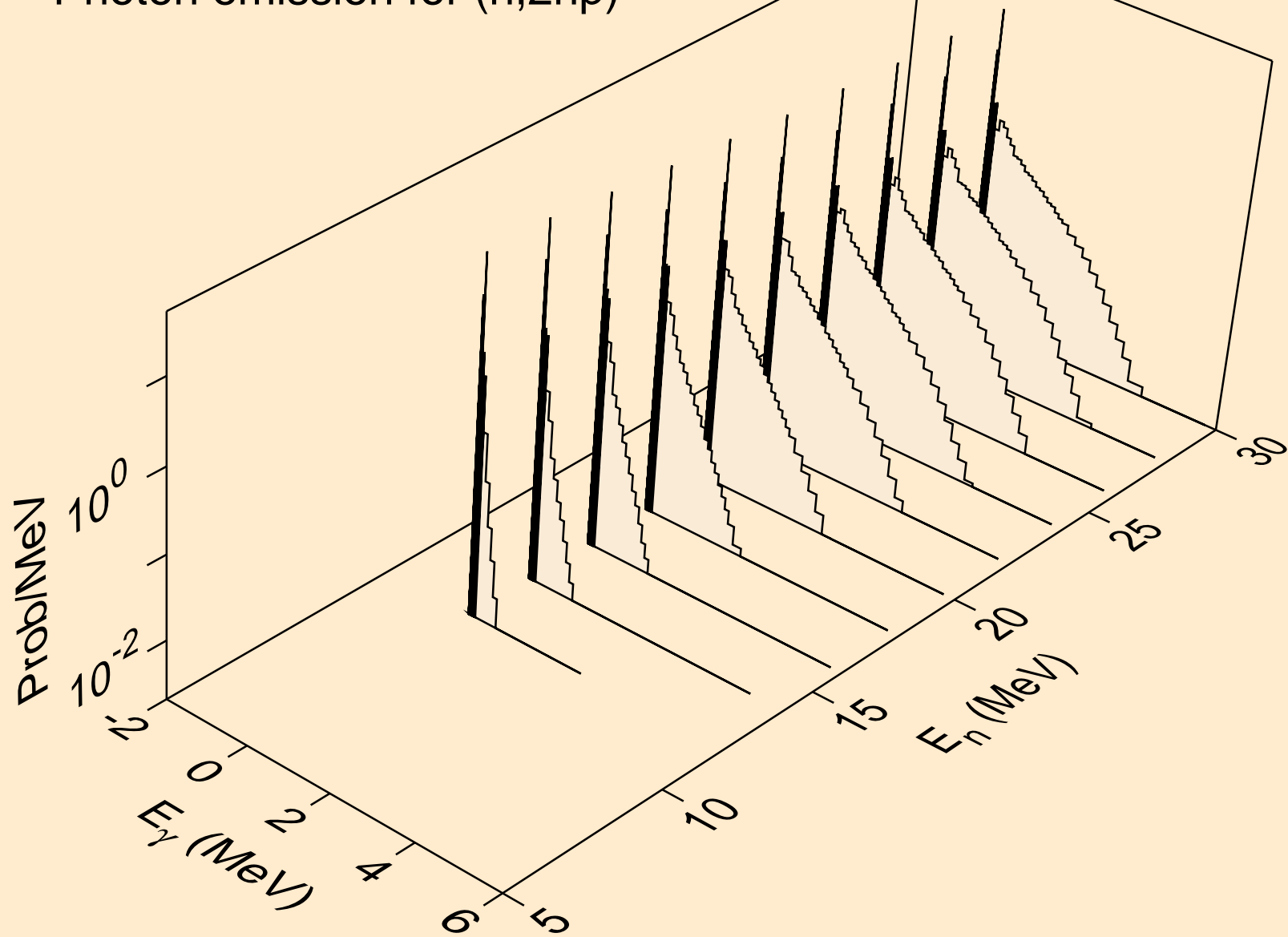

LU186 TRITON ACER TENDL-2023 LIBRARY; T=0.K  
Photon emission for (n,3np)

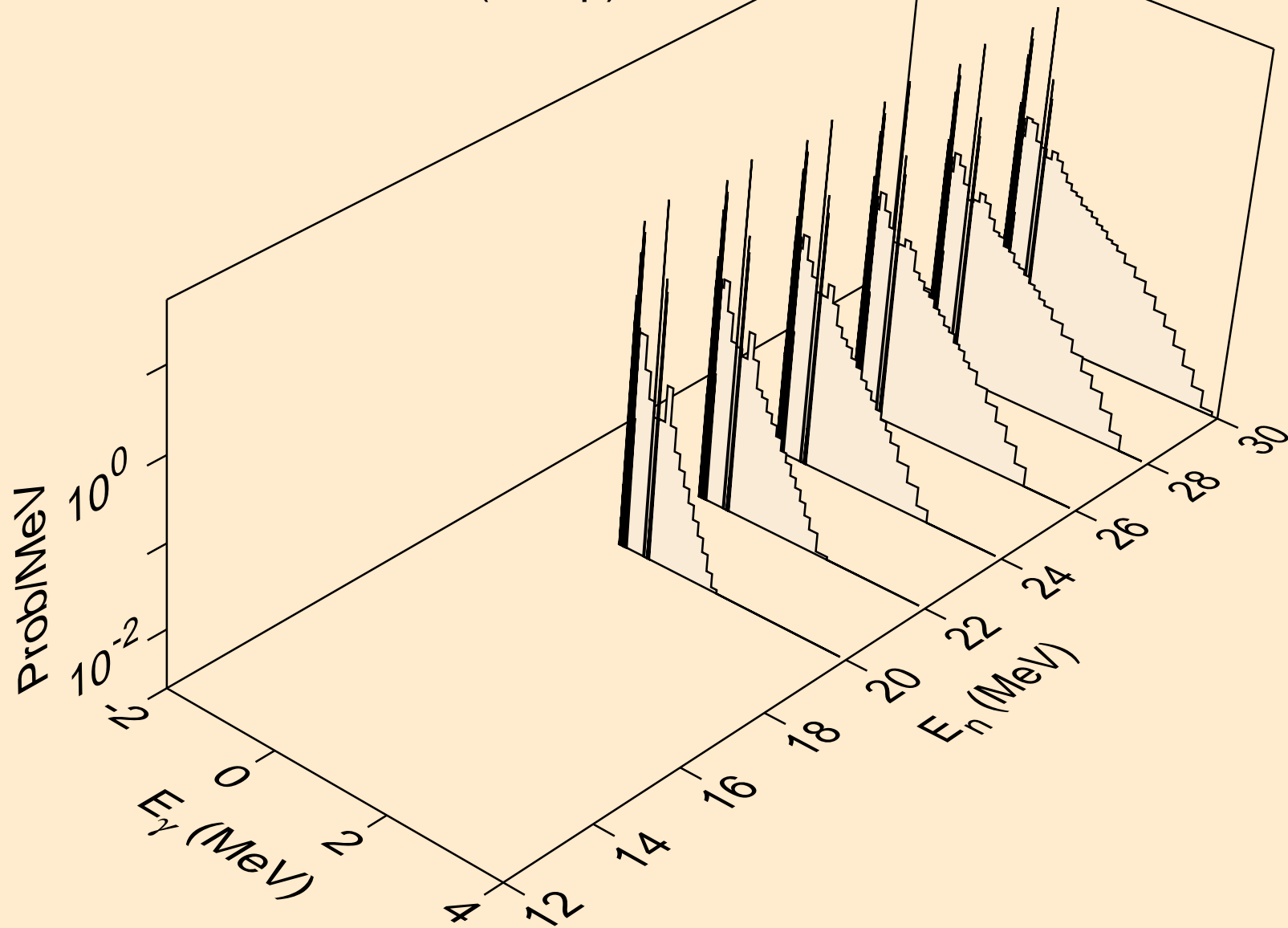

LU186 TRITON ACER TENDL-2023 LIBRARY; T=0.K  
Photon emission for (n,n2p)

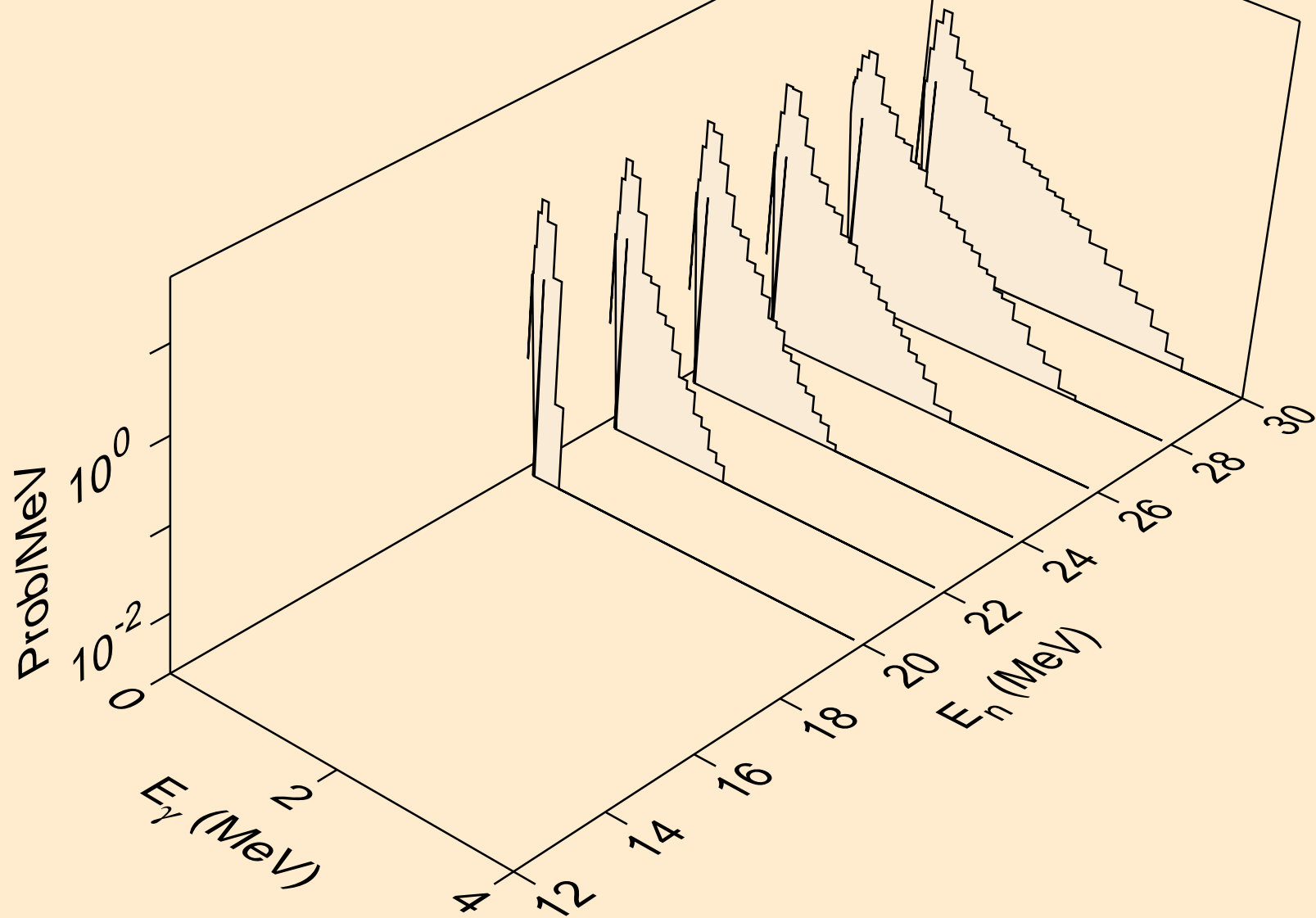

LU186 TRITON ACER TENDL-2023 LIBRARY; T=0.K  
Photon emission for (n,gma)

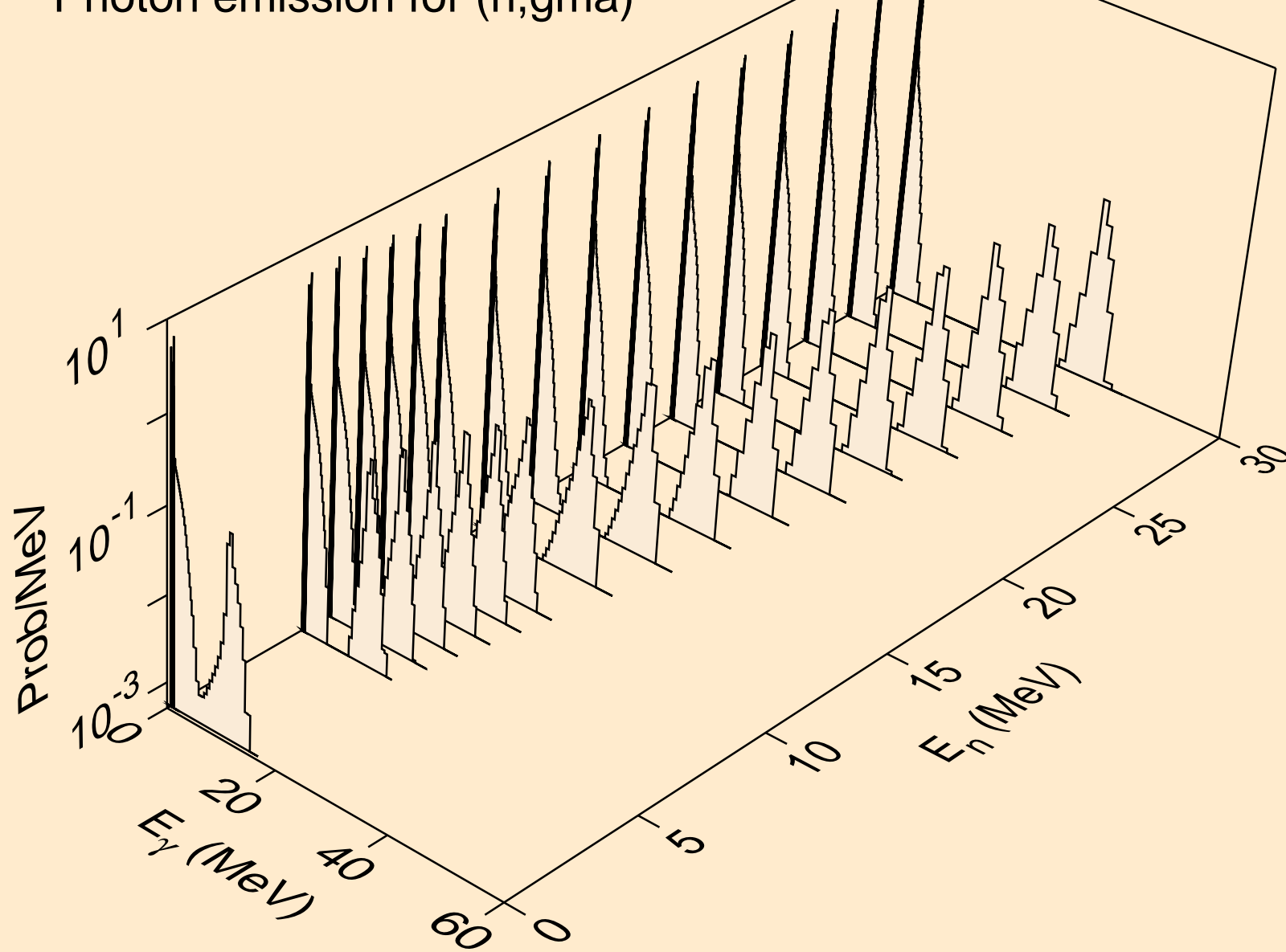

LU186 TRITON ACER TENDL-2023 LIBRARY; T=0.K  
Photon emission for (n,p)

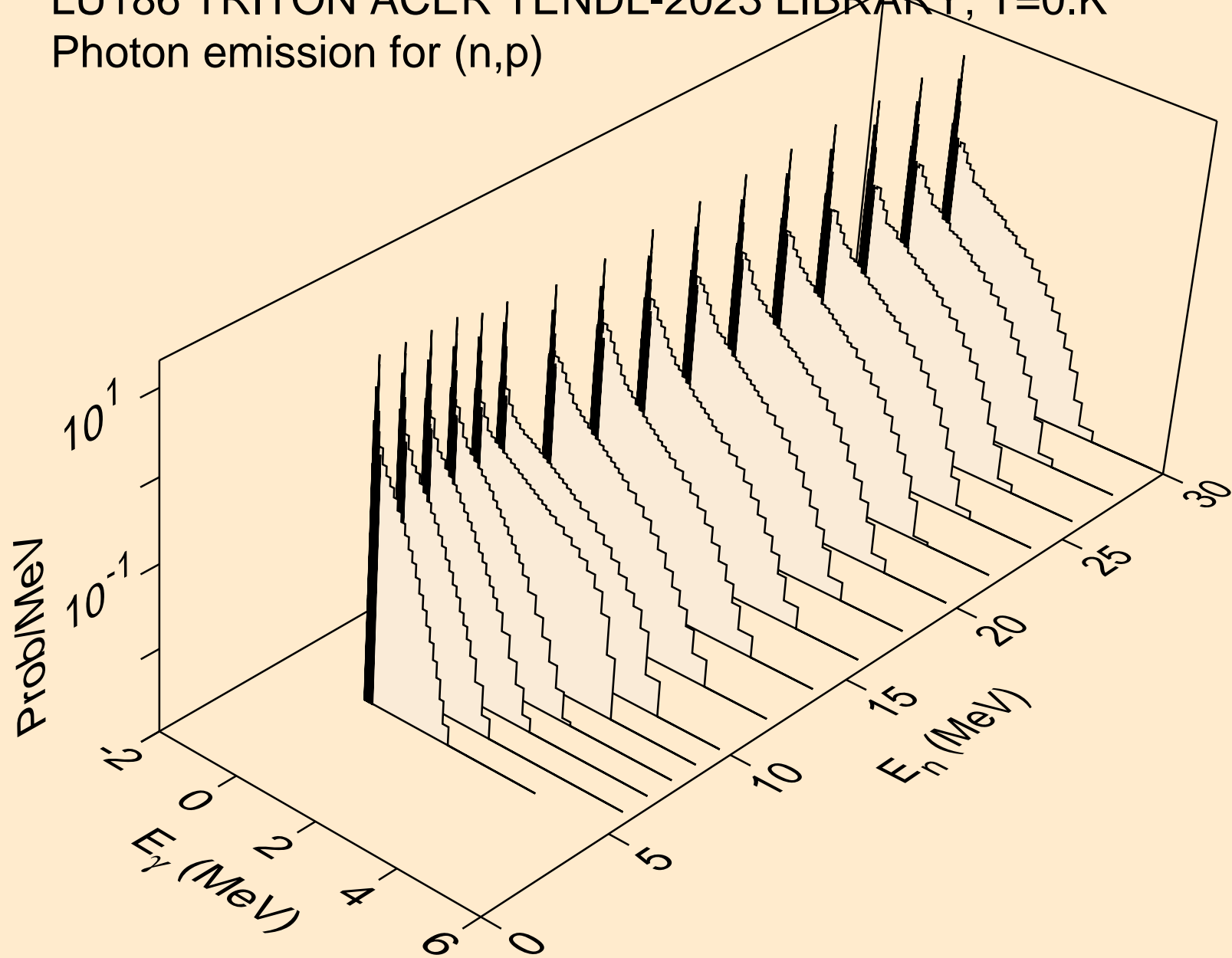

LU186 TRITON ACER TENDL-2023 LIBRARY; T=0.K  
Photon emission for (n,d)

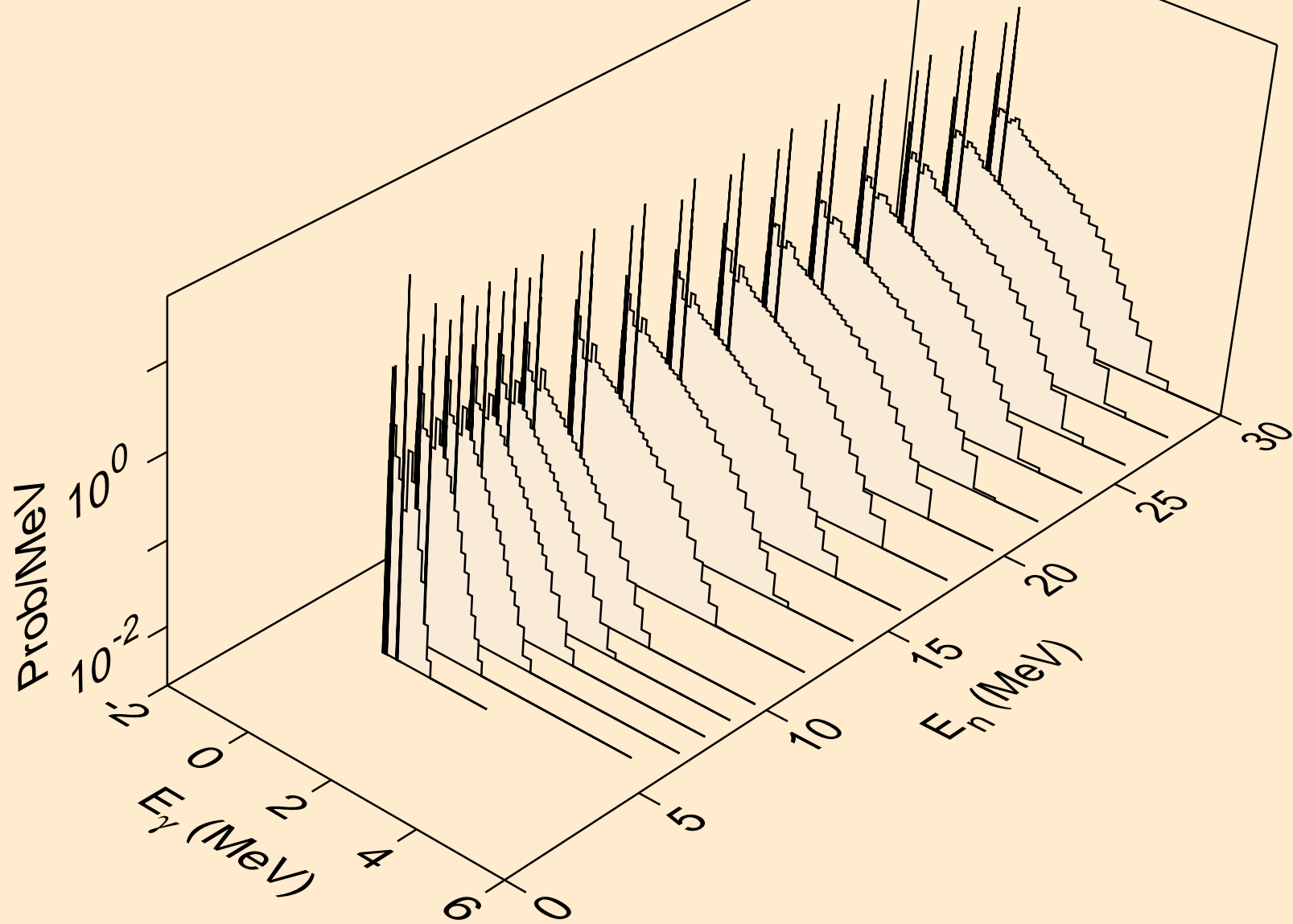

LU186 TRITON ACER TENDL-2023 LIBRARY; T=0.K  
Photon emission for inelastic

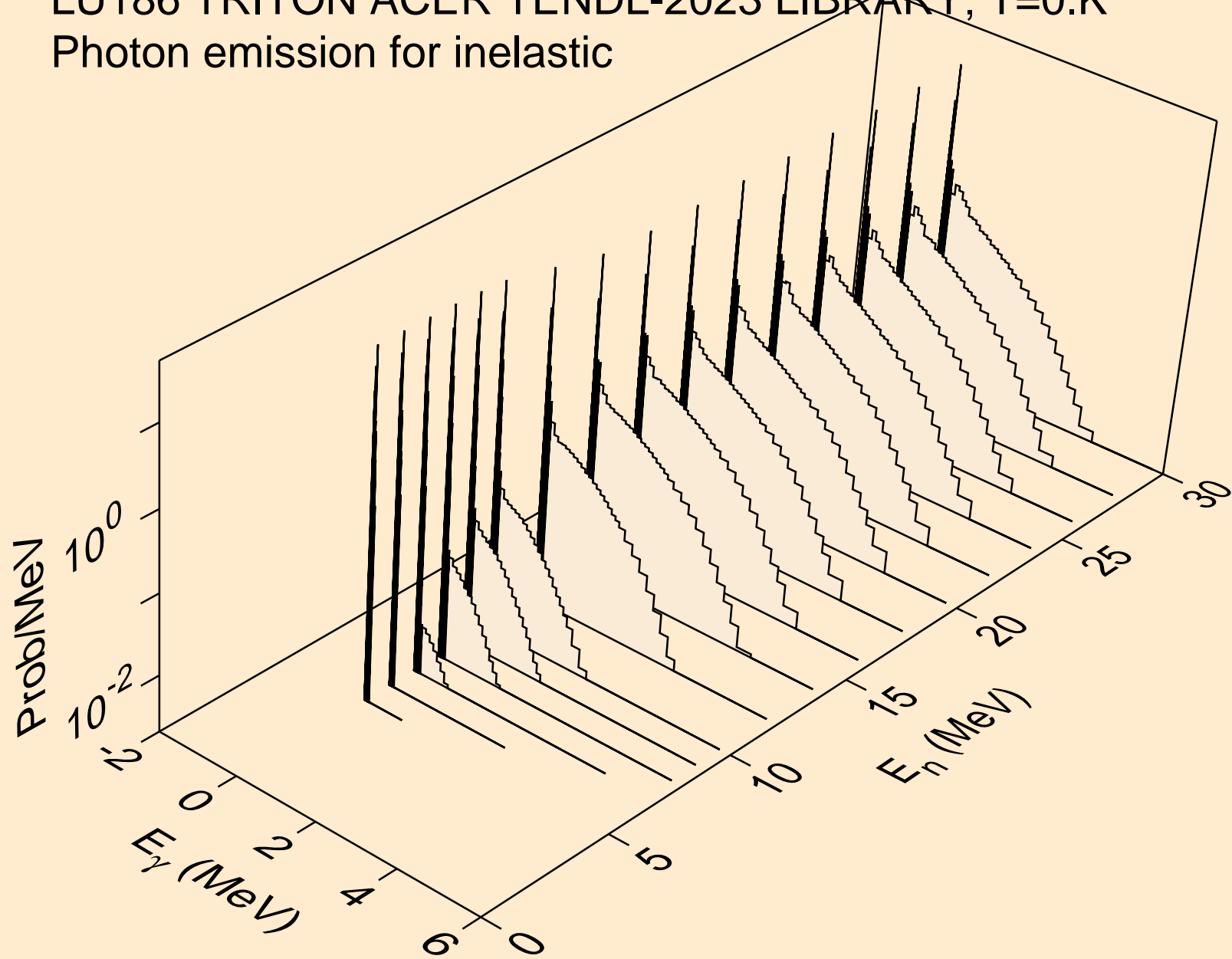

LU186 TRITON ACER TENDL-2023 LIBRARY; T=0.K  
Photon emission for (n,he3)

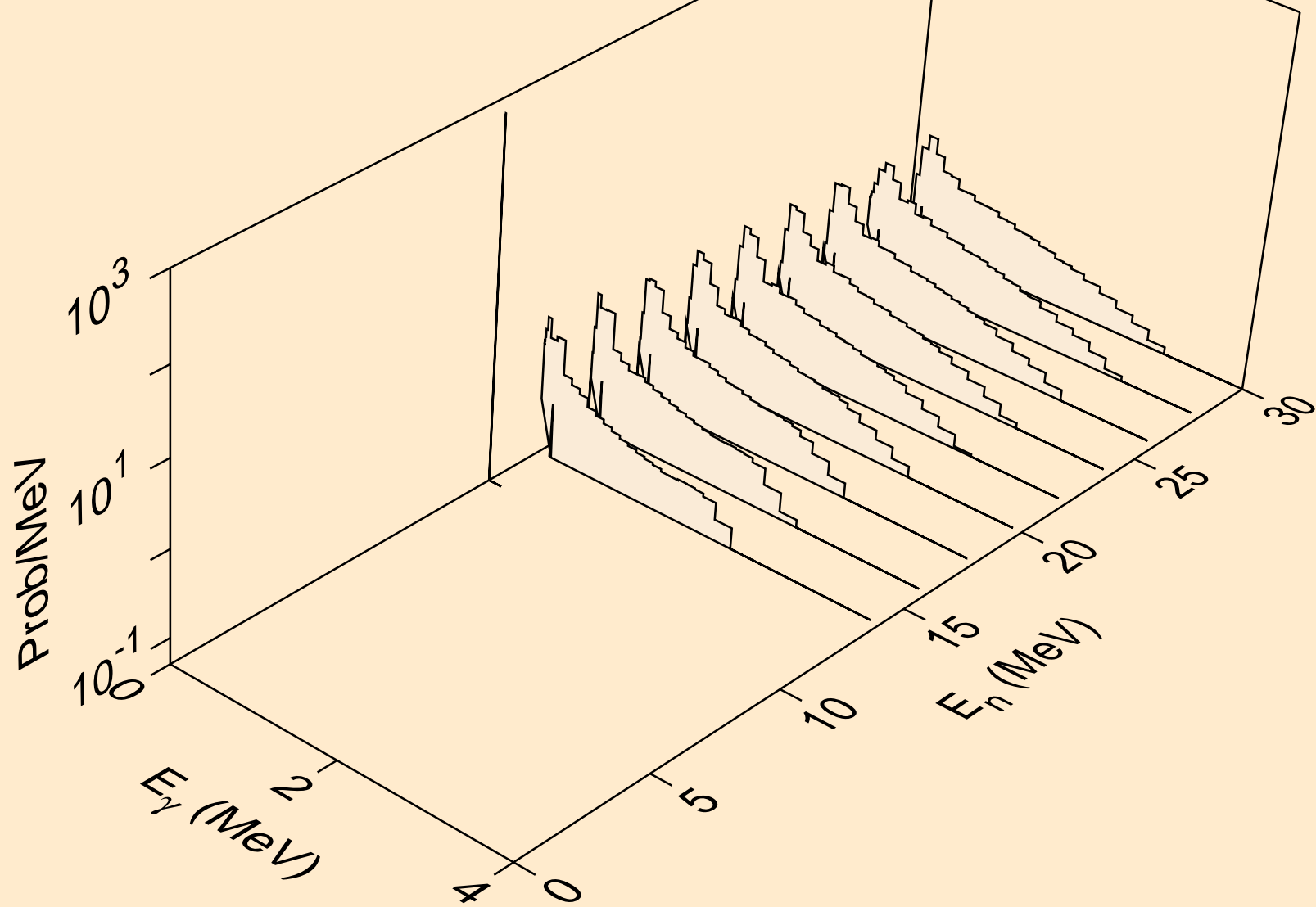

LU186 TRITON ACER TENDL-2023 LIBRARY; T=0.K  
Photon emission for (n,a)

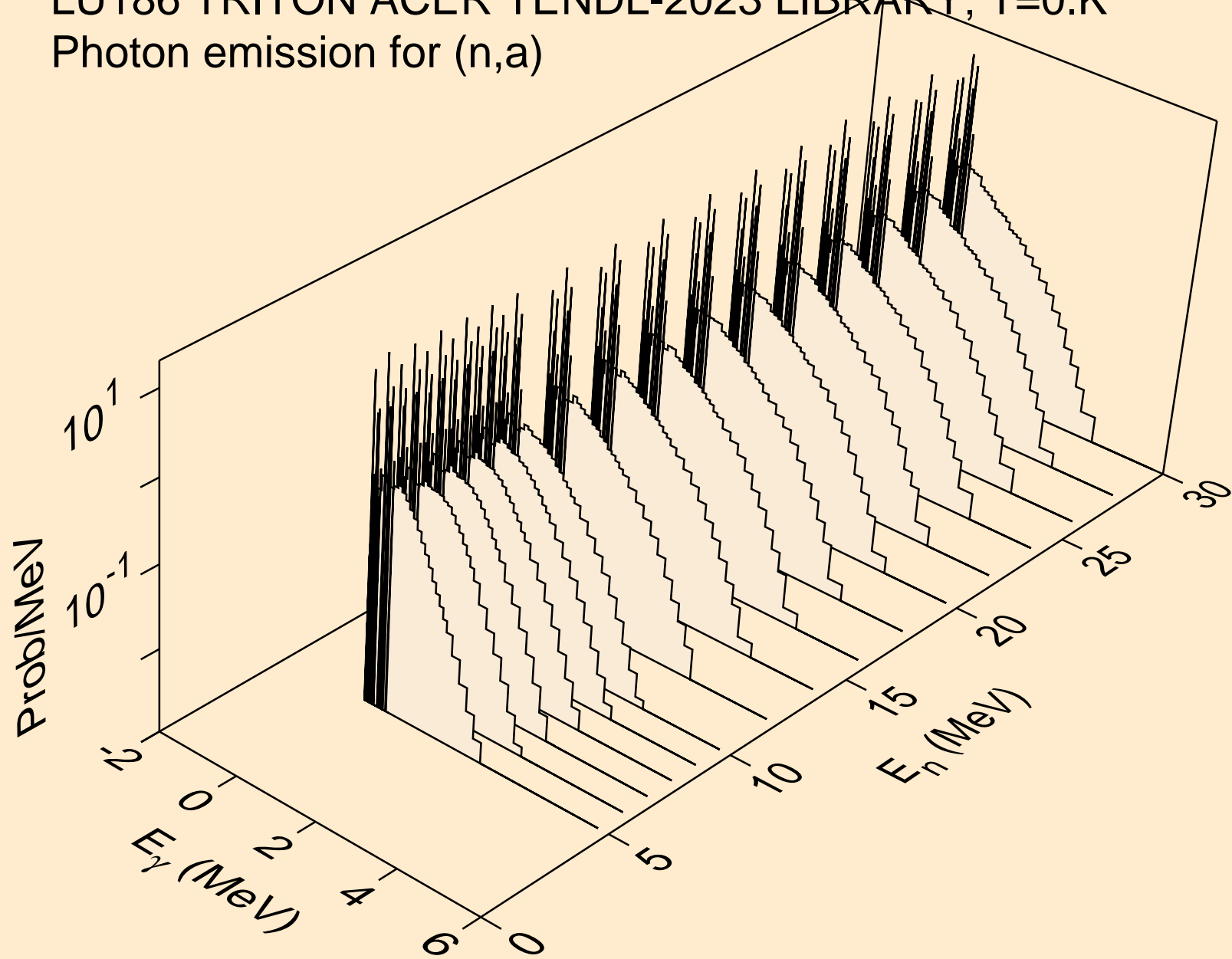

LU186 TRITON ACER TENDL-2023 LIBRARY; T=0.K  
Photon emission for (n,2p)

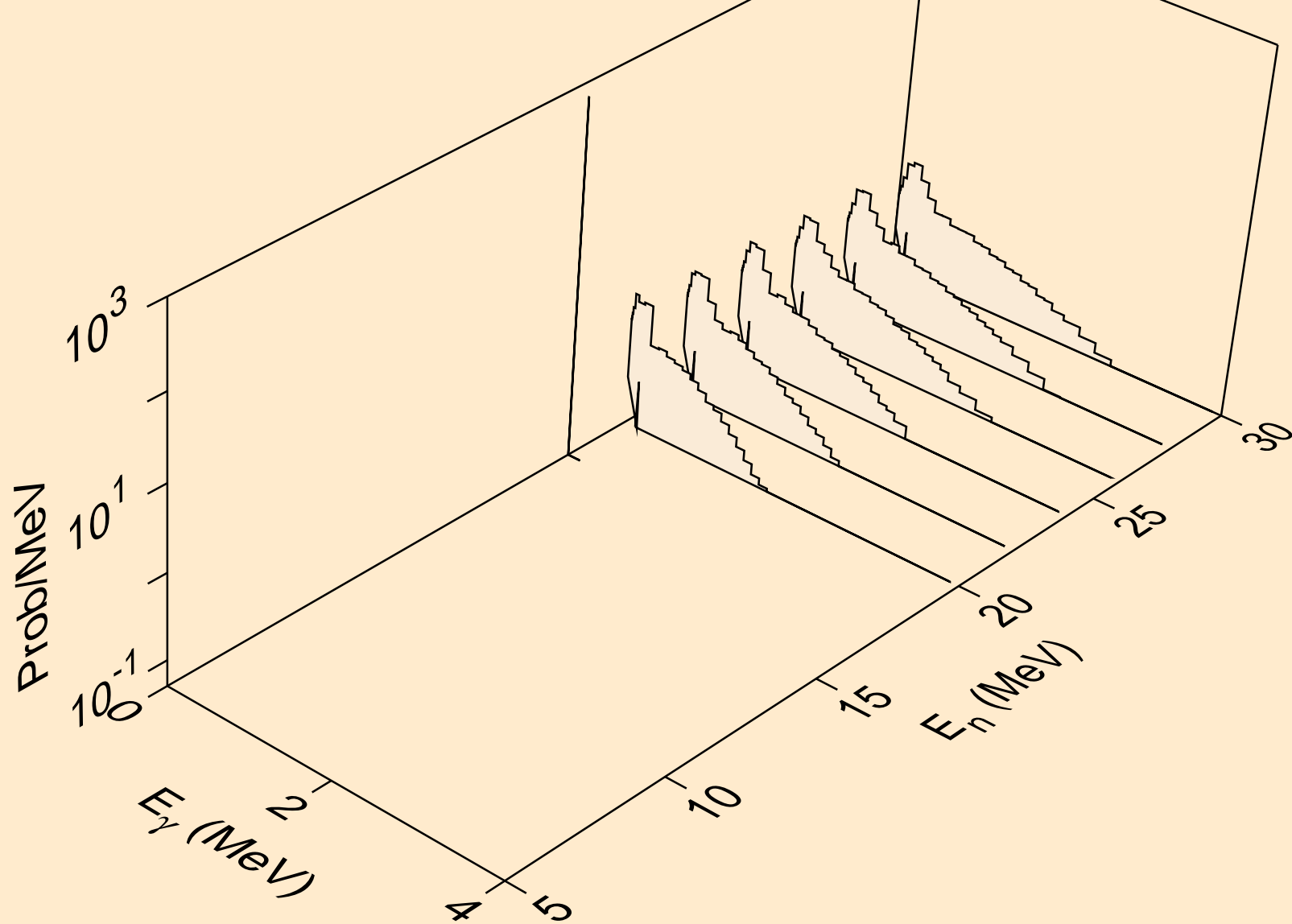

LU186 TRITON ACER TENDL-2023 LIBRARY; T=0.K  
Photon emission for (n,pd)

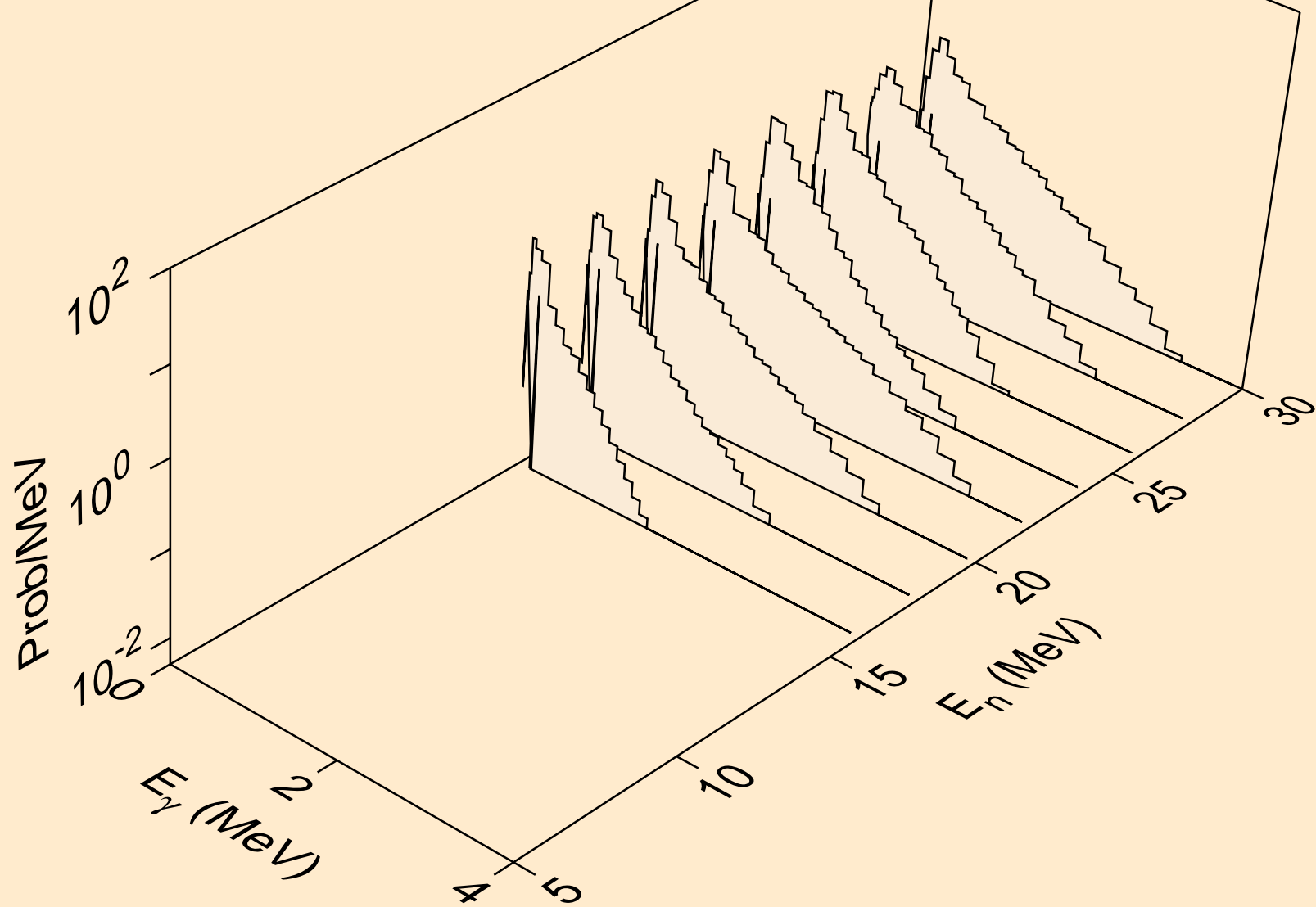

LU186 TRITON ACER TENDL-2023 LIBRARY; T=0.K  
Particle heating contributions

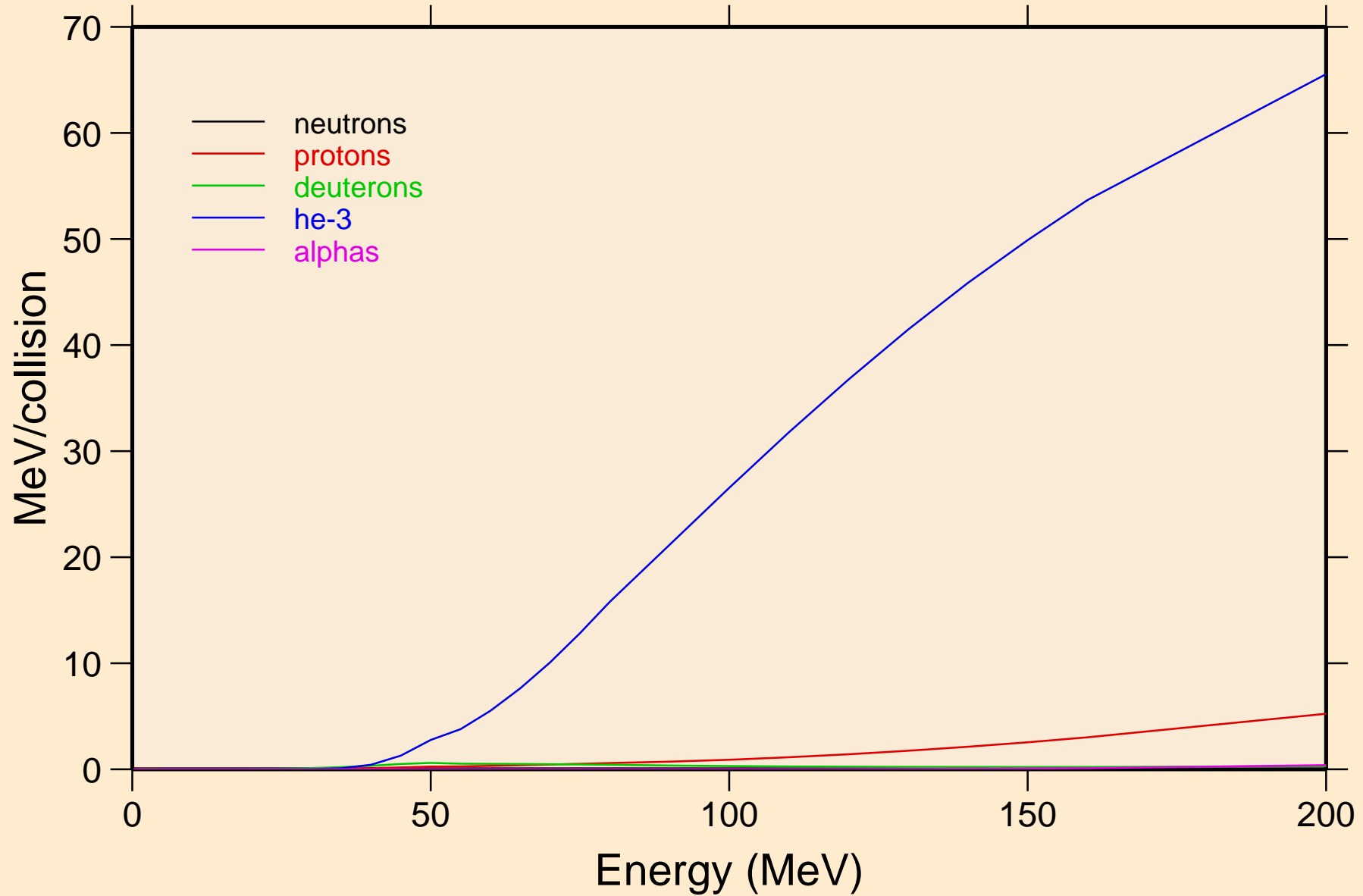

LU186 TRITON ACER TENDL-2023 LIBRARY; T=0.K  
Recoil Heating

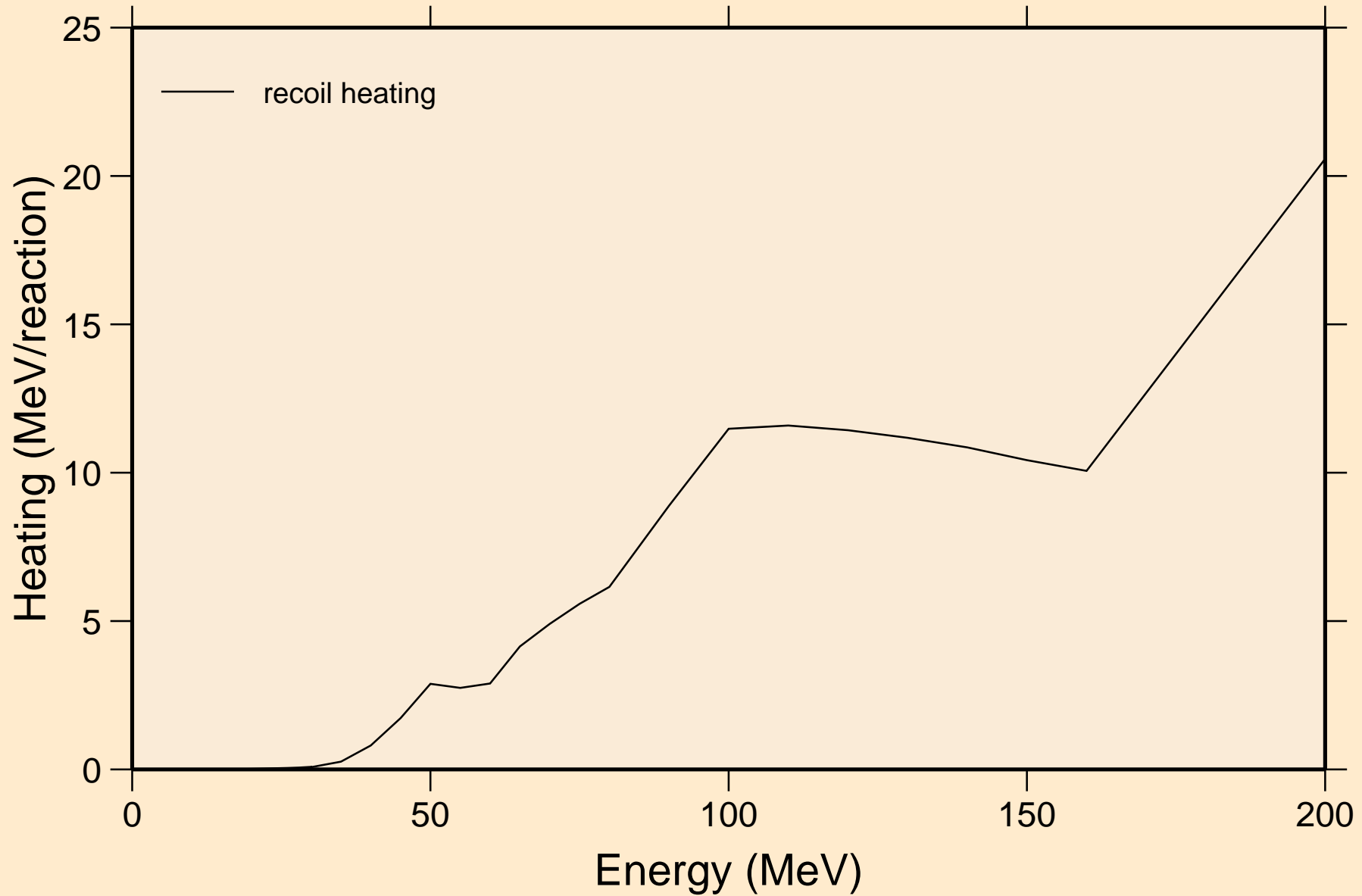

LU186 TRITON ACER TENDL-2023 LIBRARY; T=0.K  
Particle production cross sections

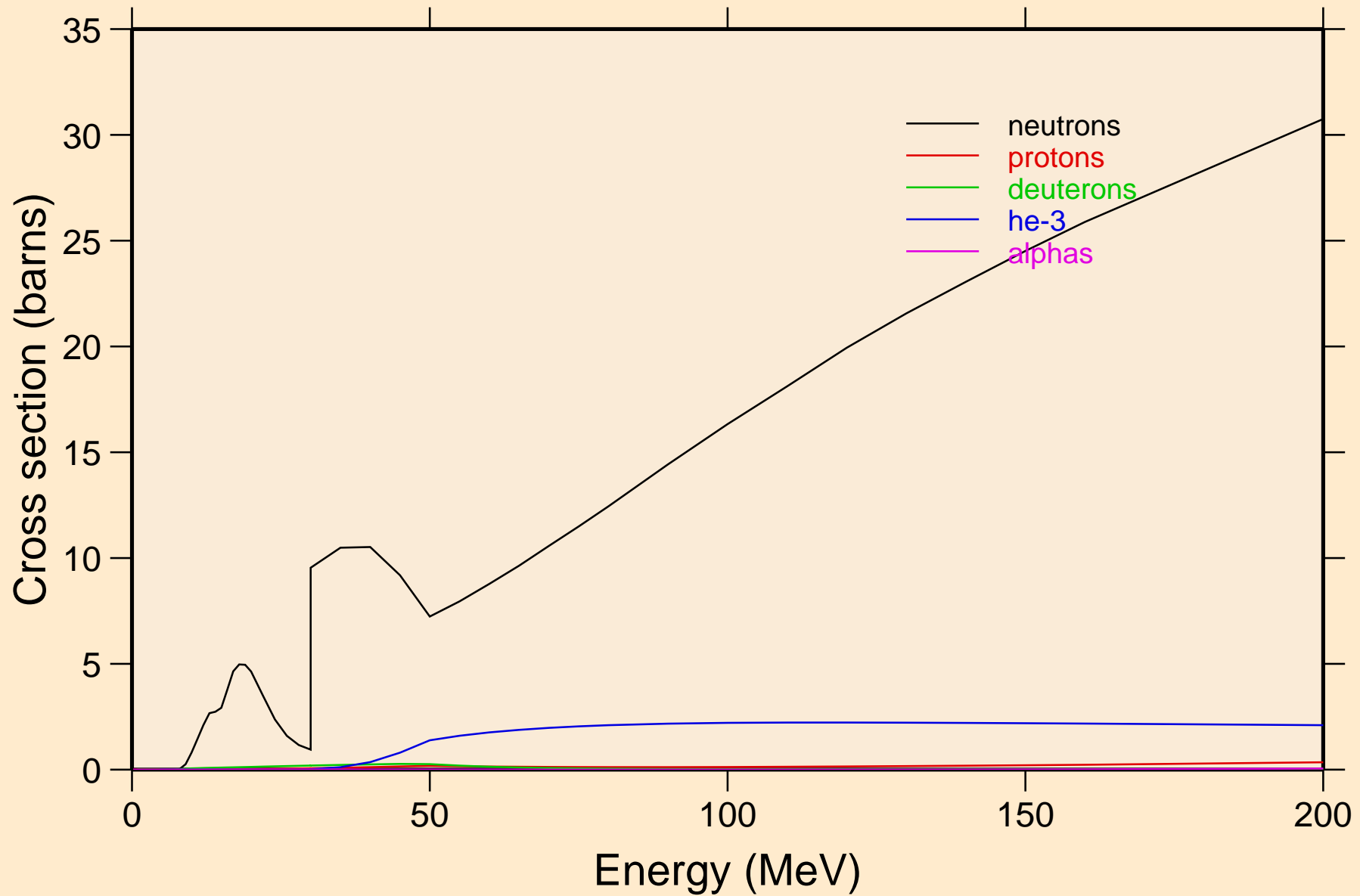

LU186 TRITON ACER TENDL-2023 LIBRARY; T=0.K  
neutrons from (t,n)

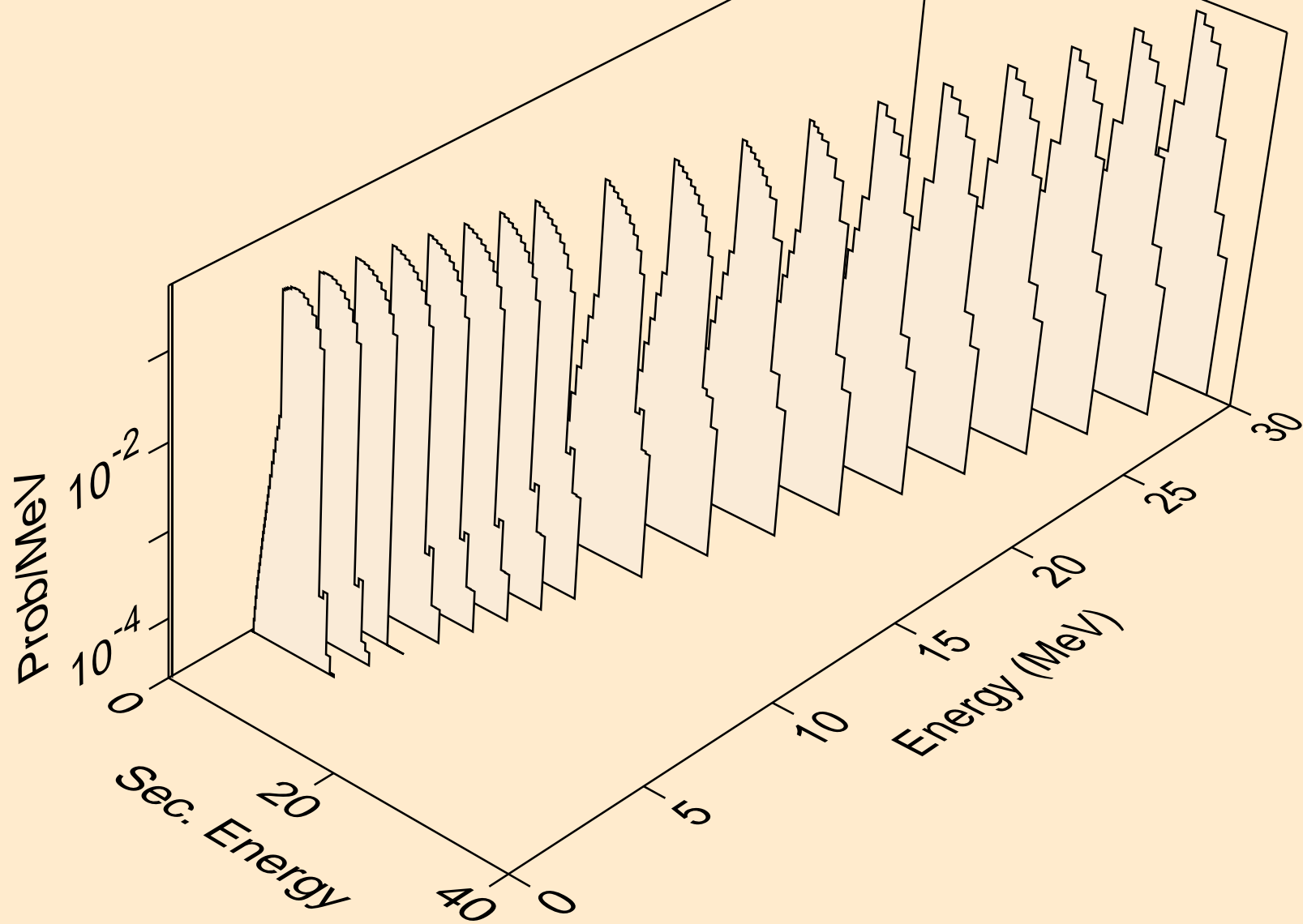

LU186 TRITON ACER TENDL-2023 LIBRARY; T=0.K  
neutrons from (t,x)

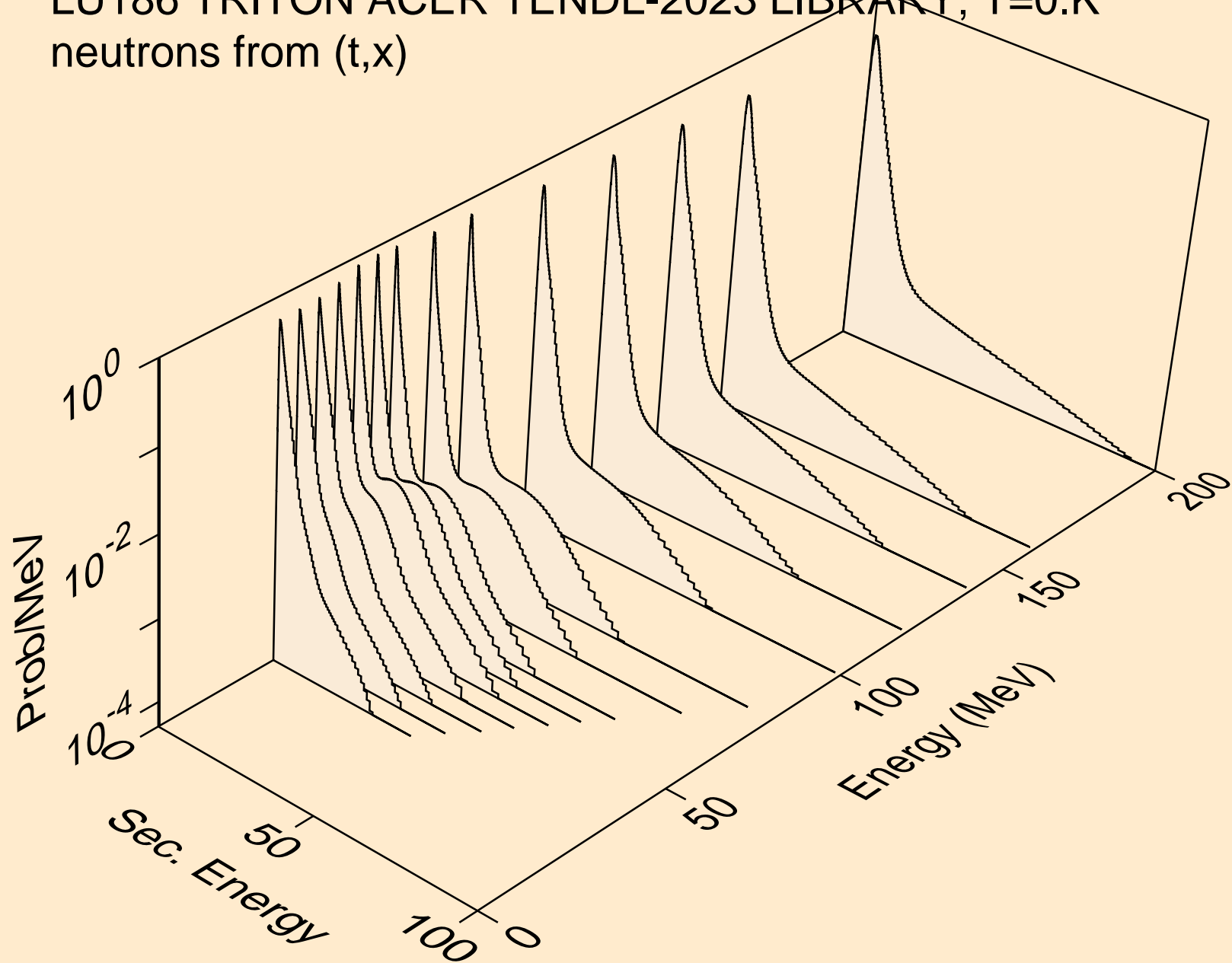

LU186 TRITON ACER TENDL-2023 LIBRARY; T=0.K  
neutrons from (t,2nd)

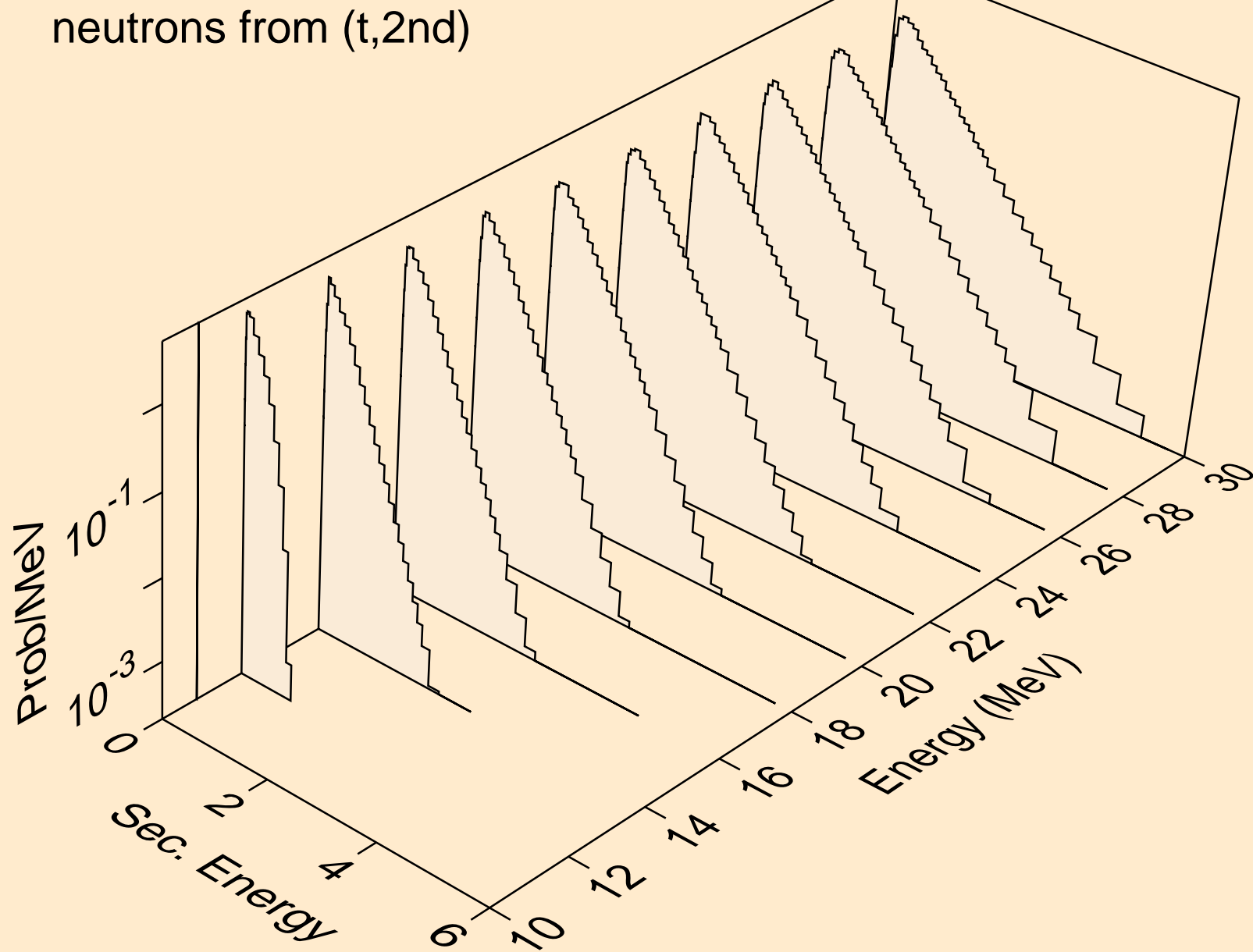

LU186 TRITON ACER TENDL-2023 LIBRARY; T=0.K  
neutrons from (t,2n)

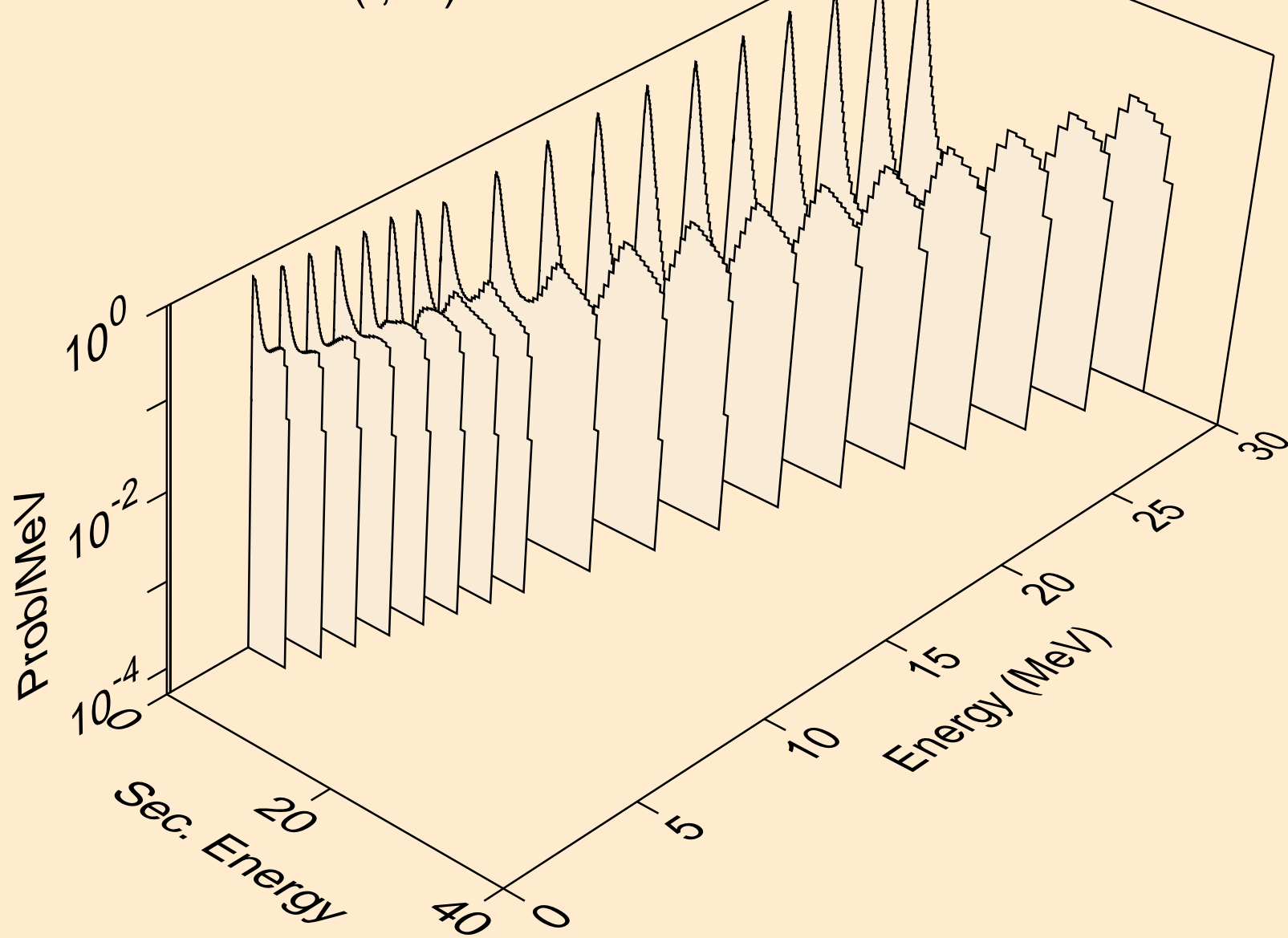

LU186 TRITON ACER TENDL-2023 LIBRARY; T=0.K  
neutrons from (t,3n)

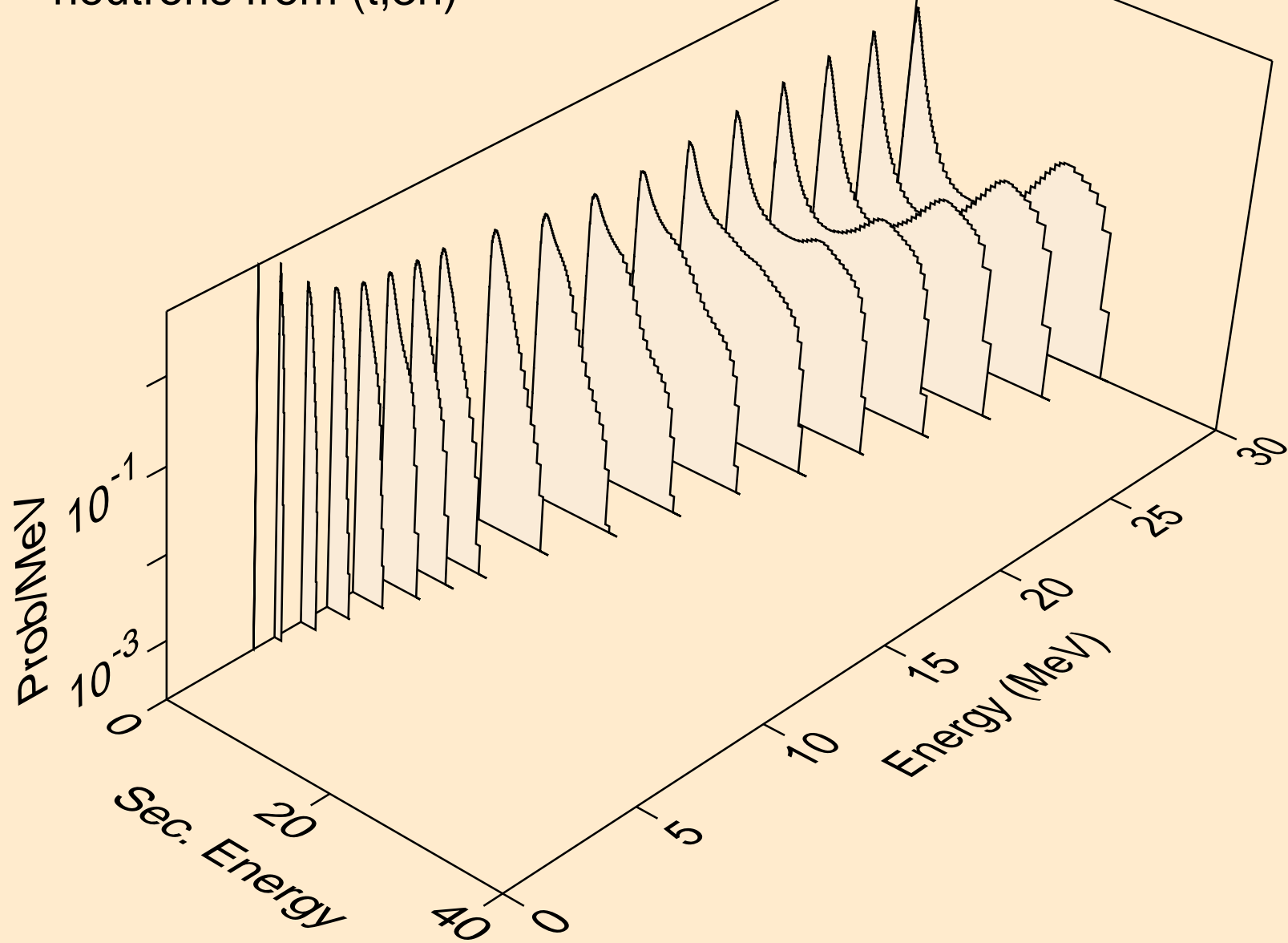

LU186 TRITON ACER TENDL-2023 LIBRARY; T=0.K  
neutrons from (t,n\*)a

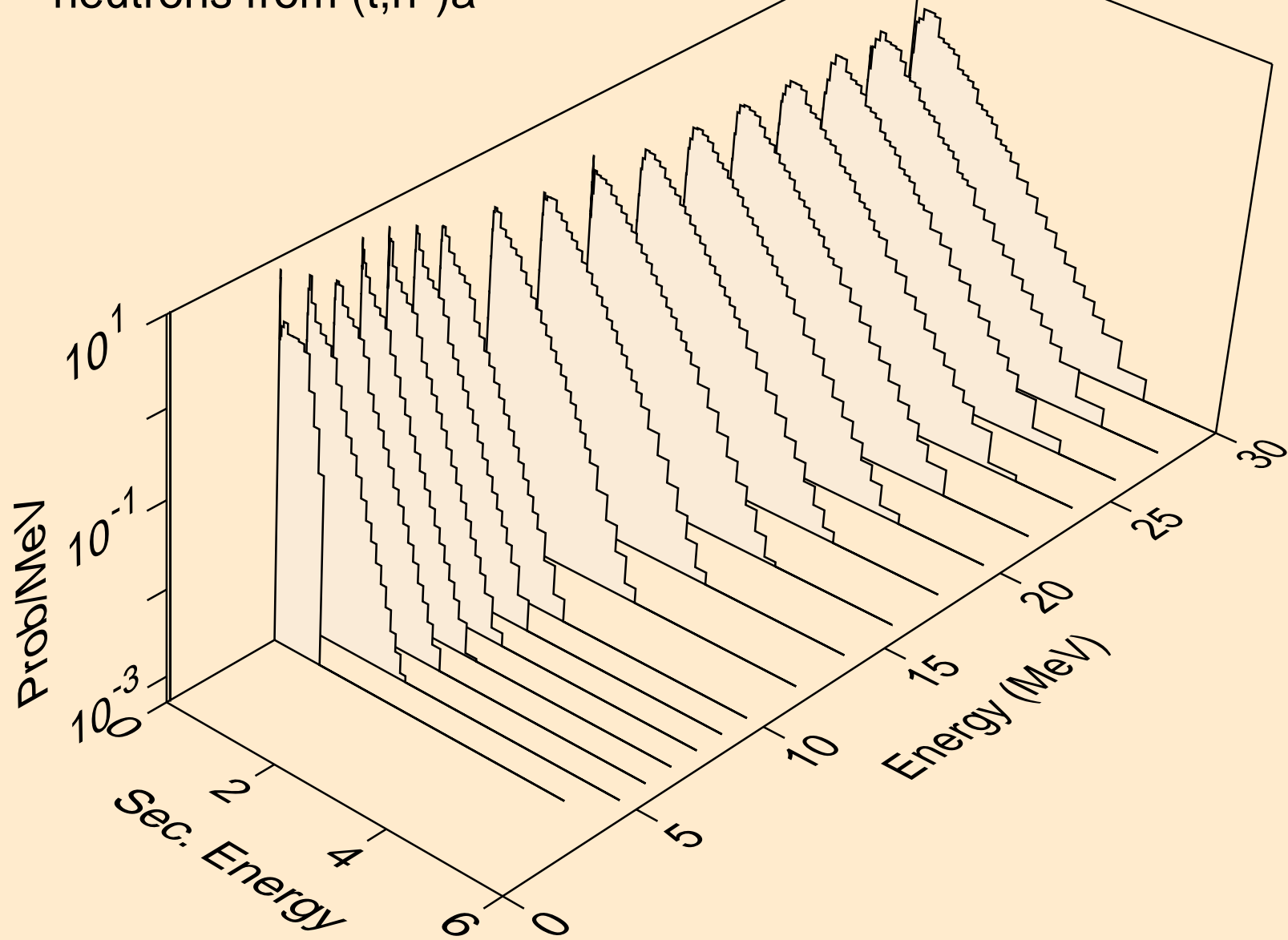

LU186 TRITON ACER TENDL-2023 LIBRARY; T=0.K  
neutrons from (t,2n)a

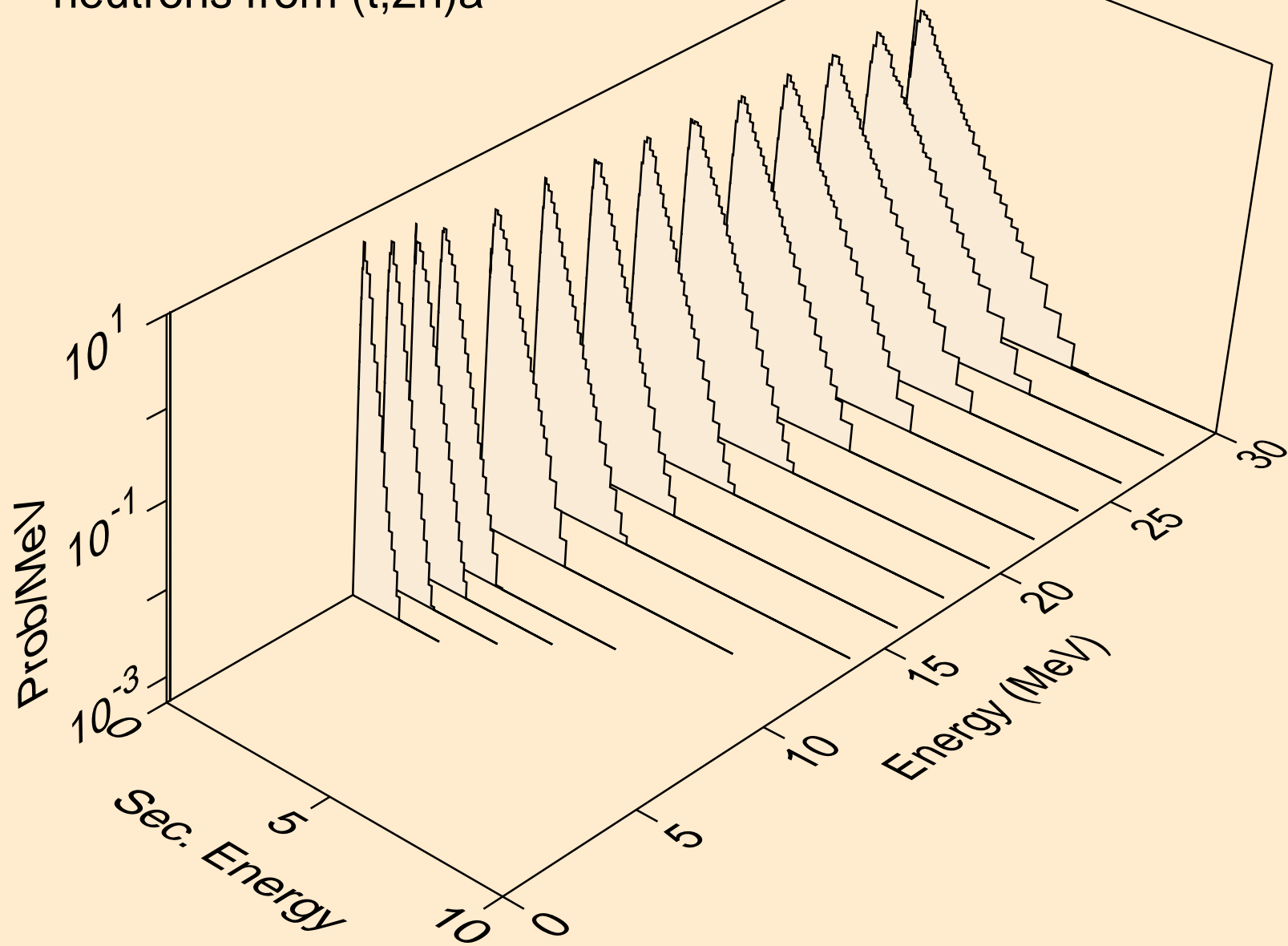

LU186 TRITON ACER TENDL-2023 LIBRARY; T=0.K  
neutrons from (t,3n)a

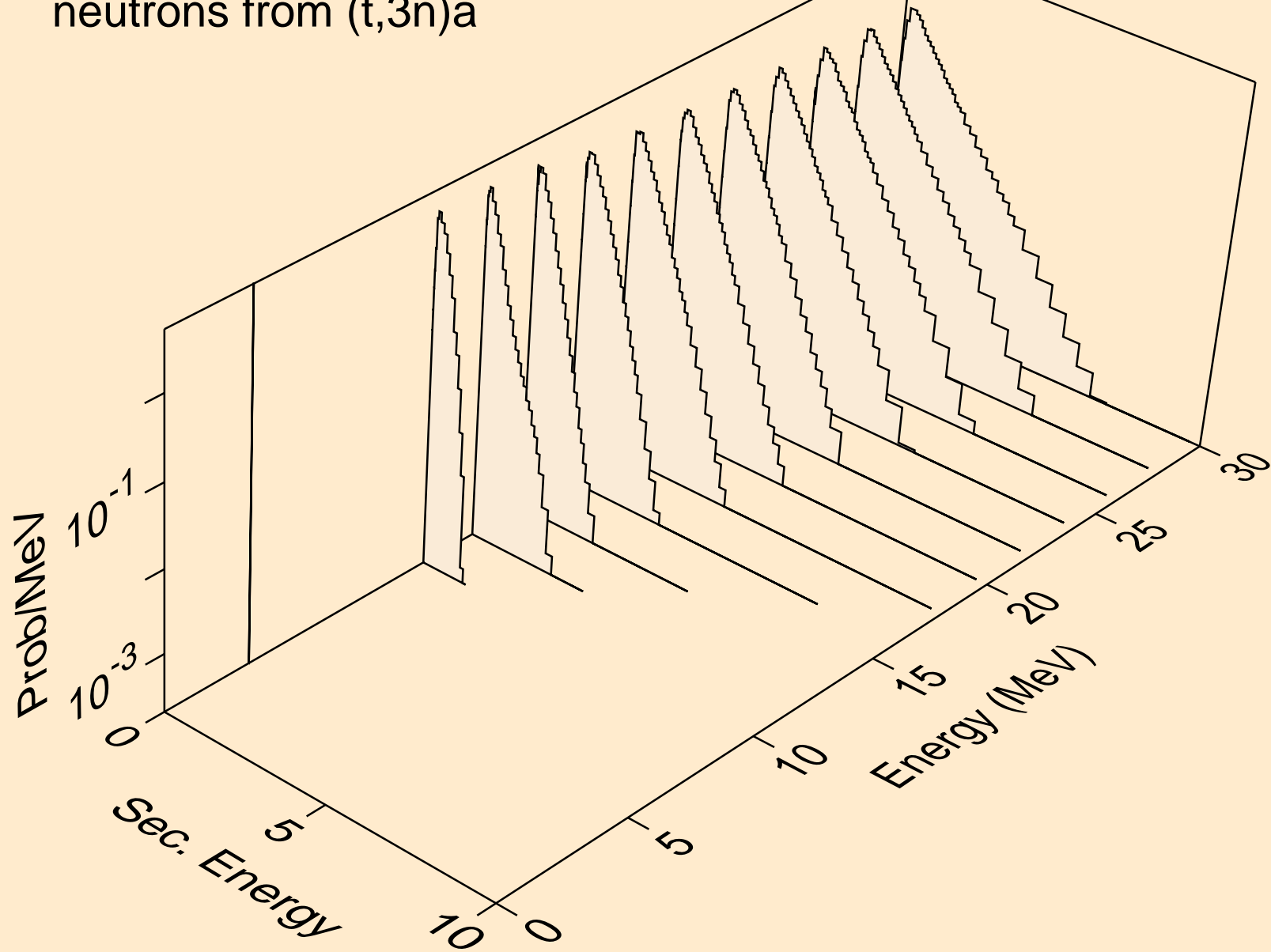

LU186 TRITON ACER TENDL-2023 LIBRARY; T=0.K  
neutrons from (t,n\*)p

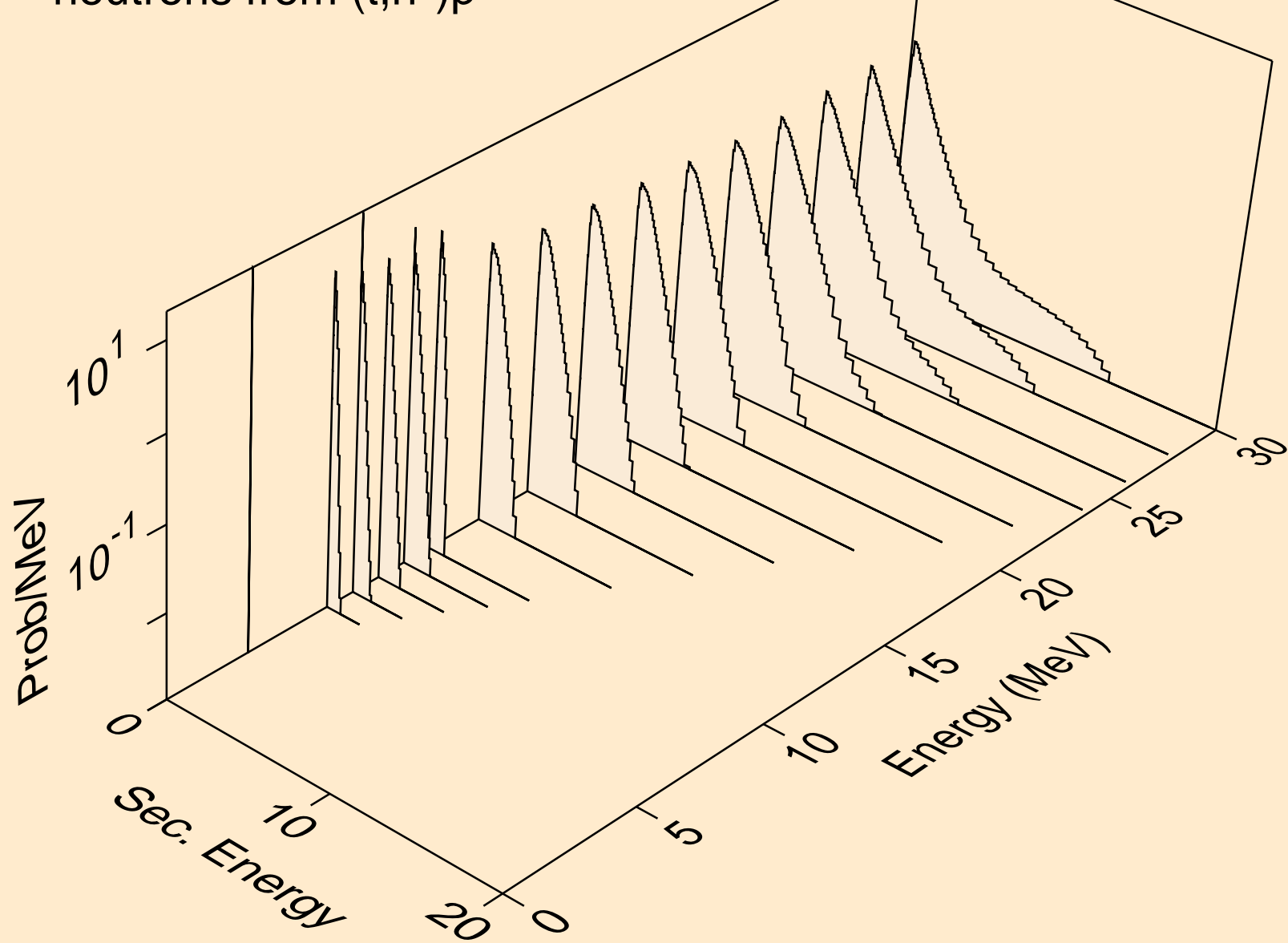

LU186 TRITON ACER TENDL-2023 LIBRARY; T=0.K  
neutrons from (t,n\*)d

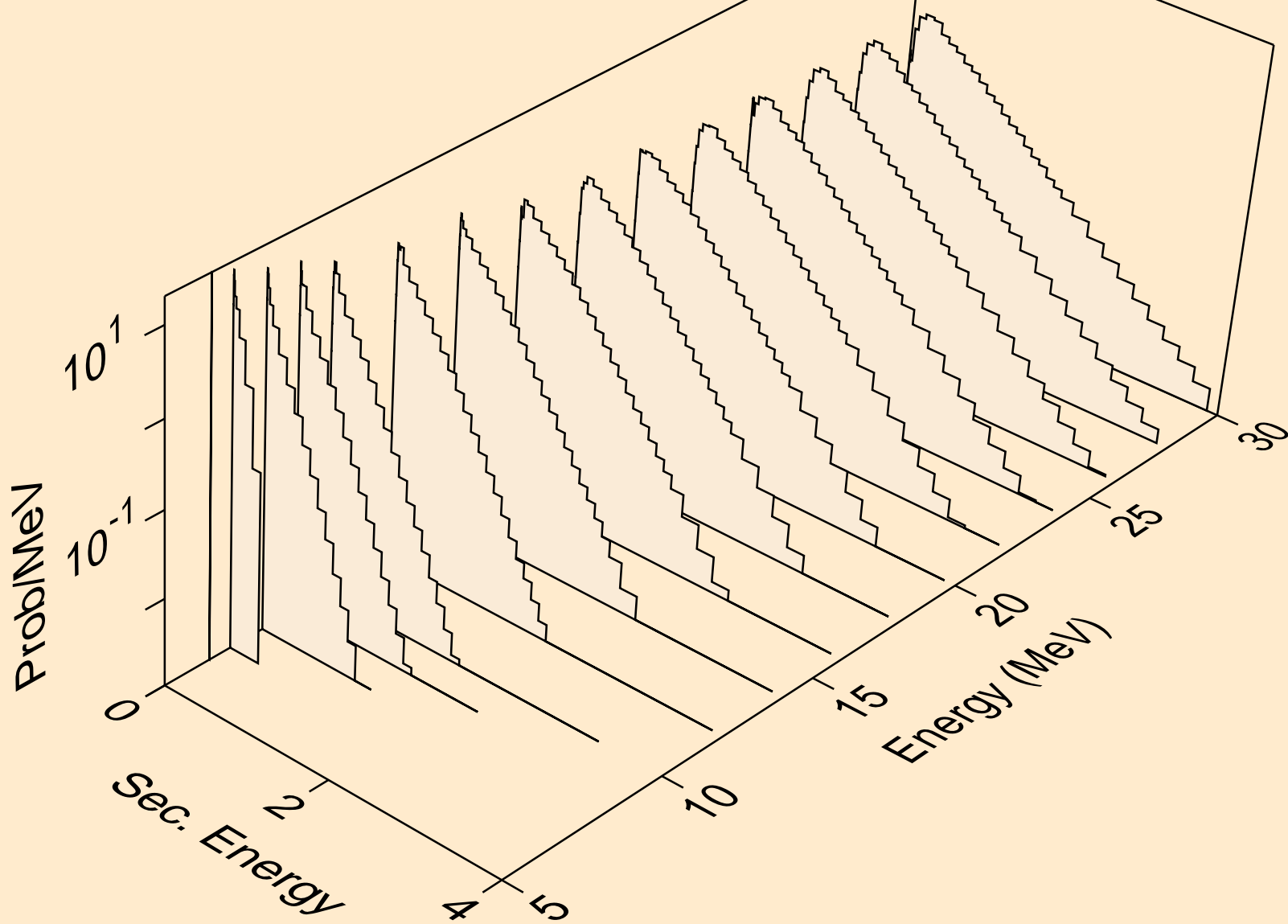

LU186 TRITON ACER TENDL-2023 LIBRARY; T=0.K  
neutrons from (t,n\*)t

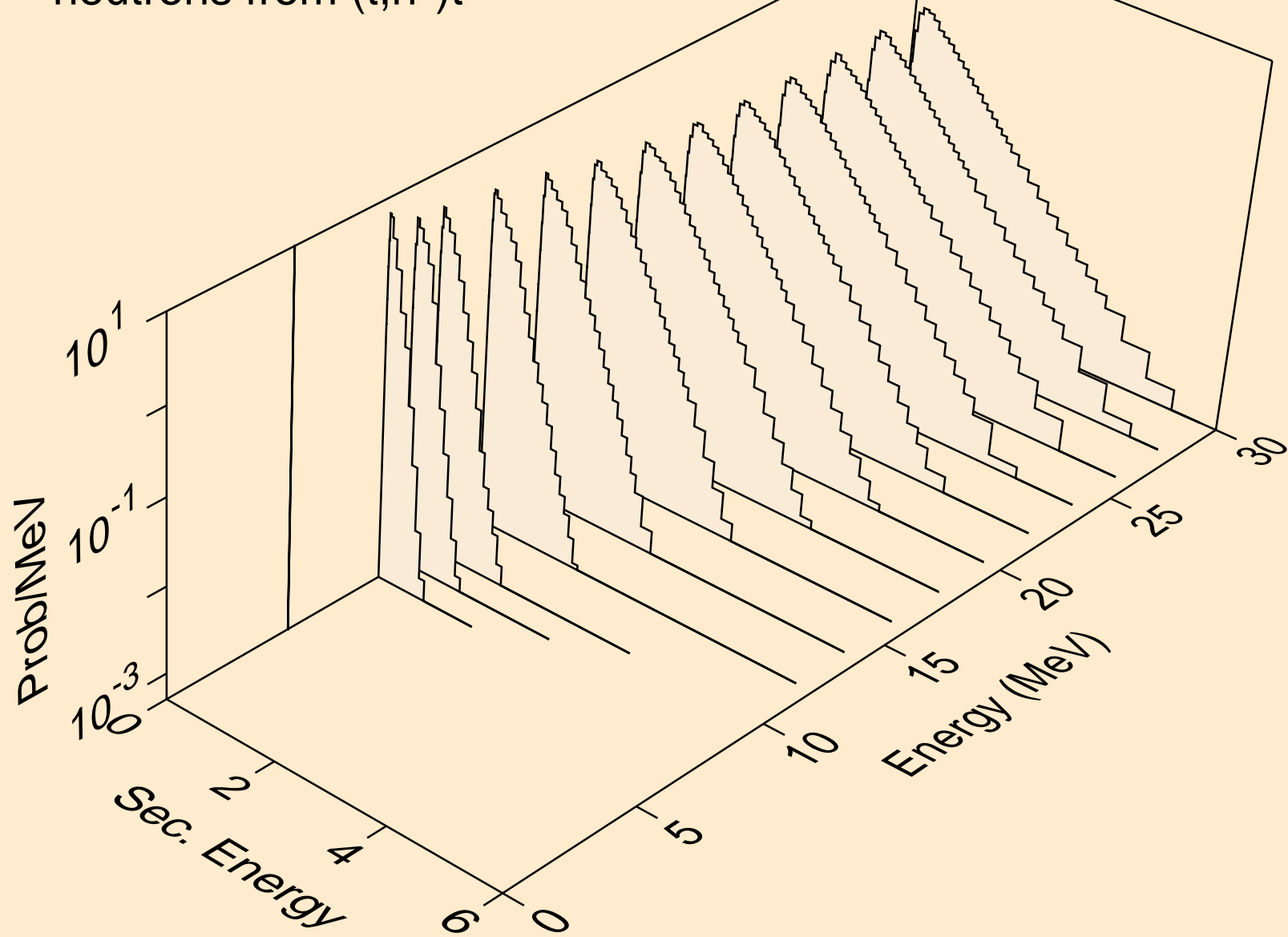

LU186 TRITON ACER TENDL-2023 LIBRARY; T=0.K  
neutrons from (t,n\*)he3

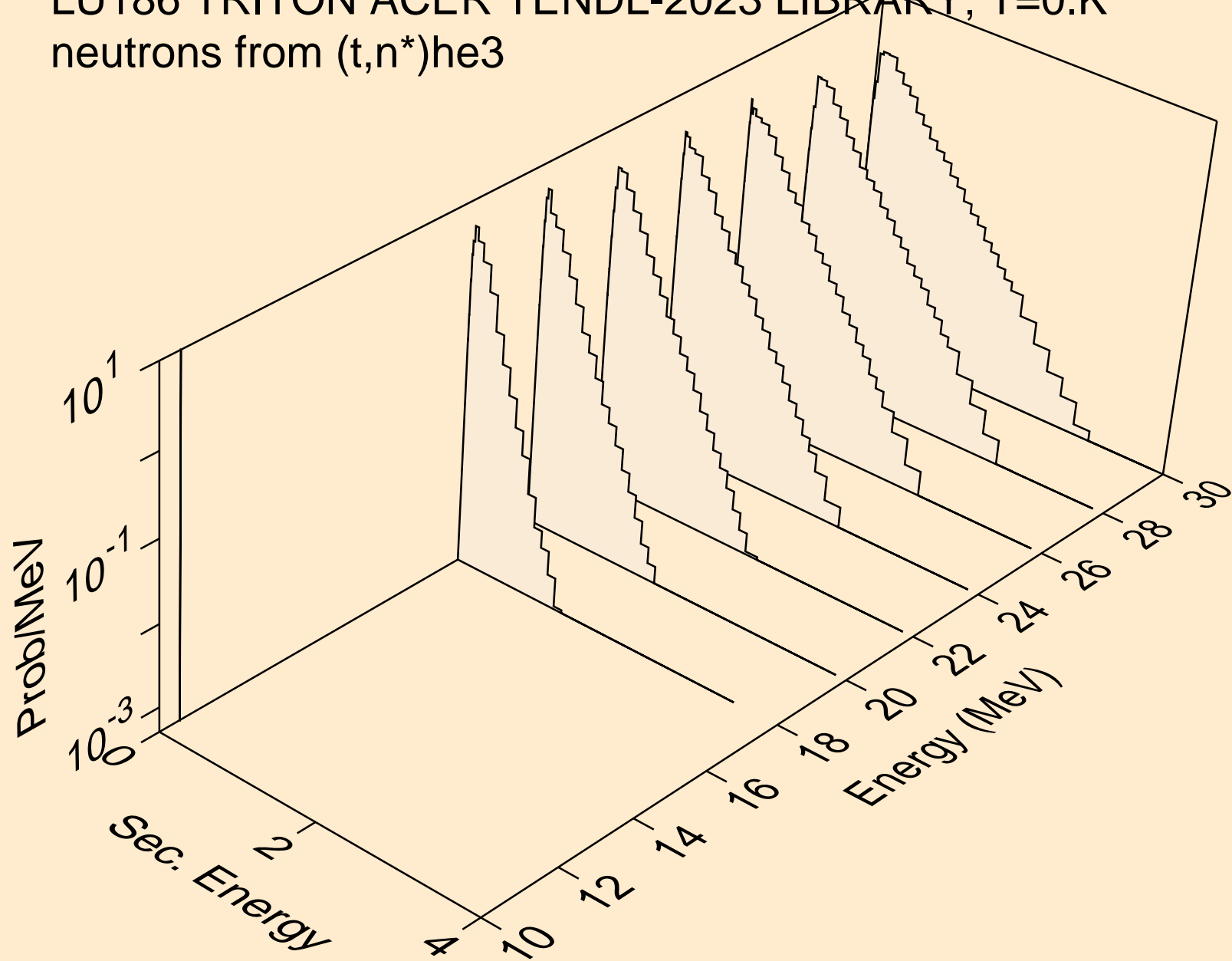

LU186 TRITON ACER TENDL-2023 LIBRARY; T=0.K  
neutrons from (t,4n)

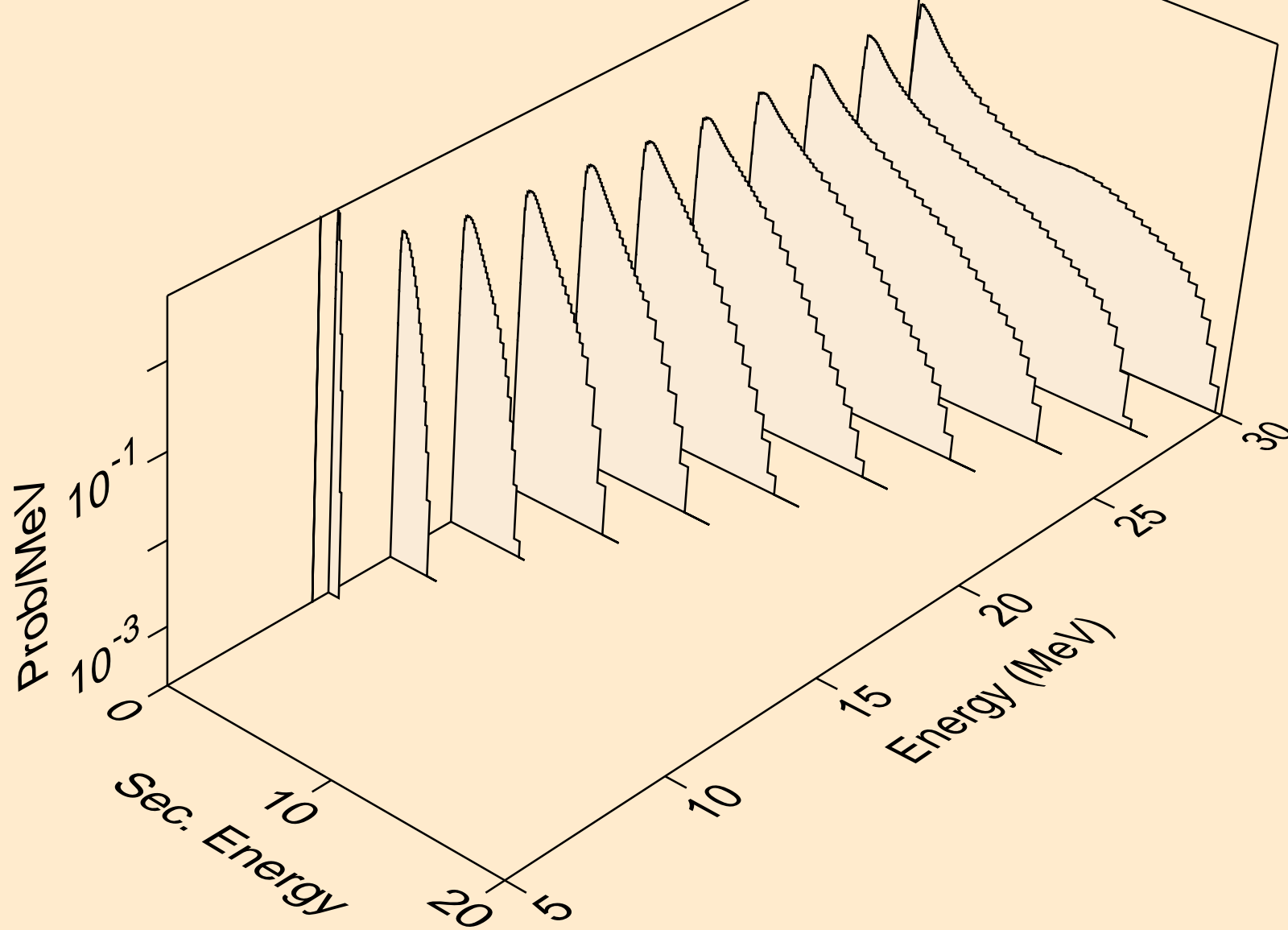

LU186 TRITON ACER TENDL-2023 LIBRARY; T=0.K  
neutrons from (t,2np)

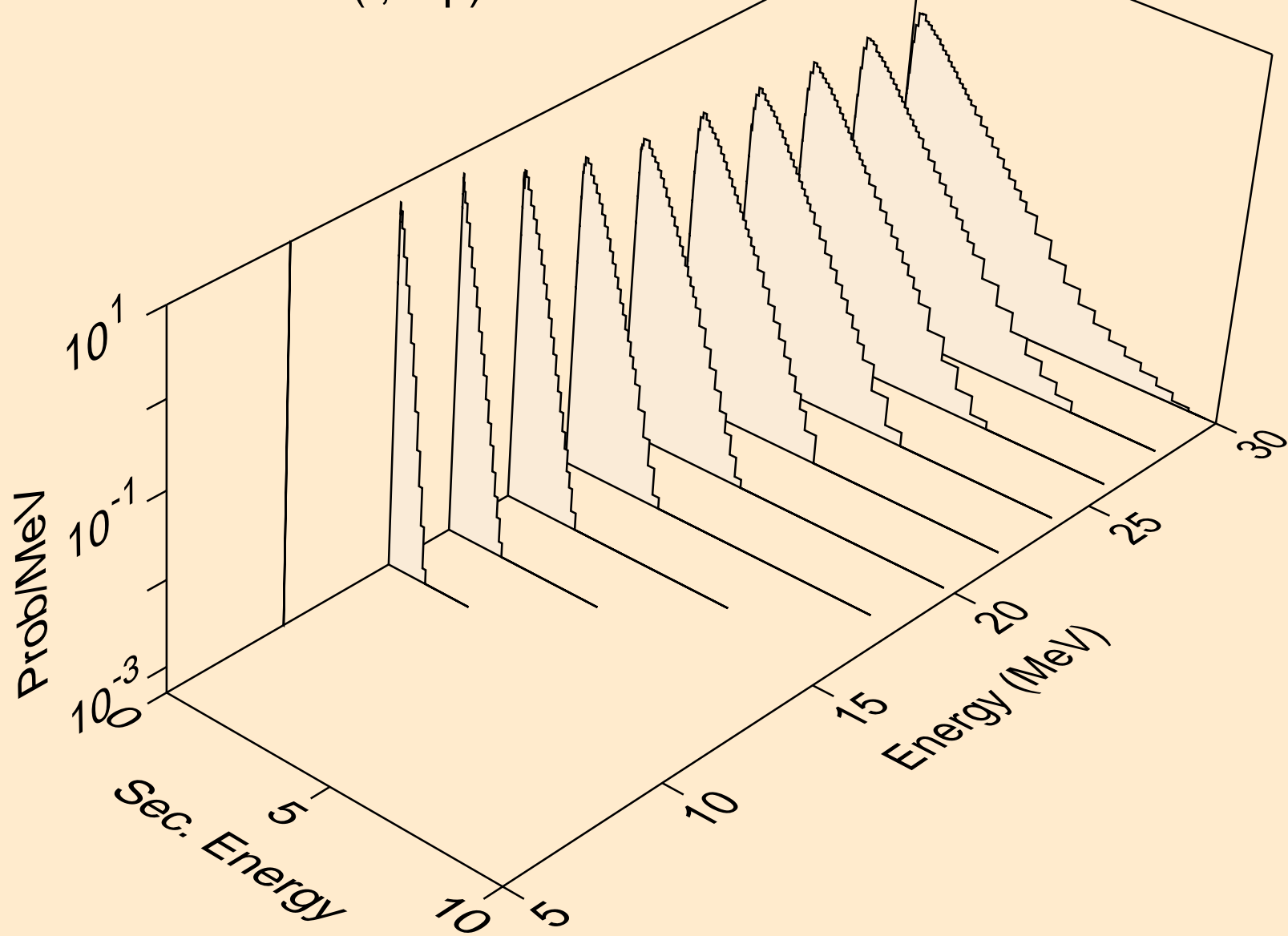

LU186 TRITON ACER TENDL-2023 LIBRARY; T=0.K  
neutrons from (t,3np)

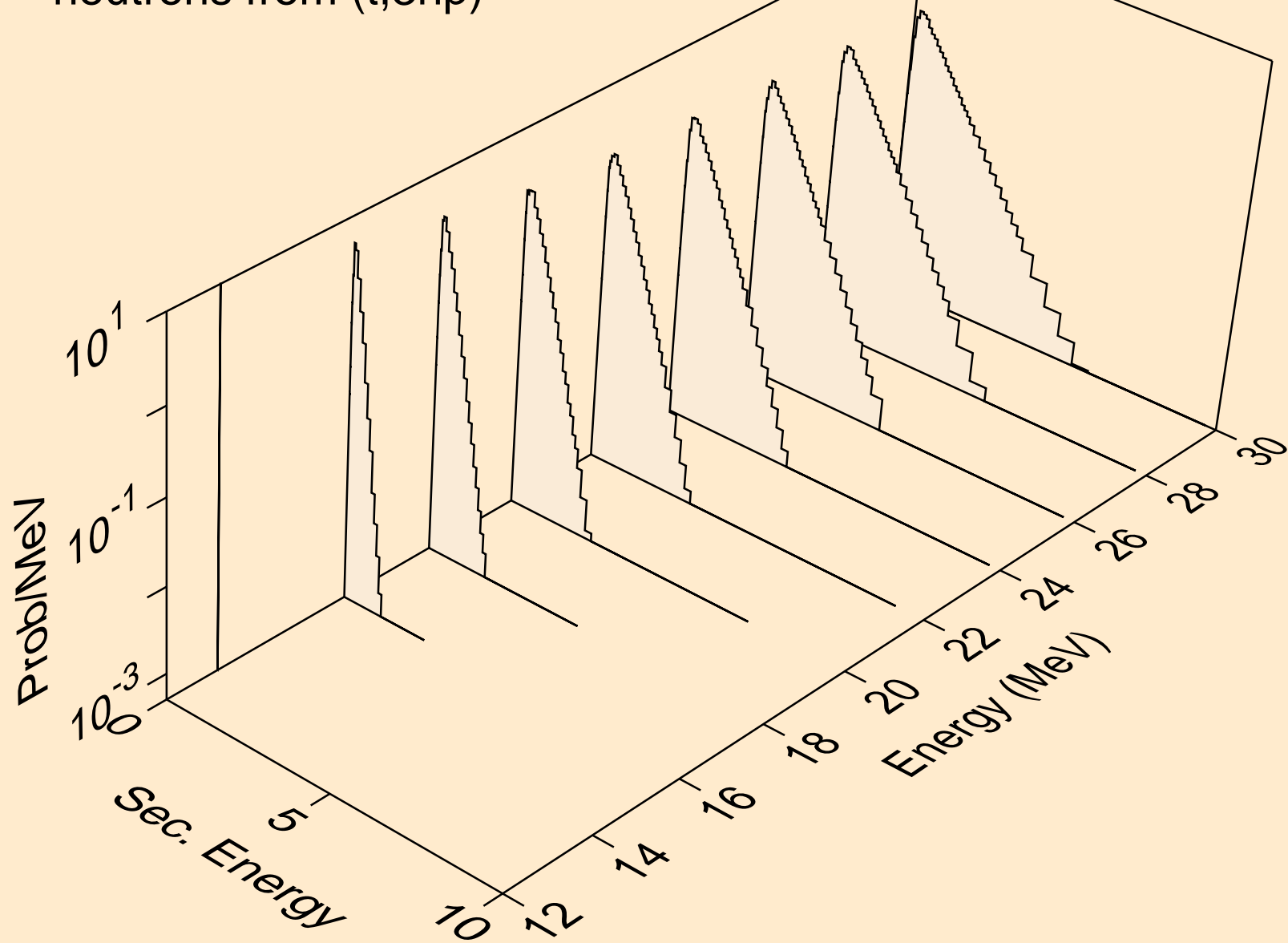

LU186 TRITON ACER TENDL-2023 LIBRARY; T=0.K  
neutrons from (t,n2p)

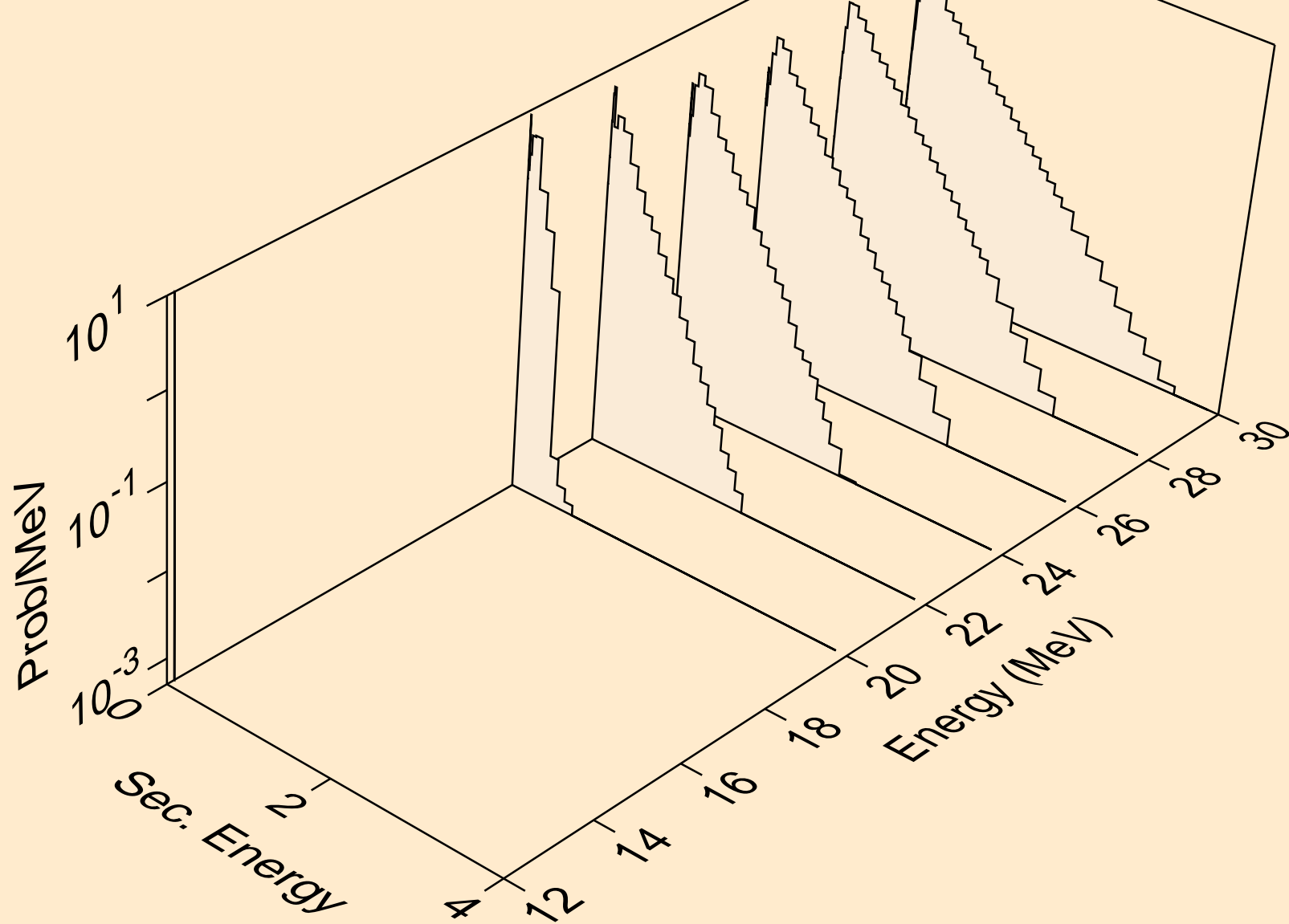

LU186 TRITON ACER TENDL-2023 LIBRARY; T=0.K  
protons from (t,x)

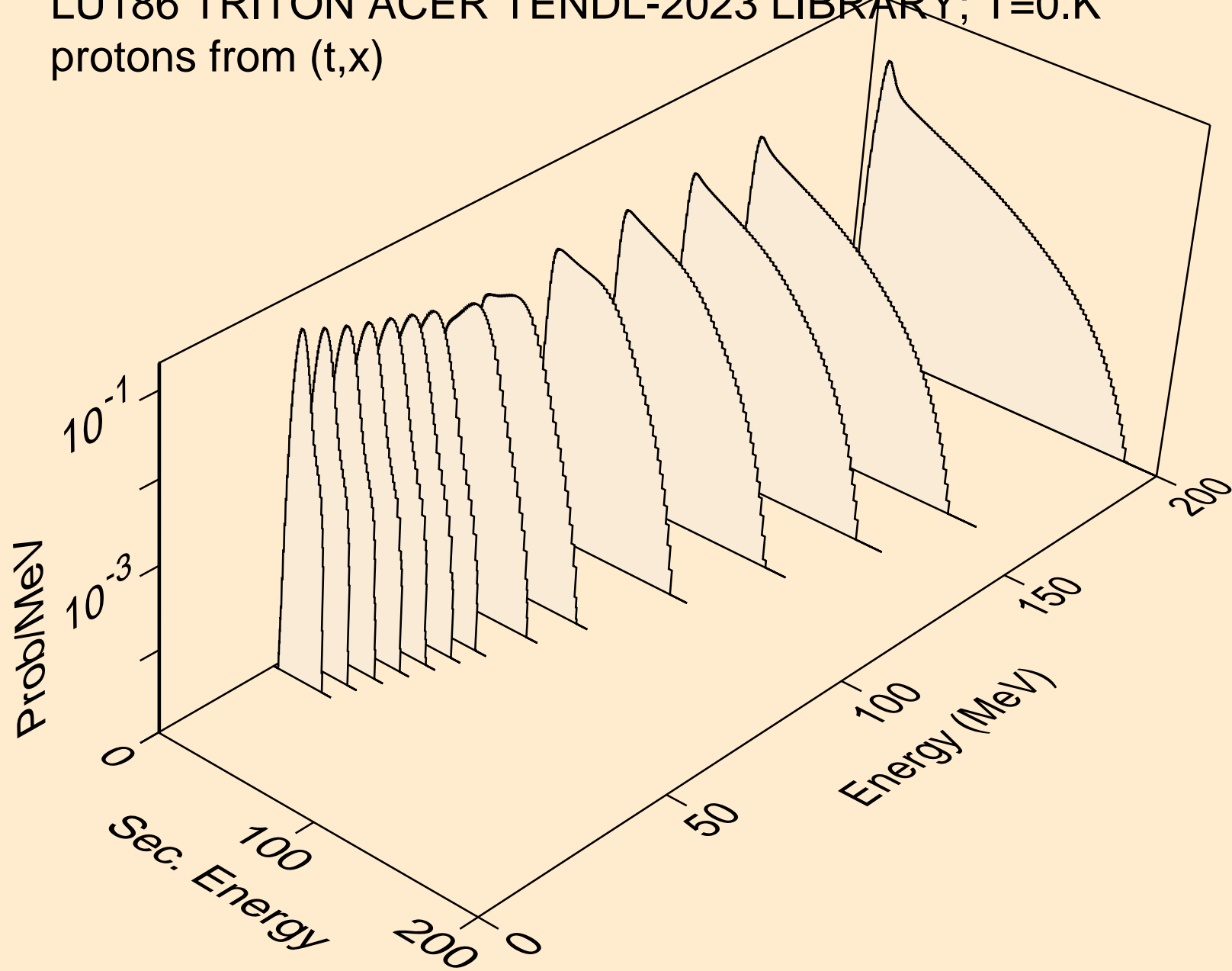

LU186 TRITON ACER TENDL-2023 LIBRARY; T=0.K  
protons from (t,n\*)p

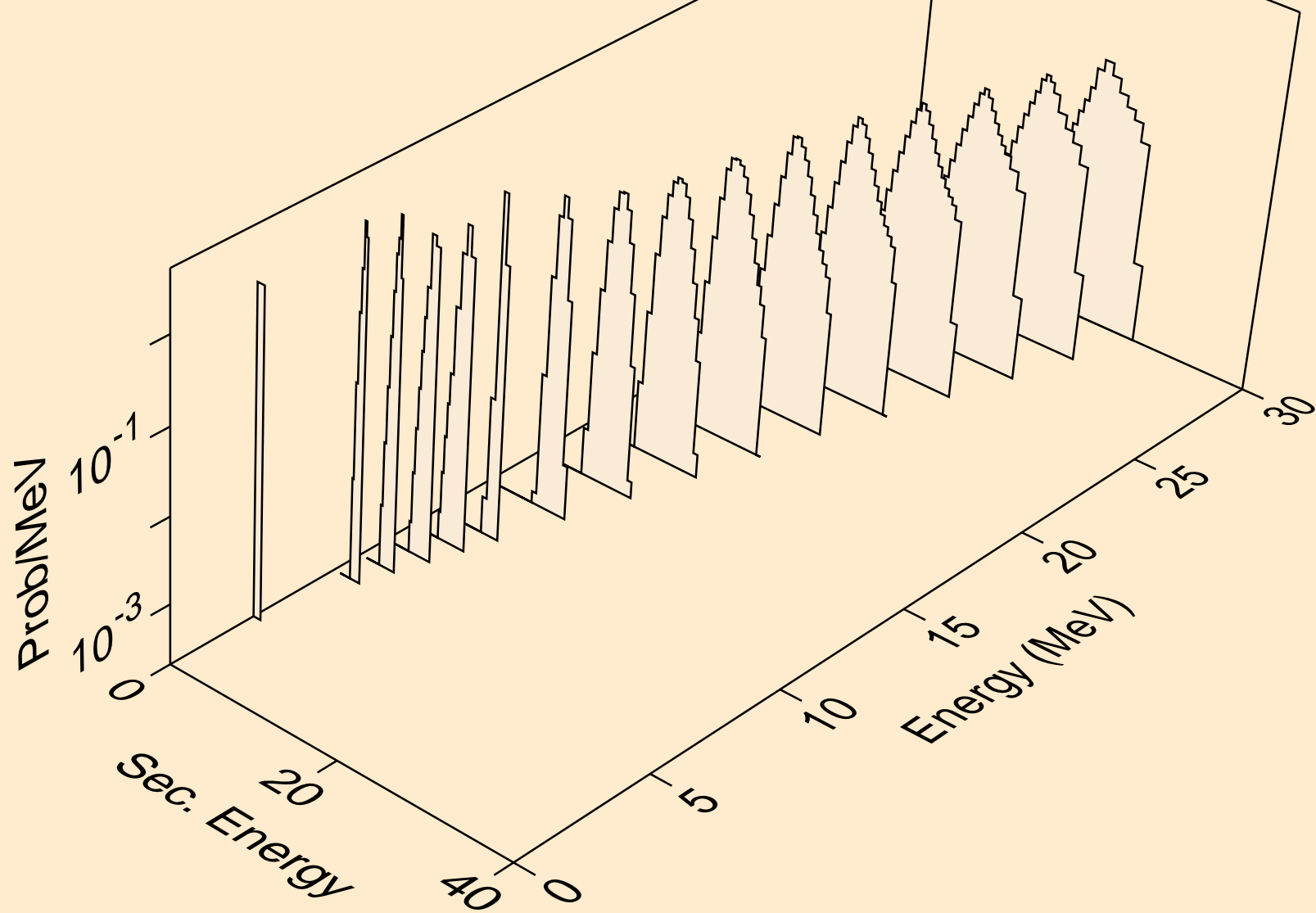

LU186 TRITON ACER TENDL-2023 LIBRARY; T=0.K  
protons from (t,2np)

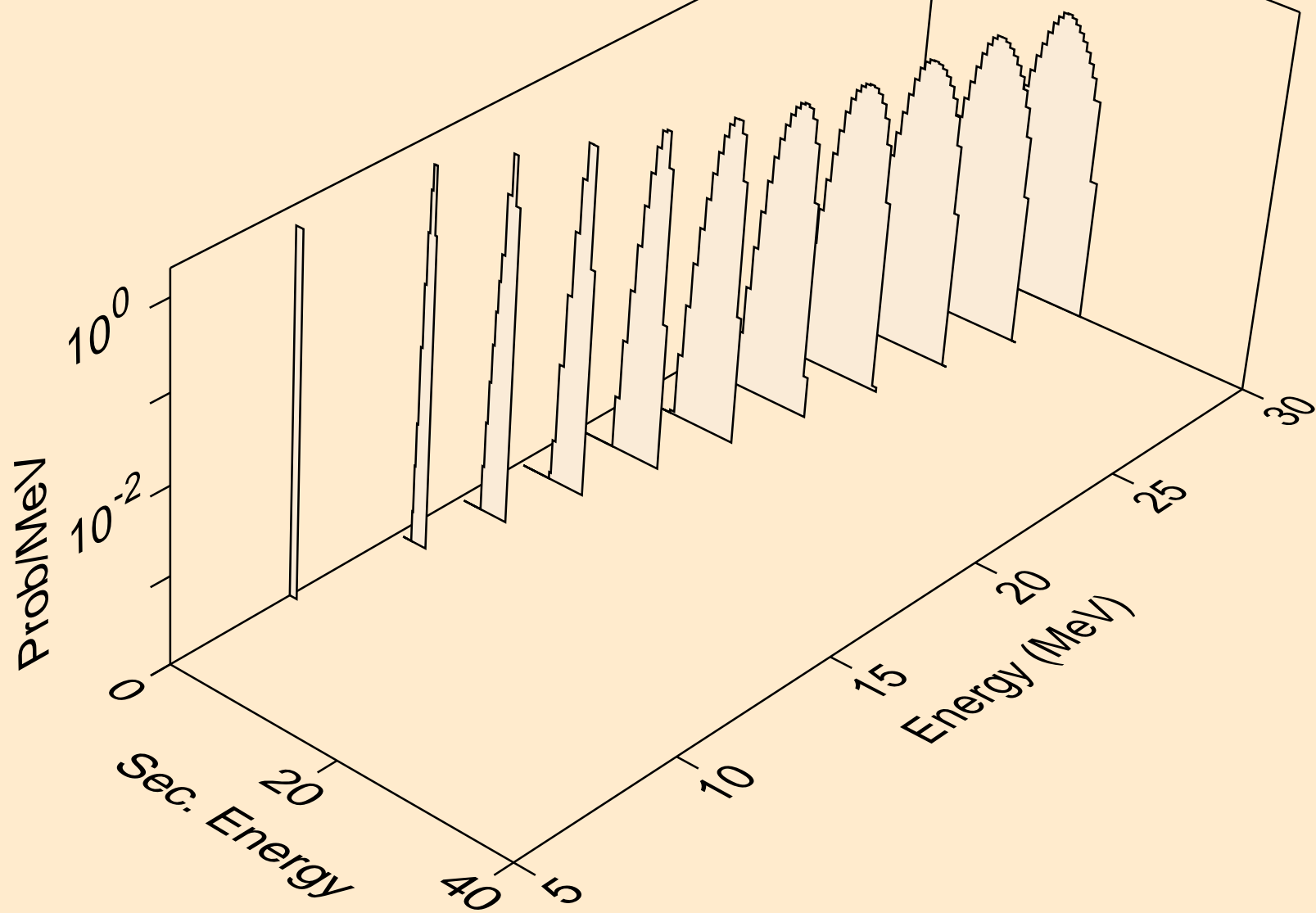

LU186 TRITON ACER TENDL-2023 LIBRARY; T=0.K  
protons from (t,3np)

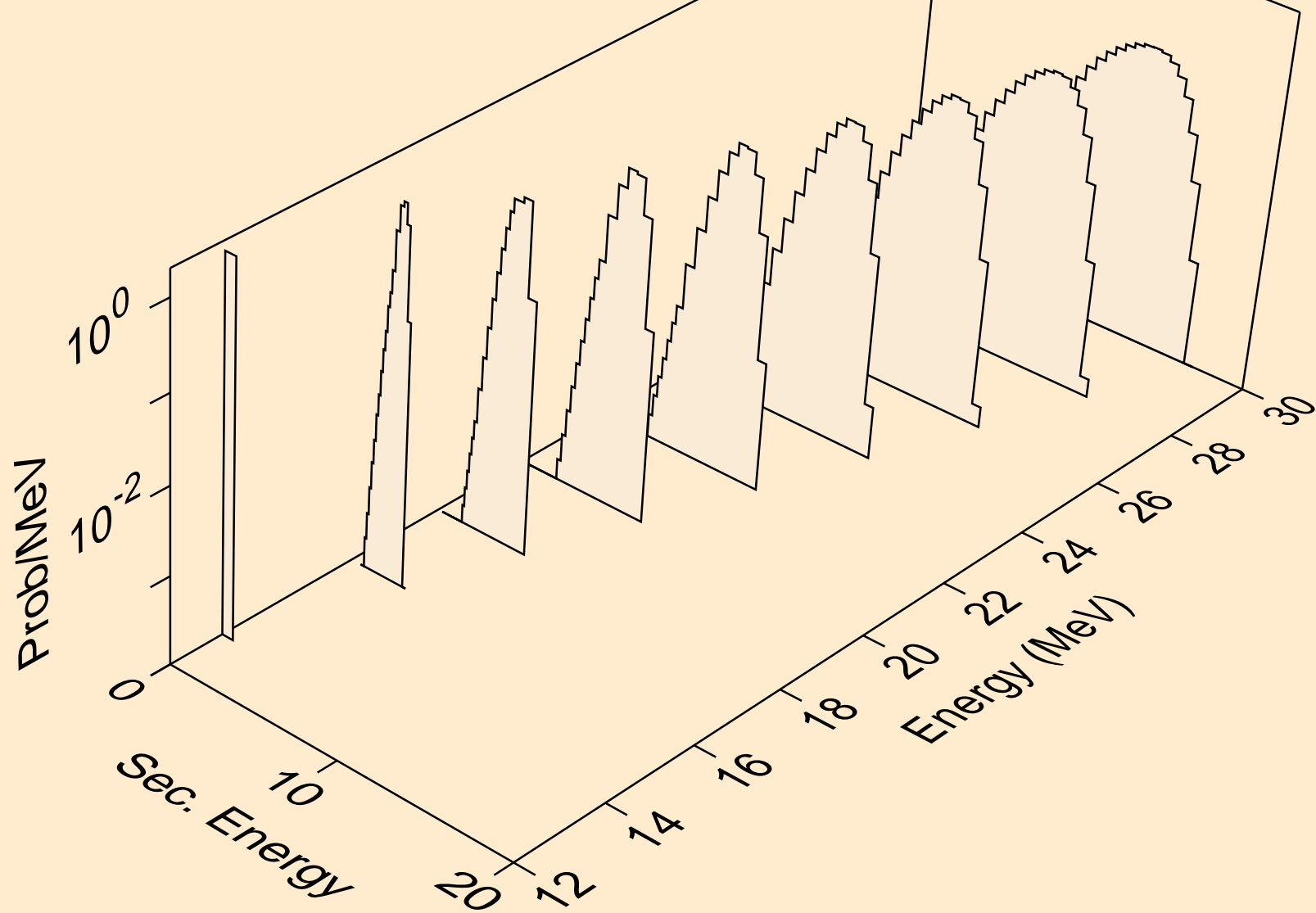

LU186 TRITON ACER TENDL-2023 LIBRARY; T=0.K  
protons from (t,n2p)

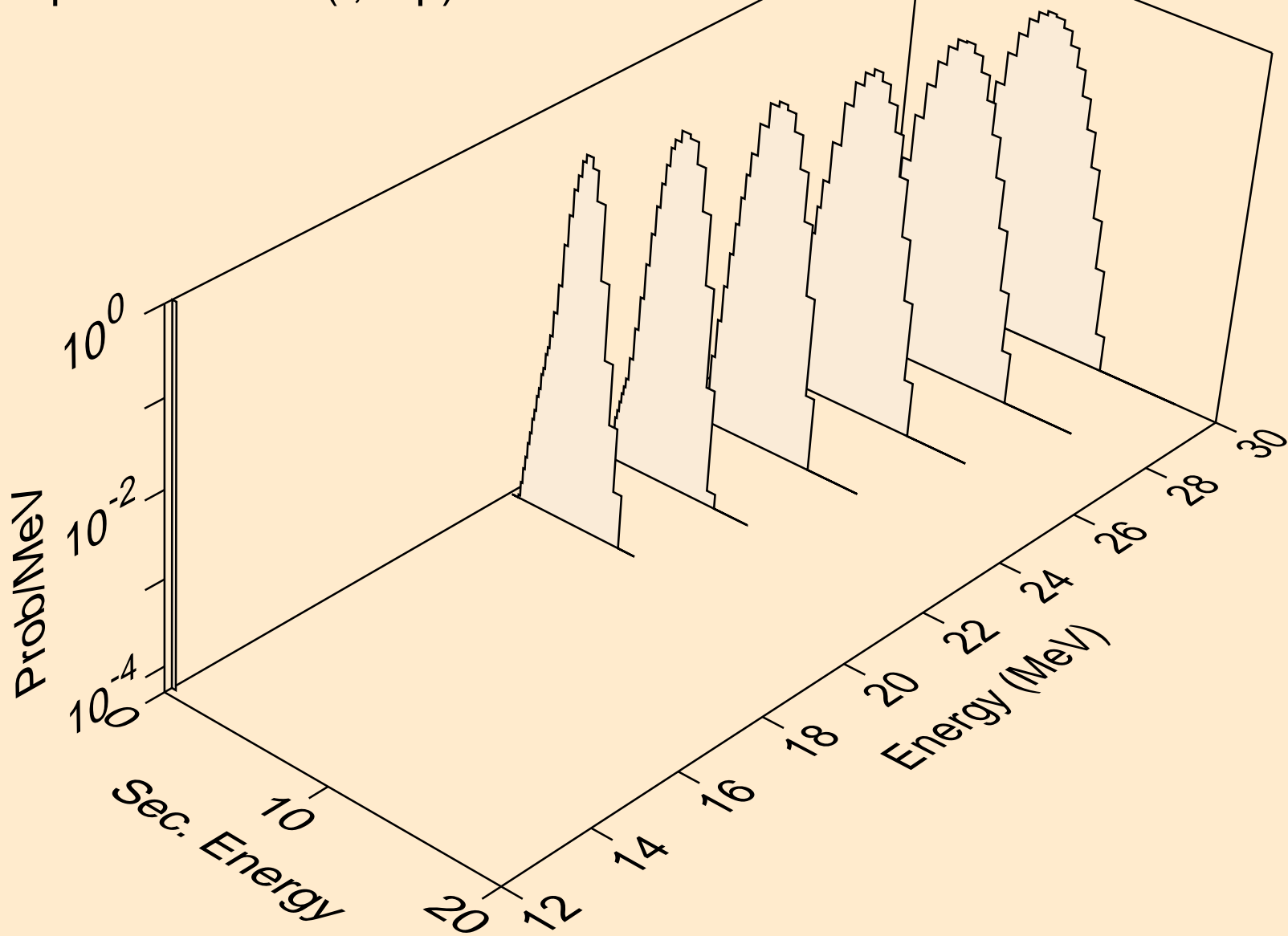

LU186 TRITON ACER TENDL-2023 LIBRARY; T=0.K  
protons from (t,p)

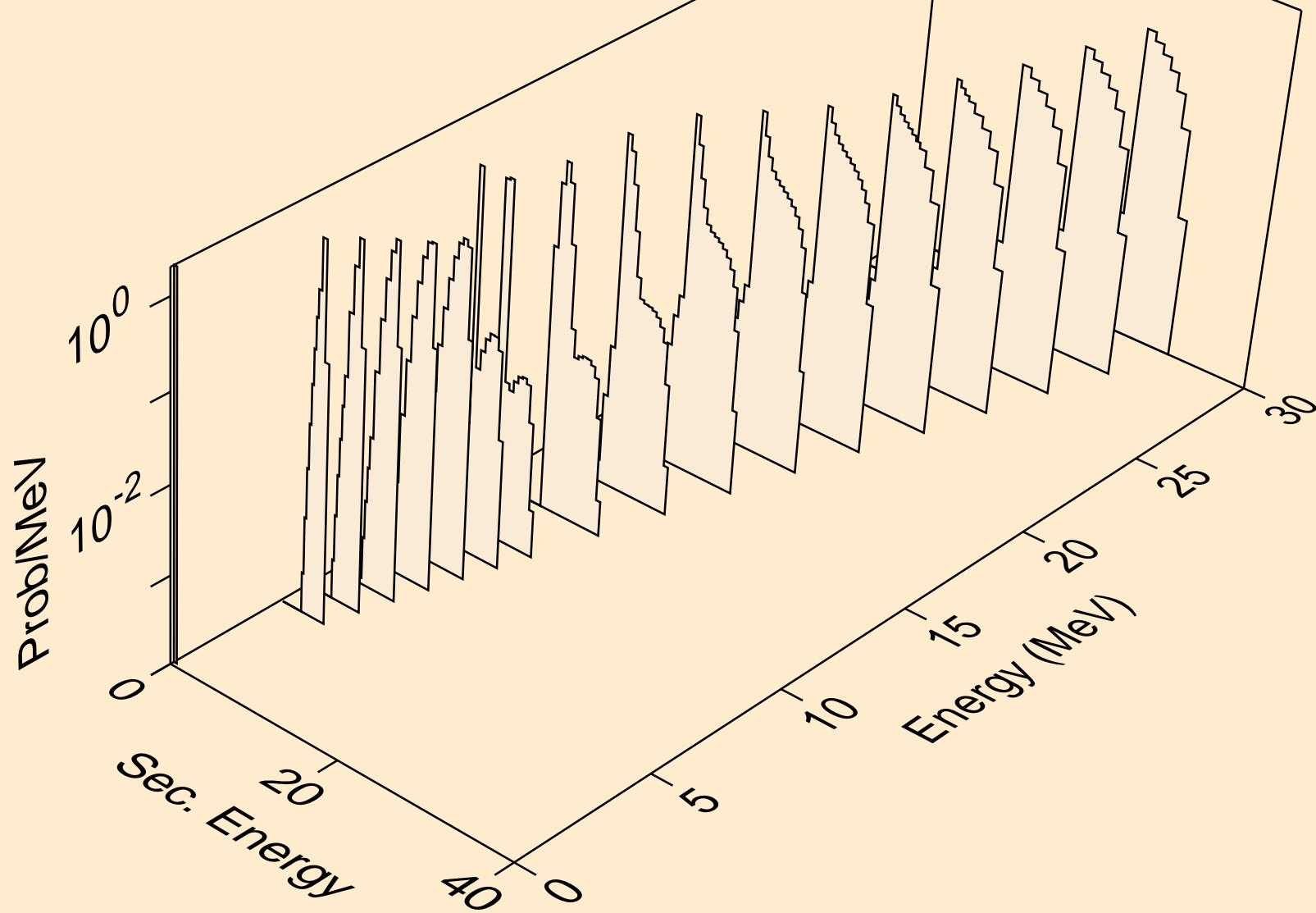

LU186 TRITON ACER TENDL-2023 LIBRARY; T=0.K  
protons from (t,2p)

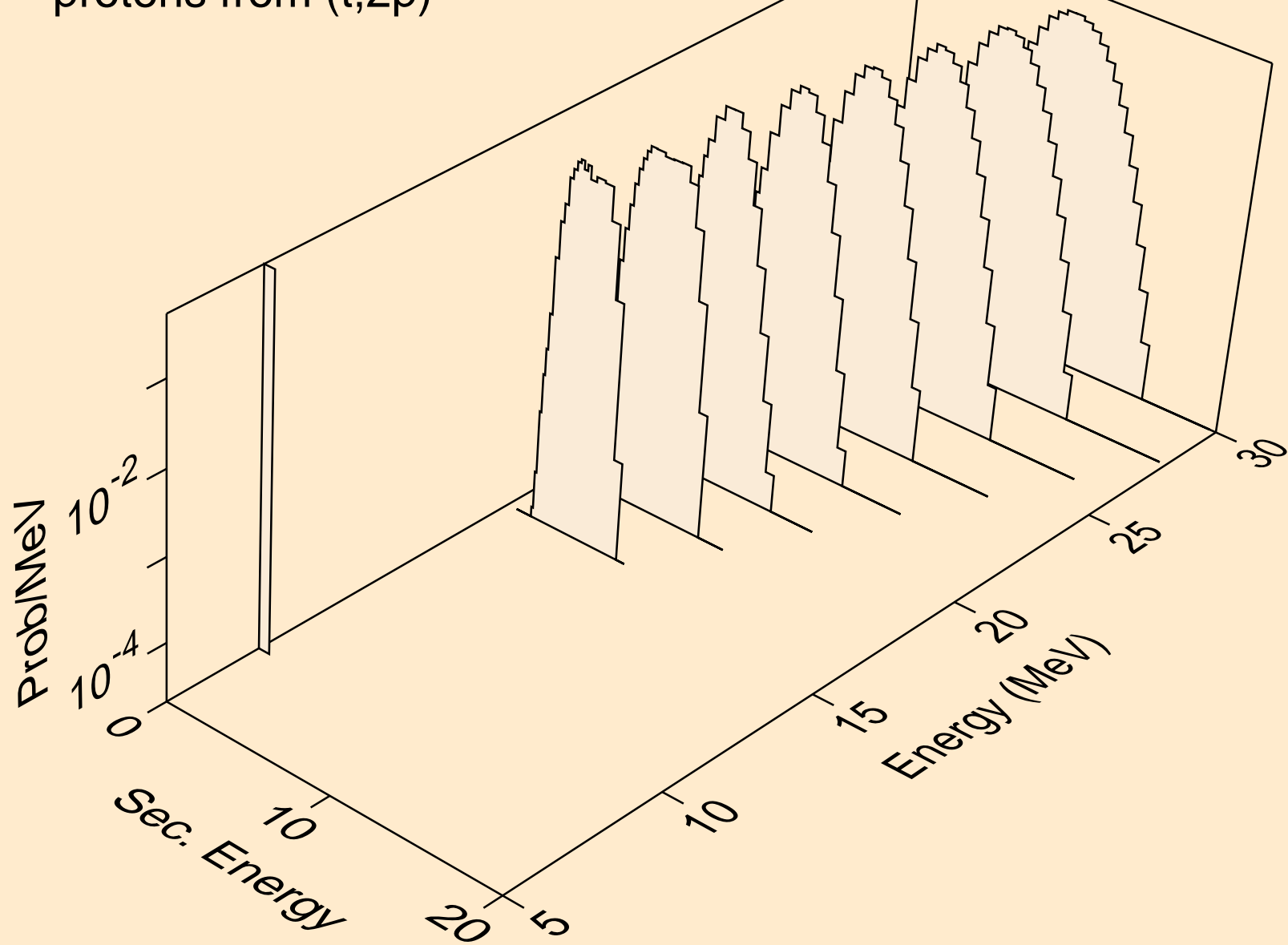

LU186 TRITON ACER TENDL-2023 LIBRARY; T=0.K  
protons from (t,pd)

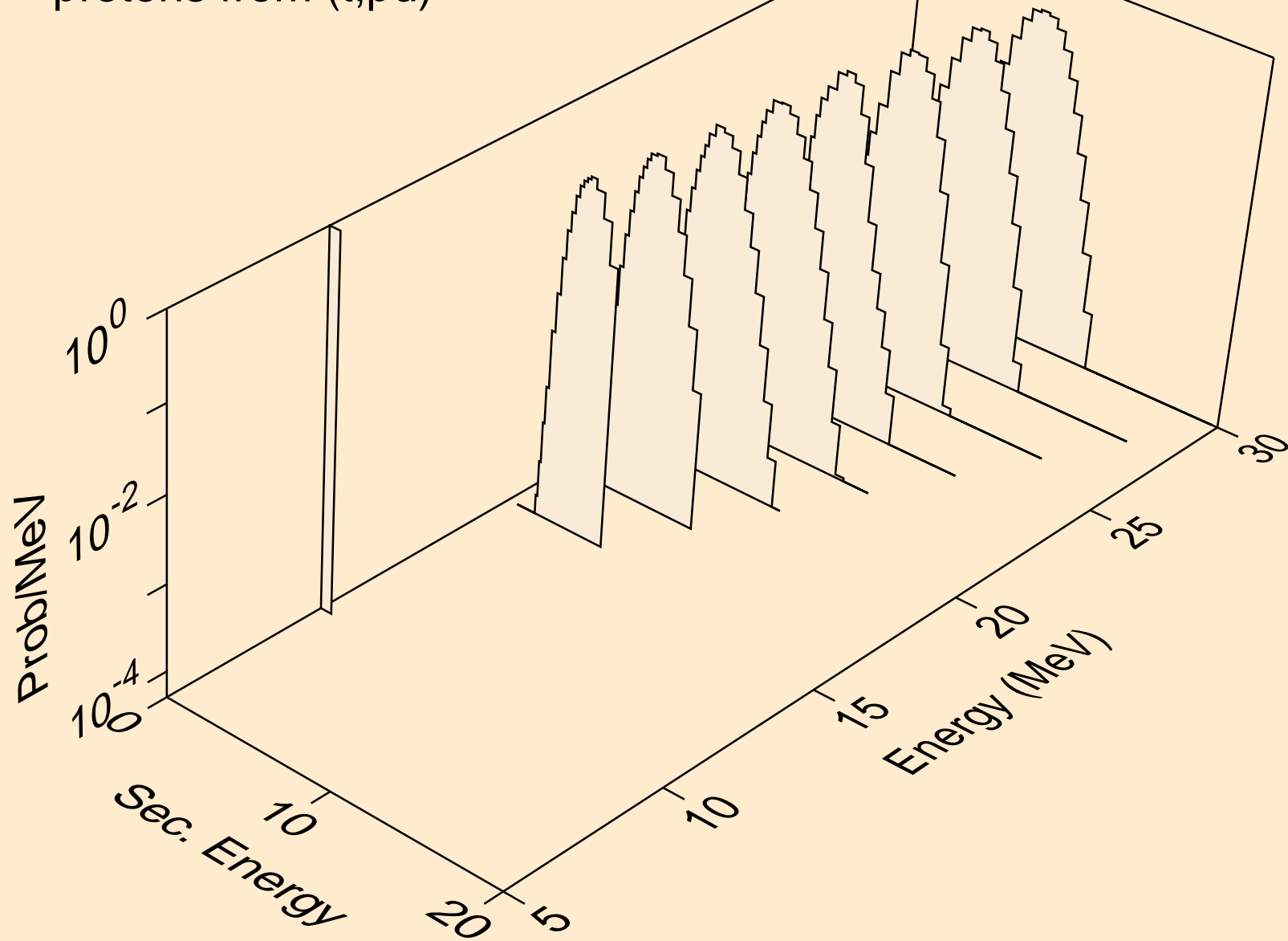

LU186 TRITON ACER TENDL-2023 LIBRARY; T=0.K  
deuterons from (t,x)

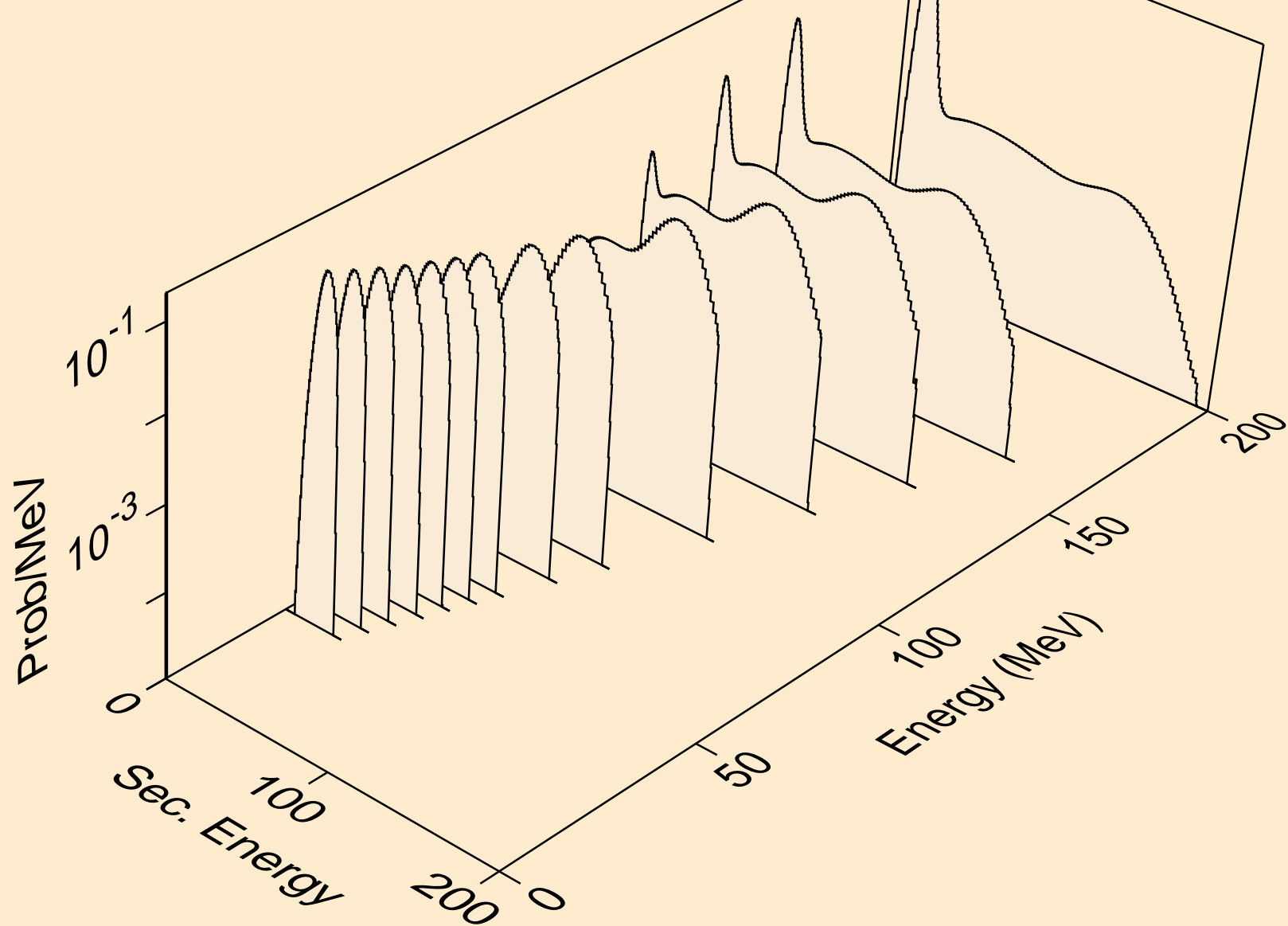

LU186 TRITON ACER TENDL-2023 LIBRARY; T=0.K  
deuterons from (t,2nd)

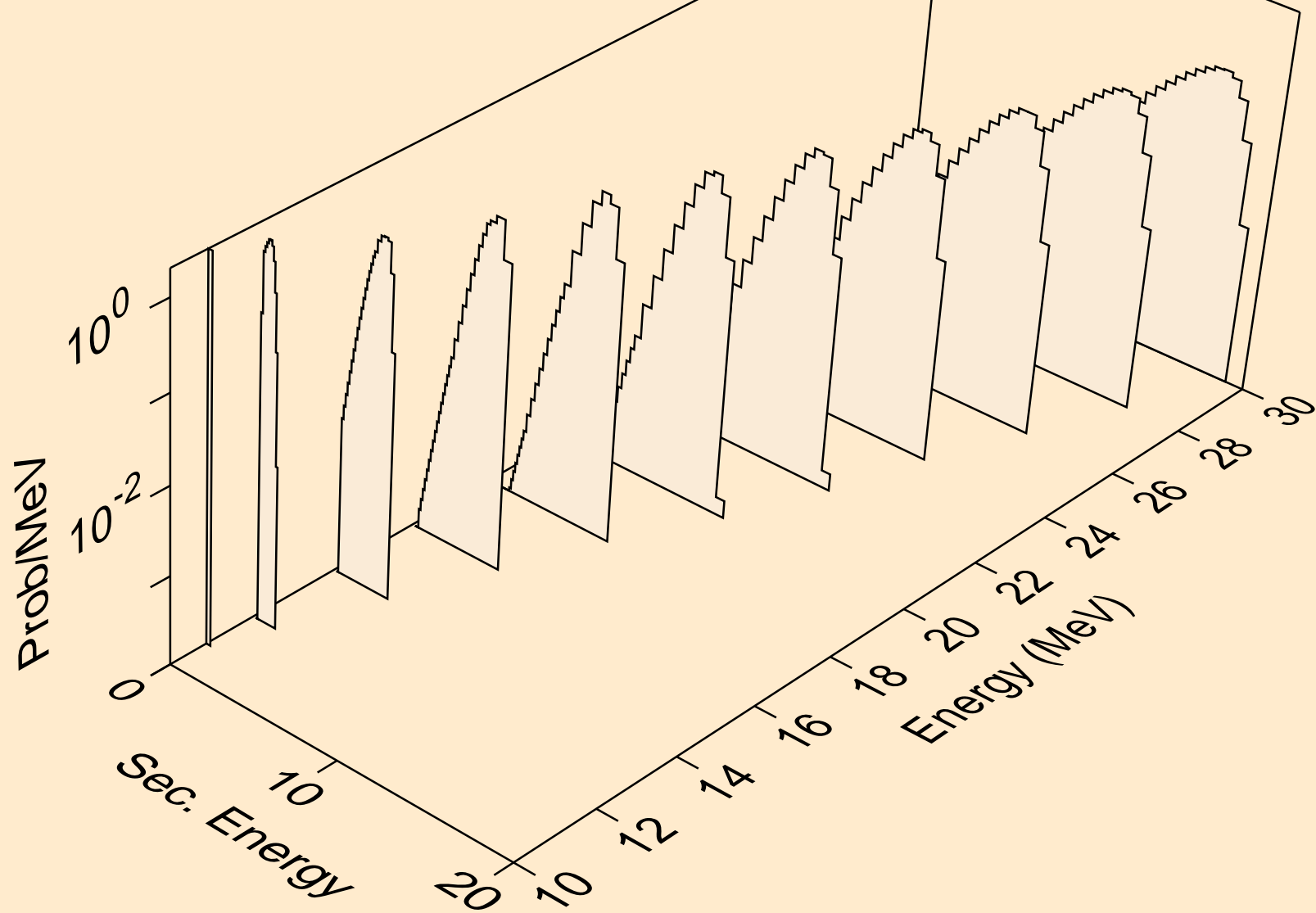

LU186 TRITON ACER TENDL-2023 LIBRARY; T=0.K  
deuterons from (t,n\*)d

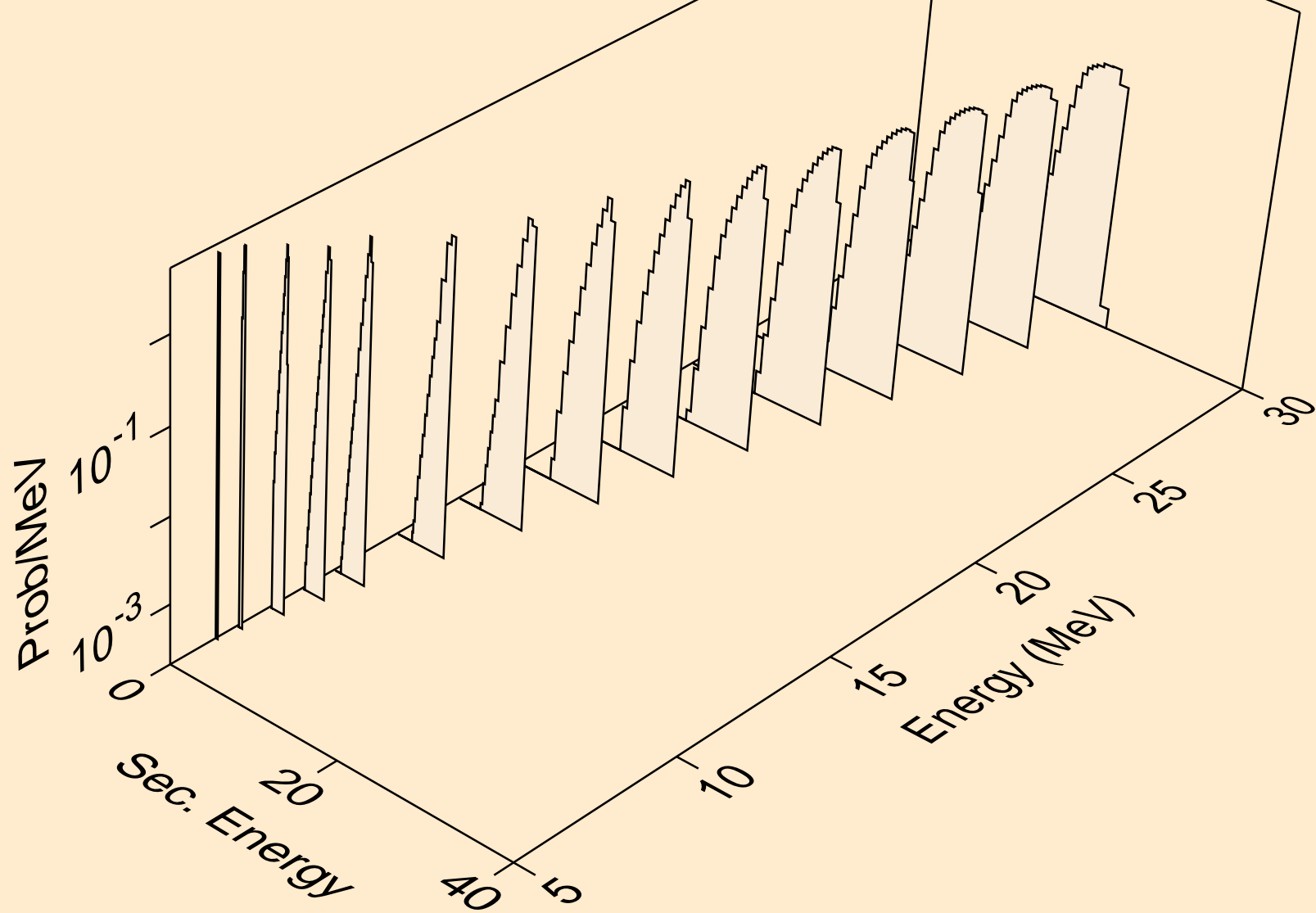

LU186 TRITON ACER TENDL-2023 LIBRARY; T=0.K  
deuterons from (t,d)

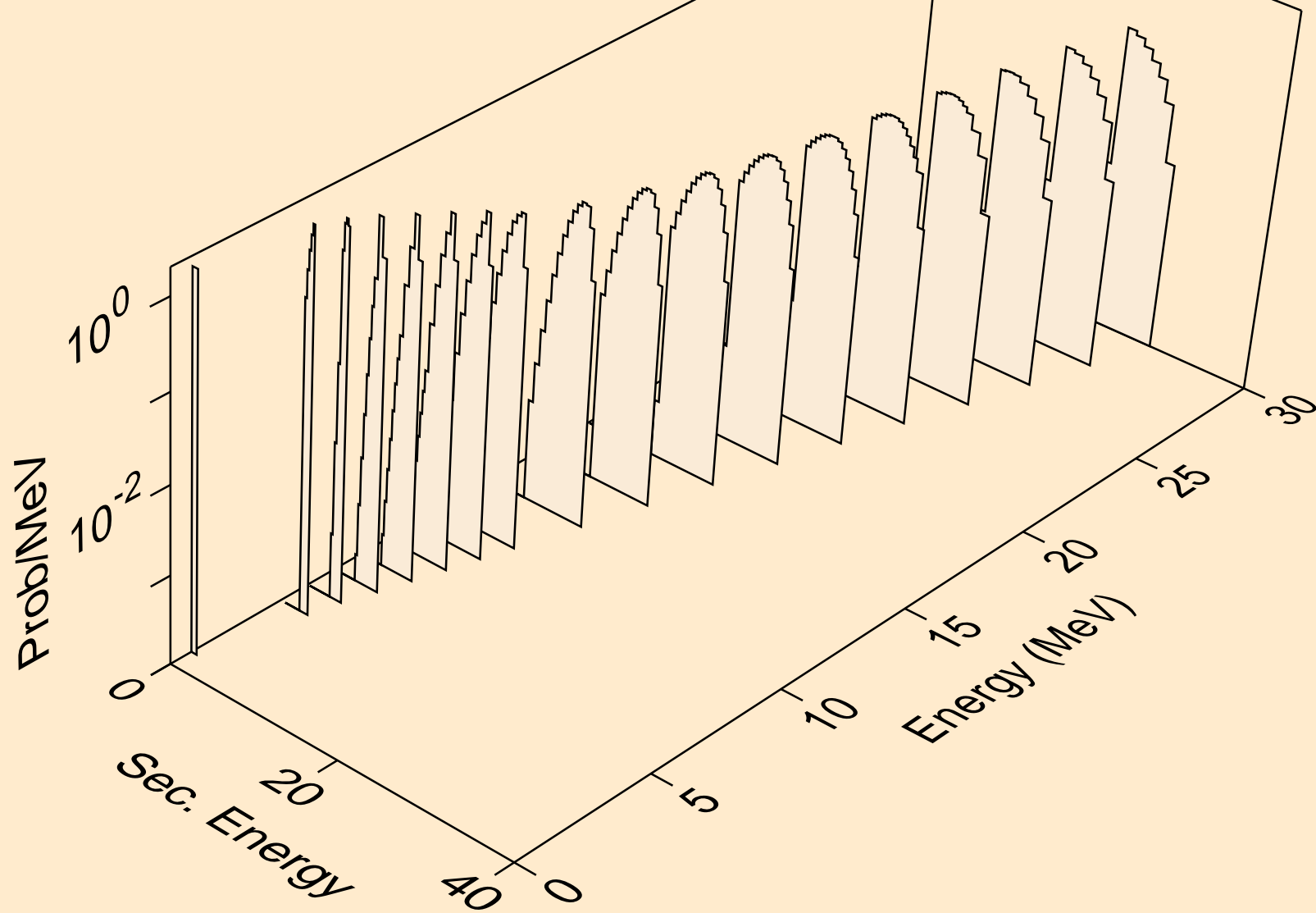

LU186 TRITON ACER TENDL-2023 LIBRARY; T=0.K  
deuterons from (t,pd)

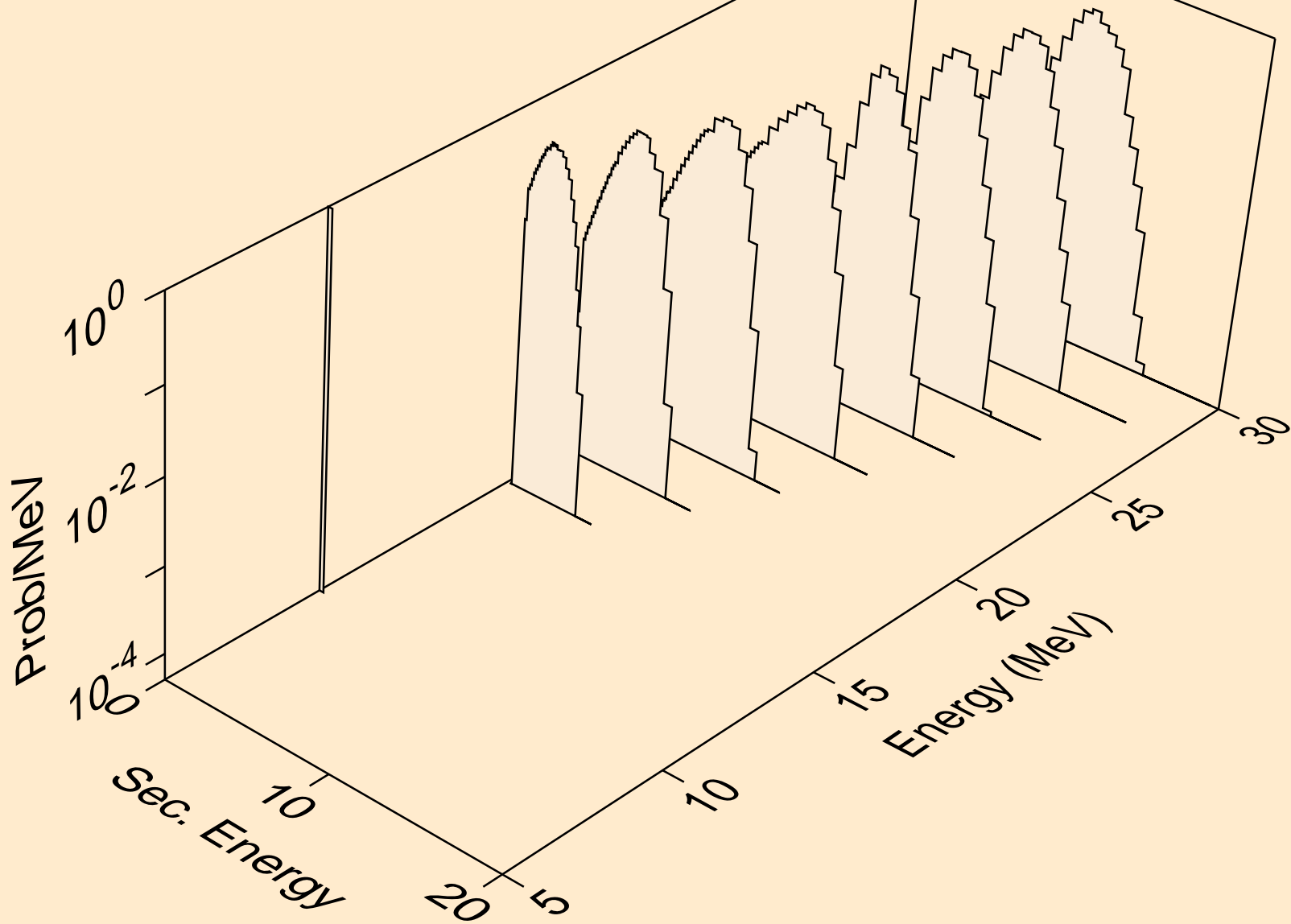

LU186 TRITON ACER TENDL-2023 LIBRARY; T=0.K  
he3s from (t,x)

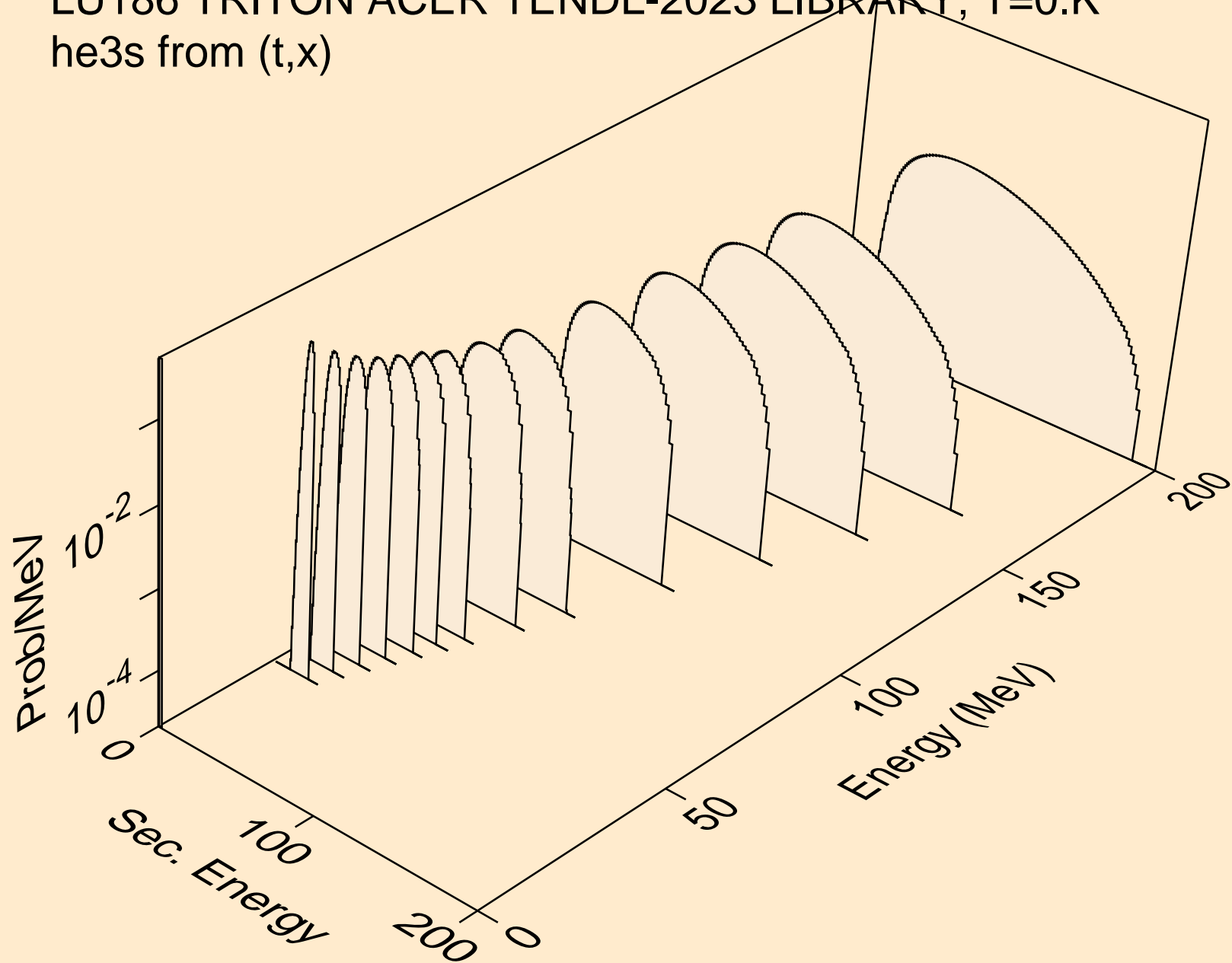

LU186 TRITON ACER TENDL-2023 LIBRARY; T=0.K  
he3s from (t,n\*)he3

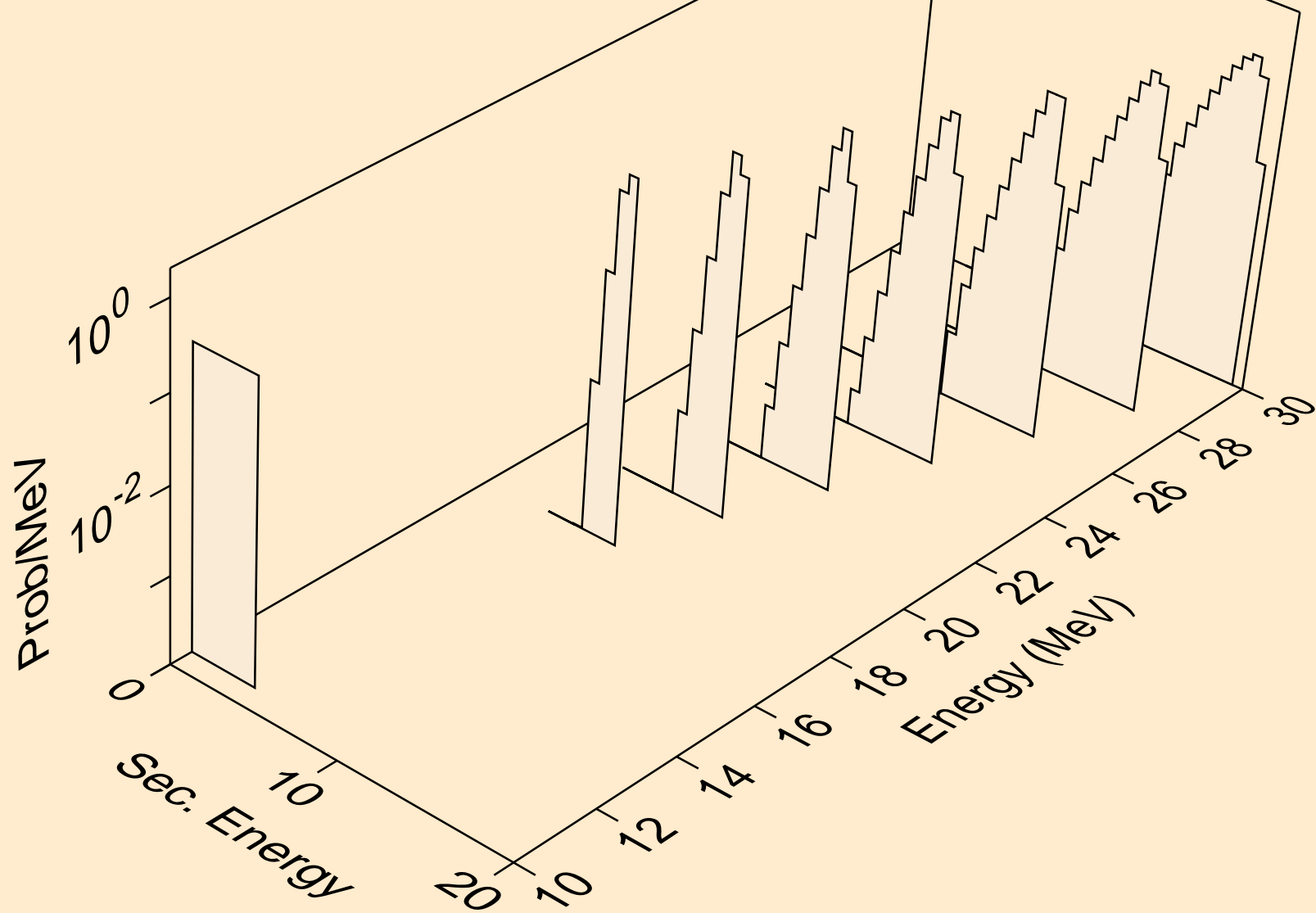

LU186 TRITON ACER TENDL-2023 LIBRARY; T=0.K  
he3s from (t,he3)

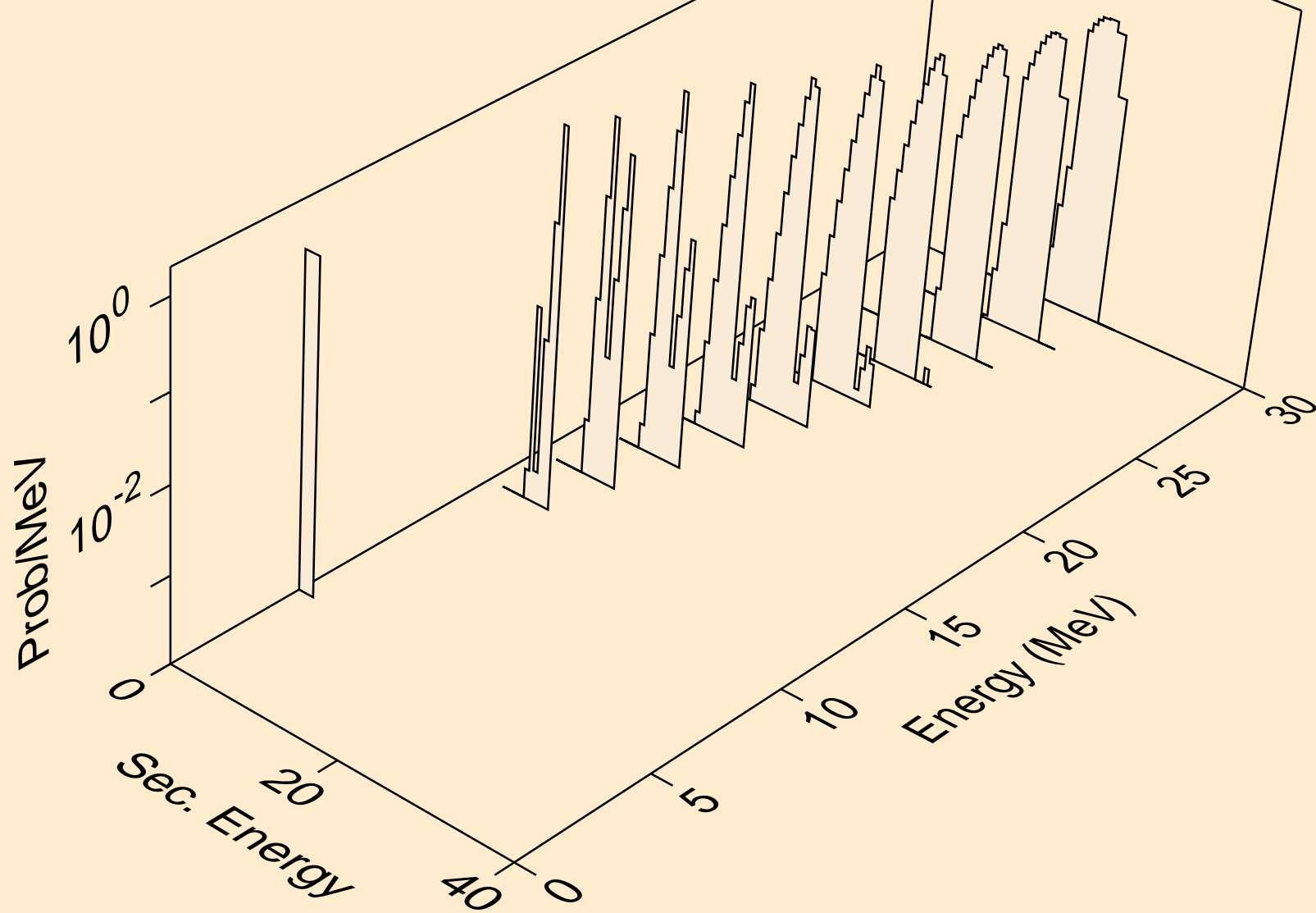

LU186 TRITON ACER TENDL-2023 LIBRARY; T=0.K  
alphas from (t,x)

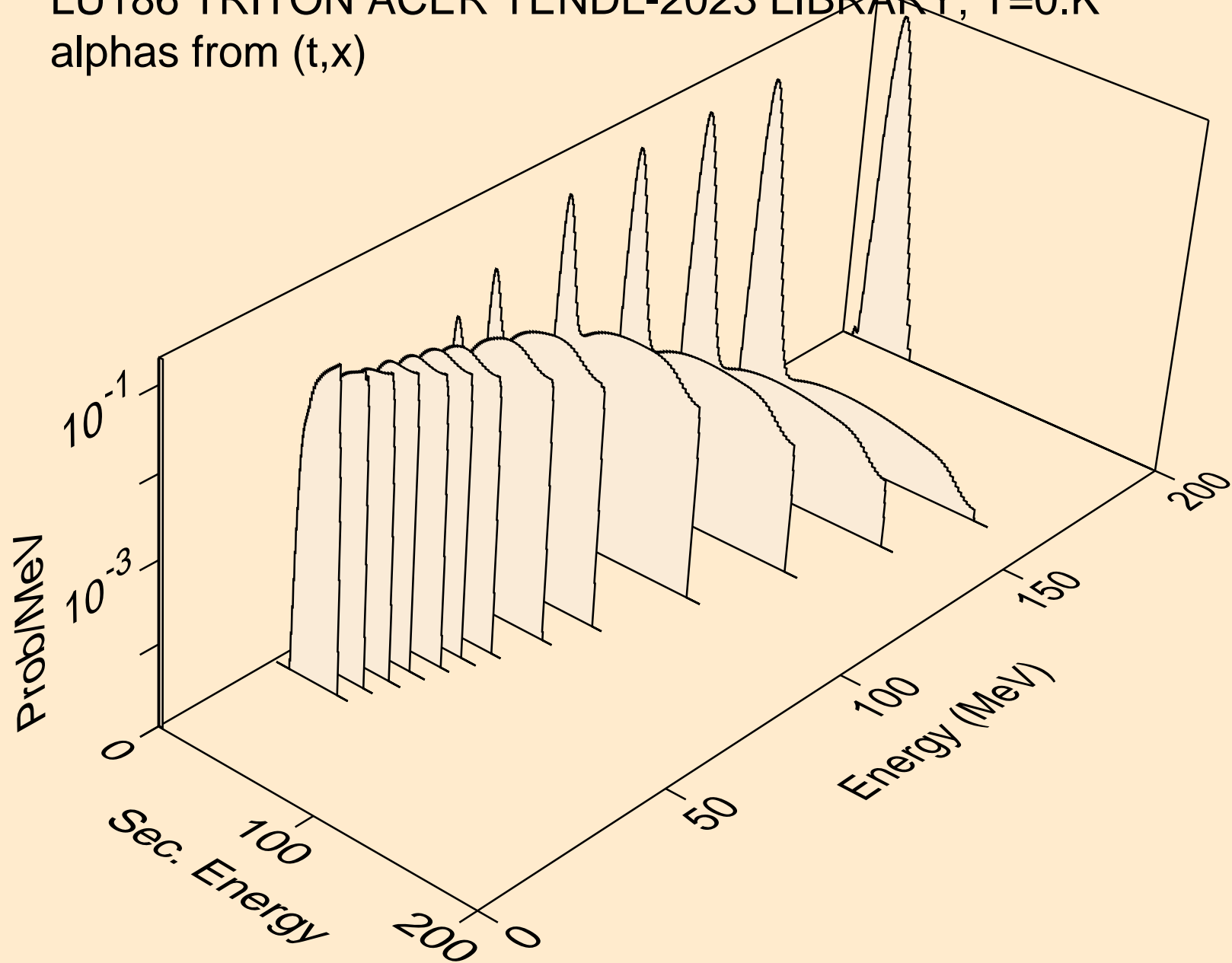

LU186 TRITON ACER TENDL-2023 LIBRARY; T=0.K  
alphas from (t,n\*)a

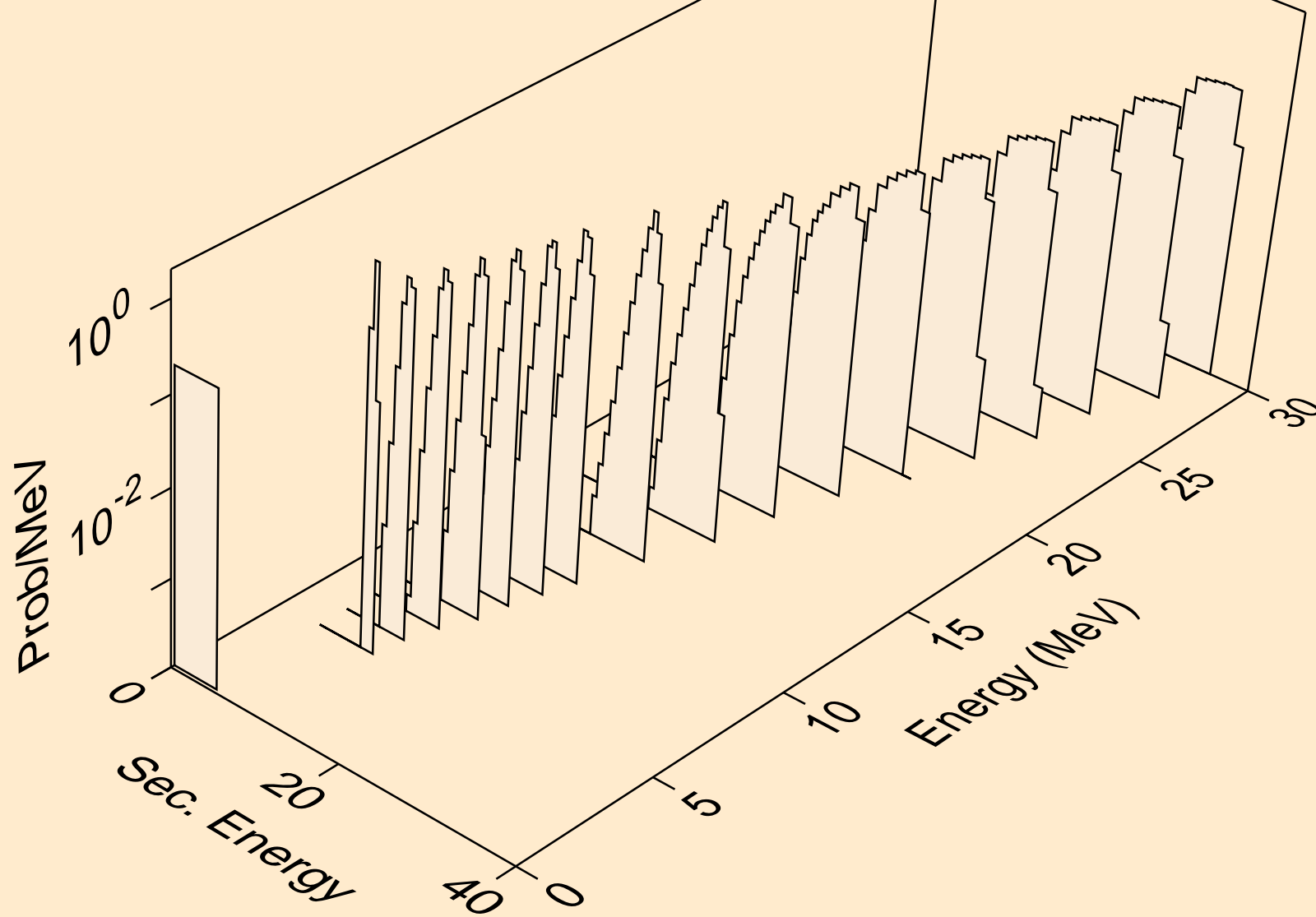

LU186 TRITON ACER TENDL-2023 LIBRARY; T=0.K  
alphas from (t,2n)a

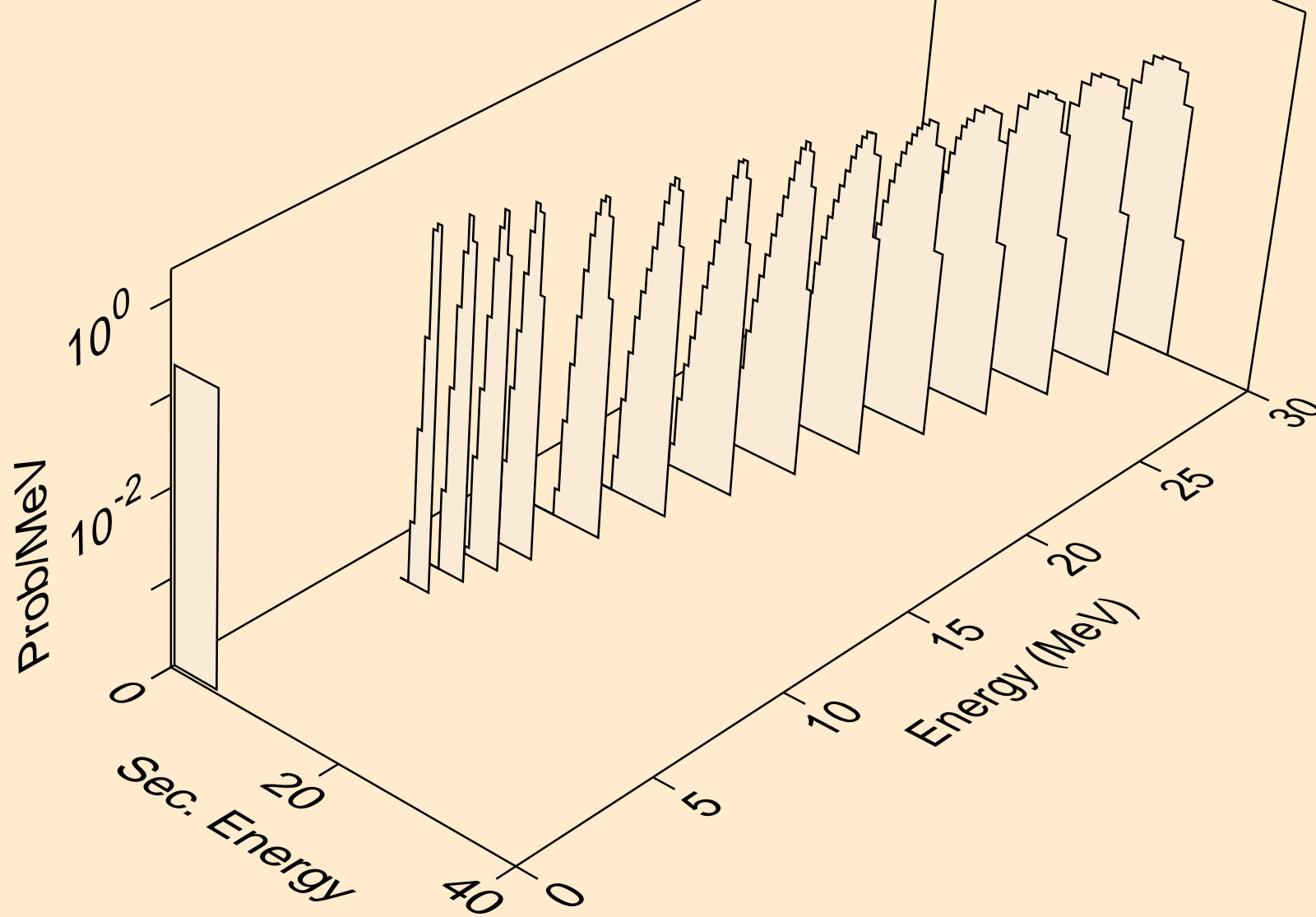

LU186 TRITON ACER TENDL-2023 LIBRARY; T=0.K  
alphas from (t,3n)a

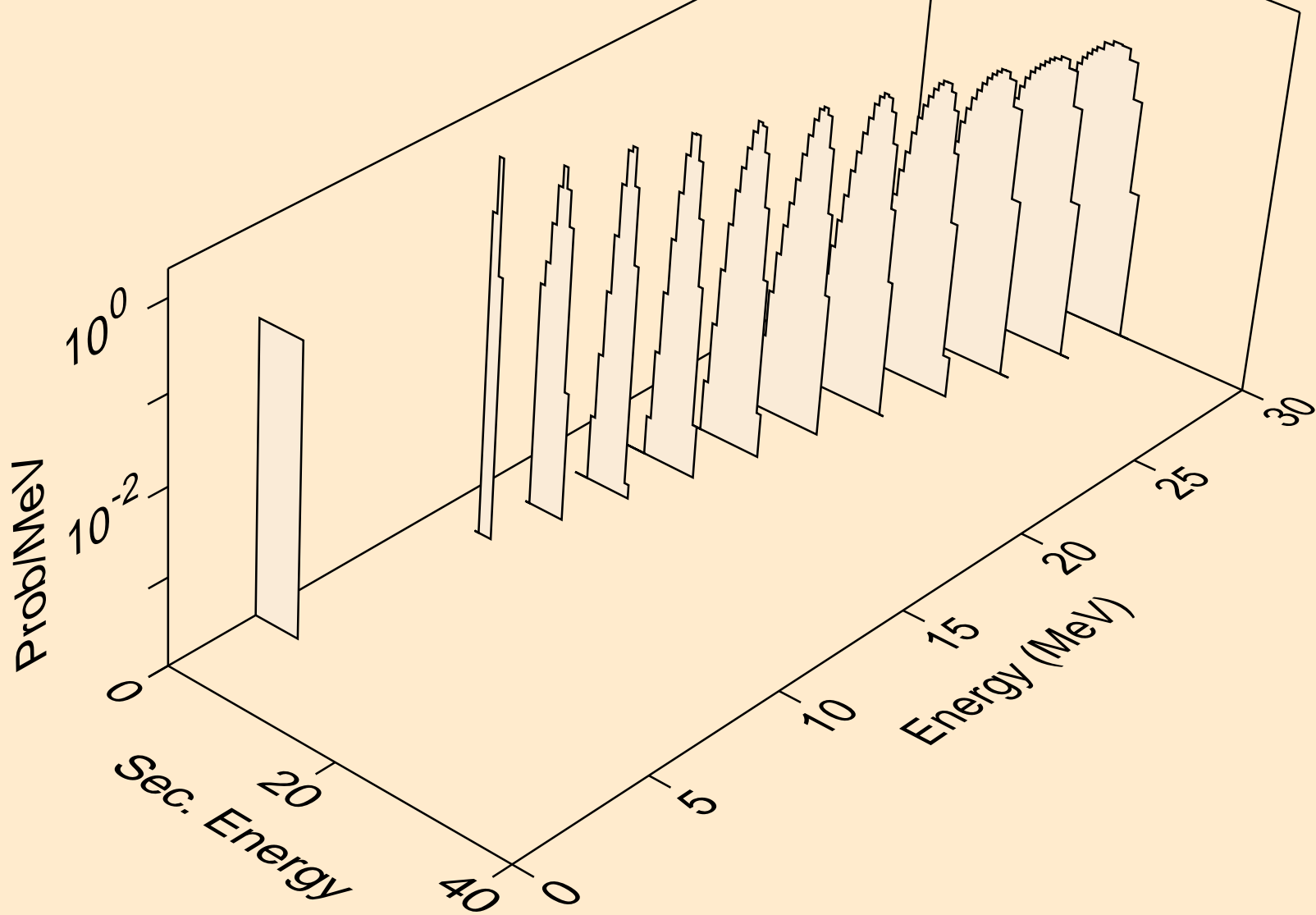

LU186 TRITON ACER TENDL-2023 LIBRARY; T=0.K  
alphas from (t,a)

